

# studio sound

July 1978 50p

AND BROADCAST ENGINEERING



TEST EQUIPMENT

See us on Stand 8+11 at the A.P.R.S. Exhibition London

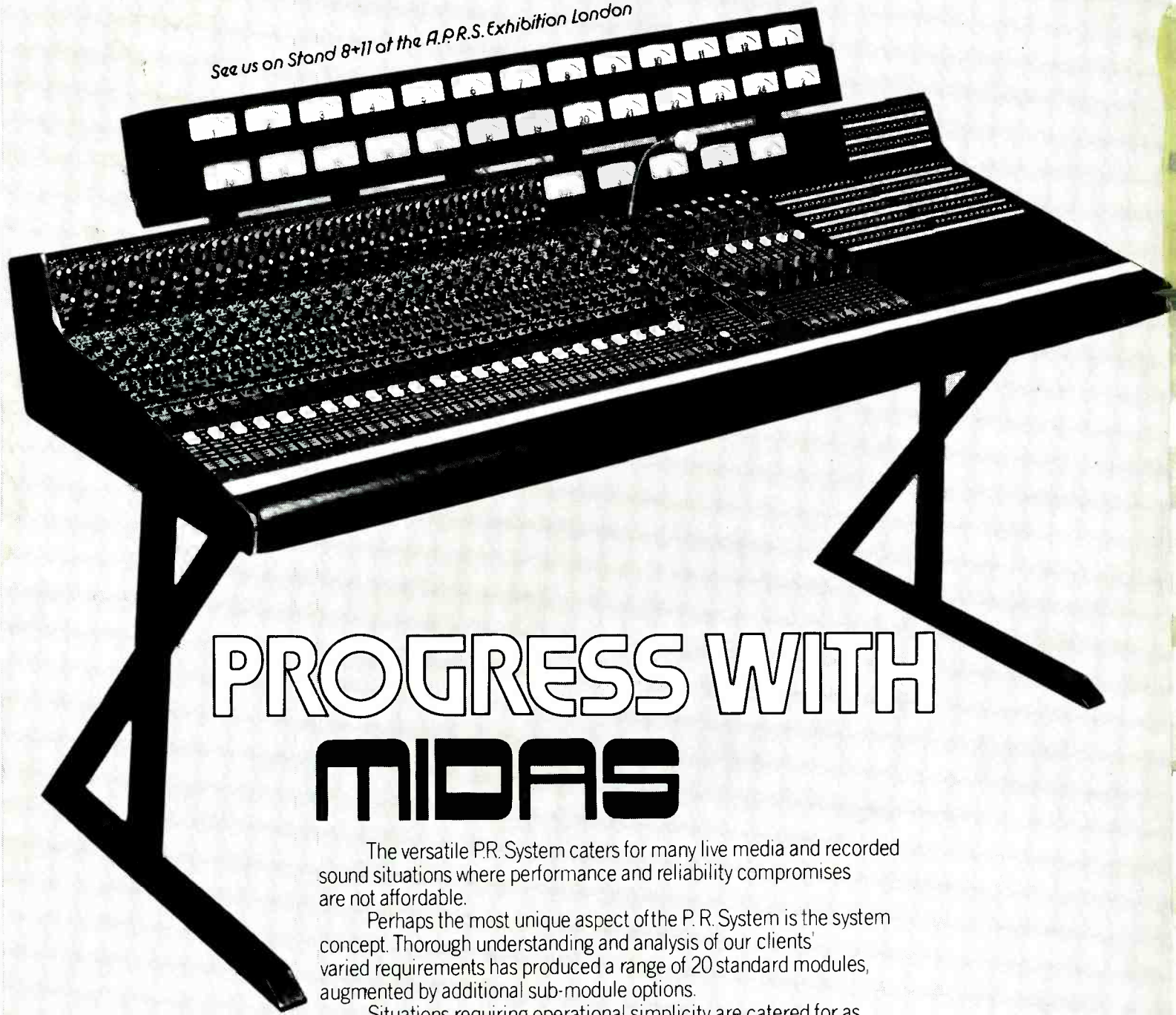

# PROGRESS WITH MIDAS

The versatile P.R. System caters for many live media and recorded sound situations where performance and reliability compromises are not affordable.

Perhaps the most unique aspect of the P.R. System is the system concept. Thorough understanding and analysis of our clients' varied requirements has produced a range of 20 standard modules, augmented by additional sub-module options.

Situations requiring operational simplicity are catered for as effectively as situations requiring comprehensive facilities. The 24 track console shown above incorporates in-line direct track monitoring with many innovative features and provides a fine example of P.R. System versatility.

With such a system every detail matters. Every control function is designed to provide optimum response. Every component is selected to assure consistent high quality performance for many years. The rugged main frame is modular and offers expansion at any future time.

The Midas P.R. System provides the reliable link between you and the perfect sound.

MIDAS AUDIO SYSTEMS LTD., JEFF BYERS, 54-56 STANOPE STREET, EUSTON, LONDON NW1 3EX. Tel: 01-388-7060 01-387-7679  
MIDAS EUROPE, LOUIS DE POTESTA, 25 AVENUE D'AVRIL, 1200 BRUSSELS, BELGIUM. Tel: 322-771-5063 322-734-5974  
MIDAS AUDIO CORPORATION, BOB SNEEGROVE, 730 MAIN STREET, NIAGRA FALLS, NEW YORK 14301, U.S.A. Tel: 716-282-4100  
MIDAS CANADA, FRANK PIMISKERTI, GERR ELECTRO-ACOUSTICS, 365 ADELAIDE ST. EAST, TORONTO M5B 4R9, ONTARIO, CANADA Tel: 416-868-0528

EDITOR  
RAY CARTER

ASSISTANT EDITOR  
MEL LAMBERT

EDITORIAL PRODUCTION  
DRUSILLA DALRYMPLE

CONSULTANT  
HUGH FORD

SECRETARY  
WENDY SMEETH

ADVERTISEMENT MANAGER  
MIKE STORMER

PUBLISHER  
DOUGLAS G. SHUARD



THE LINK HOUSE GROUP

Editorial and Advertising Offices:

LINK HOUSE, DINGWALL AVENUE,  
CROYDON CR9 2TA, ENGLAND

Telephone: 01-686 2599

Telex: 947709

Telegrams: Aviculture Croydon

© Link House Holdings Ltd 1978

All rights reserved.

STUDIO SOUND is published on the second Friday  
of the preceding month.

#### SUBSCRIPTIONS

STUDIO SOUND is available at an annual subscrip-  
tion of £8.20. All enquiries to: Subscription Dept,  
Link House, 25 West Street, Poole, Dorset BH15 1LL.  
Poole (02013) 71171. STUDIO SOUND is also available  
on a rigidly controlled requested basis to qualified  
personnel. For terms of control please see back page.

#### OVERSEAS READERS

For overseas readers, outside Europe,\* who require  
STUDIO SOUND within days of publication instead  
of weeks, we have the facility to send the magazine by  
Accelerated Surface Post (USA only) or Airmail.  
The Accelerated Surface Post charge is \$10 per annum.  
The Airmail charge is £12 (sterling) per annum.  
If you would like your copies of STUDIO SOUND  
sent by either of these methods, please write to the  
Editorial Office at Croydon.

On receipt of your remittance all subsequent issues of  
STUDIO SOUND will be sent to you by ASP/Airmail.  
\*All copies to Europe are sent Airmail.

#### BINDERS

Loose-leaf binders for annual volumes of STUDIO  
SOUND are available from Modern Bookbinders,  
Chadwick Street, Blackburn, Lancashire. Price is £2  
(UK and overseas). Please quote the volume number  
or date when ordering.



MEMBER OF THE AUDIO  
BUREAU OF CIRCULATIONS

Total average net circulation of 12111 per issue during  
1977. UK: 6175, Overseas: 5936.

# studio sound

AND BROADCAST ENGINEERING

## Bit between the teeth

Although you'll have to wait until next month's issue for a full report plus pictures of the Los Angeles AES show, we can report that one or two interesting trends seem to be emerging, both to do with digital technology. The first, possibly more obvious, connection is that digital recording is definitely here to stay, but that a lot of studios face a frustrating year or two before sufficient, reasonably-priced machines make their appearance. Why frustrating? Because, quite simply, once you've heard the quality of a digitally-recorded tape—witnessed by the look of incredulity on the faces of visitors to the Soundstream and JVC stands, this pair having laid on the most convincing of demonstrations—you don't want to have to put up with second best.

OK, so many observers of the current scene—ourselves included—have made more than the passing reference to the fact that digital recording is more a case of 'all or nothing'; because once the master tape has been digitised you have to find a cutting room that knows about 16-bit (or whatever) decoding. It's our guess, however, that the drastic increase in quality will far outweigh the problems of compatibility between analogue and digital recordings.

But, tape machines aside, there is an equally important aspect of digital hardware becoming more and more obvious. In the field of outboard or ancillary gear, the advent of cheap analogue-to-digital converters has given an added impetus to the development of inexpensive digital delay lines. And ones that have a very usable bandwidth and distortion performance even at long delay times. Furthermore, these newly-available units aren't just being marketed simply as delay lines. There were at least two new devices on show at Los Angeles that proved, to this magazine at least, that at long last manufacturers are turning on to the fact that studios need reasonable spec plus *usability*. By which we mean that the controls look as if they were designed for use by engineers—and not just inveterate knob twiddlers—with front-panel facilities that would normally need half a desk to duplicate.

After all, it's not much use being provided with a six-output delay line with continuously variable delay at each output, if you tie up several channels by simply interfacing it so you have some reasonable degree of control over the final effect. How much better to do the mixing at the delay-line and return the processed signal in mono or stereo. It can be argued that two well-designed ddl/special effects units don't exactly constitute a trend. Nevertheless, if more studios only bought equipment that looks like it was actually put together with an engineer in mind, then the industry would be more creative both technically as well as artistically.

A thought to carry round this year's APRS exhibition, previewed on page 64. See you there.

## Farewell

This is my last issue of STUDIO SOUND as Editor, so I would like to offer my final thanks to all of you for all your help and encouragement over the last couple of years. It's a privilege to have been part of the recording scene and I really can't imagine a more friendly and rewarding industry in which to work. So good luck and best wishes to all of you, and in particular to my successor.

Ray Carter

## contents

### FEATURES

SOUND ON STAGE—THE MUSICIAN'S CONTROL	
Terry Nelson	
SOUND AT NAB 1978	44
Peter Granet	
WAVEPOWER	50
Tony Attwood	
APRS EXHIBITION 1978, A PREVIEW	56
SURVEY: TEST EQUIPMENT	64
	78

### COLUMNS

NEWS	
LETTERS	36
AGONY	54
WORK	60
	90

### REVIEWS

SONY PCM-1 DIGITAL RECORDING SYSTEM	
Hugh Ford	
VALLEY PEOPLE TRANS-AMP LZ	96
Hugh Ford	
TRIDENT CB9109 LOW DISTORTION OSCILLATOR	102
Hugh Ford	
	104

JULY 1978 VOLUME 20 NUMBER 7

# THE EVENTIDE MODEL 1745M DIGITAL DELAY SYSTEM

Unequalled versatility and portability combined with studio quality specifications to provide the optimum solution to any delay line requirement.

## FEATURES

The 1745M employs random access memories instead of shift registers for maximum versatility. The standard 1745M offers two independent outputs, each providing up to 640 ms delay which is continuously variable. Up to 3 additional outputs are available.

The modular design of the 1745M allows the later addition of many special features, including:

**Pitch Changing**, employing circuitry for wide range pitch and tempo variation and musical harmonizing

**Flanging** including manual and automatic flanging with digital versatility.

**Remote Control** both manual and automation compatible.

Other devices available in the Eventide range include the  
**HARMONIZER FLANGER OMNIPRESSOR**

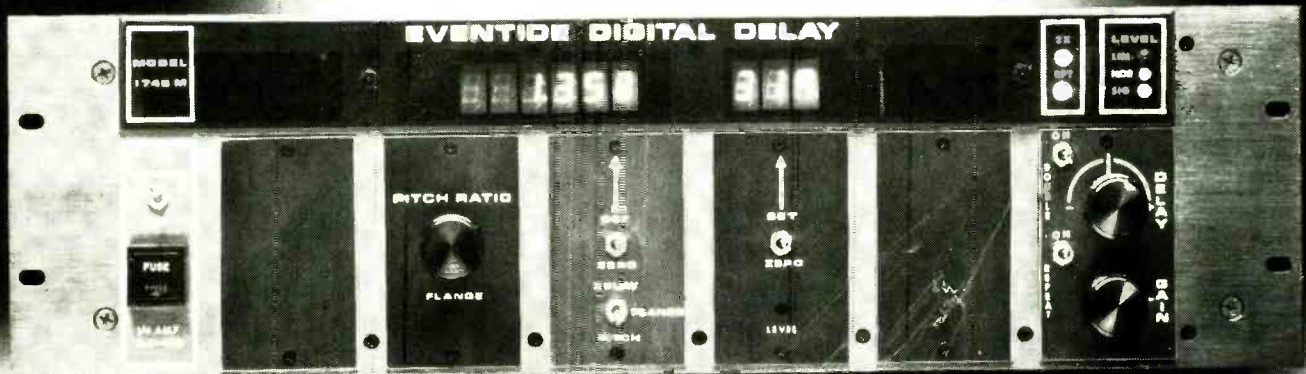

Eventide, Instant Flanger, Omnipressor and Harmonizer are trade marks designating the products of Eventide Clockworks Inc.

U.K. Distributors  
 **Feldon Audio Limited**

126 Great Portland Street, London W1. Telephone: 01-580 4314. Telex: London 28668

# The IE-30A Audio Analysis System from IVIE

- 1/3-octave Spectrum Analyzer
- Full-octave Spectrum Analyzer
- Precision Sound Level Meter
- True RMS AC Voltmeter
- RT<sub>60</sub> (Reverberation)\*
- THD (Harmonic Distortion)\*

For the first time, a real time analyzer and precision sound level meter have been combined into a portable audio analyzer "system" with features and accuracies rivaling the best laboratory instruments available.

The fully digital IE-30A comes standard with a precision laboratory microphone calibrated in dB-SPL and remoteable up to several hundred feet, a test probe with two precision attenuator settings for calibrated dB $\mu$ V measurements (true rms, average or peak), nickel cadmium batteries with charger, and a hard shell, foam lined travel case.

\*Using optional accessories



Other features include selectable detector responses, gated mode operation for measurement of reflections and time delay events, dual involatile memories that store or accumulate data that can be recalled to the IE-30A display up to weeks later.

The IE-30A was designed to accommodate an inexpensive new family of optional accessories. The IE-17A measures RT<sub>60</sub> (reverberation time) in 1/3-octave bands up to 99.99 seconds with 10 millisecond resolution. The IE-15A measures total harmonic distortion (THD) to less than .01%.

## SPEC BRIEFS

- 1/3 octave or full octave bands 30 filters on ISO centers 25Hz to 20KHz.
- Highly selective three pole-pair filters exceed ANSI S1.11-1966 Class III, B.S. 2475-1964, DIN 45652, and IEC255-1966.
- 1/3 octave display weighted A, C or Flat.
- LED array 30 x 16. Resolutions of 1, 2 or 3 dB for display ranges up to 45dB.
- Precision SLM has *Fast, Slow, Impulse* or *Peak* responses with A, C or Flat filter weightings.
- 4 digit 0.1dB resolution readout with display hold mode.
- Meets requirements of:  
ANSI S1.4-1971 TYPE S1A, S1C, BS 4197-1967  
DIN 45633 B1.1, B1.2 (Impulse) IEC 179-1973
- 30 to 149 dB SPL re 20 $\mu$ N/M<sup>2</sup>.
- Microphone is omnidirectional condenser Type 1 (Precision). Flat 10Hz to 20KHz.
- Signal outputs for recorders, oscilloscope displays and voice prints.



IVIE ELECTRONICS, INC.  
500 West 1200 South  
Orem, Utah 84057 U.S.A.  
(801) 224-1800  
TELEX or TWX 910-971-5884

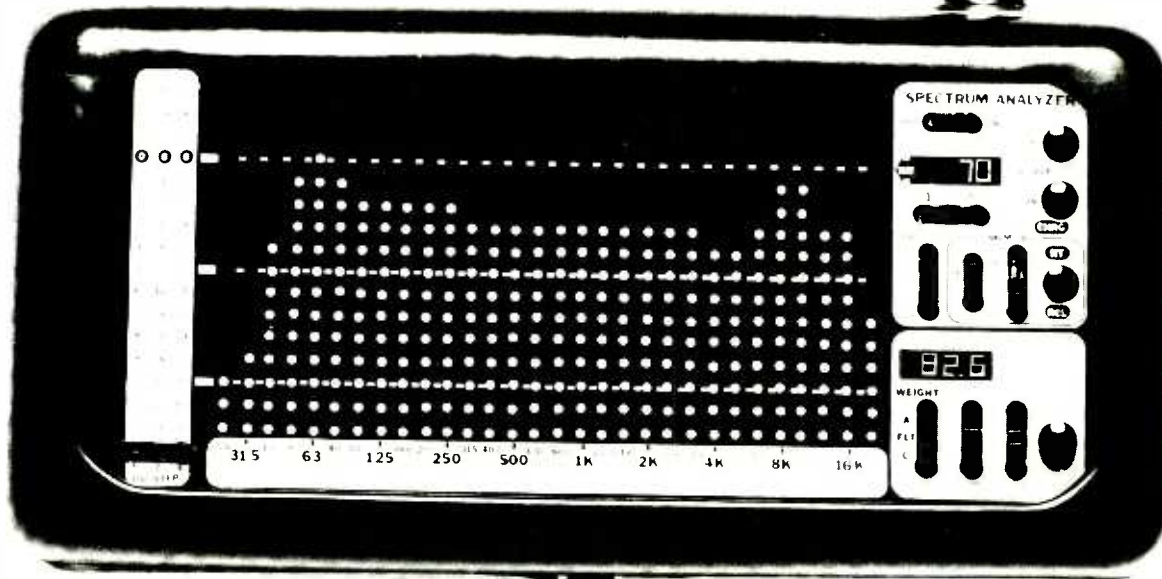

Call your nearest Ivie representative for further information:

Australia, Melbourne  
KLARION ENTERPRISES  
Tel 61 3801

Belgium, Brussels  
S.E.D.  
Tel 02-522 70 644

Denmark, Hvidovre  
S C SOUND APS  
Tel (01) 47 12 22

Finland, Helsinki  
MS AUDIOTRON  
Tel 410688

France, Paris  
REDITEC  
Tel 935 97 86

Italy, Milano  
ROJE TELECOMUNICAZIONI  
Tel 414.41.41/41/43

Japan, Tokyo  
ELECTORI CO.  
Tel (03) 950-6262

Malaysia/Indonesia, Singapore  
ELECTRONICS & ENGINEERING  
Tel 75873

Netherlands, Amsterdam  
SELECTRONIC  
Tel (02963) 4838/4966

Norway, Oslo  
MORGENSTIERNE & CO.  
Tel (02) \*35 61 10

Spain, Madrid  
NEOTECNICA  
Tel 242-0900

Sweden, Stockholm  
ELFA  
Tel 80/730 07 00

Taiwan, Taipei  
ASIA ELECTRIC TRADING CO  
Tel 5925545-8

United Kingdom, London  
FWO BAUCH  
Tel 01-953 0091

Venezuela, Caracas  
ELECTRONICA GRAMOKO  
Tel 351419

# REW Professional

**We Will Beat Any Genuine Advertised Price**

## Europe's Largest Suppliers of Studio



### EQUALIZERS

**SOUNDCRAFTSMEN**  
Graphic EQ's.  
**SAE** Parametric EQ's.  
**JVC** SEA 10 (2 x 5 Band),  
SEA20 (2 x 7 Band)  
**TECHNICS** SH9010 (2 x 5  
Band), SH9090 (1 x 10 Band)  
**MXR** (1 x 5 Band), (1 x 10  
Band), (2 x 10 Band)  
**MM-Pace** (2 x Band), SR271  
(1 x 27 Band)

### WOLLENSAK

WOLLENSAK/West  
End Distributors

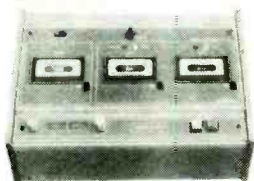

High Speed Duplicators.  
£1498.90 + VAT. New 2772A/V  
gives 2 stereo musicassettes in  
under 4 minutes. Call in for a  
demonstration.

### UHER PORTABLE RECORDERS

As used by most  
Broadcasting Companies.  
All models in stock plus every  
accessory available.



Very low  
prices, e.g.  
4000IC £225  
+ VAT.  
+ SONY +  
NAKAMICHI  
+ JVC +  
TECHNICS +  
TEAC.  
Portables all  
Off the Shelf.

### REVOX

Incredible stocks at  
ridiculous prices!



A77, B77, A700 Off the Shelf.  
High speed, low speed, vari-  
pitch + all accessories!  
Ring us now for the lowest price.

### TAPE AT TRADE PRICES

Any quantity—  
same price  $\frac{1}{4}$   
tape, 10 $\frac{1}{2}$ " reels.

AGFA PEM368 Metal ..... £10.06  
AGFA PEM368 Plastic ..... £7.79  
SCOTCH 207 Metal ..... £9.81  
SCOTCH 207 Plastic ..... £8.03  
MAXELL UD180 Metal ..... £8.89  
TDK AUDUA LB3600 Met £11.40  
TDK AUDUA L3600M Met £9.50  
SONY SLH-11-1100BL Met £10.00  
SONY SLH-740B Metal ..... £6.89  
REVOX 601 Metal ..... £11.80  
REVOX 601 Plastic ..... £10.00  
All above prices exclusive of VAT.  
Also large stocks of 7" & 5" reels.

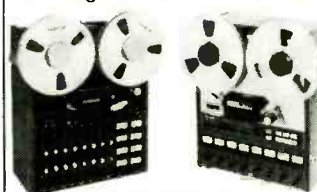

### 8 TRACKS $\frac{1}{2}$ " or 1"

Both Tascam and Brenell  
Recorders in stock for immediate  
delivery.  
Plus complete range of 8 Track  
ancillaries.

### MICS OVER 500 ALWAYS IN STOCK!



**AKG** We carry every model  
inc. capacitors  
**BEYER** Most dynamic + ribbons.  
**CALREC** 600 Range.  
**SENNHEISER** Large stocks.  
**SONY** All models.  
**NAKAMICHI** All models.  
**E.V.** Selected range.  
**SHURE** Very large range.  
**NEUMANN** All popular  
models.  
+ Cables, Transformers, Stands,  
Connectors & Clips, Windshields,  
etc.

### CANNON XLR'S

ANY QUANTITY—SAME PRICE

	XLR-3-11C	£1.39 + VAT
	XLR-3-12C	£1.06 + VAT
	XLR-3-31C	£1.85 + VAT
	XLR-3-32C	£1.06 + VAT

### AMPLIFIERS

**HH** S500D, TPA, All stage  
amplifiers.  
**SAE** From 2 x 50 watts to  
2 x 400 watts RMS.  
**QUAD** 405, 303, 50E usually  
in stock.  
**JPS** A fantastic range of budget  
studio amps.  
**AMCRON** DC 300A, D150A,  
D60. Trade prices.



### TEAC-TASCAM CENTRE

Britain's Largest Stockists.  
All Models on demo in our studio  
3340S 4 CH  
2340SX 4 CH  
3300SX2T 2 TR  
6100 2 TR  
7300 2T 2 TR  
TASCAM 80-8 8TR

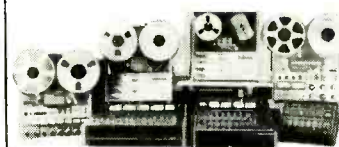

### MIXERS

The widest range under one  
roof!

From £35-£2500.  
Mixers in stock:  
**SOUNDCRAFT** 16/2, 12/2,  
12/4 Series II.  
**HH** 16/2, 12/2.  
**MM** All models.

**TEAC-TASCAM** Models  
1, 2, 3, 5 + Accessories.  
**CANARY** 10/2, 10/4.  
**HILL** 16/2, 10/2.  
**SONY** MX8, MX510, MX650.  
Plus **ALLEN & HEATH**,  
**JVC**, **UHER**, **EAGLE**, etc.



Plus Echoe's, Phasers, Flangers,  
Limiters, Noise Reducers,  
Expanders, Mix-Downs, Mic  
Stands, Cable Drums, Disco  
Gear, Chassis Speakers, Studio  
Monitors, Headphones, Demags,  
Splicers, etc.

# REW

**PRO-AUDIO & DISCO: 146 Charing Cross Road, WC2 01-836 2372**  
**VIDEO & HI-FI: 114-116 Charing Cross Road, WC2. Hi-Fi 01-240 3386 Video 01-240 3066**  
**TAX-FREE EXPORT & EXPRESS MAIL ORDER: REW House, 10-12 High Street,**  
**Colliers Wood, SW19. 01-540 9684** ● Also at 230 Tottenham Court Road, W.1.

# The Professional Everything Store

# Audio

Established 1948

**Largest Stocks Lowest Prices!!**

## & Stage Equipment

### EXCLUSIVE FROM REW

**SAE** A superb range of studio electronics from the U.S.A.

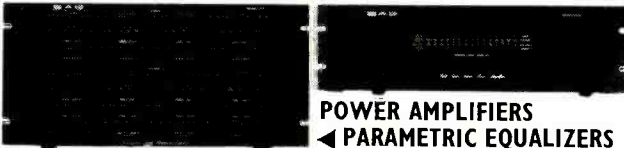

**POWER AMPLIFIERS**  
**PARAMETRIC EQUALIZERS**

Prices exclude VAT

2800 Parametric equalizer 2 x 4 Bands .....	£408.00
1800 Parametric equalizer 2 x 2 Bands .....	£239.00
4000 Electronic crossover, stereo, variable frequency .....	£155.00
4100 Digital time delay, stereo .....	£354.00
2200 Power amplifier 2 x 100 watts .....	£346.00
2400L Power amplifier 2 x 200 watts .....	£578.00
2500 Power amplifier 2 x 300 watts .....	£755.00
2600 Power amplifier 2 x 400 watts .....	£887.00
5000 Impulse noise reduction unit .....	£176.00

### SOUNDCRAFTSMEN

America's Largest Manufacturer of Graphic Equalizers



#### GRAPHIC EQUALIZERS

2204 2 x 10 Bands .....	£199.00
2205 2 x 10 Bands, rack mount .....	£226.00
2209 2 x 10 Bands, rack mount, 600 ohm balanced in/out XLR .....	£319.00

#### NEW CLASS H POWER AMPLIFIER

MA5002 2 x 250  
watts, meters .....

£399.00  
Prices exclude VAT



#### DOKORDER

Pro 1/4" 4 Channel Recorders

1140. 15 + 7 1/2 ips, 10 1/2" reels. Full motion sensing logic. Auto rewind-play. Auto-sync switching. Front Panel variable bias. Peak LED's. Eye-level electronics. £698 + VAT.

Open 9.30 am — 6 pm — 6 days a week  
 Just walk in — 95% of advertised  
 gear available off the shelf

Payment by: Cash,  
 Barclaycard, Access,  
 American Express, Diners,  
 HP (Instant credit possible)

**THE LOW PRICE HOT  
 LINE 01-836 2372**

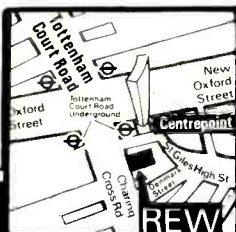

**NEAREST TUBE STATION  
 TOTTENHAM COURT ROAD UNDERGROUND**



# Sound International

**SOUND INTERNATIONAL** forms a link between professional musickers and those recording sound. The focus is on news from both sides of the recording fence, providing musicians, studio engineers, and home recordists with a monthly point of reference on the music scene. The magazine reports the international news of people and events and reviews the latest in recording equipment and musical instruments. Also scheduled are regular articles on technique and problem solving together with behind-the-scenes look at events in the big studios and concerts.

There is no doubt **SOUND INTERNATIONAL** is a lively forum in the world of music and recording.

I enclose cheque/International money order, made payable to The Link House Group (Subscriptions) to the value of.....

Name .....

Street .....

City .....

County/State .....

Country/Zip Code .....

**Annual Subscription Rates:** UK £8.20, Overseas \$25.00

To: Subscription Manager, Sound International, Link House Holding Ltd., Link House, 25 West Street, Poole, Dorset BH15 1LL SS 7

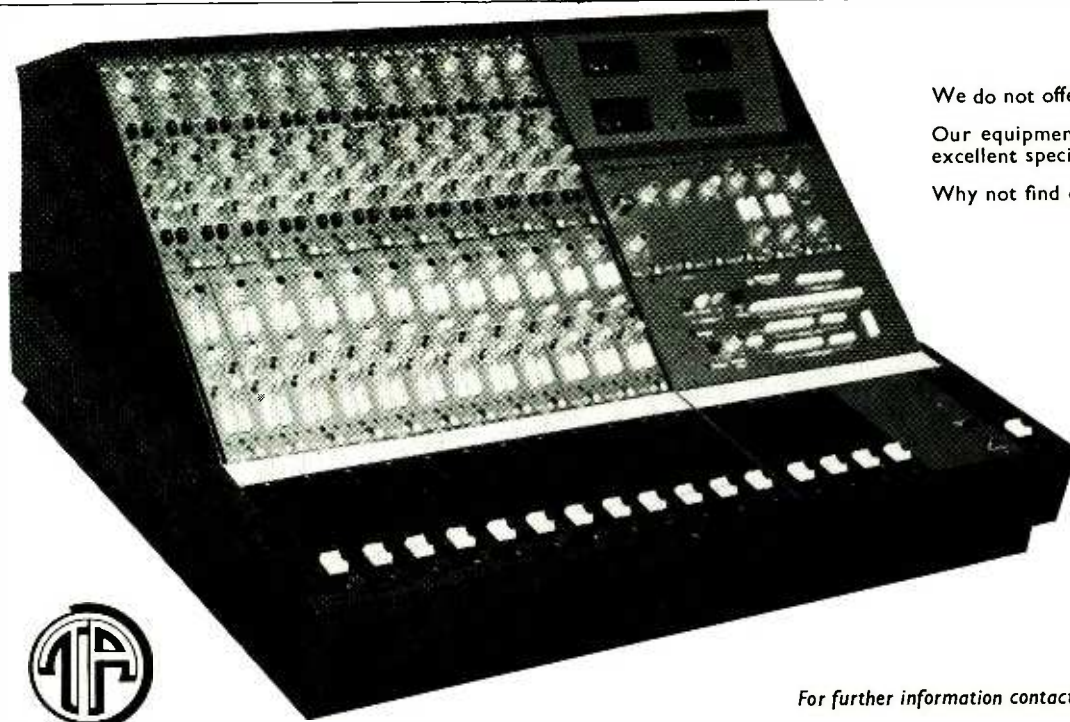

We do not offer any gimmicks.

Our equipment is designed to last with excellent specification at realistic prices.

Why not find out more about it?



For further information contact nearest office.

**3M UK Ltd.,**  
Witley Works,  
Witley Gardens,  
Southall, Middlesex.  
Tel: 01-574-5929/6045

**Tweed Audio,**  
Pinnaclehill Industrial Estate,  
Kelso, Roxburghshire.  
Tel: (05732) 2983  
Telex: 727633

1640 Fifth Street,  
Santa Monica,  
California 90401  
Tel: (213) 451-0688



## INTERNATIONAL BROADCASTING CONVENTION

LONDON 25-29 SEPTEMBER 1978

To be held at the Wembley Conference Centre,  
London's new major conference venue.

The **TECHNICAL SESSIONS** will cover new techniques, systems and developments in sound and television broadcasting including:

- |   |   |
|---|---|
| microprocessors and minicomputers in broadcasting;                | sound systems, stereo and quadraphonic;   |
| low-budget broadcasting systems;                                  | television cameras, electronic graphics, visual effects and other studio equipment; |
| satellite broadcasting and distribution systems;                  | video and audio recording and storage;  |
| studio lighting technology;                                       | lightweight programme equipment;  |
| propagation and service planning;                                 | audio and video measurement technology;   |
| transmitters, transposers and aerials;                            | future possibilities in receiver design.  |
| new broadcasting systems (e.g. teletext and traffic information); |   |

The **EXHIBITION** complementing the technical sessions ranks as one of the most important market places in the world for broadcasting equipment and services. Leading world manufacturers will show and demonstrate their latest equipment.

The **SOCIAL PROGRAMME** during the Convention will include a Reception, Visits and a special Ladies' Programme.

The **INTERNATIONAL BROADCASTING CONVENTION** is sponsored by the:

Electronic Engineering Association — Institution of Electrical Engineers — Institute of Electronics Engineers — Institution of Electronics and Radio Engineers — Royal Television Society — Society of Motion Picture and Television Engineers.

For **FURTHER INFORMATION** about IBC '78 please write to the Secretariat, International Broadcasting Convention, IEE, Savoy Place, London, United Kingdom WC2R 0BL.



# NEW LEADERS IN FRANCE

## Publison Audio Professional Manufacturing

### COMPRESSOR-LIMITER PUBLISON CL 20 B



Stereo-compressor-limiter with fast photocel—very low noise : - 102dB and low distortion when compression operates : > 0.1%—use fat opa bandwidth 100 kHz even for + 20 dB—insertions in side-chains—stereo-coupling—display of compression ratio by 11 led—special circuitry to suppress distortion on low frequencies.

### HARMONIZER-DELAY LINE DHM 83 with MEMORY MODE



**STEREO VOLTAGE CONTROLLED DELAY** up to 360 mS for 5 kHz - bandwidth (180 mS for 10 kHz - 120 mS for 15 kHz).  
**HARMONIZER**: from - 20 to + 1 octave—micro-computer operates phase coincidence of successive sequences and suppresses **ARTIFACTS** precedently usual in such systems.  
**MEMORY MODE** with keyboard remote control, one can play with any memorised sound.  
**TRUE DYNAMIC RANGE**: 100 dB by the mean of a 13 bits flying comma D/A converter.

## Publison Audio Professional Distributor

### ANALOG DELAY LINE/FLANGER—LOFT 440



At last an analog delay system that gives you the best of two worlds. It has the long delays, greater bandwidth and higher S/N of the better digital units, without digital step error or quantizing noise. Delays are continuously variable from 5 mS right up to 160 mS. The bandwidth is still 18 kHz at 40 mS and a very respectable 6 kHz at 120 mS. A sophisticated noise reduction system preserves dynamic range while lowering noise and avoiding input limitations common to most delay units. The voltage controlled time-sweepable function combined with the clock mix and regenerate controls provide the potential for an unlimited variety of new and exciting effects. True doubling, stereo synthesizing, slap-back, short echoes, vibrato, resonant pitches, and of course a wide range of flanging, to name a few, can all be derived from the unit.

For further information, contact **PETER DEAN**—Publison Audio Professional  
**5-7-9-11, Rue CRESPIN DU GAST—75011 PARIS**

Tel: (0-11-33-1) 357 64 08

**SEE US ON STAND 43 AT APRS EXHIBITION**



# MONITOR EQUALISER!

**ALSO:**

## ANALYSERS

- MODEL 140 1/3 OCTAVE ANALYSER FOR ROOM EQ
- MODEL 142A SIGNAL MONITOR
- MODEL 150 OCTAVE BAND ANALYSER

*White*

**instruments,  
incorporated**

P.O. Box 698 AUSTIN TEXAS 78767  
PHONE AREA 512/892-0752

Scenic Sounds Equipment,  
97-99 Dean Street, London W1. Tel: 734 2812

### FEATURES:

- 27 1/3 octave bands on ISO centers from 40 Hz through 16 kHz.
- 10 dB boost or cut on continuous control. Equal Q in both boost and cut conditions.
- Variable high-pass filter from 20 Hz to 160 Hz with 12 dB/octave roll-off.
- Filter Q optimized for best summation with adjacent bands.

- Noise guaranteed to be -90 dBm or better.
- Sealed Mil-Spec pots.
- EQ IN/OUT switch on front panel

### PLUS OPTIONAL CROSSOVERS FOR BI-AMPING!

- Dual buffered outputs for bi-amp operation.
- Accessory socket to permit insertion of 12 dB/oct. or 18 dB/oct. low level crossover for bi-amp outputs.

Belgium:  
S. E. D. Rue Bara Straat 146  
1070 Bruxelles Tel: 922 7064  
A. R. C. SPRL Rue Th. Decuyper 134  
1200 Bruxelles Tel: 771 3063

Denmark:  
Lake Audio APS  
Amalievej 3D  
DK-2300 Copenhagen S  
Tel: 570 600

France:  
3M France SA - Minicom Div.  
Boulevard de Oise  
95000 Cergy  
Tel: 749 0275

Holland:  
Peter Bollen Geluidstechniek  
Hasterweg 5 - Eindhoven  
Tel: 512 2777

Sweden:  
Tel & Ton Musik & Electronics AB  
Kungsgatan 5  
S-111 19 Ljersborg  
Tel: 130 716

Spain:  
M. Evelyn Jones  
AP Postal 8178  
Madrid 8, Spain  
Tel: 632 0752

Norway:  
Siv Ing Benum AS Skogvn 22  
Oslo 2 Tel: 565 753

**JP** **STELLAVOX**

**NAGRA 3 AND NAGRA 4  
ADD A BIT, AND SOME MORE  
WATCH THE COST,  
THINK OF WEIGHT  
ITS ALL INCLUDED  
IN THE SP8 !**

**Total weight with batteries, tape and  
carrying case - 4.6kg**

**Includes Pilot, STEREO, MONO,  
half or double tracks**

**for further details:**

**JOHN PAGE LIMITED**  
WESLEY HOUSE, 75, WESLEY AVENUE, LONDON, NW10  
☎ 01-961 4181      TELEX: 24224 REF 568

**- TURNER -**  
**PROFESSIONAL STEREO POWER AMPLIFIERS**

**SPECIFICATION MODEL B 302-XLR**

Power Output	60W-16, 100W-8, 150W-4 ohms
Power Response	±0.1dB 20Hz-20kHz, 80W 8ohms
Distortion	<0.005% at 1kHz, 80W 8ohms
Noise	>110dB below 100W 8ohms
Crosstalk	>90dB at 1kHz, 100W 8ohms

**SPECIFICATION MODEL B 502-XLR**

Power Output	100W-16, 170W-8, 280W-4ohms
Power Response	±0.1dB 20Hz-20kHz, 150W 8ohms
Distortion	<0.005% at 1kHz, 150W 8ohms
Noise	>110dB below 170W 8ohms
Crosstalk	>90dB at 1kHz, 150W 8 ohms

TURNER ELECTRONIC IND. LTD, 175 Uxbridge Road, Hanwell, London W7 3TH, Great Britain.      Tel: 01 567 8472

# AMPEX ATR 700

*Now every studio can afford Ampex!*



Distributed by :

## ITA

1-7 Harewood Avenue, Marylebone Road, London NW1  
Tel: 01-724 2497. Telex: 21879

FRANCE: Son Professionnel, 29-31 Avenue André Morizet  
92100 Boulogne (Paris). Tel: 605 3363

Please rush me full details of the  
Ampex ATR-700

Name \_\_\_\_\_

Address \_\_\_\_\_  
\_\_\_\_\_  
\_\_\_\_\_

# Multitrack Consoles by AMEK

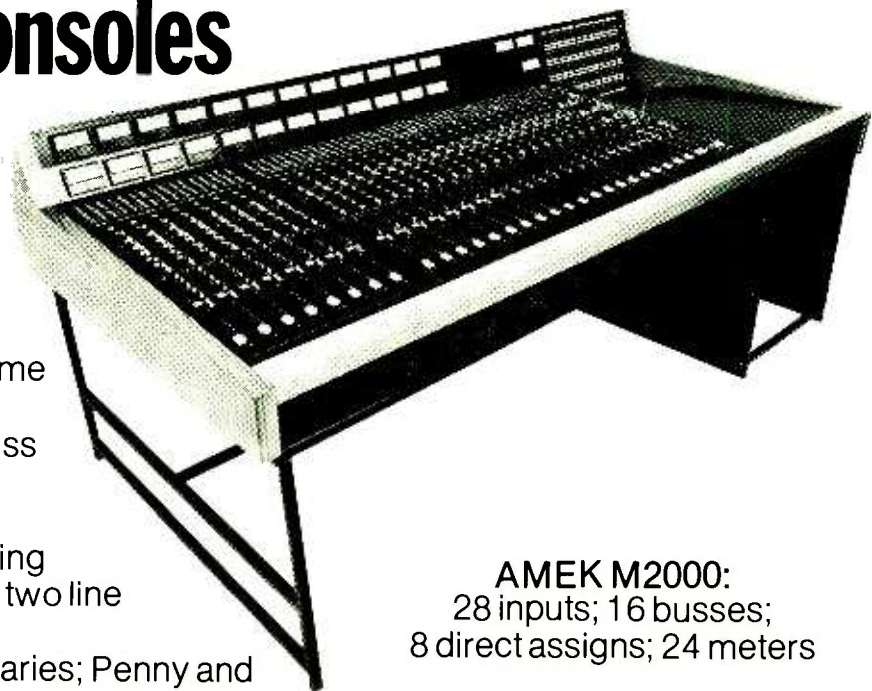

**AMEK M2000:** the purpose-built multitrack console — mainframe for 28 inputs, with 24 track-reading meters — 16 buss outputs and 8 direct assigns.

In-line format with panning between live busses; mic and two line inputs; 4 band equalizer with switched frequencies; 4 auxiliaries; Penny and Giles faders; in-place solo on channel and monitor.

Stereo buss for remix; 4 separately addressable stereo subgroups to remix; eq. to monitor facility; separate studio and control room monitor selection systems; built-in oscillator and talkback systems; 240 point jackfield; 48V phantom power supply.

Excellent performance specifications.

**AMEK M3000:** Favourably comparable to any console currently available, the M3000 features VCA faders with DC subgrouping; overall status commands for desk operation; 32-track monitoring; complete quad mixdown; comprehensive reciprocal-curve 4-band parametric equalization on all i/o modules; + 24 dBm headroom on the mic amp, and a favourable price.

A computer will be available by Advanced Music Systems using time-lock to tape via SMPTE code and floppy disc store, with access to several mixes.

**AMEK M2000:**  
28 inputs; 16 busses;  
8 direct assigns; 24 meters

**Contact — UK: Nick Franks and Graham Langley, AMEK SYSTEMS AND CONTROLS LTD.**  
Islington Mill, James Street, Salford, Lancashire M3 5HN. Tel: 061-834 6747. Telex: 668127

**Or — Australia:**  
Con Psorakis,  
AUDIO CONTROLS,  
22 Finnis Street,  
North Adelaide,  
Tel: 08-267-4529  
Telex: 88729

**Benelux:**  
Luc Ardyns,  
JUST BORN STUDIOS,  
Terlindenstraat 76,  
1790 Hekelgem,  
Belgium.  
Tel: 053-70 50 03

**France:**  
Francis Linon,  
SOCIÉTÉ CYBORG,  
72 Ave. Lenine,  
Gentilly 94250.  
Tel: 161-657 0812  
161-366 1772

**Germany:**  
Manfred Brunwey,  
RECORD STAR STUDIO,  
Bernstorffstrasse 123,  
D-2000 Hamburg 50.  
Tel: 40-439 7254

**USA:**  
Brian Cornfield,  
EVERYTHING AUDIO,  
7037 Laurel Canyon  
Boulevard,  
North Hollywood,  
California 91605,  
Tel: 213-982-6200  
Telex: 651485

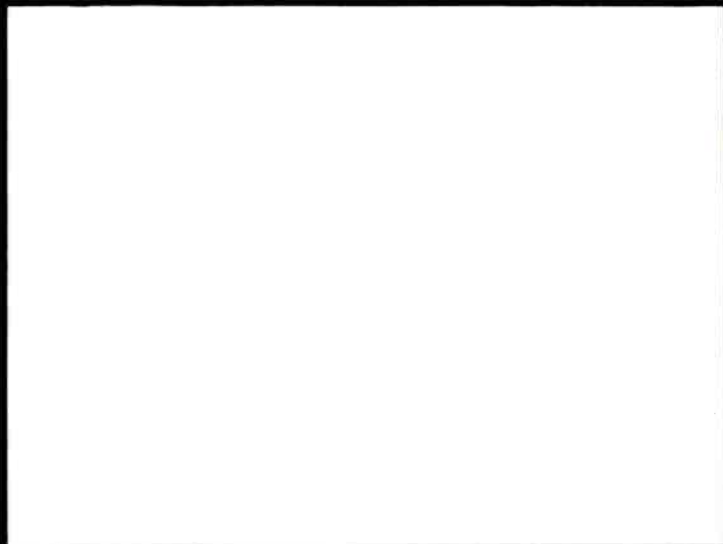
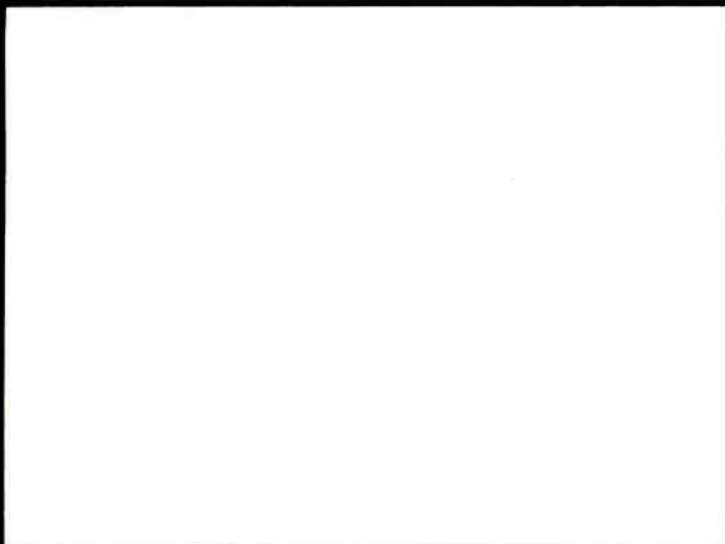

# NO COMPETITION

The superb 3.77 is the only choice in compact professional recorders.

## Who says?

Hundreds of satisfied professional users— Broadcast authorities, studios, record companies, universities etc etc.

## What makes it the best?

The 3.77 provides more performance and features for your £ than any other model. Like 3 speeds, flat metal facia with excellent editing facilities, 100% variable speed control, logic control with motion sensing, line-up oscillator.

## Is it reliable?

The 3.77 uses the famous REVOX A77 chassis— there are more A77 recorders in use in studios than any other recorder. The industry depends on it.

## How about delivery?

As quick as you can dial 01-724 2497/8.

3¾ + 7½ + 15 £575    7½ + 15 + 30 £610

An **ITA** Product.

1-7 Harewood Avenue, Marylebone Road, London NW1. Tel: 01-724 2497. Telex: 21879

# PROLINE 2000TC

## You now have to choose...

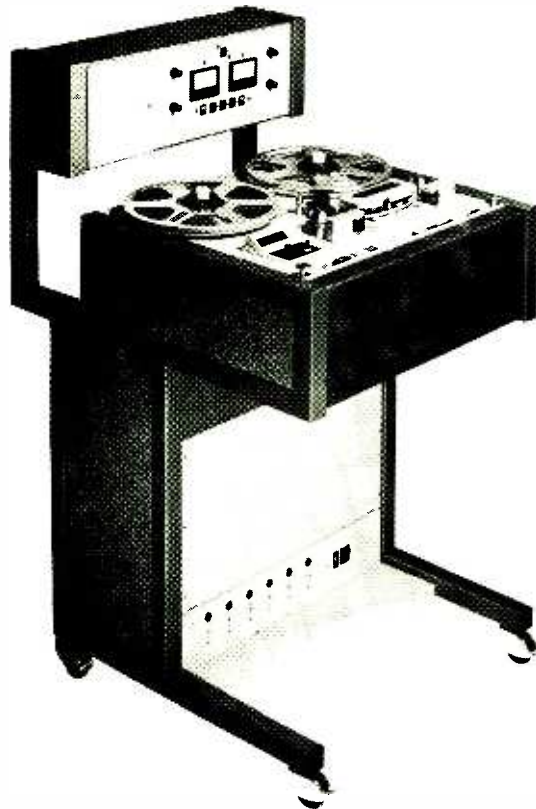

**because the choice  
of audio recorders has just  
been increased!**

It's sound sense to choose the new Proline 2000 TC now that the choice of Proline Professional audio recorders has been increased to two. Proline Professional have already been acclaimed for their performance and reliability worldwide with the economically priced Proline 1000. And now, from Leavers-Rich, largest and most experienced manufacturers of professional recorders in Britain, comes



the Proline 2000 TC with a Twin Vari-speed servo capstan.

The Proline 2000 uses electronics in place of mechanics — on board solid state analogue switches — modular construction for easy maintenance, and a host of other high technology concepts adding up to the most sophisticated recorder in large scale production in Britain today.

Have a word with Tony Costello or John Robinson at 01-874 9054 Leavers-Rich Equipment Ltd 319 Trinity Road London SW18 3SL Telex 923455

# ITAM 806

## A new standard in compact multitrack recorders

NEW Compact cabinet, with optional console base.

NEW tape heads, giving outstanding cross-talk characteristics.

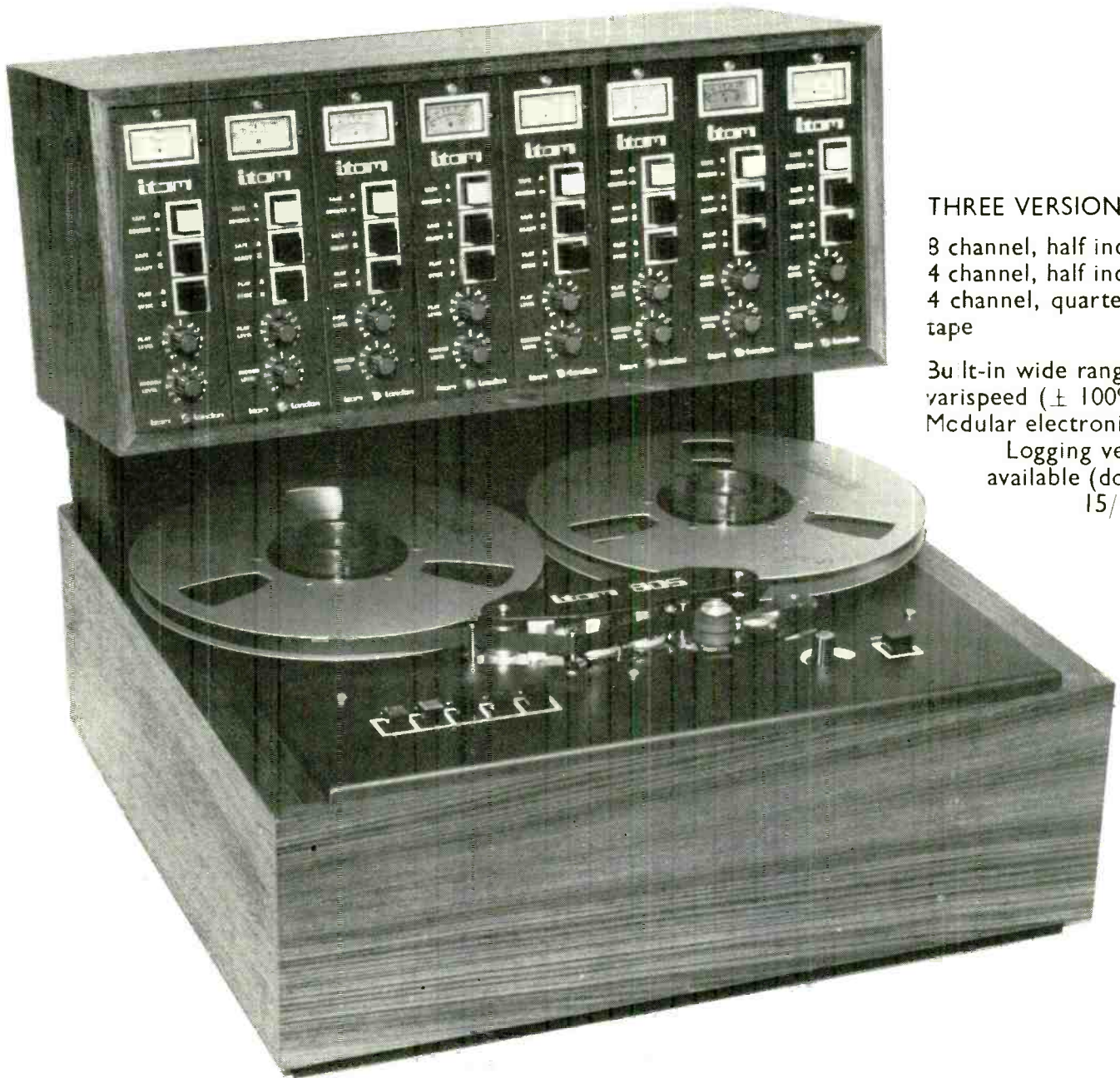

### THREE VERSIONS

8 channel, half inch tape  
4 channel, half inch tape  
4 channel, quarter inch tape

3u lt-in wide ranging  
varispeed ( $\pm 100\%$ ).  
Modular electronics.

Logging versions  
available (down to  
15/16 ips)

**itam**

1-7 Harewood Avenue, Marylebone Road, London NW1.

Tel: 01-724 2497 Telex: 21879

FRANCE: Son Professionnel, 29-31 Avenue André Morizet,  
92100 Boulogne (Paris). Tel: 605 3363

# You always perform better with the right equipment

With Neal Ferrograph you get the right equipment for the job, and the best in its class. A good formula for success, of which you can be assured every time you choose from the fully - integrated range of specialist recording and ancillary equipment in the NEAL FERROGRAPH range.

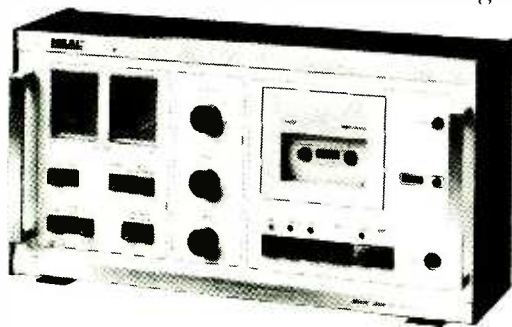

### The NEAL 302.

Incorporating a 3-motor mechanism, controlled by a full solid state logic system actuated by ultra light touch buttons, this is the machine used by top recording studios and broadcasting stations, for quality cassette copies and for in - cassette duplication masters.



### The Ferrograph Logic 7.

A transportable tape recorder of unrivalled facilities; taking all spool sizes up to 27 cm, and providing three speeds, plus positive action push buttons in association with logic circuits ... for fast, safe tape handling under all conditions.

### Studio 8

A professional studio tape recorder logic controlled for superb tape handling characteristics, offering a choice of stereo, twin track and full or half track mono heads, PPM or VU meters, IEC (CCIR) or NAB equalisation, console or transportable models.

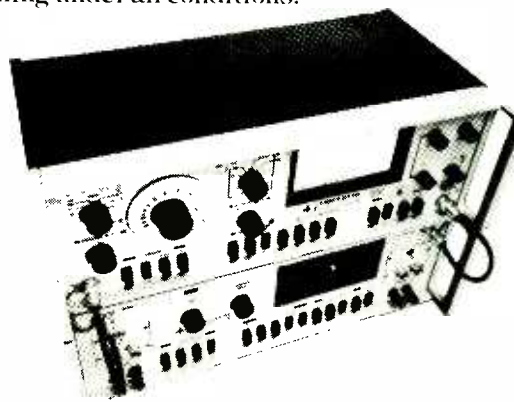

### The RTS 2.

Combines in one easy to use compact instrument the measurement of gain, noise, frequency response, input sensitivity, output power, distortion and the parameters relating to recording equipment, such as wow and flutter, crosstalk, drift and erasure. Its range of application can be extended even further by the addition of the Auxiliary Test Unit ATU 1.

**NEAL FERROGRAPH**  
TOTAL TAPE TECHNOLOGY

SIMONSDOWN WORKS · SOUTH SHIELDS · TYNE & WEAR NE34 9NX Telephone · SOUTH SHIELDS (0632) 566321 Telex · 537227



# Now-VARISPEED plus CRYSTAL CONTROL

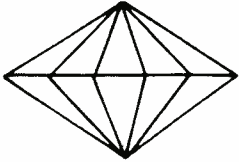

Industrial 3340SX available with  
VARISPEED + CRYSTAL CONTROL

# TEAC

NEW VERSIONS EXCLUSIVE TO ITA  
VARISPEED OPENS A NEW AREA FOR CREATIVE EFFECTS



Industrial 3300SX with  
VARISPEED + CRYSTAL CONTROL

Wide range VARISPEED provides 40% speed variation for effects. Crystal control guarantees capstan motor speed error less than 0.001% whilst mains locked versions depend on power line frequency up to 2% error.

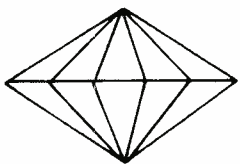

DON'T ACCEPT LESS

1-7 Harewood Avenue, Marylebone Road, London NW1.  
Tel: 01-724 2497 Telex: 21879

# ITA

# Alice

See us at **APRS** stand 17-18

*Our small mixers aren't cheap.....*

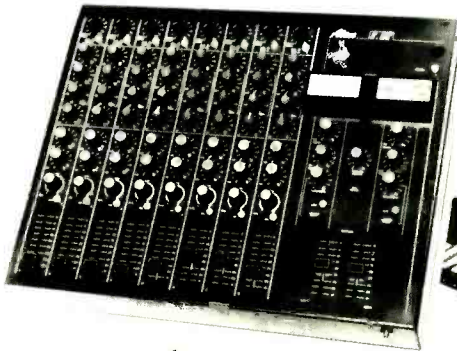

The 828 — *Alice's* new baby



*...but then our big mixers aren't expensive.*

## Alice (Stancoil Ltd.)

38 Alexandra Road, Windsor, England

The *Alice* Custom Modular  
20 input, 20 output, 16 track monitoring  
console at 'Dodgy Demos', Berkshire

Tel: Windsor (075 35)51056/7 Telex: 849323 a/b Aegis G

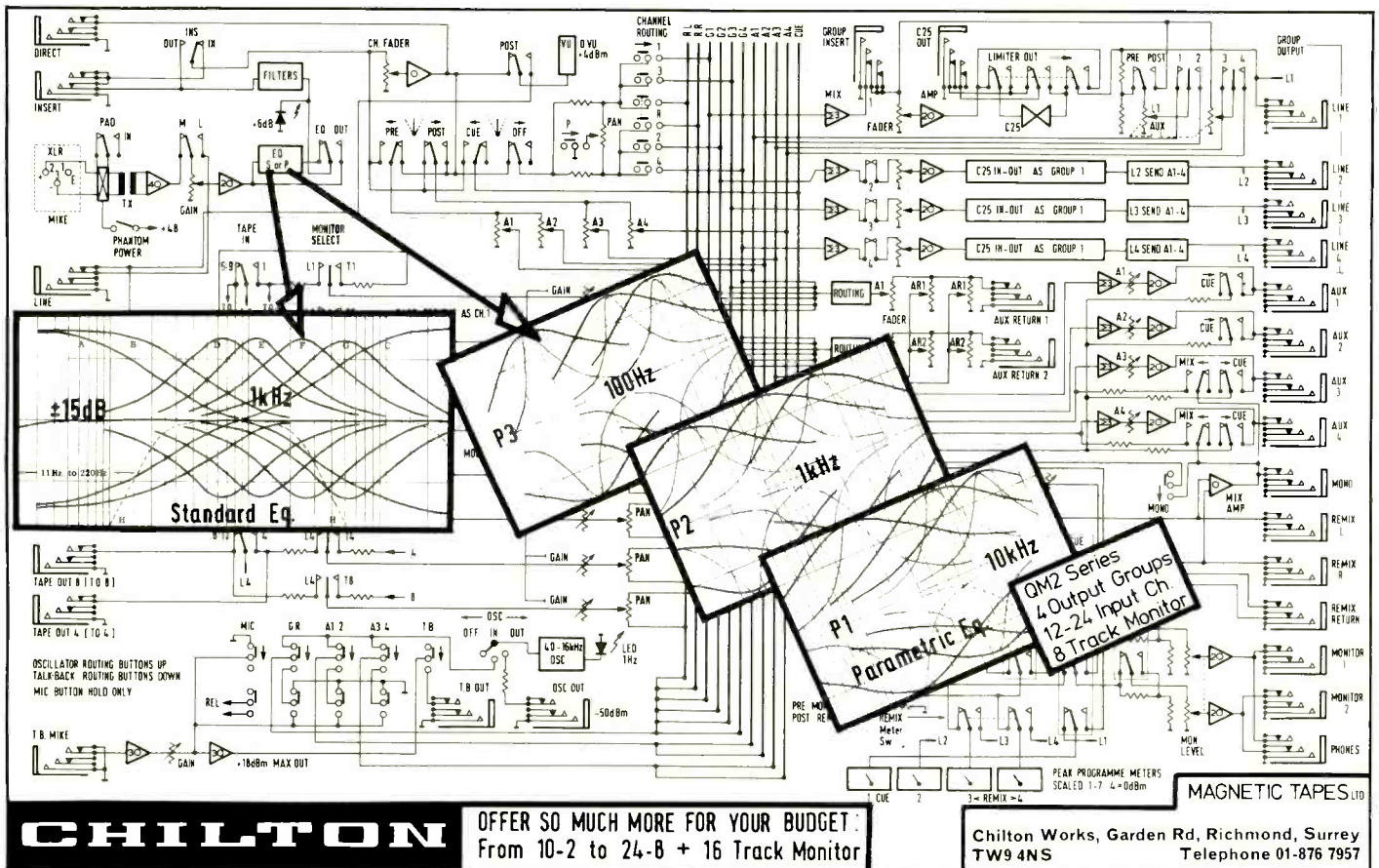

### CHILTON

OFFER SO MUCH MORE FOR YOUR BUDGET:  
From 10-2 to 24-B + 16 Track Monitor

Chilton Works, Garden Rd, Richmond, Surrey  
TW9 4NS Telephone 01-876 7957

# NEW PRODUCTS BULLETIN

## ITA



### ORBAN PARASOUND from USA

Dual channel multispring reverb unit. Each channel features four springs — far smoother than single spring systems. "Twang" and "boing" are virtually eliminated by incorporating a floating threshold limiter. Bass, mid-range EQ and bandwidth controls. The best compact reverb unit available.

### ITAM 882

New Stereo Mixer, built to a specification not a price! Ultra low noise —128dB. 8 inputs+ 8 direct outputs, 2 outputs with VU meters. 2 limiters. XLR mic inputs (balanced). 3 band EQ + mid sweep.  
£395 + VAT



### AURATONE



The amazing 5C Super Sound Cube. Only 6" x 6" — but it sounds enormous!

Only £38 per pair.

### OTARI DP4050 0CF IN CASSETTE DUPLICATOR

Now with 3 1/4 + 7 1/2 master capability and Ferrite heads. Duplicates 6 cassettes each run at 8 times speed. Over 80 stereo C60 per hour. Unquestionably the finest in cassette copier available from the world's largest duplicator manufacturer.



### RSD Studio Master 16 x 4

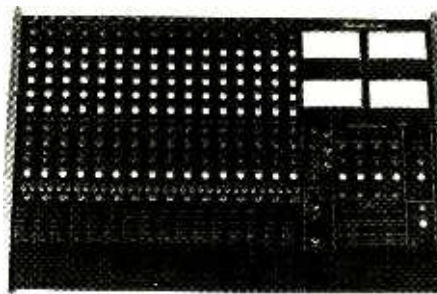

A really comprehensive budget-priced mixer. 16 inputs, 4 outputs. Pre-fade monitor, multi-band EQ including 3 EQ and 2 sweep controls balanced inputs, XLR connectors, comprehensive monitoring.  
£767 + VAT

Also available: 12 x 2 model with direct outputs.  
£385 + VAT



### QUAD

The new 405 power amplifier is now in stock. 100 watts per channel — simply the best, for £££'s less! Immediate Delivery!



1-7 Harewood Avenue, Marylebone Road, London NW1.  
Tel: 01-724 2497 Telex: 21879

FRANCE: Son Professionnel, 29-31 Avenue André Morizet,  
92100 Boulogne (Paris). Tel: 605 3363

# NEW from **amcron**

## REAL TIME ANALYSER RTA 2

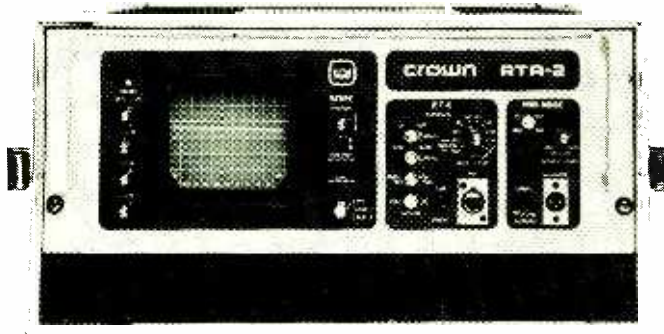

- \* 5" CRT Display
- \* Internal Pink Noise Source
- \*  $\frac{1}{3}$  or 1 octave Display
- \* Frequency range 20-20 kHz
- \* Outputs for X-Y Recorder
- \* Compatible with any microphone
- \* Price £1960 ex. VAT

The Amcron RTA2 Real Time Analyser is designed as much for use as a production tool as it is for on-site audio analysis of Theatres, and Recording Studios. A flight case is available.

## POWER AMPLIFIER D75



The Amcron D75 power amplifier replaces the previous model D60. Employing completely new type circuitry it offers also many new features, but without any increase in the price.

- \* New Amcron IOC comparator.
- \* Balanced XLR input connectors.
- \* Signal presence indicators.
- \* Separate Signal/chassis earth.
- \* 45 watts into 8 ohms per channel.
- \* Price £230 ex. VAT

Other Amcron Products include:

DC300A 500 watts/channel	£550
D150A 200 watts/channel	£350
VFX2A Crossover unit	£270
EQ2 Equaliser unit	£599
IC150A Preamplifier	£250
IMA Intermodulation Distortion Analyser	£610

### **MAGINNES LABORATORIES LIMITED**

Carlton Park Industrial Estate,  
Saxmundham, Suffolk. Tel. Sax. 2262/2615

Macinnes France  
18 Rue Botzaris,  
Paris 75019.  
Tel. 206 60 80  
206 83 61

---

# A REALLY PROFESSIONAL MICROPHONE

---

## THE EAGLE PRO M90 MICROPHONE

- A tough cardioid mike for stage use.
- Voice or music. Indoors or out.
- A mike with really good feedback control and an amazing 40 to 16000 Hz frequency response.
- Three layer windshield. XLR connector.
- Custom-built clip for stand use.
- A mike that will never let you down.



That's why the real professionals use it.

# EAGLE

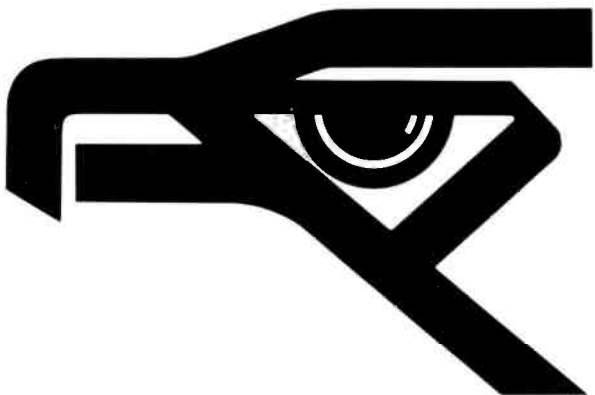

Please send me details of all the Eagle mikes, mixers, stands and other studio equipment.

Name \_\_\_\_\_

Address \_\_\_\_\_

\_\_\_\_\_

\_\_\_\_\_

Phone \_\_\_\_\_

### EAGLE INTERNATIONAL

Eagle International Precision Centre, Heather Park Drive,  
Wembley HA0 1SU, Middlesex Tel: (01) 902 8832

SS1

# The Music Laboratory just has to go!

Due to rapid expansion of business over the last two years, we have been forced to move to larger premises, which are situated in Central London, making it more convenient for our professional customers.

The hire department will provide excellent hire facilities, with machines ranging from small tape recorders, to the Music Laboratory's complete 8-track packages.

We are the official Revox Centre (London), and the leading distributors of Revox; which we also service, plus other well-known makes of recording equipment.

In the new premises, the Music Laboratory will hold an extensive range of stock, such as Revox and the complete Teac and Tascam range, which can be demonstrated in our fully-equipped demonstration studio.

For further enquiries please telephone 01-388 5392 or 01-349 1975.



**74 Eversholt Street, London N.W.1. Telephone 01-388 5392/3/4/5.**

Come and see the new TSM, Fleximix and range of peripheral equipment.

**Stands 28 & 29**  
**A.P.R.S. London**

21st-23rd June '78

You'll be there if you know what's good for you!

**JIGSAW**  
"put it all together"  
with Fleximix...  
the master mixer.



Jigsaw, a leading 8 track studio, chose the incredibly versatile **Trident Fleximix** for its outstanding performance.

Make a record of these **Fleximix** points:

- Fully Modular
- Total system flexibility – a module can be placed anywhere in the mainframe.

- Expandable at any time from mono to 24 track with no pre-wiring necessary.

- Maximum of 10 mixed output groups (8 sub-masters and 2 main left-right masters), plus monitoring facilities up to 24 tracks.

- Individual illuminated channel metering and L.E.D. column indicators to P.P.M. specification on sub-master groups.

- Complete patchfield facilities including direct channel outputs and pre-fade limiter insertion on input channels and output groups.

- Self-contained power supply system. Each mainframe contains a fully regulated and protected dual power supply which can be used to "slave" another mainframe in the event of failure.

- Now available with P. & G., conductive plastic faders.

For full details contact:

Trident Audio Developments Ltd.,  
Sales Office,  
112-114 Wardour Street,  
London, W1V 3AW.  
Tel: 01-734 9901/6.  
Telex: Tridisc 27782



**TRIDENT**  
Crossing the  
frontiers of sound.

*Photograph shows Dave and Sue Williams at work in their Jigsaw studios*  
Tel: 01-668 3457

# "THE GAUSS HIGH SPEED TAPE DUPLICATING EQUIPMENT WE PUT TO WORK IN 1968 IS STILL WORKING, THREE SHIFTS."

Richard P. Blinn, Director,  
Studio Operations & Electronic Development  
Capitol Records

"Gauss high speed tape duplicating technology was originally developed right in this department at Capitol in the late 60's. And, the first ten machines are still in full operation at our Jacksonville, Illinois facility. In fact, they're working three shifts a day. They're even better machines than they were in 1968... because we've continually upgraded them with new innovations from Gauss and our own engineers. Today, they're performing at the leading edge of the technology. If they weren't, Capitol would find something better."

At Gauss, we engineer the quality in. Modularly. Solid state. That way, as we improve the technology, you can upgrade your equipment. We're engineers building for engineers.



Gauss 10 MHz Bias System assures you lower noise and distortion. Wow/flutter is less than 0.05% RMS. And that's just the beginning of our engineering story.

Name your format. 2-track, 4-track, 8-track, cassette, or reel-to-reel. Gauss delivers. And, you can change formats in less than 10 minutes. What's more, you can choose between 32:1 or 64:1 duplicating with the flip of a switch.

Here's the acid test: Ask anyone who owns a Gauss high speed tape reproduction system what they think of their system. They'll tell you that Gauss

engineering means high productivity, highest-quality sound reproduction and maximum reliability. If those are your criteria, we think you'll choose Gauss.

**gauss**  
by **Cetec audio**

CETEC AUDIO  
13035 Sarcay Street  
North Hollywood, CA 91605  
(213) 875-1900  
TWX 910-499-2669

CETEC INTERNATIONAL LTD.  
16 Uxbridge Road  
Ealing, London W5 2BP England  
01-579-9145  
TLX 935847  
Divisions of Cetec Corporation





# HH S500-D



## The Perfect Power Amplifier for Top Sound Systems....

Since its introduction, the HH S500-D has become established as one of the world's leading power amplifiers. Many prestigious organisations have confirmed the amplifier's unique performance and dependability under tough operating conditions.

The list of users is long and varied but here are a few of interest:

Installers — Scenic Sound Limited, in co-operation with Eastlake Studios (for world-wide recording studio use); Martin Audio Limited (P.A. systems builders); Harold Fielding Limited (Theatrical use); International Sound (Italy); Virgin Record Hire; Dolby Laboratories.

The London Palladium; The Grosvenor House Hotel, London (S500-Ds in the main ballroom); Colac P.A. Hire Co. (S500-Ds on Dr. Hook European tours); The Duane Family (Winners of the Variety Club of Great Britain Award 1977); E.M.I. Publicity Department; Supertramp (U.S.A. and European tours); The Rubettes; Colosseum II; Black Sabbath; Liverpool Express; Simon Townsend Band; Island Records; Gallagher and Lyle; Tangerine Dream; Five Hand Reel; Horslips; The Barron Knights; . . . . the Admiralty Surface Weapons Establishment (for hush, hush use!)

### POWER CAPABILITY:

500W RMS	-2.5 ohms	900W RMS - 5 ohms Mono
320W + 320W RMS	-4 ohms Stereo	640W RMS - 8 ohms Mono
200W + 200W RMS	-8 ohms Stereo	400W RMS -16 ohms Mono

### TECHNOLOGY AND COST

Professionals are buying the S500-D for two reasons — firstly, the superb performance and advanced technology and secondly, the price which is lower than other less advanced amplifiers of similar power rating.

HH gives unbeatable performance — the best value for money.

### PERFECT POWER FOR YOUR SOUND SYSTEM

Please send me full information on the S500-D

NAME.....

ADDRESS.....

.....

.....



H.H. Electronic  
Viking Way, Bar Hill, Cambridge CB3 8EL  
Telephone: Crafts Hill (0954) 81140  
Telex: 817515 HH ELEC G

# Gelf

## Lo-Cost Range

- 16 - 32 inputs
- 3 Band variable EQ
- P & G Faders
- 2 Effect sends
- 2 Foldbacks
- 4 Stereo Sub-Masters
- Mute, P.F.L., Pan, Patching
- XLR connectors
- O/P +22db at 600  $\Omega$
- THD < 0.05%
- Noise, relative
- i/p noise < -126db



**GELF Electronics Limited**

Unit 5, Mount Avenue, Bletchley, Milton Keynes. MK1 1LS.

Telephone  
Milton Keynes  
(0908) 77503  
647262

# ITC - the first name in cartridge machines

ITC's engineers are acutely aware that broadcasters need cartridge machines which are both simple to use and ruggedly made. That's why the baseplate of every deck is hewn from a half-inch thick slab of toughened aluminium. All sub-assemblies are plugable (not hard wired), thus dismantling and service is rapid and simple.

The SP reproduce-only cartridge deck can be employed as an individual desk-top unit or as twin units in a 19" rack width. The pressure roller assembly utilises ITC's innovative air-damped solenoid via a chain and sprocket linkage for fast, reliable and above all, 'quiet' operation.

You can order the SP as a mono or stereo machine, with single or additional secondary and tertiary cue tones, with or without high speed cue (4 times nominal 7.5ips).



By specifying model WP, the reproducer is ready for rapid up-date to full record facility.

Discover for yourself why ITC have won the respect of numerous broadcasting studios on both sides of the Atlantic.

## **F.W.O. Bauch Limited,**

49 Theobald Street, Boreham Wood, Hertfordshire WD6 4RZ.  
Telephone: 01-963 0091.

**TRAD**

# ELECTRONICS SALES LTD.

Telephone : Watford 47988

Specialists in Service and Repair of T.R.D. recorders.

All parts, motors, etc., available. Collection and delivery: London and Home Counties. Prices ex-Watford. Delivery extra.

## FOR SALE

1 3M M79 16 track, like new ...	£10,000	Ferrograph Mk 6 stereo ...	£120
1 Scully 280 16 track ...	£5,000	ITA compliment comp/lim ...	£177
1 3M 400 Series 16 track ...	£5,500	Allen & Heath 16-8-16 desk ...	£1,900
1 Ampex MM1100 24 track with auto locate & varispeed ...	£16,000	Glen Sound Broadcast monitoring Unit battery/mains ...	£350
Telefunken 1" 4 track valve machine	£450	Mellotron FX Console ...	£1,000
Telefunken M10 valve stereo ...	£350	2 BBC LSU 10 Monitors with valve amps ...	£220
Telefunken M9 valve stereo ...	£300	Astronic Graphic 9 band (each) ...	£40
Audio Developments 20-4 desk as new	£3,500	White Spectrum analyser... ..	£1,400
Rosser 10-4 Broadcast desk ...	£1,800	1 Neumann KM74 Mics ...	£75
1 MCI Custom desk 29-24 ...	£9,500	Various 19" racks and cabs from Boom stands new ...	£15
1 MCI JH114 24TR + 16HB + A/L	£17,500	Revox A77 from ...	£300
1 Spectrasonics 24-24 desk ...	£16,000	Radford valve amplifiers type MA15	£25
1 MCI JH10 24 track ...	£9,500	Agfa PEM 468 2" Tape per reel new	£35
1 Garrard 401 turntables ...	£30	Racal Zonal 1/4" on cores ...	£2.75
1 Klark Teknik Stereo T/R, SM2	£2,000	Marconi AXBT Ribbon mic ex BBC circa 1945 ...	£100
A & D scamp racks & PSU ...	£200	Calrec CMI050c mics ...	£45
A & D scamp cards for above (each)	£135	AKG D110 mic ...	£20
1 Tascam 80-8, DX 8, remote new	£2,600	Beyer XIN mic ...	£25
Plessey rec/play cart M/C ...	£175	STC 4033 mic ...	£17
1 Trident 40-24 desk ...	£17,000	1 Studer A80 16 track ...	£10,000
1 Neve 20-16 mixing desk ...	£15,000	1 MCI 32 in/out desk ...	£14,000
Plessey replay only cart M/C ...	£100	1 Studer J37 8 track valve ...	£2,400
JBL 4502 monitors (pair) ...	£650	1 Amity Schroeder 16 track ...	£5,250
AKG C45IE Mics with CK1 ...	£55	1 Ampex AG440 8 track ...	£3,600
AKG C45IE Mic with CK5 ...	£75	1 Ampex MM1000 8 track Headblock	£500
2 Cadac Monitors + amps ...	£650	1 Scully 8 track Headblock ...	£350
Schoeps CMC56 Mic 6 months old	£295	1 Tandberg 11-IP mono full track with pilot ...	£275
1 pair Lockwood type cabs with Tannoy 15" reds ...	£300	1 Sennheiser MICH804 Gun Mic	£100
Studer A80 MK1 8 track headblock	£900	1 Amcron D60 Amplifier ...	£185
2 Ampex 351 stereos each ...	£350	1 ITA 10-4 with talk back, multi-core and phantom powering oscillators ...	£525
Now available new Webber, Laboratory standard test tapes.		Sign Electronics low distribution... 6 hZ-60 kHz ...	£35

1/4" NAB 15ips	£16
1/2" NAB 15ips	£22
1" NAB 15ips	£82
2" NAB 15ips	£150
2" NAB 30ips	£160

CCIR and other speeds P.O.A.  
 Manufactured in the United Kingdom  
 Why pay more! In stock now.

**WANTED—ALL STUDIO EQUIPMENT***All prices are exclusive of VAT*

## NEW XLR TYPE CONNECTORS

Male in line ...	£1.00
Female in line ...	£1.00
Male chassis mounting ...	.80
Female chassis mounting ...	£1.30

**149B ST. ALBANS ROAD, WATFORD, HERTS.**

Tel. WATFORD 47988

Telex 262741

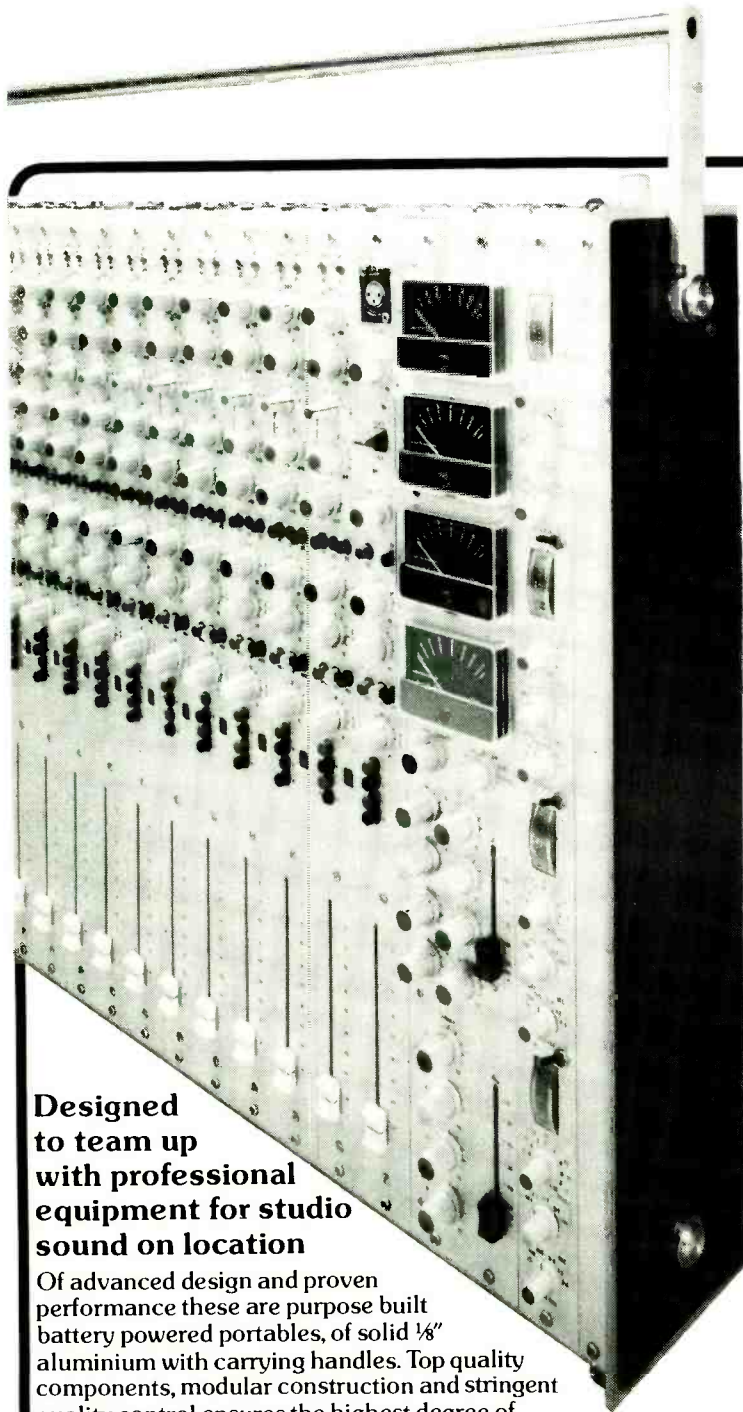

**Designed to team up with professional equipment for studio sound on location**

Of advanced design and proven performance these are purpose built battery powered portables, of solid 1/8" aluminium with carrying handles. Top quality components, modular construction and stringent quality control ensures the highest degree of reliability. For use on location with professional tape recorders—Nagra/Stellavox etc, outdoor broadcast, stage mixing or to supplement studio consoles when added capacity is required. Over 300 in trouble free use world wide.

**Audio**

Developments

Hall Lane, Walsall Wood  
 WALSALL, W. Midlands, WS9 9AU  
 Telephone: Brownhills 5351/2/3 (STD Code 05433)  
 Telex: 338212 Audio

See the full range of

**Audio**

Developments

**Portable professional mixers**

on stand No.16

**APRS 78**

Wednesday, 21st June

Thursday, 22nd June

Friday, 23rd June

Connaught Rooms, Great Queen Street,  
 Kingsway, London WC2

**MINIMIXER AD 007** 8 in 4 out. Compressors.

**MICROMIXER AD 031** 8 in 2+1 out+options

**PICOMIXER AD 045** 6 in 2 out

**PICOMIXER AD 045 Plus**

**AND NEW!**



**Stereo Compressor Limiter**

**Pro Graphic Programmable Graphic Equaliser**



# Reliability in its most compact form the TELEFUNKEN "magnetophon" 15A Multi-Track: the complete system



Unprecedented flexibility and operating ease. A system approach to all accessories: a micro-processor based autolocator with 9-position memory and stop timer, remote track selectors and a capstan speed controller with crystal precise digital speed read-out. The TELEFUNKEN M15A multi-track. All in all a totally new generation of master recorders from the inventors of modern tape recording. Up to 32 tracks on 2" tape! 12 1/2" reel diameter capacity. Versions with the TELEFUNKEN "telcom c4" noise reduction system (built-in for up to 24 tracks). Readily upgradable to higher track configurations. Crystal locked 7.5/15 or 15/30 ips tape speeds, NAB/CCIR/AES switchable equalization and clock-timed record/erase functions to permit gap-less, inaudible electronic splicing. It's the recorder for the engineer who wants to pay for performance - not for gadgets: the experienced professional.

WAK 578 E

Please send me the brochure on  
»magnetophon 15A  
Multi-Track-Systems«

Name \_\_\_\_\_

Address \_\_\_\_\_

Telephone \_\_\_\_\_

**GOTHAM**  
AUDIO CORPORATION

Hayden Laboratories Ltd.  
Curchfield Road  
Chalfont St. Peter, Bucks. SL9 9EW  
Gerrards Cross 88447 (STD 02813)  
U.K.

741 Washington Street  
New York, NY: (212) 741-7411  
1710 N. La Brea Ave.,  
Hollywood, CA: (213) 874-4444  
USA

AEG-TELEFUNKEN  
Magnetbandgeräte  
P.O. Box 2154  
D-7750 Konstanz  
W.-Germany



**professional tape recorders  
by AEG-TELEFUNKEN**

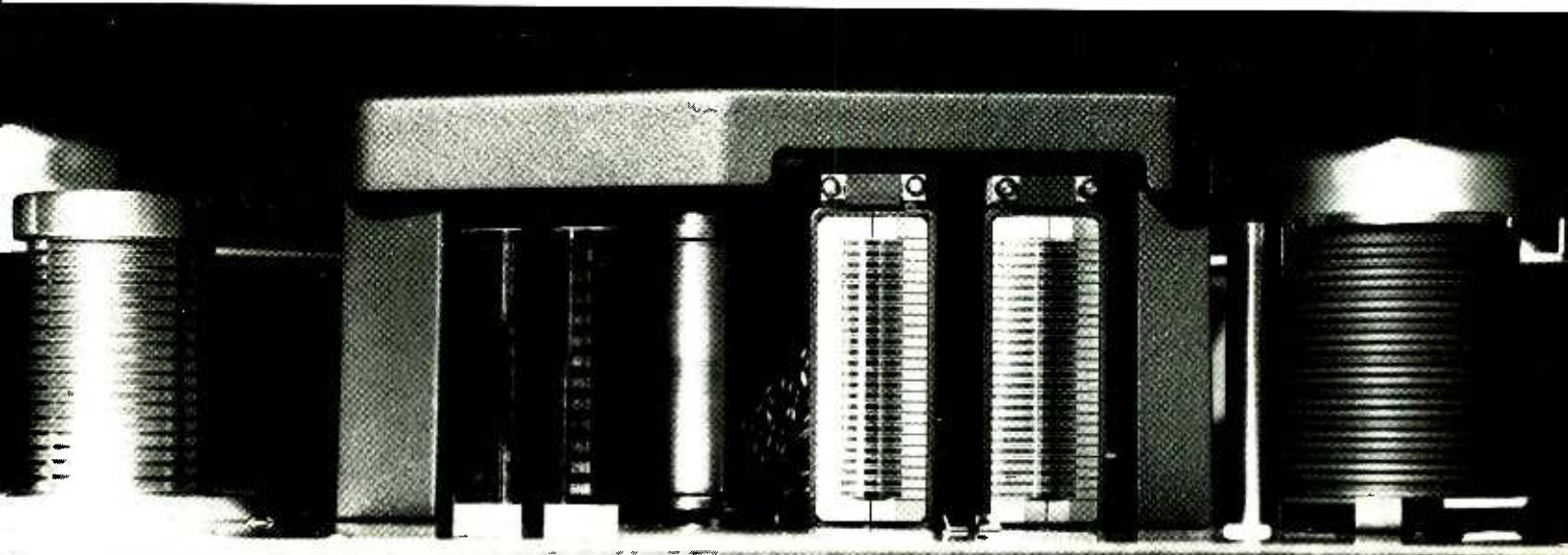

# WHAT'S IN A MICROPHONE STAND?

Into our microphone stands are built years of listening to the comments of engineers and studio technicians and acting on their advice.

You can benefit from all this experience by sending for our new catalogue.

MOBILE STAND  
MODEL MSW



*Write or Phone  
to:-*

**KEITH MONKS (AUDIO) LTD.**  
**26 READING ROAD SOUTH, FLEET, HANTS.**

**Telephone: Fleet (02514) 20568/9.**

**Telex 858606**

**SOLD WORLD-WIDE THROUGH APPOINTED DISTRIBUTORS**

# RA200/ADS1

## Frequency response analysis with a difference

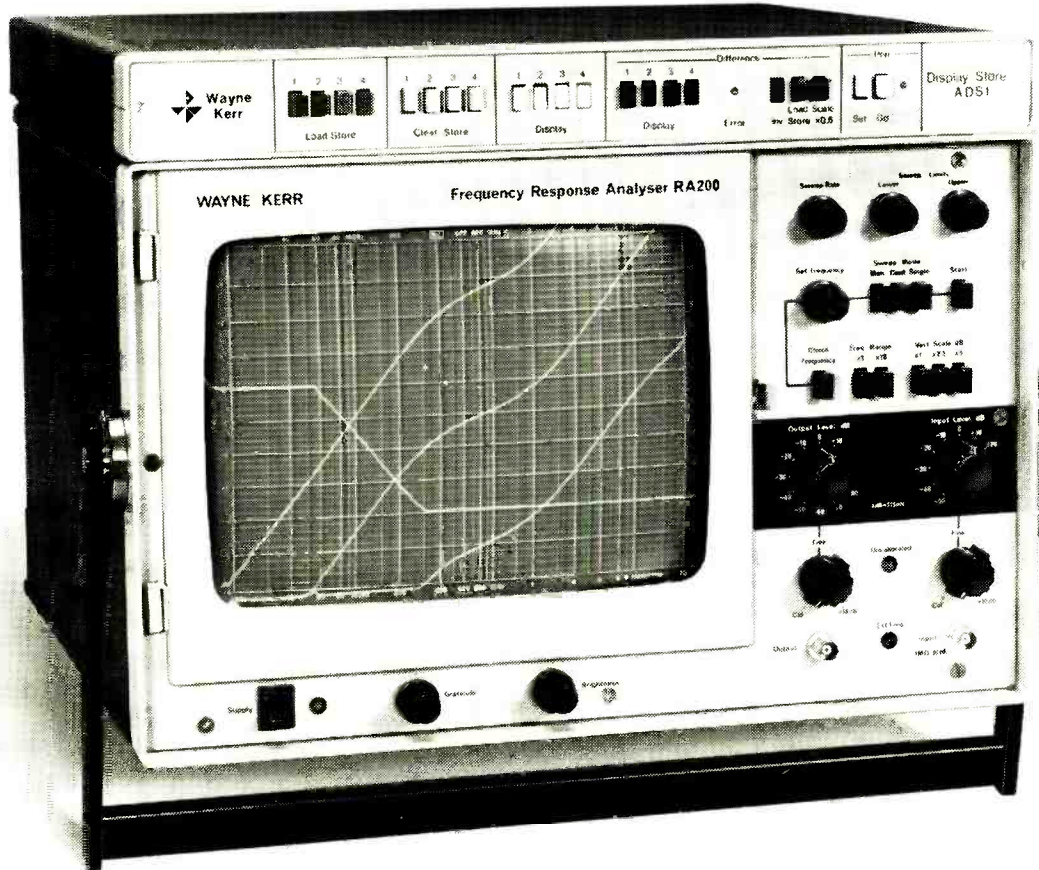

The Wayne Kerr RA200/ADS1 is undoubtedly unique. It gives fast, accurate frequency response measurements for any audio system - displaying up to five different curves as gain/frequency plots on a long-persistence CRT. The basic unit, the RA200, performs all the detector and sweep functions, requires no synchronisation, and will adjust automatically to the incoming frequency.

#### Four Channel Digital Store

The matching display store, the ADS1, is a fully compatible digital storage unit powered by the RA200, and can give continual updating of each curve stored to ensure fast, precise readouts.

It incorporates rechargeable batteries to permit stored data to be retained for up to two weeks when the unit is switched off.

#### The RA200/ADS1

This complete unit provides facilities for displaying the difference between any two stored curves, or comparison of any new input with a stored reference curve. Minor variations from a desired characteristic can be readily amplified, and departures from a linear response clearly shown as deviations from a straight line by use of the store 'invert'. Slow-acting pen recorders can also be driven by the unit.

For more details fill in the coupon or contact your nearest distributor:

Tekelec-Airtronic, Cite des Bruyeres,  
Rue Carle-Vernet, 92310 Sevres,  
Paris, France. Tel: 027 75 35.

Keithley Instruments GmbH,  
Heiglhofstrasse 5, 8000 Munchen 70,  
West Germany. Tel: (089) 7144065.

G & P Electronics AG, Bernerstrasse-Nord  
182, Ch-8064 Zurich, Switzerland,  
Tel: (01) 643231.

C N Rood BV, PO Box 42, 11-13 Cort van  
der Lidenstraat, Rijswijk ZH 2109, Holland.  
Tel: (70) 99 63 60.

Unitronics SA, Torre de Madrid, Princesa 1,  
Piso 12 Oficina 9, Madrid 8, Spain.  
Tel: 242 5204.

Scandia Metric AB, Fack 171 19, Solna 1,  
Banvaktsvagen 20, Sweden.  
Tel: (08) 820 410.

Please send me further  
information on the Wayne Kerr  
RA200/ADS1.

Name \_\_\_\_\_

Company \_\_\_\_\_

Address \_\_\_\_\_

Tel: \_\_\_\_\_

 **Wayne Kerr**

Wilmot Breeden Electronics Limited  
442 Bath Road, Slough, Berkshire SL1 6BB England

SS/7/78

# Master-Room Reverberation Units

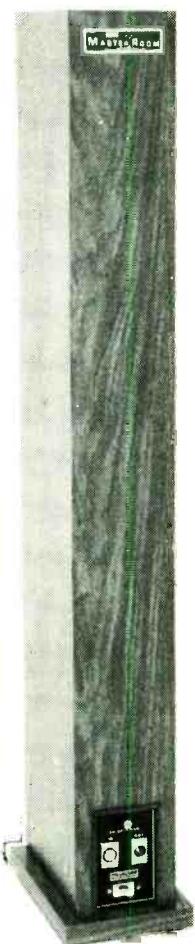

A complete range of superbly natural sounding reverberation devices equally suitable for fixed or portable operation. Master-Room models are in reliable daily use with broadcasters, film dubbing facilities, multi-track music recording studios and P.A. companies.

Illustrated: Master-Room Model MR111 fixed decay time stereo output reverberation unit

U.K. List £934



Sound columns not shown

Master-Room Model CSR23 EQ two independent channel variable decay time reverberation unit with comprehensive reverb return equalisation

U.K. List £1,384

For full details on the MICMIX Master-Room range contact:

**Scenic Sounds Equipment,**  
97-99 Dean Street, London W1. Tel: 734 2812

Belgium  
S.E.D., Rue Bara Straat 146,  
1070 Bruxelles. Tel: 522 7064

A.R.C. SPRL, Rue Th. Decuyper 134,  
1200 Bruxelles. Tel: 771 3063

Denmark  
Lake Audio APS,  
Artilleivej 40,  
DK-2300 Copenhagen S  
Tel: 570 600

France  
3M France SA, Mincom Div.,  
Boulevard de l'Oise,  
95000 Cergy  
Tel: 749 0275

Holland  
Pieter Bollen Geluidstechnik,  
Hastelweg 6, Eindhoven  
Tel: 512 777

Norway  
Siv Ing Benum AS, Skovvn 22,  
Oslo 2. Tel: 565 753

Sweden  
Tal & Ton Musik & Elektronik AB,  
Kungsgatan 5,  
411-19 Gothenburg  
Tel: 130 216

CA Design

## 'music class'

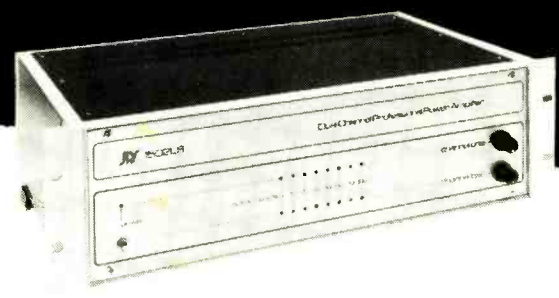

power amplifiers from JPS



J P S ASSOCIATES, Belmont House, Steele Road, Park Royal, London NW 10 7AR 01 961 1274

Available from:

**ENGLAND (South)**  
REW Audio Visual  
146 Charing Cross Road,  
London W.C.2  
Tel. 01-240 3064  
Contact John Cowan

**ENGLAND (West)**  
Sevenside Audio & Lighting  
29 The Promenade,  
Gloucester Road,  
Bristol BS7 8TZ  
Tel. 0272-41666  
Contact Dave Rayfield

**ENGLAND (North)**  
Atmosphere Lighting & Sound  
57 Nelson Street,  
Aberdeen,  
Scotland.  
Tel. 0224-572905  
Contact Keith Main

**BELGIUM**  
I.A.T.A.  
Kerkstraat 16,  
Wigmaal 3020,  
Belgium.  
Tel. 032 16 443377  
Contact Leo Maebé

## FROM E.S.E

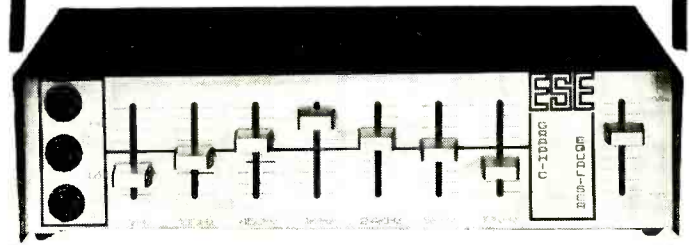

A full frequency range graphic equaliser **YOU** can afford !!

**For JUST £38.85 plus VAT** You can tune out all unwanted noises at seven different frequencies!

Bring all your recordings, P.A., discs, lead guitar, bass guitar, organ, anything amplified to life at the touch of a slider !!

No more annoying amplifier noises—just clear, true sound! Frequencies from 60Hz to 10kHz!

Cut or boost each frequency by maximum of 15 dB!

Hi and lo gain inputs.

Powered by just two PP3 batteries which last for ages. Or mains powered unit available. £49.95 plus VAT.

Trade enquiries welcomed.

Try it and you'll buy it—it will change your concept of sound. **Condensed Technical Spec** Max output: terminated to 600Ω — 10 dB > 1.6 volts peak to peak, 2.5 volts R.M.S.

**Signal to noise ratio:** input terminated with 47K resistor. All filters at max. better than —70 dB.

**Frequency response:** All filters at central better than ±2 dB.

**Filter slope:** Better than ±13 dB per octave.

**Filter ranges:** Max. ±15 dB at 60, 180, 480 Hz, 1, 2.4, 5 and 10 kHz.

To: **E.S. ELECTRONICS,**  
2 Upper Fant Road,  
Maidstone, Kent.



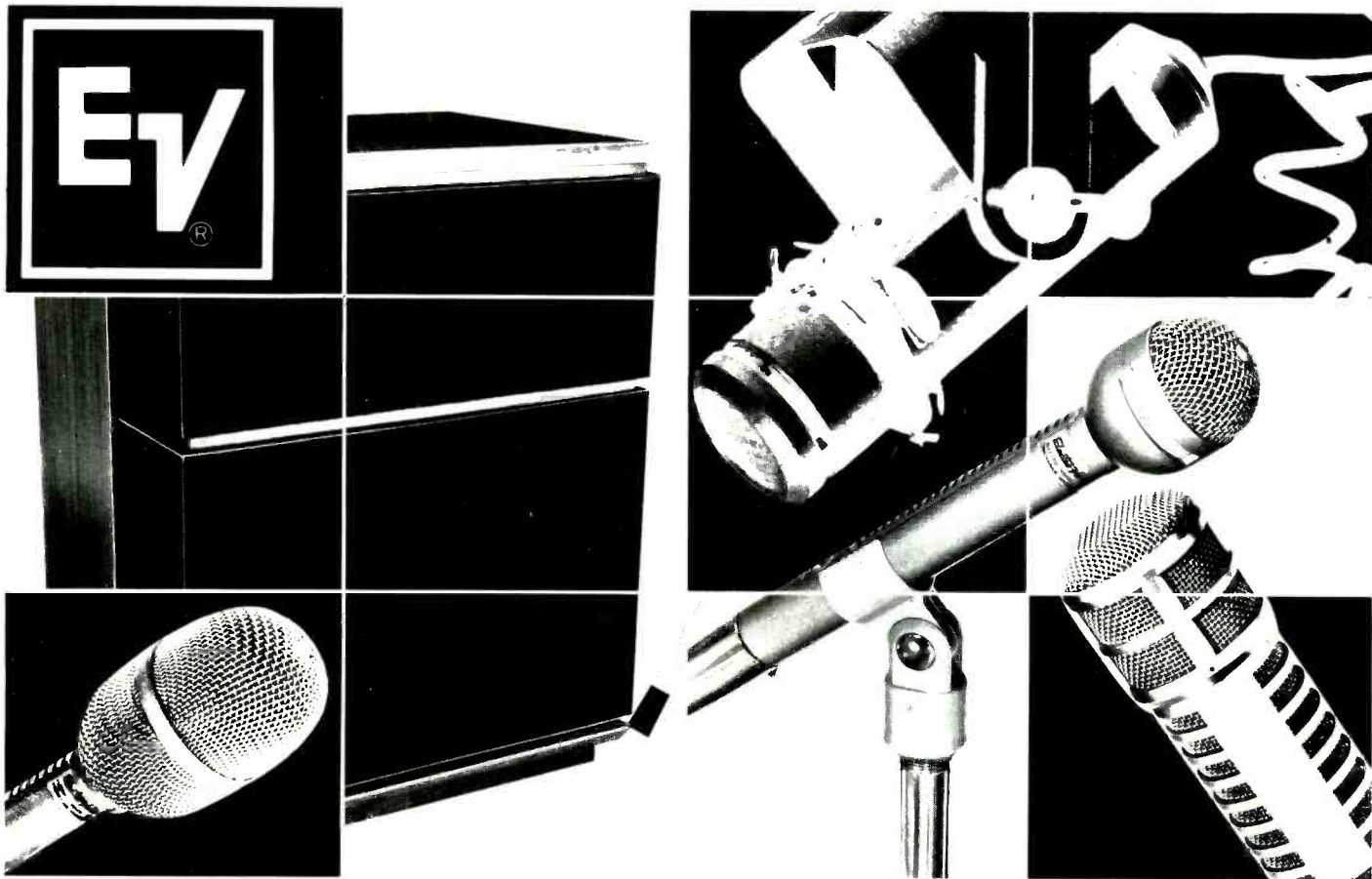

# Professionals speak very highly of our microphones and monitors

**EV** In microphones and monitors  
Electro-Voice leads all the way

What Electro-Voice has to offer by way of microphones and monitors sounds really good. The numerous wireless, TV and recording studios using Electro-Voice microphones and monitors show it.

Where only the best is good enough, Electro-Voice is always there. Be it with studio- or soloist-, omnidirectional-, Single-D-cardioid-, variable-D-cardioid microphones or monitors speakers.

Why not send in the coupon and get detailed particulars? You will immediately realize that every Electro-Voice product is backed up by an outstanding technology, and why professionals always speak so highly of our microphones and monitors.

**PRIMARY DISTRIBUTORS:**

*Theatrescene Limited  
12/13 Henrietta St.,  
London WC2  
Tel: 01-240 2116*

*Satur Electrical  
63 Livingstone Rd.,  
Sheffield  
Tel: 07 415 64585*

*Sound & General  
59 Dury Street  
Dublin 2  
Tel: 711222*

## COUPON

*Please forward detailed particulars on:*

- Electro-Voice microphones*
- Electro-Voice loudspeaker systems*

*Name* \_\_\_\_\_

*Address* \_\_\_\_\_

*Send to: Electro-Voice Division  
Gulton Europe Ltd.  
Maple Works  
Old Shoreham Road  
Hove BN3 7EY*

## Strawberry open cutting room

Mention the word 'strawberry' to a market stallholder in Strutton Ground, Westminster, and he's likely to quote you a price per punnet. But when you do find the door discreetly labelled Strawberry Mastering (UK) Limited, you can look forward to a feast for the eyes and ears rather than the palate.

The new facility has broken records already, being described as the largest Eastlake mastering room to date. Despite its name, it is not owned by the Strawberry organisation. 'We still think of ourselves as a team—the three Strawberries, North, South and now this—but the main connection is simply the name', remarked Melvyn Abrahams, manager and co-director. The other link is co-director Ric Dixon, also a director of Kennedy Street Artists, who have a stake in Strawberry North.

The mastering suite comprises a reception area (a red illuminated strawberry shines down from the main wall) leading off to kitchen and toilets; a lounge area—where Mel Abrahams' armoury of disc awards are displayed—equipped with a colour tv; and mastering room leading off from the lounge. Luxury offices for Strawberry Mastering and Kennedy Street Artists are under construction.

JBL monitors have been specified in preference to Gauss and Emilar units used in the original Eastlake enclosures, driven by Crown amps via White graphic equalisers. Auxiliary monitoring is on Auratone units in custom cabinets mounted either side of the cutting desk.

Equipment was specified by cutting consultant Sean Davies with Mel Abrahams, and installed into a custom console by Ian Phillips and Tony Cockell of Formula Sound (which, by coincidence, has its home above Strawberry North in Stockport). Mel Abrahams, who oversaw the whole design and installation operation, gives full praise to Formula Sound. And looking at the quality of the work it's easy to see why. 'They've taken great care on this job', said Abrahams, 'and if it weren't for

them putting in such an effort and doing things they didn't have to do, we wouldn't be ready to open yet.'

Abrahams entered the business five years ago as a tea boy at the ill-fated Command Studios, later moving to IBC as a cutting engineer. He is all too familiar with the back-room image of disc cutting



prevalent in many quarters. In Strawberry Mastering he has sought to create a relaxing environment where the cutting engineer is part of a production team, as the recording engineer is in a studio. 'I like to spend a good deal of time playing tapes through and getting to know the aims of the producers', said Mel. 'The test cuts are then considered attempts and soon lead to a prime cut.'

The control console is fitted with remote control of all operational functions for the Neumann VMS 70 lathe, including cutter head temperature, current meters and a linearised grooves-per-inch meter.

Two sets of stereo Helios equalisation are available, each acting on audio and advance signal paths by ganging. This duplication of eq permits adjustment during cutting without the inter-band panic normally experienced. Also available are Audio & Design *Vocal Stressors* and limiters. 'We've got Teletronics limiters as well', said Mel, 'which I prefer to use on albums because they "cruise" [sense rms values rather than peak] whereas I'd use Audio & Design on singles for a punchy sound. It doesn't always apply, of course, but that's a general rule.'

'An important feature', said Sean Davies, 'is the facility of switching out equipment not actively employed in the signal path. I don't believe in going through line amps and transformers of equipment not in use, no matter how wonderful they may look in the specifications. So we've incor-

Ortofon, as is the replay pickup which, Mel feels, is more hard-wearing than the Shure V15s he has used. Plans are underway to fit a switch to the pickup arm, so that replay is selected automatically on monitors when the arm is cued. A portable microscope has been acquired for precise inspection of cutting head symmetry, an important factor for accurate cutting. Visual monitoring on the desk is provided by two horizontal light band meters, with red coloured overload sections. Phase indication is two-fold—a centre-zero phase meter and a small crt screen mounted next to monitor faders. The crt effectively presents a picture of what the cutting head is doing in vertical and horizontal directions. An out-of-phase condition would appear as a vertical display on the screen.

'The reason we have the two phase metering systems', said Sean, 'is because the moving coil meter, which is according to the German Broadcasting Standard, indicates the phase compatibility as far as listening is concerned. When the meter indicates negative, the effect will sound unpleasant. However, in disc-cutting one is also concerned with instantaneous movements of the stylus which could make tracking difficult. The crt display is instantaneously responding and would indicate conditions too fast for the moving coil.'

Either side of the central control area, plumbed into the console, are two Studer A80 tape machines, the 76/38/19 cm/s mastering version to the left, and standard version to the right for copies. 'We've done something to the mastering machine which I think is unique in the business', remarked Sean Davies, 'although it's so obvious, one wonders why nobody else has done it. We've synchronised the motor to the mains and knocked out the standard servo arrangement. This is sensible because the lathe is also synchronised to the mains. But we've made it switchable, so that copying operations between tape machines are completed under normal servo control.'

A final word from Mel Abrahams. 'We've all had to work hard on getting things right, and spend money on the best equipment available, because to open a mastering suite in London today and attract the respected names in the business, you can't afford to cut corners.'

The address of the new cutting room is 20 Strutton Ground, Westminster, London SW1. Phone: 01-222 2191.

Richard Dean

38 ▶

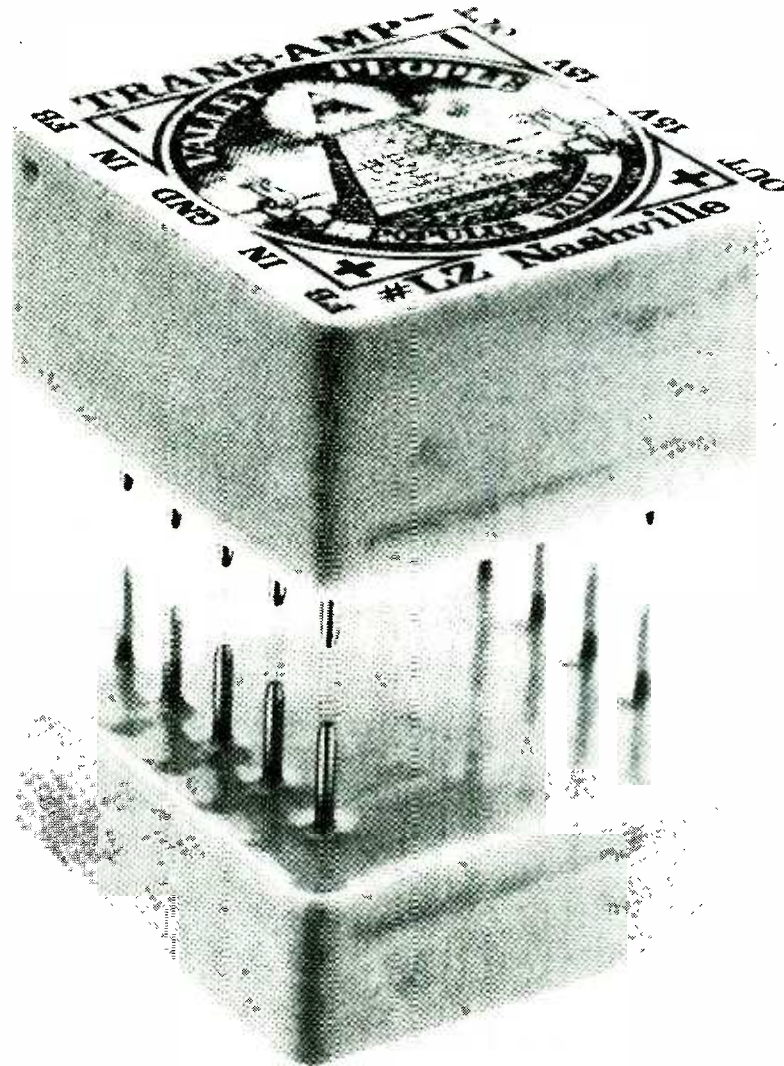

# The Simply Revolutionary Transamp™

A new and genuinely revolutionary audio and instrumentation differential amplifier module from Valley People Inc. of Nashville, Tennessee.

Its extremely low noise input circuitry is equally suited for interface with such low impedance devices as microphones, tape heads and phono pickups or for true, balanced, virtual earth summing amplifier applications.

When used to eliminate console microphone input transformers, Transamp™ produces otherwise unrealisable noise performance – and turns in subjectively superior audible results.

## The technical specifications – briefly

- Noise – within  $\frac{1}{2}$  dB of theoretical limits, when direct coupled to a  $150 \Omega$  microphone (Noise Voltage –  $.5 \eta V \sqrt{HZ}$ )
- Bandwidth – .3Hz to .5MHz (@ 60dB gain)
- Slew Rate –  $26V/\mu$  sec. (Differential output)
- Distortion – .005% typical, any gain and any input level (IM or THD)
- CMRR – Well in excess of 100dB
- Size – 32mm x 32mm x 16mm

## The cost

1-9 pieces £20 post paid within Europe. Substantial quantity discounts apply.

For full specifications and details of quantity prices, write or call the European Distributors:

**SCENIC SOUNDS EQUIPMENT,**  
97-99 Dean Street, London, W.1. Tel: 01-734 2812 Tlx: 27939

Transamp™ is a registered trade mark of  
Valley People Inc., P.O. Box 40306, Nashville, Tennessee 37204, U.S.A.  
Device patents pending

## NEWS

### Standard reverb spec

The IEC has just published a new specification relating to reverb and time delay equipment for use in recording and sound reinforcement. Publication 268:9 provides engineers with a list of characteristics to be specified for artificial reverb gear. It covers such details as frequency response, ambient acoustic noise levels, reverb and delay time, etc.

Further details can be obtained from International Electrotechnical Commission, 1 Rue de Varémbe, 1211 Geneva 20, Switzerland. Phone: 340150.

### Sony microphones in UK

The full range of Sony professional microphones are now available in the UK. They range in price from £59 for the cheapest to £495 for model C-47 (no relation) with variable polar diaphragm.

Sony pro microphones are manufactured with both electret and true capacitor microphone capsules. The company claims that its electret models feature a new fabrication process enabling a reduction of diaphragm thickness. It states that its back-electret mics possess a similar performance to capacitor models. Sony UK Ltd, 134 Regent Street, London W1R 6DJ. Phone: (01) 439 3874.

### Neve changes name

Rupert Neve & Co Ltd, the sales and marketing company of the Neve group has changed its name to Neve Electronics International Ltd. The company wishes that it should continue to be known in the business as 'Neve'.

The name change accompanies a slight restructuring of the erstwhile Rupert Neve & Co Ltd to strengthen further the sales organisation of the company. Derek Tilsley becomes managing director; Jonathan Pedre joins the board as marketing director with Les Lewis as sales director. Tore Nordahl, president of the entirely UK-owned Rupert Neve Inc, joins the board to represent the North American marketing subsidiaries.

The name change was made for both cosmetic and practical reasons. Rupert Neve, the Neve group founder who has a purely consultancy role in the company commented: 'I think that it is a conscious decision to de-personalise the company. They wanted something that wasn't personal to myself. They

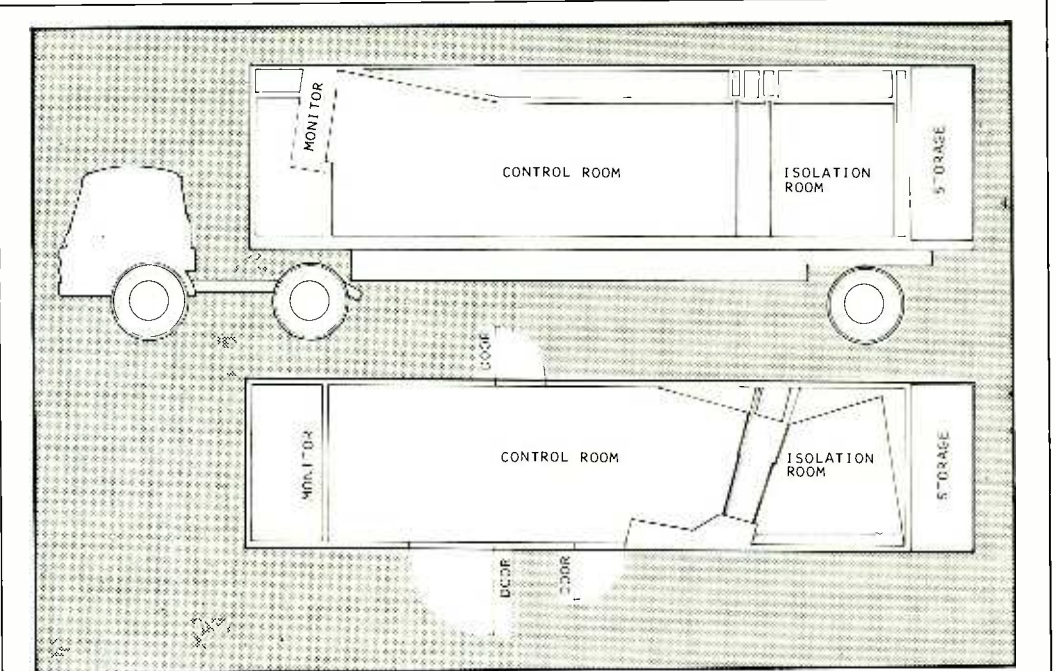

### Tom Hidley-designed mobile for Radio Clyde

The first European-based mobile designed by Tom Hidley of Eastlake (there are about half-a-dozen units in use in the States) is currently under construction in Scotland. The mobile is being built for Radio Clyde but will be available for hire by other clients. Completion date is set for early-August.

Around the middle of June the mobile, which measures 10m in length and is almost 4m high, should be completing its first stage of construction at Penman, a Scottish company who are building the basic box structure and the articulated tractor chassis into which the Ford power unit will be dropped. The partially-completed unit will then be taken down to Eastlake's cabinet makers in Oldham for the first stage of internal fitting out. After a period of about three weeks the mobile is due to be moved to Brabury Electronics in Reading who are installing the desk, electronics and wiring. This stage should take between four

and six weeks, after which the mobile will be ready for final internal fittings, possibly with Tom Hidley on hand to give the final seal of approval.

All construction work is being supervised by Tape One, who will be also responsible for the day-to-day running and booking of the Clyde Mobile, as it will probably be known, for the Glasgow-based iir station. However, Radio Clyde will use their creation 'occasionally'.

Pride of place in the control room will be a MCI JH-400 Series 36-in/24-out desk, linked to a Trident Fleximix submixer to give a total of 50 inputs and full monitoring facilities — in effect a combined 50/50/50 configuration. Why so many inputs and outputs? Well, there are plans to install not one, but two MCI JH-16 24-track machines linked together with one of the new MCI synchronisation units. In fact, there are also plans to use the synchroniser to allow one or more multitrack machine to be hooked up to a vtr for television work. Other tape machines will com-

prise a pair of two-track MCI mastering machines and a four-track for making stereo soundtracks for television use (stereo plus one track for the SMPTE sync code).

Ancillary gear will include a full rack of Audio & Design Scamp signal-processing modules, plus a pair of Dolby M24 racks. The final decision whether or not to run one or both multitrack without Dolby, or maybe to run them both at 76 cm/s and do away with noise reduction altogether, will be left to the client.

Because of its potential use for music outside broadcasting, a Post Office interface is to be installed with separate ppms, limiters and equalisers to suit IBA/BBC requirements into PO landlines. A Post Office radio telephone covering the whole of the UK—not just one or two regions—is also to be fitted.

Full details of availability and costs can be obtained from Barry Ainsworth or Bill Foster at Tape One, 23 Carburton Street, London W1. Phone: 01-388 7762.

can't be dependent on the name "Rupert Neve" for ever.'

It was also pointed out that the business name 'Neve' and the company name 'Rupert Neve' caused a considerable amount of confusion in things like show catalogue listings. There are no issues of company finance involved in the name change, according to Neve sources. The overall company structure

remains as before with Neve Electronic Holdings being the parent company of the group, which in turn is owned by the Energy Services Group; this relationship has remained unchanged since 1973.

Company business appears to be on the up and up with a healthy showing in all markets in which Neve competes. To underline this, the company has recently sold

around £350 000 of equipment to Japan. Part of the consignment included a Necam mixdown system destined for CBS-Sony together with three 40-input desks.

Neve Electronics International Ltd, Cambridge House, Melbourn, Royston, Herts, UK.

Phone: 0763-60776. Telex: 81381.

Frank Ogden

# Neve

 supreme in sound

## Tommy Steele chooses Neve for his new Nova Suite



Why not let Les Lewis meet your console requirements - Tommy Steele did.

# Neve

**Neve Electronics International Ltd.**, Cambridge House,  
Melbourn, Royston, Herts. SG8 6AU, England.  
Tel: Royston (0763) 60776. Telex: 81381.  
Cables: NEVE Cambridge.

**Rupert Neve Inc.**, Berkshire Industrial Park,  
Bethel, Ct. 06801 USA. Tel: (203) 744 6230. Telex: 969638.

**Rupert Neve of Canada Ltd.**, 2721 Rena Road,  
Malton, Ontario. Tel: 416 677 6611. Telex: 21 06 983502.

**Rupert Neve GmbH**, D-6100 Darmstadt, Bismarckstrasse, 114.  
W Germany Tel 6151 87038. Telex: 419581.

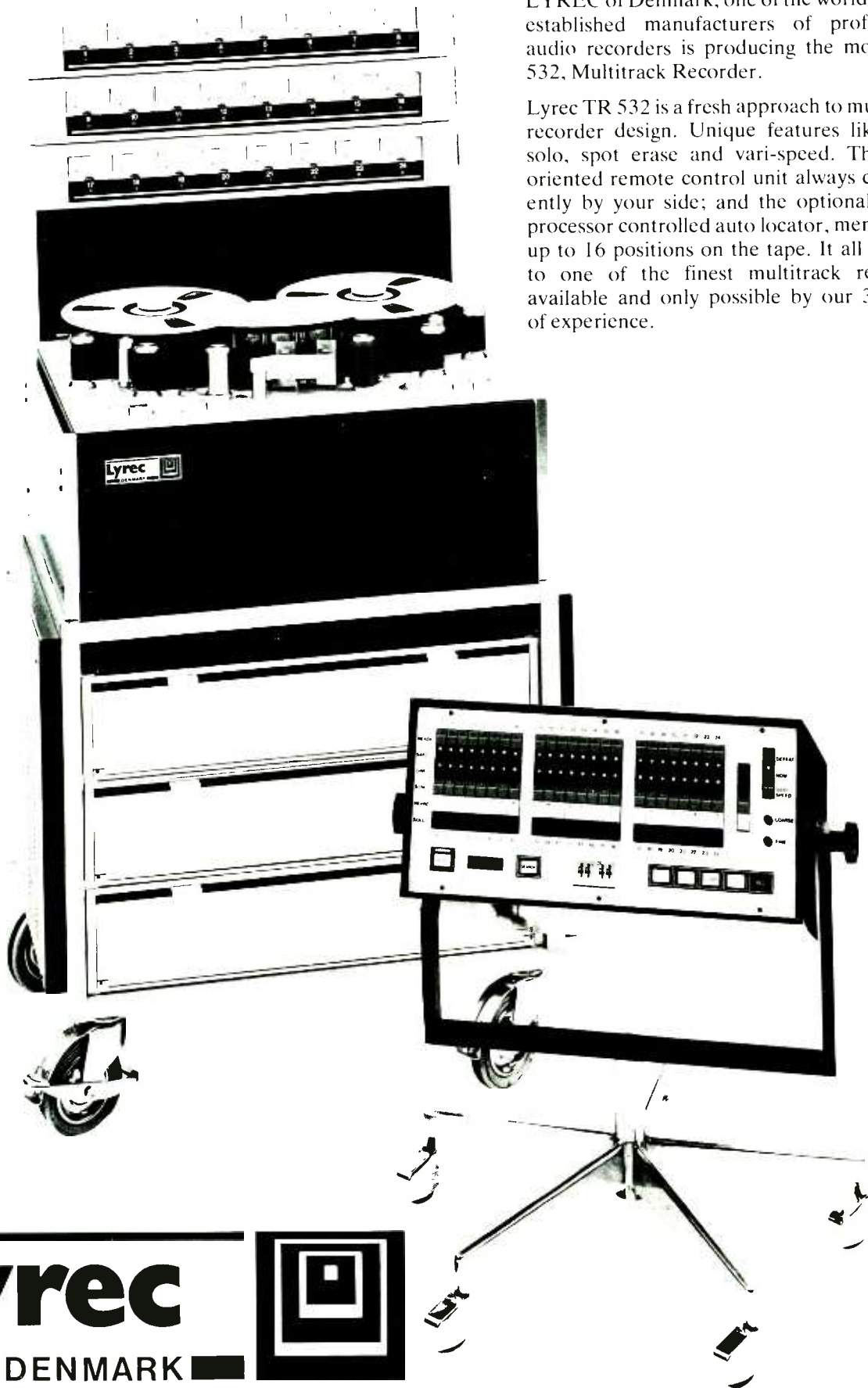

LYREC of Denmark, one of the world's oldest established manufacturers of professional audio recorders is producing the model TR 532, Multitrack Recorder.

Lyrec TR 532 is a fresh approach to multitrack recorder design. Unique features like track solo, spot erase and vari-speed. The user-oriented remote control unit always conveniently by your side; and the optional micro-processor controlled auto locator, memorizing up to 16 positions on the tape. It all adds up to one of the finest multitrack recorders available and only possible by our 30 years of experience.



Lyrec Manufacturing A/S, Hollandsvej 12, DK-2800 Lyngby  
Tel. 02-87 63 22

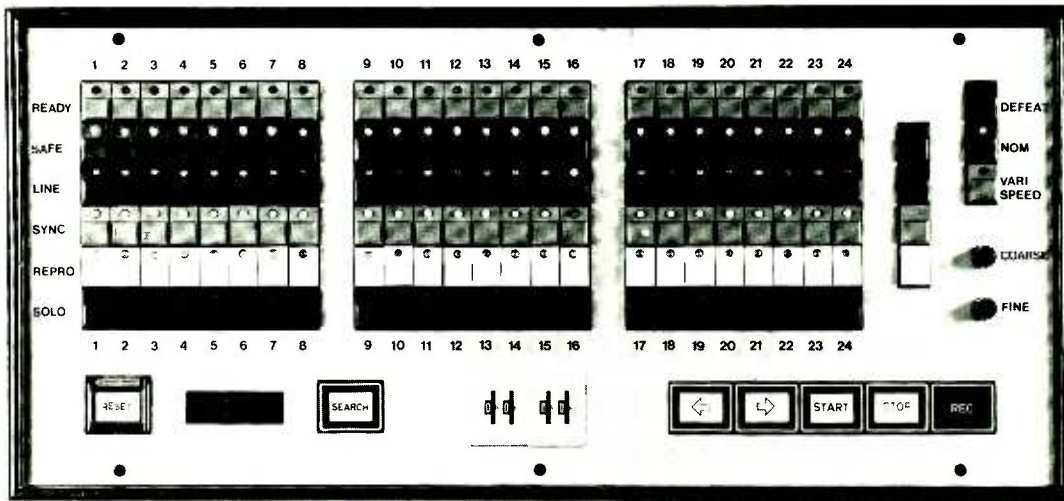

The standard remote control unit, which comes with every recorder, gives the engineer full control of both tape deck and all audiotracks.

Apart from normal tape deck remote, the unit also contains SEARCH to any preset tape position (selected with thumb-wheel switch), tape timer and varispeed control. The tape timer is also used to display actual tape speed without interfering with the timer.

Recording is preselected for each track with the READY button and actual drop in/drop out is effected with the REC button. Drop out can also be done for individual tracks by using the SAFE button.

The output of each audioamplifier can be selected to LINE, SYNC and REPRO. For quick changeover, master buttons is available for simultaneously switching of all tracks.

Tracks selected to SYNC automatically switch to LINE during recording and back to SYNC at drop out.

Each track is also equipped with a SOLO button affecting the output of the recorder only, thus having solo in place.

The SOLO function can also be used to build three groups where the amplifiers of each group can be opened with one button.

**UK:** Lyrec (UK) Ltd., 17 Erncroft Way, Twickenham, Middx. TW1 1DA. Tel. 01-891 2770.

**Benelux:** SAIT, Ch. de Ruisbroek 66, 1190 Brussels. Tel. 02 376 20 30.  
Sound Techniques Nederland bv, Groenelaantje II, Alkmaar. Tel. 072 112944.

**France:** Soracitel, 161 Boulevard Lefebvre, 75015 Paris. Tel. 01 828 05 64.

**Germany, north:** Estemac Electronic GmbH, Alter Teichweg 67, D-2000 Hamburg 70, B R D. Tel. 040 61 06 60.

**Germany, middle:** Studiosound + Music GmbH, Schöne Aussicht 16, D-6000 Frankfurt/M 1, B R D. Tel. 0611 28 49 28.

**Germany, south:** g.t.c.-Studiotechnic GmbH, Stollbergstrasse 17, D-8000 München 22, B R D. Tel. 089 29 39 40.

**Italy:** Roje Telecomunicazioni S.p.A., Via Sant'Anatalone 15, 20147 Milano. Tel. 02 415 41 41.  
Roje Telecomunicazioni S.p.A., Via Di Porta Pinciana 4, 00187 Rome. Tel. 06 400 029.

**Norway:** Siv.ing. Bjorn Benum A/S, Boks 2493, Solli, Oslo 2. Tel. 02 56 57 53.

**Spain:** Mike Llewellyn-Jones, Ap. Postal 8-178, Madrid-8. Tel. 01 637 07 52.

**USA:** Rupert Neve Inc., Berkshire Industrial Park, Bethel, Connecticut 06801. Tel. (203) 744 6230.

**Canada:** Rupert Neve of Canada Ltd., 2717 Rena Road, Malton, Ontario. Tel. 416-677 6611.

**Japan:** Nissho Electronics Corporation, Konwa Bldg, 12-22 Tsukiji I Chome, Chuo-Ku, Tokyo. Tel. (03) 544-8311.

**Australia:** Rank Industries Australia Pty. Ltd., P.O. Box 632, Chatswood. Tel. 406 5666.

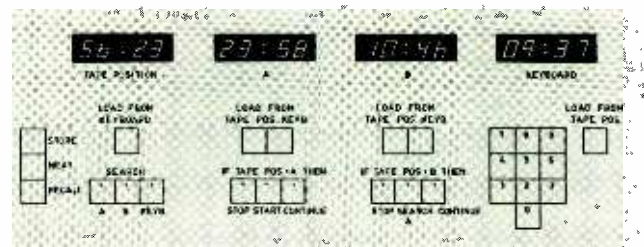

#### Lyrec Tape Position Controller, TPC (optional)

The Lyrec TPC is built into the remote control unit. It is built up around four displays and a microprocessor. One display is used for tape position and displays A, B and keyboard are used for programming the unit for searching different tape positions. By using the KEYBOARD any tape position can be loaded into the displays. Search can be done to three different tape positions and recycling between two positions.

The TPC also contains a memory where sixteen tape positions can be stored, recalled and searched.

The vast possibilities of this unit can hardly be described in words and we are happy to give you a full demonstration.



Lyrec Manufacturing A/S, Hollandsvej 12, DK-2800 Lyngby  
Tel. 02-87 63 22

# Sound on stage—the musician's control

Terry Nelson

*In the May issue we looked at the sound system in the hands of the engineer—this part of the article will deal with the sound system in the hands of the musicians and the philosophy behind it.*

THE basic pa as already discussed fails to meet certain artistic requirements in many cases and when this is so, it is necessary (in my opinion) to define the objectives and then realise them in terms of hardware. Very often a contradictory situation! One is beaten at the start if 'normally accepted practice' is taken as the point of departure. As some music teachers say, learn the rules so that you can break them!

One of the main drawbacks of the standard system is that control is taken out of the hands of the musicians and put in the charge of a sound engineer. This means that realtime correction in sound or deviations from a rehearsed programme are difficult, due to the fact that the engineer may not be on the same wavelength as the musicians and may try to counteract the desired effect. Thus, the moment we have an engineer in the hall, we also have a communication problem.

Another drawback is the situation of having two sound systems, viz the house pa and the monitor installation. For reasons already mentioned, the musicians may have difficulty in hearing each other properly or find that even a well set up monitor system is inadequate for their needs. For many rock musicians, the concert is a total experience having much in common with opera and ballet in the theatre, ie sophisticated staging effects such as lighting, decor, props, etc, coupled with vocal and instrumental music. The styles may differ but the principle remains the same.

Musicians are often very temperamental animals, and this means that if the sound isn't right or there is a lack of communication and involvement, then the music will suffer. One answer is that a 'true professional' will make do with anything, even a cricket bat with strings—trouble is, it will sound like that too. For my money, the 'true professional' will take the time and trouble to get his or her instrument right in order to share their talents with us and not their frustrations. Accepting the premise that for the rock musician the amplifier is as much a part of his instrument as his guitar, organ, synthesiser or what have you—and that you can only play as well as your instrument will let you—it follows that the same care taken in selection of an instrument is needed for the amplification. To illustrate this type of set-up where the artist is in touch with the total sound, and is thus able to feel and hear exactly what is going out to the audience, we shall use a system already in use, that of the Grateful Dead. It is itself an example of technology working for artistic ambitions and not vice versa (see fig. 1).

The first thing that springs to mind is the fact that the complete amplification array is behind the performers and that this is one gigantic monitor system and house pa combined. Straightaway we can see that this solves the stage monitor problem as each musician

can hear exactly what is going out to the audience from himself and his fellow members. The problem of reverberation being created by pick-up from onstage monitors is also eliminated, making for a cleaner and tighter sound. Looking at the setup more closely, the array is made up of 11 independent systems as follows:

- |   |               |      |       |
|---|---------------|------|-------|
| 1 | Vocal         | 4    | Piano |
| 2 | Lead Guitar   | 5-8  | Bass  |
| 3 | Rhythm guitar | 9-11 | Drums |

With an amplification setup such as this, the artist is literally bathed in sound, both aurally and physically, and for many musicians this is what rock music is about. In addition, expression is not inhibited by a mixing engineer, and realtime corrections to sound and mood are possible due to the nature of the single system. Aurally, the system gains by each instrument having its one sound source projecting out into the auditorium, thus giving an excellent stereo image with the added benefit of no intermodulation distortion. Above all, this is an installation that sounds *musically* satisfying—now there's a thought!

As can be imagined, the design and construction of such a system was (and is) not without problems, and for convenience we shall look at each part—or channel—separately.

**Vocals** The main problem to be overcome was that of pick-up from the instrument towers right behind, the microphones tending to pick up more instruments than vocals. This was solved by the use of a differential microphone, which at first was two dynamic microphones spaced 6 cm apart, this being the best compromise for good bass and treble response. The two microphones were connected in series opposition (see fig. 2), with the input impedance of the pre-amplifier being considerably higher than the generator impedance of the microphones, allowing each microphone to generate its voltage properly. In this way excellent results were obtained. The microphone has since been much refined using B & K cartridges with Nagra pre-amps, complete with sensitivity control, enabling the performer to control his own volume by varying the polarising voltage; and heaters to prevent condensation. In order to meet situations where the mic outputs needed to be split, ie live recording or broadcasting, the simple series connection was improved to the multiple circuit as shown in fig 3. At the same time provision was made to control remotely the mic sensitivity for people unfamiliar with this type of unit and also to switch out the ambience microphone, converting the unit to omni-directional.

In all, five vocal microphones were used and resistively mixed, the difference between the direct and ambience mics being fed into an ultra low distortion amplifier. This in itself was a compromise as it was felt that, ideally, each vocalist should have his own

46 ►



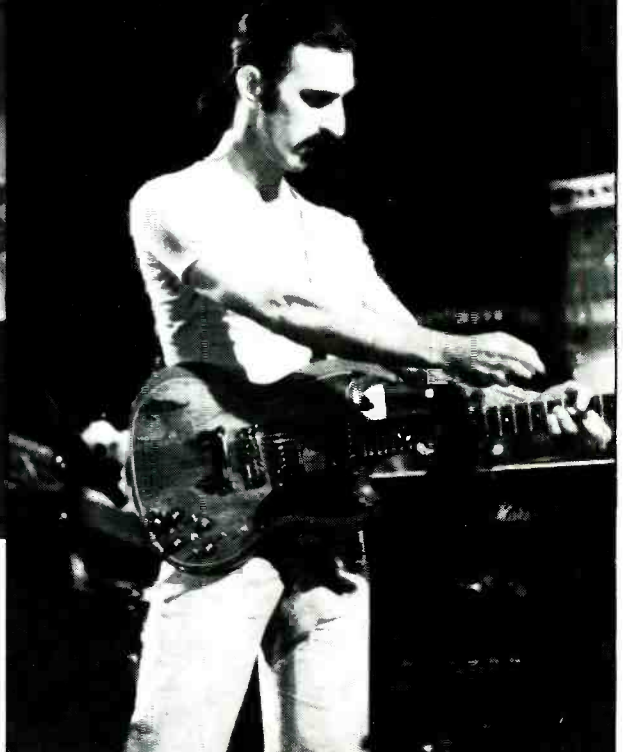
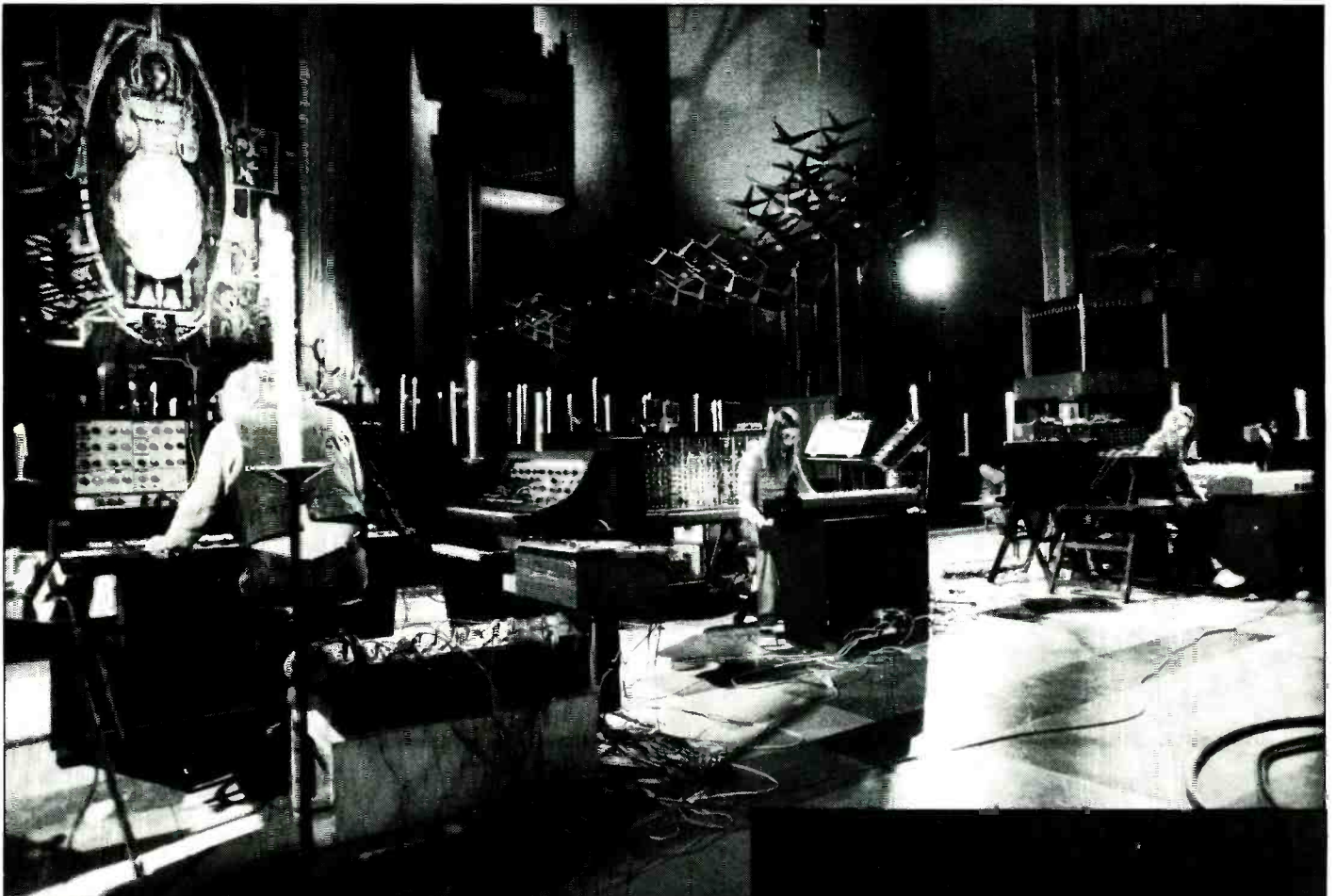

*Top: Tangerine Dream at Coventry Cathedral*  
*Above: Roger Daltrey in full swing.*  
*Right: Frank Zappa getting tuned in*

## SOUND ON STAGE—THE MUSICIAN'S CONTROL

independent system! Perhaps in the near future . . . ? From the mixer the signal goes to a peak limiter (with high threshold) and then on to a 4-way active crossover with frequency bands of below 250 Hz, 250 Hz-1 kHz, 1 kHz-4 kHz, 4 kHz and above. Third-octave equalisers were inserted into the two mid-bands and a third equaliser may be used for the tweeters. This was done in preference to the normal method of connecting the graphics between mixer and crossovers. Pink noise was inserted into the two mid-bands and the systems equalised for flat response over four octaves, ie flat for one octave past each two crossover points. Power was provided by 19 Mackintosh stereo (300W/channel) amplifiers, a feature of these amplifiers being the ability to drive into low impedance loads down to 0.5 ohms, thus enabling all speakers to be wired in parallel.

As can be seen from fig. 1, the speaker arrays for the four frequency bands are arranged in columns with the exception of the tweeters. The bass frequencies are handled by a single column of sixteen 15 in (38 cm) speakers in single closed cabinets 26.5 feet high, this forming part of the solid wall of cabinets. The mid-bass is projected by 12 columns of five 12 in (30 cm) speakers and upper mids by 30 columns of four 5 in (12.5 cm) speakers. The treble band by a single row of 30 Electro-Voice T35 horn tweeters, all other cone loudspeakers being JBL. As can be seen, with the exception of the bass column, all the vocal loudspeakers are mounted into a solid, curved array on an arc of 120 degrees. Dispersion of this array when measured was 150 degrees horizontal and 30 degrees vertical at the half power points. Note that the curved array also forms a part of the solid block of cabinets, hence the excellent horizontal coverage.

**Guitars** The lead guitar system is the only one to use open-backed cabinets (the rest of the speakers using sealed cabinets)—partly due to radiation characteristics required and also due to the type of sound that Jerry Garcia prefers. Here again we have a single column of speakers, this time ten twin-12 in (30 cm) cabinets driven by one stereo amp, as for the vocals. As pre-amp, Jerry used to use part of a

Fender *Twin Reverb*, but more recently has been seen using Mesa Boogie amps, so the final setup may vary from gig to gig.

Bob Weir also had the same speaker/power amp combination with Alembic parametric eq, Orban Parasound reverb and Eventide d/d and phaser. However, the rhythm guitarist has also been using Mesa amps recently, and the new Ibanez analogue flanger/delay unit.

Phil Lesh (bass) has two columns of eighteen single 15 in (38 cm) speakers driven by four Mackintosh 2 x 300W amplifiers with Alembic *F-2B* pre-amps and other ancillary equipment. Phil also has a custom Alembic bass with separate outputs for each string and, though used mainly in mono, this does give the possibility for the system to be used as four sub-systems on chording effects on the bass to avoid im distortion.

**Piano** Amplification of a grand piano on stage always presents problems and to this end a special pickup using condenser elements was designed by the Dead's engineer, Dan Healy, and built by Countryman Associates (this being the basis, if I'm not mistaken, of the Countryman piano pickup of today). The assembly is suspended above the piano strings, rather like a normal guitar pickup in reverse. The amplification itself is a scaled-down version of the vocal system and uses eight Mackintosh amplifiers to drive a 3-band speaker array consisting of one column of sixteen single 15 in (38 cm) cabinets for the bass and a curved assembly built up of thirty-two 12 in (30 cm) and eighty 5 in (12.5 cm) speakers. Noise and hiss problems are taken care of by Burwen dynamic noise filters.

**Drums** Aha! This is the part that the cynics have been waiting for! At the time of writing, and from my sources of information, this system is under review and work was in progress on the mixing and distribution systems, as well as on the microphones and pickups being used. However, in the setup illustrated the bass drum mic is fed to a single column of sixteen single 15 in (38 cm) speakers and the rest of the kit is routed into a stereo mixer feeding two towers to give a stereo image. Each tower is a 3-way system and consists of five cabinets, each holding two 12 in (30 cm) and six 5 in (12.5 cm) speakers for mediums and topped by twelve T35 tweeters. Power is provided by ten Mackintosh amps, meaning about 6000W capability

Reproduction of diagrams courtesy dB magazine

FIG. 1 THE GRATEFUL DEAD EQUIPMENT (HOLLYWOOD BOWL JULY 1974)

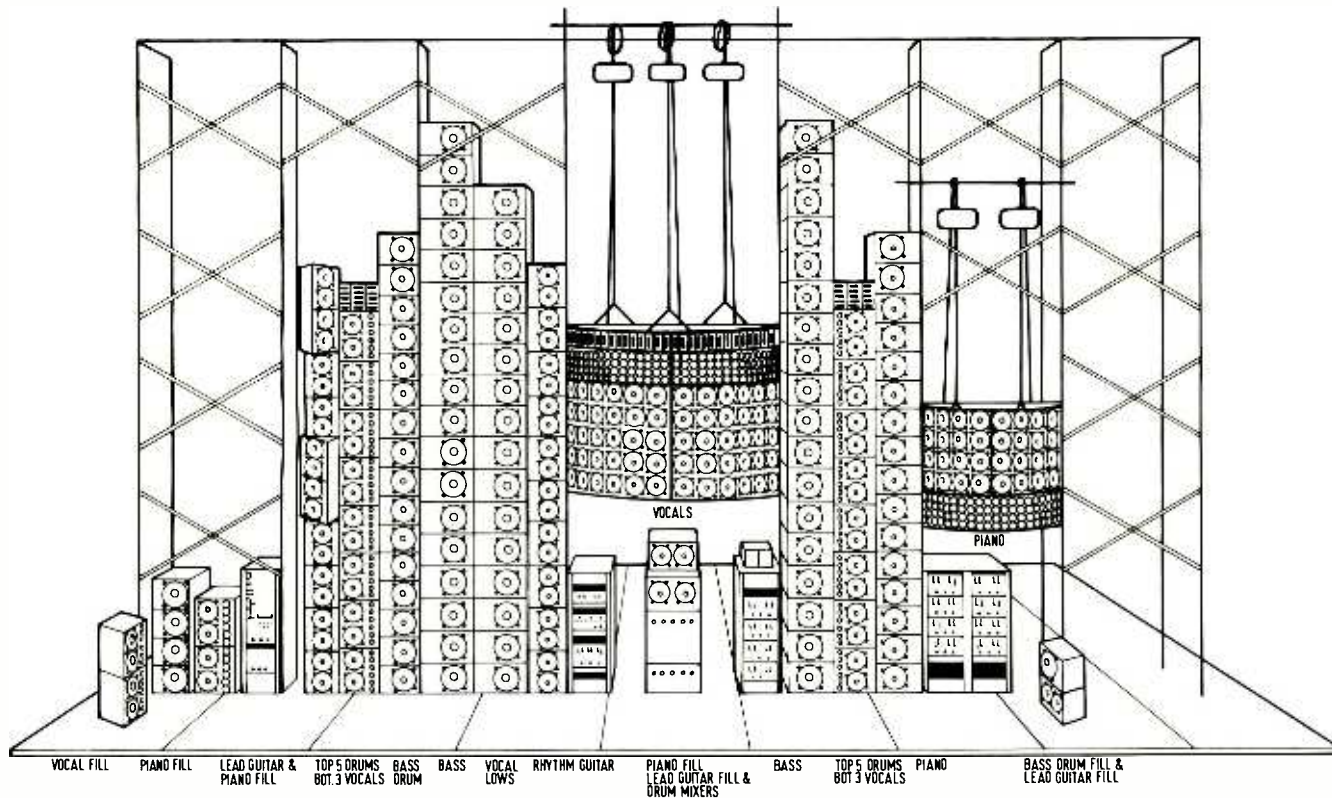

for the drums alone. (Cor, more than our entire pa!)

Though this kind of array can be very loud, this is not the purpose behind it and it is easy to see that the kind of quality that can be obtained is fairly awe-inspiring. Dynamics can be handled without breakup and due to the 'cleanness' of the system *forte* passages of, say, 110 dB will sound loud and powerful (not to say impressive) compared with mid-range horns pushing out distorted peaks of 125-130 dB. To quote one manufacturer's ad: 'Loud is beautiful, if it's clean' and for once I must concede that they are right. As for the Dead's system: though I have tried to do my homework and present as much of an up-to-date picture as possible, the array is under constant revision and improvement and some details may already be out of date. However, there is enough here to provide much food for thought and if you have \$350,000 to invest in your own equipment and integrated stage, maybe this is the pa for you.

When we were discussing the two principal types of pa it was also mentioned that another possibility could be an adaptation of the two; that is amplification through an overall sound system in conjunction with one or more individual system(s) for principal instruments. A recent example of this is Frank Zappa and his band (see photo in Part 1) where Frank has his own elaborate setup and the rest of the musicians are balanced around him. When I saw the group recently Frank appeared to be using a Mesa Boogie amp linked up with several Marshall heads and three custom 4 x 12 (4 x 30, to be consistent with metrication) cabinets, as well as a complete rack cabinet filled with various goodies such as dds, echoes, eq—you name it, he had it! The foot controls for the rack and additional pedals were all housed in a roadcase at his feet.

The second guitarist had a similar equipment setup, though on a smaller scale, and I had the impression that he was reinforced through the pa. The two keyboardists, percussionist, drummer and bassist were all fed by mics and directs into the main sound system. The two keyboards each had their own on-stage submixer which then went into the stage monitor mixer and main console. The main console, or consoles, were two Sony 16-channel desks which are due for replacement, but up until now have been 100% reliable

throughout their 18 months on the road. I had quite a chat with Zappa's engineer, Davy Moire, who told me that their system is, hopefully, to be expanded. But as Frank has to do all the financing for the moment, economics are a bit of a problem.

Some engineers may be interested in a technique he uses for drums. These have their own stereo mixer and before going into the main board the submixer goes into an Allison *Gain Brain* followed by a *Keplex*, thus giving dynamic limiting on the drums with some noise reduction. As Davy said, 'There are a hell of a lot of open mics up there!' I didn't notice a general overhead pair, however.

All instruments and mics were mixed in mono, with stereo being reserved for drums and special effects. dbx compressors seem to find their way into a lot of pa rigs and this was no exception—a couple of UREI level controllers were there, too. These were all used for vocal mics, eg Terry Bozzio's mic needed compressing and Frank's expanding.

I find that a mixture of independent and overall sound systems is often a very good solution. This does mean that the pa is freed from one or several principal instruments, resulting in less im distortion if only one or two main outputs are being used, while keeping a control on the vocals and 'rhythm section'. This evidently demands a lot of practice and discipline on the part of the performers, but then this could equally apply to most things in life—if it's worth doing, then it's worth doing well.

Before going on to the next part of the article and taking a brief look at how some of the other big boys do it, perhaps one or two little suggestions on how to make existing life easier for musicians and engineers may be in order. Many musicians today use a lot of effects pedals and to make sure your guitarist doesn't spend half his time playing football across the stage running after his phaser (unless he plays with Rod Stewart), get all of those units mounted solidly onto a board or road case. This way they are there when and where you want them. It is interesting to note that an English firm, Electrolabs, has brought out a range of effects pedals that clip together powered from a 'mother' mains supply. Another idea is to have your effects installed into a rack cabinet—especially if you already have one or two items of professional rack mounting equipment—with a multicore going to a foot-controller pedalboard. (Do-it-yourself enthusiasts should check out Craig Anderton's book for Guitar Player Productions, 'Electronic Projects for Musicians', which contains tried and tested circuits for a multitude of effects and is eminently suited for pedal or modular construction.) Another thing is to experiment in making the best use of your equipment. One example could be a guitarist using two amps.

Here there is a possibility to make the most of dynamics by using one stack for rhythm and/or backup lead and then switching in the second by a foot control to provide added depth and 'kick' for solos and high points. (I suspect that this is how Ritchie Blackmore of Rainbow makes use of his two Marshall stacks). This technique also makes it possible to have preprogrammed effects on one amp with the other being 'straight'. This sort of setup can easily be controlled by a pedal unit containing either separate switches or one changeover for amps A and B, and switch for A + B; status leds would also be a good idea. While on the subject of foot controls I will take the opportunity to have a gripe at manufacturers about the quality of some of the footswitches used. In a stage situation one doesn't have time to be gentle, and having a switch fold up in mid-performance is a drag, to say the least! And the problems don't end there: just try getting a replacement! For those making up switch controls or custom footboards I would recommend looking around for footswitches used in cars, or industrial foot controls as used with sewing machines, etc. If at first they seem a bit expensive, they more than earn their keep by being tough and reliable (you can even jump on them if that is your thing) with the added bonus of being nice and large, so that your toes won't slip off and miss.

On a final note: if you use a lot of effects, and residual noise starts becoming a problem, a noise-gate is not a bad investment. People like MXR and Electro-Harmonix make units at a reasonable price—often with the bonus of also being fitted with auxiliary line-driver outputs. (Once again, do-it-yourselfers should check out the February and March issues of 'Guitar Player' for Craig Anderton's 'multi-talented noise-gate'. This really is the one for electronic effects freaks—and your engineer might be interested in it too!)

How the others do it—a look at the concert setups over the past

48 ▶

FIG. 2 THE PREFERRED SIMPLE DIFFERENCE CONNECTION FOR MICROPHONES

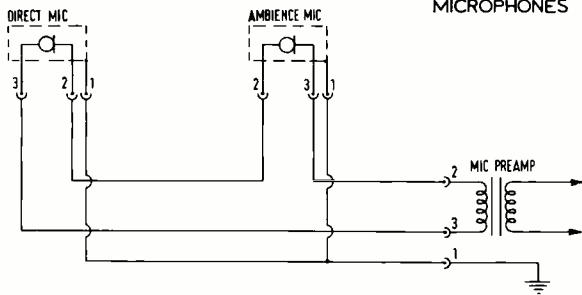
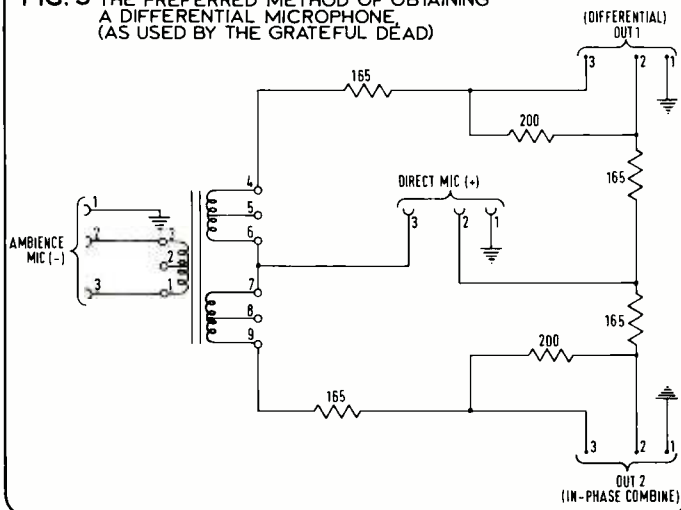

FIG. 3 THE PREFERRED METHOD OF OBTAINING A DIFFERENTIAL MICROPHONE (AS USED BY THE GRATEFUL DEAD)



## SOUND ON STAGE—THE MUSICIAN'S CONTROL

year of some of the name groups will explain. To begin with, **Yes** (for the speaker placement at the Zurich concert see the May issue of **STUDIO SOUND**). Star of their pa is the 32-channel custom-built desk mixing down to six stereo sub-groups and stereo main outputs, with the luxury of lightbeam meters running alongside the channel faders giving an immediate indication of the mixing situation at a glance. Very nice. The console has been specially designed for the road, folding in half in its own roadcase. The rest of the equipment was a Trident *Fleximix* for the keyboard submixer, and a neat rack with patchbay containing the dbx compressor/limiters, *Kepekes*, ddi, Universal Audio compressor and two White  $\frac{1}{2}$ -octave equalisers with analyser. In general the sound was very good—a group like **Yes** makes for a very demanding mix situation—but once again the distorted guitar tended to cover everything at times. However, that could be just a personal quibble, since to achieve even a passable sound in the Hallenstadion is a major triumph.

Next—**Jethro Tull**. British equipment for a very British group—Audio & Design *F760* compressor/limiter and other odds and ends, plus a full-blown Cadac desk. A fantastic concert last year at Basle was marred by the  $\frac{1}{2}$ -second, plus slapback, echo in the indoor sportscentre against which their engineer was forced to compete. (And some artists complain about the Royal Opera House, Covent Garden!) Though I'd rather have seen the long low line of speakers converted to a short high one, and the fact that the amplifiers appeared to be grossly overloading at the end of the concert spoiled things a bit. The overall sound—especially in view of the acoustic conditions—was excellent.

Ian Anderson's flute sound was an object lesson in itself, as were the drums. The vocals were also clear and distinct; and in view of Ian's stage-chat, this is an absolute necessity. If anything, the keyboards tended to be a bit lost at times, but this could easily be put down to the hall acoustics. (This kind of venue well illustrates the need to use the audience as an acoustic absorber as discussed earlier on.)

For **Rainbow**, Tasco appear to handle the sound on tours and this was certainly the case last year at Winterthur, where they continued to live up to their good reputation. For the Swiss concert the accent seemed to be on reinforcement, the instruments all having substantial stage amplification, apart from the drums, vocals and special effects. In fact it was often difficult to hear the difference between the stage amplifiers and the pa, this being a very difficult test to pass. Arnie (the engineer) was obviously pleased with their new Midas desk and seems to have a good working relationship with the group when it comes to discussing the sound system techniques to be used. He does, however, sometimes have a battle with them, in order to keep the stage volume down a bit!

The **Who**. For a group with the Who's reputation you would expect a system that is big and loud—and also one that is of high quality. The present 55 kW setup used for the group's large US concerts is the end product of years of experimentation and the combined ideas of Bob Pridden (the Who's engineer) Peter Townshend, Bob Heil (formerly of Heil Sound Hire) and Showco, who now actually supply the equipment. The system itself is 4-way with 28 800 watts powering 48 folded horns, each containing four JBL *K130* 15 in (38 cm) speakers (40-250 Hz); 10 800 watts powering 36 mid-bass horns, each with two *K120s* (250-800 Hz); 7 800 watts powering 60 radial medium and long-throw horns (800-6500 Hz) and 7 200 watts powering a mixture of high-frequency horns and tweeter arrays (6500-18000 Hz). By the way, all the amps are Amcron *DC300As*.

Mixing is done through two Showco 30/8 desks aided by the now usual collection of ddls, limiters, graphics and so on. Depending on the material performed, the pa can be set up either in stereo or quad (as for *Quadrophonia*). While the Showco engineer handles the main mix, Bob Pridden does the on-stage monitor mix on his Mavis desk. There are two monitor systems, both designed by him: one being for prerecorded tapes and with the cabinets forming part of the wall of instrument cabinets, and the second for vocals, etc, which is fed through back-facing monitors at the front of the stage. The guitar and bass both have substantial amplification and it is worth having a look at it.

Pete Townshend's setup consists of three custom-built HiWatt 100W amps with three 2 x 4 twelve inch (30 cm) stacks, one of the stacks containing JBL speakers to give more punch and brilliance. One of the normal cabinets is miked, as is also one of the JBL cabinets, giving the sound engineer the ability to change the guitar sound by mixing between the two speakers. The bass system is more complex. Here the stereo output from the Alembic bass is routed into two Stramp Professional Series stereo pre-amplifiers, each with comprehensive eq and other facilities. The output from the pre-amps then passes into a Gelf crossover and into one of four Sunn *Coliseum* 300W amplifiers; or, more exactly, two of the Sunns are used for the bass, one for the mids and uppers and one is used full range. This method of a mixture of bi-amping and full range for bass is one I really like, often smoothing out the bumps sometimes encountered at the crossover frequency.

John's speaker system comprises a pair of Sunn *W* bins, each with a Vega 18 inch (45 cm) speaker, two standard Sunn 18 inch (45 cm) enclosures, two Sunn 4 x 12s and two Sunn 3 x 12s. Entwistle's aim is to have a system capable of reproducing the high and low notes of his bass with good separation and clarity (he even changes his strings before each concert for maximum brilliance) and so far he has found the flexibility of this setup to meet his needs. Pete and John also have reciprocal extension monitor cabinets in order to hear each other better and to have an exact idea of the guitar or bass sound going out front.

**Kansas and Tangerine Dream**. I have put these two together only for: the reason that I saw them both recently at the Hammersmith Odeon, though soundwise as well as musically they were worlds apart. I had begun to think that perhaps as a rock venue the Hammersmith was not quite up to it after the Nugent disaster last year (not the music—just the sound) and Kansas didn't do too much to lift my doubts. However, Tangerine Dream showed that good sound was (and is) possible, so carry on Hammersmith!

**STUDIO SOUND** is not a music critic's magazine but I hope that for once you will bear with me. **Kansas** were using the familiar type of overall sound system (with the familiar speaker arrangement) and had a lot of instrumentation to get over, viz bass, drums, violin, guitar, keyboards and second keyboards/guitar plus harmony vocals. Musically, they are America's answer to Deep Purple/Yes/Genesis/King Crimson/Gentle Giant et al and as such have a lot of potential. However, at the London concert the aim seemed to be 'outdo Purple' and the only recourse left to try and get the solos out was boost the 10 kHz and over and hope for the best. Thus we were left with a thundering deep bass and screaming high treble with 'sweet fa' in the middle! Whereas in the passages when things were got together it was a shame that a lack of understanding of dynamics marred some of the music. 'Quiet' passages start off loud and when some 'oomph' is required the only thing left to do is overdrive the power amps/mixer.

Three nights later Tangerine Dream restored faith in modern technology and, even though the music may not be everybody's cup of tea, I think most would have conceded that the sound was first class. Briefly, Tangerine Dream is a German group featuring three keyboardists/synthesists—and also playing guitar and a whole variety of reed instruments—including two large Moog modular synthesisers, Oberheims, ARPs, Mellotrons, Yamaha piano, Korg, etc, etc, and drummer (drums, percussion and percussion synthesisers).

It can be seen that the sound projection of this type of group is not an easy proposition. As far as I could see, everything went direct to the console, with the exception of a Marshall either miked or ddi'd for the guitar, and came up back on stage through high quality wide range monitors. With the music, opinions may differ on the mix at times as it is not always easy to know the effect required by the group. For example, the guitar was often fairly down in the mix during the several times that it was used, but this may have been the effect wanted—at no time did we hear the pa cracking up. As can be expected, we were treated to very bass sounds right through to very top, with wide dynamics, but there was no trace of peakiness or distortion, just showing that it can be done.

No article on sound systems would be complete without the **Pink Floyd** and this will certainly be no exception. However, after being well received at Britannia Row (Thanks, Nick and Robbie) and loaded with reams of information, time and space dictate a 'Pink Floyd Special'. See next month's issue. ■

# If you aren't thinking about this you shouldn't be buying a console.

Solid State Logic Ltd. Church Rd. Stonesfield Oxford England. Telephone (099 389) 324.

U.S.A. — Australasia: Sierra Audio Corp. Burbank California U.S.A. Telex 691138.



# Sound at NAB 1978

Peter Granet

*This year's Convention of the National Association of Broadcasters was held at the Las Vegas Conference Centre from April 9 to 12.*

**I**F YOU consider that broadcasting is one huge gamble, then Las Vegas is obviously an appropriate place for the NAB Convention. If, on the other hand, your opinion is that broadcasting is an oasis of rest and culture in the desert of modern life, then Vegas is equally appropriate. Of course, if you're lucky—and American—you can win yourself enough to open up a whole new string of radio stations, but you're much more likely to lose your whole year's capital budget and come away empty-handed. Nevertheless, one feels that the Mormon Founding Fathers of the city would have looked kindly on such a high-minded activity as the NAB Convention. They might also have approved of another outstanding characteristic of the place—the adequate sufficiency of feminine company, though not perhaps of the way in which it is presented.

The early Mormon settlers were forced to withdraw from their stronghold, largely because the lead bullets which they cast from plentiful deposits of metallic ore proved remarkably ineffective against the marauding Paiute Indians—scarcely surprising when it is realised that the ore proved to be not lead but silver. This is a confusion which does not arise in the minds of the present inhabitants.

It is wise to arrive a day or two before the Convention, in order to find your way about. Friendly attendants will tell you which slot machines are currently paying out well (disregard this advice) and you can track down those bars which will sell you a pink gin for only three times the London price. This process is known as recovering from jet lag, and will enable you to walk through the lobby of your hotel, past the slots offering \$250,000 jackpots, with scarcely a tremor. And only the slightest queasiness from over-indulgence in the great American gastronomic delights of Giant Hamburgers, and Pancakes with Syrup for breakfast.

But enough of the travelogue. Suffice it to say that Las Vegas is entirely fascinating, and that if only we can arrange to have the IBC in Monaco, the broadcaster's cup will be filled to overflowing.

UK firms were well represented among the exhibitors, and it was encouraging to hear how well most of them were thought of. My

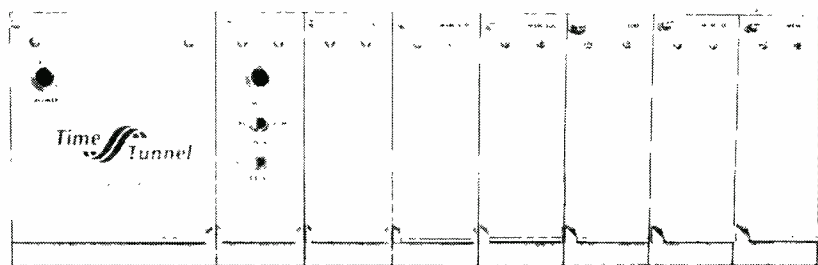

*Time Tunnel delay unit from Comex Systems*

own interest at the moment being mainly radio, I naturally spent most of my time with those firms making equipment for the radio broadcaster, although there were some very interesting developments in the tv field. But that, as a more prolific writer has said, is Another Story.

A most encouraging discovery was that practically everyone had read John Lumsden's excellent article on cartridge machines, and most of them were taking it very seriously indeed. Only one manufacturer adopted the attitude that what was good enough for America was good enough for the rest-of-the-

world so what were the 'Goddam British worried about for Chrissake', but as this particular firm does not sell in the UK, that may well be sour grapes. Elmo Franklin of ITC is promising something new shortly—maybe even in time for IBC—and Cuemaster are also working along the lines suggested by John Lumsden, although they are determined not to come to market until they have something markedly superior to the present range. Larry Cervone of Spotmaster is another who is taking John's article extremely seriously, and the whole outlook is definitely encouraging.

*Cuerc automated broadcast system*

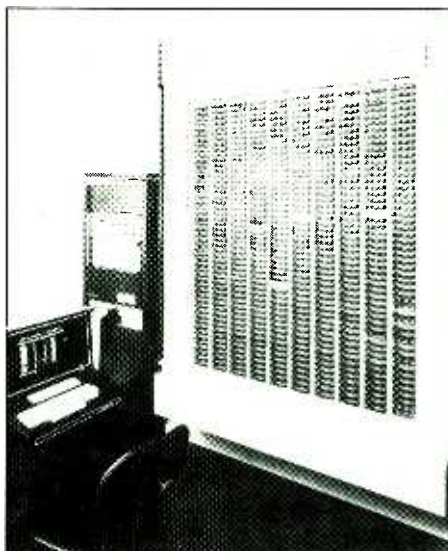

Telex were showing their *MC Series* broadcast cart machines with belt drive from a dc servo Hall-effect motor, giving claimed wow and flutter figures of less than 0.12% peak weighted, and speed stable to 0.2%. An interesting point about this machine is that the tapeguides are manufactured of glass-filled Valox, which has memory and will, so it is claimed, return to its original shape if accidentally deformed. A rival manufacturer suggested that the motor was perhaps a little small for the job, but again this is almost certainly sour grapes.

Harris were showing their very reasonably priced *Criterion 90*, which seems very solidly engineered: claimed wow and flutter of 0.15% DIN, but still using an ac hysteresis motor, which seems a pity in a modern machine.

Two very interesting multi-cartridge machines were on show. ITC had a prototype of their *IK* machine on the stand, which holds 1024 cartridges in two circular vertical library stacks. Cartridges are removed from their library locations and automatically 52 ►

# There is a Dolby noise reduction unit for every professional application

## Professional recording and transmission applications



### 360

The Dolby 360 is a basic single-channel A-type noise reduction unit for encoding or decoding. This unit is normally used in a fixed mode such as in disc cutting or landline sending or receiving, the operating mode is manually selected.



### 361

The Dolby 361 is similar to the 360, providing a single channel of A-type noise reduction, but with relay switching of operating mode and tape recorder connections. The changeover can be controlled automatically by the recorder.

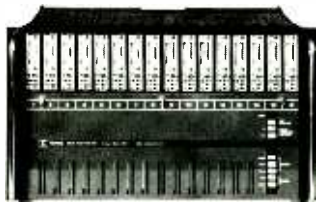

### M-Series

The Dolby M16H A-type unit is designed specifically for professional multi-track recording, and incorporates 16 channels of noise reduction in a compact chassis only 10 1/2 inches high. The similar M8H is an 8-track version, and the M8XH allows simple extension of the M16H for 24-track use.

## Noise reduction module



### Cat no. 22

The Dolby noise reduction module, Cat no. 22, is the basic functional unit employed in all A-type equipment. The Cat no. 22 is available as a spare or in quantity to OEM users for factory installation. A half-speed version of the module (Cat no. 40) is also available.



**Dolby Laboratories Inc.**  
Dolby, Dolbyized and the double-D symbol are trade marks of Dolby Laboratories Inc.

## Motion picture industry



### 364

The Dolby 364 Cinema Noise Reduction Unit is intended primarily for use with Dolby A-type encoded optical sound-tracks. The 364 also includes a standard 'academy' filter for conventional tracks, and provision for playback of magnetic sound tracks with or without Dolby system encoding.



### E2

The Dolby E2 Cinema Equalizer is a companion unit to the 364, and has been specifically designed to solve the response equalization problems of cinemas. Used with the 364 and Dolbyized optical sound-tracks the E2 enables most cinemas to achieve modern sound reproduction standards without replacement of existing equipment.

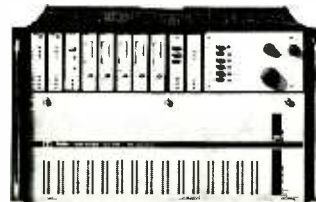

### CP100

The Dolby CP100 Cinema Processor is designed for the reproduction of all current and presently foreseeable film sound-track formats including conventional optical and magnetic tracks, Dolby encoded monaural optical tracks, Dolby encoded magnetic sound-tracks and the new stereo optical release prints. Up to three noise reduction modules can be incorporated. Typically, three channels of theatre equalization, as in the E2, will be incorporated, but facilities exist for five channels of equalization and the connection of an external quadraphonic decoder.

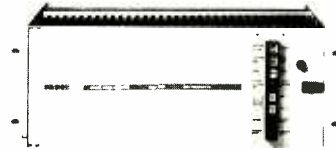

### CP50

The new Model CP50 is intended for the reproduction of all optical soundtrack formats, Dolby encoded and conventional, mono and stereo. The unit is designed to interface with an existing fader and magnetic stereo installation. A wide range of accessories is available.

731 Sansome Street, San Francisco, CA 94111  
Telephone (415) 392-0300. Telex 34409  
Cable Dolbylabs

## Professional encoders for consumer media



### 330

The Dolby 330 Tape Duplication Unit is a professional quality unit with B-type (consumer) noise reduction characteristics. The unit is used for encoding duplicating master tapes in the high-speed duplication of Dolbyized cassettes, cartridges, and open-reel tapes. The 330 is a two-channel unit.



### 334

The 334 FM Broadcast Unit allows broadcast stations to encode stereo FM broadcasts with the Dolby B-type characteristic. The unit also provides for a reduction of high frequency pre-emphasis to 25 microseconds, this reduces the need for high frequency limiting, thus allowing a significant additional improvement in reception quality.

## Test set (A-type)



### Cat no. 35

The Dolby NRM Test set, Cat no. 35, permits rapid verification of performance of Cat no. 22 noise reduction modules without their removal or the need for additional test equipment.

## Noise weighting filter



### Cat. Nr. 98A

Noise weighting filter to CCIR/ARM characteristic (recommended by Dolby Laboratories). Filter is used with average responding meter (ordinary millivoltmeter) allowing noise measurements to be made on tape recorders, tapes, FM tuners, etc., with results which correlate closely with the subjective effect of the noise. Filter can be used for the testing of professional and consumer equipment.

346 Clapham Road, London SW9 9AP  
Telephone 01-720 1111 Telex 919109  
Cable Dolbylabs London

# letters

Dear Sir, With reference to the review of The Compliment stereo compressor-limiter (October '77 issue) Hugh Ford's criticism of the mains switch construction has been noted; although these switches have been used without problems for several years in other applications, they have since been changed.

In his paragraph 'inputs and outputs' there may have been a misprint with respect to the 3:1 maximum limited output level. His fig 7 diagram shows a level of +12 dBm, while the text states +18 dBm. In the same paragraph he states that because there is no buffer amplifier in the bypass mode that this could lead to embarrassment. As we see it, the unit would be placed between two units already matched, and provided that the source could drive the input impedance of the Compliment/Gemini Compact, there will be no problems when operating the bypass switch. In our view this direct link is useful in the event of failure, since the signal path is not lost.

We were slightly disappointed with the summary in view of the excellent noise (84 dBA ref limit threshold) and distortion performance which is more than comparable to many systems designed for professional use.

On a general point: Hugh Ford is entitled to

his opinion as to when a limiter is not a limiter etc, but it is worth pointing out that respected valve units (eg Fairchild 663 in George Peckham's article in the same issue) are used as limiters in disc-cutting. The attack time is around 1 mS. Most recording mediums are not that critical in terms of clipping odd transients. In fact, of course, tape limiting is widely used in both classical and pop recording since there can be no modulation effects.

The Compliment/Gemini Compact has been designed to perform well on a wide range of musical signals even under extreme compression situations. The transistor limiter has come in for a lot of knocking, not because tightness and grittiness are due to feedback circuitry (as one manufacturer's advertising would have us believe), but because attack times of a few microseconds with tight ratios quickly degrade the signal. There is little doubt that these very fast attack speeds and 'brick-wall' ratios have evolved as a commercial response to the user computation 'fastest and tightest must be best', rather than out of usefulness or necessity.

Too often units are bought on specification rather than on an assessment of musical performance. When comparable attack and ratio para-

eters are used, a transistor device of feedback design can equal the quality of performance for which some of the old valve systems are renowned.

Yours faithfully, Mike Beville, Audio & Design Recording Ltd, Shinfield Road, Reading, UK.

Hugh Ford replies: It would seem most unfortunate that these points were not discussed with me at any time, for my original notes on the review measurements have now been destroyed. However, the type of mains switch used does not comply with the requirements of British Standard 415, the intention of which is to lay down a standard to provide safe use of electrical equipment. The statement that 'these switches have been used without problems', seems to say that 'we've not killed anyone yet.'

Regarding the available output levels, I'm not now able to check these figures, but it's possible that an error has crept into the graphical data.

While I take the point about the bypass mode providing protection in the event of failure, I stand by my comments about the change in matching conditions between the normal mode and the bypass mode.

I really do not understand the need to complain about the review in terms of noise and distortion performance, for I said about noise 'The above noise performance is very good . . .', and made similar polite remarks about the distortion performance in some detail. So far as the discussion about whether the unit is a true compressor, this tends to be an ill-defined area. But I regard a true limiter as a device that does not overshoot, and such devices are necessary to limit the signal applied to, for instance, transmitters where over-modulation is disastrous.

## For the Flutter you can't afford

EMT have an extraordinarily versatile flutter meter at a price you can afford—the new low cost EMT 422.

Flutter and FIM (frequency inter-modulation) distortion measurement can be made in five ranges from 0.1% to 10% FSD to DIN/ANSI/IEC standards. In addition, three further filters can be selected for a rapid initial analysis of flutter frequencies. Weighted peak and slow speed deviation values are clearly displayed on separate large size meters.

A unique feature is the programmable threshold level option which provides an instant visual indication at three preset levels for simplified quality control and production line testing.

Outputs are provided for use with external filters, graphic recorders or oscilloscopes to further extend the EMT 422's unique capabilities.

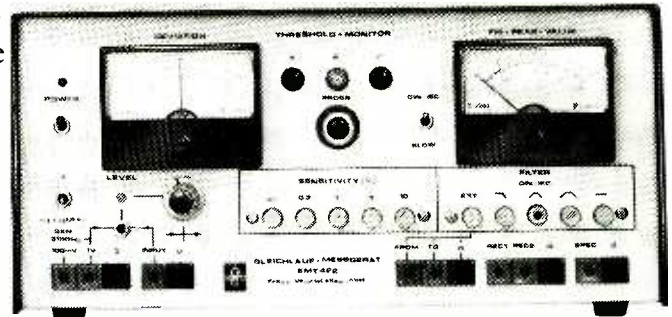

**F.W.O. Bauch Limited**

49 Theobald Street, Boreham Wood  
Herts. WD6 4RZ Tel: 01-953 0092 Telex: 27502



# OTARI

## Professional perfection to produce one-inch eight-track masters. Otari MX7800 for discriminating recordists.

Otari sets another new standard in multichannel recording. Incorporating latest electronics and engineering technologies, the new MX-7800 is designed to meet the demands of professional recordists. Direct-drive DC-servo capstan motor for less than 0.04 % wow/flutter, with  $\pm 12\%$  pitch control. Standard servo controlled reel motors and LSI-TTL motion sensing control logic. Greater than 63dB S/N. Front panel edit and adjustable cue. Stepless bias capability for high energy mastering tapes. +4dBm output with XLR connectors. NAB, CCIR, IEC or AES equalization. Remote controllability for transport and amplifier sync play functions. And it comes with the latest plug-in electronics with instant accessibility.

Its reliability and durability have been proven through strict testing which stands behind all Otari products designed to withstand critical professional applications. For the full story of the sophisticated machine, get in contact with your nearest Otari distributor.

**U.K.:** C E Hammond & Co., Ltd., 111 Chertsey Road, Byfleet, Surrey KT14 7LA

**France:** Reditec, 62-66, Rue Louis Ampère, Zone Industrielle des Chanoux, 93330 Neuilly-s/Seine

**West Germany:** Peter Struven GmbH, 2 Hamburg 53, Bornheide 19

**Belgium:** Trans European Music S A., Koeivijverstraat 105, 1710 Dilbeek, Brussels

**Italy:** Exhibo Italiana S R L., 20052 Monza, Via F. Frisi, 22

**Switzerland:** Audio Bauer AG, CH-8048 Zurich, Bernerstrasse-Nord 182, Haus Atlant

**Australia:** Klarion Enterprises Proprietary Ltd, Regent House, 63, Kingsway, South Melbourne, 3205

**Japan:** Otari Electric Co., Ltd., 4-29-18 Minami-Ogikubo, Suginami-ku, Tokyo 167, Japan

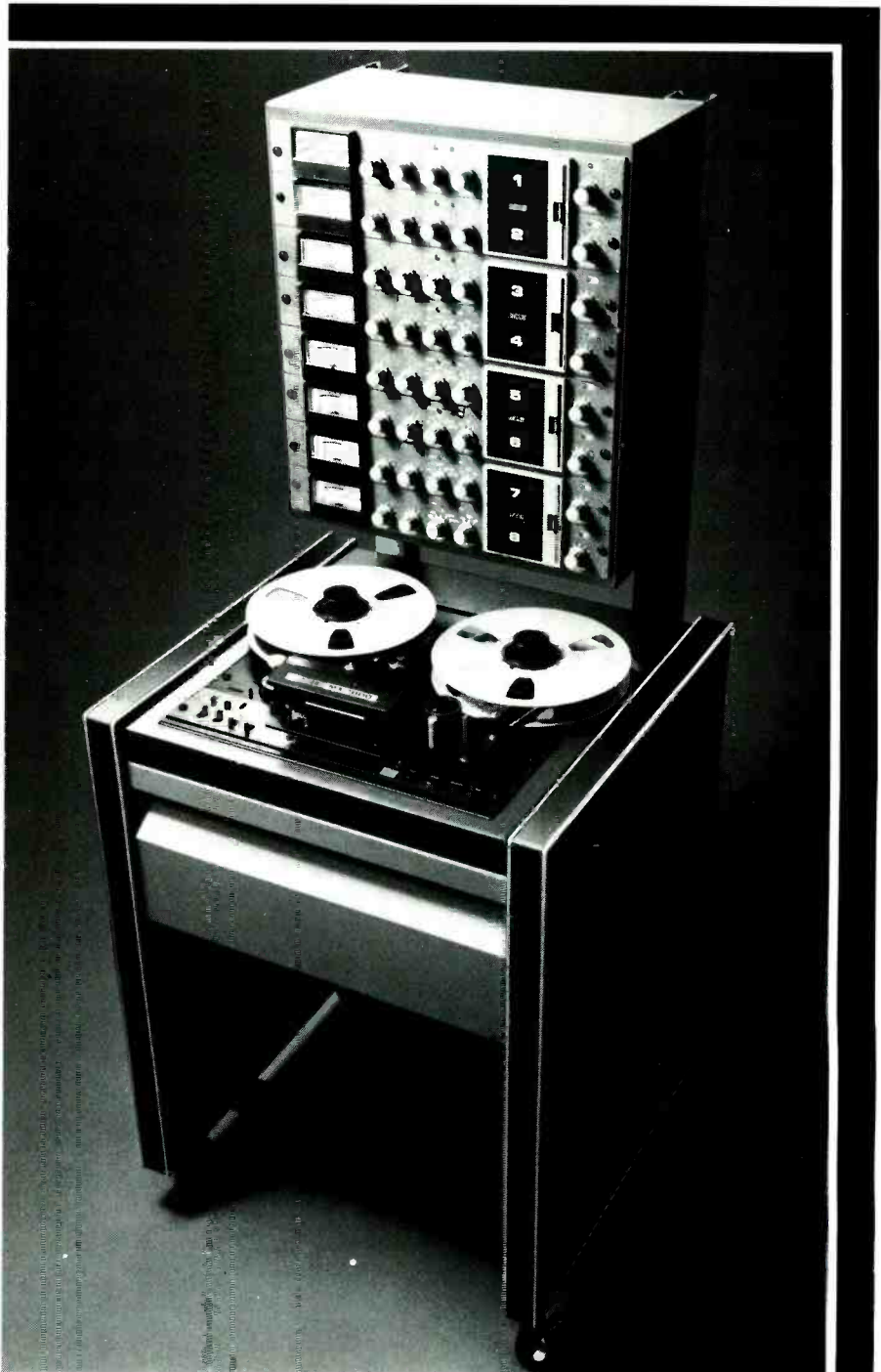

Please send me details on

**MX7800**

Name \_\_\_\_\_

Company \_\_\_\_\_

Address \_\_\_\_\_  
\_\_\_\_\_

SS

# Wavepower

Tony Attwood



*Having spent possibly months on the recording and mixing of a single or album, we are not totally disinterested in its commercial success. Without doubt, however, whether a record makes money depends heavily on its being played on daytime radio. If a record company can get the record onto a station's playlist at least the public will get to hear it. And people seem to buy what they hear on the radio. How did the playlist attain such importance?*

ONCE upon a time there was a single called *Deck of Cards* by Wink Martindale (still available as an import from Lightening Records). The record tells the appallingly sickly story of a soldier who takes a pack of playing cards into a church because, he claims, he uses them as a *aide-memoire* for communication with the Almighty. Apart from its unmitigated display of bad taste there was nothing particularly special about the record. It was released in December 1959, and was in the charts for just about one week, reaching number 19. Mr Martindale and the record then mercifully sank into oblivion.

The oblivion, however, was not to last. Four years later someone (no one knows who, but whoever it was has a lot to answer for) sent in a request for the record to be played on the BBC's *Two-Way Family Favourites*, which was broadcast every Sunday as a backdrop to the roast beef and Yorkshire pudding. Immediately a new public interest in the record was aroused, the London record label re-released the record and it at once soared up to number five in the charts, this time staying in the Top 50 for almost five months. Nearly ten years later a similar event occurred when *Amazing Grace* by the Royal Scots Dragoon Guards Band was issued on an lp. It was played on the radio, and letters flooded in from listeners anxious to know how they might get a copy. The record company was tipped off and the single stayed in the Top 50 for over six months.

These two incidents reveal the incredible power of radio in influencing record sales. Of course, when *Amazing Grace* was released there were no commercial radio stations in existence. And back in the days of *Deck of Cards* the power of the BBC was even greater, for not only did they have a monopoly of legal broadcasting

from within the UK, they also had a policy of playing as little recorded pop music as possible. Thus the impact of anything they did deign to play was enormous.

The main outlets for music at the time were Brian Matthew's 'Saturday Club' which leaned heavily on special guests who were required to re-record their hits in order to satisfy a Musicians' Union agreement (which in turn often meant a final sound vastly inferior to that on the record) and Alan Freeman's 'Pick of the Pops', with its highly structured presentation of new releases, new entries into the Top 20, one lp track and the Top 10. The net result of this pop starvation was that any record that did get played on the BBC's Light Programme and was not already in the top 20 stood a remarkably fine chance of making it into the charts.

It was this lack of music time, combined with various agreements with the MU, that brought to the fore many second-rate British artists in the early Sixties. The agreements meant that the BBC was unable to play many records by American artists. And so UK record companies jumped at the chance of getting anyone who was British to record a cover version of a US hit, knowing that it would stand a far greater chance of success in the UK than the original through the possibility of its getting air time—despite being of possibly inferior quality to the original version.

Another influential factor was the BBC's censorship of records they considered unsuitable for broadcasting. This led to the banning of some naughty American records which used unacceptable words and phrases like 'for God's sake'. Naturally British record companies were quick to ensure that their cover versions did not contain the offending words, and thus were suitable

for transmission. Indeed, any company concerned to make a profit from pop music would have been foolish not to fall in line with the dictates and whims of the BBC.

But the record companies did not simply respond to the wishes of the BBC—they used the situation to their advantage whenever possible. I well remember, for example, in the Sixties, writing to the BBC and asking if a particular group that had appeared on 'Saturday Club' had made a record. A little while later I received a letter from the record company with the details I'd requested. It had also enclosed a dozen stamped postcards to give to my friends so that they might send in requests for this record to be played on future editions of the show. Although the music-on-radio situation is now much more complex this traditional approach lives on, with record companies and fan clubs choosing to concentrate their attentions on one or two local stations rather than influence the massive BBC Radio 1 mailbag.

The first change in the situation that existed up to the early Sixties came with the appearance of British rock groups, who insisted on telling uncomprehending fans that they owed everything, not to Elvis Presley or Bill Haley, but to black American stars the fans had never heard of. For the first time since the War the mainstream record buying public began to realise that there was a pop music beyond that presented by the Beeb. Of course, Radio Luxembourg had been doing its own thing for many years, but perhaps because it relied at this time almost totally on sponsorship from the multinational record companies—or maybe because it always tended to follow the BBC rather than dare to lead the way—its influence in the record sales market remained low.

When people suddenly lose faith in a national institution the results are often quite dramatic. In this case thousands of teenagers suddenly began to feel that the Light Programme had been leading them up the garden path. It was as if the blinkers were suddenly removed and they realised that there were hundreds of interesting records released each year they had missed out on. For many it became a matter of principle *not* to listen to the Light Programme. Such an attitude, of course, was potentially disastrous for the record industry, which if left without a viable radio outlet was liable to die from suffocation.

The record industry was saved by the advent in the early Sixties of the pirates. Radio Caroline appeared first, quickly followed by Atlanta, City, Scotland and a host of other illicit off-shore radio stations. The pirates brought with them non-stop music, 24 hours a day. What they also brought, but which is often forgotten, was a belief in the strict programming format that has been with us ever since. The best exponent of this technique among the radio ships was Radio London—commonly known in its day as Big L. Throughout the day the station played records in strict rotation—Top 40 followed by a new release, another Top 40 single and then a 'revived 45'. Not until John Peel appeared between midnight and 2 am did the format change. The success of Radio London in terms of audience size (and thus advertising revenue) encouraged many others to follow suit. In order to keep ahead of each other stations used to devise their own Top 40. Thus there was no need to wait for the sales of a record to drop before removing it from the charts. Every record had a chance for one week as a new release—if it didn't make it into the charts the following week it was unlikely to be heard of again.

Almost every record company is very reserved about saying anything about its relationships with the pirates. The actual advertising of a new single or album in a way that is now commonplace on its stations was virtually unheard of. It was noticeable, however, that some of the pirates (particularly the smaller ones) did play the records of certain companies more than one might otherwise have expected. But whatever the attitude of the record companies the pirates did present them with a problem—how to communicate their product to more than a dozen stations rather than just one.

In 1967 most of the pirates were forced off the air by the Marine Offences Act, and the record producers concerned themselves with the best way of dealing with the newly-created BBC Radio 1. The new network decided to base its output on the lines of Radio London, which was only natural since most of the London DJs (Blackburn, Everett, Peel etc) were signed up by the Beeb. However, instead of the Top 40, Radio 1 adopted a playlist system that included almost all of the Top 20, those records rising up the Top 50, and some recently-released singles that had not yet made the charts but which

the members of the playlist selection committee thought were worthy of air time. Although the phrase, 'Number one in our fab 40', took on a new meaning (the Beeb used the British Market Research Bureau charts), the net result of the playlist was similar to Radio London's own Top 40 chart—since in both systems it was possible to include records that people within the stations particularly liked. It is this playlist system combined with oldies and new releases that has subsequently been adopted by virtually every UK commercial radio station, and which still remains the basis of most of Radio 1's output.

An interesting result of this development has been the change in attitude of the listeners towards the average daytime output of the music stations. Whereas with the pirates the novelty, illegality and unpredictability (in that things could, and often did, go radically wrong) of the broadcasts kept the audience alert and attentive, Radio 1 and its local commercial rivals have now lapsed into utter predictability. After a few hours of listening to the playlist on any station, with everything going according to plan, the station must become audio wallpaper. A similar situation has existed for many years in the USA. But there audiences can not only choose the texture of the wallpaper by turning into soul, reggae, jazz or of course Top 40 stations, they can also find a few stations whose programming is so outlandish as to be unpredictable in the extreme.

This situation has made the work of record companies quite straightforward in the UK today. Research has clearly shown that if you play a piece of music to a group of people and then ask them to grade the record out of 10, the marks will get higher according to the number of times they have heard the music before. This difference in marking can even appear between the first and second hearing of the record. It is obvious, then, that the best way of getting a record into the charts is either to get it onto the playlists or, failing that, advertise it as often as can be afforded on the commercial stations. A record which makes no stations' playlists and which lacks the backing of a very large advertising budget can be written-off immediately.

58 ►

*The exterior of Broadcasting House*



## WAVEPOWER

It is the job of the a & r department of all singles-oriented companies to keep a close eye on the playlists. The reasoning here is simple: if record x made it onto some of the lists, then the company's next single (record y) should sound quite like it. Having produced record y the next move is to get it to the ears of the djs and producers of the radio stations across the country (presuming, of course, that it is the djs and producers of programmes who make up the playlist committees). This is where the pluggers come in—telephoning and personally visiting the panel members; desperately trying to convince them that record y is even better than record x; that it is so good that it will make the charts without air-play; but *maybe* this station should play it so as not to be left out in the cold when the record takes off, etc etc. Being a plugger for a record company that puts out second and third-rate singles is the most depressing job in the music industry.

By and large the whole procedure is quite straightforward. The records that producers are looking for must be able to fit into the current playlist, and need to be up-tempo enough to keep the programme moving along without the dj having to do any hard work. Very, very rarely one station might slip into the playlist something totally different, possibly because somebody really liked it and persuaded the rest of the panel to go along with the idea. Or perhaps because someone in the station is the brother-in-law of the drummer. A week later another station may possibly pick up on the record and within a week the music press will hail this as the 'New Sound'. From executive suites in the West End, top record company officials will call their a & r departments demanding to know how many New Sound groups they have on their books. And why isn't Radio Anytown playing their records? It is this sort of process that has resulted in the series of fits and starts that pop music in the UK has been through recently. Every new trend is battered to death until the radio stations start to change the style of their playlists.

Another outcome of the current concept of the playlist is the domination of the airwaves by singles. It is almost unheard of for a station to put an lp track in the playlist unless that track is also released as a single. Thus the utterly bizarre situation can arise where djs suddenly start frothing at the mouth over a new-wonderful-great-sensational-just-released-single which has in fact been available on an lp for months. The latter-day Radio Caroline did make a major stand against this in 1976-7 by playing only lp tracks 24 hours a day, and by restraining any tendencies to concentrate on those tracks which had been released as singles. On the rare occasions that radio stations do allow djs to put lp tracks into their programmes the results can be remarkably refreshing—it's as if someone suddenly came in and changed all your wallpaper, which makes you notice your walls for the first time in years.

Unfortunately, this is just the effect most stations *don't* want to achieve, for by and large music on radio is essentially background material. Industrial psychologists have shown that production in a factory, for example, will increase if the background music is well-known to the workers and to their general taste. (And we know that it will be to their taste if they hear the same thing often enough.) On the other hand, if the background music is not known by the workers, productivity is liable to drop—presumably because some workers may stop work and actually listen.

The most sad aspect of this emphasis on singles by the stations is the impact that it has had on lps. Since there is little hope of pushing an lp on the radio, the next best thing is to make the lp appear to be a collection of singles. Before the advent of commercial radio in the UK there was a slight movement away from this idea with lp tracks becoming more and more adventurous. In the last year, however, even well-established progressive artists such as Yes and Roy Harper have found themselves producing lps that contain their hit single. This can be equally annoying for the pop fan who is into today's singles market, for he or she is quite likely to find the albums by Top 20 stars containing three, four or even more tracks he has already bought as singles.

All in all the picture of music on radio in the UK today is depressing when considered from the point of view of someone who is interested in the music as music. One only has to look at the 'Dealer Guide to Airplay Action' published each week in 'Music Week' to see the incredible similarity between the output of various

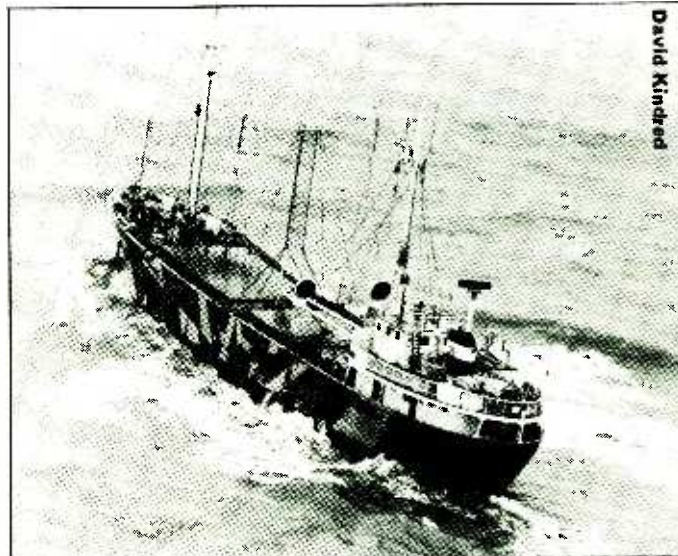

Mebo II—Radio Northsea International RNI

stations. The playlists are not identical but they are very similar. One reason for this is the controlling hand exerted by the IBA, who issue the franchises to the ilr stations, and from whom they rent the transmitters. Thus the IBA is able to issue directives to all stations not to play certain records, and invariably these are universally obeyed.

Nevertheless, from time to time little rays of sunshine do appear in the gloom. There was, for example, the time in 1974 when London's Capital Radio went out on a limb by playing Sparks' *This Town Ain't Big Enough For Both of Us*. It gave the single a high position in their own chart when Radio 1 didn't even have it in their playlist. Eventually the BBC gave in (despite the anxiety of some top officials who were unable to understand a single word on the record) and the record reached number 2 in the BMRB charts. The mastermind behind this breakthrough was Kenny Everett, who is also remembered for his insistence on playing a tape of the Beatles' *Across the Universe* at a time when EMI had absolutely no intention of releasing the track at all. On that occasion Kenny once again influenced the course of history and the song was released. But even he sometimes fails—as witnessed by a regular series of plays for *Hang on to a Dream* by Tim Hardin; despite weeks of eulogizing no reactivation of the record was achieved.

The other major name in breaking the programming rules is the BBC's John Peel, currently to be heard on Radio 1 between 10 pm and midnight during the week. John consistently plays what he likes and takes little notice of detractors—although he, like everyone else, is forced to submit to official bans on records (as with *God Save the Queen* by the Sex Pistols, removed from the airwaves in Jubilee week because of its unacceptable political standpoint). Currently he likes punk and new wave (with the occasional shot of reggae) and is undoubtedly responsible for the continuing success of one or two artists in these fields. This sort of influence is not new to him. In his early days on Radio 1, when he operated a Sunday afternoon show, it was his insistence on playing records by such 'underground' artists as Country Joe and the Fish, and Jefferson Airplane, that brought these groups to the attention of the British public—and at the same time brought Peel a far more dedicated following than that accorded to any other dj.

There can be no doubt that, together with Kenny Everett, John Peel has offered a serious service to radio listeners by consistently offering an alternative to monolithic playlists. It is slightly strange therefore that the one group Peel's name is associated with more than any other—Tyranosaurus Rex—should now be regarded as a straightforward teeny bopper group, the sort of group for which playlists are made. John's support for the group (or in reality for its leader, the late Marc Bolan) actually ended when they had their first number 1 hit, but by then his work had been done, as is witnessed by the 21 chart entries in the UK alone between 1968 and 1976.

David Kinred

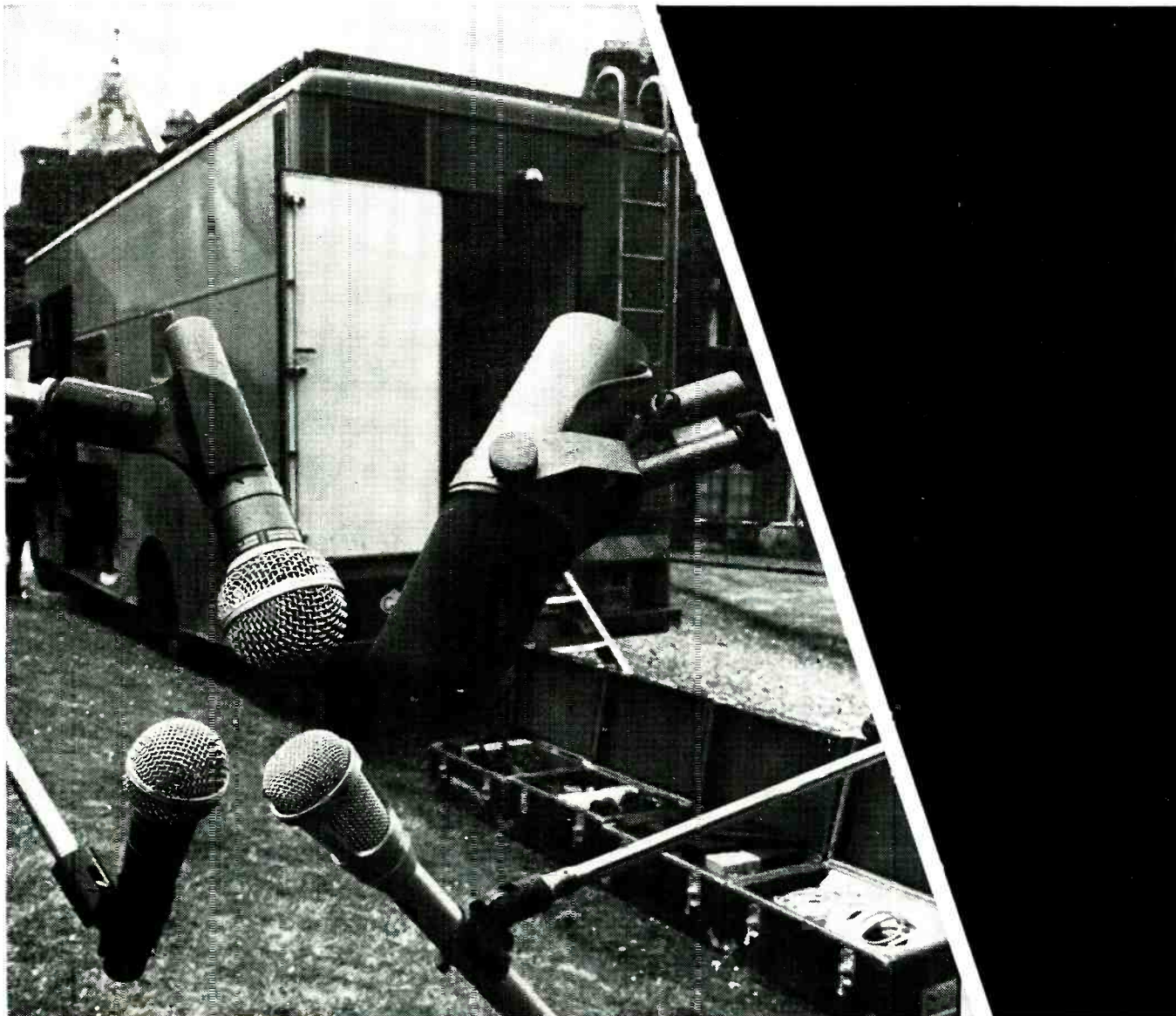

## Stones' Rolling Studio



A complete recording studio in a van? For Mick Jagger, it is almost a necessity. Mick and the Stones can be inspired to produce their next hit anytime, but when they're on tour or on vacation, the best recording studios aren't always around the corner. The Stones rely on their Shure-equipped mobile studio for the unmatched recording perfection they insist upon, for these moments of midnight inspiration. Whether in a recording session or on stage, the Stones' SM7, SM58, SM82, SM53 and SM56 microphones are their assurance of consistent quality and natural sound.

Shure Electronics Limited  
Eccleston Road, Maidstone ME15 6AU  
Telephone: Maidstone (0622) 59881



## Microphone windshields & shock mounts

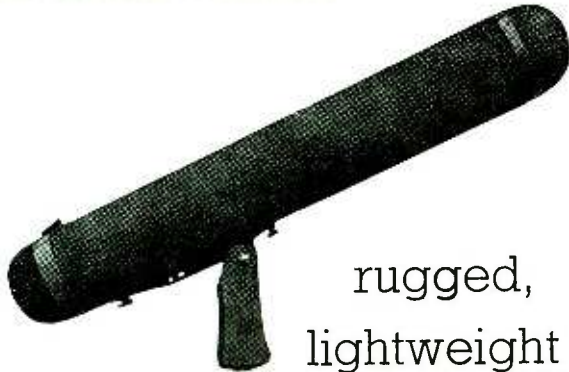

rugged,  
lightweight  
made to last,

by **Rycote**

Edgehill Farm,  
Edge, Stroud,  
Glos. GL6 6PA

for Sennheiser 816, 416, 435  
AKG 451, CK1, CK8, CK9  
Schoeps CMC series.  
Telephone: Painswick 813615

# DIRECT BREAKTHROUGH!

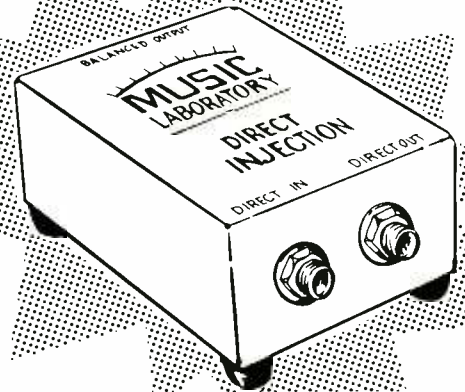

At last, a D.I. box to meet the most stringent requirements. Utilising the best matching transformer available. Housed in factory-finished rugged box, as used in professional recording studios.

Frequency Response: 10Hz—20kHz  $\pm$  1 db.

Telephone for details: 01-388 5392/3/4/5

74 EVERS HOLT STREET,  
LONDON NW1.

*music  
laboratory*

Our business is  
helping you with yours...



Custom rolling  
consoles available  
for all Teac recorders.  
The unique design  
allows for the storage of  
tapes or a noise reduction  
unit. Features also include  
swivelling castors and easy  
assembly-supplied as a flat-pack kit.

Are you ready  
for  
Multitrack?

The Turnkey book includes comprehensive information about our products and services. Please write or call for your free copy. Teac's 16 page booklet "Are you ready for multi-track?" is also available on request.

key

8 East Barnet Road, New Barnet, Herts EN4 8RW Telephone: 01-449 2344 Telex: 25769

# Update.



Install this new 19" unit from Soundcraft Magnetics and bring the electronics of your multitrack tape machine right up to date.

The unit has 8 plug-in modules with studio line level interfaces, and fully professional specifications.

Line out—switched replay, line in and sync. Separate sync line out for foldback or noise gate use.

Remote control unit is standard; compatible tape heads and power supplies are available.

S/N 72dB (Ref. 320 nWb/m A weighted).

Get up to date by calling Soundcraft.

Soundcraft Magnetics Ltd  
5-8 Great Sutton Street,

London EC1V 0BX Telephone: 01-251 3631 Telex: 21198

**SOUNDCRAFT**  
MAGNETICS LIMITED

**ARE YOU AFRAID TO ASK THE PRICE?**



24 input/subgroup/output channels, each with two parametric equalizers, overload indicator with memory, stereo cue, four auxiliary lines, 100 mm linear fader—Full patchbay wired for 16 track recorder and all auxiliary equipment—Built-in oscillator and phase-meter.

Write for further details to:

Steven, 17 Vernon Road, Bushey, Herts. WD2 2JL, England. (Callers by appointment only.)

**WOULD YOU BELIEVE ..... £3950.**

**PROBABLY THE MOST  
ATTRACTIVE PERIPHERALS IN THE BUSINESS**



**DMX 15-80 PROGRAMMABLE DDL**

- \* 15 bit, 90 dB dynamic range for ultra clean sound
- \* 18 kHz bandwidth at all delays
- \* Over 1 second delay capability in 1 ms steps
- \* Computer controlled, allowing delay storage and interface with computerised mix down facilities
- \* Designed to accept computer controlled pitch-change and reverb cards

- \* 'Over the top', through infinity tape phase simulation
- \* Multiple delay paths
- \* Infinitely variable flanging, tunneling, pitch shifting and delay effects. All capable of single or cross modulation.
- \* Stereo outputs for psycho-acoustic image shifting
- \* Ramp generator section for enhanced Leslie type effects
- \* Wide bandwidth and low noise

**EVEN THE PRICE IS ATTRACTIVE**

**WEST GERMANY**

ELMUS GMBH      RECORD STAR STUDIOS  
BERLIN          HAMBURG  
Tel. (030) 312 2012      Tel. (040) 439 7254

**BENELUX**

JUST BORN STUDIOS  
HEKELGEM  
Tel. (053) 70 5003

**HOLLAND**

PIETER BOLLEN  
EINDHOVEN  
Tel. (040) 512 777

**SWITZERLAND**

BRUNO SPOERRI A.G.  
ZURICH  
Tel. (01) 479912

**ADVANCED MUSIC SYSTEMS**

66 IGHTEHILL PARK LANE  
BURNLEY ENGLAND  
Tel: (0282) 36943

# APRS Exhibition 1978, a preview

The 11th annual exhibition of the Association of Professional Recording Studios will be held at its traditional venue, the Connaught Rooms, Great Queen Street, London WC2, on Wednesday June 21, Thursday June 22 and Friday June 23.

Opening hours are from 1000 to 1800 (Wednesday), 0900 to 1800 (Thursday) and 0900 to 1700 (Friday). Some 84 companies will be showing their wares, worth in total over £2 million.

Acoustic Research plan to exhibit the full range of Teac Tascam products, including the 'budget' 2340 and 3340 four-track tape machines, plus the new Model 2A mixer which features tone control on all channels. The 80-8 eight-track on 12.7 mm tape machine; the DX-8 eight-channel dbx noise-reduction unit; Models 3 and 5 8-in/4-out mixers; the new 90-16 16-track on 25.4 mm tape machine (on show for the first time in the UK); and (hopefully) the new Model 15 24-in/8-out/16-monitor desk can also be seen.

Agfa plan to display the latest in their range of 3.81 mm bulk cassette tape, professional and 'amateur' recording tapes and compact cassette range.

AKG plan to show a selection of equipment, including the new D222 microphone that uses the two-way technique found in the D202. The new mic is approximately two-thirds the size of the D202 and features a newly-developed two-way system that can be changed very easily; built-in wind and pop protection; 'uniform and frequency independent cardioid characteristic'; plus a

three-step bass cut switch. Also on show: the new SM2000 portable 6/2 mixer of modular design with universal phantom powering; the new BX10 portable reverb unit, which is said to offer professional specification with two independent channels at a lower price than the well-established BX15 and BX20; and a selection of the company's range of dynamic and capacitor microphones, headphones and stereo pickup cartridges.

Alice will be exhibiting several examples of their 'highly successful' new ACM custom modular mixing system, ranging from small production and transfer desks to a 16-input/20-output/16-track monitoring console. Also on display will be Alice's six-month old baby, the 828 portable stereo mixer, and a rack-mounting version of the new ACM 9904 compressor-limiter.

This year Allen & Heath/Brenell will have on display, for the first time, the finished production version of the Syncon 'synergetic' console. The desk is now capable of free routing, plus subgrouping with either 16 or 24-track (split bussing). The new desk

boasts an equivalent input noise of -128 dB, which is claimed to make it one of the quietest available. Syncon is available with up to 28 input/output modules, all featuring 16/24 routing, two parametric equalisers, two switchable frequency shelving equalisers and six auxiliaries. The system was designed with quadraphonic recording in mind and features quad monitoring mixdown and subgrouping. The lower range of studio mixers has been enhanced by the introduction of the Series III modular console, known as Mod III. A new output module has been introduced that offers four subgroups, eight echo returns and stereo mastering and metering. This module enables the Mod III to be used as a 'high-quality' sound reinforcement mixer, with a heavy duty flight case and multicore assembly available as accessories. The Brenell Mini-8 eight-track on 25.4 mm tape machine will also be demonstrated complete with its new remote control system, a digital tape counter and varispeed unit.

Allotrope/Future Film Developments: no information received.

Amek will be showing an M2000 Series console offering 28 inputs, 16 busses, eight direct assigns and 24-track metering. The console, based on the in-line principle, has a remix subgrouping system, 240-point patchbay and many other 'useful' features. Also on display will be modules from the new M3000 system. This console offers 36 inputs, 24 busses, direct assigns and 32 meters. Inputs have four-band, completely parametric eq, six auxiliaries, quad mixdown, vca faders with dc subgroups (including echo returns) and many other facilities. A computer will be available soon, designed by AMS. The price of the complete system including computer will be about £40-45 000.

Amity Shroeder will be exhibiting their range of broadcast cartridge/record players, together with their 25.4 and 50.8 mm tape transports. The NAB cartridge machines are claimed to meet or exceed the standard for



Alice ACM  
20/20/16  
console  
installed  
at Dodgy  
Demos  
Studios

66 ►



# STRAWBERRY RECORDING STUDIOS SOUTH

61, South Street, Dorking, Surrey.

With Strawberry you expect the finest in recording technology and Strawberry South in Dorking is undoubtedly one of the most advanced and sophisticated studios in the world today. 10CC will finish recording their new album there at the end of June.

**From 1 July 1978 Strawberry Recording Studios South will be available for commercial bookings (minimum period of one week)**

**For bookings please ring the Studio Manager,  
Tony Spath or Polly Burgess on  
0306-87852/3**

## APRS PREVIEW

equipment laid down by the NAB and IBA. Also on display will be the wide-tape transport, which is aimed at companies wishing to build their own multitrack machines; they are claimed to provide an excellent performance and smoothness of tape handling.

**Ampex** will be showing a selection from its wide range of tape-related products. The *MM-1200* is to be demonstrated in a 24-track version, with search-to-cue, electronic tape timer, sel-sync and large-reel capacity as standard features. Representing Ampex mastering equipment will be the *ATR-100* tape machine, which is available in one, two or four-track configurations, and has many options available including NAB/CCIR switching and a disc-mastering preview accessory. The *ATR-100* is to be linked in a demonstration of the *MQS-100* video/audio synchroniser with an Ampex *VPR-1* helical-scan recorder. Also to be seen: *406/407* and *Grand Master Series* mastering tapes, plus tapes for duplicating cassettes, cartridges and digital recording.

**Audio & Design** plan to show their complete range of signal-processing equipment, including the new *S24 Time Shape Module* adt/flanger and *S23* auto-pan unit from the rack-mounting *Scamp* range. Also to be seen: the *F760* Complex limiter; *F769* Vocal Stressor; *F600* broadcast limiter; *F300* expander gate, *SO3* and *SO4* equalisers from the *Scamp* range; and the new *E950* Paragrophic equaliser.

**Audio Developments** will be exhibiting their complete range of portable mixers, including the new *Pico Plus* specially designed for tv and film ob use. The *ADO55* compressor-limiter and other plug-in limiters will also be demonstrated. Centrepiece will be the *ADO70* Prographic equaliser which has storage facilities for up to 16 graphs with instant recall to the display—even during recording. A remote station capable of controlling four *Prographics* is said to further extend the unit's versatility.

**Audio-Kinetics** will be exhibiting the new *XT-24 Intelocator*, a microprocessor-based autolocator which is said to 'learn' a given tape and transport. The unit has six programmable aim points and can also display a varispeed reference figure in 'ips' (wot, no metric cm/s?). It will interface with the *3M M79*, *Studer A80*, *Ampex MM1200* and *MCI JH-16* machines. Recently appointed as UK agents, A-K plans to exhibit the *Quad-Eight CPR-16* digital reverberation unit. This is said to represent a real alternative to the plate with the added advantage of a built-in digital delay and echo programme. Reverb time can be varied from 0.25 to 20s. A module from the new *Quad-Eight Coronado* console, plus details of the *Compumix 3* automation system, will also be on show. Also to be seen: the established range of acoustic screens plus a Mk II version of the *Sonapanel* system launched at last year's APRS.

Among the items to be exhibited by **Audix** is a console that has been specially designed to meet BBC Radio requirements. Items from the recently introduced *3500* range of modules can also be seen. Based on a 35 mm pitch,

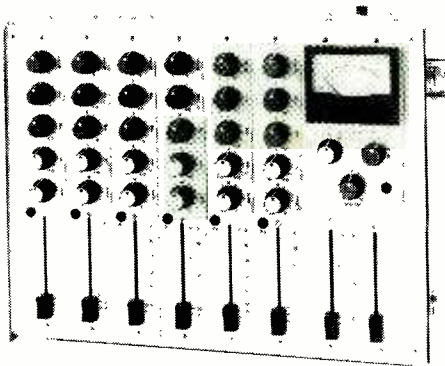

A new portable mixer from Audio Developments

these modules are said to offer facilities acceptable to both broadcasting and recording studios. Comprehensive equalisation and filters plus eight group and six auxiliary output facilities are available. In the smaller mixer field the *MXT-1000* transportable will again be on show. Suitable for the smaller studio and outside broadcast work, this should be of particular interest to local radio stations. Also to be seen: a new graphic equaliser in two versions—*type 902* having 11 octave centres and *type 908* having 27  $\frac{1}{3}$ -octave centres.

**Avcom Systems:** no information received.

**BASF** will be demonstrating the *Uniset* cassette system in conjunction with the purpose-built *Unimatic* machine. Designed for professional broadcasting, especially portable recording and the automation of radio programmes, the machine uses 6.35 mm tape and gives a 20-30 minute playing time at the tape speed of 9.5 cm/s. Also on display: the *SPR50LH* range of tape, *TP18LH* and *LHS* cassette tape and a full range of calibration, test tapes and cassettes.

**FWO Bauch** will be displaying the following studio equipment: *Studer A800* 24-track machine with tape synchronisation system, *A80RC* 6.35 mm master recorder, *B67* 6.35 mm tape machine, *169* portable mixer and *A68* power amp; *Revox B77*, *A700* and *A77* stereo tape machines, *B790* direct-drive turntable, *A740* power amplifier and a selection of accessories; *Neumann* condenser microphones, including a new shot-gun mic, plus disc cutting equipment; *EMT* model 250 electronic reverb unit, professional turntables, four-track logging recorder, compact compressor, limiter, de-esser and noise filter modules and various items of test equipment; *Ivie* portable spectrum analysers and spl meters; *ITC* NAB cartridge machines; *Urei System 200* response plotting system and *Sonipulse* acoustic analyser, *LA-4* compressor-limiter and *LA-5* leveller, *UA545* parametric equaliser, *UA1176* limiter, *BL-40* modulimiter, *UA527A*, *529*, *530* and *532* graphic equalisers, and *UA565T* filter set; *Transco* disc-recording blanks; *MRL* test tapes; *Lexicon Delta-T 92* and *102* mono and stereo digital delay systems, *Model 27* pitch changer and *Varispeech 2* time compressor-expander; *Allison Kepex* and *Gain Brain* modules; *Klein & Hummel* parametric equaliser and monitor loudspeakers; *Danner* faders and microphone stands; and *Switchcraft* audio connectors. Should be something there to please most visitors.

**Beyer:** no information received.

For the first time **Broadcast Audio** will be showing the *Spotmaster* range of NAB cartridge machines and accessories at APRS. Since taking the *Spotmaster* distributorship in 1975, the company has sold in excess of 380 cartridge machines to radio, tv stations and studios in the UK, Scandinavia, Ireland, France, Germany, Hong Kong and the Seychelles. Sales are handled from the Isle of Man, but a full technical and engineering service is based in West London.

**B & K:** copy received after deadline.

**Cadac** will be showing its latest modular *In-Line* automation console. Automation data is stored, retrieved and updated through the *CARE* system on floppy disc. Each input/output channel features a six-band stepless variable-frequency equaliser switchable to microphone or monitor channels. *V-cat* faders allow dc ganging to seven subgroup faders, or the seventh may act as gang master with control over all faders. The numerical display on each *Penny & Giles* fader indicates the selected gang assignment, with channel logic clearly marked. The *In-Line* console series incorporates music recording, film dubbing, and broadcast variations with extensive customer options.

**Calrec:** no information received.

**Cetec:** no information received.

**Dolby** will be showing their full range of noise-reduction equipment, the emphasis being on new applications and on the exchange of experience and views on developments within the industry. Recording studios were the first and are still the major customers for *Dolby A* noise-reduction circuits. For this market *Dolby* are showing the *M32H*, an addition to the *M-series* multitrack range available with less than 32 modules if required. Film studios are now using *Dolby A* noise-reduction in the recording, transfer and dubbing stages. The major dubbing studios in Hollywood and London are said to be mainly using *model 360* units with their magnetic film recorders, and *E2* equalisers with their loudspeakers to achieve a standardised acoustical frequency response. Substantially improved sound quality can now be obtained in cinemas, where *Dolby A* noise reduction is claimed to make it possible to increase the frequency bandwidth, reduce distortion and keep the noise level down. Over 500 cinemas in the USA, and more than 30 in the UK are already equipped to play *Dolby*-encoded film soundtracks.

**Eardley Electronics** will have on display the following products for which they are sole UK agents: a new range of *Neutric XLR*-type connectors and panel-mounted sockets; the *Neutric ATR1* portable and completely self-contained unit for frequency and time plots of various acoustic and electronic parameters (for example, frequency response of transducers, amplifiers, tape machines and the measurement of complete audio systems, including room acoustics); the *Neutric AD4* delay time unit that provides four constant percentage delay outputs from one input, with a continuously variable delay over a 4:1 range from 12.5 to 200 ms; a range of *Preh* DIN plugs and sockets as well as faders and stepping potentiometers; and a portable *Pentagon* cassette copier that uses a

68 ▶

# SYNTOVOX 221

*The Intelligent Machine*



- 20-channel analysis and synthesis
- 54 dB/octave filters
- real time analysis LED read-out
- matrix patching
- fill-in facility
- built-in audio pulse generator
- random vlf and step modulation
- lfo modulation
- 56-way multiconnector for external control and computer applications
- 19" case
- £ 3,000

Syntovox 221 is one of the latest developments in sound effects equipment by Synton Electronics, also the creator of the famous 903 Phaser/Band Filter.

Syntovox 221 is a 20-channel electronic effects vocoder which features a range of fascinating new sound effects for everyone who is involved with music, film, television, radio or theatre.

One of the most distinguishing qualities of Syntovox 221 is its intelligibility which can be considered as a standard for technical quality in a vocoder.

More than one year of research resulted in a highly accurate analyzing and synthesizing system which is the heart of Syntovox 221. An extensive control system was designed to make Syntovox 221 sound more natural than any other vocoder.

For a 60 seconds' demonstration call Syntovox 221. It will speak to you on Synton's special vocoder line: Netherlands/03462-3432. Night and day. If the line is busy, try again, or write for more details.



**synton<sup>®</sup> electronics b.v.**  
HOLLAND

**breukelen holland**  
P.O.B. 83 TEL. 03462/3499

## APRS PREVIEW

The new *DN70* digital time processor can be seen on the **Klark-Teknik** stand for the first time at an APRS exhibition, together with the established *DN36* analogue time processor. Also to be seen: their well-established range of equalisers, which comprises the *DN27*, *22* and *15* models.

**Lee Engineering** will be exhibiting examples of the products for which they are UK agents: the new *Scully 250 Series* of low-cost broadcast replay-only tape machines; samples of the new *Audiopak 44-3 NAB* cartridge fitted with a new high-output, lubricated tape; the new *IGM Instacart* 'instant access' cartridge machine capable of holding up to 48 cartridges, any of which can be replayed instantly; and an *Audicord* cartridge machine that is claimed to meet or exceed all the new *NAB/IEC* specifications and offers specific operational advantages over earlier designs; plus the *Nortronics* range of tape machine and head-care products, and replacement heads.

Highlight of the **Leavers-Rich** stand will be the *Proline 2000TC* range of 6.35 mm tape machines, which can be supplied in two console housings—standard and penthouse—with control panels to suit the differing requirements of tv and radio stations and recording studios. Of particular interest should be the radio version with facilities and control panel developed in collaboration with *John Lumsden*, Chief Engineer at *Radio Clyde*. This version is already in service at *Radio Clyde* and also at the *IRN* parliamentary studios. Complimentary to the *2000TC* range is the *Proline 1000*, which is available in rack-mount, transportable and console versions and can be supplied with either servo-controlled or direct-drive capstan motors. Features include electronic servo-controlled tape tension, motion sensing logic and modular construction. Also on display: the *Han-D-Mag* for which *Leavers-Rich* are now sole UK agents. This is a hand-held unit for demagnetising heads, tape guides etc.

**Lennard Developments** will be exhibiting, for the first time in the UK, two new wow and flutter meters, *Models ME106* and *ME108*, manufactured by *Woelke* of West Germany. In addition the company will again be showing the *Woelke ME201* flutter classification unit for use with all *Woelke* wow and flutter meters; and the *ME401* automatic distortion meter, an automated, direct-reading, third harmonic distortion analyser for alignment of tape machines. Also to be seen (possibly): the *Asona model 2004* fully-automatic tape duplicator and winder.

**Libra Electronics** will be exhibiting their theatre sound control console. This has been *New Klark-Teknik DN70 digital time processor*

developed primarily for use in theatre and conference/arts centres where live sound reinforcement and the reproduction of music and effects from tape or disc are called for. It is entirely self-contained and a range of additional optional facilities is available to meet the specific requirements of each customer. The prime advantage of the *Libra* system is claimed to lie in the flexibility of input and output selection; to each plug-in control module can be selected any input and any combination of outputs. This permits a single input to be assigned through any fader to any configuration of outputs. If required a single input may be assigned to several control modules, any of which may be used; thus it is possible to preset cues on inactive modules without affecting those in use. Maintenance of the *Libra* system is by straight exchange of control modules or printed-circuit boards, which are so priced as to be within most production budgets and allow the desk to be expanded as funds become available.

**Lockwood:** copy received after deadline.

**Lyrec** will be exhibiting the *TR532* multitrack tape machine, together with the new microprocessor-based *TPC* tape position controller. The *TPC* enables searching to three different preset tape positions and recycling between two positions. It can also store 16 different tape positions that can be recalled and searched at the operator's convenience. All machines come complete with a comprehensive remote control unit containing search-function, varispeed with four-digit readout and tape timer. The unit also contains controls for all amplifier functions—for each track a selection can be made between ready, safe, line, sync, repro and solo. Also on display: *Lyrec* high-speed cassette copying equipment, including a new vertical loop-bin. All slaves are built as twin units for maximum capacity in minimum space.

**Macinnes** are introducing three new products from *Crown/Amcron*. Foremost among these should be the *RTA2* realtime analyser, which *Crown* first developed for their own use and which is now being marketed as a 'high-quality' unit of test equipment. The *RTA2* has a 12.7 cm crt display and is switchable from  $\frac{1}{3}$ -octave to 1-octave ranges. It has an internal pink noise generator and can be used with most professional microphones; the *RTA2* can be seen in operation with the *EQ2* equaliser. Another new unit is the *D75* power amplifier, which replaces the old model *D60* but is of the same dimensions. The *D75* is fitted with the *IOC* input/output comparator as well as a 'signal-present' indicator on each channel, which shows when an output signal of at least 0.125W is present. Power output per channel of the *D75* is 45W into 4 ohms, and 35W into

8 ohms. Also to be seen: the 'well-proven' *DC300A* and *D150A*, and the new *Macinnes 18/4* portable mixer.

**Maglink:** copy received after deadline.

**Magnetic Tapes** plan to show the new *Chilton QM2* range of consoles available in 12 to 24-input/4-out/8-track monitoring or 16 to 24-input/8-out/16-track monitoring formats. Features include standard or parametric eq; full-sweep high and lowpass filters; peak-reading vu meters with led overload; four auxiliary channels; 'off' light; pfl; pushbutton channel assignment; and 48V phantom powering. Peak programme metering on output groups is also available, with provision for built-in compressors in each output that can be routed to inputs. Also on show: the smaller *M10/2* 'broadcast-quality' console.

For the first time **MCI** will this year have its complete range of equipment on show. This is by courtesy of *Red Bus Records* who have agreed to let the company exhibit the equipment ordered for their new studios. On display will be the following items: a *JH500 Series* automated console, *JH114-24* multitrack machine and the new *JH110A/8* eight-track based on the *JH110* transport. In addition, there will be the *JH110M* broadcast machine said to be developed especially for European broadcasters, with scissors, marker, monitor speaker/amplifier and new electronics to *IBA* and *EBU* specifications. Also to be seen: several mastering machines designed for disc-mastering and time delay; and *JH440B series* consoles.

**Midas:** no information received.

**3M:** copy received after deadline.

**Mosses & Mitchell:** copy received after deadline.

**National Panasonic:** no information received.

**Neal-Ferrograph** plan to show the *Studio 8* range of mono or stereo tape machines, available in transportable, rack-mounting and console versions. The machines use full logic control in association with a rugged tape transport system to provide 'maximum operational convenience in a design intended for heavy-duty use'. Particular attention has been paid to editing facilities and the requirement for remote control. A recent addition to the *Ferrograph* range of semi-professional machines is the *Logic 7 Series* of three-speed machines accepting 27 cm spools. The open-face head block is claimed to give unobstructed access for fast and accurate editing. The series is available in half and quarter-track versions, with or without 10W stereo amplifiers, and with *Dolby* noise-reduction circuits if required. Also to be seen: the *Ferrograph RTS2* audio test set and *ATU1* auxiliary unit; plus the latest addition to the *Neal* range of studio cassette machines—the three-motor, logic-controlled *model 302*.

**Neve** are to show several new additions to their wide range of standard consoles. The latest addition to the range is the *model 8078 40/32 desk*, the performance of which can be 'enhanced' at any time by the addition of *Necam* computer-assisted mixing system (as a factory or field-fitted option). The *8078* incorporates a separate 32-track monitor/mixdown section with horizontal faders and

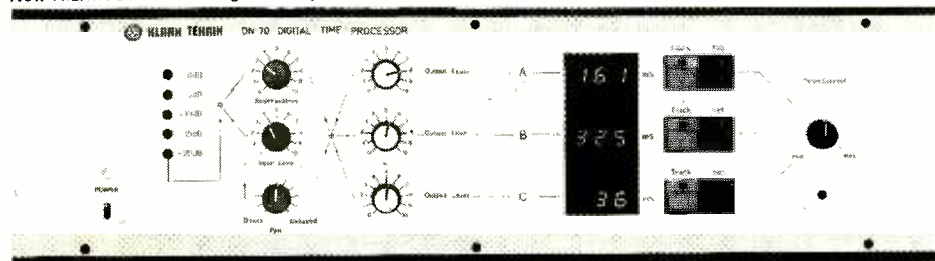

# three from Telex



**TELEX/MAGNECORD MC SERIES CARTRIDGE MACHINES** incorporate state of the art design to meet the real needs of broadcasters providing operating convenience and reliable performance at reasonable cost. Four machines to choose from mono replay and record/replay and stereo replay and record replay.

Prices from £620

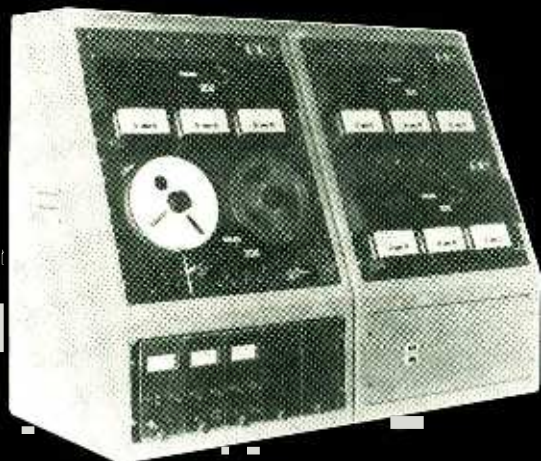

**TELEX 300 SERIES DUPLICATORS** combine total system flexibility with the capability of expansion as production demands increase. Individual modules can be intermixed to suit the exact duplicating requirements, open reel to cassette, cassette to cassette, open reel to reel or even cassette to open reel. Systems are available in  $\frac{1}{2}$ -track 2-channel mono or  $\frac{1}{4}$ -track 4-channel stereo.

Prices from £2450

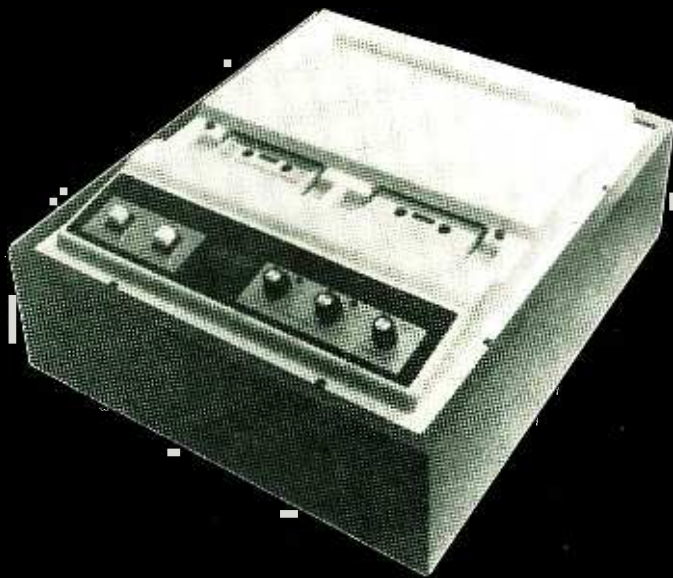

**TELEX CASSETTE COPIERS** feature ultra simple function controls with reliable high speed operation (30 ips mono + 20 ips stereo). Automatic erase, automatic rewind and illuminated track select indicators enable even non-technical personnel to successfully duplicate cassettes. Add-on slave units will expand production to a total of 5 cassettes per pass.

Prices from £560



for further details write to:

**Avcom Systems Ltd.**

P.O. Box 755 London W12 7HS 01-743 2201

## APRS PREVIEW

routing to four track outputs. Useful features are said to include separate mic and line inputs equipped with 31105 equalisation amplifiers, eight of which can be switched for use as reverb returns. Also being exhibited for the first time is the model 8066 20/16 console that features separate mic and line inputs, this time equipped with 31099 or 31102 equalisation amplifiers. A separate 16-track mixdown section with horizontal faders allows routing via stereo positioning controls to four track outputs. All channels can be routed to two mono and one stereo cue/foldback output, while another two mono auxiliaries are provided on the monitor section. A new suitcase 8/2 mixer, model 5422, suitable for ob van and location work will also be shown.

**Penny & Giles** will be exhibiting equipment from their range of products, including the 1500 Series linear-motion faders with a wide choice of output functions, switch facilities, single, double, four and eight-track format; the 1900 Series long stroke length faders; the 'cost-effective' 1100 Series; and the 900 Series slimline fader with its compact body width of 12.7 mm and stroke length of 65 mm. Also on show: a twin fader providing two separately-operated stereo outputs within a body width of 25 mm; and a joystick quadraphonic pan pot.

**Philip Drake**: copy received after deadline. **Professional Tape Marketing Associates** will be showing a new-style cassette especially designed for in-cassette duplication, studio

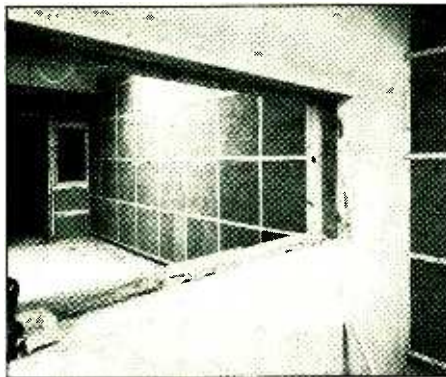

Rockwool unfaced acoustic slabs in evidence during the construction of John Wood Studios

and audio-visual applications. The cassette has lubricated pins, flanged rollers and 'hard' windows. Non-jamming with PTFE-type foils, it can be custom made to any required length from C1 to C96. Each cassette carries an unconditional 25-year guarantee against any manufacturing fault and is precisely loaded to within  $-0/+6s$ . Also on show: 'professional-quality' cassettes available in most lengths, and which come complete with side labels, inlay cards and library cases; and a new 'competitively-priced' cassette labelling machine that will label up to 500 cassettes an hour and is said to need no experience to use.

**Publison**: copy received after deadline. A new range of octave-band spectrum analysers to be shown by **Pyral** should be of great interest to those who require fast, accurate a/b comparisons of frequency

performance on any disc cutting or tape copying work. Major recording studios in Europe have already installed these analysers. Also on show will be the Pyral range of cassettes, including the new *Superferrite*. Duplicating-quality cassette tape, including the new high-output *Microferric*, master lacquer discs, magnetic sound track film and *CJ87* studio tape can also be seen.

**RAC** will have on display a 16/8 mixer destined for a Belgium studio. Servicing is said to be fairly straightforward, since all circuits are on plug-in cards and replacements of all types are kept in stock. These cards are also available separately as RAC plug-in *Audio Modules*. New this year are a range of complete mixer units, including a limiter, disc pre-amplifier and two-channel mic amplifier with phantom powering; further units are under development. Also to be seen: a range of power amplifiers in 50W, 100W, 200W and 50 + 50W versions, with optional 100V line facilities.

**Racal Zonal** will once again be showing their wide range of recording tapes and cassettes for all applications, including music mastering, broadcasting, duplication and speech monitoring. Also on display will be the company's capability of producing cassette shells and components, custom-wound cassettes and private label cassettes.

**Radford** will be exhibiting its existing range of measuring instruments and amplifiers. Also on show will be four new items: the *DMS4* distortion measuring set capable of measuring total harmonic distortion to better

74 ▶

## MINIFLUX

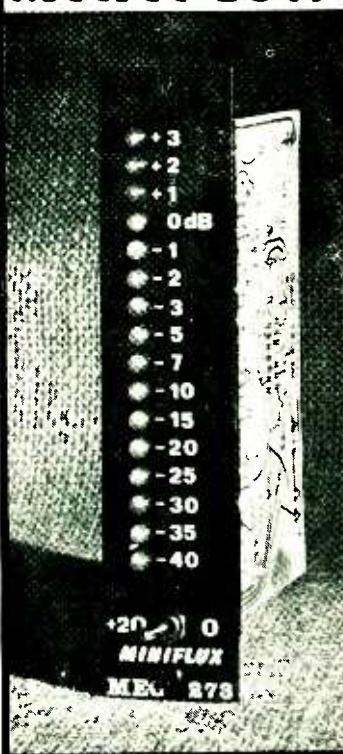

MEG 273 Peak Level Indicator uses a column of green and red LED lamps which ignite alongside a dB scale in accordance with input signal levels.

The indicator has no moving parts and its very high sensitivity allows it to be used at Test Tape levels and for system noise checks. The display is easily readable in multi-channel applications and its vertical orientation is ergonomically suited to the slider movement in mixers.

The circuit has been subject of long-term development and uses only five integrated circuits. The accuracy is  $\pm 0.1$  dB. Max. sensitivity: 60 mV to give 0 dB. Input Z: 100 kohm unbalanced. Supply:  $-32$  to  $-50V$ . Integration time and Decay to IEC 268-10.

**MINIFLUX electronics limited** Tel: 01 959 5166  
8 Hale Lane London NW7 3NX England  
ATHENS: 815 858 BRUXELLES: (02)-771.30.63 STOCKHOLM: 08-83 60 00

## STUDIO EQUIPMENT

We may be able to supply the equipment that you require



COMPACT STUDIO MIXERS, FOR MONO OR STEREO. All with comprehensive mixing facilities to suit fixed installations, or mobile situations. Where prestige demands the finest quality sound mixing equipment; for clubs, theatres, colleges and universities, install SONIFEX, and be assured of reliability and performance.

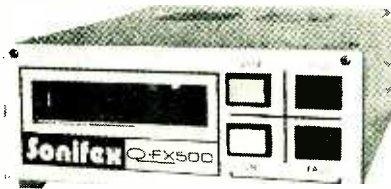

Also: A wide range of NAB cartridge reproducers covering basic requirements, through to broadcast specification.

Ask for details:

**SONIFEX**

15 COLLEGE STREET  
IRTHLINGBOROUGH  
NORTHANTS. 0933-650700



## For appearances' sake and functional excellence **SPECIFY SIFAM KNOBS**

These best-of-British collet knobs and accessories were created with function, styling, handling and easy assembly as the main criteria. The range of 10mm, 11mm, 15mm, 21mm and 29mm knob sizes now includes short as well as standard length wing knobs in the 15mm, 21mm and 29mm sizes.

Caps, pointers and figure dials, as required, simply plug into the knob to form a rigid, vibration-proof assembly. Many different colour combinations are possible.

Knobs, caps and pointers are made from matt-finish Nylon; figure dials are of transparent Polycarbonate or coloured Nylon; and all these moulded parts are stable in the temperature range -20°C to +70°C. Collets, sleeves and nuts, fitted during manufacture, are of brass.

Sifam Collet Knobs and Accessories are illustrated in colour in a 16 page catalogue which includes specifications, sizes and a simple ordering code. Please send for your copy now.



*Sifam knobs (shown) Applications like this 38 channel audio console bring out the best in Sifam design features. The meters are from the Sifam 'Director' range.  
(Photograph by courtesy of Zoot Horn of London)*



*These oscilloscopes made by Scopex Instruments Ltd. of Leitchworth were re-styled to incorporate Sifam collet knobs. Collet fixing is positive and no 'play' develops in use.*



**SIFAM LTD**

Woodland Road Torquay Devon England TQ2 7AY  
Telephone Torquay (0803) 63822 Telex 42864.  
*Agents throughout Europe, Africa, North America and Australasia.*

## APRS PREVIEW

than 0.0005%; the *DMS5* distortion measuring set intended for general purpose use in the studio and which can measure to 0.001% thd; and the *TT100* and *TT50* stereo valve amplifiers. Both measuring sets cover the frequency range 10-100k Hz and feature semi-automatic nulling. The *TT100* and *TT50* amplifiers have power outputs of 100W and 50W per channel respectively, and incorporate crossover feedback to provide a performance claimed to be not previously obtainable in valve amplifiers.

**Raindirk:** copy received after deadline.

**Rockwool** will be exhibiting their range of tissue-faced and unfaced mineral wool slabs for use in acoustic control. Also on display will be their range of *Rockfon* acoustic tiles and panels, all of which are said to possess excellent sound absorption qualities. Being made from mineral wool, in addition to their sound absorbent qualities Rockwool products are claimed to provide excellent thermal insulation and, being incombustible, fire protection.

**Roger Squire:** no information received.

**Scenic Sounds Equipment:** copy received after deadline.

**Shure** will be introducing a microphone new to the UK. The *SM81* is a unidirectional condenser microphone designed for most applications in studio recording, radio and television broadcasting and sound reinforcement. It features a wide-range frequency response with cardioid polar pattern, uniform with frequency and symmetrical about axis, plus a selectable low-frequency response providing flat, 6 or 18 dB/octave rolloff, and a 10 dB lockable attenuator. Phantom-powered, the *SM81* will operate on voltages of 12-48V dc. A wide range of other products can also be seen on the company's stand.

**Sifam** will show its full range of vu and peak programme meters, collet and push-on knobs. Built to the accepted relevant ASA and British standards, the meters are available in a wide range of case styles and scale lengths. In addition to traditional round and rectangular meter cases, the latest low-profile *Monitor* style will be shown. This is said to be notable for its front-of-panel, space-saving slimmness that adapts well to the needs of studio

The new  
from  
Soundcraft  
EX4S  
crossover

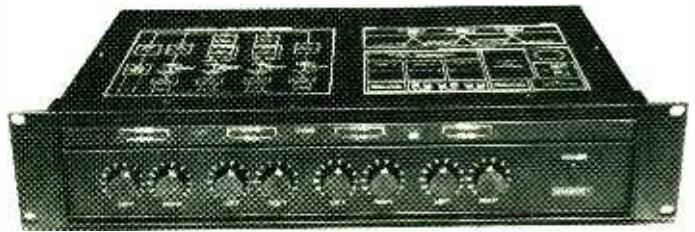

console design. New to the Sifam range this year are push-on knobs and a larger, 38 mm diameter 'short' collet-fixing knob, which is available in plain form or as a special cranked version.

**Solid State Logic** will be demonstrating for the first time in the UK the *SL4000* automated consoles and computer mixing system. Each channel includes an 'instrument-quality' compressor-expander and a four-band parametric equaliser with variable 'Q'. Machine remotes are included within each channel, and the 'unique' *Supercue* logic automatically provides artists with correct foldback resources, even during complex drop-ins. The *SL4000* computer mix recognises—for the first time, it is claimed—simple commands in English and song or mix titles without restriction. A 24-line tv display gives track and title listings and vca fader status as required. The system includes an SMPTE reader-generator and a 'fast learning' intelligent autolocator.

**Soundcraft** will be exhibiting their range of sound mixing equipment, which comprises the *Series 1S* portable stereo and four-group mixers and the *Series 2* and *3* studio mixers for four to 24-track recording. The *Series 3* is being exhibited for the first time in the UK. A console of fully modular construction, *Series 3* is said to offer the engineer an ergonomic and attractive console featuring a four-band equaliser (each band sweepable frequency) on each input channel; eight auxiliary busses; auto solo (pre and post-fade stereo); sixteen channel monitor mix into main stereo buss; plus 16 and 24-track main frame options. Cost of the *Series 3* is under £11 000. Also to be exhibited for the first time in the UK is the new *Series 1S* range of stereo and four-group mixers. The stereo format includes the aluminium carrying case into which the mixer is built, an optional walnut console being available for permanent installation. Three

sizes are available: 12, 16 and 20-input channels respectively. *Series 1S-4* is the four-group version being introduced at APRS. Based closely on the format of the stereo *Series 1S*, it is designed with the four-track demo studio in mind, and is presented as a table-top console. In addition, the first in a projected range of 483 mm rack-mounting professional accessories can be seen. The *EX4S* stereo electronic crossover is switchable for two, three or four-way operation, and costs £425.

**Soundex** plans to show a new free-standing peak programme meter, plus the *Series 1300* four-channel and *Series 6 Mk II* six-channel desks. The *Series 1300* are portable mixers for use with a crossed pair of microphones and two 'spot' mics. The *Series 6 Mk II* have break-in send and return facilities and elaborate input switching to allow most of the common signal sources to be matched to the mixer.

**Sound International** is a new monthly magazine from the people who brought you Studio Sound, aimed primarily at sound engineers and musicians, both professional and semi-professional. The first two issues, dated May and June 1978, will be at the show and give an indication of the diversity and depth of coverage. With the current trend towards smaller studios, it has become obvious that a well-crafted publication is needed to provide the vital link between the music makers and those recording sound. Sound International provides that link.

Mel Lambert and Mike Stormer will be on hand to tell it like it is about **Studio Sound**.

**Superscope Tape Duplicating:** no information received.

**Surrey Electronics** will be showing a wide range of broadcast-related products, including a high-quality stereo disc amplifier for broadcasting, disc monitoring and transfer applications; a ppm to IEC268-10A and BS5428, the drive circuit of which is built under licence from the BBC and Ernest Turner ppm movements with flush-mounting adaptors and illumination kits; a 10-outlet distribution amplifier that is said to meet IBA requirements and is available as a complete boxed unit or as a set of parts excluding the case and all *XLR* connectors; a frequency shifter (range 1-10 Hz) for howl reduction in high-quality public address and foldback systems; a spectrum shifter that frequency shifts between 0.1 and 1k Hz for 'wierd' special effects on speech or music; a peak deviation meter for monitoring mono or stereo fm stations; and a chart recorder that monitors the output from the peak deviation meter.

**Tandberg** are exhibiting the by now 'well-established' *10X* tape machine, plus a new reel-to-reel deck taking 26.7 cm spools.

### 10 OUTLET DISTRIBUTION AMPLIFIER 2



One floating input, 10 floating outputs at 600 ohms for general studio work or feeding multiple slave pa amplifiers. Electronic input circuit which withstands mains or static voltages on the signal lines.  
THD, all outputs loaded 600  $\Omega$ , at  
1KHz  
30Hz-20KHz  
STATIC IMD, 50Hz + 7KHz, 4:1  
Output +12dBV.7  
DYNAMIC IMD (DIM 100)  
Output +14dBV.7 sine equiv.  
The unit meets the IBA 'signal path' specifications and is available as a complete unit or as a set of all parts excluding the case and *XLR* connectors.

**STEREO DISC AMPLIFIER 2**  
UNMATCHED PERFORMANCE FOR BROADCASTING,  
DISC MONITORING AND TRANSFER June, page

**SURREY ELECTRONICS**  
The Forge, Lucks Green, Cranleigh, Surrey GU6 7BG  
Telephone STD 04866 5997





**setting standards**

For the full story contact F.W.O. Bauch Limited,  
49 Theobald Street, Boreham Wood, Herts. WD6 4RZ

**REVOX**

## APRS PREVIEW

Complimenting the *10X* is the *TCD 330* three-head stereo cassette deck, which incorporates a source and tape monitoring facility. Also to be seen: various items of domestic gear, including the *TR2075 Mk II* stereo receiver offering 75W per channel into 8 ohm, and the *Studio Monitor* loudspeakers which handle 160W 'music' power into an 8 ohm load with a frequency range of 25-20k Hz.

**Tannoy:** no information received.

**Trad** will again be showing a representative range of equipment they have in stock at the time of the APRS exhibition, including an 18-month old Spectra Sonics 24/24 console. Various other items of ancillary equipment will also be on display, including mics, signal processing gear etc.

**Trident** will show the new *TSM Series* of consoles equipped with separate quad and stereo outputs, 32 inputs and four-band parametric equalisation on each input. Also on display will be the modular *Fleximix* desk, which is expandable from mono to 24 tracks without rewiring, and has a maximum of 10 mixed output groups (eight submaster and two main left/right masters) with monitor on up to 24 tracks. The *CB 9076* parametric equaliser/filter, the *CB 9109* oscillator and test set (see Review page 104), plus a stereo compressor-limiter can also be seen.

**Turnkey:** copy received after deadline.

**Tweed Audio:** no information received.

**Vitavox** will be launching the *Oracle*, a high-efficiency, all-horn-loaded monitor transducer. Because of horn-loading of bass and high-frequency sections, the unit is said to be capable of handling the most severe signal transients, 'giving low distortion natural

and lively reproduction over the whole dynamic range'. Maximum achieved output is quoted at around 130 dBA at 1m with full rated input power. Price is around £700. The company will also be showing part of its range of microphones and stands, multicell horns, loudspeakers for studio use and the *Thunderbolt* horn-loaded speaker system.

The main feature of the **Walter Luther** exhibit will be the company's range of stands for microphones, loudspeakers and studio lighting applications. This range spans the lightweight *Combi Major*, a design complete with boom arm and counterweight, to the *SHD/1*, a heavyweight design capable of supporting the largest of loudspeakers.

Inbetween these two extremes are offered the *HD1* and *HD2* multipurpose stands, which can be supplied with a number of accessories enabling them to be used for a variety of

applications. Also featured will be a range of magnetic film and tape.

**Webland** will be showing the well-known **BGW** models *250*, *500D* and *750A* power amplifiers, plus a new professional range comprising the *100*, *250C*, *750B* and *750C*. There is also a new pre-amplifier with the model *410* (200W power amplifier) for the domestic market. The professional range has been tailored to meet pa, studio and disco requirements, and features include *XLR* and mono jack plug connectors. Input gain controls have now moved to the front panel with clip indicators. New 'improved' low-noise fans have been incorporated for even greater reliability. As with the old range, crowbar protection continues to be a prominent safeguard, and modular construction is said to give ease of service for quick turn round time in emergencies. ■

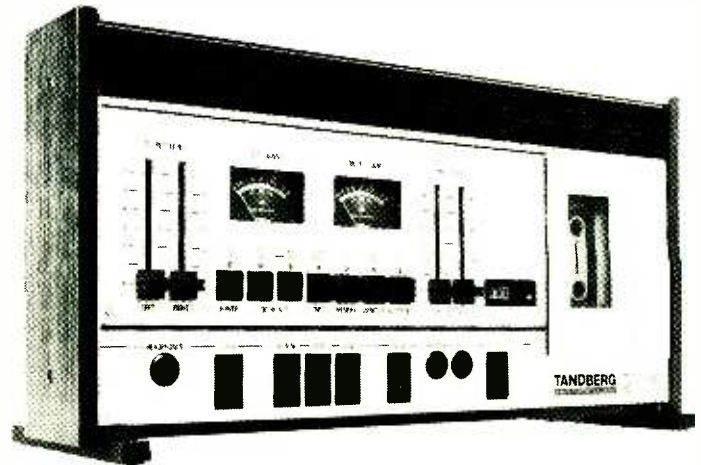

Tandberg  
TCD 330  
stereo  
cassette  
machine

## EXHIBITORS LIST

Acoustic Research (Teledyne)	93	Formula Sound	112b	Neve	47, 48
Agfa-Gevaert	72	C E Hammond	66, 67	Penny & Giles	73
AKG Acoustics	9, 10, 12, 13	Harman Audio	86	Philip Drake	97
Alice (Stancoil)	17, 18	Hayden	35	Professional Tape Marketing Associates	104
Allen & Heath/Brenell	40, 41	Helios	27	Publison	113
Allotrope/Future Film	19, 20	H/H	82, 83	Pyral	57
Amek Systems	52, 53	ICM Cassette Merchandisers	119	RAC	74
Amity Shroeder	81	ITA	75, 76, 77	Racal-Zonal	38, 39
Ampex	64, 65	'International Musician'	100	Radford	102
Audio & Design	21, 22	Jackson Recording	42	Raindirk	44
Audio Developments	16	Jacques Levy Professional	25	Rockwool	94
Audio Kinetics	85	Recording Services	89	Roger Squire	105, 106
Audix	58, 59	James Yorke	49	Scenic Sounds Equipment	43
Avcom Systems	107, 108	John Page	90	Shure Electronics	49
BASF	5	Keith Monks	71	Sifam	103
FWO Bauch	1, 2, 3	Klark-Teknik	99	Solid State Logic	56
'Beat Instrumental'	50	Lee Engineering	15	Soundcraft	36, 37
Beyer	61, 62	Leevers-Rich	23	Soundex	111
'Billboard'	117	Lennard Developments	27	'Sound International'	24
Broadcast Audio	115	Libra Electronics	6	'Studio Sound'	24
B & K	98	Lockwood	88	Superscope Tape Duplicating	114
Cadac	33, 34	Lyrec	14	Surrey Electronics	109
Calrec	30, 31	Macinnes	84	Tandberg	51
Cetec	80	Maglink	63	Tannoy	101
Dolby	45, 46	Magnetic Tapes	7	Trad	32
Eardley Electronics	118	MCI	8-11	Trident	28, 29
Electro-Voice	78, 79	Midas	4	Turnkey	112a
EMI	68	3M	120	Tweed Audio	95
Feldon Audio	70	Mosses & Mitchell	87	Vitavox	60
		National Panasonic	96	Walter Luther	116
		Neal-Ferroglyph		Webland	92

# NOW POLYDOR ARTISTS CAN TELL IF THEY STILL SOUND LIKE THEMSELVES.

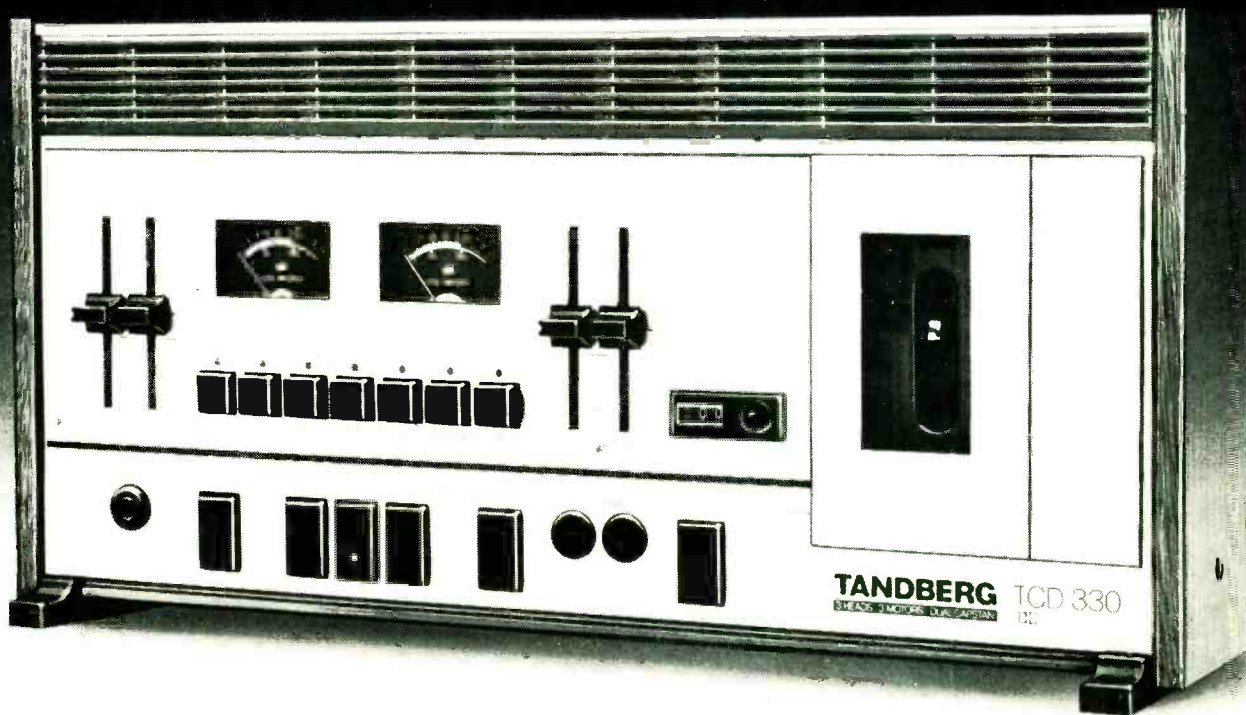

Polydor have a machine in their London studios that they use to copy sessions. Then the artist, producer, composer or whoever can take the day's work home and study it before the next session.

The machine is the Tandberg TCD 330 deck. *Cassette* deck, that is.

Because cassette decks have come of age, and Tandberg make one of the finest you can buy. In many ways it compares well with professional reel-to-reel equipment—and has advantages of its own as well. Just ask any of Polydor's artists....

## SOME OF THE TCD 330's ADVANTAGES

Three heads for A/B monitoring. Professional peak level record/ playback meters. High-speed wind and rewind (C60 in 45 seconds). Logic touch controls. Simple to oper-

ate azimuth adjustment gives excellent results with a variety of cassette brands.

Frequency range: 20 Hz to 20000 Hz (DIN 45500), 30 Hz to 18000 Hz ( $\pm 3$  dB) with FM/MPX disconnected. Harmonic distortion less than 0.3% from the amplifier with 0 dB rec. level, less than 3% from the tape with 0 dB rec. level. Can be used vertically (special feet provided) or horizontally. Remote control facility available.

See and hear the Tandberg TCD 330 for yourself (with a new 10" reel-to-reel recorder) on Stand 51, Empire Room, APRS Exhibition, Connaught Rooms, London WC2, 21-23 June, or ask us for a leaflet with all details and a complete tech-spec.

# TANDBERG

Tandberg (UK) Limited, 81 Kirkstall Road, Leeds LS31HR. Tel: (0532) 35111

# Survey: test equipment

Clearly it would be impossible to include full details of all equipment offered by every manufacturer. The following survey comprises an abbreviated directory of currently-available test and calibration hardware on a manufacturer-by-manufacturer basis.

Forthcoming surveys include monitor loudspeakers (September), studio ancillaries (October), broadcast and pa mixers (December) and multitrack consoles (January 1979). Manufacturers and agents are invited to submit product details for inclusion to reach the editorial office (address page 3) at least six weeks before the issue publication date (preferably a lot earlier).

## ACOUSTILOG

Acoustilog Inc, 19 Mercer Street, New York, NY 10013, USA.  
Phone: (212) 925 1365.

**Products**  
REVERB TIMER

## ADI

Audio Developments International Corp, 644 Emerson Street, Palo Alto, Ca 94301, USA.  
Phone: (415) 321 3035. Telex: 470464.

**Products**  
SPECTRUM ANALYSERS

## AEC

Audio Engineering Components GmbH, 6053 Obertshausen, Geleitstrasse 11, West Germany.  
Phone: 09104-42324.

**Products**  
SPECTRUM ANALYSERS AND ACCESSORIES

## ALICE

Alice Stancoil Ltd, Alexandra Road, Windsor, Berkshire, UK.  
Phone: Windsor 51056. Telex: 849323.

**Products**  
NOISE MEASURING SETS

## AMBER

Amber Electro Designs Ltd, Suite 403, 4810 Jean Talon West, Montreal H4P 2N5, Canada.  
Phone: (514) 735 4105.

**Export:** Gotham Export Corp, 741 Washington Street, New York, NY 10014, USA.  
Phone: (212) 741 7411. Telex: 129269.  
**UK:** Scenic Sounds Equipment, 97-99 Dean Street, London W1V 5RA.  
Phone: 01-734 2812. Telex: 27939.

**Products**  
AUDIO TEST SET AND ACCESSORIES  
SPECTRUM ANALYSERS

## B & K

Brüel & Kjaer A/S, 18 Naerum Hovedgade, 2850 Naerum, Denmark.

Phone: 02-800500. Telex: 37316.  
**UK:** B & K Laboratories Ltd, Cross Lances Road, Hounslow, Middlesex.  
Phone: 01-570 7774. Telex: 934150.  
**US:** B & K Instruments Inc, 5111 West 164th Street, Cleveland, Ohio 44142.  
Phone: (216) 267 4800. Telex: 810421.

**Products**  
ACOUSTIC STANDING WAVE MEASUREMENT  
BEAT FREQUENCY OSCILLATORS  
DISTORTION ANALYSERS  
FREQUENCY RESPONSE MEASUREMENT  
IMPULSE RESPONSE TESTING  
INTERMODULATION DISTORTION ANALYSERS  
LEVEL RECORDERS  
MICROPHONE CALIBRATION GEAR

NARROW BAND ANALYSERS  
NOISE ANALYSERS  
NOISE GENERATORS  
OSCILLATORS  
PHASE METERS  
PSOPHOMETERS  
REAL TIME ANALYSERS  
SINE RANDOM GENERATORS  
SPECTRUM ANALYSERS  
TIM AND BIM DISTORTION SYSTEMS  
VOLTMETERS  
WOW AND FLUTTER METERS

## COURT

Court Acoustics, 50 Dennington Park Road, West Hampstead, London NW6.  
Phone: 01-435 0532.

For a full list of overseas agents see March 1978 issue, page 60.

**Products**  
SPECTRUM ANALYSERS

## CROWN/AMCRON

Crown International, Box 1000, Elkhart, Indiana 46514, USA.

Phone: (219) 294 5571. Telex: 2942160.  
**UK:** Macinnes Laboratories Ltd, Macinnes House, Carlton Park Industrial Estate, Saxmundham, Suffolk IP17 2NL.  
Phone: 0728-2262/2615.  
Agents in most countries

**Products**  
SPECTRUM ANALYSER AND ACCESSORIES

Acoustilog model 232 reverb timer

80 ▶



# Union Studios Munich take C.A.R.E.\*

with the new inline  
D40/40 (WITH 32 TRACK  
BUSSING)  
for 38 track recording

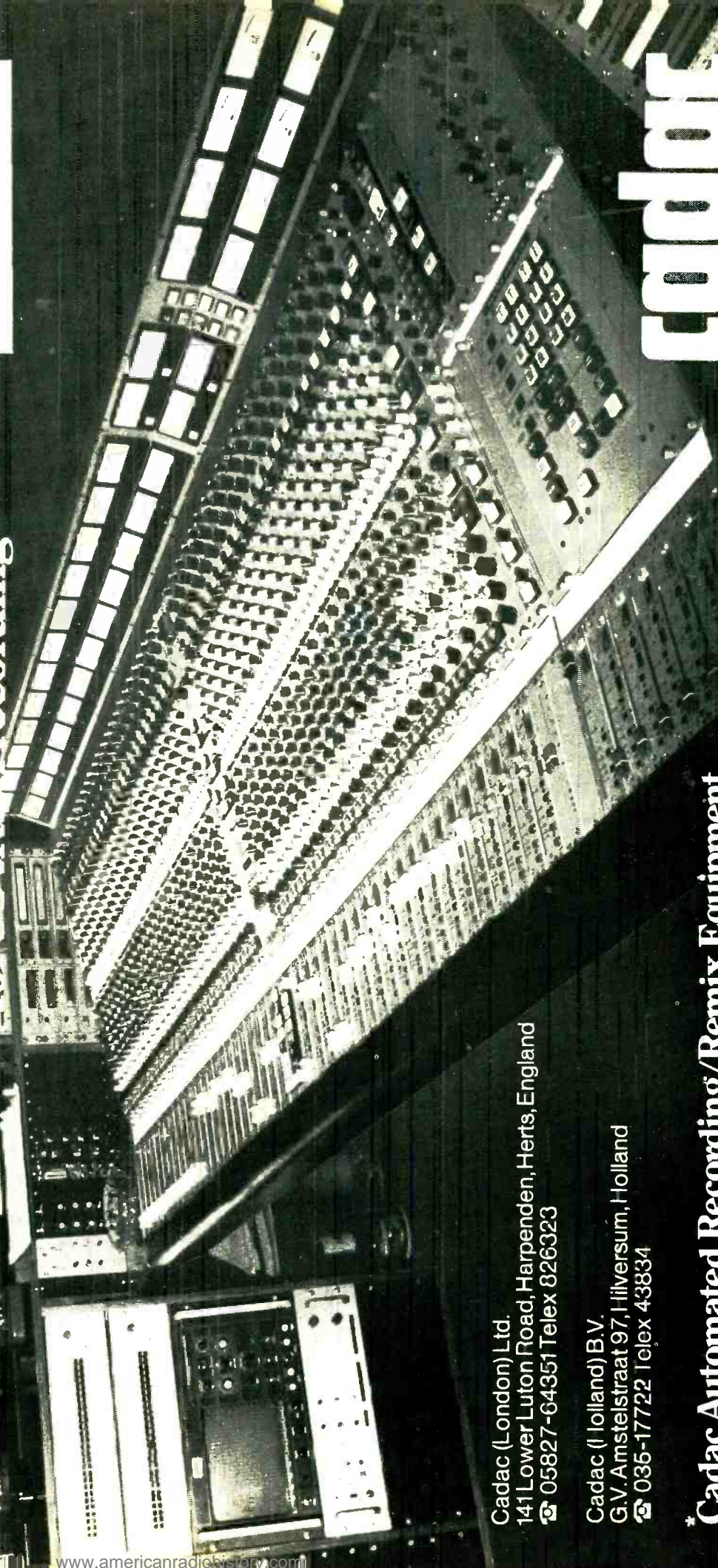
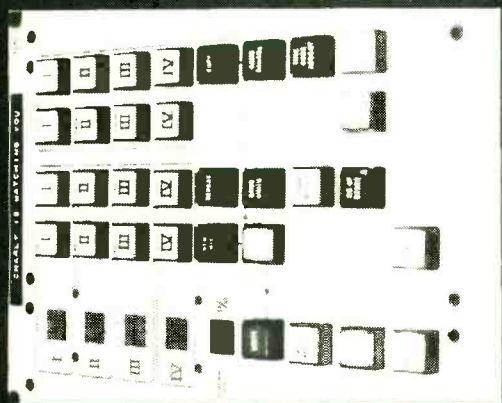

Cadac (London) Ltd.  
141 Lower Luton Road, Harpenden, Herts, England  
☎ 05827-64351 Telex 826323

Cadac (Holland) B.V.  
G.V. Amstelstraat 97, IJlversum, Holland  
☎ 035-17722 Telex 43834

\*Cadac Automated Recording/Remix Equipment

# Cadac

## SURVEY: TEST EQUIPMENT

### DANELCO

Export: Hammer Trading Co ApS, Dalen 8, DK-3060 Espergaerde, Denmark.  
Phone: 03-233826.  
UK: Telonic Berkley UK, 2 Castle Hill Terrace, Maidenhead, Berks SL6 4JR.  
Phone: 0628-28507. Telex: 849131.

#### Products

WATTMETER  
WOW AND FLUTTER METER



EMT 328 micro-impedance meter



EMT 422 wow and flutter meter

### DORAM

Doram Electronics Ltd, PO Box TR8, Wellington Road Industrial Estate, Wellington Bridge, Leeds LS12 2UF, UK.  
Phone: 0532-452458.

#### Products

LOW-DISTORTION OSCILLATOR  
MILLIVOLTMETER  
DISTORTION METER



EMT 424 flutter analyser

### EMT

EMT-Franz VGmbH, D-763 Larh 1, Postfach 1520, West Germany.  
Phone: 07825-512. Telex: 754319.  
UK: FWO Bauch Ltd, 49 Theobald Street, Borehamwood, Herts WD6 4RZ.  
Phone: 01-953 0091. Telex: 27502.  
US: Gotham Audio Corp, 741 Washington Street, New York, NY 10014.  
Phone: (212) 741 7411. Telex: 27502.

#### Products

POLARITY TESTER  
FLUTTER METER  
MICRO-IMPEDANCE METER

Farnell cont'd

SIGNAL GENERATORS  
SWEEP GENERATORS  
SYNTHESISED SINE GENERATORS

### FARNELL

Farnell Instruments Ltd, Sandbeck Way, Wetherby, Yorkshire, LS22 4DH, U.K.  
Phone: 0937-63541. Telex: 557294.  
Agents in most countries.

#### Products

OSCILLATORS  
FUNCTION GENERATORS  
MILLIVOLTMETERS  
MODULATION METERS  
OSCILLOSCOPES

### FERROGRAPH

North East Audio Ltd, Simonside Works, Leam Lane, South Shields, Tyne & Wear NE34 9NX, UK.  
Phone: 0632-566321. Telex: 537227.  
US: Hammond Industries, 155 Michael Drive, Syosset, NY 11791, USA.  
Phone: (516) 364 1900. Telex: 961396.

#### Products

AUDIO TEST SET AND ACCESSORIES 82 ►

Danelco wow and flutter meter



## INTERNATIONAL DEALERS

### United Kingdom

Audio Kinetics (UK) Ltd., Verulam Road, St. Albans AL3 4DH Tel: (0727) 32191

### Austria

Acousta Elektronik, Hofhaymerallee 15, A-5020 Salzburg Tel: 06222/46164

### Germany

Estemac Electronic GmbH, Alter Teichweg 67, 2000 Hamburg 70 Tel: (0 40) 61 06 60

### Norway

Siv. Ing. Benum & Co., Boks 2493, Solli, Oslo 2 Tel: (02) 56 57 53

### France

Recording. Electronic. Design., 3 Rue Du Telegraphue, 75020, Paris Tel: 636 73 10

### South America

Electronica Gramcko, Av. Sanz - Edificio Escar, Local B - Apt. 75442, El Marques, Caracas, Venezuela Tel: 35 43 78

### Hong Kong

Fee Lun Radio Service, Wai Shun Bldg., 11th Floor, 5 Yuk Yat Street, Tokwawan, Kowloon Tel: 3-656611

### Republic of China

Linfair Engineering & Trading, 7/F 7, Jen Ai Road, Sec. 2, Taipei, Taiwan Tel: 3214454-7.

### Canada

Commercial Electronics Ltd., 1305 Burrard Street, Vancouver 1 B.C. Tel: (604) 685-0301.

### New Zealand

Magnetic Products Ltd., 108-110 Jervois Road, Herne Bay, Auckland 2 Tel: 760-607.

### Australia

Rank Industries Australia (Pty). Ltd., 12 Barcoo Street, East Roseville, N.S.W. 2069 Tel: 406 5666.

### Indonesia

P. T. Kirana Yudha Teknik, P.O. Box 71, Jatinegara, Jakarta Tel: 883823.

### Japan

Electori Co. Ltd., Mondo Bldg., 1-19-3 Kamiyochiai, Shinjuku-Ku, Tokyo Tel: (03) 950-6266.

### Singapore

Electronics & Engineering Pte. Ltd., 271 Outram Road, Singapore 3 Tel: 75873.

### Philippines

Electro-Systems, Corinthian Plaza, Garden Floor, 121 Paseo de Roxas, Legaspi Village, Makati, Metro Manila Tel: 85-99-96

### India

Magna-Tech Electronic, 273/4 "Rama Baug", Deohar Road, Matunga, Bombay Tel: 400 019.

### Quad/Eight International Quad/Eight Electronics

11929 Vose St., No. Hollywood CA91605  
(213) 764-1516 Telex: 662-446



*Introducing the Coronado:  
40 input, 24 Mixing Buss Console  
with Compumix III Automation*

*For the Artist in Every Engineer*



**Quad/Eight Electronics  
Quad/Eight International**

11929 Vose Street, North Hollywood, California 91605 (213) 764-1516 Telex 662-446

[www.americanradiohistory.com](http://www.americanradiohistory.com)

## SURVEY: TEST EQUIPMENT

### FIDELIPAC

Fidelipac Inc, 109 Gaither Drive, Mt Laurel, NJ 08057, USA.  
Phone: (609) 235 3511.

**Products**  
WOW AND FLUTTER METER

### FORMULA SOUND

Formula Sound Ltd, 3 Waterloo Road, Stockport, Cheshire.  
Phone: 061-480 3781.

**Products**  
SPECTRUM ANALYSER AND ACCESSORIES

### FLUKE

John Fluke Manufacturing Co Inc, PO Box 43210, Mountlake Terrace, WA 98043, USA.  
Phone: (800) 426 0361.  
UK: Fluke International Corp, Garnett Close, Watford WD2 4TT.  
Phone: Watford 33066. Telex: 934583.  
Agents in most countries.

**Products**  
DIGITAL VOLTMETERS  
DIFFERENTIAL VOLTMETERS  
FREQUENCY COUNTERS AND TIMERS  
SIGNAL GENERATORS  
DATA LOGGERS

### HEWLETT-PACKARD

Hewlett-Packard Corp, 1501 Page Mill Road, Palo Alto, Ca 94304, USA.  
Phone: (415) 493 1501. Telex: 348461.  
UK agent: Hewlett-Packard Ltd, King Street Lane, Winnersh, Wokingham, Berks RG11 5AR.  
Phone: 0734-784774 Telex: 847178.  
Agents in most countries.

**Products**  
DISTORTION ANALYSERS  
FOURIER ANALYSERS  
FUNCTION GENERATORS  
GROUP DELAY MEASUREMENT  
NETWORK ANALYSERS  
OSCILLATORS  
SIGNAL GENERATORS  
SPECTRUM ANALYSERS  
SWEEP GENERATORS  
WAVE ANALYSERS

### INOVONICS

Inovonics Inc, 503B Vandell Way, Campbell, Ca 95008, USA.  
Phone: (408) 374 8300.

Hewlett-Packard 5370A universal time interval counter

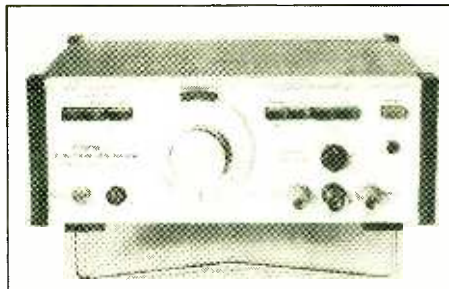
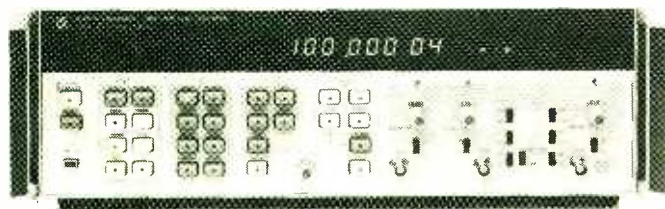

Farnell FG3 function generator

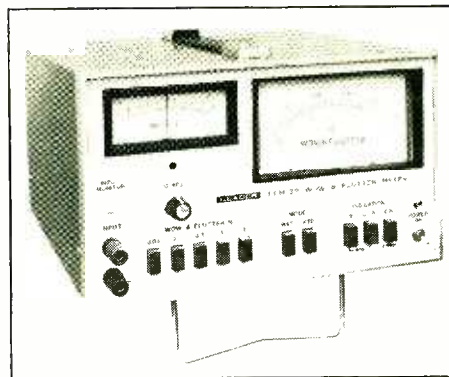

Leader LFM-39 wow and flutter meter

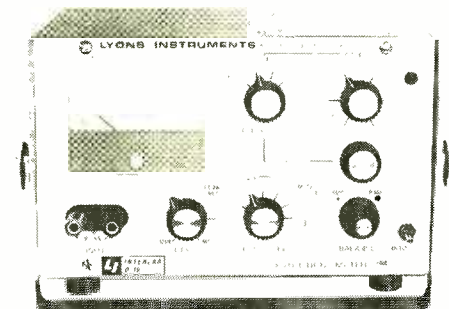

Model D10 distortion meter from Lyons Instruments

**Products**  
SPECTRUM ANALYSERS AND ACCESSORIES

### IVIE

Ivie Electronics Inc, 500 West 1200 South, Orem, Utah 84057, USA.  
Phone: (801) 224 1800. Telex: 9715884.  
UK: FWO Bauch Ltd, 49 Theobald Street, Borehamwood, Herts WD6 4RZ.  
Phone: 01-953 0091. Telex: 27502.  
Agents in most countries.

**Products**  
PORTABLE SPECTRUM ANALYSERS AND ACCESSORIES

### LEADER

Leader Electronic Corp, 2-6-33 Tsunashima Higashi, Kohoku-ku, Yokohama, Japan.  
UK: C. E. Hammond & Co Ltd, 105-109 Oyster Lane, Byfleet, Surrey KT14 7LA, UK.  
Phone: Byfleet 51051. Telex: 262525.  
US: Leader Electronic Corp, 151 Dupont Street, Plainview, NY 11803, USA.  
Phone: (516) 822 9300.

**Products**  
OSCILLOSCOPES  
WOW AND FLUTTER METERS  
AUDIO GENERATORS  
FREQUENCY RESPONSE ANALYSERS  
MILLIVOLTMETERS

### LEVELL

Level Electronics Ltd, Moxon Street, Barnet, Herts EN5 5SD.  
Phone: 01-449 5028.

**Products**  
OSCILLATORS  
MILLIVOLTMETERS  
AC VOLTMETERS

### LYONS

Lyons Instruments Ltd, Ware Road, Hoddesdon, Herts EN11 9DX, UK.  
Phone: Hoddesdon 67161. Telex: 22724.

**Products**  
AF SIGNAL GENERATORS  
DISTORTION METERS  
FUNCTION GENERATORS  
MILLIVOLTMETERS  
NOISE GENERATORS  
OSCILLATORS  
Lyons are also UK agents for Elgenco, Helper, Millivac and NF Circuit products.

### MARCONI

Marconi Instruments Ltd, Longacres, St Albans, Herts AL4 0JN, UK.  
Phone: 0727-59292. Telex: 23350.  
US: Marconi Electronics Inc, 100 Stonehurst Court, Northvale, NJ 07647.  
Phone: (201) 767 7250 Telex: 9919752.  
Agents in most countries.

**Products**  
DISTORTION ANALYSERS  
FREQUENCY METERS  
MODULATION METERS  
OSCILLATORS  
SIGNAL GENERATORS  
SPECTRUM ANALYSERS  
SWEEP GENERATORS  
BROADCAST TEST EQUIPMENT

Inovonics model 500 acoustic analyser

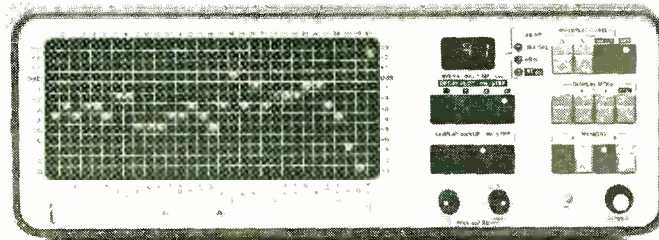



### REVOX B77

The new Revox with full logic, easy editing, varispeed option. Check our new low prices on this and the A77 range



### ALLEN & HEATH SD12-2

New 12/2 Sound re-inforcement mixer which may also be used for 4 track recording.

£430  
+ VAT

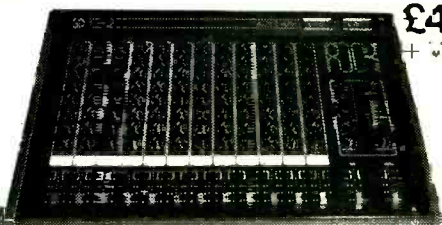

### H/H STEREO 12

Quality 12/2 desk from a manufacturer needing no introduction - many features at a sensible price.

£330  
- VAT

on demonstration with comparison echo/effects module.

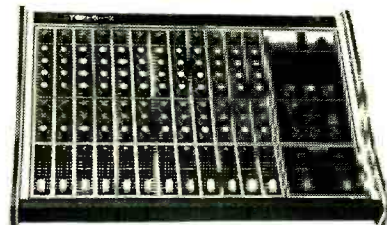

# Roger Squire's PRO-AUDIO

BRITAIN'S LEADING SUPPLIERS OF  
PROFESSIONAL AUDIO EQUIPMENT

### QUAD 405

Unique "current dumping" monitor amplifier

£160  
+ VAT

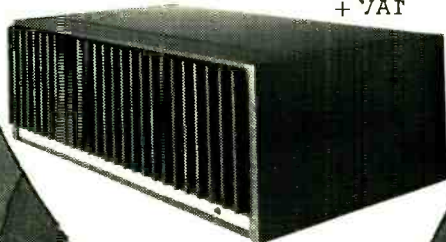

### TEAC TASCAM 80-8

Economic operation, simplicity of use - 8 track recording at a price for those with more talent than money.

£2314  
+ VAT



DX-8 8 channel DBX Unit  
£680 + VAT

All Teac, Tascam multi-track range or full demonstration.

### ANGLE POISE MICROPHONE ARM



£14.75  
+ VAT

We are sole U.K. distributors of this product. Available with wall, table or clamp mounting bracket. Available in black and chrome.

All prices correct at the time of going to press.

You'll find the approach quite different at Roger Squire's Pro-Audio, it's something known as service. Like other suppliers we carry large stocks (a wider range and larger than most). Yet before the point of purchase we want you to be convinced you are making the right choice.

You are invited to visit our showrooms where you will find a vast range of mixers, multi-track tape machines, microphones, monitor amps, etc. wired ready for demonstration, which together with our Technical Advisory Service is an unbeatable combination.

Should you meanwhile wish to consider the extent of our product range, it's contained in our NEW 60 page catalogue. We would be pleased to send a copy FREE of charge upon request.

Branch Manager: Cliff Lake  
Sales Engineer: Dave Whittaker  
55 Charlbert St. London, NW8 6JN  
Telephone: 01-722 8111 Telex: 298133

Showrooms open - Tuesday - Saturday 10.00 a.m. - 5.00 p.m.  
Late night Weds. until 8.00 p.m.  
Local parking - 5 mins. from St. Johns Wood Tube.  
EXPRESS UK AND EXPORT DELIVERY SERVICE



AGENTS FOR:

PEG · BEYER · CALREC · SHURE · TEAC · TASCAM · MM · CHILTON · CANARY · H/H · ALLEN & HEATH · BRENEL · RECORDING STUDIOS DESIGN · HILL · SCJNDRAFT · OTARI · FERROGRAHER · REVOX · UHER · QUAD · AMCRON · BOSE · TANNO · JBL · KLARK-TEKNIK · MIX · DBX · TECHNICS · RUSSCO · NEUTRIC CONNECTORS · OVAL MIXERS · STANTON · TAPSCASTER · TRIDENT

Aphex Audio Systems UK, Ltd  
35 Britannia Row  
London N18QH England  
Tel: 01-359 0955/6  
Contact: Robbie Williams

Aphex West  
7801 Melrose Avenue  
Los Angeles  
Calif. 90046  
Tel: 213.655.1411  
Contacts: Kent Beyer  
Pat Taylor

Aphex New York, Ltd.  
1400 Pleasant Valley Way  
West Orange  
New Jersey 07052  
Tel: 201.736.3422/212.964.7444  
Contacts: Stephan Galfas  
Charlie Conrad

Aphex Systems Canada, Ltd.  
311 Adelaide Street  
E. Toronto  
Ontario M5A 1N2, Canada  
Tel: 416.363.1715  
Contact: Ron Lynch

Aphex France  
42 Rue Pergolese  
75116 Paris France  
Tel: (1) 256-50-50  
Contact: Georges Blumendeld

Aphex Germany, GmbH  
c/o Rockoko Production  
Elsterweg 4,  
6333 Braunfels  
Germany  
Tel: (06442) 5303  
Contact: Peter Hauke

Aphex Benelux  
18 Avenue Bes Me,  
1190 Brussels  
Belgium  
Tel: (02) 345-4444  
Contact: Lucien F. Velu

Aphex Scandia  
Box 5349  
102 46 Stockholm  
Sweden  
Tel: 08-678069  
Contact: Bengt Olwig

Aphex Switzerland  
Place du Grand-Mont  
CH-1052 Le Mont-sur-Lausanne  
Switzerland  
Tel: 021-33 3355  
Contact: Gaston Schaefer

Aphex Audio Systems Australia,  
Pty Ltd.  
21 Pier Street  
Sydney 2000 Australia  
Tel: 261381  
Contact: Ron Purvis

Aphex Hawaii Ltd.  
679 Auahi Street Honolulu  
Hawaii 96813  
Tel: (808) 521-6791  
Contact: Sam Holt

## SURVEY: TEST EQUIPMENT

### 3M

**3M Company, Mincom Division, 3M Centre, St Paul, Minn 55101, USA.**

**Phone: (612) 733 1110.**

**UK: 3M UK Ltd, Mincom Products Group, Recording Materials Division, PO Box 1, Bracknell, Berks RG12 1JU.**

**Phone: 0344-26726. Telex: 849371.**

Agents in most countries.

### Products

AUDIO TEST SET  
WOW AND FLUTTER METER  
WAVE ANALYSER

### MJS

**MJS Electronics, 27 Walnut Close, Yateley, Camberley, Surrey GU17 7DA, UK.**

**Phone: 0252-871401.**

### Products

NOISE AND LEVEL TEST SET

### MUIRHEAD

**Muirhead Vatric Components, Measurement and Control Division, 154/160 Croydon Road, Beckenham, Kent.**

**Phone: 01-650 4888. Telex: 262710.**

### Products

ATTENUATORS  
BITS  
AUTO TRAK  
AUTO SCAN

### NEUTRIK

**Neutrik AG, SI 9494 Schaan, Obergass 16, Liechtenstein.**

**Phone: 075-26383. Telex: 77771.**

**UK: Eardley Electronics Ltd, Eardley House, 182-184 Campden Hill Road, London W8 7AS.**

**Phone: 01-221 0606.**

### Products

PORTABLE FREQUENCY AND TIME PLOTTER

### PYRAL

**Pyral SA, 70-72 av du Gal-de-Gaulle, Eschat 661, 94022 Creteil Cedex, France.**

**Phone: 377 1251. Telex: 230520.**

**UK: Pyral Magnetics Ltd, Airport House, Purley**

Way, Croydon, Surrey CRO 0XZ.

**Phone: 01-681 2833. Telex: 946670.**

**US: Gotham Audio Corp, 741 Washington Street, New York, NY 10014.**

**Phone: (212) 741 7411. Telex: 129269.**

Agents in most countries.

### Products

SPECTRUM ANALYSERS AND ACCESSORIES

### RACAL-DANA

**Racal-Dana Instruments Ltd, Duke Street, Windsor, Berks SL4 1SB, UK.**

**Phone: Windsor 69811. Telex: 849013.**

**France: Racal-Dana Instruments SA, 91 Route des Gardes, 92 Meudon-Bellevue, Paris.**

**Phone: 027-7575. Telex: 200207.**

**US: Racal-Dana Instruments Inc, 18912 Von Karman Avenue, PO Box C19541, Irvine, Ca 92713.**

**Phone: (714) 833 1234. Telex: 678341.**

### Products

FREQUENCY METERS  
DIGITAL VOLTMETERS  
SIGNAL GENERATORS  
OSCILLOSCOPES  
Racal-Dana are also agents for EIP, Exact and Cushman products.

### RADFORD

**Radford Laboratories Ltd, 4 High Street, Nailsea, Bristol, UK.**

**Phone: 02755-856637.**

### Products

DISTORTION MEASURING SETS  
LOW-DISTORTION OSCILLATOR  
NOISE METERS  
VOLTMETERS  
PHASE METERS

### SENNHEISER

**Sennheiser Electronic, 3302 Bissendorf, Hanover, West Germany.**

**Phone: 05130-8011.**

**UK: Hayden Laboratories Ltd, Hayden House, Churchfield Road, Chalfont St Peter, Bucks SL9 9EW.**

**Phone: Gerrards Cross 88447. Telex: 849469.**

**US: Sennheiser Electric Corp (NY), 10 West 37th Street, New York, NY 10018.**

**Phone: (212) 239 0190. Telex: 421608.**

### Products

MILLIVOLTMETERS

86 ▶

Racal Dana model 9093 two-tone signal source



# This tape has been Aurally Excited.

The <sup>®</sup> Aphex Aural Exciter is an astonishing signal processing instrument, which brings sound to life and makes it louder without any actual level change.

This is the principle behind it.

Sound waves enter our ears with subtle phase information relating to the location of the sound source—left or right, up or down, front or back, direct or reflected. By using a sum and differencing technique, the brain provides us with our critical aural perception.

But collecting sound, mixing it and then recording it often destroys or masks much of the subtle information resulting in a "flatter sound" than the original.

However, the Aphex introduces phase information in the form of a series of minute delays, whose magnitude depend on frequency.

The formula by which Aphex selectively processes the audio signal is not random; it has been designed after considerable research into the mechanisms of the ear, in particular the reflections and minute time delays caused by its shape.

Aphex is best used on selected channels, normally in the remix stage of production, fed from the echo or foldback send. The output from Aphex is then mixed back into the main signal at about -15 to -30dB.

Aphex is already famous for what it does to vocals. But any instruments with natural sound (ie not electronically produced) like snare drums, cymbals, acoustic guitars, strings and brass sound amazing when Aphexed.

Call it what you will, this effect causes no changes in level, confirming that it is truly a psychological effect.

Because the Aphex principle is young, we expect to replace it continually with new and even more exciting versions, so you can't buy it; you must lease it.

Contact us for more details, or to arrange for a demonstration.

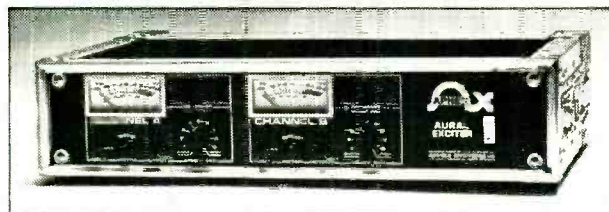

APHEX AUDIO SYSTEMS UK LTD., 35 BRITANNIA ROW, LONDON N1 8QH. TELEPHONE 01-359 0955/6

® APHEX IS A REGISTERED TRADEMARK OF APHEX SYSTEMS LTD OF LOS ANGELES, CALIFORNIA, USA.

[www.americanradiohistory.com](http://www.americanradiohistory.com)

# IF YOU NEED JACKFIELDS WHY NOT TALK TO THE SPECIALISTS?

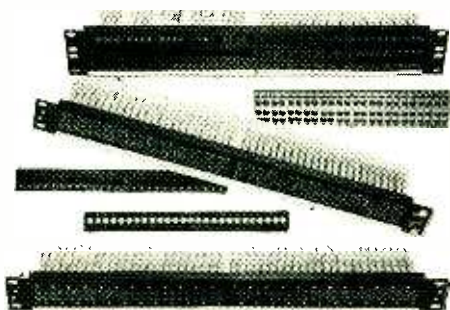

## PANELS AND ASSEMBLIES

No supplier offers a wider range of panels, inserts and accessories for just about any configuration. And you can get them in any stage of assembly . . . individual components, sub-assemblies, or complete pre-wired and connectorised assemblies ready to install. Our Bantam range gives a space saving of up to 50 per cent.

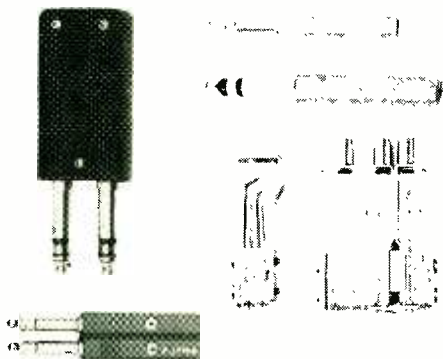

## JACKS AND PLUGS

Singles, twins, back-to-back, 2+1, patch and switchboard cords, in long frame and Bantam, and our new Printed Circuit Board Jacks. Most standard types are available for immediate off-the-shelf delivery.

For further information on these and our range of B.P.O. type components, telephone or send the attached below to:

## C.A.E. LIMITED

70/82 Akeman Street, Tring, Herts.  
HP23 6AJ  
Tel. (044 282) 4011 Telex: 82362 BATECO G

Please send us copy of current catalogue  
NAME .....  
COMPANY .....  
POSITION..... Tel.....  
ADDRESS .....

## SURVEY: TEST EQUIPMENT

### SHURE

Shure Brothers Inc, 222 Hartrey Avenue, Evanston, Ill 60204, USA.  
Phone: (312) 328 9000.  
UK: Shure Electronics Ltd, Eccleston Road, Maidstone ME15 6AU.  
Phone: 0622-59881. Telex: 96121.  
Agents in most countries.

Products  
SPECTRUM ANALYSERS AND ACCESSORIES

### SOUND TECHNOLOGY

Sound Technology Int'l, 1400 Dell Avenue, Campbell, Ca 95008, USA.  
Phone: (048) 378 6540.  
UK: C. E. Hammond & Co Ltd, 105-109 Oyster Lane, Byfleet, Surrey KT14 7LA.  
Phone: Byfleet 51051. Telex: 262525.  
West Germany: Audio Engineering Components GmbH, 6053 Obertshausen, Geleitstrasse 11.  
Phone: 06104-42324.

Products  
AF SIGNAL GENERATOR  
DISTORTION ANALYSER  
LOW-DISTORTION OSCILLATORS

### SUGDEN

J. E. Sugden & Co Ltd, Carr Street, Cleckheaton, West Yorkshire BD19 5LA, UK.  
Phone: 0274-872501.

Products  
DISTORTION MEASUREMENT SET  
MILLIVOLTMETERS  
OSCILLATORS

### TRIDENT

Trident Audio Developments Ltd, 112-114 Wardour Street, London W1V 3AW, UK.  
Phone: 01-734 9901. Telex: 27782  
US: Studio Maintenance Services Inc, 12438 Magnolia Boulevard, North Hollywood, Ca 91607.  
Phone: (213) 877 3311.

Products  
LOW-FREQUENCY OSCILLATOR AND FREQUENCY COUNTER (see Review on p104).

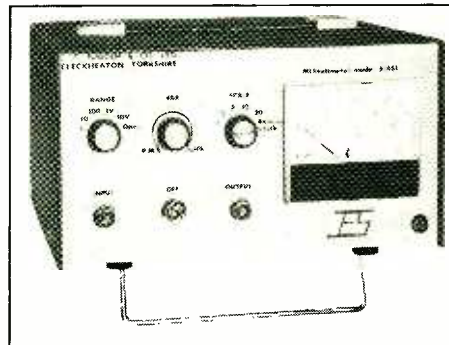

Sugden model Si 451 millivoltmeter

### UREI

United Recording Electronics Industries, 11922 Valerio Street, North Hollywood, Ca 91605, USA.  
Phone: (213) 764 1500. Telex: 651398.  
Export: Gotham Export Corp, 741 Washington Street, New York, NY 10014.  
Phone: (212) 741 7411. Telex: 129269.  
UK: FWO Bauch Ltd, 49 Theobald Street, Borehamwood, Herts WD6 4RZ.  
Phone: 01-953 0091. Telex: 27502.

Products  
ROOM AND SYSTEM ANALYSER  
AUTOMATIC RESPONSE PLOTTING SYSTEM

### WANDEL & GOLTERMANN

Wandel & Goltermann, Postfach 45, 7412 Ennigen, West Germany.  
Phone: 07121-3226. Telex: 0729833.  
UK: Wandel & Goltermann (UK) Ltd, 40-48 High Street, Acton, London W3 6LG.  
Phone: 01-992 6791. Telex: 934480.

Products  
LEVEL METERS  
NARROW-BAND WAVE ANALYSERS  
PCM TEST EQUIPMENT  
SPECTRUM ANALYSERS  
SWEEP MEASUREMENT SET  
WHITE NOISE GENERATOR

### WAVETEK

Wavetek Inc, 9045 Balboa Avenue, San Diego, Ca 92112, USA.  
Phone: (714) 279 2200. Telex: 910-3352007.



Sound Technology  
1710A distortion analyser

# More than just a new microphone. More a new way to record.

The Calrec sound-field microphone represents a new departure in microphone technology, giving unprecedented operational flexibility and accuracy of stereo recording.

Based on an application of the mathematical theory of Sampling in which a closely spaced array of capsules and associated matching electronic circuitry completely characterise the first-order directivity of the sound reaching the microphone.

Four outputs are generated proportional respectively to the sound-field pressure and to the three components of pressure-gradient (left minus right, front minus back, and up minus down). From these four signals, known as B-format, any first-order microphone characteristic can be synthesised. That is to say -any combination of omni-directional, cardioid, hyper-cardioid, or figure-of-eight.

Any number of such microphones can be synthesised simultaneously and the microphone control unit provides, in addition to mono and multi-channel feeds, the output of a stereo pair.

Controls are provided which enable the angle between the two microphones of the pair to be varied, as well as the directivity patterns of the individual microphones. The whole stereo pair can then be panned or tilted in any direction. **These controls can be exercised either live, or in post-session processing of the B-format tape.**

This new facility goes of course much beyond the capability of the usual kinds of variable-pattern microphone. An additional advantage is that over most of the audio spectrum the virtual microphones of the stereo pair are strictly coincident. This gives worthwhile improvement over the usual kind of close-spaced stereo pair in which phase-errors can exceed 180° at the top of the audio band.

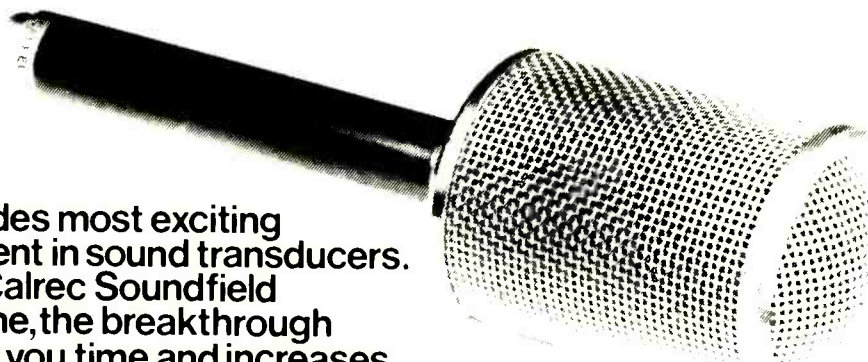

The decades most exciting achievement in sound transducers. The new Calrec Soundfield Microphone, the breakthrough that saves you time and increases your recording scope.

## CALREC SOUNDFIELD

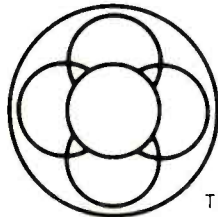

*Calrec Audio Limited*

MANUFACTURERS OF CAPACITOR MICROPHONES  
AND SOUND MIXING EQUIPMENT  
HANGINGROYD LANE, HEBDEN BRIDGE,  
YORKSHIRE, ENGLAND HX7 7DD. TEL. 0422 84 2159  
TELEX 517479 ANSWER BACK 'SERVICE'.

**APRS  
Stand 30/31**

## SURVEY : TEST EQUIPMENT

**UK:** Wavetek Electronics Ltd, 109 Crockhamwell Road, Woodley, Reading, Berks RG5 3JP, UK.  
Phone: 0734-694944/692467. Telex: 849301.  
Agents in most countries.

### Products

FUNCTION GENERATORS  
OSCILLATORS  
PHASE METERS  
SIGNAL GENERATORS  
SWEEP GENERATORS

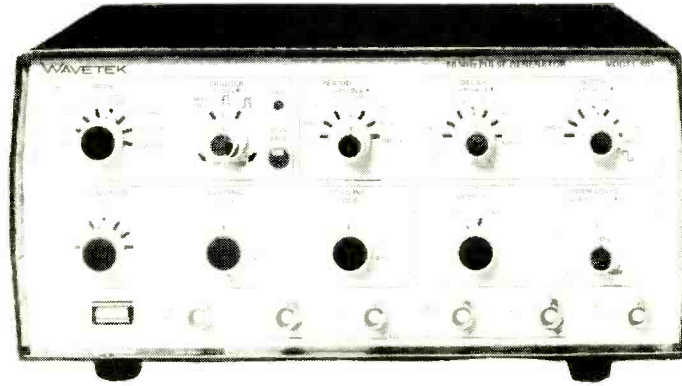

*Wavetek model 801 pulse generator*

## WAYNE KERR

Wilmot Breedon Electronics Ltd, 422 Bath Road,

*TTI 1120 af test set available in the UK from  
Wandel & Goltermann*



## Slough SL1 6BB, UK.

Phone: 06286-62511. Telex: 847297.

### Products

AF BRIDGES  
AUTOMATIC TEST EQUIPMENT  
FREQUENCY RESPONSE ANALYSER

New York, NY 10014.

Phone: (212) 741 7411. Telex: 129269.

### Products

DISTORTION TEST SET  
WOW AND FLUTTER METER  
WAVE ANALYSERS  
AUTOMATIC DISTORTION METER  
COERCIMETER

## WOELKE

Woelke Magnetbandtechnik GmbH, Woelke-Strasse 2-3, 8069 Schweitenkirchen, West Germany.

Phone: 08444-394. Telex: 55547.

UK: Lennard Developments Ltd, 206 Chase Side, Enfield, Middlesex, EN2 0QX.

Phone: 01-363 8238.

US: Gotham Audio Corp, 741 Washington Street,

## USSR IMPORT

Z & I Aero Services, 44A Westbourne Grove, London W2 5SF, UK

Phone: 01-727 5641. Telex: 261306.

### Products

FULL RANGE OF TEST EQUIPMENT



**MXT-1000  
AUDIO  
MIXING  
SYSTEM**

The new MXT-1000  
A unique system enabling  
your own requirements to  
be built from standard  
equipment

8 channel, 2 group MXT-1000 - each channel fitted with compressor

Manufacturers of  
sound systems  
and electronics

Station Road, Wenden  
Saffron Walden  
Essex CB11 4LG

Saffron Walden  
(0799) 40888

**audix**

# SOUND SENSE FROM RACAL-ZONAL

Good news really travels fast so it's hardly surprising that Racal-Zonal has built such a reputation in the world of sound. Professional recording studios, motion picture and TV studios and broadcasting networks—they all know and trust our range of professional audio tapes, audio cassettes and magnetic sound recording film.

Magnetic recording is our genius. Whatever needs to be recorded, we've got it taped. From multi-track recording to motion picture soundtracks, Racal-Zonal makes sound sense.

Racal-Zonal Ltd,  
Station Hill,  
Pound Hill, Crawley,  
Sussex RH10 4AZ.  
Tel: Crawley  
(0293) 34982.  
Telex: 87651.

**RACAL**

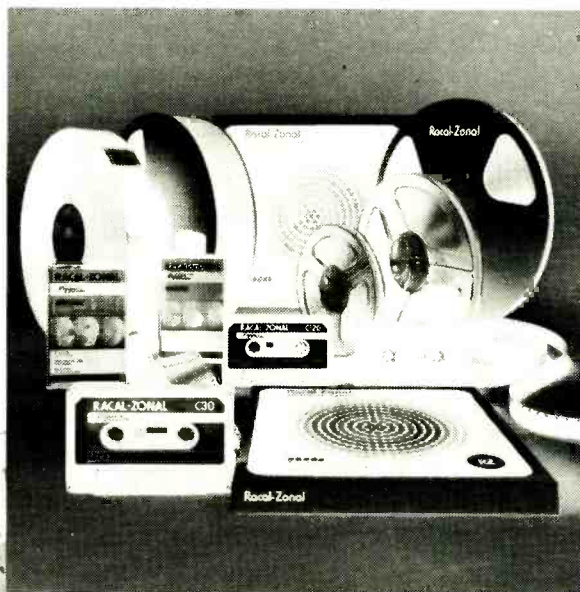

## Racal-Zonal

the professional approach to magnetic recording media

# work

## Le Château revisited

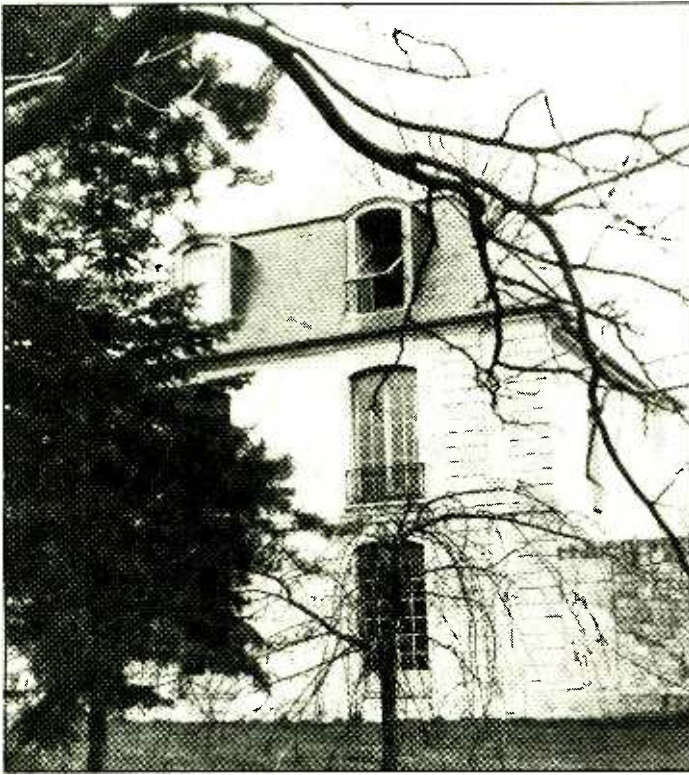

The studio actually has windows

Ever since visiting the Château studio at Hérouville near Paris a few years ago (see May 1975 issue, page 26) I have had a purely selfish desire to go back. Quite simply it's such a very nice place to be. If only all writing work could involve visiting a 15th Century château deep in the Van Gogh countryside of the Ile de France, eating like a king, sleeping like a log and working in a Westlake control room overlooking a tiny French village straight out of Jacques Tati's *Jour de Fête*. Like visiting the Manor, it sure as hell beats the pressures of London.

But it wasn't just memories of the quiet life that stirred me into revisiting the Château. As much as anything it was to find out whether it really was still 'the most creative place in the world'—as the car stickers proclaim—or whether there

was any fire behind the smoke of some staggeringly frank unpleasanties that appeared in the 'Melody Maker' early last year.

The original portrait of the Château that I wrote for *STUDIO SOUND* in 1975 was pretty flattering and I wanted to know one way or the other whether things had changed—and if so how and why. My original plans to return last year were frustrated first by letters that went astray and then by illness on my part, causing a last minute cancellation. But I finally got there early this spring, en route to the Festival du Son in Paris. For my money the original portrait still stands; if I were an engineer or musician I couldn't imagine a nicer place to work. Presumably the musicians, producers and engineers of Bad Company, Bee Gees, Rainbow, Magma, John McLaughlin

and the Rubettes feel the same way, because all these groups have spent time at the Château over recent months. Try listening to the soundtrack album of *Saturday Night Fever*. The first four tracks of side one have a warmth and magic about them that is missing from the remainder of the album. All four were recorded by the Bee Gees at the Château (with overdubs and remix back in the USA) with production by Karl Richardson and Albhy Galuten.

There is, of course, something to be said for not raking over old coals, but what was written in the 'Melody Maker' last year cannot be unwritten. What was written by a very well-known record producer was: 'We found the studio totally useless; the people who now own it don't seem to care'. Inevitably there followed a published reply from the Château and then there was another attack and another reply. Apart from the obvious damage potential of such a damning statement in such a wide circulation music business magazine, the outburst seems quite genuinely to have hurt those at the Château, who really do seem anxious to create a relaxed and creative atmosphere where musicians and engineers are happy to work and thus work well. The Château were also put in an invidious position. To defend the accusations meant publicly attacking a past client and breaching the bond of confidence that inevitably rises between a studio and those who work there.

I was struck this visit, as during the last, by the very definite reluctance of all those at the Château to criticise the ability or product of anyone who had worked there in the past, even those involved in the 'Melody Maker' slanging match. And this reluctance held good even in off-guard moments, for instance, after much food and wine late into the night. Every anecdote that involved a name was inoffensive and where offence could have been taken no names were mentioned. Everyone for instance is anxious to talk highly of the Bee Gees, their professionalism and how there is never any argument between the producers and the group—if the producer suggests 'do it again' they do it again. Likewise there's flattering talk of the businesslike RSO management, even down to organising a suitcase full of British sausages if that's what the group want while in France. And there's admiring talk also of Rick Wakeman's manager who once had to cope with a coachload of press transported from England to the Château to meet Wakeman, when Wakeman had himself already left for England.

Even a tale of disappearing power is told without any apparant rancour. It wasn't a ghost who kept cutting off the mains supply, but a visiting musician who finally owned up that he had found a way of tripping the mains fuse by short circuiting a plug in his room.

Very sensibly, I feel, the 'Melody Maker' incident was finally *fermé* not with a writ but a 'you are welcome any time' open letter from Pierre Calamel, one of the three Château directors, to the mud-slinging producer. So enough said about the past. As Laurent Thibault, another director and resident engineer, remarked: 'If I really am an inadequate engineer, as suggested, then time will find me out'. Personally, having now seen Thibault at work on two occasions, I don't think he has anything to fear.

Thibault was first thrown in at the deep end as an engineer during the earliest of several visits to the Château by the late Marc Bolan. Bolan's engineer left suddenly and Thibault took over. Apart from a freelance spell he has been resident ever since. Likewise Jean-Claude Delaplace remains business manager and the only change in 'ownership' has been the arrival of Pierre Calamel. Calamel and Thibault have known each other since student days when Calamel helped to manage a band in which Thibault played bass. Calamel became part of the Château a couple of years ago and there has been a fair amount of work done under the new triumvirate since my last visit.

To recap briefly, the idea of converting the 15th Century Hérouville Château into a recording studio was first conceived in 1968 by Michel Magne, the French film composer. By 1970 the Château was 16-track and starting to attract mainly American and British stars who, not surprisingly, loved the idea of recording at leisure in such a welcoming setting. With a swimming pool, barbecue and tennis court in the massive grounds, plus French-style accommodation, cooking and booze, it was all too easy in the summer to spend up to three months on an album. Hardly surprisingly, the albums sounded relaxed and sold well. So the Château became a by-word for country-style recording with the Manor, Rockfield and so on subsequently adopting similar policies and finding similar success. What session musicians, making a jingle or disco album to a tight schedule, need is a city-centre studio with a rigid timetable. A relaxed album of songs and sunny music is more likely to emerge from the low-gear-long-stay-loose-schedule-approach in country surroundings. 92 ▶



# Mod II The Expandables

In today's recording world it is essential to maintain flexibility within your chosen operational format.

Our basic package deal can give you a low cost 8 track studio which can grow as far as you can take it!

for full details of Mod II and Brenell multi-track tape machines write today or visit — our demonstration studio at Pembroke House.

Allen and Heath Brenell Limited,  
1000 St. James, Campbourne Road,  
Hullway, Leamington, CV8 7PT  
Telephone: 0-340 3291 Telex: BATGRP 267727

Audiotechniques Inc.,  
142 Hamilton Avenue,  
Stamford, Connecticut 06902, U.S.A.

## WORK

But as all country studios find out to their cost, the low-gear, long-stay approach has its own particular problems. It needs tight and efficient management and maintenance, coupled with a flexible approach from the studio staff, if the musicians are to be able to record as and when, and for how long, they like. Some groups may want to spend all day in the sun and work hard at night—perhaps all night. But the studio facilities must be ready to go as the mood takes the musicians. So maintenance and other works need to be got out of the way during the day. But the maintenance engineer still has to be on the spot and available if problems arise at night. Other groups like the Rubettes may want to work 20 hours out of 24. Maintenance will then have to fit into those spare four hours. There's also the problems of hangers-on. If a famous group spends a month at a studio the word soon gets around. At a building as large as the Château, with three wings and more bedrooms than you can count, it is all too easy for the management to find they are accommodating and feeding a fair percentage of uninvited and unpaying guests.

In the early days at the Château it seems that their policy was to encourage hangers-on, especially if they looked good in a miniskirt. This is one of the main reasons why the studio ran into financial problems and was temporarily closed down in the early Seventies. Financial problems brought legal problems and at the time of my first visit the business was still finding its feet. Improvements and renovation still continue, and, like painting the Forth Bridge, will never really be finished, but it is visibly feeling, sounding and looking better all the time.

Thank goodness those in control appear to have great sympathy for the building and what it has to offer. Just one example. It was Elton John on a non-recording visit betwixt Paris and Holland for a concert who suggested that 'something should be done about the sound' of the main (George Sand) studio high up in one wing of the building. It was where he made *Honky Château* and *Yellow Brick Road*. But times change and musicians learn to want more from the sound of a studio. So the Château called in Tom Hidley and asked for the Westlake treatment. The first scheme proposed by Hidley for the control room involved sacrificing one of the two windows which overlook the rolling Van Gogh countryside. It also in-

involved covering over the original wood beams on the ceiling. 'Leave me my beams and my window', said Laurent Thibault. Hidley came back with another plan that left the beams and both windows.

Come to think of it the Château studio and control room must be one of the few in the world with windows. Most, whether above or below ground, are best suited to moles. Only roadies dislike the Château studio. It's three floors up a winding stone staircase and has windows and real daylight. Incidentally, the Bee Gees' *Saturday Night Fever* songs were written on the large stone-walled staircase that leads up to the top floor studio—it has a very live natural acoustic ideal for unamplified guitar and voice. A few drummers have been recorded on the top landing, too.

It seems well established in the area, and for that matter in Paris,

pestered and forced to be blunt. The buck stops with the studio. It also clearly worries Calamel that he may have to refuse the release of master tapes for 'unknown' clients until bills are paid in full. But the only way for a studio with overheads like the Château to remain in business is self-preservation. And there's a fine line between self-preservation and self-destruction. One group of four musicians arrived with 21 hangers-on, including a grannie (yes, really a grannie) and several aunts. Current rate for hiring the Château is around 8000 francs a day, for unlimited recording at any time and with full food and accommodation for everyone connected with the group. But if everyone is 25 hungry people it's easy to run at a loss. So now the rate is cited as 'including board and lodging for up to ten people'. Extra people cost extra (as do drinks for

various Eventide goodies. Natural echo is through three chambers deep in the bowels of the Château. First priority was to get the studio control room acoustically right and fully equipped. Next priority was to improve accommodation and go for greater comfort. This can now be done, indeed is now being done, because at last the Château is finding a new owner. Whereas previously ownership has been confused by the lingering original debts, these are now being paid off by the present three directors. For the first time in several years those running the Château actually own some of the bricks and mortar, and there is thus an incentive to spend money on improvements that can't be carried away.

It has long been a hobby horse of mine that nowadays, given a reasonably blank cheque and a routine shopping list, any fool can set up a studio that is technically equipped to do whatever a client wants. Provided that maintenance is good, the business is efficiently run and there is an engineer on hand who knows how to work everything, there is no reason why such a studio should not churn out acceptable work in an efficient manner. What really matters today is that extra something that can't be put on a shopping list, and a blank cheque won't buy. It's this extra something that every well-known, well-booked studio (like The Manor, Rockfield, Advision, Air and so on) has to offer—and for each studio that extra something is something different. For the Château it's being in deep French country, within easy reach of Paris and, most important of all, in congenial company. And that's why I was so anxious to go back and see—more accurately to feel—for myself whether things had changed at the Château. Of course, it's easy to impress a visiting journalist and his wife by giving them the star suite, candle-lit meals and lifts by car into Paris. That you can fake. What you can't fake is the feel of a place taken over three or four days. I'll buy the feel. So it seems do the Rubettes who were expected a few days after I left for a return visit. The plan was to redecorate and revamp some of the rooms, install a couple of new bathrooms and convert what had once been a maintenance room just under the main studio into a rest room for the musicians. They'd been at the Château a few months beforehand.

'We want them to come back remembering what it was like and find it even better', says Calamel.

Laurent Thibault at MCI console



which is only 30 km and half an hour away by the new motorway that runs into Pontoise a couple of villages away, that hangers-on and groupies are no longer welcome at the Château. One longhair appeared during Bad Company's recent stay.

'Is he one of yours?', asked Calamel. He wasn't. 'Please go', said Calamel.

'I will when I've found my bag', replied Longhair, and disappeared for a couple of days. He next turned up playing ping-pong and pinball in the musicians' recreation room.

'Please go', said Calamel.

'I would, but I don't have any transport', replied Longhair.

To make sure, one of the Château staff drove him to Paris. It clearly upsets Calamel to be that blunt. But there's no other way. Musicians cannot work well if

pretty obvious reasons). This has had the desired effect of cutting down on group followers like magic. That's self-preservation and it makes good business sense, into the bargain leaving the musicians less distracted by those to whom they would find difficulty in saying no. But way back in the 'problem' days one past owner of the Château used to follow the musicians around with a note book totting up the number of drinks. That's self-destruction. So is having open house and free food and drink for anyone who cares to drop in, as used to happen in the free-for-all days of the early Seventies.

With the Westlake conversion came an MCI Series 500 28/24 console, a Studer A80 24-track and MCI 2- and 4-track machines. There's, as the Château put it, 'all the toys' including *Kepex*, *Scamp*, Klark-Teknik equalisers and the

# LAI BACK & STUDIOS

77 Sunset Boulevard, Hollywood, California 901828

## MEMO FROM THE DESK OF ARNIE SCHWARTZ

TO THE STUDIO DIRECTOR

In answer to your request for a report about the new equipment this studio needs, I feel that the reason we are losing business to other studios is our lack of a good synthesizer. I therefore recommend this purchase and below I have outlined our requirements and provided my answers to the problems.

### REQUIREMENTS

- 1) A "proper" synthesizer that plays in tune and stays in tune.
- 2) A system that we can build up as and when we can afford it.
- 3) A modular system that allows rapid expansion or contraction - important for maintenance so that if one section is out, the rest will function.
- 4) A synthesizer that sounds like the best synths in the world - makes the sounds clients like.

### RECOMMENDATIONS

- 1) The Roland System 700. This system is a totally flexible synthesiser in the original sense. It is easy enough to operate but it doesn't use any presets to condition creativity.
- 2) The Roland System 700 is probably the most stable big synth in the world, once you've tuned it, it stays in tune - unlike the others.
- 3) We can build the System 700 up as we go along. Because it's modular we can just start with the keyboard control unit and the main console. Later we can add expander modules as we need them. There's also a new "smaller" version of the main system available. This is called the Laboratory version, and although I feel we need a full System 700, the directors may consider the Lab version more "appropriate."
- 4) The Micro Composer. This is a unique computer sequencer made by Roland. I feel that this unit would make our studio considerably more attractive. This is the world's first musical sequencer and if you want to get Mike Oldfield in for a block booking we'll have to have one.

Chief Balance Engineer

*ASchwartz*

P.S. All the other Roland gear we've got works real good!

P.P.S. When you're next in England check out Roland stuff at:-

Brodr Jorgensen (UK) Ltd,  
Great West Trading Estate,  
983 Great West Road,  
Brentford,  
Middlesex.



## WORK

With the studio virtually free for a few days while the domestic decision was taken, changes were underway, to let Laurent Thibault to do what had always been planned: namely make his own album. Recently Magma (for which Thibault had once played) had been in for a month, with Thibault producing and engineering the group. For the first time they had a full month of studio hours to seek the kind of perfection that they had always been previously denied by shortage of time or facilities. Now it was Thibault's turn. For his album he collected together a bunch of musician friends, and night after night they were working on a complex of overdubs. For the others the prime task was to fit a new wire fencing round the tennis court as someone remembered that some of the Rubettes liked to play tennis, and the winter weather had unexpectedly turned to spring. One part of the court had just been repaired—a secret tunnel from the Château to what was presumably a priest's hole in the garden had caved in, and left a gap on the service line. With the

sun shining the next job would be to clean out the swimming pool.

Pierre's brother Patrice, a truly superb cook, was out buying food in bulk with a special thought to what he remembered as the group's tastes. Although capable of *Cordon Bleu* cooking, Patrice can cope with most things. Macro-biotics is now routine for one group as is the particular penchant of another visitor from abroad—beans, beans and more beans on beans. Another favourite for one group's engineer is bread and chips. For his birthday Patrice made him a birthday cake of bread and chips. While I was there one of Thibault's visiting musicians also had a birthday. After the meal and the cake (not bread and chips but a fine fresh gâteau) the stories started coming—everyone a French 'Agony' in its own right. Because we English are such rotten linguists they are either told or retold in English.

There's the time when the Château hired a piano tuner they had never seen before. He went up into the studio and stayed there for a while. On his way out he called into the office for payment.

'Have you finished', someone asked.

'What?', he replied.

'Have you finished tuning the piano?'

'Sorry', said the piano tuner cupping his hand to his ear. 'You'll have to speak up, I'm deaf'.

The world over musicians' humour is the same; like W C Fields they are no respecters of physical impediment. One of Thibault's musicians revealed that he had once worked in a band with a blind organist. He must have been a very good-natured blind organist. One night after a gig, very drunk, he was sat in the driving seat of the band's waggon and left to steer the car while someone else worked the foot pedals. Hardly surprisingly the vehicle shot a red light in a French village deep in the country. More surprisingly there was a policeman lurking on duty. He flagged down the car.

'Show me your driving licence', he bellowed at the driver.

Straightfaced the organist fumbled in his pocket and handed the policeman his certificate of blindness, entitling him to free travel on the Paris metro.

On another occasion the band stopped the car on the way to a gig saying they fancied a drink.

'This looks a nice bar', they agreed leading the blind organist

into a post office and propping his elbow against the counter.

'I'll have a red wine', he demanded of a surprised clerk selling postage stamps.

This in turned reminded someone of a famous visitor to the Château who at 6 o'clock in the morning, drunk on red wine after a night's recording, announced that he was going fishing. The nearest river is 6 km away, but undaunted he set off on foot, staggering into the dawn with a fishing rod and keep net. An hour or so later he was back with no fish but accompanied by a couple of policemen.

A few more stories and verres du vin and it's off to work for Thibault and his musicians. It figures that what comes out of that kind of atmosphere stands a pretty good chance of sounding good and selling well. It also brings its own gratifying rewards. When Thibault flew to Florida to discuss the MCI purchases he took a taxi from the airport.

'What do you do then Mac', asked the taxi driver.

'I work at a recording studio in France', replied Thibault.

'Oh', nodded the taxi driver, 'that must be the Honky Château'.

**Adrian Hope**

# WE'LL SHOW FRENCH GOLD, B.B.D.O. AND COLLETS YOUR DEMOS BEFORE YOU WILL.

Wouldn't you love a rep who was always in the right places at the right time?

Well, right now the Creative Handbook seems to be the hottest rep in the advertising world.

There is simply no better way you, as creative suppliers, can show your work, or put across your facilities, to over 2,600 art and print buyers and the key decision makers who buy creative services.

This year more than 4,000 copies have been distributed among the top creative people in leading London and provincial advertising agencies and major national advertisers, and will be

used by double this number.

A recent survey disclosed that 87% turned to it for new or alternative suppliers. Others used it as a portfolio reference, a telephone directory, or a source of new business leads.

The Creative Handbook covers just about every creative service. So before you heave your portfolio up numerous flights of stairs, contact Annie Roe or Stewart Swindell at: The Creative Handbook Ltd., 9 Chichester Chambers, 13 Chichester Rents, Chancery Lane, London WC2. Tel: 01-405 2663/4/5.

They'll tell you how to be represented in the Creative Handbook. Then, with a bit of luck, you won't have to call French Gold, BBDO, Collets and the like.

They'll call you.



**THE CREATIVE HANDBOOK.**

# THIS MAY NOT CONVINCE YOU

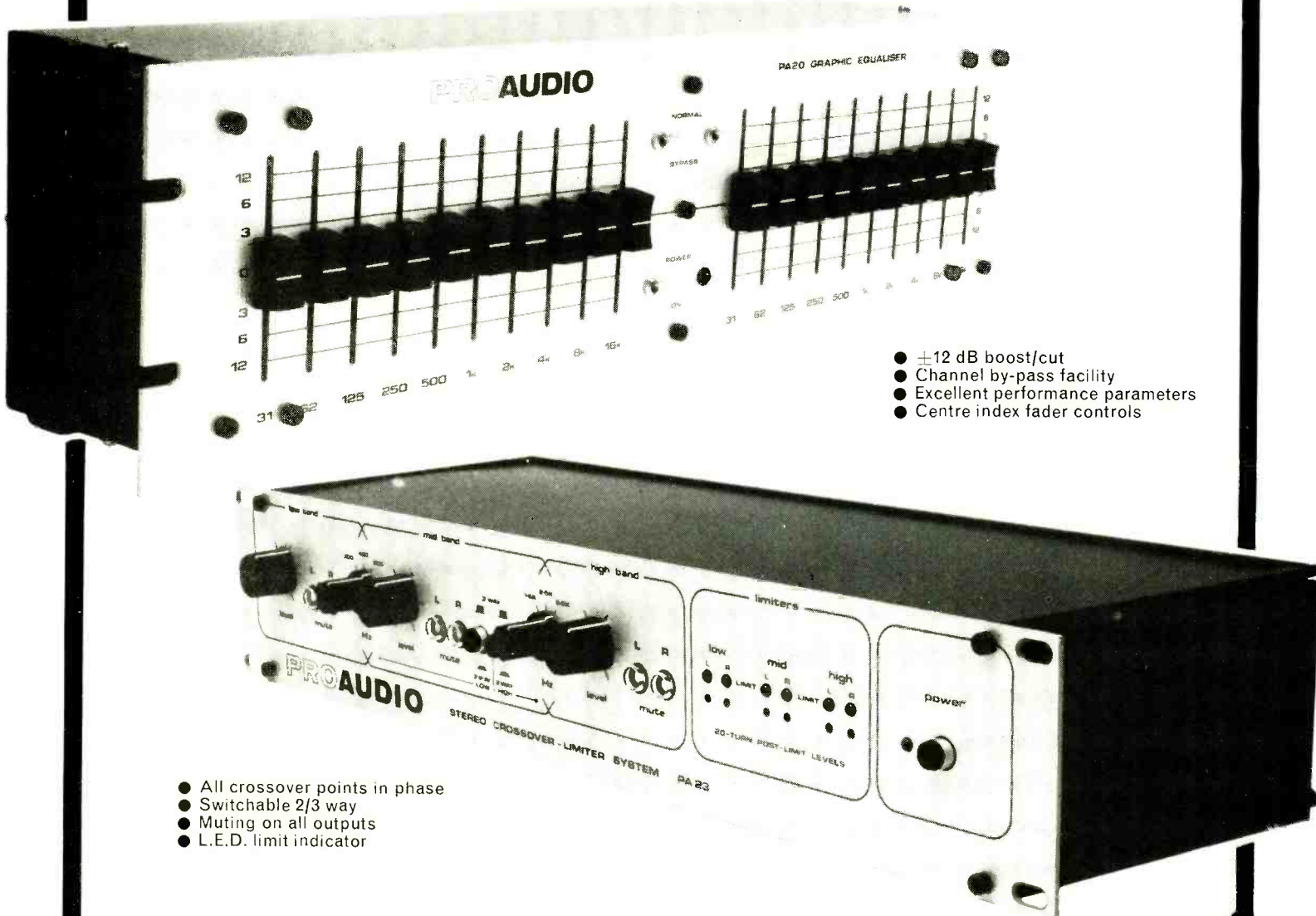

- $\pm 12$  dB boost/cut
- Channel by-pass facility
- Excellent performance parameters
- Centre index fader controls

- All crossover points in phase
- Switchable 2/3 way
- Muting on all outputs
- L.E.D. limit indicator

# BUT THE SOUND WILL

U.K. AGENT



**P.A. Hire & Sales**  
Unit F - New Crescent Works  
Nicol Road - London NW10 9AX  
Telephone 01 961 3795

For further details  
**PRO AUDIO**  
80 WOLSEY DRIVE  
WALTON ON THAMES  
SURREY

Name .....  
Address .....  
Tel. No. ....

# reviews

## Sony PCM-1 digital recording system

Hugh Ford



### MANUFACTURER'S TENTATIVE SPECIFICATION

**Recording system:** linear quantisation pcm.

**Number of channels:** two.

**Sampling rate:** 44.056 kHz.

**Video bandwidth:** 1.726 MHz.

**Data packing:** one line contains 94 bits. This includes three words of 26 bits (13 bits per channel) plus 16 bit crc.

**Dynamic range:** 85 dB (2 Hz to 20 kHz).

**Harmonic distortion:** 0.03%, at 1 kHz.

**Frequency response:**  $\pm 1$  dB, 2 Hz to 20 kHz.

Inputs:	Sensitivity	Impedance	Jack
Mic:	0.3 mV ( $-68$ dB)	600 ohm	standard
Line:	95 mV ( $-18$ dB)	100k ohm	phono
Video input:	1V p-p	75 ohm	phono

**Wow & flutter:** below measurable limits.  
**Dimensions (whd):** 430 x 170 x 435 mm (approx).  
**Weight:** 19 kg (approx).  
**Suitable vtr:** Betamax or U-matic (any model).  
**Price:** UK price to be announced.  
**Manufacturer:** Sony Corporation, Osaka, Japan.  
**UK:** Sony (UK) Ltd, 134 Regent Street, London W1R 6DJ.

THE SONY *PCM 1* recording system is, in effect, an audio-to-video converter which converts the twin-channel audio input into a video standard signal that can be recorded on Sony video cassette machines in the form of a normal 1V video signal. Similarly, the video signal is replayed and converted back into a twin-channel audio signal.

The signal as recorded by the video recorder is a digitally-encoded version of the audio input signals, each video line containing three words of audio 'data' and a 16-bit cyclic redundancy check word derived from the previous three

words of audio data. In fact, each word of audio data consists of a 13-bit sample alternatively from the left and the right input channel. Thus there are three samples per line of video which, with a line frequency of 15.734 kHz in the 525-line system, corresponds to a sampling rate of 47.202 kHz. However, the practical sampling rate is less than this at 44.056 kHz, presumably to deal with the problem of frame-blanking periods.

At the time of writing the error-correction system is not clear, but the 94 bits in each video line (6 x 13 data bits plus 16 redundancy bits)

are recorded such that the odd-numbered bits are the first, followed by the even-numbered bits. All that is known is that upon replay any detected errors result in the missing bits being replaced by an average of the surrounding bits.

Using 13 bits/sample leads to a theoretical dynamic range of 78 dB with linear digital encoding (where one expects to achieve 6 dB per bit). The *PCM 1*, however, has the optional use of pre-emphasis which increases the dynamic range by approximately 10 dB at the expense of losing the ability to record the same level at all frequencies. Nevertheless, this is a normal property of conventional tape machines, particularly at the lower tape speeds.

The audio inputs to the *PCM 1* consist of unbalanced inputs in the form of low level microphone jacks on the front panel, or *XLR* plugs on the rear panel connected in parallel with phono sockets. A three-position front-panel switch selects either the line-level *XLR* or phono connectors or the microphone jacks, either direct or via a 20 dB attenuator. Large diameter record level controls are provided for each channel. Also included on the front panel is the pre-emphasis 'in/out' switch, a stereo headphone jack and its associated level control, and the level metering system. The latter is a fast peak-reading meter that operates from the encoded digital signal, and thus takes the pre-emphasis into account so far as the high-frequency boost is concerned.

The level meter covers a range in excess of 42 dB in 22 steps, with calibrations at 0, -6, -10, -20, -30 and -42 dB. In addition, there is an overload indicator above the 0 dB mark—a useful feature since with digital systems an overload means hard peak clipping. Another good feature is that a switch has been included to enable the meter system to either operate as a fast attack and fairly fast fallback meter, or to hold the maximum peaks. In practice the meter is fed from the output section of the unit such that any failure in the encoding section, the video recorder or part of the decoding logic will be shown on the meter.

The only remaining user features are the video input and output connections in, surprisingly, the form of phono sockets, plus a front-panel power on/off pushbutton switch.

Inspection of the internal construction of this prototype review sample revealed a very high standard of construction, with large glassfibre plug-in printed wiring boards being used to house the mass of integrated circuits associated with the digital part of the *PCM 1* system. In practice the audio section is largely separate from the digital section, the audio electronics occupying only a small part of the circuitry.

Rather than remind readers at this stage of the advantages of digital tape machines, I will now proceed with the measured performance and then comment upon the significant features of the *PCM 1* system itself.

### Frequency response

The overall record/replay frequency response of the *PCM 1* recorder from 2 Hz upwards is shown in fig. 1, from which it can be seen that the unit is within an envelope of  $\pm 0.5$  dB from 2 Hz to 12.5 kHz, falling slowly to 20 kHz above which there is a very sharp loss. While it is felt that the slow roll-off is not necessary, the very sharp cut at 20 kHz is the result of the anti-aliasing filter which is an essential part of digital systems.

**FIG. 1 SONY PCM1 OVERALL FREQUENCY RESPONSE AT FULL MODULATION**

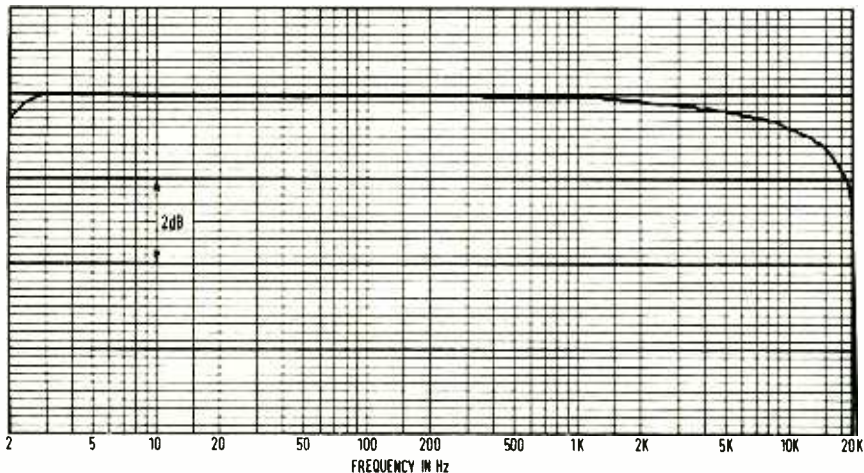

**FIG. 2 SONY PCM1 THIRD HARMONIC DISTORTION**

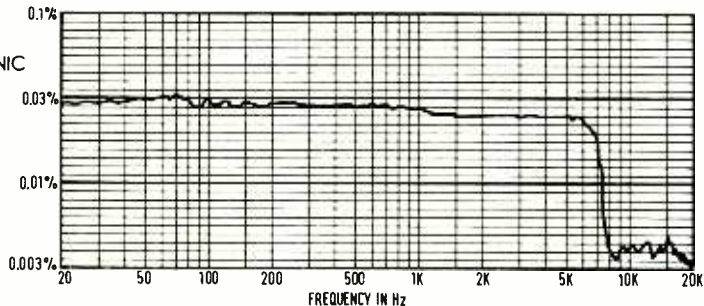

**FIG. 3 SONY PCM1 INTERMODULATION DISTORTION**

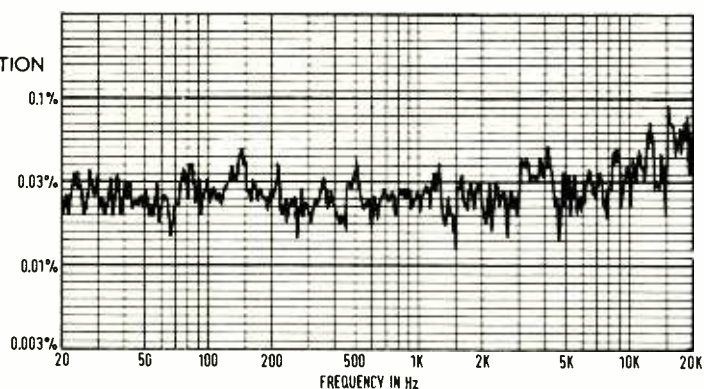

Unlike conventional analogue tape machines the frequency response shown was plotted at maximum record level, the response being identical at lower recording levels. It can also be seen that the low-frequency response, which falls off in a cyclic pattern around 30 Hz in analogue machines, goes in a straight line down to 2 Hz in this digital machine—thus eliminating a number of problems in tape copying or noise-reduction systems.

With pre-emphasis in use the recorded level was found to be increased by about 7.5 dB at 10 kHz and 10 dB at 20 kHz, with the result that musical material having a large high-frequency content has to be recorded at a lower level. This is, however, typical of analogue machines but

there is one important difference in that digital recording systems cannot be used as a compressor, since they have a 'hard' clipping point at all frequencies.

**Distortion**

Following on from the last remark it follows that as the recording level is increased at any 'in-band' frequency the distortion will show little increase (if any) until the system overload point is reached; the distortion will then show a very rapid rise, rather like a transistorised power amplifier, depending upon the digital coding system in use and other considerations.

So far as the third harmonic distortion was

**EMS VOCODER 2000**  
for the treatment  
and modulation of human  
speech and the production of  
speech-like effects from  
music or other sounds.  
Used by radio, television,  
studios, groups  
and theatre.

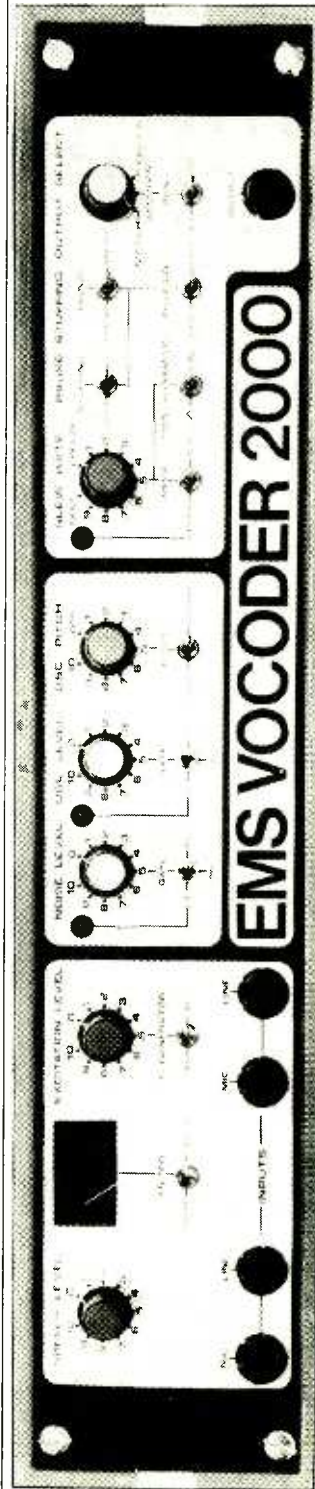

Electronic Music Studio Supplies  
5832 Westminister Avenue  
Montreal  
Quebec H4W 2J8

Piano Center  
122 Rue de Paris  
Montreuil 93100  
Paris

EMS West Germany  
7257 Ditzingen 3/Hiemerdingen  
Finkenstrasse 4  
07152 — 53273

EMS  
The Priority  
Great Milton  
Oxford  
08446 — 729



## REVIEW- SONY PCM-1

concerned the two channels of the *PCM 1* showed several dB difference, but this matter is subject to modification by Sony and maybe I'm being unkind by showing the performance of the worst channel. Anyhow, **fig. 2** shows the third harmonic distortion of the worst channel at maximum recording level without pre-emphasis. It can be seen that the third harmonic is constant around 0.03% up to 7 kHz, above which it falls off very rapidly as a result of the turnover frequency of the anti-aliasing filter. Investigations at lower recording levels did not reveal any increase in harmonic distortion and it should be noted that this performance is orders of magnitude better than conventional analogue machines.

Similar remarks can be made about the intermodulation distortion to the SMPTE method using two tones in a 4:1 ratio, with one tone fixed at 70 Hz and the other swept up to 20 kHz. The result was that the intermodulation products were at least 60 dB down—0.1% is unheard of in analogue machines! Measurement of the intermodulation distortion to the CCIF method, using two equal amplitude tones separated in frequency by 70 Hz and swept from 20 Hz to 20 kHz for the lower frequency tone, produced **fig. 3** at maximum recording level without pre-emphasis. It can be seen that the distortion is almost constant at just under 0.03% up to 10 kHz—again a performance that is unknown in conventional analogue machines!

Investigations into the recording and reproduction of tone bursts showed that at low frequencies there will be no significant difference

between the input and output bursts. **Fig. 4** shows that high-frequency bursts such as the 10 kHz tone burst produce mild ringing. This was found to be more serious using squarewaves, the results of recording and reproducing a 1 kHz squarewave being shown in **fig. 5**. This demonstrates substantial ringing that was found to be independent of the recorded level. I would regard this degree of ringing as undesirable in any machine, but it probably has little subjective effect?

### Noise

Checking the output noise spectrum revealed that any spurious tones from the sampling frequency or logic were at least 110 dB below the full output with mains hum at least 90 dB down.

**Table 1** shows the record/replay noise related to the full output when using the line input, there being no difference in noise between the linking of the input and output at the video connectors or using a video recorder. As is seen,

**TABLE 1 NOISE PERFORMANCE**

Measurement method	Maximum output-to-noise ratio	
	with pre-emphasis	without pre-emphasis
Band-limited rms 20-22k Hz	86.5 dB	77.5 dB
A-weighted rms	88.5 dB	81 dB
CCIR-weighted rms ref 1 kHz	80.5 dB	73 dB
CCIR-weighted quasi-peak ref 1 kHz	76 dB	67 dB

100 ►

**Fig. 4** 10 kHz tone burst.

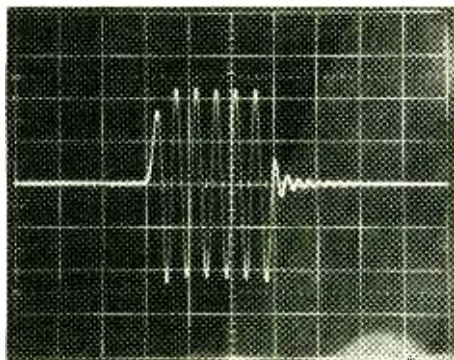

**Fig. 5** 1 kHz squarewave.

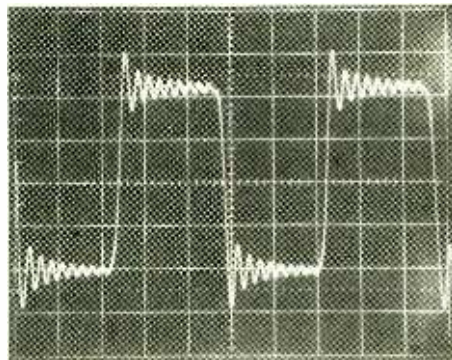

**FIG. 6**  
SONY PCM1  
CROSSTALK

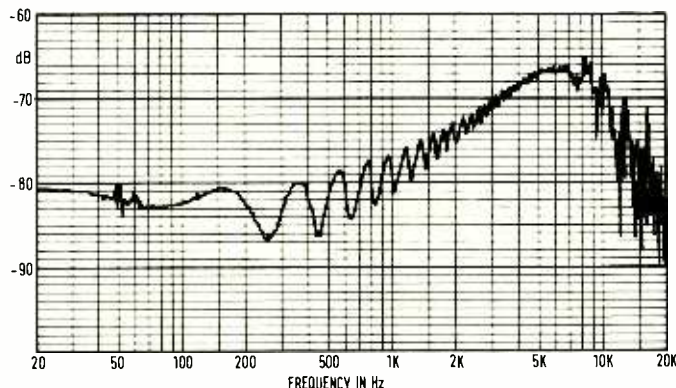

## Worldwide agents for audio & design recording.

### Australia

Audio & Recording, Holden Hill, S.A.  
Tel: 261 1383

### Austria

Soundmill Vienna, Peter J. Müller.  
Tel: 222 Telex: 75922.

### Brazil

Serion Ltd, Sao Paulo. Tel: 34 8725.

### Canada

Noresco (Mfg) Co. Ltd., Ontario.  
Tel: (416) 661 0541.

Telex: 065-24478, a/b Norescomfg.

### Denmark

Ole Christensen, Audiophil,  
Copenhagen. Tel: (01) 341 622.

### Eastern Europe

Denis Tyler Ltd., West Drayton, UK.  
Tel: (089 54) 43681. Tlx 23977.

### Finland

Harold Burgen, Helsinki. Tel: 692 5308.

### France

3M France, Paris.  
Tel: (1) 031 61 61. Telex: 695185

### West Germany

Elmus GmbH, Berlin.  
Tel: (030) 312 2012.

### Greece

Audiolab Hellas, Athens.  
Tel: 822 5222. Tlx 5800.

### Holland

Pieter Bollen, Eindhoven.  
Tel: (040) 512 777 Tlx 59281

### Italy

Roje Telecomunicazioni, Milan.  
Tel: 415 4141. Tlx 39202.

### Japan

Nissho-Iwai Co. Ltd., Tokyo.  
Tel: (03) 544 8311.

### New Zealand

General Video Co. Ltd., Wellington.  
Tel: 872 574. Telex: 31255.

### Norway

Siv. Ing. Benum & Co., Oslo, 2.  
Tel: (02) 56 57 53.

### South Africa

Eltron (Pty) Ltd., Johannesburg.  
Tel: 23 0018.

### South East Asia

Brunei, Indonesia, East Malaysia,  
West Malaysia, Singapore — c/o  
O'Connor's (Pty) Ltd., Singapore 5,  
Tel: 637 944. Tlx Oconsin RS 21023

### Sweden

KMH ljud Ab, Stockholm.  
Tel: (08) 98 07 55. Telex: 13366.

### Switzerland

Jim Duncombe, Zurich. Tel: 72 56 877.

### United States

Audio & Design Recording Inc.,  
Honolulu. Tel: (808) 845 7226.

### UK and All Other Territories

Audio & Design Recording Ltd.,  
Reading, UK. Tel: (0734) 53411.  
Telex: 847605 a/b Tillex G.



# George Martin's choice...

**SCAMP**

## — The F 300 Expander/Gate System

**‘**WHEN I originally sat down to plan the equipment installation for my new studio, *Air Studios Montserrat* my initial inclination was to draft a list of, shall we say, ‘established’ names. But then other, equally important, factors like price, performance, reliability, and availability have to be considered. That’s why I personally opted for the **Audio & Design SCAMP F 300 Expander/Gate** system for the new venture. Very competitively priced, I believe that the **Audio & Design SCAMP F 300 Expander/Gate** system offers performance and flexibility that is hard to match.’



George Martin of AIR Studios London, internationally successful record producer, arranger and musical director is presently producing and arranging the musical soundtrack and album of the forthcoming RSO film ‘Sergeant Pepper’s Lonely Hearts Club Band’ in his London Studios and Los Angeles.



The F 300 Expander/Noise-Gate system is simple to operate yet highly sophisticated in its dynamic performance with an unequalled flexibility for effects use.

In the AUTO mode really smooth dynamic characteristics are obtained with freedom from ‘hunting’ on the most difficult of signals. This means that these units can be used with confidence on multi-track mix-down to provide noise reduction and a degree of automation.

As non contributing tracks are being automatically attenuated, added tape noise is kept to a minimum, and in most applications involving limited dynamic range signals (ie pop), the noise will be masked by the signal.

Perhaps most important, especially to systems already equipped with a complementary noise reduction system, objectionable source noise (ie instrument amps, hiss from electronic devices, general studio ambient noise and crossmic pickup) will be eliminated — a very significant area in which established noise reduction units can do nothing.

### Technical Specification

- INPUT:**  
10KΩ balanced.
- OUTPUT:**  
<1Ω source balanced clip level +24dBm.
- DISTORTION:**  
<0.1% THD at line levels for unity gain.
- FREQUENCY RESPONSE:**  
±0.5dB, 30Hz — 20kHz.
- NOISE:** (Ref. +8dBm)  
Normal: < -103dB  
Effect: < -86dB
- RANGE:**  
0 — 40dB variable.
- SLOPES:**  
Expand: 1:1 to 3:1 variable  
Gate: 20:1 with hysteresis.

- \* Auto-Dynamic Characteristics
- \* Expander & Noise Gate slope options
- \* Keyable from external signal
- \* Variable release, Range & Threshold
- \* Superb performance
- \* Ultra compact (17 units to a rack)

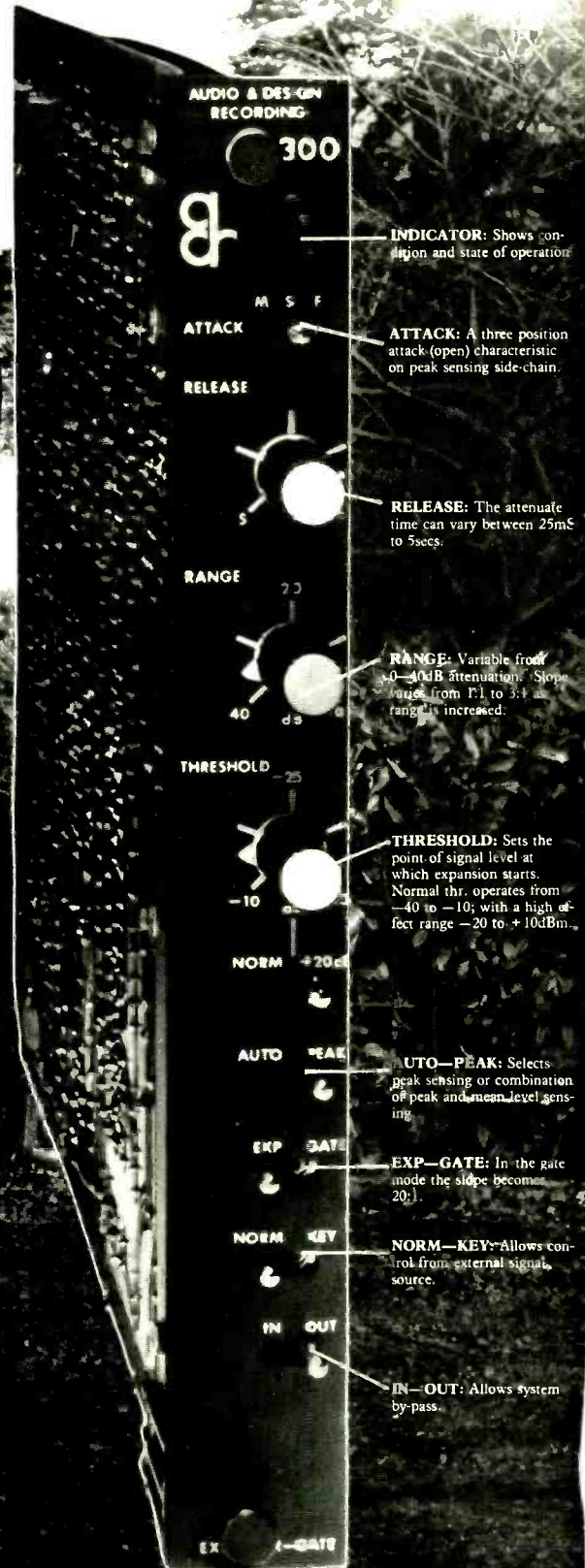

**INDICATOR:** Shows condition and state of operation

**ATTACK:** A three position attack (open) characteristic on peak sensing side-chain.

**RELEASE:** The attenuate time can vary between 25mS to 5secs.

**RANGE:** Variable from 0 — 40dB attenuation. Slope varies from 1:1 to 3:1 as range is increased.

**THRESHOLD:** Sets the point of signal level at which expansion starts. Normal thr. operates from -40 to -10; with a high effect range — 20 to +10dBm.

**AUTO-PEAK:** Selects peak sensing or combination of peak and mean level sensing.

**EXP-GATE:** In the gate mode the slope becomes 20:1.

**NORM-KEY:** Allows control from external signal source.

**IN-OUT:** Allows system by-pass.

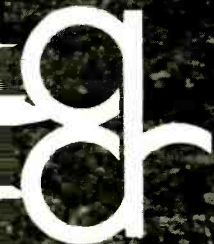

**audio & design (recording) Ltd.**

84 Oxford Road, Reading, Berks. RG1 7LJ England

Telephone: Reading (0734) 53411

Telex: 847 605 a/b Tillex G

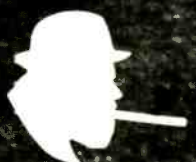

**Q.**  
What's smaller  
than a breadbox,  
tells the truth,  
and won't  
flutter your RFI  
or wow  
your wallet?

**A. FIDELIPAC®  
WOW &  
FLUTTER METER.**

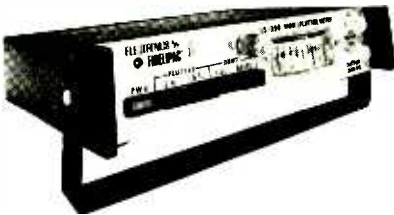

For less than \$425.00 you can have a portable, solid-state instrument that quickly and accurately measures the wow, flutter and drift characteristics of any sound reproducing device . . . cartridge or reel-to-reel tape recorder, turntable, film chain, etc. It's easily connected to your equipment and features a standard phone output jack for oscilloscope connection as well as a self contained switchable weighting filter. With its internal precision 3,150 Hz reference oscillator and its complete immunity to EMI and RFI, Fidelipac's Model 65-390 Wow and Flutter Meter is truly indispensable for your test bench or studio.

For more information,  
contact Fidelipac

Prices shown are domestic U.S. and do not reflect shipping, customs duties, VAT or similar charges and are subject to change without notice.

**ELECTRONICS by  
FIDELIPAC®**



109 Gaither Drive  
Mt. Laurel, NJ 08054  
(215) 628 3050

\*Trademark

## REVIEW: SONY PCM-1

the pre-emphasis makes a substantial change in the noise performance. The performance is clearly very good in terms of the measured performance of conventional analogue machines, but it must be remembered that the measured dynamic range for a digital machine has a different subjective effect. There are two reasons for this: firstly, the 'hard' clipping at the overload point; and secondly, that the digital machine does not record signals that are below noise level—we can hear them with an analogue machine in spite of noise.

### Inputs and outputs

Both the audio outputs were found to deliver 3.3V rms at full recording level or 3.32V rms at clipping level from a source impedance of 560 ohm in an unbalanced configuration. It is felt that for professional use a balanced output would be desirable from a lower source impedance, the *XLR* and the phono socket outputs being in parallel.

The line inputs are *XLR* and phono connectors again in parallel in an unbalanced configuration. Again it is felt that a balanced connection would be desirable for professional use, but the input impedance of 100k ohm in parallel with 40 pF is very satisfactory, as is the input overload level at over 10V rms and sensitivity of 460 mV rms.

The front-panel microphone jack connectors again are unbalanced and have the option of two sensitivities by means of a source selector switch. The sensitivities and overload limits

**TABLE 2 MICROPHONE INPUT**

Input selector	Sensitivity	Overload input	Input impedance
'Mic'	2.23 mV	85 mV	3.3k ohm
'Atten'	23 mV	850 mV	4.3k ohm

given in table 2 would appear to be directed at domestic applications. Furthermore, it was found that as a result of the insertion of a resistive attenuator in the low-level circuits, the noise associated with the microphone input was poor in the attenuated position; the overall noise performance being degraded by 4-5 dB when the attenuated microphone input was used.

On the other hand the input impedance of all

**Fig. 7** Scrape flutter test shows two sidebands 60 Hz either side and 50 dB down

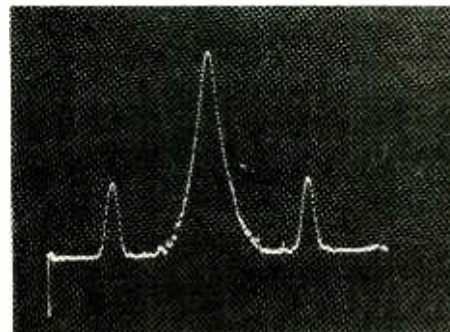

inputs was constant with the setting of the input level controls, these being very smooth in action. For some reason the overall gain and the measured sensitivities do not agree with the manufacturer's data, but the video levels were found to be in agreement.

### Other matters

The crosstalk performance of the system was measured by recording one channel at maximum level and not recording any signal on the other channel. The results are shown in fig. 6, from which it can be seen that the crosstalk is at an extremely low level at all audio frequencies—a performance that would be impossible with an analogue system.

While it is claimed that the effective wow and flutter from the system is below measurable limits, this is not entirely the case. Using the IEC quasi-peak weighted measurement this is certainly true (or at least below 0.002%) but the unweighted measurement showed a wow and flutter of 0.08% with the 'offending' component being centred on 60 Hz, the video frame rate of the system.

A similar situation arises with my normal test for scrape flutter in analogue machines—that is recording a 10 kHz tone and making a narrow-band spectrum analysis of the reproduced tone. Even though the sideband components would have been below the lower limit of my normal measurements, fig. 7 shows two well-defined sidebands 60 Hz either side of and 50 dB down from the 'carrier'.

An important factor which could not be measured because of its low level was the phase jitter 'between tracks'; even using an oscilloscope with a delayed timebase no jitter could be observed.

Finally, attention was focused upon the meter system, which consists of twin bar-type meters that are driven by the 'replay' electronics in the digitally-encoded part of the circuitry. These were found to have a very fast response time such that they responded fully to a single cycle with a full back time in the order of 250 ms to return to their 'rest' position. These parameters are ideal such that peaks were fully indicated and the readability was very good. Furthermore, as is most desirable if not essential in a digital system, the metering was after the pre-emphasis when this was switched into use.

### Summary

The performance of this Sony *PCM 1* system matches the performance of today's most advanced analogue machines, and indeed offers many advantages over them. However, in terms of forthcoming digital machines it is not up to the expected professional digital standards, as the future professional machines will incorporate a higher sampling rate and more bits—thus having a wider frequency response and dynamic range.

This is not to say anything against the *PCM 1* system which has a great deal to offer, and for those who already possess a suitable video recorder the *PCM 1* is a most attractive proposition.

It is, perhaps, of particular interest on the domestic front as a source of very high quality audio. For it is understood that the Japanese broadcast authority NHK has already broadcast digitised audio from their television transmitters for recording by owners of the *PCM 1* system. ■

# Audio jack sockets & audio jack fields

Approved suppliers to B.B.C., Post Office, Pye Telecommunications, Pye T V T, and other major users.

Mosses & Mitchell supply many of Britain's biggest users with Audio Jack Sockets and Audio Jack Fields to specification. If you have a need for long runs, or batch quantities, Mosses & Mitchell have the modern facilities to provide them—including the ability to design and manufacture precisely the component that you must have.

- Prompt delivery by work's vehicle, U.K. only
- Rigid inspection
- Keen quotation
- Fully illustrated brochure on request

## MOSSES & MITCHELL LTD

A member of Plasmec  
Weydon Lane,  
Farnham, Surrey.  
Tel. Farnham 21236

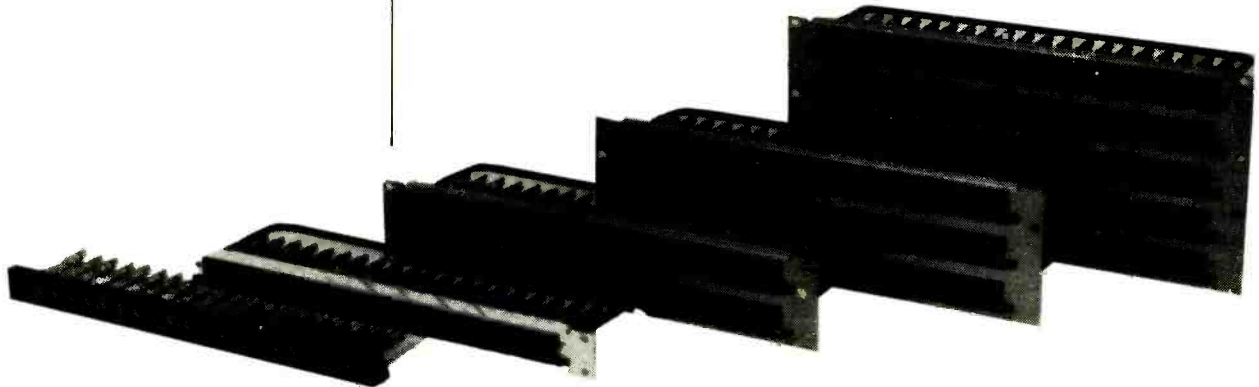

## Don't multiply types

Use a small modular potentiometer for all your applications, and enjoy our good delivery times.

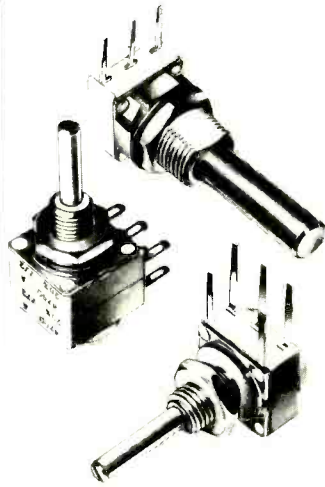

# P11

CERMET 1/2" square

Spindle  $\phi$ : 3 mm-4 mm-6 mm Ganging up 6 elements only 5.08 mm extra depth per added element.

SMOOTH FEEL

1 W at 70°C 22 $\Omega$  to 2.2 M $\Omega$

Tol.  $\pm$  10% or  $\pm$  20% linear, CW log, ICW log laws

Environmental conditions -55°C/ +125°C/ 56 days

MANY OPTIONS:

long life, panel sealing, slipping clutch  
differential terminals configuration

**COUNTING-SFERNICE LTD**

5 ELSTREE WAY BOREHAM WOOD  
HERTFORDSHIRE WD6 1SF



## Our slaves are yours to command

Loop bin cassette duplicating, Dolby A and B systems, fixing heat-seal cassette labels, open reel duplicating, large or small runs.

Sound Communication (Publishers) Limited,  
Dewsbury, West Yorkshire. Telephone (0924) 469436

## SHEFFIELD SOUND CENTRE

*SPECIALISTS IN HI-FI*

Main agents for Teac, Tascam, AR, Uher, Dokorder, Revox, Spendor, JBL, Dahlquist, Tannoy, Lowther, Ferrograph, Marantz, Bic Technics, Quad, Armstrong, Sony, Nagra, IMF, Dbx, Otari, and many more.

*Competitive prices, terms, part exchange*

**101a and 107 ECCLESALL ROAD**

Tel: 0742 23365

# Valley People Trans-Amp LZ

Hugh Ford

## TYPICAL PERFORMANCE

As a transformerless microphone pre-amplifier, line amplifier, transducer amplifier (balanced input):

**Differential input impedance:** 100k ohm.

**Full power bandwidth:** 180 kHz.

**Maximum output level:** +27 dBm with output buffer.

**Maximum input level:** +21 dB ref 0.775V rms at 6 dB gain.

## Performance at 60 dB gain with 150-1k ohm floating source

**Noise figure:** 0.5 dB broadband 20-100k Hz.

**Frequency bandwidth:** 0.3-500k Hz.

**Distortion:** under 0.01% im or thd to 20 kHz.

**CMRR:** greater than 100 dB to 20 kHz.

As a true balanced differential current summing amplifier:

**Full power bandwidth:** 180 kHz.

## Performance re 40 inputs at 10 dB summing gain

**Noise figure:** 0.5 dB broadband, 20-100k Hz.

**Buss output noise:** -86 dB ref 0.775V rms, 20-20k Hz.

**Frequency bandwidth:** 4.5 MHz.

**Distortion:** under 0.01% im or thd to 20 kHz.

**CMRR:** determined by resistor tolerances.

**Power requirements:**  $\pm 15V$  bipolar at 10 mA.

**Size:** 30.5 mm square by 15.9 mm high epoxy module.

**Price:** between £15 and £20, dependent on quantities.

**Manufacturer:** Valley People Inc, PO Box 40306, 2821 Erica Place, Nashville, Tennessee 37204.

**UK Agent:** Scenic Sounds Equipment, 97-99 Dean Street, London W1.

THE Trans-Amp LZ is an amplifier module intended for low-level input stages and other critical parts of the audio chain. In addition, it is suitable for industrial use, particularly as a transducer amplifier.

Basically the LZ is a balanced differential-in/differential-out device, the gain of which is controlled by feedback inputs that are separate from the signal inputs. Thus the overall gain does not depend upon the source impedance, and similarly the input impedance is not affected by the gain. When the amplifier is required to operate in a current summing mode the feedback can be returned to the signal inputs, thus forming a virtual earth to which the input signals are applied. If the

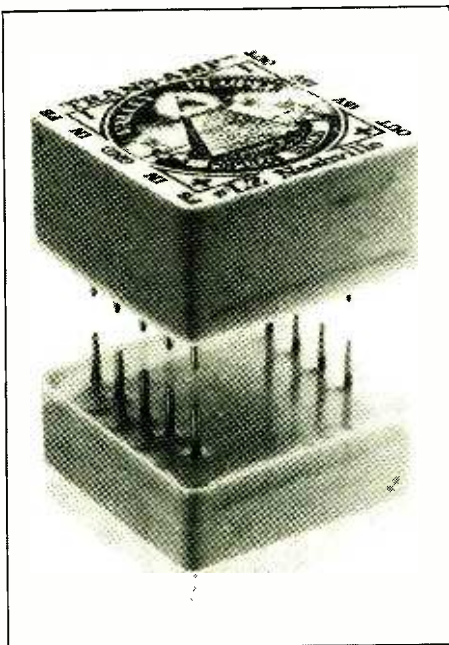

module is required to feed an unbalanced output, the amplifier's output may be buffered with an operational amplifier—this requires the minimum of components.

Unlike conventional operational amplifiers the open loop gain of the LZ in fact increases as the feedback is decreased. Hence the bandwidth is larger at small gains, with the result that the amplifier is highly stable. The manufacturer claims that the bandwidth at unity gain is 5 MHz and remains constant up to a gain of 40 dB; above this gain the bandwidth decreases.

From the point of view of audio applications the optimum input source impedance for minimum noise is very convenient for matching transducers, since the optimum impedance is in the range 100-2k ohm with the manufacturer claiming a noise figure of less than 0.25 dB for source impedance between 300 and 500 ohm.

## Measurement results

The measurements on the Trans-Amp LZ were made while using it as a 60 dB gain input amplifier having both the input and the output balanced. The supply voltage was fixed at  $\pm 15V$  bipolar, as recommended by the manufacturer. Under these conditions the output level for the onset of waveform clipping was found to be +24.5 dBm from an output impedance in the order of 1 ohm. Distortion into a high impedance is given in table 1 for +24 dB ref 0.775V rms output. When working into a 600 ohm load the distortion rose a little to 0.01% third harmonic at 1 kHz or 0.02% at 10 kHz. However, this performance is excellent and distortion at lower output levels was even less.

TABLE 1 DISTORTION MEASUREMENT

Frequency	Second harmonic	Third harmonic
63 Hz	<0.01%	<0.01%
1 kHz	<0.004%	<0.004%
10 kHz	<0.003%	0.006%
20 kHz	<0.003%	0.015%

Like distortion, the noise performance as measured was extremely good (table 2). While relation between noise and source impedance agrees with the manufacturers' data, the actual level of noise is slightly higher. However, this may well result from the difficulties in obtaining a defined noise bandwidth suitable for measuring noise to tolerances of a fraction of a decibel, the bandwidth used for table 2 was 20-20k Hz, with 24 dB/octave filtering. The noise spectrum itself was effectively white noise from 20 to 100k Hz, with a slight rise in density above 100 kHz.

TABLE 2 NOISE PERFORMANCE

Source impedance (ohm)	Noise figure (dB)
100	2.4
200	1.3
660	0.9
1k	1.0
2k	1.4
5k	2.3

Using the recommended circuit at the previously stated 60 dB gain the frequency response was within  $\pm 0.1$  dB from 2 to 30k Hz, but rose to +3 dB at 150 kHz (fig. 1). This high frequency rise could be readily corrected by shunting the feedback resistors with a small capacitor.

A final matter of interest is the common mode rejection ratio, which is particularly important for applications such as microphone input stages. This was measured as being in excess of 100 dB at 1 kHz—much better than normal transformer inputs, with an associated input impedance of 100 k ohm.

## Summary

This brief evaluation of the Trans-Amp LZ module suggests that it has exceptional properties, particularly from the point of view of noise. Thus it can well find applications in low-level input stages, such as microphone inputs. While it was not tried with equalisation in the feedback loop, there is no reason to suppose that this will pose any problems. It may be assumed, therefore, that the LZ module will be very good as a tape or pickup pre-amplifier. ■

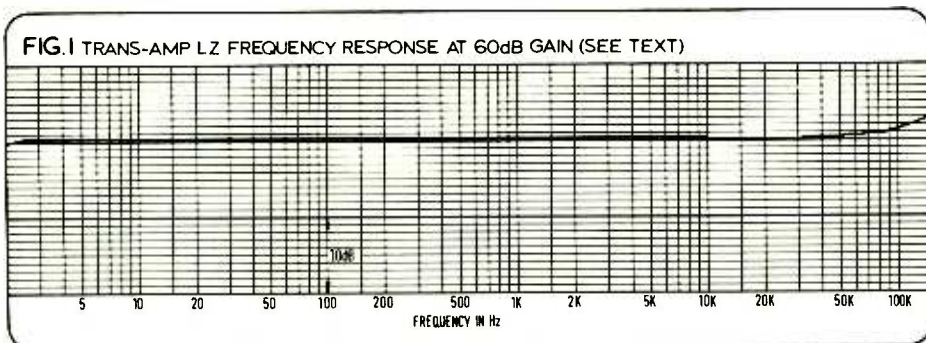

# You can win them all!

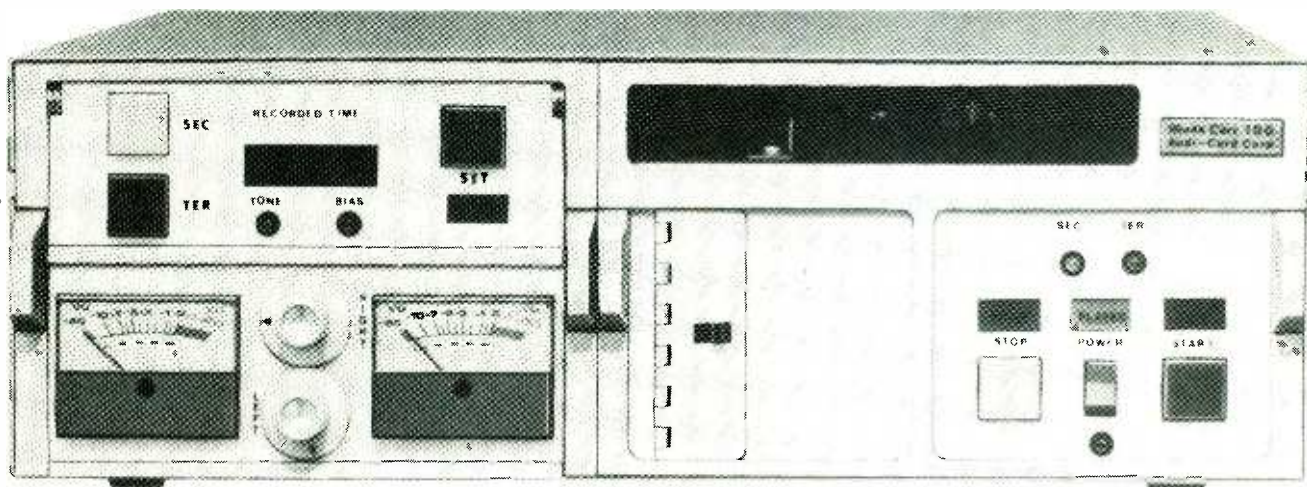

## WITH THE NEW AUDI-CORD CARTRIDGE MACHINE

The all new Audi Cord cartridge machine has many new features to win over the most demanding producer.

It also has all the technology, ultimate reliability and ease of access in console, to win over the most demanding service engineer. Even your accountant, when he sees how competitive the prices are, will know you have found a winner.

15 years of understanding and design experience coupled with modern circuitry and components for improved electrical performance and reliability are brought together to bring you the best cartridge machine on the market. Meets all new NAB/IEC specifications.

### FEATURES

#### For the Production Department:

- \*Control logic affords four selections of replay mode, replay only by removing and re-installing cartridge, replay not prevented "played" light indicates status, etc.
- \*Optional precision digital recording timer with true recorded time indication
- \*The circuits have been designed to have more than sufficient overload capability to take the soon to be available high output/low noise cartridges

#### For the Maintenance Department:

- \*Wide use of CMOS digital and linear integrated circuits
- \*Motor, solenoid and cartridge sensing are all solid state controlled
- \*Pressure regulating solenoid system improves tape skew and eliminates adjustments
- \*Top adjusted head mounts that remain fixed
- \*All pre-sets for equalisation and for the six position meter switch for circuit checks have access through hinged front panels
- \*Dual record/replay Hi-Lo equalisation adjustments
- \*No relays or micro switches

### OPTIONS

Multiple replay featuring automatic switch-over and silence sensing, mono and stereo, single or multiple cue tones and delay units

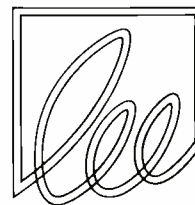

For further information contact:  
C Welsh

## LEE ENGINEERING

Napier House Bridge Street  
Walton-on-Thames Surrey KT12 1AP  
Telephone: Walton-on-Thames 43124/5/6  
Cables: LEETECH Telex: 928475

# Trident CB9109 low distortion oscillator

Hugh Ford



## MANUFACTURER'S SPECIFICATION

**Output capability:** +25 dBm into 600 ohm; large output level meter.

**Output distortion:** typically 0.006%, at 1 kHz.

**Squarewave output:** fast rise time.

**Overall frequency range:** 10-20k Hz.

**Output attenuator range:** +20 to -70 dB in 10 dB steps, with fine control and mute button.

**Integral frequency counter:** gives continual display of oscillator output frequency in both sine and square modes.

**Separate frequency counter input:** accessible on front-panel input; timing range is selected by the frequency range pushbuttons.

**Power requirements:** 110/240V, 50/60 Hz.

**Dimensions (wdh):** 432 x 178 x 89 mm; rack mounting is possible by the addition of two angle brackets.

**Finish:** black anodised, brushed aluminium with anodised silver lettering.

**Construction:** alloy case easily removable for servicing. Electronics contained on glass-fibre printed circuit boards, with 'highest quality components and selected solid-state-devices being used throughout'.

**Price:** £325.

**Manufacturer:** Trident Audio Developments Ltd, 112/114 Wardour Street, London W1, UK.

THE Trident combined low-distortion oscillator and frequency counter is basically a low-distortion oscillator with a digital display of tuned frequency. However, the counter may be accessed via a jack socket, allowing the frequency of external waveforms to be displayed. The frequency counter has, in effect, two ranges which are selected by the frequency controls of the oscillator section, the ranges being a four-digit display of either 9999 Hz maximum or 99.99 kHz maximum. The latter range is selected when the oscillator frequency range switches are in the upper two ranges of 1-10 kHz or 10-100 kHz; the lower ranges being 10-100 Hz and 100-1 k Hz. In fact these four selector buttons, which are of the self-illuminating type, serve two purposes in conjunction with a further two buttons. One of these is identified as 'preset/dial' and when released allows the frequency to be set by a roughly-calibrated frequency dial; when depressed the frequency is preset to lower frequency of the selected range. Thus preset frequencies of 10, 100, 1k or 10k Hz are available; the

second extra pushbutton allows the preset frequency to be doubled and hence providing 20, 200, 2k or 20k Hz.

Two further buttons control the oscillator's mode, and offer a choice of either sinewave or squarewave outputs in addition to a choice of normal or low-distortion modes. In the latter mode the oscillator's amplitude is not so well controlled, there being bounce when changing frequency and a less accurate frequency response in comparison with the normal 'sweep' mode.

Both the sinewave and the squarewave output from the oscillator use the same attenuator and output terminals. These comprise a BNC socket in parallel with terminals/sockets that whilst of the standard 4 mm diameter variety but were not on the standard spacing. This is rather irritating, but it is understood that the manufacturer is correcting the problem.

Output level is controlled by a variable fine-level potentiometer in conjunction with five self illuminating pushbuttons. One of the push-buttons provides an oscillator mute function and the other four individual non-interlocked attenuators identified as +20, +10, -20 and -40 dBm, the output level being shown on an analogue meter calibrated in both dBm and volts.

Since the meter has calibrations in one-decibel steps from +5 dBm to -10 dBm, the available output range is from a maximum of +25 dBm with the +20 dB attenuator, down to -80 dBm with the +10, -20 and -40 dB attenuators. Although the maximum output of +25 dBm is very useful for modern audio equipment, the lower measured limit of -80 dBm is felt to be too high for measuring microphone circuits, and the like; I would have preferred to have seen an extra 10 dB of attenuation available.

The remaining front-panel features are two led indicators that show which of the two frequency counter ranges are in use; a 'hold/count' switch for the frequency counter; and the power on/off switch.

To the rear of the unit there is the IEC mains power connector and its associated mains fuse which was properly identified in rating. Underneath the cabinet are two feet for tilting the instrument to a good viewing angle.

Within the unit virtually all the electronic components are mounted onto a good quality glass-fibre pcb, which is printed with clear component identifications and tidily laid out. What exists in the way of hand wiring is also tidy, with terminations being sleeved and the wiring well secured.

The main cabinet is of sheet metal and the front panel a substantial thick alloy plate (about 3 mm) with very clear control identifications. Thus the whole unit is reasonably substantial and quite well finished. In general the controls were easily identified and handled well. But I would have liked to have had a fine frequency control for accurate frequency setting as is required in tuning sharp filters. Also, the voltage scale on the meter is in integral volts with no intermediate scale marks, making voltage reading a little too much guesswork.

## Performance

The flatness of the oscillator output in the low-distortion mode and in the normal sweep mode is shown for each frequency range in fig. 1. It

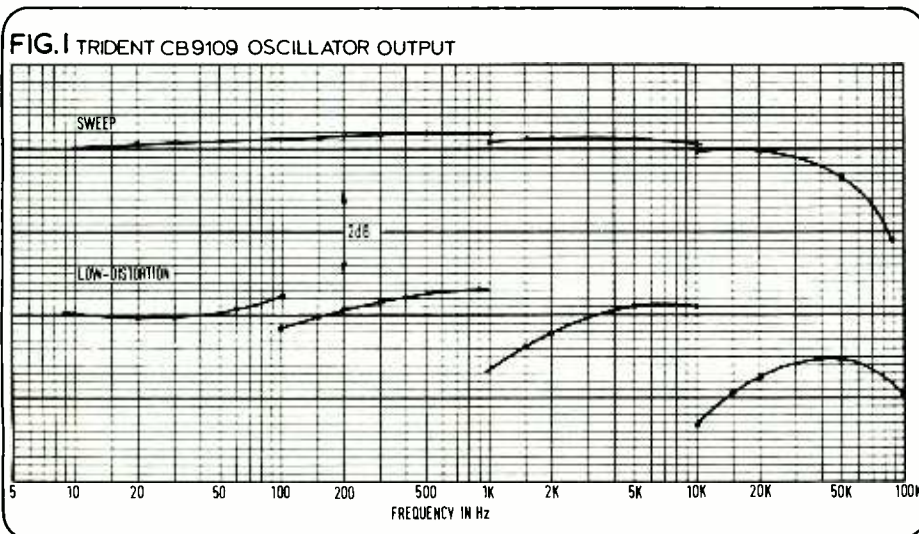

# AH

## Production Mixer S6-2

The A & H S6-2 is neat, black and capable. It features inputs for two microphones, 2 stereo lines and 2 magnetic grams, all fitted with their own 2 way equalisers and variable input sensitivity controls.

Also included is a comprehensive override system and a separate power supply/relay box which is coupled with the remote start controls.

All this represents real value for money at £420+ VAT. The A & H production mixer is just that. A desk to provide pure production-ability.



Showrooms open—  
Tuesday—Saturday 10.00 am—5.00 pm  
Late night Weds. until 8.00 pm.  
Local parking—  
5 mins. from St. Johns Wood Tube.  
EXPRESS UK AND EXPORT  
DELIVERY SERVICE.

# Roger Squire's

## PRO-AUDIO

### THE MIXER CENTRE

We have one of the largest selections of mixers, all wired ready for demonstration at our showrooms.

Why not come along and discuss your particular requirement with our team and experience a thoroughly professional approach.

Branch Manager: Cliff Lake  
Sales Engineer: Dave Whittaker  
**Roger Squire's PRO-AUDIO**  
55 Charlbert St., London NW8 6JN  
Telephone: 01-722 8111 Telex: 298133.

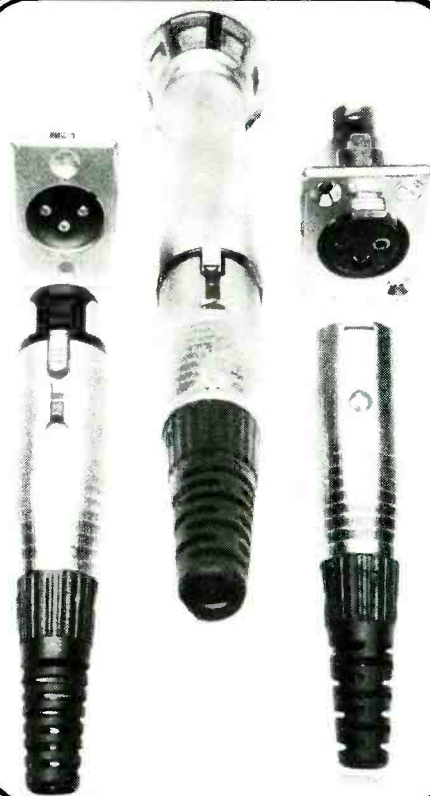

# NEUTRIC

## SWISS MADE

Competitively priced XLR type connectors and sockets in silver or black, extensively used in the U.K. Distribution nationwide.

See us at APRS, Stand No.118.

Sole U.K. Agent,

# Eardley Electronics Ltd

Eardley House, 182-184 Campden Hill Road,  
London, W8 7AS. Tel. 01-221 0606 Telex: 299574

**AFTER NAB**  
**Cuemaster**  
**STILL THE BEST**  
**CARTRIDGE MACHINE**



**Granet**

Communications Ltd.  
 39 BEECHCROFT MANOR, OATLANDS  
 DRIVE, WEYBRIDGE, SURREY KT13 9NZ  
 Weybridge (0932) 47785

**REVIEW: TRIDENT CB9109**

can be seen that in the sweep mode the flatness up to 20 kHz is within  $\pm 0.2$  dB, which is acceptable for most audio work. However, above 20 kHz the output falls to about  $-2$  dB at 100 kHz, which leaves something to be desired. Clearly the flatness in the low-distortion mode is unacceptable for frequency response measurement, and it is felt that the manufacturer should make these limitations clear in the instrument's specification.

While the frequency stability with time is not often important for an audio oscillator, it does become important for such applications as measuring tape speed drift. As can be seen from the plot of frequency (1 kHz) against time in fig. 2, the frequency drift is excessive for such applications. In practical terms it can be seen that the maximum rate of drift is in the order of 0.1% in two minutes, where with a tape machine we are probably interested in 0.1% drift in a full reel of tape—maybe 30 minutes.

So far as the frequency counter is concerned, this has its reference derived from an internal crystal oscillator. Measurements showed that the accuracy was within 3 parts in  $10^4$ , which shows as errors in the display above 10 kHz. But the crystal has a trimming capacitor that allows the crystal to be correctly adjusted. This should have been done by the manufacturer before the instrument was submitted for review.

The sensitivity of the external input to the frequency counter is claimed to be 300 mV. It was found, however, that the indication was unreliable at this level and that a minimum of 400 mV input gave safe indications at frequencies up to 99.99 kHz.

The output impedance varied from 84 ohm at low output attenuator setting up to 150 ohm with the  $+20$  dBm output level setting. The actual output levels into a high impedance and into a 600 ohm load are shown in table 1.

**TABLE 1 OUTPUT LEVEL**

	High impedance	600 ohm load
Maximum output	14.04V	11.18V
Nominal +20 dBm	+19.96 dBm	+11.18 dBm
Nominal -10 dBm	-10.13 dBm	-9.81 dBm
Nominal -20 dBm	-20.18 dBm	-20.17 dBm
Nominal -40 dBm	-39.9 dBm	-40.1 dBm

Clearly the accuracy is very good. The meter calibration accuracy was also excellent, with less than 0.2 dB error in output level over the meter range  $+5$  dBm to  $-5$  dBm.

Using the mute button facility effectively removed the output, with the level at 100 kHz being dropped by 120 dB, and that at 10 kHz greater than 140 dB.

As far as the squarewave output is concerned the meter indicated within 0.4 dB of the true rms value of the squarewave; however, it was felt that the quality of the squarewave

108 ▶

**FIG. 2 TRIDENT CB9109 FREQUENCY DRIFT**

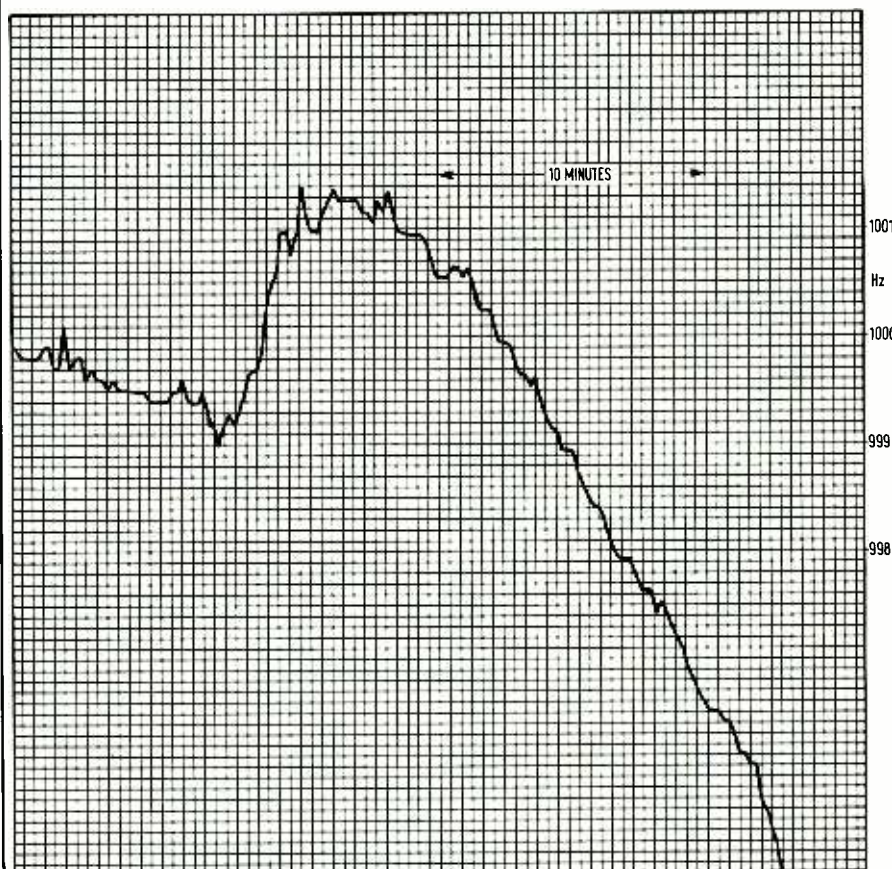





**STUDER B67**  
**Professional Tape Recorder**  
Respected STUDER quality at attractive prices.

# Performance — we guarantee it...

tomorrow's generation with features you requested,  
available today

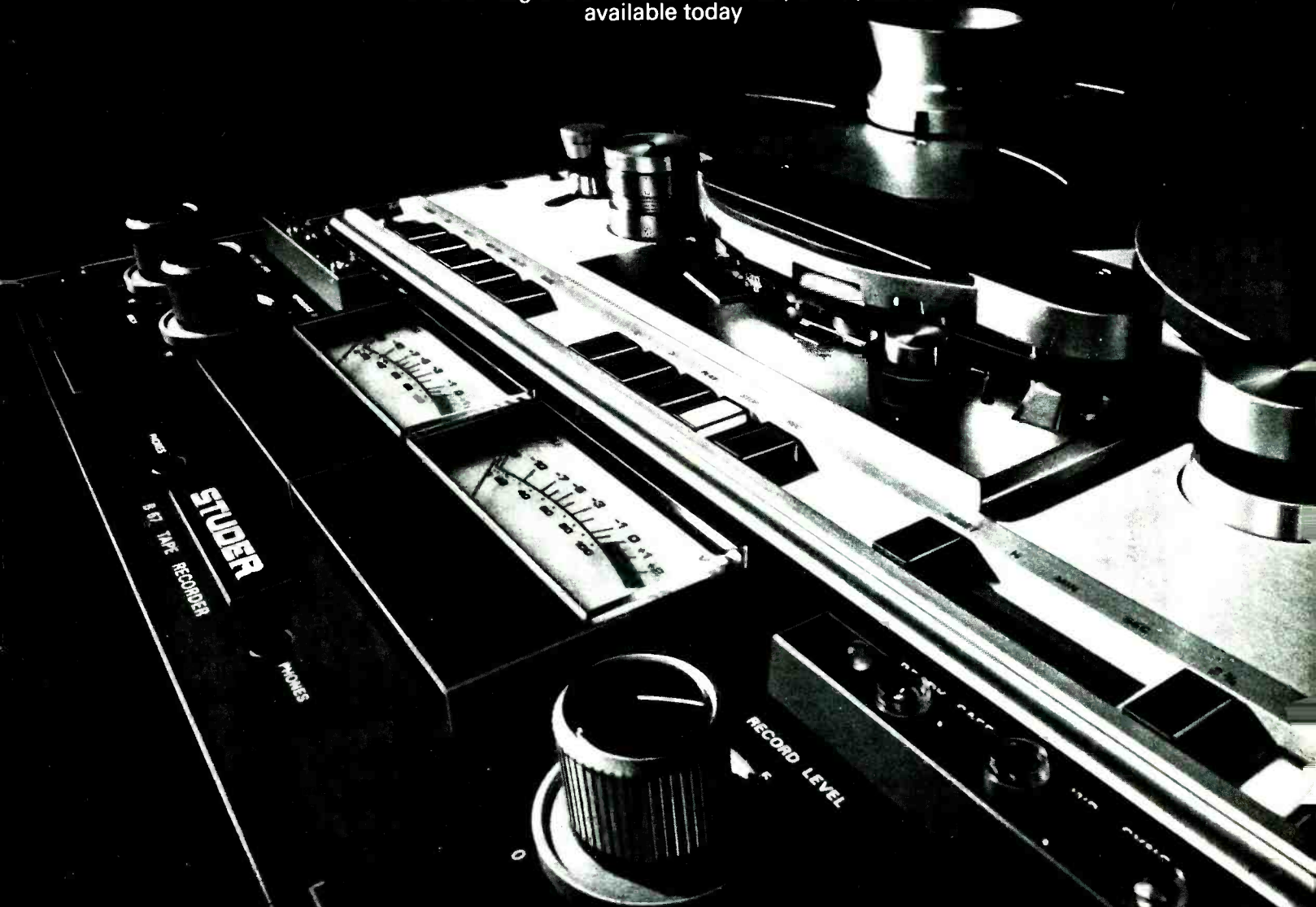

# STUDER INTERNATIONAL AG

CH-8105 Regensdorf, Phone (01) 840 29 60, Telex 58489

STUDER REVOX AMERICA INC., Nashville, Phone (615) 329-9576, Telex 55-4453

STUDER REVOX CANADA LTD., Toronto, Phone (416) 423-2831, Telex 06-23310

STUDER FRANCE S. à r.l., Paris, Phone 533 58 58, Telex 24-744

F.W.O. BAUCH LTD., Boreham Wood, U.K., Phone (01) 953-0091, Telex 27502

[www.americanradiohistory.com](http://www.americanradiohistory.com)

## REVIEW: TRIDENT CB9109

output was not very good. Firstly, the variable attenuator provoked some overshoot at the maximum output position as is shown in fig. 3; this shows the leading edge of a square-wave in two attenuator positions. Fig. 4, the output waveform at 10 Hz, shows there is substantial droop at low frequencies. In addition, the mark/space ratio of 1:1.2 is unimpressive and the risetime of 2.2  $\mu$ s slow. Finally, in the review instrument the output in the range 10-100 kHz was useless because of instability of the waveform.

Reverting to the sinewave performance, as received the distortion at all frequencies was outside the specification. However, the manufacturer provided very prompt attention to the problem, with the result that the designer of the instrument attended my laboratory and modified the instrument. After modification, the distortion performance within the audio fre-

quency band was good, as can be seen from table 2. As with many low-distortion oscillators the settling time in the low-distortion mode was fairly long and there was some bounce in the output level, but it was not felt that this was excessive.

The final matter to be investigated was the accuracy of the eight preset frequencies. This transpired to be a variable feast with all except 100 Hz, 200 Hz, 1 kHz and 2 kHz being within 1%. The 100 Hz was 6% high, 200 Hz a staggering 25% high, 1 kHz 2.7% high and 2 kHz 4% high—it would appear that the 200 Hz error is likely to be an incorrect component value?

### Summary

While this is potentially an interesting instrument that I had looked forward to reviewing, quite frankly this prototype was disappointing. When modified it worked quite well as a low-distortion oscillator within the audio frequency band, but there are too many other

shortcomings some of which have been mentioned.

In addition to the form of frequency display being irritating because it visibly flickers and then stops for a short time to display frequency, the pulses driving the display leak into the oscillator's output—hence the inclusion of a 'counter-hold' switch. However, the amount of 'rubbish' in the oscillator's output depended upon the time at which this switch was operated.

The manufacturers' comments on this review would suggest that this will be an attractive instrument when modified to the production version.

### Manufacturer's Comment:

The review by Hugh Ford praises many features of the low-distortion oscillator. It is surprising, however, that Mr Ford should summarise his report in the way shown. From about 35 individual review comments he praises 20 of them with 12 being either personal views or specific market requirements. There could appear to be therefore only three or four serious criticisms, and this comment of being unable to give the unit *any* recommendation does not seem to agree with the review in general.

The spacing of the sockets has been investigated and the error traced to a metalwork drawing. This has now been corrected.

The attenuator comments are felt to be personal, as in any event most good circuits today deliver  $\pm 20$  dBm and therefore gains of  $\pm 100$  dB can be checked with this unit.

The voltmeter scales are tabulated in the handbook which unfortunately was not ready for Mr Ford's review.

The reference to frequency stability has to be questioned, as the unit tested by Hugh Ford has since been checked and providing the LDO is in the sweep mode and allowed to stabilise for say 30 minutes (as is common practice with frequency counters and the like) the frequency stability is much greater than he has measured, and certainly satisfies his requirement. It is agreed this stability is not obtained in the low-distortion mode and possibly his tests were done in that state. Once 'warmed up' the oscillator is stable for many hours within 0.05%.

A direct output for squarewave is now featured on the rear panel of the LDO and provides a ttl-compatible squarewave with no droop and a rise time of 20 nanoseconds.

The preset frequency buttons are intended for spot checks in general amplifier testing and are not intended to be exact frequencies.

The error on the 200 Hz button has been investigated and found to be, as suggested, an incorrect component value; although the component is marked as being correct the tolerance is outside its specification. It would appear practical to have these preset frequencies within 5%, as the user can tune to much closer frequencies with the frequency counter should he so desire.

The reference to 'rubbish' in the oscillator's output is being considered and, as can be seen from Mr Ford's figures, the distortion parameter measured is very good and could be improved even further by inhibiting the counter during very low distortion measurements.

Although we cannot agree entirely with the remarks of Hugh Ford they are naturally very well received. The aforementioned problems will be adequately considered and, where possible, rectified before this unit is released. ■

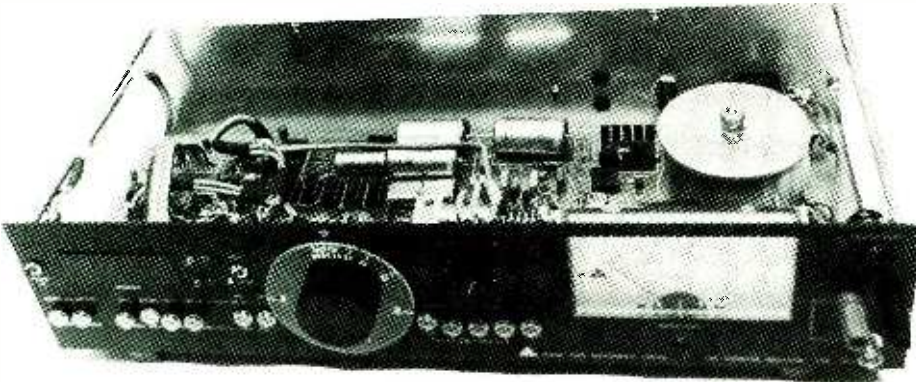

Fig. 3. Overshoot at maximum output.

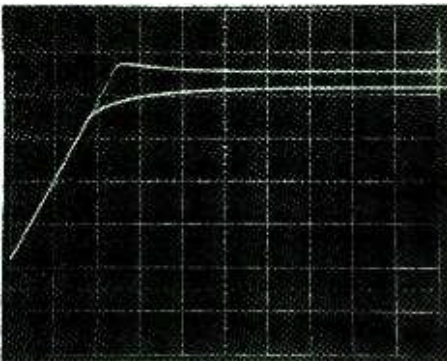

Fig. 4. 10 Hz squarewave output.

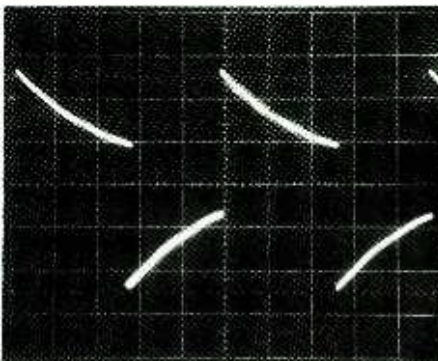

TABLE 2 DISTORTION

Frequency	Low-distortion mode			'Sweep' mode		
	Total harmonic	2nd	3rd	Total harmonic	2nd	3rd
10 Hz	0.09%	0.03%	0.10%	0.35%	0.03%	0.35%
100 Hz	0.02%	<0.01%	0.02%	0.08%	<0.01%	0.08%
1 kHz	0.005%	<0.003%	0.005%	0.013%	<0.003%	0.013%
10 kHz	0.006%	<0.006%	<0.006%	0.019%	0.01%	0.01%
20 kHz	0.008%	0.01%	0.006%	0.023%	0.017%	0.016%
50 kHz	0.013%	0.018%	0.08%	0.095%	0.11%	0.08%
100 kHz	23%	29%		20%	26%	



## AUDIO MEASURING INSTRUMENTS

### NEW ITEMS

#### DMS4 Distortion Measuring Set. Precision

#### DMS5 Distortion Measuring Set. General Purpose

The DMS4 is a precision instrument intended for laboratory use, capable of measuring total harmonic distortion to better than 5 parts per million (0.0005%).

The DMS5 is intended for general purpose use in the studio, test department, or factory and can measure to 0.001% T.H.D.

Both instruments cover the frequency range 10Hz-100kHz and are semi-automatic nulling. The instruments will operate from any signal source. Nulling to zero is automatic after the DMS has been tuned to the test frequency. The instrument will thus continually read distortion whilst adjustments are made to equipment under test providing the test frequency is not changed.

### EXISTING ITEMS

#### LDO3 Low Distortion Oscillator

A continuously variable frequency laboratory oscillator with a range 10Hz to 100kHz having virtually zero distortion over the audio frequency band with a fast setting time.

#### Specification:

Frequency range: 10Hz to 100kHz (4 bands)

Output voltage: 10V r.m.s. max.

Output source resistance: 150 ohms or 600 ohms (unbalanced)

Output attenuation: 0-100 dB (eight 10 dB steps plus 0-20 dB variable)

Output attenuation accuracy: 1%

Sine wave distortion: Less than 0.001% 10Hz to 10kHz (typically below noise of measuring instrument)

Square wave rise and fall time: 40/60 n.secs.

Monitor output meter: Scaled 0-3, 0-10 and dBv or dBm

Mains input: 110V/130V, 220V/240V

Size: 17in. (43cm) x 7in. (18cm) high x 8½in. (22cm) deep

#### LDO3B Low Distortion Oscillator, balanced output

As LDO3 but additionally fitted with output amplifier and screened transformer providing a 600 ohm floating balanced output and 150 ohms unbalanced. Unbalance: -80 dB 1kHz, -60 dB 10kHz.

#### ANM1 Audio Noisemeter, average sensing

#### ANM2 Audio Noisemeter, true r.m.s. reading

#### ANM3 Audio Noisemeter, Quasipeak/true r.m.s. reading

The noisemeters have 16 measurement ranges from 10µV f.s.d. to 300V f.s.d. incorporating a 5in. mirror scale of excellent linearity calibrated in Volts and dBv or dBm. The instruments are in accordance with DIN 45.405 and incorporate recommended weighting characteristics.

#### Brief Specification for all noisemeters:

Frequency response as voltmeter: 4 Hz to 250 kHz, ±0.5dB

Input impedance: 1 M ohm shunted by 30 pF

Attenuator accuracy: 0.25%

Meter scale linearity: 1%. Typically better than 0.5%

Waveform error in true r.m.s. instruments: ±1% for crest factor 10

Noisemeter included weighting characteristics: WIDE BAND (flat response voltmeter)

DIN 'AUDIO BAND'

IEC/DIN 'CURVE A'

CCIR

Size: 11¼in. x 7¼in. x 8½in. deep overall (28 x 18.5 x 22cm.)

## RADFORD LABORATORY INSTRUMENTS LTD.

Ashton Vale Road, Bristol BS3 2HZ

Telephone 0272 662301

USA Patrick McVeigh. Tel. 201 746 5461

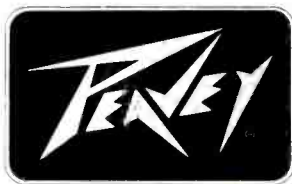

## PROFESSIONAL SOUND EQUIPMENT FOR ALL MUSICIANS

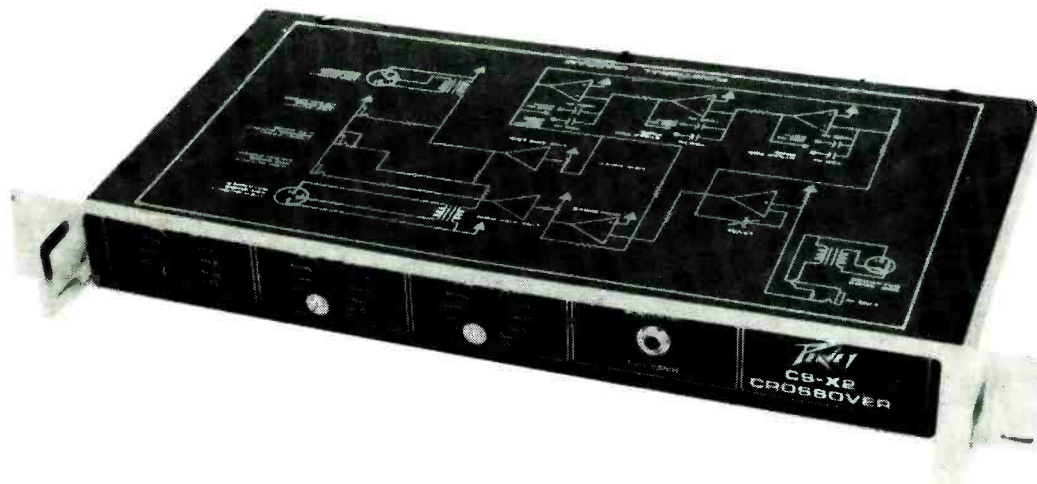

Distributed in the U.K. and Eire by:

**PEAVEY ELECTRONICS (UK) LTD.**

**UNIT 8, NEW ROAD, RIDGEWOOD, UCKFIELD, SUSSEX TN22 5SX.**

# R. D. G. AUDIO VISUAL LTD.

12 HILL VIEW, NEWPORT PAGNELL

DUNSTABLE 607192 evenings 0908 61300/0525 403528

## RECORDING MACHINES

Studer A80 16 track MkII new ... ..	offers	
MCI 24 track auto locate 16 track ... ..	10,000	
Ampex MM 1100 24 track auto locate ... ..	15,000	
3M M79 16 track prewired 24 as new ... ..	10,500	
3M M56 16 track vgc ... ..	9,000	
Studer A80 MkI 8 track ... ..	6,000	
Studer C37 stereo vgc ... ..	950	
3M M79 4 track with stereo H/B ... ..	offers	
Ampex AG300 all transistors 4 track immaculate	950	

## CONSOLES

Sonag 24 x 24 ... ..	9,000
Raindirk series 3 16 x 8 x 16 new ... ..	offers
Trident B 40 x 8 x 24 ... ..	16,000

Trident B 30 x 16 x 16 vgc ... ..	16,000
Audio Developments 14 x 4 x 8 ... ..	4,500

## MICROPHONES

Various makes and types in stock

## MISCELLANEOUS

Lockwood Majors new, pair ... ..	690
A&D S760 XRS stereo comp/lim ... ..	600
A&D phaser ... ..	400
JBL 4311 new, pair ... ..	550
Various H/H amps S/H ... ..	P.O.A.
Tweed Audio comp/lim in 19" rack & PSU (free)	650
Bell Electronics phasers new 19" rack mounting	280
Bell Electronics flangers new 19" rack mounting	290

**COMPLETE CUTTING SUITE:** Neumann VMS 66 with rack VG66S, mixer EMT 930, Ampex 6 x 2, Neumann EQ, Parametrics, Dolby's BX20, N79, M10, Urei LA3A, EMT 156 comp/lim, etc., etc.

Offers around 370,000 French francs

ALL STUDIO EQUIPMENT WANTED

# GET BEHIND BGW's NEW 750 SERIES

## The Competition Already Is.



BGW's characteristic rack handles, front panel LED's and fans have long been exploited as symbols of design excellence by competitors who know good amplifiers when they see them.

But professional power amps live or die by their guts, not their facades. And that's where BGW's new top-of-the-line 750 Series leaves the competition behind.

Identical but for their front panel power indicators, the Model 750B, with light-ladder VU meter, and the Model 750C, with clipping indicators, each generate more than 360 watts of continuous power per channel into 4 ohms.

Sophisticated arc-interrupting and time-delay circuits protect monitors and guarantee transient-free switching. Twenty (20) large-geometry, full complementary output transistors provide unequalled SOA in an ultra-conservative design. These professional power amps employ high-quality magnetic circuit-breakers, XLR-type connectors, and input transformer sockets. Separate circuit and chassis grounding eliminates annoying ground loops. TIM figures are held to an incredibly low 0.02%!

Your franchised BGW dealer can give you still more reasons why your professional peers are getting behind BGW... and why the competition stays behind!



**BGW SYSTEMS**  
13130 South Yukon Avenue  
Hawthorne, California 90250 **Get Behind Us!**  
213/973-8090

In Canada: Omnimedia Corp., 9653 Cote de Liesse,  
Dorval, Quebec H9P1A3

\*Measured according to Leinonen/Otala/Curl method, AESJ, Vol. 25, No. 4.

# We made the man with the triangle in the Boston Pops extremely happy.

## He wasn't cut off this time.



Arthur Fiedler's Boston Pops and Crystal Clear production made this new direct-cut record.

To be sure, they used three different combinations of cutting equipment. And the result, the Scully cutting machine with Ortofon cutterhead, was chosen by Arthur Fiedler and the sound experts. Not only to please the triangle player in the famous orchestra - but the depth in the music responded to the name "Crystal Clear".

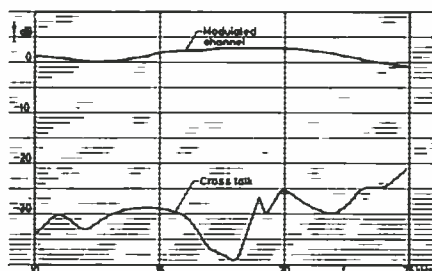

Channel separation measured on cut lacquer disc by interferometric methods. DSS 731/GO 741.

**The explanation:**  
The special construction of the Ortofon cutterhead

Every cutting engineer knows the difficulty of cutting frequencies in the supersonic area because of problems with the resonances in the cutterhead. These problems can be solved in several ways. The high frequencies can be cut off. Or an equalizer can be used to compensate for the resonances. Excellent when producing "middle-of-the-road". But for more sophisticated music you'll need the Ortofon equipment because we have solved these resonance problems. The Ortofon cutterheads DSS 731 and DSS 732 have the lowest secondary resonance above 30 kHz and 24 kHz respectively. This ensures a flat frequency response and high channel separation in the lacquer.



"The Lathe" by L.J. Scully.  
The Perfect Partner.

We looked for a cutting machine designed to meet the most stringent requirements of the master record industry. And found it.

Which means that Ortofon now represents this unique mastering unit in Europe. Just as L.J. Scully Manufacturing Corporation represents Ortofon in America.

We believe Ortofon and Scully to be a perfect combination. And so do others. Just ask Arthur Fiedler . . .

**ortofon**  
accuracy in sound

ORTOFON MANUFACTURING A/S  
11 B. Mosedalvej,  
DK-2500 Copenhagen - Valby,  
Denmark

## Why not let us have your requirements. We won't cut you off.



U.K. Distributors

**Feldon Audio Limited**

126 Great Portland Street, London W1. Telephone: 01-580 4314. Telex: London 28668

# May we introduce ourselves...

We have been well established as an important domestic Hi Fi and Video supplier for some years and we have now finalised a formidable professional audio section designed to cater for studios and professional users like yourselves.

To give you some idea of the standard we set, look at the company we keep.

We are main agents for:

- JBL (we are the only place to have 4343, 4315, 4301, 4380 monitors on dem and available, and a full stock of drive units).
- KEITH MONKS, complete range in stock:
- TEAC & TASCAM • AKG • QUAD • ALICE • REVOX • ALLEN & HEATH • NEAL • BRENELL.

We also supply:

- Beyer • DBX • Amcron • Studer • Rusco
- Master Room • SIS • EMI • EMT • Dolby • MCI • Shure • 3M • Sennheiser • BGW • Orban/Parasound • A&R • Klark • Teknik • Agfa to name but a few.

Pricing:

very, very competitive with (proper) professional discount structure.

Stock:

big and getting bigger for fast delivery times.

Delivery service, demonstration facilities, consultancy service, and account facilities.

As you can see, a large percentage of your equipment requirements (splicing tape to 24tk masters) can be obtained from one source at your normal pricing. We do the running around and paperwork, you just phone.

...give us a try, you have nothing to lose, - you could gain a lot!

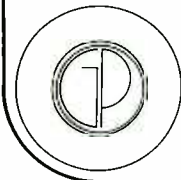

## GRAHAMS PROFESSIONAL

86-88 Pentonville Road, London N1.  
Tel: 01-837 4412 Ext. 66 Telex: 299446

# Probably the best cassette sound you've ever heard

Large runs for record companies and smaller runs for studios all given the same precise attention with regard to quality and speedy turnround. **Blanks wound any length.**

Collection and delivery service door to door for both cassette and master tape copying.



Contact  
**Dave Rees**  
at  
**061-795 7666** to  
discuss your  
requirements.

supplying studios, schools, the broadcasting industry and governmental departments - carrying a full range of products  
Beyer Revox Neal Quad JBL Phase Linear Tannoy Teac DBX AKG Allen and Heath Brenell Turner Ferrograph Uher.

Accessories:

XLR Mics Stands spools De Magnetisers Splicers Signal Processors Mixers.

## PRO-WORKSHOP AND MOBILE SERVICE FACILITIES

Buy and sell second hand Studio Equipment, collections/delivery

now at new premises

THE  
STUDIO  
SHOP  
Oxgate Farm  
Coles Green Rd  
London NW2 7EY  
Ring 01-452 1979



**studio  
equipment  
services**  
LIMITED

# Trust James to get it together time after time

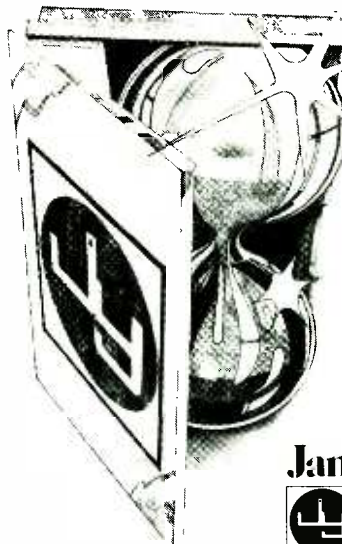

We provide a total product package for the industry. Orders of up to 30,000 perfect copies per week from your 1/4" or 1" master present no problem. For smaller runs we can turn your order around in 48 hours.

Design and print of your cassette stationery is part of our service together with choice of shell types and colours.

Full Dolby facilities are available in house. Your inquiries are invited for the manufacture of 8 track cartridges.

**James Yorke Limited**



Fossebridge Cheltenham  
Glos GL54 3JW  
tel Fossebridge (028572) 423

We have a lot to live up to... and we do.

Dolby is a registered trademark of Dolby Laboratories Inc.

# SLIMLINE

## Penny & Giles small development in the fader business

Penny & Giles new Slimline fader is only 12.7mm wide with a 65mm electrical stroke. Yet, within that 12.7mm body width you can have mono or stereo outputs, optional switch linear or audio taper with an infinitely smooth and stepless fade - plus the other performance advantages of Penny & Giles conductive plastic faders.

Our small development sounds good - and has a small price to match.

Write for full details or phone  
our sales office.

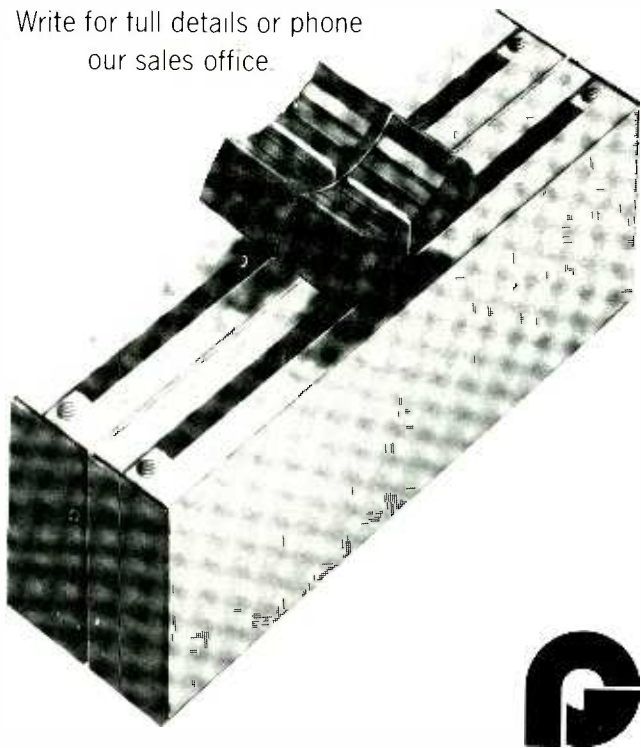

**Penny & Giles Conductive Plastics Limited**  
Newbridge Road Industrial Estate Pontllanfraith Blackwood  
Gwent South Wales Telephone Blackwood (0495) 223771  
1640 5th Street Santa Monica California 90401  
Telephone 213 393 0014

# RAC

**RAC MIXERS** custom built for studios, Hospital radio, broadcasting

**RAC UNITS** new range of auxiliary units including limiter, mike amp, mixer, disc amp, (all complete)

**RAC AMPS** power amps 50 to 200w with 100v line options

**RAC MODULES** circuit cards for building or extending mixer desks

**SEE US AT STAND 74 APRSEXHIBITION**

contact Martin Bennett,

Rugby Automation Consultants

19 Freemantle Road, RUGBY Tel. 0788 810877

## The only way to see multitrack sound

### A&R (Cambridge) PLM 14 LED audio level indicator

- Fully modular
- Accurate metering at low cost
- Precise VU and PPM characteristics available at the push of a button
- 38 dB dynamic range
- Green LEDs for normal levels, red for overload
- Electronically balanced input
- Front panel sensitivity preset
- Remotely adjustable brightness
- Single +24V power supply
- 16 channel case/power supply available now, 4 channel shortly
- OEM enquiries welcome

For further details contact

**AMPLIFICATION and RECORDING  
(Cambridge) LTD.**

French's Mill, French's Road, Cambridge  
Tel. (0223) 54507



# Ampex—leader in the business of total production and post-production capability

ATR-100  
professional  
audio  
recorder



AG-440C  
professional audio recorder



VPR-1  
video recorder

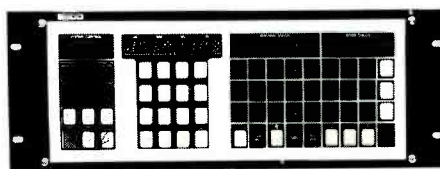

MQS-100 video/audio synchronizer

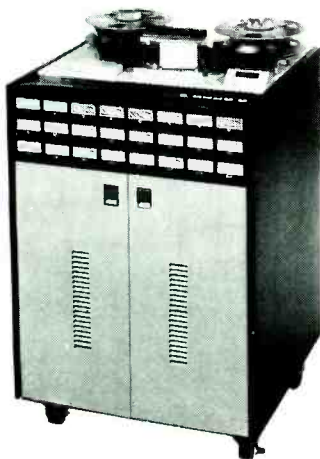

MM-1200 multi-track  
audio recorder

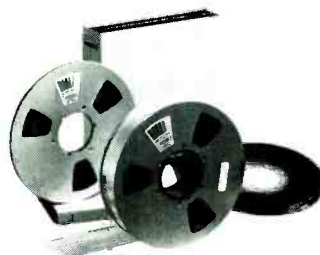

... and for every machine,  
the best tape

## The Many Ampex Features

	AG-440C	ATR-100	MM-1200
Console Version	O	O	S
Rack-mount	O	O	—
Portable case	—	O	—
Video Layback Head	—	—	O
Multi-point Search-to-Cue	—	O	O
Disc Mastering Preview Version	—	O	—
MQS Synchronizing Equipment	O	O	O
Variable Speed Oscillator	O	O	O
PURC (electronic editing)	O	S	O
Large reel capability	14"	14"	16"
NAB/CCIR Switchable	—	O	—
Additional overbridge	O	—	O
Mono	O	O	—
Stereo	O	O	—
4-track	O	O	—
8-track	O	—	O
16-track	—	—	O
24-track	—	—	O

O = Option    S = Standard

For further information,  
please call your nearest  
Ampex sales office or  
write to:

**Ampex International,  
Acre Road, Reading,  
Berks RG2 0QR, England.**  
Tel: (0734) 864121  
Telex: 847611

Athens (Greece)	682.3819
Frankfurt (W. Germany)	60581
Fribourg (Switzerland)	22.73.31
Paris (France)	609.91.55
Reading (England)	85200
Rome (Italy)	54.69.91
Stockholm (Sweden)	28.29.10
Utrecht (Netherlands)	612921

**AMPEX**



# Classified Advertisements

Advertisements for this section must be pre-paid. The rate is **18p** per word, minimum **£3.60**. Box Nos. **45p** extra. Semi-display rates on application. Copy and remittance for advertisements in **AUGUST 1978** issue must reach these offices by **10th JUNE 1978** addressed to: The Advertisement Manager, **Studio Sound**, Link House, Dingwall Avenue, Croydon CR9 2TA.

**Note:** Advertisement copy must be clearly printed in block capitals or typewritten.

Replies to Box Nos. should be addressed to the Advertisement Manager, Studio Sound, Link House, Dingwall Avenue, Croydon CR9 2TA, and the Box No. quoted on the outside of the envelope. The district after Box No. indicates its locality. **SEX DISCRIMINATION ACT 1975:** No job advertisement which indicates or can reasonably be understood as indicating an intention to discriminate on grounds of sex (e.g. by inviting applications only from males or only from females) may be accepted, unless (1) the job is for the purpose of a private householder or (2) it is in a business employing less than six persons or (3) it is otherwise excepted from the requirements of the Sex Discrimination Act. A statement must be made at the time the advertisement is placed saying which of the exceptions in the Act is considered to apply.

## FOR SALE—PRIVATE

★**Phase linear 4000**, the world's most versatile Pre-Amp. Immaculate bargain. Tel: 031 445 1260. G

★**8 track 1"** Leevers Rich deck with Richardson Electronics, 12/2 mixer, all leads and 6 reels virgin tape, £2250. Tel: 01-263 0423. G

★**Two Dolby A361s** £600, Amcron IC-150 Pre-Amplifier and Amcron D-150 power amplifier £500. TEAC AN80 Dolby B unit offers? Box No. 788 c/o STUDIO SOUND. H

★**20 into 4** mixer, ITA, ultra quiet, 4 limiters £750 ovno. Also EMI monitors £150. Tel: 01-505 1110 or 01-505 5221. G

## WANTED

★**Power pack** for Neumann SM2 microphone or microphone for sale. Tel: Rik or Rob 237 1737. G

★**Wanted Allen & Heath** mod 1 input modules any condition also used 2" tape and boom mic stands. Tel: Wheathampstead 3334. H

★**Wanted Studio** mixer, 16 or 24 into 8 (Allen & Heath mod II or similar) cash waiting. Tel: 01-987 1681. G

★**35mm transfer** machine required. RCA or others, Sands Films Ltd., 119 Rotherhithe Street, London SE16 4NF. Tel: 01-231 2209. G

★**Revox's urgently** wanted. The Music Laboratory. 01-349 1975. X

★**Wanted. Revox and Teac** Tape Recorders. Best prices paid. R.E.W. Professional Audio. 01-836 2372. X

★**Tannoy Speakers** Wanted. The Music Laboratory. 01-349 1975. X

★**Teac 3340 (S)** urgently wanted. The Music Laboratory. 01-349 1975. X

★**Nagras** wanted urgently. Exceptional prices given. Paul Simmon Ltd., 2 Market Street, Halifax, Yorks. 0422 57442. G

## FOR SALE—TRADE

★**Uher equipment** best prices around immediate delivery. Example cash prices inc VAT Model 4200C ½ track stereo reel to reel £298, Model CR210 portable cassette £321, Model CR240 Dolby portable cassette £343. Tel: Ray 01-935 8161, AV Distributors (London) Ltd. H

★**Ampex MM1000** 8-track 1" tape, offers over £3000. Ampex 2-track in console, both good condition. Tel: Glasgow 041 638 0724/221 9407. G

★**Used Hi Fi** Pr. quad ELS £249, pr. Sony SS7000 (DM70) £229, pr. Sony 7200 £97.50. Sony TC 280 £119.50. Bedmaster 4000 £220. Technics SA 5400X £119.50. Marantz 4270 mint, with extras £399. Kenwood KR8140 £179. Lecson AP3 £190. Amcron IC150/D150 £399. Lux 308 £199. Amcron D60 BGW 250B/202 P.D.A., Quad 33/303 £155. Sansui AU101 £47.50. Sorry no lists—ring/call Erricks, Foto-sonic House, Bradford (0274) 22972. G

★**For sale** five Neumann N4521 power supplies 240 volts A/C/48 volts DC. Two channel XLR connectors £45 each. Tel: Kidmore End 3062. G

★**Ferrograph studio** 8 stereo tape machine (console model) 2 years old v.g.c. £1400 ono. Contact Vic Gamm. Tel: 01-951 0222. G

## SOWTER TRANSFORMERS

### MAKE YOUR OWN MICROPHONE SPLITTER WITH SOWTER TRANSFORMER TYPE 4079

This transformer has a high impedance nominal 200 ohm primary, balanced and centre-tapped, and two secondaries each for 200 ohms loading. Suitable for most types of microphone requiring loads up to 1200 ohms, it will handle 2.3 volts (rms) at 30 Hz so that for normal levels DISTORTION IS NEGLIGIBLE. When each secondary is loaded with any values of resistance from 200 ohms to 2500 ohms THE FREQUENCY RESPONSE IS PLUS/MINUS ±dB from 20 Hz to 20 kHz.

This transformer is contained in a Mumetal can 33 mm diameter x 37 mm high with two tapped holes in the lid for fixing. (The height is increased to 60 mm if a one hole fixing bush is required.) The hum reduction of the can is at least 30 dB and the colour coded end leads are normally 20 cm in length. Further details of THE CONSTRUCTION OF A SPLITTER USING THIS TRANSFORMER ARE AVAILABLE ON REQUEST. The following price breakdown is valid for three months:

In lots of	1-5	6-12	13-24	Strictly nett
PRICE EACH	£7.55	£7.25	£7.05	cx works Ipswich

Extras are 20p per transformer for postage and packing, and VAT is 8% overall. Dispatch for small quantities is EX STOCK but otherwise not more than 2 weeks from receipt of remittance. FOR EXPORT p. and p. is AT COST and there is no VAT. The weight of one transformer and packing is approx. 200 gms.

We also invite your inquiries for PRACTICALLY ANY TYPE OF AUDIO TRANSFORMER and will quote by return.

**KINDLY NOTE OUR NEW ADDRESS AND TELEPHONE NUMBER**

**E. A. SOWTER LTD.**  
Transformer manufacturers and designers  
The Boatyard, Cullingham Road, IPSWICH,  
Suffolk IP1 2EG, ENGLAND  
Tel. 0473 52794 and 0473 219 390

## STUDIO FACILITIES

★**Cathedral Sound** manufacture a professional standard compressor/limiter module for under £25, mixer modules, and complete mixer channels. Professional discounts available on Revox, N.E.A.L., Sennheiser, also MM mixers. S.A.E. details. Cathedral Sound, Fourways, Morris Lane, Halsall, Lancs L39 8SX. Tel: Halsall (0704) 840328. X

★**Revox, Teac, Otari, Brenell, Tascam, Nakamichi, Tannoy** sales and service. The Music Laboratory. 01-349 1975. X

★**Wow and flutter** meter, Rank Kalee type 1740, similar to latest model, calibrated and in good working order. £150 plus VAT. Burgess Lane & Co. Ltd., Thornton Works, Thornton Avenue, London, W.4. 01-994 5752 and 5953. X

★**Ellie Jay** records, comprehensive record and sleeve manufacturing services, high quality, low prices, quantities 100-100,000. Studios and mobile facilities from several bases throughout UK. Ring 01-908 2735 (11.00a.m.-11.00pm any day). H

★**Tape/disc** masters, demos (Scully/Westrex), pressings, cassettes, mobile recording studio. Free brochure. Tam Studio, 13a Hamilton Way, London N3. Tel: 01-346 0033. X

★**Fanfare Records**. Tape-disc pressings, demo's, masters, any quantity. Studio/mobile Neumann disc cutter. S.A.E. brochure. 1 Broomfield Close, Rydes Hill, Guildford. Tel. 0483 61684. X

HIGH SPEED CASSETTE COPYING IN MONO OR STEREO AT COMPETITIVE PRICES

Long or short runs.  
Blank cassettes supplied in bulk.  
A growing reputation for reliability.

**MORARD SOUND PRODUCTIONS**  
THORNTON HEATH, SURREY  
Telephone 01-689 7424

**SPR**

SPEECH RECORDING  
CASSETTE DUPLICATING  
OPEN-REEL DUPLICATING  
LANGUAGES/AUDIO-VISUAL

**SPEECH-PLUS RECORDINGS LTD**

32, PAGES WALK, SOUTHWARK, LONDON SE1 4SB.

01-231 0961/2

**CASSETTE FAST-COPYING**  
Stereo or Mono. High Quality. Prompt Personal Service.  
Also bulk supplies of excellent virgin cassettes.

**SOUND CASSETTE SERVICES Ltd.**  
P.O. BOX 2, GERRARDS CROSS, BUCKS.  
Tel. 02813 84409

**COUNTY RECORDING SERVICE**  
From your tapes we cut master discs, demo discs, using our Scully lathe fitted with the latest ME/76 UK stereo disc-cutting system.  
Dolby 'A', Dolby 'B' and DBX Noise Reduction.  
Telephone Bracknell (0344) 54935.  
London Road, Binfield, Bracknell, Berks, England

**WOLLENSAKS**  
**CASSETTE FAST COPIERS**  
2770 mono & 2772 stereo, meticulously aligned by Experts. HEAVY DUTY RECORDERS: 2551 Visual Sync & 2520 9 watt.  
**SOUND CASSETTE SERVICES Ltd.**  
P.O. Box 2, Gerrards Cross, Bucks. SL9 7PH  
Tel. 02813 84409

**SERVICES**

★**Small Studios.** Are you a small studio owner in the Kent, Sussex or London area needing the services of highly qualified maintenance engineers? Then maybe we can help you by providing services in both maintenance and design. Phone: Tunbridge Wells 38893. G

**IF YOU NEED . . .**

Cassette Duplication	Empty Tape Spools
Blank Cassettes	White Tape Boxes
1/2" Tape	8T Cartridge Bodies
Leader Tape	Lubricated Tape
Splicing Tape	Head Cleaner Tape

Why not ring us on 01-399 2476/7 and let us quote you for your next requirements.

**MEDIA TAPE LIMITED, 29a Tolworth Park Road, Surbiton, Surrey.**  
01-399 2476/7

★**For hire at very reasonable rates:** Audio Developments micro and pico mixers. Brenell 8-track, Nagra IV and IS tape recorders, microphones by AKG, Sennheiser, STC and Sony (ECM 50). Tel. 01-940 6276 evenings. G

**REVOX**  
SERVICE CENTRE

Service and overhaul.  
High speed conversions.  
Head changes,  
Sel-sync,  
Automatic double tracking.  
Varispeed/varipitch.

**MUSIC LABORATORY** 01-388 5392/3/4/5

★**Tape copying service.** Open reel and cassette available. The Music Laboratory, 01-349 1975. X

High Quality Tape Spools  
Ex Stock or on Short Delivery  
5", 5 1/4", 7" in bulk

T. Plastic Plastics Ltd  
38 Waller Way, Mitcham, Surrey, CR4 4HR  
Telephone: 01-840 0145/9

**TRAD**  
**WATFORD 47988**

All Studio Equipment bought and sold.  
See our advertisement on page 67.

149B St. Albans Road, Watford, Herts.  
Tel. Watford 47988

★**Your Tapes to Disc.** Mono or Stereo cutting. Vinylite pressings, Sleeves/Labels. Top professional quality. S.A.E. for photo leaflet. Deroy Records, "Eastwood," Cove, Dunbartonshire, Scotland. X

★**Aerco Productions Ltd.** Quality disc pressings Professional Record Producers and engineers. Publishers. S.A.E. leaflet. 27 Chobham Road, Woking, Surrey. 04862-4667. X

**OFFSHORE CASSETTE DUPLICATING**  
High Quality - Low Cost  
No order too small or too large. Inlay cards and labels designed and printed.

**VIKING MANN STUDIOS**  
29A Duke St., Douglas, I.O.M.  
Telephone (STD 0624) 3872

**REVOX EDITING CONVERSION**  
Fits all models A77  
KIT £75 plus VAT — FITTED £85 plus VAT  
New machines supplied standard or converted  
**SOUND ASSOCIATES LIMITED**  
23 Redan Place, LONDON W2 4SA  
Tel: 01-229 0101  
Authorised Revox Industrial Agents

**SITE WANTED**  
FOR RECORDING STUDIO  
Greater London area only;  
lease or purchase

All replies treated in confidence—  
all reasonable offers considered

Details to: K. Kovach  
40 Oakley Street,  
London S.W.3

**Scotch**  
**PROFESSIONAL TAPE**  
Type 206, 207, 250, 256  
available on 10 1/2" metal  
NAB reels, 206 and 207 on  
5" reels.  
Quantity discounts.  
Prices on application.  
Mail Order service.

**MUSIC LABORATORY** 01-388 5392/3/4/5

**SITUATIONS WANTED**

- ★**Australian 24 years old,** experienced in film and TV sound, seeks work, ESP, multi-track. D. Carlisle, 53 Gordon Square, London WC1. G
- ★**Enthusiastic electronic engineer** (26, degree), some audio design experience, familiar with modern recording techniques, but no studio experience, seeks position as assistant maintenance engineer with a studio in London. Box 789 c/o STUDIO SOUND. G
- ★**Recording engineer,** seeks position in multi-track studio, this country or abroad. Box 787 c/o STUDIO SOUND. G

**SITUATIONS VACANT**

**YOUNG ENGINEER WANTED**

To work with modern expanding company in Central London, with an interest in tape recorders and studio equipment. Must have a good basic knowledge of electronics.

Please reply in writing to:-

The Service Manager,  
Music Laboratories,  
76 Lyndhurst Gardens,  
Finchley, London N3.

**GO WITH A PROGRESSIVE COMPANY**  
**MCI UK**  
REQUIRE

A field engineer, extensive experience in trouble-shooting digital and micro-processor based studio equipment absolutely essential. Must be prepared to travel. Second language would be an advantage.

Apply in writing to:

**D. FELLNER**  
**MCI HOUSE**  
54/56 Stanhope Street,  
London NW1 3EX

## Get binding!

Keep your copies of **STUDIO SOUND** in smart black binders (each holds 12 copies) with title in golden block letters on the spine. Price: £2.00 each which includes inland and overseas postage. Send your order with cheque or postal order to: Modern Book Binders Ltd. Chadwick Street, Blackburn, Lancs. (state clearly your name and address and the relevant magazine title).

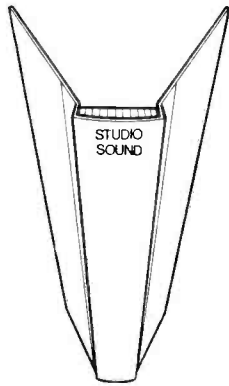

LINK HOUSE GROUP

## DO YOU USE TELEPHONE CIRCUITS? PARTRIDGE ELECTRONICS

Outside Broadcast Equipment solves your problems at reasonable cost.

- \* Portable Battery self/op unit incorporating auto level drive, mic & tape inputs, monitor amp (export models fitted with dial).
- \* Studio terminal with auto level send & receive for two way call-in broadcasts.
- \* Line drive & receive units—Telephone line protection barriers.

FOR WIDE BAND MUSIC QUALITY CIRCUITS:

- \* Auto level send & receive units

**FULL RANGE OF AUDIO MIXERS & SUB UNITS**

For details consult us at: (please note our new address)

**56 Fleet Road, Benfleet, Essex, or call 03745 3256 for advice on equipment.**

## TELEVISION ENGINEERS

The Media Department of the British Council has two vacancies for broadcast engineers in its studios in Tavistock Square, London. The studios are used to train personnel from countries overseas in broadcasting techniques and for the production of videotapes, films and other audio-visual programmes.

For the more senior post we are looking for someone who will be responsible for the operation and maintenance of the TV Studio and its associated equipment. Experience in TV studio operations, vision control and camera line-up is essential, and experience in quad videotape and lighting operations desirable. Applicants should have broadcast engineering training, or be in possession of a full City and Guilds Telecommunications Certificate, HNC or equivalent. Annual starting salary is £4767 rising by three annual increments to £5202. (Pay rise pending).

For the less senior post we require someone with some studio experience who will be responsible for the operation and maintenance, under supervision, of the TV sound area. Experience of camera, videotape and lighting equipment would be an advantage. Applicants should have the City and Guilds Telecommunications Intermediate Certificate, or ONC or broadcast engineering training. Annual starting salary is according to age ranging from £3489 at 21 to £4462 at 28 and over. Thereafter salary rises by annual increments to £4767. (Pay rise pending).

Some of the training takes place overseas and there may be occasional opportunities for travel. Annual leave for both posts is 22 days plus 2½ privilege days and there is non-contributory pension scheme.

For further details and an application form telephone 01-499 8011 extension 3028 or write to Staff Recruitment Department, The British Council, 65 Davies Street, London W1Y 2AA, quoting reference HS/7.

## POWER AMPLIFICATION BY MUSTANG



Our SS.100 and SS.50 are economical amplifiers with outputs of up to 175 and 100 Watts RMS into 4-16 ohms, typical THD figures being 0.1%, slewing rate > 10v/µs, noise > 90dB down, zero level input, and full electronic protection.

Considering these points with their proven reliability and robust construction, plug in output transistors and driver board, optional balanced input and 100V line output, and virtually ex stock despatches we reckon we take some beating! Contact us now for the full technical specifications.

Manufacturers of mixers, integrated mixer amplifiers and slave amplifiers, studio power amplifiers, transformers, lighting control equipment and cabinets for the home and export markets. Contact us for full illustrated technical brochures.

## MUSTANG COMMUNICATIONS

Nelson Street, Scarborough,  
North Yorkshire YO12 7SZ  
England  
Telephone 0723-63298



## A BRAND NEW FOUR CHANNEL COMPRESSOR/ LIMITER from CATHEDRAL

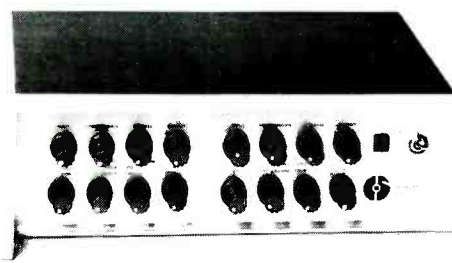

Four identical compressor/limiters, completely self powered, in high quality instrument case.

Low noise, low distortion.

Ideal for four-track studio, and many recording applications.

Very low crosstalk.

Ensures accurate levels and gives maximum 'punch' to your recordings.

Competitive price.

## CATHEDRAL SOUNDS LTD.

FOURWAYS, MORRIS LANE, HALSALL, ORMSKIRK  
LANCS. L39 8SX

Telephone: Halsall (0704) 840328

# INDEX TO DISPLAY ADVERTISERS

<b>A</b>		<b>M</b>	
Advance Music System .. .. .	63	Macinnes Laboratories Ltd. .. .. .	20
AKG Equipment .. .. .	61	Magnetic Tapes Ltd. .. .. .	34
Alice (Stancoil) Ltd. .. .. .	18	MCI Ltd. .. .. .	26
Allen & Heath/Brenell .. .. .	91	Midas Ltd. .. .. .	IFC
Amek Systems .. .. .	12	Miniflux .. .. .	72
Ampex International .. .. .	114	Monks, Keith .. .. .	32
Amplification & Recording .. .. .	113	Mosses & Mitchell Ltd. .. .. .	101
Aphex .. .. .	84, 85	Music Laboratories .. .. .	22, 62
Audio & Design Recordings Ltd. .. .. .	98, 99	Mustang Communications .. .. .	117
Audio Developments Ltd. .. .. .	30		
Audio International .. .. .	118, IBC	<b>N</b>	
Audix Systems Ltd. .. .. .	88	Neal/Ferrograph .. .. .	16
Avcom Systems Ltd. .. .. .	71	Neve, Rupert & Co. Ltd. .. .. .	39
<b>B</b>		<b>O</b>	
Bauch, F. W. O., Ltd. .. .. .	28, 54, 107	Otari .. .. .	55
BGW .. .. .	110	Ortofon .. .. .	111
Brodr Jorgenson .. .. .	93		
		<b>P</b>	
<b>C</b>		Page, John, Ltd. .. .. .	10
Cadac .. .. .	79	Peavey Electronics (UK) Ltd. .. .. .	109
Calrec Audio Ltd. .. .. .	87	Penny & Giles .. .. .	113
Cathedral Sound .. .. .	117	Pro Audio .. .. .	95
Cetec .. .. .	24	Publison .. .. .	9
Communications Accessories & Equipment Ltd. .. .. .	86		
Counting Sfernice .. .. .	101	<b>Q</b>	
Creative Handbook .. .. .	94	Quad 8 .. .. .	80, 81
Crowmay .. .. .	40		
		<b>R</b>	
<b>D</b>		Racal Zonal .. .. .	89
Dolby Laboratories .. .. .	51	Radford Audio .. .. .	109
		Raindirk Ltd. .. .. .	27
<b>E</b>		RDG Audio Visual Ltd. .. .. .	110
Eagle International .. .. .	21	Revox .. .. .	75
Eardley Electronics .. .. .	105	REW .. .. .	6, 7
Electro-Voice .. .. .	35	Rugby Automation .. .. .	113
EMS .. .. .	97	Rycote Microphones .. .. .	62
E.S. Electronics .. .. .	34		
Exposure Hi Fi .. .. .	63	<b>S</b>	
		Scenic Sounds Equipment .. .. .	34, 37, 60
<b>F</b>		Sheffield Sound Centre .. .. .	101
Feldon Audio .. .. .	4	Shure Electronics Ltd. .. .. .	59
Fidelipac .. .. .	100	Sifam .. .. .	73
Fraser Peacock Associates Ltd. .. .. .	40	Solid State .. .. .	49
Future Film Developments .. .. .	68	Sonifex .. .. .	72
		Sound International .. .. .	7
<b>G</b>		Soundcraft .. .. .	53, 62
Gelf Electronics Ltd. .. .. .	28	Sound Recording Plant .. .. .	112
Grahams Professional Ltd. .. .. .	112	Squires, Roger, Ltd. .. .. .	83, 105
Granet Communications Ltd. .. .. .	106	Strawberry Studios .. .. .	65
		Studio Communications .. .. .	101
<b>H</b>		Studio Equipment Services .. .. .	112
H. H. Laboratories .. .. .	25	Surrey Electronics .. .. .	74
Hayden Laboratories Ltd. .. .. .	31	Synton Electronics .. .. .	67
<b>I</b>		<b>T</b>	
IBC .. .. .	8	Tandberg .. .. .	77
Industrial Tape Applications .. .. .	11, 13, 15, 17, 19	Technics .. .. .	41
Ivie Electronics Inc. .. .. .	5	Trad Electronics Sales Ltd. .. .. .	29
		Trident Audio Developments Ltd. .. .. .	23
<b>J</b>		Turner Electronics .. .. .	10
JPS .. .. .	34	Turnkey .. .. .	62
		Tweed .. .. .	8
<b>K</b>			
Klark-Teknik .. .. .	IBC	<b>V</b>	
		Vitavox .. .. .	63
<b>L</b>			
Lee Engineering .. .. .	103	<b>W</b>	
Leavers-Rich Equipment Ltd. .. .. .	14	White Instruments .. .. .	10
Lockwood Acoustics .. .. .	69	Wilmot Breeden .. .. .	33
Lyrec Manufacturing A/S .. .. .	42, 43		
		<b>Y</b>	
		Yorke, James .. .. .	112

## The professional alternative.

Your tone controls are just not designed to compensate for

- Room acoustics
  - Speaker placement
  - Old or bad recordings
  - Deficiencies in component interaction
- We built the C-41 Equalizer to solve these problems and more.

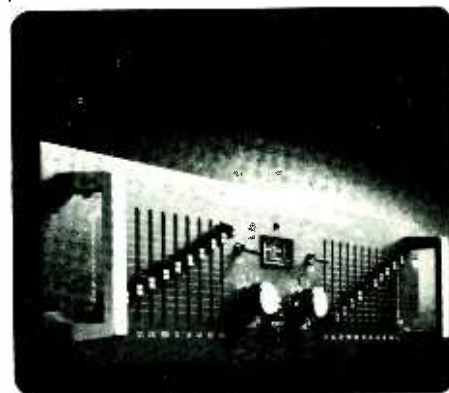

AEC C-41 Dual Channel Equalizer

These are some of the ways:

- Individual Octave Control for each channel
- Long throw, oil-damped linear slide pots for greater accuracy
- Advanced technology and switching facilities
- Capable of driving any load at any equalization setting
- Low distortion-less than 0.01% THD and IM
- Low noise-greater than 90dB
- 5-year parts and labor service contract
- AEC's philosophy of uncompromised performance

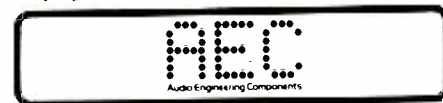

You'd have to look a long time to find an EQ that delivers this much value. AEC innovation has done it.

**AUDIO INT'L**  
Hermann  
Hofmann  
6 Frankfurt 56  
Box 460270

Audio Int'l.  
Box 560 229, 6 Frankfurt 56, W-Germany

Please send me available literature why the AEC C-41 Dual-Channel Equalizer is the professional's choice

Name \_\_\_\_\_

Street \_\_\_\_\_

City \_\_\_\_\_ Zip \_\_\_\_\_

# Progress from HARRISON

Second Edition Models 4032 + 3232  
Automated Master Recording  
Consoles

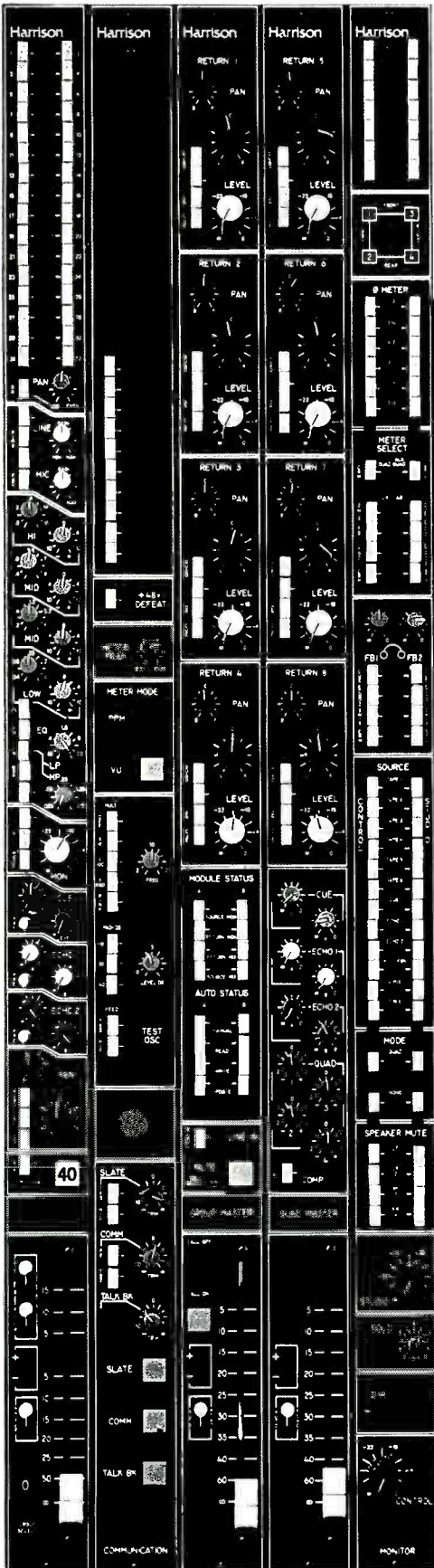

In response to your suggestions,  
Harrison's Second Edition consoles  
offer you many new features and functions.

- Programmable and Manual Muting.
- Group Muting.
- Fader Automation Null Lights.
- 2 Stereo Foldback Systems With Extensive Source Selection.
- Optional High Resolution Phase Meter.
- 2 Phase Meter Source Selection Matrices.
- Pink Noise Generator.
- 48 Volt Phantom Power On/Off Switch.
- Improved Parametric Equalizer Range.
- Optional Step-Type Equalizer.
- Stereo and Quad Meter Source Selection Switches
- Optional 36 Segment, High Resolution Light Meter With Front Panel VU and PPM Characteristic Selection.
- Master VU/PPM Characteristic Selection Switches
- Optional NTP Meter Overbridge.

"Still No Compromise"

**Harrison** 

Harrison Systems, Inc.  
P.O. Box 22964 • Nashville, Tennessee 37202

# The DN27 and DN22 graphic equalisers. In a class of their own.

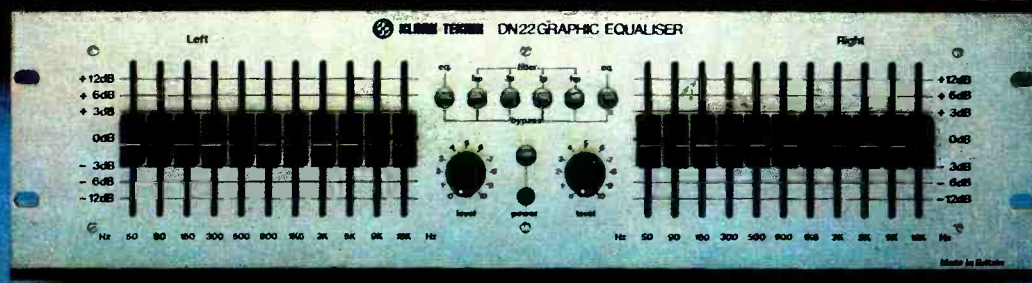
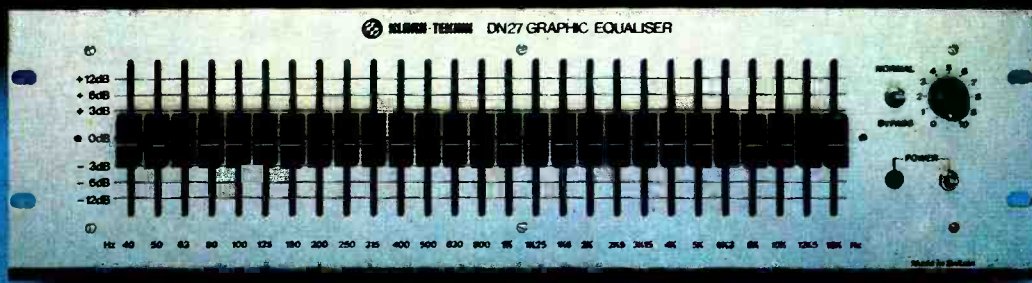

Every now and then there comes on to the market a product whose quality is such that it becomes a generic in its own right.

This has been the case with the Klark Teknik equaliser.

All over the world our equalisers have proved themselves to be the ultimate in tone control for sound recording, reproduction and measurement systems.

Inevitably, they cost a

great deal.

But we offer guaranteed performance which meets all your personal requirements.

In equalisers which have been assembled and checked by engineers rather than a production line.

And specifications which meet your own exacting demands in every way.

Shouldn't you be the owner of a Klark Teknik equaliser?

You'll never settle for second best again.

For further information about our equalisers, the new DN34 and DN36 analogue time processors and DN70 digital time processor, contact:



## KLARK-TEKNIK

You know it's the best.

Klark Teknik Research Limited, Summerfield, Kidderminster, Worcs DY11 7RE, England.  
Telephone: Kidderminster (0562) 64027.  
Telex: 339821.

Worldwide Distributors: AUSTRALIA: Klarion Enterprises, S. Melbourne. BELGIUM: A.R.C. Sprl., Bruxelles. CANADA: Hammond Industries, Toronto. DENMARK: Teamsound, Helsingør. FRANCE: R.E.D. Studio Centre, Paris. GERMANY: Hausman Concert Electronics, Berlin. HOLLAND: Pieter Bollen, Eindhoven. ITALY: Laboacustica Srl., Roma. JAPAN: Continental Far East Inc., Tokyo. NORWAY: Siv. Ing. Benum, Oslo. NEW ZEALAND: General Video, Wellington. SINGAPORE: Ultralinear International. SOUTH AFRICA: Colosseum Acoustics, Johannesburg. SPAIN: Mabel Sdad., Barcelona. SWEDEN: SATT Elektronik, Stockholm. SWITZERLAND: Dr. W. A. Gunter, Zurich. TAIWAN: Yang's Audio Visual, Taipei. USA: Hammond Industries, Syosset, N.Y.