

A LINK HOUSE PUBLICATION

November 1987

US \$4.00 £1.50

STUDIO SOUND

AND BROADCAST ENGINEERING



MONITORING POWER AMPLIFIERS

Performance the Swiss would be proud of. At a price even the Japanese will envy.



If you thought the only way for your studio to achieve the highest professional standards was to stretch to a multitrack you can't really afford, rather than settle for a budget machine with limited performance, think again.

Because with the Soundcraft Saturn there's no such compromise – ask any of our growing list of owners.

Its performance and features are equalled only by the Studer A820 (take a look at the comparison chart below).

COMPARISON CHART	SATURN	A820	MX80	JH24
PROCESSOR CONTROL OF AUDIO	YES	YES	NO	NO
AUTOMATIC ALIGNMENT	YES	YES	NO	NO
ALIGNMENT AND METERING FROM STANDARD REMOTE	YES	NO	NO	NO
SPEEDS/EQS	3/3	3/2	2/2	2/2
PROCESSOR CONTROL OF TRANSPORT	YES	YES	YES	NO
OPEN LOOP TENSION CONTROL	YES	NO	NO	NO
REWIND TIME (2400 FT)	56 S	(56 S)*	80 S	85 S
FULL FUNCTION LOCATOR WITH PROGRAMMABLE FUNCTION KEYS	YES	NO	NO	NO
14" REEL CAPACITY	YES	YES	NO	YES
W & F (30 ips)	<0.03%	0.03%	0.04%	0.03%
S/N (500 nWb/m, 20Hz-20kHz, 30 ips REC/REP)	66dB	-	61dB	64dB
VARSPEED RANGE (30 ips)	+100% -50%	-	150%	120%

* MEASURED AT EXHIBITION, NOT PUBLISHED

Yet its price is little more than an Otari MX-80, a machine it outperforms in virtually every respect.

With such a significant saving, a Dolby SR system becomes a realistic proposition you can actually buy a Saturn with SR for less than an A-820 without.

Saturn's technical superiority is underlined in features like the COLT (Calculated Open Loop Tension) transport with its unrivalled tape handling, the fully digital Total Remote control and autoalignment.

And its excellent reliability record confirms our confidence in providing 2 years' Warranty Support, backed by our 364-day Rapid Response Service.

Call us to arrange a personal demonstration. We'll show you how British engineering has put Saturn ahead of the world.



STUDIO SOUND

AND BROADCAST ENGINEERING

CONTENTS

- 5 Editorial:** Keith Spencer-Allen questions the reliance on mini monitors
- 14 General news:** SSL in Moscow... £25 million tape investment... Tannoy-Goodmans merger... Change of address... Addendum... New from MIDEM... Award to Teldec... DISC reference CDs... Agencies... Forthcoming events... Tall stories part II—slow crane coming... Contracts... In brief... People
- 18 Product news:** Argent's MIDI Communicator... Wonder Widgets' Video Pen... Celestion SR series... RCF loudspeakers... tc 8201 test generator/analyser... Fazioli grand... BBC sound FX CDs... Soundtracs MRX... Three more from MTR
- 22 Source Independent Measurement:** David Mellor visited Wembley Arena to find out how this system of room equalisation works
- 29 Monitoring:** We have compiled a listing of current monitor manufacturers and agents, together with a brief description of models available
- 41 Power amplifiers:** Amps primarily designed for recording studio monitoring systems form the basis of this listing of manufacturers, agents and units available
- 52 Perspective:** US correspondent Martin Polon speculates on the future of recording media in the light of CD, CD-V, CD-I, Optical Disc, DAT, etc
- 57 Business:** Barry Fox speculates on the market for CD-V
- 62 Puk Two:** Janet Angus revisits Puk in Denmark who are about to open a new studio and even more leisure facilities
- 66 Oldfield's new pastures:** Mike Oldfield made an unusual choice when he decided on some of the equipment for his new studio. Keith Spencer-Allen visited him on the eve of an album release
- 82 RCF SCD 6000:** Neil Grant's technical evaluation of a set of middle range monitors

Range of Reflexion Arts monitors (see page 29)

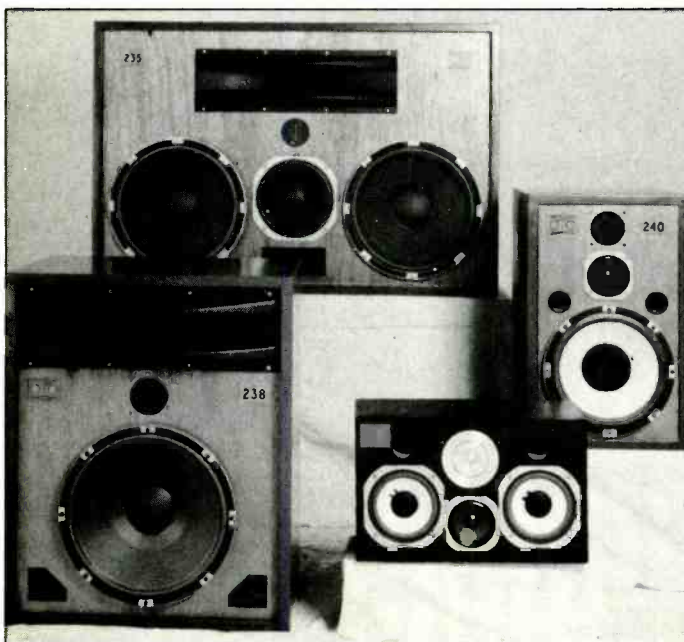

Power amps from Carlsboro (see page 41)

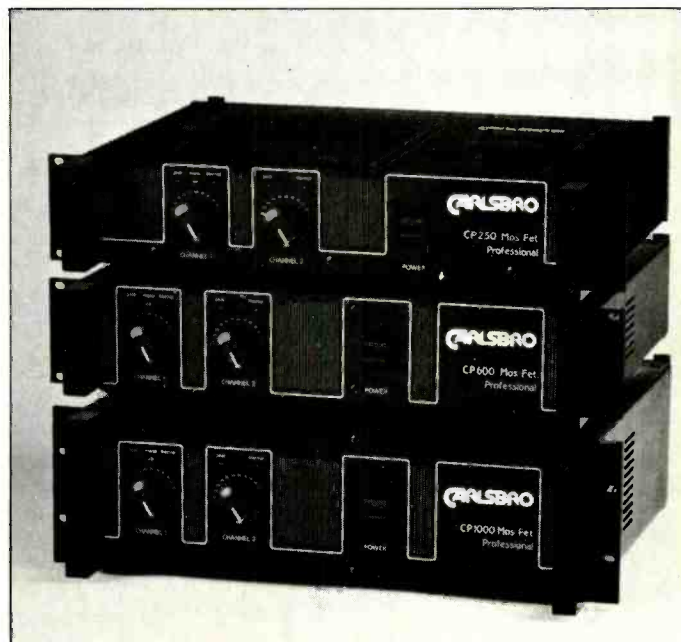

D&R Dayner Series In-Line

The "NEW" DAYNER In-line module is our innovative approach to the many demands from Midi and recording studios for such features as dual inputs, dual EQ, and dual inserts per module. We add this module to the popular DAYNER system to further expand your capabilities. Available for recording and sound reinforcement is the DAYNER "Split I/O" Module and "Tape/Effects Return" Module. Drawing shows In-line module.

Features:

Up to 160 mix inputs in less than 2.50 mtr (8½ feet)

Channel insert & monitor insert (patch point)

Channel/monitor fader reverse

Split EQ (EQ on ch. & EQ on monitor)

Stereo in-place solo & mono PFL

8 aux send busses

Unique "Floating Subgroup System"

Digital quality specs

Welded steel chassis



Dayner Series Beyond Comparison

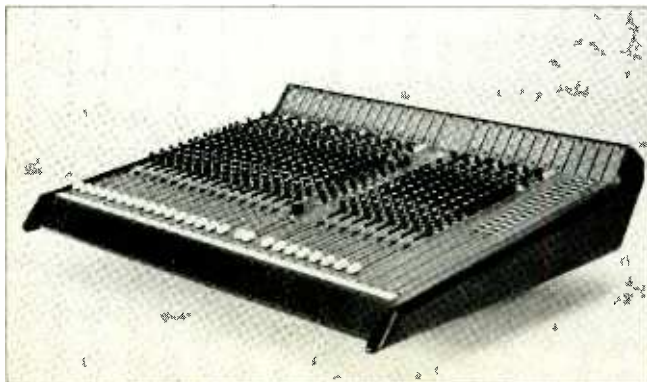

D&R USA

1720 Chip N Dale Dr.

Arlington, TX 76012

Phone (817) 548-1677

Tlx 910-250-3462

Fax 817-277-6066

D&R Electronica b.v.

Rijkade 15B,

1382 GS Weesp, Holland

Phone (31) 2940-18014

Tlx 18503 dr nl

Fax (31) 2940-16987

AUSTRALIA, AUDIO & RECORDING, 2019 Sydney, 36-38 Daphne St. Botany tel: 61-26669935
AUSTRIA, KUHNEL & WURZER, A-4020 Linz, Waldeggstrasse 68 tel: 43-732668125 **BELGIUM**,
A.S.E. pvba 2800 Mechelen, Kon. Astridlaan 216 tel: 32-15421152 **CANADA**, J MAR M4H 1E9
Ontario, 6 Banian Drive, Toronto tel: 1-4164219080 **DENMARK**, POWER PLAY MUSIC APS. DK
2200 Kopenhagen, Norrebrogade 102A tel: 45-1244048 **ENGLAND**, contact D&R Holland directly
FINLAND, SAHKOLIHKKEIDEN OY 01301 Vantaa 30, P.O. Box 88, Sahnkometsa tel. 358-908381
FRANCE, METTLER AUDIO, 75009 Paris, 1-3-5 Blvd de Clichy tel: 33-148782911 **GERMANY**,
SOUND SERVICE 1000 Berlin 15, Fasanenstrasse 45 tel: 49-308834262 **ITALY**, PROFESSIONAL
EQUIPMENT Srl, 20142 Milano, Viale Famagosta 37 tel: 39-2817839/39-28910241/2/3 **NORWAY**,
VEDUM ELEKTRONIKK, N-1381 Heggedal, Aarnotveien 2 tel: 47-2798990. **SPAIN**, BOSE SA
28027 Madrid, Arisoteles 3 tel: 34-4050611 **SWEDEN**, MONTEZUMA RECORDING 10265 Stock-
holm, Kocksgatan 17 tel: 46-8436291 **SWITZERLAND**, ISLER AG 8048 Zurich, Badenerstrasse
808-810 tel: 41-14321444.

STUDIO SOUND

AND BROADCAST ENGINEERING

November, 1987
Volume 29 Number 11
ISSN 0144-5944

EDITORIAL

Editor: Keith Spencer-Allen
Staff Writer: Jonathan Kaye
Production Editor: Ann Horan
Production Assistant: Carrie Love
US Commentator: Martin Polon
Secretary: Cecilia Farrelly

ADVERTISEMENTS

Sales Manager: Mark Walsh
Display Sales: Andrew Knox
Production Manager: Jacky Pearce
Secretary: Joanna Jeleniewicz

Japan and Far East Agent: Media Sales
Japan Inc, Tamuracho Bldg 3 3 14,
Shimbashi, Minato-Ku, Tokyo, Japan
Tel: (03) 504-1925. Telex: J25666.
Fax: (03) 595-1709. Contact: Mikto Tsuchiya.

USA Advertising/Commercial Manager:
Robert J. Sinnott, 2 Park Avenue, 10th
Floor, New York, NY 10016.
Tel: (212) 779-1212.

Deputy Publisher: Phil Guy
Director: Douglas G Shuard

CIRCULATION

Circulation Manager: Sally White

Editorial and advertising offices: Link House,
Dingwall Avenue, Croydon CR9 2TA, UK
Tel: 01-686 2599
International tel: +44 1 686 2599
Telex: 947709
E-mail: 78-DGS1071
IMC: STUDIO SOUND-UK/US
Fax: 01-760 0973

CIRCULATION ENQUIRIES

Controlled circulation: Controlled Circulation
Dept, Studio Sound, Link House Magazines Ltd,
Central House, 27 Park Street, Croydon CRO
1YD, UK

Paid subscriptions: Subscription Dept, Studio
Sound, Link House Magazines Ltd, 120-126
Lavender Avenue, Mitcham, Surrey CR4 3HP,
UK

2nd class postage paid New York, NY: Postmaster
please send address corrections to Studio Sound
c/o Expeditors of the Printed Word Ltd, 515
Madison Avenue, New York, NY 10022, USA

© Link House Publications plc 1987 all rights
reserved

Printed in England



A LINK HOUSE
PUBLICATION

Studio Sound and Broadcast Engineering
incorporates Sound International and Beat
Instrumental

Studio Sound is published on the second Friday
of the month preceding the cover date. The
magazine is available on a rigidly controlled
requested basis, only to qualified personnel (see
back page for terms)

Annual subscriptions are available for non-
qualifying personnel or where more than two
copies are required in a studio or small
organisation as follows:

UK £18.00

Overseas surface mail £24.50

Overseas airmail £46.50

ABC

MEMBER OF THE AUDIT
BUREAU OF CIRCULATIONS

Total average net circulation of 14,686 per issue
during 1986. UK: 6,094. Overseas: 8,592
(ABC audited)

EDITORIAL

Some of you out there are living dangerously and I just hope you know who you are. We have heard your proud boasts about the way you do things and, in the misquoted words of Queen Victoria: "We are not impressed."

Many years ago when I was but a coffee maker/sandwich collector cum trainee engineer all mixing consoles used to have a soft piece of cloth somewhere on their more upright regions, behind which lurked one of the most dreadful speakers that you ever heard. I can remember the chief engineer telling me that it was there to give a 'real world reference' from the studio's main monitors. How it did that I have no idea—most likely it came from the back of some stock room somewhere in London's Lisle Street, which used to be the last refuge for the electrical surplus. Its only resemblance to the real world was that it was closer to the size of home systems than the monitors but so peculiarly coloured in its response that it was more likely a negative benefit. If you then consider that this speaker was then mounted in a wood and metal cabinet of about 9 ft x 3 ft x 3 ft—just where is the real world?

Chief engineer: "Well perhaps it has just a little more bass response than it should. Just don't rely on it." The truest words he ever said. Just don't rely on it. Perhaps he could have put it more meaningfully, such as 'Never trust a monitor under 10 cubic feet', but that wasn't his way.

I haven't seen a serious console with a built-in speaker for years except those used for intercoms, although the cult of the small speaker carries on. So what is the role of small monitors within the control room? They quite neatly fall into being either reference monitors or nearfield monitors. A reference monitor is a compact speaker that is meant to give some kind of indication of how the track being worked on will sound on a speaker of that size. This is quite a valid concept but you are placing rather a lot of emphasis on these speakers, particularly if your main monitors say one thing and the reference monitors say another. Just how loud is that tambourine?

The nearfield monitor is just a monitor that has been scaled down to get it nearer to the engineer who will then hear less of the room acoustic as part of his monitoring listening. As its size is decreased so is its low frequency response. There is also a sub-set of these monitors that includes hijacked hi-fi-type speakers referred to as secondary monitors and in certain circumstances they can work very well, although these are rather a matter of taste. There are now speakers being built for precisely this market and very good some of them are but the requirements are rather ill-defined. There is still some truth in the feeling that these smaller monitors are far more accurate than the larger types. This, however, is less true than it was a couple of years ago. It really comes down to the amount of reliance that you wish to place upon them. There is no reason why music should ever be mixed entirely on small speakers. There is no reason other than perhaps in broadcast TV but only under special circumstances.

Even the old chief engineer knew this as he used to bring his home hi-fi into the studio when mixing one of his projects. Today the compact monitor is far, far better than in those old days. There is also a completely new generation of nearfield monitors but they are still all lacking in the low frequency region. For these reasons a nearfield monitor will never be much more than an upgraded reference monitor in fully professional terms. The compact disc has a response that extends at least two octaves below most of these monitors and if you cannot hear this region then you are working blind. The responsibility for standards has to remain with the studio, the engineer and the producer, as the record company will only rarely care.

Those who are proudly proclaiming that they have mixed a complete album on mini speakers ought to be ashamed of themselves. There is no way they can be aware of the low end although the CD consumer may very well be. Remember the lows!

Cover: The main feature of this month's cover is a graphic of the Windmill Munro M4 monitor. This was created by Windmill Lane Productions using the Bosch FGS 4500 digital computer graphics system. The power amplifier is a Carver PM-1.5 photographed by Roger Phillips



We'll take it from here!

Ask any studio owner, engineer or client... when only the best is good enough... AMS has the answers.

From the world's number one microphone, the Calrec Soundfield, to Audio File, the world's most versatile digital recording, editing and mastering system.

From a range of digital reverberators and audio processors to the Calrec UA8000 music recording console, now available with The AMS Studio Computer.

In our digital age when audio quality matters, from microphone to master, whatever stage you're at, AMS has the best.



The Queen's Award for Export Achievement to Edendeck Ltd. 1984/85 and AMS Industries plc 1986. In July 1985, Edendeck Ltd. became AMS Industries plc.



ADVANCED MUSIC SYSTEMS

AMS Industries plc, Burnley, Lancs. BB11 5ES, England
Tel: (0282) 57011. Telex: 63108 AMS-G. Fax: (0282) 39542

Harris Sound Inc.
6640 Sunset Blvd., Suite 110, Hollywood, CA 90028. U.S.A.
Tel: (213) 469-3500



TAPE ONE — OUR LATEST DIGITAL INSTALLATION

In fact, our seventh and most comprehensive to date. Neve DTC with AMS Audiofile and two Sony PCM-1630s, CD, DAT and 701. Full digital patching in both control room and equipment room. System with custom panels, installed and fully tested by us in less than 3 weeks, and of course including our DBM-1 digital metering unit.

Let our experience of Analogue and Digital systems help your installation work at its best right from the start.



TOTALSYSTEMS

Weller Eggar House,
High Street, Hartley Wintney, Hants RG27 8NY
Tel: 0251 26 4757

FM ACOUSTICS

introduces the

— FM 214 PRECISION
BALANCED LINE DRIVER

— FM 216 PRECISION
LINE LEVEL INTERFACE



They resolve any level and impedance problem between -10 dBv semi-professional and consumer equipment, audio sections of video recorders, CD players and professional balanced equipment working at +4 dBv, +6 dBv, +8 dBv and similar levels.

FM ACOUSTICS LTD
Tiefenhofstr. 17 CH-8820
Wädenswil/Switzerland
Telephone: 01-780 64 44
Telex: 875414 FMAC

US OFFICE:
FM ACOUSTICS USA
P.O. Box 854, Benicia
CA 94510
Tel: (707) 745 4444
Telex: 550161



PRECISION AUDIO ELECTRONICS
FROM SWITZERLAND

Who keeps on choosing Neutrik XLR type connectors in the UK?

Who are the large network of independent nationwide Neutrik Distributors in the UK?

We are pleased to say no regular name dropping is necessary.

Just to say we thank you for your continued custom and trust in Neutrik Connectors.

Ultimately it is our users who have given Neutrik connectors this **Professional Image.**

We have a lot to live up to!



NEUTRIK
CONNECTORS SWISS

also available

TP401 Audio Measuring System

(Made by Neutrik AG on the Isle of Wight)

Neutrik Audiograph Audio/ Acoustic Analysis System

Sole Agent UK

Eardley Electronics Ltd.

Eardley House, 182-184 Campden Hill Road
Kensington, London W8 7AS

Telephone: 01-221 0606/01-727 0711

Telex: 23894 Telefax: 01-727 9556

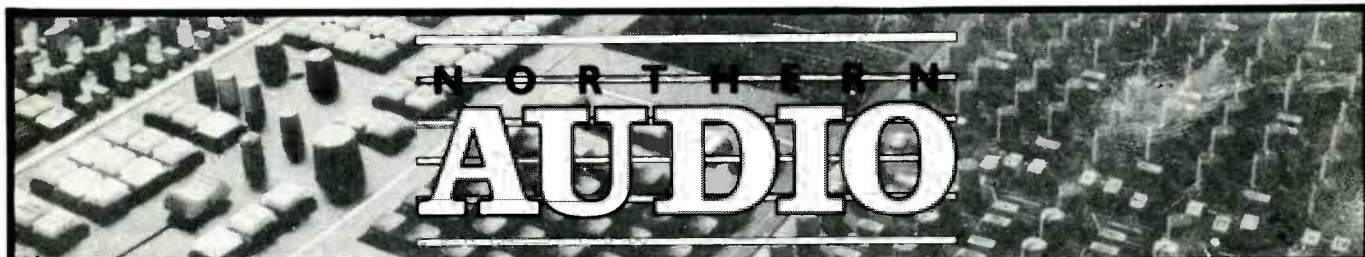

NORTHERN AUDIO STOCK LIST

SECOND HAND CONSOLES

S.S.L. 6000 E 48 frame with Plasma and Total Recall. 32 channels fitted with Adam Smith Synchroniser Master Transport Selector and all interfaces. Video switch and distribution. Events controller. 26" colour monitor. Stopwatch. 12 months old in very good order. Available end of May 87	£129,000.00
Neve "V" Range 48 frame with 36 fitted. Nevecam 2 automation fitted. Two years old with wooden end checks. In good condition. Available within 4 weeks of purchase	£85,000.00
S.S.L. 4000E 48 frame with 40 fitted Total Recall. V/U meters patchbay on the left with auxiliary housing. Producer desk on the right. commissioned Feb 86	£98,000.00
M.C.I. 559D with JH50 automation. commissioned 1980. 56 fitted in full working order. Can be demonstrated. In very good clean condition	£50,000.00
Harrison MR2 40 frame 40 fitted. automation ready. full parametric E/Q. 10 sends. 48 track assign. 40 monitors. 40 line inputs. 10 sends. full patch. 5 years old in good shape	£50,000.00
Amek Angela 36 frame 36 fitted with Mastermix. 14 months old in good condition. offers	£33,000.00
Harrison HMS console 42 frame 32/8/2 fitted 16 aux. 4 band parametric. 3.4 years old. 2 consoles for sale. In very good condition	£40,000.00
Harrison HMS console 42 frame 16/8/2 fitted 16 aux. 4 band parametric. 3.4 years old in very good condition	£30,000.00
Harrison Alive Desk 24/8/2. 3.4 years old in good working order	£22,000.00
Midas 24/6/2 PA console PR. 1A modules. 4 band E/Q with patchbay. P/G faders 6 years old	£3,500.00
Trident 80 32/24/24. 7 years old. nice condition	£12,500.00
Raindark Concord 28 in-line console full patch. 6 years old in good order. re-chipped throughout	£6,500.00
Soundcraft TS 24 32 input. three years old	£19,500.00
Trident T.S.M. 32/24/24 in good condition	£20,000.00
Harrison 40/32 frame 40 fitted with Alison 65K programmer and Alison VCA Fader mixers. 6 years	£27,500.00
Raindark Series 3 Console 24/8/24 Full Patchbay	£7,000.00
S.S.L. 4000E Mono channels. secondhand (each)	£1,350.00
Trident Trimax 16/8/2 6 years old. in good shape	£1,950.00
Soundcraft 15/24 with patch and 8 monitor module	£7,500.00
Soundcraft 400B 24/4/2 console. 2 years old	£2,950.00
Soundcraft 16/24 with patch and 8 moti/mod	£6,500.00
Raindark Concord 28 in-line. 4 years old	£6,500.00
Soundcraft 2400 28/24 Barographs. 3 years old	£10,500.00
TAC Matchless 26/24/8/2 patchbay and stand. 2 years	£7,500.00

WE ARE CONSTANTLY ON THE LOOKOUT FOR USED EQUIPMENT ...

NOTICE

We also act for studios as selling agents. let us handle the hassle of getting rid of unwanted items. it does not matter where you are in the world. why not drop us a line listing your equipment or ring us on the numbers below for the best rates. We assure you of our best attention and service plus the utmost confidentiality at all times

Studer A80 Mk4 with Auto and Remote. 1 year	£20,000.00
Orari MTR 90 Mk2 with auto and remote. 14 months	£22,500.00
Studer A80 Mk3 24 track. 14 months old. 2000 hours	£27,500.00
Studer A80 Mk3 24 track. 14 months old. 2000 hours	£3,350.00
Studer A80 Mk3 24 track. 14 months old. 2000 hours	£17,500.00
Orari MTR 90 Mk2 with auto. 3 years. 4000 hours	£31,500.00
Studer A80 Mk3 6 months less than 500 hours.	£11,500.00
Orari MTR 90 Mk1 autolocator	£3,950.00
Tascam 85/166 with autolocator. 3 years old	£3,500.00
Ampeck ATR 102 master machine with spares (mini)	£800.00
Ampeck 700 44" in light case	£15,500.00
Studer A80 wide body Mk2 24 track auto	£4,500.00
Studer A810 4"	£7,500.00
Soundcraft Mk2 24 track with autolocator. 9 mem	£6,500.00
Soundcraft Mk2 24 track with remote. 4 years	£6,500.00
Soundcraft Mk2 24 track with auto. 5 years	£6,000.00
PPG System 23 Wave Version Waveterr. B 16 bupages. two revision discs. All PPG discs. Version 3	£9,995.00
Amzoms	£50,000.00
Synclavier. 32 voices. 2 Winchester discs. 1 sampling monophonic. no midi	£6,500.00
Lexicon 480 L. 2/3 months old	£8,500.00
Linn 9000 Drum machine as new. Available Oct 87	£4,500.00
24 SP Dolby rack complete system	£4,850.00
Publison 1150 internal machine	£3,250.00
Q-lock 3 years old. in very good order	£800.00
Publison DHM89B2 with 5 seconds (mini condition)	£1,100.00
Sony 501 with SLF 25 cassette recorder (new)	£2,650.00
2 EMT 240 Gold foil reverb units (each)	£4,680.00
A.M.S. 1580s with 1 x 4 08 card + 2 x 1.6 cards. First pitch change and deqlitch (new)	£1,450.00
A.M.S. 1580s with 1 x 4 08 card + 2 x 1.6 cards. First pitch change and deqlitch (new)	£1,450.00
EMT 140 TS plate (four in stock)	£300.00
Evenude instant Flanger	£475.00
Lexicon PCM 70. New in stock	£1,650.00
Bel BD80 with 8 seconds (new in stock)	£475.00
1 Audio Kinetics automation system as new	£15,000.00
White 4400 s Ocave. Two in stock (each)	£425.00
Neve 2245e Comp/Lam	£375.00

FOR A COMPLETE STOCK LIST WRITE OR
RING TONY BAYLEY ON

061-483 9563/4299

4 CHEVIOT ROAD, HAZEL GROVE, STOCKPORT, CHESHIRE SK7 5BH. TELEX: 666597 NAUDIOG.

ABACUS ARTA 600

Use the ARTA 600 third-octave audio analyser adaptor and your own oscilloscope as the most cost effective solution to real-time analysis.

Verify the audio frequency responses of tape, film and VTR recorders in moments and save hours in daily maintenance.

£795 plus VAT



Abacus Electronics 10 Barley Mow Passage, London W4 4PH England
Telephone: London 01-994 6477 Telex 8811418

Gateway

SCHOOL OF RECORDING
MUSIC TECHNOLOGY
AND
MEDIA STUDIES

EUROPE'S LEADING MUSIC

INDUSTRY SCHOOL

Courses for 1987:-

- *Primary and Advanced Multitrack Recording*
- *Sampling and Midi Workshops*
- *Composing and Producing Radio and T.V. Commercials*
- *The Synthesizer Week, FM/DX Programming Weekends*
- *Synchronisation, using codes (SMPTE/EBU) Music to Picture*

For complete Brochure and Prospectus Call:-
Gateway School of Recording
and Music Technology
1A Salcott Road, London SW11 6DQ. 01-350 0340

We give a Certificate of Recognition for each completed Course.

**Gateway Courses should not be confused with
ANY others offered . . .**

VOICE PROCESSING WORTH SHOUTING ABOUT.



**Affordable five-in-one
problem solver with
Mic preamp, De-esser,
Compressor/Limiter,
Parametric EQ/Notch
Filter and much more!**

Symetrix

For about what you'd expect to pay for one component, the Symetrix 528 Voice Processor delivers it all.

Ultra-clean Mic Preamp with 48V phantom powering. Sweepable De-esser. Compressor/Limiter with "soft knee" transition. Downward Expander to increase dynamic range and decrease noise. Fifteen-dB-boost/30dB-cut Parametric EQ/Notch Filter. Even a fast slew rate Automatic Drip Coffee Maker with switchable de-caf limiter.

Plus output gain control, 8-LED VU-calibrated output and gain reduction displays, balanced line input and a proven track record with demanding studio and sound reinforcement engineers worldwide. And all in a single rack space.

Perfect for breathy vocals, juicy voiceovers, persistent P.A. problems or anywhere else you need to draw on an arsenal of state-of-the-art signal processors.

Call your distributor today for a detailed brochure on the Symetrix 528. You'll agree that no other product has ever racked up as many useful features in a single space.

Signal processing at its best

In the UK:
SOUND TECHNOLOGY PLC
6 Letchworth Business Centre
Avenue One, Letchworth
Herts SG6 2HR
Telephone: 0462 480000

International Representation:
E & E INSTRUMENTS INTERNATIONAL, INC
PO Box 1313
Laguna Beach, CA 92653, USA
Telephone (714) 494-0231
Telex 182291 EASTMAN LGNH



THE ULTIMATE DIGITAL PROCESSING EQUIPMENT

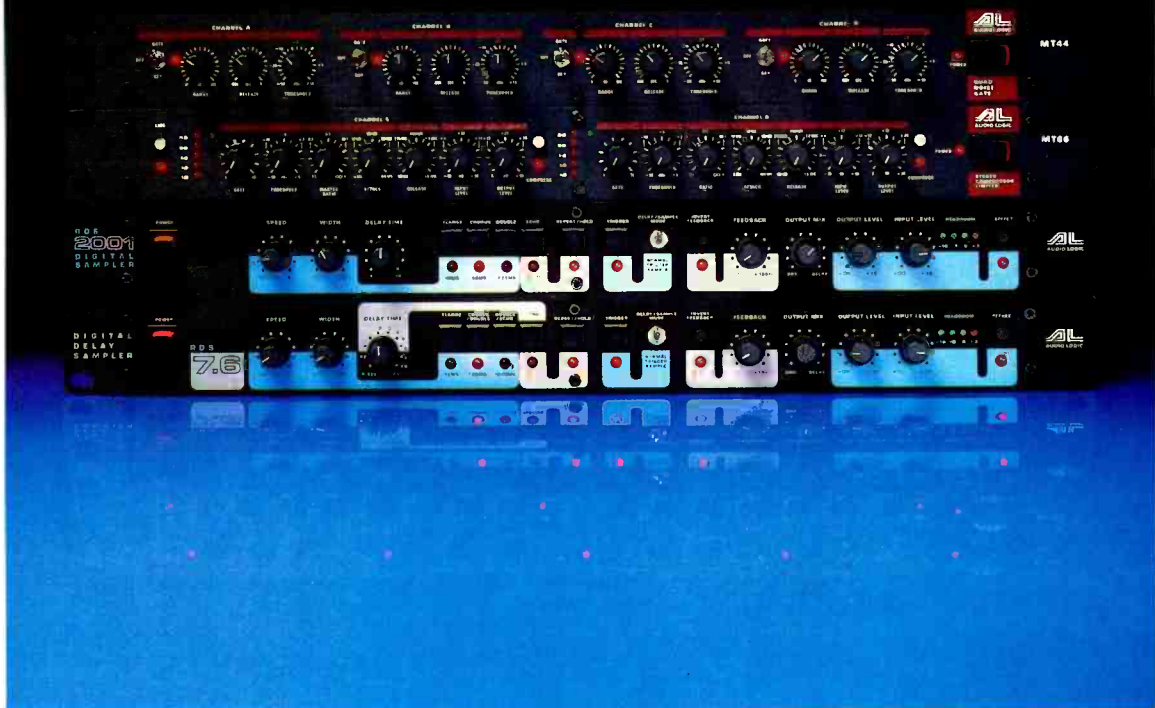

AUDIO LOGIC and DOD
The best in digital delays, graphics equalisers
and sound processing.

YET MORE



6 Letchworth Business Centre, Avenue One, Letchworth, Herts SG6 2HR
Telephone 0462 480000. Fax: 0462 480800. Telex: 826967
DOD International, 10 Cindy Drive, Nashua, NH 03062. Phone: 603-888-5230. Fax: 603-888-6750

THE LANGUAGE OF OTARI

SPOKEN AS ONLY
WE KNOW HOW

When we speak Otari, we mean business. Because for a busy studio it would be hard to find a better multitrack proposition.

Especially when you add the expertise of the UK's top Otari specialists – backed by Service Director Rod Thear and his team, with over 15 years' Otari experience between them.

The MTR-90 needs no introduction; its tape handling is flawless and with our new, custom Dolby SR[®] overbridge its status as the world's most successful multitrack is assured.

The MX-80 multitrack brings Otari's high performance, precision handling and reliability within reach.

Sound quality is remarkable; with the Dolby rack it's outstanding. Outmoded or secondhand machines are no longer the only options.

Finally, the new MTR-20 – the ultimate analogue mastering recorder. Its sophisticated electronics, engineering quality and operational flexibility set standards others will aspire to.

Whichever one suits your needs, you'll find our back-up as solid and reliable as Otari machines themselves.

And that's great news in any language. Call Garry Robson or Mick Boggis for details.





◀ **MTR-90** Top quality multitrack in 1" 8 track and 2" 16 or 24 track versions. Pinchrollerless PLL capstan transport under electronic control with fast lock-up, digitally timed gapless punch in/out and 14" max reel size. Facilities include spot erase, bidirectional cue, elapsed-time indicators and easy-access tilting deckplate. Interfaces provided for transformerless audio I/O (or transformer option), RS232C I/O and SMPTE. Optional: Dolby SR* overbridge.

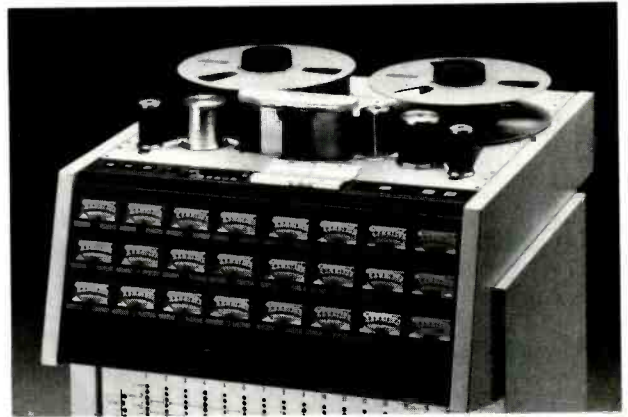

▲ **MX-80** New multitrack in 2" 16/24/32 track versions. Features closed-loop constant tension transport with 30/15/7.5 ips speeds, each with gapless punch in/out. Integral facilities include Dolby HX-Pro*, synchroniser interface, switchable EQ curves and 4-cue autolocator. Full remote provided; Dolby SR* overbridge, timecode-based autolocator and chase synchroniser optional.



▲ **MTR-20** New stereo mastering recorder with quartz-PLL capstan and closed-loop Optimum Tape Guidance System with electronic control. Full auto-align plus 2 memory set-ups per speed/EQ, 4-point autolocator, optional broadcast I/O including fader start, gapless punch in/out, reverse play/erase, library wind mode and tape time/timecode display. Options: full autolocator, 1 or 2-button punch in/out, variable wind speed and many more.

OTARI®

AT

Stirling **ITA**

1 Canfield Place, London NW6 3BT. Telephone 01-625 4515
Fax. 01-372 6370. Tlx. 946240 CWEASY G Ref No. 19014280

*Dolby SR and HX-Pro are trademarks of Dolby Laboratories Ltd.

A RAMSA amp can handle the heaviest tracks.

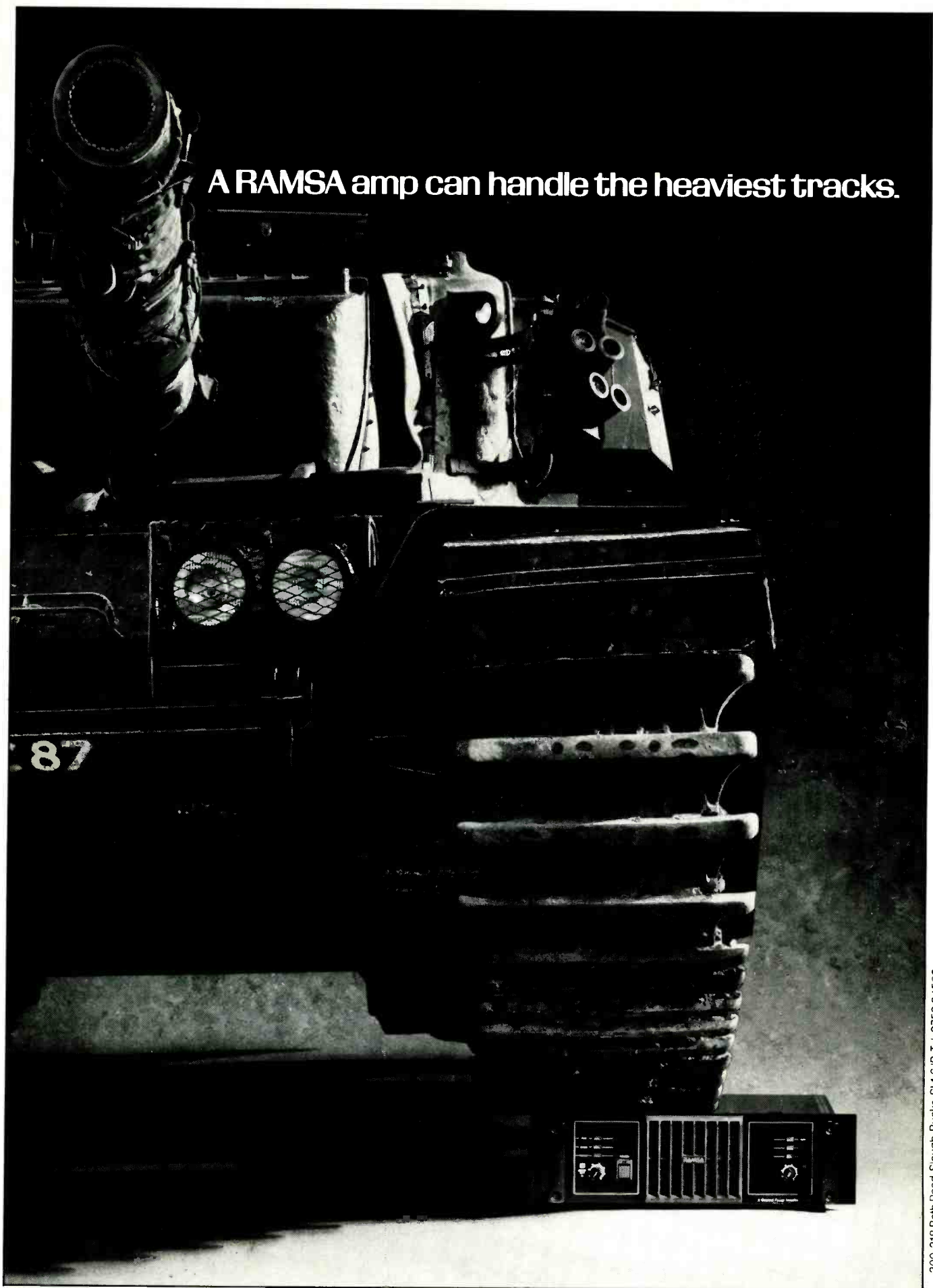

300-318 Bath Road, Slough, Bucks. SL1 6JH. Tel: 0753 34522.

RAMSA
PRO-SOUND

All RAMSA amps carry a five year guarantee. See the full range of amps, microphones and speakers at your specialist dealers.



Six hours later he's smiling

And the reason why?

He's happy with the final mix, and feeling relaxed wearing the DT100 Headphones.

Designed for professionals, this headphone can be worn for long periods in total comfort.

The DT100 is a standard control headphone, used worldwide by studio engineers and home recording artists.

Reproducing a true and transparent sound with a natural bass response.

The DT100 Headphones are multi-purpose, rugged and reliable, just right for the technician.

Demand the best from your equipment. Insist on a Beyerdynamic headphone.

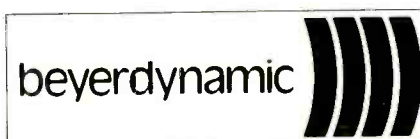

EXCELLENCE IN SOUND

*BeyerDynamic, Unit 14, Cliffe Industrial Estate,
Lewes, Sussex BN8 6JL. Tel: 0273 479411*

Tannoy-Goodmans merger

Goodmans Loudspeakers Ltd have announced the merger between themselves and Tannoy Group Ltd to form TGI plc (Tannoy-Goodmans International), who intend to seek a full listing on the stock exchange early in 1988. Initially, TGI will have three subsidiaries: Goodmans Loudspeakers, Tannoy Ltd and Morduant-Short Ltd (recently acquired by Goodmans). Group chairman is Norman Crocker and

chief executive is Terry Bennett, currently chairman and MD of Tannoy and Goodmans, respectively.

TGI becomes the largest UK manufacturer in the loudspeaker industry, with an annual turnover already in excess of £35 million. The head office will be based at 2 Marples Way, Havant, Hants PO9 1JS, UK. Tel: 0705 486344. Further information from Roger Fearn, at the above address.

NEWS

Addendum

SSL in Moscow

The Novosti Press agency (APN) in Moscow have confirmed an order for an *SL 6000 E*. APN, who specialise in producing public relations material in a variety of media, are now moving into the video field and have commissioned the construction of a major project in Moscow.

The first phase of the project will be geared to an electronic field production (EFP) operation, using

compact video equipment for producing and recording on location. The resulting material will be edited and processed in the new facility, involving audio for video post-production on the SSL stereo video console.

APN's future plans include the extension of the Moscow facility to a full-blown production centre.

£25 million tape investment

Nippon Magphane Ltd, a jointly owned subsidiary of Rhone-Poulenc (France) and Toyobo (Japan), are to invest 6 billion Yen (approx £25 million) in a new production line for Terphane polyester based films for audio and video tapes at the Tsuruga

plant in Japan. This is part of Rhone-Poulenc's strategy to be more active in the tapes market. They have two lines in their plant near Lyon, and a recent \$35 million investment was made for a Brazilian plant, due for completion in autumn 1988.

Change of address

• Digital Creations Corporation have moved to: 50 Werman Court, Plainview, NY 11803, USA. Tel: (516) 756-9620. Fax: (516) 756-9622. Telex: (510) 600-5040.

• Teac UK have moved to: 5 Marlin House, The Croxley Centre, Watford WD1 8YA, UK. Tel: 0923 225235. Fax: 0923 36290. Telex: 915417.

We would like to correct an address in the Disc Recording survey carried in the September issue. Under New England Digital we gave UK distribution as Harman (Audio) UK Ltd, which is correct but rather than moving to the Slough address

following the Turnkey/Harman merger, the division representing *Synclavier* have remained at their original address, which is Brent View Road, London NW9 7EL. Tel: 01-202 4366. Telex: 25769.

New from MIDEM

The MIDEM exhibition to be held in Cannes might be of interest to British studios, according to the organisation's sales director, Peter Rhodes. British studios are apparently missing out on the advantages of getting together with major manufacturers, record companies and publishers. At the time of writing, more than 20 CD pressing plants had booked space, including the likes of Philips-DuPont and Sony, along with record companies such as CBS, PolyGram and Nimbus, plus a large number of

pro-audio equipment manufacturers and music publishers.

Rhodes pointed out that British studios were entitled to government grants, and that a first-time exhibitor would pay only £1,200 for a fully equipped stand, including telephone, electricity and so on, once the grant was taken into account.

Rhodes urged any studios interested to get in touch quickly, since the deadline for booking space was in the first weeks of November. Further information from Peter Rhodes, tel: 01-499 2317.

Award to Teldec

Teldec GmbH of West Germany have won the 1987 Maker of the Microphone Award, presented annually in memory of Emile Berliner, inventor of the microphone and the disc record, for 'an outstanding contribution to the world of sound'. Teldec were recognised for

their invention of the direct metal disc record mastering system, which is now being applied to optical based discs. The occasion seemed fitting as 1987 marked the 100th anniversary of Berliner's invention of the disc record.



**THE NAME OF
THE MANUFACTURER OF THIS
NEW LOUDSPEAKER CONNECTOR
WON'T COME AS A SHOCK.**

DISC reference CDs

Reference CDs are now available from DISC of California: just as LP reference discs can be made for musicians, producers and record companies, this new service provides a reference CD playable on any standard CD player.

The CD reference disc uses a glass substrate with the same dimensions as a pressed CD. When the 'cutting' is finished, the disc is metallised and given a protective coating, as with pressed CDs.

DISC work from a ¼ in U-matic digital master tape that has been recorded in the PCM 1610/30 format. The PQ codes are entered on audio track 1 from the cue sheet. DISC guarantee indexing accuracy within ±1 SMPTE time frame.

One CD reference disc with up to 72 minutes playing time will cost from \$750 with a 24 hr turnround, down to \$500 for a 5-day turnround (excluding shipping time). Quantity discounts are available.

This service is primarily for CD-Audio discs but CD-ROM reference discs are also available provided the master data program is supplied on the U-matic tape format.

DISC design and manufacture compact disc mastering systems, CD stamper analysers and supplies peripherals for manufacturing compact discs.

Digital Intelligence Systems Corp, 2865 Pullman Street, Santa Ana, CA 92705, USA. Tel: (714) 261-5654.

Agencies

● Syco have been appointed exclusive London agents for the new Stepp DGX guitar controller, and have announced that they will be providing complete MIDI packages

based around it.

● gtc Ltd have been appointed sole UK distributors of the Quantec QRS/XL realtime signal processor.

Forthcoming events

November 5th to 8th The Institute of Acoustics' Reproduced Sound 3 (in collaboration with the AES, ACSE, EMAS and APRS), Windermere Hydro Hotel, Windermere, UK.

November 14th to 15th The Turnkey Hands On Show, Centrepoint, London.

November 16th to 18th Entertainment and the Arts '87, International Conference and Exhibition Centre, Harrogate, UK.

November 16th to 20th 28th Salon International des Composants Electroniques, Paris, France.

November 23rd to 26th Digital Information Exchange '87, Private Member's Suite, London Zoo, UK.

1988

March 1st to 4th AES 84th Convention. Palais des Congrès,

Paris, France.

March 9th to 13th Frankfurt Musik Messe '88, Frankfurt, West Germany.

March 21st to 24th 7th International Conference on Video, Audio and Data Recording, University of York, UK.

April 5th to 8th Acoustics '88, University of Cambridge, UK.

April 8th to 12th NAB, Las Vegas, USA.

April 25th to 28th Audio Visual '88, Wembley Exhibition Centre, UK.

May 18th to 20th ShowTech Berlin '88, Berlin Exhibition

Grounds/International Congress Centre, Berlin, West Germany.

September 23rd to 27th International Broadcasting Convention '88, Metropole Conference and Exhibition Centre, Brighton, UK.



Tall stories part II— Slow crane coming

This month's continuing saga of the plight of airborne consoles comes from FWO Bauch. When last we heard, Bauch had just sold a Harrison series 10 to London-based radio and TV commercial specialists Saunders and Gordon, whose third-floor premises house their new multitrack studio. On delivery, it was soon established that the staircase would not be wide enough for the Harrison (not to mention the 47

people needed to carry it), so an alternative route was sought—through the window, which as luck would have it was wide enough without removal. A crane was used to lift the Harrison expertly through the window (a throughput as it's known in the trade), where Bauch transport personnel immediately took over. And so ends another heart-warming story from the world of pro-audio.



NEITHER WILL THE CONNECTOR.

The new AXR/PDN connector from ITT Cannon is a safer speaker connector. Designed to handle high power outputs we've also designed the contacts to make sure you don't end up handling high power outputs as well. It has all the benefits of a smaller body shell with a simple cable clamp arrangement and like AXR is available in a wide range of configurations. The PDN (Phase, Drain, Neutral) insert is a 3-pole connector and is available with optional colour coded boots.

For full technical details call Tim Richardson at the address below. There's no sound alternative.

ITT CANNON
JOIN THE FORCES OF THE FUTURE.

Jays Close, Viables Estate, Basingstoke, Hampshire RG22 4BW. Tel: 0256 473171 Telex: 858105

NEWS



Lucasfilm engineers at SSL (see Todd-AO/Glen Glenn)

Contracts

- Morning Studio in Milan have purchased a new Neve V series console with *Necam 96* automation. The console includes the largest *Necam* display yet used—a 1.5 m wide projection screen between the main monitor speakers for video when the desk is used for dubbing.
- Recent contracts for Amek include an automated 40-input *G2520* to Viewplan in Stockport; a large *BCII* to Telegenic Ltd in London; three large *BCII* consoles to Molinare in London for their *A/V* complex, plus a 56-input chassis *G2520* with digital fading together with a *BCII* all-stereo input submixer for their new post-production suite; four *BCII* consoles to Turkish Radio and TV; a new studio chassis console from the *BCII* range for Radio Telefis Eireann; and a contract to supply Sunset Sound Inc of Los Angeles with an *APC1000* assignable console, a 56-input version in 64-input chassis with *GML* automation, plus recall and reset systems.
- Crest Audio are to supply Maryland Sound Industries with 100 of their new *8001* amplifiers, in preparation for the forthcoming Pink Floyd tour.
- Stirling/ITA are to supply Saunders and Gordon's Studio Four with an Otari *MTR-90* fitted with the

Stirling ITA/Dolby overbridge plus a Dolby A rack, along with other gear from Yamaha, AMS, AKG and Sony. Stirling have also announced the first sale of the new *DDA DCM 232* in-line console: a 40-channel version goes to Woodbine Street studios of Leamington Spa.

- Apogee Electronics have supplied their *944-S* and *944-G* anti-aliasing filters to mastering facilities including A&M Studios, Atlantic Records, Capitol Recording, Editel, Masterdisk and Precision Lacquer, all for their *PCM-1630s*. The Hit Factory, the Power Station and Alan Parsons have all updated their *3324s* with Apogee filters. Meanwhile, Apogee are to collaborate with New York engineer/designer Dave Smith in the design of a D/A conversion box expected to be out by March 1988.
- Recent news from SSL includes a contract worth more than \$2 million to supply Todd-AO/Glen Glenn with eight *SL 5000M* film sound production consoles between October 1987 and July 1988. Other contracts include the installation of an *SL 4000E* master studio system to the Enterprise's Studio C in Burbank, California, while across the Pacific in Japan, JVC Studios are about to install their seventh SSL and Onkio Haus their fifth.

In brief

- The AES Educational Foundation have announced the recipients of their educational grants for the 1987-88 academic year. Richard Karstens, Vincent Luciani, Daniel Powell, J Clarke Stevens and David Yuen—all in post-graduate studies—were selected on a basis of demonstrated past interest and achievements in audio, and on faculty recommendations. Additional information and application forms are available from the AES at 60 East 42nd Street, New York, NY 10165, USA. Tel: (212) 661-8528.

- A new multitrack, MIDI-recording, post-production facility has opened in Los Angeles. The 'million-dollar operation' is equipped with a Neve *8058* 48-input console with an additional 48 Wolstein Labs inputs, a Studer *A800* plus a full complement of outboard and MIDI gear. Further information from Jefferson Chitouras, tel: (213) 461-0734.

- News from Bombay is that since its launch in June 1986, *Playback and Fast Forward*, which is free of charge, has successfully established itself as the leading pro-audio magazine in India. With the industry there growing steadily, *Playback* wants to make manufacturers aware of the potential in India. Contact Anil Chopra, Publisher, *Playback and Fast Forward*, Business Press Private Ltd, Maker Tower 'E', 18th Floor, Cuffe Parade, Bombay 400 005, India. Tel: 366478.

- UK company Applied Microsystems, manufacturers of timecode synchroniser equipment, have been acquired by ASC. Applied Microsystems will supply software and new designs to ASC who will take over the manufacturing and marketing aspects.

- gtc, the German manufacturers of timecode-based equipment, have set up a sales and marketing division in the UK. Further information is available from systems consultant Bob Nicholas at: gtc Ltd, 5 Fulmer Drive, Gerrards Cross, Bucks SL9 7HH, UK. Tel: 0753 884319.

- Molinare have announced the start

of their £¼ million refurbishment. Carried out by Windmill Munro, the work is expected to be completed by November 1st. Projects include a new entrance, two completely rebuilt dubbing studios and complete inter-studio compatibility.

- The British Standards Institution have announced a new testing service that allows manufacturers to claim that a sample of their product has been passed by BSI Testing as complying with the relevant BS number and report. For more information and technical reports, manufacturers and agents can contact Robin Dandy, assistant director of BSI Testing on: (Hemel Hempstead) 0442 230442.

- Transcom Digital in New York have made available to outside programmers and producers their new 18,000 ft² production/post-production facility. Major equipment includes an SSL *SL 6000 E*, Sony *3324*, and a CompuSonics-based digital audio network, integrating up to 10 hours of sound effects and music storage with the console and recorder. For more information, contact: Eleanor Kearney, Transcom Digital, 902 Broadway, New York, NY 10010, USA. Tel: (212) 529-1000.

- D P Ayyappan has opened a consultancy in acoustics in the US, specialising in architectural acoustics in theatres, studios and liturgical facilities. Information from: 1908 University Drive, Richardson, Texas 75081, USA. Tel: (214) 644-2130.

- Soundcraft Electronics have announced their move into a new R&D block, giving almost four times the space for product development. Besides the recent 50% increase in staff, the facility houses eight CAD systems, logic analysers and an in-circuit emulator for software development in assignable console and automation projects.

- Wireworks, the New Jersey-based cabling suppliers, were designated official cable supplier for the opening and closing ceremonies of this year's Pan American Games, which were held in Indianapolis in August.

People

- Horst Hanfeld has been appointed divisional director to head up the audio-video division of BASF UK Ltd. Hanfeld comes from the Australian headquarters where for the last 10 years he was manager of the consumer products division and a member of the board.

- Harrison Information Technology have appointed David Graham as UK sales manager for their range of pro-audio equipment. Graham comes most recently from *International Musician* where he was ad manager.

- Electro Sound have appointed Bob Becker as plant manager, who will assume responsibility for all day-to-day plant operations and associated aspects.

- The Bose Corporation have appointed Alan Kilford as managing director of Bose UK, following his 14-month tenure as general manager.
- Soundcraft have appointed Amanda Bateman to head their marketing co-ordination. Bateman comes from film and video production company AKA.



DIGITAL AUDIO PROCESSINGS

COMPACT DISC TAPE MASTERING CENTRE

Rue des Deux Eglises, 46 – B-1040 BRUSSELS – BELGIUM – Tel.: Int. + 32-2/217.45.89 – Telex: 20558 dig kr b.

NEWS

Argent's MIDI Communicator

London-based Argent's have released two MIDI interfaces for the Apple Macintosh. The *MIDI Communicator* sits beneath the Macintosh, concealing the mains, printer, modem and MIDI cabling. The Apple's printer and modem ports are used for MIDI communication, with the actual hardware connecting to extension

ports on the interface at the side, providing two MIDI inputs and eight MIDI outputs. The *Mini MIDI Communicator* is a budget model with integral power supply having one MIDI input and four MIDI outs. Argent's, 20 Denmark Street, London WC2, UK. Tel: 01-379 6690.

Wonder Widgets Video Pen

Wonder Widgets, the London-based manufacturers of tape accessories, have developed the 'write & wipe' *Video Pen*. Available in a range of bright, opaque inks, the pen can be used on any non-porous surface and wiped clean with a damp cloth. This means mixing desks, synthesizers, cassette cases and so on are all fair game as potential writing surfaces.

Also new is the *Audio Widget*, for replacing the safety tab on audio cassettes. Also available are *Video Widgets*, video labels and video cassette cases.

Wonder Widgets Ltd, 218 Canalot Production Studios, Kensal Road, London W10 5BN, UK. Tel: 01-960 5768.

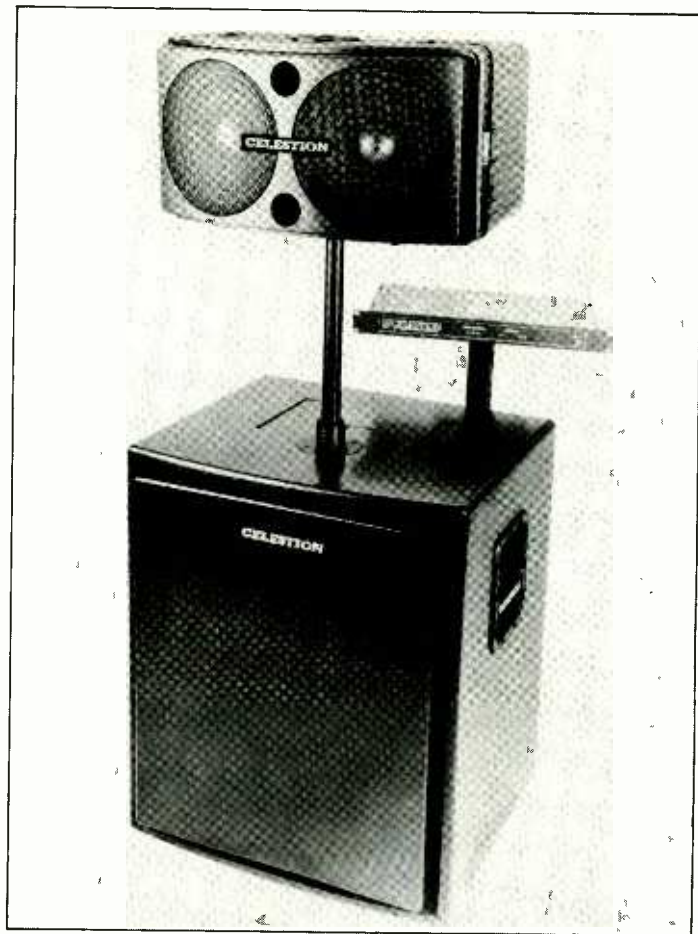
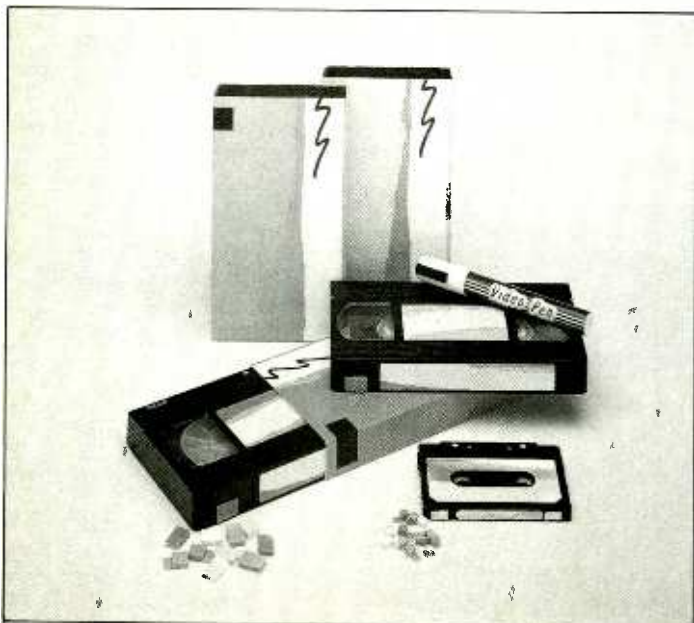

Celestion SR series

Celestion have recently introduced their *SR* series sound reinforcement system, comprising the *SR1* and *SR2* loudspeaker units, plus the *SRC1* 'intelligent' controller. The heart of the system is a pair of *SR1* 8 in drivers mounted alongside each other in a single cabinet. Each driver is of a dome/cone configuration, with a frequency range of 50 Hz to 20 kHz, and able to handle up to 500 W. This unit is mounted on the *SR2* subwoofer cabinet, via a tubular support. The subwoofer itself is a single 18 in driver capable of handling 1000 W, and putting out frequencies from 40 to 150 Hz. Finally, the *SRC1* electronic

controller monitors voice coil temperature and cone excursion, with circuitry, which the manufacturers claim the leading edge of potentially harmful LF transients and inaudibly compresses them before instantly restoring complete low end power.

The cabinets of both loudspeaker units are made of high impact, injection moulded reinforced polymer, and can be easily painted to suit any environment.

Celestion International Ltd, Foxhall Road, Ipswich IP3 8JP, UK. Tel: 0473 723131.

USA: Celestion Industries Inc, Kuniholm Drive, Holliston, MA 01746. Tel: (617) 429-6706.

RCF loudspeakers

RCF of Italy have introduced several new products to their range of loudspeaker components. The *N681* is a 1 in exit driver with a 100-hour sine wave power handling of 35 W (100 W programme), using a titanium diaphragm with aluminium voice coil on a polyamide former. The *N980* is a 2 in exit driver with a carbon fibre diaphragm and copper voice coil on a polyamide former; power handling is rated at 250 W programme. The *N481K* is an update of the *N481*, having phenolic diaphragm with copper voice coil on a polyamide former and power handling of 45 W RMS. The *H6040* is a 60x40°

structural polyurethane constant directivity horn, while the *H9041* is a miniature (1 in) constant directivity horn. A new 12 in loudspeaker is the *12P400*, handling 200 W RMS with a frequency response of 34 Hz to 4 kHz, and a new 15 in model is the *15P200A*, with a copper voice coil on a polyamide former, and handling 300 W RMS.

RCF International Srl, Piazza Matiri 7 Luglio, 3, I-42100 Reggio Emilia, Italy.

UK: Court Acoustics Sales Ltd, 29 Beethoven Street, London W10 4LG. Tel: 01-960 8178.

SONY®



An unbeatable track record

The number of tracks is one of life's dilemmas.

There are not enough for some, too many for others. So working on the theory that 24 tracks were enough for many projects but 48 were often necessary, we designed the PCM-3324. We followed that with the RM-3310 Remote Control and Synchronizer... 24 or 48 tracks as you like, when you like. Not only that, we made sure that the DASH format provided for up to 48 tracks on a single machine, guaranteeing upward compatibility.

Producers were not slow to realise the creative advantages of this way of working. Studio Managers saw a safer return on their investment, so thanks to them we had a success on our hands. Now we have added the IF-3310 and VSU-3310 to further improve system flexibility.

If you want to know how to solve the track dilemma, find out more about the Sony system, then contact our customers who'll tell you just how good it is. Who are they?... If you don't know perhaps you shouldn't be reading this advertisement.

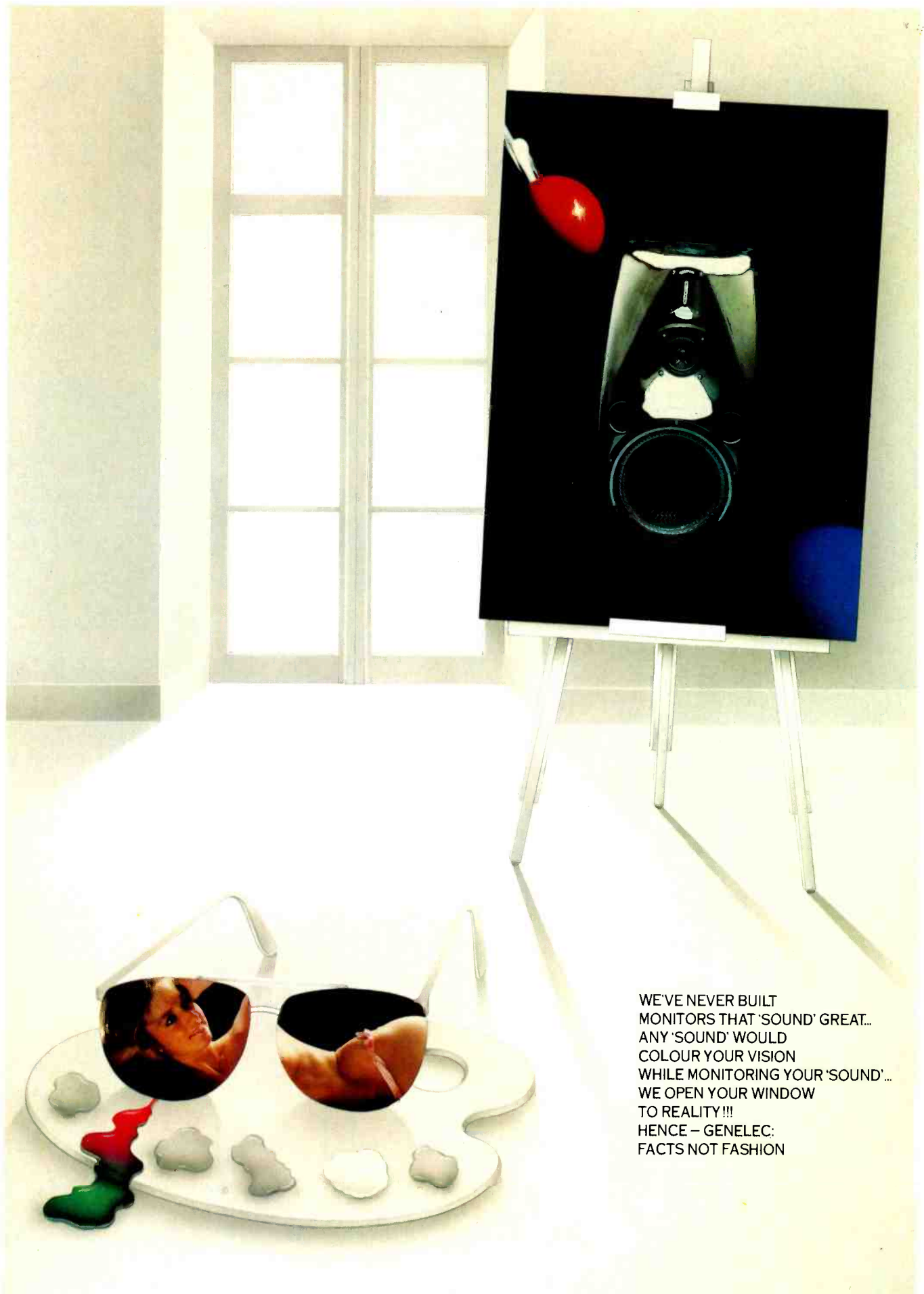

WE'VE NEVER BUILT
MONITORS THAT 'SOUND' GREAT...
ANY 'SOUND' WOULD
COLOUR YOUR VISION
WHILE MONITORING YOUR 'SOUND'...
WE OPEN YOUR WINDOW
TO REALITY!!!
HENCE - GENELEC:
FACTS NOT FASHION

GENELEC

FINLAND, Tehtaantie 17, PL36
74100 Iisalmi tel. 3587713311

BELGIUM, Hes Electronics tel. 02-4652917, FRANCE, Publison Audio Professional
tel. 1-43608464, ITALY, Audio Equipment S.R.L. tel. 039-836767, THE NETHERLANDS,
Audioscript B.V. tel. 02158-5124, NORWAY, Siv Ing Benum A/S tel. 02-145460, SPAIN,
Aprilia International tel. 3-2128915, SWEDEN, Intersonic AB tel. 08-7445850,
SWITZERLAND, Emm-Studio AG tel. 061-542045, WEST GERMANY, FFD
Vertriebsgesellschaft tel. 089-2780404, HONG KONG, Power Source Development Ltd.
tel. 3-7446189, JAPAN, Otartec Corporation tel. 03-392-7811, USA, Redwood Marketing
tel. 615-3314743, UK, Scenic Sounds tel. 01-387 1262.

NEWS

TC 8201 test generator/analyser

TC Electronic of Denmark has introduced a *TC 8201* digital audio interface test generator/analyser, intended for testing digital audio output on both professional and consumer equipment conforming to the AES/EBU and IEC specifications. It has detailed access to both digital audio information, and the subcode associating the audio information.

The generator section can send anything up to 24-bit resolution waveform with any length up to 100 ms. These are selectable either directly or via a menu, as is the subcode information to be sent. The analyser measures audio input frequency, amplitude, sample rate, distortion and signal-to-noise, and has access to single samples. The analyser displays the subcode information in a decoded and readable format. Both the generator and analyser can operate independently on any sampling frequency from 28 to 53 kHz, or they can be locked together. The unit is

run through any RS232 ASCII terminal.

Also new from TC Electronic are options for the *TC 2290* multi-effect unit and sampler. The SA02 (sampling option 2) enables crossfading by using a dual-head D/A converter, and includes sequencing, looping, sound on sound, and chromatic pitch adjustment. The Fast Trig option (*FATR*) plays sampling on audio trig with an accuracy of $\pm 2 \mu\text{s}$. The Stereo Sampling link (*STSA*) can lock two *TC 2290s* together in true phase-correct stereo sampling for up to 32 seconds. **tc electronic, Grimhoejvej 3, DK 8220 Braband, Denmark. Tel: 06 262800.**

UK: State of the Art Distribution, High Lane Village, Near Stockport, Cheshire SK6 8AA. Tel: 06632 2442.
USA: tc electronic, PO Box 5039, 52 Woodbine Street, Bergenfield, NJ 07621. Tel: (201) 384-4221.

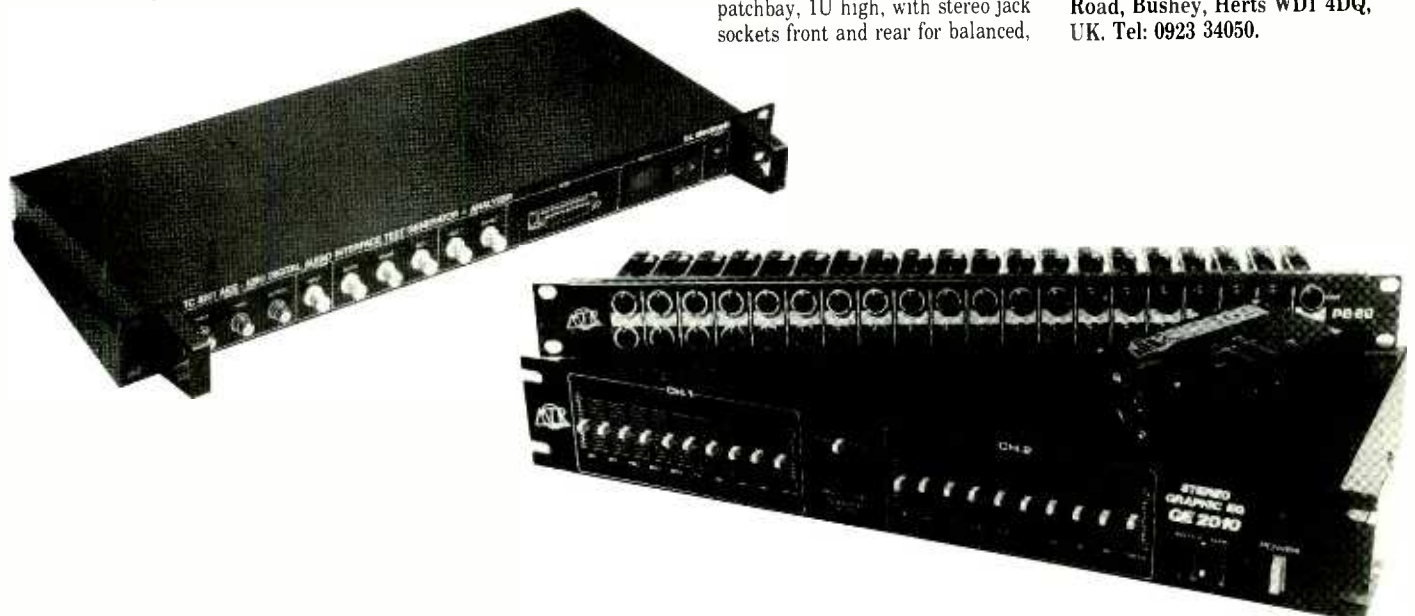

Fazioli grand

Italian piano manufacturers Fazioli have recently unveiled their 3.8 m grand piano, their largest and the largest hand-built grand in the world. Following our article on Fazioli in the March issue of *Studio Sound*, the piano was introduced at the Goldoni Theatre, Venice, in June, and from

all accounts was an unqualified success.

Fazioli Pianoforte srl, 33077 Sacile-Pordenone, Via Ronche 47, Italy. Tel: 0434 72026.

UK: Christofori Ltd, 20 Conduit Place, London W2, UK. Tel: 01-402 4304.

BBC Sound FX CDs

The BBC, with the largest sound effects library in the world, are now providing professional users with an introductory set of 10 *Sound Fx CDs* with more than 450 effects, over 90% of which are newly recorded in digital stereo. The discs are supplied in a compact stacking system, and

each is accompanied by a booklet with a comprehensive index. A chart detailing the contents of each disc is included in the package.

BBC Records and Tapes, Room C231, Woodlands, 80 Wood Lane, London W12 0TT, UK. Tel: 01-576 0602.

Soundtracs MRX

Soundtracs have updated the *MR* series of consoles with the introduction of the *MRX* series. Major changes include entirely new cosmetics and extended mainframe versions, with a choice of either 24 or 32 inputs without patchbay, or 26 and 34 inputs with patchbay that can be supplied with optional stereo input modules.

Main features include 4-band EQ with two sweepable midranges and

six dedicated aux sends on the inputs, 3-band EQ, six aux sends and 16-track monitoring on the groups. LED bargraphs are standard, for 16-track tape, auxs, LR mix and solo. **Soundtracs plc, 91 Ewell Road, Surbiton, Surrey KT6 6AH, UK. Tel: 01-399 3392.**

USA: AKG Acoustics Inc, 77 Selleck Street, Stamford, CT 06902. Tel: (203) 348-2121.

Three more from MTR

MTR have announced three new products. The *GE 2010* is a 19 in rack mountable stereo 10-band graphic equaliser, which is 2U high with multi-detent faders, jack and phono connectors, EQ bypass and a tape copying facility. The *PB-80*, which replaces the *PB-1*, is a 40-way patchbay, 1U high, with stereo jack sockets front and rear for balanced,

unbalanced and MIDI patching. Finally, there is the active balanced Direct Injection box, with a 3-way ground switch (ground, floating or lifted), 3-way attenuator (-40, -20 or 0 dB), powered by a 9 V battery or phantom power.

MTR Ltd, Ford House, 58 Cross Road, Bushey, Herts WD1 4DQ, UK. Tel: 0923 34050.

SOURCE INDEPENDENT MEASUREMENT

SIM engineer Bob McCarthy manned the equipment at a recent Wembley Arena concert. He talked to David Mellor about the current system and its possibilities

Source independence, as the name implies, is the distinguishing feature of this system of room equalisation developed by Meyer Sound Laboratories. Stevie Wonder was the source on this particular occasion but that should be of minimal importance if *SIM* works as well as we are told it does. The 'room' was Wembley Arena, its acoustics being memorable to PA engineers and paying customers alike.

'Source Independent' means the system does not require a known test signal to make frequency and phase response measurements. The 'industry standard' method is 1/3-octave realtime analysis using pink noise, which contains equal energy per 1/3-octave bandwidth. A system is lined up so that it gives out similarly equal energy, or some variation of that, which may be considered preferable.

The difference between this and *SIM*, is that *SIM* is a 2-channel measurement. The signal feed from the mixing desk is compared with the signal from a reference microphone in the auditorium and the difference between the two observed by the operator. Whatever the output of the console, provided that it has energy at all frequencies of interest, it can be monitored at the microphone position and checked for frequency and phase. Music can be used as the test signal, so measurement can be carried out throughout the duration of a concert. Measurements, and graphic displays, are handled by a Hewlett Packard 3582A Fast Fourier Transform spectrum analyser (FFT), which is like a conventional spectrum analyser but more precise and clever. Any necessary corrections are made manually using Meyer *CP10* parametric equalisers.

Bob McCarthy explains: "You have a source and a microphone in the room. The purpose of this system is to go into a room with the sound system and eliminate or minimise the acoustical contribution of that room and bring it back as close as you can to a free-field acoustic environment, that is a flat frequency reproduction

of the system. What I'm trying to do is give the mixing engineer the power to take exactly what is coming out of his desk and for that to be the sound that people are hearing in the hall. The secondary goal is for that to be the same sound in both level and frequency response throughout the hall."

So, when a capacity crowd arrives in Wembley Arena, the *SIM* engineer can update the system and hopefully bring it back to a flat response. What 'flat' means, in this case, is an accurate reproduction of what is coming out of the mixing desk. If the engineer is EQ'ing the vocal or whatever, then that is not part of the measurement system. In the Wembley system, the mix engineer, Chris Lindopp, was given his own graphic equaliser so he could adjust for an overall sound he liked.

"After hearing rooms that have typically 20 or 30 dB in the very deep low end, it's a bit of a shock for them to hear a sound system which is

producing a flat frequency response. We give them that tool so they can work their way back to a familiar place. The idea is to leave the artistic control of the sound in the mix engineer's hands. Our role is much more scientific, it's to give them the same sound everywhere and to give them the sound that they are putting out."

At Wembley Bob McCarthy had four B&K microphones, one at the mix position and three flying in free air in front of the various clusters. Hopefully, the sound at the mix position is identical to what is coming out of all the speaker clusters. How much attention does the system need during the concert to keep things in order?

"Every night of this particular concert series we've had a different level of attendance, which has kept me pretty busy. The humidity has been quite different, one night it rained and the other nights it's been drier. I've found myself having to make minor adjustments for the first 30 to 45 minutes of the show before the system had gone completely solidly back (to flat), and then it's a dynamic process. When the people get dancing they generate quite a lot of heat, that has its own effect. I'm always looking, it's like a radar scanner, I just keep going through each mic for as long as the concert's going on. If I see something, I home in on it and make sure that it's really a problem—then I fix it."

PA

Fig 1 shows the set-up for this series of concerts. The sound system was very similar to that used for Luciano Pavarotti's recitals in the same hall last year. All speakers, including monitors, bore the Meyer brand. The main clusters each comprised 10 *MSL-3s* for long throw, four *MSL-3s* for medium throw and four *UPA-1s* for downfill. Side clusters had four *MSL-3s* and two *UPA-1s*. There were also four subwoofers at stage level. As one of the aims of *SIM* is to achieve and maintain even coverage throughout a hall, physical speaker alignment has to be right first. As in any installation, a lot of time is spent walking through the seams of the system checking for hot-spots and dead areas.

SIM could be used with speakers from manufacturers other than Meyer but not unless they fulfilled a number of criteria.

"We won't just *SIM* any sound system. The system needs to be linear. That means it needs to be low distortion. It means that the frequency

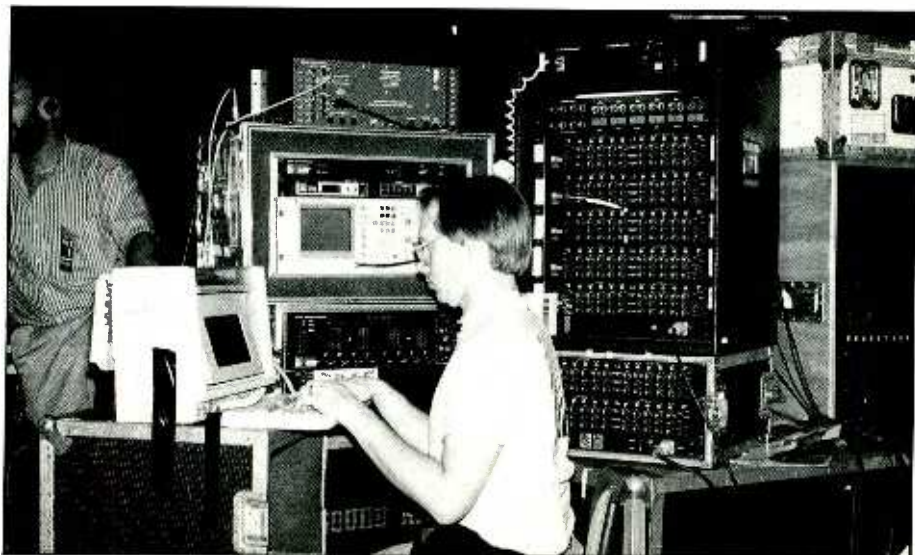

Bob McCarthy operates the SIM system

response does not change with level. It must have a flat phase response. It must have a flat frequency response when in free field. It must be arrayable.

"The speakers we're using are low distortion—the high frequency drivers are less than 1% distortion—they are linear over level until you actually run the system into limiting. It has a flat time response, all these units are phase corrected. They are set to a flat frequency response when in free field. The significance of this is that now your speaker system is not in free field anymore, that is it's in Wembley Arena and when they no longer exhibit a flat frequency response you can begin to attribute that to the room itself rather than to the speakers. When you make the corrections you're restoring them to the free field response. You're putting them outdoors.

"Arrayable means that when you put more than one speaker up in the system you get an amiable pattern of coverage rather than a destructive pattern. When you start to look at the dispersion of this system, because of the fact that it's arrayable I can put microphones in the field of this system and I can make judgements on how it's going to sound."

Origins

When *SIM* was first conceived, the Meyer engineers attempted to make equalisation corrections using standard 1/3-octave graphic equalisers. The problem was that resonances did not always coincide sufficiently closely to the band centres. It was found, for instance, that trying to correct a resonance at 450 Hz using the

400 Hz and 500 Hz filters would often create more problems than it solved, when viewed on the Fast Fourier Transform spectrum analyser.

"It became obvious to us that the only proper tool to do this is the parametric equaliser. The Meyer *CP10* was developed on a prototype level then we actually went out doing shows and we finally arrived at the frequency and the bandwidth settings for what we're doing. It stops at 1/10 of an octave, which is the minimum bandwidth on the *CP10*. From our experience this is the minimum size of resonance occurring in a room that appears to be truly universal and not position dependent. If you look with sufficient resolution with the microphone at some position, you are going to find a whole series of reflections and cancellations. If you look at 1/1000-octave resolution you are going to find thousands of tiny notches. Anytime there is a reflection off any surface it will come back at some point and give a cancellation. At another point it will give an addition. What we found is that if we move the microphone 1 cm, all those tiny 1/1000-octave cancellations move around. When a problem comes up that is 1/10-octave wide and is of sufficient level to warrant being dealt with, then it's something that you can deal with, and that correction will cover a large area of the hall. We look at higher resolution but we make corrections at 1/10-octave or any larger bandwidth."

Fig 2 shows the equalisation chain. The master EQ adjusts the long throw system, tracking from that is the medium throw, and tracking from its output is the downfill. The other clusters operate in a similar manner. In setting up the equalisation system, obviously the choice is between a series and a parallel connection for the

equalisers. In this case the series connection won.

"This is something that we've tried both ways. The main long throw system is an independent system, it's the first system into an area therefore it gets its own independent EQ. We've found that a slave system—a dependent system—tracks best if it has the same EQ plus whatever corrections that are needed to fit in. Likewise, there is a third level-dependent system on the front fill. We've found that when we did it the other way, just sending them all in parallel, we ended up having to make the same corrections over and over again, everybody had to get rid of 180 Hz so they used up three filters when we could have done it in one. Furthermore, from venue to venue the relationships of the clusters tend to track, the relationships between the independent system and the dependent systems tend to stay very close to the same."

In order to get valid measurement, the system needs to be synchronised so that the input arriving at one channel of the FFT, that is the output of the mixing desk, and what's entering the microphone have to arrive at the same time. Because it takes time for sound to travel through air the feed from the desk needs to be delayed in order to synchronise it to the microphone, a delay line is therefore one of the pieces of the *SIM* system. The delay can be set by looking at the phase response when it's flat, then synchronisation has been achieved. Although delayed speakers were not used in this particular set-up, *SIM* can cope and even help to set the delay. The delay can be measured by the FFT rather than calculated (or guessed).

So far, it appears that *SIM* consists of the FFT and a few parametric equalisers—and indeed it does. To make a practical system takes rather more hardware, otherwise to make adjustments during a concert would be too time consuming to be worthwhile.

The heart of the whole system is the Hewlett Packard Integral Personal Computer, which runs the 'SIMCAD' software. Its function is to control the various line switchers and the microphone switcher, and also the delay line so the *SIM* engineer can quickly measure any parameter in which he is interested.

"The mic switcher gives phantom power to the microphones, it has an SPL meter for the microphones, and switcher to the various mics. The role of the line switcher is a little more interesting because what I do in *SIM* is not only to look at the desk versus the microphones but in addition I look at the equaliser itself and I do that by viewing its response on the FFT. In the course of the night I can look at three different types of measurement on a single branch (a speaker system monitored by a microphone). I can look at the EQ itself, I can look at the equalised room and I can look at the room as if it had no EQ."

As well as displaying frequency and phase information, the FFT can also supply a graphic display of 'coherence' versus frequency. Suppose you had one musician—a flautist—playing one continuous note. Although the FFT only has good data for that one frequency, it will give an amplitude versus frequency display as though it had a full range of good data. What is happening is that it is picking up noise in the auditorium and displaying that. The answer is for the FFT to look at both inputs—from the console and the auditorium—to see how much similarity there is. Where there is a lot of similarity, the coherence is said to be good. Anything less than 40% coherence would be taken by the *SIM* operator as bad data and ignored.

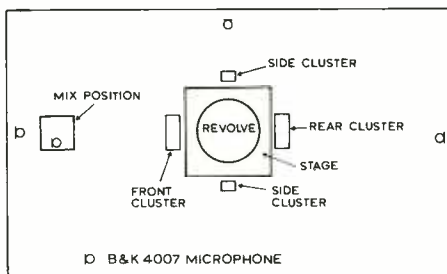

Fig 1



Hewlett Packard FFT and Lexicon digital delay



Hewlett Packard integral personal computer showing stored SIM trace

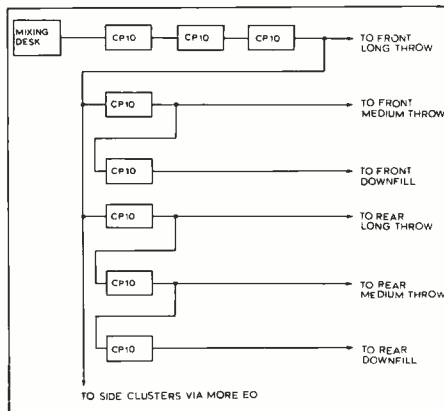
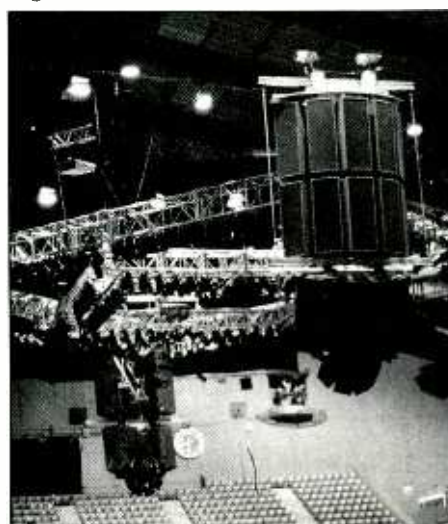

Fig 2



Sound Hire's Meyer system for Stevie Wonder concert

SOURCE INDEPENDENT MEASUREMENT

Although the Pavarotti concerts at Wembley took place less than 18 months ago the *SIM* system has become somewhat more sophisticated since then.

"When Pavarotti was in town we had the same computer and the same analyser but at that time the delay line and the switching to the equalisers had to be manually set and there was no facility to switch to a second microphone or third or fourth. They had to use one single microphone which they had to traipse about to different places in the hall during set-up, but you could only monitor from one point during the show. This unit that I've built here can take eight microphones. The system is set up so that it can handle 10 of these switchers. That would be 80 microphones and no EQs or 80 EQs and no mics or something in between. Above about 16 microphones I think you're getting way above practicality for any kind of show. If it was a two-hour show you would may be only have about three minutes per microphone. I love having four mics and I would be glad to expand it to more than that. In terms of set-up it's a tremendous advantage, and when they say go, I can set the system up very quickly."

Domains

It's considered almost axiomatic these days that, in any room, you cannot cure a time domain problem with a frequency domain remedy. For example, most rooms will have different reverberation times at different frequencies and probably have the odd resonance or two. Is it possible to have control over this and make reverberation time changes merely by changing the EQ of the signal being sent to the speakers?

"We do actually have control. Provided that no-one actually moves the walls of the building and no-one moves the speakers, the reflection paths which occur in the building are fixed events, provided those parameters don't change, the reflection paths don't change—the things that might change them very slightly would be a rise in humidity, or a temperature variation at one side of the hall.

"Because we continue to average we are looking not only at the room but the ambience in the room as well. There are other types of measurement systems that actually have a sliding filter that filters out so you are only hearing the initial wave of the sound system, therefore you are able to measure a system as though it isn't in a room. That's an interesting theoretical practice but the facts are that the audience is in the room.

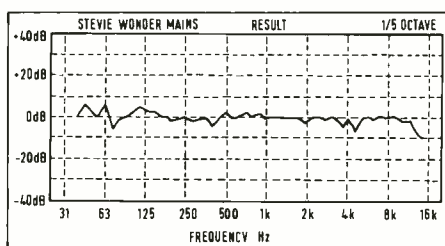

SIM coherence display—stored computer trace (Wembley Arena)

Our job is to minimise the effects of the room."

One definition of acoustic perfection in any room might be that the reverberation time at all frequencies is equal. Could *SIM* claim to do this by purely electronic means?

"That is one of the prime things that we do. Take a typical very non-linear hall like Wembley. You've heard big slaps coming off walls and things which seem to go rumbling on forever. With very careful equalisation it has the subjective effect as if we'd removed the slaps and the big long decay times. I'd be very surprised if you didn't hear a decreased decay time in that room. You will definitely hear a lack of slap because of two things: the careful arraying of the system to keep energy off the flat surfaces in that room where there are no people, and the careful equalisation. When a band of frequencies goes out of control, when it's 10 dB above the norm, that means that its pattern is much longer than the other frequencies, which is what keeps it rumbling around the room. It's around for longer because it had more energy to get into that reflective pattern. Whereas other frequencies had *x* amount of energy these frequencies have more and so they stay for longer."

When you know how *SIM* works and look at the equipment it uses, it's tempting to think that anyone could put a *SIM* system together with off-the-shelf components and a few relay switch boxes. It may be slightly more complex than it appears at first sight.

"I don't doubt that other people could make it.. There are a couple of criteria that are quite important though. Number one, people that design sound systems don't very much like hum to be introduced, therefore all the EQ ins and outs have a proprietary isolation input, which is a wonderful isolation that keeps me from being able to introduce hum into the sound system. In addition, this whole system is addressed on the GPIB (General Purpose Interface Bus), a computer interface bus that gives the information to these switchers and addresses this delay line. We had to

customise a delay line and build an external unit in order to interface it with the GPIB. It was no simple task.

"Everything now responds on the computer bus. I don't set the delay line and I don't push switches on this thing. When I say 'mix position', bingo it turns on the right relays and sets the right delay. If I set mic position EQ, it sets the right relays and bypasses the delay because I don't delay between EQ in and out, there's no propagation delay because you are not looking at a microphone. So it's got quite a few things to keep track of."

Although the *SIM* equipment is highly automated, Bob McCarthy seemed pretty busy all through the first half of the concert. It's one matter to know how the equipment works and to be able to operate SIMCAD, quite another to interpret the traces on the FFT screen into EQ changes on the parametrics. It isn't an art because when the changes have been made correctly it can be seen on the FFT that all is well. It's more a question of how long does it take to determine what change has to be made and how long it takes to make it. Training a *SIM* operator takes some time.

Development

McCarthy: "The present format will be used for the next year or two. In the very long range it will continue to develop. The software is in a continuous state of development. Obviously the end and final step of the whole thing is to present a black box that analyses, gain sets and equalises. That's a big project, I can't give you a timescale. The system has to be able to detect, by itself, good data from bad data and only act on the good data. It has to very carefully smooth the curves out so it doesn't over-equalise for the microphone's position. It has to do all this dynamically. The sound industry is just not ready, they're barely ready to have someone sitting in the booth adjusting the house EQ and taking that away from the sole domain of the balance engineer. People are nervous of giving their system over to a black box that is going to magically equalise your system. Just imagine, giving it over to someone they can talk to is scary enough when they don't know exactly what I'm doing. It's going to take some adaptation."

The ultimate question is, of course, what did it sound like? Well, it didn't sound bad and as Bob said, no objectionable slaps or echoes were noticeable. A success then? Wembley Arena is notorious acoustically and to see the frequency response displays was illuminating. If *SIM* works, then it should be completely down to the mix engineer, to get a good sound, and as the engineer on the night said: "It's another tool to be used."

He seemed happy. □

SIM

Hewlett Packard 9807A integral personal computer with SIMCAD software
 Hewlett Packard HP 3582A spectrum analyser
 Lexicon 1300 digital delay (modified by Meyer)
 MS 4x2M mic switcher
 MS 8x2L line switcher (quantity according to system configuration)
 Meyer CP 10 5-band parametric equaliser (quantity according to system configuration)
 B&K 4007 microphones (quantity according to system configuration)

Was this the type of delay you originally specified?



Series 700 Digital Delays have proven their reliability over ten years of use: like all Klark-Teknik products, they undergo 100 hours of testing before

being shipped. Our standard procedures include stereo dynascope board inspections, full performance verification and a cycled burn-in followed by a complete re-check. Lower standards of design, construction and testing could make our delays easier to purchase. But it would make them far more difficult to install and operate. There simply are no short cuts to true "set and forget" operation.

If you dislike unnecessary delays as much as we do, investigate Klark-Teknik digital delay lines, graphic and parametric equalizers. For full information on their design, construction and applications, please contact Klark-Teknik or your local distributor.

Klark-Teknik reliability means fewer unplanned service calls

When you're responsible for maintaining intelligibility, malfunctioning distribution delay lines can garble your schedule, along with the program your venue has scheduled. Klark-Teknik delays are designed to produce outstanding audio quality, and produce it reliably.

Klark-Teknik experience means superior performance

Digital circuit design is a science, but one that involves a considerable amount of art. For over a decade, Klark-Teknik has developed and refined digital audio technology to create delays of superlative performance. Each of the DN 716's three outputs is independently adjustable up to 1.3 seconds of delay in 20 *microsecond* increments, for total alignment precision. And each output has a full 20 Hz—20 kHz bandwidth with 90 dB of dynamic range, achieved with proprietary 16 bit linear A/D and D/A converters.

Klark-Teknik quality stems from unrelenting scrutiny

Our standards are demanding: so are Klark-Teknik installations like Yankee Stadium, St. Paul's Cathedral and leading Broadway and West End theaters. We use only the highest grade components: lithium battery backup for the non-volatile memory, sturdy rack mount chassis, an electronic safe switch that prevents unauthorized access to the delay settings.



Each of Klark-Teknik's Series 700 Digital Delay Lines, Series 300 Graphic Equalizers and Series 400 Parametric Equalizers is optimized for specific applications.

Klark-Teknik Electronics Inc.,
30B Bantí Plaza North,
Farmingdale, NY 11735 (516) 249-3660
Klark-Teknik Plc., Klark Industrial Pk., Walter Nash Rd.,
Kidderminster, Worcs., U.K. DY11 7HJ (0562) 741515
Distributed in Canada by: Omnimedia Corp., 9653 Côte de Liesse,
Dorval, Quebec H9P 1A3 (514) 636-9971



What does it take to pro-audio centre

It takes more than a warehouse full of the best audio equipment.

We've got that of course.

Names like Amcron – we have every

Our directors started out building sound systems for rising stars, and the staff all have very similar backgrounds.

We've found that customers from way back are still regulars – like Phil Collins, who we knew when he was just a drummer.



model. Yamaha – we're the biggest pro-audio stockist in the UK. Sony – we launched low-cost digital in this country.

It also takes experience: at HHB you won't find slick salesmen, just a team that knows its business inside out.

You'll also find everyone at HHB has a one-track mind. (Or 24 track if you want to see our range of Amek TAC consoles and Sony recorders!)



It takes space for facilities: while you're exploring our demo room, you can be sure that our service and hire



Be the best equipped in the country?

departments are hard at it to preserve our reputation for the best back-up in the business.

Our enlarged digital editing suite now includes AMS Audiofile, as well



as Sony CD mastering.

It takes comfort: we realised that the hair shirt was out of fashion



and so in our new premises you'll find a high level of comfort that extends throughout the building.

And of course to make your visit more palatable we're always happy to offer you suitable refreshments.

We feel that, with our unmatched technical expertise, approachability and reputation – and our new premises – we've earned the right to call ourselves the first pro-audio – centre in the country.



UNIQUE SIGNAL PROCESSORS... ONE COMMON TRAIT...

***KEPEX II (Noise Gate/Expander)**—Nothing exceeds the KEPEX II's ability to eliminate leakage on drum tracks. The secret to the unit's success is its extremely fast attack, high ratio capability, and wide range (0 to 90 dB). KEPEX II's logarithmic release shape option is ideal for use with extremely fast release times to preserve natural decay and sounds, such as snare overring, while eliminating "popping", which is common in less sophisticated gates.

***GAIN BRAIN II (Variable Ratio Limiter)**—Other limiters struggle with Peak or RMS detection schemes that squeeze the life out of music, but GAIN BRAIN's response is variable and dependent upon the degree of waveform complexity, thanks to proprietary **LINEAR INTEGRATION DETECTION** circuitry. L.I.D. allows the GAIN BRAIN II to distinguish between the absolute voltage level of a signal and its loudness as perceived by the human ear. As a result, a vu meter monitoring the output of a GAIN BRAIN II will indicate a constant output signal level, while the listener will still perceive the dynamic range inherent in the program material.

***MAXI Q (Fully Parametric 3 Band Equalizer)**—Maximum equalization capability is what the MAXI Q delivers. Each of the unit's 3 bands may be switched to either the peaking or shelving mode or the "out" position, so that the operator may employ only the needed portion(s) of the equalizer. The MAXI Q's variable "roll off" rate in the shelving mode provides the opportunity to create artificial tonal or "phasing" effects. The exclusive **TUNE** mode of the MAXI Q allows the operator to disconnect the main audio feed, leaving only the output of the one filter selected. This feature provides exceedingly accurate set-up and application, since the only part of the audio spectrum which is heard is the portion passed by the selected filter.

***DSP (Dynamic Sibilance Processor)**—Users of de-essers have found that the devices are literally "ess removers," a high frequency limiter of sorts, quite effective on spoken word, but virtually unusable on vocal musical tracks and especially offensive on mixed program. The DSP's proprietary circuitry allows the unit to "seek out" sibilance, which is characterized by sinusoidal signal content. When sinusoidal information is detected, the unit's control circuitry inverts the tone, and sums it with the original signal, thus handily eliminating the sibilance. This action takes place instantaneously without

"holding" or coloring the original signal. The unit's **TUNE** mode allows the DSP to be adjusted simply by listening and observing the control status indicators.

***LEVELLER (Audio Level Controller)**—The wide spectrum of sounds, from musical instruments and voice to mixed program material, comes out just the way the human ear wants to hear it, sonically correct, when processed through the LEVELLER, thanks again to **LINEAR INTEGRATION DETECTION**. Fast, effective results are easily obtained with the LEVELLER. More or less "levelling" action is achieved with the unit's threshold control. There are no attack time or release time controls to adjust on the LEVELLER. **AUTOMATED PROGRAM DEPENDENCY** circuitry automatically optimizes the unit's attack time, release time, and ratio dynamically as the program content changes.

***COMANDER (Compressor/Expander)**—Our **SYMMETRICAL RELEASE COUPLING** circuitry allows the COMANDER to compress the audio signal for precise dynamic range control with complete freedom from noise level recovery, thanks to the unit's interactive expander. **LINEAR INTEGRATION DETECTION** ensures that correct musical relationships are maintained in the processed material, while **PEAK REVERSION CORRECTION** circuitry compensates for discrimination against low frequencies to eliminate "pumping" or "breathing," a common occurrence in conventional compressors.

Even the enclosures for the 800 series modules are special. The PR-2 is ideal for those jobs requiring only one or two processors. Identical modules, appropriate for stereo processing, may be linked via a convenient front panel switch.

The PR-10 houses up to 10 modules and has a beefier power supply than any other rack system on the market today. Its two-section bipolar supply offers improved regulation, RF filtering and heat dissipation. And, in the unlikely event of regulator failure, five of the ten modules enclosed in the PR-10 remain active.

While the 800 series is unsurpassed in quality, you will find it fiercely competitive in price!



UNSURPASSED PERFORMANCE.

The 800 series from...

AEG Nederland N.V.
Prof. Audio Dept.
Aletta Jacobslaan 7
1066 BP AMSTERDAM
THE NETHERLANDS

AEG
Phone Number: 020-5105486
Fax 131: 020-5105240

VALLEY
INTERNATIONAL, INC.

P.O. Box 40306 • 2817 Erica Place
Nashville, TN 37204 • (615) 383-4737
FAX (615) 269-5441

Export: GEXCO INTERNATIONAL, INC. FSC
Jersey City, NJ/TELEX 285261 GEXCI

GEXCO International Inc.
317 St. Paul's Avenue
Jersey City, NJ 07306/USA
Tel. (201) 653-2383, Telex 285261
GEXCI, Fax. (201) 653-2386.



GEXCO is the worldwide exporter of the Valley 800 series and other high quality products for the recording, broadcast, and post production industries.



GRISBY MUSIC PROFESSIONAL s.r.l.
Via delle Industrie, 4
80022 CASTELFIDARDO (Ancona) - Italy
Phone (071) 781714-5-6 - Fax (071) 7819048

Stirling ITA
1 Cornfield Place, London NW6 3BT, Telephone 01-425 4515
Fax 01-372 6370, Tlx. 946240 CWEASY G Ref No. 1904280

Amber TECHNOLOGY
Unit 8, 346 Frenchs Forest Road Frenchs Forest NSW 2086, Australia PO Box 942
Brookvale NSW 2100, Australia Sales
(02) 975 1211 Service (02) 975 1255
Accounts (02) 975 1477 Fax (02) 975 1368

MONITORING

A compilation of monitoring speaker manufacturers and agents, together with a brief description of their products, from information available to us at the time of writing

Acoustic Energy

AE1: compact 200 W power handling nearfield 2-way monitor, 5 in LF and 1 in drivers.

AE2: two 5 in LF units with 1 in tweeter, 400 W programme.

Acoustic Energy Ltd, 3A Alexandria Road, London W13 0NP, UK. Tel: 01-840 6305.

AKG

LSM150: reference monitor, up to 50 W.

Akustische U Kino-Geräte GmbH, Brunhildengasse 1, Wien, A-1150, Austria. Tel: (222) 956517.

UK: AKG Acoustics Ltd, Vienna Court, Catteshall Lane, Godalming GU7 1JG. Tel: 04868 25702.

USA: AKG Acoustics Inc, 77 Selleck Street, Stamford, CT 06902. Tel: (203) 348-2121.

Altec Lansing

9813B: 3-way monitor 40 W.

9842-8A/D: 2-way control room monitor.

9849-8A/D: 2-way control room monitor.

Altec Lansing Corp, PO Box 26105, Oklahoma City, OK 73126-0105, USA. Tel: (405) 324-5311.

UK: Shuttlesound Ltd, Unit 15, Osiers Estate, Osiers Road, London SW18 1EJ. Tel: 01-871 0966.

APL

Control Room Monitor: 3-way active with dome/cone coaxial, time-corrected alignment.

Acoustical Physics Laboratories, 3877 Foxford Drive, Doraville, GA 30340, USA. Tel: (404) 934-9217.

ATC

SCM50: 3-way softdome midrange, 12 in bass driver, 50 to 500 W in 50 litre enclosure.

SCM50A: same as above but with electronic crossovers and three MOSFET amps.

SCM100: 3-way softdome midrange, 15 in bass driver, 50 to 50 W in 100 litre enclosure.

SCM100A: same as above but with electronic crossovers and three MOSFET amps.
Loudspeaker Technology Ltd, Aston Down, Stroud, Gloucestershire, UK. Tel: 028576 561.

Auratone

5C: reference monitor, up to 60 W.

T6: reference monitor, up to 80 W.

Auratone Corporation, PO Box 698, Coronado, CA 92118, USA. Tel: (619) 297-2820.

UK: Scenic Sounds Equipment Ltd, Unit 2, 12 William Road, London NW1 3EN. Tel: 01-387 1262.

B&W

CM1: 2-way nearfield, 120 W max.

801FS: 3-way, minimum 100 W into 8 Ω .

808: 5-way (two 300 mm bass drivers, two 100 mm midranges and one HF driver), with optional facilities for bi- and tri-amping; same power handling as 801FS.

B&W Loudspeakers Ltd, Meadow Road, Worthing BN11 2RX, UK. Tel: 0903 820415.

North America: B&W Loudspeakers of America, 345 Nugget Avenue, Unit 22, Scarborough, Ontario M1S 4J4, Canada. Tel: (416) 297-0595.

Boxer

Boxer 2: 3-way active, tri-amped, with two 12 in drivers, including crossovers.

Boxer 2 Film: same as above but including extra monitor and smaller boxes for cinemas Dolby 'Surround' use.

Boxer 4: 3-way active, tri-amped, with four 12 in drivers, including crossovers.

Boxer 4 Film: with same additional components as *Boxer 2 Film* including crossover.

DRL London Associates, Unit 15, North Field Industrial Estate, Beresford Avenue,

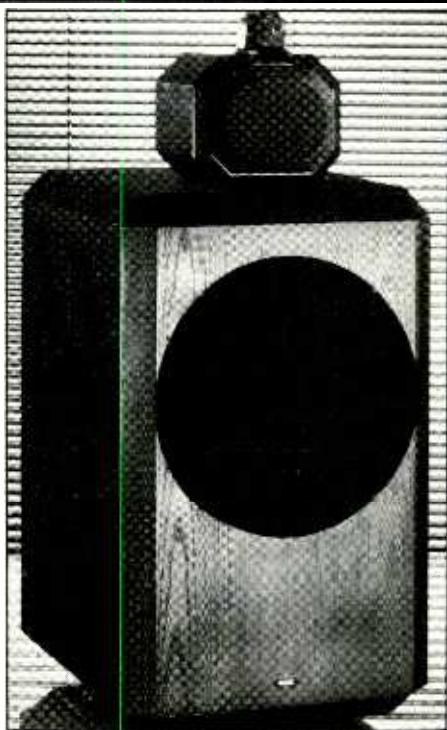

B&W 801



Altec Lansing 9842-8A/8D



Court SN20, SN30 and SN60



The new SR series from Celestion with its sheer power, pure sound quality and compact size is setting a precedent for the future in the SR market.

Developing this innovative system was the next logical step for a company who have consistently proved that the evolution of sound excellence should never be compromised.

Using the latest laser and computer technology, our research engineers have perfected a totally new, three component system; the Celestion SR series. It sounds better, installs practically everywhere, and is virtually indestructible.

**The SR1—
innovative features for pure sound quality.**

The SR1 is the key product in the range with a design based on a revolutionary new driver, capable of full range reproduction, free from harmful resonances even at the highest sound pressure levels.

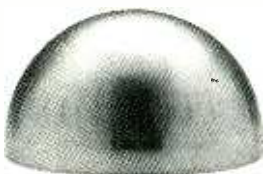

The secret lies in the strongly reinforced, hemispheric shape of its dome radiator which is immune to the ringing, flexing and twisting that causes distortion in all other standard designs.

The result is a sweeter, clearer top-end performance.

The dome is directly coupled to a reinforced Kapton former which supports a powerful 16mm long voice coil, edge wound with ribbon wire for extra efficiency and rigidity.

This exceptionally long coil is no less than twice the depth of the speaker's front plate allowing a greater low distortion excursion than the competition, resulting in vastly superior bottom-end capability.

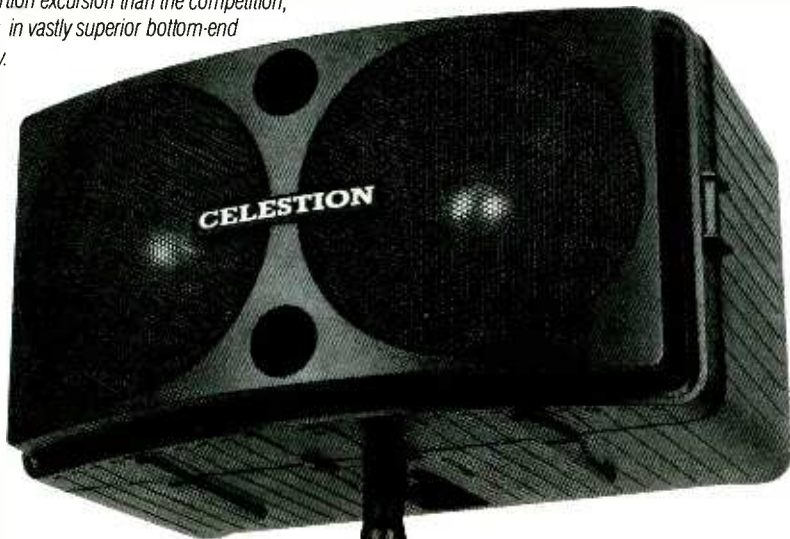

THE SR SERIES FROM CELESTION.

This unified coil/dome structure forms the centre of an 8" cone driver that is at the heart of the SR1 system. Since the dome and cone are one, the system is naturally time aligned, hence avoiding phase/frequency response aberrations.

The rigidity of the centre structure allows higher power levels to be applied to the driver at all frequencies without distortion, which means that the necessary amounts of equalisation can be effected without loss of quality.

Each SR1 unit has two of the new 8" drivers contained in an indestructible cabinet, capable of withstanding any amount of rough handling without damage.

Designed to provide high quality, foreground music in fixed installations and for the portable musician market or as a monitor, the SR1's wide range of mounting options gives tremendous installation versatility.

SR2.

Integrating totally with the SR1, the SR2 coupled-cavity bass bins create a powerful, biamped system for

larger venues where higher sound pressure levels at low frequencies can be achieved.

Employing an 18" driver which is capable of handling a massive 1000 Watts—at a sensitivity of 98dB, frequency response 40-150Hz, the SR2 speaker is housed in a compact dual cavity cabinet which is tuned to create a natural bandpass.

Like the SR1, it is extremely hard wearing, incorporating inaccessible apertures which make it difficult to place objects into the unit.

For both fixed installation and portable use the SR2 is totally flexible. It can be used on multi-configurations together with the SR1 as it has simple brackets and fastening facilities compatible with the SR1 or other SR2s (including provision for pole-mounting the SR1).

SRC1—an integral part of the SR system.

The SRC1 controller is the 'brains' of the SR system as it is not only an equaliser, but also an intelligent protection system which renders the SR1 virtually electrically indestructible!



You simply can't blow it up. And to ensure fool proof protection, nothing will work unless the controller is properly connected in circuit. Both peak overload and three levels of thermal protection are provided, and unlike comparable systems this controller monitors conditions at both line and feed levels.

So not only does the output of your mixer pass through the controller, but so do the power amp's speaker feeds.

**The SR series from
Celestion—once heard
never forgotten.**

As you'll soon be hearing, the SR series is just the beginning of an exciting revolution in sound reinforcement.

And remarkably, the price too is sensationally low. For a demonstration of the new SR series or further information please contact:



Celestion International Limited, Ipswich IP3 & JP
England Tel: 0473 723131 Telex: 98365 Ditton G

CELESTION
YOU'LL BE HEARING MORE FROM US.

MONITORING

Wembley, Middx HA0 1YB, UK. Tel: 01-900 0355.

USA: Valley Audio, 2821 Erica Place, PO Box 40743, Nashville, TN 37204-3111. Tel: (615) 383-4732.

Celestion

SL600: 2-way nearfield monitor, 120 W.

SL700: upgrade option on SL600.

Celestion International Ltd, Ditton Works, Foxhall Road, Ipswich, Suffolk IP3 8JP, UK. Tel: 0473 723131.

USA: Celestion Industries Inc, Kuniholm Drive, Holliston, MA 01746. Tel: (617) 429-6706.

Cetec Gauss

7258: single coaxial freefield, up to 400 W.

7228: single coaxial freefield, up to 400 W.

7351: 3-way bi-amped, wall-mount, up to 400 W.

Cetec Gauss, 9130 Glenoaks Boulevard, Sun Valley, CA 91352, USA. Tel: (213) 875-1900.

UK: HHB Hire & Sales, Unit F, New Crescent Works, Nicoll Road, London NW10 9AX. Tel: 01-961 3295.

Court

SN20: 2-way passive, up to 150 W.

SN30: 3-way passive, up to 200 W.

SN60: 4-way, passive or active, 200 or 400 W respectively.

S J Court & Associates, 3 Primrose Hill Studios, Oppidans Road, London NW3 3AG, UK. Tel: 01-586 5139.

Davies

841: 3-way passive with separate bass driver reflex chamber and HF Annular driver; minimum 175 W RMS into 8 Ω . Two options are brick enclosure with infinite baffle for claimed response of below 10 Hz, or two 15 in drivers per side in separate reflex enclosures.

S W Davies Ltd, 5/7 Buck Street, London NW1 8NJ, UK. Tel: 01-485 8559.

UK: Audio Design Ltd, Unit 3, Horseshoe Park, Pangbourne, Berks. Tel: 07357 4545.

USA contact: Straight Wire Audio Inc, 4611 Columbia Pike, Arlington, VA 22204. Tel: (703) 979-1990.

Dynaudio

3-way active monitor and compact 2-way monitor. Dynaudio ApS, Sverigesvej 15, DK-8660 Skanderborg, Denmark. Tel: 6-523 411.

Eastlake

JM3T: 2-way active control room monitor, 400 and 100 W.

JM7T: 2-way active control room monitor, 400 and 100 W.

Eastlake Audio (UK) Ltd, Unit 2, 10 William Road, London NW1 3EN, UK. Tel: 01-262 3198.



E-V Sentry 500E

Electro-Voice

Sentry 100EL: 2-way active up to 50 W.

Sentry 100A: 2-way passive up to 30 W.

Sentry 500E: 2-way up to 100 W.

THE BEST REQUESTED QUESTED

SARM WEST, TOWNHOUSE, SWANYARD, BATTERY, SOHO, RIDGE FARM, MASTER ROCK, POWERPLANT, ALAN PARSONS, WESTSIDE, HOOK END MANOR, UTOPIA, CAVA, KONK, JACOBS, LINSTER, TRIDENT, ROOSTER, WORKHOUSE, J MICHELE, JARRE, LOGIC, EDEN, FARMYARD, GREENE STREET, FAIRLIGHT SELT, GREAT LINFORD MANOR, ALASKA...

It's no coincidence that over 70 top studios use Quedsted Monitoring Systems.

And with launch of the new Quedsted H405 compact near-field monitor every studio can now afford to fit the best. Ring for a demonstration.

Exclusively from



OUTFITTERS FOR THE STUDIO

59 MALTINGS PLACE BAGLEYS LANE LONDON SW6 2BX 01 371 0458

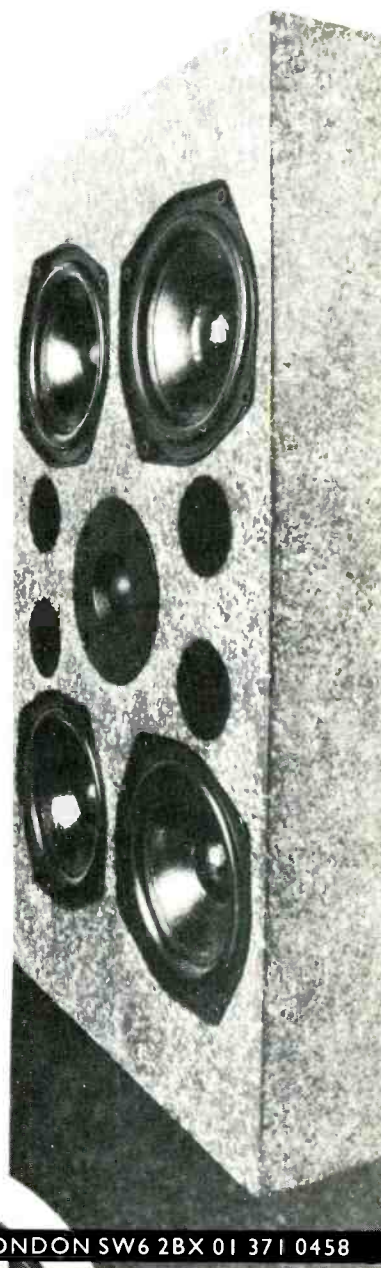

MONITORING

Sentry 505: 2-way up to 100 W designed for wall mounting.

Electro-Voice Inc, 600 Cecil Street, Buchanan, MI 49107, USA. Tel: (616) 695-6831.

UK: Shuttlesound Ltd, Unit 15, Osiers Estate, Osiers Road, London SW18 1EJ. Tel: 01-871 0966.

Fostex

RM 765: co-axial reference monitor, 120 W.

RM 780: co-axial reference monitor, 150 W.

USA: Fostex Corporation of America, 15431 Blackburn Avenue, Norwalk, CA 90650. Tel: (213) 921-1112.

Genelec

1019A: 2-way active nearfield, to 96 dB.

S30: 3-way active nearfield, to 105 dB.

1022A: 3-way active freefield, to 110 dB.

1024B: 3-way active freefield, to 115 dB.

1025A: 4-way active control room monitor (two 15 in bass drivers), to 122 dB.

Genelec, PO Box 36, 74101 Iisalmi, Finland.
Tel: 358 77 13311.

UK: Scenic Sounds Equipment Ltd, Unit 2, 12 William Road, London NW1 3EN. Tel: 01-387 1262.

Hidley/Kinoshita

1: 2-way passive, single woofer.

2: 2-way passive, twin woofer, horizontally mounted.

3V: 2-way passive, down to 31 Hz.

4V: 2-way passive, down to 24 Hz.

5V: 2-way passive, down to 20 Hz.

Hidley Design, Route de Glion 24, Residence Panorama 6-B, CH 1820 Montreux, Switzerland.

UK contact: Stirling ITA, 1 Canfield Place, London NW6 3BT. Tel: 01-625 4515.

JBL

4312A: 3-way freefield, up to 100 W.

4406: 2-way nearfield, up to 75 W.

4408: 2-way nearfield, up to 100 W.

4410: 3-way nearfield, up to 125 W.

4412: 3-way nearfield, up to 150 W.

4425: 2-way with bi-radial high frequency horn/compression driver, up to 200 W.

4430: 3-way with bi-radial horn, up to 200 W.

4435: 4-way passive freefield, same as above but with two 15 in bass drivers going up to 400 W.

Control 1: 2-way reference up to 150 W.

JBL Professional, 8500 Balboa Boulevard, PO Box 2200, Northridge, CA 91329, USA. Tel: (818) 893-8411.

UK: Harman Audio (UK) Ltd, Mill Street, Slough, Berkshire SL2 5DD. Tel: 0753 35306.

KEF

KM1: 3-way active (four LF, two midrange and one tweeter), tri-amped, up to 400 W.

KM1P: ported version of above.

P60 system: pair of 2-way nearfields, up to 150 W, plus *K300* amplifier delivering 150 W/channel.

KEF Electronics Ltd, Tovil, Maidstone, Kent ME15 6QP, UK. Tel: 0622 672261.

UK: Michael Stevens & Partners, Invicta Works, Elliott Road, Bromley, Kent BR2 9NT. Tel: 01-460 7299.

USA: KEF Electronics of America Inc, 14120-K Sullyfield Circle, Chantilly, VA 22021. Tel: (703) 631-8810.

Keith Monks

LS5/3: 2-way, BBC spec.

Keith Monks Ltd, Progress House, Albert Road, Aldershot, Hants GU11 1SZ, UK. Tel: 0252 334121.



Klark Acoustic JADE 1 MkII

Klark Acoustic

JADE I Mk II: 2-way nearfield active, with MOSFET amplification up to 100 W.
Klark-Teknik, Klark Industrial Park, Walter Nash Road, Kidderminster, Worcestershire DY11 7HJ, UK. Tel: 0562 741515.

USA: Klark-Teknik Electronics Inc, 30B Banfi Plaza North, Farmingdale, NY 11735. Tel: (516) 249-3660.

Klein & Hummel

Model OY: 3-way active freefield.

Klein & Hummel, D-7302 Ostfildern 4, Kennat, Postfach 3102, West Germany. Tel: 0711 45 50 26.

UK: FWO Bauch Ltd, 49 Theobald Street, Borehamwood, Herts WD6 4RZ. Tel: 01-953 0091.

USA: Gotham Audio Corp, 1790 Broadway, New York, NY 10019-1412. Tel: (212) 765-3410.

Lockwood

Universal Major: 2-way freefield, up to 120 W.

Studio Academy 1: dual concentric freefield, up to 85 W.

Studio Academy 2: dual concentric freefield, up to 60 W.

Studio Academy 3: dual concentric freefield, up to 50 W.

Lockwood, 51 High Road, Bushey Heath, Herts WD2 1EE, UK. Tel: 01-866 0671.

Meyer

833: 2-way freefield, up to 400 W.

834: subwoofer in cabinet, up to 200 W.

Meyer Sound Laboratories Inc, 2832 San Pablo Avenue, Berkeley, CA 94702, USA. Tel: (415) 486 1166.

UK: Autograph Sales Ltd, 2 Spring Place, Kentish Town, London NW5 3BA. Tel: 01-267 6677.

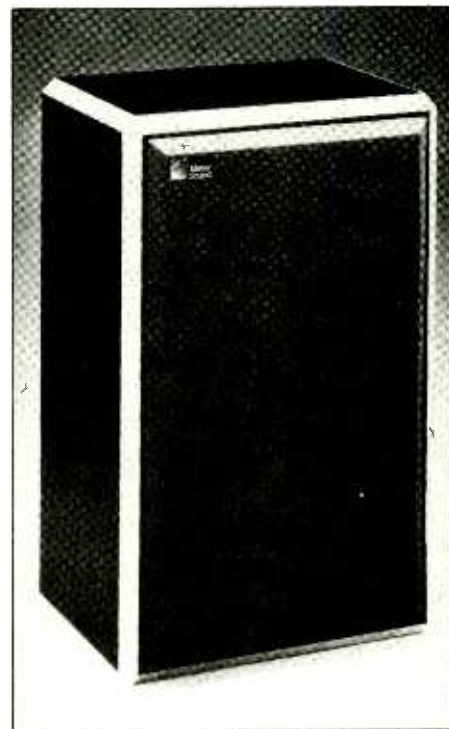

Meyer 833



Alex Frederiksen of TOCANO, keeps them firing on all twelve – in business and pleasure!

Secure in the knowledge that his six Lyrec twin copying units can accelerate past all his customers production targets, Alex can relax behind the wheel of his 12 cylinder Jaguar and enjoy another smooth running performance.

The Lyrec P-2500 high speed tape duplication system.

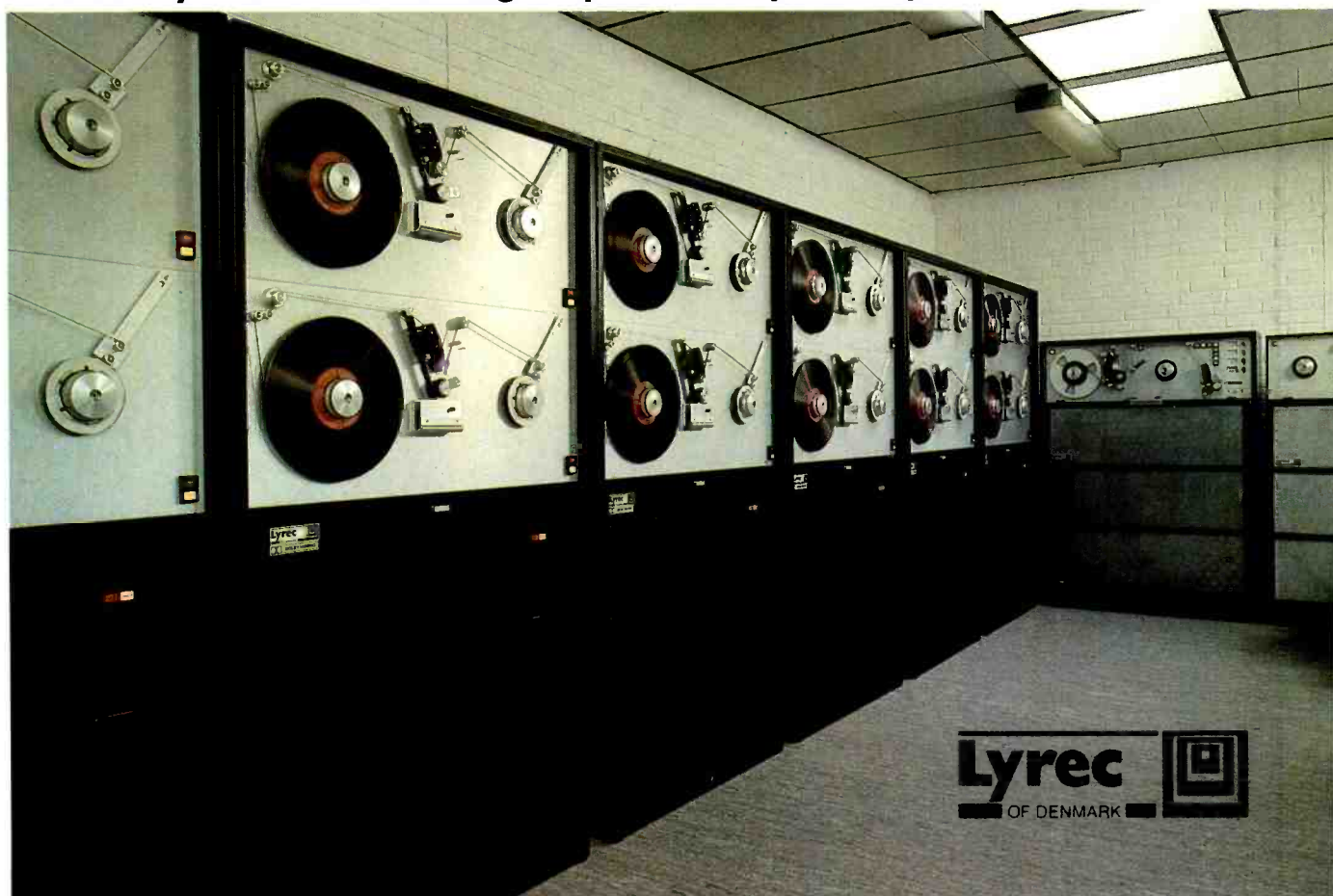

Lyrec (U.K.) Ltd., 'Arhaven House', Old London Road, Milton Common, Oxford OX9 2JR. Tel: (08446) 8866 Fax: (08446) 8810 Tlx: 838725 LYREC G
Lyrec Manufacturing A/S Hollandsvej 12, DK-2800 Lyngby, Denmark. Tel: +45 2 876322 Tlx: 37568 LYREC

Neve V Series – when only the best is good enough.



PHOTO: PRT STUDIOS LONDON

“ We were delighted by the exceptionally clean response of the console and the ease of operation of the Nevecam system during mixing.”

GEOFF CALVER & CHRIS CAMERON (Producer/Engineer & Producer/Arranger)

“ ...without doubt the finest console I have worked on.”

BOB MALLETT (Resident Engineer PRT Studios)

NEVE ELECTRONICS INTERNATIONAL LIMITED, CAMBRIDGE HOUSE, MELBOURN, ROYSTON, HERTS, SG8 6AU TEL: 0763 60776. TELEX: 81381. FACSIMILE: 0763 61886.
RUPERT NEVE INC, BERKSHIRE INDUSTRIAL PARK, BETHEL, CONNECTICUT 06801. TEL: (203) 744 6230. TELEX: 96-9638. FACSIMILE: (203) 792 7863



MONITORING

Munro

M3: 3-way control room monitor with dome HF.
M4: 4-way control room monitor, similar to *M3* but with additional low/mid driver.
M5: 5-way large control room monitor, including two 30 in LF units.
Windmill Munro Design, 26 Soho Square, London W1, UK. Tel: 01-434 0011.

Quad

ESL-63: electrostatic loudspeaker with classical monitoring application.
Quad Electroacoustics Ltd, Huntington PE18 7DB, UK. Tel: 0480 52561.
USA: Tovil Distributors, 14120-K Sullyfield Circle, Chantilly, VA 22021. Tel: (703) 631-8810.

Quested

HM415: 4-way active freefield 800 litre.
H405: 2-way passive nearfield.
H210: 3-way passive nearfield.
Q412: 3-way active freefield.
Q215: 3-way active freefield.
Q212: 3-way active freefield.
Q115: 3-way active freefield (not marketed but can be made on request).
Q112: 3-way active freefield.
Q209SB: 4-way active freefield.
Q209: 3-way active freefield.
Quested Monitoring Systems Ltd, 59 Maltings Close, Bagleys Lane, London SW6 2BX. Tel: 01-734 6080.
USA: Apogee Electronics Corp, 1517, 20th Street, Santa Monica, CA 90404. Tel: (213) 828-1930.

RCF

SCD 6000: 3-way nearfield, up to 200 W.
SCD 6010: 3-way nearfield, up to 150 W.
SCD 6020: 2-way nearfield, up to 40 W.
Radio Cine Furniture, Via Notaru 1/a, Reggio Emilia, San Maurizio, I-42029, Italy. Tel: (522) 401 4133.
UK: Court Acoustics Sales Ltd, 29 Beethoven Street, London W10 4LG. Tel: 01-960 8178.

Reflexion Arts

233: 3-way active monitoring system.
235: 3-way active monitoring system, higher rating.
238: 3-way passive monitor.
240: 3-way passive monitor.
250: 4-way nearfield monitor.
Music Services International, 14-18 Market Road, London N7 9PL, UK. Tel: 01-609 0246.

Rogers

LS2: 2-way compact, up to 100 W.
LS6: 2-way compact, up to 100 W.
LS7t: 2-way nearfield, up to 200 W.
Studio 1a: 2-way passive nearfield, up to 200 W. Active version available.
LS3/5a: 2-way, up to 60 W, BBC spec.
LS5/9: 2-way, up to 150 W, BBC spec.
LS5/8: 2-way active, using Quad 405-2 dual power amp, BBC spec.
RM2: 2-way freefield, up to 200 W.
PM510.S2: passive version of *LS5/8*, up to 350 W.
Swisstone Electronics Ltd, 310 Commonside East, Mitcham, Surrey CR4 1HX, UK. Tel: 01-640 2172.
UK: Michael Stevens & Partners, Invicta Works, Elliott Road, Bromley, Kent BR2 9NT. Tel: 01-460 7299.

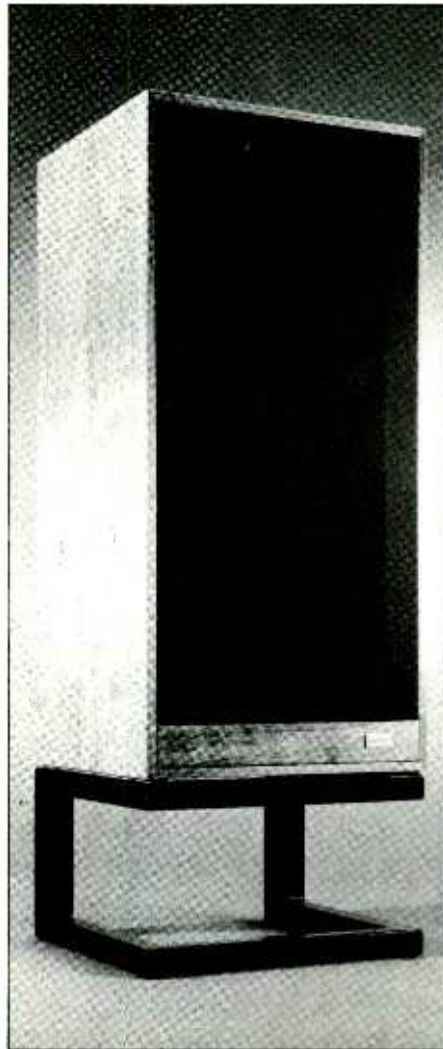

Spendor SP1

USA: Audio Influx Corp, PO Box 381, Highland Lakes, NJ 07422-0381. Tel: (201) 764-8958.

Spendor

SP1: 3-way passive, up to 90 W.
SP2: 2-way passive, up to 80 W.
Prelude 2: 2-way passive, up to 75 W.
BCI: 3-way passive nearfield, up to 55 W.
BCII: same as above but with large voice coil and magnet assembly.
BCIII: 4-way passive, up to 70 W.
LS3/5A: 2-way, up to 40 W, BBC spec.
A series: active versions of *SP1*, *BCI* and *BCIII* are available.
Spendor Audio Systems Ltd, Station Road Industrial Estate, Hailsham, Sussex BN27 2ER, UK. Tel: 0323 843474.
USA: RCS Audio International, 1035 Thomas Jefferson Street Northwest, Washington DC 20007. Tel: (202) 342-0400.

SOTA

CF-1000: 4-way control room monitor.
CF-2000: similar to above but with extra bass driver for rooms more than 120 m².
State of the Art Electronik Inc, 43-1010 Polytek Street, Ottawa, Ontario K1J 8Z2, Canada. Tel: (613) 744-1003.

Studer

A2706: 3-way freefield, up to 120 W.
Studer International AG, Althardstrasse 10, CH-8105 Regensdorf, Switzerland. Tel: 840 29 60.
UK: FWO Bauch Ltd, 49 Theobald Road, Borehamwood, Herts WD6 4RZ. Tel: 01-953 0091
USA: Studer Revox America Inc, 1425 Elm Hill Pike, Nashville, TN 37210. Tel: (615) 254-5651.

TAD

TAD-1: 2-way, bi-amped control room monitor, up to 600 W.
TAD-2: 2-way, bi-amped control room monitor, up to 300 W.
Technical Audio Devices, 5000 Airport Plaza Drive, Long Beach, CA 90815, USA. Tel: (213) 420-5700.

Tannoy

DTM-8: single dual concentric nearfield, up to 110 W.
LGM: single dual concentric, up to 200 W.
SGM 10B: single dual concentric, up to 150 W.
SGM 12X: single dual concentric, up to 200 W.
SGM 1000: single dual concentric, up to 100 W.
SGM 3000: single dual concentric, up to 300 W.
FSM-U: 2-way (dual concentric plus bass driver), up to 500 W.
Tannoy Ltd, The Bilton Centre, Coronation Road, Cressex Industrial Estate, High Wycombe, Bucks HP12 3SB, UK. Tel: 0494 37431.
UK: FWO Bauch Ltd, 49 Theobald Street, Borehamwood, Herts WD6 4RZ. Tel: 01-953 0091.
North America: Tannoy North America Inc, 97 Victoria Street, Kitchener, Ontario N2H 5C1, Canada. Tel: (519) 745-1158.

MONITORING

Toa

312-ME-AV: 3-way nearfield, up to 135 W.

280-ME-AV: 3-way nearfield, up to 90 W.

265-ME-AV: 2-way nearfield, up to 75 W.

RS-21M: compact reference monitor.

UK: Toa Electronics Ltd, Tallon Road, Hutton Industrial Estate, Hutton, Brentwood, Essex CM13 1TG. Tel: 0277 233882.

USA: Toa Electronics, PO Box 2047, South San Francisco, CA 94080. Tel: (415) 588-2538.

UREI

809A: single coaxial (12 in driver) nearfield, up to 100 W.

811C: single coaxial nearfield, up to 150 W.

813C: 2-way (coaxial and one LF driver), up to 150 W.

815C: 3-way (coaxial and two LF drivers), up to 150 W.

JBL Professional, 8500 Balboa Boulevard, PO Box 2200, Northridge, CA 91329, USA. Tel: (818) 893-8411.

UK: Harman Audio (UK) Ltd, Mill Street, Slough, Berks SL2 5DD. Tel: 0753 35306.

Visionik

D 6000/7000: 2-way reference, up to 50 W/60 W resp.

D 8000/9000: 3-way nearfield, up to 100 W/120 W resp.

Kurt M Bruns (GmbH & Co),

Nordkanalstrasse 46, 200 Hamburg 1, West Germany. Tel: (040) 232111.

UK: RJ Education Supplies Co Ltd, Unit 2,

Westham Trading Estate, London Road, Westham, Kent TN6 3BR. Tel: 0959 62255.

USA: Visonik of America, 701 Heinz Avenue, Berkeley, CA 94710. Tel: (415) 548-4005.

Wellard

Middle Monitor: 2-way active nearfield.
Wellard Research Ltd, Whitehall Park, Weobley, Hereford HR4 8QT, UK. Tel: 0544 318800.

Westlake

TM-3, TM-4: 3-way control room monitor, bi-amplified, up to 400 W. *TM-4* tri-amplified.

HR-1: 4-way control room monitor, up to 300 W.

BBSM-4/BBSM-5: 2-way nearfield, up to 50 W/60 W resp.

BBSM-6/BBSM-8: 3-way monitor, up to 60 W/100 W resp.

BBSM-10/BBSM-12: 3-way monitor, up to 120 W/180 W resp.

BBSM-15: 3-way monitor, optionally bi-amplified, up to 300 W.

Westlake Audio, 2696 Lavery Court, Unit 18, Newbury Park, CA 91320, USA. Tel: (805) 499-3686.

UK: Pro-Britto Ltd, 53 Corsica Street, London N5 1JT. Tel: 01-226 1226.

Yamaha

NS 10M: 2-way nearfield.

NS 10S: 2-way nearfield, up to 50 W, modified for studio use.

UK: Yamaha-Kemble Music (UK) Ltd, Mount Avenue, Bletchley, Milton Keynes MK1 1JE. Tel: 0908 71771.

USA: Yamaha International Corp, PO Box 6600, Beuna Park, CA 90620. Tel: (714) 522-9105. □

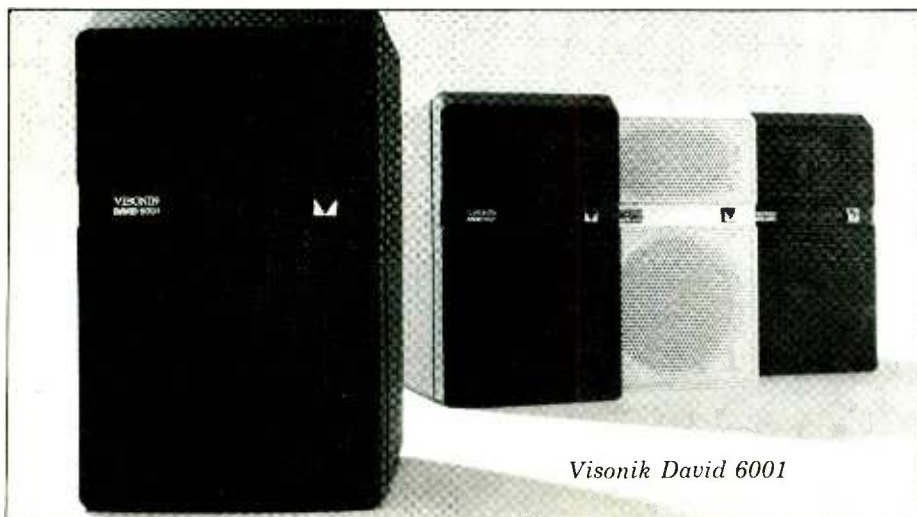

Visonik David 6001

WORLDWIDE AGENTS

AUSTRALIA: A.T.T. AUDIO CONTROLS PTY LTD

MELBOURNE (03) 379-1511

AUSTRIA: AUDIOSALES

MOEDLING (2236) 26123

BELGIUM: T.E.M.

DILBEEK (02) 569-1823

CANADA: OMNIMEDIA CORP.

MONTREAL (514) 636-9971

DENMARK: PER MEISTRUP PRODUCTIONS

KARLSUNDE (02) 151300

FINLAND: MIS AUDIOTRON

LAHTI/LAHTI (90) 566-4644

FRANCE: REGISCENE

PARIS (01) 4396-5050

GREECE: ALPHA SOUND

ATHENS (01) 363-8317

HOLLAND: AMPCO

MAARSSSEN/BOEK (30) 433134

HONG KONG/CHINA: TOM LEE MUSIC CO

HONG KONG (3) 722-1098

INDONESIA: PT AUVINDO MERIEK PRIMA

JAKARTA (01) 323029

ISRAEL: BARKAI

RAMAT-GAN (03) 735178

ITALY: AUDIO LINK

PARMA (0521) 598723/4

JAPAN: EDGE TECH (JAPAN) LTD

TOKYO (03) 295-4731

KOREA: YUNG NAK SO RISA CO

SEOUL (00) 267-9697

NORWAY: NORDTEK EQUIPMENT

OSLO (02) 231590

SINGAPORE/MALAYSIA: SWEE LEE

SINGAPORE (03) 336-2307

PORTUGAL: CASA CAIUS ARTIGOS MUSICAIS LTD

OPORTO (02) 0384456

SPAIN: LEXON

BARCELONA (03) 203-4804

SWEDEN: SOUNDTECH

TULLINGE (08) 778 1177

SWITZERLAND: SINEC

SCHONENWERD (64) 413747

TAHITI: MUSIC SHOP

PAPIETE (689) 428-563

THAILAND: BANGKOK CINE/GRAPHIC CENTRE

BANGKOK (02) 314-3570/

K.C.M. BANGKOK (02) 222-4712

TURKEY: NEFAN

ISTANBUL (00) 160-4514

U.K.: TURBOSOUND LTD

LONDON (01) 226-0099

U.S.A.: TURBOSOUND, INC

NEW YORK (212) 460-9940

WEST GERMANY: ADAM HALL

USINGEN (608) 16031

UK DISTRIBUTORS:

SOUTH-EAST: BODLEY KNOSE LTD, UNIT 2, THE PINES TRADING ESTATE, BROAD STREET, GUILDFORD GU3 3BH. TEL: (0483) 504868.

CONTACT: SIMON CURRY.

SOUTH-WEST: DR. THE MAMES,

LOWER TREGENNA, ST. COLUMB MINOR,

NR. NEW QUAY, CORNWALL, TR8 4HS.

TEL: (0637) 875824. CONTACT: ROGER VINTON.

LONDON: ELECTROMUSIC, 89-97 ST. JOHN STREET,

LONDON, EC1M 4AB. TEL: (01) 253 9079.

CONTACT: MIKE NOVAK.

NORTH: THE MUSIC COMPANY, UNIT K,

HALLAM ROAD INDUSTRIAL ESTATE,

CANAL ROAD, BRADFORD, TEL: (0274) 370966.

CONTACT: PAUL SMITH

SCOTLAND: THE WAREHOUSE, UNIT 14,

50 WEST HARBOUR ROAD, EDINBURGH, EH5 1PU.

TEL: (031) 552 8194. CONTACT: NEIL HUTTON.

I **INSTALL A TURBOSOUND SYSTEM** **AND WE'LL GUARANTEE** **YOU A WIDER AUDIENCE.**

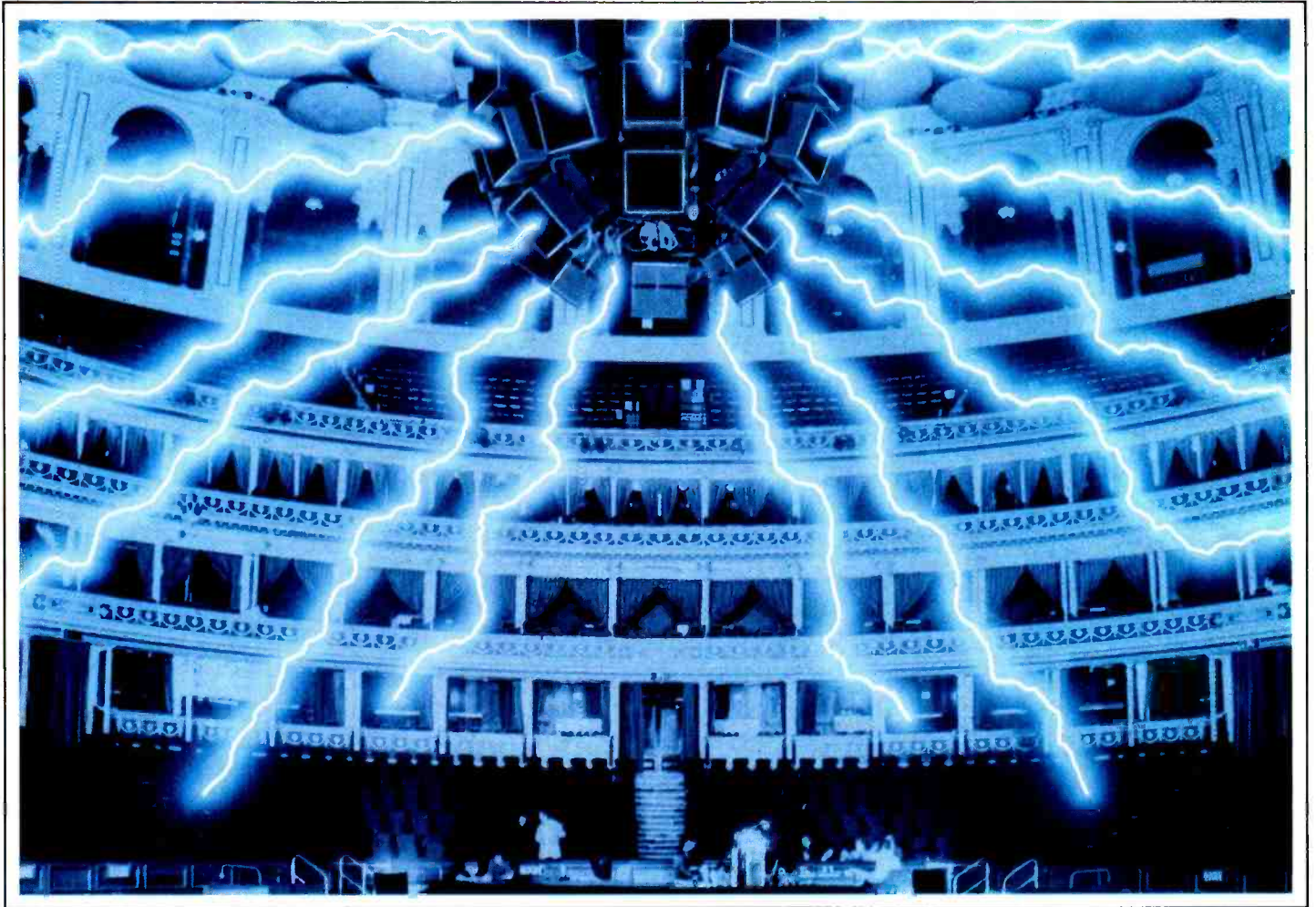

If your venue's sound system is restricting your options, rest assured you're in good company.

Thousands of 'house systems' have been installed over the years. But few are capable of doing justice to today's breadth of material.

So if attracting a wider audience is your objective, we suggest you join the enlightened venues that are changing to Turbosound.

Because among conventional house systems, ours comes like a bolt from the blue.

A combination of low distortion, tightly controlled dispersion and high efficiency means it's as dynamic at disco as it is confident with conferences.

Unique Turbosound loading principles help convey the clarity and vocal performance of a top quality hi-fi system.

With the controlled power to project right into your venue's farthest corners. Directing front-row sound quality to every seat in the house. The benefits don't end there though.

Our 'natural technology' enclosures (almost every component of which we design and build ourselves) require no

'black box' electronics, no external trickery, to produce their optimum performance.

So as well as being straightforward to operate, their inherent reliability means faultless operation year after year.

As you're probably beginning to appreciate, this is no ordinary sound system.

Installations from the Grand Ole Opry in Nashville to Blackpool Winter Gardens, from the Sydney Entertainment Centre to the Portsmouth Guildhall, testify to that.

To give your ears a chance to judge for themselves, call one of the official distributors listed or our Head Office, to arrange a personal demonstration and details of our comprehensive installation service.

We guarantee you'll reach a wider audience than you'd ever thought possible.

 **Turbosound** 
ONCE HEARD NEVER FORGOTTEN

TURBOSOUND LTD., 202-208 NEW NORTH RD., LONDON N1 7BL. TEL. (01) 226 0089. TLX: 265612.
FAX. (01) 354 4940. IMC. TURBO-UK. TURBOSOUND INC., 611 BROADWAY, NEW YORK, NEW YORK 10012.
TEL. (212) 460 9940. TLX: 230199. FAX. (212) 460 9947. IMC. TURBO-US.

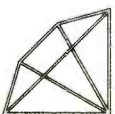

an  **EdgeTech** company
LONDON • NEW YORK • TOKYO

www.americanradiohistory.com



SL 4000 G Series Master Studio System



•
G SERIES AUDIO SYSTEMS—
UNPARALLELED SONIC PERFORMANCE

•
G SERIES STUDIO COMPUTER—
A NEW GENERATION

•
THE WORLD'S ONLY TOTALLY
INTEGRATED MASTER STUDIO SYSTEM

G Series Audio systems are the result of a complete reappraisal of each and every stage between the microphone and the recorder. Together with the recently

launched Studio Computer, the G Series Master Studio System is the only totally integrated audio system in the world for both tracking and mixing.

Now, and for many years to come, the G Series Master Studio System will have no equal.



Solid State Logic

Oxford · Paris · Milan · New York · Los Angeles

Begbroke, Oxford, England OX5 1RU · (08675) 4353
1 rue Michael Faraday, 78180 Montigny le Bretonneux, France · (1) 34 60 46 66
Via Cesare Cantu' 1, 20092 Cinisello Balsamo, Milan · (2) 612 62 81
320 West 46th Street, New York, NY10036 · (212) 315-1111
6255 Sunset Boulevard, Los Angeles, California 90028 · (213) 463-4444

SSL Representatives: Anaslab, Venezuela (58) 2-987-4845 Audio Consultants Co Ltd, Hong Kong (852) 3-7125251 Sn Ing Benum A.S, Norway (47) 2-145460 Cinac, Eastern Congo (41) 24-71-1600 EMT, West Germany (49) 7825-1011 Dr W A Gardner, Switzerland (41) 1-391-3939 Savana Comunicacoes Ltda, Brazil (55) 21-274-5009 Studer Revox Japan Ltd, (81) 3-320-1101 Swissco International Pty Ltd, Australia (61) 2-406-4700 TER, Turkey (90) 41-380296 Trans European Music, Belgium (32) 2-569-1823

24 TRACKS - 24 HOURS A DAY TASCAM PROVES THE WAY TO WORK



TASCAM PROFESSIONAL ATR-80-24 2-inch Recorder/Reproducer

For years TASCAM multitrack recorder/reproducers have been the backbone of private and many professional studios running up to 16 tracks. Superb sound, smooth operation and extraordinary dependability have made them a standard in the field. Now TASCAM takes on a new dimension with the ATR-80-24, 24-track Recorder/Reproducer. Years of accumulated experience and the latest technology have come together to create a 24-track machine that gives you what you need to compete.

If you're going 24-track, now is the time to go TASCAM.

TASCAM

POWER AMPLIFIERS

We have compiled a list of amplifier manufacturers and agents, together with a brief description of their products, from information available to us at the time of writing

This survey of power amplifiers is intended to include units designed for professional use primarily in the areas of recording studio monitoring systems. It also includes some units for use in live sound although we have omitted units for commercial sound installation where identifiable. Because the definition of what comprises a power amplifier suitable for these applications is open to a degree of interpretation, there may be some omissions. Further the number of manufacturers active in this field is so large and internationally based that there are almost certainly names that have not been included. We will endeavour to include any subsequent information received at a later date.

All power amplifiers are 2-channel with all wattages quoted in RMS watts unless otherwise stated.

ACES

M150: single-channel 100 W into 8 Ω .
S300: 100 W/channel into 8 Ω .
S750: 150 W/channel into 8 Ω .
S960: 150 W/channel into 8 Ω , 480 W/channel into 2 Ω . Separate power supplies.
ACES (UK) Ltd, Featherbed Lane, Shrewsbury, Shropshire SY1 4NJ, UK. Tel: 0743 66671.
USA: Power Studio, 13453 Hollow Oval, Stongsville, OH 44136. Tel: (216) 238 9426.
USA: The Rock Studio, 430 Kansas Street, Norman, OK 73069. Tel: (405) 329-8431.

Altec Lansing

1268: 60 W/channel into 8 Ω ; 200 W bridged into 8 Ω .
1269: 120 W/channel into 8 Ω ; 400 W bridged into 8 Ω .
1270B: 220 W/channel into 8 Ω ; 800 W bridged into 8 Ω .
Altec Lansing Corp, PO Box 26105, Oklahoma City, OK 73126-0105, USA. Tel: (405) 324-5311.
UK: Shuttlesound, Unit 15, Osiers Estate, Osiers Road, London SW18 1EJ. Tel: 01-870 9300.

AMR

PMA-200: 100 W/channel into 8 Ω .
PMA-70+: 35 W/channel into 8 Ω . Half rack width.
Audio Media Research, PO Box 1230, Meridian, MS 39301, USA. Tel: (601) 483-5372.
UK: Audio Media Research, Hatton House, Hunters Road, Weldon North Industrial Estate, Corby, Northamptonshire NN17 1JE. Tel: 0536 205520.

BGW

250D & E: 100 W/channel into 8 Ω , 300 W bridged into 8 Ω . Difference between models in metering.
750D & E: 250 W/channel into 8 Ω , 800 W bridged into 8 Ω .
GTA: 350 W/channel into 8 Ω , 1800 W bridged into 4 Ω .
320B: 100 W/channel into 8 Ω .
620B: 200 W/channel into 8 Ω .
2125: single-channel 100 W into 8 Ω .
8000: single-channel 225 W into 8 Ω .
7500: single-channel 200 W into 8 Ω .
6500: single-channel 100 W into 8 Ω .
85: 35 W/channel into 8 Ω , 90 W bridged into 8 Ω . Broadcast use.
150: 50 W/channel into 8 Ω , 150 W bridged into 8 Ω . Broadcast use.
SPA-1: amplifier system to power sub bass in sound reinforcement systems. Incorporates crossover and EQ. 250 W/channel into 8 Ω , 1200 bridged into 4 Ω .
SPA-3: 3-way amp system with crossover and EQ. 250 W/channel into 8 Ω , 1200 W bridged into 4 Ω .
BGW Systems Inc, 13130 S Yukon Avenue, Hawthorne, CA 90250, USA. Tel: (213) 973-8090.
UK: Pro-Britro, 53 Corsica Street, London N5 1JT. Tel: 01-226 1226.

Bose

1800 series II: 280 W/channel RMS into 8 Ω ; 425 W/channel RMS into 4 Ω .
Bose Corporation, 100 Mountain Road, Framingham, MA 01701, USA. Tel: (617) 879-7330.
UK: Bose UK Ltd, Trinity Trading Estate, Sittingbourne, Kent ME10 2PD. Tel: 0795 75341.

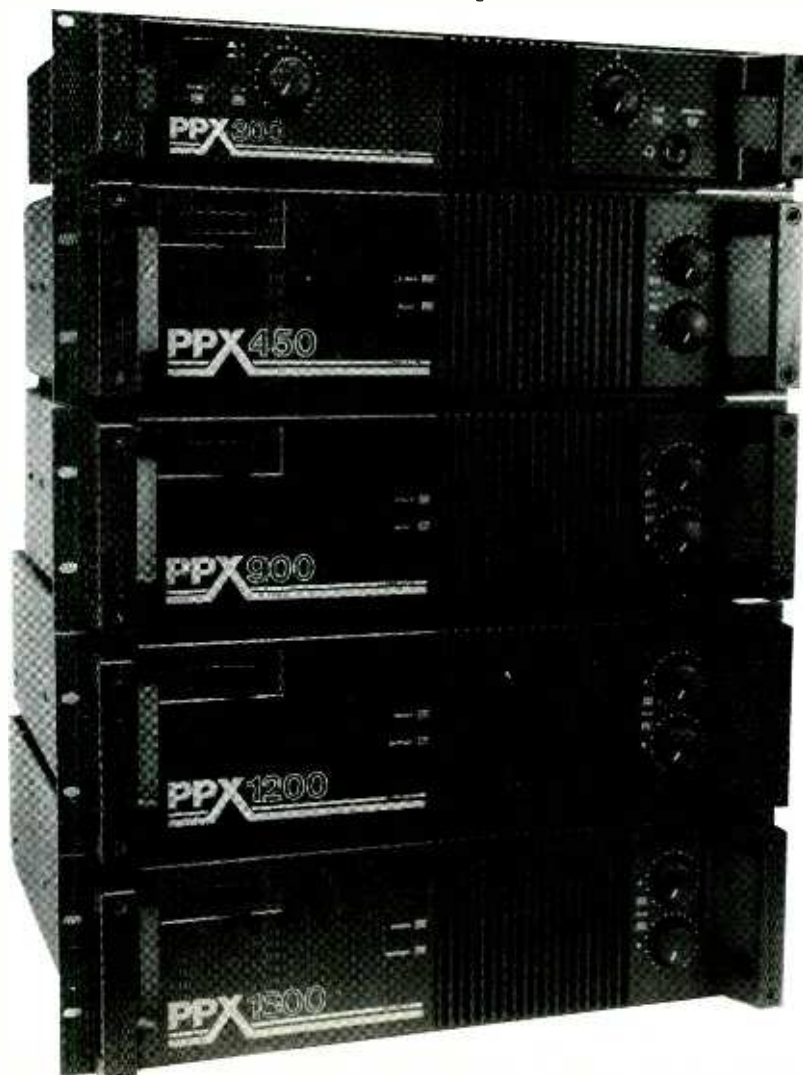

POWER AMPLIFIERS



introducing the DX300, DX800
and DX1500 power amplifiers

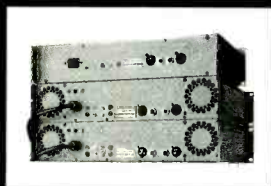
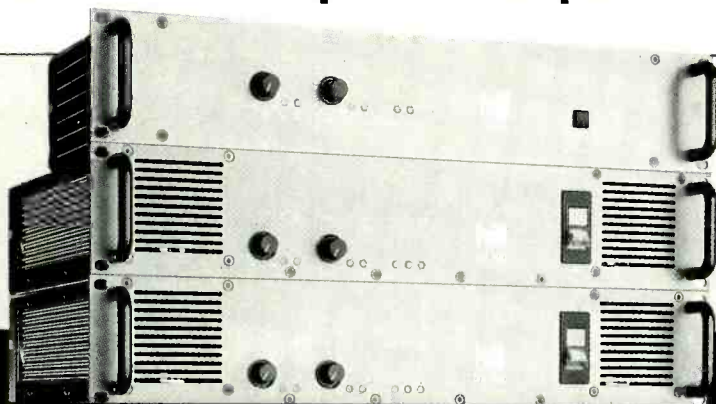

The DX300, DX800 and DX1500 amplifiers all feature balanced XLR inputs, balanced and unbalanced 1/4" inputs, banana outputs, ground lift switch and a terminal block with access to all inputs and outputs.

DX300 output power: 200 watts into 8Ω (per channel, both channels driven, 20Hz-20kHz, -0.5dB) 400 watts into 8Ω, 450 watts into 4Ω (burst power*) distortion (250mW to rated power at 8Ω): IMD SMPTE: <0.01% THD (1kHz): 0.01% THD (20kHz DIN): <0.02% size: 2 rack spaces, 8 1/2" behind front panel weight: 7Kgs, 16 lbs. cooling: 2 passive heatsinks.

DX800 output power: 250 watts into 8Ω, 400 watts into 4Ω (per channel, both channels driven, 20Hz-20kHz, -0.5dB), 800 watts into 8Ω (bridged mono), 900 watts into 4Ω (burst power*) distortion (250mW to rated power at 8Ω): IMD SMPTE: <0.01% THD (1kHz): <0.01% THD (20Hz-20kHz DIN): <0.02% size: 2 rack spaces, 13" behind front panel weight: 13Kgs, 29 lbs. cooling: 1 servo controlled DC fan.

DX1500 output power: 300 watts into 8Ω, 500 watts into 4Ω, 750 watts into 2Ω (per channel, both channels driven, 20Hz-20kHz, -0.5dB), 1000 watts into 8Ω, 1500 watts into 4Ω (bridged mono) 1500 watts into 2Ω, 1600 watts into 1Ω (burst power*) distortion (250mW to rated power at 8Ω): IMD SMPTE: <0.01% THD (1kHz): <0.01% THD (20Hz-20kHz DIN): <0.02% size: 2 rack spaces, 13" behind front panel weight: 15Kgs, 34 lbs. cooling: 2 servo controlled DC fans.

*Burst power is a 1kHz tone for 10ms every 100ms, single channel (an indication of the amplifiers ability to handle music transients and tolerate deviations in nominal speaker impedance)

Total Audio Transparency

Manufactured in the UK:
Hill Audio Ltd., Hollingbourne House, Hollingbourne, Kent ME17 1QJ England
Tel: (062 780) 555/6/7 Tlx: 966641 HILL

U.S. Sales Office:
Hill Audio Inc., 5002B N. Royal Atlanta Dr., Tucker, GA 30084 USA
Tel: (404) 934-1851 Tlx: 293827 HLAD



Boulder

500: 150 W/channel RMS into 8 Ω; 250 W/channel RMS into 4 Ω; 500 W bridged into 8 Ω.

Boulder Amplifiers, 4850 Sterling Drive, Boulder, CO 80301, USA. Tel: (303) 449-8220.
UK contact: Syco Systems Ltd, 20 Conduit Place, London W2. Tel: 01-724 2451.

Bryston

2B: 50 W/channel RMS into 8 Ω; 200 W bridged into 8 Ω.

3B: 100 W/channel RMS into 8 Ω; 400 W bridged into 8 Ω.

4B: 250 W/channel RMS into 8 Ω; 800 W bridged into 8 Ω.

6B: single-channel, 500 W into 8 Ω; 800 W into 1 Ω.

Bryston Ltd, 57 Westmore Drive, Rexdale, Ontario, Canada M9V 3Y6. Tel: 746-1800.

UK: Roksan Engineering Ltd, The Turnmill, 63 Clerkenwell Rd, London EC1R 5BH. Tel: 01-251 1021.

USA: Brystonvermont, RFD 4, Berlin, Montpelier, VT 05602. Tel: (802) 223-6159.

Carlsboro

CP 250: 250 W/channel into 8 Ω; 250 W bridged into 8 Ω.

CP 600: 200 W/channel into 8 Ω; 600 W bridged into 8 Ω.

CP 1000: 300 W/channel into 8 Ω; 1000 W bridged into 8 Ω.

S600: 200 W/channel into 8 Ω; 300 W/channel into 4 Ω.

S300: 105 W/channel into 8 Ω; 150 W/channel into 4 Ω.

Carlsboro Sales Ltd, Cross Drive, Low Moor Road Industrial Estate, Kirkby-in-Ashfield, Notts NG17 7LD, UK. Tel: 0623 753902.

Carver

PM-1.5: 450 W/channel into 8 Ω; 1500 W bridged into 8 Ω.

PM-175: 175 W/channel into 8 Ω; 500 W bridged into 8 Ω.

PM-350: 350 W/channel into 8 Ω; 900 W bridged into 8 Ω.

Carver Corp, PO Box 1237, Lynnwood, WA 98046, USA.

UK: Kelsey Acoustics Ltd, 28 Powis Terrace, London W11 1JH. Tel: 01-727 1046.

C-Audio

SR 808: 805 W/channel RMS into 4 Ω; 1700 W into 8 Ω bridged; 2500 W into 4 Ω bridged.

SR 606: 600 W/channel RMS into 4 Ω; 1200 W into 8 Ω bridged; 1500 W into 4 Ω bridged.

SR 404: 400 W/channel RMS into 4 Ω; 800 W into 8 Ω bridged; 1100 W into 4 Ω bridged.

SR 202: 200 W/channel RMS into 4 Ω; 400 W into 8 Ω bridged.

C-Audio Ltd, Barnwell Road Business Park, Cambridge CB5 8UY, UK. Tel: 0223 211333.

Citronic

PPX 300: 100 W RMS/channel into 8 Ω; 300 W bridged into 4 Ω.

PPX 450: 140 W RMS/channel into 8 Ω; 450 W bridged into 4 Ω.

PPX 900: 280 W RMS/channel into 8 Ω; 900 W bridged into 4 Ω.

Why No Other Touring Amp Stacks Up To BGW's GRAND TOURING AMPLIFIER...



1. GTA Packs 1800 Watts Into Just 5 1/4". That's more than 2 horsepower! The GTA delivers 900 watts per channel into 2 ohm loads; 1800 watts bridged punch, the GTA's massive power supplies store an enormous 320 joules of energy. It's the most powerful amplifier ever from BGW.

2. It's Heavy-Duty All The Way. Make no mistake, this is no "flyweight wonder". Our engineers don't believe in taking shortcuts. From its one-piece welded steel chassis to totally redundant dual-mono design (with field-swappable modules), the Grand Touring Amplifier is built to take everything the road can dish out. It's the first powerful compact amp with legendary BGW reliability.

3. Details, Details, Details. For all its raw power, the GTA is a highly refined amplifier. It features low feedback circuitry for superb sonic performance. D.C. speaker protection is included, of course. The GTA internally accommodates two BGW crossover cards. And BGW builds-in the subsonic filters that you need, but other manufacturers "forget".

4. Have It Your Way. Choose high performance active balanced inputs (featuring 70dB+ common mode rejection), or specify transformer isolated inputs (to eliminate stubborn ground loops).

5. What Price Glory? Less than you'd expect. Under a dollar per watt buys you the massive power, small size, full roster of features, magnificent performance, and rock-solid reliability of the GTA.

6. It All Adds Up. Our new Grand Touring Amplifier clearly stacks up as THE road amp of choice. Your next move? Call BGW at 1 (800) 252-4800 Toll-Free (In CA-(213) 973-8090), to arrange for a demo trial.

Engineered To Be The Best.
 BGW Systems Inc.
 13130 South Yukon Avenue.
 Hawthorne, CA 90250



Distributed in Canada by AKG Acoustics
 601 Milner Ave. Scarborough Ontario
 M10 1M8 (416) 292-5161



UK Distribution: PRO-BRITRO LTD.
 53 Corsica Street, London N5 1JT
 Telephone: 01-226 1226
 Telex: 26284 Proud G
 Fax: 01-359 1454

POWER AMPLIFIERS

PPX 1200: 400 W RMS/channel into 8 Ω ; 1200 W into 4 Ω .

PPX 1600: 480 W RMS/channel into 8 Ω ; 1600 W into 8 Ω .

Citronic Ltd, Halifax Road, Bowerhill, Melksham, Wilts SN12 6UB, UK. Tel: 0225 705600.

Crest

PL300: 220 W/channel into 8 Ω ; 650 W bridged into 8 Ω .

PL400: 290 W/channel into 8 Ω ; 900 W bridged into 8 Ω .

3001: 240 W/channel into 8 Ω ; 1240 W bridged into 4 Ω .

3000: as 3001 but with VU meters.

4001: 325 W/channel into 8 Ω ; 1500 W bridged into 4 Ω .

4000: as 4001 but with VU meters.

8001: 750 W/channel into 8 Ω ; 1200 W/channel into 4 Ω ; 2400 W bridged into 8 Ω and 3000 W bridged into 4 Ω .

Crest Audio, 150 Florence Avenue, Hawthorne, NJ 07506, USA. Tel: (201) 423-1300.

Europe: Crest Audio (UK) Ltd, PO Box 36, Royston, Herts SG8 7RQ. Tel: 076 382465.

Crown/Amcron

D-75: 40 W/channel into 8 Ω .

D-150A series II: 96 W/channel RMS into 8 Ω ; 280 W RMS bridged into 8 Ω .

DC-300A series II: 180 W/channel RMS into 8 Ω ; 600 W bridged into 8 Ω .

MT-600: 230 W/channel into 8 Ω ; 600 W bridged into 4 Ω .

MT-600LX: as MT-600 but with XLRs, display and custom front panel adaptable to user's connectors.

MT-1200: 320 W/channel into 8 Ω ; 1200 W bridged into 4 Ω .

MT-1200LX: as MT-600 but with XLRs, display

and custom front panel adaptable to user's connectors.

Power Base-1: 200 W/channel into 8 Ω ; 400 W bridged into 8 or 16 Ω .

PSA-2X: 220 W/channel RMS into 8 Ω ; 1200 W RMS bridged into 4 Ω .

DO-2000: single-channel, 600 W into 8 Ω .

Crown International Inc, 1718 West Mishawaka Road, Elkhart, IN 46517, USA. Tel: (219) 294-5571.

UK: HHB Hire & Sales, 73-75 Scrubs Lane, London NW10 6QU. Tel: 01-960 2144.

UK: Shuttlesound Ltd, Unit 15, Osiers Estate, Osiers Road, London SW18 1EJ. Tel: 01-871 0966.

d&b audiotechnik

AMP: 220 W/channel into 8 Ω ; 800 W bridged into 8 Ω .

d&b audiotechnik, Steinstrasse 40, D-7054 Korb, West Germany. Tel: (07151) 3 10 18.

Dynamic Precision

No. 1: 250 W/channel into 8 Ω , 1300 W into 4 Ω bridged.



TWIN TWIN PPM



Two TWIN movements and two PPM9 boards give simultaneous monitoring of A/B on red and green and M/S on white and yellow pointers. Together these provide complete information about stereo signals, in contrast to the ambiguous readings of phase meters. PPM9 is a two channel PPM driver featuring inherent stability with the law under microprocessor control. Manufactured under licence from the BBC.

ALSO: PPM7, the highest specification analogue drive circuit on the market; PPM3, unbalanced; PPM5, 20 pin DIL hybrid; illuminated TWIN boxes; PPM8, IEC/DIN -50/+60 dB scale.

**SURREY ELECTRONICS LTD, The Forge, Lucks Green, Cranleigh, Surrey GU6 7BG
Tel: 0483 275997**

Norwegian Audio Designs A/S, Jerikoveien 10, 1067 Oslo 10, Norway. Tel: 2 32 20 40.

UK: Phase Audio UK Ltd, 80 St Mary's Road, Market Harborough, Leicester LE16 7DX. Tel: 0858 31717.

FM Acoustics

FM300A: 100 W/channel into 8 Ω ; 150 W/channel into 4 Ω and 180 W/channel into 2 Ω .

FM600A: 250 W/channel into 8 Ω ; 350 W/channel into 4 Ω and 400 W/channel into 2 Ω .

FM800A: 400 W/channel into 8 Ω ; 600 W/channel into 4 Ω and 850 W/channel into 2 Ω .

FM801: 420 W channel into 8 Ω ; 750 W/channel into 4 Ω and 1000 W/channel into 2 Ω .

FM1000: 450 W/channel into 8 Ω ; 750 W/channel into 4 Ω , 1300 W/channel into 2 Ω and 1800 W/channel into 1 Ω .

FM Acoustics Ltd, Tiefenhofstrasse, CH-8820 Wadenswil, Switzerland. Tel: 01 780 64 44.

USA: FM Acoustics USA, PO Box 854, Benica, CA 94510. Tel: (707) 745-4444

Hafler

P125: 62 W/channel RMS into 8 Ω ; 125 W into 16 Ω bridged.

P225: 105 W/channel RMS into 8 Ω ; 350 W into 8 Ω bridged.

P505: 255 W/channel RMS into 8 Ω ; 800 W into 8 Ω bridged.

P500: 255 W/channel RMS into 8 Ω ; 800 W into 8 Ω bridged.

XL280: 145 W/channel RMS into 8 Ω ; 400 W into 8 Ω bridged.

David Hafler Company, 5910 Crescent Boulevard, Pennsauken, NJ 01809, USA. Tel: (609) 662-6355.

UK: HW International Ltd, 3-5 Eden Grove, London N7 8EQ. Tel: 01-607 2717.

HH Electronics

VX 150: 80 W/channel RMS into 4 Ω ; 160 W into 8 Ω bridged.

VX 200: 105 W/channel RMS into 4 Ω ; 210 W into 8 Ω bridged.

VX 300: 155 W/channel RMS into 4 Ω ; 310 W into 8 Ω bridged.

VX 450: 230 W/channel RMS into 4 Ω ; 460 W into 8 Ω bridged.

VX 600: 310 W/channel RMS into 4 Ω ; 620 W into 8 Ω bridged.

VX 900: 470 W/channel RMS into 4 Ω ; 940 W into 8 Ω bridged.

VX 1200: 610 W/channel RMS into 4 Ω ; 1220 W into 8 Ω bridged.

HH Electronics Ltd, 9 Clifton Road, Off St Peter's Road, Huntingdon, Cambs PE17 7DW, UK. Tel: 0480 432227.

UK: Elliott Bros (Audio Systems) Ltd, Osney Mead, Oxford OX2 0ER. Tel: 0865 249259.

USA: Audio Techniques Inc, 652 Glenbrook Road, Stamford, CT 06906. Tel: (203) 359-2312.

Hiletron

3076: single-channel, 100 W into 8 Ω .

Teksam Srl, Via 1 Maggio, 47, 20021

Baranzate, Milano, Italy.

UK: Michael Stevens & Partners, Invicta Works, Elliott Road, Bromley, Kent BR2 9NT. Tel: 01-460 7299.

Hill

DX300: 200 W/channel RMS into 8 Ω .

A FIRST CLASS REFERENCE

If you require a testimonial for Toa's ME-AV monitors just ask any number of major recording studios in the USA.



Or better still why not try them for yourself?

You won't be surprised!

As with all Toa equipment the ME-AV range assures top quality performance and total reliability.

Especially designed for use with audio visual equipment. The 3-way 312 ME-AV (135 watts) the 280 ME-AV (90 watts) and the 2-way 265 ME-AV (75 watts) near field reference monitors incorporate magnetically shielded speaker components to eliminate interference on nearby video screens.



Toa Electronics Limited, Tallon Road, Hutton Industrial Estate, Brentwood, Essex CM13 1TG. Tel:0277 233882

Drawmer

Ingenuity

M500

A TIME OF CHANGE

THE M500 DYNAMICS PROCESSOR... UNNERVING CAPABILITY



Auto levelling, Auto Fade, De-Essing, Compression, Expansion, Limiting, Auto-Pan, Filter-Pan and probably the most comprehensive Noise-Gate in the world... simultaneously.

DRAWMER DISTRIBUTION LTD

CHARLOTTE STREET BUSINESS CENTRE
CHARLOTTE STREET
WAKEFIELD, WEST YORKSHIRE
WF1 1UH ENGLAND

Telephone: 0924-378669 Telex: 556649



Power Station selects t.c.electronic installs 6 TC-2290 sampler/delays

“I love the sound, the ease of operation, and the complete control over all parameters. With the three modulation parameters, speed, depth and waveform on the front panel, and the special key functions to access software T.C. allows fine tuning of parameters that are predetermined in other units.

The combination of dynamic delay and pan modulation allow quite a variety of effects within a single processing device. T.C. was very smart about this. The 2290 does a lot more, and is more affordable than any other unit we've used. **”**

Engineer Don Rodenbach

A demonstration model of the new TC 2290 was sent to Power Station by Martin Audio. The first engineer to use the 2290 was Don Rodenbach, who was so pleased with the sound, and features of the 2290, as well as "the clarity of the :32 samples," that he bought one for his own rack. His unit then started making the rounds of various sessions at Power Station. Today there are six TC 2290 units at Power Station and no waiting. Each unit has 32 second capability for sampling (and delay), can be locked in perfect synch with a second 2290 for stereo sampling (*The new stereo link update*), and has Sampling 2 software, along with "Fast Trigger," update.

Sampling 2 Features

- 1) Multi-layering of samples. Up to 16 samples on top of each other with no degradation of signal, into the same pre-set.
- 2) Fancy Dancing-samples triggering samples any order, or number, as many times as desired.
- 3) :32 second delay possibility
- 4) Crossfade-After the first sample is triggered, a second sample can be triggered, and the first sample will continue to play simultaneously.
- 5) Note counter for pitchshift of samples.
- 6) 1 millisecond sample looping and sound on sound possible.

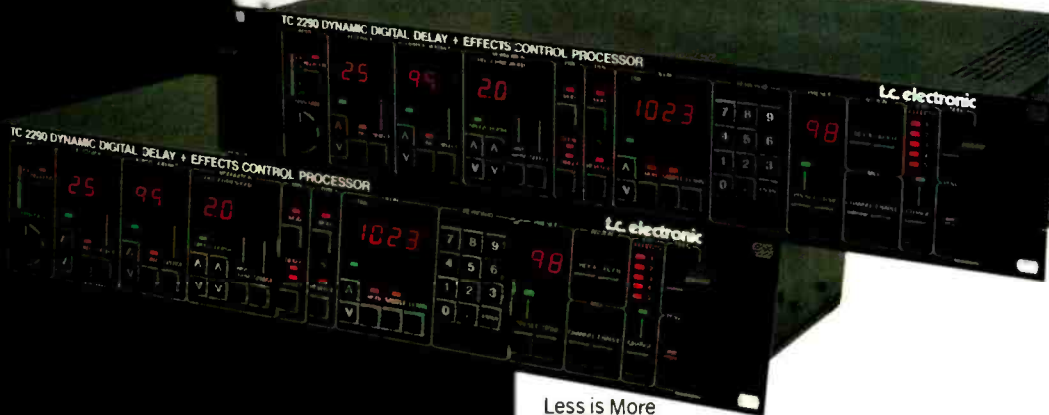

Less is More

The TC 2290 offers 2 bits more resolution, at a quarter the price of any truly competitive unit. T.C.'s 18 bit resolution, 1 MegaHz sampling rate, and 20-20KHz bandwidth (rolling off at 33KHz even out to 32 seconds) make the TC 2290 a remarkable unit for sampling, multi-effect delays, and panning programs.

Write for more informations.

OF DENMARK

t.c. electronic

U.K.: STATE OF THE ART DISTRIBUTION, STUDIO HOUSE
HIGH LANE VILLAGE, NR. STOCKPORT SK6 8AA, Phone: 06636 2442

WEST GERMANY: 08157 7677, DENMARK: 06262800, GREAT BRITAIN: 066362442,
SWEDEN: (031) 134950, NORWAY: (033) 26798, HOLLAND: BELGIUM, LUXEMBURG:
003110-4588166, AUSTRIA: 00498157 7677, ITALY: (02) 5084. 1, FRANCE: (91) 498728,
SPAIN: 91-4426426, USA: (201) 384 4221, CANADA: (416) 727-1951, JAPAN: (03) 329-8051,
AUSTRALIA: (03) 4805988, FINLAND: 90-914133, GREECE: 01-3628541,
SWITZERLAND: 073 226616.

POWER AMPLIFIERS

DX800: 250 W/channel RMS into 8 Ω; 800 W into 8 Ω bridged.
DX1500: 300 W/channel RMS into 8 Ω; 1500 W into 4 Ω bridged.
DX1000: 375 W/channel RMS into 8 Ω; 1200 W into 8 Ω bridged.
DX2000: 400 W/channel RMS into 8 Ω; 2000 W into 4 Ω bridged.
DX3000: 550 W/channel RMS into 8 Ω; 3000 W into 4 Ω bridged.
DX1000A: 500 W/channel RMS into 8 Ω; 1600 W into 8 Ω bridged.
Hill Audio Ltd, Hollingbourne House, Hollingbourne, Kent, UK. Tel: 062 780 555.
USA: Hill Audio Inc, 5002B N Royal Atlanta Dr, Tucker, GA 30084. Tel: (404) 934-1851.

HIT

Xi150: 75 W/channel into 4 Ω.
Xi300: 150 W/channel into 4 Ω.
Xi600: 170 W/channel into 8 Ω; 600 W bridged into 8 Ω.
Xi1000: 300 W/channel into 8 Ω; 1000 W bridged into 8 Ω.
Xi1200: 350 W/channel into 8 Ω; 1200 W bridged into 8 Ω.
Xi1600: 450 W/channel into 8 Ω; 1000 W/channel into 2 Ω, 1600 W bridged into 8 Ω.
P900: 270 W/channel into 8 Ω; 900 W bridged into 8 Ω.
DSA300: 150 W/channel into 4 Ω, 300 W bridged into 8 Ω.
DSA500: 250 W/channel into 4 Ω; 500 W bridged into 8 Ω.
DSA800: 400 W/channel into 4 Ω; 800 W bridged into 8 Ω.
DSA1200: 600 W/channel into 4 Ω; 1200 W bridged into 8 Ω.
Harrison Information Technology Ltd, Unit 3, Button End, Harston, Cambs CB2 5NX, UK. Tel: 0223 871771.

Industrial Research

DH 4020: 100 W/channel RMS into 8 Ω; 300 W into 8 Ω bridged.
Industrial Research Products Inc, 321 Bond Street, Elk Grove Village, IL 60007, USA. Tel: (312) 439-3600.
UK: Knowles Electronics Ltd, Victoria Road, Burgess Hill, Sussex RH15 9LP. Tel: 04446 5432.



JBL/UREI

6215: 35 W/channel into 8 Ω; 90 W bridged into 8 Ω.
6230: 75 W/channel into 8 Ω; 300 W bridged into 8 Ω.
6260: 150 W/channel into 8 Ω; 600 W bridged into 8 Ω.
6290: 300 W/channel into 8 Ω; 1200 W bridged into 8 Ω.
JBL Professional, 8500 Balboa Boulevard, Northridge, CA 91329, USA. Tel: (818) 893-8411.
UK: Harman (Audio) UK Ltd, Mill Street, Slough SL2 5DD. Tel: 0753 76911.

Lenco

PPA-100: 100 W/channel into 8 Ω.
Lenco, 300 North Maryland Street, PO Box 348, Jackson, MO 63755, USA. Tel: (314) 243-3147.

Meyer

MS-1000: 300 W RMS/channel into 8 Ω; 1000 W bridged into 4 Ω.
Meyer Sound Laboratories Inc, 2832 San Pablo Avenue, Berkley, CA 94702, USA. Tel: (415) 485-1166.

Peavey

CS-800: 400 W/channel into 4 Ω; 800 W bridged into 8 Ω.
CS-900: 450 W/channel into 4 Ω; 900 W bridged into 8 Ω.
CS-1200: 600 W/channel into 4 Ω; 1200 W bridged into 9 Ω.
M-2600 MkV: single-channel 130 W into 4 Ω.
M-3000 MkV: single-channel 210 W into 4 Ω.
M-4000: single-channel 200 W into 4 Ω.
M-7000: single-channel 350 W into 4 Ω.
DECA-424: 200 W/channel into 4 Ω. Digital Energy Conversion series.
DECA-724: 350 W/channel into 4 Ω.
DECA-1200: 600 W/channel into 4 Ω.
Peavey Electronics Corp, 711 A Street, Meridan, MS 39301, USA. Tel: (601) 483-3565.
UK: Peavey Electronics (UK) Ltd, Hatton House, Hunters Road, Weldon North Industrial Estate, Corby, Northants NN17 1JE. Tel: 0536 205520.

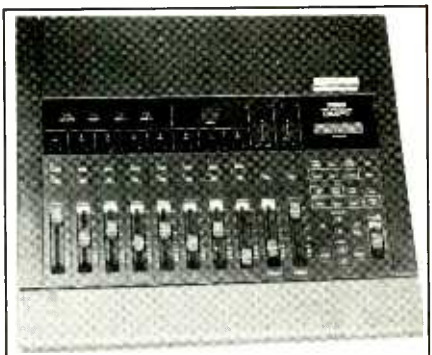

YAMAHA D.M.P. 7

Most people know about the revolutionary new Yamaha Total Recall Mixer. Some dealers may even give you a quick demo. At Thatched Cottage we believe that three DMP 7s linked together will represent the ultimate in affordable automated mixdown. Because of this we have installed three in our (Munro analysed) 24 track demonstration studio and we are inviting any studio to bring along a 16 or 24 track master and mix down a track at our expense. We will provide an engineer, world class outboard plus coffee for as long as it takes! If you feel that 24-track total recall for under £9,000 will help bring business into your studio why not contact Dave Simpson and arrange a demonstration (accommodation available).

Some of our secondhand & ex-demonstration stock

8 channels Bell noise reduction (3 available). £350 each
 3M M79 24 track with autolocate, good condition £7,900
 Fostex model 80 8-track, NEW £1,129
 BEL BDE 3200, 32 sec. 99 window super-sampler, as new, silly price £999
 Akai MG 14D rack mounted 14 track ex-demo £2,500
 Sony PCM 501 digital mastering (new) £495
 BOKSE US8 Universal synchroniser £245
 Q.Play programmable remote for E16, B16 + M80 £99
 Fostex E16 w/remote - Mint £3,600
 Slapback scintillator (exciter) (new) £125
 Yamaha 31 band graphic eq. (2 only) £160 each
 Symetrix quad expander gates £325
 Drawmer DS221 compressor/limiter £275
 AHB Keymix computer mix down system £999 (fits any desk - routing & muting - 16T)
 Akai S900 Super Sampler £1,199
 24 channels Bel Noise Reduction £1,000
 Electrospace time Matrix Multitap Delay £699
 Yamaha NS10's £160
 Drawmer DS201 Gates £245
 Tascam 38 (NEW) £1,399
 Symetrix 511 Noise Reduction £350
 MXR 31 Band Graphic £175
 Aphex Dominator £875
 Digitech 1900 delay 2 seconds full bandwidth £165
 JBL 4430 Monitors immaculate £1,500
 Seck 18/8/2 £1,100
 Fostex B16 new heads fitted by us £2,750
 Fostex A8 new heads £850
 Tascam 3340S mint £500
 Yamaha RX5 £699
 Yamaha KX88 mother keyboard £750
 24 Channels Dolby A £7,000
 Tascam 32 two track £750
 Plus loads more - give us a ring!
 All prices exclude VAT

Amazing Nomad SMC 1.0 SMPTE reader generator only £299 + VAT

Sony PCM 501 (new) plus reconditioned (guaranteed) Sony C7 £699

Just some of the new products we stock
 Akai S900, S700, X7000 and the brand new 24-track Yamaha - RX5, DX7II, TX81Z, SPX90II plus

RSD series II desks, TASCAM Matchless and Scorpion, Fostex E16, Tascam, Tannoy and loads more.

From Fostex to Neumann, Tascam to Yamaha, we are main dealers for all the latest high quality products, most of it on permanent demonstration in our three 24-track studios.

If you have any audio requirements, give us a ring

Axxeman - at last a No' Noise Studio Quality Guitar Processor with chorus, filters, ADT, overdrive, compression and gate. Money back if not satisfied - £260 + VAT

Special offer computer package. Atan 1040 Steinberg Pro-24 and Nomad SMPTE/Midi reader generator - £950 + VAT

• EXPORT • FULL CREDIT FACILITIES AVAILABLE • MAIL ORDER •



Thatched Cottage Audio

Telephone

Cambridge (0223) 207979 (3 lines)

Thatched Cottage Audio,

North Road, Wendy, Nr. Royston, Herts.



QUIETLY INNOVATING, BOLDLY ACCOMPLISHING

For the past few years Soundtracs have been quietly developing a new range of audio mixers with powerful and exclusive new innovations.

These are no ordinary consoles.

Their versatility and audio performance are to say the least superb.

Utilising recent advances in circuit and component technology these consoles are quiet and virtually distortion free.

With stringent attention to detail and the use of the latest computer based manufacturing and quality control techniques, Soundtracs have the edge on less advanced designs.

Surprisingly this high quality and ensuing reliability can remarkably cost you less than other named brand consoles.

As a result they have attracted worldwide attention from top producers, commercial recording studios, leading rental and hire companies and talented musicians.

Quiet innovations boldly accomplishing new perspectives in console architecture.

Soundtracs and the indicative  are trade marks of Soundtracs PLC.

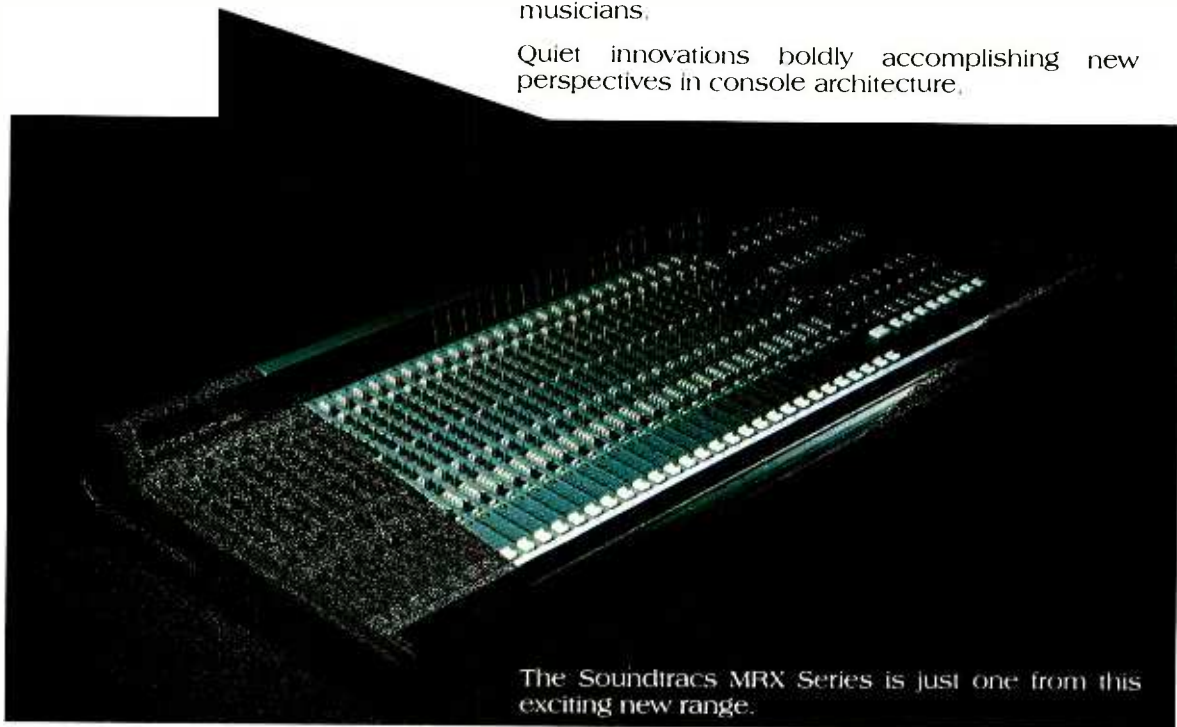

The Soundtracs MRX Series is just one from this exciting new range.

It's a 'split' recording console with excellent sonic qualities and independent monitors.

Intelligently designed for simplicity of use.

Optional stereo inputs and a fully complimentary patchbay are available.

Call your exclusive Soundtracs Dealer for a very convincing demonstration, now.



Soundtracs plc. 91 Ewell Road, Surbiton, Surrey,
KT6 6AH, England Telephone: 01-399 3392
Telex 8951073/STRACS/G Fax: 01-399 6821
U.K.: Studio Equipment Distribution (0582) 452495

- Soundtracs innovations include:
- Dual line levels
 - Digital routing on localised keys
 - SMPTE mute automation
 - MIDI mute automation
 - Low cost digital console control
 - Centralised digital control of external devices
 - Dual servo feedback mic amps for improved linearity, distortion and dynamic range
 - Virtual earth parametric Eq for improved transients



POWER AMPLIFIERS

Perreaux

3000B: 180 W RMS/channel into 8 Ω ; 400 W RMS bridged into 8 Ω .

6000B: 300 W RMS/channel into 8 Ω .

6200B: similar to 6000B but designed for low impedance loads: 650 W RMS/channel into 2 Ω .

8000C: 500 W RMS/channel into 8 Ω ; 900 W RMS/channel into 4 Ω ; variable reference output level metering.

9000B: spec as 8000C but with simple clipping indicators.

Perreaux Sound Ltd, Niven Street, PO Box 847, Napier, New Zealand. Tel: (070) 435-219.

UK: DW Labs Ltd, Unit 30, Roman Way, London Road, Godmanchester, Huntingdon, Cambs PE18 8LN. Tel: 0480 413277.

USA: Perreaux International, 875 Merrick Avenue, Westbury, NY 11590. Tel: (516) 683-3000.

Quad

520F: 100 W/channel into 8 Ω .

510: single-channel 135 W into impedance from 2 to 75 Ω .

405-2: 100 W/channel into loads from 4 to 16 Ω .

606: 180 W/channel into 8 Ω .

306: 70 W/channel into 8 Ω .

Quad Electroacoustics Ltd, Huntingdon, Cambs PE18 7DB, UK. Tel: 0480 52561.

USA: Quad USA, 695 Oak Grove Avenue, Suite 3a, Menlo Park, CA 94025. Tel: (800) 227-9985.

QSC

1080: 35 W/channel RMS into 8 Ω ; 100 W bridged into 8 Ω .

1200: 100 W/channel RMS into 8 Ω ; 300 W bridged into 8 Ω .

1400: 200 W/channel RMS into 8 Ω ; 600 W bridged into 8 Ω .

1700: 325 W/channel RMS into 8 Ω ; 1000 W bridged into 8 Ω .

3200: 110 W/channel RMS into 8 Ω ; 280 W bridged into 8 Ω .

3350: 200 W/channel RMS into 8 Ω ; 600 W bridged into 8 Ω .

3500: 300 W/channel RMS into 8 Ω ; 900 W bridged into 8 Ω .

3800: 375 W/channel RMS into 8 Ω ; 1200 W bridged into 8 Ω .

MX1500: 330 W/channel RMS into 8 Ω ; 1000 W bridged into 8 Ω .

QSC Audio Products Inc, 1926 Placentia Avenue, Costa Mesa, CA 92627, USA. Tel: (714) 645-2540.

UK: Music Lab Sales, 72-74 Eversholt Street, London NW1 1BY. Tel: 01-388 5392.

Ramsa

WP-9110: 100 W/channel into 8 Ω .

WP-9220: 200 W/channel into 8 Ω .

UK: Panasonic UK Ltd, 300 Bath Road, Slough, Berks SL1 6JB. Tel: 0753 34522.

USA: Panasonic Professional Audio Division, Matsushita Corp of America, 1 Panasonic Way, Secaucus, NJ 07094. Tel: (201) 348-7000.

Rauch

DVT25S: 100 W/channel into 8 Ω .

DVT50S: 140 W/channel into 8 Ω ; 430 W bridged into 8 Ω .

DVT250S: 325 W/channel into 8 Ω ; 1000 W bridged into 8 Ω .

DVT500S: 1000 W/channel into 8 Ω .

Powerbloc 44: 295 W/channel into 8 Ω ; 990 W bridged into 8 Ω .

Rauch Precision Engineering Ltd, Unit 27, Tything Road, Arden Forest Industrial Estate, Alcester, Warwickshire, UK. Tel: 0789 763789.

UK: Harman (Audio) UK Ltd, Mill Street, Slough, Berks SL2 5DD. Tel: 0753 76911.

Reflexion Arts

4180/700: 3U unit containing four 180 W/channel amps with pair 2-way crossovers.

Reflexion Arts, 14-18 Market Road, London N7 9PL, UK. Tel: 01-609 5999.

SAE

A202: 100 W/channel into 8 Ω .

A502: 200 W/channel into 8 Ω ; 500 W bridged.

Scientific Audio Electronics Inc, PO Box 60271, Terminal Annexe, Los Angeles, CA 90060, USA.

UK: Presence Audio, The Old Posthouse, Plummers Plain, Horsham, Sussex RH13 6NU. Tel: 0403 76777.

Studer

A68: 175 W/channel into 4 Ω .

Studer International AG, Althardstrasse 150, CH-8105, Regensdorf, Switzerland. Tel: 01 840 29 60.

UK: FWO Bauch Ltd, 49 Theobald Street, Borehamwood, Herts WD6 4RZ. Tel: 01-953 0091.

USA: Studer Revox America Inc, 1425 Elm Hill Pike, Nashville, TN 37210. Tel: (615) 254-5651.

Studiomaster

Mosfet 1000: 300 W RMS/channel into 4 Ω .

Mosfet 500: 160 W RMS/channel into 4 Ω .

Stellar Fet 1: 100 W RMS/channel into 4 Ω .

Recording Studio Design Ltd, Studiomaster House, Faircharm Trading Estate, Chaul End Lane, Luton, Beds LU4 8EZ, UK. Tel: 0582 570370.

USA: International Music Corp, 1316 East Lancaster Street, PO Box 2344, Fort Worth, TX 76113. Tel: (817) 336-5114.

Tannoy

SR840: 250 W/channel into 8 Ω ; 1220 W bridged into 4 Ω .

Tannoy Ltd, The Bilton Centre, Coronation Road, Cressex Industrial Estate, High Wycombe, Bucks HP12 3SB, UK. Tel: 0494 450606.

UK: FWO Bauch Ltd, 49 Theobald Road, Borehamwood, Herts WD6 4RZ. Tel: 01-953 0091.

North America: Tannoy North America Inc, 300 Gage Avenue, Unit 1, Kitchener, Ontario N2M 2C8, Canada. Tel: (519) 745-1158.

TOA

P-300D: 300 W/channel into 8 Ω .

P-300M: single-channel 300 W into 8 Ω .

P-150D: 150 W/channel into 8 Ω .

P-150M: single-channel 150 W into 8 Ω .

P-75D: 75 W/channel into 8 Ω .

TOA Electric Co Ltd, Kobe, Japan.

UK: TOA Electronics Ltd, Hutton Industrial Estate, Tallon Road, Brentwood, Essex CM13 1TG. Tel: 0277 233882.

USA: TOA Electronics Inc, 480 Carlton Court, South San Francisco, CA 94080. Tel: (415) 588-2538.

Turner

B502: 340 W/channel into 4 Ω ; 190 W/channel into 8 Ω .

B302: 150 W/channel into 4 Ω ; 100 W/channel into 8 Ω .

Turner Electronic Industries Ltd, PO Box 49, Etchingham, East Sussex TN19 7NZ, UK. Tel: 0435 882581.

Yamaha

P1150: single-channel, 100 W into 8 Ω .

P1250: single-channel, 170 W into 8 Ω .

P2150: 100 W/channel into 8 Ω ; 300 W bridged into 8 Ω .

P2250: 170 W/channel into 8 Ω ; 500 W bridged into 8 Ω .

P2075: 75 W/channel into 4 Ω ; 150 W bridged into 8 Ω .

P1150C: single-channel, 100 W into 8 Ω .

P1250C: single-channel, 170 W into 8 Ω .

P2150C: 100 W/channel into 8 Ω ; 300 W bridged into 8 Ω .

P2250C: 170 W/channel into 8 Ω ; 500 W bridged into 8 Ω .

PC1002: 100 W/channel into 8 Ω ; 300 W bridged into 8 Ω .

PC2002: 240 W/channel into 8 Ω ; 700 W bridged into 8 Ω .

PC2002M: as PC2002 but with meters.

PC5002M: 500 W/channel into 8 Ω ; 1500 W bridged into 8 Ω .

Yamaha, Nippon Gakki Co Ltd, Hamamatsu, Japan.

UK: Yamaha-Kemble Music (UK) Ltd, Mount Avenue, Bletchley, Milton Keynes MK1 1JE. Tel: 0908 71771.

USA: Yamaha International, PO Box 6600, Buena Park, CA 90620. Tel: (714) 522-9011.

YBA

YBA1: 85 W/channel into 8 Ω .

YBA2: 70 W/channel into 8 Ω .

YBA3: 150 W/channel into 8 Ω .

YBA Company, Phlox Electronics, F-91440 Bures-sur-Yvette, France.

UK: Presence Audio, The Old Posthouse, Plummers Plain, Horsham, Sussex RH13 6NU. Tel: 0403 76777. □

Partners in time

From location to studio, Nagra Kudelski set the standards with their IV-S Time Code and T Audio Time Code machines.

SMPTE / EBU 80 COMPATABILITY

NAGRA KUDELSKI TIMECODE

FILM / VIDEO DUBBING

NAGRA KUDELSKI TIMECODE

FILM / VIDEO SEPARATE SOUND

NAGRA KUDELSKI TIMECODE

FILM / VIDEO SOUND FOLLOWER

NAGRA KUDELSKI TIMECODE

FILM / VIDEO EDITING

NAGRA KUDELSKI TIMECODE



Please send me information on the Nagra Kudelski IV-S and T Audio Time Code Machines.

NAME

ADDRESS

.....

.....

NAGRA KUDELSKI

Hayden Laboratories Ltd, FREEPOST, Hayden House, Chiltern Hill, Chalfont St Peter, Bucks SL9 9BS. Tel. (0753) 888447



Shure Field Products, for those awkward situations.

Wherever your job takes you, and whatever your special demands, Shure have a range of FP amps and mixers to get you out of trouble. Built specifically for ENG, EFP, film and video work, Shure FP products have built-in ruggedness and reliability which won't fail, in any predicament.



FP32

For Stereo Remotes

The FP32 Stereo Mixer is comparable in size and features to our famous FP31. Its stereo capability, light weight, easy-to-use controls and convenient shoulder harness make it the first choice of field crews. Our FP42 Stereo Mixer simplifies mic cueing, so important in situations like sports remotes. Plus it enables you to easily mix down stereo in



FP42

your post production booth. It offers all the features of the popular M267 plus stereo capability and a stereo headphone amp.

The Industry Standards

The FP31 is Shure's original field production mixer. Thousands bet their audio on it world-wide. The FP16, a one-by-six distribution amp with transformer balancing and link jacks, outperforms all competition. It's also ideal as a portable press bridge.



FP16



FP31

For Long Yardage Situations

The FP11 Mic-to-Line Amp provides freedom from noise in long line situations, with up to 84 dB of gain in 15 6-dB steps. It converts any mic to line level and includes an invaluable limiter circuit. The FP12 Headphone Bridging Amp is a must for shotgun and boom operators. It keeps them on target without need for a return line.



FP11



FP12

It's ideal for multiple headphone feeds, troubleshooting, and as an intercom.

SHURE

For Further Information Contact: HW International, 3/5 Eden Grove, London N7 8EQ. Tel: 01-607 2717.

MARTIN POLON'S PERSPECTIVE

The young male customer just past puberty has been inside the brightly lit record store for almost an hour. The only thing that has broken his obvious cycle of indecision is his entrancement with the garishly made up and black clad female 'Models' that back up Robert Palmer with the sensual video *Addicted To Love* on the store's monitors. The pimply-faced clerk has played that particular video five times in the hour. Finally, the customer approaches the clerk and states his interest in buying the Palmer album. The clerk asks, "What format?" The young man stares dumbfoundedly. "I mean do you want an LP, a CD, a CD-V, CD-I, Optical Disc, Analogue Cassette, Digital Audio Tape, Super VHS-HiFi, VHS-HiFi, Laser Disc, Digital Laser Disc or on a ROM chip." The young man stares open-mouthed and then points dazedly at an LP record. "Oh, one of those old things, uh?" asks the clerk. "It makes sense since the Palmer album is one of the 'golden oldies'. It will have to come from central warehouse. We don't have the room here for all of that. You pay now and you'll have it on Tuesday."

The LP is dead; long live... the CD? Or is black vinyl really dead and is the CD really on top? Will the record companies sell their LP pressing plants to Third-World and Eastern Bloc countries where the LP will soldier on into the next century. Will small and large labels alike find out that the Western World will not cavalierly discard 250 million LP record players and will a trip to Albania or Paraguay become a necessity for custom pressing?

Where the business of selling recorded music goes for the rest of this century is very much a function of which media becomes the new standard or if such a standard can even exist in the current climate of rapid technological change. The CD could and should be the logical successor to the LP. Record company executives privately admit that five years from now they would like to be clear of the LP business, however, CD is threatened directly by the portability potential and lower consumer costs offered by DAT. Concomitantly, the CD could well become the victim of a consumer 'whispering' campaign if the record industry does indeed use the notch and the technical press grabs the issue. However, the implied threat of 'The Big Notch' would not be the direct effect of 'can you hear it?' It would be the question of 'is it degraded in quality' as the audio consumer press carries out its threatened propaganda war against the actual use of the notch (if that really happens). Like the Faulkner script for Howard Hawkes's *The Big Sleep*, you don't have to understand 'The Notch', or even be able to hear it, to know that the public could well see it as a degradation of quality. Ask cranberry producers, Mexican beer brewers and baby formula manufacturers about just how fickle the public interest is when the perception of damage is raised by, and in, the press.

One can almost see record company personnel

interviewers in double-breasted suits with snap-brim fedoras interrogating potential new employees. "Have you now or have you ever been an owner of a Digital Audio Tape (DAT) machine? Will you sign a loyalty oath to that effect?"

However, the record companies need the quality of the digital tape if they intend to succeed in the business of selling music off optical storage. One must first understand that the record companies of the world desire to sell music but without the headaches of distribution imposed by the current technologies and the need for physical inventory, warehousing, transportation and book-keeping. The record companies want to record and sell music without the need for jewel boxes, album art, in-store promotions, shipping and that ever-popular classic of the industry—returns.

Storage could be accomplished in several different technologies, with the in-store WORM (Write Once, Read Many) optical disc or Dolby Delta-Modulated CDs being the most likely favourite since hard disc systems do crash from time to time. The WORM disc would have a gigabyte capacity and the high modulation density CDs would have similar capacity. A 'jukebox' with a number of these discs would allow a relatively small store to have a library of 10,000 to 15,000 current and past record titles for downloading. A custom cassette would be assembled from any musical source in the collection with any cut or selection from any album available for inclusion.

The reason such a scheme (and the record companies) needs the acknowledged 'master' quality of DAT is that all the previous attempts at in-store digital delivery of recorded music via telephone line or directly from hard disc foundered due not to the delivery system but rather because of the poor quality of home audio tape playback. The number of homes with stereophonic cassette decks of high enough quality are few and far between. An overall success for DAT could make this kind of direct music marketing much more successful. It is curious to consider that if the record companies succeed in legislatively killing off DAT, mandate euthanasia for the LP and notch the CD to the detriment of both the industry and the public, we could be left only with the analogue cassette as the most successful surviving medium for this system and for all other methods of music distribution in the short term.

Several aspects of the retail personality of the music consumer do complicate successful application of direct distribution systems. Most consumers buy on impulse and want delivery NOW. Study after study confirms that recorded music sales tend to follow that model, especially for the record companies' current under-30s target audience and their rock music purchases. Most major record retailers who would be high volume candidates for such a system have migrated to shopping malls or high street locations. The likelihood of consumers waiting overnight and then having to return to the shopping mall or high street location seems unlikely in terms of

the way people spend their money, their shopping impulses and their lives. Further, the problem of having clerks make up the custom 'album' tapes to fill the customer's order could make the very success of such a system its failure. It could require a large night staff and extra duplicators and master systems to meet unpredictable public demand.

The record retailer worldwide also has strong thoughts on where the record industry is trying to go with this concept of in-store delivery. Key retailers sense the record companies' drift towards intangible software and welcome the concept of reduced inventory. The only problem that most express concern about is in whose store the in-store system will be located. A record retailer in England felt so strongly about the whole thing that he threatened to leave the business. "If this happens, there will be no need for a record store. The one-hour photo operation, the service counter in your Sainsbury or Safeway that rents you a flick, the W H Smith's book chain, a counter at a Boots chemist... Why, practically any high street retailer could have a terminal and produce these custom tape albums. A real boon for the record companies with the in-store computers doing all the accounting. But no more record stores. At least not for me."

Another potential direction for the electronic entertainment industry would be the CD derivative systems such as CD-V or CD-ROM or CD-I. Many analysts dismiss CD-V out of hand as a 'silly and expensive' format best suited to music videos due to the shortfall of video playback time with the format. The players have given the laser and digital audio laser video disc systems a much needed shot in the arm since they will play both formats. Beyond this, we have the marriage of computer data with the capacity of the CD in the form of CD-ROM and the extension of audio and video to CD-ROM with CD-I. These formats have had some impact on the computer industry with projections of future potential being substantial. However, the dynamics of consumer product technology mandate that only a recording version of CD-I and then some, would create the necessary demand to sweep the marketplace.

The recording CD could be the 'ideal' product of the consumer electronics industry for the 1990s. It would replace the LP, the CD, the video disc player, the VCR and the floppy disc and hard disc for the home computer. One problem with such a system is that the ideal size and characteristics of such an optical recording/playback system might not allow compatibility with CD. Current development in optical WORM drives ignores the physical and technical dimensions of the CD. Since the computer industry is one of the driving forces for such a product, to escape the minor mechanical uncertainties of floppy and hard disc systems, the marketplace might not accept the format of a 15 year old technology. Then we would have yet another 'standard', however, with Philips and Sony actively pursuing this technology, compatibility will remain a major consideration.

Also, the time frame for recording optical disc remains uncertain because the developers of optical disc systems feel that the issue of unlimited erasability is immutable. Current technology is in place to record and to reproduce but erasure is viable only for a finite number of uses. Current laboratory figures seem to indicate anywhere from 50 to 100 times as the practical limit with a thousand cycles as an attainable goal. It is felt that the consumer marketplace would not accept any limits and that is probably an accurate measurement.

A STAR IS BORN!



X-86

2-TRACK
DIGITAL AUDIO

The X-86 digital 2-track is the first system compatible digital mastering machine. Experience gained in producing and delivering over 300 digital audio machines over the past three years, and our recent advances in high density recording and DSI technology have resulted in a leap into the second generation of digital 2-track audio.

The X-86 is the key to total self-sufficiency in digital mastering, all functions can be carried out without any external equipment, and we've built in a performance capacity so advanced that it'll be in a class of its own for many years.

With frequency response flat from 20Hz to 20KHz, dynamic range of more than 90dB, distortion of 0.05%, the X-86 will virtually outperform any other machine on the market. Unique features include 14" reel



capacity, tach or SMPTE counter, built-in autolocator, external sync input, two analog cue tracks, time code track and auxiliary digital track, ideal for recording sub-code information during CD mastering. Simple razor splice editing, low power consumption and easy servicing complete an unbeatable specification.

With the new 16 channel X-400 multitrack now available, the cost of high quality PD compatible digital audio throughout the whole recording process is becoming increasingly affordable. Compared to other 2-track digital systems available, the X-86 is highly cost-efficient, and, considering its technological advances, is surprisingly close in price to the best analog machines on the market.

To get a little Mitsubishi into your professional life, phone Adrian Bailey at Mitsubishi Pro Audio and ask for a demonstration.

 **MITSUBISHI PRO AUDIO GROUP**
DIGITAL ENTERTAINMENT CORPORATION

Headquarters: 225 Parkside Drive, San Fernando, CA 91340 • Phone (818) 898-2341 • Telex: 311786
New York: Suite 1530, 555 W. 57th Street, New York, N.Y. 10019 • Phone (212) 713-1600 • Telex: 703547
Tennessee: 104 Eastpark Drive, Suite 306, Brentwood, TN 37027 • Phone (615) 371-6602 • Telex: 510617477
Canada: 260 The Esplanade, Toronto, ONT. M5A 1J2 • Phone (416) 365-3363 • Telex: 06219839
United Kingdom: Unit 13, Alban Park, Hattfield Road, St Albans, Herts. Phone 0727 40584 Fax: 0727 67684 Telex: 826542

 PD
PRO AUDIO

MARTIN POLON'S PERSPECTIVE

Then there is the frequently held perception that this ideal product of recording optical disc will cause mass consumer adoption. "Ethel, give me a hand with all of this junk." Ethel runs in from the kitchen, gasping. "Harold, why are you throwing out the VCR, the record player, the CD and Junior's floppy disc machine?" "Why Ethel,"

gesticulates Harold, "we don't need all of these other things. Our recording CD will do it all." Cut to the neighbours eagerly picking up the discarded units from the trash piled in front of the house.

Yet another problem is that one unit that does it all becomes one unit to fight about as Junior

wants to use the computer while Sis wants to hear Billy Joel with Dad looking forward to watching *The Battle of Britain* and Mum is interested in recording *Dallas*. Cut to two police cars in front of the ideal home that has just bought the ideal product. That kind of incompatibility, no unit can solve.

If there is a major fly in the ointment, the issue of product and software life cycles is it. The consuming public has come to believe in the long life of product cycles in the consumer electronics and electronic entertainment industry. The 78 RPM record had a 30+ year life cycle. It appears that the LP record will have reached a 40+ year life cycle before it expires slowly of benign neglect by the small labels and malignant neglect by the major ones. While the Philips cassette could expire before it reaches the 40 year mark, it will probably drag along for some time to come. Along comes new technology—high technology—and we can now promise the record consuming public five years... maybe! One development is hardly out of the starting gate before the next development is in place for release. CDs followed by CD-V and then DAT tape followed by CD-I followed by Recording Optical Disc and so on, *ad infinitum*.

It is also not apparently clear to those who are planning these cycles of technological assault on the home, just how strongly consumers expect some permanence in their home entertainment, if not in the rest of their lives. A recent study found 78% of those questioned indicated strongly that they would reject consumer electronic and electronic entertainment products and formats that did not have at least a 10 year life cycle. Curiously, the older the consumer the greater the interest in longevity of hardware and software. Follow up studies filtered out those with an innate fear of technology and found that concern about a lack of appropriate software motivated the response of the over-35s. The issue was an association of Prince and Boy George with new technology, as though optical disc would have no dixieland jazz, country or big band releases available. Unfortunately, the perceived experience with CD versus LP seems to have caused that response. The music favoured by the huge population (and affluence) bulge of the over-35s has diminished in availability in the marketplace over the last 10 years in contrast to releases for the youth market so favoured by major labels today. The reality of release media evolution has been somewhat different from the public's perception and, of course, CDs do not have a great deal to do with the trends of record company release management. But it does point out again how fragile the hold on the public's discretionary dollar is for all sectors of electronic entertainment.

Obviously, not all the blame for this confusion can be placed at the doorstep of the record companies. The consumer hardware makers are eagerly embracing each new step of technology as a way of boosting sagging sales, as consumer electronics settles in as a mature industry. It would seem far better to accept one or two complementary formats such as digital disc and digital tape and create evolutionary changes in product improvement, retaining all compatibility. The public, after all, can deal with evolution far better than with revolution.

Record dealers are all carefully noting the proliferation of formats. "Clearly, this mismanagement of technology will end up leaving us [record retailers] no options and nowhere to go. For starters, I cannot afford to stock the variations that are coming down the pike. Now, let's say that the movie about the '50s rocker, *La*

Classic AUDIO PROCESSING



PE-1A PROGRAM EQUALIZER

Both of these excellent Tube-Tech units are modern reproductions of classic valve technology, offering an unparalleled warmth and natural quality to your recordings, without maintenance or reliability problems.

PE-1A Equalizer – The Tube-Tech valve equalizer has been built to emulate the 'PULTEC' equalizer of the 1950's and 60's. The PE-1A not only looks like its classic predecessor it also gives the same superb quality of sound (like PULTEC, Tube-Tech even wind their own chokes!)

ME-1A Mid-Equalizer – also available

CL-1A Compressor – Like the PE-1A, the CL-1A Compressor has been built to accurately reproduce the sound of a classic from the 1950's and 60's, 'The Fairchild'. Now the Tube-Tech CL-1A offers the same superb dynamic range control, and maintains the natural warmth and feel for which its classic forerunner was so revered.

Please contact us for further details or a demonstration.



CL-1A COMPRESSOR

don
LARKING
AUDIO SALES

29 GUILDFORD STREET, LUTON,
BEDS LU1 2NQ
TELEPHONE: 0582 450066

Bamba, will be available today as in this year or next, on LP, on CD-V, on CD, eventually on DAT, on analogue cassette, as a CD single, on laser video disc, and on VHS-HiFi; in all cases either as a standalone record or as part of the home video release of the movie. If I carried 20 units in each current format at my cost, my investment would be about \$100 in LP, \$240 for CD-V, \$200 for CD, \$100 for DAT, \$80 for analogue cassette, \$120 for a CD single, \$400 for laser video disc and \$400 for the VHS tapes. Obviously I am estimating a bit, off the top of my head and I don't give away all of my trade secrets, but these figures are relatively adequate as an example. I am expending \$1640 to maintain moderate stock in one store. I have four stores in different communities. That means I will spend \$6560 on one release. The number 20 is probably low so I could be spending more. If it was a new Michael Jackson effort and I was a betting man, I might stock 100 in each format or some balance in between. But, my bottom line is that I am carrying a minimum of \$6,560 per title. If I try and stock 2,000 titles in all formats in each store, I will need \$13,120,000 in operating capital. At what I pay for commercial money, I could be paying over \$1 million a year in interest. In the 'good old days' of five years ago, I stocked only LPs and a few cassettes at far less than 10% of the potential cost of multiple formats today. Now I am exaggerating the consequences of multiple formats to make my point but not so much as you might think.

We cannot cope with the cost or space requirements of the SKUs (stock control units) required to do business in multiple formats. The small independent record dealer is already an endangered species. This will finish him off."

There is a bottom line here and it is very clearly defined. There are very real limits to what the public will tolerate in the consumption of electronic entertainment. To begin with, the state of the recording industry from 1947 until 1977 is worth ruminating about. At the end of the '40s, all the players were in the same camp as it were, large and small. The development laboratories of the large corporations were working separately but eventually everybody aligned. That means that ATT, CBS, GE, RCA and many others all played a part in the birth of the LP record and its companion 45 RPM single. The RIAA, IEEE, EIA and the AES all worked towards establishing standards for equalisation and usage. Quality control in software production was the byword. Ten years later, stereophonic recordings saw the joint efforts of all the above contributors and London Decca, DDG, Electrola, EMI, Philips, Teldec and Telefunken to name a few. Everybody worked together to produce a common software for playback on common hardware to create a common good. Everybody benefited. What disputes there were occurred behind closed doors. The public was not exposed to an airing of laundry so dirty as to shake its confidence, excrementally speaking. Witness and contrast today's ugly RIAA-IFPI-EIA-EIAJ dispute over CD, DAT and notching, aired in the open chambers of the US Congress, the European Parliament and with the aid and abetment of the world's press. All we are doing as an industry today is telling the public in so many words: 'You cannot trust us. We may or may not deliver music without modification. We may or may not sell you a system that will be obsolete in five years. Most of all, do as we say but do not do as we do.'

It will be very curious to see how well the public picks up on our industry's cues. Oh well, next stop, the ROM record. □

AUDIO TEST AUTOMATION THE EASY WAY

COMPREHENSIVE AND COMPETENT: Audio Precision's System One fills audio production test needs -- at industry - leading performance levels. System One measures: harmonic, inter-modulation (including dynamic), quantization distortion and SINAD; wideband or selective amplitude and noise; phase; frequency; wow and flutter; dc Volts and resistance. Guaranteed performance <0.001% total system distortion; 0.05 dB flatness; 1.5 microvolts noise.

PAINLESS SOFTWARE: Software ease and speed may outrank performance. Tests set up in minutes via on-screen instrument panels. Acceptance limits created in minutes. Tests linked together into procedures in minutes, without knowledge of programming languages. Complete test procedures are thus done in minutes-to-hours, not weeks-to-months typical with other test systems.

PRODUCTION ORIENTED: Audio Precision's signal switchers let you test up to 192 inputs and outputs of single or multiple devices. System One supports prompts to the operator, control of device under test or external devices, graphic or tabular hard copy of test results or error tags, disk storage of test data in formats compatible with most other software.

AFFORDABLE: Best of all, System One is priced competitively with lower-performance, slower audio test systems. The savings in software development alone pay for the whole system in the first few months. If your goal is testing products rather than writing software, System One gets you there!

Call or write Audio Precision today for complete technical data and prices on System One.

Audio precision

P.O. Box 2209, Beaverton, OR 97075
503/627-0832 1-800/231-7350

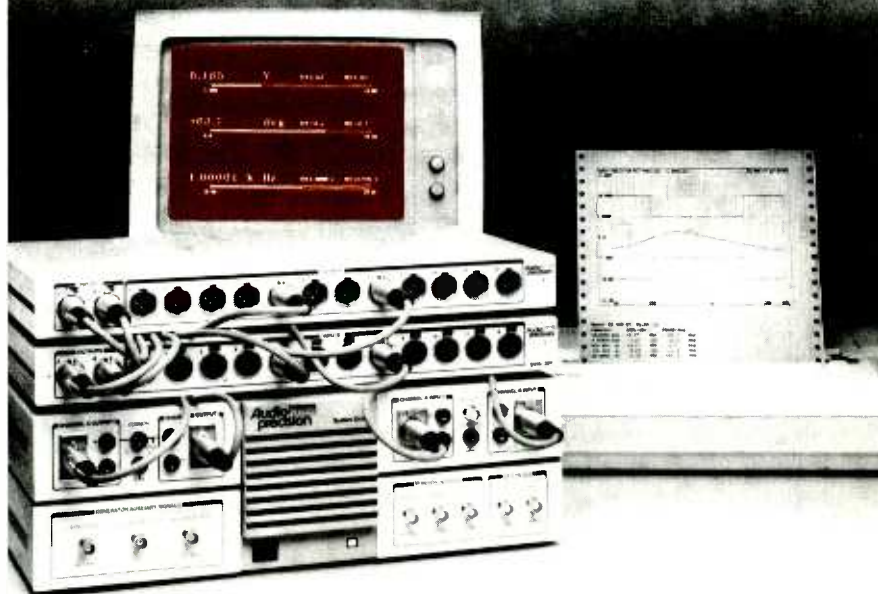

ET TA CARTE!

KIT Communication

SAJE

www.americanradiohistory.com

BARRY FOX'S BUSINESS

It happened with *Laservision* video disc, with metal powder audio tape and with *V2000* video tape. Philips demonstrated exciting new technology and generated widespread publicity but then hit technical problems and delayed sales. By the time significant quantities of saleable products reached the shops, interest had died.

Laservision and *V2000* failed commercially. Metal powder audio tape cassettes sell in miserably small numbers. Exactly the same thing happened with compact disc but the system was so good, and so heavily supported by the Japanese, that it survived the initial foul-ups that are now forgotten.

Now there are warning signs of a re-run with CD Video. If Philips put CD-V on the market before it is technically ready and before there is adequate software, the trade, press and public will rebel. But Philips have now, in the company's own words, 'launched' CD-V: in America at the June Consumer Electronics Show; in September in Britain, at a London nightclub party; and in Germany and the rest of Europe at the Berlin Funkausstellung exhibition.

"The first CD-V player," say Philips, "will be priced between £400 and £500..." and will be available "...in selected outlets in London from November, and nationwide from January."

'Selected outlets in London' spells limited opportunity to capitalise on the pre-Christmas sales boom. Post-Christmas sales time is hardly the best moment to launch an expensive new consumer electronic product. Already the pre-Christmas roll-out of CD-V in America has been postponed until the first quarter of 1988. On the evidence of what I saw of PAL CD-V both in Berlin and at the London launch, I just cannot see significant quantities of saleable players and discs reaching the shops in Britain until the spring. By then the tide of publicity will have ebbed.

At the Berlin show, only a few companies were showing CD Video and then usually in NTSC standard. Although the main entrance hall was given over to a CD-V display, most of the players were NTSC. The racks of 5 in discs were mainly audio CDs.

There were several PAL CD-V players in the Philips pavilion but picture quality varied from barely acceptable to downright awful, depending on the discs. Significantly, the same disc played on Pioneer's PAL CD-V player produced far better pictures.

There were only a very few CD-V discs

available (some 12 in, some 8 in and some 5 in) and handfuls trickled through every day from Blackburn. The Polygram publicity for CD-V singles listed a string of artists, with a catch-all caption 'Various record companies have announced they are working on releases by...'

By far the strongest commitment comes from Unitel with an impressive catalogue of opera. The plan for feature films to be marketed as 'collectible concepts' are still very vague.

At the Berlin show Philips' engineers were still trying to pinpoint the problems seen on screen from PAL 5 in discs: interference bars are caused by the motor mechanism sucking too much current from the power supply; noise, which makes the picture look grainy and adds an unwelcome swirl to saturated colours, is due to poor signal-to-noise ratio caused by inaccurate tracking of the solid state laser so it reads two tracks instead of one; dropouts (either white or black depending on the compensation circuitry used) are caused by blemishes in the pressing and faulty mastering; picture breakup and loss of sync occurs when the disc signals are not strong enough to lock the player; colour smudges are due to delay line mismatches.

Clearly the Pioneer combi PAL player has better servo control and dropout compensation than the Philips *CDV 475* combi. The Pioneer NTSC player also appears better than the Yamaha. All the Philips PAL players at Berlin carried a large yellow label on the rear declaring 'This apparatus has been assembled with piece parts from the trial run and thus not intended for measurements as it does not meet the requirements of the specification'.

In London, at the Kensington Roof Gardens launch party, most of the celebrities present probably went away boggling at the high quality CD-V pictures. But I have to play spoilsport and report that the pictures displayed on monitors round the club and back-projected on to a large screen were sourced from three separate systems: a Betacam professional broadcast tape unit, a Pioneer NTSC CD-V player and a Philips CD-V PAL player. The Betacam pictures, used for the main presentation, were of course excellent. So were the NTSC CD-V pictures screened later.

At the end of the formal launch presentation there was a brief demonstration of PAL CD-V, with Curiosity Killed the Cat's new single *Free* loaded into a Philips combi player. Because the player takes around 10 seconds to cue up, the displayed signal was sourced from a second, pre-cued PAL player behind the scenes. Fair enough. But immediately there was a marked loss of

picture quality, with a stationary interference bar right down the middle of the screen. After that it was downhill all the way for PAL CD-V.

While music industry celebrities ate, posed, danced, got drunk and wondered at the miracle of life and CD-V, the disco DJs switched between audio-only records, Betacam pop videos, NTSC CD-V pop videos and—very occasionally—PAL 5 in CD-Vs. These were immediately recognisable as embarrassingly bad. On one occasion a PAL CD-V was switched off halfway through because interference and loss of sync made the pictures unwatchable. Wisely the DJ switched the video source to a camera trained on the dance floor.

Alongside the dance floor a display of future products, including a portable clip player and CD Video rack system were—despite low key lighting—clearly identifiable as dummy mock-ups, with painted pictures instead of screens.

Philips said, at the beginning of September, that the Hasselt factory in Belgium was already producing CD-V combi players. It is worrying to think of a factory mass-producing players while Philips engineers were unable to tweak CD-V prototypes to produce PAL pictures approaching the quality of VHS tape. And how can Philips, inventors of *Laservision* who have been making video discs for over a decade, end up 'launching' a product that is clearly not ready for sale?

Reliable sources suggest that some people inside Philips and Polygram started out believing that quality did not matter for 5 in pop videos. By the time they were set straight valuable development time had been lost.

The Philips Du Pont pressing plant at Blackburn has also had problems. By the Berlin/London launch, Blackburn had pressed 60, 5 in clip titles in NTSC and 15 in PAL. Several of these were never demonstrated because the original source material was so poor.

So far all the 5 in CD-V discs have been mastered in Eindhoven and then the stampers made at Blackburn for pressing in Blackburn. But 5 in mastering equipment has now been installed at Blackburn and was due to be ready for October. This should ease the mastering bottleneck that has slowed software supply. Blackburn already masters 8 and 12 in CD-V discs as well as industrial *Laservision* (with analogue soundtrack) for both PAL and NTSC.

Currently Blackburn have many dissatisfied customers in the industrial *Laservision* field because the LV mastering facility had to shut down from May 29th through to the beginning of August due, first, to dust clogging the air conditioning system, and then holidays. The dust was caused by building work involved in installing new 5 in equipment. The air conditioning had to be completely stripped down and this has created a large backlog for industrial *Laservision* orders. But there was no pressing shut down.

Blackburn acknowledge that the quality of PAL 5 in clip pictures has been very poor, and has been trying to establish what's the fault of the player and what's the fault of the disc.

In early September Dave Wilson, customer services manager at Blackburn, said of current 5 in clip product, "We have measured the quality parameters and are now very happy with signal-to-noise ratio. Dropout levels are excellent—as good as for professional *Laservision*. But some source material is still poor."

The unspoken inference from Blackburn's guarded statements is that Philips' prototype players could not yet do justice to discs that meet the CD-V spec. This was borne out by the far better results obtained from Pioneer players. □

WHICH IS MORE INVESTING IN DIGITAL

Few people would dispute that digital audio is here to stay.

The absence of progressive degradation gives it a decisive advantage over traditional analogue. The sound quality which digital offers is increasingly demanded by record companies, producers, musicians and film makers.

Yet, in digital tape machines, the benefits are accompanied by drawbacks. The incompatibility of formats; the problems involved in editing; the uncertain reliability and longevity of temperamental tape.

They represent an unsatisfactory compromise between the technology of today and the storage medium of the past. They are unavoidably limited, both in their current application and their future upgradability.

To quote Doug Dickey of SSL, at last year's Digital Information Exchange: "Digital recording proliferates despite everything because of its inherent advantages. The worrying thing is that in the midst of all this, there lurks the spectre of what may well prove to be the most expensive round of early obsolescence ever suffered by the audio industry."

So where does the future lie? With tape, or with a tapeless alternative?

Not surprisingly, many people are biding their

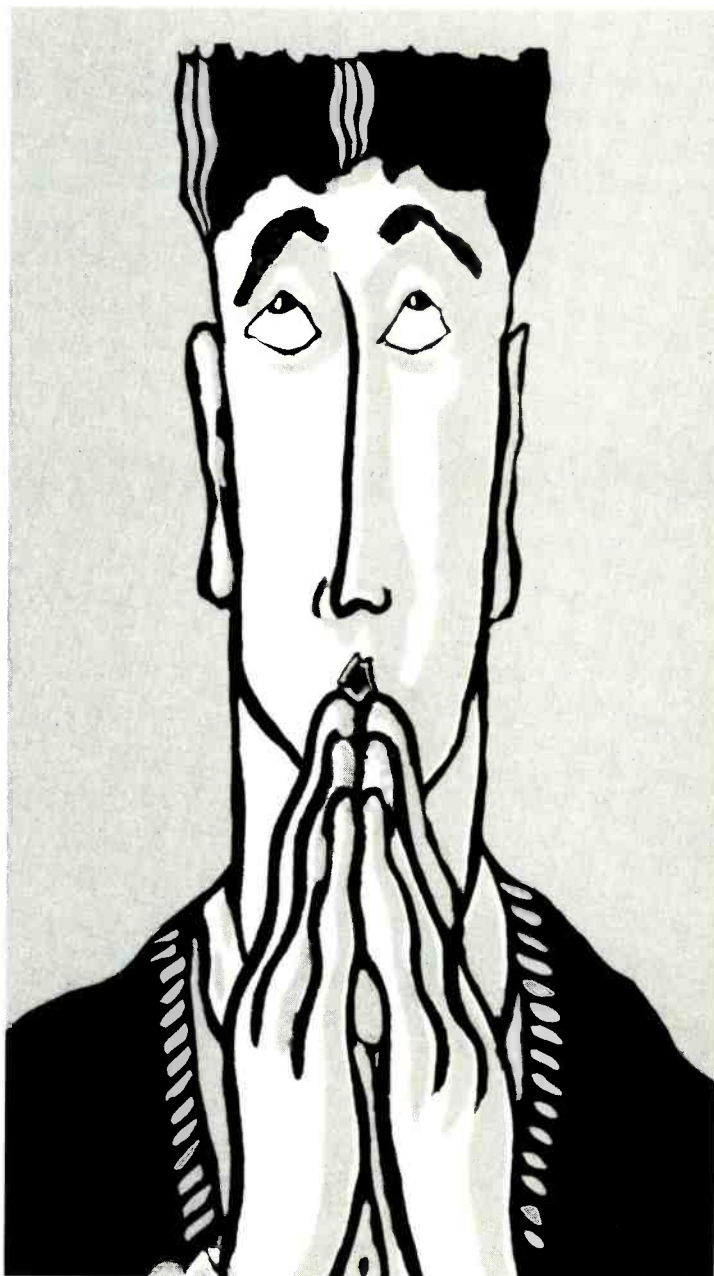

time at present. Waiting for clearer indications before putting their money on the line, in the knowledge that the decisions they make will have a fundamental effect on the direction and prosperity of their business.

But in the highly competitive environments of recording and post-production, no-one can afford

DANGEROUS? AUDIO OR IGNORING IT?



to lag behind. Going into digital too late could be as fatal as going into it too rashly.

Which way is up?

Sitting on the fence is a position which becomes more and more uncomfortable, the longer you try to maintain it.

The sooner you can invest with confidence and start acquiring experience and a reputation in the new technology, the better. That confidence, however, relies on three essential factors.

The immediate ability and dependability of the system. Its potential for future development and expansion. And the credibility and capacity of the company which created it.

You have no doubt spotted the Synclavier logo at the bottom of the page, and by now your eyebrows have probably gone into vertical take-off.

But if you really want to be surprised, you should arrange a demonstration of the Synclavier digital audio system and the Direct-To-Disk[®] multitrack recording system, by calling David Whittaker or Yasmin Hashmi on 01-202 4366 or sending the coupon to Harman UK, Brent View Road, London NW9 7EL. In Germany, you should call Harman Deutschland on (071) 813400.

What you will see and hear could make a very dramatic difference to the way you view the options that are open to you.

Synclavier[®]
DIGITAL AUDIO SYSTEM

Please send me information on the Synclavier and Direct-To-Disk systems Please call me to arrange a demonstration

NAME _____

ADDRESS _____

TELEPHONE _____

COMPANY _____

POSITION _____

SS/11/87

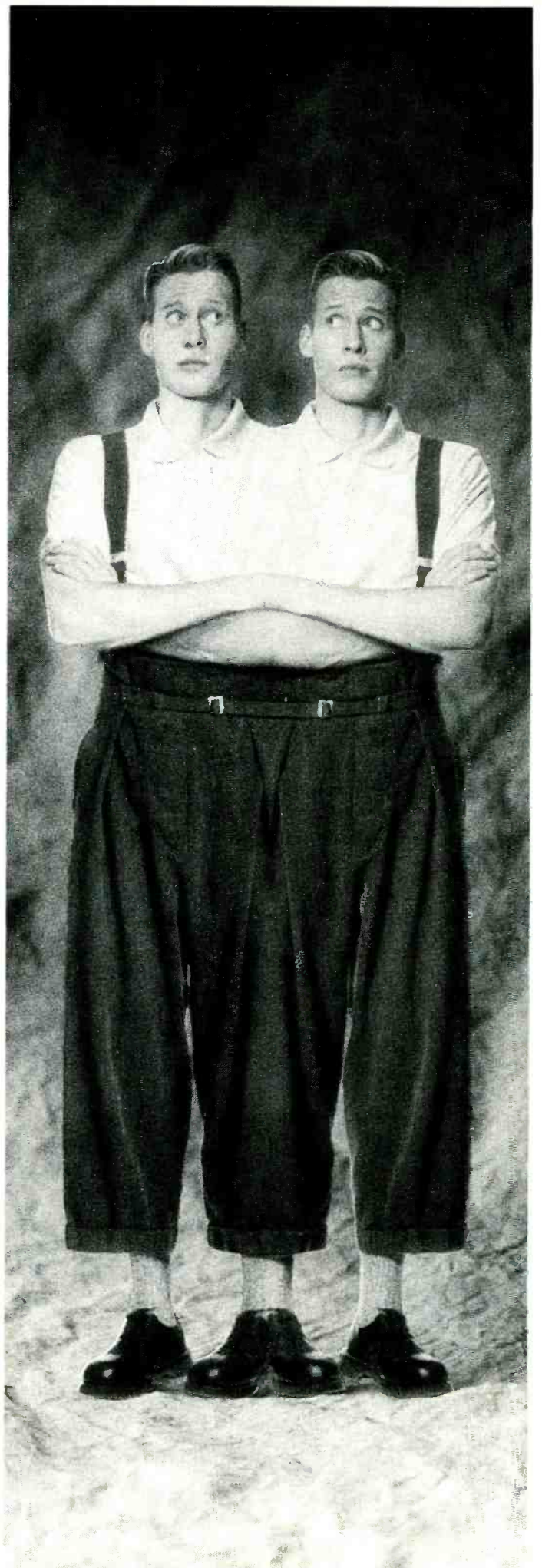

B.S.S. AUDIO LTD, 202-208 NEW NORTH RD, LONDON N1 7BL (01) 226-0099 FAX: (01) 354-4940 TLX: 265612 IMC. BSS-UK U.K. DISTRIBUTORS Autograph Sales Ltd London (01) 267-6677 Stirling ITA London (01) 625-4515 WORLD WIDE AGENTS - Australia Syntec Regiscene Paris (01) 4396-5050 - Greece Ban Studios Athens (01) 363-3572 - Holland Ampco Maarssenbroek (30) 433134 - Hong Kong Tom Lee Music Co Hong Kong (3) 722-1098 - Indonesia Pt. Auwindo Merien Prima Jakarta (021) 323029 - Israel MOR (02) 11-4085 - Portugal Casa Cais Oporto (02) 384456 - Singapore Lingtec Pte Ltd Singapore (03) 747-1951 - South Africa Cokosseum Acoustics Johannesburg (11) 234541 - Spain Lexan Barcelona (03) 203-4804 - Sweden Intersonic Stockholm (08) 744-5850



AT LAST. SIGNAL PROCESSING THAT ISN'T GATED, DIVIDED OR LIMITED BY CONVENTION.

BSS equipment does much more than just process signals. Everyday tasks are merely the starting point from which we've explored signal dynamics. And some startling ideas have resulted.

The **DPR-502** is our new 'intelligent' 2-channel MIDI noise gate. Besides providing unusually accurate and responsive control functions, it expands on the expected with some rather exceptional features.

Like switchable Auto Dynamic Enhancement (ADE™)

which subtly enhances leading edge transient information. And Key Level Metering – a unique, simultaneous peak and average LED array which displays the signal level in relation to the 'gate open' threshold.

With bi-directional MIDI, the DPR-502 generates and receives MIDI data including input velocity – making it possible to replace recorded sounds with dynamically-matched samples.

The **MSR-604** is a highly versatile Active Signal Distribution system. Each of its four channels supplies low-noise balanced and buffered feeds to two mixing positions and two other facilities, such as broadcast and mobile recording.

With phantom power and remotely-switchable gain, the MSR-604 completely overcomes the problem of supplying multiple feeds from a single source.

The **DPR-402** combines compression and de-essing with peak limiting. It gives the control and flexibility of multifaceted dynamics processing, without the usual compromises in signal clarity and user complexity.

Its unique double side chain architecture (with a parallel VCA control path) brings real audible benefits. And with internal high and low pass filters inserted in the control chain, you have unprecedented problem-solving power.

You'll find all BSS Signal Processing is a step beyond conventional designs.

Because convention is something we'd certainly never allow ourselves to be limited by.



Sydney (02) 406-4700 - Austria Audiosales Mödling (2236) 26123 - Belgium T.E.M. Dilbeek (02) 569-1823 - Canada Gerr Audio Toronto (416) 868-0528 - Denmark SC Sounds Taastrup (02) 998877 - Finland MS Audiolab Laittanti (90) 0566-4644 - France Productions Tel Aviv (03) 454-003 - Italy Audio Link Parma (0521) 398723/4 - Japan Edgetech (Japan) Ltd (03) 295-4731 - Korea Young Nak So Ri So Co Seoul (01) 267-8987 - New Zealand Maser Auckland (09) 444-358314 - Norway Lyd Rommet Oslo Switzerland WA Guenther Zurich (01) 391-3939 - Thailand Mahajak Dev. Co Bangkok (02) 2517-417 - Turkey Netan Istanbul (01) 160-4514 - U.S.A. Klark Teknik, Inc. New York (516) 249-3660 - West Germany Audio Vertrieb Quickborn (04106) 69999

an Edgetech company
LONDON • NEW YORK • TOKYO

Three years ago the name Puk simply inspired silly jokes about the connotations of its English pronunciation. Nowadays it represents one of the largest most adventurous and luxurious residential recording facilities in Europe.

The original Puk Studio One created a ripple of interest throughout the recording world partly because of its sheer size, partly because the mixing console was the new Calrec UA8000 music console and partly because the monitoring system was the biggest monster ever to come within 100 miles of a studio's control room. (See *Studio Sound*, November 1985.)

Since that first facility, designed by Andy Munro, the project has spawned a second identical recording studio, four 3-bedroomed houses and a leisure facility, the like of which no other studio in Europe begins to approach.

A remotely located studio in Denmark had a lot to learn

PUK TWO

Denmark's Puk have realised the need to entertain and accommodate visiting artists, in a big way. Janet Angus visited as they were about to open Studio Two and extended leisure facilities

about the needs and demands of international clientele, a fact which the people at Puk readily admit. The original accommodation at the studio proved inadequate and attempts to house bands in local hotels was even more unsatisfactory. Remote Danish towns and villages simply do not know how to cope with international rock stars and their lifestyles.

There was only one thing for it, build accommodation facilities to match the studios. The four terraced houses were designed by the studio's architect Mogens Hansen in bright and comfortable Scandinavian style. Each has three bedrooms, shower room, a kitchen/dining area and living room with Bang & Olufsen hi-fi/video/TV system including satellite reception. Furnishing is again consistent with the Danish manner with leather suites, marble coffee tables and comfortable beds, etc. Whitewashed on the outside, the walls are brick and pine painted white on the inside.

"If you're wondering why there is no bath in the bathroom I'll show you," said Puk, the studio's owner, mysteriously.

Located at the end of the row of houses is a large new building. 'This is a barefoot area' says the notice on the door. Inside it's relaxation heaven. Two saunas, jacuzzi, sunbed—all with variable mood lighting—table tennis and snooker rooms, gym area and, pièce de résistance: the indoor heated swimming pool with luxurious poolside furniture and windows all round overlooking the in-the-process-of-being-landscaped garden and fields beyond.

Puk (real name John Quist) decided to carry his almost maniacal search for the ultimate through to the recreation facilities. As he said, it's difficult to explain on paper just how fabulous these facilities are. "We can write that we have a swimming pool, but so what? Big deal. You can't tell people what it is really like. It is good for band members to escape from each other and the control room if they want. It's good here in the summer, but imagine what it will be like in the winter when you sit in here and see it is snowing outside and it's all warm and lovely in the pool."

There is also a small kitchen and upstairs is the snooker room and gym and a seating area overlooking the pool.

No expense is spared: the small chandelier-type light at the pool side alone cost £2,000. In all, the houses and recreation centre have cost the studio in the region of £1 million. Is it really worth investing that kind of money?

"If we get lots of clients, yes; if we don't, no! The point is the old accommodation we had was not good enough, and bands get tired of hotels. This is more private. As a studio we need to be completely self contained and we want to attract the sort of clients who really appreciate something like this."

The taxman apparently took some convincing that it was a business expense and not purely for private use. Danish taxmen also have a problem understanding the international recording market.

Bearing in mind the fact that most of the world thought Puk was pretty mad to spend the sort of money represented solely by Studio One, the fact that there is now Studio Two and all this accommodation just begs the question, where on earth has all the money come from?

"We don't have to respond to an outside investor wanting to make lots of interest on his investment. We have bank loans, mortgages on the houses, etc, and we are able to re-invest as much money as we like. We didn't plan all this in one go. Three years ago it was only going to be the one studio."

Studio manager Mogens Balle dismisses everything in six words: "It's just the way Puk is." He always starts out with fairly modest ideas and they just escalate.

Three years on, the 5-way monitoring system, 'designed for digital', has been receiving a favourable response from visiting engineers. Comprising two 30 in and two 15 in Postex, 8 in JBL, JBL 2445 and a Postex tweeter per side, quite apart from anything else, at first sight it looks pretty frightening. At the



AMEK *Angela*

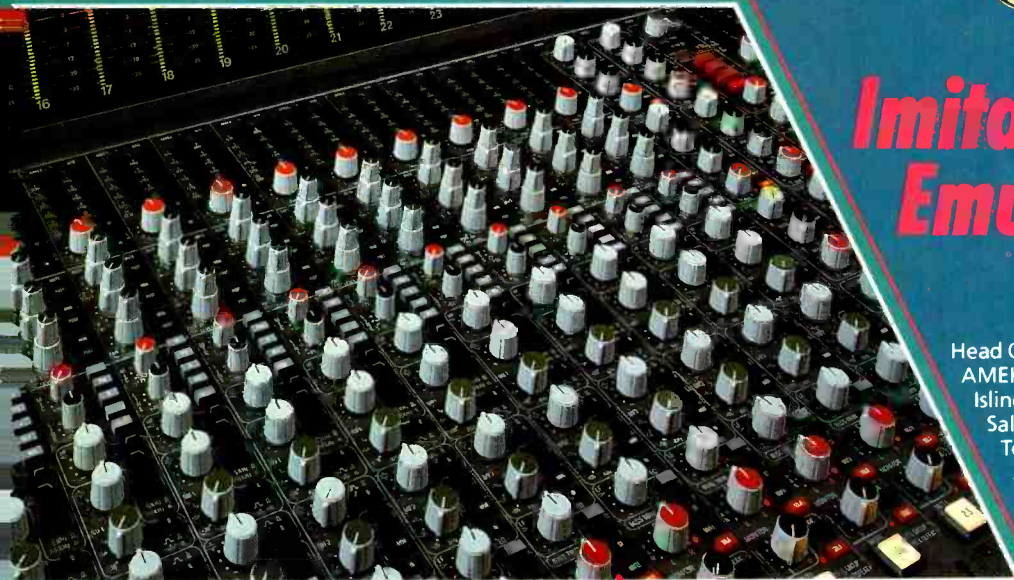

Imitation and Emulation

Today, the mid-range console market is crowded with manufacturers who want to fill the space in the middle of your control room with their console.

Each one of them has a marvellous claim about specifications, low-noise performance for digital, flexible signal path, strength of mechanical construction, equalization, price, ergonomics, multiple inputs, high-quality components, superior technology, and how they consulted a hundred top engineers before they set pen to paper.

Let them claim. We wish them well. Fashions come and go; our emphasis is on engineering. There are now over 180

AMEK ANGELA installations worldwide. We set the standard in ergonomics, performance, specifications, equalization and build quality. Imitation is the sincerest form of flattery. Emulation is a little more difficult.

Actually, we admit one concession, but not to our competitors. The new 1987 ANGELA is now finished in grey, to harmonize with the rest of the AMEK product line. Otherwise, ANGELA is still available in 3 chassis sizes each with onboard or external jackfields, giving 28 to 62 dual-channel i/o modules (ie, 56 to 124 inputs, plus returns) and a choice of either 24- or 48-track monitoring in the larger versions. Manual or VCA faders are the standard options, and Audio Kinetics 'Mastermix' is the recommended automation package.

Head Office, Factory and Sales:
AMEK Systems and Controls Ltd,
Islington Mill, James Street,
Salford M3 5HW, England.
Tel: 061-834 6747. Telex: 66127.
AMEK G E-MAIL : AMEK-UK.
Fax: 061-834 0593.

In the USA: AMEK Inc.
10815 Burbank Blvd.
North Hollywood,
CA 91601. Tel: 818/508 9788.
Telex: 662526 AMEK USA.
E-MAIL: AMEK-US.
Fax: 818/508 8619.

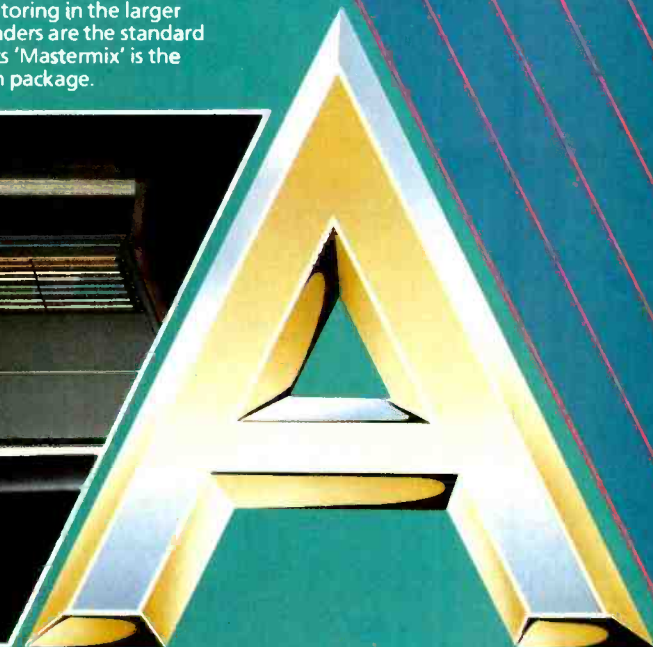

time of its installation, Andy Munro described it thus: "It is driven by a 5-way amp system consisting of custom-built SLT MOSFETs in bridge mode, very carefully quality matched and giving a total power of something like 4,000 W per side. It is designed to give peak transient sound pressure levels in the region of 140 dB with comfortable maximum SPL of 130 dB. The point is not to generate sound pressure levels of 140 dB but to get a minimum headroom of 10 dB even on what would normally be considered to be peak levels."

Balle explains that on first arrival clients tend to be very sceptical about the monitoring. "After all, the bass driver is the size of a jacuzzi. But they get used to it and use it more and more."

Puk: "Everyone in the industry is talking digital—digital quality, special microphone leads, 16-bit versus 18-bit, special microphones, talk, talk, talk—all that, and then they listen on a pair of 2,000 DK (approx £180) speakers. That's because most of

high bass really clearly."

"The problem for many studios is that they simply don't have the room to build it," continued Puk. "The way people worry about the Fairlight being 16-bit and then record on digital, which is only 20 Hz to 20 kHz is silly; why isn't it good enough?"

"It doesn't matter what speakers you prefer to balance on, you need a good analytical system as well. Our system is just one of the theories of monitor speakers but you just have to listen and your instinct says it's right. The resolution is so much better on the big systems so your mix will also sound good on small speakers. People should stop going on about all the other elements in the chain until they sort their monitoring out because what people are listening on at home is better these days too."

Those with good memories may recall that in September '85, a few months after the opening of Studio One, the old Puk 16-/24-track facility adjoining it burnt down. A short in a lead underneath the multitrack resulted in very near disaster.

It was 3.30 am, and Puk was going to bed: "The light went out. Thinking it was just the bulb I went out into the hall but the light there wasn't working either. So it must be the fuse but I couldn't push the lever back up. I went in search of a candle in the kitchen next to the studio. Suddenly there was such a loud bang from the studio. I opened the studio door and there was so much smoke and so much heat. I tried to phone for help but I couldn't see the phone to dial the numbers. They seemed so slow to come—it took them 12 minutes and after six I phoned them again: 'What are you doing? We are burning!' Then, when they arrived, the firemen threw the *Synclavier* and Fairlight and all this equipment out of the window and started pouring water all over it! It was just terrible."

The happy ending of course was a brand new Studio Two built in the mirror image of Studio One. The control room, apart from being reversed, is identical to One in every way except the mixing console: this time it is SSL. Puk naturally didn't intend it this way but as usual he just got carried away. The initial concept of a big control room with relatively cheap equipment ("It's easy to update equipment, but not rooms") just grew.

"Puk's policy," laughs Balle, "when he can't choose between two things is just to buy them both. We had lots of clients asking about SSL. It was not an easy decision but we are very happy with it. We were going to go SSL with analogue multitrack but of course ended up with digital (Sony 3324). At the time we were really Mitsubishi enthusiasts but having both types of machine we now know that both are brilliant. We have two Mitsubishis (enabling safety copies, etc) and three Sony (for the number of tracks) machines. We originally thought that one Fairlight would be enough but it didn't work. A band either wants to use it or they don't and if they do they want it all the time, so we had to get another. The series *III* is very fine and the sampling quality very good."

Puk: "When the Calrec computer is ready we will get it and we will also get the new SSL computer. Of course we will get it. A lot of English engineers have grown up with SSL. Producers and engineers want to work with a piece of gear that they are familiar with. Having said that all those who have worked with the Calrec console love it and our *MasterMix* is brilliant: it's fast and really good."

The SSL console, in order not to disturb the acoustics of the room which were designed with the Calrec in mind, is a 64-frame with 56 channels plus patchbay, making it exactly the same surface width as the Calrec. Otherwise, the outboard equipment is as abundant as that in Studio One. The recording areas are different: three rooms, an isolation/programming room off the control room and a piano room behind the control room as in Studio One. The only difference between the piano rooms is that Two has less glass in it.

Balle: "The room faces west and we didn't want it to get too much sun, it would be too hot to work in." But surely the sun rises in the east? "Yes but bands get up late. We have a joke out here that Puk thinks the sun rises in the south because he gets up so late."

Long debates on how to make the two facilities look different didn't get them anywhere—even a change in the colour of the fabric could not be agreed upon. After all Studio One has gone down so well, why change a winning formula? □

Puk Recording Studios aps, Kaerbyvej 65, 8983 Gjerlev, Denmark. Tel: 6 47 46 00.

PUK TWO

the big systems are not reliable enough and they aren't spend all that money on a big system that might not work. Our system is flat down to 17 Hz, and it is the only system to do this."

Balle: "The woofers cross over from 30 in to 15 in at 100 Hz; by using the 30 in with frequency response 20 Hz to 100 Hz, we have taken the strain off the 15 in and so can reproduce the



Studio Two



Control Room Two

The art of shaping sound.

SONEX is a high-performance acoustical foam that upgrades your studio inexpensively.

Ideal for a temporary isolation booth, it can also eliminate slap echo and harsh resonances in the main room or silence noisy tape equipment in the control booth. Write for our color brochure today.

SONEX is manufactured by Illbruck and distributed exclusively to the pro sound market by Alpha Audio.

Alpha Audio
2049 West Broad Street
Richmond, Virginia 23220 USA (804) 358-3852
Telex 469037 (ALPHAUD CI)

Acoustic Products for the Audio Industry



HARDWARE HOUSE

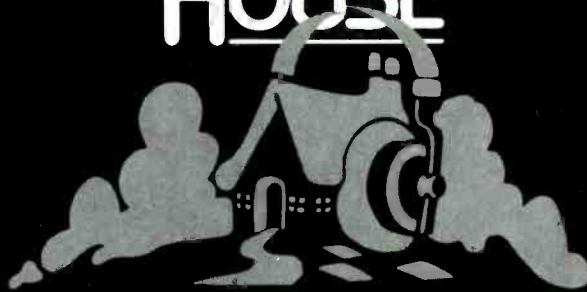

**10 YEARS EXPERIENCE
IN LIVE PERFORMANCE SOUND**

- Equipment Rental and Sales •
- Specialist Radio Mic Applications •
- Sound Design and Engineering •

Share our experience · Contact us on:

01-986 6111

West Works Chalgrove Road
London E9 6PB
Telex 265871 Attn. DG5 2220
E-Mail Hardware-UK

Distributor for
The Hackney
Cab speaker
System



A member of the Association of
Professional Entertainment Hire
Companies

Dealer for AKG, Amcron, Beyer,
Countryman, Electrovoice, JBL,
Samson, Sennheiser, Shure, Yamaha.

"This amplifier was the best tested of its power rating."

Hi-Fi Choice



"This very powerful, professional amplifier has passed the critical listening test associated with more delicate exotics intended for 'audiophile' hifi use. Lab performance was very good, while the load tolerance was fine, and the power output exceptional. Its very good sonic rating probably means that *this amplifier was the best tested of its power rating*. Given its high standard of engineering, it represented good value and is recommended."

Hi-Fi Choice

"With an explicit presentation, the speed and dynamics of good programme material was reproduced well, with a low fatigue factor. Overdriven, it clipped well showing a peak sound level rather greater than the specification suggested."

In conclusion, while this amplifier can be used for workhorse duties due to its generally durable design and professional build quality, its metier was undoubtedly in monitoring applications where an accurate programme transfer to the speaker system is essential. Large enough for almost all monitoring setups it offered a high standard of sound quality which rated well above the norm. With that special performance in mind, plus the good load tolerance and the programme power of some 400W per channel, eight ohms, or 800W, four ohms, this amplifier gets a firm recommendation."

Sound Engineer & Producer

Designed and manufactured in Great Britain by

TANNOY

The Bilton Centre, Coronation Road, Cressex Ind. Est.,
High Wycombe, Bucks. HP12 3SB
☎ 0494 450606 Telex: 83251 TANNOY G

Even from his earliest recorded output Mike Oldfield has had a reputation for doing things himself. Although *Tubular Bells* was not the first 'one man' album, it has probably been the most successful and quite clearly redefined the use of the term 'solo album'. His career has continued with a succession of albums since those heady days of the early '70s, all largely using the similar working technique of solo operation. As is almost the norm these days, successful artists look to set up their own recording facilities and this was something that Mike did in the mid '70s—a time when this was not so usual, certainly not on quite the scale he did. For a solo artist easy access to recording equipment is a must as working methods can be far more time consuming. For these reasons Mike Oldfield has invested a great deal of money in recording equipment.

The majority of his recording is now completed in his own facility although not exclusively so. At the time of writing he was in the process of planning a new studio to house his equipment, which in the meantime is spread throughout a number of different locations. The new studio will also house Mike's other interest—video—and he hopes it will allow him to further his experiments in combining audio and video as a single medium.

By the time you read this, the first new Mike Oldfield album

for several years—*Islands*—should have been released and from the recording aspect alone this will be an interesting listen. During the last 18 months he has changed his console for a Harrison series 10 and Dolby SR has been added to the tape machines. With this combination of equipment, representing something of a peak in analogue recording equipment development, it seemed a good idea to ask some questions about the series 10 and Dolby SR and how this may have changed working practice, if at all, for someone who is very closely involved with both the musical and technical sides of recording.

Background

The album Mike has just finished has taken about two and a half years to complete although this was not continuous working time. As if to contradict everything so far, some of the early sessions for the album were recorded 'live' with other musicians playing in the studio using his previous console and without any form of noise reduction at all. With the arrival of Dolby SR these recordings were copied SR encoded and parts have been edited into later recorded material, particularly the instrumental title. This may give some indication of the type of material the album includes—a mixture of songs and a long complex instrumental with multiple musical changes that involve complete changes of instrumentation tempo and about every other musical change you can make—a complete mixing nightmare! To make life more difficult Mike also decided to use different producers for different tracks across the album.

Working

With so many other changes is this album also in the solo tradition?

Mike Oldfield: "Yes, but these days it has become more of a case of sitting down with the Fairlight. I spent three months in Switzerland just doing the programming."

This is a little more understandable when you listen to the 20 minute instrumental *Wind Chimes* and the wide variety of instrumentation such as tympani, oboes, bassoons, and other traditional acoustic instruments, and are told that these are all samples played from the Fairlight. In fact there are not many acoustic instruments on the track at all.

At present, the Fairlight is always recorded rather than being sync'd to the track. This is a pattern of working that Mike has adopted from the time when the Fairlight software would not SMPTE chase—something very necessary for this work style.

"Maybe on the next album I won't record the Fairlight but if you have been working on a sequence for a week and you can put it down on tape it is one less thing to worry about." In fact the Fairlight is probably the most demanding thing in numbers of channels that the series 10 sees in its record mode with up to 16 inputs involved. These will then be submixed dependent upon the content. If they are keyboard-type parts they will normally be mixed down to two tracks while bass or percussion tracks will be kept separate.

With the recording of the Fairlight and the fact that most of the instruments are played by Mike, this would tend to suggest that several multitrack machines are being used but you would be quite wrong. The sole multitrack is a 24-track Studer A800.

I think that people always regret using a large number of tracks. I always say: 'Make a decision, burn the bridge so you can't go back.' It reduces your choices and saves you time

Coinciding with a new album, Mike Oldfield talks to Keith Spencer-Allen about analogue recording and his choice of console

MIKE OLDFIELD'S NEW PASTURES



YOU PROMISED YOURSELF A NEW 2" OTARI RECORDER, ONE DAY. TODAY IS THAT DAY.

There's a difference between Otari's new MX 80 and the 2" machinery on offer from other manufacturers.

And it's a difference your accountant's just as likely to notice as your clients.

For a start, the MX 80 offers a full choice of formats. From 16-track, through 24 tracks and right up to 32.

Features like Dolby HX-Pro, serial remote control, gapless, seamless punch in/out and a built-in mini autolocator make it perfect for the true professional.

And with options like an overbridge that can take Dolby A and SR racks, you can even

start to rival the digital boys.

But here's the surprise. Otari's MX 80 is so keenly priced that a go-ahead studio like yours can probably afford it right now.

So could we advise you send for details or ask for a demo right away?

If you've always wanted an Otari, it would be a shame if you ended up on a waiting list.

OTARI®

Otari Electric (UK) Limited
22 Church Street, Slough, SL1 1PT, Berkshire.
Telephone: (0753) 822381. Telefax: (0753) 823707
Telex: 849453 OTARI G

Otari Corporation,
2 Davis Drive,
Belmont, California 94002
Telephone: (415) 592-8311
Telefax: (415) 591-3377
Telex: 910-376-4890 OTARICORP BLMT

Otari Electric Co Ltd,
4-29-18 Minami-Ogikubo,
Suginami-ku
Tokyo 167
Telephone: (03) 333-9631
Telefax: (03) 331-5802
Telex: J26604 OTRDENKI

Otari Singapore Pte Ltd,
625 Aljunied Road,
07-05 Aljunied Ind,
Complex Singapore 1438
Telephone: 743-7711
Telefax: (743) 6430
Telex: RS36935 OTARI

Otari Electric Deutschland GmbH,
Rudolf Diesel Strasse 12,
D-4005 Meerbusch 2
West Germany
Telephone: 010 49/2159/50-861, -862 or -863
Telefax: 010 49 2159 1778
Telex: 8531638 OTEL D

FRESH AIR NEW AUTOMATIC GRAPHIC EQUALIZER

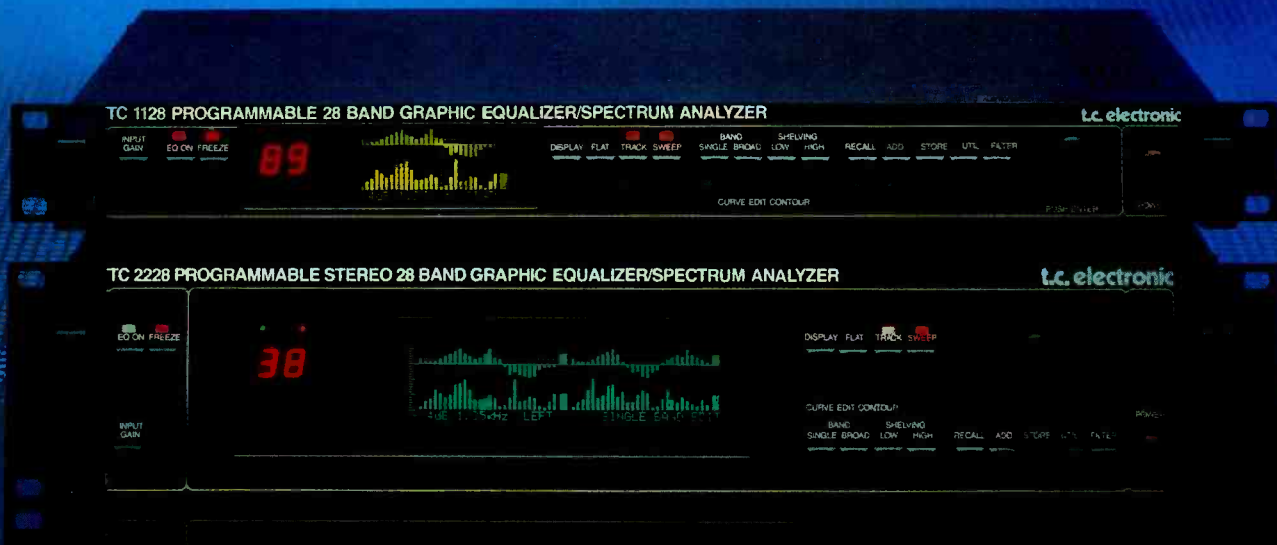

When you switch on this new TC unit you will discover that you are in possession of an exciting innovation.

What we mean by this is that the new TC graphic equalizer is the first EQ that takes an active part in sound engineering whether in recording studio, in sound reinforcement or in sound contracting. The TC 1128/2228 gives maximum acoustic control like never before.

100 percent offer you the ability to store your

favorite EQ settings facilitating high speed A/B tests. This TC EQ can also change settings by reading SMPTE code (optional feature) thereby killing unwanted clicks etc. and maintaining full dynamic control by negotiating the use of processing devices. ITS WHAT WE CALL THE FRESH AIR APPROACH.

The TC 1128/2228 has AUTOMATIC ROOM SETTING with a built in spectrum analyzer. For sound reinforcement it can be midi controlled

allowing any number of EQ's to be linked together, with a full status over AUTOMATIC FEEDBACK SEARCH AND DESTROY.

Dynamic range: more than 110 dB. THD: less than 0,002%, Frequency response: 10-100.000 Hz +0/-0,5 dB, 28 bands 1/3 octave filters on iso centers, +/- 12 dB or +/- 6 dB, 1 or 1/2 dB steps, Highcut and lowcut filter.

Send for literature.

OF DENMARK
t.c. electronic

U.K.: STATE OF THE ART DISTRIBUTION, STUDIO HOUSE
HIGH LANE VILLAGE, NR. STOCKPORT SK6 8AA, PHONE: 06636 2442 FAX: 06636 2328

WEST GERMANY: 08157/7677, DENMARK: 06262800, GREAT BRITAIN: 06632/2442, SWEDEN: (031) 134950, NORWAY: (033) 26798, HOLLAND, BELGIUM, LUXEMBURG: 003110-4588166, AUSTRIA: 00498157/7677, ITALY (02) 5084.1, FRANCE (91) 498728, SPAIN: 91-4426426, USA: (201) 384-4221, CANADA: (416) 727-1951, JAPAN: (03) 329-8051, AUSTRALIA: (03) 6992388, FINLAND: 90-814133, GREECE: 01-3628541, SWITZERLAND: 073/226616.

And worse still: before there was chase lock on the Fairlight a further three tracks were being used for code, leaving just 21 for audio recording.

"I think that people always regret using a large number of tracks. For a start you have to wait for the slave machines to lock up. Drummer Simon Phillips (who co-produced *Wind Chimes*) was telling me about some sessions he has played on where they have had four or five slave reels and so the producer sits at the desk and says, 'Let's try this track with this drummer, this bass guitar and this guitar. No! We don't like it so let's try these drums with this bass and this sax solo!' It really must get out of control. It is nice to have some limitations. I always say 'Make a decision, burn the bridge so you can't go back'. It reduces your choices and saves you time."

Does this mean then that Mike sees the recording process as the creative side and the mixdown as just the balancing aspect?

"No, the mixing is creative but I like to be able to listen to the recording with the faders static and have at least a rough mix. The tape should be completely clean and if something is not needed then I would erase it. In the mix I just want to adjust and fine tune."

One could have assumed that using a console with the dynamic automation possibilities of the series 10 it would have been very tempting to leave alternate or additional tracks on the tape to keep some options open at the mix stage but Mike prefers to use the mix automation in a rather more creative way, which will be mentioned later. And although with SR tape noise is no longer a problem on long instrumentals, all the non-active tracks were muted on the series 10 so it was possible to check that everything was working and make sure that it could be mixed in one pass.

Working with SR

"I was quite happy using no noise reduction but it did mean that when mixing you had to go through muting everything. And also adding top was a problem. Music (recorded) has a lot more top these days and with SR you don't have to worry about boosting the high end, especially on an instrument such as a bass that doesn't have much of a high end to cover up any hiss. As a result I have never had so much top on an album as this. I felt that my last two albums were not as bright as other people's probably because they were working digitally and could add top on everything but using the Dolby SR I have not had to worry about that."

Were there any line-up problems at all or any other operational difficulties?

"Well it's the main thing about it—just plug the cards in and there are no extra things to worry about because of SR. I think the worse thing about using it was that you could hear the noise coming from other places such as mix channels, compressors and the EQ. I found that I was listening for that."

Did Mike have any comments about the increased headroom or improved transient response? Did it make working less level-conscious and therefore quicker?

"Only on drums. I used to watch levels very carefully otherwise the snare drum sound would really suffer but it isn't a worry now. For other instruments I have got used to playing to the meters anyway."

The SR cards were also carried between several different studios and apparently there were no compatibility problems at all.

Mike: "There's not a lot to say about them, is there?"

Perhaps not on the operational side other than the fact that they work well. Mixdown was made to three different machines—Sony PCM 1630, Ampex ATR100 with SR and a Studer DASH machine. Mike's comment was that he couldn't tell the difference between the finished mixes on any of them when using AB'ing.

There is also the possibility of not decoding the recorded track. This was done accidentally on one track and left that way because it sounded good—the encoded sound sounding less processed than even Dolby A.

At this point it should be asked why he had not considered digital multitracks since they would bring many of the advantages he was looking for. Was this a conscious decision?

"Yes, I don't like them. To be honest they sound distorted to



MIKE OLDFIELD'S NEW PASTURES

my ears. On this album one of the SR tapes was copied to a digital format for a producer who worked with one but I was really disappointed with the results and it was remixed from the SR tape. We cut the album at Tape One on a Neve digital console. At that stage going to digital format does not seem to make very much difference but at the multitrack stage it does.”

Mike’s method of working also involved many multitrack edits and as such the ability to remain in the analogue domain makes life much easier.

The series 10

The series 10 is a major step on from most other console designs but it does seem to demand some adjustment from the user to accommodate its potential. How long did it take to get the feel of it?

“Well, it’s a really different machine and I think it took about two months to become familiar with it. For a start it is really two desks depending on whether you are looking at the left or right side, and that can drive you mad. Also getting used to the fact that a knob isn’t a knob but a controller was difficult. But the more you work on it, it becomes instinctive and then it becomes a miraculous machine—a dream come true.”

Most of the talk about the Harrison has centred on its mixdown abilities. What is it like as a recording desk?

“Well, I’ve only ever recorded myself on it. I would imagine it would be a nightmare for an unfamiliar engineer to record a live band.”

Did this give any problems at all with the different producers that Mike was co-producing with as presumably they would not so easily be able to be part of the technical aspects?

Mike: “It was funny really. Some of them were really scared of it, ‘How do I put some top on the guitar?’ It didn’t really

restrict their input as I was operating on the desk and we were working together.”

Having had one of the first series 10s there were a few software problems (surprise surprise) initially but that was quickly remedied and apparently works very well now.

One aspect of the console that some people have expressed doubts over has been the large number of LEDs per channel that indicate various functions; they look slightly intimidating, initially. How is it in practical terms?

“They are all colour coded and you really just get used to it. You soon know for example that an orange LED means that it’s reading something back from the computer. There are also buttons that have different functions depending on how they are pressed but you do become familiar with the technique. I would have taken three days to mix a single but with the series 10 it takes about half a day now and I can still come back and change just one thing.”

I was interested to find out if Mike still thought in terms of recording and mixing with the series 10 and whether there was a dividing line between the two activities. Or was it that he was able to use the automation on both? The answer lies in the different types of automation that the desk can offer—realtime and snapshot—and they use whichever is the more appropriate. For example, when recording it is possible to use automation on your monitoring, or rather record those settings to memory. Mike will quite frequently use snapshots for verse or chorus settings on the console that can be recalled or reset from memory when required. In cases such as these he would use snapshots rather than realtime automation because it is quicker than having to give the tape a 10-second pre-roll for the desk to get into gear when you are working on a simple five second section.

“There were certain sounds that I discovered—they were a combination of Fairlight and Kurzweil MIDI’d together and they all had their specific settings on the Harrison. It was then easy to bring back that setting whenever I wanted it for other tracks as well. I have got into the habit of saving anything that began to sound right and then that would be used as the basis for mixing.”

Although we only touched on the subject, the series 10 also allows control of the input patching, or as Mike put it “everything apart from the aux masters”.

Turning to the mixdown, particularly on the very long instrumental, it is obvious that this will present quite a challenge even with the series 10. Previously, these titles would have been edit mixes but now the aim is for the continuous run.

The console is obviously very helpful when mixing with such intricacy but how long did *Wind Chimes* take to mix?

“It took about three weeks—something like that—and in the end the size of stored data got so large within the 10 that if you wanted to change one pan position you had to wait two minutes afterwards for the instruction to be merged with the mix.”

Hardly a surprise that three weeks worth of instruction to the console for a 20-minute track should slow operation down but Mike says that he has been talking to Harrison about the possibilities of a sectional mix mode where you can work on just a small section at a time and then merge the one section into the main automation data rather than every single automation change as it occurs. These only become a problem, of course, when the automation is rather stretched by people working on long instrumentals with multitudinous changes.

“The only problem that we now have is the auxiliary

The series 10 is a really different machine and I think it took about two months to become familiar with it. But the more you work on it, it becomes instinctive

YOU AND SUCCESS . . . Are you getting all set for success in 1988? Then **APRS 88** has to be in your planning. The 21st annual **APRS Exhibition** will take place once again at Olympia 2, London - one of Britain's finest exhibition centres. Get the date in your diary NOW! 22-24th June, 1988.

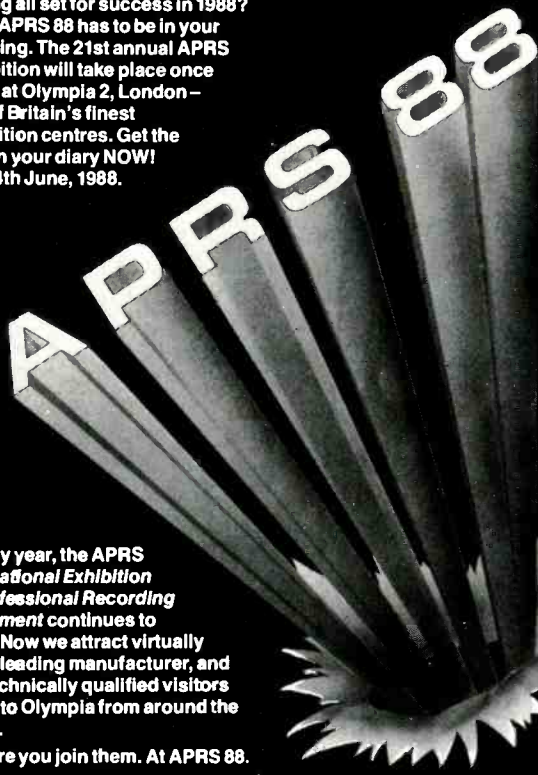

Year by year, the **APRS International Exhibition of Professional Recording Equipment** continues to grow. Now we attract virtually every leading manufacturer, and our technically qualified visitors come to Olympia from around the world. Be sure you join them. At **APRS 88**.

If you would like to visit the International APRS 88 Exhibition, or to participate as an exhibitor, please contact Philip Vaughan, Secretary General, Association of Professional Recording Studios Ltd., 163A High St., Rickmansworth WD3 1AY, England.



The Professional's Choice



Rogers Monitoring

HEAR MORE FROM THEM AT

Michael Stevens & Partners

UK PROFESSIONAL DISTRIBUTOR
Invicta Works Elliott Road Bromley Kent England
Tel: 01-460 7299 Telex 896979 TACS G

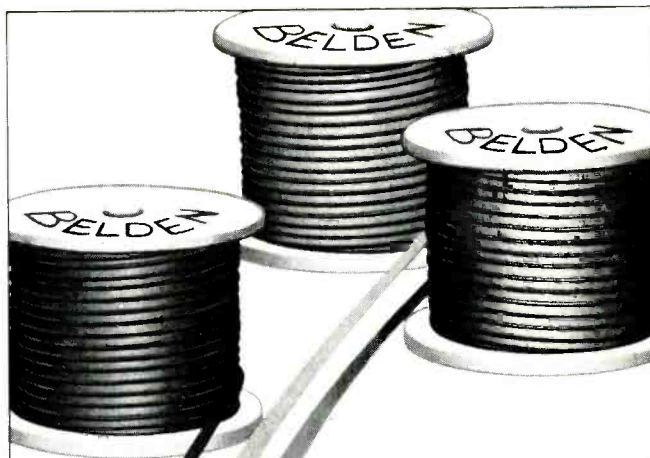

**Data Cable—
Immediate
delivery direct
from stock**

Same day
despatch (or collect
from our trade
counters)



The Belden® cable range includes low-loss, super-shielded twisted pairs, multi-conductors, co-axial and special LAN cables manufactured from the latest flame retardant low smoke emission materials.

**WADSWORTH
ELECTRONICS**

Central Avenue, East Molesey, Surrey KT8 0QB
Tel. 01-941 4716
Telex 892335 WADLECG Fax: 01-979 3213
Unit 74, Gravelly Industrial Park, Tyburn Road,
Birmingham B24 8TL
Tel. 021-326 7846
Fax: 021-327 1731

equipment. We still have to go along changing DDL time, reverb times and settings—it would be nice to tie that in. And we will soon be using MIDI for control although I am having to change some of the equipment to do it.

"The mix is built up initially in the snapshot mode: you can store 100 and just step through them as you need. Once we have got a snapshot for each section from the beginning to end we return to the beginning, put the console into realtime automation, out of automation at the end of the section and when that is completed, back into snaps for the next section, and then into automation and so on. When you've got everything moving like that you can just use the automation to smooth over the changes."

One of the highlights of the full series 10 demonstration has been the dynamic automation of aspects of the mix, such as panning and EQ, in ways that would be almost impossible on any more manual console. For instance, the title *Wind Chimes* has effects like guitar fills that move in regular precise patterns in the stereo picture and fully in tempo. Some of the more exposed drum beats and toms have their sustain panned to alternate left and right. EQ changes, for what sounds like both effect and mixing reasons, in smooth transitions and all these effects could be occurring within a very short space of time. In the wrong hands this could sound very unpleasant but the results of a continuously changing sound picture is a very exciting tool when used to emphasise musical sections.

"It was great being able to sweep the EQ at the same time as panning something from left to right. In places on *Wind Chimes* we have automated panning on every channel for a merry-go-round effect. Previously, panning used to be a static thing and if a lot of movement was needed you needed a lot of hands and it would have been very random, whereas this desk allows you to choose exactly where you want the pan by a digital readout of the position."

The only problem that we now have is the auxiliary equipment. We still have to go along changing the DDL time, reverb times and settings—it would be nice to tie that in

Video

Currently Mike is working on the video to accompany the album that hopefully will be commercially released as a video album at a later date. Did he see the audio and the video aspects as one thing when creating the album?

"It was my original idea to build up the album and pictures at the same time. In fact, I had the video control desk next to the audio desk but it was just too much to think about at once. In fact, it probably put me back about a year trying to do that. You need all your concentration just to do the music and then all your concentration for the video even though we did film a few things at the time for later use."

Mike describes his investment in video as 'substantial', which includes four Sony 1 in C-format VTRs, some high quality vision mixers, a Quantel *Mirage* effects system (that allows the manipulation of a flat image as if it were a solid object) and a portable 1 in C-format *VPR5* that is being used in helicopters and over cliffs, etc. He is also involved in creating the album covers through video manipulation of a frame store.

Although he operates the video equipment himself as well as in collaboration with other people such as computer graphics specialists, he makes no claim to specialist knowledge in video or audio other than how to operate the equipment and claims that he is not technically minded at all. That is until equipment fails in out of the way places and he is desperate to work. Then we hear the stories of dismantling tape machines and measuring transistor voltages by telephone—just a little more than your average artist.

Returning to the combination of audio and video, Mike sees possibilities in the combination of the two but still believes "Music is worthwhile by itself as you can let your imagination run away with the music."

"If you have been given a specific picture to watch it can't do that. That's not to say that I am not going to do it but I don't know if it will become really popular or remain a fringe thing."

Did he envisage a particular kind of set-up for his studio and video equipment in the near future?

"I will keep the video and studio separate and maybe just send an audio mix to one of the VTRs and then 'overdub' pictures on top. It was my original idea to put them together but it takes such a long time to do both. I can't be thinking, playing with the Fairlight and working the video desk at the same time. If I were working with a team of people maybe it would be possible but it's too much for just one person." □

Music is worthwhile by itself as you can let your imagination run away with the music. If you have been given a specific picture to watch it can't do that

MIKE OLDFIELD'S NEW PASTURES



TRUTH...

OR
CONSEQUENCES.

If you haven't heard JBL's new generation of Studio Monitors, you haven't heard the "truth" about your sound.

TRUTH: A lot of monitors "color" their sound. They don't deliver truly flat response. Their technology is full of compromises. Their components are from a variety of sources, and not designed to precisely integrate with each other.

CONSEQUENCES: Bad mixes. Re-mixes. Having to "trash" an entire session. Or worst of all, no mixes because clients simply don't come back.

TRUTH: JBL eliminates these consequences by achieving a new "truth" in sound: JBL's remarkable new 4400 Series. The design, size, and materials have been specifically tailored to each monitor's function. For example, the 2-way 4406 6" Monitor is ideally designed for console or close-in listening. While the 2-way 8" 4408 is ideal for broadcast applications. The 3-way 10" 4410 Monitor captures maximum spatial detail at greater listening distances. And the 3-way 12" 4412 Monitor is mounted with a tight-cluster arrangement for close-in monitoring.

CONSEQUENCES: "Universal" monitors, those not specifically designed for a precise application or environment, invariably compromise technology, with inferior sound the result.

TRUTH: JBL's 4400 Series Studio Monitors achieve a new "truth" in sound with

an extended high frequency response that remains effortlessly smooth through the critical 3,000 to 20,000 Hz range. And even extends beyond audibility to 27 kHz, reducing phase shift within the audible band for a more open and natural sound. The 4400 Series' incomparable high end clarity is the result of JBL's use of pure titanium for its unique ribbed-dome tweeter and diamond surround, capable of withstanding forces surpassing a phenomenal 1000 G's.

CONSEQUENCES: When pushed hard, most tweeters simply fail. Transient detail blurs, and the material itself deforms and breaks down. Other materials can't take the stress, and crack under pressure.

TRUTH: The Frequency Dividing Network in each 4400 Series monitor allows optimum transitions between drivers in both amplitude and phase. The precisely calibrated reference controls let you adjust for personal preferences, room variations, and specific equalization.

CONSEQUENCES: When the interaction between drivers is not carefully orchestrated, the results can be edgy, indistinctive, or simply "false" sound.

TRUTH: All 4400 Studio Monitors feature JBL's exclusive Symmetrical Field Geometry magnetic structure, which dramatically reduces second harmonic

distortion, and is key in producing the 4400's deep, powerful, clean bass.

CONSEQUENCES: Conventional magnetic structures utilize non-symmetrical magnetic fields, which add significantly to distortion due to a nonlinear pull on the voice coil.

TRUTH: 4400 Series monitors also feature special low diffraction grill frame designs, which reduce time delay distortion. Extra-large voice coils and ultra-rigid cast frames result in both mechanical and thermal stability under heavy professional use.

CONSEQUENCES: For reasons of economics, monitors will often use stamped rather than cast frames, resulting in both mechanical distortion and power compression.

TRUTH: The JBL 4400 Studio Monitor Series captures the full dynamic range, extended high frequency, and precise character of your sound as no other monitors in the business. Experience the 4400 Series Studio Monitors at your JBL dealer's today.

CONSEQUENCES: You'll never know the "truth" until you do.



JBL Professional
8500 Balboa Boulevard
Northridge, CA 91329

OUT OF THE FUTURE



QUANTEC QRS/XL is a freely programmable digital signal processor with infinite flexibility and uncompromised technology, allowing audio signal processing of the highest quality. In stand alone form the 90 factory stored ROM presets include the famous QUANTEC "QRS" room simulation programmes in addition to flanging, chorus, sampling, delay, digital filters and other special effects. With the external PC control all available parameters may be adjusted and stored in user memories. QUANTEC is dedicated to continuous development of new application programmes all of which will be available at no cost to the QRS/XL customer. At last a real time digital effect processor which will not go out of date. Call 0753 884319 to arrange for a demonstration. **YOU OWE IT TO YOUR EARS AND YOUR IMAGINATION.**

g.t.c. Limited
Malby House
5 Fulmer Drive
Gerrards Cross
Bucks. SL9 7HH
Tel.: 0753 884319
Fax: 0753 884319

MESSAGE TO SWEDEN

ARVA PROFESSIONAL SOUND.

Arva Ljud är till för dig som använder ljudteknik yrkesmässigt. Vi erbjuder dig ett samlat grepp, en komplett kedja med de här delarna:

Projektering. Vi hjälper dig att hitta bästa totala lösning i förhållande till mål och användningsområde, lokaler, arbetssätt, budget, framtidsplaner och alla andra faktorer som spelar in.

Försäljning. Vi är det enda företaget i sydsverige som kan erbjuda dig alla tunga proffsprodukter.

Installation. Vi gör mer än bara monterar, vi gör verklighet av projektplanen. Plus att vi detaljpassar alla tekniska delar till varandra och till lokalen, så att de arbetar ihop akustiskt.

Service. Genom att satsa på kvalitetsutrustning, rejäl installation och förebyggande underhåll ser vi till att utrustningen fungerar också i framtiden. Skulle något ändå hända så finns våra tekniker alltid till hands.

VI HÖRS MER OCH MER!



ARVA LJUD AB, Södra Esplanaden 9 A, Box 1160,
221 05 LUND. Tel. 046-14 04 50 och Regementsgatan 14,
211 42 MALMÖ. Tel. 040-23 53 03.

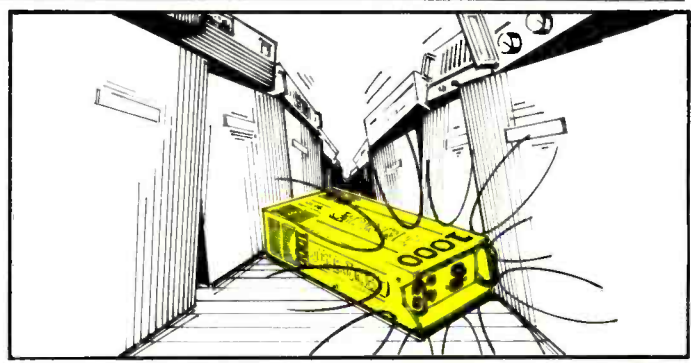

AND THE WALLS CAME TUMBLING DOWN...

The new Jericho 1 kilowatt amplifier from Tunewell is breaking quite a few barriers. Probably the best performing and most robust amp. in its class, Jericho is, unlike many items built for the PA market, a properly designed product – not just a box of bits.

- Jericho delivers sound quality:
 - Better than 0.01 per cent distortion at full load.
 - Drives complex loads down to 0.25Ω.
 - Variable speed fan keeps things quite when the volume is down.
- Jericho delivers reliability:
 - Robust "roadie-proof" metal casing and industrially proven circuitry.

- No more fuses – Jericho features input and output circuit breakers.

- No more overheating – innovative "pin fin" heat sink and efficient cooling developed from industrial heat exchanger technology ensures optimum running temperature is maintained.

Jericho is compact (500mm x 170mm x 109mm) and light (14kg), making it easy to handle and economical with storage and transport space.

To experience Jericho, telephone Ian Turner or Phil Rimmer on 01-888 6044 – we will be delighted to arrange a demonstration.

Tunewell Transformers Ltd,
115a Myddleton Road,
London N22 4NG
Tel: 01-888 6044.



PPX AMPLIFIERS

CITRONIC

A SIGN
OF
QUALITY



Technically superior and totally dependable high quality power amplifiers.

PPX, better performance.

Citronic Ltd, Bowerhill, Melksham, Wilts, SN12 6UB, Telephone (0225) 705600, Telex 444131

FLAT!

That's the only way to describe the response curves of the Court Acoustics Graphic Equalisers. With our 'Uniloop' filter circuitry, even with all faders set at maximum boost or cut you still get a substantially flat response.

The result is a natural sound that is unique amongst graphic equalisers, with highly flexible control over the full frequency range.

With three models offering stereo or mono equalisation over $\frac{1}{3}$ octave or $\frac{1}{2}$ octave bands, there is a Court Acoustics Graphic Equaliser to suit your application.

Check them out now and hear the difference.

The Graphic Equalisers



Court Acoustics Sales Ltd., 29 Beethoven Street, London W10 4LG. Telephone 01-960 8178. Telex 94012115 CASL G



OVER 2000 INSTANT VOICES

GUESS WHAT FORAT HAS IN STORAGE FOR YOU?

The MSM 2000 Modular System Memory from Forat offers you the ability to store over 2000 custom sounds, including the 512 free sounds we give you, for your Yamaha DX-7, RX-11 or Roland keyboards. All at the push of a button.

Like your tape machine, the MSM 2000 has three buttons: Fast Forward, Rewind and Record. The first two allow you to step or scroll through 64 banks of 32 sounds each. Pressing Fast Forward or Rewind will move you through the banks of sounds, one bank at a time. You then access individual sounds through your keyboard or drum machine. In a hurry? Hold either button down and quickly scan through the banks. A single MSM 2000, by simply swaping RAM cartridge interfaces, will operate with your Yamaha DX-7, RX-11 or Roland keyboard. Your favorite sounds are on line all the time.

To save a sound, just push the Record button. Once activated, the Record light comes on telling you that

"Memory Protect" is off. Now you may save to or format the bank currently shown in the display window. Once formating or saving is complete, the light will automatically go off and "Memory Protect" is enabled. You may cancel the record function by simply pushing Fast Forward or Rewind.

To insure that all your precious work won't get lost, the MSM 2000 comes standard with automatic memory self protection. This is provided through maintenance free rechargeable batteries. Every time you plug in the MSM 2000, the batteries are automatically recharged.

Only the MSM 2000 can give you the freedom, speed and flexibility you need, on the road or in the studio. To experience the remarkable MSM 2000, contact your favorite professional music dealer or call Forat for the authorized dealer near you.

FORAT

11514 Ventura Boulevard, Studio City, CA 91604 (818) 763-3007 FAX (818) 763-3977
Dealer/Distributor Inquiries Invited.

© 1987 Forat Electronics

OLSON mains distribution panels

DATA PROTECTOR
Rated at 10A 250V

VERTICAL—HORIZONTAL
UP TO 20 SOCKETS

NOW WITH
BRITISH
AMERICAN
FRENCH
GERMAN
AND
6A CEE22/IEC
SOCKETS

Attenuation of up to 80dB is provided

for 19" rack mounting

DATA BOXES AND PANELS
PANELS WITH CLEAN EARTH SOCKETS
ELCB PROTECTED SOCKET OUTLETS
110V-240V 10mA-30mA
FOR WALL MOUNTING,
SLOPING TRUNKING
FOR BENCHES

* SPECIALS
TO ORDER

4FT-6FT LONG 30 Amp INTERNAL WIRING

OVER 300 TYPES FROM STOCK!

OLSON Electronics Ltd
UNIT 3, FOUNTAYNE HOUSE,
FOUNTAYNE ROAD, LONDON N15 4QL
TEL: 01-885-2884 TELEX: 296797

• More details. Circle 196 readerlink card

Media Products

Our new range of BPO audio jackfields are of the highest quality and economically priced, from £155.

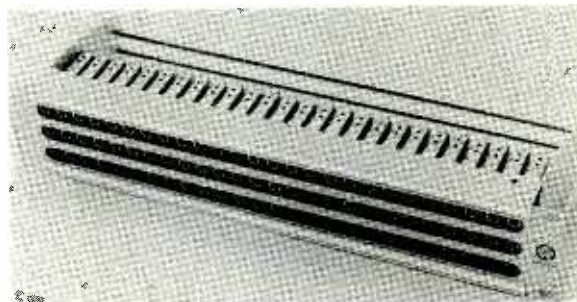

Featuring Mosses & Mitchell 5-point palladium contact guage B jacks, the jackfield occupies just 2U, of rack space. Standard versions are 2 or 3 row in 20, 24 and 26 ways. Please contact us today for information on our range of audio and video systems equipment.

'It's in the name'

Media Products Limited
Unit 4,
Chiltern Enterprise Centre,
Station Road, Theale,
Reading, Berks., RG7 4AA
United Kingdom.

Phone (0734) 303800
Telex 858893 FLETET G
Fax: 0734 323121 (Group 2 & 3)

CASSETTE TRIAL (You're The Judge)

We've got a great range of Bulk and Fully Packaged cassettes for you to try.

With five screw shells and high grade mechanics they're ready for the most gruelling examination.

The tape itself (we'll come clean) is made for us by a leading Japanese manufacturer and we load it here in the U.K. which is why, in the matter of costs, you'll find us most reasonable.

To bring matters to a hearing, fill in the coupon. We're confident that after hearing all the evidence you'll pronounce the following short sentence:

"They're excellent."

PMD CASSETTES

You'll Never Know 'Til You Try.

Send to: PMD CASSETTE TRIAL, PO BOX 19, STRATFORD-ON-AVON, WARCS

Yes, I would like to judge PMD Cassettes
Please send me (tick preferences)

Studio Ferric (Bulk) Low Noise, High Output
 Master Ferric (Bulk) Advanced Ferric, Mastering Quality
 Master Chrome (Bulk) High Bias, Mastering Quality
 Professional Series (Fully Packaged) High Output Ferric

Name.....Position.....
Company.....Tel.....
Address.....

Turn your back on the rest



Choose...

GRAFF High Speed Cassette Duplicators

The Gem range of cassette duplicators offer superior sound reproduction truer to the master than with any comparable tape duplicator. Wideband audio circuitry, long life glass lined high frequency response ferrite heads, and the ability to select metal, chromium or ferric tape types, ensures that each copy is a faithful reproduction of the master.

Unlimited expandability, high speed – allows both sides of a stereo C60 cassette to be copied simultaneously in under two minutes, carefully tested, each machine is designed for heavy duty use.

REMEMBER, turn your back on the rest, GRAFF's British made high speed audio cassette duplicators represent the standard against which all the others are compared.

- GEM DIAMOND – Expandable stereo copier.**
- GEM CRYSTAL – Expandable stereo or mono copier.**
- GEM SAPPHIRE – One to one stereo copier.**
- GEM RUBY – One to one mono copier.**



GRAFF Electronic Machines Limited
Woodhill Road, Collingham, Newark,
Nottingham NG23 7NR, England
Tel: 0636 893036 Telex: 377119



A truly professional range of ceiling, floor and desk mounting systems for loudspeakers, monitors and receivers, acoustic horn/driver combinations etc.

Models to hold weight loads from ounces to 225 lbs, each featuring the exclusive Omnimount angle and lock system.

The uses for Omnimount are limited only by your imagination.

Call or send for reference catalogue from UK distributors – Unilet Products Ltd, 35 High Street, New Malden, Surrey, KT3 4BY. 01 942 9567. Telex 881 4591.

**UNILET
HI-FI**

Unilet Products Ltd,
35 High Street, New Malden, Surrey KT3 4BY.
Telephone: 01-942 9567.

SOWTER AUDIO FREQUENCY TRANSFORMERS

You name it! We make it!

For the past 45 years we have concentrated on the design and manufacture of high grade audio transformers during which period our total sold exceeds half a million. We continually take full advantage of all the improvements in magnetic and insulating materials and in measuring techniques utilising the most up to date instrumentation.

We have a very large number of original designs made for clients all over the world but naturally there are certain types of Sowter Transformers which are in constant demand. These have taken into account the tendency towards small size without sacrifice of performance, particularly for PCB mounting, and a few of these are listed below. They can be supplied with or without mumetal shielding cans. Performance requirements can be modified on request (utilising our readily available questionnaire) and generally without alteration in price.

We specialise in **LOW COST AND QUICK DELIVERY** which means a few days only or ex-stock.

TYPICAL PERFORMANCES

Sowter Type No.	3575	4652	3678	6499	4079	6471	6469
Description	Miniature bridging transformer	Line output	Multi primary microphone transformer	Line output high level low distortion toroidal core	Splitter combiner transformer	Midget mc transformer for BT private systems	Very high quality microphone transformer
Impedances	10k (1) 10k (2) can be fed from 50-600 (2)	600 or 150 (2) inputs or outputs	Py 60, 200 or 600 (2) 5k (2) down to 1k (2)	600 (2) 600 (2)	200 (2) 18k Primary TWO 200 (2) Secondaries	Py 600 (2) 5v 60k (2)	200 (2) Primary for 1k (2) leading (Bifilar) B 1 step up
Frequency range	20Hz-20kHz	20Hz-20kHz	30Hz-20kHz	20-20kHz	20Hz-20kHz	300Hz-3kHz	20Hz-20kHz
Performance	-0.1dB over above range	-0.25dB over above range	-0.5dB over above range	+0.3dB 40Hz-15kHz -0.5dB 20Hz-20kHz	-0.5dB over above range	-0.5dB over above range	-0.2dB over above range
Maximum Level	7.75V r.m.s. on secondary	7.75V r.m.s. on 600 (2)	on 5k (2) 4V r.m.s. at 30Hz	26dBm at 30Hz	2.3V r.m.s. at 30Hz	0.6V p.p. on Py	2.0V r.m.s. on Py at 30Hz
Maximum Distortion	With 10V r.m.s. at 40Hz only 0.12%	Using 600 (2) and low impedance source it is 0.1%	Less than 0.1% at 1kHz	0.1% at 30Hz at 26dBm	negligible - 0.1% at 1kHz	negligible	0.1% at 20Hz
Shielding	Electrostatic screens and mumetal can	Mumetal can if desired at extra cost	Mumetal can	Toroidal can	Mumetal can rigid fixing bolts	PCB mounting	Mumetal can
Dimensions	33mm diam - 22mm high	36mm high - 43mm - 33mm	33mm diam - 22mm high	50mm diam - 36mm high	33mm diam - 37mm high	11.1mm high - 19mm - 17mm	33mm diam - 22mm high
Prices each at works	15-£10.83 90-£9.77 100-£9.27	15-£9.67 50-£8.89 100-£8.69	15-£9.67 50-£8.67 100-£8.41	15-£17.12 50-£15.88 100-£15.35	15-£14.59 50-£13.37 100-£13.08	15-£3.89 50-£3.55 100-£3.29	15-£11.38 50-£10.12 100-£9.92

E. A. SOWTER LTD. (Established 1941) Reg. No. England 303990
The Boat Yard, Cullingham Road, Ipswich IP1 2EG, Suffolk. PO Box 36, Ipswich IP1 2EL.
England. Phone: 0473 52794 & 0473 219390 – Telex: 987703G SOWTER

Why pay 15%-25% More?

Studiospares
the UK's largest
microphone dealer
with over 75 models
IN STOCK for
delivery
today or tomorrow.



Why pay 50%-100% More?

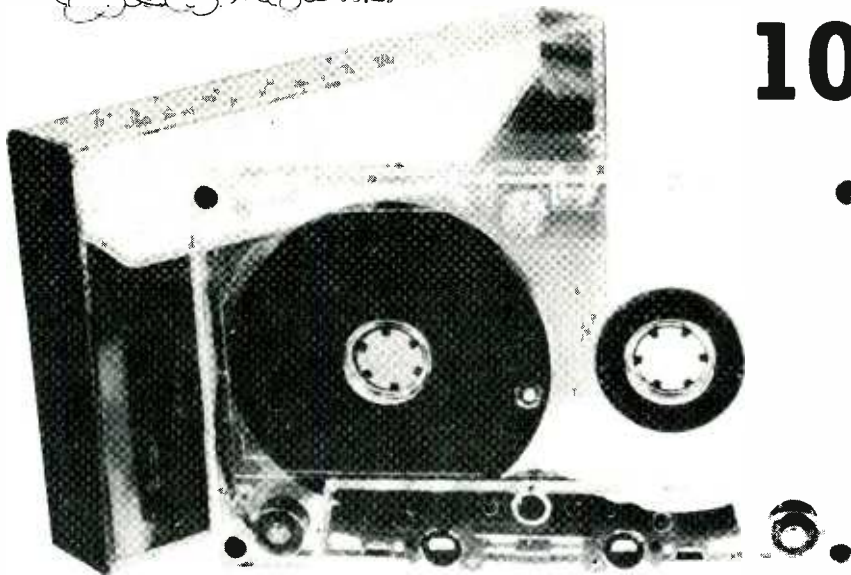

Chrome Cassettes
Shape Technology
Cassettes represents
the highest
attainable quality
irrespective of price.

C20 49p-52p

C46 59p-68p

C60 65p-74p

C90 75p-89p -VAT

INCLUDES LIBRARY CASE

Save time - phone

STUDIO SPARES

first

TRADE COUNTER

Open 8.30am - 5pm (Mon - Fri)

TELEPHONE ORDERS: 01-482 1692

ADMIN: 01-485 4908

16 Stucley Place, Hawley Crescent, Camden Town, London NW1 8NS

Please send free 56 page catalogue

Please send account application form

NAME _____

ADDRESS _____

SS/11/87



Drum up more business

At *MIDEM '88*
Music's International Marketplace.
Palais des Festivals, Cannes. Jan 25-29 '88

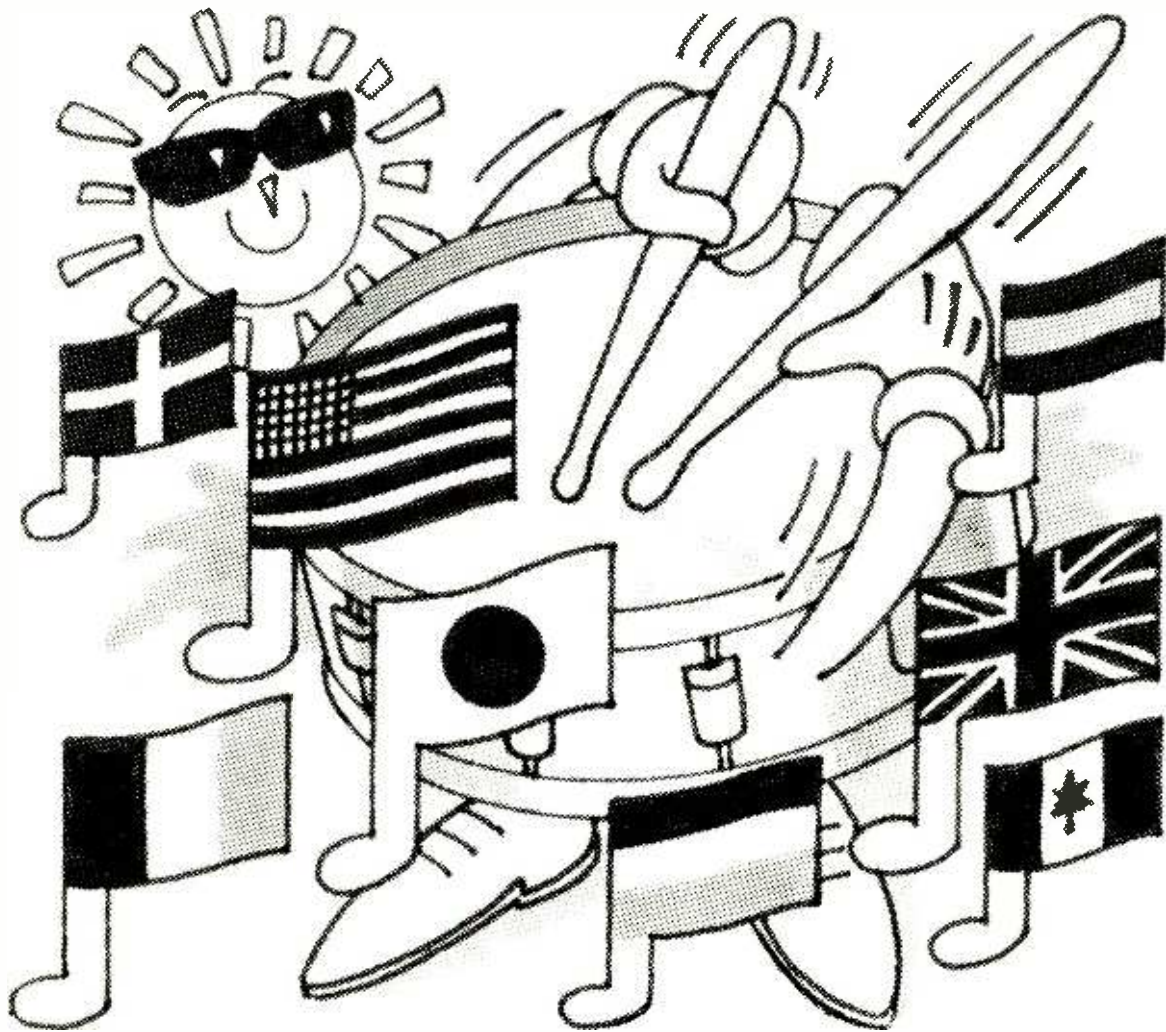

All the Big Names will be exhibiting at MIDEM '88. So will many of the smaller companies who play such a vital role in the world's music industry. Why not join them? As an Exhibitor, you're not just part of MIDEM you are the show, ranking with the biggest names, and with all the business pull of the music industry's greatest international marketplace.

LIASE. MIDEM is where global deals are struck that build company prosperity. It's where you'll find all the top producers, record companies, publishers and independents from over 50 countries.

LOOK. MIDEM is the place for viewing or screening the latest video promos. It's where you'll find out all about Compact Video Discs and be updated on state-of-the-art studio equipment and hardware. Nowhere else comes close for promoting records, catalogues and artistes.

LISTEN. And where else can you attend the famous MIDEM Galas, or see so many top bands performing live? Or attend the MIDEM MIP RADIO — the fifth great International Radio Programme Market?

The rest of the world always has a special welcome for MIDEM's British Exhibitors (and that includes the 700+ international press and TV journalists).

LEARN. Ring Peter Rhodes right now on LONDON 01-499 2317. He'll tell you all you need to know about exhibiting at MIDEM '88. Almost everything is done for you — including fully-equipped and furnished stands with phone and hi-fi equipment. All in all you will be surprised by how little it costs to exhibit at MIDEM '88.

MIDEM'88

I like the sound of MIDEM '88. Please rush me details.

Name _____

Company _____

Title _____

Address _____

Phone _____

International Exhibition Organisation Ltd., 4th Floor, 9 Stafford Street, London W1X 3PE. Tel: 01-499 2317. Telex: 25230.



Σ sigma 24

High performance orientated design with user comfort and ergonomics as primary design criteria has produced the Sigma series.

- Fully modular
- 24 bus
- Frame capacities of 36, 48 and 60 modules
- In-line and split format systems
- Vu and bargraph metering options, 16, 24 and 32 track
- Fader options including full automation
- Mute synchronisation to MIDI included
- Producers desk/patchbay options
- Eight auxiliary sends
- Dedicated auxiliary output meters
- Excellent sonic performance, transformerless design

The choice is yours, for a cost effective, high quality mid priced console that lets you perform. Call now for a full information pack and to arrange a demonstration. Tel: 0273 24928

AHB

Mixing Art with Science

69 Ship Street · Brighton BN1 1AE · England · Tel: 0273 24928 · Telex: 878235 MBIAHBG
UK Fax No: UK 0273 821 767 · Overseas Fax No: +44 273 821 767
UK: State Of The Art Distribution: 0663 62442

AHB USA · 5 Connair Road · Orange · Connecticut 06477 USA · Tel: (203) 7953594

REVIEW

A technical evaluation of the RCF SCD 6000 monitor by Neil Grant



The RCF SCD 6000 speaker falls into an increasingly interesting category of monitors somewhere between the book shelf type of device and the larger systems that are either separately mounted on stands, or built within the existing structure of the control room in some way.

There is a growing market for a middle range speaker; one that can be used as comfortably within the smaller, independent, or home studio,

as within the second facility that is a part of a fully commercial installation.

There are now a number of serious contenders for this market, and the SCD 6000 is a studio monitor purpose-designed for this size of facility. This speaker, however, has a number of interesting and unusual features that could be of more interest than would otherwise be the case with a system that was simply adapted.

This is a direct radiating system that uses a softdome midrange and tweeter assembly, along

with a 300 mm bass driver within a simple reflex ported chamber. Interestingly, the mid and high frequency drivers share a common magnet motor system. This magnet system has a common back plate and front plate, with two pole pieces, and a single mounting assembly, carrying the two dome diaphragms. This has enabled the designers to place the two diaphragms close together: between 30 and 80 mm closer than with typical comparative designs that use separate motor units, it is claimed.

The advantages in this system are that the acoustic centres of the mid and high frequency drivers are placed closer together, and thus any offsets between the acoustic centres in the vertical plane are minimised. This reduces the imaging and amplitude anomalies that can occur when listening to two drivers that are radiating the same information but are displaced from each other, as would normally be the case with a design using discrete components.

Externally, the cabinets reflect more of a high fidelity ancestry, than that of a series of studio monitors. The carcass of each cabinet is fabricated from a medium density 20 mm particle board, and the main baffle assembly from 30 mm medium density particle board. The low frequency driver is screwed directly to the baffle board, and then neatly trimmed off with a fabric-covered moulding and surround, while the mid and high frequency units are bolted to a metal high pressure die-casting, which is in turn bolted to the main baffle. This can be rotated through 90°, neatly solving the problem of orientating the cabinet to suit the installation yet maintaining the mid and high frequency drivers in vertical alignment to preserve lateral imaging.

A further casting forms the reflex vent, and holds two switch selectable attenuators, controlling the mid and high range level.

The speaker terminations to the rear of the cabinet are rather lightweight and set into a moulding. This is unsatisfactory for terminating competent contemporary cables.

Cabinet construction is reasonable, though repeatedly dismantling the baffle assemblies—as the tests proceeded and access was required to the crossover, components and drivers—proved increasingly alarming. There are metal trim pieces between the mid and high range mounting plate, the attenuator fitting and the low frequency driver trim. Removing the various panels, keeping track of the trim pieces and correctly re-assembling the whole became increasingly tiring and tiresome as time went by.

There was also some concern as to the long term stability of some of the fixings, such as the screw fastenings for the bass driver; it is hoped, of course, that these should not need inspection or removal in use, but they were clearly not designed for repeated removal.

The crossover assembly is neatly wired and an outline circuit is provided in the accompanying literature.

The crossover is a relatively simple assembly of second order high, low and band pass networks in the traditional manner, with the addition of RLC networks in the mid and bass sections to remove resonant peaks in the free air response of these drivers, and a Zobel network in parallel with the midrange driver. This acts to balance the rising inductance of the voice coil assembly through the stop band of the mid band low pass network, thus terminating the network with a relatively linear impedance.

Both mid range and high frequency domes are supplied with ferro-fluid in place in the gap. I have always been concerned about the use of

Manufacturer's specification

3-way system:

Continuous power: 200 W
Programme power: 400 W
Impedance: 8 Ω
Sensitivity: (1 W/1 m) 90 dB
Frequency response: 44 Hz to 20 kHz ±3 dB
Crossover frequencies: 900 Hz and 4.5 kHz
Controls: attenuators—±2 dB on mid and high frequency units

Woofers:

Nominal diameter: 300 mm
Voice coil diameter: 75 mm
Voice coil material: copper
Magnet assembly weight: 7.5 kg
Flux density: 1.3 tesla

Mid/tweeter unit:

Magnetic assembly weight: 7.5 kg
Midrange voice coil diameter: 50 mm
Midrange voice coil material: copper
Midrange flux density: 1.6 tesla
Tweeter voice coil diameter: 25 mm
Tweeter voice coil material: copper
Tweeter flux density: 1.67 tesla

General:

Cabinet weight: 30 kg
Dimensions: 674 × 372 × 350 mm

Radio Cine Forniture, Via Notaru 1/a, Reggio Emilia, San Maurizio, I-42029, Italy.

UK: Court Acoustics Sales Ltd, 29 Beethoven Street, London W10 4LG.



The M20 from AEG sets new standards for professional tape recorders in the studio.

This professional machine is right at the cutting edge in terms of technology, ease of operation, reliability and ergonomics.

The M20 is the latest development from the inventor of the magnetic tape recorder in a successful line stretching back 50 years.

It has every impressive feature the professional could ever desire. The latest microprocessor technology.

Sync amplifier for monitoring with the recording head during electronic editing. Electronic and storable automatic bias adjustment for different types of tape, with all sorts of equalization (such as NAB and IEC), and that at all 4 speeds. Incorporation in computer-controlled systems via standard interface. Timecode option. Built-in or portable for studio and mobil operation. Optimal operating in horizontal or vertical position. Continuous vertical and horizontal adjustment of Variostand allows perfect ergonomics for any operator. Suitable for 19" plug-in systems.

The M20 represents the ultimate combination of state of the art electronics and high-precision mechanics. For higher demands and new applications, e.g. in conjunction with computer-controlled editing systems or stereo television. It's tomorrow's answer to today's sound studio.

Please forward further information about the new Magnetophone M20 from AEG.

Name _____

Company _____

Street _____

Post Code/City _____

AEG Aktiengesellschaft
 Professional Tape Recorder Branch
 Bücklestrasse 1-5
 D-7750 Konstanz
 West Germany
 Phone: (07531) 862370
 Telex: 733233

SS/11/87 K2 WAK 37/30 E

AEG

AKG

ACOUSTICS

ULS: THE ULTRA LINEAR SERIES

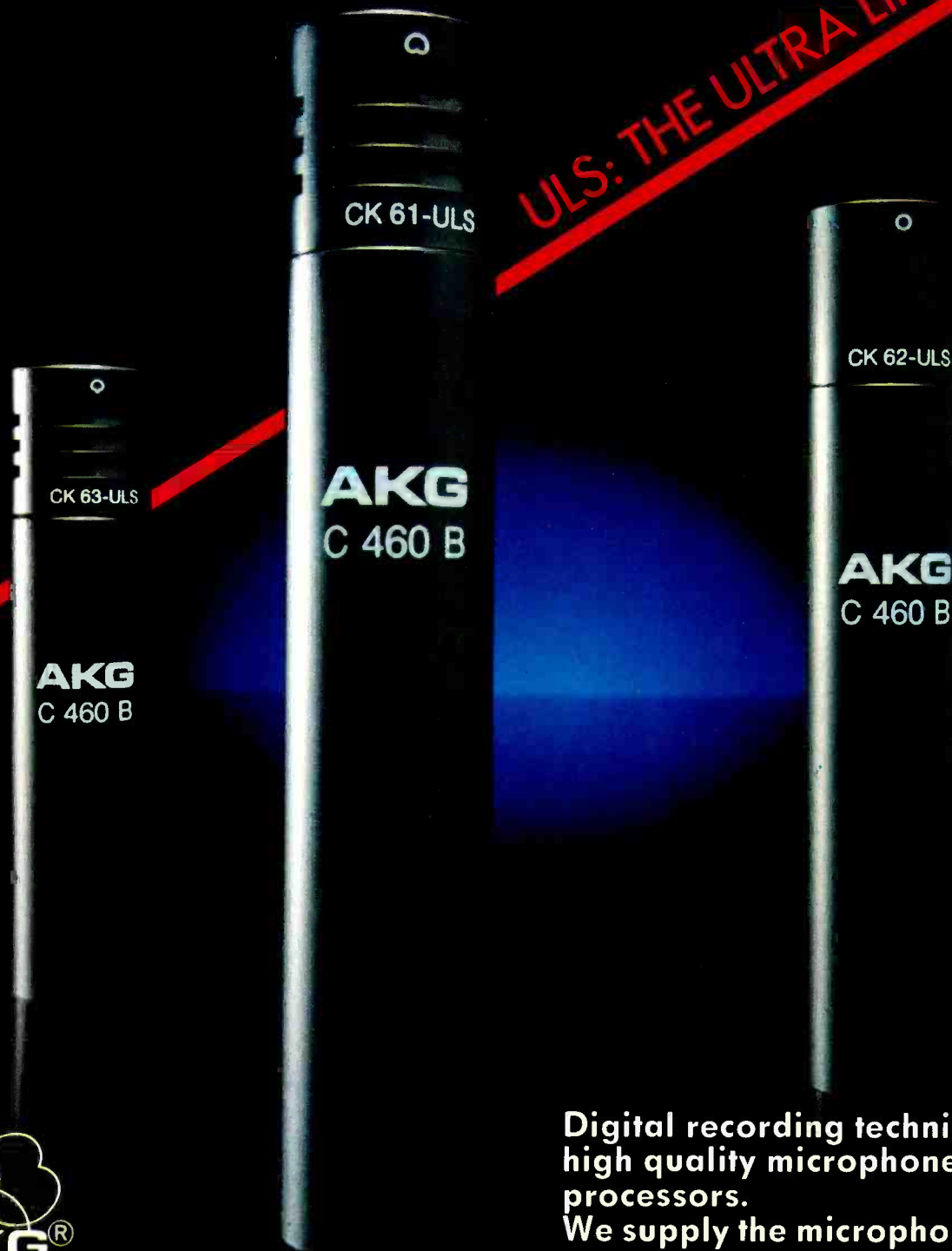

ADV 355/1/E



Digital recording techniques call for high quality microphones and audio processors.

We supply the microphones.

Get more information from your dealer or directly from

AKG AKUSTISCHE U. KINO-GERÄTE GESELLSCHAFT M.B.H. Brunhildengasse 1, A-1150 Vienna/AUSTRIA Tel: (222) 95 65 17-0, Tx: 131839 akg a, Fax: (222) 92 34 58
AKG ACOUSTICS LTD., Catteshall Wharf, Catteshall Lane, Godalming, Surrey GU7 1JG/GB Tel: (4868) 25 702, Tx: 859013 akgmic g, Fax: (4868) 28 967

www.americanradiohistory.com

REVIEW

ferro-fluids in relatively high power systems that are subject to the sort of abuse present in a recording environment. If either of these two drivers is electrically destroyed in a way that leaves debris in the voice coil gap, it could be extremely difficult, if not impossible, to remove without de-magnetising and stripping down the whole assembly.

In theory, the ferro-fluid should act to improve the dissipation of heat away from the voice coil assembly to the thermal mass of the motor unit but in practice it is still very easy to exceed the thermal limits of these drivers.

Each system is supplied with a pair of 'proof of performance' curves, warranty card and a reasonably detailed leaflet. The leaflet provides a comprehensive collection of data and predicted

curves, and it would have been nice if the proof of performance measurements had been original but they were photocopies.

The leaflet provides general background and advertising information, some mechanical and performance details, amplitude, distortion, impedance curves, and an exhaustive set of directional and polar information. This is in the form of normalised horizontal and vertical off-axis response curves for both cabinet orientations and a series of 16 standard polar plots with both horizontal and vertical information overlaid.

Electrical performance

The cabinet is generally described as an 8Ω unit and Fig 1 shows that this is generally the case, with the impedance dropping below 8Ω at 30 and 250 Hz.

In general terms this is a benign load that most amplifiers should have little difficulty driving. Variation of the level controls over their stated maximum produced surprisingly little variation in the electrical impedance, as the modulus of

impedance covering the balance of the bandwidth in Fig 2 shows.

The worst case phase angle measured was a capacitive phase angle of some 53° , and was below the pass band of the system.

Time Domain

Fig 3 shows the magnitude of the time response of one cabinet, the energy time curve. This shows the bulk of the energy present has passed through the system within a little over 2 ms. This is creditable and is due partly to the coherence of the upper two sources with the rather band limited performance of the low frequency section of the system.

Generally there is little diffraction, the lack of grille assemblies and similar protrusions helping, and the transient performance of the system is good.

Frequency domain

Fig 4 is the on-axis amplitude response. This generally progresses smoothly but rises quite

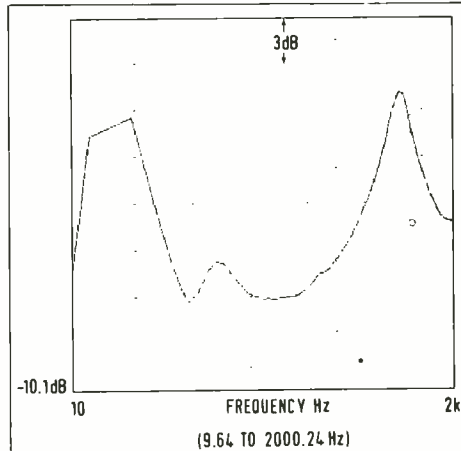

FIG 1 MODULUS OF IMPEDANCE—LOW FREQUENCY
0 dB is located at 8Ω
Log frequency axis: 2.7 decades
Resolution: $1.0836E + 02$ m and $3.1653E + 00$ Hz
Sweep rate and bandwidth: 10.02 Hz/s and $3.1653E + 00$ Hz

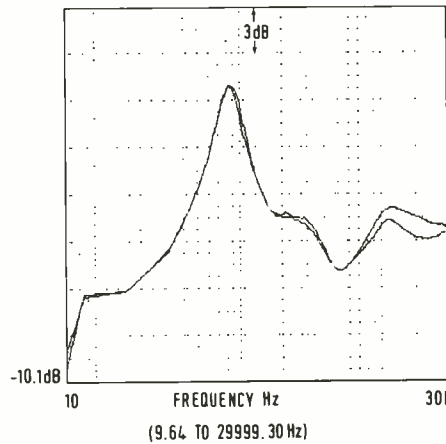

FIG 2 MODULUS OF IMPEDANCE—MID AND HIGH FREQUENCY
0 dB is located at 8Ω
Log frequency axis: 2.7 decades
Resolution: $1.0836 + 01$ m and $3.1653E + 01$ Hz
Sweep rate and bandwidth: 1001.91 Hz/s and $3.1653E + 01$ Hz
Input configuration: balanced with 30 dB of input gain and 18 dB of IF gain

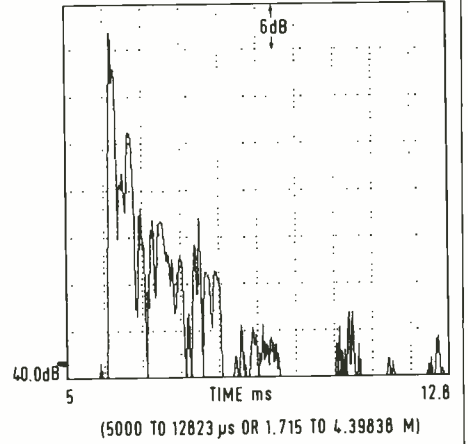

FIG 3 ENERGY TIME CURVE—MAGNITUDE OF TIME RESPONSE
0 dB is located at 0.00002 Pa
Scale: $7.3366E - 01$ m/in or $2.8884E - 01$ m/cm
 $2138 \mu\text{s/in}$ or $842 \mu\text{s/cm}$
Line spacing: $19.6072 \mu\text{s}$ or $6.72526E - 3$ m
Line width: $26.6658 \mu\text{s}$ or $9.14636E - 3$ m
Sweep rate: 500.96 Hz/s
Sweep range: -20000.20 to 31001.50 Hz
Window file name: A:HAMMING.W8T

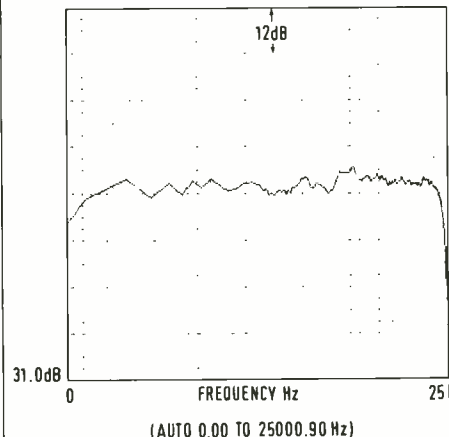

FIG 4 FREQUENCY RESPONSE—ON-AXIS AMPLITUDE
0 dB is located at 0.00002 Pa
Log frequency axis: 2.7 decades
Resolution: $7.6111E + 00$ m and $4.5066E + 01$ Hz
Time of test: $5942 \mu\text{s}$, $2.0379E + 00$ m
Sweep rate and bandwidth: 2030.90 Hz/s and $4.5066E + 01$ Hz

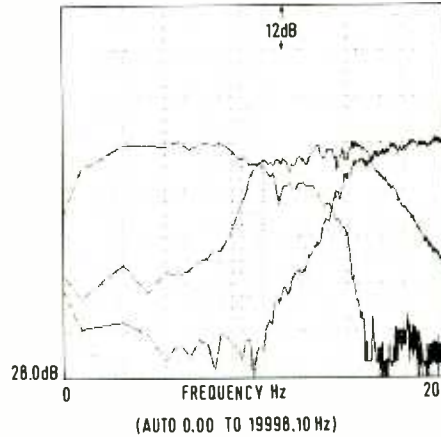

FIG 5 FREQUENCY RESPONSE—DRIVER OVERLAYS
0 dB is located at 0.00002 Pa
Log frequency axis: 2.7 decades
Resolution: $4.3912E + 00$ m and $7.8112E + 01$ Hz
Time of test: $5969 \mu\text{s}$, $2.0472E + 00$ m
Sweep rate and bandwidth: 2030.90 Hz/s and $2.6000E + 01$ Hz

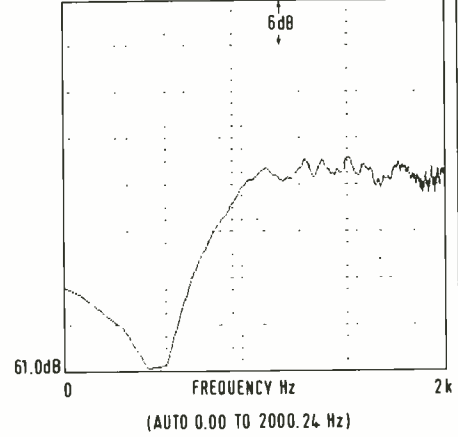

FIG 6 LOW FREQUENCY RESPONSE—BASS SECTION
0 dB is located at 0.00002 Pa
Log frequency axis: 2.7 decades
Resolution: $2.4198E + 01$ m and $1.4175E + 01$ Hz
Sweep rate and bandwidth: 200.92 Hz/s and $1.4175E + 01$ Hz

REVIEW

noticeably between 4 and 5 kHz. The high frequency response extends to a little over 20 kHz, a reasonable performance only for a 25 mm driver with a paper voice coil former, though the curve is smooth and even.

Examining Fig 5, the rise in the upper mid band response can be traced to excess energy at the crossover point between the mid and high

frequency drivers. The high frequency driver is really very well behaved but the midrange unit shows a marked rising response and a peak just prior to the crossover region, much of which is reflected in the combined response.

The rising response is a function of the half space flush mounting and a lack of any directional control over the device in the first octave of its pass band, and could only be corrected with a separate mounting flange, which might well affect the dispersion of the system over those frequencies.

Acoustically the crossover points are at 900 Hz, and 6 kHz.

The low frequency performance is shown in some more detail in Fig 6, and though smooth, well damped and controlled, there is little real bass extension.

Charitably, the -3 dB point is at 71 Hz, given a whole space measurement, and to achieve the figures quoted in the RCF literature, it would be necessary to mount the speaker back into a wall structure, and re-measure in half space.

It was noticeable during tests that there was substantial 'chuffing' from the reflex port during low frequency sweeps. Generally this occurred below the system cut-off but could be discerned in programme material as well. The reasons for this are the restricted size and cut-off of the port itself.

There are two 4-position switch attenuators mounted on the front panel, which together control mid and high frequency level and which individually tilt the high frequency response, cut and boost the upper mid band.

Though both these controls worked well, and much more satisfactorily than the more common potentiometer arrangement, the range of control was very limited, and was just a little bit subtle for some of the potential users.

Fig 7 illustrates the range of response. The top curve set shows the result of the four positions of the high frequency level control. The centre curve set shows the effect of the mid range control, whereas the lower curve set shows the combined effect of moving both attenuator sets together. The total range in this last condition is barely ± 2 dB, and it would be an improvement to increase the effective range of control, though otherwise these work in a nice, predictable fashion.

Fig 8 confirms my earlier comments with regard to the transient response of the system. This illustrates the cabinet's behaviour to the passing of transient information. This display is the rear half of a quasi 3D file set, showing the decay of the system. The rather aggressive peak between 4 and 5 kHz is still very much in evidence, along with some mid band diffraction scattering, and a little lower mid band resonance. The low frequency decay is well controlled and very well damped.

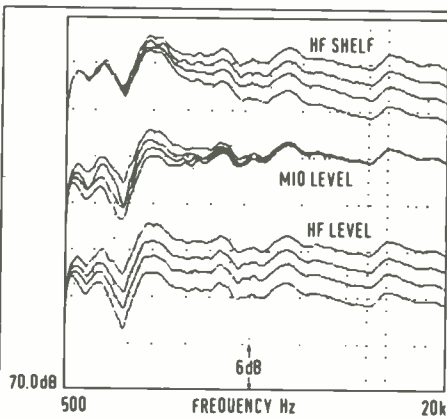

FIG 7 MID AND HIGH FREQUENCY LEVEL CONTROLS
0 dB is located at 0.00002 Pa
Scale: 5330.96 Hz/in or 2098.80 Hz/cm
Resolution: 5.7058E - 01 m and 6.0115E + 02 Hz
Time of test: 5969 μ s, 2.0472E + 00 m
Sweep rate and bandwidth: 75143.30 Hz/s and 1.2500E + 02 Hz

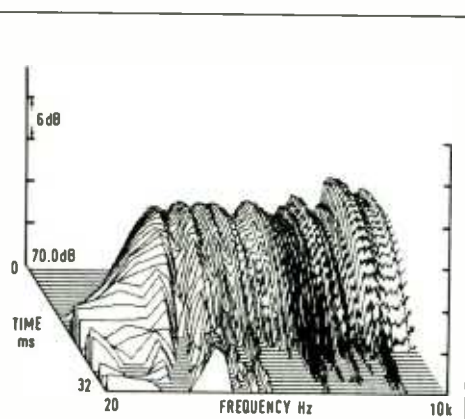

FIG 8 ON-AXIS 3D DECAYS, BROAD BAND RESPONSE
0 dB is located at 0.00002 Pa
Resolution: 4.7928E + 00 m and 71.57 Hz
Time of test: 32,000 μ s 1.0976E + 01 m (front) to 0 μ s 0.0000E + 00 m (back) - 1032 μ s/step or 0.354064516129 m
Sweep rate and bandwidth: 5009.55 Hz/s and 70.00 Hz

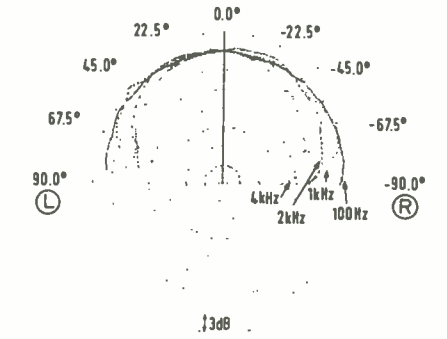

FIG 9 HORIZONTAL POLAR RESPONSE—SET 'A'
Data gathered at 5.6° increments
Centre of display is 21.00 dB down

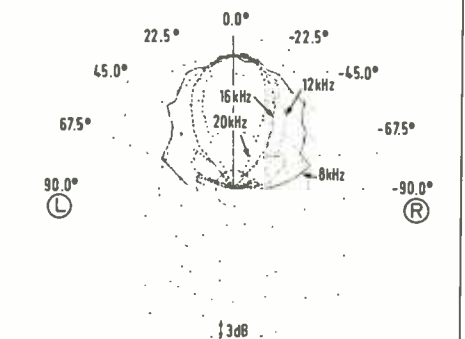

FIG 10 HORIZONTAL POLAR RESPONSE—SET 'B'
Data gathered at 5.6° increments
Centre of display is 21.00 dB down

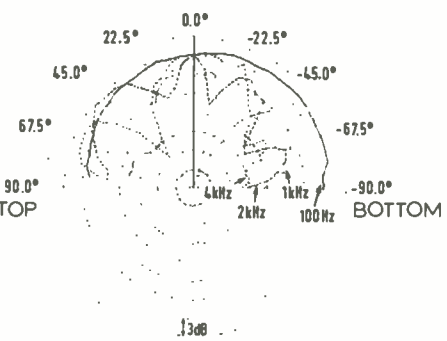

FIG 11 VERTICAL POLAR RESPONSE—SET 'A'
Data gathered at 5.6° increments
Centre of display is 21.00 dB down

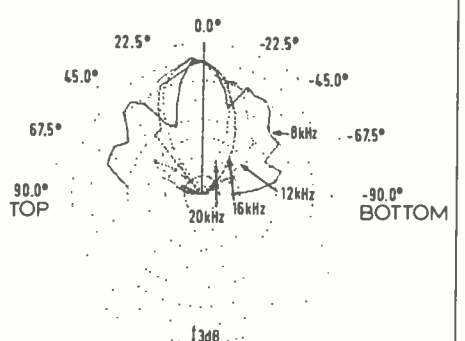

FIG 12 VERTICAL POLAR RESPONSE—SET 'B'
Data gathered at 5.6° increments
Centre of display is 21.00 dB down

Polar response

Considering the extensive series of measurements of the dispersion of the cabinets, it was felt necessary to go a little further than had been the case in previous reviews in order to corroborate, or otherwise, the manufacturer's data.

The measurements themselves were taken in the usual fashion, by rotating a microphone round the forward face of the cabinet through 180° in 5.6° increments. The T_0 , the time delay offset in the measurement, is held constant for all the sweeps, which are loaded into a 3D file. This data can then be displayed as a quasi 3D file, or post-processed in polar form.

Figs 9 and 10 show some of the 400 available polar responses for the horizontal position, and Figs 11 and 12 show the same displays for the vertical dispersion. In this case the bass section of the cabinet is to the right of the display, and the high frequency section is to the left.

Fig 9 shows the 100 Hz, 1 kHz, 2 kHz, and 4 kHz curves for the horizontal axis overlaid. These are in general agreement with the supplied data and are good in their class. Fig 10 overlays the curves for 8 kHz, 12 kHz, 16 kHz and 20 kHz. While these measurements show more resolution than the published data there is still good correlation, and the horizontal dispersion is acceptably good.

Fig 11 shows overlays of 100 Hz, 1 kHz, 2 kHz, and 4 kHz and these are not quite so good. Note

AUDIO JACKFIELDS & JACK SOCKETS

Mosses & Mitchell are the largest manufacturer of Audio Jacks and Jackfields in the UK. We are approved suppliers to the BBC, British Telecom, Pye Telecommunications and many other major telecommunication companies throughout the world. We manufacture a complete range of Audio Jacks & Jackfields and offer a design and manufacturing service geared to meet your specific requirements. For further information and technical data on our products contact:

MOSSES & MITCHELL

Plasmech Systems Limited
Weydon Lane, Farnham, Surrey GU9 8QL
Telephone: Farnham (0252) 721236
Telex: 858820 Plasmech G

the most significant A80 upgrade available

The MIRAGE 802 phase compensated record amplifier is a low noise direct replacement for the Studer 1.080.802 record preamplifier card. The M802 is fully compatible with A80 Mk2 machines and with minor modifications to the amplifier mother board is totally compatible with the A80 Mk1. The board is switchable between either 7.5/15 or 15/30 ips. The major advantages of phase compensated recordings are

Many more multiple generation copies with less signal degradation.

Improved noise reduction tracking.

Cleaner transient response.

The one off price is £120 + vat.

Other products include the Mirage S300 Ultra high quality three unit active speaker system and the C10 preamplifier system, the MGD SMPTE/EBU time code analyser/regenerator.

MG Designs · 19 Hatton Street · London NW8 8PR

Telephone: 01-724-7544 · Fax: 01-724 2058



KEITH MONKS

THE LS SERIES STUDIOMONITOR

LS1/8 — c/w PO standard tip-ring and sleeve jack input
LS1/8-XLR — c/w XLR audio input
LS1/9 (pictured) — c/w all XLR audio and DC inputs

Deep bass reflex cabinet gives optimum dynamic performance ● Screened toroidal transformers c/w worldwide mains voltage options ● I/P impedance: 10KΩ/600Ω @ 0dB ● S/N ratio: >65dB ● Recessed volume control c/w power switch.

Designed approved and produced to BBC specifications for studio and general use . . .

NOW AVAILABLE WORLDWIDE

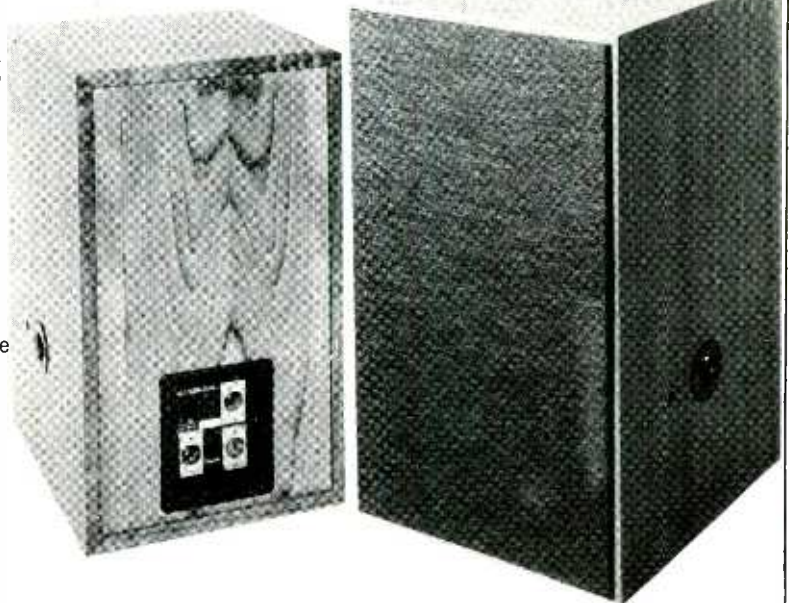

KEITH MONKS LTD, PROGRESS HOUSE, ALBERT ROAD, ALDERSHOT, HAMPSHIRE GU11 1SZ, UK.
TEL: 0252-334121/2/3/4 (Overseas: area code 252) Telex: 858606 KMAL G

REVIEW

the skew in the direction of the bass driver of the 100 Hz response (this is to be expected) and then the severe lobing of the 1 kHz and 4 kHz curves,

the 2 kHz curve, however, is acceptably even.

This is due to the effect of the path length differences seen by the microphone as the sweep passes through the crossover region. At these points there are two sources of the same signal, as discussed previously, and these sources are displaced from each other. In the case of the SCD 6000 these sources may be closer than in competitive products but the results are still obviously there. The lobing is due to cancellation because of path length differences between the two sources and the measurement microphone.

This is not reflected in the polar data supplied

by the manufacturer though, to be fair, it can easily be discerned in the beam-width and dispersion data also supplied. The polar data merely lacks the resolution to discriminate the detail necessary.

Fig 12 shows the balance of the polar information for the vertical sweep, overlaying 8 kHz, 12 kHz, 16 kHz, and 20 kHz. This is much more similar to the horizontal information now that the crossover regions are passed, and is generally good. Note the bias towards the high frequency section of the cabinet that would be expected.

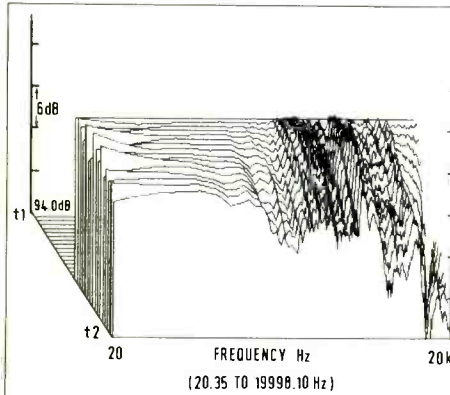

FIG 13 RIGHT HAND HALF—QUASI 3D OF HORIZONTAL POLAR RESPONSE NORMALISED TO ON-AXIS RESPONSE
0 dB is located at 0.00002 normalised
Resolution: 3.3109E +00 m and 1.0362E +02 Hz
Time of test: 5942 μ s 2.0381E +00 m (front) to 5942 μ s 2.0381E +00 m (back) 0 μ s/step or 0 m
Sweep rate and bandwidth: 10734.80 Hz/s and 1.0362E +02 Hz

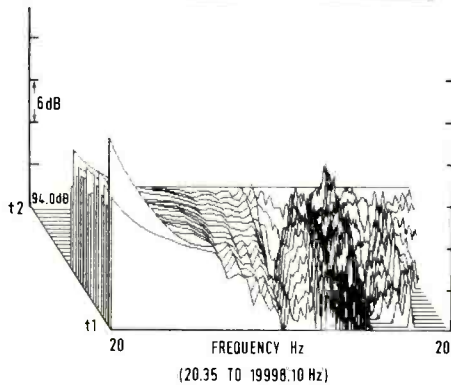

FIG 14 LOWER SECTION—QUASI 3D OF LOWER HALF OF THE VERTICAL POLAR RESPONSE NORMALISED TO ON-AXIS RESPONSE
0 dB is located at 0.00002 normalised
Resolution: 3.3109E +00 m and 1.0362E +02 Hz
Time of test: 5942 μ s 2.0381E +00 m (front) to 5942 μ s 2.0381E +00 m (back) 0 μ s/step or 0 m
Sweep rate and bandwidth: 10734.80 Hz/s and 1.0362E +02 Hz

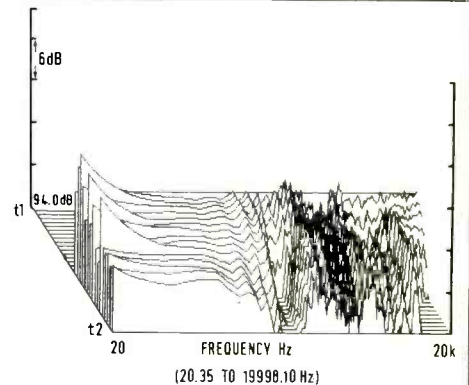

FIG 15 UPPER SECTION—QUASI 3D OF UPPER HALF OF THE POLAR RESPONSE NORMALISED TO ON-AXIS RESPONSE
0 dB is located at 0.00002 normalised
Resolution: 3.3109E +00 m and 1.0362E +02 Hz
Time of test: 5942 μ s 2.0381E +00 m (front) to 5942 μ s 2.0381E +00 m (back) 0 μ s/step or 0 m
Sweep rate and bandwidth: 10734.80 Hz/s and 1.0362E +02 Hz

ASONA for Complete Cassette Production

The new semi-automatic WINDER 2015 compliments the ASONA line of loop-bin/slave duplication systems.

Approximately 950 C-60 cassettes can be produced per shift with one winder.

The winding and splicing phases are fully automated, enabling two winders to be operated by one person, or five machines by two persons.

Length preselection is provided for blank tape, automatic cue-tone detection for recorded tape.

Robust construction, with a minimum of moving parts.

Low maintenance requirements, low personnel costs.

Economically priced.

ASONA Winder 2015

The WINDER 2015 is designed for universal installation. Completely self-contained; may be plugged in wherever needed. No compressed air or external vacuum required. Compact size; easily transported with integrated carrying handles.



We can tailor a cassette production system to your needs. Write or call for a proposal.

ASONA is manufactured in West Germany by ASONA AUDIO - TECHNIK GmbH & Co. KG, Bahnhofstraße 60, D - 7634 Kippenheim
Tel.: (0)78 25 - 10 68, Telex: 7543 25 auvis d

THE ULTIMATE VCA.

That's a strong statement, but it's a fact. After 6 years of development, the Audio Silicon Specialists are in full production of the SSM 2014 Operational Voltage Controlled Element chip. So unique, it's patented.

Use it like a standard current in/current out VCA, or get exotic and use its true differential front end and complementary current/voltage outputs for a whole new range of possibilities, such as a voltage controlled potentiometer, preamp, or equalizer to name just a few.

Depending on your preference, the 2014 can operate in class A, AB, or in between. And by using a simple level detector, it can switch between the two for optimum results.

How about performance? The 2014 sports a 116dB dynamic range, 0.01% distortion, ultra low control feedthrough, and as much as 12MHz effective gain bandwidth product. All for a price so low it should surprise you.

The ultimate in flexibility. The ultimate in performance. The SSM 2014. Call or write for more details.

The Audio Silicon Specialists™



**Solid State
Micro
Technology**
for Music, Inc.

2076B Walsh Avenue, Santa Clara, CA 95050 U.S.A.
(408) 727-0917 Telex 171189

In England, contact Hartech Marketing Ltd. at 0243-773511.

STUDIO · WORLD

NEW & SECOND USER STUDIO EQUIPMENT SALES

New

Unrestricted by franchise—we aim to supply what YOU want!

Good as New

Major items are inspected, installed and commissioned by our own engineers — so we're not afraid to offer you a guarantee.

Complete Studio Systems

Designed, installed and maintained.

We Buy

Good used Studio Equipment.

Export enquiries welcome.

WHERE SERVICE COUNTS

Call (0727) 58977

153a Victoria Street, St Albans

EVENT

REAL TIME LOGIC LTD

SETTING A NEW STANDARD IN SMPTE/EBU/MIDI PROCESSING



FEATURING

- * VERY HIGH RESOLUTION SYSTEM TEMPO RESOLVED TO -01 BPM
- * VIDEO LOCKED TIMECODE TO PAL/NTSC/SECAM.† AND JAM SYNC FORWARDS AND BACKWARDS.
- * 4000 BEAT (APPROX 1/2 HOUR) HIGH RESOLUTION TEMPO SEQUENCER.
- * A THREE CHANNEL ADVANCE/DELAY MODULE ALLOWING OUTPUT CLOCKS (INC MIDI) TO BE SHIFTED RELATIVE TO EACH OTHER.†

† OPTIONAL PLUG-IN MODULES

THE REST . . .

Read, generate and Jam all SMPTE/EBU TIMECODE formats with auto select on code reader and a full 24 hour offset facility. Time code generator may be pre-set and locked on to PAL/NTSC/SECAM composite video signal for correct frame locked timecodes.

Timecode to MIDI auto-locate function (resolved to 1/256th of a frame), allowing precise MIDI sequencer position relative to incoming timecode. May be user-configured to work with 'difficult' sequencers.

Very high resolution system tempo, 01 BPM (1/256th of a frame) for precise lock, allowing total compatibility between lesser systems.

Merge incoming MIDI data with timecode generated MIDI clock for direct to sequencer recording.

Record up to 4000 beats (approx 1/2 hour) of external fixed or varying tempo data (ie. real drums, MIDI, pulse etc) to an accuracy of 01 BPM and replay the tempo sequence locked to timecode.

Simple and comprehensive entry and editing of time signature, tempo, song position and program change parameter.

Four fully programmable clock channels (2 Pulse, 1 MIDI and 1 External). All clock parameters such as PPGN, Wave shape, Enable type etc are fully programmable. The external clock will accept any clock and can be converted, multiplied or divided accordingly.

A seven channel event timer with 62 events per channel (totaling 434 events) for frame accurate timecode controlled mutes, triggering etc.

Non volatile system memory with a reliable external load/save and verify function.

A · D · T
AUDIO DIGITAL TECHNOLOGY

WORLD WIDE DISTRIBUTION BY
Unit 4, Brook Lane Business Centre, Brook Lane North, Brentford, Middx.
Tel: 01-977 4546
Telex: 265871 MNU117

REVIEW

As an alternative view, the 3D polar file set has been displayed as an assembled file in Figs 13, 14 and 15.

In Fig 13 the right half of the horizontal sweep only is shown, the left half, being almost identical and hidden to the rear of the file set, has been suppressed.

It is now obvious that the low frequency radiation is nearly hemispherical and the two crossover regions at 900 Hz, and 6 kHz can be seen as valleys. This is due to the directivity of the low frequency driver at the crossover point being greater than that of the midrange driver

that it should be matching, which results in a step in the power response. The same is true of the matching to the high frequency driver.

The effect of this is that the frequency balance of the speaker changes off-axis, altering frequency perception as the engineer moves around the room. This will affect both amplitude and image decisions. To be fair to the SCD 6000, it is not particularly bad in this respect but considering the care taken to minimise these problems, it should be better.

Figs 14 and 15 illustrate the behaviour of the cabinet in the vertical direction, Fig 14 being the lower section, passing from the base of the cabinet towards the centre, and Fig 15 the sweep from the centre to the top of the cabinet. This last curve has been displayed on the nearer side of the file set for clarity.

The crossover losses are now clearly obvious as sharp valleys. It should be noted that for all these measurements, the mid and high range were mounted vertically, the cabinet being in standard book shelf format.

Fig 16 illustrates the excellent distortion performance of the system, and the slightly greater than published sensitivity of 91 dB for 1 W at 1 m.

The principal distortion components are consistent over the measured range, though starting to rise markedly above the 100 W limit. This performance is good, and what would be expected of a competent dome-based system of this type.

Conclusions

This is a speaker system that has obviously been tooled for serious quantity production. In small runs, the complex top plate of the mid high range driver would be prohibitively expensive, let alone the castings and mouldings used on the baffle structure of the cabinets.

The result is different, visually distinctive, and will possibly polarise reactions from potential customers. Provided access to the internals or drive units is not required frequently, the mechanics of the cabinet are adequate for the job, though hardly robust.

Set against price, the system performance is good, though the general on-axis balance is felt to be aggressive, with too little control over the overall shape of the curve. Transient behaviour is excellent, the horizontal dispersion good, the vertical problematic.

The cabinets are a little too large to sit comfortably, either vertically or horizontally on top of a current console, and it would be of concern as to how these units are mounted over a console. In smaller rooms a Unicol or similar stand could be used, or a simple arrangement of shelving. This could exclude these cabinets from some control rooms.

There is not a substantial power handling margin, especially in the upper frequency range, and there would be concern over diaphragm damage if the units were stressed beyond the limits recommended in the brochure, which are accurate but not conservative.

Providing the finishing style is to your tastes, this is an inexpensive, innovative and somewhat idiosyncratic system that is worth auditioning as a general monitor and large nearfield device for the home studio, or smaller production facility. □

THE ULTIMATE MIDI AUTOMATED CONSOLE

Series II features include:

- * MIDI controlled muting of input channels and auxiliary returns. Tri-colour LEDs indicate channel status
- * 6 pre/post auxiliaries with fully routable, MIDI controlled returns. Effects return to foldback function
- * 4 band parametric equalisation
- * Individual channel 48V phantom power
- * Phase reverse
- * Insert points on all inputs and outputs
- * Two separate 2-track returns
- * Built-in talkback condenser microphone. Talkback to groups and studio foldback
- * 100mm ALPS faders
- * LED metering of all outputs and SOLO in unique meter pod (pod also contains talkback mic)
- * Rack mountable external power supply Type EP3
- * Available as 16.4.2, 16.8.2, 16.16.2
- * Input and Tape Monitor expanders for building consoles up to 40.16.24.2

Contact your Studiomaster dealer or us direct for further details:

STUDIOMASTER Studiomaster House, Chaul End Lane, Luton, Bedfordshire LU4 8EZ. Telephone: 0582 570370 Telex: 825612 STUDIO G Fax: 0582 570242
 U.S.A.: STUDIOMASTER INC. 1340-G Dynamics Street, Anaheim, California 92806 U.S.A. Telephone: (714) 524 2227 Fax: (714) 524 5096

Series II

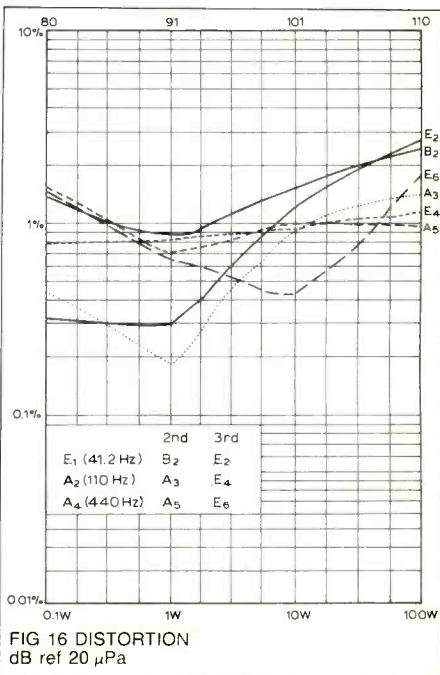

FIG 16 DISTORTION dB ref 20 µPa



BREAKING THE BARRIERS OF SOUND

Fane professional audio components represent the ultimate in advanced design technology, superlative performance and outstanding durability. Every product is designed according to the most up-to-date developments in materials and magnet system research. They are hand built to a standard which ensures that its original performance excellence will be retained indefinitely.

Breaking the barriers of audio research . . .
towards perfection.

FANE

Towards Perfection

Fane Acoustics Limited
296 Bradford Road, Batley,
West Yorkshire WF17 5PW, England.
Telephone: Batley (0924) 476431
Telex: 556498 AUDIO G



BROADCAST
EQUIPMENT
& SYSTEMS

The RHA Collection

*... a further collection
of equipment which must be
sold to make room for
our Systems work.*

- Audio Kinetics Q.Lock 3.10-3 synchroniser
c/w interfaces£3,500
- Otari MX5050 Mk3-8 ½" eight-track£2,800
- Otari MTR 10-2 ¼ two-track£2,500
- Pro-Ac Studio 3 Monitor Speakers.....£600
- Sony BVW10P Betacam Playerseach £10,500
- Sony BVU800P Hi-band Recorders ..each £8,000

07356 77221 (5 lines)
APOLLO 8, CALLEVA PARK
ALDERMASTON
BERKSHIRE RG7 4QW

Your Guarantee

NO GUESSES

NO GIMMICKRY

The circulation of this publication
is independently audited to the
professional standards
administered by the Audit
Bureau of Circulations



The Hallmark of Audited Circulation

STUDIO SOUND

AND BROADCAST ENGINEERING

CLASSIFIED ADVERTISEMENTS ORDER FORM

Please use this coupon for all your sales and wants.

Rates: 60p + VAT per word. Min £15.00 + VAT.

**Box Nos. £5.00 + VAT extra. VAT (UK only) \$rate \$2.00
per word, minimum \$50.00, Box No. \$10.00 extra**

PLEASE PRINT IN BLOCK CAPITALS

To: STUDIO SOUND, please publish the above advertisement for insertions under
the heading Cheque/P.O. to be made payable to LINK
HOUSE PUBLICATIONS LTD, LINK HOUSE, DINGWALL AVENUE, CROYDON CR9 2TA.
Is a Box No. required Yes/No. If no, please include remittance to cover name and address
and/or tel. no.

Name Address

SOUND BUSINESS RECORDING EQUIPMENT SALES



EAST LONDON AND ESSEX'S
TOP RECORDING EQUIPMENT
CENTRE

NEW AND SECONDHAND

NEW FANTASTIC AFFORDABLE SMPTE UNIT

X R03 SMPTE/EBU reader/generator, 8 digit display, programmed to show either hour/minute/sec frame or bar # min/sec/frame. Generate. Reads SMPTE 30/drop frame/EBU 25/Film 24. Up to 10 tempo changes inflight (and be programmed for each recording). Auto locates, starts, synchronises and stops MIDI sequencers. MIDI delay dump to computer, £199.95 inc.

We are main suppliers for:

REVOX, TASCAM, FOSTEX, YAMAHA, AIWA, ACES, SONY, SOUNDTRACS, RSD STUDIOMASTER, ALLEN & HEATH, DYNAMIX, RAM, SECK, MTR, SOUNDCRAFT, DRAWMER, BEL, APHEX, ALESIS, SYMETRIX, LEXICON, AKAI, TANNOY, JBL, AKG, NEUMANN, SENNHEISER, DENON, BOY, STEINBERG, ATARI, CABLES, PLUGS, WALL BOXES, PATCHBAYS — DI BOXES ETC. ETC. ETC.

HOME STUDIO RECORDING—ONWARDS & UPWARDS TO THE FULLY PROFESSIONAL

Check out Computer Window. Your 4 track system could become 28 track, 8 track could become 32 track, 16 track could become 40 track. Tape plus computer — The sky is the limit!

CALL JIM WINSTON ON: 01-989 6359 NOW!

"Full back up and technical service"

SOUND BUSINESS STUDIO SALES

Sound Business House, South Woodford (Central Line), London E18 1DG

APRS MEMBER

☎ 01-989 6359

Come and visit us in friendly informal surroundings. Easy parking (no yellow lines), 200 yards from South Woodford (Central line) tube, 25 minutes West End, we are situated just off the North Circular Road and the M11 junction. Easy access.

OPEN 7 DAYS — 9am to 9pm + EXPORT ARRANGED

Still Hanging Around

Waiting For Your Sampler To Trigger?



UNFORTUNATELY

MR. X

HAD'NT HEARD OF

THE SX303

The SX303 Sampling update can now be fitted to most professional delay lines. With an audio trigger time of less than 0.1mSec you won't be kept waiting!

PLEASE CALL OR WRITE FOR FURTHER INFORMATION

Audio
Engineering
Services



Chelmer House, Woodham Walter, Maldon, Essex. CM9 6RZ U.K.
Tel: 0245 415083 Telex: 995801 GLOTLX-G Quote Ref: A34

EUROPE'S NUMBER

1

DIGITAL HIRE COMPANY



FIRST....for Sony PCM 3324, PCM 1630 and PCM F-1 digital recorders.

EXPERTISE, service and advice.

LOCATION recording facilities a speciality.

DIGITAL....AND (let us not forget)....analogue.

OUTBOARD equipment and microphones.

NOISE reduction.

FELDON AUDIO (HIRE) LIMITED 126 GREAT PORTLAND STREET LONDON W1N 5PH
TELEPHONE 01-580 4314 TELEX 28668 ADDAX G

CLASSIFIEDS

Advertisements for this section must be pre-paid. The rate is 60p+VAT per word, minimum £15.00+VAT. Box Nos. £5.00+VAT. VAT (UK only) \$ rate \$2.00 per word, minimum \$50.00. Box No. \$10.00 extra. Semi-display rates on application. Copy and remittance for advertisements in **DECEMBER** issue must reach these offices by **22nd OCTOBER** addressed to: The Advertisement Manager, **Studio Sound**, Link House, Dingwall Avenue, Croydon CR9 2TA. Cheques made payable to Link House Publications (Croydon) Ltd. **Note:** Advertisement copy must be clearly printed in block capitals or typewritten.

Replies to Box Nos. should be addressed to the Advertisement Manager, Studio Sound, Link House, Dingwall Avenue, Croydon CR9 2TA, and the Box No. quoted on the outside of the envelope. The district after Box No. indicates its locality. **SEX DISCRIMINATION ACT 1975:** No job advertisement which indicates or can reasonably be understood as indicating an intention to discriminate on grounds of sex (e.g. by inviting applications only from males or only from females) may be accepted, unless (1) the job is for the purpose of a private householder or (2) it is in a business employing less than six persons or (3) it is otherwise excepted from the requirements of the Sex Discrimination Act. A statement must be made at the time the advertisement is placed saying which of the exceptions in the Act is considered to apply.

The attention of advertisers is drawn to "The Business Advertisements (Disclosure) Order 1977", which requires that, from 1st January 1978, all advertisements by persons who seek to sell goods in the course of business must make that fact clear. From the above date consumers therefore should know whether an advertisement relates to a sale by a trader or a private seller.

SERVICES

Check It Out...



DIRECT FROM OUR MODERN U.K. PRESSING PLANT

- CUTTING · PRESSING
 - TEST PRESSING
 - LABELS · SLEEVES
 - CASSETTES
 - ARTWORK
 - COMPETITIVE PRICES
- MARKET LEADERS**

SRT
01-446 3218



THE CASSETTE DUPLICATING SPECIALISTS

Real time & high speed loop bin duplication, printing & packaging. Blanks wound to length

TEL: 061-973 1884

THE COMPLETE SERVICE. Disc cutting, pressings, duplicated cassettes and blanks. Bin Masters. Location Recording. Free Brochure. Tam Studio, 13a Hamilton Way, London N3 1AN. Tel: 01-346 0033. (X)

100 C 60 cassettes beautifully copied in stereo from **£59.50** (plus VAT)
We can copy from 100 to 5,000 high quality cassettes on our high speed loop-bin system, load them precisely into top-class shells. Price includes library case and all production work from your 1/2 an edited master. Any length C-5 to C-90. Ring for price check.

STUDIO REPUBLIC



47 High Street, Pinner 01-868 5555 01-866 5555

THE COMPLETE SERVICE

includes:

BLANK CASSETTES (C1 - C100 incl. Chrome)
HIGH-SPEED LOOP-BIN CASSETTE COPYING
OPEN-REEL COPYING
CASSETTE LABELS & INLAY CARDS
EMPTY TAPE SPOOLS & TAPE BOXES
LEADER TAPE & SPLICING TAPE
AMPEX MAGNETIC TAPE

and is available from -
MEDIATAPE LIMITED

The Courtyard, 152-154 Ewell Road, 01 399
Surbiton, Surrey KT6 6HE England 2476 7

QUALITY CASSETTE COPYING & processing, any quantity. Video prod., PAL — NTSC — SECAM systems transfer and duplication. While you wait service. Open 24 hours, 7 days a week. Central London, W2. GWBB Audio Vision. Tel: 01-723 5190. (X)

AUDIOCLONE - THE NEW NAME IN CASSETTE DUPLICATION



REAL TIME PERFORMANCE - HIGH SPEED SYSTEM - DELIVERED AT THE RIGHT PRICE AND ON TIME

AUDIOCLONE
01-847 2785

NEW HEADS FOR OLD!

All makes relapped

TAPETEK: 01-254 5203 or
0836 215900 (car)

APPROVED BY



RELY ON YOUR EARS FOR A LIVING? Have your hearing checked. For confidential, prompt and reliable service call Mike Breslin 01-247 1953 Ext 209 (days), 01-358 9114 (evenings).

CASSETTE DUPLICATORS LIMITED

Offer the latest technology in Cassette Duplication High Speed Loop Bin System. Specialists for custom wound blank cassettes to exact length.

For Service and Prices write or phone:
Unit 2, Southern Avenue, Leominster,
Herefordshire HR6 0QF
Tel: 0568 3777 or 0789 765507

CASSETTE DUPLICATORS

Specialists in the supply and service of cassette duplicators, bulk custom wound cassettes, and accessories

GRAFF SONY TELEX WOLLENSAK

Main Dealers UK and Export

SOUND CASSETTE SERVICES LIMITED
BODEN STREET, CHARD, SOMERSET

0460 67237

NATIONWIDE

CASSETTE DUPLICATING:
GAUSS Loop-Bin / **TELEX** In-Cassette
High Quality Blanks / Label Printing
OPEN REEL DUPLICATING
(ANY SPEED - ALSO TO BROADCAST SPEC.)
SPEECH RECORDING
(VOICE-OVERS; LANGUAGES; AUDIO-VISUALS)
SPEECH-PLUS RECORDINGS LTD.

UNIT 32, NO. 19, PAGES WALK, LONDON SE1 4SB. TEL: 01-231 0961

CLASSIFIEDS

SERVICES

MRC

A ZONAL COMPANY

The Magnetic Recording Company, a subsidiary of Zonal, Britain's leading manufacturers of professional magnetic sound recording products, offer you cassette duplication of music, speech and data using Gauss loop bin, as well as the best equipment for winding, printing onbody labels and inlay cards.

You will get the service and quality that is expected of a company that has been in the magnetic products business for over 30 years.

MAGNETIC RECORDING COMPANY

Holmethorpe Avenue,
Redhill, Surrey, RH1 2NX.
Tel: 0737-767171
Telex: 946520
Fax: 0737-767610

jbs records
MUSIC-SPEECH-DATA
REAL-TIME/HIGHER-SPEED Quality Cassette
Duplication and Blanks from 1-1000 - Computer printed
Labels. Solo. 1/4" reel, Sony, Betamax recording.
Fast security Delivery service.
FILTERBOND LTD, jbs records div. FREEPOST
19 SADLERS WAY, HERTFORD SG14 2BR 0992-500101

HIGH SPEED COPIERS SALES AND SERVICES. Real time cassette copying. Blank cassettes. Audio visual supplies and servicing. Contact Sound Marketing on 0603 667725. (J)

REAL TIME CASSETTE COPYING

All work carried out on Nakamichi machines to the highest standard. Normal or chrome tape available.
We also supply blank cassettes wound to length.
AGFA and BASF chrome tape available
GATEWAY CASSETTE SERVICES
GAUDEN ROAD, LONDON SW4 6LR
TEL: 01-627 4758

AA Tape Winders 0268 765010

For rapid supply of exact length
Audio Cassette + Tape Duplicating

RAPER & WAYMAN

THE SOUND AUTHORITY

EXPERT REPAIRS

REVOX, TEAC/TASCAM, FOSTEX, UHER and all major names. Large spares stock held. A personal service by experienced engineers, PLUS collection and delivery.

34 Danbury Street, The Angel, Islington, London N1 8JU
Telephone: 01-359 9342/3030 or 01-226 7215

CASSETTE DUPLICATION

Quality Cassette Duplication, High-Speed and Real Time. From 1/4", PCM-Fl or Cassette Masters, Overwrapping, custom wound blank cassettes, labels and inlays
Tel: Leicester (0533) 602064
ACCURATE SOUND LIMITED
QUENIBOROUGH (Ind. Est.) MELTON ROAD
QUENIBOROUGH, LEICESTER LE7 8FP

FOR SALE—TRADE

M and B RADIO TEL: 0532 435649

Studer A80 8 track	£4,500
Studer A80 1/4 track master (as new)	£4,500
Studer B62 stereo	£675
Ampex stereo (Klark Teknik elec)	£750
Studer A62 mono + stereo	from £195
Leevers Rich Proline stereo	£500
Quantity of Ferrograph Studio 8 (as seen)	£375
Revox A77HS	£250
Studer C37 valve	£650
Uher 4000L	£85
Nagra III	£400
Leevers Rich stereo E200 (as new)	£395
Neve 24-8-4 returns	£7,000
Neve 16-4-8 console	£5,500
Rebis 28-16-4 returns	£4,750
EMT 240 Gold Foil Echo	£1,000
EMT 140 with 162 stereo reverb amps	£1,000
AKG BX20E reverb	£450
AKG C28 valve	£200
AKG C12A	£200
Neve comp limiters 2262	pair £850
Sennheiser 415T 805 815T, in stock	
Quad 50D amps	pair £150
Technics SP10 MkII record decks	NEW £350
10" Rascal zonal 1/4 mastering tape	NEW £9
2" Agfa Pem 468 (used OK)	£5

ALL PRICES + VAT

M & B RADIO

86 BISHOPSGATE STREET, LEEDS LS1 4BB

DISC CUTTING EQUIPMENT FOR SALE. Neumann VMS66 with Technics motor and Ortofon Electronic, Studer A80 Preview Mark 2, Studer A80 Recorder Mark 2, many more items. Bargain retirement. Box No. 958 (D).

KGM Studio Specialists

NEUMANN	JBL	LEXICON	SOUNDCRAFT
SENNHEISER	TANNOY	DRAWMER	STUDIOMASTER
SHURE	REVOX	D.B.X.	B.E.L.
BEYER	TASCAM	YAMAHA	APHEX
UREI	QUAD	AMPEX	APPLIED MICROSYSTEMS
TRIDENT	ROLAND	AKG	AUDIO KINETICS

18-42 Charlotte Street, WAKEFIELD, W. Yorks WF1 1UH
Tel: (0242) 371766. Export Enquiries welcome. Telex: 556849

CLEARWATER "SOFT DOME" MONITORS, 300wts, £350 o.n.o.; Neal 302 cassette machines, £200 ea; quality used equipment always available. Urgently required for cash! Quality microphones, outboard monitors. Studioline 0273 421138.

SOUNDCRAFT 762 II 24 track, autolocate, excellent cond., approx 950 hours, available immediately, price £9,000. Phone 010 45 1 821666/FAX 010 45 2 132357.

SPOOLS/BOXES

1/4" x 5" up to 2" x 14"

Full range of sizes now available
Ring or mail for details



Battersea Wharf, Queenstown Road,
London SW8. Tel: 01-627 3760
P.O. Box 19, Stratford-on-Avon. Tel: 0789-68579

TEAC 244/34/38 discounts and HP and leasing. Erricks VCD, Brighouse 722121 (Bob) (X)

WOULD YOU BUY A CAR WITHOUT A TEST DRIVE? THEN WHY BUY A MIXER WITHOUT A TEST DRIVE?

Thinking about a new project - from a small Mixer to a large studio complex - come and talk over ideas with the people who offer manufacturing and user experience at our new premises:

**Unit D, 318 High Road,
Benfleet, Essex SS7 5HB**

**TO TAKE THAT TEST DRIVE -
PHONE 0268-793381**

(Weekend Committee visits welcome by prior arrangement)



PARTRIDGE ELECTRONICS

A. C. PARTRIDGE LTD.

Head Office: 56 Fleet Road, Benfleet, Essex SS7 5JN
Telephone 0268-793256

THE "NEW" BEL BDE 26005 stereo sound sampler, 13 secs stereo, 26 secs mono, 18 kHz bandwidth. Complete with dual disk drive unit. Due to cancelled export order, new and boxed at £2,500 (normal price is £3,300), only 3 available, cash with order. Shep Associates 0763 61686, Fax: 0763 62154.

DISC CUTTING EQUIPMENT and systems bought, sold, installed and manufactured (under licence from ORTOFON). TAM/ENGLAND, 13a Hamilton Way, London N3 1AN. Telephone 01-346 0033. (X)

LOCKWOOD, TANNOY, etc., new and used equipment always available and wanted. Lockwood Audio Sales 01-866 0671. (X)

OTARI DP 4050 C2. 1 master, 2 slave high speed cassette duplicator and manual. £1,000. Tel: 051-639 3773/051-691 1079.

TASCAM/SENN/BEYER, trade counter. Erricks VCD, Brighouse 722121. (X)

24 TRACK STUDIO EQUIPMENT SALE comprising Soundcraft 1624 desk, Soundcraft 24 track AMS. Bel Scamp, Klark-Teknik, Tannoy etc. Telephone: 0532 633717.

MITSUBISHI X-850

32-TRACK DIGITAL RECORDER

9 months old. Purchased for a specific project - now surplus to requirements. Latest software, meter bridge etc.

Perfect condition £89,000

Contact: Sue Turner 01-221 2046

ALPRO AUDIO

SPECIALIST SUPPLIER OF PROGRAMMING SUITES AND ANCILLARY EQUIPMENT

• ATARI • MACINTOSH • HYBRID ARTS • DR T • STEINBERG •
• OPCODE • MARK OF THE UNICORN • ROLAND • YAMAHA •
• KORG • AKAI • KIAWA • ELECTROVOICE • TANNOY •
• SENNHEISER • FOSTEX • TASCAM • DENON • TC ELECTRONIC •
• PLATINUM • BEYER • JBL • SECK • SWITCHCRAFT •

1 NEW WAKEFIELD STREET, MANCHESTER M1 5NJ
TEL: 061-228 1335

CLASSIFIEDS

SITUATIONS VACANT

Dubbing Supervisor

We have a vacancy for an experienced Dubbing Mixer to work in the Dubbing theatre based at our television centre in Bristol. Work involves the mix down of a broad spectrum of film and video productions covering international dramas as well as local current affairs.

Applicants should have the personality and experience to develop a good rapport with production staff.

Suitably qualified candidates should write for an application form enclosing a self addressed envelope and quoting reference SS/643 to the Personnel Manager, HTV Limited, The Television Centre, Bristol BS4 3HG.

We are an equal opportunities employer and we welcome all applications irrespective of sex, ethnic origin, disability or marital status.



Professional Audio Engineers

Our clients are leaders in the sale and manufacture of professional audio equipment. A number of exciting opportunities exist for experienced engineers wishing to pursue careers in the following areas:

- Sales Engineering**
- Service Management**
- Sales Support**
- Service Engineering**

Stop Press. Vacancies for 2 Engineers with console design/service experience in United States.

For further information contact Mike Jones on (0256) 470704

Professional & Technical Appointments

BROADCAST DIVISION

drake

SALES SUPPORT ENGINEER

We are looking for someone with related broadcast experience, to provide general and technical support to the Sales department. This will involve maintaining the sales records and data base systems, answering sales enquiries and the preparation of detailed technical quotations for Drake's range of products and services.

We offer an excellent salary to the successful applicant, and pleasant working conditions.

If you feel your abilities and experience make you suitable for this position, then send your cv to:

Alison Chapman, Personnel
PHILIP DRAKE ELECTRONICS LTD
 37 Broadwater Road, Welwyn Garden City
 Herts AL7 3AX

drake

IF YOU DON'T NEED A NEW JOB

but you're always ready for a new challenge, why not read further. We are a leading manufacturer of high end professional audio equipment. We are looking for a personality with the right blend of commercial and technical capacities and with existing contacts in both the PA and the studio business.

If you are capable of setting up a distribution network in the UK please send us all relevant details, your conditions and a photo of yourself.

Applications to Box No. 956

STUDIO ENGINEER

A well known Central London recording studio requires an experienced radio and TV Post-Production Recording Engineer.

We have the latest computerised consoles and multi-machine synchronisers used for digital and analogue recording.

If you are able to work quickly and effectively under pressure and respond to clients requirements sympathetically please send your CV to:

BOX NUMBER 955



An electronics technician, minimum HND with thorough knowledge of digital and analogue design. Also machine level programming (preferably Z80).

Applications with full CVs to

ROBERT SPAIN
SARM Studios (West) Ltd
 9-10 Basing Street
 London W11 1ET
 01-229 1229

SPEECH STUDIO REQUIRES freelance engineers to work on site, and at home (preferably with own 2TK machine). Must have experience of speech recording and editing. Contact Richard Creasey at Motivation Sound, 35A Broadhurst Gardens, London NW6 3QT. Phone: 01-328 8305.

POWER PLANT STUDIOS

seek

SENIOR TECHNICAL & MAINTENANCE ENGINEER

with major studio experience, to work with Nick Clarke in running current three studio complex (SSL and Harrison desks) and to assist in future expansion.

Thorough knowledge of all latest technology essential

Please contact

Callie Mather on 01-451 3727
 or write with full CV to Power Plant Studios
 169-171 High Road, Willesden, London NW10

SITUATIONS WANTED

INTERESTING AND VARIED technical support/service position required by engineer with excellent technical and management experience. If you require a first class professional, phone: 01-968 3586.

CLASSIFIEDS

FOR SALE—TRADE

SECOND-HAND EQUIPMENT WORLDWIDE

+44 923 ☎ 772351
+44 923 ☎ 720060
+44 923 FAX 774713

TLX 262284 REF 1728G

JACKSON MUSIC GROUP

RECORDING CONSULTANTS
AUDIO-VIDEO-FILM
EQUIPMENT DATABANK
PACKAGES & INSTALLATIONS
SHIPPING & VALUATIONS
TECHNICAL SUPPORT



THE STUDIOS, RICKMANSWORTH
HERTS, ENGLAND WD3 2XD



FOR SALE—PRIVATE

TAC — SCORPION 16/8/82 eQ ON MONS.
Klark Teknik DN332 eQ, Harrison X300 amp,
AKG C414EB and C451 + CK1, all brand new.
Phone: 01-965 4320 for details.

SOUNDCRAFT SERIES 2 16-8 DESK. GPO Pat-
chbay. Multicore wiring to 16 track, effects. £1,000
plus VAT. Telephone Dave 01-743 3055.

STUDIO DESIGNERS
AND CONSULTANTS

FOR TOP QUALITY AND COMPLETE studio
construction and equipment consultants phone
BMS Studio Construction on 04868 29068/20293.
The cost effective way to build your studio. (D)

INSTALLATIONS

Audio, Video & Electrical Contractors
Complete project management
Prefabrication off-site

Elliott Bros

0865
249 259

EDUCATION

NFTS

THE NATIONAL FILM AND TELEVISION SCHOOL

offers a three year programme leading to a
specialisation in the area of Sound Recording
including location recording/transfer/
track laying, post-sync, music recording,
mixing and experience of all other areas of
film making.

The Sound Department is one of ten at
Beaconsfield; the others are Animation, Art
Direction, Camera, Direction, Document-
ary, Editing, Film Music Composition, Pro-
duction and Script Writing.

Closing date for applications is the 15th
January 1988 for Autumn 1988.

Write or telephone for Prospectus to:

Admissions Office, Dept. St.S.
National Film and Television School
Station Road, Beaconsfield, Bucks
Beaconsfield (04946) 78623

TAPE HEADS

REPLACEMENT of all
types of magnetic recording
heads.

REFURBISHMENT of worn
heads to as good as new
standard.

BRANCH & APPLEBY Ltd.
Stonefield Way, Ruislip,
Middx HA4 0YL 01 864 1577

STUDIOS FOR SALE

W. CORNWALL. Converted school - mod. house, sep. annexe flat. All
in walled det. location. Village ¼m. Town 2m. Present use Local Record
Co. & accom. Main studio (8Tr) approx. 48' x 18' x 15'. Lge control rm.
Established label & catalogue. In-house cass. prod. Plenty of room for
expansion, up-date or sep. enterprise. Reason: owners coming
retirement. Offered complete with Company, or as property only.
Ring (0736) 731246.

COMPLETE DISC CUTTING STUDIO FOR
SALE. Neumann VSM80, 2 stk Studer A820 ¼" or ½", Studer PCM DAD 16 digital preview
unit, transfer console, Klark analyser, Sony system Pal and NTSC RTW AD2, Studer
cassette A710, Revox PR 99, 2 stk Tannoy FSM. Bargain retirement. Box No. 958 (D).

FREEHOLD FOUR BEDROOM HOUSE, shop
and fully equipped 24 track studio (Yorks area).
Telephone: 0532 633717.

FREEHOLD HOUSE WITH ATTRACTIVE
purpose-built detached recording studio (fully
equipped 16 track), South London/Surrey for
details. Send SAE to Box No. 957.

AUDIO LEADS

Cable Technology
PRO AUDIO CABLES & SYSTEMS

IMPORTERS OF KLOTZ PROFESSIONAL
AUDIO CABLE, CABLE SYSTEMS AND
CONNECTORS FOR THE MOST
DEMANDING USE IN RECORDING,
BROADCAST, AUDIO VISUAL AND P.A.

72-74 EVERSOLT STREET, LONDON NW1 1BY
TEL: 01-387 5783 TELEX: 28159 MUSLAB G

FOR HIRE

35 BRITANNIA ROW LONDON N1 8QH

BRITANNIA ROW

01 226 3377

Multitrack, 4-Track,
Dolby SR + Telcom

WORKING IN THE USA?



"THE BEST THAT MONEY CAN RENT"
Complete selection of pro audio equipment for hire.
Outboard Equip ★ Digital Recorders ★ Walkie Talkies
599 Eleventh Avenue, New York, NY 10036
Phone (212) 582-4400

CLASSIFIEDS

AUDIO SERVICES

Professional Audio & Audio for Video Equipment
 Phone and ask for our latest list - more bargains are coming in daily!

NEW HIGH-TECHNOLOGY EQUIPMENT

- WOW-TECH Studios supplied and installed to all budget requirements - Ring for demonstrations/ installations
- Ring for full demonstration of T.C. Electronic 2290 Spatial Expander, Gurtar Effects & Para Eq's
- From JELLINGHAUS of W. Germany comes a major break through. A cost effective ladder automation system called the C-Mix System, which is retrofitable into virtually any mixer from 16 to 64 inputs utilizing the capabilities of the now well established ATARI 1040 ST. The C-Mix can bring real time automation to many smaller studios. Example price for 32 Faders £2,600. Computer, Write or phone for details.
- From Nady Systems of America, innovators of the Wireless Microphone, we now have in stock the brand new 'NADY 49' budget microphone & receiver (hand held tie-clip or guitar system microphones), starting at a ridiculous price of £195.00. Other Nady microphones available. Nady 701 Professional true diversity microphone starting from £1,495.00
- Rebis Midi Gate - A very useful production tool. Acts like a Drawer DS-201 but with a few extra tricks like trigger mask, trigger delay key filter may be used on audio plus a midi output which sends note on and key velocity dependent on audio amplitude information. Price £495
- Due to a discount in Alan computer prices we can now offer the Steinberg Pro 24 + Atari 1040ST-F + M1215 Monitor - Word Processor software at an unbeatable price of £725.00. As above but with Colour Monitor £875.00
- The superb TANTEK M4000 Master Matrix micro-processor based signal routing patchbay now in stock. Price £786.00. Send for colour brochure

SECOND HAND, EX-DEMO & NEW EQUIPMENT

TAPE RECORDERS		
STUDER A80 Mk IV 24 Track - Including Autolocate New		£22,950
STUDER A80 2 rehs 16 Trk - Superb Condition		£8,500
STUDER A62 Stereo - Lovely Condition		£795
STUDER B67 c/w Console/Overbridge - Mint		£2,500
TARI MX-5050 XHD 4 Trk - Little Use		£1,200
TARI MX-5050B Mk II 1/2" 8 Trk. with Remote - Perfect Condition		£2,285
ASCAM ATR80 2 Trk. In Console with Centre Trk. Time Code - As New		£2,500
ASCAM ATR-80 24 Trk 2" - New		£795
AC 3440 - As New		£595
TEAC 3440 - RX-9 dBx - Both Mint		£745
TEAC 35-2 Superb 2 Trk - S/H		£795
ASCAM MS-16 with dBx + Autolocate + Console Stand	Package Deals	£795
ASCAM ATR-60 1/2" Eight Track Professional + Console + Overbridge + Auto-Q		£4,950
ASCAM ATR-60 2 Trk. - As New		£2,995
ASCAM 480B - One Only Special		£2,995
ASCAM 32 - New Ex-Demo		£875
ASCAM 38 - New		£1,595
ASCAM 38 c/w 2 x DX4D in Tascam CS607 Stand - Perfect Cond		£1,795
ASCAM 38 New Heads with 2 x DX-4D in Console - All Boxed		£1,595
ASCAM 34B - As New		£895
ASCAM 34 S/H - New Heads		£995
ASCAM 22-4 - Perfect Condition		£495
OSTEX E2 1/2" Stereo + Centre Track		£2,400
OSTEX M80 - As New		£895
OSTEX Model 80 - New		£1,369
OSTEX E-16 - From Stock	£P O A	
TASCAM T2640 MS Cassette Duplicator - New 1 Only		£1,500
TEAC 32 5 Yrs Old. Relapsed Heads		£895
IEVOX B77 II - S/H As New		£1,095
IEVOX B77 II		£1,295
IEVOX PR-99 II		£1,395
IEVER 4200 c/w Case & Mics		£495
2 x AKAI MG-14D + Adams Smith Zelta 3 Synchroniser (24 Trk Recording)	Package Deals	£6,995
AKAI MG14D		£825
AMPEX ATR-700 2 Trk - Immaculate		£1,495
BRENNEL 8 1/2" 8 Trk c/w Full Function Remote		£995
TAM 806 1/2" 8 Trk - Good Condition		
MIXING CONSOLES		
AHB Sigma - All Formats Available	Prices From £8,892	
AHB Syncon B 34/24 P & G's + Stand - As New		£10,500
AHB System 8 Mk III 24 16 with JELLINGHAUS Automaton		£4,895
AHB System 8 1616 Mk II - As New		£1,195
AHB System 8 Mk II 16 8 - S/H		£1,095
AHB CMC 24 Mk II (24 16) - New		£1,950
AHB CMC 16 Mk II (16 8) - New		£1,395
AHB CMC 24 Mk II - New		£3,100
AHB CMC 32 with Jellinghaus Fader Automation + CMPTe Automated Routing & Muting		£7,080
AHB Studio 12 For Broadcast or Disco Applications		£1,395
AHB S 62 Production Desk		£2,795
SOUNDTRACS MRX Series 24 8 16		£5,200
SOUNDTRACS PC Midi Series 16 Input version		£4,045
RAM RM-16 - As New		£695
RAM RM-10 - As New		£495
RSD Studiomaster 16 8 2 - New Ex-Demo		£1,120
TASCAM M312 (12 4 8) - New Ex-Demo		£1,395
TASCAM M520 (20 8 16) - 2 Available. As New		Each £2,900
TASCAM M50 Inc. 04 Way Patchbay + Wing Loom		£450
TAC Matchless - New - To Order		£P O A
TAC Scorpion	Prices From £2,950	
FOSTEX 350 + 3060 Meterbridge - As New		£395
M & A Custom Console 26 16 2.5 Band Eq. 5 Aux - Impressive Board	Offers Around £1,850	
SOUNDSCRAFT Series 3B 24 - Good Condition		£8,950
SOUNDSCRAFT Series II 16 8		£695
SOUNDSCRAFT 400B 16 4 2 + 8 + 8 Mtrs		£1,995
TWEED Audio 24 16 Console Patchbay + Stand. All PPM's + P & G's Cost 26K New	Bargain £5,000	
OUTBOARD EQUIPMENT ETC		
AMS RMX-16 - Latest Software - 9 Months Old		£3,000
LEXICON 224 XL - New Model		£10,950
LEXICON PCM 70 Effects Processor		£1,850
LARK TEKNIK DNR1 Reverb	Special Offer	£1,950
T.C. ELECTRONIC 2290 with 32 Secs Sampling - New		£2,985
T.C. ELECTRONIC 2290 8 Secs		£2,085
MONITORB Drev 128 Pro Quality Reverb & Harmoniser (2 Remaining)		£325
AUDIO KINETICS Q-Lock 310 With Interfaces - As New		£4,500
BEI DEF 2600 Stereo Inc. Remote & Disk Drive		£2,995
YAMAHA REV-5		£1,042
YAMAHA SPX-90 II - New		£499
YAMAHA DMP-7 Digital Reverb/Mixer Monized Faders, Midi Etc. - New		£2,800
YAMAHA GC2020B Balanced - New		£245
ART Pro Verb - Available From Stock		£294
ALESIS Microverb - New		£715
3 x ALESIS Microverbs inc Rackmount Kit - New		£599
ALESIS Midverb II - New		£375
MARSHALL M5002 Time Modulator		£400
AKG BX-20E - Perfect	Bargain	£295
KORG DRV-1000 Reverb - New		£195
KORG DRV-2000 Reverb - New		£375
KORG DRV-3000 Inc. Infrared Remote - New		£795
REBIS RA701 Midi Gate - New		£495
AUDIO + DESIGN Gemini Dual Comp/Lm - New	Special Offer	£250
AUDIO + DESIGN Panscan Auto Panner - New		£375
AUDIO + DESIGN Complex Stereo 760 RS		£750
AUDIO + DESIGN F700RS - As New		£495
DRAWMER DS-201 Noise Gate	(Quantity Discounts)	£295
DRAWMER DL-221 Comp/Lm	(Quantity Discounts)	£76
DRAWMER LX-20 Comp/Exp	(Quantity Discounts)	£75
REBIS Rack 2 Freq. Conscious Gates RIAA Pre-Amp P Bay + PSU		£395
SYMETRIX 511 - 1 Only	Special Offer	£385
BEL BC-3BT - As New		£295
IBANEZ SDR-1000 - New		£425
OTARI Remote/Locator for MX-5050 8 Trk S/H		£290
TANTEK M4100 Master Matrix Automated Signal Routing		£795
ROLAND DS0 - In Stock		£1,120
STATIK IK1 SA20 Reverb - As New		£275
T.C. ELECTRONIC 1210 Spatial Expander		£795
T.C. ELECTRONIC 2240 HS 4 Band 2 Chan Parametric		£575
T.C. ELECTRONIC 1140 HS 4 Band Mono Parametric		£485
T.C. ELECTRONIC 1220 2 Band Stereo Parametric		£525
HARRISON GR215 2 x 15 Graphic		£495
HARRISON GP130 Mono 31 Band		£475
HARRISON GP230 2 x 30		£580
TASCAM DX-4 4 Chan DBX	Special Offer	£250
I.O. SYSTEMS Clarifier - In Stock		£235
FENDER STRAT Red Maple Neck Trem Custom Electronics		£395
FENDER RHODES Stage 73 - Good Condition		£50
LINN DRUM L/M2 With Expanded Memory	Price Reduced to	£350
OBERHEIM DMX - New Condition		£80
LOADS OF SECOND HAND MICS		
MICROPHONES New & S/H Used From NEUMANN AKG SENNHEISER BEYER SHURE TOA/NADY	RING FOR PRICES	
AKG C422 Comb. Mint		£995
STC 4038		£250
TOA Hand Held Radio Mc System S/H		£495
E.V. RE20 - S/H - As New		£425
JAMO J-230 Monitors - S/H		£595
MONITORS From JBL (Full Range In Stock) TANNY, YAMAHA, UREI		
AMPLIFICATION BY HARRISON UREI YAMAHA QUAD & RAUCH		

Loads more equipment in stock - we have gear coming in all the time.

Please note: the prices above do not include VAT.

STUDIO HOUSE All major credit cards accepted. LONDON
 High Lane Village 4 Wellington Road,
 Stockport SK6 8AA St. John's Wood.
 Tel: 06636 4244. Telex: 665721. Fax: 06636 2328 London NW8. Tel: 01-586 3167
 Normal opening hours are 9.30 am to 6.00 pm Monday to Friday, 10.00 am to 2.00 Saturdays
 If you intend to call at either of our premises we recommend you make an appointment first

INDEX TO ADVERTISERS

APRS	71
AMS Industries plc	6
Abacus Electrics	8
AEG Aktiengesellschaft	83
AKG	84
Allen & Heath/Brenell	81
Alpha Audio	65
Amek Ltd	63
Ampeg (UK)	IBC
Arva Sound	74
Asona	88
Audio Digital Technology	89
Audio Engineering Services	93
Audio Precision	55
Audio Service Co	98
BGW	43
BSS	60, 61
Beyer Dynamics	13
Celestion	30
Citronic Ltd	75
Court Acoustics Sales Ltd	75
D & R Electronica	4
DDA	25
Digipro International	17
DOD Electronics Corp	9
Don Larking Audio	54
Drawmer Distribution Ltd	45
Eardley Electronics	7
Fane Acoustics Ltd	91
Feldon Audio	93
FM Acoustics Ltd	6
Forat Electronics	76
FWO Bauch Ltd	IBC
GTC Ltd	74
Gateway	8
Genelec OY	20
Graff Electronic Machines Ltd	78
H W International (Shure)	51
Hardware House	65
Hartech	89
Hayden Laboratories Ltd	50
HHB Hire & Sales	26, 27
Hill Audio Ltd	42
Home Service Ltd, The	31
ITT Canon	14, 15
JBL	73
Keith Monks Ltd	87
Lyrec UK Ltd	33
MG Designs	87
Media Products Ltd	77
Michael Stevens & Partners	71
Midem	80
Mitsubishi Pro Audio Group	53
Mosses & Mitchell Ltd	87
Neve Electronics Labs Ltd	34
Northern Audio	7
Olson Electronics Ltd	77
Otari	67
Pangbourne Musical Distributors	77
Ramsa	12
Recording Studio Design Ltd	90
Rotherford Harrison Association	92
Saje	56
Solid State Logic	38, 39
Sony Broadcast Ltd	19
Sound Business	93
Soundcraft Electronics	IBC
Soundtracs	48
Sowter Ltd, E.A.	78
Stirling ITA	10, 11
Studio Spares	79
Studio World	89
Surrey Electronics	44
Synclavier	58, 59
Symetrix	8
T C Electronic	68, 46
Tannoy	65, OBC
Teac UK	40
Thatched Cottage Audio	47
TOA Electronics Ltd	45
Total Systems	6
Tunewell	74
Turbosound	36, 37
Unilet Ltd	78
Valley People	28
Wadsworth Electronics	71

Studio Sound is available without charge to qualified readers: these are directors, managers, executives and key personnel actively engaged in sound recording in any part of the world. The Publisher reserves the right to refuse applications considered inappropriate and restrict the number of free copies sent to any one company or organisation. Non-qualifying readers can buy Studio Sound at an annual subscription of £18.00. All enquiries to: Subscription Department, Link House Magazines, 120-126 Lavender Avenue, Mitcham, Surrey CR4 3HP. Published by the proprietors Link House Magazines Limited, Link House, Dingwall Avenue, Croydon CR9 2TA and printed by Lawrence-Allen Ltd., Gloucester Street, Weston-super-Mare, Avon BS23 1TB.

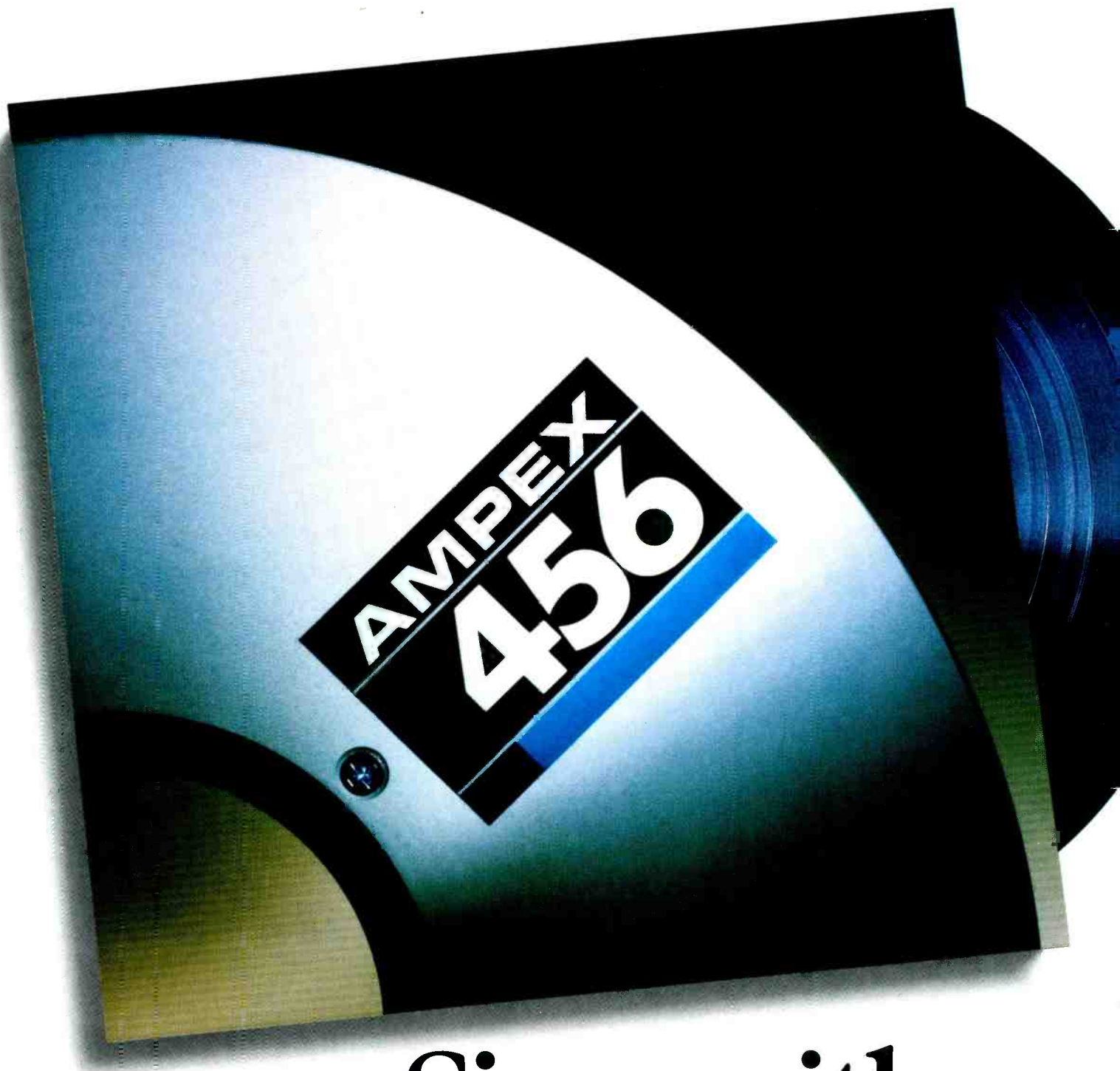

Sign with a major label

When it comes to hitting the top of the charts, the choice is Ampex Grand Master® 456 studio mastering tape.

It's not surprising, when you consider that our continuing refinements allow Grand Master 456 to always deliver unequalled performance.

No other mastering tape provides such consistent quality and reliability, or commands such respect from musicians and studio professionals alike.

More top performers have signed with Ampex tape than any other tape in the world. While opinion may vary on what it takes to make a hit, there's no argument on what it takes to master one.

AMPEX

Ampex Magnetic Tape Division, Acre Road, Reading, Berkshire RG2 0QR England (0734) 875200



The Gold Standard.



Tannoy has been setting standards in the audio industry for the past 60 years and has now created a new standard for audio monitoring from speakers to power amplifiers. The Gold Standard – for alchemy in sound.

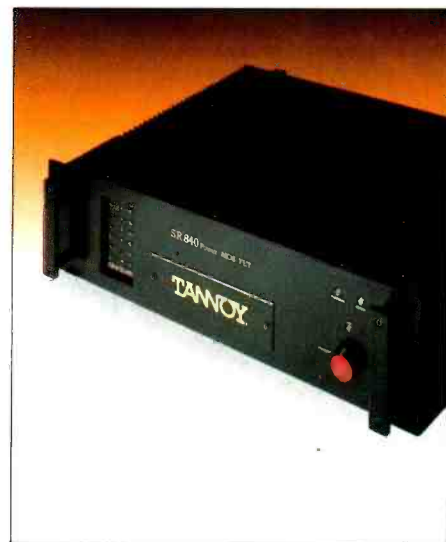

TANNOY
The Name for Loudspeakers

BAUCH

F.W.O. Bauch Limited, 49 Theobald Street, Boreham Wood, Herts. WD6 4RZ. Tel: 01-953 0091. Fax: 01-207 5970.