

# the TAPE

PRICE 1/6

JUNE 1962  
Vol. 4 No. 5

# RECORDER

INCORPORATING "SOUND AND CINE"



## IN THIS NUMBER

- Tape at the Audio Festival ● Tape Recorder Workshop ● Synchronised Sound Films
- Details of New Products ● Too Many Cooks-A Study of Tape Systems ● Equipment Reviewed
- Tape Recorder Service ● Readers' Letters ● The Calibration and Use of Test Tapes ●  
● News from the Clubs

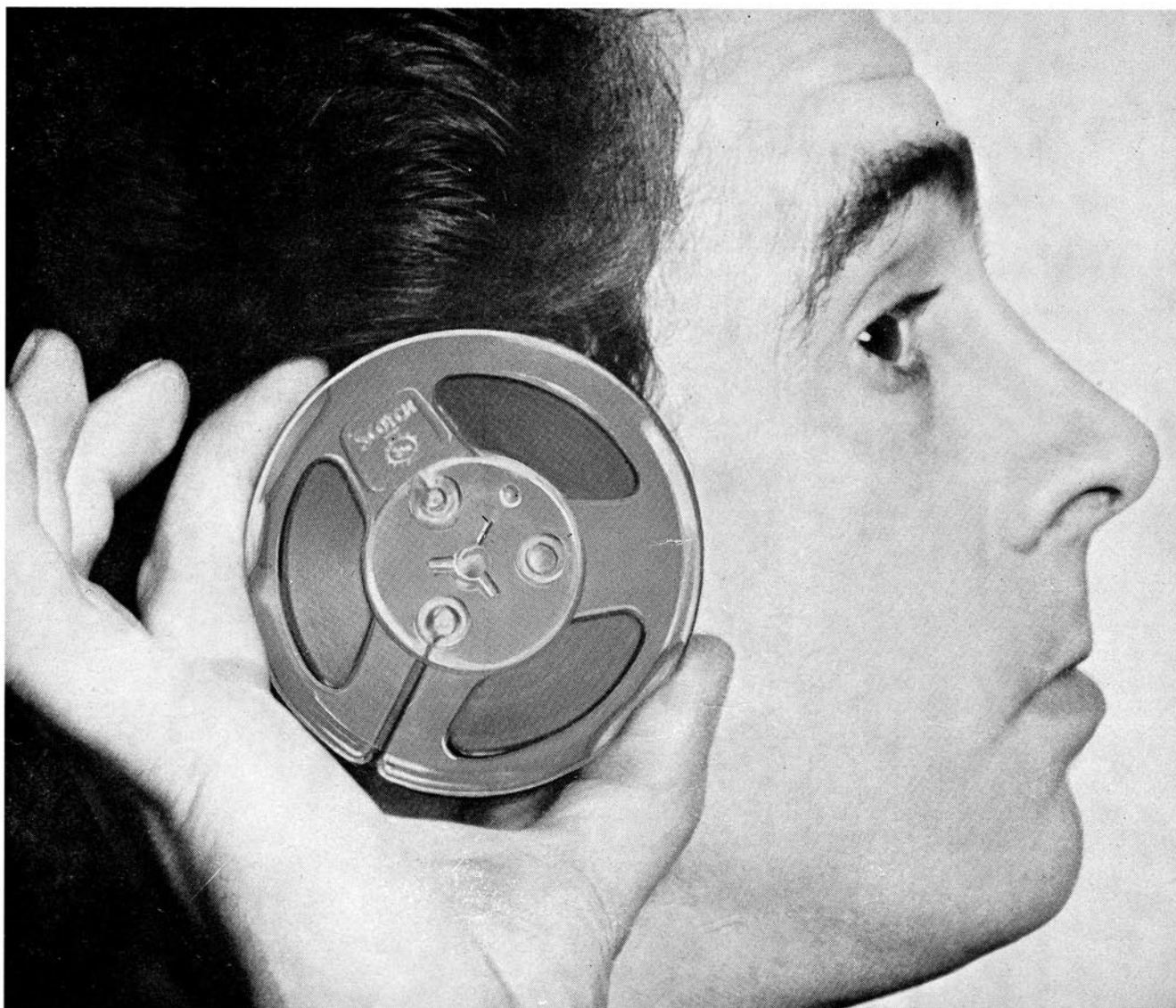

## HEAR **ALL** MAKES

See all makes. Dozens of different models, by all well-known makers. They are *all* at the Tape Recorder Centre—the country's leading specialists in tape recording. At the Tape Recorder Centre you can see all makes, hear all makes, compare all makes, on the spot. Experts are on hand with informed advice, based on the wealth of Tape Recorder Centre experience, to make sure you choose the model that is best suited for you (and for your pocket). You will find everything you need for tape recording, office dictation and hi-fi at the Tape Recorder Centre, plus excellent HP terms. Hear all makes, see all makes, at

**THE**  
**T C R**  
**TAPE**  
**RECORDER**  
**CENTRE**

**Philips**  
**Elizabethan**  
**Grundig**  
**Ferrograph**  
**Stella**  
**Vortexion**  
**Brenell**  
**Ampex**  
**Tandberg**  
**etc**

82 HIGH HOLBORN, LONDON, W.C.1. Telephone CHA 7401



# 2 YEARS FREE SERVICING!!



## FREE HOME DEMONSTRATIONS!!

So great has been the demand for Home Demonstrations that we have decided to extend the scope of these to all prospective customers residing in the Greater London Area, and its immediate suburbs. To avail yourself of this wonderful opportunity simply cut out and fill in the form below and upon the date requested, we will demonstrate, in the comfort and convenience of your own home, the recorders you wish to see, hear and compare. Our City Manager, Mr. Wells, who is well known as the Chairman of the famous Walthamstow Tape Recording Club, will personally supervise each demonstration. You may therefore be assured of expert technical knowledge and experience, plus a personal interest being shown. Alternatively a personal visit to our showrooms will enable you to see the finest and largest selection of both new and second-hand tape recorders on display in this country. All new recorders carry our unique **TWO YEARS FREE SERVICING GUARANTEE**, ensuring two whole years of worry-free, trouble-free and above all cost-free servicing.

**Specialists in**  
 BRENNELL · REFLECTOGRAPH  
 FERROGRAPH · VORTEXION  
 GRUNDIG · REPS · REVOX · ETC

- ★ OVER 250 NEW AND LOW PRICED SECONDHAND RECORDERS ON DISPLAY ★
- ★ GENEROUS PART EXCHANGES ★ CASH and H.P. TERMS OVER 9-24 MONTHS ★

### Free Home Demonstration Application

NAME..... ADDRESS.....  
 ..... TELEPHONE No.....  
 DATES CONVENIENT (ALL DEMONSTRATIONS ARE AFTER 7 P.M.).....  
 RECORDERS YOU WISH TO HEAR. (Max. 3).....  
 IF YOU WISH TO PART EXCHANGE STATE DETAILS BELOW.....  
 MAKE..... TYPE..... AGE..... CONDITION.....  
 ADDRESS FORM TO: Mr. B. Allerhand, City & Essex Tape Recorder Centres, 2 Maryland Station, Stratford, E.15

#### SHOWROOMS

228 BISHOPSGATE, E.C.2    BIS 2609  
 OPPOSITE LIVERPOOL STREET STATION

2 MARYLAND STATION, STRATFORD, E.15  
 ADJOINING MARYLAND STATION    MAR 5879

205 HIGH ST. NTH., EAST HAM, E.6  
 OPPOSITE EAST HAM STATION    GRA 6543

## CITY & ESSEX TAPE RECORDER CENTRES

For highest  
quality equipment

Heathkit

DAYSTROM

at lowest  
possible prices

**HI-FI FM TUNER, Model FM-4U**

Available in two units which for your convenience are sold separately: Tuning unit (FMT-4U—£3 2s. incl. P.T.), despatched wired and tested, and I.F. amplifier (FMA-4U—£12 5s.). Printed circuit for I.F. amplifier and ratio detector. Built-in power supply; 7 valves. Tuning range 88-108 Mc/s. (Illustrated bottom right). Total price **£15.8.0**

**HI-FI AM/FM TUNER, Model AFM-1**

Also available in two units as above: Tuning heart (AFM-TI—£5 5s. 6d. incl. P.T.) and I.F. amplifier (AFM-AI—£20 13s.). Printed circuit board; 8 valves; consecutive FM limiting and ratio detector. Tuning range FM: 88-108 Mc/s; AM: 16-50, 200-550, 900-2,000m. Switched wide and narrow AM bandwidth. Built-in power supply. Total price. **£25.18.6**

**TO ALL MUSIC LOVERS AND  
HI-FI ENTHUSIASTS**

Our wide range does not permit adequate coverage here of all models. A **FREE CATALOGUE** and full specifications of any particular model will be gladly sent on request without obligation on your part. **ASSEMBLED MODELS NOW AVAILABLE, PRICES ON REQUEST.**

All prices include free delivery in U.K. Deferred terms available on orders over £10.

**Tape Recording and Replay Hi-Fi Amplifiers  
Models TA-IM (Mono) and TA-IS (Stereo)**

For use with most tape decks. Thermometer type recording indicators, press-button speed compensation and input selection, 3-position bias level and printed circuit construction.

TA-IM ...	£19.2.6
TA-IM and Collaro "STUDIO" ...	£30.10.0
TA-IM and Truvox D83 ...	£47.2.6
TA-IM and TRUVOX D84 ...	£45.5.0
TA-IS (illustration Centre) ...	£24.10.0
TA-IS and Collaro "STUDIO" ...	£35.14.0
TA-IS and TRUVOX D83 ...	£52.6.0
TA-IS and TRUVOX D84 ...	£50.9.6

A **WHOLE RANGE OF PACKAGED DEALS (INCLUDING "CONNOISSEUR CRAFTSMAN" TURN-TABLE and DECCA fms PICK-UP) NOW AVAILABLE TO SAVE YOU FURTHER MONEY.**

**HI-FI EQUIPMENT CABINETS**



A range of equipment cabinets is now available to meet the differing needs of enthusiasts. All are accurately machined for ease of assembly and left "in the white" for finish to personal taste. Designed for maximum operating convenience or for where room space is an overriding consideration, this range has at least one model to meet your requirements. Why not send for full details?

**£11.12.6 to £18.10.0**

**THE "MALVERN"**

**"COTSWOLD" HI-FI FREE SUSPENSION  
SPEAKER SYSTEM**

This is an acoustically designed enclosure 26 in. x 23 in. x 14 1/2 in. housing a 12 in. bass speaker with 2 in. speech coil, elliptical middle speaker, together with a pressure unit to cover the full frequency range of 30-20,000 c/s. Capable of doing justice to the finest programme source its polar distribution makes it ideal for really Hi-Fi Stereo. Delivered complete with speakers, cross-over unit, level control. Tygan grille cloth, etc. All parts pre-cut and drilled for ease of assembly and left "in the white" veneered for finish to personal taste. Can be easily assembled in an evening and you then have a system fully comparable with any in the £40-£75 class. Assembled weight 61 lb. **£23 4s. 0d.**



**COTSWOLD**

**Here are some other easy-to-build Heathkit Models for you:**



SSU-1

**HI-FI SPEAKER SYSTEM Model SSU-1.** This kit is easily assembled. It contains twin speakers and balance control in its direct ducted port reflex cabinet. It is equally suitable for stereo or mono in average room. (Legs 14/6 optional extra). **£11 5s. 0d.**



S-33

**HEATHKIT ELECTRONIC WORKSHOP KIT, Model EW-1.** This new kit will help your boy to understand electronics, by making at least 20 exciting experiments, including Transistor Radios, Intercom Sets, Burglar Alarm, Electric Eye, etc. **£7 18s. 0d.**



AG-9U

**HI-FI STEREO 6-WATT AMPLIFIER Model S-33.** Attractively styled, completely self-contained. Printed circuit makes it easy to build. Only 0.3% distortion at 2 1/2 W/chal. U/I output, ganged controls. **£13 7s. 6d.**

**AUDIO SIGNAL GENERATOR Model AG-9U.** Delivers up to 10 volts pure sine-wave (less than 0.1% distortion, 20 c/s to 20 kc/s). Decade switch-selected frequencies from 10 to 100,000 c/s. Internal 600 Ohm N/I load, or external. **£21 9s. 6d.**



MA-12

**POWER AMPLIFIER 12-WATT Model MA.12.** Single channel, ideal for stereo conversion. **£10 19s. 6d.**



USP-1

**LOW INPUT HI-FI STEREO PRE-AMPLIFIER Model USP-1.** An input of 2-20 mV will produce an output adjustable from 20 mV to 2 volts. This enables low-input p.u.'s, etc., to load fully subsequent amplifiers of medium sensitivity. Negligible distortion. **£7 7s. 6d.**

**COLLARO "STUDIO" TAPE DECK.** Two tracks. "Wow" and "flutter" not greater than 0.15% at 7 1/2" p.s. Long Term Speed Stability better than 0.5%. **£17 10s. 0d.**

**SUGDEN MOTOR UNIT "CONNOISSEUR CRAFTSMAN".** Heavy duty motor, operating at 33 1/3 and 45 r.p.m. Very heavy 12" turntable. **£18 3s. 6d.**

**VARIOUS AUDIO ACCESSORIES** such as Speakers and Microphones etc. available. List sent on request.



USC-1

**HI-FI STEREO 18-WATT AMPLIFIER Model S-99** within its power rating, this is the finest stereo amplifier available, regardless of price. U/L push-pull output. Printed circuit construction. **£27 19s. 6d.**

**TRANSISTOR INTERCOM.** Models XI-1U and XII-1U. Ideal for office or home. Each Master operates up to five Remotes. 9v battery operated. XI-1U £10 19s. 6d. XII-1U £4 7s. 6d.

**STEREO CONTROL UNIT Model USC-1.** A deluxe stereo control unit with variable filter, switched rumble filter, printed circuit boards and many other refinements. Operates direct from tape heads. **£19 10s. 0d.**

**TRANSISTOR PORTABLE RADIO Model UXR-1.** Superbly styled hide case, with golden relief and crystal easy-to-tune dial; this completely self-contained 6-transistor dual-wave set performs brilliantly everywhere, even in a car. Reproduction is exceptionally good. Printed circuit. **£14 3s. 0d.**

**SHORTWAVE TRANSISTOR PORTABLE Model RSW-1** Four wave-band seven transistor portable with telescopic and ferrite aerials, slow-motion tuning. Covers Medium, Trawler, and 6-26 Mc/s in four switched bands. Uses printed circuit board and latest circuit technique. Superbly styled leather case. **£22 8s. 0d.**

**TRUVOX D83 AND D84 TAPE DECKS.** High quality mono/stereo Tape Decks. D83 2-track for highest-fidelity. **£31 10s. 0d.** D84 (identical presentation) 4-track for most economical use of tape. **£29 8s. 0d.**

**"MOHICAN" GENERAL COVERAGE RECEIVER Model GC-1U.** Fully transistorised. Four piezo-electric transistors. To overcome the problems of alignment, etc., the R.F. "front end" is supplied as a pre-assembled and pre-aligned unit. **£39 17s. 6d.**

**GOLDRING-LENCO TRANSCRIPTION RECORD PLAYER Model G.L.58.** Fitted with the G.60 pick-up arm, it has infinitely variable speed adjustment between 33 1/3 and 80 r.p.m. and four fixed speeds. 3 1/2 lb. turntable to reduce rumble, "wow" and "flutter". **£19 12s. 6d.**

**SOME OTHER HEATHKIT MODELS AVAILABLE**

World's largest-selling VALVE VOLTMETER ...	Model V-7A	£13.18.6
G/P OSCILLOSCOPE (5 in. Flat-face screen) ...	Model O-12U	£38.10.0
"HAM" TRANSMITTER ...	Model DX-40U	£33.19.0
VARIABLE FREQUENCY OSCILLATOR ...	Model VF-1U	£11.17.6
TRANSISTOR RADIO for the youngsters ...	Model UJR-1	£2.13.6
RESISTANCE/CAPACITANCE BRIDGE ...	Model C-3U	£9.5.0
AUDIO VALVE MILLIVOLTMETER ...	Model AV-3U	£14.17.6
AUDIO WATTMETER ...	Model AW-1U	£15.15.0



S-99



RSW-1



UXR-1



GL-58



F.M. TUNER

JUST POST THIS COUPON FOR FURTHER INFORMATION

Without obligation please send me

★ **FREE BRITISH HEATHKIT CATALOGUE ...**  
FULL DETAILS OF MODEL(S) .....

Kindly write below in BLOCK CAPITALS

NAME .....

ADDRESS .....

TICK  
HERE

\_\_\_\_\_

\_\_\_\_\_

\_\_\_\_\_

HT11

**DAYSTROM LTD. DEPT. HT11  
GLOUCESTER, ENGLAND**

A member of the Daystrom Group, manufacturers of  
**THE LARGEST-SELLING ELECTRONIC KITS IN THE WORLD**



**IT'S NOT THE  
ONLY HOBBY  
YOU KNOW—  
OR DO YOU?**

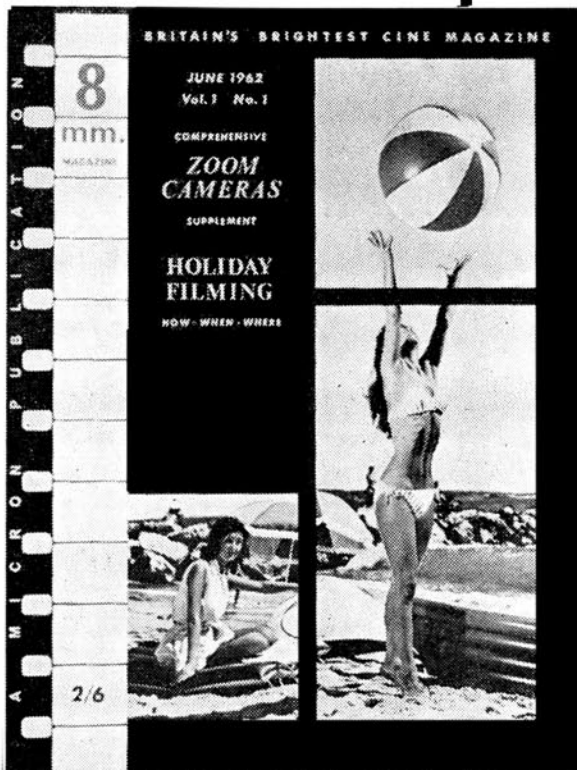

Any 8mm. enthusiast will tell you, tape recording is highly complimentary to cinematography. Don't say we said so, but 8mm. cine can also be usefully employed to supplement tape recording. Sound and sight are rarely separable and regular reference to 8mm. Magazine and the Tape Recorder will keep you up to date in both fields.

Don't take our word for it and rush to spend anything from twelve to two hundred pounds on a camera. Take 8mm. Magazine home this month and see for yourself.

**Make sure of your  
copy by ordering now  
8mm. MAGAZINE**

**FIRST ISSUE ON SALE  
FRIDAY, JUNE 1st**

**G. M. SMITH  
PUBLISHING CO. LTD.**

MICRON HOUSE,  
GORRINGE PARK AVENUE,  
MITCHAM, SURREY

# WORLD RECORD CLUB OFFERS YOU THE CHOICE OF ANY 3 PRE-RECORDED TAPES

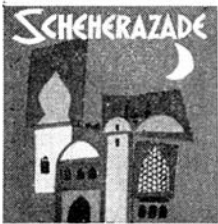

31. Rimsky-Korsakov: Scheherazade. Sir Eugene Goossens conducts the LSO in a breathtaking performance of this rich and exotic masterpiece. Also on disc: mono/stereo

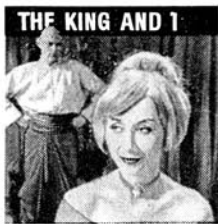

32. Star cast and orchestra stage all the famous songs: Getting to Know You, Hello Young Lovers, I Whistle a Happy Tune, Shall We Dance, etc. Also on disc: mono/stereo



53. These two suites, containing some of Bizet's most thrilling music, are given magnificent performances by the Sinfonia of London under Muir Mathieson. Also on disc: mono/stereo

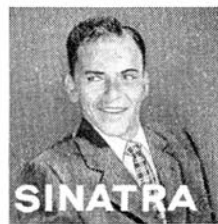

19. Look Over Your Shoulder, My Lean Baby, White Christmas, Don't Worry About Me, Melody of Love. 12 top numbers sung by the fabulous Sinatra. Also on disc: mono only



56. All the magic of old Vienna! starring Jacqueline Delman, John Larsen, Linden Singers and Sinfonia of London conducted by John Hollingsworth. Also on disc: mono/stereo



33. Beethoven 5th, plus Egmont, Josef Krips and LSO in a titanic interpretation which matches the tremendous power of this celebrated music. Also on disc: mono/stereo



30. Ian Carmichael, Joyce Blair, star cast/orchestra. As Long as He Needs Me, Consider Yourself, all the hit numbers from Lionel Bart's great show. Also on disc: mono/stereo



39. Great ballet conductor John Hollingsworth and the Sinfonia of London in a sparklingly fresh interpretation of Tchaikovsky's famous Ballet. Also on disc: mono/stereo



20. Answer Me, Nature Boy, Ruby and the Pearl, these plus 8 more favourites sung especially for you by the unique Nat King Cole. Also on disc: mono only



40. Superb singing by Bruna Rizzoli and Giuseppe Savio with the chorus of the Teatro Nuovo di Milano and orchestra conducted by Napoleone Annovazzi. Also on disc: mono only



29. Me and My Shadow, Among My Souvenirs, Mean to Me, How About Me... the fabulous Judy Garland sings 11 of her greatest songs. Also on disc: mono only



25. Ian Wallace, Joyce Blair and chorus. Some Enchanted Evening, I'm In Love With a Wonderful Guy, and all the unforgettable songs from this great musical. Also on disc: mono/stereo



34. Stardust, How High the Moon, Nearer of You, 'Round Midnight, King David—eight numbers by the vibraphone genius, Lionel Hampton. Also on disc: mono/stereo



48. Deep in My Heart, Drinking Song, Serenade—all the old favourites (fresher than ever with Marion Grimaldi, Linden Singers and Orchestra. Also on disc: mono/stereo



37. Revolutionary Study, Polonaises A and A flat, Fantaisie-Impromptu—12 favourites in all played by the pianist of Dirk Bogarde's 'Song Without End'. Also on disc: mono only



22. 12th St. Rag, Isle of Capri, Smile, Blue Moon, Bunny Hop Mamba, Satin Doll. 12 top numbers played in characteristic style by the Duke and his band. Also on disc: mono only



2. Grieg Piano Concerto. Alexander Jenner in an electrifying performance with the Bavarian State Radio Orchestra conducted by Odd Gruner-Hegge. Also on disc: mono only

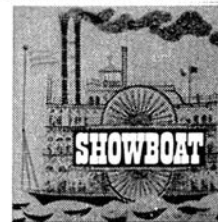

35. Ol' Man River, Bill, Make Believe, many more well-loved numbers from this famous musical memorably sung and played by full star cast. Also on disc: mono/stereo



44. Leopold Ludwig and LSO combine brilliantly in an exciting 'double': two of the world's greatest symphonies receive vivid new interpretations. Also on disc: mono/stereo

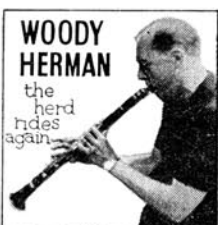

45. Crazy Rhythm, Bijou, I Cover the Waterfront, Northwest Passage, Blowin' Up a Storm, etc. The master clarinetist plays 12 numbers in great style. Also on disc: mono/stereo



38. Hervey Alan, Ian Wallace, Marion Grimaldi and chorus sing the immortal favourites: Cobbler's Song, Robbers' Chorus, Chu Chin Chow, etc. Also on disc: mono/stereo



14. Tchaikovsky Symphony No. 5. Sir Malcolm Sargent and LSO combine to give this famous symphony a dramatic and colourful rendering. Also on disc: mono/stereo



43. Andy Cole, Barbara Leigh, Mike Sammes singers: High Society, Three Coins, Harry Lime, Gigi, The High and the Mighty. 11 top film hits. Also on disc: mono/stereo

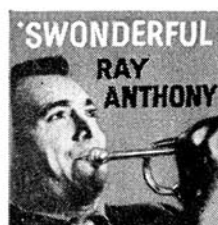

41. Night and Day, King Porter Stomp, Pennies from Heaven, Christopher Columbus, Don't Be That Way, with the top American bandleader/trumpeter. Also on disc: mono only

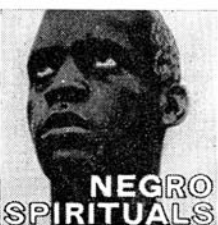

42. Jericho, Swing Low, Shadrak... 12 of the best loved Negro Spirituals movingly sung by George Brown, Isabelle Lucas and Linden Singers. Also on disc: mono/stereo



36. Beale Street Blues, After You've Gone, The Sheik of Araby, My Kind of Love, 12 tremendous hits by one of the world's greatest jazz trombonists. Also on disc: mono only

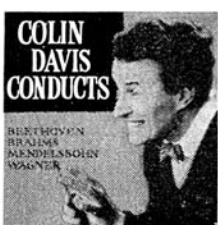

49. Beethoven's Fidelio Overture, Brahms' St. Anthony Vars, Mendelssohn's Hebrides, Wagner's Siegfried Idyll. All under Britain's greatest young conductor. Also on disc: mono/stereo

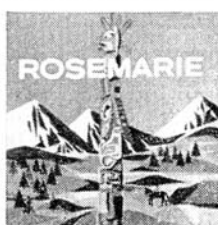

50. David Hughes, Barbara Leigh, Andy Cole and chorus sing Indian Love Call, Rose Marie, and all the other tunes from Frim's well-loved musical. Also on disc: mono/stereo



47. Brahms Violin Concerto. Superb playing by Endre Wolf and Sinfonia of London under the baton of Anthony Collins makes this a truly memorable performance. Also on disc: mono/stereo



46. Elizabeth Larner, Andy Cole, Peter Knight singers. Exciting 'double' featuring highlights from two famous shows by Frederick Loewe and Cole Porter. Also on disc: mono/stereo



# FOR ONLY 30/-

## THE GREATEST BREAKTHROUGH SINCE TAPE RECORDING!

Here is the greatest World Record Club introductory offer ever made . . . a unique offer never before matched by any record club or company anywhere in the world!

EVERY ONE OF WORLD RECORD CLUB'S UNRIVALLED RELEASES AS 12" LPs IS NOW AVAILABLE ON 3½ ips TAPE!

Now you have the opportunity to play any WRC release on your tape recorder. Each of these 'tape records' runs at 3½ ips, mono, on 5" spools and can be played on either 2 or 4 track recorders. New electronic techniques of tape-to-tape transfer give these 3½ ips WRC pre-recorded tapes a standard of reproduction unattainable previously at less than 7½ ips.

### WORLD RECORD CLUB 7-POINT PLAN MEANS BETTER LISTENING FOR YOU!

#### 1. AN UNPARALLELED INTRODUCTORY OFFER.

Choose now, any three of the superb 3½ ips pre-recorded tapes shown here, for only 10/- each and number them on the attached coupon. (If you wish, of course, you can choose 12" LPs instead. Both disc and tape are the same price.) Please send no money until after you have received, played and approved them. We want you to prove to yourself, before paying, that our tapes are equal to the world's best.

#### 2. THE OPPORTUNITY TO BUILD A UNIQUE TAPE COLLECTION.

The WRC plan offers you an exciting and varied annual repertoire of more than 60 selected tape releases, covering classics, jazz, shows, ballet music, light music and 'pops'. Every one is a superlatively recorded 3½ ips mono tape (or 12" LP—mono and stereo). Each is offered to you at the

privilege club price of 29/- (plus a small charge for post and packing)—much less than you would pay elsewhere for recordings of anything like this quality.

Your only obligation, as a Club member, is to agree to buy four more tapes (or 12" LPs) over the year. Beyond this, there is no subscription or membership fee.

#### 3. A PLANNED PROGRAMME.

Every World Record Club release is hand-picked by an independent panel of Britain's top musical authorities. The Countess of Harewood, Lord Montagu of Beaulieu, Sir Arthur Bliss, Richard Attenborough, Cyril Ornadel, Ray Ellington, Leon Goossens, Malcolm Arnold, Steve Race, John Hollingsworth, Antony Hopkins—and, as special adviser on tape, Miles Henslow.

#### 4. FREE MONTHLY MAGAZINE.

A monthly magazine, packed with fascinating musical articles, reviews, news and pictures, is issued free to all members.

#### 5. SPECIAL CONCERT PRICE CONCESSIONS.

Many concert halls and theatres throughout the country (including the Royal Festival Hall) allow special concession rates to club members for many performances.

#### 6. FREE BONUS TAPES.

The more you buy, the more you save! After fulfilling the minimum membership obligations, you earn another tape of your own choice free for every extra three you buy!

#### 7. EXCLUSIVE EXTRA RELEASES.

In addition to the regular monthly selections, the club offers members exclusive extra tapes at the standard Club price.

World Record Club is unique—the first and greatest Record and Tape Club in Britain, with the largest show catalogue (on tape and mono/stereo disc) in the world. No other method of tape—or record-buying offers you so many additional benefits, so much freedom and variety of choice, with no 'high-pressure' selling. And, of course, there are no subscriptions or membership fees of any kind—only a small deposit of £1 (later refundable) when you become a tape member.

Don't miss this great opportunity. Send off the coupon today, for your 3 introductory selections for only 30/-



... AND IF YOU OWN A STEREO TAPE RECORDER hear the fantastic reproduction of **STEREO 21** THE NEWEST, TRUEST SOUND ON TAPE TODAY!

Revolutionary new STEREO 21 pre-recorded tapes (7½ ips twin-track) are issued exclusively by World Record Club. But they are offered without membership commitments of any kind. The first list of all new STEREO 21 releases is now available. It features 30 superb stereophonic tapes ranging from Beethoven's *Eroica* with Josef Krips conducting the LSO, to a lavish full-cast production of *Oklahoma*.

As always, WRC prices present unparalleled value—all STEREO 21 releases cost either 50/- or 60/- depending on playing time (up to 50 minutes). STEREO 21 tapes are now obtainable through leading retailers or direct by post from World Record Club. Send for full catalogue now—STEREO 21 must be heard to be believed!

## 7-DAY FREE TRIAL OFFER—POST TODAY!

## STEREO 21 FREE BROCHURE

To WORLD RECORD CLUB (Dept TRR6)  
PARKBRIDGE HOUSE, RICHMOND, SURREY.  
SEND NO MONEY NOW

3½ ips pre-recorded tapes	12" LPs
---------------------------------	---------

Tick which you want

Please send me, without obligation, on 7-day free trial, the three selections indicated. (Your 3 selections must be either all tape or all disc.) If satisfied, I will pay you 30/- plus 3/- postage, packing and insurance. Only at that stage may you enrol me as a full member of World Record Club, entitled to all the benefits described. My only obligation as a member would be to agree to purchase 4 more top quality 3½ ips tapes (or 12" LPs) over a 12-month period at the special club price of 29/- each. If I am not completely satisfied with my 3 selections, I will return them to you within 7 days, in good condition, and owe you nothing.

NOTE I understand I will be asked to pay £1 deposit when I become a tape member (this does not apply to disc members). This deposit is refundable.

Signed.....  
this offer applies in Gt. Britain and N. Ireland only.

MY 3-SELECTION 'PACKAGE' COMPRISES  
Choice No. 1 Choice No. 2 Choice No. 3



(place tape/disc key numbers only in the circles)

Tick here if stereo 12" LPs are required where available

Mr/Mrs/Miss .....  
(BLOCK CAPITALS PLEASE)

ADDRESS .....

To WORLD RECORD CLUB (Dept TRR6)  
Box 11 PARKBRIDGE HOUSE, RICHMOND, SURREY.

Please send me your free colour brochure, showing the full range of your new STEREO 21 releases.

NAME .....

ADDRESS .....



# NEW FI-CORD 202

**PORTABLE  
BATTERY/MAINS  
RECORDER**

***so much in so little space***

**The FI-CORD 202 offers all these features:**  
 2 speeds— $7\frac{1}{2}$  and  $3\frac{3}{4}$  • Standard 4" spools • Vu-meter • Fast forward wind • Fast rewind • Resettable counter • Manual and automatic volume control • Built-in loudspeaker • Extension speaker socket • Low and medium input sockets • Socket for remote control • Safety record switch • Easy-load battery cassettes • Battery warning lamp • Mains input.

FI-CORD 202 the new portable battery/mains high fidelity tape recorder, has been developed after years of exacting tests in the Fi-Cord laboratories. It is a worthy successor to the famed FI-CORD 1A, used internationally by broadcasting companies during recent years.

FI-CORD 202 is for the most exacting professional and equally for the enthusiastic amateur demanding the highest professional standards. It incorporates all the practical advantages of a full-size recorder in a small, light-weight machine.

FI-CORD 202 gives you high fidelity recording at your fingertips—whenever you wish, wherever you go.

**AND the FI-CORD 202 weighs only  $6\frac{1}{2}$  lb, measures  $9" \times 6\frac{1}{2}" \times 4\frac{1}{2}"$ .**



**Price: 66 guineas, including long life mercury batteries and tape.**

**ACCESSORIES INCLUDE:**  
 Carrying case, choice of microphones, power packs for mains and car.

Write for fully illustrated brochure and address of nearest stockist to:

**FI-CORD INTERNATIONAL**  
 40a Dover Street, London W1. HYDe Park 3448



## the truest sound

For sound reproduction as it should be—as close as possible to the original—make Shure microphones your unvarying choice. They are the finest for every purpose, years ahead of others in the technical excellence of their design and performance, the most comprehensive range obtainable anywhere.

**Model 545 'Unidyne III'** for public address, tape recording, communications and similar applications requiring compactness with maximum operating efficiency.

**Model 420 'Commando'** can be used indoors or outdoors, for all general-purpose applications. Quality performance at moderate cost.

**Model 540S 'Sonodyne II'** This versatile new microphone features *variable frequency response*, allowing the user to tailor the microphone to the application.

**Model 55SW 'Unidyne'** The most widely used microphone in the world, specified by leading sound engineers and requested by celebrities.

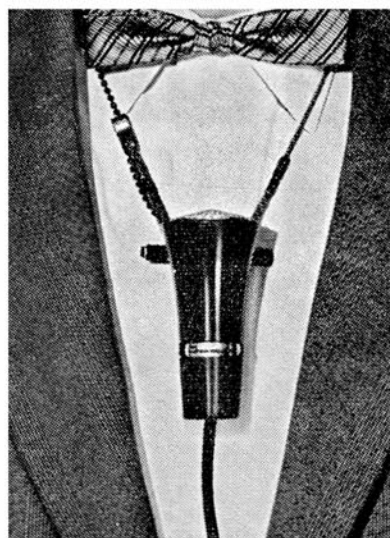

Model 420 'Commando'

The new Shure microphone catalogue is available on application to the address below

**SHURE ELECTRONICS LIMITED**  
84 Blackfriars Road · London SE1  
Telephone: WATerloo 6361

**SHURE**

Setting the world's standard in sound



Model 55SW  
'Unidyne'

Model 540S  
'Sonodyne II'

# You buy the future-when you buy

THE **BRILLIANT**

# SIMON SP5



*Cabinet designed by  
LUCAS MELLINGER, A.R.I.B.A., A.M.T.P.I.*

*(above) ready for use and (right) as it looks when carried.  
Note that the handle does double duty as a carrying  
handle, and also as a support in the record/play position.*

Brilliantly designed, brilliantly styled, giving brilliant results—the SIMON SP5 uses well proved techniques and circuitry in a cabinet of revolutionary but functional design. The combination gives superb performance — and an outstanding range of facilities.

- ★ *Seven-inch spools, twin tracks, two speeds, and pause control are features of the ruggedly designed high performance deck*
- ★ *A spectacularly successful cabinet design provides optimum acoustic conditions, efficient ventilation, and easy-operation control panels*
- ★ *Transistors and valves are each used to their best advantage in circuits setting patterns for the future*
- ★ *10" x 6½" speaker with 4" tweeter*
- ★ *Simultaneous monitoring of record signal through loud-speaker or headphones, mixing, fade-in control*
- ★ *Re-recording facilities — transferring the signal from one track to the other with simultaneous mixing of microphone or radio input*
- ★ *Conversion to stereo at minimum cost, using ready-wired circuitry*

SEE AND HEAR IT AT YOUR LOCAL DEALERS NOW!

To SIMON EQUIPMENT LIMITED  
48 George Street London W1

Please send me your free leaflet on the new SIMON SP5 and the name of my nearest stockist

NAME \_\_\_\_\_

ADDRESS \_\_\_\_\_

\_\_\_\_\_

T6

**SIMON**  
EQUIPMENT LIMITED  
48 George Street London W1  
Telephone: WELbeck 2371  
Telegrams: SIMSALE WESDO LONDON

**SEE the shape of the future! HEAR perfection in sound!**



# U.S.A.'s 3rd LARGEST SELLER NOW ARRIVES IN BRITAIN!

## AKAI *Terecorders*

*for those who expect the earth in a world of sound*



### MODEL 69 'DE-LUXE'

**Wide Frequency Range:** Equipped with a record/play head which consists of specially treated core-materials being imported from West Germany.  
**Output Power:** 6 watt, can drive larger size extension speaker up to 12 in. Self contained speaker is 6½ in. in diameter.  
**7 in. Reel Capacity:** Accepts 3 in. and 5 in. reels as well.  
**Level meter:** with pilot lamp for easier determination of correct volume control setting when recording.  
**Index (Revolution) Counter.**  
**Instant Stop Control:** Spot editing and momentary stops are easily accomplished by use of the Instant Stop Lever.  
**Monitoring and better reproduction:** Monitoring of your recording may be accomplished by plugging a crystal earphone into the recorder's Output Jack. Superb reproduction can be obtained by operating a large Hi-Fi speaker direct from the Output Jack. Also your existing power-amplifier that does not have a pre-amplifier of its own may be driven from the same Jack.  
**Head Output and three position Power Switch:** If desired, the tape transport mechanism (tape deck) of the recorder can be operated independently of the built-in amplifier and speaker. The Head Output Jack and the three-position Power Switch are provided to make this special function possible.

Retails at 79 GNS.

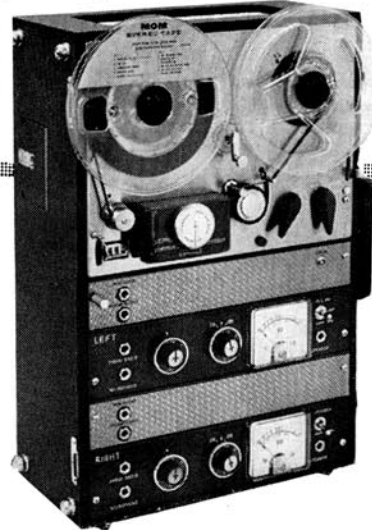

### MODEL M6

Records and plays back either 4-track stereophonically or 4-track monophonically and also plays back 2-track prerecorded stereo tapes. Hysteresis Synchronous Motor always ensures constant tape speed. Designed for vertical or horizontal operation. Two inline and accurate VU-Meters reads recording and playback levels. A precision Index Counter. Recording/play head consists of specially treated core-materials which are being imported from West Germany. Maximum output power of the built-in amplifier is 6 watt on each channel (total 12 watt) which can drive up to 12 in. extension speaker system. Dual Head and Preamp Outlets are provided for connection direct to any other pre-amplifiers or stereophonic amplifier.  
**Instant Stop Lever.** All operating controls are interlocked.  
**Automatic stop device.**  
 The pinch wheel is always automatically released from capstan which protects it against a "spot" on the soft rubber surface causing uneven running.

Retails at 130 GNS.

### HI-FI WIDE RANGE STEREO SPEAKER SYSTEM MODEL SS-50

Matched with the Model M-6 in styling and size, complete with connecting cables.  
**Speakers:** Two 8-inch mechanical 2-way (with built-in coaxial tweeter) speakers in a dividable carrying case.

Retails at 30 GNS.



Akai's new modern factory in Japan where the finest equipment is produced under the most up-to-date conditions.

Akai\* is the most important contribution that has been made to first-class tape recording equipment for years. In a comparatively short time, they have established themselves in a leading position in the American Tape Recording Field.

Now they have come to Britain and one has only to examine them to see why they are going to prove serious competition to those European manufacturers, who have led the field for so long. You find this hard to believe? Then see the Akai Terecorders for yourself, contact your usual dealer or the sole importers.

\*Due to trade agreements Akai are sold under the name of Roberts in the U.S.A.

For descriptive literature and full information of the Akai Terecorders contact your usual dealer or  
**NORTHGATE (CAMERAS) LIMITED, 119/125 Wardour Street, London, W.1**  
 Tel.: GERrard 7030, 7038, 7939.

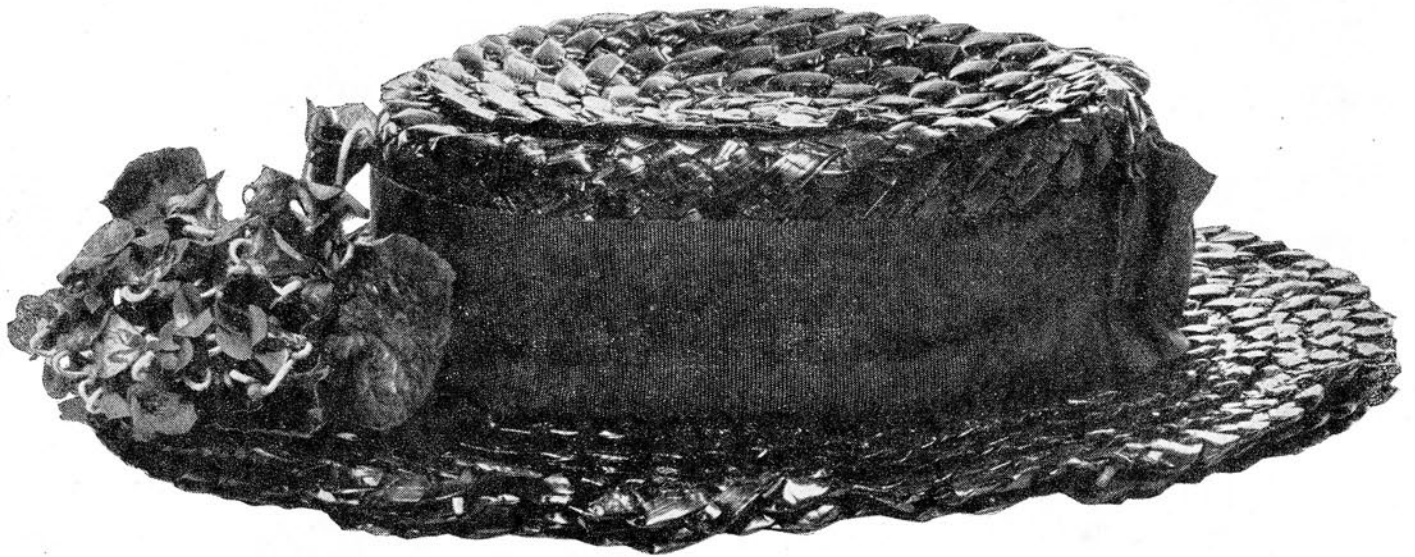

**'I want to be a lady in a flower shop'  
 - says Emitape**

And Emitape has said it (and much more) for *every one* of My Fair Lady's performances. Stagesound and Emitape supply the effects, from the sound of St. Paul's Bell in Act 1, Scene 1—to Eliza Doolittle's cri-de-coeur in the last act. Stagesound would not be without Emitape. There's no question of things *not* being all right on the night, so it's Emitape for them every time! Use Emitape—the choice of the experts.

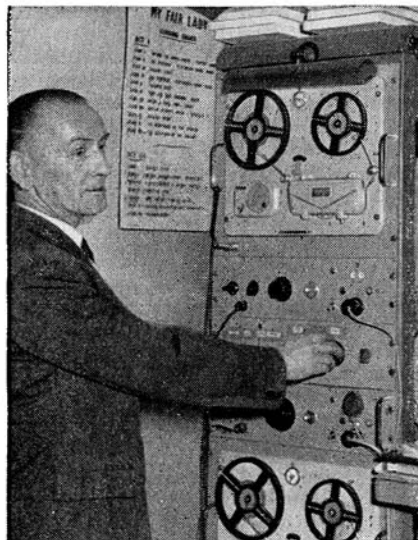

\*\*\*\*\*

**Stagesound** Equipment  
LONDON LTD  
 at Theatre Royal, Drury Lane

**Emitape**  
 Magnetic  
 Recording Tape



E.M.I. TAPE LIMITED  
 HAYES, MIDDLESEX. HAYES 3888



# the TAPE RECORDER

Editor ----- MILES HENSLOW  
 Advertising Editor ----- Julian Berrisford  
 News Editor ----- Alan Lovell  
 Editorial Offices --- 99 Mortimer Street, London, W.1  
 Telephone ----- MUSEum 3967 to 3969



## EDITORIAL

MEMBER OF THE  
 AUDIT BUREAU  
 OF CIRCULATIONS

WHAT is a tape recorder? There is a popular, biting rider in conversational use, on the lines of . . . "If you ask very silly questions, etc. etc. . . ." But that opening sentence is not so daft as may be thought. A tape recorder is a hybrid affair, in relation to all other invaders of the domestic scene—including the gramophone, we add, to forestall argument. A tape recorder is part mechanical: part electronic. In its domestic form it also has a box. The order of these three ingredients is, in our considered opinion, the order of their importance; and it is a pity that, in some extreme cases in the recent past, this order has been completely reversed for high-pressure selling.

We do not wish to belittle the importance of good electronics in this dissection, for in any efficient tape recorder the electronics and the mechanics should rank equally in terms of goodness; but the inescapable fact is that even the very best electronics are simple to design, make and maintain, compared with the mechanics. For illustration of this point, a knowledgeable home-constructor can buy and assemble all the electronic "bits and bobs"—can add them to a tape deck—and can thus make a potentially fine recorder in a matter of hours. A reversal of the electro-mechanical buy-and-build process is out of the question—even in a matter of weeks or months.

This is why the tape recorder market became so chaotic, only a year or so ago. The electronics were all too easy to "sling together"; the decks (bought in at the lowest possible price) were all too little understood—or cared about; the box covered a host of misalliances. This is also the reason why Continental machines made such a big impression—financially and in terms of user appreciation; because they were, in the main, designed and made as whole units; and they therefore worked more happily. This is also why the better-known and well-established English machines are still the best known and best appreciated.

Now all the foregoing can be boiled down to read as a simple, logical statement: "Given really good decks to work on, the conscientious manufacturers can turn out really good recorders". And it is with this in mind that the would-be buyer of a tape recorder can today feel considerably more at ease than he was able to feel only a year or so ago. There has been really remarkable progress made in English deck production, and this progress is accelerating. Tape recorders built around—or, more correctly, based upon—English decks are now every bit as mechanically reliable as their Continental competition. There are some exceptions, of course—and there will always be a boxful of gremlins for some unfortunate buyer, no matter how reputable the source of manufacture—but, by and large, we can now recognise this pleasant fact.

The basis of a good deck is simplicity. The more bits and pieces it contains, the greater the possibility of mechanical trouble. One of the main reasons for the success of the B.S.R.

JUNE - - - - - 1962

VOL. 4 - - - - - No. 5

## CONTENTS

	Page
<b>Tape at the Audio Festival</b>	
By H. J. F. Crabbe ... ..	198
<b>Tape Recorder Service (No. 6)</b>	
Philips EL. 3536, EL. 3514 and EL 3585	
By H. W. Hellyer ... ..	202
<b>News from the Clubs</b> ... ..	205
<b>Sound and Cine</b>	
Synchronised Sound Films	
By L. F. Weir ... ..	206
<b>Too Many Cooks</b>	
A Study of Tape Systems	
By Graham Balmain ... ..	209
<b>Tape Recorder Workbench</b>	
No. 35 Microphones (Part 2)	
By A. Bartlett Still ... ..	211
<b>The Calibration and Use of Test Tapes (Part 4)</b>	
By A. Tutchings ... ..	213
<b>Readers' Letters</b> ... ..	215
<b>Details of New Products</b> ... ..	217
<b>Equipment Reviewed</b> ... ..	219
<b>Classified Advertisements</b> ... ..	224
<b>Advertisers' Index</b> ... ..	226

deck was its basically simple design. The Wright and Weaire product, so little changed in its many years on the market, owes very much to that same fact. The new "Planet" deck, too, has already been praised by many acute observers for this reason. It has still to be launched in full production—but it looks so good that it should be as good as its looks.

We, in this office, know well that the improved English decks are the main cause of increasing satisfaction among tape recorder owners. We know this with relief, because our monthly postbag includes fewer and fewer letters from disheartened owners.

Many people forecast that the tape recorder boom of two or three years ago was a flash-in-the-pan, and that interest in this new form of home entertainment would soon level itself out—even die away. We have never subscribed to this view. We look forward to a steadily-growing interest in this field for many years to come—with far bigger developments than we have so far seen. And it is with great satisfaction that we see this present, intelligent approach to "the basic unit" by English designers.

## COVER PICTURE

MICROPHONES used in television are rarely seen, but kept well out of camera range. However this month's cover photograph reverses the procedure and brings the instrument into focus. It shows the new STC 4108 condenser microphone recently shown for the first time at the 1962 Audio Festival.



JUNE  
 NUMBER

★

Contents include:

A New High-Fidelity  
 amplifier

Making your own cabinets  
 Equipment Reviewed

★

NOW ON SALE

# TAPE AT THE AUDIO FESTIVAL

**T**HIS year's International Audio Festival and Fair was a winner as far as tape and tape recorders were concerned. A full two dozen firms were showing recorders, including a fair sprinkling of new and very recent models. Ten exhibitors were offering tapes and tape records.

The manufacturers' enthusiasm was matched by that of the visitors. Wandering around the corridors at the Hotel Russell, listening to odd snatches of conversation, and noting the density of the crush in each demonstration room, one received the impression that tape—so long a Cinderella of the hi-fi fraternity—had arrived in earnest. Whether this has resulted from the increased availability of pre-recorded tapes, or a growing realisation that top quality *disc* reproduction is very expensive, or because a larger number of enthusiasts are recording live music, one cannot tell, but very great interest there certainly was.

A considerable number of visitors were looking for tape equipment to add to existing gear with the minimum of upheaval, which kept a fair-sized crowd in the room where *Truvox* were

★

**TRUVOX  
PD 82  
TWO-TRACK  
RECORDER**

★



showing two versions of their Series 80 recorders for addition to stereo hi-fi set-ups. Known as the PD 86 and PD 87, quarter and half track models respectively, these are self-powered deck assemblies mounted on leather-cloth-covered plinths and incorporating three heads, two record amplifiers with erase and bias supply, push button controlled level meter, and two replay pre-amp channels with compensation for the two speeds of  $7\frac{1}{2}$  and  $3\frac{1}{2}$  i/s. Provision is made for recording from track to track while mixing with additional inputs. The price of these models is 60 guineas, the decks being available separately at 32 guineas.

Another recorder using a Truvox deck is the *Wyndor International*, mentioned briefly in the April issue. This is a four track mono machine with the unusual feature of a vertically mounted deck; virtues claimed for this are improved convection cooling and smaller space requirements when in use. Many facilities are included and the frequency response extends (within 3dB) down to 20 c/s. The price of 75 guineas includes a ribbon microphone.

## A New British Deck

For the more ambitious amateur who intends to build his own electronics a new British deck with a no-compromise specification, using new materials and having a professional look, yet selling at £39 10s., is something of an event. Such is the *Planet U 1*, a three-speed unit with press button controls and exceptionally low wow and flutter figures. Following Continental practice, the *Planet* uses a single Papst hysteresis synchronous motor, the various driving motions being imparted via idlers and pinchwheels. These latter have frictional surfaces moulded from a new plastic material claimed to be greatly superior to rubber.

A professional touch is the absence of pressure pads. The tape is held against the heads by stainless steel pins which give

a wrap-round effect; this reduces head wear and improves traction. The very low wow and flutter content of 0.08 per cent. at  $7\frac{1}{2}$  i/s is achieved, in part, by a balanced  $2\frac{1}{4}$  lb. brass flywheel. Also contributing to consistency in this respect is a system of controlled drag on the tape which keeps the forces constant as the radius of wind changes on the spools. Speed accuracy is also exceptional at  $\pm 0.2$  per cent.

Other features of note include a completely interlocked press-button control system, a solenoid-operated automatic stop which retracts all friction drives, magnetic clutch providing smooth take-up, and a three-head two track system using *Miniflux* components. Preamplifiers are available if required.

Another recorder seen for the first time was *E.M.I.* model RE 301, a transportable professional machine of flexible application which is being used for scientific and educational work in addition to formal studio recordings. An extremely robust construction ensures lengthy periods of use without servicing. For professional on-the-spot interview work, *E.M.I.* continue the RE 321, while the TR 52/2 suits the small stereo recording studio. The famous TR 90 high-grade professional machine was also seen at the Fair, but was there to be coveted rather than bought.

While dealing with professional equipment, mention must be made of the superb *Leavers-Rich* Series E Mark IV recorders, made in the best tradition of uncompromising craftsmanship. Everything is fully accessible and absolutely reliable, and the rack mounted amplifier units are an object lesson in how things should be done. Incidentally, tapes played on one of these machines made some of the sweetest sounds heard at the show.

Also in this elevated studio atmosphere was the *Ampex* equipment, with special emphasis on the Fine Line 1200 series. Now that quarter track recording has become firmly and finally entrenched in the U.S.A., the *Ampex* engineers have really gone to town to eliminate all the earlier objections to narrow track working. By using precision tape tracking techniques of the sort previously associated with multi-track instrumentation equipment, their claim to have produced best half track results from quarter track recorders seems substantiated.

Another series of machines with tip-top performance even on quarter track, and continued at the Fair unchanged, were the *Pamphonic Reflectograph* models and the *Tandberg* Series 6 machines supplied by *Elstone*. Owners of *Reflectographs* may be interested in the *Cosmonaut* cabinet specially designed for housing these recorders.

Well established machines like the *Brenell* Mark 5 and *Ferrograph* 420 stereo model attracted their much deserved quota of attention, while the *Simon* SP 5 could hardly fail to make itself

★

**E.M.I.  
TR 52/2  
STEREO  
RECORDER**

★

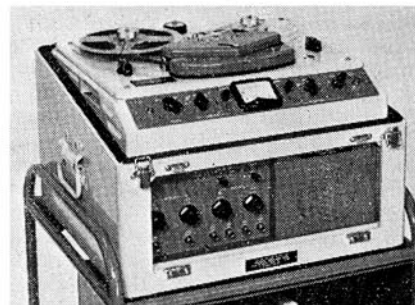

seen as well as heard! The latest stereo recorder from *Vortexion* is the CBL, with mixing of inputs, stacked heads and over 6 watts total output. Meter monitoring of bias and signal, and facilities for recording from track to track with additional signals, are features of note. Entirely separate low impedance micro-

# TAPE AT THE AUDIO FESTIVAL

phone inputs permit the stereo experimenter to depart—if he dares—from the Blumlein technique. A multitude of Vortexion mixers and fader units were also shown.

A frequent complaint from amateur recordists concerns the inadequacy of 7-inch spools when recording long musical works at  $7\frac{1}{2}$  i/s. Well, from now on anyone wishing to purchase a semi-professional machine of the highest quality can banish this particular limitation by getting a *Revox RE 36*. This Swiss machine distributed jointly by *Audiocraft* and *Mordaunt*, takes 10-inch spools.

Spool size apart, this recorder offers a very serious challenge, at 110 guineas, to models in the same price category. It is a stereo instrument with separate record and replay heads and associated amplifiers, designed as a completely integrated mechanical/

★  
**REVOX**  
**RE 36**  
**RECORDER**

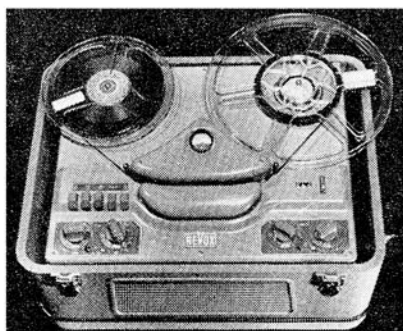

electrical entity. Its Swiss manufacturers have previously specialised in professional models, and many of the uncompromising precisions of very expensive equipment have found their way into the RE 36.

Speeds are  $7\frac{1}{2}$  in  $3\frac{1}{2}$  i/s, and the pole-switching capstan motor has an outside rotor, the inertia of which contributes to the low wow and flutter figure of 0.1 per cent. Frequency response extends from 40 c/s to 15 Kc/s and 12 Kc/s at the two speeds respectively, within +2 and -3dB. The NARTB characteristic is used for recording but on playback both this and the CCIR response are available at the flick of a switch. This highly desirable feature enables pre-recorded tapes from both sides of the Atlantic to be played correctly, and every good recorder should have it (manufacturers please note).

The signal-to-noise ratio is better than 50dB, and so is channel separation on stereo, except at the highest frequencies where it falls to 40dB (disc and pickup manufacturers please note). High and low sensitivity inputs are provided, and twin cathode follower outputs allow easy connections to external equipment. The built-in monitor amplifier delivers 6 watts at less than 1 per cent distortion.

Mechanically, this recorder is robust and unpretentious, with a comprehensive set of switches and push-buttons for selection of the various functions. The wiring and component lay-out are neat and logical, screening of the heads is extremely thorough, and the capstan bearing runs in a sealed plastic chamber filled with lubricant. This is a very interesting recorder, not designed for idiots, as is the next on our list.

The "idiots recorder" was a surprise introduction half-way through the Fair from *Telefunken* via *Welmec*. Known as the *Magnetophon Automatic*, it stakes a claim as the world's first fully automatic tape recorder. The word automatic is used here in the same sense as a self adjusting camera with built-in light meter is automatic. With one, you simply look at the view and press the button; with this recorder you simply press the record button and speak.

The recorder is intended for use in the home and is left per-

manently connected to the mains. The valve heaters remain alight continuously, so there is no warming-up delay or separate switching on; this does the valves no harm and probably increases their life. It is also intended that the machine be normally connected to the radio, the microphone taking automatic priority when plugged in. No adjustment of recording level is necessary—or possible. An electronic contrast compression circuit ensures that the tape is not overloaded for a wide range of inputs and a magic eye is fitted (how much does it cost?) just to convince sceptics that the circuit works!

By speaking quietly, then suddenly shouting, one can make the system overload just momentarily, but even with this extreme test the reproduction sounds quite clean, though with reduced range of course. Other features of this single speed ( $3\frac{1}{2}$  i/s) recorder are: a wholesale abandonment of controls for utmost simplicity of operation, an output of 2½ watts to a built-in speaker, and moving parts reduced to an absolute minimum. The manufacturers claim that the automatic camera opened up  
*(Continued on page 201)*

A LOT OF THE FUN OF THE FAIR COMES FROM FINGS WHICH

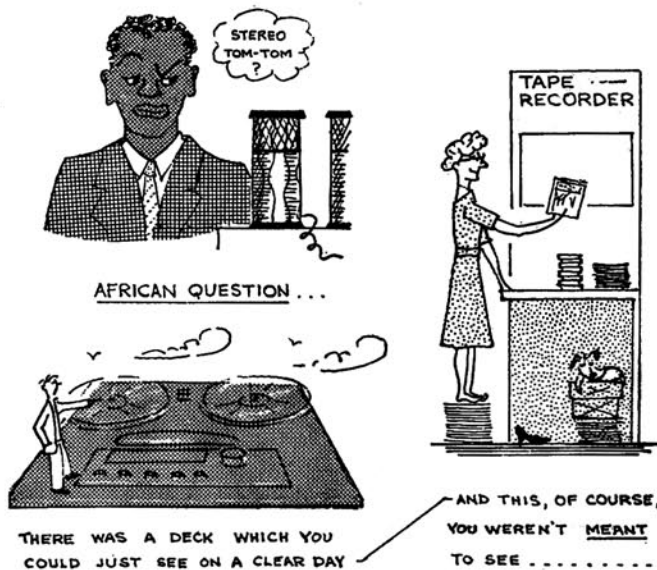
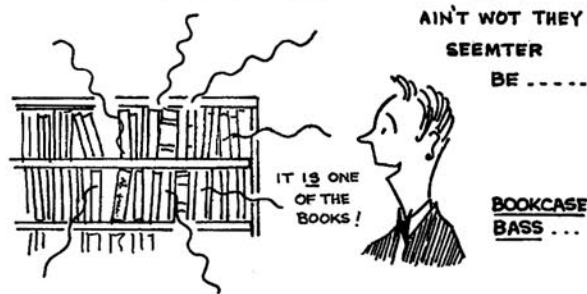





CAPTURE  
A SUMMERFUL  
OF  
SOUND

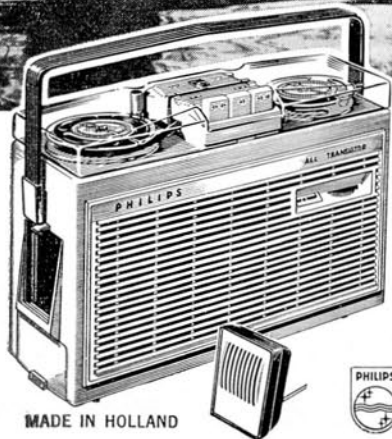

MADE IN HOLLAND

Capture a moment of delight on the river . . . capture happy times anywhere, any time, exactly as they happen. With Philips Battery Tape Recorder you can take instant, lifelike snapshots in sound all summer long. Come September, you'll own an album of sounds you'll keep playing for years to come. Talk to your dealer about this fine tape recorder today.

**24** GNS (excluding batteries) Supplied complete with microphone, 4" reel of LP tape and empty 4" spool. Optional extra: carrying case and strap 45/- complete.



**PHILIPS** All-Transistor Battery Tape Recorder

THE PORTABLE RECORDER WITH THE LIFELIKE SOUND

# TAPE AT THE AUDIO FESTIVAL

an entirely new photographic market and that this recorder will tap a similar non-technical public. At a price of 53 guineas this reviewer, at least, has his doubts.

Three other new *Telefunken* portable recorders were also seen at the Fair, types 95, 96 and 97, priced 59, 69 and 95 guineas

★

**TELEFUNKEN  
MODEL 97  
FOUR-TRACK  
RECORDER**



respectively. The first is a twin track three-speed model and the second its approximate four track equivalent. Model 97 is a four track stereo machine with the second speaker in a detachable lid.

Another German firm, *Grundig*, augmented its established range of recorders with the TK.23, a four track version of the TK.14 with a number of small improvements and a price of 45 guineas. On demonstration—and the main item of interest—was the TK.40, a three-speed four track model with comprehensive facilities at 75 guineas.

Two other recorder firms with an imported range covering the whole price spectrum were *Philips* and *Sony*, the latter distributed by *Tellux*. Pride of place in the Philips range went to the stereo model EL 3536 which gives exceptional value for money at 92 guineas including a moving coil stereo microphone.

Sony recorders range from 29½ guineas for a two-speed portable weighing only 10 lb. to 190 guineas for model 777 professional studio recorder. Intermediately priced machines provide various facilities, including 8 mm film synchronisation on model 464 at 72 guineas. As is common at Audio Fairs most interest was shown in the more ambitious models, the fully stereo 521 receiving much attention. This is an exceptionally comprehensive model with numerous refinements including twin VU meters. The price is 124 guineas.

The outdoor recordist was well served at this Fair, with three completely new transistorised battery recorders in addition to established models.

The *Fi-Cord* 202 is a two-speed (7½ and 3½ i/s) model weighing only 6½ lb. including mercury batteries. It measures 9×6½×4½ inches and carries 4 inch spools. Claimed wow and flutter is less than 0.3 per cent. 0.4 per cent. at the two speeds respectively. Separate batteries are used for the motor and electronics, the

★

**FI-CORD 202  
TWO-SPEED  
RECORDER**



cells being loaded in interchangeable cassettes. Expected battery life is 30 hours for the motor (at 3½ i/s) and 60 for the circuit. A line output provides a signal of one volt maximum, while a built-in speaker may be driven at 180 mW. Fast forward and rewind, a VU meter and response flat to 12 Kc/s at 7½ i/s make this a versatile high quality recorder. Price is 66 guineas.

*Denham and Morley* added two battery recorders to their range at the Fair, the *Butoba* MT 7 and a public address version

of the well-known MT 5. The MT 7 is smaller and neater than the MT 5 and is aimed mainly at the popular market. It employs six transistors, one diode and a magic eye level indicator, the speed being governed by a transistorised control circuit which guarantees an accuracy of ±0.5 per cent. Two speeds are featured (3½ and 1½ i/s) the claimed response at the higher extending to 12 Kc/s. The output is 0.8 watt and weight including four U2 cells is 8 lb.

The special *Butoba* MT 5 "S" is adapted from the standard model and uses either an eight or sixteen watt power amplifier which can be fitted in the recorder in place of the battery container. Thus additional facilities are added to the normal battery/mains portable recorder. The recorder itself costs 82 guineas and the power stages 32 guineas (16 W) or 24 guineas (8 W). A particularly suitable application for this public address recorder would be for relaying pre-recorded messages from a car with loudspeaking equipment.

Other transistor recorders, already known, were shown by *Loewe-Opta* (Highgate Acoustics) and *Stuzzi* (Recording Devices). The former also offered a range of mains recorders in the middle price region. New from *Stuzzi* was a *Dictamat* attachment for the *Tricorder*, which switches the machine on by sound, and a

★

**BANG AND  
OLUFSEN  
"BELCANTO"  
RECORDER**



new mains recorder model 201. This is a two-speed quarter track machine using a Papst motor, with a frequency range of 40 c/s to 14 Kc/s and a price of 45 guineas.

Rounding up the remaining recorders firms at the Fair, there was the unlikely event of a British deck in use on a Scandinavian recorder. This was the *Belcanto* made by *Bang and Olufsen*, of Denmark, using a BSR deck and imported by *Aveley Electric*. *Garrard* still offered the magazine deck and *Robuk* the RK 3 recorder with a number of minor improvements.

The lifeblood of tape recording was represented at the Fair in the form of tape from *E.M.I.*, *Philips*, *Scotch*, *Irish*, *Gaevent*, *Soundcraft*, *M.S.S.* and *Zonal Films*, while *Saga* put up an impressive display of pre-recorded tapes. *B.A.S.F.* presented tape in a slightly new light by showing how model trains could be controlled by pre-recorded signals.

Many new microphones were on show for the first time, and one could not fail to notice the improvements in design following the introduction of American microphones in this country by *Shure Electronics*, *Acos*, *A.K.G.*, *Grampian*, *S.T.C.*, *Lustraphone*, *Reslo*, *Shure Electronics* and *Vitavox*, together with *Fi-Cord* who displayed the *Beyer* range of microphones, gave the recording enthusiast much food for thought. A microphone which will almost certainly be seen very shortly in use in television studios is the STC 4108, a condenser microphone just produced by this company. The price will be a little high for most amateurs. *Lustraphone* introduced two new models, a ribbon and a cardioid, one of which was very compact and reasonably priced. *Grampian* produced the GR1 and GR2 ribbon microphones, the GR1 having a reduced back sensitivity, while the GR2 has a figure 8 sensitivity pattern. A full range of *Shure* microphones was on display, including a new cardioid ceramic microphone, complete with neck halter and fitted with an on/off switch. Altogether an outstanding year for new microphone designs!

All-in-all this year's Fair has produced a bumper crop of new equipment covering a wide range of types, almost sufficient in fact to keep *The Tape Recorder* technical review staff busy until next spring.

# TAPE RECORDER SERVICE

by H. W. HELLYER

No. 6 PHILIPS EL 3536,  
EL 3514 and EL 3585

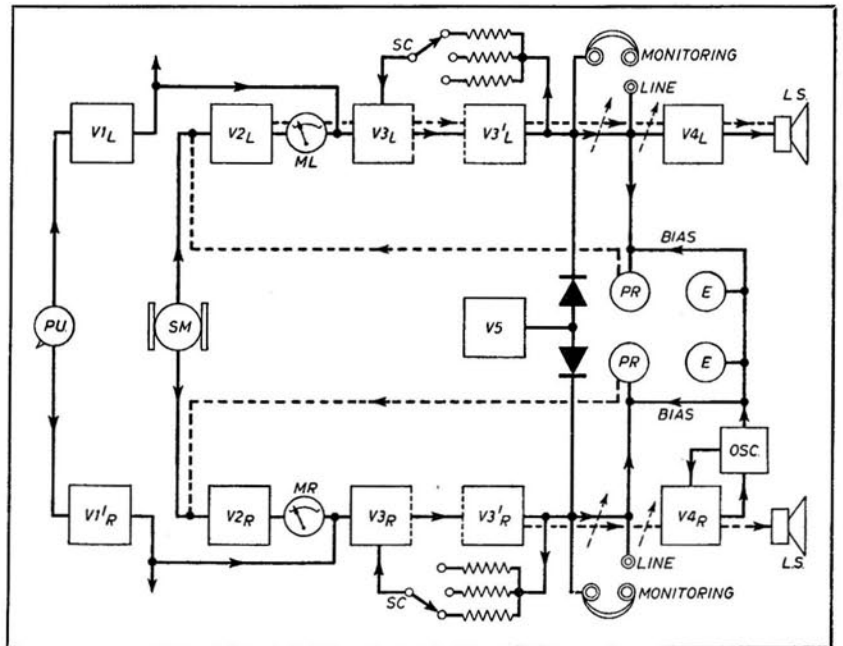

IN the previous article, a brief attempt was made to describe the "popular" models in the Philips range. We can now progress to the more elaborate stereo machine, the EL3536, and the latest release, the battery-operated "slimline" tape recorder that has aroused much interest in the trade. Before getting involved with technicalities, however, the author would like to introduce a personal note. Several readers have written, with special queries. In some cases, it has been necessary to refer directly to manufacturers. I should like to take this opportunity of thanking the commercial and service departments of Messrs. Philips for the help they so readily give. At this time, when we hear so many strictures on service organisations, this attitude is welcome and heartwarming. So—to business.

The EL3536 is a three-speed machine, with a dual amplifier channel and four-track heads which make full stereo recording and playback available. This, in a tape recorder as compact as those previously described. An interesting circuit is used in the EL3536, with seven valves, a magic eye modulation indicator, two crystal diodes and a contact-cooled rectifier.

## Complex Circuitry

Some idea of the complexity of this circuit can be gained from a study of fig. 1. This is a block diagram, showing the stages of the complete machine, and the system switching that enables the same valves to be used in different ways during *Record* and *Replay*. Block diagrams of this nature can be very useful to the engineer, and the enthusiast; they allow a quick grasp of the complete machine, where a study of the detailed circuit would necessarily take more time and care. Often, a fault can be isolated to a particular stage and attention concentrated on that section of the circuit, saving much wasted effort.

Referring to fig. 1, it will be seen that the incoming sound, picked up by the twin diaphragm of the stereo microphone, SM, is passed to the two EF86 amplifier valves, V2 R and L. From the output of each EF86, the signal passes, via a modulation control, to the grid circuit of V3, which is half of a double triode ECC83. (Although shown as meters on the diagram, ML and MR are actually variable potentiometers, in conventional gain control circuits.)

At this point, a further input from the diode, pickup, or external line (PU), amplified by two sections of another ECC83, can be mixed. Variation of this input is provided by further gain controls. The input levels to these pre-amplifiers are: Microphone 3 mV into 100,000 ohms; Radio, P.U., 150 mV into 1 megohm; diode, 5 mV into 100,000 ohms.

The signal (or mixed signals) passes through V3 and V3' and thence to the separate gaps of the record head. From the output of V3', a switched feedback circuit is taken to the cathode of V3,

allowing separate frequency correction for each of the three speeds. This simplified switching is shown as SC. From this same output point a tapping is taken to the *Line* socket, giving 2 V into 50,000 ohms, and a headphone monitoring socket, 100 mV into 10,000 ohms.

Up to this stage, the two channels are similar, but now we find that the left-hand channel passes its signal to V4L, an EL84 valve, which amplifies for monitoring on the internal loudspeaker. The other EL84, in the right-hand channel, acts as oscillator at 50 to 60 Kc/s, supplying erase voltages and bias. The correct adjustment of bias voltage is important, and should be checked with a valve-voltmeter at the test socket which can be found between the radio-gram sockets on the plastic connector panel and the microphone socket. The machine should be switched to stereo recording and a reading of 70 V obtained, the two concentric trimmers, visible in the approximate centre of the layout below the deck, being adjusted for this reading.

Modulation level is checked by the EM84 indicator, which receives a sample signal from each channel, via a pair of OA85 diodes. A preset variable resistor is available for the setting of the modulation indicator so that an input of between 110 and

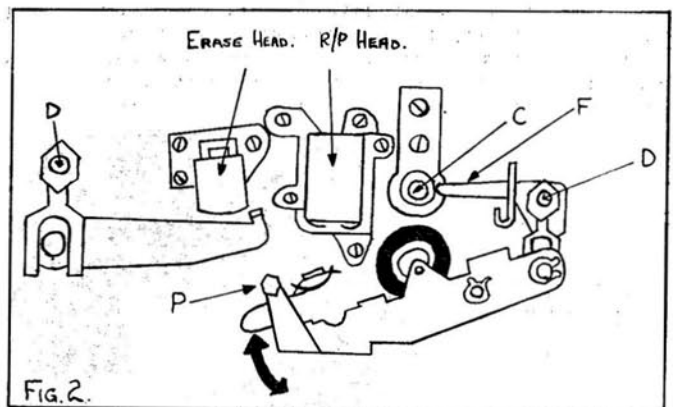

155 mV at 1,000 c/s gives an output of 1 V at each channel test point when the green bands of the EM84 just reach the red, central strip. Any encroachment then indicates overloading. But it should be remembered that this adjustment, and those previously described, should not be attempted unless a fault is proven. I make no apology for repeating my slogan: "Indiscriminate twiddling should be avoided like the plague".

The *replay* sequence is shown in the block diagram as a dotted line. From the tape, recorded signals are passed through



the heads to the input circuits of V2 L and R. They are amplified by V3 and V3', and passed via tone, volume and balance controls to the output stages V4L and V4R, the internal loudspeaker being fed from the left-hand channel. A protection circuit for the right-hand stage is thus needed, in case the machine is inadvertently operated on stereo playback without an extension loudspeaker connected. (This would result in damage to the RH output transformer and over-running of the RH EL84 output valve.)

The circuit switches are operated by the loudspeaker plugs in such a way that the grid of the output stage is earthed (RH) until the extension loudspeaker, in the lid of the machine, is connected. An alternative switching arrangement makes it possible to connect a balanced pair of external loudspeakers, which can be a positive advantage when siting difficulties crop up—as they always seem to do when one takes a machine to a strange location!

#### Monaural Playback

The arrangement for monaural playback is rather different, both output stages being connected in parallel by the "Monaural" switch, although only the left-hand amplifier channel is used. Similarly, monaural recording employs the left-hand channel, and disconnects the erase head of the other track.

A good deal of space has been devoted to the description of the EL3536 circuit, mainly for the benefit of those readers who may not have seen a detailed "breakdown" of a stereo recording machine, and who could become confused by its apparent complexity. As can be seen from fig. 1, the design falls neatly into an electrical pattern. As for the mechanics, much of what has been said before also applies to these machines. But on some later production runs important changes have been made. The principal differences are shown in fig. 2, which is a sketch of the head and pressure assembly of the more recent machines.

Here we find the erase head, *E*, set obliquely and the R/P head placed 1 mm farther back toward the rear of the deck. A tape pressure pin, *P*, is fitted at the end of the pinch wheel arm to ensure complete contact of tape with head faces. *C* is the capstan and *D, D*, the tape guides, both of which are spring loaded. On the right-hand guide, a moulded finger, *F*, holds the automatic stop contact leaf spring. The post is earthed, and the contact strip is in a series circuit with a relay, which becomes energised when the metallised leader of the tape short circuits the contact strip to the post. (Fig. 3).

This relay serves as a switch, its contacts closing the energising circuit of another relay, the latter doing the actual work of releasing the locking bar and neutralising the push buttons.

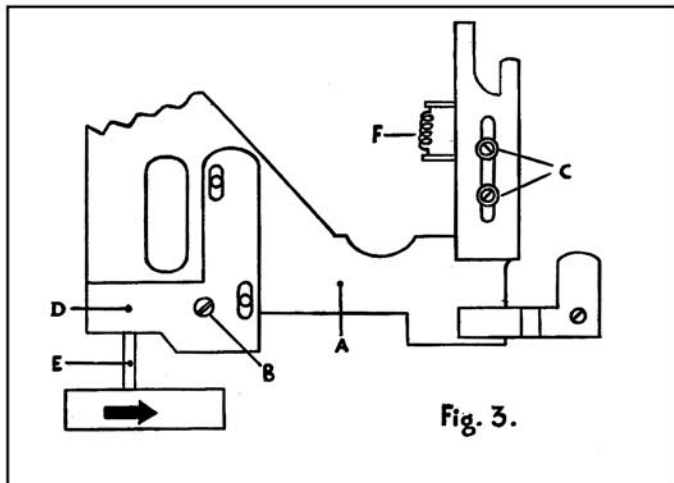

Fig. 3.

This dual relay arrangement gives a much more positive action, enables the use of simple relays, and allows a switch sequence ending in an "open" position.

The service department of Messrs. Philips advise us that the cure for slow rewinding on some machines is to replace the 44 mm felt disc beneath the right-hand turntable with a 38 mm ring, as used under the left-hand turntable. It is also noted

that the P.V.C. bearing under the RH friction disc must be kept adequately greased.

The use of slider switches, in conjunction with printed circuitry, has become widespread, and is particularly apt to cause trouble if clumsy adjustment is attempted. Cables are terminated with nipples that seat in angled forks, and these may be bent for exact location of switch sliders. But great care should be taken not to over-run the switch movement, or the end contacts can be damaged.

#### Philips EL3585 and EL3514

Quite different in design and styling are the latest additions to the Philips range of tape recorders. The vertically fashioned plastic cabinet with the reels and controls at the top, a clear plastic lid and flexible carrying handle make this a most attractive break from the solidity of previous designs. The top of the deck is clean and uncluttered, operations are reduced to the minimum, servicing, once the case has been removed, is

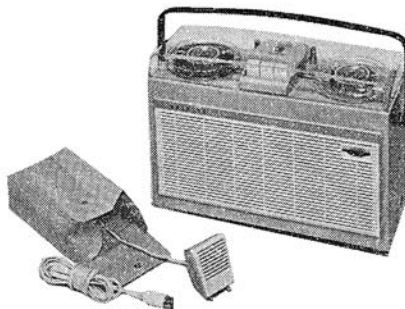

★  
PHILIPS  
EL 3514  
FOUR TRACK  
MAINS  
RECORDER  
★

quite straight forward, and the quality of output is remarkably good for a machine designed expressly for the "popular" market. (Is this possibly a sign that manufacturers are beginning to realise that to be "popular" is not necessarily to be shoddy?)

The above photograph gives an idea of the outward appearance of the EL3514. The EL3585, battery-operated model is similar, but slightly smaller and lighter. It has a number of common features, including, the use of a large loudspeaker (6½-inch in the mains version, 4-inch in the battery version), uses six transistors and a crystal diode and is powered by six unit 1½ volt cells (U2). This is a standard twin-track machine (the mains version being 4-track).

#### Removing the Case

Removing the cabinet of these tape recorders is a procedure that appears to have given some difficulty. There are two reasons: one, the circlips around the handle mountings are tight and any attempt to lever them off with a screwdriver usually results in damage to the case; two, there is a tendency to remove all four fixing screws in the top panel, which allows the clamp plates to drop inside the mechanism—the resulting tinkle usually bringing on a bout of alarm and despondency in the owner!

But, not to worry. All we need do is prise off the circlips with two pointed instruments, inserting them in the holes near the open ends and levering, scissors-fashion, while the machine is held firmly. A special tool, known by a name that I cannot print here, is used in the trade for removing these circlips, but I am sure the ingenuity of readers will supply alternative methods that do not lead one to gash the plastic case. Having removed the microphone, battery cover and batteries and the two end circlips, unscrew one fixing screw of each pair in the top cover. This allows the separation of the two moulded halves, leaving the clamp plates in place.

#### Avoid Overloading

One important point to note when using this machine is that overloading of the input should be avoided. For this reason, a 2.2 megohm resistor is inserted in series with the red lead of the extension cable supplied with the instrument for recording from a source other than the microphone. The moving coil meter

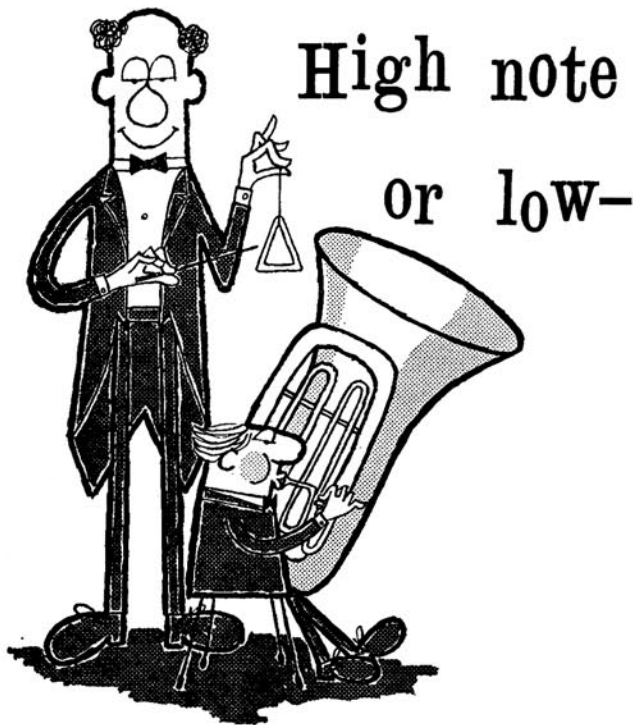

## Grampian DP4

is equally sensitive to both

Here's a microphone that responds accurately to the tinkle of the triangle, the boom of the tuba and every other sound between 50 and 15,000 c/s. Uniform frequency response over such a wide range means that the reliable, medium-priced DP4 makes an essential contribution to high quality recordings.

Also for broadcasting, public address and call systems.

Low impedance microphone, complete with connector and 18 ft. screened lead ..... £8.0.0  
 Medium and high impedance models ..... £9.0.0

*A complete range of stands, swivel holders, reflectors and other accessories is available.*

Write or 'phone for illustrated literature:

**GRAMPIAN REPRODUCERS LTD**

Hanworth Trading Estate, Feltham, Middlesex. Feltham 2657



## TAPE RECORDER SERVICE—(continued)

which is used as a modulation indicator can also be a handy reminder when battery voltage is falling below the useable level. During playback, the needle should deflect to the green segment. If it only reaches the red, the batteries should be replaced.

Adjustments to the mechanism can be roughly divided into: (a) the tape transport system; (b) motor, clutch and pulley assembly; and (c) brakes.

(a) To ensure the tape is running level and true, observe its passage through the guide plate of the erase head, adjusting the central screws of the turntables to raise or lower slightly, as required. When correctly set, the top edge of each turntable should be  $14 \pm 0.2$  mm. above the mounting plate. Head adjustment is by a three-screw mounting, as previously described, and the R/P head should be adjusted for maximum output on a pre-recorded test tone.

The pressure bracket assembly is shown in fig. 3. When correctly adjusted, the tape should make an equal angle about the centre line of the erase head while being held in the *play* position. To adjust, first remove the spring *F*, and slacken the screws *B* and *C*. (The latter will be found holding the forked bracket that locates with the cutaway on the *record* button). Next, push bracket *A* forward until the tape is under correct pressure, as described above. It will be necessary to hold the pressure roller against the capstan now that the tension has been removed. Then, slide plate *D* back against bracket *E* and tighten *B*. Finally, slide the forked plate into the record slot and tighten the two screws *C*. For more delicate adjustments, it is necessary to use a spring balance or gauge, and to bend lugs—but this sort of operation should be workshop procedure and only undertaken as a last resort.

### Speed Adjustment

(b) The speed of the EL 3585 can be checked by marking off a 15 ft. length of tape. This should run through in 93 to 101 seconds. Motor speed can be adjusted by a regulator screw on the motor spindle bracket. The vertical movement of the flywheel is also important, and a locknuted screw limiting this will be found through the upper plate. Turn this until it just touches the flywheel, then back off a full turn and tighten the locknut.

The clutch adjustment occasionally calls for checking. This requires that the rubber clutch wheel, when just touching the flywheel, should have a  $\frac{1}{2}$  mm gap between its insert hub and the stop bracket. The stop bracket can be bent to ensure this. The fast wind pulley, at the centre of the space between the

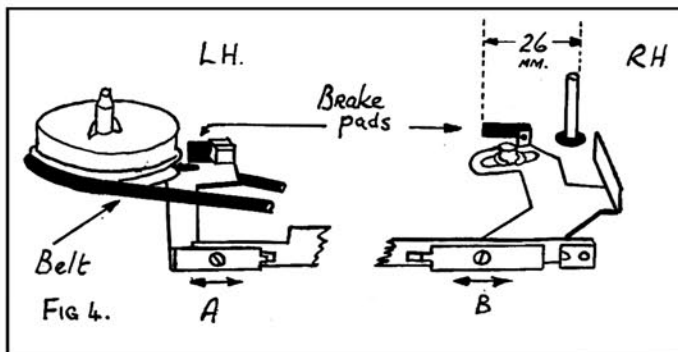

flywheel and RH turntable when the machine is "off", should press against the turntable with 75–100 grammes pressure when *forward wind* is engaged. The *rewind* pulley is also spaced at  $\frac{1}{2}$  mm from the flywheel, driving the LH turntable via a belt (see fig. 4). The pulley is held on a bracket, under spring tension of 20–25 grammes in the *off* position.

(c) The illustration fig. 4 shows the brake adjustment. With the *Rewind* button pressed, the LH brake block should be  $\frac{1}{2}$  to 1 mm from the turntable. Slacken *A* and move bracket. The RH brake needs more care; first remove the turntable, slacken *B* and set the bracket to give 26 mm between the end of the brake-block and the right-hand edge of the turntable spindle. The friction pad beneath the RH turntable also has an adjusting screw, to assist even rewinding.

# NEWS FROM THE CLUBS

**T**HE North London Tape and Hi-Fi Club's first quarterly newsletter is now in circulation. Consisting of excerpts from club competition entries and part of recordings of Christmas carols made for playback at a local hospital, the tape has been sent to the Jarrow and District Tape Recording Society. It is hoped that members there will record a similar newsletter to begin a regular round-robin of four or five clubs.

The meeting on which this was recorded, as with other recent meetings, gave practice to members in microphone technique.

Following a talk by secretary Richard Collinson, members recorded practice interviews between one another. The results—



Members of the North London Tape and Hi-Fi Club watching chairman, Sinclair Scott, wiring an electronic mixer.

played back later in the meeting for comment—included some interesting information from the leader of a first-aid group who two budding roving reporters with a portable had found elsewhere in Bush Hill Park School.

Microphones—the different types, positioning, avoiding unwanted reverberation—were also the main topic at a March meeting, when chairman Sinclair Scott illustrated a talk on the subject with tests he had recorded showing which mic' was best for a particular job.

Meetings of the club are held at Bush Hill Park School, Main Avenue, Enfield, Middlesex.

**O**N April 2nd the Cotswold Tape Recording Society (Cheltenham) welcomed Messrs. Spark and Poulton, from the firm of Garrard, Swindon—the second time this pleasure has been enjoyed. The programme began with a lecture from Mr. Poulton on the history and development of stereo recording, with a technical account, in simple terms, of some of the problems involved. This was then illustrated by a disc recital, beginning with the earliest stereo issues and proceeding to the latest "phase four" technique recently presented by Decca. Reproduction was, of course, from a Garrard turntable and pickup, through a Jason amplifier to a pair of Celestion Colaudio speakers—the first time that these interesting units had been heard by most of the members.

The interval gave an opportunity for regular members to meet at least six newcomers whom we all hope to see again as members. Mr. Spark then took over and demonstrated mono and stereo tapes through the well-known Garrard magazine-deck. Once again the complete absence of audible wow and flutter on this deck greatly struck members. The last part of the demon-

stration showed a new technique for operating the changer on a slide-projector which Mr. Spark is developing commercially. A new silver compound is painted on to the reverse side of a recorded tape; and this operates contacts which are fitted to the non-business side of the tape transport system, and in turn the switch mechanism of the projector. This provides a simple method of changing slides at precise points during a commentary or musical accompaniment; and the silver can be easily removed when it is no longer required.

Further details from P. D. Turner, Cave Cottage, Oakridge Lynch, Stroud, Glos.

**C**HAIRMAN Bill Blake's presentation of the first of a new series entitled "A Generation of Sound" proved the star feature at a recent meeting of the Whitstable and District Tape Recording Club. Members sat enthralled as they heard again voices and sounds of the past 35 years. Subsequent instalments will be heard monthly.

Also at the meeting were demonstrations of stereo tapes, played on a Philips stereo recorder, and of the Simon Minstrelle by new member Bob Watson. Incidentally it is hoped to have the Simon representative down shortly to demonstrate the rest of the Simon products.

The fortnightly quiz was again won by the secretary, Tom Robinson, and furtive mutters about handicaps and being barred were heard from the depths of the room. The Canterbury Playcraft Theatre Group was very pleased with the efforts of the club in recordings all the sound effects for their recent production of "The Lady's Not For Burning", and member Peter Handley put in a lot of hard work in supervising at all the rehearsals and at the five evening performances.

The secretary is T. Robinson, 17a St. Anne's Road, Whitstable.

**O**NE of our readers, who is an audio enthusiast, is considering organising for blind audio enthusiasts a free service on tape of readings from technical articles in this and other British and U.S.A. Journals and from books on Audio.

Readings would be made on 5 in. reels of two track tape at 3½ i/s and the only cost to the recipient would be the return postage.

So that a decision can be made as to whether there is a demand for this service, we would be pleased to hear from any blind subscriber who would like to take advantage of the service if it was established and perhaps he would confirm that he has facilities for playing tapes recorded as mentioned above.

Readers interested in this venture should address letters to "The Tape Recorder" 99 Mortimer Street, London, W.1, marking the envelope (Tapes for the Blind).

## EDUCATIONAL RECORDINGS LTD.

Pioneers of personalized Psycho-Tapes and Discs, also supply pre-recorded tapes and discs on many vital and interesting subjects, including :-

**SLEEP LEARNING  
HYPNOTISM  
MIND MANAGEMENT  
AUTO-SUGGESTION  
PUBLIC SPEAKING, ETC.**

Latest release—"Your Charm School at Home"

Free Brochure describing our full range of recordings gladly sent under plain cover on receipt of a post-card.

**EDUCATIONAL RECORDINGS LTD.**  
Dept. 13, 21 Bishops Close, Church Lane, London E.17



# SYNCHRONISED SOUND FILMS

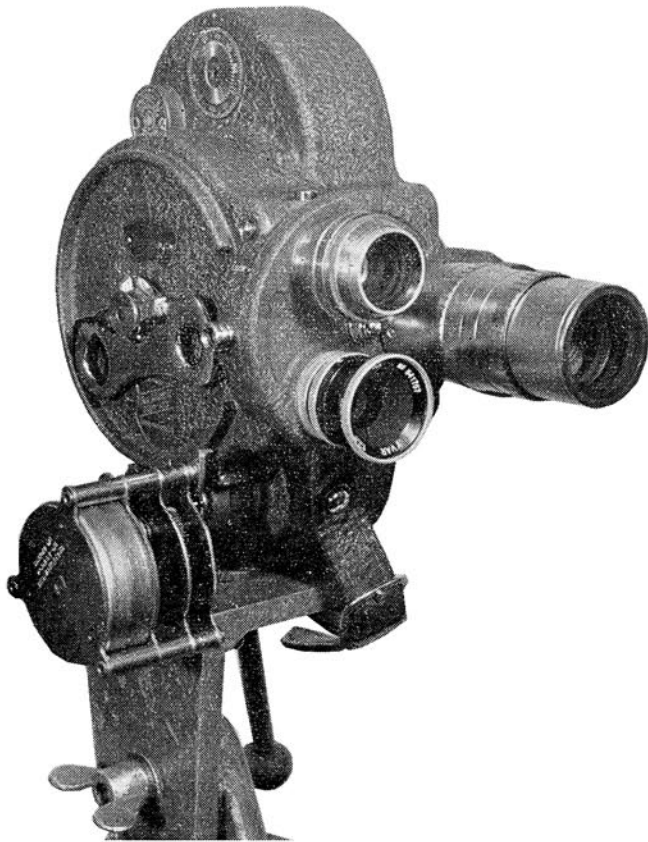

The above photograph shows a Bell and Howell 16 mm camera model 70DL fitted with a small generator for supplying the synchronising pulses.

FOUR years ago I bought my first tape recorder, a *Ferroglyph* 4 AN machine. Here at once a new field of entertainment opened up. There seemed to be so many uses to which a tape recorder could be put. As an enthusiastic amateur film maker for many years, it had long been my ambition to marry the cine film and the tape recorder together in order to produce sound films. I believe there are still many enthusiasts who think that one just makes the recording, turns on the projector and recorder, and lo and behold, we have a sound film. However, as readers of this magazine know well, the whole matter is not nearly as simple as it appears at first. Apart from the actual mechanics of synchronisation, the preparing of a film sound track can prove to be a most complicated procedure. It was my wish to produce a sound film but also my desire to obtain much pleasure from designing and building equipment which would be able to produce synchronised sound films of high technical quality. When I say here "high technical quality" I mean, of course, technical in its scientific and engineering sense; the production and drama side is another specialised and complicated business.

My requirements were quite strict; they were that: (1) The synchronising must be absolute and foolproof; it must be automatic and require no adjustment by hand; it must be easy to start. (2) A method must be worked out and equipment built for the satisfactory compilation of a sound track. (3) High fidelity results must be obtainable. With these three requirements in mind a start was made on the designing and building of equipment. After three years of work, the equipment is just about to go into operation.

### Basic Principles of Operation

The equipment works on the principle of arranging for the tape recorder to control the speed of the projector. A stereo machine is used for this purpose, one track on the tape carrying the sound track whilst the other carries synchronising pulses.

When the tape is played through the recorder, the pulses on the bottom track are amplified and fed into Servo gear on the projector, thus keeping the projector in step with the tape and hence with the sound.

The equipment involved for this work was as follows: *Projector*—standard Bell Howell 129 machine, fitted with Servo gear and automatic starting contacts. *Camera*—a Bell Howell 70DL fitted with a small generator for supplying the synchronising pulses. *Tape Recorders*—one *Ferroglyph* type 4AN fitted for stereo operation and one *Ferroglyph* type 808. *Power amplifier* for Servo gear—One 10 watt push pull amplifier with special output transformer, control relays and projector motor resistances. *Editor*—Murray, to which has been fitted a frame counting device, a high-speed electro-magnetic counter capable of counting up to 3,000 counts per minute, distributed by Lancashire Dynamo and Crypto Company.

### Practical Considerations

As has already been said, synchronising pulses are recorded on one track of the tape whilst the audio signal is recorded on the other track. Thus, so far as the tape is concerned, the sound and the synchronising pulses are at all times in the same relationship to one another. If the projector can be made to keep in perfect step with the pulses on the tape, always provided that the tape and film are started up in correct relation to one another, then perfect synchronising will be maintained throughout the film. There are doubtless many elegant ways in which the professionals achieve this in practice, but the following amateur method was achieved after many months of experiment and research, much heart burning and, in my case I am afraid, the expenditure of much money!

The pulses on the tape are in the form of a 50 cycle sine wave, recorded from either the mains in the case of post-synchronised film or from a small generator attached to the camera in the case of live sound filming. The generator is a small synchronous motor of the type fitted to electric clocks. It is fitted in the re-wind socket of the camera as shown in the photograph. In order to economise on film, the gearing is arranged so that a frequency of 50 cycles is generated when the camera is

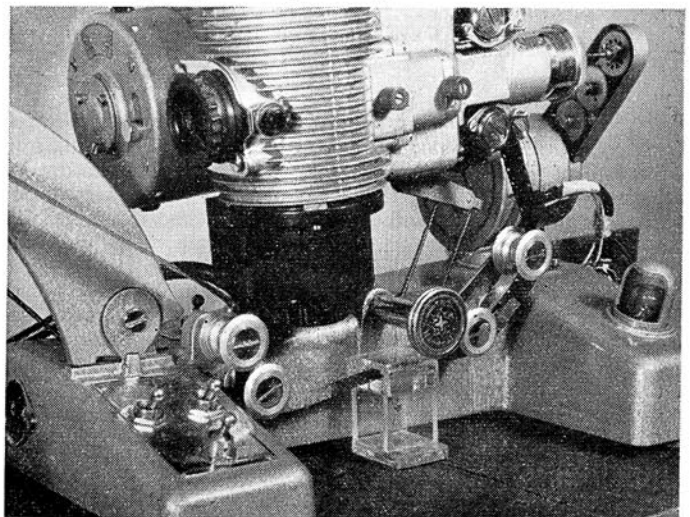

The projector showing film laced through recorder starting contact assembly (made of perspex).

# SYNCHRONISED SOUND FILMS

running at 16 frames per second. During projection the recorded 50 cycle wave is taken from the recorder and amplified through a 10 watt amplifier. The voltage is stepped up to 240 volts through a special output transformer and this voltage is supplied to another small synchronous motor contained in the Servo gear attached to the projector.

This Servo gear is the heart of the equipment. It is a compact unit which is attached to the front of the projector as shown in the photograph and it is this unit which continuously adjusts the projector speed in order to maintain synchronism. The mechanism consists of a differential gear train, a synchronous motor and a sliding contact for varying a resistance in series with the projector motor. As is well known, if the opposite sides of a differential gear train are driven in opposite directions, then the intermediate wheel remains stationary so far as its rotation

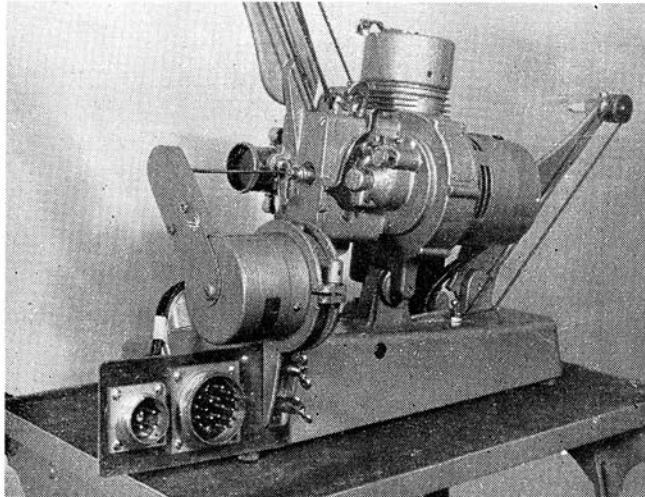

*The projector showing synchronising unit in the foreground.*

around the axis of the outside wheels is concerned. Any difference in speed between the two outside wheels will be transferred to the intermediate wheel. In the equipment, one wheel of the differential train is driven by the synchronous motor, whilst the other is driven through suitable gearing from the projector. The intermediate wheel carries the sliding contact which, as it moves, varies the current to the projector motor. The projector will thus run at a speed entirely dependent on the speed of the synchronous motor.

## Starting

One of the problems to be solved was that of starting up the equipment. It was desired that it should be entirely automatic and should not call for any adjustment once a start had been made. The problem was that whilst the Ferrograph would start up practically instantaneously when switched on, the projector took time to run up to speed. It was of little use marking the film and the tape since it could not be guaranteed that the projector would always run up to speed in exactly the same time. It was therefore arranged that the projector would be switched on manually and that when it was up to speed it would automatically start the tape recorder at the right instant. The arrangements are as follows:

A pair of contacts has been fitted to the projector in the film

path. The leader of the film has a small piece of aluminium foil stuck on to it (I use photographic dry mounting tissue.) The projector is switched on in the normal manner, the supply to the synchronous motor of the Servo gear being direct from the mains. When the projector is up to speed the metal foil on the film closes the pair of contacts which starts the capstan of the Ferrograph. Immediately this happens there is a 50 cycle output from the bottom track of the Ferrograph. This is used to operate a changeover relay which changes over the supply to the Servo gear's synchronous motor from the mains to the Ferrograph.

## Editing

A little serious thought on the making up of a sound track reveals what an extremely complicated matter it is. However, the complications largely disappear if, having given some thought to the matter as regards methods, suitable equipment is built up with which to do the job. Various tape recorders and a mixer are the basic tools but they are of little use without some form of measuring device. This method of synchronising by using a stereo recorder makes possible an easy and accurate way of measuring tape lengths. By recording a 50 cycle wave on one track of the tape, the tape has virtually been marked out as a ruler in 1/50ths of a second. By using a decatron or a high-speed electro-magnetic counter, the tape length can be measured to 1/50th of second.

I have built on to the "Muray Editor" a frame counting device which makes it possible to measure accurately to one frame any length of film. With these two devices one has required measuring facilities which greatly assist in putting the sound track together and also making possible, of course, for lip synchronised inserts to be made at any point of the film.

This system has proved to be an expensive one mainly because two stereo recorders are required. Only one recorder, of course, is normally used during projection but the other one is necessary for the compiling of sound tracks. When various programme sources are mixed on to the single tape the synchronising 50 cycle sine wave has to be transferred as well.

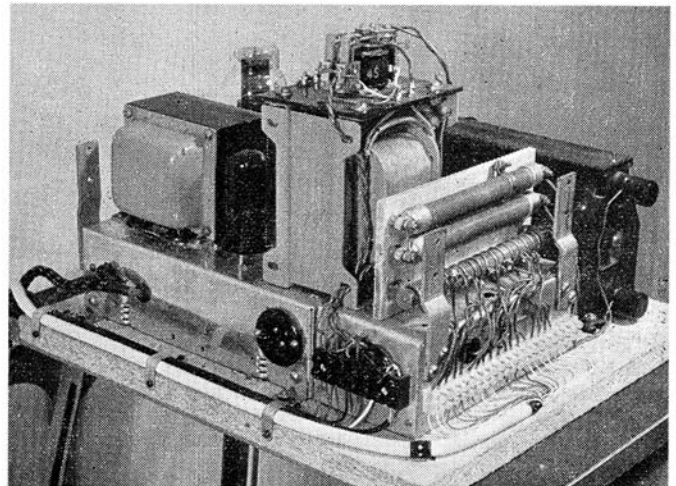

*10 watt amplifier showing special output transformer on which is mounted the changeover relay. On the right is the tapped resistance for the projector motor circuit.*



**BIGGER THAN EVER**

1962  
**Hi-Fi YEAR BOOK**

**QUAD** for the closest approach to the original sound

PICKUPS · MOTORS · TUNERS · SPEAKERS ·  
AMPLIFIERS · MICROPHONES · RECORDERS

10/6

11'6 Posted

C1  
R5  
+9V  
OUTPUT

**JUST PUBLISHED—COMPLETELY REWRITTEN**

The 7th edition of this world renowned annual publication has been enlarged and now contains 272 pages and includes articles by leading authorities. The disc Stereo Picture and Microphones by Stanley Kelly; New Developments in Transistor Amplifiers by George Tillet; Radio Tuners by Arthur Wayne; The Dynamic Decibel and Time on Tape by Graham Balmain. Loudspeakers for 1962-3 by Ralph West. Technical specifications are given of over 1,000 items of Hi-Fi and Tape Equipment, and over 500 of these are photographically illustrated.

Available from your local bookseller, newsagent or direct from the publishers.

**MILES HENSLOW PUBLICATIONS LTD. 99 MORTIMER ST., LONDON, W.1**

**hifi**  
BOOKS



# TOO MANY COOKS

## A NOTE ON TRACK ARRANGEMENTS IN NARROW-TRACK TAPE SYSTEMS

THE introduction of the first workable low-speed narrow track tape system by R.C.A. in 1958 caused (apart from an initial reaction of shocked and cagey silence) a disturbance in the audio world exceeded only by the rumpuses which attended the introduction of long-playing records, and, later, that of stereo. Readers may remember that the reactions to both were very cautious at first—(indeed, stereo is still regarded with much suspicion)—but the *l.p.* scene quickly became a free-for-all with no holds barred, technically speaking.

This was sorted out rapidly enough here by the bigger record companies and the British Standards Institution, and no one now questions that the *l.p.* record had to come. Unless something similar is done for narrow-track tape recording, however, we shall be stuck with a prototype system which no-one bothered to develop into a practicable proposition.

Most people have been so busy waiting to see which way the cat would jump, it seems, that they have not noticed the cat is surrounded by hot bricks. As a result, when the movement eventually got under way, recorder manufacturers were more or less forced to adopt the most likely-looking system without having time to examine among themselves whether it was really as good as it could be or not. The one generally chosen was in fact R.C.A.'s, or a slight modification of it in the case of some European manufacturers, which is probably the best of the suggested systems for domestic use though not, in my view, as good as it could be.

### Suggestions Already Made

Let us look first at what *has* been suggested at one time or another. Fig. 1 shows most of the important published ideas, I believe; but there may be others. Note that (b), (e), (g) and I think (d) were associated specifically with tape cassette systems, although of course not confined to them; also that (e) and (g) are primarily intended for three-channel stereo or similar arrangements. The standard  $\frac{1}{2}$ -track layout (a) and the data-recording layout (f) are included for comparison. Complete or not, readers will surely agree that this is enough to be going on with.

Now let us consider for a moment reasonable requirements for a narrow-track layout, which might be summarised as follows: 1. It must not make unreasonable demands on the tape. 2. It must allow a practicable space between the tracks on the heads for windings and screening. 3. It must allow for reasonable mechanical tolerances in the transport mechanism (in respect of tape guiding, head adjustment and so on) and in the tape itself. 4. It must aggravate as little as possible any of the inherent difficulties (hum, background noise, etc) found in any recording system. 5. It should, if possible be compatible with wider-track systems, at least for playback purposes. 6. It should make obsolete as little of existing equipment, tape-record and component stocks as possible.

In practice one must make a compromise between these requirements, of course, as some of them are conflicting. Requirement (2), for instance, is satisfied the more as the track width is decreased (when one is dealing with wire gauges in the forties and fifties, every extra thousandth of an inch eases production problems in multi-track heads) while (4) requires that the track be as wide as possible to gain signal/noise ratio; and (3) supports this for mechanical reasons (see "Facts about 4-track Recording", *The Tape Recorder*, November 1961) up to the point where the edges of adjacent tracks approach so closely that there is danger of inter-track interference.

The first requirement perhaps deserves some explanation. It is (in my view) a defect of all but one of the proposed systems

that the tape is scanned right out to its edges. To be sure, most tapes are very cleanly and evenly slit these days, but even so there is no insurance against their edges being damaged in sub-

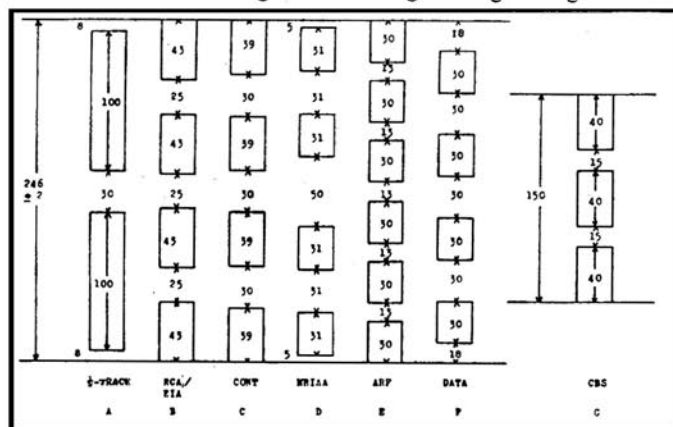

Fig. 1. Narrow-track layout proposals: (a) International  $\frac{1}{2}$ -track (approximate). (b) Radio Corporation of America. (c) Continental 1mm. tracks, now apparently obsolescent. (d) Magnetic Recording Industry Association of America. (e) Armour Research Foundation. (f) British Standards Institution recommendation for data recording. (g) Columbia Broadcasting System, using 0.15 in. tape. All dimensions in thousandths of an inch.

sequent use either accidentally or due to mishandling by the mechanism or the user. Either way the damage need not be immediately visible to cause trouble. A ragged edge can lift a considerable proportion of a narrow outer track away from the head, for example, and thus cause loss of short-wavelength signals. Besides, placing heads so as to scan the tape edges offends against requirements (4) and (5).

Considering the mechanical performance of some of the mechanisms now in use and the supposed tolerance of the average domestic user towards amounts of distortion and general roughness which the enthusiast finds audibly shocking, it could be argued that some of these requirements are fussy; no. (3), for instance. "Who", some will ask "is going to notice a bit more variation among what there is already?" Those who ask probably will, for a start. But I cannot agree that nominal adjustments and tolerances should be any less precise on domestic machines than on professional, whatever the excuse.

The nearer everything is to being in the right place, the less effect do the normal working tolerances have on the audible result (see again *The Tape Recorder*, November 1961 issue); there is no sense in turning a small unavoidable variation which may not be readily appreciable into an easily avoidable larger one which is, by mere default.

Looking at fig. 1 again, readers will probably agree with the majority of manufacturers that the R.C.A./E.I.A. layout is indeed the best of the available systems. Nevertheless, it can be improved greatly by a small and very simple modification; by dropping the heads relative to the tape by a few "thou". Fig. 2(a) and (b) show probably what are the minimum and maximum reasonable amounts of shift, about 5 and 8 "thou" respectively. The former is, I think, preferable for general purposes, but both concentrate much of the otherwise wasted tape area in the centre of the tape, where it could be usefully used by anyone who wanted a cine synchronising track or a reference track for a pilot tone com-

# BUTOBA

TRANSISTOR BATTERY  
MAINS RECORDER



MODEL MT5  
66 GNS.

including  
connecting  
lead and  
empty spool.

"The Butoba looks so good, is so cleverly designed, performs so well that your reviewer had to be firm with himself to keep his superlatives within bounds."

\* Mr. John Borwick, leading authority on tape recording.

- Two speeds,  $3\frac{1}{2}$  and  $1\frac{1}{2}$ , with frequency response of 50 to 13,000 cycles at  $3\frac{1}{2}$ , i.p.s., giving true mains machine high fidelity.
- Very high quality playback through large-sized  $7" \times 5"$  internal speaker, with full 1.2 watts output (not just milli-watts).
- Adjustable Treble Control operative on playback and record, giving high fidelity from widely different sound-sources.
- Monitoring facility, with magic eye and 'phones, off mike or radio/gram. recordings.
- High sensitivity level—no lack of gain with this machine.
- Very low background noise level—lower than on many mains machines, 40dB.
- Playback through radio or amplifier, with or without recorder's speaker operating.
- "Buy-anywhere" normal flashlight U2 batteries—not special radio-type batteries. Life up to 50 hours with standard cells.
- $5"$  reels of tape can be used, giving 4 hours, with d.p. tape on  $1\frac{1}{2}$  r.p.s.
- Interchangeable Mains converter for home use or use with car battery.
- Prompt service facilities.
- Designed and engineered by an old-established firm which for years has produced precision clocks and watches, then clockwork tape recorders, and now, for the last five years, all-battery recorders. This valuable experience has culminated in the unique Butoba MT5.

Full details of the machine and accessories from :

**DENHAM & MORLEY LTD.,**  
Denmore House, 173-175 Cleveland Street,  
London, W-1 Tel. EUSon 3656-7

pression control, for example. Note that this change does not involve any alteration to the head itself, only to its height adjustment on the deck or that of the tape. It thus satisfies requirements (6), and at one puff most of the others as well.

The situation can be improved still more on machines having separate record and playback heads by making the recorded track wider than that of the playback head, which causes the inevitable slight looseness in tape guiding to lose most or all of its sting, audibly speaking. This is an obvious enough measure—and one used extensively in professional recorders where it is hardly needed—yet as far as I know only Tandberg of Oslo have put it into practice on machines outside the professional class by having recording tracks some 4 thou' wider than on playback. The same idea could well be applied to commercial tape records also, of course; even  $\frac{1}{2}$ -track records extend to the edge of the tape and thus overlap the usual playback track, but  $\frac{1}{4}$ -track records seem to be firmly confined to their 43 thou' or whatever. Something like fig. 2(c) would cover all possible and reasonable head positions, at least until the unlikely event of proposals such as those above being adopted.

Regarding the use of any of the published systems on two- or three-track stereo, it should be pointed out that the objective signal/noise ratio achieved is improved by the very use of the increased total track width (apart from any subjective effects resulting from the use of stereo techniques) although it is naturally

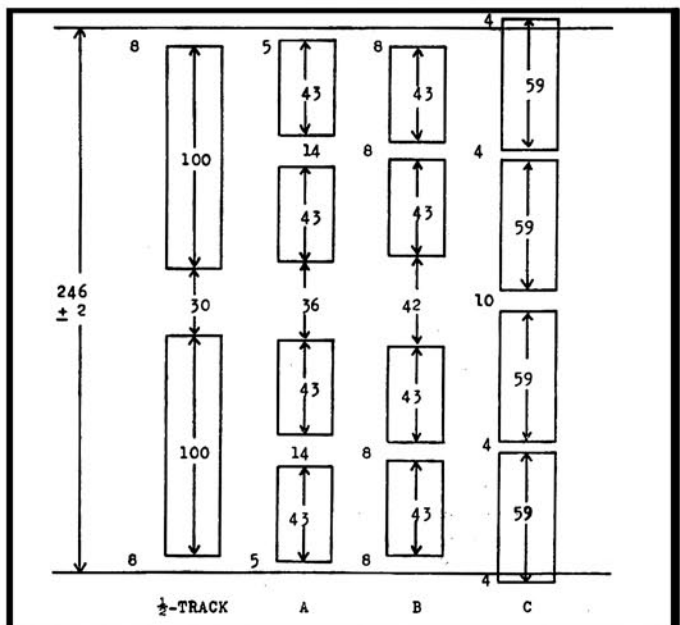

Fig. 2. Author's proposals for narrow-track domestic systems: (a) R.C.A./E.I.A. heads, minimum shift. (b) Ditto, maximum shift. (c) Tracks on tape records.

still less than is obtainable from a twin- $\frac{1}{2}$ -track system. It is the single-track monophonic reproduction which really suffers in narrow-track systems, and all the more as the track width decreases. True, the data system uses 30 thou' tracks only, but in data applications not only is the tape usually magnetically saturated either in one sense or the other (which means a fixed and unimportant modulation noise about 30-40dB down) but the reproducing equipment is also strongly selective towards the wanted signal. In these applications dropouts and inter-track interference (hence the wide track spacing) cause far more trouble than noise, which need in some systems be no more than 20dB or so down to be harmless. But note that the tape edges are avoided even under these favourable conditions.

Although standardisation committees' proceedings are virtually secret until their final recommendations are published, both the B.S.I. and the I.E.C. are known to be discussing these and other aspects of magnetic recording at the moment. The simple suggestions for improving  $\frac{1}{4}$ -track layout made here may appear merely to be the desire of yet another cook to stir the pot; nevertheless I believe them to be reasonable and beneficial.

# ... tape recorder workbench

## No. 35 MICROPHONES (Part 2)

by A. Bartlett Still

LAST month we had a look at the characteristics of the crystal and condenser types of microphone, which are basically high impedance devices and as such, purely voltage generators. The electromagnetic types, on the other hand, are low impedance sources, as we shall see, and may be considered as current or power generators.

### Moving coil types

A wide variety of moving coil microphones are available at prices from about three or four pounds. The system is ideally suited to a compact instrument and it is not surprising that advantage has been taken of this to produce hand microphones for individual use of pleasing design. As mentioned earlier, three impedance versions are now generally available, but it is proposed to deal only with low and high impedance models.

A usual low impedance figure for a moving coil microphone is 25 ohms, and the sensitivity would be given as around 88 dB below 1 Volt/dyne/cm<sup>2</sup>. This is where the confusion previously referred to can arise. The same microphone with an impedance of 50 K ohms, would be quoted as -54dB. The second case takes into account the voltage transfer of the "input" transformer, whereas the first does not. These figures are reasonable for the type and show little difference from crystals.

The frequency response to be expected will, however, show a wider change. The average moving coil "desk" microphone will cover the approximate range 70-6,000 c/s, but "hand" models, having usually a smaller diaphragm, would probably have a response from 150 to 10,000 c/s. This can be compared with a crystal unit using a comparatively low value of input load resistor.

When it is required to use a longer line between the microphone and pre-amplifier, the advantages of a source impedance of only 25 ohms will be obvious. Unless really long lines of 20 yards or more are considered, it is often not necessary to provide any screening for the cable. It must, however, be borne in mind that the resistance of the line should be low, to avoid insertion loss, remembering that we are dealing with a power generator and should restrict the current as little as possible.

### Ribbon type

Many tape recorder owners are known to consider that the possession of a ribbon microphone means that they have the best. This is a point of view that may be largely due to the higher purchase price, from eight to ten pounds upwards. Although vast improvements have recently been made in this direction, the sensitivity of ribbon microphones is generally lower than that of the other types. The high impedance versions will normally range from -60 to -56 dB. Our "average man", speaking at three feet distance, will only produce about 1 mV at the grid of the pre-amplifier valve.

It is on turning to the question of frequency response, however, that the ribbon microphone begins to show advantage over other types. Not only do we get better response to the bass frequencies, but the treble response extends to 12 or 14 Kc/s. Further, the response curve over that range is much cleaner and, on the more expensive models, may well be held to limits of  $\pm 2$  dB.

It will be found that both 25 ohms and *hi-z* versions are available for the more popular makes, as with the moving coil. Unlike the moving coil microphone the ribbon microphone is definitely a fragile instrument, and note must be taken that it is not suitable for out-door use.

Finally, while other forms of construction are normally omnidirectional, the ribbon microphone is inherently directional in its pickup, having a "figure-of-eight" polar diagram.

After this brief look at four different types of microphone, one of them, the condenser, already begins to look like the "odd

man out". Similar performances can be obtained from other types which do not suffer from some of the disadvantages that arise with the use of a condenser microphone. Such a dismissal should not be taken to mean that they are "no good". In fact, they are often used for instrument work. Their rejection is, however, a logical step in the circumstances we are considering.

It is hoped that it will now be apparent to the reader that no one microphone can be obtained capable of fulfilling every recording task—an unfortunate fact that has to be faced. Nevertheless, there are always those who have to obtain the best possible for a minimum of outlay, and here, surely, the crystal

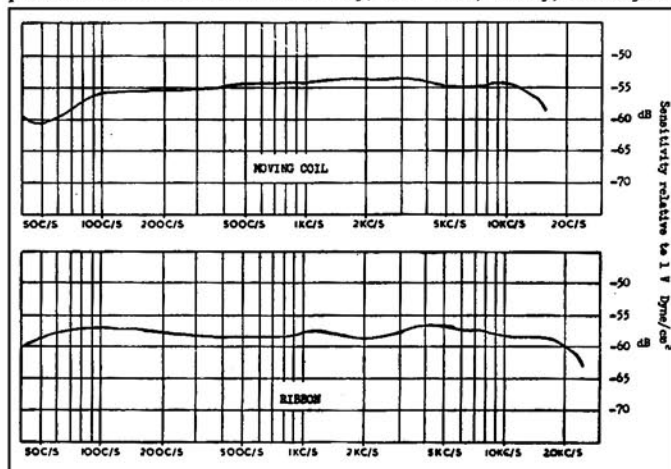

Fig. 1. Microphone frequency response and sensitivity. These curves are typical of the general type only.

microphone is the most attractive proposition. The sensitivity, connected directly to the tape recorder, should be adequate for normal home recording purposes. Live musical recordings would suffer from a lack of overtones, but should otherwise be acceptable. It will, perhaps, have been noticed that many of the cheaper commercial tape recorders are supplied with crystal microphones.

### Choosing of Microphone

To those who are able to afford a greater outlay it must be said that a ribbon microphone is the *second*, not the *first* that should be bought. For the vast majority of live recordings that the amateur will wish to make, better results can be obtained with a moving coil microphone costing eight guineas than with a ribbon that costs fifteen. Speech forms a high proportion of home recordings, for which a ribbon microphone requires tone correction. In view of what has been said earlier about the better frequency response of the ribbon, this may sound surprising; but if such a microphone is used within a couple of feet or so of the speaker the ribbon tends to respond to pressure rather than velocity, giving an unnatural booming effect. Under such conditions, bass cut should be used, rolling off to some 10 or 15 dB down at 50 c/s. It is still better, in terms of frequency response, to use the ribbon, without correction, at least

(Continued on page 212)



**VENER**  
14 DAY  
CLOCKWORK  
TIME SWITCHES

29/6 P & P  
2/6

KINGSWOOD SUPPLIES (T.R.1), 4 Sale Place, London, W.2. PAD 8189

AUTOMATIC CONTROL over radio and/or tape recorder. Will switch ON OFF or OFF/ON once every 24 hours at any manually pre-set time. Minimum time lapse 30 minutes. It has a current rating of 1 amp sufficient to carry radio and/or tape recorder. Complete with key and mounting bracket. Used but in perfect condition. Fully guaranteed.



**Superb musical reproduction at low cost!**

**NOW you can record and play back tapes on YOUR OWN Radiogram or Gramophone!**

WITH A **Gramdeck** Instantly turns any gramophone into a Tape-Recorder and back into a record-player in a moment

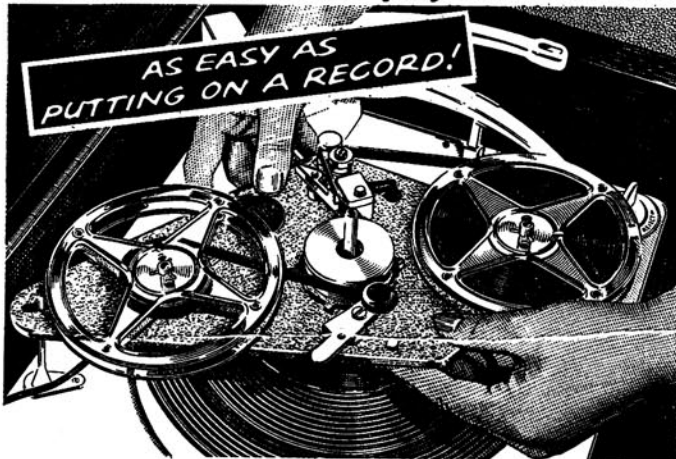

**IIGNS**

OR 19 FORTNIGHTLY SUMS OF 13/- Ready to record complete with Control Unit, and 600 ft. of Twin-track tape. Special moving coil microphone extra.

Gramdeck is an ingenious invention that instantly turns your gramophone into a tape-recorder and back into a gramophone at will! You simply slip it on your turntable and you are ready to record direct from radio or microphone . . . the voices of your family . . . your favourite music—and you can instantly play it back through your own gramophone or radio with *Lifelike Fidelity*. Made by the people who make radar runs for Viscounts and Britannias, the amazing Gramdeck now brings full tape-recording and playing facilities to every gramophone owner, at little extra cost.

**SEND FOR FREE GRAMDECK BOOK**

"Real hi-fi results." "Better than many so-called hi-fi recorders . . ." These are typical comments of famous technical journals. The fully-illustrated Gramdeck Book tells you all about Gramdeck . . . what Ted Heath, Max Jaffa and others think about it . . . how YOU can add HIGH-QUALITY tape-recording to YOUR gramophone . . . photographs, Easy Terms, etc. . . . send for the Gramdeck Book today—FREE!

You can hear GRAMDECK at SELFRIDGES in London or at LEWIS'S in Liverpool, Manchester, Birmingham, Glasgow, Leeds, Hanley, Leicester & Bristol. Also: Demonstrations daily at the address on coupon.

- ★ Uses standard tapes. ★ Plays at 7½" per sec. or 3 other speeds. ★ Records direct from Radio or microphone. ★ Erase and fast rewind.

**POST COUPON NOW!**

**Free!**

To: GRAMDECK (DEPT. TA/817)  
29 WRIGHT'S LANE, LONDON, W.8  
Please send the Gramdeck Book FREE.

NAME .....

ADDRESS .....



**Gramdeck** GRAMOPHONE TAPE RECORDER

ADDS A SUPERB TAPE RECORDER TO YOUR GRAMOPHONE

TAPE RECORDER WORKBENCH—(continued)

5 or 6 feet from the speaker. This means that the sensitivity of the ribbon microphone is effectively much less than the moving coil.

The hi-z versions, now obtainable, obviously are more convenient for use with an existing tape recorder that has a high impedance input. The recommended load impedance for these types, by the way, is from 470 K ohm to 1 Megohm. Wherever possible, though, the writer would recommend the use of low impedance microphones, with a separate matching transformer.

**Room Acoustics**

The subject of "Room Acoustics" was mentioned briefly earlier on, and it is felt that a further word here might prove to be of assistance. The best of ribbon microphones, connected to the best of tape recorders, will not necessarily do justice to the living room piano. In the humble opinion of the writer, this is largely due to selective properties of the ear. When listening to the sound "live" we unconsciously reject, to a large extent, the reflected sound coming from walls, windows, furniture, etc., each of which has different properties of absorption for the different frequencies. The microphone, however cannot do this, and the ultimate replay gives us the total sound from the one loudspeaker, where the ear has no chance to exercise its selective powers. The problem can be overcome to a large extent by utilising any directional properties of the microphone, placing the instrument to be recorded in one "lobe" and deadening the zone to the rear of the microphone by (say) draping blankets over a clothes horse.

Although moving coil microphones are usually non-directional, they can be obtained with a heart-shaped or "cardioid" response, which would be found to be an advantage, even with speech recordings. Such microphones are virtually "dead" to the rear, and will considerably reduce the background noise of, for instance, other people who may be talking.

**Not Necessarily a Weak Link**

It has been the intention of the writer, in these two articles, to show that the microphone need not be the weakest link in the tape-recording chain. If it is, it is often because it is being asked to perform a task not within its capabilities; or it possibly only seems to be, because the local acoustic conditions are poor. It is here, of course, that the home enthusiast starts off at second best, compared with recording and broadcasting studios, but it is surprising how patience and experiment will overcome some of these difficulties.

Finally, remember when choosing a microphone, have an eye to the type of recording that you will most often wish to make. A good moving coil microphone, at a given price, may easily be a far better buy than the same money spent on a cheap ribbon type.

**BUYING OR SELLING**

For quick results advertise in the Classified Columns—  
See Page 224



**FOR AUDIO IN BIRMINGHAM**

SALES OR SERVICE ON ALL QUALITY EQUIPMENT  
14 YEARS SPECIALIST KNOWLEDGE AT YOUR DISPOSAL  
SERVICE AGENTS TO GOVERNMENT DEPARTMENTS,  
LEADING MANUFACTURERS AND INDUSTRY

MAIL ORDER SERVICE THROUGHOUT THE WORLD

416 MOSELEY ROAD, BIRMINGHAM 12  
Telephone Calthorpe 2554

# THE CALIBRATION AND USE OF TEST TAPES

PART 4 ————— By A. TUTCHINGS

ALL test tapes discussed so far have contained pure tones recorded at well defined levels and discrete frequencies. Now, in contrast, we turn to tapes which contain all frequencies simultaneously and where the signal amplitude is changing continuously. I refer to White Noise test tapes. White noise is made up of an infinite number of components differing in frequency by infinitesimal steps and having completely random phase relationships. It is usually produced by a special gas discharge lamp, but a saturated diode, or even thermal noise from a metallic resistor is very nearly "white".

The amplitude distribution of the noise peaks is constant over the frequency range, but there are more of them in a given bandwidth at the high frequency end of the spectrum than at the low frequencies; this leads to the concept of "equal noise power per cycle", i.e. noise power is proportional to frequency so that each time the frequency is doubled the power is also doubled, or to put it into audio parlance the noise power rises 3dB per octave. It is convenient to pass white noise through a filter so that the power content falls 3dB per octave so that a constant *r.m.s.* level will be measured when the noise is passed through any constant percentage bandwidth filter; such noise is known as "Pink Noise". Before investigating the uses of filtered white noise, let us see what applications there are for recordings of simple wide range white noise.

## Azimuth Alignment Tape

A tape recording of unfiltered white noise, recorded on a machine with the head set to exact azimuth, can be used to align the playback head of any other recorder without the use of any meter or test gear whatsoever; in fact the ear can give us information about the head gap and tape contact which would be extremely difficult to extract from meter readings. The noise sounds like a rather "hissy roar", and as the playback head is

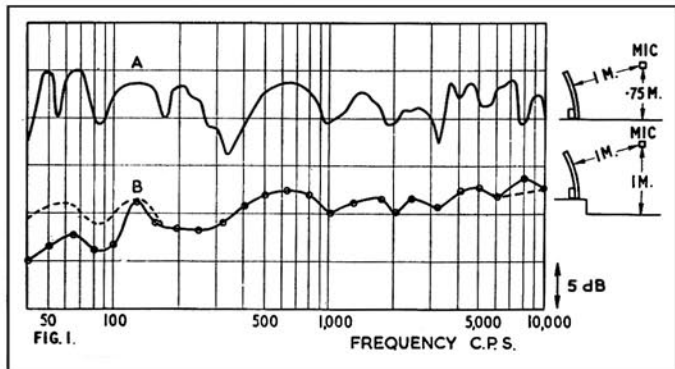

Response of the Quad electrostatic speaker. Fig. 1a measured in the open air; Fig. 1b measured in a lecture theatre.

moved off azimuth the hiss disappears, leaving only the low pitched roar. With a good head, with a well-shaped gap and tape contact, the correct azimuth setting is unmistakable; the hiss comes up quite sharply, and it is easy to find the point of maximum output as the low frequency roar provides a constant reference. With a bad head, however, the high frequency content certainly alters but there is no well defined peak; as one frequency component is reduced another comes up. This could be due to a curved or stepped gap which favours different wavelengths as the head is rocked. The white noise tape at least tells us that something is wrong; a single high frequency tone could be set for maximum output on such a head and yet the mean azimuth for slightly lower frequencies, which carry much of the programme content, could be out.

## Subjective Tests

We have said that wide range white noise contains all frequency components simultaneously. It also has a peaky transient quality which can shock excite any electrical or acoustic resonant circuit or cavity so that, to a skilled observer, it provides useful information on such complex devices as loudspeakers, cross over networks, microphones and enclosures or cabinets, etc. particularly if a good reference speaker and enclosure is available to refresh ones memory of what it "should" sound like. Any "ring" or "chink", or impression of a sustained musical tone, is an indication of an undamped resonance which must be attended

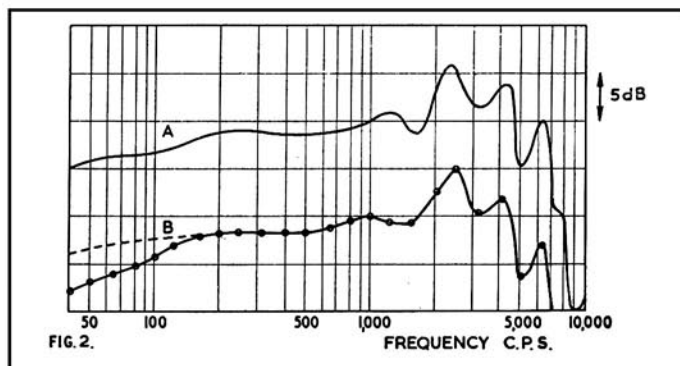

Response of a crystal microphone. Fig. 2a measure on test equipment; Fig. 2b using white noise test tape.

to if colouration of the programme material is to be avoided. As will be seen later, filtering the noise into one octave or one third octave bands allows one to pin-point the approximate frequency of the offending resonance, and also to define the top and bottom cut off frequencies of an overall electro-acoustic system.

## Elimination of Standing Wave Effects

Perhaps the most useful feature of white noise is that the effect of multiple reflections from the listening room boundaries is very much reduced, as no single frequency is sustained for more than a few milliseconds, and there is little chance of a standing wave pattern building up to give the enormous peaks and dips in apparent frequency response which occur if steady sine tones are used for acoustic measurements. Such irregularities in response are a function of the room in which the measurements are made and bear no relation to the true response of the unit under test. Until the advent of the white noise method of acoustic testing, all such tests had to be done in the open air, preferably at a height of about 20 ft. to avoid ground reflections, or the test had to be made in a special anechoic room with specially treated walls floor and ceiling to prevent standing waves.

A white noise generator and set of band pass filters is an expensive investment, but the output of this complex equipment can be recorded on tape and made available to any laboratory relatively cheaply. The white noise test tape thus consists

(Continued on page 214)

## SUBSCRIPTION RATES

The subscription rate to *The Tape Recorder* is 21/- per annum (U.S.A. \$3.00) from The Tape Recorder, 99 Mortimer Street, London, W.1. Subscription + Index, 24/- (U.S.A. \$3.25).

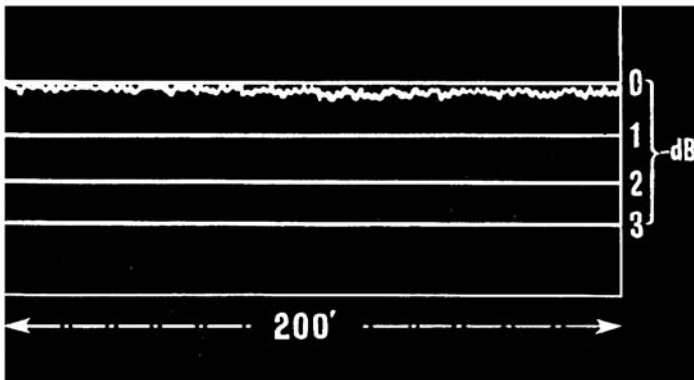

## This is an outline . . .

of the penrecording made by  
**F. C. Judd, A. Inst. E., Technical Editor**  
**"Amateur Tape Recording"**

### On Doubleplay Polyester 'ELECTRONIC WORLD' TAPE

Mr. Judd's other test findings include:-  
 Maximum drop-out, on any grade, less than 1.5 dB. Uniformity of output; Double Play Polyester  $\pm 0.25$  dB; Long Play Polyester better than  $\pm 0.5$  dB; Standard Play Acetate  $\pm 0.5$  dB. Noise level measurement recording and erase tests: Satisfactory in every way, even on a domestic tape recorder.

#### DE VILLIERS (Electronic World) LTD.

16d Strutton Ground, London, S.W.1

##### STANDARD PLAY (Acetate base)

3in. spool 175ft. 4 spools for 18/-  
 or 48/- dozen  
 4in. spool 300ft. 4 spools for 25/-  
 5in. spool 600ft. 2 spools for 25/-  
 5½in. spool 850ft. 15/- per spool  
 7in. spool 1,200ft. 17/6 per spool

##### LONG PLAY (Polyester Base)

3in. spool 225ft. 4 spools for 22/-  
 or 60/- dozen  
 4in. spool 450ft. 2 spools for 20/-  
 5in. spool 900ft. 2 spools for 33/-  
 5½in. spool 1,200ft. 22/6 per spool  
 7in. spool 1,800ft. 29/- per spool

##### DOUBLE PLAY (Special polyester base)

3in. spool 375ft. 4 for 36/-  
 or 100/- per dozen  
 4in. spool 600ft. 2 for 27/6  
 5in. spool 1,150ft. 25/- per spool  
 5½in. spool 1,750ft. 33/- per spool  
 7in. spool 2,400ft. 42/6 per spool

I enclose remittance for £      s.      d.

Name.....

Address.....

BLOCK LETTERS PLEASE

Mail only, cash with order

of 25 one-third octave bands of filtered white noise recorded so that when the tape is replayed on a machine equalised to the C.C.I.R. 100 microsecond characteristic the *r.m.s.* noise energy in each band is equal. A voice announcement identifies the centre frequency of each band.

A meaningful response of any loudspeaker can be obtained in an ordinary room by feeding the loudspeaker from the output of the tape recorder and measuring the sound output on a calibrated microphone. The response is smoothed slightly due to averaging the sound output over each one-third octave band. Fig. 1A shows the response of a Quad electrostatic speaker measured in the open air on £2,000 worth of B. & K. equipment. Fig. 1B shows the response of the same loudspeaker, measured on the platform of the Royal Society of Arts lecture theatre on the occasion of a recent lecture by the writer to the British Sound Recording Association, using a £2 reel of white noise test tape, a £60 recorder and an S.T. & C. £27 "ball and biscuit" microphone. The sharp dip at 320 c/s in fig. 1 is due to ground reflection, and the dotted curves in fig. 2 are corrections for slight deviations from a level response of the microphone used for these tests.

In the same way, a microphone can be calibrated against a standard by setting the loudspeaker level on each band to give a constant output from the reference microphone and then switching to the test microphone and plotting its output for each of the

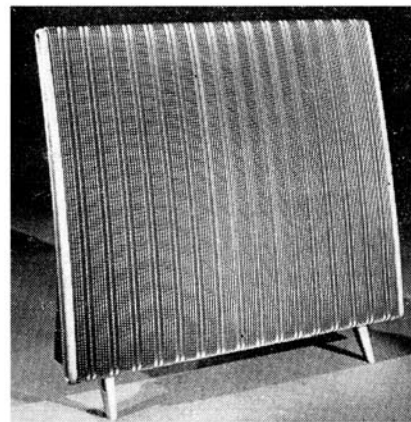

*The Quad electrostatic speaker used in the tests described by the Author.*

25 noise bands. Fig. 2A shows the response of a cheap microphone as measured on Stanley Kelly's B. & K. equipment, and fig. 2B is the curve obtained using the white noise test tape under the same conditions as fig. 1B.

A one octave white noise test tape is also available and this is used for production or batch testing of loudspeakers or microphones where a detailed response is not required and the shorter testing time is an advantage.

Either of these tapes can be used for sound insulation or reverberation tests where pure tone testing would be completely impossible due to standing waves or undamped resonances.

#### BRAND NEW FAULT FREE 100% TESTED TOP QUALITY RECORDING TAPE

(As supplied to the Far East Broadcasting Corp.)

#### WHY PAY MORE?

Polyester Long Play. Super Quality			P.V.C. Standard		
Size	Length	Price	Size	Length	Domestic Price Super
3"	220'	3s. 0d.	3"	160'	2s. 3d. 2s. 6d.
5"	900'	11s. 6d.	5"	600'	8s. 6d. 9s. 0d.
5½"	1200'	16s. 0d.	5½"	900'	10s. 9d. 11s. 6d.
7"	1800'	23s. 0d.	7"	1200'	15s. 3d. 16s. 0d.

REFUND GUARANTEE (Never requested)

N. WALKER, 28 Linkcroft Avenue, Ashford, Middlesex



# our readers write . . . . .

## . . . about pre-recorded tapes

**From:—F. G. Carlsen, Skolegade 7, Skrydstrup, Vojens, Denmark.**

*Dear Sir:*—I have just seen the letter from Mr. Cisler in Kentucky, U.S.A., about the amount of pre-recorded tapes operating with  $3\frac{1}{2}$  i/s 2-track stereo available in European countries.

Mr. Cisler is wrong about his investigations of this matter in Scandinavia. I have just looked through the catalogue of "Phono-band", i.e. I could only find a supplement to the main catalogue from January 1961. But in this supplement were mentioned—not 10 as Mr. Cisler mentioned—but 91 titles. I suppose that up to this moment there are about 150 titles of pop, jazz and classics on as well  $3\frac{1}{2}$  i/s 2-track,  $7\frac{1}{2}$  i/s 2-track or  $7\frac{1}{2}$  i/s 4-track stereo. (All titles can be had on either speed as preferred). "Phono-band" are made in Sweden, but also sold in Denmark, and—as I understand—Germany. *Yours sincerely,*

\* \* \*

**From:—W. George, 205 Avon Road, Chelmsford.**

*Dear Sir:*—I was interested to read Mr. Cisler's comments in reply to my letter on  $3\frac{1}{2}$  i/s stereo tapes.

It is certainly surprising to learn there are so few  $3\frac{1}{2}$  i/s stereo tapes available.

We have seen so often in *The Tape Recorder* and *Hi-Fi News* that "so and so's" tapes will shortly be released, but they never get on the market!

Two years ago at the Audio Fair there were at least 100 titles ready to be released by one exhibitor but they never found their way to English shops.

If the tape-deck manufacturers keep selling  $3\frac{1}{2}$  i/s stereo decks where do they suppose we are to get  $3\frac{1}{2}$  i/s pre-recorded tapes?

I think this all emphasises the points I made, i.e. the people concerned must get together and standardize speeds and say so publicly, then get down to issuing pre-recorded tapes.

I must say I am enjoying the World Record issues of pre-recorded tapes but again they do not issue  $3\frac{1}{2}$  i/s stereo.

If the tape-makers will say that  $7\frac{1}{2}$  i/s is to be the speed for stereo then I will sell my  $3\frac{1}{2}$  i/s deck and buy one to use the standard tape speed.

Let us hear from "Decca" and "E.M.I." *Yours faithfully,*

\* \* \*

## . . . about sound effects

**From:—A. P. Hammond, 385 High Road, Tottenham, London, N.17.**

*Dear Sir:*—Having recently acquired a "Cirse-sound" 8 mm projector, we are busily editing the films that I took on recent visits to both Morocco and Libya in connection with my work for the Boy Scouts in promoting International interest in the movement, we are now faced with the dilemma of not having secured any local music or background effects in the countries where the films were shot, in fact at that time we did not visualise that at some time we should go in for sound movies.

Any of your readers who might have any local Arabic music and sound effects on tapes, that were recorded in those countries, if they would loan us these for transcription on to the magnetic sound tracks of our films it would greatly assist us. There must be many Servicemen who are, or have been, stationed in these places who might be able to help us. *Yours faithfully,*

\* \* \*

## . . . about a previous letter

**From:—K. F. Jefferson, 21 St. Georges Road, Sevenoaks, Kent.**

*Dear Sir:*—Regarding Mr. Casburn's letter in your April issue, it is to be hoped that his views are not widely shared by the rest of your readers. Else, surely, we should all still be easing a recalcitrant cat's whisker on to that elusive spot on the crystal.

Does he, I wonder, fill his car with paraffin, for cheapness? For that would match the indifferent performance he must be

experiencing. In most things, we get what we pay for and whilst it is no concern of mine if Mr. Casburn records all his music on a minimum of tape, I do feel concerned if he rushes into print declaring his idea to be a good one, in the face of learned counsel from Mr. Bartlett Still, who deserves our solid backing.

The difference in quality, on even a Ferrograph (with two track) at the slower speed is so marked that I never use it for music I intend to keep. Again, many broadcasts today are BBC recordings and it is possible to get adding and cancelling effects showing up particularly with piano works. Such defects are obviously worse with the slower speeds.

It is possible to motor through France living on baked beans, fish 'n chips and tea but few would consider they were getting the best out of life.

My Leak/Ferrograph/Wharfedale rig gives superb quality and to me great pleasure but I look forward to the day when we can record and play back at will from BBC stereo broadcasts, at  $7\frac{1}{2}$  i/s 2-track, of course and that Mr. Casburn is full track. As it is quality we want, not quantity, I must wholeheartedly agree with Mr. Bartlett Still that this alone represents progress.

*Yours faithfully,*

\* \* \*

## . . . about a circuit diagram

**From:—E. A. Layton, Oakmount, Boyneswood Road, Four Marks, Alton, Hants.**

*Dear Sir:*—I should like to obtain a circuit diagram and other details of the "Top Twenty" tape recorder, one of which has been brought to me for a check up. If any of your readers will be so kind as to loan me a circuit diagram of this machine, I will undertake to return it in good condition within forty-eight hours. It is, of course, understood that any postage or other costs will be refunded. *Yours faithfully,*

# Ferrograph

(Appointed Dealer)



Geoffrey V. Smith

## Special Announcement

Many visitors to our London Showrooms remark that our stock of high quality tape recorders and audio equipment surprises them—many express the wish that they had visited us **FIRST**.

For really personal service and attention, for first-class equipment and after sales service executed in our own service departments, we maintain, **IT PAYS TO DEAL WITH A SPECIALIST.**

## Accessories For Your **Ferrograph** The Nusound "Numix"

The "NUMIX" is a convenient mixer which enables a Ferrograph user to mix and fade at will two programmes, from microphone and radio/radiogram. Alternatively, speaker output sockets from power amplifiers can be used. Any combination of two programmes is possible with the Nusound "NUMIX" device. Price: £47.6. Radio Lead complete 7/6.

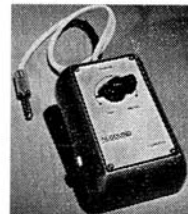

Write for leaflet on "NUMIX" and "MONITOR"

# NUSOUND RECORDING CO.

35 CRAVEN STREET, W.C.2. TELEPHONE TRA 2080

# THE BEST OF BOTH WORLDS

**Brenell**

That is what you can expect when you buy a Brenell tape recorder—top quality, high performance and versatility at a reasonable price. The Mark 5 deck at 28 gns., the Mark 5 recorder at 64 gns., or the Mark 5 Type M at 88 gns. are all unbeatable in their class.

Mere illustrations can only show the functional appearance of these machines, but a practical demonstration will reveal the realism and beauty of recorded sound obtainable from a Brenell. Ask your specialist dealer for a demonstration and you will hear what we mean.

All Brenell tape decks are fitted with an hysteresis synchronous capstan motor with an outer rotor and a large statically and dynamically balanced flywheel. This drive system is widely regarded as the most efficient for use in tape recorders. "Wow and Flutter" are reduced to below 0.1% at 7½ ips.

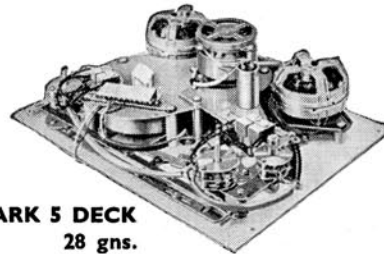

MARK 5 DECK  
28 gns.

A NEW DEVELOPMENT FROM  
BRENELL—

## THE Mk 510 DECK

This new introduction is basically the same deck as the Mk 5 but modified to take 10½ in. N.A.B. as well as standard spools. All other features remain as before. It is available in hammered gold or hammered grey finish and is supplied for use on 200/250V 50 c/s mains only. The additional cost is 7 gns.



MARK 5  
TYPE m  
88 gns.

MARK 5 64 gns.



### Brief Specification—Mark 5 deck

4 recording speeds 1½, 3½, 7½ and 15 ips · 3 independent motors · Interlocked controls · Pause control · Digital rev. counter · Fast rewind (1,200 ft. in either direction in 45 secs.) · Provision for additional heads · 8½ in. reels accommodated.

Other recorders in the range:—

3 Star 58 gns.

3 Star stereo 89 gns.

Mark 5 stereo £99.12.0

BRENELL ENGINEERING CO. LTD. 1a DOUGHTY STREET, LONDON, W.C.1 HOLBORN 7356 (3 lines)

## BRITAIN'S LARGEST PART EXCHANGE SPECIALISTS

### AND APPOINTED AGENTS FOR

Ferrograph 4AN	... 81 gns.
Veritone 1	... 89 gns.
Ferrograph 422/4	
Stereo	... 110 gns.
Reflectograph 'A'	... 105 gns.
Tandberg 6 Stereo	... 110 gns.
Vortexion WVA	... £93.13.0
Brenell Mk. 5 'M'	... 88 gns.
Simon SP.5	... 93 gns.
Brenell Mk. 5	... 64 gns.
Truvox R7	... 82 gns.
Philips Stereo	... 92 gns.
Sony 521 Stereo	... 124 gns.
Reps R10	... 59 gns.
Ampex Stereo 971	... 225 gns.

ALL ABOVE RECORDERS  
AVAILABLE FROM STOCK

WE HAVE THOUSANDS OF SATISFIED CUSTOMERS  
THROUGHOUT THE BRITISH ISLES

### TRANSISTOR-BATTERY

Grundig TK1	... 29 gns.
Minivox C	... 23 gns.
Butoba MT5	... 69 gns.
Fi-Cord A1	... 59 gns.
Philips EL3585	... 24 gns.
Stuzzi Magnette	... 59 gns.

Tuners  
Amplifiers  
Microphones  
Speakers  
Pick-Ups, etc.  
Transcription Motors

Large stocks of new and used tape recorders at bargain prices. Ask for list. 30% to 60% reductions on original price.

## MAIL ORDER EXPERTS

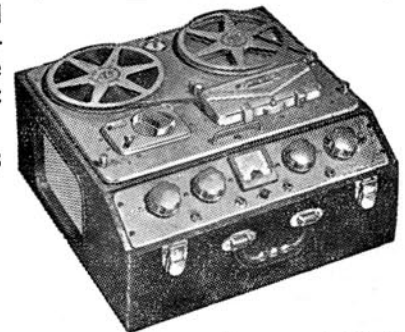

Ferrograph 4AN

ALL GOODS AVAILABLE ON OUR FAMOUS  
**NO INTEREST TERMS**

20% deposit, balance 12 months. 18 to 24 months terms available

FREE SERVICING—FREE DELIVERY—300 MACHINES ON DISPLAY—OUR MAIL ORDER DEPARTMENT WILL DEAL WITH YOUR ENQUIRY BY RETURN. WRITE—PHONE—CALL FOR A QUOTATION ON YOUR MACHINE. A LARGE SELECTION OF USED TAPE RECORDERS. TELEPHONE: BALHAM 7710

**REW** EARLSFIELD LTD., 266 UPPER TOOTING ROAD, LONDON, S.W.17  
100 yards from Tooting Broadway underground station: opposite Tooting Market

# TAPE, RECORDERS & ACCESSORIES

## FIRST DETAILS OF NEW PRODUCTS

● We remind our readers that notices of equipment listed and illustrated in this monthly feature are in no sense reviews. When figures, specifications and diagrams are published, these data are extractions from manufacturers' lists. When samples of this equipment are submitted for test, they are passed to our technical contributors, whose reports are published in a separate section.



★  
**RESLO  
DYNAMIC  
MICROPHONE**

A SPECIAL "hand microphone" version of the well-known CD dynamic microphone with cardioid response will shortly be available. This model has been developed specially for interviewing under television or sound broadcasting conditions or for conference and similar applications with public address systems.

It is fitted with a satin chrome tubular handle incorporating a positive action sliding switch, and is supplied with the optional perspex ring baffle for modifying the response to speech frequencies when required. The handle terminates in the standard Reslo T.C. connector and each microphone is supplied complete with 6 yards of flexible P.V.C. twisted and screened cable fitted with the appropriate connecting plug. The overall length including the detachable plug is approximately 8 in. (20 cm).

The price is £12 10s. (low impedance model); £13 (medium impedance model); £13 (high impedance model). Manufacturers: Reslosound Ltd., 24 Upper Brook Street, London, W.1.

The TK.23 is finished in two-tone pastel grey and weighs under 20 lb. It measures 14½ in. x 11½ in. x 6½ in. The price complete is £47 5s., including a Grundig long play tape, spare spool, connecting lead, mains lead, and the high quality Grundig moving coil microphone, GDM 18. Further details can be obtained from Grundig (Great Britain) Ltd., 40 Newlands Park, Sydenham, London, S.E.26.



★  
**GRUNDIG  
TK.23  
FOUR-TRACK  
RECORDER**

A FOUR-TRACK tape recorder—the TK.23—is announced by Grundig (Great Britain) Limited. Although basically following the design of its popular twin-track counterpart, the TK.14, new features have been incorporated.

A single speed machine operating at 3½ i/s, the TK.23 is completely controlled by simple piano key push buttons. There is a temporary stop that can be locked in the stop position and quickly released in a single operation, and an automatic stop, the metal foils on the end of the tape causing a solenoid to be energised, releasing the Start or Fast Wind buttons.

There are facilities for superimposition, simply by rotating and depressing the recording button when playing back a previously recorded tape. A digital type position indicator is fitted allowing accurate location of any recording and perfect recording are ensured with the magic eye recording level control.

The Grundig pressure "sling" fitted to the pressure roller arm makes immediate tape head contact, giving a good high frequency response and reducing the drop out losses to which many four-track machines are prone.

The valve line up of the TK.23 is EF86, ECC81, EL95, EM84, EF86 and an additional valve which provides the extra gain required by the Input Mixing Controls. Frequency response claimed is level from 60 c/s to 12 Kc/s and the signal to noise ratio is 47 dB. Wow and Flutter figures are ±0.2 per cent.



★  
**SHURE  
ELECTRONICS  
INTRODUCE  
TWO NEW  
MICROPHONES**

SHURE ELECTRONICS LIMITED announce two new series of low-cost ceramic microphones of particular interest for tape recording or public address applications and suitable for use even in adverse climatic conditions.

Series 245 "Uniplex" (shown above) are cardioid ceramic microphones employing the Shure "Uniphase" principle. The unidirectional characteristic of the "Uniplex" allow satisfactory operation under adverse conditions of background noise and reverberation. These are available with or without switch and are supplied either with a stand or for mounting to a flexible gooseneck. The finish is satin-chrome, and the price is £11 13s. 4d.

Model 275S is a pressure-operated diaphragm-type microphone with an omni-directional characteristic. It is supplied complete with stand adaptor and lavalier cord and may also be used in the hand. A switch is incorporated. The price is £5.

Details from Shure Electronics Ltd., 84 Blackfriars Road, London, S.E.1.

you'll be glad  
you recorded it on  
**gevasonor**  
magnetic tape



Ask your dealer  
for free descriptive leaflet

GEVAERT LIMITED · CRENTFORD · MIDDX.



## Lothian Tape to Disc Service

Speedy and efficient service with excellent results.  
Highest Grade Professional Equipment  
Used in all Cases.

### LIST OF CHARGES

#### TAPE TO DISC TRANSFER

7" Std.	...	45 rpm (3½ mins)	8/9d. per side
7" EP	...	45 rpm (6 mins)	10/6d. per side
10" LP	...	33½ rpm (8 mins)	12/6d. per side
10" LP	...	33½ rpm (15 mins)	14/9d. per side
12" LP	...	33½ rpm (22 mins)	18/9d. per side

(Times shown are per side.)

If tapes require editing a charge of 5/- is added.

#### CUTTING ACETATE MASTERS FOR PROCESSING (Mono)

7" Std.	...	45 rpm (3 mins)	25/- per side
7" EP	...	45 rpm (6 mins)	35/- per side
10" LP	...	33½ rpm (15 mins)	55/- per side
12" LP	...	33½ rpm (22 mins)	75/- per side

Prices for processing and supplying pressings on application.

#### TAPE TO TAPE COPYING

7/6d. per half hour, plus cost of tape used.

Tapes may be full track, half-track or quarter-track recorded, at speeds of 3¾, 7½ or 15 ips.

### GEORGE JEFFREY LTD.

23 EARL GREY STREET, EDINBURGH, 3

Telephone: FOU 8389

## TAPE RECORDER COVERS



Smart, waterproof cover to give complete protection to your tape recorder. Made from rubberised canvas in navy, wine, tan, grey and bottle green with white contrasting pipings, reinforced base, handy zip microphone pocket and name panel.

Grundig TK.1	...	49/6	Philips EL3536	...	70/-
" TK.5	...	55/-	" EL3515	...	57/6
" TK.8	...	63/-	" EL3541/15	...	57/6
" TK.14	...	59/6	" Starmaker	...	66/-
" T.K.20	...	52/6	Cosor 1602	...	57/6
" TK.24	...	55/-	" 1601	...	63/-
" TK.25	...	55/-	Stella ST455	...	63/-
" TK.30	...	60/-	" ST454	...	57/6
" TK.35	...	63/-	Saja MK.5	...	57/6
" TK.40	...	60/- †	Suzzi Tricorder	...	59/-
" TK.50	...	60/-	Saba	...	63/-
" TK.55	...	63/-*	Wyndor Viscount	...	60/-*
" TK.60	...	75/-*	" Victor	...	60/-*
" TK.830/3D	...	63/-	Elizabethan Princess	...	46/-
" Cub	...	35/-*	" Avon	...	46/-
Telefunken 85	...	60/-	" Escort	...	57/6*
" 85	...	65/-	" Major	...	43/-
" 75/15	...	55/-	" FT.1	...	46/-
" 76K	...	55/-	" FT.3	...	75/-
" 95	...	69/6	Fi-Cord	...	52/6
Philips 8108	...	57/6	Korting (4 track stereo)	...	43/-
" 8109	...	63/-	Harting Stereo	...	64/-
" EL3538	...	63/-	Fidelity Argyle	...	55/-*
" EL3542	...	63/-	Simon SP4	...	63/-*
			Clarion (with strap)	...	52/6
			Brenell Mk.5	...	77/-
			" 3 star	...	69/-
			Minivox C	...	61/-
			Robuk RK.3	...	67/6
			Ferroglyph	...	80/-
			Sony 521	...	90/-

\*Without pocket. †Price to be announced.

### A. BROWN & SONS LTD.

24-28, GEORGE STREET, HULL Tel: 25413, 25412

## MAKE YOUR TAPE RECORDER REALLY PORTABLE

### WITH A Valradio CONVERTER

A Valradio converter enables you to operate your tape recorder from car, boat or caravan battery, or any other source of low voltage or D.C. supply, making it possible for you to record outdoor events, or dictation, or to provide entertainment when you go on holiday or picnics, etc.

Prices range from £6.10.0., many models available

Write for fully descriptive folder to



VALRADIO LTD.  
Dept., TR/C.,  
Browells Lane,  
Feltham, Middlesex  
Tel. Feltham 4242



Valradio and Stereosonoscope are the registered trade marks of Valradio Ltd.

To Valradio Ltd., Dept. TR/C., Browells Lane, Feltham, Middlesex,  
Please send me fully descriptive folder of converters suitable for tape recorders

NAME \_\_\_\_\_  
ADDRESS \_\_\_\_\_

## 6 "Technically Luxurious" HI-FI TAPE UNITS

The most economical way to add tape to your existing system. These units consist of a "Series 80" Deck with pre-amp and recording amplifier, push-pull erase bias oscillator and power supply, all mounted in an attractive plinth. Easy connection to mains and hi-fi amplifier, radiogram or even good-class radio. Precision engineered by Truvox—the ideal add-on unit.



Model PD86

Model PD82 Standard 2-Track £42.0.0	Model PD85 Professional 4-Track £52.10.0
Model PD83 Professional 2-Track £48.10.0	Model PD86 Stereo ½-Track £63.0.0
Model PD84 Standard 4-Track £46.0.0	Model PD87 Stereo ½-Track £63.0.0

## TRUVOX 80

SERIES

Full technical details of these units, complete Tape Recorders and Tape Decks from

TRUVOX LIMITED

NEASDEN LANE, LONDON,  
N.W.10 Tel.: Dollis Hill 8011

# EQUIPMENT REVIEWED

★  
**PLANET**  
**U.1**  
**TAPE DECK**  
 ★

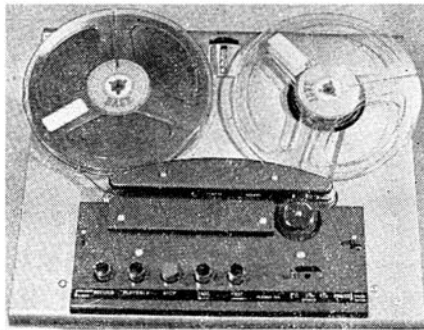

**Manufacturer's Specification:** Heads: Three-head two-track system fitted to standard deck. High impedance record and playback coupled with special triple-field erase head all of Miniflux type. Any other combination of heads can be fitted upon request. **Tape speeds:**  $7\frac{1}{2}$  i/s,  $3\frac{1}{2}$  i/s and  $1\frac{1}{2}$  i/s. **Reels:** 7 in. max. **Rewind:** Tight even stacking. 90 secs. 1,200 ft. **Tape position:** Four digit counter. **Obtainable frequency response:**  $7\frac{1}{2}$  i/s 30-10,000 c/s,  $3\frac{1}{2}$  i/s 30-15,000 c/s,  $1\frac{1}{2}$  i/s 30-7,000 c/s. **Wow and Flutter:** 0.08% R.M.S. at  $7\frac{1}{2}$  i/s, 0.12% R.M.S. at  $3\frac{1}{2}$  i/s and 0.18% R.M.S. at  $1\frac{1}{2}$  i/s. **Speed:** plus or minus 0.2%. **Motor:** Papst Hysteresis Synchronous. **Auto stop:** By Solenoid (6-12 v A.C. or D.C.) operates by metal foil on tape and removes all idler and pinch reel pressures. **Power:** 200-250 volts A.C. 50 c/s, 32 Watts. 100-145 volts A.C., 50 or 60 c/s to order. **Tape pressure system:** Stainless steel pins wrap tape across face of head (reduces wear to minimum). **Balanced drag:** Wow and flutter same at beginning and end of tape. **Clutch:** Variable speed magnetic. Smooth take up. No uncontrolled spinning of free spool. **Extra heads:** Space for fourth head.

Can be supplied complete with mounting plate and tape pin plate at small extra cost. **Head to amp. connections:** Via co-axial sockets below deck. **Controls:** Press button. Record with interlock to prevent accidental erasure, Playback, Stop, Fast Rewind, Fast Forward, all with interlock. Pause control with lock. **Dimensions:** Top mask 14 in. x  $12\frac{1}{2}$  in. Bottom plate  $11\frac{1}{2}$  in. x  $10\frac{1}{2}$  in. Depth between mask and bottom plate 2 in.; motor protrudes a further  $2\frac{1}{2}$  in. **Weight:**  $12\frac{1}{2}$  lbs. **Price:** £39 10s. **Manufactured by Planet Projects Ltd., Planet Works, Conlan Street, North Kensington, London, W.10.**

I HAVE reproduced the above specification in full because it is well written and gives all the essential information about the deck concisely and without too much wishful thinking on the part of the sales manager. So far as I have been able to check, it is a sober statement of fact and, like the deck, it gets on with the job without too much talk. This deck has been designed and assembled with but one end in view: A long, trouble-free life and exceptional performance. Every part has been engineered to give many years of trouble-free service. All controls have a solid satisfying feel about them and the tape is handled gently with never a hint of a thrown loop or any undue stress during the most vigorous braking sequence. The speed change is a delight and joy, and one is tempted to change speed more often than necessary just to show it off.

**Wow and flutter:** The pen recordings of fig. 1 were taken at  $7\frac{1}{2}$  i/s at two different paper speeds to show the short-term speed variations usually known as flutter and the slower speed changes known as wow. The total integrated r.m.s. figure is given against each trace, and meets the specification exactly. More important perhaps is the other information given by the pen traces: friction effects, which can cause high-frequency flutter and under-signal noise, are notably absent from the high-speed fluttergram, and this is almost certainly due to the complete elimination of pressure pads in favour of the much more satisfactory pin guides which wrap the tape around the head faces and ensure intimate contact without the wear and stickiness caused by undue

pressure. The long-term speed variations are also extremely low due to the even take-up of the magnetic clutch and the gravity back tension on the supply reel. When the combined wow and flutter gets down to this level of 0.05% to 0.08% reel effects usually begin to show up, but on this machine the efficient tape traction, low friction and tape tension, all combine to reduce this effect to the absolute minimum.

Fig. 2 shows the wow and fluttergrams at  $3\frac{1}{2}$  i/s. A very slight 25 c/s flutter from the 1500 r.p.m. motor shaft is just discernible, but the capstan rotation frequency of about 4 c/s is the one which adds and cancels to give the small variation from 0.1% to 0.12%. This is seen on the lower 20 second pen recording.

At the lowest speed of  $1\frac{1}{2}$  i/s the cumulative wow and flutter does not exceed 0.17% and there are about equal amounts of 25 c/s motor shaft flutter and 2 c/s capstan wow. Once again it is the capstan wow which adds and cancels to give the limits shown in fig. 3. It will be seen that the 25 c/s flutter from the motor shaft is present most of the time due to lack of flywheel

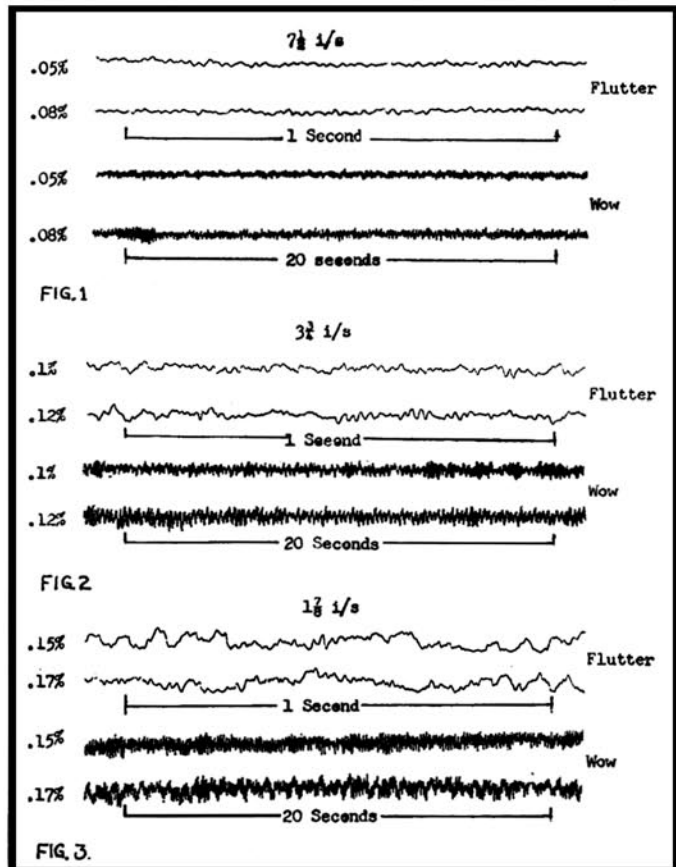

smoothing at this low speed (see top trace of 20 sec. recording), but that cancellation of the capstan flutter can be sustained for long periods. In this connection it was noticed that the usual trick of touching the supply reel to slip the tape slightly at the capstan, and so show up the adding and cancelling effect, did not work on this deck. Even stopping and starting the machine did not upset the phasing; and it was usually necessary to move the tape forward or backwards relative to the capstan to demonstrate the extremes shown in fig. 3. This shows that the new pressure roller material provides a very firm grip of the tape and helps to explain the extremely low reel effects mentioned earlier.

Before leaving wow and flutter tests, let me explain that the above dissertation is not in any sense a criticism of the wow and flutter performance of this deck, but rather an effort to analyse the very small amount of each which was present

# PROFESSIONAL TAPES

by



DIVISION OF

## COLUMBIA BROADCASTING SYSTEM

*now  
available  
to all  
recorder  
users*

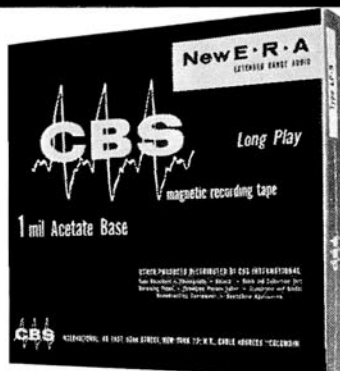

Specially prepared fine magnetic iron oxide dispersion; precision and uniformity in processing with quality control at all stages—these are some of the features that result in C.B.S. Tapes giving you extended frequency range, better wearing; better transients and the chance to make magnificent recordings from all sources even on quarter track at  $3\frac{3}{4}$  i.p.s. In all sizes—standard, long play and double play. Particularly recommended for  $\frac{1}{4}$  track and stereophonic uses.

### BETTER QUALITY FOR LESS COST

		5"	5 $\frac{1}{2}$ "	7"
Standard...	1 $\frac{1}{2}$ Mil	600' 17/6	900' 23/-	1,200' 27/6
Long Play	1 Mil	900' 21/-	1,200' 25/-	1,800' 35/-
Double Play	$\frac{1}{2}$ Mil	1,200' 34/-	1,800' 45/-	2,400' 56/-
Standard Mylar	...	600' 21/-	900' 28/-	1,200' 35/-
Long Play Mylar	...	900' 25/-	1,200' 32/-	1,800' 47/-
Double Play Mylar (Tensilised)	...	1,200' 42/-	1,800' 55/-	2,400' 68/-

- ★ With leaders and stop foils
- ★ Superb quality at  $3\frac{3}{4}$  i.p.s.
- ★ Long wearing
- ★ Recommended specially for four track instruments
- ★ Consistently high quality in all grades

**CBS TAPES** 12-16 WATLING ST., LONDON, E.C.4  
CITY 2238

# Pure Bass

in  
small  
space

## MODEL W2

A really compact loudspeaker system giving full range performance on mono and stereo

**SIZE:**  
23 $\frac{1}{2}$ " × 14" × 12".

**WEIGHT:**  
37 lb. complete.

**FREQUENCY RANGE:**  
30-17,000 c/s.

**MAX. POWER:**  
15 watts.

**IMPEDANCE:**  
15 ohms.

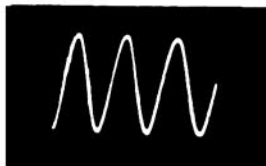
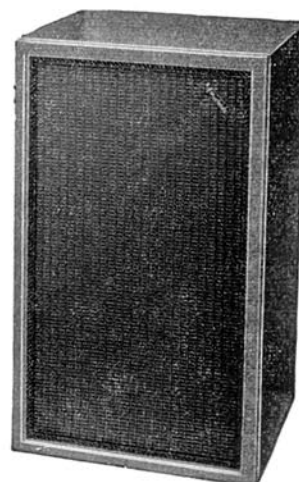

£27.10.0 in whitewood.  
£29.10.0 fully finished with a choice of oak, walnut or mahogany veneers.

As the waveform shows, the enclosure gives distortion-free performance down to 30 c/s with 4 watts input.

LEAFLET ON  
CABINET MODELS  
FREE ON REQUEST

**Wharfedale**  
WIRELESS WORKS LTD

Idle, Bradford, Yorkshire

Telephone: Idle 1235/6  
Telegrams: 'Wharfedel' Idle Bradford.



## ELECTRONIC WORLD TAPES

in the review unit. To reduce the wow or flutter contribution of any single component from 1% to 0.5% is a matter of elementary engineering; to reduce it to 0.25% is a little more difficult and may take ten times more time and effort; to get down to 0.1% may mean installing completely new machinery, and elaborate test gear for inspection and control of the offending part. With each component of the tape transport system contributing something in the order of 0.05%, and the resultant overall

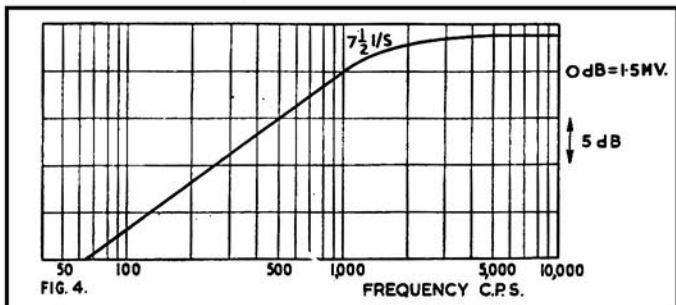

performance the result of random mixtures of the various effects, we reach a point beyond which it is not practical or economic to go without pushing up the price into the professional class.

**Head performance:** Figs. 4 and 5 show the playback responses from my standard test tapes which are recorded with surface induction characteristics of 100, 200 and 400 microseconds for tape speeds of  $7\frac{1}{2}$ ,  $3\frac{3}{4}$  and  $1\frac{7}{8}$  i/s respectively. Simple bass lift equalisation only is required over the frequency ranges shown, as gap losses and high frequency iron losses are low. The inductance of the playback head is 550 milli-henries so that the amplifier connecting cable should be kept short to avoid resonance between the head inductance and the lead capacity. The total lead and valve input capacity should not exceed 200 pfs

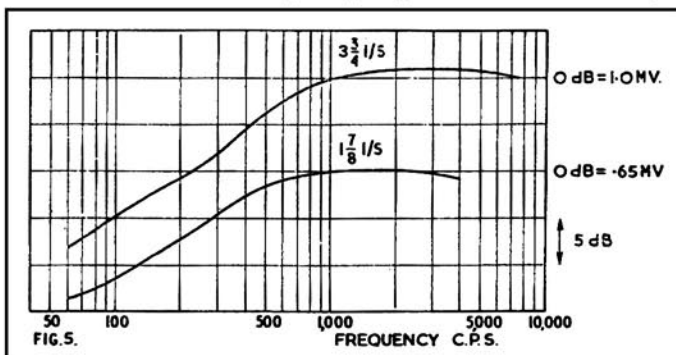

to keep the peak above 10 Kc/s. In the same way the combined capacity of the record head lead and that of the bias feed condenser should be kept below 200 pf to avoid resonance with the 550 mh record head. Optimum bias is about 70 volts at 55 Kc/s.

The erase head has a ferrite core fitted with nickle-iron pole tips which give a concentrated field across the main erasing gap, preceded and followed by secondary gaps between the ferrite and iron to give weaker fields which effectively prevent recovery of the very weak remanent signal. 45 volts at 55 Kc/s gives 80dB erasure, but over 50dB can be obtained with only 30 volts.

**Comment:** Mr. Sealy-Clarke and Mr. Underhill are to be congratulated on producing a very fine deck which shows evidence of careful design and vigorous inspection. This is the first British deck to approach the very low wow and flutter figures of certain Continental machines, and I feel sure that, with production experience, the performance will settle down to a consistently fine level. This is the key word *Consistency*—any reasonable deck can be fiddled to give superlative results for a short time—and even standard production decks occasionally turn up with wonderful test figures (this is one of the things which make the reviewer's life so difficult), but to get every one to give a stable uniform performance is another matter altogether. It all costs time and money, and this, in part, accounts for the rather high price of this deck, but if you want the best you must be prepared to pay for it and, so far, this is the best British deck I have handled.

A. Tutchings.

**R**EGULAR readers will know that, for some time now, I have been trying to devise objective measurements on tapes which tie up with the sometimes very subtle subjective differences which can be detected by careful listening tests. The arrival on my desk of two batches of tape for review and test brought matters to a head, and I was determined to do something about it.

The present series of tests are the result of my deliberations and experiments. I decided that the following parameters had to be measured: frequency response, directional effect, sensitivity, bias, drop outs and under signal noise. On the principle that "a picture is worth a thousand words" I have called my high speed pen recorder into service for amplitude modulation or drop out tests and such records will be known in future as "drop out charts". In the same way frequency response and directional effects can be concisely rendered as a frequency response curve with a sensitivity figure against each curve. It now only remains to define the conditions of test and some of the terms used in expressing them.

### Conditions of Test

All tests are performed at a tape speed of  $7\frac{1}{2}$  i/s, half track. Bias, input signal and output level are monitored continuously and can be reset with precision to any desired value. A very large number of tapes have been tested and a mean bias and input sensitivity determined; the sensitivity of a tape is expressed in dBs above or below this mean, i.e. a tape with a sensitivity figure of -2dB will give an output 2dB down on reference for the standard recording current and bias. The equalisation of the test machine has been adjusted so that the mean response is within plus or minus 1dB over the range 100 c/s to 7,500 c/s.

Each tape is tested in two directions and any difference in response plotted as a dotted line. If the response with standard bias is abnormal in any way the bias is altered for optimum response and special reference made to the probable reasons for the peculiarity. Drop out charts are for 30 sec. periods at a recorded frequency of 10 Kc/s; several 30 sec. checks are made and a sample selected for publication which is representative of the reel tested.

The final test is experimental in nature and is based on the discovery that some tapes are very much better than others when used with D.C. erase and bias. It is well known that simple D.C., or permanent magnet, erase followed by D.C. biasing of the tape gives rise to relatively heavy background noise, the hiss component of which is determined mainly by the oxide particle size and the surface finish of the tape, and a low frequency "rumble" which is a function of the smoothness of the oxide dispersion and base material. This "D.C." noise is expressed in

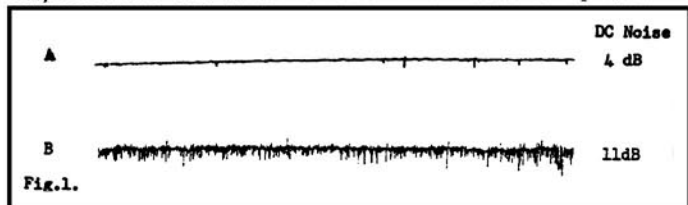

dB's above bulk erased tape noise and seems to tie up nicely with the drop out charts and with the subjective impression of "mush" mixed up with the high frequency response of a recording. At least it gives us a meter reading which, together with the drop out chart, seems to correlate with certain bad characteristics of a tape.

Fig. 1. A and B shows drop out charts and D.C. noise factor figures for two extreme tape samples; A is for one of the best tapes I could find, drop outs were few and seldom totalled more than six in a 30 sec. run. D.C. noise under our test conditions was only 4dB above bulk erased noise and the meter reading was steady with little low frequency flutter. B was from a reasonably good P.V.C. based tape which had been used intermittently in the laboratory over a period of several months. The tape surface had lost its pristine sheen and was of a matt texture. The drop out charts show an almost purely surface

# FREE H.P!

**YOU PAY CASH  
PRICE ONLY—NO  
INTEREST CHARGES**



**WE HAVE THE BIGGEST SALES IN THE COUNTRY! WHY?  
BECAUSE WE GUARANTEE YOU THE BEST TERMS.**

*They include:*

DEPOSITS FROM ONLY 10% ★ UP TO 2 YEARS TO PAY ★ SPECIAL FREE OFFERS & CUSTOMER DISCOUNTS ★ COMPLETELY FREE SERVICING—NO LABOUR CHARGES ★ FREE DELIVERY ANYWHERE IN U.K. ★ NO PURCHASE TAX ★ COMMISSION PAID ON SALES YOU MAKE FOR US ★ 15% INTEREST PAID ON YOUR DEPOSIT ★ SPECIAL INSURANCE POLICY ON ALL H.P. SALES ★ ALL TAPES, MICROPHONES & ACCESSORIES ALWAYS IN STOCK ★ *and lots more besides.*

As THE APPOINTED MAIN AGENTS for ALL the best makes, our Mail Order Department specialises in orders by post with thousands of sales throughout the whole of England, Scotland, Wales & N. Ireland—order from us wherever you live—You get cheaper terms, faster delivery, better service from us.

Nearly 500 machines in stock—dozens of different mains, battery & stereo models on permanent demonstration in our showrooms.

**Open to 8 p.m. FRIDAYS & 6 p.m. SATURDAYS.**

*If you want proof of how you can actually save money by buying from us, write, phone or call in NOW for free brochures and full details of our terms:*

# HOWARD

## TAPE RECORDERS

218 HIGH STREET, BROMLEY, KENT. RAVensbourne 4477 & 4000

effect as the 10 Kc/s wavelength penetrates the oxide only a few microns; the D.C. noise test, however, probes deeper and shows up defects all the way through the oxide layer and even into the base material. Tape samples were found which showed drop out charts intermediate between A and B but which had noise factors of 15dB or so with very unsteady meter readings which made them difficult to read accurately. In general acetate based tapes showed slightly more drop outs, and a higher D.C. noise, than the softer, limper Mylar or P.V.C. tapes.

THESE tapes were submitted for test by De Villiers (Electronic World) Ltd., 16c Strutton Ground, London, S.W.1. They are, I understand, American tapes and the relatively low selling price is affected by buying in bulk, selling direct by mail order and eliminating such non essentials as leaders, polythene bags and expensive packaging. Three 7 in. reels were sent for review: a standard acetate base tape at 17s. 6d. per 1,200 ft. reel, a long play Mylar base tape (1,800 ft.) at 29s. per reel and a double play Mylar base tape (2,400 ft. on 7 in. reel) at 42s. 6d.

These tapes went through the frequency response and drop out tests as described earlier and the results of these tests are shown in figs. 1 and 2. It will be seen that the high note res-

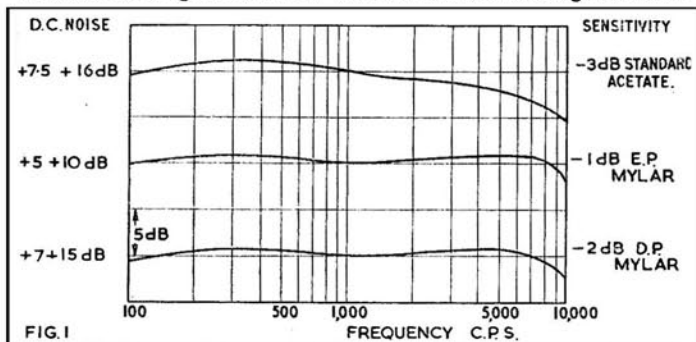

ponse of the acetate standard play tape is down a little on the average, and that, as is usual with the slightly stiffer base, the drop-out count is higher. However, the drop-outs are low compared to many other acetate tapes tested, and the slight tilt in the frequency response would only be noticed on expensive equipment on direct comparison with the better tapes. Altering the bias did not effect any improvement in high note response and it also increased the drop-outs slightly and dropped the sen-

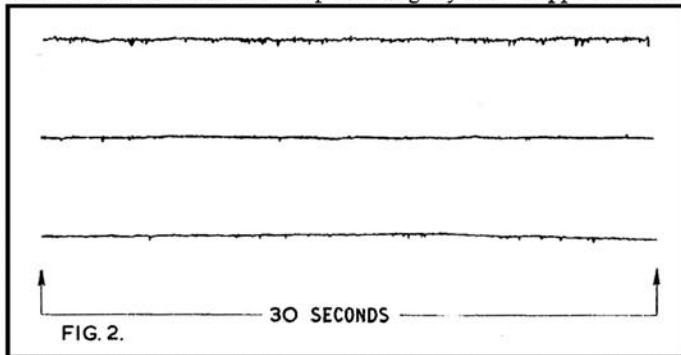

sitivity still further. This would indicate that the actual oxide layer is a bit thicker than usual on this sample.

The extended play Mylar tape was satisfactory in every way: the sensitivity was within 1dB of my mean, the drop outs were exceptionally low, and the response was well up to standard. The D.C. noise was also appreciably lower than that of the other tapes and it can be recommended for the highest grade recording.

The double play Mylar base tape also gave a good account of itself as regards frequency response and drop outs, and, although the D.C. noise is a little higher than the best, it is perfectly satisfactory for normal use. I was interested to see that there was no sign of "directional effect" on any of these tapes; they gave exactly the same response forward or backwards.

I tried samples of the three tapes on a variety of recorders over a range of speeds, track configurations and programme material and found them excellent for general use. A. Tutchings.

## YOUR TAPE DEALER

Specialists in Hi-Fi Equipment and Tape Recorders

### CHELSEA RECORD CENTRE

203 KINGS ROAD, S.W.3 FLA 2596

Open till 8 p.m. (except Thursdays)

Disc and Tape Reproducing Equipment and Tape Recorders  
by Leading Manufacturers

CUSTOM BUILT INSTALLATIONS

All High Fidelity Requirements and Services Available

Estimates Free

Personal Service

### Custom High Fidelity

371 Green Lanes, Palmers Green, London, N.13

Tel. PALmers Green 5228

# hifi

FOR ALL LEADING  
AUDIO EQUIPMENT

call, write, or telephone

hampstead HIGH-FIDELITY

91a Heath Street, Hampstead, London N.W.3 Telephone HAMPstead 6377

## LASKY'S RADIO

ALL LEADING MAKES IN STOCK

Cash or Easy Terms

LONDON'S FINEST SERVICE

207 EDGWARE ROAD, W.2

PAD 3271/2

42 TOTTENHAM COURT ROAD, W.1 MUS 2605

LEONARD G. FRANCIS PRESENTS . . .

### SHEEN TAPE RECORDER CENTRE LTD.

SPECIALISTS IN TAPE RECORDERS AND ACCESSORIES, ETC.,  
YOUR CENTRE FOR FRIENDLY HELP—SALES AND SERVICE

8 STATION PARADE,  
SHEEN LANE, SHEEN,  
LONDON, S.W.14

Showrooms Open until 7 p.m.  
PROSPECT 0985  
(Next to Mortlake Station S.R.)

## Country and Provincial

BOURNEMOUTH

### NATIONAL RADIO SUPPLIES

66 Holdenhurst Road,

Bournemouth

Tape, Hi-Fi & components

Tel. 25232

H. D. KIRK

# Stereolectrics

Specialists in High Fidelity

150 HIGHER BRIDGE STREET

Phone: 23093

**BOLTON**

R.E.S. (COVENTRY) LTD.

### SPECIALISTS IN HIGH FIDELITY

and all makes of Tape Recorders

All leading makes of High Fidelity Equipment stocked and demonstrated under ideal conditions. ★ The Best Selection—Terms and After Sales Service in the MIDLANDS.

R.E.S. (Coventry) Ltd. 128 Far Gosford St.

Coventry 28781/2



## — YOUR TAPE DEALER —

EXETER—DEVON

**FILDEWS** • 99 FORE STREET  
EXETER  
PHONE: 74161/2

We cover the whole of Devon—Dorset—Cornwall and West Somerset with Tandberg—Brenell—Phillips—Grundig, Tape Recorders etc. Main Ferrograph distributors for area.

FARNHAM, SURREY

- ★ Stockists of all the leading makes of High-Fidelity Equipment
- ★ Comparative Demonstrations
- ★ Cabinet Manufacturers and Designers
- ★ Personal service and satisfaction guaranteed
- ★ Specialists in custom-built Hi-Fi Equipment

**LLOYD & KEYWORTH LTD, The Record Shop**  
26/7 Downing Street, Farnham, Surrey. Telephone: Farnham 5534  
SURREY AND HAMPSHIRE'S HI-FI DEALERS

**TAPE RECORDER CENTRE (HALIFAX)**

Stock all the best Tape Recorders; Hi-Fi Equipment; Tape; L-P Records, etc.

DEMONSTRATIONS DAILY BY EXPERT STAFF  
2 years FREE SERVICE ON NEW RECORDERS over £35

30 King Cross Street, Halifax. 'phone 66832

LEICESTER

ALL YOUR HI FI REQUIREMENTS

Speakers by:	H.M.V.	QUAD	LEAK	ROGERS	
	TANNOY	MORDAUNT	LOWTHER	W.B.	
Tape:	WHARFEDALE	GOODMANS.			
	FERROGRAPH	REFLECTOGRAPH	GRUNDIG		
	SIMON	BRENELL.			

Record Department: ALL LABELS-PARASTAT SERVICE.

LEICESTER CO-OPERATIVE SOCIETY LIMITED, High Street, Leicester. Tel: 20431

MANCHESTER

See the sound SPECIALISTS for your New Tape Recorder  
Stockists of FERROGRAPH, PHILIPS, BRENELL,  
GRUNDIG and other well-known makes

LANCASHIRE HI-FI LTD.

Home Music Centre — 8 DEANSGATE  
(near Grosvenor Hotel) MANCHESTER

**TAPE  
RECORDERS  
and HI-FI**

The Largest Electrical store in the North

**Fenham Radio**

158, NEW BRIDGE STREET,  
NEWCASTLE UPON TYNE 1  
Telephone: 29866

**WESTWOOD'S** of **OXFORD**  
46 GEORGE STREET  
PHONE: 47783

PETERBOROUGH, NORTHANTS

Tel: 5545

**CAMPKINS RECORD SHOP**

RECORD TAPE AND HI-FI EQUIPMENT SPECIALISTS

NEW  
ADDRESS

**15 LONG CAUSEWAY**  
(IN CITY CENTRE)

LARGE  
STOCKS

## CLASSIFIED ADVERTISEMENTS

Advertisements for this section must be pre-paid and accompanied by a postal order, money order, or cheque. The rate is 6d. per word with a minimum charge of 7/6d. Box numbers may be used for an extra charge of 1/6d. The trade rate is 9d. per word, plus 2s. for a box number, conditions on application. Send replies to box numbers, c/o "The Tape Recorder", 99 Mortimer Street, London, W.1.

All advertisements for the July issue must arrive not later than June 4th.

For Sale

**Pre-recorded tapes.** Unique complete catalogue listing all makes, mono, stereo. 7½ and 3½ i/s including World Record Club tapes. Call for free copy or send 1s. mailing fee. Dept. T.R.3 Teletape Ltd., 33 Edgware Road, W.2 PAD 1942.

**Recording Tape.** Save up to 30%. Send for list. Also 50 second-hand Recorders in stock. E. C. Kingsley & Co., 132 Tottenham Court Road, London, W.1. EUS 6500.

Ask your dealer for American Ferrodynamics "Brand Five" recording tapes. The best tape value!

Test Tapes as used in my reviews. C.C.I.R. and White Noise. Send S.A.E for leaflets, Tutchings Electronics Ltd., 14 Rook Hill Road, Friars Cliff, Christchurch, Hants.

Find that review you want—get a copy of the index to volumes 1, 2 & 3 Tape Recorder. Price 2s. each posted.

Use up those odd lengths of tape, splice them together professionally after reading "How to Splice Tape", price 2s. 6d. posted, from The Tape Recorder, 99 Mortimer Street, London, W.1.

Repairs and modernising of Tape and Gram equipment. New heads, Amplifiers, etc., fitted by Experts. Prompt service. Specialised Hi-Fi equipment built to order for private or Studio use.—Harding Electronics, 120a Mora Road, London, N.W.2. GLA 1770.

"Brand Five" American Tape. Standard Play 5 in. (600 feet) 16s., Long Play 5 in. (900 feet) 18s. 6d.; 5½ in. (1,200 feet) 23s. 6d.; 7 in. (1,800 feet) 35s. Sent by return. Post Free!—Watts Radio, 54 Church Street, Weybridge, Surrey.

All makes of tape recorders repaired or modified. Mini/lux heads supplied. Audio installations built to your specification by John C. Latham, Deimos Ltd., 8 Corwell Lane, Hillingdon, Middx.

American Recording Tape, new boxed, long-play tape, 1,800 ft. on 7 in. 27s.; lots of 4, 100s.; 900 ft. on 5 in., 16s.; lots of 4, 60s. Satisfaction guaranteed and post free. Empty reels available. J. L. Darvell, 31 Hamilton Crescent, London, N.13.

The largest selection in London of used and new but slightly soiled Tape Recorders, All guaranteed. Obtainable on our no interest terms, special terms for cash customers. Write for list or call, Tape Recorder and Hi-Fi Centre, R. E. W. Earlsfield Ltd., 266, Upper Tooting Road, London, S.W.18. Tel.: Balham 7710.

Petecorder Midget battery operated recorder. Ideal for dictation, note taking, telephone recording. Only 12 gns. Tutchings Electronics Ltd., 14 Rook Hill Road, Friars Cliff, Christchurch, Hants.

Is your tape recorder worth the price of a reel of tape? Lee Electronics are able to offer the following Tape Recorder Covers at approximately 50 per cent. below Retail Price, due to bulk purchase of manufacturers stock. These are available for most machines, are tailored to fit, in best quality coloured canvas, with white piping and zip fasteners and, where necessary, microphone compartment. They will give protection against external damage and will greatly increase the re-sale value of your machine.

Some examples of the offers are: Telefunken 85 cover—listed 65s., offered at 32s. 6d. Grundig TK20 cover—listed 52s. 6d., offered at 29s. 6d. Grundig Cub cover—listed 35s., offered at 17s. 6d. Grundig TK5 cover—listed 55s., offered at 35s. Send for free lists of covers and other special offers of tapes, tape recorders, etc. Lee Electronics, 400 Edgware Road, Paddington, W.2.

THE WAL D-MAG, head demagnetiser,  
long nylon covered probes. £2.10.0

WAL GAIN transistorised pre-amplifiers,  
Mono £5, Stereo £7.10.0 and Hi-Gain  
(latter CCIR equalised). £7.16.0

THE WAL BULK ERASER. £7.18.6

Available from all leading dealers. (Wholesale include T.D. & B., London, and A. C. Farnell, Leeds).

WELLINGTON ACOUSTIC LABORATORIES LTD.  
Farnham, Surrey (6461)

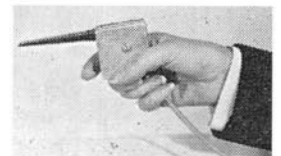

# Tandberg

## SERIES 6

### 4 TRACK

and now also by  
special request

### 2 TRACK

EACH MODEL **110** gns

Tandberg<sup>GB</sup>



## Stereo Tape Deck

### 3 speeds - 3 heads

### 4 amplifiers

The Tandberg Series 6 is a "no compromise" instrument capable of delivering consistently fine "professional" quality when used with comparable amplifier and speaker systems. Booklet of 4-track technical reviews on request.

ELSTONE ELECTRONICS LTD · EDWARD STREET · TEMPLAR STREET · LEEDS 2 · Tel: Leeds 3-5111 (7 lines)

# irish

## Ferro-sheen process MAGNETIC RECORDING TAPE

A. C. FARNELL LTD · HEREFORD HOUSE · VICAR LANE · LEEDS 2  
Tel. LEEDS 3-5111

# FRANCIS OF STREATHAM

### ● TAPE RECORDERS AT 169/171

Brenell Mk. V Model M ...	88 gns.	*Telefunken 85 KL ...	79 gns.
*Brenell Mk. V ...	64 gns.	*Telefunken 95 ...	59 gns.
Brenell 3 star ...	58 gns.	*Telefunken 96 4 Tr. ...	69 gns.
Brenell 3 star stereo ...	89 gns.	*Telefunken 97 Stereo ...	95 gns.
Cossor 4 Tr. 1602 ...	37 gns.	Truvox Series 80/2 Tr. ...	55 gns.
Cossor 4 Tr. 1601 ...	59 gns.	Truvox Series 80/4 Tr. ...	59 gns.
Elizabethan 'Popular' ...	24 gns.	Truvox R7 ...	82 gns.
Elizabethan TT3 ...	39 gns.	Veritone 16 ...	91 gns.
*Ferrograph 422 or 424 ...	110 gns.	Uher Universal ...	83 gns.
*Ferrograph 4AN ...	81 gns.	*Vortexion WVA ...	£93.13.0
*Ferrograph 4AN/S ...	88 gns.	*Vortexion WVB ...	£110.3.0
Fidelity Argyl Major ...	28 gns.	*Vortexion C Stereo ...	£148.10.0
Fidelity Minor ...	22 gns.	Wyndor Heron ...	25 gns.
Grundig TK14 ...	35 gns.	Wyndor Victor ...	45 gns.
Grundig TK 24 ...	55 gns.	<b>NEW 4-TRACK MODELS BY PHILIPS, COSSOR, STELLAPHON AS ADVERTISED.</b>	
Grundig TK40 4 Tr ...	75 gns.	<b>BATTERY PORTABLES</b>	
*Grundig TK60 Stereo ...	128 gns.	Philips Portable ...	24 gns.
*Harting HM8 Stereo ...	86 gns.	Optacord 412 ...	45 gns.
Optacord 403 ...	43 gns.	(Mains/Battery/Car)	
Optacord 412 ...	45 gns.	Butoba ...	66 gns.
(Mains/Battery/Car)		Grundig TKI ...	29 gns.
Philips 4 Tr. 3541 ...	34 gns.	Clarion ...	19 gns.
Philips 4 Tr. 3542 ...	59 gns.	Clarion Twin Set ...	8 gns.
Philips 4 Tr. Stereo 3536 ...	92 gns.	Clarion Phono-trix ...	39 gns.
*Reflectograph 'A' ½ Tr. ...	105 gns.	Minivox C ...	23 gns.
*Reflectograph 'B' ½ Tr. ...	115 gns.	Fi-Cord 202 ...	66 gns.
Reflectograph 'D' Deck ...	75 gns.	Stella ...	25 gns.
Robuk ...	36 gns.	Stuzzi Memo-Cord ...	25 gns.
*Simon SP5 ...	93 gns.	*Microphone extra	
Sony Stereo 462 4 Tr. ...	75 gns.	<b>FACTORY-FRESH BATTERIES ALWAYS IN STOCK</b>	
Sony ½ and ¼ Track ...	124 gns.	<b>WE SPECIALISE IN</b>	
Stellaphone 4 Tr. ...	37 gns.	● Tape to disc service	
Stellaphone 4 Tr. ...	59 gns.	● Tape copy service	
Stuzzi 4 Tr. ...	28 gns.	● RECORDER HIRE SERVICE	
Stuzzi Tri-Corder ...	63 gns.		
*Tandberg Series VI Stereo ½ or ¼ Track ...	110 gns.		
*Tandberg Mono, 3B ...	76 gns.		

LEADING STOCKISTS OF EQUIPMENT FOR

## TAPE and HI-FI

... and NO EXTRA FOR CREDIT TERMS

- ★ Minimum Deposit
- ★ No Interest or Service Charges on H.P. up to 18 months
- ★ Free Service during Guarantee Period

Prices subject to alteration as announced by manufacturers.

### ● MICROPHONES AND MIXERS

Grampian DP/4 Dynamic	£8. 0.0
Lustraphone LD/66 ...	£4. 2.6
Lustraphone VR/64	
Ribbon ...	£7.17.6
Lustraphone LRV/59	
Dynamic ...	£8.18.6
Simon 'Cadenza' Ribbon	£10.10.0
Reslo Ribbon or Dynamic	£9.12.6
Reslo Cardioid ...	£9. 2.6
AKG Stereo	
Dynamic D.88 ...	£19.19.0
TSL 3 Channel Mixer ...	£2. 2.0
Grundig Mixer ...	£16.16.0

Also in stock microphones by ACOS, FILM INDUSTRIES, TELEFUNKEN  
All WAGLAIN PRODUCTS

### ● TAPES & ACCESSORIES

Standard, Double Play and Long Play in all sizes by all leading makers.  
● Pre-recorded Tapes by Columbia, H.M.V., Saga, etc.

Bib, Bond and Romagna splicers. Matching transformers. Plugs, sockets, etc.

AT OUR HI-FI DEPT. AT 181 Streatham High Road

● STEREO AND MONO AMPLIFIERS by Quad, Walgain, Rogers, Leak, Dulci, Armstrong  
● TUNERS by Quad, Rogers, Leak, Dulci, Armstrong  
● LOUDSPEAKERS by Quad, G.E.C., W.B., Wharfedale, Goodmans, Tannoy, Audistatic, Mordaunt, Leak  
● MOTORS, PICKUPS, by Garrard, Tannoy, Goldring, Lenco, Shure, Connoisseur, Decca Stereo, Philips, Ronette, All-Balance, B&O, Ortofon, SME

All types of Diamond and Sapphire styli, stereo and mono. Microlifts, Garrard SPG3. Acos Dust Bug.

CABINETS  
Record Housing  
Leak 'Southdown'

Please note our only addresses as below

169-171 STREATHAM HIGH ROAD, LONDON, S.W.16

Between St. Leonard's Church and Streatham Station

STReatham 0466/0192

Hi-Fi Dept. 181 STREATHAM HIGH ROAD, S.W.16

**CLASSIFIED ADVERTISEMENTS — (continued)**

**Simon SP4 Automatic recorder.** Excellent condition (just serviced by manufacturer); one year's occasional use. Complete with ribbon mic., £70. Owner going overseas.—Norman Greville, 7 High Street, Maidenhead. (Tel.: 230).

**American Pre-Recorded Tapes supplied.** Send 3s. 6d. for current catalogue, all makes.—Imported Records, 42 Broadway, London, S.W.1.

**Butoba Transistor.** Only a few months old and hardly used, £50.—McNeil, 6 Lowwood Close, Northwood, Middx. Northwood 22345.

**Immediate capacity available for Coil Winding.** Assembly and Wiring of Electronic Equipment, Prototypes.—Olson Electronic Limited, 54 Myddelton Street, London, E.C.1. TER 8081.

**American recording tape 1,800 ft. LP. 7 in. Boxed. 24s. 6d.** Lots of 4 90s. Money back guarantee. Trade enquiries invited.—Zodiac Ltd., 19 Gerrard Street, W.1.

**Sony 521 Stereo Recorder.** Twin dynamic microphones, plastic cover. Bought for scientific research but serious illness now necessitates sale of this unused apparatus still in sealed carton. No more advanced or versatile recorder exists in the world today. Cost £131 accept £105. Also **Stuzzi Magnette** portable recorder complete with case, microphone, leads, etc. Perfect working condition, cost £64 accept £35.—Dr. M., The Grove, Lincoln.

**Fi-Cord 1A.** Preh Plug. Charger AC plus DC 12 V. Mint, £50.—Talltrees, Bowbridge, Wallingford, Berks.

**Fi-Cord with DP4 and Fi-Cord microphones,** two sets of batteries, charger, tapes, as new, cost £75 sell £45.—Stevenson, 47 Roe Lane, Southport

**Brand New Surplus Stock Bargains!** Casian Trav-ler Battery portable, £14 10s. (£30 9s.); Verdik Incorporating Studio Deck, £26 10s. (£40 19s.); Telefunken Stereophonic Amplifiers, £7 (£16 6s.); Collaro Studio Tape Decks, £10 10s. (£17 10s.); Autochangers, BSR UA14, £7 10s.; (UA20 £6 17s. 6d.); Many Other Bargains. Detailed Lists S.A.E. World's Transistor Radios. Over 70 Models, £5-£200. Complete List S.A.E.—Tape Services, Library House, Lossiemouth, Morayshire.

**Make the most of your recorder.** List of tape libraries send for s.a.c.—D. O. French, 136 Tollington Park, N.4.

**Fi-Cord, Grampian Microphone,** Charger, Excellent condition, £45.—Platt, 8 Sollershott West, Letchworth, Herts. Telephone 1791.

**Butoba MT 5.** Few months old complete with Mains unit, Mic., Leads, covers and Batteries offered at 2/3rds list price. 10 Tapes included free.

**50 prerecorded Tapes,** unused and in Manufacturer's Boxes, mainly classical at 7½ 1/s. Original cost, 35s. to 50s. each. For quick sale, 21s. each or 5 for £5. Offers invited for the 50.—Hardinge, "Pinjarra," Pinewood Grove, New Haw, Weybridge, Surrey.

**Miscellaneous**

**L. Bishop Ltd., Tape Recorder Services,** 1708 Bristol Road South, Rednal, Birmingham. Telephone: Rubery 709. Grundig Specialists.

**Tape to Disc**

**Tape/Disc/Tape transfer, editing, duplicating.** If quality and durability matter (especially with L.P.s from your precious tapes) consult Britain's oldest transfer studio. Recording equipment supplied with home maintenance guarantee. Generous part-exchange. 48-page photographically illustrated Hi-Fi catalogue 2s. 6d. 1,800 branded tapes 30s. Sound News, 10 Clifford Street, London, W.1.

**Tape to Disc service, editing, and dubbing,** all speeds. Studio available for musical groups. Outside recordings our speciality. Ilford Sound Recording Service, 63, Aintree Crescent, Barkingside, Ilford, Essex. Telephone: CRE 8947.

**Quality Service, quantity discount, printed labels/covers.** Audio equipment supplied: callers welcome. MJB Transcription Service, 7, High Street, Maidenhead. Tel.: 230.

**Tape to disc recording service.** All speeds. 50 minute L.P.'s. Photographic sleeves with all recordings.—E.R.S., 162 Shirland Road, London, W.9.

**RAPID RECORDING SERVICE**

**78s & LPs from your own tapes**

**Master Discs and pressings**

*Recording Studio equipped with Bechstein Grand Mobile Recording Van—"Off the Air" Service*

Practising studios with or without accompanist  
21 Bishops Close Church Lane, E.17 COP 3889

**— YOUR TAPE DEALER —**

**HAMILTON ELECTRONICS**  
**HIGH FIDELITY**  
**TAPE RECORDERS 35 LONDON ROAD**  
**SOUTHAMPTON**  
TEL. 28622

**SOUTHAMPTON—SALISBURY**

- ★ All the best makes of Tape Recorders
- ★ Hi-Fi Systems and Records
- ★ Expert knowledge and advice

The West of England High Fidelity Specialists  
**J. F. SUTTON** 421 SHIRLEY ROAD, SOUTHAMPTON  
15-18 QUEEN STREET, SALISBURY

**WORTHING, SUSSEX**

We stock Hi-Fi Equipment by Leak, Quad, Goodsell, RCA, Acos, Garrard, Collaro, Tannoy, Wharfedale and Goodman and give fully comparative Demonstrations

**BOWER & WILKINS LTD.**  
1 Becket Bldgs., Littlehampton Road Worthington 5142

**TAPE RECORDERS · AUDIO EQUIPMENT · DISC CUTTING STD & LP FROM TAPE · STUDIO FACILITIES · HIRE SERVICE · SALES · EXCHANGES**

**MAGNEGRAPH**  
1 Hanway Place, London, W.1 Tel: LAN 2156

**ADVERTISERS' INDEX**

	Page
Brenell Engineering Co. Ltd. ....	216
British Ferrograph Recorder Co. Ltd. ....	228
A. Brown & Sons Ltd. ....	218
C.B.S. Ltd. ....	220
City & Essex Tape Recorder Centres ...	187
Denham & Morley Ltd. ....	210
Educational Recordings Ltd. ....	205
Elstone Electronics Ltd. ....	225
E.M.I. Tape Ltd. ....	196
Fi-Cord Ltd. ....	192
Francis of Streatham ...	225
Gevaert Ltd. ....	217
Gramdeck Ltd. ....	212
Grampian Reproducers Ltd. ....	204
Heathkit ...	188
Howard Tape Recorders ...	222
Geo. Jeffreys Ltd. ....	218
Kingswood Supplies ...	211
Magnegraph ...	226
Northgate (Cameras) Ltd. ....	202
Nusound Recording Co. ....	215
R. E. W. Earlsfield Ltd. ....	216
Philips Electrical Ltd. ....	200
Rapid Recording Service ...	226
The Recorder Co. ....	227
Reeves Sound Service ...	212
Reps Tape Recorders Ltd. ....	227
Shure Electronics Ltd. ....	193
Simon Equipment Ltd. ....	194
Tape Recorder Centre Ltd. ....	186
Truvox Ltd. ....	218
Valradio Ltd. ....	218
D. Villiers ...	214
N. Walker ...	214
Wellington Acoustic Lab. Ltd. ....	224
World Record Club ...	190-1
Wharfedale Wireless Works Ltd. ....	220
8mm. Magazine ...	189



# Two Years Guarantee

NOT MASS PRODUCED BUT VIRTUALLY HAND-MADE FOR RELIABILITY AND CONSISTENTLY HIGH STANDARD OF PERFORMANCE

**R10 SPECIFICATION:** 2 or 4 track version. 10 watts push/pull output.

Record Replay Responses—

7½ ips. 40-16,000 C.P.S. } ± 3 dBs.  
3¾ ips. 40-10,000 C.P.S. } At optimum  
1⅞ ips. 50- 6,000 C.P.S. } bias setting.

Signal/Noise ratio—

half track 50 dBs at 3¾ ips.  
quarter track 45 dBs at 3¾ ips.

Modified Collaro Studio Deck. Microphone and Radio/Gram inputs each with separate gain controls for mixing. Separate bass and treble controls. ± 12 dBs at 50 cycles and 12 k/cs. Adjustable monitor volume control independent of record level. Peak signal lever meter 2¼ in. square. Bogen heads. Record safety device. 600 ohms Cathode follower output. Two per cent total harmonic distortion on peaks. 200/250 volts 50 cycles or 100/120 volts 60 cycles. Valve line up: 3 EF86, 2 ECC83, 1 ECC82, 2 ECL86. Metal rectifier, contact cooled.

Prices: 2 Track 7" spools ... .. 59 gns.  
4 Track 7" spools ... .. 69 gns.



Fully illustrated literature available on request to—  
**REPS (TAPE RECORDERS) LTD.**  
118 Park Road North, South Acton,  
London, W.3 Phone: Acorn 4141

## 18 Months to Pay

	Deposit			18 Monthly Payments			Gns.
	£	s.	d.	£	s.	d.	
<b>MAINS 2-TRACK</b>							
Truvox R82	11	11	0	2	11	4	55
Brenell 3 Star	12	4	0	2	14	0	58
Reps R.10	12	8	0	2	15	1	59
Brenell Mk. 5	14	4	0	2	18	11	64
Telefunken 85KL	17	19	0	3	12	3	79
Ferrograph 4A/N	18	1	0	3	14	6	81
Brenell 5 Type "M"	18	10	0	4	2	2	88
Simon SP/5	19	11	0	4	6	10	93
Reflectograph "A"	22	5	0	4	17	6	105

### 4-TRACK MONAURAL

Grundig TK24	11	11	0	2	11	4	55
Brenell 3 Star	12	4	0	2	14	2	58
Philips EL3542	12	8	0	2	15	1	59
Stella ST455	12	8	0	2	15	1	59
Truvox R84	12	8	0	2	15	1	59
Elizabethan Major	14	5	0	3	0	0	65
Reps R10	14	10	0	3	4	5	69
Grundig T.K.40	15	15	0	3	10	0	75

### 4-TRACK STEREO/MONAURAL

Korting MT 157	17	17	0	3	19	4	85
Telefunken 77K	17	17	0	3	19	4	85
Philips EL3536	19	12	0	4	5	7	92
Telefunken 97	20	0	0	4	8	8	95

Open all day Saturday—  
Friday 6.30 p.m.

## THE RECORDER CO.

commends the technically luxurious

### TRUVOX TAPE UNITS

consisting of Series 80 TAPE DECK with PREAMPLIFIER, RECORDING AMPLIFIER and POWER SUPPLY—all in attractive plinth. An ideal Hi-Fi Add-on Unit.

MODEL PD.82. Standard 2-Track £42 0s.  
Deposit £4 4s. and 9 monthly payments of £4 4s.

MODEL PD.84. Standard 4-Track £46 0s.  
Deposit £4 12s. and 9 monthly payments of £4 12s.

MODEL PD.86. Stereo Quarter-Track £63-0s.  
Deposit £6 6s. and 9 monthly payments of £6 6s.

MODEL PD.87. Stereo Half-Track £63-0s.  
Deposit £6 6s. and 9 monthly payments of £6 6s.

- ★ INTEREST FREE terms
- ★ FREE INSURANCE COVERING YOUR PAYMENTS IN THE EVENT OF SICKNESS OR UNEMPLOYMENT
- ★ FREE DELIVERY ★ PART EXCHANGES

## 9 Months to Pay

	Deposit			9 Monthly Cash Payments			Gns.
	£	s.	d.	£	s.	d.	
<b>MAINS TWIN-TRACK</b>							
Argyll Minor	2	6	3	2	6	3	22
Grundig TK14	3	13	6	3	13	6	35
Elizabethan TT3	4	2	0	4	1	11	39
Spectone "161"	5	2	11	5	2	11	49
Reps R10	6	3	11	6	3	11	59
Telefunken 95	6	3	11	6	3	11	59
<b>4-TRACK</b>							
Stuzzi	2	16	6	2	14	6	26
Philips StarMaker	2	16	9	2	16	9	27
Argyll 4-T	3	4	0	3	4	0	29½
Elizabethan FT1	3	11	5	3	11	5	34
Philips EL3541	3	11	5	3	11	5	34
Stella ST 454	3	17	9	3	17	9	37
Sound	4	15	0	4	14	6	45
Elizabethan FT3	4	15	0	4	14	6	45
<b>BATTERY</b>							
Clarion Mk. 1	1	19	11	1	19	11	19
Philips EL3585	2	10	5	2	10	5	24
Stella ST 470	2	15	0	2	12	3	25
Clarion Mk. 2	2	16	9	2	16	9	27
Grundig TK1	3	1	0	3	0	11	29
<b>Optacord Battery/</b>							
Mains							
Ficord IA	4	15	0	4	14	6	45
Stuzzi Magnetze	6	3	11	6	3	11	59
Bucoba MTS	6	18	8	6	18	8	66

If unable to call, write for free brochure or send deposit now for quick delivery.

# THE RECORDER CO.

(Dept. R) 188, WEST END LANE, WEST HAMPSTEAD, LONDON, N.W.6.

Telephone: SW1 4977

# To the man who already owns a Tape Recorder

A recent Survey among Ferrograph owners has disclosed one rather astonishing fact—how few of them chose the Ferrograph as their first Tape Recorder. On the contrary, they *changed* to the Ferrograph as they became more experienced and, therefore, more critical. As one owner recently wrote “Your machine is really beyond praise. I’m pleased to have bought it even though it means discarding many of my previous recordings”.

Yet, perhaps, not so astonishing after all. For the Ferrograph has never been advertised in the newspapers and its distribution is limited to those few dealers specialising in and demonstrating High Fidelity equipment.

And such is the almost legendary reputation of the Ferrograph eagerly passed on by word of mouth and personal recommendation that we have never been able to satisfy the demand. For as users know the Ferrograph is no ordinary Tape Recorder. It is *not* mass produced. Behind it stands the accumulated experience of over twelve years specialisation in Tape Recording. Those engaged in its manufacture are experts dedicated to the art of high fidelity sound reproduction. All that we ask of them is that they make each instrument to satisfy their own exacting standards as if, in fact, they were going to own it themselves. We believe—and those who change to Ferrograph appear to endorse it—that the Ferrograph sets a standard which is in accord with the highest traditions of British engineering skill. It is, in fact, a Tape Recorder you’ll be proud to now and one that will be the envy of your friends.



## Series A/N

With standard Monaural recording and playback facilities at  $3\frac{1}{2}/7\frac{1}{2}$  i.p.s.

81 GNS

## Series 420

For Monaural and Stereo recording and playback, with monitoring, re-recording from one track to the other, introduction of echo effects and many other advanced features. Requires power amplifiers and external loud speakers.

110 GNS

Three Independent Motors · Synchronous Capstan Motor · Recording Level Meter · Brief Stop Interchangeable Plug-in Heads · Switch Speed Change with Compensated Correction Network · Separate Tone Controls · High Fidelity  $2\frac{1}{2}$  Watts Output Stage · Uses  $8\frac{1}{4}$ " Tape Spools · Gear-Driven Turns Counter · Automatic Switch Cuts Motors at end of Spool · Endless loop Cassette (optional Extra)

*The Incomparable*  
**Ferrograph**

THE FERROGRAPH COMPANY LTD

84 BLACKFRIARS ROAD, LONDON, S.E.1. Telephone: WATERloo 1981