

the TAPE *price 2/-* **RECORDER**

JULY 1963
VOL. 5 NO. 6

INCORPORATING "SOUND AND CINE"



TAPE EDITING EQUIPMENT

COMPLETE
AUDIO
REALISM

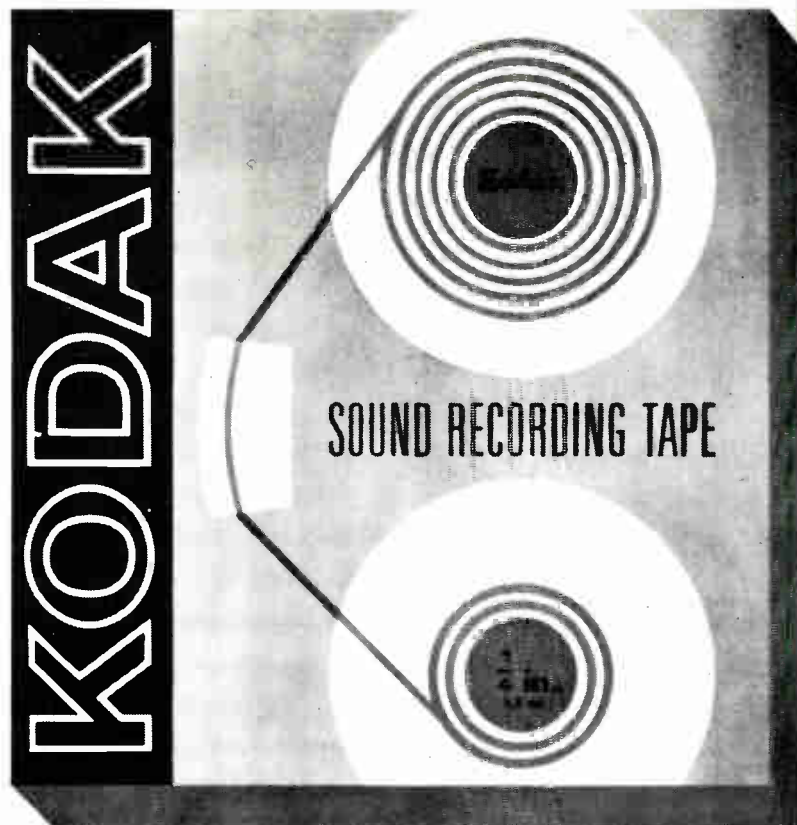

—from new Kodak Sound Recording Tape

There's never been a tape so sensitive as new Kodak Sound Recording Tape. For the first time you can capture complete audio realism. Sound so true you'll hardly believe it's recorded.

- ▶ High output sensitivity
- ▶ Low noise performance
- ▶ Full audio frequency range response
- ▶ Double-lubricated for smooth transport
- ▶ Low bias adjustment

New Kodak Sound Recording Tape is manufactured to the same super-critical standards as Kodak film. Standards that have never been excelled in any coating process. Standards that give a coating uniformity that never varies more than plus or minus 20 millionths of an inch.

There are four types of new Kodak Sound Recording Tape to suit all requirements: standard, long play, double play and triple play—the extra strong tape with the extra long playing time.

Each reel is wrapped in a polythene bag and packed in a sturdy box. A form for recording data is printed on the back of the box. Each reel incorporates a special clip which eliminates tape spillage.

Write for further details of this new tape, to Dept. T2, Kodak Ltd., Kodak House, Kingsway, London, W.C.2.

KODAK LTD.

Kodak

DEPT. T2, KODAK HOUSE, KINGSWAY, LONDON, W.C.2.

PROUDLY

FOR THE FIRST TIME, AN AUTHENTIC CONDENSER MICROPHONE OF OUTSTANDING QUALITY AT A DOWN-TO-EARTH PRICE

ANNOUNCING

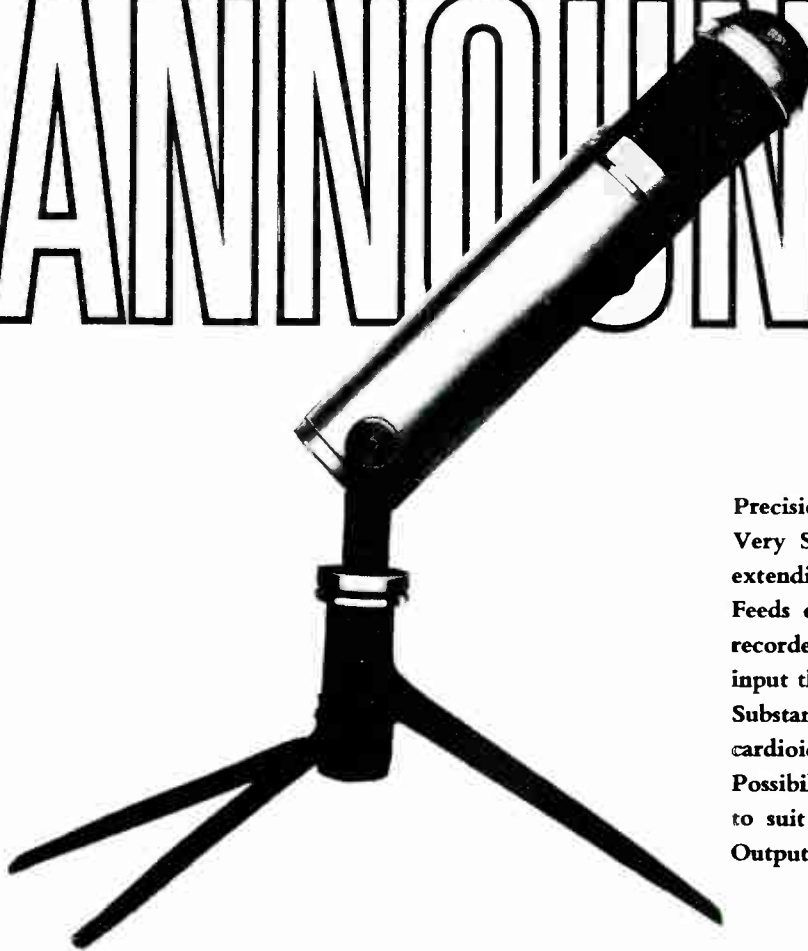

Precision-made Capsule.

Very Smooth Frequency Response extending over the whole audible range.

Feeds directly into any amplifier/tape recorder with a "radio" or high impedance input thanks to its unusually high output (150mV)

Substantially omni-directional but cardioid in axis of capsule.

Possibility of limiting Response to suit individual needs.

Output Impedance: 600 ohms cathode follower.

MICROKIT CONDENSER MICROPHONE

IN KIT FORM FOR ASSEMBLY The MICROKIT Condenser Microphone is finished in attractive 'matt-chrome', complete with swivel bracket and stand adaptor. Available in kit form with comprehensive manual and easily understandable step-by-step instructions, illustrated **price 20 gns.**

ASSEMBLED AND TESTED The MICROKIT Condenser Microphone assembled and tested, including Power Pack **price 25 gns.**

Our unique One Year Free Replacement Service Guarantee applies to either kit form or assembled version

Immediate delivery from Stock.

Write, call or telephone for further details.

Trade enquiries are also invited.

World distribution

CHATEAU PRODUCTIONS LIMITED

DETRIBUTORS OF PROFESSIONAL ELECTRONIC RECORDING EQUIPMENT

25 DENMARK STREET · LONDON W.C.2

Telephone COVent Garden 3026

Cables Kassmusic London

WORLD RECORD CLUB OFFERS YOU THE CHOICE OF ANY 3 PRE-RECORDED TAPES



31. Rimsky-Korsakov: Scheherazade. Sir Eugene Goossens conducts the LSO in a breathtaking performance of this rich and exotic masterpiece. Also on disc: mono/stereo



32. Star cast and orchestra stage all the famous songs: Getting to Know You, Hello Young Lovers, I Whistle a Happy Tune, Shall We Dance, etc. Also on disc: mono/stereo



53. These two suites, containing some of Bizet's most thrilling music, are given magnificent performances by the Sinfonia of London under Muir Mathieson. Also on disc: mono/stereo



54. The fabulous dynamic Duke Ellington himself in eight great numbers including Stomping at the Savoy, In the Mood and Honey-Suckle Rose. Also on disc: mono only

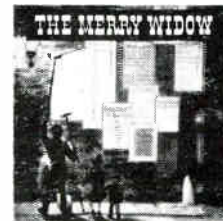

56. All the magic of old Vienna! starring Jacqueline Delman, John Larsen, Linden Singers and Sinfonia of London conducted by John Hollingsworth. Also on disc: mono/stereo

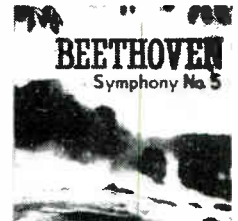

33. Beethoven 5th, plus Egmont, Josef Krips and LSO in a titanic interpretation which matches the tremendous power of this celebrated music. Also on disc: mono/stereo



30. Ian Carmichael, Joyce Blair, star cast/orchestra, As Long as He Needs Me, Consider Yourself, all the hit numbers from Lionel Bart's great show. Also on disc: mono/stereo



39. Great ballet conductor John Hollingsworth and the Sinfonia of London in a sparklingly fresh interpretation of Tchaikovsky's famous Ballet. Also on disc: mono/stereo



20. Answer Me, Nature Boy, Ruby and the Pearl, these plus 8 more favourites sung especially for you by the unique Nat King Cole. Also on disc: mono only



40. Superb singing by Bruno Rizzoli and Giuseppe Savio with the chorus of the Teatro Nuovo di Milano and orchestra conducted by Napoleone Annovazzi. Also on disc: mono only



29. Me and My Shadow, Among My Souvenirs, Mean to Me, How About Me... the fabulous Judy Garland sings 11 of her greatest songs. Also on disc: mono only

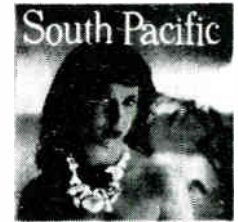

25. Ian Wallace, Joyce Blair and chorus. Some Enchanted Evening, I'm In Love With a Wonderful Guy, and all the unforgettable songs from this great musical. Also on disc: mono/stereo



34. Stardust, How High the Moon, Nearness of You, Round Midnight, King David—eight numbers by the vibraphone genius, Lionel Hampton. Also on disc: mono/stereo



48. Deep in My Heart, Drinking Song, Serenade—all the old favourites fresher than ever with Marlon Grimaldi, Linden Singers and Orchestra. Also on disc: mono/stereo



37. Revolutionary Study, Polonaises A and A flat, Fantaisie-impromptu—12 favourites in all played by the pianist of Dirk Bouwae's 'Song Without End'. Also on disc: mono only



22. 12th St Rag, Isle of Capri, Smile, Blue Moon, Bunny Hop Mumbo, Satin Doll, 12 top numbers played in characteristic style by the Duke and his band. Also on disc: mono only



2. Grieg Piano Concerto. Alexander Jenner in an electrifying performance with the Bavarian State Radio Orchestra conducted by Odd Gruner-Hegeac. Also on disc: mono only



35. Oh! Man River, Bill, Make Believe, many more well-loved numbers from this famous musical memorably sung and played by full star cast. Also on disc: mono/stereo

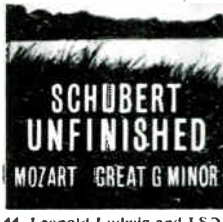

44. Leopold Ludwig and LSO combine brilliantly in an exciting 'double'—two of the world's greatest symphonies receive vivid new interpretations. Also on disc: mono/stereo

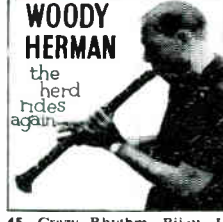

45. Crazy Rhythm, Bijou, I Cover the Waterfront, Northwest Passage, Blowin' Up a Storm, etc. The master clarinetist plays 12 numbers in great style. Also on disc: mono/stereo



38. Hervey Alan, Ian Wallace, Marion Grimaldi and chorus sing the immortal favourites: Cobbler's Song, Robbers' Chorus, Chu Chin Chow, etc. Also on disc: mono/stereo



14. Tchaikovsky Symphony No. 5. Sir Malcolm Sargent and LSO combine to give this famous symphony a dramatic and colourful rendering. Also on disc: mono/stereo



43. Andy Cole, Barbara Leigh, Mike Sammes singers: High Society, Three Coins, Harry Lime, Gigi, The High and the Mighty, 11 top film hits. Also on disc: mono/stereo

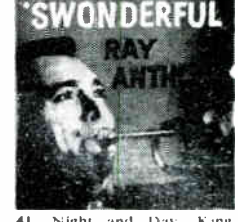

41. Night and Day, King Porter Stomp, Pennies from Heaven, Christopher Columbus, Don't Be That Way, with the top American bandleader trumpeter. Also on disc: mono only



42. Jericho, Swing Low, Shadrak... 12 of the best loved Negro Spirituals movingly sung by George Brown, Isabelle Lucas and Linden Singers. Also on disc: mono/stereo



36. Beale Street Blues, After You've Gone, The Sheik of Araby, My Kind of Love, 12 tremendous hits by one of the world's greatest jazz trombonists. Also on disc: mono only



49. Beethoven's Fidelio Overture, Brahms' St. Anthony Vars, Mendelssohn's Hebrides, Wagner's Siegfried Idyll. All under Britain's greatest young conductor. Also on disc: mono/stereo

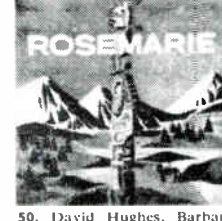

50. David Hughes, Barbara Leigh, Andy Cole and chorus sing Indian Love Call, Rose Marie, and all the other tunes from a film's well-loved musical. Also on disc: mono/stereo



47. Brahms Violin Concerto. Superb playing by Endre Wolf and Sinfonia of London under the baton of Anthony Collins makes this a truly memorable performance. Also on disc: mono/stereo



46. Elizabeth Larner, Andy Cole, Peter Knight singers. Exciting 'double' featuring highlights from two famous shows by Frederick Loewe and Cole Porter. Also on disc: mono/stereo

FOR ONLY 30/-

THE GREATEST BREAKTHROUGH SINCE TAPE RECORDING!

Here is the greatest World Record Club introductory offer ever made . . . a unique offer never before matched by any record club or company anywhere in the world!

EVERY ONE OF WORLD RECORD CLUB'S UNRIVALLED RELEASES AS 12" LPs IS NOW AVAILABLE ON 3 1/2 ips TAPE!

Now you have the opportunity to play any WRC release on your tape recorder. Each of these 'tape records' runs at 3 1/2 ips, mono, on 5" spools and can be played on either 2 or 4 track recorders. New electronic techniques of tape-to-tape transfer give these 3 1/2 ips WRC pre-recorded tapes a standard of reproduction unattainable previously at less than 7 1/2 ips.

1. AN UNPARALLELED INTRODUCTORY OFFER.

Choose now, any three of the superb 3 1/2 ips pre-recorded tapes shown here, for only 10/- each and number them on the attached coupon. (If you wish, of course, you can choose 12" LPs instead. Introductory discs and tapes are both the same price.) Please send no money until after you have received, played and approved them. We want you to prove to yourself, before paying, that our tapes are equal to the world's best.

2. THE OPPORTUNITY TO BUILD A UNIQUE TAPE COLLECTION.

The WRC plan offers you an exciting and varied annual repertoire of more than 60 selected tape releases, covering classics, jazz, shows, ballet music, light music and 'pops'. Every one is a superlatively recorded 3 1/2 ips mono tape (or 12" LP—mono and stereo). Tapes are offered to you at the

privilege club price of 29/- (12" LPs at 26/6) plus a small charge for post and packing—much less than you would pay elsewhere for recordings of anything like this quality. Your only obligation, as a Club member, is to agree to buy four more tapes (or 12" LPs) over the year. Beyond this, there is no subscription or membership fee.

3. A PLANNED PROGRAMME.

Every World Record Club release is hand-picked by an independent panel of Britain's top musical authorities. The Countess of Harewood, Lord Montagu of Beaulieu, Sir Arthur Bliss, Richard Attenborough, Cyril Ornadel, Ray Ellington, Leon Goossens, Malcolm Arnold, Steve Race, John Hollingsworth, Antony Hopkins—and, as special adviser on tape, Miles Henslow.

4. FREE MONTHLY MAGAZINE.

A monthly magazine, packed with fascinating musical articles, reviews, news and pictures, is issued free to all members.

5. SPECIAL CONCERT PRICE CONCESSIONS.

Many concert halls and theatres throughout the country (including the Royal Festival Hall) allow special concession rates to club members for many performances.

6. FREE BONUS TAPES.

The more you buy, the more you save! After fulfilling the minimum membership obligations, you earn another tape of your own choice free for every extra three you buy!

7. EXCLUSIVE EXTRA RELEASES.

In addition to the regular monthly selections, the club offers members exclusive extra tapes at the standard Club price.

World Record Club is unique—the first and greatest Record and Tape Club in Britain, with the largest show catalogue (on tape and mono/stereo disc) in the world. No other method of tape—or record-buying offers you so many additional benefits, so much freedom and variety of choice, with no 'high-pressure' selling. And, of course, there are no subscriptions or membership fees of any kind.

Don't miss this great opportunity. Send off the coupon today, for your 3 introductory selections for only 30/-



... AND IF YOU OWN A STEREO TAPE RECORDER hear the fantastic reproduction of **STEREO 21** THE NEWEST, TRUEST SOUND ON TAPE TODAY!

Revolutionary new STEREO 21 pre-recorded tapes (7 1/2 ips twin-track) are issued exclusively by World Record Club. But they are offered *without membership commitments of any kind*. The first list of all new STEREO 21 releases is now available. It features 30 superb stereophonic tapes ranging from Beethoven's *Eroica* with Josef Krips conducting the LSO, to a lavish full-cast production of *Oklahoma*.

As always, WRC prices present unparalleled value—all STEREO 21 releases cost either 50/- or 60/- depending on playing time (up to 50 minutes). STEREO 21 tapes are now obtainable through leading retailers or direct by post from World Record Club. Send for full catalogue now—STEREO 21 must be heard to be believed!

7-DAY FREE TRIAL OFFER—POST TODAY! STEREO 21 FREE BROCHURE

To WORLD RECORD CLUB (Dept TRR 10)
PARKBRIDGE HOUSE, RICHMOND, SURREY.

SEND NO MONEY NOW

| | |
|------------------------------------|---------|
| 3 1/2 ips pre-recorded tapes | 12" LPs |
|------------------------------------|---------|

Tick which you want

Please send me, without obligation, on 7-day free trial, the three selections indicated. (Your 3 selections must be either all tape or all disc.) If satisfied, I will pay you 30/- plus 3/- postage, packing and insurance. Only at that stage may you enrol me as a full member of World Record Club, entitled to all the benefits described. My only obligation as a member would be to agree to purchase 4 more top quality 3 1/2 ips tapes over a 12-month period at the special club price of 29/- each (or 4 12" LPS at 26/6 each.) If I am not completely satisfied with my 3 selections I will return them to you within 7 days in good condition, and owe you nothing.

Signed _____

this offer applies in Gt. Britain and N. Ireland only.

MY 3-SELECTION
'PACKAGE' COMPRISES

Choice No. 1 Choice No. 2 Choice No. 3



(place tape/disc key numbers only in the circles)

Tick here if stereo 12" LPs are required where available

Mr/Mrs/Miss _____
(BLOCK CAPITALS PLEASE)

ADDRESS _____

To WORLD RECORD CLUB (Dept TRR 10)
Box 11 PARKBRIDGE HOUSE, RICHMOND, SURREY.

Please send me your free colour brochure, showing the full range of your new STEREO 21 releases.

NAME _____
(BLOCK CAPITALS PLEASE)

ADDRESS _____

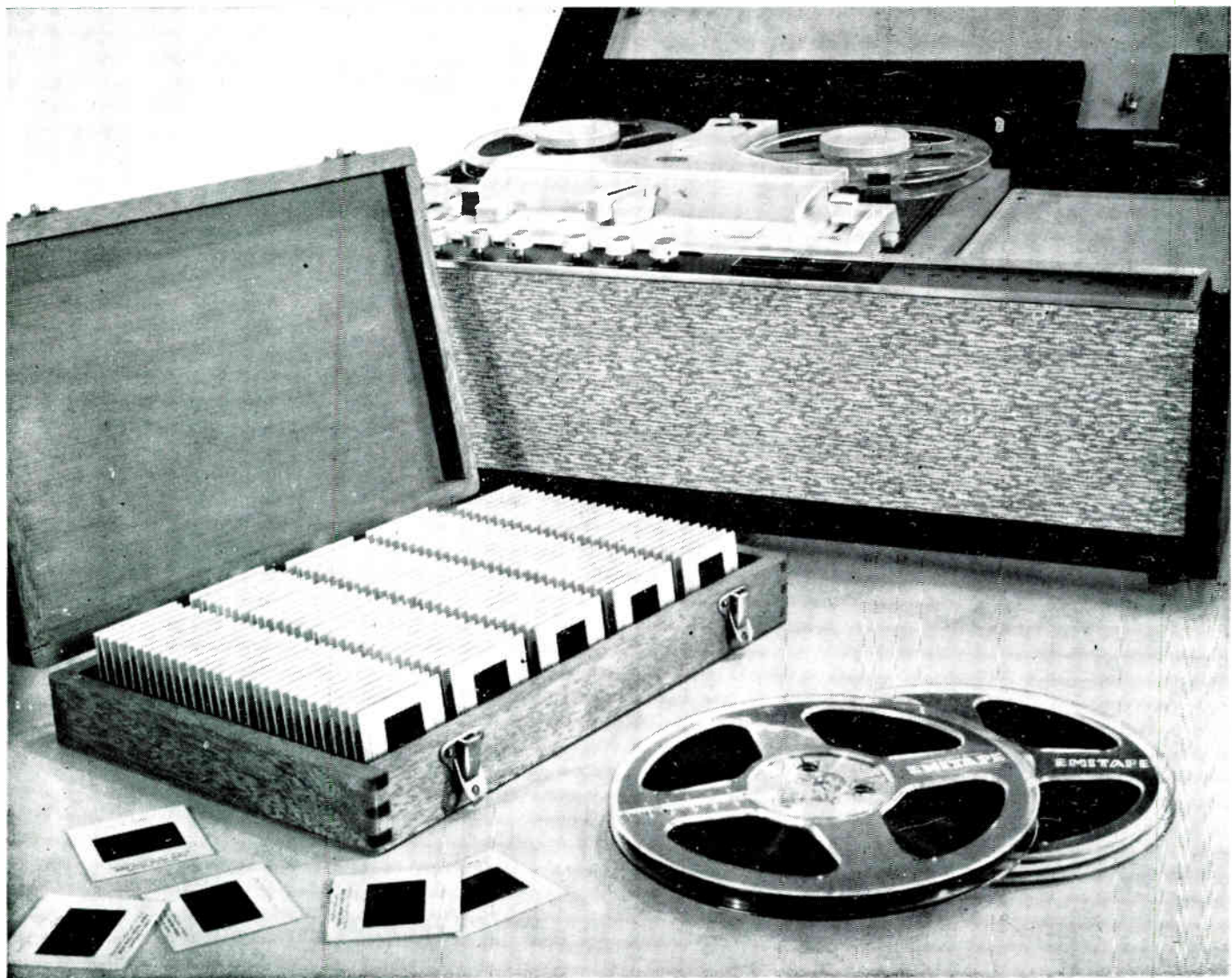

How to make slides speak for themselves with Emitape

A colour slide show is twice the fun when it's planned around a sound-track on Emitape. Get a new reel now. Then team up your recorder and camera, and start collecting sounds as well as pictures.

You can snap the voice with the face, and capture the *sound* of a scene. Afterwards you have fun editing the tape, matching effects against slides, adding music, and recording a commentary. The show will be the

smoothest you have put on, because it has been planned and prepared beforehand, slide by slide. Emitape never hesitates or forgets a name!

NOT SURE HOW TO START? Then write in for No. 3 in the new series of Emitape leaflets: *Adding Sound to Slides with Emitape*. It has been written specially for Emitape by John Borwick, and it's completely free. Also available: *Two and Four-track recording with Emitape*.

Get another reel of **Emitape**

Please send me your free leaflets *Adding Sound to Slides with Emitape* and *Two and Four-track recording with Emitape*.

NAME

ADDRESS



TRI

E.M.I. TAPE LIMITED, HAYES, MIDDLESEX

the TAPE RECORDER

Editor - - - - - MILES HENSLOW
 News Editor - - - - - Alan Lovell
 Advertisement Editor - - - - - Julian Berrisford
 Editorial Offices - - - - 99 Mortimer Street, London, W.1
 Telephone - - - - - MUSEum 3967 to 3969



MEMBER OF THE
 AUDIT BUREAU
 OF CIRCULATIONS

EDITORIAL

This month, in the centre eight pages of the magazine, we plug the cause for tape editing in a pictorial-cum-directory supplement. In spite of all this—and in spite of what we have written about it in the past—we know only too well that it is going to take more than two or three dozen photos and a few paragraphs of persuasive words to put across something that all too many people at present regard as “plain unnecessary and a waste of time”. Furthermore, we are in complete sympathy with many of the readers who look at it that way. Those who have bought tape recorders for occasional domestic use, and who merely want them for an hour’s fun at a party, or when on holiday—those people and many others with the same outlook truly have no use for tape editing. For them it would indeed be a waste of time—or for most of them, we should add. But there are all too many people who have bought tape recorders (with the original idea of making useful and interesting sound records) who have long since given up using them, because they found it an irritating and frustrating effort to replay any sequence of sounds (even if they were able to locate them on the tape), once the spool was filled to the last inch with bits of everything. It is these people, in this category, who would discover, through tape editing, that their machines would give them exactly what they had originally hoped for when they bought them.

We have often wondered why it is that so many people have not made proper use of the equipment which cost them good money. In most cases, we think, it is lack of confidence: in some cases, of course, it is natural laziness. Though the analogy is not quite right, let us consider tape recording and photography (from the laziness angle!). Mrs. Brown buys a camera and a roll of film. She bangs off the eight or twelve or thirty-six exposures, takes them to the chemist when she goes shopping (or gets her husband to take them for her) and is quite often delighted with the prints that she receives in a few days’ time. She buys another film, and continues to pop off pictures for year after year. Mrs. Smith makes a tape recording (lots of them on one spool) but there is no counterpart of the chemist’s shop to which she can send her spool for editing. In the first place, only *she* can tell what bits she wants to keep, and what bits are useless. So she does not buy another spool, and the tape recorder makes a useful box to stand things on.

SUBSCRIPTION RATES

The subscription rate to *The Tape Recorder* is 27/6 per annum (U.S.A. \$4.00) from The Tape Recorder, 99 Mortimer Street, London, W.1. Subscription + Index, 30/- (U.S.A. \$4.25). The same rates apply to *Hi-Fi News*.

JULY - - - - - 1963

VOL. 5 - - - - - No. 6

CONTENTS

| | Page |
|---|------|
| News from the World of Tape | 229 |
| Tape Recorder Service | |
| No. 19. Butoba Recorders | |
| By H. W. Hellyer | 233 |
| Build this Ribbon Microphone | |
| Part One. Construction | |
| By M. H. O. Hoddinott | 230 |
| Tape Editing Equipment—a Survey | 237 |
| Sound and Cine | |
| By Richard Golding | 245 |
| Details of New Products | 249 |
| Equipment Reviewed | 251 |
| Tape Recorder Workbench No. 48 | |
| by A. Bartlett Still | 254 |
| Classified Advertisements | 256 |
| Advertisers’ Index | 258 |

● The editorial content of this magazine is Copyright. No feature, or part of it, may be reproduced without the written consent of the publishers.

There are many Mrs. Smiths and Mrs. Browns who (did they but realise it) could develop their own rolls of film, and contact print them just as well as the man to whom the chemist sends them. The apparatus would cost them at most a couple of pounds. But this brings us back to the angle of lack of confidence. Tape editing, at its simplest, is a matter of slitting a length of tape (with scissors or razor blade) twice, taking out the unwanted still bit, and re-jointing the two new ends with half an inch of *special* “sticky” tape. It requires no confidence. Anyone, other than a ham-fisted Harry, can do it perfectly.

The main secret of tape editing—particularly if the owner has only one machine—is to *make the recording on one track only*. Then the tape can be cut into a thousand slices, and reassembled, without losing anything that is wanted intact. This, to some people, sounds like gross extravagance. The idea of buying a second spool of tape, with one track of the first spool still empty. . . ! But would those same people paste up in their photo albums all the strips of print, under-exposed, overexposed, decapitated picnic groups and double-exposures? And would they consider it a similar waste of money to buy a spare roll of film?

There are, doubtless, many able dealers up and down the country who will copy the edited tape on to one track of a new tape. The user can then use the first tape again (one track only) for further recording; and when that is again edited, the same dealer will doubtless oblige by copying the second edited track on to the spare track of the new tape. The result . . . a worthwhile tape with two usefull sound tracks, and the first tape which can still be sliced about until it contains as much jointing tape as magnetic tape! That makes sense out of tape recording. It also spells economy. Please take our advice. Select a splicer from the models we have illustrated, and buy a reel of tape. Start cutting!

COVER PICTURE

Readers who have bought our booklet, “*How to Splice Tape*”, will recognise some of the photographs that we have re-assembled for this month’s cover picture. Like the subject matter, it was mainly a matter of slicing and jointing!

Index to Volume 4 of THE TAPE RECORDER
 Available now - - - - Price 2s. 6d.

**For highest
quality equipment**



**at lowest
possible prices**

HI-FI FM TUNER, Model FM-4U

Available in two units which for your convenience are sold separately: Tuning unit (FMT-4U—£2 15s. 0d. incl. P.T.), despatched wired and tested, and I.F. amplifier (FMA-4U—£12 6s.). Printed circuit for I.F. amplifier and ratio detector. Built-in power supply; 7 valves. Tuning range 88-108 Mc/s. (Illustrated bottom right.) Total price £15 1s. 0d.

HI-FI AM/FM TUNER, Model AFM-1

Also available in two units as above: Tuning heart (AFM-TI—£4 13s. 6d. incl. P.T.) and I.F. amplifier (AFM-AI—£20 13s.). Printed circuit board; 8 valves; consecutive FM limiting and ratio detector. Tuning range FM: 88-108 Mc/s; AM: 16-50, 200-550, 900-2,000 m. Switched wide and narrow AM bandwidth. Built-in power supply. Total price £25 6s. 6d.

**NEW! "OXFORD" DE-LUXE TRANSISTOR
DUAL-WAVE PORTABLE RECEIVER
Model UXR-2**

Ideal for use in the home, car or as a personal portable receiver. Features:—Solid leather case; Slide-rule tuning scale; Printed circuit board; 7 transistors; 3 diodes. 7" x 4" Loudspeaker. Send for details. £14 18s. 0d. incl. P.T.

**ASSEMBLED MODELS NOW
AVAILABLE, PRICES ON REQUEST**

All prices include free delivery in U.K. Deferred terms available on orders over £10.

**Tape Recording and Replay Hi-Fi Amplifiers
Models TA-IM (Mono) and TA-IS (Stereo)**

For use with most tape decks. Thermometer type recording indicators, press-button speed compensation and input selection, 3-position bias level and printed circuit construction.

- TA-IM £19 2s. 6d.
- TA-IM and Collaro "STUDIO" £30 10s. 0d.
- TA-IM and TRUVOX D83 £47 2s. 6d.
- TA-IM and TRUVOX D84 £45 5s. 0d.
- TA-IS (illustration Centre) £24 10s. 0d.
- TA-IS and TRUVOX D83 £52 6s. 0d.
- TA-IS and TRUVOX D84 £50 9s. 6d.

A WHOLE RANGE OF PACKAGED DEALS (INCLUDING "CONNOISSEUR CRAFTSMAN" TURN-TABLE and DECCA 8ms PICK-UP) NOW AVAILABLE TO SAVE YOU FURTHER MONEY.

HI-FI EQUIPMENT CABINETS

A range of over a dozen equipment cabinets is now available to meet the differing needs of enthusiasts. Designed for maximum operating convenience or for where room space is an over-riding consideration, this range includes kits, accurately machined for ease of assembly and "left in the white" for finish to personal taste, ready assembled cabinets or assembled and fully finished cabinets, and has at least one model to meet your requirements. Why not send for full details?

Prices from £6 19s. 6d.—£29 8s. 0d.



"MALVERN"



"COTSWOLD"

"COTSWOLD" HI-FI FREE SUSPENSION SPEAKER SYSTEM

This is an acoustically designed enclosure 26" x 23" x 14 1/2" housing a 12" bass speaker with 2" speech coil, elliptical middle speaker, together with a pressure unit to cover the full frequency range of 30-20,000 c/s. Capable of doing justice to the finest programme source, its polar distribution makes it ideal for really Hi-Fi Stereo. Delivered complete with speakers, cross-over unit, level control, Tygan grille cloth, etc. All parts pre-cut and drilled for ease of assembly and left "in the white" veneered for finish to personal taste.

"COTSWOLD" MFS SYSTEM

Similar performance to standard "Cotswold" but designed for the smaller room. Size 36" high x 16 1/2" wide x 14 1/2" deep. Either model. £23 4s. 0d.

Here are some other easy-to-build Heathkit Models for you



S-33

NEW! MONO CONTROL UNIT Model UMC-1. Designed to operate with the MA-12 or any amplifier requiring 0.25 v or less for full output. Suitable for cabinet mounting or free standing. Size 10" x 7" x 4". Available shortly. £8 12s. 6d.



DELUXE 6 WATT STEREO AMPLIFIER Model S-33H. A stereo/mono amplifier with the high sensitivity necessary for light-weight ceramic pickups (e.g. Decca Deram). Deluxe version of the S-33. £15 17s. 6d.



MA-5

HI-FI STEREO 6 WATT AMPLIFIER Model S-33. Attractively styled, completely self-contained. Printed circuit makes it easy to build. Only 0.3% distortion at 2 1/2 W/ch. U/I output, ganged controls. £13 7s. 6d.



HI-FI MONAURAL AMPLIFIER Model MAS. An ideal general-purpose reasonably priced mono amplifier, 5 watts output at only 0.5% distortion, has inputs for Gram, Radio. Printed circuit board. Size 11" x 6 1/2" x 4 1/2" high. £10 19s. 6d.



SSU-1

HI-FI SPEAKER SYSTEM Model SSU-1. This kit is easily assembled. It contains two speakers and balance control in its ducted port reflex cabinet. It is equally suitable for stereo or mono in average room. (Legs 1/4" optional extra.) £10 17s. 6d.



AG-9U

AUDIO SIGNAL GENERATOR Model AG-9U. Delivers up to 10 volts pure sine-wave (less than 0.1% distortion, 20 c/s to 20 kc/s). Decade switch-selected frequencies from 10 to 100,000 c/s. Internal 600 Ohm N/I load, or external. £21 9s. 6d.



MA-12

POWER-AMPLIFIER 12-WATT Model MA.12. Single channel, ideal for stereo conversion. £11 9s. 6d.

COLLARO "STUDIO" TAPE DECK. Two tracks. "Wow" and "flutter" not greater than 0.15% at 7 1/2 p.s. Long Term Speed Stability better than 0.5%. £17 10s. 0d.

SUGDEN MOTOR UNIT "CONNOISSEUR CRAFTSMAN". Heavy duty motor, operating at 3 3/4 and 45 r.p.m. Very heavy 12" turntable. £16 6s. 6d. incl. P.T.



USC-1

HI-FI STEREO 18-WATT AMPLIFIER Model S-99. Within its power rating, this is the finest stereo amplifier available, regardless of price. U/L push-pull output. Printed circuit construction. £27 19s. 6d.



TA-IS

TRANSISTOR INTERCOM, Models XI-1U and XIR-1U. Ideal for office or home. Each Master operates up to five Remotes. 9 v battery operated. XI-1U £10 19s. 6d. XIR-1U £4 7s. 6d.



TRUVOX D83

STEREO CONTROL UNIT MODEL USC-1. A deluxe stereo control unit with variable filter, switched rumble filter, printed circuit boards and many other refinements. Operates direct from tape heads. £19 10s. 0d. incl. P.T.



STUDIO

TRANSISTOR PORTABLE RADIO Model UXR-1. Superbly styled hide case, with golden relief and crystal easy-to-tune dial; this completely self-contained 6-transistor dual-wave set performs brilliantly everywhere, even in a car. Reproduction is exceptionally good. Printed circuit. £12 11s. 0d. incl. P.T.

SHORTWAVE TRANSISTOR PORTABLE Model RSW-1. Four wave-band seven transistor portable with telescopic and ferrite aerials, slow-motion tuning. Covers Medium, Trawler, and 6-26 Mc/s in four switched bands. Uses printed circuit board and latest circuit technique. Superbly styled leather case. £19 17s. 6d. incl. P.T.

TRUVOX D83 AND D84 TAPE DECKS. High quality stereo Tape Decks D83 2-track for highest-fidelity. £31 10s. 0d. D84 (identical presentation) 4-track for most economical use of tape. £29 8s. 0d.

GARRARD AUTO/RECORD PLAYER Model AT-6. A 4-speed stereo/mono unit with manual or fully automatic record selection; adjustable counter-balanced arm. Fitted with Decca Deram ceramic cartridge £14 6s. 1d. incl. P.T., or Ronette 105 mono/stereo cartridge. £13 12s. 1d. incl. P.T.

GOLDRING-LENCO TRANSCRIPTION RECORD PLAYER Model G.L.58. Fitted with the G.60 pick-up arm and Ronette 105 mono/stereo cartridge, it has infinitely variable speed adjustment between 3 3/4 and 80 r.p.m. and four fixed speeds. 3 1/2 lb. turntable to reduce rumble, "wow" and "flutter". £18 19s. 2d. incl. P.T.



S-99



RSW-1



UXR-1



GL-58



F.M. TUNER

JUST POST THIS COUPON FOR FURTHER INFORMATION

Without obligation please send me

★ **FREE BRITISH HEATHKIT CATALOGUE...** FULL DETAILS OF MODEL(S).....

Kindly write below in BLOCK CAPITALS

NAME.....

ADDRESS.....

TICK
HERE

HT7

ANNOUNCING OUR NEW INTERNATIONAL MAIL ORDER SCHEME COVERING THE AMERICAN HEATHKIT RANGE OF 250 MODELS. For direct delivery from the U.S. plant to your U.K. address. Illustrated American Catalogue and full details of the scheme can be obtained from us at the nominal charge of 1/- post paid.

**DAYSTROM LTD. DEPT. HT7
GLOUCESTER, ENGLAND**

A member of the Daystrom Group, manufacturers of
THE LARGEST-SELLING ELECTRONIC KITS IN THE WORLD

NEWS FROM THE WORLD OF TAPE

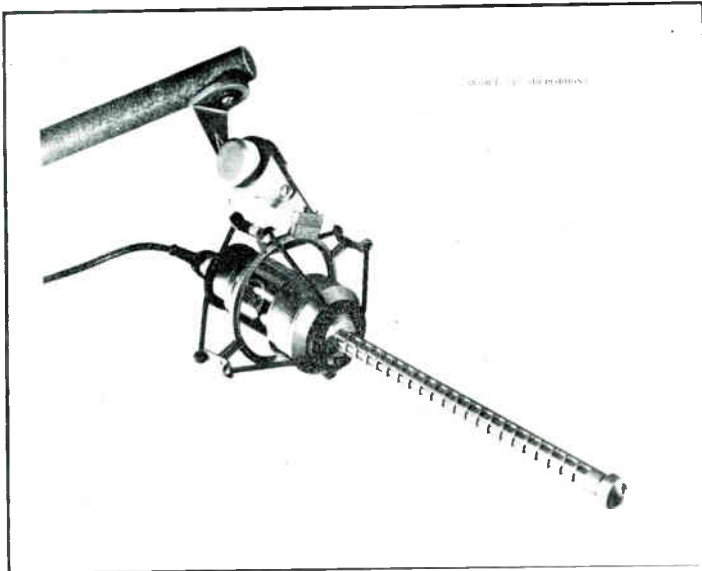

ELECTRO-VOICE MOVING COIL MICROPHONE

An Academy Award, believed to be the first bestowed on a microphone design in the past twenty two years, was conferred on Electro-Voice, Inc., by the Academy of Motion Picture Arts and Sciences, at the nationally televised award ceremonies held in Santa Monica, California. Basis for the award was the firm's contribution to motion picture sound pick-up, made possible by a highly directional microphone permits the simultaneous filming and sound recording of the action, even at considerable distances from the point of origin. Before the development of this microphone, the Electro-Voice Model 642, such scenes were filmed without sound, but added later. The agents in this country for the complete range of Electro-Voice microphones are K.E.F. Electronics Ltd., Tovil, Maidstone.

* * *

A revolutionary new system, called *Editec*, for automatic editing and animation on television tape has been introduced by Ampex International. The Editec time element control system combines with the Ampex Electronic Editor to transform the VR 1000 series of *Videotape*



THE AMPEX "EDITEC" SYSTEM

recorders into a production tool capable of any editing function at a much lower cost than film. The Ampex Electronic *Editor*, solved part of the problem, making possible push button editing without cutting tapes. Combined with the Editec, the Editor now becomes the complete production accessory, permitting frame by frame editing.

The system operates by placing marker tone bursts on the cue track. These markers electronically gate the recording and monitoring circuits. As a result splice time base errors are reduced to less than 1 microsecond.

CLASSIFIED ADVERTISEMENTS 256

Music on Tape, who claim to be the first Company to make a commercial proposition of four track stereo tapes recorded at $3\frac{3}{4}$ i/s, have announced that their new "Scroll" series is now available. Titles include *Scheherazade*, *L'Arlesienne* and the overtures to *Leonora*, *Egmont* and *Prometheus*. Details of these and later releases can be obtained from Music on Tape, 188, Vauxhall Bridge Road, London, S.W.1.

* * *

Truvox Ltd. have asked us to print an apology to those people who have been unable to obtain equipment because of the long waiting list. We have been advised that the present delivery situation is as follows: R62 and R64 recorders, two weeks; R82 and R84, three weeks; PD82/5 two weeks; PD86 and PD87 ten to twelve weeks.



Truvox R84

* * *

The most recent of the famous members of the show business fraternity to join the exclusive *Shure* Gold Microphone Club is the ever popular Sammy Davis Jr. He received his personally inscribed gold-plated *Shure* Unidyne III microphone when he visited the *Shure* factory during his highly successful run at the Villa Venice, near Chicago, U.S.A. The award is part of the continuing *Shure* programme of appreciation for outstanding showmanship and recognition of the microphone's critical importance to successful entertaining.

PERMANENT BINDING

We can undertake the permanent binding of all volumes of *The Tape Recorder*. Send your copies to us, the price is 36s. which includes index and postage. They are individually hand stitched and covered in black buckram, gold block on spine. Other colours and leather bindings are also available, details on application.

Index to Volume 4 of THE TAPE RECORDER
Available now - - - - Price 2s. 6d.
99 Mortimer Street · London · W.1



THERE must be many owners of a tape recorder who, like myself, find that it has to fit into a tight household budget. Ribbon microphones, mixers, extra speakers, pre-amplifiers, etc., are but dreams to many of us. However the absence of a goldmine in the back garden does nothing to subdue the desire for "Hi-Fi" or the urge to capture for future generations that earnest and private conversation over the ludo board between very young sons and daughters. Before very long the brazen head of Do-it-Yourself appears in all its over-optimistic glory and the seeds of an idea are sown.

My entry into this field of tape recording was initiated by the realisation that good quality recordings of live functions, particularly music, could only be obtained by possessing a ribbon microphone. At an average price of £10 for the cheaper types, however, these instruments are most costly items, especially when one remembers that they are essentially for studio use only, and are not suitable for outdoors. After seeing one "in the flesh", I felt that here, surely, was an item well within the scope of the home mechanic. So, after a visit to the local Public Library to obtain all the facts, I plunged into the job and eventually produced the instrument described in this article.

Structurally Simple

Although apparently a formidable thing to make, the ribbon microphone is structurally very simple; in fact probably the simplest of the three types in common use. It consists of a very light and thin aluminium ribbon held between the poles of a permanent magnet. The sound vibrations move the ribbon in sympathy and a minute electric current is generated. This current is collected at each end of the ribbon and passed on to the amplifier. The real secret of success lies in the accuracy of the construction, the care with which it is carried out, and the overall design. It is thus particularly well suited to home construction, the material cost being low and the accuracy required obtainable by time—at no cost at all!

The tools required are the barest minimum found in the mechanic's workshop. A hacksaw, vice, hand-drill, files and assorted B.A. screws are the essential items. Perhaps only the 10 B.A. tap for threading may be missing but this is easily obtainable at the ironmonger.

The complete unit, without its protective gauze case, is shown in fig. 1. The shape and dimensions of this design are dependant on the only commercially made items in it—the magnets, of which full details are given at the end of the article. From this drawing the layout is clearly shown, and I would advise the constructor first to study it and get the overall idea of a ribbon microphone clearly fixed in his head before pro-

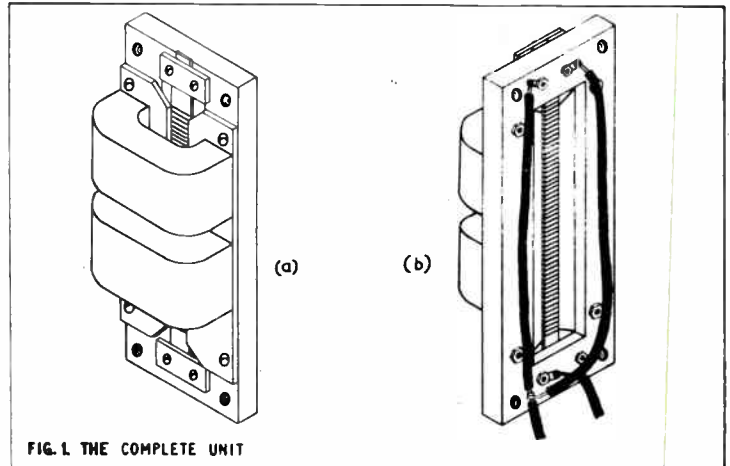

FIG. 1 THE COMPLETE UNIT

ceeding with the job. When this has been done a reference to the list of raw materials should be made to ensure that everything is available.

The frame

Commence work on the $\frac{1}{8}$ in. thick paxolin frame, cutting it to the dimensions shown in fig. 2, and marking off the central slot. Also mark out the centre line of the frame and expand it to $\frac{3}{16}$ in. wide. The use of this guide mark will be obvious later (dotted lines fig. 2). The cutting of the slot may present a little difficulty to some so I will describe a simple way (See fig. 3).

List of Materials Wanted and Possible Suppliers

Paxolin Sheet, $\frac{1}{8}$ in. thick

Price: About 6/-d. per square foot. Obtainable at radio or electrical suppliers.

Mild Steel Sheet, $\frac{3}{32}$ in. thick

Price: For small amounts negligible. Obtainable at ironmongers or scrap merchants.

Brass Sheet, $\frac{3}{32}$ in. and $\frac{1}{16}$ in. thick

Price: For small amounts about 1/-d. Obtainable at ironmongers or sheet metal workshops.

Perforated Sheet (Meat Safe Type)

Price and source as for the brass.

Brass Wire Gauze

20 holes per inch (wire 0.015 in.) for outer grille.

100 holes per inch (wire 0.004 in.) for inner lining.

Source: Messrs. Greening Ltd., Britannia Works, Warrington, Cheshire. Price: approx. 10/-d. per sq. ft.

Screws

10 B.A.— $\frac{1}{4}$ in. round headed }
8 B.A.— $\frac{1}{4}$ in. round headed } Ironmonger or model shop.
(these are to be brass)

Matching Transformer

Price: 10/-d. "W.G." bell type, 200 250 V. in. 3 5 8 V. out. Ref. E/1095. Made by Ward and Goldstone, Manchester 6.

Magnets

"Eclipse" Power Magnets type No. 812B. Price: 8/-d. Obtainable through ironmongers.

Brass Sheet for the Case, $\frac{1}{8}$ in. thick

Price: 30/-d. per square foot. About $\frac{1}{4}$ square foot wanted for the case and is obtainable from A. J. Reeves, 416 Moseley Road, Birmingham 12.

Brass Sheet for the back and front plates of case

Price: 16/-d. per square foot. About 8 square inches wanted. Also obtainable from A. J. Reeves.

Perspex as an alternative

Obtainable from handicraft shops.

MAKE THIS RIBBON MICROPHONE

THE FIRST OF TWO PARTS

DESCRIPTION AND PREPARATION

Drill out a series of small ($\frac{1}{8}$ in.) holes close to one another inside the marked out area of the slot. When a complete rectangle of holes has been made, gently chisel out the material between each hole and prise out the central portion. This will leave the slot with an irregular outline which can be filed out level until the edges correspond with the marked outline. Mark out the twelve holes in the frame as shown in fig. 2 and drill and tap them according to the diagram.

The polepieces

Obtain a piece of mild steel about $\frac{1}{2}$ in. thick, ensuring that it is reasonably flat and not badly rusted. Mark off the two pieces and cut them slightly oversize. Clamp the two together in a vice and finish off to the correct size with a fine file. A point of importance here is the actual pole edge that will eventually be parallel to the ribbon (R in fig. 4). It is essential to get this as near perfectly straight as possible and great care must be taken in the final filing. Check the edge frequently with a steel rule.

For those whose filing is not all it might be there is a way to cheat a little here. Take the original piece of mild steel, before working on it, to a local tinsmith or model engineer and ask him to trim up one edge accurately on a shearing machine. Reserve this edge then, which will require little or no filing up, for the vital pole. Whilst the two polepieces are still clamped together mark off and drill the two 8 B.A. clearance holes and, with a needle file, file them out slightly oval in the direction shown in fig. 4. This is to allow for fine adjustment over about $\frac{1}{32}$ in. when positioning the poles on the paxolin frame. Finally, rub them down on all surfaces with an abrasive paper, clean thoroughly

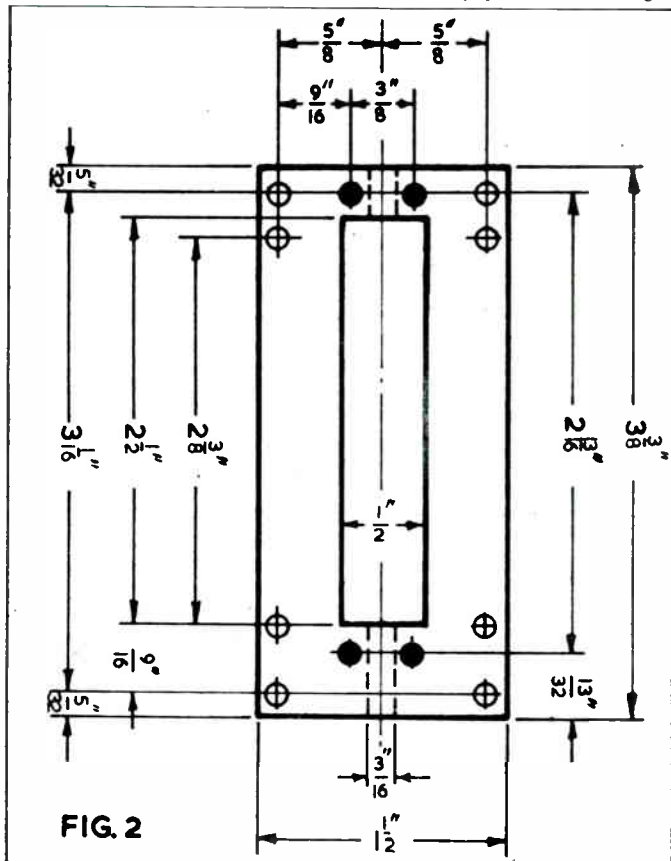

Fig. 2. The frame, $\frac{1}{4}$ Paxolin. Holes marked solid are 10 BA tapped. Holes in outline are 8 BA clearance

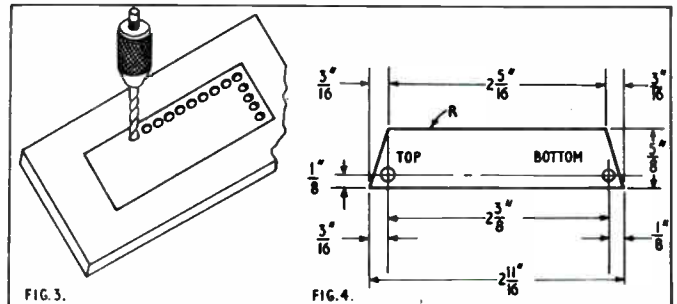
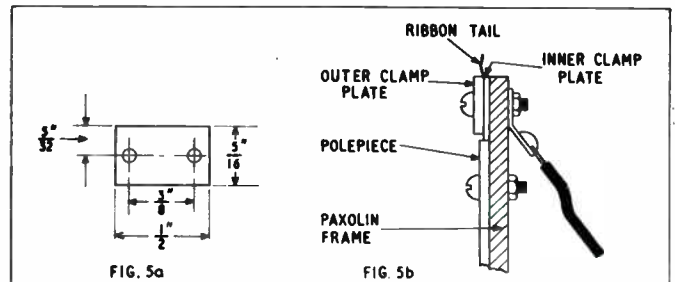

Fig. 3. A method of cutting out the central slot in the frame, using a drill
Fig. 4. Pole-piece dimensions. Note that the 8 BA clearance fixing holes are filed oval

Fig. 5a. Ribbon clamping plates. Make two at $\frac{3}{32}$ " thick and two at $\frac{1}{4}$ " thick. Holes are 10 BA clearance. Fig. 5b is an enlarged edge-on view of one end of frame showing part of poles, ribbon and ribbon clamp



and paint them with either cellulose or epoxy resin paint to prevent corrosion.

The ribbon

Making the ribbon is undoubtedly the most difficult part of the job, not only requiring great precision but a high standard of cleanliness not usual in a home workshop. It is advisable, therefore, to take certain precautions before starting. All filing and swarf from the previous work must be cleared away completely, and the bench top covered with a piece of clean card. This action is not only important at this stage but at any time later when the microphone is open and unprotected by its gauze. It should be clearly understood that, once made, the ribbon cannot be touched without damaging it, except at the extreme ends, otherwise it will be distorted and spoilt.

Ideally, the ribbon should be made of 0.0002 in. thick aluminium foil. If you remember that cigarette packet foil is roughly 0.001 in. thick the extreme fragility of the correct ribbon will be obvious. However, foil of 0.0002 in. thick is not readily available on the retail market and I had to do some searching before I found that the foil in the common waxed capacitor would do. It is rather thicker than the correct type, being about 0.0004 in. but nevertheless works quite well. The capacitors in the 0.001 microfarad range seem to be the most fruitful, though it may be necessary to open up a few before finding the right one.

Aids to Cutting

The capacitor case should be cleaned of its wax by allowing it to melt off on to a newspaper by a stove, and the cardboard stripped with a pair of pliers. Unwind the foil and paper core right out and separate the foil. Cut it into 4 in. lengths and drop them into a tin of degreaser (carbon tetrachloride is ideal). Leave them to soak for several hours to remove any oil or grease and then swill in a tin of clean degreaser. Dry immediately between blotting paper and store between the pages of a book until wanted.

The following items of equipment should now be prepared for the cutting operation. A small (6 in. square) sheet of glass, a hardwood

SPECIALISTS IN

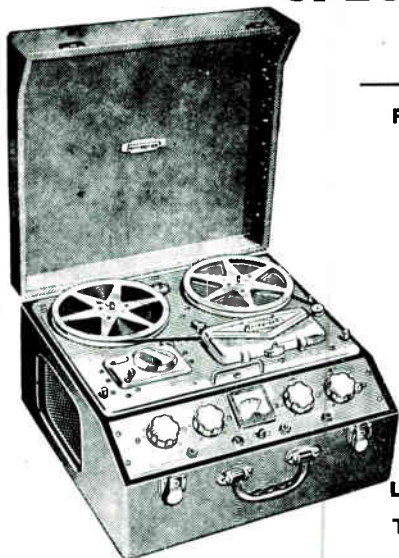

FERROGRAPH
VORTEXION
TANDBERG
BRENELL
AMPEX
REPS
SONY
REVOX
PHILIPS
GRUNDIG
LOEWE OPTA
TELEFUNKEN
ETC.

FANTASTIC!!

FANTASTIC!! An understatement indeed, for so vast is the range of selection of new and secondhand recorders to be seen in our showrooms that no other word can describe it. Call into any of our branches and see the largest and finest selection of recorders on display in Great Britain. Every recorder can be seen, heard and compared and each member of our experienced and expert staff will be happy to offer you honest, unbiased advice in order to assist you in the selection of a recorder to suit your individual requirements.

- ★ HIGHEST PART EXCHANGE ALLOWANCES
- ★ OVER 250 NEW & S/H RECORDERS ON DISPLAY
- ★ H.P. TERMS OVER 9-24 MONTHS
- ★ FREE HOME DEMONSTRATIONS
- ★ TAPE RECORDER REPAIR SPECIALISTS
- ★ FREE DELIVERY. FREE TECHNICAL ADVICE

NOTE.—OUR CITY SHOP OPEN MON.—FRI. 9-6. CLOSED SAT.
OPEN SUN. 9-2 p.m.

CITY & ESSEX TAPE RECORDER CENTRES

228 Bishopsgate, E.C.2. Opp. Liverpool St. Station. Bis 2609
2 Maryland Station, Stratford, E.15. (Adj. Station) Mar 5879
205 High St. Nth. (Opp. East Ham Station), E.6. Gra 6543

block of about the same size and any handy thickness ($\frac{1}{4}$ in.), and a couple of new stainless steel razor blades.

Place one of the 4 in. lengths of foil on the glass and smooth it by gently rubbing it with the forefinger in one direction until all the creases have gone. If it curls up turn it over and repeat the smoothing. Transfer the foil to the hardwood block and lay over it a 6 in. steel rule near one edge as a guide. With the razor blade held at an angle of about 30 degrees to the horizontal, make a steady *continuous* cut from top to bottom of the foil along the rule. To ensure a perfect edge it is imperative that this cut is made in one sweep, and care should be taken to place the fingers holding down the steel rule in a position that will not interfere with the cut.

After making sure that a clean edge has been obtained, measure off $\frac{3}{8}$ in. from it and repeat the cutting operation using a *new* edge of the razor blade. If all has gone well a strip of foil 4 in. long by $\frac{3}{8}$ in. wide will result. If necessary the strip can again be smoothed on the glass at this stage, but with great care, so as not to distort or twist it.

The ribbon, which should now only be handled at its end with tweezers, must be carefully examined with an eyeglass before going any further to ensure that there are no tears, etc. I have noticed that some capacitors seem to be prone to pinholing, and this should be carefully watched out for.

The final job on the ribbon itself is to provide it with transverse ribbing to improve its stability (fig. 7). This can easily be done by very gently pressing it against a coarse comb. Ideally a grill of $\frac{1}{16}$ in. bars, spaced with about $\frac{3}{2}$ in. between them, should be used. If you have a cat which owns a steel comb, this will be found to be almost exactly to specification.

Place the ribbon on the comb at right angles to the teeth and put on top of it a piece of about $\frac{1}{4}$ in. foam plastic sheet, and a metal plate also about $\frac{1}{4}$ in. thick. None of these sizes are critical but are solely to ensure that the ribbon will be evenly ribbed along its length. The foam/plate combination should cover the ribbon for about $2\frac{1}{2}$ in. of its length and leave about $\frac{3}{4}$ in. at each end uncovered. Very gently apply a light pressure on the plate over its whole length. If this is done carefully the ribbon will take on a series of slight indentations across it and evenly impressed (See fig. 7). Here again, practice is essential, though failure far less final as the ribbon can be smoothed out on the glass plate

FIG. 6 POLES AND
RIBBON CLAMPS

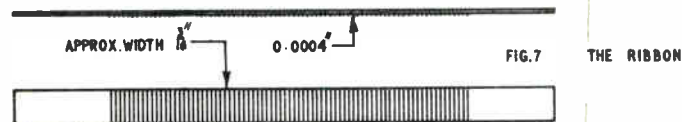
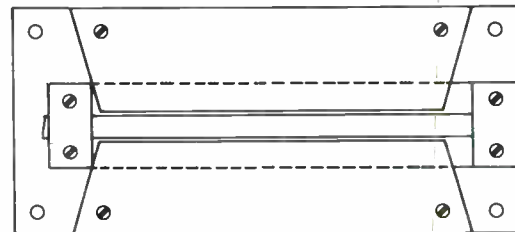

The ribbon clamps

There are two of these ribbon clamps made of brass, one at each end of the frame. Each one is itself a pair, made up of an outer $\frac{1}{2}$ in. plate on top of an identical inner one of a thickness as near as possible half that of the thickness of the polepiece metal. Thus if the poles are made of $\frac{1}{2}$ in. steel, this underside piece of the clamp should be $\frac{1}{4}$ in. thick. The reason for this is that each end of the ribbon which is sandwiched between these two clamping plates must be held about the centre of the thickness of the pole pieces to ensure that they are in the area of maximum field strength. A reference to fig. 5(b) will show clearly how this idea is applied.

Mark off on one of the $\frac{1}{2}$ in. pieces of brass the clamp dimensions as shown in fig. 5(a) and the two 10 B.A. clearance holes. Hold all four roughly cut parts of the two clamps together in the vice and finish off the filing to size as shown on the marked off piece. Drill the 10 B.A. holes and clean up all edges with fine abrasive paper.

The polepieces and ribbon clamping plates can now be fitted for test to the paxolin frame as shown in fig. 6. At this stage the alignment and adjustment of the poles, using the oval 8 B.A. holes, should be checked and the ability to parallel up the two poles accurately noted. The gap between them should be $\frac{1}{4}$ in. adjustable to $\frac{3}{16}$ in. This can be checked by fitting a strip of tinfoil, $\frac{3}{16}$ in. wide in the central slot to act as a dummy ribbon.

TAPE RECORDER SERVICE

By H. W. HELLYER

One of my correspondents asked me recently why I "wasted my time" writing about the older decks, when there were such fine new machines as the later *Grundigs*, the automatic *Teletunken*, the *Sony*, the *Planet*. . . . After having used this space for eighteen months the reason for my concentration on earlier models should have been clear. If it is not, I must have failed in my object! Nothing would be simpler than to follow in the footsteps of the reviewers, describing specifications of these later decks and adding comment on construction. But what, owner of, say, the latest *Clarke and Smith*, the *Revox E36*, the *Akai M6*, to name but a covetable few, is going to be tempted to delve into its innards just for the fun of checking my ham-fisted working drawings.

Surely not the new—yet!

There are two reasons for our choice of machines to discuss: first, any new tape recorder is presumably going to be serviced under guarantee, and manufacturers take a dim view of technical hacks who advise readers to lay about them indiscriminately with soldering iron and pliers. Second, the number of requests for information that come to the *Lap Recorder* office give a pretty fair indication which machines need detailed description. And, incidentally, those faults that are most prevalent.

So that's why I concentrate again this month on a machine that has been superseded by an improved design—quite radically different—and has now gone out of production. The *Butoba MT4* and *MT5* must be familiar to us all. They have been widely advertised, and are still in plentiful supply at quite reasonable prices. For the purpose of this article we shall refer to the *MT5*—differences were mainly in production modifications. So, first a few facts.

There are two motors, one for capstan drive and the other for fast

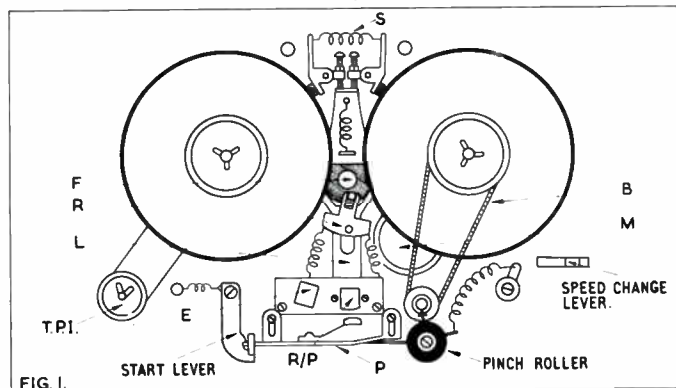

winding. The take-up torque is provided by a thin spring belt *B* from the capstan to the clutch drum of the righthand spool. This spring is tensioned by its grip on a "cord reel" of aluminium which is pressed on the capstan shaft *C*. I shall probably get shot for saying so, but the remedy for reluctant take-up is either an increase in belt tension by careful shortening (not a simple job if you want to avoid annoying knocks) or a judicious attack on the aluminium with a penknife. This is, providing the flywheel itself is not slipping. The flywheel *A* has a rubber rim which is engaged by the appropriate step on the motor pulley for $3\frac{3}{4}$ or $1\frac{1}{2}$ i/s tape speeds. Note that this is not an outer rim, but a raised inner section *D*, and the motor lifts boldly to swing into place when the speed change is operated. As there is less pressure on the rubber at the lower speed, it is advisable, to prevent undue wear and resultant "wow", to leave the machine set on the $1\frac{1}{2}$ i/s speed when it is switched off.

Two motors

Both motors are 6-volt, but the drive motor *M* has a regulator consisting of a centrifugal switch and OC76 transistor, which allows constant speed over the voltage range 6.7 V to 4.9 V. There is a contact screw for this switch which provides a small range of speed adjustment (clockwise

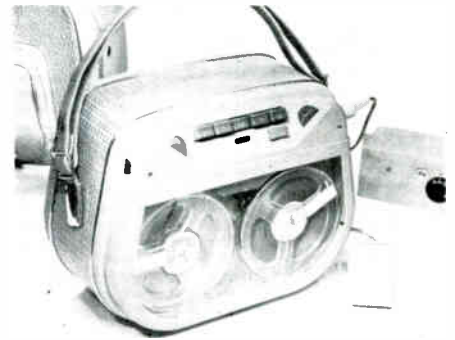

Butoba MT5

to increase), but if it is at its limit for the correct speed of tape travel, the two 100 mfd electrolytics *G* should be checked. These are tucked away under the deck-plate, between the base of the motor (by which I mean the end remote from the pulley) and the speed change lever. Since the production of the *MT5* a number of miniature electrolytics of similar capacity and rating (15 V DC) have come on the market, and replacing them is no trouble.

As a check on motor efficiency, it is convenient to measure current consumption, which should not exceed 125 mA, loaded. But even if it does, do not chase off in haste to order a new one—these motors are intended to operate on very light loading, and pinch pressure, head felt pressure and left-hand spool braking should be checked. When the motor is completely unloaded, the current should not exceed 50 mA. If it does, try tapping lightly against the motor case as it is running, with the blade of a screwdriver, to free the bearing. But go easy on the lubrication—oil

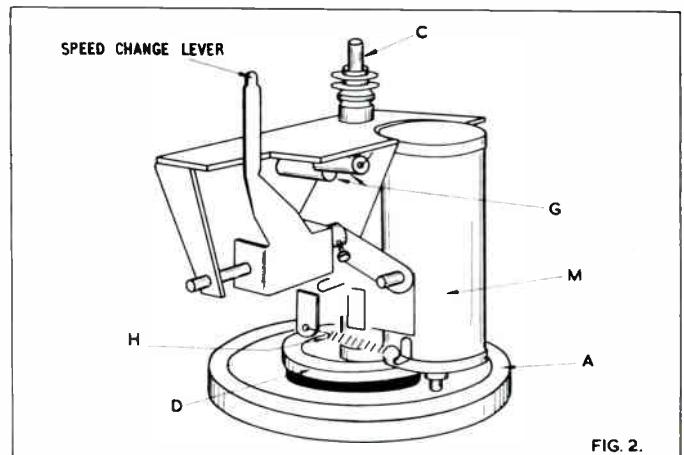

FIG. 2.

will run down to the pulley and onto the rubber of the flywheel.

Remember that the motor is sprung into position *H*, and has an "elbow" movement, so that it can become dislodged, especially if the machine has a bump! Check that the springs have not become unhooked, the lever bent and fouling the edge of its slot, or the stop-rail jammed.

The *Fast Wind* function is effected in the same way, by physical engagement of the motor *F*—also a 6 V unit, but with no regulator—with the appropriate spool carrier. Each of these has a large lower drum with a rubber rim, also used for braking. There is a rocker arm *R* with a cutaway engaging a spigot on the motor casing. This arm is directly impelled by the appropriate key, and a switch also energises the motor by the same action. There are two important springs to each arm of the rocker.

Beneath this rocker is another, larger lever *L* which operates the brakes, sliding toward the operator when "On", allowing the swivel brackets with their common spring *S* to turn to the limit determined by the locknotted screws. Adjustment is straightforward, but do not overlook the auxiliary brake beneath the deck, consisting of an angle bracket and felt pad which supplies friction to the left-hand spool carrier during forward winding and play/record. This is adjustable by screw and small clamp, and care must be taken that too much friction is not applied—check with full and empty spool and during fast wind in both directions before locking the clamp.

The head assembly is fairly simple. Two-screw azimuth alignment is provided, and the pressure pads are mounted on the main roller bracket



NEW FI-CORD 202

**PORTABLE
BATTERY/MAINS
RECORDER**

so much in so little space

The FI-CORD 202 offers all these features:

2 speeds— $7\frac{1}{2}$ and $3\frac{1}{2}$ • Standard 4" spools • Vu-meter • Fast forward wind • Fast rewind • Resettable counter • Manual and automatic volume control • Built-in loudspeaker • Extension speaker socket • Low and medium input sockets • Socket for remote control • Safety record switch • Easy-load battery cassettes • Battery warning lamp • Mains input.

FI-CORD 202 the new portable battery/mains high fidelity tape recorder, has been developed after years of exacting tests in the Fi-Cord laboratories. It is a worthy successor to the famed FI-CORD 1A, used internationally by broadcasting companies during recent years.

FI-CORD 202 is for the most exacting professional and equally for the enthusiastic amateur demanding the highest professional standards. It incorporates all the practical advantages of a full-size recorder in a small, light-weight machine.

FI-CORD 202 gives you high fidelity recording at your fingertips—whenever you wish, wherever you go.

AND the FI-CORD 202 weighs only $6\frac{1}{2}$ lb, measures $9" \times 6\frac{1}{2}" \times 4\frac{1}{2}"$.

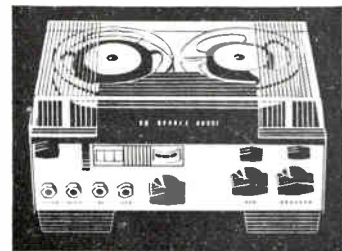

Price: 66 guineas, including long life mercury batteries and tape.

ACCESSORIES INCLUDE:

Carrying case, choice of microphones, power packs for mains and car.

Write for fully illustrated brochure and address of nearest stockist to:

FI-CORD INTERNATIONAL
40a Dover Street, London W1. HYDe Park 3448

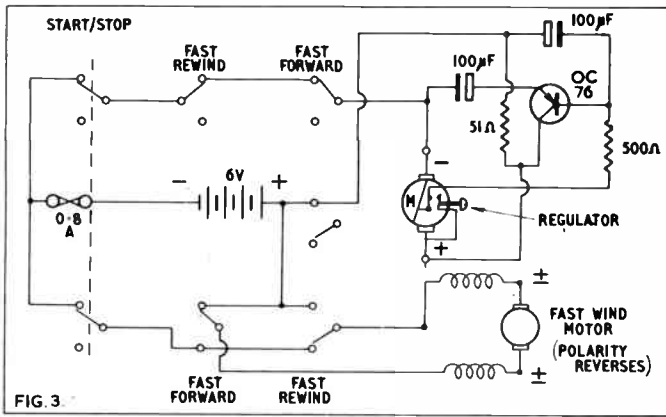

FIG. 3

P via a separate sprung lever. It is easiest to take this last item off to adjust head height, then set the screws of the mounting plate so that the tape is flush with the upper edge of the erase head. Allow no more than a 1 mm. overlap of head to tape. Then set the R/P head height individually, replace the pad arm and play through a test tape for maximum output, making final adjustments.

Electrical tests are rather difficult without recourse to a valve voltmeter. And life is made easier with a signal tracer, which need not be a complicated instrument—Mr. Bartlett Still could probably knock us up one between meals. For the benefit of those who have suitable facilities, here are some typical figures:

Oscillator check: measure 6 v a.c. across erase head, see that magic eye lights up, if not, check filaments, (0.8 1.1 V), and DC voltage at collectors of the two OC74 transistors. These should be equal, about 6 v, and a low reading may indicate a circuit fault, provided the playback is in order. If both record and playback are faulty and the magic eye does not light up, change the OC74s. These should be matched, but a 25 K variable resistor allows balancing, for correct oscillation during record, while another 25 K preset taps off the correct voltage to the centre-tap of the driver transformer secondary. An easy check of the amplifier is its overall current. At 6 V working, without input, during playback, there should be about 50 mA drawn. If this is in order, and the voltages of the two output transistors match, it will be necessary to check the transformer windings.

If our problem is distortion, there are one or two adjustments that can be made before taking an axe to the printed panel—“doing a Lizzie”, in the trade parlance. Check the biasing voltage, which should be between 12 and 15 volts a.c. (incidentally, the bias and erase frequency is as low as 30 Kc/s). There is a 10 K preset to regulate this bias level, taken from a tap on the oscillator transformer via a 0.022 mfd capacitor. If the erase circuit is in order but recording is distorted, and this voltage low, replace the last item. These parts are situated on the small printed panel. The large panel contains the 4-stage amplifier.

If signal tracing is to be carried out, it is most likely necessary on Record. For Playback tracing, simple noise reproduction—the old screw-driver approach—is sufficient until the source of loss is established—from then on it is a matter of distortion tracing. The head should deliver between 150 and 250 microvolts at 1 Kc/s from a test tape (fully modulated). To revert to Record, take the amplifier on the larger panel as a complete unit and apply 150-250 microvolts at 1 Kc/s to the OC603 base. Disconnect the erase oscillator to avoid spurious responses, and to enable tracing all the way through to the head: unsolder the two blue terminals on the erase coil. It should then be possible to read a full 3 V at the OC76 output.

Noisy reproduction is another bugbear—especially if a machine has been standing for a long while. I would emphasise that this is very rarely caused by transistors themselves. More often, it is a change in operating conditions beyond the limits stipulated by the manufacturers, or quite different component failure. If I seem vehement, it is because of the strong rubbish talked by many people about transistorised radios—when, quite often, the circuits which the transistor manufacturers designed so carefully have been pared by the receiver manufacturers to save costs or to speed production.

At the risk of a hollow laugh from some unfortunate owners, I would aver that this rarely happens with tape recorder design, so if there is

noise, there must be a reason, and *ipso facto*, the transistors are the last parts we need to check.

On this machine, there is the possibility of a dried-out coupling capacitor—these components are happier with regular use. Hum or motor-boating may be the result of one or more of the 100 mfd electrolytics failing—but this is an obvious fault, common to all stages, more noticeable as one traces along the chain. The sort of noise that sounds like atmospheric hash is more likely to be caused by a current carrying resistor. As might be expected, this kind of fault is more noticeable in early stages, for the thermal noise produced is amplified along the chain. The higher the ohmic value, the more pronounced the effect. In the machine we are discussing, there is one resistor, a 100,000 ohm from the decoupled negative line to the base of the OC603, which is prime suspect, and should be replaced with a high stability component. It is usually situated at the left upper side of the board, right beneath the OC603.

Before closing—a word of warning about component replacement. There is a temptation to be niggardly, to bend connecting wires and keep components for further use. Do not succumb: better to clip off the

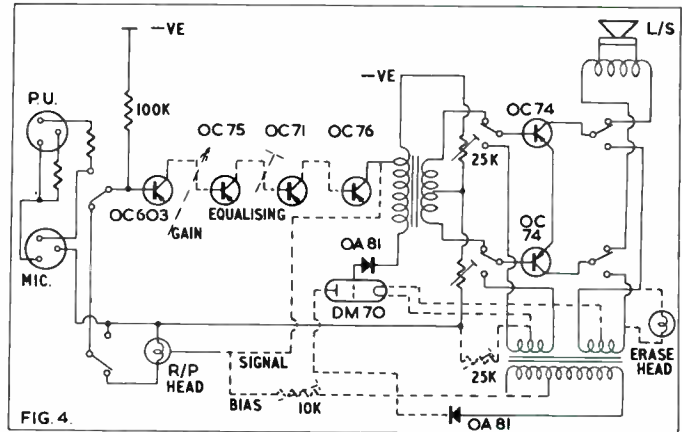

component and let the tail end of the connecting wire drop off with the minimum of applied heat, then to bend the wires of the new component exactly to length, avoiding too sharp an angle where a wire enters the body, clean the wires and the print, leaving insertion holes clear, fit the component to its flush position, solder with as brief an application of heat as is compatible with a good joint, finally cutting the excess tails from the print side.

Wasted words? I do not think so, for, like the advice to use a heat shunt, gripping the wire between iron and component with a pair of pliers, or even a crocodile clip, it is too often honoured in the breach. And if you change the resistor we have been talking about *without* providing a heat shunt for the transistor that shares its anchoring, you may well cure your noise trouble by getting no signal at all!

Index to Volume 4 of THE TAPE RECORDER
Available now - - - - Price 2s. 6d.



SUPER SOUND

American Hi-Fi Recording Tapes
(made by C.B.S.)

| New, Boxed & Guaranteed | | |
|-------------------------|----------|-----------|
| 5 ins. | 600 ft. | Std. 13/- |
| 5 ins. | 900 ft. | L.P. 17/6 |
| 5 ins. | 1200 ft. | D.P. 30/- |
| 5 1/2 ins. | 900 ft. | Std. 16/- |
| 5 1/2 ins. | 1200 ft. | L.P. 19/6 |
| 5 1/2 ins. | 1800 ft. | D.P. 35/- |
| 7 ins. | 1200 ft. | Std. 21/- |
| 7 ins. | 1800 ft. | L.P. 28/- |
| 7 ins. | 2400 ft. | D.P. 45/- |

With leader and Stop Foil

Suitable for ! & ! Track Recorders

CASH WITH ALL ORDERS : BY RETURN : ALL POST FREE : ALL CALLERS WELCOMED

K. & K. ELECTRONICS LTD.

DEPT. T.R., 25/39 ROMAN ROAD, LONDON, E.2 Tel.: ADVance 1936



SPECIAL

1/2 PRICE OFFER

ONLY 3 GNS.

NEW GRUNDIG GCM 3 CONDENSER MICROPHONES

Suitable for all makes of TAPE RECORDERS and AMPLIFIERS

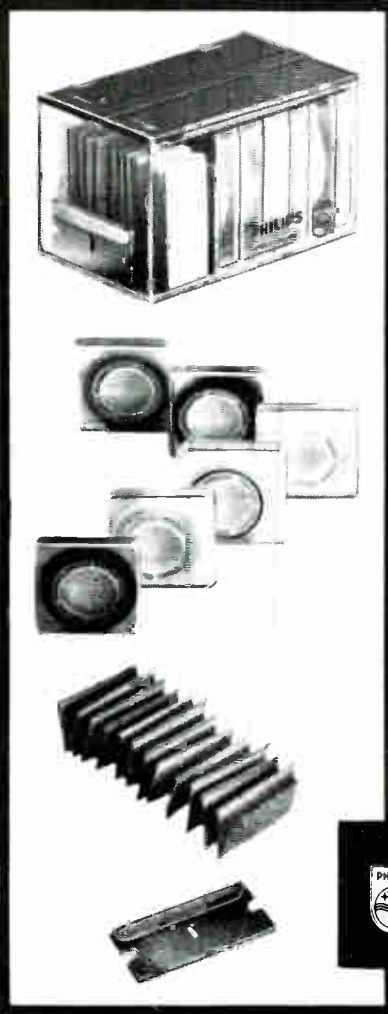
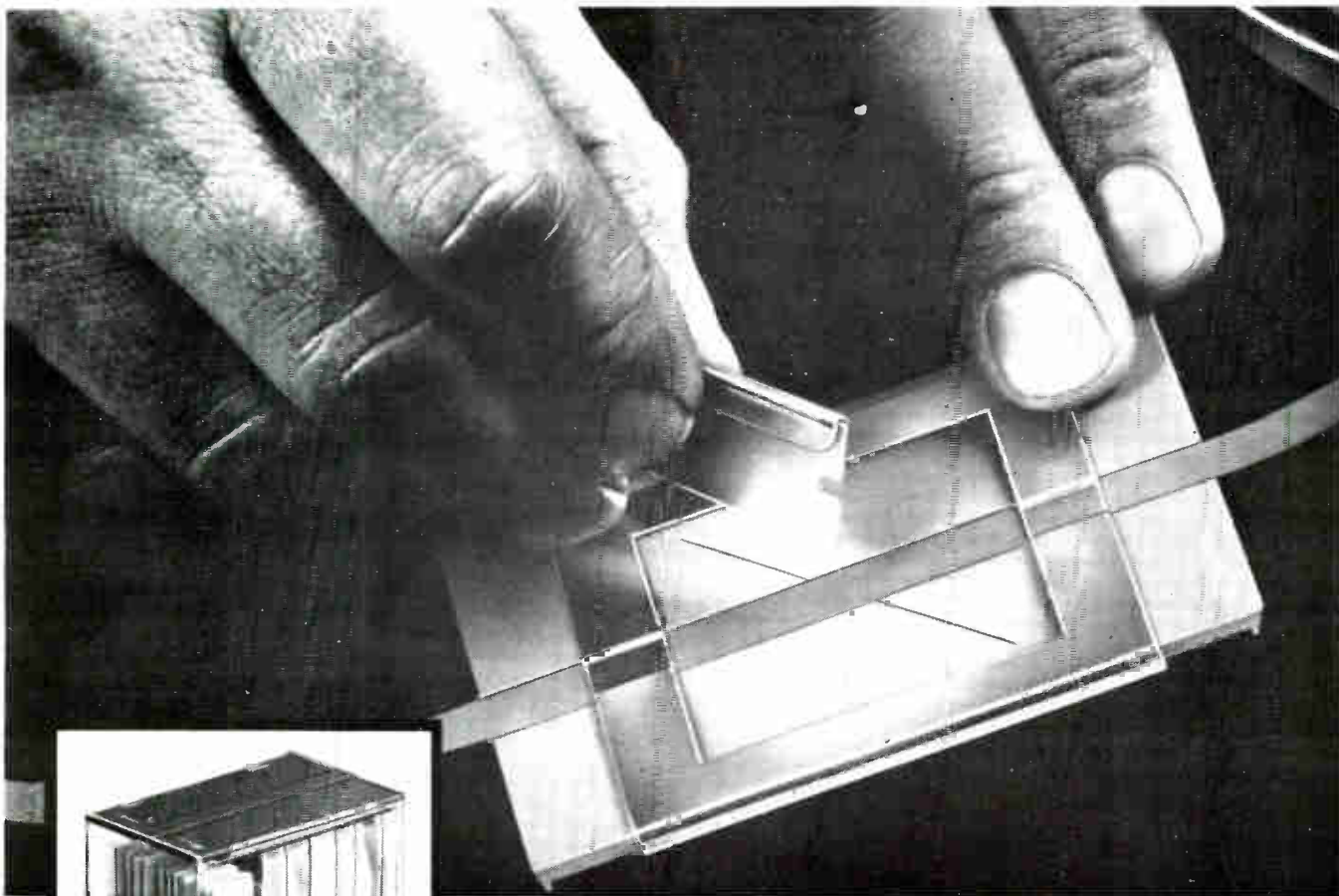

HERE'S THE COMPLETE TAPE SPLICING KIT!

An ingeniously designed splicing jig that doubles as the box lid—plentiful supplies of leader and adhesive tape: these are only a few of the contents of the new Philips tape splicing kit. It gives you everything you need for perfect tape splicing and editing. In its compact box of sturdy transparent plastic, it's indispensable to every tape recording enthusiast. See your Philips dealer about it today!

CONTENTS OF THE PHILIPS TAPE SPLICING KIT

Separate 32 ft. (approx.) spools of white, green, red and blue leader tape for indicating tracks and making notes. One 16 ft. spool of switching foil for automatic stopping at end of tape. 32 ft. spool of white adhesive tape for splicing and connection of switching foil, magnetic tape, and leader tape. 25 adhesive labels for making notes on recordings—to be stuck on reel flanges. One tape cutter.

AND IT COSTS ONLY 23/-



PHILIPS

THE FRIEND OF THE FAMILY

PHILIPS ELECTRICAL LTD · ELECTRO-ACOUSTICS DIVISION
CENTURY HOUSE · SHAFTESBURY AVENUE · LONDON W.C.2.

(PTR4207)

TAPE EDITING EQUIPMENT

★Elementary tape editing is a job that anyone can do with a little patience and inexpensive equipment. It consists of cutting out unwanted lengths of tape – from maybe $\frac{1}{4}$ inch to several feet – and joining the ends together. The professional uses the very simple items shown below: the amateur can buy splicers that do most of the tricky work for him. In the following four pages we give pictures and details of a wide range of available equipment. Tape editing opens up a new field for every tape recorder user. For those who want to know more about it, we recommend the booklet "How to Splice Tape", published by this house. For details see page 252.

THE owner of a tape recorder who does not edit his own tapes is not taking advantage of a most fascinating hobby which can be enjoyed at little cost and which can be the means of effecting economies in expenditure on tape. A tape splicer is an invaluable tool for anyone who undertakes recording.

It is hardly necessary to mention that one advantage of recording tape over cinematograph film is that the unwanted portions of tape can be jointed together and used again. The other equipment therefore required is either a clean basket or box in which the excised pieces of tape can be dropped and then jointed together later. As the signal to noise ratio varies with different brands of tape, it is as well to keep the different types in separate boxes.

Those unwanted words

There are numerous broadcast programmes which the tape recording enthusiast will wish to record, many of them will be musical programmes incorporating spoken commentaries or introductory remarks about the items being played. Whilst one may wish to hear the music many times the spoken words become monotonous, and use of a tape splicer could remove them without difficulty. The recording enthusiast who undertakes the job conscientiously will gain a sense of achievement when he has completed his work. An excellent example of the kind of programme I have in mind is the many broadcasts of musical shows either covering a certain period or associated with a specific theatre.

Other owners of tape recorders whose musical tastes are for popular records may wish to build up a tape of popular songs and dance music, and by cutting out the introductory announcements tapes can be made which are eminently suitable for dancing or listening. In fact until one possesses a tape splicer one cannot appreciate how useful this device can be in producing tapes to form a permanent or semi-

permanent library. Recording tapes that have been properly jointed will last indefinitely and give as good service as tapes that have not been jointed. At the many national radio shows loops of tapes in which 20 joints have been made have run continuously through a recorder for the duration of the exhibition, which has been equivalent to more than 100 hours' playing time. This far exceeds the time any owner of a tape is likely to play one section of it.

Use one track only

It is, of course, impossible to edit tapes which contain more than one track of recording, the economical user will therefore, edit one track and then use the other track or tracks on the tape for recording continuous programmes of music which he knows will not require editing.

It is of course, possible to make "trick" tapes with the assistance of a tape splicer. Recordings from the radio, those made on location and in the home from a microphone can be edited and jointed to produce most amusing finished recordings. If the tape recording enthusiast is using his machine for recording performances of local operatic societies judicious editing of tapes can remove extraneous sounds and even replace faulty notes by ones played or sung on a different part of the recording or at another performance. It may not be generally realised that the high standard achieved by commercial gramophone records would be very difficult to obtain without being able to splice tapes. Some of the master tapes from which the disc records are made contain hundreds of splices.

Real tape splicing enthusiasts who wish to prove how accurately and efficiently they can undertake their art can amuse themselves by recording a friend giving a speech and then cutting the length of the speech by at least 20 per cent, whilst still retaining all the words.

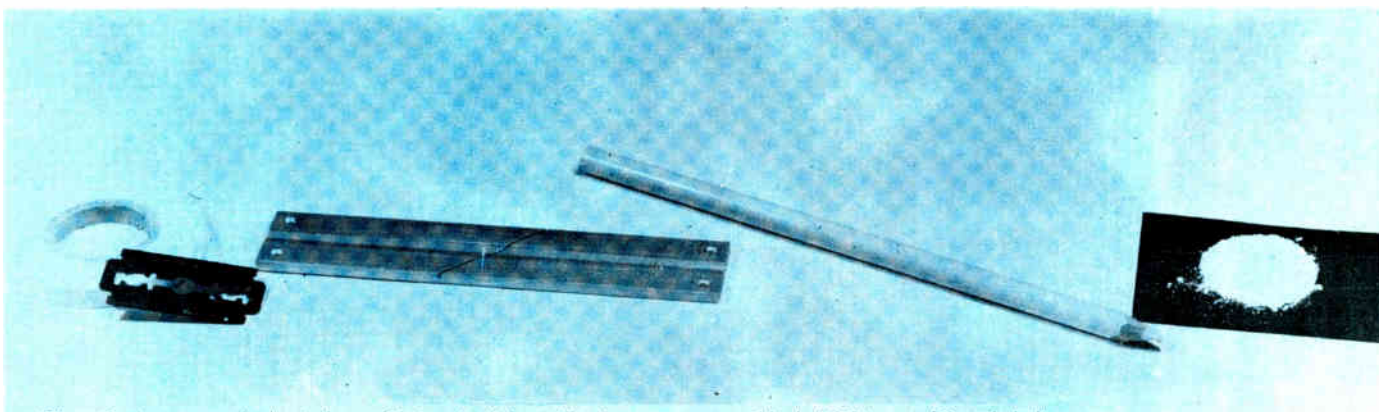

● These five items are the basis for professional editing. Jointing tape, cutter, block, "Chinagraph" and chalk

THE PROFESSIONAL FINISH
Starts With
LOW BACKGROUND NOISE

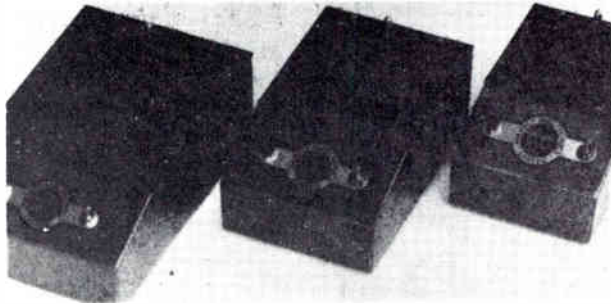

Harvey Electronics Bulk Erasers under test by an independent recording studio show an appreciable reduction in background noise. These units are available to amateur recorders as well as professionals and a complete range is available.

Model 102/103 200-250v/100-115v 3"-8½" reels £8-15-0

Model 104/105 200-250v/100-115v 3"-12" reels £14-5-0

(Special models available for ½" and 1" tape)

Write or phone for leaflet No. 109

HARVEY ELECTRONICS LTD.

Farnborough Road, Farnborough, Hants. Tel. 1120

Trade inquiries invited

**BUY A
Bib**

**THE PROFESSIONAL
TAPE SPLICER**

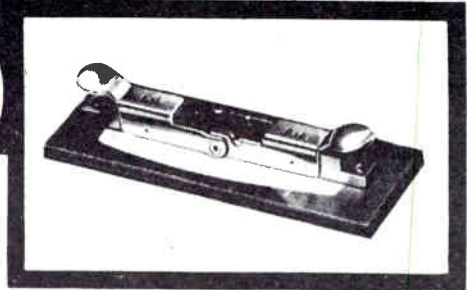

—The most reliable and easy to use.

All metal—beautifully plated—compact in size—mounted on flock covered base. Easily and permanently attached to your tape recorder. Ferrograph, Vortexion, Reflectograph and Wearite decks already have fixing holes for the Bib splicer.

Complete with
razor cutter
only 18/6

Clamps hold the magnetic or leader tapes in the precision cut channel—no danger of damaging the edges—most important with 4 track recordings. Right angle and oblique cutting slots are provided to facilitate editing to a syllable.

The Bib tape splicer saves tape and makes editing a fascinating hobby.

More Bib splicers have been sold in recent years than any other make. It is incorporated in the "Scotch" Tape Accessory Kit and is used by recording studios and broadcasting organisations.

MULTICORE SOLDERS LTD.

MULTICORE WORKS, HEMEL HEMPSTEAD, HERTFORDSHIRE

CHMS 13

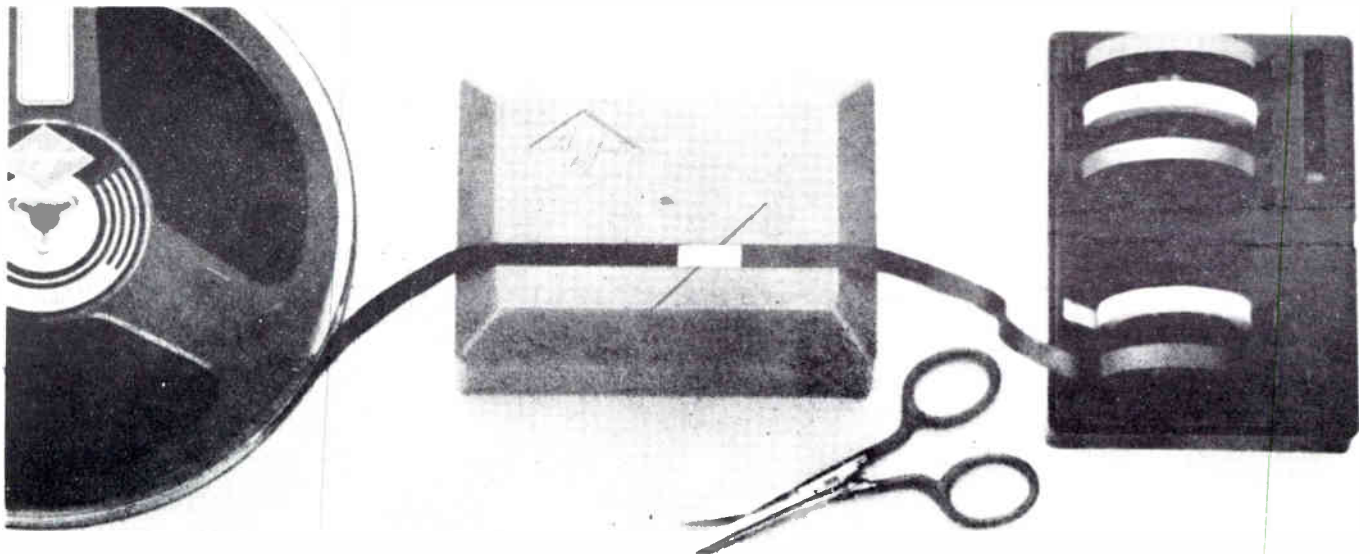

ALL YOU NEED FOR TAPE EDITING

AGFA ACCESSORY KIT

Leader tapes in red, green and white for easy identification of recordings
Silver stop foil
Splicing tape, non-magnetic scissors, spool clips
All neatly housed in a plastic box (3¼" x 4¼") with built-in splicing guide on cover



AVAILABLE NOW

34/6 Complete

27 REGENT STREET LONDON SW1 · REGENT 8681/4

CUTTING & SPLICING TOOLS

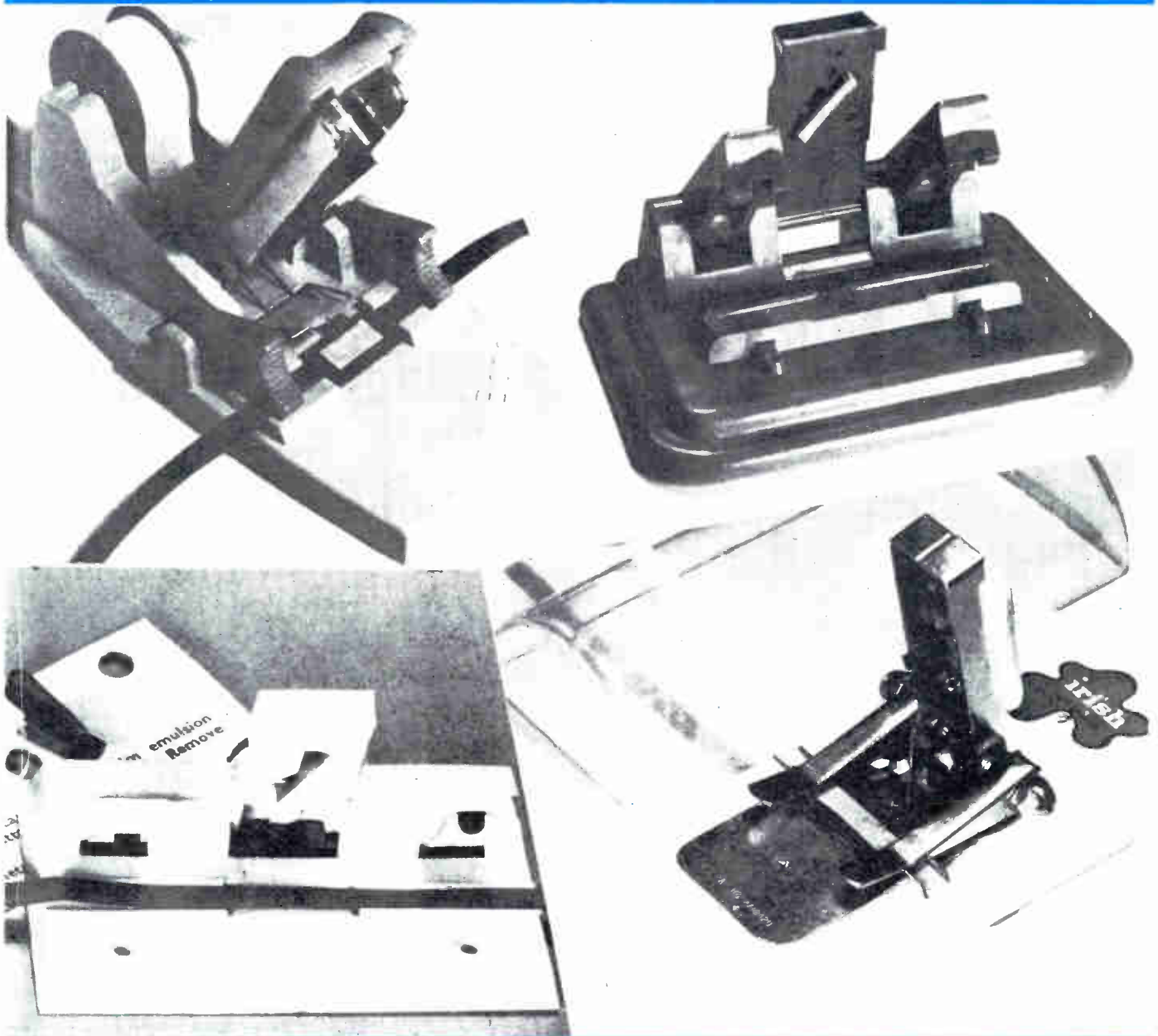

On this and the following three pages we illustrate and give brief details of some twenty useful products for tape editing. On this page are four currently popular models of tape splicers. Top left is the "Bond", a self-contained automatic tool, with tape retaining clamps and cutting blades for a 45-degree cut, and for trimming the edges after the jointing tape has been applied. Price 29/6. **Cine Accessories (Brighton) Ltd., 15 Bond Street, Brighton, Sussex, England.** Top right, the "Sound" splicer, CM6, with replaceable blade and tape guide. Price 32/6.

Tape Recorders (Electronic) Ltd., 784/788 High Road, Tottenham, London N.17. Bottom left, the "Metro" splicer for tape or 8-mm film has spring-loaded clamps and a non-magnetic cutter adjustable for any angle. Price 15/-. **Metro-Sound Manufacturing Co. Ltd., 19a Buckingham Road, London N.1.** Bottom right, the "Irish" splicer SP3, with spring-loaded tape clamps, stainless steel blade for a 45-degree cut and further blades which trim the tape after splicing. Replaceable pads and blades. Price 67/3. **A. C. Farnell, Ltd., Vicar Lane, Leeds 2, England.**

TAPE EDITING EQUIPMENT



There are six tape editing kits on the English market. Above, top left is the "Scotch" Accessory Kit which incorporates the famous "Bib" patent splicer, a reel of $\frac{1}{2}$ -inch splicing tape, reels of marked timing tape and white leader, 10 fastening clips and a cutting blade. Price 29/6. **Minnesota Mining and Manufacturing Co., 3M House, Wigmore Street, London W.1.** Right, the *Emitape Accessory Kit*, comprising reels of stop foil, splicing tape and green, red and white leader tapes, two cutting blades and Emitape jointing block with two cutting slots for 90- or 45-degree cuts. The whole

is contained in a plastic rack with spaces for two extra spool holders. Price 37/6. **E.M.I. Tape Ltd., Blyth Road, Hayes, Middlesex, England.** Bottom left, *Emitape non-magnetic scissors*, Price 16/-. Bottom right, the *Philips E.L. 1901/50 Splicing Kit*, in its transparent plastic container. The lid embodies a splicing jig with clamp and channel for 45-degree cuts. Four reels of leader, one of stop foil, one of splicing tape, a cutting blade and indexing labels are included. Price 23/-. **Philips Electrical Ltd., Century House, Shaftesbury Avenue, London W.C.2.**

CUTTING & SPLICING TOOLS



Above, top right, the *Agfa tape Accessory Kit* in plastic case containing red, green and white leader, splicing tape, stop foil, non-magnetic scissors and tape clips. Moulded into the case top is a splicing template with 45-degree slot. Price 34/6. **Agfa Ltd., 27 Regent Street, London S.W.1.** Top right, the *BASF "Cutter Box"*, incorporating a splicer, spare cutting knife, four tape clips, three spools of leader tapes, stop foils and tape indexing labels. Price 52/6. **BASF Chemicals Ltd., 5a Gillespie Road, London N.5.** Bottom centre, the "daddy" of all splicers, the "*Bib*" with 90- and 45-degree

slots (Price 18/6) and, to its left, the "*Bib*" *Accessory Kit*, which includes a "*Bib*" splicer, tape reel labels, splicing tape, four blades, and a data card of playing time for all speeds. Price 28/6. **Multicore Solders Ltd, Hemel Hempstead, Hertfordshire, England.** Bottom right, two types of *Emitape Jointing Compound*, AP35 for acetate base and AP77 for PVC base tapes. These are for making permanent moulded joints without the use of splicing tape. Price 7/6 per bottle. Address ----- **E.M.I. Tape Ltd., Blyth Road, Hayes, Middlesex, England.**

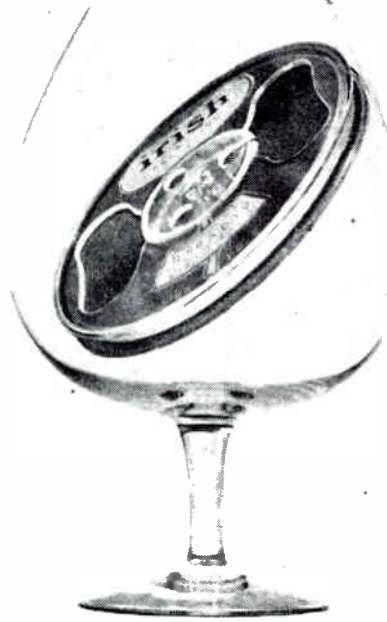

for the connoisseur

IRISH

You prefer Brittany to Brighton. Hock to highball. Van Gogh to Velasquez. You're choosy as well as selective. Irish is your tape. Irish professional tape has connoisseur advantages precision-engineered into its mirror-smooth surface. The unique Ferrosheen process, by which this microscopically fine surface is obtained, provides exceptional high frequency response due to intimacy of contact between tape and heads . . . head wear is at minimum . . . makes for freedom from head contamination by oxide build-up, considerable reduction in background noise, minimum drop-out. Only Irish tapes have free 'signature binding' kit for authentic library-style filing—simulated Moroccan leather with 23-carat gold foil for simple 'tooling' of title. People like Tandberg recommend Irish. And every Irish tape carries a 100% unconditional guarantee. Your Irish Tape stockist, and other details including technical data, from: A. C. Farnell Ltd., Hereford House, Vicar Lane, Leeds 2. Tel: Leeds 35111.

'IRISH', 'FERROSHEEN' and 'Signature Binding' are registered trade marks of Orradio Industries Inc., Opelika, Alabama.

Don't let

hiss-s-s-s spoil your recordings

The recording head of any Tape Recorder tends to become magnetised in use. Small at first but gradually building up, this residual magnetism can seriously affect the quality of your recordings by progressively increasing the hiss level. It can also impart a noisy background—which can never be removed—to any pre-recorded Tape *at the first time of playing.*

Fortunately, residual magnetism can be instantly removed with the Ferrograph De-fluxer. Get one to-day and, if you use it from time to time, you'll always enjoy tape recordings with a background as silent as the night.



50/-

Get a Ferrograph *DE-FLUXER*

Sold by all Hi-Fi Dealers and made by

THE FERROGRAPH COMPANY LTD.

84, Blackfriars Road, London, S.E.1.

Telephone: WATerloo 1981

METRO SPLICER

For both recording tape and 8 mm cine film.

- Splicing kit..... 15/-
- Spare cutting units..... 2/6
- Spare film emulsion scraper..... 1/-

Only splicer in the world that can be suitable for tape and 8 mm film.

METRO STOP

A revolutionary step forward in tape control.

- Makes splicing and jointing with stop foil unnecessary.
- Reduces tape headwear.
- Each METRO-STOP set includes Rod Applicator and Removing Fluid.

Manufactured by the Metro-Sound Group

METRO SOUND

**Metro-Sound MFG, Co. Ltd.,
19a Buckingham Rd., London N.1.**

Telephone: CLIssold 8506/7

TAPE EDITING EQUIPMENT



Bulk erasure and "spot" erasing of tapes are part of editing. Top left, the *Harvey bulk eraser*. Different models handle spools from 3¼ to 12 inches. Prices from £6 5s. to £15 10s. **Harvey Electronics Ltd., 273 Farnborough Road, Farnborough, Hampshire, England.** Top right, a small splicer in two simple parts, the "*Gibson Girl*". Price 18s. 3d. **A. C. Farnell Ltd.** (address on page 239). Centre left, the *Wearite Defluxer*, primarily for demagnetising tape heads, also useful for "spot" erasing. Price 50s. **Wright and Weaire Ltd., 84 Blackfriars Road, London S.E.1.** Centre, *Indicord*,

a fluid which makes recordings visible for editing. Supplier not known. Send postcard for details. A similar tool (not shown) is the *Cinesmith Depolariser*. Price 45s. **Cinesmith Products Ltd., Britanic Works, Regent Street, Barnsley, Yorkshire, England.** Bottom right, a small bulk eraser, the "*Instant*", handles spools from 3¼- to 7-inch diameter. Price 35s. **Osmabet Ltd., 46 Kenilworth Road, Edgware, Middlesex, England.** Bottom right, the *Romagna* editing block, with 45- and 90-degree cutting slots. Price 7s. 6d. **Romagna Reproducers Ltd., Bycullah Avenue, Enfield, Middlesex,**

Two Years Guarantee

NOT MASS PRODUCED BUT VIRTUALLY HAND-MADE FOR RELIABILITY AND CONSISTENTLY HIGH STANDARD OF PERFORMANCE

R10 SPECIFICATION: 2 or 4 track version. 10 watts push/pull output.

Record Replay Responses—

| | |
|--------------------------|--|
| 7½ ips. 40-16,000 C.P.S. | } ±3 dBs. At optimum bias setting. |
| 3 ips. 40-10,000 C.P.S. | |
| 1½ ips. 50-6,000 C.P.S. | |

Signal/Noise ratio—

half track 50 dBs at 2¾ ips.
quarter track 45 dBs at 3¾ ips.

Modified Collaro Studio Deck. Microphone and Radio/Gram inputs each with separate gain controls for mixing. Separate bass and treble controls. ±12 dBs at 50 cycles and 12 k/cs. Adjustable monitor volume control independent of record level. Peak signal level meter 2¼ in. square. Bogen heads. Record safety device. 600 ohms Cathode follower output. Two per cent total harmonic distortion on peaks. 200/250 volts 50 cycles or 100/120 volts 60 cycles. Valve line up: 3 EF86, 2 ECC83, 1 ECC82, 2 ECL86. Metal rectifier, contact cooled.

Prices: 2 Track 7" spools 59 gns.
4 Track 7" spools 69 gns.



Fully illustrated literature available on request to—
REPS (TAPE RECORDERS) LTD.

118 Park Road North, South Acton,
London, W3 Phone: Acorn 4141

FRANCIS OF STREATHAM

LEADING STOCKISTS OF EQUIPMENT FOR TAPE and HI-FI

... and NO EXTRA FOR CREDIT TERMS

- ★ Minimum Deposit
- ★ No Interest or Service Charges on H.P. up to 18 months
- ★ Free Service during Guarantee Period

Akai M6 j & j Tr. St. 130 gns.
*Brenell Stereo STB. 1 £120
*Brenell Mk. V Model M 88 gns.
*Brenell Mk. V Series 2 69 gns.
Cossor 1604 2 sp. 39 gns.
Cossor 1605 4 Tr. 4 sp. 62 gns.
Cossor 1603 4 Tr. 28 gns.
Elizabethan Popular 22 gns.
Elizabethan LZ 32 gns.
Elizabethan LZ29 36 gns.
Ferguson 3200 26 gns.
Ferguson 3202 2 sp. 4 Tr. 33 gns.
*Ferrograph Series 5 85 gns.
*Ferrograph 422 or 424 110 gns.
Fidelity Minor 22 gns.
Grundig TK14 35 gns.
Grundig TK18 "Magic Eye" 39 gns.
Grundig TK23 4 Tr. 45 gns.
Grundig TK40 4 Tr. 75 gns.
Grundig TK41 2 Tr. 75 gns.
*Grundig TK 46 99 gns.
Loewe Opta 403 45 gns.
Philips 4 Tr. 3541 36 gns.
Philips 4 Tr. 3549 62 gns.
Philips Starmaker 4 Tr. 27 gns.
Philips 3535 4 Tr. Ste. 92 gns.
*Reflectograph "A" j Tr. 105 gns.
Robuk 36 gns.
*Simon SP5 93 gns.
Sony Stereo 462 4 Tr. 75 gns.
Sony 521 Stereo 124 gns.
Stella 4 Tr. 459 62 gns.
Stella 456 28 gns.
*Tandberg Series 6 110 gns.
Tandberg Series 7 93 gns.
*Telefunken 85 De Luxe 83 gns.

*Telefunken 95 59 gns.
*Telefunken 96 4 Tr. 69 gns.
*Telefunken 97 4 Tr. Ste. 95 gns.
*Telefunken 98 j Tr. Ste. 95 gns.
Truvox 60 2 or 4 Tr. 39 gns.
Truvox Series 80 2 Tr. 55 gns.
Truvox Series 80 4 Tr. 59 gns.
*Vortexion WVA £93.13.0
*Vortexion WVB £110.3.0
*Vortexion C Stereo £148.10.0
*Vortexion CBL Stereo £160
Wyndors Trident 33 gns.

BATTERY PORTABLES

Uher 4000 93 gns.
Cossor 1620 25 gns.
Philips Portable 24 gns.
Loewe Opta 414 47 gns.
(Mains Battery Car)
*Butoba 66 gns.
Clarion Phonotrix 39 gns.
*Fi-Cord 202 66 gns.
Stella 25 gns.
Stuzzi Memo-Cord 25 gns.
*Microphone extra

Mains Power Pack for Philips, Stella or Cossor Grundig Mains Power Pack £5.0.0 8 gns.

TRUVOX DECKS WITH PRE-AMPS

PD 82—Standard Twin Tr. £42.0.0
PD 85—Professional 4 Tr. £52.10.0
PD 86—Professional 4 Tr. Stereo £63.0.0

Tape Decks by Brenell, Wright & Wearie.
Tape to disc and copy service.

● MICROPHONES, MIXERS ETC.

AKG D. 19c Mic. £17.10.0
AKG D 88 Stereo £19.19.0
Grampian Reflector £6.0.0
Lustraphone VR 64 Ribbon £7.17.6
Lustraphone LFV 59 £8.18.6
Grampian Ribbon £11.0.0
Grampian DP 4 Dynamic £8.0.0
Simon 'Cadenza' Ribbon £10.10.0
Reslo Cardioid £10.2.0
Reslo Ribbon £10.2.0
Reslo Dynamic Cardioid £10.15.6
TSL 3 Channel Mixer £2.7.6
Grundig Mixer Stereo 18 gns.
AKG K 50 Headphones £7.10.0
Telefunken D.11 B 8 gns.

Also in stock microphones by ACOS, FILM INDUSTRIES, TELEFUNKEN, etc.

- ALL WALGAIN PRODUCTS
- Splicers, Matching Transformers, Plugs and Sockets, Reels, etc.
- Stands of all types and accessories.
- TAPES by all leading makers in all grades and sizes as advertised.
- Pre-recorded by Columbia, H.M.V. Saga, Music-on-Tape.
- Defluxers by Wearite, Walgain.

Prices subject to alteration as announced by manufacturers.

HI-FI

● STEREO AND MONO AMPLIFIERS
Quad H.M.V. Rogers Pye
Leak Aveley Armstrong
Tripletone Scott B & O
Chapman Eagle
● TUNERS
Quad Rogers Pye Leak
Aveley B & O H.M.V.
Armstrong Chapman
Tripletone
● LOUDSPEAKERS by
Quad Pye Rogers
W.B. Wharfedale
Goodmans Tannoy Kef
Mordaunt Leak Lowther
Lockwood Colrad
● MOTORS, PICKUPS
Garrard Tannoy EMI
Goldring Lenco Shure
Connoisseur Decca Stereo
Decca Deram Philips Ronette
BSR B & O Pickering
Eagle Ortofon SME Mk. II
Acos Thorens ADC
All types of Diamond and Sapphire stylis, stereo and mono. Microflits, Garrard, Goldring and Acos Pressure Gouges Acos Dust Bug Disc Greener
CABINETS by Record Housing and GKD

169-173 STREATHAM HIGH ROAD, LONDON, S.W.16

Between St. Leonard's Church and Streatham Station

STReatham 0466/0192

PLEASE NOTE THIS IS OUR ONLY ADDRESS. OPEN ALL DAY SATURDAY

SOUND AND CINE

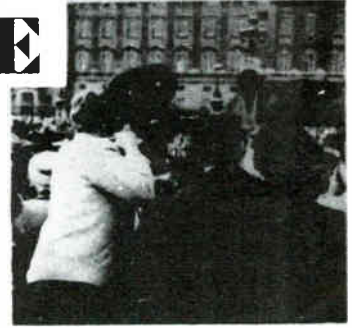
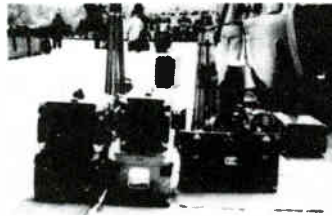

A camera assistant receiving instructions over his Sony transceiver — Camera cases and spare lens cases provide the foreground as the *Old Guard* march by — The Arriflex mounted on the steps of the Queen Victoria Memorial — German Television does a "What's On In London"

Even cameramen and other technicians from the Bavarian Studios in Munich have a most enviable assignment. They are travelling Europe, spending three weeks in each Capital, making an hour-length film of a day in each great city. The story revolves around one central character (played by a well-known German Television actor) showing how he spends a day, from dawn to midnight, in each particular city.

The London sequence begins with him leaving Calais by boat and shows his journey, condensed of course, and his arrival in town. He goes to his hotel and then leaves to ride on a London bus to see some well-known spots. He stops off to see the changing of the Guard at Buckingham Palace. From there he sets off to Putney to visit a school where a choir is performing. The rest of the day includes visits to the Tommy Steele show for a performance, the Lyceum Ballroom to see some dancing championships and to the *Pigalle* and *Gargoyle* clubs in Piccadilly and Soho for some light, late evening entertainment.

The Changing of the Guard

Although the film lasts for only one hour on the television screen the crew were hard pressed to get everything in during the three weeks of their stay here and the changing of the Guard had to be fitted in on a Saturday morning. Fine weather brought people early and in large numbers. The three 35 mm Arriflex cameras and their crews had to be in position for more than an hour before the start of the ceremony and, as the crowd density and heavy traffic prevented the use of long leads, the Nagra recording equipment had to be set up close to the main camera position. The first Arriflex was mounted high on the steps of the Queen Victoria Memorial facing the main gate of the Palace to deal with the approach of the soldiers, panning with them as they marched round to the right-hand gate and to film them again as they marched away through the main gate at the end of the changing over.

The second Arriflex was set up on the pavement, left of the main gate and the third, occupying the main camera position together with the Nagra in synchronisation, was between the main and right-hand gates. As both these cameras had to shoot through the railings into the Palace forecourt and also to be able to pan away to provide cutaways for camera number one their positions had to be carefully chosen. No fewer than two were in use at any one time and the material covered gave plenty of scope to the Editor back in Munich.

Radio links for camera operators

The German Director was with the third camera but he was able to communicate with the other crews by use of a *Sony Transceiver*. There were six of these instruments in use. The German continuity girl was stationed on the steps but she was quite able to follow all camera directions over her Sony and to note down exactly which camera covered which shots. The Sony, by the way, is just a little larger than a pocket transistor radio, it is extremely economical on batteries and it has a range of about two miles.

Location Film Services

The Sonys, and indeed all equipment and production facilities for the German Television teams on the film series, are supplied by Location Film Services Limited of Goldhawk Studios, London, W.12 who are, themselves a very well known film production company in their own

right. The list of feature films for which they have full credit is impressive and includes such spectaculars as *Solomon and Sheba*, *Exodus* and *The King of Kings* and top box office home products such as *Taste of Honey* and *The Loneliness of a Long Distance Runner*.

The range of equipment carried by the company is most extensive. The Sound Department, headed by John Hales, can supply no fewer than eleven different types of recording unit, seven different types of microphone and four completely different types of radio transmitter-receiver. The afternoon that I was at the studios I was told that seven complete recording units were out on location at that very moment, working for Television and Documentary companies, and that this was in addition to equipment in use for their own films in Ireland (*Once Upon A Summer*), Malaya (*The Third Road*, starring William Holden) and Africa (*The Zulu*).

The Nagra.

The newest additions to the Sound side are three Nagra HiP recorders and John Hales is so pleased with their performance that he is inclined to use them in front of the *Perfectone*. Like the *Perfectone*, the Nagra HiP is a Swiss machine designed for recording in synchronisation with a film camera. It is transistorised and completely portable, weighing only 15 lb. It has a frequency response of 15,000 c/s \pm 1 dB at 15 i/s; 30-12,000 c/s \pm 1.5 dB at 7½ i/s; and 50-7,000 c/s \pm 3 dB at 3¼ i/s. It runs on 12 x 1.5 volt torch batteries for a life of about 20 hours. On alkaline accumulators it has a life of about 70 hours.

It differs from the normal Nagra recorder (a high quality professional portable) by virtue of its *Neopilot* head and some additional electronic circuits. The *Neopilot* head is in addition to the audio heads on the tape recorder but it is positioned to face the tape in such a way that the recording of a pilot signal from the power frequency that it makes will not interfere with the programme material. When the camera is driven by a synchronous motor supplied by the mains, or by a very stable converter, the pilot signal (1 volt at low impedance, less than 10 ohms) is taken

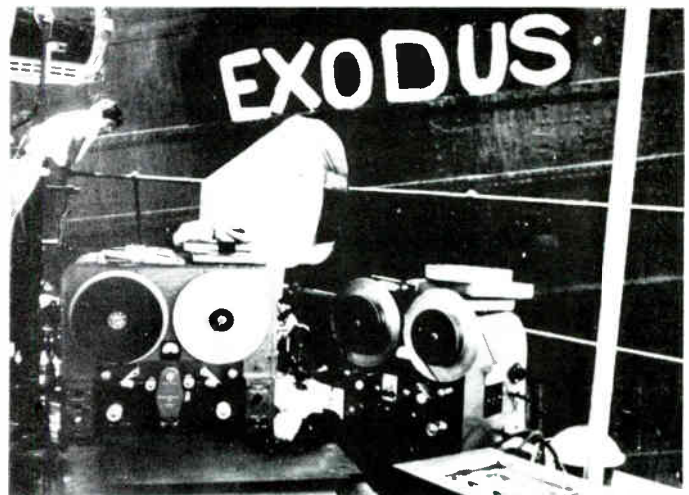

Westrex 1135 recorders on location for the film *Exodus*

● **A NEW MACHINE?
IT'S EASY . . .**
GET IT NOW FROM THE
**PART EXCHANGE
SPECIALISTS**

Call, phone
or write for
immediate
offer on your
machine.

Every enthusiast wants to improve his equipment. The fast and friendly R.E.W. Mail Order Service smooths the way . . . makes it easy for you to enjoy the professional results only possible with an advanced Tape Recorder. Get in touch with us now. We have thousands of satisfied customers and a reputation for generous part exchange, reliability and specialist service.

MACHINE OF THE MONTH

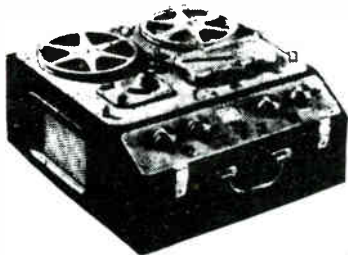

FERROGRAPH 5 A/N 85 GNS

The magnificent Ferrograph 5 A/N, complete with its own superior quality elliptical speaker. Speeds $3\frac{1}{2}$ and $7\frac{1}{2}$ i.p.s. Separate tone controls for bass and treble cuts. Frequency response ($7\frac{1}{2}$ i.p.s.) 40-15,000 c.p.s. . 3 db.

This superb machine can be yours NOW for only £9 5 0 deposit (and 12 monthly payments of £6 13 4, or 18 of £4 13 4, or 24 of £3 13 6)

Bargain Basement!

We have an unrivalled stock of leading makes of new and used machines at unbeatable bargain prices—30%—60% reductions on original prices! Make a point of asking for our Special Bargain List.

**300
MACHINES
ON DISPLAY!**

Call, see, hear and choose the Tape Recorder you've always wanted from one of the biggest ranges anywhere. Just about every model for off-the-shelf delivery — including Ferrograph 5AN 85 gns, Brenell Mk. 5/2 69 gns, Brenell Mk. V "M" 88 gns, Revox Stereo 110 gns, Reflectograph Type "A" 105 gns, and hundreds of others.

You're guaranteed maximum satisfaction with the R.E.W.

**"PLUS FIVE"
SERVICE**

- Generous part exchange allowances.
- No interest terms—lowest deposits.
- Off-the-Shelf delivery from the biggest range under one roof.
- Free servicing and free delivery.
- Optional personal insurance.

**NO INTEREST
TERMS!**

Take your pick from our wide range and have any machine you want for 10% deposit, balance twelve months and no interest charged. (18-24 months H.P. terms also available).

Home demonstrations in the London area gladly arranged. By return enquiry service. Agents for all makes.



R·E·W
(Earlsfield) Ltd.
Mail Order Department
266 Upper Tooting Road,
London, S.W.17.
Telephone: BALham 7710

People in Search of Perfection Choose

FILM INDUSTRIES

Type M8

RIBBON MICROPHONE

A high quality microphone with good output. Size only $1\frac{1}{2} \times 3\frac{1}{2}$, with inbuilt transformer.

Mounted by three-pin plug and socket on flexible fitting with internal leads. The ribbon, although extremely thin, is secure against reasonable acoustic shock.

Usual output impedance 30Ω. Other impedances available up to 57K ohms. Three Alcomax III magnets. Treble stainless steel protecting gauzes.



M8A microphone, similar to the M8 but no plug and socket connection between the microphone head and flexible tubing, this being one integral unit. The M8A is supplied complete with desk stand.

Write for full details

FILM INDUSTRIES LTD.

90 BELSIZE LANE, LONDON, N.W.3 HAM 9632 3

**YOUR
RECORD
& EQUIPMENT
SHOP**

**CHELSEA
RECORD
CENTRE**

203
KINGS
ROAD
CHELSEA
SW 3
FLAXMAN 2596

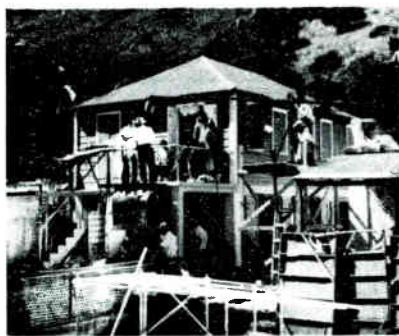

Production on the feature film *Virgin Island*

The NAGRA sound-transfer system

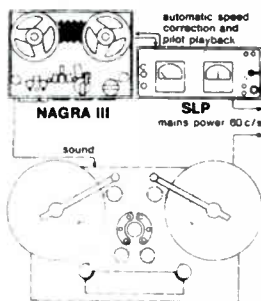

Layout showing the SLP connected to the Nagra III

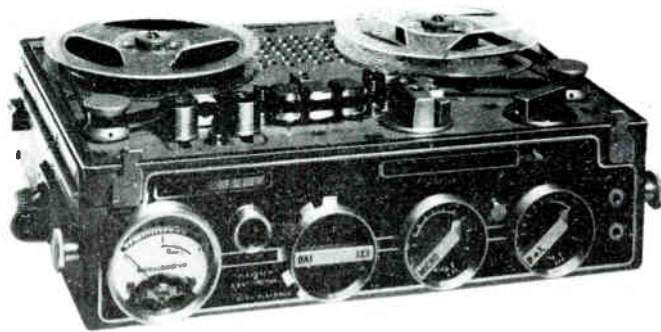

The Nagra III recorder

directly from the Nagra's regular power (it is desirable, here, that the converter will produce the 50 cycles at a $\pm 1\%$ tolerance).

The synchronous motor, however, has the disadvantage that it is heavy and the necessary accumulators and rotary converter are also heavy and awkward to carry. It is more convenient to use a motor which works directly from batteries, in which case it is possible to incorporate in the camera a *Piloton* generator which will produce the necessary signal. When the camera turns at exactly 24 frames per second (25 for TV) the generator will produce exactly a 50 cycles signal. This pilot signal is then tied to the speed of the camera and everything works as though the camera were driven by a synchronous motor powered by a rotary converter. It has been possible for some time to secure delivery of Arriflex cameras equipped with a Piloton generator and it is now also possible to obtain such generators for many other camera makes. The important point is that the motor should turn at a constant speed. There are many motors with centrifugal speed stabilisation which are nearly satisfactory but an electronic stabilisation system is preferable.

The Transfer

When the recording has been made the transfer to perforated film or tape should be effected with the Nagra SLP synchroniser. This is a smaller instrument which is connected to the pilot signal input of the Nagra III after the SLP has been set to the mains tension. Its function is to modify the playback speed according to the phase difference.

Constant Speed device

Once the playback is begun the SLP will react. A click is heard and the left-hand meter on the SLP will show the tension of the pilot signal which should normally read between 20 and 100 micro-volts. The right-hand meter will oscillate faster or slower according to the phase difference between the mains and the pilot signal. One oscillation back and forth per second will correspond to a phase difference of 2° , but this is an extreme example. By setting the SLP selector to Automatic Speed Control, the SLP will start to modify the speed of the Nagra recorder. If the needle does not move this means that there is no error and therefore no speed correction is taking place. Movement of the needle to the right means that the Nagra III is being slowed down, movement to the left, accelerated. If the needle moves to the right or left and then jumps back to the centre in a sudden jerk, it means that the phase difference is larger than 1.5° tolerance and that the Nagra should be controlled manually.

SOUND AND CINE—continued

I watched the Location Sound engineers transfer the German recordings from the Nagra via a *Westrex* dubber to 17.5 mm fully coated sprocketed filmstock and not once did they have to go over to manual control. I was told that they have never had to on any of their previous recordings either. This 17.5 mm copy, plus another copy on $\frac{1}{4}$ inch tape, were to be sent to Munich with all picture takes and complete continuity notes for a German commentary to be added to the edited film.

As I left the Location Sound Services studios plans were being made to ship off the three *Arris*, the *Nagra* recording equipment and all the German technicians plus one British Maintenance engineer, to Athens for the next stage in the tour of European Capitals. After this they will have a three weeks break back in Munich and then they will be off again.



DO YOU SPLICE TAPE?

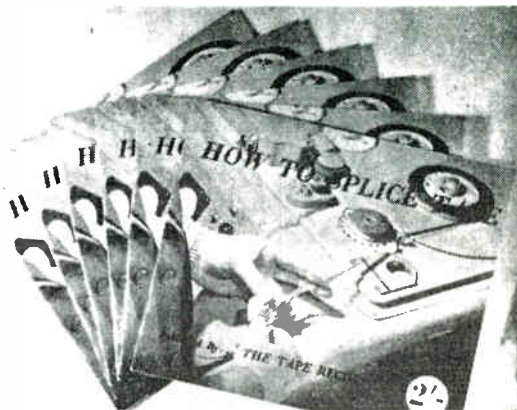

HOW TO SPLICE TAPE

★ If you use tape, sooner or later you will need to know how to splice tape—how to repair simple or complicated breaks—how to edit your material—how to cut out words or syllables, etc. All this is described in this well-illustrated booklet, in which stage-by-stage photos and text provide the complete answer to professional tape splicing.

Price 2/6 . . . Postage paid

THE TAPE RECORDER
99 Mortimer Street, London, W.1

for Professional Performance... **Tandberg**

SERIES **6**

STEREO TAPE DECK

3 SPEEDS
3 HEADS
4 AMPLIFIERS
***4 TRACK and 2 TRACK**

- High and low level mixer inputs and cathode follower outputs.
- "On and off the Tape" monitoring.
- Sound-on-Sound simultaneous record and playback.

110 gns

Booklet of Technical Reviews on request.

SERIES **7**

STEREO TAPE RECORDER

3 SPEEDS
2 HEADS
 and 2 Power Amplifiers

- Two Indicators.
- Two Monitor Speakers.
- Two outputs for additional speakers or Hi-Fi.

***4 TRACK and 2 TRACK**
 Send for leaflet.

BUILD-IT-IN OR CARRY-IT-AROUND!

93 gns

4 track model 74
 2 track model 72
 (Luggage type carrying case. £7 1s 8d. extra).

Tandberg GB

ELSTONE ELECTRONICS LIMITED,
 Edward St., Templar St., Leeds 2.
 Telephone: Leeds 3-5111 (7 lines)



Alive to every sound

Like the ears of this wary fox, the Gramplan DP4 microphone is sensitive to an extremely wide range of sounds. With its uniform frequency response from 50 to 15,000 c/s, the reliable, medium-priced DP4 will greatly improve the standard of your recordings.

Gramplan DP4

—also for broadcasting, public address and call systems.

Low impedance microphone, complete with connector and 18 ft. screened lead **£8. 0. 0.**
 Medium and high impedance models . . . **£9. 0. 0.**

A complete range of stands, swivel holders, reflectors and other accessories is available.

GRAMPIAN—sounds like the real thing!

Write or phone for illustrated leaflets :

GRAMPIAN REPRODUCERS LTD
 Hanworth Trading Estate, Feltham, Middlesex. Feltham 2657



TAPE, RECORDERS & ACCESSORIES

FIRST DETAILS OF NEW PRODUCTS

● We remind our readers that notices of equipment listed and illustrated in this monthly feature are in no sense reviews. When figures, specifications and diagrams are published, these data are extractions from manufacturers' lists. When samples of this equipment are submitted for test, they are passed to our technical contributors, whose reports are published in a separate section.

Standard Telephones and Cables Ltd. announced two new microphones in the medium price range at the 1963 Audio Festival. They are the Type 4113, a ribbon cardioid, and the Type 4114 moving coil microphones. The first of these is a uni-directional microphone with an impedance of 30 ohms. The directional discrimination is 50-20 dB. It weighs only 10½ oz. and measures 2½ × 1½ × 2 in. The price is £11. 11s.

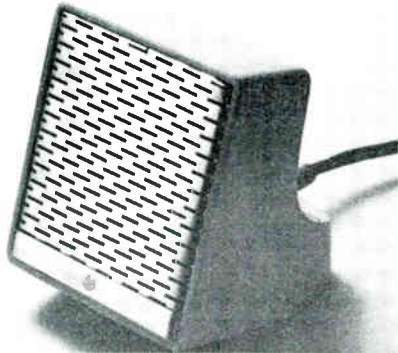

The 4114 is an omni-directional microphone which has been designed for sound reinforcement and announcing systems, tape recorders and transistor amplifiers. The nominal impedance is 200 ohms which is suitable for feeding transistor input stages without the use of an input transformer. The response is claimed to be 100-8,000 c/s. A threaded insert in the base of the microphones enables it to be fitted to a standard camera tripod stand. The price is £3. 13s. 6d. **Manufacturers Standard Telephones and Cables Ltd., Connaught House, 63, Aldwych, London, W.C.2.**

A new four-track, two speed tape recorder has been introduced by **Stella Radio and Television Co. Ltd.** The Model ST.458 has a sloping fascia panel at the front of the machine which houses the speaker and all but two of the controls. The exceptions are the speed selector switch, which is placed at the top of the deck layout between the reels and the track selector switch. On the control panel are push button controls for record, play, pause, fast wind, stop and fast rewind, together with controls for microphone, tone, pickup radio and playback volume. Fitted at the top of the panel is a four position digital programme indicator, with a press button zero reset. Recording levels can be checked with a magic ribbon type indicator.



★
A STELLA
4-TRACK
MONO
RECORDER
★

The machine is supplied with a five inch spool of long play tape, but the deck has been designed to take seven inch reels. By using an additional pre-amplifier, together with an amplifier and loudspeaker pre-recorded

stereo tapes (3¾ i/s) can be played. A parallel playback facility enables simultaneous replay of tracks one and three or two and four.

Quoting from the specification received, the frequency response figures claimed are 60-13,000 c/s at 3¾ i/s and 60-10,000 c/s at 1¾ i/s. Both ±3 dB. Wow and Flutter is less than 0.6% peak to peak, and the signal to noise ratio; better than 40 dB. A 6½ in. diameter speaker is fitted to take the 2½ watts output. The weight of the ST.458 is 18 lb., dimensions 14½ × 14½ × 7¼ in. The price is £40. 19s. **Manufacturers Stella Radio and Television Ltd., Astra House, 121/3 Shaftesbury Avenue, London, W.C.2.**

The Uher Royal Stereo is a four track, four speed, fully transistorised recorder that takes 7 inch spools and weighs only 20 lb. Simple adjustments make eleven different operations possible without the use of extra accessories. These include stereo recording and playback, transfer of recordings from one track to another, automatic slide projector synchronisation, and echo.

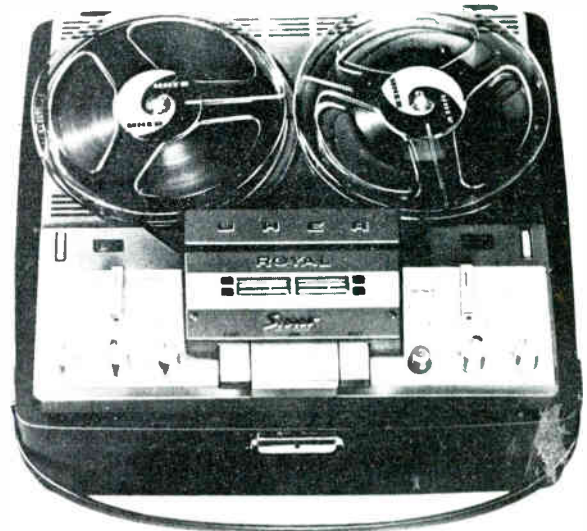

The specification supplied gives the following frequency response figures 50:20,000 c/s, 7½ i/s; 50-16,000 c/s, 3¾ i/s; 50-8,000 c/s, 1¾ i/s; 50-4,000 c/s, 1½ i/s. Wow and flutter figures are claimed to be 0.15% at 7½ i/s. The power output is 2 watts per channel. Dimensions of the Royal Stereo are 15 × 14 × 7 in. Price £141. 15s. **Distributors are Bosch Ltd., 205 Great Portland Street, London, W.1.**

★
★
★
THE NEW BSR
3-SPEED DECK

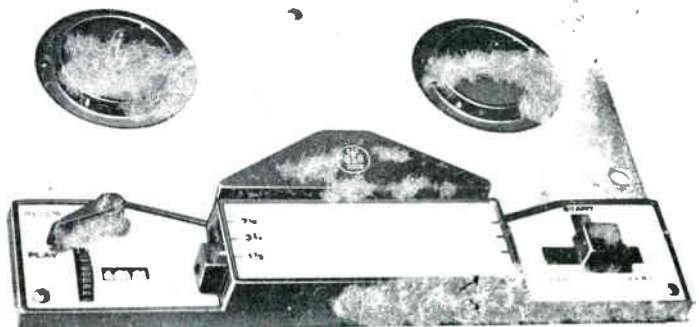

Lee Electronics

TAPE RECORDER • HI-FI AUDIO SPECIALISTS

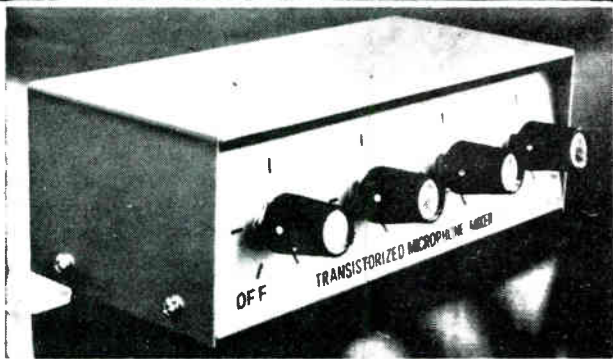

AT LAST A 4-CHANNEL TRANSISTORISED MICROPHONE MIXER AT A REASONABLE PRICE

Four high impedance inputs, e.g. four mics or two mics, one gram and one radio. Output gain approximately 6dB. Inputs, standard jack sockets. Battery PP3

Price complete with PP3 circuit diagram, instructions etc

£3 - 19 - 6

TRADE SUPPLIED

Details of this, and other offers, available on request.

400 Edgware Road, Paddington

PAD 5521

THE Ferrograph CENTRE



NEW SERIES

MODELS

5A - 422 - 424

on

PERMANENT DEMONSTRATION

It pays to deal with a specialist



ONLY A PILLAR BOX AWAY . . .

Wherever you live, you are only the nearest pillar box from the biggest Tape Recorder dealers in the British Isles.

Thinking of buying a Tape Recorder, Hi-Fi Equipment, or a Camera? Willing to risk 3d. to see if we really do offer you better terms than anyone else? Then contact us for full details of all our offers (which include INTEREST FREE H.P. up to 18 months on most Tape Recorders) and free brochures, etc.

If we do not convince you, you will only have lost 3d.—and you can still go elsewhere (but we bet you won't!).

Write, phone, call in or send carrier pigeon:

218 HIGH ST.

BROMLEY

KENT

RAVensbourne 4000 & 4477

HOWARD

TAPE RECORDERS • CAMERAS • HI-FI

EQUIPMENT REVIEWED

TRUVOX MODEL R82 RECORDER



Manufacturer's Specification. Reel size: maximum diameter usable 7". **Tape speeds:** 1 $\frac{1}{2}$, 3 $\frac{3}{4}$ and 7 $\frac{1}{2}$ i/s. **Motors:** 1 capstan drive, 2 wind motors. **Speed variation:** less than 1% at either tape speed. **Wow and flutter:** maximum total content: 0.15% at 7 $\frac{1}{2}$ i/s, 0.2% at 3 $\frac{3}{4}$ i/s and 0.3% at 1 $\frac{1}{2}$ i/s. **Brakes:** mechanical. **Counter:** digital. **Recording sense:** British and American two track. **Record heads:** high impedance, gap length 0.00014". **Erase heads:** low impedance. **Valve line up:** EF86, ECC81, ECC82, ECL86, EM87, OA81, B250-C75. **Output power:** 4 watts. **Frequency response:** 7 $\frac{1}{2}$ i/s, 30-20,000 c/s, 3 $\frac{3}{4}$ i/s, 30-12,000 c/s, 1 $\frac{1}{2}$ i/s, 30-8,000 c/s all plus or minus 3 dB. **Inputs:** Microphone, 1 millivolt at 2 meg. **Radio gram,** 150 millivolts at 500 K. **Outputs:** high impedance line 1.0 v at 47 K, low impedance 3 and 15 ohms at 4 watts. **Power consumption:** 80 watts. **Weight:** 35 lbs including tape and microphone. **Size:** 16 $\frac{1}{2}$ " by 15 $\frac{1}{2}$ " by 10" including lid. **Price:** £57 15s. **Manufactured by** Truvox Ltd., Neasden Lane, London, N.W.10.

THIS recorder uses the new Type 80 deck which is built on a heavy die cast plate, with a *Papst* external rotor hysteresis capstan drive motor, and separate spooling motors for each reel. It features such refinements as micro-switches for all mains and motor switching to prevent the common trouble of arcing at the switch contacts, and a spring loaded *Record-Play* switch which returns to the *Play* position whenever the *Stop* key is pressed. Mechanical design is slightly on

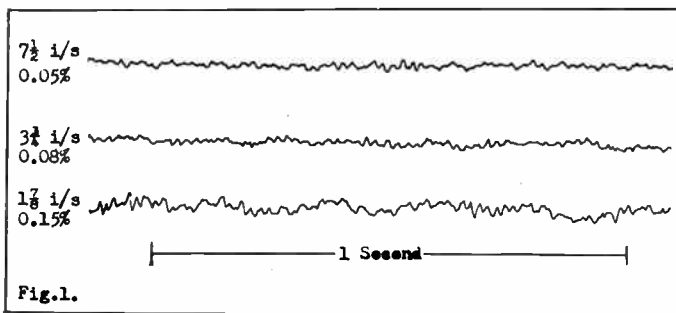

the heavy side and this is reflected in the feel of the control keys which are wide enough to take three fingers or a thumb, either of which must be used for positive operation of the controls. Despite this, I would rate this amongst the top three British decks available at the present time.

Wow and Flutter

The fluttergrams of fig. 1 show that the short term speed fluctuations are extremely low with R.M.S. readings of 0.05%, 0.08% and 0.15% at the three tape speeds of 7 $\frac{1}{2}$, 3 $\frac{3}{4}$ and 1 $\frac{1}{2}$ i/s. There was little evidence of cumulative build-up between record and playback wow or flutter, and this indicates that all rotating parts are running true to very fine limits.

"Play only" Responses

The playback equalisation was checked by playing *C.C.I.R.* test tapes, recorded to surface induction characteristics of 100, 200 and 400 microseconds time constant at 7 $\frac{1}{2}$, 3 $\frac{3}{4}$ and 1 $\frac{1}{2}$ i/s, to give the curves

of fig. 2. The signal was measured at the high impedance line output with a low capacity valve voltmeter. The slight dip in response, which moves down in frequency as the tape speed is reduced, is characteristic of the *Miniflux* short pole face heads used in this machine (see previous reviews and my article in the April, 62 issue).

Noise and hum with no tape passing over the heads was 36 dB below test tape level or 48 dB below peak recording level with optimum recording conditions.

Record-play Responses

Recording tests at 500 c/s showed that waveform distortion was negligible at a level 12 dB above that of the test tape and that the level could be raised to 13 dB, where the indicator beams just met, before tape overload became evident. This shows that the bias is optimum for maximum output and lowest distortion.

Frequency runs were made at the three tape speeds to give the responses shown in fig. 3. These are sensibly the same as the test tape responses, except for a high frequency roll off at the two lower speeds. This indicates that the recording characteristic is close to the *C.C.I.R.* standards of 100, 200 and 400 microseconds, and that the bias has been properly set for the highest tape speed of 7 $\frac{1}{2}$ i/s. The response is still satisfactory at 3 $\frac{3}{4}$ i/s, but the bias would have to be reduced at the lowest speed to meet the specified 8 kc/s high frequency limit of 3 dB/s. Such a change in bias would increase the distortion at the higher speeds. (Why has no designer switched the bias to suit the tape speed and so get the best of both worlds?)

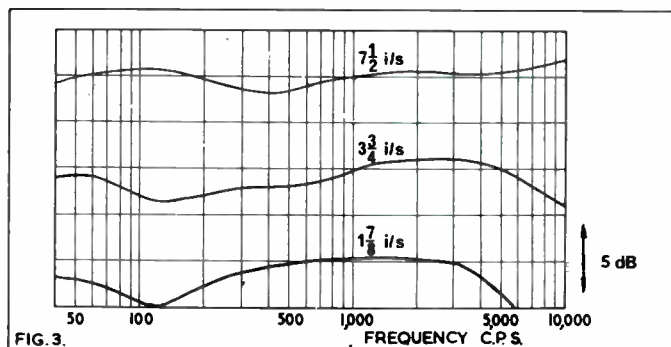
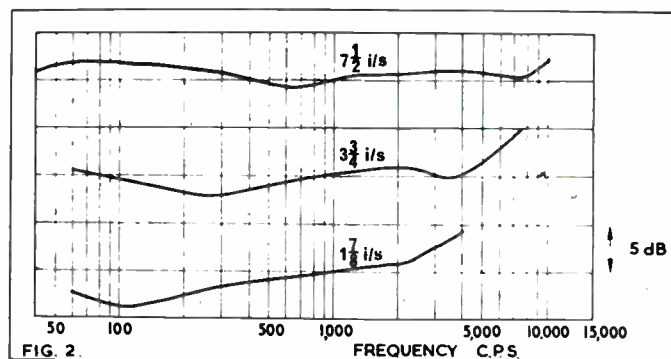

Signal Noise Ratio

Bulk erased tape noise was 1 dB above the system noise of 48 dB below peak recording level measured in the playback tests, but tape erased and recorded on the machine with all gain controls at zero showed a level 12 dB above virgin tape noise. C.R.O. examination of this signal showed that it was mainly pure 50 c/s hum, which was not audible on the internal speaker of the recorder. Subjective listening tests proved that the hiss level was also up by an estimated 4 to 6 dB but, without delving into the internal circuitry, it was difficult to know whether this was a bias effect or the under signal noise carried by the 50 cycle hum. A wide range external speaker showed up the hum

USE YOUR TAPE RECORDER FROM ANY D.C. SUPPLY

You can operate your recorder from a car, caravan or boat battery, or from any D.C. mains supply with a VALRADIO D.C. CONVERTER. These D.C. converters enable you to operate T/RECORDERS, etc., for play-back music, telephone conversations and reports whilst on long journeys, in addition to making outside recordings. Electronic types of converters are also available for 200/250 D.C. with outputs up to 200 watts 50 c/s. from ships' supply or D.C. mains. Available for practically all makes of recorders, record players, radiograms, amplifiers, etc., with prices ranging from £7.3.0., VALRADIO D.C. CONVERTERS add versatility to your equipment.

For further details just post coupon below to:



LIMITED,
Browells Lane,
Feltham, Middlesex.
Tel. Feltham 4242 & 4837



Valradio and Stereosonoscope are the registered trade marks of Valradio Ltd.

Please send me fully descriptive leaflet, ref: TR on D.C. CONVERTERS for tape recorders and other equipment.

NAME

ADDRESS

Make and type of equipment:

D.C. volts in: A.C. watts out:

DO YOU SPLICE TAPE?

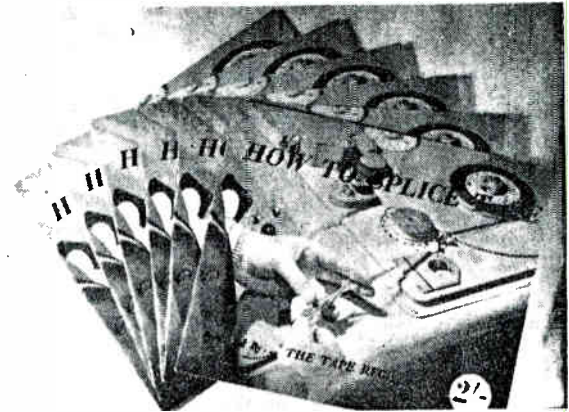

HOW TO SPLICE TAPE

★ If you use tape, sooner or later you will need to know how to splice tape—how to repair simple or complicated breaks—how to edit your material—how to cut out words or syllables, etc. All this is described in this well-illustrated booklet, in which stage-by-stage photos and text provide the complete answer to professional tape splicing.

Price 2/6 . . . Postage paid

THE TAPE RECORDER

99 Mortimer Street, London, W.1

THE RECORDER CO.

for best machines on advantageous terms

| | Deposit | 12 Monthly Payments | Cash Price |
|--------------------------------|---------|---------------------|------------|
| | £ s. d. | £ s. d. | Gns. |
| 4-TRACK STEREO/MONAURAL | | | |
| Akai M6 | 13 13 0 | 10 4 9 | 130 |
| Sony 521 | 13 2 0 | 9 15 2 | 124 |
| Grundig TK46 | 10 12 0 | 7 15 7 | 99 |
| Telefunken 97 | 10 0 0 | 7 9 7 | 95 |
| Sony 464 CS | 10 0 0 | 7 7 10 | 94 |
| Philips EL3534 | 9 16 0 | 7 4 8 | 92 |
| 2-TRACK STEREO/MONAURAL | | | |
| Telefunken 98 | 10 0 0 | 7 9 7 | 95 |
| MAINS TWIN-TRACK | | | |
| Simon SPS | 9 16 0 | 7 6 5 | 93 |
| Brenell 5 Type "M" | 9 5 0 | 6 18 7 | 88 |
| Telefunken 85 | 8 15 0 | 6 10 8 | 83 |
| Akai Model 69 | 8 6 0 | 6 4 5 | 79 |
| Grundig TK41 | 8 0 0 | 5 17 11 | 75 |
| Brenell 5/2 (Meter) | 7 15 6 | 5 16 7 | 74 |
| Brenell 5/2 | 7 5 0 | 5 8 8 | 69 |
| Reps R10 | 6 4 0 | 4 12 11 | 59 |
| Telefunken 95 | 6 4 0 | 4 12 11 | 59 |
| Truvox R82 | 5 15 6 | 4 6 8 | 55 |
| Grundig TK18 | 4 2 0 | 3 1 5 | 39 |
| Truvox R62 | 4 2 0 | 3 1 5 | 39 |
| Grundig TK14 | 3 13 6 | 2 15 2 | 35 |
| Wyndor Trident | 3 10 0 | 2 11 11 | 33 |
| Elizabethan LZ30 | 3 7 3 | 2 10 5 | 32 |
| Ferguson 3200 | 2 16 6 | 2 0 10 | 26 |

H.P. also over 18 and 24 months

Open Saturday until 6.0 p.m. — Friday 6.30 p.m.

If unable to call, write for free brochure or send deposit now for quick delivery.

INTEREST FREE TERMS

Agents for FERROGRAPH, VORTEXION, REFLECTOGRAPH, SONY, GOODMAN'S, ETC.

Whatever the time — Wherever you are — you're completely independent with the NEW —

UHER 4000 S

Price 93 gns.



Ever-ready leather carrying Case—9 gns. extra

4 speeds, 7½, 3½, 1½ and ½ i.p.s. Reel size up to 5". Push button controls. Remote Control. Combined Record level/Battery Meter Indicator. Operated from rechargeable "Dryfit" storage Battery, or 5U2 batteries, or Mains operated Power Unit. Complete with Dynamic Remote Control Microphone and 5" Tape.

We will be pleased to demonstrate this fine model or send full details.

THE RECORDER CO.

(Dept. R) 188, WEST END LANE
WEST HAMPSTEAD, LONDON, N.W.6

Telephone: SW1 4977

Nearest Station: West Hampstead, Bakerloo Line

FREE DELIVERY · PART EXCHANGE

EQUIPMENT REVIEWED — continued

"loud and clear", and touching the reels caused a change in pitch, proving that it was indeed recorded on the tape.

No circuit diagram was provided with this recorder so that I can only guess at the cause of the trouble. No hum was evident on playback so that I do not think it was an H.T. smoothing fault. My guess would be that the constant current head feed resistor is too low so that the "normal" low level hum on the plate of the recording stage is recorded on the tape at 25 dB below test tape level, or 37 dB below peak recording level.

Acoustic Response

The overall response from tape to sound output from the internal speaker was measured by playing a 7½ s White Noise test tape, and measuring the sound level on the speaker axis with a calibrated microphone. The resultant response is shown by fig. 4. This shows

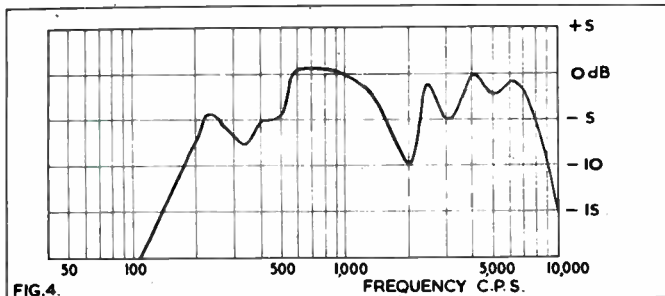

clearly why the 50 c/s mains hum is not audible. The rather ragged response in the mid upper register, together with the sharp cut at 250 c/s, gave a thin edgy quality to the sound and I would guess that there is considerable intermodulation and frequency doubling near the low frequency cut off frequency of this speaker.

Comment

An excellent deck and tape transport mechanism, let down by its amplifier and speaker. I have said nothing yet about the cabinet because this can only be a personal opinion. I do not like the eastern pagoda-like styling, and if anybody mentions the lid catch I am liable to go hot under the collar: twice it jammed shut so that, try as I would, I could not gain access to the interior. On both occasions I had to remove the rear hinges to get inside. Perversely, when the closed cabinet was placed on the ground the lid tended to fly open, due to some "give" at the hinges, so that if the reels of tape had not been firmly secured by the excellent "hubloc" system, they would have rolled off across the room.

I am quite prepared to be told that I was unlucky, and that other people have had no trouble with the lid or catch — but seriously, I do think the excellent deck deserves a better housing and associated equipment than it has been given in this review sample.

A. Tutchings

Manufacturer's Comment

An encouraging review, but we do not quite understand the remarks concerning the amplifier in view of the comment under the heading: "Play and Record Responses". We suspect that the mains transformer has moved causing hum induction and in this respect a new transformer mounting was introduced recently, as it was found under certain conditions that it would shift. We also suspect that the characteristic of the oscillator valve has changed causing an increase of tape noise after erasure.

The type of heads used have an impedance of 100K ohms at 20Kc/s and ideally the feed resistor should be higher than this. It is in fact, 220K ohms.

The cabinet lid catch has been modified to overcome the problem experienced by the reviewer.

PLEASE MENTION "THE TAPE RECORDER" WHEN REPLYING TO ADVERTISEMENTS.

— YOUR TAPE DEALER —

Specialists in Hi-Fi Equipment and Tape Recorders

CHELSEA RECORD CENTRE

203 KINGS ROAD, S.W.3 FLA 2596

Open till 8 p.m. (except Thursdays)

Disc and Tape Reproducing Equipment and Tape Recorders

by Leading Manufacturers

CUSTOM BUILT INSTALLATIONS

All High Fidelity Requirements and Services Available

Estimates Free

Personal Service

Custom High Fidelity

371 Green Lanes, Palmers Green, London, N.13

Tel. PALmers Green 5228

hifi

FOR ALL LEADING
AUDIO EQUIPMENT

call, write, or telephone

hampstead HIGH-FIDELITY

91a Heath Street, Hampstead, London N.W.3 Telephone HAMpstead 6377

ENGLAND'S BIGGEST SPECIALISTS

HOWARD

218 HIGH ST. - BROMLEY - RAV. 4000

LASKY'S RADIO

ALL LEADING MAKES IN STOCK

Cash or Easy Terms

LONDON'S FINEST SERVICE

207 EDGWARE ROAD, W.2

PAD 3271/2

152-153 FLEET STREET, E.C.4. FLE 2833

33 TOTTENHAM COURT ROAD, W.1. MUS 2605

★ PART EXCHANGES WELCOMED ★

- ALL MAKES Hi-Fi & Tape Recorders supplied
- PART-EXCHANGES. Terms 12, 18 or 24 months
- SONY SPECIALISTS. Full Range Stocked
- GUARANTEED. Recorder Repair Service

MAG'S CAMERA SHOPS LIMITED

250-252 KING STREET, HAMMERSMITH, LONDON W 6
RIV 8581-2 Hrs 9-6 Thurs 9-1

LEONARD G. FRANCIS PRESENTS . . .

SHEEN TAPE RECORDER CENTRE LTD.

SPECIALISTS IN TAPE RECORDERS AND ACCESSORIES, ETC..

YOUR CENTRE FOR FRIENDLY HELP—SALES AND SERVICE

8 STATION PARADE,
SHEEN LANE, SHEEN,
LONDON, S.W.14

Showrooms Open until 7 p.m.
PROSPECT 0985
(Next to Mortlake Station S.R.)

CROYDON'S TAPE RECORDER CENTRE

All leading makes in stock. Hi-Fi equipment, cabinets etc.
Service agents for AKAI Tape Recorders

SPALDING ELECTRICAL LTD.,

352/354 Lower Addiscombe Road,
CROYDON.

AD Discombe
1231 2040

ELECTRONIC WORLD

is by far the cheapest
HIGH QUALITY TAPE
on the market

★ **Acclaimed by experts**

Reprints of reviews available

★ **Backed by our Guarantee**

If you are not completely satisfied
with any purchase, we undertake to refund
the full price plus your return postage

POST COUPON NOW!

DE VILLIERS (Electronic World) LTD.
16d Strutton Ground, London, S.W.1

STANDARD PLAY (Acetate base)

3 in. spool 175 ft. 4 spools for 18/-
or 48/- dozen

4 in. spool 300 ft. 4 spools for 26/-

5 in. spool 600 ft. 2 spools for 26/-

5½ in. spool 850 ft. 16/- per spool

7 in. spool 1,200 ft. 19/- per spool

ARCHIVISTS' GRADE (S.P. Polyester)

7 in. spool 1,200 ft. 22/6 per spool

LONG PLAY (Acetate Base)

7 in. spool 1,800 ft. 28/-

LONG PLAY (Polyester Base)

3 in. spool 225 ft. 4 spools for 22/-

or 60/- dozen

4 in. spool 450 ft. 2 spools for 21/-

5 in. spool 900 ft. 2 spools for 35/-

5½ in. spool 1,200 ft. 24/- per spool

7 in. spool 1,800 ft. 31/- per spool

DOUBLE PLAY (Special Polyester Base)

3 in. spool 375 ft. 4 for 40/-

or 108/- per dozen

4 in. spool 600 ft. 2 for 30/-

5 in. spool 1,150 ft. 27/- per spool

5½ in. spool 1,750 ft. 35/- per spool

7 in. spool 2,400 ft. 45/- per spool

I enclose remittance for £ . s. d. **Post Free**

Name

Address

BLOCK LETTERS PLEASE **Cash with order**

tape recorder

★ one of the great encouragements to me personally, over the years that I have been writing these articles, has been the number of letters that I receive from readers. To those who have been able to find something complimentary to say, I would record my particular thanks, but I am grateful for all letters because they help me to maintain my perspective. They tell me, also, that I am not only writing for a variety of tastes, but for all strata of technical ability. I try to maintain a balance, but I would ask you all to be kind enough to remember that, while some are absolute novices, there are others who, though amateur in status, are professionals in terms of knowledge and ability.

I am not often presumptuous enough to aim my article at those whose experience may well be greater than mine, but I make no excuses that my words this month are for the inexperienced, those just starting with a tape recorder and who may have little practical knowledge. For all that, I suspect that there are those, whom I would not dare to call novices, who are not quite certain why there should be several types of tape available to them, and what are the relative merits, or otherwise, of each.

The Different Base Materials

First of all, let us determine just how to decide what base materials should be used, and how to recognise the different types. There are three sorts of base material, acetate P.V.C., and Polyester. "Mylar" is a trade name for American polyester base material, the English material is known as "Melinex." (The latter is made by I.C.I. and I have been told that Mylar is made by Du Pont under licence from I.C.I.)

Acetate tape is cheap, but suffers the disadvantage that it is brittle, and will become more so with time, making it a poor medium for recordings that are to be kept. P.V.C. is more durable and quite suitable for general purposes, but if important recordings are to be made, particularly those that you may wish to keep indefinitely, I would consider that polyester has better lasting properties and would make a technically superior recording. When the thinner tapes are being considered (long or double-play) polyester tape again is better because of its increased strength and longitudinal stability.

Now, how to identify the type of base material on a reel when it is held in the hand. Of the three types let me first take P.V.C. The reverse side of this tape is not so shiny as the other two, it normally has a slight curl across its width, with the oxide on the inside, and if the spool is held up to a bright light the wound tape is completely opaque.

With Polyester tape (Mylar or Melinex) there is no curl, the backing is glossy and if held up to the light it is not completely opaque. Acetate tape is also glossy with no curl but if held up to the light is considerably more transparent. If a small sample can be destroyed, when pulled, acetate tape is brittle and will snap cleanly. P.V.C. will "wire-draw" to about 3 or 4 times its original length and then snap. Polyester tape acts similarly to P.V.C. but is stronger, and will extend much further before breaking.

Should the tapes be of different thickness, naturally the foregoing will have to be modified accordingly. Bearing in mind that the oxide coating will be substantially the same, the thinner tapes, with a thinner base material, will tend to be less transparent.



workbench

No. 48 by A. Bartlett Still

The oxide coating itself can vary, but this will occur from one brand to another; normally a given make of tape uses a similar oxide coating whatever the base material or thickness. By and large one must not be too dogmatic about this question of oxide but, in theory, each variation demands a different bias setting on the recorder, and may require a different level of record treble pre-emphasis. With the cheaper domestic machines, whose performance may often leave something to be desired, the change from one brand to another may not be noticeable. Where closer limits are considered, and this particularly applies in professional circles, the machine and the tape have to be adjusted in combination to produce the desired result. It is then that one is able to obtain a relative assessment of tape performance—output for a given distortion level—sensitivity—frequency response, etc.

The use, the choice, the price

To sum up, it will be apparent that the type of base material used will be something about which an intelligent choice can be exercised, bearing in mind the purpose for which the tape is required. As far as the brand of tape is concerned, you are always at liberty to experiment but, because of possible variations in oxide, the results may be inferior. They may, equally, be better, but this will not necessarily mean one brand of tape is better than another. Lacking any other guide, it is always safest to use the brand recommended by the recorder manufacturer, since it should be for this particular oxide that the machine has been adjusted.

So far I have not mentioned price. For a long time all tape, whether imported or home produced, seemed to cost exactly the same to place on the shop counter. Now tapes are available at prices that considerably undercut the so-called standard and a lot of them seem to be of excellent quality, and certainly worth a try in view of the possible savings. Who knows, perhaps one day tape will be available at a realistic price, allowing us to get away from rout-track working at impossibly slow speeds?



"—Let's face it . . . with tape at a farthing a foot, you're not much of an investment . . ."

— YOUR TAPE DEALER — — Country and Provincial —

BOURNEMOUTH
NATIONAL RADIO SUPPLIES
66 Holdenhurst Road,
Bournemouth
Tape, Hi-Fi & components Tel. 25232

H. D. KIRK
Stereolectrics
LIMITED
Specialists in High Fidelity — Phone: 23093
150 HIGHER BRIDGE STREET **BOLTON**

R.E.S. (COVENTRY) LTD.
SPECIALISTS IN HIGH FIDELITY
and all makes of Tape Recorders
All leading makes of High Fidelity Equipment stocked and demonstrated under ideal conditions. ★ *The Best Selection—Terms and After Sales Service in the MIDLANDS.*
R.E.S. (Coventry) Ltd. 128 Far Gosford St. Coventry 28781/2

FARNHAM, SURREY
★ Stockists of all the leading makes of High-Fidelity Equipment
★ Comparative Demonstrations
★ Cabinet Manufacturers and Designers
★ Personal service and satisfaction guaranteed
★ Specialists in custom-built Hi-Fi Equipment
LLOYD & KEYWORTH LTD, The Record Shop
26/7 Downing Street, Farnham, Surrey. Telephone: Farnham 5534
SURREY AND HAMPSHIRE'S HI-FI DEALERS

TAPE RECORDER CENTRE (HALIFAX)
Stock all the best Tape Recorders; Hi-Fi Equipment;
Tape; L-P Records, etc.
DEMONSTRATIONS DAILY BY EXPERT STAFF
2 years FREE SERVICE ON NEW RECORDERS over £35
30 King Cross Street, Halifax. 'phone 66832

LEICESTER
ALL YOUR HI FI REQUIREMENTS
Speakers by: H.M.V. QUAD LEAK ROGERS
TANNOY MORDAUNT LOWTHER W.B.
WHARFEDALE GOODMANS.
Tape: FERROGRAPH REFLECTOGRAPH GRUNDIG
SIMON BRENELL
Record Department: ALL LABELS-PARASTAT SERVICE.
LEICESTER CO-OPERATIVE SOCIETY LIMITED, High Street, Leicester. Tel: 20431

STOCKPORT
FAIRBOTHAM & CO. LTD.
47 LOWER HILLGATE STO 4872
FERROGRAPH, REVOX, TANDBERG, BRENELL,
SIMON, TRUVOX, SONY, PHILIPS, MAGNAVOX
All models on comparison demonstration
Evening demonstrations by appointment

PLEASE MENTION "THE TAPE RECORDER" WHEN
REPLYING TO ADVERTISEMENTS.

— YOUR TAPE DEALER —

MANCHESTER
LANCASHIRE HI-FI Limited
 and now incorporating
The Tape Recorder Specialists
DIXONS ELECTRONIC (Sales and Service)
 8 DEANS GATE - - - next to Grosvenor Hotel

TAPE RECORDERS and HI-FI  *The Largest Electrical Store in the North*
Fenham Radio
 158, NEW BRIDGE STREET,
 NEWCASTLE UPON TYNE 1
 Telephone: 29866

WESTWOOD'S of **OXFORD**
 46 GEORGE STREET
 PHONE: 47783

PETERBOROUGH, NORTHANTS Tel: 5643/5644
CAMPKINS RECORD SHOP
 RECORD TAPE AND HI-FI EQUIPMENT SPECIALISTS
 NEW ADDRESS **15 LONG CAUSEWAY** LARGE STOCKS
 (IN CITY CENTRE)

HAMILTON ELECTRONICS
 HIGH FIDELITY TAPE RECORDERS **35 LONDON ROAD**
SOUTHAMPTON
 TEL. 28622

18 QUEEN STREET **SALISBURY**
J. F. SUTTON
RECORDS — RECORDERS — HI-FI
 421 SHIRLEY ROAD **SOUTHAMPTON**
 111 EAST STREET

Audio Electronics (Midlands) Ltd.
 Specialists in Dictation Mcs., Tape Recorders, Inter-Com., Tapes and Accessories
 Full After Sales Service on all Equipment
 PHILIPS, GRUNDIG, TRUYOX, UHER, ETC.
 203 STAFFORD STREET WALSALL Tel.: 21086

WORTHING, SUSSEX
 We stock Hi-Fi Equipment by Leak, Quad, Goodsell, RCA, Acos, Garrard, Collaro, Tannoy, Wharfedale and Goodman and give fully comparative Demonstrations
BOWER & WILKINS LTD.
 1 Becket Bldgs., Littlehampton Road Worthington 5142

CLASSIFIED ADVERTISEMENTS

Advertisements for this section must be pre-paid and accompanied by a postal order, money order, or cheque. The rate is 6d. per word with a minimum charge of 7 6. Box numbers may be used for an extra charge of 1 6. The trade rate is 9d. per word, plus 2s. for a box number, conditions on application. Send replies to box numbers, c/o "The Tape Recorder", 99 Mortimer Street, London, W.1.

No responsibility will be accepted by the editor, the publishers, or the printers of *The Tape Recorder* for the quality of any goods offered, bought or exchanged through the medium of these columns, or for any failure in payment, etc., though the greatest care will be taken to ensure that only bona fide advertisements are accepted.

Advertisements for the August issue must arrive not later than July 4th.

FOR SALE

Find that review you want—get a copy of the index for "Tape Recorder", volumes 1, 2, 3 and 4. Price 2s. each volume, plus 6d. postage, from 99 Mortimer Street, London, W.1.

Easysplice Tape Splicer makes accurate splicing easy—guaranteed 5s. 6d. Scotch Boy splicing tape 3s., P. & P. 6d. Easysplice, 30 Lawrence, Ealing.

Hitachi Tape recorder, model TRQ-370. All transistor, portable leather case, two speeds, all accessories £28. E. A. Searle, Uganda House, Trafalgar Square, W.3.

Ferrograph deck Series 4. Excellent condition. £30 o.n.o. Full data available. Phone GATley 3383. Box No. (Cheshire), 315.

Ampex Professional Recorder 970 2/4 tr. stereo. P/B amplifiers and speakers included carrying case. Cost over £200 for medical research which failed. Just checked and verified perfect by makers. Accept £132. Also Sony 521 2/4 tr. stereo. Never unpacked. Cost £135. Accept £120. Dr. M., The Grove, Lincoln.

E.M.I. Portable tape recorder, L.2., valve model 7½ i.p.s. Little used condition. Best offer secures. Box No. (Glam), 316.

TRADE

A Service for the Connoisseur. Ferrotape available by post, all sizes in stock. Also Hublok empty spools. Send for price list.—J. Turner, 51 East Street, Horncastle, Lincs.

Ferrograph 5A/N, 422 and 424, Revox F36, etc., always in stock.—City and Essex Tape Recorder Centres (see page 232).

Tape and gram equipment repairs/mods.—Harding Electronics, 120A Mora Road, Cricklewood, N.W.2.

Deimos Ltd., announce an outstanding new type of amplifier. This is the most versatile unit ever offered to the tape enthusiast, mono or stereo, magic eye or meter up to 7 mono channels etc. Specifically suitable for the Planet Decks. Send for full details to 8 Corwell Lane, Hillingdon, Middx.

Recorder need Repairing? Then let City and Essex Tape Recorder Centres do it for you expertly and economically (see page 232).

Cinesmith Depolariser demagnetizes your record/playback heads in situ. Use occasionally for better recordings without hiss and with background silent as the grave no matter how often played. From your dealer or Cinesmith Products, Regent Street, Barnsley. £2 5s. Write for leaflet.

Pre-recorded tapes. Unique complete catalogue listing all makes, mono, stereo. 7½ and 3¾ i/s including World Record Club tapes. Call for free copy or send 1s. mailing fee. Dept. T.R.3 Teletape Ltd., 33 Edgware Road, W.2. PAD 1942.

AUTOMATED SLEEP-SUGGESTION

- WHAT IS SLEEP-SUGGESTION ?
- HOW DOES IT WORK ?
- HOW CAN IT BENEFIT YOU ?

SEND NOW for FREE BROCHURE for up-to-the-minute information on this vital subject.

EDUCATIONAL RECORDINGS LTD.
Dept. 13, 21 Bishops Close, Church Lane, London E.17

“ you've never heard it so good ”

● LEAK . QUAD . GARRARD . THORENS . Lenco (New G88 Turntable £17.14.0) . SHURE M33.5 . DECCA Mk. II . HACKER Players and Radios . B & O BEOLIT 609 deluxe Transistar AM/FM—£33.8.2 Superb! (Review Feb., "The Gramophone")

● DERAM STEREO CARTRIDGE—£4.14.6 with ROGERS CADET Mk. II Stere Amp.—£26.15.0 and our BOOKSHELF SPEAKERS—£10.10.0 each, plus turntable, arm and cabinet, gives you a complete stereo system for less than £70.

● B & O MAGNETIC STEREO CARTRIDGE now further improved is a real bargain at £6.3.5 used with PYE MOZART STEREO AMP—£35 and you have a stereo system with the advantages of a magnetic pickup from £80.

● ARMSTRONG A20 PCU25—12 watts pp per channel, filters, full specification—only £44.12.6. With B & O CARTRIDGE, etc., etc. TOTAL from £95.

STUDIO 99

TAPE RECORDERS—Just a few

| | |
|-------------------------------|-----------|
| REVOX F36 stereo (new model) | £117.10.0 |
| TANDBERG 6 stereo | £115.10.0 |
| TANDBERG 7 stereo (new model) | £97.13.0 |
| STELLA ST459 (new model) | £65. 2.0 |
| * PLANET U1 Deck 3 heads | £39.10.0 |

10 a.m. to 9 p.m. incl. Saturday
Closed Sunday and Thursday

57 F RFAUX ROAD SWISS COTTAGE NW6 MA1 8855



A BETTER RECORDING

Starts with a better microphone

Most popular models available from stock post free.

Grampian, Reslo, Film Industries, A.K.G.,
Cadenza, Lustraphone, Foster, Grundig, etc.

Send particulars of your requirements or 6d. stamp for full list.

416 MOSELEY ROAD, BIRMINGHAM 12
Telephone Calthorpe 2554

BRAND NEW TOP QUALITY 100% TESTED RECORDING TAPE

(As supplied to the Far East Broadcasting Corp.)

| | Size | Length | Price |
|-------------|--------|--------|-------|
| STANDARD | 3" | 160' | 2/6 |
| | 5" | 600' | 9/- |
| | 5 1/2" | 900' | 11/6 |
| LONG PLAY | 7" | 1,200' | 16/- |
| | 3" | 220' | 3/- |
| | 5" | 900' | 11/6 |
| DOUBLE PLAY | 5 1/2" | 1,200' | 16/- |
| | 7" | 1,800' | 23/- |
| | 5" | 1,200' | 23/6 |
| | 5 1/2" | 1,800' | 28/6 |
| | 7" | 2,400' | 41/- |

Postage 1/- per spool 4 or more P.F. Refund Guarantee (never ever requested)
Recorder repairs at reasonable prices. (Collected and delivered in London Area)

N. WALKER, 28 Linkcroft Avenue, Ashford, Middlesex
Telephone: ASHFORD 53020

TAPE RECORDER COVERS



Smart waterproof cover to give complete protection to your tape recorder. Made from rubberised canvas in navy, wine, tan, grey and bottle green with white contrasting pipings, reinforced base, handy zip microphone pocket and name panel.

| | | |
|----------------------|-----|-------|
| Philips EL3536 | ... | 70/- |
| " EL3515 | ... | 57/6 |
| " EL3541/15 | ... | 57/6 |
| " Starmaker | ... | 66/- |
| Cosmor 1602 | ... | 57/6 |
| " 1601 | ... | 63/- |
| " 1605 | ... | 84/- |
| Stella ST455 | ... | 63/- |
| " ST454 | ... | 57/6 |
| " ST459 | ... | 84/- |
| Saja MK.5 | ... | 57/6 |
| Stuzzi Tricorder | ... | 58/- |
| Saba | ... | 63/- |
| Wyndor Victor | ... | 40/-* |
| Elizabethan Princess | ... | 60/- |
| " Escort | ... | 57/6* |
| " Major | ... | 63/- |
| " FT.1 | ... | 66/- |
| " FT.3 | ... | 75/- |
| " LZZ9 | ... | 75/- |
| Fi-Cord | ... | 52/6 |
| Harting Stereo | ... | 66/- |
| Fidelity Argyle | ... | 55/-* |
| Silicon SP4 | ... | 55/-* |
| Clarion (with strap) | ... | 63/-* |
| Brenell Mk.5 | ... | 77/- |
| " 3 star | ... | 69/- |
| Minivox C | ... | 61/- |
| Robuk RK.3 | ... | 67/6 |
| Farrograph | ... | 80/- |
| Sony 521 | ... | 90/- |

*Without pocket. †Price to be announced

A. BROWN & SONS LTD.

24-28, GEORGE STREET, HULL TEL: 25413, 25412

BINDERS

for
THE TAPE RECORDER

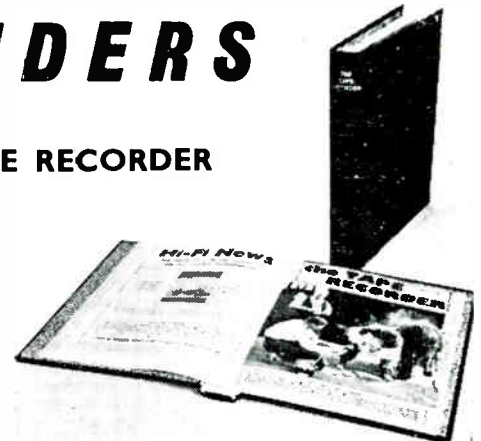

Semi-permanent Binders for
Volume 5 now available.

From the first number keep your copies clean and ready for easy reference. Semi-permanent binders are available for volume 4. Each case will take twelve copies plus index and will open flat at any page. They are covered in black buckram and gold blocked on spine with name and volume number. Also available, volume 3.

Price 15s. post free.

MILES HENSLOW PUBLICATIONS LTD
99 MORTIMER STREET, LONDON W.1

CLASSIFIED ADVERTISEMENTS

Use up those odd lengths of tape, splice them together professionally after reading "How to Splice Tape", price 2s. 6d. posted, from The Tape Recorder, 99 Mortimer Street, London, W.1.

All makes of tape recorders repaired or modified. Miniflux heads supplied "Audiomaster" equipment serviced. Audio installations built to your specification by John C. Latham, Deimos Ltd., 8 Corwell Lane, Hillingdon, Middlesex.

Full building instructions for the remarkable "Tricolumn" loudspeaker are available in reprint form from Hi-Fi News, 99 Mortimer Street, London, W.1. Price 2s. 6d. post free.

Collaro Studio Tape Deck. Official Spares and Service, New Decks can be supplied mounted on plinths with $\frac{1}{2}$ track or $\frac{1}{4}$ track heads. Monitor heads also available. Hampstead High Fidelity, 91a/b Heath Street, Hampstead, N.W.3. HAMpstead 6377.

Mains power units for transistor recorders. Grundig Cub or TK.1 £3 each. List price 8 gns. New, unused, Grundig products, Chattell, 40 High Street, North, Dunstable.

Sensational Tape Offer. 7 in. 2400 ft. Mylar Base, 27s. 6d. c.w.o. David Cavalier, 17 Leigh Park Road, Leigh-on-Sea.

A Unique Buy! Recording tape top brand, 5 $\frac{1}{2}$ in. 1200 ft. 19s. 6d.; 7 in. 2400 ft. D.P. 28s. 6d. P. and P. 1s. 6d. per spool. Bargains in all sizes. S.A.E. for list. E. C. Kingsley & Co., 132 Tottenham Court Road, London, W.1. EUSton 6500.

WANTED

Good Cash prices for tape recorders.—Tel.: Maryland 5879 (see page 232).

Vortexion Mixer, 3 or 4 channel. Must be mint. Molloy, 20 Eddington Drive, Newton Mearns, Renfrewshire.

EDUCATIONAL

Frenchman teaches French by tape recorder. Captivatingly vivid 1963 style lessons. Takes half the time to learn at home by post. (Also Spanish.) To enrol, write—R. de Breville, 22 University Street, Belfast, 7.

Sleep Learning. Of fascination to all TR enthusiasts. Send 6s. 6d. for book. Refund guarantee.—York House, Huddersfield.

TAPE TO DISC

Tape to Disc service, editing, and dubbing, all speeds. Studio available for musical groups. Outside recordings our speciality. Ilford Sound Recording Service, 63 Aintree Crescent, Barkingside, Ilford, Essex. Telephone: CRE 8947 and GRA 5107. S.A.E. for list.

Rapid Recording Service, 78s and L.Ps from your own tapes. (48-hour service) Master Discs and pressings. Recording studio. Mobile recording van. Manufacturers of the Sleep-o-matic Unit. Foreign language courses available for sleep-learning. Brochures and price lists on request from Dept. T.R. 21 Bishops Close, London, E.17.

EXCHANGES

Three good microphones for one. Enthusiast will exchange AKG D19B, Lustraphone Stereolus and B. & O. multi-impedance ribbon for one AKG D24B 60 ohms model. Consider other arrangements. Box No. (Kent) 317.

Published by Miles Henslow Publications Ltd 99 Mortimer Street
London, W.1 and printed for them by Portia Press Ltd., London.

— TAPE TO DISC SERVICES —

The following are members of the Association of Professional Recording Studios who can be relied on to give satisfaction

MJB RECORDING & TRANSCRIPTION SERVICE
specialise in the production of microgroove records from Professional and Amateur recordings (Acetate copies; Processing Masters and Pressings at 16 $\frac{1}{2}$; 33 $\frac{1}{2}$ & 45 r.p.m.) Extended playing times achieved by controlled cutting. Editing, Label printing, Mobile and "Off the Air" Services.
7 HIGH STREET, MAIDENHEAD Tel: (230)

TAPE RECORDERS · AUDIO EQUIPMENT · DISC CUTTING STD & LP FROM TAPE · STUDIO FACILITIES · HIRE SERVICE · SALES · EXCHANGES

MAGNEGRAPH

1 Hanway Place, London, W.1

Tel.: LAN 2156

PLEASE MENTION "THE TAPE RECORDER" WHEN REPLYING TO ADVERTISEMENTS.

PERMANENT BINDING

We can undertake the permanent binding of all volumes of The Tape Recorder. Send your copies to us, the price is 36s. which includes index and postage. They are individually hand stitched and covered in black buckram, gold block on spine. Other colours and leather bindings are also available, details on application.

Index to Volume 4 of THE TAPE RECORDER Available now - - - Price 2s. 6d. 99 Mortimer Street · London · W.1

ADVERTISERS' INDEX

| | |
|-------------------------------------|-------|
| Agfa Ltd. | 238 |
| A. Brown & Sons Ltd. | 257 |
| A. C. Farnell Ltd.—Irish Tape | 242 |
| Chateau Productions Ltd.—Microkit | 223 |
| Chelsea Record Centre Ltd. | 246 |
| City & Essex Tape Recorder Centres | 232 |
| De Villiers (Electronic World) Ltd. | 254 |
| Educational Recordings Ltd. | 257 |
| Elstone Electronics Ltd. | 248 |
| E.M.I. Tape Ltd. | 226 |
| Ferroglyph Company Ltd. | 242 |
| Fi-Cord Ltd. | 234 |
| Film Industries | 246 |
| Francis of Streatham | 244 |
| Grampian Reproducers Ltd. | 248 |
| Harvey Electronics Ltd. | 238 |
| Heathkit | 228 |
| Howard Tape Recorders | 250 |
| K & K Electronics Ltd. | 235 |
| Kodak Ltd. | 222 |
| Lee Electronics | 250 |
| Metro-Sound (Sales) Ltd. | 242 |
| Multicore Solders Ltd. | 238 |
| Nusound Recording Co. | 250 |
| Philips Electrical Ltd. | 236 |
| Recorder Co. | 252 |
| Reeves Sound Service Ltd. | 257 |
| Reps Tape Recorders Ltd. | 244 |
| R. E. W. Earlsfield Ltd. | 246 |
| Valradio Ltd. | 252 |
| N. Walker | 257 |
| World Record Club | 224 5 |

hi-fi books

CINE YEAR BOOK . . .

For the first time ever, a comprehensive survey in one complete volume of the cine market for the cine user. The new reference book for the professional, the enthusiast and the photo dealer. This valuable book follows the unique pattern set and maintained by the "Hi-Fi Year Book"—separate and detailed directories for every product group—Cameras, Lenses, Exposure Meters, Lighting, Film Stock, Screens, Projectors, etc. Some 200 photographic illustrations, suppliers' addresses, product specifications, library lists, cine services are all included in this book. **Price 11s. 6d. post paid**

HI-FI FOR BEGINNERS . . .

The ideal book for everyone who has just started, or is about to start the hobby. The various chapters deal with Loudspeakers, Amplifiers, Pickups, Turntables, Radio Tuners, Stereo and Installing. Hi-Fi Readers whose particular interests lie with tape will find that Chapter 7 alone will make the book worthwhile. **Price 8s. 3d. post paid**

SOUND & CINE FOR BEGINNERS . . .

An up-to-date guide for the beginner by Richard Golding, with an introduction to some advanced methods including the latest means of producing experimental soundtracks. Contents include making up separate tape tracks; sound stripe; optical sound-on-film; special recording apparatus; recording sessions; how to write commentaries, etc., with photographs and line illustrations. "The most comprehensive small book ever to be written on the subject of adding sound to film." **Price 8s. 3d. post paid**

CABINET MAKING . . .

This book gives you all the necessary information for building your own Hi-Fi cabinet. Subjects covered include, designing; ordering timber, marking out, tools; materials; joints and finishes. The many photographs and diagrams help to make this book indispensable not only for Hi-Fi applications but also for general cabinet work encountered in the home. It is written by the well-known expert Wheater Smith whose recent articles in "Hi-Fi News" have created considerable interest. ". . . highly recommended." **Price 8s. 3d. post paid**

EXPERIMENTAL RECORDING . . .

This book presents in convenient form the series of articles by A. Tutchings on "Twenty Practical Experiments in Magnetic Recording" and full introductions for "Building a Fully Portable Recorder", using a clockwork motor and transistor amplifier. **Price 5s 9d post paid**

STEREO FOR BEGINNERS . . .

For those who are confused or not wholly converted by Stereo reproduction this book gives all the answers. The author, B. J. Webb, explains in clear language what stereo is, and how best to obtain it, whether from disc, tape or radio. Advice and guidance on the purchase, installation and maintenance of suitable equipment; a six page glossary, many illustrations and special drawings are included. **Price 8s. 3d. post paid**

AVAILABLE SHORTLY

Available from Hi-Fi Dealers, W. H. Smith & Sons Ltd., or direct from the publishers:

MILES HENSLOW PUBLICATIONS LTD. 99 MORTIMER ST., LONDON, W.1



THE HI-FI SCENE—1963

Photo: 

first published in 1956 the Hi-Fi Year Book has steadily grown in size. This year for the first time it tops the 300 page mark and yet still costs the same price — 10/6. All the entries have been revised and brought up to date and there are new articles by leading authorities, on Pickups, Tuners, Amplifiers, Speakers, Tape Recording, Microphones together with an Audio Diary. The 16 Directory Sections cover all High Fidelity products currently available in the U.K. giving a brief specification, price, also manufacturers' names and addresses.

HI-FI YEAR BOOK

COMPLETELY REVISED

Price



(11/9 post paid)

TAPE RECORDERS

MOTORS

TAPE AMPLIFIERS & MIXERS

SPEAKERS

CONSTRUCTIONAL KITS

PICKUPS

AMPLIFIERS

TUNERS

MICROPHONES

TAPES

TAPE ACCESSORIES

HI-FI DEALERS

MILES HENSLOW PUBLICATIONS LTD. 99 MORTIMER ST., LONDON, W.1