

VACUUM TUBE VALLEY

Published Quarterly

Celebrating the History and Quality of Vacuum Tube Technology

Issue 1 Volume 1
May 1995

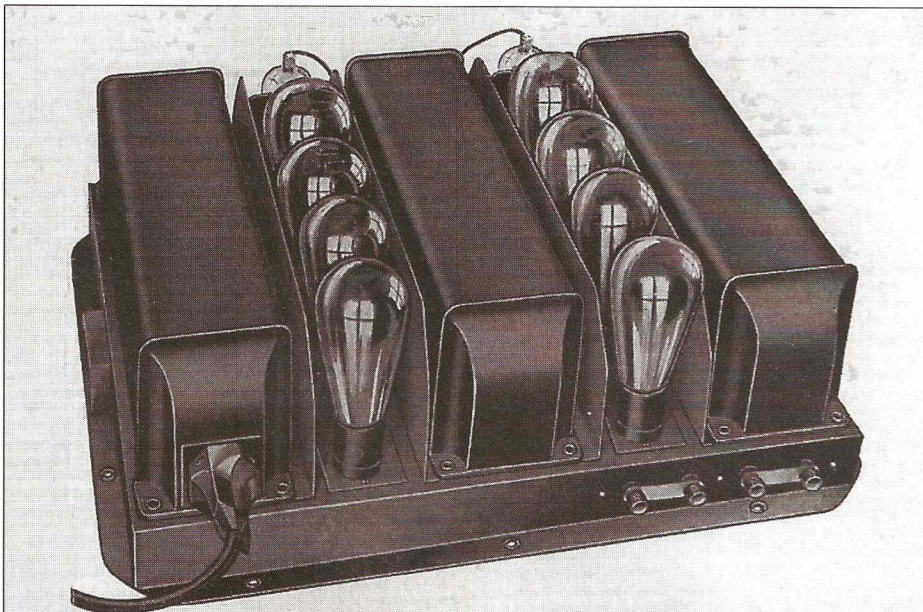

PAM 29—PRICE \$225.00—MEASURED POWER OUTPUT 24.5 WATTS

1931 Samson Electric PAM-29

In This Issue..

Dynaco - The Early Years

From the PAM-1, to the Stereo 70 and Mark VI - Dynaco was a very popular producer of tube hi-fi equipment during the Golden Age of Hi-Fi.

Charlie Kittleson outlines the story of one of the most prolific manufacturers of Hi-Fi for the masses. *page 5*

Tube Screening - Get The Most from Your Equipment.

How to spot bad tubes and how to evaluate the good ones.

John Atwood explains tube testing and screening for maximum performance from your gear. *page 8*

Tube Review - 12AX7

The 12AX7 is probably the most common audio tube. Learn the history of this important tube.

Eric Barbour evaluates the best of the old and the new. *page 13*

Dynaco, Manufacturing for the Masses

There are more Dynaco Stereo 70s than any other tube stereo amp on the planet. The Mark III has higher production figures than any other tube mono amplifier.

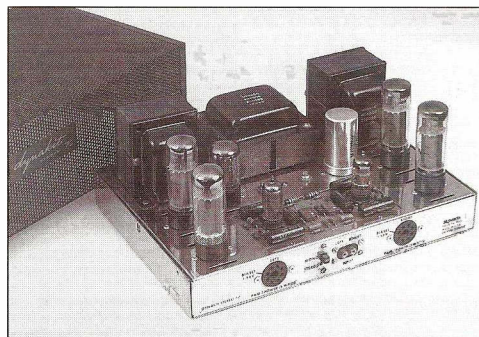

Dynaco ST-70



Dynaco Mark III

Early Amplification

Imagine a world before amps. Then imagine what the very first high quality amps looked like and how they performed. Get prepared for a nostalgic look at the early days of tube audio from the 1920's and 1930's on page 3.

Problems with Transistors

One of the most controversial arguments between different types of audiophiles is the debate of "tubes vs transistors". Learn more about the "pros" of tubes and the "cons" of transistors on page 10.

Tube Industry News

What are some of the newest and hottest audio tubes? Eric Barbour's regular column on the world tube industry will keep you up-to-date on page 11.

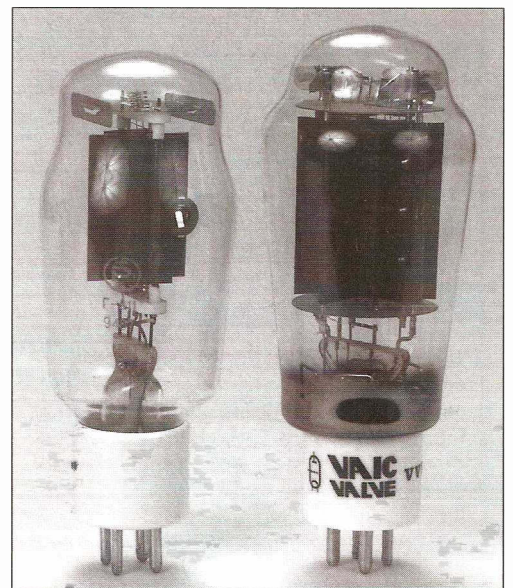

Svetlana SV811 and VAIC VV30B

Cathode Bias

The technical aspects of tubes and tube designs are covered in John Atwood's regular column. In this issue, the merits of "audio tubes" are discussed on page 12.

Vacuum Tube Valley News is published quarterly for electronic enthusiasts interested in the colorful past, present and future of vacuum tube electronics.

Written and Produced in the United States of America

Welcome to VTV!

Charlie Kittleson
Editor

Welcome to Vacuum Tube Valley! Enjoy the scenery and the sounds, you might even learn something. This publication will explore the colorful technical history of vacuum tube electronics. We will also cover contemporary technical aspects of amplifier design, passive component evaluations (capacitors, resistors, wire, etc), speaker technology, transformer design, tube performance characteristics and vacuum tube research. We will review tube musical instrument amplifiers both modern and vintage.

Why are people re-discovering tube sound? To many music lovers and musicians, tube amps add more realism, excitement and dimension to pre-recorded sound. Most tube amps and preamps are much easier to listen to for longer periods because they are typically smooth and musical sounding with more second order harmonics. To many listeners, most solid state amps are less musical, flat sounding, have wimpy mid-range and brittle highs. Most mid-fi solid state audio is designed to a price point and has a much shorter user life than tube products. Solid-state replacement components can be hard to find after several years of use.

Sixty year old vacuum tubes can sound wonderful. Properly restored tube hi-fi equipment made in 1948 can make better music than a lot of the latest digital gear.

The history of vacuum tube technology and audio reproduction is vast. We will concentrate our focus on the classic and contemporary designers, companies, equipment and products in America and across the globe. This will not be a high-end equipment review publication. There are several other publications that can supply you with that information.

Watch these pages for a nostalgic time machine visit back to the Golden Era of Hi-Fi during the Fabulous Fifties. We also will feature quality tube audio projects for those on a budget. Journey back to the movie theaters from the Roaring Twenties through the Sexy Sixties for a look and listen to the sound systems from the Golden Era of motion pictures.

Our audio experts will show you how to build exciting sounding amplifiers with "scrap bin" parts. We will explore several useful techniques to reduce distortion, noise and overload so you can enjoy the true realism and dimension of live music at home without spending a small fortune.

Contemporary audio tubes will be evaluated, life tested and compared to the best available vintage glass. There will be extensive studies on new and classic audio output transformers such as Acrosound, Dynaco, Peerless, UTC and more.

The writers and contributors to this publication are engineers, enthusiasts and historians, so you will get a perspective from the past as well as the present state of tube audio.

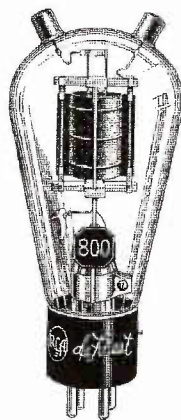

Editorial Team:

John Atwood - Digital and audio design engineer for several audio and silicon valley companies provides a rich knowledge of circuit design, tube and transformer characteristics. John will set the record straight on several of the audio myths that persist regarding tube technology.

Eric Barbour - Electronics engineer and writer for several audio publications has a vast knowledge of the tube industry including historical aspects of tube manufacturing, the new Soviet and European tube types and real-life performance and listening evaluations of new and vintage glass.

Charlie Kittleson - Industrial engineer, musician and vintage hi-fi expert will explore the Golden Age of Hi-Fi. He will examine and evaluate the very best in classic tube audio equipment from 1930-65. Charlie covers the history of the early hi-fi manufacturers.

Norman Braithwaite - Engineer, classic radio expert and electronics historian will take us back to the early days of audio (1920's-30's) for an informative look at the development of single-ended amps and high performance radios. Norm will also show us how to build quality amps on a budget.

Future issues of VTV will feature other writers who are experts in the field of vacuum tube audio electronics and related subjects.

This is a quarterly publication with minimal advertising from tube, transformer and related vendors. The subscription rate is \$25/yr - \$35 foreign for four issues.

We welcome your comments, suggestions and contributions. Be sure to tell your friends about us. Enjoy!

EDITORIAL STAFF

Vacuum Tube Valley News is published quarterly for electronic enthusiasts interested in the colorful past, present and future of vacuum tube electronics.

Subscription rate is \$25.00/year (4 issues) US and \$35.00 Foreign.

To subscribe, renew or change address call or FAX us at (408)733-6146.

Charles Kittleson - Editor and Publisher

John Atwood - Technical Editor

Eric Barbour - Tube Industry Editor

Norman Braithwaite - Electronics Historian

Steve Parr - Electronic Publishing Consultant

Copyright 1995 Vacuum Tube Valley
All rights reserved.

No part of this publication may be reprinted or otherwise reproduced without written permission of the publisher. Printed in the USA.

Send circulation and editorial correspondence to VTV, 1095 E. Duane, Ste. 106, Sunnyvale, CA 94086 USA

IN THE BEGINNING . . .

By **Norman Braithwaite**

"Go placidly amid the noise and haste but remember what peace there may be in silence"... Yes, there was a time when there were no amplifiers. And, in fact, the world does not revolve around an amplifier! Nevertheless, amplifiers are fun and even necessary in today's technological society.

Prior to the days of electrical signals there were no practical amplifiers. Reproduction of sound was accomplished by transducers which were only able to convert the existing mechanical energy into acoustical pressure waves (for the non-technically oriented, sound waves). Amplification could only be accomplished in a mechanical system by resonance and addition of mechanical energy. Unfortunately, addition of mechanical energy was not simple and was limited to resonant systems. Consequently, prior to electric signals, all acoustic reproduction was limited to the available energy stored on the recording media. The quality of sound from these mechanical devices was also rather crude. I'll take the silence!

The first electronic amplifiers were developed early in this century to meet the demands of the military and long distance telephone applications. Early electronic devices advertised as amplifiers were often devices which more efficiently transduced the signal into sound such as the first Magnavox Telemegaphone sets developed by Peter Jensen. The first Telemegaphone reproducers employed an electromagnet and conventional voice coil making them an order of magnitude more efficient than any previously developed electric reproducer. These early Telemegaphone sets were simply much more efficient transducers and not amplifiers.

Shortly after World War I with improved access and reliability of triode "audions", several companies started manufacturing electronic amplifiers for the purpose of increasing the energy of weak audio signals. Applications for these amplifiers now included telephone, radio, public address and home entertainment for those who were willing to convert their acoustic phonograph reproducer over to an electric reproducer.

Amplifiers of the early 1920s were primarily built for voltage amplification. They would often include two or three stages of amplification for the purpose of boosting the signal voltage out of the microvolt range and into the millivolt range. Most of these amplifiers used tube types such as the RCA/GE UV-201A and Western Electric 216A. Portable amplifiers running off batteries used low filament current tubes

including RCA/Westinghouse GE WD-11, UV-299 and Western Electric 215A or 239A. High gain tubes were not available at the time therefore all of these tubes had low amplification factors of approximately 10.

All amplifiers built in the early 1920s were transformer coupled and required batteries for power. Most were single ended. Output impedences were high (typically 2000 ohms) for driving headphones, horn, drum or inverted paper cone speakers.

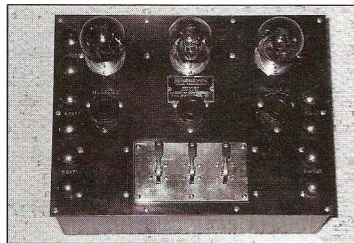

Magnavox AC-3

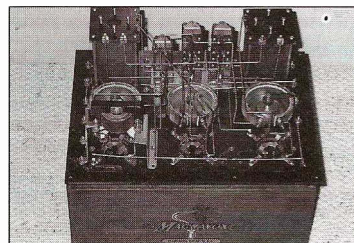

AC-3 chassis

Construction of these amplifiers was purely practical. There were no decorations other than the manufacturer's label and no styling, special materials or finishes beyond what was necessary for the operation of the amplifier.

The Magnavox AC-3 amplifier is typical of the amplifiers of the early 1920s. Unusual features of this amplifier include top mounted tubes (most amplifiers had the tubes located inside a cabinet). The amazingly inefficient audio transformers had iron wire cores (the little audio transformer near the front left of chassis) and the ability to use both RCA and Western Electric type tubes, including the W.E. 205-D tube.

The positions of the switches in the middle front of the amplifier defined the number of stages of amplification desired. Other early 1920s amplifiers were manufactured by Western Electric (W.E.s model 2C amplifier was very similar to the Magnavox AC-3) and by many radio manufacturing companies.

Starting around 1925, the requirements of amplifiers began to change. Radios and other sources of electronic signals were being built with ample voltage amplification. The first auditorium speakers and dynamic drum speakers were arriving on the market. The impedance of some of these

speakers were dropping to approximately 500-ohms and the power requirements were up. Along with the new, better sounding speakers (keep in mind that these speakers sound real bad by today's standards), new amplifiers were offered with greater power. Greater power in 1925 was around a watt or two!

Cabinets for some amplifiers were built of more durable and better looking materials. The better general purpose amplifiers



RCA AP-935

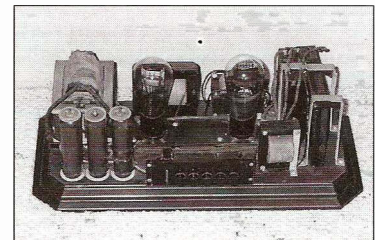

RCA AP-935 (without cover)



WE 25B

were built to operate from the AC line. From an electrical standpoint these amplifiers were still very practical. Transformer coupling was used almost universally and most amplifiers were still single ended. Amplifiers typical of the mid 1920s include the RCA AP-935 (Figure 1) "Uni Rectron" and the Western Electric 25B. Construction practices used on these two amplifiers are very similar. A schematic of

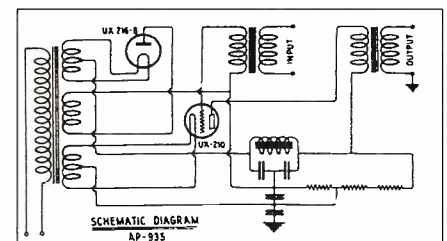
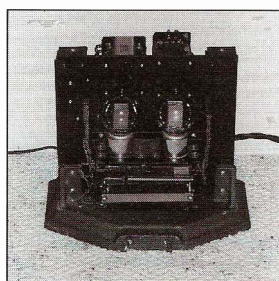

Fig. 1 - RCA AP-935 schematic



WE 25B (without cover)

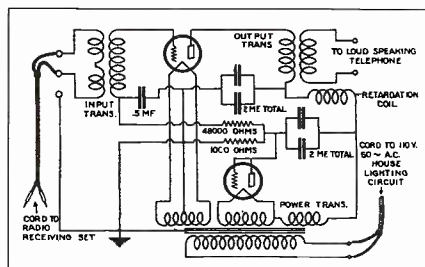

Figure 2 WE 25B Schematic

the Western Electric amplifier is shown in figure 2. Electrically, these amps are nearly identical.

The RCA amplifier uses an RCA type UX-216B tube for a rectifier and a type UX-210 tube for the audio amplifier. The RCA type UX-216B tube is not to be confused with the Western Electric type 216B amplifier tube. The RCA tube was a short lived half wave rectifier, predecessor to the type UX-281. The change in designation was understandable considering the similar names.

The Western Electric amplifier used a type 217B half wave rectifier or 205D triode for the rectifier and a type 205D triode for the audio amplifier.

Power amplifiers used in consumer products near the end of the 1920s used newly developed power tubes including the RCA types UX-245 and UX-250. These triodes were the first popular power tubes for home entertainment use. Most high quality radios and electronic phonographs would use a pair of UX-245 or UX-250 tubes in the output stage driving early dynamic cone speakers. General Electric introduced the first dynamic cone speaker in 1928. The General Electric speaker along with similar speakers

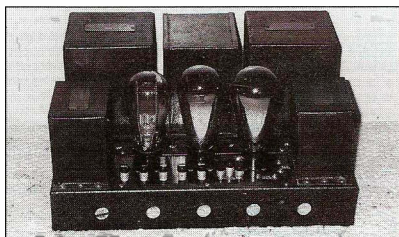

E. H. Scott Single Ended Amplifier

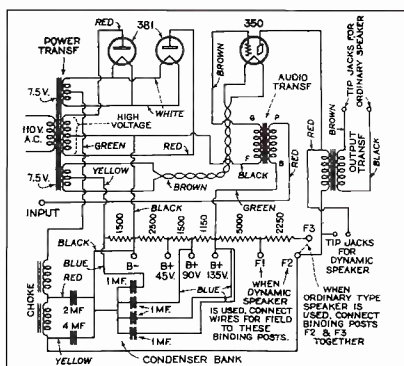
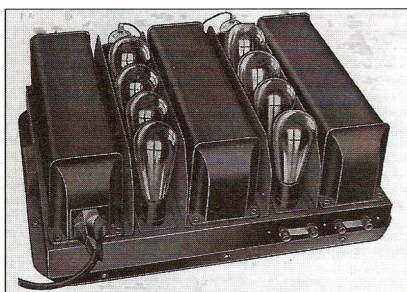

Figure 3 Scott Shield Grid "9" schematic

by Jensen and others were capable of producing much better sound reproduction, but required greater power to do so.

Manufacturers of expensive radios and amplifiers made a nearly complete transition from single ended amplifiers in 1927 to push-pull and push-pull parallel amplifier circuits by 1932. Around the same time in 1927, the UX-222 screen grid tetrode was introduced by RCA of Camden, New Jersey. The tetrode's claim to fame was greater amplification and efficiency which meant fewer tubes were needed in radio sets to get the same performance. The tetrode's screen grid also reduced the Miller effect in triodes which can reduce the frequency response of the tube. Many manufacturers began using the tetrode in radios and amps, replacing the use of triodes in the output stage.



Samson PAM-29 Amplifier

The larger commercial amplifiers manufactured by Western Electric used Western Electric type 211D tubes for high power applications and continued to use Western Electric type 205D tubes for small power applications. Other manufacturers of commercial amplifiers used the RCA type UX-250 tubes. Starting in the late 1920s power amplifiers manufactured for commercial purposes began to deviate in design and construction practices from amplifiers built for consumer use. Also in the late 1920s many of the commercial amplifiers were built to fit in equipment racks.

The Scott Transformer Corporation amplifier was used as an amplifier for their "World's Record Shield Grid Nine" receiver.

In addition to providing audio power capable of driving a high quality dynamic speaker, these amplifiers served as a B+ power supply for receivers. Although offered as an option for the Shield Grid Nine receiver, the Scott amplifier could be purchased separately and used with other receivers or for other purposes.

The schematic for the Scott amplifier is shown in Figure 3. Note that output from this amplifier is provided for an ordinary speaker (2000-ohms) or a dynamic speaker (output transformer attached to speaker). This is one of the last single ended power amplifiers built for radio use.

The PAM-29 amplifier made by Samson in 1931 used four RCA type UX-250 power tubes. Measured power output was 24.5 watts. Although capable of being mounted inside of some radio cabinets, this amplifier was primarily marketed as a commercial amplifier. I am not aware of any other radios manufactured during this time period which used an amplifier of this size.

Since the time when these early amplifiers were indicative of the highest mark in sound reproduction there have been many improvements in amplifier components and design. Among these innovations were push-pull operation, screen grid power tubes, direct and resistance coupled circuits, beam power tubes, negative feedback, tone compensated volume controls, silicon steel core audio transformers, Williamson circuits, Ultra-Linear circuits, balanced differential circuits, Wiggins Circlotron circuits, numerous circuits of which I do not know the name, output transformer-less amplifiers, transistors, op-amps, integrated circuits, etc. Through this period of time substantial improvements have also been made in the signal source media and sound reproducers.

Perceived as ironic to the average listener, some of the highest quality and best performing amplifiers are now once again being manufactured using vacuum tubes. Of these new tube amplifiers, among the most highly regarded are the all triode and single ended amplifiers.

As a result of my insatiable appetite for truth and knowledge, I have built a simple all triode direct coupled single ended amplifier from which I can derive my own opinions and conclusions. In my humble opinion it is the best sounding amplifier to which I have listened (several acquaintances shared the same sentiment hence I am not alone). From this experience I would like to share a conclusion which can be best summed up by the following phrase:

Go placidly amid the circuits and devices but remember what fidelity there may be in simplicity!

THE HISTORY AND FUTURE OF DYNACO TUBE AUDIO

by **Charlie Kittleson**

During the mid-Fifties, hi-fi and the kit building craze was at its peak. Many music lovers wanted to build their own hi-fi sets because factory built equipment was expensive. Some audio enthusiasts opted to scratch build their equipment using circuits from published articles in Audio magazine or Radio-Electronics. For others with less electrical and mechanical ability, a kit amplifier was more appealing. Thus the demand for audio kits began.

David Hafler, the founder of Dynaco, got his start in the world of commercial audio by partnering up with Herb Keroes in the late 1940's. The two formed a Philadelphia, Pennsylvania company called Acrosound in 1950 to build high quality audio output transformers. By 1952, they had developed and marketed the famed "Ultralinear" circuit. The Ultralinear circuit topology was originally patented in the late 1930's by Blumlein in England.

In the early 1950's, push-pull class A triode amps were the "high-end" choice. Their major drawback was low power, usually only 10-12 watts using a pair of 2A3s. Tetrode and pentode push-pull designs were more efficient and powerful in class AB-1 mode. Using the 6L6, KT-66 or 807, an amp designer could get between 20 and 40+ watts. Major drawbacks of these were higher odd-order distortion than triodes and high output impedance, producing low damping factors. The output impedance and distortion could be reduced by feedback, but this required a high quality transformer and still left the amp with a "pentode" sound.

To reduce this distortion, Hafler and Keroes used the Blumlein circuit and a proprietary output transformer with a patented 43% Ultralinear ratio that achieved the power of a beam tetrode circuit and reduced distortion to that of triode amps. The output transformer was equipped with taps for the screen grids with a reduced turns ratio which ran the output tubes part way between the triode and pentode connection. In the mid to late 1950's, the Ultralinear circuit and transformer became very popular and was used by many start-ups and established hi-fi manufacturers. EICO, Heathkit and other manufacturers offered Acrosound output transformers as a premium upgrade



Mark II

for their amp line.

In 1954, the relationship between Keroes and Hafler began to wane, so they parted ways and Hafler formed his own company – DYNACO. Hafler's goal was to produce an affordable amp with high quality transformers, a stable circuit, high power, easy to assemble and affordable. In 1955, the first Dynaco amplifier was introduced - the Mark II.

It was a 50 watt amplifier using the patented tapped screen-grid output transformer (A-430 with 4 and 16 ohm taps), push-pull Mullard EL-34 tubes, and a single 6AN8 tube with the triode portion used as a cathodyne phase inverter and the pentode section used as the driver. The rectifier was the popular 5U4G. The Mark II was unique in a number of ways. First, it was available in either assembled or kit form under the "Dynakit" name. Second, the entire driver and front-end circuit were pre-built on a printed circuit board. Third, it was low priced - \$59.95 in kit form and \$79.95 assembled for a 50 watt RMS power amp - complete with all tubes and a protective cage. The chassis was cadmium plated steel and the case was perforated steel, painted black. The amp was a success and was sold through the early 1960's.



PAM-1 (with power supply)

Also in 1955, Dynaco introduced their first preamp, the PAM-1 (\$34.95), that required a separate power supply or could be powered by the octal power out socket on the Mark II amp. The preamp was very compact and unobtrusive. It featured controls for volume, bass, treble, function selector and phono equalization. Tube complement was two 12AX7/ECC83 dual triodes, typically Mullard or Telefunken. These brands were chosen for smooth sound, low microphonics and long life. The unit was packaged in either a dark gray or ivory enameled sheet metal case with lacquered brass face plate and white plastic knobs. The PAM-1 was available through the early 1960's.



Mark III (early)

In 1957 McIntosh, Fisher and Scott sold 60+ watt power amps. Not to be outdone, Hafler introduced the Mark III amp in 1957. It was the first commercial US amp to use the new KT-88 power tube from Genalex of England. It produced a solid 60 watts RMS and used the same 6AN8 driver/phase inverter circuit from the Mark II. Changes included the use of a 5AR4/GZ-34 slow warm-up rectifier tube, higher voltage (500+) power transformer, newer output transformer (A-



Mark III (late)

431 with 4, 8 and 16 ohm taps), beautiful nickel plated chassis, and a heavy gauge perforated steel cage finished in dark gray. The amp sold for \$79.95 in kit form and \$99.95 assembled. It was an instant success and was used in more systems than probably any tube mono power amplifier. It is estimated that several hundred thousand Mark III's were made from 1957 through 1977, its final year of manufacture. Early versions used cloth covered wire on the transformers that had gray painted end bells. Later versions, in the 1970's, had a different variant output transformer (Z-216) and a power transformer using plastic-insulated wire. The cage and transformers were finished in gloss black. It should be noted that using 6550As in place of KT-88s in Mark III amps may cause thermal runaway. (The grid resistor in stock Mark III's is much larger than the value specified for the 6550A.)

Dynaco used Tresco, a Philadelphia, Pennsylvania transformer manufacturer as the source for most of their transformers. In the mid-1960's Dynaco used Japanese sources for their power transformers (tar/epoxy dipped) and some output transformers.

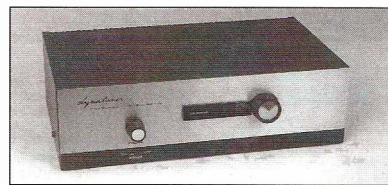

FM-1

After the explosion of the television industry in the post-war era, more interest was focused on FM radio. To respond to the public's needs, Dynaco introduced the FM-1 (\$79.95) in 1957. It was a monophonic tuner available in assembled or kit form that was relatively easy to build and align. The case was gray or ivory enameled sheet steel with a lacquered brass faceplate.

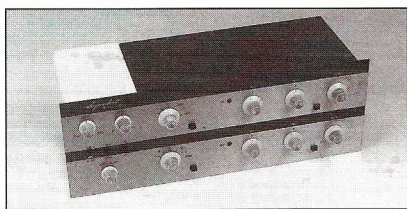

PAS-1

In the late 1950's, stereo records became available and the need for stereo playback equipment began to grow. Many audiophiles just bought a stereo phono cartridge, another amplifier and another speaker to play their records and tapes in living stereo. Dynaco's first stereo component was the PAS-1. It consisted of two PAM-1 preamps and a passive stereo adapter box. All three items were attached to a large brass faceplate. Power was supplied from the octal power sockets from either Mark II or III amps. This setup was a maze of cords and interconnects and was only available for a short time.

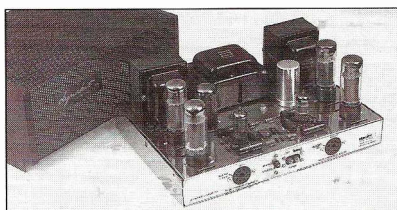

Stereo 70

Dynaco saw the need for a single chassis stereo power amp, and in 1959 introduced the legendary Stereo 70. The amp originally sold for \$99.95 in kit form and \$129.95 assembled. The entire front end circuit for both channels was mounted on one printed circuit board. The circuit consisted of a 7199 tube used as a driver/phase inverter for each channel. The 7199 was introduced by RCA in the late fifties specifically for audio applications but was similar in construction and characteristics to a 6AN8. The output stage was push-pull EL-34 Mullard or Amperex beam tetrodes. Output transformers were the famed A-470 Ultralinear type and were rated at 35 watts RMS/channel.

There were several variations of the A-470 transformer over the years including those with cloth lead wire, plastic lead wire and different stack densities. The power supply used a GZ-34/5AR4 and a large power transformer which also had a number of variations over the years. Early Stereo 70s had nickel plated chassis and later ones were chrome plated. The cages were originally brownish-gray perforated steel. Later versions were grayer in color and the last ones had black cages. There were probably more Stereo 70 amps manufactured than any other stereo power amp. Some esti-

mates are that almost 500,000 units were produced.

The Stereo 70 is also the most modified and upgraded amplifier in existence. Probably more Stereo 70 amps have been passed on from father to son than any piece of audio equipment. It is easy to improve the amp with an upgraded driver board and beefier power supply. There are thousands of Stereo 70s in service today. In fact, there have been two re-releases of the amp in the late 1980s and early 1990s.



PAS-2

As a match to the Stereo 70, Dynaco introduced the PAS-2 (\$59.95) stereo preamp in 1959. The PAS-2 eliminated the need for separate mono preamps and stereo adapters. It was a complete, low cost stereo control center in one compact box. The majority of the circuit was on two printed circuit boards – one for the phono stage and one for the line stage. Tube complement was four ECC-83/12AX7s (typically Telefunken smooth plates) for the phono and line stages. The rectifier tube was the 12X4. Filaments were run from DC and rectified by a selenium stack. (Note: the selenium rectifiers deteriorate with age and must be replaced with silicon diodes for optimum performance). The faceplate of the PAS-2 was lacquered brass, the case was either dark gray or ivory white and the knobs were brown plastic with brass colored inserts.

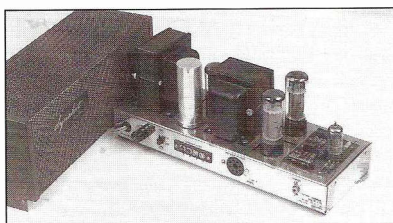

Mark IV

In 1960, the Mark IV (\$59.95) 40 watt power amplifier was introduced. It was aimed at the audio purist who wanted the performance of a mono amp using the Stereo 70 topology. The Mark IV was identical in most ways to the Stereo 70 including front end circuit, push-pull EL-34 output stage and the A-470 output transformer.

Differences were the power transformer, smaller than the Stereo 70's, but with higher plate voltage and different packaging. Mark

IVs will actually put out about 44 watts RMS. The amp is rectangular in shape and was not made in large numbers. It too, is an excellent candidate for modifications or upgrades.



PAS-3

In 1964, Dynaco changed their front panel design. The PAS-3 (\$69.95) was equipped with similar circuitry to the PAS-2, but featured an aluminum champagne anodized faceplate and all-metal knurled knobs.

In 1966, the PAS-3 was replaced by the PAS-3X featuring a different tone control circuit. The PAS-3 and PAS-3X were available in assembled or kit form and were made through 1977. There are probably more PAS-3s than any other tube stereo preamp. In the late 1980s Dynaco introduced a re-issue of the PAS-3 with different topology and power supply.



FM-3

In late 1961, when the FCC approved a standard FM multiplex stereo broadcasting system, many hi-fi manufacturers released FM stereo tuners, receivers and stand alone multiplex adapters to convert FM mono tuners. Dynaco upgraded the FM-1 to the FM-3 and included an on-board multiplex system to receive both mono and stereo broadcasts. They also introduced a multiplex upgrade kit for the FM-1, the FM-3X.

The FM-3 (\$109.95) was available in assembled or kit versions and was produced through the 1960s. The faceplate was champagne gold aluminum with metal knurled knobs.

Stereo "bookshelf" integrated amps were very popular in the early 1960's because they were simple and used up little space. Dynaco introduced the SCA-35 (\$99.95) integrated amp in 1962. It produced about 17 watts per channel and was very popular with music lovers and record collectors. The circuit featured two 12AX7s for the



SCA-35

phono and line stages, two 7199s for the driver/phase inverter stages and four EL-84/6BQ5s for the output stages. The rectifier was solid state. The output transformers were very high quality units (Z-565) and are thought by some to be the best sounding Dynaco output transformers.

For audio enthusiasts who wanted the sweet sound of EL-84s, Dynaco produced the ST-35 (\$59.95) basic power amp (no photo). It produced 17.5 watts per channel and used a 7247 driver/phase inverter and push-pull EL-84/6BQ5s. The rectifier was solid state. The chassis was cadmium-plated and cage was gray perforated sheet steel. The ST-35 is very popular for bi-amping horns because of its sweet and smooth characteristics. Very few ST-35s were produced and they are quite scarce.

In the mid-1970s, Dynaco moved their design and manufacturing facility to Blackwood, New Jersey and expanded production there. The later versions of the Stereo 70 and the Mark III amps with black cages were produced at this location.

The Mark VI (no photo) was the last all tube amp to be produced by the original Dynaco. It was introduced in the mid-1970s and aimed at the Japanese tube audiophile market. It produced 120 watts RMS and used four type 8417 beam power pentodes. The driver/inverter tube was the 7199. A biasing and output meter was on the front panel which was black anodized aluminum. The power and output transformers were massive and the rectifier was solid state. Some experts claim that only 1000 Mark VIs were produced. Most of the Mark VIs were not assembled at the Dynaco plant, but were sold unassembled to Stereo Cost Cutters (now Sound Values) and other companies who sold them as kits or assembled.

In the mid-1960's, Dynaco began producing solid state amps and preamps which we will not cover in this article. In the late 1970's David Hafler sold Dynaco to TYCO Industries, a toy manufacturer. He then started another company called Hafler and sold solid state amps and preamps.

Stereo Cost Cutters of Ohio bought a huge stock of inventory from Dynaco's Blackwood, New Jersey facility. They sold parts, tubes and some un-assembled kits. They also re-designed the PAS-3 preamp and Stereo 70 power amp in the late 1980's.

In the early 1990's, Panor Corporation of Hauppauge, N.Y. purchased the Dynaco name and began selling Dynaco-branded solid state amps and preamps. In 1991, they designed and produced an all tube pre-amp, the PAS-3, Series 2. In 1994, they introduced the PAS-4. and the Stereo 80 all tube power amp. These new products were designed by John Nunes and Arn Roatcap, previously of MFA. Dynaco will be introducing the PAS-5 all tube remote control line stage only preamp in mid-1995. They recently introduced a tube type compact CD player and will be introducing the Stereo 160 power amp soon. The warm glow of tubes is now alive and well at Dynaco.

MUSICAL REFERENCES

by Mark Stanford

References

What are my musical references? What equipment do I use at home? My basic references are orchestras. Listening to different symphonies, different conductors and different halls. Orchestras are not my only live reference, just the one I enjoy the most. The orchestra I most frequent is the San Francisco Symphony. But I make it a point to hear the symphonies in every city I travel to throughout the country.

Sorry to say, but I've never heard a demonstration that sounds just like a live performance. Live venues and home stereo/entertainment centers are two different animals. I don't ever anticipate having the same musical experience at home as I do at a live event. Many times I've heard recordings of events I've attended, and SURPRISE!!!, the two don't sound at all similar. Home and live venues should be taken on their own terms. There's a quality and experience found only when one attends events with musicians performing live, of watching and focusing on different musicians, of real acoustics and of the excitement of the audience, recalling the last live event.

My home system does not disappoint me after attending live events. Violins sound real, horns, pianos and voices sound like what I'd heard the evening before. But I never am able to mistake my home system for the live concert. It only jogs my memory.

At the front of the system we find a vintage all tube tuner, a CD source with tubes in it, my turntable arm uses a moving iron cartridge, a recent preamplifier with lots and lots of tubes, a tube phone stage and custom tube amplifiers powering British loudspeakers. It's all tubes, bless them -- except for the front part of my CD player.

I think that the bottom line in all this is that I spend a tremendous amount of money, time and effort in attending concerts. It's well worth it to me. I encourage you to do the same. Otherwise, I suspect that you may be just fooling yourself as to

what's real, and what's not.

BBC Music Magazine

This fine monthly publication from the BBC comes with a CD. Its cost is well under a ten-spot. Many of these BBC CDs seem to come from deep in the vaults of the BBC. I could only make a very uneducated guess as to how deep these reserves are. But I've heard that there may be over 25,000 performances. But let's talk about these CDs, the music. The quality of the sound is just great. Usually its much better than those fancy pricy labels and CDs. Must be the microphone recording techniques they used. Might be that they didn't fool around equalizing the material. May be because they didn't do a lot of editing. What ever they do do, it does sound like real music. The other thing I've noticed is that a great many of the recordings are done at live events. Yup, I hear the audience. And, since that's my frame of reference and it really doesn't bother me, it only reminds me of a real concert...something I really love. I can "hear" the concert hall, "hear" the audience and even catch a cough or two in the recording -- all perfectly natural. It reminds me of an actual event, making the recording believable. My advice to you is to sign up for the BBC Music Magazine. You may not like everything you receive but you'll surely enjoy exploring some new material!

\$7.50 per issue (Book,CD and shipping)
BBC Classical Music Service
P.O. Box 60041
Tampa Florida, 33660-0041

Jazziz Magazine

JAZZIZ magazine also has a CD included with each edition. So, in this way it is similar to the BBC magazine. And the similarity ends right there. The music is a sampling of current jazz releases, and they seem to be primarily newer jazz and fusion artists. There is nothing meaty, with substance, with soul, nothing you can sink your teeth into. Adding insult, the cuts are sequenced on a Sony MiniDisc MDS 501 MiniDisk Recorder for preparation for CD mastering. So, these cuts are only an overview of the real disks, and may not bear any sonic resemblance to the actual CDs. But the CDs may do well in your car where you can't hear quality anyway.

\$8.50 per issue (CD, book & shipping)
JAZZIZ Magazine
P.O. Box 60035
Tampa Florida 33660-0035

Vinyl Records

Where did all the records go to? Yes, the very same place our tubes and transformers went. The Far East Museum of Audio. I'm sure that the Japanese will take care of them. Our old records will not be used for shotgun practice.

SCREENING VACUUM TUBES

How to evaluate new and used tubes

by **John Atwood**

Why is this article called "screening tubes" rather than "testing tubes"? Mainly, this is because testing tubes suggests checking them on a tube tester, and throwing away the ones that are bad. This article will cover more than just tube testing - it will describe the important defects and failure modes of tubes, and how to screen out the unwanted tubes.

Why screen tubes? Aren't the new tubes I buy from the tube dealer just fine? Isn't that box of junked tubes I saw at the swap meet not even worth looking at? Well, no, and yes. New tubes can sometimes have defects. The equipment using the tubes may have a particularly stringent requirement for its tubes. Many used tubes may be quite good, and still have a long lifetime. In fact, the quality of old used tubes may be better than new tubes made with questionable quality controls. Or, tubes that have been rejected for a critical use may be just fine for a less-critical application.

This article will examine the types of failures and defects common in tubes, and common ways of screening tubes for the characteristics of a given system.

Failure Modes in Tubes

Failure modes are the common ways that a given device fails or is defective. In the case of tubes, there are two categories of failure modes: ones for unused tubes, and ones for used tubes. The failure modes for unused tubes are primarily caused by manufacturing defects or mis-handling. Failure modes in used tubes include the ones for new tubes, but also include wear-out mechanisms.

In new tubes, the most common defects are:

1. **Shorts** - often caused by loose elements or marginal construction.
2. **Bent grid wires** - caused by mis-handling during tube construction. This causes poor cut-off, which in audio tubes usually translates to higher distortion.
3. **Noise or microphonics** - caused by chemical contamination or poor construction techniques. Microphonics can also be caused by rough handling of the tube.
4. **Mislabeling** - caused by intentionally or unintentionally marking one tube as another. Often the tube will "work" in the circuit, but have higher distortion. A classic case of this were the 6ES8s (ECC189s) that were marked as 6DJ8s. The tubes look the same, but the 6ES8 has a remote

cut-off characteristic, leading to high distortion.

Used tubes of unknown origin (e.g. that box of loose tubes from the swap meet) can have the following failures:

1. **Poor emission/transconductance.** This is the most common failure in newer (> 1950) tubes and is especially common in small tubes with high transconductance. This is caused by "wear-out" or contamination of the cathode material.
2. **Open filament.** This is more common in older (< 1950) tubes and battery tubes.
3. **Gas.** This is common in power tubes, especially ones that have been abused.
4. **Heater-cathode leakage** or shorts.
5. **Noise** - often associated with weak emission.
6. **Cathode Interface Resistance.** This causes the cathode to lose the ability to put out sustained current.

Visual Checks

Checking the appearance of a tube can help screen out some obvious problems, plus help determine if a tube in a box is really N.O.S. (New Old Stock - old, but unused).

The first place to look is the getter - that silvery reflective area where metal (usually barium or magnesium) is flashed onto the inside of the envelope to trap stray gas molecules. If the getter is completely white, there is a gross air leak, and the tube is no good. If the getter is very faded with just a small reflective spot left, then the tube has seen hard use and may be gassy. It may still be OK, but it is suspect. If the getter is fresh - with no darkening or discoloration around the edges, then the tube is more likely to be good, or at least have low usage, but it still may have other problems.

Shake the tube. If something rattles, look inside. If it is a small piece of glass, then don't worry, but if it is a piece of metal, then throw the tube away. Sometimes octal tubes will have loose material in the base. This is not usually a problem unless the whole base is loose.

You may find boxed tubes that appear to be unused (N.O.S.). But are they really? They may just be defective tubes ("pull-outs") that a service technician stuffed back in the new tube's box. Looking at the tube can help tell if the tube is a pull-out. First, is the brand of the tube the same as the brand on the box? If not, it is unlikely to be N.O.S. Are the markings reasonably clear? Most tubes have very fragile brand markings that easily rub off with handling or cleaning. Are there obvious finger prints or dust accumulations? Is the glass substantially darkened? Is the getter noticeably eroded? While some tubes have some slight darkening or what appears to be slight getter erosion

when new, most should look fresh. If any of these visual signs indicate the tube is used, go to the next step, and check its transconductance. And, don't pay an N.O.S. price for the tube!

Emission & Transconductance Testing

Decline in electron emission from the cathode is the major cause of tube wear-out or failure. This is caused by the cathode oxide coating getting poisoned by gases or having key elements depleted from the cathode surface. Low cathode emission manifests itself as low transconductance (amplification) and inability to supply high amounts of current. Emission normally declines very slowly over the life of the tube, then drops quickly near the end of its life. Tubes that have a high current density from their cathodes, such as small RF tubes, will lose emission sooner than tubes that draw low current or are run well below their specs.

Cheap tube testers, including the drug-store variety, usually are "Emission Testers", meaning that they simply apply a voltage from the cathode to all other elements, and see how much current is drawn. This will show weak emission, but can actually damage tubes by drawing excessive current, causing cathode stripping, or overheating delicate grid structures. If the tube tester does not say "Transconductance Tester" or the equivalent on it, and it looks fairly cheap, it is probably an emission tester. Don't use it.

The majority of tube testers are "transconductance" testers - meaning that they apply a small AC voltage on the grid, and look at how much AC current appears on the plate. This is a more realistic test, and does not over-stress the tube. Most transconductance tube testers apply a pulsating (unfiltered) voltage to the plate, so the "transconductance" reading is not really an precise value, but is more of a composite reading. While not good for laboratory testing, this composite transconductance is quite useful for evaluating the emission of a tube, regardless of the exact tube characteristics. Some sophisticated testers, such as the "laboratory" models and the Hickok 123 Cardomatic, apply carefully-controlled DC voltages to the tube, and get a relatively accurate measurement of transconductance. However, because the tube is tested only at a data-book operating point, and not over a wide range of currents, low emission at high plate currents is not always revealed. So, general-purpose transconductance tube testers, such as the military TV-7/U, the Heathkit TT-1, most Hickok testers, etc., are good choices for testing the emission of tubes.

With the exception of laboratory-type testers, each tube tester's readings are somewhat arbitrary. The manufacturer will pick a "sensitivity" or "english" setting for each

tube that will put good tubes into the green area on the meter. Alternatively, the military testers will give a minimum acceptable transconductance reading. Every type of tube tester has its own personality, and before accepting or rejecting any tubes, some known good tubes should be tested to give an idea of the reading of good tubes. On my TV-10/U (the military version of a Hickok 6000), most good tubes read 1.5 to 1.9 times the minimum acceptable transconductance. Thus if a tube comes in at just barely over the minimum acceptable value, it is on its way out, and I reject it. However, other testers are different - and should be calibrated with known good tubes.

If a tube does not pass the transconductance test, then it is either defective or worn-out. Unless you want to save it as a display piece, or use it in a very non-critical application, throw it out.

Curve Tracing

A characteristic curve tracer plots on an oscilloscope screen the actual plate current over different plate and grid voltages. The characteristic curves, as seen in data books, can be easily viewed. However, the most interesting curve for tube screening purposes is plate current versus negative grid voltage. This shows the curvature of the transfer curve and how well the tube cuts-off. If there is a lot of curvature, there will be more distortion. If some grid wires were bent during manufacturing, the plate current will not go to zero - indicating incomplete cut-off. If a remote-cutoff tube had been mis-marked as a sharp-cutoff tube (i.e. a 6BA6 marked as a 6AU6 or a 6ES8 marked as a 6DJ8), the remote cutoff would be obvious.

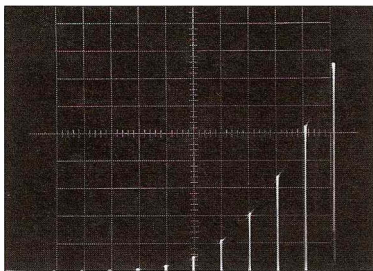

Figure 1 Normal 12AT7

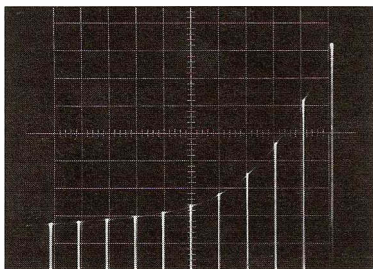

Figure 2 Poor Cutoff 12AT7

Figure 1 shows one section of a 12AT7 (in this case a mil-spec Raytheon JRP-12AT7 from 1960). This shows the normal, but somewhat curved, transfer curve, characteristic of most 12AT7s. Figure 2 shows the other section of the same tube, with incomplete cut-off. This example is fairly gross, but it is interesting that this defective tube still found its way into the military. Fortunately, defects like this are fairly rare.

Curve tracing, at least for screening tubes, is more of a qualitative test than a quantitative test. Running tubes through a curve tracer will quickly show defective manufacturing or high distortion. It does not show weak emission as well, unless it is extreme. So, curve tracing is supplemental to transconductance testing.

The only mass-produced tube curve tracer was the Tektronix 570, introduced in 1955 and manufactured through the early 1960s. Unfortunately, few were produced, and they are extremely hard to find. There have been a few curve-tracer construction articles over the years. With the availability of cheap A/D and D/A boards on PCs, it would not be hard to build a computer-controlled curve tracer. What is needed is a cheap kit or assembled curve tracer for tubes.

Noise and Microphonics

Noise and microphonics are two different things. Noise is the hissing or crackling noise caused by: shot noise (the actual variations in electron flow), unstable cathode states (showing up as 1/f or "excess" noise) as well as the inherent noise (Johnson noise) in all resistive devices. Microphonic noise is caused by mechanical movement of different elements within the tubes, and only is manifested when vibration is applied to the tube. Hum is also a type of noise, but in well-designed tubes, is usually only a problem if there is heater-cathode leakage. Most modern high-gain designs run the filaments from DC, eliminating hum as a problem.

The best test for noise is to actually run the tube in a sensitive amplifier, such as a phono pre-amp, and measure the output. Tapping the tube or chassis will reveal microphonics. Alternatively, a special test bed, consisting of a high-gain amplifier with a grounded grid, can be used. It is hard to quantify noise and microphonics, so the best test is to test many tubes and pick out the quiet ones. Noise and microphonics are usually only a problem in low-level stages, such as pre-amps. However, occasionally you will find extremely noisy or microphonic tubes (way beyond the average). This is indicative of some processing or manufacturing problem, and those tubes should be avoided.

It should be mentioned that noise and

microphonics, as measured above, are mainly relevant to low-frequency (audio and video) amplification. The noise figure of an RF stage is primarily determined by transconductance. Microphonics have little effect at RF. This is why most RF tubes can be horribly microphonic - it just isn't too critical. A possible exception would be the local oscillator of an FM tuner. Noise and microphonics can cause phase noise, which will be added to the FM signal.

Gas (Grid Emission)

A more accurate term for gas testing is grid emission testing. The control grid can emit electrons if either there is some gas in the tube or if some cathode material was sputtered onto the grid, and the grid is running hot. The net effect of grid emission is to shift the operating point of the tube to a higher current. This is particularly a problem with power tubes, and in circuits that have a high value grid resistor. If there is excess grid emission in a power amplifier tube that is running with fixed bias, the tube can go into a run-away meltdown as increasing plate current causes higher grid current, which causes higher plate current, etc. Amplifiers with cathode bias or DC servoing are much less susceptible to this, since the grid bias compensates for changes in the average plate current.

Grid emission is typically tested by running a normal current through a tube, and measuring any voltage across the grid resistor. Most tube testers have effective grid emission ("gas") tests. Often grid emission does not manifest itself until the tube has been running for a while, so a quick check on a tube tester may not be good enough. If power tubes are being burned-in in a burn-in fixture, it is good to measure the grid current after the tube has been running for a while.

Shorts and Leakage

Outright shorts are caused by broken or bent tube elements. Leakage can be caused by metal deposition across the glass or mica between tube elements, or caused by conductive impurities across the base of the tube. Most tube testers have effective tests for shorts. Many shorts will cause other tests to fail. Leakage is usually only a problem in very sensitive applications, so may have to be tested by trying tubes in circuit.

Conclusion

In this era of dwindling numbers of tube manufacturers, and increasingly demanding users of tubes, effectively screening tubes is important. Not only does it help choose the best tube for a particular application, but it allows the still vast amount of used and N.O.S. tubes to be made available for replacements or new products.

PROBLEMS WITH TRANSISTORS

by John Atwood and Charlie Kittleson

A sure-fire way to spark controversy between different types of audiophiles is to start the debate of "tubes vs transistors". While most of the arguments tend to be of a religious nature, there are some technical aspects applicable to both sides. If you get caught up in such an argument, here are some reasons why solid-state devices are not as good as tubes. Note that some of these reasons are inherent to the device physics of semiconductors, while others have more to do with how most solid-state amplifiers are designed.

Sound Quality

1. The distortion products of transistors have more high-order terms than tubes, resulting in a harder, harsher sound in audio applications. This high-order distortion also causes more intermodulation and overload problems than tubes in RF applications.

2. Bipolar transistors are low impedance devices, and generally require large coupling and power supply bypass capacitors. These usually are electrolytic capacitors, which have poor sonic qualities compared to film-type capacitors that can be used in high-impedance tube circuits.

3. The parasitic capacitances within bipolar or field-effect transistors change substantially with signal voltages - resulting in distortion in some types of circuits.

4. Small signal transistors and ICs can have thermal time constants in the audio range - meaning that the gain can change as the device heats or cools with the applied signal, leading to another form of distortion.

5. Transistor amplifier designers often apply large amounts of feedback to get around distortion and bias stability problems, which if not correctly applied, can cause TIM (Transient Intermodulation Distortion). High amounts of feedback also tend to reduce the perceived dynamics and make clipping more abrupt.

6. Many solid-state power amplifiers and op-amps use class B biasing - which leads to cross-over distortion - a particularly unpleasant type. A tip-off that this exists in an amp is harmonic distortion that *increases* with decreasing power output.

Design/Reliability Problems

7. Fundamental properties of semiconductor devices change with temperature, resulting in gain and operating point changes. This complicates biasing and limits modes of operation.

8. The inherent gain of transistors has a

huge (often > 100%) manufacturing spread, requiring special circuit configurations to make this variable gain unimportant. The gain of tubes is usually within 10% of spec value.

9. Bipolar transistors have a time lag between input and output which complicates applying feedback at high frequencies (usually not a problem at audio frequencies).

10. Solid-state devices are fragile and have short thermal time constants, making them susceptible to catastrophic failure. Tubes can withstand extreme overloads with often little or no degradation.

11. Most solid-state audio amplifiers are direct-coupled to the loudspeaker, making the speaker prone to damage if the amplifier fails. The transformer coupling needed by most tube amplifiers inherently protects the speaker from DC voltages.

Repair/Longevity

12. Transistors are unforgiving, requiring higher skill in debugging and repair by service technicians than with tube circuits.

13. Many solid-state amplifiers use proprietary transistors, ICs and modules which are difficult to obtain a few years after the amplifier is out of production.

14. Solid-state amplifiers usually fail quickly and unexpectedly. Tube amplifiers, while requiring periodic tube replacement, generally fail more gradually, and can give warnings about bad components.

15. Semiconductors are quite susceptible to ionizing radiation, whereas tubes are nearly immune to radiation. This might be an important consideration to those audiophiles who plan to use their equipment after the nuclear holocaust.

This list doesn't mention many of the drawbacks of tubes. However, many of the drawbacks of semi-conductors are unknown to those arguing the merits of either tubes or transistors.



l to r - VT-4, 845, WE-211D

GUITAR AMPLIFIERS - A TRIP TO THE WINTER NAMM SHOW

by Charlie Kittleson

Recently I attended the NAMM Show in Anaheim, CA. I was pleased to see that tube musical instrument amplification is alive and well in 1995. There were dozens of guitar amp manufacturers including the established brands - Fender, Mesa Bogie, Marshall, Peavey, Rivera and others. Many of the larger amp manufacturers are leaning more towards the "vintage" styling and circuitry. Several of the vintage type amps feature tube-type rectifiers instead of diodes, claiming that the amp sings or "sags" better with tube rectification. Many of the manufacturers continue to use classic circuitry that originally came from early RCA tube manuals and the Radiotron Designer's Handbook. Fender really pioneered the use of these circuits in his first guitar amps of the early 1940s. Marshall and other British manufacturers caught on and used derivatives in their amps. Now several manufacturers are reviving the high quality standards of the past with modern tone shaping, channel switching and distortion schemes.

What was interesting at the show were the large number of "boutique" amp companies selling handwired, vintage type combo amps at prices approaching \$4,000! Many amps employ point to point wiring and use quality transformers, capacitors and other components. They are made in small quantities some being tuned to the individual player's tastes. One of the neatest "retro" styled amps was the **Tone King** ((410) 327-6530) - combo amps that were like something right out of 1958. **Groove Tubes** ((818) 361-4500) besides selling quality matched tubes, also displayed amps, mixers and a chrome and gold plated stereo mixdown amp for engineers who like their editing sessions smooth. For those who must have **POWER**, there's the **Shrapnell** - ((707)224-0951), delivering a devastating 200 watts RMS to 6 speakers mounted at 180 degree dispersion.

It wasn't surprising that most of the amps continue to use 5881, EL-34, EL-84 and some use of 6550A output tubes. Some designer amps were using higher quality US or German tubes. **Josephs Musical Amplifier Company** ((716) 877-3261)- used 6146B transmitting tubes to deliver better fullness and mid-range harmonic richness to the tone. Josephs also used many other high quality parts including a machined nickel output transformer. It will be interesting to see more amp companies start using larger transmitter tubes and possibly even filamentary triodes.

In future issues, look for interviews with amp designers and manufacturers, restoration and repair of vintage and contemporary guitar amplifiers.

INDUSTRY NEWS

New Tubes Types for 1995

by Eric Barbour

Svetlana SV811

I am pleased to announce an entirely new audio tube. The Svetlana SV811 is a power triode with a directly-heated cathode of thoriated tungsten. It is derived from the old 811A transmitting triode, but has no plate cap, and a much lower mu.

The pinout is the standard 4-pin basing of the 2A3 and 300B. The filament is 6.3 volts at 4 amps. This tube has been tested by VTV, and it is an excellent audio device. Although the plate resistance is on the order of 2000-2500 ohms, this tube has great potential for high-end audio. It is available with a mu of 3 for lowest possible distortion, and with a mu of 10 for easier drive requirements.

The user can choose the mu based on the driver circuit desired. With 800 volts on the plate, a push-pull pair of SV811-10s produces 46 watts into 8 ohms, through a transformer of 6600 ohms primary impedance. The thoriated filament will guarantee a lifetime in excess of 10,000 hours. Best of all, the price will be much lower than those of the various low-mu triodes on the market today. Suggested retail: \$30 each.

Available from:
Svetlana Electron Devices, 8200 S. Memorial Parkway, Huntsville AL 35802. phone (205) 880-8020, fax (205) 880-8077.

WE 300B

You know how AT&T has been running those "You will" ads on TV for the past three years or so? About how we'll get phone calls on our wrists, and there will be high-tech computer terminals everywhere with all the libraries in the world available on those terminals, all thanks to high-tech AT&T?

Well, AT&T is getting back into making vacuum tubes.

Recently, I spoke to Charles Whitener, president of Westrex Corporation (formerly Western Electric Export Corporation, the marketing arm of Western Electric audio and broadcast products until 1958. More on the history in a future issue). Seems that Westrex had been made aware of the Japanese market and subsequent American market for the WE 300B. Through Japanese publications, such as MJ and Stereo Sound, two of Japans leading audio magazines, Whitener was amazed to learn that the NOS (new old stock) WE 300Bs were advertised at levels exceeding \$1,800 per pair. The tube was selling for \$125 at wholesale when Western Electric made the last production runs in 1988. Whitener, convinced of the opportunity at hand for the re-release of the WE 300B, approached his affiliates at AT&T and determined that not only was

the original tooling still available, but key employees involved in the manufacturing of the WE 300B at the AT&T Western Electric Kansas City works were still available and excited about participating in this re-release.

Westrex had also interviewed several existing tube manufacturers both in the U.S. and overseas for the possible production of the tube or it's subassemblies, but determined that none of these manufacturers were able to offer facilities that met Western Electric quality standards. Therefore Westrex decided to have the tubes built in the Kansas City works once again. Initially, Allentown was considered but the Kansas City works was newer and had produced the last run of WE 300Bs. All aspects of the tube's new production - from the special high purity carbonized nickel plate to the aging procedures - will be identical, both functionally and cosmetically, to previous manufacture.

Whitener was at the 1995 Winter CES, and reports that interest was extremely high among OEMs that manufacture 300B based amplifiers. Limited production will begin in September, with general availability forecasted to be around late October. Westrex has developed a distributor network, and wholesale distribution will be limited. Suggested list price is \$350 domestic, \$400 overseas. Assuming sales of electron tubes continue to grow at current levels, the Kansas City works will produce other types, following with the robust WE 274B duo diode rectifier. Other types, such as the WE 212E, are in the planning stages.

Available from:
Western Electric High Fidelity Products, AT&T Promenade II, 1230 Peachtree Street, Suite 3750, Atlanta, GA 30309. Phone (404) 874-4400, FAX (404) 874-4415

VAIC VV30B

Early word on the VAIC VV30B is now in. This company is located in Prague, the company office is in Italy and the primary investor is in Switzerland. The engineer who designs these tubes, Alesa Vaic (pronounced "vaysh"), intends them to be run hard and to produce more power than the 300B. Plate dissipation of 65 watts is "to be expected". There are 3 grades; one is for up to 11 watts output power, two is for up to 15 watts, and three is for up to 20 watts. All will be expected to give a full 10,000 hour lifetime, with some derating at dissipations above 65 watts. Vaic tubes are made with old Tesla production equipment, and nearly all the work is by hand, even the blowing of the glass bulbs.

VTV recently received two early examples of the VV30B. Both of these tubes came in Tesla lamp boxes. Seems like a good product, although the early samples were not properly packed and some were damaged in shipment. Vaic will replace any early samples that test bad. I have heard from some users who have gotten examples of the second

sample run - they have only nice things to say about the VV30B. I've found that the filament runs very cool with a slight red glow. This would indicate the use of high-efficiency coating, probably with some rubidium oxide. This is similar to the old battery-radio tube types such as the 3Q5 which gave good performance with so-called "dull emitters".

Plans are to sell the VV30B thru the American distributor, Electra-Print Co. of Las Vegas NV, directly to consumers by mail. The retail price will be \$380. Vaic is planning to produce two other types. The VV50B will be capable of 80W plate dissipation and 18-24 watts out single-ended, into a load (transformer primary) of 1500 to 3000 ohms. The VV52B is very similar but has a higher plate load requirement, 2000 to 4500 ohms. There is also the possibility of a driver triode, again with a directly-heated filament.

Available From: Ing. Alesa Vaic, Jilovska 1164, 142 00 Prague 4, Czech Republic. phone (00-422) 4718524.

USA distributor: Electra-Print Co, 1555 N. Winwood, Las Vegas NV 89108. phone (702) 646-7990

Note: Do you manufacture, wholesale or distribute audio tubes or tube equipment? Please send your press releases to:

Vacuum Tube Valley, 1095 E. Duane, suite 106, Sunnyvale CA 94086 USA, or FAX to (408) 733-6146.



SV-811



VV-30B

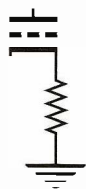

Cathode Bias

by

John Atwood

What is an "Audio Tube"?

This column is dedicated to discussing the technical issues of vacuum-tubes and vacuum tube circuit designs. As they say, "the opinions expressed here are those of the author, and do not necessarily reflect those of the staff or management".

In the audio news groups on the Internet, periodically someone makes the comment that some tube type is not an "audio tube". This has included the 6DJ8, the 807, and even the 2A3 (presumably because it was used in a transmitter)! The implication is that, correct or not, since a certain tube type was not intended for audio use, it is should not be used in audio designs. Is this valid? Should we stick to increasingly hard-to-find traditional audio tubes, or can we branch out and use other, more available tubes?

First of all, let's define an "audio tube". It is presumably one that the original tube designer intended to be used as in audio circuits. The descriptions in the RCA Tube Manual can help us here. However, note how many "audio" tubes are derived from "radio" tubes. The 12AU7 is made up of two sections of a 6C4, yet the 6C4 is called an RF oscillator and class C amplifier. Yet you would find few people who would say that the 12AU7 is not an audio tube. In some cases, such as the 7591 and 8417, the tubes were clearly optimized for hi-fi audio use.

The technical requirements for a good audio tube are:

1. Low distortion
2. Low noise and microphonics (for low-level stages)
3. Low hum from the heater (for low-level stages with AC on the heaters)

What is **not** very necessary for tubes used in audio are:

1. Low stray capacitance and inductance
2. Very high transconductance

Generally desirable characteristics:

1. Low cost
2. Low power-supply voltages
3. Consistency of characteristics
4. Small size

Many of these characteristics are conflicting. However, if we look at these

requirements, and look at the repertoire of available tubes, it is clear that many tubes designed for RF, TV, industrial, or other uses work just fine as "audio" tubes. A well-known example is the 6DJ8/ECC88. While its high transconductance and low stray capacitance make it a good RF tube, its frame-grid construction makes it very linear. While not always low in microphonics, some selected versions are very quiet. It also has high permeance, making it work well at low plate voltages. The net result is a tube that can work quite well as an audio amplifier.

A counter example would be the 7199 triode-pentode. While highly touted by RCA as a good audio tube, its only real audio feature is a low-hum filament. In modern designs with DC filament supplies, this is not much of an advantage. On the other hand, it is otherwise derived from a TV tuner tube, with poor linearity and poor consistency. Its unique pin-out insured that, once designed-in, RCA would have a captive market for the tube.

Another example of the cross-over of a tube design to different markets is the 6L6. Originally designed by RCA as an audio tube¹, the same internal structure was used for the 807 (RF transmitting tube), 6BG6G (TV horizontal sweep tube), 5881 (military ruggedized tube), and 7027 (hi-fi amplifier tube). Of course, each of these types had some changes to enhance their usefulness, but the basic electrical characteristics are identical. For use as an audio output tube, any one of these would work well.

Where the biggest differences occur in tubes used in audio equipment is in their sonics – how they actually sound. Take a batch of 6L6s – ranging from early metal types to the latest Russian versions, and plug them into an amplifier with little or no feedback. The difference in sound quality between tubes will be striking. Some of the reasons for the sonic differences can be explained – better mechanical tolerances, different cathode materials, etc. But a lot of the sonic differences don't seem to have a good explanation. Instead of saying that there are no sonic differences (because we can't find an explanation), let's admit to what our ears hear, and leave the reason for the differences open to further research.

So what makes a good audio tube? The fundamentals have to be right – low noise, if needed, low distortion, etc. But the sonics have to be right, too. Instead of limiting the choice of tubes to a few traditional or "designer" types, all types should be examined, and their merits evaluated. You will find many "sleepers" that will work great as audio tubes – as long as you keep an open mind.

¹ – O.H. Schade, "Beam Power Tubes", Proceedings of the I.R.E., Feb. 1938.

Featured articles in the next issue of Vacuum Tube Valley:

• MATCHING AUDIO TUBES

John Atwood describes effective techniques for matching audio tubes to achieve the best performance.

• GOLDEN AGE - HEATHKIT

Charlie Kittleson shares the development and evolution of early Heath Hi Fi and the Williamson series WM-1 through WM-7.

• TUBE SURVEY - EL-34/6CA7

Eric Barbour explores the development, history and performance of this popular audio tube. Vintage NOS and current types will be evaluated.

• EARLY AMPLIFICATION

Norm Braithwaite covers very early audio transformers, their development and characteristics.

• VINTAGE BOOK REVIEW

Paul J. Bourbin reviews a very popular and essential audio/hifi book from the 1950's.

• BUILDING A SINGLE-ENDED AMPLIFIER

David Wolze shows us his latest creation using Russian EL-509 tubes connected in "enhanced" triode mode using bargain basement parts.

• VINTAGE THEATER SOUND - WESTERN ELECTRIC

VTV reviews a classic Western Electric amplifier from the 1930's.

TELL YOUR AUDIO FRIENDS ABOUT VTV!!

GOOD TIMES ARE AHEAD!!!

12AX7: A HISTORY AND COMPARATIVE ENCYCLOPEDIA

by Eric Barbour

It is ironic that the most popular audio tube of all time first appeared as an unimportant industrial type. But that is exactly what happened to the 12AX7 when it first went on sale in March 1948. Up it popped, in RCA's receiving tube manual RC-15, along with its medium- μ cousin 12AU7. The 6AV6, which predated the AX7, is basically one triode of an AX7 ($\mu=100$). Each section of a 12AX7 has identical characteristics to the triode section of the 6AV6: $\mu = 100$. They were little noticed at the time, and did not rate a mention in the RCA JOURNAL.

Soon, though, the 12AX7 was selling briskly. Since it was the first dual triode to have been designed for very high gain, low noise and low hum all at once, it became the tube of choice in preamps and analog computing circuits. The die was really cast when low-output magnetic phono pickups (primarily the GE variable-reluctance and the Pickering) became popular in the early 1950s. Versions of the 12AX7 were being made by Sylvania, GE, National Union, CBS-Hytron and Tung-Sol by 1952.

The original versions could be improved upon. The tacit admission of that was the introduction of the 5751, circa 1950. This was intended to be a ruggedized miniature version of the 6SL7, with extra mica spacers and careful parameter control. The first version was from GE, and had only a doubled spacer on top. Later GEs (also sold by Raytheon for a time) had two separated spacers. The 5751 was quite expensive to produce, since each tube was tested carefully. It was considered too expensive for consumer electronics. Virtually all of its production was used in military and industrial applications. The first home audio device to intentionally specify it is believed to be the Conrad-Johnson Premier One preamp, introduced in the late 1970s. Today there are serious audiophiles who have found that 5751s can usually be used in place of 12AX7s in preamps, giving much improved performance over the run-of-the-mill tubes. 5751s were made by all the American factories above, and some foreign versions (MOV, Matsushita and Hitachi are known) also existed. You can be certain that a 5751 is old stock, as all production ceased in the late 1980s. Any tube of modern production claiming to be a 5751 is merely a rebranded 12AX7.

In the early 1950s, the engineers at Philips had examined the American 12AX7s and found them wanting. Usually, the major manufacturers had trouble producing the grids consistently, which was difficult for such a high-gain tube intended to be made by the millions. The result was usual-

ly higher even-order distortion. In fact, there are tube testers that have difficulty testing some 12AX7s because of the high μ and very sensitive grid.

By this time, hi-fi was developing into a major market, and Philips wanted to dominate it. So they produced the first European version of the 12AX7, known as the ECC83. With careful control of the grid winding similar to the 5751, plus better cathode materials and a coiled heater to further reduce hum, the result was a tube that became almost ubiquitous in high fidelity equipment. Telefunken produced the most famous version of the ECC83, and it was so good that it was commonly utilized in vintage hi-fi components, usually rebranded with the name of the hi-fi manufacturer (Dyna, Fisher, Scott, Heathkit, Eico, McIntosh all used Teles, rebranded with their own names). It's also notorious for its outrageously long life - often 100,000 hours or more. I should note that the two versions of the Telefunken ECC83 - the so-called "smooth plate" and "stamped plate" - were virtually identical in performance and sound. The smooth-plate version seems to command a premium today, probably due to its smaller supplies rather than any major physical difference. As with all makers, toward the end of production Telefunken's quality became rather erratic, and in fact many tubes were sourced from other factories. A true Tele has a small diamond-shape molded into the glass base. There are some Tele ECC83s from the 1970s being marketed today; be warned, they are often noisy. Most came as surplus from a medical equipment manufacturer, who rejected them as too microphonic.

Mullard and Amperex also produced excellent ECC83s from the late 1950s until the 1980s. Other manufacturers of ECC83s included Ediswan, Tungram, Siemens, Tesla, MOV, Valvo, EMI/Cossor, Fivre, Mazda and Brimar. Many of these companies were British or had British factories, but the chaotic state of post-WWII European tube manufacture makes it difficult to tell if a given 1950s tube was actually made by the branded company, or if it was simply a rebrand. Many rebrands of the 1960s and 70s were made in Japan. Usually it's easy to tell a Japanese receiving tube from the style of the type lettering frosted onto the glass (if there is such lettering). Matsushita, Hitachi, and Toshiba are known to have made 12AX7s. The jury is still out on the quality of Japanese tubes, they have a reputation for poor quality control which was partly earned by their use in Japanese hi-fi components of the late 1960s.

Because of the domination of the hi-fi preamp tube market, American companies tried to devise a competitor for the ECC83. The result was the 7025, which was basically a standard 12AX7 with a coiled heater to

reduce hum. This type usually is no better in distortion or other parameters than ordinary American 12AX7s, except that hum induction from the heater was guaranteed to be below a certain level. They were not very successful, except in the guitar-amp market, where distortion was expected but musicians were willing to pay more for lower hum in the output of their amps. True 7025s are no longer in production, and any new tube marked 7025 (including the Reflector/Sovtek version introduced last year) is just a rebranded 12AX7.

The 12AT7 is a different animal ($\mu = 70$, $gm = 5500 \mu\text{mhos}$), but can usually be run in a 12AX7 socket. It was made as a VHF amplifier for TV and radio. Many old FM tuners used it either as an audio amplifier or as the RF stage, or even both. Several pundits recommend against its use in hi-fi due to higher second-harmonic distortion. But it also tends to sound a bit "hard" compared to even the best ECC83s; the smaller plate structure and different microphonics tend to contribute. It is known as the ECC81 in Europe, and all the companies that made 12AX7 types also had versions of the 12AT7. In the 1960s it rivaled the AX7 in popularity for industrial and military applications.

There are a few obscure types that are very similar to the 12AX7 as we know it: 12AD7 (believed to be Japanese only), 12BZ7, 12DF7, 12DM7, 12DT7, 6679, 6681, 6851 and 7729. Some were just "industrial" versions of the 12AX7 or 12AT7, were made on the same production lines, used many of the same parts, and have the same problems. Regrettably, for hi-fi use the old American product isn't quite the best unless the user spends more for an NOS 5751 or ECC83. And even that can be risky; there are cheap Chinese tubes sporting Mullard logos, without Mullard's permission.

Tung-Sol and CBS-Hytron both ceased producing all receiving tubes in the 1960s. By 1980 only Sylvania (by then owned by Philips), GE and RCA were still making 12AX7s, and they junked their production lines in the late 1980s. The fate of the production equipment is unknown; most miniature tubes of the 60s and 70s were produced by highly automated machinery, which was complex and difficult to maintain.

Today, there are only four factories known to be making 12AX7 or 12AX7-like dual triodes: Tesla of the Czech Republic (actually an independent company with rights to use the Tesla name), EI of Serbia, Shuguang of China and Reflector of Russia (most commonly known under the "Sovtek" brand). Rebranding has always been a major and annoying part of the tube industry, but it reached a state of chaos in the

1970s. Buy a Philips, RCA or GE tube now, and (if it isn't NOS), it will have probably originated from one of those four remaining factories. This goes for most other tube types, as well. The Shuguang 12AX7 is easy to spot, as it is a version of an old British military version (CV4004) and is built with old equipment from the UK, either Mullard or MOV. It has two shiny metal stiffeners around the plates, which help make it low in microphonics. Teslas and EIs look much like old European types, with the EIs often passed off as being Telefunken-like because of their large plates. (What this has to do with electrical performance or sound remains open to question. The original RCA and GE versions had large plates, but later ones had smaller plates—yet there was little difference in electrical behavior. And the Sylvania always had large plates, but were avoided by audiophiles.)

The Reflector 12AX7s come in three types as of this writing, a regular A, a 7025, and a "WXT" version, claimed to be a high-gain military version. All of these types have their problems; Shuguangs tend to wear out fast, EIs are usually microphonic, and Reflectors have distortion problems similar to old American 12AX7s. In spite of these complaints, you can be very sure that 12AX7s will be made for the foreseeable future, since the vast majority of tube guitar amps and tube hi-fi preamps use them.

The Details

The testing equipment used to develop this data consist of a fixture built especially to compare different tube types, plus a Vu-Data 101B harmonic distortion analyzer. The fixture is set up to give typical voltages seen on preamp tubes in a line stage. The plate load used for the 12AX7 types was 240K ohms, and the cathode connected directly to the star ground, with a variable negative 0-5 VDC supply used to provide bias to the grid. B voltage was 250 volts. Only one channel of each tube was tested, but both triodes were tested for gain mismatches on a transconductance tester. With the level control all the way up, AC hum on the output was less than 1 mV as filaments were always run from a regulated DC supply. I must note that all of the tubes listed here gave a frequency response that was 1 dB down at well past 20 kHz.

The Vu-Data analyzer is a wavemeter—a very special device. It provides a low-distortion oscillator, a good AC voltmeter, and a distortion meter. The latter is why I used this unit: it measures second harmonic and third harmonic SEPARATELY. Such a feature is very rare in the audio industry, and I suspect that it was meant for vibration analysis, not audio.

Measurements (Table 1) were made at 1000 Hertz, with input signal adjusted until the output read 10 VAC. The analyzer's

residuals, .020% of second harmonic and third harmonic, were subtracted out of the readings before being entered into the table. Readings were approximated for the third digit as the analyzer's meter was difficult to read to that precision. BIAS indicates the negative bias voltage applied to the tube grid that gave the lowest second harmonic reading; at that point, the second and third harmonics were read. In preparing this list, I had to resort to used tubes in some cases due to the scarcity of the NOS types. They are indicated with an asterisk. All the others were new out of the original box. All of the tubes here, new or used, were tested on a Hickok transconductance tester and were known to have higher-than-rated transconductance, so the used tubes can be considered to be like new. If there is more than one listing of a given type and version, that is another example of the same type.



L to R: Tele (smooth), Amperex, Mullard

The microphony data (Table 2) were found by a standard procedure which I devised. Because striking a tube envelope on its side (the old method of determining microphonics) can give different results on each tube depending on the point of the strike relative to the plate structures, I applied the physical shock by dropping a doughnut-shaped weight onto the TOP of each tube. The weight was a ferrite core of 41.6 grams. The distance of drop was 5 cm, using a brass cylinder placed over the top nipple of the tube so as to guide the doughnut onto the top shoulder of the glass. The peak voltage can vary considerably from sample to sample, but the time for the impulse to drop to about zero volts is a fairly good indicator of the microphonic tendency of the tube. All of the data in Table 2 was derived by running the drop test several times on each tube, using an oscilloscope to observe the impulses, and taking the average. I was surprised that the new sample EI tubes did well here; perhaps there have been improvements, as past versions had a reputation for mechanical noise. Not all of the tubes in the distortion list were checked for microphonics as they were too rare and valuable to drop weights on.

About the Results

It seems that the 12AX7/ECC83/etc. is extremely variable from type to type. This is not an advantage. The ECC83s and

5751s were best overall, yet the Chinese Shuguang is fairly good quality. Since the latter is still in production, it has to get the nod along with the EI 12AX7, which shows improvement. The American versions (all out of production) tend to have much higher distortion and greater microphony. And there wasn't much difference between the "smooth-plate" Telefunken and its "stamped-plate" cousin. Why the smooth plate commands a premium is beyond me.

The best performer in the distortion list is an early Mullard ECC83 with an unusual box-shaped plate structure. It is extremely scarce today, don't count on finding any at your local distributor. Although the lower tubes on the list are usually avoided by hi-fi users, some guitarists deliberately seek them out for the greater distortion. As you can see, the bias point that gives lowest distortion can vary quite a bit, even with two otherwise identical tubes. This is typical of all 12AX7s, and accounts for some of the wide differences heard when tubes are replaced with seemingly identical ones. I've been testing tubes for 2 years with this setup, and I have been unable to discern a pattern to the bias variations.



12AT7s tend to be slightly superior in clarity of sound, despite the presence of substantial 2nd harmonic distortion. Versions of the type were less variable in distortion than with the AX7s. Since the AT7 was developed after the AX7, and the AT7 was intended more for critical RF applications while the AX7 was apparently just intended to be a low-cost type for general application, more development effort seems to have gone into the AT7, and it still shows today. Some discerning listeners find AT7s too "hard" in sound quality, so it's not often seen in modern hi-fi. But it is common in the driver stages of guitar amps. Usually an AT7 will work in an AX7 socket with little effect on tone controls; this is an experiment that any user can try. Personal preference is the only guide here. The 12AU7, 12AV7, 12AY7, and their derivatives are really medium-mu and can't really be considered replacements or substitutes for high-mu types. So, they are not covered here, since they can't really be stuck in place of 12AX7s or 12AT7s easily. If there is interest, I will cover them in the future.

1 2 A X 7 T E S T D A T A T A B L E

**TABLE 1:
DISTORTION AND LEVEL
TESTS OF 12AX7 TYPES
AND 12AT7 TYPES**

Note: good used samples are indicated with (*).
Samples whose two triodes were more than 10%, or about
1.0vAC, apart are indicated with X in the right-hand column.
Listed in order of increasing second harmonic distortion.

VERSION	MANUFACTURER	2ND	3RD	BIAS	INP	DF
ECC83	Mullard box plate 1956	.015	.000	-0.8	.150	
ECC83	Amperex bugle boy 1950s	.015	.000	-0.5	.162	
ECC83 *	Telefunken smooth 1960s	.020	.000	-0.5	.157	
ECC83 *	Telefunken smooth 1960s	.020	.000	-0.6	.150	
ECC83 *	Amperex bugle boy 1960s	.020	.000	-0.5	.142	X
5751JAN *	Philips/Syl 1980s	.020	.002	-0.8	.160	
5751JAN *	Sylvania 1960s	.020	.002	-0.8	.170	
ECC83 *	Telefunken smooth 1960s	.022	.002	-0.7	.150	
5751JAN *	Raytheon 1960s	.025	.000	-0.9	.180	
ECC83 *	Amperex bugle boy 1960s	.025	.000	-0.8	.157	
7025 *	Mullard 1970s	.025	.000	-0.6	.140	
12AX7JAN *	Sylvania 1960s	.025	.002	-1.2	.172	
5751JAN *	Sylvania 1960s	.025	.002	-1.0	.180	
5751JAN *	Sylvania 1960s	.025	.002	-0.9	.170	
5751JAN *	RCA 1960s	.025	.002	-1.0	.190	
5751JG	GE 1953	.027	.000	-0.4	.187	
ECC83 *	Amperex bugle boy 1960s	.027	.000	-0.7	.155	
5751 *	GE Five-Star 1960s	.027	.000	-0.6	.180	
ECC83 *	Telefunken stamp 1960s	.027	.000	-0.6	.142	
5751	Hitachi 1960s	.030	.000	-1.1	.190	
ECC83 *	Telefunken stamp 1960s	.030	.000	-0.6	.150	
5751JAN *	Tung-Sol 1960s	.030	.007	-1.1	.185	
12AX7JAN *	Tung-Sol 1960s	.030	.020	-0.8	.150	
ECC83 *	Telefunken stamp 1960s	.032	.002	-0.7	.147	
5751	RCA "Command" 1950s	.032	.002	-1.0	.205	
5751JAN	Tung-Sol 1950s	.035	.000	-1.0	.190	
5751JAN *	RCA 1960s	.035	.002	-1.0	.185	
5751JAN *	RCA 1960s	.035	.002	-1.2	.185	
ECC83 *	Telefunken stamp 1960s	.037	.002	-0.5	.150	
ECC83 *	Mullard 1970s	.037	.002	-0.8	.142	
12AX7 *	Matsushita 1970s	.037	.002	-0.6	.147	X
B339	MWT 1950s (Brit mil)	.037	.002	-1.2	.147	
12AX7	EI Yugoslavia 1990s	.037	.005	-0.9	.132	
12AX7	EI Yugoslavia 1990s	.040	.002	-0.7	.125	
12AX7JAN *	Tung-Sol 1960s	.040	.022	-1.0	.150	X
ECC83 *	Tung-ram 1970s	.062	.000	-0.9	.165	X
5751JAN *	Raytheon 1960s	.065	.000	-0.9	.182	
5751 *	GE Five-Star 1960s	.065	.002	-0.6	.190	
12AX7	Shuguang 1990s	.065	.005	-0.8	.145	
12AX7 *	Hitachi 1970s	.070	.002	-0.8	.147	
12AX7JAN *	GE 1970s	.070	.020	-0.9	.140	
12AX7JAN *	GE 1970s	.075	.020	-0.8	.142	
12AX7JAN *	GE 1970s	.078	.020	-0.9	.140	
12AX7JAN *	GE 1970s	.085	.020	-0.8	.140	
12AX7	Sylvania Industrial 1950s	.090	.000	-0.6	.125	
5751JAN *	Raytheon 1960s	.090	.002	-0.9	.180	X
7025B	Sovtek 1994	.102	.005	-0.5	.162	
7025B	Sovtek 1994	.115	.005	-0.7	.155	
12AX7WXT	Sovtek 1990s	.127	.005	-0.9	.132	
12AX7WXT	Sovtek 1990s	.140	.002	-0.8	.140	X
12AX7JAN *	Sylvania 1960s	.142	.017	-0.9	.120	X
7025	Sylvania 1960s	.145	.005	-0.8	.140	X
7025	Sylvania 1960s	.150	.015	-0.8	.120	X
12AX7JAN *	Sylvania 1960s	.150	.015	-0.6	.130	
12AX7JAN *	Sylvania 1960s	.150	.015	-0.7	.130	

TABLE 1 (CONT)

VERSION	MANUFACTURER	2ND	3RD	BIAS	INP	DF
12AX7WXT	Sovtek 1990s	.152	.002	-0.4	.145	
12AX7JAN *	Sylvania 1960s	.202	.015	-0.8	.130	X
12AT7 *	Westinghouse 1960s	.082	.005	-0.9	.252	X
12AT7 *	Raytheon (Japan) 1970s	.092	.007	-0.7	.275	
12AT7 *	Sylvania 1960s	.112	.007	-1.0	.250	
ECC81 *	Telefunken 1960s	.120	.007	-0.4	.227	
ECC81 *	Telefunken 1960s	.122	.007	-0.5	.250	
12AT7 *	GE 1960s	.330	.005	-1.6	.270	X
6201 *	GE 1970s	.390	.005	-1.7	.290	
6201 *	GE 1970s	.400	.010	-1.8	.300	

TABLE 2:

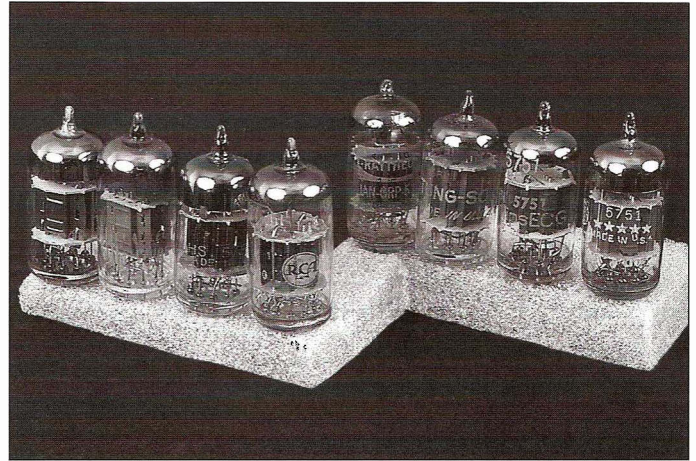

L to R 5751 types: GE, RCA, Sylvania, RCA Command, Raytheon, Tung-Sol, Phillips ECG, GE 5 Star

**RESULTS OF MICROPHONIC TESTS
ON SOME SAMPLE 12AX7 TYPES AND 5751S**

Arranged by increasing zero time.

VERSION	MANUFACTURER	PEAK VOLTS	TIME DROP TO ZERO
ECC83	Telefunken stamp 1960s	.20 V _{peak}	10 ms
12AX7	EI 1990s	.20	10
12AX7	EI 1990s	.20	10
ECC83 *	Amperex 1960s	.30	10
ECC83 *	Amperex 1960s	.30	10
12AX7	Shuguang 1990s	.30	20
5751JAN *	Raytheon 1960s	.30	20
7025B	Sovtek 1994	.30	20
ECC83	Telefunken smooth	.35	20
5751JAN *	Syl/Philips 1980s	.60	20
5751JAN *	Sylvania 1960s	.15	25
5751 *	RCA 1950s	.15	30
ECC83	Telefunken smooth	.30	30
5751 *	GE "JG" 1960s	.30	40
12AX7WXT	Sovtek 1990s	.40	40
7025 *	Sylvania 1960s	.50	40
12AX7WXT	Sovtek 1990s	.35	45
ECC83	Telefunken stamp 1960s	.20	50
7025B	Sovtek 1994	.20	50
7025 *	Sylvania 1960s	.40	50
12AX7A *	Westinghouse 1960s	.40	50
5751 *	GE Five-Star 1960s	.15	70
5751 *	GE Five-Star 1960s	.32	70
7025 *	Sylvania 1970s	.50	70



12AX7s L to R: Tung-Sol, GE, RCA, Amperex Bugle Boy, Mullard (early), Telefunken

one electron™

Products and Services...

UBT-1 Single-Ended Output Transformer

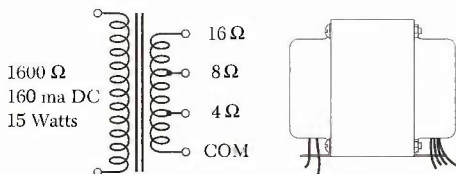

Recycled Tubes – The U.S. Defense Dept's Finest

Removed from gov't equipment - fully checked

0A2	6AK5/5654	6V6GT	5687
0B2	6AQ5/6005	7F8	5751
2C51/5670	6AU6/6136	12AT7/6201	5814
5R4GYB	6AL5/5726	12AU7/6189	6080

... and more

Design Services:

- Audio designs - specializing in tubes
- Digital system and IC design
- PC Board Layout

Write or FAX for information and prices.

One Electron
65 Washington Street, Suite 137
Santa Clara, California 95050 USA
FAX: 408 985-2006

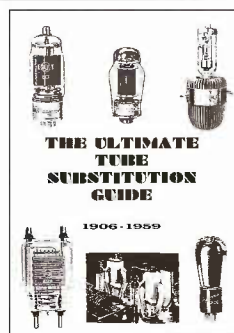

THE ULTIMATE TUBE SUBSTITUTION GUIDE

No tube enthusiast should be without this unique 240 page book with over 10,000 tubes listed including audio, radio, transmitting and special. Features audio tube equivalents and tube testing information.

\$29.95 ppd/\$39.95 Foreign
CA Residents add \$3.15 Tx

AVAILABLE NOW!

**VINTAGE HI-FI
THE GOLDEN ERA
1947-1965**

A professionally produced video covering the early hi-fi era. Over 80 classic tube audio items shown and described. 34 min. Color, NTSC

\$24.95 postpaid US/\$35.00 Foreign
CA residents add \$2.06 state tax



VACUUM TUBE VALLEY

1095 E. Duane Ave. Ste 106,
Sunnyvale, CA 94086
408-733-6146 phone/FAX