

VACUUM TUBE VALLEY[®]

Issue 18 Quarterly

The Classic Electronics Reference Journal

Price \$10.95

Magic Eye Tubes

Fisher 100 Tube Tuners

First In a Series On Vintage Sound



Emery Sound

Boutique Amp Designer Profile



Rudy Bozak

Legendary Speaker Pioneer

BOZAK

Display until 9/15/02



Visit us on the web www.vacuumtube.com

My darling, will
you ever leave
me again?



NYΣT!

-Svetlana

The finest audio power tubes in the world are available again in the
US and Canada, exclusively from PM of America, Inc.



Svetlana

www.svetlanausa.com



1687 Shelby Oaks Drive / Suite 8 / Memphis, TN 38134 / 901-388-2424 / fax 901-388-2405

**VTV Issue 18
Table of Contents:**

Tuning Eye Tubes	4
Contest for High Fidelity	9
NOS Tube Investments	14
Rudy Bozak Profile	17
Fisher FM100 Tuners	22
Curt Emery Amp Designer	26
JJ 828 Amp Review	28
Amp-Speaker Interface	30
Advertisers	37

Some Thoughts for This Summer

New technologies have allowed us to be more productive. We now have scads of electronic toys to distract us and isolate ourselves from our true nature as humans. Digital technology has made our world more two-dimensional. Reality is being substituted by modeling, simulators and sampling schemes like MP3 and home theater systems.

Twenty-five years ago, people went out to see live music for entertainment instead of sitting at home surfing the web or watching their home-theater system. We actually had conversations face-to-face instead of using email. Yes, I know, we cannot turn back the clock. However, we have the right to experience life to its fullest and not settle for artificial substitutes. Experience life to its fullest, go hear some live music or go to a play. Support the performing arts whenever you can.

Lynn Olson Joins VTV as Technical Editor

Lynn Olson, noted audio journalist and experimenter is replacing John Atwood as Technical Editor for Vacuum Tube Valley. Lynn spent his childhood in Hong Kong and Japan and came to the USA to attend college in Claremont, California. In 1973 he invented the Shadow Vector Quadraphonic Decoder and sold it to Audionics. He also was a loudspeaker designer at Audionics from 1975 to 1979. He worked at Tektronix as a technical writer from 1979 to 1988. From 1988 to 1994 he was a system engineer at THE COMPUTER STORE. In response to popular demand, he designed the Ariel loudspeaker which was first published in *Positive Feedback Magazine* in 1995 and on the web in 1996 (www.aloha-audio.com). Lynn holds three patents and has written for the *AES Journal*, *Positive Feedback Magazine*, *Glass Audio* and was the Editor of *Valve and Tube News*.

CE Distribution Produces New High Voltage FP Can Capacitors

CE Distribution is now producing high voltage quad can capacitors based on the original Mallory FP design. Currently, they are producing the quad 20uf@475 and the dual 100uf@500V. More values are planned for the future. Contact them at: 480-755-4712 or www.cedist.com

VTV is Looking for Articles

If you have a great sounding audio design or have researched audio or tube history, we may be interested in publishing it. We pay authors for quality articles published in VTV.

John Atwood to Start New Audio Publication

John Atwood, who was the VTV Technical Editor since our founding in 1995, is developing a new audio publication called *Clarisonus* (Clear Sound). John will still be a contributor to VTV. For more information on his new publication, check the website: www.clarisonus.com

VTV Distribution Update

Although many readers subscribe to VTV, several purchase the magazine from vendors or news racks. We have improved our distribution with additional sellers.

Bookstores carrying VTV include: Books-A-Million, Borders Books, and Tower Music. Armadillo Distribution in Southern California distributes VTV to several independent book stores and news racks in the Los Angeles area.

Other catalog and electronics stores carrying current VTV and back issues include: Antique Electronic Supply in Tempe, Arizona; Audio Directions in Honolulu, Hawaii; Falcon Electronics in Ontario, Canada; Hong Kong Bush Electronics in Hong Kong; The Parts Connexion in Canada; Triode Et Compagnie in Paris, France; and Well Audio Lab in Singapore.

If you would like to sell VTV or know of a dealer or bookstore who would like to carry the magazine, please contact us.

VTV Issue #19

Due to space requirements, the Richard Sears KT88 amplifier project article will not be in this issue. It is slated to be in VTV #19 which will cover the KT88 and 6550 tubes.

Vacuum Tube Valley® is published quarterly for electronic enthusiasts interested in the colorful past, present and future of vacuum tube electronics.

Subscriptions: US\$40/4 issues 3rd Class-\$49 1st Class; Canada/\$52; Asia/\$68; Europe/\$66

US Bank Check, Credit Cards or Cash are accepted for payment.

**Phone (707) 263 - 5881
FAX (707) 263 - 7648**

Editorial Staff

- Charles Kittleson** Editor and Publisher
- Eric Barbour** Senior Editor
- Lynn Olson** Technical Editor
- Ron Veil** Guitar Amp Tech Editor
- David Bardes** Associate Editor
- Steve Parr** Art Director
- Julie P. Werner** Copy Editor

Visit us on the web!
www.vacuumtube.com

Copyright 2002 **Vacuum Tube Valley**®
All rights reserved.

No part of this publication may be reprinted or electronically reproduced without written permission of the publisher.

Send circulation and editorial correspondence to:

Vacuum Tube Valley
P.O. Box 1499,
Lakeport, CA 95453 USA
e-mail triode@vacuumtube.com

ISSN # 1095-4805

Magic Eye Tubes

By Eric Barbour ©2002 All Rights Reserved

1. Background

Today's electronics professional would be surprised to learn how expensive a voltmeter was in the 1920-1950 era. A good-quality d'Arsonval meter movement would have cost \$5 to \$10, a large sum, especially for a tuning meter in a consumer-type radio receiver. Professional and amateur equipment used mechanical meters routinely. But for a common table or console radio, meters are costly and difficult to drive with simple tube circuitry. In the early 1930s an alternative appeared.

It was a tiny, low-voltage electrostatic CRT made just to give a visual indication of proper station tuning. Being a tube, it was easy to drive from a high resistance and could be mass-produced on conventional tube production lines, lowering the cost. Plus, it gave off its own light and didn't need a pilot lamp. This "eye" tube was sometimes called a "cat's eye" because its glowing pattern was round and resembled a cat's slit pupil. It was also called a "magic-eye" tube in marketing literature of the time. One can usually tell a top-of-the-line radio from the 30s or 40s, because it will have a cat's eye tube on its front panel. Less expensive radios had no tuning indicator at all; the eye was a valuable convenience feature that let a listener find the lowest-distortion tuning without guesswork.

In contemporary circuits, an eye tube could be used for its original purpose, in a radio receiver. With a small interface circuit, an eye could even be fitted to a solid-state radio or FM tuner. But here, we will concentrate on its use as an audio level indicator. Eye tubes haven't been used in electronics for a LONG time, so eyes on new audio equipment are a distinctive novelty. Cary Audio has an eye tube in one of its single-ended amplifiers, and there's a VAC preamp with eyes. And in 1996, VTV reviewed Magnum-Dynalab's top-line FM tuner, which uses a rare EM1 eye tube as a tuning indicator.

A typical eye tube has a hot cathode and a "grid" or control electrode, plus a "target" which is the accelerating anode. A positive 250 volts or so is placed on the target, and the cathode is grounded or placed at a negative volt-

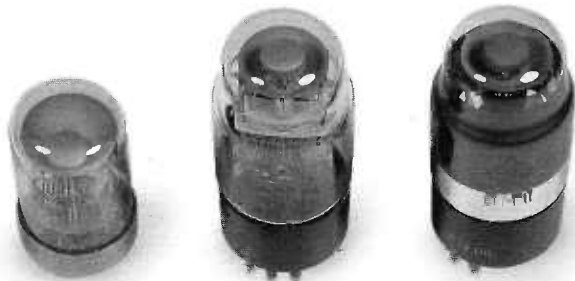

Lorenz EM2, Telefunken EM11, Telefunken EFM11

age. By varying the DC voltage on the control electrode, the glowing area on the target (usually green phosphor, same as that found in oscilloscope CRTs) will show a wedge of darkness that varies in angle with the voltage. Since this electrode usually required a considerable voltage swing to have full effect on the shadow, many eye tubes included a conventional medium-mu triode to provide

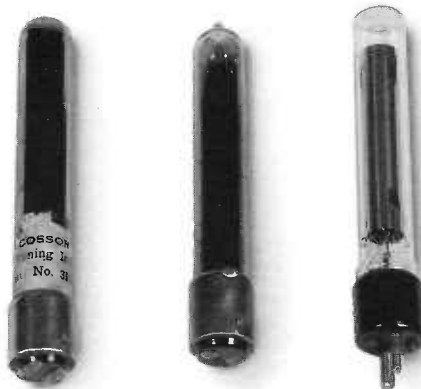

Cossor 3180, Atwater-Kent Tune-A-Light, G4H



RCA 6E5, Arcturus 6T5, Sylvania 6U5

more gain. The triode was typically driven from the AGC voltage in a superhet radio--if the signal was tuned in, the AGC voltage increased or decreased, causing the shadow on the eye tube to decrease to minimum size.

2. Types

The originating types are the 6E5 family. This includes the 6E5, 2E5, 6G5, 6T5, 6U5, 6AB5 and 6N5. All have more-or-less similar characteristics and use the same 6-pin basing, so they are pretty much interchangeable (except the 2E5 with its 2.5 volt heater). The 6E5 was introduced by RCA in 1935, and was a very popular item, although I suspect it was actually manufactured by GE under contract, like many RCA tubes over the years.

Each member of this family includes an amplifying triode to increase the sensitivity of the eye. The 6E5 uses a plain triode, while the 6G5 has a variable-mu triode to let it handle larger voltage swings. The 6AB5 and 6N5 were intended for battery radios, having lower filament consumption. Brimar once marketed a UK variation called 12U5G, with an octal base and 12.6v heater. And Ediswan had a 6M1, which was also called 6U5G. It had their not-quite-compatible Mazda octal base. Rogers of Canada made a similar (but incompatible) eye tube, called 6X6G.

The rare 6T5, introduced by Arcturus and Sylvania in 1937 and also made by Raytheon, has an annular ring shadow around its center, rather than the conventional angle shadow. It was not successful, allegedly because the glow was more difficult to see than in the 6E5, and it was seen in only a few Zenith and STC sets. The 6T5 is now a very hot collector's item. It is believed that M-OV made a similar tube, called T165, which was also not successful.

Two years before the 6E5 made its USA debut, STC in the UK demonstrated their "Tunograph" tuning indicator. This device was apparently cruder than the 6E5, with a simple electron gun, two deflecting plates, and a target/anode with phosphor. The gun cast a small spot on the screen, which was moved to the side by varying the deflection voltage and viewed through the side of the envelope. Apparently this device was not a big success, as very few radios used one. Allen DuMont developed a similar device in 1932, but he apparently did not bother to commercialize it.

Unfortunately, none of these early indicators are good choices for new design, for a very simple reason: scarcity. Production stopped decades ago on all of these types. 6E5s were used in nearly all deluxe radios of the 30s and 40s, plus in some radios and hi-fi equipment of the 50s. All of them wear out quickly, so they must be replaced regularly. The sheer number of old radios in collector's hands has made the demand for these types of eye tube constant, and this has made fresh ones valuable and hard to find. 6E5 types were also used in popular test equipment of the 50s and 60s, such as capacitor checkers and signal tracers. Although Russian tube factories made 6E5s, they are also scarce in Russia today.

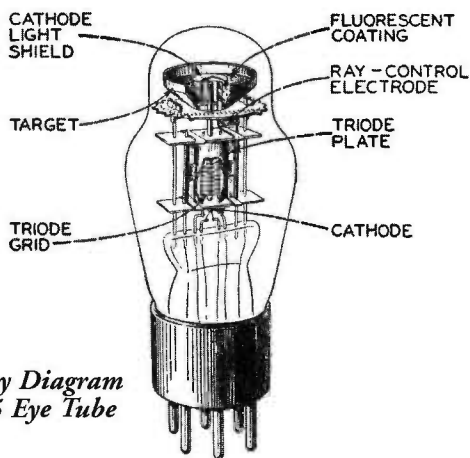

Cut-Away Diagram of a 6E5 Eye Tube

A similar round pattern is found in the types 6AD6, 6AF6 and 1629. The 6AD6 and 6AF6 are similar. They are not at all like the 6E5 types, because they have no internal amplifier triode. Instead, they have two control grids, each controlling the opening angle of its own dark wedge independently of the other. This was useful for things such as FM radios where one side might show signal strength and the other would show multipath or as stereo volume indicators. They are much less sensitive than 6E5 types, needing a voltage swing of 100v or more.



Japanese 6ME10, Raytheon 6AF6G, Fivre 6E5GT



Telefunken AM-2, Mullard EM4, Siemens EM4

Some eye tubes were made with added "space charge grids" inside, which were claimed to increase the lifetime of the display. This was an invention of Tungfram in Hungary. They made versions of the 6G5, 6G5G, VME4, ME4 and ME6 with the added grid. Whether it actually works is debatable. Eye tubes tend to wear out faster than other small-signal types, due to deterioration of the phosphor by the electrons striking it--occasional overvoltage conditions accelerates the damage. The extra grid supposedly limited the electron current to a steady value.

The 1629 is an oddity which is found only in WWII military equipment. Its base is octal, unlike the previous types, and it has a 12.6v heater rather than the usual 6.3v heater. It has a 6E5 design, with a target plus a driver triode, though it apparently needs different component values from the other tubes. There are NOS surplus 1629s still available, so they would be a good, inexpensive choice for a new application. (Indeed, a Canadian company called Mapletree Audio Design has been marketing a stereo audio meter using 1629s; and Cary Audio's top-line 845 SE amplifier contains a 1629. If this continues, even 1629s will become scarce and costly.)



Marconi EM35, Telefunken EM35, Valvo EM34

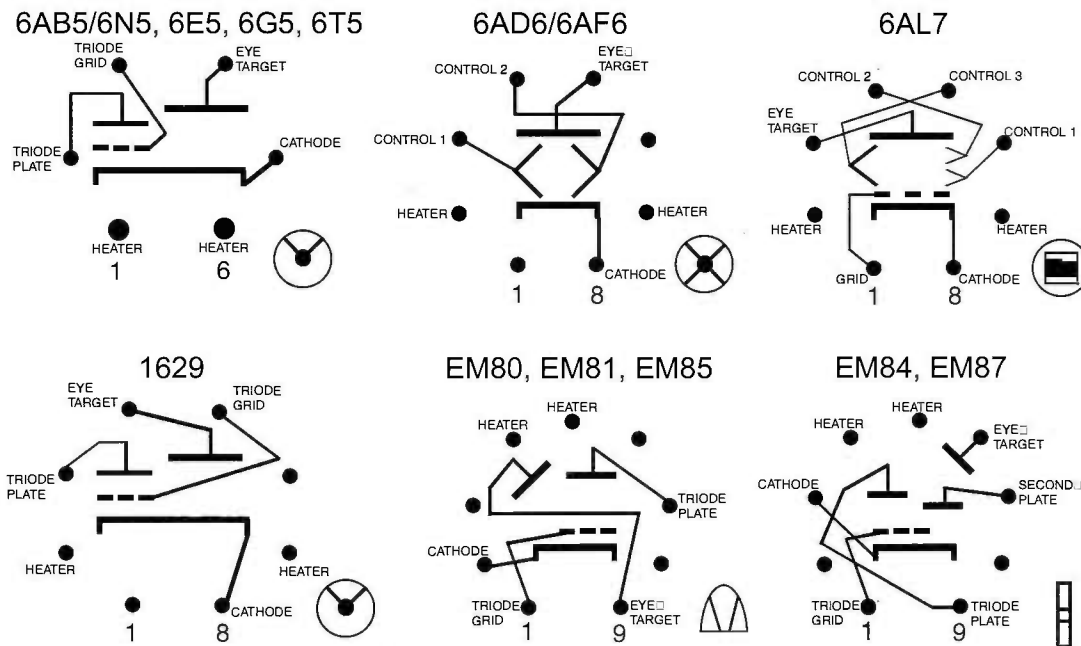

Figure 1: pinouts of commonly-available eye tubes.

Copyright 2002 Vacuum Tube Valley. All rights reserved.

The 6AL7 is a very cheap and easy-to-get eye tube. General Electric introduced it around 1948, for use in hi-fi FM tuners. It was one of the first eye tubes to break with convention; its display pattern was square, not round. In fact, its "display screen" is divided into three rectangular bar-graph indicators, with two on top, side by side, and a double-wide third bar below. The purpose here was to use the lower bar to show IF limiter current, as a meter for maximum signal strength, then use one upper bar to show center-of-channel tuning. See (*Audio Anthology*, Vol. 1, page 22) for an article about applying the 6AL7. This tube was not popular; I've only seen it in some circa-1950 FM tuners, such as Browning's RJ series, as well as a couple of circa-1950 TV sets. Yet GE made scads of 6AL7s, heaven knows why; and many are still with us today. The 6AL7 is rated to take up to 365 volts on its target, much more than most eye tubes. Thus, it might find use in a tube power amp which has fairly high B+ available. I have used it as a simple level indicator in two of my single-ended triode amps to date, plus a few of the Metasonix vacuum-tube synthesizers. The small size, octal base and low-voltage drive make it easy to use.

In the 1950s, miniature European eye tubes hit the American market. Most were developed by Telefunken in the 1950-1956 time period. The EM8X series was all 9-pin miniature, and less expensive than domestic types. If you own a Dynaco FM-1 or FM-3 tuner, or certain FM

tuners made by companies like McIntosh, Fisher, Pilot or H. H. Scott, then you have been using one of these Euro tuning indicators. The most common are the two-bar EM84 and EM87. They also appear in many European-made radios of the late 50s. The two bars lengthen as the grid voltage decreases until they meet. These two types look similar but have different characteristics and phosphor color. All of these tubes usually have green P3-like phosphor except the EM87, which is blue-green.

More unusual are the EM80 and EM81. They have patterns in a half-oval shape with a wedge in the middle, which closes as the grid becomes more negative. They differ only in polarity, with the EM80 having a glowing wedge and the EM81 having a dark wedge. I have seen an EM80 in an old Pilot FM tuner, and it is found in some German radios as well. The rare EM85 looks like an EM81, but with a smaller display.

If you own an old Tandberg or other European tape recorder, chances are it uses EAM86 eye tubes for signal monitors. They are similar to EM84s, except the bars are horizontal to the base (wrapping around the tube barrel partly), rather than vertical.

The EMM801 is used in the Dyna FM-3 tuner. Its display is unique, with a pair of EM84 two-bar displays side by side. These can be controlled separately. The older EM83 was similar, though its two bars were single-ended.

And the EM82/E82M had two bars with triangular shapes, which shadowed from the center to the outer edge. These are very rare--I have never seen one.

The EM80, 81, 84 or 87 might be suitable for use in a new design. They are very common, old stocks abound, and their prices are reasonable (for now). In fact, I understand that Russian-made EM80s are readily available from Russian surplus tube dealers, under the original number 6E1P (6E1n). The Soviet tube industry also made an EM84 (6E2n) and a 6E5 with an octal base (6E5c). The EMM801 is an exception; it currently goes for \$100, and that is increasing. It always was much more expensive than the other EM types, since it's much more complex.

There are a number of scarce and/or expensive Euro eye tubes that we won't mention here, mainly because I haven't been able to get any of them to experiment with or because they are overly costly. Although the EM85 is mentioned in tube manuals, it is very hard to get. I once saw an EFM11 and I regret not buying it; that one has an ordinary round eye, but an extra pentode built in, plus the obscure prewar "German octal" base.

There are the EM1 thru EM5 (all having prewar side-contact bases), UM34, UM4, UM80, VME4, EFM1, VFT4, FT4 and a slew of others that are very rarely seen in the USA. Most had the 6E5-type display, while the EM71/72 had a round eye display that was offset from the center axis of the tube. Most radio collectors know of the EM1 with its four-bladed "Maltese Cross" shadow pattern--the AM1, EM3, EM5, EM31, EM35, EM11, UM11, UM35 and Ediswan octal 6M2 all had a four-blade shadow. Some types in the EM and UM series were made with yellow, and even red, phosphor.

The EM35 is a replacement for the 6U5 that's in the GE tube manual. The final (1994) issue of the **Vade Mecum** has more information on European eye tubes on pages 388-394, including drawings of their shadow patterns.

For that matter, the GE manual speaks of the U.S. type 6355. I have seen one in the hands of a tube collector; it is a 7-pin miniature with a small round eye on the tube end.

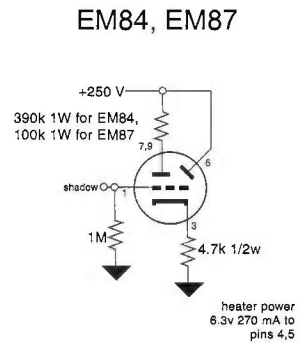
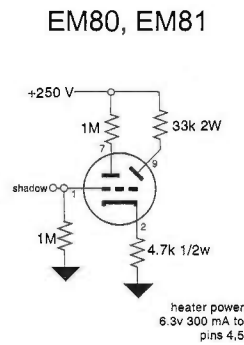
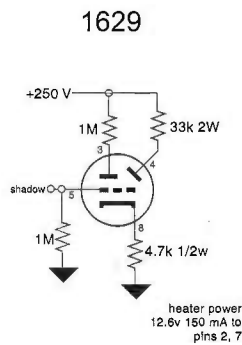
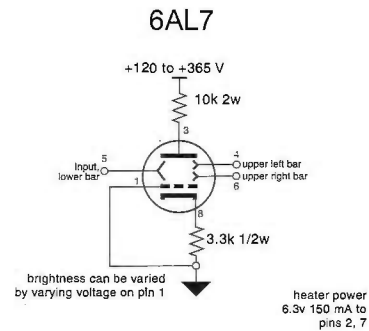
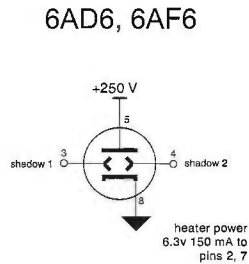

Figure 2: connection of some common eye tubes as audio level meters.

Copyright 2002 Vacuum Tube Valley. All rights reserved.

6355s would be great for collecting purposes, as nobody seems to know what equipment they were used in, and they are very scarce.

Before eye tubes, special long-electrode neon lamps were developed for tuning indicator use. These lamps were made with two, three and even four electrodes. Some prewar European radios used them. The Philips 4662 is an example--it had a long cathode, a short anode, and a trigger electrode. Varying the trigger voltage (when AC was applied to anode and cathode) caused the length of the glow discharge to vary. Similar devices were made by M-OV and Cossor. Sparton had a "Viso-Glo" lamp made for their 1934 models, which was quickly replaced with 6E5 types. Unlike the other types, Viso-Glo had a circular electrode.

There were even a few eye tubes intended for use in tube battery radios. I have a DM70/1M3, a subminiature tube with 8 wire leads, only 4 of which are used. Its filament is for 1.4 volts and its target is meant for 45v to 90v. The pattern is a glowing green exclamation mark about 3/4" high. The DM71/1N3 is similar but with short wire pins. The DM160 is similar to the DM70 but barely half as large. Ediswan/Mazda made the DM70/71, only under their own numbers 6M1 and 6N1. The remaining stocks

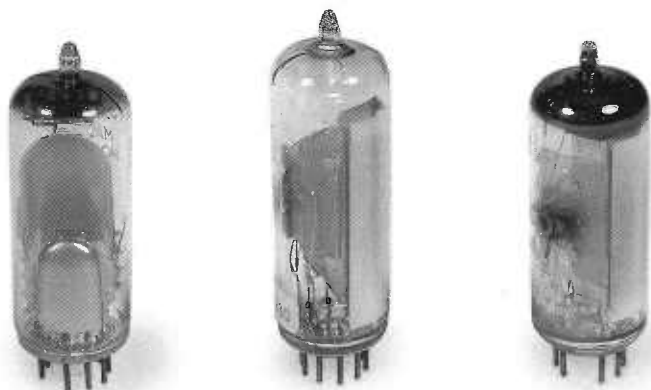

Amperex EM81, Philips EM84, Siemens EM4

of DM70s and DM71s might be useful in modern battery gear or in solid-state equipment, as their prices are reasonable and supplies are good.

Scarcer is the DM160, also called 6977. This is my candidate for the world's smallest glass electronic tube--barely 3/4" long and as wide as two match sticks. Philips, and their US division Amperex, tried to market the 6977 in the late 1960s as a logic monitor for digital computers. Unfortunately, some radio collectors have found that it can be substituted for 01As in radios, by soldering it into a 4-pin UX base. It makes a very nice low- μ triode. Supplies of the 6977 are expected to dry up quickly. There was also a DM21, a large device from the 1940s with an octal base and a 2-bladed round eye. It had a low-power filament like the other DMs, for use on 1.5v battery power. Apparently it required too much target voltage, making it unsuitable for battery sets.

Japanese companies made a few of their own unique eye tubes. I have a type 6G-E12A, which was pulled out of a junked Pioneer hi-fi tuner. It is totally unavailable in the USA, and I can't even find data or pinouts for it. Still, a 6G-E12 might make an unusual audio meter. It has an octal base and its eye pattern is rectangular, with two open wedges which are controlled separately. It was often used in binaural AM-FM tuners. And there are some other Japanese types out there, such as the 6ME10. It looks like a 6355 with a black phenolic base. None of these types are available in this country in NOS form. Besides, the irony of using a Japanese eye tube is a bit much, since Japan is the country that mass-produced cheap mechanical tuning meters, making eye tubes obsolete.

3. Using Them for Audio

In Figure 1 (p. 6), we have the pinouts of the eye tubes listed in the GE tube manual of 1973. Next to each pinout is the shape of its eye, showing how the shadow or wedge opens and closes with grid voltage. All of them are roughly the same physical size, but their visibility in room light varies greatly from type to type. Overall, I'd say the EM84 and 87 are capable of the greatest brightness, along with the 6AF6 and 6AD6. Note that most of the miniature EMs are side-view, while all the American types are viewed from the end. Also, the American ones are usually much

larger than the EMs. The 6AD6/6AF6s give bright displays but require control-electrode voltages of more than 50 volts, as they do not have internal driver triodes.

Figure 2 (p. 7) shows how to wire up the least expensive types. I leave out the 6E5 family types because of scarcity, and I can't even get a 6355 so I don't know any more about it. If you MUST use a 6E5 type, it can be wired up much like the 1629: the 1-meg resistor goes to pin 2, the 33k goes to pin 4, +12v to pin 5, Vin to pin 3 and 6.3v filament power to pins 1 and 6. The 33k resistor can be shorted out for some more brightness, at the cost of some of the tube's lifetime.

Table 1 shows how their displays vary with Vin. Note how similar they are, with the exception of the 6AL7 which responds in exactly the opposite polarity of the others. I've left out the DM70 since it's a very simple device to apply. I leave it up to you to figure out its response. Hint: target (pin 8) goes directly to +45-90v, filament (pins 4 and 5) to 1.4v, and input to pin 1.

Phil Taylor also suggests the EM71, which has a short envelope and a large target. It was made only by Lorentz in Germany and apparently has one of the brightest displays ever made. NOS EM71s are readily available in the UK.

4. Exit

The eye tube is a distinctive and unique indicator, and nothing like modern LCD and LED bar-graphs or vacuum-flourescent displays. Since almost no one under the age of 30 has ever seen an eye tube, it has the power of an obscure, but not-quite obsolete technology. And if you put one in your homebrew tube amp or preamp, it is guaranteed to grab attention for your work.

Table 1 - Eye Tube Responses To VIN, Volts DC, With Target Voltage=150V: (all are approximate, vary from sample to sample, and are dependent on the target voltage)

	1629	EM80	EM84	EM87
Full Open	13.75	13.0	16.4	12.0
Intersect	6.5	5.4	2.5	1.6
Overlap	3.5	1.9	0.2	0
6AL7		Lower	Upper	
Smallest Bar		-5.0	-4.5	
Half Bar		0	2.0	
Full Bar		3.0	4.0	

Acknowledgements

Many thanks to Alan Blake and Phil Taylor for information on the Tunograph and other European developments, and to Norm Braithwaite, Al Jones and Steve Shepard for help with obscure types.

The Contest for High Fidelity:

Western Electric vs RCA

Part 1 - Introduction to Series

By Scott Frankland ©2002 All Rights Reserved

Prologue

A recent business headline in the NY Times reads: "AT&T Plans to Split Up Again." The article explains the split as a natural consequence of corporate mitosis:

"As a corporate pater familias, AT&T has been more virile than any company in the nation's history, with the possible exception of the original Standard Oil. Over the last two decades alone, AT&T has spun off units that themselves now have a combined market value of at least \$450 billion, rivaling that of the General Electric Company [1]."

It is fitting that these two icons of the electronic age, AT&T and GE, should be juxtaposed as mutual measuring rods. Their histories contain striking parallels. For example, they were each established at the peak of the electrical revolution: AT&T in 1885, and GE in 1892. Within a decade, they each controlled large blocks of their respective markets: AT&T in communications, and GE in power and illumination. And they each made critical improvements to de Forest's three-element vacuum tube.



Fig. 1. Elisha Gray's musical telegraph, used in traveling exhibitions to demonstrate his multiplex system (1876).

Before the Amplifier

It is well known that the advent of the high-vacuum tube (1913) marks the turning point of the acoustic era. What's not so well known, but deserves to be, is the means by which this transition was effected. At the center of it all

was a long piece of wire.

During the 1870's, various attempts were made to improve telegraphy. Joseph Stearns of Boston patented a method to send messages in both directions at once (duplex). Soon afterward, attempts were made by others to send several signals in multiplex.

Among the first to achieve multiplex was Oberlin physicist Elisha Gray. Gray used vibrating steel reeds as oscillators to produce discrete tones (Fig. 1). Each tone could be interrupted by its own telegraph key to produce dots and dashes. It must have been maddening at the receiving end. {1}

At about the same time, Alexander Bell of Boston tried to use tuning forks coupled to electromagnets to superpose electrical waves at discrete frequencies. Bell applied Helmholtz's theory of sympathetic resonance to the transmitting and receiving forks with some success.

These well-known acoustical theories were adapted to electrical devices after it was discovered that superposed electrical waves behave much like sound waves [2,3], i.e., they modulate and carry one another, they resonate at tuned frequencies, and they produce electrical standing waves in wires.

Among the first to recognize this was George Campbell of AT&T. At the turn of the 19th century, Campbell adapted the acoustical theory of standing waves to the design of long telephone lines to increase their efficiency. Loading coils were spaced out along the line like beads on a string to "harmonically tune" the speech currents. {2}

Campbell noted that the effect of loading was twofold: first, that wave reflections at the end of the line could be controlled by distributing the coils at discrete distances along the line; and second, that attenuation could be minimized by providing an impedance match at the two ends. This involved taking into account the series and shunt impedance of the line itself. Campbell's technique was so successful that he was made chief analyst at the Telephone Company.

Campbell's work with loaded lines (1899-1910) led him to the theory of electrical filters, which he called "wave filters." Campbell's wave filters became the basic building blocks of amplifier and radio circuits following the advent of the high-vacuum tube. All of the above-mentioned acoustical adaptations helped to extend the well-known physics of sound waves into the lesser-known electrical realm. {3}

Soon after the turn of the century, the emerging theory of electrical impedance began to surpass that of acoustics as an analytical tool. Arthur Kennelly of Harvard was among the first to generalize the new impedance concepts for electrical networks and apply them to the acoustical elements in telephone sets (think of the equivalent circuit of a loudspeaker, which shows the impedance vs frequency) [5,6].

This "analysis in reverse" completed the circle of the

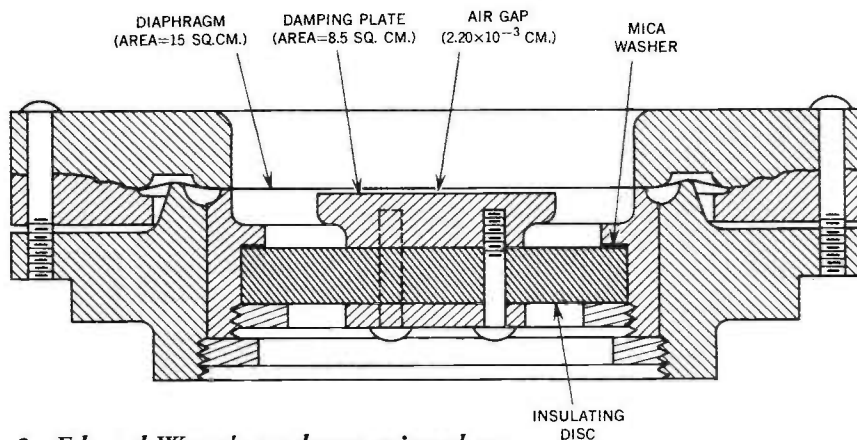

Fig. 2. Edward Wente's condenser microphone.

acoustic-wave analogy and allowed the two sides of transducers "electrical and acoustical" to be reconciled in common terms: that of network theory [7]. This new, unified analysis found wide application following the advent of the vacuum-tube amplifier, which changed everything. With amplifiers, all of the familiar demands for efficiency and sensitivity could be subordinated to the quest for higher quality sound.

After the Amplifier

In terms of high fidelity, the first important result of network theory was the mating of the Wente condenser microphone to the tube amp at Western Electric (1916) [8]. This microphone (Fig. 2), originally designed as a lab instrument, soon found other applications: in telephony, public address, radio, phonography, and theater sound.

These applications fall into two general subcategories. The first category "being primarily concerned with the transmission of sound" includes telephony, public address, and radio; while the second category "being primarily concerned with the storage of sound" includes phonography and theater sound. [4]

Within the category of transmitted sound, local telephony is the simplest type, followed by long-distance telephony and public address. Public address in its simplest form is essentially a "loud speaking telephone," but it becomes more complex when the signal is branched out into networks and transmitted over long lines. Radio is effectively a wireless form of public address far more broadly cast. [5] Telephony, public address, and radio were combined during the radio boom to provide network broadcasting [10].

Within the category of stored sound, disc recording is the simplest. Early theater sound used disc recordings to convey the sound portion of the film [11]. Sound-on-film later displaced sound-on-disk. Theater sound is thus one step more complex than phonography, because with film, sight and sound must be combined and synchronized.

Audio development at Western Electric and RCA encompassed both transmitted and stored sound, always moving toward systems of greater complexity and refine-

ment. Each mode of sound storage and transmission contributed its share to the establishment of high-fidelity sound (Fig. 3, p. 11).

The aim of this series of articles is to trace the impact of these applications on audio development at RCA and Western Electric. In each of these key areas the two companies competed for market share. In effect, a contest for high fidelity was waged between the two.

High Fidelity

The transition from the acoustic to the electric era was complete by 1925, when electromagnetic pickups, amplifiers, and electrodynamic loudspeakers appeared in the same console. Each of the new transducers--microphones, cutterheads, pickups, and loudspeakers--depended on amplifiers for their operation, and they were each designed and optimized accordingly. From here on out, acoustical audio began to decline.

One point I wish to bring out in this series is that high fidelity, as a working concept, arose during the radio boom. The adoption of the term "high fidelity" corresponds to the introduction of the amplified radio/phonograph console circa 1925. The term was in currency by 1926 [12], and was widespread by 1934 [13].

That the notion of high fidelity was well understood by 1926 may be judged from the following quotation by the designers of the "Orthophonic Victrola," the crowning achievement of the acoustic era [14]. In a white paper presented at the 1926 AIEE convention, Joseph Maxfield and Henry Harrison of Western Electric state: "Phonographic reproduction may be termed perfect when the components of the reproduced sound reaching the ears of the actual listener have the same relative intensity and phase relation as the sound reaching the ears of an imaginary listener to the original performance would have had [15]."

By "components" is meant the tones and overtones (Fourier components) of the acoustical waveform. This formulation leaves out the spatial relations of the sound waves, but that is not surprising considering that reproduction was then in mono. By 1933, however, Western Electric well understood the need for directional cues, which they proved in a public demonstration involving three sound channels [16].

So what, then, is high fidelity? As a practical matter, high fidelity is an objective set of specifications derived from hearing research and listening tests. The resulting standards are intended to provide benchmarks for "distortionless" sound. The problem is one of confirmation. Hearing research is statistical: one man's transparency may be another man's opacity.

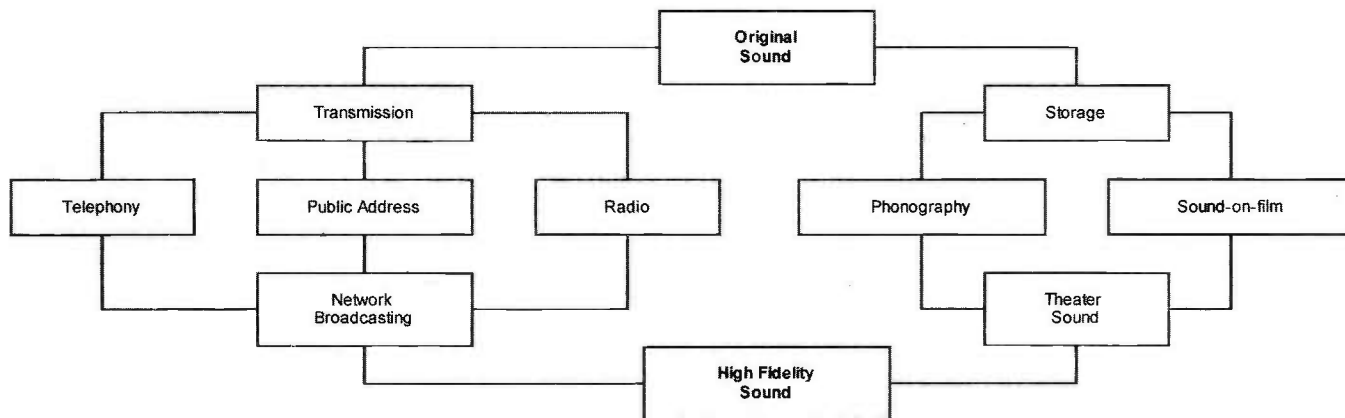

Fig. 3. High Fidelity flow chart.

Harry Pearson's choice of The Absolute Sound as the name for his magazine (1973) is intended to highlight this dilemma [17]. In addition, Pearson wanted to distinguish his magazine from that of High Fidelity—a magazine he considered too liberal in its use of the term. To do so Pearson coined a new term: high-end audio. His purpose was not to satisfy a set of objective specifications, but to search for the subjectively absolute (i.e., subjective perfection).

There is, in principle, no difference between subjective perfection and a perfect illusion. At the crossroads to high fidelity following the radio boom, RCA's research director, Alfred Goldsmith, put it this way: "To simplify the problem let us assume that we desire to reproduce in the home, or rather in the mind of the listener, precisely the impression which would be created were the listener actually present in the studio or concert hall. In other words, there is sought the "illusion of reality"."

Goldsmith expressed these thoughts to the Institute of Radio Engineers in the fall of 1933. His presentation was published the following January in the influential IRE Proceedings [18]. What Goldsmith here describes is nothing less than the long sought absolute sound, which has yet to be achieved. Goldsmith's formulation, however, had been floating around for 40 years before Pearson reconceived it and gave it a name.

A problem remains with respect to confirmation. How do we really know when the illusion of reality is complete? Goldsmith apparently contemplates a subjective confirmation, while Maxfield and Harrison clearly anticipate an objective confirmation. The attempts to define and demarcate perfect sound reproduction (or a "precise illusion" of such) have been ongoing.

Pearson's mode of confirmation is extraordinary for the purity of its subjectivity. There is no consideration at all of whether a component meets or beats an objective criterion. What Edward Wente did for dynamical analogies in the first quarter of the 20th century, Pearson did for literary analogies in the last quarter: he mined a rich vein of language drawn from specialized fields, especially photogra-

phy, which he used analogically as descriptors of sound.

Pearson wielded his photo-analogical method to mold the course of high fidelity (he would say "high-end audio") to his vision. Anyone with a keen sensibility and a good sense for words could relate to Pearson and understand his points. In contrast, understanding the use and limits of objective specifications requires a technical background. Understanding both points of view at the highest level is extremely rare in audio.

The general requirements for high fidelity began to take shape at the Telephone Company during the public address era leading up to the radio boom [19,20]. These findings were based on systematic hearing research and listening tests [21]. Subsequent to the radio boom, Harry Olson and Frank Massa of RCA made a detailed study of these findings and added significantly to their content [22]. Harvey Fletcher of Western Electric did the same [23]. The resulting data has been updated every ten years or so [24-28].

A continuing problem is to define high fidelity in a manner that makes it valid for all listeners. The final arbitration clearly cannot come from objective standards until such time as those standards can objectify a predictable illusion for any listener.

A proof that objective standards, when set high enough, can lead to dramatic progress is evidenced in our own time by the new high-speed digital audio standards. A further proof is the existence of the Rockport turntable, a paradigm of engineering orthodoxy if there ever was one. These two products have each received wide acceptance by hardened audiophiles.

The history of high fidelity teaches that if a problem can be identified subjectively and be made repeatable, an objective solution will not be far behind. It is reasonable to expect, therefore, that a reciprocation of objective and subjective methods of confirmation will lead to better results than either alone can muster.

This reciprocal approach to confirmation is currently

practiced by John Atkinson of *Stereophile* magazine [29]. His approach, while more limited in scope, closely parallels that of Western Electric and RCA following the radio boom [21-30].

Fig. 4. Triple-horn loudspeaker, circa 1925

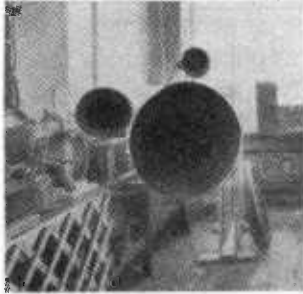

Perfect Fidelity

Before we can rely on either objective or subjective standards of confirmation, we need to clarify the difference. We can do this by first defining perfect fidelity in a formal way, i.e., as theoretical perfection.

This can apparently be obtained when five conditions are met at each instant of playback with respect to the original sound source(s):

1. The ambient noise level is 100% preserved in level and composition.
2. The frequency of every tone and overtone is 100% preserved.
3. The intensity of every tone and overtone is 100% preserved.
4. The arrival time of every tone and overtone is 100% preserved.
5. The direction of every tone and overtone is 100% preserved.

This formulation may actually be overkill. In reality we may be fooled by less than a 100% preservation of each factor. Our senses are not perfect. It may be that 97% of each factor is sufficient to fool anyone. If so, then 97% becomes the predictable threshold of Goldsmith's paradigmatic "illusion of reality."

Thus, in regards to a subjective criterion, whatever falls between 97% and 100% can be deemed "complete," and whatever does not, is simply incomplete fidelity, i.e., not a totally credible illusion of reality. The term "high fidelity" is now seen to be a gray area playing over the threshold of Goldsmith's paradigm.



Fig. 5. Electrostatic loudspeaker, circa 1925

We cannot call fidelity perfect, however, unless the 100% level is achieved for all five factors. What all this points to is that for confirmation of 100% fidelity we must apply objective standards; but for confirmation of Goldsmith's paradigm we must apply subjective standards. John Davies comments on this dilemma in his book, *The Psychology of Music* (1978):

"This then is the problem. If we accept definitions in terms of perceptual quality, we encounter all the problems of subjective report resulting from the lack of an objective externally verifiable criterion. If, on the other hand, we couch our definition in scientific terms, such as physical properties of tones, or mechanisms of the ear, we may find ourselves in the absurd position of having explained a phenomenon which has no perceptual existence."

Epilogue

In the early 1930s, both RCA and Western Electric arguably achieved high fidelity in the lab [31,32]. Figures 4 & 5 show two popular loudspeaker configurations of our own time in the GE Research Lab. These speakers are described, along with other exotica, in a white paper presented by Chester Rice and Edward Kellogg at the 1925 AIEE convention [33].

Three events conspired to keep high fidelity in the lab: the Great Depression, World War II, and television. During this period (1929-1945) RCA began to dominate all aspects of the entertainment business, a business for which Western Electric remained content to manufacture and install hardware.

In 1938, a consent decree banned Western Electric (ERPI) from the business of theater sound [9,34]. Their near-monopoly had backfired. During the 1930s, Western Electric's revenues declined by more than 48%, and its labor force was reduced by almost 62% [46]. To make things worse, tube sales were down. Bernard Magers reports on the state of the tube business at Western Electric leading up to the Great Depression:

"At this time [1925], the Labs were employing about 100 people on tube research. A growth began which carried the Tube Shop to 1000 people by the fall of 1929 and production reached \$2.7 million. Tube business fell to a low level after 1931. Personnel dropped to 250 by 1933 and production was less than \$0.5 million [35]."

There was a recovery in tube production leading up to the war, but by then, hi-fi was on the back burner; and Western Electric turned to defense work, telephony, and the transistor for the bulk of its revenue [46]. Stephen Adams and Orville Butler summarize the transition to government work:

"The percentage of the company's business dealing with the government rose from less than one percent in 1939 to more than 80 percent in 1943 and 1944..... The Federal government would be Western's second largest customer (behind the Bell system) for the duration of Western's existence [46]."

A general revival of interest in better sound followed in

the wake of the war, giving rise to high fidelity's "golden era" (WWII-1965). This is the era of Ampex, Westrex, RCA Living Presence, Quad; and Marantz. I call the first era of high fidelity the "silver era" (1925-WWII).

1965 marks the year the Marantz 10B tuner was reviewed in *Audio* magazine. *Audio* called it "the Rolls Royce of tuners" [36]. In many ways, the 10B stands as the most potent symbol of the golden era. Nearly everyone who has heard one agrees that no better tuner has ever been built.

The heroic struggle to design and produce the 10B drove Marantz into bankruptcy [37]. Marantz's downfall ended for many years the heroic strain in the audio world. {6} It would be ten years before that strain recovered its wind, largely through the inspiration of *The Absolute Sound*.

The choice of 1965 as the end of the golden era is somewhat arbitrary on my part. I could just as well have chosen 1963, the year RCA began using their new "Dynagroove" ("Dynamic Spectrum EQ") recording process [39]. The Dynagroove recordings were reviewed in 1963 by a horrified J. Gordon Holt. {7}

With these fateful words, Holt signaled the ascendancy of subjective audio: "If Dynagroove becomes accepted as a new standard of fidelity, and other record manufacturers follow suit with their own variations on this no-fi theme, high fidelity as we know it will be a thing of the past [40-42]."

Holt's augury was soon echoed by Chester Stanton of *Audio* magazine [43], who poured scorn on RCA: "the new Bolero is the most distorted stereo record ever produced by the American disc industry." Later critics reinforced these sentiments. Among them was Eric Leinsdorf, who looked back on his Dynagroove legacy at RCA with great regret.

The common thread that runs through all these criticisms is that RCA abandoned its originally pure ideals of high fidelity in order to accommodate the equipment preferences of the man in the street.

In 1989, Sid Marks began a retrospective survey of RCA's legendary Living Stereo catalog for *The Absolute Sound* [44] {8}. One of the first things Marks did was to thrash Hans Fantel of the *New York Times* for waving the banner of Dynagroove (*High Fidelity* also liked it). Marks declared, in so many words, that the introduction of Dynagroove marked the fall of RCA as a power in high fidelity. "Sic transit gloria mundi," said Marks. RCA never recovered.

It may be mentioned by some that too much has been left out of this history; by others that too much has been attempted. For my part, from so vast a panorama I am content to focus narrowly on the heart of the history, and to approach it from a single, manageable point of view—that of a contest for high fidelity between RCA and Western Electric. The innumerable details of what remains will have to be told by others.

To be continued. (This is the first of a twelve-part series on the early history of high fidelity and the related electronics)

Footnotes (Are indicated by the following brackets { })

1 Elisha Gray's electrical researches paid off in 1867, when he developed a new form of telegraph relay. In 1869 Gray formed a partnership with Enos Barton to manufacture telegraph equipment. Barton had previously worked as a telegraph operator for Western Union. In 1872 they joined forces with Western Union and reorganized as the Western Electric Manufacturing Company.

2 The loading idea derives from Heaviside, who developed a theory of electrical impedance (as applied to the telegraph wire) circa 1886. Prior to that, Lagrange analyzed the effect of beads attached to vibrating strings (1759). Lagrange's results were generalized by Godfrey in 1898, which is what guided Campbell in his research on loaded lines [3].

3 Maxwell wanted to present electricity in its simplest form, which he did, in 1873. In the course of this work, Maxwell investigated electrical resonance (1868) in terms of equivalent dynamics (differential equations common to all dynamic systems) [3,4]. The technique of dynamical analogies (think of springs for capacitance and mass for inductance) has been used ever since in electrical work.

4 Other forms of recording were studied, such as the light recorder and the magnetic-wire recorder, but apparently neither was considered promising enough for a full-scale research program at Western Electric [9]. Light recorders, however, made a comeback in the 1920's as a means of capturing sound on film.

5 Radio can be encoded, however, so to serve as an adjunct to wired telephony.

6 The 10B is comprehensively profiled, with schematic and interviews, in *Vacuum Tube Valley*, Issue 5 [38]. In 1964, Saul Marantz sold his company to Superscope [37].

7 J. Gordon Holt was *Stereophile's* founder (1962). He now writes for *The Absolute Sound*. Holt sold *Stereophile* to Larry Archibald about 1980 or so, changing the magazine from its original character.

8 Marks later summarized his findings in *Ultimate Audio* [45].

References (Are indicated by the following brackets []))

Due to space constraints, a complete list of references on www.vacuumtube.com under the references link.

Figure Credits

Fig. 1. Elisha Gray's musical telegraph, used in traveling exhibitions to demonstrate his multiplex system (1876). Source: Elisha Gray and "The Musical Telegraph" (1876), http://www.obsolete.com/120_years/machines/telegraph/

Fig. 2. Edward Wente's condenser microphone. Source: Fagen, M.D., ed., *A History of Engineering and Science in the Bell System, the Early Years (1875-1925)*, Bell Telephone Laboratories, Inc., 1975, p. 181.

Fig. 3. High Fidelity flow chart. Source: Author

Fig. 4. Triple-horn loudspeaker, circa 1925. Source: Chester W. Rice & Edward W. Kellogg, "Notes on the Development of a New Type of Hornless Loud Speaker," *Trans. AIEE*, Apr 1925, p. 462.

Fig. 5. Electrostatic loudspeaker, circa 1925. Source: Chester W. Rice & Edward W. Kellogg, "Notes on the Development of a New Type of Hornless Loud Speaker," *Trans. AIEE*, Apr 1925, p. 462.

NOS Audio Tubes: The World's Best Investment?

By Eric Barbour ©2002 All Rights Reserved

No doubt, VTV readers who use tube amps have noticed the dramatic rise in prices of common NOS tube types during the past decade. Since tube audio became a really "hot" business in the late 1980s, the quantitative demand for audio types has probably quadrupled worldwide, with ongoing growth (slowed only temporarily by the 2001 recession). Yet as far as we can tell, nobody has actually quantified the price increases of audio tubes. Because popular devices such as 12AX7s and EL34s are still being made, and the market for such new tubes is competitive, the prices of new production are not much greater than they were 10 years ago. However, the relentless demand for the "best" tube has become a common identifying trait of the habitual audiophile and vintage amp collector. This trend has influenced electric-guitar players, who now seek out older NOS production rather than being satisfied with current manufacture.

It's not unusual to see a decent European-made 6922 or 7308 dual triode, branded Philips, Siemens, Mullard or Telefunken, selling for \$150+ today. Such a tube used to bring perhaps \$20 in 1990. And the prices of NOS Western Electric 300Bs have risen from \$350 to about \$2000, in spite of the ready availability of new 300B tubes from a resurgent Western Electric and from many other factories. During this same time period, the famed NASDAQ stock index, heavy with "hot" high-tech companies, has risen only from about 500 in 1990 to around 1900 today, after plummeting from its Internet-fueled peak of 1999. Median housing prices in the San Francisco Bay Area, once touted as the hottest real estate market in the world, have only risen about 216% during this period--and are now dropping slowly. Worst of all for conservative investors, the price of gold has declined during the 1990s. (fig. 1). The information on that chart came from NASDAQ's own website, from the California Association of Realtors, from the ECONODAY website--and the tube prices were derived from eBay auction results and from discussions with major tube retailers.

1950s Western Electric 300B

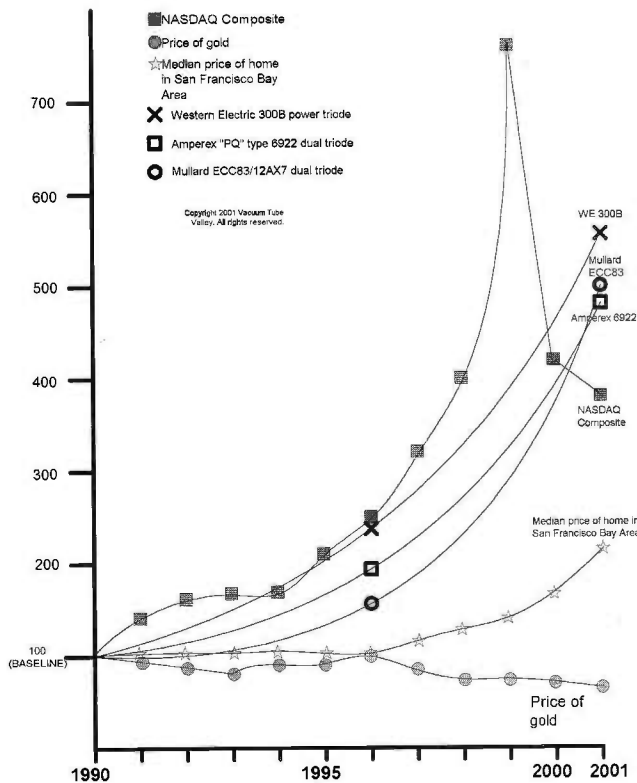
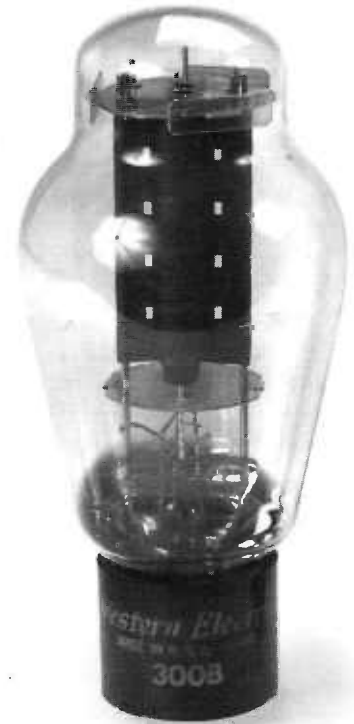

Figure 1:
VARIATION OF PRICES OF CERTAIN NOS AUDIO TUBES DURING THE PERIOD 1990-2000
VERSUS LEADING ECONOMIC INDICATORS (all prices adjusted to 1990 baseline=100)

Yet even these are not the most extreme price increases. In 1990, the 6SN7Ws made by Sylvania or Tung-Sol during World War II sold for perhaps \$5, sometimes as much as \$10. They were commonplace radio tubes of little value--until the late 1990s. Thanks to increasing recognition of the 6SN7 as a high-fidelity amplifier, the prices of such early versions are now hovering around \$200 apiece. That represents an increase of as much as 4000% in 11 years---363% per year on average. No stock, mutual fund or other investment that I know of has risen so much. Not even the world's most expensive corporate stock, Berkshire Hathaway, can claim such an increase (during the 1990s, Berkshire Hathaway Class A shares rose only about 260%). And this happened in spite of the fact that one can still buy lower-quality Russian-made 6SN7s for prices in the \$5 neighborhood.

There is a dramatic difference between NOS tubes and other "vintage" items with collectible status: the people who buy NOS tubes are usually audiophiles or guitarists.



Early 1940s Sylvania 6SN7W Metal Base

These buyers plug the tubes into amplifiers, and wear out their cathodes--by using them. So, NOS tubes are more like fine vintages of wine or Cuban cigars than like other collectibles. People are using them up by enjoying them. This can only drive the prices up further. Eventually, there may be a peak price beyond which nobody is willing to go--perhaps. Just keep in mind that very old bottles of French wine sometimes sell for millions of dollars at auction. Will new-in-the-box WE 300Bs from the 1930s be selling for mil-

lions of dollars a century from now? Nobody knows. (I do know some tube dealers and collectors who would be ecstatic if this happened, even though they won't live to see it.) An average Stradavarius violin can sell for \$2 million--pretty good money for a hunk of carved wood. And even the best Strads haven't risen in price like a WWII 6SN7W.

I can tell you this: if a mutual fund, managed by a hired gun, had risen by such levels during ALL of the past ten years, that manager would be celebrated on the cover of Forbes magazine, as if he or she were a pop singer or a movie star. There is an enormous industry based upon stock portfolio investments, all hanging on the pronouncements of "geniuses" such as these. Some, such as the now-disgraced Internet stock hypesters Henry Blodget and Mary Meeker, worked for major investment firms and enjoyed solid reputations. Investors (and worse, media outlets) hung on their recommendations as if these Ivy League-trained "visionaries" had some kind of twinkly pixie dust that could turn web retailers into fairy gold. It wasn't even the fault of the experts, or of the media--all of them were along for the ride, puffed up by the fears of average investors and day-traders. Such folks should not invest in the stock market, which was traditionally seen as mostly "gambling for rich people." Since a whole generation of baby boomers feels they have the divine right to retire wealthy, they proceed to place their trust in total strangers and in half-baked companies. This attitude was encouraged by personal-finance rags such as *Money* and *Kiplinger's*. Everyone involved in the high-tech industry

and in the investment world gets to shoulder some of the blame for the dot-com disaster.

Not many stocks have risen by multiples in recent months--they are usually special cases such as Nvidia, the company that makes video-graphic accelerators for the Microsoft XBOX video game console. It is quite possible that Nvidia is being inflated by speculation and raves from insiders, and will eventually crash back to earth. It happened to a long list of bigger tech firms--remember Netscape? Or Silicon Graphics? Or Excite@Home? Or Webvan? Or Rambus?

And how about massive investment firms that have collapsed, such as Long-Term Capital Management? Can you really trust stock touts, while not expecting that audio-philes will continue to drive up the prices of NOS tubes?

Let's face facts: Wall Street is run by a pack of well-dressed confidence men. They wear Paul Stuart suits, but they are still a pack of con artists. And they've spent the 1990s raping the retirement accounts of average working Americans, as well as the discretionary funds of overpaid doctors and lawyers.

A major cause of the price inflation seems to be the trade in tubes on eBay. Indeed, we obtained many of the

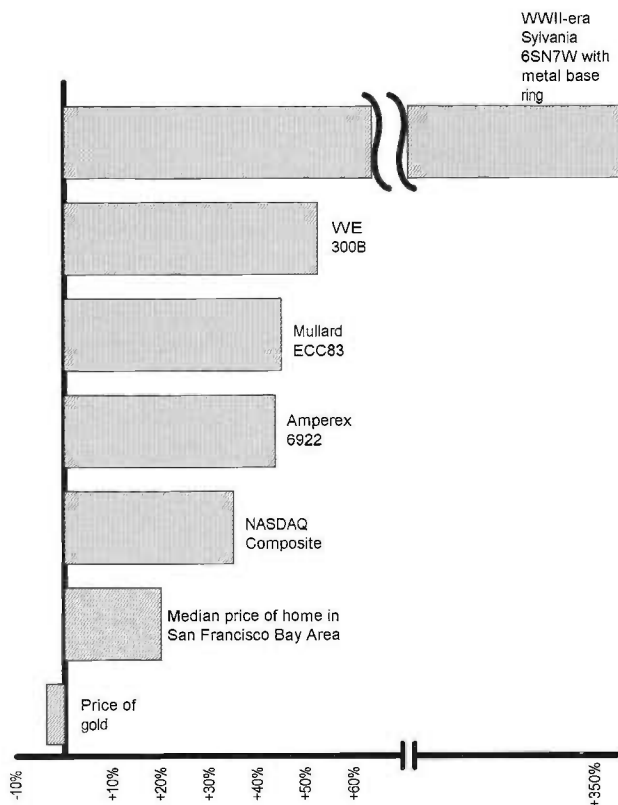

Figure 2: AVERAGE ANNUAL PRICE RISE DURING PERIOD 1990-2001 OF CERTAIN NOS AUDIO TUBES VERSUS LEADING ECONOMIC INDICATORS

Copyright 2001 Vacuum Tube Valley. All rights reserved.



*1970s Amperex PQ 7308/E188CC
(high quality 6DJ8)*

current tube prices for this article from recent eBay results. The rise of this online, world-blanketing auction site has meant the decline of stability in prices for many collectibles. Price guides, usually published by an expert in the field and frequently containing questionable price evaluations (but adding stability to prices), have been shoved aside as eBay becomes the "standard." This has also irreparably damaged the circulations of

magazines specializing in classified ads relating to tube audio, such as *Antique Radio Classified* and *Audiomart*. Every issue of *Tube Collector* magazine now contains a list of recent auction prices for collectible tubes and related items, mostly taken from eBay (though they do also include the results from specialized antique-radio auctions). And there are even a few con artists using eBay to market relabeled cheap tubes as NOS. Because eBay is a low-cost automated auction system, there is very little oversight by real human beings. They're just taking advantage of a fine digital-inspired opportunity to cheat insecure tube audio nuts.

And why haven't the investment "experts" discovered this? Why haven't antique dealers or collectors written books on the subject? Because, whether we like it or not, tube audio is the bastard stepchild of the electronics industry. The commonly-held view among industry brahmins is that audiophiles who pay such prices are mentally ill. Publications such as the *Skeptical Inquirer* and the *Audio Critic* publish lengthy screeds attacking tube audio users, lumping their practice in with \$5000 audio interconnects and \$600 bricks which are advertised to have magical results when used in a home-audio system. This is the mainstream view--that NOS tube prices are deranged because tubes are bought by deranged people. Who, being deranged (in the opinion of arrogant "experts"), can be safely dismissed and ignored. The quality of sound issuing from tube equipment is assailed as being no better than that available from cheap IC-based stereo receivers. This is the prevalent attitude of "experts" such as *Audio Critic* publisher Peter Aczel and Audio Engineering Society nabob Dan Davis. These guys like to point to "unbiased"

ABX listening tests, some of them conducted by Davis himself.

The situation is complicated by the fact that only certain tubes are enjoying these extreme price jumps. Only the highest quality audio tubes that can be used in audiophile equipment or guitar amps are appreciating. Most radio and TV tubes remain worthless or nearly so. A short list of appreciating tubes would include 6L6 types, EL34s, 6550s and KT88s, 6DJ8/6922s and variants, 12AX7 types, oxide-cathode power triodes such as 45s, 50s and 300Bs, and a few assorted small-signal types. Large TV sweep tubes, such as 6LQ6 and 6LF6, are rising in price because of continued use in amateur-radio and CB power amplifiers--but that market is far more price-sensitive than the neurotic audio business. Some of the more unusual types that are seen in vintage equipment, such as the 7199 or 7591, have risen in price considerably, although not as much as the few types being used in current amplifiers and preamps. New manufacture of a 7591 has eased the demand for this small beam-power tube, stabilizing prices for what little NOS remains.

Brand name is important. A fine Amperex 6922 can sell for \$150, but a GE-made 6DJ8 of the same age--essentially the same tube--always sells for much less. True 6922s were tested to very stringent specifications, since they were intended for critical applications such as avionics and medical equipment. The "6922s" being made in Russia today do not truly conform to the 6922 specs, causing perfectionists to seek out the older special-quality tubes. Snobbery and elitism matter in this field, just as they do in winemaking and caviar fishing. See our past audio-tube evaluations for the top scorers. It's a safe bet that those tubes will appreciate. And by all means, this situation has paved the way for con artists to take current tubes and remark them with old brands.

Get used to it. Certain NOS tubes represent a very good, reasonably safe possible investment for the future. Unlike artwork or antique furniture, NOS tubes are being used up, and can only increase in price even further, and faster than more traditional collectibles. Even so, there are plenty of well-regarded engineers who will happily criticize you for spending money on "old junk." However, keep one thing in mind: during the 1996-2000 Internet boom, many highly questionable companies were touted by "stock experts" as being the "next big thing." Most of those firms are now in bankruptcy court.

We're not going to recommend stockpiling NOS audio tubes--we don't feel it is our place to play the Henry Blodgett game. It doesn't work, in the long run, and verges on criminality. And the available tube stock that you CAN purchase is declining fast. (There are always plenty of puffed-up penny stocks and junk bonds.) Just don't be a fool with your money. Put some of it in boring, slow-rising investments, and don't expect to become the next Larry Ellison or Warren Buffett. You probably aren't that lucky. Judging by recent events, your kids might not go to college if you put your 401K into "hot" items. Just be prepared to pay even more for that nice-sounding, non-microphonic Amperex 6922.

Rudy Bozak

Legenday Speakers from a True Pioneer

By David Bardes ©2002 All Rights Reserved

The next time you read an advertisement about the latest development in loudspeakers, where superior transient response and the use of wide bandwidth drivers makes brand x speakers sound more natural than their competitors, think of Rudy Bozak. Rudy Bozak was making such speakers long before brand x was around, and probably before the president of brand x was born! Very little is written about Rudy Bozak and his early professional career. His name is little known to any but serious audio enthusiasts, but the speakers bearing his name are legendary.

Humble Beginnings

With a BS degree from the Milwaukee School of Engineering, Bozak first worked for the Allen Bradley Company in 1932. While developing tone compensated volume controls for radio applications, he discovered that



1937 Cinaudagraph SU-18-12

the loudspeakers of the day were not up to the task of testing the circuits he was working on. This was the seed that sparked a great career in loudspeaker design.

Four years later, Bozak was hired on as assistant chief engineer at Cinaudagraph Company, a manufacturer of loudspeakers for movie theaters and other public venues. Bozak designed speaker magnets and transformers there before getting directly involved with speaker design. In 1938 he was promoted to Chief engineer and he was able

to work on some very exciting audio projects of the era.

One of Bozak's biggest achievements, quite literally, was the design of the woofer for the Legion of Nations sound installation at the New York Worlds Fair. Eight of these 26"

woofers were horn loaded (the mouth of these horns was over 14 feet wide, and these drivers were direct coupled to 500 watt tube amps!) in four pods set in the lagoon as part of a very large sound installation that piped in live orchestral music during the light and fountain show. (Look for a future article on this amazing installation.)



Rudy Bozak (mid 1950s)

Bozak's work at Cinaudagraph gave him valuable experience in designing speakers, but it was almost a decade before he struck out on his own. In 1940, Cinaudagraph was sold to UTC and Bozak moved to Chicago. During this time most engineering work was war related, and so his work was diverted from loudspeaker design. In 1944 with the end of the war in sight, Bozak went to work for C G Conn, a band instrument company with plans to make electronic organs. 1946 found Bozak at the Rudolph Wurlitzer Co. working on organ reeds. In 1948 as the economy slowed, Wurlitzer downsized and Bozak was laid off.

Bozak's work experience during the '40s was diverse and provided a strong background for his future career as a loudspeaker designer. His work had also introduced him to many leading audio engineers of the day including, Lincoln Walsh (designer of the Brooks 10-A). Bozak had designed a 2-way speaker system for Walsh, and Walsh encouraged Bozak to go into business for himself.

In May 1949, an ad appeared in *Audio Engineering* magazine (later *Audio* magazine) for the B-201, the Bozak company's first speaker. Unlike any speaker of its time, the B-201 was a two-way speaker system using wide bandwidth direct radiating drivers and a 6db slope crossover. It was housed in a large 32" diameter hemispherical infinite-baffle steel enclosure. Bozak, with 16 years of audio and engineering experience, had launched his company and career.

Engineer and Critical Listener

Bozak was an innovative engineer, but he was also an extraordinary critical listener. Those who worked with him were in awe of his "acoustic memory. An avid classical music fan, he attended the Boston symphony regularly. His genius was his ability to retain the memory of live performances when voicing his speakers, and designing and refining his drivers. As an engineer, he knew that at best, speakers are a compromise, leaving it to the speaker designer to select key aspects most important to natural sound. As a musician (he played piano and organ) and critical listener he could voice his speakers to sound more true-to-life.

Rudy reportedly owned at least three different houses in the towns of Darien, Greenwich and Westport. He had different audio systems set up in each of these estates to conduct listening sessions and other audio experiments

Introducing
MODEL B-201 LOUDSPEAKER
 A two way direct radiator system
THE ONE ABOVE ALL OTHERS IN



Full and Natural Bass
 Freedom from Resonances
 Clarity of Reproduction
 Naturalness of Highs

SPECIFICATIONS:

- Response 40-13,000 cycles
- Input Power 12 watts
- Impedance 8 Ohms
- Enclosure—32" diam. Hemisphere

R. T. BOZAK
 90 Montrose Ave. Buffalo 14, N. Y.

BOZAK SPEAKER

The Bozak Speaker Systems shown here are all formed by various combinations of the three basic Bozak Loudspeakers and Crossover Networks described on the pages following. They are mounted and wired ready for use, in the infinite-baffle enclosures illustrated. The cabinets are of heavy plywood, glued and screwed and braced internally to prevent cabinet resonance; heavy lining and curtaining with acoustical-damping material eliminate cavity resonance. All are available in beautifully finished mahogany, walnut or birch veneer, with harmonizing grille cloth of woven-plastic material that permits free transmission of all audible frequencies. Plans and instructions for building all Bozak enclosures are available on request.

of low cone mass and tight magnetic coupling provided the woofer with an accurate, fast sound. With a stated free air resonance of 40 cycles, the B-199 was flat out to 4500 Hz.

The B-209 was the 6 inch midrange driver used in most of the Bozak three way systems. First made of paper, later models used an aluminum cone. It used a neoprene surround and was the first aluminum cone to be successfully tamed (aluminum cones are notorious for ringing and severe break up modes). Again narrow magnet gaps were used. A robust 1-1/2 pound alnico magnet powered the driver. Early paper models had a frequency range of 200 to 3500 Hz; the later aluminum models were flat to 10,000 Hz.

THE SUPREME B-310

Long recognized as The Supreme Accomplishment in the Reproduction of Sound, this magnificent Bozak four-woofer three-way Speaker System re-creates the "biggest" and most complex music with unsurpassed realism and listening ease. From a whisper to an orchestral crescendo . . . from the lowest notes of the organ to the shimmering overtones of the triangle the B-310 preserves faithfully the precise dynamics and unique tonal character of every voice and instrument with smooth coverage of the entire room.

Equipment — Four B-199A, one B-209, one B-207A, one B-310 crossover — 20 to 16,000 cycles.
Power Rating — 400 and 2500 cycles, impedance — 8 Ohms.
Power Rating — 50-50 Watts continuous, peaks to 100 Watts.
Enclosure — Infinite Baffle, 36" wide, 18" deep, 30" high.
Weight — 210 pounds.
 The B-310 is available with two B-300's.

THE B-302A GEM

In an E-300 Enclosure, the minimum recommended for a single Bozak woofer, this compact three-way Speaker System delivers a quality of sound far above the promise of its size and price. From 40 cycles to 16,000 Hz its response is clean and balanced . . . typically Bozak in its realism and listening ease. Use a pair for binaural (two-channel stereophonic) program material, or for distributing monaural sound throughout large rooms.

Equipment — One B-207A, one B-209, one B-302A, one B-300 crossover — 40 to 16,000 cycles.
Power Rating — 40 and 2500 cycles, impedance — 8 Ohms.
Power Rating — 50 Watts continuous, peaks to 40 Watts.
Enclosure — 6" deep, infinite Baffle, 24" wide, 12" deep, 30 1/2" high.
Weight — 55 pounds.

B-300

Equipment — One B-207A, one B-209, one B-300 crossover — 40 to 16,000 cycles.
Power Rating — 40 and 2500 cycles, impedance — 8 Ohms.
Enclosure — E-300 (see B-302A).
Weight — 60 pounds.

THE CHARMING B-305 PROVINCIAL

Authentically styled for period interiors, this acoustical-twin of the Contemporary B-305 charms the eye as happily as it pleases the ear . . . adds a grace note to the living room and a pure voice to a fine music system. Specifications of the Provincial are the same as of the Contemporary (far right), except that it is 40" wide, 20" deep and 31" high, and weighs 120 pounds.

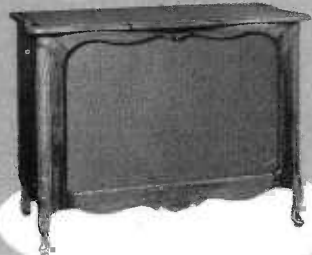

tion. During the 1950s, Bozak teamed up with McIntosh at the annual Audio Fairs in New York Los Angeles and San Francisco. McIntosh tube amps were often seen driving Concert Grands at many of these shows.

Driver Driven

Bozak's success was based on superior drivers. Years ahead of the industry, Bozak developed three drivers around which most of his speaker systems were developed. These drivers were used in different combinations from smaller speakers to the ultimate Bozak speaker, the Concert Grand. His speakers all shared an infinite baffle enclosure design and 6db slope crossovers. Bozak strongly felt that correct phase response and proper transient response were responsible for lifelike sound reproduction. His speakers are a strong testament to these beliefs.

The B-199 was the 12 inch woofer used in all but the smallest of Bozak speakers. Bozak addressed the breakup modes and the mechanical impedance issues found in all cone woofers with proprietary cone materials and forming processes. The B-199 cone was formed with a paper pulp slurry doped with lambs wool. The slurry was then formed on a screen form but more of the slurry was used at the apex of the form. When compressed and dried, the cone had a variable density profile (one of the first uses of a variable-profile cone on record). It was very stiff at the center and progressively became looser as it approached the edge, until it was "as floppy as a felt hat" at the cones edge. This provided the proper mechanical impedance to reduce distortion from energy reflected at the edge of the woofer common in many lesser speaker designs. A narrow magnet gap was used to provide the most magnet-coil coupling and thus superior damping ability. This combination

The B-200 is the tweeter, often used in multiples and in the larger speakers in 8 driver arrays. This driver also started out as a paper cone driver (200X and 200Y) and was later made with an aluminum cone (200-Z). This tweeter was the precursor to the Peerless HFC-225, as used in the Fulton FMI-80 and other speakers in the 1970s. Using a clamped and damped disk for a diaphragm, these amazing drivers were phase and amplitude flat to 16,000 Hz. By design, a single capacitor was all that was needed for a

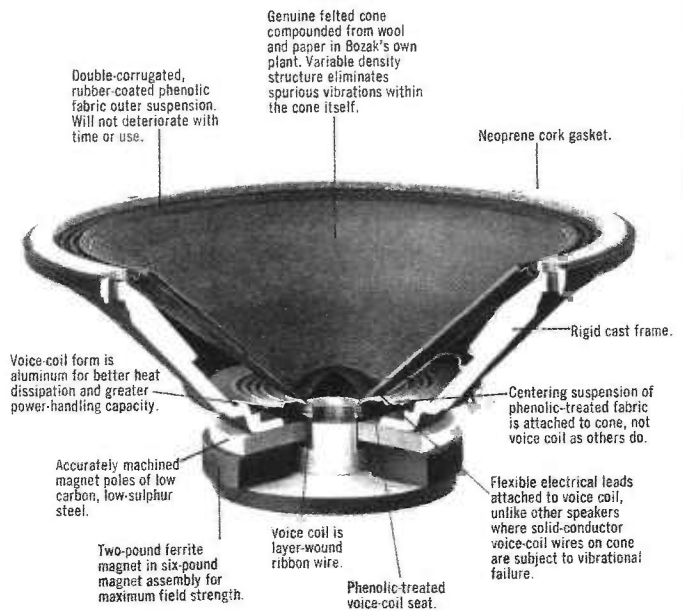

Bozak Component Speakers

All Bozak speaker systems are combinations of these components. They have design and manufacturing features that are not duplicated by any competitive units. Untiring qual-

ity control ensures that no component ever leaves the Bozak factory without testing and inspection to assure that all specifications shown are met.



B-199A Bass Speaker

Response*, 40 to 4,500 Hz / Impedance, specify 8 ohm or 16 ohm / Power rating, 25 watts / Resonance, less than 40-Hz in free air / Voice coil, ribbon wire on 1½" aluminum form / Field, 13,000 Gauss (6½ lb. magnet structure) / Dimensions, 12½" OD, 5½" deep / Mounting: 11" dia. cutout with four equally-spaced bolt holes on an 11¾" dia. circle / Recommended enclosure, infinite baffle stiffened and acoustically lined / Cavity, 5 cu. ft. for one, 8 cu. ft. for two, 16 cu. ft. for four / Weight, 9½ lbs.

*... extended by use in multiples.



B-200Y Treble Speaker Dual Unit

Response, 1500 to 20,000 Hz / Recommended crossover, 2500 Hz / Impedance, 8 ohms (two 16-ohm sections in parallel) / Power rating, for use in Bozak 25-watt systems / Voice coil, ¾" diameter / Field, 14,000 Gauss (2 lb. two magnet structures) / Dimensions, 6½" wide, 3¼" high, 1½" deep / Weight, 2½ lbs / Mounting, coaxially on B-199A, or as described elsewhere.



B-800 Wide-Range Speaker

Response, 50 to 16,000 Hz / Impedance, specify 8 ohm or 16 ohm / Power rating, 25 watts / Voice coil, ribbon wire on 1½" aluminum form / Field, 13,000 Gauss (6½ lb. magnet structure) / Dimensions, 8¼" OD, 3¼" deep / Mounting, 7¾" dia. cutout with four equally-spaced bolt holes on a 7¾" dia. circle / Weight, 8½ lb. / Enclosure, 1½ cu. ft. min.

B-800A

A highly damped version of the B-800 with same specifications for use as a midrange speaker.



B-209B Midrange Speaker

Response, 65 to 16,000 Hz / Working range, 150 to 3,500 Hz / Recommended crossovers, 400 (or 800), and 2,500 Hz / Impedance, specify 8 ohm or 16 ohm / Power rating, for use singly in Bozak 25- to 75-watt Concert Series systems / Resonance, none acoustically / Voice coil, 1½" / Field, 13,000 Gauss (6½ lb. magnet structure) / Dimensions, 6½" OD, 3" deep / Mounting, 5½" dia. cutout with four equally-spaced bolt holes on a 6" dia. circle / Enclosure, in woofer cavity or ½ cu. ft. lined cavity / Weight, 7½ lbs.



B-200YA Treble Array

Response, 1500 to 20,000 Hz / Recommended crossover, 2500 Hz / Impedance, 8 ohms / Power rating, for use in Bozak 100-watt systems / Voice coil, ¾" diameter / Field, 14,000 Gauss (8 lb., eight magnet structures) / Dimensions, 12" wide, 6½" high, 4¾" deep / Weight, 14 lbs.



B-207B Full-Range Two-Way System

One each B-199A bass and B-200Y mounted coaxially on a rugged cast-aluminum frame with 4-mfd condenser / Response, 40 to 20,000 Hz / Crossover, 6 dB/octave at 2500 Hz / 25 watts / Dimensions, 12¾" OD, 6" deep / Mounting, 11" dia. cutout with four equally-spaced bolt holes on a 13¼" dia. circle / Weight, 14½ lbs. / Enclosure, infinite baffle, minimum 5 cu. ft. for one, 8 cu. ft. for two units.

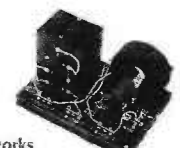

Crossover Networks

N-10102A This is a convertible network useful throughout the Concert Series by simple modification. By a change of connections it can have 8-ohm crossovers at 800 and 2500 Hz for the B-313G and B-302A, and 16-ohm for the B-305; the addition of the N-25 Condenser Bank and change of connections make it 8 ohms at 400 and 2500 Hz for the B-310B and B-410. 8" x 6" x 3½" H. 5 lb.

N-104 Specifically for B-4000A, B-4005, B-310B and B-410; 8 ohms; crossovers at 400 and 2500 Hz. 8" x 7" x 5½" H. 6 lbs.

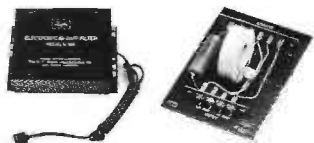

Bi-Amping Networks

N-106 A low-level electronic stereo two-way crossover used in bi-amplification. It is inserted between the control/pre-amplifier unit and the power amplifiers to separate low and mid frequencies at low-level. Input power is 115-volt AC. Crossover is 6 dB per octave at 400 Hz. One is required in a bi-amp system.

N-107 A speaker network which, in bi-amp systems, provides midrange treble crossover. It is a passive LC network requiring no external power. Crossover is at 6 dB per octave at 2,500 Hz. One is required for each speaker system when using N-106.

proper crossover. These drivers did not have much energy above 16,000 Hz, but this was not a problem in the 50s and 60s when LP surface noise and tape hiss were ever present. (Tech Note: Very few 1950s and 60s phono cartridges had usable response beyond 16KHz, while FM radio rolls at 15 KHz.)

A basic building block for many of the Bozak speakers was the B-207A. This consisted of two B-200 tweeters mounted on a bar across the B-199. This driver combination provided a frequency response of 40 to 16,000 Hz. The B-209 midrange driver was then added for a smoother midrange. Multiple B-207 drivers were used in larger cabinets such as the B-305. Additional drivers were eventually added to the Bozak lineup, but these three superior drivers were used for a majority of the Bozak speakers.

Built to Last a Lifetime

Bozak was a stickler for details and quality. All speaker and cabinet components were made from tried and true materials. While other speaker manufacturers were experimenting with foam surrounds or plastic cones, Bozak speakers continued to use paper and aluminum cones and neoprene surrounds.

Because of his insistence on using the infinite baffle for-

mat for his speakers, Bozak speakers were usually large. In the 60s when other speaker manufacturers began to develop bass reflex and ported speaker designs which reduced

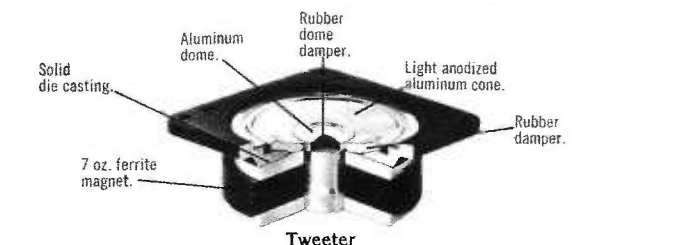
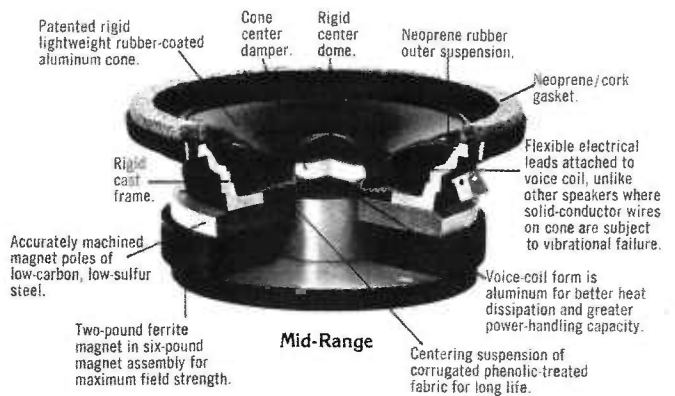

Panel-Mounted Bozak Speaker Systems

All Bozak speaker systems except the compact Models B-301, B-312G and B-313G are available as panel-mounted systems, ready for installation in a wall or in an existing enclosure.

These panel-mounted systems are identical to complete Bozak systems in enclosures, except that crossover networks are mounted on the back of the panel rather than the bottom of the enclosure. Thus, these illustrations of panel-mounted systems also show the layout of speakers in the corresponding complete Bozak systems.

In selecting and installing panel-mounted systems, it is important for maximum performance that they be mounted in a rigid enclosed cavity of at least 4 cubic feet for each bass speaker in the system. For example, a Model P-410P system requires an enclosure of at least 16 cubic feet to achieve its full performance capability.

Performance specifications for complete Bozak systems in enclosures are identical to those indicated for panel-mounted systems.



Concert Grands
Model P-310BP

31" W x 46³/₄" H
x 1¹/₂" Thick

The ultimate in realistic music reproduction. Model B-310B with its tweeters in centered line array and Model B-410 offered in mirror-image pairs with tweeters at the right and left edges.

Total number of speakers 14
Speaker complement: B-199A Bass 4
B-209B Midrange .. 2
B-200Y Dual Treble 4

Crossover: N-104 LC Network
Frequency response: 28 to 20,000 Hz
Impedance: 8 ohms
Crossover frequencies: 400 and 2,500 Hz at 6 dB/octave

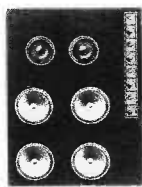

Model P-410P

34³/₄" W x 46³/₄" H
x 1¹/₂" Thick



Symphony No. 1
Model P-4000AP

25" W x 41" H x 3/4" Thick

Second only to the Concert Grand for the most natural sound. Mirror image left- and right-hand versions assure symmetry of reproduction.

Total number of speakers 11
Speaker complement: B-199A Bass 2
B-209B Midrange .. 1
B-200Y Dual Treble .. 4

Crossover: N-104 LC Network
Frequency response: 35 to 20,000 Hz
Impedance: 8 ohms
Crossover frequencies: 400 and 2,500 Hz at 6 dB/octave



Concerto Grosso
Model P-305P

35" W x 23" H x 3/4" Thick

Bozak's standard three-way medium-size speaker system, provides amazing presence in even larger rooms.

Total number of speakers 7
Speaker complement: B-199A Bass 2
B-209B Midrange .. 1
B-200Y Dual Treble .. 2

Frequency response: 35 to 20,000 Hz
Impedance: 16 ohms
Crossover: N-10102A LC Network
Crossover frequencies: 800 and 2,500 Hz at 6 dB/octave



Concerto V
Model P-302AP

23" W x 27¹/₂" H x 3/4" Thick

Bozak's basic three-way speaker system, the Model 302A is the second step in the Bozak Plan for Systematic Growth. Suitable for rooms of moderate size.

Total number of speakers 4
Speaker complement: B-199A Bass 1
B-209B Midrange .. 1
B-200Y Dual Treble .. 1

Crossover: N-10102A LC Network
Frequency response: 40 to 20,000 Hz
Impedance: 8 ohms
Crossover frequencies: 800 and 2,500 Hz at 6 dB/octave
Power Handling Capacity: 50 watts program



Symphony No. 2
Model P-4005P

35" W x 23" H x 3/4" Thick

Recently introduced, a major Bozak system for those wishing "Symphony" sound in a low-profile horizontal.

Speaker complement: specifications same as Symphony No. 1



Concerto IV
Model P-300P

23" W x 27¹/₂" H x 3/4" Thick

This is the basic Bozak two-way speaker system and the first step in the unique Bozak Plan for Systematic Growth.

Total number of speakers 3
Speaker complement: B-199A Bass 1
B-200Y Dual Treble .. 1
Frequency response: 40 to 20,000 Hz

Impedance: 8 ohms
Crossover frequency: 2,500 Hz (electro-acoustical)
Power Handling Capacity: 50 watts program
All speakers and crossover are mounted in a single frame. This coaxial configuration without panel or enclosure is Bozak's Model B-207B.
NOTE: Model B-300 is convertible to Model B-302A.

the size and efficiency of their products, Bozak continued to use the larger infinite baffle enclosures. But what enclosures they were! Manufactured in-house, Bozak speakers were sturdy pieces of furniture. They were available in several styles from Urban and Contemporary, to Moorish and French Provincial, using real wood and veneers of cherry, mahogany and walnut. Bozak cabinets were the finest examples of cabinetry in the industry. Careful attention to construction and materials along with superior drivers have allowed Bozak speakers to survive over time, while other speakers have broken down and fallen apart.

The Cadillac of Speakers

While many Bozak speakers are coveted vintage collectables, the Concert Grand is the ultimate statement in vintage speakers (to this writer, the Concert Grand sounds better than the JBL Paragon or Hartsfield). Weighing in at 210 pounds, the Concert Grand used four B-199 woofers, a single B-209 midrange, and a convex-angled array of 8 B-200 tweeters. This 16 cubic foot giant was flat to 28 Hz, and possessed wide dispersion treble to 16,000 Hz. Initially introduced as the B-310, this speaker went through several revisions including the addition of a second midrange, a change in the tweeter configuration to a center line array

(the B-310B), and finally to a mirror image speaker pair with the tweeter line array near the inside edge of the speaker (the B-410).

The sound of the Concert Grand series is nothing short of amazing. They definitely have a vintage sound with lots of warm midrange and a rolled-off top end. But they just plain sound big, filling even large rooms with music without strain. They possess an effortlessness that makes many modern speakers sound like they are shouting. And with those four 12 inch woofers, "they got bass!" They sound best with a good push-pull tube amp with a fair amount of damping factor. Bozak was a believer in bi-amping and later brochures show a line-level, bi-amping crossover in their product lineup. The Concert Grand sounds even better when bi-amped.

Today's owners can update the sound of the Concert Grand with a well integrated super tweeter, and perhaps by upgrading the capacitors and if present, the aluminum inductors in the crossovers. One shouldn't modify these speakers too much, however, as they will lose their vintage appeal and worth. Besides, a stock Concert Grand can be listened to for hours without fatigue.

BOZAK CROSSOVER NETWORKS

These are all-electric devices, built ruggedly and honestly, that separate the audio spectrum into three ranges and distribute them to the proper speakers in a Bozak three-way System. Unlike conventional speaker systems, the Bozaks overlap the adjacent ranges broadly, so there is no sense of "disembodiment" of instruments. The "slow" 6-db-per-octave Bozak Networks are inherently free of transient distortion ("ringing").

**BOZAK N-10102
CONVERTIBLE CROSSOVER NETWORK**

This unit is engineered for easy conversion to facilitate Systematic Growth of a Bozak Speaker System from a B-302A into a B-305 by a simple change of taps, and to a B-310, B-310A or B-400 by the addition of the N-25 Condenser Bank. The available characteristics are: For the B-302, 8-Ohm Crossovers at 800 and 2500 cycles; for the B-305, 16-Ohm Crossovers at 800 and 2500; for the B-310, B-310A and B-400, 8-Ohm Crossovers at 400 and 2500. Complete instructions are given in the special illustrated Bulletin upon request.

Dimensions — 8" wide, 6" deep,
5½" high.
Weight — 5 pounds.

**BOZAK N-103
CROSSOVER NETWORK**

16 Ohms — 6 db per octave, 400 and 2500 cycles. FOR B-305 SYSTEMS.

For the luxury of the subtle enhancement of the mid-range by a 400-cycle crossover in the B-305.

Dimensions — 8" wide, 8" deep,
5½" high.
Weight — 6 pounds.

**BOZAK N-104
CROSSOVER NETWORK**

8 Ohms — 6 db per octave, 400 and 2500 cycles. FOR B-310, B-310A and B-400 SYSTEMS.

When the growth capabilities of the N-10102 are not required: ready-to-use with a four-woofer three-way Bozak Speaker System.

Dimensions — 8" wide, 8" deep,
5½" high.
Weight — 6 pounds.

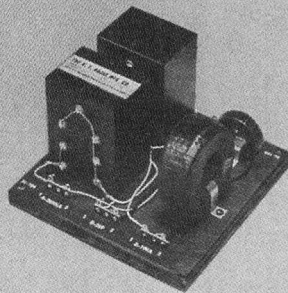
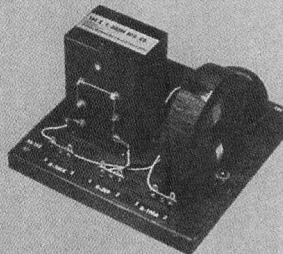
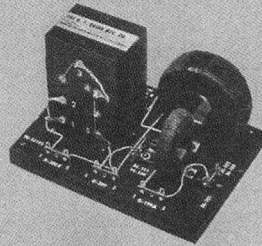

Other Gems

Other Bozak speakers to keep on the look out for are the Symphony series, which is basically a half a Concert Grand in either a vertical format (B-4000) or horizontal format (B-4005). These speakers boast bass response to 35 Hz, and have two B-199 woofers, one B-209 midrange and the B-200 tweeter line array on the vertical speaker and the angled tweeter array for the horizontal speaker. The Concerto series uses either one (B-302) or two (B-305) B-207 woofer + tweeter units and a midrange driver.

A fun feature of all of these speakers (including the Concert Grand) was the option of ordering a cabinet and a minimum set of drivers. The owner could then add drivers as one could afford them and eventually own the complete complement of drivers. These same speaker configurations also were available as panels for in-wall mounting.

The Bard is Bozak's weatherproof speaker, and is a small-

er version of the B-201, Bozak's entry into the speaker business. Looking much like a kettle drum tipped on its side, the Bard offered up quality sound for patio and pool-side listening. Bozak literature claimed that the Bard was completely waterproof and only needed occasional cleaning with a garden hose! The Bard used either a single full-range driver or this same driver with a coaxially mounted tweeter.

Later speakers of note included the Monitor C, the LS-200A and the MB-80. These speakers all had the aluminum 6 or 8 inch wide-band mid-bass drivers in common. The Monitor C boasted four 8" mid-bass drivers and an eight-tweeter array. These very efficient speakers were capable of very loud volume levels when driven by high-powered amps. The LS-200A mated a modified Audax tweeter with the 8 inch mid-bass driver. This was a controversial change inside the Bozak organization at the time, but the outsourced tweeter provided better frequency extension than the Bozak tweeter. The MB-80 was a two-way that used the 6 inch mid-bass unit. A matching sub-woofer was available for the MB-80 sporting two modified 8" aluminum drivers and on-board crossover and amplifier.

The 60s and '70s

While the 1950s brought growth and success to Bozak with the Concert Grand, Symphony and Concerto speaker lines, the 1960s saw a lot of diversification at the Bozak company. Keeping pace with a changing market place, several new series of compact speakers were developed. New drivers were designed to accommodate these new speaker lines, including a nice 8 inch full-range rubber coated aluminum driver, and a similar 4 inch midrange driver. In addition, a line of electronics was introduced including amps, preamps, active crossovers, mixers, microphone amps and delay effect generators. These were developed by the Swiss engineer David Frey. These discrete, high voltage designs (read: lots and lots of headroom), were impressive in their day and added to the Bozak reputation for quality. In fact, the 10-2DL mixer is still considered one of the best mixers available.

The 1970s was a decade of ups and downs for the Bozak company. Bozak speakers were used at the Pope's open air Mass in Yankee stadium, and they were installed in Chicago's Ravinia Pavilion. Even while the reputation of Bozak speakers continued to soar, Rudy Bozak's health began to fail. Sadly, his company's success seemed to track Rudy's health. At times during this decade, quality control suffered as did the morale of the employees. At other times the company was producing its best and most innovative products. But eventually, Rudy Bozak could no longer continue to work, and the company was sold in 1979. Rudy Bozak passed away about a year later. With his passing, many of his special speaker manufacturing techniques were lost. More importantly, the audio community lost in Rudy Bozak a rare combination of talents: designer, engineer and gifted ear.

A very special thanks to Peter Ledermann, CEO and chief engineer of the Sound Smith, without whose help this article would not be possible.

Fisher 100 FM Tube Tuners

Vintage Hi-Fi Series #1

By Charlie Kittleson ©2002 All Rights Reserved

Fisher collection courtesy Earl Yarrow

Throughout the mid to late fifties, FM radio was exploding across the US and Western Europe. FM broadcasting was noted for having many stations which had a laid-back format with minimal commercial interruptions, playing long sets of classical, jazz or mood music. In those days, FM radio meant "free music" or "fine music" in both content and sonics.

Many American hi-fi manufacturers who started operations right after WWII started to improve the performance of their FM tube tuners. Companies like Fisher, H. H. Scott, Sherwood, Radio Craftsmen and countless other forgotten companies were producing FM tuners like toasters. Features included AFC (automatic frequency control), interstation muting, tuning meters, center of channel meters, etc. In addition, companies were touting their tuner's sensitivity ratings as being the best. Many FM listeners lived in remote or "fringe" areas outside of the city limits. This required an outside antenna with a very sensitive tuner.

Avery Fisher began selling component tube hi-fi in the late 1930s. His New York City company was reputed to be the first true consumer hi-fi company in the USA. After a write-up in Fortune magazine in late 1946, Fisher's sales took off. They were selling to the super-elite music lovers as well as the 1950s techno audio nerds. Early Fisher mono tuners included the 90-R AM and FM tuner (1957-58), the FM-90 (1956), the famous FM-90X high performance mono tuner (1957-59), FM-200 (1959-60), 202-R (1960), FM-50 (1959), 100-T (1959-60), 202-T (1959-60), etc.

One has to remember that up until 1961, FM signals were broadcast in mono. However, there was an experimental format in the mid-fifties called binaural broadcasting that transmitted one channel of a stereo signal on AM and the other on FM. H.H. Scott, Fisher and many other companies produced tuners with dual front-ends that could receive AM and FM simultaneously. Fisher's entry into this arena was the 101R AM and FM tuner in 1958.

In this article, we will cover the Fisher FM-100 series tuners made from 1959 to 1965. This includes the FM-100, FM-100B and FM-100C. Other Fisher tuners will be covered in subsequent VTV articles.

FM-100

Fisher introduced the FM-100 in the summer of 1959. Their advertising touted the fact that Fisher tuners were used by radio stations, satellite tracking stations and government agencies. According to their ad copy, the FM-100 had the best FM tuner sensitivity in the world at 0.4 microvolts for 20dB of quieting. Other features included: an interstation noise silencer (muting), tuning eye tube, multiplex adapter input jack, four IF stages and uniform frequency response of 20 to 20,000 Hz. Front controls included a selector/function/power switch, muting, MPX



New! And designed for a long future!

FISHER DOES IT AGAIN! Year after year, tuner after tuner, there is only one best—THE FISHER. Today, the leader is the FM-100, latest in a series of FISHER FM tuners now used by radio stations, the Satellite Tracking Project of Ohio State University and by many government agencies. The reason is simple—these tuners meet the exacting standards of performance and reliability required by professional users.

■ And where standards are concerned, *the audio enthusiast* is, in his own right, a professional. He desires *maximum sensitivity* for optimum reception of stations near and far. **FM-100 SENSITIVITY** is 0.8 microvolts for 20 db of quieting! ■ *The audio enthusiast* wants an FM tuner that permits simple adaptation to stereo. **THE FM-100 IS CUSTOM-DESIGNED FOR STEREO.** It has space directly on its own chassis for installation of a multiplex adaptor. Moreover, it includes feed-through facilities for FM-FM and FM-AM stereo as well. ■ *The audio enthusiast* expects *maximum fidelity*. **THE FM-100 OFFERS FOUR WIDE-BAND IF STAGES**, uniform frequency response (20 to 20,000 cps) and less than 0.5% harmonic distortion. ■ *The audio enthusiast* wants an FM tuner that eliminates noise when tuning between stations. **THE FM-100 EXCLUSIVE INTERSTATION NOISE SILENCER** automatically eliminates noise, side-band response and unwanted weak and noisy signals. *For the audio enthusiast who buys the best at the outset, there is only one truly logical choice—IT IS THE FISHER FM-100 TUNER.*

\$159.50 Cabinet, \$15.95

Slightly Higher in the Far West.

WRITE TODAY FOR COMPLETE DESCRIPTIVE LITERATURE

FISHER RADIO CORPORATION • 21-29 44th DRIVE • LONG ISLAND CITY 1, N. Y.

Export: Morhan Exporting Corp., 458 Broadway, New York 13, N. Y.

AUDIO • AUGUST, 1959

separation and tuning. There were individual channel level controls, channel A and B outputs, fuse and antenna connections on the rear of the chassis.

The FM-100 was prepared for the still-undecided FM multiplex system. There was a multiplex input, power supply plug and cut-out in the chassis with cover plate intended to hold the MPX-20 multiplex adapter. There were ten tubes in the FM-100 including: 6DJ8 (RF amplifier), 6AQ8 (oscillator and mixer), four 6AU6 (IF amplifiers and limiters), 6AV6 (muting oscillator and rectifier), EM84 (tuning indicator), 12AX7 (audio output) and 6V4 (full-wave rectifier).

FM-100B

When the Zenith multiplex standard was adopted by the FCC in the summer of 1961, most tuner manufacturers were preparing to release their new FM multiplex tuners. Fisher introduced not only the FM-100B (\$229.50), but also the FM-50B (\$194.50), FM-200B (\$299.50), FM-1000 (\$429.50), FMR-1 (\$439.50) and the R200 AM/FM tuners.

FM-100B featured a wide-band design with advanced multiplex circuitry. The high-gain Golden Cascode front-end with five IF stages and four limiters assured the clearest and most reliable reception on even the weakest and most distant stations.

The FM-100B had a 300 ohm balanced antenna input with a sensitivity switch for local and distant reception. The FM circuit used a 6DJ8 cascode RF amplifier, a 6AQ8 oscillator-mixer, five 6AU6's to serve as the IF and limiting stages, plus a crystal diode for the ratio detector. In stereophonic operation, the ratio detector's output was fed to a 12AT7 amplifier stage in the multiplex adapter section of the tuner. Part of the output from this stage was fed through a 19kHz tuned transformer to a 19kHz amplifier stage (1/2 of the 12AT7), the output of which synchronized a 38kHz oscillator (12AX7). The oscillator's output was fed to a pair of balanced-bridge demodulators containing four crystal diodes each. The 38 kHz switching signal on one bridge was 180 degrees out of phase with the 38kHz switching signal of the other bridge. When this composite signal was applied to the demodulators, the signal was sampled in such a way that the output from one bridge was the left channel and the output from the second bridge was the right channel. The signals were fed through a balancing circuit (containing a separation control) to 12AT7 amplifier stages, 15kHz low-pass filters and the final 12AX7 output stages where de-emphasis occurred.



Fisher FM 100



Fisher FM 100B



Fisher FM 100 C

An August 1962 *Audio Magazine* review of Fisher tuners rated the performance of the FM-100B as "excellent in more ways than one." Usable sensitivity was 1.8 microvolts at 98 Mc. Harmonic distortion was .4% at 1kHz and intermodulation distortion was measured to be 0.04%! The FM-100B had a signal-to-noise ratio with 73dB from a 2 volt output. Dial calibration was excellent and frequen-

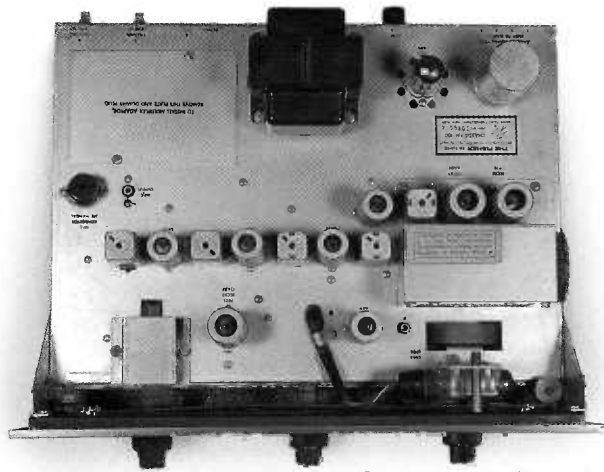

Fisher FM 100 (top view)

cy response was essentially flat from 35Hz to 20KHz.

Both channels in stereo operation had uniform response characteristics. Response was measured as flat from 50Hz to 9KHz within plus 0 and minus 2dB, and from 25Hz to 13KHz within plus 0 and minus 4 dB.

FM-100B Technical Specifications

- Frequency Response - 20-15kHz +/- 1dB
- Sensitivity 0.6 microvolts (20 dB quieting)
- Sensitivity 1.8 microvolts (IHFM standard)
- Signal to Noise Ratio - 70 dB (100% modulation)
- Selectivity - 60 dB
- Capture Ratio - 2.2 dB (IHFM)
- Front-End Circuit - Golden Cascode
- IF Stages - Five, wide band
- Limiters -Four, wide band
- Harmonic Distortion - 0.4% (100% modulation)
- FM Stereo Separation - 35 dB (at 1kHz)
- Rated Audio Output - 2.0 volts
- Chassis Dimensions - 15 1/8 inches wide, 4 13/16 inches high, 13 inches deep
- Weight - 18 pounds

Front panel controls included a selector switch (mono, stereo, stereo filter), muting (on, off, variable), AC power (on, local distant stations), and main tuning knob. There was also a tuning meter in the upper right side of the dial and a red jeweled stereo beacon light. The front panel was made of anodized aluminum in various shades of gold or champagne gold toning. The chassis was cadmium plated steel.

Tube complement consisted of: 6DJ8 (RF amp), 6AQ8 (oscillator and mixer), four 6AU6 (IF amplifiers and lim-

iters), 6DJ8 (stereo beacon and muting oscillator), 12AX7 (audio output amps). The multiplex adapter used two 12AT7s (19kHz amp and audio amp) and one 12AX7 (38kHz sync oscillator).

In 1961, Fisher introduced the Stratakit line that featured tuner and amplifier kits. The tuner kit was the famous KM-60 that in many ways looked like the FM-100B. There were some differences including: four IF stages (instead of five on the FM-100B), two limiters (instead of four on the FM-100B), and stereo beam eye tube in addition to the tuning meter. It did not have variable muting and also was missing a local/distance switch. Technical specifications and performance were otherwise very close. The kit came with factory pre-aligned front-end and multiplex sections. The KM-61 was the factory-assembled version of the KM-60.

FM-100C

By 1964, tubes were a minority in American hi-fi equipment. They were being phased out by the cool, dry and cheap transistor. People were getting tired of replacing tubes. Fisher responded with the FM-100C multiplex tuner in 1964. The FM-100C featured the latest (at the time) Golden Synchrode Nuvistor front end that was already featured on the FM-200B and 500C receivers. By 1964, they had already changed the styling of the faceplates to a cast aluminum with different knobs. Controls included a selector switch (mono, stereo, automatic), muting (off, 1, 2), AC power and main tuning. Other features included a meter, muting light, tape jack and stereo beacon light. It also had the time-aligned solid-state multiplex adapter.

Fisher FM 100C (top view)

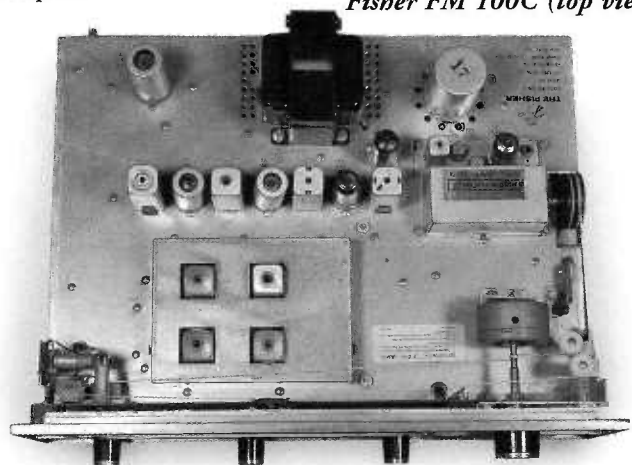

Listening and Performance

Most vintage hi-fi enthusiasts will agree that Fisher made some of the best-sounding tube FM tuners on the planet. They just seem to work exceedingly well, even after 40 years of storage. Compared to modern sorry-state phase-lock-loop digital chip tuners, the Fisher tube stuff is awesome. If you are lucky enough to live in an area with good FM stations who do not use distortion-generating compressors in their signal, most any vintage tuner will

sound wonderful (if properly serviced and aligned).

Any of the FM-100 series tuners, if properly restored and aligned, will make much better FM music than most any modern tuner. In VTV Issue 5, we evaluated 26 FM tuners and found the Fisher FM-100B to be a "best buy" of vintage tuners.

Many tuner enthusiasts prefer the FM-100B over the FM-200B as well. I have owned several FM-100Bs and find them to be an incredibly sensitive, selective and musical tuner. In many ways the 100B is a better performer than the Scott and McIntosh tuners of the era.

If you live in an urban area with lots of FM stations, you may only need an indoor antenna for best performance. If you live in a fringe area, you will need an outdoor FM antenna specifically designed for FM reception. Do not use a TV antenna, as it will result in lesser performance.

Restoration of Tube Tuners

The most important part of owning a vintage tube tuner is being able to service it, or finding a competent and reliable technician who can. Unfortunately, there are only a handful of what I would call "competent" tube FM techs in the US. Any who are good are usually very busy.

The first part of any restoration is to inspect your tuner for any obvious missing or broken parts. Things like IF cans and tuning capacitors are more difficult to replace or repair than capacitors, tubes or resistors. Next, check under the chassis for any obviously burnt or damaged resistors, capacitors, diodes, etc.

Next, check the tubes in a calibrated tube tester. If a tube is marginal, replace it with a new one. Fortunately, at the current time, most tuner tubes are inexpensive (under \$10-18 each).

The power supply and audio section capacitors should be replaced with modern film types. Even though some people like to leave the original Mylar signal caps in Fisher gear, they can and do go bad. Not only that, they sound flat and rolled-off. The best bet is to replace them with a modern film cap. I prefer to use Illinois capacitors for vintage restorations in general. They are cheap, reliable, smooth and musical sounding without being dry and irritating.

For the sake of time, we will go through the components that should be replaced in an FM-100B tuner. In the main tuner section, replace the following caps: C10 (.01uf), C36 (.1uf), C45 (.1uf), C49 (.1uf), C54 (.1uf), C50 and C55 (.02uf ceramic), C65 (8uf/50V electrolytic). In the multiplex section, replace the following caps: C120 (1uf/350V), C214 (.0047uf), C221, C222 (.02uf ceramic). The power supply electrolytic, C24 (40, 40, 40, 40uf @200 and 300V) should be checked and if necessary, replaced with either separate axial electrolytics or if you can find one, an FP can-type Mallory electrolytic.

The diodes in the RF, IF and multiplex adapter should be left alone unless they are defective. However, the seleni-

um bridge used in the DC power supply should be replaced with a modern silicon bridge or a bridge using HEXFRED type diodes. The resistors used by Fisher were made in Germany and were very high quality. They were 1/3 watts (typically) and in most cases, with 5% tolerance. They seem to last much longer than the Allen-Bradley and Ohmite resistors used in H.H. Scott and McIntosh equipment. A bonus is, they sound great.

After you have replaced all the passive components, check all the tubes and replace any weak, marginal or defective ones with new old stock glass. Turn the tuner on and let it burn in for about 40-80 hours to stabilize the new capacitors and tubes. After the burn-in, if you have the right equipment and skill level, you can align the tuner. You will need a stereo FM signal generator, a DC VTVM and an Oscilloscope. You will also need the knowledge of how to align the front-end, IF strip, detector and multiplex decoder. This is a difficult job that is best reserved for experienced FM tuner techs and not beginners.

Fisher FM tuners are still a bargain on eBay and from other sources such as garage sales and flea markets. If you like FM radio, Fisher tuners may be just what the doctor ordered!

A special thanks to John Eckland and Earl Yarrow for their assistance with this article.

Introducing the world's smallest triode amplifier.

That's right---

it's a true single-ended triode amplifier, and it fits in your coat pocket!

Use it almost anywhere--home, office, on the road. Incredible sound from a tiny 5-pound package.

Use with headphones or with high-efficiency speakers--delivers 1 watt/ch. of pure TRIODE stereo sound.

Designed by VTV senior editor and longtime Glass Audio contributor Eric Barbour, the TM-4 is equipped only with NOS tubes.



METASONIX

WWW.METASONIX.COM
PMB 109, 881 11TH STREET,
LAKEPORT CA 95453 USA - (707) 263-5343

AVAILABLE FROM VACUUM TUBE VALLEY AND
OTHER MUSIC - ELECTRONICS DEALERS.

Curt Emery

Mini Boutique Amp Designer

VTV Tube Designer Profile #1

By Ron Veil ©2002 All Rights Reserved

Guitarists, unlike audiophiles, look for tonal textures that define their personal taste and preference. This is usually achieved by turning the musical instrument amplifier up to a point where it starts generating a tube distortion. In this way the guitar responds musically and takes on a life of its own. On the negative side, it can be quite loud and annoying.

Curt Emery understood this, and set out to produce this phenomenon on a smaller scale. He is not only a professional guitarist who has toured with a musical group, and who has recorded two albums, but is an electronic engineer, and with both skills set out to develop a unique amplifier. He worked as a service tech/engineer for ADA (Analog Digital Associates) in Oakland, CA for about five years. ADA was making programmable tube preamps, digital effects, and other studio recording devices. At that time, he was also doing a lot of vintage amp repair jobs for extra money. By repairing all that gear, he really learned about what was important for good guitar sound. During a lunch break one day, he took some parts off the shelf and built a simple single-ended EL84 six watt amp. It had a complexity to the tone that surprised everyone who heard it. This idea was developed by ADA into the Rocket A10 amplifier. The company started having financial problems toward the end of his tenure. It was then that he realized the potential for making and marketing better amps on his own. So in 1997, Curt decided to start his own company, Emery Sound, instead of trying to find another job.

Curt realized it was much more than just the electronic components that went into the sonic equation. His goal was to take a hard working output tube, essential for clari-

ty and dynamic note response, and produce as little volume as possible. A single-ended cathode biased design was chosen because the tube is running "wide open" at all times.

This topology had the benefit of being both electronically inefficient and sonically very lush. Another plus side of this decision was that any number of rectifier, power, and preamp tubes could be utilized to

change the sonic delivery in a variety of ways a push-pull amp could never achieve. His creation also had to have a speaker that could be driven hard enough to sound "big," even when powered by only a few watts. Home recording is a big business these days. However, what good is it if you have cheesy sound? Many professional recording studios and home studio owners have purchased Emery Sound amps.

Curt deliberately had a minimalist point of perspective. There was only one volume and one (defeatable) tone control on his amps. The passive tone control cuts treble when you turn it to the left and cuts bass when you turn it to the right. The controls were interactive so you can set your gain structure in a variety of ways. Emery Sound amps were also point to point constructed on terminals, with no circuit boards. A high priority was placed on minimizing the wire lengths and number of solder connections.



The aesthetics were an important consideration and Curt borrowed some ideas from the audiophile side, like a simple chassis design, with a retro look to both the amp layout and the speaker cabinet, with brushed aluminum, wood panels, and plexiglass shells on some of the models. Curt felt that his product had to be unique, beyond the average black tolex box.

The first model Curt came up with was called the Spotlight. It was a Class A cathode biased circuit, that was switchable between 8 and 4 watts. It came with an Alnico 10 inch speaker, tube rectifier (5Y3 or 5AR4), a variety of different power tubes (6L6, 6V6, EL34, KT-66), a single preamp tube (usually a 12AX7), and only 2 control knobs - volume and tone. The front panel was a solid mahogany carved face, with a plexiglass shell encompassing the chassis in the back. It resembled a table top cathedral radio, rather than a guitar amp.

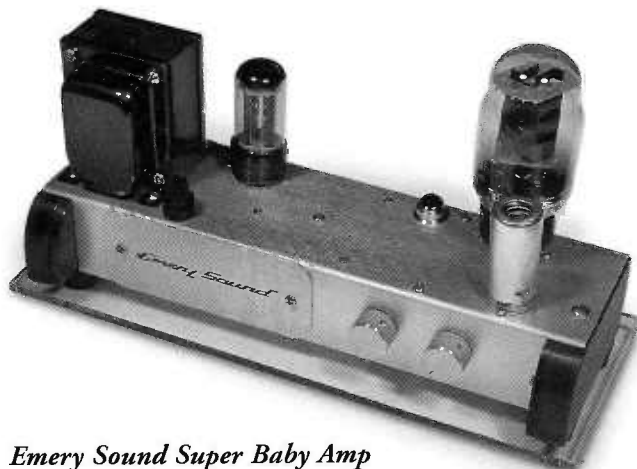

Emery Sound Super Baby Amp

The second amp model was the Dominatrix. It was a departure from the single-ended amp design Curt originally came up with, in that it had 2 push-pull EL84s for 15 watts switchable to 9 watts. It was also a piggy-back design with an amp head on top of a separate single 12 inch speaker cabinet.

The third model, and the most popular Emery Sound amp, was the Superbaby. It's basically a Spotlight-in-a-head-version, class A cathode biased, producing 8 watts, switchable to 4 watts. This three-tube amp can use a variety of 12AX7/5751 input tubes, a huge variety of octal power tubes from the 6V6, 5881, EL34, KT66, EL37, 6L6GC, etc. and octal rectifier from a 5Y3GT to a GZ34. The matching speaker cabinet was dovetail constructed from solid thin hardwood to maximize the resonance, with no vinyl coverings to dampen the sound.

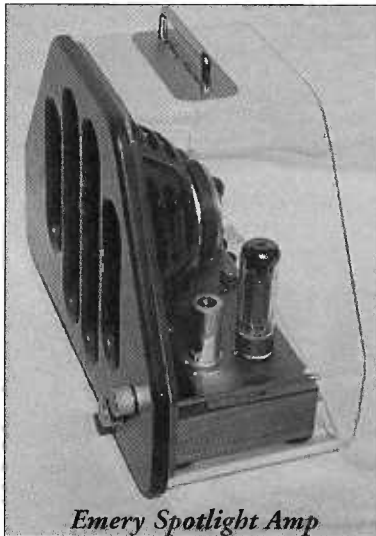

Emery Spotlight Amp

Curt just introduced a fourth model, called the Microbaby. This amp came about

because his wife just gave birth to a baby boy (Keith), and he needed to keep the volume down even further. The amp puts out two watts of Class A power using a 6G6G pentode that was originally used in car radios. The rectifier was a 6X5GT. With this amp, you can also use a 6V6GT or a 6K6GT and they can really scream at living room volume levels.

He is also working on a dual octal (EL34, 6L6, KT66, etc.) power tube push-pull amp putting out 25-35 watts depending upon the tube set up. This amp was aimed at players who want the minimalist approach but with stage volume sound.

Emery Sound is located in El Cerrito, CA, near Berkeley. Their telephone number is 510-236-1176, their email is amps@emerysound.com and their website is www.emerysound.com.



Super Baby with 10 inch Cabinet

Specialty Tube Audio Services

**Score a cool tube amp on Ebay?
Find a mint tube receiver at a garage sale?
Can't find anybody competent to restore your tube equipment?**

Specialty Tube Audio Services, a division of VTV, will restore your tube audio equipment in a professional manner with no hassles or delays.

We have over 35 years of tube audio experience.

- High-End Tube Audio Repair and Service - All Makes
- Vintage Tube Hi-Fi Repair and Restoration - All Makes
- Vintage and Boutique Guitar Amplifier Repair
- Precision FM Tuner Alignment
- Pro-Audio Vintage and Modern Gear Service
- Custom Designs and Performance Upgrades

Check www.vacuumtube.com for more information and rates

**Specialty Tube Audio Services, PO Box 1499, Lakeport, CA 95453
(707) 263-5881 or (707) 263-7648 FAX
email - triode@vacuumtube.com**



JJ 828 Amplifier

Push Pull Thrill Ride

A VTV Equipment Review

By David Bardes ©2002 All Rights Reserved

Maybe you're like me. I take great pride in my SE rig. My friends are always amazed and delighted when I play it for them. Small jazz ensembles and female voices are recreated with a realism beyond anything they have imagined. But secretly I sometimes wish for a sound that my SE rig can't produce. Sometimes I crave the power and grip that only big amps can provide. Power to make monster orchestras in cavernous venues sound as large as life. Power to make rock and electronic music really, really rock. The power to play music way too loud!

Brawn and Beauty

If it is this type of power you seek, look to the JJ 828! From the makers of those Slovak tubes, JJ Electronic, comes an integrated stereo amp with all the power you desire. Sporting a total of eight KT88's, this stereo amp is very conservatively rated at 70 watts per channel.

But brawn is not the only feature of this amp. It is an attractive and full-featured integrated amp. The front face has a beautifully sculpted wood finish, and the remote control is similarly finished. This amp was easy to use, with all the controls intuitively placed. Five inputs are provided and can be selected on the front of the amp or from the remote control. The motorized volume pot and power switch also are on the front, but may also be operated from the remote control. While there is no phono stage, or a tape monitor loop, Tape Out jacks are provided in the back. Bias is set by matching LEDs set next to the tubes, and does not require opening up the case and using a meter.

In Da House!

The JJ828 was designed by JJ Electronic's engineers and is manufactured in house. Some of the caps and all of the transformers are designed and manufactured by JJ Electronic specifically for this amp. Separate power transformers are used for each channel. The C core output transformers utilize special air gap techniques to keep the signal linear at all power levels and they also have special secondary windings used in the amp's two feedback loops. Total feedback is a modest 11db.

In addition, the amp uses the ECC99, a JJ special driver tube designed to drive KT88 and 300B tubes. The ECC99 most closely resembles a 12BH7 on the tube tester, but provides more gain, greater linearity, and requires less bias.



12AU7's power the Concertina phase inverter and the pre-amp section of the amp. (Tech Editor Note: The ECC99 is available for anyone to use, and is a very linear 7119-like tube with a 12AU7 pinout.)

Thrill Ride

Unlike monster solid state amps, the JJ828 has a firm composure to it without any hint of grit, glare or zing. But it shares the unmistakable deep well of reserve power that makes big amps so exciting to listen to. Plus, this amp sounds much bigger than the 70 watt spec. implies.

The JJ828 is unflappable. Cranking up the volume knob will distress your ears and may distress your speaker cones, but the signal from the amp remains the same, with no increase in harshness or audible distortion, and no hint of compression. This amp has the power to fill large rooms or drive diminutive monitor type speakers with the damping and control they need to sound their best. It would have

been fun to hook this amp up to some planar speakers, I'm sure they would have handled these greedy speakers with ease.

Familiar recordings sounded quite different played through the JJ amp when compared to my SE amp. While the JJ amp doesn't have quite the detail or musical depth of an SE amp, other aspects of the music come to the fore. For example, the JJ amp had more control and clarity in the mid-bass and bass which gave the music a firmer foundation and enhanced the musical tempo in Diana Krall's *Besame Mucho (The Look of Love - Verve Records)*. Reverb was clean and well defined if not as deep and liquid when played through my SE amp.

Large complex music such as Beethoven's *Fifth* - (Leonard Bernstein and the New York Philharmonic Sony Classical) revealed the amps dynamic character, clean definition of instruments and the all important "big" factor. I was truly convinced I was listening to 70 plus musicians playing their hearts out! Parallel push-pull pentode amps have a reputation for sounding veiled and smeary. I am happy to report that the JJ828 does not suffer from this malady. (Tech Editor Note: The high-current capability of the ECC99 probably helps drive the multiple KT88 grids better than most.)

Taking off the kid gloves, I played some of the music from Thomas Newman's *American Beauty* film score (*American Beauty* - Dreamworks Records). The score is a torture test for many sound systems with lots of complex percussion and synthetic deep bass. At reasonable volume levels the floor shook and a smile broke out on my face. At loud volume levels the windows rattled. Beyond loud, the 12 inch woofers of the JBL S312 loudspeakers couldn't handle the extreme excursions necessary to produce the deep loud bass, but the amp still had plenty of gain and head room. The JJ828 gave electronic music such as Crystal Method's *Vapor Trail (Vegas - Outpost Records)* drive and an intensity that I have not heard from any other tube amp in my living room. It rocked!

JJ Electronic has produced a wonderful amp to showcase their vacuum tubes. It is good looking, powerful, and has a big, clean sound. Designing the amp and many of its components in house, JJ Electronic has been able to leverage their efforts into a superior product. Rock on!

The scale is 1 to 5 with a score of 5 being the very best.

Overall Rating: 4.5

JJ 828	Dynamic Range	Transparency	Frequency Extension
	5	4	4

JJ 828	Dimensionality	Pace and Rhythm	Musical Involvement
	4	4.5	4.5

Specifications:

MSRP: \$2500 with remote

Output Power: 70 watts per channel

Tube Complement: Eight - KT88s; Four - 12AU7s; and Two - ECC99s

Frequency Response: 20 Hz - 22kHz +/- 1db

Noise & Hum: - 88 dB below full output

Input Sensitivity: .5 volt RMS

Dimensions in Inches: 18.9" W x 13.8 D x 7 H

Weight: 75 lbs.

Power Requirements: 115/230 V - 50/60 Hz

JJ Electronic, A Hlinku 4, 022 01 CADCA, Slovak republic +421/041/432 55 38 www.jj-electronic.sk

US Distributor: Eurotubes, Milwaukie, OR 503-659-7401 www.eurotubes.com

Test System Components: Jolida JD 603 CD player with Mullard CV4004 tubes in the analog output section. JBL S38 and S312 loudspeakers. Homebrew fine wire speaker cables using three strands of 30 awg silver-coated copper wire in a kynar jacket. TEK LINE PC 2 Signature power cords for both the amp and CD player, and VSE Super Clear interconnects.

STEREO TUBE AMP KIT \$139.95*

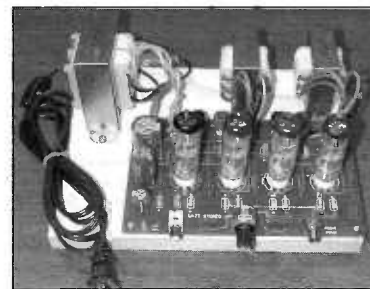

ALL TUBE DESIGN RIVALS SOUND OF \$1000 HIGH END AMPLIFIERS

- Power Output: 8 Watts per channel
- Frequency Response: 20 TO 20 kHz
- Distortion: Less than 1% at 1 Watt
- Input Impedance: 100K Ohms
- Output Impedance: 8 Ohms
- Minimum Input: 0.4 V for full output

Uses type 11M58 tubes included in kit with circuit board, base board and all parts, including transformers, power cord, etc.

Easy to follow instructions.

*Assembled and tested \$169.95.

Add \$10 for shipping and handling.

S-5 ELECTRONICS

1625 Twin Acres, Chandler, AZ 85249
Phone: 480-895-2521 Fax: 480-895-4164

The Amplifier-Speaker Interface

By Lynn Olson ©2002 All Rights Reserved

Introduction

For better or worse, amplifier designers don't know much about speaker design, and speaker designers don't know much about amplifiers. The amplifier designers I've met are pleased with themselves if they know that speakers are a reactive load; they're always hoping that someday, somewhere, someone will design a speaker with a purely resistive load, preferably at a high impedance.

Speaker designers like to visualize amplifiers as perfect voltage sources with gain; even world-class designers sometimes think that the only significant differences between well-designed amplifiers is output power and source impedance (damping factor = source Z in ohms/speaker impedance).

These assumptions are so simplified that they are downright misleading. Amplifiers are not perfect voltage sources, and assuming that the source impedance can be accurately modelled with a resistor seriously misrepresents what amplifiers really do when driving physical drivers. Speakers in turn are nowhere close to simple reactive networks, and attempts to make the speaker system emulate a resistor works against high-quality speaker design.

Speaker Drivers

Since the readers of VTV are primarily interested in electronics, I'll start with the model of a speaker that usually assumed by amplifier designers. The crudest model is an ideal 4, 8, or 16-ohm resistor, which is then reflected through the output transformer to resemble a resistive plate load anywhere from 2.5 to 10 K ohms. Of course, when you actually measure the DC resistance of an off-the-shelf driver, an "8-ohm" driver measures 5.5 to 6 ohms.

If you graph the free-air impedance of almost any direct-radiator driver (woofer, mid, or tweeter), you'll see a (big) bump at the low-frequency end, a wide and shallow valley in the middle of the working range, and a gentle rise at the highest frequencies.

This can be modelled with a parallel LCR for the bass bump, a series R for the wide and shallow midrange, and a series L for the rise at high frequencies. This five-element network forms the starting point for Theile/Small theory.

Remember, this is an ideal driver, not anything you can buy. However, it's close enough that Theile/Small modelling works pretty well in the bass region. As speaker designers know, Theile/Small theory loses validity in the mid and high frequencies, and you have to directly measure the acoustic performance of the driver with a calibrat-

ed microphone and measurement system.

The reasons are pretty simple; cones, domes, horns, whizzers, whatever you can dream up, all come apart as frequencies go up, wavelengths get shorter, and cone velocity increases. Speaker cabinets have internal standing waves that are only partly damped by fiberfill or wall damping. Cones, surrounds, and dustcaps have their own set of characteristic resonances, cabinet edge diffraction creates a series of echoes in the time domain, and nonlinear breakup modes appear at high levels and high frequencies. As long as you're dealing with drivers made with physical materials, these effects are present. It doesn't matter if the diaphragm is made of paper, plastic, Kevlar, metal, carbon-fiber, synthetic diamond, or magic pixie dust, the problems are there.

Speaker cabinets and horns add additional colorations of their own in addition to everything described above. Open-back enclosures have the charm of not much cabinet coloration, but there's a heavy price to pay in terms of cone excursion, amplifier power, and equalization. If you go in the other direction, and employ techniques to raise efficiency, such as horn loading, you can decrease excursion and amplifier power substantially ... but at the cost of additional time-domain reflections and very complex behaviour outside the passband of the horn.

There's no way around it: if speakers are made from physical materials, they'll resonate, and in remarkably complex ways that exceed the capabilities of the most advanced measurement systems. How does this affect the amplifier designer?

One thing to consider is Back-EMF (Electro-Motive Force) from the driver(s). Speaker drivers store energy in the form of scores of high-Q narrowband resonances, and this resonant energy is radiated into the air, passed as vibration into the speaker enclosure, and converted back into electricity at the voice coil. There's nothing theoretical about this; that's what creates those little ripples you see in the impedance curve of a driver.

But what difference could a tiny wiggle make? It's only a fraction of an ohm; heck, turn on 1/3 octave smoothing and it'll disappear from the trace entirely. Make the trace neater, too.

To answer this question, we have to go back and see what D.E.L. Shorter was doing at the BBC in the late 1950s. Using instrumentation of his own design, he discovered "buried resonances" hidden within the usual swept-sinewave response curves. Not only that, but resonances that were 10 to 20 dB below the main curve (and thus appeared as very tiny ripples) were actually quite audible and artificial-sounding.

This discovery is the point where the British diverged from the mainstream US (Altec/JBL/Klipsch) school, which remained focused on swept-sinewave response and IM distortion. Mainstream US engineers didn't begin to concentrate on removing hidden resonances until MLS techniques became inexpensive in the late 80s.

D.E.L. Shorter built a "chopper" that counted out ten cycles of a sinewave, sent a triggering signal to an oscilloscope, muted the sinewave for twenty cycles, turned the sinewave on again, and repeated the cycle. When you combine the chopper with a swept sinewave source, you can examine how a speaker driver handles a sinewave that is suddenly cut off. What you find as you gradually sweep the oscillator is that the driver cleanly shuts off at most frequencies, but at certain narrow frequencies, sometimes only 20 to 100 Hz wide, long decay tails appear, lasting as long as 5 to 30 milliseconds. Nowadays we can simply use a MLS system like MLSSA and see this directly on a 3D "waterfall" display that shows freq. vs. time vs. decay in minus dB. The resonant "tails" that Shorter saw on his scope are the long front-to-back ridges of a 3D waterfall display.

The chopper and modern MLS systems can be used in a different way: instead of measuring the acoustic response of a driver with a microphone, you can simply measure the current going through the voice coil. The same resonances appear there as well - the voice coil is connected to the driver, after all! This technique can actually look closer at driver behavior than conventional techniques, since room noises and reflections are less troublesome, and you are directly examining the back-EMF transmitted to the amplifier. For example, a driver that appears to have a broad peak at 3.5 kHz might actually have three closely spaced resonances 200 Hz apart! (True story: this is what I saw on a 1975 KEF B110.)

Amplifiers

Well, big deal, you might think, what does this have to do with amplifiers? It's just another way to find out what's wrong with speaker drivers. Well, not really. This is Electro-Motive Force we're talking about. This isn't the simple and predictable linear reactance of the Theile/Small model; this is true spurious energy, only indirectly correlated with the audio signal, and scattered over a broad frequency range. The resonances are narrowband, true, but there's a quite a few of them, and they have high Qs, lasting much longer than any time-constant in the power amplifier.

This highly concentrated form of speaker coloration is transmitted straight into the amplifier. The output transformer will accurately multiply the voltage, and a differential signal will appear on the primary.

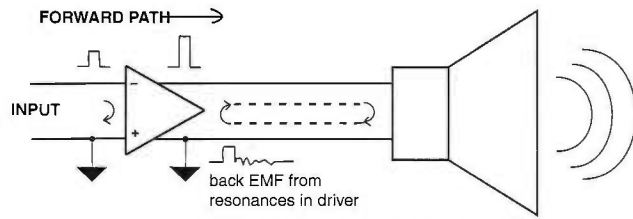

Figure 1: Back-EMF resonances.

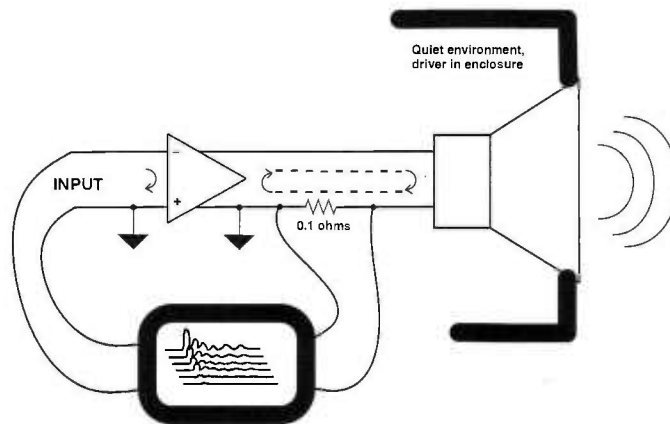

Figure 2: Measuring current to examine resonances in back EMF, using MLS-type cumulative decay 3D waterfall display.

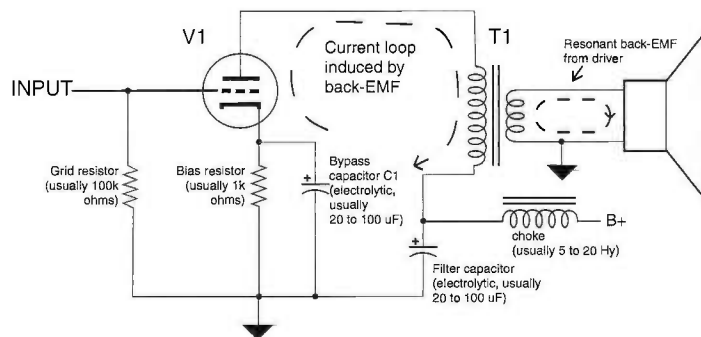

Figure 3: Path of back-EMF through SE triode amplifier.

This back-EMF will seek the path of least resistance: in a single-ended amplifier, a current is induced that goes from one end of the primary, through the power-supply caps, the cathode-bypass cap, the power triode, and back to the other end of the primary.

If the amplifier is push-pull, most (but not all) of the induced current will flow from plate-to-plate. As a result of inevitable imbalances, there will also be a residual SE type of current flow, going from the primary center-tap through the power-supply cap and returning to the cathode of the (slightly) dominant power tube. (This secondary path can be suppressed by a choke or current source in series with the cathodes or CT of the output transformer.)

If there's feedback, it gets worse. The back-EMF energy also appears at the summing node at the input, where it can cross-modulate with amplifier distortion, producing a type of coloration that wouldn't exist at all if the speaker back-EMF could be isolated from amplifier distortion.

Crossmodulation in a Full-Duplex System

Telephone and communications engineers will see what's going on here. When you add a back-EMF signal to the forward audio signal, you create a bidirectional full-duplex circuit. *Any* non-linear elements in the shared pathway will create cross-modulation products.

In the very simplest case, a non-feedback single-ended DHT amplifier, the back-EMF current flows through the output transformer primary, the core, the secondary, power-supply cap,

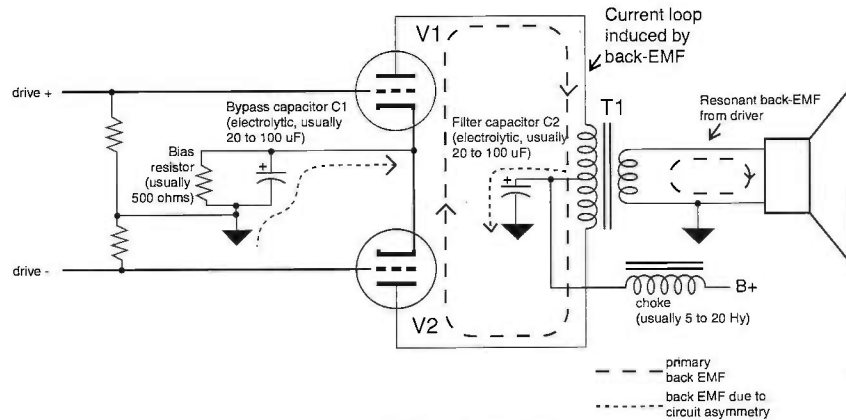

Figure 4: Path of back-EMF in push-pull triode amplifier.

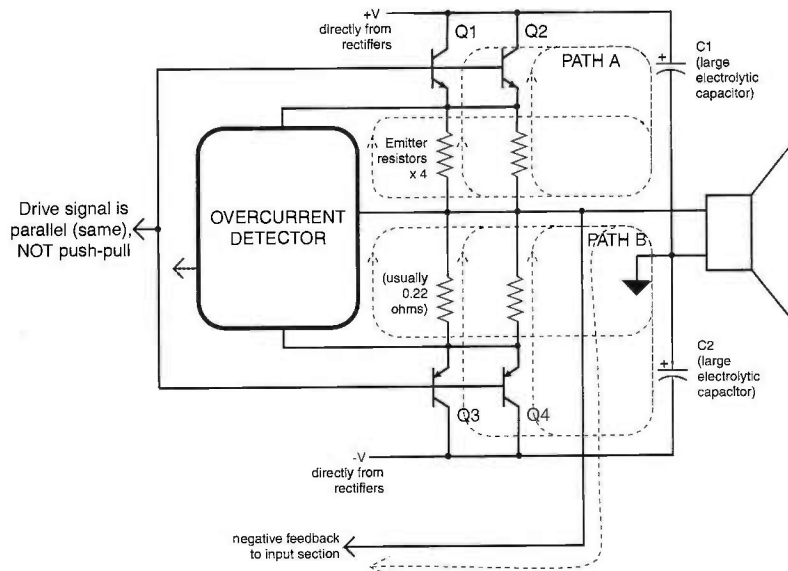
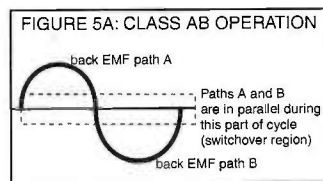

Figure 5: Path of back-EMF in push-pull transistor amplifier. Note that all back-EMF currents are asymmetrical.

Copyright 2002 Vacuum Tube Valley. All rights reserved.

the cathode-bypass cap, and the power triode. Any distortion in any of these elements will selectively crossmodulate speaker resonances with amplifier distortion, producing entirely new colorations that neither the speaker nor the amplifier could generate on their own. 100 milliseconds is not a long time for a speaker, but it's forever to an amplifier. This is why amplifiers, for example, have plainly audible bass and midbass colorations, even though nothing in the circuit appears to be doing anything in that frequency range.

Minimizing the area and scale of the full-duplex pathway is obviously desirable. There's nothing we can do about the voice-coil; it's bidirectional no matter what we do. In fact, the tighter the magnetic coupling (higher BL product), the more back-EMF! Speaker systems with near-flat impedance curves typically have low magnetic coupling, while speakers with the most reactive and aggressive curves have tight magnetic coupling. Loudspeakers, by their very nature, are reactive, energy-storing devices.

Damping Factor

We can now see why damping factor has essentially nothing to do with the way an amplifier sounds. Source impedance is merely the average of the actual dynamic impedance, which is not necessarily linear over the entire AC waveform. Since amplifying devices are not linear, neither is the output impedance constant over the AC cycle.

Let's back up a bit and look closer at how a triode, or any tube, operates. A tube is simply a voltage-controlled variable resistor: the input node is the voltage potential between the grid and cathode, and the output node (the variable resistor) is between the plate and the cathode. That's basically it. No ground reference is needed for the tube to operate, and the tube doesn't really care. For purposes of AC analysis, it's convenient to think of a little AC source inside the tube, connected to the cathode and plate, but the AC source does have a nonlinear output impedance. The value of R_p stated in the tube manual is merely the average impedance as the tube swings up and down around the nominal plate voltage.

This doesn't look too good for SE amplifiers; since the back-EMF current is not directly correlated with the main signal the tube is amplifying, the varying impedance of the plate will create crossmodulation products between the main signal and the back-EMF currents.

But we're not necessarily home free with PP output stages, either. If there are any Class AB tendencies in the output stage, during the course of one cycle, the output impedance will shift from one tube alone (+), to both tubes in parallel (though the zero-crossing), to one tube alone again (-), both tubes in parallel (though the zero-crossing), and so on.

This is worse than the SE amplifier; the fluctuations in output impedance are closer to the zero crossing, and they happen twice as often! What might have been a mild "tubey" coloration is now transformed into a new artifact that is even less correlated with the original desired signal and the back-EMF coloration. With pentodes, the prob-



Learn how to build this KT88 mono-block amplifier in VTV #19! Also a comprehensive profile and listening test covering current and vintage KT88 and 6550 tubes. Plus lots more! Due out Summer 2002

lem is aggravated. The high-order nonlinearity of these devices as they approach zero current generates a complex, high-order shift in output impedance for every swing of the AC cycle.

A close look at a complementary NPN/PNP transistor output section shows the worst crossmodulation problems of all. There are multiple back-EMF paths that switch on and off as the signal goes through the Class AB transition. Not only that, a large value power supply electrolytic is part of this path, and goes through one polarity, both capacitor polarities in parallel, and the other polarity, twice per cycle!

It should be added that a solid-state bridge directly feeding a large-value cap is the noisiest power supply possible, so generous amounts of power supply hash get added into the crossmodulation that's already present.

Feedback can flatten out this mess to some degree, but the instantaneous variations in conductance will always be there, just reduced in magnitude. Feedback can linearize (flatten out) the output impedance, but it does nothing to change the shape (the order) of the underlying nonlinearity. It's also doubtful if feedback can have much effect on complex time-delay nonlinearities such as Dielectric Absorption from dissimilar electrolytic capacitors being switched in and out of circuit by the switching action of Class AB transistors.

Feedback has another serious drawback of inviting back-

EMF crossmodulation to an earlier stage of the amplifier. Although the input stages work at a lower level and are more linear than the output, they have their own set of nonlinearities to deal with. RFI pickup from the long speaker cable also becomes a more serious issue, with the potential of exceeding the slew rate of the input stage. It should be remembered that the greatest dV/dT (rate of change) of a signal is around the zero-crossing, not the peaks, so adding just a little RFI (or power-supply hash) can make a big difference to how much slew headroom remains. Just a little RFI in the wrong place can add a lot of grit-n-grain to the sound (while not showing up on any THD measurement).

The Way Forward

If there is a secret to the "simple" topologies, limiting crossmodulation between back-EMF and the main audio signal is it. Although a single-ended triode amplifier may not be ideal for large signal swings, it has the enormous benefit of linear behaviour around zero-crossing. This is not a trivial advantage, since most music has a peak-to-average ratio of at least 20dB, and room reverberation is another 20-60 dB below that. In effect, most of the sparkle, dimensionality, and "you are there" quality is in the -40 to -100 dB range. If signals in this range are damaged or obscured, you get a flat, 2-dimensional, artificial sound.

Awkwardly enough, the lowest distortion, highest BL-product speaker drivers are also the worst behaved in terms of back-EMF. Even the best speakers generate delayed resonant back-EMF long after the musical transient. Even though the SE-DHT amplifier gets in trouble at high levels, its low-level behavior is exemplary - and that's where the important musical subtleties are hidden. Subjectively, this correlates well with the perception of more air, more inner detail, and more "space" with a low-distortion SE-DHT amplifier.

Although the large-signal capabilities of PP are attractive thanks to a theoretically constant source impedance as the waveform moves up and down, the challenge is making sure this obtains at low signal levels. It is especially important that Class AB operation and nonlinear devices are avoided, otherwise multiple kinks will appear in the swing versus output impedance characteristic. This will have a destructive impact on low-level detail, as well as exaggerating speaker colorations.

Ever wondered why speakers can sound different at high and low levels, indeed, why some high-end systems can't play background music at all? Small instantaneous variations in the source impedance of the amplifier can have a big impact on the sound.

The simplest and oldest techniques for PP appear to be the best; low-distortion interstage transformer coupling, low-distortion direct-heated triodes, avoiding paralleled devices, and very deep Class A biasing. I am beginning to suspect that PP might actually need more current per tube than SE just to stay well away from the Class AB region. All of the classic techniques for squeezing more power out

of PP have the serious side-effect of degrading source-impedance linearity in the zero-crossing region.

It makes a difference for SE and PP how the cathodes and power supply are bypassed; read the "Ultrapath, Parallel Feed, and Western Electric" article in VTV #16 for techniques to optimize the parts quality in the cathode-to-plate current loop. Back-EMF currents can and will cross-modulate with low-quality electrolytic caps. If you are skeptical about the distortion characteristics of caps, do some reading about what really happens with Dielectric Absorption, which has some pretty unusual time-constants.

Not surprisingly, Western Electric had a lot of the most interesting circuit ideas. You can do further reading at http://www.aloha-audio.com/library/Rosetta_Stone.html, which is a companion piece to the VTV #16 article as well as this article. On further reflection, maybe it's not too surprising that Western Electric got there first with low-distortion full-duplex circuits - after all, they were doing it with telephones long before vacuum tubes were invented!

Note to the reader: The concepts in this article were initially presented at the 2001 Vacuum State of the Art Conference. You can do further reading about driver characteristics at the Aloha Audio website <<http://www.aloha-audio.com/>>, as well as Siegfried Linkwitz's Website at <<http://www.linkwitzlab.com/>>.

SILVER SONIC™ Audio Cables

*Making the High End
Affordable!*

"With tube amps and hybrids, the
Silver Sonic competed with the best."
Bound for Sound

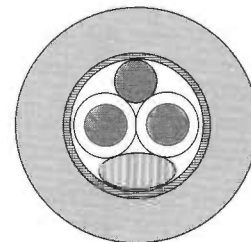

Silver Sonic T-14 Speaker Cable
Silver Sonic BL-1 Series II Interconnect
Silver Sonic D-110 AES/EBU Digital
Silver Sonic D-75 Digital Cable
Hook up wire & Connectors

D.H. Labs, Inc.
612 N. Orange Ave., Suite A-2
Jupiter, FL 33458
(561) 745-6406 (phone/fax)
www.silversonic.com

Vintage Microphone Profile From 1957 RCA Sound Products Catalog

Velocity Microphone Type 44-BX MI-4027-D

Features

- Sensitive ribbon element for faithful reproduction. Free from cavity or diaphragm resonance and pressure doubling.
- Uniform and smooth reproduction over the entire audio range.
- Response adjustment to provide the best possible frequency characteristics for either vocal or musical pickup.
- Bi-directional "figure eight" type pattern which allows placing of artists on both sides of the microphone and greatly reduces reflection pickup from side walls.
- Unaffected by temperature, humidity or changes in air pressure.
- Ruggedly built for hard usage.
- Shock mounted.
- Attractive in appearance.

Uses

The 44-BX is primarily intended for studio use where a microphone of the highest quality of reproduction is desired. It can be used with practically any audio facilities system and lends itself readily to unusual or difficult studio problems. The 44-BX is also well suited for high quality remote work. The 44-BX is found in almost all of the leading studios in the country and has become a recognized symbol of broadcasting.

Description

The bi-directional pattern of the Type 44-BX Microphone is of the familiar "figure eight" type. Unlike other types of microphones, it has no diaphragm—the moving element being, instead, a thin metallic ribbon so suspended as to be able to vibrate freely between the poles of a permanent magnet. Because of its lightness, the motion of this ribbon corresponds exactly to the velocity of the air particles and the voltage generated in it is, therefore, an exact reproduction of the sound waves which traverse it. Moreover, since it has no diaphragm and is open in construction so that air flows freely through it, the Type 44-BX Velocity Microphone is free from the effects of cavity resonance, diaphragm resonance and pressure doubling, which cause undesirable peaks in the response of all pressure type microphones.

The 44-BX is attractively designed in satin chromium and umber gray to harmonize with practically any modern studio interior. The yoke mounting permits a wide range of tilting angles. The shock mounting reduces undesirable pick-up from floor vibrations, etc.

Specifications

Directional Characteristic.....	Bi-directional
Output Impedances (tapped transformer).....	50/250 ohms
Effective Output Level.....	-55 dbm*
Hum Pickup Level.....	-112 dbm**
Frequency Response (see curves).....	30-15,000 cycles
Finish.....	Umer gray and satin chromium
Mounting.....	1/2" pipe thread
Dimensions, overall	
Height (including cushion mounting).....	12"
Width.....	4 3/4"
Depth.....	3 3/8"
Weight (unpacked, including mountings).....	8 1/2 lbs.
Cable (MI-62 2 conductor, shielded).....	30' less plug
Stock Identification.....	MI-4027-D

* Referred to one milliwatt and a sound pressure of 10 dynes/cm².

** Level referred to a hum field of 1 x 10⁻³ gauss.

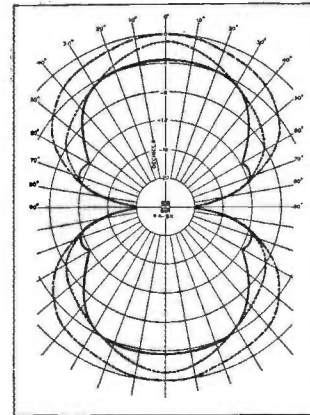

Directional characteristic of a typical 44-BX Velocity Microphone

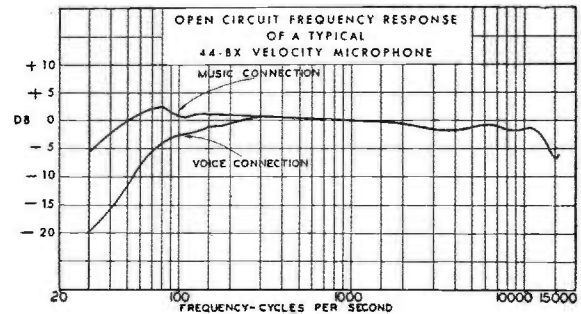

Vintage Microphone Profile From 1957 RCA Sound Products Catalog

Polydirectional Microphone Type 77-D MI-4045-A



Features

- High fidelity.
- Adjustable directional characteristic, continuously variable, provides non-directional, bi-directional or uni-directional operation.
- Three position "voice-music" switch allows selection of best operating characteristic for voice or music.
- Well shielded output transformer assures low hum pick-up.
- Reduced reverberation pick-up through selection of proper directional characteristic.
- Efficient shock mounting reduces building vibrations.
- Small size—light weight.
- Attractive appearance.

Uses

The RCA 77-D is a high-fidelity microphone for use in broadcast studios. With this one microphone a variety of directional patterns may be obtained by operating a screw-driver adjustment which is conveniently located on the back of the microphone. The 77-D combines the best features of the velocity and pressure microphones. The polydirectional characteristics of this microphone aid materially in obtaining a better balance, clarity, naturalness and selectivity in studio pickups. It is also of considerable value where difficulties are encountered in reverberant locations since the undesired sound reflections may be reduced by a choice of the proper directional pattern.

Description

The 77-D is similar in appearance to the previous Type 77-C1 Microphone but differs in operating principle. The 77-D consists of a single ribbon placed in the air gap formed by the pole pieces of a permanent magnet, a variable acoustic network, a well-shielded matching transformer with low hum pickup and a perforated metal case housing. Effective shock-mounting is used between the microphone and stand to reduce building rumble.

One side of the microphone ribbon is completely closed by a connector tube which in turn is coupled to a damped pipe or labyrinth. An aperture, placed in the connector tube directly behind the ribbon, is made variable in size by a rotating shutter. The directional characteristics of the microphone are controlled by varying the area of the aperture in the labyrinth connector. When the aperture is so large that the back of the ribbon is effectively open to the atmosphere, as in a velocity microphone, the acoustic impedance is zero and a bi-directional characteristic pattern is obtained. When the aperture is completely closed, the acoustic impedance is infinite and the characteristic pattern is non-directional which is typical of a pressure operated microphone. As the area of the aperture is varied, a critical value introduces a phase shift which results in a uni-directional characteristic. Other positions of the shutter result in patterns varying between bi-directional and non-directional.

On the back side of the 77-D wind screen (upper shell) is a slotted shaft control adjustment which is brought out flush with a designation plate mounted on the screen. The plate is marked "U", "N", and "B", as designations for the uni-directional, non-directional and bi-directional response curves. A special uni-directional plate, marked with a large "U", is provided with the microphone. When fastened over the designation plate, it fixes the directional pattern control shaft in the uni-directional position; thereby identifying the microphone as a uni-directional microphone, when this plate is attached.

The lower half of the case contains the acoustical labyrinth, output transformer and a selector switch for voice or music. This switch will attenuate the low frequencies below 300 cycles for voice pickup and has three positions designated as "M", "V₁" and "V₂". The switch is operated by a screw driver and is accessible from the bottom of the lower cylindrical shell. A protective cloth bag is shipped with each Type 77-D Microphone. The bag can also be used with Type 77-D and 77-C Microphones and ordered separately as MI-4087.

Specifications

Directional Characteristic (adjustable)	
Bi-directional, uni-directional and non-directional	
Output Impedances (tapped transformer)	50/250/600 ohms
Effective Output Level	-57 dbm**
Hum Pickup Level	-118 dbm**
Frequency Response	See curves
Finish	Satin chrome and umber gray
Mounting	1/2" pipe thread
Dimensions, overall	
Height	11 1/2"
Width	3 3/4"
Depth	2 1/2"
Weight (unpacked including mountings)	3 lbs.
Cable (MI-43 3 conductor shielded)	30' less plug
Stock Identification	MI-4045-A

Accessories

Microphone Plug	MI-4630-B
Protective Cloth Bag	MI-4087

* Referred to one milliwatt and a sound pressure of 10 dynes/cm².

** Level referred to a hum field of 1×10^{-3} gauss.

VacuTrace™

Vacuum Tube Curve Tracer



VacuTrace is your low-cost solution to accurate vacuum tube measurement. Quickly and easily generate characteristic curves for most popular audio and receiving tubes. Obtain static readings for voltage, current, transconductance and output conductance at any bias setting. \$1295

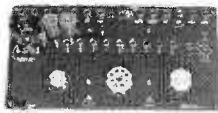

Now available with a flexible Jumper Adapter Card!

www.hagtech.com

Hagerman Technology LLC
PO Box 26437
Honolulu, HI 96825 USA
Phone: (808)-383-2704
Fax: (808)-394-6076



Vintage NOS Audio and Guitar Tubes Premium Quality

One of the largest selections of genuine, tested, premium grade NOS audio tubes for sale:

5U4GB	5AR4	6CA7	6L6GC
6SL7GT	6SN7GT	6V6GT	12AT7
12AU7	12AX7A	45	50
807	811	5687	5881
6201	6550A	6681	6922
7308	7355	7581	7591
7868	8417	EF86	EL34
EL84	396A	417A	KT66
KT77	KT88	KT90	MORE!

www.vacuumtube.com
(707) 263-5881

You Don't Have To Be Obsessive
to own Clarity Wires.



Just Fanatical

Interconnect cables for
the
Discriminating Listener

Distributed and sold by Response Audio
Toll free 1-888-785-9773 till 11pm Eastern/7 days
Email: Response34@aol.com
www.responseaudio.com

Save \$\$\$ – Factory Direct
www.Mr-Cable.com

Mr-Cable offers factory direct audio cables at huge savings. We manufacture *power cords, interconnects, speaker wire, digital and video cables & more.*

Mr-Cable also offers accessories, equipment, kits and parts.

Mr-Cable carries: *RCA's, spades & bananas, binding posts, AC & wall outlets, cones, isolation devices, cable kits, speaker kits, Heatshrink, equipment & more.*

Mr-Cable offers the following brands for your audio needs: *Acme, Audio Mirror (Tube Amps), Aurios, BDRC, Bullet Plugs, Caig, Canare, Cardas, Cascade Audio Sound, Durama, FIM, Furutech, Hubbell, Marincos, MSB, Neutrik, PS Audio, Schurter, Speaker Art, Switchcraft, Vampire, WATTGATE, WBT, direct imports and more.*

NOW AVAILABLE– North Star Design 192 kHz-24 bit d/a converter with upsampling.

Sales@Mr-Cable.com
Phone: (310) 233-2561 Fax: (866) 545-4313

VTV Dual Triode Preamp Vacuum Tube Characterizer

***New Product - Reserve Your Copy Now For The
Introductory Price of \$599!
(After July 1, 2002 price will be \$649)***



Dual Triode Preamp Vacuum Tube Characterizer

Finally, an instrument-grade audio preamp tube tester for OEMs, tube dealers, audio techs and guitarists/audio enthusiasts. This valuable tool allows you to accurately test and grade new and old/used dual triode audio tubes. Our instrument performs tests on audio tubes that are not possible with Hickock and other radio/TV tube testers. It features a built-in four inch speaker and headphone jack so you can actually listen to the tube being tested for noise and microphonics. In addition, it tests for gain on both medium and high-mu types, triode balance and shorts. You can quickly check both triodes with the flick of a switch. This money-saving device is just what the doctor ordered for premium grading of audio tubes.

Controls/Features: Calibrated dual red illuminated meter (indicates gain and triode balance); On/Off toggle switches for power, 6/12 volt filaments, tube type selector, triode in test; rotary switch for high and medium mu, push-button for triode balance, volume control for audio output, BNC output for scope or distortion analyzer, four-inch internal speaker and headphone jack. It is housed in a sturdy, die-cast 3/16 inch thick metal enclosure for a long service life.

Tests the following dual triode preamp tubes: 6CG7, 6FQ7, 6DJ8, 6922, E88CC, 7308, E188CC, 6SN7GT, VT-231, 6SL7GT, 12AT7, ECC81, 12AU7, ECC82, 5814, 12AX7, ECC83, 5751, 12SN7, 12SL7, etc. Optional octal socket adapter and 9-pin socket saver are available for an additional **\$50**.

Reserve yours now for **\$599** plus shipping and applicable tax. Note: Price goes up to **\$649** after July 1, 2002.

**Available exclusively from: Vacuum Tube Valley, PO Box 1499,
Lakeport, CA 95453 USA**

707-263-5881 phone - 707-263-7648 FAX www.vacuumtube.com

THE HOUSE OF TUBES

Putting the Glow in Your Audio System

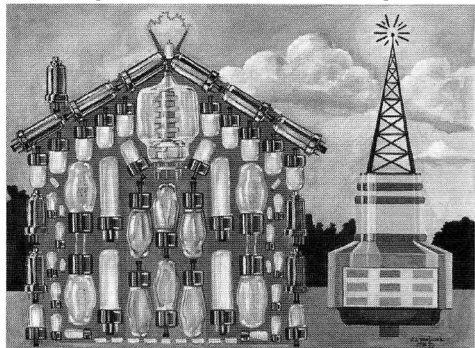

We know that tubes are the heart of a transceiver and the soul of an amplifier. That's why we're dedicated to reliable tubes at excellent prices. We offer the finest in audio tubes and quality components, and we've made ordering convenient.

Tubes—They're our foundation.

Visit us at: www.houseoftubes.com
e-mail: info@houseoftubes.com

ELECTRA-PRINT AUDIO

Quality Handwound S.E. Output Transformers

- Primaries from 1.8K to 10K
- Exclusive wideband design
- Line Stage with Headphone Out
- Single Plate to PP Grids

Custom-Built Power Transformers / Chokes

- Wound to your requirements
- Heavy-duty design for Class A use
- DC Filament Supply Windings
- HV chokes to 15H, 300ma
- Low voltage, high current filament chokes

Component Pricing and Specifications
Catalog Available

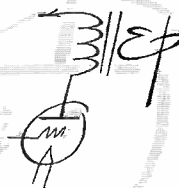

**ELECTRA-PRINT
AUDIO**

4117 Roxanne Drive
Las Vegas, NV 89108

702-396-4909 FAX 702-396-4910



Dehavilland Awesome Class A Power for your listening pleasure



Available From: **VACUUM TUBE VALLEY**
P.O. Box 1499 Lakeport, CA 95453 USA
Phone (707) 263-5881 FAX (707) 263-7648
email - triode@vacuumtube.com

Emery Sound

Lo-watt Tube Guitar Amps

PLAY your tube collection
without biasing hassles

5Y3
5AR4
GZ34
GZ32
5V4
5R4
5T4
5CG4
5Z4
5AZ4
12AU7
12AT7
12AX7
5751
12AD7
12DT7
12AY7
12DT7
6189



6L6
6L6GA
6L6GB
6L6GC
5881
KT66
KT77
KT88
6V6
6V6GT
7581
6550
6CA7
EL34
EL37
7408
5932
5814

"The Superbaby is simply amazing"

Buy Direct: 510.236.1176
www.emerysound.com

EUROTUBES

IMPORTERS OF HAND CRAFTED EUROPEAN VACUUM TUBES AND HIGH-END AUDIO AMPLIFIERS BY JJ ELECTRONIC. "EXCELLENCE WITH EVERY DECIBEL"

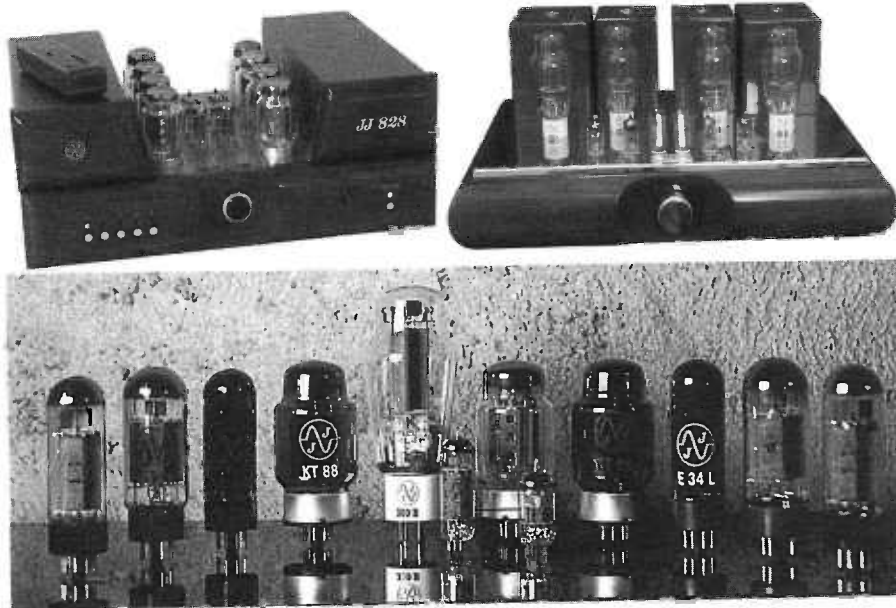

www.eurotubes.com

Eurotubes offers the full line of JJ Electronic vacuum tubes and high-end hifi amplifiers at wholesale prices, directly to the public.

The JJ 322 class 'A', single-ended amps surpass all other 300B amps in both power and sound quality.

The JJ 828 is an unvelievable power house of ultra linear sound quality.

We believe you will find these to be the very finest vacuum tubes and amplifiers being made today!

phone 503-659-7401

Chaffee **Hickok**
And **TUBE AMP** service
Alamo, CA.

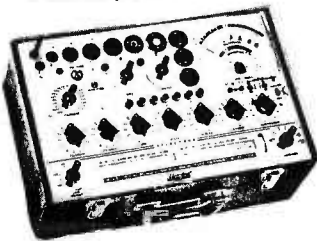

- Repair & calibration from 532 to Cardmatics
- **VINTAGE AMPLIFIER Repair/mod/upgrade**
- Economical shop rates
- Used **Hickoks** for sale.
- See website for testers And tube amp repair.
www.Tubewizard.com
(Kara Chaffee, engineer at deHavilland)
email: 6SN7@abac.com
Phone : (925) 837-7201

one electron

Single-Ended Output Transformers

High Quality for a Reasonable Price
Designed and Built in the USA



UBT-1

Designed for parallel operation of:
2A3s, EL34s, 300Bs, 6AS7s, etc. or
Sweep-tube in "enhanced triode" mode
1.6k primary
15 watts
160mA

\$99.00

UBT-2

Can be used with:
300B, 50, SV811-3, etc.
4.8k primary
15 watts
110mA

\$119.00

UBT-3

Good for single ended:
2A3 or 300B
3k primary
15 watts
110mA

\$99.00

BFT-1B

Designed for use with UBT-1s
770vct / 520vct @ 340 ma
6.3vct @ 9.6a
6.3v @ 4a
5vct @ 4a

\$169.00

quantity pricing available

NEW!

P-RC-1 and P-RC-2 Audio Chokes

Designed for shunt-feed single-ended output applications, but are also useful where quality inductive loads are needed or as high-quality filter chokes. They have the same overall dimensions and use the same high-quality M6 laminations as the UBT transformers. Each have two identical windings, allowing series and parallel combinations.

6221 S Maple Avenue Tempe, AZ 85283
ph: 480.820.5411 fax: 480.820.4643 or
00.706.6789 e-mail: info@tubesandmore.com
www.tubesandmore.com

TUBE AMP BOOKS by Kevin O'Connor

Books boutique amp builders rely on:

THE ULTIMATE TONE - US \$55
Modifying and Custom Building
Tube Guitar Amps

THE ULTIMATE TONE - Volume 2
Systems Approach to
Stage Sound Nirvana US \$40

TONNES OF TONE - US \$25
Electronic Projects for Guitar & Bass

The hifi hobbyist's reference:

PRINCIPLES OF POWER - US \$35
A Practical Guide to Tube Power
Amplifier Design

READY SET GO! - US \$20
An Electronics Reference for
the Everyman

SHIPPING: US add 5% surface or 10% air
Int'l: add 10% surface or 40% air
MC, VISA, cheque or money order

POWER PRESS PUBLISHING

PO Box 1777, Station B,
London, Ontario, CANADA, N6A 5H9
Phone 519-668-3132 FAX 519-668-2055

Purveyors of "Classic" Transformers & Enclosures



*Single Ended, Push-Pull
and Potted Tube Output
Transformers*

Filter Chokes



*Open & Enclosed
Filament Transformers*

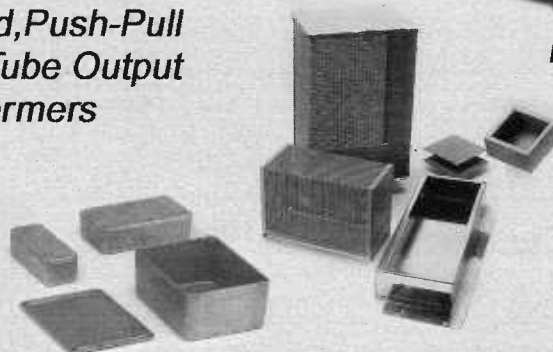

*Aluminum & Steel Chassis
and Diecast Aluminum
Enclosures*



*High Voltage Plate
Transformers*



Contact us for a free catalog & list of stocking distributors



HAMMOND MANUFACTURING™



256 Sonwil Dr. - Cheektowaga, NY 14225 USA
Phone: (716) 651-0086 Fax: (716) 651-0726
394 Edinburgh Rd., N. - Guelph, Ontario N1H 1E5 Canada
Phone: (519) 822-2960 Fax: (519) 822-0715

www.hammondmfg.com

VACUUM TUBE VALLEY

"The finest tube-only magazine on the planet"

Ken Kessler - Hi Fi News and Record Review - June 2000



VTV #1 Spring 1995 \$12.95
Vintage Dynaco Tube Equipment - 1955-77
History and Testing of the 12AX7/ECC83 dual triode
Tube Testing Methods + Why Tubes Sound Better

VTV #2 Fall 1995 \$12.95
Heathkit - The Tube Williamson Years 1950-61
EL34/6CA7 History, Types and Tests
Magnum SE EL509 Amplifier Project by Dave Wolze
1927-34 Western Electric Theater Sound Systems

VTV #3 Winter 1995/96 \$12.95
Eico Mono Tube Gear - 1955-62
Altec Lansing 604 Coaxial Loudspeaker History
Western Electric 300B History and Listening Tests
300B SE Transformer Listening Tests

VTV #4 Spring 1996 \$12.95
6L6 History, Types and Listening Tests
Vintage Bookshelf Speakers 1955-1965
Early FM Broadcasting History
HK Citation I & II Amplifier History and Mods

VTV #5 Fall 1996 \$12.95
The Ultimate FM Tuner Shoot Out
Red Bank Guided Missile Tubes for Hi-Fi
The Birth of the Marantz 10B
Choosing Rectifier Tubes for your Guitar Amplifier

VTV #6 Winter 1997 \$12.95
Fisher 500 - History, Models and Restoration
A Tribute to Avery Fisher by the Fisher Doctor
6550 and KT88 History, Types and Listening Tests
Lofin-White Amplifier History by Alan Douglas

VTV #7 Summer 1997 \$12.95
6DJ8, 6922 and 7308 - History and Tests
Altec 1950s Theater Amps and Modifications
The Great Voice - Peter Jensen Story
Multi-Tube Line Stage Project - Eric Barbour
Uncle Eric's Tube Dumpster - 417A/5842

VTV #8 Fall 1997 \$12.95
EL84 History, Types & Listening Tests
RCA Tube Mfg at Harrison, New Jersey
200 watt OTL Amp Project by Allan Kimmel
300B Listening Tests: NOS and Vintage Types
Interview with Bruce Moore, Tube Audio Pioneer

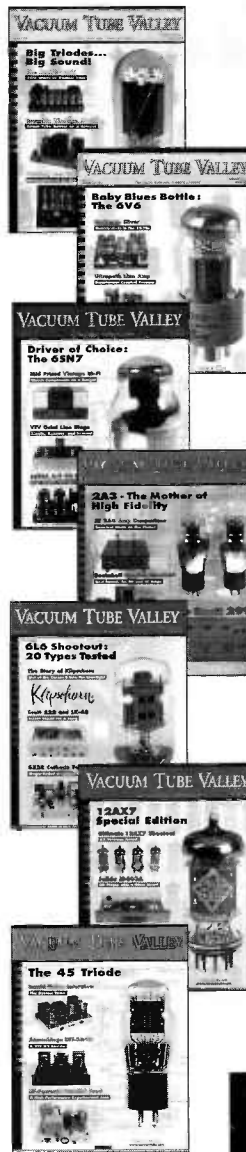

VTV #9 Spring 1998 \$12.95
Transmitting Tube Review, Ampeg SVT Guitar
Amp, Altec 287W amp, Bargain Vintage Hi-Fi

VTV #10 Summer/Fall 1998 \$12.95
Story of the 6V6 and listening tests, Hi-Fi radio
in the 30s, PP SV572 amp, Ultrathin Line Stage

VTV #11 Spring 1999 \$12.95
6SN7: History and Tests, Octal Line Stage
Project, Mid-Priced Vintage High-Fi, OTL
Headphone Amp, Capacitors and FREDs

**VTV #12 Summer 1999 - 2A3 History
and Tests, 2A3 SE Amp Reviews, Bookshelf
Speaker Test, Scott 299: History and Mods,
300 Watt SV572 Amp Project \$12.95**

VTV#13 Winter 2000
6L6 Shootout, Paul Klipsch Interview,
Klipschorn Lore and Mods, Scott 222 and
LK-48, PP 2A3 Amp Project \$12.95

VTV #14 Summer 2000 \$12.95
12AX7 History and Tests (52 Versions)
PPSV83 Amp Project
Elliano's Direct Reactance Preamp Project
David Hafler - The Acrosound Years

VTV# 15 Winter 2001 \$12.95
The 45 Triode - History and Tests
RF-Powered Parallel Feed Amp Project
David Hafler - The Dynaco Years
12AX7 Hi-Fi Shootout

For back issue orders, please add shipping and handling: US \$1.50, Canada \$2.00, Europe \$5.00, Asia/World \$6.00 + \$2.50 handling.

VTV is a highly researched and finely crafted reference publication covering the finest in tube audio electronics, vintage hi-fi, musical instrument amplification, loudspeakers, DIY, listening tests and honest equipment reviews. If you are into tubes, you need VTV!

VTV Subscription Rates

4 Issues / Year
\$43/year US First Class
\$34/year US Third Class
\$46/Canada-\$59/Europe
\$69/Asia & World
Pre-Payment Required Please
AMEX, MC or VISA OK

VTV Subscription and Back Issue Order Form (FAX or Mail)

Name _____
Address _____
City _____ State/Country _____
MailCode/ZIP _____ Telephone# _____
I want to subscribe for _____ Years - Payment Encl. _____
Send Me the following back issues _____
Payment Enclosed (including shipping) _____

VACUUM TUBE VALLEY

P.O. Box 1499
Lakeport, CA 95453 USA
Phone (707) 263-5881
FAX (707) 263-7648
email - triode@vacuumtube.com

Visit our on-line Pro-Tube Shop for the best selection of gourmet NOS audio tubes, quality tube amplifiers and more.

www.vacuumtube.com

“a major artistic achievement”

Dr. Harvey Gizmo Rosenberg, www.enjoythemusic.com/triode/tgawards

The best
audio output
transformers
in the world
— with specs
to prove it.

Ultra Wide Bandwidth Toroidal Output Transformers for Tube Amplifiers

- o Single Ended
- o Push - Pull
- o Triode
- o Pentode / Super Pentode
- o Cathode Feedback
- o Unity Coupled



We specialize in audio transformers.
Since 1983 Plitron has supplied
toroidal transformers to high-end equipment manufacturers.

“The highest quality audio transformer
I have ever heard.

Incredible low-end response.”

Alex Aguilar, President
Aguilar Amplification, N.Y., N.Y.

“This new sample looks super!
Congratulations to you and Menno on great
design work. Consider this as an enthusiastic
acceptance of production.”

Christopher Russell, VP Engineering
Bryston Manufacturing, Peterborough, Ontario

“The build quality and reliability are
excellent... simply the best.”

Gilbert Young, President
Blue Circle Audio, Toronto, Ontario

“...your design seems to be really elegant.”

“...absolutely amazed at the low
frequency performance of your design.”

Dr. Vincent McGinn, Chairman Electrical
Department, Northern Illinois University



8, 601 Magnetic Drive
Toronto, ON, Canada M3J 3J2
www.plitron.com
e-mail: techinfo@plitron.com
1-800-PLITRON
(1-800-754-8766)
Tel. 416-667-9914
FAX 416-667-8928

www.plitron.com



EXTINCT?

You might think so, but we've probably got what you're looking for!

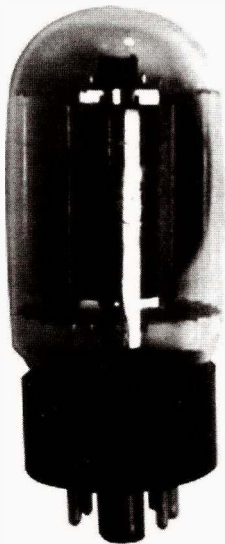

If you're looking for that unique mix of new and vintage components for a special project, Antique Electronic Supply has the right equipment. There's a good chance that we carry everything you're looking for, all in one place.

We specialize in vacuum tubes, both new-old stock and current production, and each tube comes with a guarantee! We also have a huge variety of transformers, capacitors, speakers, supplies parts, and books related to vacuum tube technology.

Contact us today to receive a free 100 page catalog or visit our website!

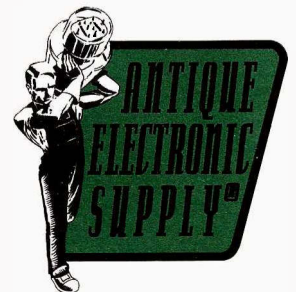

6221 S Maple Ave Tempe Arizona 85283 ph: 480.820.5411 fax: 480.820.4643 of 800.706.6789 e-mail: info@tubesandmore.com

www.tubesandmore.com