

audio **X** PRESS

THE AUDIO TECHNOLOGY AUTHORITY

MARCH 2004

US \$7.00 Canada \$10.00

Celebrating **35** Years

an **Amazing** super-sensitive
Measurement Unit
for under **\$150**

build this **Single-Ended**
8W Tube Amp

a **Classic Study of**
Amp Harmonic Distortion

DIY Burn-In Kit

thin **Speaker Upgrade**

building **Boxes with**
Slanted Fronts

showcasing a neat
"First" Amp

plus:
Software to Restore
Sound Recordings

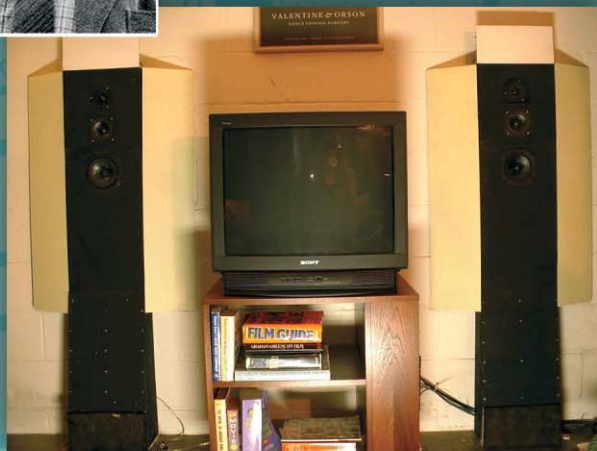
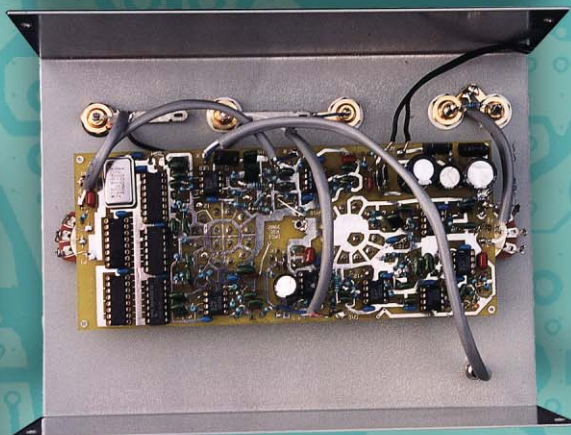

www.audioXpress.com

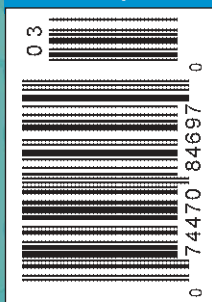

WORLD CLASS HIGH END

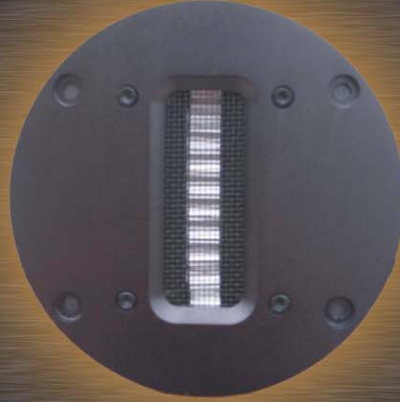

E-Speakers.com
Very High End Components and Kits

NEW !!



SILVER SONIC™

HIGH PERFORMANCE AUDIO CABLES

The Ultimate RCA Connector *DH Labs "High Copper Alloy"*

Virtually all of the RCA Connectors used by today's top cable manufacturers are made from brass. There are a number of different brass alloys, generally featuring a combination of copper (around 60%) and varying amounts of zinc, lead, and even tin. The presence of these other metals greatly reduces the manufacturing cost and conductivity of the resulting alloy.

The conductivity of brass alloys is only about 26% that of pure copper. This loss (almost 75%), directly affects the performance of a terminated cable.

Our exclusive *"High Copper Alloy"*™ material is sourced from the **U.S.A.** for purity, and composed of more than 99% pure copper. Simply stated, this is the finest connector anyone has ever made....

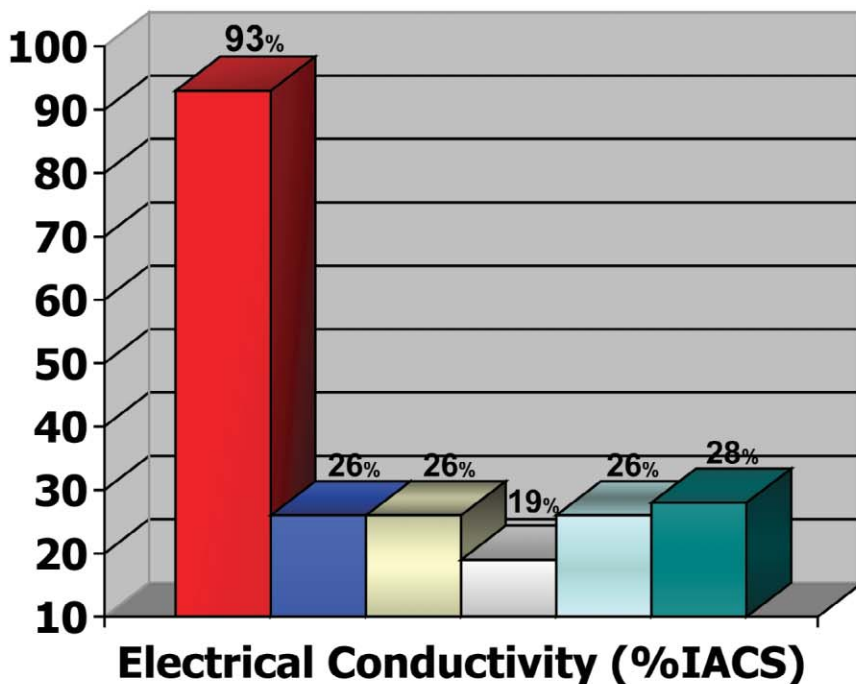

| | |
|---|-------------------------------|
| ■ | DH LABS HC ALLOY - |
| | Copper Content - 99.3% |
| ■ | WBT 101 TOP LINE - |
| | Copper Content - 68%* |
| ■ | VAMPIRE 807 - |
| | Copper Content - 63%** |
| ■ | VAMPIRE 800C - |
| | Copper Content - 88%** |
| ■ | CARDAS SRCA - |
| | Copper Content - 62%** |
| ■ | WBT 147 MID LINE - |
| | Copper Content - 52%* |

*Taken from manufacturer's published data
**Determined by Certified Chemical Analysis



612 N. Orange Ave. #A-2
Jupiter, FL 33458 (561) 745-6406

www.silversonic.com

HC Alloy is a trademark of DH Labs, Inc.

Never Build Another Speaker Cabinet

Sit back and enjoy the music



Premium quality finished cabinets available in three real wood veneer finishes and six different sizes. Baffles are removable and blank providing limitless possibilities for custom loudspeaker designs. Complete with grills, hardware, and veneered backs.

To see our complete line of finished cabinets go to www.partsexpress.com/cabinets

Parts Express 725 Pleasant Valley Dr., Springboro, OH 45066-1158 Phone: 1-800-338-0531 ♦ FAX: 937/743-1677 E-Mail: sales@partsexpress.com

Source Code: AXM

PIONEER

ON MARCH 9, 2004 PAUL W. KLIPSCH
WOULD HAVE BEEN 100 YEARS YOUNG.
HIS LEGACY WILL LIVE ON FOREVER!

"HAPPY BIRTHDAY PAUL. I LOVE YOU.
YOU ARE MY EVERYTHING."

-VALERIE

PAUL WILBUR KLIPSCH
MARCH 9, 1904 - MAY 5, 2002

"LOOKING BACK HAS BEEN PLEASURABLE
BUT THE CHALLENGE IS STILL TO LOOK
FORWARD."

PAUL WILBUR KLIPSCH: THE LIFE... THE LEGEND
[THE ONLY AUTHORIZED BIOGRAPHY OF P.W.K.]

DESIGN BY MARCO PROZZO



PAUL W. KLIPSCH
INVENTOR.

VISIONARY

FEATURES

A 1 PPM IM DISTORTION ANALYZER

You can build this low-cost, unbelievably high-sensitivity IMD instrument to measure small amounts of distortion.

By Richard Crawford.....8

AN 8W 2E24 SE AMP

This author's parallel, single-ended amp design features 8W of power and a "clean, clear" sound.

By Don Kang.....20

AMPLIFIER MUSICALITY

This classic study from a respected audio authority correlates measurements and musical performance.

By Jean Hiraga32

FRYKLEANER: AN AUDIO BURN-IN GENERATOR

An inside look behind the hardware design of a complete self-contained burn-in system.

By Jim Hagerman36

AGAINST THE WALL: AN UPGRADE

In this author's continual efforts to upgrade his speaker system, he presents an improved version of his popular "thin speaker" project published in Dec. '02.

By John Mattern40

WHY SPEAKERS HAVE SLANTED FRONTS, PT. 4

This audio veteran concludes his extensive study with tips on positioning your tipped-front-panel enclosures and how to build them.

By G. R. Koonce52

REVIEWS

VIRTOS NOISE WIZARD

Improve the quality of your recordings with this digital editing software.

Reviewed by Richard Honeycutt 58

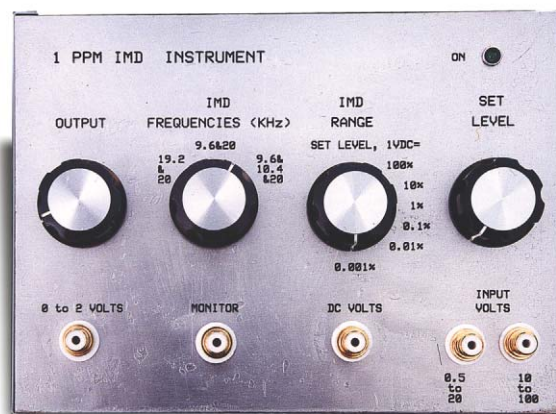

page 8



page 20



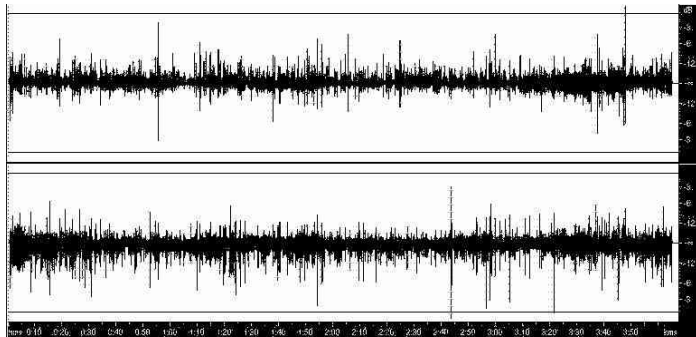

page 58

DEPARTMENTS

OBITUARY

PETER WALKER, 1916-2003
By Reg Williamson 4

BOOK REVIEW

Producing in the Home Studio with Pro Tools
Reviewed by Bill Fitzmaurice 57

NEW CHIPS ON THE BLOCK

Bicron Transformers and Burr-Brown DSS1700 DAC
By Charles Hansen 60

XPRESS MAIL

Readers speak out 61

SHOWCASE

A Bulgarian Builds a Spencer Amp
By M. Nyssen 72

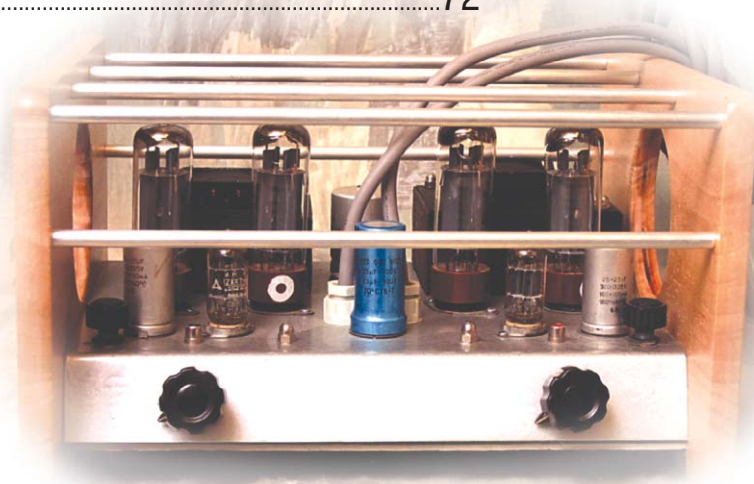

page 72

Articles



solid state



tubes



speakers

LEGAL NOTICE

Each design published in *audioXpress* is the intellectual property of its author and is offered to readers for their personal use only. Any commercial use of such ideas or designs without prior written permission is an infringement of the copyright protection of the work of each contributing author.

SUBSCRIPTION/CUSTOMER SERVICE INQUIRIES

A one-year subscription costs \$34.95; a two year subscription costs \$58.95. Canada please add \$12 per year. Overseas rate is \$59.95 for one year; \$110 for two years. To subscribe, renew or change address write to the Customer Service Department (PO Box 876, Peterborough, NH 03458-0876) or telephone toll-free (US/Canada only) 888-924-9465 or (603) 924-9464 or FAX (603) 924-9467. E-mail: custserv@audioXpress.com. Or online at www.audioXpress.com

IN EVERY ISSUE

CLASSIFIEDS

Audio-related items for sale or wanted 70

AD INDEX 71

YARD SALE

Free classifieds for subscribers 71

THE STAFF

Editor and Publisher
Edward T. Dell, Jr.

Regular Contributors

| | |
|-------------------|------------------|
| Eric Barbour | Erno Borbely |
| Robert Bullock | Richard Campbell |
| Joseph D'Appolito | Vance Dickason |
| Bill Fitzmaurice | Gary Galo |
| Charles Hansen | G.R. Koonce |
| James Moriyasu | Nelson Pass |
| Richard Pierce | Reg Williamson |

Vice President
Karen Hebert

| | |
|------------------|----------------------|
| Dennis Brisson | Assistant Publisher |
| Amity Palmer | Editorial Assistant |
| Richard Surrette | Editorial Assistant |
| Tina Hoppock | Graphics Director |
| Amy Wyman | Production Assistant |
| Ben Leece | Production Assistant |
| Laurel Humphrey | Marketing Director |
| Kelly Bennett | Customer Service |
| Sharon LeClair | Customer Service |

Advertising Department

Strategic Media Marketing
1187 Washington St.
Gloucester, MA 01930

Peter Wostrel

Phone: 978-281-7708

Fax: 978-283-4372

E-mail: peter@smmarketing.us

Nancy Vernazzaro

Advertising/Account Coordinator

The peculiar evil of silencing the expression of an opinion is, that it is robbing the human race; posterity as well as the existing generation; those who dissent from the opinion, still more than those who hold it.

JOHN STUART MILL

CLASSIFIEDS & WEB LISTINGS

Contact Nancy Vernazzaro, Advertising Department, *audioXpress*, PO Box 876, Peterborough, NH 03458, 603-924-7292, FAX 603-924-6230, E-mail nancy@audioXpress.com.

Printed in the USA. Copyright © 2004 by Audio Amateur Corporation. All rights reserved.

Peter Walker 1916–2003

By Reg Williamson

The death of Peter Walker of “Quad” on December 10, 2003, brings to an end an important chapter in the development of high-quality reproduced sound. It was in the immediate post-war years that interest renewed in the design of suitable equipment, taking advantage of the advances in technology, which hitherto were concentrated on the war effort.

After a long debate in the letters columns of the (then) prestigious English magazine *Wireless World*, the late DTN Williamson published what became a seminal article on the subject, and he offered a suitable design for a preamplifier and power amplifier. Thousands were made throughout the world; but it became clear that in many respects, it lacked commercial viability.

INNOVATIONS

Peter Walker (*Photo 1*) already ran his own small company making public address amplifiers (from 1936), but like so many of us active in audio design, his motivation was the love of music. He was an accomplished flautist, a hobby he practiced in the local Huntingdon Philharmonic orchestra. In 1941, concentrating now on high-quality amplifier design at a new factory in Huntingdon, he developed a series of tube preamplifiers and power amplifiers, the last of which was the model Quad 22/2 series.

Peter demonstrated an impressive talent for innovative thinking. Negative feedback (nfb) derived from a tertiary winding in the cathode path of the output tetrodes—in this case the new KT66s used by Williamson—helped the power amplifier achieve very low distortion. Walker also acknowledged a simple fact, seemingly lost today, that you are likely to have imperfections that could be improved by correction in the source of your program material. The preamplifier was unique in providing a variable slope low-pass steep cut filter, with three cho-

sen cutoff frequencies along with variable slope bass and treble boost/cut filters. He remained faithful to this principle right into the transistor era.

With the transition to transistors, the company’s first effort was not without its problems—as indeed, many other designers found out. Transistors, it was soon discovered, did not have the inherent robustness and tolerance of tubes under overload conditions, particularly if there were any appreciable reactive components in the load. It was this latter characteristic of some loudspeakers that produced conditions where the output devices could be required, albeit momentarily, to simultaneously exceed both the rated maximum current and voltage. The result was usually instant demise!

In collaboration with Peter Baxandall, another prolific worker and friend of many years, Walker examined thoroughly and solved the problems. The concept of the Safe Operating Area or (SOAR) of a power transistor’s operating characteristics is now well established. The Quad 303 was—and still is—a highly successful design, and the Quad model 33 preamplifier, incorporating most of the features of its tubed predecessor, still attracts enthusiasts. Walker’s major contribution to the design of high-quality transistor power amplifiers was the extraordinary concept of current dumping.

Early transistor amplifiers were often based on the first Lin quasi-complementary design and used Class-B working for efficiency, but insufficient attention was given to minimizing the phenomenon that became known as crossover distortion. This is caused by the tiny hiatus that occurs when both output transistors are simultaneously in a non-conducting mode.

Since high levels of overall nfb are essential, at this point, there is no gain—therefore, no nfb. So, the amplifier pro-



PHOTO 1: Peter Walker.

duces minute but particularly unpleasant levels of high odd-order harmonics, giving rise to the so-called “transistor” sound. While circuit design techniques existed to minimize it, other designers tried to eliminate it altogether by using the highly inefficient Class-A mode.

Walker developed what many consider the ideal solution. He designed an amplifier that operated in Class-A at low levels, but—should higher power be required—relatively low-cost, high power transistors would “dump” the extra current into the load. It was an extraordinarily ingenious answer to the problem, and the transition from one mode to the other was seamless and inaudible. The first of these current dumping amplifiers was the Quad 405, and, to this day, if you could look on the back of many monitor loudspeakers in the studios of a broadcast company, you are more likely than not to see a dust-covered Quad 405.

MAJOR ACHIEVEMENT

However, Peter Walker’s most important contribution was in the field of loudspeaker design. It had long been recognized that the electrostatic princi-

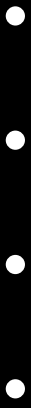
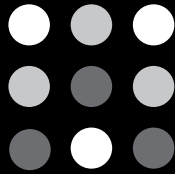

THE ART OF CONNECTION



Attain
^aHigher
Level of Fidelity

- Does your banana plug have an expandable contact pin, a brilliantly executed crimp technique or bi-wiring compatibility?
- Do you struggle making connections in tight places? You need the one hand operation and space saving angle of the WBT-0645.
- From the masterful design to the high conductivity and large surface contact area, this is the connector your system has been craving.



- Five way post with two piece tightening nut for secure attachment of spades without tools.
- Easy upgrade to most standardized binding posts. Dual termination of crimp or solder to suit your needs.
- You will recognize the masterful design and appreciate the high conductivity. This is the connector you and your system have been craving.



•801-621-1500
•www.wbtusa.com

ple was ideal for minimal distortion and linear frequency response; indeed, tweeters already existed for use with conventional middle and bass systems. Walker set himself the task of producing the world's first full-range electrostatic loudspeaker, and, in collaboration with DTN Williamson, published a sequence of articles in May, June, and August 1955 of *Wireless World*, discussing the many possibilities and most of the design criteria. Even today, for anyone interested in the subject, it is required reading.

The Quad prototype first saw the light of day in 1956. Many stood in line to hear this wonder at an audio show organized by the (now defunct) British Sound Recording Association. Even now, I can vividly recall the impression it made on me when I had the opportunity to hear it locally, and can remember the recording: Rita Streich singing the *Lost Rose of Summer* from Flotow's "Martha." Although it was in mono, the sheer clarity and transparency of sound bowled me over, almost as though the singer was somewhere just through the diaphragm.

Walker reminded me later of another pioneer's famous comment (Paul Voigt—when he suggested that it should sound as though you are listening to the real thing through an open window), which he regarded as one of the basic tenets of his own design philosophy. The production models came out a year later and many are still in use today. However, stereo was soon to arrive and the original ESL57 (as it became known) showed some deficiencies when used as a stereo pair.

Walker was already thinking ahead and in 1963 began work on a revolutionary concept, still using the electrostatic principle. Only a hint of what was to come came from a paper presented to the AES in 1979. By this time, Peter and I were firm friends, after he gave me valuable advice on the design and construction of capacitor microphones, my particular preoccupation at the beginning of the '60s. Every time I found myself near the factory at Huntingdon, a visit was a must—and after I was invited into the secret room behind his office to view progress, we'd have a leisurely lunch at a nearby hotel. It was invariably accompanied by a long dis-

cussion on the steady deterioration in equipment review standards, a distaste we both shared.

The new speaker appeared in 1981 and was an immediate success. For a full description of the principles on which it is based, I can only refer you to my article in *Speaker Builder* 1/82. Suffice to say, it was based on the concept that the ideal sound radiator was a sphere.

Since it was physically impossible to make a speaker of this shape, Walker made the flat plastic diaphragm operate as a sphere by delaying the sound to arrive sequentially to each of a series of six concentric rings. This produced the illusion of sound coming from a pulsating sphere about 30cm behind the speaker (which incidentally, like its predecessor, was a bipolar radiator so the effect was the same, front or back—no cabinets were involved, so no structural resonances). The actual plastic film radiator was lighter than the air surrounding it. The ESL63 is still the benchmark standard to which all other designs are inevitably compared.

Peter Walker belonged to that generation of audio designers who firmly believed, as I do, that—provided the natural laws of physics are faithfully observed—it is usually possible to predict with almost 100% accuracy how a particular design will behave. This was vividly illustrated to me when on a visit to the factory with my wife, who unusually (and I do not intend being sexist) has a fascination with hi-fi (a tautological corruption I hate).

We had just taken delivery of a pair of ESL63s. I casually mentioned her interest to Peter, and an invitation came with alacrity! She regards this as one of the most interesting days of her life, not so much seeing the work going on, but the obvious respect and affection in which Peter was held by his workforce—all were on first name terms.

The final test of a production ESL63 consisted of being in close proximity opposite a reference model with a B & K high-grade microphone positioned approximately between them. Each was fed a square wave (if my memory is correct, around 800Hz). The phase was reversed on one, so it followed that if each performed to specification, it should be possible to position the mi-

crophone equidistant from both speakers, and the output should then be nil. As indeed, it was—just noise.

I very unwisely asked whether it was desirable to listen to some music. Peter looked at me in genuine amazement and exclaimed "Whatever for? Oh, dear me, no. No point. We leave our customers to do that. . . ." He became increasingly irritated by the outpourings of an emerging breed of equipment reviewer, whose talents were confined to writing entertainingly—but invariably with no engineering background whatsoever.

For many years, he refused to allow reviews of Quad products, particularly after an incident in which a reviewer insisted that all [*sic*] amplifiers sounded different and that tube amplifiers always differed in some degree from transistor amplifiers. He made the serious error of citing Quad products. Peter, like me, does not accept this premise, if the amplifier is designed properly in the first place. But his Quad products had been held to be defective in some way, resulting in a deluge of letters to the factory.

Peter set up a test panel to take place over two days, and invited a number of Golden Ears to take part. He invited the original complainant to suggest suitable speakers. He chose a pair of very costly Japanese models but subsequently declined to take part because "The relays switching the speakers from amplifier to amplifier were not gold plated." No comment is needed, I think.

Three amplifiers were used: the original tube Quad 22; the first transistor model 303; and the later 405. The chosen panel was invited to suggest for test material, and I provided a master tape of one of my own recordings. The switching between amplifiers was random, literally on the toss of a coin.

Individually and independently, each member of the panel was invited to decide which amplifier was in use, and at the end of the two days, a statistician examined the results. His conclusion was that the toss of a coin would have produced the same results. Another respected engineer, James Moir, also handled the whole expensive exercise independently. The reviewer—now discredited—departed the audio scene and started to write for the emerging computer magazines!

(to page 19)

Over the Top

Music performance and craftsmanship that exceed your expectation in every way

Compass DANCER SERIES

Compass DANCER SERIES DESIGN HIGHLIGHTS:

- Carbon-paper woofer cone
- Silk-fabric soft dome tweeter; Ceramic type on some models
- Innovative magnet flux design with corrective cooper elements on all drivers, resulting in significantly reduced third and second harmonic distortions
- Cast aluminum driver frame
- Hand picked, matched-pair drivers on all models
- Phase coherent crossover designed by world renown master of speaker design, built with components of the highest quality and thoroughly tested with digital-based measuring equipment
- Massive, sonically dead front baffle which places drivers in a time-coherent physical arrangement
- Multi-chamber reinforced cabinet with solid wood side panels, handcrafted to the highest furniture grade

Behind the Scene

Dr. Joseph D'Appolito has been working as consultant for Usher Audio since early 2000. A world renown authority in audio and acoustics, Dr. D'Appolito holds BEE, SMEE, EE and Ph.D. degrees from RPI, MIT and the University of Massachusetts, and has published over 30 journal and conference papers. His most popular and influential brain child, however, has to be the MTM loudspeaker geometry, commonly known as the "D'Appolito Configuration," which is now used by dozens of manufacturers throughout Europe and North America.

Dr. D'Appolito designs crossover, specifies cabinet design, and tests prototype drivers for Usher Audio, all from his private lab in Boulder, Colorado. Although consulting to a couple of other companies, Dr. D'Appolito especially enjoys working with Usher Audio and always finds the tremendous value Usher Audio products represent a delightful surprise in today's High End audio world.

With an abundance of original concepts in loudspeaker design, backed by thirty years experience in manufacturing and matched with an eye for fashion and unparalleled attention to detail, is USHER the ideal original design manufacturer you've always been looking for? Find out the answer today by talking to an USHER representative.

USHER

USHER AUDIO TECHNOLOGY

67, Kai-Fong Street, Sec.1, Taipei 100, Taiwan

Tel: 886 2 23816299 Fax: 886 2 23711053

Web site: www.usheraudio.com E-mail: usher@ms11.hinet.net

A 1 PPM IM Distortion Analyzer

Measure the intermodulation distortion (IMD) of your power amplifiers or preamps to 0.0001%. This article shows you how, and makes some comparisons between total harmonic distortion (THD) and IMD.

By Richard Crawford

Total harmonic distortion (THD) measurements are the most common distortion measurements used for audio equipment. THD is a measure of the nonlinearity of the device under test (DUT). By nonlinearity, I mean that the output is not a true replica of the input. The DUT can be any part of the audio chain, from microphone to amplifier to loudspeaker. In THD testing the source is a sine wave of low distortion.

WHY IMD?

IMD measurements are another way of expressing the nonlinearity of audio equipment. In IMD testing the source is a combination of two (or more) sine waves, and the IMD is a signal (produced by the nonlinearity) at some different frequency. More than 50 years ago Bill Hewlett (of Hewlett-Packard Company) helped write an article about the similarity between THD and IMD measurements¹. Broadly speaking, the second-order term in the nonlinearity equation gives (1) second harmonic distortion, and (2) IMD at the sum or difference frequency of the two sine waves. Similarly, the third-order term in the nonlinearity equation gives (1) third harmonic distortion and (2) IMD at the sum and difference frequencies of multiples of the frequencies of the input sine waves.

Reading the last sentence, I can understand why THD measurements are more popular! For the rest of this article, I will use the terms second-order and third-order to describe the intermodulation measurements, and you

can relate these to second and third harmonic distortions.

THD VS. IMD

Given that both THD and IMD arise from the same nonlinearities, and can be related mathematically, which is preferred?

THD measurements are more common, and there is a large number of existing measurements on a variety of components and devices, and it is useful to be able to compare these measurements. Viva THD measurements. Another advantage of THD measurements is that the signal is a sine wave, and the peak-to-peak voltages are 2.83 times the RMS value of the sine wave.

IMD measurements with two equal signals (two tone) means that the RMS value is 1.414 times that of each of the two signals, but the peak-to-peak signal is 5.6 times the RMS value of each signal. So for two-tone IMD signals the peak-to-peak value is four times the RMS. And for three equal signals (three tone), the RMS value is 1.73 times that of each signal, while the peak-to-peak signal is 8.4 times the RMS value of each signal. For three-tone IMD signals, the peak-to-peak signal is about 4.9 times the RMS. Thus the

ratio of peak-to-peak signals to RMS signals is different for IMD test signals than it is for THD testing, and it changes depending upon the number of test tones used.

This is important because good audio electronics produce audible distortion only when the peak-to-peak voltages are near the limits set by the power-supply voltages. So if you measure the IMD of a power amplifier using RMS calculations, the IMD measurements will show distortion at much lower output power than the THD measurements. My answer to this is to make my IMD measurements based on peak-to-peak voltages. To make a comparison to RMS voltages, divide the peak-to-peak voltages by 2.83.

On the other hand, I believe that it is easier to design—and cheaper to build—an IMD instrument of high sensitivity. By high sensitivity I mean an instrument that will measure very small amounts of distortion. This article describes an IMD instrument that can measure IMD of 0.0001% (equal to 1ppm); a THD instrument of that sensitivity would cost much more. I need a distortion tester of high sensitivity because I am working on some power am-

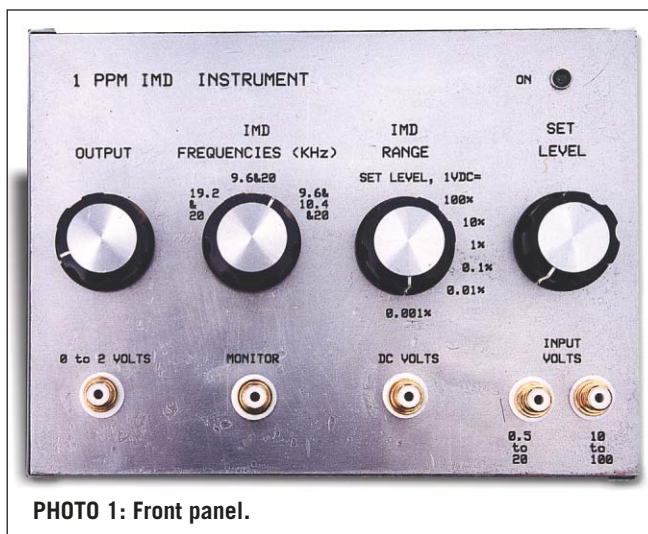

PHOTO 1: Front panel.

plifiers whose distortion is less than most THD analyzers.

Some assert that IMD testing is more strongly related to music than THD measurements, because the distortion that you hear (in orchestral music, for example) is the IMD between the musical instruments. I don't believe this is valid, because the source of THD and IMD are the same nonlinearities. However, to satisfy those who do believe this, I have designed this IMD instrument so that it can independently measure both second- and third-order nonlinearities. I believe that it is easier to design this independent measurement in an IMD instrument than in a THD instrument.

A THD instrument will usually measure total harmonic distortion including hum and noise, while this IMD instrument measures only the IMD, ignoring the hum and noise. This helps in very sensitive tests, because hum and noise can contaminate the distortion tests. There is no excuse for hum, but it can obscure the distortion tests.

GOALS

My design goals for this IMD instrument include:

1. Generation of IMD test signals, and measurement of IMD signals, on a single printed circuit board of about 3" x 7".
2. Measurement of IMD from 100% to 0.001% in six decade ranges.
3. Measurement of both second-order and third-order IMD.
4. The use of IMD test signals near 20kHz where audio electronics are most susceptible.
5. Input signal levels from 0.775V RMS (0dBm @ 600Ω) to 100V RMS.
6. Ease of use.
7. Low cost.
8. The use of an external DC voltmeter to simplify the design and lower cost.

FREQUENCIES

Most modern IMD measurements use two-tone signals of equal amplitude at 19kHz and 20kHz². The reason for these high frequencies is that they stress amplifiers the most, and is thus a revealing test. However, these frequencies are not very good for testing loudspeakers because they would only test the tweeters. The two high frequencies

evaluate the second-order nonlinearity by measuring the amplitude of the 1kHz difference frequency.

In this design I have a two-tone test, but I use 19.2kHz and 20kHz, with the difference frequency at about 800Hz. But I also have a two-tone test using 9.6kHz and 20kHz. This evaluates the third-order nonlinearity by measuring a difference frequency at about 800Hz. Finally, I have a three-tone test of 9.6kHz, 10.4kHz, and 20kHz, all at the same amplitude, and this gives several difference frequencies near 800Hz for both second-order and third-order non-

linearities.

I achieve these four frequencies (19.2, 9.6, 10.4, and 20kHz) by dividing a 1MHz crystal clock by (52, 104, 96, and 50). This is simple, low cost, with few parts, and no adjustments. The resulting square waves are stable in amplitude and frequency. All of the difference frequencies are near 800Hz:

1. 1MHz (1/50 - 1/52) = 20kHz - 19.231kHz = 769Hz
2. 1MHz (1/50 - 2/104) = same as previous, 769Hz
3. 1MHz (1/50 - 2/96) = 20kHz -

MCM AUDIO SELECT™
Quality Home-Theater and Pro-Sound Drivers at Unbeatable Prices!

6 1/2" Fiberglass/Honeycomb Die-Cast Woofer
Order #55-2322

3" Aluminum Cone Shielded Driver
Order #54-609

5 1/4" Die-Cast Woofer with Steel Phase Plug
Order #55-2455

10" Musical Instrument Driver
Order #55-1740

6 1/2" Aluminum Cone Shielded Woofer
Order #55-1860

Over 40,000 Products Stocked



FREE CATALOG

- Access to over 1.5 million electronic parts and related products
- Superior customer service
- Special offers and discounts
- Quotation team, send us your quotes for quick response
- State-of-the-art automated warehouse

Call toll free
1-800-543-4330

or visit
www.mcminone.com/magazine

Source Code:
AE04



MCM

an in one company

20.833kHz = 833Hz

4. 1MHz (1/96 - 1/104) = (10.417kHz - 9.615kHz) = 802Hz

With a single bandpass filter at 800Hz, I can measure all of these IMD signals. I can achieve the differentiation between second- and third-order IMD by the choice of input signals to the DUT, but use the same bandpass filter for measurement.

BLOCK DIAGRAM

The block diagram (Fig. 1) shows the device under test (DUT), the generator(s), the measurement section, the voltmeter, the power supply, and the wiring for the front panel. The wiring is important because it minimizes the hum generated by ground loops. What I call the voltmeter is really an AC to DC converter, and I use a separate DC voltmeter for measuring the IMD.

Figure 2 shows the schematic of the frequencies generator. A 20kHz square wave is generated by feeding the crystal clock (U1) into a divide by 50 circuit (U2). U3 and part of U6 produce a divide by 13 circuit, which is followed by a divide by four and divide by eight counter (U4), which produces the 19.2kHz and 9.6kHz square waves. U5 and part of U6 are a divide by six circuit, which is followed by a divide by 16 integrated circuit (IC) (half of U4), which gives a square-wave output of 10.4kHz. I use CMOS ICs because of their low cost, ready availability, and rail-to-rail outputs.

All of the frequencies generator outputs are square waves, with outputs from 0V to +5V. These square waves are unsuitable to drive the DUT directly because:

1. The square waves contain many harmonic frequencies, which could confuse the IMD measurements.
2. The fast rise and fall times of the square waves might cause problems in the DUT.

GENERATOR FILTERS

It is desirable to reduce the harmonics in the square waves from about 40% to about 1%. This is accomplished by the generator filters: U7, U8, and U9 (Fig. 3). U7a is a low-pass filter for the 20kHz and 19.2kHz square waves. U8a and

U8b are low-pass filters for the 9.6kHz and 10.4kHz square waves. All of these signals are combined, in varying amplitudes, in U8b.

Switch S1 (the frequencies selector

switch) selects the resistors (R17, R18, R19, R20, R22, and R23), which give the proper signal amplitudes for each of the IMD modes. Switch S1 is a 4-pole, 3-position switch, but it is not shown that

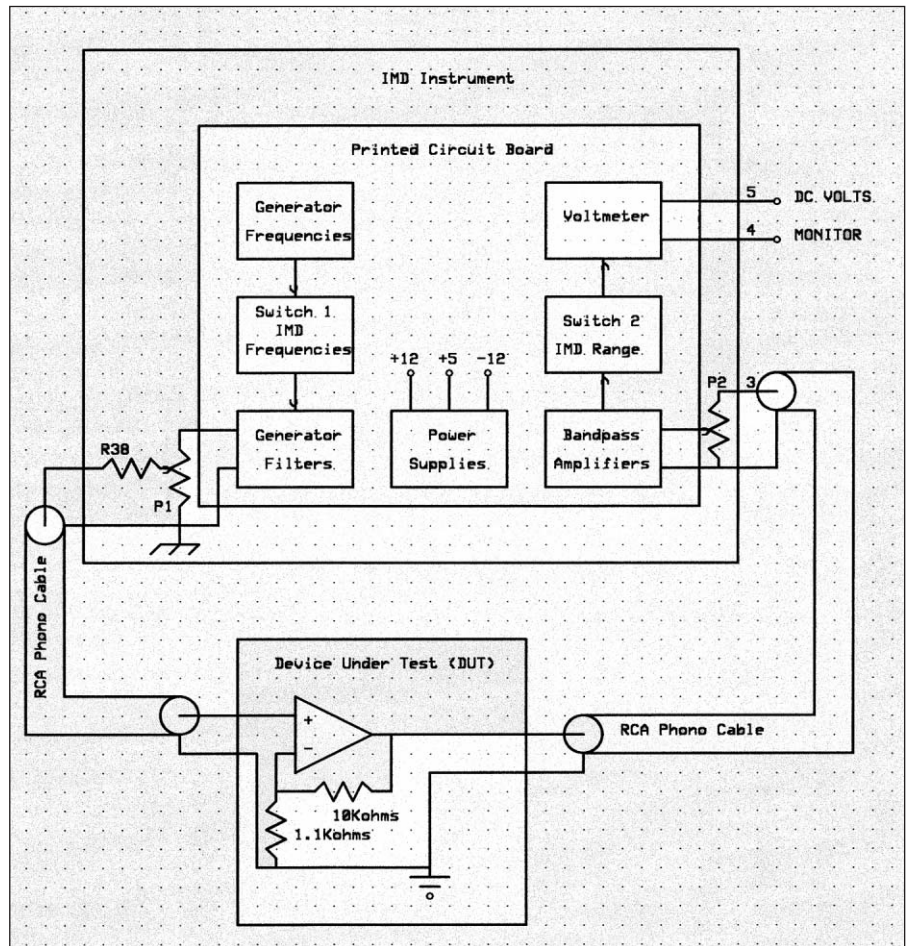

FIGURE 1: Block diagram of IMD instrument.

A-2178-1

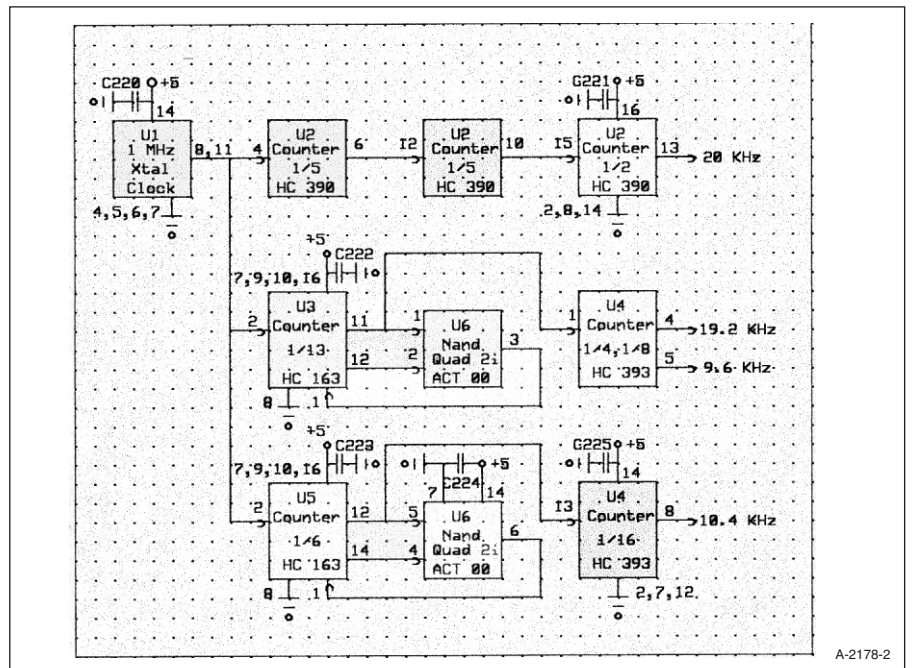
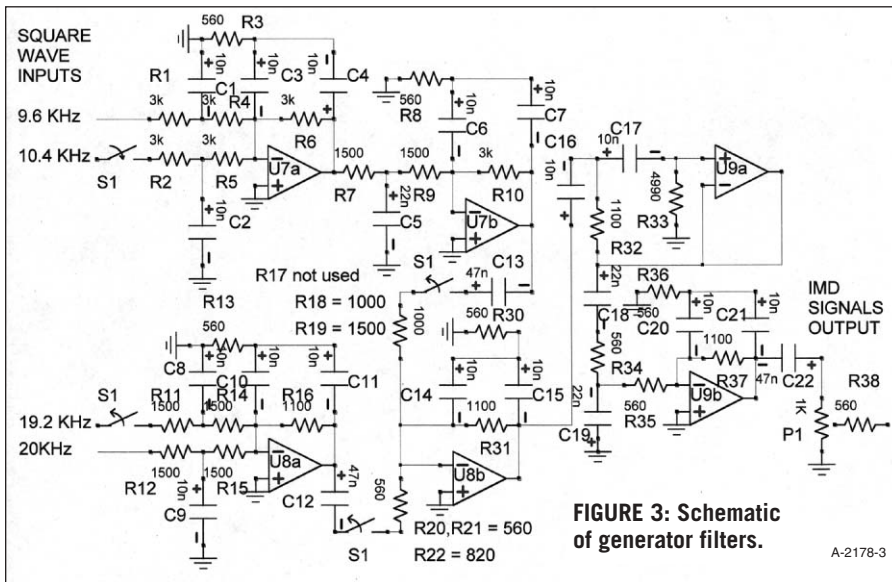

FIGURE 2: Schematic of frequencies generator.

A-2178-2



way on the schematic because of limitations of my schematic capture program. U8b also acts as a low-pass filter. U9a requires explanation. Both U7 and U8 can have two signals present, and they will generate some IMD at about 800Hz. I want the generator output signal to be unblemished by any IMD, else how can I distinguish IMD generated by the DUT from the IMD supplied by the generator?

U9a is a high-pass filter which attenuates the 800Hz IMD. C12, C13, and C22 also produce high-pass filters which further attenuate the 800Hz IMD. U9b is a low-pass filter which reduces the harmonic content of all signals in the output, and which supplies the output signal. P1 is the output level control. R38 is used to keep the output impedance near 600Ω, and to prevent long cables from causing problems with U9b. The output signal level is about 2V RMS, which gives peak-to-peak outputs of as much as 10V. I want to keep the output signal level as low as possible to reduce the IMD in the generator, but high enough to drive any audio gear.

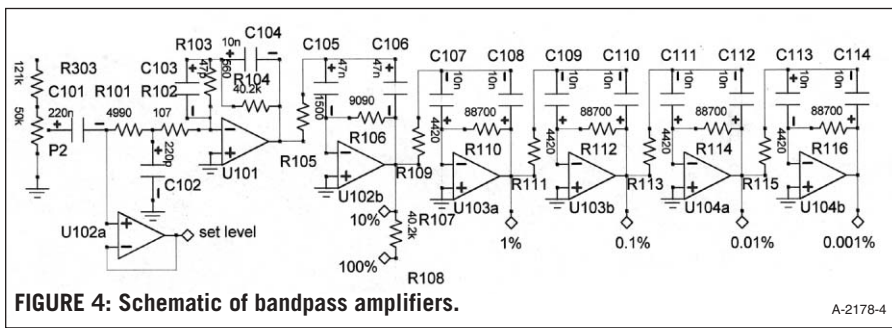

WELBORNE
Laboratories

DIRECT REACTANCE DRIVE

45, 2A3 and 300B Versions
SET Monoblock Design
Kit or Assembled
Prices Start at \$900

www.welbornelabs.com

DRD300B

DRD45

MEASUREMENT SECTION

The goals for the measurement section include a dynamic range from 0.75V RMS to 100V RMS, an IMD level of -130dB, and a signal-to-noise ratio of 130dB. Achieving this combination was the hardest part of this design. It would be even harder to achieve in a THD instrument, because the bandwidth is about 100 times larger than in this IMD instrument.

Figure 1 shows the input signal attenuator and level control. The range of input signal levels is handled by having two inputs—one for 0.75V to 30V and the second from 25V to 100V.

VOLTMETER

I need a voltmeter that will measure the IMD over a range from 100% to 0.0001%. I achieved this dynamic range by building an AC voltmeter which is accurate over a 20dB range (1V to 0.1V), and coupled this to an amplifier chain which has five stages with 20dB gain per stage. This lets me switch (with S2) the AC voltmeter to the desired gain stage, thus giving the desired IMD range. S2 selects between:

1. Set input level, wherein the input gain is adjusted to give 1V DC at the voltmeter. This measures all the signals in the audio bandwidth (no bandpass filtering). Set input level requires a nominal 0.75V RMS at the input of U102a.
2. 100% IMD, wherein the voltmeter

reads 1V DC for 100% IMD.

3. 10% IMD, wherein the voltmeter reads 1V DC for 10% IMD.
4. 1% IMD, wherein the all-knowing voltmeter reads 1V DC for 1% IMD.
5. 0.1% IMD, wherein the overworked voltmeter reads 1V DC for 0.1% IMD.
6. 0.01% IMD, wherein the astounding voltmeter reads 1V DC for 0.01% IMD.
7. 0.001% IMD, wherein the beleaguered voltmeter reads 1V DC for 0.001% IMD.

BANDPASS AMPLIFIERS

In order to measure the IMD I use a chain of 20dB amplifiers, but I need to filter out the signals above 800Hz. I do this by making the 20dB amplifiers into bandpass amplifiers which are tuned to 800Hz. This combination of five cascaded bandpass amplifiers results in an overall gain of 100dB, with a bandwidth of about 160Hz. This gives more than 130dB of attenuation at 9.615kHz.

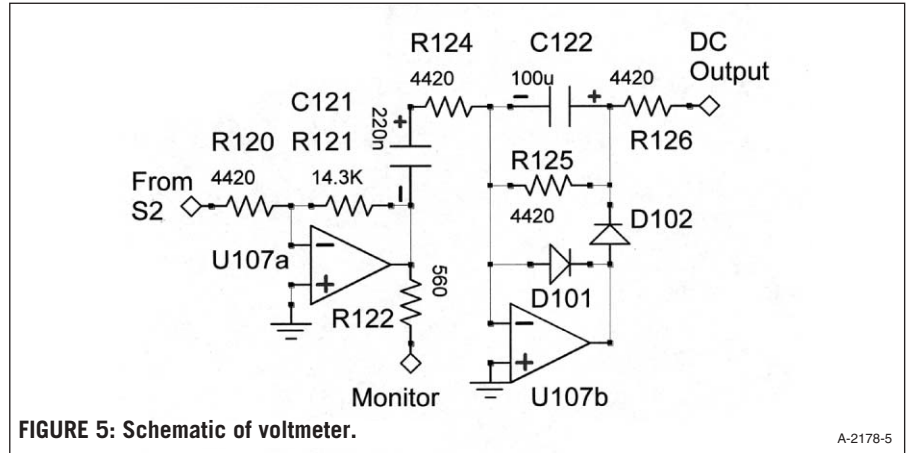

FIGURE 5: Schematic of voltmeter.

A-2178-5

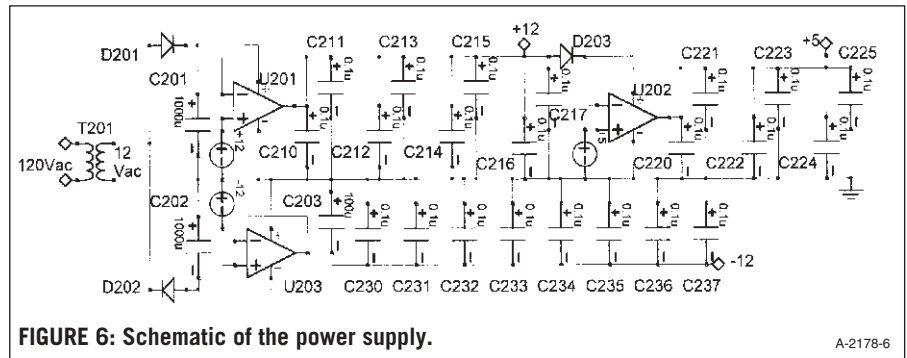

FIGURE 6: Schematic of the power supply.

A-2178-6

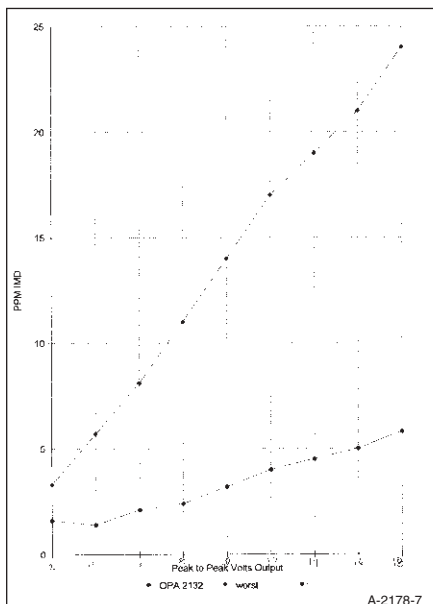

FIGURE 7: IMD of FET input op amps.

A-2178-7

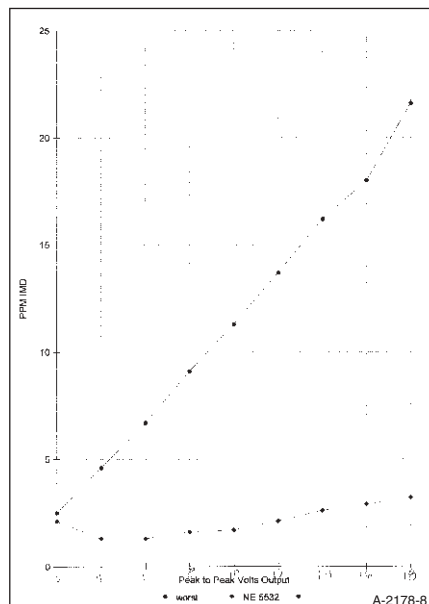

FIGURE 8: IMD of bipolar input op amps.

A-2178-8

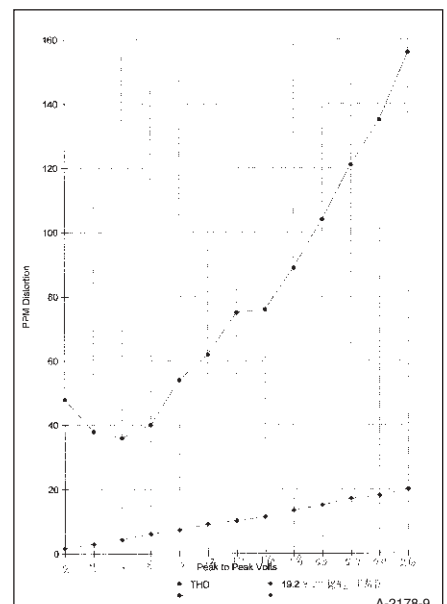

FIGURE 9: Comparison of THD and IMD.

A-2178-9

These bandpass amplifiers also reduce the 60Hz hum by more than 130dB. In order to reduce the noise to -130dB, I need an input noise level of less than 245nV. With a noise bandwidth of 160Hz, the noise referred to the input needs to be below about 19nV per square root Hz. This is achievable with low-noise devices.

The input amplifier (U101) of Fig. 4 has the hardest job. It is an inverting amplifier, because I found that this gives the lowest IMD. It uses a low-noise op amp (NJM 5534) to give the required signal to noise. To reduce the requirements on the succeeding stages, U101 has gain (about 12dB at 800Hz) and is a low-pass filter, reducing the signals at 9.615kHz

and above by more than 20dB (compared to the 800Hz).

U102b is a bandpass amplifier tuned to 800Hz, with about 8dB of gain at 800Hz. (U102b is similar in design to U103a described later). The combination of U101 and U102b gives a gain of 10 (20dB) at 800Hz, and thus the output of U102b represents 10% IMD. R107 at-

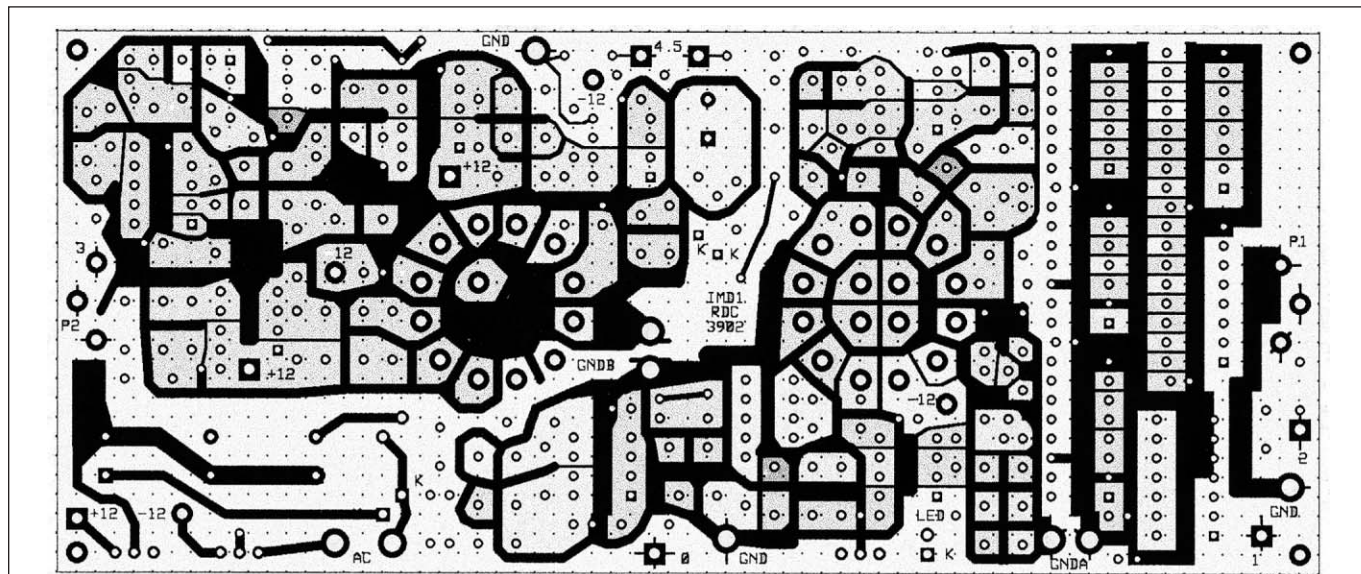

FIGURE 10: Component side of the printed circuit board.

A-2178-10

LC Audio Technology Inc



LClock XO3

The latest in Advanced Low Jitter Clock Technology!



Complete Reference Clock kit with all you need!

A Complete Precision Clock kit is now available for Audio Research CD2!

The kit is specially designed for AR CD2 and includes all you need:

Reference Clock (XO3 Ultra High Precision Clock)

Wire Harness specially adapted for CD2

Easy to follow Step by Step Mounting instructions, with photos how to update the CD2 player

to the highest sound quality, using modern Low Jitter Clock Technology. **It really Works!**

More Natural Sound - Better Placement in Soundstage - Improved Bass Distinction

Further Information: www.lcaudio.com

NOTE LC Audio Technology is an independent third party vendor, and has no associations with Audio Research

Price
Reference Clock kit for
Audio Research CD2
US\$ 399

USA: **DIYCABLE** ● 153 Mountain Home Road ● Port Angeles WA98362 ● Washington ● tel 360-452-9373 www.diycable.com

Australia: **Soundlabs Group Pty.** ● POBox 307 ● Surry Hills NSW 2010 ● tel 02 9660 1228 www.soundlabsgroup.com

Scandinavia: **LC Audio Technology Inc** ● Christiansgade 1 ● DK7500 Holstebro ● tel +45 97410863 www.lcaudio.com

TABLE 1
PARTS LIST

0–100 = generator; 100–200 = measurement; 200–300 = power supply; 300–400 = panel

CAPACITORS

| | | | |
|---|---------------------------------|--|---------|
| C1–C4, C6–C11, C14–C17, C20, C21, C104, C107–C114 | 10nF/100V/2% film capacitor | Mouser 140- PF2A103F | \$10.75 |
| C5, C18, C19 | 22nF/2% film capacitor | Mouser 140- PF2A223F | \$1.44 |
| C12, C13, C22, C105, C106 | 47nF/2% film capacitor | Mouser 140- PF2A473F | \$3.15 |
| C101, C121 | 220nF/5% | Mouser PF2A224J | \$0.68 |
| C102 | 220pF/10% NPO ceramic | Mouser 21RD622 | \$0.12 |
| C103 | 47pF/10% NPO ceramic | Mouser 21RD747 | \$0.10 |
| C122, C203 | 100µF/100V electrolytic, 105° C | Digi-key P10776-ND or Mouser 647- UPW2A101MHH | \$2.88 |
| C201, C202 | 1000µF/35V electrolytic, 105° C | Digi-key P10305-ND or Mouser 647- UPW1V102MHH | \$3.14 |
| C210–C217, C220–C225, C230–C237 | 0.1µF X7R ceramic | Mouser 21RX310 | \$4.18 |

CONNECTORS

| | | | |
|---------------------------------------|--|-------------------------|---------|
| RCA panel mount phono jack, insulated | | Parts Express 091- 1120 | \$15.90 |
|---------------------------------------|--|-------------------------|---------|

DIODES

| | | | |
|------------|-----------------------------|---------------------|--------|
| D101, D102 | 1N4148 small-signal silicon | Mouser 78-1N4148 | \$0.10 |
| D201, D202 | 1N4002 1A/100V rectifier | Mouser 583-1N4002 | \$0.06 |
| D203 | Green LED | Radio Shack 276-069 | \$2.29 |

ENCLOSURE

| | | | |
|----------------|-------------------|-------------------|---------|
| LM Crown Royal | 6"H × 8"W × 4.5"D | Mouser 537-CR-864 | \$22.48 |
|----------------|-------------------|-------------------|---------|

INTEGRATED CIRCUITS

| | | | |
|-------------------------|---------------------------|------------------------|--------|
| U1 | 1MHz clock | Mouser 73-X0 54B100 | \$2.24 |
| U2 | Dual divide by 10 74HC390 | Mouser 511- M74HC390 | \$0.58 |
| U3, U5 | Binary divider 74HC163 | Mouser 511- M74HC163 | \$1.04 |
| U4 | Dual divide by 16 74HC393 | Mouser 511- M74HC393 | \$0.58 |
| U6 | Quad NAND 74ACT00 | Mouser 511- 74ACT00B | \$0.34 |
| U7, U8, U102–U104, U107 | JRC5532 | Mouser 513- NJM5532D | \$3.30 |
| U9 | Burr-Brown OPA2132 | Digi-key OPA2132PA- ND | \$4.48 |
| U101 | JRC 5534 | Mouser 513-NJM 5534D | \$0.33 |
| U201 | +12 regulator 78F12 | Mouser 513-NJM 5534D | \$0.36 |
| U202 | +5V regulator 78F05 | Mouser 513- NJM7805FA | \$0.36 |
| U203 | –12 regulator 79F12 | Mouser 513- NJM7912FA | \$0.55 |

| | | | |
|----------------------------|--|----------------------|---------|
| Knobs | | Radio Shack 274- 402 | \$2.98 |
| PC (printed circuit) board | | | \$40.00 |

RESISTORS

ALL 1% METAL FILM, UNLESS NOTED

| | | | |
|--|----------------------------------|------------------|--------|
| R1, R2, R4, R5, R6, R10 | 3kΩ | Mouser 271-3.0K | \$0.54 |
| R3, R8, R13, R20, R21, R30, R34, R35, R36, R38, R302, R103, R122 | 560Ω | Mouser 271-560 | \$1.08 |
| R7, R9, R11, R12, R14, R15, R19, R105 | 1.5kΩ | Mouser 271-1.5K | \$0.63 |
| R16, R31, R32, R37 | 1.1kΩ | Mouser 271-1.1K | \$0.36 |
| R17 not used | | | |
| R18 | 1.0kΩ | Mouser 271-1.0K | \$0.09 |
| R22 | 820Ω | Mouser 271-820 | \$0.09 |
| R33, R101 | 4.99kΩ | Mouser 271-4.99K | \$0.18 |
| R102 | 107Ω | Mouser 271-107 | \$0.09 |
| R106 | 9.09kΩ | Mouser 271-9.09K | \$0.18 |
| R109, R111, R113, R115, R120, R124, R125 | 4.42kΩ | Mouser 271-4.42K | \$0.63 |
| R104, R107 | 40.2kΩ | Mouser 271-40.2K | \$0.18 |
| R110, R112, R114, R116 | 88.7kΩ | Mouser 271-88.7K | \$0.36 |
| R303 | 121kΩ | Mouser 271-121K | \$0.09 |
| R121 | 14.3kΩ | Mouser 271-14.3K | \$0.09 |
| P1 | Potentiometer, 1kΩ, audio taper | Mouser 31VJ301 | \$1.25 |
| P2 | Potentiometer, 50kΩ, audio taper | Mouser 31VJ405 | \$1.25 |

SWITCHES

| | | | |
|----|----------------------------------|-----------------|--------|
| S1 | 4-pole, 3-position, PC terminals | Mouser 105-2457 | \$2.57 |
| S2 | 1-pole, 7-position, PC terminals | Mouser 105-2454 | \$2.57 |

TRANSFORMER (AC

TO AC ADAPTER)

| | | | |
|------|-------------|-------------------|--------|
| T201 | 12V AC @ 1A | Mouser 412-212101 | \$5.49 |
|------|-------------|-------------------|--------|

Total: \$139.57

tenuates the output of U102b by a factor of ten, thus giving a signal which represents 100% IMD.

U103a is a bandpass amplifier with a gain of ten. It uses a bridged-T RC network with:

1. Gain = 1/2 (R110/R109)
2. Q = (1/2) [square root of (R110/R109)]
3. Fo (tuned frequency) = 1/[(2 pi){square root of (R110)(R109)(C107)(C108)}]

For R110 = 88.7kΩ, R109 = 4.42kΩ, C107 and C108 = 10nF, the gain is 10.0, the Q is 2.24, and the tuned frequency is about 804Hz. 0.75V RMS at the output of U103a represents 1% IMD. U103b, U104a, and U104b are all tuned amplifiers identical to U103a. Thus, 0.75V RMS at the output of U103b represents 0.1% IMD. Similarly, 0.75V at the output of U104a represents 0.01% IMD, and the output of U104b represents 0.001% IMD.

U102a is a voltage follower that monitors the voltage across the series combination of R101 and R102. This is a signal which is an attenuated version of the signal from the DUT. The output of U102a is used as the “Set Level” for S2. When S2 selects the “Set Level,” the SET LEVEL control is adjusted to give 1V DC output from the voltmeter. The gain of the voltmeter is designed to give 1V DC output for 0.75V RMS AC input.

The voltmeter (Fig. 5) is a conventional half-wave average responding detector (U107b). The time constant of the DC filter (R125 and C122) is about 0.4 second, which seems a little slow. The output is a DC voltage of 1V full scale. The voltmeter will have better accuracy if the input signal is large, so U107a is a buffer amplifier which boosts the nominal 0.75V RMS signal from S2 to 2.4V RMS. The buffer amplifier also supplies the monitor output, which has a source impedance of about 600Ω, and is intended for use with external high impedance instruments such as oscilloscopes or audio spectrum analyzers.

POWER SUPPLY

The power supply is simple (Fig. 6). It uses a 12V, 1A, AC to AC adapter. Half-wave diode rectifiers and 1000µF filter capacitors give about +18.2V and –18.6V of unregulated voltage. The 7812

voltage regulator (U201) provides +12V, the 7805 voltage regulator (U202) provides +5V, and the 7912 voltage regulator (U203) provides -12V. The positive supply has the most drain (of about 100mA), because this supplies the +5V for digital as well as the +12 analog. The voltage regulators without heatsinks are warm, not hot, to the touch.

An LED, to indicate that the instrument is on, is included in the power supply. You can put the LED on the PC board, or mount it on the front panel and wire it to the PC board. If you wire the LED backwards, it won't light, and the +5V regulator won't work. If you don't want an LED, put a jumper of bare wire into its wiring holes on the

PC board. My apologies if the drawings for the voltage regulators U201, U202, and U203 are not normal, but this is due to limitations of my schematic capture program.

ENCLOSURE

The printed circuit board is 2.8" high x 6.6" wide, and will fit in a 3" x 7" enclosure.

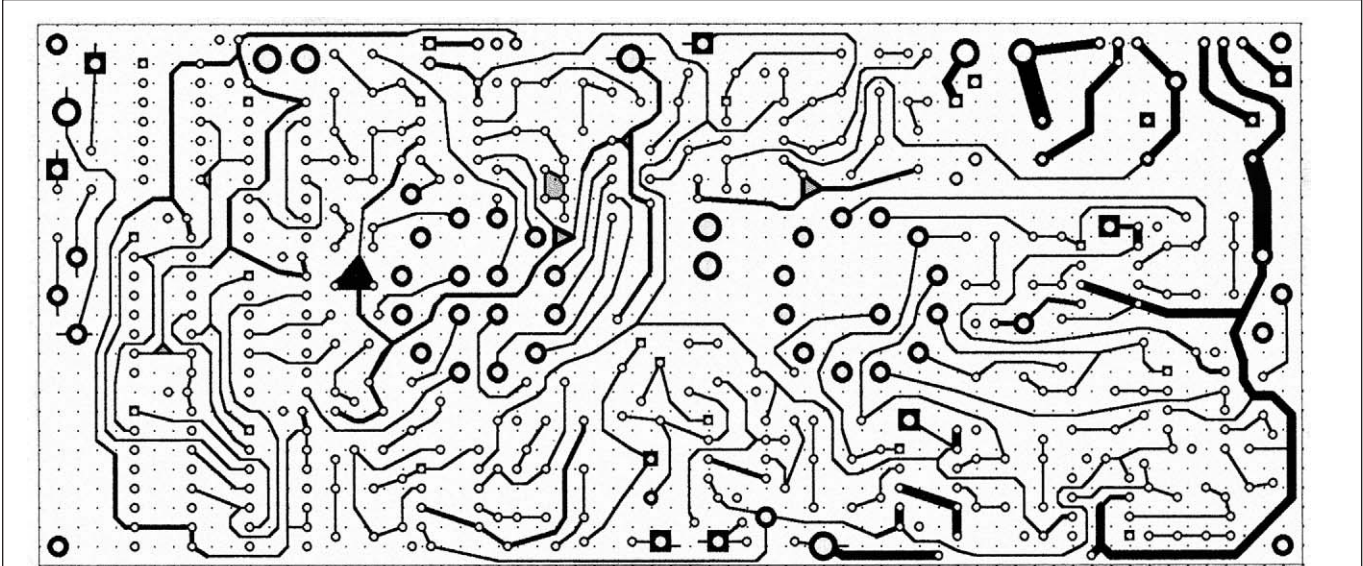

FIGURE 11: Circuit side of the printed circuit board.

A-2178-11

ABOUT ALPHA-CORE

Founded in 1982 as a manufacturer of magnetic cores for transformers and inductors. In 1993 branched into products minimizing distortion in fine audio systems.

In 1988 developed Laminax™, composites of foil conductors and dielectric film, used as winding conductors and for EMI/RF shielding.

In 1995 developed flat magnet wire, now used in motors and power supplies throughout the world.

Milestones in Audio

- 1993 GOERTZ™ speaker cables US Patent. 5,393,933
- 1995 Air-Core Foil Inductors for crossover circuits.
- 2001 Micro Purl & TQ2 interconnects. US Patent 6,225,563
- 2002 BP30, Symmetrical, Balanced power supply.

All products are created and manufactured at our facility in Bridgeport, Connecticut, USA.

www.alphacore.com



Alpha-Core, Inc. 915 Pembroke St., Bridgeport, CT 06608
 • 800-836-5920 • 203-335-6805 • Fax 203-384-8120



DRIVERS:

- ▶ ATC
- ▶ AUDAX
- ▶ ETON
- ▶ FOSTEX
- ▶ LPG
- ▶ MAX FIDELITY
- ▶ MOREL
- ▶ PEERLESS
- ▶ SCAN-SPEAK
- ▶ SEAS
- ▶ SILVER FLUTE
- ▶ VIFA
- ▶ VISATON
- ▶ VOLT

CUSTOM COMPUTER AIDED CROSSOVER AND CABINET DESIGN

SOLEN CAPACITORS AND INDUCTORS - USED BY THE MOST DISCRIMINATING LOUDSPEAKER MANUFACTURERS.

HARDWARE

HOW TO BOOKS

Contact us for the free
Solen CDRom Catalog.



SOLEN

4470 Avenue Thibault
St-Hubert, QC, J3Y 7T9
Canada

Tel: 450.656.2759
Fax: 450.443.4949
Email: solen@solen.ca
Web: www.solen.ca

sure. My prototype (*Fig. 7*) is built in a metal box of 6"H × 8"W × 4.5"D, because I wanted more room on the front panel for large knobs, which let you more easily adjust the output level and set level controls. I tried a plastic enclosure, but on my workbench this did not work well because the IMD instrument is sensitive to magnetic fields. I recommend a metal enclosure.

PERFORMANCE

There is a minimum noise of this IMD instrument, and in my unit this measures about 0.3ppm. This is slightly more than -130dB down, and corresponds to about 150nV referred to the input. This is less than 12nV per square root hertz, and is mostly due to R101, the 4.99kΩ input resistor.

The worst residual IMD occurs on the two-tone (19.2kHz and 20kHz) mode. I believe this is because these are the two highest frequencies, which tend to generate more IMD. This residual IMD measures about 0.3 ppm.

The combination of noise and residual IMD establishes a lower measurement limit, or "floor," of about 0.5ppm. This is low enough to reliably measure 1ppm (0.0001%) IMD.

SOME MEASUREMENTS

The process used in making an IMD measurement is to hook up the DUT as shown in *Fig. 1*. Set S1 to select the desired test frequencies. Adjust the output level of the IMD instrument (P1) to give the desired signal level from the DUT. If the DUT has its own gain control, you usually will get better results if you set the output level of the IMD instrument at maximum, and adjust the gain control of the DUT to give the desired signal level. You will need to measure the output signal level from the DUT using either an oscilloscope or an AC voltmeter.

Next, set the IMD range switch to the SET LEVEL position. Then adjust the SET LEVEL control (P2) to give 1V output at the DC voltmeter terminals and slowly rotate the IMD range switch clockwise through each successive IMD range until the DC voltmeter reads more than 0.1V. The IMD is the DC voltmeter reading in volts times the IMD range. For example, if the DC voltmeter reads 0.5V on the IMD range of 0.1%, then the

IMD is 0.05%.

In order to evaluate this IMD instrument, I used a test circuit (the DUT) shown in *Fig. 1*. This is a gain of ten stage, and I tested some good op amps. I used the non-inverting configuration because it typically has more distortion than the inverting version. The FET input op amps have a good reputation in audio circles, so I tested the LF412, the TL072, the OPA 2132, the OPA 2604, and the AD712.

Figure 7 shows the results for the best and worst op amps, but I identify only the best one—the OPA2132, which is expensive at about \$5 for a dual op amp. I use the OPA 2132 for U9, because this allowed me to achieve an output level of 2V RMS, whereas other op amps limited me to less than 1V RMS output.

Figure 8 shows the best and worst results for some bipolar input op amps. I tested the 5532 from three manufacturers, and the LT1124. The best bipolar op amp was the NE5532 from Signetics (now part of Philips). I found a four-to-one variation in IMD for 5532s from different manufacturers.

If you look at my parts list (*Table 1*), you will see that I use the NJM 5532D extensively, and it is not the best 5532! I designed the IMD instrument before I made these tests. The NJM 5532D is good enough for the IMD instrument. All of the 5532s are reasonably priced, some going for less than a dollar.

Figure 9 shows some comparisons between IMD measurements and THD measurements, at the same peak-to-peak voltages. I needed to use one of the worst bipolar op amps to get enough THD to make these comparisons. I used 20kHz as the frequency for the THD measurements. Notice that the THD measures about eight times larger than the IMD. This seems to be due to two causes:

1. The IMD is more sensitive than the THD by about a factor of 3.2¹.
2. The IMD frequency is about 800Hz, and this is 25 times smaller than the 20kHz used for the THD measurements. This means that there is about 25 times more negative feedback at 800Hz than at 20kHz, and this greater negative feedback reduces the IMD by about 25 times.

These two causes reduce the IMD by a factor of (25/3.2), or about eight. Still, the IMD instrument is more than ten times as sensitive as the THD instrument, because its IMD "floor" is much lower than that of the THD. The IMD instrument will be even more sensitive than that of the THD instrument if it is used on digital signal processors such as D to A converters, A to D converters, and so forth.

Figures 7, 8, and 9 show only the IMD measured using 19.2kHz and 20kHz. The IMD measured with other frequencies was much lower, and I left it off the graphs for reasons of simplicity.

The test circuit IMD results are in the 1.4ppm to 24ppm range. This is more than the IMD of the IMD tester, and a natural question is why? The reason is that I use lower distortion circuit design for the input stages of the IMD instrument, and the 800Hz tuned amplifiers in the IMD instrument reduce the higher frequency test signals (above 9.6kHz) in the following stages, thus reducing their IMD.

Still, 24ppm IMD is very good, and is beyond the limit of some expensive THD instruments. Why are these op amps so good? One answer is that I measured only op amps that have a good reputation. Another answer is the IMD frequency is near 800Hz, and all of these op amps have lots of negative feedback at this frequency, thus lowering the IMD. An IMD instrument with a larger difference frequency (e.g., 12kHz - 8kHz = 4kHz³) would be more sensitive at detecting IMD, but this is a more expensive IMD instrument.

If you look closely, you will notice that some of the op amps measure more IMD (2ppm) at 1V output than at 2V output (1.4ppm). Is this true? No. The problem is noise. 2ppm at 1V output is 2µV. If the DUT produces 2µV of noise in the 160Hz bandwidth of the IMD instrument, then it will seem to be 2ppm IMD. Some op amps with a gain of ten produce this much noise.

Another question is "Could I hear the difference between these op amps?" The answer is "not likely." 24ppm is the worst IMD I measured, and this is 0.0024% IMD. The most acute listener might discern IMD of about 100 times worse.

The final question is "Then why bother?" and the answer is that high fidelity

is a search for unquestionable reproduction, and the IMD instrument is a tool to help in that search. Besides that, I deliberately chose good op amps to measure, and other devices, such as switching power amplifiers, or A to D

converters, or D to A converters, or any means of digital processing or recording, might be much worse. Don't get me wrong, I like digital processing; it's just that I need to know what it is doing to my audio signals.

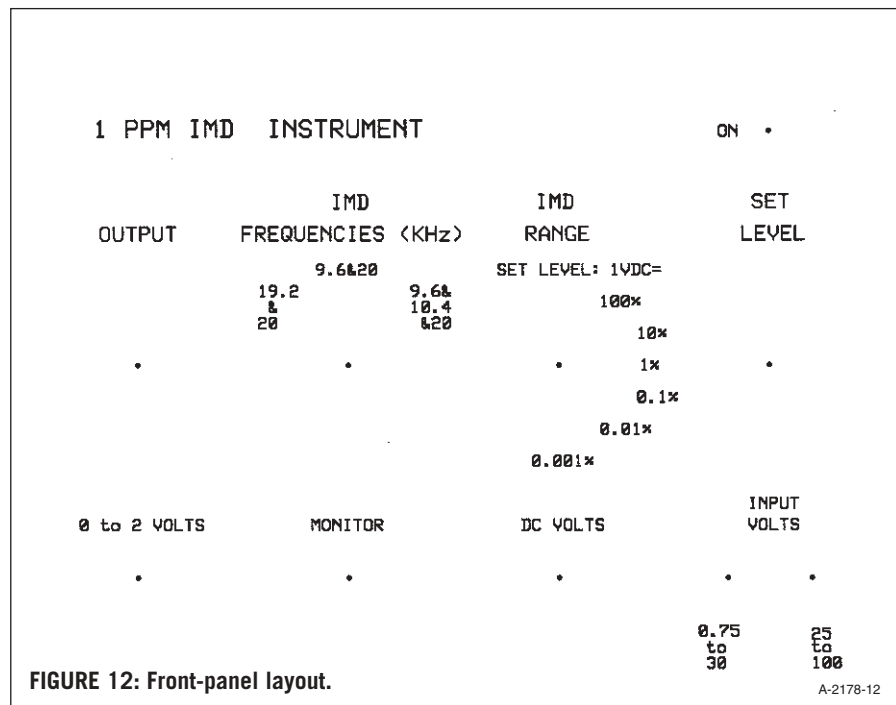

Supplier Of High Quality Speaker Kits & Components For The Audio Enthusiast

Supplier of high quality speaker kits and components for the audio enthusiast. The advertisement features a central list of brands: Eminence, vifa, scan-speak, Cabasse, B&C SPEAKERS, ACCUTON, Versa-Tronics, VERA-TRONICS INC., LEAP, AEON, FOCAL, RAVEN, and Pioneer. At the bottom, it includes the company name 'SPEAKER CITY U.S.A.', contact information (115 S. Victory Blvd., Burbank, CA 91502, Vox 818-846-9921, Fax 818-846-1009, www.speakercity.com), and ordering details (Orders Only! 800-595-9924, Mon-Sat 10am-6pm). A logo for 'SELENIUM LOUDSPEAKERS' is also present.

SELENIUM LOUDSPEAKERS

115 S. Victory Blvd.
Burbank, CA 91502
Vox 818-846-9921
Fax 818-846-1009
www.speakercity.com

Orders Only! 800-595-9924
Mon-Sat 10am-6pm

SPEAKER CITY U.S.A.

CONSTRUCTION

The IMD instrument, designed for the hobbyist, uses a single printed circuit board, with no adjustments. In order to eliminate adjustments I needed to use components of high accuracy. I kept the design as simple as I could, but the active filters and tuned amplifiers of the IMD instrument require a lot of parts. There are some jumpers on the PC board, and there is some front panel wiring. *Photo 1* shows the front panel.

I do not recommend this as a first project, because of the complexity, but I do believe that the amateur who has built a couple of other projects will be able to successfully build this one. *Photo 2* shows the interior of the prototype, giving you an idea of the wiring complexity. *Figures 10* and *11* show the

component side and circuit side of the printed circuit (PC) board.

The construction should start with the front panel. I show a recommended layout in *Fig. 12*. The switches (S1 and S2) solder directly to the printed circuit board, and thus their mounting holes ($\frac{3}{8}$ " diameter) need to be $2\frac{1}{2}$ " apart. You don't need the anti-rotation tabs for S1 or S2.

The pots (P1 and P2) can be 6" apart ($\frac{3}{8}$ " diameter holes) and in line with the switches. This makes the connections from the pots to the PC board straight pieces of wire. This is easy and avoids confusion. I recommend anti-rotation holes for the pots.

I use insulated RCA phono jacks (five in all) for the inputs and outputs. The chassis is grounded to the front panel at the output phono jack. In my prototype this gave the lowest hum due to ground loops, which can be a problem, as in some measurements I have detected hum components at the 11th, 13th, and 15th harmonics of 60Hz (660, 780, and 900Hz).

There is no connector for the 12V AC input, simply a hole in the cabinet to allow the 12V AC wires from the AC adapter to enter the enclosure. *Figure 13* shows the component loading diagram.

PARTS LIST

Table 1 shows the parts list. The total cost of the parts is less than \$150, not including the DMM. The Radio Shack model 22-809 DMM costs about \$40 and seems more than adequate. What is needed here are at least three digits at 1V DC. For less than \$200 you can build an IMD instrument of top-notch performance.

CONCLUSION

Years ago I had a Heathkit IMD instrument, and I miss it. This IMD instrument is many times better than that Heathkit at measuring the performance of electronic gear. The measurements that I've made show that modern op amps have much lower IMD than you are ever apt to hear. That's the way it should be. If you want to build amplifiers or preamps, this IMD instrument will tell you whether they have the low distortion you want. ❖

REFERENCES

I particularly recommend the reference by R.H. Small, which I didn't find until my design was completed.

1. W. J. Warren and W. R. Hewlett, "An Analysis of the Intermodulation Method of Distortion Measurement," Proc. of the IRE, April 1948.
2. Charles Hansen, "Product Review: EarMax Pro Tube Headphone Amplifier," *audioXpress*, Sept. '02, p. 53.
3. R. H. Small, "Total Difference-Frequency Distortion: Practical Measurements" J. Audio Eng. Soc., June 1986.
4. J. Borwick (et al.), *Loudspeaker and Headphone Handbook*, 2nd ed., ISBN 0 240 51371 1, pp. 459-461.

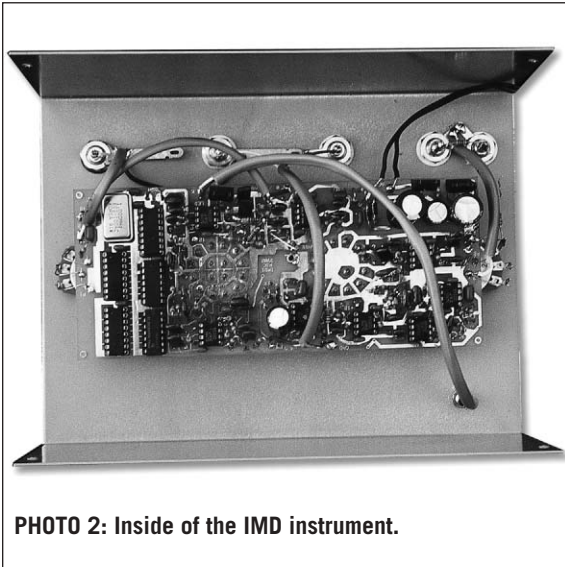

PHOTO 2: Inside of the IMD instrument.

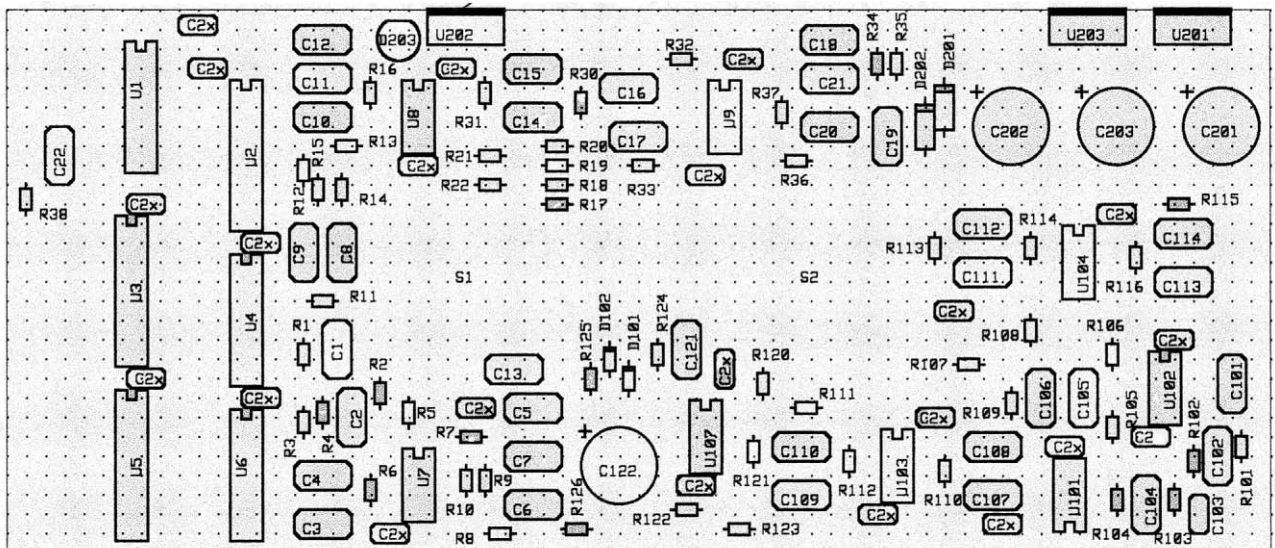

FIGURE 13: Loading diagram of the printed circuit board.

A-2178-13

Peter Walker
from page 6

Peter developed a number of fascinating tests to support his thesis, one of which consisted of passing a signal—any signal, pure tones as well as complex programs—through one of his power amplifiers, and, after attenuation, into a simple difference amplifier. He fed the original signal into the other input via some passive reactive networks to simulate what happened in any amplifier, such as minute phase shifts. When summed and at the same level, cancellation would occur if identical and without any added artifacts. He could always demonstrate that the result was, inevitably, just noise!

HONORS

Peter was responsible for the succinct description of the ideal amplifier as “A Straight Wire with Gain.” It was towards the end of his highly creative career that his work began to be appreciated. The AES finally recognized this with an award after a short, and I suggest slightly tarnished, episode in which that august body had some misgivings, since its rules required a recipient to have a degree. Redemption came when he was appointed a Fellow in 1980 and given the Society’s Silver medal in 1989. No such problems attended the award of an OBE and the Queen’s Award for Industry to the Quad Company.

It was while I was part-time teaching at the University of Keele that I discovered my colleagues in the Electronics and Music departments shared my admiration for this remarkable man, so nomination for an honorary doctorate presented no problem. The then Chancellor, Sir Claus Moser, himself a music lover and owner of a complete Quad system, made Peter’s award.

Peter was a family man, with two children, and his son Ross succeeded him as CEO of the company after Peter’s retirement. Through the difficult days of a small company striving to make a name, his wife Peggy was loyally supportive. She died a few years ago from cancer, but Peter subsequently remarried a former school friend. Sadly, fate can be quite vindictive at times and he found himself bereaved once more

after a distressingly short time.

Peter’s final years were marred by serious ill health, the consequences of a progressive lung disease, and he became dependent upon others for care until the end. The family no longer owns his company, and the jury is still out on whether the new owners will maintain the high standards on which he insisted. Sadly, the world of commercial hi-fi is now highly competitive and the label is slapped on almost anything that makes a noise. For example, I can well imagine his robust reaction to the suggestion that connecting cables have a characteristic.

So, as to the future, I would like to be more optimistic, but it is difficult. With recent publication of a book about the company, *Quad—The Closest Approach* (Available from Old Colony Sound Lab, PO Box 876, Peterborough, NH, 03458-0876, 603-924-9464, sales@audioXpress.com, #BKIA1), there is some encouraging evidence that a genuine attempt is being made to maintain the prestige Peter Walker enjoyed in his lifetime, accompanied by a rightful tribute to his exceptional legacy. ❖



SUNRISE
Faithful Connection
Sunrise Transformers
www.us2sunrise.com

Sunrise E.&E., Inc.
tel:909-598-9136 FAX:909-468-0307

**Precision Acoustic Measurements
Require Precision Microphones**



PS9200KIT™ \$1650 USD

A complete IEC and ANSI traceable Type 1 Measurement Microphone System 2 Hz to 40 kHz, 15 dBA to 160 dB SPL
*1/2 inch capsule *4012 Preamp *PS9200 2 Channel PS
*AC adaptor *WS1 windscreen *SC1 die cut storage case.
Options: 511E Calibrator; 1 & 1/4 inch mics; and Gain for DRA’s MLSSA and other board level products.

ACO Pacific, Inc.
2604 Read Ave. Belmont, CA 94002 USA
Tel: (650) 595-8588 FAX: (650) 591-2891
e-mail acopac@acopacific.com

ACOustics Begins With ACO™



An 8W 2E24 SE Amp

This author makes good use of 2E24 tubes to produce a single-ended amp with plenty of power. **By Don Kang**

Since the return of the vacuum tube amplifier to the high-end audio scene, I have wanted to build a WE300B SE amp. However, the price tag of the WE300B turned me off. When I found a dozen 2E24 tubes at a local ham swap for \$1 each, my desire to build the SE amp re-ignited. The 2E24 is a filament version of the popular 6146, but one size smaller.

According to the GE data book, the 2E24, as a beam tube, delivers 3.9W of power. By doubling two, the output power becomes 7.8W, which is about at the WE300B power level.

IDEAL AMPLIFIER

My ideal amplifier has the following requirements:

1. A directly heated triode for the final power amplifier tube
2. Single-ended configuration
3. No capacitors in the grid signal paths
4. No overall (global) negative feedback
5. Only one stage triode voltage amplifier

This amplifier consists of two tubes: one resistor and one transformer (Fig. 1).

2E24 POWER AMPLIFIER STAGE

Before I started this amplifier design, I wanted to know how other people were using the 2E24 tube for audio applications. Based on my limited search, I found nothing. I used a Tektronik 577 curve tracer to obtain the plate charac-

teristics of the 2E24 in triode mode connecting the screen grid to the plate. For a power tube requiring a higher grid voltage, you need an external voltage source.

Because of the anticipated paralleling operation, I manually plotted all 12 tube

plate V/I curves on a 0.1" grid paper (Tops #35101). There was some spread in the V/I curves, but I found no problem in pairing them up because I had so many. I checked the screen grid current with a low resistance resistor, which is placed in series with the screen grid. The power loss was acceptable.

You can graphically estimate the power output on the V/I curve plot by selecting a load line and control grid swing along the load line. The 2E24 has maximum plate power dissipation of



PHOTO 1: The completed unit.

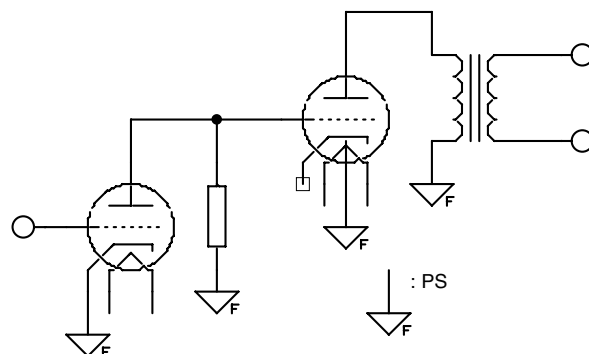

FIGURE 1: My ideal amp.

G-1573-1

ABOUT THE AUTHOR

Don Kang is an electronic engineer specializing in silicon chip making. He enjoys various DIY projects. Currently he is busy with submarine torpedo power systems for USN. He has a Ph.D from the Ohio State University and is a lifetime member of the IEEE.

Look!!

Click <http://www.eifl.co.jp>
or send e-mail to info@eifl.co.jp
for more products information

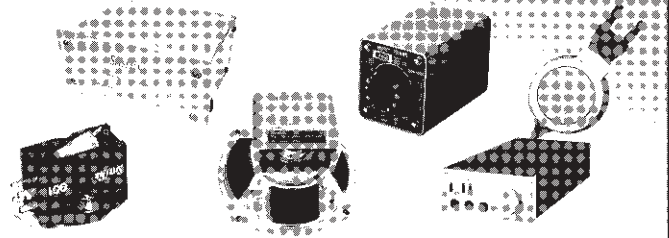

Cartridge

| Model | Price (US\$) | Postage (Air Economy) |
|--|--------------|---|
| Denon DL-102 (MONO) | 150 | Area I China, Korea \$ 18 Hong Kong Taiwan |
| Denon DL-103 (STEREO) | 200 | |
| Denon DL-103R (STEREO) | 250 | Area II Singapore \$ 22 Malaysia Indonesia |
| Denon DL-103 PRO (STEREO) | 350 | |
| Shelter Model 501 II (CROWN JEWEL REFERENCE) | 750 | Area III North America \$ 27 Oceania Europe |
| Shelter Model 901 (CROWN JEWEL SE) | 1,400 | |

These Area I ~ IV are for all products except book.

Japanese Audio Book

Postage \$ 15

| Title | Price (US \$) |
|--|---------------|
| Attractive Tube Amps Vol. 1&2 (Isamu Asano) | 30 each |
| The Joy of Vintage Tube Amps 1&2 (Tadaatsu Atarashi) | 30 each NEW |
| Direct & Indirect Tube Amps (Kiyokazu Matsunami) | 40 NEW |
| SE Amps by Transmitting Tubes (Kouichi Shishido) | 50 |
| The Remembrance of Sound Post (Susumu Sakuma) | 30 |
| Classic Valve (Hisashi Ohtsuka) | 40 |
| MJ Selected 300B Amps (MJ) | 30 |
| Top-Sounding Vintage Power Tubes (Stereo Sound) | 30 |
| Output Trans of The World (Stereo Sound) | 30 |
| 20TH CENTURY OF AUDIO (Stereo Sound) | 30 |
| Vintage Speaker Units (Stereo Sound) | 30 NEW |
| Tube Amp Craft Guide (MJ) | 30 |

MC STEP UP TRANS

| Model | Specifications | | | Price (US\$) | Postage** |
|-------------------|----------------|---------------|------------|--------------|--|
| | Pri. Imp (Ω) | Sec. Imp (kΩ) | Response | | |
| Shelter Model 411 | 3~15 | 47 | 20Hz~50kHz | 980 | Area I \$ 25 Area II \$ 30 Area III \$ 40 Area IV \$ 50 |
| Jensen JE-34K-DX | 3 | 47 | 20Hz~20kHz | 550 | |
| Peerless 4722 | 38 | 50 | 20Hz~20kHz | 300 | |

STAX

| Model | Price (US\$) |
|-------------------------------------|--------------|
| OMEGA II System (SR-007 + SRM-007t) | Ask |
| SRS-5050 System W MK II | |
| SRS-4040 Signature System II | |
| SRS-3030 Classic System II | |
| SRS-2020 Basic System II | |
| SR-001 MK2 (S-001 MK II + SRM-001) | |

Speaker

| Model | Specifications | | | | Price* (US\$) | Postage** (US\$) | | | | |
|----------------|----------------|---|------------|------|---------------|------------------|----|----|-----|-----|
| | D (cm) | Ω | Response | db | | w | I | II | III | IV |
| Fostex FE208 Σ | 20 | 8 | 45Hz~20kHz | 96.5 | 100 | 296 | 62 | 74 | 120 | 156 |
| Fostex FE168 Σ | 16 | 8 | 60Hz~20kHz | 94 | 80 | 236 | 42 | 50 | 73 | 98 |

*Price is for a pair ** Air Economy

TANGO TRANS (ISO) (40 models are available now)

| Model | Specifications | | | | Price (US\$) | Postage** (US\$) | | | |
|----------------------------------|----------------|----------------|---------------|-----------------|--------------|------------------|-----|-----|-----|
| | W | Pri. Imp (kΩ) | Freq Response | Application | | I | II | III | IV |
| XE-20S (SE OPT) | 20 | 2.5, 3.5, 5 | 20Hz~90kHz | 300B,50,2A3 | 396 | 47 | 56 | 84 | 113 |
| U-808 (SE OPT) | 25 | 2, 2.5, 3.5, 5 | 20Hz~65kHz | 6L6,50,2A3 | 242 | 42 | 50 | 73 | 98 |
| XE-60-5 (PP OPT) | 60 | 5 | 4Hz~80kHz | 300B,KT-88,EL34 | 620 | 62 | 74 | 115 | 156 |
| FX-40-5 (PP OPT) | 40 | 5 | 4Hz~80kHz | 2A3,EL34,6L6 | 320 | 47 | 56 | 84 | 113 |
| FC-30-3.5S (SE OPT) [XE-60-3.5S] | 30 | 3.5 | 20Hz~100kHz | 300B,50,PX-25 | 620 | 62 | 74 | 115 | 156 |
| FC-30-10S (SE OPT) [XE-60-10SNF] | 30 | 10 | 30Hz~50kHz | 211,845 | 620 | 62 | 74 | 115 | 156 |
| X-10SF [X-10S] | 40 | 10W/SG Tap | 20Hz~55kHz | 211,845 | 1160 | 90 | 110 | 180 | 251 |
| NC-14 (Interstage) | — | [1+1 : 1+1] 5 | 25Hz~40kHz | [30mA] 6V6 (T) | 264 | 30 | 40 | 50 | 70 |
| NC-16 (Interstage) | — | [1+1 : 2+2] 7 | 25Hz~20kHz | [15mA] 6SN7 | 264 | 30 | 40 | 50 | 70 |
| NC-20F (NC-20) (Interstage) | — | [1 : 1] 5 | 18Hz~80kHz | [30mA] 6V6 (T) | 640 | 42 | 50 | 73 | 98 |
| NP-126 (Pre Out) | — | 20,10 | 20Hz~30kHz | [10mA] 6SN7 | 264 | 30 | 40 | 50 | 70 |

** Air Economy

TAMURA TRANS (All models are available)

| Model | W | Pri. Imp | Freq Response | Application | Price | I | II | III | IV |
|--------------------|----|----------|---------------|-------------|-------|----|----|-----|-----|
| F-7002 (Permalloy) | 10 | 3.5 | 15Hz~50kHz | 300B,50 | 836 | 60 | 70 | 110 | 145 |
| F-7003 (Permalloy) | 10 | 5 | 15Hz~50kHz | 300B,50 | 836 | 60 | 70 | 110 | 145 |
| F-2013 | 40 | 10 | 20Hz~50kHz | 211,242 | 786 | 70 | 84 | 133 | 181 |
| F-5002 (Amorphous) | 8 | 3 | 10Hz~100kHz | 300B,2A3 | 1276 | 65 | 80 | 120 | 160 |

** Air Economy

10W and maximum plate voltage of 250V. First, I entered these two quantities on the V/I curve plot (Fig. 2). The point "S" satisfies both requirements. I drew a tangential line at "S." This is a load line and "S" is an operating point. For a normal operation, the control grid swings to the positive direction from -22V to 0V and swings to the negative direction with the same amount from -22V to -44V.

The grid swing on the load line forms a side of the shaded triangle (abc). The area of this triangle (abc) represents the power output. The load line meets X-axis at 510V and Y-axis at 78mA. The load impedance is $510V/78mA = 6.53k\Omega$.

At the operating point "S," $V_p = 250V$, $I_p = 40mA$, and $V_g = -22V$. The vertical distance <ac> represents current swing Δi , and the horizontal distance <cb> represents voltage swing Δv .

The formula for the power output P_{out} is:

$$P_{out} = \Delta i \times \Delta v / 8 = (390 - 108) V \times (61 - 18) mA / 8 = 1.51W$$

This is too low. Readjustment of load line did not increase P_{out} much. To make this triangle much larger, it should expand in all directions. Since I do not have any other application for 2E24s, I decided to explore the 2E24 further.

CLASS A2 OPERATION

For a normal Class A1 amplifier, the control grid stays in the negative potential at all times. There are some transmitting tubes operating in the positive potential with respect to the cathode. This kind of operation is classified as Class A2. In order to find the possibility of A2 operation, I plotted the plate V/I curve with the control grid voltage of +5V and +10V.

Knowing the P_d max. of 10W, I was very careful not to exceed this limit. I lowered the plate voltage of the 577 curve tracer whenever possible during the Class A2 investigation. Fatal mistake! I lost two 2E24s. The control grid was shorted to the filament. An autopsy revealed that a molten metal ball was touching the filament.

When the control grid is in the positive potential, the grid and the plate are



PHOTO 2: Inside the amp.

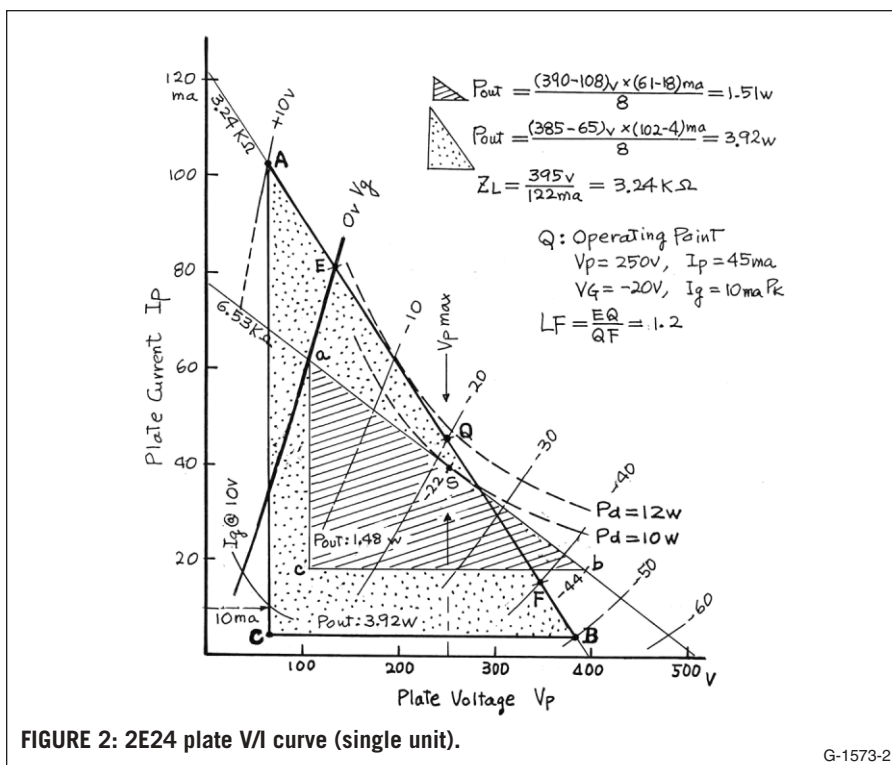

FIGURE 2: 2E24 plate V/I curve (single unit).

G-1573-2

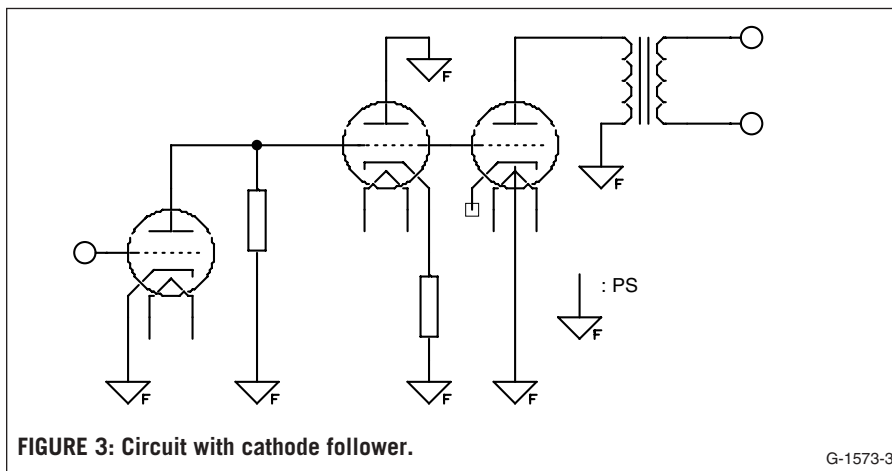

FIGURE 3: Circuit with cathode follower.

G-1573-3

competing to attract electrons. As the plate voltage goes low, the grid absorbs more electrons. For a given positive grid voltage, as the plate voltage decreases, the electron current to the grid increases very rapidly. The energy dumped by the electrons melted the grid wire. The molten liquid of grid wire formed a round ball due to the surface tension. This liquid ball was big enough to bridge the distance between the grid and filament.

To get more power output, the plate dissipation is relaxed to 12W and Class A2 operation is permitted with the following conditions. With non-continuous base, the control grid can take as high as +10V and 10mA. In order to ensure the 10mA limits, the plate voltage should be kept no lower than 65V at all times.

With this new guideline, you obtain a larger dotted triangle (ABC) in Fig. 2. The point "A" is automatically set by +10V of control grid and 65V minimum of plate voltage. The highest impedance load line is from "A" to the Pd = 12W line. Unlike the shaded triangle (abc), the operating point Q is not on the 12W line but on the load line at 250V.

At this operating point, $V_p = 250V$, $I_p = 45mA$, and $V_g = -20V$. The grid swings from -20V to +10V to the positive direction and from -20V to -50V to the negative direction. The total swing is 60V. The load impedance is $395V/122mA = 3.24k\Omega$. The position "A" is 65V, 102mA, and the position "B" is 385V, 4mA.

$$P_{out} = (385-65) V \times (102-4) mA/8 = 3.92W$$

When two 2E24s are paralleled, the load impedance becomes $1.62k\Omega$ and the output power doubles to 7.84W.

LINEARITY FACTOR

The grid voltage line intersects the load line on the plate V/I curve. The distance between the intersecting points is not equal. Near the operating point, the changes are uniform and the distance becomes progressively smaller toward the X-axis.

Taking the well-behaved middle part near the operating point, the "Linearity Factor" (LF) will be introduced. In this case, the region to be used is from $V_g =$

0 to $V_g = -40$; that is a 20V range on both sides of the operating point Q.

$$LF = \text{distance } \langle EQ \rangle / \text{distance } \langle QF \rangle = 1.2$$

This means the positive half of the signal is amplified 20% more than the negative half. This unbalance can be cancelled out if the voltage amplifier does the opposite. As a matter of fact, the following voltage amplifier will do just that.

Summary of the 2E24 Power Amp Design:

Operating Point Q: $V_p = 250V$, $I_p = 45mA \times 2$, $V_g = -20V$

V_g swing: +10V to -50V, total 60V (peak-to-peak)

I_g : $10mA \times 2$ at the positive peak

$$P_{out} = 3.92 \times 2 = 7.84W$$

LF = 1.2 ($\times 2$ means two tubes)

VOLTAGE AMPLIFIER

A nominal input signal of 0.5-1.0V RMS should produce a 60V PP output. Taking the midpoint figure of 0.75V, the gain required is $60V/0.75V \times 2 \times 1.4 = 60V/2.1V = 28$. Many small signal triodes are capable of giving a gain of 28,

Do you suffer from Audiophilia Nervosa?



Audio Asylum - an institution for the care of audiophools.

Audio Asylum is a free and independent resource staffed by a small, volunteer group of audio lunatics. Our mission is to create a unique community for stimulating discussion and helpful interchange without the flame wars and slow load times often found at other sites.

Here's what inmates have to say:

"This is what the Asylum actually is: USEFUL."

"... the Asylum has taken me to a higher level of knowledge than I ever could have acquired on my own."

"I have saved hundreds...maybe thousands of dollars on equipment through the good advice received here. And not a banner ad in sight!"

"...the best return on your audio dollar will be the Asylum!"

Get committed today.



AudioAsylum.com

but none of them can supply 20mA of current at the positive peak. They are operating with a few milliamperes or less of plate current.

A very low output impedance device with 20mA of driving capability should be inserted between the voltage amp and the 2E24. A cathode follower is an impedance transformer ideally suited for this application. Because of the finite value of the output impedance, though it is very low, there is a voltage drop equal to the product of output impedance and the driving current. The voltage drop I can tolerate is 0.5V. At 20mA, the maximum impedance is $0.5V/20mA = 25\Omega$.

The output impedance of a cathode follower is given by the formula

$$Z_{out} = rp / (\mu + 1). \text{ For a large } \mu, \text{ it becomes}$$

$$Z_{out} = rp / \mu = 1/gm = 25\Omega$$

$$gm = 40,000\mu S$$

where rp is plate resistance, μ is voltage gain, and gm is transconductance. Any triode tube with transconductance of $40,000\mu S$ or more can satisfy the driving condition.

Going through the tube data book for higher gm , I chose the 5842 and 6KN8 (or 4KN8). When the two sections of the 4KN8 triode are paralleled, the gm value doubles to $32,000\mu S$, which is higher than the $24,000\mu S$ of 5842. The gm value is not quite 40,000. The voltage drop is $20mA \times 1/32,000\mu S = 20mA \times 31\Omega = 620mV$, which is acceptable.

The circuit with cathode follower is shown in Fig. 3. The 4KN8 has a μ of 45, which is also adequate for the voltage amplifier. Figure 4 is a plate V/I curve for the 4KN8. As discussed at the 2E24 design, the nonlinearity introduced by the 2E24 can be cancelled out at least near the operating point because the polarity of the signal is reversed from the voltage amp to the 2E24 power amp. The cathode follower does not reverse the polarity, and the linearity factor is considered very close to unity. Thus, all the compensation is taking place at the voltage amplifier stage. If you have a two-stage amplifier, you must come up with a combined linearity factor to match that of the power amplifier.

After a few trial load lines, I selected a $46k\Omega$ load with 170V plate voltage.

This selection met LF of 1.2. The operating point was $Vg = -1.5V$, $Vp = 70V$ and $Ip = 2.2mA$. I chose the 1.5V because of the possibility of using a battery.

CATHODE FOLLOWER

Unlike the voltage amplifier, the cathode follower handles a peak current of 20mA on top of its normal current. The plate V/I curve in Fig. 5 shows the 4KN8 cathode follower operating in higher

current with both triodes in parallel. I chose the cathode resistor of $7.5k\Omega$ and 170V of plate voltage, which gave a good compromise between power dissipation and high current operation.

A cathode follower is an amplifier with the load connected at the wrong side of the power supply. The V/I curve still works with this connection. The amplified signal appears at the cathode side and becomes a part of the input in

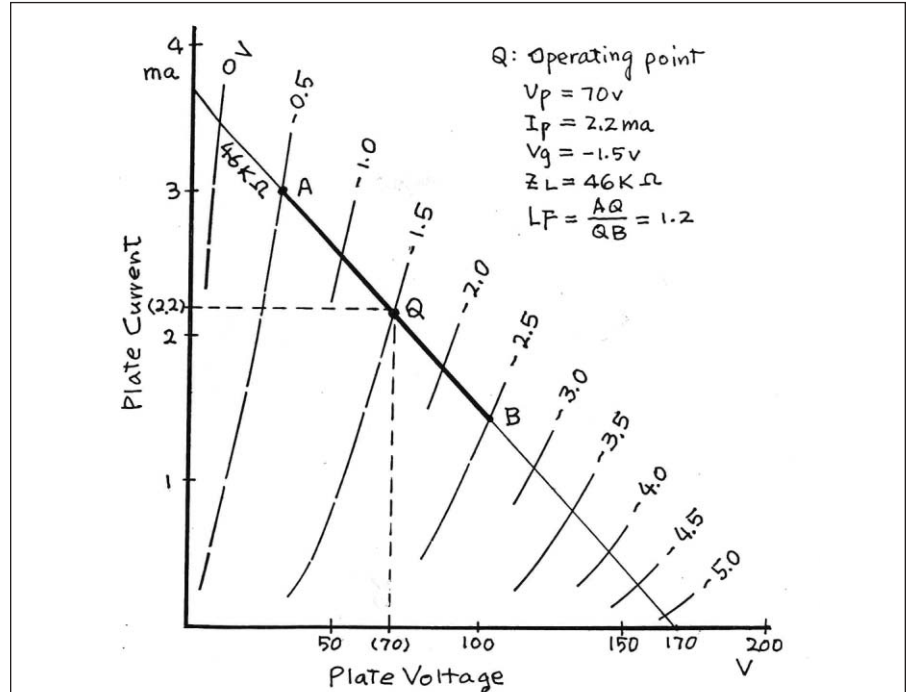

FIGURE 4: 4KN8 voltage amplifier.

G-1573-4

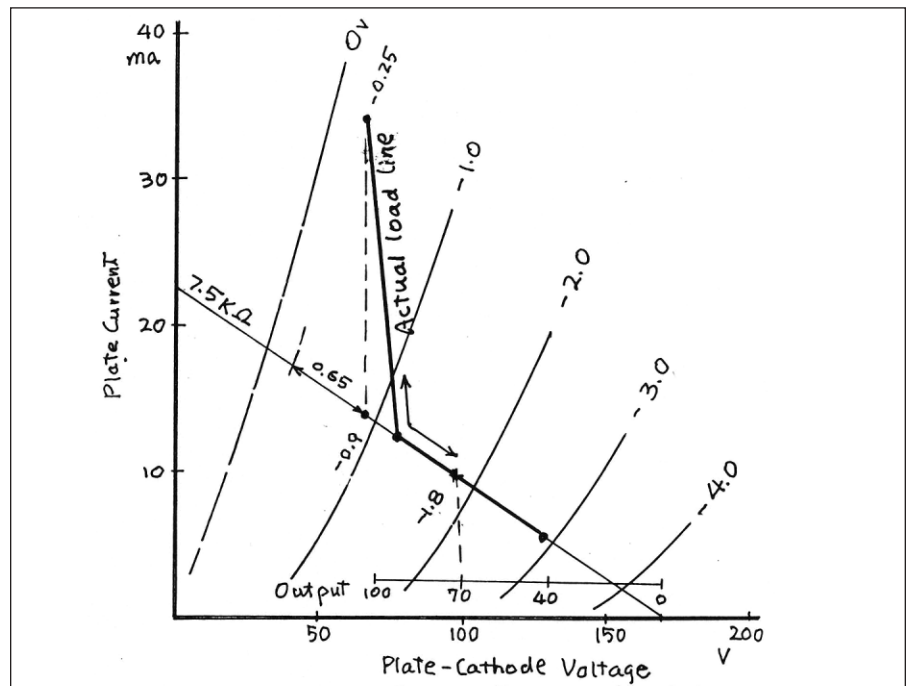

FIGURE 5: 4KN8 cathode follower (both sections).

G-1573-5

the reverse direction, thus producing 100% negative feedback. All the gain is reduced to one.

At the no signal condition, the cathode follower grid is at 70V and the output voltage is 71.8V. When the output voltage hits 91.8V ($V_g = 0$), the 2E24 grid starts to draw current. At its peak the current reaches 20mA.

In order to support an additional 20mA, the cathode follower grid voltage takes a new value of $-0.25V$ from $-0.9V$. The net change is 0.65V. This is a reasonable agreement with the figure obtained with the gm value alone. This amplifier is no longer my ideal amplifier because of the cathode follower insertion.

POWER SUPPLY

All the power supplies are added in Fig. 6. If the filament/heater supply is included, a total of six power supplies are needed. Using all independent supplies is ideal.

This amplifier has three signal levels. The lowest level is the input level. The next level is the signal at the output of the voltage amplifier. The same

signal is at the input of the 2E24 power amp. The highest signal level is at the output of the 2E24.

The power supply 170V (B) and 170V (C) could be combined. This is okay because the voltage is not only the same but also associated with the same signal level. The power supply 91.8V (D) also handles the same signal. The complete amplifier circuit with rearranged

power supply is shown in Fig. 7.

Because of the DC nature of this amplifier, any drift in the power supply voltages will alter the operating conditions. The impedance "Z" is defined as $Z = \Delta V / \Delta I$. If the output voltage is stabilized while the current is changing, $\Delta V = 0$ and $\Delta I \neq 0$. Thus $Z = 0$. It is an ideal power supply. The output impedance of a voltage-regulated power supply is

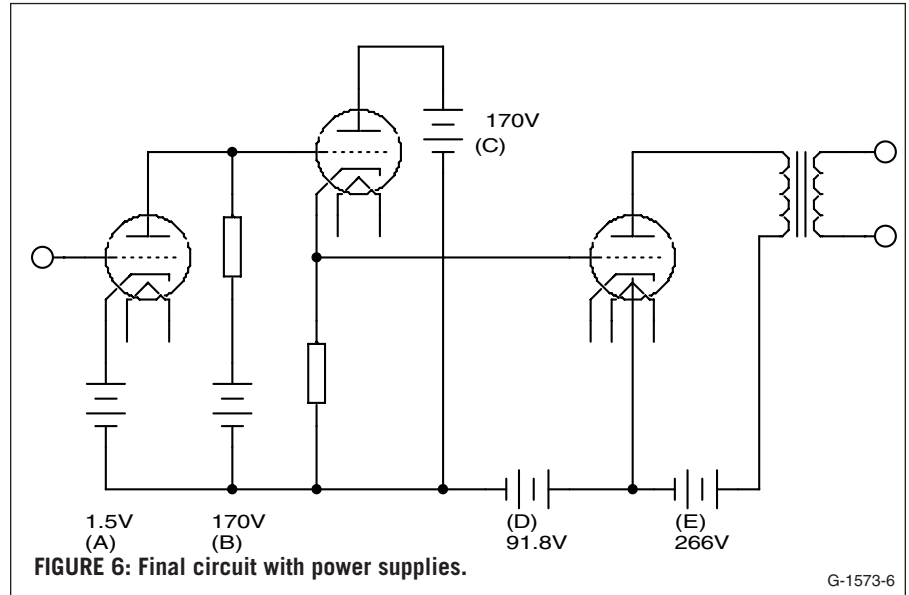

FIGURE 6: Final circuit with power supplies.

G-1573-6

PARTS CONNEXION

VISA MasterCard AMERICAN EXPRESS
PAYPAL, BIDPAY, MONEY ORDER/BANK DRAFT/CASHIER'S CHECK

YOUR DO-IT-YOURSELF TUBE AUDIO SUPERSTORE!

No matter what your requirements are, pcX has what you need. Whether it be vacuum tubes (both newly manufactured, NOS or OS), sockets, transformers, caps, resistors, connectors, hook-up wire, etcetera—we've got a world class selection of all the best brands... and more arriving every month!

toll free order line **1-866-681-9602** US & Canada only.
www.partsconneXion.com

Tel: 905-681-9602 Fax: 905-631-5777 info@partsconneXion.com



2885 Sherwood Heights Drive, Unit #72, Oakville, Ontario, CANADA L6J 7H1 • NOTE: No "on-site/walk-in" business at this time.

much lower than an unregulated one.

Since the P1 (1.5V) supply does not carry any current and handles the low-

est signal, a battery is an excellent choice. This independent source produces a pure DC power. The life is 2-3

years with an AAA alkaline battery, which is directly connected to the grid of the voltage amplifier. Using a smaller

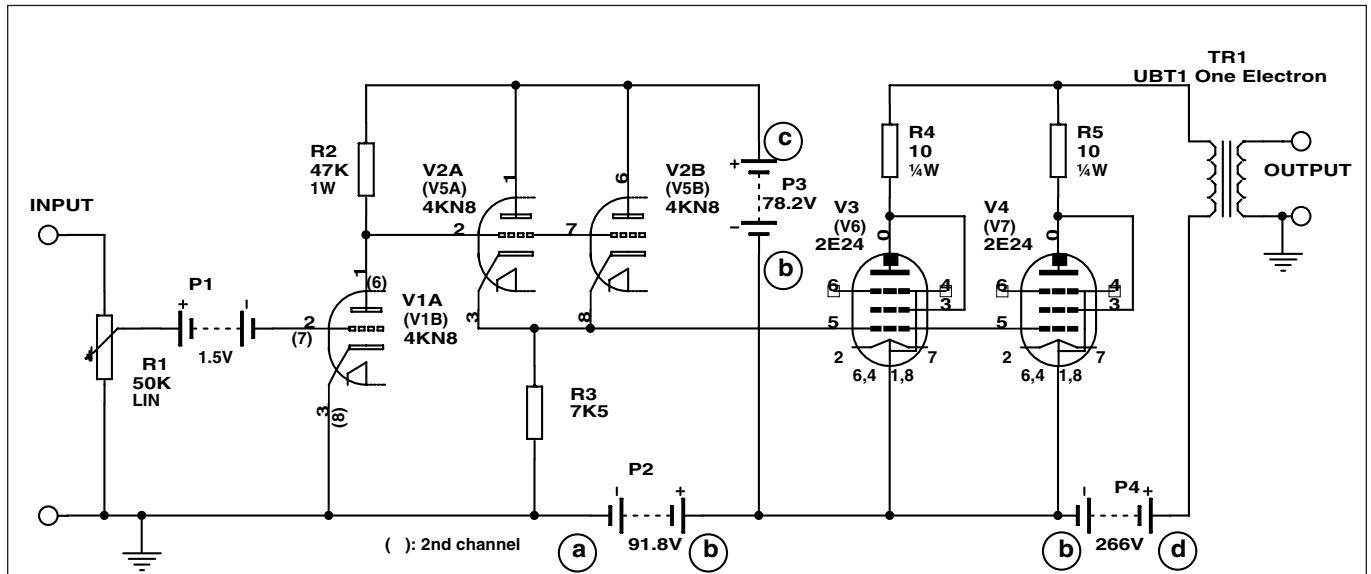

FILE: KANG_4.DSN-G-1573-7

FIGURE 7: Complete amplifier.

G-1573-7

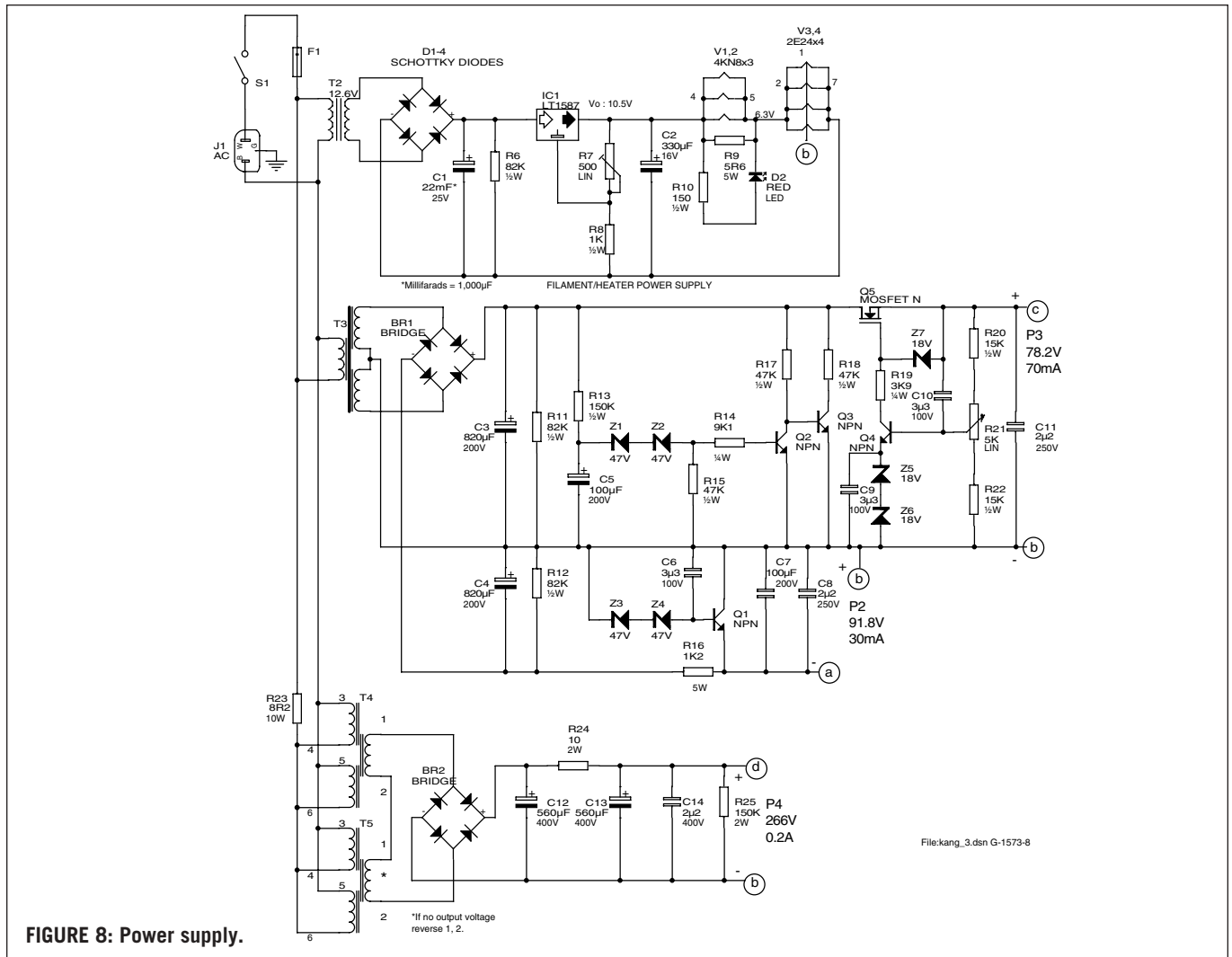

FIGURE 8: Power supply.

File:kang_3.dsn G-1573-8

watch type battery with a holder may be a better way. Today, shelf life of a 5–10 year battery is available. This connection makes the potential of the voltage amplifier cathode at ground level.

The P2 (91.8V) is regulated with a zener diode circuit known as “amplified zener.” The P3 (78.2V) requires better regulation for the 20mA peak current. One transistor error amplifier and one power MOSFET pass element takes care of the regulation. A higher gain circuit can give a lower output impedance, but it may become unstable as the circuit becomes warmer. The P4 (266V) is for the 2E24 plate supply. Because it handles a high-level signal and it is independent, close regulation is not required.

I used three isolation transformer N-68Xs (50VA, 115/230) for all the plate supplies. The heater/filament supply is a regulated 10.5V DC voltage source

from a 12.6V filament transformer. Because of their small size, I mounted all four transformers at the bottom of the chassis.

A delay circuit is incorporated in the P3 supply to keep the 2E24 off for about 50 seconds. The C5 and R13 in the P3 diagram make up the delay timing. I placed an 8.2Ω/10W power resistor at the V4 transformer primary circuit to get the right voltage to the plate. I did not like the use of a power resistor to reduce the voltage here, but there was no simpler way. Since it was working, I decided to keep the resistor. The complete power supply circuit is shown in Fig. 8.

I have read many tube amplifier articles describing changes in sound quality when power supply capacitors, chokes, rectifiers, and even the AC power cord,

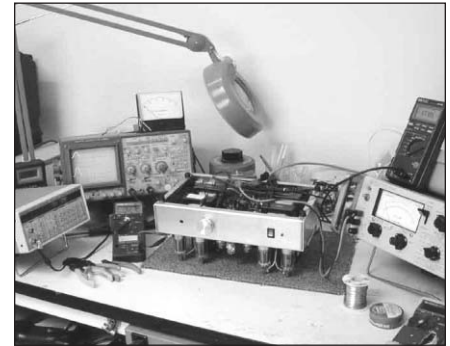

PHOTO 3: On the test bench.

TABLE 1

| | P1 (1.5V) | P2 (91.8V) | P3 (68.2V) |
|-------|-----------|------------|------------|
| 100Hz | 0.73 | 2.36 | 0.47 |
| 1KHz | 0.27 | 0.54 | 0.36 |
| 10KHz | 0.12 | 0.13 | 0.21 ohm |

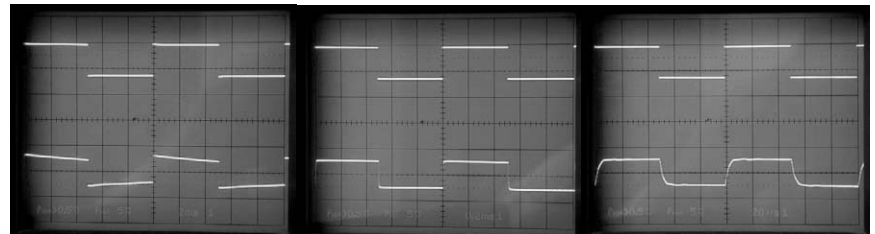

FIGURE 9: Rectangular wave input response.

G-1573-9

LANGREX SUPPLIES LTD

DISTRIBUTORS OF ELECTRONIC VALVES, TUBES & SEMICONDUCTORS AND I.C.S.

1 MAYO ROAD, CROYDON, SURREY, ENGLAND CR0 2QP

24 HOUR EXPRESS MAIL ORDER SERVICE ON STOCK ITEMS

E-MAIL: LANGREX@AOL.COM

PHONE
44-208-684-1166

FAX
44-208-684-3056

A SELECTION OF OUR STOCKS OF NEW ORIGINAL VALVES/TUBES MANY OTHER BRANDS AVAILABLE

STANDARD TYPES

| | | |
|---------|----------|-------|
| ECC81 | RFT | 3.00 |
| ECC82 | RFT | 6.00 |
| ECC83 | RFT | 8.00 |
| ECC83 | EI | 4.00 |
| ECC85 | RFT | 5.00 |
| ECC88 | BRIMAR | 6.00 |
| ECC88 | MULLARD | 10.00 |
| ECL82 | MULLARD | 5.00 |
| ECL86 | TUNGSRAM | 10.00 |
| EF86 | USSR | 5.00 |
| EF86 | MULLARD | 15.00 |
| EL34 | EI | 6.00 |
| EL37 | MULLARD | 30.00 |
| EL84 | USSR | 3.00 |
| EL509 | MULLARD | 10.00 |
| EL519 | EI | 7.50 |
| EZ80 | MULLARD | 5.00 |
| EZ81 | MULLARD | 10.00 |
| GZ32 | MULLARD | 25.00 |
| GZ33/37 | MULLARD | 20.00 |
| PL509 | MULLARD | 10.00 |
| UCH81 | MULLARD | 3.00 |
| UCL82 | MULLARD | 2.00 |

AMERICAN TYPES

| | | |
|----------|----------|-------|
| 5R4GY | RCA | 7.50 |
| 5U4GB | SYLVANIA | 15.00 |
| 5Y3WGT | SYLVANIA | 5.00 |
| 6BX7GT | GE | 7.50 |
| 6FQ7 | EI | 5.00 |
| 6L6GC | SYLVANIA | 20.00 |
| 6L6WGB | SYLVANIA | 15.00 |
| 6SL7GT | USA | 7.50 |
| 6SN7GT | USA | 7.50 |
| 6V6GT | BRIMAR | 7.50 |
| 12AX7WA | SYLVANIA | 7.50 |
| 12BH7 | BRIMAR | 12.00 |
| 12BY7A | G.E. | 7.00 |
| 211/VT4C | G.E. | 85.00 |
| 807 | HYTRON | 7.50 |
| 5687WB | ECG | 6.00 |
| 6072A | G.E. | 10.00 |
| 6080 | RCA | 10.00 |
| 6146B | G.E. | 15.00 |
| 6922 | E.C.G. | 6.00 |
| 6973 | RCA | 15.00 |
| 7308 | SYLVANIA | 5.00 |
| SV6550C | SVETLANA | 20.00 |

SPECIAL QUALITY TYPES

| | | |
|-------------------|---------|-------|
| A2900/CV6091 | G.E.C. | 17.50 |
| E82CC | SIEMENS | 7.50 |
| E83CC | TESLA | 7.50 |
| E88CC G. PIN | TESLA | 8.50 |
| E188CC | MULLARD | 20.00 |
| ECC81/6201 | G.E. | 5.00 |
| ECC81/CV4024 | MULLARD | 6.00 |
| ECC81/M8162 | MULLARD | 7.50 |
| ECC81/6201 G. PIN | MULLARD | 10.00 |
| ECC82/CV4003 | MULLARD | 15.00 |
| ECC82/M8136 | MULLARD | 17.50 |
| ECC83/CV4004 | MULLARD | 40.00 |

SOCKETS

| | | |
|--------|-------------|------|
| B7G | CHASSIS | 0.60 |
| B9A | CHASSIS | 1.00 |
| OCTAL | CHASSIS | 1.00 |
| OCTAL | MAZDA | 2.00 |
| LOCTAL | B8G CHASSIS | 2.50 |

SCREENING CANS

| | | |
|-----------|--|------|
| ALL SIZES | | 1.00 |
|-----------|--|------|

MANY OTHER BRANDS AVAILABLE

These are a selection from our stock of over 6,000 types. Please call or FAX for an immediate quotation on any types not listed. We are one of the largest distributors of valves in the UK. Same day dispatch. Visa/Mastercard acceptable.

Air Post/ Packing (Please Enquire). Obsolete types are our speciality.

are changed. To me, this is similar to a situation in which you have built a fancy soundproof room, yet you are hearing sound leaking in from the next room and even from the rooms beyond.

The audio frequency spectrum is very wide. It ranges from near DC to 100kHz where the signal can readily escape to the space. The impedance of reactive components is directly related to the frequency. Many aluminum electrolytic capacitors that work well at low frequency start to lose their function as capacitors when the frequency approaches 10kHz. It becomes a resistor, and beyond that it acts more like an inductor. Some non-electrolytic capacitors exhibit a sharp peak or dip at the high end of the spectrum.

All the capacitors have a resistor element called "Equivalent Series Resistance" (ESR). Most of the aluminum electrolytic capacitors have high ESR. The capacitors in the high voltage supply are primarily for AC line hum reductions. These capacitors are also providing a return path for the signals. When the power supply is connected in series with the transformer, the power supply becomes a part of the load.

If the impedance of the power supply is not low, a significant amount of signal voltage is induced at the power supply terminals, and this voltage will be distributed back to the voltage amplifier stages through the RC de-coupling circuit, which is frequency dependent and not perfect. Some attenuated signal will arrive at the input of voltage amplifier as a feedback signal. This is the case if only one plate voltage source is used.

When any one of the power supply components is replaced, impedance will be modified. You are certainly changing your amplifier "equalizer" settings in a very complex way. The power supply impedance should be low enough not to influence sound quality. A dedicated plate voltage supply or separating DC and signal path of the final amplifier will cure the problem.

Another power-supply-related problem is RF noise when you use silicon rectifiers. A silicon PN junction generates RF noise pulse from its reverse recovery. If the power supply circuit provides a right tank circuit for the RF

noise, it is amplified and escapes as a radio wave. The entire amplifier becomes polluted. Some ride with signal; some are rectified and modify bias conditions. Use of fast recovery rectifiers, different circuit components, and physical layout can minimize this problem.

CONSTRUCTION AND TUNE-UP

The performance of this amplifier is directly related to the quality of the output transformer. I used a pair of One Electron UBT-1s from Antique Electronic Supply, Tempe, Ariz. Other than a pair of output transformers, there are no critical parts. You may use what you already have, but do not forget that the capacitors in the power supply circuits should provide an easy path (low impedance) for the return signals.

Though I experienced no instability with this amplifier, it is always a good practice to make wirings short and secure. Semiconductor parts are not as generous as vacuum tubes when it comes to the mistakes. Even when the power is off, some residual charge in the capacitor may destroy semiconductor parts.

Make sure the capacitors are fully discharged before you make any measurements or replace parts. For the bleeder resistor, I used higher resis-

tance values for lower power losses. You should test all four power supplies individually with a proper dummy load.

Because the design is based on the actual plate V/I curve, the operating conditions should be close to the designed values. The main voltage to home-in is -20V at the 2E24 control grid. If any adjustment of the bias voltage is needed, tweak 46kΩ load resistor or P3 voltage.

I temporarily placed a 10Ω resistor at each 2E24 plate to check the matching status. Because the voltage drop is only about 0.5V, I did not bother to remove the resistors afterward.

PERFORMANCE AND MEASUREMENTS

The frequency response is flat from 20 to 50kHz/2dB at 1W. The rectangular wave input responses at three different frequencies are shown in Fig. 9. The total harmonic distortion is plotted in Fig. 10.

The linearity factor used at the amplifier design was 1.2. Further adjustment made no significant changes on the distortion figure. I took all the test measurements with a 4Ω 10W power resistor as the load. I measured the output impedances of the P1, P2, and P3 with full power seen from the load and listed them in Table 1.

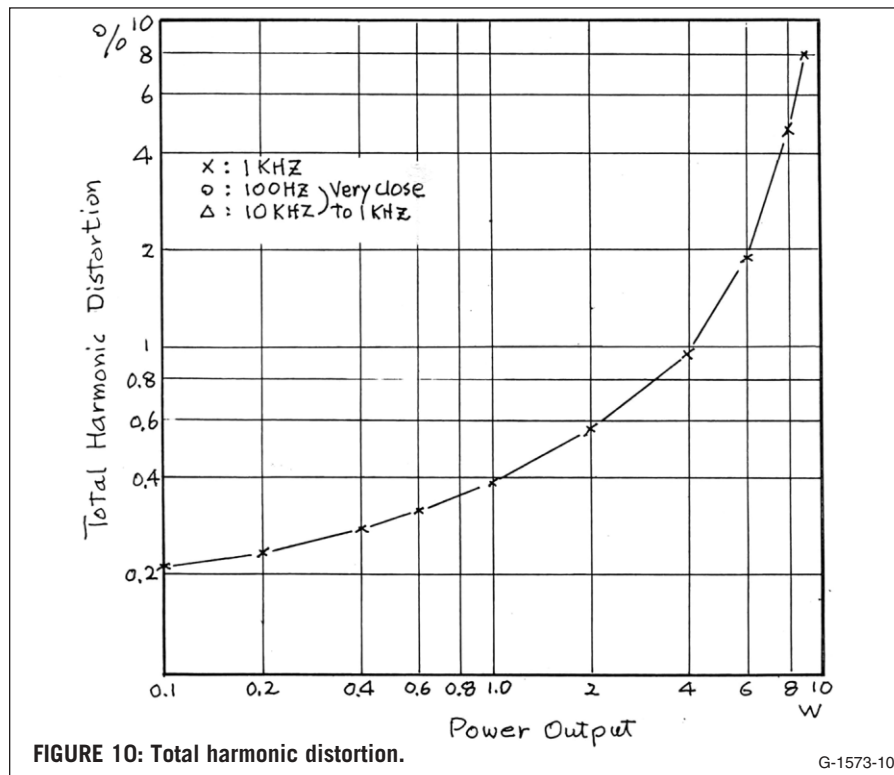

FIGURE 10: Total harmonic distortion.

G-1573-10

Transformers & Enclosures

In Stock...



Torodial Power:

13 sizes (15 - 1500 VA)

6 VAC - 240 VAC

"Classic" Tube Output:

Single Ended (up to 75 watts),
Push-Pull and Potted (up to 280 watts)

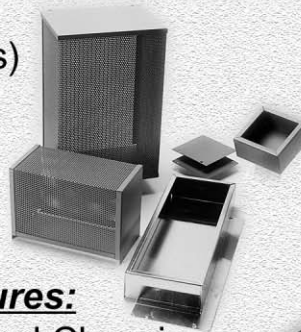

Enclosures:

Aluminum & Steel Chassis,
Diecast Aluminum, Plastic
and Rack Mount

Filament & Low Voltage

Power Transformers:

Open & Enclosed

"Classic"

High Voltage Transformers:

Plate, Plate/Filament Combo
& Filter Chokes (Open & Enclosed)



Contact us for free catalogs & a list of stocking distributors

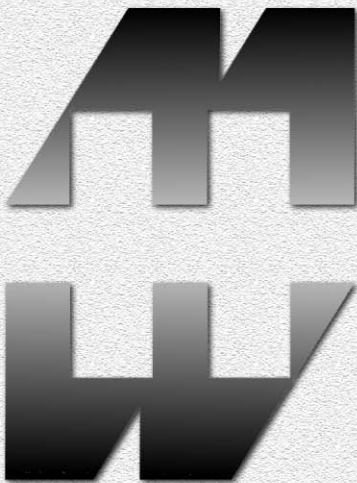

HAMMOND MANUFACTURING™

256 Sonwil Dr. - Cheektowaga, NY 14225 USA

Phone: (716) 651-0086 Fax: (716) 651-0726

394 Edinburgh Rd., N. - Guelph, Ontario N1H 1E5 Canada

Phone: (519) 822-2960 Fax: (519) 822-0715

www.hammondmfg.com

Test CDs From OLD COLONY SOUND LAB

CBS Records Standard Test Disc Pro Series CD-1



For measuring CD player performance with E.I.A. standard signals. 21 tracks including separation, frequency response, linearity, and other signals.

CD1\$45.00

CD-CHECK®

Easily ensure your CD-player delivers the complete range of digital sound.

CDDR2\$24.95

AUDIO-CD®

An easy and inexpensive way to detect hearing loss early—allowing you to take preventive and corrective action.

CDDR1\$24.95

Mix Reference Disc-Deluxe Edition

Expanded collection of audio test signals for pro audio or multimedia applications.

CDMX1\$39.95

"My Disc"-The Sheffield/A2TB Test Disc

For critical evaluation of audio components, listening environments, and your critical listening ability. 86 tracks including musical selections.

CDSH3\$29.95

EIA-426-B Loudspeaker Power Rating Test CD

from ALMA International

Developed as a companion to the written standard, the CD contains the calibration and test signals for all tests defined in the standard and outlines the procedures for making best use of the disk in setting the power ratings of loudspeakers and the amplifiers that drive them. Also includes a number of test-signal tracks, including additional higher-frequency pure tones and shaped tone bursts, not a part of the standard. 2001.

CDAL2\$99.00

NEW! CARA Test CD for Room Acoustics

ELAC Technische Software GmbH

The CARA Test CD is designed to help you test the acoustics of your listening room. Tracks 1–28 contain Pure Sine Wave Tones (70 seconds per track). Tracks 29–55 reproduce narrowband (1/18 octave) and pink noise (70 seconds per track). The last four tracks on the disc provide coloration, polarity, and phase testing.



CDCARA\$19.95

Auditory Demonstrations Test Disc

Philips

79 tracks featuring demonstrations of cancelled harmonics, decibel scale, masking, virtual patch, logarithmic and linear frequency scales, effect of echoes, and more.

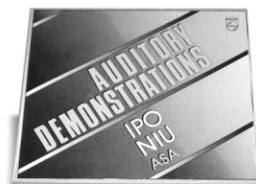

CDAC\$37.95

Studio Reference CD



Prosonus

Developed especially to allow high-quality test and evaluation procedures to be made easily and quickly. 62 bands of test signals.

CDSA1\$69.95

Stereophile Test CD Three

From the publishers of *Stereophile* magazine, contains 27 tracks which include musical selections and signals for testing loudspeakers and rooms, electronic components, amplifiers and CD players.

CDSTPH3\$9.95



Shipping weight of all CDs is 1 lb. each.

TO ORDER:

call 1-888-924-9465

or fax 603-924-9467

Order On-line at

www.audioXpress.com

Check out more test CDs and track listings for these products on-line at www.audioXpress.com

Old Colony Sound Lab, PO Box 876 Dept. X4, Peterborough, NH 03458-0876 USA

Phone: 603-924-9464 Fax: 603-924-9467 E-mail: custserv@audioXpress.com

HOW DOES THIS AMPLIFIER SOUND?

The sound is coming from a speaker. To evaluate an 8W amplifier, you should connect it to a relatively high efficiency speaker. My speaker system is a transmission line construction using Audax HM170Z0, HM170G0, and Raven R1 in a D'Appolito configuration. The sensitivity is about 91dB/W/m.

Some of us have misconceptions regarding the output transformer primary impedance. The specified impedance can be realized only when the right impedance load is connected at the secondary terminals. Any deviation will be reflected back to the primary side by the square of the transformer turns ratio.

Modern speaker systems contain

many reactive components. Very often, the speaker itself has an impedance peak that is several times higher than the published value. If the speaker impedance seen from the amplifier is off from the designed value, expected performance may not be realized.

For the sound evaluation, I like to listen to the human voices that are directly recorded. We have a better appreciation of human voices than any other sound. This amplifier sounds very clean and clear. At a moderate power level it is very natural.

By today's standards, this amplifier is by no means a low distortion amplifier. At a normal listening level of a few watts, the total harmonic distortion is probably 100 times higher than today's

high-end amplifiers. However, the distortion of this amplifier is as low as it can get without negative feedback.

WHAT I LEARNED

When paralleling the output tubes, a matched pair is mandatory. For lower distortion, matched linearity of the power tube and voltage amplifier tube is just as important. More emphasis should be placed on the combined linearity rather than the individual tube linearity. Many designers rely on the negative feedback for linearity improvement. However, the feedback should be the secondary means.

I placed a greater emphasis on the power supply impedances and the separation of power supplies. I believe that the low impedance and use of separate power supplies really helped to avoid high-frequency instabilities and cross couplings. This amplifier has no bandwidth limiting components except the output transformers.

This project has motivated me to study a large number of plate V/I curves on many different tubes. I have observed, within the same family, the DC parameter variation of as much as 50%. Even supposedly identical twins in the same envelope exhibited unacceptable variations.

However, the AC parameter variations were far less than the DC counterparts. When directly replacing tube A with tube B of the same family, tube B may not operate under the same conditions. Thus tube B generates a different set of distortion patterns. The tube comparison by direct replacement can be very misleading.

I need to point out what the "matched pair" really means, and also the term "average" plate characteristics. The parameter variation of $\pm 20\%$ is very common. Without the knowledge of the actual plate V/I characteristics, it may be very difficult to optimize the amplifier performances. As with designing a custom suit, you must know the body dimensions.

The Linearity Factor used is an indicator of second harmonic distortion. Using a different LF value, you can control the second harmonics in the output. I choose to handle this topic separately as a sound-making tool for the SE amplifier. ♦

| ITEM | VALUE/DESCRIPTION | PART NUMBER | SOURCE |
|-----------------------|---|----------------|---------------------------|
| RESISTORS | | | |
| R1 | 50k variable—linear | | |
| R2 | 46k 1W | | |
| R3 | 7.5k 2W | | |
| R4, 5 | 10 Ω ¼W | | |
| R6, 11, 12 | 82k ½W | | |
| R7 | 500 Ω variable—linear | | |
| R8 | 1k ½W | | |
| R9 | 5.6 Ω 5W | | |
| R10 | 150 Ω ½W | | |
| R13 | 150k ½W | | |
| R14 | 9.1k ¼W | | |
| R15, 17, 18 | 47k ½W | | |
| R16 | 1.2k 5W | | |
| R19 | 3.9k ¼W | | |
| R20, 22 | 15k ½W | | |
| R21 | 5k variable—linear | | |
| R23 | 8.2 Ω 10W | | |
| R24 | 10 Ω 2W | | |
| R25 | 65k 2W | | |
| CAPACITORS | | | |
| C1 | 22,000 μ F 25V electrolytic | P-6461-ND | Digi-Key |
| C2 | 330 μ F 16V electrolytic | P-10246-ND | Digi-Key |
| C3, 4 | 820 μ F 200V electrolytic | P-6830-ND | Digi-Key |
| C5, C7 | 100 μ F 200V electrolytic | P-7517-ND | Digi-Key |
| C6, 9, 10 | 3.3 μ F 100V electrolytic | P-10767-ND | Digi-Key |
| C8, 11 | 2.2 μ F 250V polyester | 23MA522 | Mouser |
| C12, 13 | 560 μ F 400V electrolytic | P-10153-ND | Digi-Key |
| C14 | 2.2 μ F 400V polyester | 146-400V 2.2K | Mouser |
| SEMICONDUCTORS | | | |
| BR1, 2 | Bridge rectifier 800V/1A | 2KBB80R-ND | Digi-Key |
| D1, 2, 3, 4 | Schottky rectifier 60V/3A | 31DQ06-ND | Digi-Key |
| IC1 | Voltage regulator | LT1587CT-ND | Digi-Key |
| Q1 | NPN power transistor | TIP41CTU-ND | Digi-Key |
| Q2, 3, 4 | NPN high voltage transistor | MPSA42-ND | Digi-Key |
| Q5 | N-channel power MOSFET | IRF630N-ND | Digi-Key |
| Z1, 2, 3, 4 | Zener diode 47V | 1N4756ADICT-ND | Digi-Key |
| Z5, 6, 7 | Zener diode 8V | 1N4756ADICTOND | Digi-Key |
| LED | 5mm red | 606-FLV110 | Mouser |
| OTHERS | | | |
| F1 | Slow blow 2A fuse | | |
| P1 | 1.5V AAA alkaline battery | MN2400 | Duracell |
| T1 | One Electron Transformer | UBT-1 | Antique Electronic Supply |
| T2 | 12.6V/3A Filament Transformer | | 553-F224X Mouser |
| T3, 4, 5 | 115/230 Isolation Transformer (1:2, red; 3: blk, 4: yel/blk, 5: red/blk, 6: grn/blk, 7: wh-ground) | 553-N68X | Mouser |
| V1, 2 | 4KN8 vacuum tube | 4KN8 | Antique Electronic Supply |
| V3, 4 | 2E24 vacuum tube | 2E24 | Antique Electronic Supply |



Amplifier Musicality

A Study of Amplifier Harmonic Distortion Spectrum Analysis

The work of this noted audio authority on objective measurements is still relative after 25 years. **By Jean Hiraga**

Modern amplifier designs are nowadays capable of very low measured harmonic distortion, on the order of 0.005% or even 0.0005%; levels which can only be measured with elaborate test instruments such as the Radford Series 3 and those from Sound Technology (USA). Despite this state of affairs it is interesting that valve amplifiers, which often have a distortion level at least 100 times greater (e.g., 0.5%) may sound subjectively no more, and can sound a lot less, distorted than transistor designs in spite of the higher measured level. This causes endless debates between the “golden eared” listener and the engineer—one quoting the position of the distortion meter needle; the other talking about the special tone of piano x of year y.

This article does not intend to discuss in detail the relationship between a particular electronic circuit design and its subjective result, as this is far too large an undertaking. However, some particular measurements have been made which may help to reconcile the engineers and the listeners. This is not simply a question of taking certain measurements or conducting blind listening tests on amplifiers, but an attempt to show that a particular measurement may result in an indication of the ability of an amplifier to reproduce a musical sound.

Figure 1 and Table 1 show the spectral composition of a violin note with its various harmonics and their relative levels. It is important to note that the

tonal color or “personality” of the violin lies in the high-order harmonics from the 4th to the 20th, whose levels are extremely low compared with the second or the third. The slightest modification of the relative levels of these harmonics will change the spectrum of the signal fed to the loudspeakers and hence the tonal “color” of the violin, making a Stradivarius sound like a very cheap violin, for example.

This spectrum analysis technique can also be applied to audio amplifiers, but as yet few people have been interested enough to analyze the actual content of the measured distortion (whether 0.5% or 0.0005%). However, the particular pattern of harmonic distortion in an amplifier is extremely significant and can provide important indications of its subjective qualities; it is not necessarily wrong to refer to “musicality of distortion.”

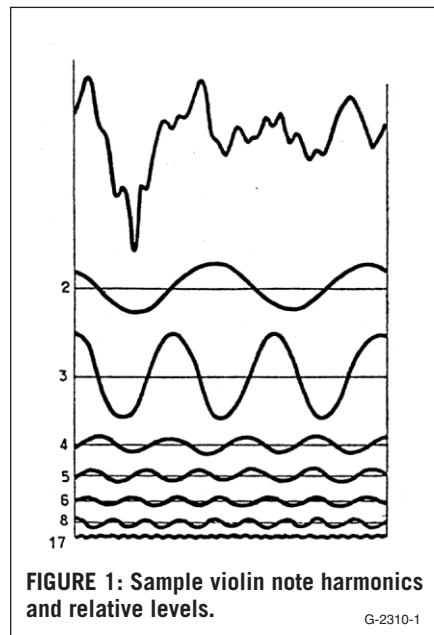

FIGURE 1: Sample violin note harmonics and relative levels.

G-2310-1

It has been possible to make these measurements by using very elaborate test equipment made by General Radio (USA). These instruments are very expensive and are only available in two places in Japan (where these tests were undertaken): the National Research Laboratory and the Kanno Research Laboratory. Kanno specializes in valve

TABLE 1

| FREQUENCIES(HZ) | HARMONIC RANGE | % OF TOTAL ENERGY | LEVEL (In dB) |
|-----------------|----------------|-------------------|---------------|
| 198 | 1 | 0.1 | 0 |
| 392 | 2 | 26.0 | 24.2 |
| 588 | 3 | 45.2 | 26.6 |
| 784 | 4 | 8.8 | 19.5 |
| 980 | 5 | 8.5 | 19.3 |
| 1176 | 6 | 4.5 | 16.5 |
| 1372 | 7 | 0.1 | 1.3 |
| 1568 | 8 | 4.8 | 16.8 |
| 1764 | 9 | 0.1 | 0.6 |
| 1960 | 10 | 0.0 | |
| 2156 | 11 | 0.1 | 1.3 |
| 2352 | 12 | 0.0 | |
| 2548 | 13 | 0.2 | 2.4 |
| 2744 | 14 | 0.0 | |
| 2940 | 15 | 0.1 | |
| 3136 | 16 | 0.0 | |
| 3332 | 17 | 1.1 | 10.4 |
| 3528 | 18 | 0.1 | |
| 3724 | 19 | 0.2 | 2.6 |
| 2920 | 20 | 0.0 | |
| Total = 99.9 | | | |

Reprinted with permission from *Hi-Fi News & Record Review*, March 1977, www.hifinews.co.uk.

Swans Tempus Kit



Swans proudly presents their first European-style, independently developed loudspeaker kit.

Due to exceptionally high standards for a kit speaker, TEMPUS is a top-level, world-class performer in all regards.

German sound magazine KLANG+TON featured the Tempus in the June 2002 issue, commending its excellent acoustic response.

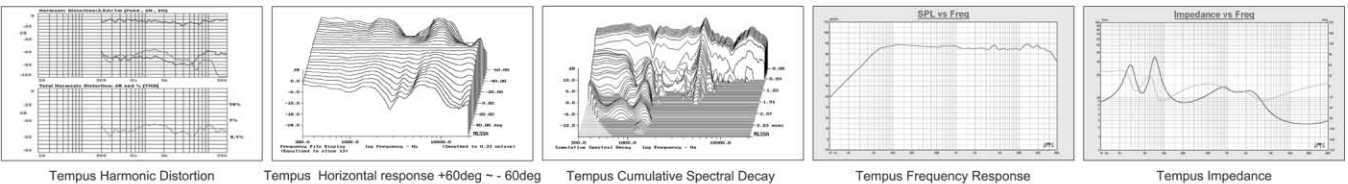
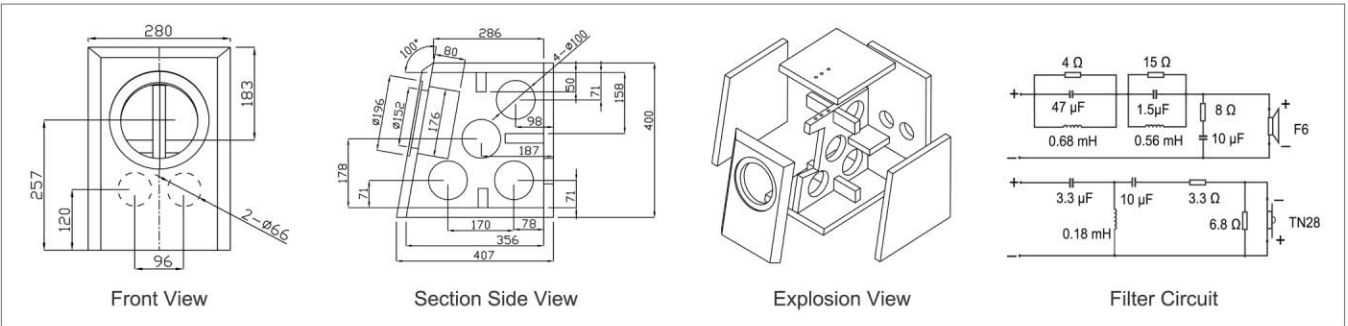

The Tempus project was initially conceived as a private work of the acoustic arts, to be executed independent of all professional affiliations. Despite a lack of traditional marketing and initial editorial commentary, the design has since received wide acclaim in the independent press and has gone on to tremendous commercial success. Tempus' reputation is therefore solely the result of unexpectedly high fidelity from a speaker of its modest origin and cost.

For Tempus' development, Swans agreed to supply premium components for what evolved into a rigorous electro-acoustics design program, executed to the highest European standards. The resulting design's performance was subjected to stringent laboratory confirmation and completely documented in the audio press, including revealing measurements not typical for any loudspeaker much less one of this type. Tempus has since gone on to claim top performance awards from acclaimed KLANG+TON magazine of Germany, during which time Swans cancelled all advertisements and further commentary.

Tempus is now one of Europe's most favored loudspeakers, leaving listeners admiring its naturally musical sound and excellent value. The design is already a classic, destined to sweep the audio world in a fashion similar to its current success.

The new Swans Tempus set includes:

- 2 x 1.1"/28mm Swans TN28 soft-dome tweeters with open-air housing, Neodymium motor, ferrofluid cooling, decompression chamber, integrated grille and German-made silk dome;
- 2 x 6.5"/165mm Swans F-6 shielded high efficiency midbass drivers, with Kevlar/paper curvilinear cone, phasing plug, and alloy basket;
- 2 x completed crossover networks with premium-grade components;
- Two sets heavy input terminals;
- Two pairs internal cable sets;
- Complete manufacturer's instructions.

All Tempus kits are thoroughly pre-tested by Swans and come in matched acoustical sets.

- Price: \$599 with Tempus parts kit only;
- \$999 with Tempus kit and cabinets;
- \$1299 assembled Tempus.



SPECIFICATIONS

Frequency Response: 48Hz-20kHz
 Sensitivity (2.83V/m): 86dB
 Nominal Impedance: 8 ohms
 Power Handling: 10-120W
 Dimensions(HxWxD): 406x286x408 mm

for more info please

Call: (323)-881-0606

SWANS SPEAKER SYSTEMS, INC

2550 Corporate Place, Suite C103
 Monterey Park CA 91754

www.swanspeaker.com
 www.theaudioinsider.com



hear different.

"Tempus"

amplifiers and audio transformers and has also been responsible for measurements concerning the "Hikari Bullet" express train. These tests give a very accurate measurement of the harmonic distortion by means of a graph which shows the relative level of each individual harmonic.

A fundamental of 200Hz was used instead of the more conventional 1kHz for various reasons, particularly in order to represent the human voice. Six transistor amplifiers were tested (mostly of Japanese origin), and five valve amplifiers, many of which were craftsman-made. The measurements were made at a power rating of 3W to simulate average listening conditions.

Olson has shown that the reproduction of a pure frequency is not musical and that it is necessary to add very regularly reduced harmonics in order to produce a sound which is subjectively musical. It is pertinent to make an analogy to the difference in taste be-

tween distilled water and "Vichy" water, where the latter is invariably preferred. Even though the distortion in an amplifier may be at extremely low levels, the content of this distortion must conform to the laws of harmonic levels in order to give subjectively musical reproduction.

It is also relevant to point out that most amplifiers use the classic push/pull circuit which reduces the even harmonics. However, it is known that these even harmonics are less audibly objectionable than odd harmonics, and to reduce only these confers no real advantage. The use of high levels of feedback is also not recommended, as this masks rather than suppresses distortion. In transistor amplifiers, this may result in the production of high-order harmonics, which is catastrophic when considering the case of the aforementioned violin. I would like to point out that amplifier designers are able to design amplifiers with both low distortion and feedback, Mr. Kaneda (Japan), Mr. Radford (England), and Mr. Vaisaire (France) being notable examples.

THE TRANSISTOR AMPLIFIERS

a) The spectrum of amplifier 1 shows the presence of unwanted harmonics at 300, 700, and 1,300Hz. Despite the low distortion level, subjectively you find a lack of upper bass and a slightly raised treble which is lacking in purity.

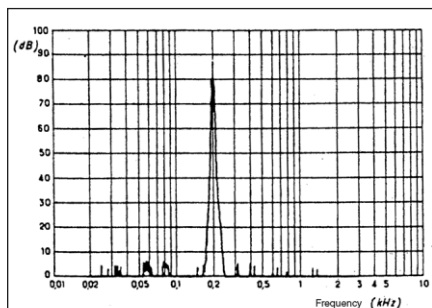

FIGURE A.

G-2310-A

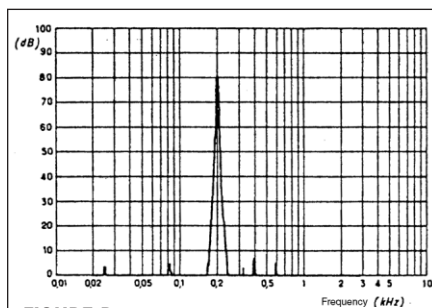

FIGURE B.

G-2310-B

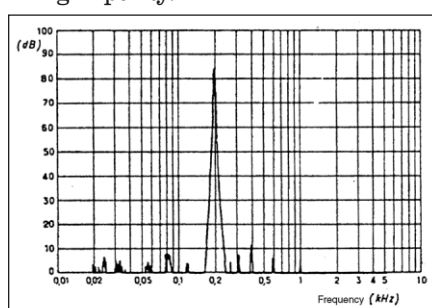

FIGURE D.

G-2310-D

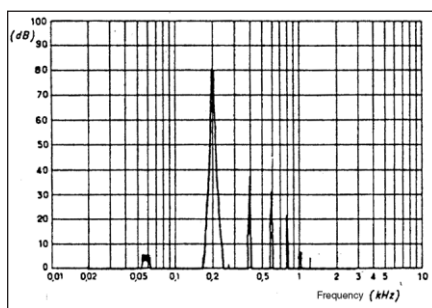

FIGURE C.

G-2310-C

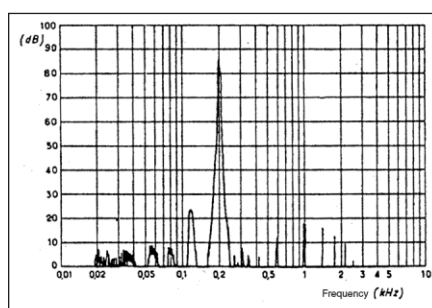

FIGURE E.

G-2310-E

b) Amplifier 2: Note the absence of harmonics beyond the third, due perhaps to the high level of feedback. Subjectively there is a feeling of a lack of lower treble, and a flat sound which gives the impression of a lack of depth, although the higher frequencies are well defined.

c) Amplifier 3 is a zero feedback design; despite the higher measured distortion level (1.5%), there is a very regular decrease in the harmonic levels. In spite of this distortion level the amplifier seems to have very low distortion subjectively and its musicality is superior to 1 or 2.

d) Amplifier 4 shows harmonics at 400 and 600 and 1kHz which are evenly reduced although there is an unwanted component at 300Hz. The unfortunate absence of the fourth harmonic at 800 derives from the circuit design.

e) Amplifier 5 has numerous faults: the effect of a badly designed power supply is seen at 50 and 100Hz and the respective levels of the harmonics are very irregular; the sound quality is subjectively very unmusical.

f) Amplifier 6 is another low feedback design. The harmonics decrease evenly, which is unusual in a transistor design.

THE VALVE AMPLIFIERS

g) Amplifier 7 shows a regular decrease in the levels of the harmonics.

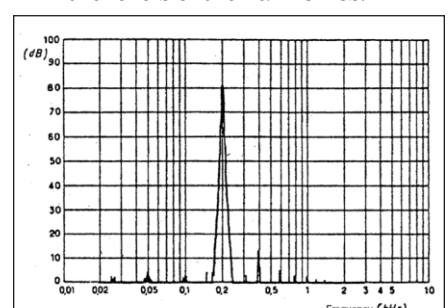

FIGURE F.

G-2310-F

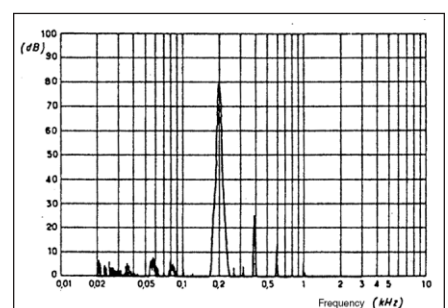
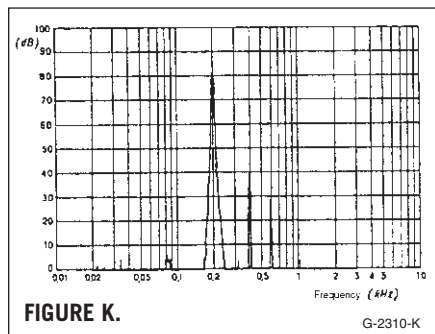
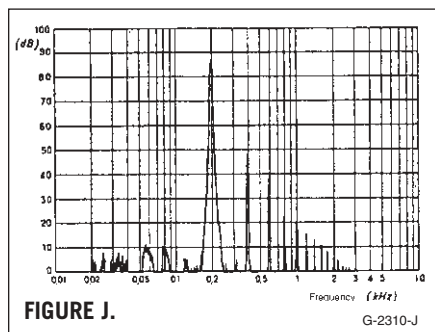
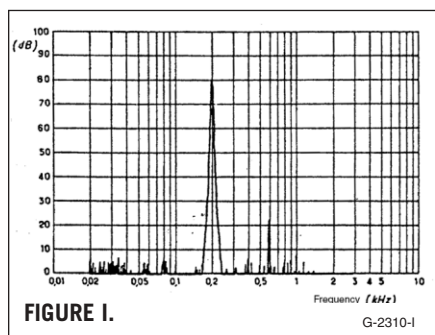
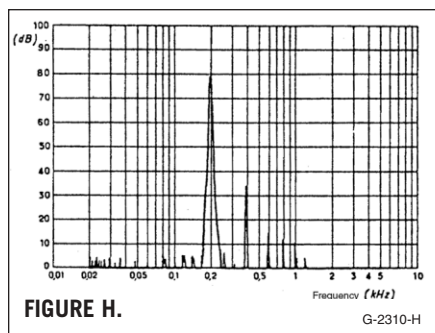

FIGURE G.

G-2310-G

The unfortunate absence of the high harmonics and the fourth (800Hz) is due to the special patented output transformer design.

- h) Amplifier 8 is well known for its musicality and particular suitability to reproducing classical music; here again, each harmonic is reproduced with a regular rate of decay. Despite the high level of the second harmonic, the subjective level of distortion is very low and the design sounds better than no. 7.
- i) Amplifier 9 has no second harmonic, and the others are badly distributed,



particularly the third at 600Hz. Feedback and a circuit compensating for distortion in the output valves could not suppress this. The middle and high frequencies are very unpleasant and sound very distorted.

- j) Amplifier 10 is a single stage amplifier without feedback, using PX4 triodes with direct heating (these valves were used in the first Mullard circuit of 1934). Due to the exceptional reproduction of the harmonics, the amplifier has a reputation for great musicality. You may also notice the slight "purring" due to the direct

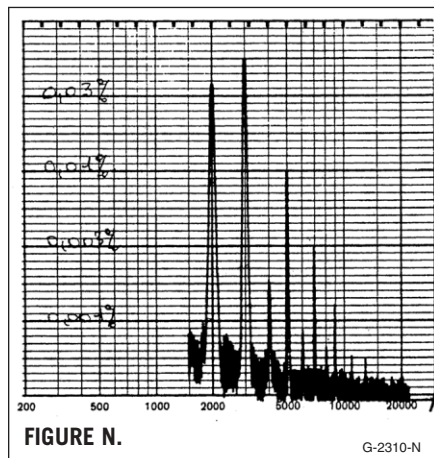
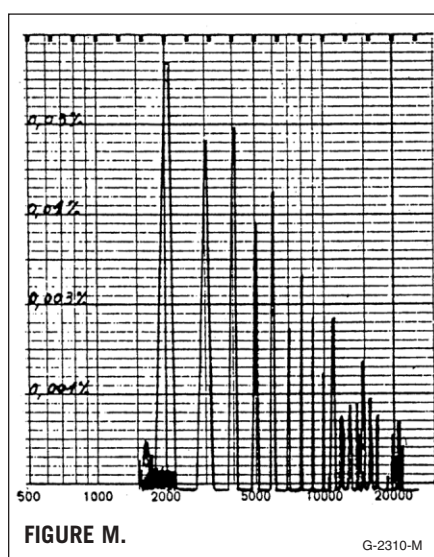
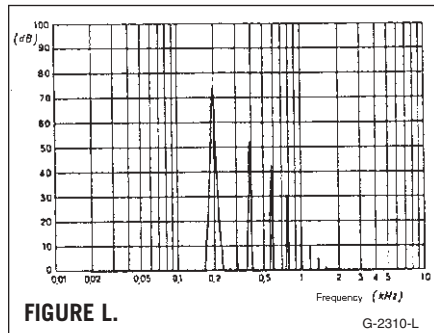

heating at 4V AC of the output valve. Despite the 2% distortion level, this amplifier has little subjective feeling of distortion; the reproduction of the sound of violins, guitars, harpsichords, and voices has an impressive reality and purity.

- k) This is also amplifier 10, but this time with a 6dB feedback. Although the distortion meter and graph shows an apparent improvement, there is a subjective feeling of loss in the middle and high frequencies; the high and evenly-degraded harmonics have disappeared.
- l) Amplifier 11 is also a single stage design using the WE300B (USA) valve, which is considered by aficionados to be the ultimate triode. Harmonic spectrum analysis shows excellent regularity in the production of each successive harmonic. A violin, in particular, is reproduced very well as harmonics 2 to 20 pass without interference in their relative levels, whereas an amplifier of type 2 would truncate many of these, absorbing them in feedback.

POSTSCRIPT

La Nouvelle Revue du Son (successor to the respected *Revue du Son*) has recently been publishing reviews of "vintage" amplifiers. These have included English classics such as the Quad II and Leak Stereo 60, and incorporate a modified version of Hiraga's test. It is important to note that the test conditions are somewhat different from the above and direct comparison is not possible: the power level used was 10W; the fundamental frequency 1kHz, and the fundamental is not shown in the graphs.

- m) Quad II. The very even spectrum may account for the excellent subjective qualities of this amplifier. The even harmonics are more prominent than the odd harmonics, but this is preferable to the converse. Noise products may be seen in the 10-15kHz region. 1kHz 10W.
- n) Leak Stereo 60. The even harmonics are consistently lower than the odd harmonics. This could account for the slightly hard sound that this amplifier gives. 1kHz 10W. ❖

FryKleaner: an Audio Burn-in Generator

Here is the design theory behind this popular low-cost DIY kit.

By Jim Hagerman

Burning-in cables, amplifiers, and other audio equipment has long been a subject of debate. This article does not argue the pros and cons of such a discussion, but confidently assumes both mechanical and electrical components benefit from such a break-in period. Indeed, on many occasions I have witnessed improvements firsthand.

You might ask what type of signal is best suited for burn-in. Music is one obvious candidate, but what type: vocals, percussion, organ, or rock-and-roll? Clearly, a full-range signal containing both high and low frequencies is desirable, particularly one with transient information. The signal should exercise and stress the entire audio spectrum.

There are now several CDs on the market containing a variety of burn-in signals, typically consisting of swept sine and square waves. This article presents an alternative hardware solution.

DESIGN GOALS

The FryKleaner™ was designed to be a complete self-contained burn-in system. Included on the deceptively small circuit board is a very sophisticated waveform generator and built-in power amplifiers capable of directly driving cables. A wall-wart supplies power.

My design goals were simple: a do-it-yourself kit using all-analog circuitry implemented with low-cost vintage bipolar integrated circuits. Certainly, a microprocessor or software realization

was possible, but this was a more interesting and practical challenge. Additionally, all parts should be readily available from a single source, and construction should be simple and straightforward.

THE WAVEFORM

First, I needed to produce a waveform containing all of the previously mentioned properties. Design work on one of my recent consulting projects (broadband modem for undersea instrumentation) employed two very useful circuits: a wideband noise source and an amplitude modulator. In fact, familiarity with these circuits is what spawned the idea to make a burn-in generator.

What better way to mimic a wideband music signal than with a noise source? Such a circuit generates all frequencies at equal amplitudes at the same time. That is, a plot of the frequency spectrum would be a flat horizontal line.

If viewed on an oscilloscope, the amplitude would be purely random with an average of zero—very much musical in appearance. For burn-in purposes, this signal covers low bass frequencies all the way up to the highest treble without emphasis on any particular band. Nevertheless, there is room for improvement.

A continuous noise signal would present a rather benign and constant load to an amplifier under burn and its power supply. Gating the noise source on and off would introduce varying thermal and current loads, thus exercising and stressing the amplifier more fully. To this end, the noise source could be amplitude modulated by a low-frequency signal, preferably a sine

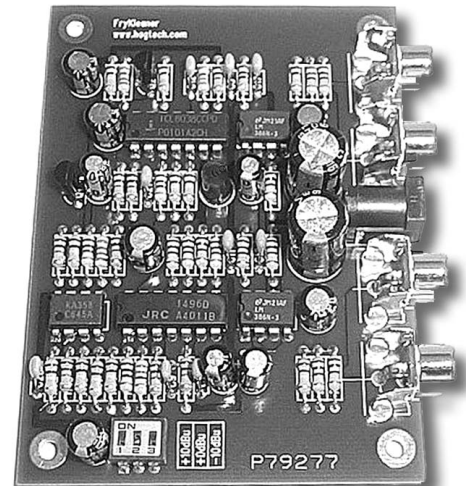

PHOTO 1: The FryKleaner board has a very clean and orderly layout, making it easy to assemble.

wave, which would prevent excessive switching transients (*Fig. 1*).

However, this, too, should not be done at a constant frequency. No particular frequency should be emphasized or eliminated; the modulation is best swept over a range. Most important, it should delve deep into infrasonic territory exerting strain on the power supply and any low-frequency system resonance.

CIRCUIT AND OPERATION

Starting backwards from the output, U1 and U2 (*Fig. 2*) are small power amplifiers in convenient 8-pin DIP packages capable of delivering a bit of output power. Typically, the output signal is a line-level voltage used to drive the input of an amplifier. However, when directly driving cables, power amplifiers are needed to deliver the required current, as a cable presents a short circuit for a load. The 100Ω series resistors (e.g., R2) serve as current limiters. Amplifiers are connected in opposite polarity so balanced cables can be driven differentially.

Cables can be burned-in using either voltage or current. Voltage mode is achieved by leaving one end of the

ABOUT THE AUTHOR

Jim Hagerman owns Hagerman Technology LLC, a supplier of unique DIY half-kits and high-end audio products. He's been designing analog circuits for 20 years.

cable disconnected. This is often a rather ineffective method, because without a current draw the magnetic properties of the conductors are not exercised. Shorting one end of the cable will generate a current flow and force the voltage to zero.

The FryKleaner's maximum output signal level of +10dBu (2.5V) produces 25mA through the cable, far greater than experienced under normal audio use. A cable can be conveniently connected between output amplifiers for the same effect.

The input to the power amplifiers comes from the modulator U4, which is really just an analog multiplier based on a Gilbert cell. These ICs were commonly used in AM radio circuits, in which an audio signal was multiplied by an RF carrier. I used it here to multiply the noise source with the swept sine wave. The multiplication process acts as a volume control for the noise source, whereas the envelope of the amplitude follows the absolute value of the low-frequency sine wave.

Gain is adjusted by changing the value of a single resistor. Switches select the three output levels of 0.25V, 0.78V (0dBu line level), and 2.5V.

There are many ways to generate a wideband noise signal. A lengthy pseudo-random bit sequence is a popular choice and can be very well controlled. One all-analog method uses a PN junction operated in avalanche breakdown mode—a zener diode. Normally implemented as voltage references, they must be bypassed with capacitance for quiet operation.

Q1 is operated as a zener diode by driving its base-emitter junction into reverse breakdown. The R1-C2 low-pass filter removes any residual 120Hz power-supply noise from getting into this sensitive circuit. U3B provides about 40dB of AC gain and a DC bias level for driving the carrier port of the modulator. One side benefit of the carrier port is that it also acts as a limiter, removing any excessive and rare noise spikes.

The sine-wave generator is based on the very clever 8038, which converts a triangle waveform into a reasonably low distortion sine wave via a ladder of diode clamps. Frequency sweeping is accomplished by changing the bias voltage on pin 9, with Q2 acting as an

SEARCH & BUY ONLINE www.mouser.com

220,000+
ELECTRONIC
COMPONENTS

Semiconductors, Optoelectronics, Lamps & Holders, LED's, Displays, Wire & Cable, Connectors, Assemblies, Sockets, Terminals, Terminal Blocks, Capacitors, Resistors, Potentiometers, Crystals, Oscillators, Inductors, Transformers, Circuit Protection, Fuses & Holders, Resettable Fuses, Breakers, Thermistors, Varistors, Industrial Automation, Switches, Relays, Speakers, Piezo Devices, Microphones, Fans, Heatsinks, Knobs, Hardware, Cabinets, Racks, Enclosures, Batteries, Battery Chargers, Battery Holders & Snaps, Power Supplies, DC-DC Converters, UPS Systems, AC Adapters, Panel Meters, Test Equipment, Tools & Equipment, Supplies & Chemicals, Prototyping Supplies . . .

MOUSER 
ELECTRONICS

FREE SAMPLE

IF YOU BUY,
SELL, OR COLLECT
OLD RADIOS, YOU NEED...

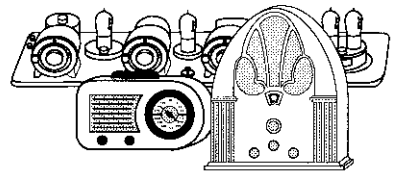

ANTIQUE RADIO CLASSIFIED

Antique Radio's Largest Monthly Magazine
100 Page Issues!

Classifieds - Ads for Parts & Services - Articles
Auction Prices - Meet & Flea Market Info. Also: Early TV, Art Deco,
Audio, Ham Equip., Books, Telegraph, 40's & 50's Radios & More...
Free 20-word ad each month for subscribers.

**Subscriptions: \$19.95 for 6-month trial.
\$39.49 for 1 year (\$57.95 for 1st Class Mail).**

Call or write for foreign rates.

Collector's Price Guide books by Bunis:

Antique Radios, 4th Ed. 8500 prices, 400 color photos \$18.95
Transistor Radios, 2nd Ed. 2900 prices, 375 color photos \$16.95

Payment required with order. Add \$3.00 per book order for shipping. In Mass. add 5% tax.



A.R.C., P.O. Box 802-A16, Carlisle, MA 01741
Phone: (978) 371-0512 — Fax: (978) 371-7129



Web: www.antiqueradio.com — E-mail: ARC@antiqueradio.com

PC BOARDS FROM



To order call **1-888-924-9465** or e-mail custserv@audioXpress.com

ALL BOARDS INCLUDE ARTICLE REPRINT. SHIPPING WT. OF ALL BOARDS: 1 LB.

LED Peak Power Indicator for Speaker—Pair
From *The Joy of Audio Electronics* ..(ea. 3/4" x 2")
PCBSB-D1\$ 3.00

Curcio ST-70 Power Supply
From *Glass Audio* 1/89 (5" x 9")
PCBGK-B1A\$27.00

Curcio ST-70 Driver Board
From *Glass Audio* 1/89 (3 1/4" x 7")
PCBGK-B1B.....\$17.00

Mitey Mike Test Microphone
From *Speaker Builder* 6/90 (1 5/16" x 4 1/8")
PCBD-2\$10.00

Muller Pink Noise Generator
From *Speaker Builder* 4/84 (4 1/8" x 2 3/16")
PCBSB-E4\$ 9.40

Pass Bride of Son of Zen Balanced Line-Stage
From *Audio Electronics* 5/97 (4 5/8" x 8")
PCBP-13A\$20.00

Pass Bride of Son of Zen Balanced Line-Stage Power Supply
From *Audio Electronics* 5/97 (4 9/16" x 4 5/8")
PCBP-13B\$11.00

Electronic Crossover DG-13R
From *Audio Amateur* 2/72 (2" x 3")
PCBC-4\$10.00

30Hz Filter/Crossover WJ-3
From *Audio Amateur* 4/75 (3" x 3")
PCBF-6\$10.00

Pass A-40 Power Amplifier
From *Audio Amateur* 4/78 (3" x 3")
PCBJ-5.....\$ 6.00

Crawford Warbler Oscillator
From *Audio Amateur* 1/79 (3 3/8" x 3 1/2")
PCBK-3\$11.20

Waldron Tube Crossover
From *Audio Amateur* 3/79 (4 1/2" x 2")
PCBK-6\$12.00

Borbely 60W Power Amplifier EB-60
From *Audio Amateur* 2/82 (3 3/8" x 6 1/8")
PCBP-3\$11.75

Borbely Servo-100 Amplifier
From *Audio Amateur* 1/84 (4 1/8" x 6 1/2")
PCBS-1\$16.00

Borbely DC-100 Amplifier
From *Audio Amateur* 2/84 (4 1/8" x 6 1/2")
PCBS-3\$16.00

Curcio Vacuum Tube Pre-Preamp Master Power Supply
From *Audio Amateur* 2/85 (3 3/4" x 4 3/4")
PCBS-6A\$10.35

Curcio Vacuum Tube Preamp/Amp Regulator
From *Audio Amateur* 2/85 (6 15/16" x 10 11/16")
PCBT-1\$27.00

Curcio Vacuum Tube Preamp Master Power Supply
From *Audio Amateur* 2/85 (2 11/16" x 3 3/16")
PCBT-1A\$ 8.00

Lang Class A Mosfet Amplifier
From *Audio Amateur* 2/86 (6 1/16" x 5 11/16")
PCBV-2\$21.40

Borbely Improved Power Supply
From *Audio Amateur* 1/87 (4 1/4" x 5 1/2")
PCBW-3.....\$16.00

Ryan Adcom GFA-555 Power Supply Regulator
From *Audio Amateur* 4/89 (3" x 6 1/4")
PCBY-2\$28.50

Valkyrie Preamp Main Board
From *Audio Amateur* 1/94 (4 1/2" x 5 3/8")
PCBK-13A\$17.65

Valkyrie Preamp Power Supply
From *Audio Amateur* 1/94 (3 1/4" x 5 3/4")
PCBK-13B\$10.25

Pass/Thagard A75 Power Amplifier
From *Audio Amateur* 4/92 & 1/93 (4 1/2" x 4 3/4")
PCBP-10A\$14.95

Pass/Thagard A75 Power Amplifier Power Supply
From *Audio Amateur* 4/92 & 1/93 (3 3/8" x 5")
PCBP-10B\$ 8.95

Didden/Jung Super Regulators
From *Audio Amateur* 3/95. Each board consists of one positive and one negative regulator. (each board-2 1/2" x 2 1/4")
PCBD-3A/B\$24.95

Pass Zen Amplifier Main Board
From *Audio Amateur* 2 & 3/94 (5" x 5")
PCBP-11\$12.95

Pass Bride of Zen Preamp
From *Audio Amateur* 4/94 (5 7/8" x 6 1/2")
PCBP-12\$12.95

Curcio Auto Mute
(1 1/2" x 2")
PCBV-3A\$ 8.00

Youtsey Anti-Jitter Board
From *Audio Amateur* 4/94 & 2/96 (3 1/2" x 4 3/4")
PCBY-3\$15.95

Old Colony Sound Laboratory, PO Box 876, Peterborough, NH 03458-0876 USA

Toll-free: 888-924-9465 Phone: 603-924-9464 Fax: 603-924-9467

E-mail: custserv@audioXpress.com www.audioXpress.com

ORDER ON-LINE AT www.audioXpress.com

appropriate level shifter for the output from the ramp generator. The frequency range is programmed at 2Hz to 200Hz, covering the infrasonic and bass regions of audio. LED D1 is driven in sync with the sine wave to provide an indication of operation.

The U3A op amp is operated as a comparator in the ramp generator circuit. Fortunately, the LM358 does not have input clamp diodes and can function in this mode. By using positive feedback and hysteresis, the circuit charges C15 from 4V to 8V and back again, producing a very slow triangle waveform. The period lasts about 20 seconds.

Simple RC networks are used as power filters for ripple rejection from the wall-wart's relatively dirty supply. Separate filters disconnect any unwanted feedback from the output amplifiers into the sensitive waveform generator circuits. The series resistors in the filters also act to drop voltage in an attempt to tune outputs to exactly 12V.

CONSTRUCTION

The FryKleaner circuit has been carefully laid out on a small circuit board (Photo 1). I chose parts for their practicality, low cost, and ease of assembly. Construction is quite simple and anyone who can solder can do it in under an hour.

FryKleaner can optionally be constructed within a chassis. Instead of mounting connectors and switches on the circuit board, you can panel-mount them to the chassis and link them via wires. This accommodates use of alternate connectors such as XLR or binding posts. It also makes for a more robust product.

RESOURCES

A high-quality circuit board and plans are available from the author at www.fryKleaner.com. You can obtain all remaining parts from Jameco Electronics at www.jameco.com. ❖

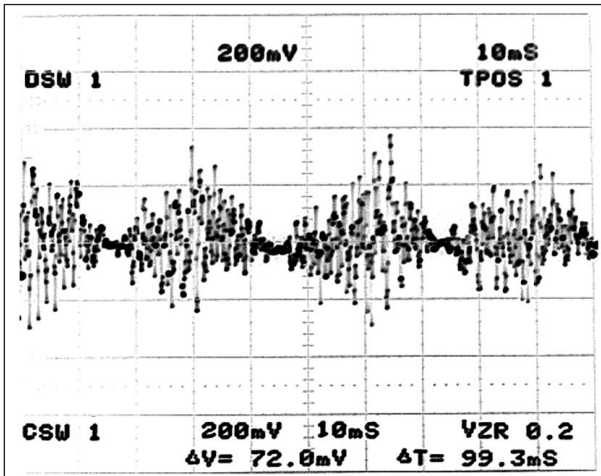

FIGURE 1: Oscilloscope trace of waveform shows noise source modulated by low-frequency sine wave. A-2264-1

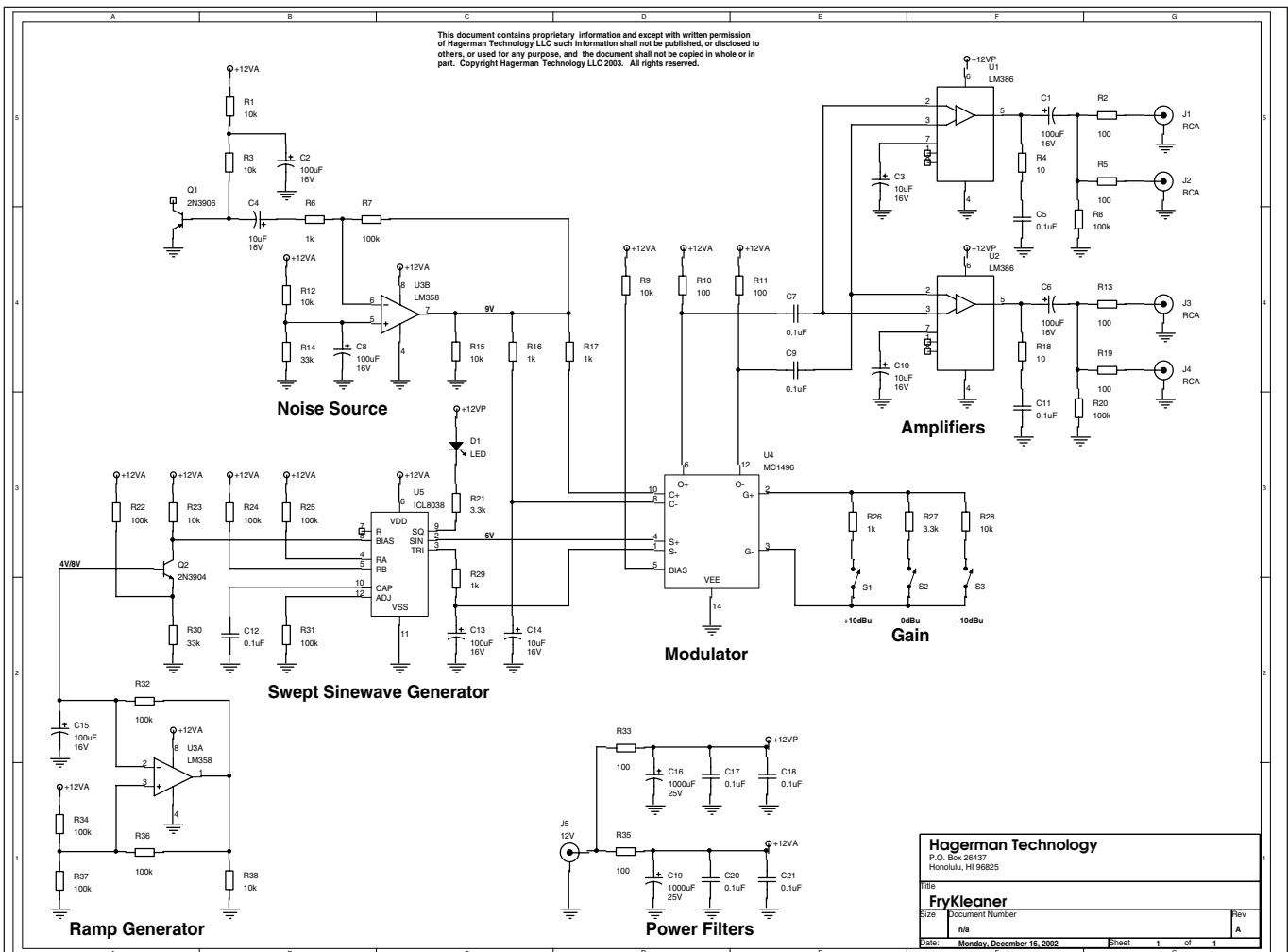

FIGURE 2: Schematic of FryKleaner.

A-2264-2

Against The Wall: An Upgrade

The author describes an improved treble speaker, and provides details on its electrical and acoustic design and mechanical construction.

By John Mattern

This new treble speaker (compatible with the bass speaker described in *aX* Dec. 2002, p. 24) uses a separate midrange and tweeter to replace the original coaxial design, each providing high-end performance. It uses a short transmission line within the midrange enclosure and a cascaded first-order crossover (CO). Axial offset of the tweeter provides for precise alignment at the listener's position. I replaced the stepped diffraction wings of the original speaker design with sloping wings without altering the original bass enclosure (*Photo 1*). This article includes details for calculating the tweeter offset, as well as a description of the testing environment and test results.

CHOICE OF DRIVERS

I chose the Audax 4" carbon fiber mid-bass for the midrange driver and a Vifa 1" tweeter with ferrofluid cooling and a double chamber to provide treble response. The Audax provides ample overlap with the bass driver and adequate overlap with the tweeter at the other end to allow use of a first-order CO design. Sufficient overlap at the top end is made possible by the low-end ex-

tension achieved by the Vifa tweeter. The two crossovers are 1kHz and 4kHz.

This combination handles considerably more power than the previous treble unit, and at the listener level has a much smoother response than the earlier coaxial design. Also, the cascaded first-order CO provides more protection for the tweeter than a two-way first-order CO would. It is more expensive to build, however.

ELECTRICAL DESIGN OF THE CROSSOVER

The cascaded first order is easy to implement and realize. *Figure 1* shows the electrical schematic for the new CO. The enclosed area in the figure is the treble component of the complete speaker system. Its two drivers are by-

passed by Zobels to flatten the impedance characteristics. I used resistance and capacity decade boxes together with the Liberty Instruments IMP to optimize the Zobels.

Table 1 provides the calculations I used for the Audax and Vifa drivers. Capacitor C5 and inductor L2 form a first-order CO at a 4kHz crossover for a 7.5Ω system. *Figure 2* shows the impedance of the finished treble speaker, which looks very much like that of a single speaker and is treated as such when designing the bass to midrange CO.

The only trial and error involved the padding to the 6Ω Vifa tweeter. Padding is required to present a 7.5Ω load to C5, while at the same time providing the correct attenuation. The Vifa tweeter is more efficient than the Audax drivers.

Capacitor C4 and inductor L1 form a first-order CO at 1.0kHz crossover for a 7.5Ω system. This works in the region above the system resonance of LS2, which is 54Hz in free air. Note that both COs are first order but that the tweeter is

TABLE 1
CASCADED FIRST-ORDER
CROSSOVER CALCULATIONS

| | |
|---|---------------------------|
| $F_{CO1} = 1.0\text{kHz}$ | $F_{CO2} = 4.0\text{kHz}$ |
| $L1 = 0.0012\text{H}$ | |
| $R1_E = R_{MIN} + 0.24 = 7.24\Omega$ | |
| $F1 = 7.24 / (2 * P_1 * L1) = 959\text{Hz}$ | |
| $C4 = L1 / (R1_E^2) = 22.9\mu\text{F}$ | |
| $L2 = 0.00030\text{H}$ | |
| $R2_E = R_{MIN} + 0.36 = 7.85\Omega$ | |
| $F2 = 7.5 / (2 * P_1 * L2) = 3978\text{Hz}$ | |
| $C5 = L2 / (R2_E^2) = 4.86\mu\text{F}$ | |



PHOTO 1: Upgraded stereo system flanking the TV in my club room.

TABLE 2
OPTIMUM LISTENING HEIGHT VS. DISTANCE FROM SPEAKER

| DISTANCE FROM SPEAKER (FT) | DISTANCE ABOVE FLOOR (IN) |
|----------------------------|---------------------------|
| 1.0 | 51.29 |
| 2.0 | 50.64 |
| 3.0 | 50.00 |
| 4.0 | 49.36 |
| 5.0 | 48.71 |
| 6.0 | 48.07 |
| 7.0 | 47.43 |
| 8.0 | 46.78 |
| 9.0 | 46.14 |
| 10.0 | 45.50 |
| 11.0 | 44.85 |
| 12.0 | 44.21 |

First-order CO: Normal Polarity
Measured value of H = 50" at D = 36" for phase match at 4kHz without CO computed axial offset (in) = 0.2614.

protected as in a second-order system, except where the midrange driver is resonant. A measurement at the midrange resonant frequency demonstrated more than 60dB rejection at the tweeter terminals. The equivalent second-order system crossover frequency is 2.0kHz.

Now what I see is the best of both worlds. The cascaded CO provides greater protection for the tweeter than the usual CO design. Because it is a

first-order design, it produces an "ideal" transient response with no phase reversals. I realize that claims made for the fourth-order CO state that you cannot notice the phase reversals, although the rapid phase change at crossover for the second-order CO can be detected. I don't dispute this, I am merely skeptical. I have plans for an experiment that may shed some light on this matter.

I must admit that I did not fully understand all the consequences of a first-order CO and depended on G.R. Koonce¹ to fill in the details. I am referring to the asymmetry that results when the midrange and treble CO outputs are in quadrature at the CO frequency. With the outputs connected in phase and the tweeter located above the midrange, there will be a dip above the position of equal acoustic path lengths. This occurs because the two sounds go farther out of phase with increasing height.

However, in the downward direction the two sounds are more in phase, causing a broad 3dB peak. At the 90° midpoint the CO action is ideal. Thus it be-

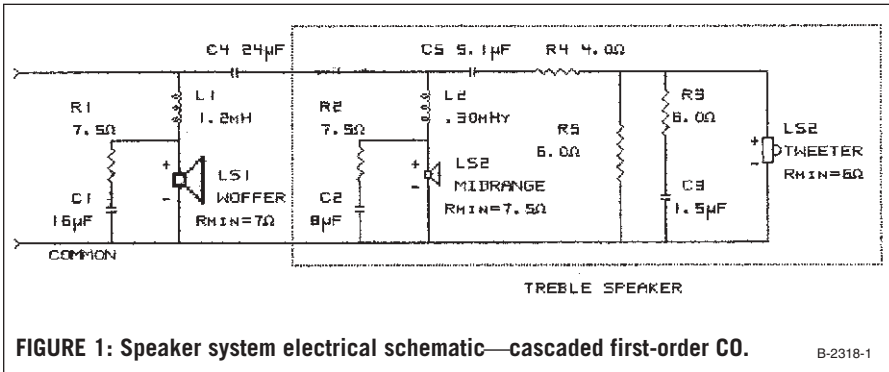
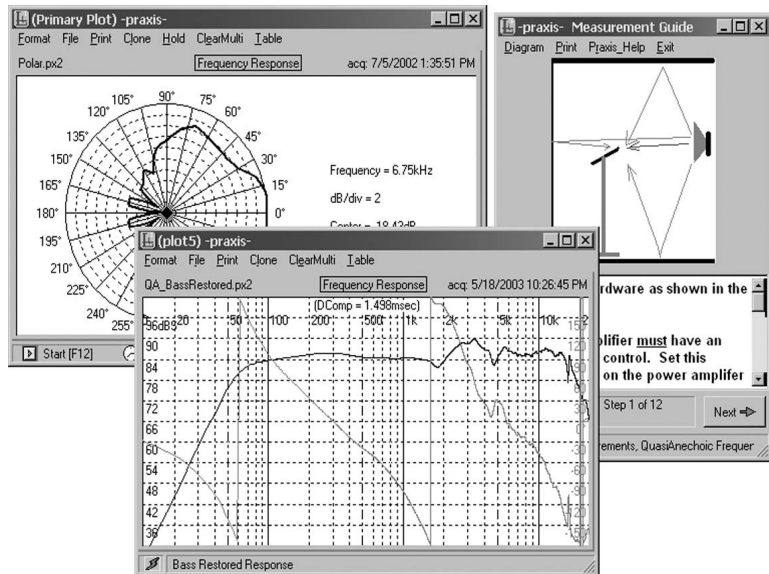

FIGURE 1: Speaker system electrical schematic—cascaded first-order CO.

B-2318-1

PRAXIS audio measurement system

- Provides full-featured customizable measurement including loudspeakers, room acoustics, noise surveys, transducers, electronics, vibration testing, PA alignment, and quality control.
- Flexible, portable system advances with the latest 24bit/192kHz soundcard converter technology.
- Latest version always available online.
- Informative website includes technical articles and downloadable demos.
- Friendly small company. No endless voicemail!



www.libinst.com

Liberty Instruments, Inc., P.O. Box 1454, West Chester, OH 45071 USA
Phone/Fax 513 755 0252, carolst@one.net

comes important to set the tweeter back from the midrange so that the acoustic paths are equal at the listener's position, presumably a seated one.

The same holds for the midrange and woofer pair. Here, though, the drivers are quite similar in design and size and also the frequency is much lower so the resultant vertical beam is broader and the offset is not nearly as critical. The midrange driver in the new treble speaker is set back slightly from the bass driver when their front panels are in alignment.

TWEETER AXIAL OFFSET

G.R. Koonce demonstrated in an unpublished paper that the first-order CO allows a wide vertical beamwidth for this driver arrangement, but with asymmetry that diminishes as the driver spacing is reduced. For this reason, I mounted the two drivers as close together as reasonable but in different planes. According to my tests this produced a below-axis alignment in time at the crossover frequency. This is desirable as the viewer is usually seated somewhat below the midrange axis.

Because there is no provision in the CO to correct the phase difference caused by the misaligned driver acoustic centers, this must be done mechanically by the enclosure front panel design. The offset consists of a 0.438" difference between the driver faceplates. An offset shortfall that I am calling residual offset (RO) is needed to obtain a slight downward slope for the optimum path. I used the first formula to

find the RO and the second formula to find the optimum height (OH) at a given distance using RO.

$$RO = (-B + \sqrt{B^2 - 4 * A * C}) / (2 * A)$$

where: A = 1

$$B = 2 * D$$

$$C = M^2 - T^2 + 2 * H * (T - M)$$

and T = height of tweeter (54.38")

$$M = \text{height of midbass (49.5")}$$

$$D = \text{distance from mike to panel (36")}$$

$$H = \text{height of mike at null (50.0")}$$

$$L = \text{distance between listener and front panel in inches.}$$

$$\text{then } OH = (RO^2 + 2 * L * RO + M^2 - T^2) / 2 * (M - T)$$

If RO were 0, the optimum height would be constant. As it is, the tweeter is too far forward (RO = 0.26"), causing the optimum height to diminish with distance, a desirable condition in this case.

Unfortunately, this involved experimentation with the panel design.

**TABLE 3
CO MECHANICAL PARTS LIST**

| QTY. | DIMENSIONS | MATERIAL |
|------|--------------------|---------------------|
| 1 | 12 x 3.5 x 0.5" | MDF (base) |
| 1 | 1.25 x 1.25 x 0.5" | MDF (support block) |
| 1 | 12 x 6.0 x 0.25" | Plywood (panel) |
| 29 | #6/32 bolts | Brass (tie points) |
| 29 | #6/32 nuts | Steel |

**TABLE 4
SPEAKER ELECTRICAL SYSTEM PARTS LIST**

| PART | VALUE | SOURCE | DESCRIPTION | MFG PT# | PARTS EXPRESS |
|--------|--------|----------------------|----------------------------|-------------|---------------|
| C1 | 16.0µF | Parts Express—Solen | 400V Polypropylene | | 027-578 |
| C2 | 8.2µF | Parts Express—Solen | 400V Polypropylene | | 027-564 |
| C3 | 1.5µF | Parts Express—Solen | 400V Polypropylene | | 027-528 |
| C4 | 24.0µF | Parts Express—Solen | 400V Polypropylene | | 027-586 |
| C5 | 5.1µF | Parts Express—Solen | 400V Polypropylene | | 027-554 |
| R1, R2 | 7.5Ω | Parts Express—Dayton | 10W non-inductive | | 004-7.5 |
| R3, R5 | 6.0Ω | Parts Express—Dayton | 10W non-inductive | | 004-6.0 |
| R4 | 4.7Ω | Parts Express—Dayton | 10W non-inductive | | 004-4.7 |
| L1 | 1.2mH | Parts Express | Air core | | 266-355 |
| L2 | 0.30mH | Parts Express | Air core | | 260-720 |
| *LS1 | 8.0Ω | Parts Express—Audax | 5.25" carbon fiber woofer | HMI30CO | 296-063 |
| LS2 | 8.0Ω | Parts Express—Audax | 4.0" carbon fiber midrange | HMI100CO | 296-053 |
| LS3 | 6.0Ω | Parts Express—Vifa | 1.0" soft dome tweeter | D27TG-35-06 | 264-526 |

*Part used in bass speaker enclosure.

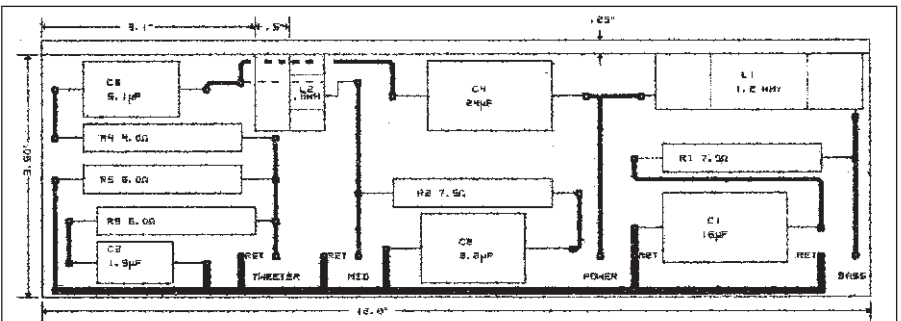
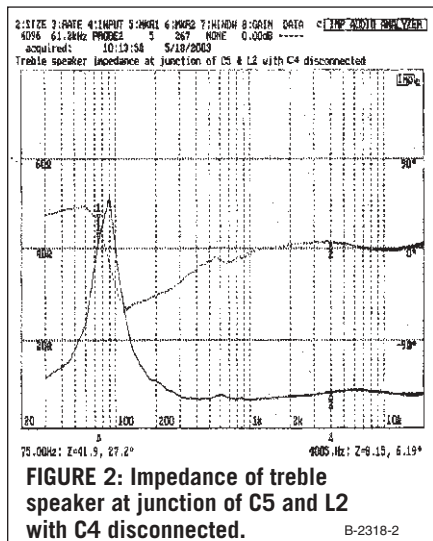

FIGURE 3: Crossover mechanical drawing.

B-2318-3



B-2318-2

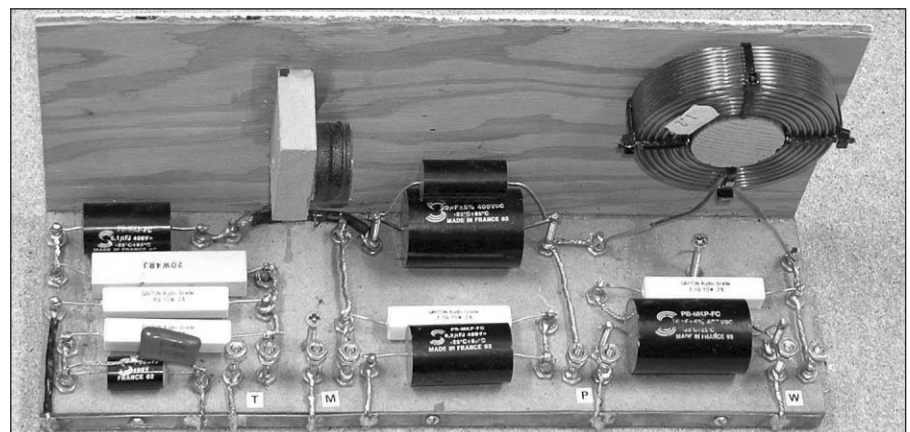

PHOTO 2: Rear view of completed CO.

Table 2 shows the result of the calculations for the final enclosure. For my viewing distance of 11' the optimum height was 45", about right for the seated listener. When the dust settled, I constructed a second treble enclosure using the final panel design. The RO that I used in the treble speaker was 0.26". The measurements that led to the numerical value of residual offset (RO) are described in the section entitled "Treble Speaker Acoustic Phase."

CROSSOVER CONSTRUCTION

This new CO is an extension of the one in the Dec. '02 issue. Table 3 shows the list of materials to construct the frame for the CO parts, and Table 4 shows the electrical parts list for the bass and treble speakers COs. Figure 3 shows the parts placement on the base and front panel.

I used brass screws for tie points and drilled holes for the screws before gluing the front panel to the base. This is also a good time to drill holes for the two wood screws that attach the CO assembly to the treble box. Next I inserted the flat-head brass screws from the bottom, securing them with the steel nuts.

Brass nuts are preferable, but they were not available at Home Depot.

I ran a 3/8" wide copper strap on the back edge of the base to serve as a ground bus, fastening the bus with small screws. I cut the strip from some used copper flashing, and soldered all

ground returns to the bus and interconnected the screws with heavy wire before attaching the components. I used a heavy soldering gun to avoid cold solder joints. In fact, I used two guns when soldering to the copper bus. The combination of heavy wire and the bus re-

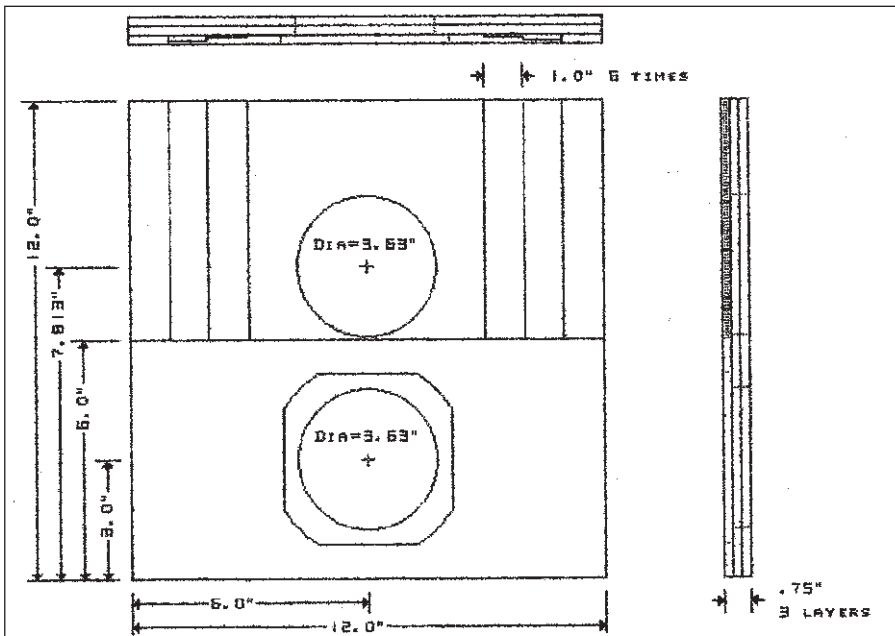
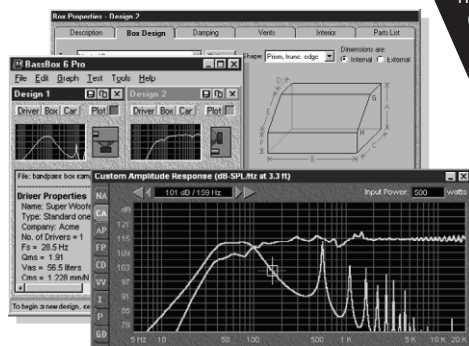

FIGURE 4: Treble speaker front panel assembly.

B-2318-4

Design speaker boxes with BassBox Pro

Design speaker boxes for any space: car, truck, van, home hi-fi, home theater, pro sound, studio, stage, PA and musical instruments. Import acoustic measurements. For example, the response of a car can be imported to simulate the in-car response.



\$129 plus S&H

Need help with your speaker designs? BassBox Pro & X-over Pro can help!



Harris Tech Pro software for Microsoft® Windows can help you quickly create professional speaker designs. Our software is easy to use with features like "Welcome" windows, context-sensitive "balloon" help, extensive online manuals with tutorials and beautifully illustrated printed manuals. We include the world's largest driver database with the parameters for many thousands of drivers.

For more information please visit our internet website at: www.ht-audio.com

Tel: 269-641-5924
Fax: 269-641-5738
sales@ht-audio.com

Harris Technologies, Inc.
P.O. Box 622
Edwardsburg, MI
49112-0622
U.S.A.

Design crossovers with X-over Pro

Design 2-way and 3-way passive crossover networks, high-pass, band-pass or low-pass filters, impedance equalization, L-pads and series or parallel notch filters. Its Thiele-Small model provides professional results without complex testing.

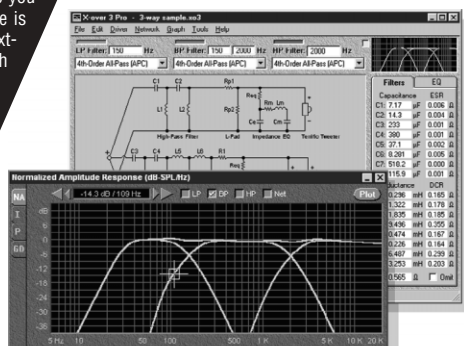

\$99 plus S&H

Sophisticated Driver Modeling and Advanced Box Design

- Multiple drivers with isobaric, push-pull and bessel options. • 3 dual voice coil wiring options. • "Expert Mode" dynamically analyzes driver parameters. • Design closed, vented, bandpass and passive radiator boxes. • "Suggest" feature provides fast box design. • All box types account for leakage losses and internal absorption.
- Advanced vent calculation. • Bandpass boxes can be single or double-tuned with 2 or 3 chambers. • 22 box shapes (shown below). • Open up to 10 designs at one time.
- Analyze small-signal performance with: Normalized Amplitude Response, Impedance, Phase and Group Delay graphs. • Analyze large-signal performance with: Custom Amplitude Response, Max Acoustic Power, Max Electric Input Power, Cone Displacement and Vent Air Velocity graphs. • Includes a helpful "Design Wizard" for beginners.

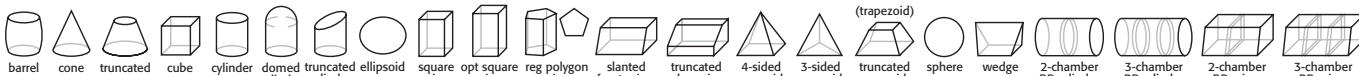

Passive Crossover Filters and Scalable Driver Modeling

- 1st, 2nd, 3rd and 4th-order "ladder" filter topologies. • Parallel crossover topology. • 2-way crossovers offer Bessel, Butterworth, Chebychev, Gaussian, Legendre, Linear-Phase and Linkwitz-Riley filters. • 3-way crossovers offer All-Pass Crossover (APC) and Constant-Power Crossover (CPC) filters. • X-over Pro's capabilities scale to fit the amount of driver data. • A crossover, filter or L-pad can be designed with just the nominal impedance of each driver. • With full Thiele-Small parameters, impedance equalization can be designed and the performance graphed.
- Graphs include: Normalized Amplitude Response, Impedance, Phase & Group Delay. • Graphs can include the full speaker response including the box. • Estimate component resistance (ESR & DCR). • Calculate the resistance of parallel or series components.

Copyright © 2002 by Harris Technologies, Inc. All rights reserved worldwide. BassBox is a trademark of Harris Tech. Other trademarks belong to their respective companies. Harris Tech reserves the right to make changes without notice. All prices are in U.S. dollars.

quires more than 100W.

I located L1 close to an upper corner and L2 in the center, both held by pieces of wood that I glued to the back of the panel. For the large coil I chose a close-fitting dowel that I fastened to the panel with glue. I glued a small rectangular block to the front panel to support the small coil that was held to the block with "Goop." The name of the game is to keep the coils away from anything that could affect their fields. Once set, the coils stay put, and there are no ferrous parts or conductors near them to affect the performance.

I finished the CO by soldering the components to the ends of the brass screws. Because these components are not subject to serious vibration, I did not glue them in place. *Photo 2* shows the rear surface of the CO complete with stuffing.

TREBLE ENCLOSURE CONSTRUCTION

The treble enclosure consists of a laminated front panel to which the sides and internal pieces are permanently attached with carpenter's glue. The back is attached with screws to the sides and internal pieces. The joint between the back and the connecting pieces is sealed with PVC foam weather-strip.

The internal pieces form a short transmission line (TL) that is filled with fiberglass and also provide rigidity to the completed assembly. The TL provides mechanical damping at the resonant frequency of the midrange driver that replaces some of the electrical damping lost by the first-order CO network. *Table 4* contains the parts list for the treble speaker enclosure.

The front panel is a laminate that I made from three sheets of fiberboard. The Audax midrange is mounted to the

front of the second layer. The Viva is mounted to the front surface of an internal sub assembly.

Figure 4 shows the construction of the laminated front panel, consisting of three hardboard pieces glued together under pressure. I started with three 12x12x.20" pieces of hardboard. After locating the centers for the drivers and with the three panels clamped in alignment, I drilled the two pilot holes through the three panels. This assured alignment of the finished cuts with my circular saws.

The round hole for the Audax was slightly undersized, so I used a power-driven drum sander to enlarge it. The ir-

regular pattern for the frame was from the Audax driver itself. With the Audax face down and centered, I traced its outline on to the first panel. I rough-cut the hole for the frame with a saber saw and filed the edges to fit. After finishing the holes, I cut panel one to its final size 12x6x.20, being careful not to break it.

I then glued panels two and three together with carpenter's glue, spreading it thinly onto the mating surfaces. For pressure I used six ordinary bricks, leaving the aligned assembly on a flat surface while the glue dried. After this I glued the shortened panel one to panel two, then checked the alignment to ensure that the Audax driver would seat

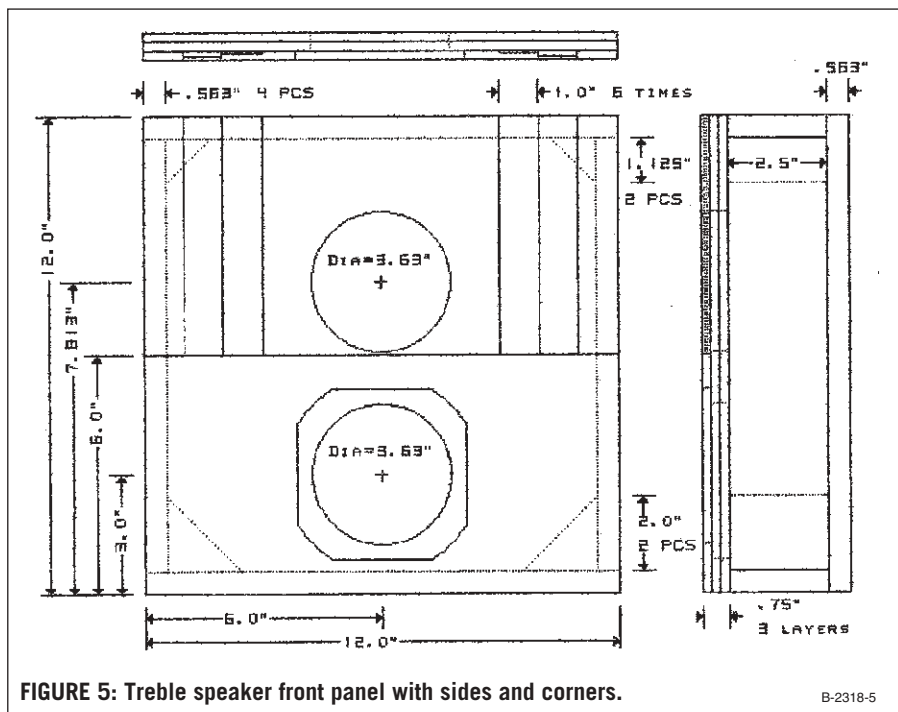
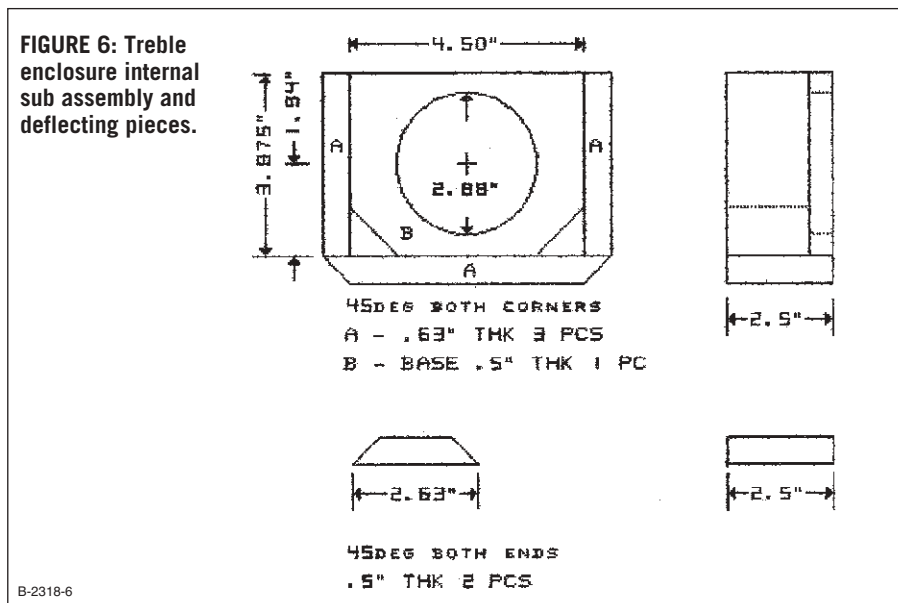

FIGURE 5: Treble speaker front panel with sides and corners.

B-2318-5



B-2318-6

TABLE 5
TREBLE SPEAKER ENCLOSURE
PARTS LIST

| QTY. | DIMENSIONS | MATERIAL |
|------|-------------------|---------------------------|
| 1 | 12 x 12 x 3/4" | MDF (front subassembly) |
| 1 | 12 x 12 x 5/8" | MDF (back) |
| 2 | 11 x 2.5 x 5/8" | Hardwood (sides) |
| 2 | 12 x 2.5 x 5/8" | Hardwood (top & bottom) |
| 1 | 6.0 x 2.5 x 5/8" | Hardwood (partition) |
| 2 | 3.2 x 2.5 x 5/8" | Hardwood (partition ends) |
| 2 | 2.63 x 2.5 x 5/8" | Hardwood (deflectors) |
| 2 | 2.0 x 2.5 x 2.0" | Wood (45° corner pieces) |
| 2 | 1.0 x 2.5 x 1.0" | Wood (45° corner pieces) |
| 2 | 1.0 x 2.0 x 1.0" | Wood (45° corner pieces) |
| 23 | #6 x 1.5" | Steel wood screws |

properly when the glue was dry.

The three steps on each side of the tweeter are added to reduce diffraction effects. They were fabricated from very thin material approximately .066" thick and glued in place after the front panel was completed. Note that one way to get the desired result uses strips having staggered widths of 1, 2, and 3".

ASSEMBLY

Figure 5 shows the complete treble box with its essential dimensions. Table 4 shows the parts list for the treble enclosure. I first glued the bottom side piece onto the front panel assembly. After brushing a thin coat of glue on both surfaces, I placed the bottom side piece on the front panel assembly and placed the top side piece in position without glue, putting bricks atop a board across the two sides to apply pressure.

Using the same procedure, I assembled the two side pieces, followed by the top piece. In both cases I used weights with clamps to apply pressure in the other direction. Next I glued in place four of the six corner pieces. I held the triangular pieces in place with

small vises while the glue dried. Note that the two larger corners are located near the midrange driver position.

Figure 6 shows details of the center piece subassembly that forms a short TL and isolates the two drivers. You attach the finished subassembly to the rear of the front panel. I suggest cutting the matching hole in the base before cutting

the base to size. First I glued the two end pieces to the base as shown in the figure using a brick to apply pressure. Next I glued the long piece to the end pieces and to the base at the same time using a brick and clamps for pressure.

You may choose to glue the 45° corner pieces in place now to complete the subassembly. I suggest that you mount

FIGURE 7:
Treble speaker enclosure—simplified view showing internal parts placement.

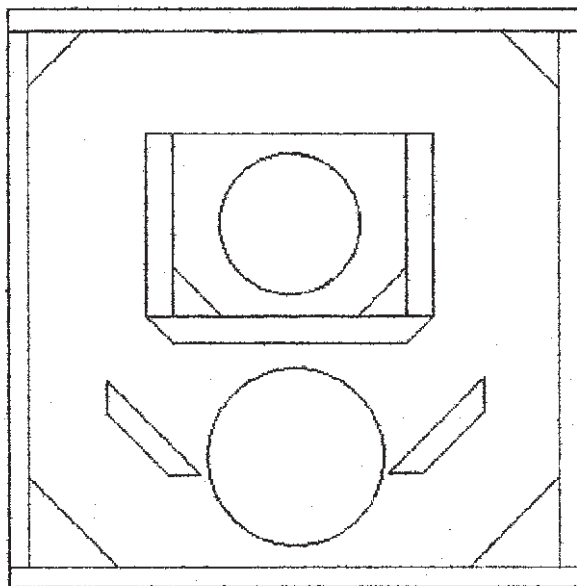

B-2318-7

The CLIO system

Turns your PC into the most complete easy-to-use electrical and acoustical measurement system ...

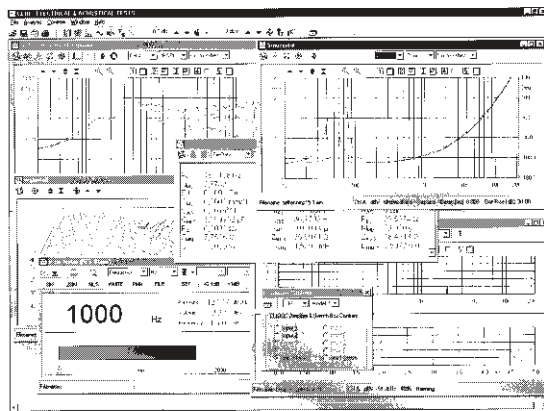
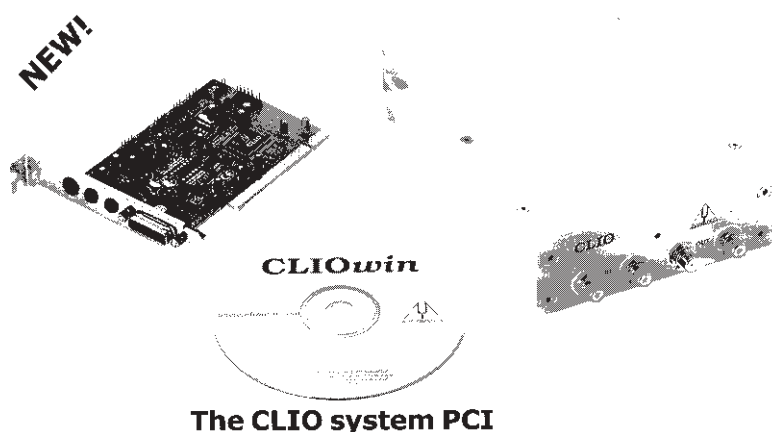

The **CLIO** system is a PC-based system for electrical and acoustical measurements. **CLIO** offers several measurement software, related measurement hardware and accessories. **A CLIO system is a complete test instrument, 100% warranted by Audiomatica; all you need is to supply a compatible computer. No Soundcards involved!**



CLIO is produced by **AUDIOMATICA** and is available also from



www.cliowin.com
www.audiomatica.com

the Audax driver next to eliminate the possibility of interfering with this sub-assembly. I used sheet-metal screws to attach the Audax, but you may prefer to use a more secure fastener. Screws hold better in the fiberboard than in the MDF.

I then fastened the subassembly to the rear of the front panel, using bricks for pressure. The two 2.88" holes should be in close alignment and the sub-assembly sides should be parallel to the

surrounding surfaces (Fig. 7). You may need to enlarge the hole to clear the Vifa magnet with the drum rasp as before. Also, you will need to cut relief notches for the driver solder lugs with a circular file as I did.

The Vifa face plate is too large to fit in the provided space, but not to worry: the acoustical need for the large face-plate is nonexistent in this environment, and you can easily file the soft

plastic face plate to size. Drill new mounting holes, and you are in business. A word of caution, though: if you solder the leads to the Vifa terminals, be careful not to overheat the lugs or you will think you have ruined the driver; that is, until you resolder the flexible lead to the voice coil.

I placed a large thin washer on the edge of the tweeter face plate to reduce diffraction effects. The OD is 3.63", the ID is 2.5", and the thickness is .10". I drilled matching holes in the washer and used the driver mounting screws to hold it in place.

Figure 6 provides the dimensions for the deflecting plates. The 45° deflecting pieces are the last parts to attach to the rear of the front panel. You should orient them as shown in Fig. 7. With the Audax fastened in place, locate the deflectors as close as possible to the Audax driver and more or less equidistant from the other surfaces as shown, then glue under pressure.

I used 5/8" closed cell PVC foam weather-strip to seal the back of the enclosure. After applying the weather-strip, I centered the back and drilled mounting holes for it. I used a #6 x 1.5" bit to drill and countersink in one operation. Table 6 lists the stuffing for the enclosure.

I used 23 screws on 3" centers where possible to attach the back. The power leads emerged at an angle from the top edge. I did not consider minor leakage at this location a problem. Photo 3 shows the open back of the enclosure after drilling the fastener holes, mounting the drivers, and installing the stuffing. Photo 4 shows the completed enclosure with the crossover attached.

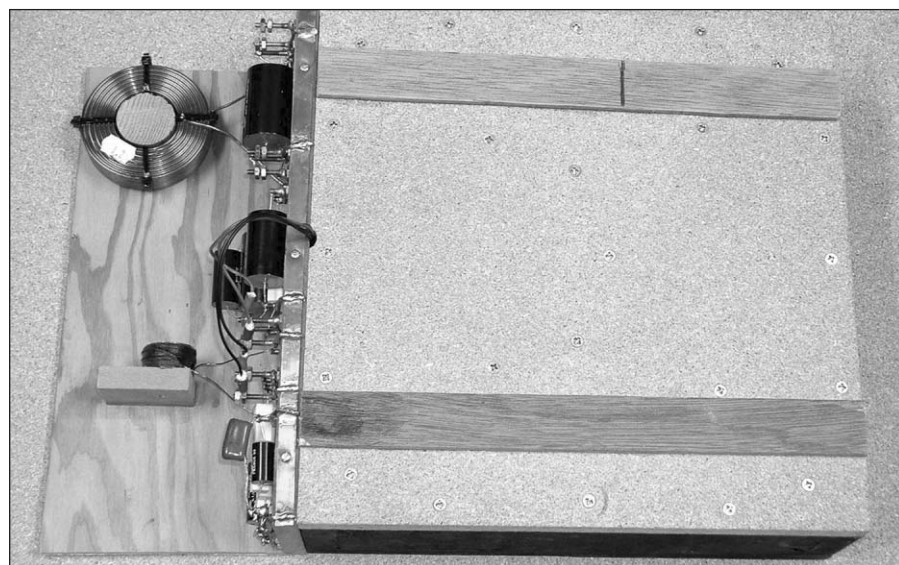

PHOTO 3: Rear view of enclosure with stuffing in place.

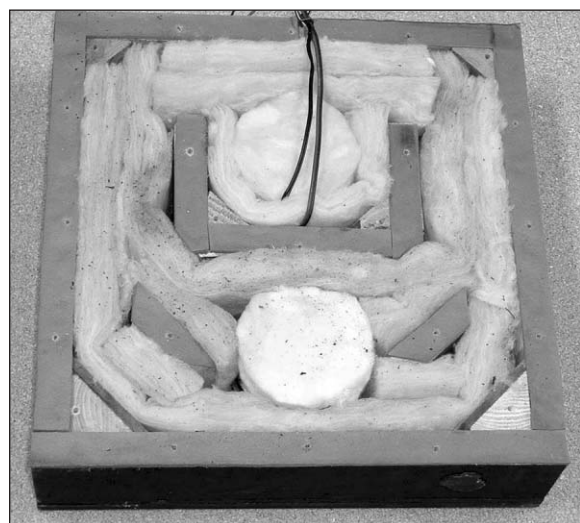

PHOTO 4: Rear view of completed enclosure with CO attached.

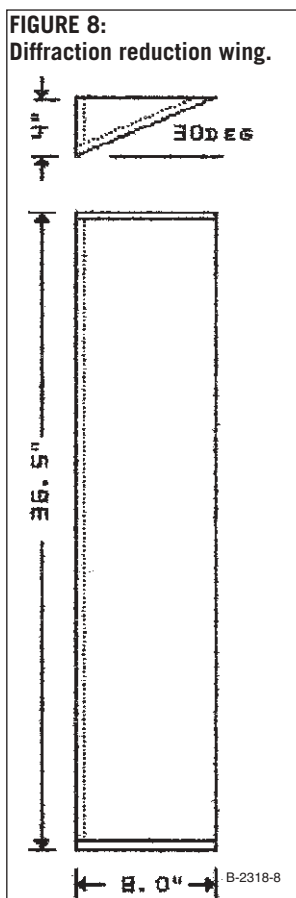

TABLE 6
TREBLE SPEAKER ENCLOSURE STUFFING—SEE PHOTO 4.

| QTY. | DIMENSIONS | MATERIAL |
|--------|-------------------|--|
| 1 | 26 × 2.5 × 2.0" | Fiberglass |
| 1 | 21.5 × 2.5 × 2.0" | Fiberglass |
| 2 | 1.0 × 3.0" Dia | Fiberglass (magnet vent cover) |
| 2 | 24 × 2.5 × 1.0" | Fiberglass pieces (cut lengths to fit) |
| 1 Pkg. | 0.75 × 0.1875" | Closed cell foam weather-strip |

DIFFRACTION WINGS
My original speaker had a diffraction wing on each side to reduce the diffraction effect at the enclosure edges. For practical reasons, these wings were stepped, although I realized that slop-

TABLE 7
MECHANICAL PARTS LIST FOR WINGS

| QTY. | DIMENSIONS | MATERIAL |
|------|-------------------|---------------------------------|
| 4 | 36 × 3.5 × 0.5" | MDF (side piece) |
| 4 | 36 × 8.1 × 0.5" | MDF (front piece) |
| 8 | 4.0 × 8.1 × 0.25" | Plywood (triangular end pieces) |
| 2 | 36 × 2 × 2" | Fiberglass (fill) |

ing wings were preferred. I have changed to wings with a 30° slope. *Figure 8* shows the dimensions and *Table 7* shows the parts. I filled the space behind the wings with fiberglass to pre-

vent suck-out by Helmholtz resonance. The wings are attached with pins set in the upper end of the bass speaker. The pins extend into the corner pieces at the top of the bass box and extend

into matching holes in the wings.

TREBLE SPEAKER CO PHASE

First I checked the treble CO for quadrature output at 4kHz with an oscilloscope

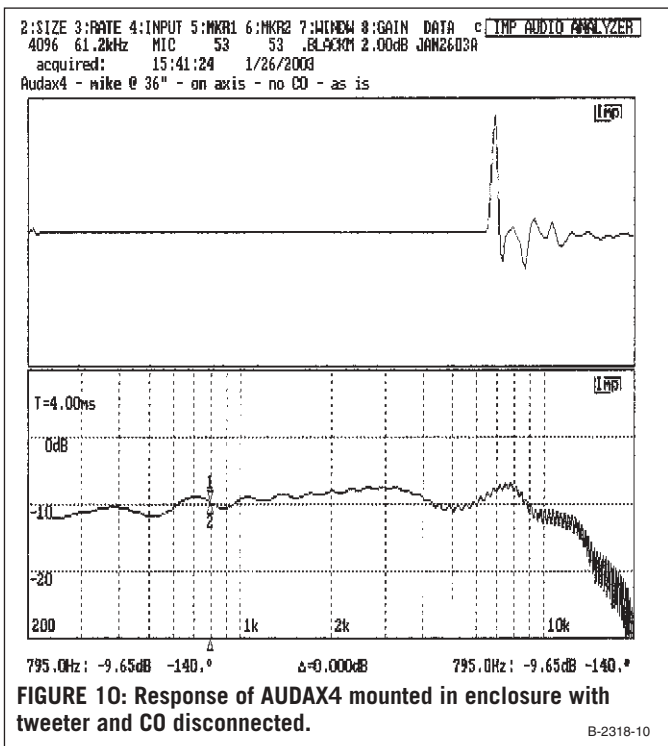
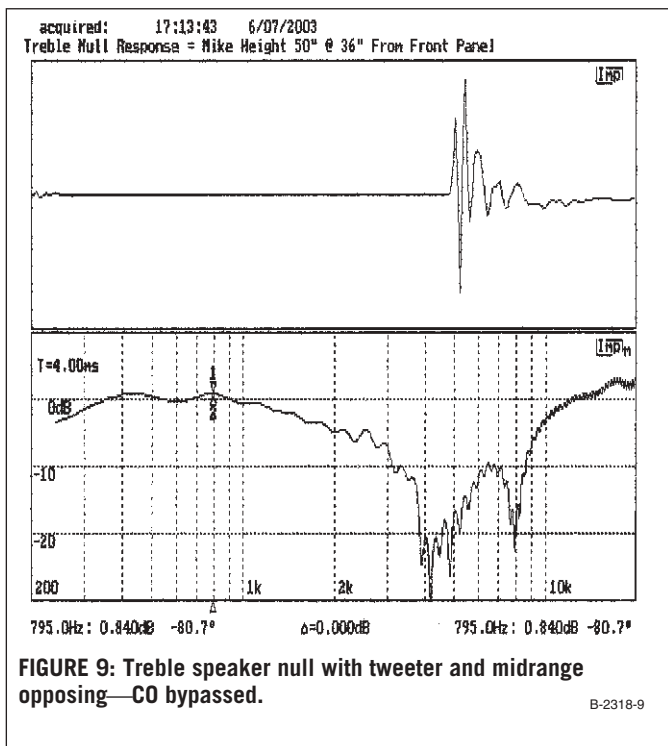

GRANDMOS

The SMART amplifier

2 Audiophile Masterpieces for the DIYer

TRIPHON

The ULTIMATE crossover system



- ✓ Probably, the nearest approach to :
"A STRAIGHT WIRE WITH GAIN".
- ✓ High end 2 x 100 W_{RMS} / 8 ohms MOS-FET amplifier.
- ✓ SILVER plated PTFE / fiberglass printed circuit boards.
- ✓ SILVER plated connections.
- ✓ Military grade components.
- ✓ Only J-FET and MOS-FET audio transistors.
- ✓ NO CAPACITOR in the sound path *.
- ✓ Minimum wiring and easy construction.
- ✓ Outstanding performances.
- ✓ Absolute Transparency and Sound.
- ✓ Extremely reliable.
- ✓ Steady performances over years.

* : under certain conditions

To complete the GRANDMOS (or any good quality amplifier) we have designed the TRIPHON system :

- ✓ Musically neutral and transparent.
- ✓ 3-way electronic crossover.
- ✓ 6 or 12 dB/octave slope (true LINNKWITZ-RILEY filter).
- ✓ 4-channel Class A minimalist MOS-FET amplifier for MID and HIGH frequencies.
- ✓ Choice of cut-off frequency.
- ✓ PTFE / fiberglass printed circuit boards.
- ✓ Fully discrete component technology.
- ✓ SILVER plated connections.
- ✓ Minimal wiring.



www.selectronic.fr

Phone : + 33 - 328 550 328 - Fax : +33 - 328 550 329
BP 513 59022 LILLE - FRANCE

>> Detailed information on www.selectronic.fr or by e-mail to : selectrocom@selectronic.fr <<

Jupiter

CONDENSER CO.



BEESWAX-PAPER-FOIL

CAPACITORS

Signal
Parallel-Feed
Speaker
Ultra-Path
Power Supply

Jupiter Condenser Co. 1525 Plantation Drive
Huron OH 44236 330-342-9590
www.jupitercondenser.com

Lissajous pattern taken at the speaker terminals. I disconnected a lead to C4 and applied the power to the junction of L2 and C5. I used a scope gain adjustment to compensate for the different driver loads. The Lissajous pattern formed by the voltages at the speaker terminals was very close to a perfect circle indicating a 90° phase difference as required by the first-order CO design.

TEST ARRANGEMENT

Photo 5 shows the test arrangement I used to evaluate the new treble speaker. I placed it next to a dummy bass speaker enclosure, which I placed on the floor against the garage door. I placed the diffraction reduction wings on the floor as shown in the photo. Details of the wing construction are provided in *Fig. 8* and *Table 7*.

I used the Liberty Instruments IMP to make the frequency response and impedance measurements, with the mike hanging from the ceiling 36" above the front panel. I used a 4ms window with .BLACKM weighting for the response measurements. Other settings are shown on the plots. I powered the treble speaker with a 20W home-brew solid-state DC-coupled amplifier, which passes an almost perfect 10kHz square wave as you can see on a 20mHz dual trace scope.

Note that the speaker system is on its side with the dummy bass box resting against the garage door. Therefore, what I call height is actually the horizontal distance from the garage door to

the mike, and what I call distance is actually the vertical distance from the front panel to the mike.

TREBLE SPEAKER ACOUSTIC PHASE

This test will determine the optimum listening height vs. distance to the listener. Since both treble unit drivers are positioned above the seated listener, it is important that the optimum angle be below the horizontal by a small amount.

The acoustic phase test is the simplest of two methods that I used to determine the optimum listening height. It used the Liberty Instruments IMP to locate the phase null resulting when the midrange and tweeter were cross-connected without benefit of the CO. Of course, it was necessary to use an Lpad to balance the gains. The best null was obtained moving the mike "vertically" at 36" "distance" in front of the panel while also adjusting the Lpad to balance the amplitude. This "vertical" movement was easily accomplished with the mike suspended by its cable from a long piece of wood that slides on the overhead garage door tracks.

The final result in *Fig. 9* shows good cancellation at 4kHz, the CO frequency, but the phase difference does not stay small over a wide band. Using the mike location (50" height at 36" distance), I calculated the residual offset for this design. Then using this residual offset, I calculated the optimum height for the various distances as shown in *Table 2*. The optimum height of 45" is about right for my seated position at 11' dis-

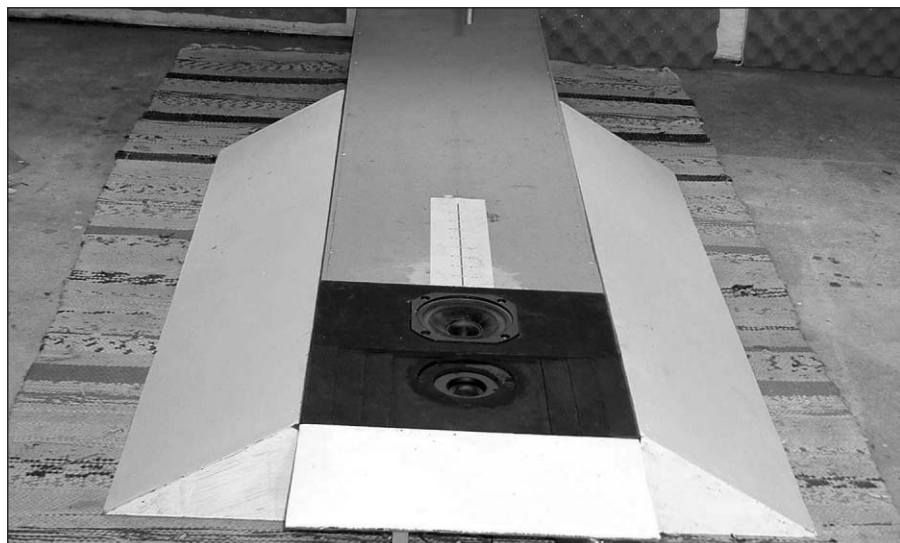

PHOTO 5: View of test arrangement on garage floor with mike hanging from adjustable support near ceiling.

tance. Echoes were a problem when I used an alternate measurement method.

MIDRANGE RIPPLE REDUCTION

The original Audax4 response is shown in Fig. 10. I have spent much time trying to find the reason for the uneven response, running many tests, making changes in the stuffing inside the enclosure and tests outside the enclosure, and concluding that the cause lies in the driver itself. Testing with a small electret mike, using 5kHz excitation of the driver, I discovered the following with the mike al-

most touching the speaker moving system.

The signal was strongest at the junction of the cone and dust cover but depended where on that junction I placed

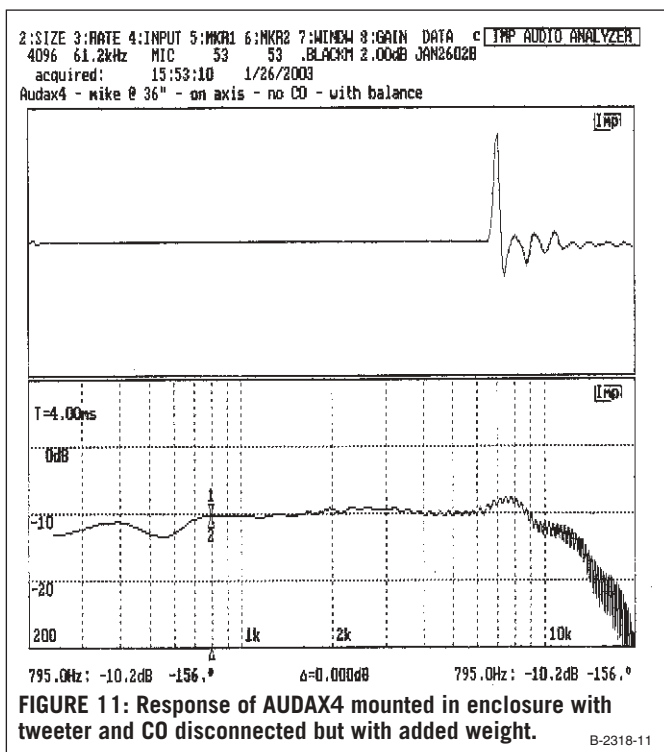

FIGURE 11: Response of AUDAX4 mounted in enclosure with tweeter and CO disconnected but with added weight.

B-2318-11

DO YOU HAVE SURPLUS STOCK OF SPEAKERS?

- US & European drivers & tweeters preferred
- Quantities from 500 to large quantities
- Prompt payment
- Contact us with details



Electus Distribution
Sydney, Australia

email:

mreynolds@electusdistribution.com.au

Fax: 61 2 9741 8500

www.electusdistribution.com.au

ELECTUS DISTRIBUTION

Hi-Fi Do Inc.

BUY & SELL

OVER A
MILLION
HITS/WEEK

USED AMPLIFIERS, SPEAKERS, PLAYERS, BOOKS, ACCESSORIES etc.

www.hifido.co.jp

OSAKA(Overseas Dept.): 4-6-10 NIPPONBASHI NANIWA-KU OSAKA JAPAN
TOKYO:TOKUHARA BLD 5-5-7 SOTOKANDA CHIYODA-KU TOKYO JAPAN
NAGOYA: 3-11-30 OOSU NAKA-KU NAGOYA JAPAN

PHONE 816-4396-7611 FAX 816-4396-7621

Get Hi-Fi Do's Free Online Newsletter >>> www.hifido.co.jp/logtop.html

Ribbon Loudspeakers

by Justus V. Verhagen

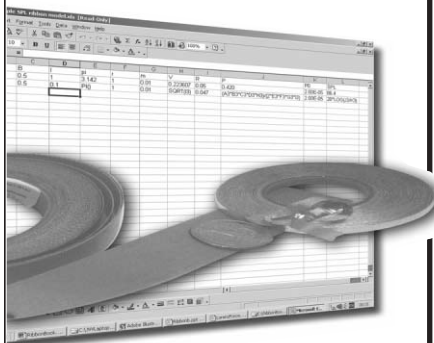

The first book dedicated to these great-sounding speakers. The author favors ribbons, especially for use at mid- and high-frequencies. They are inexpensive and can be easily constructed with a minimum of tools. The book presents the theory and history of ribbon speakers and includes construction details for building your own ribbon loudspeakers. An extensive resource section is included along with a detailed listing of ribbon loudspeaker patents. 2003, ISBN 1-882580-44-3. Sh. wt: 2 lbs.

BKAA65 **\$24.95**

Order on-line at
www.audioXpress.com
or call toll-free

1-888-924-9465

Old Colony Sound Laboratory
PO Box 876, Peterborough, NH
03458-0876 USA
Toll-Free: 888-924-9465
Phone: 603-924-9464
Fax: 603-924-9467
E-mail:
custserv@audioXpress.com
www.audioXpress.com

the mike. It was weakest near the point where the power leads attached to the voice coil former and strongest opposite this position. The voice coil appeared to be rocking at this frequency. I concluded that the cone possibly was unbalanced by the power leads.

To test this theory I added a 0.3 gram of mastic rolled into a short cylinder at the point of maximum output. *Figure 11* shows the resulting response. I used this modification when making all the tests reported here. I also added this material to the two speakers systems that I regularly use and so far all the weights have stayed in place.

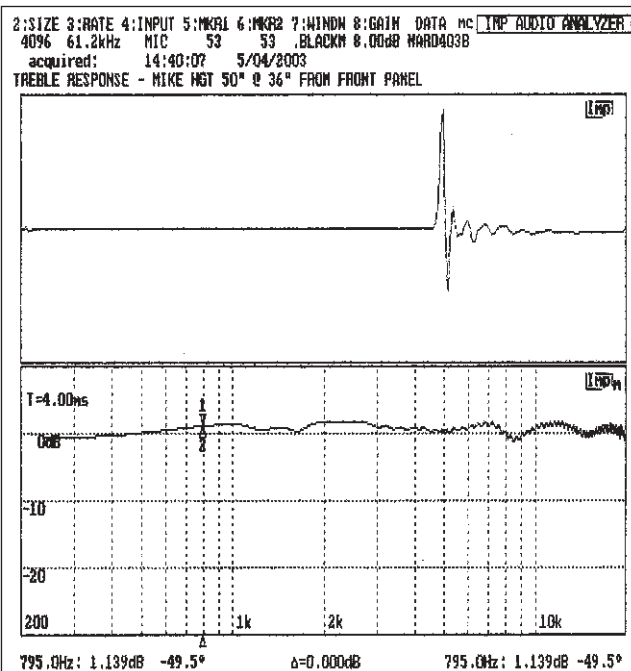

FIGURE 12: Response of treble speaker with VIFA tweeter. B-2318-12

TREBLE SPEAKER FREQUENCY RESPONSE

I obtained the quasi-anechoic frequency response using the test setup described in a previous section with the Liberty Instruments IMP equipment. The microphone was positioned at 36" "distance" and at 50" "height," which I determined was the point that gave equal acoustic path lengths from the tweeter and mids to the mike. This point is also on the optimum path to the seated listener in my listening area.

Figure 12 shows the first arrival response on the path of optimum height. A listener on this path receives the first arrival that is unaffected by the vertical asymmetry peculiar to the first-order CO. I have not included the degradation caused by horizontal effects, because this is not as severe when the drivers are in line vertically.

COMPENSATING THE BASS SPEAKER

Response measurements on the bass speaker reported in Dec. '02 aX indicated the response at 30Hz to be -6dB below the maximum for the bass driver. I tried to compensate for this rolloff. *Figure 13* shows a circuit that I am using that puts a 3dB boost at 30Hz and more at lower frequencies. I use one stereo circuit in series with the CD/DVD output to the receiver CD input and another stereo circuit in series with VCR/TV output to the AUX

Now IN THE
6th
EDITION

The LOUDSPEAKER DESIGN Cookbook

Everything you need to know to build that dream loudspeaker system for your home theater and through your car stereo. About 1000 pages, color and black and white photos, and diagrams. Easy to use as the owner's manual to find your way to your own dream loudspeaker system. Process diagrams, wiring of all loud speakers, and easy step-by-step instructions for assembly.

by Vance Dickason

- More Pages
- More Graphs
- More References
- Brand New Chapters
- Explanations of New Technology

BKAA60
\$39.95

Order Your Copy
TODAY
by calling
1-888-924-9465
or order on-line at
www.audioXpress.com

Shipping and handling add \$7.25, Canada add \$11.00
Overseas surface mail add \$10.25, air mail add \$22.25.

Old Colony Sound Laboratory, PO Box 876
Dept. X4, Peterborough, NH 03458-0876 USA
Phone: 603-924-9464 Fax: 603-924-9467
E-mail: custserv@audioXpress.com

output on the receiver.

When using the compensation, I bypass the receiver tone controls. When listening to FM radio, I switch in the receiver tone control set to the +3dB point. I have not experienced any infrasonic effects when using the boost. This

is a clumsy arrangement that I hope to improve upon with the next round of upgrades to the entertainment system.

CONCLUSIONS

I found the design of the treble speaker to be much more difficult than expect-

ed. The coaxial approach involves timing and interaction phenomena between the midbass and tweeter that appear unavoidable, at least in the small sizes. On the other hand, it gives good results with little effort.

The separate driver approach opens up a can of worms that only worsens as the separation of the drivers increases. In the simplest case of the first-order CO the vertical pattern is asymmetrical. With normal polarity G.R. Koonce's data shows a deep dip above the optimum angle and a shallow but broad maximum below the optimum angle. I notice this dip when standing close to the speakers and the sound becomes dull.

For an in-line vertical arrangement the horizontal effects occur because of differences in the horizontal patterns rather than because of delay differences between the drivers. The horizontal degradation, therefore, is not as severe.

The bottom line as far as I am concerned is that the separate approach leads to audibly better sound quality. This is quite noticeable at the higher power levels. ❖

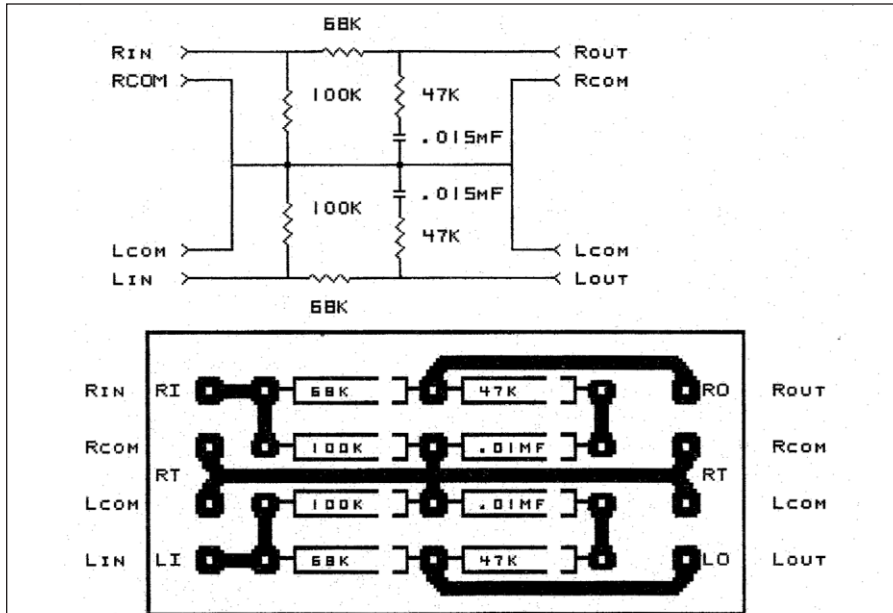

FIGURE 13: Bass equalizer schematic and layout resistors. 1/4W 5% or better capacitors. Film type, preferably polypropylene.

B-2318-13

The Ultimate Acoustic Analysis System.

For real-time testing of Audio System performance!

- 1/12th Octave Real-Time Analyzer (RTA)
 - Energy-Time Graph (ETG) with octave & 1/2 octave band filters
 - Sound Pressure Level Meter
- Speaker Distortion Meter (THD+N)
 - Signal to Noise Ratio
 - Speaker Polarity Test
- Integrated Audio Signal Generator
- Handheld, Portable, Battery Operated
- Serial Data Download and Report Software



Powerful • Portable • Affordable

SENCORE

1-800-736-2673 • sencore.com • e-mail sales@sencore.com

Subscribe To The **SENCORE** News at www.sencore.com

Why Speakers Have Slanted Fronts, Part 4

Some concluding tips on how to achieve success in your own designs.

By G. R. Koonce

CALCULATION OF FRONT PANEL TIP ANGLE

Figure 46 shows the conditions for a floor-standing enclosure with a tipped front panel. All positive angles are shown and exaggerated in this figure for clarity. The front-panel tip angle (FPta) is the angle that the front panel is tipped back from vertical. Tipping the front panel rotates the tweeter's zero degree line an amount equal to the FPta. A positive VBA rotates the "line" to the listener upward even more. The object is to pick a FPta that aims the VBA at the seated listener.

Figure 47 offers a plot to help accomplish this. On the horizontal axis locate the height the tweeter will be above the floor (TH) in the enclosure. Go vertical to the line nearest your listening distance (LD). Then horizontal to establish the required seated total angle (TAX), which is the angle from horizontal to the "line" to the listener (Fig. 46).

The FPta is equal to the TAX minus VBA. It is quite possible that FPta will turn out negative, indicating the front panel must tip forward at the top. I have never built a cabinet like this and suggest you develop some alternate approach. Lowering the tweeter in the box surely would help.

Consider an example using the Sys119 developed earlier. This 8" woofer with 1" dome tweeter showed a VBA of -8° . With a pedestal under the box to mount the CO, the tweeter is going to be about 14" off the floor.

Start at 14" on the horizontal axis of Fig. 47 and move vertical to, say, 8' listening distance (LD). Then, move horizontal to get TAX = 14° . This means FPta = $14 - (-8) = +22^\circ$, which is an excessive

angle to tip back a front panel covered with heavy drivers. I normally limit the tip angle for boxes with a vertical array of drivers to 15° .

Now examine Sys119 for the possibility of building with the woofer above the tweeter. This means the VBA is now $+8^\circ$ and the tweeter height is about 6" off the floor. Using Fig. 47, this results in a TAX of 18° and a FPta of $(18 - 8)$ or $+10^\circ$. Constructed with the woofer at the top, Sys119 sounded just fine.

CHANGE IN LISTENING ANGLE FOR STANDING LISTENER

If you optimize the design for the seated listener, you also need to have some idea of what happens for the standing listener. Figure 48 solves this—both for the box on a stand and the floor-standing box.

Identify the tweeter height from the floor (TH). Locate this value on the hori-

zontal axis and move vertically to the closest listening distance (LD) line and then horizontally to the change in beam angle, which to the standing listener is the VBA plus this change. Since the standing listener is taller than the seated listener, the change in angle is always positive.

For example, first, consider the BT2W system as used on tall stands with the tweeter above the woofer for a LD of 10'. The tweeter height turned out to be 46" for the system VBA of -4° . Figure 48 yields a change in beam angle of $+13^\circ$, meaning the standing listener will listen to the system at $+9^\circ$. The system vertical polar plot (Fig. 21 in Part 3) and the vertical directivity plot (Fig. 22 in Part 3) show the vertical response is just starting to deteriorate by $+10^\circ$.

Suppose you built BT2W with the tweeter at the bottom, and the tweeter height for 10' listening was 30" and the VBA = $+4^\circ$. Using Fig. 48 yields a change in beam angle of $+13^\circ$. So the standing listener vertical angle is $+17^\circ$.

Now because you have inverted the angles by putting the woofer at the top, you need to look at the polar and direc-

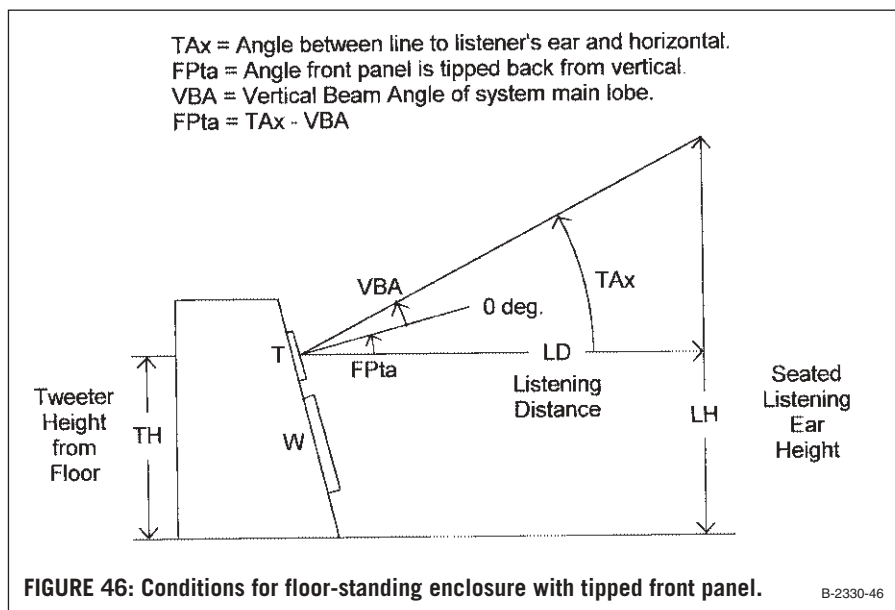

FIGURE 46: Conditions for floor-standing enclosure with tipped front panel.

B-2330-46

tivity plots at -17° . This system holds up much better for negative angles, so building with the woofer at the top and using lower stands looks like the better option.

With Sys119 the only real option was building with the woofer at the top, which gave a tweeter height of 6" and a VBA of $+8^\circ$ with a listening distance of 8'. From Fig. 48 you get a change in vertical angle of $+13^\circ$. This adds to the VBA, giving $+21^\circ$ as the standing beam angle. Again, because you have inverted the system, you must look at the polar plot (Fig. 30 in Part 3) and directivity plot (Fig. 31 in Part 3) at -21° . This system holds up much better at negative angles than positive, so once again building with the inverted configuration looks good.

If you are especially interested in a system that is flat for the standing listener, you can compromise by aiming the VBA slightly above the seated listener's ears. This compromises the seated listener's response slightly to give a more consistent response between seated and standing listening. You can accomplish this by designing with a very high seated listener ear height, perhaps using the average of the seated and standing ear height.

SIMPLE WAYS TO BUILD WITH TIPPED FRONT PANELS

This section shows some of the methods I have used over the years to construct boxes that have a tipped front panel and are relatively easy to build.

Figure 49 shows the simplest construction I know for building an enclosure with a tipped front panel (FP). The basic internal box is rectangular, while the sides are extended down and cut off at an angle. While not recommended for large enclosures, this simple approach has several neat features.

You can determine the angle on the side boards and cut it at the last minute or even possibly re-cut it on the finished box. You can fill the gap below the bottom board at the front with a "fill strip," which is the only piece you need to cut at a blade angle other than 90° . The pedestal formed below the box is an ideal place to mount the CO.

Note in Fig. 49 the FP has been set back to form a grille frame. You could make the FP flush with the box front

and even cut the bottom board short so the FP is full height to avoid the fill strip.

Figure 50 shows the classic approach to a tipped FP with a box that has a horizontal top and bottom with a vertical back. Again, you can flush or set back the FP as desired, or even add a pedestal for the CO. This box requires angular cuts (blade not at 90° to the face of the board) on both ends of the FP and one end of the top and bottom, but all cuts are the same angle. Construction is thus reasonably simple.

Figure 51 shows a construction that I have used many times. The top is perpendicular to the back while the bottom is perpendicular to the FP. This box is ideal for a vented-box system using the diffusor port that I like. The port duct is located in the bottom board and dumps into the triangular area formed by the floor and bottom board.^{13,14}

This construction also has the advantage that the sides are the only parallel opposing panels. Again, you can flush or set back the FP to form a grille frame, and add a fill strip at the front,

below the bottom board, to allow the pedestal to house the CO. One problem is designing this structure to a given volume. It is simple to compute the volume of a defined box, but difficult to determine the required depth or height for a desired volume.

Once again I mention the approach used by David Weems,¹¹ which is to build a rectangular box and set it on a very low stand that sets the FP tip angle by tipping the entire box. Remember this will slightly change the tweeter height and may require recalculation of the desired tip angle, but this approach does offer the advantage of building such stands after you have experimented with listening to the boxes at various tip angles set by convenient shims at the front. If you use the speakers in different locations with a large difference in listening distance, you could build different stands suitable for each location.

SUMMARY

Is there any way to know the location of the vertical beam angle for your system without modeling or testing capability? Certain configurations are predictable,

ROCKLER®
WOODWORKING AND HARDWARE

Pre-drilled holes to mount pads, cauls and jigs

50 years
1954-2004

A taller base — no more knuckle knocks...

Exceptionally stable, just won't tip during glue-ups!

This isn't your father's pipe clamp!
Introducing the innovative Sure-Foot™ pipe clamp.
Call or go online to get your FREE catalog today!

Code 14013

1-800-403-9736 -or- rockler.com/go/V4339

but in general I believe the answer is no. I have reviewed a reasonable number of systems using second-order electrical COs, and the VBA varied from about -10° to $+15^\circ$. Tweeter wiring polarity did not predict whether the VBA would be positive or negative. The following are the only ways I know to determine the vertical beam angle without testing or modeling:

1. Go with a developed design having a known vertical beam angle.
2. Build with a quality coaxial type driver that will have a VBA near zero degrees.
3. Build with the D'Appolito symmetrical W-T-W configuration where the symmetry will force a zero degree VBA about the tweeter. The usable width of the main vertical lobe may still be an unknown that could affect the standing listening. This configuration is developed in reference 15.
4. Build the upper end of the system—i.e., the region above the subwoofer—with a single driver per satellite. The satellite will have a zero degree VBA about the center of that driver. The low-frequency CO to the subwoofer does not have the same type of problems we have been discussing, because the wavelengths are so long.

Note that the development of a three-way system can be even more difficult. You need to develop CO networks so that the VBA for both CO frequencies work together. The lower the CO frequency, generally the wider the vertical lobe, so you need to work for a usable VBA for the upper CO that fits well in the wide vertical lobe of the lower CO frequency. Here the vertical directivity plot shows whether you have accomplished this much quicker than trying to compare vertical polar plots about the two CO frequencies.

There is little doubt that flush-mounting tweeters reduces the edge diffraction that occurs at the edge of the faceplate. Flush-mounting the woofer may also help the tweeter's response, but testing has shown not as much as you would expect, because even a flush-mounted woofer does not show a "flat" front panel to the tweeter's response. You must keep in mind that such flush-mounting changes the relationship of the acoustic

centers for the drivers, and this must be factored into the CO design.

Moving a midrange or tweeter off the cabinet centerline is also helpful in spreading out the edge diffraction that

occurs at the cabinet edges. An offset of an inch or so is not a problem, but large offsets are harmful to the horizontal directivity.

This article totally ignores the prob-

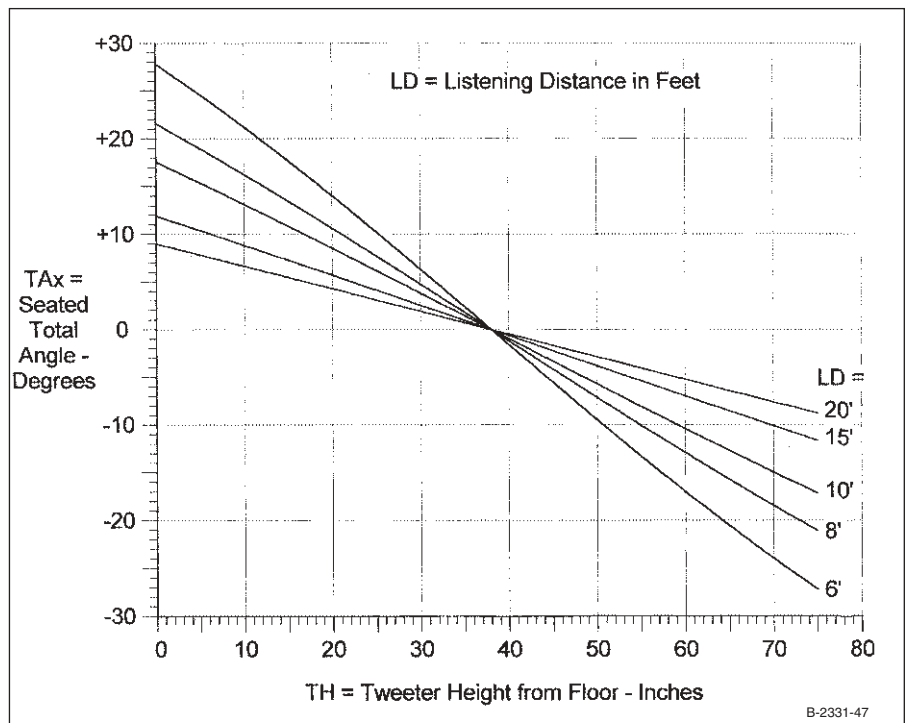

FIGURE 47: Plot to allow establishing seated total angle for a floor-standing enclosure with tipped front panel.

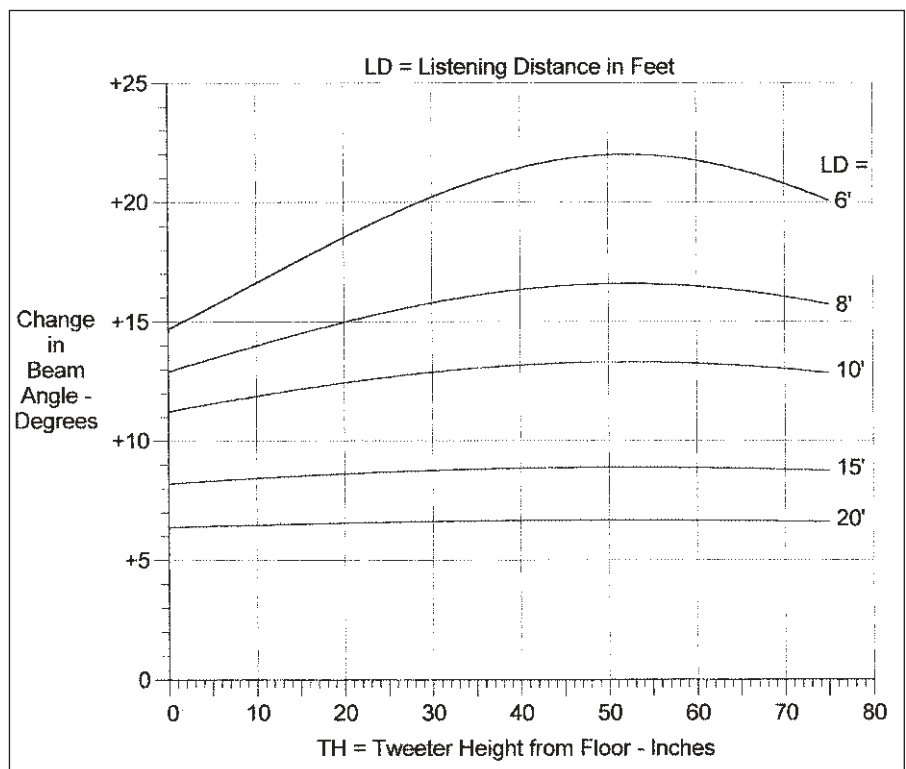
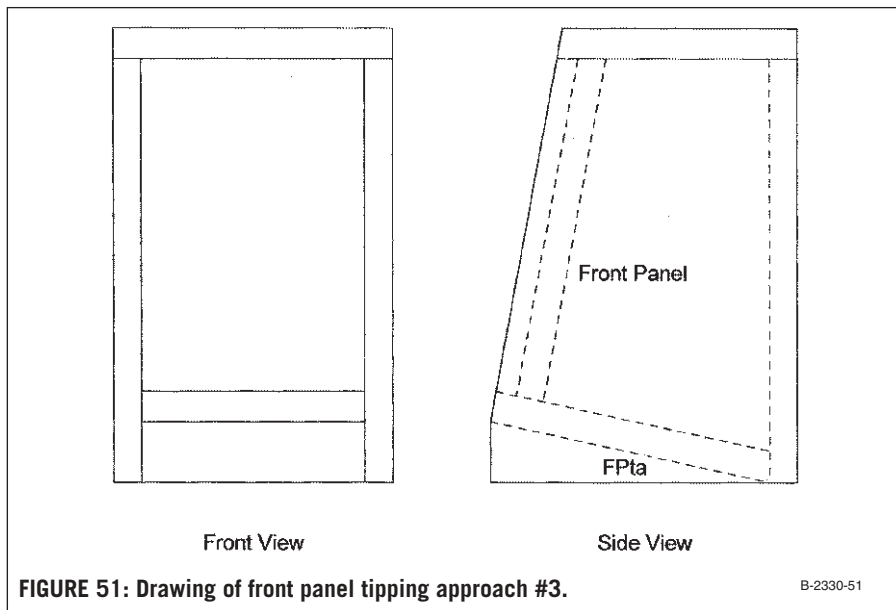
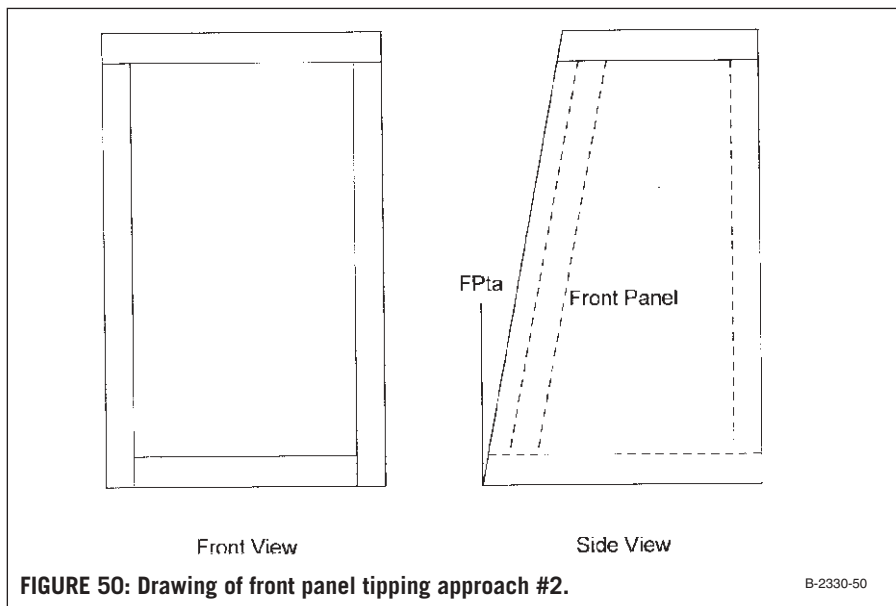
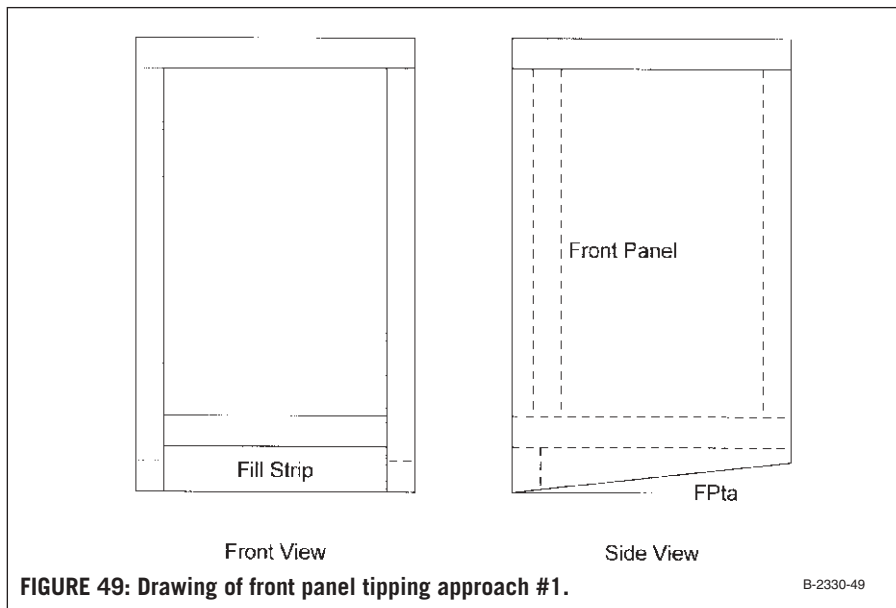

FIGURE 48: Plot of change in beam angle versus tweeter height.



Toroids for Audio



Tube Output

Toroidal transformers for tube output applications. Plus related products.

Standard Series (push-pull)

Single-ended

Specialist Range

Special Designs

Power Transformers

Chokes

Chassis for Tube Amplifiers

PCB for 70W & 100W Amps

Book by Vanderveen

Electrostatic

Step-up toroidal transformers for Electrostatic loudspeaker applications.

Solid State Power

Low noise, low inrush
500 to 2000VA fully
encapsulated power
transformers.

Standard Power

A broad range of high
quality, approved,
toroidal transformers.
Designed for general
purpose applications.
From 15 to 1500VA.



PLITRON
MANUFACTURING INC

8-601 Magnetic Drive
Toronto, ON M3J 3J2
Canada

416-667-9914

FAX 667-8928

1-800-PLITRON

(1-800-754-8766)

www.plitron.com

FOUNTEK JP2.0 RIBBON

Madisound is pleased to introduce the JP2.0 5" Pure Aluminum Ribbon Tweeter by Fountek.

In most tweeters, a coil of wire is driven by a magnetic field and this motor moves a radiating dome to produce sound. In an aluminum



ribbon tweeter, the ribbon itself is both the conductive material and the radiating mass moved by the magnet to produce sound. This method results in a wider band width and very smooth phase response. At 0.011 grams, the pure aluminum ribbon has a mass of about 1/20th that of a dome tweeter with comparable surface area.

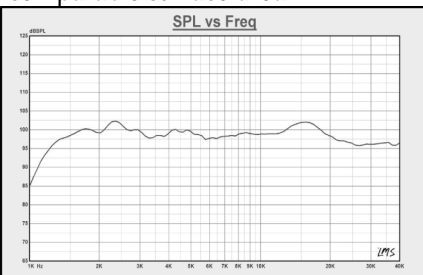

The built-in transformer provides an impedance curve that is easily driven by your amplifier. The JP2.0 is shielded for use near a CRT.

Specifications

| | |
|--------------------|----------------------|
| Ribbon Material | Pure Aluminum |
| Ribbon Mass | 25 mg |
| Ribbon Area | 960mm ² |
| Magnet | Neodymium Boron |
| Impedance | 8 ohm |
| Frequency Response | 1400Hz~40kHz |
| Sensitivity | 98dB/2.83V/1M |
| Power | 17W nominal, 40W max |
| Weight | 1065g / 2.35lb |

Price \$118.00 Each

Madisound Speaker Components, Inc.
8608 University Green #10
P.O. Box 44283
Madison, WI 53744-4283 U.S.A.
Tel: 608-831-3433 Fax: 608-831-3771
info@madisound.com ; www.madisound.com

lem of diffraction spreading loss, which causes the on-axis bass response to fall below a certain frequency based on the size of the enclosure. This problem occurs in enclosures that set out from the walls. It is not as severe for floor-standing boxes with low mounted woofers, but must be considered for tall, thin enclosures with high mounted woofers and boxes setting on stands. It can also be a big problem on tiny satellite enclosures where it can modify the on-axis response up into the midrange frequencies.

Keep in mind all of the work presented here represents modeling or testing in a near-anechoic environment. When using a speaker system in real rooms, not addressed here, you consider all sorts of room effects that come into play. Most of these room effects are most prominent in the bass frequency

range, but some may factor into your choice of driver CTC spacing. This sometimes makes your CO design problem even more difficult.

For a listener perceived flat frequency response, it has been demonstrated that the direct or "first arrival" response should have a flat frequency response. For good imaging it is considered important that the frequency response degrades smoothly in the horizontal plane. These are what this work has concentrated on achieving. ❖

REFERENCES

13. Koonce, G. R., "A Diffuser Port for Small Boxes," *SB 2/81*, p. #16.
14. Koonce, G. R., "The Diffuser Port," *Ask Speaker Builder, SB 2/91*, p. #45.
15. D'Appolito, Joseph, "A High-Power Satellite Speaker," *SB 4/84*, p. #7.

EQUATIONS FOR ESTABLISHING STAND HEIGHT OR FRONT PANEL TIP ANGLE

Note: All angles in degrees and all linear dimensions in inches. All angles are taken as positive moving up from horizontal.

VBA = Vertical beam angle—center of system's vertical response lobe.

LH = Seated listener ear height in inches (38" used in plots).

LD = Distance from speaker to listener in inches (plots show LD in feet for convenience).

TH = Height of the tweeter center above the floor in inches.

A. For figuring the stand height for an enclosure with a vertical front panel:

$$TH = LH - [LD \times \tan(VBA)]$$

The required stand height is one that puts the tweeter center at height = TH.

B. For figuring the front panel tip angle for a floor-standing enclosure:

FPta = The required front panel tip angle in degrees. Positive means the front panel is tipped back into the box at the top.

TAx = Total angle from horizontal up to the line from tweeter center to the seated listener. Above horizontal is taken as positive.

$$TAX = \text{ArcTan}[(LH - TH) / LD]$$

$$FPta = TAX - VBA$$

C. To calculate the beam angle for standing listening. Can be used for both stand-mounted and floor-standing boxes.

LHs = Standing listener ear height in inches (plot used 66").

SVBA = Vertical beam angle to standing listener.

$$SVBA = \text{ArcTan}[(LHs - TH) / LD] - \text{ArcTan}[(LH - TH) / LD] + VBA$$

If the front panel is vertical, for either case, this reduces to:

$$SVBA = \text{ArcTan}[(LHs - TH) / LD]$$

Be careful here if you have "inverted" the system (built with woofer over the tweeter). This changes the sign of the VBA, and you must remember to change the sign of the SVBA when referring to plots.

Book Review

Producing in the Home Studio with Pro Tools

Reviewed by Bill Fitzmaurice

Time was, recording in the studio meant working with wax as a storage medium, giving way eventually to Bakelite and vinyl, then magnetic tape. A few years back, I switched from tape to computer hard disc as my storage medium, though the mixing console, compressors, effects, and whatnot remained unchanged. Thus, despite the fact that I record on 16 digital channels sampling at 96kHz with 60 gigabytes of storage, I'm still in the "dark ages" of recording technology—so to speak—because I use a mixing console. The state-of-the-art today in sound recording is the computer.

There are quite a few advantages to recording with a computer, one being that if you have a computer then you already own the storage medium and the basic framework for recording and mix down. All you need to add are some tools that allow the computer to act as a recorder/mixer. To be more specific, all you need is Pro Tools.

Pro Tools consists of hardware that allows you to enter analog or digital sounds into the computer's memory, and software that allows you to manipulate it once it's there, with the end product being a self-produced CD hot off your own burner. But, as with most computer programs, using Pro Tools is not particularly intuitive. The best way to acquire the necessary skills to handle Pro Tools would be to take a class in its use at a school such as Berklee College of Music. A close second would be to buy this book, written by songwriter/musician/producer and Berklee graduate David Franz.

Franz starts off showing how to install the Pro Tools hardware and software, how to connect instruments and MIDI devices to it, and how to connect the computer to the rest of your studio gear, including amps and speakers. Using Pro Tools is not all that difficult once you get used to it. For instance,

while you may not have a mixer per se, you do have a "virtual mixer," the control panel of which appears on your computer monitor screen, with all the normal mixer functions accessible via the mouse.

Chapter Two covers basic recording techniques, while subsequent chapters delve even deeper into the subtle nuances that the software allows. The chapter on editing reveals the true power of digital recording, as individual notes or entire tracks can be cut, copied, or pasted in much the same fashion that you can manipulate text with a word processing program. Gone forever is the razor blade and Scotch tape method of editing. Computer recording is particularly adept at handling MIDI instruments, as you can produce an entire CD with dozens of tracks without the aid of a single musician. On the other hand, recording with instruments and voices via microphones is handled equally well, and with fidelity that tape-based systems could never approach.

Post-production was once merely the process of mixing tracks, but today the chores of adding EQ and dynamics processing, effects and panning, fixing glitches, and adding additional tracks make the mixing process far more time consuming than the original recording sessions. The time saved performing these tasks on a computer is almost immeasurable. Only a few years ago these tasks required outboard gear that often filled an entire room, but with Pro Tools, software plug-ins have replaced racks full of processors. Everything you need to produce an air-quality recording can fit on a small desktop. On the other hand, some of us old-timers are more comfortable with the feel of a pot than the click of a mouse, so for us there are mixers that interface with the computer to allow hands-on control of the mixing process in real-time.

When all else is done, it's time to

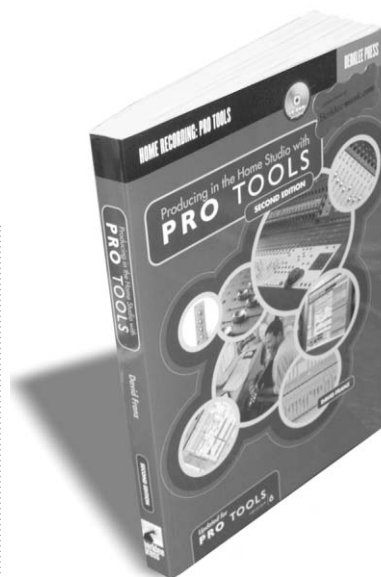

make a CD or an MP3, or for that matter put your work out on the Web. Once again, a couple of mouse clicks and the job is done. Pro Tools lives up to its name, as the results you can obtain are truly professional. But while you can certainly use *Pro Tools* with a dedicated computer in a sound studio, the beauty of the system is that you can also do the entire job start to finish on the PC in your living room, monitoring on your home hi-fi, and end up with a truly professional result.

If you want to get into home recording, or if you're contemplating making the move from analog to digital in your home studio, Pro Tools definitely deserves consideration as your operating system, with *Producing in the Home Studio with Pro Tools* as indispensable a recording accessory as razor-blades and Scotch tape once were. ❖

TEST TRACKS

What music selections do you use to test your audio setup? Simply describe your seven favorite pieces (not to exceed 1000 words); include the names of the music, composer, manufacturer, and manufacturer's number; and send to TEST TRACKS, Audio Amateur Corp., Box 876, Peterborough, NH 03458, e-mail editorial@audioXpress.com. We will pay a modest stipend to readers whose submissions are chosen for publication.

Product Review

Virtos Noise Wizard

Reviewed by Richard Honeycutt

Virtos is a relatively new software company (founded in 1999) whose two divisions focus on software for digital media production and editing; and Internet, database, and E-commerce applications, respectively. Located in Karlsruhe, Germany, Virtos markets their products worldwide.

THE PRODUCT

The Virtos Noise Wizard is a DirectX-compatible set of tools for removing clicks, crackle, hiss, hum, and other types of noise from old recordings. It requires a digital audio editor, such as Cool Edit or Sound Forge, to host its operation.

Noise Wizard consists of five plug-ins:

- The DeClicker/DeCrackler provides the function that some of us old-timers remember in the Garrard click and pop machine of the early 1970s. It removes short-duration impulsive noises such as those caused by vinyl (lacquer, on old 78s) surface imperfections.
- The DeNoiser removes broadband noise such as hiss or hum.
- The Filter Toolbox is a software-implemented parametric filter.
- The Stereo Processor produces stereo recordings from mono sources by applying time offsets. It can also function as a vocal eliminator.
- The Band Extrapolator provides Aphex-exciter-like effects, as well as increasing apparent bass, by synthesizing high- or low-frequency harmonics.

OPERATION

You can download the software from the Virtos site (see URL at the end of the article) and even run it in demo mode. You really don't want to do this for long, because a repetitive tone burst becomes inserted into whatever file you're working on in order to encourage you to purchase the product and

register it. I can affirm that the tone bursts work as intended!

In addition to the wave editor, system requirements include a 350MHz or faster computer (but see my comment later) running Win95 or later, 64MB of memory, a hard drive with 2MB free for installation, plus a good bit of space for the operation of the wave editor, and, of course, a stereo sound card.

Installation proceeded without incident, except for some trouble getting the program to accept my registration. The trouble may have been due to my using an old computer running Win95. The folks at Virtos e-mailed me a solution which gave me enough info to register the program.

In the operational tests that follow, I used the default settings on each feature. Certainly, you can improve on the functionality of the software by tweaking the parameters of each plug-in. Time considerations limited my knob-twiddling.

DE-CLICKING

The first project I chose was to restore a recording of Dobie Gray's "Drift Away." The LP was one of about a dozen I purchased in the late '70s since I routinely used that track in auditioning new speaker designs. Consequently, the track showed substantial wear, especially at the beginning, because it is the first track on the LP. *Figure 1* shows the .wav file of that track as recorded from the LP. The serious pops are clearly visible.

The most convenient computer for me to use for the Noise Wizard evaluation was a 266MHz Win95 computer. The program works just fine on this old clunker, except that the preview function is understandably choppy,

due to the slow processor. Thus de-clicking the four-minute file took about ten minutes.

Please note that this computer runs about 15% slower than the stated minimum speed for operating Noise Wizard, so for a computer meeting the minimum system requirements, the functions would have been performed much more rapidly. Still, the various denoising functions require a good bit of analysis as well as subsequent data manipulation, so even on a fast machine, some time will be needed to complete an operation.

Figure 2 shows the .wav file after de-clicking. You can easily see the reduction in pops and clicks by comparing *Figs. 1* and *2*. The audible difference was likewise impressive. Except for the first

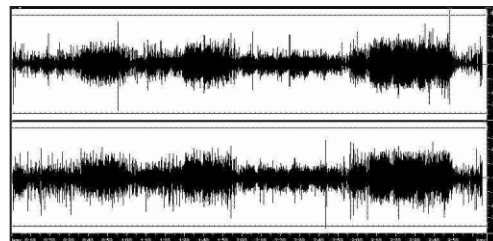

FIGURE 1: Original .Wav file.

A-2198-1

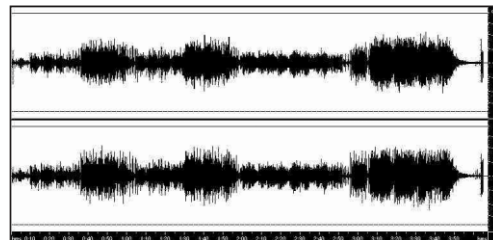

FIGURE 2: .Wav file after de-clicking.

A-2198-2

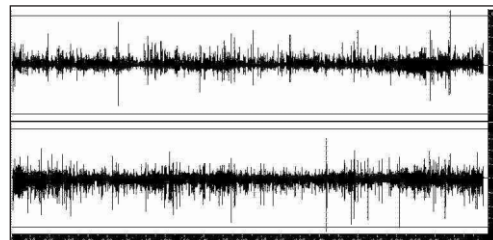

FIGURE 3: The trash that was removed by the declicker.

A-2198-3

few bars of the music, which are also the first few grooves on the LP, click and crackle were gone, without any detectable change in the actual music.

Another way to see the good results is to preview and/or record the residual noise—the stuff that was removed. *Figure 3* shows just how much trash the de-clicking process took out. I think you can imagine the improvement in sound!

DE-NOISING

To check out the de-noiser, I tried each of two files. The first was a lecture recording I had been asked to restore; the second, a song with voice, guitar, and bass mastered on cassette. The lecture recording had about a 30dB signal-to-noise ratio, which the de-noiser improved to about 50dB. However, it also produced a sort of warbling artifact that was more distracting than the noise had been. I think the additional distraction results from an almost-regular warble that draws your attention. Please note: first, this was not really the kind of test for which the software was designed; and second, the artifact introduced by Cool Edit's de-noiser was considerably worse than that produced by the Virtos software.

The music recording originally had about a 50dB signal-to-noise ratio, and was essentially white noise. The de-noiser removed it to inaudibility with no perceptible artifacts. This was a better test of the software, since it reflects the type of noise it was designed to handle. The bottom line is that the de-noiser works well, but you should be aware that some files are too far gone for it to improve, and they will result in the artifact I mentioned.

FILTER TOOLBOX

The filters are easy to use, if you understand the use of parametric equalizers. You can do any of the four basic filter types: high-pass, low-pass, bandpass, or notch. In fact, you can produce just about any filter response shape that you can draw. The versatility of this function is limited mainly by your experience in filter manipulation.

STEREO PROCESSOR

I used the stereo processor to synthesize a stereo version of a mono

vocal/guitar recording. It provided a very pleasing result, although you must use discretion on which files you choose to process in this way. A folk singer with an 8' wide mouth is a frightening thing to contemplate.

BAND EXTRAPOLATOR

If you want that Aphex-exciter vocal-cords-hanging-off-the-tip-of-the-tongue sound (read: female vocalist on pop radio), or if you want PHAT BOTTOM, the band extrapolator will give it to you. Those with taste can adjust the settings for just a bit of added sizzle or fattening at the low end. A very effective tool for specific jobs, if used correctly.

THE BOTTOM LINE

The Virtos Noise Wizard is an excellently conceived and executed piece of software. It will add significant capabilities to your digital editing palette. If you're in the market for the functions it offers, you should buy it.

Virtos Noise Wizard

\$119

Media Technology Group, Virtos GmbH

<http://www.virtos-audio.com/>

Virtos GmbH

Kaiserstrasse 51

D-76131 Karlsruhe

Germany

+49-(0)721-384 21-24

info@virtos-audio.com

Manufacturer's response:

We would like to bring forward some issues in regard of the content:

1. The license fee of Virtos Noise Wizard has recently been reduced to \$89.25.
2. Virtos Noise Wizard is also available as separate plug-ins, e.g. DeClicker/DeCrackler \$51.75, DeNoiser \$51.75.
3. Virtos' postal address has been changed to Virtos GmbH
PO Box 111544
D-76065 Karlsruhe
Germany

Best regards,
Carl-Henrik Liljegren
Executive Director
Virtos GmbH

Front Panels?

Download the free *Front Panel Designer* to design your front panels in minutes ...

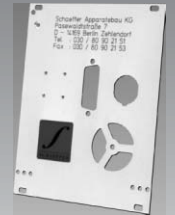
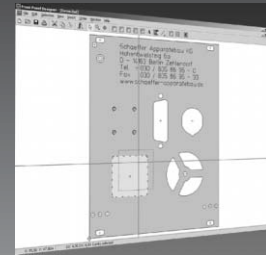

... and order your front panels online and receive them just in time

Unrivalled in price and quality for small orders

www.frontpanelexpress.com

World-Class Audio Discount Prices

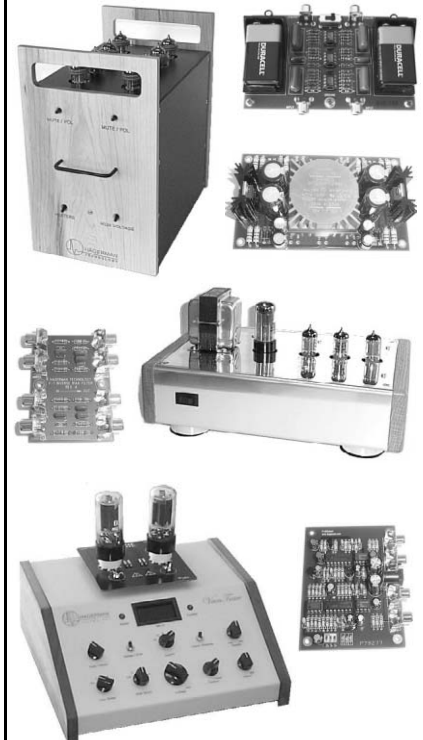

www.hagtech.com

New Chips on the Block

By Charles Hansen

Bicron Transformers

Bicron Electronics has introduced the AA series toroidal power transformers for audio applications, ranging from 20VA to 2kVA. All transformers have dual primaries that can be connected for 120/240V AC. In addition to a large number of standard secondary winding connections, the website has a custom design calculator for specific amplifier

applications. Efficiencies are in the 85%–95% range, with low losses for reduced standby power consumption.

The transformers are designed and manufactured for low vibration, and minimal audible and electromagnetic noise. Various mounting, shielding, and output termination options are available. The transformers are de-

signed to meet all CAS, IEC, VDE, and UL standards. ❖

Bicron Electronics Co.
50 Barlow St.
Canaan, CT 06018
www.bicronusa.com
(860) 824-5125

Burr-Brown DSD1700 DAC

The DSD1700 is a unique digital-to-analog converter designed for DSD audio applications. The DSD1700 consists of a single-channel, 8-tap analog FIR filter with a double differential circuit architecture, ensuring excellent dynamic performance and high power-supply noise rejection. The DSD1700 also includes the necessary logic required to interface directly to a DSD decoder IC.

The overall features and performance of the DSD1700 make it an ideal choice for high-performance Super Audio CD players and DSD studio applications.

FEATURES

Direct transfer of Direct Stream Digital data stream to analog output

Dual Differential analog FIR filter

Direct, CMOS logic interface to DSD™ decoder IC

Data Clock: 2.8224MHz (64 * 44.1kHz)

System Clock: 11.2896MHz (256 * 44.1kHz)

1-bit Resolution

Dynamic Performance

THD+N: 0.001% (typ)

Dynamic Range: 110dB (typ)

SNR: 110dB (typ)

Frequency Response (–3dB): 100kHz

Single +5V supply

27.5mW Pd (typ)

2822.4kHz sampling rate (max)

The DSD1700E is available in a small 28-pin package for \$9.95 US in 1000+ quantities. ❖

For more information call:

Texas Instruments

Burr-Brown Products

PO Box 11400

Tucson, AZ 85734

(800) 548-6132

www.burr-brown.com

thetubestore.com

Your online source for name brand audio tubes

- Over 1000 types available online
- Perfect Pair matched power tubes
- Capacitors and sockets

Order online at **thetubestore.com**

or call toll free **1-877-570-0979**



IONOVAC SPEAKERS

The August issue with Daniel Schoo's discussion of the Ionovac tweeter ("Care and Maintenance of Dukane Ionovac Tweeters," p. 50) came at an opportune time, as I had two Duk-10 "add-on tweeter sections" in for repair. Here are my experiences with those units and some additional information accumulated along the way.

Although the cabinets were in very good condition, the insides were very dirty due to extended use, and there was what looked like cigarette ashes inside the throat of the driver. I disassembled everything and cleaned all the sub-assemblies and covers with liquid detergent and water. The hardest cleaning was getting at the accumulated grunge, which was way down inside the horn just in front of the grille. I scraped this grunge carefully away and used nail polish remover to clean the inside of the throat as best I could.

Fortunately, the electrode looked almost new, and the quartz cell was very clean. The connecting cable between the power supply and the horn assemblies were shot and needed to be replaced (the significant degradation of the insulation is probably due to the ozone generated by the plasma). I was able to clean and re-solder one 6DQ6 plate cap, but discarded the other, making a replacement plate cap from a paper clip shaped to fit by winding it around an appropriate size drill bit.

After replacing the power cable and reassembling the pieces, I used a Variac to power up each unit. During this process I discovered one bad electrolytic section in each tweeter. I suggest that you check all four sections with an ohmmeter, even though it takes time to unsolder one terminal. My tipoff to possibly bad capacitors was that 5A fuses had been installed instead of the correct 1A size. The bad electrolytics had partial shorts, which caused the power

supply to draw enough current to blow the "normal" 1A fuse.

I also noticed that the 100Ω 5W resistor in the power supply runs very hot and was right up against one electrolytic, burning a hole in its cardboard cover and hardening up the insulation of any wires in the vicinity. Repositioning the wires and lifting up the resistor will, I hope, eliminate further unwanted heating.

Once the input voltage was up near 100V, the electrode began to glow and the power supply voltage on the first unit was dead on when the input AC was 115V. The first unit functioned normally after applying audio to its input terminals, but the second unit had no glow and ended up having a modulation transformer with an open secondary. I could not locate either PA transformer mentioned in the article but was able to find another workable substitute—a Merit A-3013. The 16kΩ secondary is obtained by connecting to terminals "com" and "5."

One point mentioned in a couple of places in the Ionovac literature that came with the units but not mentioned in Mr. Schoo's article is that the low frequency content of the audio supplied to the tweeters should be reduced in order not to overdrive and harm them. The literature recommends a two pole (12dB per octave), 3500Hz high-pass filter.

In the back of these particular Duk-10 units was a DuKane network with the designation 9A770, along with an "L" pad volume control. Neither of these components were connected and no additional information was supplied. I determined the correct wiring for the "L" pad and was able to take apart the potted 9A770 network and determine its components. Let me try and describe this network.

Inside was a 3.7μF capacitor in series with a 0.6mH inductor (choke) in series with a second 3.7μF capacitor in series

JFETS

ULTRA LOW NOISE
LS843 - 3nV/Hz typ

TIGHT MATCHING
LS843 - 1 mV max

- ◇ N & P Channel
- ◇ Duals & Singles
- ◇ Custom Screening
- ◇ Spice Model Library
- ◇ Die, SMT, Thru-Hole
- ◇ No Order Minimum

Second Source for Domestic
& Foreign JFETs & Bipolars
Full Service U.S. Manufacturer
of Specialty Linear Products

LINEAR SYSTEMS

4042 Clipper Court
Fremont, CA 94538
510-490-9160/510-353-0261(Fax)
E-mail: Sales@Linearsystems.com
WWW.LINEARSYSTEMS.COM

PASS DIY

Printed Circuit Boards

Key Components

Plans

Zen Variations

Pearl Phono

and more...

PO Box 12878
Reno, NV 89510

www.passdiy.com

Test Equipment Depot

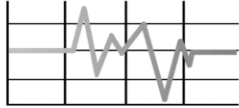

800.996.3837

The source for premium electronic testing equipment

New & Pre-Owned

- Oscilloscopes
- Power Supplies
- Spectrum Analyzers
- Signal Generators
- Digital Multimeters
- Network Analyzers
- Function Generators
- Impedance Analyzers
- Frequency Counters
- Audio Analyzers



Call now to speak to one of our knowledgeable salespeople or browse our extensive online catalog

www.testequipmentdepot.com

- Sales
- Repair & Calibration
- Rental
- Leases
- Buy Surplus

VISIT ON-LINE AT audioXpress

www.audioXpress.com

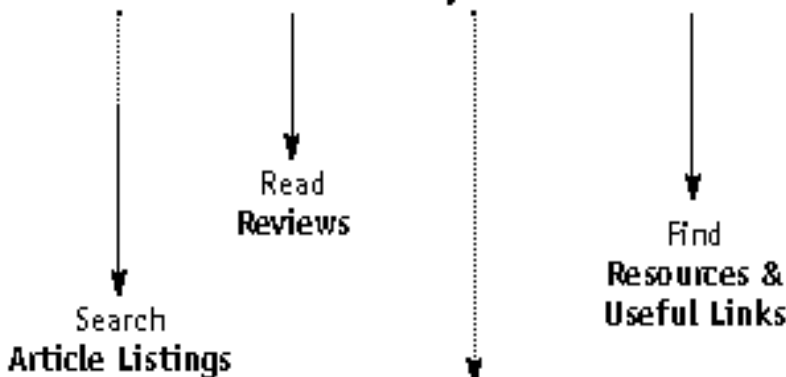

Shop On-Line for **Books, PC Boards,
Test CDs and Other Products**

with another 0.6mH choke (all four components are in series). There are six screw terminals on the cover of the network. Terminal #6 is at the start of the series chain; terminal #3 is between the first capacitor and choke; terminals #2 and #5 are paralleled together and connected between the first choke and the second capacitor; terminal #4 is connected between the second capacitor and second choke; and terminal #1 is connected to the end of the last (second) choke. I can't deduce the full intent of this network, but came up with a two pole, 3500Hz high pass filter by connecting the Ionovac in parallel with one inductor (terminal #3 plus, terminal #2 minus) and connecting the "plus" side of the audio signal to the capacitor (terminal #6) and the minus side to terminal #5 (connected internally to 2).

Finally, my thanks and a question for Mr. Schoo. Does he have electrodes available?

Charles King
Clinton, Conn.

Daniel Schoo responds:

The story that Mr. King relates about his restoration of a pair of DuKane Ionovac speakers is a familiar one. Many of the problems he discovered and solved are to be expected for a piece of equipment that old. His success at getting them going again is commendable.

Dirt and accumulations in the horn and cell are typical because of the high temperatures and the tendency of air convection to draw dust into the horn, where it is heated and burned. Mr. King's observation that "the electrode looked almost new and the quartz cell was very clean" suggests that it had been replaced and not operated for very long.

Ordinarily a dark orange to brown crust forms on the tip of the electrode and the inner surface of the cell after several hundred hours of operation. When that happens the plasma often takes on an orange cast or bright orange glow. I usually clean the electrode at about 200-hour intervals.

Cleaning the electrode and cell will restore the plasma color to normal after a short restarting break-in time. During the break-in you will often see some initial bright flashes and orange glow until things settle down. I am not aware of DuKane ever recommending cleaning the electrode or cell during its oper-

ating life. Their solution to problems was to replace the cell with a new one.

Other problems such as cracked insulation and burned plate caps are common. The cable DuKane used was a common rubber-covered wire susceptible to heat, age, and the ozone that Mr. King points out. Every one of the units I have seen had an overheated plate cap. I suggest replacing every one whether it is still serviceable or not. They were a poor design and prone to failure.

His use of a paper clip to manufacture a replacement is ingenious. I would use a more conventional approach and buy a good ceramic shell or spring wire type clip that might be more reliable in the long run.

Electrolytic capacitor problems are always to be expected in anything more than a few years old. As is standard practice with antique radio restoration, even an old electrolytic that seems in good shape should be replaced to minimize the possibility of catastrophic failure later. The cardboard shell capacitors that DuKane used were not known for long life, although many of them continue to function even now. Before powering up a supply, I always check the electrolytic filter capacitors and/or replace them in equipment of this age.

Failure of the modulation transformer is too often seen. I found the specifications on the Merit A-3013 transformer that Mr. King used as a replacement. It is a typical 70.7 constant line to voice coil transformer used in multiple speaker sound reinforcement systems. The A-3013 has approximately the same turns ratio as the original, but it is not exact.

The A-3013 has a 16kΩ primary, which is the same as the original DuKane. It has two secondary windings of 3.5 and 7Ω. The DuKane transformer used a single 8Ω winding. While the Merit transformer will work satisfactorily, the speaker sensitivity and rated maximum input voltage will be changed from the original specifications. The lower impedance primary winding implies a higher primary to secondary turns ratio.

This will result in higher sensitivity and a lower maximum input voltage limit. Because of this difference, using this speaker in a pair with another that has an original modulation transformer will cause unbalance in the volume levels from one speaker to the other. You should either replace the transformer in the other speaker to match or, preferably, find another transformer that has the exact same turns ratio as the original.

It seems that fewer and fewer sources are available for this kind of transformer. Line to

From Audio Kits to all types of electronic parts. . . we are *THE* Audio Electronic Supply Source.

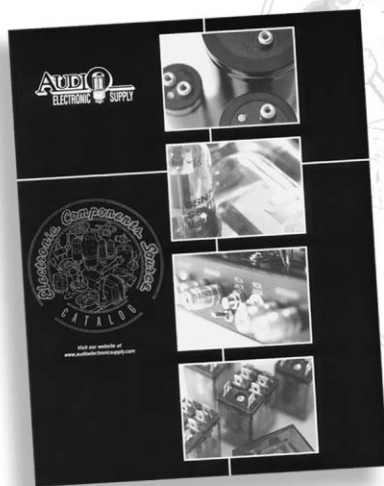

Receive a **FREE** Catalog

AUDIO

ELECTRONIC SUPPLY

1020 Goodworth Drive
Apex, NC 27539
919.355.0014 (voice)
919.355.0013 (fax)

Visit us online for the latest Audio Electronic Supply Catalog at:
www.superamp.com ■ www.audioelectronicsupply.com ■ www.sixpacs.com

Audio Consulting

GLASPERLENSPIEL Single ended
300B stereo amplifier featuring
SMPS and 4 Silver Rock transformers



Emotion in Sound

DULCET 98 dB/w/m efficient
Two driver loudspeaker
system by Mantra Sound



www.audio-consulting.ch



ROCK SOLID Silver wire input
transformer solid state amplifier
Point-to-point silver wiring

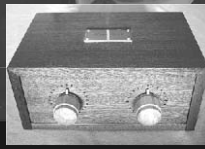

SILVER ROCK
Silver wire passive transformer-
attenuator preamplifier



SILVER ROCK PHONO
Solid state phono preamplifier with
MC silver wire step-up and inductive
RIAA equalization

ALL ELECTRONICS

C O R P O R A T I O N

Thousands of electronic parts available online
www.allelectronics.com

Special Quantity Pricing Green T-1 3/4 LED

Liteon# LTL-307G.

Our lowest price ever on standard green 5mm diameter (T-1 3/4) LEDs. Green diffused, standard brightness LEDs. Clean, full-leaded devices. Original manufacturer packaging.

CAT # LED-2 **10 for \$1.50**



100 for 12¢ each
1000 for 5¢ each (\$50.00)
5000 for 4 1/2¢ each (\$225.00)
10,000 for 3 1/2¢ each (\$350.00)

2-Conductor Power Cord with Thumbwheel Switch

7 foot black 2 cond./18AWG power cord. SPT-2 insulation. In-line thumbwheel switch rated (6 Amps / 125 Vac) is 16" from the end of the cord. Molded polarized plug one end. Stripped and tinned ends. Hanked. UL, CSA.

CAT# LCAC-142



90¢ each

Case of 250 70¢ each
1000 for 55¢ each

2 Phase Stepper Motor

Oriental Motor Co.
Vexta # PH265-04-C9
2-phase, 1.8 degree per step. 5 VDC 1 Amp. 2.22" diameter x 2" long. 2.3" square mounting flange with 4 holes on 1.85" centers. 0.25" diameter x 0.75" long shaft. 6 color-coded wires.

CAT # SMT-67

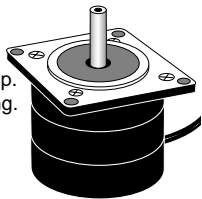

\$15.00 each

ORDER TOLL FREE

1-800-826-5432

CHARGE ORDERS to Visa, Mastercard,
American Express or Discover

TERMS: NO MINIMUM ORDER. Shipping and handling for the 48 continental U.S.A. \$6.00 per order. All others including AK, HI, PR or Canada must pay full shipping. All orders delivered in CALIFORNIA must include local state sales tax. Quantities limited. NO COD. Prices subject to change without notice.

CALL, WRITE
FAX or E-MAIL
for our **FREE**

96 Page
CATALOG
Outside the U.S.A.
send \$3.00 postage.

MAIL ORDERS TO:
ALL ELECTRONICS
CORPORATION
P.O. Box 567
Van Nuys, CA 91408
FAX (818)781-2653

e-mail allcorp@allcorp.com

voice coil transformers are still common, but the selection is becoming very limited in types with the required 70V line and .312W taps. The Stancor A-8105 is still listed on their web page. Finding a stocking distributor is another issue.

I completely agree with the statement that Mr. King made about limiting low frequency energy into the Ionovac. The scope of my article was mainly on maintenance and repair part of a system, so I made no mention of this. A little more emphasis on crossover use and protection is appropriate.

While the speaker itself has greatly decreasing output at frequencies below the 3500Hz recommended rollover, the electronics can and does respond. The modulation transformer is capable of response to below 20Hz and will couple audio at low frequency into the oscillator circuit. Although the horn unit will not reproduce audio at this frequency, it will cause modulation of the plasma and can quite easily drive it into cutoff causing serious distortion.

I would like to stress that it is very easy to overdrive an Ionovac, so you should take great care not to exceed the maximum rated input voltage at any frequency to avoid distortion and damage. Overdriving promotes modulation transformer failure and arcing of internal components. It is essential for you to use a high pass filter or crossover to limit the high levels of the low frequency content in audio program material applied to the Ionovac.

Mr. King's request for electrodes is not the first I've had. I have had electrodes made in small quantities for testing. I have done extensive research on electrode material, burning different alloys for thousands of hours and observing the results. I touched on some of this research in the article. As a result I have found materials with a very good service life.

In response to several requests I have decided to have a limited quantity of electrodes manufactured. As of late September they have not been delivered, but I expect to have them soon. When they are delivered I will perform an inspection and life tests to confirm that they meet specifications. After testing I will be happy to make them available for sale, subject to supplies on hand.

The quartz cells are difficult and expensive to make. I have no plans to have any quartz cells made because of the high cost. On the bright side, you can clean a quartz cell so that it remains in service through several electrode changes.

SACD/DVD AUDIO BIAS?

As a fellow audio hobbyist, I enjoy Gary Galo's writings, reviews and comments, and I enjoy the mod space he works in. For example, I enjoyed his tips and advice for using Canare and DH Labs audio and data cabling and have built up sets for such use. [So I hope you'll take my comments as constructive and not negative. As we all know, such issues of tone don't always transfer especially successfully in the written medium.]

After reading Gary's review of the Onkyo universal disc player (12/03, p. 52), I'm left wondering whether there isn't an editorial bias for SACD and against DVD-Audio. The author's comments about a dearth of high-quality DVD-Audio recordings seem inexplicable when original, high-resolution recordings from AIX Records and others are widely available and commonly cited as good sounding.

He also laments that players with combined SACD and DVD-Audio capabilities are relatively rare when in fact many such universal players exist and have for quite a while. They have been somewhat scarce in the high-end space, but Pioneer has had three or four models ranging in price from below \$200 to thousands of dollars. Denon, JVC, and others make universal players and have for quite a while now also.

Still, I enjoyed hearing about the use of linear power supplies—which somewhat surprised me—and the use of specific AD and crystal chips in the Onkyo. Notes about the digital output formats supported by the player and its value as a transport are of particular interest to me, though it was not clear whether his comments applied as a CD or DVD or SACD transport. Like Gary, I have a Pioneer DVD player with 96 x 24 output connected to an Assemblage D2D-1 upsampler and upgraded DAC-3.0 for which I'd be interested in a new universal transport. I was therefore pleased to learn that the Onkyo sends relatively full resolution DVD-Audio outputs to the S/PDIF jacks, since I would want to connect and use these components as he did.

I especially valued and empathized with his comments on the widely variable quality of the purportedly high-resolution recordings available on SACD and DVD-Audio. (The same could be

said of recordings in general.) I fully agree that for these new media to be explored meaningfully, you need good new recordings. Poor transfers of old analog production masters and relatively low resolution digital releases are sadly disappointing.

Though some high-resolution digital releases of older analog recordings such as those from Classic Records like the VOX Rachmaninoff can offer good sound, and even newer analog tape masters can have excellent sound, I still find that high-quality analog tape has a discernible sound. While that sound can be pleasingly even, it does impose a slight sonic character, the very act of which is philosophically anti-hi-fi.

Original, higher-resolution digital recordings have the potential to produce a new level of sound quality, so I hope we all can keep an open mind and not deprecate either of the new formats before they've been given a fair chance. Based on what I've heard so far, particularly from 96 × 24 PCM recordings on DVD-V, they offer good hope for improving the fidelity of recorded sound.

Jeff Chan
Los Altos, Calif.

Gary Galo responds:

I can assure Jeff Chan that there is no editorial bias against DVD-Audio, in favor of SACD. On the contrary, my initial "bias" was in favor of the DVD-Audio format, due to its PCM compatibility, and the resulting ease of using outboard D/A converters with the existing S/PDIF interface. But, my opinion has changed due to the dearth of material using the full resolution of the format.

The only way DVD-Audio can compete sonically with SACD is if 192kHz sampling rates are employed. 96kHz sampling rates offer less than half of the bandwidth of SACD, and associated phase shift problems due to the steeper filtering that must be used. After receiving Mr. Chan's letter, I checked the AIX website. I found that all of their DVD-Audio releases have stereo programs at 96kHz—the only 192kHz recordings they have issued are five tracks on their DVD-Audio Demonstration and Test Disc (which I have ordered, along with the 96/24 Stravinsky and Ravel disc—I may report on them in a future issue).

DVD-Audio will always be at a disadvantage in surround format, since 96kHz is the highest sampling rate available for multi-channel (i.e., greater than two) programs. SACD has the same resolution in stereo and surround. Mr. Chan is correct that there are now a number of inexpensive players that will handle both formats.

I agree that DVD-Audio should be given a fair chance. But, it is up to the major record companies to give DVD-Audio a fair shake. If they continue issuing DVD-Audio recordings at sampling rates of 44.1 or 48kHz, the format will never get the chance it deserves.

REVIEWERS—SACDs, PLEASE!

I just completed a two-year project, a 220W stereo tube amp. It has *too much* transparency for CDs—that is, their slight but masking grain and massed-strings congestion are ruthlessly exposed. Not so with an SACD that was recorded *directly* in DSD—these sound excellent.

Lest you doubt, consider an article a few years ago in *Stereophile*: they compared the SACD and CD layers of a hybrid disc, listening and measuring. Sampling the same short segment of

complex orchestral music, spectral analysis showed that from 10–20kHz, the CD layer had about 8dB less energy than the SACD. But the CD layer sounded *brighter!* (And hard.) How could this be? High-frequency IM and compression, of course. The top octave with its complex detail is compressed, hence the lower level; but it's also intermodulated into spurious frequencies, hence the "sandpapering" into a brighter, hard sound. (Listen to a CD string section after hearing one live!)

This may be masked by the high-order distortion of solid-state amps, but not by most any good tube amp. In any case, I strongly recommend reviewing all components with good SACDs (or DVD-As). Otherwise, with CDs, a component judged as "hard" or "bright" sounding may simply be revealing more truth!

This is nothing new—*The Absolute Sound* has been saying this about 16/44 CDs ("Perfect Sound Forever") since their infamous inception.

Dennis Colin
Gilmanton I.W., N.H.

AUDIO TRANSFORMERS

AMERICA'S PREMIER COIL WINDER

Engineering • Rewinding • Prototypes

McINTOSH - MARANTZ - HARMAN-KARDON
WESTERN ELECTRIC - TRIAD - ACROSOUND
FISHER - CHICAGO - STANCOR - DYNACO
LANGEVIN - PEERLESS - FENDER - MARSHALL
ELECTROSTATIC SPEAKER TRANSFORMERS

Williamson Amplifier Transformer Specialist

WE DESIGN AND BUILD TRANSFORMERS
FOR ANY POWER AMPLIFIER TUBE

PHONE: [414] 774-6625 FAX: [414] 774-4425

AUDIO TRANSFORMERS

185 NORTH 85th STREET

WAUWATOSA, WI 53226-4601

E-mail: AUTRAN@AOL.com

NO CATALOG

CUSTOM WORK

POWER TRANSISTOR SUBS

In response to Bill Wallace's Help Wanted letter in *aX* 12/03 (p. 63) in search of a 2SK134 or 2SJ49 power transistor, I suggest he look at

<http://www.profusionplc.com/> and specifically at

<http://www.profusionplc.com/hitachi.htm>.

Profusion has a wide range of substitutes. I have used a couple and found no problems at all. A note should be placed at checking bias after replacing. The safest way is to power the amp up with a Variac (that is, variable AC) while monitoring the standing current, eventually rebiasing the amp to come to the original or desired value. I note that they sound best at 600–800mA, but the power supply/heatsinks should be able to cope with these as well.

Guido Tent

Guido@tentlabs.com

SOFTWARE FOR THE HOME

As a long-time subscriber—from back in the early *Audio Amateur* days—I would like to contribute a lead to a

free software program that could be of interest to many readers as an aid to audio analysis, especially in home projects or by someone just starting to delve deeper into the hobby (avocation?). You may choose to post the URL or do a capsule product report in an upcoming issue.

The product is called "Audacity," which is a wave editor/sound analysis program that may be just fine for some of the lighter or casual inquiries into the sound produced by home stereo equipment. The URL is <http://audacity.sourceforge.net/about.php>.

Please keep up the great work. *Audio Amateur*, *Glass Audio*, *Speaker Builder* and now *audioXpress* have filled a very real need in the audio hobbyist community.

Dennis Bayzer

Dbayzer@earthlink.net

PREAMP SERIES

Regarding the Adcom GFP-565 mod (aX 11/03, 12/03, 1/04, and 2/04), are the preamp outputs capable of driving a 600Ω pair of headphones? Thanks. I've

enjoyed your work over the years.

Les Winter

Joanleswinter@aol.com

Gary Galo responds:

The short answer to Mr. Winter's question is "yes." The AD811 buffer used in the line stage described in Part 3 can easily drive 600Ω, and can actually drive headphones with impedances as low as 100Ω. For headphones with impedances in the 40–50Ω range, the series output resistors R239 and R240 can be lowered to 49.9Ω. With any other impedances, make sure that the sum of the series output resistor and the headphone impedance is at least 90–100Ω. Very low impedance headphones will be impractical for this circuit since the voltage drop across the series resistor will be high in comparison to that across the headphone, resulting in low volume levels.

In the article I cited from the 2002 *Analog Devices' apps book*, Walt Jung suggests a 4μH air-core inductor in parallel with R239 and R240 to compensate for excessive voltage drop across the series resistor, but I still think that 40Ω headphones are a practical limit for



FROM Old Colony Sound Lab Testing Loudspeakers

by Joe D'Appolito

World renowned authority on loudspeaker testing, Dr. Joseph D'Appolito, has assembled his knowledge in this one accessible volume.

CHAPTERS INCLUDE:

Driver Testing

Acoustical Testing of Single & Multiple Driver Systems

Time, Frequency & the Fourier Transform

Testing with PC-based Acoustic Data-Acquisition Systems

Finally, a complete discussion of this elusive subject presented in a single volume, *Testing Loudspeakers*, will serve as an excellent resource for all loudspeaker designers and manufacturers.

Order Today By Calling: **1-888-924-9465**

Order On-Line At: **www.audioXpress.com**

Shipping wt: 2 lbs. BK0A45 \$34.95
SHIPPING & HANDLING: \$7.00 IN US,
\$8.50 CANADA, \$9.25 SURFACE ELSE-
WHERE, \$16.75 AIR ELSEWHERE.

OLD COLONY SOUND LABORATORY

PO Box 676, Dept. X3, Peterborough, NH 03458-0676 • Phone: 603-924-9464 • Fax: 603-924-9467 • E-mail: custserv@audioXpress.com

a circuit such as this. Very low-Z headphones are best driven by a small power amplifier.

SERVO SUB

I wanted to express my interest in the article "A Servo Dual Voice Coil Subwoofer" by Daniel L. Ferguson (11/03, p. 18). I would like to see a project that carries his preliminary findings to a final hobbyist level product.

Some ideas that I have that might be good for a future article are:

1. 15" woofer downward firing in a small cabinet.
2. Integrated "plate amplifier" from a commercial source.
3. Servo electronic module for insertion between preamp (or home theater receiver) and sub amp.
4. Circuit board design for easy DIY assembly—Old Colony could offer the board. Packaging is left to the hobbyist.

I have built and enjoyed transmission line subs for years. However, the size of the enclosure makes the integration of a multi-sub system into a typical room difficult. Now that plate sub amps are low cost, have reasonably good sound, and offer high power, the Servo Sub makes sense.

A Servo Sub would also be a great project for me to build for my children. Their bedrooms do not have enough space for a transmission line sub. Again, the compact size of a Servo Sub would allow all to enjoy tight, well-defined bass.

Sincerely,
J.L. Ritch
Ritch_joe@hotmail.com

Daniel L. Ferguson responds:

I will attempt to respond to each of your suggestions in the order you gave them.

1. I am in the planning stages now for a project article incorporating a high-excursion 12" woofer. It looks to be a good compromise between size and output. The problem with 15" drivers is that few of them have a low enough Qts. This is made worse by driving only one voice coil, as that essentially doubles the driver's Q. At this point I have found maybe one 15" candidate, and I'm guessing it will require

a 3ft³ box—larger than I prefer.

2. I thought about the possibilities of using a plate amplifier but have some concerns. Successfully using a plate amplifier for this project could be a matter of luck:
 - a. First, I don't think you can use the built-in electronic subwoofer filter, as the crossover characteristics may not be compatible. If you build my subwoofer filter and bypass the built-in filter, your chance of success is increased.
 - b. The amplifier must have flat frequency response down to 20Hz (or less) and minimal phase shift. I have no idea how accurate these low-cost amplifiers are. I'm not saying it can't be done or shouldn't be attempted. At this point, I don't know which plate amplifier has these attributes.
3. My circuit can, in fact, be inserted between the preamp output and subwoofer amplifier. However, it includes the electronic crossover, which must be ahead of the servo circuit in the signal chain and is an essential part of the servo. So if the subwoofer amplifier has an electronic crossover built in, it must be bypassed. On the other hand, I have always found it less problematic to use the speaker level outputs to the main speakers as the signal source for any subwoofer.
4. I tend to do all my circuit boards on a project board from Radio Shack, so there are no plans at present to design a custom circuit board. I will provide details of the board layout in any future article(s).

Regarding servo subwoofers and reduced size, I am finding that there are limits on how small you can make a servo enclosure. When the air spring becomes too stiff, the driver response can become asymmetrical. Using only one of the voice coils exacerbates this as the motor strength is weakened. It will be interesting to see how the 12" driver I chose will perform in smaller and smaller box sizes.

Thanks for your well-thought-out suggestions. Perhaps we can put them to use in the future.

I've read the great article in your November issue ("A Servo Dual Voice Coil Subwoofer") and was puzzled as to what configuration of closed box the author (Mr. Daniel L. Ferguson) used on this project. I'd like to try to build one myself, but I need to know how the passive voice coil is sitting in the

box—behind it or merely outside of the box like on his setup velocity bracket.

Thanks a lot and keep up the good sound!

Pascal Sauvageau
Gravy Audio
Montréal, Canada

Daniel L. Ferguson responds:

Mr. Sauvageau raises an interesting question. I didn't show the closed test box in my article (it was too ugly) because I assumed that the term "closed box" was a sufficient description. To set the record straight, I used only one woofer in the final experiments, and the magnet was inside the box. It never occurred to me to install the woofer with the magnet outside the box, which would have made some of the hook-ups easier. In my opinion, it shouldn't make any difference which way the driver is facing.

AMP AUTHOR

It was a pleasant surprise to see Mr. Cordell's recent letter exchange with Douglas Self after many years of apparent disappearance into the audio

Sound Product. Pure Sound.



Improve your audio experience with non-inductive **metal foil resistors** by Alpha Electronics.

- Metal foil technology
- Available in any value
- Quality sound **for less**

Pure and simple...

Contact Sara at **(763) 258-8550**
Email: audiofoil@alpha-amer.com

AE Alpha Electronics Corp.
of America

Minneapolis, Minnesota
www.alpha-amer.com

auricap



**World's finest capacitor,
Sonically transparent,
Superior technical
specifications.**

- Auricap is the best I have tried by a long, long way.
Kendrick Pavey/VP Melbourne Audio Club
- Auricaps are great parts, and represent a significant step forward in capacitor technology and audio-musical performance... Better and cheaper. What more can you ask for?
Jennifer White-Wolf Crock, Sr. Technical Editor - Positive Feedback Magazine
- If you want absolute transparency, then you must give Auricaps a try.
Giorgio Pozzoli/TNTAudio.com

OEM & dealer inquiries invited.
Call (800) 565-4390
www.audience-av.com

Our Samples Are Better Than

FREE!



We're so sure you'll love our Square Drive Screws we'll practically pay you to try them. **Return this ad with \$10** and we'll send you our famous "Try-Pack" Sampler of 200 screws (25 each of #8 x 1-3/8, & 1-7/8 Flat Head ProMax®, # 8 x 5/8, 1-1/4, 1-1/2 & 2 Std Flat Head, and #8 x 1-1/4 & 2 Round Washer Head), a driver bit for your drill, our catalog listing 900 types of fasteners, and a coupon for **\$10 off** your first order of \$75 or more! (Limited time offer. Available in USA only.)

"We tried a box of 1-3/4" #8 prelubricated flat heads with nibs from McFeely's, which quickly became our favorite fastener." Speaker-Enclosure Screws, Robert J. Spear and Alexander F. Thornhill, *Speaker Builder*, 2/94

© 2002 McFeely's All Rights Reserved

McFEELY'S

SQUARE DRIVE SCREWS

Box 11169 • Lynchburg • VA • 24506

Call 1-800-443-7937 or FAX 1-800-847-7136

woodwork ("Xpress Mail," 8/03, p. 65). I've long been fascinated by his amplifier design with the error-correcting MOSFET output stage that appeared in the JAES and an International Rectifier applications note. Here's to hoping that you can induce him into updating the design as a DIY article for *audioXpress*!

Brian Lenharth
Tucson, Ariz.

SUPERTEX FETS

I was reading David Davenport's line stage article ("Odyssey of a Line Stage, Parts 1 and 2, aX 2/03 and 3/03) and noticed the depletion mode MOSFETs. He lists K & K Audio as a source; however they only seem to have these available as part of a kit! It would be nice to be given "real world" suppliers for the listed devices! I was aware—in the back of my mind—of the fact that Supertex made these things, which are basically high-voltage JFETs. A visit to the website did not help with sourcing the parts, but a call to the company did.

I was told that Arrow, New Horizon, and All American are distributors for the parts, but the salesman did not have the slightest idea who had what, or if they had any at all! He did say that there were 4000 of the Dn2540N5s—TO-220 (the only useful one for CSs) sitting in the warehouse in Hong Kong if a distributor ran out.

Supertex has a note: "not recommended for new designs" for all of the TO-220 devices—not a good thing, as these are single source parts! However, when asked about the implications of this, the salesman said that Supertex will, allegedly, notify everyone who has ever purchased these devices, whether they are to become obsolete—certainly a comforting thought to those of us who have called to re-order a part and were informed that it was eliminated . . . several years ago.

A visit to Arrow's website showed that they have hundreds of the DN2540s, LND150s, and so on. Forget about the surface-mount parts! Arrow, at least, wants you to buy 2k of them, as they are on tape and reel. If you order online, there is no minimum order, and you can avoid a \$5 handling fee.

A thought: what is the 500V LND150

good for with its 1mA Idss? Would it be possible to make a cascode, CS loaded source follower buffer—basically an active probe for measuring high impedance, high voltage ($\pm 600V$) nodes in tube equipment, using four devices? Ever see what happens to the bias voltage/current when you hang a meter or scope probe on the output tube grids when you have a 220k grid resistor?

This gets into "tweak" territory, where I have seen opinions by various authors in your magazine and others. First of all, tubes: Mr. Perkins wrote an article years ago about cleaning tube pins and how this would improve the sound. I have noticed that "new" tubes are coming through with bright, plated pins. It would be nice to have an assessment of what improvements are attributable to this. Also, from my experience, I would judge that the biggest difference in the sound of various tubes is their microphonic behavior.

How do tube shields affect sound? I was exchanging tubes in a BF Bassman Head I refurbished for a client—trying to get the hiss/noise level down—and found that a more microphonic tube actually started feeding back when the steel-spring-loaded shield was installed! How does the shield affect the "sound" of the tube as an amplifier? Amp guru Ken Fischer, in his "Trainwreck Pages" (the uncensored version is contained in Gerald Weber's first book, *Tube Amp Talk for the Guitarist and Tech*, available from Old Colony Sound Lab), contends that the electron beam, within the tube, can "see" the grounded potential through the plate as possibly added capacitance, and this will adversely affect the sound.

Will adding the P.E.A.R.L. or IERC tube coolers, which are non-magnetic, affect a tube's performance? Ken also explained—in a personal correspondence—that EL84s, at least, will put out appreciably more power if they are really cooking and their cathodes are really hot.

How about circuit board materials? Andy Nehan and Mike Van Evers have both suggested Teflon circuit boards, writing that fiberglass is a rotten insulator—especially at tube voltages, I would imagine—and is hydroscopic. I have dealt with "Fender disease," where leakage, due to moisture, in their car-

bon-loaded fiberboard can easily add 0.75V DC on the first two preamp tube grids. It would be nice to see some sort of comparison—at least electrical—between commonly used construction materials, including the phenolic terminal strips of old.

John Nickerson
Old Harbor Company
Chatham, Mass.

David Davenport responds:

Thank you for reading my article and taking the time to send a letter, which covers a wide variety of topics. I am not sure I am qualified to address all of them, so I will limit my response to your question and comments on the article.

You are correct about the importance of being able to source parts, so I was concerned about your not being able to order the DN2540 from my recommended source. I called Kevin Carter at K&K Audio and asked him about this. He said that although the MOSFET was part of a CCS kit, as you mentioned, he does in fact sell the MOSFET alone, and has sold a good number of them. Kevin is not in the general electronics parts business, so he doesn't list them on his website.

As to the TO-220 package becoming obsolete; unfortunately the DIY market does not drive the semiconductor industry, so we must take what the telecommunications industry says it wants. I suspect that the TO-220 will still be around for a while, and then perhaps a NOS MOSFET cottage industry will surface.

HORN SPEAKER

In the January '04 issue Bill Fitzmaurice presented a very interesting article on the construction of his DR250a horn speaker ("The DR250 Horn," p. 20). In his closing statement he says he built a unit without the ducts and using piezo tweeters. I am wondering how the performance of this version compared with the original ducted version. I am more concerned with the low-end response as opposed to the HF. Do the ducts have a dramatic impact in the LF response below the 50Hz point? I would appreciate any comments the author might have on this.

Thank you and keep the speaker building articles coming. I will attempt

to build this DR250a as soon as I finish the classic ALTEC A7 (828 cabinets). Can't wait to find out whether the DR250a can produce home theater thunder on the same scale as the A7.

Gerald Hynes
APPLIED COMMUNICATIONS
Winnipeg, Manitoba

Bill Fitzmaurice responds:

The sealed rear chamber version of the DR250a is stronger than the vented version from 100 to 150Hz, but weaker below 100Hz. How you build yours depends on whether you plan on using a sub with it. If you don't plan on using a sub, and wish for maximum bass extension, tune it to 50Hz. If you prefer to cross over to a sub at 80Hz or so, tune it to 80Hz, and if you choose to go to a sub at 100Hz, omit the ducts entirely.

As to how the DR250a compares to a stock A7 with the original or equivalent drivers, I think you'll be very surprised at what the 250a can do. Just remember that the trade-off of getting so much power and bandwidth from such a small box lies in the lack of flat response. So for stereo or HT, use at the very least a 4 band parametric EQ, though I'd recommend a 31 band digital EQ for best results.

HELP WANTED

Reflecting on tube experimentation encouraged in *audioXpress* articles, I was wondering whether any readers or regular contributors to the magazine have experimented with double beam tetrode type 832A in a triode mode SE, parallel SE, or P-P application—found in the WW2 VHF Bendix transmitter type BC-625? Also having difficulty locating source of a schematic for the RCA amplifier type MI-4288-JY using two pairs of 6L6s (metal) in parallel P-P. Many thanks in anticipation.

Ken Domminney
11 Sycamore Close
Eastbourne, BN 22 OSJ
UK England
Tel/Fax: +44 (0) 1323 500174

Readers with information on this topic are encouraged to respond directly to the letter writer at the address provided.—Eds

Electronic Crossovers

Tube

Solid State

Line Level Passive

Crossovers

Custom Solutions

We can customize our crossovers to your specific needs. We can add notch filters, baffle step compensation, etc....

All available as kit

Free Catalog:

Marchand Electronics Inc.

PO Box 473

Webster, NY 14580

Phone (585) 872 0980

FAX (585) 872 1960

info@marchandelec.com

www.marchandelec.com

Ready, willing
and
AVEL



offering an extensive
range of ready-to-go
toroidal transformers
to please the ear, but won't
take you for a ride.

 Avel Lindberg Inc.

47 South End Plaza
New Milford, CT 06776
tel: 860-355-4711
fax: 860-354-8597
www.avellindberg.com

Classifieds

VENDORS

AUDIOCLASSICS.com Buys-Sells-Trades-Repairs McIntosh, B&W, Krell, Klipsch, Tannoy, CJ, VPI, Sunfire, Marantz, Levinson, Lexicon & more. **800-321-2834**.

Principles of Power, tube audio books, kits, FAQ www.londonpower.com

www.southwestelectronics.com

**Tubes & Transformers
Guitar Amp & parts**

Eliminate Vibration Noise Distortion

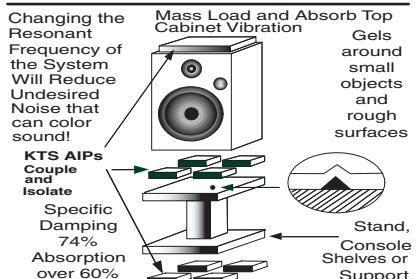

Secures Cabinets/Components to Wood Tile Metal Non-Toxic, Non-Destructive Removable
www.kleintechsys.com P. 561-969-2298
email: support@kleintechsys.com

SPEAKERBITS

Foam, cloth and rubber surrounds, spiders, cones, dustcaps, horn diaphragms, world's best voice coils & braid wire. Genuine foam surrounds for Dynaudio, Tannoy, Scan-Speak & more.

Dealers welcome - email for your user ID to access trade prices. We ship worldwide.

www.speakerbits.com

WWW.AUDIOELECTRONICSUPPLY.COM— We are your supply source for all electronic parts—tubes, transformers, capacitors, potentiometers, connectors, and so on, as well as DIY kits and assembled products. Call **(919) 355-0014** or e-mail us at info@audioelectronicsupply.com.

These CONCRETE CABINET loudspeakers are a rock-solid Sonic revelation, What HiFi. Buy or build, www.faradaysound.co.uk

**CLEANER SOUND
LESS DISTORTION
EASY INSTALLATION
GREATER SOUND PRESSURE LEVELS
DESIGNED AND MADE IN THE USA**

Precision Sound Products, Inc.
Phone: 815-599-0662
Fax: 309-279-0359 www.psp-inc.com

tubes?
www.tubes.it

BILLINGTON EXPORT LIMITED

All types of audio tubes. 300B 6DJ8 ECC81 ECC83 KT88 Mullard GEC Sylvania. Discount for large quantity. Billington UK. Tel (0)1403 784961. Fax (0)1403 783519. Email/website www.bel-tubes.co.uk

Pro-audio mic pre, headphone amp, crossovers, lineamps, power amps
www.borbelyaudio.com
Borbely Audio kits in USA:
www.audiokits.com
Borbely Audio kits in Japan:
<http://homepage3.nifty.com/sk-audio/>

JENA LABS
Our websites are our information centers for interconnects and cables, AC power solutions, DIY and OEM parts, Immersion Cryo services, and dealer list. [jenalabs.com](http://www.jenalabs.com) [jenatek.com](http://www.jenatek.com)

gear racks, media drawers and more
Factory direct since 1984
Free brochure (mention audioXpress)
Per Madsen Design (800) 821-4883
www.rackittm.com

Build your own loudspeakers with top components from
www.E-Speakers.com

Welborne Labs

The largest selection of tubes, audio kits, and parts.
It's all online at

<http://www.welbornelabs.com>

Visit Our
Website
www.audioXpress.com

Yard Sale

FOR SALE

Large selection of high-end woofers, mid-bass drivers, and tweeters from Audax, Focal, SEAS, Vifa, and Usher. All new. Used only briefly in speaker system design and testing. 50% to 60% off list. Joe D'Appolito, 34 Rust Pond Road, Wolfeboro, NH 03894 or audioldt@metrocast.net.

Electronics Workbench V4.1c for Macintosh. Discontinued for Mac since '96. Circuit simulation using built-in schematic build and measuring/graphing generation and display. Requires System 6.0.5 or higher or System 7 with 4 MB RAM/5 MB HD. Asking \$120+ postage. Louis 450-435-6058.

Two Tango power transformers set up for 6C33C single ended amplifier. NO-11395. (115V) – (80V 0.1A) – (160V – 180V – 200V – 0.95A) – (6.3V 6.6A) – (6.3V 6.6V) – (300V 0.1A) – (6.3V 3A). Used once eight years ago. Excellent shape. \$125.00 each. HP 339A Distortion Measurement Set. \$450.00 picture available. Perreaux power transformers from PMF 2150B, 3150B, 5150B. Perreaux PMF 2150B power transformers 4 \$40.00 each. Six capacitors \$5.00 each. Perreaux PMF 3150B power transformer 1 \$40.00. Two capacitors \$10.00. Perreaux PMF 5150B power transformer 1 \$40.00. Two capacitors \$10.00. Contact Ashby and Shelly, ashby123@comcast.net.

Large collection of audio goods—parts, tubes, transformers, speakers, Edgar Monoliths, other finished goods, and more. Also some woodworking items. Send e-mail for a detailed list. Matthew Cottrell, Mccottrell@comcast.net.

AD INDEX

| ADVERTISER | PAGE | ADVERTISER | PAGE |
|------------------------------|------|--------------------------------|------|
| ACO Pacific Inc | 19 | Linear Integrated Systems | 61 |
| Alpha Core | 15 | Madisound Speakers | 56 |
| Alpha Electronics | 67 | Marchand Electronics | 69 |
| All Electronics | 64 | McFeely's | 68 |
| Antique Radio Classified | 37 | Mouser Electronics | 37 |
| Audience | 68 | MCM Electronics | 9 |
| Audio Amateur Corp. | | Parts Connexion | 25 |
| Classifieds | 70 | Parts Express Int'l., Inc. | CV4 |
| <i>Loudspeaker Design</i> | | Pass Laboratories | 61 |
| <i>Cookbook 6th Edition</i> | 50 | Plitron Manufacturing | 55 |
| PC Boards | 38 | PWK Legacy | 1 |
| <i>Ribbon Loudspeakers</i> | 50 | Rockler Woodworking & Hardware | 53 |
| Test CDs | 30 | Selectronics | 47 |
| <i>Testing Loudspeakers</i> | 66 | Sencore | 51 |
| Website | 62 | Solen, Inc. | 16 |
| Audio Consulting | 63 | Speaker City USA | 17 |
| Audio Electronic Supply | 63 | Sunrise E&E Inc | 19 |
| Audio Transformers | 65 | Swans Speakers | 33 |
| audioasylum.com | 23 | Test Equipment Depot | 62 |
| Audiomatica | 45 | The tubestore.com | 60 |
| Avel Lindberg Inc. | 69 | Usher Audio | 7 |
| Classified Audio-Video | 71 | WBT-USA/ Kimber Kable | 5 |
| Diamond Groove | 72 | Welborne Labs | 11 |
| DH Labs | CV3 | | |
| E-Speakers | CV2 | CLASSIFIEDS | |
| EIFL | 21 | Audio Classics LTD | 70 |
| Electra Print Audio | 48 | Audio Electronic Supply | 70 |
| Electus Distribution Pty Ltd | 49 | Billington Export | 70 |
| Front Panel | 59 | Borbely Audio | 70 |
| Hagerman Technology | 59 | E-Speakers | 70 |
| Hammond Manufacturing | 29 | Faraday Sound | 70 |
| Harris Technologies | 43 | JENA Labs | 70 |
| Hi Fi Do Inc | 49 | Klein Tech Systems | 70 |
| Jupiter Condenser | 48 | London Power | 70 |
| K&K Audio | 72 | Per Madsen Design | 70 |
| KAB Electro-Acoustics | 71 | Precision Sound Products | 70 |
| Kimber Kable/WBT-USA | 5 | SouthWest Electronics | 70 |
| Langrex Supplies | 27 | Speakerbits | 70 |
| LC Audio Technology ApS | 13 | Vintage Hi-Fi | 70 |
| Liberty Instruments | 41 | Welborne Labs | 70 |

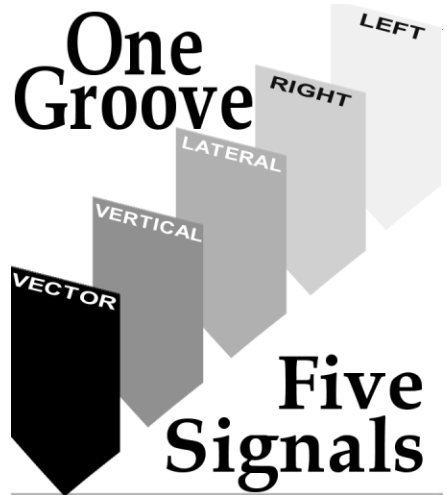

PERFECTLY ALIGNED

KAB introduces Groove Tuning™ A new concept that lets you mix the five signals of a mono groove for the best sound possible.

Learn More Online

KAB
Preserving The Sounds
Of A Lifetime
www.kabusa.com



www.audiokits.com

We accept MasterCard, Visa, Discover and American Express.

All-FET Ribbon 20/40W Power Amp
All-FET Line Amp
All-FET DAC
All-FET Millennium Mono Block Amps

Build Tube Phono Preamp & Line Amp

Better Class A Headphone Amplifier

Audio 15W SE Power Amplifier Super Buffer Accessories/Parts Enclosures

Have questions? Email us at info@audiokits.com.



DIAMOND GROOVE

- Analogue Productions
- Audio Fidelity
- Cisco Music
- Classic Records
- Mosaic Records
- Simply Vinyl
- Speakers Corner
- Sundazed

Many other non-audiophile labels
Over 1,200 new vinyl titles in stock

www.diamondgroove.com

1-877-DGROOVE

info@diamondgroove.com

the whole sound of vinyl
for Canada and the world

Lundahl Transformers in the U.S.

K&K Audio is now selling
the **premier European audio
transformers** in the U.S.

**High quality C-core transformers and chokes
using silicon iron, mumetal, and amorphous
cores.**

- Power output transformers – SE or PP
- Interstage transformers – SE or PP
- Line output transformers – SE, PP, and parallel feed
- Input transformers – MC or line
- Audio chokes
- Power transformers
- Power supply chokes

**High End Audio Kits using Lundahl
Transformers**

- MC Phono Step-up Unit
- Phono Preamplifier
- Line Stage Preamplifier
- Microphone Preamplifier

**For more information on our products
and services please contact us at:**

www.kandkaudio.com

info@kandkaudio.com voice/fax 919 387-0911

Showcase

A Bulgarian Builds A Spencer Amp

Reader M. Nyssen was so impressed by Rick Spencer's article "A Great First Amplifier Project" (12/01 *aX*) that he built a half-dozen variations on the Spencer design, and proceeded to sell them at an audio meet in Bulgaria. He sent the editor a handful of photos from which we selected three.



PHOTO 1: Two channel 15W/channel, ultralinear with a separate power supply. The chassis is U-shaped aluminum with wood end pieces held together with internally threaded aluminum rods.



PHOTO 2: Separate power supply constructed similarly. High voltage 300V DC.

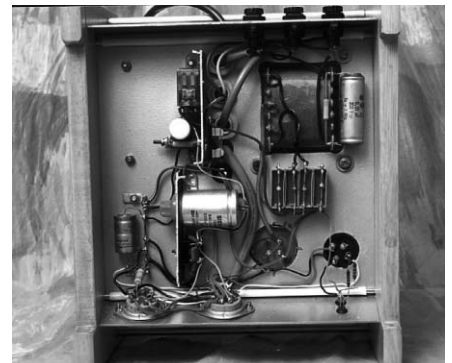

PHOTO 3: Neat underside of the power supply unit.