

SOUND PRACTICES

A JOURNAL OF AUDIO TECHNOLOGY

FALL 1994

FIVE DOLLARS



The IN Crowd

Vol. 2:#3 Issue 7



Get on our list - to get closer to this list.

- MIT MultiCap • Wonder Cap • Kimber Kap • Solo • Hovland MusiCap • Solen • Siemens • Wima • Holco
- Rel-Cap • Draloric • IRC • Allen-Bradley • Jensen • Resista • Vishay • Mills • Caddock • Matsushita • TKD
- Noble • Cardas • Kimber Kable • van den Hul • Discovery • Audioquest • MIT • Alps • Bourns • Shallco • Elma
- Electroswitch • Nichicon • Gold Aero • RAM • Mallory • Panasonic HFQ • Nichicon • Elna • N.O.S. • Ruby Tubes
- UltraAnalog • Burr-Brown • Crystal • Linear Technology • Analog Devices • Edison Price • Motorola • UCC
- International Rectifier • Hitachi • MagneQuest • Sonic Frontiers • Pearl • Tube Sockets • WBT • Neutrik
- Sound Coat • Curcio Audio Engineering • Assemblage and other kits

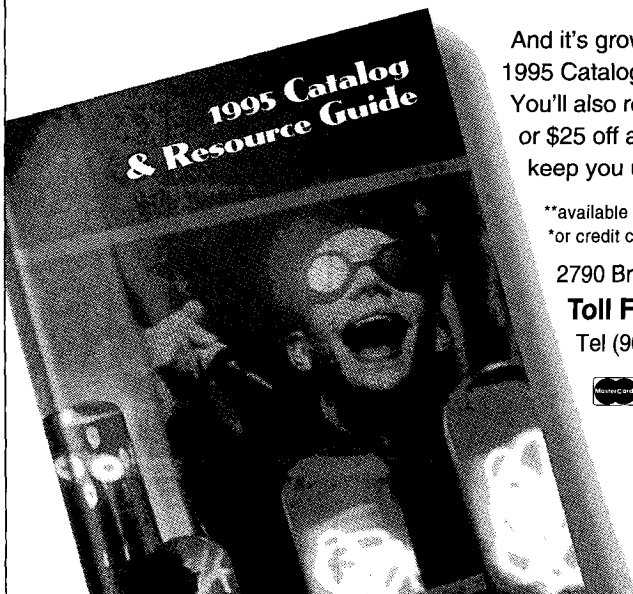

And it's growing and growing. To order The Parts Connection 1995 Catalog & Resource Guide**, send \$10* and mailing information. You'll also receive a Discount Coupon worth \$10 off a purchase over \$100 or \$25 off a purchase over \$250 as well as *The Breadboard* bulletin to keep you updated on our latest news, information and growth spurts.

**available March
*or credit card information

2790 Brighton Road, Oakville, Ontario, Canada L6H 5T4

Toll Free Order Line 1-800-769-0747

Tel (905) 829-5858 Fax (905) 829-5388



**THE PARTS
CONNECTION®**
A DIVISION OF SONIC FRONTIERS INC

EVEN IF YOU'RE NOT RICH, ANGELA'S STILL SINGLE!!!!

AUDIO NOTE KIT ONE

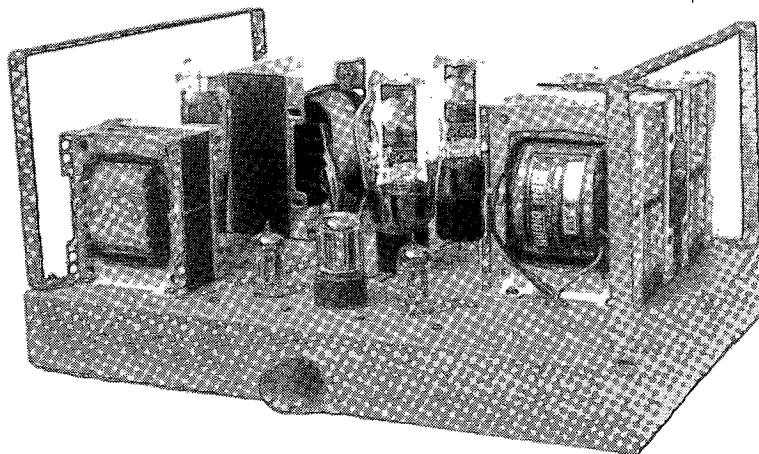

OVER THE PAST YEAR WE'VE BEEN MAKING NEW FRIENDS ALL OVER AMERICA WITH THE FINE SOUNDING, RELIABLE **AUDIO NOTE KIT ONE STEREO AMPLIFIER**. EIGHT GLORIOUS WATTS OF PURE CLASS A SINGLE-ENDED TRIODE POWER. TUBE COMPLEMENT: TWO 300B, TWO 5687, ONE 6SN7, AND ONE 5U4GB RECTIFIER. DESIGNED FOR THE EXPERIENCED D.I.Y. TUBE AUDIO ENTHUSIAST BUT SEVERAL CRAFTY ABSOLUTE BEGINNERS HAVE ALSO CRASHED THE PARTY! IF YOU CAN MOD A DYNA, YOU CAN BUILD THIS KIT! **INTRODUCTORY PRICE: \$1150, TUBES INCLUDED! VISA/MC/AMEX OK FOR PHONE ORDERS. WE SHIP ANYWHERE. CURIOUS? FIFTY PAGE KIT ONE MANUAL AVAILABLE SEPARATELY FOR \$15 POSTPAID. DUE IN BY THE TIME YOU READ THIS: THE AUDIO NOTE KIT THREE AMPS.** ESSENTIALLY A MONOBLOCK VERSION OF THE KIT ONE WITH DOUBLE THE POWER, THE SAME COMPONENTS AND ON TWO CHASSIS INSTEAD OF ONE. FEATURES TWO 300B PER CHANNEL RUNNING IN PARALLEL SINGLE-ENDED YIELDING 17 WATTS. **PRICE: \$2247. KIT THREE MANUAL ONLY \$17.**

ANGELA MODEL 91

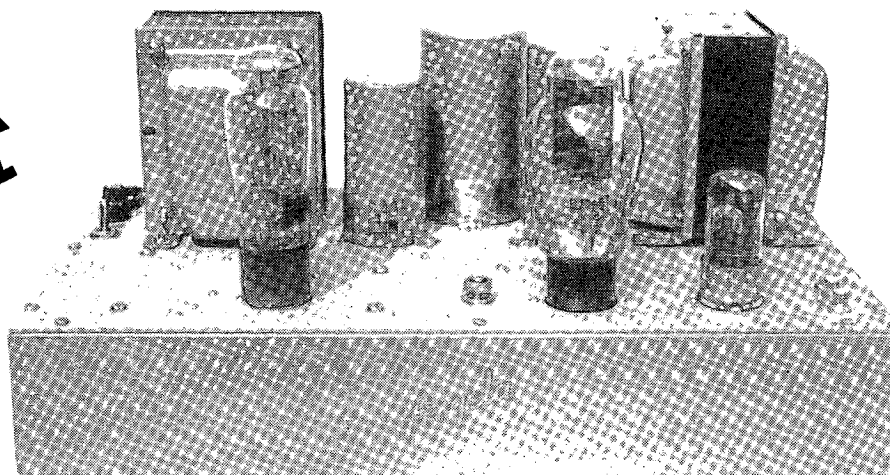

THE ANGELA INSTRUMENTS 1995 CATALOG FEATURES SIMPLIFIED PICTORIAL PLANS FOR BUILDING **WESTERN ELECTRIC MODEL 91** STYLE SINGLE-ENDED 300B MONOBLOCKS. IF YOU'VE ALWAYS WANTED TO TRY BUILDING AMPS BUT FEEL INTIMIDATED BY SCHEMATIC-ONLY PLANS, THEN THIS ONE'S FOR YOU! YES, THIS 'OBSOLETE' DESIGN SOUNDS WONDERFULLY MUSICAL, INTERFACES WELL WITH THE MODERN HIGH-END COMPONENTS IN YOUR SYSTEM, AND COMPARES VERY FAVORABLY WITH SIMILAR DESIGNS COSTING THOUSANDS MORE. NO, YOU WON'T HAVE TO GO RUNNING ALL OVER CREATION TO FIND THE PARTS: WE'VE GOT 'EM ALL IN STOCK, INCLUDING METALWORK AND **AUDIO NOTE** OUTPUT TRANSFORMERS. TO RESERVE YOUR COPY OF OUR CATALOG MAIL US A CHECK FOR \$5 OR CALL/FAX WITH VISA/MC NUMBER AND EXPIRY DATE.



EST. 1977

ANGELA INSTRUMENTS

10830 GUILFORD ROAD, SUITE 309
ANNAPOLIS JUNCTION, MD 20701
PHONE (301) 725-0451
FAX (301) 725-8823

Laurel

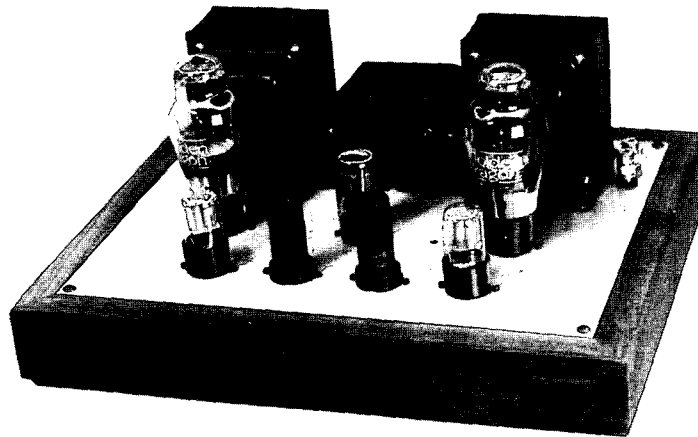

A
300B
Single-Ended Amplifier Kit

Featuring

Alan Kimmel's Mu-Stage Design
Hand Wound Output Transformers by MagneQuest™
Choice of Hovland MusiCap or Audio Note paper-in-oil Signal Caps
Golden Dragon Kimber Kable Solen Allen Bradley and other Quality Components used throughout
Assembled on A Beautifully Crafted Walnut and Brass Chassis with Cardas Terminations

Laurel Stereo
w/MagneQuest FS-030 Outputs
\$1600 Complete / \$1250 Less Tubes

Laurel III Mono Blocks
w/MagneQuest FS-030 Outputs
\$1900 Complete / \$1540 Less Tubes

Laurel IIII Mono Blocks
w/MagneQuest DS-025 Outputs
\$1620 Complete / \$1260 Less Tubes

Welborne Labs

P.O. Box 260198
Littleton, CO 80126 USA

Phone: (303) 470-6585
Fax: (303) 791-5783
Bus. Hours: Mon.-Fri. 9am to 9pm MST



Send for our **New** 1994/95 Catalog & Design Manual. It contains over 250 pages of kits, parts, and useful how-to info. Send \$12 U.S. & Canada, \$16 International. Or call/fax with VISA or Mastercard

MIT MultiCap • Kimber Kap • Wonder Cap • Solen • Hovland MusiCap • Largest selection of WIMA capacitors • Siemens • Mallory
Largest selection of Caddock resistors • Roederstein • Mills • PFT • Strongbox • Vampire • Cardas • WBT • Neutrik • Alcoswitch
Grayhill • Ram Labs • Golden Dragon • Tesla • Sovtek • NOS tubes • Northern Technologies • MagneQuest™ • TKD • Bourms • Noble
DH Labs • Kimber Kable • Linear Technology • Analog Devices • Toshiba • Motorola • IR HexFreds • Caig Labs • Sorbothane
TEC-200™ Film • Keipro • OCSL Books and More!

Try our new **Assist™** Printed Circuit Board Layout Software for PCs. It's the **Only** layout software produced exclusively for audio design. It features: PCB layout, schematic drawing, extensive editing utilities, and libraries of over 200 pre-built component templates and schematic symbols including: tube sockets, op amps, fets, regulators; Caddock, Resista, Holco, Vishay & other resistors; MIT Wonder, Kimber, Solen, Wima & other caps; or create your own libraries of often-used components. Introductory price of just \$35.00 (regularly \$49.95). Or send \$40.00 and get the **Assist™** software and our 250 page Catalog & Design Manual.

Sound Practices

SOUND PRACTICES (Pending) is published quarterly by Sound Practices at 9405-C Grouse Meadow Lane, Austin TX 78758. Application to mail at Second Class rates pending at Austin, TX.

Please address all correspondence to SOUND PRACTICES Box 180562, Austin, TX 78718. Voice/FAX 512-339-6229. e-mail: SP@tpoint.com. Due to critical time/resource pressures, we must discourage calls for general advice or technical assistance.

This publication exists to encourage audio experimentation and to promote the exchange of related information. Permission is given to reprint all contents for worthy purposes, except for individually copyrighted articles. Please be sure to mention Sound Practices as the source in any reprints and send us a copy.

Subscriptions for Vol. 2 are available at the rate of \$20 yearly in the US, \$24 in Canada, \$30 UK/Europe Airmail, \$35 Elsewhere Airmail. Regardless of the month in which you subscribe, you will receive all four issues published in the current volume.

Sound Practices actively solicits contributions of written material of interest to our readership. Please contact us to discuss your ideas. Display advertising rates and deadlines available upon request.

POSTMASTER: Send address corrections to Sound Practices, POB 180562, Austin, TX 78718-0562.

FALL 1994 Contents

The Promise of Horns.....	5
<i>Joe Roberts</i>	
Mass Suicide	10
<i>Seth Goldwin</i>	
Good Old QUADs.....	13
<i>Haden Boardman</i>	
On the Frontier: VV30B.....	21
<i>JC Morrison</i>	
Suggested 300B SE Circuits.....	17
<i>Electra Print Co. and one electron</i>	
Junk Box Chokes.....	23
<i>Sherman H. Hubelhank</i>	
Knock your Socks Off.....	34
<i>The Baroda Bard and Ray</i>	
Taming Diode Noise.....	39
<i>John Camille</i>	
Readers' Forum.....	43

... and MUCH MORE !!!

Fashion is the devil

For a while there, triodes were the biggest craze to hit audio in a decade at least. After years of nothing more exciting than new digital formats, the single ended amplifier exploded onto the local marketplace and captivated the attention of audiophiles and industry gurus. It was different, it was new, it was classic, and it was HIP. At first, triodes had the ultimate qualification for hipness going on — you couldn't buy the stuff even if you had the money. You either had to build 'em yourself or import some exotic electronics from a foreign land.

What followed the revival of triodes did a lot to reaffirm my faith in the capitalist system. As predicted by the classical models, when there is demand some ambitious producer will rise to meet the challenges. Two years later, there are a dozen single ended amps that you can buy, a few real nice triode kits, and a number of exciting new tubes on the market. Everybody is involved in the triode enterprise: the mainstream magazines, the Chinese and Russian governments, and now even AT&T is getting in on the act. There ain't no "In Crowd"— *everybody's in*.

I always welcome heavy capital investment by mega-corporations and foreign ministries of trade destined to enhance my personal music listening pleasure. Let triodes take up the slack in a global economy shifting away from military and defense-related expenditures. If this is New World Order audio, bring it on!

Anyway, the absorption of triodes into the mainstream of international commerce and world audio institutions signals that the era of faddishness for the triode is past and events suggest that some permanence for the technology is guaranteed. Elsewhere on the planet, triodes have been around for a few decades and enjoy a faithful following. For an industry dependent on worldwide export sales for economies of scale and profitability, triodes are an ideal commodity. The language of triodes is today a lingua franca among the top few percent of audiomaniacs everywhere, as it has been for some years in certain pockets of esoteric activity, and I think it is safe to say that we will continue to see an expansion of the triode dialogue and growth in the market for triode-based music systems in coming decades.

Now that the whole issue of fashion is out of the way, maybe we can get down to learning the lessons which this timeless technology offers us. Hopefully, in another few years, we will have a sufficient knowledge and experience base to make good use of this tool. We will need to learn how to build whole systems which showcase the special talents of triode technology and meet its unique challenges. And most importantly, we have to be ready to adapt our ears and our aesthetic systems to measure progress in the new directions in sound that we are pursuing.

One undeniable benefit of the appearance of triode amps on the scene is that it shook up the "high end" where it needed to be shaken, at the level of unquestioned assumptions. For all the self-reflection of the Stateside audio press, they are a complacent bunch as far as the fundamental rectitude of their analytical program is concerned. They act as though they believe there really are absolutes in the experience of musical beauty and they know what they are. Single ended puts us back where we need to be, in an atmosphere of productive mystery, and it reminds us that we are still novices at reproducing music after only 100 years.

As triodes are being taken seriously by more and more people in the business these days, a few traditional industry figures are now calling triodes the "death of the high end." Funny that players in a movement whose philosophical strength derived from a bold willingness to question the supreme importance of specs and put music first are now assaulting SE because the specs are off the map. Triodes aren't the "death of the high end" — rather they provide us with an opportunity to continue in the pioneering spirit of the old high-enders of the 1970s, forcing a radical critique of existing technical and evaluative institutions with the goal of more perfect music reproduction ahead. Tunnel vision or blind adherence to fashion, whether old or new, is the death of the high end.

Model 88
 "The Black Pearl"
 \$15,000 per 8' pair

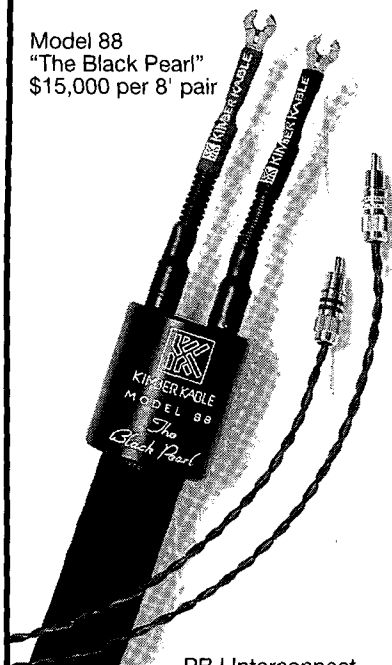

PBJ Interconnect
 \$62 per Meter pair

Quality and Value for Every Budget.

At the Summer 1994 Consumer Electronics Show our brochure was honored with a major award. We are very proud and pleased, and would like to send you one. But we would point out that our cables are even better, and our cables have been receiving "note worthy" accolades for 15 years. Yes, the humor in the last ad was deliberate. It was our way of making you smile—that is if you don't have Kimber Kable in your system... yet!



**KIMBER
 KABLE**

2752 South 1900 West
 Ogden, UT 84401
 (801) 621-5530

New Products

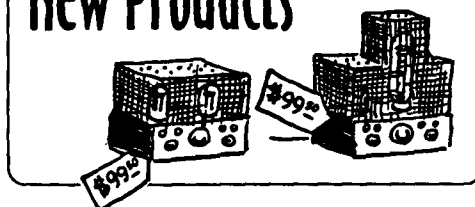

Western Electric® THE SECOND COMING

Believe it or not, the famed Western Electric 300B is back in production! That should shake up the 300B market a bit, huh? Pinch me to make sure I'm awake.

The new production WECO 300Bs will be identical to previous production runs, both in performance and appearance. These tubes will be produced in the US from original tooling, materials, engineering specifications, and manufacturing processes. Some of the individuals responsible for previous production are involved in this release. The tubes will be marked with the original Western Electric "flash" logo and will include manufacturing date codes, as did previous runs. Each tube will undergo rigorous quality control testing by AT&T.

Western Electric will also be involved in the digital and analog interconnect market, featuring cables designed under the supervision of internationally renowned AT&T Bell Labs scientists William Nutt and John Plewes. The first Western Electric high fidelity product of the new era, Lightguide ST-II format digital interconnects, will be available very shortly.

The new WE 300B will be available summer 1995. Interested OEMs and distributors may contact Westrex (formerly Western Electric Export Company, Ltd.) at the fax number below for more information on Western Electric High Fidelity Products.

Western Electric
 Westrex Corporation
 AT&T Promenade II
 1230 Peachtree Street
 Atlanta, GA 30309-3575
 404-874-4415 fax

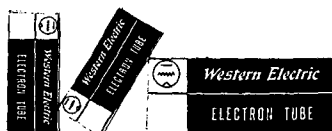

VALVE NEWSLETTER

The Seattle based tube audio club, Vintage Audio Listeners And Valve Enthusiasts, puts out a nice monthly newsletter for vintage tube audio nuts. Recent topics include Heath W5 mods, tube rectifiers, homebrew circuits, and miscellaneous chat about good old tube gear and classic speakers.

A subscription to the newsletter is \$20 yr. US, \$35 Overseas. Full members of the club enjoy certain other privileges of interest to the classic hi-fi aficionado. Contact VALVE for more details.

VALVE
 1127 N.W. Brite Star Lane
 Poulsbo, WA 98370
 206-697-1936

DAC KIT

The Parts Connection is offering the Assemblage DAC-I digital processor kit to the hobbyist market. Designed for the first-time DIYer, it should go together in an hour or two using only common hand tools and a soldering iron.

The DAC-I comes with an assembled and tested board featuring a Burr Brown 1702 DAC, a Crystal 1412 input receiver, an NPC 5813 digital filter, Analog Devices AD844 and 847 op amps, and a toroidal power transformer.

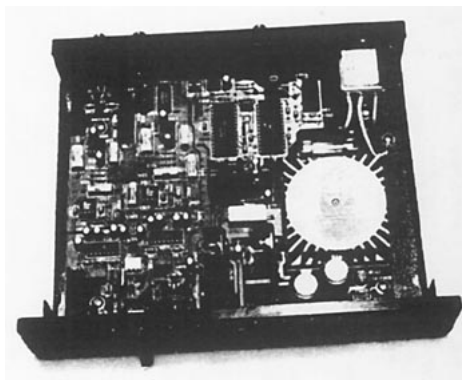

Retail cost of the DAC-I kit is \$499 US and it comes with an assembly guarantee in case you can't get it working, a 30 day money back satisfaction guarantee, and a two year limited warranty.

The Parts Connection
 A div. of Sonic Frontiers
 2790 Brighton Road.
 Oakville, Ontario
 L6H 5T4 CANADA
 905-829-5858

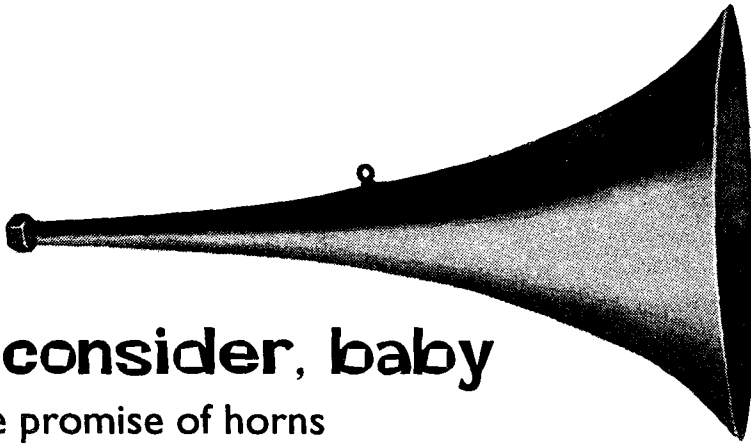

reconsider, baby

The promise of horns
in the contemporary situation by Joe Roberts

For being a totally out of the blue concept, single-ended triode amplifiers enjoyed a relatively easy ride to respectability. The stuff is cool, no doubt about it, and that doesn't hurt a bit. In fact there are lots of people who are big fans of triode amps who never heard them — they got whipped up into a frenzy just thinking about it. Many others who viewed these fleapower amps with suspicion were won over by the *experience* of good triode amps.

Triodes do all the things the mainstream audio institutions say good audio amps have to do extremely well. You want imaging, soundstaging, back wall, yak yak yak? Look no further. The triode is your best friend if 3-D is your illusion of choice. But the lesson in triode amps for the "high-end" is that there are a few things that the general run of audio amplifiers does not do, things that we don't even have words for yet. The way good triodes play music leaves many jaded audiophiles speechless when they hear it.

Then the project of building a system around one of these fabulous amps runs you right into the question "What do I use for speakers?" Good question, one of the eternal questions in audio regardless of whether you're running two watts or two thousand. It gets a bit trickier when you leave behind the established power and sensitivity norms of the industry and enter the domain of "experimentation." With five watts, you're on your own looking for speaks, homes — at least as far as the high end speaker world is concerned.

Believe me, eight watts from a 300B will play many available speakers to at least *medium* listening levels. People are more or

less happily running ProAcs, Ensemble Reference 3As, Spica TC-60s, etc. After all, all of these people running around raving about SE amps are listening to them on *something*, no? As reported by CG in *Stereophile*, my two watt 45 amp played loud and proud on a pair of ProAc Studio 100s.

The *subjective* sense of power that a triode amp can deliver far exceeds expectations. It is not unusual to hear reports that this or that >10W amp sounds louder, fuller, and weightier than this or that 100W transistor amp or p-p pentode amp. Whether a particular speaker will work on a particular amp is a question for empirical research. A high and flat impedance and >90 dB sensitivity helps.

From *my* listening chair, I say power ain't nuthin but a number as far as musical and emotional impact are concerned. But *my* chair is in front of a huge pair of high-efficiency speakers: 15" Altec woofers, Edgar midrange horns, Gauss compression tweeter. The listener with 8 watts and an 88dB speaker will encounter limits. How constraining these limits are depends on your needs. If you really like to crank up your stereo now and again or large scale orchestral music is your passion, the speakers you already have probably won't really shake the rope on three watts.¹

Triode amps sound great turned up to realistic SPLs, which makes the whole situation even more tragic.

¹— One obvious solution to the power challenge is to BI-AMP, preferably with crossovers before the amps. Use that SE triode amp on the mids and/or highs and use your Jadis, ARC, VAC, Aragon, or whatever on the low end. I resisted the concept of

Enter Horns

Thanks to the collective search for good high efficiency loudspeakers to use with low-powered amplifiers there's a lot of curiosity afoot about horn loudspeakers, probably the most unfashionable topic known to the modern high-end. Even 8 track gets more (and better) press than horn speakers in the US specialist mags.

Once upon a time, in the post WWII era, the earliest balls out hi-fi systems were constructed from recycled theater gear. Through the 50s and into the 60s, swanky top-of-the-line home hi-fi speakers featured arrays of horn-loaded squawkers and tweeters. A lot of this plastic horn and phenolic diaphragm stuff is a bit rough on the modern audiophile ear, but it sure was cool to be a "horn man" back then. Ain't that way now.

The need for high sensitivity dwindled as transistor power multiplied. Designers focused on ribbons, electrostats, and miscellaneous cones in sealed boxes intended to be driven by banks of steaming transistors or big hog parallel 6550 amps. The pioneers of the "high-end" as we know it had a different listening program and horns didn't fit. Quite a switch from the McIntosh and JBL 1950's upper crust hi-fi mentality. The horn ceased to exist in the mind of the modern US audiophile, except as a bad joke.

This is where triode amps and horns differ: single-ended amps are something totally new in the Western audiophile cosmos, horns have been tried and rejected. Nothing does more damage to music than a bad horn system and everybody knows it.

You can get a lot of music out of a good triode amp and a *good* horn. But, of course, it's not that easy. One minor problem is that *good* horns are extremely uncommon. Most horns are *totally unlistenable* in a serious music listening context. In my opinion, the bad reputation horns have endured among latter-day audiophiles is largely deserved. Most horns are junk.

But it is obvious that the kind of sensitivity a horn can provide would sure come in handy when you've got three watts and some change to burn. Plus the kind of crazy romantic audio nuts adventurous enough try

multiamp systems for years because I thought it was too complicated to work. I was dead wrong. Using different kinds of amps in roles where they'll perform best makes sense to me and it gets around the low power issue entirely.

a single-ended amplifier just to see what it can do are just the type who would gamble on horns too. So, here we are giving triodes and horns, the cutting edge technology of the thirties, a try in the Pentium age.

RISK OF TRIVIALIZING THE ISSUE

Because most horns are awful beyond description, if the goal is to pick up a few tricks which will lead us toward more perfect reproduction systems, we must be very selective. Most horns will be a total waste of time. If it looks like a cheap piece of junk, it is. Any horn made out of thin cheap plastic or cast metal that rings like a bell is going to be a problem. After all, how many cheap thin plastic or cast aluminum musical instruments can you name?

Our forebears figured out that most of those bottom of the line Jensen and EV \$6.98 horn tweets were junk back in the fifties. We don't need to go through that discovery procedure again. Because horns vary so wildly in quality and performance, there is a real risk in thinking a "horn is a horn" and leaving it at that. While an "average" triode amp still sounds pretty decent, an "average" horn will DESTROY MUSIC.

Only the top 10% of the horn population is worthy of consideration for serious music listening. A few lesser horns are okay to play with for fun and may do some really interesting things, but they will have at least one dire failing which will have them in the

garage after a few weeks playing time. Leave the junk in the airport paging systems where it belongs.

In recent attempts at covering the "Horn and Triode Scene," whatever that is, one big reviewer hooked up some cheap and junky squawk boxes with popularly priced SE amps and, in essence, reported that "Wow, this is better than I thought it would be but it's not that great, *really*." The writer was obviously having a good time, which is fine by me, but I don't think that he exhausted the possibilities of the horn genre with that experiment.

Screwing around with some funky cheap speakers is great recreation — I do it every chance I get— but it will not provide a lasting contribution to the goal of achieving real magic in the listening room.

What is needed is a *profoundly deviant* mindset. We have to search for something *way better* than what we've got to get where we need to be. Our sights must be elevated. Listening to junk and finding that it is slightly better than expected does little to shake the pillars of mundane audio practice.

If we start dredging up all the trash horns that have been justifiably scorned for years and reverifying what we already know, i.e. cheap horns flat-out suck, we run the risk of trivializing the issue. A serious dialogue on horns, centering on open-minded evaluation

of the finest of the species and reevaluation of our present-day goals and achievements, might get us to new and exciting places.

Horns and Mainstream Aesthetics

One day I was discussing the marketplace realities of horns with Peter Qvortrup of Audio Note UK. He evaluated the situation thusly: "There is so much suspicion about horns in the marketplace that listeners will be against the product before they even hear it. If you go out on the market with a product that doesn't do what they want and *expect*, you'll get destroyed".

Come to think of it, there is a bit of a party line regarding what constitutes "good" in the audio mainstream, a standardized aesthetic program. So what if horns do some musically relevant things better than cone and planar "high-end" speakers? Even the very best horns I have heard do not do some things on the 1994 Official Audiophile Speaker Criteria List.

Peter's findings were that horns do not give you "hall sound" and he predicts that reviewers will freak out if there is no "hall sound" regardless of how right the speaker is otherwise. Minus this critical performance factor, there could be PR problems ahead for our old friend the horn speaker.

I personally think "hall sound" is a cool illusion. Hall sound, as I understand it, is a recreation of the original acoustic space in which a recorded performance took place. This is, of course, partly a matter of the quality of a stereo recording, but a reproduction system has to be tuned in the right way to furnish an illusion of the original recording space. It's become a given that good systems do all this "hall sound" stuff right and a lot of contemporary audiophiles like this phenomenon. Most, I am sure, never questioned the issue since it sounds so good on paper.

Granted that hall sound is a neat illusion, isn't it strange that when we are supposedly trying to get to the sound of live music, we evaluate what we hear in terms of "sound-staging" and "imaging"? These concepts are strictly audio geek notions, totally irrelevant to the experience of live music. The language some people use to talk about reproduced sound suggests they are more concerned with questions of architectural acoustics of the hall than the music on the stage.

Trivializing the issue . . .



99⁹⁹
Each

Save \$50
2-way speaker
with 15" woofer



2 x 6" horn tweeter
75W rms, 150W max. 2 kHz-25 kHz. 94 dB SPL. 40-1379 14.99

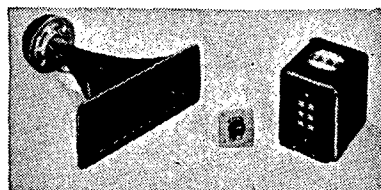

KTX-3 STEP-UP KIT

Provides efficient, distortion free reproduction from compression-driver horn-loaded in the important midrange from 600-4000 cycles. Converts Jensen "CX" Series and similar speakers to a true 3-way system.

Dionomite!

At \$25,000, Be Yamamura's full-range, single driver, multi-horn Dionisio is unlikely to show up at your local high end saloon, or in my system, for that matter. But after listening to a cone-driven Edgar mid horn for a few years, I am a champion of this concept. At a range of ten feet, metal midrange drivers can blast a hole in the wall behind your listening position. A horn loaded cone can really sing close in.

The Dionisio uses a modified Lowther PM-4 to drive this 2.3 m tall cork covered fiberglass sculpture between 27 Hz to 16kHz with better than 100dB efficiency. Said to play on two watts.

Yamamura has various smaller and larger versions of the Dionisio in the works, some priced down in the economy car range. Crazy price aside, paper cones, cork, and no crossovers sounds like a reasonable recipe to me.

US Representative:
Virtual Audio
POB 1598
Novato, CA 94948
415-898-8067

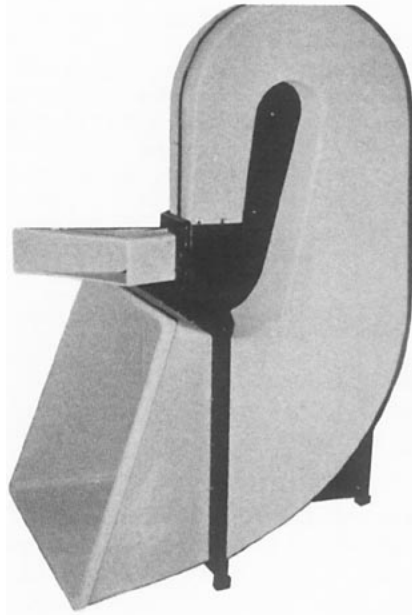

Dionisio

Once Heard, Never Forgotten —

so goes the motto for the Turbosound line of top-shelf pro sound speakers.

Next time you want to hear Dark Side of the Moon, wheel in a pair of Turbosound monitors and put the LS3/5As in the closet. If they're good enough for Pink Floyd concert performances, maybe they're good enough for our home systems.

The TCS-612 system pictured above is set up for bi-amping with an electronic crossover. LF sensitivity is 98 dB @ 1m/1W and HF sensitivity is 103 dB @ 1m/1W. Response +/- 4dB 60-20000 Hz. Nice comfortable 16 ohm load. Size is manageable: approx. 23H X 14.5 W X 14.75D. Midrange uses a horn loaded 6.5" paper cone with concentrically mounted titanium compression driver tweeter. The 12" bass is reflex loaded. Turbosound also makes some mighty impressive high power systems with modular components in the 106-108 dB sensitivity range.

I haven't talked with anybody who evaluated this stuff with triode amps in a home listening situation but it sure looks promising in theory. Can audio nirvana be found in the pages of *Mix* magazine?



Turbosound TCS-612

While it is nice to sit in a great hall and hear some unamplified acoustic music, it is unnatural to focus on the hall sound while you are there. You came to hear the music, right? Nobody talks about music that way and, as far as I can tell, live music doesn't even do most of the 3-D stuff that audiophiles insist on from their systems.

Furthermore, the effect of imaging is contrived and fake even when done well. I loved my Spica TC-50s but there wasn't any way they could reproduce any music except solo mandolin with a realistic sense of scale. Would you accept what passes for good hall sound in your speakers as good sound in an actual hall? No way, Jose.

Far from being an *absolute* part of listening to music, all this a soundstage jazz is an acquired taste and a rather obscure one at that. I like it quite a bit myself, but it took me a lot of magazine reading back in the Seventies and Eighties to even figure out what the writers were talking about.

Concepts like "dial in the soundstage with some Shun Mook ebony root pods from

Mother Africa" are not intuitive. Ever notice how your non-audiophile friends never volunteer that your imaging is superb or remark, "Wow, I never heard the back wall on that recording before."

If you have to *learn how to hear* this stuff and *learn* that it is important, this suggests to me that hi-fi is not directly realistic despite the claims of the orthodox ideology. What we consider "real" is a matter of agreement rather than anything "absolute". There are codes and styles in reproduced sound just as there are in "realistic" visual art.

They are HERE

Contrary to popular folklore, horns *can* project three dimensional images. They are still "better" images than you get live. Big weighty images that grab you with presence and impact, just like real music, rather than relying on unnatural levels of hot top end "detail". 3-D is no problem for good horns.

Horns have a very forward presentation. Back in the Seventies, "too forward" was a

common criticism of speakers. What people were looking for was that backward sound, I guess.

The illusion horns provide is a "they are here" sound rather than the old "you are there" illusion. That is, the sound is so dynamic and alive that it sounds like the music is going on IN YOUR ROOM. True, the "soundstage" illusion of reproducing the original hall sound is skipped over as a consequence. After a few years of listening to horns, I strongly prefer the "right here in the room" sound of horns to the "looking into the room from a hole in the wall" sound I used to get with mini-monitors.

My real complaint about most soundstage projecting speakers, and I haven't heard them all, is that they can't rock out. Sometimes I just gotta listen to some old Funkadelic and whatnot. Stage boundaries are irrelevant in this context.

Maybe there is some grand cosmic tradeoff between dynamics and soundstaging. I think a lot of the hall sound master speakers

STAGE ACCOMPANY SA 8535 COMPACT DRIVER

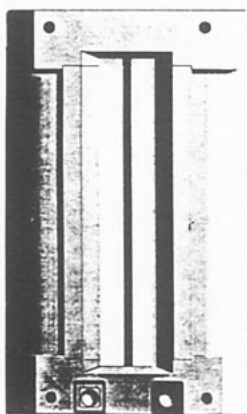

Nominal Impedance 12 ohms flat
 Frequency range 1-30 kHz
 Peak power 1000 W peak /60 W cont.
 Sensitivity 125.5 dB @1m/2.83V
 (127.2 dB @1m/1W)

The Compact Driver is a ribbon driver with a neodymium magnet. Unlike the plumbing fixture pro horns of yore, this unit would be a civilized addition to your listening room decor. The driver only weighs about 9 pounds. The optional wave guide horn is less than 11 inches square.

You might be inclined to think of this ribbon driver in terms of super tweaked up Deccas and Kelly Ribbons. But these hot rods are in a different class entirely. Fitted with the optional horn, they can reach down to 1K, handle 1200W peaks and can produce 125 SPLs continuously. Try THAT with a pair of Decca Londons! I wouldn't stand where you could be hit with shrapnel while attempting it. If you're a real headbanger, a cooled version is available that can handle 4000 Watt peaks and crank out 131.5 dB continuous.

The sensitivity of this driver is so high that the question of compatibility with low powered triode amps and the like is settled in advance. Two watts was enough to blow me out of my listening chair. Funny that they work so well with ancient 45 type tubes when they were designed to withstand the total output of racks of steaming Crown amps.

The 12 ohm resistive load these drivers present to your amps will make your SE triodes smile.

Stage Accompany makes a full line of complete systems incorporating the Compact Driver. Most are 2-way designs with one or two 12" woofers. Not many horn-based loudspeakers can give you such wide bandwidth from a two way setup. Life is complicated enough without a three way horn system in your living room.

At roughly \$1300 a pair, the Compact Driver is a bit pricey as an OEM part for high end manufacturers. But if you think you'll find this level of performance for \$12.95 from a catalog featuring VCR belts and Pyle Drivers, think again.

US distribution:
 Stage Accompany USA
 4106 Fox Run Trail 6
 Cincinnati, OH 45255
 513-528-4035
 513-528-4037 fax

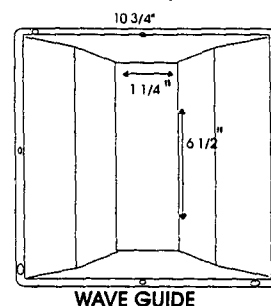

create that unitary soundspace illusion by flattening out the dynamics somewhat and confining the presentation to a small listening window.

How can a 6" cone and a dome tweeter produce a powerful and spatially grandiose recreation of an orchestra? Most of the instruments you are trying to reproduce are way bigger than these dinky boxes. How can you expect "real" sized piano presence or the visceral growl of a bowed cello in front of a 6" plastic cone? Forget it. Getting the dynamics right and a larger sense of scale creates a stronger illusion of reality for me than fake soundstage information, even on well-miked acoustic music.

In Search Of The Perfect Jukebox

Horn lover and audio philosopher Dennis Fraker nailed it down in a recent phone chat: "What audiophiles want is a really good jukebox, except they don't know that's what they want because they never been exposed to it and people are telling them that they want something else. But when they hear it, they know that's what they really want. You know, the right jukebox in the right bar can be magic. . ."

Whew, that phone call went off on a wild tangent, but he had a point there. Back when I was a snobby, sweater-wearing "high-end" salesman I often used the word *jukebox* as a term of derision, as in "the IRS ain't nothin' but a rich man's *jukebox*." Years

in the hobby later, I realize that the perfect jukebox is perhaps the loftiest goal a music listener can aspire to attain. And perhaps the most challenging and difficult goal as well. The perfect jukebox, think about it.

If you're looking for buying advice, I can't give you a turnkey horn package purchase recommendation yet. At this stage of my explorations, I have enjoyed glorious results with my enormous 3-way Edgarhorn based system and I found a few "parts" that demonstrate real promise for music listening. The Stage Accompany Compact Driver is one such intriguing "part" (*see sidebar*).

After unpacking a loaner pair of Compact Drivers, I popped them on top of my Altec 416/Onken bass cabs, connected a 10 mF Hovland MusiCap speaker cap in series to the woofer line, and turned on some music. Nice! LOUD! CLEAN! That was easy. 10 minutes down and we were rocking.

You know how well done live amplified music has that immediate sound that you can't get in your home reproduction even though both are products of amps and speakers? Well, the Stage Accompany sounds like a great sound reinforcement speaker. It's the kind of speaker you hope the jazz club has when you go down to hear Betty Carter and it can bring Betty into your home for your listening pleasure.

Reminds me of a discussion I read on the Internet one time. One sage hobbyist wrote something to the effect that "of course, blues music sounds great on paper cone speakers and tube amps — it was produced on paper cone speakers and tube amps!"

Conversely, if your thing is music that went through a microphone or pickup at the live venue, maybe something like the Compact Driver is what you need. It is musically satisfying and fun to listen to a speaker that can slice through ether the way a Hammond B-3 played through a Leslie cabinet does. Leslies don't "image" and "localize", they energize the whole room.

The ultra clean sound of the Compact driver really helped out acoustic music too. Listening to Ralph Stanley transported me right back to old Virginia. The banjo notes sprayed out like ice and the fiddle breathed and moaned. "Natural" is a good word to use to describe the sound of this ribbon speaker and I'm not using this word in the metaphorical audiophile sense here.

My experiments with the compact driver really showed me some new possibilities in sound. What more could you ask from a component than a glimpse of the beyond? It may be years before you can go out and buy a "high-end" approved horn system. Might never happen. In the meantime, listen and grow.

WHY THIS CULT IS DESTINED FOR MASS SUICIDE



*Shopping for
speakers for a
7 watt amp
with
Seth Goldwin*

Ya wanna know what's wrong with this magazine? I'll tell ya what's wrong with this magazine, speakers, that's what's wrong with this magazine; that's what's wrong with this whole damned single ended cult trend thing if you ask me.

I got hooked into SE amps by a really great demo of a tiny 3 watt 2A3 amp at the now, sadly, defunct Fi retail store. I then built my own 7 watt AudioNote Kit One amp and have been thrilled by the sounds I'm able to get out of it. But when I started trying to make a stereo system, that is amp AND speakers, based around the AudioNote that I could sit down and listen to day after day I started running into trouble.

I have a pair of NHT SuperZeros that are cheap, tiny, accurate, are an easy load for an amplifier to drive, sound great and even look pretty good. But the maximum cruising volume I can get out of them from my 300B amp is about 90dB. To get more volume, I gotta get more efficient speakers.

To get an equivalent range of frequency response from a cool, modern, miniaturized horn, like those from Dr. Edgar, I would need a four way, Frigidaire sized system. And that is the mini version. An even cooler retrochic WE VOT setup would require a Manhattan living room for each speaker. No wonder Vinny "Retro Boy" Gallo decided mono was the key to the future.

So I started looking for speakers that you can actually go to a store and buy, that might fit into a human's house, that cost less than a car and that can be driven to ecstasy by a 7 watt, 300B amplifier. I scoured the *Audio Equipment Directory*. Out of five billion speakers listed there, about a dozen have claimed efficiencies of greater than 95dB.

I have listened to tons of the less than 90dB efficient speakers most people buy, the stuff that clogs up most of the pages of the Oct. *Audio* directory issue. I know how rare a good speaker is *regardless* of how big your amp is. Trying to find the gems is like playing the percentages with women. If you hit

on every damn female that ever crosses your path, eventually one might come across. On the other hand, nothing in the laws of nature says that one absolutely *will* come across, but it might make you feel better that you've put in the effort.

A much better method is to get introduced by mutual friends who *might* help to filter out some of the psycho sludge that seems to be my primary date material (not you, sweetie, you're special), not to mention the class of speakers I end up living with.

So I tried to be smart. I asked around a lot to find out what people are using with their 300B amps. Boy, did that get me nowhere. People are using EVERYTHING! Linæums rewired with silver, new and old QUADs, Radio Shack shitboxes, ProAcs, AudioNote's "I am not a Snell" lookalikes, Klipsch (of course), and many, many, many homemade bastardizations of time honored horn systems.

But nobody I know of is 100% thrilled with their rig. Everyone's constantly diddling. Personally, I dig diddling. To a point. Then I want to sit down and listen to MUSIC, know what I mean?

The two speakers I listened to in the last couple of months were not specifically designed for use with watt wimps like the AudioNote. The Klipsches discussed below were designed for megawatt home theater installations. Those down cats in Hope, Arkansas probably haven't seen a functioning tube amp since the 60s. The Swans were designed for wimpy amps, but not quite as wimpy as the ones I like, expecting to see something more like 20 to 100 watts. Nonetheless, both speakers fit all my other criteria for availability, size and cost and at least *offer* the possibility of delivering the sonic goods from a tiny SE amp.

KLIPSCH EPIC: HIGH END HORNS!

When I read that Klipsch was introducing a new, audiophile oriented speaker line I got all excited. And every SE cultist I spoke to about it also got excited. Then I flexed the reviewer muscle and got a pair of the Klipsch Epic CF-3s trucked to my apartment. Now I was *really* excited!

The new Epic series is Klipsch's attack on the high end audio/video speaker market. The series are all pretty alike, varying mainly in woofer and cabinet size. They are two-way bass reflex designs, set up in a

D'Appolito fashion with identical woofers receiving an identical signal from the crossover, surrounding a plastic tractrix horn tweeter.

The Epic line starts with 6 1/2" woofs and tops out at 12". The one I got is the CF-3, second from the top, sporting twin 10" woofers and at the bottom, two front facing bass ports. The CF-1's, with the 6-1/2" woofers claim 96dB efficiency. The ones I got claim 100dB! Cool! ROCK 'N' ROLL!

Klipsch designed these speakers for actual living rooms, unlike some of their older designs which seem happier in more, uh, exotic settings like, for instance, someone *else's* living room. While still pretty big for the modern home at 41" X 17" X 17", the review pair came finished in a very nice light oak veneer and actually was a lot less overwhelming in the room than I expected a box of this size to be. The front of the speaker is a black inset with beveled edges to reduce diffraction. Covering this is an easily removable (and replaceable) cloth grill cover. I felt the covers ever so slightly muffled the sound and left them off most of the time.

A lot of technology has gone into these speakers and the designers have spent a lot of time playing off the lobing characteristics of the cone woofers and the horn tweeter to achieve a more tightly focused spray of sound than you usually get out of a horn system, the net result of which is supposed to be imaging and soundstaging, two areas high efficiency horn speakers have traditionally sucked at. Did they succeed? Have I mentioned the 100dB efficiency?

YOU CAN'T ALWAYS GET WHAT YOU WANT
I was warned by Mike Dyer at Klipsch to break these babies in for at least 20 hours before listening to them. I was so excited to get them though I ignored his warning and fired them up the minute I had pried them out of their boxes. BOY, was he right. Completely dreadful, ragged, peaky highs and WAY boomy bass. I resolved to always pay attention when Mike tells me something.

To break the speakers in I pushed them together face to face so they were firing into each other, reversed the phase on *one* of the speakers and threw a blanket over both of them. This arrangement very substantially cut the volume of the sound crud leaking out of the speakers so I could then safely blast track 8 off the XLO test disc on

infinite repeat all day while I went off to my job. The XLO break in disc sounds like broadband pink noise with a frequency sweep over it and seemed to work pretty good but I would think that setting your tuner between FM stations would be just as effective. Or playing Maceo Parker's *Life On Planet Groove* over and over until your cats are ready to knife you the minute ya' git home.

When Mike warned me about the break-in, he also told me to take off the rear set of spikes so the speakers would have that ever-cool pulling-a-wheely look and to make sure that the listening seat was 1.33 times the distance between the speakers. I played around with all sorts of setup options, finally arriving at something sorta like what Mike suggested.

To begin with, I was too close to the speakers and they were too close to each other. Unlike the NHTs, the image these throw is strictly limited to between the speakers. Supposedly because of the Controlled Focus technology, the Klipsches don't seem to

mind being close to the sidewalls, a situation that usually results in smeared imaging. At any rate, the imaging never got better as I squished them closer together. In order to get more distance between the speakers while still maintaining the 1.33 to 1 listener/speaker ratio I had to disassemble and redo my whole room. This additional space between me and the speakers paid off and I didn't feel quite as assaulted by these kinda upfront speakers.

Finally, I got them into what I thought was the best sounding position in my room, about 28" from the center of the speaker to each side wall and 65" from the wall behind them, with each speaker toed in so that from the center of my sofa I couldn't see either side of either speaker, only the front. In other words, they were aimed right at me. This put about 9' between the speakers and me 11' from a point midway between them.

How'd they sound, you might ask? On the plus side, the Klipsches will go just about as loud as I could want them to offa' seven

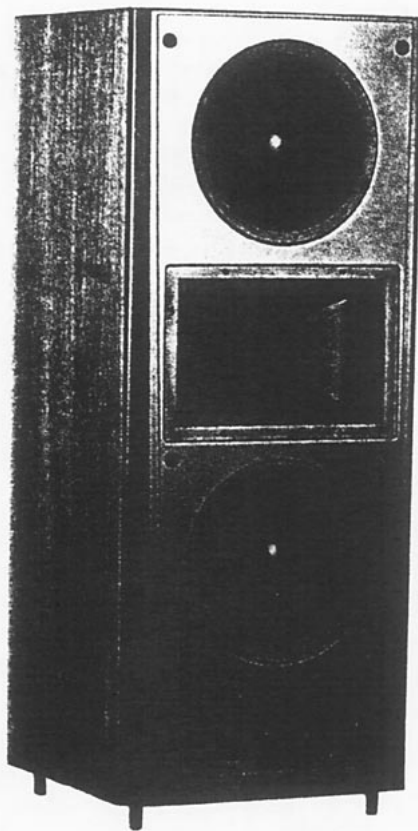

KLIPSCH epic CF-3

Bandwidth: 35-20 kHz \pm 3 dB

Sensitivity: 100 dB SPL @ 1 Watt/Meter

Nominal Impedance: 8 Ohms

Power Handling: 250 Watts

Enclosure Type: Bass reflex 2-way

Drive Components:

1-2" (5.08 cm) Tractrix horn tweeter

Aluminum diaphragm

2-10" (25.4 cm) woofers

Crossover Frequency: 1500 Hz

Price: \$ 2000

Corporate Offices & Customer Service:

Klipsch and Associates
8900 Keystone Crossing
Suite 1220
Indianapolis, IN 46240

Tel. 1-800-KLIPSCH
Fax (317) 581-3199

measly watts and even at lower SPLs they have wads of dynamics, which my acoustic suspension speakers driven by the same low power amp can't touch for all the tea in China plus a free pass to the new speaker strip-joint down the mall. I did not find them to have the honky sound a lot of people accuse horns of having (although I *am* the horny honky a lot of people accuse *me* of being), nor was there any evidence of the uncontrolled cabinet resonances that others have reported hearing from a lot of horns in big plywood bass reflex cabinets.

In short, the CF-3 seemed like a reasonably flat, reasonably accurate reporter of the frequencies and dynamics recorded on the CD. There was a touch too much upper bass energy which gave a full, exciting sound on some cuts, like Nirvana's "Teen Spirit" and Metallica's "Enter Sandman", but made other stuff, like Hamiet Bluiett's alto sax on the World Saxophone Quartet's *Breath of Life* sound mushy where it should have been crisp.

Not despite, but *because* of this excess bass warmth coupled with truly swinging dynamics, I found a lot of material I could really enjoy on the CF-3s. Loud, punchy rock 'n' roll played with the volume UP sounded great. The more people who were over at the time it was being played, the better it sounded. *Exile On Main Street*, early Joe Cocker, Creedence Clearwater Revival, nasty electric blues like the Red Devils *King King* played at 100dB just kicked out the jams.

What appealed about these gritty songs played loud was that the Klipsches gave an approximation of the sound of funky electric blues played live in a small club through a PA system. It had the feel of live electric music. I put on "Commanche" off the *Pulp Fiction* Soundtrack which has got drums and bass recorded into the right channel and gee-tar in the left and not a hell of a lot in between. My friend Ron, who was over at the time, said "It sounds just like my band in high school sounded when we played at this shitty little club in Providence. Guitar over *there*. Bass and drums over *here*. I LIKE IT!"

On the negative side, and this tuned out to be a biggie for me, the Klipsch CF-3s just wouldn't know a soundstage from a hole in the ground. As a gross generalization, I've never particularly taken to the horn systems I've heard because of how they fall down on the job when asked to decode the sound of

instruments in a room. In my experience horns can do a fabulous job describing the sound of a particular instrument, but they ain't so hot when it comes to describing the complex sonic event of a group of instruments playing together in a space. Or even not playing together in a non-space, like most of the panpotted, close-miked rock 'n' roll I usually listen to. Despite the recording method, most of these discs still have a definite sense of space even if it's a totally concocted one. In all fairness, the Epic was better than other horns I've heard at creating a stereo image. BUT, it didn't even come close to the cheap and li'l NHT SuperZero's I happily use as my usual speakers while I search for the ultimate.

The Klipsches' image usually spread between the speakers, but it was consistently flat, dimensionless, and the horns did about the worst job of presenting soundstage information of any speaker I've auditioned in my room. While I occasionally had a limited sense of depth behind the musicians, I never felt the soundstage come forward and envelop me. And I *never* felt the speakers just disappear. Both of these are regular experiences with the SuperZeros and with the Swans I talk about later.

On music that depended on volume and dynamics to communicate its message the Klipsches delivered the goods. When the message depended on an interplay of musicians in a space, the Klipsch didn't do the job. But even though rock tends more to the former, lots of rockin' CDs I dig the mostest just don't play good on the Klipsches. For instance, Henry Threadgill's *Too Much Sugar For A Dime*. Ostensibly this is a jazz album, as only a band featuring *two* tuba players could be, but with enough rhythmic drive and dynamic contrast to at least appeal to most rockers, myself included. It should be heaven on the Klipsches, but there's such a dense interplay of musicians that you really need a space decoder like the Swans just to figure out what's going on.

Even on simpler material, like Liz Phair's *Exile In Guyville*, sounds which regularly spread across the room and to the back wall with the SuperZeros got flattened into a two foot thick slab anchored exactly by the front, back and outer edges of the Klipsches.

Call me a fussy, picky pain-in-the-butt, but what I'd really like is both volume and space. When I put on an excerpt from

Massenet's "Le Cid" ballet from a Klavier sampler disc, it clearly demonstrated both the pluses and minuses of these speakers. This cut is a dialog between the woodwinds and the brass, with a quiet pooty-flooty section answered by a thunderous response from the whole rest of the orchestra. I've found this to be a great test cut 'cause a) it's fun to listen to, b) the thunderous response bit is a great test of bass power and dynamics, c) the quiet parts are a fine test of imaging capabilities and d) there's a castanet that cuts through the orchestra, clearly from far in the back of a big room. If the speaker you're listening to does NOT represent that, it doesn't do soundstaging. Period. The Klipsch didn't do that. Instead, it was just a clacking sound coming from the right speaker. On the other hand, it just rocked the house when the whole orchestra kicked in.

The clincher for me was one night when I had to work 'til 11:00 PM at my real job and came home tense, tired and none too pleased with the world. As I opened the door to my apartment, the thought flashed through my mind "I wish the NHTs were set up so I could just listen to some music." I guess I just didn't want that nostalgic "go to a club, get shitfaced, and wake up in a puddle of your own vomit" feeling that the Klipsches were so good at delivering.

THE SWANS BATONS

The Swans Baton is a regular old floorstanding box speaker, with a slightly better than normal efficiency of 90dB, that gets talked about as being usable with way low power SE amps. So we called Prince Edward Island in Canada and schmoozed it up with Frank Hale, the speaker's designer, and his extremely well organized wife, Margie, who handles calls from pesky reviewers, and got them to send a pair of them for inclusion in this review.

These are damn nice looking speakers. Mine came in a truly gorgeous rosewood with the finest book matched veneer work I've ever seen on a commercial speaker. They are about 40" tall on spikes, 9" wide and 11" deep. They really look good in a room. Too good looking for my taste, but those with more sense than hifiitis, like your wife, will dig 'em for sure. Beneath the veneer is inch thick MDF, heavily internally braced holding a 7" Focal woofer and a 1" Morel tweeter. In other words, standard 2 ways.

YOU JUST MIGHT FIND,
YOU GET WHAT YOU NEEE-EEE-EEED

Right out of the box, these guys sounded good. Not killer good, not sell-the-kids-I'm-never-coming-back good, but good nonetheless. Civilized, correct and pleasing. Definitely, *not* additive. They threw an exquisitely focused center image and they were absolutely no slouch at projecting soundstage info both front and back. In addition the upper end was nice and sparkly.

Basically the Batons did just great on everything that the Klipsches threw up on. Then I started putting on the things the Klipsches did great on. And the Swans didn't do bad with it either. Could have been more dynamic and definitely could have gone louder. But, these are really nice speakers in the ProAc Response 2 class. Grown up, mature, reasonably priced for the quality of workmanship and materials, terrific little speakers.

Given that they're two-ways, based around a 7" woofer with a lotta cabinet, you wouldn't really expect them to go that low

and they don't. While they can pump out something from the Stereophile Test CD 2 even down to 25Hz, it ain't a lot and it ain't very pretty. The worst thing about these speakers was a slightly unpleasant quality to the bass information around the region where it stopped being able to produce the fundamentals. It had a slightly sharp, truncated bass sound on some lower down material such as Jimmy Smith's organ bass pedals on *Organ Grinder Swing*. I was able to effect significant changes in the bass by playing around with the distance from the rear wall. Clearly the best, fullest and most pleasing bass sound was with the speakers much closer to the rear wall, like 24" away, than I usually like my speakers. While the bass was pretty good, this position compromised the Batons' stellar soundstaging ability.

So what's a gal to do? Being the possessor of just enough info to feel dangerous I made up a pair of cheap 1 cap/1 resistor, 1st order high pass filters to drain off any low frequencies under say 80Hz and switched

those over to my NHT SW2P subwoofer. This allowed me to pull the speakers back out into the room, giving them room to breathe and develop the sense of performers in a room that I really enjoy. Now, I don't know if you'll find this as helpful as I did, but to me it was a big revelation to find out how totally EASY it is figure out the necessary elements in a cheap n' cheerful high pass filter like this.

I had learned how to make filters like this from Corey Greenberg's review of the SuperZeros in the January 1994 issue of *Stereophile*. In the review there's a cryptic footnote from the editor that supposedly tells you how to derive your own resistor and cap values, but it left out crucial information for the electronics novice, such as myself, like a) how to find out the input impedance of your amp and b) how to calculate the combined resistance of the amp and your chosen resistor.

Well, I got the information, and I got it from Corey who was nice enough to help a recent immigrant from buy-it-at-the-store land. He explained it in a totally clear, highly useful way and I pass the info on to you.

First, find the input impedance of your amp. Turn off the amp, plug an interconnect into it and measure the ohms at the other end with your multimeter (put the black lead on the outside barrel of the RCA plug and the red lead onto the pin). Then figure out the values of the resistor and cap to use by doing the following calculations. Its way easier to do this with a spreadsheet than on paper, because you need to substitute different R and C values to get to the corner frequency you want. The corner frequency, by the way, is the frequency at which the sound will be -3dB and then continue dropping at 6dB an octave after that.

Usually, the process is made easier because you might have some caps lying around and that limits the number of calculations you have to make to get where you want to go.

Lets call the amp's input impedance R1 and the value of the resistor you want to use R2. Then figure out the combined resistance of the amplifier and the resistor with this formula: $(R1 * R2) / (R1 + R2)$.

Since the AN impedance measured out at 475 kOhms and I wanted to use a 33K resistor the calculation $(475,000 * 33,000) /$

SWANS BATON

Bandwidth: 48-18.5 +/- 3 dB

Sensitivity: 90 dB 1W@1M

Nominal Impedance: 5 ohms

Max Power: 200W

Min Power: 11W

Driver complement:

7" cone

1" soft dome

Price: \$2075 oak

Cosmetic and biwire options available at additional cost.

Swans Speaker Systems

RR #1 Mason Rd.

Charlottetown P.E.I.

Canada C1A 7J6

Tel. 902-569-5520

Fax 902-569-5123

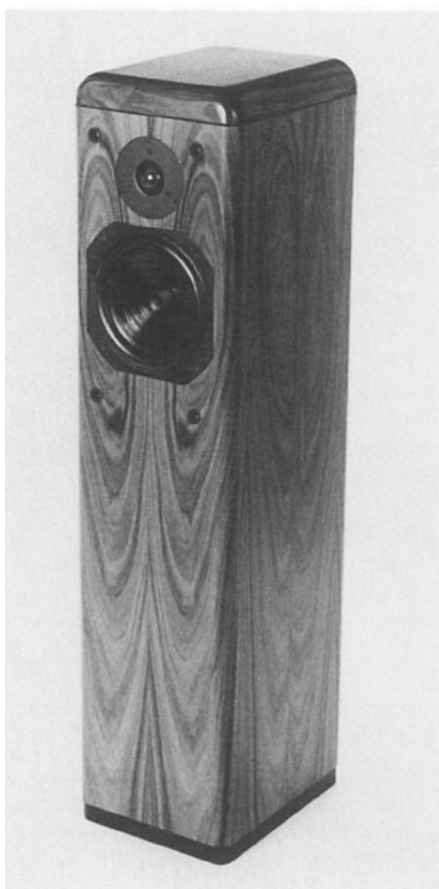

(475,000 + 33,000) yielded a result of 30.856 kOhms, which we'll now call R.

Then plug the result into the following formula: $1 / (0.628 * R * C)$ where C is the capacitance of the capacitor you want to use expressed in Farads, so if the cap says .1uF then the number you use is .00001.

Personally, I have a hard time getting the zeros right, so I just add zeros until the resulting frequency looks right. Since I had some .068uF MIT multi-caps in the house, these were what I used. The calculation $1 / (.628 * 30,856 * .00000068)$ equaled 75.9, just about the Hz number I wanted to get to. The actual filters themselves are easy to make as pie, if, like me, you do all your baking with a soldering iron. For info, I refer you to Corey's original article.

With the Swans set up in this way, I'd come home from 16 hours on the job, exhaustedly plop down into my sofa, listen for an hour or so to unwind, go to sleep, then do exactly the same thing the next day. So it didn't hit me for a while how much I was actually enjoying these speakers. Without a lot of fanfare they were delivering what I needed them to deliver, the music I like to listen to whatever that might be at any given moment, be it Schubert or Sonny Sharrock. They weren't hopping around the room going Oh, look at me, I'm the best speaker you ever did see, Oh, Oh, please look at me, they just sat there doing the job.

The Batons offer first rate imaging and soundstaging, smooth response, detail and clarity without any specific performance characteristic demanding your attention. But, as my friend Patty said one day, "These aren't good speakers for having company over, 'cause they make you want to pay attention to the music." Sounds like as good a distinction between high-end and mid-fi as I've yet heard.

So why aren't I peeling huge wads of dollars off my bulging roll to run out and buy a pair for myself? Whelll, ish like dish: after all is said and done they just don't go loud enough off of seven watts to either fulfill my stringent review criteria or to make me want to buy them. Its no big deal, its not that they don't do what they were designed to do, its not Frank Hale's fault or anything. They just need another 3 to 5 dBs of efficiency more than the 90dB they deliver.

I called Frank and asked him about this and not surprisingly he wasn't surprised. From my chat with him its clear that he thinks the single-enders are onto something and that something is sitting down with your stereo at the end of a hard day or the beginning of an easy one and just enjoying your music. That's what he had in mind for the Batons, and in my opinion that's more or less what he delivers.

Yeah, I had to play with them and use a subwoofer to get the best possible sound in my living room, but even without the sub they deliver the musical goods except on the most way down material. But, they don't go loud enough and Swans knows about it. Frank is designing two new speakers, which will get their introduction at the Winter CES in Las Vegas, designed to eke a few more dBs out of standard cones. Based on my pleasing, but too quiet, experience with the Batons I'll look forward to hearing them.

THE EVIL TWIN SYNDROME

After having the Batons as my main speakers for about five weeks, I put the Klipsches back up while I finished the review. It's just two different worlds. The Klipsch has got all the volume and dynamics you could want but it literally flattens every disc. The Batons don't play loud enough and don't have half the dynamic swing of the Kippers but paint a really full blown, wall-2-wall 3D sonic picture. It's the evil twin syndrome. If I was forced at gunpoint to choose one of these two speakers, I'd have to pick the Swans because they play more of my music but the Klipsches were definitely a lot of fun on certain material. What I'd really like is to force the Klipsch and Swans to mate so's I could buy the bastard children. Except with my luck, recessive genes from nowhere would land me with a squalling baby Bose AM-5!

AES SE-1 AMP KIT UPDATE

After last issue's love gush on the AudioNote Kit One, I started thinking about the ol' unloved AES SE-1. How could I improve it?

Joe Roberts had some good (and CHEAP) ideas so I tried them¹. I unsoldered the 10K

1— Some experimenters advise changing both 4.7K resistors in the 6SL7 circuit to 2.2K and bypassing the bias supply with a 47 mF/250 V cap between the bias adj. pot and the 220K grid resistor. Try it.

metal resistors going from pin 3 of the power tube socket to the terminal strip above it, and replaced 'em with 15 cents of Radio Shack 1K carbon resistors. And I removed the poly bypass caps around the big lytic cap on the left (when the amp is upside down). I was rewarded with an increase in transient response, but now it was harsh, baby, harsh. I took one of the Vitamin Q caps I had been only too grateful to remove just weeks before and used it as a bypass on the big cap. Now I was getting somewhere! This combo gave me the increased snap I was looking for but without the grating harshness I wasn't looking for.

But still I didn't prefer the SE-1 to any of the other amps I had. I pestered Joe to send me some 2A3 tubes. (*You better lay off my stash, punk—ed.*) He finally dug up a pair of used GE babies that he said tested good. I geared myself up for a major redo of the amps internals to fit this new tube. I sat down to plan my strategy and came up with the following: throw the tubes in and readjust the bias to 100ma. That's it. That's the extent of the mods needed to try the 2A3.

And, man, did it pay off! Finally, a setup on this amp I could actually enjoy. Less power, even lower volume, but smooth, integrated, loads of detail and no obvious weaknesses at either frequency extreme. The amp even looks better, more correctly proportioned, with 2A3s in it.

So why does the SE-1 do so good with 2A3s and not do so good with 300Bs? Could it be that the 337V B+ supplied to the tubes is just about perfect for a 2A3 type tube, but a little skimpy for a 300B which really wants more like the 420V supplied by the AudioNote? But if it's perfect for a 2A3 tube, why is the SE-1 sold as a 300B amp? Beats the hell out of me, that's for sure. I just wish I had some great sounding high efficiency speakers so I could really hear those 3 watts.

MANUFACTURERS' COMMENTS

SWANS

Thank you for the colourful and positive review of the Baton. We are honoured to be in the pages of what I consider a vanguard magazine. Although there are many that still consider single ended amplifiers to be a fad, we look at them with the same interest as the introduction of the CD. They are definitely here to stay. Now if we only had a

decent selection of speakers for these babies...

There is hope. While most high-end manufacturers are pursuing the audio-video market, Swans has decided to dedicate all of its R&D efforts to designing speakers that work well on low, as well as high, wattage power amps. All of our new speakers including those at the WCES will be at least 90 dB efficient.

Seth, your analogy between finding the perfect date, or "the Speaker from Heaven," rings a familiar bell. Unfortunately many get led astray by purchasing equipment based on what they have read rather than by what they hear. After a while one learns that life is filled with compromises, no matter HOOOWWW much you spend or look. Anyone who says differently is a liar.

As an audiophile I have constantly been frustrated auditioning two way designs that would be fine if they just had a little more bass. Finding an efficient speaker that does this narrows the field significantly. The Baton is not audio nirvana incarnated, but it does deliver a full and satisfying sound that is not analytical or hard. With the right amp it delivers emotion in aces and spades. In my wife's (and business partner) words when she heard the Baton for the first time, "It's like being wrapped in a warm blanket." In Seth's (if I may anticipate), "But sweetie, it's better with tubes."

Frank Hale
Swans Speaker Systems

KLIPSCH

Mr. Goldwin's review once again reminds me of the importance of individual *point of reference* regarding audio reproduction. All of our opinions and responses to whatever stimuli are cumulative effects of what we have experienced in the past. As we all know, there is no such thing as "the perfect sound reproduction system". Horns sound different than direct radiators, transistors different than tubes and so on and so on. Any system that we as designers and builders or as consumers and listeners put together will be a series of compromises, maximized to match the priorities of the individual. What is right for one person may or may not be the best choice for another. I refer to this as *point of reference*.

When I worked in a hi-fi store, customers often would come in and ask, "Which speaker is the *best*?" My usual response was "Compared to what?" If the individual expounded on the virtues of this or that hi-fi system, than I led them to a product with wonderful "soundstaging and imaging" and ever important ACCURACY. If, on the other hand, they were musicians or heavy concertgoers, I moved in the direction of products that were strong in dynamics, transient response and "feel". Different smokes for different folks.

During the development of the epic series of products at Klipsch, our goal was to bridge the gap between these two camps. Imaging with punch, soundstaging with dynamics. Finesse at 102 dB sensitivity!

Have we achieved Nirvana? Nah. But we are convinced that the Epic products offer the strongest case to date for a product that can hold its own on any subjective or objective criteria.

Mr. Goldwin's wish that he could have multiple systems available at any given time is not unusual. I know I wish I could have a specific system maximized for each piece of music in my collection. I would also like to own a city house, a country house, a ski chalet, a place on the ocean and one in Hope, Arkansas (to cut travel time and stay out of the Holiday Inn, but that's another story. . .) but I can't afford those either. My point is that all systems make compromises and if a mini-monitor that "disappears" is preferred by an individual, that's OK, but it doesn't indicate superiority over a product that sounds *live* (there I go using those subjective terms again).

Klipsch is a company that continues to develop the state of the art in horn type loudspeakers. As the Klipschorn set the standard for horn type loudspeaker design 50 years ago, so does the epic series today. As the Klipschorn has evolved and improved over the years, so will the epic products. Klipsch is a company that is never complacently satisfied with its products. Our chief design engineer, Roy Delgado, will surely continue to look for ways to improve the epic series, which we believe to be the finest imaging horn system produced by Klipsch to date.

Mike Dyer
Klipsch

Factors Determining Tube Life

by Prof. A.V.J. Martin

Reduced service life is often due to high voltages

SOME of the tubes used in modern electronic circuits are exceptionally hard-working components, especially in television receivers. It is a well-known fact that some of them have a relatively short service life, mainly because of the operating conditions (high power, pulse operation, etc.).

However, there are several common factors which influence the average life of all tubes, namely, excessive heater voltage and excessive plate dissipation.

The effect of heater overvoltage is shown in Fig. 1A for a 6.3-volt tube. It does not take into account the probability of the heater opening up but only the exhaustion of the oxide film which constitutes the cathode. The life of the tube at the nominal voltage of 6.3 is taken as 100%.

More frequently, the overvoltage fluctuates around an average value. An unstable heater voltage is extremely detrimental to tube life, as seen in Fig. 1B where curve 2 refers to a tube which is alternately normally and excessively heated. For comparison, curve 1 refers to a tube having a constant heater voltage equal to the average value of the irregular voltage of curve 2.

Fig. 1C shows the effect of plate overload which is evidently less detrimental since an overload of 50% reduces tube life by only 25%.

The conclusion is evident. The best way to insure maximum tube life is to operate all tubes well within their design ratings.

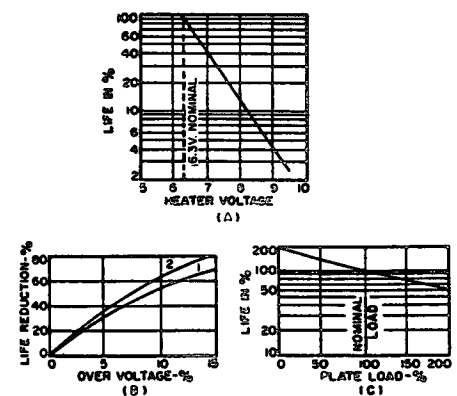

Fig. 1. (A) Effect of high heater voltage on tube life. (B) How fluctuating voltage shortens the life of tube. (C) The effect of plate overload on tube longevity.



THE QUAD ELECTROSTATIC LOUDSPEAKER

by
Haden
Boardman

Mellotone
Acoustics

A good electrostatic has something special, a magic spell that weaves itself over you. Critics (of which there are few) moan on about "won't play rock" or "only for string quartets". Ask these plaintiffs what system they have, or what kind of speakers, and the usual response is some old west coast monster.

Electrostatic speakers generally consist of four main parts: a *power supply*, to provide the necessary electrostatic charge; a *rigid plate* (or plates) to hold the charge; a *flexible plate* to act as diaphragm (only $2.5\mu\text{m}$ thick in the QUADs) which makes the music, driven by a *step up transformer* to multiply the voltage output from your amplifier to a level high enough to move the flexible plate.

It's a difficult thing. The fixed plate has to let the sound pass through it, and so is usually perforated. The flexible plate has to have near zero mass to be moved by the output from the amplifier. It's amazing the whole thing works at all.

It's funny that while in studios condenser microphones are the bees knees, the electrostatic loudspeaker has never enjoyed a similar level of "professional" attention, and therefore suffered a relative lack of development.

Although electrostatic speakers have been known to exist from the nineteenth century, the first *commercially* made speakers were fitted to a few picture houses in Chicago in the late 1920s. Nothing is known about these early devices, if anyone has any information about these I would be delighted to know.

Peter Walker was the first in 1956 to offer to the public a High Fidelity electrostatic loudspeaker. Others have followed: Acoustats, Audiostatics, Dayton Wrights, Martin Logans, etc. But QUAD were first. QUAD still manufacture an electrostatic, of course. 1980 saw the introduction of the ESL 63, so called because that was the year that Walker & Co. started work on a replacement for the original. In a lot of people's perspectives, mine included, the new design did not quite match the earlier speakers' performance in some areas, for others the new model was a revelation.

The original's cookie '50s look amuses me something rotten. The expanded metal grille, the stubby little feet are all pure 1950's Britain. Most were fitted with "bronze" grilles and with classic teak end caps. Later production had severe (and very boring) black grilles along with rosewood end caps. There were variations — I recently picked up a pair of late 1959 items with black end caps and baby sick green grilles. I will be parading these things about next year at shows, be warned!

There are few, if any loudspeakers that raise as many passions as the QUAD electrostatics. Like the DECCA cartridges, Linn LP12, Tim de Paravicini, LS3/5a and other quirky Brits a relationship with a pair of QUADs is either pure love or pure hate relationship.

Let's get the hate bit out of the way right now. If you head bang, please turn to The Gallo's article (in SP #6) right now, waste no more time, do not pass go, do not collect \$200. Maximum SPLs are about 100dB for a pair, in an average British living room, less I would imagine at yer average Texan ranch. Stacking a pair can of course give you far more headroom, if less house room, but more on that later. Subwoofers and other

low life can also add a few extra SPLs thanks to the reducing burden on the ESL. But basically ESLs will never make your ears bleed.

The biggest total hate (on my part) is the directivity of the thing. These speakers are so directional it hurts. For those inexperienced in the ways of the ESL, these things make a pair of ALTEC 604s sound like an omnidirectional design.

Forget using ESLs if using some super amplifier or super budget amplifier. Powerwise, pair of ESLs need 15 watts per channel, a stacked pair double. Any more and you risk of destructive lightning within your speakers' panels. Due to the varying impedance (1.8 ohm at 20 kHz, to over 60 ohm at 150 Hz.) and highly capacitive load, ESLs are not suitable for any amp that is not totally stable into any load.

I once saw the remains of a little Rotel RA 820BX that some bafoon wired up to a pair of ESLs, the innards resembled a scaled down model of downtown Hiroshima, circa 1946. Craters where transistors once sat, melted resistors and capacitors everywhere. Single ended triodes are fine, in fact more than fine, they're great with the ESL, as long as you do not mind mushy bass.

*QUADs have bass,
and anyone who wants
to argue the toss is
either a wimp or tone
deaf, so there.*

Final fly in the ointment is the build quality. QUAD has a reputation for making the best built kit here in Blighty, and I do not want to chink the armour but it has to be said some of the production techniques used to assemble the originals is a bit dire, if limited by fifties technology. This manifests itself mainly in dust cover rattles. Yes folks, ESLs can rattle, pop, buzz and fart.

Enough of this negative vibe, what about the plus side? Well, thankfully to say it is a much longer list. For spec. freaks, these babies are a dream.

Frequency response? 40 Hz to well past 20 kHz. Distortion? Compared to any moving coil unit, it's non existent. Impulse test? Quicker than the measuring microphone. Fine, but how does this mumbo jumbo manifest itself in the sound quality?

I do not want to mislead subjectives into hating this speaker on the "measure fine, must sound like dog shit" knee jerk reaction — although they *would* be right with some QUAD crap like the 405 family. This speaker was extremely well regarded from the outset. It earned the nickname of "Walker's Wonder" very quickly. Both Harold Leak and Gilbert Briggs went into blind panic on first audition in the '50s. Leak quickly set to work on his own ESL (although nothing other than a couple of *Wireless World* articles ever came of it). Briggs answered with the not totally unsuccessful Wharfedale sand filled baffle three. Logic being if you can do it with static lectric you can bloody well do it with big magnet speakers. Even Goodmans (Mr. E. Jordan, one of my heroes) developed one.

A pair of electrostatics can sing. They add no spice to the sound. They play it as the electrical signal on their input terminals tell them. They add nothing and take very little away. The truth, the whole truth and nothing but the truth. If your system is bogus, on the end of a pair of ESLs it will sound "line me up and shoot me" bad. If your system really sings, and does not need speaker coloration to give it bass, check out a pair or, even better, a *stacked* pair.

The most common criticism against them is the lack of bass. This is total bullshit. Yes, the bass will not play loud enough to annoy the neighbours. Yes, it's free from the usual boxy boom most makers engineer into their crappy little box speakers. What bass there is, is clean fast and unbelievably cool. I get totally pissed off with all these "boom" box subwoofers. Most of them have resonances about 30 Hz, adds a Technicolor bass bloom. Christ, even QUAD themselves are at it now. When is a dipole subwoofer not a dipole subwoofer, when its a Gradient of course! As for these over amplified boom boxed which seem to have gathered street cred in the last couple of years, most of 'em are ripoffs of Audio Pro. QUADs have bass, and anyone who wants to argue the toss is either a wimp or tone deaf, so there.

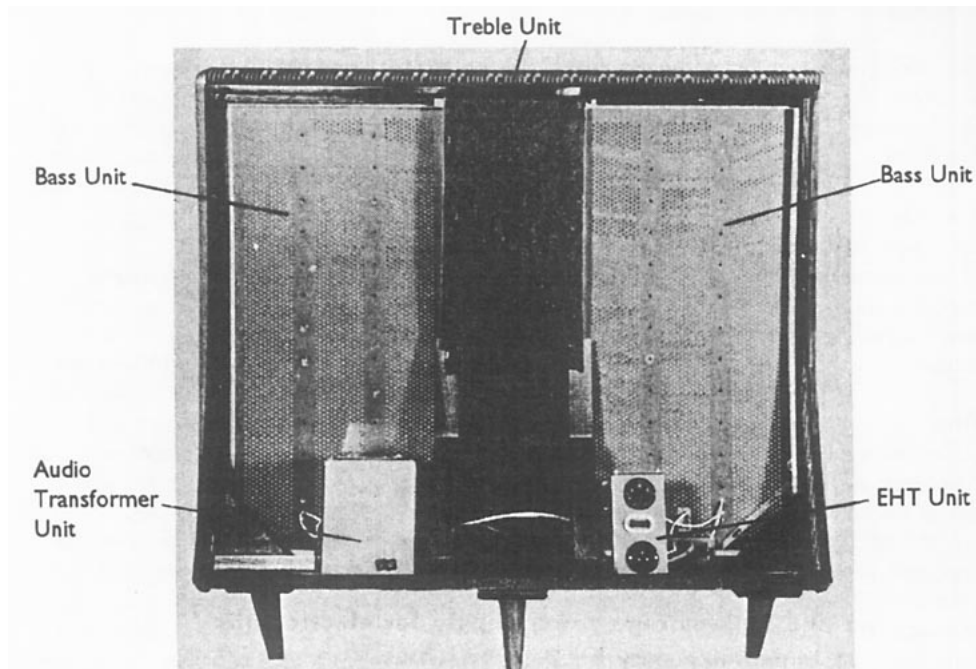

Internal workings of QUAD ESL

At the other frequency extreme it's just as delightful. So clean and free of sibilance. No spit. No sizzle. Nothing added, very little taken away. Some do complain the ESL rolls the top off, and I suppose it does a bit, but then so do half of the single ended amps on the market at the moment. The bit in-between also rates as "jolly". The midrange is ever so natural and unrushed. You could never accuse the ESL of forcing the sound onto you. You walk "into it" rather than it walking over you. I can think of no other speaker that handles the midrange as well as the original ESL, *period*.

By now, you either want a pair or have already turned over to a different article. Two very important words to remember when chasing QUADs: *caveat emptor* or if you skipped on Latin lessons at school, let the buyer beware. And boy, does the buyer have a lot to watch.

Budget on at least £500 minimum for a pair when refurbished, if it costs you any less, you have been very lucky. If buying condition unknown, never pay more than £100 for a pair. Serious. In time everything can and will go wrong with an Electrostatic speaker. Budget on a complete set of new panels, (there are three in each speaker, two bass and a treble panel) plus a new EHT unit. These items cover 99% of Electrostatic ailments.

The treble panel is usually the first to have problems. Solid state amps tend to clip quite hard into an electrostatic speaker (due to the difficult load and falling impedance at higher frequencies). This tends to cause arcing, which burns holes right through the centre diaphragm and removes the electroconductive paint off the fixed plates. This reduces the efficiency and power handling as well as causing strange popping noises



from the panel. Bass panels suffer similar problems, over excursion causing a similar effect, although the symptoms can be more tricky to spot, it usually manifests as lower efficiency.

EHT units tend to die with age. Either no output or so low you cannot hear it are the fault. The rest of the electronics are pretty reliable. I have seen both audio transformers and mains transformers dead, and they are most certainly not cheap to source. QUAD automatically fit a protection circuit ("clamp") on the ESL these days, which does its best against abuse. It's not 100% perfect, so watch yourselves.

Anyone thinking about doing DIY work on QUAD ESLs should plan to be extremely careful. Disconnect the mains, leave for a minimum of six hours and disconnect the amplifier. This last bit is very important. The audio transformer steps up the AC signal (sound) to a very high level, if by accident music is playing into an unenergized QUAD and you happen to touch the wrong wire, YOU ARE DEAD. It's far more potent than the ESLs' power supply, due to the low source impedance of the audio transformer.

An engineer for whom I once had very little respect told me in the case of most home brew audio gear said Destroy It Yourself would be more appropriate. Well, an ESL bites back, Destroy Yourself, if you are not sensible, please be careful. Take no chances, electricity takes no prisoners.

Servicing the ESLs is fairly easy. Unscrew the back panel, the wooden end cheeks. Carefully tease out the staples from the metal grill and remove them. If you have no cats, dogs, or rug rats, and don't object to staring at naked QUADs, use 'em like this. The expanded metal grille does a big fat zero for the sound quality, if everything for the looks.

Carefully unsolder the connections from the back of the panels (make a sketch to show where each wire came from). There are 5 wires on the treble panel and 3 on the bass panels. Be very careful when moving the units. They have a thin "cling film" protective dust cover over the entire frame. Watch for dropping "solder blobs" which will drop straight through the panel. Inspect yours closely. Any tears, rips or holes should be rectified with some new dust covers.

Most covers sag periodically, the cure being a heat gun or hair dryer. On the lowest motor speed setting and maximum heat, carefully move around the diaphragm with the heat, and most of the wrinkles will disappear. Sonically, loose grilles equal buzzes, rattles and farts. It is impossible to completely mitigate, you will always have a bit of a buzz. Dust covers are always replaced when replacing a faulty panel.

Damp is the biggest threat to the longevity of the panels. If you put your ear close to the speaker and detect a slight rustling noise, trapped humidity is eating away the conductive paint on your panels. This is the main reason why the panels lose efficiency for no apparent reason. I suppose this is going to be a bigger problem to me than most reading *Sound Practices*. Manchester does have a bit of a reputation as far as damp is concerned.

All of the electronics are screwed to the base of the cabinet. Audio transformer with crossover components soldered underneath to the left, EHT power supply (6000 volts for the bass and 1500 volts for the treble) and mains transformer to the right. On the whole, these are fairly robust. As earlier mentioned, the older EHT units have just about run out of steam, making necessary their replacement. I have seen unserviceable audio transformers, but not many. Their failure is usually due to the speaker being connected to some 4000 watt monster of an amplifier that did not like the difficult load and decided it would eat it instead.

Tweaks and mods are all now pretty well established. For the unacquainted, here's the HTB guide to QUAD tuning:

1) If using a single, use a rigid stand, ideally about 18" to two feet tall. I have seen several different stands for these beasts now, some of which clamp the sides, some of which screw into the sides where the wooden end cheeks are. Most seem pretty competent. Best solution was by a good friend of mine, who built a mini brick wall underneath them.

2) Positioning. Never put an ESL flat against the wall, or running parallel with a wall. Don't forget, as much energy comes out of the rear as comes out of the front. It's wrong to say ESLs are only for large rooms, I've found they work better in small rooms. The most ridiculous was an 7 x 8 foot room. They sounded really great. If you are lucky, and have a bloody big room, best idea is as much space behind them as in front. Keep the beasts a minimum of a metre away from the side walls. On 18 inch stands like this, they really sing.

3) Lurking behind the panels are a couple of furry devices designed to stop the sound reflecting back from the wall behind the speaker. With the aforementioned positioning, all our furry little friends do is make the speaker sound dirty. Remove 'em. The items over the bass units resemble sack cloth!

4) Grille removal. Dodgey one this. Not only does it expose the naked panels to the outside world, risking the film dust cover's life, it exposes 4000V to your room, risking some bugger else's life. Like everything else in audio they sound really good naked, but it ain't for the party man or the family man. Tread carefully. Easy to do, see above.

5) New frame. The original frame has a slightly contoured shape. When the panels are securely mounted, they take on this slightly bananas profile. Although this aids dispersion, it does not help the rattles. A new, more rigid frame helps quite a lot. I have built several now, and have taken the opportunity to position the electronics at the bottom in a plinth, with the frame and panel up in the air. Drive units flat.

6) Which leads us nicely to the ultimate QUAD mod, STACKING. Extra efficiency, higher SPLs and deeper bass. Twice the height also equals twice the W.A.F. (sorry Joyce). If you just want to stack an original framed pair, it's quite easy. If you want to be a real smart ass, build complete new frames for both, so you can locate the panels as close as you can together, awesome. Most just stick to the original QUAD recommendations.

7) For those who like to hang upside down, only like the dark, and get miffed if there is not much output past 20 kHz, DECCA ribbons have been used to complement the higher registers. A buddy of mine has horn bass (under the house!) electrostatic mid

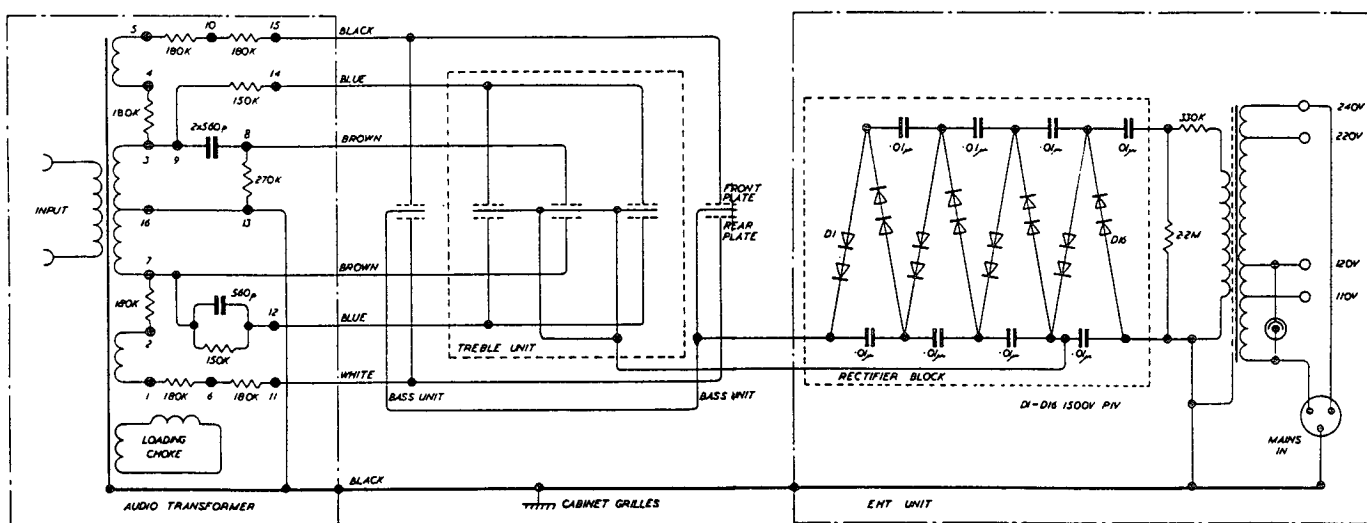

Electronic diagram of QUAD ESL

CROFT

PURE TUBE BRITISH HANDBUILT AUDIO COMPONENTS

PRE-AMPLIFIERS

EPOCH/MICRO	\$500
CHARISMA	\$750
ENGMA	\$990
ABSOLUT 1	\$1650

TRANSFORMER COUPLED AMPLIFIERS

THE VISION/INTEGRATED	\$850
THE QUEST/SERIES 5	\$700
THE WAY/SERIES 5R	\$925
THE POWER/SERIES 6	\$1200

OUTPUT TRANSFORMER-LESS AMPLIFIERS

THE ILLUSION/SERIES X	\$850
THE ESSENCE/SERIES 3R	\$1550
THE QUINTESSENCE/SERIES 2R	\$6000

EXCLUSIVE USA SALES AGENT:

ANGELA INSTRUMENTS
10830 GULFORD ROAD, SUITE 309
ANNAPOLIS JUNCTION, MARYLAND 20701
PHONE (301) 725-0451
FAX (301) 725-8823

SEND \$2 FOR DESCRIPTIVE LITERATURE

and ribbon tops, all home made, being driven via single ended transistor. Anyone who thinks this can't work, should think again—it does, really well.

For my ears, the ultimate QUAD setup is a stacked pair in solid frame. One of the best sets I've heard belongs to "Mr. Hard-wired" himself, Glen Croft. Lover of OTLs, No. 1 fan of Julius Futterman (I think Glen has a Futterman shrine buried somewhere in his Erdington workshop), Glen has produced the best sound I have heard out of a quartet of QUADs.

Running without the film dust covers is a very silly idea, this screws the beasts up in a matter of months. Even if it does sound cool.

No, the first commercially produced ESL has a lot going for it. Just watch the reliability. When they were discontinued around 1985, after a production run spanning back to 1956 over 60,000 pairs have been made. The price then was £700 a pair, roughly 60% the cost of the inferior ESL63. Today's price for the '63 is near enough £3000. A rough calculation makes an original ESL worth around £1800. Second-hand, you get laughed at if you ask any more than about £600 for a mint pair. I reckon they are worth triple that.

Transmission Digital Cable S-L Analog Cable Chassis Wire BPC Bypass Caps



PO Box 1053 Valley Stream, NY 11582 Phone/fax 516-285-1950

On the FRONTIER

j.c. morrison
reports from the
borderlands
on the

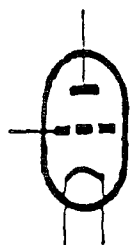

VAIC VALVE VV30B

Vaic VV30B Specifications

75 W max plate dissipation
600V max. plate voltage
200 mA max plate current
3.85 amplification factor
700 ohm plate resistance

5V@ 1.2A filament

Plug compatible with 300B

Price: TBA

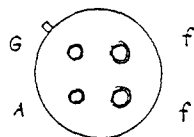

Manufacturer:
Vaic Valve Italia
via Machiavelli 12/a
Bassano del Grappa
36061 ITALY
(39)424524395 fax

Webster's dictionary defines *frontier* as a border between two countries, that part of a settled civilized country that lies next to an explored or undeveloped region, any new field of learning, thought, etc., or any part of a field that is still incompletely investigated.

So much American culture and style is built on the ideology of an unexplored country, frontier zones are part of almost every discipline. It is curious that the whole notion of the frontiers of "high-end" audio has been carefully dodged for years. Instead, they celebrate the total success of technology in conquering all its mysteries. I can specifically recall the words, "all amps sound the same . . . if you can't measure it, it ain't there." Judging from what you read, even in the more subjective reviews, perfection is at hand or at least within reach of our current practice. Refinement of the existing and suspicion of the truly innovative is the industry hallmark.

I'm not talking only about technology, but more importantly, the way we think ideal hi-fi is supposed to sound. Innovation can also happen between the ears.

One powerful benefit of our constant exploration or curiosity linked to our definition of frontier is the role one plays as a rank beginner in an unfamiliar territory. This status allows an open-mindedness generally hard to come by in the hard knocks, bottom line, status quo, real time world. Open mindedness is what we need to get ahead. The frontier wanderer needs to be careful and pay attention, and especially not take anything for granted.

For example, one area never really explored by the "high-end" is dynamics. With one exception, there is no American speaker manufacturer identified with the "high-end" that makes any product I might even accidentally confuse as dynamic. The exception is notable: David Wilson's X-1 SLAM . . . forget everything else he's made. "Slow and ponderous" is a more accurate general description of nearly all hi-fi speakers and the defense most manufacturers weakly hold out as a response is simply "use more powerful amps." Apogee, for example, recommends 1000 Watts if "real world dynamics are to be

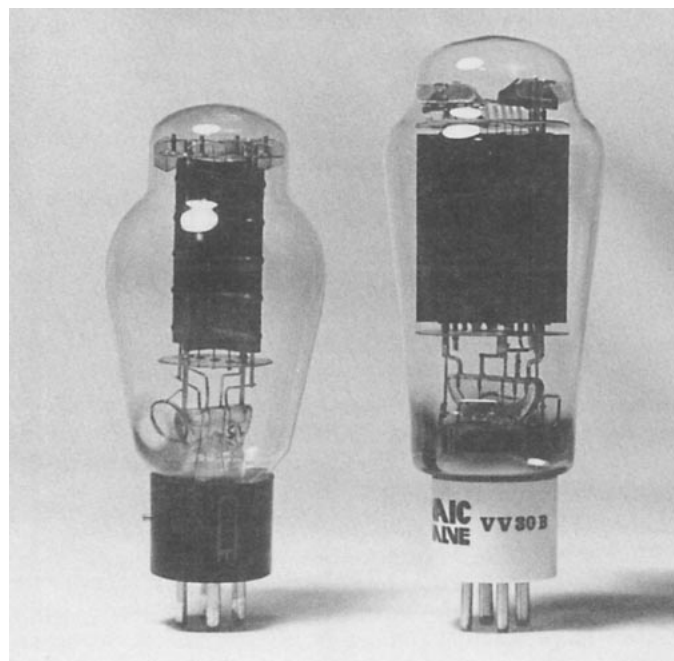

Current production Cetron 300B (left); Vaic VV30B (right)

achieved" on its Divas. Forget it, even with 10,000 watts they will flat out refuse to boogie. Compression and group delay are part and parcel of the high end sound. In general, the goals pursued in the last 25 years have primarily centered on a different ideal of "accuracy", namely the *well behaved* kind. The dynamics of musical sound are fundamentally *unruly*.

Reproduction of musical dynamics doesn't pose a problem for contemporary engineering, the difficulty is that the idea does not fit with the expectations of ideal "high-end" sound. Dynamics are taken totally for granted in the pro sound arena. As a for instance, Altec 604s may not be my idea of a great sound but even this utterly conventional studio monitor vastly outperforms all high-end contenders in terms of realistic reproduction of dynamics. It should not be a controversial thing to point to this as a legitimate "yet" for hi-fi audio. Jump factor and air-moving capacity do not even belong to the high end vocabulary for most audiophiles. Mini monitors anyone?

Another unacknowledged frontier for the "high-end" is active devices. It is true that the "comeback" of the triode amplifier enhanced the repertoire of the adventurous designer, yet real innovation in circuits and application have occurred mostly on the fringes. Most of the "pro" players are using reintroduced traditional approaches, using components designed over a half a century ago. Sure these devices are good enough to compete sonically with anything from the Seventies and Eighties but why don't we really push the envelope?

What about the possibility of NEW vacuum tube design? The KT-90 and 99 are only black comedy as far as I'm concerned. The issue was unaddressed in any serious assault — until now.

Vaic VV30B

The first NEW directly heated audio power triode in more than 30 years was revealed at the Milano "Top Audio" show in October. Rumors have been flying around for a while, but I not only saw a crate of samples and heard them plugged into an Audio Note Kassai, I met the people responsible for it and managed to snatch a few specimens for testing and listening. You might find the story interesting, no?

A few months ago, Peter Qvortrup of Audio Note invited Herb Reichert and me to tag along on one of his constant audio road trips. This one went from Brighton to Paris then to the audio show in Milano.

Peter is as lost in high fever land as any of the lead poisoned triode freaks I run with. His funky bungalow in Brighton has hot and cold running people and children and music playing all the time. Heated discussions take place until late at night and start up again early in the morning. He has twenty thousand records at least, which are played through a combination of Audio Note gear and various experimental "bits" as he likes to call them. I didn't sleep at all for the first 48 hours.

The trip began in earnest when we reached Calais. Peter revved his Mercedes station wagon up to 125 mph and kept it there pretty much the whole time. Maybe he gunned it once or twice to pass someone. The guy's a total leadfoot. Istvan and Handoko, representing Audio Note Hungary and Indonesia respectively, were the other

two nutjob passengers on this excursion. We ran into some organizational problem with the Paris show so, after scarfing down a North African snack, decided to press on to Milano directly. Twenty espressos later, the sun came up as we raced through the Alps towards the Chamonix tunnel and Italia. We were in Milano by ten.

Bleary eyed and partly flatlined, me and Herb staggered around the hotel trying to find a quiet corner to doze off for a minute, when Peter came to drag us off to the Audio Note room. Qvortrup thrives on sleep deprivation. Anyway, to cut to the chase, standing in the doorway was a well-dressed older gentleman, energetically waving his arms for emphasis, firing away in rapid fire Italian at a small group crowded around him. Peter introduced us to Dr. Ricardo Kron, tube manufacturer.

Over the next few days, I had several opportunities to speak with Dr. Kron, his wife, Mrs. Eunice Kron, and with their interpretive services, Alesa Vaic (pronounced "vaish"). They are the principals behind the Vaic VV30B, a totally new power triode designed as a drop in replacement for a 300B.

Dr. Kron was born in Northern Italy, a while ago. He was crazy about radio and hi-fi in its early days and was actually hired by Leak to install Toscanini's first system. Kron is today what we call here in America a real radio man. Scrounging around in European hamfests a few years ago he ran into a very young Czech tube man who was selling replicas of early radio valves. He made them himself. Kron and Vaic hit it off and began a small business selling Marconi "I" valves and limited production replicas of various 1918-1923 vintage valves. Total production numbered about 3000 pieces and they sold all over Europe and Asia as well.



Vaic handmade replica of a Marconi "I" valve. What a hobby!



Dr. Kron and Alesa Vaic at the Milano "Top Audio" Hi-Fi show

Alesa Vaic is now twenty eight years old. A graduate of the University of Prague in electrical engineering, his specialty is in thermionic materials and electrical measurements. Vaic is really passionate about vacuum tubes. His familiarity with the history of Western Electric's entire tube production, and all tube technology for that matter, is shocking. He's like a walking encyclopedia who likes good food and drinks lots of beer. His internship at Tesla's experimental laboratory gave him the opportunity to hone his skills and network the best oldtimers for high grade tricks and new technologies.

Two years ago, because of the heightened attention on the 300B in Europe, Kron began broaching the subject of getting really serious about business and perhaps producing a local 300B. After looking at the market, Vaic and Kron decided to design a new triode power tube instead of a retrofit. Their initial criteria was to take advantage of the most up to date innovations in materials, chemistry and engineering. A recent Japanese technology for constructing anode materials allowed for an increase of max dissipation without increasing size. The Tesla archives were pillaged for their best data. Vaic also tried out some new ideas.

The "old way" of developing a tube depended on a mathematical model which was empirically modified. Vaic, together with friends from the university made a computer model and tested it against materials at the department of metallurgical studies in Prague. A novel, and now patented, filament construction of Vaic's own design, was developed to improve both the quality and the quantity of emission.

The VV30B filament is constructed of a double ribbon paralleled in eight flat sections, which provide a total of 32 emissive surfaces. The cathode emission is exactly the same at all points for AC or DC operation. The flat filament directs current in a planar fashion, so side and secondary emission are almost eliminated. Additionally, the distance between grid and plate can be reduced to minimize transit time and lower impedance. A year and a half of computer modeling plus six months of engineering were necessary before the first production was completed at Tesla's research facility.

The VV30B is constructed of 98 separate pieces. Special jigs are required for assembly because of the close spacing — 400 operations are necessary to complete one tube. The geometry is critical and the construction is sophisticated, equaling or surpassing the craziest of Western Electric tubes (417A, 418, 436, 437A, etc.).

Vaic told me that without the help of his buddy, Filip Macek on computers, and four old salty dogs from Tesla, the project may never have succeeded. The glass specialists particularly, Ladislav Krouzel and Antonin Procnazka, who have 40 years experience making tubes, gave the ultimate push that brought the VV30B from design to reality. Vaic, Macek, Krouzel, Procnazka, Miroslav Kvapil (cathode specialist) and Pavel Bena (mechanical) make up the main production team.

The VV30B is physically impressive, the lead crystal glass and ceramic base are beautiful. The plate construction resembles the Siemens "Ed" — the German answer to the English PX-25, and one of the most highly regarded power triodes of all time. When I mentioned this resemblance to Vaic he smiled coyly.

The VV30B plate is a fraction of the size of that in any 75 watt tube I'm familiar with. The directly heated cathode construction is completely encased by the plate and large barkhausen plates are visible at the top of the siderods. Vaic told me that the cathode filament is three meters long! The filament is rated at 5 volts 1.2 amps so it will drop into any 300B amplifier. I have mentioned the 75 watt plate dissipation, but this comes with a max plate voltage of 600 volts and a max plate current of 200 milliamps — whichever you reach first!

Dr. Kron was very generous to give me some samples of the tube to bring back for testing and review. As soon as I got home, I called in celebrity tube photographer Steve Berger to take some snaps for this article then I sent a pair over to Lynn Olson and Matt Kamna in Oregon for running characteristic curves and general testing. Arthur Loesch brought in a new parallel single amp for 300Bs that we (Herb, Bob Cummings, A. L. and myself) eagerly tested with the new tubes. The stuff ROCKS! I left two pairs with Arthur to bring back home and we're expecting a detailed report from him soon.

My initial impressions of the VV30B, specifically compared to Western 300Bs, are that they have a similar harmonic signature. However, the VV30B flushes out more information at low dynamic values. There are more colors and more ambient information, and in general it could be said to provide a richer recovery. Still, the basic character is very similar to the 300B. Is it an improvement? Yes, I think it is.

This brief article should be understood as only an introduction. Many people will have a lot more to say about this development in the near future once overseas distribution arrangements are worked out and full production gets underway. The manufacturer expects

that the VV30B will be available in the States by February 1995. The first production run went to Japan where obviously it attracted a lot of attention in the local audiomania community. The VV30B will be a limited production product more or less in the same price league as select grade 300Bs, so it won't be the plentiful and cheap tube that I hope to see coming out of Russia someday. But if it doesn't say Vaic it ain't a VV30B.

Time is needed to really explore the possibilities but I'd be lying if I didn't admit my excitement about new tubes. Audio needs more of this, really. The frontier starts right here.

Notes on the Plate Curves
by Lynn Olson and Matt Kamna

Since the graphs are bafflingly similar, the only real way to compare them is to make full-size photocopies, overlay a pair of graphs together, shine a bright light through them, and slide the horizontal (voltage) axis back and forth until the -60V grid-lines overlap. Then the differences become more apparent, particularly in the low-current regions.

Note the startling similarity of the Sylvania 2A3 graph to the VV30B, with both exhibiting very good low-current linearity. In a perfect tube, the grid-lines would all be parallel (indicating equal R_p at all drive levels) and equally spaced (indicating equal gain at all drive levels). This is where the 2A3 and the VV30B show an advantage over the other types on close examination.

The Shugang tubes show some odd behavior at very high current levels (although this region would only be traversed in a near-short-circuit condition). This phenomenon is possibly due to the tube running out of emission. This guess is based on the power consumption of the filament being on the low side compared to all of the other 300Bs under test. Another possible explanation is grid-current starting to flow due to gas in the tube and causing the HV amp to current-limit (this explanation seems like a bit of a long-shot, however).

J. C. Morrison's preference for high current operation becomes much more obvious with this data. The behaviour in the low-current region *really is* pretty bad, with high-order distortion implicit in the highly-curved regions of the graphs.

Based on this data, it appears appropriate to push the quiescent current as high as tube longevity permits — thus calling for moderate plate voltages, transformer primary impedances that are on the low side, and as much current as possible (instead of the usual 60mA, 80-90mA looks better for the 300Bs). This does get you a little closer to the grid-current cutoff, but it also gets the quiescent operating point much further away from the really nonlinear low-current region.

Vaic VV30B Plate Curves

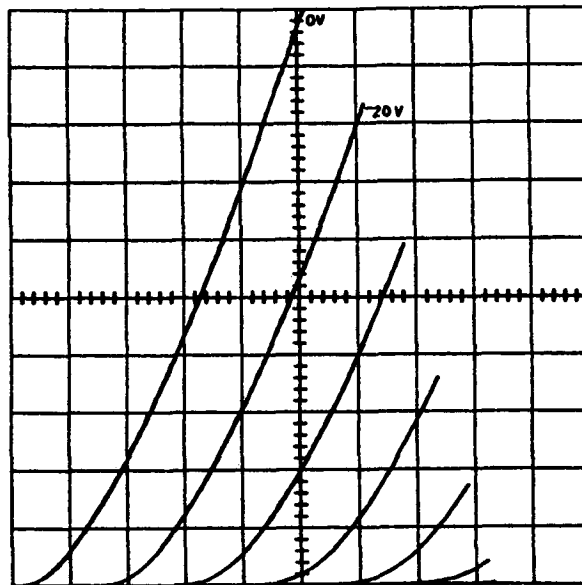

VERT/DIV
50mA
HORIZ/DIV
50 V
PER STEP
20V
% OF COLLECTOR
PEAK VOLTS
100.0

Used WE300B

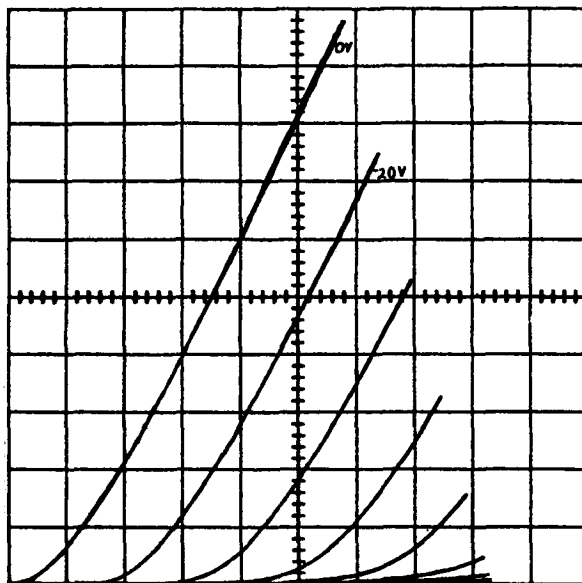

VERT/DIV
50mA
HORIZ/DIV
50 V
PER STEP
20V
% OF COLLECTOR
PEAK VOLTS
100.0

Shugang 300B

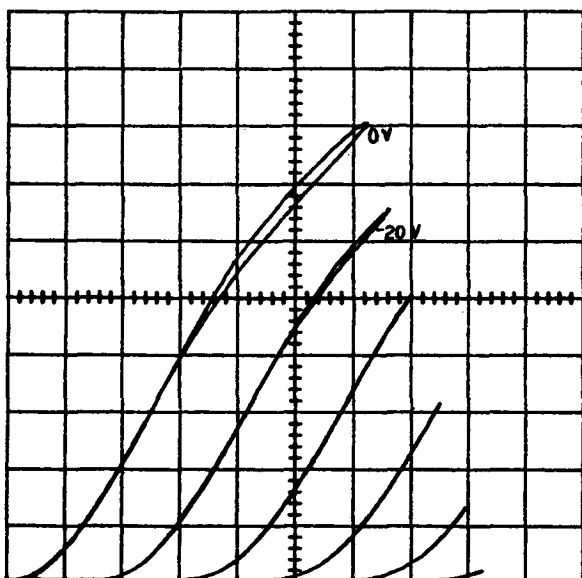

VERT/DIV
50mA
HORIZ/DIV
50 V
PER STEP
20V
% OF COLLECTOR
PEAK VOLTS
100.0

Remember, the brief 1-10mSec peaks in music are 20-30dB higher than the average level, and the ambient reverberation is 40-60dB below that. So in reality, the tube spends 95-99% of its time staying very close to the quiescent operating point, with only very occasional excursions away from it. If the immediate region around the quiescent operating point is free of high-order distortion, the subjective sound will be much more relaxed and natural at normal listening levels.

Folks who are unfortunate enough to own garden-variety audiophile speakers (efficiency from 82-87dB/metre) are out of luck, since those speakers require 30 to 150 watts to really get motivated. (That's why I designed the Ariels for the Oregon Triode Society — 92dB/metre at least opens the door to moderate-power triode amplifiers, and the builders don't have to make a whole-hog commitment to multi-amped horn systems.)

In future months, Matt and I intend to do real comprehensive measurements that compare the harmonic spectra of the various 300Bs and 2A3s out to the 11th harmonic. We'll use a spreadsheet program to isolate the even and odd harmonics and chart the harmonic spectra. We did this with an SRPP project earlier in the year and it proved to be interesting.

We extend our thanks to J.C. Morrison, VAIC Valve, Tektronix, Linear Technology and Burr-Brown for assistance in making this project possible.

Test Protocol for Directly Heated Triodes →

- Test settings for 370A
- Vert = 50 mA/div.
- Horiz = 50V/div
- Step = 2V (multiplied to 20V by ext. amplifier)
- Step # = 8 steps

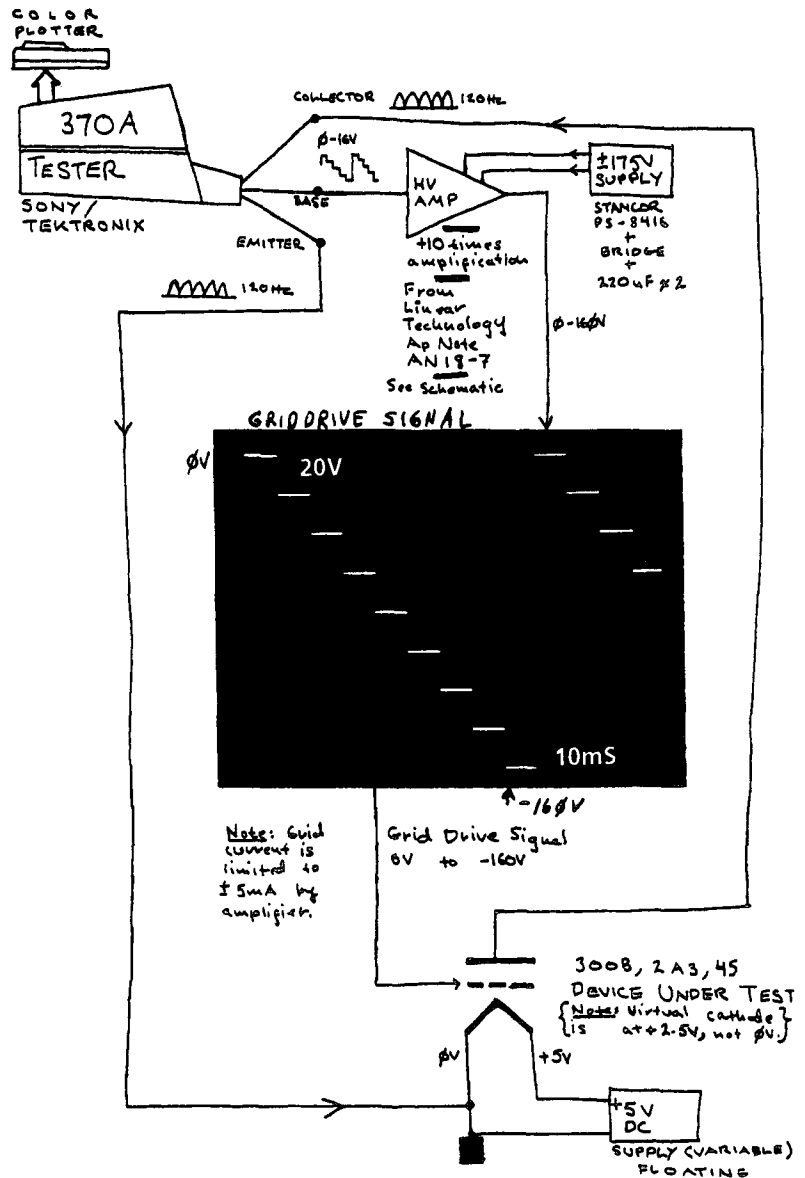

Used Sylvania 2A3

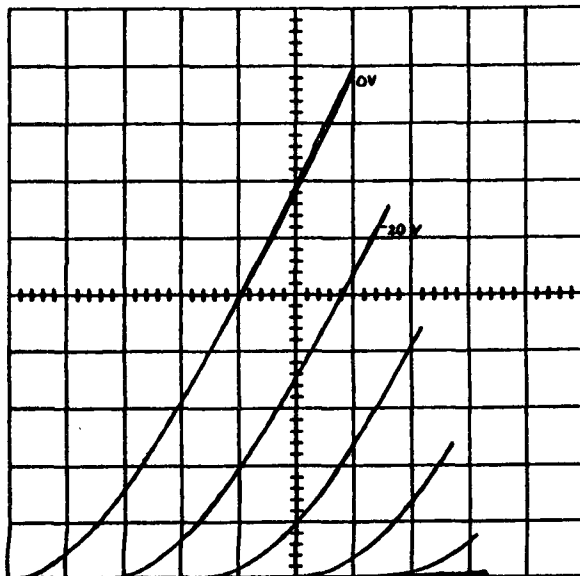

Cetron 300B

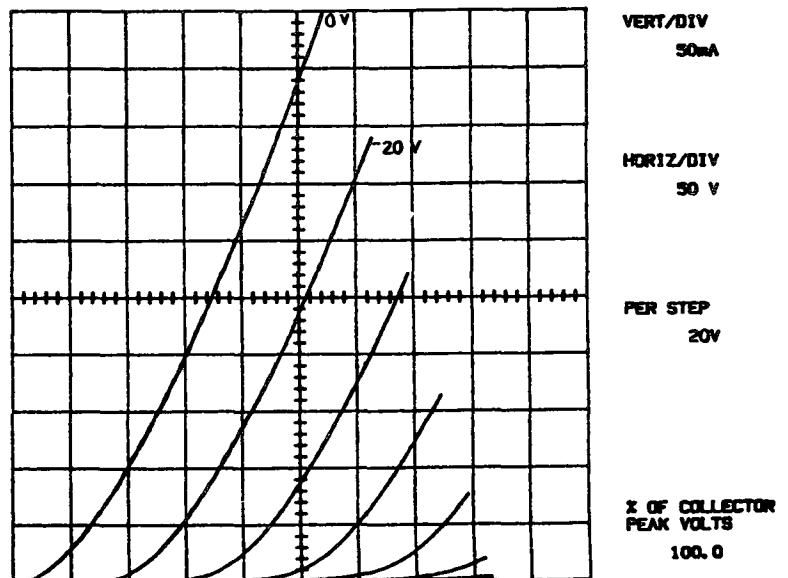

SUGGESTED SE TRIODE AMPLIFIER CIRCUITS



 **one electron**
Electra-Print Co.

Here's what transformer makers are building for themselves

ONE ELECTRON SEA-1 TRIPLE 2A3 AMPLIFIER by John Atwood, one electron

The SEA-1 amplifier is a straightforward single-ended audio power amplifier that delivers about 11 watts, using only medium and low- μ triodes. No negative feedback is used, other than local cathode degeneration. No voltage regulation or semiconductors are used in the design. The sound of the amplifier is characteristic of triodes: smooth and detailed. Despite the lack of feedback, the bass is surprisingly solid. This amplifier has been tested on a variety of speakers, and no incompatibilities have been found, except, of course, the need for relatively efficient speakers (approx. 90 dB/watt or better).

The SEA-1 was designed to evaluate the prototypes of the UBT-1 transformers. In order to provide flexibility in testing, the SEA-1 was designed to be used with a separate external power supply. There is no reason why the power supply could not be included on the same chassis as the amplifier, as long as hum inducing components, such as power transformers, are kept away from the amplifier driver circuits. The supply needs to provide 395 volts DC at 160 mA, and 6.3 volts AC at 1.8 Amps. Filtering is not critical, since filter chokes are incorporated into the amplifier. A surplus Dressen-Barnes model 30180 "Unregulated

Power Supply" was used for each channel in the SEA-1 prototypes. A simple capacitor or choke-input power supply, as described in the *RCA Receiving Tube Manual* or *Radiotron Designer's Handbook*, can be used.

Note that this amplifier description is intended to aid experienced tube amplifier designers and builders. People with little experience building vacuum tube audio amplifiers should not attempt to build this amplifier based on just this description. The voltages used in this amplifier are lethal; precautions for working on high voltage equipment must be followed.

Circuit Operation

Choke-capacitor filters are used for both the output and driver stages. Separating the power supply filtering this way reduces feedback from the output to the driver, and helps insure the highest possible B+ voltage to driver tube V2. Locating the filter chokes on the amplifier chassis instead of the power supply helps isolate the amplifier from external noise. Every electrolytic capacitor is paralleled with a film capacitor. R20 is a bleeder resistor to help drain the filter capacitors when powered-down.

The input stage is a conventional resistance-coupled amplifier using the octal 6J5 or 6C5. The metal version is preferred here, due to the electrical and magnetic shielding of the envelope. The cathode is only partly

bypassed. The ratio of R3 and R4 was chosen to give an overall amplifier sensitivity of 22 dB.

The second driver stage, using paralleled sections of a 6BL7GTA, has the difficult task of driving the highly capacitive inputs of the three 2A3s at up to 100 volts peak-to-peak. Despite the relatively low plate resistor of 12.1K, this stage is still the limiting factor in the overall high frequency response. To help prop up the response and reduce phase shift at high frequencies, the "unbypassed" cathode resistors of V1 and V2 have small compensation capacitors, C1 and C8, which were chosen experimentally to give the flattest overall frequency and phase response.

The output stage is cathode biased, with about 20 volts extra drop in the cathode resistors to allow a bias adjustment, using R13. Medium and low frequencies are bypassed around the cathode resistors R14 and R15 by the 2000 mF capacitor, C12, at the center-tap of the 2.5V filament transformer. High frequencies are bypassed by C10 and C11 from each filament terminal to ground. This keeps high frequencies from flowing through the filament transformer and helps filter out power-line noise.

The resistors R8, R9, and R16-18 are intended to suppress parasitic oscillations. R2 helps protect the input stage from RF overloading on the input.

As with most American power transformers, the primary of T2 is rated at 115 volts, whereas the average power-line voltage in the United States is 120 volts. In order to keep the output tube filaments at the correct voltage, R19 was added in series with the primary to drop the filament voltage. Since your average power-line voltage may vary, R19 should be chosen so that 2.5 volts RMS appears on the 2A3 filaments. Similarly, resistance may be needed in the 6.3 volt filament supply. In the prototype, the wire resistance of the connecting cable supplied the correct resistance.

Variations

V1 could be replaced by a 6C4, 1/2 of a 6SN7, 1/2 of a 6FQ7, or 1/2 of a 12AU7. There is no direct replacement for V2, although two 6S4 in parallel or a 5687 should work (but these have not been tested). Replacing the 2A3s with 6A3s or 6B4Gs will cause excessive hum and is not recommended unless their filaments are run from a DC supply.

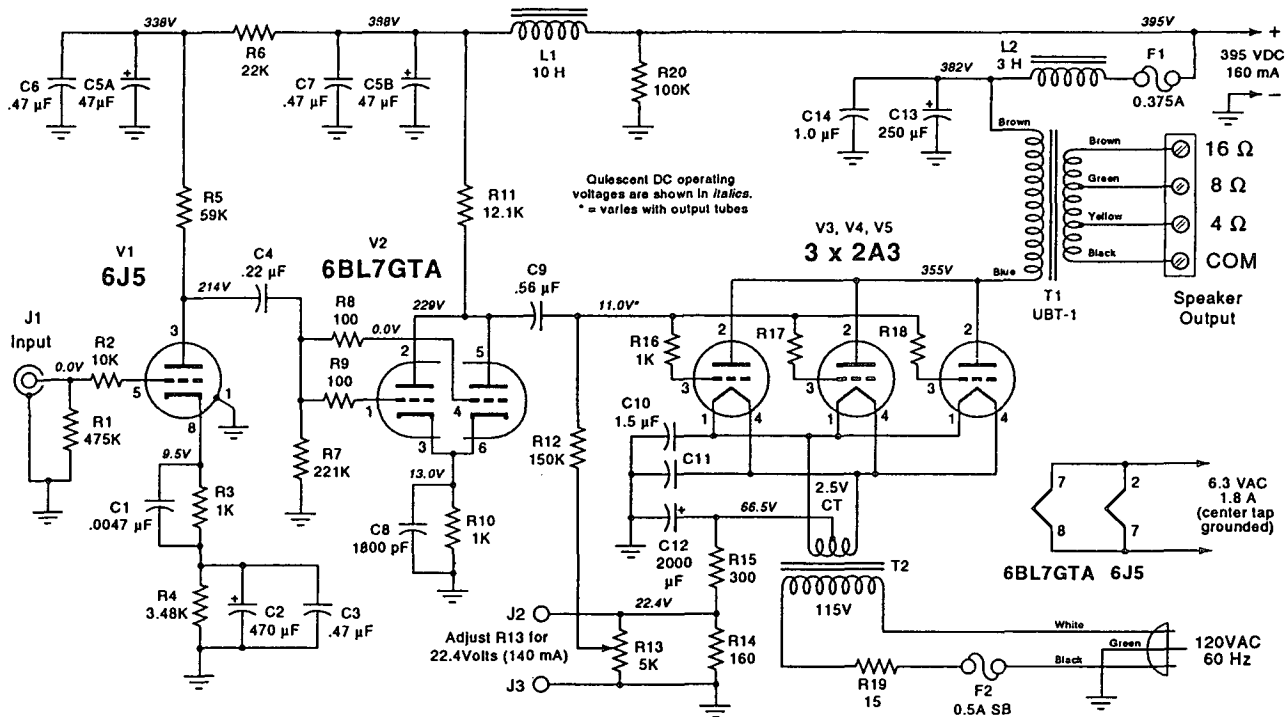

- C1 - .0047 μ F 100V Polypropylene
- C2 - 470 μ F 25V Low-ESR Electrolytic
- C3 - 0.47 μ F 100V Polypropylene
- C4 - 0.22 μ F 400V Polypropylene
- C5 - 2 x 47 μ F 500V Audio-grade Electrolytic
- C6, C7 - 0.47 μ F 600V Polyester
- C8 - 1800 pF Glass or Mica
- C9 - 0.56 μ F 400V Polypropylene
- C10, C11 - 1.5 μ F 250V Polypropylene
- C12 - 2000 μ F 75V Computer-grade Electrolytic

- C13 - 250 μ F 450V Computer-grade Electrolytic
- C14 - 1.0 μ F 630V Polypropylene
- F1 - 0.375A type 3AG fuse
- F2 - 0.5A type 3AG Slow-Blow fuse
- J1 - RCA-type phono jack
- J2 - Red pin jack
- J3 - Black pin jack
- L1 - 10H, 30 mA, 515 Ω Choke (Merit C-5503 or equivalent)
- L2 - 3H, 150 mA, 90 Ω Choke (Stancor)

- C-2309 or equivalent)
- R1 - 475K 1/4W Carbon Film
- R2 - 10K 1/4W Metal Film
- R3 - 1K 1/2W Metal Film
- R4 - 3.48K 1/4W Metal Film
- R5 - 59K 1/2W Metal Film
- R6 - 22K 1W Carbon Comp.
- R7 - 221K 1/4W Metal Film
- R8, R9 - 100 1/4W Carbon Comp.
- R10 - 1K 1/2W Metal Film
- R11 - 12.1K 2W Metal Film

- R12 - 150K 1/2W Metal Film
- R13 - 5K 2W Potentiometer
- R14 - 160 1% 10W Wirewound
- R15 - 300 20W Wirewound
- R16, R17, R18 - 1K 1/2W Carbon Comp.
- R19 - 15 5W Wirewound
- R20 - 100K 3W Metal Oxide
- T1 - 1600 Ω , 160mA primary to 4/8/16 Ω output transformer (One Electron UBT-1)
- T2 - 2.5VCT, 10A filament transformer (Triad/Magnatek F-3X or equivalent)

Unless otherwise noted, all resistances are in ohms. Star grounding is not shown.

SEA-1 - Triple-2A3 Amplifier

rev 1, 8/94, One Electron

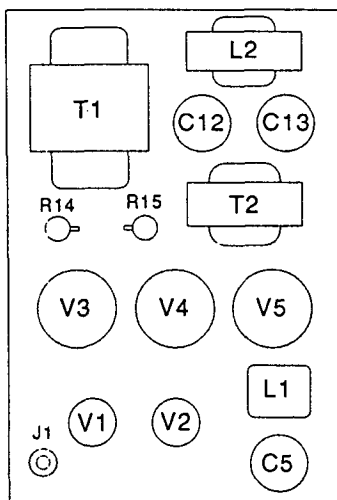

SEA-1 Chassis Layout, Top View

Measurements

Frequency Response:
10 Hz to 44.5 KHz
(-3dB at 1W)

Output Power and
Harmonic Distortion:
see graph at right.

Sensitivity: 22 dB
(to 8 ohm tap)

Damping Factor: 3.5

All measurements were made into a low inductance 8 ohm resistor connected to the 8 ohm output tap.

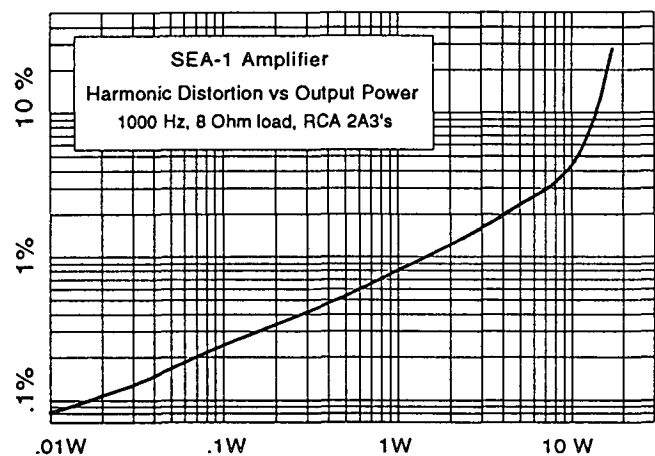

Most component values are not critical. In fact, all components except the plate and cathode resistors and the compensating capacitors C1 and C8 could vary by as much as 50% without seriously affecting the amplifier's operation. The plate and cathode resistors should be chosen within 10% of the values shown. If R14 is not 160 ohms, then the bias adjustment voltage should be altered to give 140 mA through the output tubes. If a stereo pair of amplifiers is being built, component values should be matched between amplifiers to insure identical responses.

The component types specified on the schematic were chosen to give a clean sound, while still using common parts. However, experimenting with different types of components (i.e. oil-filled capacitors instead of polypropylene or bulk-foil resistors instead of metal film) is encouraged. Since there is no feedback, parts differences will be more noticeable than with feedback amps.

Output Tube Notes

Traditional American 2A3s, by RCA, Sylvania, Tung-Sol, etc. give the highest output power and lowest measured distortion. However, they are very hard to find, and are quite expensive. The "Sino" 2A3s (made in China) are readily available at a reasonable price, but give slightly less power and higher measured distortion. In many listening tests with the SEA-1 prototypes, however, the Chinese tubes sounded better than the American tubes!

A problem has been noted with the Sino 2A3s: occasional erratic popping, buzzing, or squealing noises. This tends to happen when they are first warming up, but sometimes persists indefinitely. These sounds are generally not microphonic, but appear to be caused by a chaotic metastable condition of the electric fields inside the tube. This seems to diminish over time, but in bad cases, the offending tube must be replaced.

Construction Notes

Construction is not critical, except to observe general good layout rules, such as keeping high signal voltage points (such as the plates of V3 through V5, and the power line), and power transformers and chokes, away from the input stage. The filament wires to V1 and V2 should be twisted and kept close to the chassis.

A variation on "star-grounding" is recommended: connect all grounds related to V1

and V2 (including C5 through C7) to one point, and all grounds related to the output stage (including C13 and C14) to another point. These two star grounds are then connected together, and tied to the chassis at a *single* point between the input and output.

© 1994 John Atwood, one electron
65 Washington Street, Suite 137
Santa Clara, CA 95050

ELECTRA-PRINT 300B SE by Jack Elliano, Electra-Print Audio

During the 1970s, my incomparable Uncle Hank told me about the sound system in the motion picture theater he owned in the '40s. "Those 45s in the output were made for good speakers," he said. The gunshots, the cannons, the music, hundreds of people escaping to another time and place for a few hours, they never questioned the sound. "What they heard was what they saw."

I never forgot what Uncle Hank said but, being young then, all I knew was that Frank Zappa was running 200 watts with his transistorized Sun guitar amps. Now that's audio!

While working at Litton Industries, Guidance and Control Systems Division in the 60s I met Cy Brennehan. Cy had just installed a dynamotor powered Williamson amplifier playing into a pair of 8" Jensen coaxial speakers mounted in the trunk of his car. Cy's love for "home-brew" tube gear was inherited from his father who still swore by his old push-pull 6A3s in his living room.

Both Cy and I worked with state of the art tube operated test gear in our day jobs. Calibration and troubleshooting this equipment showed us tube circuitry that defies logic. As time passed, Cy moved on to manage an NBS traceable calibration lab and I went to Project Gemini and designed all-tube recording equipment on the side. We kept in touch over the years.

One day, Cy suggested that we check into these single-ended triode amps that were then very popular in Japan. Good for maybe 7.5 watts of very high quality audio. "Wow man, will I need to change my circuit breakers?" I asked.

Well, I did check it out. I discovered that push-pull cancels all even-order harmonics

of the signal and produces its own waveform. Single-ended class A reproduces the total signal including all harmonics. That got me off the couch! I bet that sounds as good as hearing all your lotto numbers being called out by Sharon Stone. So we plugged in the soldering irons and got to work.

Designing a driver stage to hold up to the infamous grid of a power triode led us to consider the renowned cathode follower. An improved version, the Mu Stage, described in *Glass Audio*, Feb. '93, by Alan Kimmel, appeared to hold definite possibilities. We built it and the search for perfection had begun. At this point we had a very low impedance, high output, wideband and distortion free driver. However, passing this super signal through a push-pull 300B output stage yielded disappointing results. 'Twas the time to seek the Triode lore of old, single ended.

Cy introduced me to Paul Bennett, a consulting engineer, with an extensive background in audio, dating back to the early 30s. Paul (who must have been born on the same day as was the vacuum tube) came to the rescue with wisdom very few possess. His knowledge gained during the tube era and his understanding of what we were up against, resulted in hours of heated discussion on audio theories, concepts, and myths.

We agreed on a concept that a power triode with its driver, an output transformer, and a speaker must work together as a team to keep the applied signal from becoming modified in the tube's non-linear regions. Paul said, "Ponder this analogy (dig this): think of a power output triode as a variable resistor, a rheostat with two shafts, one controlling the wiper and the other changing the total resistance. A tube's plate resistance changes with grid drive (or bias); the load changes with speaker motion. The output transformer, of course, sits in the middle of the whole thing."

We knew that to pull off what we were trying to do, we would need an exceptionally well designed SE transformer. A search for this elusive device led us to realize that it did not exist. Well that dumped "dog-doo" on our donuts! We would have to build our own. Paul grinned, then said, "With the specs you're demanding, I hope you know some black magic, because as far as I know its never been done, even by the big boys." The quest was on, and we divided up the projects. Cy worked on the circuitry with

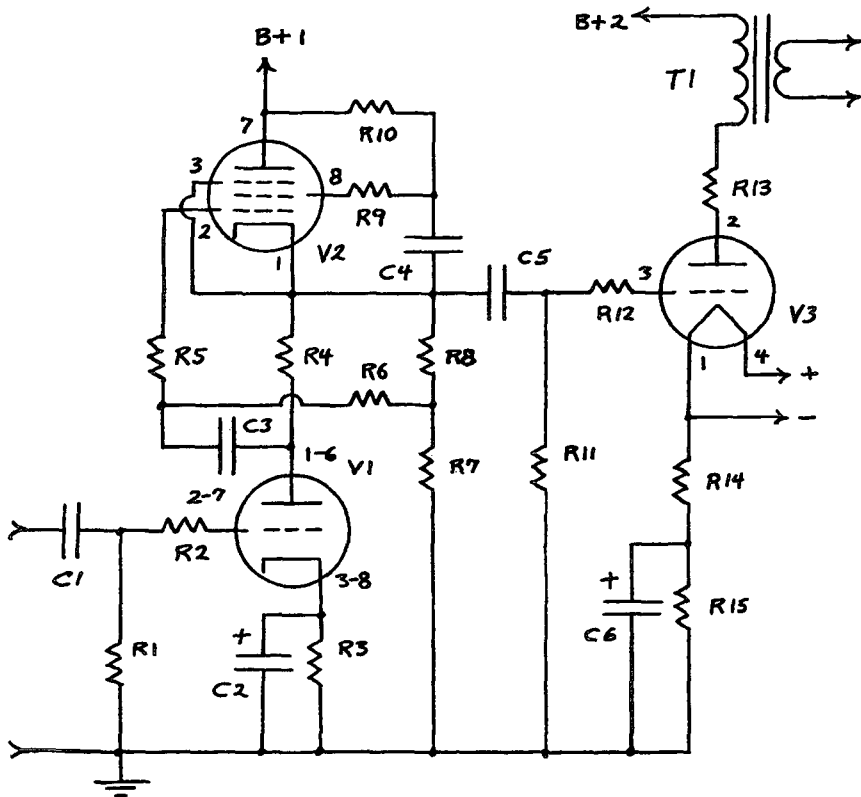

Electra-Print 300B or 50 Single Ended Amplifier

Parts List

- R1 47K
- R2,R5,R9 150
- * R3 910
- R4 40K 5W
- R6 1meg
- * R7 20K 5W
- * R8 220
- R10 47K 2W
- R11 51K 1W
- R12 1K
- R13 10
- * R14 440 5W
- * R15 390 5W

*approximate value
All are 1/2 watt unless specified.

- C1 1mf 200V high quality
- C2 500mf 10V elect.
- C3 .33mf 400V high quality
- C4 .68mf 400V
- C5 1.5mf 400V high quality
- C6 500mf 50V elect.

- V1 6AQ8
- V2 12HG7
- V3 300B or 50

High voltage requirements:

- B+1 650V reg. 25ma.
- B+2 475V reg. 100ma.

Filament:

- V1 6vdc .5a
- V2 12vdc .5a (isolated 325V)
- V3 5vdc 1.5a reg. slow start
- V3 7.5vdc 1.5a

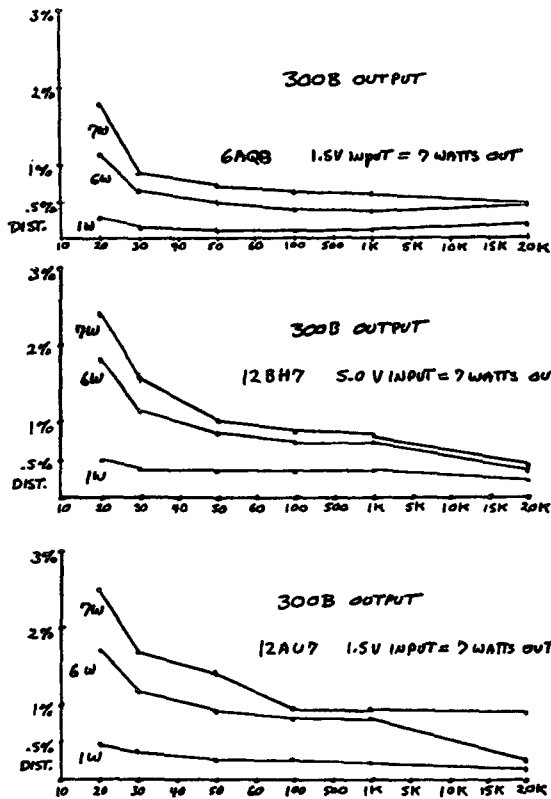

Fig. 1 — Distortion curves for 6AQ8, 12BH7 and 12AU7 with above circuit

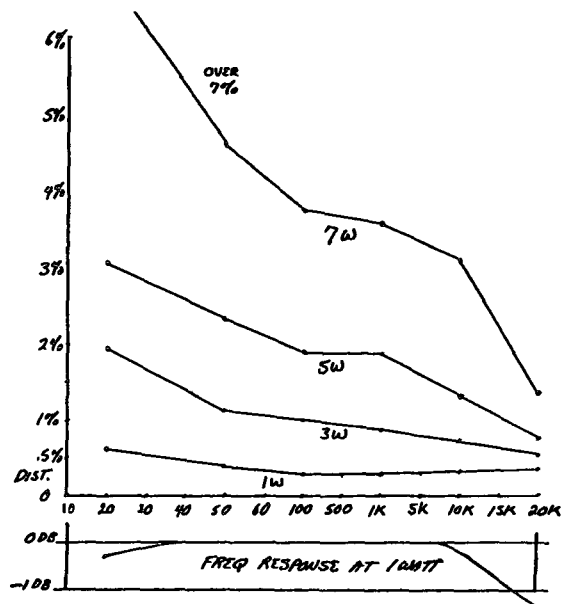

Fig. 2 — 300B SE amp with conventional driver circuit

the top quality audio test gear he accrued over the years, and I worked on the transformer designs.

Until the transformer was complete, Cy kept busy with driver circuit design, evaluation of input tubes and regulated power supplies. I wrestled with the many variable factors to be considered in design of a transformer: proper choice of material and size of core, wire size, fill, number of turns, countless configurations of interleaving and control of interwinding capacity. Each one affects the overall performance of the output system.

This transformer had to be approached as a system, the blending of many disciplines. We needed a large core mass due to the continuous DC plate current and to allow headroom for the signal. After eight months and many pounds of magnet wire all went well. Believe me, the satisfaction of finding a \$20 bill as you step out of your car is nothing compared to hearing a transformer you wound working beautifully.

The output measurements were as good as any 300B could produce, but Cy still was not satisfied. A fact of life exists that all power triodes due to their electrostatic geometry, produce second harmonic distortion. This type of distortion created by the output stage is undesirable; however the output stage must reproduce even as well as odd harmonics from the signal source. Output tube generated second harmonic distortion can only be minimized by increasing the load impedance into the lower power portion of the tube; therefore the distortion goes down, but it still exists.

One problem we pondered was how to eliminate the tube generated second harmonic without the use of feedback. Cy worked on this while I worked on transformer design. He came up with a driver stage that would duplicate the second harmonic distortion 180 degrees out of phase to be fed into the output tube to cancel the unwanted distortion.

This theory was based on the fact that when the driver was deliberately distorted in a certain way and this signal was applied to the output grid, the resulting distortion figure at the output was an order of magnitude lower. The distortion was "nulled out." It also appeared that no phase shift type distortion was present proving that the distortion is manufactured by a tube and not a

reactive component. It is important to have an output transformer that will not add its own distortion at 20Hz. Therefore the distortion at the extreme high and low end is the result of reactive components.

After trying just about every triode input tube known to man, the choice narrowed down to a 6AQ8 with a 12HG7 as a current source/cathode follower. This marriage gave the best results using a Western Electric 300B. And with slight variations of a few resistor values, it worked with a type 50 also. We tried all the audio standards, 12AU7, 6SN7, 12BH7, 6DJ8, etc. and others with very little nulling effect on the output.

The amplifier output distortion results of several driver tubes are shown in fig. 1 A, B, C. The distortion chart of the 6AQ8 (fig. 1A) shows the dramatic difference compared to a conventional 300B amplifier (fig. 2) using a conventional drive circuit.

We arrived at these measurements by first setting the output tube operating point at 40 watts plate dissipation. With a low distortion source on the input and a distortion analyzer on the output, we fine tune resistor values until the distortion and power figures are best. Optimal resistor values change from tube to tube. We discovered that starting the test procedure at the low end of the spectrum had a definite advantage overall, due to the reactive components at that frequency starting to affect the performance.

The schematic of the amplifier provided here does not include the regulated high voltage supplies which are a must for this type of amplifier. The regulated supplies offer voltage stabilization and ripple rejection for a solid low end. Also not shown is a slow start regulated filament supply needed to minimize hum and to "make love" to your precious 300B.

We all had worked with tube audio for most of our lives and we were IMPRESSED beyond all expectations. When we tried an early version of this amp on Bruce Edgar's horn system we knew that we were on the right road. Single ended triode sound had instantly flushed all push-pull tube, solid state, and tetrode powered amplifiers down the tubes, as far as I was concerned.

I figured it was mostly the result of no feedback but there was more to it. Our

discussion and theories about the tube, transformer and speaker working as a team and that the transformer is in the middle of all this impedance changing, has merit. The transformer with its relatively steady flux can reflect any impedance change instantly as opposed to a push-pull core, reluctantly swinging up from zero flux on the half cycle and trying to stay in motion, then starting all over again in the opposite direction, canceling all even order harmonics and giving you a nice and powerful but *different* waveform.

Go ahead! Remove the feedback from a push-pull class AB amp and measure the distortion and damping factor. My money is on single ended triodes because of two plain facts: the speaker moves and the plate resistance changes with grid drive.

Since all of us are in the audio business, it seems proper to offer a well designed product for sale. After all, capitalism is still legal. The transformers are available through Electra-Print Company, as well as details on the driver circuit distortion and null adjustment procedure. We recommend C3K for 300B or parallel 2A3s or 5M5K for type 50s.

In closing, we the above described FBEs (fire bottle engineers) cannot emphasize the pleasure and camaraderie that comes with such an absorbing project. We know there is always room for improvement, so until they confiscate our soldering irons, we will continue the quest.

Electra-Print Audio Co.
1555 N. Winwood Street
Las Vegas, NV 89108

VINTAGE GEAR HOUSECLEANING BLOWOUT

Even in a converted movie theater we managed to run out of space. Tubes, amplifiers, speakers, parts, etc., MUST GO to make room for production. No reasonable offer refused. Write or fax for list.

CHIMERA LABS
1707 S. Ervay Street
Dallas, TX 75215
214-428-3901 voice
214-421-1550 fax

Vacuum Tubes for Audio Are Back!

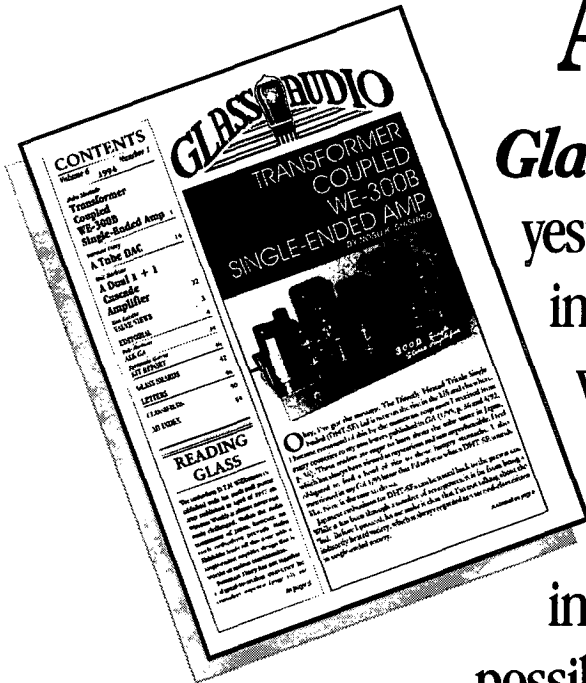

Glass Audio brings together yesterday's tube with today's improved components, voltage control, and the exciting new Soviet tubes, to make smooth sound in your livingroom possible again!

Get your first issue FREE to examine, without obligation.

YES!

Please send me an issue of *Glass Audio* to examine FREE for 30 days. When I choose to subscribe, I'll pay just \$23.00 for six issues (1 year) of the best information on tubes to be found anywhere! If I decide that *Glass Audio* is not for me, I'll write "cancel" on my invoice and owe nothing.

Name _____

Street & Number _____

City _____ State _____ Zip _____

In Canada, add \$6 per year in postage. Overseas Rates: \$45 for one year. Remit in US \$ drawn on a US bank only. Price good through Nov. 1, 1995.

Glass Audio

PO Box 176, Dept. SDP5, Peterborough, NH 03458-0176 USA
(603) 924-9464 or FAX 24 hours a day to (603) 924-9467

USE THOSE "JUNK BOX" CHOKES!

Salvage those unidentified parts by running tests to determine their electrical characteristics

by **Sherman H. Hubelhank**
Connecticut Telephone and Electric Corp.

When designing or building a voltage-regulated power supply with a choke input filter, the average experimenter or ham usually casts a furtive eye at his "junk-box" when he reaches the stage for the selection of the proper choke. Usually he has a number of iron-core chokes that appear to be physically large enough to carry the current needed, but not enough data is known to identify them, in order to build a good ripple-free, voltage-regulated power supply.

As a result, unless the builder can identify the choke by manufacturer and part number, his only recourse is to go to a catalogue and buy a choke that will meet his requirements. However, by setting up a relatively simple circuit (see the schematic diagram) and following the procedures outlined, those "junk-box" chokes can be readily identified as to their electrical characteristics and, hence, can be salvaged.

To properly identify the electrical characteristics of an iron-core choke it is necessary that the basic characteristics of iron-core chokes and their effects upon power supplies be understood.

One of the most important characteristics needed to properly evaluate the suitability of a choke as an input filter for a voltage-regulated power supply is to know the relationship of inductance to the d.c. current flowing in the choke. This is important because as the d.c. current varies, so does the flux density of the core and, consequently, the inductance. This means that an iron core choke may have vastly different inductances under "load" and "no-load" conditions.

This characteristic may be utilized to good advantage in power supply filtering, because for most efficient filtering action the inductance should increase with a decrease in load current. It should be noted that a choke is called a swinging choke if the inductance is high at low values of direct current yet decreases markedly with increased direct currents. However, if the power supply has a bleeder resistor in parallel with the load, the importance of the ability of the choke to have its inductance increase with a decrease in load current diminishes, since there is always a minimum value of load current flowing through the choke.

At some point the choke will reach saturation as the current increases. This is due to the iron core becoming saturated, which decreases the permeability of the iron, and hence decreases the inductance of the choke. This, of course, determines the upper limit of usability of the choke under load conditions. In addition, it is important to know the maximum current the choke may carry without overheating.

It is also necessary to know the critical inductance of the choke, that minimum value of the input-choke inductance which prevents the d.c. output voltage from rising above the average of the rectified a.c. wave. This minimum value, the critical inductance, must be maintained at all currents, in order to prevent the filter from acting as a capacitor-input filter.

Therefore, it becomes evident that to properly use a "junk-box" choke it is necessary to have a plot of inductance *versus* load current. Then if the inductance range of the "junk-box" choke is proper for the design range of the filter needed, it may be readily used.

A relatively quick and comparatively simple procedure may be employed to plot this curve, using only a vacuum-tube voltmeter and an ammeter as test equipment. The test circuit should preferably be the full-wave rectifier of the power supply being built, with the choke and a high wattage rheostat in series across the output. (See schematic diagram).

The test procedure is based on the following theory. An assumption is made that the d.c. resistance of the choke is small in comparison to its inductive reactance.

Hence, the normal equation for impedance: $Z = \sqrt{R^2 + X_L^2}$ becomes $Z = X_L$. The current flow through L and R is equal, consequently:

$$I = E/Z = E_L/X_L = E_R/R$$

Solving for $X_L = E_L/R = 2\pi fL$. Therefore $L = E_L/R \cdot 2\pi f$.

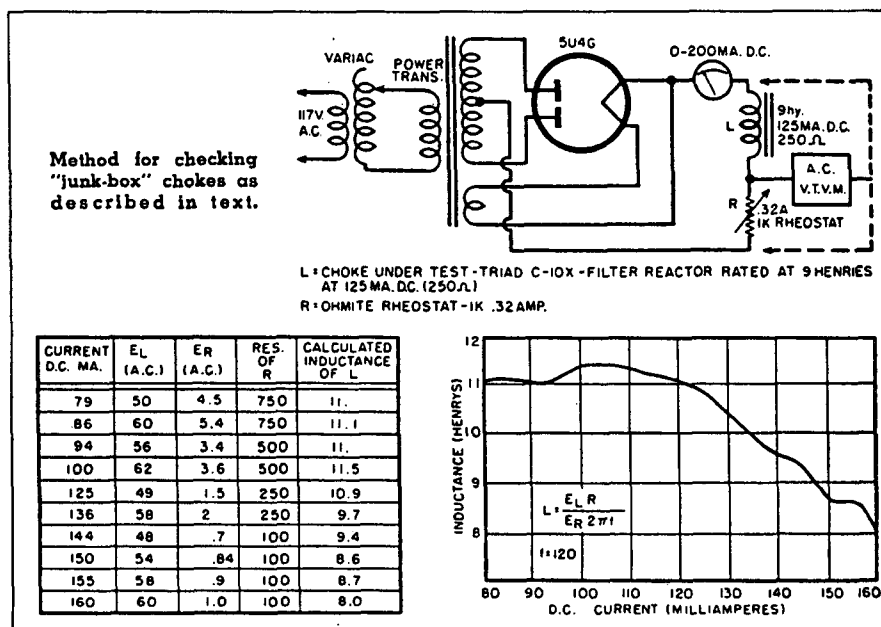

In actual use, vary the rheostat until the ammeter reads a low value of current. Measure the voltages across the rheostat and the choke with the vacuum-tube voltmeter, then measure the resistance of the rheostat. Substitute these values in the formula $L = E_L R / E_R 2\pi f$ and solve for L . The value of f in a full-wave rectifier circuit is 120.

Record this value of inductance and the current at which it was measured. Repeat this procedure until all the possible ranges of current that the power supply may require have been recorded.

When the curve has reached a point where the inductance starts to level as the current increases, the saturation point of the choke has been reached. Since this determines the upper limit of usability of the choke under load conditions, this is also the point at which the current rating of the choke should be checked. Leave the load connected for ten or fifteen minutes, carefully observing the case for signs of overheating. The choke may get warmer than body temperature, but should not burn the hand or get unduly hot. If the actual temperature of the choke is desired, fasten a thermometer to the case with putty. Be careful not to place the thermometer near the rectifier or any other heat producing tube. The temperature should be between 180° and 170° F.

The previously described plot will accurately show the point of saturation and how the inductance of the choke varies under different load conditions, and from this it can be readily determined if that "junk box" choke can be used in the power supply and whether it meet the design requirements.

© 1956. Reprinted by permission of Gernsback Press.

The Search for Musical Ecstasy by Harvey "Gizmo" Rosenberg

RE: TECHNO-SHAMANS

Since the late Paleolithic period, in every culture, a special group of men — those endowed with both courage and gifts — have been responsible for exploring the outer limits of knowledge: ecstasy. We are the modern incarnation of these shamans, and like our ancient brothers we use our music to open the door to higher states of being. Some anthropologists would argue that solder flux is hallucinogenic, the soldering iron is a magic wand, and our single-ended triodes are totems — all used to release a primal instinct for musical ecstasy.

My fellow techno-shamans, now is the time to cast off the mealy minded robe of mediocre audio orthodoxy and explore an expanded gizmological metacontext for the electromechanical arts that create an ecstatic aural metaphor. . . with me.



In other words dudes, read my new 350 page richly illustrated book which will stiffen your resolve, conviction, and whatever else you use to explore the audio arts. It is \$25, plus \$4 shipping, \$11 overseas airmail. Send checks, VISA, MC.

Image Marketing Group
PO Box 4744
Stamford CT 06907
1-800-243-6615

Dear Friends:

During 1993 and 1994, my position as author and designer allowed me to travel and experience many exotic hi-fi systems in the States and abroad. As I traveled, I searched for persons with highly developed "internal references" for beauty and musical pleasure. These contacts taught me lessons about myself and the wide possibilities of the art of audio engineering.

I discovered that many music lovers have systems beyond what is available at *any* cost in normal high-end stores. These exceptional systems were always single-ended triode powered and they played ALL types of program with equal aplomb.

Every record, no matter how poorly recorded, was a joy and a revelation. Great performances which are unlistenable on most systems because of poor recording quality, became simply GREAT PERFORMANCES.

It wasn't that these components unnaturally embellished or beautified the recording. On the contrary, I never heard so much detail, texture and color provided for my listening pleasure, and I never heard hi-fi sound so right. I felt privileged to be listening to the music . . . like I was the first man on a new planet. I beheld what I was hearing with awe and amazement. There was a deep sea of information but it was human and completely unmechanical. When a system's tonal character is *truly* natural, the aesthetic worth of *all* recordings is elevated.

Believe me, this really happens — even on rip roaring rock and roll. I know this all sounds like hyperbole, but I am writing this letter to explain what I have heard, what is possible, and point out a rewarding approach to music reproduction in your home.

There are only a few systems of this quality in America, but there are hundreds in Europe and Asia. I don't know of any present-day US "high-end" manufacturer with the aesthetic sophistication, ethical values, or engineering open-mindedness to create this sort of *system*. I say *system* because it can't be done by six different component manufacturers. A system of the highest quality can only be made under a single, highly evolved, whole-system engineering aesthetic. Some of the great systems I heard were lovingly built by their owners. The rest were designed by Hiroyasu Kondo of Audio Note in Japan or the engineers at Audio Note UK.

After I heard systems built around the *Ongaku*, the *Kassai*, the *Neiro*, and the *Meishu*, I began to wonder: "How many more years would it take me to design a complete system on this level?" I wasn't sure if I could build anything more than a copy, hopefully something almost as good.

The answer is: I have assembled a complete silver wired, Kondo-designed Audio Note system at the Staten Island Firehouse. My Bliss system is now all Audio Note. I would like to invite you to audition an audio *system* that will raise your internal reference for authentic musical reproduction.

AUDIO NOTE
new york city

Herb Reichert
718-876-9742
718-816-8598 fax

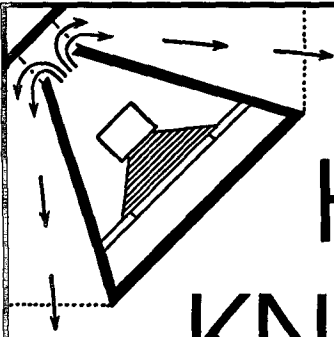

HOW TO KNOCK YOUR SOCKS OFF WITH 5 WATTS

Some general observations
by The Baroda Bard and Ray

My friend Ray knows a lot about speakers. He designed them professionally for about 25 years and probably would do it again under the appropriate circumstances. The other day, I went over to Ray's house on the St. Joe River for lunch. After we chatted about close friends, poetry, pipe organs, music for same, fine food and wine, we talked about speaker efficiency, a favorite subject for both of us.

This article isn't about amps, at least not directly. The title screams that, I guess. But inherent in any discussion about single-ended triode amps, there is the nagging question of what speakers to use. What follows are notes that we put together as our discussion on speaker efficiency continued on for a few weeks.

Yes, I know there are some answers — ranging from classics like Western Electric and Altec "Voice of the Theatre" cinema sound systems, vintage home hi-fi systems, still available "vintage" designs like Klipsch La Scalas and K-horns, to contemporary "pro sound" gear, and home-brew designs of various sorts.

But how does one sort through this strange menu? How can you know which direction

to go? While I'm convinced that the way to go is the speaker that "plays the most of your records" in an emotionally connecting way, I'm also inclined to get to this fine place via some grounded rationale. (Help, if you will).

Cut to the chase, you say. And don't bore or confuse me. OK! It's probably not far off to say that most contemporary "high-end" audio consumers are purchasing power amps ranging from 100 to 300 watts per channel. This is a difference in power that, all else being equal, produces a difference in sound pressure level (SPL) of 4.8 decibels (dB). 4.8 dB is a rather *modest* difference.

SPL Increase	Amp Power Increase	Subjective Reaction (You)
1 dB	1.3 times	Can just hear, if you're paying close attention.
3 dB	2.0 times	Pretty obvious, but not if the increase is at all gradual (not A-B).
6 dB	4.0 times	Can get your attention, even if you're not listening for it.
10 dB	10 times	Knocks your socks off. Twice as loud.

The above-described power range of 4.8 dB has sort of evolved to "work out" with a range in loudspeaker sensitivities (SPL developed with a 1-watt input at a distance of 1 meter) of something like 81 to 91 dB. This is a 10 dB difference, just over *twice* that of the power amps. A 10 dB difference in SPL is a difference of the genuine knocks-your-socks-off variety.

The 4.8 dB amp difference is able to deal with the 10 dB speaker difference due to variations in type of music listened to, the degree to which the listener wants to duplicate the SPLs of live music, the tolerance and closeness of the neighbors, size of pocketbook, size of room, etc.

Now, enter the single-ended triode amp! Not 100 watts! Not even 50 watts (cept the Cary 805 monoblocks). More like 10 or 12 watts. Or the 2A3-powered AES SE-1 kit on my credit card—five (hot) watts. And me wanting to try that 2A3 amp I read about that does about 2.5 watts.

In short, with SE triodes on the scene, the contemporary status quo of speaker sensitivities no longer cuts it. Specifically, 2.5 watts is *16 dB down* from 100 watts, a LOT more than the 5 and 10 dB differences noted above. This article is about guidelines for building loudspeaker systems which can really knock your socks off with lower powered amplifiers by making up for the power shortfall with greater speaker efficiency.

The following comments are relatively brief and could build into several more detailed, longer articles—some more obvious than others. Making a speaker one of the ways described doesn't say it will necessarily sound good or be a perfect partner for your new flea-powered SE-triode amp, but the physical laws behind the examples might help select or design a speaker system that doesn't wimp out when powered the way you like it.

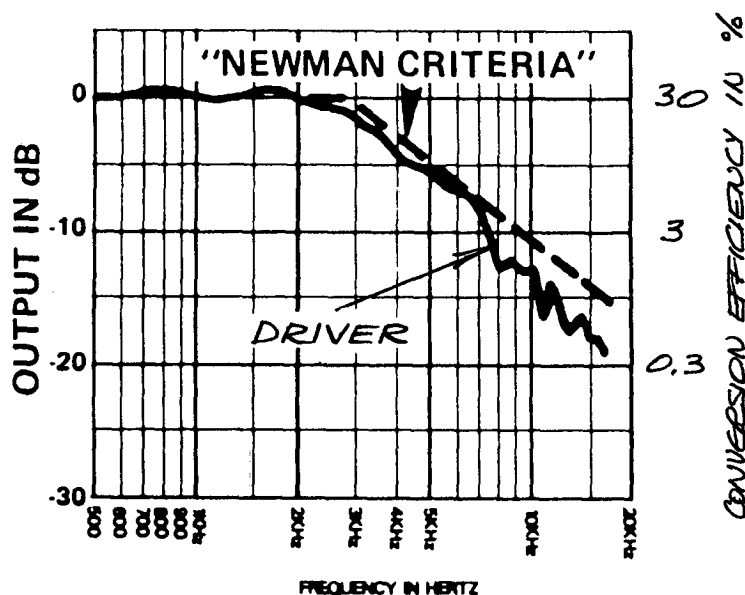

Figure 1—The "Newman Criteria" for Compression Drivers Compared to a Typical High-Quality Example (basically no exceptions)

High-Frequency Compression Drivers

Compression drivers can theoretically be about 50 percent efficient, that is, convert 50 percent of the electrical power input into the acoustic power we hear.

Physical realities, like air squeezing through small slots and friction in diaphragm suspensions, conspire against this happy result, to produce a real-world maximum of around 30 percent. (This is just over 2 dB down from the 50-percent maximum.) And that maximum only holds up to about 3 kHz, beyond which additional gremlins produce a treble roll-off of about 6 dB per octave. That means that at 6 kHz the efficiency drops to 7.5 percent. At 12 kHz, efficiency is just under 2 percent! And this is for a very well designed driver.

Around the world, I've spoken about this more-or-less ignored (except to those who make a living designing compression drivers) characteristic, and dubbed it the "Newman Criteria," after my friend Ray, who first explained it to me over 20 years ago. The Newman Criteria and the performance of a typical high-quality compression driver are illustrated in Figure 1.

The reality of the Newman Criteria means that if you just slap a good compression driver on a horn and sit back to listen, it's going to, by definition, sound dull, unless:

1. The designer has depressed its mid-band efficiency to produce a sound with "more highs." Or—

2. The driver has been placed on a horn whose coverage angle decreases with frequency in a way that compensates (or partially compensates) for the driver's inherent high-frequency roll-off. Straight-forward exponential horns and the closely related radial horns (e.g., Altec 511B and 311-90) display this characteristic. It amounts to a sort of "acoustic equalization" that applies only to the guy listening on the horn axis. Off-axis listeners will end up being short changed.

In my experience, the most respected "professional" compression drivers hew close to the Newman Criteria: Altec 288, TAD 4001, JBL 375, 2441, 2445, 2446, and EV DH1 and DH1A. I suspect it also applies to the Western Electric originals. But many drivers don't come close. Meeting the criteria is expensive.

And the criteria also applies to tweeters, e.g., JBL "bullets" or the EV ST350, except that they join the Newman Criteria on its downward slope above 3 kHz, since their diaphragms and horns are too small to go down in frequency to the 30-percent efficiency range.

What About Woofers?

Ray says that horn-loaded woofers never seem to quite reach the 30-percent figure, for reasons he has never seen explained, topping out at about 20 percent. That's about 2 dB down from 30 percent. Horn-vented "combination" low ends such as the Altec Voice of the Theatre approach the 20-percent figure only in the upper octave or so of their overall operating range (about 50 to 500 Hz), because their relatively small, straight horns are insufficiently large to act as horns in the lower octaves—they turn into vented direct radiators in this range (see next paragraph).

Very-high-efficiency direct-radiator woofers are about 5-percent efficient in an acoustic half-space (where the output is restricted by a large baffle to one-half of a sphere). These speakers pack all or most of the voice coil in the gap, and include 1950's JBL, Altec, Stephens and EV hi-fi designs, among others; and whose currently available descendants are still used by guitar players, (e.g., EV EVMs and the JBL E series). 5-percent efficiency is down almost 8 dB from the compression driver's 30 percent!

And if -3dB low-frequency limits in the 32- to 40-Hz range are sought, efficiency offerings in the 2- to 3-percent range result in enclosures much less like refrigerators. I like the 32 Hz, which Ray once described to me as a "magic" number because it encompasses a 16-foot, 32 Hz organ stop.

Picking the 2.5-percent middle of the range, that's nearly 11 dB down from the 30-percent-efficient compression driver! And for those of us who remember when Ed Villchur (Acoustic Research) invented the acoustic suspension bookshelf speaker system, c.1956: its half-space efficiency was about 0.5 percent, nearly 18 dB below all those WE compression drivers that first appeared in movie theaters. If 5 watts works for a good ol' WE driver, digging up 18 dB of efficiency reduction jumps the power requirement to over 300 watts. Ouch!

Table 1 summarizes these efficiencies, the related 1W@1m sensitivities, dB SPL losses that result as efficiency is reduced from the 30 percent top, amp power implications, and the net internal box volume required to realize low-frequency 3-dB-down points (f_3 's) of 40 Hz. (Double all the box volumes for 32-Hz f_3 's).

I added one particularly interesting system type to the chart, the multiple direct radiator. Up to the 300 to 500 Hz range, using multiple drivers increases efficiency, and four direct radiators essentially match the efficiency of a fully horn-loaded device—with a box one-half to one-quarter the size. Think about that!

RAY'S DISCUSSION of TABLE I

In the table, a number of low-frequency systems with varying efficiencies are noted with dB SPL losses that result as efficiency is reduced from the 30-percent top limit. Also noted are the internal box volumes required when a - 3 dB low-frequency limit of 40 Hz is desired. The various systems shown are nearly optimum designs for the efficiency levels shown.

Several interesting things are revealed by the table:

1. Relatively high efficiencies (5 percent and above) imply relatively large boxes, less deep bass, or both.
2. As efficiency requirements are lowered, box volume reduces proportionately for a fixed low-frequency limit (40 Hz here).
3. Multiple direct radiators can compete with bass-horn efficiency and have smaller boxes.

[Not in the chart but note: reducing the acoustic environment from the specified half space to that of a corner, an acoustic eighth space, changes the game enough to, for example, reduce the horn volume by roughly a factor of four, to 20 ft³! Paul Klipsch's classic corner horn is one approximate example.]

4. While loudspeaker "sensitivity" and "efficiency" are often spoken of as the same thing (which does well enough for the rough approximation), these are two different concepts related by the directional properties of the loudspeaker.

For example, while 10 and 15 inch loudspeakers may radiate the same amount of acoustic power from a given electrical power input (and thus have the same *efficiency*, i.e. output power divided by input power and expressed as a percentage), the larger

Table I —Fundamental Efficiency, Sensitivity, Amp-Power and Size Facts for Selected Low-Frequency Loudspeaker System Types with Low-Frequency 3-dB-Down Points of 40 Hz

System Type	Half-Space Conversion Efficiency	dB Down from Compression Driver Efficiency of 30% ¹	Factor of Amplifier Power Increase to Make Up for the Difference	Probable Sensitivity (1 W/1 m) ²	Net Internal Box Volume ³
Fully horn loaded (mouth large enough for a half-space environment)	15-20%	1.8-3 dB	2.0-3.1 times	108 dB ⁴	80 ft ³
High-efficiency direct radiator (single woofer)	5%	8 dB	6.3 times	99 dB	7.2 ft ³
Medium-high-efficiency direct radiator (single woofer)	2.5%	11 dB	13 times	96 dB	3.6 ft ³
Low-efficiency direct radiator (single woofer)	0.5%	18 dB	63 times	88 dB ⁵	0.72 ft ³
Multiple high-efficiency direct radiators (four woofers)	18%	2 dB	1.6 times	107 dB	26 ft ³

1. $10 \log_{10}(\text{efficiency } X\%/30\%)$ rounded to the nearest dB.

2. 100-800 Hz. The horn and multiple-direct-radiator sensitivities are from commercial examples available in the last decade. The high-efficiency direct radiator example is actual performance of a 15-inch system currently available. The other direct-radiator examples are calculated from the efficiency differences relative to the 5% direct radiator. For the direct radiators, actual results could vary slightly due to directivity differences. Also, the horn is more sensitive relative to the 5% direct radiator (108 dB - 99 dB = 9 dB) than the efficiency difference alone would indicate ($10 \log_{10}(5\%/20\%) = 6 \text{ dB}$) because the radiating area of the horn mouth is significantly larger than that of even a 15-inch cone.

3. Direct radiators are in vented enclosures producing "maximally flat" response.

4. 20 percent efficient.

5. Not by any means the lowest sensitivity rating typically encountered for high-end loudspeaker systems.

Four high-efficiency direct radiators can provide the efficiency of a horn — 19 dB more sensitive than a typical small monitor.

That difference would turn five SE watts into 397 watts!

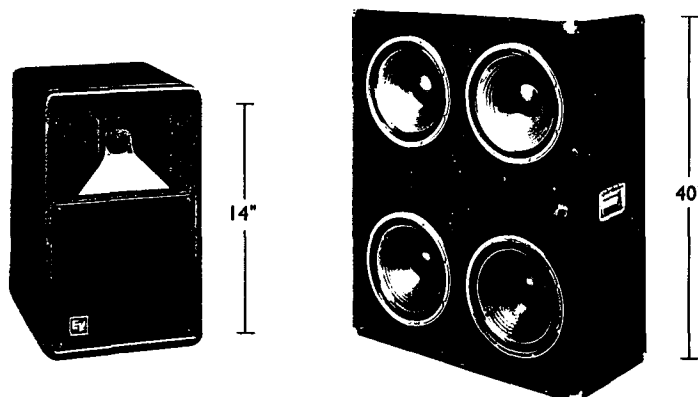

loudspeaker has a narrower coverage angle above the low-bass range and will therefore have a higher *sensitivity*—producing a higher on-axis SPL at mid and high frequencies for a given power input. This is because squeezing the same amount of acoustic power into a smaller angular zone results in higher sound pressure on axis. This concept is intuitive, I think.

System Interrelationship Equation

The points illustrated by the table are not arbitrary. They follow a scheme that is dictated by something we have come to call the "system interrelationship equation." This equation allows you to interrelate certain important performance and size matters to the hardware required in pulling it off. This equation is:

$$E = CV(f_3)^3K$$

where "E" is efficiency, "C" is a constant fixed by the environment being radiated into and the numerical system being used, "V" is the box's internal volume, "f₃" is the low-frequency 3-dB-down point (notice that it is *cubed* in the equation) and "K" is another constant, the system constant,

related to the type of system you have (sealed, vented, horn, etc.).

As you might expect, the loudspeaker itself (unmounted) needs to be appropriately designed for the equation to hold true. Two good-guys named Thiele and Small go into this in detail—I will try to avoid that but bear with me because the equation is a neat piece of mathematics.

This equation holds for the low- to mid-frequency range, from whatever you're willing to settle for at low frequencies to something like 500 Hz (give or take an octave). It's also what's called a "small-signal" equation so it doesn't tell you much about cone excursion.

The system constant, K, typically varies from something like 0.5 to 4 in a certain measurement system. Well-designed sealed systems can approach a K value of 2, vented systems can approach 4 and very good horns appear to be between 1 and 2 although the results aren't completely in on them.

And now, my final (gasp) remarks:

1. Because f₃ is *cubed*, the thing can really turn on you when you want more bass. One more octave down (i.e., one-half) means one-eighth the efficiency (a 9 dB loss). To hold the same efficiency, *eight times* the box volume is required.
2. When you shrink box volume something has to give (efficiency or f₃) unless you can up K somehow.
3. A larger K helps everywhere and (with certain restrictions) can allow direct radiators to have very high efficiencies in smaller boxes (or lower f₃'s) than horns.
4. The constant "C" gets larger as you restrict the angular zone radiated into at low frequencies. Corners, an acoustic eighth space (as noted earlier), are most helpful (but often not the most available) and hanging in space (an acoustic whole space) the least.

The really great thing about the system interrelationship equation is that it reveals a lot about what you can and can't do. Here's to the Bard's 2A3 five watts!

DINOSAUR
TRIODE AMPS AND SPEAKERS

KOMURO/MORRISON
604 E. 9th Street #5
New York, NY 10009
212 982 6421

Development of a 211 Amplifier

Part 3: Reducing Diode Noise

John Camille, Chimera Labs

OVERVIEW

Much has been written these past few years about the deleterious effects of solid state rectification in audio amplifiers. Excellent treatises on the cause of these effects have appeared in TAA, GA, and other audio periodicals.

This article will provide the experimenter with a few techniques to cure or reduce the problem in existing equipment. New equipment can be built with better than 100 dBV reduction in diode noise when the techniques outlined in this article are used together with the techniques outlined in my previous article on the 211 power supply.

Done properly, silicon diode supplies can be built that are quieter than untreated vacuum diode designs. One must remember that vacuum diodes also generate a significant amount of white noise that should be corralled in better designs.

Noise reduction for either vacuum or silicon diode rectifiers is a worthwhile undertaking. When silicon diode noise is controlled, the reliability factor and the virtually limitless lifespan of solid state diodes in properly designed supplies points toward the choice of silicon rectifier devices over vacuum tubes.

DIODE NOISE

The primary culprit responsible for the noise generated by good quality silicon junction diodes is the turn-off characteristic. A reverse pulse is generated by the minority carriers crossing the junction after the majority carriers have galloped through. Tremendous strides have been made recently in reducing this effect in diodes designed for use in switched mode power supplies (SMPS). The processes used to create these fast turn-off devices avoid many of the noise and oscillation problems of older diodes.

However, reverse recovery pulses still exist. The energy distribution as a function of time varies with each device but the general trend is down at a rapid rate, as semiconductor designers seek to meet requirements for more efficient SMPS designs.

I have been doing empirical work with the simple-minded idea that the very fast fall time pulse excites the LC resonant circuit presented by the secondary winding of the transformer. The excitation of the LC circuit produces a damped wave burst of RF energy centered on the resonant frequency of the transformer. I have measured the burst frequency fundamental on different transformers at frequencies between 6 kHz and 165 kHz. Of course, the oscillation frequency (f_0) is transformer and installation specific.

What all this means to the experimenter is that there are one or more transmitters buried in your amplifier. These transmitters produce 120 harmonically-rich pulses each second with a fundamental frequency (f_0) for each diode rectified supply. These pulses are radiated and conducted to other parts of the amplifier where they are detected and amplified along with the desired signal. Those beautiful wiring harnesses of old are real sonic killers for this reason. What you get is "diode grunge" that rides on the audio signal.

A more insidious problem is that these diode created bursts are also coupled back into the AC mains where they can affect unprotected low level stages elsewhere in the system.

My first practical experience with this phenomenon occurred a while back when overhauling a 6 1/2 digit DVM. A periodic toggling of the last two digits was eventually

traced to a 50 kHz damped wave burst at a 120 Hz rate that beat with a 50 kHz clock causing the false toggle. This few hundred millivolt burst rode through the 17 V regulator into a second regulator that provided a 7 V reference for the ADC.

After trying the usual bypass and filtering cures to get rid of the pesky wiggle on the scope trace, the eventual cure was very simple in retrospect. I replaced the two 3A diodes for the 5V power supply with Schottky diodes. The original pn diodes ran too hot and their silver plating was whispering. "Son-of-a-gun!" . . . the pesky burst disappeared from all the supplies as soon as I put the Schottkys in.

Afterwards, I rationalized the cure, thinking that Schottky diodes have relatively few minority carriers, thus they provide little kick to the LC resonant circuit formed by the secondary winding. Since then, I have routinely replaced all of the pn diodes with Schottky diodes when I rebuild and recalibrate instruments for my shop.

I discovered the same pn burst problem during early work on the 211 amplifier. The attitude at the time was, "If I could see an artifact on the scope, it would be audible". In went the Schottkys on all low voltage and bias supplies. The high voltage supply for the 211 was another problem, however. A suitable bridge for the 1400 V power supply would require around a hundred 90V devices in the stack! Enter brute force techniques . . .

RESONANT FILTERS

The resonant frequency of the plate transformer secondary was measured and parallel resonant RLC filters were added between the winding and the HV pn diode Stack. This expedient reduced the pn burst from several Volts p-p to 50 mV p-p. A series resonant filter added between the bridge output and ground reduced the burst to a few mV. A low-pass pi filter with a cut-off frequency around 400 Hz was installed between the diode bridge and the first filter capacitor. Afterwards, the burst was no longer visible on the 100 uV position of the scope!

The resulting suppression circuitry is shown in Fig 1. Parallel resonant RLC circuits Z1 and Z2 are high impedance traps that dissipate 26 kHz energy in the parallel resistor. The inductance (L) and capacity (C) of this circuit is determined from the formula:

$$LC = \frac{2.533 \times 10^{10}}{f^2}$$

where: f = frequency (kHz)
L = inductance (uH)
C = capacitance (pF)

So, if f = 26 kHz, then, LC = 9.7423 X 10⁵
select L = 470 uH, then C = 2073 pF
use 2200 pF (Mallory CK05 Bx222K)

The value of R1 is determined experimentally. A good starting point is to make R1 equal to the DC resistance of the transformer secondary. R1 should be a 0.5W carbon or metal film. Do not use wirewound resistors unless they are wound to provide the appropriate inductance (L). Many small chokes have appreciable DC resistance which can alleviate the need for an out-board R1.

The current rating of L should be 2 to 4 times the DC current rating of the supply. The capacitor for this network should be a CK05 or CK06 ceramic unit rated at 100 or 200 V.

LC values for the series resonant RLC circuit Z3 are determined with Formula 1. The current rating for L needs to be only a few mA. The voltage rating of C must safely exceed the peak value of the rectifier output. A 3 KV ceramic would work well here. The value of R2 again can be determined empirically. Try the supply load resistance for starters, calculated as DC output voltage divided by DC output current.

A resistance value somewhere between the load resistance and a short (zero ohms) will usually provide the best null for the burst. Use a binary hack technique to determine the null, i.e. parallel a 24K, then a 12K, then a 6K, and so on. The null is very broad (or possibly nonexistent in some cases), so don't expect miracles.

The low pass filter Z4 should be sized to provide as low a cutoff frequency as available parts allow. The idea is to have the burst frequency as far down the attenuation slope as possible. Those that have modern network-theory design computer programs can implement a low pass response with a notch at the burst frequency. For us slide-rule guys, an m-derived π section out of your favorite text should work well. I usually employ the TLAR (that looks about right) principle along with my reactance slide rule when selecting parts for my first gouge at this type of filter. The input and

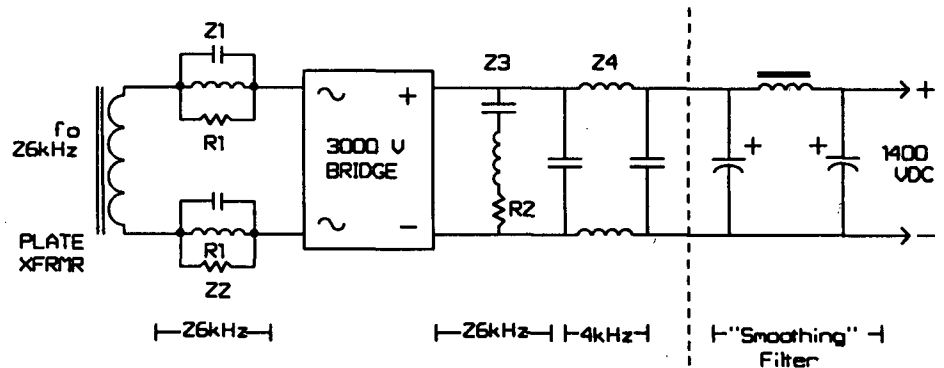

Figure 1: Primary Components of Diode Suppression Network

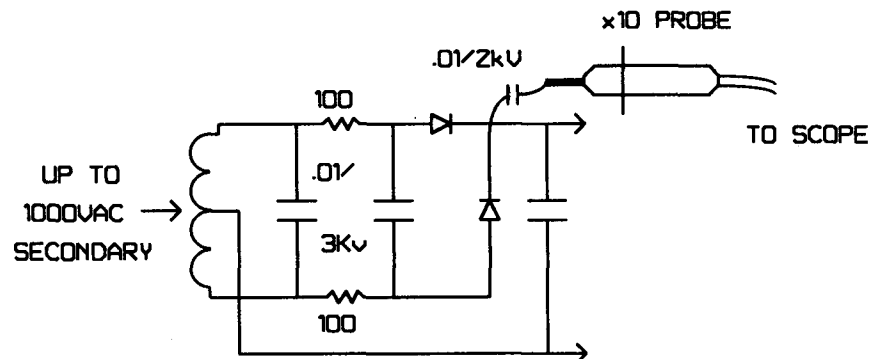

Figure 2: RC transient suppression and pn burst observation

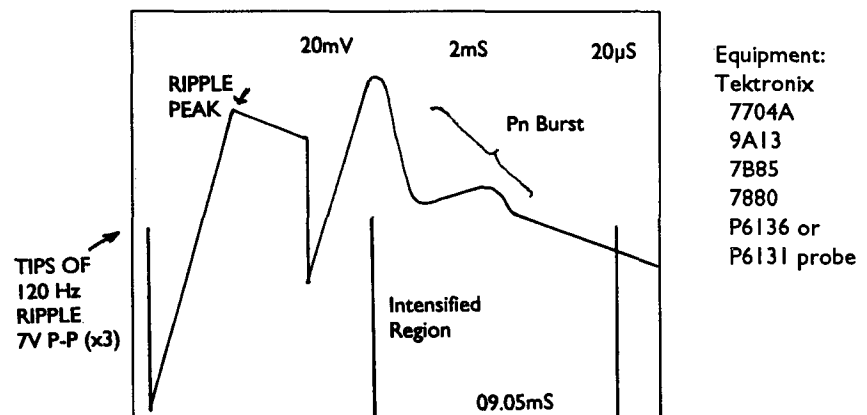

Figure 3: Depiction of scope display of the pn burst

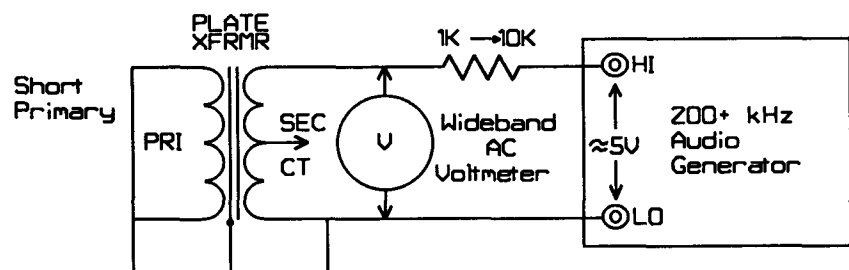

Figure 4: Test setup to measure HV secondary winding resonant frequency

output impedances vary wildly and are virtually impossible to model. When finesse is too difficult, use a bigger hammer!

RC FILTERS

Simple RC filters can be used on low current supplies for voltage amplifier and driver stages. Several 100 ohm resistors and two .01/3 KV capacitors are all that have been necessary for complete elimination of pn burst in a number of systems. See Figure 2. The resistors added in this location can also be increased as necessary to bring B+ values down to the original value when replacing vacuum diodes with pn diodes. Dale type RH and RS style power resistors work well here even though they are wire wound.

LOCATING pn BURST NOISE

A sensitive oscilloscope with a dual or delaying time base is necessary to observe pn burst effects. Connect the scope test probe to the rectifier output as suggested in Figure 2. Increase the sensitivity on the vertical channel while varying DC offset to keep the positive peaks of the ripple on the screen. Engage the delayed sweep and scan the area behind a ripple peak with the DELAY TIME control, see Figure 3. *Caution:* use a .01/2KV capacitor in series with a conventional probe when working with HV supplies.

DETERMINING f_0

The resonant frequency of a transformer installation can be measured directly from the display shown in Fig. 3. This method may be more accurate since it takes into account installation effects. However accurate sweep measurements require more elaborate scope facilities than your average audiophile might possess. The RLC networks described above have very broad characteristics which allow for considerable error in measurement anyway.

The setup shown in Figure 4 may be used to measure the "dry" resonant frequency of the transformer. This frequency measurement will probably be well within the bandwidth of the RLC traps described above. The audio oscillator and the high impedance AC voltmeter should be capable of operation to at least 200 kHz. The value of the source resistor is not critical. Use the highest value that gives a usable reading on the meter. Higher value resistors will give a sharper peak in the measured response.

To measure the resonant frequency: slowly sweep the oscillator over the 1 kHz to 200

kHz frequency range. A number of small peaks and valleys will usually be observed along with a single prominent peak at the fundamental resonant frequency of the secondary. This peak can reach several times the input voltage on very high quality transformers. Traps are cut for the frequency where the peak occurs.

CONCLUSION

The noise suppression technique described above will remove several layers of grunge from the sound of an amplifier. One or more sets of traps may be necessary to remove this noise. The process is strictly empirical at my level of understanding.

Some rules of thumb are:

Better transformers (C cores and toroids) may require a combination of the parallel, series, and pi filters for best results. Older transformers with poor insulation and high secondary resistance may require only the simple RC filter.

Very high-speed diodes are harder to tame. A high-speed, 1 or 2 nS rise time scope will show the initial spike, though greatly suppressed when using LCR traps. I use the 4 uS ERCOL-15 "Collmer" rectifier from Allied. This diode, although relatively slow, has clean noise characteristics and does not oscillate in the knee of the transfer curve. The parallel resonant traps between the diode stack and the transformer is usually adequate treatment for this diode.

The transformer-rectifier-filter interface must be *short and sweet!* I am wary of leads (antennas) over one inch long. My "new construction" supplies are fully shielded per a future article in SP. VHF RF construction techniques will make even the quietest amplifier quieter and sweeter! If you must bundle wires, use triaxial coax with proper grounding techniques. Think RF!

In closing, thanks for the many comments on the first two articles of this series. The comments and computer analysis of Bill Petrowsky have been especially helpful and much appreciated.

REFERENCES

- Marovich, Scott. "Snubber Strategy" in Letters to the Editor, *Audio Amateur* 3/94
- Miller, Rick. "Measured RFI Differences between Rectifier Diodes in Simple Capacitor Input Power Supplies," *Audio Amateur* 1/94

FISCHER AUDIOLAB

Vacuum Tube Technology

DESIGN ENGINEERING - MEASUREMENT
MODIFICATIONS - CONSULTATION

COMPLETE TEST FACILITIES FOR
VACUUM TUBE AND SOLID STATE
DESIGN & FABRICATION OF VT & SS

Regulated Power Supplies
Active Crossovers
Power Amplifiers
Preamplifiers

UPGRADES FOR:
McIntosh - Dynaco
Cary - Heath - WE

14528 Behrens Ave.
Norwalk, CA 90650
TEL: (310)929-3936
FAX: (310)929-1416

one electron™

The UBT-1 Transformer...
...a single-ended transformer
for the rest of us.

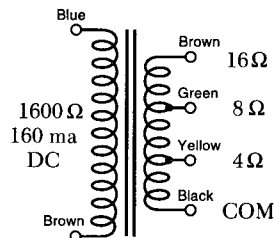

\$95.00

plus applicable taxes and shipping.
Quantity discounts are available.

- 12 Watts using three 2A3s
- 10 Hz - 58 KHz (-2db, @1W)
- Quality American design and construction
- Superb Sound!

Write for more information.

One Electron

65 Washington Street, Suite 137
Santa Clara, California 95050 USA
FAX: 408 985-2006

Believe Us?

You don't have to . . . see the excellent review of our *Cardinals* in TAS #99. We can't say much more than this!

Also, look for the *Sine*, the only single stage, non-inverting, totally tube line level preamplifier. Now shipping!

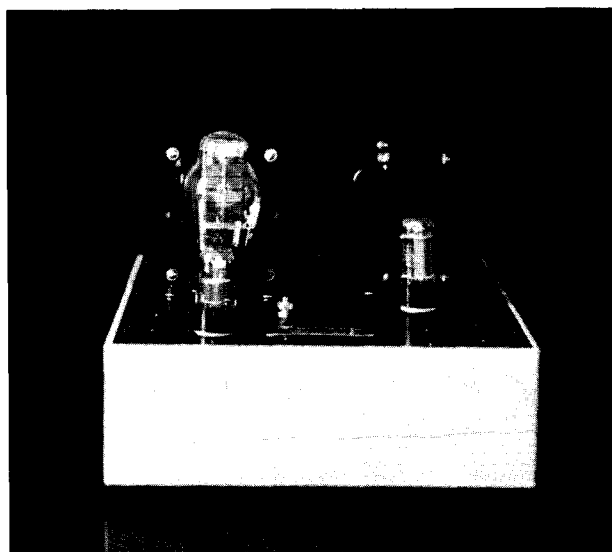

Cardinal 300B 7.5W Monoblock Amplifier

Wavelength Audio

4539 Plainville Road, Cincinnati, OH 45227 (513) 271-4186 phone/fax/voicemail

WE SPECIALIZE IN

SE TRANSFORMERS

— ONLY —



Model	Primary Z	Optimum Current	Frequency Response	Price
CT3K	3000Ω	100mA	-1dB@16Hz to 38 kHz	\$300
MT5K	5000Ω	60mA	-1dB@15Hz to 32 kHz	\$300
JTIK	1250Ω	160mA	-1dB@14Hz to 45 kHz	\$385

- Steel flangeless case 6.25"L X 4.75"W X 5.75"H
- Teflon silver plated leads
- Terms: COD or prepaid, plus shipping (20 lbs. each)

ELECTRA-PRINT AUDIO

1555 N. WINWOOD ST.
LAS VEGAS, NV 89108

702-646-7990
fax 702-646-7752

Silver Sonic

High performance audio cables

"The Silver Sonic cables are extremely smooth and extended...with plenty of the elusive air and space, yet free of any harshness. I have found them to be extremely musical over the long haul." Gary Galo, *Speaker Builder* magazine, Issue 4, 1994.

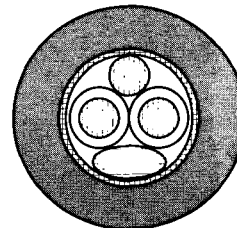

Model BL-1 Interconnect: \$95/1 meter pair
Model T-14 Speaker Cable: \$3.95 per foot

Manufactured by:
D.H. LABS
6633 Glenway Drive
West Bloomfield, MI 48322
(810) 851-1296 (phone/fax)



Delusions of Manhood

I was interested to read Seth Goldwin's review of the Audio Electronic Supply SE-1 in the Vol. 2, no. 2 issue of *Sound Practices* but was puzzled by one of his observations. On page 7 Mr. Goldwin states, "Successfully building your own gear is the kind of thing that makes you proud to be a MAN, if you know what I mean." Hmmm. I just finished building an Audax of America A652 speaker kit, but I never noticed delusions of manhood setting in. I must not have been paying attention.

Nancy MacArthur
White Rock, NM

Tweak of the Week

I wanted to throw in my two-cents worth regarding the Audio Electronics Supply SE-1 amp. I have built two of them to bi-amp a pair of homebuilt speakers (Aria 5-types using Cabasse drivers and external crossovers achieving 92 spl sensitivity). One amp powers the mid-bass drivers with 300Bs off the 4 ohm taps. The other amp powers the tweeters using 2A3s off the 8 ohm taps. I am extremely happy with the system, but this wasn't always so.

When I built and ran the first amp, I had the same impressions Seth Goldwin described in his review. The sound was pretty good but was afflicted with dynamic compression, slightly soft transients, and lack of high and low extension. The amp seemed to be missing important spatial information, presenting a rather small, flat, and glassy smooth image. Given the good quality transformers and basic circuit layout, I knew this amp could do better.

I initially used Vitamin-Qs for coupling because I prefer the slightly dark, rich sound they provide (I prefer espresso to Columbian for similar reasons). I replaced them with Hovlands and indeed got better transient response and more light on individual instruments. However, soundstage width and depth were still undersized and dynamics had not improved. I then looked at the power supply stage as a possible culprit. In

reviewing the schematic, I noted a 20 ohm resistor between the two 560mf electrolytic caps in the pi filter. I replaced the resistor with a 2.5 henry, 300 mA choke, which I was able to mount on top of the chassis between the left 6SL7 tube and 560mf cap. The improvement was remarkable. The soundstage grew five feet in every direction and instrument placement was much more 3-D.

After this very pleasant surprise wore off, I became unpleasantly aware of grit in the upper frequencies, which I attributed to the heavy-handed use of electrolytics throughout the power supply stage. I downsized both 560mf electrolytics with 230mf electrolytics. I also removed the two 47 mf caps on the 6SL7 power supply. Using a bunch of 12mf, 1000V canister-type oil caps I acquired from an electronics surplus store at \$2 apiece, I made four cap banks of four caps each. I wired a bank to each of the vacant 47mf positions, and bypassed the 230mf caps with a cap bank. As a result, the highs have acquired a wonderful satin sheen. Massed violins were especially pleasant to listen to. The amp's dynamics, speed, and rhythm greatly improved. I did not notice an increased noise floor or loss of resolution; on the contrary, high frequency resolution improved.

I should note that my power line is heavily filtered via an 8.5 constant voltage transformer cascading to an 8 amp isolation transformer. I have found that such filtering produces at least a 20% improvement in the sound of triode amps.

Given the upgrades to the power supply, I went back to my Vitamin-Qs and was able to fully appreciate their special beauty. The moral of the story is: don't blame the coupling caps for everything — the power supply is equally important in single-ended circuits.

I am now extremely happy with my SE-1 amps. Given their low initial cost and ease of modification, I can strongly recommend them. In tandem, the amps deliver the bass punch and headroom necessary to drive a wide array of speakers, not just ultra-sensitive horns. Where else can you get this much world-class triode power for less than \$1800 (or \$1300 if you use Chinese tubes!)?

Michael Pashall
Newton, MA

Vitamin Q Caps

We have a limited supply of metal case caps - paper/oil, Sprague, Westcap, Gudeman, J. Fast, etc.

N.O.S. Electron Tubes - American & European N.O.S. tube sockets - Phenolic, Mica, Ceramic - Amphenol, Johnson, Millen, EBY, Cinch, etc. Surplus Mil-Spec Ceramics.

We try to maintain a stock of all items, but many are very limited quantities. Stock lists for caps and sockets available on request.

No list on electron tubes, because they move so quickly and specific items are available only in limited quantities. Please phone or fax requests on tubes.

Karluff Enterprises

P.O. Box 2204
Irwindale, CA 91706
Tel 818-444-7079
Fax 818-444-6863

clean line

High Performance Line Conditioning

by *VansEvers*

Here's what they're saying about clean line—

"The difference is, before we had sound, now we have music."

"Wow! Day and night!"

"The fuzz is gone!"

Professional and consumer models available, priced from \$150 to \$1500. 10 year warranty on main filter components.

For more information write

VansEvers
5815 6th Street
Tampa, FL 33611

"WOULD YOU LIKE TO COME UP FOR A NIGHT CAP?"

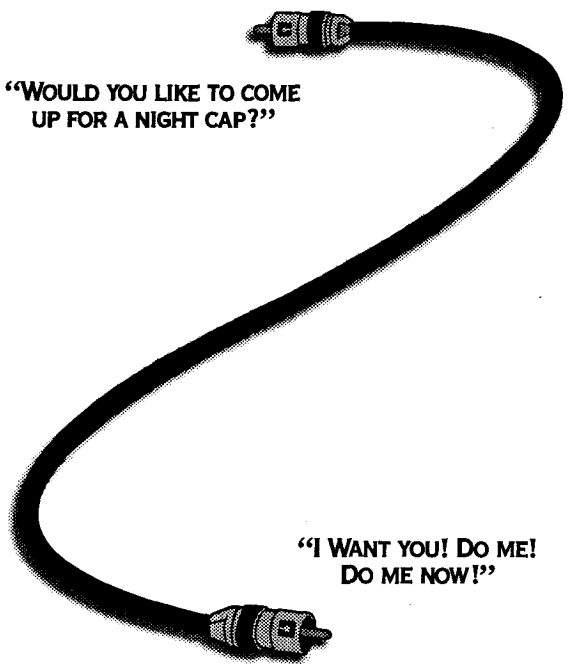

"I WANT YOU! DO ME! DO ME NOW!"

THINGS ALWAYS SOUND BETTER WHEN THEY'RE ABSOLUTELY CLEAR.

"THE NEW SYNCHESTRA PURE SILVER FROM LAT IS MY IMMEDIATE FIRST CHOICE WITH ANY SINGLE ENDED TRIODE AMPLIFIER."
—LYNN OLSEN, POSITIVE FEEDBACK

LUMINOUS AUDIO TECHNOLOGY
8706 W. BROAD ST. RICHMOND VA 23284
804.288.9387

You've come a **LONG WAY** looking for something *different* in 'phile publications, eh? Something to go with this truly cool copy of *Sound Practices*?



Time for a CLOSE ENCOUNTER with POSITIVE FEEDBACK Magazine!!!

Essays, reviews, DIY projects, tubes, solid-state, analog(ue) and digital, audio engineering, satire, cartoons — and more! (Audio CAN be fun!) Dozens of writers internationally, including some of the best known names in high-end design. Published bi-monthly in 1995; six issues are \$25 in the U.S., U.S. \$40 in Canada, U.S. \$75 on the rest of the planet. Mail your check or M.O. to POSITIVE FEEDBACK, 4106 N.E. Glisan, Portland, OR 97232 (503) 235-9068 (voice/FAX)

**THE WESTERN ELECTRIC 300B.
THE NEW MAGNEQUEST
300B SILVER TRANSFORMER.**

**AT LEAST YOU'LL NEVER REPLACE
THE TRANSFORMER.**

PURE SILVER WINDINGS, ALL HANDCRAFTED, \$800 EACH.
PURE COPPER, FROM \$150.
MIXED VERSIONS FROM \$500.

MAGNEQUEST, 1404 E. BRISTOL ST. PHILADELPHIA, PA. 19124
VOICE/ FAX (215) 288-4816
E-MAIL: MagneQuest@aWorld.com

MagneQuest
HANDBUILT WITHOUT COMPROMISE
TO PERFORM WITHOUT EQUAL

SP Internet Mailing List
featuring highbrow discussion of audio technology and its possibilities

To subscribe, send a message to:
sound-request@tpoint.com
with this info in the first line of the text:
"subscribe sound firstname lastname"

Post messages for circulation to:
sound@tpoint.

Editorial office e-mail address:
sp@tpoint.com

**Department of Corrections
Issue #6**

Morrison 71A line stage/xover

p. 14 — 90 V should have been penciled in at the plate of the 71A rather than on the supply side of the plate resistor. Supply voltage is approx. 220V

Vans Evers Chorus

p. 50 — R101, mysteriously absent from the component list, is a 2K unit. The unlabeled resistor located next to it in the power supply is 100 ohms.

Camille Shunt Regulator

p. 44 — the unlabeled resistor between the 4K32 and the 49R9 is a 1K unit.

ATARASHI-SAN

Just a note to tell you what I suspect Alan Douglas has already. In *Sound Practices* Summer 1994 (Vol. 2:#2), Orfeo 211 A, pg. 19, the authors refer to a 1971 Atarashi circuit. In Japanese, the word "atarashi" means "new". I don't think this word is a proper name in Japanese as used in the article.

I have also asked several of my Japanese friends and none have ever heard of anyone named Atarashi. Just thought I should write and let you know. Keep up the good work.

Charles M. Wilson
Burnsville, MN

I have received *SP* issue 6, so my last week-end was saved. Let me go into details regarding the ATARASHI circuit (p.19). The published schematic is not the original circuit, but a circuit revisited by Jean Hiraga to adapt an EL34 driver tube instead of the scarce Japanese 6GA4.

Note that some French audiophiles use that circuit with WE300B in the driver stage, and vapor mercury rectifiers in the B+ power supply.

Marc Veyer
Lille, France

ed— Yes, Virginia, there is an Atarashi. He worked for Denon and Phillips Nippon, according to Jean Hiraga's book. More on Atarashi-san and big triodes next issue.

**Handmade Electronics
Catalog 1994/1995**

Handmade's new catalog offers many of the great products that allow you to build the audio device that you have dreamed of

Parts of all price ranges in many of the popular audio and industrial lines such as:

Allen-Bradley/Stackpole carbon resistors, Dale potentiometers, Golden Dragon, MagneQuest, Solo, Ruby tubes, Hammond transformers, chokes & metal work, MITcapacitors, IRC film and wirewound resistors, Kimber, Gold Aero, Nichicon capacitors and so much more!

3 loose .29 stamps in the US or 3 IRC's (from your post office) gets you our catalog. *Send to:*
**1825 Roth Avenue
Allentown, PA 18104 USA**

Announcing...

The Gold Aero Tube Library

Vol. 1 - Tube Compliment and Substitution Guide

Sec. one gives OEM compliments for nearly every piece of audio tube gear sold in the past 45 years, with tube upgrade recommendations. Sec. two gives a complete tube substitution guide from the 1950s up to the present day — the 1st of its kind printed in several decades. Approximately 350-pages. 8-1/2"x11", 3-holed drilled. Due January, 1995. **\$29.95**

Vol. 2 - Classic Circuits and Their Tubes

This volume will give specification guides and specs of all the classic tube circuits, and the tubes they use. Perfect for the "hobbyist". With lots of graphs, charts and circuit drawings. Approximately 300-pages. 8-1/2"x11", 3-holed drilled. Due April, 1995. **\$29.95**

Vol. 3 - New-Old-Stock Spotter's Guide

This volume will be the definitive guide to differences between true N-O-S and current production tubes. Includes over 150-photos to help you separate the good from the bad, and is sure to stir up a lot of controversy. Approximately 300-pages. 8-1/2"x11", 3-holed drilled. Due out July, 1995. **\$29.95**

Vol. 4 - Historical Perspectives

This volume will cover all vacuum tubes used in audio applications, and who did what, when, how and where. Approximately 350-pages. 8-1/2"x11", 3-holed drilled. Due December, 1995. **\$29.95**

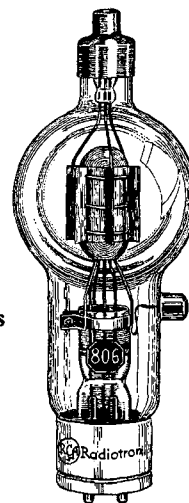

Also Available from Cool Sounds Press...

The Vacuum Tube Logic Book by David Manley. This "audio classic" is now in its 3rd printing and is the definitive book for understanding tube electronics and why they are considered by most audiophiles as the best. Only **\$19.95**.

TubeTalk ...

Finally, a quarterly newsletter for tube fanatics. No cartoons, no ads — just good talk about tubes. Issue #1, available in January, includes articles by Frank Morris of *Gold Aero* on the 6D6B family of tubes; Michael Green of *RoomTunes* on setting up your room; excerpts from Bob Harley's book *The Complete Guide to High-End Audio*, classifieds, and more! Published quarterly. Now only... **\$19.95 per year.**

Order from...

Cool Sounds Press
P.O. Box 110695,
Campbell, CA 95011-0695
(408) 377-9050
(408) 377-1282 Fax
Note: Prices shown are in U.S. dollars. Add \$4.00 S&H (slightly more outside U.S.). Visa & M/C accepted. Calif. residents add 8.25% Sales tax.

World Renowned for Sonic Excellence. . .

TANGO TRANSFORMERS . . . TAMURA too!

We know that few Japanese suppliers respond to overseas inquiries . . . but you can definitely count on us.

Worldwide service at our local prices.
Write or fax for a free catalog.

A SoundShop BIG Exclusive:

New custom Tango single-ended output transformers designed to provide optimal performance with the new VV30B !!!

Specifications:

Primary Impedance 2.75K,
16 Hz-60 kHz (-2dB)@150 mA DC,
40W at 30Hz @ 1% distortion

SoundShop BIG

A Tango and Tamura distributor

12-20-8 Kita, Yachiyodai, Yachiyoshi, Chiba 276, JAPAN fax: +81-474-82-3039

TUBES • PARTS • SUPPLIES YOUR COMPLETE SOURCE

TUBES:

3000 audio, receiving and industrial types in stock, including early and foreign types. Discount prices!

TRANSFORMERS:

Hard-to-find power transformers, audio transformers, and filter chokes for tube equipment.

PARTS:

Resistors, lamps, tube sockets, potentiometers, grill cloth, knobs, vibrators, etc.

CAPACITORS:

High voltage electrolytic and mylar capacitors for tube circuits.

LITERATURE:

Extensive offering of literature and books on antique radios, hi-fi, communications equipment, tube data, and circuit diagrams.

SUPPLIES:

Chemicals, grill cloths, wire, batteries, tools, etc.



"Write or call for our 36 page wholesale catalog"

ANTIQUE ELECTRONIC SUPPLY

6221 S. Maple Avenue, Tempe, AZ 85283, Phone (602) 820-5411, FAX (602) 820-4643
Toll Free Fax (800) 706-6789 (U.S. & Canada)

Fall 1994 Semi-Condensed Flyer

My "What I Say is What You Get" policy means that I don't re-label tubes with phony brand names, or put fancy gold lettering and boxes on them, or sandblast them and make up wild stories about where they're from in order to charge you 5 or 10 times what they're worth. I guarantee the goods you get are actually the brand and type advertised. Cheers, Ned The Proprietor.

Most Popular Tubes - Prices Availability ARE subject to change!
for matched pairs (where not listed) add \$1 per tube for power tubes (6V6,6E6)

32 per tube for dual section preamp types (6DJ8, 12AX7, 6SN7, etc)
 12AX7/Russia 12AX7/WA 3.95, Russia 12AX7/WB/7025 4.95...
 Russia 12AX7/WXT (hi-gain version of "WB") 5.95 China 3.95

Tesla 12AX7/EC803S gold pin 21.95
 Tesla (Czech) 12AX7/EB3CC 7.95, Tesla 12AX7/EC803S gold pin ECC803-S
 12AU7/China 3.95, Yugoslavia 5.95, Tungsten 5.95 GE (5963) 5.95 E Germany 5.95

12A17, China 4.95, British 12A17/white box, "genetic" may be Mullard or 4.95 each
 6DJ8 and equivalent (E98CC, E188CC, 6922, 7308) Russia 6922 5.95...
 Tesla (Czech) 6922/E88CC 7.95 Siemens 7308/E188CC gold pin 21.95

6550A General Electric USA 6550A-V1 Matched Pair \$4.95
 NEW Russia 6550A-V1 Very nice quality, looks like GE! match pair 33-90
 Note-Russian 6550 not compatible with McIntosh and certain C-J

units unless bias voltages adjusted. They work fine in most everything else.
KT88 National USA Not cheap but if you want sound and quality similar to old Genalex
 soda can "fund" em it's the next best thing. Call us for current discount price.

6CA7/E134 EL34-G Russia Narrow bulb- sim to Siemens 14.95 matched pair
 6CA7/E134 Russia like bulb (Looks like GE) 21.95/match pair
 6CA7/E134 Tesla, looks just like E341, but base color is different. 19.95/matched pair

With our boards we suggest large bulb Russian 6CA7
 Dynaco ST70/MK4 should use EL34-G or Tesla. Mark II can use all 3 types.
 With our boards we suggest large bulb Russian 6CA7

616-GC, Russia 616/GC/881 15.90/match pair Russia 616-GC 11.90/match pair GE(USA) Call
 6V6-GT Russia 3.95 each Bimar (England) 6V6-GT/CV311 9.95 each
 5AR4/GZ24 Russia (new improved type) 8.95

300B Cetron USA made 179.00 each
 Russian Tubes 5U6-G 5.95 6A5T-G 7.95 6BQ5/E184 3.15 6C33 29.95 6EL7 9.95
 6N7-GT 3.95 6N7-GT 3.95 6N7-GT 3.95 6N7-GT 3.95 6N7-GT 3.95 6N7-GT 3.95

7189/E184-M 5.95 7189 8.95 Chinese Tubes 2A3 15.95 211 26.95 845 26.95
Other popular tubes Lots more not listed, please call! (call for info on current stock)
 5U6-G 12.95 6AN8 5.95 6B4-G 6A3, and 6A5-G use 2A3. These are all identical except for

filament and baseing. (The Chinese ones work fine in lieu of US made if you can't find any!)
 6BM8/E182 3.95 6C4 4.95 6CA4/E281 4.95 6CWA 4.85 6DL4/EC88 4.95 6FQ7 USA, Call
 6GK5 USA 5.95 6GWB/E186 3.95 6I7 3.95 68C7 6.95 6VA 3.95 6X4 3.95 788...see

2C51/5670 (electrical equivalent) 12BH7 9.95 12BY7 9.95 12X4 3.95 5751 Call 5879 7.95
 5965 5.95 7247/12DW7 14.95 DC7-32 59.95

SORRY: We do NOT have Amperex or Telefunken items in most of the popular numbers!
 TUBE SALE: Prices and quantities on following items are limited to stock ON HAND, and all
 sales FINAL (that's why they're cheap!) If you need more info please ask first.

All are unused and most in original cartons. 6AK5/E95/5654 1.50 6AK6 75¢ 6AL5/5726 95¢
 6AT8 1.50 6AU8 1.00 6AU8-GT 1.50 6AX4-GT 1.50 6BK5 50¢ 6BN6/6K56 1.95
 6B07/6B27 1.95 6CB6 1.50 6DC6 1.95 6D76A 50¢ 6EH7/EF183 75¢ 6EW6 1.50

6GK5 Japan 1.50 6GF7 1.95 6GS7 50¢ 6HA/SEC900 95¢ 6IB5/6IC5 95¢ 12AL5 25¢
 40B3/5591 1.95 407A 1.00 408A 1.00 5870/7C31W 1.95 5920/E90CC 1.50 6689/E83F 3.95
 7721 4.95 7722/E280F 4.95 7734/6E8 9.95

Limited Quantities on following Philips/Sylvania Tubes 6188/68L7-WGCT (almost-a-5691)
 5.95 12F07 (Italy) 6.95 40XG6/PL1509/PL1519 (USA) 7.95 6CH8 (USA) 2.95 7895 9.95

Tube Manuals RCA 1939 reprint (RC-19)10.95 Western Electric Reprint 15.95
 RCA Transmitting Tube manual, (TT-5), covers 811A, etc. reprint 12.95
 OEM Spec sheets (usually 4-8 pgs. with curves, etc.) for most tubes available, \$2.00 per tube

Replacement PC boards for Dyna ST70, Mark 3

Ideal for those who wish to experiment as well as upgrade, unrivalled versatility as well as
 good fundamental design and reasonable price. Better performance than boards using
 6GH8, reliable, easy to install and modify.

Too much to explain here... Ask for our flyer for more details.
Note: Board prices do not include tubes. Construction requires a good volt/ohmmeter,
 simple hand tools, good basic knowledge of electronic principles and components.

ST70 requires 1-12AX7, 2-12AU7, Mk3 requires 2-12AU7 per board (4 for 2 amps)
 PC Board Blank 29.95 (ST70) 49.95 per pair (MKIII)
 PC Board assembled ready to install 69.95 (ST70) 99.95 per pair (MKIII)

All above include our comprehensive manual.



filled to limit NOS failures. We reserve the right to limit quantities. Tubes are unused,
 vintage stock. Most have original boxes, some are OEM stock or had damaged boxes and were
 boxed by us. We guarantee for 30 days, occasional cosmetic defects not included.

Where no mfr listed we have several brands on hand, please call for details.
 5Y3-GT RCA, GE or Sylvania 5Y4-GA Sylvania 4.95 6C5 GE 3.95 6C6 2.95 6D6 2.95 6F5 2.95
 6Y7 RCA 9.95 6F07/6C7 RCA clear top 14.95 6F07/6C7 Sylvania/RCA or GE 11.95

6N7 metal USA 5.95 6SF5 2.95 6S17 metal USA 5.95 6S17-GT GE, Sylvania 9.95
 6N7-GTB Sylvania 7.95 12A17 RCA, GE, Sylvania 7.95 12AX7A/7025 Tungston 14.95
 12AX7A OEM labelled "Webcor" (actually GE mfr) 9.95 12S17-GT 2.95 12SL7-GT 2.95
 12SN7-GT 2.95 56 4.95 75 7.95 76 RCA, JAN Nikl Union 5.95 80 4.95 864 9.95
 5879 RCA, GE, Sylvania 7.95 6005/6AQ5W 1.95 6072 RCA 11.95 81724X150G Eimac 19.95

Special limited quantities/Ask for complete clearance flyer.
 OC Cap 17 + 4 uF 440VAC, tested, clean, used 4.95
 Computer grade capacitors 1900 uF 250V Mallory 4.95 580 uF 400V Mallory 4.95
 1100 uF 450V Sprague 9.95 270 uF 150V 3.95 (Clamps-1.50)

Capacitors, These are 1.38" dia. 32-32-16-16 at 450V 6.95
 1" dia mount on sideways clamp (included) under chassis:
 16-16 uF at 450V 2.95 16-16-16 uF at 450V 3.95

1.5" dia mount on sideways clamp (included) under chassis:
 HV Polypropylene, your choice: 001-1500V, 0015 1KV, 0047 1600V, 0068 1KV .39 each
 Kodertren 037-400V axial polypropylene .29 each

Sprague 410P Axial 1.5 uF 300V .29 each F-Dyne 022-400V axial pprop .29 each
 ALPS 50K stereo combo Volume & Balance control, large case, detents 4.95
 Noble 250K, 100K, or 25K dual volume, cast case, conductive plastic 19.95

Filament Transformers 25VCT 3 amp, 3.95 6.3V 1.2 amp, 3.95
 Terminal Strips, Phenolic Bag of 30 pcs 1.95
 Soldering Irons, big ones for thick metal Wood handle 60 watt 4.95, 100 watt 6.95

Transformer, #23V17 (Thorndarsen) 117V 300 ma, open frame 9.95
 Choke, Stancor #C2344 1.5H 10ma, 1500V hipot 1.95 ea
 Choke, H/C9121, 600 mh 600 ma, 18 ohms DCR, 1.95

Other ceramic capacitors, EBY USA, fits standard 1 1/2" mounting centers, mil spec 7.95 each
 Teflon film resistor kit, 100 pcs, 20+ popular values 1/2 watt 1%, 6.95
 Metal Film resistor kit, 100 pc, 20+ pop values 3 to 7W metal oxide 12.95

Power Resistor Kit, slow turn on devices, 10 pcs set ohms, 2.95
 Thermistor Kit, slow turn on devices, 10 pcs set ohms, 2.95
 Time Delay Relay, 6NO6GT, 30 sec, 6.3V actuator, 9 pin base 4.95

Fun Tube Facts: The 8941 planar triode is only 2 1/4 inches (56 mm) long and weighs only
 2 ounces (56 grams), but is rated for 5,000 volts on the plate (anode), has 750 watts of anode
 dissipation (with a heat sink adaptor), and can pass a 3 use pulse up to 4 amps (thus generating
 a 10,000 watt pulse). The mu factor is 200 with a transconductance of 75 mA/V (75,000 umho).
 They are generally intended for advanced aerospace use and have a list price of \$1,200.

No "voice mail",
no brain-dead sales clerks,
no "audio guru" or
secret illuminati operatives.
Just "Worldwide Service,
Neighborhood Prices",
since 1985.

**All Phones:
312-871-7459**

Mail: Box 578501, Chicago, IL 60657 USA Office: 2010 W Roscoe St, Chicago, IL 60618

All Phones: 312-871-7459 Fax machine (24 hours) 312-871-7938
Phone/Order Pickup Hours (CST) Mon-Fri 12 noon to 5 PM
 Rules: No minimum order for credit cards or cash, however minimum shipping charge
 (UPS) \$4.00 Heavy items charge is chart rate plus \$1.00 (USA) plus \$3.00 (export)

UPS-COD (USA/Puerto Rico Only) add \$3.00. COD's are cash-only, \$50 min order, \$5 charge.
 Illinois residents add 7.75% tax, Chicago residents & pickup customers add 8.75% tax.
 Most parts except for tubes and sale items can be returned for credit within 30 days if with
 original packing and unused. There is a 10% service fee for returning goods that are not
 defective, this is normally waived if you use credit for other purchases. We reserve the right to
 limit quantities and require insurance and/or registration on packages. Most Tubes (except sale
 items where noted) are warranted 6 months at the office, please note. We can extend only

allow persons to "browse" the warehouse. Please phone 1 day in advance to pick up parts.
 Thanks for your help. Until we get a larger facility unfortunately we will have to ask our
 generous and understanding customers to suffer with occasional busy signals, due to the number
 of overseas calls we receive we cannot use voice mail or put customers on hold for very long.

We are here and better than 90% of orders are shipped within 1 business day.
 we appreciate your patience!

Mystery Parts...where do they come from? Don't ask, that's why they're a mystery!
 I found that by buying parts in OEM quantities without the fancy labels I could save you a bunch of
 money. Mystery Parts make experimenting and restoring vintage gear affordable for the average person.

Mystery Gold Connectors
 RCA Jacks, gold plated with teflon insulation and teflon washer to insulate from
 chassis. Same as "Royce-style", may be used to sell. Specify Red or Black. 2.95 EACH

Insulated Gold Blinding Post, 15A capacity. Specify Red or Black. 2.95 EACH
Metal Gold Blinding Post, with color-coded insulating washer. 15A capacity.
 Specify Red or Black. 2.95 EACH

Banana Plug, gold, takes up to 10AWG cable. Specify Red or Black. 2.95 EACH
Spade Lug, gold, takes up to 10AWG cable. Specify Red or Black. 2.95 EACH
SuperFlex 12AWG OFC copper speaker wire for use with above plugs/lugs.
 259 strands #36 wire rope lay. Roll of 25 feet (about 8 meters) 13.99 per roll

Mystery Polystyrene Capacitors Hard to find high voltage values.
 These types rated 630V, 1% tolerance: 10 pf, 12 pf, 15 pf, 18 pf, 22 pf, 27 pf, 33 pf,
 47 pf, 56 pf, 68 pf, 82 pf, 1-9 pcs 1.95 each, 10-24 pcs, 1.59 each, 25 + pcs 1.35 each
 Rated 630V, 1% tol: 100 pf, 120 pf, 150 pf, 180 pf, 200 pf, 220 pf, 270 pf,
 330 pf, 390 pf, 1-9 pcs 99 each, 10-24 pcs .79 each, 25 + pcs .69 each

Rated 630V, 5% tol: 470 pf, 560 pf, 620 pf, 680 pf, 750 pf, 820 pf
 1-9 pcs .69 each, 10-24 pcs .55 each, 25 + pcs .49 each
 Rated 630V, 5% tolerance: 1000 pf, 2200 pf, 3300 pf, 4700 pf
 1-9 pcs .49 each 10-24 pcs .39 each, 25+ pcs .35 each

Mystery Polypropylene Capacitors. All 10% tolerance. Quantity discounts as follows:
 10 to 24 pcs, 20% off. 25 or more 33% off. Over 100 pcs please call for quote.
 Rated 630V: 01 uF .45, .022 uF .45, .033 uF .45, .047 uF .45, .1 uF .60, .15 uF .75
 .22 uF .75, .47 uF .95, 1.0 uF 1.50 Rated 400V: .15 uF .50, .22 uF .60, .47 uF .75

Other Regular Stock Useful Items
Mallory Twist-Lok Capacitors, new (1993 date code!) 1.38" (35mm) base unless otherwise specified
 20-20-20 uF at 475 volts FP-475 14.95 20-20 uF at 450 volts FP-234 1" (25mm)lean 10.95

Computer grade capacitors, clamp mount 1.38" dia. Made in England
 220 uF 500V 9.95 multi section 50-50 at 500V 7.95 Clamps add 1.50
Actal Electrolytic Capacitors Other lower voltages also stocked
 500V: 22 uF 1.95, 47 uF 3.95 100 uF 7.95

450V: 10uF 75¢ 22 uF 1.25 33uF 1.65 47 uF 1.95 80 uF 2.50 100 uF 2.95
5 watt Zener diodes, your choice 47, 82, 100, 110, 120, 130, 140, or 150 volts 1.95 each
Diodes, 1N4007 1A 1000V, pack of ten, 95 2.5A 1000V pack of five 95

High Voltage Diode, 500 ma 12,000 volt PRV rating (w/ov) 5.95 each
Claroast 2 watt linear controls, for bias/balance, etc. 1K, 3K, 10K, 25K, 50K, 100K. 5.95 each
Poly-carbonate hospital grade power plugs, USA mfr, 2, 3, 3 prong, 4.95
Neutrik XLR connectors gold plate contacts, black case, specify male or
 female, cord or chassis mounting. 4.95 each

Chassis boxes (see cages below) for tube power amps, 95X52 alum 13.95 12X8X3 alum 22.95
 10X8X3 alum or steel 25.95 17X10X3 alum or steel 28.95 17X14X3 steel 44.95
Bottom covers and feet included. Aluminum chassis are natural, steel are grey enamel.

Cages for above chassis, perforated enameled steel, 5" vertical clearance,
 9 X 5 \$30, 12 X 8 \$30, 16 X 8 \$33.00 and 17 X 10 \$34 each
Punch Kits, will punch all chassis above (up to 18 ga steel), covers all
 popular tube socket holes, 5/8", 3/4", 7/8", 1", 1-1/8", 45.95 each

Lettering kits, dry transfer, for marking above or other chassis. Specify Black or White.
 Choose Audio Words (#AUD-1) Terminal Letters and Numbers (#TC-13)
 or Dial Marking (for volume/selectors, etc) (#DM-13) Large pack \$3.29 per pack.

FM Radio Alignment Tool Kit, has most popular types. #AT-1 1.95
Sockets, Octal (for GZ34, EL34, 6X50, 6L6, etc tubes) British Micanol (brown plastic)
 (McMurdo) phosphor bronze contacts, standard 1 1/2" mnt centers 1.95 each
 9 pin chassis mount McMurdo socket, similar to above 1.95

Ceramic Octal with gold plated contacts, direct fit for Dynaco, 6.95 each
Ceramic Octal with silver plate contacts, slightly smaller than above item. 2.95 each
 9 pin ceramic/gold, PC or Chassis mount, fit USA dimensions, exc quality 5.95

9 pin white plastic/gold PC mount very nice 2.95 Same item no gold plate 1.95
9 pin chassis mnt, ceramic/silver with shield included, fits 12AX7, 6DJ8, etc 1.95
Junebo 4 pin for 211, 845, etc Very good copy of Johnson 9.95
Junebo 4 pin for 300B, 2A3 metal saddle 9.95

Ceramic/Silver 4-pin (300B, 2A3) or 5-pin (807 etc) wafer socket 2.95
Cinch 9 pin chassis mount socket, black plastic, ground lugs. 95
Have Tube Sockets and Top Caps of all sorts. If you don't see it here please ask.

Dusty Files Part 1 Twenty interesting tube amp schematics 1938-1988.
 with emphasis on the bizarre and high powered, plus 6 pages narration. 4.95
Dusty Files Part 2, Favorite Amp Plans, 25 tube power amplifiers that may be constructed from
 generally available, reasonably priced parts. Includes handy Resistance Coupled Amplifier charts. 9.95

Full line of power transformers/choke available, ask for our flyer

WELCOME BACK TO THE FUTURE

Single-ended triode vacuum tube amplifiers, tube pre-amplifiers and **would you believe, a 15" woofer and horn loaded mid range tweeter loudspeaker system!**

What do we call this new future of high fidelity equipment?

Fun...Fun...Fun!!!

Music in the comfort of your home should not be "high-end", "mid-fi" or "low-fi". It should be fun. Fun and enjoyable for your entire family. Audio Electronic Supply is pleased to offer the future of high fidelity sound for the comfort and enjoyment of all music lovers. Everything else is just so common and dated. Orders shipped daily to countries around the world.

Call today for ordering information and your free AES Catalog.

919.460.6461

919.460.3828 (FAX)



AUDIO
ELECTRONIC SUPPLY

111A Woodwinds Industrial Court
Cary, North Carolina 27511

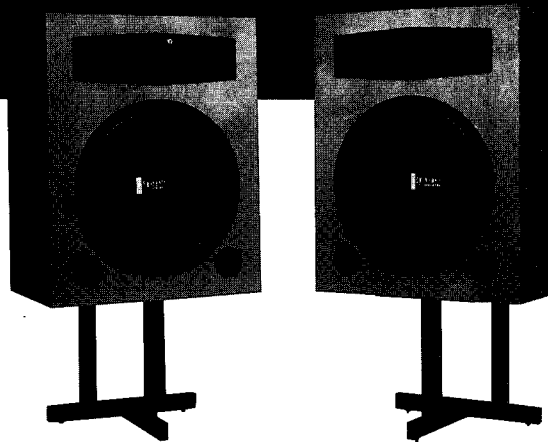

SP-1 Loudspeaker System 97 dB Efficiency
\$1495/Pair Factory Assembled

ST-1 16" Speaker Stands for SP-1
\$129/Pair

Coming Soon!
SP-2 Loudspeaker
System High
Efficiency Mini-
Monitor
\$399/Pair Factory
Assembled

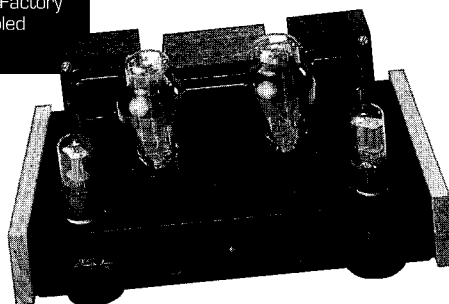

SE-1 Single-ended 300B Stereo Amplifier
\$1050 Factory Assembled with Cetron 300B Tubes
\$899 Kit Form with Cetron 300B Tubes
\$549 Kit Form less 300B Tubes



AE-1 Dual Mono Tube Preamp
\$599 Factory Assembled
\$449 Kit Form

Audio Electronic Supply Company - Your Audio Fun House.

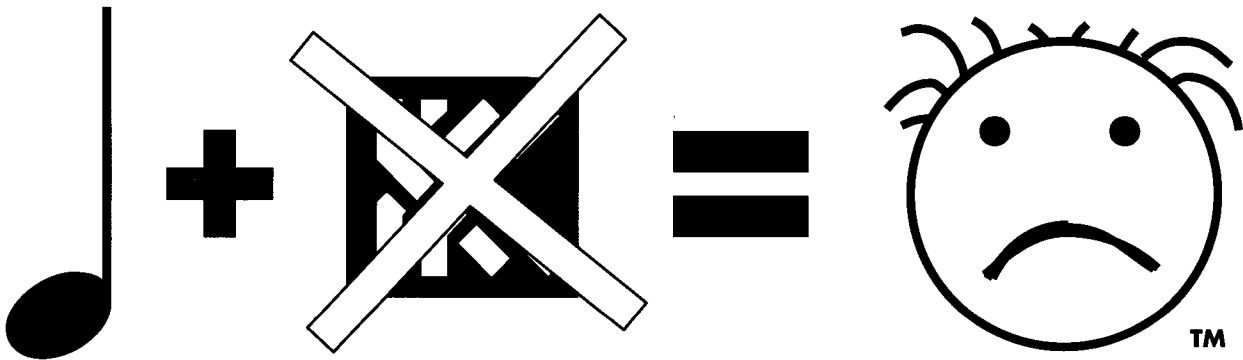
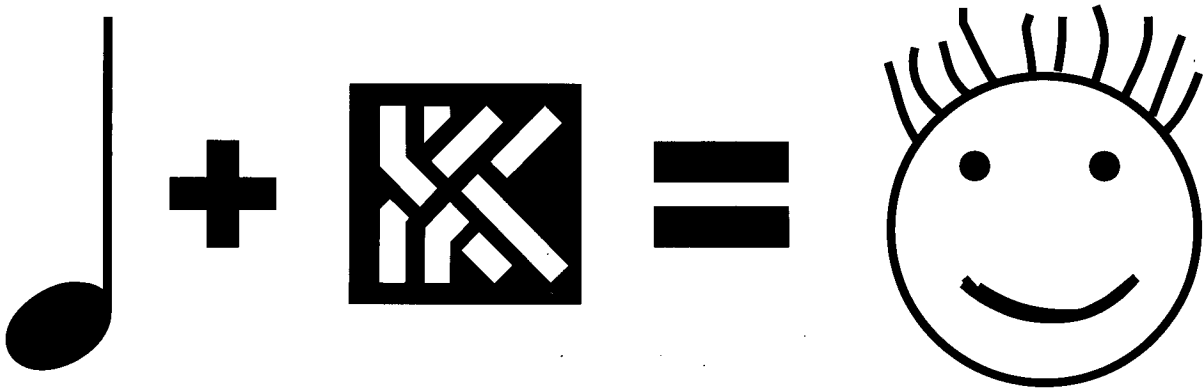

some equations are simple.



2752 south 1900 west • ogden Utah • 84401 USA • 801.621.5530