

# SOUND PRACTICES

---

A JOURNAL OF AUDIO TECHNOLOGY

WINTER 94/95

FIVE DOLLARS

---

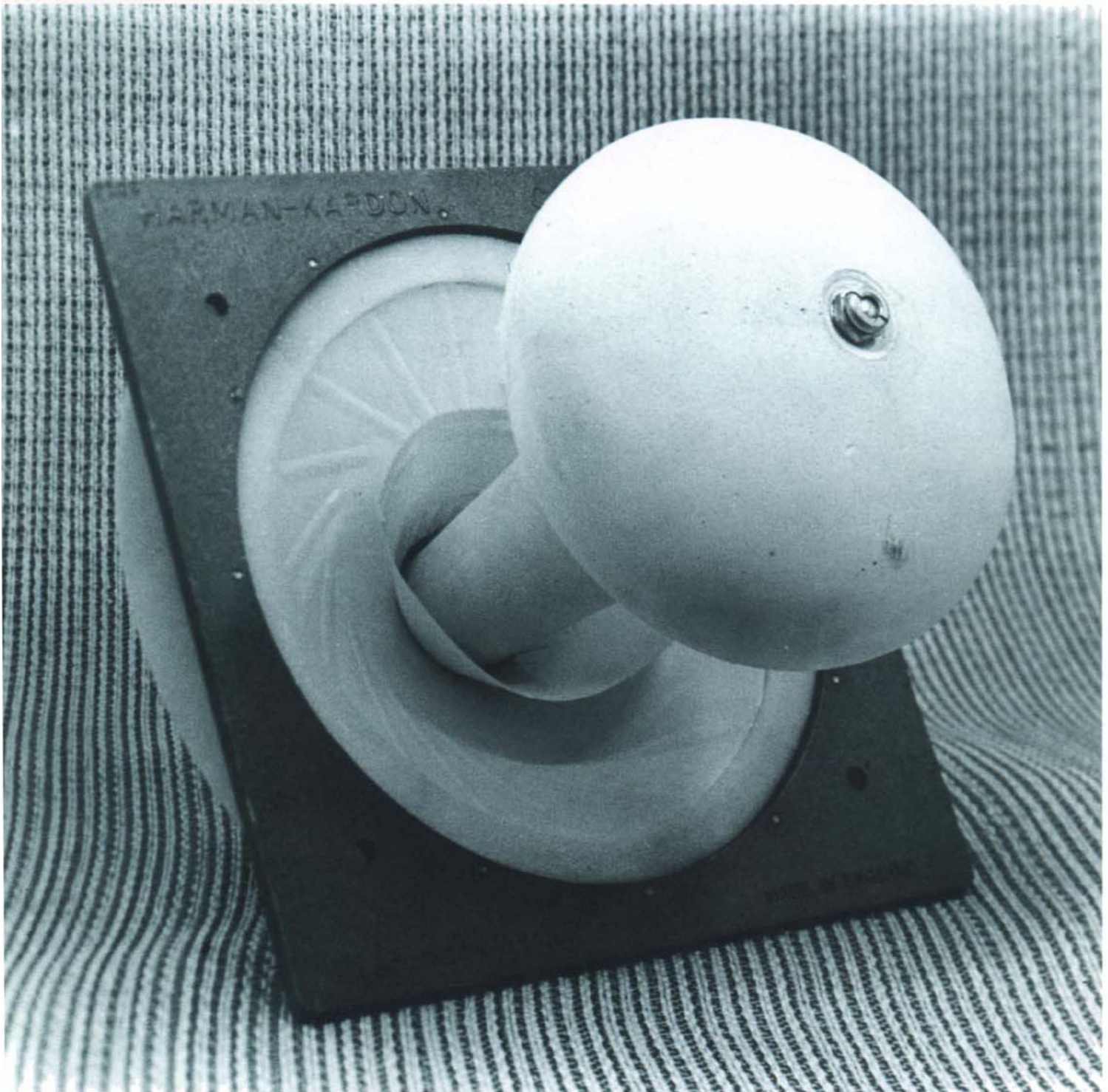

---

towards perfection

Vol. 2:4 Issue 8

# WELCOME BACK TO THE FUTURE

Single-ended triode vacuum tube amplifiers, tube pre-amplifiers and **would you believe, a 15" woofer and horn loaded mid range tweeter loudspeaker system!**

What do we call this new future of high fidelity equipment?

**Fun...Fun...Fun!!!**

Music in the comfort of your home should not be "high-end", "mid-fi" or "low-fi". It should be fun. Fun and enjoyable for your entire family. Audio Electronic Supply is pleased to offer the future of high fidelity sound for the comfort and enjoyment of all music lovers. Everything else is just so common and dated. Orders shipped daily to countries around the world. Call today for ordering information and your free AES Catalog.

**919.460.6461**

**919.460.3828 (FAX)**



**AUDIO**  
ELECTRONIC SUPPLY

111A Woodwinds Industrial Court  
Cary, North Carolina 27511

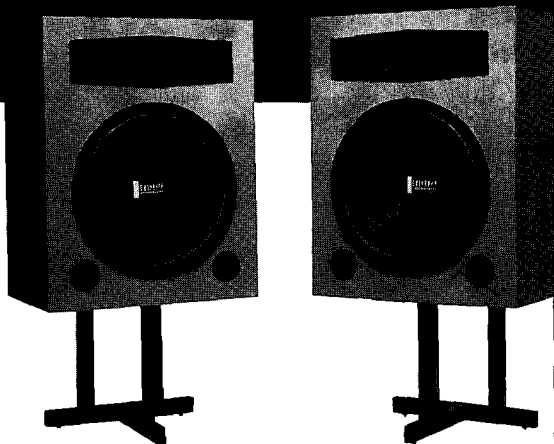

SP-1 Loudspeaker System 97 dB Efficiency  
\$1495/Pair Factory Assembled

ST-1 16" Speaker Stands for SP-1  
\$129/Pair

Coming Soon!  
SP-2 Loudspeaker  
System High  
Efficiency Mini-  
Monitor  
\$399/Pair Factory  
Assembled

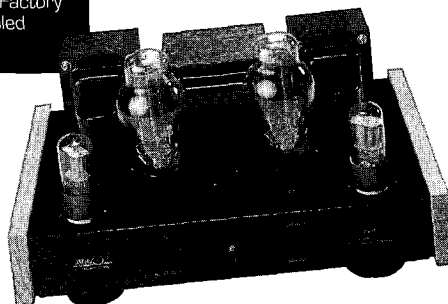

SE-1 Single-ended 300B Stereo Amplifier  
\$1050 Factory Assembled with Cetron 300B Tubes  
\$899 Kit Form with Cetron 300B Tubes  
\$549 Kit Form less 300B Tubes

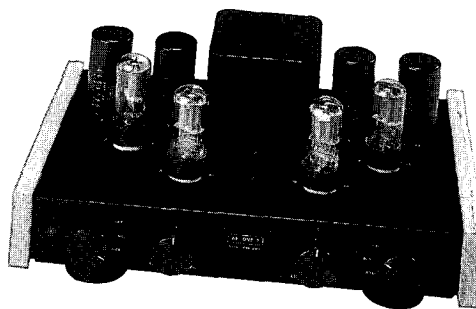

AE-1 Dual Mono Tube Preamp  
\$599 Factory Assembled  
\$449 Kit Form

**Audio Electronic Supply Company - Your Audio Fun House.**



## Get on our list - to get closer to this list.

- MIT MultiCap • Wonder Cap • Kimber Kap • Solo • Hovland MusiCap • Solen • Siemens • Wima • Holco
- Rel-Cap • Draloric • IRC • Allen-Bradley • Jensen • Resista • Vishay • Mills • Caddock • Matsushita • TKD
- Noble • Cardas • Kimber Kable • van den Hul • Discovery • Audioquest • MIT • Alps • Bourns • Shallco • Elma
- Electroswitch • Nichicon • Gold Aero • RAM • Mallory • Panasonic HFQ • Nichicon • Elna • N.O.S. • Ruby Tubes
- UltraAnalog • Burr-Brown • Crystal • Linear Technology • Analog Devices • Edison Price • Motorola • UCC
- International Rectifier • Hitachi • MagneQuest • Sonic Frontiers • Pearl • Tube Sockets • WBT • Neutrik
- Sound Coat • Curcio Audio Engineering • Assemblage and other kits

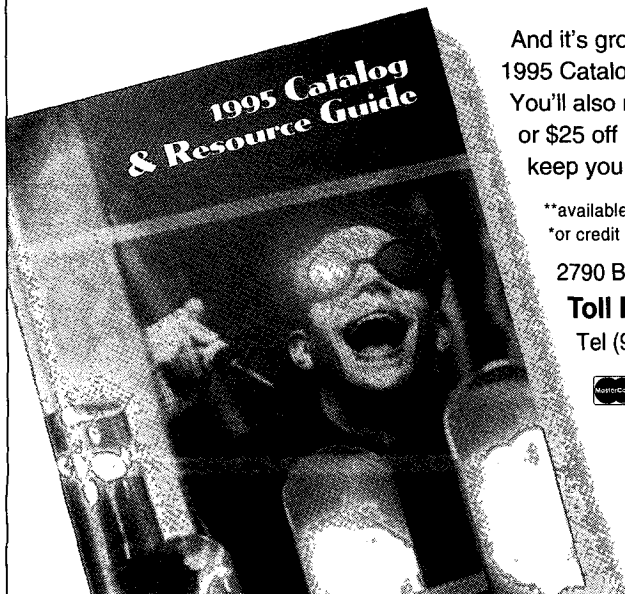

And it's growing and growing. To order The Parts Connection 1995 Catalog & Resource Guide\*\*, send \$10\* and mailing information. You'll also receive a Discount Coupon worth \$10 off a purchase over \$100 or \$25 off a purchase over \$250 as well as *The Breadboard* bulletin to keep you updated on our latest news, information and growth spurts.

\*\*available March  
\*or credit card information

2790 Brighton Road, Oakville, Ontario, Canada L6H 5T4

**Toll Free Order Line 1-800-769-0747**

Tel (905) 829-5858 Fax (905) 829-5388



**THE PARTS  
CONNECTION®**  
A DIVISION OF SONIC FRONTIERS INC

# Laurel

## A 300B Single-Ended Amplifier Kit

Checkout our  
New Low Laurel  
Kit Prices

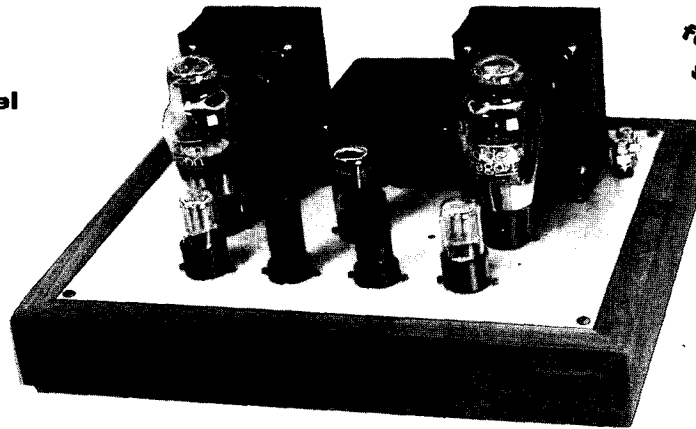

Now Available  
Laurel IIS & IIS  
featuring Magnequests  
Silver Transformers

Hand Wound Output Transformers by MagneQuest™  
Choice of Hovland MusiCap or paper-in-oil Signal Caps  
Assembled on A Beautifully Crafted Walnut and Brass Chassis with Cardas Terminations

*Laurel Stereo*  
w/MagneQuest FS-030 Outputs  
\$1450 Complete / \$1175 Less Tubes

*Laurel III Mono Blocks*  
w/MagneQuest FS-030 Outputs  
\$1700 Complete / \$1425 Less Tubes

*Laurel III Mono Blocks*  
w/MagneQuest DS-025 Outputs  
\$1470 Complete / \$1195 Less Tubes

## Two New Kits from Welborne Labs

The  
**GATEKEEPER™**  
A Unique  
AC Line Conditioner Kit

Priced at \$206\*

\*Includes discount

The  
**"Compleat" Hybrid Linestage**  
Alan Kimmel's Mu-Stage Design  
Selectable Gain  
Accepts a Variety of Tubes  
5814, 5963, 6922, 6DJ8, 6FQ7, 12AU7  
Starting at \$675\*

## Welborne Labs

P.O. Box 260198  
Littleton, CO 80126 USA

Phone: (303) 470-6585  
Fax: (303) 791-5783  
Bus. Hours: Mon.-Fri. 9am to 9pm MST



Send for our *New* 1995 Catalog & Design Manual. It contains over 250 pages of kits, parts, and useful how-to info. Send \$12 U.S. & Canada, \$16 International. Or call/fax with VISA or Mastercard

MIT MultiCap • Kimber Kap • Wonder Cap • Solen • Hovland MusiCap • Largest selection of WIMA capacitors • Siemens • Mallory  
Largest selection of Caddock resistors • Roederstein • Mills • PFT • Strongbox • Vampire • Cardas • WBT • Neutrik • Alcoswitch  
Grayhill • Golden Dragon • Tesla • Sovtek • NOS tubes • Northern Technologies • MagneQuest™ • TKD • Bourns • Noble DH Labs  
Kimber Kable • Linear Technology • Analog Devices • Toshiba • Motorola • IR HexFreds • Caig Labs • Sorbothane TEC-200™ Film  
Kepro • OCSL Books and More!

Try our new *Assist™* Printed Circuit Board Layout Software for PCs. It's the *Only* layout software produced exclusively for audio design. It features: PCB layout, schematic drawing, extensive editing utilities, and libraries of over 200 pre-built component templates and schematic symbols including: tube sockets, op amps, fets, regulators; Caddock, Resista, Holco, Vishay & other resistors; MIT Wonder, Kimber, Solen, Wima & other caps; or create your own libraries of often-used components. Introductory price of just \$35.00 (regularly \$49.95). Or send \$40.00 and get the *Assist™* software and our 250 page Catalog & Design Manual.



# Sound Practices

SOUND PRACTICES [ISSN 1079-1310] is published quarterly by Sound Practices at 9405-C Grouse Meadow Lane, Austin TX 78758. Second Class postage paid at Austin, TX. Printed in the USA.

Please address all correspondence to SOUND PRACTICES Box 180562, Austin, TX 78718. Voice/FAX 512-339-6229. e-mail: SP@tpoint.com. Due to critical time and resource pressures, we must discourage calls for general advice or technical assistance.

This publication exists to encourage audio experimentation and to promote the exchange of related information. Opinions expressed are those of the authors and may not reflect the opinions of any other person or entity.

Subscriptions for Vol. 3 are available at the rate of \$20 yearly in the US, \$24 in Canada, \$30 UK/Europe Airmail, \$35 Elsewhere Airmail. We will start your subscription with the most recent back issue or two, depending on availability.

Sound Practices actively solicits contributions of written material of interest to our readership. Please contact us to discuss your ideas. Display advertising rates and deadlines available upon request.

POSTMASTER: Please send address corrections to Sound Practices, POB 180562, Austin, TX 78718-0562.

## "Winter" 94-95 Contents

Blue Thunder.....	6
<i>Christian Rintelen and R. Luigi Andreoli</i>	
Towards Perfection.....	11
<i>Haden Boardman</i>	
Join the Club.....	20
<i>Joe Roberts</i>	
Flesh and Blood.....	24
<i>Herb Reichert</i>	
Homebrew Gallery.....	28
<i>Readers' Photos</i>	
The Rejuvenation Process.....	31
<i>Heiner Jakobi</i>	
New Triode Development.....	33
<i>George Badger</i>	
The Ultimate .....	36
<i>Rickard Berglund</i>	
Cathode Follower Bridge Amp.....	39
<i>Alan Kimmel</i>	
The Tube Preamp Cookbook.....	45
<i>Allen Wright</i>	
Readers' Forum.....	50

... and MUCH MORE!!!

## The information explosion

Considering the vast possibilities of the written word, it is unfortunate that every major audio magazine these days follows the strictly-commercial "formal review" format. Sure reviews bring in ad revenue and, true, most readers do like to read about new gear. Granted that some review content is both necessary and desirable, one can still argue that large circulation mags could be a lot more than just show reports, endless reviews, recommended component buyers' guides distilled from reviews, and pricey four color ads featuring quotes from reviews in fancy italics.

Back in the 1950s when Hi-Fi was getting started, newsstand audio magazines were focused on the practical ways of sound technology. There were lots of good entry-to-mid-level technical articles, often written by practicing engineers and manufacturers sharing the dope on their latest gizmos. Product reviews were rare and usually limited to a few crisp paragraphs in length when they did pop up. You could actually learn something from mainstream hi-fi mags back in the old days, even if 50% or more of what you were reading was total bunk, just as it is today.

Big audio mags went downhill when all them damn "professional reviewers" nosed into the act, filtering the whole discourse of audio electronics and audio aesthetics down to 2500 word diary-style confessions reliving the neurotic process of formally evaluating item *x*. Even when done well, reviews tend to be more about the psycho-drama of the author's mind than about the gadget under review. On the whole, the formal review is one bone-dry, overworked, and tedious literary formula. How many picky distinctions can one writer make in a single year? How many can you stand to read?

The ultimate tragedy of the formal review magazines is that in exchange for all that highly-skilled editorial effort, acres of fallen timber, and 50 gallon drums of color ink, next year all we'll have to show is a tall pile of boring out-of-date reviews and at most an xtra-slim sheaf of solid articles worth saving to *re-view* for educational purposes.

Thankfully, a popular revolution in audio publishing has been brewing these last few years. The info gates open wider by the month. Lively new labor-of-love small press magazines are popping up everywhere. Some focus on highly esoteric subject matter. Some do reviews in their own ways, some are like scientific journals, and a few are into personal essays, parody, and other literary genres. With some mags, you never really know what to expect upon turning the page. Of course, some of it is nonsense, but at least it's *fresh* nonsense. None of these small axe publications threaten to blow the big boys off the newsstand this year but the beneficial effects of a broadening public dialogue are accumulating.

I can't remember ever encountering such a w-i-d-e variety of audio opinion on the street as we have today. In the new magazines and in the online universe you get to hear a whole chorus of audiophile voices besides the steady nasal drone of the priestly class of pro reviewers. Thanks to the spread of PC communications and affordable desktop publishing, manufacturers, hobbyists, and experimenters—i.e., people who actually *do* things—are getting their ideas and insights into general circulation through the side door.

Ideas move progress and there are a lot of them flying around right now, faster and hotter and farther than ever before. As a result of this beefed-up information flow, we're getting back to a sense of wonder and the kind of productive confusion that can lead to a better audio future and a deeper understanding of our craft over the long run. That's the way it should be.

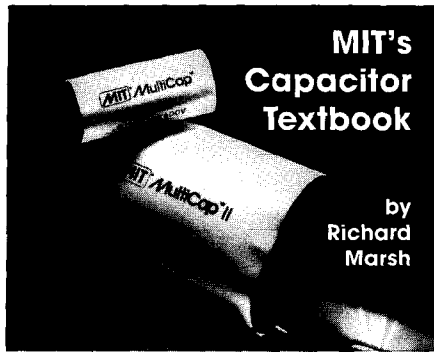

## Debunking the Myths

### Cap Myth # 1

Silver, gold, or stranded lead wires make an ordinary, single-wind cap sound great!

### Cap Fact

The body of the capacitor - not the lead - brings about superior performance:

- On any component part, the shorter the lead, the greater the overall sonic performance.
- PCB mounted caps have leads cut to 1/8 to 1/4 inch long.

**Result:** The rest of the expensive lead metal is tossed away!

- Stranded leads don't fit easily into PCB holes & loose strands reduce reliability & can cause shorts in the circuit.
- Stranded leads reduce capacitor performance by allowing air, moisture & contaminants into the body of the cap through the gaps between strands. Lead insulator material cannot bond as well to the protective epoxy end-fill seal.

**Result:** oxidation & corrosion within the cap

**Result:** increased distortion (ESR), potential cap failure, degraded sonic quality over time

### Solution?

MIT's **MultiCap** leads are single, heavy-gauge tin-coated copper, which forms an excellent seal to maintain low ESR and phase anomalies over time.

In addition, the MultiCap's internal bypass design reduces distortions and saves time & space, insuring immediate value & top performance over the life of your equipment.

Call for copies of Richard Marsh's articles from Audio, The Audio Amateur, and TAS, and MIT white papers on capacitor design.

**And watch for Cap Myth # 2: Plate Materials!**

**MIT** ELECTRONIC COMPONENTS

MUSIC INTERFACE TECHNOLOGIES™  
For National & International Inquiries:

Phone: 916/823-1186 Fax: 916/823-0810

## New Products

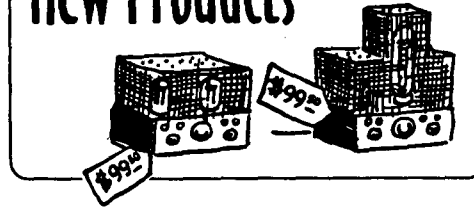

### SHORELINE 800

Grown weary of the power limitations of your single ended 2A3? Looking for an unquestionably stout bass amp for your biamp system? Step up to the Shoreline 800 from Rainbow Electronics, without a doubt the biggest and baddest vacuum tube amplifier on the block.

Each 350 pound monoblock delivers 800 Watts continuous and 6 kilowatt peaks, thanks to the push pull parallel 813 beam power transmitting tube in the output stage. The quantity of current available out of the wall is the limiting factor for peak output in this design. A switch is provided to use only one pair of output tubes in case your circuit breakers can't take the stress or your air conditioner can't keep up with the heat. The 800 comes fitted with grand piano castors for easy mobility.

Shoreline designer John McCormack preaches that POWER is the key to live sound. He claims that the sonic vibrations from the Shoreline 800 travel through walls as if they weren't even there, yet

the amps don't sound "loud" even when hooked up to his horn loaded super high efficiency reference loudspeakers and turned up a few notches past sanity.

The \$100,000 per pair Shoreline 800 gets its name from McCormack's highest goal as an audio designer: to recreate the majestic sound of the ocean crashing against the shore with full impact and presence. Remember when you were a little kid on the beach and the sound of the surf enveloped you? That's the ideal that the Shoreline aspires to recreate.

The argument that tens of thousands of watts is required to reproduce the true dynamic range of naturally occurring sounds is not a new one, but the Shoreline 800 is the first vacuum tube audio amplifier intended for in-home listening that really takes the concept seriously.

Despite its previously unheard of power delivery capability, McCormack views the Shoreline 800 as a mere starting point power-wise. He says that if you really want to experience the sound of the seashore in full glory, you'll have to wait for the Shoreline 25000!

Rainbow Electronics  
5800 Madison Av., Suite G  
Sacramento, CA 95841  
916-334-7277 VOICE  
916-334-7280 FAX



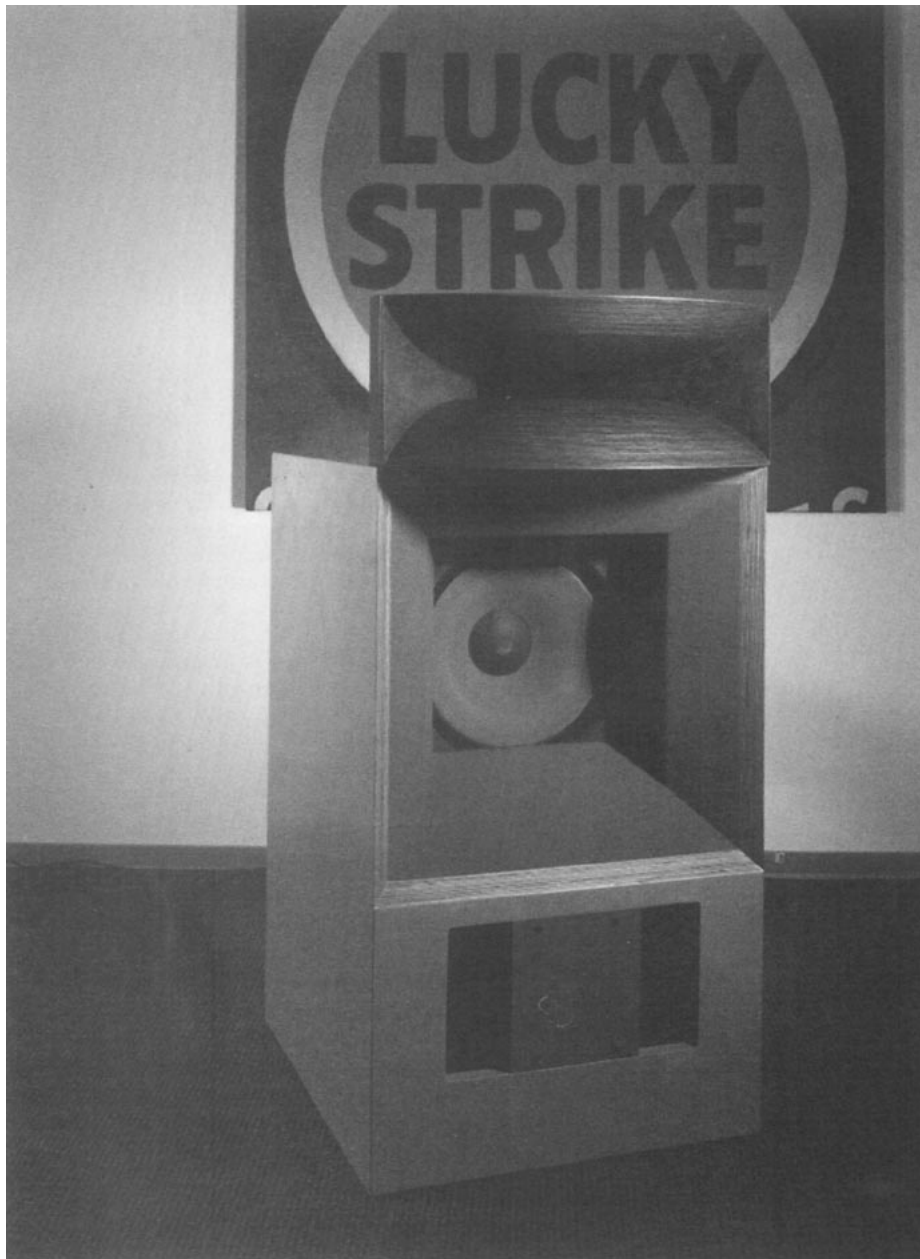

# BLUE THUNDER

*by Christian Rintelen and R. Luigi Andreoli*

It all started with commercially available 94dB/W/m speakers and a custom-built triode amplifier. The virtues of this combination were evident — but so were its flaws. As always, different component swaps confirmed that the speakers were the weak link in the chain.

We looked and listened around for a speaker that would enhance the strengths and tone down the weaknesses of that configuration. But no commercially available speaker met all our requirements: they were either too big or too ugly or colored too much or did not match the amp or . . .

In short, we decided to start from scratch and build a speaker exactly to our taste.

Building a speaker always means dealing with compromises. The no-compromise speaker does not exist, despite all claims by manufacturers. Satisfaction has a lot to do with defining goals and being fully aware of compromises. There will still be a lot of surprises to handle during the process, but it's better to start with fixed goals. Otherwise, it's a never-ending story.

We defined our ideal speaker as follows:

- It should be a true full-range speaker with drivers that handle as much bandwidth as possible, preferably two-way.
- It should be of high efficiency (SPL over 100 dB @1W/1m).
- It should be easy to drive for triode amplifiers (loads, resonances).
- Its sound should be powerful and dynamic — yet natural, detailed and as uncolored as possible.
- It should not only please the ears, but also the eyes.
- It should work well in medium-sized (i.e. 30 m<sup>2</sup>) rooms.
- It should not require a listening distance of more than 4 meters.

We couldn't use the room corners for various reasons, so we had to forget about corner horns like certain Klipsch or Lowther designs.

Which way to go? Our goals were lofty and the restrictions clear. We thus decided from the very start that we were willing to invest in the best available components.

The demand for high efficiency and pleasing esthetics narrowed the choice down to reflex port bass and horn-loaded upper bass systems or Onken-like cabinets. Going two-way all the way, on the other hand, required a driver that could manage all frequencies above 500 Hz. Furthermore, such a driver should be horn-loaded to assure homogeneity with the presumably horn-loaded bass.

There are not many high-efficiency drivers that fulfill these requirements. But an evaluation of the different possibilities showed that one driver was perfectly up to the task—the TAD 4001 compression driver. This 2 inch unit with a beryllium diaphragm has a flat frequency response from 600 Hz to well above 20 kHz and a 12 ohm impedance at the crossover frequency range.

Efficiency is around 110 dB/W/m, due to the 2 kilograms of Alnico magnets. The compression driver weighs a hefty 13 kilograms.

Designing a horn that covers such a wide frequency range with uniform sound dispersion and without high frequency rolloff is a tricky job. We thought about building our own horn using a Hypex or Tractrix expansion. Doing so would require a lot of work and money without guaranteed satisfaction. TAD, on the other hand, offers a horn especially designed for the 4001 compression driver. We decided to go for that option, assuming that the guys at TAD surely know how to tweak the best out of their drivers. After all, their driver/horn combination is considered hot stuff in recording studios all over the world. *[and well received in global audiophile circles, except in the US market where a decades-old divide between pro and high-end gear has prevailed. Of course, the price of the top professional compnents like TAD is somewhat restrictive but Class A high-end speaks ain't cheap either —ed.]*

The TAD horn width is 61 centimeters — a measurement of some significance since we didn't want the speaker to look like a haphazard stack of boxes. The original Onken design is some 80 centimeters wide. Putting the TAD horn on top of it would have been an eyesore. In short, the cabinet of the bass speaker should also be 61 centimeters wide.

This ruled out any Onken-style cabinets with 15 inch woofers, since the area of the reflex openings on that design is equivalent to the driver surface. The Onken bass enclosure was originally designed to be used with transistor amps (even the models with the reduced vents are reported to have a slightly lumpy bass with tube amps compared to transistor designs). It would also have needed a large lower midrange horn to offset the decreasing sound pressure of the direct radiating woofer, so we decided against it.

Comparing the different driver options for the woofer, we went for the Focal Audiom 15 VX II instead of the Altec 416, since the latter needs a 30% larger enclosure volume for the same bottom end. Horn loading all the way down was out of question, since the opening required for 25 Hz would be 4m<sup>2</sup>!

So we settled for a vented cabinet with horn loading down to approximately 120 Hz, similar to the Voice of the Theatre. Tractrix or exponential? The Tractrix curve horns sound good in the 150 to 500 Hz

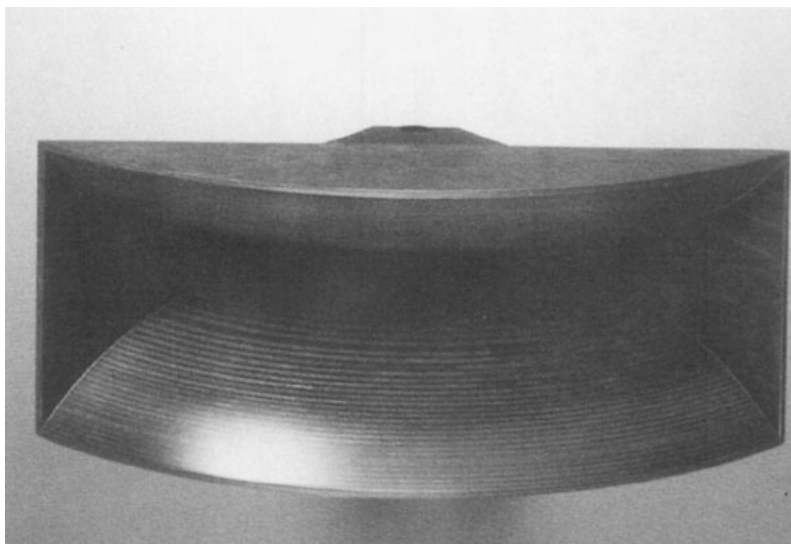

## TD-4001 High-Frequency Driver

The TD-4001 successfully achieves all the design objectives we set forth — very high efficiency, wide and perfectly flat response from 600Hz to 20kHz, and low distortion.

**DIAPHRAGM.** The TD-4001 employs a pure beryllium diaphragm 3-15/16 inches (100mm) across. Beryllium is a light but very rigid material that features very high-speed sound propagation. The weight of the dome section has been reduced to a mere 1g, contributing to the very high efficiency (110dB/W) of this driver.

**VOICE COIL.** The TD-4001 employs an aluminum ribbon voice coil, insulated by alumite film and wound edgewise on the bobbin. The voice coil has a small mass yet offers a high conversion efficiency. The bobbin is formed of polyimide film, displaying excellent heat resistance to temperatures as high as 752°F (400°C).

**MAGNETIC CIRCUIT.** Total magnetic flux is 228,000Mx, with flux density of 20,000G, thanks to the use of a very heavy (6 lbs. 10 oz./3kg) alnico 5DG magnet. An oxygen-free copper shorting ring prevents impedance rise, resulting in low distortion.

**DESIGN.** The TD-4001 is of the rear compression design, which eliminates the resonance and phase distortion produced by a surround. It also eliminates cavity resonance interference, achieving very flat frequency response, extremely natural sound and superb definition. A phasing plug helps smooth the response of extra high frequencies.

**CROSSOVER.** We recommend the use of a crossover frequency of 600Hz or higher, and a cutoff slope of 12dB/oct. or sharper.

### TD-4001 SPECIFICATIONS

**Voice coil impedance:** 16 ohms **Voice coil diameter:** 4 inches/101mm **Equalizing system:** 5-slit type  
**Frequency range:** 600 — 20,000Hz **Maximum input power:** 60 watts (600Hz, — 12dB/oct.) **Sound pressure level:** 110dB/W (1m) **Crossover frequency:** over 600Hz (— 12dB/oct.) **Total magnetic flux:** 228,000 maxwells **Magnetic flux density:** 20,000 gauss **Hole size for throat connection:** 1-15/16 inches/49.4mm **Mounting dimensions:** 4 inches/101.6mm (4 holes) **Weight:** 29 lbs. 12 oz./13.5kg  
**Outer dimensions (diameter × depth):** 7 × 6-1/8 inches/178 × 155.5mm

## TH-4001 Stabilized Dispersion Horn

The TAD TH-4001 is a stabilized dispersion horn designed specifically for use with the TD-4001 high-frequency driver. It allows you to exploit the wide frequency response of this unit, providing excellent dispersion of all frequencies, including high frequencies above 10kHz, a feat rarely achieved by large horns. The dispersion pattern is optimized, based on our measurements of actual room acoustics. As a result, the entire output of the TD-4001 is uniformly distributed over a large area. High resolution is another result of our acoustic engineering. The horn is made of genuine maple, for clean, rich, natural sound.

### TH-4001 SPECIFICATIONS

**Type:** Stabilized dispersion horn **Cut-off frequency:** 320Hz **Flare type:** Hyperbolic curve **Radiation angle:** 90° (horizontal)/40° (vertical) **Throat diameter:** 1-31/32 inches/50mm (suitable driver throat diameter: 1-15/16 inches/49.2mm — 2 inches/50.8mm) **Driver mounting system:** P.C.D. 4 inches/101.6mm L90° 4 bolt mounting **Weight:** 24 lbs. 11 oz./11.2kg **Outer dimensions (W × H × D):** 24-1/8 × 9-7/16 × 16-1/8 inches/612 × 239 × 410mm **Accessories:** Horn mounting hardware pieces × 6, Washers × 6, Bolts with hexagonal heads × 6

US office for TAD Professional Components: Pioneer Electronics Service, Inc.,  
PO Box 1750, Long Beach, CA 90801 Voice 800-872-4159 FAX 310-952-2821

Catalog Descriptions of Technical Audio Devices Horn and Driver



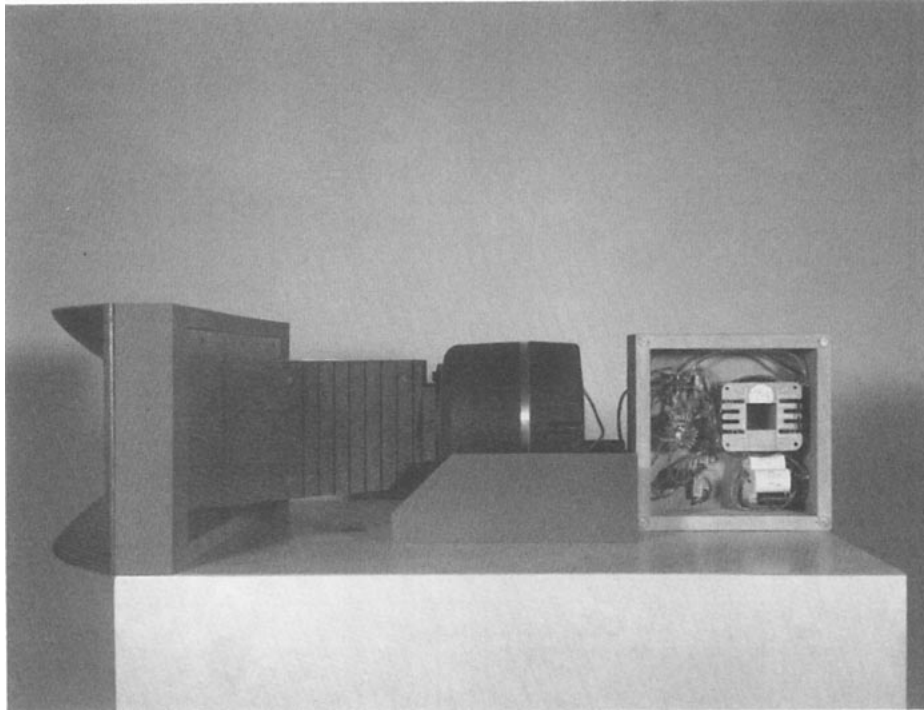

Highpass filter with 0.2 dB per step attenuator, 1.2 mH/0.13 Ohm DCR coil, and five PP caps bypassed with a tinfoil cap shown mounted behind the TAD horn

#### Interior view of bass cabinet.



The interior of the cabinet is lined with black acoustic foam. No further stuffing was used.

Birch plywood "sounds" very nice and is ideally suited for this kind of speaker, but it is a real pain to work with.

Note the two hefty (10 kg each!) 0.27 mH 0.17 Ohm DCR coils made of 5 mm<sup>2</sup> wire used in the symmetrical low pass filter.



range. In addition to this, a Tractrix curve would allow a nice visual effect because the 45 degree angle of the cabinet walls blends perfectly with the miter joints we intended to use for the cabinets. According to Dinsdale's and Lambert's work, the true cutoff in a Tractrix horn occurs at the 70% to 80% point of the mouth area — the cabinet walls precisely made up for this percentage.

The Audiom driver needs a volume of about 220 liters (0.22 m<sup>3</sup>) in a vented cabinet to produce bass down to 40 Hz. Add that to the volume of the horn plus the massive plywood, and you get a fairly big cabinet. With the front being relatively narrow, the speaker looks impressive but neither intimidating nor overly conspicuous. The finished speaker is 61 cm wide, 125 cm high, and 70 cm deep (including midrange horn). It weighs approximately 150 kilograms. The finish is clear lacquer for the enclosure and dove-blue Nextel for the Tractrix horn and the crossover box.

The speaker was intended to be used in bi-amp setup using two stereo amps with 6336 dual triodes in the output stage. The amp allows one to drive the twin power triodes either P-P or SE, since phase-splitting is done in the pre-amp and the four channels of the power amps are each connected with two coaxial leads carrying the 0 and 180 phase signal. For push-pull, both input signals are connected and both sections of the 6336 are driven. Conversion to SE can be done in two seconds by disconnecting the phase inverted input signal, so only one section of the twin power triode is driven. We use P-P for the bass and SE for the midrange.

The crossover frequency is 560Hz with a 12dB design using two huge coils in the bass to minimize DC resistance. We chose a symmetrical configuration since the output transformer of the amp is not grounded. This allows the woofer to be driven equally on both leads. The crossover for the TAD can either be used in a conventional configuration for single amp operation with a stepped attenuator providing 0.2 dB steps or with the attenuator bypassed for bi-amping. The choice of excellent drivers allows simpler crossover designs since you don't need extensive filtering to fix any inherent glitches and flaws.

The Audiom woofers were "burned in" for three days with different frequencies before mounting. Despite our best efforts at initial break in, the bass reproduction continued to improve significantly for half a year!

## Simplified Version of Tractrix Upper Bass Horn

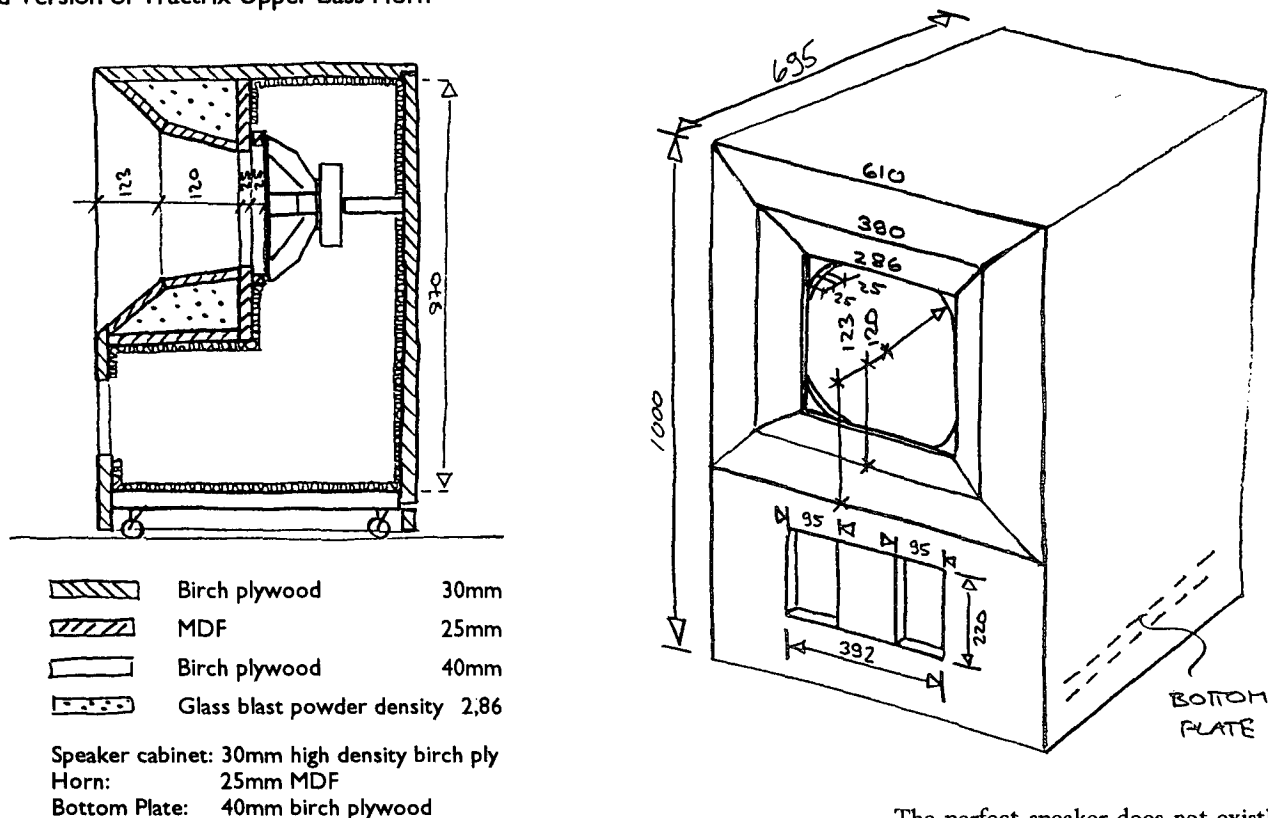

We selected 30 millimeter birch plywood for the cabinet in order to raise cabinet resonance to a point well above the radiated frequencies. The Tractrix horn was made of 25mm MDF — a wise choice considering the many odd angles of the Tractrix horn. The cavity between Tractrix horn and cabinet was filled with sandblast-grade glass beads.

Like everybody, we wanted a speaker capable of credibly reproducing all kinds of recorded music. To us, this "credibility" includes (among other criteria):

- Convincing micro- and macro-dynamics
- Timbral correctness
- No disturbing coloration in any frequency range
- Credible reproduction of sound stage depth and width
- Authority (i.e. the necessary body and air real music has).

Just a brief description of what we ended up with — as unbiased as possible: the speaker produces a big, emotionally involving, but nevertheless precise and thus credible reproduction of the recorded event. It does not turn a lousy recording into gold, but even mediocre recordings and pressings really shine.

The bottom end has tremendous energy and authority. It is fast, colorful, tight and controlled without audible cabinet resonances. It really moves air when kick-drums are kicked. The far left of a piano has the necessary attack and speed to be considered "almost real." Plucked bass is reproduced sonorously with plenty of snap and color.

The midrange is seamless and very homogeneous, despite the crossover in the critical 500 Hz range. Harmonics of bass instruments really "sing." Forget any prejudice about horn speakers not being suited for voices — the TAD sure is. The highs are neutral, extended and sweet. Hot or bright recordings can be tamed by the very fine increments of the attenuator. What is especially pleasing with this two-horn speaker: you don't have to move 6 meters away to get homogeneity and a seamless blend of the two horns — 3 meters is enough.

We are happy with the result. Of course, the speaker is big. But it integrates well into rooms that measure 30 m<sup>2</sup> or more. The money spent on excellent component quality was well invested. Our recommendation to all DIYers: Don't build a big speaker with little money — build a small one with the best components you can afford. It certainly pays off!

The perfect speaker does not exist! A fully horn-loaded bass, for instance, would speed up the bass even more. A super-tweeter above 15 kHz would probably add some extra air and reduce the directionality of high frequencies. And who knows how much more magic a SE 2A3 amp with built in passive crossover would add to the TAD drivers? But that's another story.

### The authors:

Christian Rintelen is a free-lance writer and spends his spare time editing *HiFi Scene*, a Swiss nonprofit underground magazine. Luigi "Blue" Andreoli studied architecture and design. After completing his first houses, he decided that hi-fi is more fun. He hand crafts everything from MC cartridges and amps to speakers of any size. Christian and Blue live in Zürich, Switzerland.

ed.- *Hi-Fi Scene* is one of those mags like *MJ* from Japan and *Costruire Hi-Fi* from Italy that makes a poor monoglot like me wish that Esperanto was the world language. Every progressive audiomaniac would enjoy the vision this "von Kennern für Kenner" German-language magazine offers. Write Christian for more info on this *inspirierte Zeitschrift*.

Hi-Fi Scene  
 Postfach 537  
 CH-8600 Dübendorf  
 SWITZERLAND  
 compuserve: 100043,2451



## THE LOWTHER-VOIGT LEGACY

### Haden Boardman, Mellotone Acoustics

Getting hot under the collar? Cannot find that 100dB/watt speaker to use with yer flea powered single-ended tube amp? Fed up with power sapping crossovers, misaligned phase fouling multiway speakers? Tired of that metal dome tweeter ting and over Q'd bass? Well, read on.

Most multiway speakers suck—period. 99% have crossovers in the 500-5000 Hz range, the area that your hearing and brain are most sensitive to.

Worse still, most makers add a "phasey" dome tweeter (any dome tweet, not just metal 'uns) to the act. The idea of the dome is to disperse the sound as far as possible. The problem is the sound "bounces" off the tweeter's face plate, the loudspeaker cabinet and nearby furniture. This gives the travelling sound wave a small amount of delay, which permanently "masks" the original fine imaging details of the recording, resulting in only LEFT - CENTRE - RIGHT imaging with no, or at least very little, depth of image. Stereo is supposed to be "3D", you do not need surround sound or quadraphonics to fill your room with "3D" sound.

The final problem with "domes" is the fact that most of the dome stays still, most of the sound comes off the edge of the voice coil rather than the mass of the dome. Imagine for a moment, you have a 16mm diameter voice coil dome tweet. 16mm is the full wave length of a 20,625 Hz wave form. Or more importantly, half a 10,312.5 Hz wave form. So if you sit at an odd axis, the sound from the edge furthest away could be out of phase with the edge closest to you. The result is partial cancellation. In practice this is a bit simplistic, but most seem to have ignored the facts, otherwise I am very sure the devilish things would not be so popular.

If you want good imaging, speakers **SHOULD** be directional, only then can they convey the original imaging data encoded in the original stereophonic signal.

Take the LS3/5a and Spica TC50s. Both speakers go out of their way to mask the diffraction and create a controlled dispersion pattern that at least tries to be in phase with itself. Both speakers have a good reputation as far as imaging is concerned. One has to wonder how much better these loudspeakers could have been if the designers had used a cone tweeter instead — presuming that any of the "big boys" in the loudspeaker chassis OEM market made any decent ones.

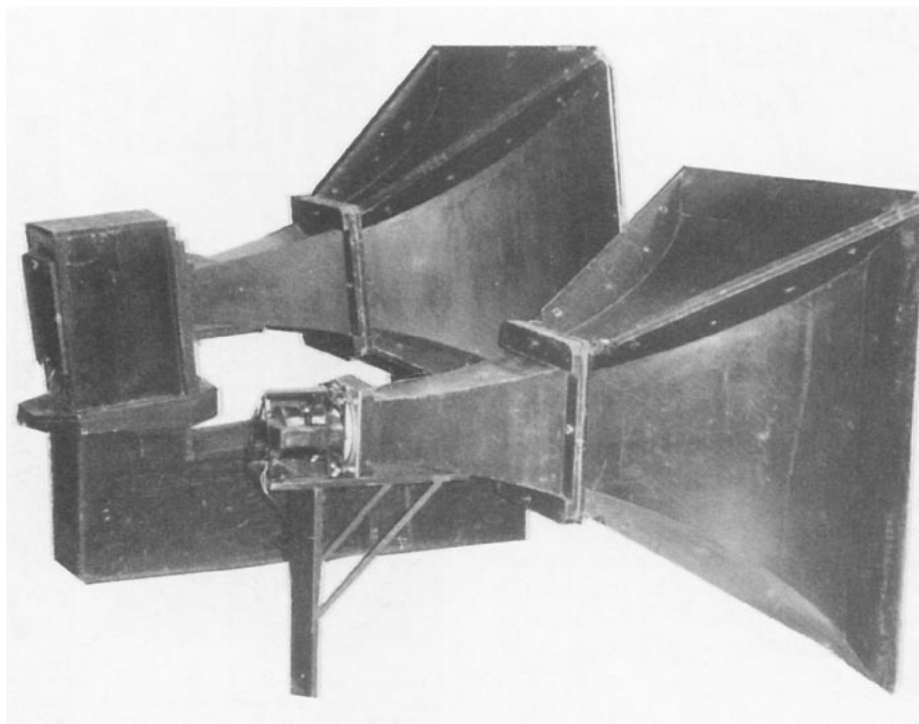

**Original Voigt wooden tratrix cinema horns from the 1930s**



"Good-bye, my dear. I'm off to talk shop with the technical staff at Voigt's demonstration rooms."

We look forward to meeting Mr. Tit and our many other friends again at  
**2, BEACONSFIELD TERRACE ROAD**

(Just opposite the Main Goods Entrance at back of Olympia)

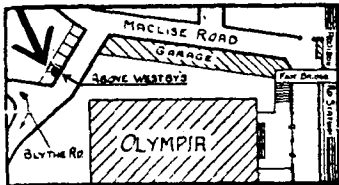

11 a.m. to 1, and 3 to 10.30 p.m.  
(i.e., ½ hour after Olympia closes)

*Come and refresh your ears!*



VOIGT PATENTS LTD

The Courts, Silverdale, London, S.E.26

Phone: SYDeham 6666.

Regd. Office: 22, Castle Street, E.C.1.

### 1939 Voigt Patents Ad

#### The Voigt Legacy

Back to the thread, there is one speaker that is not hard to construct, is efficient, has output past 20 KHz, with no bloody treble ting or bass boom. It is based on the work initially of one gentleman, Mr. P. G. A. H. Voigt.

Back in the 1920s Voigt worked on the design of the moving coil loudspeaker, while

unknown to him at the time, Rice & Kellogg were working on a very similar design, both using a medium sized 6 1/2 inch cone. R & K beat Voigt to the patent, thus denying Paul Voigt whatever fame and fortune was involved.

At this time, Voigt was working for a small English company, J.E. Hough, Ltd. (which later became Edison Bell), manufacturing radios and records. It was here that Voigt patented an early condenser microphone and all electric recording cutting system, instead of the purely acoustic method.

Voigt then left this outfit and set up his own company, Voigts Patents Ltd, after Edison Bell crashed in the Great Slump of 1933. It was now that he began to produce the famous Voigt Corner Horn, which had a mains energised (200 volt, 42 watt) field coil, a single six inch cone, front mounted tractrix horn for the mids and highs and a quarter wave "bass chamber".

A few years later, Voigt patented the "twin cone" cone. If the guy had earned a penny for every twin cone loudspeaker produced after his patent lapsed, he would easily have

been a millionaire several times over. This was added to the Corner Horn, with another clever idea — a double wound voice coil. This must be a pain in the ass to make. The only way I can see it being done is to wind the first coil onto a "forming" rod, wrap the voice coil card over it and then wrap the second coil over the whole lot, presumably adding lots of glue as you go. Incidentally, the voice coil is wound with aluminum wire.

The cone itself is folded from a flat piece of trimmed-to-shape paper, the whole thing held together by glues, lacquers and varnish. Operation of the Voigt Voice Coil spider is very impressive. The cone was terminated in a soft roll surround.

At the same time in the 1930s, another small company was prospering with its "high quality" wireless and gramophone equipment. This company was called "Lowther", run by a Mr. Peter Lowther. The two names were eventually tied up in a marriage that has lasted until the present day.

I often wondered what was the point in making "high quality" equipment, when you

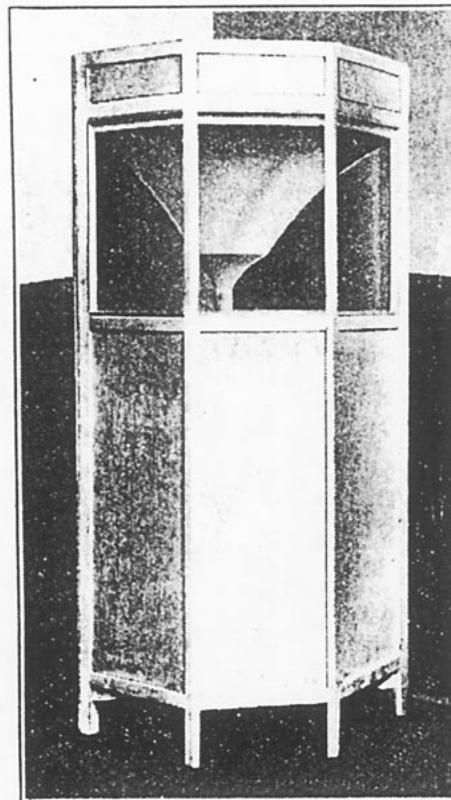

Designed to fit into a corner of the room the latest Voigt domestic speaker has similar characteristics to those of a 4ft.-mouth horn.

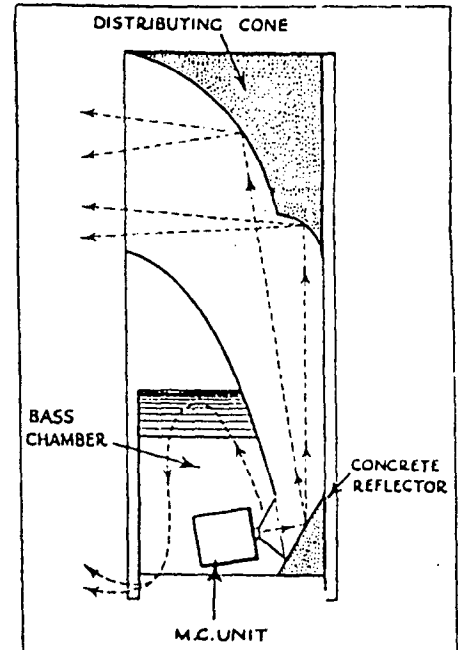

The Voigt Corner Horn of the 1930s used reflectors to tame the directionality of the driver and spread out the sound, making a single speaker sound like a whole band. Perhaps this idea was 100% right for mono but it's 100% wrong for stereo, where the strong directionality of an "unreflected" Lowther driver assists stereo imaging and dimensionality.

played your records with a pick up that lacked any finesse, and was lucky to play anything past 5 kHz. It would have been lucky if the records contained information much higher than this anyway. No FM remember, only AM. Why did Voigt make such joy that his speaker had good output past 13,000? What *was* the point?

It is easy to forget that AM radio is capable of a very high quality of sound reproduction. These days, with stations limited to an 8 kHz bandwidth and crammed on your radio's dial like sardines in a tin, AM is not even lo-fi, it's no-fi.

Sixty years ago the waves were not as crowded. A radio station could take up as much bandwidth as it was capable of. Microphones of quality were around, as were electronics capable of decent bandwidth. Imagine our illustrious radio listener circa 1935. He could tune into one of the BBC's live concerts, free from any kind of processing (practically none existed), straight to the transmitter, and onto an empty radio band, virtually free from interference.

In the home, genuine "radiophiles" would have nothing other than a "straight set" (or TRF, if you prefer). These receivers had massive bandwidth giving good frequency response, and no superheterodyne whistle to hide. Sensitivity was down to the amount of aerial you had up. The most complicated straight sets consist of two stages of R.F. amplification and "diode" to remove the sound wave from the RF carrier wave. Amplification via a couple of PX4 triodes, push pull class A, all driving the Corner Horn. I can imagine the whole thing being quite awesome.

I once built (sort of as a joke) a wide bandwidth AM tuner (TRF of course) and matching transmitter. I was amazed at how good the medium actually was. Perhaps we all took to FM a little too early. At any rate, the early quest for great radio sound was where what later came to be known as Hi-Fi has its roots.

### Lowther through the Hi-Fi Years

Voigt left England soon after the end of WWII hostilities, bad health meant he had to go to the warmer climate of the North Americas. His designs were left in the capable hands of Lowther, and particularly Mr. Donald Chave, although Mr. Mordant, later of Mordant Loudspeakers, also played a very important role.

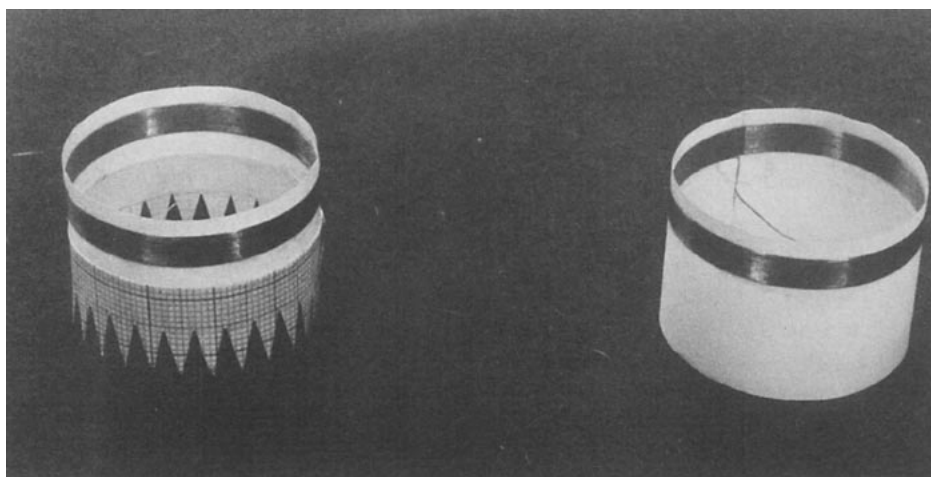

**Dual wound voice coil - Aluminum for low weight**

The original Voigt Corner Horn was carried back into production virtually unchanged after the war. Voigt and Chave, working independently, introduced the first *permanent magnet* drive units in the late 1940s.

Chave's PM-1 unit brought about a small improvement in gap flux, and dispensed with the need for 200 volts DC. The PM2 followed, and around the same time Voigt's original spider disappeared, to be replaced with a more modern type. This switch allowed Chave to fit a "phase plug" in the centre of the voice coil, to prevent the very

high frequencies from cancelling themselves out in the apex of the cone, thereby extending the frequency response from the previous 13,000 to past 18,000 Hz.

The PM3 was the next drive unit to be offered. This was a custom drive unit for the TP1 enclosure, which offered a front mounted Tractrix horn on the front of the units and an exponential horn for the bass. As with the early corner horns, the TP1 must be used in a corner.

An update of the Voigt Corner Horn, the PW2 followed. It was fitted with the new "baby" PM6 unit, which despite its magnet's physical size, had an in-gap flux higher than the PM1 it effectively replaced. The PW2 was not as good as the original Voigt Corner Horn but it was far cheaper.

Later drive units are the PM2 mkII (Lowther's biggest magnet), PM2 mkIII (essentially a mkI with a different mounting bracket), PM4 (a PM2mkII with cobalt pole pieces) and last of the line, the PM7, which despite its smaller size I think is a better unit than the bigger PM2, and much easier to use.

All these units share the same basic cone/chassis. PM2s and the PM4 have a magnet support frame, the original chassis cannot support the full weight of the magnet. The PM3 looks like it is mounted in a saucepan!

There are two options on phase plugs, one is a small beastie that is used in cabinets where the front of the unit is not coupled to a horn, the larger item is for a unit coupled via a horn.

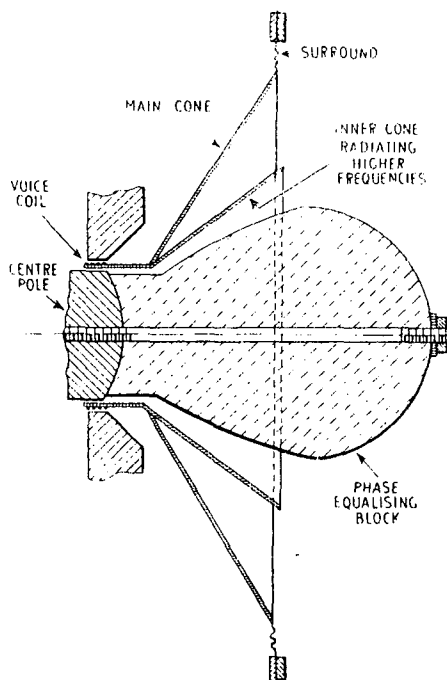

**Cross-section of Lowther-Voigt driver**



# LOWTHER *Drive Units*

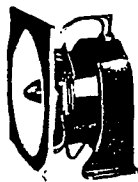

**PM 2 Mk. 1.**  
Gap flux 21,000 gauss. Total flux 281,000 maxwells. Frequency range 20-22,000 Hz. Impedance 15 ohms. Capacity 6 watts. Weight 6 kilos.

**PM 5**  
Size and details as PM2 Mk. 1 BUT with 23,200 gap flux.

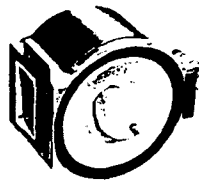

**PM 3** (Not available as a separate unit from TP 1 enclosure.)  
Gap flux 21,000 gauss. Total flux 281,000 maxwells. Frequency range 20-22,000 Hz. Impedance 15 ohms. Capacity 6 watts. Weight 10 kilos.

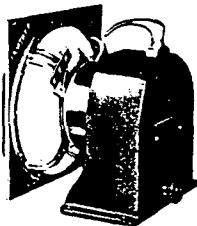

**PM 2 Mk. II**  
Gap flux 23,000 gauss Total flux 350,000 maxwells. Frequency range 20-22,000 Hz. Impedance 15 ohms. Capacity 6 watts. Weight 8 kilos.

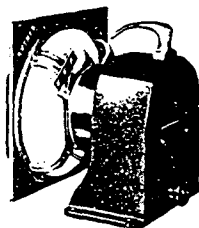

**PM 3/5**  
This improved PM 3 unit has a gap flux of 23,200 gauss.

**PM 4**  
Gap flux 24,000 gauss. Total flux 385,000 maxwells. Frequency range 20-24,000 Hz. Impedance 15 ohms. Capacity 6 watts. Weight 8 kilos. PM 4 drivers are fitted with special cobalt alloy pole pieces.



**PM 6**  
Gap flux 17,500 gauss. Total flux 196,000 maxwells. Frequency range 20-22,000 Hz. Impedance 15 ohms. Capacity 6 watts. Weight 3 kilos.



**PM 7**  
Gap flux 19,650 gauss. Total flux 250,000 maxwells. Frequency range 20-20,000 Hz. Impedance 15 ohms. Capacity 6 watts. Weight 4 kilos.

The special design of the PM 6 drive unit preserves the fundamental to harmonic relationship throughout the entire audio range, thereby ensuring smooth, natural sound. Designed especially to meet the requirements of horn-loaded operation, the PM 6 should never be used as a conventional direct radiator.

PM 6 Mk. I is a PM 6 magnet assembly with a new diaphragm assembly: LOWTHER SPECIAL SILVER speech coil, roll surround and back centering providing an improved performance.

**Representative Lowther lineup from late '60s through early '70s**

Lowther's mainstay cabinet range during the 1960s was called the Acousta line. Originally in two forms, an odd looking corner thing, that fired the unit into the room's corner, and a much better model, with the unit and mouth of the horn pointing at you. Most Lowther cabinets were now fitted with constant width rear horn, the exceptions being TP1, Audiovector and the L.I.B. (Lowther Ideal Baffle, which used a "drone cone").

Chave constantly updated the designs. The small Corner Acousta became the Dual Position Acousta, and the standard Acousta was updated to suit the PM6 and PM7 units.

Throughout the 1970s countless different variations on the Acousta theme appeared. Mini Acoustas, Super Acoustas, Twin Acoustas — you get the picture. Cabinet material changed from ply to MDF. In my humble opinion, this was a BIG mistake. Chave should have listened to Voigt's then thirty year old ideas.

## Lowther Today

Later in the early '80s, Lowther were the last to switch over to ceramic magnets from the alnico/ticonal they had previously used, although thankfully they still manufacture the original superior units. The current owners of Lowther are convinced ceramics are much better than the alnicos. You can guess what I think.

The current line includes several models using the "BICOR" principle, wherein two different sized horns are fitted to one cabinet. I make no bones about not liking one bit of these designs, although others swear by them.

In recent times, the design of the basket has been improved to some extent. Over the years, there were four generations of Lowther-Voigt drive units: early mains energized electromagnetic units, the mainstay of the '50s through the early '70s one piece alloy cast chassis, to the latest "black" chassis. During the '70s some production was fitted with a plastic basket.

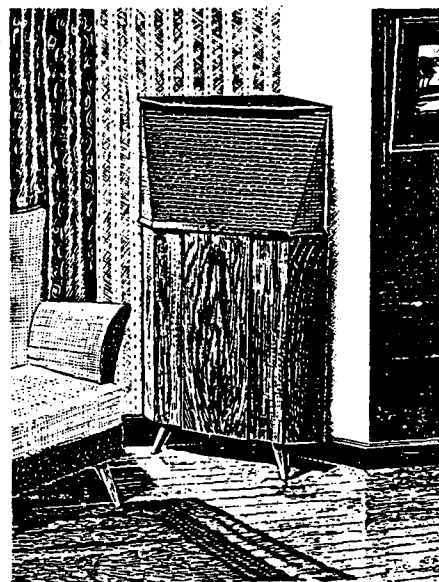

Corner housing Type P.W.2, Walnut Finish.

**Build the 1964 Acostas**

The design we are presenting here in *Sound Practices* is the 1964 version of the full size Acousta. This model will work happily with PM6A, PM7A, or if you are on a tight budget, the PM6C. It is a pretty self explanatory blueprint, an' I am no great woodworker, but I would offer these few tips:

Always build a folded horn from the best grade of ply you can afford. NEVER use MDF. When assembling the cabinet make sure you sand all of the internal joints so they are s-m-o-o-t-h, this is especially important near the "neck" of the horn. If you have rough patches, the bass horn loses its efficiency. Worse still, if it is rough near the neck, soundwaves reflect back through the cone and give the sound a "dirty" complexion.

PM6 ceramics have three problems not associated with their Alnico brothers. First the large ceramic puck reflects sound from the rear of the cone back towards it, the alnico version has carefully shaped magnets to avoid this problem. Unfortunately, it would be impossible to duplicate it in ceramic.

Due to this magnet shape, to use the ceramic speaker you must make a "gasket" of 1/4" ply, because there ain't no way that big ceramic baby is gonna fit in the li'l magnet box given in the 1964 plans.

Final problem with the PM6C is more serious and a touch bizarre. For some strange and unexplained reason, Lowther fit a cone to the ceramics which is embossed with an annular pattern. I call this cone the "ribbed for extra sensation", I suppose it is whatever takes your fancy. I can see what they are trying to do, they are trying to stop "bell mode" cone breakup. Problem is, it does not help the other cone breakup mode, the "concentric" mode. The originals have a much better idea. "Diagonal" patterns are deeply embossed into the paper cone. This helps stop both "concentric" and "bell" modes of cone breakup from occurring.

At the end of the day I must conclude that unless you are totally and utterly strapped for cash, go for a pair of PM6 or PM7 alnicos. 'Tis the best, no doubt.

Sound wise all three magnet options kick ass. Even the "ribbed for extra sensation" PM6C sounds good. I use a pair of carefully made Acousta fitted with PM7A drivers.

# LOWTHER

## CORNER REPRODUCERS MODEL T.P.1

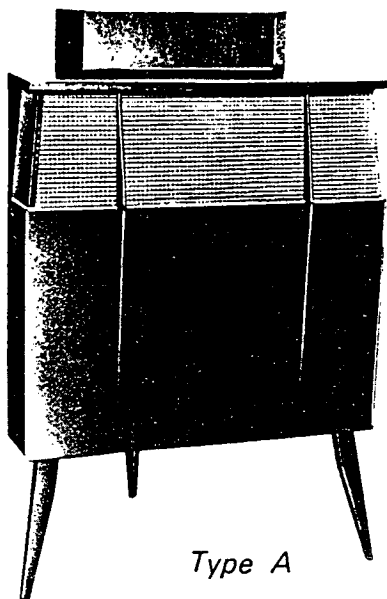

Type A

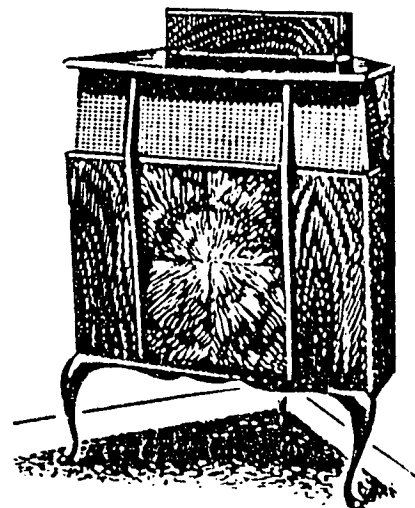

TYPE B

Model 'C'

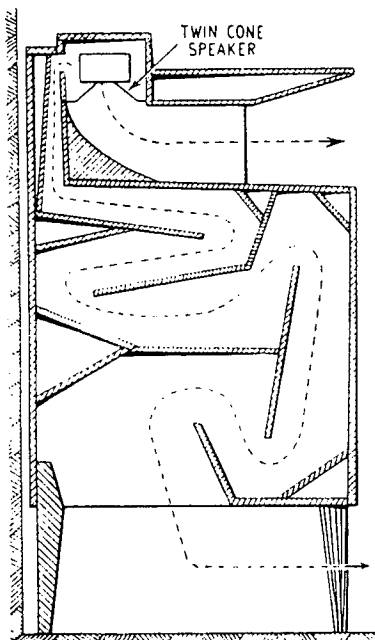
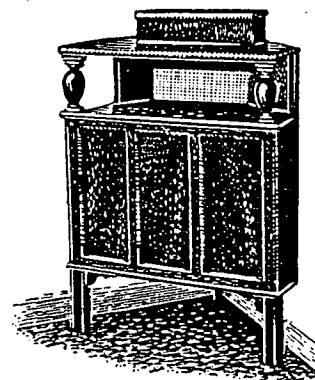

UPPER MIDDLE AND HIGH FREQUENCIES RADIATED FROM SHORT HORN

LOWER MIDDLE AND LOW FREQUENCIES RADIATED FROM REAR OF CONE VIA FOLDED HORN

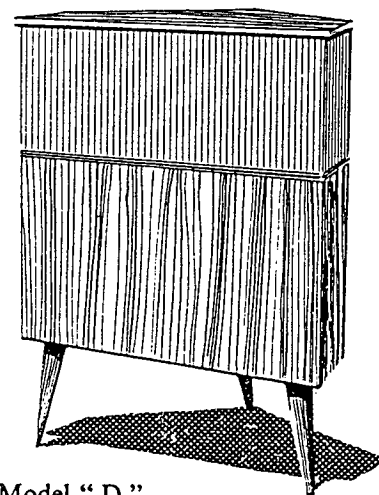

Model "D"

## MODERN LOWTHER DRIVERS

ABRIDGED SPECIFICATIONS Specifications abrégées Kurz Spezifikationen	PM6A	PM7A	PM2A	PM5	PM4
Overall Diameter Diamètre hors tout Gesamt - Ø	23.2cm	23.2cm	23.2cm	23.2cm	23.2cm
Overall depth Épaisseur hors tout Gesamttiefe	10.5cm	11.0cm	13.0cm	13.0cm	15.5cm
PCD Mounting Centres Ø de cercle primitif de centres de montage Teilkeis-Ø D.Befestigungspunkte	20.8cm	20.8cm	20.8cm	20.8cm	20.8cm
Baffle hole cut-out Ouverture du baffle Schallwandöffnungs - Ø	19cm	19cm	19cm	19cm	19cm
Voice coil diameter Diamètre de la bobine mobile Schwingspulen-Ø	3.9cm	3.9cm	3.9cm	3.9cm	3.9cm
Voice coil impedance (nominal) Impédance de la bobine mobile Schwingspulenimpedanz	8 or 15ohm	8 or 15ohm	8 or 15ohm	8 or 15ohm	8 or 15ohm
Air gap width Entrée Luftspalt	1mm	1mm	1mm	1mm	1mm
Magnet type Type d'aimant Magnetttype	Alcomax 2	Alcomax 3	Alcomax 3	Alcomax 3	Alcomax 3
Flux Density (1 Tesla = 10,000 Gauss) Densité du flux Kraftliniendichte	1.75 Tesla	1.95 Tesla	2.1 Tesla	2.3 Tesla	2.4 Tesla
Diaphragm Diaphragme Membran	Twin-paper Double/papier Doppelmembran/pappe				
Frequency response Réponse de fréquence Übertragungsbereich	30Hz-20kHz	30Hz-20kHz	30Hz-22kHz	30Hz-22kHz	30Hz-22kHz
Nominal air resonance Résonance nominale à l'air libre Nennresonanzwert in freier Luft	36Hz	36Hz	36Hz	36Hz	36Hz
Sensitivity at 1m/1kHz/1Watt Sensibilité 0.2MN/m <sup>2</sup> Anspruchempfindlichkeit 0.2MN/m <sup>2</sup>	96db	96db	97db	98db	98db
Maximum voice coil travel Déplacement de la bobine mobile Schwingspulenweg	±1mm	±1mm	±1mm	±1mm	±1mm
Shipping weight Poids d'expédition Versandgewicht	4.0kg	4.0kg	6.0kg	6.5kg	10.0kg

ABRIDGED SPECIFICATIONS Specifications abrégées Kurz Spezifikationen	45C	55C	PM6C	PM7C	PM2C
Overall Diameter Diamètre hors tout Gesamt - Ø	17.4 cm	17.4cm	23.2cm	23.2cm	23.2cm
Overall depth Épaisseur hors tout Gesamttiefe	5.6cm	5.8cm	7.6cm	7.6cm	7.8cm
PCD Mounting Centres Ø de cercle primitif de centres de montage Teilkeis-Ø D.Befestigungspunkte	15.6cm	15.6cm	20.8cm	20.8cm	20.8cm
Baffle hole cut-out Ouverture du baffle Schallwandöffnungs - Ø	14cm	14cm	19cm	19cm	19cm
Voice coil diameter Diamètre de la bobine mobile Schwingspulen-Ø	3.9cm	3.9cm	3.9cm	3.9cm	3.9cm
Voice coil impedance (nominal) Impédance de la bobine mobile Schwingspulenimpedanz	8ohm	8ohm	8ohm	8ohm	8ohm
Air gap width Entrée Luftspalt	1mm	1mm	1mm	1mm	1mm
Magnet type Type d'aimant Magnetttype	Feroba 2	Feroba 2	Feroba 2	Feroba 2	Feroba 2
Flux Density (1 Tesla = 10,000 Gauss) Densité du flux Kraftliniendichte	1.75 Tesla	1.98 Tesla	1.75 Tesla	1.88 Tesla	2.1 Tesla
Diaphragm Diaphragme Membran	Twin-paper Double/papier Doppelmembran/pappe				
Frequency response Réponse de fréquence Übertragungsbereich	80Hz-20kHz	80Hz-22kHz	30Hz-20kHz	30Hz-20kHz	30Hz-20kHz
Nominal air resonance Résonance nominale à l'air libre Nennresonanzwert in freier Luft	60Hz	80Hz	36Hz	36Hz	36Hz
Sensitivity at 1m/1kHz/1Watt Sensibilité 0.2MN/m <sup>2</sup> Anspruchempfindlichkeit 0.2MN/m <sup>2</sup>	93db	94db	95db	96db	97db
Maximum voice coil travel Déplacement de la bobine mobile Schwingspulenweg	±1mm	±1mm	±1mm	±1mm	±1mm
Shipping weight Poids d'expédition Versandgewicht	2.5kg	3.0kg	3.0kg	3.5kg	4.0kg

They are totally compelling. The stronger the magnet, the more high frequencies you get. The '6C has a pleasant, almost "soft" sound compared to the more expensive Alnico versions. If you are having hum problems with your setup, the '6C might be the one to go for due to its lower (97 dB) sensitivity. Overall, the '6C is very easy on the ear.

By way of improvement, the Alnico PM6A gives an extra 3 dB sensitivity and a "cleaner" presentation. With the Cs you are aware you are listening to Hi-Fi, but the '6As just disappear, leaving only the music behind. The music seems to come from nowhere.

The PM7s go all the way. It is amazing how much extra detail these babies can pull out of the signal. The PM7 is even higher sensitivity (102 dB/1W), cleaner, sharper, and more focused. If these drive units were cameras, the 6C would be a Leica miniature, the 6A a Bronica, and the 7A without doubt a Hasselblad.

If you have carefully constructed the cabinet, you should have very little coloration,



Acousta cabinet fitted with PM7A

and by the time you have "tuned in" (this process usually takes five minutes) you will not notice any.

At first audition, the Acoustas will seem odd. The bass will appear thin, the treble will lack sparkle, but the sound will grab your attention. All of a sudden, a real bass note will come along—BANG you are blown out of your chair by a pair of 6" woofers. A cymbal is brushed and then tapped, at last you can hear the difference. No more phasy ting or engineered bass bloom, everything very natural.

I guarantee you have not experienced anything as dynamic and true to life as this speaker, regardless of your choice of drive units. A 1 watt per channel amp will make your ears bleed (unless you are in a very large room, and then you may have to insist on at least a 2A3 SE).

The Acoustas are so "correct" you will find everything else "odd". If you try to switch back to your TING-BOOM speakers, you now will hear real coloration, and you won't like it.

Be careful to sit on axis with the Acoustas, off axis the sound takes on a woody coloration. The HF is very directional. Sometimes moving your head an inch can cause the highs to do a disappearing act.

My fave Lowther design is the classic TP-1. This speaker is the best. There is a school of thought in audio that if something is buttugly, it must work well. The TP-1 is the most odd looking piece of woodwork I have ever clapped eyes on. Whoever decided to fit this thing with Regency style Queen Anne legs must have had a sense of humor. The damn thing looks alive in the corner of the room, almost like some strange robot from a B movie.

But the sound . . . the front horn gives them more presence and less "spotlight" treble than the smaller Acoustas. The bass is just awesome. Even heavy rock fans will love the TP-1.

Given the choice of either a pair of Tannoy 15" silvers/Lancaster cabinets or Quad ESLs against the Acoustas or TP-1s, Lowther wins hands down. It is far more natural, more lifelike, more "you are there", less from a box, less from a pile o' tubes, capacitors and resistors.

If sourcing drive units second hand, be careful. Lowther were one of the first to go to foam surrounds, which have usually rotted by now. Lowther-Voigt in the UK will repair them, but at a high price. NEVER use a Lowther with any transistor amp that comes on with a thud! Any amount of DC through the coil will see the inner voice coil fall off the former, with disastrous and expensive results.

The gap between pole pieces in the Lowther drivers is very small compared with most designs. This helps to saturate the voice coil in magnetism. The PM4A is the only speaker made that has a totally saturated voice coil gap. 24,000 gauss! Nothing comes close.

Even a lowly PM6C has a good magnet to cone mass ratio. It has to in order to get the high frequencies. If a PM4 were a car, it would have a power to weight ratio of 1,000,000 BHP per ton!

It is interesting to note that mechanically the units cross over twice. Very high frequencies come directly off the edge of the inner voice coil (hence the need for a phase

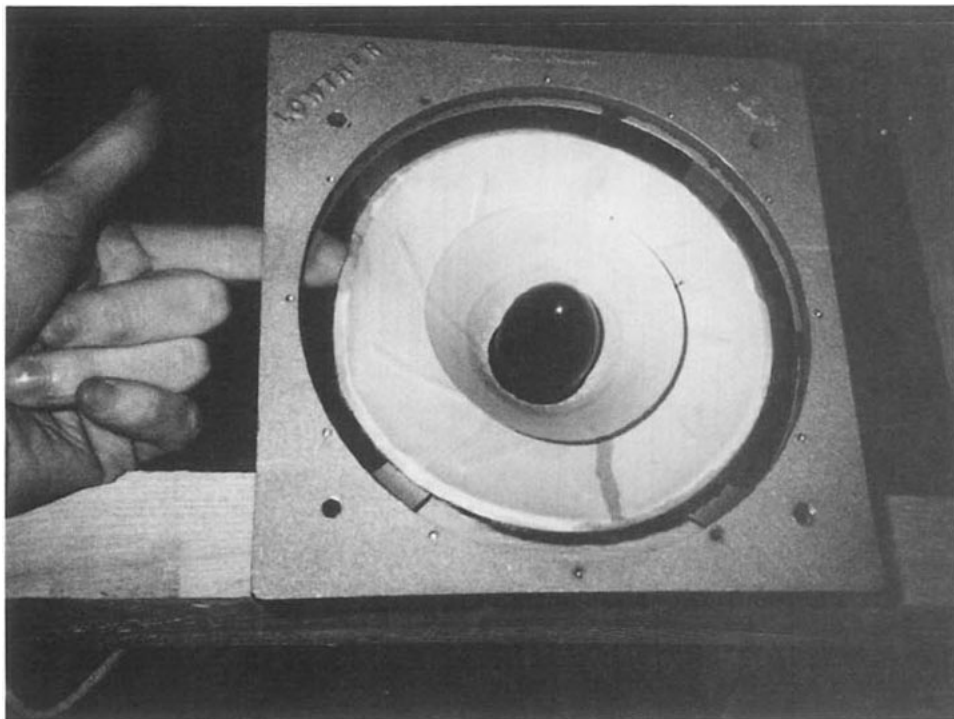

**When buying vintage Lowther drivers, watch that foam!**

plug), the next frequencies down are handled by the "whizzer" cone, and finally the 6" cone.

Nothing is ever perfect, on a swept frequency response the Lowthers do themselves no favours (especially the PM6A, which has a curious peak at 11 kHz, adding a bit of false presence). But on a pulse test, they are in the electrostatic class.

If you overload them they damage very quickly, a small SE or small PP amp is *de rigueur*. When forced to handle 15 watts, you can make the voice coil fry. Just remember that 15 watts in a Lowther is in excess of 111dB! That is painful. Most owners will NEVER use any more than 1,000 milliwatts of power.

Prices of Lowther drive units vary from £250 for PM6C up to £900 for a pair of PM4A. Second-hand prices vary wildly from country to country—just watch that foam on vintage units.

TP1 and Audiovector cabinets fetch very high prices, justifiably so. In my estimation, Lowther can offer no new complete loudspeaker to match these underrated classics.

I get the feeling that the factory considers the old top of the line cabinets somewhat old fashioned and dumb, but they sound as good today as they ever did. The TP-1 is

certainly not an amateur woodworking project but if you have the skill and the plans, go for it. If you happen to have the plans for the original TP-1, *pleeeze* send me a copy care of SP, so I can get myself a pair.

Perhaps price has something to do with it. In 1962, a Tannoy 15" dual concentric cost £37 10s, while a Lowther PM4 cost £48! The price of TP-1A was just under £200 a pair. For what you're getting for your money, I consider the present selling price of Lowther drivers to be far too cheap. Buy yours now before they realize and shove the price up!

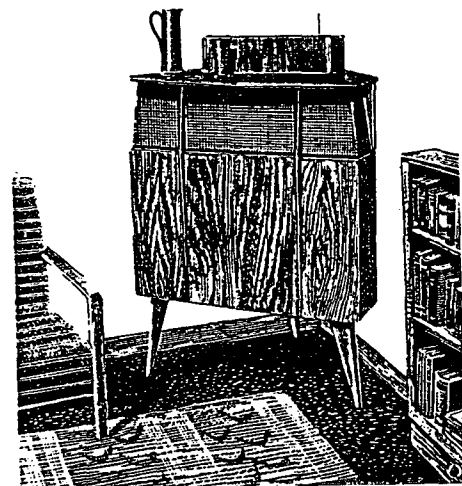

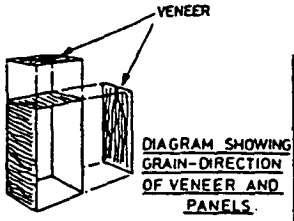

BACK REBATE AS FOR  
BOTTOM PANEL

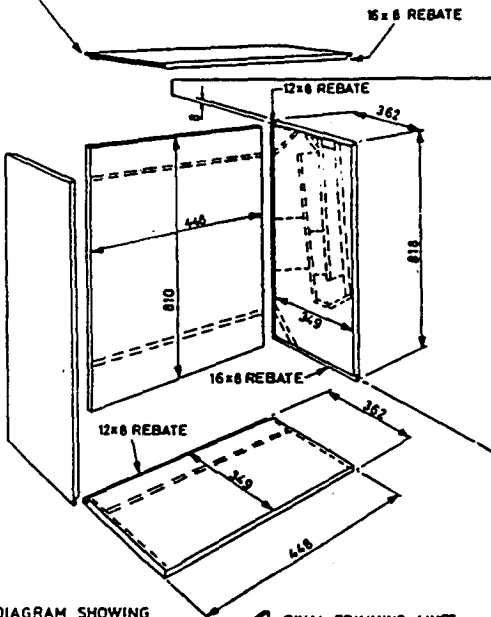
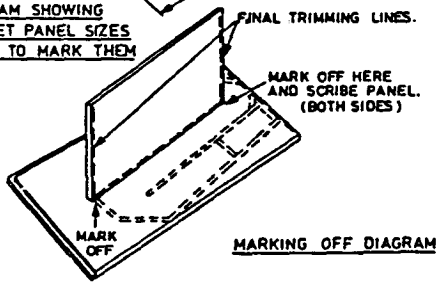
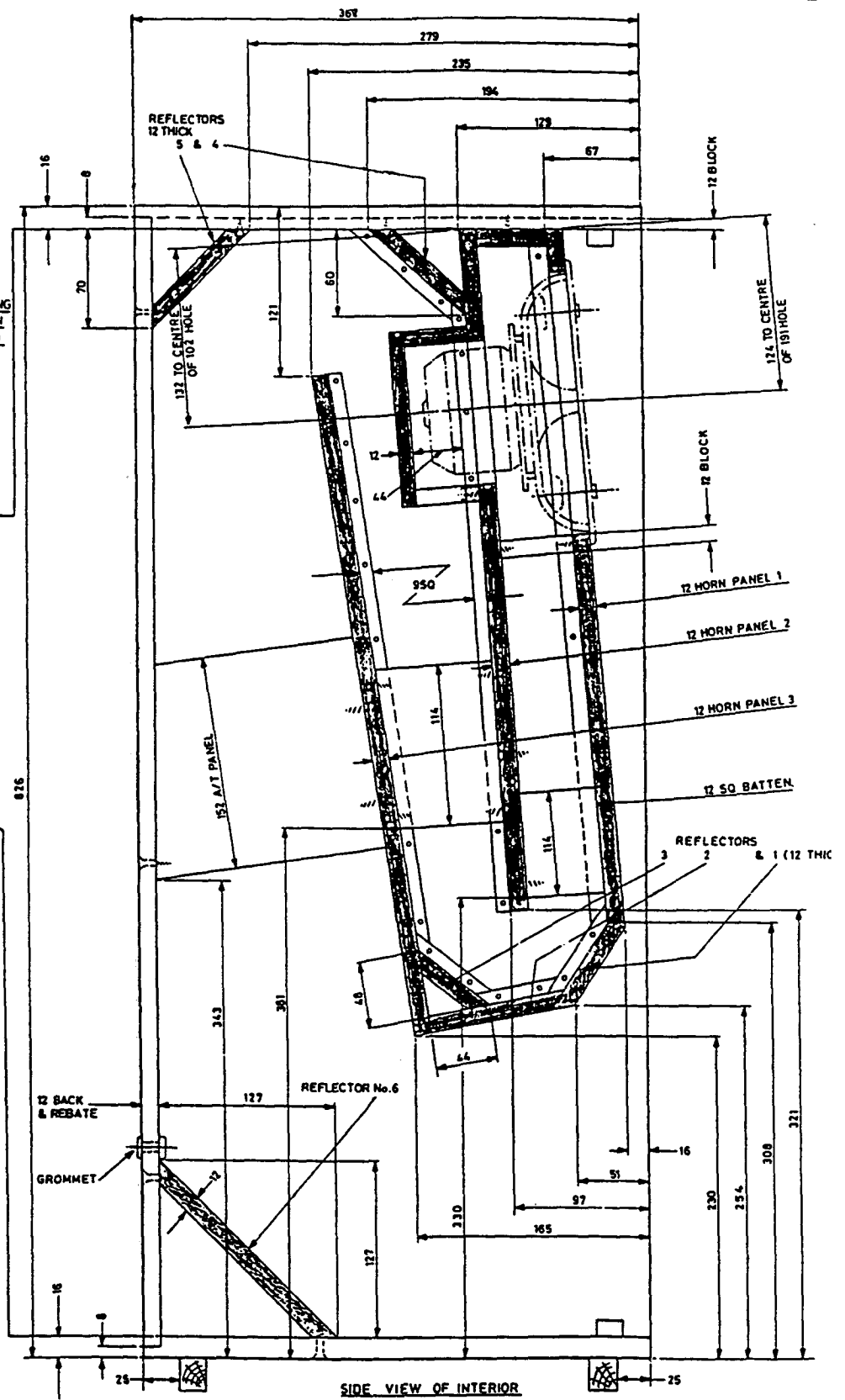

DIAGRAM SHOWING  
CABINET PANEL SIZES  
& HOW TO MARK THEM  
OUT.



**THIS ENCLOSURE IS DESIGNED  
FOR USE WITH THE LOWTHER  
PM6 DRIVE UNIT.**





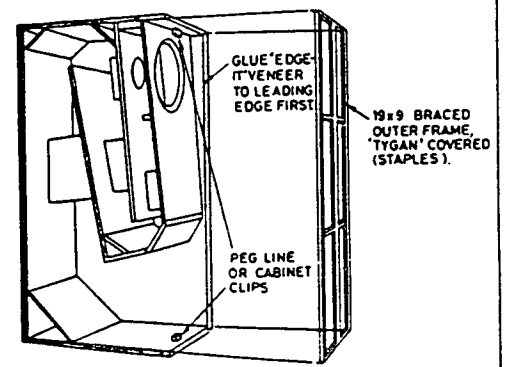
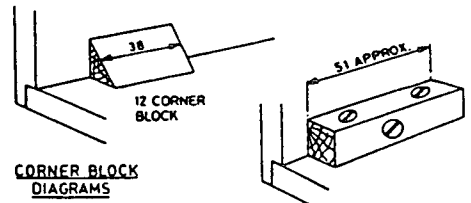
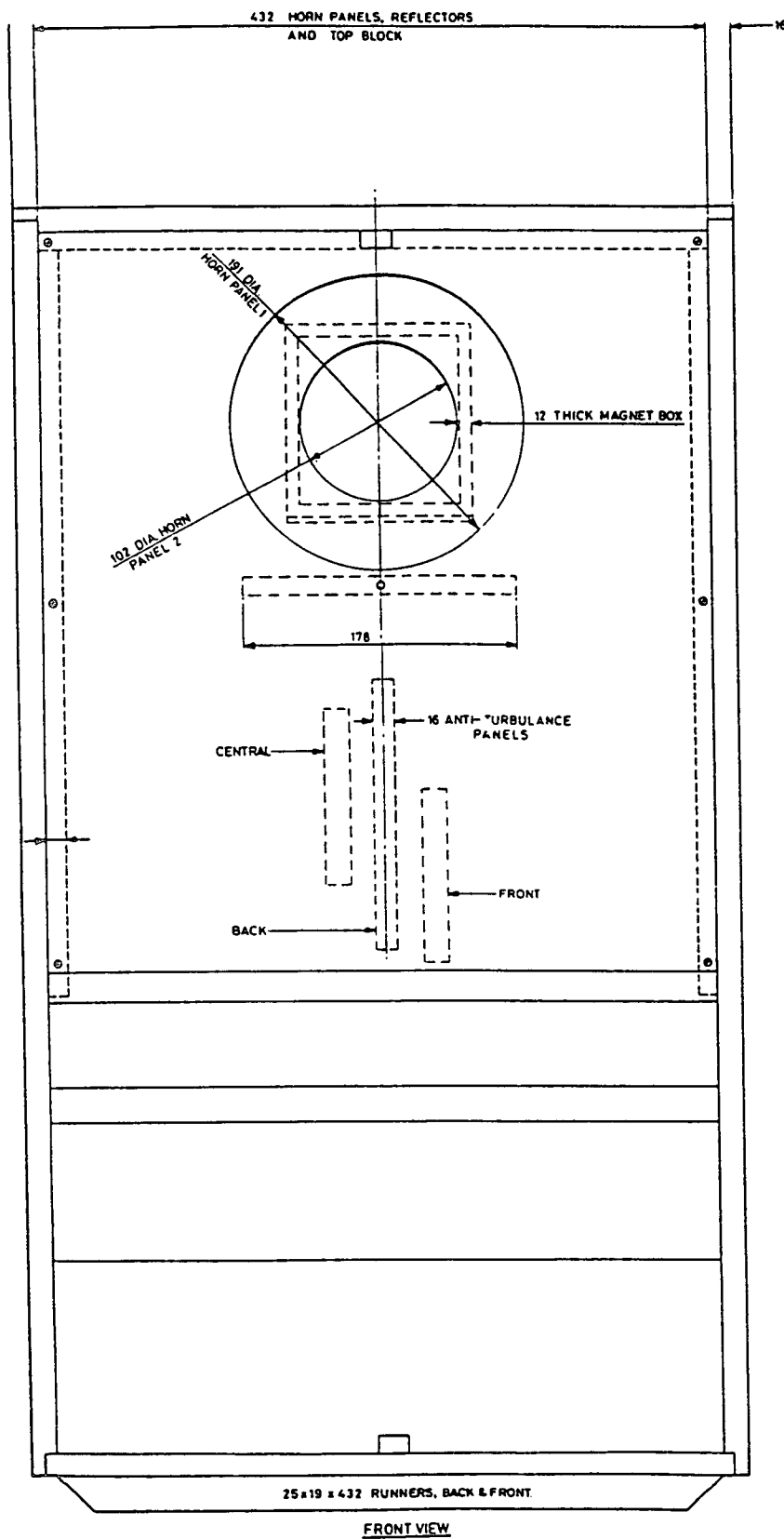

CUTTING LIST

DESCRIPTION	SIZE	N <sup>o</sup> OFF	DESCRIPTION	SIZE	N <sup>o</sup> OFF
16 BLOCKBOARD*			REFLECTOR 1	86 x 432	1
SIDE PANELS	826 x 362	2	" 2	98 x 432	1
TOP PANEL	464 x 362	1	" 3	67 x 432	1
BOTTOM PANEL	451 x 362	1	" 4	95 x 432	1
			" 5	98 x 432	1
			" 6	178 x 432	1
12 BLOCKBOARD			BATTENS	1250 x 495	2
BACK PANEL	821 x 451	1	"	950 x 432	2
HORN PANEL 3	478 x 432	1	"	950 x 407	2
HORN PANEL 2	491 x 432	1	"	950 x 73	2
HORN PANEL 1	503 x 432	1	"	950 x 70	2
MAGNET BOX	127 x 127	1	"	950 x 60	2
"	127 x 51	2	"	950 x 70	2
"	102 x 51	2			
HORN PANEL SPACERS	56 x 432	1	RUNNERS	25 x 19 x 432	2
"	52 x 178	1	BRACED FRAME	19 x 9 x 408	1
A/T PANEL	152 x 165	1			
"	114 x 90	1			
"	114 x 54	1			

\* OR GOOD QUALITY CHIPBOARD.

ALL DIMENSIONS IN MILLIMETRES.

REV No.	DESCRIPTION	No. OFF	DRG. No.	MATERIAL	REMARKS
	THE LOWTHER ACOUSTIC 115 ENCLOSURE		LOWTHER ONLIFE DEVELOPMENT LTD. BROMLEY, KENT, ENGLAND		
	D.O.P.	D.O.P.	SCALE: AS SPECIFIED	DRG. No. 651 SHT. 1	
	<small>1:6.71 REDRAWN DRAWING ORIGINALLY QUARTER FULL SIZE NOW HALF SCALE AND DRAWING CONVERTED TO MILLIMETER DIMENSIONS.</small>				
	<small>DATE</small>				
	<small>MODIFICATION</small>				



# Join the Club!

by Joe Roberts

Like all 20th Century American youth, I was brought up to believe in the inevitability of progress. Over time, I realized that some very worthy concepts and tools disappeared in the marketplace scramble over the decades. You can find good stuff under all those Kraco 8 track players, LED wrist-watches, IBM Selectric typewriters, blown out Phase Linear amplifiers, 6 V tube car radios, and Commodore 64 computers down at the town dump. Might even unearth a few directly heated triodes if you dig deep enough.

Some observers call the current interest in vacuum tube technology *retro* audio, as if to say "aha, *nostalgia* buffs". True that some of us are history students, but most are just looking for some good tunes in 1995, don't know anything about all that old junk, and often couldn't care less. People who are listening to triode amps proudly consider themselves to be *futurists* not retro geeks. Triode listeners are not living in the past.

And why should they want to? There is a lot going on in the audio universe right here in 1995. In particular, the tube scene is healthier than it has been for decades, maybe since the rise of the transistor. There is no longer any need to be an antique hound if you're into hollow state. You can build an amp out of triodes and fancy output transformers that came out only this year if you really want to be *au courant* and whatnot.

After fifteen years of push-pull parallel 6550 amps, audio was certainly ready to take the next step. I admit that reproducing music is an astoundingly difficult feat, but we weren't even getting *close* with most of the fake rackmount tube amps of the high-end era. Who's fooling who?

Okay, so maybe we haven't come *that* far since 1992, but at least there's real excitement in the air for a change. People who have been in audio all their lives feel like they're really getting somewhere bringing music home, often just when they were on the verge of giving up the quest, selling the Gold Lion KT-88s in the safe deposit box, and investing the proceeds in a remote control home theater setup.

Perhaps after all the hype and love at first sight about triode amplifiers evaporates and we have a chance to absorb what we're hearing, maybe it will turn out that we really *are* learning something important about music reproduction in the flux and confusion of the present moment. Maybe in a few years we'll really learn how to use tubes to play music. Hope springs eternal.

What people are calling *retro*, I call refusing to let a good idea die. A good idea is one we can still learn something from, regardless of vintage. We sure can't go home to the Thirties after twenty years of reading *TAS* and *Stereophile*. Just because you use a few classic parts and techniques out of Lee de Forest's attic doesn't mean you're a time traveler. We're headed into the future on a one way track. Ain't no going back.

Yesterday's brilliant solutions become quaint curiosities when they no longer answer the questions that are being asked. New goals and changing technological contexts leave two year old hi-tech wonder products sitting by the curb on trash night. Obsolescence often doesn't have anything to do with user satisfaction or what a user would consider quality. It's usually a business decision, based on cold numbers alone.

Freedom of choice for the mass consumer ultimately boils down to freedom to choose

from whatever they're trying to sell you at any given point in time. You can only eat what is on the menu — unless, of course, you're willing to cook for yourself.

Today we're experiencing a refreshing initiative among audio people to create our own idiosyncratic niche of electronics, based on the best of the past, present, and future. We're moving beyond obsolescence, nostalgia, and the tunnel vision of the mainstream. The synthesis of hindsight and forward thinking we're seeing today is a sign of maturity, experience, and an emergent late 20th c. pragmatism toward our past audio achievements and future audio goals. This surely isn't retro, it never happened before.

## ALIVE AND KICKING

The Lowther-Voigt story is one of the great sagas of 20th century audio technology. Their mainstay product, Paul Voigt's twin cone full-range loudspeaker, has been in continuous production, with refinements and changes, for almost *fifty* years. Today's high tech doesn't last fifty weeks.

No doubt Lowther ran into hard times during the transistor muscle amp era when an ultra high efficiency, limited power handling dainty thing like a Lowther was considered a peculiar prehistoric artifact. Who needs 100 dB efficiency with half kilowatt amps? The merest touch of DC offset on the output of your Ampzilla and your dual-wound Lowther voice coils transform into a puff of expensive grey smoke. Down at the audiophile society, the whizzer cone alone is enough to provoke fits of laughter.

But those who understood the product weren't laughing. Lowther has always enjoyed a very dedicated following and many stayed with the company through the dark ages of the high-powered high-end. This core of Lowther devotees together with determined management kept the company going over the past few dry decades.

Apparently, sales have been on the upswing in recent years with the resurgence of general interest in tube amplification and low power tubes in particular. Lowther currently has a tube amplifier and matching preamp in the works. They are actively expanding their world distribution network. Business is good in the Asian audiomania market, where locals have taken a liking to Lowthers. Like I was saying, it's hard to keep a good idea down. For Lowther, maybe it was just a question of sticking around until the world caught up with them again.

## ONE WAY OUT

The appeal of an uncompromising one-way speaker like the Lowther is obvious. No other approach maintains the fundamental wholeness of the signal. *All* crossovers segment the analog continuum. In the minds of some holistic purists, this is an unnatural thing to be avoided. It's like having one instrument playing the fundamental and another playing the harmonics.

A similar line of argument is often levied at digital. Why take something apart that is whole to begin with and needs to be whole at the output? Can we really take it apart expertly enough to put it back together again properly? It is a strange idea to break up music into constituent parts with electronics then reassemble it, but we do it all the time without thinking about it.

The glaring drawback with full-range cones is that in most instances they are not *really* full range according to industry standards. Typically a big chunk of the low end is missing and anything above 13-15K is gone. There is no reason to accept that kind of bandwidth limitation in even the most unambitious systems if you're willing to use more than one driver. A \$3 tweeter can get you out to 22 kHz. On the other hand, getting a single driver to play 40-20K full range is a wildly ambitious engineering effort. What? Much more work? Way higher cost? Same specs? Pass the tweeters.

The challenge and art of the traditional full-range cone, or any kind of speaker, is balance. In short, if you don't have an extended low end, you can't have an extended top end or the sound will be thin. The LF and HF rolloffs must be complementary. If you put a tweeter or woofer on a full range cone, or use loading tricks to extend bandwidth on the low end, you can ruin it. Limited range can sound very satisfying but it has to be limited at the right points. A mini monitor that only goes down to 70 Hz with the wind blowing in the right direction should be bandwidth limited up top also. 70-30K doesn't work as well as 70-13K.

The Lowther drivers escape this conundrum, since they are *truly full range* devices when appropriately installed. Given that they are intended to be rear horn loaded for the low end, yielding a bass efficiency boost, the high end output is adjusted accordingly. For this reason, you can't just put a Lowther in a bass reflex or on a flat baffle. The price you pay for Lowther-style full-range one

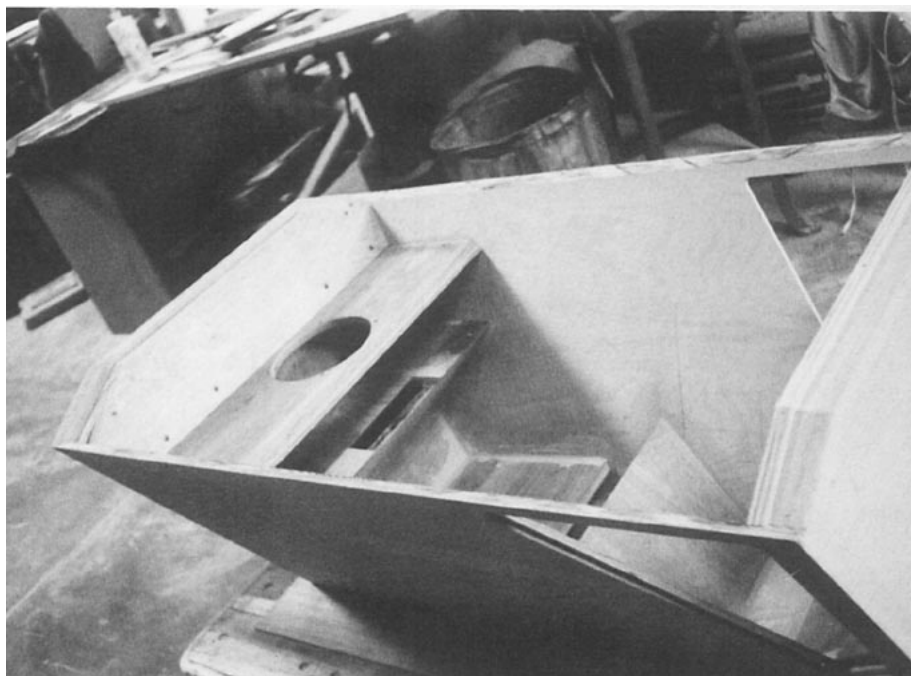

Homespun Opus One cabinet in progress in Lowther enthusiast Frank Reps' workshop. Frank says that since he's been into triode amps, the QUAD ESL-63s live in the closet and the TP-1s are in the listening room making sweet music with his Audio Note Ongaku doing the honors.

way sound is complexity in box design and a hefty bill from your cabinetmaker.

It sure would be nice if mechanical simplicity came along with the conceptual simplicity of the single full-range driver, but that's not the way the universe works. Achieving the bandwidth which the Lowther speakers provide in a one-way design takes heavy engineering and careful execution.

The Lowther magnets are incredible, especially on the upstream models. Enthusiast Frank Reps took an old PM6A he was restoring over to a super high tech magnetizing laboratory out in California and they couldn't re-magnetize the unit to factory specs. This feat requires very special and precise Lowther factory procedures. All that magnetic flux is provided to move the cone through a total excursion of 1 mm!

The Lowther drivers have always been hand made and the end result of that fine British craftsmanship comes out looking like a dainty flower with a huge chunk of magnet where the stem should be. At first glance you know that there is nothing else like a Lowther. And it sounds like it looks.

Living with Lowthers is an adventure that benefits from a thoughtful appreciation of and a close personal relationship with the technology at hand. Hartmut said it all in a message on the Internet:

"If anything ever is or was the Bugatti of something then the Lowther drivers are the Bugattis of speakers. In all respects, mind you . . . and not disregarding the Bugatti Owner's Manual suggestion for starting a Bugatti on what the Bugatti might consider a cold day — nothing complicated, just tap off all the oil and heat it gently on a stove to some recommended temperature . . . and then follow all the other simple instructions and in the end your Bugatti will start if it feels like it."

If you go around asking about Lowthers you'll hear tales like this, but the thing is that usually they come from the lips of people who LOVE Lowthers and wouldn't listen to anything else. Lowther owners enjoy telling war stories but look at where their hearts are. Basically the Lowthers are instruments requiring intelligence and care in use. They'll last for many years if treated well but they're not bulletproof by any stretch.

With such a hyper-strong magnet and a ultra-slim magnetic gap, the danger of some sliver of ferrous junk getting in there and interfering with voice coil movement is something to worry about. Best to work with the naked drivers in a clean environment, not on a dirty garage floor or junk-strewn workbench. Keep the drivers in plastic bags when not safely installed in a cabinet. Old timers suggest protecting the front of the driver by stretching a nylon stocking across the cone after installation as a dust cover.

Might also want to slip off your automatic Rolex before handling your PM4s and keep a strong grip on the screwdriver during installation. The magnets on Lowthers are wickedly powerful and recone kits ain't free.

Lowther was the first manufacturer to use foam surrounds. The dreadful foam on most of the early foamed speakers is crunchy brown dust by now. The new foam is much more durable and long lasting but the ancient jokes about Lowther foam persist. You can still get cone kits, so any disaster short of theft is repairable.

Some Lowther aficionados insist that the cones take a few *years* to break in, and the older they are the better they sound. The paper Lowther cone is indeed almost a living thing. I listen to a pair of PM6As in my Edgarmans off and on and I know what they mean about sensitive. Changes in humidity trigger sonic changes. Nothing sounds better on a rainy day than a Lowther, not a problem in England, I'm sure.

Beyond the routine care and feeding issues involved in keeping a British hotrod like the Lowther on the road, a bottomless tradition of tweakery grew up around them over the years. Every substance known to man has been smeared on a Lowther cone at some point in time. Start cataloging some of the crazy cabinets designs that Lowther fans have been spinning since the 1930s and you'll realize that you struck one of the main veins of hi-fi tweakery. Five whole issues of SP dedicated entirely to Lowther wouldn't even scratch the surface.

In short, the Lowther is a pure enthusiast's speaker. If you want something you can take to the beach, buy a Bose Wave Machine. For people willing to invest some thought and care in planning and operation, maybe this is it. Lowthers are not for everybody but they are for some of us. You know who you are!

### THE CLUB SCENE

Lowther-Voigt developed an interesting sort of distribution system specially tuned to the needs of the hobbyist. On the one hand, Lowther offers a line of finished cabinets for the global retail market, with the 15K\$ Opus One at the top of the heap. On the other hand, Lowther services the hobbyist and experimenter market through a network of Lowther "clubs"—enthusiast-run organizations providing drivers, cabinet plans, service, technical assistance, and

other forms of emotional and practical support.

The club scene is a parallel channel of availability distinct from the "official distributor" network. The clubs are run by and for Lowther fans who are in it for the love of the product. I consider myself a fan of Lowther drivers but I gotta say that these club guys are heavy-duty, big league Lowther-Voigt nuts. A few weeks ago, I wrote Andreas Mau of Lowther Club Deutschland just to introduce myself and say hello. Andreas was so excited about the opportunity to spread the gospel that he sent me 26 faxes so far and several hundred pages of related info, including a cabinet design article he wrote back in the mid-eighties called "Lowther for Life!!!" and pictures of what appears to be a religious shrine with a Voigt theme. His faxes come signed "Lowther is the answer!!!, Andreas" — hard core, indeed!

The German and Danish Clubs work together closely to promote and support the proliferation of the speaker with the white cone. Hundreds of people belong to the European Lowther Clubs and it seems like they have a real nice thing going on, sharing information, circulating new cabinet plans, and generally having a good time.

### LOWTHER CLUB OF AMERICA

Unfortunately for us Yanks, Lowther hasn't had a US distributor for many years. During the '50s, Lowther cabinets were produced here by Brociner under license. In the early '60s, Stuart Hegeman designed a loudspeaker for Harmon Kardon called the "Citation X" featuring the outrageous-looking special version Lowther (pictured on the cover of this issue) mounted in an up-firing position. Hegeman also designed at least one top of the line cabinet for Lowther for the British domestic market, the stately Lowther-Hegeman Corner Reproducer.

Although there was a powerful Lowther cabal among top ranking Stateside hi-fi operatives during the '50s and '60s, it was an extremist fringe scene. After the new generation came in and tubes went out, Lowther vanished from the US market. The way I see it, Lowther, old chaps, you didn't miss any action not being in this market while we were all lusting after Vandersteens and Apogees to go with our Adcom 555s and Krells.

But nowadays with all this triode stuff going on, Lowthers make sense again. With the A series you can get 100 dB sensitivity in a



Andreas Mau of Lowther Club Deutschland with his prized Opus One corner horns.

reasonably proportioned box and NFB SE friendly 16 ohm voice coils as a bonus. There ain't nothing like a Lowther but a Lowther, so check out a Lowther if that's what you're after.

That the time is once again ripe for Lowthers was not lost on Mr. Tony Glynn. Tony is a longtime Lowther enthusiast and Oregon Triode Society member who somehow got suckered into selling his prized Acoustas during a move in the early '80s, one of those deals that makes sense at the time but leads to eternal regret and dismay, kind of like that time I "lent" Vinny Gallo one of my Altec 755As for a "few days" three years ago.

The story goes something like this: Tony contacted the factory with the idea of purchasing a pair of drivers to get back with the one way scene and, a year later, he's forming the Lowther Club of America! Alright! I'm joining. I want to be the second US member, after Tony Glynn of course.

The major point of debate among Lowther freaks is over which cabinets to go with. Like all worthwhile audio questions, there is probably no correct answer to this one. For example, some people who have owned various old cabinets prefer certain new cabinets, while others stick with the old 50s and 60s designs, decrying the new stuff as a sign of the decline of Western Civilization.

There are lots of plans out there for Lowther cabinets. The 1964 Acousta design so heartily recommended by Haden above is a reasonably easy to build, high-performance box. Other cabinets range in complexity from later Acoustas with a flat front for simpler carpentry, to mind-boggling projects like the old TP-1 and the modern Opus One corner horn (60 precision-cut parts per side!). Since I never saw or even heard of most Lowther cabinet designs, don't ask me! Find yourself an "expert". Join the club. If you come up with something really good, be sure to let us all know. I like to think that the "best" Lowther cabinet has yet to be built. Gentlemen, start your table saws!

The way I see it, a good old answer to an even older question is always worth a listen. Since Lowther traces its heritage to one of the very first moving coil speakers ever, it's a very old answer indeed. The fact that Voigt's genius loudspeaker is still alive and well more than fifty years after its conception suggests that a lot of people over the ages thought it was a very *good* answer too.

You can't accuse me of nostalgia for old British technology, even though I do think some of it is pretty cool. I'm from Philly and I grew up playing stickball not cricket. I'm just looking for a good speaker to use with my tube amps like everybody else. My plan for a better audio future in my living room doesn't rule out giving the classic solutions another shot in a new context. Scholars say that each generation writes its own history, weighing past deeds in light of where they are and what they aspire to accomplish. In my picture of 20th c. audio, Voigt is a giant and whizzer cones aren't always a joke.

Lowther-Voigt, Ltd.  
PO Box 184  
Sidcup, Kent  
DA14 4NL ENGLAND  
FAX 081-308-0778

Andreas Mau  
Lowther Club Deutschland  
Postfach 12 46  
24584 Nortorf GERMANY  
FAX 04392 / 81 68

Tony Glynn  
Lowther Club of America  
PO Box 4758  
Salem, OR 97302  
FAX 503-375-3988

Many thanks to Tony Glynn, Andreas Mau, Peter Qvortrup, John "Count 8-Track" Peterson, Tom Hodgson, Frank Repp, and Bruce Edgar for contributing pictures, information, and opinions for the Lowther articles in this issue.

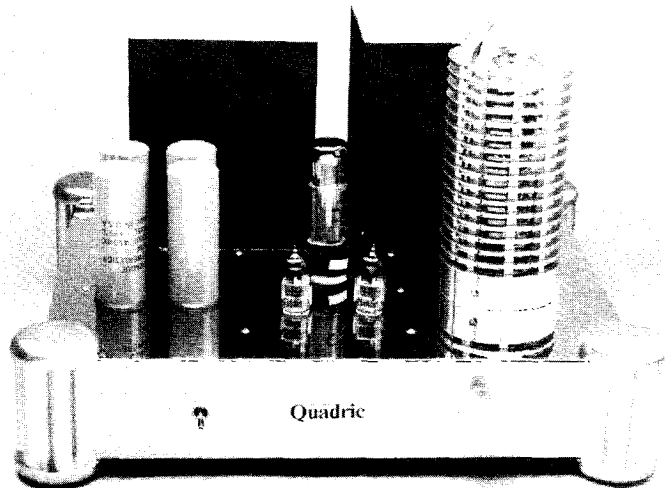

## Quadric Audio USA presents . . . **845 SE Monoblocs**

*Chrome Finish w/Volume Control for direct line input.  
28 watts, 4 and 8 ohm Taps. Self-Biasing, Cascade Driver Stage  
Promotionally priced for direct sale!*

Send SASE for more info, pricing to:  
Quadric Audio USA, 464 Hudson Street, Box 160, NY, NY 10014

# EDGARHORN

## THE SMALL HORN SYSTEM FOR TYPICAL LISTENING ROOMS

FOR INFO:

Dr. Bruce Edgar  
Box 1515  
Redondo Beach  
CA 90278

310-370-1302  
310-371-8085 FAX

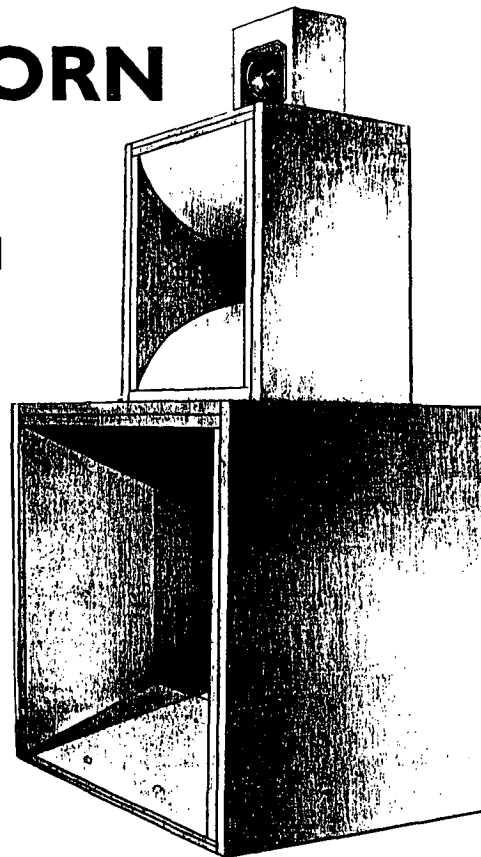



# FLESH AND BLOOD

## THE REICHERT 300B

by Herb Reichert  
Audio Note, NYC

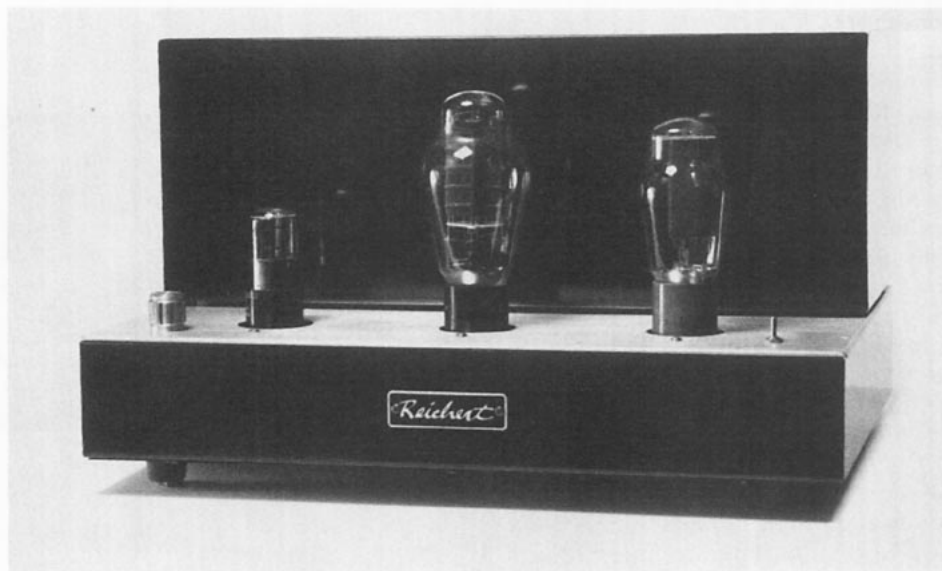

The light from the streetlights mixes with the glow of the bright emitters in my listening room. Nyiregyhazi plays Liszt in front of me and my skin seems electric but I am completely relaxed. I let out my breath and my pulse is near flatline. Audio can really be good to us . . . if we let it. This is why we must seek to create and explore the frontiers of audio. This is why many of you build your own audio equipment.

I started building and designing my own audio because I am a 'gearhead' by nature, not because I thought I could do better than the pros. However, one day I took the negative feedback out of an amplifier I had built and my whole body went limp. Big symphonies by Mahler began to expand and breathe. A strong sense of voluptuousness replaced a feeling of tension and hardness. Average and poorly recorded program began to become part of my midnight repertoire. I concluded I was on to something important. I realized that there must be more design decisions, big ones, like this one with the feedback, that impact the basic character of my system. This is the point at which I became "high fever". I now had a sense of what was possible. I began to engineer with a purpose.

Over the last decade, I looked carefully at each part of the audio amplifier design process. My first rule was: take nothing for granted and keep an open mind. This attitude steered me down many wrong roads; like the six months I spent chasing A/C balance in push-pull amps or looking at pentode driver stages. Big dead ends!

On the other hand, looking into every detail of the single-ended, directly-heated triode

amplifier has netted results beyond my wildest dreams. The whole world of high-end audio is changing and believe me, it is the result of the work you and I and our friends are doing in our homes. We are experiencing a 'new dawn' in audio, but this new dawn is only the beginning and there is much NEW work to do. So, I want you to take this design as a beginning and build on it. Apply your own audio ethics and benchmarks.

From the letters and phone calls I receive, I know that many of you believe that if you can get a schematic for a great amp, then go out and buy what you think are some great parts, and put it all together carefully, then you will end up with a great amp. Sorry, it just doesn't work that way. You might get a GOOD amp by this method, if you are lucky and inspired, but to get a GREAT amp you must suffer. Whenever I build a BAD amp, and I have built quite a few, J.C. always says, "Welcome to the next level." It is the failures and the mistakes that get you to the other side of the mountain. Each failure makes more clear what you do not want. Each success enlarges your vision of what is possible. The process of building is to wire your mind, to focus your sights on that point on the horizon where greatness lays.

I know the Reichert 300B-SE amp doesn't look like an unusual or original design. But, on the test bench, this amplifier design sets very high standards for bandwidth, rise time, and distortion. My main design goals were vividness, body, color, and dramatic contrast. I want a vibrant, breathy, gripping sort of presentation. I am an artist, a painter

in the painterly, romantic tradition. I want my hi-fi to paint with strong, rich strokes.

What I don't want is distant, thin, or mechanical sound. Lots of flesh and blood. Lots of drama and empathy and lots of Technicolor and Panavision; this is what I was after when I designed this amp. Each design decision was a trial and error attempt to get to this end. Please understand, this is not a 'part of the month' design. Each parts choice has a personal evolution, all yin/yanged to my taste. If you change ANY part, it is your amplifier design, not mine.

Amplifiers are engineered from the output terminals backward. The amp/speaker interface is EVERYTHING and one's focus must always be on the 'black & red'. Amplifiers are always designed for a particular speaker or speakers and any amp designer who says differently is trying to sell you something he doesn't own. How the amplifier behaves into the chosen speaker load is the first point to consider when making all major engineering decisions. This amplifier was created to power Altec VOTs, Edgarhorns, WE-755As, and Altec 601As. I have also discovered that it works very well with LS3/5As, AR-M1s, Lowther PM-6s, and Audio Note Model 2s & 3s. I used a circa 1946 Altec VOT system to do the initial design work. Final touches were done with the Onken/Edgar system and Audio Note Model 2 & 3 speakers.

Output transformers are the cornerstones of any tube amplifier design. Since 1980, I have tried outputs from UTC, ACRO, Peerless, Dynaco, Fisher, Partridge, Western Electric, Chicago, Hammond, Magnequest,

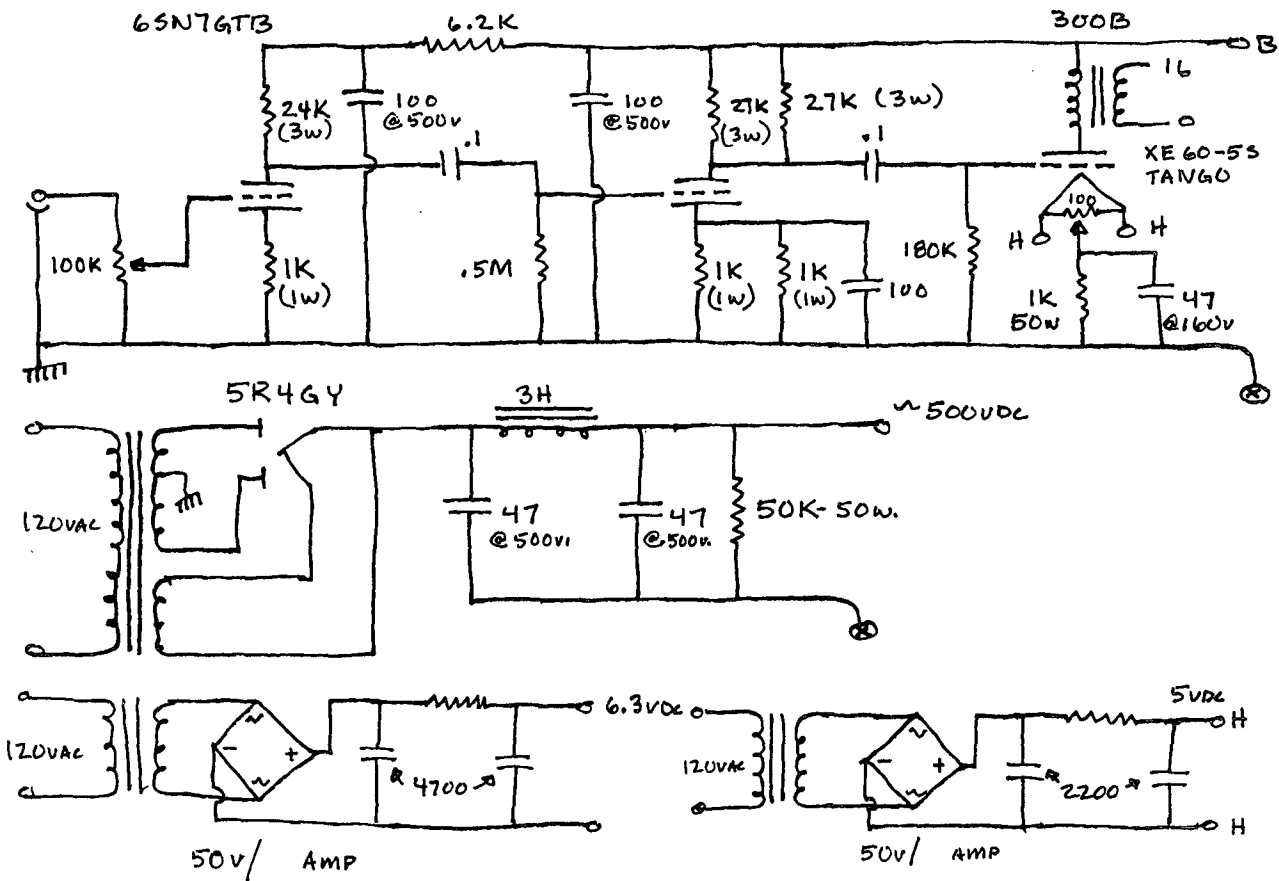

RCA, Audio Note, and God only knows...? I prefer the Tango to any other. I distributed Tango in the U.S. until 1993. Maybe that's why I began this design with the Tango XE-60-5S single-ended output. I do not care how "romantic" you want to be, you must have speed and bandwidth. An amplifier that is slew limited or unstable outside of its passband will never have good tone character.

I believe the ultrasonic and infrasonic behavior of a SE amp must be carefully examined. Excessive phase shift or ringing in these regions will surely sabotage the amplifier's potential for greatness. If the output transformer rotates phase more than 40 degrees below 100 Hz, the amp will sound slow and the bass will seem to lag behind, lacking "tunefulness". Bass transients will sound dull. Likewise, if there is ringing in the ultrasonic region, the amp will sound hard and 'hollow'.

The proper selection of core material, core size, aspect ratio, and winding technique is far more critical in SE designs. Poor choices lead to soft, lazy, unrefined sounding amplifiers. The Tango line is unique in that it is the product of two decades of continual development. World-wide, there are thousands of SE amps with Tango outputs. The Tango XE-60-5S measured 18-80 kHz,

-2dB in this amp. This is at 7 watts! Remember, I do not sell these transformers anymore. I just still love them.

I chose the WE 300B tube after living with amps built around the 6B4G, 2A3, 50, 45, 801A, and the 10Y. 10Ys push/pull are still my personal favorite, but even the VOTs like more than 3 watts. Of the available triodes, the 300B plays the most records with the greatest ease and the most refinement. It is voluptuous and elegant. Also, it is the ONLY tube I am aware of with perfect sample to sample consistency. The Western Electric 300B is always quiet and it will last forever. There is a hypnotic quality to the 300B sound that draws me into the performance like no other type of amplifier.

Operating points are next on the design agenda. My best friend and tube maven, J.C. Morrison, has already written the book on this subject: run your triodes hot! With pentodes, I like low plate voltages and high current. With triodes I like high plate voltages AND high current. I run the WE 300B at 425VDC on the plate and 80mA standing current. I want deep class A1. I want to tickle the center of the B/H curve and swing very little current across the power supply. Symmetrical clipping and fast graceful recovery are a combination of power tube operating point, driver stage design and

power supply engineering. These three elements work in concert and must be designed together with a clear sonic goal in mind. The amplifier's ability to drive speaker loads with ease and refinement will be seriously handicapped if we make a bad decision here.

I chose the 6SN7 cascade after examining the distortion spectrum and sonic character of the SRPP, transformer coupling (Tango NC-16 and NC-14), 5687 anode follower, the mu-follower, and several variations on direct coupling. With the R-C coupled 6SN7 and 500VDC raw supply the amp 'locks' into class A1 with a minimum of A2 voltage. The 12K plate load on the driver stage gives me the rise time and low odd-order distortion product I wanted. Don't laugh, but I only like the GE 6SN7GTB in this position. You must use GTBs to get the required plate dissipation and the GE version sounds best to me. The first stage is R-C coupled to the driver stage to hold the output tube grid swing to max even with poorly matched tube sections or aging tubes. Direct-coupled designs seem to change their sound over time even though their minimum phase character is highly appealing. In this design, the time constants have been very carefully considered, so don't go changing any resistor or capacitor values.

The power supply is everything in these little amps and it also seems to be the area where designers agree the least. All the SE 300B amps I have heard sound very different from each other. Some sound more mechanical than the worst solid state designs. The reason, I expect, is wildly different ideas on power supply design. First rule of triode amp design: Solid state rectifiers = mechanical sound. You don't think so? Then you haven't really compared. I promise you, IF there is only ONE thing I have learned in ten years of amp design, it is this first rule. A lot of time went into selecting the rectifier tube for this design. Normally, I use the WE 274A/B, but this amp sounded best with the RCA-5R4GY.

The pi-filter is the heart of this amplifier. If this amp sounds better than others, it is probably due to the choke/cap selection on the pi-filter. I don't like to waste a lot of energy charging and discharging caps: I want a narrow torque curve - high rev supply. Low impedance and minimum storage gives fast recovery and fine texture to the sound. Remember, most amps under 2000 watts are running at or near overload. Let's make them sound unstressed at overload. Then the music will sound unmechanical. The power transformer should be rated at least 500mA at 800VCT. An even higher current rating is better (I use 750mA) because I want a small value bleeder resistor at the end of the filter. I like to bleed at least 25% of the total standing current. This stabilizes and regulates the supply. With the small Black Gate caps, the heavy bleed appears to enhance the clipping characteristic.

We want 480 to 500 volts across the output of the pi filter. The choke should have a DCR of less than 300 ohms. I aim for 10-20 Ohms DCR! This is a big chunk of iron, but it is a very important part of the design. The number of Henrys is less important than the DCR rating. Two to ten Henrys is fine. We are looking for a B+ that is fast and linear, but loosely and naturally regulated. Remember, the reservoir and decoupling capacitors are part of their respective stage's transfer function. This means that they are just as important as the tubes in determining the linearity and character of the amplifier.

For caps there are a few choices. I have tried all the usual stuff: WE oil and paper, photoflash, polypropylene, etc. The Black Gates (47uf at 500vdc x 2) are now my first choice, but only if you play music every day. These are electron-transfer/electrostatic and must be kept charged. They take

a full 24 hours to recharge when left to discharge. These are not electrolytics. They work more like an electrostatic speaker. There is no electrolyte or electrochemical delay. These caps are super wideband, linear, non-resonant, and quiet. The Cerefine are almost as good. They use a ceramic powder instead of pure carbon like the Black Gates. This ceramic powder allows for a quicker charge up time. Both caps behave very gracefully under A/C conditions. Do not use polypropylene. If you do, this is your amp design, not mine.

I am not going to get into the parts philosophy thing except to tell you I have tried everything I could lay my hands on. My ideas change daily so here are today's recommendations. No Teflon. No silver plated wire. No MIT multi-caps. No metal film or metal oxide resistors. No polypropylene caps. No Vitamin Qs. No Solen. No REL caps. No Holcos. No metal oxides. No Vishays. No SCR. No MKP-1845s. No solid state diodes. No solid state current sources. No silicon anything. If you use this stuff, you know who's amp design it is NOT.

Please use Allen-Bradley resistors in the plate circuits. Paralleled resistors, in plate circuits, are quieter and sweeter sounding. Use Audio Note Tantalum resistors in the cathode and grid circuits. On the cathodes of the 300Bs use Caddock 50 watt MP 850s. You can use Caddock MG or MX in the plate circuits if you are a noise freak, but I think the A/Bs sound more relaxed and showcase the wood and brass tones on orchestral music. I have only three recommendations for coupling capacitors and they are all Audio Note. Due to my affiliation with Audio Note you probably won't take my coupling cap recommendation too seriously, but that's OK. You lose! If you want even a chance of catching my Ongaku sonically you must use Audio Note silver foil paper in oil coupling capacitors. If you can't afford these use AN copper foil paper and oil capacitors. There simply are no other choices.

Wire is a separate issue. Wire is a system thing. After twelve years of building amps, I only KNOW two things for sure: 1) Use tube rectifiers 2) You can never have too much silver in the signal path. Go without food or clothes, but buy lots of records and wire your hi-fi in silver. Audio Note or Kimber silver wire are my first choices for internal wiring of this amp. If you can't afford this stuff, just use Carol PVC hook up wire. Nothing is worse than silver-plated copper.

Stay away from all Teflon coated wire if you are looking for relaxed natural sound. Believe me the Carol PVC stuff is good for everything in your system from the tonearm to the speaker. If you can't afford silver, and you trust me, try it.

In fact, if you want to build this amp on a budget, try this—you can still say it is my design. Use the Tango XE-20S or the Audio Note outputs. Use the Carol PVC wire, the AN Paper and Oil Caps (Regular type), Allen-Bradley resistors, and Sprague or Mallory power supply and bypass caps. You will lose some of the refinement but none of the naturalness.

If you make substitutions with parts try to avoid plastic, especially hard plastic. Think voluptuous and colorful. Oh yeah, even if you are on a budget, try to use a copper chassis, 2-4% silver solder, and high quality ceramic tube sockets.

Please, try to wire the circuit just as given on the drawing, observing the ground points of the cathodes and the PS capacitors. Do not buss the power supply caps. The pi-filter and the 300B cathode resistor should be grounded at the same point. Likewise the 6SN7 cathode resistors, the driver stage bypass condenser and the decoupling capacitors should all go to the same point.

All of this design talk may be for naught. You see, I believe most deeply that the real magic ingredient in any amp design is the *wu* of the designer. This *wu* flows from the designer's hands during construction and raises the effort above the common and imperfect. Therefore it might be best if you design your own amplifier, for your own speaker, based on what you already know and what you think of my ideas. My philosophy rests on the romantic and the expressive. Drama and contrast with the grace and poise of a bullfighter are my audio system goals.

This circuit and these parts choices were developed inside the world of MY hi-fi—to my taste! If you want an exceptional music reproduction system in your home you must first develop your internal reference for natural sound. Then you must outline your aesthetic and make a series of design decisions that reflect that aesthetic. But remember, you won't be happy if you acquire your aesthetic from reviews and audio pundits. You must discover your own. Trial and error is tedious and it takes a long time to become a wizard, but I am sure you will look good in the wizard's cap.



Amigos:

After finishing work on Edgar's Midrange Horns and Monolith (which took several months of hard labor and lots of patience—all well worth it), I decided that the next project would be a lot smaller. This decision made my wife extremely happy.

I got myself a steel chassis (17" X 3") and went to work on a PP 6A3 amplifier. Why PP? Because I already had a pair of Peerless 5K outputs. I also got lots of help with the electronics from James Novak, the biggest and brightest electronic nut on the Atlantic coast.

I wanted it to have that old 30's or 40's retro look. Consequently, I got a pair of panel meters, an eye tube, and a few cans of black wrinkle paint. I spent a few weeks laying out the chassis, till the look I was after started to emerge. Then it was just a matter of putting to work all those years experience as a machinist.

I also wanted to use tubes that have a certain amount of presence, or should I say "color". For this I chose mercury vapor rectifiers and an eye tube. There is also an OD3 which, aside from regulating, has that soft pinkish-red look that reminds me of those beautiful sunsets on the west coast of Spain where I grew up under El Generalissimo Francisco Franco's watchful eye.

Speaking of eyes, this tube serves a practical purpose as well. It reminds me that the amp is on, in case I do not notice that the 6A3 filaments are red hot or that the mercury in the rectifiers is vaporized or that the panel meters are pointing to 120 mA.

The power supply uses four polypropylene in oil caps (30 mF@700VDC) and there is not a single electrolytic anywhere else, except for a 10000 mF filter as part of the output tube filter. This amp puts out 8 Watts of pure class A and sounds better than any PP triode I've ever heard. When I first started this project, I never thought it would be so involved, complex, and at times frustrating, but in the end it was incredibly rewarding.

Raul Gil  
New Jersey



Raul Gil's latest project. . . Direct coupled SE 300B with 5692 + 6SL7 drivers regulated by four 6S4s. The 300Bs are regulated by a 6AS7.

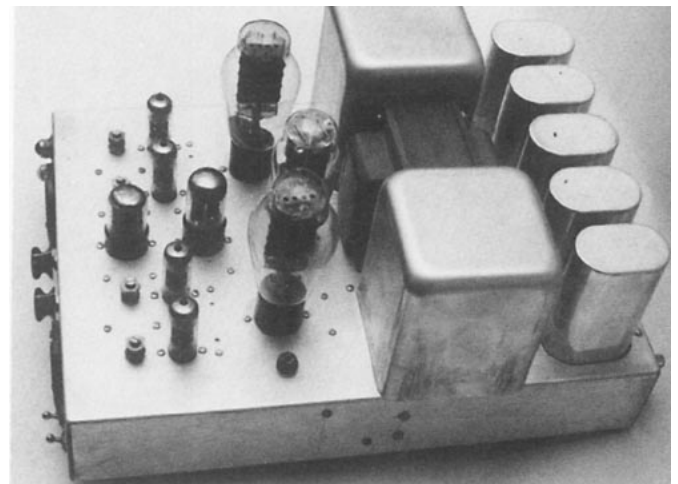

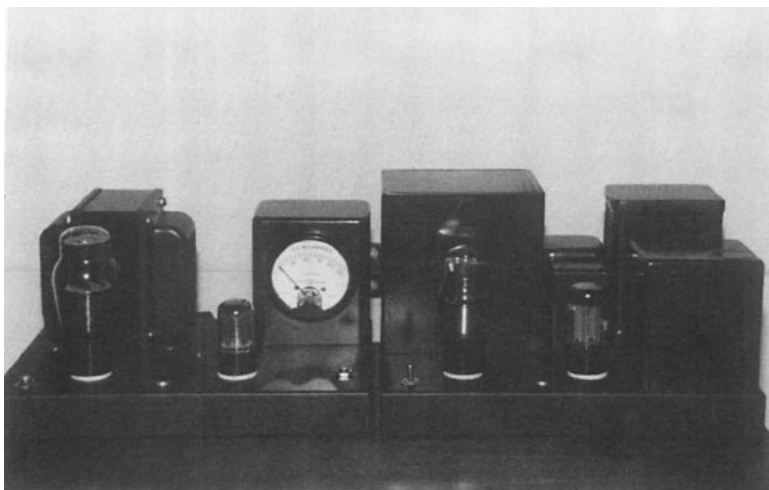

Ed Johnson of Crandall, Georgia turned out this classy two box 6B4-G SE with MQ FS-030 iron.

Experimental SE807 built by Eric Carmichael of Tucson, AZ. The amp uses a pair of 6KW 50 Watt Partridge 5353 transformers designed for push-pull operation. Plays real good as a midrange amp in a bi-amp setup and does decent square waves above 500 Hz, but the bass is "worse than absent" according to the builder. Fun experiment though.

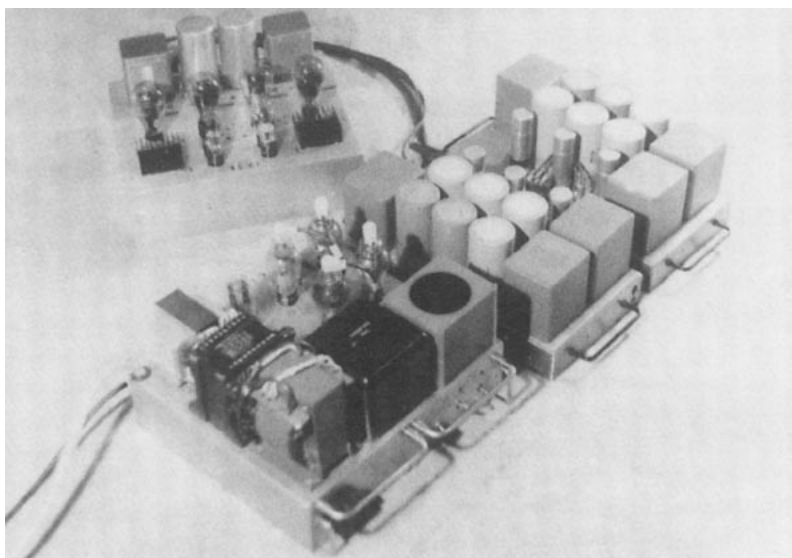
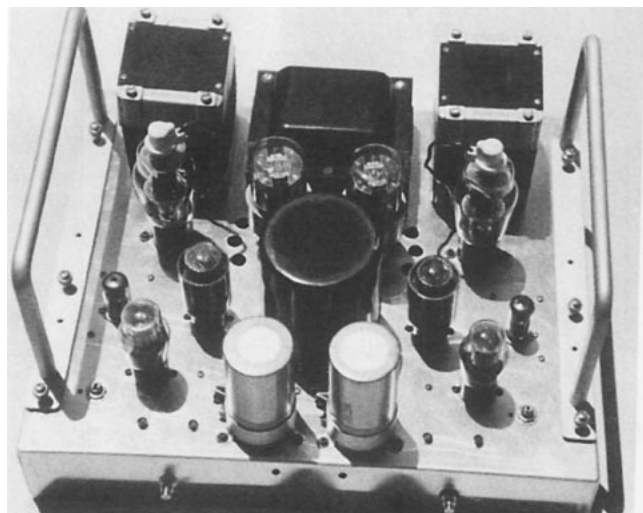

← Push pull monster from the lab of Jeff Medwin, AKA "Dr. Lo Mu Triode" of KC, MO. This stereo 250 PP amp uses 76/6P5GT input tubes, type 45 drivers, and UTC phase splitter/driver transformers, feeding the grids of a pair of Globe 250s wired into a pair of vintage Peerless outputs. The outboard power supply chassis (plural) provide a separate regulated, highly filtered supply for each stage. The power supply uses mercury vapor rectifiers and select low DCR transformers and chokes. Dr. Lo Mu insists that his extremist approach to amp design yields a level of sonic results *entirely unobtainable* through lesser means.



Dr. Lo Mu Triode waiting for feeding time in the Triode Wing of the Kansas City Institute for Terminal Audiomania, his home away from home.

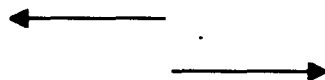

The Doctor's other 1994 homespun amps: PP Class A 6B4-Gs with a dual diff-amp 5687 front end current sourced by an additional 5687. The input is direct coupled to 6BX7s running at a high current 29 mA per plate for a driver stage with real "moxie".

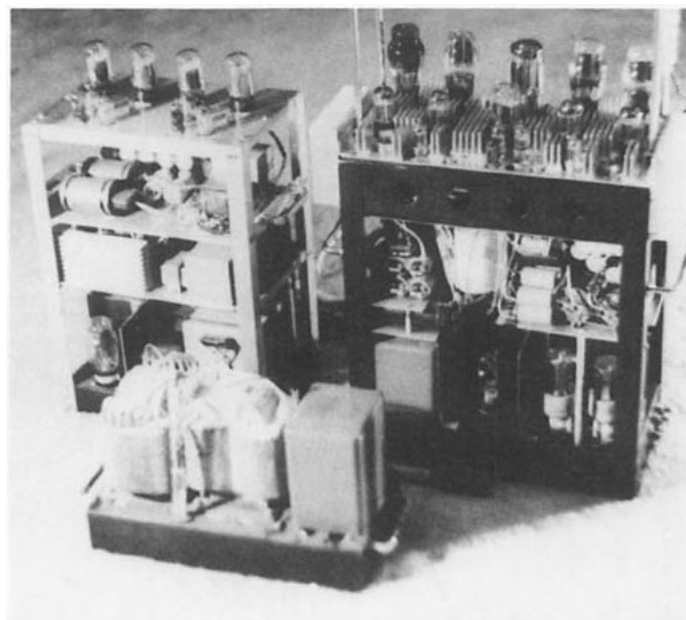



# The Rejuvenation Process

## How to get the longest life out of your power triodes

by Heiner Jakobi, England

Since there is a shortage of high quality power triodes just like in the 1940s—although, touch wood, for different reasons — it is necessary for the tube amp user to consider some old recipes which were common in the 1940s and earlier on. This one was passed on to me by an old tube lover from Germany.

I will use as an example the European type AD-1. This tube is considered by some to be one of the best output triodes ever built and it has become very rare.

The AD-1 was invented by Philips in Holland and built there under Philips and Valvo and by Tungram and Telefunken in Germany. Later, Tesla made a copy which was not on par with the Western European production. A professional version with different basing called the Ed was produced by Valvo under contract for Siemens for use in telecommunication systems. Also, RFT from East Germany built a tubular version, later replaced by the even more powerful, indirectly heated Ec.

A regenerated tube does not look like a new tube. The shiny getter deposit will still look "burnt" or "bleached" like it was — but the tube will perform for its full life one more time, usually another 2000 hours. If regenerated yet another time, it might last another 50%!

### AD-1 data

Filament 4V/0.95A  
Plate voltage 250V/60 mA  
Negative grid voltage - 45V  
That's all you need to know!

We start with the heating process: Instead of 4 volts we use about 7 volts and overheat our triode for about 10 minutes! Then go down to 5 volts on the filament and add plate voltage. Apply so much that the plate starts to glow red. That's right!

Most important is a milliampere meter to read how much current the triode is drawing. With an AD-1, the max current is around 250 mA and this occurs around 600 V on the plate.

When new tubes are produced, a small amount of barium compound is vaporized inside the sealed tube in order to bind gases and impurities inside the glass. What we are doing is using getter material that wasn't used during the initial production process. Up to 60% of the barium is left over from the first process and we can use this potential now to rejuvenate the tube! As you heat the tube, you will see the barium glowing green, evaporating, and doing its proper job all over again.

The critical thing in this process is that you keep your eyes on the meter. After about ten minutes (and this time will vary), the current drops. You must switch off IMMEDIATELY!!! One second too late and the tube is dead! Forever. You have not lost anything since you couldn't use it anyway. I leave all you tube lovers to experiment with this idea and to use your common sense about which settings are correct for each triode.

### Some Guidelines:

- 1) Heat the filament for about 10 minutes with around 40-50% more than the rated value.
- 2) Drop down to around 20% overrated filament voltage, then,
- 3) Add plate voltage until your milliamp meter does not rise, i.e. max current, and the plate shall glow red!!!
- 4) Keep your eyes on the meter until current falls and *immediately* switch off!

In the old days there were special tube rejuvenators on the market, but nowadays you will have to build it yourself!

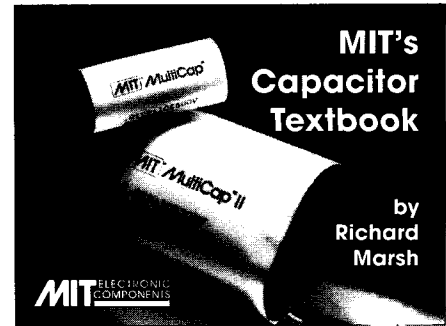

## Debunking the Myths

### Cap Myth # 2

The plate metal is the most important factor in capacitor performance.

### Cap Fact

- The compatibility of the plate material with the ends' sprayed-on metal and the solder & lead metal brings about lower ESR (therefore better, more stable performance) than using exotic plate materials.
- Silver & copper foils are potentially good, but they must be made into a capacitor immediately upon manufacture. Otherwise these foils will oxidize quickly.
- Oxides form rapidly on silver and are difficult to remove. Oxides are difficult to attach onto leads, and create unreliable connections. Oxides also become imbedded in the solder, again creating an unreliable join.
- Use of high purity copper will reduce oxide formation in copper foils. But the molten metal sprayed on the cap ends, to connect the foil plate edges, is typically an aluminum alloy, which is incompatible with copper. This combination will corrode in time, through electrolysis between dissimilar metals.

### Solution?

The MIT **MultiCap** uses the most compatible metals and alloys throughout. Our tin MultiCaps, for example, offer thick tin plates attached to tin-plated copper leads, hand soldered with high-tin content solder. This ensures reliability and long term performance, and lowest ESR for consistently fine performance.

### Watch for Cap Myth #3!

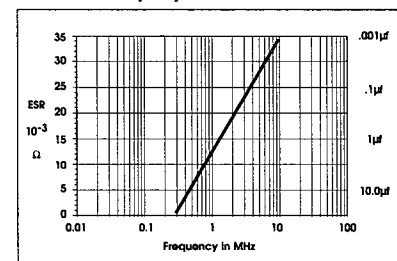

### ESR vs. Frequency vs. Capacitance

Graph showing low distortion obtained by the decreased parasitics (ESR) of the self-bypassed MultiCap. MultiCap performance falls to the right of the line, indicating fewer parasitics, i.e., fewer colorations & increased accuracy. Measurements of standard caps, even with exotic foils, falls to the left of the line, indicating compromised performance. (Measured at MIT)

MUSIC INTERFACE TECHNOLOGIES™  
For National & International Inquiries:  
Phone: 916/823-1186 Fax: 916/823-0810

# Vacuum Tubes for Audio Are Back!

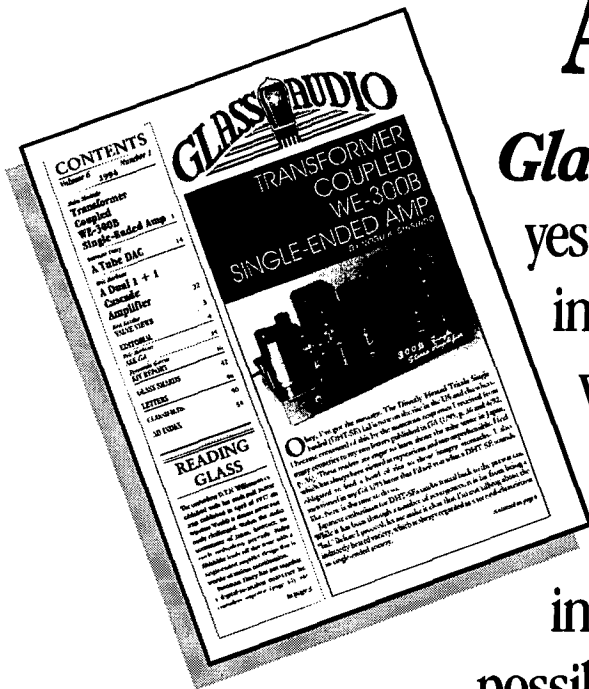

*Glass Audio* brings together yesterday's tube with today's improved components, voltage control, and the exciting new Soviet tubes, to make smooth sound in your livingroom possible again!

Get your first issue FREE to examine, without obligation.

**YES!**

Please send me an issue of *Glass Audio* to examine FREE for 30 days. When I choose to subscribe, I'll pay just \$23.00 for six issues (1 year) of the best information on tubes to be found anywhere! If I decide that *Glass Audio* is not for me, I'll write "cancel" on my invoice and owe nothing.

Name \_\_\_\_\_

Street & Number \_\_\_\_\_

City \_\_\_\_\_ State \_\_\_\_\_ Zip \_\_\_\_\_

In Canada, add \$6 per year in postage. Overseas Rates: \$45 for one year. Remit in US \$ drawn on a US bank only. Price good through Nov. 1, 1995.

***Glass Audio***

PO Box 176, Dept. SDP5, Peterborough, NH 03458-0176 USA  
(603) 924-9464 or FAX 24 hours a day to (603) 924-9467

# New Svetlana™ Triode Development SV811 Series

by George Badger  
President, Svetlana Electron Devices, Inc.

Svetlana is Russia's leading designer and manufacturer of power tubes. The company offers a line of well-engineered, rugged tubes for broadcast and industrial users. Svetlana has been a leading vacuum tube supplier since it first developed electron devices in 1928. The company was founded in St. Petersburg in 1889 and began manufacturing incandescent light bulbs in 1913. Svetlana, which means 'light' in Russian, established a laboratory for developing vacuum tubes in 1928 and won the Grand Prix for transmitting tubes from the International Exhibition of Art and Technology in Paris in 1933.

Svetlana was reorganized as a privatized open stock company in 1992. In the same year, Svetlana Electron Devices, Inc. was formed to bring Russian power tube technology to the world outside of Russia. This U.S. based company owns a major share of the joint stock company and is working with the newly-privatized Svetlana in St. Petersburg to introduce tube types widely used in Russia and new to Western equipment designers. The companies are also providing exact replacement, plug-compatible Western tube types to broadcast and industrial end users and hobbyists.

Svetlana Electron Devices, Inc. has its corporate headquarters in Huntsville, Alabama with marketing and engineering offices in Portola Valley, California. Svetlana Electron Devices, Inc. manages the worldwide marketing, sales and support for Svetlana products. The company is led by a management team including old hands from the US tube industry and members of the Russian engineering and design group responsible for tube development, manufacturing and applications.

Svetlana has an exceptionally clean manufacturing environment, and its tubes are vacuum processed at higher temperatures

than are common in the West. This enables the company to manufacture both thoriated tungsten and oxide cathode tubes with extended life and consistent performance. It also means that Svetlana's long life tubes can be backed by the most generous warranty in the industry.

The joint venture for power tubes has grown rapidly and has been so successful that we recently brought the Svetlana Glass Tube Facility into the organization. The work in the glass tube engineering and manufacturing complex is directed toward the world audio and instrument amplifier market. All marketing is through the joint venture.

## SV811 Triode Development

The Svetlana Electron Devices, Inc. product line also includes some exceptional tubes made in other manufacturing facilities in Russia. An example is the subject of this paper, the newly developed SV811 series. It was developed in cooperation with the Electronpribor Manufacturing Corporation in Ryazan. The strict manufacturing and quality control systems at Electronpribor are on a level with those at the Svetlana complex in St. Petersburg where Svetlana ceramic power tubes and the majority of Svetlana glass power tubes are produced.

The newly developed Svetlana SV811 series audio power amplifier triodes are intended for use in class A, AB, or B amplifiers. The high plate power dissipation of 65 watts and the high plate voltage rating of 800 volts provides the capability of reasonably high power output in Class A circuitry.

The SV811 series design is derived from transmitting tube technology and manufactured under transmitting tube processes and controls. Unlike the typical audio power output tube, the SV811 is not an "upgraded" receiving tube. It is the smallest tube made in a *transmitting* tube plant rather than the biggest tube made in a receiving tube facility.

The SV811 series uses a directly-heated thoriated tungsten filament for the warm sound and soft glow of this classic cathode, familiar to audio people who know the visual beauty and power of the 211 and 845 triodes.

The emission performance of thoriated tungsten filaments under peak overload conditions is far superior to the performance of the oxide coated cathodes used in most familiar audio power tubes. Thoriated tungsten filaments offer consistently better sound over a longer useful lifespan than oxide cathodes. Thoriated tungsten filaments are exceptionally stable and not manufacturing process sensitive.

The SV811 series has two temperature-initiated getters mounted directly on the plate for superior gas absorption. This type of getter, used in high-power transmitting tubes, continues to absorb gases throughout the life of the tube. Consequently, they are more effective than the familiar one-shot "flash" getters vaporized during factory processing. Also, flash getters spew material over the inside of the glass envelope, impairing radiation cooling and spoiling the natural visual aesthetics of glass audio tubes.



SV811-10

The envelope of the SV811 series is made of a type of hard glass intended for transmitting tubes, which is highly resistant to power overload, overheating, and subsequent outgassing.

The internal tube parts are supported by ceramic insulators for high temperature operation and high voltage hold-off. Stressed mica supports are used against the envelope to absorb vibration, thus controlling microphonic effects. The internal structure is aligned with respect to the base pins to avoid internal shorts if the tube is operated in a horizontal position.

We recognize that audio tubes are usually installed on the outside of high-end audio amplifiers in plain view of people who truly appreciate a good looking tube. The SV811 will be controlled for external mechanical and visual characteristics in addition to electrical characteristics. These tubes feature a bright glazed white ceramic base which contributes significantly to the classic appearance. A matching glazed ceramic 4 pin socket, the SK4, will be available.

#### SVETLANA SV811-3 & SV811-10

We developed two new audio triodes for this series, the SV811-3 and the SV811-10, with amplification factors of 3.5 and 10 respectively, as indicated by the type number suffix. The following preliminary data is furnished to provide an introduction to the SV811 series and is subject to change. Interested parties are welcome to contact Svetlana for final data sheets which will be available by the time you're reading this article.

##### SV811-3

Amplification Factor (average)	3.5
Transconductance	1800 $\mu$ S
<b>Maximum ratings</b>	
DC Plate Voltage	800 V
Plate current, max signal	160 mA
Plate dissipation	65 W
Filament Ratings	6.3 V, 4A

##### SV811-10

Amplification factor	10
Transconductance	3900 $\mu$ S
<b>Maximum ratings</b>	
DC plate voltage	800 V
Plate current, max signal	160 mA
Plate dissipation	65 W
Filament Ratings	6.3 V, 4A

The experience of Russian-American teamwork we enjoyed in the development of these tube types was greatly satisfying. It is indeed a pleasure to contribute to the renaissance of our favorite classic tube technology. At the same time we are bringing the rapidly growing Western tube market to the people who still know how to make tubes well. These exceptionally well educated and skillful tubemakers are masters at their art and therefore deserve to participate in our exciting Western World economy.

Special thanks to Dave Wolze for his time and assistance in providing real world measured audio amplifier service performance data.

**Headquarters:**  
Svetlana Electron Devices, Inc.  
8200 South Memorial Parkway  
Huntsville, AL 35802  
800-239-6900 voice 205-880-8077 fax

**Marketing & Engineering:**  
Svetlana Electron Devices  
3000 Alpine Road  
Portola Valley, CA 94028  
415-233-0429 voice 415-233-0439 fax  
800-5-SVETLANA toll free

World Renowned for Sonic Excellence. . .

# TANGO TRANSFORMERS . . . TAMURA too!

We know that few Japanese suppliers respond to overseas inquiries . . . but you can definitely count on us.

Worldwide service at our local prices.  
Write or fax for a free catalog.

#### A SoundShop BIG Exclusive:

New custom Tango single-ended output transformers designed to provide optimal performance with the new VV30B !!!

#### Specifications:

Primary Impedance 2.75K,  
16 Hz-60 kHz (-2dB)@150 mA DC,  
40W at 30Hz @ 1% distortion

# SoundShop BIG

A Tango and Tamura distributor

12-20-8 Kita, Yachiyodai, Yachiyoshi, Chiba 276, JAPAN fax: +81-474-82-3039

# THE ULTIMATE

by Rickard Berglund, Höör, Sweden

At last, the battle between SE and PP is won!

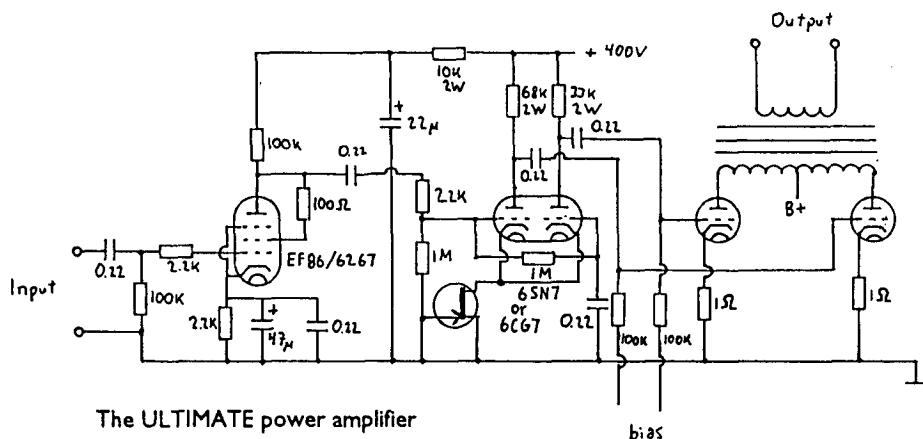

The ULTIMATE power amplifier

Many people like single ended amplifiers because of the natural harmonic relationship of this type of amplifier. The second harmonic dominates over the third harmonic, the third dominates over the fourth, and so on. The main disadvantage of single ended amplifiers is that the output transformer must be expensive and heavy in order to maintain low bass response.

The ULTIMATE amplifier consists of a standard push-pull output transformer connected to two triode output tubes or two triode connected pentodes or tetrodes. The drive signal is not equal for the two tubes as it is in a push-pull amplifier. In the ULTIMATE amplifier, the drive signal for one of the tubes is twice as big as that of the other tube. This approach produces a harmonic spectrum very close to that of a single ended amplifier. Another advantage is very smooth clipping, much better than a push-pull amplifier.

The ULTIMATE amplifier circuit is shown to the left. The transistor can be any low noise J-FET with an Idss of 8-10 mA. The one ohm resistor in the cathode circuit should be used for bias measurements. If you use directly heated triodes, place the resistor in the plate circuit instead.

Table 1 shows you some of the output tubes that you can use. The damping factor is dependent on the output tubes: KT-88 provides a damping factor of 4, 300B gives 5, and 6336 gives 6. The input sensitivity is also dependent on the choice of output tubes. A volume control can be fitted to the input if desired.

Details of a power supply for a stereo KT-88 ULTIMATE amplifier are given. If you use 6336 or 6C33 output tubes, you must use one power supply per channel or substitute solid state rectifiers for the GZ-34 tube rectifier due to high current requirements. I have not done any distortion measurements but I estimate that the ULTIMATE amplifier gives 4% second harmonic and 1% third harmonic at full power output. Table 2 provides transformer secondary voltages required for different tube types.

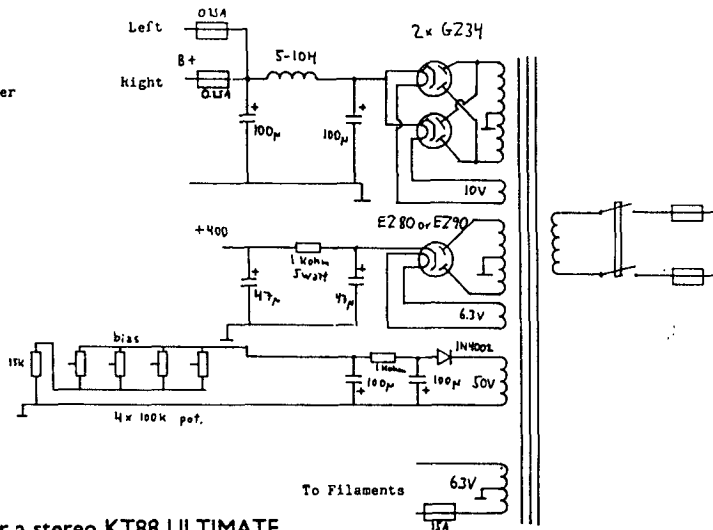

Power supply for a stereo KT88 ULTIMATE

Tube	B+	Pri Z	P <sub>out</sub> W	Plate I mA/tube	Bias
2A3	250	6600	7	60	-45
300B	350	7600	14	80	-72
6C19P	250	13000	6	40	-100
6C33*	250	2800	18	150	-100
6080	180	5200	7	70	-75
6336	250	3500	15	110	-120
6L6*	400	13000	9	50	-38
KT-88*	400	8000	15	80	-43
PL519*	400	9000	18	80	-55?

\* triode connected

TABLE 1

Determining transformer secondary voltage for desired DC output:

Capacitor input filter with solid state full-wave bridge or full-wave vacuum tube rectifiers.

DC Volts	SS bridge	Tube
180	140	2X160
250	190	2X210
350	270	2X290
400	310	2X330

When solid state rectifiers are used, the transformer secondaries should be rated for twice actual current.

TABLE 2

# WORDS OF LOUDSPEAKER WISDOM (the BIG ten)

by Ray Newman

0. If left alone, solutions to acoustic problems will eventually be resolved by a creeping Darwinian process. Better solutions will occur with increasing frequency under conditions of use, until they eventually become the norm. Applying keen intelligence gets you there faster and with more pizzazz.
1. Loudspeaker design is a technologically based art form.
2. Perceptions mean a lot--especially *visual* perceptions.
3. Get to know continuums from catastrophes. Most matters of acoustics respond gradually and forgivingly to small changes and won't crash. Just don't miss drilling the loudspeaker bolt-circle diameter by more than 1%!
4. Know how to relate dBs to subjective experience.
5. The louder system always sounds better in a direct comparison.
6. Understand the concept of using the volume of space allocated to a loudspeaker system in the most efficient manner possible, even if you must make compromises later.
7. Watch out for the implications of the small and large-signal relationships once you find out what they are.
8. Learn to separate first-order technological matters from second-order ones, much less third-order ones.
9. Send the acoustic message in the right direction as much as you can. Loudspeaker directional characteristics count.
10. Beware of the "Laws of Physics"--people who use this term often don't know what they are talking about.

This document was passed around in a loudspeaker engineering lab as a "philosophical" offering some years ago where it pretty much got lost in a black hole. Here's a copy for posterity.

# AUDIO NOTE

## MAKING THE BEAUTIFUL - TANGIBLE

You have just started listening to your first triode amp. Reproduction now seems a little vapid and under powered for your speakers which are left over from your previous, non-triode system. You were hoping Single-Ended would bring new excitement, but your recordings are not demonstrating the magic and vibrancy you thought you were going to get with the change to triodes. Believe me, this is where every experimenter with this new technology ends up at some point. I was there five years ago, before I got into big horn systems.

Sadly, after four years of hard work, I had to give up on the horns. They seemed to capture the dynamic signature of the musical presentation, they got the leading edge of transients, but they seemed to lose the harmonic development that follows the leading edge. The room acoustic, the overtone structure, the sense of a whole energized musical environment was lost on the horn system. The horns had difficulty being subtle or refined.

When I gave up the horns, I was back at the start looking for a speaker to use with low power triodes. At this point, I was just tired of the struggle. I wanted to find a speaker that would showcase the differences in amp design and let me focus on investigating new program.

Now, I am sitting back, smoking my pipe and selling Ongakus. I can afford ANY speaker that will show off the radical perfection of Kondo's design. You know what? I was a slow learner, but I found the speaker that does the most things right with SE triodes. The answer was right in my back yard all along. The Audio Note Model 2 & 3 speakers allow 7 watts to play full-range, deep, rich and fast. With these speakers, reproduction is tonally correct, unstressed and natural. I use the silver wired Model 2/SPX (\$2,695) to demonstrate the Ongaku (\$89,000). Don't spend the next five years trying to "get your system together." Pick a speaker you can live with for a long time and design your system around it.

**HERBERT REICHERT  
MIKE TREI  
AUDIO NOTE NYC  
Tel. 718-876-9742**



# Try a screen driven driver stage

by Rickard Berglund

Some output tubes (211, 845) need a very high drive voltage with low distortion. Some tube freaks have used the 300B tube as a driver but it is very expensive. Others have tried to use a triode connected EL34 but it is not linear enough.

A pentode driven on the screen grid is very linear. I have tried this concept in a new driver stage, as shown on the accompanying schematic. The first two tubes V1 and V2 form an asymmetrical mu-follower. V3 is a screen grid driven pentode. Adjust the potentiometer R9 to 350V DC at the plate of V3. You can use many different tubes for V3.

I made distortion measurements for some different tube types with the results given in table 2. EL36 and 5881 are the two best tubes. The linearity of these two tubes in this "enhanced" mode is even better than for a 300B tube used as a driver.

The sensitivity of this driver stage is so high that it can be used direct with a CD player. Use an 100k ohm pot as volume control. Both the 400V and 700V supplies should be well filtered, maximum ripple 2mV.

You can of course use higher voltage than 700V for better linearity. The EL36 tube can withstand more than 1000V. The 6DN6 tube can also be used for very high operating voltages. Never use more than 1000V B+ supply voltage and be sure to set the anode voltage to 50% of B+ voltage. Use a separate filament supply for V2. Be careful, high voltages are dangerous!

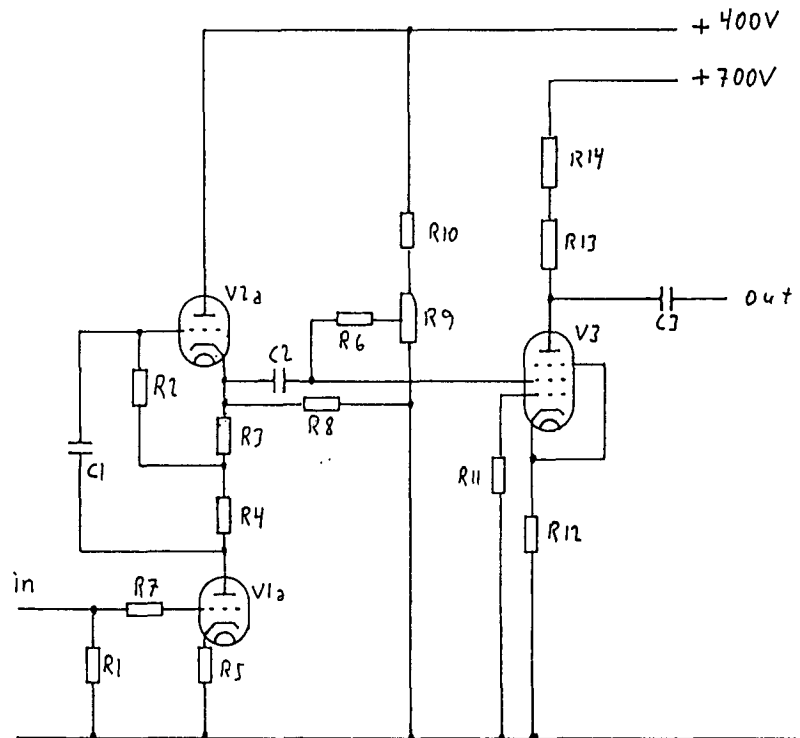
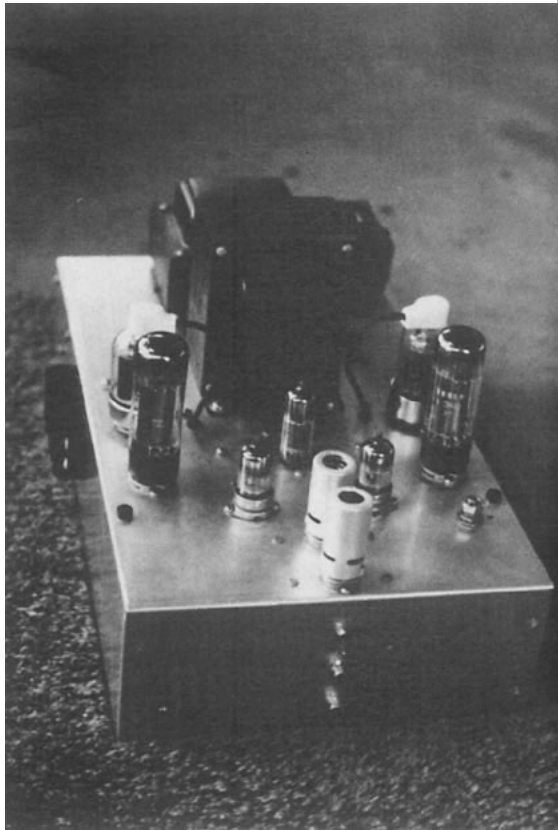

**TABLE 1 - Parts List**

R1, R6	100k ohm	R12	100 ohm
R5, R7, R11	1k	R13, R14	12k 6W
R2	470k	C10	.10uF 400V P
R3	68k	C2	1uF 400V PP
R4	22k	C3	1uF 630V PP
R8	68k 2W	V1	12AX7/ECC83
R9	50k pot.	V2	12AU7/ECC
R10	150k 2W	V3	see text

**TABLE 2 Distortion for different tubes at V3 measured at 50V RMS output**

V3	Distortion in dB		Drive mV for 50V out	Brand
	2nd	3rd		
EL34	-46	-43	141	Telefunken
EL36	-47	-74	65	Tungsrham
5881	-48	-73	122	Sovtek
6L6GA	-45	-54	144	Tungsrham
6AV5GA	-45	-68	82	Sylvania
6DN6	-47	-58	51	G.E.
6CD6GA	-39	-47	68	G.E.



# THE GRAPE OX

A Cathode Follower  
Bridge Power  
Amplifier

by Alan Kimmel

## *Time for the PP Pentode Revival?*

Like many others, I have been dissatisfied with conventional vacuum tube output stages, whether single-ended or push-pull. Without the assistance of negative feedback (NFB) they have too much distortion and their output impedance is high. Performance in other areas is poor also. I felt it would be ideal, sonically, if performance could be significantly improved while using zero or little NFB. Push-pull amplifiers are making a comeback and this article sets forth one attempt to improve the PP amp.

It seems also that some *SP* readers are prejudiced against pentodes. The myth that all pentodes sound bad is just that—a myth. Note that the first stage of the renowned WECO 91 is a pentode. Pentodes can sound good, even excellent, when used properly. Sometimes simply changing brands will make the difference.

The point I want to make is: HOW pentodes are used can make ALL the difference. Pentodes have gotten a bad rap that they don't deserve, partly because of failure to use them optimally and largely because of nothing more than hearsay/myths. The belief that *only* triodes can sound real is an

oversimplification. Reality seldom conforms to our neat simplifications.

I don't say that pentodes are better than triodes, or vice-versa. I say, let's make the most of both. Rather than pitting one against the other, it is possible and desirable to allow them to work together synergistically. One application where pentodes excel is as cathode followers.

One of my main objectives was to obtain a low source impedance to drive the output transformer. This suggested a cathode follower (CF) output stage. I looked at CF amplifier construction articles from the past but most left something to be desired. After trying various CF output stages I tried an idea I've always wanted to try: a PP pair of "single-ended push-pull" (SEPP) output stages, each driving one end of the output xfmr primary, forming a bridge output stage (PPSEPP).

The idea of a bridge output stage is not new, e.g. Kerim Onder built one in 1954 using 6AS7 triodes in the output stage of an OTL amplifier to drive a 400 ohm speaker to 8 watts (*Electronics*, Feb. 1954). My CF bridge amplifier presents a refined variation of the concept.

Before further discussing the bridge output stage I want to mention something about conventional PP output stages. When signal is applied, an output tube conducts and pulls its plate down toward ground. At the same time, the opposite output tube conducts less and its plate voltage increases by the same amount that the conducting tube's plate voltage decreases. This see-saw effect is due to transformer action from one primary half to the other. In this process, the less-conducting tube's plate voltage increases well above the B+. In many conventional amps the plates can swing as high as 1KV or even higher. Also, current increases through the conducting tube's half of the OT primary while current through the other half decreases.

In a bridge output stage, both halves of the primary see equal current at all times with benefits such as prevention of OT saturation, reduction or elimination of PP switching transients, and good performance even without negative feedback.

## **Bridge Output Stage**

In this amp the "bottom" pair of output tubes (EL-34s) are operating pretty much normally except that they are getting a lot of assistance from and are dominated by the "top" output tubes (6146Bs). In fact it is more accurate to say the 6146Bs are being helped by the EL-34s. The less a 6146B conducts, the more its EL-34 conducts, and vice versa. This ensures that a low impedance is driving the entire output xfmr primary all the time. The 6146Bs are the CFs of the output stage and the EL-34s can be thought of as active loads for the CFs. You could say the output stage is "dual push pull", i.e., a bridge output. Because the output CFs dominate the output stage, I call this a CF/Bridge output stage.

At first I tried straight CFs for the output stage—no bridge. The center tap of the output xfmr primary was grounded. I was able to get much more power with the straight CF output stage but it had a lot of crossover distortion with an 8 ohm load. To kill the x-over distortion the output tubes had to be idled at high current, a problem which apparently could have been dealt with by paralleling a lot of output tubes to share that current. The situation changed when I went to the bridge output stage. It could operate at significantly lower idle current than the straight CF output stage while keeping distortion down.

**Fig. 1 — PP Cathode Follower Power Amplifier**

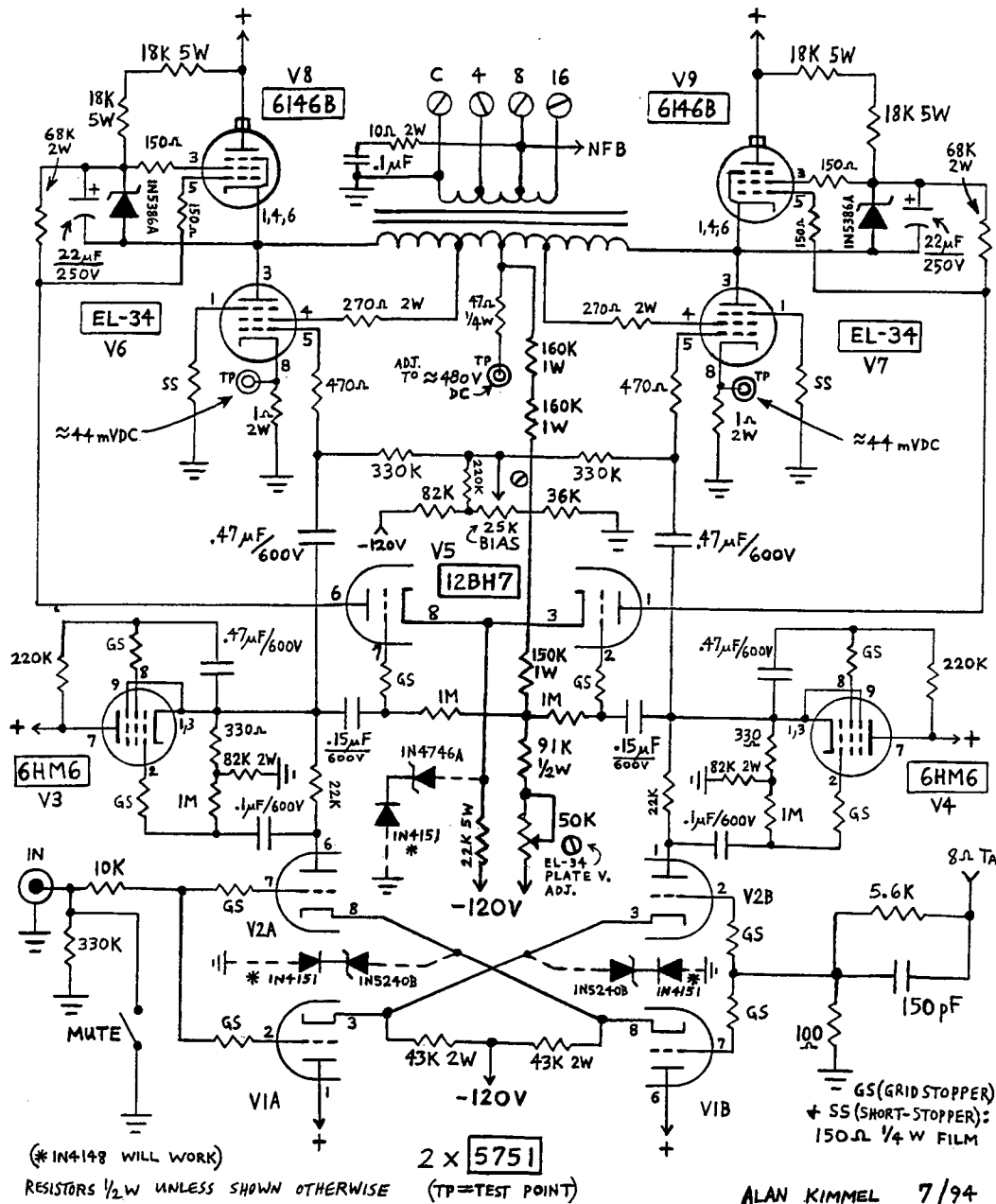

Since this bridge output stage does not use the c.t. of the output xfmr primary, the usual voltage-multiplication found in conventional output stages is gone. To compensate requires a B+ equal to a little more than the peak voltage I want across the primary. In this prototype the total B+ for the output stage is 960 VDC, and the quiescent voltage across each output tube is 1/2 the total B+.

Radio amateur handbooks feature many transmitter construction projects with a B+ exceeding 1KVDC. A growing number of audio amplifiers are using transmitting tubes such as types 211, 811A, 845, etc. Those amplifiers often have a B+ exceeding 1KVDC so there's no need to raise an eyebrow over a comparatively modest 960 V. 450 V can rearrange your hair just as well as 1 KV. Nevertheless the proper precautions and high voltage construction techniques are required. This amp should be built ONLY by those who have had plenty of experience in working with such voltages. Ensure that all wires associated with the power supply and the output stage have insulation rated at well over 1KV.

When I began experimenting with the bridge output stage, power triodes (triode-connected EL-34s) were tried for the upper output CFs; this resulted in comparatively feeble output power and poor high frequency response. That situation could have been improved by adding a pair of CFs to drive the triode output CFs but I discovered a simpler and much better solution: Replace the triode outputs with power pentode CFs.

A bridge output stage does not use the center tap of the output xfmr primary; thus the same current flows through the entire primary. Therefore, although the screen taps are used, it should be difficult, if not impossible, to saturate the output xfmr in this amp no matter how unmatched any output tubes may become.

At first glance it may appear that we are indeed using the c.t. of the output xfmr but a closer look will reveal that the c.t. does not connect to a source of B+. In this amp the c.t. serves only as a test point and as a

convenient place to derive DC NFB. The DC NFB helps stabilize the quiescent plate voltage of the EL-34s which is helpful when the bias is adjusted or when output tubes or the 12BH7 tube are changed. The 50K pot is adjusted so that the voltage at the output xfmr primary is 1/2 the B+ (480 VDC in this prototype). Though the DC NFB reduces interaction between the voltage adjustment and the bias adjustment, they still might interact a little. When adjusting either pot you may have to go back and forth between the two a time or two. I like to use locking pots for voltage and bias adjustments.

Though this deprived me of the joy of adding more tubes and parts, the pentode CFs gave more power and also provided significantly better HF response due to their lower input capacitance. When building a pentode CF it is best to use a pentode with low screen grid requirements. This rules out tubes like the EL-34.

The first tube I tried as a power pentode CF was the 6JN6, and it did a very good job, but its plate dissipation rating (Pd) is a bit low. I really wanted a low screen voltage pentode having a higher Pd than the 6JN6

but also requiring about the same filament current as the 6JN6. This led to the 6146B, which does a really good job. 6146s were used in audio amps by RCA, Altec, and other manufacturers during the '50s and '60s.

Incidentally, horizontal deflection output tubes work nicely for the upper output CFs; besides having low screen requirements, such tubes are high-perveance types, and make good CFs. In fact, at one point 6LF6s were tried as the top output CFs, along with 8417s in the bottom of the bridge. The 6LF6 + 8417 combo worked quite well. *Important:* Each upper CF output tube in this amp must have its own separate floating filament winding.

We tried triode-connected EL-34s for the bottom output tubes of the bridge also but the improvement obtained by connecting their screen grids to the screen taps was so great that we kept it that way. EL-34 anode-followers were also tried at the bottom; results were better than with triode-connected EL-34s but not as good as the partial triode ("ultra-linear") connection.

Making the bottom tubes constant current sources might be a good idea but was not tried; in effect the EL-34s are already acting as constant current sources for the 6146Bs.

Standard audio output tubes which require a relatively high screen voltage (like the EL-34) are best for the bottom half of the bridge. Overall, the best combination seems to be: power pentodes with low screen requirements for the upper tubes, and ultra-linear operation of standard pentode audio

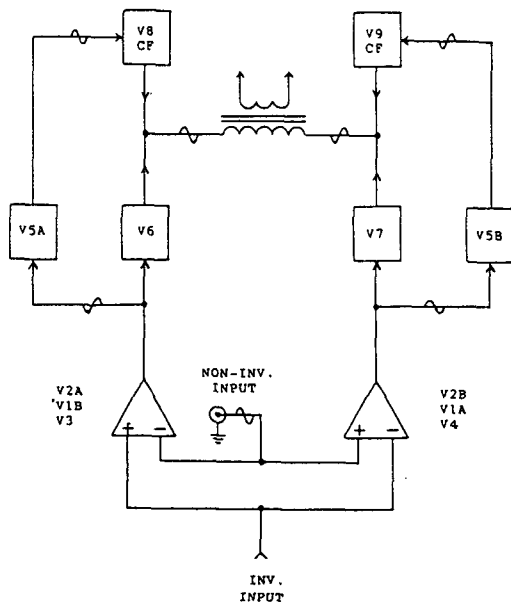
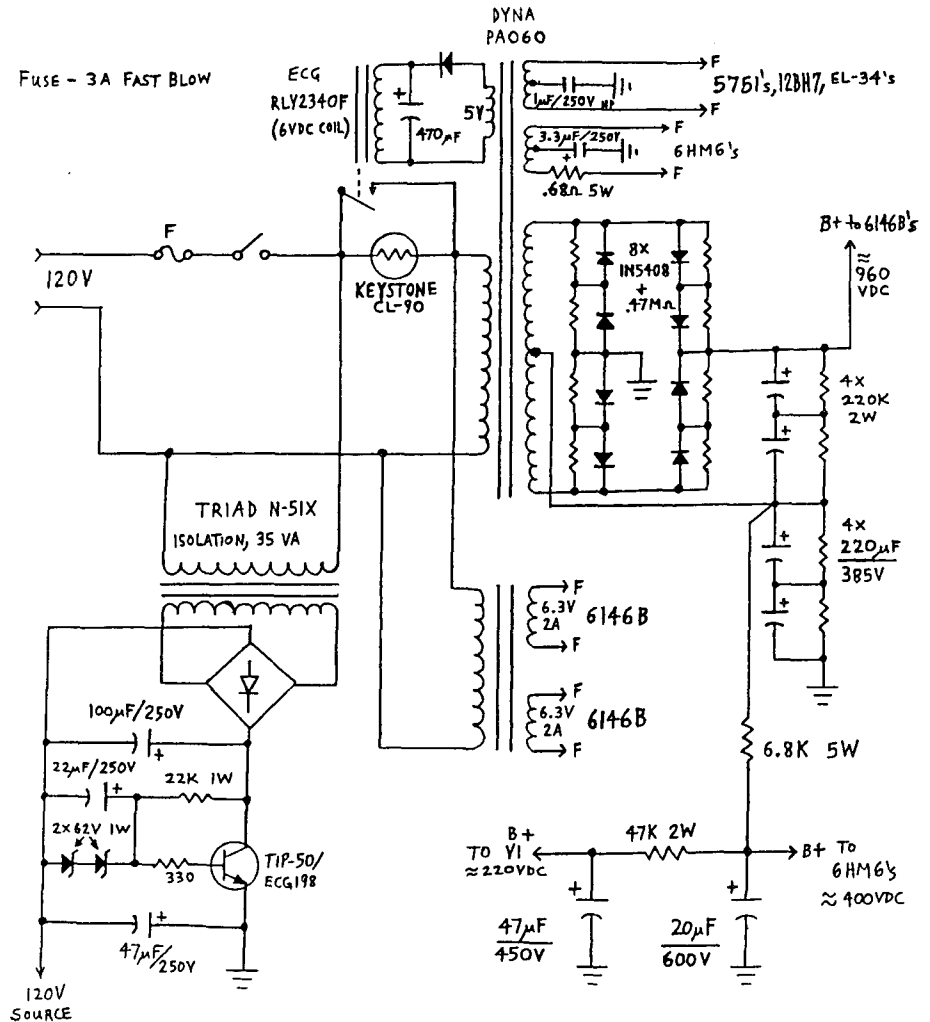

Fig. 2 — Block diagram of amp

Fig. 3 — Power Supply



output tubes for the bottom section of the bridge. Additional improvement can be obtained by giving each upper output tube its own dedicated floating 180V screen supply, however the amount of improvement would probably not be worth the trouble.

More about the bottom tubes: the bottom output section (the EL-34s) has slightly higher overall gain than the upper output section (the 12BH7 and 6146Bs). This slight difference in gain provides best performance. This became even more evident when 8417s, which have higher gain than EL-34s, were tried at the bottom. The 8417s provided somewhat better performance than EL-34s but EL-34s were chosen because they are more plentiful. 6550s were also tried at the bottom. Performance was no better than with EL-34s and perhaps even slightly inferior probably due to the lower gain of the 6550. Other brands might make a difference but were not tried.

About the only thing I did not yet try with the bottom tubes was to operate them in "enhancement" mode, that is, applying the drive signal to the screen grid (grid #2) rather than the control grid (grid #1). If properly done this should work well, provided an adequate gain ratio is reestablished between the bottom and top portions of the bridge.

It's a shame to let the 8417 tube fade away. Its high gain can simplify many amplifier designs. And it would be real nice if somebody would manufacture a higher power version of the 8417 — they could call it a 9417. It could revolutionize high power tube amp design.

Perhaps this amplifier has a little more power than many of the readers of this magazine are into, but higher power has its advantages, such as less clipping and better ability to drive inefficient speakers.

### Driver Stage

A CF output stage requires very high drive voltage. The high drive voltage needed for the output CFs, provided by the 12BH7, was easily obtained with Mu Stage type bootstrapping. Properly applied, bootstrapping can be a wonderful aid. Note that the time constant at the input of the 12BH7 should be identical to the time constant at the input of the EL-34s because the 12BH7 and EL-34s work concurrently, in unison. By the way, a 6BL7 might be ideal in place of the 12BH7 but I haven't tried it yet.

You could say this amp has a triode output characteristic because the 12BH7A dominates the output CFs and the output CFs dominate the output stage. The triodes are in complete control of the amplifier. The pentodes are but slaves of the triodes, acting primarily as precise extensions of the triodes in the amplifier.

The front end of this amp, consisting of V1 thru V4, is the dual diff-amp Mu Stage from Fig. 7 of my Mu Stage article (*Glass Audio* 2/93). It is simply two Fig. 6 diff-amps (from the same article) with their inputs cross-connected to get push-pull output. This front end (shown as two op amps on the block diagram) provides the phase inversion as well as voltage gain. V2 provides the voltage gain; V1, V3, and V4 are CFs. I could have used any kind of gain stage and phase inverter but I feel that this circuit is sonically superior to most other driver circuits, gain stages, and phase inverters.

The 6HM6s (V3 & V4) might be hard to find but probably most, if not all, of the tubes having the same pinout should work. (6JC6As were tried and they worked well.) V3 & V4 can share the same filament winding and it is best if that winding is used only for V3 & V4.

My favored approach to Mu Stage design entails having a pentode CF on top of the stage. One of my design goals, and one of the benefits of having a pentode CF on top, is that we have a gain stage that can deliver very large outputs; thus it is easy to make a Mu Stage that can deliver a pk-pk output voltage approaching the B+. This is one of the characteristics that make it ideal for use in power amplifiers.

Other equally important characteristics are good linearity, wide frequency response, and low output Z. The bottom half of the Mu Stage, a triode, sees a very high

impedance load with extremely low shunt capacitance. Sonically, it's an ideal environment for the triode (a "triode in paradise"). A pentode CF is extremely transparent, very musical. The result is a very wide open window through which the triode can convey the music--the real goal of the Mu Stage.

I know some of you SE fans are prejudiced against *all* phase inverters. Yes it's true that many phase inverters cannot deliver a wide frequency response and low distortion at both of their outputs; often the performance of one output is far below that of the other output. This phase inverter, however, combines two very good driver stages; one is a non-inverting driver stage and the other a mirror image inverting driver stage. This circuit provides a high quality homogeneous push-pull drive signal to the output tubes, avoiding the sterile, pasteurized sound (and performance) of mediocre phase inverters.

This amplifier is versatile; if a single input and zero NFB is desired, the inverting input is grounded. If a balanced input and zero NFB is desired, the inverting input is used as the other input for a balanced line, in which case both inputs would use equal value input resistors. The third option is to use the inverting input for NFB as Tom Tutay and I chose to do.

If zero NFB is chosen, the gain of the amp can be set by the first two tubes at the front end, V1 and V2. If high gain is desired, plug in a pair of high mu tubes. For low gain, plug in a pair of low mu tubes. Because a properly designed diff-amp creates the same quiescent DC plate voltage and current regardless of the tube used, this amp can accept nearly any pair of dual triodes (but V1 and V2 should be alike). 6SN7s are highly recommended. Or a pair of 12AU7s or 5814s can be used. For more gain a pair of 12AY7s can be used, a pair of 12AT7s, a pair of 12AX7s, etc. Virtually any pair of dual triodes will work and will exhibit good linearity in this circuit.

After comparing the sound of the amp before and after NFB, we decided to install some NFB. The sound with zero NFB was very good, but adding 7 dB of NFB helped tighten up the bass a bit and improved overall focus. A little NFB was better than either zero NFB or lots of NFB. If you use NFB in this amp V1 and V2 should be high gain types. We chose 5751 tubes for V1 and V2.

Incidentally, to give an amp even tighter control of the speaker, connect your 8 ohm speaker to the amp's 4 ohm tap. With high powered amplifiers you can still get enough power even when connecting a speaker to a lower impedance tap.

This amplifier has low noise even with zero NFB. All B+ passes through CFs. None of the voltage gain stages get their B+ directly from the power supply; they get it through a CF. This is true of the output stage as well, ensuring good Power Supply Rejection. Thus all amplifier circuitry is isolated from whatever sonic signature the power supply may have. This contributes to the excellent ability of this amp to deliver music.

The prototype uses an Eico #32024 output xfmr by Stancor (from the Eico HF-89 amplifier) because a pair were on hand and we wanted to put those xfmrs to work. The lower source impedance of the CF/bridge output stage should make it compatible with a wide range of output xfmrs. Because the output xfmr carries virtually no DC current (except the screen current of the bottom output tubes), it seems that a low power output xfmr should be able to yield more power in this amp than in a conventional output stage.

The prototype's power xfmr is a Dynaco #PA060, made for the well known Dyna ST-70. Using a solid-state full wave bridge rectifier with a power xfmr that was intended for a push-pull rectifier tube will slightly more than double the DC output voltage. In this way, conventional tube amp power xfmrs can power an amplifier that has a bridge output stage.

I used the 5V winding of the power xfmr for a soft-start circuit. It prevents the big inrush current surge when the amp is switched on. Any amp with a solid-state B+ rectifier should have some sort of soft-start. In fact, most amps can benefit from soft-starting and the soft-start circuit used here is a nice and simple addition to the amp, besides putting the otherwise unused 5V winding to work.

Years ago I tried a similar popular soft-start circuit that used a 120 VAC coil relay, with the relay coil connected across an amplifier's power xfmr primary. That soft-start circuit worked, but as it went through its sequence the relay sounded like an electric saw, and was almost as loud; that didn't give me a warm feeling. I discovered that it calmed

down very nicely if a DC relay is used. The result is a well behaved soft-start sequence. This soft-start circuit can be used in any amplifier. The thermistor was suggested by Tom. A thermistor is indeed the preferred choice and saves space, but a fixed power resistor can be used instead, probably around 50 ohms @ 20W, give or take a few tens of ohms. The value of the resistor, combined with the load that the amp presents to the resistor, determines how long it will take the relay contacts to close. (If too large a fixed resistor value is chosen, the relay contacts will stay open too long or never close at all, overheating the resistor). Besides reducing start-up stress, the soft-start permits a fast-blow fuse to be used which provides more protection than a slo-blo fuse.

Ideally, a longer delay of the B+ would be obtained if indirectly-heated rectifier tubes were used to make up the entire B+ bridge rectifier. A minimum of three rectifier tubes would be required: one 5AR4/GZ34 plus two half-wave rectifier tubes (plus 3 separate filament windings). Though three more tubes would have certainly been merrier, I felt I should draw the line at 9 tubes lest someone think this is a tube tester doubling as an amplifier, or vice-versa.

#### Other Ideas

As with most amp designs, additional refinements are possible. Here are a few minor ones for this amp:

1) Optional "warm-up cathode clamps" (the diodes shown in dotted lines on the schematic) can be added; they cushion the grids of the diff-amps during warm-up and go open-circuit immediately upon warm-up. They're a good idea for any tube circuits that use a -V<sub>kk</sub> supply.

2) Increase the gain of the DC NFB loop. One way to do this is to replace each 160K resistor with a 160V 1W zener diode. This should make the EL-34 plate voltage adjustment and the bias adjustment practically 100% independent of each other. (Using the 160V Zeners may or may not require a filter capacitor of about 1 μF from ground to the junction of the 91K resistor, the 150K resistor and the two 1 meg 12BH7 grid resistors.) We might do this in the prototype someday but the amp is stable enough as is.

3) A special AC balance control can be added (Fig. 4). This can cancel any remaining

distortion arising from whatever slight imbalance there may yet be somewhere. However, this amp is already quite good about AC balance and therefore an AC balance control was not installed in the prototype.

The mute switch is an option that's convenient for inserting or removing connections to the amp's input while the amp is powered up. This saves the amp the needless stress of being turned on and off each time input connections are changed. Because it is a shunt switch, it is completely out of the signal path when open, having no effect whatsoever on the sound. I think all amps should have one.

On the schematic, "short-stopper" resistors are shown at the suppressor grids (grid #3) of the EL-34s. In the unlikely event a short occurs from the suppressor grid to the plate, the SS resistor will blow and prevent a disaster. It's a little technique I like to use on any power pentodes that bring their suppressor grid out to a separate pin. Statistically this technique is unimportant, so if you prefer, connect the EL-34 suppressor grid (pin 1) to the cathode (pin 8).

Recommended current through each EL-34: 40 to 44 mA. (The current that flows through an EL-34 also flows through the 6146B on top.) When setting the bias a DVM is necessary to read the small voltage across the 1 ohm EL-34 cathode resistors.

Fig. 4 — AC Balance

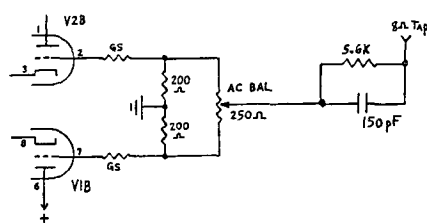

This AC balance pot varies the NFB from one diff-amp to the other to increase the gain of one diff-amp while simultaneously decreasing the gain of the other. (In a Mu Stage, standard plate-circuit AC balance schemes are ineffective). AC balance pots are best adjusted with a distortion analyzer. Even a very unbalanced PP amp will probably have lower distortion than a typical SE amp. However, AC balance has more influence on distortion figures than on perceived sound. That's why I made the AC balance control optional.

The EL-34s are a matched pair. The 6146Bs should also be matched but this is not as important as matching the EL-34s.

A good CF amplifier from the past was designed and built by Mr. J.C. Witherspoon and shown in the January 1959 issue of *Audio* magazine. Mr. Witherspoon and I had similar objectives but we reached our goals in two very different ways. He called his amplifier "The Purple Cow", so I nicknamed my amplifier "The Grape Ox", which is easier than saying "The Cathode Follower/ Bridge Power Amplifier".

In conclusion, this amp is a bridge to great sound . . . an attempt to address inherent weaknesses of tube amps. It is stable and well behaved. A lot more could be done to further improve its performance before NFB. For example, it can be modified to accept 8417s at the bottom of the bridge and 6LF6s at the top, permitting a higher idle current in the output stage, which in turn would further reduce distortion and output Z. We stayed with EL-34s and 6146Bs because they are quite adequate for us. Still another possibility is to parallel the output tubes (PPSEPPP), which would also permit higher idle current in the output stage.

#### For Spec Inspectors . . . A Few Specs:

**Zero NFB** 1 kHz input, RL = 8 ohms:

8 ohm tap: Z<sub>out</sub> ≈ 2 ohms

THD: The prototype measured: ≈ 0.06% 1W, 0.25% @ 10 W, 4.4% @ 50 W.

4 ohm tap: Z<sub>out</sub> = 1 ohm

THD: 0.06% @ 1 W, 0.11% @ 10 W, 0.9% @ 45 W.

Noise: < 1 mV with shorted input.

Frequency response @ 5V rms output into 8 ohms: flat from 20 Hz to 20 kHz

Idle current for each output tube: ≈ 44 mA.

**7 dB NFB** 1 kHz input, RL = 8 ohm

8 ohm tap: Z<sub>out</sub> = 0.8 ohm

THD: 0.04% @ 1 W, < 0.04% @ 10 W, 1.9% @ 45 W, 4.6% @ 70 W.

4 ohm tap: Z<sub>out</sub> = 0.4 ohms

THD: 0.03% @ 1 W, 0.04% @ 10 W, 0.43% @ 45 W

Noise: Lower than with zero NFB.

Freq. response: Wider than with zero NFB.

Idle current for each output tube: 44 mA.

#### Notes:

THD will vary depending on inherent linearity of V2, V5, and idle current of output stage. Different output xfmr's will of course affect the specs. Some xfmr's will yield better specs, while other xfmr's will not do as well. As readers of this magazine know, specs don't tell the most important story.



An excerpt from. . .

# "THE TUBE PREAMP COOKBOOK"

by Allen Wright, Vacuum State Electronics

*Will a component by any other name sound as sweet?*

## BUILDING BLOCKS . . .

### \* **A is for Air - The Insulator!**

Use it wherever you can: between components, cables, between cabinet walls and components, between everything! Don't get ridiculous and run 0 cm of wire between each connection but sometimes a little more (good) wire is better than unwanted interference and cross coupling. Use some air to get more "Air"!

It does sound so much better than any other dielectric — and it's cheap!

### \* **B is for Battery - and real DC**

There used to be a cult group in Melbourne (Oz) who used car batteries to supply the heater current for their X7 preamps, and they swore it was worth the hassle. And they also said if you had the charger in circuit when listening you were wasting your time...

Batteries in a smaller format can be used for tube bias, and there's a pix of such a usage in SP Vol. 1 #3, p. 26. And if you need a noise free source of voltage with very low source impedance, why not?

### \* **B is for Books - there are a few**

#1 - *The Radiotron Designers Handbook* by F. Langford-Smith. This classic book for tube people is an Australian masterpiece with so much data that you could never learn it all. My copy has lost so many of its outer pages I can't tell when it was published, but it's at least forty years old, and I'm sure there were editions out before the war. Long out of print, I found mine in a second hand book shop in Sydney one day when the sun was really shining.

#2 - *Vacuum Tube Amplifiers* by Valley & Wallman. These were the dudes at Bell Labs who amongst other things, invented the cascade circuit! This is the book to have and those Tek and HP guys must have carried it

around in their hip pockets. It's the only source I know for the military driven tube applications research of the 40s and 50s! Out of print although I was told that it was being reprinted, but my promised copy hasn't arrived yet!

### #3 - Tube Manuals

Any and all tube manuals from any of the tube companies: RCA, GE, Philips, Telefunken, Mullard Sylvania etc. The really interesting ones are the pro ones that cover special tubes, and they give all sorts of trick data you never find anywhere else.

\* **C is for Cable - which is a book in itself**  
Well I've got a book on the subject coming, and I'm not going to cruel my sales by giving you all the hot dope here. But here's a little of it.

The Guru shared these secrets with me one dark night, and I rushed home to try it out. Once again he was right and these are the key points he entrusted to me:

1. Audio signal cable must be solid core.
2. This solid core must be as thin as absolutely possible!
3. The material is not as critical as the thinness, thin copper is better than thicker silver.

Now this means what it says: 1.0 mm diameter (~18ga.) is better than 2.0 mm, 0.5 mm is better than 1.0, 0.25 mm is better than 0.5—and getting really crazy—0.125 mm is better than 0.25. There is no theoretical limit to this, thinner is better, sonically! This is wild I know and I would never try to put it on you if it hadn't been backed up by someone with some real credentials and pages of Math!

In an article printed in *HFN & RR* August '85, Professor Malcolm Hawksford did a brilliant examination of basic Maxwellian theory and how it applies to audio cables. And I think there was an even more Math heavy version in the *JAES* around the same time, if you're into that sort of self abuse.

The Prof. explains how cables really work for AC signals and for the first time anywhere gives scientific backup to what we've been hearing for years. And what he says fits exactly into what the Guru told me that night and I've since demonstrated to hundreds of mostly still disbelieving people. Thin cable bypasses the bandwidth restrictions and time smearing caused by thicker cables. It fits better into the requirements presented in the philosophy section and it sounds noticeably cleaner and less distorted!

Now I don't want to hear you bleating that you can't get good thin wire to try this out: Van den Hul sells 0.125 mm extruded solid core silver with teflon insulation, and that's what I use for myself. Audio Note offers 0.05 mm polyurethane 99.9% solid silver which seems about perfect to me and I'll be trying that next.

But for the cheapest good wire you can use, cruise down to your local Radio Shack/Tandy store and buy a reel or two of their 0.25 mm (~34 ga.) wirewrap wire. It's amazing, a silver plated copper with a 'strip-able' Tefzel insulation, for pennies a meter! I've used it for years and lightly twisted it has other uses...Whoops, that's saying too much...send off and get my *SuperCables Cookbook*, it's less than the cost of a meter of 'the best' cable.

Now no freaking out on me, I know this thin cable idea is 100% opposite to what you've been told, read in all the glossy ads or seen on those huge cable spools in the HiEnd stores! But I heard somewhere that super cable is a four billion dollar a year business now, so how much profit do you think they'd make if they changed over to selling wire not much thicker than a strand of hair?

Could there be some misinformation in the air, do you suppose? Some subtle suppression of the truth?

Loud noises are heard from the back of the room, from the harassment group: "Yeah, but what about series resistance?" "If we make it too thin it'll just fuse!" "You can't work with wire this thin, it'll just break off in your hands!"

OK, OK, I hear you, but have you ever looked at the wire in your MC cartridge or the wire in a Jensen microphone transformer, or the wire in a \$1000 AKG dynamic mike? That's thin, and yet they don't seem to have problems using it! And you don't hear of these items fusing, do you? Except

when some idiot plugs them into an output—and then plugs the cable from the power amp into the MC input! (The sound of the cantilever in its death agony will remain etched in my brain forever...)

0.05 mm wire can take at least 50mA before it gets in any way stressed; so it will be fine most anywhere in a preamp. The series resistance is never more than a fraction of an ohm anyway, but it stays that way from DC to right out to beyond anywhere even you want to go! And it sounds sublime! Trust me, try it.

**\* C is for Capacitor-  
A device from the Dark Side!**

The only good capacitor is no capacitor, or so the story goes, and I'm inclined to agree. With the tube designers quitting before they figured out a PNP tube, capacitors are pretty well unavoidable in our units, so let's use as few as possible and then only the best.

I consider as a flat unbreakable rule that electrolytic capacitors have no place in any audio signal path, which means they have almost no place in a preamp. I'll only use them upstream of a SuperReg, and if you don't use such a regulator, with its almost infinite isolation between the AC and the DC, then there's no place for them, nowhere!

As cathode bypasses they're fully in the signal path and just horrible, and as + rail bypasses they are also 100% in the signal path, if you think it through. So straight out junk them! You want real music don't you? You want a least a chance at the 2 MHz/120db Audio Matrix! And do the same with Ceramics and Silver Micas. Nasty-nasty things!

"OK, smartass, so what do we use?" There are two schools of thought here: the Plastics and the Oilers. In each there's a pecking order and for Plastic, which is the team I'm familiar with, it goes a bit like this:

\* Blue Caps/Green Caps/Brown Caps—these are your regular junker polyesters you can get most anywhere and occasionally you'll be surprised.

\* Metallized polypropylenes (MKP) from the European manufacturers like Rifa and Wima are available up to 10F in a wide range of voltages. Wima MKP10s are those bright red block caps you see in all sorts of good(ish) gear and we'll use them in the low end Vacuum State products. They're OK.

\* Foil/polypropylenes (FKP) from Wima, etc. Only available up to 0.22F, but now we're getting better.

\* Foil/polystyrenes in values up to maybe 0.022F (22nF) from a variety of European manufacturers, Wima, Siemens, Rifa, etc. You can find these in 1% tolerance straight off the shelf here in Munich, and perfect for RIAA networks.

Beware, I'm talking about the modern single ended rectangular caps here, in pretty colors, with both ends of the stack fully welded to the leads and hence pretty much free of inductance.

But what people often use for EQ networks are the older (also 1%) tubular polystyrenes, that are clear and have axial leads, not from the center of the roll, but from 2/3rds the way out and are often known as Styroflex or Styrodeal. Like the ones Audio Research uses in the SP6 and 8 for example.

They are considered perfect by most everyone, but these crappy little suckers are poison, and you'll do everyone a big favor if you trash them every time you see them. I don't step on bugs but I'll sure step on these sorry apologies for a precision component!! And because they have such a big rep on the street, you'd never consider them when hunting for that 'yukky-ness' that's become real apparent since you got everything else so clean!

The Guru once spent about a week, call it 100 hours, trying to get a preamp singing after I'd fitted these caps, and even he never thought of changing them... But after everything else was tried, he finally scrapped them in desperation and . . . Voila! Music!

\* The specialist audiophile caps from Solen, Wonder, Hovland, Kimber and MIT etc., etc.... and not in any order of preference as each manufacturer has so many models and constructions.

\* Then there are the really freaky Teflon and Glass caps, which I've seen pictures of, but never used.

Unfortunately I'm not about to say what's the ultimate best for all applications because I don't know, but the best I've used are the old Sidereal Caps, now replaced by the supposedly identical KimberKap.

But it's all so very subjective and I have a freak friend in Oz who swears the Sidereals steal about 50% of the information, and he'll only use brandless 'Blue Caps'.

The other big team playing on the capacitor field are the Oilers, who will not even admit to the existence of plastic caps. They can be seen praying to deadly old PCP filled relics, or swooning over the solid silver foil/paper/oil Audio Note specials that cost about the same as a good used BMW, and are used in the Audio Note amps that can cost more than a good new BMW!

And I'm not knocking them. In Oz we didn't have access to much of this exotica and I never thought to try old caps. Old tubes, sure, but old caps? Fair go, Mate!

So I've yet to try a good modern paper/oil cap but it's on the agenda and I'm hoping for magic things. Choose what you like, but use as few as possible!

**\* C is for Chassis-  
But is that a component?**

Wire, PCB traces and anything else carrying signal or power supply currents produce electric and magnetic fields of one form or other, and they will interact with any sheet metal in your chassis and cabinet and naturally, always in a non-optimum way!

If your chassis is made from some non-magnetic metal (copper, brass, or good ol' aluminum) you will have less effects than with a magnetic material (Steel, Iron, Nickel) but the best thing to use from the sonic point of view is something totally non-conductive and nonmagnetic like our near perfect dielectric—Air!

Perhaps a little impractical if you have cats, kids or a wife, so the next best is a plastic, or some great looking wood. We put our production FVP2 preamp into a cabinet made from that super hard artificial wood used for speaker cabinets, and it sure sounded better than the same PCB with the same components mounted up in one of those 'off the shelf' steel rack boxes!

But even with one of these better materials, keep your cabinet walls as far away from the wiring as possible for the least interaction. Have you ever seen those little tweak gadgets sold to keep speaker cables up off the floor—same thing!

Also keep any PCBs well above the chassis, and if you're doing it right with 'Point to Point' wiring, keep the wiring and components clear of the chassis. But using the chassis as a genuine ground plane is a great alternate way to go and the best material for such a ground plane is copper, unless you already have your M3 (the BMW!) and then

you could use pure silver sheet (which is not as expensive as you might think), or at least have the copper silver plated.

Brass is the other option, it's much harder and stronger than copper and when really silver plated, and not just passed over some warm silver offcut, it's as good as silver plated copper, anyway.

More noises from the back, someone down there's getting pretty upset by all this unconventional engineering. Not at all what they did at the Old School: "But with all these non shielding materials, what about the HUMMMMMM?"

Good question, but even with no cabinet at all, if you really handle any earth loops in your wiring, there shouldn't be any hum pickup, and if you use a fully balanced design (keep reading) and also handle the earth loops, there will be NO hum!

☉ **C is for Choke - a forgotten device**

If you really want to filter your power supply, this is the tool! There's a point where you can't get any more filtering from capacitors, and the HF garbage will just float over the top of the big ones anyway, so get down and choke it out of existence!

Overheard one day: "Your filter choke should be as big as the transformer, or you've been shortchanged, Pal!"

☉ **C is for Connectors - a necessary evil**

Just like capacitors, the only good connector is no connector. And if you're really serious, why use any? Just hard wire the whole system together and a lot of your problems will go right out the window!

The connectors we use regularly use in audio are about the worst that could be designed, even if you sat down and thought about it. The guy responsible for the 'RCA' ('Cinch' in Europe) connector gave a bad name to a great ol' tube company and should have been boiled in oil, been made to listen to digital audio for ever, or made to listen to digital while being boiled in oil!

As a connector it does everything wrong! And the same thing goes for those #@&\* DIN connectors! The XLR is better, but it suffers from the problem that the pins (while rugged and making a good contact) are too big in diameter to be a good match to the super fine cable you should be using by now!

The Lemo connectors used on the Mark Levinson equipment are really good, they are

small and make a really good gas tight contact. In this day of high pollution, it's good to know your connectors are suffering less than your lungs.

The only problem with Lemos is: when did you last see a Lemo-Lemo cable for sale? Even at my local ML emporium, every Lemo connector on the back of the gear has a Lemo-RCA adapter plugged into it so commercial cables can be used. Rather defeats the purpose I would think, but I doubt if the average ML client could hear it anyway.

An inexpensive but great connector is the BNC used throughout the professional instrumentation and video industries. It's small, locking and 100% reliable, way better than the RCA!

Why couldn't that have been the standard? But if I was putting together a new 'built from the ground up' ultimate system and I absolutely had to put a connector in the signal path (note the use of the singular) I'd use one of those really neat subminiature UHF connectors that you see all over the inside of microwave test equipment (like 12GHz Spectrum Analyzers) and that look like baby BNCs—such as the SMB series. They use tiny connectors so the signal is impaired as little as possible, but they have moon shot connection integrity. Wonderful!

And what do these mil spec. marvels cost in these days of \$60/pair RCAs packaged in a wooden box? How about \$5.50 a piece? Five bucks for something that looks like it's been machined from a solid block of gold by Swiss watchmakers? Who's ripping who off here in our favourite toy shop?

\* **G is for Gold - Warning time!**

The only change I would make to those SMBs would be to find some in silver (rather than gold) over beryllium copper, because silver's by far the best sonic solution for all audio connectors. Gold isn't the problem, it's the junk needed under the gold to allow it to plate to the base metal. Now solid gold might be cool...

There was a frightening story in *The Absolute Sound* many years ago from Doug Sax of Sheffield Records who changed his whole Direct to Disk studio over to gold XLRs, and then had to go through it all again to shift back to silver—cause the sound from the gold was unusable!

Now that's what happens when you take advice from Audiophiles and don't check it out for yourself first!



Modern tube design at its best  
- built with love and physics :

- Tube CD Filter
- modular Preamplifier
- integrated Hybamp
- Line Purifier

Try us - start listening

Distributor in Asia / Japan wanted

Tel: ++49 208 32 089  
Fax: ++49 208 39 0938  
Compuserve: 100570,1612

**All instruments  
German - quality  
built**

Scharpenberg 64a D-45468 Mülheim

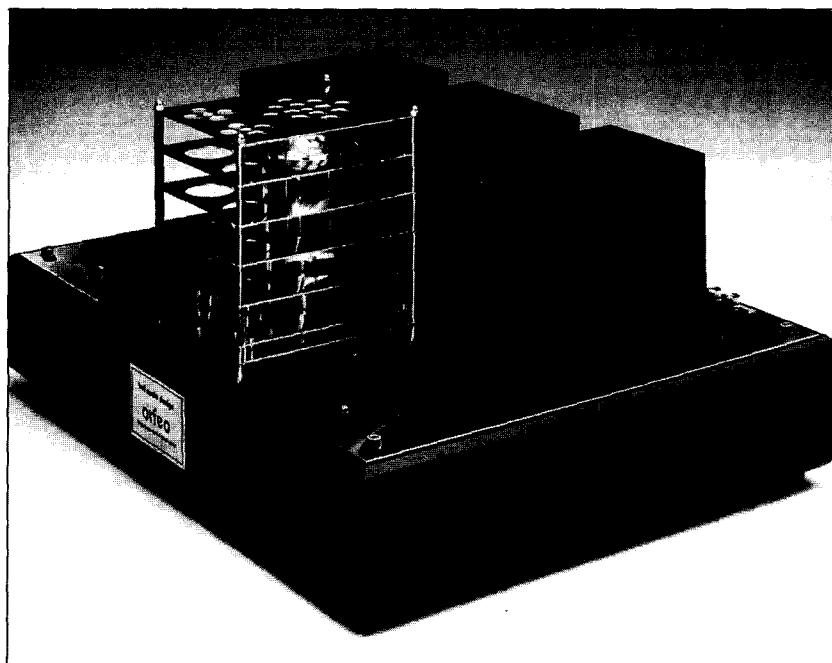

# Orfeo

Single-ended  
845 Triode  
Monoblock  
Amplifiers

... the Orfeo disappears like  
no other amplifier,  
reproducing the beauty and  
nuances of musical expression  
in a most convincing manner  
... designed and hand  
manufactured in the USA.

**bel canto**  
D · E · S · I · G · N

Please contact us for literature and  
the name of your nearest dealer.

10250 Valley View Road, #135-A  
Eden Prairie, MN 55344 USA  
Tel: 612-942-9919  
Fax: 612-942-9990

*dedicated to technical virtuosity and beauty of sound*

**\$800 BUYS YOU ONE  
MAGNEQUEST  
ALL SILVER TRANSFORMER.**

**OR THE LEADS ON  
OUR COMPETITOR'S \$12,500  
SILVER TRANSFORMER.**

PURE SILVER WINDINGS, ALL  
HANDCRAFTED, \$800 EACH.  
PURE COPPER, FROM \$150.  
MIXED VERSIONS FROM \$500.

CATALOG AVAILABLE UPON REQUEST.

MAGNEQUEST, 1404 E. BRISTOL ST.  
PHILADELPHIA, PA. 19124  
VOICE/ FAX (215) 288-4816  
E-MAIL: [MagneQuest@eWorld.com](mailto:MagneQuest@eWorld.com)

**MagneQuest**

HANDBUILT WITHOUT COMPROMISE  
TO PERFORM WITHOUT EQUAL

### Audio Note Output Transformers For Single-Ended/Parallel S.E.

2.5K, 15W, 300B/2A3 SE, 90mA, \$75!!!  
2.5K, 30W, 300B/6B4 SE, 90mA, \$140  
3K, 30W, W.E. 300B/EL34, 140mA, \$160  
2.3K, 60W, KT88/6550 PSE, 110mA, \$200  
2.1K, 30W, 6L6/KT66 PSE, 140mA, \$165  
1.25K, 30W, 2A3/6B4 PSE, 90mA, \$160  
1.25K, 50W, 300B/Etc. PSE, 180mA, \$235  
1.5K, 30W, EL34/6CA7 PSE, 180mA, \$175  
2.5K, 50W, 845/Etc. PSE, 180mA, \$270  
5K, 75W, 211/VT4C PSE, 240mA, \$350  
10K, 50W, 211/845 SE, 150MA, \$225

All A.N. S.E. units are air-gapped. Most are 4/8 ohm secondaries. As found on fabulous A.N. UK S.E. amps! 1000's of these fine transformers are now in service worldwide!

### Audio Note Output Transformers For Push-Pull/Parallel

8K, 15W, EL84/6V6/6AQ5 PP, \$55  
6K, 25W, EL34/6L6/2A3/Etc. PP, \$80  
5K, 30W, 300B/2A3/6B4/Etc. PP, \$95  
6.6K, 50W, 6L6/KT88/807/Etc. PP, \$99  
3K, 50W, EL34/6L6/KT66/Etc. PPP, \$115  
6.8K, 50W, 845/Etc. PP, \$180  
4.3K, 60W, KT88/EL34 Ultralinear PP, \$110  
2.2K, 100W, KT88/EL34/Etc. UL PPP, \$200  
All impedances are calculated for Class A. Most have 4/8 ohm secondaries.

### Audio Note Chokes And Inductors

3H/250mA for Ongaku, etc., \$38  
5H/150mA, \$34  
5H/400mA, \$50  
10H/125mA, \$42  
10H/200mA, \$55

### Audio Note Power Transformers (SEND SASE FOR SCHEMATICS)

Model One, as found on the A.N. KIT ONE, for stereo amps with 2-300B, 2-5687, GZ34 rectifier tube, 1-6SN7, 120-240V, \$160.  
Model Two, for Sound Practices "Poor Man's Ongaku" stereo 211 amp, \$175.

### Angela 'UNIVERSAL' Monoblock Power Transformer for Tube Amp

**D.I.Y. Projects! NEW! NEW! NEW!**  
120V/240V primary! 380-320-55 (BIAS TAP)-0-320-380 at 200mA! 5V at 3amps for tube rectifiers! 6.3V CT at 3 amps! 5VCT at 1.5 amps so you can run a 300B or a 2A3! Simple color coded hookup leads; send SASE for schematic! Build a Western Electric Model 91 style amp! Build a push-pull or S.E. 2A3 amp! Build a 50W Acro/Dyna KT88/EL34 amp with fixed bias, using the convenient 55V bias tap! YOU be the BIG BOSS MAN! Made in USA! Conventional upright end bell mounting. FIVE YEAR GUARANTEE. EACH \$110!!!!

### 'MIL. SPEC.' Potted Power Transformers for Tube Amps!

120V primary! 6.3 at 5.5 amps! 560VCT at 110 amps! Built like a little tank! Potted in sealed, welded steel cans like old UTC military units! MINT condition U.S.A. gonzo government surplus! Great for building compact single-ended EL34/ KT88/6L6/5881 and other tube monoblock amps! Mounting studs and hookup lugs are on the bottom of transformer. Approx. 3 and 1/2" X3" X4 tall. TONS IN STOCK! EACH \$38!!! WOW!!!!

SEE OUR '95 CATALOG FOR DOZENS OF OTHER NEW/VINTAGE/N.O.S. KOOL POWER & OUTPUT TRANSFORMERS FOR TUBE HI-FI & GUITAR AMPS BY DYNA, UTC, FENDER, ACRO, MORE!  
**CROFT UK EPOCH MICRO PREAMP!**  
All tube, point to point wired, complete with phono stage, latest model, NEW! \$500 shipped! Exclusive U.S. agent! New stereo Croft OTL amps in stock from \$850. Send \$2 for information packet.

### Audio Note UK Kit Amplifiers

**Kit One!** 8 glorious watts of pure class A single-ended triode power! Tubes: 2-300B, 2-5687, 1-6SN7, 1-5U4/GZ37. Designed for the experienced D.I.Y. tube audio enthusiast but several absolute beginners have crashed the party! If you can mod a Dyna, you can build this kit! PRICE \$1200, TUBES INCLUDED! We ship anywhere! Curious? 50 page Kit One manual available separately for \$15 postpaid. If you'd like to hear the Kit One in action, please call us for an appointment when you're in the D.C.-Baltimore area. Hundreds of these fine amplifiers are now in service worldwide.  
**Kit Three!** Essentially a monoblock version of the Kit One with double the power, the same components and on two chassis instead of one. Features two 300B per channel running in parallel single-ended yielding 17 watts. Price \$2247. Kit Three Assembly Instruction Manual only \$17.

### Angela Model 91 Single-Ended 300B Triode Monoblock Amps

The Angela Instruments 1995 Catalog features simplified pictorial plans for building Western Electric Model 91 style 300B monoblock amps as featured in Issue One of *Sound Practices!* If you've always wanted to try building amps but feel intimidated by 'schematic only' plans, then this one is for you! A copy of our Catalog is \$5. The Angela Model 91 amps are available as a kit, complete with tubes, for \$1300 per pair, or assembled for \$1600. We also offer all of the individual parts for sale to those of you who prefer 'scratch' building.

### Angela Oil/Polypropylene Filter Capacitors for Tube Amplifiers

15MFD/600VDC, 1.75 inch diam., \$10  
50MFD/515VDC, 2.50 inch diam., \$16  
30 MFD/515VDC, 1.75 inch diam., \$12  
GREAT FOR TUBE POWER SUPPLIES!  
**Audio Note Paper In Oil Signal Caps**

.015/400VDC, \$5  
.022/400VDC, Silver Leads, \$8  
.082/400VDC, \$6.75  
.12/400VDC, \$7.75  
.15/400VDC, Silver Leads, \$11  
.18/400VDC, Silver Leads, \$12  
.22/400VDC, \$9  
1.4/400VDC, \$24  
.0015/630VDC, \$4.50  
.022/630VDC Silver Leads, \$8  
.056/630VDC, \$7  
.082/630VDC, \$7.50  
.1/630VDC, \$10  
.22/630VDC, \$9  
.33/630VDC, \$11.50  
.39/630VDC, \$13  
.47/630VDC, \$10  
.47/630VDC, Silver Leads, \$15  
.22/1000VDC, \$12  
1.2/1000VDC, \$26  
.22/1600VDC, \$16  
.22/2000VDC, \$19

*These axial lead caps are thought by many D.I.Y. 'hipsters' to be superior to any of the other plastic or oil caps available today! Great upgrade for old or new tube amps!*

### Audio Note Paper In Oil Copper Foil Axial Lead Signal Capacitors

.047/630VDC, \$19  
.1/630VDC, \$23  
.15/630VDC, \$25  
.22/630VDC, \$31  
.47/630VDC, \$42  
1/630VDC, \$46.85

*These wonderful caps feature silver axial leads and oxygen free copper foil! Highly recommended for premium applications!*

### Audio Note Tube Sockets

1. Octal/8 pin for EL34, KT88, 6L6, etc., chassis mount to 1 & 1/8" hole found on old Dyna, Marshall and most other gear. Avail. in finest white ceramic and gold, each \$7.  
2. Octal/8 pin, ceramic/silver, each \$7.  
3. 9 pin chassis mount from above, white ceramic and gold, each \$6.60.  
4. 9 pin chassis mount from below, white ceramic and gold, each \$6.50.  
5. 9 pin chassis mount from above, white ceramic and silver, each \$5.  
6. 9 pin chassis mount from below, white ceramic and silver, each \$5.  
7. 9 pin PC mount, ceramic/gold! \$6.50.  
8. 9 pin PC mount, ceramic/silver, \$5.  
9. UX4 sockets for 300B, 2A3 and other four pin 'antique' tubes. Finest white ceramic and gold. Requires a 1 & 3/16" chassis opening, mounts from below, \$6.  
10. UX4 sockets like above but white ceramic and silver, each, \$8.  
11. Western Electric/Johnson 224 type socket for 300B, etc., silver plated contacts, finest white ceramic base, KILLER! \$22!  
12. 5 pin socket for 807, etc, finest white ceramic and gold, mounts from below chassis, requires 1 & 3/16" opening, \$11.  
THE ABOVE ARE THE BEST YOU CAN BUY! AS FOUND ON ONGAKU, ETC.!

### Black Gate Electrolytic Capacitors

1. 100+100/500VDC, 1 & 5/16" diameter, clamp mount, solder lugs on bottom, \$100.  
2. 100/500VDC, 1 & 5/16", clamp mount, solder lugs on bottom, \$78.  
3. 47+47/500VDC, 1 & 5/16" diam., clamp mount, solder lugs on bottom, \$78.  
4. 100/100VDC, compact with radial leads, popular for bias supplies, each \$12.  
THE BEST ELECTROLYTIC CAPS? SEND \$2 FOR B.G CATALOG & INFO.

### Orange Drop SBE 716P Series Film & Foil Polypropylene Capacitors

.01/600VDC, \$1.  
.022/600VDC, \$1.  
.047/600VDC, \$1  
1/600VDC, \$1.50  
.25/600VDC, \$2  
Radial leads but adaptable to axial mount SBE is the successor to Sprague. These have solid copper leads and are of better quality/lower price than some of the highly touted 'audiophile' plastic caps. Steve sez, "BEST BUY" for hi-fi and guitar amp fixin'!

### Audio Note Silver Solder! THE BEST!

1. 50 grammes or about 9 meters, 1mm diameter, acid and chloride free! \$30.  
2. One Kilo roll, 1mm diameter, \$245.

### N.O.S. Mullard EL34 Circa 1972

Welded plates! Made in UK! THE REAL THING! Matched pairs \$120. Quads \$240.  
**LOOKIN' FOR GOOD GZ34 TUBES?**

1. Mullard UK N.O.S. GZ34, '72, \$45!  
2. Matsushita N.O.S. Japan 70s GZ34, similar to British Mullard, much better choice than recent Russian junk, \$16!  
3. Mullard GZ37/CV378, mo' betta' too, \$18!

### Jolda Chinese Triodes On Sale!

1. 300B, suprisingly good sound and longevity, 30 day warranty, \$69 EACH!  
2. 2A3, can't bust 'em! SMOOOOTH! \$15!  
3. 845, no fancy logo but only \$30 EACH!

### Hammond Transformers In Stock!

1. 10H Choke, 125A for tube amps, \$22!!!  
2. 1.5H Choke, 200mA for Dyna, \$18!!!  
3. 5V/2A filament trans. for triodes, \$16!!!

We are now authorized Hammond dealers!

Call us for the best prices and fast service!

### SOLELY POLYPROPYLENE CAPS NOW IN STOCK! CALL OR FAX FOR LIST!

Popular signal, power supply, x-over caps!



"OUT THERE" SINCE 1977...

**ANGELA**  
INSTRUMENTS

10830 GUILFORD RD., SUITE 309  
ANNAPOLIS JUNCTION, MD 20701  
PHONE (301) 725-0451  
FAX (301) 725-8823

VISA/MC/AMEX OK FOR PHONE/FAX/MAIL ORDERS  
OR PREPAY WITH CERT. FUNDS. \$35 MINIMUM! WE  
SHIP UPS/AIRMAIL WORLDWIDE! OUR KOOL 256  
PAGE CATALOG IS \$5 POSTPAID USA., \$8 FOREIGN.  
WE'VE GOT TONS OF RARE TUBE SPECIALTY ITEMS.