

SOUND PRACTICES

A JOURNAL OF AUDIO TECHNOLOGY

FIVE DOLLARS



Alternatives to Home Theater

Issue 10

SE-811 SINGLED-ENDED HIGH FIDELITY FUN

We call it the SE-811.
You will call it great music!

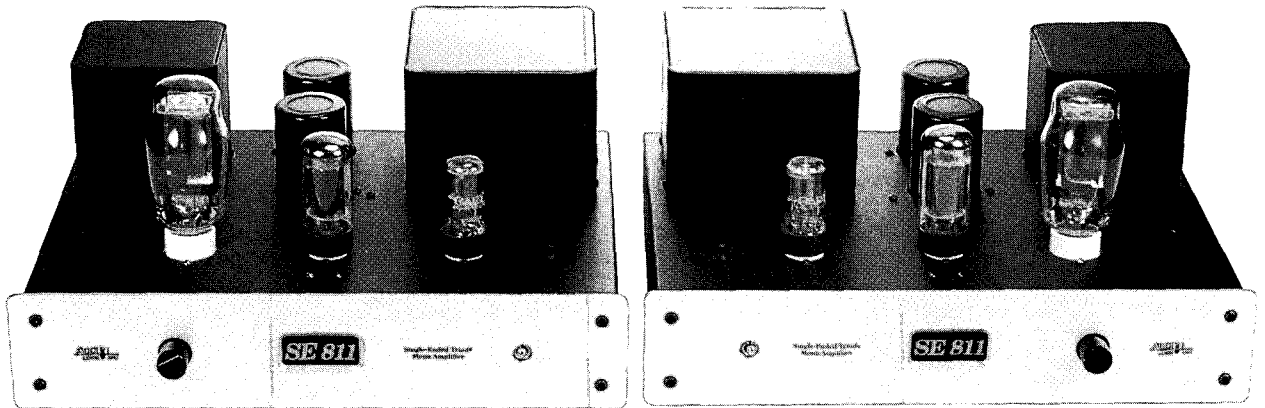

Now every music lover will be able to experience the musical magic from, *real*, three element triode vacuum tube single-ended amplifiers from Audio Electronics. The new SE-811 mono-blocs are a blend of the Cary design talent and the ingenuity of the Svetlana tube engineers. The 811-3 tube is inexpensive and is designed to last for years. The SE-811 amplifiers are modest in price and life size in music reproduction.

Over the years the Cary sound has swept music lovers into a new fresh world of music reproduction. A world of tube sweetness, air and transparency.. a world of musical enjoyment in your own home for the entire family to enjoy.

When we developed the SE-811 mono-blocs we had more years of experience designing and manufacturing single-ended triode vacuum tube amplifiers than any of the "me too" copycat audio companies now following our musical beat.

The SE-811 pure class A triode amplifiers are amps you "feel." A pair of mono-blocs that deliver "goose-bumps," "raised hair" and a "jump-factor" that transcends you into the dream of live music in your home. Amaze yourself along with your family with hour after hour of musical enjoyment with the new SE-811 amplifiers from Audio Electronics.

*Now available at select dealers or factory direct.
Call today!*



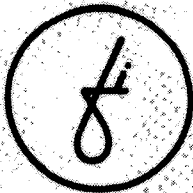

30 VERANDA PLACE
 BROOKLYN NY 11201
 718 625 7353 FAX 718 875 3972

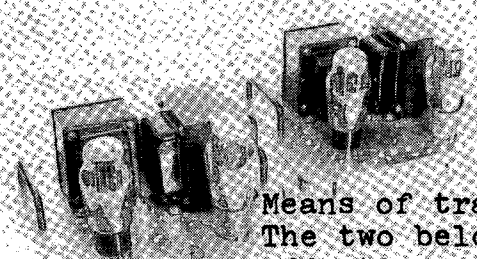

Means of transcendence.
 The two below are very
 effective. Then there's
 the f1 2A3. Try it,
 you'll like it.

Handwritten signature or initials.

FOSTER - KLEISER

☐ to assume a mental set voluntarily. ☐ to shift voluntarily from one aspect of the situation to another. ☐ to keep in mind simultaneously various aspects. ☐ to grasp the essential of a given whole; to break up a given whole into parts and to isolate them voluntarily. ☐ to generalize; to abstract common properties; to plan ahead ideationally; to assume an attitude toward the 'mere possible' and to think or perform symbolically. ☐ to detach our ego from the outer world.

自
我
觀
念
·
考
或
形
行
·
云
除
世
俗
之
理
念
;
意
向
真
一
·
而
思
合
和
消
去
相
同
點
;
先
備
體
和
孤
立
各
小
節
·
五
綜
變
·
三
內
心
同
念
各
事
·
三
心
智
自
動
·
三
應
事
自

FOSTER - KLEISER



Jingle Bells

J&B Rare pours more pleasure.

Sound Practices

ISSUE 10 (Winter 1995) SOUND PRACTICES [ISSN 1079-1310] is published quarterly by Sound Practices at 9405-C Grouse Meadow Lane, Austin TX 78758. Second Class postage paid at Austin, TX. Printed in the USA.

Please address correspondence to SOUND PRACTICES P.O. Box 180562, Austin, TX 78718. Voice/FAX (512) 339-6229. e-mail: SP@tpoint.com. Due to the volume of calls received, we must discourage calls for general advice or routine technical assistance.

This publication exists to encourage audio experimentation and to promote the exchange of related information. Opinions expressed are those of the authors and may not reflect the opinions of any other person or entity. All rights reserved.

Subscriptions are available at the rate of \$20 yearly in the US, \$24 in Canada, \$30 UK/Europe Airmail, \$35 Elsewhere Airmail. MCVISA Accepted.

Sound Practices actively solicits contributions of written material of interest to our readership. Please contact us to discuss your ideas. Display advertising rates and deadlines available upon request.

POSTMASTER: Please send address corrections to Sound Practices, POB 180562, Austin, TX 78718-0562.

Issue #10 Contents

CES Report	5
<i>Joe Roberts</i>	
Turn Your Table	10
<i>Dr. Götz Wilimzig</i>	
Euridice Preamplifier	16
<i>Ciro Marzio, Cristiano Jelasi & Luca Chiomenti</i>	
WOT Preamplifier	19
<i>Diego Nardi</i>	
State of the Art: 1935.....	24
Mauhorn.....	27
<i>Andreas Mau</i>	
Building the Mauhorn.....	29
<i>Jérôme Phaneuf</i>	
Not Your Father's Dyna	34
<i>Dave McDonald & Matt Kamna</i>	
To Be, or Not To Be, Linear!.....	37
<i>Dr. Tom Hodgson</i>	
Casual Reactions.....	41
<i>Herb Reichert</i>	
Readers' Forum.....	45

... and MUCH MORE !!!

Mystery Cafe

They sell a lot of different kinds of gourmet coffee beans down at the local health food supermarket. Some of the beans come from organic collectives in Mexico and some of them are imported from Java, an area known for a particularly rich cup. I know all this because this isn't just a coffee stand. This place is a damn Coffee Information Center. They got a rack of free pamphlets, a few coffee aficionado magazines, and self-published books on the holy bean so you can study up on the spot and make a well-informed purchasing decision. If reduction of uncertainty is your thing, you came to the right place to buy your French Roast.

That's one way to approach it—read a few books, go out and talk to a few knowledgeable salesfolks about the best coffee for your needs, and you can probably develop a pretty good feel for what kind of coffee to get down with when you're ready to make that big investment. I'm sure you will find plenty of people to talk with about grinders and whatnot, if that's what you want to do. People into coffee love to talk coffee, and everybody has an opinion. With a little study, one could certainly get a handle on the expert consensus on which beans to like and why, for whatever it's worth.

Down at the far end of the coffee aisle, almost out of sight, there are usually three or four bulging bags of pre-ground coffee marked down to a ridiculously low price, like \$1.99 a pound. The label says MYSTERY COFFEE. It's a total crap shoot. Could be primo Kona AAA ground for auto drip just like you want it or it could be the mongrel residue that the janitor scrapes out of the grinder pans at the end of the day. Good luck.

I don't know who buys this mystery coffee but I don't think they're buying it only because it's cheap. Maybe they're the type who can get some worthwhile sensations from any kind of coffee. Live with anything for a week, appreciate it for what it is, and learn from the experience. I know that some hardcores are into the special buzz only a headlong dive into the unknown can bring. Some probably wish for the scrapings from the end of the day, craving the mysteries of the cup in their fullest mystery. All are living in an expanding universe. Every sip a new step. Mystery coffee drinkers are a special breed. Experimenters.

I'm sure the people who subscribe to those fancy coffee magazines do not look upon the mystery coffee drinker with favor. Why not just get in the groove and drink the fine brew everybody else is happy with? Many well-reviewed beans are available here in town. There's even a Starbucks in the Austin airport now. Nonetheless, some choose the mystery coffee. Perhaps they recognize that truth in coffee only resides in individual experience. You can never know the taste until you drink it yourself.

That's the problem with reading about drinking coffee. You can get caught up in the logic of the written word and follow your mind to a place where you only think you'll be happy. It's easy to get misled because you like or dislike certain metaphors or verbal images and lose sight of the unique non-linguistic character of the coffee drinking experience. Think of all the people who missed out on Raspberry Mocha because it got a few bad reviews.

There's a wide wide world of coffee out there. From syrupy Turkish to the barely-brown mop water served up in seafood chain restaurants in the American Midwest, one word can hardly contain it. Finding the right blend is a big job but it's worth taking the time to do, yourself the favor. You'll know it when you find it. You can't know it before you do.

Silver Sonic

High performance audio cables

"With tube amps and hybrids, the Silver Sonic competed with the best,"
Bound for Sound, No. 4/95.

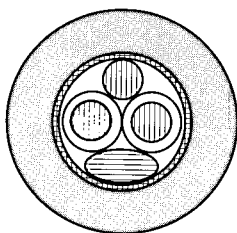

Model BL-1 Interconnect: \$95/1 meter pair
Model T-14 Speaker Cable: \$3.95 per foot

Ask about our hook up wires for your construction projects.

We've moved!
Note our new address:

D.H. LABS
P.O. Box 31598
Palm Beach Gardens, FL 33420
(407) 625-8998 (phone/fax)

AUDIFON

Vacuum tube electronics - Loudspeakers
Esoteric Hi-Fi - Vacuum tube history and
update news

Available: numbers 1,2,3,4 Please ask for list of
issue on vacuum tube hi-fi.

GIAMPIERO PAGNINI EDITORE

Piazza Madonna Aldobrandini 7 50123 Firenze

Tel and voice fax 055/293267

NIRVANA

WHEN TECHNOLOGY
EXCEEDS
EXCELLENCE,
IT BECOMES
ART



P.O. BOX 1053
VALLEY STREAM, NY
11582-1053 USA

PHONE/FAX: (516) 285-1950

E-MAIL: SCREAMER@LI.NET

HTTP://WWW.NIRVANAAUDIO.COM

Are You Into Tubes?

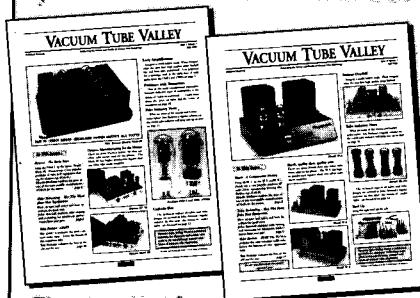

Then You Need

VACUUM TUBE VALLEY

Now Available

A New High Quality Publication devoted to
the Best in Modern and Vintage
Vacuum Tube Electronics.

Hi-Fi Amps, Guitar Amps, Tubes,
Tuners, Speakers, and More!

4 Issues - 1 Yr. \$25 US or \$35 Foreign
No Credit Cards

Vacuum Tube Valley

1095 E. Duane Ave. #106 Sunnyvale, CA 94086

If you've ever cried at the end of a great album, conducted the Vienna Philharmonic from your sofa, varied the speed of your driving to match the pace of what's on the radio, or simply sat on the floor playing records and occasionally laughing out loud with no one else around, then you know what heights recorded music can reach. But if those moments don't occur as often as they should—if you find yourself just hearing the sound instead of the music—we'll be all too happy to help.

We're *Listener*—America's hi-fi magazine.™ We're professional, opinionated, witty, irreverent, and technically literate without having to beat our readers over the head with it. All that, plus reviews of real (that is non-audiophile) records, written by people who really know something about music.

A subscription is only \$17.70 for four (quarterly) issues. MasterCard or Visa accepted. If you want to 'try before you buy,' a check for \$5 will get you a sample issue. (Well, okay, that's buying, too...)

Remember when hi-fi was fun? Then you should be reading *Listener*.



Listener

MAGAZINE

36 Chestnut Street, Oneonta, NY 13820
ph. (607) 433-0808 fax (607) 433-0803

VEGAS 1996

The CES that time forgot

by Joe Roberts

Even though I'm sure there was a lot of great transistor amplification in the house, solid state was dead as a stone at this year's CES. That new design transistor sound could have been better than ever, but it didn't matter. Most of the amp manufacturers, most of the speaker manufacturers, most of the wanderers in the hall seemed to be into tubes. I'd say 70% of the rooms used tubes and 90% of the interest was in tubes. Yes, indeed, tubes were the biggest in Vegas this year.

Not only is the venerable vacuum tube enjoying a major explosion in popularity, the general level of innovation and experimentation in tube audio is very much on the rise. We're moving way beyond the standard issue 6550 and EL-34 space heater push-pull amps that have been passing for exotica for the first two decades of "high-end" audio. Usually, CES is just a bunch of Americans, Europeans, and Asians trying to sell each other the same old retreat PP ultralinear designs. This year signs of intelligent life in the tube audio community were everywhere.

We're lucky to be living in an era of rapidly expanding options in tube audio. I consider the late 90s to be nothing short of a new golden age of vacuum tube audio. There was a healthy supply of genuinely inspired and exciting tube amps at CES '96, including more fancy big triode amps than I ever thought I'd live to see.

But there are some old-style push-pull amps around and some of the oldest are among the newest. Perhaps *timeless* is the word.

I couldn't believe my eyes but MARANTZ is reissuing the Classic line of tube equipment, namely the 7C preamp, 8B stereo amplifier, and Model 9 amplifier. The aim of the project was to make the reissues as close to the early articles as possible, using parts from the original suppliers whenever possible and so on. They put real 5-way binding posts and IEC connectors on the stuff but otherwise it looks mighty authentic down to the ultra-cool bias meter on the 8B.

Of course, the Marantz Classics will be built in the USA. A new North Carolina plant just opened where Kevin Hayes of VAC will oversee production. The 7C and the 8B will go for \$3800 each. The Model 9 monos are \$4200 apiece. Seems on line with Asian collector market pricing for the used stuff but at least nowadays you can get a fresh unit and a manufacturer's warranty.

Isn't it interesting that Marantz, a subsidiary of Dutch Philips, would be investing a bank of Guilders in the bygone fantasy that Marantz represented back when it was a small specialist company out on Long Island making top-notch gear for 1950s purist hi-fi buffs. Some dreams are eternal, I suppose. Universal, perhaps.

Yo, what about the Model 1 Audio Console mono preamps, my favorite Marantz item? What about the fabled Marantz Electronic Crossover? Huh? The legendary Marantz 10B tuner??? These days, anything is possible. I wouldn't be surprised if they start making false teeth out of wood again.

If the 7C/8B/9 classics are too retro for you, Marantz is showcasing a major statement piece in the form of an enormous \$50K per pair 845 triode push-pull monoblock power amplifiers called the Project T-1.

The T-1 is another significant marker of the timeless and international character of the emerging tube super-fi scene, and all-out design of the engineers at Marantz Japan. The T-1 reflects a vision of audiomaniac splendor germinated within the upper strata of the Japanese experimenter community where the quest for good sound is not constrained by narrow concepts of "up-to-date" design practice. In a combination blast from the past and whiff of the future, the Project T-1 incorporates an input transformer and two interstage transformers per side! The audio transformers are all classic American UTC designs remanufactured to Marantz order (note LS numbers on schematic).

Seriously, an amp like the T-1 makes you wonder where old ends and new begins. It's like an ancient thing that never happened before. The Project T-1 uses a pair of 300Bs to drive another pair of 300Bs which drive a pair of 845. Never saw that tube lineup before. A second pair of diode-wired 845s serve as rectifiers for the output 845s in the manner of the prewar Western Electric Model 43 theater amplifier where you could recycle the old 211 output tubes in the rectifier socket. Truly a directly-heated triode lover's dream!



Classic Marantz fans inspecting the goods

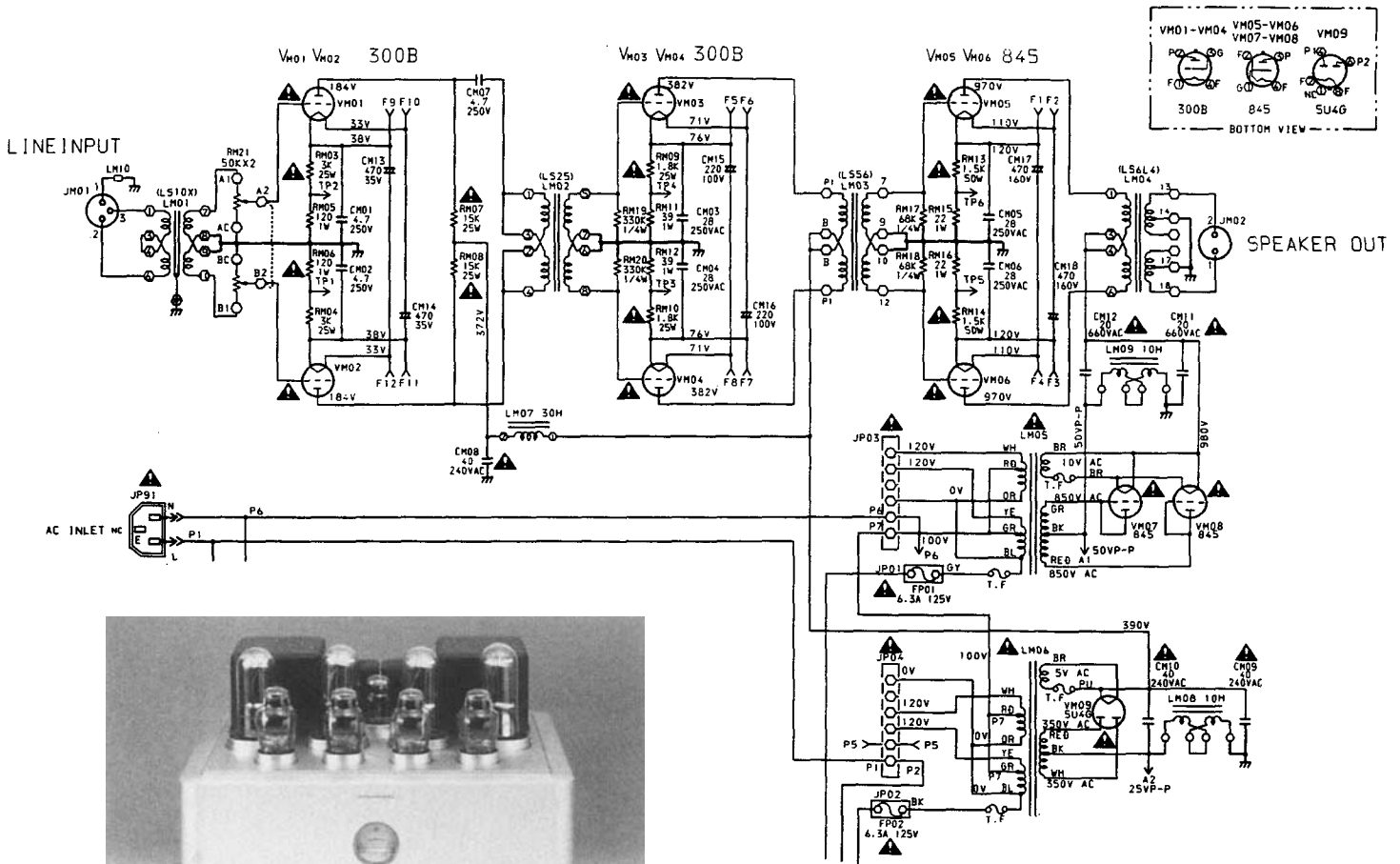

marantz

T-1
Monaural Amplifier

The Project T-1 resonates with old-time feeling but it is as modern as the World Wide Web. Microprocessor controlled turn-on circuitry and solid state current-regulated heater supplies run those good old fashioned triodes. This amp definitely ain't no antique.

Some of the top audio gurus in Japan swear by interstage transformer-coupled amplifiers and all I can say is let's hear it, even at \$25K and 120 pounds per side!

If you're intrigued with the concept of interstage transformers but you like your triodes served up single-ended, the man you need to see is Nobu Shishido, designer of the luxury class WAVAC SE-DHT amplifiers crafted by YOSHIKI INDUSTRIAL CO., LTD.

Shishido, a legendary figure in the Japanese DIY scene and senior contributor to *MJ* and other Japanese experimenter magazines, was one of the first public advocates of SE directly heated triode amplifiers back in the 70s. He discovered interstage transformers a few years later, so before anybody was listening to him about SE-DHT he had already taken the next step into the beyond.

PROJECT T1 BLOCK DIAGRAM

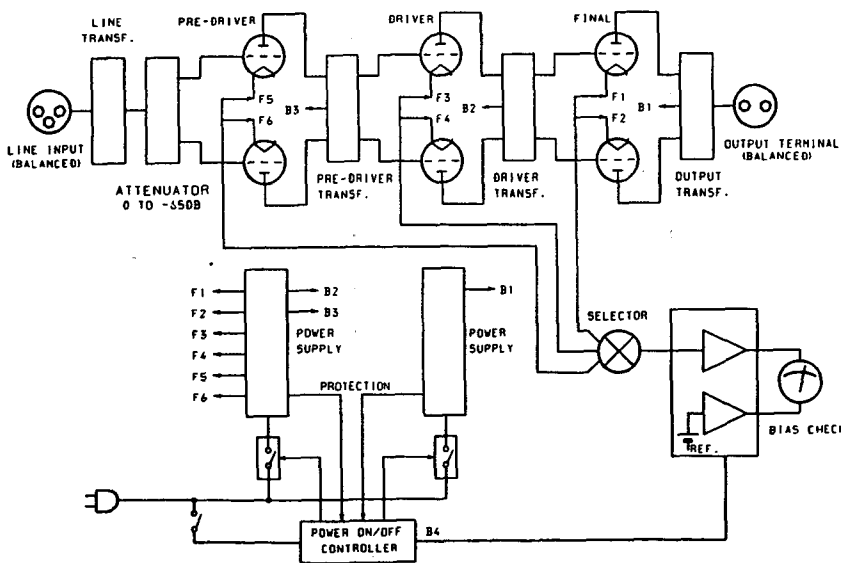

Nobu-san argues that interstage transformers provide an enhanced experience of the subtle information at the threshold of hearing, making SE amps even better instruments of low level resolution. Although Nobu-san insists on SE DHT, he argues that PP amps can also benefit dramatically from transformer coupling.

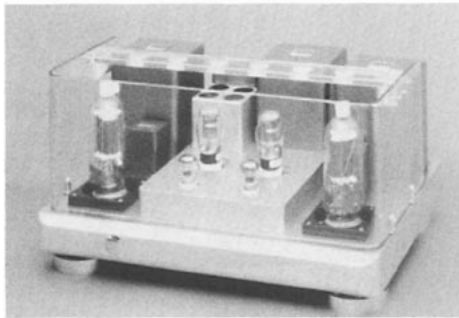

The unbelievable WAVAC 805 from Yoshiki Industrial, Co., Ltd.

Mr. Shishido's major claim to fame is the Inverted Interstage Transformer (IIT) circuit, a design that has become known as the "Shishido amplifier" in honor of the inventor. This genius circuit topology allows husky directly-heated triodes originally designed for Class B and Class C RF applications to go to work in Class A single ended circuits. These industrial-strength transmitting tubes can provide real world power levels, they are super well made, and they are objects of great beauty to the discriminating eye. Furthermore, the cost of such tubes is reasonable by contemporary audio standards and NOS availability is good.

Shishido amps typically employ a power tube driver stage coupled with a step-down transformer to the grid of the transmitting tube. A regulated positive DC bias is fed to the grid through the secondary of the transformer. Power grid tubes are designed to be run under grid current conditions and this class of operation is linear, efficient, and capable of high power output while retaining the musical superiority of SE DHT circuits.

The WAVAC 805, Yoshiki's flagship product, is a 50 watt using the classic RCA 805 triode in the patent-pending IIT configuration, a beefy triode-wired 6L6 driver, and a WE 437A input tube. The WE 437A developed for wideband telephone amplifier applications in the 1950s, is arguably the ultimate small signal tube ever installed in a glass envelope. Clearly, these guys did their tube manual homework.

The WAVAC amplifiers are NC machined out of solid chunks of aerospace-grade aluminum and fitted with a heavy glass canopies. The tube sockets are milled out of teflon. Top class all the way. Overall, the WAVAC amps look like work-of-art \$1000 per watt amplifiers. Hope I get to own something that nice before I die, but if I have to build it myself, it ain't never gonna happen!

Shishido's approach has been a real hit among Japanese DIYers over the past 10 years. His 1992 book, *Sohshinkan niyoru Single Amp Siesakushu—Single Ended Amplifiers with Transmitting Tubes*—sold over 5000 copies in the Japanese market. [Seibundo Shinkohsa Press, ISBN 4-416-192209-6 — Available from April Audio in NYC or Nippon I.P.S., the overseas MJ distributor, fax: +81-3-3238-9046 Attn: Miss Y. Muramatsu.] This volume contains IIT circuits using 830, 811, 808, 838, 8012A, 826, and an 805 circuit similar to the WAVAC 805. Shishido's classic passive EQ 6DJ8 phono preamp circuit and his famous Loftin-White style 2A3 circuit that opened the door to SE back in the 70s, are also included. I should have studied Japanese instead of French.

I recently built the Shishido 801A IIT amplifier to get an idea of what's going on with this stuff. The 801A is not the king of audio tubes for regular circuits. It's good for a meager 1.8W in typical Class A operation, requires a hard-to-get high impedance transformer, and it tends to sound a bit thin and wiry anyway. In the IIT circuit, the 801A puts out a reasonable 8W and sounds totally



International Triode Mafia Qvortrup, Reichert, Shishido

natural and transparent with a powerful and punchy low end. As Nobu told me, "We use some concepts with a connection to old romantic days, but I am interested only in the most modern sound for today's listeners."

As the 801A IIT schematic indicates, the grid of the output tube is biased positively and the plate voltage is kept low, consequently the tube operates in a grid current mode. The secondary of the interstage transformer provides a low DC resistance path so

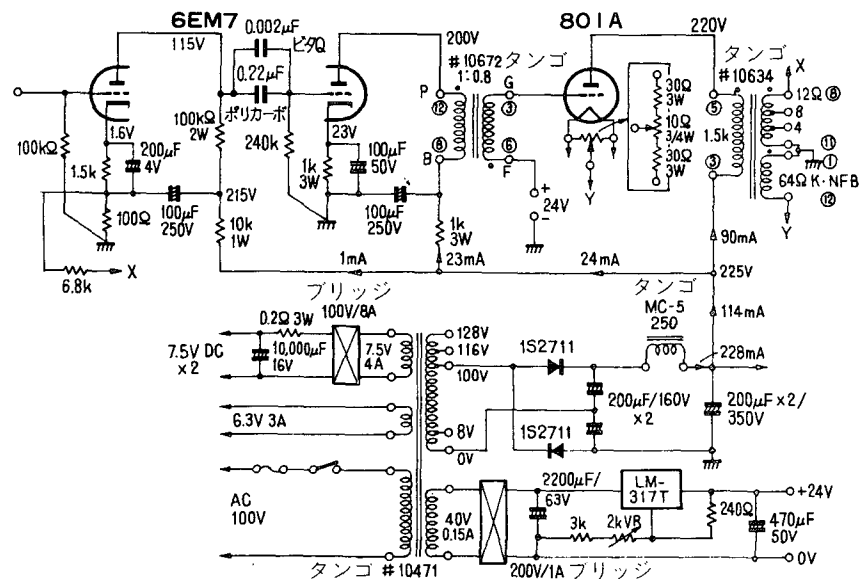

Nobu Shishido's 801A Inverted Interstage Transformer Amplifier

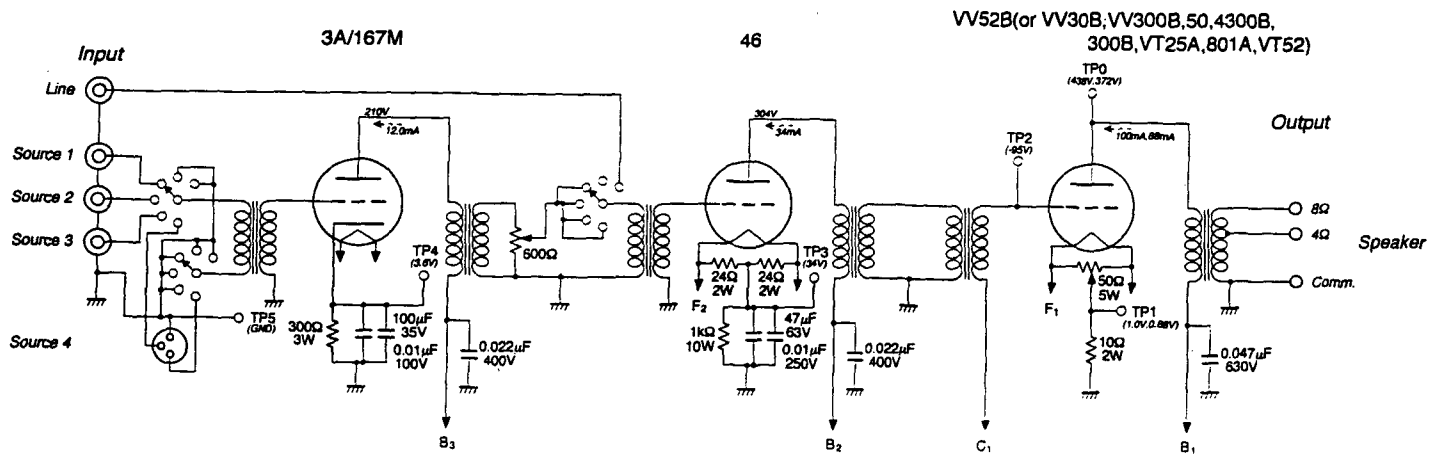

83

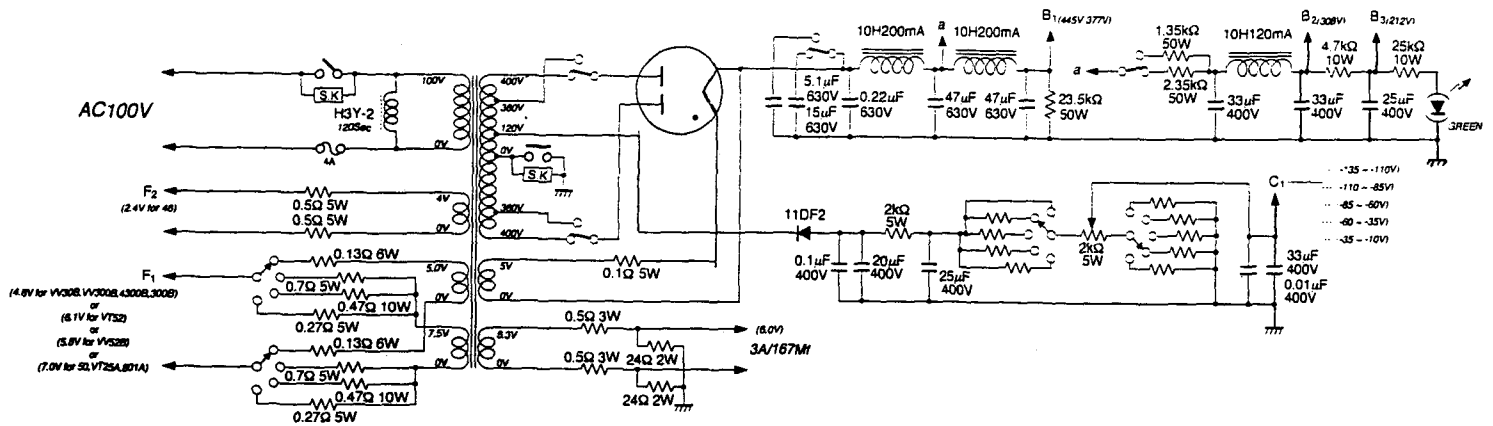

Plenteous VV52B, VV30B, VV300B, 50, 4300B, 300B, VT25A, 801A, VT52 SE Mono Power Amplifier



the voltage remains constant with variations in grid current. The interstage transformer is a special air-gapped design that features a step down ratio for low impedance drive to the grid. At +24 grid volts, the 801A curves in the RCA manual are ruler-straight.

Clearly, the WAVAC amplifiers are intended for a special class of devoted audiophiles whose bank account is as big as their love of audio. Several WAVAC creations are currently in the hands of Stateside reviewers, so we will get to read more about these fancy amplifiers in coming months. For the "rest of us," forced by mortgages and grocery bills to forego the luxury-class industrial art of Yoshiaki Industrial Co. products, take heart that you can homebrew your own humble version of the Shishido IIT amps for less than the cost of a new Toyota. Long live DIY.

TRIODE SUPPLY JAPAN also weighed in with a high mass transformer-coupled mono SE amp called *Plenteous*. I suppose the name comes from the fact that there is plenty of iron on those babies—count 'em, TEN miscellaneous transformers and chokes per side, all painted a show-stopping vibrant green!! Cool! Heavy!

The *Plenteous* is set up to run plenty of different output triodes also. Adjustment switches are provided to allow the user to dial in the plate voltage, filament voltage, and bias voltage as required. This colorful creation sounded very smooth, distinctive,

and alive with that big VV52B plugged in the socket. The *Plenteous* is available direct from the manufacturer for \$9800/pr.

Only six months after the SVETLANA SV-811-3 power triode hit the market, the brothers are already putting it to good use. I ran into George Badger of Svetlana at the show and after hearing a few of the amps burning the new Russian firebottles, he was really impressed with the whole tube audio scene. Being an old radio guy, I'm sure he thought we were all nuts just a year ago but he didn't realize how crazy we really are. More tubes, George! Arf arf!!



AES SE811 Monos



The new Edgar Lineup

For example, AES/CARY just introduced a SV811-3 mono amp called the *SE-811*. This 12 Watter features a beefy "screen-driven" 5881 driver and it sounded like they were driving this tube right into a pair of lead-lined Focal-based prototype loudspeakers. According to Dennis Had, the *SE-811* might ultimately be available in kit form, so be on the lookout.

Those hometown Vegas transformer-winders from **ELECTRA-PRINT** had several sharp-looking SV-811 based amps. The 50 Watt *Vershina* really showcases the brilliant white glow of those thoriated tungsten SV-811 filaments with four parallel SE power tubes per side. This \$10k a pair, 85 pound monoblock is class all the way, down to the gen-u-ine 24K plate on the transformer end bells. Of particular interest to the DIY community, E-P serves up full and partial kit versions of two of their SE amplifiers, the \$4300 eighteen-watt stereo *218EP* VV30B amp and the \$3200 stereo *210EP* SV811-3 ten-watter. Being crazed experimenters themselves, Jack Elliano and Cy Brenneman love to work with fellow DIYers looking for a worthwhile project. Aside from the considerable therapeutic and educational value of building a kit, you can save over half the cost of the assembled versions by soldering your own connections. Gold plate optional.

Several new species of **EDGARHORN** were on hand at the show. Photo shows three Edgars, the *System 50*, the *System 80*

and *Bruce* himself. The second-biggest Edgar is the \$10K two-way that Bruce engineered as an answer to all the "fancy European stuff" that's coming out these days. The circular wood-horned compression driver HF was big and smooth on vocals. Wood is definitely the ticket. Forget those amusical cast aluminum airport paging horns. Low end is handled by a 50 Hz wood horn of substantial proportions.

The *System 80* is a 42"x 19"x 18" integrated horn setup with a 5 foot long folded tractrix 80 Hz horn, a 5" JBL mid on a 400 Hz tractrix mid, and a tractrix horn tweeter. Designed for against the wall placement for bass reinforcement, incidentally making it an ideal horn solution for installations where floor space is at a premium. Whopping two watts recommended minimum power at 103 dB 1W/1m system sensitivity. Popularly priced at \$1200/pr. Watch out, *La Scala!*

CLASSIC AUDIO REPRODUCTIONS added a new horn rig to their collection of fine furniture neo-classic horn loudspeakers. The *Studio Standard* is a three-way system based on the design principles of the legendary *Hartsfield*, featuring a 15" woofer crossed over to a JBL titanium diaphragm compression driver fitted with an acoustic lens topped off with a wide dispersion HF unit. The smaller, more rectangular footprint of this system is an advantage over the *Hartsfield* in some setups. Sensitivity of this \$6350 system is a roaring 103 dB 1W/1m.

These diehard JBL nuts were also demonstrating a killer "bookshelf horn" with a JBL mid/high horn and a pair of fancy imported 6 1/2" inch woofs. Called the *Cinema Music Channel*, these 96 dB 1W/1m, 8 ohm speakers are being presented as a home theater accessory, but they sure sounded powerful and hearty playing rockin tunes on 8 watts from a *Cary SE-1*. Suggested list on these sleepers is \$2030/pr. He might not remember the conversation but after a couple beers at the *Fi* party, John Wolff offered to extend a very special introductory deal to *SP* readers to get 'em started on horns. I'm your witness . . . operators are standing by. . .

Classic Audio Reproductions
515 Red Fox
Brighton, MI 48116
810-229-5191/810-229-5969 FAX

In five pages, I can only explore the tip of the thermionic volcano that was CES '96. Also worthy of note were the **BEL CANTO** 845 amps, **VAIC VALVE AGs** corral of luxury SE amps, the **N.E.W.** battery operated preamp, the **FRENCH AUDIO SCULPTURE BY AUDIO MATIERE** amps that run single 845s with a triode-wired 813 that kicks in when extra power is needed, the **MPR SV811** amps from that hotbed of tube experimentation, Italia, and on and on. Consumer Electronics Shows are always full of new products. What made this year different for me is that with all the fresh spirited action that went down this year, I'm actually looking forward to Vegas '97! Unbelievable.

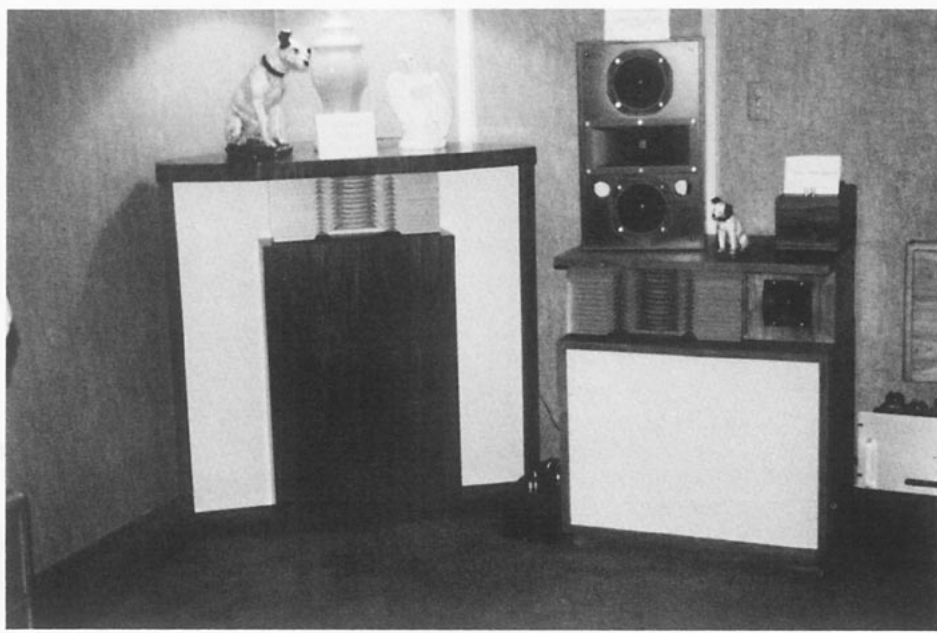

Classic Audio Reproductions' stable of horn speakers

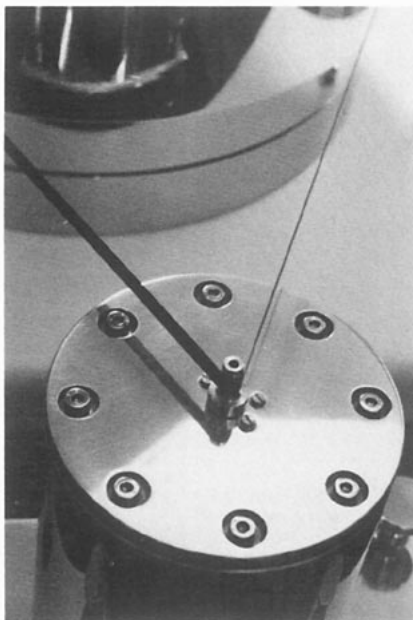

TURN YOUR TABLE

by Dr. Götz Wilimzig

"If you are going to be an egghead, you might as well be a hardboiled one."

Ursula K. LeGuin

Would anybody enjoy a sports car engine producing shake, rattle and roll? Or do we expect smooth action up to the highest speed of rotation? The stock DC engine supplied with my hundredandtwenty pounds of turntable is a common 12V type made by Philips. Rotated at 7 to 12V without any load it forced my hand to vibrate. At the time I knew nothing about high quality motoring but I simply couldn't believe in vibrating engines as an optimum solution. Thus began my search for a real high end driving unit.

There exist some simple tests to determine if this story is for you too. Please stop reading if you insist on feeding a synchronous engine with AC. They're always vibrating like hell. I am familiar with TD 124 and listened to EMT work horses. Yes, I like oldies, goldies, and all of you giving the highest reputation to old German professional turntables. Later on you will find some reasons why a synchronous motor can't be the best choice. And yes again, I do know how amazing antiques sometimes reproduce music. But there have been strong faults too.

Remember the rumble of wheel driven tables, remember that call for "nothing below 40Hz on our records"? Two friends of mine are riding old TD 124s. Both prefer hearing my modified turntable.

Quality check

So let's start testing that unknown motoring. You have to measure the voltage your engine needs for 33 RPM and 45 RPM. Furthermore, a regulated DC supply is necessary, take that one in your laboratory. Remove the DC engine from your turntable and feed it through your lab voltage regulator.

First test. Increase voltage from zero to the manufacturer's limit. (It should be given. A DC engine of quality can be driven at higher voltage a short time without damage. Usually maximum is within 6 to 24V.) Does the engine vibrate in your hand? Well built ones will run at more than 10,000 RPM absolutely smoothly.

Second. Click the engine on and off feeding in the working voltage for 33 RPM. Repeat this test for 45 RPM. Do you feel when it's clicked on? Does it cause any reaction when starting? Does it "jump" in your hand?

Third. No electricity necessary for this one. Remove the pulley. Hold the engine in one hand. Place the shaft between thumb and forefinger of the other hand. Now move one finger forward, one backward, and vice-versa. Thus shaft and rotor have to change their turning direction back and forth. Do you feel any moment of inertia acting against changes of direction?

Fourth and last. Remount the engine. Use manufacturer's supply as usual. Hear some records. Then switch over and feed the engine through your lab voltage regulator. Listen again. Do you notice more detail, greater dynamic range, increasing low level performance, less muddled sound?

The right answer is always "no". If this happens to you: congratulations! You're the lucky one. I bet most of you will answer one "yes" or more, no matter how expensive the turntable was. From my experience engines in conventional turntables are simple, reliable and cheap, but not at all sophisticated, high quality or high end. So we have to look for technical improvement by ourselves. But is it really necessary?

First link in the chain

Getting music from vinyl sometimes comes along with a slight misunderstanding. Lots of audiophiles take for granted that picking information out of the groove is the first thing done in their chain. Audiophilism believes in dream cartridges. This isn't wrong at all. It's just the smaller part of the truth. The second part.

Any cartridge simply will reproduce the information presented by the turntable. Cartridges alone can't read music. They'll take every fault of the platter as a signal. And there are faults. The music encoded in the groove can be transformed to music again only if the driving unit gives the most accurate speed to your platter—every microsecond! The more precisely the platter moves, the more music you hear. This is the awful truth.

Nevertheless audiophiles upgrade their systems buying very expensive cartridges. Of course this varies the sound of the system, as the salesman promised. A new and different exhaust pipe will alter the sound of your car too. Does that convert any vehicle into a sports car? Maybe your car finally will be able to win a race. Asking for this you can't be wrong to call Roger Penske for better motoring instead of buying pipes at your local dealer.

The heart of a sports car is the engine. It's the heart of your turntable too. And why not go for the best? Building a new driving unit yourself will not only renew the very first link in the audio chain, it also will bring you a thrilling experience. The experience of getting deeper into the music. That might be worth some labour.

During the last decade I heard and reviewed a number of turntables. Can't remember them all. There is no one with a DC engine of precision known to me. Most manufacturers are driving the platter with cheap engines and try to decouple them using a rubber or plastic belt. The vibrating energy of the engine floats into the belt. Construction theory says this energy could be neglected.

Now imagine a vibrating, springing belt—is it really the best in giving ultra smooth and most exact performance to the platter? Some audiophile turntables use string instead of a belt. It may cause less vibrating energy and better decoupling, who knows. I tried dozens of strings, becoming the best known non-fishing visitor at my local fishing shop. Yes, all those so called audiophile strings like Kevlar, Dyneema, etc. are constructed for anglers. I even tried grandma's sewing cotton, but never was satisfied. Maybe some strings minimize vibrating problems. So you lose one problem and win another one. The area of contact between a pulley and a string is unbelievably small, all strings slip. The rotation of the engine isn't really translated to the platter as it should be.

Newton's Law

For evaluation it was inescapable to go back and start with a basic question: What happens to a platter in action? What's going on in those short times we can't spy?

Well, let's say the diamond is in the groove and the groove is moving at the right speed. First signal comes. Just for simplicity let's assume it's a sine wave. Following this wave the diamond has a friction. And the friction is different as each part of the sine wave is different. Any friction acts as a force speeding down the platter. The amount of force depends on the signal. (And individually on the shape of the diamond and the pressure the tone arm gives to it. But we're talking general rules now). The greater the friction is, the more force is generated; furthermore the faster the diamond has to pass through the sine wave, the greater the force.

Newton's Law describes the relation between force and change of speed. It's valid till now.

$$F = m \times b \quad \text{or} \quad F = m \times dv/dt$$

F is force, m rotating mass of the platter and b or dv/dt is acceleration or change of rotating speed. It doesn't matter if the acceleration acts speeding up or speeding down. For a given mass of the platter the change of speed depends on the force. There is no possibility to avoid a "braking" of the rotation if a force arises.

This is essential: in the act of playing records, your platter will lose some speed, no matter what we do, no matter how good the driving unit is—the rotating speed is always going down a little, depending on the movement of the diamond.

Regarding Newton's Law increasing the platter's mass will minimize the change of speed. This seems to be the nicest idea, and indeed there do exist some turntables with high mass platters. But wait a minute. The loss of energy ΔE is:

$$\Delta E = .5 \times m \times (\Delta v)^2$$

with Δv being the amount of lost speed. The driving unit has to counteract this loss of energy which grows with the platter's mass. This isn't easy to do for the engine as will be exposed.

So in reproducing a single sine wave the platter changes speed from microsecond to microsecond, destroying the original phase. It's possible to pick up the amplitude of the signal as encoded in the groove, but it's impossible—and always will be—to get the right phase relation, because the actual speed of the platter is changing with the signal. There will be errors of time, and to do our very best we reach out to use the engine and the whole driving unit to reduce them.

These special errors are the birthmark of the turntable. Keep that in mind, please! Therefore it always has been good advice to listen not only to vinyl, but to a good tuner and tape recorder too. And the best advice of course is to listen to original music. Transporting the tape may cause mechanical faults, but they are not in the least dependent on signal. That's the difference.

Welcome to the real world

Seems a little bit strange to me that these birthmark faults never have been realized by measuring technicians. Nevertheless it's true. Till today there are serious measuring faults related to the platter speed, but speed alone doesn't mean a thing. It would be necessary to compare time errors to the original phase, whereby they will be translated into a correct magnitude. As far as I know this never was done. Being without correct measurements we should follow Newton's law and try to improve the driving unit to our physical cognition. There is no other way to improve our turntable.

Electrical engines don't think. To react to anything the engine must have seen an action first. The only action we can give to it is the platter's decreasing speed of rotation. This has to be translated to the shaft of the engine, and to realize this is a big problem requiring an optimum connection between platter and pulley. If the string or belt runs at the outer side of the platter and the pulley has a size of 9mm, the pulley's speed

of rotation is above 1,000 RPM. The contact area on the pulley is very very small compared to that on the outer ring of the platter. Therefore every slip will occur on the pulley. If the platter's speed is going down within microseconds, there is a huge risk to cause slip on the pulley— unless we find an optimum connection between platter and pulley.

Going back to our sine wave again the greatest force is given to the diamond within the first twelfth of the period. There it rises to half of the amplitude approximately as a straight line. At 1kHz this twelfth is passed by in 83 microseconds. The change of speed just happens at the same time. To transport platter speed variations to the shaft of the engine, the material of the string or belt has to be absolutely stiff. Any elasticity will prevent the translation of high speed movement to the pulley within microseconds as required.

Additionally, the belt material should offer the greatest possible contact to the pulley, giving not only a good grip but a big contact area too. I couldn't solve this problem for some years. Then my friend Alex once asked me: "Why don't you use this?" And the flashlight of a fascinating idea dazzled my brain. The idea shows up a stunning simplicity, seems to be the product of real genius. And the material is well known to audiophiles all over the world. Why don't you use *recording tape*, Alex asked me. I did. From that time on professional tape of 6.25mm size has been running on the outer side of my platter. And I'm satisfied. Believe me fellas, this it is. If you don't believe it: try it.

You'll have to look for a cylindrical pulley of 7 to 9mm diameter with a rim at the lower side. Adjust the axis of the engine in parallel to the axis of the platter. The adjustment should be brought to precision. The tape will run properly without an upper rim.

Hunting for engines

To follow the platter's motion immediately the rotor of the engine must have a moment of inertia of zero. This is what physical science demands. They can't build it, yet it forms the first and most important condition to choose an engine:

- (1) The rotor's moment of inertia should be low low down.

That's why all engines with high mass rotors like synchronous engines don't fit. They can't follow the platter's motion.



Author's Platine Verdier with recording tape belt and new motor

First condition fulfilled the second question arises. How should the engine react? Losing speed is a fault we must try to minimize. Therefore a regulating engine would fit best. An electrical regulator increases current in case the voltage decreases. The right motor should produce more torque if the speed of rotation is lowered. This reaction is valid as well for those changes of speed coming in slower motion and—hurrah—there does exist one fulfilling this specification: the DC engine driven with constant voltage.

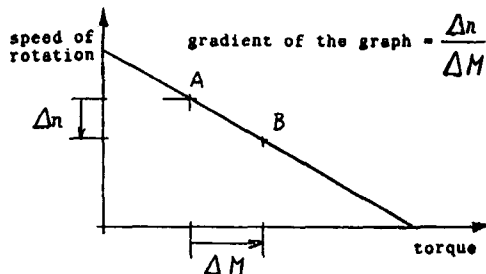

Figure 1: DC engine at constant voltage

Figure 1 describes every DC engine at constant voltage. For 33 RPM it is running at point A with more than 1,000 RPM as recognized above. If the platter is lowering speed by Δn , the engine goes to point B and rises torque by ΔM . The quotient $\Delta n/\Delta M$ is constant and a describing datum for an engine. It is the gradient of the graph and is given in $1/\text{min} \times \text{mN} \times \text{m}$ (mN = milliNewton and m = metre). The smaller the value, the stronger is the engine. (The wattage doesn't matter. It should not be exceeded. We never will. So don't ever choose an engine judging on wattage). Thus we have the second condition:

- (2) The DC engine is a real must. Without any exception.
- (3) Look for a strong engine, specified by a low value of $\Delta n/\Delta M$.

Unfortunately this is contradictory to (1). So we have to vote for strength or for a low moment of inertia. Voting depends on your platter. If you prefer a high mass platter you have to go one more step for strength.

To diminish the errors of speed the engine has to pull back the platter to 33 or 45/min. It should do that like a rocket. We are looking for a sprinter reaching his speed in the shortest time, Carl Lewis would be just right. Some manufacturers publish data regarding how quickly the engine runs up to 63% of its maximum speed of rotation without load. So:

- (4) Run up time has to be short. Imagine Carl Lewis is leaving the starting block.

These are four fundamentals. There are some more conditions to complete our first look at the engine and add a little background to pick up the place.

Crucial choice

Till now we have been discussing only concepts we can't see. Remember we're dealing in microseconds. Whatever happens to the platter within this time never will be visible to the human eye, it's too fast. Every look at the stroboscope desk will fool you with an average speed, even if this average is indicated with reasonable precision.

As we've pointed out the platter is flickering around its average speed, falling down a little and being pulled up by the engine again. This is the other, the invisible reality. Of course there are connections between both worlds. The DC engine running smooth at an average speed most probably will be smooth at quick action. So we have to look at the visible too, concentrating on four items. There are more, of course, but this isn't a quick run on constructing engines.

For audio use, low noise and smooth action are essentials. Every engine built by man causes vibration and noise since they can't produce them at zero tolerances. The biggest part of the problem is generated by the bearings. Therefore:

- (5) Choose sintered bronze bearings for quiet and smooth action.

Pulling aside the belt creates a radial force acting on the shaft of the engine. Strings always cause the greatest radial force, tape much less. So:

- (6) Ensure the engine's maximum radial force will not be exceeded.

Points 5 and 6 are somewhat contradictory within engine design. Ball bearings can tolerate a greater radial force but are much noisier. Regarding bronze bearings, the radial force is diminished with the diameter of the engine. That's why engines of small diameter are not always the best choice, even though they are best in terms of a low moment of inertia. We live in a contradictory world, all we can settle for is a well-sized compromise.

We'll finish with two electrical items. The DC engine has to be driven through a built-in commutator. The current reaches the coil by passing across that commutator. And commutators cause spikes (see Figure 2).

- (7) The brushes of the commutator have to be precious metal ones. No graphite allowed here.

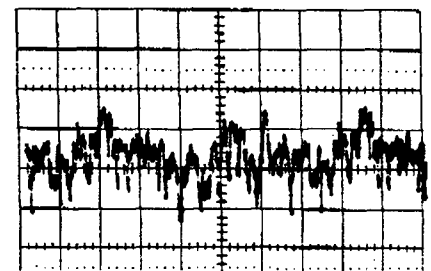

Graphite brushes

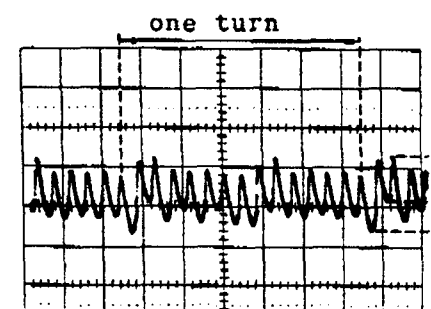

Precious metal brushes

Figure 2: Spikes caused by commutator

To get constant voltage we'll need a regulator. For practical reasons it would be nice to make it adjustable. The DC engine's speed of rotation is determined by voltage. Therefore the voltage has to be adjustable with great precision and stability.

reference (see text)	parameter	unit	recommended	dc-engines				
				#1	#2	#3	#4	#5
(1)	moment of inertia	g x cm ²	up to 10	0.5	2.5	8	8	10
(3)	$\Delta n/\Delta M$	1/min x mN x m	100 to 1000	1,300	1,000	200	200	40
(4)	run up time to turns	msec	5 to 25	7	23	17	18	5
		1/min	2,000 5,000	11,000	5,000	4,000	5,000	7,000
(6)	maximal radial force	N	1 to 5	1.5	3	4.5	4.5	16
(8)	turns to voltage	1/min x V	150 to 400	500	200	200	200	200
none	nominal power at turns	W	up to 10	2.5	2.5	4	6	20
		1/min	up to 10,000	17,000	8,000	6,000	9,000	10,000
none	diameter length	mm	13	13	26	26	26	25
		mm	33	33	45	45	45	55

Abbreviations: cm = centimetre; g = gram; min = minute; mm = millimetre; mN = milliNewton; msec = millisecond; N = Newton; sec = second; V = volt; W = watt.

The engine manufacturer should publish the ratio of turns to voltage (given in 1/min x Volt). If they didn't, you can find that value dividing the maximum speed of rotation by the maximum voltage.

(8) Make sure the engine will perform optimally with an easy to build regulator.

If you never have looked at manufacturers' data before, you should allow yourself a little training before buying a new engine. I want to show up some general data combined with realistic examples, completed with a comment on each example. If you're familiar with electrical engines, the columns containing numerical values might still be of interest to you. Please notice European units.

Comments on Engine Parameters

#1. Gorgeous, this pen size engine: 17,000 RPM. Hunting for a low moment of inertia only, this would be the one. Good for ultra short run up time, but this engine is the weakest of them all at carrying any load, as indicated by the $\Delta n/\Delta M$ quotient, which in my view is too high. (Most miniaturized engines are ordered with a gearbox to adjust it to the speed and torque wanted; but any gear means more noise, more rattle, more bearings, more tolerances...) The turns to voltage ratio is a little bit unpractical, this one has to be driven at 2.0 to 2.5V. Furthermore there are problems we didn't mention. Corresponding to the reduced diameter this engine comes without a thread and will be difficult to mount. There is a shaft of 4mm length and 1.5mm diameter to fix the pulley—once again a little bit unpractical. (A lot of these pen sized beauties come with toothed wheels ready mounted). All these are reasons to look for another.

#2. This one offers the same wattage at a more convenient speed of rotation. The turns to voltage ratio sets #2 (and the following ones) at an easy to regulate five to six Volt margin. Run up time is a little bit on the limit, yet I could live with this. Radial force is high enough to pull the most stretched string. This feature promises an extended lifetime. Summing up you could use the engine for a low to medium mass platter, for example a Roksan, Thorens TD 126 or Linn.

#3. The moment of inertia is raised. The $\Delta n/\Delta M$ quotient shows a stronger engine. Given the same loss of speed this one will put out a torque ΔM five times higher than #2. In real world DC engines there is no way to combine the low inertia of #2 with the greater strength of #3. You have to vote. The shaft offers 3mm in diameter and enough length to mount any pulley with ease. (This is the same for #4 and #5). Added the high radial force this one will run properly with high mass platters.

#4. The brother of #3. But not big brother. All values are equal except run up time, which is comparable. There'll be no differences in practice except one. The higher wattage is realized conceding a higher speed of rotation. To reach this without losing lifetime the manufacturer changed the brushes of precious metal versus graphite ones (see figure two). Don't be misled by the nominal 6W rating. Go for #2 or #3.

#5. The muscle car. Lots of power. Quick. Strong. This is doctor's choice to cut your bones if necessary. It's for medical saws, etc. Supposing doctor is a speedy cutter the engine will resist up to 70W (!) as short time overload. It's built with the hardest ball bearings to stand double speed of rotation.

And graphite brushes of course. Doctors don't ask for smoothness. So very sorry, powerfreaks, thinking big not always cures problems. Small is beautiful. Constructing an unique 211 amp of 15W, John Camille finally discovered that 50 to 500mW was all he ever needed. Driving your platter the DC engine doesn't consume a higher wattage. (If it does there is something wrong with your table; check the main bearing; renew the whole turntable).

Following the route

It would be fine to detect one manufacturer offering such an assortment. More often you will find only one piece—or none—worth considering. Maybe there are half a dozen specialized in high precision DC engines, maybe more, I don't know. They're not at all accustomed to handle high end freaks. They're looking for "normal" orders starting with one hundred pieces. Asking for only one you have to fight your own way through that business jungle. Yet it's worth the labour.

To complete the driving unit the engine has to be mounted. I recommend an aluminum plate of 1/10 of an inch. Place this on top of a metal case of at least 10 pounds. And decouple the mounting plate, but don't apply rubber or anything like that. Remember the pulley has to stay parallel with the axis of the platter—no motion allowed here.

Furthermore you'll need a DC regulator. Listening to a turntable driven by a DC engine of quality you will notice unbelievably small changes in the regulator's design. Take care. If your engine is the best, the regulator has to be in the same class. Look for parts of highest quality only and keep in mind that you're building a supply for a very few milliamps. Anybody out there specialized in those regulators?



Platine Verdier installation of Christian Rintelen, *Hi-Fi Scene* Editor

Bringing together the whole unit you should work like a clockmaker does. Take an artist's look on things. Any resistance in a no compromise preamp isn't just resistance, it's a special one. It has taken time, experience and a long way of searching to bring it up to the best. Fixing your engine and mounting the driving unit you should do the same in choosing screws, washers, etc. There are no parts of minor importance. If your system is up to the standard, you will hear the smallest difference. So we reach the final question: How does it sound?

Last not least

To start with a confession: I'm not really an audiophile. Audiophiles end up hearing 300 to 500h hifi a year and about 3 to 5h music by chance. I'm on the opposite side. Three members of my family play, so I'm hearing natural instruments at close range in average living rooms every day I'm home. I don't listen to hifi every day. Adding up a year there'll be as much music as hifi. Everything I ever tried was to minimize the huge difference between hifi and the original thing.

A well built driving unit leads one step closer to the real thing but I don't know if you'll be pleased. Maybe it will sound nasty. For example, if there is a SME 3012 and a Denon 103 it definitely will. Because this combination isn't at the same level. Maybe the faults within your system will be pointed out much clearer. Undoubtedly there will be less time errors, better phase relation, better transients, more pulse, more low level detail. There will be more music. Once again, I

can't predict your view. Those who tried call it a big step forward.

Of course you can adapt this driving unit to sort of a Thorens 125 but, obviously, the better the turntable the better it will match. I like it with a Platine Verdier. My turntable carries a Series V and an Ortofon Vero, followed by a step up transformer, an all the way 6922 preamp and a pure triode SE amp. I just kicked out my former 300B Legend (by *L'Audiophile*) after modifying it for some years. The amp drives a DIY one way speaker of high efficiency based on a Siemens driver mounted in a vented box.

Using a highly evaluated system you should compare a driving unit such as I describe with any manufacturer's solution. You'll need only very few seconds of the first track on a Jennifer Warnes record to get clear. That's what I want to say.

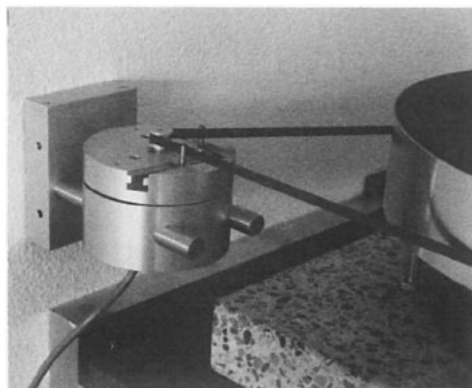

Wall-mounted motor unit

Postscript

John Baier and Herb Reichert proved the TD124 to be great. They're right. J.C. Morrison goes for Garrard 301. He's right. Vinny Gallo loves EMT. Just wonderful, Vinny. All these guys vote for turntables of the other party. They use wheel drive and really big engines ignoring every quick move of the platter. And here's yours truly pointing out some rare ideas of flickering platters et cetera. So what's right, what's wrong?

All these jurors are doing an excellent job. I'm right on their side bringing back to our knowledge that once components were built to better than today's standards. I always admired that deep sense of craftsmanship delivered in those goodies. Yes, I love oldies.

However, take notice that none of these was ever constructed to serve other than professional needs. Keep them running, that's the idea. For example, EMT's tonearm and cartridge and Ortofon's famous 309 and SPU were designed to work under worst case conditions. Life was tough at radio stations—and still is. (Two interesting years I lived with the latter combination). No audiophile touch there. Audiophilism should ask for optimum conditions to reach and stretch out the limits. That's a different approach. It's my approach too, looking at the turntable in a focused manner.

Working out a new idea always breaks some old practice. Nobody is accustomed to call for DC engines of highest quality. Nobody usually thinks of ultra-fast motions happening to the platter. You are trained to believe in electrons you can't see or measure. Yet you believe they exist. You believe in electronic waves and you believe in audio signals you've never seen that are said to be inside your amps. And first and most important they're in your brain. Till now any quick action of your platter wasn't in your brain. It's not at all surprising that you doubt if a flickering platter could be real.

Yes, it's real. It goes back to old cognition found out by Newton (1643-1727). Till now Newton's Law is valid. Physicists up to Einstein proved it. Given the conditions of our physical world, this is the truth—or as close to the truth as man can be. If your pen is falling down it's following Newton's Law. If your car is bumping up and down it's following Newton's Law. And your platter is flickering around its average speed following Newton's Law. As long as signal in the groove is changing there doesn't exist any millisecond during which your platter is moving at a constant rotation. Therefore it's

(Continued on page 43)

TURNTABLES (continued from page 14)

the audiophile way to construct a driving unit to minimize these errors.

After using a Platine Verdier for six years now, I definitely lost that down-to-earth feeling. I wonder why so many American freaks creating great amps and speakers never felt the necessity to match them with a high-end turntable. Bringing a 300B amp to perfection or taming a VOT— is that down to earth or up to audio heaven? Anyway the best advice I can give to you is:

1- Sell any Garrard, TD 124, and, in my humble opinion, Linn, or place them in your private museum. Don't mess up those old goodies!

2- Start with a Xerxes by Roksan, if you don't want to jump forward to a Platine Verdier. Xerxes still has one of the finest bearings I've ever seen in a commercial product. You can buy a bearing and inner/outer platter assembly from Roksan and mount it on a subplatter of your choice [Roksan distributor in US: May Audio Marketing, 423-966-8844/8833 FAX. Approximate cost of platter and bearing is \$600].

3- Find a good engine or use the Swiss-made 24V Maxon part # 2326 942-12-111-050 [available at \$231.10 in single qty. from Maxon, 838 Mitten Road, Burlingame, CA 94010 415-697-9614.] You can try the much cheaper "941" 30V version if you are confident that you can build a low voltage regulator. Christian Rintelen of *Hi-Fi Scene* uses the rare and expensive "949" 42V version. The Maxon is #3 in my chart and it will serve as a classic in all applications. Avoid Pabst.

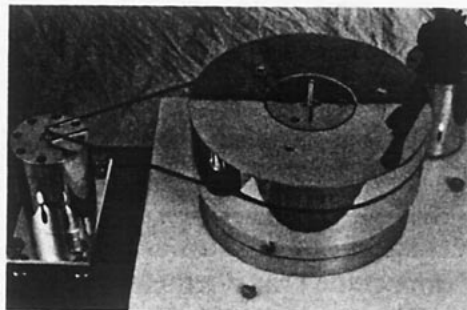

Realization of Audio Contact, Germany

4- Try a home-spun driving unit as described above, using tape as a belt. The optimum tension is where the platter runs at the lowest voltage. Use the best pulley you can get, even if the cost is excessive. For the Maxon motor, I recommend a pulley of 9mm diameter. Audio Contact in Germany can provide a ready-built pulley of this size and they also sell engine/pulley systems. (Audio Contact, Lindenweg 12a, D-22395 Hamburg, Germany).

5- Build a variable regulated power supply which can be as simple as an LM 317 chip or as complex as you wish.

That's it! Most probably this will outperform 301, 124, LP 12, or whatever you name. If you're out for the top turntable, you will have to build it yourself. That truth is simple and always the same. I'm sure you can do it and without becoming a mechanical engineer.

VAIC VALVE, TRIODE SUPPLY JAPAN, BLUE CIRCLE AUDIO, DENNESEN ELECTROSTATICS, LOWTHER AMERICA, AND HUNDREDS OF MUSIC LOVERS HAVE CHOSEN JENA LABS AS THE WORLD REFERENCE INTERCONNECT SYSTEM

IN ADDITION TO OUR COMPLETE INTERCONNECT RANGE, WE NOW OFFER A FEW SUPPLIES TO THE DIY EXPERIMENTER.

WIRE WHY PAY \$100.00 OR MORE A FOOT FOR THE POLITICALLY OR RELIGIOUSLY CORRECT SILVER WIRE WHEN A SONICALLY SUPERIOR WIRE SYSTEM CAN BE HAD FOR MUCH LESS. JENA HOOK UP WIRE, PREVIOUSLY AVAILABLE ONLY TO OEM PURCHASERS, IS NOW AVAILABLE TO THE DIY HOBBYIST. THIS IS THE SAME CONDUCTOR SYSTEM USED AS THE MAIN CURRENT PATH IN OUR MOST EXPENSIVE INTERCONNECTS, THE SINEWAVE SYSTEM. 18.1 GA. - HEAVY WALL, MODIFIED P.E. INSULATION - SUPER ANNEALED STRESS FREE HIGH PURITY COPPER \$12.00 FT.

RCA CONNECTORS ALSO AVAILABLE IS THE JENA MODIFIED CARDAS™ RCA PLUG WITH EXCLUSIVE SILICONE COMPRESSION RINGS \$35.00 PAIR, \$65.00 QUAD. ALSO, CARDAS™ PANEL MOUNT FEMALE JACKS AT COMPETITIVE PRICES.

JENA LABS

TECHNOLOGY AND ARTISTRY IN NATURAL HARMONY
19235 PILKINGTON ROAD LAKE OSWEGO OREGON 97035 USA
Michael and Jennifer Crock VOICE +1-503-639-7551
24 HOUR FAX +1-503-968-7261

X - D A C 3 . 0

The advanced DAC kit

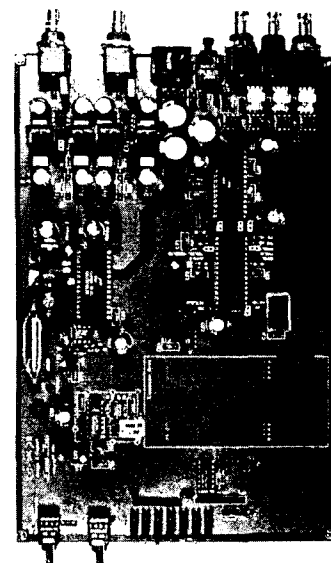

- On-board filter reduction with AD1891 and balanced drive clock unlocks the true potential of the CS8412/CS4328 chips.
- External 30 watt supply feeds nine regulator power system.
- High speed high current analog section.

Write for detailed information

Audio Crafters Guild

5102 East 38 Place
Tulsa OK 74135 U S A

EURIDICE

A TRANSFORMER OUTPUT LINE LEVEL PREAMP

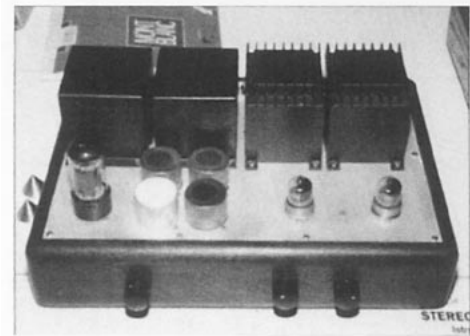

BY CIRO MARZIO, CRISTIANO JELASI & LUCA CHIOMENTI

A single ended transformer output line level preamp could in this day and age seem a bit strange. For sure, this concept is unusual in the Western audio scene either as a commercial product or a unique DIY item. The fact that this topology is uncommon in the contemporary hi fi scene does not mean it is anything new. In fact the basic circuit is not very different from the one used in the famous Audion—the first audio amp ever built back in 1912.

In the early years of audio the standard amplifier stage used a transformer at its input and a second one as an output device. The latter could be used either to drive a speaker or as a coupling unit to the next amplifier stage. Batteries were used everywhere in power supplies.

Resistance-capacitor coupling appeared in 1916 but it was seldom used since a big amount of the precious energy supplied from the batteries went wasted in the plate resistor. RC coupling has lower gain than transformer coupling and adding more amplifier stages to compensate for the lost gain would increase battery consumption more and more.

In those years, transformers with a step up ratio were the norm since they provided voltage gain without power consumption. With the advent of AC power lines and early high μ triodes things changed. RC coupling became practical since batteries were no longer the primary source of power. Gain became much less expensive with AC electrification. Yesterday as today, economics plays the major role in determining the course of mainstream design. Cost usually wins out over quality.

Modern high permeability low loss magnetic materials were not available so the construction of high quality transformers was very difficult. But it is astonishing that with

modern capabilities, transformer coupling is so seldom used. After all, transformer coupled circuits were a mainstay of the highest quality professional studio gear through the 1960s. How did contemporary hi-fi design get so overspecialized and banal that a simple classic transformer-coupled circuit appears totally revolutionary?

We started this project a couple of years ago in Milan. It was a pleasant September night and we were eating and drinking after a very hard working day at the *Top Audio Show*. Almost the whole staff of *Costruire HiFi* was there talking and chatting. After a very short time the conversation turned to audio and music and somebody asked us our point of view about preamps. We started talking about a hypothetical transformer-coupled preamp and after maybe half an hour and a couple of glasses of Italian red wine we decided to build one.

We love the living natural effortless sound of single-ended amplifiers so we chose this design topology. Despite its apparent simplicity designing such a stage is everything but easy. In a plate loaded configuration, a single-ended stage has an output impedance practically identical to the active device internal resistance. Most of the commonly used signal triodes have a plate resistance of several kohms. It ranges from 2-3 kohms of the 6DJ8 family through 6-7 kohms of the 6SN7 and 12AU7 families up to the 60 Kohm and more of the 6SL7 and 12AX7 family.

Those values of output impedance don't give excessive problems if we intend to drive only a few inches of cable and the grid of a following voltage amplifier stage. Things change completely in a preamplifier which is included in a separate chassis.

First of all, a coaxial cable is anything but an easy load whether it is 3 or 12 feet long.

Secondly, with a separate low-level amplifier, we are not designing a closed system. We cannot know in advance what will be the input impedance of the power amp(s) we have to drive.

In order to drive heavy loads, we will need a very low output impedance—say 200-300 ohms. By "heavy loads," we mean solid state amps, input transformer amps (whose typical input impedance is 600 ohms), or a parallel of several tube amplifiers in a multi-amplification system.

The above mentioned triodes do not suit our requirements for low output impedance unless we use more than one stage and add plenty of negative feedback. Since we systematically avoid any kind of negative feedback, including cathode followers, we have two remaining possibilities.

We can either use low plate resistance power triodes (6AS7 family) which are intended for series regulation (usually do not sound so good) or transformer coupled medium μ signal triodes.

The transformer solution is the one we chose to pursue. An output transformer would give us the low output impedance we need while avoiding the use of a very critical coupling capacitor in the signal path.

A further benefit is given by the enormously lower DC resistance of the plate load which avoids the waste of a big quantity of energy. For example, the voltage drop in the primary winding of our output transformer with its typical DC resistance of about 100 ohms is only 2 volts at 20 mA, while a 4700 ohm load resistor will give a drop of 94 volts at 20 mA. That means that we need to build a power supply capable of only 162 volts—instead of 254 volts—in order to get 160 volts at the plate.

But the most important advantage is the greatly improved plate circuit efficiency. This is the ratio of the audio frequency power output to the DC plate dissipation (power input). To better understand this let's see what would change in our preamp using the two different topologies.

We tried different versions of our circuit having fine results either using 5842-417A or 3A167M-CV5112 triodes. We will discuss the differences between the two types later; now let's examine what happens using a 5842-417A.

This 417A has a μ of 43, high transconductance (24,000 μ mhos) and low RP, thus is suitable for transformer coupling. We chose to run it at 160 Volt 20mA for a plate dissipation of 3.2 watts, plate load 4700 ohms; under these conditions the power output is about 660 mW. We will not consider the interconnect cable influence in order to simplify things.

The real load seen by an RC coupled output device (5842) corresponds to the result of the parallel combination of plate resistor (4.7 kohm) with the following stage input resistor, ordinarily several times higher than the plate resistor. Let us consider a value of 47 kohm. The RC coupled stage will therefore work on a load of 4272 ohms which is still acceptable. However, the effective power available on the input will be very low.

In fact 10/11ths of the audio output power (600 mW) will be wasted on the 4700 ohm plate resistor while only 1/11th (60 mW) will be available on the input resistor (47 kohms) which is the load we actually intend to drive. Therefore the plate circuit efficiency will correspond to 60/3200 thus 1.875%. Isn't that terrible?

Let's see what happens in a transformer coupled circuit. In this case the plate load will correspond to the load applied to the secondary winding of the transformer multiplied by the square of the transformation ratio. The power available on the load (input resistor) will correspond to that available on the plate circuit less transformer losses which will typically be less than 10% even if you use a very simple transformer design; thus 90% or more of the power (600 mW) will be available to drive our load.

Consequently, the plate circuit efficiency equals 600/3200 or 18.75%. This is ten times higher than in a usual RC coupled stage! Furthermore we can easily match our

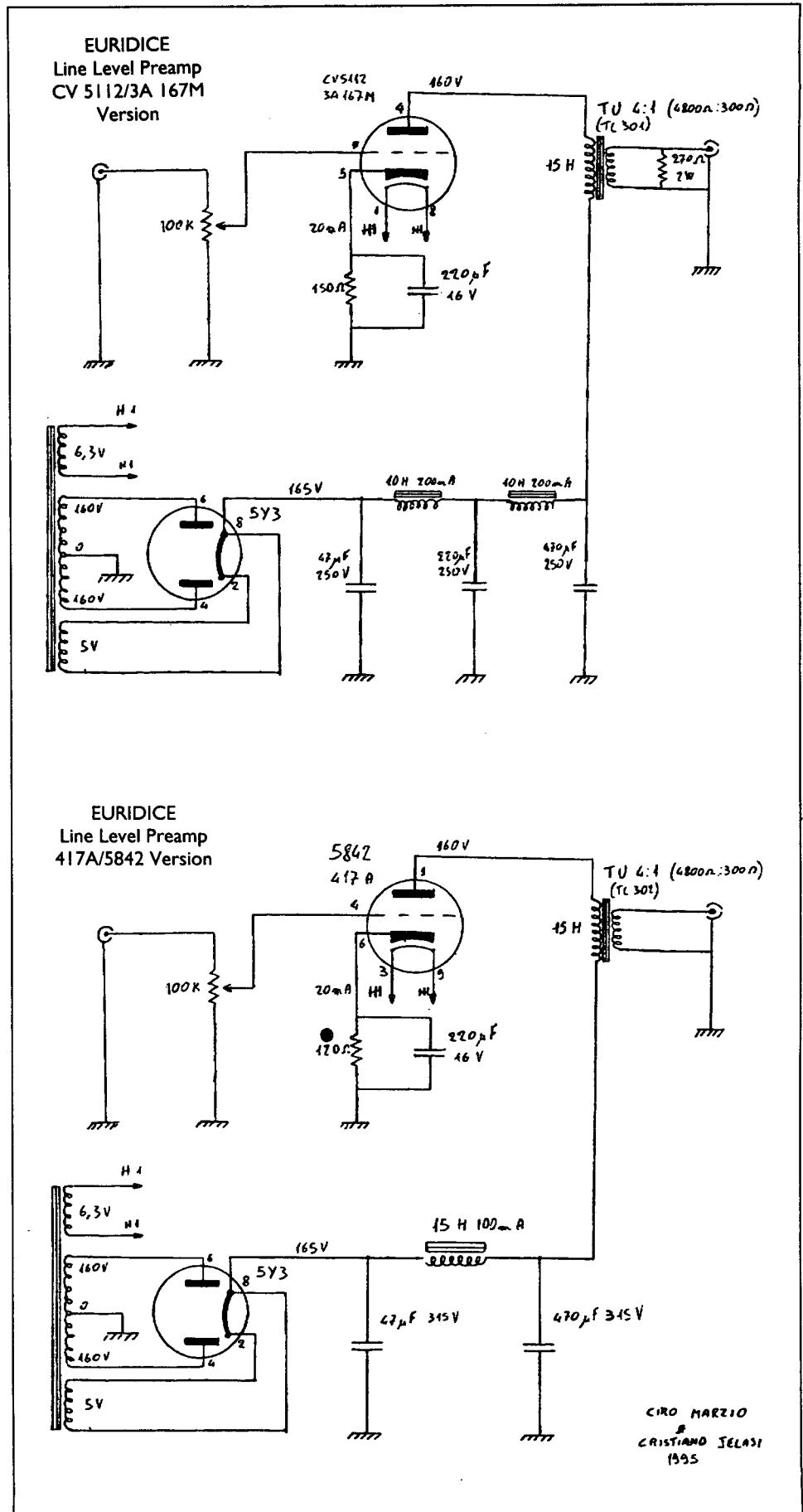

output stage to the load by varying the value of the resistor that terminates the secondary of the transformer.

The trouble with output transformers—every rose has its thorns—resides in the design difficulties of such devices, not to mention high costs. The transformer should perform musically better than a capacitor of the same price range or else it's not worth it. This is not easy when the secondary of the transformer has many windings (as for a 4700 ohms/220 ohms device) because of the well known problems due to stray capacitance between primary and secondary winding.

A very good design is required as well as expensive and hard to find high permeability cores. Several conversations with the famous K. Imai of Audio Tekne helped us choose the right coils ratio and to solve some of the problems related with the design and construction of our transformers. We designed two different types of output transformers that have been produced for us by Megahertz of Naples, Italy. Contact info is provided below in case you don't want to wind your own.

The smaller one *TL301* features a MO core (75mm x 62.5mm x 40mm) with a standard 0.35mm lamination; 14 sections winding; turns ratio is 4:1 and primary inductance is 10H. They are pretty big since they can deal with 30 mA of DC current.

The bigger *TU1001* was designed also to be used to drive high impedance loudspeakers and features a beefy MO core (96mm x 80mm x 50mm) with a very thin (0.1mm) lamination; 18 sections winding; turn ratio is 4.4:1 and primary inductance is 20H. It can handle up to 80 mA of DC current; this means that if you like you can design your own preamp around a 300B or a VV30B. This output transformer performs superbly even if it may seem somewhat expensive.

Using a TL 301 or a TL 302 in conjunction with a 5842 triode, the overall gain of our circuit is about 8 with a maximum output of 14 Volts RMS on a 300 ohm load. Enough to drive any power amp we know.

In essence, the circuit is very simple. It is basically an output stage of a classic single ended amp. That means that all passive components must be of excellent quality. We used paper in oil caps and A-B resistors in our version.

The volume control could be a series stepped attenuator or even better a ladder attenuator. You can find detailed instructions on the construction of such a device in the Welborne Labs Catalog (ph. 303-470-6585; fax 303-791-7856). We used Holco resistors and Grayhill switches in ours. This solution costs something more than a good film potentiometer but performs way better.

Among 417A type tubes, Raytheon 5842 and Western Electric 417A gave us best results. If you go for WE 417A, watch out for microphonic specimens. 3A167M/CV5112 is even a better choice. This monster tube which has a plate dissipation of 12 watts even less than that of a 6J5, features an unbelievably high transconductance of 47000 μ mhos, a μ -factor of 47 and an internal impedance of only 1000 ohms. Unfortunately this triode, manufactured by ITT and STC, is very scarce even in Europe. Be aware of the fact that many of those tubes are microphonic.

The power supply uses a 5Y3 valve followed by a classic capacitor input π filter. In order to preserve the rectifier tube we used a rather small filter input capacitor to limit inrush charging currents at turn-on. On the output of the filter we used a large capacitor to lower the internal impedance of the power supply in order to enhance bass and mid-bass performance. We used custom made polypropylene caps bypassed with paper-oil capacitors.

We are quite satisfied with the sound of this preamp. Music has great impact, a rich harmonic presentation and a flawless dynamic range. Even if you use the small TL 301 output transformer and 5842-417A triode you will enjoy music in a way that is more 'alive', less 'reproduced' than with any conventional hi end design.

We think that this preamp—although a very simple basic design—is a step beyond conventional preamps, but if you want more you may improve power supply filter realization by adding further LC cells and using high quality paper in oil caps.

The way *Euridice* gives energy to the music is really impressive: even the lower level details come to your ears without any apparent effort. To go back to your Audio Note, Conrad Johnson, Convergent Technology, etc. could be shocking: the sound will seem dull, lifeless and unexpressive.

Other Directions

If you want to go even further you may try to use DHT. We have tried—with fine results—single plate 2A3, 45, 71A, VT52, and VV30 using a high quality super-permalloy core step up input transformer to obtain the gain we needed. Of course there are many other DHT well suited to this use, many paths of experimentation to pursue.

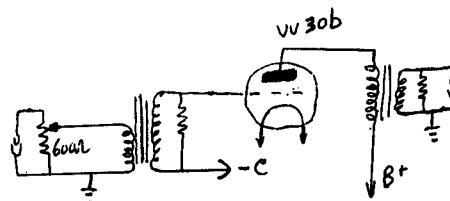

**Transformer-coupled line amp
1:4 step up transformer, VV30B**

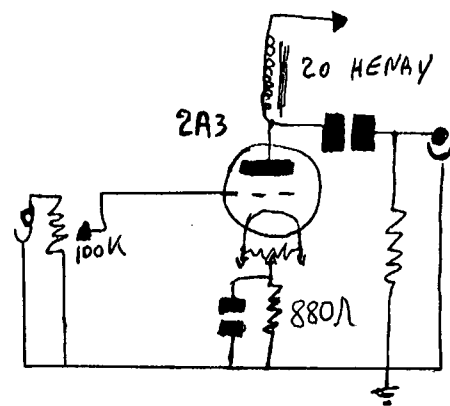

Choke loaded preamp

Good Italian Reading

This circuit originally appeared in the 1/1996 issue of the Italian language *Costruire HiFi*, one of the world's leading DIY journals.

Prices for 10 issues/1 year:
 European countries Lit. 150.000
 Overseas addresses Lit. 180.000
COSTRUIRE HIFI
 Mozart Editrice
 Via Rismondo 10
 05100 Terni, Italy
 Fax: 0744/428401

Euridice Transformer Supplier

Megahertz, Ptta Eritrea 3,
 80137 Napoli, Italy.
 Voice/fax +39-81-7613583

Retail prices are:
 TL 301 US\$95 each (plus shipping)
 TL 302 US\$129 each (plus shipping)
 TU 1001 US\$315 each (plus shipping)
 TU 1001p (potted version) US\$338
 each (plus shipping)



WOT

(With Output Transformer)

A TRANSFORMER-COUPLED LINE LEVEL PREAMPLIFIER

Diego Nardi, Audio Note Italia

*More transformer-coupled action
from the Boot of Italy*

Everything began when a customer asked me to build a competent line level preamp to drive his Audio Note P3 power amp.

When someone asks me to build something, especially if it's apparently simple (and what in the world is more apparently simple and inherently tricky than a line preamp?), and the budget is not too strict I think there is really no point in giving him a product that may be similar to anything commercially available. A custom product must be real special and, from my standpoint, this is how this preamp had to be — special.

Besides, in that period I was working on the development of a pair of "reference" quality, 300B based parallel single ended monoblocks and I wanted to design a dedicated preamp to partner them. My customer willingly offered himself as a guinea pig for this experimentation! This set of circumstances is where the WOT project originated.

Why a Line Preamp?

A while after CD started gradually replacing the LP as the main audio source of the "average" listener, a previously nonexistent item was invented, the line-level-only preamplifier. Most of its claim to fame in my opinion are business considerations rather than strictly technical ones. After getting away from the most "preampish" part of the preamp, the phono stage, the audio industry, and especially the smaller companies manufacturing high-end gear could not afford not to sell preamps anymore.

I'm saying this because, in a merely technical view, i.e. from the standpoint of impedance matching, gain/distortion distribution characteristics and dynamic behavior, it is my opinion that a line-level-only system is much more sensibly (and "better soundingly") built around an appropriately designed integrated amplifier.

The only limitation to this is when there is more than one power amplifier. This is just a general consideration which applies to several situations, spanning from the simplest case of a monoblock pair to the sophisticated electronic-crossovered multiamping possibility.

All of the above configurations have one thing in common: if sensibly implemented, they're NOT to be met in cheap systems (before anybody starts to doubt: exceptions like bi-ampings with four bridge-connected \$300 NADs are NOT classified as sensible in this article).

The above talk sets an initial quality target to justify the effort: an accordingly sensible line preamp, and this time by "sensible" I'm meaning "competent with the above", shall NOT be designed or built on a budget, since mediocre quality would rob it of any meaningfulness.

At the risk of repeating myself, cheap line preamps are complete rubbish, conceptually more than qualitatively, because they're useless. If you are on a budget and only listen to CD you don't have to hunt for a preamp at all. Get or build yourself a proper integrated instead, and you will live happily. And please, don't waste money trying to

multiamp with crap amplifiers. A single good amp is ALWAYS better than a row of tin boxes, for the same price.

How a Line Preamp?

After deciding our line preamp is meant to be "good", what do we want it to do then? First of all, we want it to put out POWER to grip the input of our power amps and not let go, then we want DYNAMICS because it's a preamp not a DBX broadcast compressor and, in order to get these dynamics, we need LINEARITY which also makes for LOW DISTORTION. We don't want too much GAIN simply because we don't need it. These are the clear and simple priorities to start with.

It is quite possible to design a preamp fulfilling the above requirements with a single stage and no feedback but, after doing that, it is important to transfer the signal so linearly modulated by the circuit to the load (the power amps) as efficiently as possible. And a transformer is by far the most efficient device for this purpose. You can use many other circuits obtaining good efficiency by electronic means (SRPP, Mu Follower) and still get a completely respectable and satisfactory machine, but believe me, there's really no comparison with transformer coupling when it is working properly.

Circuit Choices

It is quite obvious that the most suitable active device for this project is a triode. An appropriate triode for this preamp must have very definite characteristics:

First of all, it has to be a high transconductance medium " μ " type because the overall gain required is quite low and it must be obtained without feedback; at the same time the input level could also be extremely low: at low volume the grid drive is barely microvolts and the tube must be extremely responsive even at these levels in order not to lose resolution under such conditions. Besides, modest " μ " and high transconductance make for low plate resistance which limits the primary inductance demands on the output transformer.

Secondly, this triode has to be extremely linear and capable of working at relatively high plate voltage with good plate dissipation, to get vast dynamic leeway and work well under maximum output conditions. This makes for very low distortion and relaxed, accurate and unconstricted reproduction of contrasts and timbres.

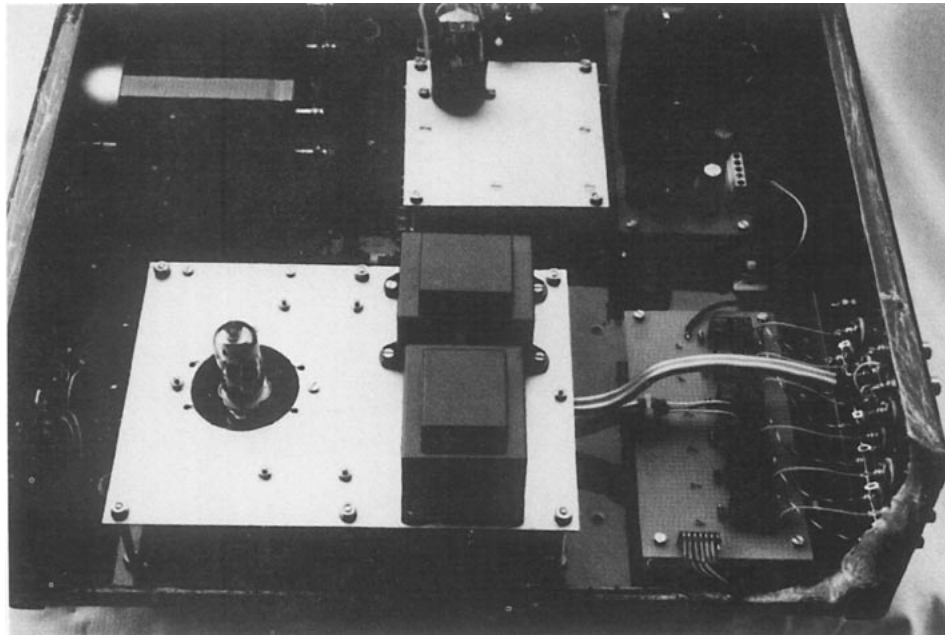

Layout showing suspension-mounting arrangement for 5687

Power triodes are unsuitable for this purpose since they are not at their best working at microvolt levels: they show excessive input capacitance, are too microphonic, too low in amplification factor although good in plate resistance, and shutting heater noise up is a pain in the ass. I mean, no 2A3 preamps. 2A3 is extremely good for the application it was originally meant for, but not this one. Sorry.

Careful consideration of all sensible triodes available to me showed the best compromise overall to be the 5687. It sports a tough plate dissipation rating, reasonable μ , very high transconductance, it is so linear it can modulate 150 Vpp even when biased with less than one milliamp, and is not very microphonic.

The 5687 is superior to the 6922 in linearity and low signal level performance, can stand much higher plate voltages than the 5842, has lower plate resistance than the 6SN7 and is not terribly expensive.

5687s have two bad characteristics, however, that require care in design: one, they tend to draw some grid current and, two, they always leak a bit between cathode and heater. Luckily, both negative effects can be neutralized with shrewd design strategies so they are not insurmountable problems.

The output transformers are custom and have been specified after setting a range of possible loads at output and assuring

optimum dynamics from open-circuit down to 5 kohm. This preamp will work correctly into virtually any possible power amp load, although its gain will obviously decrease with increasing load. That is, lower power amp input impedance will mean lower chain sensitivity at preamp input.

This unit is NOT designed for particularly low output impedance but rather for best power transfer and dynamics; therefore it must not be loaded with excessively capacitive loads, otherwise the slew rate will suffer. This is no serious limitation provided you don't use silly cables or big bad transistor acoustic polluting machines.

Otherwise the circuit is extremely simple. Either section of the tube takes care of one channel and is biased with a bypassed resistor. The grids are directly coupled to the wipers of a precision ganged pot which in turn is directly coupled to the input selector. The pot with its short leads is sufficiently insensitive to 5687 grid current not to give trouble. The output is unbalanced and grounded to chassis in such a way as to make the preamp non-inverting, but the output transformer secondaries do have center taps so that a balanced XLR output is obtainable if desired.

Attempts to obtain a floating output (grounded at power amp side only) caused such big troubles to consider this option totally out of the question.

WOT parts you need

R1, R2	5k6/5W	ceramic wire wound
R3, R6	1R/2W	wire wound
R4, R5	68R/1W	carbon film
R7, R8	270k/1W	carbon film
R101, R201	22k/1/4W	metal film
R102, R202	390R/1/4W	metal film
VR1	100k B taper	volume potentiometer
C1	47 μ F/450V	electrolytic
C2	150 μ F/400V	electrolytic
C3, C4	1800 μ F/400V	electrolytic
C5, C6	10,000 μ F/35V	electrolytic
C7-C11	470 μ F/16V	special low ESR electrolytic, Rubycon PS1/PS2
C101, C201	220 μ F/16V	Rubycon Black Gate standard type
BR1	80V/3A	bridge rectifier
D1-D12	1N4004	
ZD1, ZD2	7V5/1.3W	BZX85 series zener diode
Q1	BDW 93	
Q2	BDW 94	
Q3	L7805CV	
C12	.1 μ F+47ohm	class Y surge suppressor
SL1	2way/6 position rotary selector	
SW1	DPST power switch, 250V/4A	
RL1-RL6	DPDT 2A miniature sealed relay, 5VDC coil, Omron type G5V-2	
TR1	Power transformer, 2x 0-110-120V primary, 230-0-230V @ 60mA, 6.3V @ 0.6A, 9.7-0-9.7V @ 1.2A	
TR101, TR102	Proprietary output transformer—available from the author \$330/pair, airmail included	
CHI	70H @ 40mA choke, DCR = 1.5kohm	
V1	5687	
V2	6X5GT	

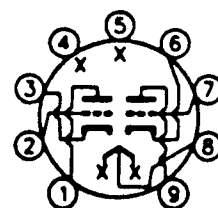

5687 Base diagram

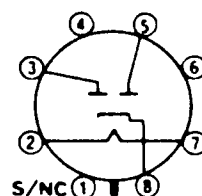

6X5 Base diagram

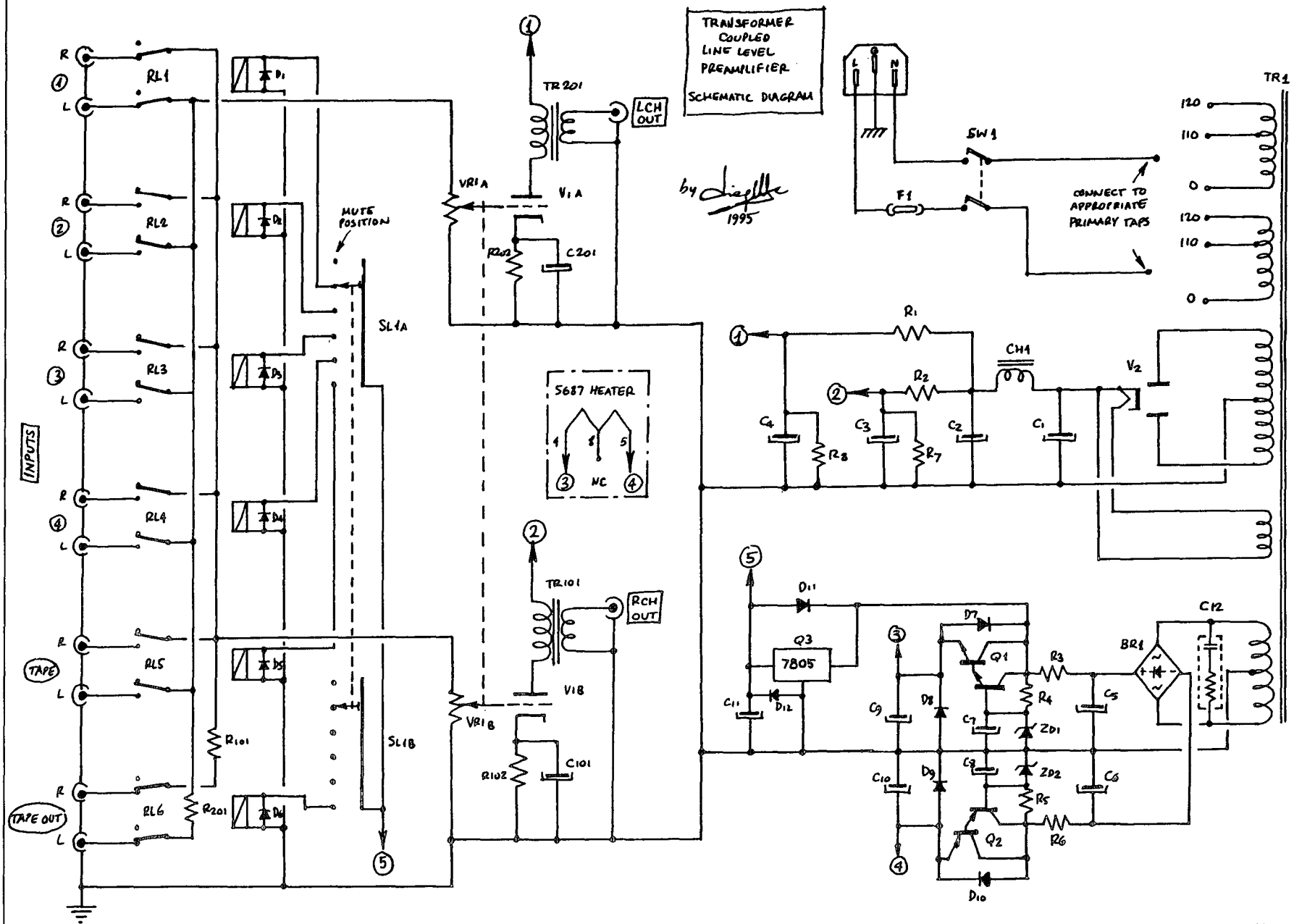

DIEGO NARDI 1995

The input selector is implemented with a bank of relays having a common coil ground and separate positive rails being operated in turn by the rotary selector on the front panel. One of these relays disconnects the tape output when the "tape" input is selected so the risk of tape loops is eliminated while doing away with the need of a tape monitor facility and therefore simplifying the signal path.

The Power Supply

A power supply for a preamp poses problems that are substantially different from those encountered in power amplifiers. The HT supply for a Class A power amp, and especially for its output stage, has to deal with a circuit modulating a large percentage of supply voltage and current if the amp is single ended (the problem is not so severe with Class A push-pull but is very similar and even worse in Class AB). Therefore it is necessary to design a fast and nimble supply with short recovery times, rather than one that stores a lot of energy.

High energy storage, to be of advantage in a power amp, would have to be SO high to be really unpractical. Trying to store "medium-high" amounts of energy would only end up in using slower components without really being of help.

This preamp, and preamps in general, if correctly designed will modulate only modest percentages of the available supply power, because it can be dimensioned for so much dynamic headroom that only a small part of the maximum possible modulation will be actually exploited in normal use. (Big dynamic leeway was one of the design priorities, do you remember?). Therefore it becomes feasible and, in my opinion, convenient to store so much energy in the power supply that the latter will virtually see no difference among the various no-signal, steady signal and transient operating conditions that the preamp is likely to handle during actual use. This is the direction I took.

The schematics of the supply are rather conventional: the rectifier is a 6X5GT indirectly heated twin diode, octal equivalent of 6X4, used in "direct-heating" configuration, i.e. with one end of the heater strapped to the cathode (in this way no use is made of the tube's cathode to heater insulation, thus eliminating the headaches potentially caused in time by cathode to heater leakage, a relatively frequent trouble in these tubes).

What is not conventional is the way the filter was calculated. The first filtering stage is

PI-configured, with capacitor input. I preferred this to the choke input due to the better ripple rejection obtainable with a single choke (OK, this preamp was NOT made on an extremely limited budget but nonetheless costs and size had to be reasonable!) and to its higher rectification efficiency. As I always do, however, I took peak current and inverse voltage diode operation characteristics into extremely careful consideration, in order to assure the longest rectifier life.

The choke and the second capacitor are sized to push the resonant frequency of the filter as low as possible, far, far lower than ripple frequency and virtually out of the preamp's bandwidth, in order to get substantially constant output impedance across the whole reproduced low end, even without decoupling.

This filter provides an extremely smooth and soft energy source, even though still at a relatively high impedance compared with regulated supplies. It is intended to operate as a sort of "battery charger" for the following decoupling stage. This is made out of a 5k6/5W resistor and a 1800 μ F/400V electrolytic cap per channel, for a time constant of about ten seconds.

These capacitors, during bench tests, display constant (and very low) ESR. up to about 50 kHz and are in fact acting as batteries in the general economy of the preamp. In fact, assuming the charged cap to be disconnected from the rest of the filter, the time constant of the filter cap and the dynamic resistance of the preamp circuit is on the order of 30 seconds while the internal resistance of the capacitor at frequencies of our interest is in the order of fractions of an ohm. Given that the average duration of a musical transient is measured in milliseconds, all of this combined makes for superb transient regulation which was precisely my goal.

Experiments in bypassing these capacitors provided horrible high-frequency colorations, confirming once again what I've long been convinced of, i.e. bypassing electrolytics is basically playing around with audiophile bullshit coloration mumbo-jumbo, and *not* an effective way of improving sound. You might in fact find it amusing that ALL of the (not many) caps used in this preamp are unbypassed electrolytics!

The heater supply, as previously noted, required some care due to the 5687's tendency to leak slightly between cathode and

heater. A solution that appeared to work fine consisted in a dual symmetrical power supply, with grounded common, lighting up the heater of the tube at 12.6 V while keeping the two extremes of the heater at basically the same impedance to ground.

Indeed, this is still a compromise because in fact the two heater elements are connected in series within the tube so that the one heating one section is powered by the positive rail and the other by the negative one. This means that cathode to heater voltage is different in the two sections, but filter time constant and regulator operation considerations made this solution appear as the most convenient overall.

The heater voltage is regulated with complementary Darlington transistors in a conventional series arrangement with no feedback. The positive heater rail also powers a 7805 IC used for relay coil operation.

Construction Tips

It is of great interest to try and limit microphony as much as possible. Any effort made in this direction will pay more than worthwhile dividends in quiet operation and sound quality.

Since builders will opt for their own mechanical solutions, it is largely up to you how to face this problem, however here's my suggestion. Instead of rigidly bolting the socket to a hole in the chassis as is normal practice, drill a hole in the circuit plate or chassis about three times the diameter of your socket and suspend the socket on tension springs (they will have to be quite stiff), then connect socket pins with flexible wires. Refer to pictures, they are clearer than any explanation. This type of mounting is surely not an effective space-saving measure but, for your joy and delight, here you only have one tube in the circuit!

The output transformers as supplied are unshielded and like all low level transformers, are prone to picking up hum quite easily. It is necessary to find an orientation that yields minimum hum pickup before securing to the chassis. The arrangement you can see on the pictures is nice looking but admittedly not optimal in this respect. As an alternative, you could also make a steel cover to protect them when they're within the preamp. Shielding these transformers at the factory was awkward for mechanical reasons given the chosen core size, so I decided to take care of isolation in the layout.

Bonus phono preamp!!!

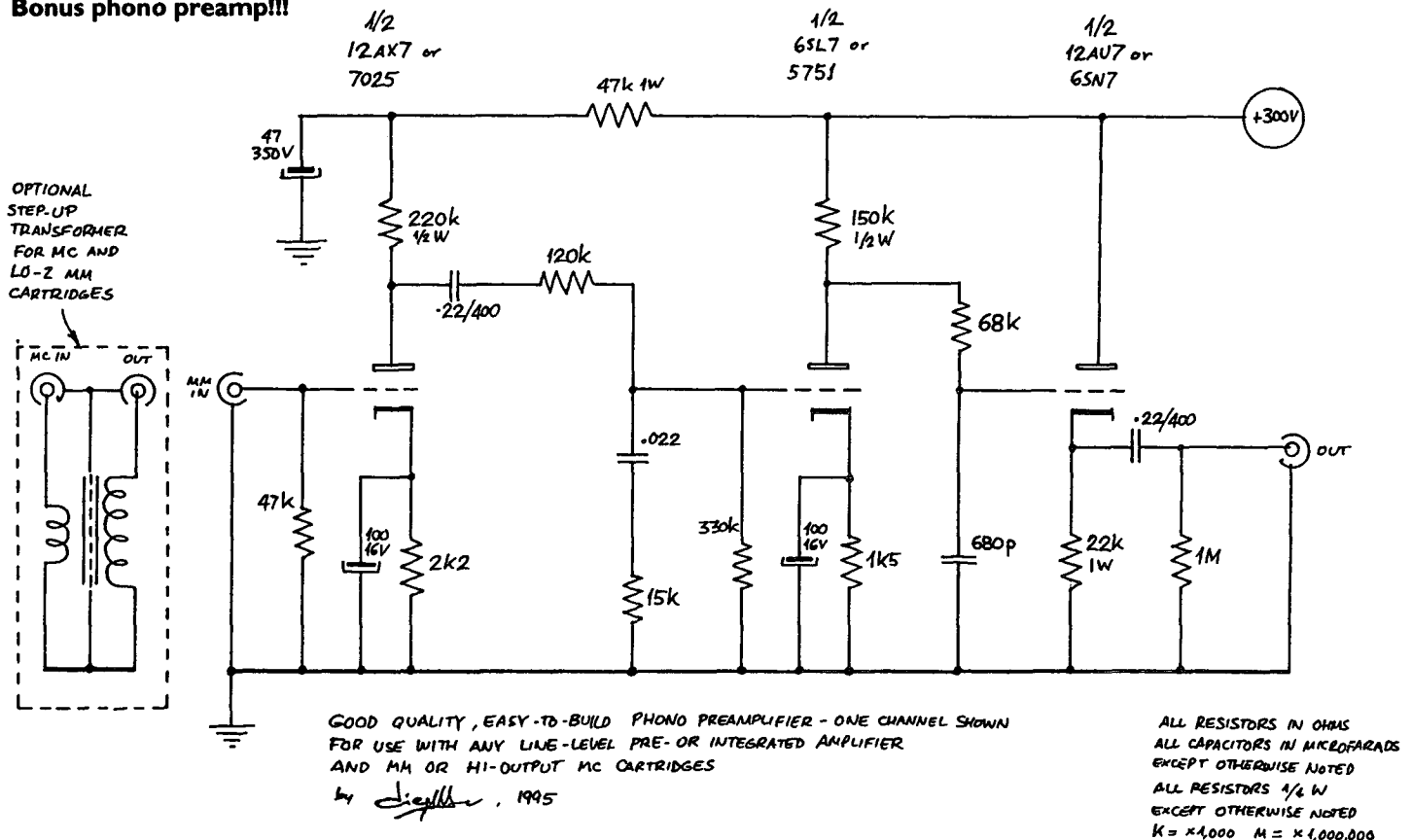

My prototype uses Black Gate cathode bypass capacitors, value 220 μ F/16V, and is wired inside with Audio Note AN-V interconnect. Unlike other products, this preamp is extremely sensitive to the quality of internal wiring and it is definitely worthwhile to use high-quality interconnections within. It is not terribly expensive to provide this design with high-quality components, as they are really few in number.

Apart maybe from some form of output transformer enclosure, I recommend the chassis be made of non-magnetic material, i.e. aluminum or copper. For my prototype, the bottom was a surplus Audio Note OTO chassis and the top and internal plates were custom built out of 1.2 mm thick aluminum. All screws are brass.

WOT Applications

This preamp is dedicated to whoever wishes an extremely high quality line preamp for whatever system, best if based on high-quality triode amplifiers which will exploit its potential to the fullest. It will blatantly outperform anything you may find at your local high-end store up to many times its cost.

Bass quality, dynamic progression and absolute lack of "electronic distortion" are its main strengths. It is actually more at its ease in reproducing music from analogue records through a very good phono preamp than with CD, provided there is proper electrical matching with the phono preamp output. CD is reproduced without strain but CD quality is clearly audible through it and is quite uncomplimentary to its transparency.

DACs having IC current to voltage conversion and/or IC output stages will come out in all their artificiality regardless of what they claim about their jitter performance.

Free Phono Schematic!!!

If you want to quickly check out the line amplifier, given above is an easy and simple phono stage I originally developed as a modification on an old C-J PV2. You can either build from scratch or on the PCB of your C-J, ARC, Jadis, Audible Illusions or anything with 3 tube sockets on it. A true phono unit for use with the WOT I will design when I have time! Try this combination out in the meantime.

Diego Nardi
via Volterra, 12
20146 Milano MI
ITALY

one electron™ Single-Ended Output Transformers High Quality for a Reasonable Price Designed and Built in the USA

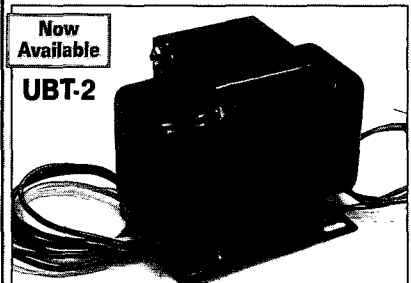

Now Available
4.8k primary
15 watts
160 mA

\$118

Can be used with:
300B, 50, 5V811-3, etc.

Also Available
1.6k primary
15 watts
110 mA

\$95

Designed for parallel operation of:
2A3s, EL34s, 300Bs 6AS7s,
etc. or Sweep-tube in
"enhanced triode" mode

Quantity Discounts Available

To Contact us On-Line www.one-electron.com
atwood@one-electron.com

Write or FAX for Information and Prices
65 Washington Street, Suite 137
Santa Clara, California 95050 USA FAX: 408 985-2006

Audio Systems

CIRCUIT A

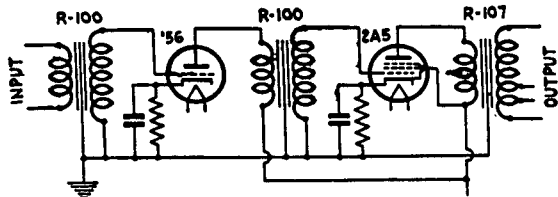

A good, straight, audio amplifier circuit. The center tap of the R-107 transformer is ignored in this circuit. From 45 to 55 Db. gain may be secured from this circuit with 3 to 4 watts power output. Fair quality.

CIRCUIT B

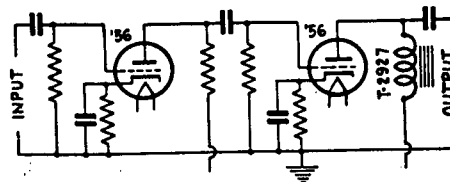

Voltage amplifier, primarily for condenser microphone or one of the newer crystal, ribbon, or dynamic microphones preceding a power amplifier. Brings signal level up about 25 to 28 Db. Good quality.

CIRCUIT C

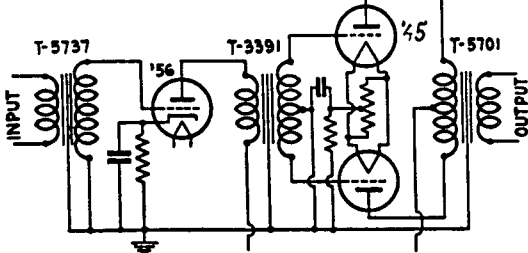

Straight audio into push-pull. Improved by use of 56 and 45 tubes over original 27 and 71A tubes used in early radio sets. Secures 20 to 25 Db. gain with about 4 watts output. Tone quality excellent.

CIRCUIT D

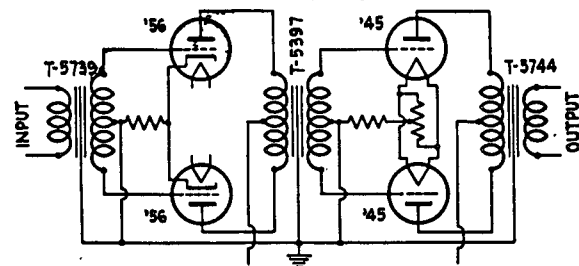

Double push-pull, a circuit with amazing handling capacity and freedom from distortion. Probably the best low power circuit in use. About 25 Db. gain with 4 to 5 watts power output.

CIRCUIT E

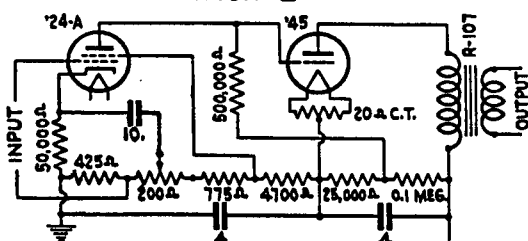

Basic Loftin-White direct coupled amplifier. Resistance values are rather critical and are given to assist servicemen in making repairs. About 45 Db. gain and good quality possible up to 3 watts.

CIRCUIT F

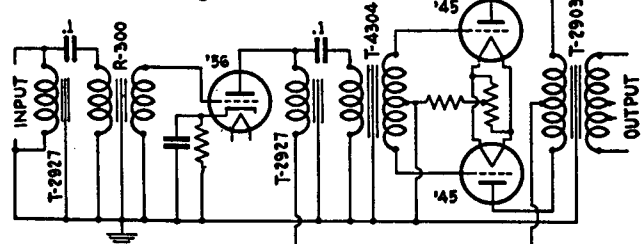

Tone compensating circuit. Different values of coupling condensers change frequency response. Primarily for use where bass notes must be overemphasized to compensate for a small speaker baffle. About 25 Db. gain.

CIRCUIT G

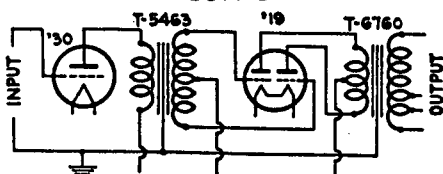

A battery operated Class B amplifier widely used in two-volt rural sets. Will deliver 2 watts with heavy duty B batteries as power supply. About 40 Db. gain with good quality on full volume.

CIRCUIT H

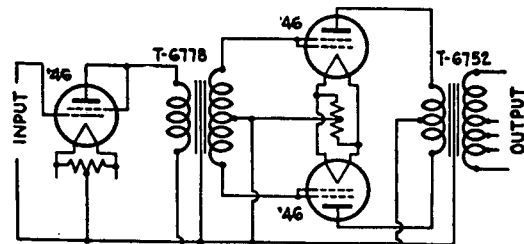

Good design in Class B utilizing the dual grid 46 tubes, first as a triode-driver and in push-push as a power output. Will deliver 20 watts if supplied from a good power pack. Only about 22 Db. gain.



The triple push pull fixed bias 2A3 amplifier circuit shown below will satisfy the most discriminating Broadcast stations and audio laboratories. The undistorted class A output is 15 watts, the gain is 80 DB. The amplifier is uniform in response from 30 to 12,000 cycles. A trap resonant rectifier filter is used for highest filtering efficiency, audio and power sections are mounted on separate drilled, heavy gauge metal decks. All LS audio filter and power components fully shielded and doubly sealed against adverse climatic conditions. List price of complete transformer kit \$152.50 [includes drilled decks and perforated protective covers—all transformers mounted at factory at no extra cost] 40% discount or net price of \$91.50 to Universities, Broadcast Stations or dealers. Purchase through your local U.T.C. distributor.

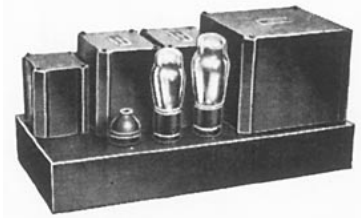

2A3 Power Supply

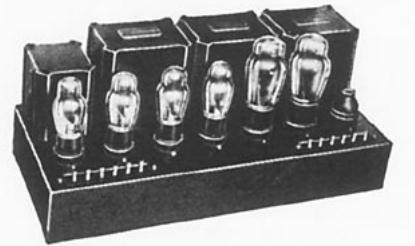

2A3 Audio Amplifier

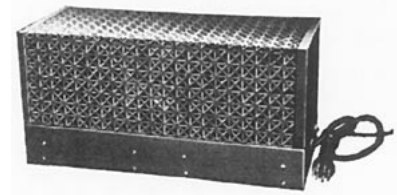
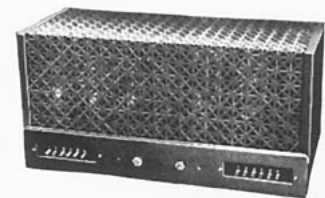
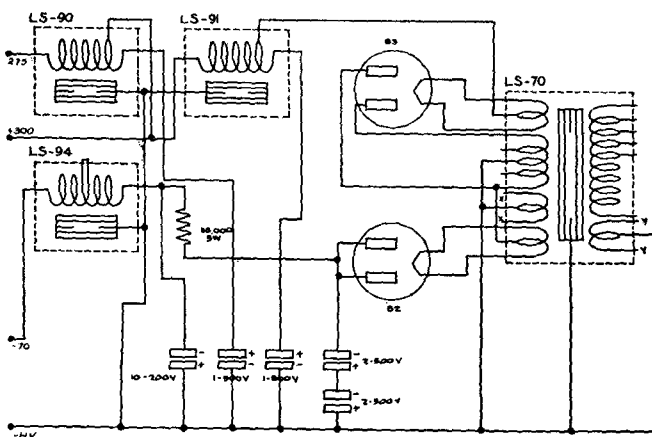
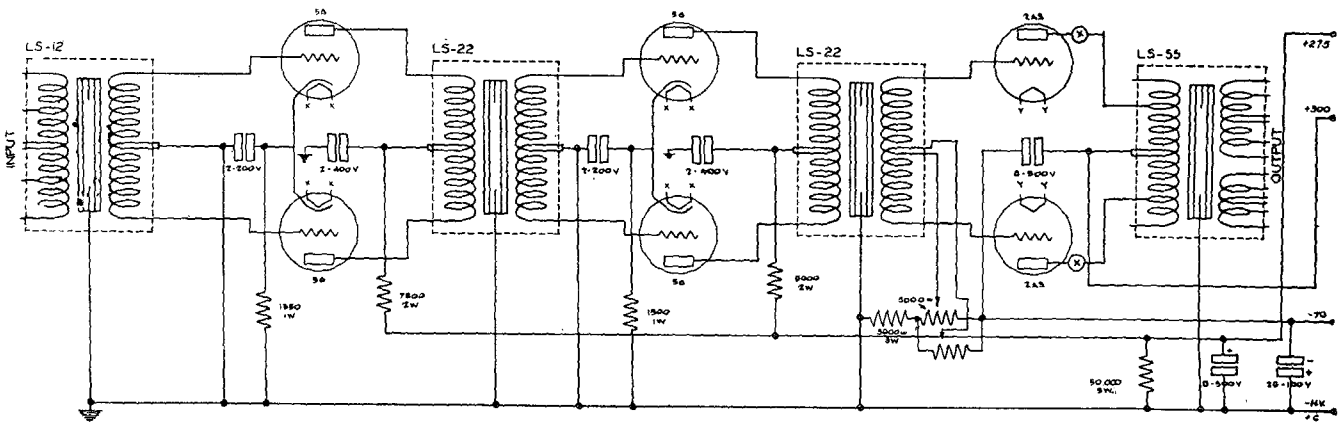

2A3 amplifier and power supply with perforated protective covers fully mounted.

MAUHORN



by Andreas Mau
Lowther Club Deutschland
World's greatest Lowther fan

My *Type IV* 3.5m horn uses 22mm boards for the outer case with the following dimensions:

2 each 102.5 cm x 82.5 cm
2 each 25.6 cm x 82.5 cm
1 each 25.6 cm x 98.1 cm

The best way to put the enclosures together is to place a large side panel on the floor or table and glue the parts of the horn onto it. The final step is to glue the other side panel on like a cover.

Lowther for Life!

The beginning of it all for me was a demonstration of the Lowther Classic 400 by a friend of mine. I was surprised how clear and natural the sound was. I built the *Acousta 124* and the *Delphic 500*. I thought the very best solution would be a one drive unit direct-radiator with a large bass horn.

I tried the old *Acousta 115* but the wood in the panels was too thin. The wood for a bass horn must have 19mm strength. The sound of the *Acousta 115* with a PM6A was fine and very clear but the bass was very thin. So I planned a larger bass horn with a little magnet chamber.

I did my research on these cabinets in 1985 and 1986 and published the results in the German loudspeaker journal *Klang & Ton* in November 1991.

My first horn with a 3.5m length was fitted with a PM7A driver. I was totally blown away with the dynamic bass response. Live sound! I closed my eyes and I was absolutely delighted. Such a clear sound I never heard before. I was a speaker builder for many years and I tested many constructions, including big transmission line cabinets fitted with KEF and Celestion drivers. They all sounded poor and unnatural compared with Lowthers on a long bass horn.

Both of my cabinets feature a small magnet chamber. One horn is 3.5m long and one is 4.5m long. Both are 25.6cm wide inside with. I used 22mm shipping boards for the outer walls of the cabinet so the outside width of the cabinet is 30cm. A combination of 19mm and 16mm boards were used for the reflectors.



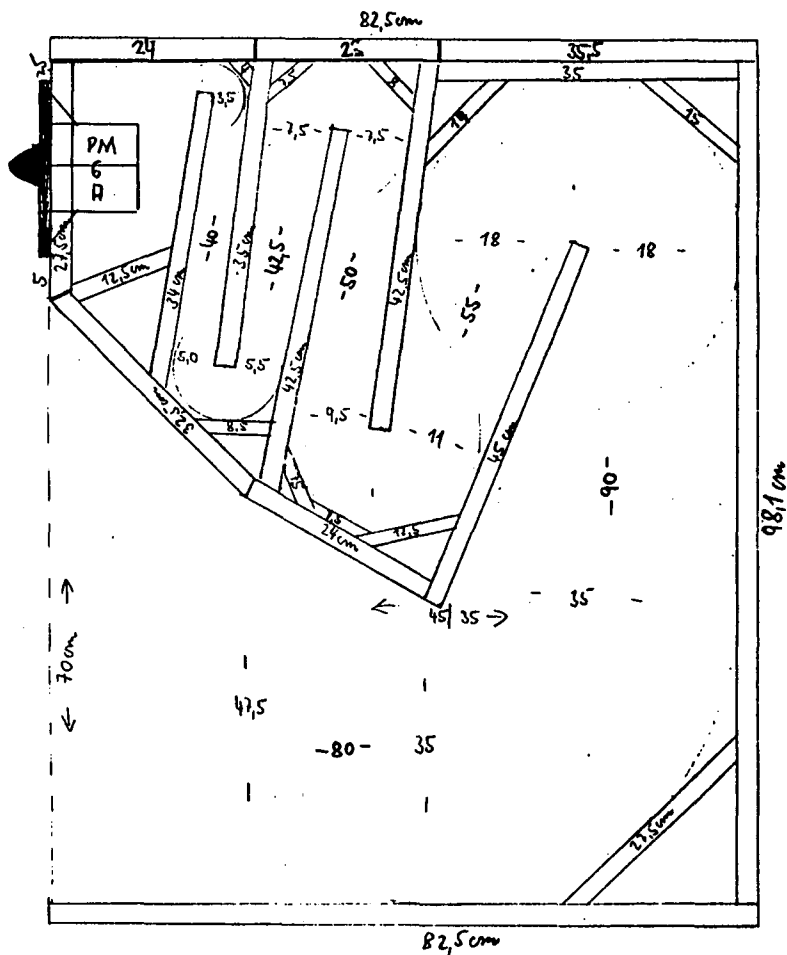

MAUHORN Type IV

Outside Dimensions
 Depth = 82.5 cm
 Height = 102.5 cm
 Width = 30 cm (26 cm inside)

Volume = 254 liters
 Bass horn length = 3.5 m

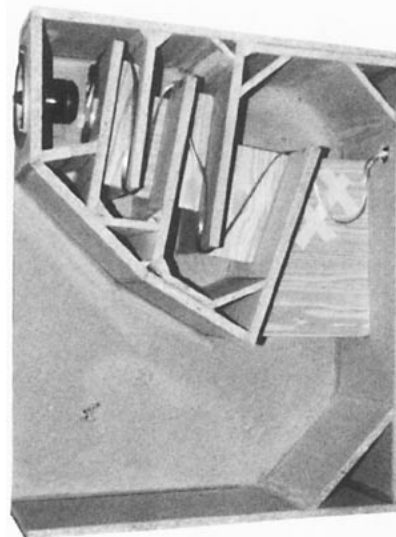

MAUHORN Type V

Outside Dimensions
 Depth = 80 cm
 Height = 100 cm
 Width = 30 cm (26 cm inside)

Volume = 240 liters
 Bass horn length = 4.5 m

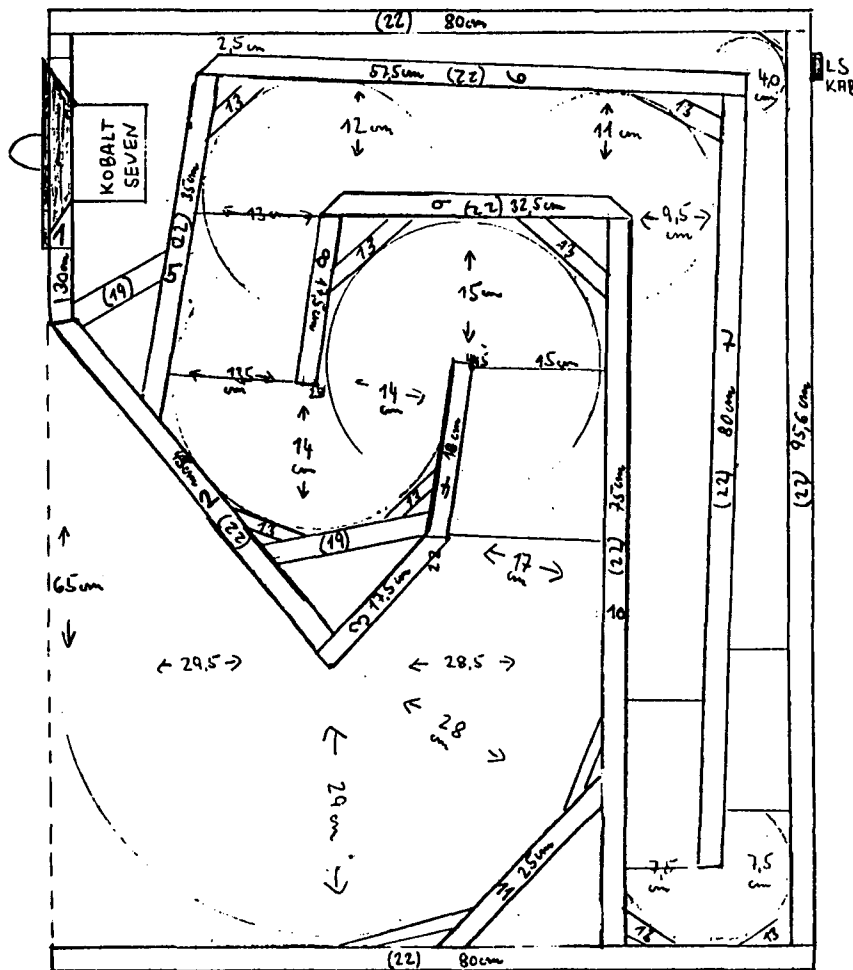
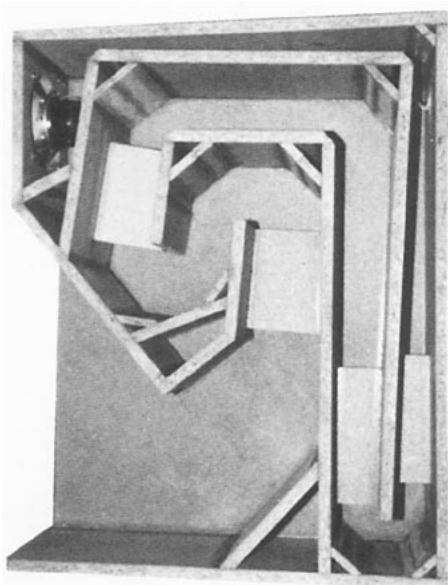

After I built the outer cabinet I installed an extra 22mm panel on each side for reinforcement. So now each cabinet weighs 80 kg and requires 6 rollers!

I initially designed these cabinets for myself, so the sketches provided below are the only drawings I have.

This cabinet is relatively small and it can be located near the side walls in the corners of the room. The cabinet can also be mounted on a wooden frame with the driver and horn mouth facing down, for use as a subwoofer. Another idea is to position the cabinets with the drivers facing the rear wall and then use a forward-facing small cabinet or midrange horn for the high frequencies.

The *Type IV* 3.5m horn is intended for use with the PM7A, 2A, and 5A drivers. The *Type V* 4.5 m horn is for PM6A and 7A drivers because of the little back chamber. I designed these cabinets as modules, thinking that more cabinets can be put together if I ever wanted to move more air.

The sound quality of both horns is fantastic. The shorter horn offers a more pressurized, high energy bass response while the longer horn sounds more inconspicuous, but extremely clear and with deeper bass extension. Standing in the corner, the wall serves to enlarge the mouth of the bass horn.

The large panels on the horn should definitely be stabilized by additional panels. There is no need for any damping material such as wool, coatings, or anything else. Note that the chamber is very small and the pressure inside is very high. I think it is a high-performance racing motor of a sports car, an old design driver in a high-pressure cabinet! This is what I did not find before in any of the factory *Acousta* and *Bicor* cabinets. To reproduce 40 Hz bass the cabinet must have a certain size. The large bass horn is the best solution. You will only need a 2 or 3 watts per channel amplifier to play music in natural live atmosphere sound.

As Paul Voigt was a son of German parents, I feel that I have to work for his name. Why do so few people know of Lowther and Voigt? As so many people are now interested in Lowther there is no need for more words. You will see what happens when great loudspeaker fans hear Lowthers for the first time. They will throw all other speakers out of the window!

The top-end Lowther cabinets are the great corner horns like the *Voigt Domestic Horns*,

TP-1, and *Opus 1*, but if you are looking for a mid-size, easy to build construction, please hear my horns. Never will you forget!

Andreas Mau
Lowther Club Deutschland
Postfach 12 46
24584 Nortorf
Germany
FAX 0049/4392/ 8168

BUILDING THE MAUHORN TYPE IV

by
Jérôme Phaneuf
Experiences Sonores

The story began when my father read the articles by Haden Boardman and Joe Roberts about Lowther in *SP*. He was impressed that they were so enthusiastic and he soon wanted to know more about the product. He called Frank Reps, a longtime votary of Lowther and after the long praises of Lowther Frank sang to him, he began to look at his *3A Master Controls* differently. Mr. Reps was apparently living an audio experience that my Dad couldn't even think possible. He sent the plan for the *Acousta* to my Dad: "Try them Christian!" Dad had a pair made by one of his friends and the reign of the 3As began to fade.

Then he wrote to Andreas Mau to ask for plans of another good Lowther enclosure. Dad wanted something simple to build, like the late model *Acousta*, since we don't have a lot of woodworking tools. Mr. Mau kindly sent him the plan of the *Fidelio* along with comments and pictures of different types of Lowther enclosures. But there was something else in the envelope. . .

It was the plan of a tremendously long horn (3.5m), featuring a very narrow baffle and a small driver chamber. The box itself is about 83 cm deep, 1 m high, and exactly 25.6 cm wide inside the horn. A big enclosure but since it is very narrow, it can fit in a medium-sized listening room quite well. Be sure that the floor is strong enough to hold them, because each of these superboxes weighs over 100 pounds! Dad was intrigued by the idea of a very long horn in a not-so-big box. And, after all, since Mr. Mau sent the plan, it was certainly a product of that world-renowned German engineering. "Son, can you build that?"

We decided to use 3/4 thick Russian veneer which is made of 15 layers of white, good

smelling, and very dense birch wood. This plywood is the best quality available here. I suppose we could have used MDF, but Dad is a no-compromise kind of guy and I hate to work with MDF. It is always crumbling. Have you ever seen a violin made of MDF? Anyway. . .

The plan was a little hard to follow since my German is not very good. The major challenge was to adapt the plan so I could use plywood of the same thickness throughout the enclosure. Mr. Mau uses boards of different thicknesses in his horn so I had to recalculate to ensure that internal dimensions remained the same.

I filled all the cavities with insulating foam to avoid box resonances (when the box is closed, it's too late, pal!). I also ran the speaker cable (silver) in the upper panel of the enclosure because I was afraid it would vibrate when the music played if I ran it through the labyrinth. This measure also reduces the length of wire required, a good thing economically (for us garage sale cheap-skates) and sonically.



Finally, following wise advice from Frank Reps, I made extra sure that all of the seams in the driver chamber were perfectly smooth. We carefully filled and sanded the edges all over the length of the horn. I'm not sure that this does any good but it can't hurt. In any event, Dad and I wanted to be sure that we maximized our efforts before the enclosure was sealed. Months of weekend work later, The Day Came.

We are not many, but we know how to find each other

SOUND PRACTICES

A quarterly journal for the advanced audiophile, featuring experimental approaches, historical perspectives, future directions, and cutting edge developments in audio technology.

One year/4 issues— \$20 USA, \$24 Can., \$30 Eur., \$35 Pacific. Sample \$5. MC/VISA accepted.

Box 180562, Austin TX 78718
512-339-6229 Voice/FAX
e-mail: sp@tpoint.com

I fitted those babies with my father's new pair of PM7A "Hi-Ferric" units. At this time, Dad was very anxious. He was choosing some CDs to make the test—Dave Grusin's *The Gershwin Connection*, MJQ and friends, some Sheffield (including Drum Test Record), etc. Oh god almighty! This was good sound! I never thought those delicate Lowther drivers could have so much bass. Clean, true, clear bass, I mean. Not that kind of fat, artificial boomy bass we hear so often. It was a good idea on the part of Mr. Mau to design the box very narrow. While improving imaging, this design make the horn stiffer so it won't vibrate a lot at low frequencies to make what I call the "box sound."

Before we listened to the **MAUHORN** or any Lowther at all, Dad's good friend Frank Reps told him that the Lowther experience was like removing heavy blankets that were hung in front of your speakers. I was a bit skeptical. How could a homemade enclosure sound better than the 3A Master Control driven by an excellent 300B amplifier? I have not heard thousands of speakers like you audio fanatics, but I've heard a certain number of very fine systems and nothing (according to my personal tastes, naturally) even approached the natural sound of the 3As.

I will tell you the truth—the 3A Master Control never played again in the house after we hooked up the **MAUHORN**. Frank was right: the blankets were removed and it was time to listen to some unmuffled music. The sound was so limpid, image so good, fine details we never noticed before began to appear—the illusion of being there with the musician was striking. The **MAUHORN** is indeed an excellent design that Andreas Mau must be proud of. Trust him! Make yourself a pair. You will have no regrets when you sell your other speakers to somebody else.

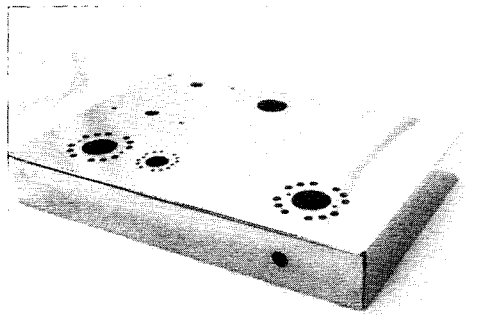
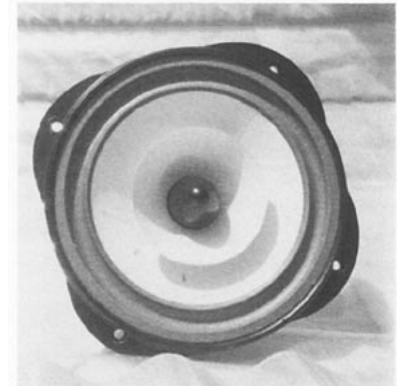

Pre-punched and mirror polished copper chassis for the MQ 2A3 — \$138.00 chassis, \$48 plate

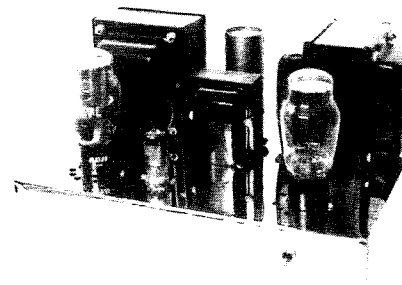

Amateur implementation of the MQ 2A3 using our polished copper chassis

COPPER CHASSIS STANDARD DIMENSIONS	Chassis with bottom plate		Bottom plate only	
	BLANK	POLISHED	BLANK	POLISHED
13" x 9" x 2" (300 x 230x 50 mm)	\$95.00	\$120.00	\$16.00	\$26.00
16" x 12" x 3" (405 x 300 x 75 mm)	\$125.00	\$160.00	\$20.00	\$32.00

TUBE SOCKET HOLE PUNCHING SERVICE: Standard dimensions available: 1/2", 11/16", 3/4", 7/8", 1", 1 3/32", 1 5/32", 1 3/16" \$3.00 per non ventilated hole, \$5.00 ventilated. Other sizes and square holes, inquire. Magnequest buyers get their holes punched FREE!

EXPERIENCES SONORES

Distributors of
Magnequest Transformers
Lowther Drivers
Products for the Audio Constructor

972 Guillaume Boisset
Cap Rouge Québec
CANADA G1Y 1Y9
418-652-2430 voice
418-652-8788 fax

Not your Father's DYNA. . . A Poor Man's SE Amp

by Dave McDonald and Matt Kamna

Dumpster diving Dyna fans take note!

How did I end up with a single-ended Dyna stereo 70? A little background will help to understand. As a kid I grew up with vacuum tubes—Knight Kit regenerative and superhet shortwave radios, 12W mono amplifiers, and later a Citation 30W integrated amp kit. There were solid state kits too, including an 80W stereo amp. I did a lot of tinkering in those early years, mostly making solid state radios, science projects, and the like.

A couple of years ago over at my friend Matt's house, I was exposed to SE WE212E amps flooding the room with light and sound. The 212E amps were too expensive for my budget. I also assisted in the creation of 2A3 and 300B amps. Listening proved that a low power amp could give that same wonderful sound.

I remember one Oregon Triode Society "DIY night" meeting where I got to hear many amps and speakers that were either modified or built from scratch. There were pentodes, triodes, tri-amp systems driving horns, etc. Those were exciting listening days!

I decided to pick up an inexpensive vacuum tube amp and start experimenting, so a Dyna ST-70 soon followed me home. Music listening was much more comfortable compared with my solid state amp.

Then I checked the ST-70 on the test bench. The amp had a bit of a problem putting out full power. While troubleshooting the problem, we uncovered a design flaw that causes premature 7199 failure (*see sidebar*). Ironically, the "failed" 7199s sounded better than the new RCA tubes that I installed. My theory was that the unbalanced phase splitter drove the PP output stage toward single-ended operation. The old tubes were much smoother and warmer sounding. The person that sold me the amp heard the difference and agreed with me.

We tried operating the EL-34s in triode mode by disconnecting the screen from the

output transformer and tying it to the plate through a 100 ohm resistor. The feedback cap from the transformer screen tap connection was left intact.

Then we tried running the amp with the main feedback loop open and the 7 kHz pole at the input pentode removed. Measured open loop performance was hopeless. The

damping factor had dropped to 1.5. The new frequency response was down 3 dB at 42 Hz and 26 kHz. I didn't even want to try to listen to my ported 2-way speakers with an amp with that low a damping factor.

I looked at commercial mods, but I decided that mod kits with excess gain were only going to make my amp sound more like a transistor amp. I spent a lot of time thinking about what I could build on this chassis that would be better than stock. I wanted a simple circuit that used the stock Dyna parts and sounded great. While tinkering, I continued to enjoy listening to my Dyna with "bad" 7199s, a JVC XL-V161 CD player, and some old 91 dB sensitivity KLH Model 33 loudspeakers.

Next I tried a variation of the triode mod mentioned above but with the global FB

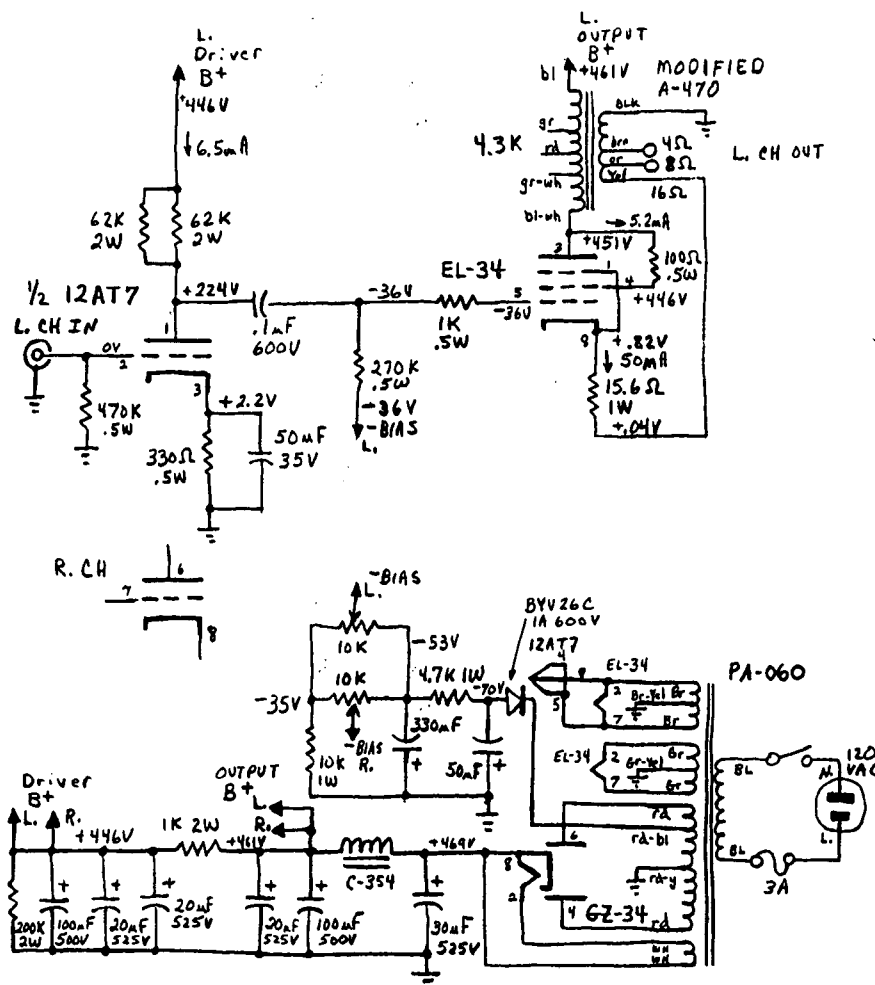

ST-70 SE

100 uF 500V caps are Nippon Chemi-con 82DA
BYV 26C - Newark Electronics
Resistors carbon comp from Newark
0.1 uF/ 600V MIT RTX - Parts Connection

DAVE McDONALD
MATT KAMNA

2/4/96

disconnected and feedback from the output transformer secondary back to the EL-34s installed to improve damping factor. I tied the 4 ohm taps to ground. Then I connected the 16 ohm taps to the EL-34 cathodes through 15.6 ohm resistors.

In this configuration, the driver circuit was simply not up to the task of driving the triode-connected EL-34s. I came to the conclusion that the 7199 drivers were hopeless without some heavy circuit changes. I feared that the circuitry was going to get more complex.

Another thing I didn't like about the stock ST-70 was that the power transformer ran way too hot. While pondering how to relieve the heat problem, I had a flash of inspiration. Why not remove two EL-34s and go single-ended? The B+ and filament draw would be cut drastically.

Typically, single-ended amps require an air gapped output transformer to prevent core saturation under DC current. So I carefully disassembled the output transformer laminations and put them all back together with all the "E"s on one side, a .010 inch spacer in the gap, and all the "I"s on the other side of the spacer. I hooked up the single EL-34 in "100 ohm triode mode" with 3 dB feedback around the output tube and transformer

Hum increased because there was no global feedback and no push-pull cancellation of B+ ripple in the output stage. A 100 uF capacitor was added in parallel to both the output and driver B+ supplies to reduce the ripple and make the unit much less objectionable to listen to. The selenium bias supply rectifier was also replaced with a fast, soft recovery diode to increase reliability. The bias supply output filter cap was increased in value to 330 uF.

At first, we tried to use the triode section of the 7199 as the driver. Using a pentode driver stage was not even considered, but the 7199's low μ of 17 made it unsuitable for a simple single gain stage. We switched to a

ST-70 SE Measured Specs

10 Watts output @ 5% THD @ 1kHz
6 Watts output @ 1% THD @ 1kHz
Voltage gain 17.5dB
Residual hum and noise 1.2 mV RMS
Damping factor 3.8
1 KHz square wave response looked excellent
Freq. response - full power bandwidth
-3dB @ 15 Hz and 60 kHz

12AT7 driver circuit used earlier for driving the really low gain 300Bs. One section of the dual triode was used per channel.

We sifted through seven EL34s to get the best results on the test bench. The old leaky paper coupling caps were replaced by some new MIT polystyrene jobs. In the process of making the modifications, some of the traces were cut off the old phenolic circuit board. There was no going back to the stock circuit. This was either going to work and sound good or not. Now we were ready to listen to a single-ended Dyna amp!

Initially we listened for a while on a highly modified three piece CD player and a set of tweaked Spica TC-50s. Then it was off to dinner and another fun D.I.Y. O.T.S. meeting. A group of a little over 30 people showed up for the event where the amp was very well received. The system used had a slightly modified CD player and Lowther horn speakers with about 100-101dB sensitivity.

Then it was time to try it at my house on the JVC player and KLH speakers. Later it was tried on the Spica using the JVC player. The KLHs played louder, but the Spicas were more controlled in the bass and had a different sound overall. Using the 84dB sensitivity Spicas required turning up the volume to hear very quiet sections of classical music. Then during loud sections of the music clipping was heard. When overdriven it sounded better than a solid state amp, but not as good as some other tube circuits.

We listened to a variety of music: jazz, classical, vocals and soundtracks. The midrange was smooth and it also had a good response at both the high and low end. It was easy to just sit back and listen. Several listeners commented on how different it sounded from the stock Dyna.

The power transformer runs much cooler now, and all of the original magnetics were utilized, even if they are modified. I have been enjoying listening to this new single-ended amp and expect to do so for some time to come.

Perhaps you will roll your own SE Dyna and maybe think of further refinements to try yourself. For example, we paralleled the EL-34s to increase the output power. In order to optimize power and distortion it was necessary to move the plate connections down to the screen tap on the output transformer primary winding. This yielded 16 watts at 5% THD and 14 watts at 1% THD.

Save those 7199s! by Matt Kamna

This article was prompted by wondering why virtually every Dynaco ST-70 I serviced needed new 7199s? Although the Dyna MK3 uses a different tube (6AN8A) it may have the same problem, as it has an almost identical circuit.

My first thought was they must be pushing the tube too hard. A few quick measurements and calculations indicated that the tube is being operated well within its power dissipation limits. Yet, under test some 7199s would show heater to cathode leakage as low as 100K ohms! This H-K leakage resistance is in parallel with the 1% matched 47K cathode resistor, thereby lowering its value and reducing drive to one of the EL34s. This results in a 12% loss of output power and a 25 dB increase in second harmonic distortion!

Further investigation showed cathode voltages routinely over +100 volts DC and as high as +135 volts DC. The maximum heater to cathode rating for this tube as well as many others is 100 volts. Remember the oxide coating is very thin. Once the 7199 has become leaky, no mod will fix the tube.

Here's how to check the 7199 leakage in circuit. This test assumes that there is typically less than about 6 uA leakage from all the other parallel circuit components.

Place a 100K resistor across the leads of a 10 Megohm input resistance digital multimeter. Set the meter to the 20 volt DC scale. Place this parallel setup between the chassis and pin 1, just below the key, of the front panel octal socket. Polarity does not matter. Just ignore the polarity of the voltage.

You should expect to see less than about 0.6 volts, which equals 6 uA. None of my tube manuals list a spec, but a similar tube has a 25 uA maximum. This would be a 2.5 volt reading or about 4 Megohm of leakage. After all this, don't forget to check the other channel while you're at it.

If you have to replace the tube, you will want to protect the new one by elevating the filament to about +75 volts DC. This is most easily done by using a resistive divider off the output stage B+ supply. Connect a 390K 1 watt resistor between

edgarhorn:1996

SYSTEM 50 - A new two way horn system, consisting of a 50 Hz sculptured bass horn and a compression driver on a round tractrix mid horn.....\$9,000

SYSTEM 80 - A new budget horn three-way horn system using a 5" driver on a 5 ft long 80 Hz folded bass horn.....\$1200

HORN SUB - A new folded 50 Hz bass horn that completes the SYSTEM 100. Includes a NHT subwoofer amp..\$1500

The SYSTEM 100 is still available for DIYers!

**CONTACT: DR. BRUCE EDGAR,
BOX 1515, REDONDO BEACH, CA 90278
(V) 310-370-1302 (FAX)310-371-8085**

the B+ and filament center taps, and a 82K 1/2 watt resistor from the filament center tap to ground. A 1 uF 200 volt capacitor connected across the 82K will reduce the divider output ripple and unwanted signal when full power, very low frequency notes are being reproduced.

This mod can be conveniently installed at the terminal strip where the dual .02 uF ceramic cap was connected. Minor rewiring is required to use these lugs.

I wonder how much of the blame for today's limited supply of these tubes can be traced to this unfortunate design deficiency in the Dynaco amps? Performing the mod outlined above should help you get the normal expected tube life out of those increasingly rare and expensive 7199s.

RCA VICTOR

RCA RIAA magnetic phono pc board - a simple easy to assemble project that will provide the vinyl lover with *hours of listening pleasure*, with minimal outlay. Uses two 12AX7A's.

PC board only:
\$15.95 + shipping

Parts kit #7-1200B- contains all connectors, caps, resistors, sockets - \$78.07 + shipping

Write:

Handmade Electronics
124 South 12th Street
Allentown, PA 18102
USA

❖ In stock ❖

Golden Dragon tubes, Hammond transformers, chokes and economical metalwork, Nichicon Muse & low ESR capacitors, Cardas connectors and hookup wire, Solo inductors, Kimber Kable wire and connectors, Black Gate and Cerafine capacitors, MagneQuest output transformers, NOS tubes, 2A3 and 300B kits, IRC RN series metal glaze resistors, IRC and Mills and wirewound resistors, Caddock film resistors (an excellent alternative to tantalums), inexpensive, high quality silver wire, Vishay resistors, Clarostat & Dale pots, large selection of Solen capacitors, tube sockets of all kinds *and a whole lot more at competitive prices.*

Equipment makers- many items available in quantity

No Voice mail, no answering machines

FROM
HANDMADE'S
NEW 1995/1996
CATALOG



We stock Hammond metalwork and chassis!
Inexpensive metalwork, that can be pre-punched at reasonable rates for your convenience. Prices for unpunched start at \$7.88

Read Sound Practices #9 for commentary on our similar 2A3 kit.

Shhh! Keep this under your hat:
There is another *great* oil cap!
Handmade's handmade
.1 & .25 uF/1000vdc
There are other choices!

For catalog:
Send 4 .32 stamps, 3 IRC's or
\$1.00 (US).

Visa/MC We Export

To Be, or Not To Be, Linear!

The Single-Ended Transformer

by Dr. Tom Hodgson

This is a sequel to my historical note in *SP #5* on the pioneering work of the late Dr. Partridge on transformer distortion. For those who missed that article, Partridge in the late 'thirties pursued the concept of larger than normal airgaps in push-pull (PP) output-transformers (OT). The airgap reduced the primary inductance and so his OTs were larger. His OTs for the 10 watt PP Williamson amplifier, which used triode-connected KT66s, weighed 14 lbs. for the EI laminated and 10 lbs. for the C-core designs respectively!

Partridge showed that OT distortion was worst at low frequencies and he even suggested a figure of merit or index for OTs using an inductance measurement at the line frequency for the design full-output power. (The industry did not adopt his recommendation). He put amplitude distortion ahead of flat amplitude response since, as he pointed out, for PP OTs the odd-harmonic distortion could subjectively swamp the fundamental at low frequencies.

The part of his work that really attracted my attention was, I quote, "Instead of having an inductance that varies enormously with the signal voltage; with an air-gapped (though larger) OT the inductance remains sensibly constant." He felt that now he could trust the low intrinsic distortion of the transformer and concentrate on the driving output-tube circuit. His theory showed that the plate resistance of the output tube(s) is the primary cause of voltage distortion at the transformer output; and so triodes with plate resistances of order $1k\Omega$ were superior to pentode output tubes because of their plate resistances of order $10k\Omega$.

My previous article applied Partridge's ideas to the single-ended (SE) OT and in particular the BH magnetization characteristics of gapped and un-gapped OTs (please note that in the first printing figures 1a and 1b are reversed). Since writing the first article I have tried to find a simpler way of describing the electromagnetic difficulties in the operation of a SE transformer, and why SE amplifiers may sound as they do. This view is

presented below, together with some magnetic measurements which I have made on two SE transformers, courtesy of Mike LaFevre of Magnequest and Peter Qvortrup of Audio Note, as well as measurements on a poor design.

What one requires of a transformer is that it should be a linear device. Let us view the magnetic properties of the iron as an output voltage V (like the flux density B) versus an input current I (like the driving magnetic force H). This graph is the same as the output versus input characteristics for any electronic device. It can look something like figure 1, which is an approximation to the BH loop for modern OT silicon iron without air-gapping. The characteristic is far from linear. At small signal levels a PP amplifier might have strong odd-order harmonic distortion (the dreaded "crossover" type). At very high signal levels corresponding to the magnetic saturation case for the iron (which occurs at flux densities of order 15 kilogauss) the signal will clip again with strong odd harmonic distortion.

Note the scale of the horizontal axis where I have suggested DC current values of only a few mA to saturate the PP OT iron. Partridge's suggestion of a significant air gap, as well as the use by Peerless of a few permalloy laminations as used in the 20-20 Plus OTs (thanks to Mike LaFevre for this historical note), all help to linearize the PP OT.

Figure 2 shows the case of the SE OT, which has a sizable air-gap, of order 0.006 inches or more, in the iron circuit. The DC current is put to work driving the air gap and this "biases" the input signal over to the right. I have selected the value of 50 mA DC as the design value of the tube DC current for this SE OT. Note that figure 2 has a "dummy" origin along the x-axis, and shows the high slope of the non-gapped iron (high permeability μ) as compared with the now linearized SE OT characteristic.

As I stated in *SP#5*, SE seems to be a very attractive proposition since it eliminates the DC and AC balancing problems of push-pull

designs, together with the PP collapsing magnetic fields which can lead to crossover distortion, etc. But there is a penalty for choosing the SE way. As a result of the air-gap, more AC current has to be applied to the primary for a given transformer. To express this point another way, the inductance of the air-gapped transformer drops significantly for a given size. So one has to have a bigger transformer than the PP case for a given design value of primary inductance. (Actually, the slope of the line in figure 2, which represents the permeability μ , is clearly much lower than the PP case). Typically the SE OT of figure 2 would have an inductance of one-third of its corresponding PP design.

Figure 2 also shows that a linear output results from the input, see the sine-wave applied at the DC "bias" of 50 mA. This might correspond to a DC flux density of 8 kilogauss, say, with a peak-to-peak swing in AC flux density of ± 0.5 kilogauss. Note, however, that for a given SE OT design one cannot increase the tube DC current too much otherwise the output signal distorts due to magnetic saturation, mainly second harmonic distortion this time (see the 100mA DC current value). This latter case is unlikely, see below. With this simplified overview my measurements of the SE OTs should be easy

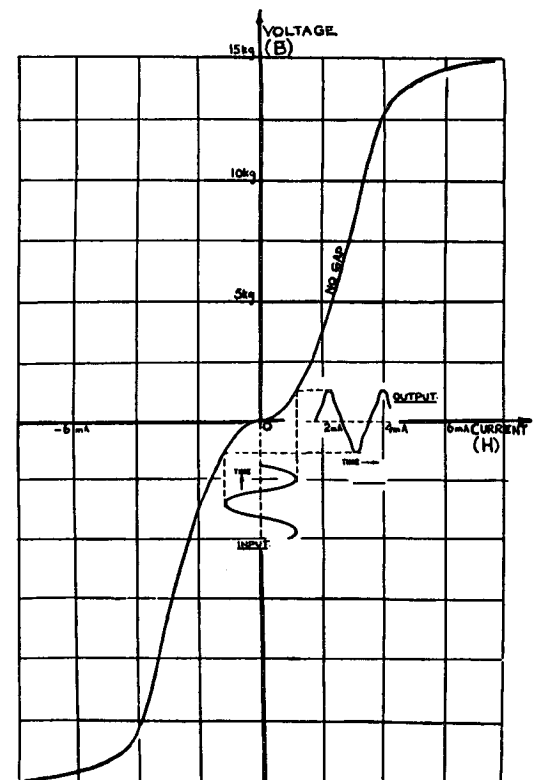

Figure 1. Input/output (BH) curve for PP OT with no air-gap

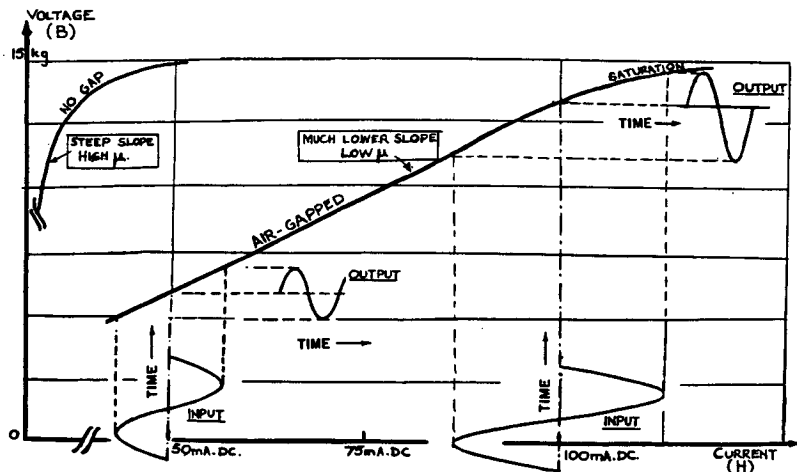

Figure 2. Input/output (BH) curve for SE OT with air-gap. (Note expanded x-axis).

to follow. We need the SE OT to be the so-called *linear inductor*, that is, its BH curve should be a straight line so that the primary inductance does not change with signal voltage, and better still it should remain constant over a range of output tube DC current.

This is demonstrated in figures 3 and 4 which show the BH characteristics for the Magnequest FS030 3kΩ and Audio Note 25W 2.5kΩ SE OTs. Following Partridge I excited the OT primaries with a 60Hz line variac of almost zero impedance. I monitored the driving current *I* and, by integration of the OP voltage, obtained the flux *B*. My results are taken from the x-y traces on an oscilloscope. This follows the standard testing procedure given in electromagnetic texts: the AC flux density swing was of order 15% of the DC value for the very large excitation voltage of 141 Volts RMS (± 200 Volts peak). This is at least double the value likely to be encountered with output tubes like the 300B etc., so any non-linearity will be immediately obvious.

There is no doubt that the OTs are linear inductors even when the DC current is at least 50% higher than the design current. The Magnequest is a particularly conservative design. Even at excessive values of DC current both transformers show only slight (2nd harmonic type) curving-over of their BH characteristics. And remember you are never likely to drive these transformers as hard as I did in my tests. Both are excellent OTs.

Following Partridge, I calculated the voltage distortion at the design DC current values for both OTs with results below 0.1% when driven by a 300B. For typical music signals the distortion is probably below 0.02%. Therefore, in my view, a well-designed SE OT such as these *does not produce distortion* driving normal output loads.

To further demonstrate that a good SE transformer is linear I have plotted the measured primary inductance versus output tube DC current in mA in figure 5 and versus signal rms voltage in figure 6. The results are self explanatory and should answer the often asked question of how close to the design value of tube DC current should one operate? I hope my measurements have convinced you that these OTs are linear inductors as seen by, say, a 300B output tube. Any distortion (which will be worst at low frequencies) will come from the tube. That

was the message of Dr. Partridge's work. Both of these transformers are fine devices.

So what should you expect in a good SE transformer? First, I will make a comment regarding the primary inductance, core size and the low-frequency roll-off of the amplitude vs frequency response. The -2 dB point at low frequencies is given by Sturley, *Radio Receiver Design*, Vol. 2, as:

$$f_{-2dB} = \frac{2 \times (\text{plate resistance})}{2 \pi \times (\text{primary inductance})}$$

For a 300B, if $R_p = 750\Omega$ and $L = 30H$, then $f_{-2dB} = 8$ Hz. I hope it is obvious by now that low frequency response costs money in an SE transformer.

With apologies to all electromagnetic scientists since I have no name for this law, if one multiplies the transformer weight (lbs) times the primary inductance (H) one obtains a kind of figure of performance per dollar cost. It is equal to 352 per \$300 for the Magnequest and 176 per \$150 for the Audio Note. (Actually the weight of the transformer is a rough measure of the core size and the amount of wire in the windings). Given today's prices, my "figure of merit" is around 1-2 for a chosen silicon iron OT (less for more exotic designs).

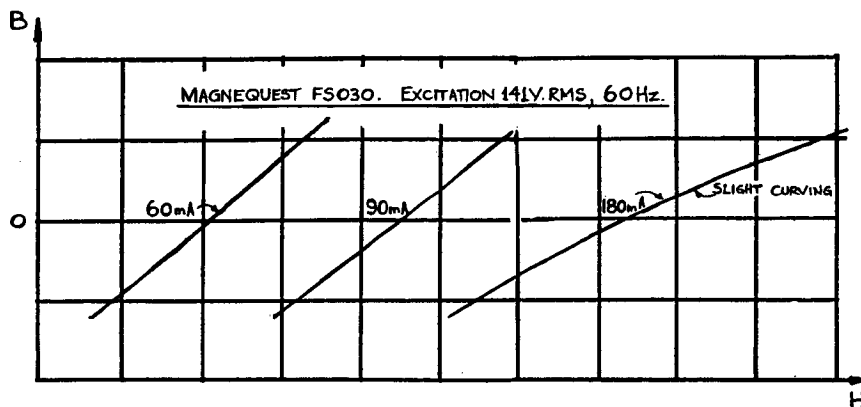

Figure 3. Magnequest FS030 — Cost = \$300 Z = 3kohm Wt = 11 lbs
 $I_{DC} = 60mA$ Core size = 1.5" x 2.25" Primary L = 32H

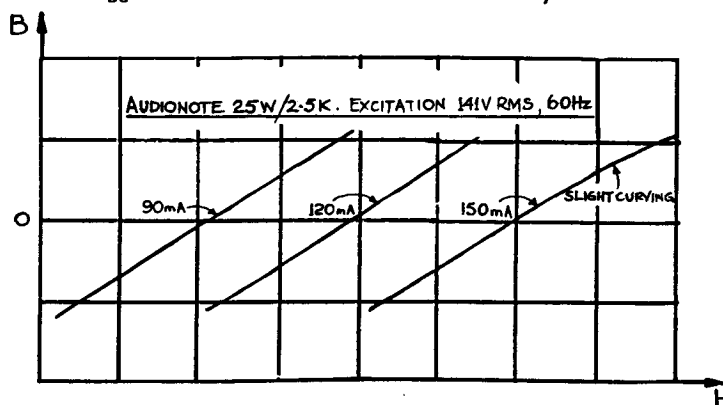

Figure 4. Audio Note 25W — Cost = \$150 Z = 2.5kohm Wt = 8.8 lbs
 $I_{DC} = 90mA$ Core size = 1.5" x 1.75" Primary L = 20H

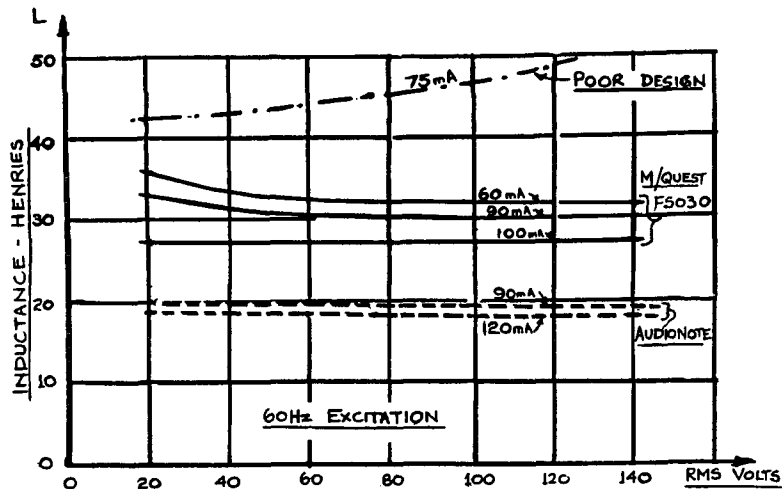

Figure 5. Inductance measurements for given dc current vs. excitation rms volts

To give an example of a "poor" design of a SE OT with non-linear characteristics, figure 7 shows a transformer with 54H of inductance for $I_{DC} = 75 \text{ mA}$, wt. = 8.6 lbs but with only a 1½ inch x 1½ inch core-size. Would you use this OT if it cost only \$80? The figure of merit is $54 \times 8.6/80 = 5.8!$ Wow, what a bargain! You can really think you are a cheapskate! Now look at the BH curves in figure 7. One is now close to the iron saturation region with a distortion at 60Hz of order 1% or greater at the design DC current value of 75mA, predominantly 2nd harmonic which produces some frequency doubling and a dark sound. What went wrong?

This is easy to answer, one cannot obtain such a high primary inductance (this also takes a lot of primary turns) with such a small core area. But with a small increase in air-gap which drops the inductance to 38H, the transformer is quite linear. (There is another factor which involves the primary and secondary wire resistance which leads to a loss factor. Remember a 1 dB power loss due to wire resistance doesn't sound much but it is 20% of your 300B's input power to the transformer. Typically you need an insertion loss factor of order $<0.5 \text{ db} = 10\%$ loss).

This brings up the subject of the output tube load resistance. Values of 2.5 to 3kohm help the OT designer since the turns count is lower, the wire diameter can be larger. Parallel 300Bs are a good idea as far as this point goes. The 16 kilohm transformer for the Ongaku SE amp (SP#2) must be a real artwork item. Yet, I am told, it rolls off above 12kHz. Again I make the point, leave SE transformer design and manufacture to the experts. But I hope this helps in what to look for in choosing a transformer.

Of course, other parameters are important like high-frequency response. Here I have been primarily concerned with the linearity of the transformer at low frequencies where most of the trouble arises. The SE transformer designer has a tougher job at high frequencies since one is not able to employ the cunning inter-winding tricks available in the case of balanced PP designs to reduce leakage capacitance and inductance.

I measured the approximate frequency response of the Magnequest and Audio Note OTs using a 1kΩ resistance in series from an oscillator with 5V rms drive (strictly one should use the output power tube to do the driving) at the design DC currents. Both OTs rolled-off around 35kHz, the Magnequest was flat at 20Hz (because of its higher inductance) while the Audio Note had attenuation of 1.5dB. I also looked at Lissajous figures for both transformers in order to examine the phase at low and high frequencies. The phase angles agreed with the amplitude responses and nothing unusual was observed.

I am still leaning toward the belief that the main advantage of SE may be the excellent linearity for small signal levels. Does this explain the greater musical resolution that can be obtained as reported to date? At low and high frequencies there may be driving problems, certainly favoring horn loudspeakers. I still hope that SP readers will have things to report on this matter as more experience is gained listening to SE designs.

Reading between the lines of SP magazine I seem to detect a recommendation for a feedback push-pull amplifier for the subwoofer and SE drive for the rest of the music spectrum (unless you have K-horns or Lowthers). I have recently heard two excellent SE amplifiers driving original Voigt

corner horns, one used a DA30 output tube, the other used an 845. The bass was noticeably more prominent, much more so than with the excellent PP designs used as a comparison. The SE designs seemed to have more low-level resolution, a more "you are there" presentation with greater depth. Most of the differences probably come from the output triode tube producing 2nd harmonic distortion from its own plate characteristics, it is not the output transformers!

But now we know the great failing of the current CD format, i.e. lousy low level resolution and harshness due to zillions of "intermodulation" products (thanks to Keith Johnson in his recent interviews). Is there a vinyl recording expert anywhere who can explain how the great LP recording engineers achieved depth, despite many wonderful, early stereo recordings being in mono at low frequencies? When I know this answer maybe I can R.I.P., but still listen to the music.

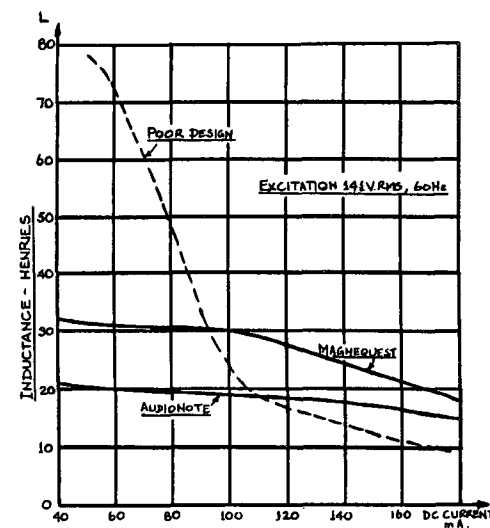

Figure 6. Inductance measurements for given 60Hz excitation volts vs. dc current

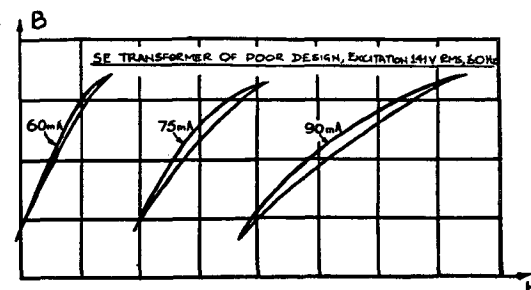

Figure 7. BH curves for different dc currents
Cost = \$80 Z = 3kohm Wt = 8.6 lbs $I_{DC} = 75 \text{ mA}$ Core size = 1.5" x 1.5" Primary L = 54H

Casual Reactions

by Herb Reichert, Audio Note NYC



triode" and Jadis makes SE 300B amps. Think about it. What many of you discovered for yourselves alone at night has affected the thinking and products of an industry giant like Carver . . . and this is just getting started!

The most amazing aspect of this is the *WHY* it happened not the *HOW*. Nothing in the history of American hi-fi is nearly so radical as this triode/horn revolution. You see, this is NOT A "RETRO" MOVEMENT. Before *Ongaku* no company *ever* sold a directly-heated, single-ended triode product in the American high-end market. Sansui and Pioneer sold economy-model single-ended receivers in the 1960s and Brook sold 2A3 push-pull amps in the fifties and that is it folks. The Western Electric gear was lease only and went into theaters. As far as American music lovers sitting in front of SE triode amps listening to recorded music, you are the beginning.

The mainstream reviewers who are in a last minute scramble to get hip about SE triodes are hooking these flea powered amps to stupid, slow, long excursion, low impedance speakers and saying they are "nice and sweet and pretty" but maybe "not too accurate". WRONG! These amps are lightspeed fast and trace signals like super race cars. A well-designed single-ended amp is so much more accurate than its hi-fi ancestors it is shameful! What you are getting with these amps is gobs more information. More leading edge definition. More harmonic development. More color and texture.

The reason people are so taken when they live with a quality SE design is these amps do not lose the vibratory life force of the music. These amps recover a breathy sort of energy that pressurizes the room, even with small speakers. You know the effect, when you put the tonearm down on the record and you can feel the room pressurize even *before* the orchestra starts playing. This is the magic of the triode horn experience. The triode thing is not about fun or nostalgia it is about heartbeat, rhythm and intensity. It is about music that LIVES.

Here is the real joke. I predict that by the end of 1996 you will see the big backlash. The old guard, royalist, solid state feedback rammer jammers will be engaged in a slam campaign. Instead of looking ahead, being creative, and trying to enhance musical culture in the home, they will be defending the technological monarchy. I am predicting a real war of concepts. The big tube companies like CJ and Audio Research will bring out

"Who made me?"

Reckon me this *Sound Practices* readers. . . "Who in world of audio fringe persons am I writing for?" The editor is not deep into market research and Joyce just says they get letters from a "broad spectrum". So who in audio hell is reading this and what are they really interested in? My best guess is that you guys are really smart (or at least hard working), really love music and are probably more than a little eccentric. In any event, let me start by thanking you and *SP* for giving me the opportunity to learn to write and practice my shaving on someone else's beard.

I don't know your faces, I have never been in your basements, so I just write about my own experiences, hoping there is something that I have done or learned that will inspire others to action. A lot of audio writers hope to educate and opionionate their readers. Me? I would rather see some action. I want to see people finish an article, then get up and do SOMETHING! Try something new and learn from the experiment. I do not believe I can *teach* anybody anything. What I can do is suggest actions and experiments that might lead the reader to his own discoveries. For me, learning to write is about learning how I can be of service.

You may not realize this, but *SP* is maybe the most esoteric magazine in the world. Directly heated triodes, bright emitters, dull emitters, tractrix horns, big chunks of air-gapped ceramic leaf steel, paper in oil condensers, ion-transfer capacitors, beeeeeeee serious! Try to talk to some new fashionable acquaintance about this stuff. They be pulling their hat down and putting up their hood and crossing the street next time they see you. This is a very serious problem. So, let me tell you about how YOU changed the history of audio and while you may be a little weird you can sleep peacefully with the thought that you contributed to an important cultural change.

Everybody's talking...

Single-ended triodes and horns—five years ago I couldn't give them away. Ten years ago

even J.C. Morrison was laughing. Joe Roberts was selling Krell and Gordon Rankin was designing mainframe computers. To say things have changed is an understatement. *SP* readers have changed the history of audio. For the first time ever, an industry has been transformed from the bottom up. A true revolution of the hi-fi proletariat.

In this case, the revolution started in basements of the audio poor and is now on the tables of manufacturers' boardrooms. Manufacturers did not invent SE triodes as the latest and greatest ploy to extract your savings. Reviewers did not "call" for a change. How come nobody in the audio mainstream 'noticed' what was going on in Japan for the last 20 years. All the big guys like Krell, Audio Research, CJ, etc. go to Japan every year for the trade shows. Did any of them come back and say, "Hey, you won't believe what I heard?" There was an audio 'cold war'.

That is how this single-ended triode "new dawn" began. A few western culture music lovers with open minds heard (or heard about) Japanese style 'ultra-fi' systems and built their own and the concept spread one record at a time, one music lover at a time. Up from the basements and into the living rooms. About two years ago I swore I could hear men all over America yelling at each other, "Yeeow! This is amazing. You are telling me this is 5 watts? No feedback? You're nuts!!! If you build another amp, can I buy this one from you?"

Peter Qvortrup and Jean Hiraga were the early Western pioneers of SE amps and efficient speakers in the UK and Europe. Later, Herb Reichert, Dennis Had and Gordon Rankin started manufacturing SE 300B amps in the U.S. And the whole time, the entrenched giants of the market were laughing. At about the same time, you guys, the *SP* readers, started soldering and sawing and demonstrating the 'new way' to so many people on a local scale that the mainstream press had no choice but to notice.

Now, Carver Corporation makes high power solid state amps with the "soul of a 9 watt

Looking for a way to improve your image?

Try some MUSICAPs!

Polypropylene film and foil construction
Stranded silver plated copper leads
Extremely low DA, DF and ESR

WHAT THE REVIEWERS SAY...

"If you want see-thru, high definition, detail and listenability, try the Musicaps."

Joe Roberts, *SOUND PRACTICES*, ISSUE 6, 1994

"The improved signal transmission of the Hovland foil capacitors elevated the (Ariel) speakers to a new level of naturalness, clarity, and immediacy."

Lynn Olson, *Positive Feedback*, Vol. 5, No.4

To order contact one of the following:

- The Parts Connection 905-829-5858
 - Welborne Labs 303-470-6585
 - Sound Products, Inc. 503-761-0743
 - A & S Speakers 510-685-5252
 - North Creek Music Systems 315-369-2500
 - Allpass Technologies, Inc. 407-786-0623
 - Anchor Cross Co., Tokyo, 81-3-3203-5606
 - SJS Electroacoustics, England 44-1706-823025
- OEMs contact: Hovland Company at 209-966-4377

300B amps, because they have no choice. There are no more quality 6550s or EL-34s and there are few new engineering concepts to apply to this technology.

The solid state guys will have to make some serious 'kick ass thumping' power amps because they know that this is the one and only thing they *might* have over triodes—forget finesse, we got the slam! The near-sighted speaker manufacturers will be going Chapter 11 (as usual) and the reviewers that hooked their wagons to the wrong horses will be looking for new day jobs.

I think it is art

Triodes and horns are capturing the imagination because they let us like music again and because they are beautiful to look at. Personally, I would pay \$20 just to see a picture of an all-out Japanese horn system. Check out Ikeda's system on the horn speaker home page!¹ What fantastic shapes! Boxes and panels can never excite the sculptural aesthetic like a horn. An EL-34 will never touch a 300B or 211 tube for cachet. Transistors look boring. Triodes look Franken-

stein wild. They will never make a coffee table picture book of solid state amps or box speakers. They make them for triodes. The simple SE circuit schematics are also beautiful. SE circuit design is not about damage control and error correction, it is about preserving the ecology of the music signal. Make it more and more simple and use better and better parts.

Pioneers in single-ended amp design seek to preserve the 'continuousness' of the music. They work to rid music reproduction of the mechanical and the electronic artifact. I am convinced that most of us had let high end audio distract us from the structure of the music and the inspiration of the performance. The single-ended amps of today are only the beginning. The door is open just a crack and I believe that you people, the brave radical ones, who read this magazine are the ones who opened the door. Thank you all for getting up from your chairs and doing something important. When the history of 20th century audio is written you can say you were there at the front line.

¹—<http://invalid.ed.no/~dunker/horns.html>

EXEMPLAR

The Music Lover's horn speaker system

Integrating the best in performance and sonics through tractrix horn loading, optimized bass reflex, professional quality drivers and premium quality passive components.

Designed to complement low power amplification offering:

Balance from the deep bass through the upper treble

Realism through abundant detail and dynamics

Efficiency and effortless presentation

Emotional impact

Triode Support Systems

17355 Saturn Lane
Houston, TX 77058
(V) 713-488-2609
(F) 713-488-5331



TURNABLES (continued from page 14)

the audiophile way to construct a driving unit to minimize these errors.

After using a Platine Verdier for six years now, I definitely lost that down-to-earth feeling. I wonder why so many American freaks creating great amps and speakers never felt the necessity to match them with a high-end turntable. Bringing a 300B amp to perfection or taming a VOT— is that down to earth or up to audio heaven? Anyway the best advice I can give to you is:

1- Sell any Garrard, TD 124, and, in my humble opinion, Linn, or place them in your private museum. Don't mess up those old goodies!

2- Start with a Xerxes by Roksan, if you don't want to jump forward to a Platine Verdier. Xerxes still has one of the finest bearings I've ever seen in a commercial product. You can buy a bearing and inner/outer platter assembly from Roksan and mount it on a subplatter of your choice [Roksan distributor in US: May Audio Marketing, 423-966-8844/8833 FAX. Approximate cost of platter and bearing is \$600].

3- Find a good engine or use the Swiss-made 24V Maxon part # 2326 942-12-111-050 [available at \$231.10 in single qty. from Maxon, 838 Mitten Road, Burlingame, CA 94010 415-697-9614.] You can try the much cheaper "941" 30V version if you are confident that you can build a low voltage regulator. Christian Rintelen of *Hi-Fi Scene* uses the rare and expensive "949" 42V version. The Maxon is #3 in my chart and it will serve as a classic in all applications. Avoid Pabst.

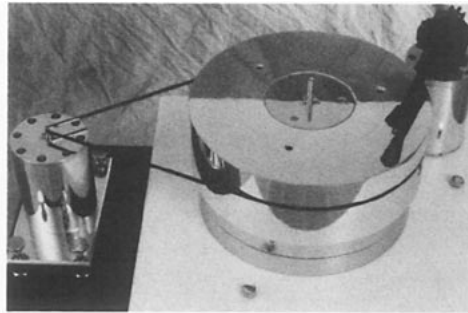

Realization of Audio Contact, Germany

4- Try a home-spun driving unit as described above, using tape as a belt. The optimum tension is where the platter runs at the lowest voltage. Use the best pulley you can get, even if the cost is excessive. For the Maxon motor, I recommend a pulley of 9mm diameter. Audio Contact in Germany can provide a ready-built pulley of this size and they also sell engine/pulley systems. (Audio Contact, Lindenweg 12a, D-22395 Hamburg, Germany).

5- Build a variable regulated power supply which can be as simple as an LM 317 chip or as complex as you wish.

That's it! Most probably this will outperform 301, 124, LP 12, or whatever you name. If you're out for the top turntable, you will have to build it yourself. That truth is simple and always the same. I'm sure you can do it and without becoming a mechanical engineer.

VAIC VALVE, TRIODE SUPPLY JAPAN, BLUE CIRCLE AUDIO, DENNESEN ELECTROSTATICS, LOWTHER AMERICA, AND HUNDREDS OF MUSIC LOVERS HAVE CHOSEN JENA LABS AS THE WORLD REFERENCE INTERCONNECT SYSTEM

IN ADDITION TO OUR COMPLETE INTERCONNECT RANGE, WE NOW OFFER A FEW SUPPLIES TO THE DIY EXPERIMENTER.

WIRE WHY PAY \$100.00 OR MORE A FOOT FOR THE POLITICALLY OR RELIGIOUSLY CORRECT SILVER WIRE WHEN A SONICALLY SUPERIOR WIRE SYSTEM CAN BE HAD FOR MUCH LESS. JENA HOOK UP WIRE, PREVIOUSLY AVAILABLE ONLY TO OEM PURCHASERS, IS NOW AVAILABLE TO THE DIY HOBBYIST. THIS IS THE SAME CONDUCTOR SYSTEM USED AS THE MAIN CURRENT PATH IN OUR MOST EXPENSIVE INTERCONNECTS, THE SINEWAVE SYSTEM. 18.1 GA. - HEAVY WALL, MODIFIED P.E. INSULATION - SUPER ANNEALED STRESS FREE HIGH PURITY COPPER \$12.00 FT.

RCA CONNECTORS ALSO AVAILABLE IS THE JENA MODIFIED CARDAS™ RCA PLUG WITH EXCLUSIVE SILICONE COMPRESSION RINGS \$35.00 PAIR, \$65.00 QUAD. ALSO, CARDAS™ PANEL MOUNT FEMALE JACKS AT COMPETITIVE PRICES.

JENA LABS

TECHNOLOGY AND ARTISTRY IN NATURAL HARMONY
19235 PILKINGTON ROAD LAKE OSWEGO OREGON 97035 USA

Michael and Jennifer Crock VOICE +1-503-639-7551
24 HOUR FAX +1-503-968-7261

X - D A C 3 . 0

The advanced DAC kit

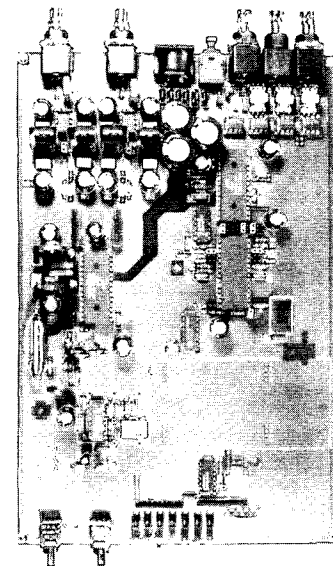

- On-board jitter reduction with AD1891 and balanced drive clock unlocks the true potential of the CS8412/CS4328 chips.
- External 30 watt supply feeds nine regulator power system.
- High speed high current analog section.

Write for detailed information

Audio Crafters Guild

5102 East 38 Place
Tulsa OK 74135 U S A



Readers' Forum

BETTER THAN OKTOBERFEST?

I just finished reading through all the issues *SP* published yet and would like to congratulate you on its fascinating contents. It sure is a shame none of my friends urged me to read *SP* earlier. Since I am more into speakers than amps, I would like to pass on my thoughts on what I read on horns while the others cherish the lasses at the beer festival.

i) Altec upper range: I found the 288C the best driver overall, if you want a finished product. Faster and more dynamic, though, is the old alnico 290 driver sans xformer and with an 288 alu dome glued to it. My own pair also has a very thin (~2µm) layer of silver applied to the poles (idea taken from JBL LE 85/2420) for even better HF performance by lowering coil inductance; it goes up to 18k @-6dB, which puts the question of sacrificing homogeneity by going 3-way to rest forever. That is, if you can live without an 8 to 15 cell horn for broad dispersion duties. Try 311-90 or 203 instead; 311-60 has some 3 to 4 dB lift on axis at 1 to 3 kHz, depending on driver/diaphragm used, but is OK otherwise. For low cutoff, try 290 or 288 with resin diaphragm on 1503 or 203 horn using steep (I mean steep) active x/o at 240 Hz.

ii) Altec phase plugs: I do not agree with the somewhat generalized view held by some of your correspondents, namely that on 1" drivers the WE-type phase plug is better than the tangerine; the best Altec 1" I know of is a 808B alnico + tangerine with 891318 ass'y (nearest equivalent is an off-the-shelf 802G driver). Although Altec's literature of the day claimed extended "high-end response while significantly reducing distortion", the midrange through a WE-type phase plug is indeed slightly clearer, the first claim nevertheless holding true. Contrary to what has been implied, an aluminium 1" works best into 511, not 311 horns, the latter sounding rather slow and restrained (overdamped?); also, the 802G top end is not better than that of a 1.4" driver modified as described above, if you ask me. I suspect some standard 288C samples might even beat a 1" driver on a 311 or 329 horn @10k, the result largely depending on the sample variations among the 1.4" driver's diaphragms. I haven't tried 1.4" tangerines yet, but comparisons might be misleading, as Altec has

changed phase plug and magnet structure more or less simultaneously as opposed to the late 70s transitional time span employed on 1" units.

iii) Tractrix upper range (in the US named after a guy who seemingly likes 4 extra chars in front of his name): First put into broad use by P.G.A.H. Voigt (nine extra) of Lowther fame pre WW2, they offer the most neutral performance I have heard. Since the impedance varies more than with some other types of horn, I'm not sure whether it's a good idea to x/ 1st order!?! As far as I know, they were first used with D54 in the 70s in a speaker past IRS price range by a company based in Duisburg now trading as A Capella. Their mid-horns are circular and employ perfectly curved surfaces in glossy white lacquer...a dream! Apparently a guy in Berlin called Martion started doing similar things at about the same time. I tried a like-looking lampshade with Yamaha NS 1000 and 2000 beryllium domes, but as all parts of 'em domes move in unison instead of warping and disengaging their central bits like your D54 does, you really need a phase plug to get output beyond 3k. Back to i), then. Maybe, though, one secret to classic joy of the law is having horns circular, as the Japanese GOTO horns (pure exponential flare laws) are circular as well and absolutely gorgeous at that!

iv) If you have the necessary spare change or are lucky to get hold of one at a giveaway price, try a Pioneer/TAD driver, especially the Alnico/beryllium-domed 4001 2-incher. Said to be the last word.

Ralph Gibbemeyer
Munich, Germany

TWEAKING TOWARD JERUSALEM

I just received issue 9 of *SP*. Speaking out! You know, the Aquarian Age for music started in 1968 and now Armageddon is not too far away anymore. Like Yasser Arafat said himself in Bethlehem; he's only 3 miles away from Jerusalem...

The best music rolls off a genuine-silver-throughout Ongaku. The global domination of tyrannical monsters can begin. Can the Ongaku stop them? Will New Age music ease your mind? Is Mr. Reichert of Audio Note NYC frustrated because of this?

The big oil companies are indeed suppressing the 300 miles per gallon carburetor. Now listen, around 1990 there was this German engineer who made a turbodiesel engine of 1.5 liter, 4 cylinder, 100 HP din, more or less. He mounted this engine in place of the Mercedes 2.5 liter turbodiesel of 90 HP din. Guess what? His 190 reached a top speed of 180km/h, that's 120 miles/h fast, and at an



Lowther

**HIGH EFFICIENCY DRIVE UNITS
ARE NOW AVAILABLE
IN THE USA!**

- Famous "A" Series Alnico magnet
- C series with ferrite magnet
- 8 or 15 ohm option
- Cabinet plans available
- Perfect for use with all vacuum tube amplifiers, including the lowest powered single-ended units
- Optional silver voice coils

— NEW! —

**ACOUSTA MEDALLION
REAR-LOADED HORN
SPEAKER CABINETS**
The ideal enclosure for
PM6 and PM7 Drivers

For more information, contact:
LOWTHER CLUB OF AMERICA
P.O. BOX 4758
SALEM, OREGON 97302
VOICE/FAX (503) 370-9115

VALVE

is a two year old pacific northwest tube audio club with a monthly newsletter devoted to vintage and gonzo-fringe-dumpster-diving-techno-bottlehead tube audio.

We publish info on auditions and projects like this:

*A7 vs. QUAD vs. Lowther - an ultimate system for 78's
a one watt, one tube SE amp - a simple tube CD output
restoring a vintage Lowther Acousta
which 6L6 sounds best? - big toobs, 304TL and 450TH*

We have members with all levels of experience from "first Stereo 70" to "scratch built an FM tuner last Sunday," who contribute great articles and letters. Want to join and get twelve monthly issues? Send a check for \$25 (\$35 overseas) to:

VALVE, 1127 NW Brite Star Lane, Poulsbo, WA 98370-8241
phone 360-697-1936 fax 360-697-3348

SINGLE ENDED TRANSFORMERS

MODEL	PRI Z.	Ip	TUBE/S	NOMINAL POWER	QTY 1-3	QTY 4-9	QTY 10+	SHIPPING WEIGHT
CT3KB	3K	100 MA.	300B,2x2A3	20W	\$195.00	\$158.00	\$138.50	14 LBS.
MT5KB	5K	60 MA.	50,45,2A3	15W	\$195.00	\$158.00	\$138.50	14 LBS.
JT1KB	1.5K	160MA.	2x300B,6338	30W	\$249.00	\$199.20	\$174.30	16 LBS.
VT2KB	2.7K	160 MA.	VV30B,2x811-3	30W	\$249.00	\$199.20	\$174.30	16 LBS.
E18B	6K	100 MA.	811-3	20W	\$195.00	\$158.00	\$138.50	14 LBS.
E48B	1.8K	350 MA.	4x811-3	65W	\$425.00	\$340.00	\$297.50	30 LBS.

NOTE: ALL TRANSFORMERS SUPPLIED WITH BLACK PAINTED END BELLS
FOR CHROME PLATED END BELLS ADD \$25.00 EACH FOR GOLD PLATED END BELLS ADD \$40.00 EACH



ELECTRA-PRINT AUDIO

1311 N. WINWOOD ST.
LAS VEGAS, NV 89108

702-646-7990
FAX 702-646-7752

clean line

High Performance Line Conditioning

by **Vans Evers**

Here's what they're saying about clean line—

"...I'm so pleased with the results obtained from the three Vans Evers devices that my system has been on and playing with every waking moment where I can lend it an ear. I can't wait to turn it on when arriving home from work, and when I'm the only one in the house I play it constantly..."*

Martin G. De Wulf in
Bound for Sound 6:1995

- * Model 83 clean line
- Model 11 clean line for analog
- Model 11 clean line for digital

For more information write
Vans Evers
1242 E. Hillsborough Av.
Tampa, Florida 33604
Voice 813-872-6862
FAX 813-874-3012

UNITED STATES POSTAL SERVICE Statement of Ownership, Management, and Circulation (Required by 39 USC 3685)

1. Publication Title: **SOUND PRACTICES**

2. Issue Date: **10/19/95**

3. Issue Frequency: **QUARTERLY**

4. Issue Month: **OCTOBER**

5. Issue Year: **1995**

6. Complete Mailing Address of Known Office of Publication (Street, City, County, State, and ZIP+4):
**9405 S. ARDREWE AVE. #200
VANUO WA 98148**

7. Complete Mailing Address of Headquarters or General Business Office of Publisher (Not Printer):
SAME

8. Full Names and Complete Mailing Addresses of Publisher, Editor, and Business Manager:
Publisher: **Joe Roberts (NAME AS ABOVE)**
Editor: **11**
Business Manager: **11**

9. Full Names and Complete Mailing Addresses of Owner:
Joe Roberts SAME AS ABOVE

10. Known Bondholders, Mortgagees, and Other Security Holders Owning or Holding 1 Percent or More of Total Amount of Bonds, Mortgages, or Other Securities:
None

11. Tax Status: **None**

12. Publication Title: **SOUND PRACTICES**

13. Issue Date: **NOVEMBER 1995 (PERIODIC 7/19/95)**

14. Issue Frequency: **Quarterly**

15. Issue Month: **NOVEMBER**

16. Issue Year: **1995**

17. Complete Mailing Address of Headquarters or General Business Office of Publisher (Not Printer):
**9405 S. ARDREWE AVE. #200
VANUO WA 98148**

18. Full Names and Complete Mailing Addresses of Publisher, Editor, and Business Manager:
Publisher: **Joe Roberts**
Editor: **11**
Business Manager: **11**

19. Full Names and Complete Mailing Addresses of Owner:
Joe Roberts

20. Publication Title: **SOUND PRACTICES**

21. Issue Date: **NOVEMBER 1995**

22. Issue Frequency: **Quarterly**

23. Issue Month: **NOVEMBER**

24. Issue Year: **1995**

25. Complete Mailing Address of Headquarters or General Business Office of Publisher (Not Printer):
**9405 S. ARDREWE AVE. #200
VANUO WA 98148**

26. Full Names and Complete Mailing Addresses of Publisher, Editor, and Business Manager:
Publisher: **Joe Roberts**
Editor: **11**
Business Manager: **11**

27. Full Names and Complete Mailing Addresses of Owner:
Joe Roberts

average speed of 55 miles/h the 3000 pounds heavy car used indeed 300 miles per gallon diesel. The man was 75 years old in 1990 and had to move to Holland because in Germany he became "dangerous"!

This principle on engine technology applied by this former M.A.N. engineer is known since 1925!!! The engine didn't lose any heat. If you placed your hand on the engine block it remained and felt cold. The thermal efficiency reached 85% inside the engine. There were double intake pipes, one row for the combustion and another row of pipes to form a cold air film at the insides of the cylinder to prevent the combustion heat to "escape" through the metal of the engine block, cylinder head, etc. The engine was not water cooled nor air cooled! But it remained a normal 4 stroke, 4 cylinder engine. I've read all this in a "save the nature" magazine. Shortly after this particular edition the magazine "disappeared".

I agree with what is published in *Sound Practices*, I recognize that silver output transformers are better sounding than copper wired ones, but you can't make me believe that Mr. Reichert's casual reaction is crying for audio tranquility. Is the Ongaku the best amplifier or not? The TRUTH will set you free! Folks, Europe is a lost continent, but don't waste America, right? The baby Ongaku will work excellent, I admit, but don't faint if one day a DIY'er comes up with a \$500 SE triode 2A3 amp that outperforms a \$50,000 Ongaku!

After more than 70 years of audio development, where are we? Fighting digital jitter and other gremlins? Anyway, I'm going to have another round of tests without test signals. But how will I ever explain myself or the discovery if I find something?

I'm glad that vacuum tubes are alive again but I'm not naive and in fact can we gain the good music again? Will people accept real music if they hear it? Paul Klipsch needed a good 5 watt amplifier for his hornspeakers. It "means" something. I don't know exactly. There are no clear facts anymore, it all became virtual. One thing I know for sure, S.E. triode amps have something that all other kinds or push-pull amps don't have. I keep on searching.

Alex Cockx
Winksele, Belgium

Now Available!
Limited quantity of long out of print SP issues #2, #3, and #4 \$5 each. Overseas: add \$2.50 per copy for airmail postage.

Sound Practices is on the Internet!

AudioWeb™

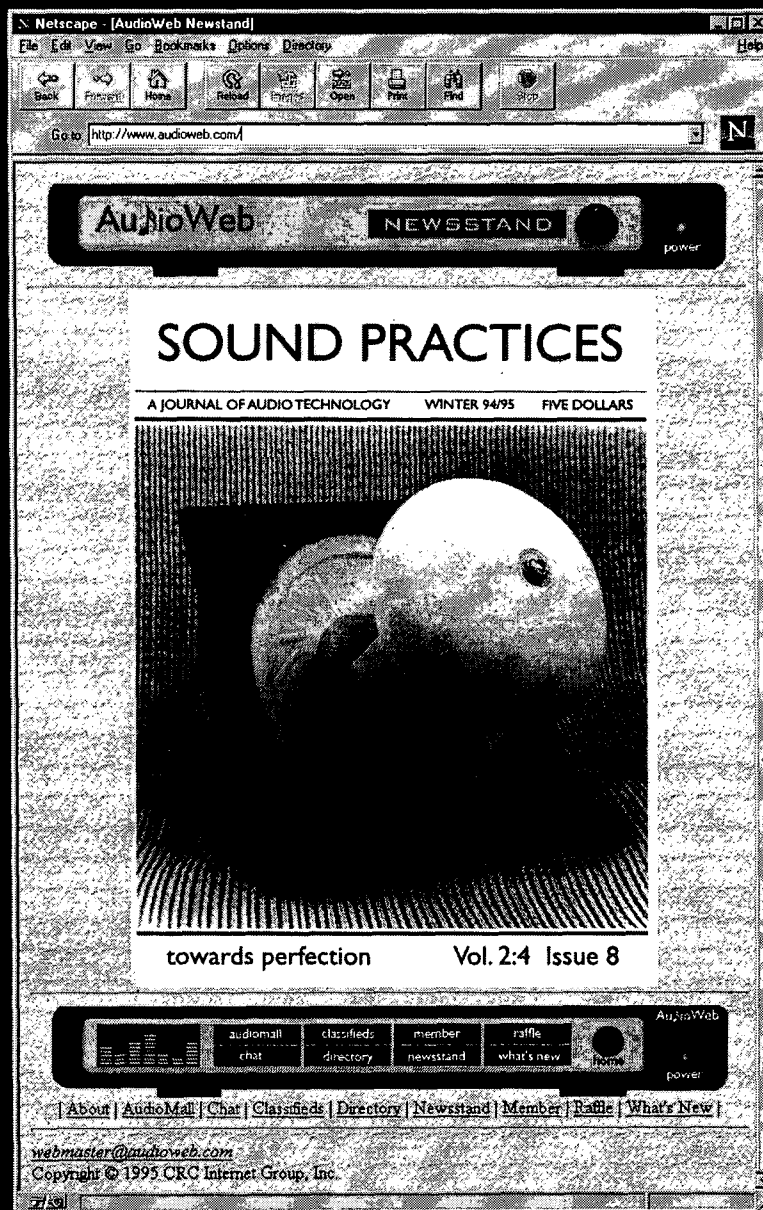

www.audioweb.com

For advertising and editorial information, please contact:

AudioWeb
c/o CRC Internet Group, Inc.
230 Sherman Avenue
Berkeley Heights, NJ 07922
908.464.7307
info@audioweb.com

NEW SENSOR CORPORATION

20 COOPER SQUARE • NEW YORK, NY 10003
 (212) 529-0466 • (800) 633-5477 • FAX (212) 529-0486

USA MILITARY JAN TUBES

NEW, ORIGINALLY BOXED, AVAILABLE IMMEDIATELY

TUBE NUMBER	1 PC.	10 PCS.	25 PCS.	50 PCS.	100 PCS.	500 PCS.	1000 PCS.
0A3 JAN SYLVANIA	1.15	.90	.75	.65	.55	.45	.40
0C3W JAN RAYTHEON	3.65	2.90	2.30	1.90	1.60	1.30	1.20
5Y3WGTA JAN PHILIPS	4.90	3.90	3.40	2.90	2.60		
6AN8a JAN PHILIPS	5.90	4.70	4.20	3.80	3.15	2.60	2.30
6AS7GA JAN GE	6.15	4.90	3.50	2.90	2.55	2.20	1.90
6BJ7 JAN	2.00	1.60	1.40	1.20	1.00	.90	.80
6BL8 JAN SYLVANIA	1.65	1.30	1.10	.80	.65	.50	.45
6BQ7a JAN GE	2.00	1.60	1.35	1.15	.95	.80	.70
6C4WA JAN PHILIPS	2.00	1.60	1.35	1.15	.95	.80	.70
6DJ8 JAN PHILIPS	3.65	2.90	2.30	1.60	1.40		
6EA8 JAN PHILIPS	2.00	1.60	1.35	1.15	.95	.80	.70
6J5WGT JAN PHILIPS	4.40	3.50	2.60	2.10	1.80		
6L6GC JAN PHILIPS	21.50	16.90	16.20	15.40	14.90		
6L6WGB JAN PHILIPS	13.90	13.30	12.80	12.30	11.80	11.50	10.90
6SJ7 JAN GE METAL	1.40	1.15	.95	.85	.75	.70	.65
6SL7WGT JAN PHILIPS	5.90	5.50	4.90	4.40	3.90	3.60	3.30
6SN7WGTA JAN PHILIPS	7.40	5.90	4.90	4.40	3.90		
6SQ7 JAN GE	3.15	2.50	2.00	1.50	1.20	1.15	1.10
6U8a JAN PHILIPS	2.00	1.60	1.35	1.15	.95	.80	.70
6V6GT JAN GE (GLASS)	12.40	9.90	9.50	8.80	8.40		
6X5WGT JAN PHILIPS	1.90	1.50	1.35	1.20	1.05	1.00	.95
12AT7WC JAN GE	6.15	4.90	4.40	3.90	3.50		
12AU6 JAN GE	1.90	1.50	1.25	1.00	.90	.80	.70
12AX7WA JAN GE	9.65	7.70	6.50	5.90	5.40	4.90	4.50
12AX7WA JAN PHILIPS	9.65	7.70	6.50	5.90	5.40	4.90	4.50
12SG7 JAN RCA	1.00	.80	.70	.60	.50	.40	.35
12SH7 JAN GE	1.00	.80	.70	.60	.50	.40	.35
12SJ7 JAN	1.25	1.00	.90	.80	.70	.60	.55
12SL7JAN GE	1.25	1.00	.90	.80	.70		
83 JAN GTE	8.75	7.00	6.40	5.80	5.50		
829B JAN CETRON	8.55	6.85	6.25	5.65	5.35	4.75	4.50
5656 JAN RAYTHEON	7.50	6.00	5.00	4.20	3.30	2.50	2.20
5751 JAN GE	4.50	4.30	4.10	3.80	3.50		
5814a JAN PHILIPS	3.75	3.00	2.75	2.50	2.20	2.00	1.90
6072a JanGE - MIL 12AY7	8.90	7.70	6.50	5.90	5.40	4.90	4.50
6080WC JAN GE	6.15	4.90	4.40	3.90	3.40	2.90	2.60
6188 JAN PHIL -MIL 6SL7	11.15	8.90	7.90	6.40	5.90	5.60	5.30
6189W JAN PHILIPS	3.75	3.00	2.75	2.50	2.20	2.00	1.90
6922 JAN PHILIPS	4.25	3.40	2.80	2.10	1.90	1.65	1.45
7581a JAN PHILIPS	19.50	18.00	17.25	16.50	15.75		

MASTER CARD/ VISA ACCEPTED • MINIMUM ORDER \$100.00 • ALL ORDERS SHIPPED F.O.B. N.Y.C.

Kimber Klassifieds

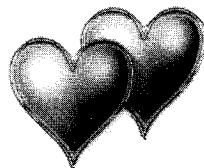

Pragmatic, down-to-earth, workin' joe seeks a no-frills situation with a sensitive music lover. I'm comfortable spending quality time at home playing records, cd's or watching movies. I would like to explore a life long relationship with you. I'm boxholder **4VS**... Comfortable as your favorite slippers, 'right as rain.' Best of all I have a heart of the purest copper. Call today you won't be sorry.



Successful, young, worldly over achiever seeks intellectual type who enjoys movies & music. Me—comfortable with bahemian and aristocrat alike. I'm from a long musical lineage and well versed in scientific disciplines too. I'm easy to fall in love with and I'll go to great lengths to please the discerning and deserving. Hook up with me today & fall in love for life. No bad amplifiers, torn cones or lo-fi situations please. \$\$\$ not important. Call 801-621-5530 ask for **PBJ**.

Seeking audiophile 4 endless intimate listening sessions. Me—I come from a scientific background and into all types of music. I can take all the power you can unleash, but respond with equal finesse to quiet moody types. Telephone 801-621-5530 lve msg box **4TC**.

Number crunchin' speed freak into x-mission line theory & wave propagation. Seeks transports & DACs 4 extended listening sessions. Me—Stable (impedance, that is). You—Thrill seeker looking for the best in binary performance. Reply to **Illuminati D-60**.

Bass freak looking for that perfect subwoofer to get down with. How low can you go? Check out box **SPR** for the low down today. I'll go to great depths to please you.

Mature, detail oriented seeks music lover. I'm trim, fit and silver with a penchant for music. I'm pedigreed and come from an advanced background in metallurgy. I'm easy to interface with and work well in upscale environments. Let me take you to the top and show new highs. I'll bring bliss to your life and life to your music **GUARANTEED!** Respond to boxholder **KCAG**.



Linking Deserving
Components Together for
Almost Two Decades.



Identical twins seeking new sources! We come equipped with the best connections and would just love to connect with you. We're ready to go the distance for you! Love at first listen assured! Ask for mbox **KC-1**. Bye, Bye.

 **KIMBER KABLE**

2752 South 1900 West
Ogden, Utah 84401 USA
(801) 621-5530

Announcing the availability of the original WE 300B electron tube.



Western

Electric

Western Electric® • High Fidelity • Electron Tubes • Interconnects

Westrex Corporation • AT&T Promenade II • 1230 Peachtree Street • Suite 3750 • Atlanta, Georgia 30309-3575
404-874-4400 • Facsimile 404-874-4415

Western Electric High Fidelity products are marketed worldwide exclusively by Westrex Corporation.
Western Electric is a trademark of AT&T licensed to Westrex Corp., a company independent of AT&T.
Western Electric High Fidelity products are manufactured in the U.S.A.
Developments of AT&T Bell Laboratories.