

SOUND PRACTICES

THE JOURNAL FOR AUDIO EXPERIMENTERS

FIVE DOLLARS

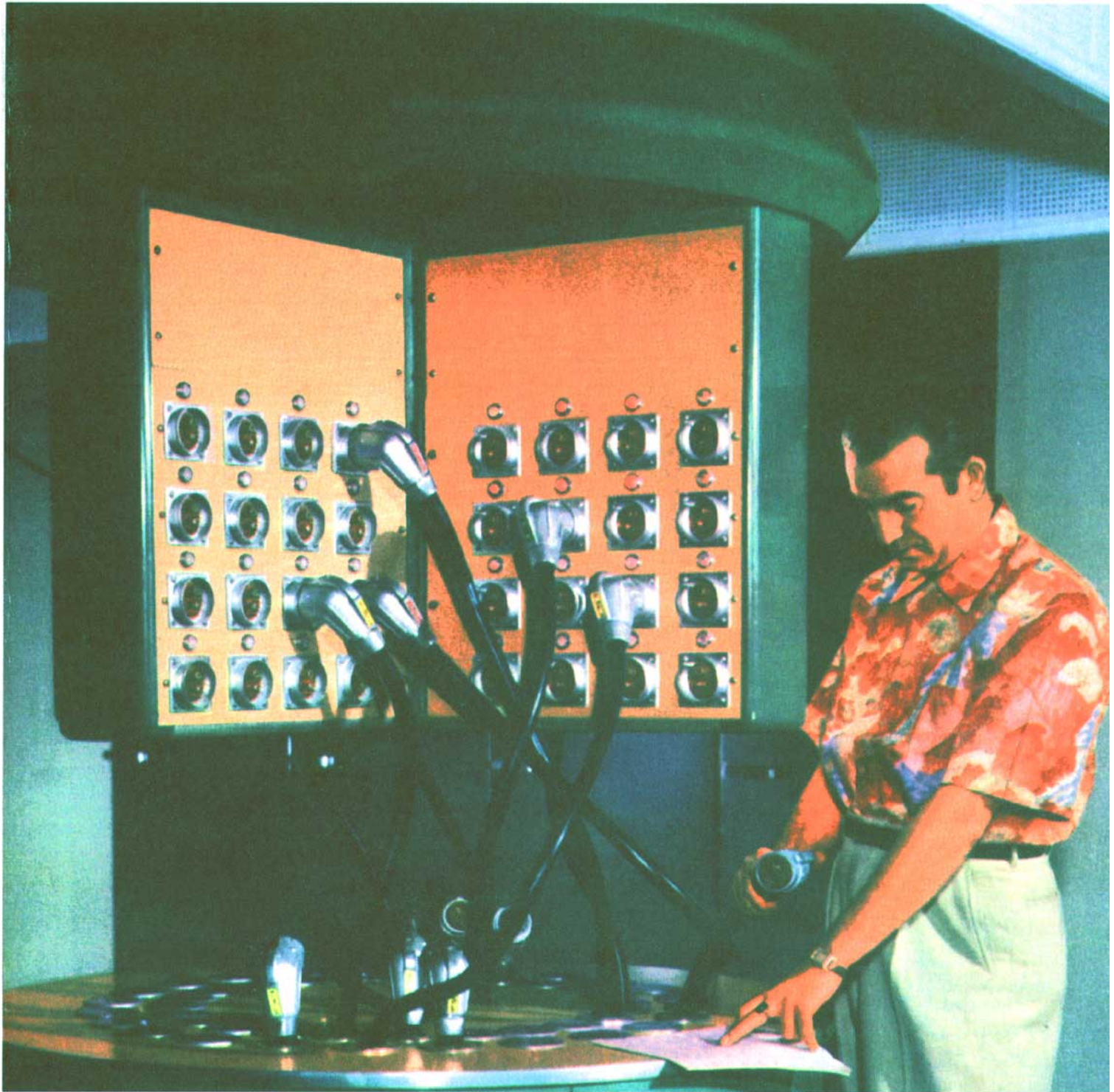

Getting Hooked Up

Issue 16

KINKY triodes

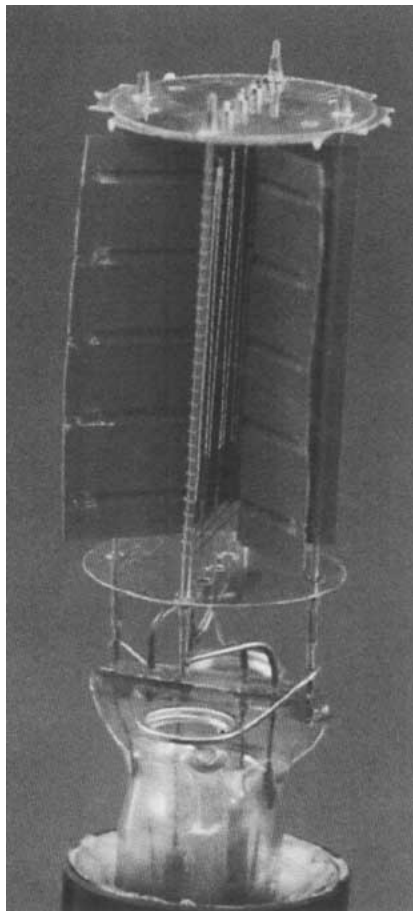
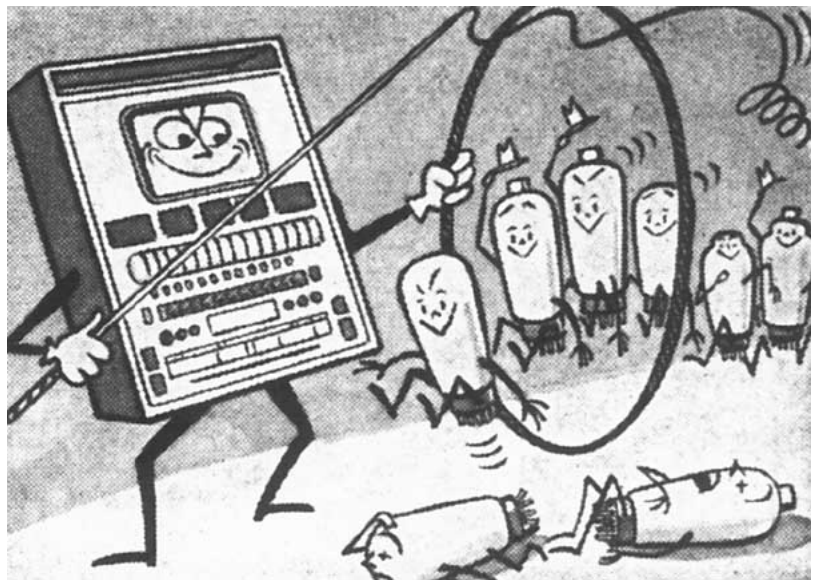

This photo shows a 300B without glass bulb whose plate has been cut with shears to examine its internal structure. We clearly see that a spire of the grid is greatly deformed and moreover the spraying of emitting coating on the filament is totally irregular and goes beyond the grid's structure down towards the base, making proper operation of the tube impossible.

by **J.C. Verdier**
Laboratoire J.C. Verdier

The producer of tube amplifiers has a very difficult task to fulfill. It is an important affair because the satisfaction of the customer is in question. That satisfaction is most often based on a simple criterion explained as follows: "Some years ago, I bought an amplifier, it is good and works well" — or, unfortunately: "The amplifier I bought is not good because it always fails."

We all know that failure in an amplifier is practically always provoked by the power tubes and for two main reasons:

- a) The tubes are used beyond their official characteristics of voltage, current and power.
- b) The tubes are used properly but they show inferior characteristics due to defective manufacturing.

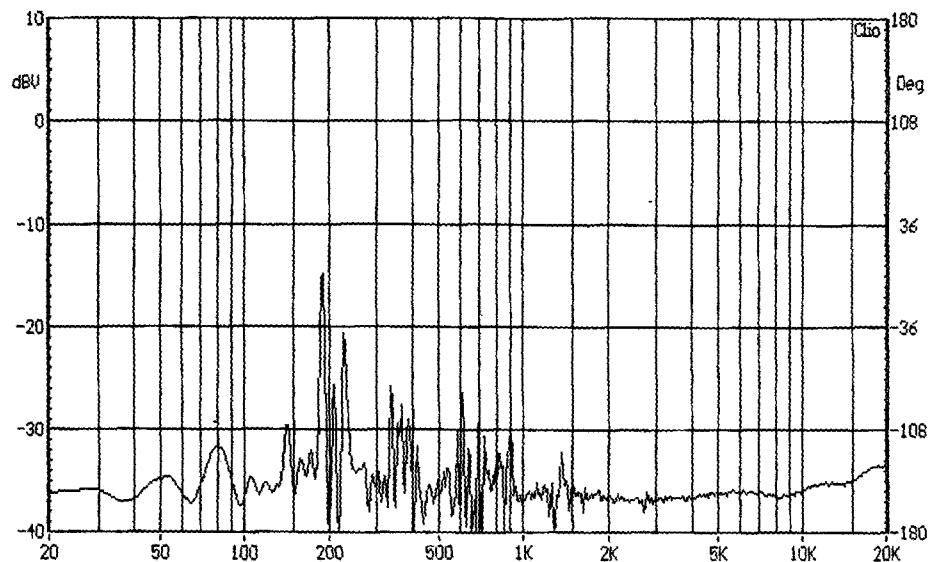

That 300B - high quality construction - but atypically the graphs show a preponderance in the resonance of the filaments and support wires located at about 200Hz while the grid's resonance is attenuated.

By artistically mixing points a) and b) we can easily produce some marvellous electronic fireworks.

The a) point can easily be improved, it is sufficient to take a safety margin in the value of B+ applied on the anode of the power tubes, without forgetting that for a main voltage of + 10% the B+ voltage will follow the same increase. Yes it is easy now, but only 10 years ago a customer was very shocked if we presented a push-pull amplifier with 6BQ5 with less power than 17 Watts or another one with 6CA7 unable to give 50 Watts well packed as in a parade like in the RCA handbooks.

Yes the customers understand that now, too much available power has to be paid for swiftly, even very swiftly, by serious failures, and today the push-pull with 6BQ5 gives 8 to 10 Watts and their elder brother with 6CA7 stays around 25 Watts. There is only one problem, that kind of circuit is considered old-fashioned in light of triode single ended amplifiers with direct heating. Among them, the amplifiers with the 300B tube are the most numerous and when I approach that famous and magic number—300B—I enter the heart of my subject.

The 300B triodes, hard to find some years ago, are now the subject of diverse offerings from various sources. The manufacturing qualities, the ability of the producers, and the often very high prices are each subjects for investigation. I have to answer them very carefully for myself at any moment to always keep the quality/price ratio of my product attractive. To get the answers, I put in place a special checking process dedicated to the 300B. Four different chapters will follow, they must take place at least on lots of 10 pieces to be significant.

APPEARANCE TEST

That begins by the measurement of the weight of the tube—a simple scale for letters will be enough. That measurement is very indicative of the global quality of manufacturing, because it indicates a possible tendency to quibble on the materials quality used, even if a material such as glass or steel should be a very low cost compared with the price of a finished tube. That fact is extremely indicative of a certain frame of mind of the manufacturer.

Very mediocre result (the worst result we obtained). However, the tube placed at work does not show its weakness of composition during listening tests.

After that come esthetic appreciations about the fitting inside the glass bulb. The perpendicularity of the bars relative to the mica parts reveals a careful assembly. On the contrary, if we have a repetitive and visible failing of perpendicularity on several tubes, we have to look forward to poor performances as regards characteristic dispersion and linearity.

Examination of the micas is also important. Split or nicked micas are the result of a less careful assembly process. In that case, some mica parts bounce around inside the glass bulb. We must look carefully at the glass where the dumet wire leads pass through the glass stem. If the tube has received big shocks during transport, the glass can chip, leaving tiny bits of broken glass to jump around inside the glass bulb. That last incident is unfortunately frequent and sometimes it is a real heartbreak to see cleanly manufactured tubes damaged in transit as a result of inadequate packaging.

The problem of inadequate packaging is quite impossible to solve because that work—really fundamental—is often left to an incompetent and changing staff impossible to suitably train.

The previous observations can be made on the whole tubes. To pursue the examination, we must break the glass bulb, of course that will be made only after all the measurements described below are finished!

When the glass bulb is broken, we have to open the plate with very little cutting pliers—in order to avoid deforming anything—and observe the grid and the filament. The grid must not show any distortion.

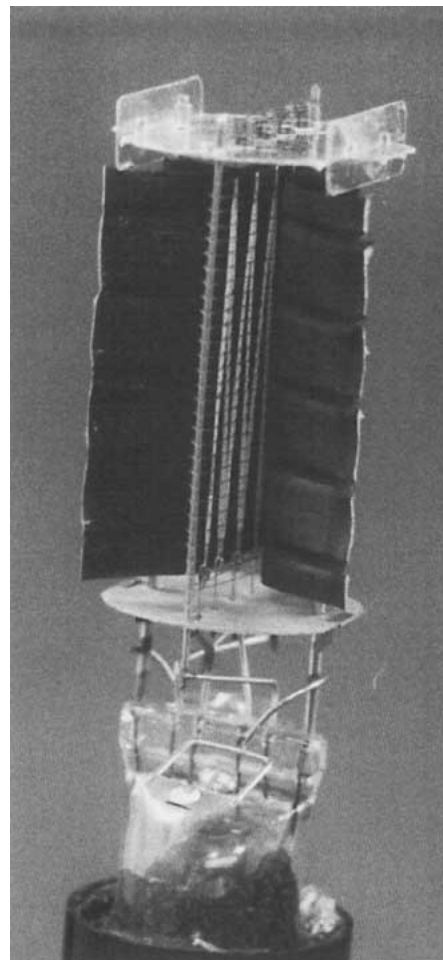

This photo shows a 300B with a regularly spaced grid and evenly applied filament coating. A little part of the emitting coating has flaked off the filament wire and is missing, but this is the only defect noticeable in this tube.

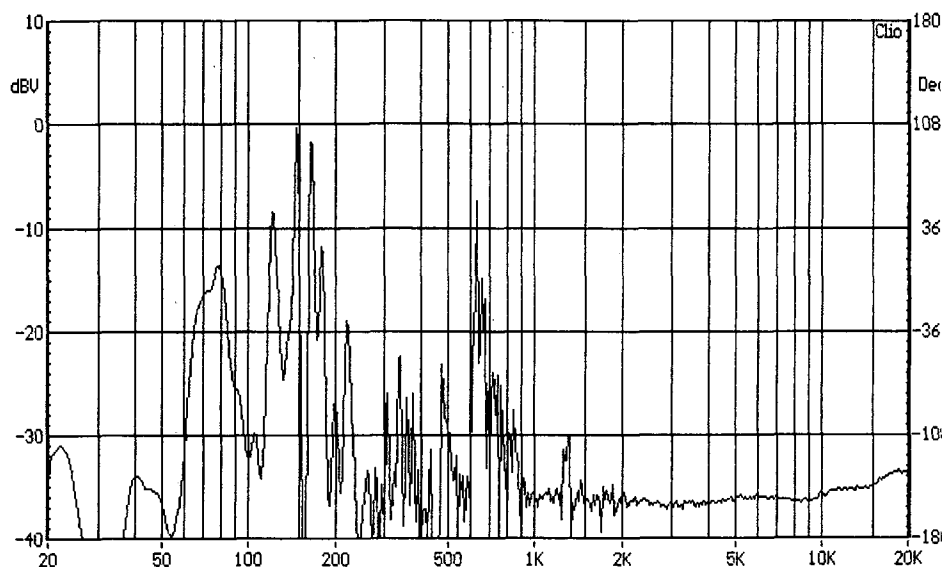

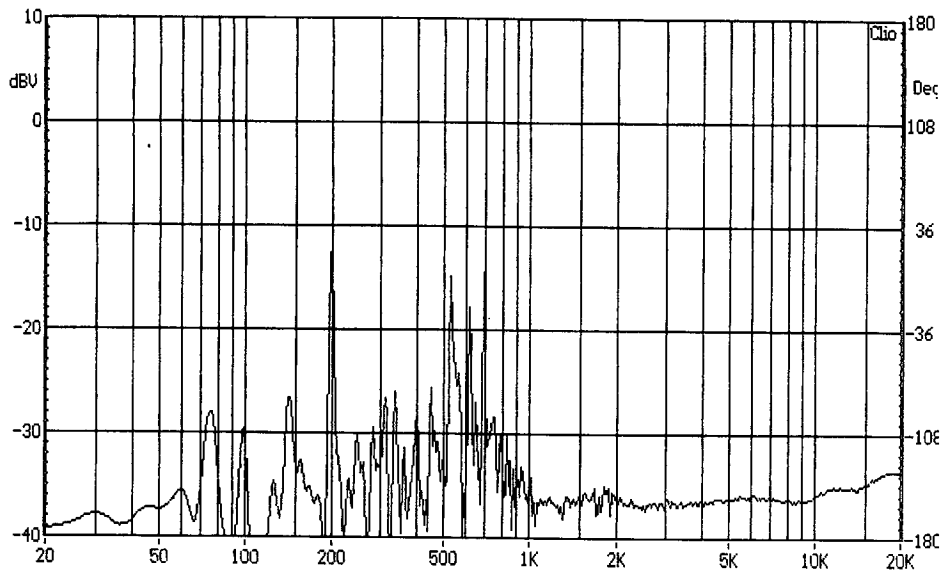

Very honorably good and typical result, it indicates precisely that we are facing a high quality production unit.

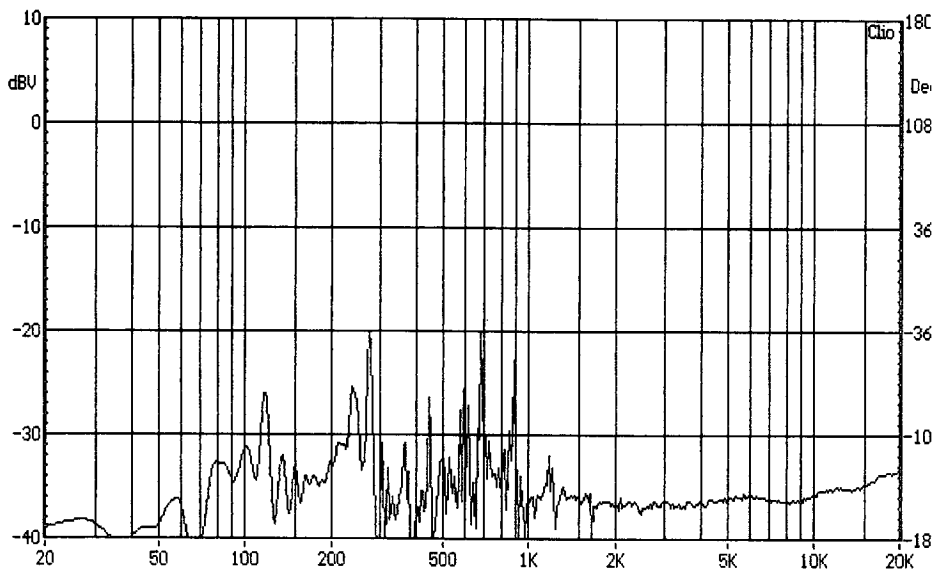

The best result obtained on those first measurements. Good blood cannot lie.



Sometimes we see that a grid spire has been hit unfortunately and that the two next grid spires are shorted together leaving a large free space for electron flow.

Another common failure is the spraying of the electron emissive coating. It is applied too high on the filaments, leaving a surface of emissive cathode more or less above the grid, which is then unable to control the electron's flow. That defect combined with the first one gives a tube

Installation prepared for the microphonics measurement. The loudspeaker is placed as near as possible to the tube. The components are locked in place so that the measurement conditions are repeatable.

where the grid is not able to control completely and continues to let flow a little current even for negative grid voltages as we will see during the electrical test.

Failure of the visual tests as described above is a bad sign and the forecast of a rapid deterioration before the final cut.

MEASUREMENT OF CONSTANTS:

Amplification Factor, Plate Resistance, Transconductance

Computers help the producers to automate complete measurements of the tubes. Before that it was unthinkable to make complete measurements because of the very substantial time investment they could take.

A good technician could draw a network of power triode characteristics in about one hour (if he worked as quickly as possible) with a conventional instrument such as our METRIX U61. Probably the same operator could have taken some liberties interpreting results—how can he reject a tube as he made the measurements of it in one hour? A capable technician would probably beg and implore us to avoid making him do stupid work. So, this was the reason why it was not possible to measure all the tubes systematically. Like I described above, times have changed.

Now, with an ordinary PC and a system such as Audiomatica's CLIO, one can measure and record all the characteristics of tubes in a way which is nearly a pleasure. Matching is made easy by superimposition of the characteristics and it is possible to appreciate the linearity given by the tube when it is in place on the amplifier. We clearly see on the drawings the colossal differences between a very good tube, an acceptable tube or a completely bent tube. And more, we can expand the base of the curve by the variation of abscissa scale and remove any doubt.

Those who imagine that 300Bs having the characteristics shown on the graphs are rarities make a mistake, I meet some of them during any measurement campaign. That failure is provoked by the imperfections described in the preceding paragraph about the step of the grid and the spraying of the filament.

In fact that failure mode provokes a flatness of the signal for sine waves which wears the grid towards the very negative areas, near cut-off. That gives an important increase of "pair" harmonics (the ones which are pleasant for everybody), we have to ask a question on this matter: is that failure provoked deliberately by the manufacturer of the tubes to give a warmer sound to his product? [Nah, I think they just messed up. -ed.]

MICROPHONIA

All the 300B tubes have a tendency to be microphonic. We used to tap on the glass bulb to check this parameter, but I think a measurement is better.

The setup for the measurement I devised includes the following: a good size power amplifier (1 X 70W Monobloc in class A); a loudspeaker able to receive the power (JM LAB Profil 3); a test amplifier (2300B modified) to power the tube we have to test.

The CLIO is programmed to come out and analyze 5 consecutive salvos of MLS sound. That signal is applied to the 70W amplifier which modulates the JM LAB loudspeaker itself placed as near as possible to the 300B tube under measurement.

The amplifier carrying the 300B is prepared for the measurement, the grid of the 300B is wired to the ground to prevent signals coming from the preamplifier stage from disturbing the measurement. The output of the amplifier is connected to the input of the CLIO which makes a FFT analysis of the MLS salvos of sound and shows the average measurement on the PC screen.

During the measurement, the operator has to wear hearing protection. That noisy test is very indicative of the rigidity of the tube's internal mechanical fitting. We can see important differences between productions with microphonia sensitivities varying up to 20dB for one model to another.

Examination of the graphs also shows that there are 2 main resonances. One is due to the filament movements and is generally situated about 150-200 Hz. The other has about the same magnitude but a higher frequency (about 500-700 Hz) which corresponds to the grid vibration.

It is clear—listening tests show it—that a less microphonic power tube is better when we listen to it, for a simple reason: if electrodes are mechanically unsteady and move and vibrate according to the violent sounds provoked by our measurement,

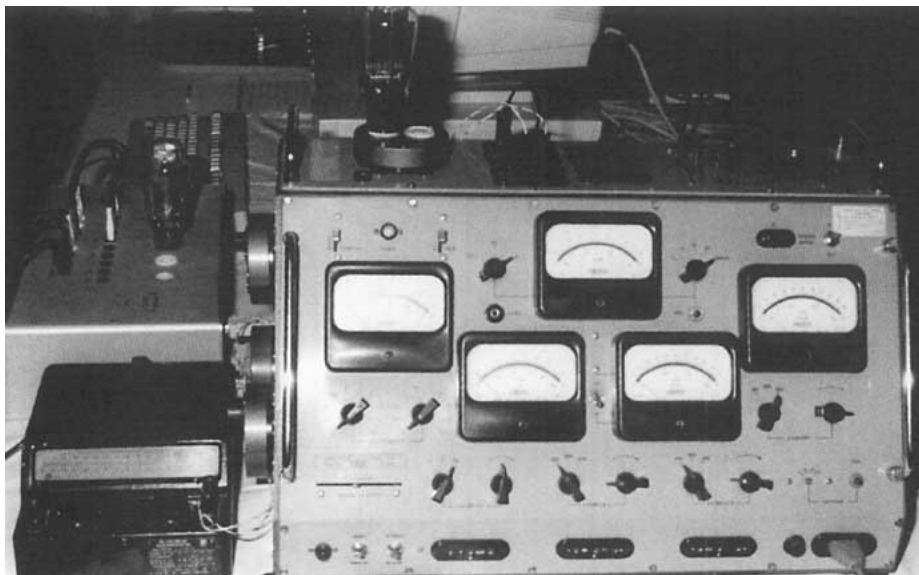

Test bench for vacuum measurement



M. Hiraga looking at the spotlight galvanometer to read the grid current

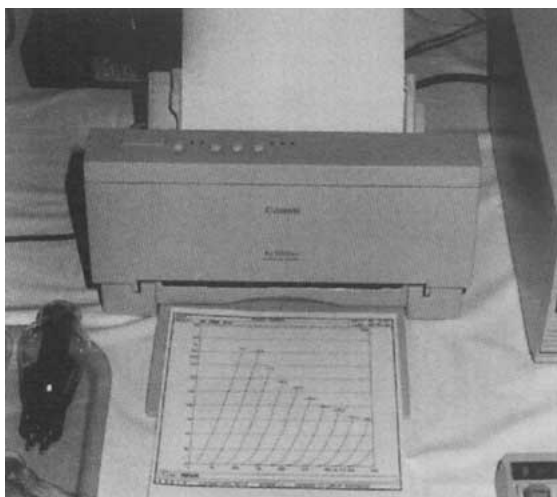

Printout of plate characteristics

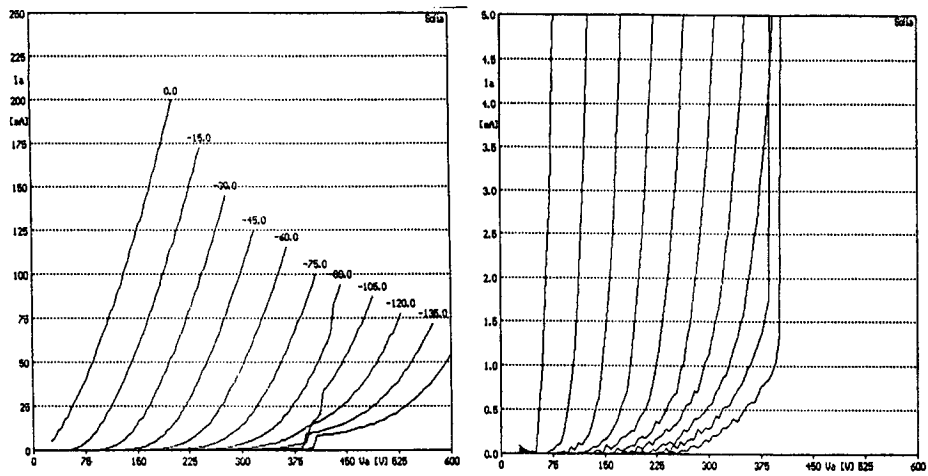

With this tube, the confusion reaches height. But we have to be honest about the cause—we dropped this tube through clumsiness and all the internal structure is twisted due to the fall. Absolutely suited only for listening to hard-rock music!

N° of sample	Ionic current (nA)	Vacuum factor	Note
1	50	0.5 x 10 ⁻⁶	New
2	32	0.32x 10 ⁻⁶	New
3	55	0.55x 10 ⁻⁶	New
4	135	1.35x 10 ⁻⁶	Twisted grid
5	7	0.07x 10 ⁻⁶	Used
6	30	0.30x 10 ⁻⁶	Used
7	75	0.75x 10 ⁻⁶	Very old
8	65	0.65x 10 ⁻⁶	Very old
9	275	2.75x 10 ⁻⁶	Unsteady vacuum

Measurement chart of the ionic current

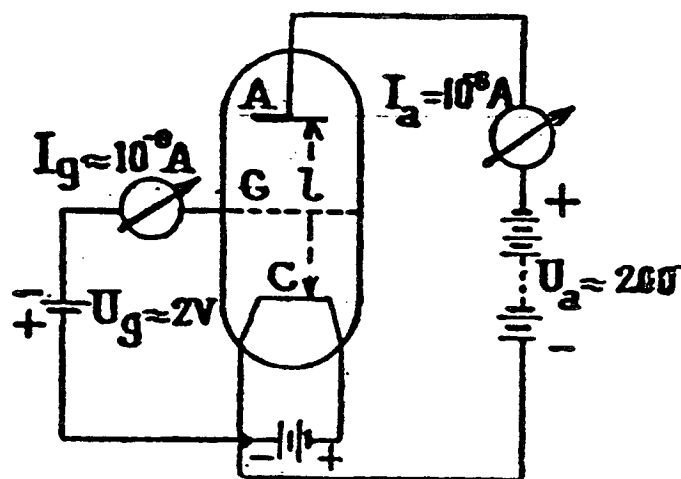

Fig. 2. — Mesure du vide.

Original schematic from Barkhausen book for the vacuum measurement

they also move when they are at work for a musical reproduction, perhaps according to the variation of the internal electric fields. However, this explanation is a hypothesis, it remains to be demonstrated scientifically.

MLS NOISE

The CLIO System provides a noise called MLS. When we listen to that noise, it seems to be a random white noise. In fact there is nothing random about it. It consists of a blend of sinusoidal signals of differing frequencies, carefully arranged and repetitive. The repetitive nature of the noise signal allows the analysis system to operate very swiftly due to recognition of the amplitude and the phase of the signals it processes.

COMPARATIVE VACUUM TESTS

A good vacuum is essential for electronic tubes. A poor vacuum reveals defective manufacturing. It can mainly indicate that there are leakages—certainly tiny ones—but they will shorten the lifetime of the tube. It also indicates that the manufacturing process is not completely perfect and has not been properly finished.

A bad vacuum does not allow stable work conditions, especially since it promotes ionization of internal areas when high voltage is present. Perhaps it is useful to explain the process of pumping modern tubes to clearly understand the whole problem. The method I describe here is a digest of a very complex reality which can be different from one manufacturer to another and also according to the model of tube.

After being completely assembled (but without its base) the exhaust pipe of the tube is connected to a double pump system fitted in series consisting of a primary pump producing a rough vacuum and a molecular pump producing a strong enough vacuum to allow heating voltage and high voltage without formation of electrical sparks between the electrodes.

During the pumping, the tube is surrounded by a coil excited by a high frequency current to heat the electrodes by induction. Simultaneously, the electrodes become red hot due to the high frequency heating, the oxides sprayed on the filament are reduced to form the final cathode emitting electrons, and the getter (a kind of little cup containing magnesium) is evaporated by the heat.

Thanks to this process, the last gas inside the electrodes is drained off and captured

by the magnesium of the getter which contains them when settling on the internal part of the glass bulb by condensation to form a reflecting area like a mirror. After all those operations, the tube is cooled and installed on its base, and it will undergo the final formatting operations of the cathode and all the tests dedicated to show its good working or its rejection.

Now, I present all my apologies to the specialists of tube production who read the previous prose which doesn't do justice to the incredible complexity and the astonishing know-how in action to lead the operations I described with so much simplicity.

For example, two or three things I know or believe to know: The production of the 'mixture' coated on the filament to form the future cathode consists of about 300 different chemical components which must be perfectly pure. The vacuum is considered as good for a value of 10^{-6} mm/Hg. To obtain that figure, it is necessary to eliminate a proportion of 1,000,000,000 gas molecules for 1 remaining. Yet the remaining molecules number an amazing 28,000,000,000 by cubic centimeter of "good vacuum."

The comparative measurement I propose seeks to underline the presence of those undesirable gas molecules by bombing them with the electronic current of the tube in function as shown on the diagram.

We see that the plate becomes positive by a voltage coming from an adjustable regulated power supply while the grid receives a negative voltage of -50V. The voltage of the plate is adjusted for each measurement so that the plate current is always 100mA. A micro ampere meter is inserted in the grid circuit and indicates the concerned measurement by the following mechanism: The grid being negative pushes away all the electrons moving between cathode and anode, but it attracts and captures the positive ions produced by the shocks resulting of the impact between flow of electrons and undesirable gas molecules remaining in the glass bulb.

The ionic current indicated by the micro Ampere meter is compared with the whole electronic current and shows a number we call vacuum factor. Theoretically it is possible to calculate the real vacuum (in mm of Hg) from this vacuum factor and to consider the dimension of the different electrodes, but that precision does not concern us here, as we are comparing tubes of the same type with

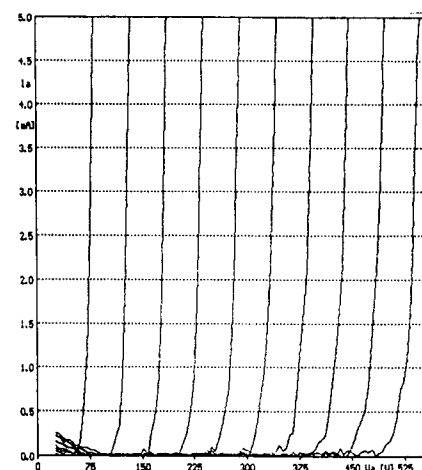
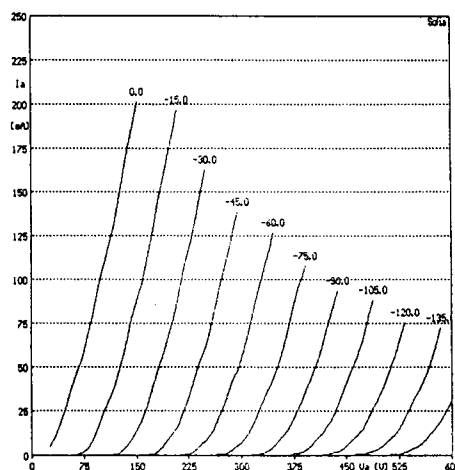

Characteristic curves of a quite perfect 300B. Left graph shows the complete curve, right graph shows the dilated curve (limited at $I_p = 5\text{mA}$). We clearly see that the plate current is completely controlled. The irregularities of this curve are due to the internal noise of the measurement system and do not reflect on tube quality.

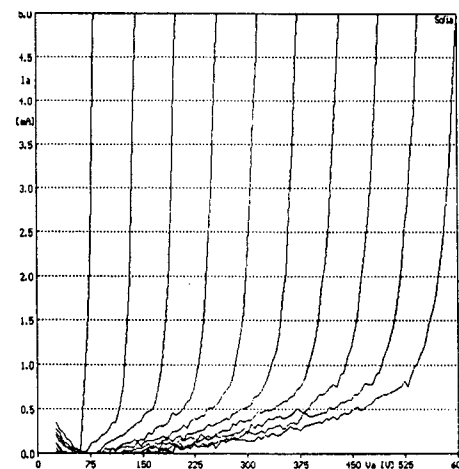
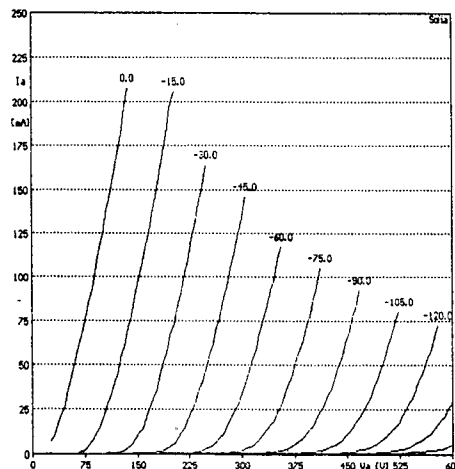

Here is a tube which is perfectly usable, but whose grid assembly has a defect. It is practically impossible to cut the anodic current while the plate voltage is $> 200\text{V}$.

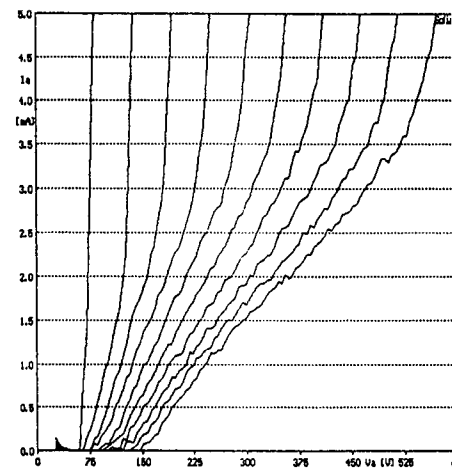
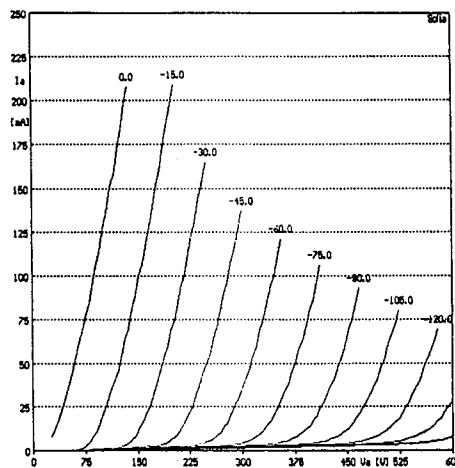

The same failure mode as above, but here it would not be possible to use the tube. This failure can be easily detected with a classic tube-tester. The current we obtain is higher than the norm and we could believe that the cathodic emission of the tube is of the best quality. Unfortunately, this is a bad interpretation. The actual cause is a serious problem in the coil geometry of the grid.

practically the same characteristics.

During these measurements, I made interesting and amazing observations. Very used tubes generally have a better vacuum factor than the new ones. The ionic current of a new tube, abnormally high at first, is stabilized after some minutes of work at a correct value. I found only one tube with a bad vacuum, unsteady and higher than the average. No doubt that the vacuum is the most delicate parameter to obtain but it is also the most watched during production.

CONCLUSION

The reader will have noticed that all the measurements published in this article are only given for example, no trademark is mentioned. The reason is that some of the results were very bad. I could not do it without the agreement of the firms concerned, because I risk big reprisals. I would like to publish in a future issue of *Sound Practices* a truly comparative article. To do that, it would be necessary to receive samples from the producers or distributors with the authorization to publish the measurement results. I think that it will be difficult to put in place, but one is always allowed to hope!

The best midrange horn available
can now accommodate any driver!

The edgarhorn 300 Hz Round Tractrix Horn

Hand-turned from Western Maple

2" dia throat (EV, JBL, TAD)	\$1200 pr
1.4" dia throat (Altec)	\$1200 pr.
1" dia throat (TAD, Altec)	\$1300 pr

edgarhorn

22113 S. Vermont
Torrance, CA 90502
310-782-8076 voice
310-371-8085 fax

RIBBED FOR YOUR PLEASURE.

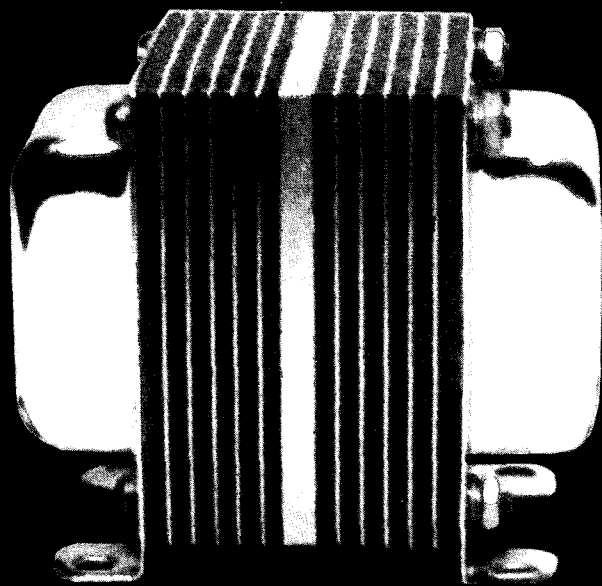

But enough about you. Let's talk laminations. Inserting the right amount of nickel lams between M-6 steel lams allows more musical detail through. We call it Pinstriping. And we have a variety of models to choose from. If you want to go all the way, try our all nickel parallel feed transformers. Either way you'll have an orgasm. Call 215-288-4816 to order yours now.

MagneQuest

HANDBUILT TO PERFORM WITHOUT EQUAL
MAGNEQUEST, 1404 E. BRISTOL ST PHIL., PA. 19124

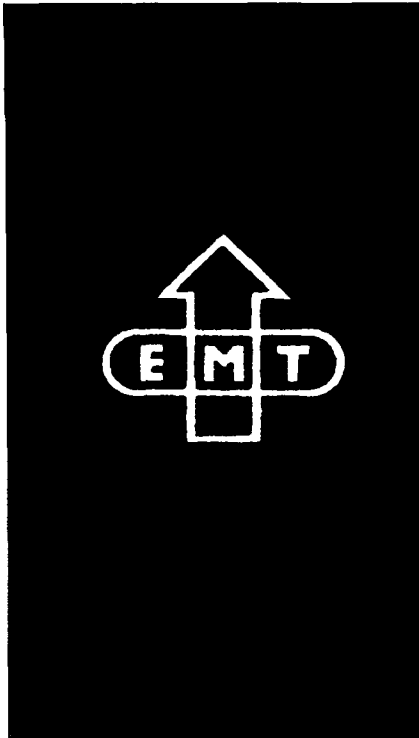

THE EMT927 & EMT930 TURNTABLES

by Heiner Jakobi

The early version of the EMT 927 (remember that in the studios the 927 was named R-80!) had no phono EQ built in and no PS to feed one. An EQ had to be ordered as a separate unit, called the EMT V-133, or V-83 in studios. This was a mono unit. In its early version it used metal tubes and then later the venerable ECC-40, an early kind of 12AU7 but much better and very dear these days!

There was a “measuring version” of the R-80, which has a glass-rubber mat instead of the standard acrylic platter mat. This mat is considered the best, and I agree fully that it is the best choice for the 927. It was later remanufactured in Japan but with a quality standard not quite up to the original. The “measuring version” was called the EMT 927D. The EMT 927A had an optical instrument that showed you the exact position of the cartridge on the record grooves. This was a very useful tool in the studios.

The next generation of the 927 was equipped with an on-board power supply to power the new EMT 139 phono equaliz-

The 927 (R-80)

Introduced in 1951, the EMT 927 was a massive turntable with an aluminum chassis, measuring 67.5 x 52 x 21.5 cm with a weight of 80 pounds. The platter has a diameter of 44 cm and sits in an amazing precision ball bearing. The bearing shaft is 16.6 cm long and has a diameter of 2 cm! The motor itself is massive. It looks like an industrial motor, 13.5 cm in diameter and 20 cm long! It is a 3 phase synchronous type with phase shifter.

A precision manufactured 3-step pulley is mounted on the motor axis and a precision idler transfers the power from the motor to the inside rim of the platter. The idler wheel can be shifted to the 78, 45, and 33 1/3 rpm positions for speed change. The platter itself is extremely heavy and the mass is distributed mainly along the outer rim. A special motor brake allows for fine adjustment of the speed. The massive power supply can be switched for 110/120/220 V inputs.

EMT turntables come with either 50 or 60 hz motors. However, Japanese and Korean EMT fans use separate oscillator power supplies or rely on the braking system (which allows about +/-10% adjustment). Some give the pulley to a precision metal worker to machine it 1mm down in diameter.



The EMT 927

er. For a short time, Pabst motors were tried, but they were not quiet enough so they went back to the old design built by SMB Metalltechnik nearby, the supplier for most of the metal work for EMT.

Mr. Schundenmeier, the former technical head at EMT died in 1997. I last spoke with him in 1996 and he told me of plans to bring the 927 back into production, but sadly this did not happen.

With the introduction of stereo, the new versions of the 927 were labeled 927st with the 139st EQ. The first solid state EQ was named the 155, with a stereo version 155st.

For a long time, the tonearms used on the 927 turntables were made by Ortofon, as well as the cartridges. The early arms were mono, of course. They can be changed to stereo with some inventiveness (and an old 10" Ortofon or EMT studio arm to use for parts). The early 12" Ortofon-made arm was called EMT RF-297, the stereo version RMA-297. Both arms are straight 12" arms and high mass designs, meant for use with Ortofon-EMT, Ortofon, and Neumann studio cartridges. There is no provision for anti-skating since it is not required for tracking forces above 2.2 grams.

These tonearms were reintroduced some years ago, as the demand from Japan was very high. The later EMT-built tonearm, the 997, was a completely different design—lighter, with different bearings, and not S-shaped but curved. It is a matter of taste which of the above-discussed arms are better, since all of them are excellent.

EMT also built a special version of the 927 turntable, the EMT 927S. It is very rare and very sought-after since it had a provision to use a second 12" tonearm on the back. Some people use, very sensibly, the SME-3012A (original) arm as the second tonearm, allowing the use of not only the studio cartridges but ordinary cartridges as well.

It is also possible to buy empty EMT headshells to fit other cartridges, but the advantage in using the 3012A speaks for itself. The 3012A is THE tonearm for the SPU-Gold or the SPU-Meister (Meistro). If no 3012A is available, then I do not recommend the 3012 versions with the plastic bearings. Go for the later versions with the metal bearings. The late model doesn't match the 3012A in sonic qualities, but it is still a very good choice.

The 927 in all its incarnations is one of the most sought-after turntables in the world.

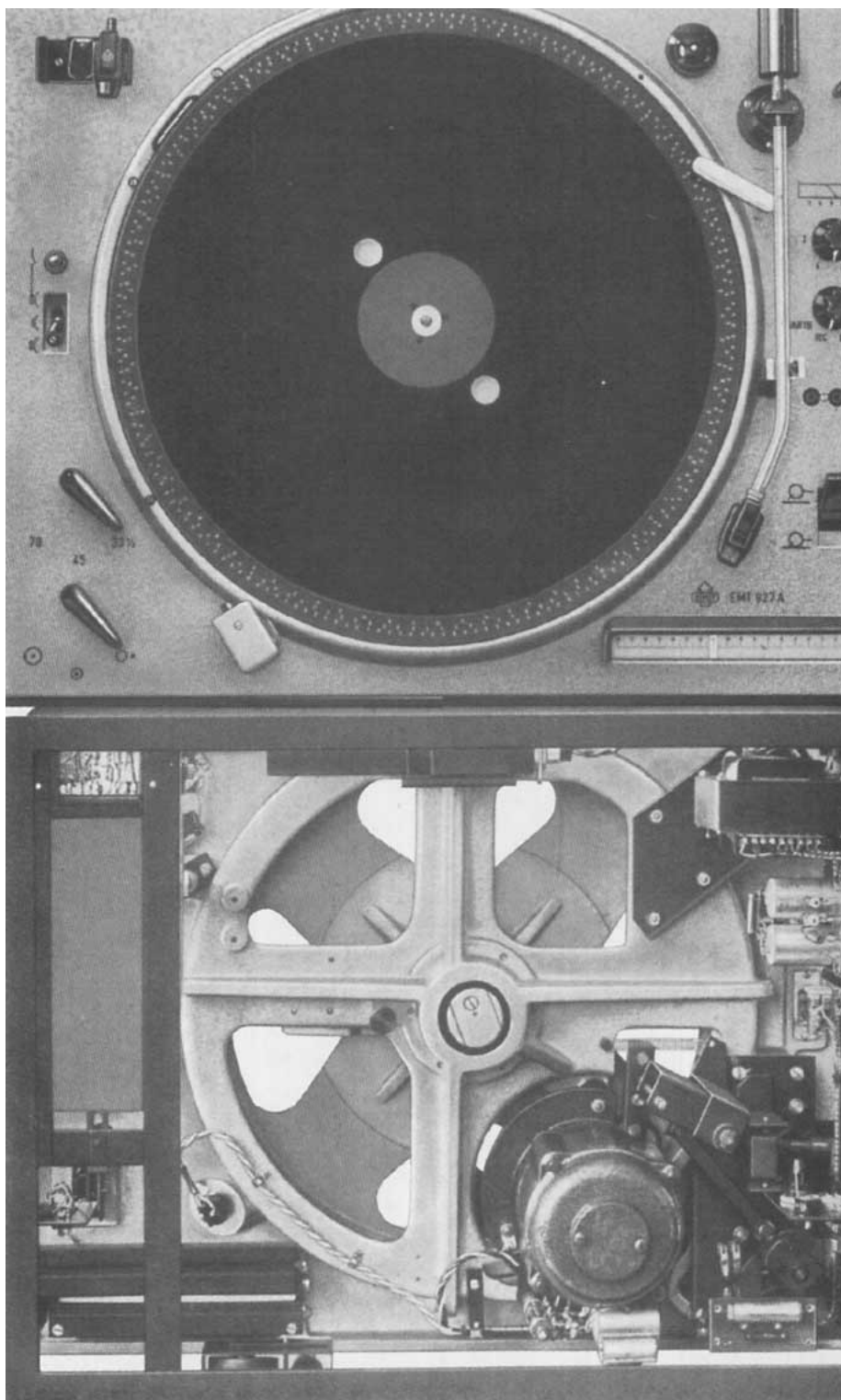

Authority, authenticity combined with stability—that's how I can describe this Rolls Royce (Mercedes) of all turntables.

The EMT 930

Introduced in 1956, the EMT 930 was not intended to replace the 927, rather it was built to meet the requirement of studios that did not need to work with the big plat-

ter of the 927. It had a smaller but very clever chassis made out of bakelite with a 30 cm platter and 10" tonearm. It was built in much larger quantities and is easier to find but nearly as expensive as its bigger brother. It weighs 45 pounds and measures 50 cm x 39cm x 17.5cm. The motor and bearing are a bit smaller than those of the 927, but of similar quality. The 930 motor

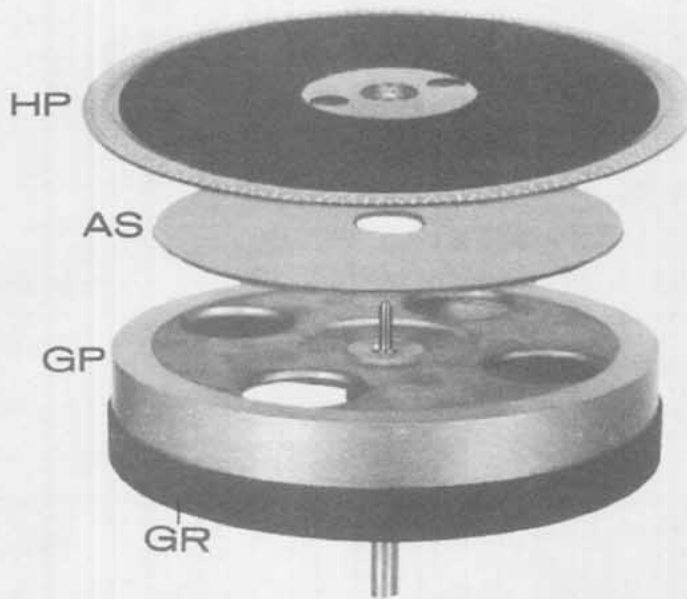

BAUGRUPPEN

- A federnde Aufhängung
- AB Arretier-Bügel
- AS Abschirm-Scheibe
- CH Chassis-Platte
- GP Gußplattenteller
- GR Gummi-Ring
- HP Hilfs-Plattenteller
- HZ Schwenkhebel für Zwischenrad
- LD Lager-Deckel
- M Motor
- RSCH Rändelschraube
- SCH Schaltschloß
- ST Stufenachse des Motors
- V Entzerrer-Verstärker
- ZR Gummi-Zwischenrad

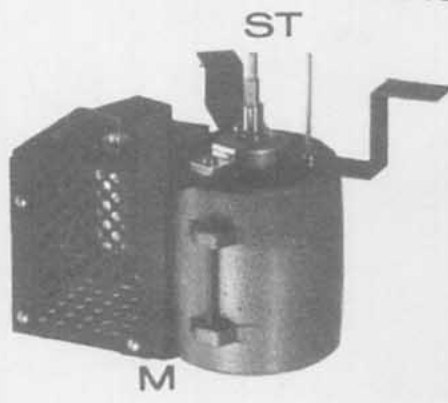
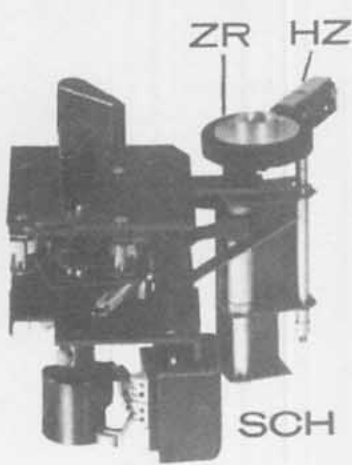
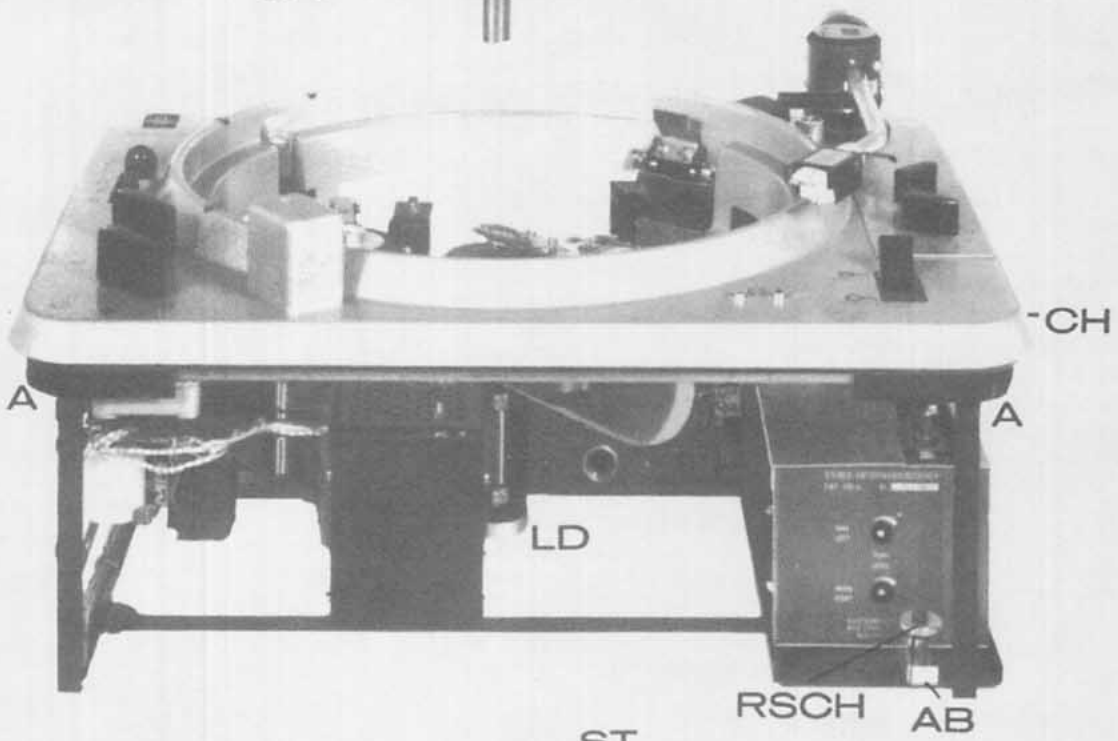

EMT 930: Exploded View

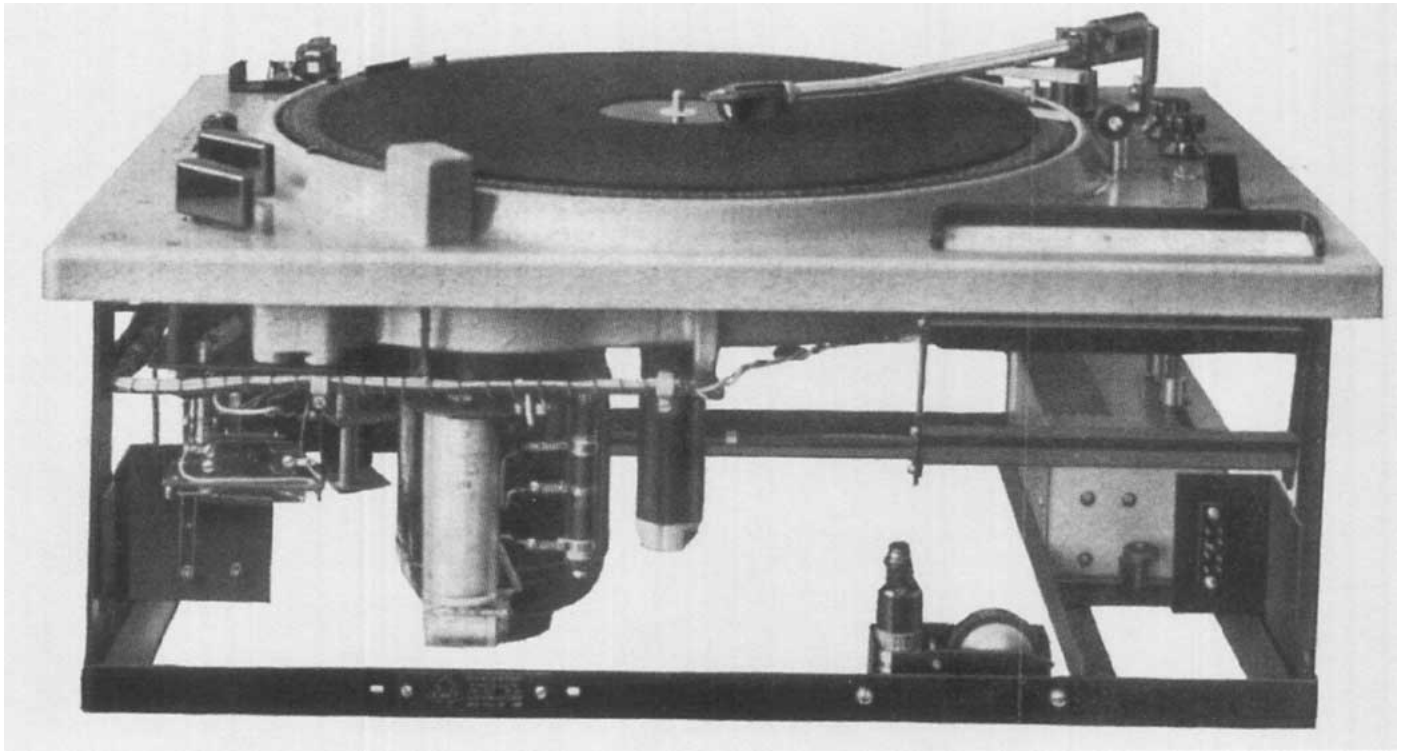

still looks like something out of an industrial vacuum cleaner rather than a turntable. The bakelite chassis is extremely dead, but here I must warn anyone who ever ships a 930 to take the bearing and platter assembly completely off of the turntable. Otherwise, the three arms of the bakelite chassis might break off! If this happens, the only answer is super glue, so this is something to be avoided!

The 930 has one of the best bearings I have ever come across and you can still get spares from EMT! The 930 was equipped with the same phono equalizers as the 927, and here it is time to speak about their quality. They are not all on par with the turntables.

The 139s are very sought after and fetch high prices, but sonically they do not compete with good modern tube designs. The EMT-133/V-83 is the best, if the curve is modified to RIAA. A pair of mono 139As come second, then the 139st. Forget the 155s! The 153s and the Swiss Eymann are better, but still not worth the money. If you find a 927 or 930 with the tube EQ, then sell the EQ. If you find one with a 155 or 153, use the chassis to build your own phono preamp inside. I often used a simple Neumann design with modern parts and first-class Neumann MC transformers (which outperform all transformers I know of) or our own Phonogen design. With the EMT preamps, you can-

not even get close to how these tables perform.

The early Ortofon 10" arm was the RF-229 (mono, can be modified to stereo) and the RMA-229 (stereo). The late EMT-made arm is called EMT-929 and is still available. The stereo version of the EMT-930 is the 930st. Most 930s were eventually fitted with a stereo tonearm.

Be careful with the power supplies! If you have the early model for the 139eq, then you can plug in the 155 as well, but if you want to use the 153, then you will have to

change the pin layout! Same for the Eymann equalizer, which is pretty rare. But again, these equalizers do not give you the full pleasure you can have with these wonderful turntables.

The 930 sounds very similar to the 927, with a little less authority and a bit more speed. The difference is a matter of taste. Of course, the 927 is more sought-after and worth every penny of its higher price. It is the question of whether you prefer to drive a top Mercedes or a top BMW! A Garrard 301 is a good Austin Minicooper.

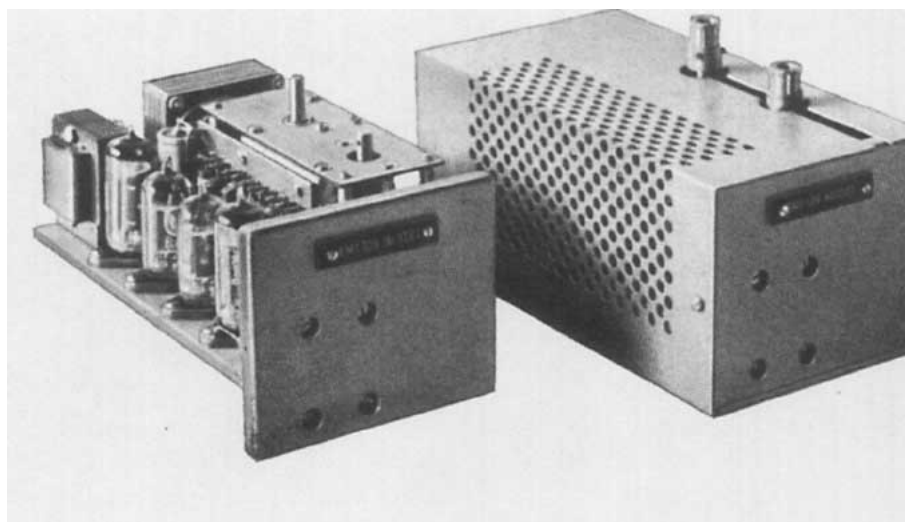

EMT 139 Mono EQ for the 927 Turntable

The EMT Cartridges and Tonearms

As mentioned before, the first EMT cartridges were all built by Ortofon. In German, they are called "Tondosen", i.e. "heads," because they are built into a headshell ready to be plugged into the arm. There is no need for alignment—the correct overhang and angle is given automatically! We have the OF-series and the T-series. The O-series are all mono heads.

When EMT started to manufacture their own cartridges, they kept the same names as when they were built by Ortofon. However, they changed from bakelite to a special magnesium alloy for the headshell material. For 78s, it is recommended to use the sapphire tip because it sounds much better. It doesn't last as long as the diamond tip, but it is much cheaper.

There are several other very famous cartridges built by EMT listed in the table to right. Also turntables: The Thorens TD-125 was built for Thorens by EMT. The EMT-928 is a modified TD-125, but these are not at all comparable with the 927 and 930 units. It would be better to go for a Garrard 301/401 with a SME 3012A or FR-64s.

TYPE	TIP	RECORDS	TRACKING
OF-25	sapphire 25	monomicrogroove	5 gr
OFD-25	diamond 25	monomicrogroove	5 gr
OFS-65	sapphire 65	78s	9 gr
OFD-65	diamond 65	78s	9 gr
TSD-12	diamond 12	stereo	2-3 gr
TSD-15	diamond 15	stereo	2-3 gr
TMD-25	diamond 25	monomicrogroove	2-3 gr
TND-65	diamond 65	78s	2-3 gr

Other Cartridges manufactured by EMT

v.d.Hul MC-1a/b	No longer available
Roksan Shiraz	EMT TSD-15 in Roksan body
Tubafon TU-2	Naked TSD-15
Tubafon TU-2S EMT	Special version of TU-2, the best available and one of the world's best cartridges for a good price
Thorens TMC-63	Head/armtube only for Thorens TP-16 mkIII
Thorens MCH-63	Head/armtube only for Thorens TP-16
Thorens MCH-1/2	90% of a TSD-15, but with a softer suspension for Thorens/EMT tonearm

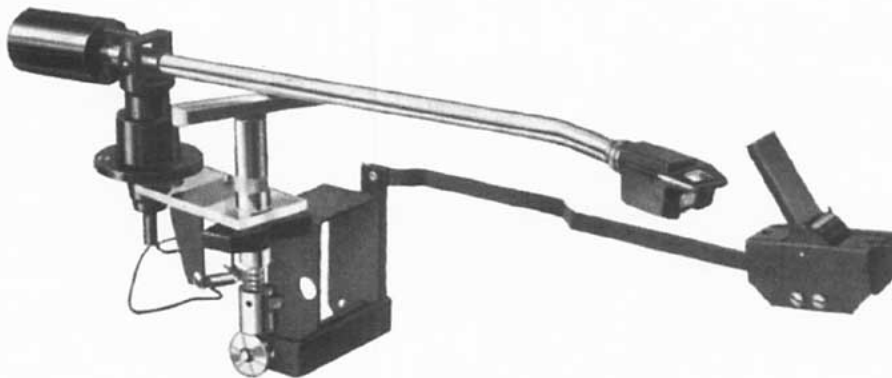

The EMT-Ortofon arm for the EMT 927 shown with arm lift mechanism

Other tonearms that work well on the EMT-927:
SME-3012A, Stax UA-70N and 90N, FR-66s, Ortofon RMG-309
For the EMT-930:

Ortofon RMG-212, Stax UA-7N/cfN, FR-64s—but not the so-called FR-64 shown in SP# 5, page 18!! Please since this is an Audio Technica AT-1503, a very cheap arm, not a FR-64!! The AT-1503 may be OK for a Garrard, but the FR-64 is of a different class.

When purchasing a used arm, it is always wise to check the bearing quality. If the bearings are no good, then you will only get 20% of what is possible! The EMT tonearms will only allow the use of studio cartridges from EMT, Neumann, or Ortofon. However, you can use an empty head to install any cartridge.

If you wish to go for a different tonearm, then the Fidelity Research is the best choice for the 930. You will have to raise the bearing a bit (easily done), otherwise you can't adjust the height of the tonearm as well.

For the 927, go for the FR-66s, the EMT 3012A, or any 3012 with metal bearings. But remember...the old Ortofon arms are being reissued for Japan and sell for high prices there—and there is a good reason for this! The Ortofon heads are wonderful also—as are the EMTs!

Installation

There is an EMT shock absorber frame, the EMT-900, which was designed for the EMT 930. This heavy unit decouples the EMT from any acoustic feedback and resonates at about 7.5 hz. It was designed by Mr. Schundenmeier, and it is still available since an ex-employee of SMB-Metalltechnik started to manufacture them again. The author can offer them at a price of \$1500, which is the price EMT charged for them back in the 80s! The 927 never had a shock absorber frame but it is available now for \$2000. These frames completely isolate the turntables from vibrations and they are very heavy and built in a sophisticated way. If no isolation is needed, i.e. good floors and stands, then a good console (Studer made very good ones) or homemade console will do with no problems.

A homemade console should be constructed with marine grade plywood with a 25.4" x 20.5" cutout for the 927 and 18.5" x 15.35" for the 927. Make sure the 930 sits on the rubber pieces supplied. If they are missing, use round rubber with a diameter of about 7mm between the underside of the chassis and the console. A very useful support for a small custom-made console is the Seismic Sink by Townshend Audio. Never place the 927/930s on the metal frame. It must be sunk into a console or similar setup, or else it will not sound good!

Service of the EMT turntables

All EMT studio turntables are built to run 24 hours a day, 7 days a week, 365 days a year. EMT's service instructions are based on this kind of continuous use. For the normal user, it is necessary to oil the motor and idler bearings every year, and to change the oil and clean the main bearing every 5 years. EMT oil is still available. Of utmost importance is to align the motor, the idler, and the bearing so that they are all parallel in their axis. EMT sold special tools to make this easier, but they are not available anymore, but it is possible to do without them.

Modifications

I only recommend two modifications. First, I do not like the fine speed adjustment and I removed it from my 930, resulting in more subjective clarity and "speed"—same rpm, of course! Then, I do not like the original platter mat. This unit only serves two functions: to read accurate speed with the built-in stroboscope and to stop the record immediately with the platter brake for studio use. This is not usually necessary at home.

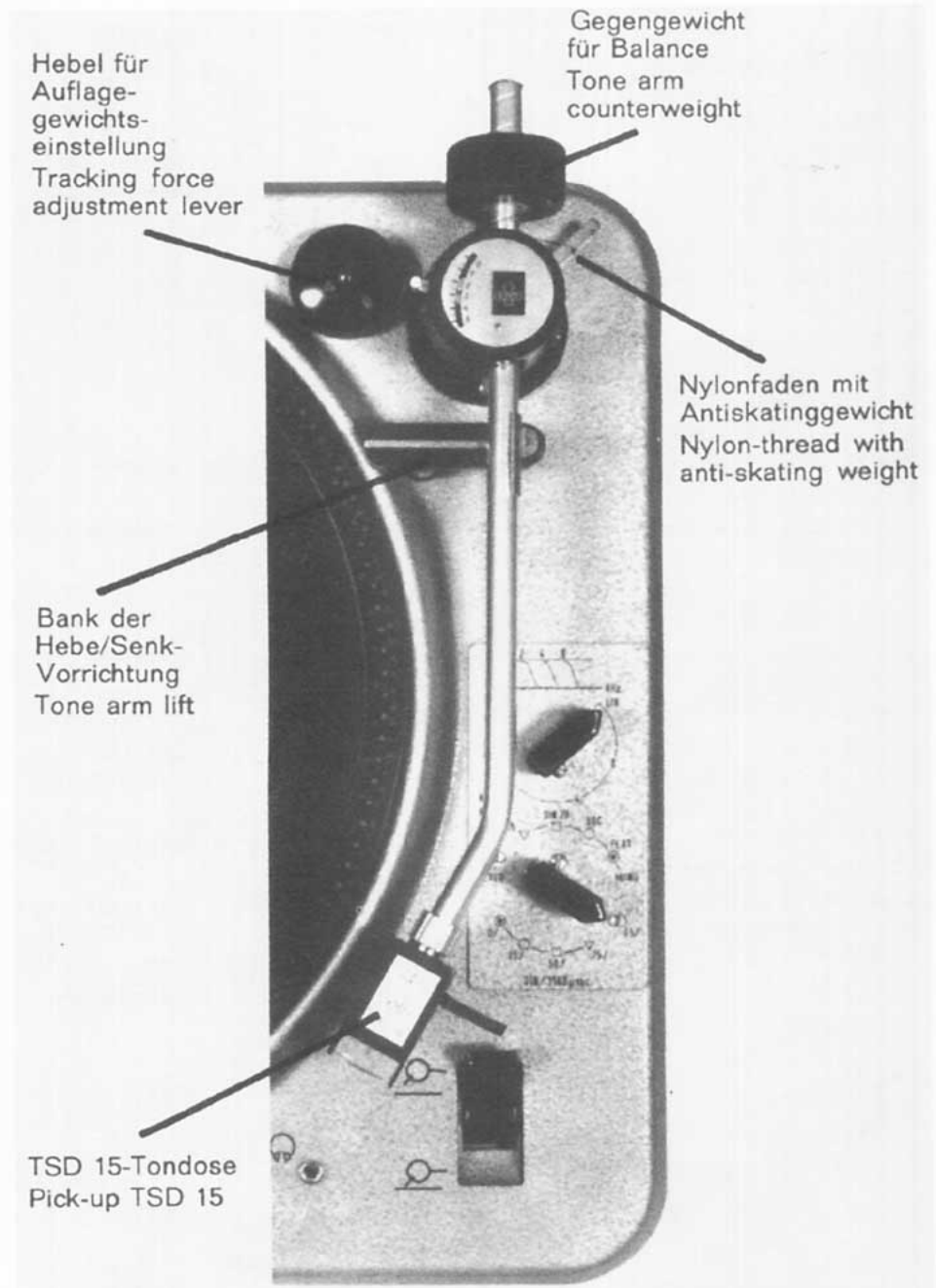

EMT 929 arm on 930 turntable fitted with a TSD15 tonehead

I had best results with an acrylic mat from Sumiko made with a sandwich construction. Both work extremely well and I am sure that some experimenting would bring desired results. I wish somebody would produce a teflon mat like the one on the Well Tempered Signature! If the tonearm sits too high due to removal of the stock mat, then just raise the main bearing. There is 1cm of adjustment available and no disadvantage in doing this. The same goes for the EMT 927 but there the "measuring" glass rubber mat is the best choice. I tried a pure glass mat once but this was terrible. A

simple felt mat is not enough. This is not a Linn or whatever baby turntable.

And, lastly, there are more modern designs built by EMT, but they are direct drive and I never heard one yet that satisfied me! I would prefer a nice modern heavy mass turntable. The good thing about EMT is that you do not lose money! They keep their value or climb up like old WE or McIntosh gear and they are built for a lifetime!

The author can be reached at the following address: H. Jakobi, Alte Schule, 55758 Sulzbach, GERMANY.

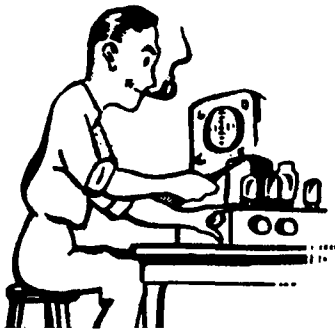

Homebrewer of the month

Thomas Mayer of Munich, Germany

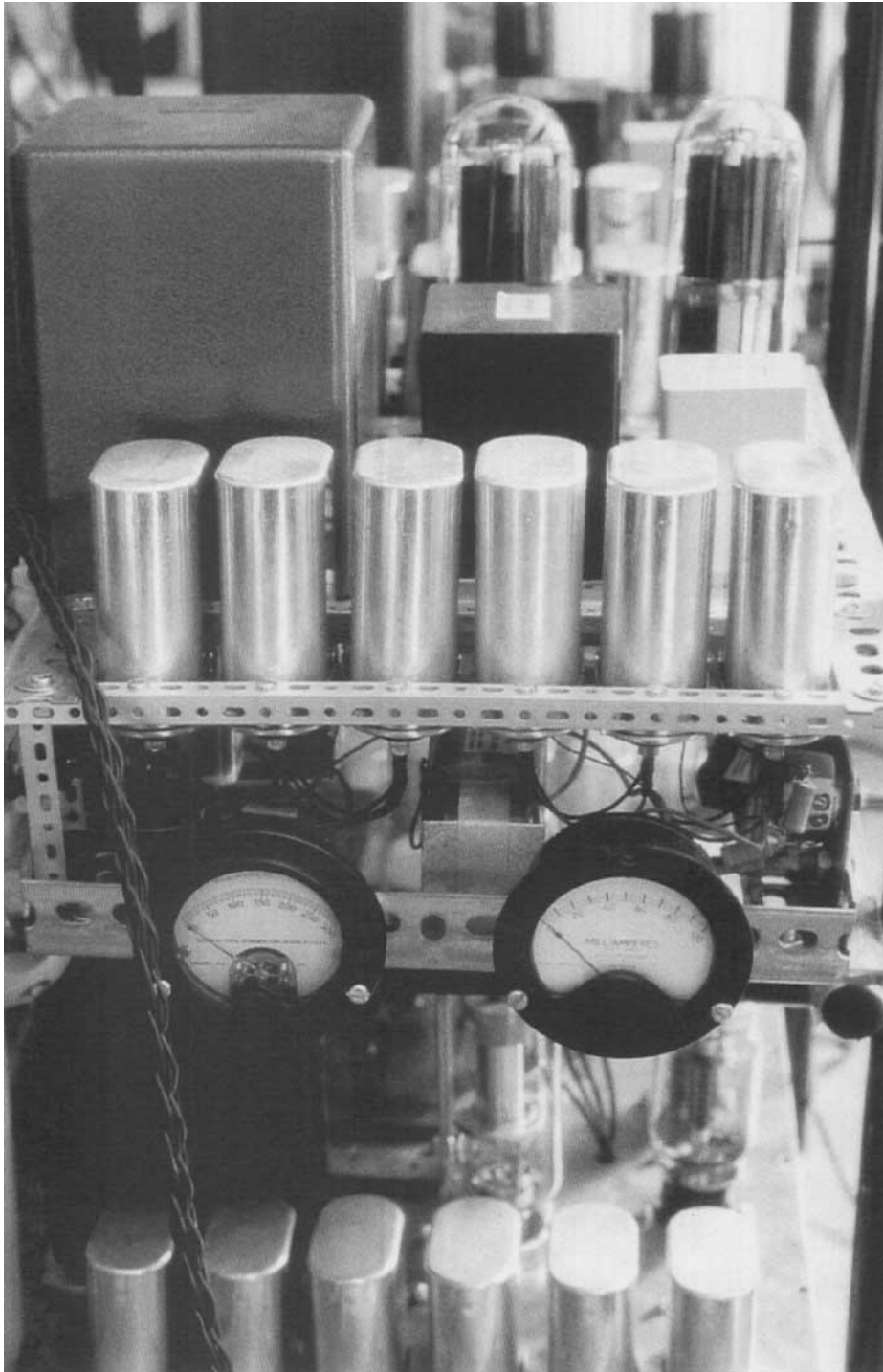

I got into the tube arena in 1989 with some used EL34 push pull amps and an ARC SP9. This blew away the solid state stuff I had before (Threshold & the like). Then, around 1992, I got hooked on single ended with a commercial SE 300B from a small German manufacturer.

When I needed some replacement 300Bs I got no help from the manufacturer. This poor service brought me into the DIY scene. I studied ads of tube suppliers in British HiFi mags and finally ordered some 300Bs from Audio Note. I read about *Sound Practices* in their ad and ordered all issues they had (*SP1-5*) at that time.

This was around 1994. I remember how I was fascinated by all those circuits in this mag. I knew nothing about tubes back then, but I got really hooked. I bought some literature like the *RDH4* and started with small steps. First attempts were 6SN7 and 6SL7 SRPP stages for a DAC (I had fiddled around with digital for a while).

That didn't satisfy me for long and I quickly planned on a SE amp to replace the 300B monos. That led me to the 211 for something *serious*. The 211 was chosen as the output tube for a few simple reasons:

- I already had a commercial SE 300B amp.
- My 92dB speaker could use a bit more power.
- The 211 is easier to drive than an 845.
- NOS 211 are still available, while the 845 is difficult to get.
- It looks cool.

I stayed with the 211 since that very first decision, while I tried out numerous input/driver stages. The first attempts used 6SN7/6SL7 stages in SRPP and mu-follower configuration. I finally dropped these to go for an all directly heated amp with transformer coupled DHT driver stages. I tried the 26, 71A 45 and 46, the 46 being the best solution of all of these. At that stage my amp design was already heavily inspired by Sakuma's artwork. So I decided to go "whole hog" and see what it's all about with his amps using big triodes as drivers.

But there was one problem. The Tango NC-20 which was my choice for the interstage transformer would not handle the DC required by the 211, although the primary impedance would be a good fit.

211s driving 211s

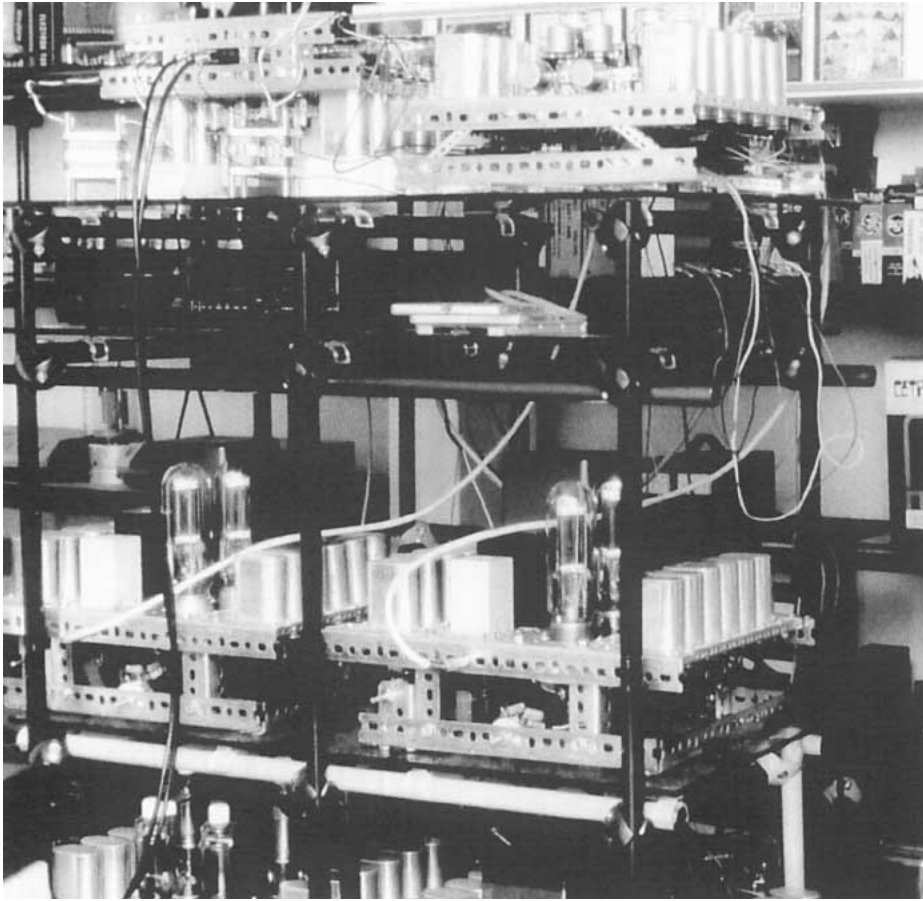

The logical choice would have been a suitable Tamura transformer, but I was reluctant to buy yet another expensive piece of iron. The Tango was too expensive to get a rest on the shelf. Besides that I didn't want to compromise the frequency response of

my amp. Most Tamura's have response figures in the range of 50Hz - 15kHz. This is an area where I don't follow Sakuma's approach. I want at least a "decent" frequency response from 20Hz to 20kHz.

The idea of the DC flux compensation scheme was originally brought up by a friend of mine. When chit chatting about tubes he suggested:

"You're applying the grid bias voltage through the secondary. Why not terminate the transformer with a suitable resistor to ground? The current drawn would compensate the DC unbalance in the primary."

Brilliant idea, I thought, but a quick estimate gave less than 2 kOhm for the resistor. This would load down the driver way too much. But the basic concept kept going through my mind. It didn't take too long until it became apparent to me that I only needed DC resistance below 2 KOhm. So a choke would be the perfect solution.

Now nothing could stop me. I wanted to hear the 211 as a driver. I dug all the chokes I had out of my parts stash and hooked them in series. All I could come up with was 80 Hy for each channel, consisting of 5 or 6 chokes in series. An additional resistor was necessary to get the right current draw. The whole mess was quickly hooked up to the amps. I ripped out the 46 and installed the Jumbo 4-pin sockets for the 211. B+ for the driver could be taken from the output tube through a dropping resistor. The power supply was oversized enough to handle the additional current.

First listening tests confirmed that this approach worked. I understood Sakuma's way of building amps. As he says in his article in SP13: "I understood his philosophy of life."

Despite the smallish inductance on the secondary, bass response was extremely good. The driver tube actually sees this inductance in parallel with the primary inductance. But I didn't want to stick with this experimental set up. After browsing some part suppliers' internet WEB sites, I found the 150Hy/50mA choke from Bartolucci. Perfect fit for my application. It is even wound specifically for plate load choke duty.

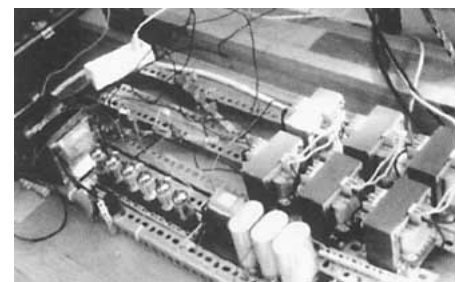
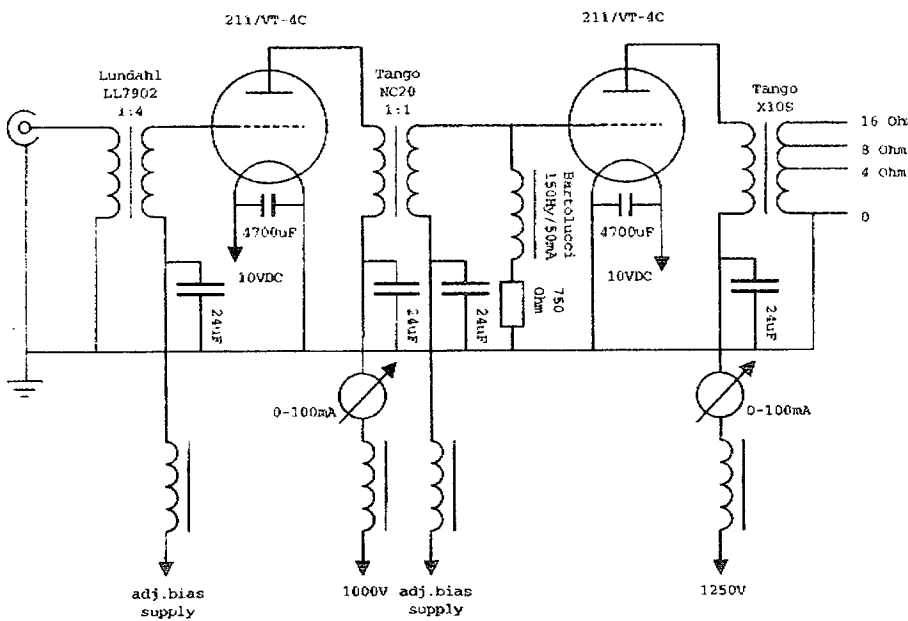

**Above: Three-Phase Power Supply
Left: Schematic of 211/211 Amplifier**

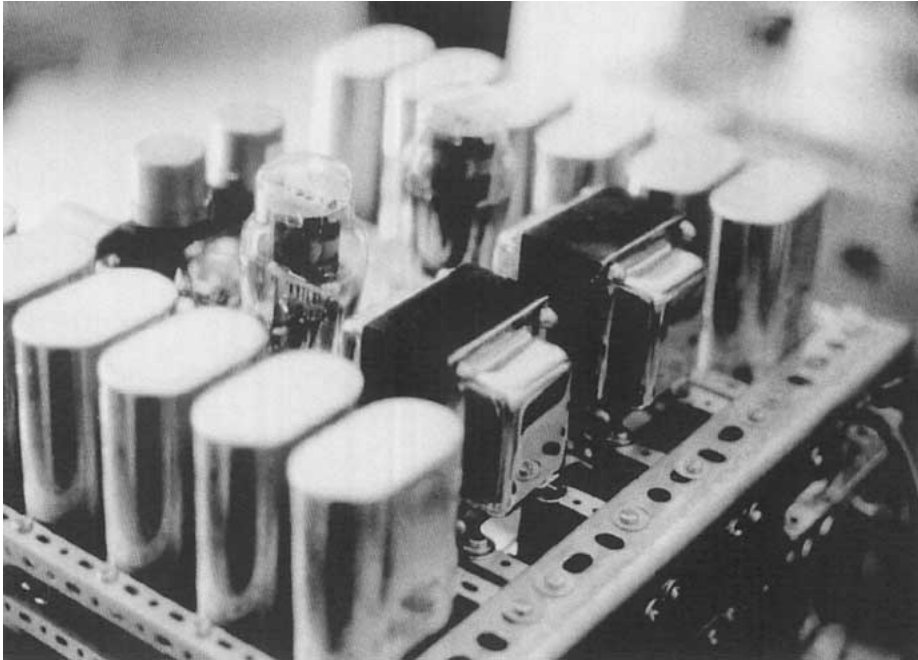

801A Directly Heated Triode Line Amplifier

The NC-20 interstage has a 150 Hy choke with a series resistor shunted across the secondary. This arrangement draws about 50 mA through the secondary from the fixed bias supply. The NC-20 is only rated for 30 mA and this DC flux cancellation trick is necessary to use the transformer with a 211 running at about 60 mA.

With the Lundahl 1:4 step-up transformer at the input, the sensitivity of the amp is about 1V RMS for full class A1 power. With the IT coupling and low impedance of the bias supply the output stage can be pushed quite far into class A2 territory.

These amps suit my personal taste perfectly. My design goal is to achieve an emotionally involving reproduction combined with high resolution and transparency.

The poly phase high voltage supply

Whenever I browsed the RCA transmitting tube manual, I was always fascinated by those complex poly phase rectification schemes in the introductory section. Serious study of that subject revealed the advantage of such a supply over conventional single phase solutions: Much higher ripple frequency at the output of the rectifier and thus higher effectiveness of subsequent LC filtering stages. With three times the ripple frequency, the AC resistance is three times higher for the choke and three times smaller for the capacitor. That translates into 9 times the efficiency for a single LC stage and 81 times less ripple for a LCLC filter!

I chose the 3-phase full wave bridge configuration as this has the best ratio between transformer secondary voltage and rectified DC voltage. I had three transformers on hand which provided 600VAC and 2* 6.3VAC for the heaters. A perfect fit!

Rectified voltage after the bridge is about

1250VDC. With the six separate heater windings I could tie all cathodes of the rectifiers to their heater to stay within maximum cathode-heater voltage ratings. Since each rectifier needs to supply only one-third of the required current, the cheaply available 6AX4GT TV damper diodes can be used.

I used a single set of three transformers and six rectifiers to supply the output and driver tubes of both channels. The supply can easily handle that current demand. A single LC filter consisting of a 10Hy choke and 24uF of capacitance leaves the residual ripple below 100mV. Not bad for a 1250V supply! Each amp has another separate LC filtering section for both driver and output, pushing the ripple into the micro Volt range.

To take advantage of such a ripple free B+ a different filament supply was necessary. I wanted to experience the complete absence of hum. Being no friend of large capacitances and since I like iron in the form of chokes and transformers I built up a DC supply for all four 211s in the amps. After achieving such good results with the poly phase high voltage supply, I tried the same approach. Six transformers along with a good handful of silicon diodes (arrgh!) provide four individual raw voltage supplies. Some dropping resistors bring

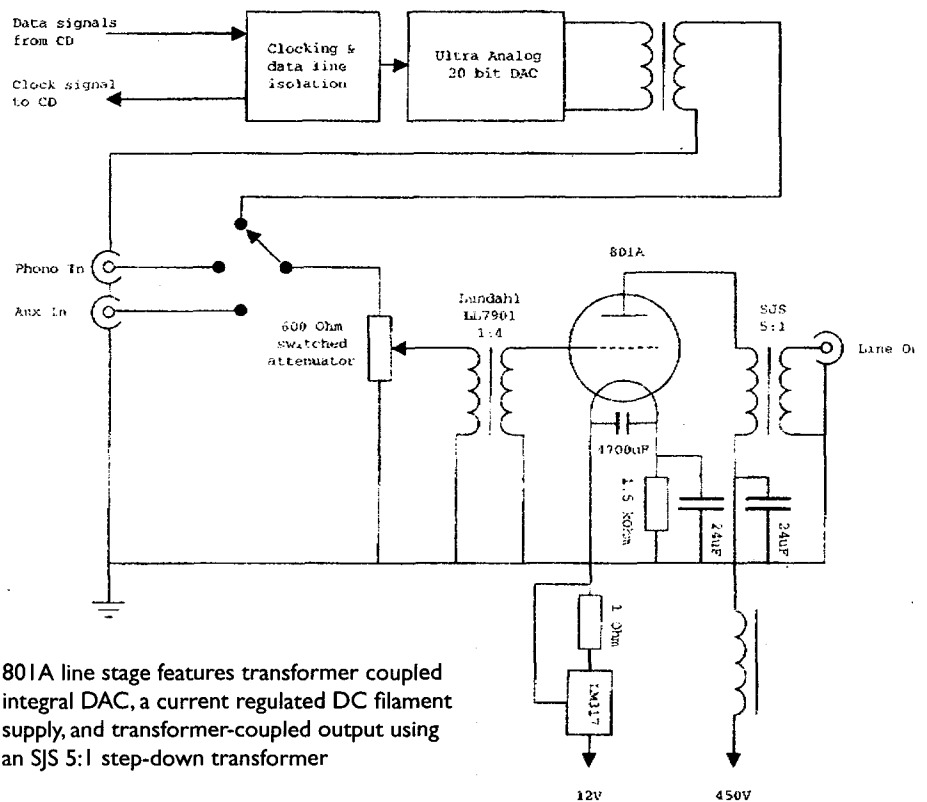

801A line stage features transformer coupled integral DAC, a current regulated DC filament supply, and transformer-coupled output using an SJS 5:1 step-down transformer



Thomas studying the tube manual in an outdoor cafe oblivious to the non-tube electronics oriented chatter of the other customers

the voltage down to the right level. Filtering is done with individual LCLC filters for each tube.

That's right, choke input filtering for the filament supply.

I bought a batch of 0.1Hy/6A chokes from a surplus dealer for this. With the double LC filtering I get away with smallish cap values (4700uF). The result is much better than a conventional supply with large capacitance values and comes sonically close to AC heating. But this silence! I thought I got used to the residual hum

from AC filament supplies, but after this I won't be able to stand any hum from the filament again.

Other remarks

All other supplies (bias, line stage and phonestage) are built conventionally with 83's as rectifier tubes and choke input filters.

As you can see from the photos I use a certain kind of cap all over the place which gives all my creations a similar appearance. This is a 8uF Matsushita "phase shift" cap. I found those cheaply at a local surplus store.

From their appearance I assume they are some kind of oil filled type. Voltage rating is 660VAC and 1250VDC. A bit tight for the 211 output stage, but ok at all other places. I typically use three in parallel, 24uF being my standard cap value. I use this cap wherever the value fits. It always gave good results. Besides B+ filtering I also use it as bypass for the cathode resistor in the linestage. It sounded good in a crossover for a speaker, and a friend reported sweet and mellow mids when using it as a coupling cap in an experimental parafeed circuit.

As the amps and linestage are now past the experimental phase I'm looking for someone to create some appropriate chassis for them.

The SE 211 evolved over the last 4 years. I've tried lots of driver stages and quite a few power supply designs. For the power amp I feel I'm where I want to be. I'll only try out some different parts and maybe an 845 as the output, since the driver can easily provide the voltage swing required for an 845.

I'll definitely stay with the 3-phase power supply and I'm even thinking about trying this approach for linestage and phono as well.

The line stage is also quite evolved and I think I'll stick with that configuration and also with the 801A.

What still needs some work is the phono stage. I want to get rid of the electrolytic

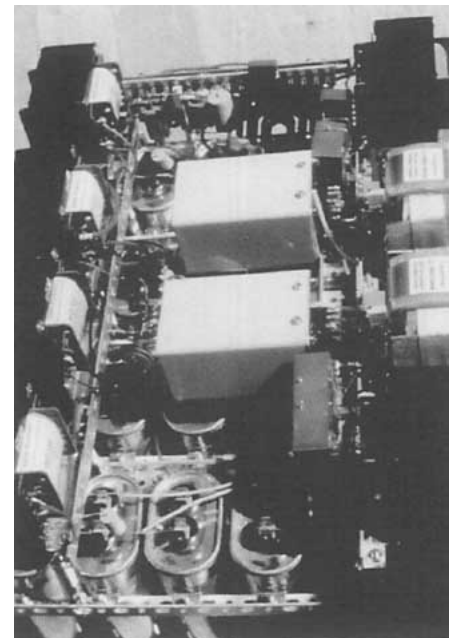
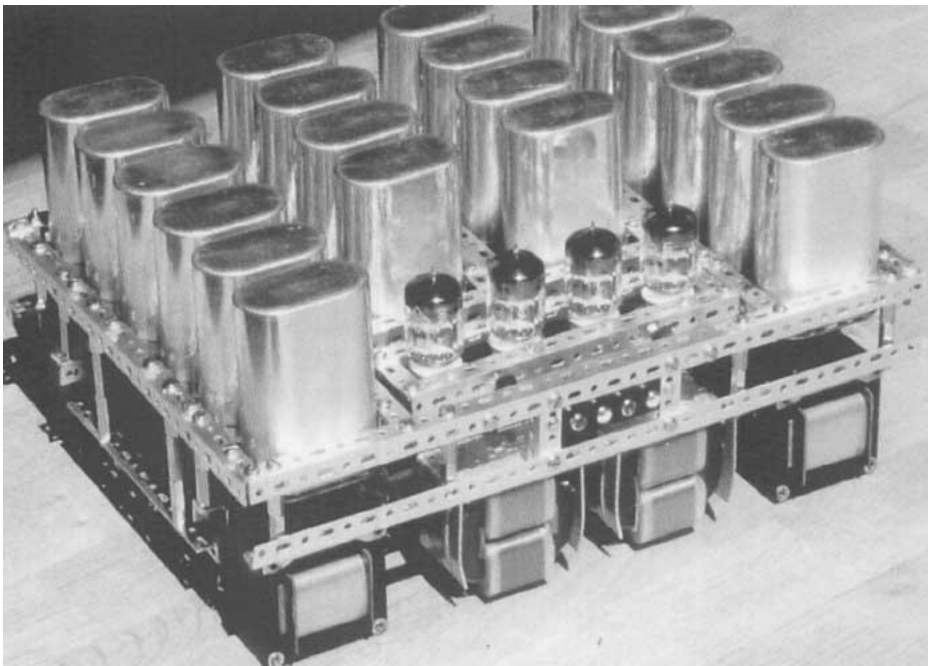

Top and Underside Views of Herr Mayer's Phono Stage

The World's First Mechanically Tuneable Power Cord

... it just looks like voodoo.

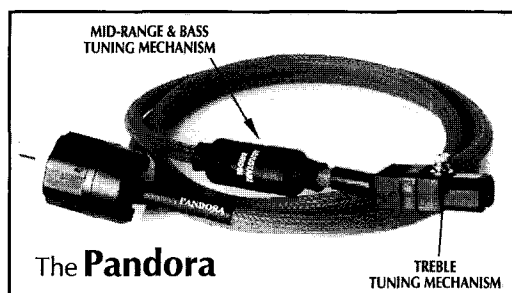

Continuously tuneable from the Lowest Lows to the Highest Highs

by *VansEvers*

The VansEvers Co., Inc. • 1250 E. Hillsborough Ave. • Tampa, FL 33604 • Ph: 813-239-0700 • Fx: 813-239-0805
vans@tampa.mindspring.com / www.vansevers.com

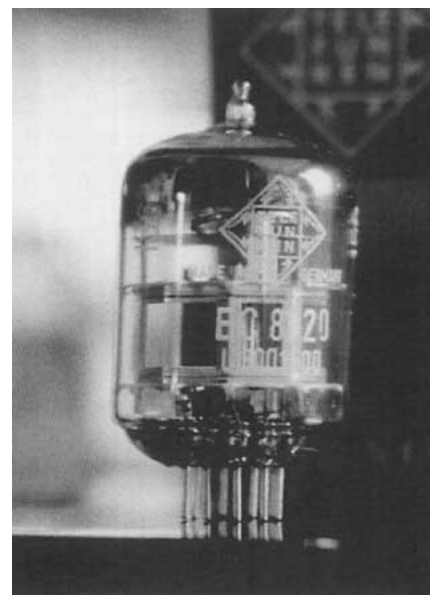

Telefunken EC8020

cathode resistor bypasses. I have some different biasing and grid decoupling schemes in mind which can use cap values in the 8uF range (so I can use my favorite cap here). And what's finally missing are decent chassis. I don't want to stick with this prototype look.

The speakers are a design I created together with a friend back in the late 80s. It is a two way bass reflex with a unique German woofer (Podszus-Goerlich) and a French kevlar tweeter (Focal). Sensitivity is 92dB. I love this speaker for its extreme transparency. I want to try out horns some time though.

The only commercial component which I'm currently using is a Well Tempered Turntable with a Sumiko Blue Point. When the current projects are completed I'll start all over with some new stuff. I stashed away enough tubes during the last 4 years to build amps for the rest of my life. Next would be a low power amp based on tubes like the 10 or 45 to go with some horns.

The current phono stage is mainly meant as an attempt to gain experience in that field. I already got some small signal directly heated triodes (acorns and subminiature type tubes) for that. First trials proved to be way too microphonic and noisy, so I wanted to try an easier route first with indirectly heated types. But the DHT phono stage will be the real challenge!

ITALIAN

AUDION

A journal of Audio Technology

Vacuum tube electronics - Loudspeakers Esoteric Hi-Fi - Vacuum tube history and update news. **Issues 1 to 15 available.**

Many kits available: Stereo 300B single ended.

Easy pre phono and line.

Loffin & White 2A3. Stereo VU meters.

Many lodspeaker's kit. Monoblock push pull 5881, ++ more and more...



Please ask for list of issue of Audion, books (schematic diagrams etc.) and our kits

GIAMPIERO PAGNINI EDITORE,
Piazza M. Aldobrandini 7 50123 Florence - ITALY
Tel and voice fax ++39 55 293267





Sound 'a la Renoir'

A Line Preamp using Type 10 Directly Heated Triodes

by Dominique Mafrand, Paris, France

Things are not always doing what we imagine them to be doing. This is particularly true with audio. We don't always understand (perhaps we don't want to?) why they are doing what they do, rather than doing what we were expecting. Either we try to understand what happened so we benefit from the smoke given off to learn a bit more or we don't want to and remain with wrong conclusions.

How many times have we experimented with designs and felt disappointed with the results? My experience was no exception. Aside from smoky designs to exploded caps, I have managed to complete some pretty good sounding gear. When I don't solder, I read audio books and magazines. Mainly *Sound Practices*. Not only do I enjoy reading it, but thanks to the mag, I designed my current preamp and power amp among a lot of other stuff.

I favor simple designs because the fewer components along the signal path, the more information goes to your speakers! In that way I have admired M. Sakuma's PP845 amp and M. Shishido's Loftin-White style 2A3 amp. These are very ingenious designs indeed because you can feel each component has been precisely inserted in the circuit. I mean the right count of right quality components at the right place, and almost best of all the minimum amount of caps. Which is not to everybody's taste. But trust them if you don't want to trust me: you do hear a HUGE difference with shrewd simplicity. This is REAL music reproduction.

If I had to summarize my choices with regard to audio, I would say DHT and permalloy transformers for preamp and amp, and paper cones, alnico magnets, and open baffles for speakers. And monophonic reproduction because listening is at least as rewarding as stereo can be, and it is less expensive! In my opinion, nothing sounds more natural and more unstressed than a combination of the above. Basically I usually go for single stage or direct-coupled two-stage circuits, and output transformers. I don't like caps of whatever technology along the signal path and try to avoid them as long as I can.

With the preamp I would like to talk to you about, I use paper cone alnico powered speakers mounted on an open baffle, fed via a Tango permalloy output transformer by an awesome sounding 10 direct-coupled to a 6072 input triode. 1500 milliwatts of pure enjoyment! A Linn turntable, a Phillips CD player and a Sony tuner are sources for the above.

So what about the preamp? I decided to design this preamp around a DHT because I couldn't understand why so few have been done before. Let's be clear: there is NO definitive reason not to use a DHT as a preamp device. Okay, let's begin the demonstration.

Basically, a line preamp gives some gain to audio signals from high impedance sources such as CD or tuner, and forwards the amplified signal to the output under low impedance. The active circuit should have gain enough to provide the amplifier input swing for full power, it should feature some input headroom not to hard clip on transients, output impedance, interelectrode capacitances of active device and noise floor shall remain low to extremely low. And, as mentioned above, component count should prefer-

ably remain minimal.

First, the gain. A DHT features low gain. It is quite absurd to have plenty of gain and to send the amp 20V if 1 or 2 induces amp output clipping! Just send what's enough and that's all.

What about transients, one could ask? Your amp has to work with all the energy the preamp sends: either it works great or it clips on transients hence adapt the gain according to your gear!

Secondly, input headroom. A DHT compared to small-signal triodes needs higher grid voltage at an identical operating point. Therefore, it is no big deal to prevent input clipping by biasing the active device accordingly. By the way, select a DC operating point at high plate voltage and high plate current to keep distortion under control.

Thirdly, output impedance. Not a problem as we are going to use an output transformer. Note that the primary impedance of line output transformers is generally far higher than the plate impedance of DHTs so bandwidth gain will benefit from this. I will come back later on this.

Fourthly, interelectrode capacitance. The grid-anode capacitance (C g-p) is the most difficult point to be addressed. DHTs show high C g-p, but single plate DHTs are good candidates for the job, like the 10 (8pF) or 45 (7pF) for example. Consider them like two 5687 (4pF) in parallel.

Fifthly, noise floor. DHTs heated with pure DC current are as quiet as are any other indirectly DC heated tubes, so just carefully design your high voltage power supply like you usually do.



The Twins...sleeping. RCA 10 in the amp, Sylvania 210T in the preamp.

Conclusion? I chose a 10/VT25 DHT because it has a moderate 5k plate resistance, a sufficient amplification factor of 8, and C g-p is on the low side at 8 pf—plus, I have got some on the shelf! We can do it, folks, we can do it!

THE CIRCUIT

This original circuit has been designed using all of the above rules. It consists of a single 10 whose grid is connected to the stereo (!) input pot wiper via two 1K resistors acting as a stereo-mono passive converter (I'm thinking about increasing that value).

One could think now to connect the DHT plate

to a SE line output transformer and use a DC heated filament to a bypassed bias resistor through a center tapped power pot.

Well, things are not always like one expects. Instead of using a SE x-fmer I have thought about putting a PP x-fmer with one primary half winding as the output x-fmer and the other half as a biasing device. This choice has been considered for various reasons:

—DC resistance values can be kept low thanks to the use of transformer windings you can compare to choke loading, enough to bias and to get huge input headroom.

—Transformer gain is increased by 2 because we work at a constant number of turns on the secondary, but only half of primary turns is dynamically involved.

—Primary half winding impedance is high so a low decoupling cap is enough, and the transformer primary windings will be biased automatically with strictly identical DC current! No grid current drawing on my 10, but it has to be checked on other samples.

However, our output x-fmer must be of the highest quality, that is to say super-permalloy core with very high permeability, because it will work in single ended mode but with the main push-pull x-fmer trade off: non linearity of flux density which induces secondary signal when magnetizing force is very low.

Remember, DHTs don't have much gain so plate voltage won't reach extreme values. Only very high permeability material can help because the hysteresis loop is extremely tight and the slope is steep hence even very low excitations will generate flux variation without audible distortion.

How lucky we are that Tango happens to manufacture this kind of scarce jewel under part reference NP-406N. Let's see the technical chart:

- Core is 78% permalloy, bandwidth with 5K plate resistance of a 10 is about 5 Hz- 80 Khz at +/- 1db, not bad!
- Maximum primary DC current = 40 mA with 1 mA max. unbalanced, okay.
- Primary half winding DC resistance = 540 ohms, which is good.
- Primary half winding AC impedance = 20 Kohms, very good.
- Secondary impedances are 150 and 600 ohms, 600 will be excellent.
- Voltage ratio is 1: 0.123 for full primary winding and 600 ohms output tap, so we are good for a 1: 0.246 in our application, fine.
- And maximum secondary voltage is 3 V RMS, just right!

Okay, we can calculate the average overall gain of our preamp. Average μ of the 10 is 8, average plate resistance is 5 K, so as we decouple the filament load overall gain is:

$$G = (\mu * Rl / (rp + Rl)) * X-fmer \text{ voltage ratio} = (8 * 20 / (5+20)) * 0.246 = 1.57$$

That is to say 1 V under high impedance at the input will give 1.57 V under 600 ohms at the output. We have got it! My amp needs about 0.8 V for full output as many amps do, so 1.57 V is

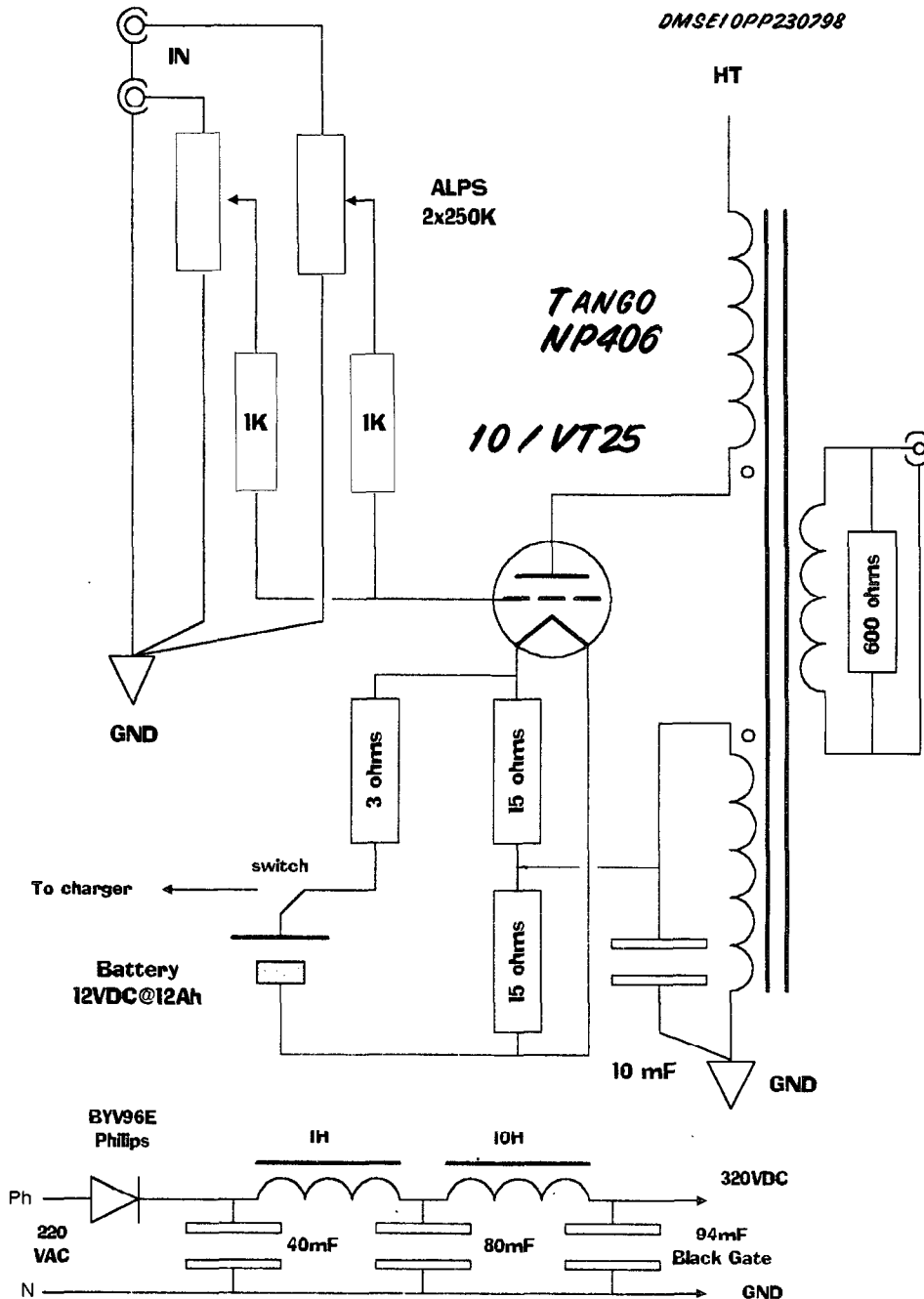

enough to drive it into overload!

This apart, the 10 is working at about 292 VDC plate voltage, 26 mA DC plate current, and it is biased at -14 VDC. With a dynamic load of 20 k Ω , the plate voltage and current swing are in a very linear part of the characteristics, so distortion is very low, the triode works far under the max. power dissipation excess, so we can expect an unusual long life for a DHT, and the grid voltage allows plenty of headroom, so no stress at the input. Note that the low gain and low C_{g-p} help minimize Miller effects.

The ground is star connected. All returns are soldered at the negative terminal of the reservoir cap. I found this method to be as humless as Mr. Sakuma's 2 point ground or Diego Nardi's buss ground method. Secondary winding has no ground reference and it is loaded with a 600 ohm resistor, helping the preamp to act independently of interconnect and amp input loading.

I hate measurements. I just check what is necessary for the circuit to perform well, and then only trust the listening tests. It has been worthwhile so far. So don't be misled with impressive figures, we all listen with our ears not our eyes, don't we?

POWER SUPPLIES

I use a transformerless cap-loaded power supply designed around a single solid state rectifier connected to the mains phase and followed by one smoothing cap, then two LC filters in Pi configurations. Ground leads are to the mains neutral.

We are lucky enough in France to have a 230 VAC mains voltage so a good PSU can provide you about 330 VDC with very low ripple. Solid state rectifiers can sound great provided you avoid transformers! Have you ever monitored voltages at the outputs of a tranny when rectifiers are rectifying? You understand a lot of things after that. Either you try to fix it using John Camille techniques (SP #7), for example, or you do without a power transformer. Also, all noise and vibration caused by a transformer are avoided too! Free bonus!

NOTE: Transformerless so-called AC-DC supplies such as this are quite DANGEROUS and should not be attempted by experimenters unaware of the hazards involved and proper precautions to follow. It is not worth dying to avoid switching noises in the power supply. Use of a transformer for isolation from the AC line is highly recommended for safety. Anyway, in the US we'd need a step up trans to get to 220V, or you'll have to unplug the clothes dryer and plug in the 10s!—ed.

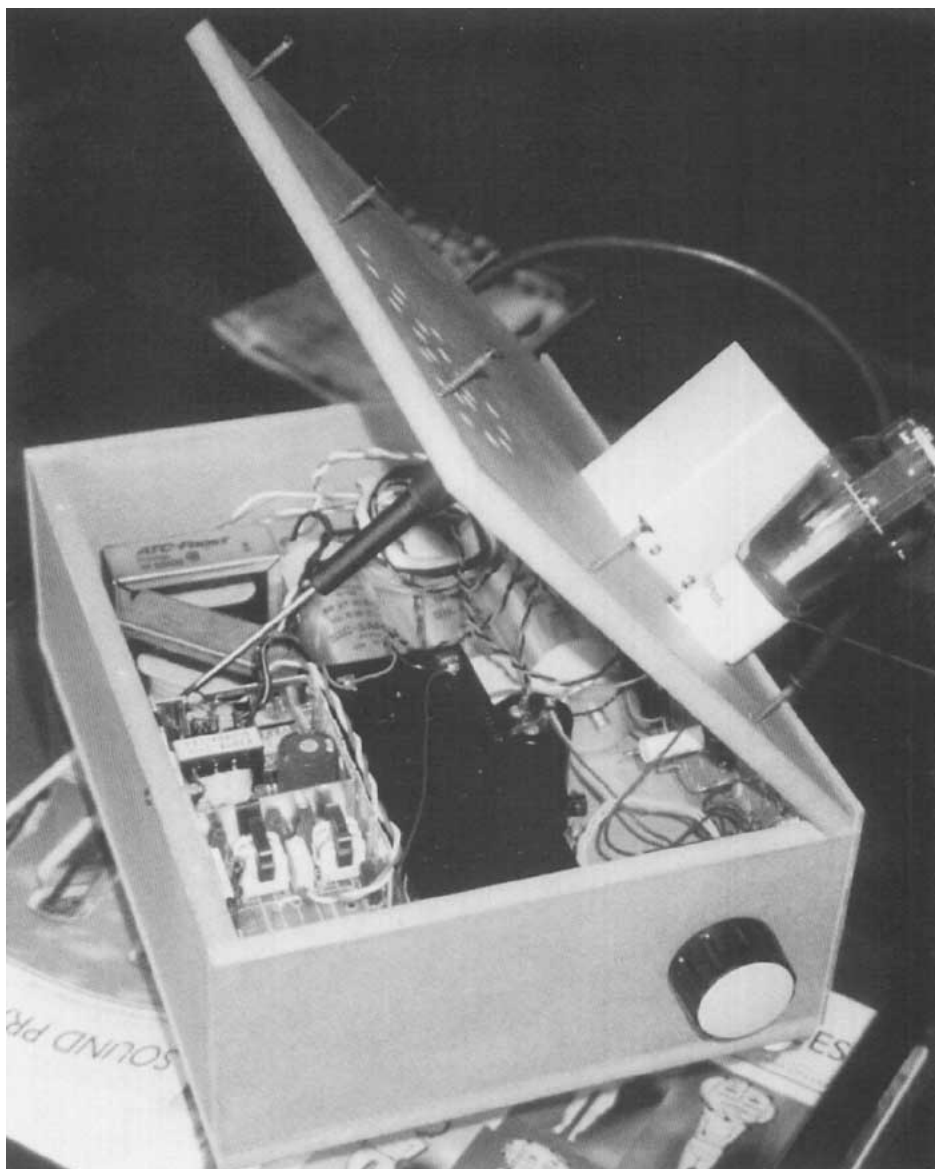

Under the bonnet

Filament is battery-supplied via a 3 ohm power resistor adjusted to provide 7.5 VDC as required, and two 15 ohms 2W resistors provide a center tap for bias connection. You want quiet, you get it!

PARTS AND CONSTRUCTION

I am currently trying various brands of 10 including RCA, Hytron, Sylvania, GE, Western Electric, Visseaux and Neotron both from France, but I haven't got final conclusions yet. I have 10, 10Y, VT25, VT25A (indirectly-heated, cathode-type triode—ed.) and 210T types. I will let you know.

Other fundamental parts are as follows. Resistors are from VISHAY, the best sounding to my taste. Decoupling cap is a 47 mF ceramic powder Cerafine type from ELNA. Others tests will include Black Gate and expensive Teflon

REL-CAP. PSU caps are polypropylene from SIC-SAFECO, France, for the first Pi section and a great Black Gate SKZ type as audio reservoir at the output of the second Pi filter. The pot is from ALPS, but I will probably swap with an Arn Roatcap's or Audiolive's beauty soon. Internal wiring is Kimber Kable TCSS pure copper which I recommend as the best quality-to-price ratio.

Battery set is 12VDC at 11Ah from YUASA and integral charger takes care of battery charging when the preamp is turned off.

Chassis is all made of waxed wood and screws. An insulated enclosure is necessary for a transformerless design to prevent body contact with the electrically hot chassis. Total weight of the preamp is 12 kg or 26 lbs.

LISTENING

Listening to this magic mixture on an open baffle speaker is quite amazing, believe me. The main speaker is a paper cone TRIANGLE full range speaker connected without filters. Note this speaker is faster than a LOWTHER PM6A or C and as natural as these English classics. High frequencies above 12 KHz are reinforced by a paper cone G.E. tweeter from the fifties, and its alnico magnet gives the music that unequalled touch of life.

My favorite musics are jazz, classical and opera.

I listen to rock and pop too but I find pop recordings and mixes so unnatural, so chaotic and so different from one disc to another that I am often disappointed, so I don't purchase many.

You guessed it—the system is unforgiving, if the source is poor, then you will listen to poor reproduction. But if the source is of high quality then you go straight forward to heaven. This is “in the flesh” reproduction, alive like a Renoir painting is alive. You miss no detail, you can touch everything if you hold your hand out.



High Quality High Fidelity Kits and Assembled Products

Largest Selection of Components and Accessories

The Most Informative Catalog in the Business

Celebrating our 10th Anniversary 1988 - 1998

Our 1998 Catalog & Design Manual is now available featuring tons of kits, parts, books, software, schematics, fun projects and the usual info. It's just \$12 U.S. and Canada, \$18 International, refundable. Visa and Mastercard Welcome.

 **Welborne Labs**

P.O. Box 260198 Littleton, CO 80126 USA
tel: 303.470.6585 fax: 303.791.5783 e-mail: wlabs@ix.netcom.com
URL: <http://www.welbornelabs.com>

Products by:

Allen Bradley
Alps
Analog Devices
Brooklyn
Caddock
CAIG Labs
Cardas
DH Labs
EI
Eina Cerafine
Golden Dragon
Grayhill
Hammond
Hitachi
Holco
Hovland MusiCaps
Hubble
IR
Jensen
Kepro
Kimber Kable
Kimber Kap
KR Enterprise
LCR Caps
Linear Technology
Lowther
Magnequest
Matsushita
Mills
Motorola
MultiCap
Neutrik
Noble
OCSL
Panasonic
PFT Chassis
Ram Labs
Roederstein
Siemens
Solen
Sorbothane
Sovtek
Svetlana
TEC-200 Film
Tesla
Toshiba
Vampire
WBT
Wima
and many more...

The trial has been worthwhile, I tried and now I can say: yes, man, DHT and high perm core in preamp circuits do convey true emotion. DHT is emotion, delicacy, life, and no doubt DHT/permalloy will remain unsurpassed as an answer to the true audio quest! But remember—The most fundamental aspect of audio homebrewing is to have plenty of fun! And you can have plenty of music too, if you follow up on your inspiration.

THANKS TO:

All the parts suppliers including Angela Instruments, USA, The Parts Connection, Canada, Audio Note UK, Sound Shop Big, Japan, and Radio Tubes France. tributors to /.

Dominique.Mafrand@wanadoo.fr



HEAR FOR YOURSELF

The film capacitors top engineers and music lovers worldwide choose for their finest designs.

H O V L A N D
MUSICAP®

"If you want see-thru, high definition, detail and listenability, try the MusiCaps."

Joe Roberts, **SOUND PRACTICES**, Issue 6

THE ULTIMATE CAP

The most naturally revealing capacitor. Film and foil polypropylene construction. Optimized for critical speakers and vacuum tube electronics. Silver-plated leads. Values from .01 to 10µF. Precision made in USA.

To listen to MusiCaps for yourself, contact:

- Welborne Labs 303-470-6585
- Modisound Speaker Components 608-831-3433
- The Parts Connection 800-769-0747
- Michael Percy Audio Products 415-669-7181
- Handmade Electronics 610-432-5732
- J Lefebvre & Associates 713-988-4621
- Anchor Cross Co., Tokyo, Japan 81-3-3203-5606
- Wilmslow Audio, England 44-01455-286603
- Tang Hill International Ltd., Taiwan 8862-2-5813605
- Hong Kong Bush, Hong Kong 852-2525-3227
- Octave Electronics, West Malaysia 603-793-793-9
- American Audio Import, Netherlands 31-78-6510567
- OEMs contact Hovland Company at :
ph 209-966-4377 • fax 209-966-4632

Diego Nardi's comments on
Allen Wright's comments
on some comments
made earlier by Diego Nardi...

plus...

The MONOphono Preamplifier

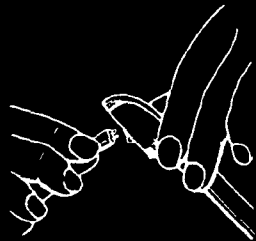

by

Diego Nardi, Audio Note Italia

I'd firstly like to thank Allen Wright for his appreciation and his criticism on my $\phi 42$ design. I like this kind of constructive debate and, therefore, I'll express some thoughts about the points Allen made, one by one.

1) Agreed.

2) Two points: Number one is that high transconductance tubes like the 417A are very attractive at first sight, but they pay a big price for their apparent ability to "resolve charge levels on the order of an electron" [?!]. The first one is that their linearity is rather poor. Also, they can only stand very limited plate voltages on the order of 100V. The only point about high current is that you must use a very low value/high dissipation plate load resistor. That makes for distortion in both the resistor and the tube—low level operation is no excuse!

The second one is that, in order to obtain 25 mA/V, these tubes have their electrodes *extremely* close together and their frame grids are wound with micron-thick wire. The problem with this is that, despite their very accurate and sophisticated construction, due to inevitable mechanical tolerances, the sample-to-sample consistency of their parameters (which is critically dependent on the inter-electrode distance) is very poor and varies widely with temperature, age, and vibration—a complicated way of saying that they're also very prone to

microphonics. Not to mention mediocre cathode-to-heater insulation resistance and relatively short life. To me, the highest transconductance tube that is really useful for audio signal is the 6DJ8/6922, but due to insufficient amplification factor and microphony, it is at its best as a power amp input stage, and I discarded it for phono input.

Conversely, the 12AX7 and—even better—the 6SL7 and the 12AY7/6072 may only have 1/20th the Gm of a 417A, but they are usually loaded with a twenty to forty times higher value load resistor, dissipating fractions of a watt with less thermal noise and no temperature coefficient problems.

Most importantly, these are audio-specific tube designs and they have better heater/cathode insulation, "infinite" life (systematically exceeds 50,000 hours and easily reaches 100,000) with satisfactory consistency and *way* better linearity.

Identifying high transconductance with high resolution *tout court* is nothing but a commonplace in my opinion, and substantially wrong if you look at loading requirements. There are other factors that matter more.

I regret that I took it for granted in the $\phi 42$ article, because the high transconductance guys seem to have missed it completely. While it is true that the input impedance of the EQ network should not overload its

driver, *it must load it!* Otherwise, the current that the tube modulates will do nothing but heat the plate resistor, no matter the Gm. Nobody seems to care about this. In the $\phi 42$ (SP#14:p.30), you will notice that R4 is only about 1.6 times R2, while in Allen's design (SP#15:p.39), this ratio is close to 10, and in the Loesch (SP#3:p.26), it is close to 20 in the 75 network and around 6 in the 3180/318 network. This way, the advantages of a high Gm stage are largely thwarted.

3) I do get RIAA paper caps matched to my specs, of course, and I can supply matched sets as well. Having said this, after quite a few years of screwing around with RIAA stages, chasing perfect accuracy like an idiot, I have come to the conclusion that ± 0.5 dB from 30 Hz to 15k and ± 1 dB above and below is all that's needed. Better accuracy than this, all other circuit parameters being the same and channel tracking being accurate, is of no interesting consequence sonically.

4) Load a high mu triode first stage to the criteria explained in point 2 above and you'll get "air and naturalness" with no need to resort to this trick.

5) I have seen too many star-wired amps turn into FM transmitters. Star-wiring is maybe OK on PCBs, but it is a big pain in the butt when it comes to hard-wired circuits of substantial size like the $\phi 42$. The physical size of the components forces one to make ground returns of some length, introducing a number of parasitic inductances you can't prevent from coupling together in a way that is virtually impossible to control, no matter how you mess with the layout. Even when the thing doesn't oscillate at 140 MHz, as recently happened to a friend of mine, the risk of "cat piss sound" is right around the corner. If you want to build my circuit, stick to buss grounding please.

6) It seems nobody has ever had any luck with cathode followers except myself and Kondo-San. When he came to Italy last year to visit Audio Note Italia, I asked him why. His very wise answer was that there's nothing wrong conceptually with cathode followers; it's the application that is tricky. I entirely agree.

The cathode follower has a low output impedance but it is not more load tolerant than common cathodes. So what? The whole point is using it properly and, if it doesn't work, this is the fault of the designer, not the circuit, period. You must look at the circuit as a whole, not as a pile of Lego

bricks. In this specific case, I purposely optimized it to work in a certain way and for a very specific purpose.

Allen's suggestion to remove it is extremely awkward, takes for granted that an interconnect is a "high-quality" capacitance (which is miles away from being true compared with a good cap of the same value, especially regarding mechanical factors and series inductance), messes up the loading on the second stage (which is guaranteed to mess up the sound), and is entirely pointless overall.

The biggest threat to all these theories that the cathode follower itself is supposed to sound evil—a point, by the way, which I have never found to be supported by any positive argument but the usual "It's a 100% feedback circuit and sounds bad" bullshit—is the sound of Audio Note Japan gear. Funnily enough, despite this, even the Audio Note UK people love to spit on the CF...

Please disregard the gossiping and leave the CF where it is...or make your own design.

7) You *must not* use the components to "find the sonic flavor you like." This is equivalent to destroying all the work you've done to try and get the circuit OK. It's already bad enough to set up the circuit "conceptually" in order to have the least sonic flavor of its own; components should be chosen to add as little as possible. If you want to intentionally color the sound, it's cheaper to bugger around with circuit parameters than components.

8) Removing electrolytic capacitors is not a cure-all, and pretty often does more harm than good. Cathode caps in particular are, in my opinion, often not replaceable. Unbypassed cathode resistors effectively rob transconductance, and all alternatives that have been proposed are guaranteed to drop you from the frying pan right into the fire. Diodes and LEDs put in lots of distortion resulting in a horrible gritty sound, batteries have inconsistent performance and cancel out lots of low-level information, and film caps of the required values are often worse than electrolytics. Much the same holds true for decoupling caps. They act as "local batteries" and an electrolytic does it better than an actual battery. Use Black Gates or Cerafines if you want the best, but look at the design as a whole and leave blind integralism to the Middle East terrorists.

9) I never spent much time experimenting with voltage regulators, mainly because I

never came across a regulated preamp that I liked. I have tried Counterpoints, Conrad-Johnsons, Audio Researches, a Lazarus, a Convergent, maybe others I don't remember, and I wouldn't live with any of them.

Maybe this has to do with the fact that all fancy voltage regulators are very high feedback amplifiers and often rely upon cheap IC opamps running open-loop or nearly so, a situation in which their distortion is NOT low, despite the good specs on the datasheets. High-gain error-amplified preamps I have heard all had a sort of mechanical/artificial, very "audiophilic" presentation which is exactly what I am trying to avoid, and that made me skeptical about them.

However, I would be curious to give Allen's *Super Reg* a try and I have the diagram and setup instructions, but no time to draw up a PCB for it. Hey, Allen, couldn't you just send me a photocopy of the PCB layout so I can etch myself a board? My address is in SP#14.

A few more general notes: Cascode-configured input stages do offer some advantages—essentially very high and easily adjustable gain—but their gain and distortion characteristics are more load dependent, which makes them less suited than high- μ triodes for the loading strategy that I like best. I happened to use a cascoded 6922 as the input stage for a small power amp (*Costruire Hi-Fi #29*) and in this application I did get good results. Besides, the very first phono preamp I ever designed used a 6DJ8 hybrid-cascoded with a transistor, but by now cascode is no longer my choice for a phono input. More gain than you can get from a $\phi 42$ is of no useful interest anyway. Direct amplification of signal from MC cartridges in order to save the expense of a good step-up transformer is a loser strategy to me, as I have already argued. The only worthwhile MC cartridges are very expensive and so deserve a transformer. Budget MCs have too many flaws and they're battered by similarly priced fixed coils very easily, so why look for an MC direct preamp?

The MONOphono

After all this talk show, I want to show you something dedicated to record collectors. It's a MONO phono stage conceptually derived from the $\phi 42$ and designed to play mono records, whatever they are, LPs, 45s, and 78s. You don't need a mono cartridge or a specially set-up playback system, at least if you only want to play microgrooves. You can use the same system you play

stereo LPs on. Of course, you will need a turntable which will spin at 78rpm (preferably with a pitch control) and a cartridge equipped with a suitable stylus if you want to play 78s. A few manufacturers still offer 78 rpm styli for their cartridges—for example, I use a Stanton 681 with 6827 stylus for this purpose, mounted on a Technics SP-15/SH-15/EPA-250 system which also wonderfully plays my stereo LPs (equipped with an Audio Note IQ-II).

Direct drive??? Yes—and direct *sound*. No more audiophile bullshit, i.e. vibrating motors, irritating start-up times, slipping belts, wow, rumble, awkward suspensions, motor and platter tweaks. Just music, positive, strong and pure. Enough said. The arm does require a bit of tweaking to work properly, however.

The Monophono offers a choice of six treble cuts (flat, 20, 50, 64, 75, and 80 microseconds), six crossover frequencies (318, 400, 450, 530, 630, and 880 microseconds), and two bass cuts (3180 and 1590 microseconds), for a total of 72 combinations. Although the 1590 bass cut is rarely used (only some Columbia LPs require it), the other time constants allow you to compensate for virtually any recording characteristic ever used. You get the RIAA/New Orthophonic (318+75), the CCIR(450+50), the AES (400+64), the London 78 (530+75), the Decca FFRR 78 (880+20), the EMI 78 (630+flat), and so on.

Don't worry about records whose recording characteristic you're not sure about: try switching the bass lift first, then the treble cut, and you'll easily find a setting at which the sonic balance is obviously most correct. It's easier than you might think. You'll find that the majority of LPs are to be played with either the RIAA or the AES, and most pre-1970s 45s sound best on AES too. 1950s 78s are generally played back with CCIR, while the situation is more varied with older ones. Most often, the optimum setting will have to be determined experimentally.

The circuit has two parallel inputs and two parallel outputs in order to be plug compatible with a stereo system. You don't need to bugger around with cartridge connections since the generators will be paralleled at the preamp input. This will cancel out the vertical modulation output, with the side advantage that all of the components of surface noise, impulse noise, and, most importantly, mistracking distortion engraved on the grooves by previous poor

tracking that are modulated vertically will be rendered inaudible also. Many old records that sound badly battered if played in stereo become much more listenable if played back in mono.

The use of a stereo cartridge for 78s also offers the possibility of playing back ancient "hill and dale" vertically modulated records. To do this, just reverse the connections of one channel at the cartridge pins—choose the channel with no ground tab, usually the right channel. In this way, the two coils are connected out of phase and, therefore, when paralleled, they output the vertical modulation. Note however that these records can have grooves of strange shape and may be difficult to track.

Another advantage of using a stereo cartridge to play mono records is that it'll

track 'em much better.

The circuit uses only two tubes, one 6SL7 and one 6J5. If you can't find a 6J5, you may use one section of a 6SN7 instead: it makes no difference apart from heater consumption.

In order not to add an extra tube, I gave up to SRPP in the second stage, but I biased the two 6SL7 halves in such a way that input acceptance is still ample. Please don't cultivate the illusion that common cathode sounds any better than SRPP. This is not true and it is claimed by those who make SRPPs with two sections of the same tube and/or a common heater supply. This is what really degrades the sound of SRPP. The circuit itself is excellent if properly biased. Please note that I don't agree with those who "load it down" to decrease static

measured distortion. This robs dynamics.

This circuit is designed to run from the same power supply as the $\phi 42$. I suggest that it is a very convenient idea to construct a flexible phono preamp with both the $\phi 42$ and MONOphono boards sharing the same chassis and power supply. I found that this solution does not in the least degrade the sound of either, provided that signal switching is avoided. Route the stereo and mono outputs via individual interconnects to two inputs of your line preamp or integrated amp, and connect the turntable leads to whichever circuit you intend to use.

Have fun! Diego



SETTING / NOTES	BASS CUT	X-OVER	DE-EMP
RCA "NEW ORTHOPHONIC," / LATER STANDARDIZED BY RIAA	N	318	75
COLUMBIA LP / THOSE THAT ARE NOT TOO OLD OFTEN SOUND BETTER ON NEW ORTHOPHONIC SETTING	Y	318	80
AES / GOOD FOR SEVERAL (NOT ALL) PHILIPS, DG, ARCHIVS OF '50'S AND '60'S AND MOST PRE-1970 45'S	N	400	64
CCIR / 1950'S 78'S ARE ALL SUPPOSED TO COMPLY, ALTHOUGH NOT ALL ACTUALLY DO	N	450	50
COLUMBIA 78 / SUPPOSED TO BE GOOD FOR SEVERAL AMERICAN 78'S	N	530	80
DECCA FERR / 1949 CURVE, PLAYS WELL ALSO POST-WAR AMERICAN DECCAS NOT YET "FERR"	N	880	20
EMI 78 / GOOD FOR HMV AND MANY OTHER BRITISH 78'S	N	630	FLAT
LONDON 78	N	530	75

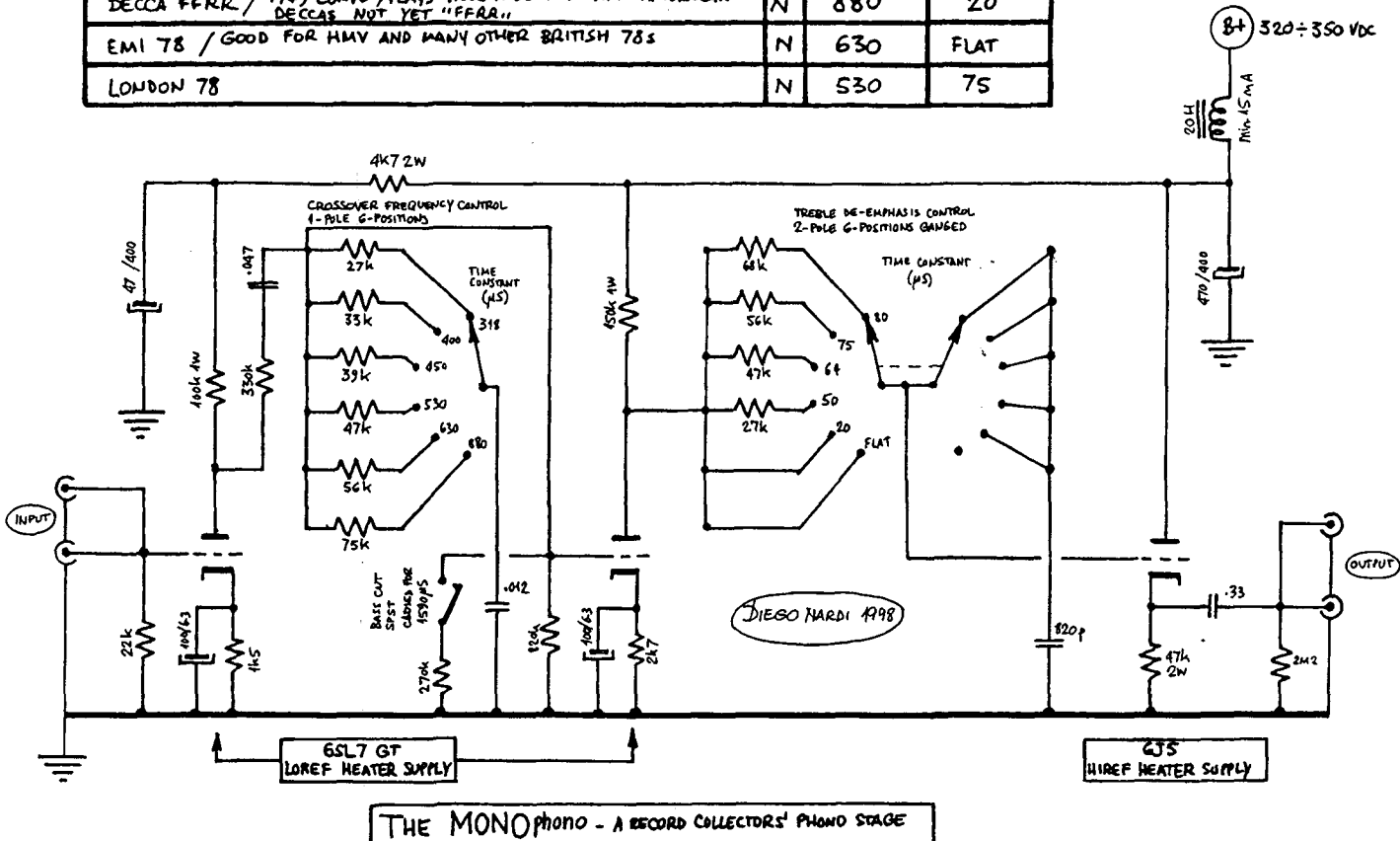

The MV-45 Convertible

by
Steve Berger, Aprilsound

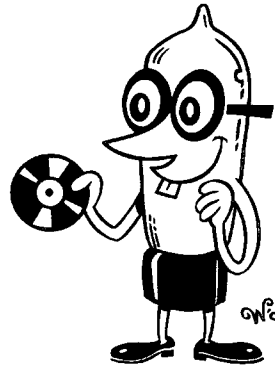

What to do with that
old burnt up c-j chassis

I know very little about electronics, maybe just enough. Everything that I have learned has been through the kind generosity and patience of the likes of J.C. Morrison, Herb Reichert, Arthur Loesch, Noriyasu Komuro, Tadataka Uchida and some of the writers in *Sound Practices*.

I think that the only reason to have a music system is to listen to MUSIC! Now, if some piece of hardware will get you to listen to music on a more regular basis, I'm all for it.

I enjoy hearing Lester Young's chorus from an old Columbia rerelease of the Basie band playing "Tickle Toe" or Schnabel playing "Kinderszenen"

These machines can, in the hands (or in front of the ears) of the right person, be transportation devices, even time machines. Where they take the individual is up to the ticket holder. Whether it's to Kansas City or Thailand, 1965, '35 or 1765. Whether it's in a VW, a "K" car or a Rolls, they all get you there. I personally think what I'd like is somewhere between an Alfa 1800 and a Mercedes 300. Ya know, something that will handle those curvy mountain roads with aplomb and still feel like home at 160 kmh on the autobahn.

In designing an amp, speed, agility and good tonal balance are the orders of the day. The name of this amp, MV-45, is kind of a joke (Get it?

this is where the MV-45 comes in. It was originally a standard kind of Stereo PP EL-34 beautifully made, nice chassis. I had to figure out what to use all the holes for. I knew that I wanted to use U-808s (one of Tango's less expensive universal trannys) for the OPTs since I have them. These are possibly the most sold OPTs in Japan and they are inexpensive. Next was a beautiful Mil-Spec PT 480VCT @ 200ma. Once I had these things I knew I was on the way.

I was going to make it a single 45, but that would leave a couple of big, gaping holes that would be nice to fill. Another good and much more important reason for paralleling was so that I could use the whole secondary of the OPT. It is much easier to design and build a hi-Q OPT with wide bandwidth with a lower primary impedance than with higher primary Z. The reasons are obvious. Since a tranny is a ratio device, if you use a smaller ratio from primary to secondary, the windings can be closer in size and hence closer together. You can achieve a closer coupling with less stray capacitances and less losses.

Time is of the utmost importance! We sense shift in phase as either sluggishness or confusion. This is not what we want! An amp that is truly elegant has a sense of spatial coherence. That is to say things seem right in time AND space. This sense is a direct result of *phase coherence*.

For these reasons, what I think we want is WIDE bandwidth. Not because we can hear 20 to 20,000, but because we can "sense" 5 to 105000 as phase shift.

This amp is not going to get us 5 to 105000 but it'll get us a lot of the way there. I measured this amp 3 dB down points at 17 Hz and about 80 kHz. You will notice that it's closer to ideal on top than it is on the bottom. This is OK because our ears are more forgiving in the bass than on top. This has to do with the apparent hypersensitivity to frequencies between 2 kHz and 4 kHz (Fletcher-Munson curve). To avoid any noticeable phase shift (distortion) through this region, we would like to have an amp that goes an order of magnitude or more farther out. I'm of the opinion that if you can achieve a nice tight, well

controlled, coherent mid bass, your ears will fill in the bottom. If not, BI-AMP! This is really the right way to do it anyway. In my experience, I've never heard a single, truly full range amp, or speaker. Unfortunately, I don't have such luxury as a system that goes to 20 hz living in a New York City apartment. So, I make do with a modest system with beautiful mids, graceful highs

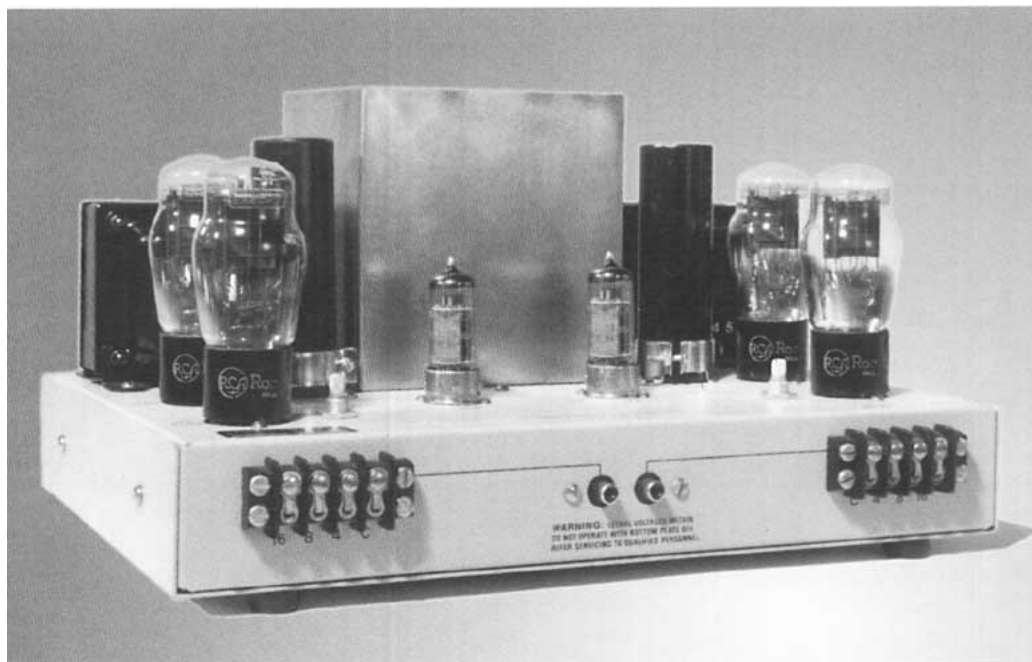

or possibly something from "Still Crazy After All These Years", none of these being great recordings, just recordings of great music.

My point is that, it's not the recording, it's where the recording takes you that is the most important thing.

Multi-Valve-45). I was called by a man who had just obtained a pair of Klipsch horns. I immediately said, "All you need now is a nice little 45 amp." He said, "What's a 45?" Anyway, he didn't want to spend more than \$2000 (we ended up trading for a Marantz 10-B) on an amp that he had never heard of, so I started looking around for on hand parts. The first part being a chassis,

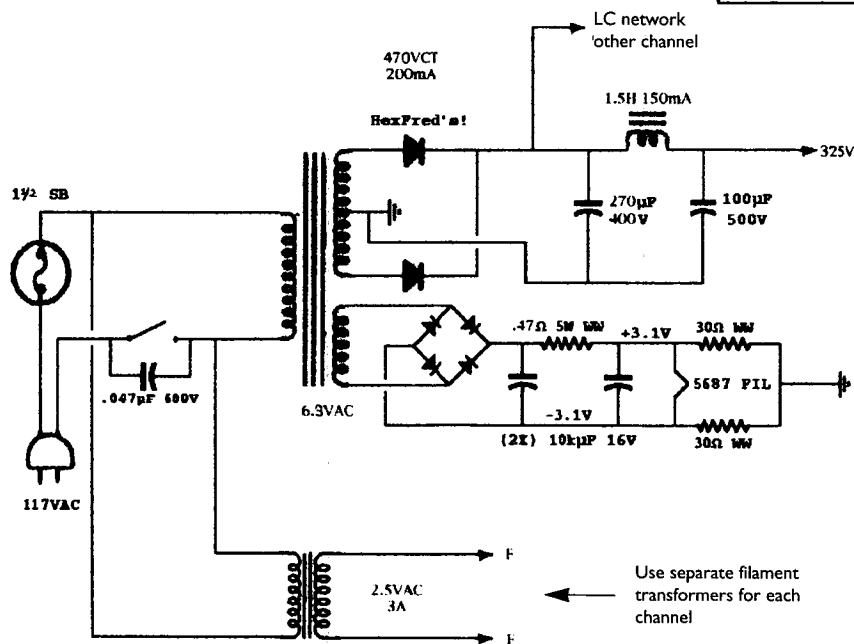
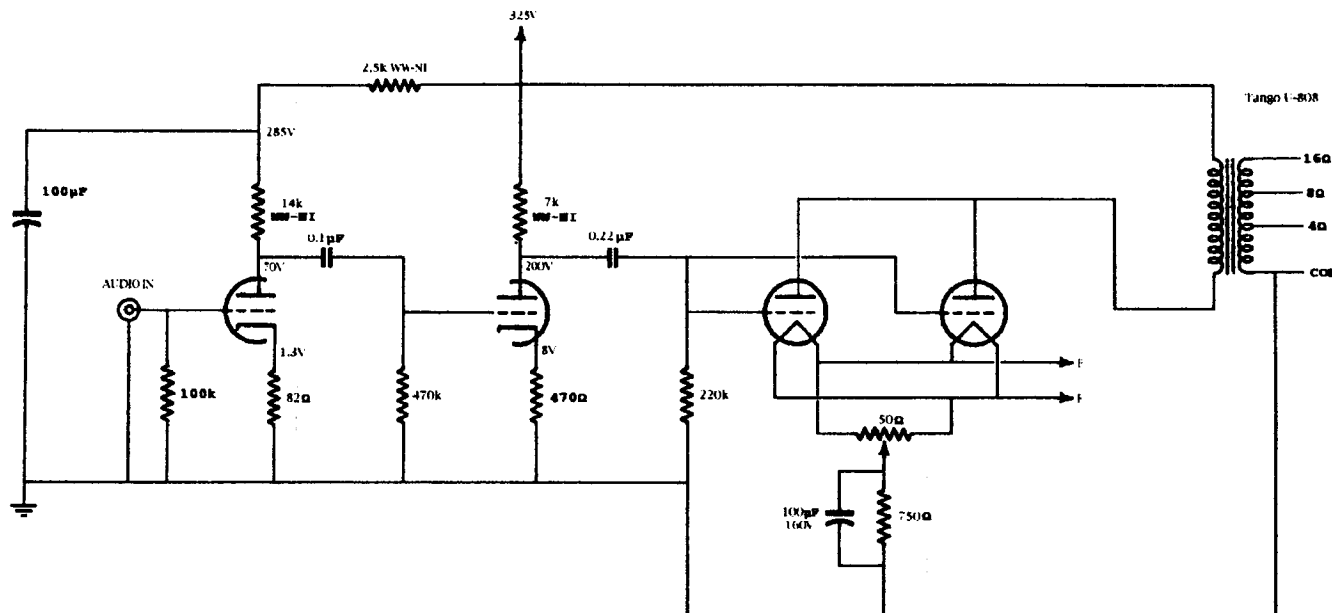

passed with Black Gate. The cathode by-pass cap is one of the most important components in the chain, don't skimp on this part. For coupling I used Orange Drop 715-Ps between the first and second stages, and Handmade's paper and oil between the second stage and the grids of the 45s. At first I had the orange drops in both places. It sounded a little plastic, so I changed to the Handmades, and ba-bing, sweet as honey, and still fast as lightning.

Because of the small size of the chassis, I could not use a large choke or a vacuum tube rectifier in the power supply. I used Hex-freds, a large filter cap, a small, low DCR choke and a 100 MF cap. Notice the lack of decoupling between the output stage and the second stage.

Freds are the closest things to tube rectifiers that I've heard so far. They are not quite as gentle, but they exhibit a similar turn-off characteristic to tubes in the sense that they don't make a big EM spike at turn off. I believe that this spike is at the root of the horrible "solid state" sound that we've all come to know and hate. The up side of using SS rectifiers is that they have a very low impedance. This can have an important impact on the overall speed and coherence of the amp. I believe the next generation of SS rectifiers will probably be even better. I know, I know, this flies in the face of everything we hear about SS rectifiers. But, as J.C. always says, "There are a hundred and forty-four ways to make a great amp!"

This amp gets right to the heart of the matter. It's fast, it's honest, it's direct. It's so direct that it doesn't sound like a power amp at all. It has a quality closer to that of a really good pre-amp. I

and a nice tight, well proportioned mid bass down to about 60 hz. I digress. If you look closely at the schematic, you will see that it bears a strong resemblance to Herb Reichert's famous "Flesh and Blood". To me it's got so many aspects in common that I was considering "Blood and Guts" as its name. It follows a lot of Herb's rules.

This is a classic, three stage, RC coupled amplifier. I chose the 5687 as the voltage amp and driver for its very straight plate curves and its low RP. Its ability to drive difficult loads makes it an ideal choice to drive a pair of 45 grids. When operated with LOTS of current going through it, it has a very rich, uncolored sound.

I tried to get the widest bandwidth I could out of the first two stages. To achieve this I pulled out SP #2 and turned to Crowhurst on "Load Lines".

Man, what a GREAT article! Armed with this information, I was able to calculate the values of all the resistors in a flash. I wanted to get my load line right in the middle of the straightest part of the plate curves. Old Norm got me right where I wanted to be. Testing the driver stage with the output tubes pulled out, it tested flat from as low as my test gear will go (10 hz) out to 500 kHz. I attribute this to the use of very small plate resistors, and the inherent linearity of the 5687.

My choice of plate resistors in high current stages is 12 watt, Mills non-inductive wire wounds. I think these are the most un-mechanical, sweet sounding resistors for plate circuits. For grid and cathode circuits, I prefer AB carbon comps. In the cathode of the output tubes, I used 25 watt Dale non-inductive chassis mount resistors, by-

think that that's the 45, because as soon as you drop in a pair of 2A3s it sounds like a power amp. Did I forget to say you can just drop a 2A3 into each channel? That's the convertible part of the title.

Build this amp! It's simple, it's elegant, it sounds great! If you want more romance, try globe 45s. Or have a romance. Use what you have. Use your heart. Use your taste! Amps really do mirror their makers. (Scary thought, isn't it?)

Notes from the other side of the MV 45 deal by Dorwin Gregory

He traded a Marantz 10B,
so good thing he liked it

Although I've written a lot of poetry and audio has been one of the great loves of my life, I had never written poetry about stereo sound reproduction or music, let alone "to" an amplifier. I just didn't look at stereo that way. Thanks to making the acquaintance of amplifier designer Steve Berger, my recent introduction into the secret world of SE amplifiers has changed all that. I have to confess, before that time I had never listened to a SEDHT amplifier, although I had read a few reviews in the popular audio press.

Paul Klipsch once wrote that what this country needs is a good five watt amplifier. Even at 104 db/m, four triode watts could not reproduce full orchestral music at realistic listening levels. It would play it but with a cameo-like diminishment of scale reminiscent of exquisitely painted illuminated Persian miniatures. To my taste, the four watt output of the SE 45 couldn't do one of the things which the Klipschorns do best: act like giant pumps to effect effortless and instantaneous pressurization and depressurization of the room air. I then tried bi-amplifying the Klipschs with the SE45 on the midrange horn and tweeter crossing over at 400 cps (6 db/octave) to the bass horn driven by the Tilden OTL, OCL 6336A triode monoblocks. These put out about 15 watts into 16 ohms, more than enough for the K Horn bass. The bottom octave is covered by two 15 inch Altec Subwoofers driven by Threshold Stasis1, no feedback monoblocks.

One of the first things I began to notice about Steve's amp was how different the imaging was from other amplifiers I was familiar with. Years of listening to OTL amplifiers have made me accustomed to an extremely wide, wall to wall, rock solid soundstage extending between the speakers and receding layer by layer behind them into the far distance. Instruments and musicians have precise spatial locations and appear as sonic holograms or fixed phantom images.

The Multivalve 45 not only is a master of spatial depth, but it projects the sound forward, out in the room in front of the speakers filling up the space between the listener and the transducers. The sound stage is almost spherical—not a curtain but a wide gelatinous bubble.

This is not a typical stable, focused, wall to wall, front to back sound stage with the people and instruments holographically fixed in space. This is a pleasure pool of pulsating plasma inviting you to dive right in with a colorful splash. And yet, for all its surrealism, there is something more correct and true to life about this kind of presentation than the cold and ridged, objective formality of the classical soundstage. This kind of emotional and esthetic involvement is more like what the mind does when it experiences live music.

This is not to say that SEDHT amplifiers don't make sonic holograms. A close miked soloist or vocalist is right there in the room with you as real as life. The sharp transient of a plucked string can be so startling as to make you jump. But these kinds of amplifiers reveal so much additional detail about the harmonic and micro dynamic structure of the music that the very notes seem surrounded by sheaths or envelopes of additional information, like the clouds of electrons surrounding an atomic nucleus. And this harmonic microstructure lingers long after the attack like a cloud of softly humming bees with the decay rippling on and on seemingly forever. And it is this kind of information which is being displayed holographically.

Sometimes the air just seems to fill with solidified sweetness—sweet, sticky cotton candy and interweaving ribbons of rainbow colored taffy like condensed sugar or shooting extrusions of candy striped, peppermint toothpaste. These are standing waves woven from the intricate, ever-changing moire patterns formed from intersecting fields of waves interacting with the senses, brain and mind. These are not only the sonic holography of the physical event but they also include the condensed forms of the emotional and esthetic aspect of the listening experience. These kinds of holograms are like luminous objects hanging suspended in space, spun not only out of the music but from one's reaction to it.

At other times the experience of Steve's amplifier is like being afloat in a vast ocean—the secret sea of SE triode owners. Here listening becomes swimming. Once merged with the sound you are no longer a fixed location in space, sitting on the sofa standing back in objective evaluation, but you become

a perpetually self-transforming musical liquid that ebbs and flows, surges and pulses, swelling and drifting until you become an oceanic superfluid washing against the walls of the room in a hydrodynamic tide. You are swimming "with" the orchestra or more correctly, swimming "in" the orchestra.

This kind of listening takes one back to childhood. Long before the compact disk and the digital domain, before the iron footed Krell—before the yawning 45 recordings, before the endless dusty succession of components stretching back like a caravan of shadows—back to childhood. Laying on the sofa on a rainy afternoon, listening to K-Jazz or Public Radio in mono FM on an old Sylvania, not listening to the speaker or the electronics but dissolving in the music and being transported by it and healed, refreshed, nourished and restored.

This was where it began, the love of music, the first imprinting of the quest for primary musical experience. This was the primal cause of the endless succession of seeking better and better sound—upgrading and upgrading until eventually I lost it. The Goddess who had inspired, uplifted and transformed the heart had vanished into the brightening air like the momentary, transitory touch of an elusive Muse leaving only the echoing memory of perfection.

Now years later, so many thousands of dollars later, expelled long ago from the Garden of Eden—after all the agony and the ecstasy—the supreme gratification and eventual disappointment and ultimate disenchantment.

I want to go back. Back to when I and the music were one, back to the innocence and simplicity of pure, direct esthetic experience before stereo became a status symbol. I don't want to be proud of my music, I want to "be" my music. I want to stop listening to my stereo system. I want to get back to the sound.

SEDHT amplifiers are ecstasy producing machines. You don't just "listen" to them, you tune into them. These devices are somehow directly connected to the pleasure center of the brain. They must alter brain chemistry on some level. Dopamine and serotonin receptors might be involved here.

SEDHT amplifiers like Steve Berger's Multivalve 45s take me back—all the way back and beyond—to a musical satisfaction I thought I would never see again. And the future? I think I'll sell the Futtermans and have Steve build me a pair of his top of the line, no compromise SEDHT monoblocks. OTL Is anyone?

A HIGH EFFICIENCY TRIODE AMPLIFIER

by
MELVIN C. SPRINKLE
Peerless Electrical Products Div.
Altec Lansing Corporation

Fig. 1 Peerless amplifier which was available in either the kit (10722) or completely assembled form, back in 1949



The legion of audio enthusiasts who have stuck by their triode amplifiers through thick and thin have been a hardy lot. They have been assailed by the beam power camps and have been deserted by commercial amplifier engineers, but through it all have held the bridge like Horatius. Through all the controversy they have always maintained that "triodes sound better."

The Achilles' heel in their argument, however, has been the inefficiency of triodes. In spite of all the subjective arguments, the fact remained that up to the present time triode power was costly. In order to realize the full benefits of triodes, it was necessary to operate with fixed bias—this meant either a high voltage power supply with higher voltage condensers or a separate bias supply. Furthermore, because of the high bias required, transformer coupling into the final stage was necessary. Resistance coupled amplifier stages just don't put out high quality signals with enough amplitude to drive triodes. Both triode power supplies and/or transformer coupling are expensive.

On the theoretical side, triodes have had at least a strike and a half on them. Assuming proper power supply for plate and bias, and good transformers, Terman states that the maximum practical efficiency of a Class A amplifier is 50%, and that practical amplifiers have efficiencies from 33% down to 20%. This meant that in order to get an output of 10 watts delivered plate-to-plate—not necessarily in the load—it was necessary to put 28.6 watts into a pair of tubes, and if the efficiency was of the order of 20%, the input power had to be 50 watts.

No wonder that triodes were limited to low output power! As a matter of fact the heads of many designers were scratched in the search for a high dissipation triode without going into the expensive transmitting tubes. The development of Class AB operation was a partial solution as the efficiencies were raised. Terman gives efficiencies of 40% to 50% for this operation, but the tube manual in its typical operation data for 2A3 tubes says that the efficiency is 34.1% when the tubes are operated with fixed bias.

Class AB operation of triodes has become accepted by audio enthusiasts who require high quality, but they have in general been very dubious about Class AB2. Up to the present time there has been some justification for their doubts. Recently, however, with the general availability of high quality transformers, operation of tubes up to, and possibly into, grid current becomes possible with no more distortion than strict Class A operation, and with a prodigious increase in efficiency.

Recently, the writer has become interested in a circuit which makes possible 18.6 watts output from a pair of 6A5 tubes at a distortion of 5% total harmonics! This represents an efficiency of 49.3%, a truly remarkable achievement. This amazing performance is made possible by two factors: (1) A good

output transformer and (2) Use of a cathode follower driver.

The output transformer is the heart of an amplifier. Almost invariably the output transformer is the only audio transformer used, the other stages, with the possible exception of an occasional input transformer, being resistance-capacity coupled. The techniques for building wide range resistance coupled stages are well known and easily put into practice. If the results are not satisfactory, the builder can easily change values until the desired results are obtained. However, when one buys a transformer, he must accept whatever the manufacturer puts into the unit. There are a few things that the user can do, but in general these have minor effects on overall performance. For example, one cannot alter external circuits to improve efficiency—the ratio between primary power and the power delivered to the load.

It behooves the constructor, therefore, to buy the best possible transformer, considering the following points:

- a) Insertion loss. The useful power output of an amplifier is the power delivered to the load, not the power measured plate to plate on the primary side.
- b) Power output over frequency extremes.

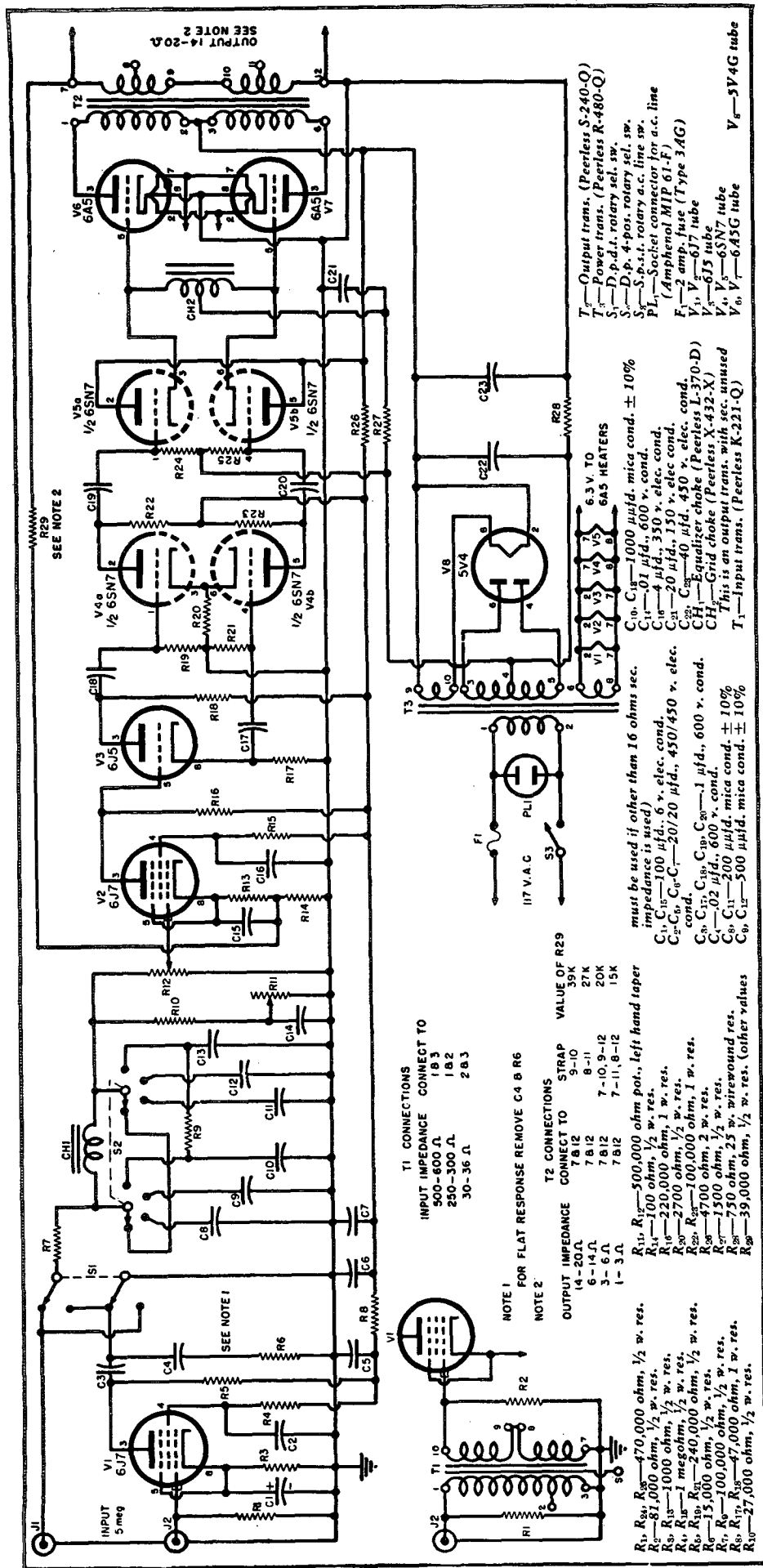

Vast numbers of amplifiers are built by audio enthusiasts who have absolutely no idea of how many watts their amplifiers deliver at 40 cycles and 10000 cycles. Their conception of performance is based upon frequency response, which is a gain measurement, not a power measurement. The factors which contribute to power output at frequency extremes are not controllable by the user.

c) Frequency response. The frequency response of a transformer is a measure of its ability to transmit various frequencies; i.e., it is inherently a gain measurement. As pointed out above, the power output characteristic is often a more important property in output transformers, and it bears no relationship to the frequency response characteristic. On frequency response, most manufacturers show response in the audible part of the spectrum, but what is more important is the response at frequencies above and below audibility. This response is of importance because in amplifiers employing inverse feedback, the response must be much broader than the range to be covered if the amplifier is to be stable.

d) Concomitant with frequency response is phase shift. This is of importance if complex signals are to be transmitted without distortion and also if stability with inverse feedback is to be achieved. Phase shift, frequency response, and transient oscillation are most easily checked with square waves.

Fig. 2 Diagram of the Peerless 10722 amplifier. Circuit includes a preamplifier for magnetic phono pickups. With the addition of a special input transformer (circuit shown in lower left) the amplifier becomes suitable for use with a 30, 250, or 500 ohm microphone or other low-impedance, low level source. The equalizing network can be removed when used with a microphone.

Notes on original circuit drawing:
5V4 is shown as a directly-heated rectifier when it is actually an indirectly heated type.

T1 is 700V@120 mA B+, Rectifier winding is 5V@ 3A per Peerless specs provided by Magnequest.

Schematic as originally published had the grid of V7 connected to the B+ line at C21, obvious error. Removed in this version.

Most audio enthusiasts are familiar with resistance or transformer coupling to Class A or AB amplifiers. These systems are quite satisfactory within certain limitations, but fail when Class AB2 operation is approached. The fundamental reason is that when the grid of a tube is driven positive, instantaneously there is a flow of electrons to the grid, which when they flow through the grid resistor, or even an inter-stage transformer, produce a voltage which is additive to the tube's bias. The effect is the same as the bias developed in an oscillator's grid leak due to grid current. In the usual Class AB2 design, a special transformer called a driver transformer is used, which is a step-down transformer. In order to supply enough signal with a step-down turns ratio, and also to supply power to the grids of the final when they draw grid current, it has been necessary to use a power tube as a driver.

Another factor that touches a sore spot in constructors is the cost of a good driver transformer. The cathode follower driver overcomes these limitations. It has been pointed out that a cathode follower is not a voltage amplifier, i.e., the output voltage can approach but not exceed the input signal. However, and this is not as widely known, a cathode follower can be a power amplifier. The power in a resistor is given by the familiar formula $P=E^2/R$ thus for a constant voltage. The power varies inversely as the resistance. Halving the resistance gives a 3 dB power increase for the same

voltage. Thus a cathode follower can take in say 25 volts and in its output develop this same voltage (almost) across a much lower load, and thus give a power gain. By simple circuit manipulation, a cathode follower driver stage can be direct coupled to a power amplifier. It is possible to obtain excellent frequency response by the direct coupling and yet supply all the normal DC voltages to both stages. A low grid circuit impedance for both AC and DC is provided and there is sufficient power developed in the cathode follower to take care of grid current demands should operation in this area occur. The combination of two equally important factors—a good output transformer and a cathode follower driver—produces a high-efficiency, high quality circuit that puts the triode on a more equal basis with beam power tubes.

This high-efficiency circuit has been incorporated into a general purpose amplifier, specifically designed for high quality music reproduction, called the Peerless A-100A amplifier.

With the development of this amplifier, the problem of low efficiency in triodes has been largely overcome. The unit has a maximum output of 20.3 watts. It uses two type 6A5 tubes in a newly developed circuit which makes practical efficiencies on the order of 49.3%. Moreover, and this is the crux of the matter, this power is useful secondary power, the implications of which were considered previously.

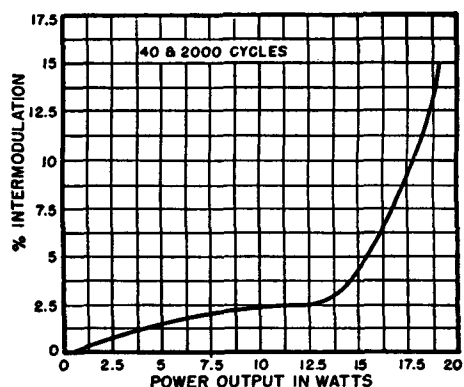
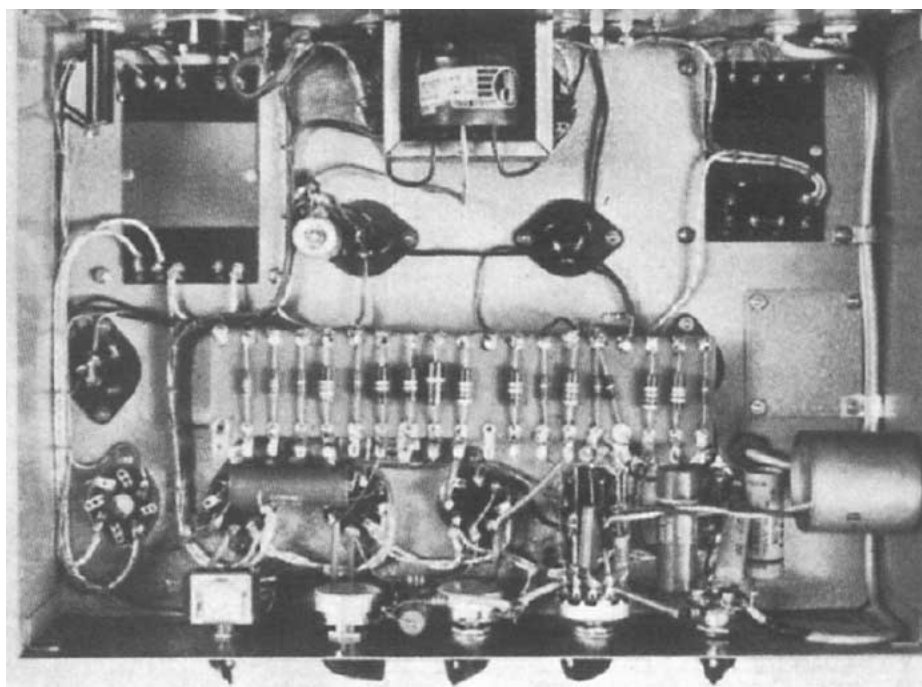

Fig. 3. Power output in watts vs. per-cent intermodulation distortion of amplifier.

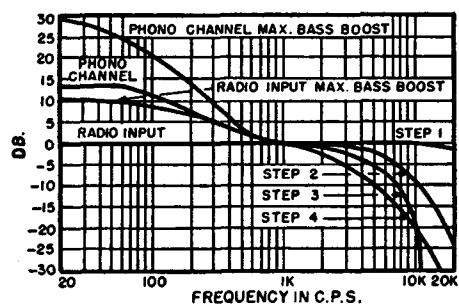

Fig. 4. Amplifier response with low-pass filter and bass-boost circuits operating.

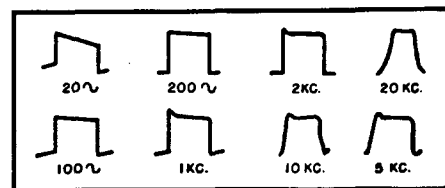

Fig. 5. Square wave patterns at various frequencies throughout amplifier range.

The frequency response of the amplifier is flat from 20 c.p.s. to 15,000 c.p.s. and is down only 1/2 dB at 20,000 c.p.s.—an undetectable amount.

The distortion is remarkably low. Using the familiar 5% harmonic content standard, the power output is 18.6 watts at 100 c.p.s. and 400 c.p.s. At 40 c.p.s., the power output is 14.8 watts and at 5000 c.p.s., the power output is 18.3 watts. Using the intermodulation method with test frequencies of 40 and 2000 c.p.s., the power output at 8% intermodulation is 17 watts.

The schematic diagram is shown in Fig. 2, and it will be seen that the amplifier is entirely straightforward in design. The first stage uses a type 6J7 tube as a voltage

Fig. 6: Under-chassis view of the amplifier which was available as a commercial kit back in 1949

amplifier. This stage is used as a preamplifier for the magnetic phono pickups so popular in high quality music systems. The plate circuit contains a series resistor-condenser combination, the values of which are adjusted to give the bass boost required for proper equalization of magnetic pickups. A feature of the amplifier is a cutout provided for the installation of a Peerless K-221-Q input transformer. With the transformer installed, the amplifier becomes suitable for use with a 30, 250, or 500 ohm microphone or other low impedance source, the equalization network being removed when a microphone is used.

Two inputs are provided, one for phono and the other for radio. A switch, S1, selects the desired input and grounds the channel not in use to prevent crosstalk. In the phono channel, a gain of 107 dB at 100 cycles is available, which permits full power output from LP records. The radio channel has a gain of 84 dB, which is more than adequate for any FM or AM radio tuner.

Following the radio-phono switch is a four position, pi-type low-pass filter which is intended for record scratch reduction. The filter uses an inductance to give sharp cut-off so that the maximum useable recorded signal can be reproduced and the higher noise frequencies eliminated. The circuit must not be confused with resistor-condenser treble roll-off circuits and is quite different in performance. Four positions are provided, the characteristics of which are shown in Fig. 4.

In addition to the low-pass filter, there is provided a continuously variable bass boost circuit. A resistor-condenser network is used to provide up to 10 dB of bass boost as shown in Fig. 4. A word of caution might be in order at this time. The bass boost control must be used with discretion, since the transformers provide considerable power at low frequencies.

The second stage uses a type 6J7 tube (V1), pentode connected to give high gain and very low distortion. A small portion of the cathode resistor is not bypassed as this is used for inverse feedback. The third stage (V2) is a type 6J5 used in a split load or cathodyne phase inverter circuit. This type of circuit has several advantages among which are almost perfect balance in the output over wide frequency ranges, independence of changes in performance with tube replacement, inverse feedback for improving linearity, etc. In addition, the circuit lends itself readily to direct coupling

from the preceding stage. The positive voltage from the preceding plate circuit is more than offset by the high bias voltage developed by the cathode resistor, so that both tubes operate properly. The direct coupling permits extension of the low frequency response to DC and eliminates coupling networks which can cause phase shift and low frequency attenuation. It will be noted in the schematic in Fig. 2 that in the "radio" channel only four coupling capacitors are used in the entire amplifier, two on each side of the push-pull system. As both of these are of generous capacity, and the frequency response of the output transformer specified is no more than 1/2 dB down at 20 c.p.s., the low frequency response is very good.

The phase inverter is resistance-capacity coupled to a type 6SN7 tube connected in push-pull. A fairly high load resistor is used in order to increase the voltage output and the cathode resistor is not bypassed to take advantage of inverse feedback action in balancing the push-pull system. The stage is resistance-capacity coupled to a type 6SN7 tube used as a cathode follower driver.

The cathode follower is direct-coupled to the push-pull power amplifier through an ingenious circuit. Each cathode is directly connected to a power stage grid. The cathode current flows through each side of a center-tapped choke, which has low DC resistance so that no DC biasing voltages are developed. The choke has sufficient inductance so that its inductive reactance, which is the cathode follower load, is high, even at 20 cycles. The cathode currents from both sections of the cathode follower flow through R27 which develops the bias voltage for V5 and the negative end of R28, which is between the power transformer high-voltage center tap and ground, providing fixed bias for the power stage.

The power amplifier consists of a pair of 6A5 tubes coupled to the loudspeaker through the output transformer, T2. As the tubes are operated with the fixed bias, the cathodes are grounded. The 6A5 is very similar to the 2A3 and 6B4 in characteristics and application, but is equipped with a cathode which is internally connected to the center point of the heater. The heater-cathode construction results in a considerably reduced hum level over the directly-heated tube types and, in addition, the internal connection provides a center tap ground for the heaters. No balancing

arrangement for DC plate currents in the output tubes was provided because the unique circuit and the latitude possible in the output transformer made it unnecessary.

It will be noted that inverse feedback is included in the amplifier. Inverse feedback is usually thought of as being used with beam power amplifiers, but the circuit is not confined to beam tubes. The benefits of inverse feedback are just as real with triodes. Approximately 7 dB of feedback is used, the feedback loop including five stages and the output transformer. More than this amount of feedback could have been used, but it was found that this amount produced optimum results. It should be pointed out that the value of the feedback resistor, R29, must be changed should the output transformer be strapped for other secondary impedances.

When the output transformer is strapped for a 16 ohm load, the internal impedance looking back into the winding, is approximately 2 ohms. Thus the damping factor, the ratio of load impedance to internal impedance, is 8 and thus the amplifier will adequately damp a high efficiency loudspeaker.

The power supply is conventional, using two high capacity filter condensers and a resistor to provide hum-free power. The resistor is used in the negative lead to provide at the same time, grid bias for the power amplifier. The type 5V4 rectifier was used as it has a low internal resistance resulting in an increased DC plate supply voltage.

Another effect of primary concern to the user is hum. Assuming that the high-voltage winding is properly center-tapped, hum can be produced by the stray magnetic fields from the power transformer. In some shell designs, using a single coil, the stray magnetic field may extend to audio transformers as far as three of four feet away, producing a hum that all the power supply filtering in the world will not eliminate. While the power transformer used in the A-100A Amplifier is of the shell type construction, it does have interesting features. The core operates normally at a flux density of 10,500 gauss and the cross sectional area of the core is uniform. The exception of course is at the joints, where only one-half of the core is continuous. It is the concentration of flux at these points which contributes so greatly to the large external field normally encountered in transformers of this type. Here though, the

interleaving of the laminations is in a 2x2 arrangement so that the transverse flux path resistance is increased to the same order as that of the air gap between the single layer E and I pieces.

While this arrangement reduces to some extent the structure permeability and increased the reactive exciting current, it also produces a more uniform flux distribution in the core, particularly at the joints. The reduction of flux "hot spots" reduces the external field. It also reduces the in-phase exciting current by an amount greater than the increase in reactive exciting current.

Therefore, two advantages result: (1) The external field is more uniform and less intense and (2) over-all I^2R losses (in both core and copper) are reduced.

The completed amplifier performs exceptionally well when tested with square waves, the square waves showing at a glance the frequency response, phase distortion, and transient response. Fig. 5 shows traces of square waves passed through the entire amplifier. At 20 cycles, the square wave shows some linear tilt which is caused by a slight phase shift. This tilt must not be confused with the exponential decay caused by lack of primary induc-

tance often observed in inferior output transformers. The good high frequency response is confirmed by the fine square waves at fundamental frequencies at up to 20,000 cycles. There is no transient oscillation and only a little phase shift up to almost astronomical frequencies, as the square wave covers frequency and phase characteristics up to at least 20 times the fundamental. Square wave testing is becoming increasingly important as the performance of audio equipment is continually improved and has been widely publicized in connection with output transformer performance.

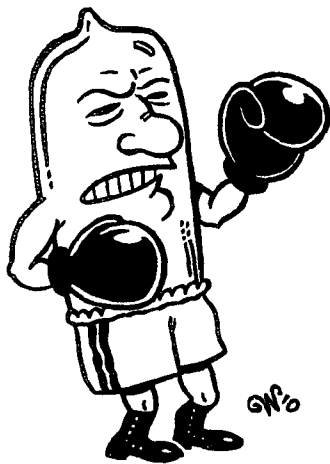

*Something I've been meaning
to do for a long time...*

I'm a big advocate of the motto "Power ain't nuthin' but a number"—a slogan that I use to give credit to low power amps. By now, however, most of us already know that a fine low power job on Altec horns or a similar sensitive loudspeaker can sound absurdly powerful in terms of subjective music playing capability, so where's the news in that?

I hate to let a classic slogan die just because it has outlived its social usefulness as a single-ended propaganda measure. Well, what about the other side of the coin, the implication that higher power amps can provide good listening too? Although the suggestion seems to be hovering around in some triode purist circles, would anybody go so far as to come out and say that an amp above ten watts automatically sucks? Of course not!

While modern experimenters have made vast progress appropriating the single triode paradigm and taking it almost everywhere it is possible to go, most alternative hi-power approaches, especially parallel and push pull triode amps, are relatively underexplored to date, an untapped world of new sounds.

Whuppin' BUTT with TRIODES

by
Joe Roberts

Back in the 80s, before I built my first SE amp, I thought PP triodes were the last word in hi-fi, just as they believed in 1949. I used to trade schematics and vintage gear impressions with tubehead super-freaks like Larry Rubins up in Jersey and Andy Bouwman (now of Vintage Tube Services) who were on the same track. Old-style homebrew PP triode amps were blowing our minds. I think I forgot how great that stuff really was.

There weren't many vintage consumer pieces that used triodes (or triode-wired beam tubes). The Brook amps, the Fisher 50A, and Bell 2145, all high-dollar products from around 1950, each had trick iron-core driver stages to waffle the power tubes into Class AB for maximum output. In other words, the expensive triode amps were high-power amps for the time. These days, in contrast, the price seems to go up as the output power goes down!

I'll get into the circuits of these 1950-era high-efficiency PP amps in part II of this article, but I found the Peerless amp design reprinted above to be an interesting distillation of high-power professional amp concepts for home hi-fi use. The topology is sort

of a baby Altec 1570 circuit, with 1/10th of the power of the big Class B 811A drive in movie theater amps. The overall A-100A design and Sprinkle's presentation of it have a classic pro-sound engineering vibe to it that I find reassuring, even though simpler approaches are much more fashionable in the late 90s.

The whole "high-efficiency amplifier" premise of Sprinkle's essay strikes me as an artifact of the professional engineer mindset of the day. Sprinkle treats *Efficiency* in itself as a greatly desirable quality, although he never proposes *why* it is so desirable or what to do with the extra power per kilowatt hour gained. One would think that most hi-fi nuts who would build this circuit, then or now, wouldn't worry too much about spinning the electric meter a few extra revolutions to enjoy the sound of a fine Class A triode amp. Given the choice, who among us wouldn't gladly pay a few additional bucks on the utility bill for sonic enhancement?

Well, I know what I'm going to do with the high-efficiency output power of the Peerless amp. I don't really need all that juice on my horn system but I sure like the idea of a beefed-up PP 2A3 for full range use. And I like the idea of the potent driver stage that Sprinkle discusses, even if I don't need the full output of the amp. If eighteen full watts ever goes up the speaker wire towards my TAD 2001 driver, I don't want to be in the room when it happens! Remember the formerly-popular concept of having substantial power overhead so the amp coasts along at normal levels? Well, I guess it can't hurt.

Part of what I wanted to get back into by building the A-100A circuit is to get back into that classic old timey approach that I used to love so much. A lot of the experimental work in progress these days is so high-tech, slick and sleek, using the most advanced tubes and smart purist/minimalist schemes, that I felt like building an "out-



The first step in building an amp is deciding to build. The second is procuring the transformers. I called Mike LaFevre of MagneQuest, custodian of the Peerless tradition, to see what it would take to scam a set of iron for these amps.

Ho, ho...no small task. As anyone who reads rec.audio.tubes knows, LaFevre is no easy shake-down target. First, I told him "Mike, when I write up this amp you'll sell so many transformer sets that you won't have to work for five years." He didn't go for that flat-out lie. I tried appealing to his love of Peerless and his sense of pride toward these fine US made iron-core components, which he now makes. That shameless pandering didn't work either. Finally, I unleashed my heaviest psy-ops tactic. I promised Mike that I would print a photo of the nifty

Alright, Homey, here's the damn race car pic, now where's the iron, sucker?

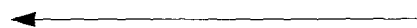

moded" amp using good old WWII tubes like top-cap 6J7s and 6SN7s. I know this uncool old school scheme can still really play music in a very satisfying manner.

Well, it sure ain't a minimalist gem. I chopped off the preamp stage and still needed seven tube sockets per amp. Yet, I can relate to why each stage is there, the reason behind the elaboration. Here's what good solid audio engineering used to look like. Those old-timers weren't afraid of an extra tube or two if they needed it. Sure, I was tempted to "update" the circuit, but then I chose to stick to the original plan and see where it goes—for starters, at least.

The ploy worked: A heavy box of iron from Philly arrived at my door and I was quickly off to the workshop.

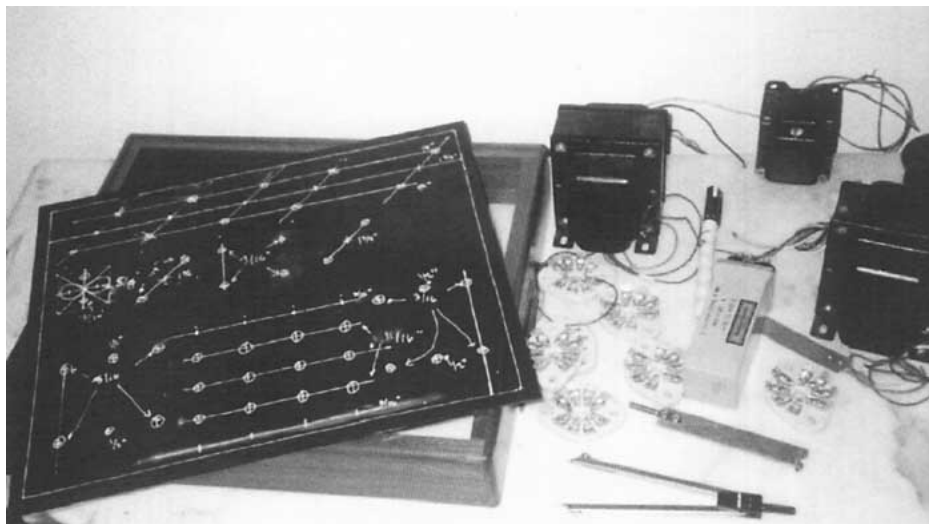

Soldering iron in a heated condition. Peerless amps edging toward completion.

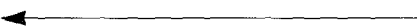

Creamsicle-orange MagneQuest-sponsored sprint car if he could arrange the long-term loan (30 years) of a pair of S-245Q and a couple power tranny's, and it wouldn't hurt to throw in some split chokes for the drivers also.

Well, finally we get cooperation. It turned out that he had some 245s wound leftover from a Japanese order sitting in his basement and the mofo was just holding out on me! Anyway, I had the OPT's and two freshly-wound powers and audio chokes (still smelling like the hot wax the coils were dipped in) at my door in a week. Of course, the race car pic was also in the box. A deal's a deal... Gentlemen, start your engines!

(To be continued)

