

BROADCAST ENGINEERING®

the technical journal of the broadcast-communications industry

'73 Buyers' Guide
'73 Buyers' Guide
'73 Buyers' Guide
'73 Buyers' Guide
'73 Buyers' Guide
'73 Buyers' Guide
'73 Buyers' Guide
'73 Buyers' Guide
'73 Buyers' Guide
'73 Buyers' Guide
'73 Buyers' Guide
'73 Buyers' Guide
'73 Buyers' Guide
'73 Buyers' Guide
'73 Buyers' Guide
'73 Buyers' Guide

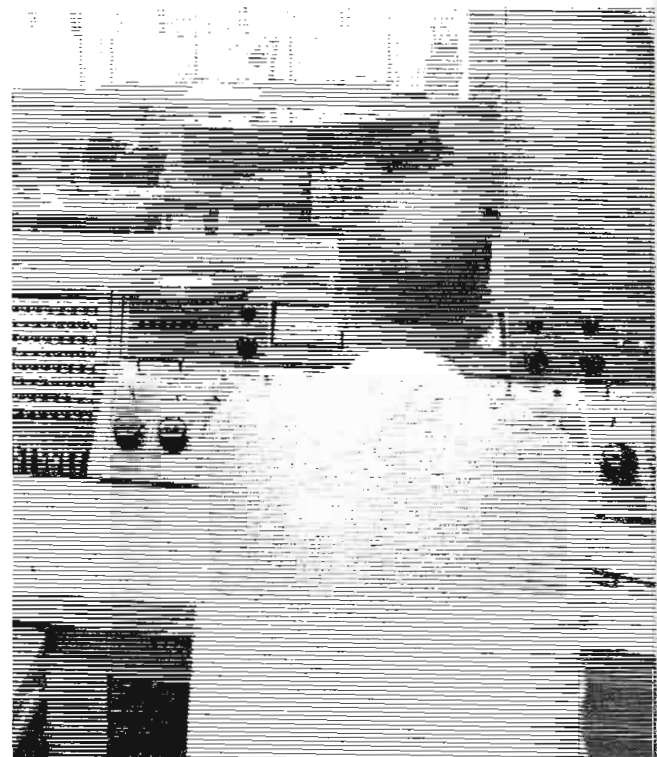
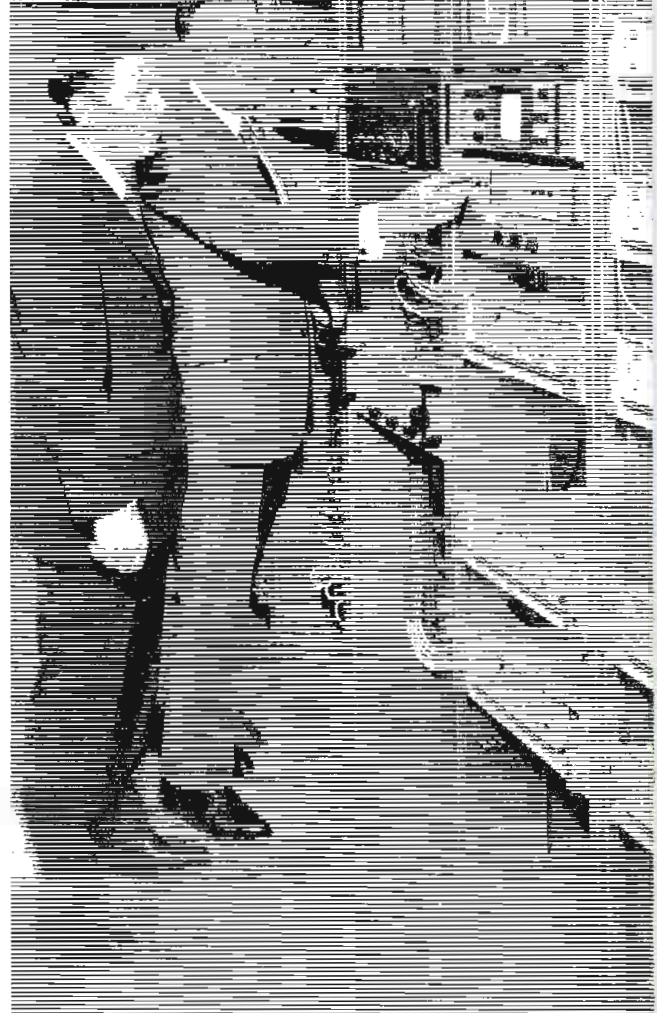

DL42

It does more
than just reach.

It helps you to
better sound.
Every take.
Every day.
Anywhere.

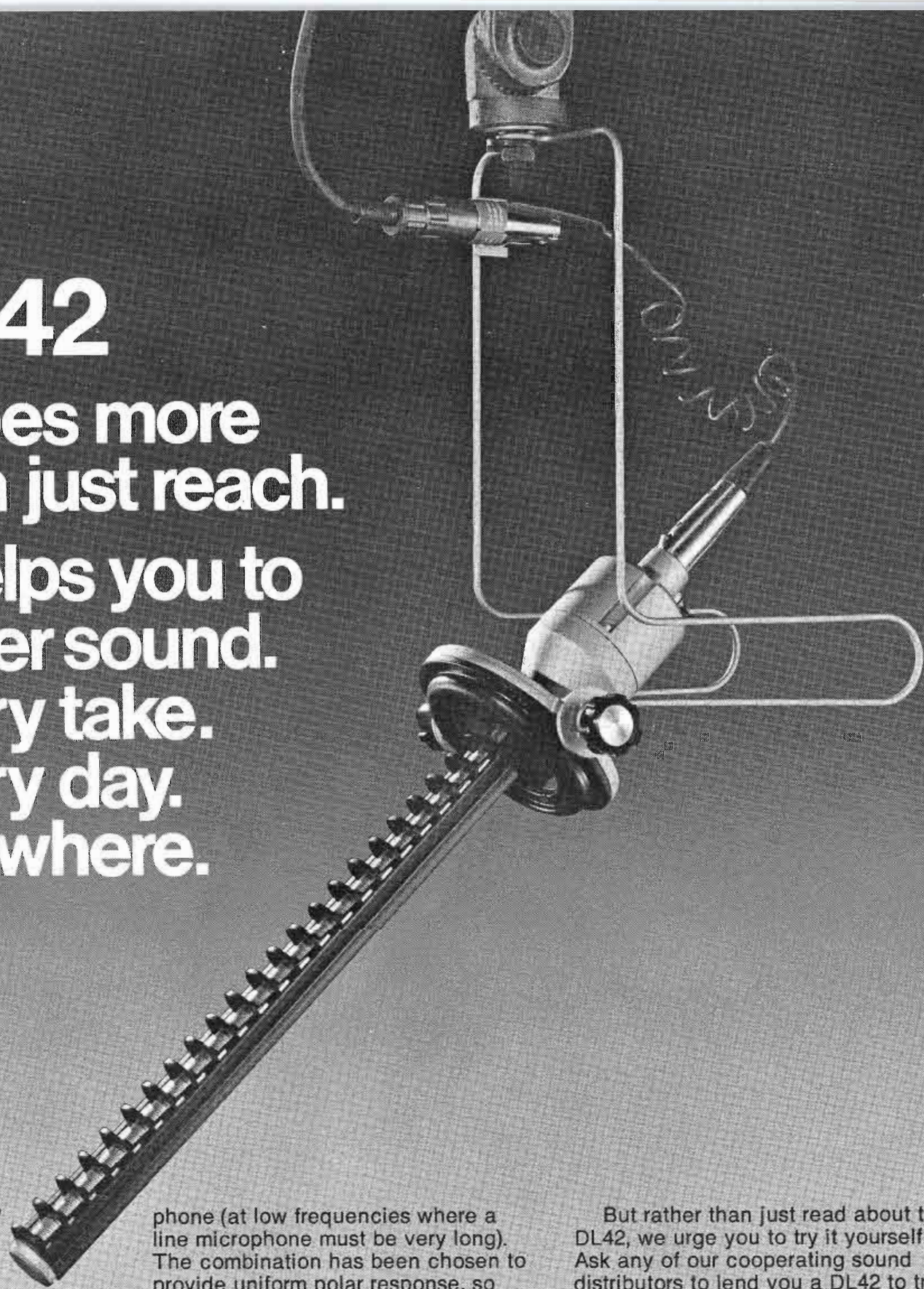

Since 1962 when the E-V Model 642 earned an Academy Award certificate for contributions to motion picture sound, there have been a lot of attempts to better this pioneering design.

Admittedly, some similar-appearing microphones were lighter and a bit smaller. But often it was at the expense of uniform polar response and wide range. Now there's a long reach microphone that's both smaller and lighter, yet maintains wide range response even off mike.

It's the E-V DL42.

Weight has been reduced to 1/4 of the 642... even less than most highly-directional condenser microphones. And size has been shaved wherever possible. The DL42 is a unique combination of line microphone (at the high frequencies) and cardioid micro-

phone (at low frequencies where a line microphone must be very long). The combination has been chosen to provide uniform polar response, so important to consistent sound quality. Off-mike pickups even sound good (although lower in level), a particular advantage to documentary units and free-wheeling shows where the unexpected is always happening.

The good pickup quality off axis has another practical benefit in the studio. Because maximum rejection is at the sides (where most of the noise comes from) you can work at a remarkable distance when necessary. So when a long shot is called for, the DL42 can be moved upward and cover the entire area with good quality and level. In fact the DL42 is more like a super-super-cardioid. And it covers with less racking and paring of the microphone than you ever needed before.

But rather than just read about the DL42, we urge you to try it yourself. Ask any of our cooperating sound distributors to lend you a DL42 to try on your next production. No cost or obligation to serious professional users. Write today for a DL42 technical data sheet. Good reach with good sound. We think you'll like what you hear.

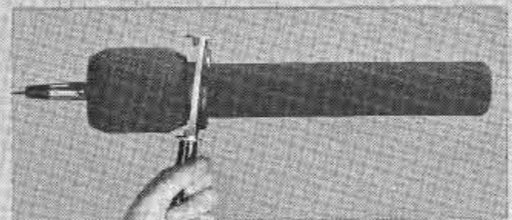

Electro-Voice

For More Details Circle (1) on Reply Card

a **Gulton**
COMPANY

AMPEREX PLUMBICON*
TV CAMERA PICKUP TUBE



*This is the tube
that was in the camera
that revolutionized TV broadcasting
seven years ago.*

INTENSIFIED
SILICON-VIDICON

SILICON-VIDICON



VIDICON

PLUMBICON

**This is the line,
the only line
that includes all four types
of one-inch camera tubes
currently used in
today's TV cameras.**

Amperex, who gave the TV industry the Plumbicon camera pickup tube seven years ago, is the only manufacturer of all of the four types of one-inch pickup tubes used in today's TV cameras.

Recognizing the obligations that have accrued to us as the number one source for the component that is the heart of the TV camera, we extend an invitation to anyone who is contemplating the purchase or the design of a TV camera system to discuss his specific requirements with us, with complete confidence in the objectivity and validity of our recommendations. Whatever the application — color or black and white, telecasting or video-taping, CCTV or CATV, industrial, educational or medical, surveillance security or military reconnaissance.

Electro-Optical Devices Division,
Amperex Electronic Corporation,
Slatersville, Rhode Island 02876
Telephone: 401-762-3800

For More Details Circle (4) on Reply Card



Amperex

TOMORROW'S THINKING IN TODAY'S PRODUCTS

Sold through
North American Philips Electronic Component Corporation

*Trademark of N.V. Philips of The Netherlands

BROADCAST engineering

The technical journal of the broadcast-communications industry [®]

in this issue...

28 Basic Digital Logic Review. John Lee continues with Part 3 of his 4-part series by covering a variety of gates used in logic designs. **John Lee.**

34 Television Down The Line. A manufacturer takes a look at what he thinks we are likely to see in TV equipment in the years to come. **Bagio Presti.**

38 Jungle Guides Needed. A station engineer discusses the problem of equipment purchases at a time when circuit sophistication is ever increasing. **Fred Moore.**

42 Read Those Specifications. A chief engineer tells what to look for in the specification sheets so your equipment comparisons will be more meaningful. **Dennis Ciapura.**

54 The FCC Expects You To Know. BE Editor reviews citations and fines against stations involved in lottery and excessive power. **Ron Merrell.**

59 Address Directory. Complete list of addresses for companies listed in this year's equipment section.

65 1973 Buyer's Guide Equipment Directory. Our new and enlarged directory includes 600 categories.

ABOUT THE COVER

Our special cover treatment this year calls attention to the industry's most complete equipment buyer's guide. Design by Webb Streit.

DEPARTMENTS

Direct Current	4
Letters to the Editor	8
SBE Journal	13
Industry News	20
Book Reviews	106
New Products	120
Classified Ads	142
Ad Index	144

Copyright, 1973, Howard W. Sams & Co., Inc. All Rights Reserved: Material may not be reproduced or photocopied in any form without written permission of publisher.

EDITORIAL
 RONALD N. MERRELL, Director
 CARL BABCOKE, Technical
 PAT FINNEGAN, Maintenance
 HOWARD T. HEAD, FCC Rules
 ROBERT A. JONES, Facilities
 WALTER JUNG, Solid State
 ANDRA BOYLE, Editorial Assistant
 H. G. ROESLER, Cartoonist
 WEBB G. STREIT, Graphic Designer
 JOE ROIZEN, Video
 ARCHER TAYLOR, CATV

EDITORIAL ADVISORY BOARD
 LES NELSON, Chairman
 Howard W. Sams & Co., Indianapolis

CIRCULATION
 EVELYN ROGERS, Manager

ADVERTISING
 E. P. LANGAN, Director
 R. JACK HANCOCK, Manager
 GREG GARRISON, Production
 JAKE STOCKWELL, Sales

REGIONAL ADVERTISING SALES OFFICES
 RON ROBINETT
 1014 Wyandotte St.
 Kansas City, Mo. 64105

Indianapolis, Indiana 46206
 ROY HENRY
 2489 E. 98th St.
 Indianapolis, Ind.
 Tele: 317/846-7026

New York, New York 10017
 STAN OSBORN
 60 East 42nd Street
 Room 1227
 New York, N. Y. 10017
 212/687-7240

Los Angeles, California
 MICHAEL KREITER
 3600 Wilshire Blvd., Suite 1510
 Los Angeles, California 90005
 Tele: 213/383-1552

London W. C. 2, England
 JOHN ASHCRAFT & CO.
 12 Bear Street
 Leicester Square
 Tele: 930-0525

Amsterdam C. Holland
 JOHN ASHCRAFT & CO.
 W. J. M. Sanders, Mgr.
 for Benelux & Germany
 Herengracht 365
 Tele: 020-240908

Tokyo, Japan
 INTERNATIONAL MEDIA
 REPRESENTATIVES, LTD.
 Shiba-Kotohiracho, Minato-ku
 Tele: 502-0656



BROADCAST ENGINEERING is published monthly by Intertec Publishing Corp., 1014 Wyandotte Street, Kansas City, Missouri 64105. Telephone: 913 888-4664.

BROADCAST ENGINEERING is mailed free to qualified persons engaged in commercial and educational radio and television broadcasting. Non-qualified subscriptions in the U.S. are \$6.00 one year, \$10.00 two years, \$13.00 three years. Outside the USA add \$1.00 per year to cover postage. Single copy rate 75 cents. Back issue rate \$1.00. Adjustments necessitated by subscription termination at single copy rate.

Controlled Circulation postage paid at Indianapolis, Indiana.



Robert E. Hertel, Publisher
 INTERTEC PUBLISHING CORP.
 Subsidiary of HOWARD W. SAMS & CO., INC.

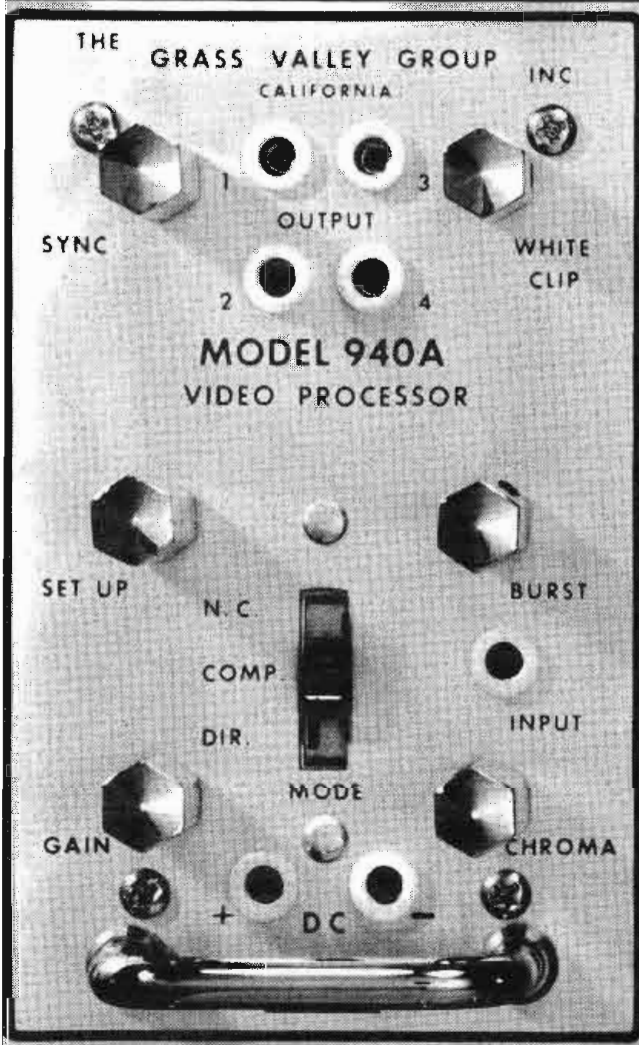
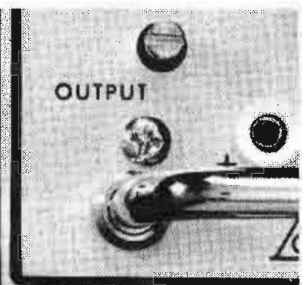
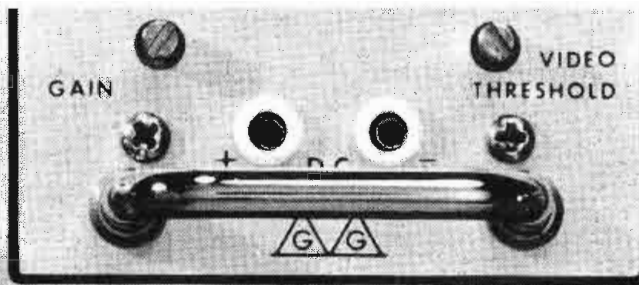
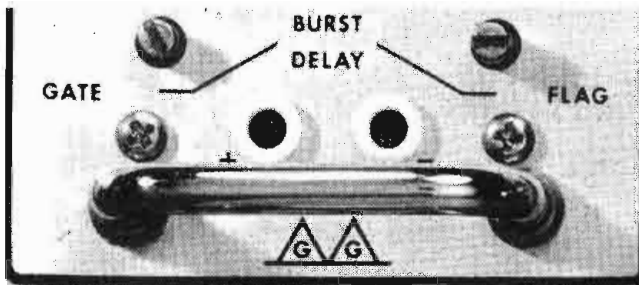

VIDEO DISTRIBUTION AMPLIFIERS
PULSE DISTRIBUTION AMPLIFIERS
VIDEO EQUALIZERS
PULSE DELAY AMPLIFIERS
VIDEO INSERT KEYS
COLOR BLACK/BACKGROUND GENERATORS
BORDERLINE GENERATORS
SYNCHRONIZING GENERATORS
VIDEO PROCESSING AMPLIFIERS
SPECIAL EFFECTS GENERATORS
CHROMA KEYS
STUDIO PRODUCTION SWITCHERS
ROUTING SWITCHERS
TELEVISION AUTOMATION SYSTEMS
DIGITAL MACHINE CONTROL SYSTEMS

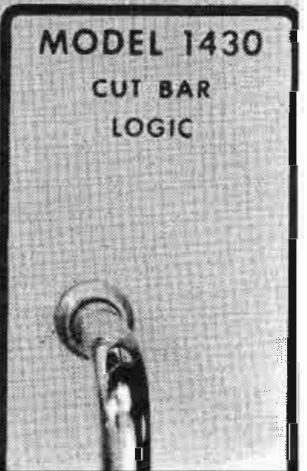
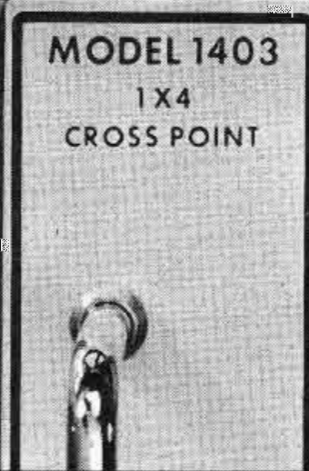
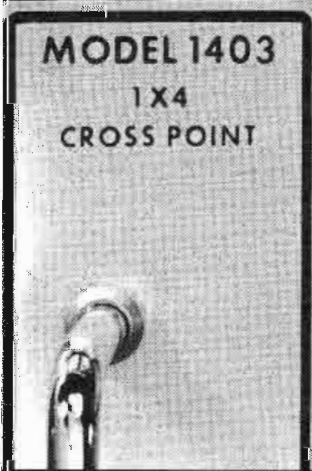
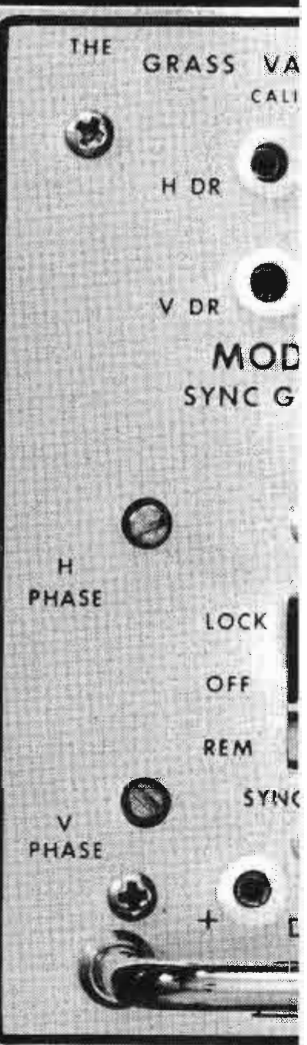

THE GRASS VALLEY GROUP, INC.

SOLD EXCLUSIVELY BY GRAVCO SALES, INC.

6515 Sunset Blvd.
LOS ANGELES, CALIF.
(213) 462-6618

Station Plaza East
GREAT NECK, N.Y.
(516) 487-1311

125 South Wilke Road
ARLINGTON HEIGHTS, ILL.
(312) 394-1344

Redbird Airport
DALLAS, TEXAS
(214) 330-1245

1644 Tullie Circle, N.E.
ATLANTA, GEORGIA
(404) 634-0521

OVERSEAS - GRASS VALLEY INTERNATIONAL - BOX 1114, GRASS VALLEY, CA 95945 - USA

DIRECT CURRENT FROM D. C.

September, 1973

by Howard T. Head

Circular Polarization To Be Tested for TV

A Chicago VHF TV station is preparing to test the effect of transmitting with circular polarization as a source of possible improvement over transmissions with the standard horizontally-polarized signal. Signals will be transmitted from the top of the world's tallest building, the Sears-Roebuck building, where it is eventually planned to locate all of the Chicago television stations.

The use of circular polarization holds promise of providing increased signal at the receiver, although, ideally, maximum improvement would be expected only when an appropriate circularly-polarized receiving antenna is also employed. However, as proved to be the case with circular polarization for FM broadcast, unexpected improvements may be realized in areas where simple indoor antennas predominate and reflected signals are numerous. One important unanswered question in TV is the extent to which time delays resulting from differing transmission path lengths may aggravate ghosting problems.

Previous tests of circular polarization in TV have been relatively limited, confined principally to tests on Ch. 10 at Altoona, Pennsylvania, Channel 31 in New York City, and Ch. 6 in El Salvador. The comprehensive test program planned in Chicago could go far to providing answers to many of the remaining questions.

Commission to Simplify Directional Antenna Operator Rules

When the Commission adopted new Rules permitting the operation of standard broadcast directional antennas by operators holding less than a first-class radio-telephone license, a requirement was adopted for a partial proof of performance consisting of at least ten field strength measurements along each radial route to verifying the directional antenna pattern. The Rules require an analysis of the data to establish the inverse distance field strength, and furthermore this entire process must be repeated annually so long as reduced-grade operators are employed.



It's no big thing!

It's only a broadcast quality, portable COLOR camera that's priced under \$4000 and weighs less than 6 lbs.!

AKAI'S new CCS-150S Portable Color Camera weighs only 5.8 lbs. yet offers professional studio quality costing thousands more in any other camera.

The specifications tell the story:

- Completely compatible with any U.S. TV system.
- Two vidicon system with separate Luminance and Chrominance channels.
- S/N ratio: Luminance—Better than 40dB
Chrominance—Better than 30dB
- 525 line scanning, 2 to 1 interlaced, locked chroma.
- Better than 300 line resolution.
- Built-in 6 to 1 zoom lens.
- Viewfinder—1.5" picture tube.
- Built-in directional microphone.
- Servo controlled Iris.
- Sensitivity control: 60 to 2,000 ft. candles (without filters)
- AC or battery operated.
- Dimensions: 3½" (W) x 10" (H) x 12" (D) including lens and grip.

The performance of AKAI's new CCS-150S color camera will amaze you! Whether you use it as the perfect tool for on-location shooting or as an alternate studio camera...

But see for yourself... it's really no big thing!

For More Details Circle (6) on Reply Card

From

AKAI™

The Innovators

AKAI America, Ltd./P.O. Box 55055,
Los Angeles, California 90055

The Commission has now concluded that this requirement is unnecessarily stringent and is preparing to change the Rules so as to require this relatively complete proof of performance only every third year rather than each year. In the intervening years, measurements at three points along each radial route are to be required, and the analysis for these years is to be omitted.

New Rules incorporating these revised provisions are expected to be issued shortly.

NAB Asks Change in FM Translator Policy

The National Association of Broadcasters (NAB) has asked the Commission to change the Rules establishing eligibility for the licensing of FM translators. Under the present Rules, an FM broadcast licensee may also hold a transmitter license so long as the translator community is within the 1 mv/m contour or if outside the contour not within the 1 mv/m contour of an FM broadcast station in another city.

These restrictions apply, however, only where the translator license is to be held by the FM broadcast station licensee. If the license is to be held by another entity, such as a local citizens group, neither of these restrictions applies. NAB contends that the present requirements may promote unfair competition and urges the Commission to extend the restrictions on translator eligibility to all licensees and not only the FM broadcast licensees.

Short Circuits

The Commission has proposed to increase allowable height of Class C and D CB stations from 20 feet to 60 feet above ground (except near airports)...The Commission has adopted Rules restricting television program exclusivity to the community of license or other communities no more than 25 miles away... Frequency monitors are no longer required at AM and FM broadcast stations; monthly frequency measurements are required... Land mobile transmitters in aircraft may now be used only for aircraft regularly flying at altitudes below one mile.

COMPUTER-ASSISTED REMOTE CONTROL



FULLY DIGITAL

- CONTROL
- TELEMTRY
- STATUS
- AUTOMATIC LOGGING

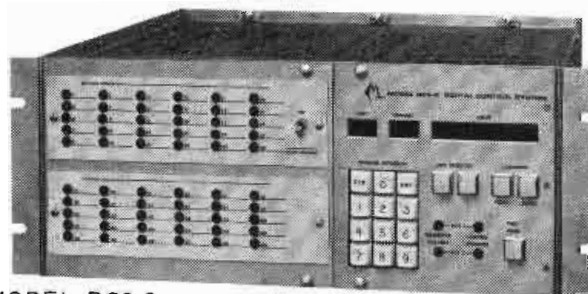

MODEL DCS-2

Model DCS-2 Digital Control System for operation of remotely located transmitter plants. Computer Option includes simultaneous display of 30 parameters and other features including tolerances for all parameters. The system can be programmed for totally automated transmitter plant operation.

AURAL STUDIO - TRANSMITTER & REMOTE PICK-UP LINKS

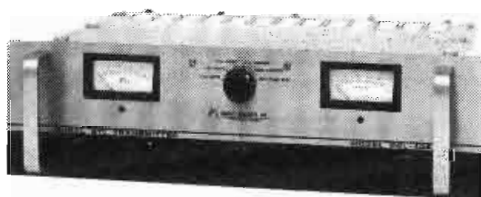

SYSTEMS FOR

- 148-174 MHz ■ 215-240 MHz
- 300-470 MHz ■ 890-960 MHz
- Others on Special Order

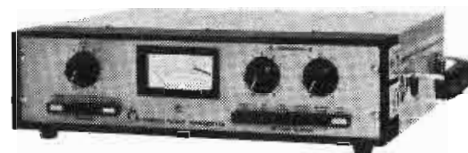

- FM Stereo on a single STL — a Moseley first!
- Time-proven STL's for all applications — AM-FM-FM Stereo
- Small-sized Remote Pick-Up Link — Models RPL 3/RPL-4

ANALOG REMOTE CONTROL

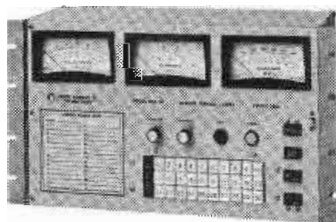

MODEL PBR-30A

Stepperless 15-channel model TRC-15A. Pushbutton model PBR-30A. Both systems available for wire and wireless service.



MODEL TRC-15A



MODEL SCG-3T FM STEREO GENERATOR

Time-proven stereo performance from an all solid-state self-contained unit.

OTHER MOSELEY PRODUCTS

- Model SCG-4T SCA Generator
- Status/Alarm Systems
- Remote Control Accessories
- Digital Automatic Logging Systems
- Tolerance Alarm Unit

For further information please contact our Marketing Department



MOSELEY ASSOCIATES, INC.
SANTA BARBARA RESEARCH PARK

111 CASTILIAN DRIVE
GOLETA, CALIFORNIA 93017
TELEPHONE (805) 968-9621
TELEX 658448

teltron

ORTHICON
VIDICON
TELICON
FABICON
ISOCON
SPECIALS

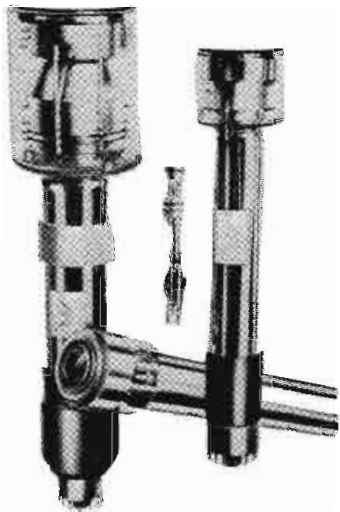

complete design and development capability for tubes with special photo cathode surfaces, face plates and targets for broadcast, government, industry and educational applications.

 **teltron** INC.
940 Willow Street Pottstown, Pa. 19464
(215) 326 2127

For More Details Circle (8) on Reply Card

LETTERS TO THE EDITOR

So What's A Lottery

Dear Editor:

At this station we deeply appreciate and thoroughly use your magazine.

The June edition of **BE** carried an article by you called "The FCC Expects You to Know." In the third column on page 48 of this story you referred to two stations in Gainesville, Florida loosing \$2000 on lottery violations. Apparently they carried advertising saying that savings bonds were being given away with the purchase of new cars.

We are curious to know if the bonds were given away with each car or only with certain models (in some method based on chance).

One of our advertisers gave 50-

gallons away with every new car. However, in the case of his most expensive automobiles he gave an additional 50-gallons. We would like to know if that might be "chance" in the same sense as in the Gainesville case and therefore in violation of the law.

Naturally we don't expect a legal opinion from you but will appreciate whatever comments you may make.

John H. Wiegman
Engineer/Newsman
KWAL
Osburn, Ida.

Editor's Note: In this issue you will find further examples of stations

AM & FM LIMITERS • REMOTE, LINE & MONITOR AMPLIFIERS • FM ANTENNAS • ANTENNA SAMPLING & TUNING EQUIPMENT
• ATTENUATORS • TONEARMS • SPARTAMATION: PROGRAM
LER, TAPE CARTRIDGE & REEL/REEL REMOTE CONTROL, P
FIER & MONITOR, TAPE CARTRIDGE CAROUSELS, TIME AN
14" REPRODUCER • REEL/REEL RECORDER-REPRODUCE
• CENTURY SERIES TAPE CARTRIDGE MODULAR RECORD-
DITIONING SERVICE • TONEARM PICKUP CARTRIDGES &
CONSOLE: MONO, STEREO (QUAD CAPABLE) • 8-MIXER
SOLES • 5-MIXER MONO OR STEREO CONSOLES • 4-MIXE
TRIDGE TIME DELAY & REVERB SYSTEM & DELAY CARTRI
ERASER • TAPE HEAD DEMAGNI
SIZE
• TEST TAPE CARTRIDGES • T
APE
MONO OR STEREO HEADPHO
NES
CENTERS WITH FURNITURE • S
PEA
TURNTABLES • AM TRANSMITT
ERS:
kw, 25 kw OR BUILT TO ORDER
• FM
2.5 kw, 5 kw, 12.5 kw, 20 kw, 40
QUENCY & MODULATION MONI
TATION MONITORS, MONO & S
WIRE LINK REMOTE CONTROL •
• INTENSITY METERS • ANTENNA
• DIRECT FM EXCITER • SCA G
LIGHTING SYSTEMS • PREAMPLIFI
POWER SUPPLIES • REMOTE PICKUP SYST
OTHER FINANCING ARRANGEMENTS • COMB
SYSTEMS • MICROPHONE STANDS & BOOMS
INERS, DIPLEXERS, MULTIPLEXERS • WIRELESS MICROPHONE
SPARTA, THE 'JUST RIGHT' COMPANY. SMALL ENOUGH TO
BE FIRST NAME FRIENDS . . . BIG ENOUGH TO OFFER EVERYTHING. CALL US COLLECT . . .

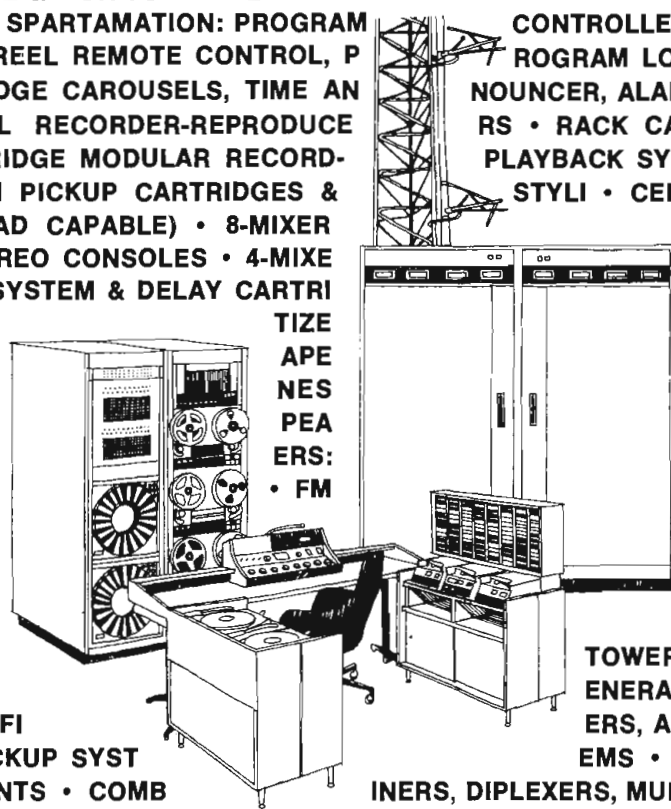

CONTROLLER, RANDOM ACCESS SUB-CONTROL-
ROGRAM LOGGING, DIGITAL CLOCK, LINE AMPLI-
NOUNCER, ALARM SYSTEM • REEL/REEL CORINTHIAN
RS • RACK CABINETS • COAX & SHIELDED CABLE
PLAYBACK SYSTEM • TAPE CARTRIDGES & RECON-
STYLI • CENTURION CUSTOM 8-16 MIXER AUDIO
MONO OR STEREO AUDIO CON-
REMOTE AMPLIFIER • TAPE CAR-
DGES • TAPE CARTRIDGE OR REEL
R • TAPE HEAD ALIGNMENT GAUGE
CARTRIDGE STORAGE RACKS •
• STUDIO OR REMOTE CONTROL
KER SYSTEMS • MICROPHONES •
50 W, 1 kw, 3 kw, 5 kw, 10 kw, 15
TRANSMITTERS: 10 W, 250W, 1 kw,
kw OR BUILT TO ORDER • AM FRE-
TORS • FM FREQUENCY & MODU-
TEREO & SCA • RF AMPLIFIERS •
S.T.L. • PHASE SAMPLERS • FIELD
TOWERS • FM ANTENNAS • ISOCOUPERS
ENERATOR • STEREO GENERATOR • TOWER
ERS, AMPLIFIERS, TURNTABLE & AUDIO • AC
EMS • AUDIO RECORDING TAPE • LEASE &
INERS, DIPLEXERS, MULTIPLEXERS • WIRELESS MICROPHONE
SPARTA, THE 'JUST RIGHT' COMPANY. SMALL ENOUGH TO
BE FIRST NAME FRIENDS . . . BIG ENOUGH TO OFFER EVERYTHING. CALL US COLLECT . . .

in a word . . .

everything



SPARTA
ELECTRONIC CORPORATION

5851 Florin-Perkins Road, Sacramento, Ca. 95828
916 383-5353 TELEX 377-488 CABLE SPARTA
A DIVISION OF COMPUTER EQUIPMENT CORPORATION

For More Details Circle (9) on Reply Card

CABLE engineering

in this issue...

Annual Cable Buyers' Guide	CE-2
Address Directory	CE-13

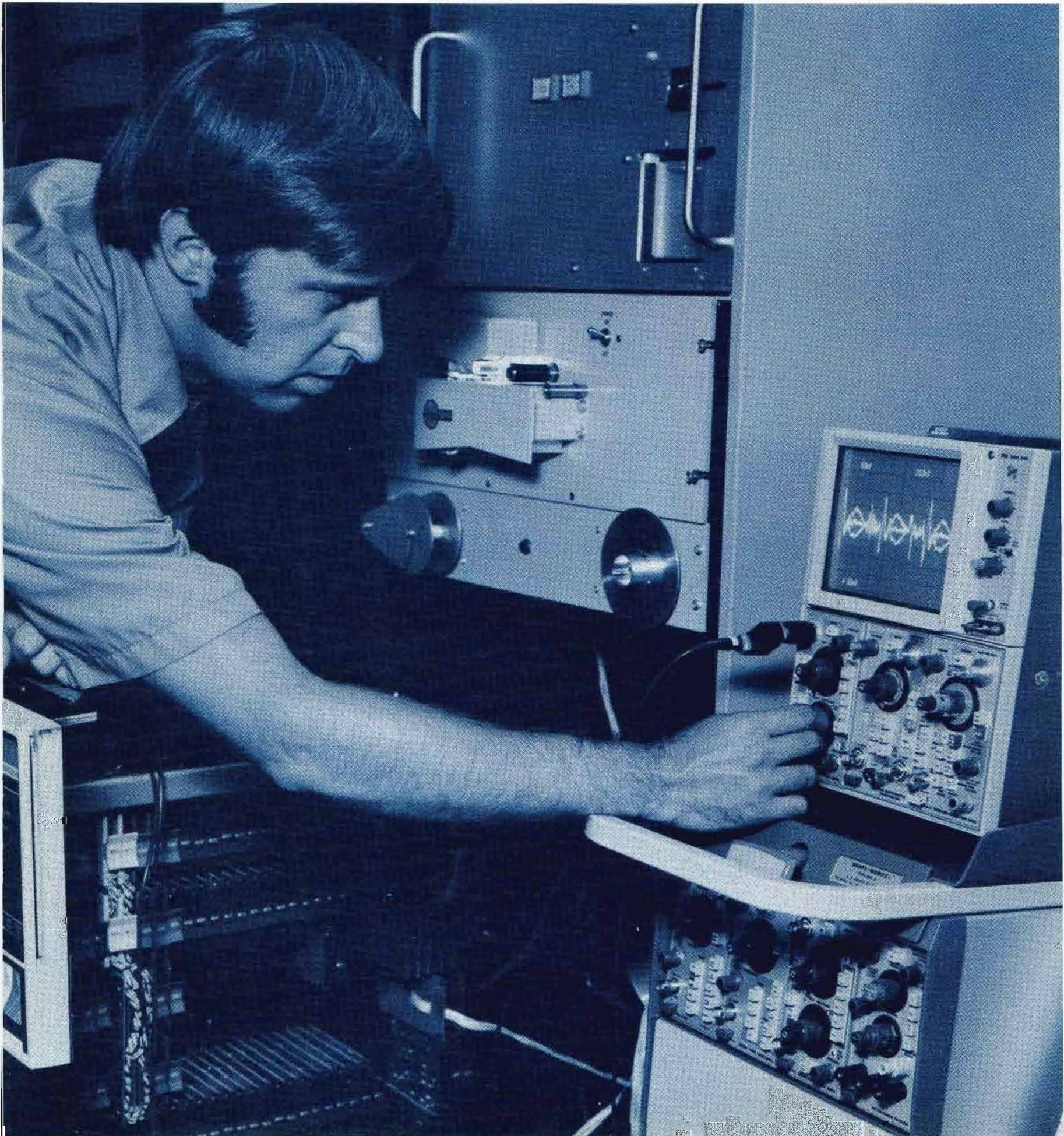

CATV Product Directory

Red listings are for manufacturers who advertised in this issue. The red listing in any category will refer you only to advertisements of equipment listed in that category.

Immediately following the cable equipment section and the broadcast-communications product sections are comprehensive lists of equipment manufacturers.

The following categories are for equipments especially designed for use in cable operations. The more general categories of communications equipment are listed under the Guide heading Broadcast-communication Product Directory. Cameras, recorders, switchers and a wide line of other support equipment are in that section.

Reader Service Card Good For One Year

Amplifiers, Bridging

Ameco, Inc.
Anaconda Elect.
Anixter-Pruzan
Blonder-Tongue Labs., Inc.
Buckeye Telephone & Supply Co.
C-COR Elect., Inc.
Jerry Conn & Assoc., Inc.
Delta-Benco-Cascade Ltd.
Elect. Indust. Eng., Inc.
Entron, Inc.
Environmental Comm., Inc.
GTE Sylvania
Jerrold Elect. Corp.
Lindsay Specialty Prods. Ltd.
Magnavox
Maspro Co., Inc.
Teleaudio Centre
Teleng Inc.
Theta-Com of Calif.
TV Cable Supply Co., Inc.
Ultra Audio Prods.
Vikoa, Inc.

Amplifiers, Broadband

AEL Comm. Corp.
Ameco, Inc.
Anaconda Elect.
Anixter-Pruzan
Avantek, Inc.
B&K Instr., Inc.
Blonder-Tongue Labs., Inc.
Broadcast Prods., Inc.
C-COR Elect., Inc.
Jerry Conn & Assoc., Inc.
Delta-Benco-Cascade Ltd.
Elect. Indust. Eng., Inc.
Entron, Inc.
Environmental Comm., Inc.
GTE Sylvania
Jerrold Elect. Corp.
JFD Systems Div.
Kay Elemetrics Corp.
KLM Elect.
Lindsay Specialty Prods. Ltd.
Magnavox

RMS Elect., Inc.
Rohde & Schwarz Sales
Sitco Antenna Co.
Teleng Inc.
Theta-Com of Calif.
TV Cable Supply Co., Inc.
Vikoa, Inc.

Amplifiers, Distribution

Omnix. See page CE-5

Amplifiers, Distribution Pulse

Omnix. See page CE-5

Amplifiers, Line Extender

Able Comm. & Elect.
Ameco, Inc.
Anaconda Elect.
Anixter-Pruzan
Buckeye Telephone & Supply Co.
Cascade Elect. Ltd.
C-COR Elect., Inc.
Jerry Conn & Assoc., Inc.
Delta-Benco-Cascade Ltd.
Elect. Indust. Eng., Inc.
Entron, Inc.
Environmental Comm., Inc.
GTE Sylvania
Jerrold Elect. Corp.
Lindsay Specialty Prods. Ltd.
Magnavox
MPI Co.
Riker Video
Teleng Inc.
Theta-Com of Calif.
TV Cable Supply Co., Inc.
Vikoa, Inc.

Amplifiers, Processing

Ameco, Inc.
Amer. Data Corp.
Anixter-Pruzan
Ball Bros. Research Corp.
CBS Labs.
Cohu, Inc.
Jerry Conn & Assoc., Inc.

Delta-Benco-Cascade Ltd.
Dynasciences Corp.
Environmental Comm., Inc.
GTE Sylvania
Scientific-Atlanta, Inc.
Video Eng. Co., Inc.
Vikoa, Inc.
Vital Indust. Inc.

Amplifiers, RF

AEL Comm. Corp.
Alaun Engineering
Ameco, Inc.
Anixter-Pruzan
AVA Elect. & Machine Corp.
Avantek, Inc.
Beaver Elect. Ltd.
B & K Instr., Inc.
Blonder-Tongue Labs., Inc.
C-COR Elect., Inc.
Jerry Conn & Assoc., Inc.
Elect. Indust. Eng., Inc.
Environmental Comm., Inc.
Jerrold Elect. Corp.
JFD Systems Div.
Kay Elemetrics Corp.
KLM Elect.
Leaming Indust. Corp.
RMS Elect., Inc.
Rohde & Schwarz Sales
TV Cable Supply Co., Inc.

Amplifiers Station, Modular

Ameco, Inc.
Anaconda Elect.
Buckeye Telephone & Supply Co.
C-COR Elect., Inc.
Jerry Conn & Assoc., Inc.
Environmental Comm., Inc.
GTE Sylvania
Jerrold Elect. Corp.
Lindsay Specialty Prods. Ltd.
KLM Elect.
Magnavox
Teleng Inc.
Theta-Com of Calif.
TV Cable Supply Co., Inc.

Vikoa, Inc.

Amplifiers, Subcarrier

Omnix. See page CE-5

Amplifiers, Trunk

AEL Comm. Corp.
Ameco, Inc.
Anaconda Elect.
Anixter-Pruzan
Blonder-Tongue Labs., Inc.
Buckeye Telephone & Supply Co.
Cascade Elect. Ltd.
C-COR Elect., Inc.
Jerry Conn & Assoc., Inc.
Delta-Benco-Cascade Ltd.
Elect. Indust. Eng., Inc.
Entron, Inc.
Environmental Comm., Inc.
GTE Sylvania
Jerrold Elect. Corp.
Magnavox
Teleng Inc.
Theta-Com of Calif.
TV Cable Supply Co., Inc.
Vikoa, Inc.

Amplifiers, Two-Way

AEL Comm. Corp.
Ameco, Inc.
Anaconda Elect.
Anixter-Pruzan
AVA Elect & Machine Corp.
Buckeye Telephone & Supply Co.
Cascade Elect. Ltd.
C-COR Elect., Inc.
Jerry Conn & Assoc., Inc.
Delta-Benco-Cascade Ltd.
Elect. Indust. Eng., Inc.
Entron, Inc.
Environmental Comm., Inc.
GTE Sylvania
Jerrold Elect. Corp.
Lindsay Specialty Prods. Ltd.
Magnavox
Scientific-Atlanta, Inc.

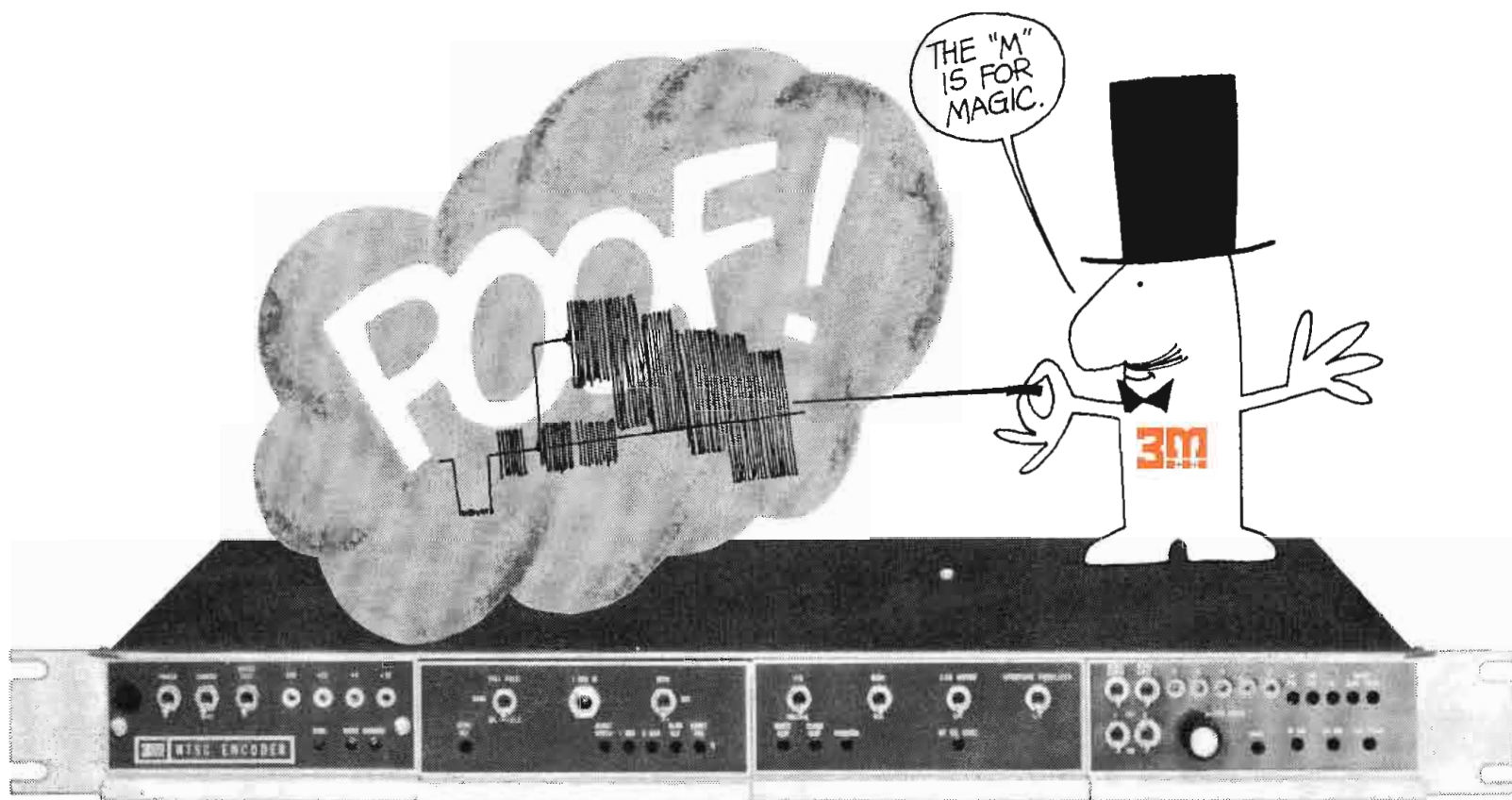

Presto! Change-o!

Before your very eyes, the flick of a switch converts the output of any 3- or 4-channel camera, no matter what its price, into an encoded signal that meets all applicable EIA and NTSC specs!

The switch is on the 3M color video encoder, and it's loaded with features and performance like nothing you've ever seen before:

Its all-digital color bar generator, accurate to within $\pm 1/2\%$, requires no adjustments and has already earned a

reputation for being rock solid with temperature variations.

Its video input clamping circuits eliminate low frequency hum and noise, and prevent APL changes and ground loops from causing color errors.

Its amplitude-dependent aperture equalizer provides noise-free picture crispening.

Its luminance-enhancement circuits increase the resolution of 3-channel cameras, improve the color fidelity of 4-channel cameras, and provide automatic green channel luminance when switching to monochrome.

And maybe best of all, its price is lower than you'd expect.

As we said, like nothing you've ever seen before, so why not let us show you? Ask for a demonstration. There'll be no hocus-pocus, no mumbo jumbo — we let the 3M color video encoder speak for itself.

We've made more believers that way.

Mincom Division, 3M Company, 300 South Lewis Road, Camarillo, California 93010. Telephone (805) 482-1911.

VIDEO PRODUCTS
Mincom Division **3M**
 COMPANY

SERVICE AND QUALITY ABOVE ALL OTHERS.

Next time your station requires tower or antenna installation, inspection or repair, check **first** with Broadcast Tower Service. You'll find that Broadcast Tower Service offers a complete range of services incorporating quality workmanship, rapid delivery and greatest economy.

An experienced crew is ready now to handle all your tower/antenna needs, whenever and wherever they occur. Scores of satisfied customers in:

- CATV
- MICROWAVE
- TWO-WAY
- AM and FM
- TRANSLATOR SITES

HEIGHTS
UP TO
600'

BROADCAST TOWER SERVICE

P.O. Box 448
Sioux Falls, South Dakota 57101
(605) 336-6080

Teleng Inc.
Theta-Com of Calif.
TV Cable Supply Co., Inc.
Vikoa, Inc.

Antenna Baluns

Anixter-Pruzan
Beaver Elect. Ltd.
Blonder-Tongue Labs., Inc.
Cablewave Systems Inc.
Jerry Conn & Assoc., Inc.
Delta-Benco-Cascade Ltd.
Gates Radio
Hy-Gain Elect. Corp.
Jampro Antenna Co.
JFD Systems Div.
KLM Elect.
Lindsay Specialty Prods. Ltd.
Maspro Co., Inc.
Scala Radio Corp.
Scientific-Atlanta, Inc.
Sitco Antenna Co.
Systems Eng., Inc.

Antennas, Broadband

Advance Indust., Inc.
Anixter-Pruzan
Beaver Elect. Ltd.
Blonder-Tongue Labs., Inc.
Cablewave Systems Inc.
Jerry Conn & Assoc., Inc.
Cush Craft Corp.
Gates Radio
Hy-Gain Elect. Corp.
Jampro Antenna Co.
Jerrold Elect. Corp.
JFD Systems Div.
KLM Elect.
Lindsay Specialty Prods. Ltd.
RF Systems, Inc.
RMS Elect., Inc.
Scala Radio Corp.
Scientific-Atlanta, Inc.
Sitco Antenna Co.
Systems Eng., Inc.
TACO Div.
TV Cable Supply Co., Inc.

Antennas, FM

Anixter-Pruzan
Beaver Elect. Ltd.
Blonder-Tongue Labs., Inc.
Cablewave Systems Inc.
Catel
Jerry Conn & Assoc., Inc.
Cush Craft Corp.
Gates Radio
Hy-Gain Elect. Corp.
Jampro Antenna Co.
Jerrold Elect. Corp.
KLM Elect.
Lindsay Specialty Prods. Ltd.
Maspro Co., Inc.
RF Systems, Inc.
Riker Video
RMS Elect., Inc.
Saxton Prods. Inc.
Scala Radio Corp.
Scientific-Atlanta, Inc.
Sitco Antenna Co.
Swager Tower Corp.

Systems Eng., Inc.
TACO Div.
TV Cable Supply Co., Inc.
Winegard Co.

Antennas, Single Channel

Anixter-Pruzan
Beaver Elect. Ltd.
Blonder-Tongue Labs., Inc.
Cablewave Systems Inc.
Jerry Conn & Assoc., Inc.
Cush Craft Corp.
Gates Radio
Hy-Gain Elect. Corp.
Jampro Antenna Co.
Jerrold Elect. Corp.
JFD Systems Div.
KLM Elect.
Lindsay Specialty Prods. Ltd.
Maspro Co., Inc.
RF Systems, Inc.
Riker Video
RMS Elect., Inc.
Scala Radio Corp.
Scientific-Atlanta, Inc.
Sitco Antenna Co.
Systems Eng., Inc.
TACO Div.
TV Cable Supply Co., Inc.
Video Eng. Co., Inc.

Antennas VHF-UHF

Advance Indust., Inc.
Anixter-Pruzan
Antsco Corp.
Beaver Elect. Ltd.
Blonder-Tongue Labs., Inc.
Cablewave Systems Inc.
Jerry Conn & Assoc., Inc.
Cush Craft Corp.
Gates Radio
Hy-Gain Elect. Corp.
Jampro Antenna Co.
Jerrold Elect. Corp.
JFD Systems Div.
KLM Elect.
Lindsay Specialty Prods. Ltd.
Prodelin Inc.
RCA Corp.
RF Systems
Riker Video
RMS Elect., Inc.
Saxton Prods. Inc.
Scala Radio Corp.
Scientific-Atlanta, Inc.
Sitco Antenna Co.
Soladyne Internatl., Inc.
Swager Tower Corp.
Systems Eng., Inc.
TACO Div.
TV Cable Supply Co., Inc.
Video Eng. Co., Inc.
Winegard Co.

Audio Equipment

Able Comm. & Elect.
Amer. Data Corp.
Ampex Corp.
B & K Instr., Inc.
Broadcast Elect., Inc.
Broadcast Prods. Inc.
Catel

For More Details Circle (152) on Reply Card

THE ONLY ONE



CA101 - I Inserter Probe

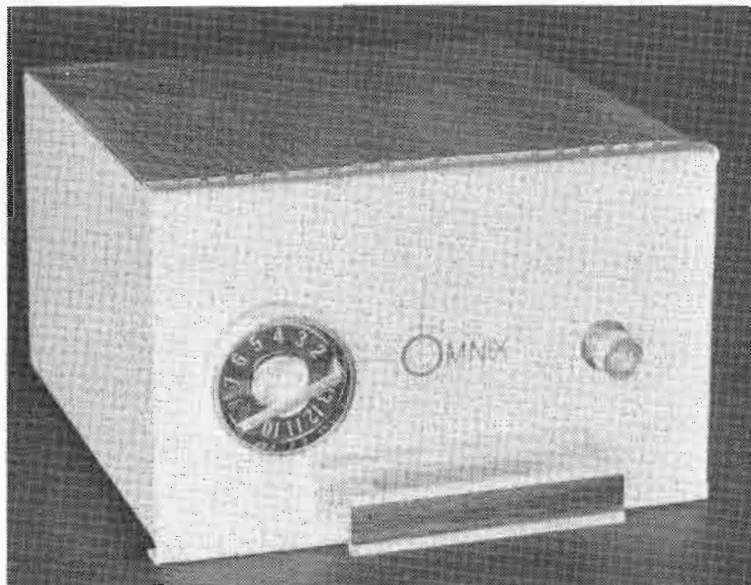

CA101 - Processor

*Add a new profitable dimension to your cable capabilities!

*Insert characters, titles, or messages over existing programs without demodulating!

*A new tool to gain new viewers!



12234 W. PICO BLVD.
LOS ANGELES, CALIF. 90064
213 826-5605

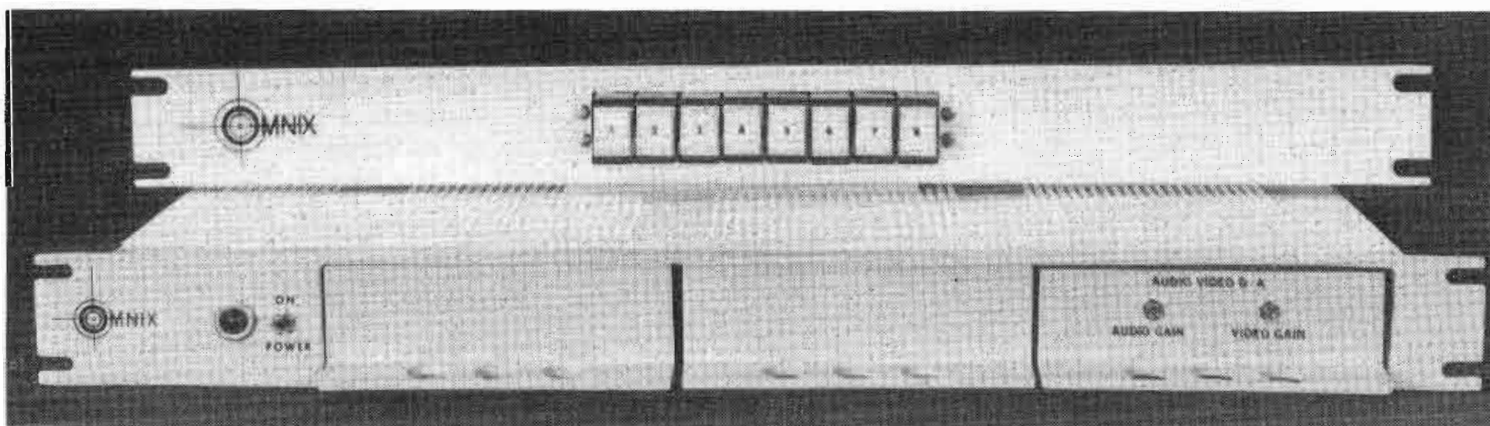

Model C81 Audio Video Routing Switcher

Remote control
Eight inputs

Balanced or unbalanced audio
Solid state video switching

2 Audio Outputs
2 Video Outputs
Great Specs.

Other Products
OMNIX
Manufactures

Special Modulators
Scramblers/Unscramblers
Video Test Signal Generators
Colorizer

Pulse, Video,
Subcarrier Distribution
Amplifiers

Video Title Inserters
Title Edgers
Video Mixers
Special Effect Generators

9 LIVES



Direct Replacement Ferrite Head for Ampex Video Recorders Lives ON and ON and ON.....

The Spin Physics Model 200112 installs in all Ampex one-inch helical scan video tape recorders with rotary transformers. The proprietary ferrite used in the manufacture of the 200112 gives improved signal-to-noise ratio and results in such extended life that each head is warranted for a full year regardless of operating hours.

Add some lives to your video recorder! Write today for details on the 200112.



spin physics inc.

11629 Sorrento Valley Road
San Diego CA 92121 (714) 453-5410

For More Details Circle (154) on Reply Card

CE-6

CBS Labs.
Comspace Corp.
Electrohome, Ltd.
Electro-Voice, Inc.
Fairchild MOD
F&B/Ceco of Calif., Inc.
Gates Radio
Kay Elemetrics Corp.
Nelson-Hershfield Elect.
Noram Comm. Ltd.
Recording Center, Inc.
Shure Bros., Inc.
Soladyne Internatl., Inc.
Sparta Elect. Corp.
Tape-Athon Corp.
Tapecaster TCM
Telaudio Centre
Tele-Cine Inc.
Ultra Audio Prods.
Video Aids Corp. of Colo.
VIF Internatl.
Visual Elect. Corp.
Vital Indust., Inc.

**Automatic Programing
Equipment**

Amer. Data Corp.
Broadcast Elect., Inc.
Broadcast Prods. Inc.
Concise Instr. Design Ltd.
Dynasciences Corp.
Gates Radio
Fung Eng. Co.
Int. Video Corp.
Jerrold Elect. Corp.
Metrodata Corp.
MSI Television
Phasecom Corp.
Sparta Elect. Corp.
Tape-Athon Corp.
Techno Prods. Co.
Texas Elect., Inc.
Video Data Systems, Inc.
VIF Internatl.

Cable Accessories

Amer. Technology Co., Inc.
Anixter-Pruzan
AVA Elect. & Machine Corp.
Beaver Elect. Ltd.
Belden Corp.
Blonder-Tongue Labs., Inc.
British Insulated
Callender's Cable Ltd.
Buckeye Telephone
& Supply Co.
Cablewave Systems Inc.
Comm/Scope Corp.
Jerry Conn & Assoc., Inc.
Diamond Expansion
Bolt Co.
Elect. Indust. Sales, Inc.
Entron, Inc.
Essex Elect. Systems
General Cable Corp.
GTE Sylvania
Jampro Antenna Co.
Jerrold Elect. Corp.
JJJ Snubber Co.
Kay Elemetrics Corp.
LRC Elect., Inc.
Panduit Corp.
Preform Line Prods. Co.
Prodelin Inc.

RMS Elect., Inc.
Rust Corp
Saxton Prods. Inc.
Smith Co.
Soladyne Internatl., Inc.
Southern Telephone
Supply Co.
Theta-Com of Calif.
TV Cable Supply Co., Inc.
Westay Co.

Cable Burial Equipment

Buckeye Telephone
& Supply Co.
Cleveland Trenchers Div.
Contender Corp.
Jerry Conn & Assoc., Inc.
Davis Mfg.
Ditch Witch

Cable Coaxial

Superior Continental. See Page CE-8-9

Alpha Wire
Anaconda Elect.
Anixter-Pruzan
Baron Wire & Cable Corp.
Belden Corp.
Berkshire Elect. Cable Co.
Blonder-Tongue Labs., Inc.
Brand-Rex Co.
British Insulated
Callender's Cable Ltd.
Buckeye Telephone
& Supply Co.
Cablewave Systems Inc.
Cohu, Inc.
Comm/Scope Corp.
Jerry Conn & Assoc., Inc.
Copperweld Corp.
Essex Elect. Systems
General Cable Corp.
Jampro Antenna Co.
Jerrold Elect. Corp.
Phelps Dodge Comm. Co.
Plastoid Corp.
Prodelin Inc.
Saxton Prods. Inc.
Smith Co.
Soladyne Internatl., Inc.
Southern Telephone
Supply Co.
Systems Wire & Cable, Inc.
Theta-Com of Calif.
Times Wire & Cable Co.
TV Cable Supply Co., Inc.
Video Eng. Co., Inc.

Cable, Messenger Wire

Alpha Wire
Anixter-Pruzan
Belden Corp.
British Insulated
Callender's Cable Ltd.
Buckeye Telephone
& Supply Co.
Jerry Conn & Assoc., Inc.
Copperweld Corp.
General Cable Corp.
Southern Telephone
Supply Co.
Swagger Tower Corp.
Systems Wire & Cable, Inc.
Times Wire & Cable Co.
TV Cable Supply Co., Inc.

let us show you

The low-cost
everything
camera
from Norelco



... what professional performance standards in color cameras are all about. And how the same exclusive design advantages of the cameras being used for more live and taped TV shows are available to you in the world's lowest cost, truly professional quality camera.

Call your nearest authorized Norelco commercial video distributor (or just send the coupon) to see this new no-nonsense, fact-filled presentation. It may be the most helpful 20 minutes you've spent in years!

Norelco®

BE 1

Philips Broadcast Equipment Corp.
One Philips Parkway, Montvale, N.J. 07645
A North American Philips Corporation

- Yes ... I'd like to see your presentation
- Just send me information right now ... and I'll see the presentation later.

Name/title

Company or Institution

Address

City

State

Zip

Check this list for the Norelco Distributor nearest you: **Alabama** Professional Communications Systems, Birmingham • **Arizona** Roh's, Inc., Tucson • **California** Vicor-Telenetics, San Diego; Vicor-Camera Systems International, Los Angeles; General Electronics, Oakland; K.D.H. Electronics, Fresno • **Carolinas** Electronic Systems, Columbia, S. C. • **Colorado** Video Electronics, Lakewood • **Connecticut** Videoplay Industries, Rockville • **Florida** Midwest Telecommunications, Miami; Florida Electronic Systems, Orlando • **Georgia** Electronic Equipment, Atlanta • **Hawaii** Hawkins Audio Engineers, Honolulu • **Louisiana** Lykes Electronics, New Orleans • **Metropolitan Chicago** Videco • **Metropolitan New York/New Jersey** Norcon Electronics, Brooklyn; TPT Communications, Long Island City; Tele-Measurements, Clifton, N.J. • **Mid-Atlantic** Lerro Electrical, Philadelphia, Wash., D.C.; Midwest Telecommunications, Norfolk, Va. • **Minnesota** Wahl & Wahl, Minneapolis • **New York** Visual Tone, Buffalo • **Northern New England** Northeast Electronics, Needham, Mass. • **Northwest** Intermountain Video, Salt Lake City, Seattle • **Ohio** Dayton Communications, Dayton • **Oklahoma** Systs-Matics, Tulsa • **Puerto Rico** Philips Electronics, Rio Piedras • **Texas** Video Systems, Dallas, Houston, San Antonio; Video Electronic Systems, Lubbock

*Reg. TM N.V. Philips of Holland

Let's keep it personal.

It's a paradox, this business.

You're growing by helping people communicate.

So are we.

And because we're both growing, there is a tendency to be less personal with each other, to forget the face on the other end of the line.

So. From time to time, we'll introduce you to some of the Comm/Scope people you've been working with.

Problems, disappointments, good news and bad, let's share it all.

Personally.

Comm/Scope Company,
P.O. Box 2406, Hickory,
North Carolina 28601.
Telephone 704/328-5271.

Comm/Scope Company

Division of Superior Continental Corporation

Cameras, B/W

Ampex Corp.
Anixter-Pruzan
Audiotronics Corp.
Avtel Corp.
Cohu, Inc.
Diamond Power
Specialty Corp.
F&B/Ceco of Calif., Inc.
Gates Radio
GBC Closed Circuit
TV Corp.
GPL-TV
Hitachi Shibaden
Corp. of Amer.
Int. Video Corp.
Javelin Elect. Co.
Jerrold Elect. Corp.
JFD Systems Div.
K'Son Corp.
Nelson-Hershfield Elect.
Noram Comm. Ltd.
Panasonic VTR/CCTV
Philips Bcst. Equip. Corp.
Sony Corp. of Amer.
Southern Telephone
Supply Co.
Telaudio Centre
Telemation, Inc.
R. H. Tyler Co.
Video Eng. Co., Inc.

Cameras, Color

Philips Bcst. Equip. See page CE-7

Ampex Corp.
Anixter-Pruzan
Avtel Corp.
Cohu, Inc.
Commercial Elect. Inc.
Diamond Power
Specialty Corp.
F&B/Ceco of Calif., Inc.
Gates Radio
GBC Closed Circuit
TV Corp.
Hitachi Shibaden
Corp. of Amer.
Int. Video Corp.
Magnavox
Noram Comm. Ltd.
Panasonic VTR/CCTV
RCA Corp.
Sony Corp. of Amer.
Southern Telephone
Supply Co.
Techno Prods. Co.
Telaudio Centre
Tele-Cine Inc.
Telemation, Inc.
Video Eng. Co., Inc.

Carrier Generators

Ameco, Inc.
Anixter-Pruzan
Blonder-Tongue Labs., Inc.
C-COR Elect., Inc.
Coastcom
Jerry Conn & Assoc., Inc.
Delta-Benco-Cascade Ltd.
Edison Elect.
Fung Eng. Co.
Jerrold Elect. Corp.
Lampkin Labs., Inc.
Southern Telephone
Supply Co.

Teleng Inc.
Theta-Com of Calif.
Channel Preamps
Alaun Engineering
Anixter-Pruzan
Beaver Elect. Ltd.
Blonder-Tongue Labs., Inc.
Broadcast Prods. Inc.
C-COR Elect., Inc.
Jerry Conn & Assoc., Inc.
Delta-Benco-Cascade Ltd.
Entron, Inc.
Environmental Comm., Inc.
Jerrold Elect. Corp.
JFD Systems Div.
Lindsay Specialty
Prods. Ltd.
TV Cable Supply
Co., Inc.
Video Eng. Co., Inc.
Winegard Co.

Character Generators

Telestrator Indust., Inc.

Colorizers

Omnix. See page CE-5

Consoles & Accessories

Alma Eng.
Anixter-Pruzan
Avtel Corp.
Beston Elect.
Broadcast Elect., Inc.
Broadcast Prods. Inc.
Fairchild MOD
F&B/Ceco of Calif., Inc.
GBC Closed Circuit
TV Corp.
GPL-TV
Int. Video Corp.
Javelin Elect. Co.
Nelson-Hershfield Elect.
Panasonic VTR/CCTV
Rosner Television
Systems, Inc.
Sparta Elect. Corp.
Techno Prods. Co.
Telaudio Centre
Telemation, Inc.
Ultra Audio Prods.
Visual Educom Inc.

Converters

Able Comm. & Elect.
AEL Comm. Corp.
Ameco, Inc.
Anixter-Pruzan
Blonder-Tongue Labs., Inc.
C-COR Elect., Inc.
Comspace Corp.
Jerry Conn & Assoc., Inc.
Delta-Benco-Cascade Ltd.
Elect. Indust. Eng., Inc.
Entron, Inc.
Environmental Comm., Inc.
F&B/Ceco of Calif., Inc.
Fung Eng. Co.
GTE Sylvania
Hitachi Shibaden Corp.
of Amer.
Jerrold Elect. Corp.
JFD Systems Div.
K'Son Corp.
Lindsay Specialty
Prods. Ltd.



Let's keep it personal

It's people like Caroline Robbins who help us keep it personal.

Caroline spends about five hours a day on the phone answering questions and solving problems for her accounts in Arizona, California, Nevada, Arkansas, New Mexico, Texas and Oklahoma.

The rest of her time she spends making sure *all of us* appreciate how important you are to Comm/Scope.

That's service.

That's Caroline Robbins.
Phone 704/328-5271.

Comm/Scope Company

Division of Superior Continental Corporation

Magnavox
Maspro Co., Inc.
Oak Indust.
Phasecom Corp.
RMS Elect., Inc.
Teleng Inc.
Terado Corp.
Tomco Comm. Inc.
TV Cable Supply Co., Inc.
Video Eng. Co., Inc.
Wilmore Elect. Co., Inc.

Demodulators

Anixter-Pruzan
Audiotronics Corp.
Jerry Conn & Assoc., Inc.
Dynair Elect., Inc.
Elect. Indust. Eng., Inc.
Environmental Comm., Inc.
F&B/Ceco of Calif., Inc.
Jerrold Elect. Corp.
JFD Systems Div.
Leaming Indust. Corp.
Nelson-Hershfield Elect.
Rohde & Schwarz Sales
SC Elect., Inc.
Telemet
Video Eng. Co., Inc.

Directional Couplers

Ameco, Inc.
Amer. Technology Co., Inc.
Anaconda Elect.
Anixter-Pruzan
AVA Elect. & Machine Corp.
Beaver Elect. Ltd.
Blonder-Tongue Labs., Inc.

Buckeye Telephone
& Supply Co.
C-COR Elect., Inc.
Jerry Conn & Assoc., Inc.
Delta-Benco-Cascade Ltd.
Dolphin Comm. Corp.
Entron, Inc.
Environmental Comm., Inc.
GTE Sylvania
Jampro Antenna Co.
Jerrold Elect. Corp.
Lindsay Specialty
Prods. Ltd.

Magnavox
MPI Co.
RMS Elect., Inc.
Rohde & Schwarz Sales
Southern Telephone
Supply Co.
Systron-Donner Corp.
Theta-Com of Calif.
TV Cable Supply Co., Inc.

Drop Cables

Aberdeen Co.
Anaconda Elect.
Anixter-Pruzan
Belden Corp.
British Insulated
Callender's Cable Ltd.
Buckeye Telephone
& Supply Co.
Canada Wire & Cable
Co., Ltd.
Cerro CATV
Comm/Scope Corp.
Jerry Conn & Assoc., Inc.

Copperweld Corp.
Elect. Indust. Sales, Inc.
Essex Elect. Systems
General Cable Corp.
Phelps Dodge Comm. Co.
Saxton Prods. Inc.
Southern Telephone
Supply Co.
Theta-Com of Calif.
TV Cable Supply Co., Inc.

Encoder, Video

3 M Co., Mincom Div.
See page CE-3

Equalizers

Ameco, Inc.
Anaconda Elect.
Anixter-Pruzan
B & K Instr., Inc.
Buckeye Telephone
& Supply Co.
C-COR Elect., Inc.
Jerry Conn & Assoc., Inc.
Delta-Benco-Cascade Ltd.
F&B/Ceco of Calif., Inc.
GTE Sylvania
Jerrold Elect. Corp.
Lindsay Specialty
Prods. Ltd.
Magnavox
Theta-Com of Calif.
TV Cable Supply Co., Inc.

Feeder & Trunk Cables

Anaconda Elect.

Anixter-Pruzan
Buckeye Telephone
& Supply Co.
Cerro CATV
Comm/Scope Corp.
Jerry Conn & Assoc., Inc.
General Cable Corp.
GTE Sylvania
Jerrold Elect. Corp.
Phelps Dodge Comm. Co.
Southern Telephone
Supply Co.
Theta-Com of Calif.
TV Cable Supply Co., Inc.

Field Strength Meters

Ameco, Inc.
Anixter-Pruzan
B & K Instr., Inc.
Blonder-Tongue Labs., Inc.
Cascade Elect. Ltd.
Delta-Benco-Cascade Ltd.
Fung Eng. Co.
Jerrold Elect. Corp.
Potomac Instr., Inc.
Riker Video
Rohde & Schwarz Sales
Sadelco, Inc.
Sencore Inc.
Vikoa, Inc.

Film Chain Equipment

Anixter-Pruzan
Avtel Corp.
Cohu, Inc.
Comspace Corp.
Eastman Kodak
F&B/Ceco of Calif., Inc.
Gates Radio
GPL-TV
Int. Video Corp.
Kalart Victor Corp.
L-W Photo, Inc.
Magnavox
Philips Bcst. Equip. Corp.
RCA Corp.
Spindler & Sauppe, Inc.
Telaudio Centre
Telemation, Inc.
R. H. Tyler Co.
Video Eng. Co., Inc.

FM Processing Equipment

Catel
CBS Labs.
Coastcom
Jerry Conn & Assoc., Inc.
Environmental Comm., Inc.
Fung Eng. Co.
Jerrold Elect. Corp.
Sparta Elect. Corp.

Generators, Carrier

Ameco, Inc.
Anixter-Pruzan
C-COR Elect., Inc.
Coastcom
Jerry Conn & Assoc., Inc.
Delta-Benco-Cascade Ltd.
Edison Elect.
Entron, Inc.
Jerrold Elect. Corp.
Panasonic VTR/CCTV
Rohde & Schwarz Sales

the strength of "Gibraltar," yet uniquely mobile and flexible.

The Quick-Set Gibraltar Balanced Pedestal offers everything you want for strength, quiet mobility and unlimited versatility.

- 125-pound camera capacity
- Floating 4-inch column
- Height range from 36 to 56 inches
- Steering wheel with brake for steering or raising and lowering
- Glides through 32-inch doorways
- 6-inch casters have cable guards
- Rubber timing belt drive to casters for silent operation
- Crab and tricycle steering



Gibraltar Cradle Head has "Quick-On" plate and is available with one or two handle operation.



send for
free catalog

3650 Woodhead Drive Northbrook, Illinois 60062
312/498-0700

For More Details Circle (158) on Reply Card

Theta-Com of Calif.
TV Cable Supply Co., Inc.

Generators, Special Effects
Omnix. See page CE-5

Generators, Sync

Amer. Data Corp.
CBS Labs
Cohu, Inc.
Comspace Corp.
Dynair Elect., Inc.
Dynasciences Corp.
Entron, Inc.
F&B/Ceco of Calif., Inc.
Magnavox
Panasonic VTR/CCTV
Rohde & Schwarz Sales
Shintron Co. Inc.
Systron-Donner Corp.
Telemet
TV Cable Supply Co., Inc.
Video Aids Corp. of Colo.
Video Eng. Co., Inc.
Viscount Indust. Ltd.

Generators, Test

Omnix. See page CE-5

Amer. Data Corp.
B & K Instr., Inc.
CBS Labs.
Delta-Benco-Cascade Ltd.
Dynasciences Corp.
Edison Elect.
Kay Elemetrics Corp.
Lampkin Labs., Inc.
Rohde & Schwarz Sales
Systron-Donner Corp.
Telemet
Theta-Com of Calif.
Video Data Systems, Inc.
Video Eng. Co., Inc.
VIF Internatl.

Headend Buildings

Ft. Worth Tower Co., Inc.
Microwave Systems Co.
Steffen, Inc.
Utility Tower Co.
Walker-Parkersburg

Headend Controls

Anixter-Pruzan
Cascade Elect., Ltd.
Coastcom
Jerry Conn & Assoc., Inc.
Delta-Benco-Cascade Ltd.
Elect. Indust. Eng., Inc.
Fung Eng. Co.
Jerrold Elect. Corp.
Phasecom Corp.
Rust Corp.
Scientific-Atlanta, Inc.

Headend Systems

Alaun Engineering
Ameco, Inc.
Anixter-Pruzan
Avtel Corp.
Beaver Elect. Ltd.
Cascade Elect. Ltd.
Jerry Conn & Assoc., Inc.
Delta-Benco-Cascade Ltd.
Dynair Elect., Inc.
Elect. Indust. Eng., Inc.
Entron, Inc.

Jerrold Elect. Corp.
KLM Elect.
Phasecom Corp.
Scientific-Atlanta, Inc.
TV Cable Supply
Co., Inc.
Video Eng. Co., Inc.

Lenses, TV Camera

Angenieux Corp. of Amer.
Anixter-Pruzan
Cunningham Corp.
F&B/Ceco of Calif. Inc.
Hitachi Shibaden
Corp. of Amer.
Javelin Elect. Co.
Magnavox
Noram Comm. Ltd.
Panasonic VTR/CCTV
Rank Precision Indust. Inc.
RCA Corp.
Southern Telephone
Supply Co.
Tele-Cine Inc.
Video Eng. Co., Inc.

Lights, Studio

F&B/Ceco of Calif., Inc.
Alan Gordon
Enterprises, Inc.
RCA Corp.
Telaudio Centre
Video Eng. Co., Inc.

Meters, RF Volts

B&K Instr., Inc.
See page CE-11

Microwave Relay Equip.

Avantek, Inc.
Buckeye Telephone
& Supply Co.
Coastcom
Environmental Comm., Inc.
Innovative Television
Equip., Inc.
Microwave Systems Co.
PRD Elect., Inc.
RCA Corp.
Soladyne Internatl., Inc.

Mixers

Omnix. See page CE-5

Modulators, Audio

Able Comm. & Elect.
Ameco, Inc.
Catel
Coastcom
Jerry Conn & Assoc., Inc.
Elect. Indust. Eng., Inc.
Fung Eng. Co.
Jerrold Elect. Corp.
Leaming Indust. Corp.
Noram Comm. Ltd.
Phasecom Corp.
Rohde & Schwarz Sales
Video Eng. Co., Inc.

Modulators, Video

Omnix. See page CE-5

Ameco, Inc.
Anixter-Pruzan
Catel
Jerry Conn & Assoc., Inc.
Dynair Elect., Inc.

Elect. Indust. Eng., Inc.
F&B/Ceco of Calif., Inc.
Fung Eng. Co.
Jerrold Elect. Corp.
JFD Systems Div.
Nelson-Hershfield Elect.
Noram Comm. Ltd.
Phasecom Corp.
Rohde & Schwarz Sales
Telemet
Video Eng. Co., Inc.

Monitors, Video

Anixter-Pruzan
Audiotronics Corp.
Ball Bros. Research Corp.
Beston Elect. Inc.
Comspace Corp.
Conrac Div.
Cunningham Corp.
Electrohome, Ltd.
F&B/Ceco of Calif., Inc.
GBC Closed Circuit
TV Corp.
Hitachi Shibaden
Corp. of Amer.
Javelin Elect. Co.
Jerrold Elect. Corp.
Nelson-Hershfield Elect.
Noram Comm. Ltd.
Panasonic VTR/CCTV
RCA Corp.
SC Elect., Inc.
Southern Telephone
Supply Co.
Tele-Cine Inc.
Telemation, Inc.

Ultra Audio Prods.
Video Aids Corp. of Colo.
Video Eng. Co., Inc.
Visual Elect. Corp.
World Video, Inc.

Monitors, Waveform

Avtel Corp.
Ball Bros. Research Corp.
Beston Elect. Inc.
B & K Instr., Inc.
Cunningham Corp.
Telaudio Centre
Ultra Audio Prods.
Video Eng. Co., Inc.

Non-Duplications Switchers

Amer. Data Corp.
Anixter-Pruzan
Avtel Corp.
Phasecom Corp.
RCA Corp.
Rich Labs., Inc.
Vital Indust., Inc.

Pedestals

Aberdeen Co.
Anixter-Pruzan
Buckeye Telephone
& Supply Co.
A. B. Chance Co.
Jerry Conn & Assoc., Inc.
F&B/Ceco of Calif., Inc.
General Cable Corp.
Jerrold Elect. Corp.
Innovative Television
Equip., Inc.
RCA Corp.

**2007
RF Selective
Voltmeter**

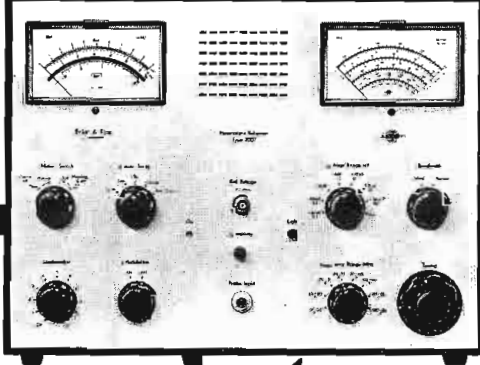

*Lab
Quality
Signal Strength
Measurements*

The Model 2007 Precision RF Selective Voltmeter is a laboratory-quality instrument designed to make precision signal strength measurements in the 100 kHz-to-305 MHz frequency range. The unit covers the full VHF, low band, high band, and super band in 8 ranges. Carrier frequency or channel numbers are easily identified using the replaceable frequency meter scales. The unit is completely portable and can operate off internal, re-chargeable, Ni-Cad batteries; 115-220 V line; or external 6 V battery.

Write or call for a data sheet.

B&K Instruments, Inc.
Brüel & Kjær Precision Instruments
5111 West 164th Street, Cleveland, Ohio 44142 / Telephone: (216) 267-4800
1440 South State College Boulevard, Anaheim, Cal. 92806 / Telephone: (714) 778-2450



Southern Telephone
Supply Co.
Tele-Cine Inc.
TV Cable Supply Co., Inc.
Video Eng. Co., Inc.

Pole Line Hardware

Aberdeen Co.
Anixter-Pruzan
AVA Elect. & Machine Corp.
Beaver Elect. Ltd.
Buckeye Telephone
& Supply Co.
A. B. Chance Co.
Jerry Conn & Assoc., Inc.
General Cable Corp.
Kortick Mfg. Co.
Preform Line Prods. Co.
Reliable Electric
Southern Telephone
Supply Co.
Swager Tower Corp.
TV Cable Supply Co., Inc.
Utilities Service Co.
Westay Co.

Power Couplers

Ameco, Inc.
Anixter-Pruzan
Beaver Elect. Ltd.
Jerry Conn & Assoc., Inc.
Delta-Benco-Cascade Ltd.
Entron, Inc.
Jerrold Elect. Corp.
Magnavox
Theta-Com of Calif.

Power Supplies

Alma Eng.
Ameco, Inc.
Amer. Data Corp.
Anixter-Pruzan
Beaver Elect. Ltd.
Broadcast Prods., Inc.
Buckeye Telephone
& Supply Co.
Jerry Conn & Assoc., Inc.
Delta-Benco-Cascade Ltd.
Entron, Inc.
Jerrold Elect. Corp.
Maspro Co., Inc.
Ratelco Inc.
Rich Labs., Inc.
Sawyer Indust., Inc.
Soladyne Internatl., Inc.
Sola Electric
Southern Telephone
Supply Co.
Systron-Donner Corp.
Terado Corp.
Tomco Comm. Inc.
TV Cable Supply Co., Inc.
Viscount Indust. Ltd.
Wilmore Elect. Co., Inc.

Preamps, Single Channel

Anixter-Pruzan
Beaver Elect. Ltd.
Blonder-Tongue Labs., Inc.
Broadcast Prods. Inc.
Jerry Conn & Assoc., Inc.
Delta-Benco-Cascade Ltd.
Entron, Inc.
Environmental Comm., Inc.

Jerrold Elect. Corp.
JFD Systems Div.
Maspro Co., Inc.
Riker Video
Rohde & Schwarz Sales
Tomco Comm. Inc.
TV Cable Supply Co., Inc.

Recorders, Audio

Ampex Corp.
Audiotronics Corp.
B & K Instr., Inc.
Broadcast Prods. Inc.
Echo Science Corp.
F&B/Ceco of Calif., Inc.
RCA Corp.
Sparta Elect. Corp.
Tape-Athon Corp.
Telaudio Centre
Video Eng. Co., Inc.
VIF Internatl.

Recorders, Video Tape

Ampex Corp.
Anixter-Pruzan
Avtel Corp.
Diamond Power
Specialty Corp.
Echo Science Corp.
F&B/Ceco of Calif., Inc.
Hitachi Shibaden
Corp. of Amer.
Int. Video Corp.
Javelin Elect. Co.
3M Co., Mincom Div.
Noram Comm. Ltd.
Panasonic VTR/CCTV
RCA Corp.
Sony Corp. of Amer.
Southern Telephone
Supply Co.
Spin Physics, Inc.
R. H. Tyler Co.
Video Eng. Co., Inc.

Scramblers, Unscramblers

Omnix. See page CE-5

Signal Corrector (Video)

Jerry Conn & Assoc., Inc.
Dynair Elect., Inc.
Echo Science Corp.
Vital Indust., Inc.

Signal Strength Meter

B&K Instr., Inc.

See page CE-11

Splitting & Mixing Networks

Ameco, Inc.
Anixter-Pruzan
Antsco Corp.
AVA Elect. & Machine Corp.
Beaver Elect. Ltd.
Blonder-Tongue Labs., Inc.
Jerry Conn & Assoc., Inc.
Delta-Benco-Cascade Ltd.
Dolphin Comm. Corp.
Entron, Inc.
Jerrold Elect. Corp.-
JFD Systems Div.
Magnavox
Maspro Co., Inc.
MPI Co.
TV Cable Supply Co., Inc.

Video Eng. Co., Inc.

Sweep Systems

Avantek, Inc.
Jerrold Elect. Corp.
Kay Elemetrics Corp.
Rohde & Schwarz Sales
Systron-Donner Corp.
Theta-Com of Calif.

Switchers

Omnix. See page CE-5

Alaun Engineering
Alma Eng.
Amer. Data Corp.
Ball Bros. Research Corp.
Beston Elect. Inc.
Blonder-Tongue Labs., Inc.
Cablewave Systems Inc.
Cohu, Inc.
Dynair Elect., Inc.
Dynasciences Corp.
F&B/Ceco of Calif., Inc.
Fung Eng. Co.
GBC Closed Circuit
TV Corp.
Hitachi Shibaden
Corp. of Amer.
Int. Video Corp.
Jerrold Elect. Corp.
Kay Elemetrics Corp.
Matrix Systems Corp.
Noram Comm. Ltd.
Philips Bcst. Equip. Corp.
RCA Corp.
Shintron Co. Inc.
Telemation, Inc.
Telemet
Video Eng. Co., Inc.
Viscount Indust. Ltd.
Visual Educom Inc.
Visual Elect. Corp.
Vital Indust., Inc.

Systems Research & Development

Omnix. See page CE-5

Tap-offs

Ameco, Inc.
Anixter-Pruzan
AVA Elect. & Machine Corp.
Beaver Elect. Ltd.
Blonder-Tongue Labs., Inc.
Buckeye Telephone
& Supply Co.
Jerry Conn & Assoc., Inc.
Delta-Benco-Cascade Ltd.
Entron, Inc.
GTE Sylvania
Jerrold Elect. Corp.
JFD Systems Div.
Magnavox
Maspro Co., Inc.
MPI Co.
Preform Line Prods. Co.
Riker Video
RMS Elect., Inc.
Saxton Prods. Inc.
Southern Telephone
Supply Co.
Theta-Com of Calif.
TV Cable Supply Co., Inc.
Video Eng. Co., Inc.

Winegard Co.

Taps, Directional

Aberdeen Co.
Ameco, Inc.
Amer. Technology Co., Inc.
Anaconda Elect.
Anixter-Pruzan
AVA Elect. & Machine Corp.
Beaver Elect. Ltd.
Blonder-Tongue Labs., Inc.
Buckeye Telephone
& Supply Co.
Jerry Conn & Assoc., Inc.
Delta-Benco-Cascade Ltd.
Dophon Comm. Corp.
Entron, Inc.
GTE Sylvania
Jerrold Elect. Corp.
JFD Systems Div.
Lindsay Specialty
Prods. Ltd.
Magnavox
RMS Elect., Inc.
Saxton Prods. Inc.
Southern Telephone
Supply Co.
Theta-Com of Calif.
TV Cable Supply Co., Inc.

Title Edgers

Omnix. See page CE-5

Title Inserters

Omnix. See page CE-5

Towers & Accessories

Advance Indust., Inc.
Allied Tower Co.
Andrews Tower, Inc.
Anixter-Pruzan
Beaver Elect. Ltd.
British Insulated
Callender's Cable Ltd.
Buckeye Telephone
& Supply Co.
Jerry Conn & Assoc., Inc.
Copperweld Corp.
E-Z Way Prods., Inc.
Ft. Worth Tower Co., Inc.
Gates Radio
Grasis Fabricating Co.
Jampro Antenna Co.
Microflect Co., Inc.
Path Prods. Inc.
RCA Corp.
RF Systems, Inc.
Rohn Mfg.
Soladyne Internatl., Inc.
Stainless, Inc.
Swager Tower Corp.
Systems Eng., Inc.
Tri-Ex Tower Corp.
TV Cable Supply Co., Inc.
Up-Right Scaffolds
Utility Tower Co.

Tower Service

Bcst. Tower Service,

See page CE-4

Trucks, Ladder & Bucket

Buckeye Telephone
& Supply Co.

McCabe-Power Body Co.
Ratelco Inc.
Telsta/General Cable
Apparatus Div.
Time Mfg. Co.
Utility Body Co.
Van Ladder, Inc.

Two-Way Home Terminal Equip.

AVA Elect. & Machine Corp.
Cascade Elect. Ltd.
Coastcom
Jerry Conn & Assoc., Inc.
Elect. Indust. Eng., Inc.
Jerrold Elect. Corp.
K'Son Corp.
Magnavox
RMS Elect., Inc.
Television Audience
Response System Div.

Video Equip. & Accessories

3M Co., Mincom Div.

See page CE-3

Quick-Set. See page CE-10

Ampex Corp.
Anixter-Pruzan
Audio-Video Eng. Co.

Avtel Corp.
Ball Bros. Research Corp.
Beston Elect. Inc.
CBS Labs.
Cohu, Inc.
Commercial Elect. Inc.
Data Disc, Inc.
Datavision Inc.
Diamond Power
Specialty Corp.
Dynair Elect., Inc.
Dynasciences Corp.
Edison Elect.
Electrohome, Ltd.
F&B/Ceco of Calif., Inc.
Gates Radio
Hitachi Shibaden
Corp. of Amer.

Innovative Television
Equip., Inc.

Int. Video Corp.

Kalart Victor Corp.
Matrix Systems Corp.
Memorex Corp.
Noram Comm. Ltd.
Panasonic VTR/CCTV
Philips Bcst. Equip. Corp.
RCA Corp.

Recording Center, Inc.
Riker Video
Rust Corp.
Sony Corp. of Amer.
Stereotronics Television Co.
Techno Prods. Co.
Telaudio Centre
Tele-Cine Inc.
Telestrator Indust., Inc.
Telesync Corp.
Television Equip. Assoc.
Ultra Audio Prods.
Video Aids Corp. of Colo.
Video Eng. Co., Inc.
Vikoa, Inc.
Viscount Indust. Ltd.
Visual Educom Inc.
Visual Elect. Corp.
Vital Indust., Inc.

Video Equip. & Editor

Ampex Corp.
Anixter-Pruzan
Dynasciences Corp.
F&B/Ceco of Calif., Inc.
3M Co., Mincom Div.
Panasonic VTR/CCTV
RCA Corp.

Telemation, Inc.
Telesync Corp.
Video Aids Corp. of Colo.
Vital Indust., Inc.

Video Tape

3M Co., Magnetic
Prods. Div.

VTR Heads

Spin Physics Inc.

See page CE-6

Weather Units

Ameco, Inc.
Anixter-Pruzan
Avtel Corp.
Beaver Elect. Ltd.
Buckeye Telephone
& Supply Co.
Concise Instr. Design Ltd.
Jerry Conn & Assoc., Inc.
Metrodata Corp.
Soladyne Internatl., Inc.
Telemation, Inc.
Telestrator Indust., Inc.
Texas Elect., Inc.
Texas Instr. Inc.
R. H. Tyler Co.

CATV Address List

A

Aberdeen Company
P.O. Box 2663
Culver City, Cal. 90230

Able Comm. & Elect.
P.O. Box 236
Palm Harbor, Fla. 33563

Advance Indust., Inc.
Lunar Comm.
2301 Bridgeport Dr.
P.O. Box 1410
Sioux City, Ia. 51102

AEL Comm. Corp.
Subs. of Amer. Elect.
Labs., Inc.
P.O. Box 507
Lansdale, Pa. 19446

Alaun Engineering
1827 Copa Way
Monterey Park, Cal. 91754

Allied Tower Co., Inc.
P.O. Box 331
809 Kansas St.
S. Houston, Tex. 77587

Alma Engineering
7990 Dagget St.
San Diego, Cal. 92111

Alpha Wire Corp.
711 Ledgerwood Ave.
Elizabeth, N.J. 07207

Ameco, Inc.
2960 Grand Ave.
P.O. Box 13741
Phoenix, Ariz. 85002

American Data Corp.
315 Wynn Dr.
P.O. Box 5191
Huntsville, Ala. 35806

Amer. Technology Co., Inc.
3630 W. Clarendon St.
Phoenix, Ariz. 85019

Ampex Corporation
Audio-Video Systems Div.
401 Broadway
Redwood City, Cal. 94063

Anaconda Electronics
305 N. Muller St.
Anaheim, Cal. 92801

Andrews Tower, Inc.
1420 Layton Ave.
Ft. Worth, Tex. 76117

Angenieux Corp of
Amer., Inc.
440 Merrick Rd.
Oceanside, N.Y. 11572

Anixter-Pruzan
1963 1st Ave. South
Seattle, Wash. 98134

Antsco Corporation
17 West Sierra Madre Blvd.
Sierra Madre, Cal. 91024

Audio-Video Eng. Co.
65 Nancy Blvd.
Merrick, N.Y. 11566

Audiotronics Corp.
Video Systems Div.
7428 Bellaire Ave.
N. Hollywood, Cal. 91605

AVA Elect. & Machine Corp.
242 Pembroke Ave.
Lansdowne, Pa. 19050

Avantek, Inc.
3175 Bowers Ave.
Santa Clara, Cal. 95051

Avtel Corp.
44 Railroad Ave.
Glen Head, N.Y. 11545

B

Ball Brothers
Research Corp.
Miratel Div.
1633 Terrace Dr.
St. Paul, Minn. 55113

Baron Wire & Cable Corp.
4300 W. Montrose Ave.
Chicago, Ill. 60641

Beaver Elect. Ltd.
70 Ronson Dr.
Toronto, Ontario,
Canada M9W-1B8

Belden Corp.
Richmond, Ind. 47374

Berkshire Electric Cable Co.
River Road
Leeds, Mass. 01053

Beston Elect. Inc.
No. 20 on The Mall
Prairie Village, Kan. 66208

B & K Instruments, Inc.
5111 W. 164th St.
Cleveland, Ohio 44142

Blonder-Tongue Labs., Inc.
One Jake Brown Rd.
Old Bridge, N.J. 08857

Brand-Rex Company
P.O. Box 498
Willimantic, Conn. 06226

British Insulated Callender's
Cables Ltd.
P.O. Box 5
21 Bloomsbury St.
London WC1B 3Qn, England

Broadcast Elect., Inc.
8810 Brookville Rd.
Silver Spring, Md. 20910

Broadcast Products, Inc.
660 Lofstrand Lane
Rockville, Md. 20850

Broadcast Tower Service
P.O. Box 448
Sioux Falls, S.D. 57101

Buckeye Telephone
& Supply Co.
1250 Kinnear Rd.
Columbus, Ohio 43221

C

Cablewave Systems, Inc.
60 Dodge Ave.
North Haven, Conn. 06473

Canada Wire
& Cable Co., Ltd.
147 Laird Dr.
Toronto, Ontario, Canada

Cascade Elect. Ltd.
1111 C Street
Bellingham, Wash. 98225

Catel
Div. of United Scientific
1030 W. Evelyn
Sunnyvale, Cal. 94086

CBS Laboratories
227 High Ridge Rd.
Stamford, Conn. 06905

C-COR Elect., Inc.
60 Decibel Rd.
State College, Pa. 16801

Cerro CATV
Hall Mill Rd.
Freehold, N.J. 07728

A. B. Chance Co.
210 N. Allen St.
Centralia, Mo. 65240

Cleveland Trencher Div.
20100 St. Clair Ave.
Cleveland, Ohio 44117

Coastcom
2346 Stanwell Dr.
Concord, Cal. 94520

Cohu, Inc.
Electronics Div.
P.O. Box 623
San Diego, Cal. 92112

Commercial Elect. Inc.
880 Maude Ave.
Mountain View, Cal. 94040

Comm/Scope Corp.
P.O. Box 2406
15 N. Center St.
Hickory, N.C. 28601

Comspace Corp.
350 Great Neck Rd.
Farmingdale, N.Y. 11735

Concise Inst. Design Ltd.
260 Geary Ave.
Toronto, 170,
Ontario, Canada

Jerry Conn & Assoc., Inc.
550 Cleveland Ave.
Chambersburg, Pa. 17201

Conrac Div., Conrac Corp.
600 N. Rimsdale Ave.
Covina, Cal. 91722

Copperweld Corp.
Copperweld Bimetallics Div.
Box 1000
Glassport, Pa. 15045

Cunningham Corp.
10 Carriage St.
Honeoye Falls, N.Y. 14472

Cush Craft Corp.
621 Hayward St.
Manchester, N.H. 03103

D

Data Disc., Inc.
686 W. Maude Ave.
Sunnyvale, Cal. 94086

Datavision Inc.
15932 Shady Grove Rd.
Gaithersburg, Md. 20760

Davis Manufacturing
1500 S. McLean Blvd.
P.O. Box 1801
Wichita, Kans. 67213

Delta-Benco-Cascade Ltd.
124 Belfield Rd.
Rexdale, Ontario,
Canada M9W1G1

Diamond Expansion
Bolt Co.
500 N. Ave.
Garwood, N.J. 07027

Diamond Power
Specialty Corp.
P.O. Box 415
East Main Pike
Lancaster, Ohio 43130

Ditch Witch
The Charles Machine
Works, Inc.
P.O. Box 66
Perry, Okla. 73077

Dolphin Comm. Corp.
181 Church St.
Pughkeepsie, N.Y. 12502

Dynair Electronics, Inc.
6360 Federal Blvd.
San Diego, Cal. 92114

Dynasciences Corp.
Scientific Systems Div.
Township Line Rd.
Blue Bell, Pa. 19422

E

Eastman Kodak Co.
343 State St.
Rochester, N.Y. 14650

Echo Science Corp.
485 E. Middlefield Rd.
Mountain View, Cal. 94040

Edison Elect. Div.
McGraw Edison
Daven/Measurements,
Grenier Field
Manchester, N.H. 03103

Electrohome, Ltd.
809 Wellington North
Kitchener, Ontario, Canada

Elect. Indust.
Engineering, Inc.
A Div. of RCA Corp.
7355 Fulton Ave.
N. Hollywood, Cal. 91605

Elect. Indust. Sales, Inc.
2300 Richmond Ave.
P.O. Box 66907
Houston, Tex. 77006

Electro-Voice, Inc.
600 Cecil St.
Buchanan, Mich. 49107

Entron, Inc.
70-31 84th St.
Glendale, N.Y. 11227

Environmental Comm., Inc.
Cable Television
Components Div.
2718 S. Grand Ave.
Santa Ana, Cal. 92705

Essex Elect. Systems
6235 S. Harlem Ave.
Chicago, Ill. 60638

E-Z Way Prods., Inc.
Commercial Div.
13155 Nebraska Ave.
P.O. Box 17196
Tampa, Fla. 33612

F

Fairchild MOD
423 National Ave.
Mountain View, Cal. 95111

F&B/Ceco of Calif., Inc.
7051 Santa Monica Blvd.
Hollywood, Cal. 90038

Fort Worth Tower Co., Inc.
5201 Bridge St.
P.O. Box 8597
Fort Worth, Tex. 76112

Fung Engineering Co.
111 Glenn Way
Belmont, Cal. 94002

G

GBC Closed Circuit
TV Corp.
74 Fifth Ave.
New York, N.Y. 10003

General Cable Corp.
730 Third Ave.
New York, N.Y. 10017

Glentronics, Inc.
(See Sawyer Industries)

Alan Gordon
Enterprises, Inc.
5362 Cahuenga Blvd.
N. Hollywood, Cal. 91601

GPL-TV, Link Div.
The Singer Co.
Binghamton, N.Y. 13902

Grasis Fabricating Co.
5601 Gardner Ave.
Kansas City, Mo. 64120

GTE Sylvania
CATV Operations
114 S. Oregon
El Paso, Tex. 79901

H

Hitachi Shibaden
Corp. of Amer.
58-25 Brooklyn-
Queens Expwy.
Woodside, N.Y. 11377

Hy-Gain Elect. Corp.
8601 N.E. Hwy. 6
Lincoln, Neb. 68507

I

Innovative Television
Equip., Inc.
P.O. Box 681
Woodland Hills, Cal. 91634

Int. Video Corp.
675 Alamanor Ave.
Sunnyvale, Cal. 94086

J

Jampro Antenna Co.
Computer Equip. Corp.
6939 Power Inn Rd.
Sacramento, Cal. 95828

Javelin Elect. Co.
Div. of Apollo Laser, Inc.
6357 Arizona Circle
Los Angeles, Cal. 90045

Jerrold Elect. Corp.
CATV Systems Div.
200 Witmer Rd.
Horsham, Pa. 19044

JFD Systems Div. of
Riker Comm.
142 Central Ave.
Clark, N.J. 07066

JJJ Snubber Co.
1105 Clayton Rd.
Creston, Ia. 50801

K

Kalart Victor Corp.
Hultenius St.
Plainville, Conn. 06062

Kay Elemetrics Corp.
12 Maple Ave.
Pine Brook, N.J. 07058

KLM Electronics
1600 Decker Dr.
San Martin, Cal. 95046

Kortick Mfg. Co.
5600 Third St.
San Francisco, Cal. 94124

K'Son Corporation
743 Dunn Way
Placentia, Cal. 92670

L

Lampkin Labs., Inc.
8400 Ninth Ave., N.W.
Bradenton, Fla. 33505

Leaming Indust. Corp.
3740 Campus Dr.
Newport Beach, Cal. 92660

Lindsay Specialty
Prods. Ltd.
50 Mary W.
Lindsay, Ontario, Canada

LRC Elect., Inc.
901 S. Ave.
Horseheads, N.Y. 14845

L-W Photo, Inc.
15451 Cabrito Rd.
Van Nuys, Cal. 91406

M

Magnavox
CATV Div.
100 Fairgrounds Dr.
Manlius, N.Y. 13104

The Magnavox Co.
Video Systems
1700 Magnavox Way
Torrance, Cal. 90503

Maspro Co., Inc.
Asada, Nissin,
Nagoya-shigai, Japan

Matrix Systems Corp.
20426 Corisco St.
Chatsworth, Cal. 91311

McCabe-Power Body Co.
8900 Frost Ave.
St. Louis, Mo. 63134

3M Co., Magnetic
Prods. Div.
3M Center
St. Paul, Minn. 55101

3M Company
Mincom Div.
300 S. Lewis Rd.
Camarillo, Cal. 93010

Memorex Corp.
Audio-Video Group
1200 Memorex Dr.
Santa Clara, Cal. 95052

Metrodata Corp.
3201 Fairview Ave., E.
Seattle, Wash. 98102

Microflect Co., Inc.
3575 25th St. S.E.
Salem, Ore. 97302

Microwave Systems Co.
15860 W. 5th Ave.
Golden, Colo. 80401

MPI Company
1524 Frankford Ave.
Philadelphia, Pa. 19125

MSI Television
4788 S. State St.
Salt Lake City, Utah 84107

N

Nelson-Hershfield Elect.
1848 W. Campbell Ave.
Phoenix, Ariz. 85015

Noram Comm. Ltd.
4626 Burgoyne St.
Mississauga, Ont., Canada
L4W 1G2

O

Oak Indust. Inc.
Crystal Lake, Ill. 60014

Omnix
12234 W. Pico Blvd.
Los Angeles, Cal. 90064

P

Panasonic VTR/CCTV
of Matsushita Elect.
Corp. of Amer.
P.O. Box 3980
Grand Central Station
New York, N.Y. 10017

Panduit Corp.
17301 Ridgeland Ave.
Tinley Park, Ill. 60477

Path Products Inc.
P.O. Box 399
Jacksonville, Tex. 75766

Phasecom Corp.
13130 S. Yukon Ave.
Hawthorne, Cal. 90250

Phelps Dodge Comm. Co.
441 Sawmill River Rd.
Yonkers, N.Y. 10702

Philips Broadcast
Equip. Corp.
One Philips Parkway
Montvale, N.J. 07645

Plastoid Corp.
42-61 24th St.
L.I.C., N.Y. 11101

Potomac Instr., Inc.
932 Philadelphia Ave.
Silver Springs, Md. 20910

Preform Line Prods. Co.
5349 St. Clair Ave.
Cleveland, Ohio 44103

PRD Electronics, Inc.
1200 Prospect Ave.
Westbury L.I., N.Y. 11590

Prodelin Inc.
P.O. Box 131
Hightstown, N.H. 08520

R

Rank Precision Indust. Inc.
260 N. Rt. 303
W. Nyack, N.Y. 10994

Ratelco Inc.
610 Pontius Ave., N.
Seattle, Wash. 98109

RCA Corporation
Comm. Systems Div.
Front & Cooper Sts.
Building 2-5
Camden, N.J. 08102

Recording Center, Inc.
3941 Fifth Ave.
San Diego, Cal. 92103

Reliable Electric
11333 W. Addison
Franklin Pk., Ill. 60131

RF Systems, Inc.
155 King St.
Cohasset, Mass. 02025

Rich Laboratories, Inc.
105 Pasatiempo Dr.
Santa Cruz, Cal. 95060

Riker Video
142 Central Ave.
Clark, N.J. 07066

RMS Elect., Inc.
50 Antin Place
Bronx, N.Y. 10462

Rohde & Schwarz Sales
111 Lexington Ave.
Passaic, N.J. 07055

Rohn Manufacturing
Div. of Unarco Indust., Inc.
P.O. Box 2000
Peoria, Ill. 61601

Rosner Television
Systems, Inc.
250 W. 57 St.
New York, N.Y. 10010

Rust Corporation
168 Tremont St.
Everett, Mass. 02149

S

Sadelco, Inc.
299 Park Ave.
Weehawken, N.J. 07087

Sawyer Indust., Inc.
748 E. Alostia Ave.
Glendora, Cal. 91740

Saxton Prods. Inc.
215 N. Route 303
Congers, N.Y. 10920

Scala Radio Corp.
1970 Republic Ave.
San Leandro, Cal. 94577

SC Elect., Inc.
530 Fifth Ave., N.W.
New Brighton, Minn. 55112

Scientific-Atlanta, Inc.
Box 13654
Atlanta, Ga. 30324

Sencore Inc.
3200 Sencore Dr.
Sioux Falls, S.D. 57107

Shintron Co. Inc.
144 Rogers St.
Cambridge, Mass. 02142
Shure Bros., Inc.
222 Hartrey Ave.
Evanston, Ill. 60204

Sitco Antenna Co.
10330 N.E. Marx St.
P.O. Box 20456
Portland, Ore. 97220

Smith Company
Div. of Preformed
Line Prods.
P.O. Box 91129
Cleveland, Ohio 44101

Soladyne Internatl., Inc.
7455 Convoy Ct.
San Diego, Cal. 92111

Sola Electric
Div. of Sola Basic Indust.
1717 Busse Rd.
Elk Grove Village, Ill. 60007

Sony Corp. of America
47-47 Van Dam St.
L.I.C., N.Y. 11101

Southern Telephone
Supply Co.
5978 Peachtree Rd., N.E.
Chamblee, Atlanta,
Ga. 30341

Sparta Elect. Corp.
5851 Florin-Perkins Rd.
Sacramento, Cal. 95828

Spectra-Vision Corp.
1528 Belfield Ave.
Philadelphia, Pa. 19141

Spindler & Sauppe, Inc.
13034 Saticoy St.
N. Hollywood, Cal. 91605

Spin Physics, Inc.
11615 Sorrento Valley Rd.
San Diego, Cal. 92121

Stainless, Inc.
3rd St.
N. Wales, Pa. 19454

Steffen, Inc.
623 W. 7th St.
Sioux City, Ia. 51103

Stereotronics Television Co.
13720 Riverside Dr.
Sherman Oaks, Cal. 91403

Swager Tower Corp.
P.O. Box 498
Fremont, Ind. 46737

Systems Eng. Inc.
804 N. Broadway

P.O. Box 736
Syllacauga, Ala. 35150

Systems Wire & Cable, Inc.
3500 S. 30th St.
Phoenix, Ariz. 85040

Systron-Donner Corp.
One Systron Dr.
Concord, Cal. 94518

T

TACO Div.
1 Taco St.
Sherburne, N.Y. 13460

Tape-Athon Corp.
502 S. Isis
Inglewood, Cal. 90307

Tapecaster TCM
P.O. Box 662
12326 Wilkins Ave.
Rockville, Md. 20851

Techno Prods. Co.
7405 Greenbush Ave.
N. Hollywood, Cal. 91605

Telaudio Centre
634 S. Victory Blvd.
Burbank, Cal. 91502

Tele-Cine Inc.
294 E. Shore Dr.
Massapequa, N.Y. 11758

Telemation, Inc.
P.O. Box 15068
Salt Lake City, Utah 84115

Telemet
A Div. of Geotel, Inc.
185 Dixon Ave.
Amityville, N.Y. 11703

Telenetics Division
(See Recording Center, Inc.)

Teleng Inc.
405 Serrando Dr.
Suite 4E
San Francisco, Cal. 94132

Telestrator Indust., Inc.
166 E. Superior St.
Chicago, Ill. 60611

Telesync Corp.
20 Insley St.
Demarest, N.J. 07627

Télévision Audience
Response System Div.
Cable Television
Components Div.
271 S. Grand Ave.
Santa Ana, Cal. 92705

Television Equip. Assoc.
P.O. Box 1391
Bayville, N.Y. 11709

Telsta/General Cable
Apparatus Div.
P.O. Box 666
Westminster, Colo. 90030

Terado Corp.
1068 Raymond Ave.
St. Paul, Minn. 55108

Texas Elect., Inc.
P.O. Box 7225
Inwood Station
Dallas, Tex. 75209

Texas Instr. Inc.
34 Forest St.
Attleboro, Mass. 02703

Theta-Com of Calif.
CATV Division
P.O. Box 9728
Phoenix, Ariz. 85020

Time Mfg. Co.
7601 Imperial Dr.
Waco, Tex. 76710

Times Wire & Cable Co.
358 Hall Ave.
Wallingford, Conn.

Tomco Comm. Inc.
2134 Old Middlefield Way
Mountain View, Cal. 94040

Tri-Ex Tower Corp.
7182 Rasmussen Ave.
Visalia, Cal. 93277

TV Cable Supply Co., Inc.
1746 E. Chocolate Ave.
Hershey, Pa. 17033

R. H. Tyler Co.
Loop 132 & Hwy. 79
Onley, Tex. 76374

U

Ultra Audio Prods.
Box 921
Beverly Hills, Cal. 90213

Up-Right Scaffolds
1013 Pardee St.
Berkeley, Cal. 94710

Utilities Service Co.
P.O. Box 627
Allentown, Pa. 18105

Utility Body Co.
901 Gilman St.
Berkeley, Cal. 94710

Utility Tower Co.
3200 Northwest 38th
P.O. Box 12027
Oklahoma City, Okla. 73112

V

Van Ladder, Inc.
Box 709
Spencer, Ia. 51301

Video Aids Corp. of Colo.
112 W. Fourth St.
Loveland, Colo. 80537

Video Data Systems, Inc.
657 Old Willets Path
Hauppauge, N.Y. 11787

Video Eng. Co., Inc.
Riggs Rd. at
First Place, N.E.
Washington, D.C. 20011

VIF International
P.O. Box 1555
Mountain View, Cal. 94040

Vikoa, Inc.
400 Ninth St.
Hoboken, N.J. 07030

Viscount Indust. Ltd.
105 E. 69th Ave.
Vancouver 15,
British Columbia, Canada

Visual Educom Inc.
Dage Television
4333 S. Ohio St.
Michigan City, Ind. 46360

Visual Elect. Corp.
356 W. 40th St.
New York, N.Y. 10018

Vital Indust., Inc.
3614 S.W. Archer Rd.
Gainesville, Fla. 32601

W

Walker-Parkersburg
Dept. CV
Box 1828
Parkersburg, W. Va. 26101

Westay Co.
P.O. Box 573
Cupertino, Cal. 95014

Wilmore Elect. Co., Inc.
P.O. Box 2973
Durham, N.C. 27705

Winegard Co.
3000 Kirkwood
Burlington, Ia. 52601

World Video, Inc.
Box 117
13 E. Philadelphia Ave.
Boyertown, Pa. 19512

Your 10-year operating cost with EIMAC tubes is the lowest in the world.

Yes! Even very high power transmitters can have low per-hour operating costs. The *vital* requirement is the long life, high efficiency and reliability of EIMAC transmitting tubes.

Prove this by projecting 10-year replacement costs, operating costs per watt or operating costs per hour for your own equipment. After comparison, you'll agree that EIMAC tubes represent the best value for broadcast communications use.

You'll join select company when you make use of EIMAC's comprehensive line of 50 kW, 100 kW, 250 kW and 1.5 MW super power tubes. Facilities now using EIMAC tubes include:

Bangladesh	Pakistan
Colombia	Portugal
Iraq	Taiwan
Mexico	Venezuela
Mozambique	Republic of Vietnam

and VOA installations in Bangkok, Bethany, Delano, Dixon, Greenville, and the Philippines.

In addition, a majority of the new high power U.S. broadcast stations are EIMAC equipped. Other facilities retrofitted to EIMAC tubes include:

KSL, Salt Lake City	Jim Creek (USN)
WLW, Cincinnati	and Annapolis (USN)
	(megawatt installations)

EIMAC power tubes will also be used at new, large facilities in:

Ireland	Jordan
Dubai	The People's Republic of China

For complete information, contact EIMAC Division of Varian, 301 Industrial Way, San Carlos, California 94070. Or any of the more than 30 Varian/EIMAC Electron Tube and Device Group Sales Offices throughout the world.

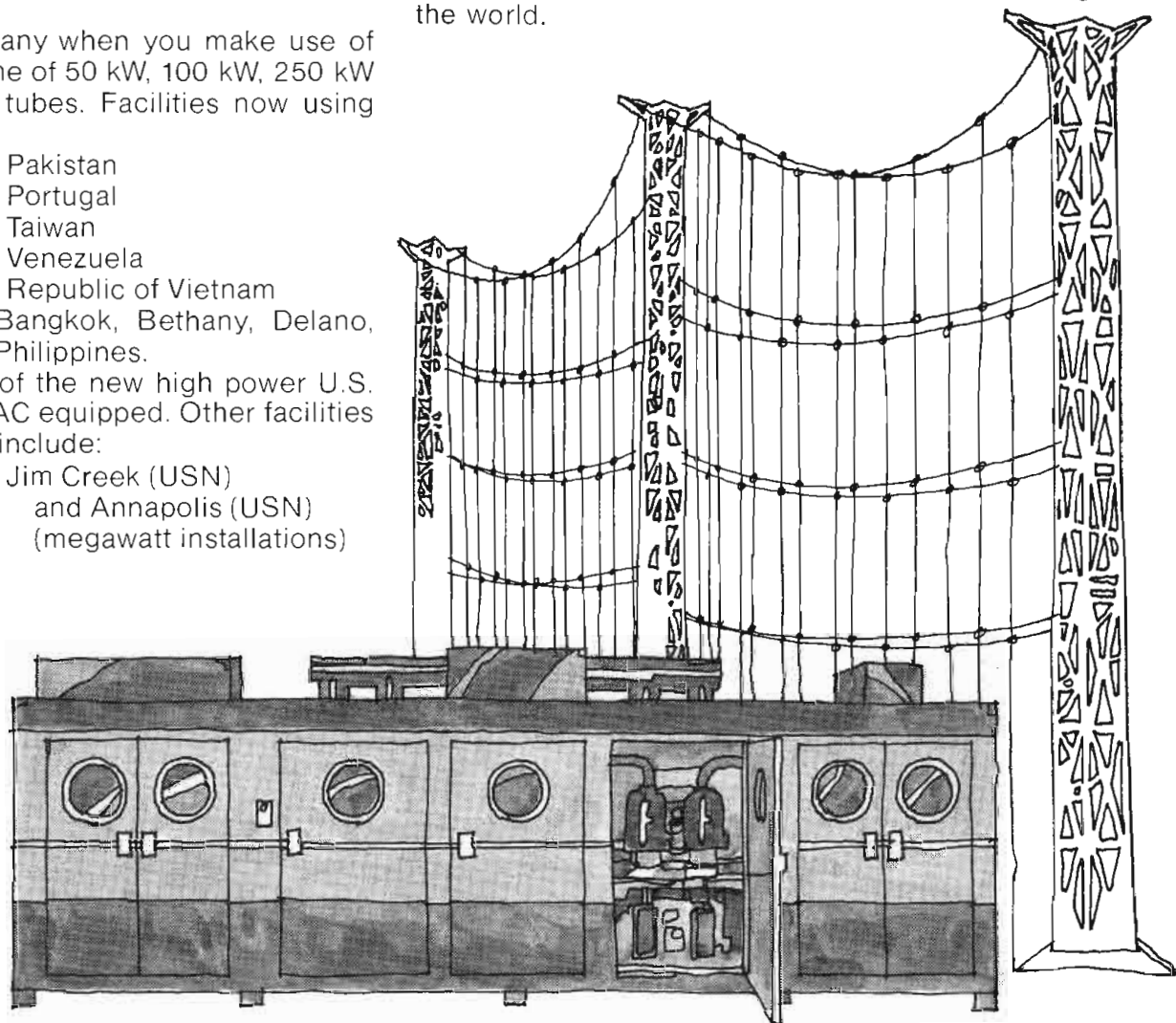

READY TO TRADE IT IN?

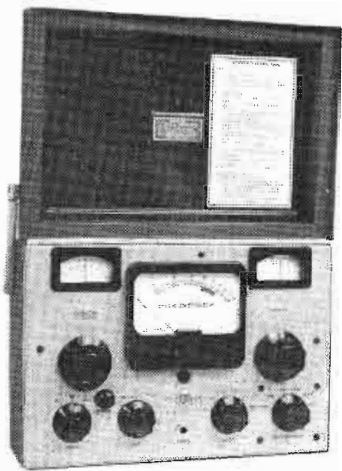

We're offering these two solid-state replacements in trade:



FIM-21
535 KHz to
1605 KHz

or



FIM-41
540 KHz to
4.8 MHz
(Measures AM Broadcast
Harmonics to -80db)

Typical Features:

- Front Panel Speaker
- Illuminated Meter and Dial
- Ganged Osc/Receiver Tuning
- High Adjacent Channel Rejection
- Stable over Wide Temperature Range
- Long Battery Life (standard D cells)
- External RF Input Jack

If you're ready to trade up to the next generation of Field Strength Meters from the manufacturer of the 120(WX-2), please write or call:



POTOMAC INSTRUMENTS, inc.
932 Philadelphia Ave.
Silver Spring, Md. 20910
Phone: (301) 589-3125

For More Details Circle (14) on Reply Card

LETTERS TO THE EDITOR

(Continued from page 10)

or FM, but be lost with a TV transmitter. Or, you might feel at home with a VTR, but pull your hair out over camera maintenance. But the hardest point to accept today is that even in the specialties, there is a daily foot race to keep up with how the units are and will be affected by the new components.

All this could be bewildering. But to the inventive and creative engineers, all these changes translate into new and better opportunities in circuit design and operation.

What's more, **Broadcast Engineering** had to change with the times. In order to keep pace, we had to sign more specialists to the staff. At the station level, it means that management must be concerned that their engineering staff is kept up to date. Otherwise, the purchase of equipment would be based on things far afield from the specs and economics. Just who would act as the station's technical interpreter?

So you are not alone in your concern. But you must admit the challenges are as great as they always were. And the future is seemingly limited only by our imagination.



"BEST LITTLE TROUBLE-SHOOTER WE'VE EVER HAD."

LETTERS DEPARTMENT Is An Open Forum

Send your letters to:
Broadcast Engineering

1014 Wyandotte St.
Kansas City, Mo. 64105

SPECIALIZED MULTIPLEX FOR THE BROADCAST INDUSTRY

- FM SUBCARRIER PROGRAM AUDIO DIPLEXERS.** The transparent program transmission for STL's, TV Networks and Satellite Links.
- SSB CHANNELS** for program audio transmission on CCITT Telephone Networks including L and N carrier.
- VOICE-OVER-VIDEO SUBCARRIER MULTIPLEX** For Microwave Applications including voice and data transmission combined with video for Remote Control, ETV Talk-Back and Inter-City Communications.
For Cable Applications including voice and data transmission channels for Industrial Complexes, Hospitals, Campuses and Local Government Communications Networks.
- COMMUNICATIONS SYSTEM BUILDING BLOCKS** including Video and Audio Filters.

Write or call today for full details and prices.

Telephone: 415/825-7500

Coastcom

2346 Stanwell Drive
Concord, Calif. 94520



For More Details Circle (15) on Reply Card



SBE Zeros In On Part 73 Re-Regulation

The SBE Re-regulation Committee, consisting of committee chairmen John Wilner, James Wulliman, and Edwin T. Karl, has been authorized to forward comments on re-regulation to the Federal Communications Commission. Each of the committee members also head subcommittees, Wilner on Television Engineering, Wulliman on Standard AM Broadcast Engineering, and Karl on FM Broadcast Engineering. Subcommittees had been directed to acquire and coordinate data from SBE chapters and individual members, as announced by publication in the pages of the **SBE Journal** (March and April 1973 issues) and by separate mailing to members.

The most significant results, from the subcommittee on FM engineering, are being forwarded to the Commission. These comments consist mainly of clarification of the FM Rules and Regulations. The subcommittee reported that they felt that the present system of evaluation of the audio system using sine waves and harmonic distortion measurements is inadequate, and in many cases, inaccurate. Also, the subcommittee feels that new alternatives should be developed to certain references in the Commission Rules and regulations pertaining to aural proof of performance measurements, including pre-emphasis standards.

The committee chairman, Edwin T. Karl, vice president, engineering, WSNL-TV, Suburban Broadcasting Corporation, Melville, N. Y., was assisted in development of the comments by William Naramore, chief engineer, WBLI, Patchogue, N. Y.; Norman Sternberg, chief engineer, WHLI, Hemstead, N.Y.; Lawrence Strasser, chief engineer, WTFM,

Fresh Meadows, N. Y.; and Edward Schoeber, Gates Radio Company, New York, N.Y.

The text of the recommended changes will be printed in our next issue.

Engineer Certification

A special meeting of the SBE Board of Directors, called by James Wulliman, president and chairman

of the board of the Society of Broadcast Engineers, was held on July 18th at the offices of Ben Wolfe, vice president, engineering, WTOP-TV, for further review of a program for certifying broadcast engineers. The idea for certification of broadcast engineers, the purpose of which is to raise the professional status of the engineer in broadcasting, had been proposed at the previous official meeting of the board which was held just prior to the NAB convention this past April.

Paragraph 73.69 of the FCC's Rules and Regulations states:

... every standard broadcast station employing a directional antenna must use a type-approved phase monitor.



FCC Approval No. 3-204

OUR AM-19 (204) IS THE ANTENNA MONITOR THAT MEETS ALL FCC REQUIREMENTS!

WHAT THIS MEANS TO YOU

1. If you're a new station or if you're making significant changes—you must have a type-approved antenna monitor by June 1, 1973.
2. If you operate your station with less than a first class radiotelephone licensed engineer, you must have a type-approved antenna monitor by June 1, 1974.
3. If you are presently operating your station by "remote control", you must have a type-approved antenna monitor Now! Or—you can use a monitor "properly configured", if such a monitor was manufactured after 1965.
4. Every other directional station must have a type-approved antenna monitor no later than June 1, 1977.

YOUR BEST CHOICE?

The AM-19 Antenna Monitor from POTOMAC INSTRUMENTS. The proven instrument for measuring phase and loop current ratio, the AM-19 can monitor up to 12 towers and accommodate DA-1,

DA-2 and DA-3 patterns. Phase meter resolution is 0.5 degrees. Loop current accuracy is $\pm 1.0\%$ with a 0.5% resolution.

AND—the AM-19 (204) is the only *type-approved* antenna monitor that meets all FCC requirements NOW!

YOU MUST HAVE A TYPE-APPROVED ANTENNA MONITOR—CHOOSE THE AM-19 (204) TODAY!

For complete information, please write or call:



Producers of
NEMS O'CLARKE
Broadcast Equipment

POTOMAC INSTRUMENTS, inc.
932 Philadelphia Avenue
Silver Spring, Maryland 20910
Phone: (301) 589-3125

RADIOMETER
COPENHAGEN

automatic distortion analyzer

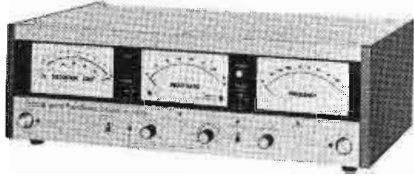

A unique instrument providing automatic simultaneous measurement and recording of distortion and amplitude response vs frequency.

- Low distortion sweep generator.
- Automatic distortion meter.
- Automatic frequency response.
- Outputs for automatic recording.

Contact us for complete information.



THE LONDON COMPANY

811 SHARON DRIVE
CLEVELAND, OHIO 44145
Tel. (216) 871-8900

221A

Wescon, Booths 1730-31

For More Details Circle (17) on Reply Card

SBE

(Continued from page 13)

As a result of lengthy discussion, the board has now authorized Ben Wolfe, as chairman of the certification committee, to proceed with the next phase of development. His responsibility aside from acting as chairman will be to spell out the professional requirements for certification. Other committee members are Al Chismark, director of broadcast engineering for Meridith Corporation, Syracuse, N.Y.; John T. Wilner, director of engineering, State of New Jersey Public Broadcast Authority; Leo Reetz, allocations and RF Systems, American Broadcast Company, New York; and Eugene Hill, vice president, engineering, Kaiser Broadcasting, Oakland, California. Chismark will be responsible for development of plans for administration; Reetz will design waiver or "grandfather" standards; Wilner will set up examination procedures.

The board has scheduled its next meeting for early November. At that time, the committee will provide specific recommendations on

setting up and implementing the plan for certification.

The basic requirements for a broadcast engineer to become certified include a minimum number of years of professional experience in responsible broadcast engineering work plus successful completion of a comprehensive written examination. Verification of experience is to be provided through professional references and supporting data provided with the application.

At the same meeting, the board also appointed a Fellowship Committee consisting of Charles Morgan, Ben Wolfe, and John Wilner. Morgan, who was elected to chair the committee, is assistant director of engineering for the Susquehanna Broadcasting group and chief engineer of WARM, Scranton/Wilkes-Barre, Pa. In April, he began his first term on the board.

The board acted to fill the vacant post of director of public relations by asking Joseph Risse, SBE director of publications, to take on this responsibility at least temporarily. Risse is associated with International Correspondence Schools, Scranton,

What they don't hear... can do wonders for your ratings!

Reducing noise pollution with the Burwen dynamic noise filter may prove to be the most profitable aspect of your programming...

Now you can broadcast discs, cartridges, and tapes with little or no distortion, full dynamic range and very low noise.

The Dynamic Noise Filter is an automatically variable bandpass filter whose bandwidth changes rapidly with each musical note and whose high and low frequency cutoffs are independently controlled by the spectral content of the input signal.

No signal encoding is required. When installed in your broadcast chain, the Dynamic Noise Filter will reduce the cumulative noise from all sources preceding it 10-11 dB with no audible effect on the music or speech. This is

accomplished with no less than 40 operational amplifiers and other precision components which provide 100 dB dynamic range with high accuracy, flat response over the entire range.

You won't believe what Burwen Laboratories' equipment can do... until you don't hear it! For complete details, call or write.



Burwen Laboratories is dedicated to engineering and manufacturing equipment and modular components having absolute perfection in performance and craftsmanship. Burwen Laboratories warrants its products

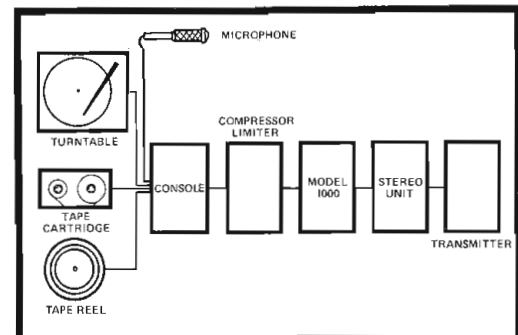

to be free from defects in material and workmanship for a period of two years from date of shipment to the original purchaser.

Burwen
LABORATORIES, INC.

209 MIDDLESEX TURNPIKE, BURLINGTON, MA. 01803/TEL. (617) 273-1488

ton, Pa., as director of the ICS television school, and also with the university of Scranton as director of engineering, Communications Department.

This Is Your Journal

Through these pages, provided by special arrangement with the publisher of **Broadcast Engineering** magazine, members of the Society of Broadcast Engineers may now communicate with each other; SBE headquarters can pass along information to the general membership; SBE chapters can report and announce information concerning their meetings or other activities; and we can air issues of vital concern to all of us who are employed one way or another in the field of broadcast engineering.

A means of communication is vital to any organization. Let's utilize this unusual opportunity which is now available.

Here are some reminders from SBE Headquarters: Chapters: Be sure to apply for annual rebates from SBE headquarters. A rebate of up to \$100 annually is possible based on membership attendance for the preceding year. To obtain this rebate it is necessary to complete the Annual Attendance Report Form which may be obtained from Virginia Doss, SBE, P.O. Box 88123, Indianapolis, Ind. 46208. Virginia would also like chapters to remind members that attractive SBE tie tacks are available from her for \$3.50 (members only).

When corresponding with SBE about your membership include your membership number. Submit change of address promptly. If you are not receiving **Broadcast Engineering** magazine, provided as a courtesy by the publisher to SBE members at no cost, notify Virginia Doss. Letters to the Editor, Chapter News, articles, and other information for publication should be sent to SBE Editor, Joe Risse, P.O. Box 131, Dunmore, Pa. 18512.

The **SBE Journal** is published as a special section of **Broadcast Engineering** magazine as a special courtesy of the publishers of that magazine.

AEL transmitter features: ...five-year warranty ...twenty-year parts availability.

The new AEL FM-25/25KD was designed to provide exceptionally high power FM broadcasting service with a high degree of redundancy and reliability to meet power level requirements of up to 50KW TPO.

To get it, we combined two AEL FM-25KD 25KW FM transmitters, whose combined outputs are connected to the antenna through a true 90° hybrid combiner.

If you're impressed so far, just wait until you see the specs and hear the whole story.

THE NEW AEL FM-25/25KD BROADCAST TRANSMITTER Packs a 50KW TPO Wallop!



American **E**lectronic **L**aboratories, Inc.

P. O. Box 552, Lansdale, Pa. 19446 • (215) 822-2929 • TWX: 510-661-4976 • Cable: AMERLAB

For More Details Circle (19) on Reply Card

Chapters In The Making

The following areas represent locations for possible future chapters.

Information on any planned organizational or technical meetings may

Location	Contact
Miami, Fla.:	John Blattner, 11001 N. Kendall Dr., Apt. A107, Miami 33156.
St. Louis, Mo.:	Arthur H. Rounds, 1321 Aspen Drive, Florissant, Mo. 63031.
Puerto Rico:	Bob Beurket, Asst. Chief Engineer, WRIK TV, Ponce/San Juan, Puerto Rico. Telephone 809-724-7575.
San Francisco, Calif.:	Robert Daines, CBS Laboratories, One Embarcadero Center, San Francisco, Calif. 94111.

be obtained from the individual listed as the "contact" in each case. Anyone interested in chapter activities in other locations may contact Virginia Doss, Assistant Secretary-Treasurer, SBE, P.O. Box 88123, Indianapolis, Ind. 46208, or at WRTV, 1330 N. Meridian, Indianapolis. In some cases, assistance from SBE national officers and directors may be available. Contact any officer or director, or SBE President James C. Wulliman, at WTMJ, 720 East Capitol Drive, Milwaukee, Wisconsin. Those involved in the development of new chapters should also keep the SBE Journal Editor posted so that this work can be aided by promotion in the Journal.

Chapter Activities

Reports of SBE chapter meetings and announcements of future events will be published in these pages monthly. It is important that chapters send information on meetings and other news as promptly as possible. Include photographs whenever available; preferred photo size is 8 x 10 but smaller sizes are also usable.

The monthly deadline for submitting copy is the 25th of the 2nd month preceding the month of publication; for example, the date by which copy must be received by the SBE editor for the November, 1973 issue is September 25th; for the December 1973 issue, the deadline is October 25th, and so on.

Letters to the SBE Editor for publication in the **Journal** are invited.

Send all material for publication to: SBE Editor, Joseph A. Risse, P.O. Box 131, Dunmore, Pa. 18512.

Chapter 1 — Binghamton, N.Y.
Chairman: Larry Taylor,
WENY-AM-FM
Mark Twain Hotel,
Elmira, N.Y. 14902

The big news relating the chapter was the announcement of the regional convention planned in cooperation with Chapter 2 of Wilkes-Barre/Scranton, Pa., and Chapter 22 of the Syracuse, N.Y. area for all day Friday, October 19th, at the Owego Treadway Inn, Owego, N.Y. Featured will be booths at which manufacturers' engineering repre-

Spotmaster®

Space Setter

\$469



5 3/8"

5 5/8"

Three/70™ Cartridge Playback Deck

Meet our midget. And don't be fooled by its modest exterior. The new Spotmaster® Three/70 packs the performance of its big brother—the incomparable Ten/70—into a pint-sized package at a pint-sized price.

Standard features include the Ten/70's direct drive synchronous motor, all silicon solid state circuitry, high output (+8 dbm) and plug-in modular construction. Deck operation is pushbutton-quick, with instantaneous response.

Now look what happens when you put a trio of Three/70s together. They fit side by side in a single rack mount. The whole thing takes up just 7" of rack space.

Three/70s accept all Type A cartridges, playing up to 10½ minutes at 7½ ips. Options include 3¾ ips operation, as well as 150 Hz and 8 kHz secondary and tertiary cue tones (to augment the 1,000 Hz primary stop/re-cue tone).

Good things do come in small packages. Learn more about the Three/70—contact us today.



BROADCAST ELECTRONICS, INC.

— A Filmways Company —

8810 Brookville Road, Silver Spring, Maryland 20910 • (301) 588-4983
 TWX 710-825-0432

representatives will demonstrate and explain equipment, and free food and refreshments. Admission will also be free at the "miniconvention" which is planned for 12 noon to 12 midnight. The Owego Treadway Inn is located just west of Binghamton, N.Y., off Interstate Route 17.

Chapter 2—Northeastern Pa.
Chairman: Paul Evanosky,
WVIA AM FM
Old Boston Road,
Jenkins Township,
Avoca, Pa. 18640

No summer meetings scheduled. See planned October regional convention being planned in cooperation with Chapters 1 and 22, above.

Chapter 9—Phoenix, Ariz.
Chairman: Charles Deen,
KOOL TV - 511 W. Adams,
Phoenix, Ariz. 85003

The most recent activity of the chapter was in the form of assistance in formation of the Tucson chapter on May 24th. Details on the first meeting of the Tucson chapter, held jointly with the Phoenix chapter, were reported in the August issue.

Chapter 11—Boston, Mass.
Chairman: Ross Kauffman,
Assis. C.E., WVCB-TV,
5 TV Place,
Needham, Mass. 02192

A program of revitalization of the Boston Chapter was initiated by Steve deSatnick, WCVB-TV director of engineering, and member of the SBE board of directors, at the May and June Meetings. On May 11th, Ross B. Kauffman of WCVB-TV was nominated and elected by acclamation as Chapter Chairman. At a meeting on June 19th, Mike Goldberg, transmitter supervisor for WGBH-TV was elected vice chairman; and Steve Cohn, WSMW, Worcester Channel 27, was elected Secretary-Treasurer. Cliff Rogers of Philips Broadcasting Equipment Corporation presented a paper on "Sound in Sync" at this same meeting. Meeting announcements were mailed out through the courtesy of Lad Hlavaty, vice president, engineering for R.K.O. Television. SBE members in the New Hampshire and Rhode Island areas aside from those of other localities are especially welcome at all chapter

meetings and activities.

Chapter 16—Seattle, Wash.
Chairman: John Maxson,
KETO FM, 17425 63rd Pl., S.E.
Issaquah, Washington 98027

On July 11th a refreshment hour and lunch preceded a talk by John Enbom, vice president, Air Control, Inc., Seattle, on the new Paar 30-30 air filter system, and its use in intercepting dust and other forms of dirt before it reaches such vital spots as high voltage sections of

transmitters and video tape heads.
Chapter 22—Central New York
Chairman: Hugh Cleland,
WCNY TV/FM
506 Old Liverpool Rd.,
Liverpool, N.Y.

Gary Hartman, secretary, has provided some additional information on the Joint Meeting, held May 8th, with Chapters 1 and 2, at the Owego Treadway Inn, relating especially to the comments of guest speaker Otis Hanson, FCC chief of

**BIG ENOUGH TO PROVIDE
 +20 DBM TO 15 OUTPUTS
 IN 1 3/4" OF RACK SPACE.
 SMALL ENOUGH TO FIT NEATLY
 INTO YOUR BUDGET.**

When it comes to distribution amplifiers, never has so much performance—and so much value—been packaged so compactly. But our engineers have done it—with a big help from state-of-the-art IC op-amps and a dual set of complementary-symmetry current drivers with heavy negative feedback

The result is 20 dbm supplied to each of 15 outputs, with crosstalk better than 70 db

down. Distortion is down, too, with a total figure of 0.2% or less. With a response of 20-20kHz \pm 1/2dB, and S/N ratio of 65 dB or better, the DA-1520 provides broadcast and recording-studio quality performance at a profes-

sional net of only \$295—reasonable enough for a PA System.

On its 1 3/4" high rack panel, the DA-1520

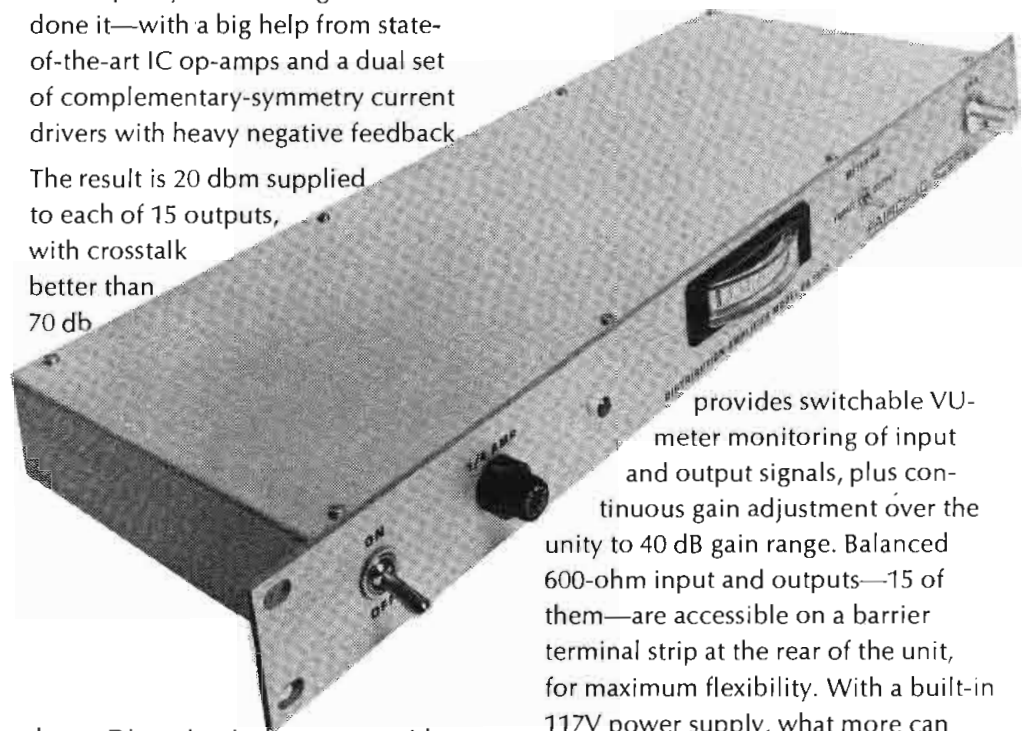

provides switchable VU-meter monitoring of input and output signals, plus continuous gain adjustment over the unity to 40 dB gain range. Balanced 600-ohm input and outputs—15 of them—are accessible on a barrier terminal strip at the rear of the unit, for maximum flexibility. With a built-in 117V power supply, what more can you ask?

For more information about the remarkable DA-1520 and the other distribution amplifiers in our line, call or write Sales Manager Rick Belmont.

ROBINS & FAIRCHILD
The first name - and the last word - in sound equipment.
A Robins Industries Corporation

75 Austin Boulevard, Commack, N.Y. 11725 (516) 543-5200
 For More Details Circle (20) on Reply Card

AUTOGRAM

Specialists in radio station automation equipment & systems

- control systems
- program automation
- program logging
- cartridge systems
- reel systems

For information, contact:



AUTOGRAM CORPORATION
MAILING ADDRESS: BOX 456, PLANO, TEXAS 75074
PLANT: 631 J PLACE, PLANO. (214) 424-8585

For More Details Circle (21) on Reply Card

existing aural facilities. Hanson stated "There is a communications gap between the FCC and stations." He said the gap exists between what the FCC expects and what stations think it expects. "We need to let the regulated know what the regulator has in mind," Hanson went on. Some new rules are not too well known, he said, and urged every station to acquire an updated copy of rules and regulations. Pointing out that he deals with AM and FM, he stated that he and his counterpart in television, Clyde Gurley, are guided in their decisions by the FCC's principal interest in the orderly development and regulation of the broadcast system. Licenses and authorizations are granted on a demand basis in accordance with international treaties with the objective of providing adequate service for as much of the population as possible, according to Hanson.

Chapter 25—Indianapolis, Ind.
Chairman: Joe Missick,
WISH TV, 1950 N. Meridian St.,
Indianapolis, Ind. 46202

The May meeting of the chapter was held at Indiana State University, Terre Haute, where a tour of the radio and television facilities was provided under the direction of Buddy Kline; Dr. Workman gave a talk on 3-point lighting. On June 13th, the meeting was at the Hawthorne Room where an open discussion on OSHA requirement was the main feature. On July 10th, at the Indiana University Hospital Cafeteria, Bob Flanders of WRTV, vice president engineering, and former national SBE president, spoke on the possibility of changing video tape standards.

Send Your
Letters To The
Editor

To: 1014 Wyandotte
Kansas City, Mo. 64105

Everything you need for complete audio testing. Ferrograph RTS-2 with Auxiliary Unit

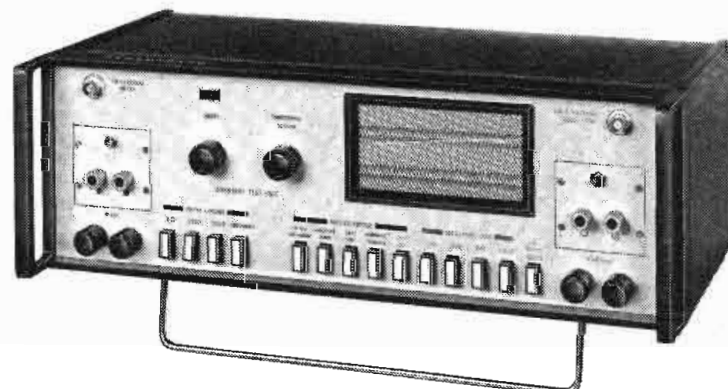
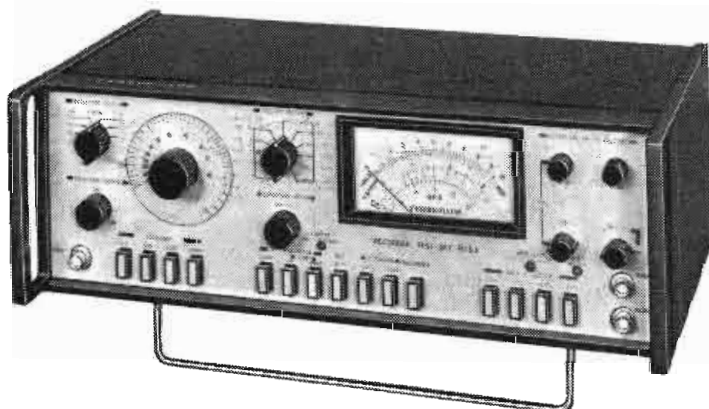

Versatile all-in-one precision test system

It's a Sine Wave generator . . .
Millivoltmeter . . . Wow & Flutter bridge
. . . Harmonic Distortion analyzer that you
can learn to use in minutes. Requiring only
two leads, setup time is minimal.
Pushbutton controls provide rapid, precise
operation. Compact and lightweight, it's
ideal for recording and broadcast studios,
testing labs and service shops.

Vastly expanded operation

By combining the RTS-2 with the ATU
Auxiliary Unit, you're ready for the most

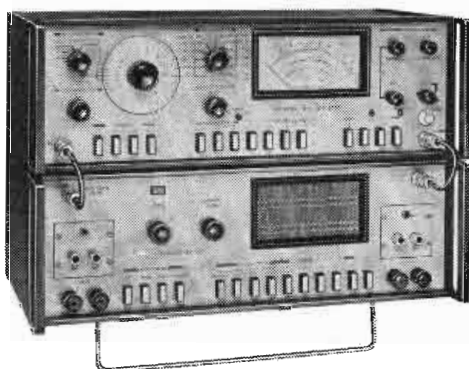

RTS-2 Test Set — \$1450
ATU Auxiliary Unit — \$560
Carrying cases optional

sophisticated audio testing. • Monitors
pre-recorded test alignment tape with
built-in speaker unit • Balanced and
unbalanced input/output. Switches
between left/right input/output channels.
Provides matching impedances for 8Ω,
200Ω, 600Ω impedances, or unloaded.
• Compares input/output signals • NAB
weighted noise filter network for S/N
measurements • Oscillator output may be
set in 10dB increments over 40dB range
by pushbuttons • Designed for use with
virtually any test equipment.

Send for list of distributors for a
demonstration.

ELPA MARKETING INDUSTRIES, INC., New Hyde Park, N.Y. 11040
For More Details Circle (22) on Reply Card

Collins broadcast equipment is priced competitively.

And that's where the competition ends.

We'll match our prices with competition anytime. But when it comes to quality, performance, reliability and service, Collins

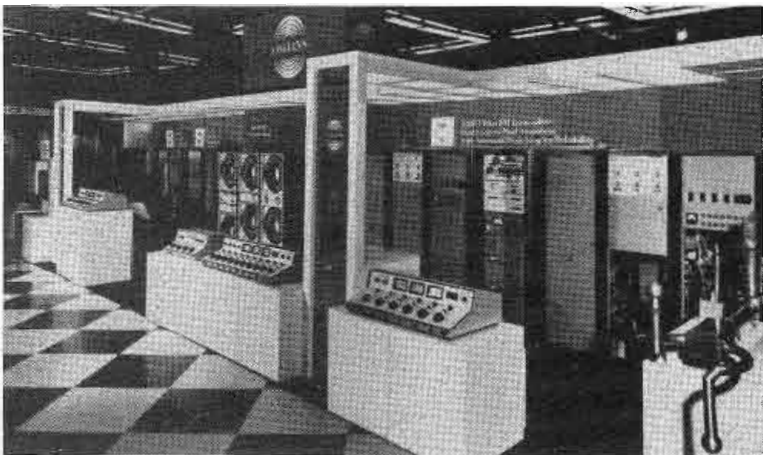

traditionally has been in a class by itself.

You can see the difference. You can hear it.

You get it in every piece of equipment we build. In our transmitters. In our consoles. In our antenna systems. In our programming equipment. In every piece of Collins equipment you use in your station.

And we back everything we make with a two-year warranty. Plus 24-hour, on-call service which means you get help when you need it.

AM. FM. Stereo. Broadcast equipment from Collins. Competitively priced to give you the best sound on the air.

Collins Broadcast Equipment



Buy the best at any cost— even if it costs you less!

Broadcast and audio engineers around the nation have chosen Ramko products on performance specs alone. Then were pleasantly surprised at our low, low prices.

Compare Ramko performance yourself. Free 10-day evaluation period and 2-year warranty guarantee you get the best.

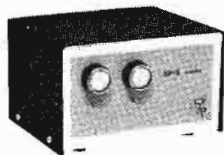

TURNTABLE PREAMPS
MP-8 \$72 (Mono) SP-8 \$114 (Stereo)

Outstanding sensitivity and incomparable reproduction. RIAA/NAB equalized ± 1 db. 0.5mv sensitivity at 1kHz for +4dbm out. Balanced 600 ohm out. -65db S/N ratio. +20dbm out max. 0.1% or less distortion. Internal power supply. Tabletop or bracket mount. Shipping weight 3½ lbs.

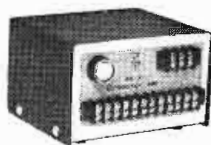

DISTRIBUTION AMPLIFIERS DA-6 \$109

Individual output amps provide maximum isolation. ± 0.5 db response, 10Hz to 20kHz. 26db gain. Balanced bridging or matching input. Six balanced 600 ohm outputs. +20dbm out max. Output level control. 0.1% or less distortion. Internal power supply. Tabletop or bracket mount. Shipping weight 4 lbs. Other models feature rack mount, output metering and up to 32 outputs, \$138 to \$425.

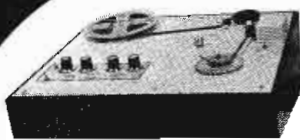

AUTOMATIC CART & CASSETTE LOADERS
ACL-25 \$159

At last automatic precision winding at a price you can afford! Eliminates guesswork because dials set tape length to the second. The exact amount of tape is fed onto the cart or cassette, then it is shut off automatically. Exclusive torsion control for proper tape pack and winding of various hub sizes. TTL digital control circuitry. Other models feature speed and tone sense options, \$266 to \$350. Shipping weight 30 lbs.



STUDIO MONITOR AMPLIFIERS SMA-50 \$105

Exceptional reproduction! Internal muting. ± 1 db response, 20Hz to 40kHz. 25w music power, 50w instantaneous peak power, 15w rms. Hum and noise, -65db below rated output. Distortion less than 1% at 15w rms; typically below 0.25% at less than full power. Load impedance, 4, 8, 16 ohms; input balanced bridging, 100kohms. Variable base contour. Internal overload protection. Internal power supply. Tabletop or bracket mount. Other models feature rack-mounted mono, stereo or dual mono options, \$128 to \$169. Shipping weight 6 lbs.

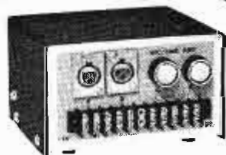

MIC/LINE AMPLIFIERS
MLA-1 \$84 (Mono) MLA-2 \$112 (Stereo or Dual Mono)

Dual function utility amps. Inputs for mic and/or line. ± 0.5 db response, 10Hz to 20kHz. Mic input -65db for +4dbm out. Balanced inputs on high-level and mic channels. Balanced 600 ohm out. +20dbm out max. 0.1% or less distortion. Internal power supply. Tabletop or bracket mount. Shipping weight 4 lbs.



COLLIMETERS
(Precision Tape Head & Guide Alignment)
Standard, C-II \$15 Multi-Cart, C-IV \$19

A Ramko exclusive! Designed by Ramko to speed up tape head and guide alignment on all cart machines. Now used by more than 5,000 engineers. Unique combination of optical and electro-sensing elements allows you to precisely adjust Height, Zenith, and Azimuth on all cartridge machines.

ORDER TODAY FOR 10-DAY TRIAL PERIOD.
Compare Ramko performance yourself.



Ramko Research Professional Audio Products

3516-B LaGrande Blvd., P.O. Box 6031
Sacramento, California 95860 (916) 392-2100

INDUSTRY NEWS

SMPTTE Ready For October Convention

Members of the Program and Arrangements Committees for the SMPTTE New York Conference have been chosen, according to a joint announcement by Program Chairman, R. L. Pointer, American Broadcasting Co., and Arrangements Chairman Charles Ahto, MPO/Tape Films.

The Conference is slated for the Americana Hotel in New York, October 14-19.

The Program Committee obtains papers for the 5-day technical sessions program. The Arrangements Committee organizes all non-program activities of the Conference.

The recently-announced members of the Program Committee are Calvin Hotchkiss, Eastman Kodak Co., Associate Program Chairman; A. A. Goldberg, CBS Labs, Topic Chairman for Digital Techniques in Television; Mal Albaum, WNET/13, Topic Chairman for Electronic News; Burton J. Stone, Precision Film Labs, Topic Chairman for Film Laboratory Practices; and Daniel Sandburg, TVC Labs, Inc., Topic Chairman for Film Production Techniques.

Members of the Arrangements Committee are: Peter Cardasis, Movielab, Inc., Auditor; Kurt Wulliman, 3M Co., Banquet/Luncheon Chairman; E. Carlton Winckler, Imero Fiorentino Assoc., Inc., Banquet/Luncheon Administrative Assistant; Irwin Young, Du Art Film Laboratories, Entertainment Chairman; Herbert R. Pilzer, Motion Picture Enterprises, Hospitality Chairman; and Edward J. Messina, ABC-TV, Hotel Arrangements Chairman.

For More Details Circle (24) on Reply Card

Additional Arrangements Committee Members are: Richard Streeter, CBS-TV Registration Chairman; Calvin Hotchkiss, Eastman Kodak Co., Administrative Assistant for Registration and Hotel Arrangements; Marian Fuller, Geocine Films, Inc., Membership Chairman; Irwin B. Freedman, Agfa-Gevaert, Inc., Message Center Chairman; Samuel Bunchez, Vacuumate Corp., Projection, Public Address and Recording Chairman; William Cooper, WPIX, Inc., Publicity Chairman; Sigmond Bajak, NBC-TV, Transportation Chairman; Marge Ahto, Women's Program Chairman.

In addition to the five days of technical sessions, the SMPTE Conference will feature a 103-booth Equipment Exhibit with the latest professional motion-picture and television equipment on display. Exhibit Chairman is Dom Capano, Cinecraft International.

An attendance of more than 3,500 is expected at this semi-annual meeting.

New Sustaining Members

Eleven companies in the motion picture and TV industries have joined the SMPTE as Sustaining Members so far in 1973, it was announced by SMPTE Financial Vice-President, Joseph T. Dougherty. This brings the number of SMPTE Sustaining Members to 163.

The new SMPTE Sustaining Members are: The Association of Motion Picture and TV Producers, Hollywood; Canon U.S.A., Inc., Lake Success, N.Y.; Dolby Laboratories, Inc., New York; Industrial Silver Corp., Hollywood; International Film Laboratory, Burbank, Calif.; i/o Metrics Corp., Palo Alto, Calif.; Lowel-Light Manufacturing, Inc., New York; Magna Tech Electronics Co., Inc., New York; Pailard, Inc., Linden, N.J.; Saudel Associates, Inc., Mahwah, N.J.; and Gordon Yoder, Inc., Dallas, Texas.

**Send Your Industry News
To Broadcast Engineering
For Better Coverage**

**IF YOU NEED
ATTENUATORS
YOU NEED THIS
CATALOG!**



AUDIO AND RF ATTENUATORS TO MEET ANY REQUIREMENT

Here in one compact and informative 24 page booklet is all the data you need to select a Precision Audio and RF Attenuator for your application.

Reference Charts, Circuit Diagrams, Types and Uses, Current and Voltage Ratio Tables, Ratings, Etc., make this a handy and invaluable reference.

SEND FOR YOUR FREE COPY TODAY.

TECH LABS, INC.

Bergen & Edsall Blvds.
Palisades Park, N.J. 07650
Tel.: (201) 944-2221

For More Details Circle (25) on Reply Card

Solve YOUR Cleaning Problems...

**4 Product
TRIAL UNIT
\$10⁰⁰**

electronic components - tape heads - contacts

**Economical MILLER-STEPHENSON aerosols take the headaches
(and a lot of expense) out of what used to be a nuisance.**

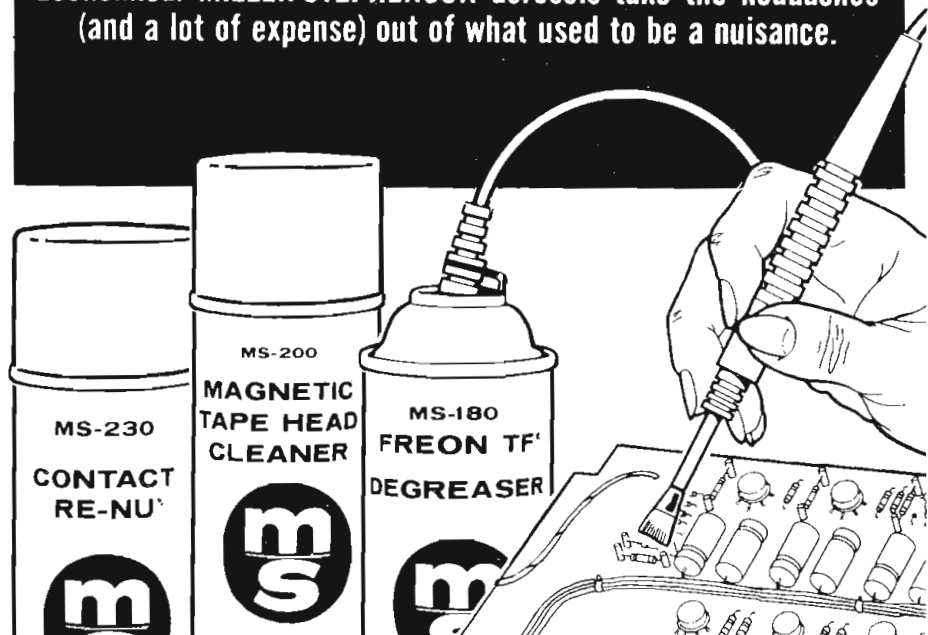

MS-180 "FREON"® TF DEGREASER — No need to disassemble components. Spray MS-180 onto relays, circuit boards, motor parts. Removes dirt, dust, oil; prevents recontamination. Non-conductive, non-flammable. Reduces maintenance costs. "Freon"® DuPont Trademark

MS-200 MAGNETIC TAPE HEAD CLEANER — Spray away oxide dust before it ruins heads and tapes. MS-200 flushes it away. Manufacturers recommend it; communications experts prescribe it; EDP operators wouldn't be without it. U.S. & FOREIGN PATS.

MS-230 CONTACT RE-NU — Renew your contacts. Re-Nu does it. Flush away dirt, carbon, and other "interferences." Will not harm insulation; leaves no residue. Switch to MS-230 for your switches — and other points.

MS-226 "Cobra" EXTENSION NOZZLE/Solvent Spray Brush — "Co-Brush" away stubborn dirt, carbon, grease, oxide build-up.

**m s miller-stephenson
chemical co., inc.**

Danbury, Connecticut 06810 (203) 743-4447

- Enclosed is \$10.00, please send my **BE** "4-Product Trial Unit".
- Please send **FREE** literature and prices.

NAME _____ TITLE _____

DEPT. _____

COMPANY _____

ADDRESS _____

CITY _____ STATE _____ ZIP _____

CHICAGO • LOS ANGELES • TORONTO Dist. in ITALY • GERMANY • FRANCE • ENGLAND • SCOTLAND • SPAIN • NETHERLANDS • LEBANON

For More Details Circle (53) on Reply Card

Equal Employment Rules

A declaratory ruling on the applicability of equal employment rules to religious organizations that are Commission licensees has been issued by the Commission. Sections 73.125, 73.301, 73.599 and 73.680 generally prohibit religious discrimination in employment.

The Commission said that there

is a limited exemption afforded "those who, as to content or on-the-air presentation, are connected with the espousal of the licensee's religious views." The Commission also said that the limited exemption includes writers and research assistants hired to prepare programs espousing the licensee's religious

views, and those hired to answer religious questions on call-in programs.

The action was in response to a request by the National Religious Broadcasters, Inc. (NRB), for a declaratory ruling on discrimination in employment on religious grounds.

The Commission on May 3, 1972 (affirmed November 22, 1972), ruled that King's Garden, licensee of KGDN, KBIQ-FM, Edmonds, Wash., had violated the equal employment opportunities requirements by discriminating in its employment practices on religious grounds. NRB asked for a clarification of the King's Garden rulings for various employee categories.

The Commission said that announcers, as a general category, would not be exempt from the nondiscrimination rules since there was no reason why an announcer had to be of a particular faith in order to introduce a program or insert news, commercial announcements, or station identification during any programs.

Aside from the positions it had discussed, the Commission noted that other categories listed by NRB were not "so clear cut," and it would not be advisable to issue a general declaratory ruling as requested by NRB. It said the area involves First Amendment rights, and it would be preferable to have "specific factual settings" before issuing rulings.

The Commission emphasized that its decisions in this area are restricted to the broadcast activities of licensees that are religious organizations. Pointing out that it would not rule on activities that are not part of broadcast operations, the Commission said religious organizations that are licensees might wish to consider whether certain employees are actually part of the broadcast operation or part of their religious activities.

NPR Offers Recommendations

Recommendations of the National Industry Advisory Committee (NIAC) for voluntary participation of the National Public Radio Network (NPR) and Public Broad-

MODUlimiter...

you can hear the difference!

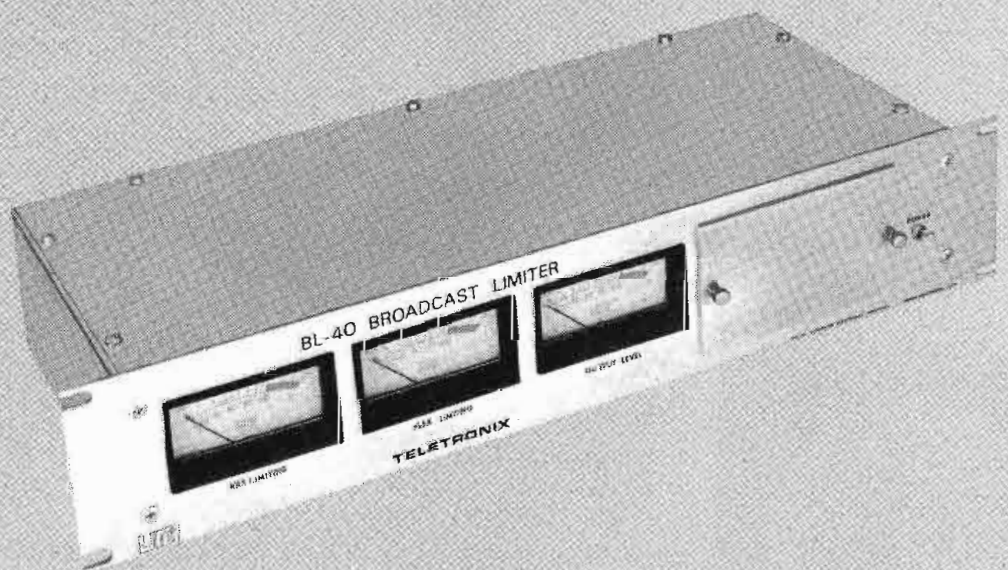

The Urei Model BL-40 Broadcast Limiter is more than a compression limiter...Modulimiter provides independent adjustment of RMS gain and peak limiting, without clipping! The result allows continuously variable, asymmetrical limiting to maximize effective power for your particular program format.

Modulimiter features low noise, low distortion integrated circuitry and has full function metering. Output meter can be calibrated to match any transmitter input. All critical adjustments are located behind a security panel and a test switch for proof-of-performance is provided.

Modulimiter is another product for the Broadcast Industry, distributed by Pacific Recorders...the Total Equipment Supplier.



PACIFIC RECORDERS AND ENGINEERING CORPORATION
11760 SORRENTO VALLEY RD, SAN DIEGO, CALIFORNIA 92121
TELEPHONE 453-3255 TELEX 695008

casting Service (PBS) audio networks in the national Emergency Broadcast System (EBS) have been approved by the FCC.

National Public Radio is a national radio network serving over 130 non-commercial broadcasting stations. Its production center and general offices are in Washington, D. C. Public Broadcasting Service was established by the Corporation for Public Broadcasting. PBS manages the national distribution of educational television programs to noncommercial television stations.

PBS volunteered to participate in the Emergency Broadcast System on July 6, 1972, and NPR on December 1, 1972. NIAC recommended participation of NPR and PBS in the Emergency Broadcast System in a report to Commissioner Charlotte T. Reid, Defense Commissioner, on February 21, 1973.

The basic EBS plan and Part 73, Subpart G of FCC rules will be revised to include the NPR and PBS. NPR and PBS will be included in all future closed circuit tests of national EBS.

WDIO Shares Water Supply With Area

Recently it was discovered asbestos like particles in Lake Superior's drinking water might pose a health problem. Upon the discovery, WDIO Television (ABC) Duluth, Minnesota took steps to supply area residents with an alternate source of drinking water.

On June 8th, results from one of many studies on the purity of Lake Superior's water revealed the asbestos like particles which are being dumped into the lake as commercial waste may pose a health problem. On June 18th, the Environmental Protection Agency suggested children under five years of age be given drinking water from a source other than Lake Superior. Immediately local dairy's began bottling water for sale at from 18¢ to 24¢ a half gallon.

On June 23rd, WDIO began offering fresh well water to area residents from the stations deep

RCA's lead-oxide Vistacons make the scene.

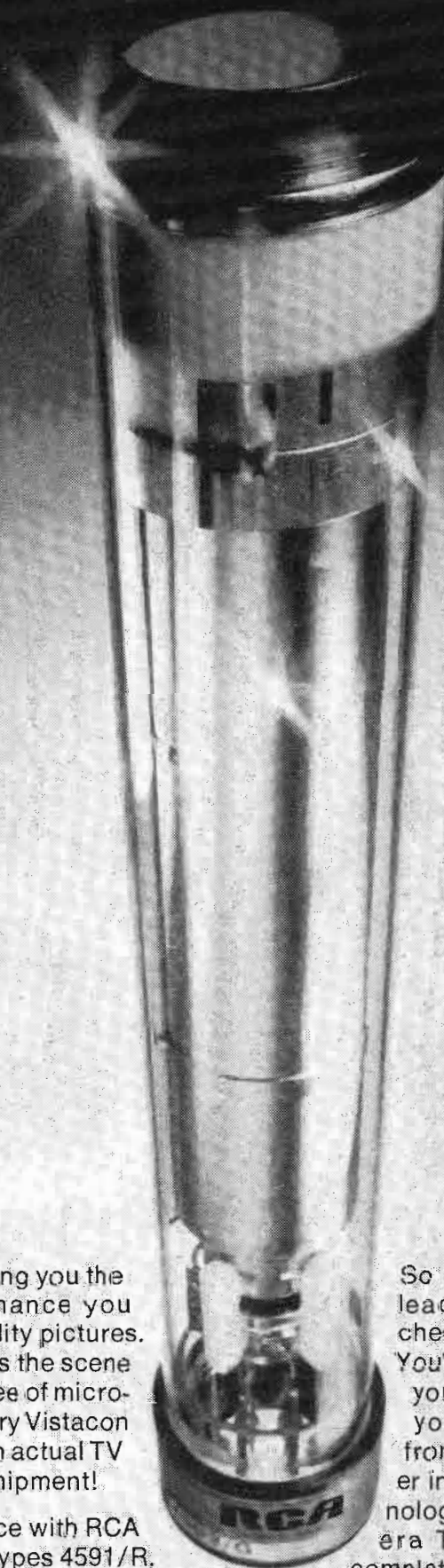

They do it by giving you the kind of performance you need for top-quality pictures. Each one delivers the scene virtually 100% free of microphonics. And every Vistacon is pre-tested in an actual TV camera before shipment!

It's easy to replace with RCA Vistacons, too. Types 4591/R, G, B, and L, respectively, are direct replacements for types 55875R, G, B, and L. And RCA's 4592/R, G, B, and L, respectively, are directly interchangeable with the XQ 1020R, G, B, and L.

So next time you need a lead-oxide replacement, check out RCA Vistacons. You'll get the performance you want with the service you've come to expect from the pioneering leader in TV camera tube technology. Call your RCA Camera Tube Distributor for complete information. Or write RCA, Commercial Engineering, Section 201 /G10, Harrison, N.J. 07029.

RCA Electronic
Components

For More Details Circle (27) on Reply Card

Specs you expect at a price you don't.

Secondary controls and functions include:

Display Size (105% and 80% scan).
Internal/External sync. selector.
External sync. input (2) — looping.
Termination 75 ohms.

Input circuit

High impedance looping (1 meg OHM in parallel with less than 8 pf) via two rear-mounted SO-239 VHF connectors. (75 ohms when terminated by a built-in switch).

Input Sensitivity

.25 to 4.0 volts p-p sync. negative to give a minimum of 50 volts p-p signal at the kinescope.

Frequency and phase response

10 MHz bandwidth ± 3 db at 50 volt p-p output.

Linearity

Vertical: Better than 2%
Horizontal: Better than 3%
(Capability better than 1% vertical and horizontal).

D.C. Restored

Display Size

Switchable from 105% to 80% of full picture size.
Geometry $\pm 2\%$.

Resolution

Greater than 800 lines in central 80% of display area at less than 30 microamps beam current.

Standards

NTSC. CCIR

Models Available

9" single rack, twin rack or case.
11" single rack or case
14" single rack or case
23" case model with optional stand, ceiling or wall mount, speaker/amplifier pod, pulse cross kit and anti-glare treatment.

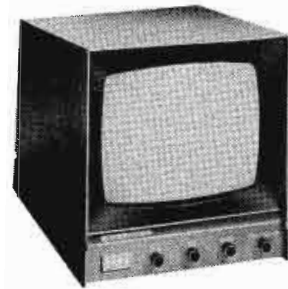

EVM9. 38 sq. in. screen.



EVM-11. 61 sq. in. screen. Also available in single rack mount.

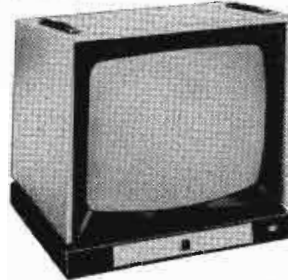

EVM-23. 283 sq. in. Optional anti-glare picture tube.

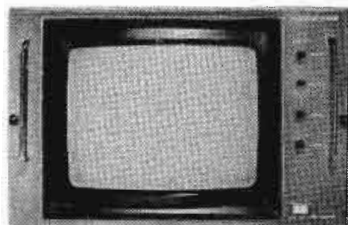

EVM-14R. 82 sq. in. Also available in case model.

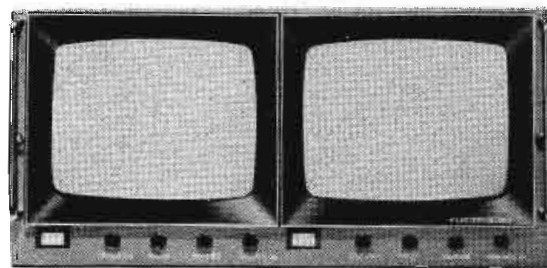

EVM9R2. Rack-mounted twin 38 sq. in. screens. Also available in single rack mount.

well which was tested and determined safe by Local County Health Department. WDIO President and General Manager Frank P. Befera drew the first gallon of water kicking off the station public service endeavor. About 10,000 people of the Duluth area have availed themselves of the service. Approximately 50,000 gallons of water have been dispensed since June 23rd.

Befera says, "WDIO Television will continue its free fresh well water offer until the water of Lake Superior is determined safe for drinking, or until a permanent alternate water supply for the area is found."

NCTA Authorized To Inspect Bureau Files

The National Cable Television Association, Inc. (NCTA), has been authorized by the Commission to inspect the FCC's "Preliminary FY 1974 Staffing Plan for the Cable Television Bureau," the Harbridge House Final Report prepared under Contract RC 10914, the Fiscal Year 1974 Budget Estimates submitted to the Congress, and certain Commission work sheets.

The action was in response to NCTA's request to inspect documents relating to the revised Schedule of Fees proposed in Docket 19658.

On January 11, 1973, NCTA requested access to 30 categories of material containing information related to the "direct and indirect cost" to the Government of regulating the cable TV industry, and used for determining "value to the recipient" of the cable TV regulatory program. NCTA contended the information was needed to prepare comments on the Commission's notice on fees. On February 21, 1973, the Executive Director granted a substantial part of NCTA's request. NCTA subsequently made a second, more specific request and asked permission to file additional comments in the proceeding (Docket 19658).

In response to NCTA's initial request, the Executive Director located documents for each of the 30

ELECTROHOME

... an extra degree of excellence in video equipment for every application.

809 Wellington Street North, Kitchener, Ontario.
919 North Michigan Avenue, Chicago, Illinois 60611



For More Details Circle (28) on Reply Card

categories specified by NCTA. NCTA was also permitted access to most of the information considered by the Commission in proposing the revised fee schedule. In response to the second and more specific NCTA request, the Executive Director determined that the Commission would be authorized to withhold the documents (Harbridge House Report, and the FY 1974 Budget Estimates submitted to the Congress) since they came within the scope of two of the exemptions to the mandatory disclosure requirements of the Public Information Section of the Administrative Procedure Act, 5 U.S.C. § 552, (Freedom of Information Act).

The Executive Director said the Harbridge Report was a management study prepared by the contractor for internal Commission use, and the Final Report had not been accepted by the Commission, and was therefore exempt from the Act. He also explained that the FY 1974 Budget Estimates submitted to the Congress had been prepared for the use of the appropriations committees of the Congress and were the property of Congress. The

Commission was advised by the appropriations committees that the documents should not be made available until after hearings had been completed and testimony released.

The Commission said that the status of the documents had changed since the Executive Director had ruled on the requests. It noted that testimony taken at the appropriations hearings had been released, and that the Commission had issued its new organization plan for the Cable Television Bureau. It pointed out that it would have been "premature" to disclose the Harbridge House recommendations while the new organizational plan for the Cable Television Bureau was being developed. The Commission noted that the draft Final Report was not used in its proposal to revise the fee schedule, and that the preliminary staffing plan was the Harbridge House material used in preparing the FY 1974 budget proposal.

NCTA also renewed its request for documents used to estimate the total number of CATV subscribers for 1973-79.

RADIOMETER
COPENHAGEN

modulation meters

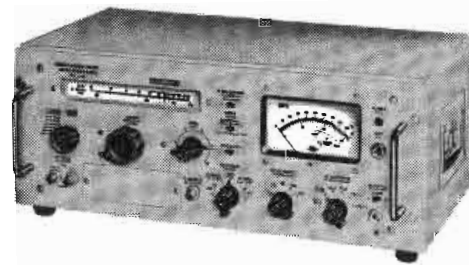

Accurate and easy measurements of AM modulation and FM deviation on RF carriers to 1 GHz.

- Narrow band and wide band models.
- Automatic level control.
- High resolution for residual AM and incidental FM measurements.
- Low internal distortion.

Contact us for complete information.



THE LONDON COMPANY

811 SHARON DRIVE
CLEVELAND, OHIO 44145
Tel. (216) 871-8900

221B

Wescon, Booths 1730-31
For More Details Circle (29) on Reply Card

New 150MHz Counter Why settle for less

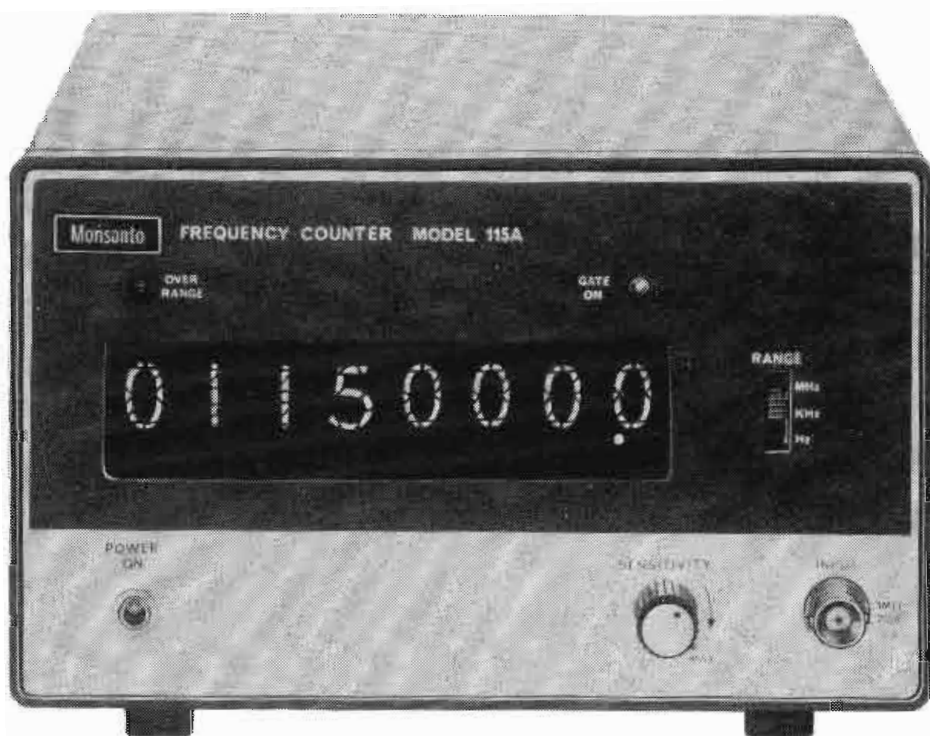

In addition to Monsanto's standard high quality craftsmanship, this great counter has these specific features: standard 6-digit display with 8-digit option—frequency range from 5Hz to 150MHz—sensitivity of 25mV to 80MHz, 50mV to 150MHz—crystal controlled clock—3 basic time bases—non-blinking display with memory—state of the art circuits including LSI, MOS and MECL 10000—optional BCD output—optional I.F. subtraction.

\$395

Contact your local Monsanto Representative today or call: **United Systems Corporation**, 918 Woodley Road, Dayton, Ohio 45403, Ph: (513) 254-6251, subsidiary of

Monsanto

You can buy player" for \$ But our ACR- cost you less \$200,000.

ACR-25 is a better investment now and in the future because it's a superior spot player, a sophisticated production machine, and the only cassette VTR with true computer interface.

Unmatched efficiency and flexibility — for your needs today and tomorrow — make it the only logical investment choice. Compare:

1. Immediate benefits from your investment

The higher your spot and production volume, the faster the ACR-25 will pay for itself.

You'll cut headwheel cost up to 80%. You'll cut hours of man-effort; free your VTR staff for production chores. Eliminate the daily spot reel which saves you headwheel and manpower cost.

And if your library numbers only 2000 segments, our reloadable cassettes can save you \$20,000 right there.

2. Exclusive time-saving spot flexibility

The headaches and costly mistakes of multiple spotting are over.

ACR-25's fast, shuffle-free sequential or random access makes spot playback equally easy to program.

Cassettes are reloadable. Your inventory cost is lower.

Cassettes are up to 6 minutes long, not 3. Use them not only for spots, but for news, sports inserts, editorials, promos, even complete program segments.

Multiple stop/start cues let you put more than one segment on one cassette, if you like.

Every tape can be verified visually with our positive Identification Data Accessory (IDA), and the identification can be printed out or fed into a computer for logging or billing purposes.

Play 10-second spots back to back. Go instantly from production to on-air operation.

You can record or dub on both transports.

And more.

3. A Complete Production Tool

ACR-25 will free up 3 to 5 reel-to-reel recorders, giving you more options, more flexibility when producing short segments.

Add dealer tags to commercials easily. No need to juggle film, slide, or audio machines.

Use ACR-25 as the master when you make cassettes or reel-to-reel dubs.

Record network news segments for later broadcast. Or other clips, like slides with audio. Promos. ID breaks. Hitchhikers. Open and close billboards for live, one-camera shows. And more.

You can even produce prerecorded, pushbutton shows that mix live shots, film, and tape footage to any length.

No other machine offers so much to the imaginative producer. Create quicker, simpler, better — and get effects you couldn't even try before.

a "spot 150,000. 25 will , even at

4. Computer Compatible

Imagine a day like this.

Just load all your short segments—taped commercials, promos, off-the-air clips, news inserts, editorials, everything—at random into your computer-controlled, automated ACR-25 system.

The system can memorize each segment, program it in the order you command, and execute it all reliably with split-second timing. All you do is replace cassettes with new ones (reloading at random), push a button to reset the sequence, and you are free for other duties for another half day or more.

Amazing? Not at all. This futuristic concept is here now. Best of all, this command and control capability comes completely built into your ACR-25.

A new dimension in broadcasting and production

ACR-25 is the most complete broadcast/production unit even conceived. No

matter how you use it, it saves money, manpower, and mistakes, making it the only logical choice as a short- or long-term investment.

For details, contact your local Ampex Broadcast Video Sales Engineer, or write for full information.

AMPEX

Ampex Corporation
Audio-Video Systems Division
401 Broadway
Redwood City, California 94063

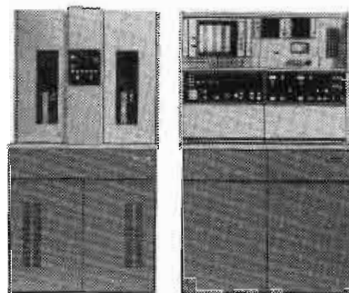

Our ACR-25

For More Details Circle (31) on Reply Card

Users worldwide who have discovered ACR-25 is the better investment

United States

WWLP, Agawam, MA
WJZ, Baltimore, MD
WBZ, Boston, MA
WIS, Columbia, SC
KDFW, Dallas, TX
WKEF, Dayton, OH
KTVT, Fort Worth, TX (2)
WFBC, Greenville, SC
WTIC, Hartford, CT
ABC, Hollywood, CA (2)
KHVH-TV, Honolulu, HI
KCMO, Kansas City, MO
KHJ, Los Angeles, CA
KTTV, Los Angeles, CA
WTVJ, Miami, FL
WDSU, New Orleans, LA
CBS, New York, NY (2)
WNEW, New York, NY
KTVU, Oakland, CA
WKY, Oklahoma City, OK (2)
KYW-TV, Philadelphia, PA
KDKA, Pittsburgh, PA
KSL-TV, Salt Lake City, UT
KTVI-TV, St. Louis, MO
KENS, San Antonio, TX
KCST, San Diego, CA
KGTU, San Diego, CA
KGO-TV, San Francisco, CA
KPIX, San Francisco, CA
WSYR, Syracuse, NY
WTVT, Tampa, FL (2)
KTEW, Tulsa, OK
WTTG, Washington, DC
WXII, Winston-Salem, NC

Great Britain

Southern TV, Southampton (2)
Thames Television, Ltd., London (2)
Granada Television, Ltd., Manchester (2)
Rank Video Labs, London
Harlech Television, Ltd., Wales (2)

Canada

CFCF, Montreal
CKCO, Kitchener
CHCH, Hamilton
CBC, Canada (3)

Australia

ATN7, Epping
ABN, Sydney

Mexico

XETV, Tijuana

Hong Kong

TV Broadcast Ltd.
RTV, Hong Kong

New Zealand

NZBC, New Zealand

Basic Digital Logic

By John Lee*

Hewlett Packard

The combinatorial and sequential devices discussed in the previous articles are, in practice, implemented in seven major technologies. These technologies or logic families as they are most often referred to are RTL (Resistor-Transistor-Logic), DTL (Diode-Transistor-Logic), HTL (High-Threshold-Logic), TTL (Transistor-Transistor-Logic), ECL (Emitter-Coupled-Logic), MOS (Metal-Oxide-Semiconductor) and CMOS (Complimentary Metal Oxide Semiconductor).

Each of these logic families possess characteristics that make them particularly suitable to a given application. Based upon his circuit requirements and the capabilities of the logic family, the logic designer selects the family that best provides the solution to his needs.

The desired features of a logic family have been classified into the following categories:

1. Logic flexibility
2. Availability of complex functions
3. Speed

4. Low power dissipation
5. High noise immunity
6. Lack of generated noise
7. Wide operating temperature
8. Low cost

Logic Flexibility And Availability Of Complex Functions

These features relate to the ease of designing a digital circuit from the devices available in the logic family. There are several important features to consider: the number of commonly available functions, the availability of complex functions, wired logic capabilities and complimentary outputs.

The number of commonly available logic functions is often related to the age of the logic family. The older the family, the more functions there will have been developed and thus, the more likely a designer will find the gate or counter that he needs.

In addition to the simple logic functions, it is also desirable to have access to more complex (MSI and LSI) devices. Often these complex functions can reduce the number of IC packages required to

implement a given design. In many cases not only is a signal required but also the inverted signal. Devices with complimentary outputs provide both these signals and thus add to the design flexibility.

Wired Logic

A unique feature of some logic families is the ability to perform a basic AND or OR function by wiring the outputs of several devices together. This is what is meant by wired logic.

Figure 1 illustrates how wired logic is possible. The two transistors represent the output stage circuitry inside the IC's. The node formed by wiring these outputs together will be pulled low whenever either output transistor is turned on.

Another way of looking at this node is that only when both outputs are supposed to be in the high state will the node formed by wiring these outputs together be high. Thus the act of wiring the outputs together has formed an AND function.

The wired logic function can be performed on more than two devices. In some logic families the

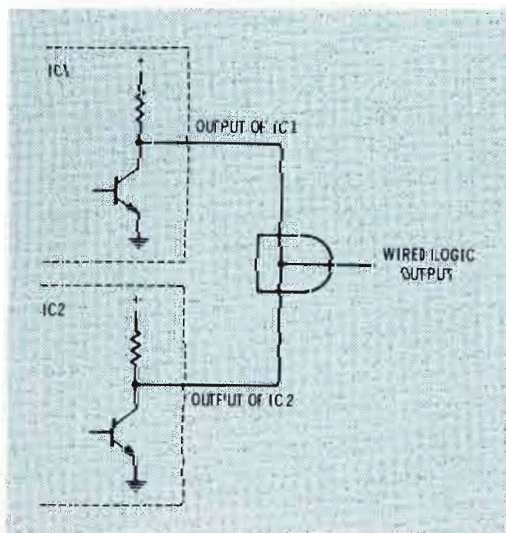

Fig. 1 Wired logic. In some families, an additional AND or OR function can be performed by wiring the outputs of several devices together. This type of output stage forms a wired-AND function.

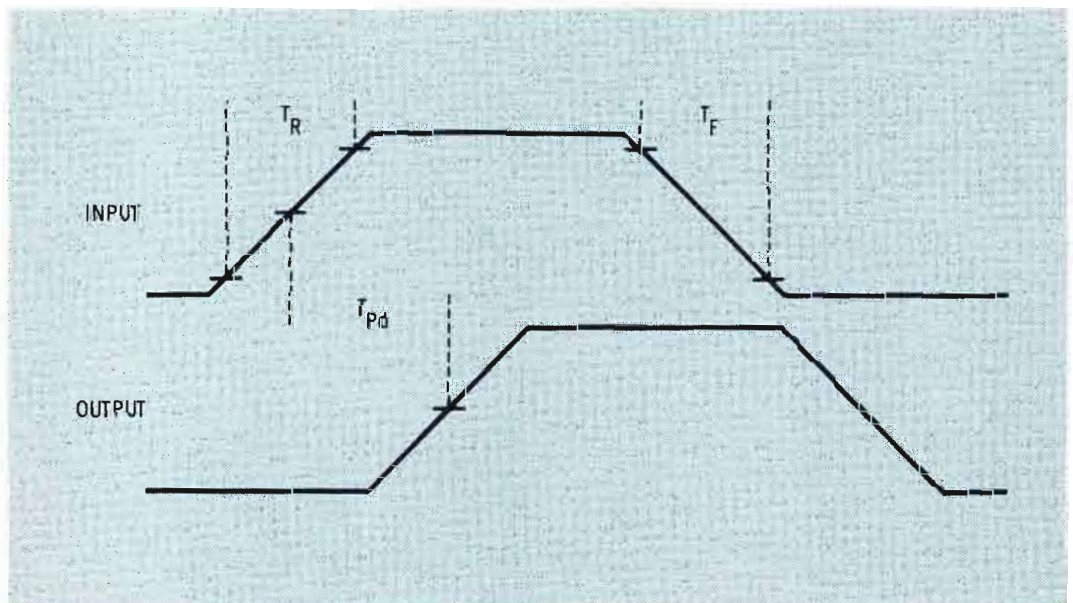

Fig. 2 Timing parameters of digital signals. Propagation delay time (T_{pd}) is a measure of how fast an output responds to a change in an input measured from the 50 percent point. Rise time (T_r) and fall time (F_t) are measured from the 10 to 90 percent points.

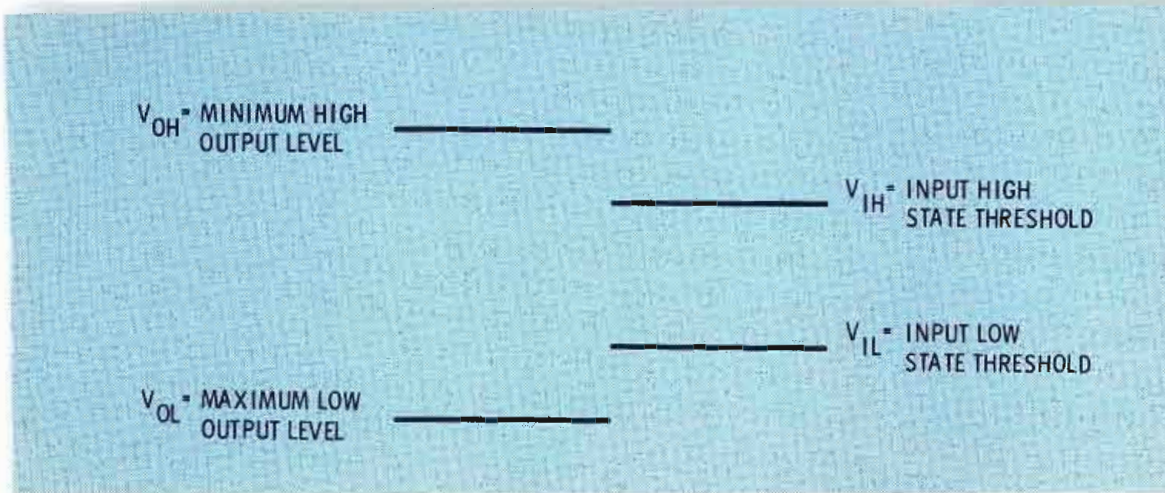

Fig. 3 Noise immunity is a measure of the amount of noise that can exist on an output before an input falsely interprets the data.

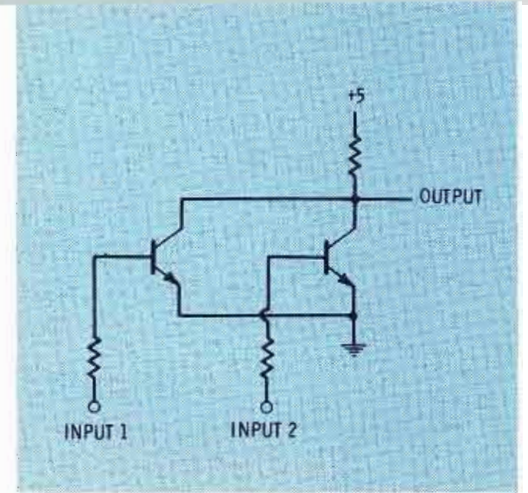

Fig. 4 Basic RTL Gate. From the similarity of the output stage of this gate and that shown in Fig. 1, you can see that the RTL provides the wired-AND capability.

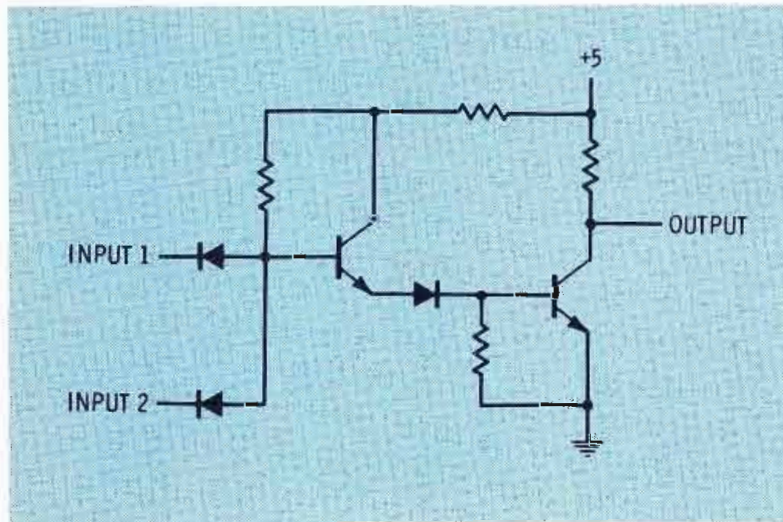

Fig. 5 Basic DTL Gate. DTL provides the wired-AND function. The basic DTL gate is a NAND function.

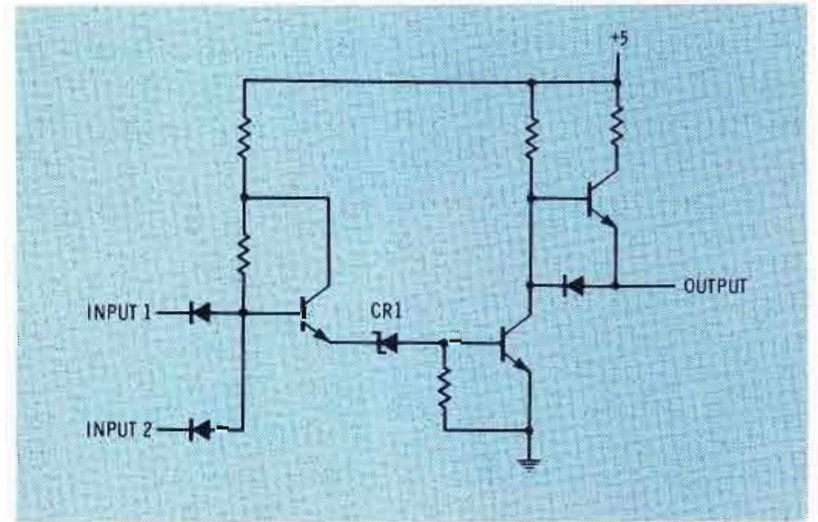

Fig. 6 HTL. The basic HTL gate provides the NAND function. The zener diode, CR1, increases the voltage swing required on the inputs to go between the high and low state.

wired logic is an AND function as described in Figure 1, in others it may be an OR. The terms "wired-AND" and "wired-OR" or "IMPLIED-AND" and "IMPLIED-OR" are properly applied to the situations that result in an AND and an OR function respectively. In practice, though, both cases are often referred to as "wired-OR". Wired logic is both a blessing (to the designer) and an evil (to the digital troubleshooter) as we will see in the next article.

Speed VS. Power

A consideration of all designs is the timing of the signals involved. The timing parameters of a logic family are (Figure 2) rise time, fall time, propagation delay time, and maximum flip-flop toggle frequency. Both rise and fall time relate to the shape of a resulting signal. Propagation delay time refers to the amount of time required for a

change on an input to cause a change on an output. Usually this time is measured from a 50 percent change on the input to a 50 percent change on the output.

The maximum rate at which a flip-flop can toggle is often important in determining the maximum cycle time of clocked designs. While higher speeds are desirable, it is also desirable to have low power dissipation. Unfortunately as speed increases so does the power dissipation. Designers are thus faced with selecting a logic family with a good compromise of the speed-power product.

High Noise Immunity And Lack Of Generated Noise

While noise in general has less effect on digital circuits than on analog circuits, it is still an important consideration in many applications. Figure 3 illustrates the con-

cept of noise immunity.

Noise immunity refers to the amount of noise that may exist on an output before the input it drives falsely interpret the signal state. A high output can have as much as $V_{OH}-V_{IH}$ noise before it falls below the input high state threshold. Thus the high state noise immunity is $V_{OH}-V_{IH}$. Similarly, the low state noise immunity is $V_{IL}-V_{OL}$. These threshold voltages are usually specified and constant for most logic families. In a noisy environment, the requirement for a high noise immunity may be the major consideration in the logic family chosen.

A second noise factor is generated noise. This refers to the amount of noise created on a systems power supply lines due to the change in state of a device's outputs. Under ideal conditions, the current drain on the power supply would be constant as the outputs

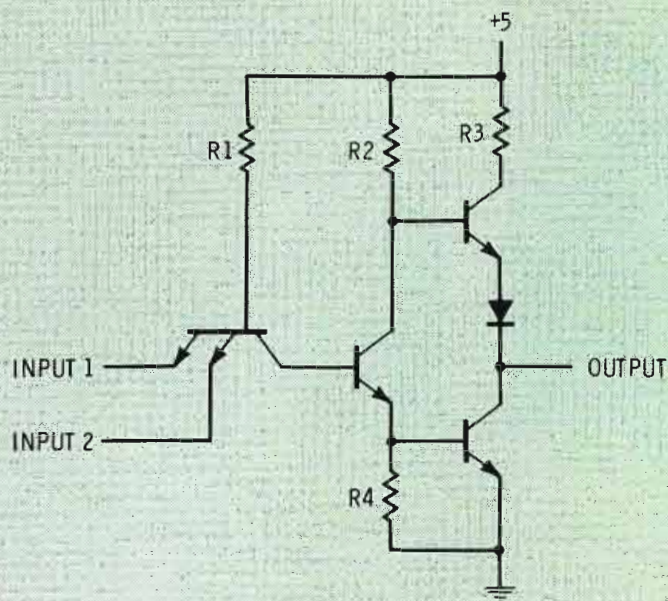

RESISTOR VALUES		
	7400 SERIES	74L00 SERIES
R1	4K	40K
R2	1.6K	20K
R3	1K	12K
R4	130	500

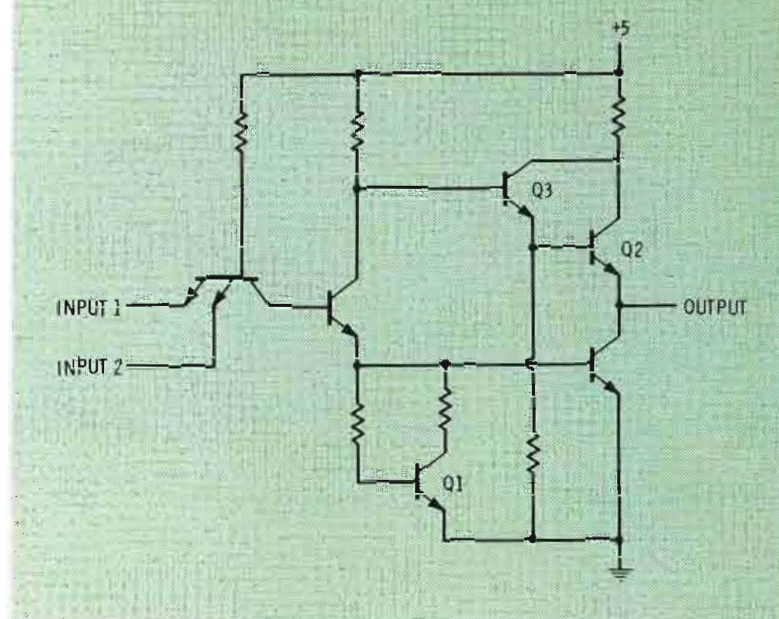

Fig. 8 74H00 TTL. By replacing the pull down resistor R3 on Fig. 7 with an active pull down Q1 and replacing the upper output transistor and diode with a Darlington pair Q2, Q3 the speed of the 7400 gate is vastly increased.

Fig. 7 7400 and 74L TTL. The main difference between the medium speed 7400 series and the low power 74L00 series gate is the resistor values are increased.

switched. In reality, though, a current surge usually accompanies the switching of an output. This current surge results in generated noise on the power supply line.

As generated noise increases, more expensive circuit layout and power supply bypassing becomes necessary. In a low cost system, this may be a very important consideration.

Wide Operating Temperature Range And Low Cost

Both low cost and a wide operating temperature range are always desired. In general, two operating temperature ranges are specified. For commercial or industrial requirements, devices are usually specified over 0°C to +75°C range.

Since the noise immunity, power supply tolerance and other design parameters degrade with increasing temperatures, some applications may depend heavily on the temperature characteristics of the logic family.

The low cost feature is one that is a little more complicated than it appears on first sight. A first approximation at cost comparison between two logic families can be based upon the cost of a basic unit such as a NAND, NOR or AND gate. But other factors also enter

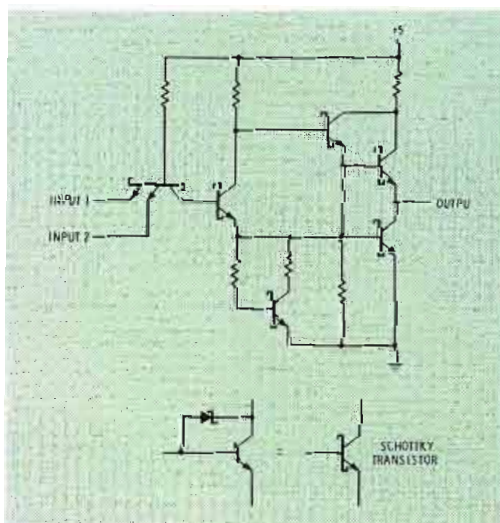

Fig. 9 74S00 TTL. The basic Schottky TTL gate is the same as a 74H00 with all transistors replaced by Schottky transistors. A Schottky transistor is a transistor with its base tied to its collector by a Schottky diode.

into the consideration.

Availability of complex functions can reduce package count and should be considered in the cost of using a given logic family. Similarly, a family with little generated noise will require a less expensive circuit layout and power supply. All of these parameters are considered by the designer in choosing a logic family that meets his cost requirement as well as his design requirements.

Resistor-Transistor-Logic

RTL was one of the first major logic families to gain popularity in the design world. As can be seen from Figure 4, only resistors and transistors are used in implementing the basic RTL gate. Whenever either input goes high, current flows through the base resistor turning on the transistor. This then pulls the output to a low state, V_{SAT} , above ground.

In logical terms, this is equivalent to saying a 1 on any input (A or B) causes a 0 on the output. Thus the basic RTL gate is a NOR function.

RTL operates from a 3.0 to 3.6 Volt power supply with low generated noise. The noise immunity of this family is fairly low (around 100 mV when operated from a 3 Volt supply). Propagation delay time per gate is around 25 ns and a typical clock rate of 2.5 MHz. Because of its age and wide acceptance, RTL is both low cost and highly flexible. Its current use in new designs is slowing since TTL, CMOS and other families provide a better trade-off.

Diode-Transistor-Logic

Another early and well accepted logic family is DTL. Figure 5 illustrates a widely used DTL gate design. Whenever any input is low, the base drive to the input tran-

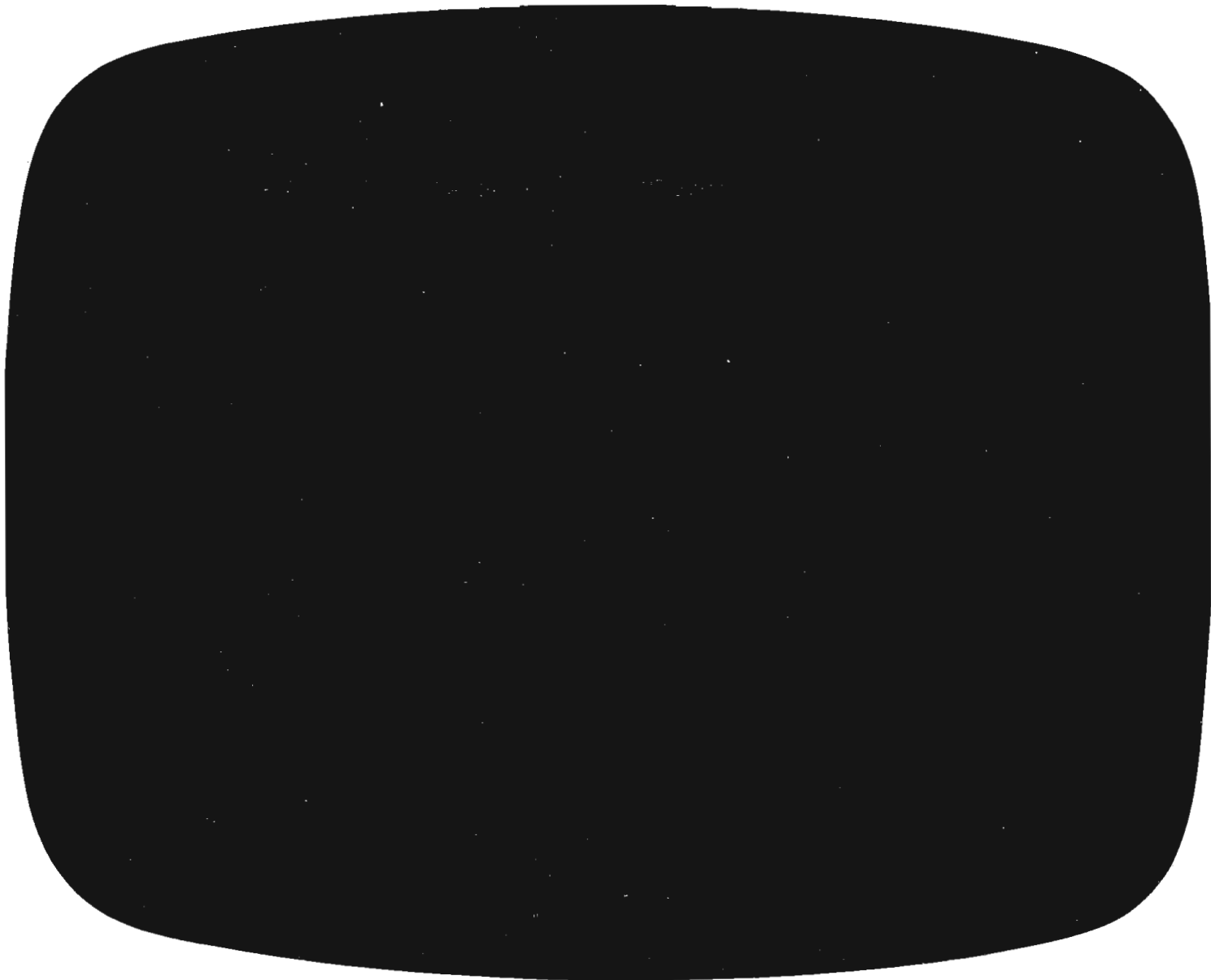

This is a picture of your picture. (during a power failure)

Yours may be the finest broadcast facility around. But you aren't transmitting much of a signal when the power is off.

Admittedly, chances of a prolonged power failure aren't great. Yet they do happen.

That's where Onan standby power comes in.

It provides "insurance" against a crippling power outage.

It doesn't have to replace utility power totally. But it can keep you on the air.

It can keep heating and ventilating equipment working. Elevators running. Lighting in critical areas burning.

So when you're ready to talk seriously about standby power for your TV or radio station, remember this:

Onan is the world's number one builder of standby power plants.

Only Onan gives you total system responsibility for the engine, generator and load transfer controls. We build 'em, test 'em, install 'em and

certify that they will perform as rated. Only Onan warranties the complete system for 5 years.

Call your local Onan Distributor (in the Yellow Pages under Generators) or send coupon.

FREE STANDBY POWER BOOKLET

Onan
1400 73rd Avenue N.E.
Minneapolis, Minnesota 55432

Please send a copy of "Standby Power... who needs it?" to:



Name _____
Firm _____
Address _____
City _____ State _____ Zip _____



**ELECTRIC GENERATOR SETS •
LOAD TRANSFER CONTROLS • INDUSTRIAL ENGINES**

For More Details Circle (32) on Reply Card

THIS IS

putting innovation to work

Custom Systems

Custom systems are the very heart of our business. Below you'll find listed just a few of our many custom products. Our engineering department can design and build this or any other equipment necessary to fit your station's exact needs.

- Full and semiautomated program control systems, including automated and manual switching systems for the control of standard cartridge, random access cartridge, and reel tape handling equipment.
- Digital master station clock and timer systems capable of interfacing with standard electric and pulse driven clocks.
- Semiautomated transmitter remote control systems.
- Jack panel assemblies wired to customer specifications.

Turnkey Equipment Installation Service

ASI has, over its ten year history gained an outstanding reputation in the field of Turnkey Installations. The same quality that goes into ASI's custom systems is an integral part of every one of our AM, FM, or TV installations. That's why we've been chosen to build the new million dollar facilities of WGPR-TV, Detroit.

Maintenance Services

Our considerable experience in broadcast engineering can be yours through any one of several maintenance programs created by ASI to serve both AM and FM broadcasters. These services cover all studio equipment (including cartridge systems) as well as all transmitting facilities.



26935 W. Eleven Mile Road
Southfield, Michigan 48076
(313) 353-7555

For More Details Circle (160) on Reply Card

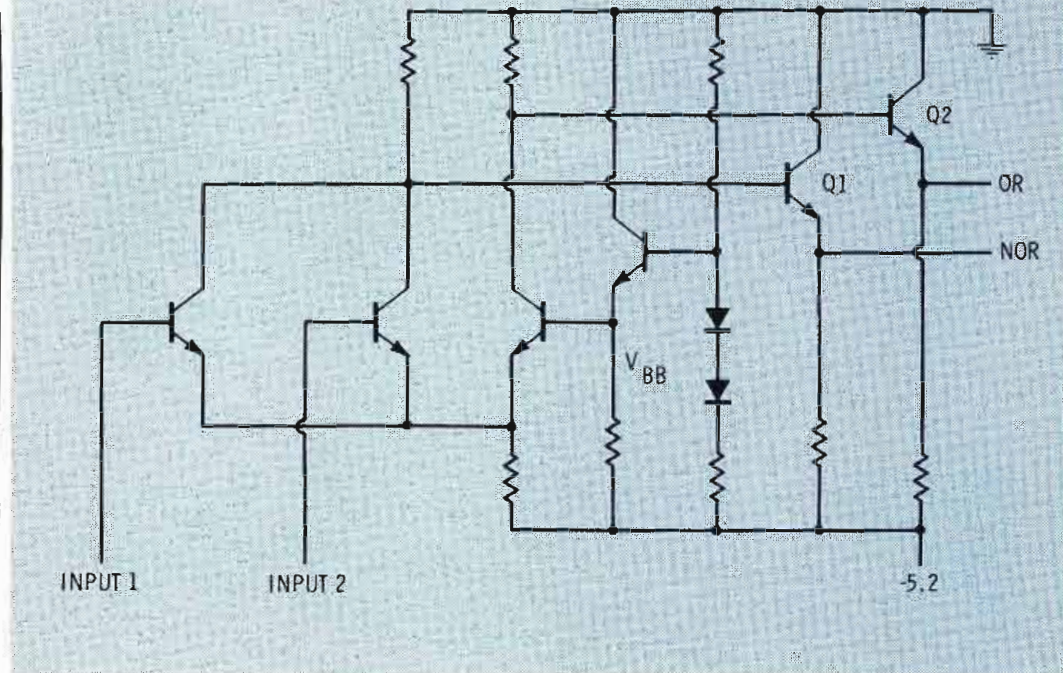

Fig. 10 Basic ECL Gate. ECL is the fastest form of logic today. Its differential outputs and wide acceptance make this a flexible family to design with. Where high speed is a major concern, ECL is often used.

When all inputs are high, all the input diodes are reverse biased, allowing the input transistor to be turned on. This turns on the output transistor, pulling the output to a low state.

Logically, this can be stated as all inputs high, the output is low. Any input low, the output is high. This is the NAND function.

By the similarity in the output states of the DTL and RTL devices, it is easy to see that DTL devices can be "wire-AND'ed". The noise immunity of DTL is around .6 Volts, which is better than RTL but not as good as HTL or TTL. The typical propagation delay time of a DTL gate is 30 ns and a typical clock rate of 12-30 MHz. Like RTL, DTL is being replaced in many new designs by TTL and CMOS.

HTL Immunity

HTL provides a high immunity to noise, making it ideal for applications in noisy environments. Figure 6 shows the design of a basic HTL gate. The zener diode, CR1, is used to increase the voltage swing required between the 1 and 0 state. Whenever any input is low, the input diode is turned on thus turning off the input transistor. This

causes the lower output transistor to be turned off and allows the output to be pulled high through the upper output transistor.

When all inputs are high, the input and lower output transistors are turned on and the output pulled low. Thus the basic HTL gate is a NAND.

The TTL Family

Transistor-Transistor-Logic is the most widely used logic family in existence today. There are four important sub-families of the TTL logic family. These are low power (74L00 series), medium speed (7400 series), high speed (74H00 series), and Schottky (74S00 series). This wide range of sub-families makes the TTL technology a very flexible and easy to use family.

The major distinction between the low power TTL gate and the medium speed gate, as far as internal design is concerned, is the value of the associated resistors (Figure 7). To decrease the power consumption, the resistor values are increased. But the operation is the same. Whenever any input is low, the input transistor will turn on removing base drive from the intermediate stage transistor, thus turning it off. Turning this transistor off turns on the upper transistor in the totem pole and turns off the lower one. Thus, the output is pulled high.

When all inputs are high, the input transistor is turned off and

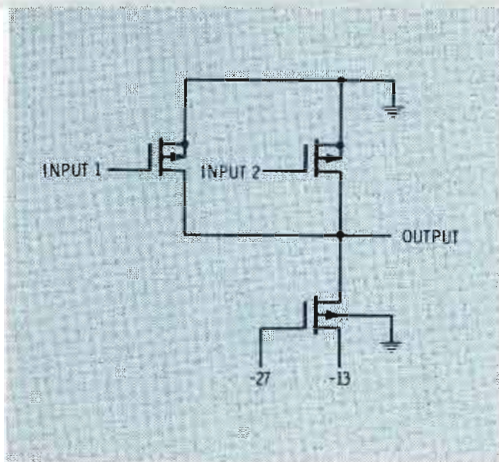

Fig. 11 P-MOS. The basic P-MOS gate is a NAND. A low signal on any input turns on the corresponding FET, pulling the output high. If all inputs are high, the input FET's are turned off and the output is pulled low.

the intermediate stage turned on. This then turns off the upper output transistor and turns on the lower one. Note that the output in the low state is then a saturated transistor to ground and hence a very low impedance. In terms of 1's and 0's, this operation can be described as a 1 on all inputs causes the output to be 0, and a 0 on any input causes the output to be 1. Thus the basic TTL gate is the NAND gate.

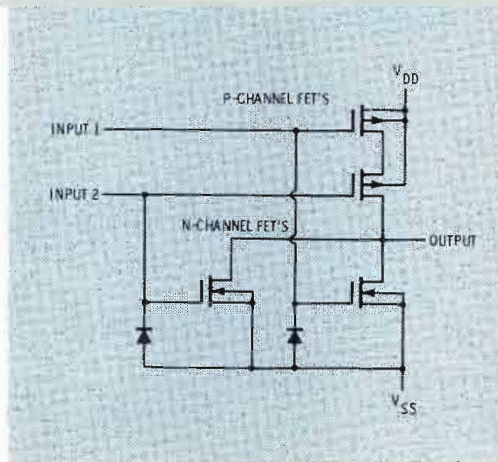

Fig. 12 CMOS. One of the fastest growing logic families today, CMOS offers very low power consumption and availability of complex devices. CMOS uses both N-channel and P-channel FET's to achieve the low power consumption.

Two modifications are made to this design to improve the speed characteristics. First, the pull down resistor on the emitter of the intermediate stage transistor is replaced with an active pull down (the transistor shown in Figure 8). Secondly, the upper output transistor and diode are replaced with a Darlington transistor pair. With these modifications and some changes in production processes, the high speed series (74H00) is developed.

As a further improvement in speed, the transistors in the design can be kept out of saturation by replacing each transistor with a Schottky transistor (Figure 9).

A Schottky transistor is just a transistor with its base clamped to its collector by a Schottky diode. Thus, as shown in Figure 9, the 74S00 series of Schottky TTL is the same as a 74H00 device with all transistors replaced with Schottky transistors.

TTL offers a wide range of speed and power consumption. The many existing devices and availability of several complex functions makes it an extremely flexible family to design with. Wired logic capabilities are not available with all TTL devices, but some devices whose output stage has been modified can be wired to form an implied-AND. These devices are known as open collector devices.

Emitter Coupled

Emitter coupled logic is the
(Continued on page 114)

The composite of all features most asked for in the Broadcast Industry

langevin series 10 Audio Control Center

- 26 Stereo Inputs
- 10 Stereo Mixing Channels
- 10 Stereo Remote Inputs
- Stereo/Mono Input Select Keys
- Digital Time Clock
- Solid State Modular Circuitry
- Conductive Plastic Stepless Faders
- Redundant Fail Safe Power Supplies
- Conjunctional Microphone Foot Switch
- Two 10 Watt Monitor Amplifiers
- Separate Program and Audition Outputs
- Separate Cue Amplifier
- Optional Equalization Controls



Cetec INC.
a subsidiary of Computer Equipment Corp.

\$5365.00 (User's Net)

MAIN OFFICE: 13035 Saticoy St. • North Hollywood, California 91605 • Phone (213) 875-1900 • TWX: 9104992669

NASHVILLE OFFICE: Route 4 • Devens Drive • Brentwood, Tennessee 37027 • Phone (615) 794-0155

EUROPEAN OFFICE: Cetec, U.K. • Shaftesbury St. • High Wycombe, Bucks, England • Phone High Wycombe 37326 • Telex: 837329

Broadcaster's Supermarket

One-stop shopping for outstanding values in Spotmaster® cartridge tape equipment and other broadcast products and accessories. Just check the boxes and send us this advertisement with your letterhead. We'll speed complete information by return mail.



Single Cartridge Equipment

Ten/70 Stereo Record-Play

Record-play & playback models, mono & stereo, compact & rack-mounted.

- The incomparable Ten/70
- The low-cost "spacesetter" Three/70
- The value-packed Six/70 (coming soon)
- Delayed programming models

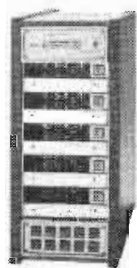

Model 305 Mini-Series Deck

Multiple Cartridge Equipment

- Mini-Series models (3 to 15 decks)
- Economical Five • Spot & Ten • Spot
- 610BX Automatic Audio System

Other Audio & Video Equipment

- Spotmaster/Revox stereo recorder (10 1/2" reels)
- Audio consoles, 5 & 8 channel, mono & stereo
- Turntables, tonearms, turntable preamps
- Audio distribution amplifier
- Compressor-limiter amplifier
- Titlemaster® TV character generator
- Modular control room furniture
- Monitor loudspeakers
- Microphones & headphones

Cartridge Tape Accessories

- Cartridge racks (wall, floor, table top)
- Degaussers
- Cartridge winder & timer
- Head brackets & replacement heads, incl. PHASE-LOK® stereo bracket
- Audiopak & Fidelipac cartridges (all sizes, any length tape or empty cartridges), no minimum order, lowest prices.

Let us fill *all* your needs. Write:

BROADCAST ELECTRONICS, INC.
A Filmways Company

8810 Brookville Rd., Silver Spring, Md. 20910
(301) 588-4983

Television... Down The Line

By Bagio Presti

Sarkes Tarzian

Equipment in television stations continues to undergo extensive development in spite of the fact that most of the designs have limited lives ranging from three months to two years!

Sometimes a development never leaves the laboratory because it has been obsoleted during the development period by the introduction of a new solid state component or product. It seems that some designs are under continuous development as the design engineer tries to avoid design obsolescence by incorporating the weekly flood of new components which have a bearing on his design.

Most industries can expect a 5-10 year life for a major development with minor improvements in the product being introduced slowly and methodically. On the other hand, most TV equipment manufacturers have products under continuous major development which minimizes or eliminates amortization of development costs. The net result is that TV equipment is expensive, has less trade-in value, is prone to be quickly obsoleted, and yet is a good buy when considered in the light of the enormous technical development cost and attention it receives.

Wasted Effort?

What has all this effort accomplished? Consider the major equipment items found in TV station studios. VTR machines and VTR computer editors have provided the program and production personnel with facilities to electronically integrate pretaped show or commercial segments with great precision. Independent control of camera color signals which allows selective hue and saturation control of individual object colors and artificial detail enhancement. This feature has provided flexibility in creative pro-

Memo to Consulting Engineers

Broadcast Engineering's "Professional Services Section" is your most economical and effective way to display your Professional Card.

- **LOW MONTHLY RATES**
\$16 per monthly issue, 12 or more times
\$18.50 per monthly issue, 6-11 times
\$21 per monthly issue, 5 or less times
- **REACH ALL PROSPECTS**
Greater at-station circulation: FM, AM and educational radio; TV, ETV, CCTV and CATV; recording studios.
- **MORE AD SPACE**
Your Professional Card in BE is a full column wide!



"HOW ABOUT UPDATING OUR TOWER LIGHTING?"

gramming and product display. Film, live camera, and VTR sources used in conjunction with switching and video effects equipment offer the creative operating talent of the TV station flexibility and latitude in programming. All the engineering expense has resulted in substantial increases in reliability and performance while equipment has become more and more complex.

Production and master control switching in television stations has become more and more sophisticated to meet the increasing demands of commercial productions. TV station production and engineering personnel are demanding complex systems with high flexibility without imperfection in technical performance. The central core of TV operation revolves around production and master control switching—all sources are funneled through these devices before being routed to the transmitter.

The rapid evolution of solid state development in IC components and MSI and LSI technology has made it practical to produce equipment which provides highly sophisticated results coupled with reliability and stringent technical performance. It has also made it possible to produce relatively complex equipment at reasonable costs. An example is the rotational travelling matte effects. This equipment makes it possible to produce a complex commercial in minutes. This would normally require several weeks while special film processing of travelling mattes were integrated with other materials.

Digital circuits have provided a large variety of rotational and transitional mattes which are available at the touch of a button and under the continuous control of the production people—mattes may be speed variable—stopped, reversed, etc., at the whim of the operator. This gives far more flexibility to the

producer of commercials as opposed to equivalent film techniques which are time consuming and costly to produce.

What's Ahead?

Now as we examine the evolution of TV systems and look forward to the future, what lies ahead? In spite of the enormous development investment made to date, the future demands an accelerated effort.

We are now on the threshold of a revolution in the technique of video processing! Revolution is the proper word because the age of digital application in television has already begun and the impact will revolutionize development in all phases of television engineering.

The industry has already started to feel the impact of the application of digital techniques in Broadcast TV, particularly in control systems, encoded sync generator pulses producing one line sync systems, logic circuits in various video equipment items, computer applications in master control switching, and TV data processing for administrative and management use, etc.

More recently other components of television systems are becoming digitized including fully digital special effects (including digitized rotational travelling mattes), digital machine control systems which reduce thousands of wires to a single pair of coax, extensive use of digital electronics in VTR equipment and VTR computer editing systems, digital remote transmitter control and monitoring systems, and many other less obvious applications. Electronic conversion between various world TV standards by purely digital techniques is already an accomplished fact and in daily use.

There has been substantial development work in this country, England, and elsewhere in digitizing video transmission. Actual use of digital transmission systems by COMSTAT, NASA, and other non-

BOGNER TV BROADCAST ANTENNAS

**Low VHF
High VHF
UHF**

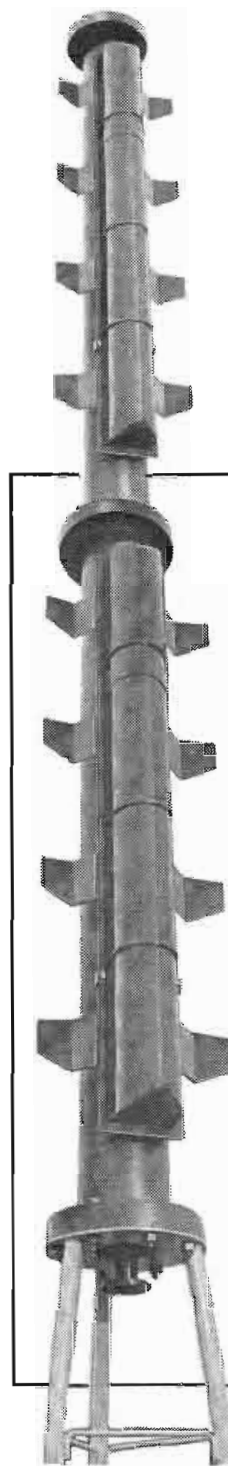

**Specifically
Designed
and Priced
for Low and
Medium Power
TV to 25 KW
Input Power.**

Omnidirectional and directional, high gain rugged slot and dipole arrays.

Available in 9 standard horizontal patterns, choice of vertical patterns . . . with power gains to over 100 and power ratings of 3 KW, 10 KW, or 25 KW.

Hundreds of Bogner Antennas have been providing continuous service in urban and remote areas since 1965.

Write for free catalog and price list, including all required electrical mechanical and structural data.

BOGNER BROADCAST EQUIPMENT CORP.

99 W. Hawthorne Avenue
Valley Stream, N. Y. 11580
(516) 561-9132

Management Highlights

Here you see the current broadcast problem: Do I buy today or wait for tomorrow's innovation? The author gives us an opportunity to peer into the future and consider what's ahead. Today's decision making team must know what is currently available and have a fair idea of what will come down the pike tomorrow.

commercial broadcast applications is in progress. This experience along with the extensive development work in the MARS planet probe in the use of digital processing of video data will have important fallout results in the broadcast industry in the future.

There are now commercial electronic modules available which convert analog video and audio data into digitized signals. Again the impact of these sophisticated units will be significant in the near future.

Other Solid State Devices

The use of digital techniques is not limited to control and video applications. Audio systems are also enjoying the advantages of digital circuit applications as well.

In addition, solid state photosensitive matrix elements are beginning to appear commercially. These units are designed as replacements for vidicon and Plumbicon tubes. Prototype solid state cameras have already been developed in several laboratories.

Even In Cameras

These solid state devices are naturally adaptable to digital techniques. Solid state cameras will utilize digital scanning and digital scanning will produce direct digital video data. This system will generate exotic results . . . it will be possible to have a direct interface of camera systems with production switching systems which will give the creative talent of a station the opportunity to manipulate the picture information in the time domain before the information reaches the switcher processing electronics. The diagram illustrates a potential TV system of this kind. TV picture contrast enhancement, element by element inversions or transpositions will be in the norm when these techniques are perfected.

Mini-computers will be central elements in studio video and audio applications. These units will become the interface between the operator and the system operated. TV systems will provide automatic synchronizing assignment timed for

all types of local and remote sources. This technique will allow high flexibility in the planning of systems combining live and recorded video/audio sources.

At the present time digital techniques are in extensive use in camera designs for remote control functions, and in automatic function as auto-registration, etc. Camera designs of the future will not require decisions as to where to implement analog to digital conversions — the camera systems will be entirely digital including picture scanning of the image, remote control, and video processing.

Digital audio and video systems of the future will have high performance characteristics providing immunity from transmission imperfections and will include techniques for restoration of lost portions of information which may result from imperfect transmission. These systems will allow the transmission of other data as newspaper, stock market reports, etc., during the blanking portion of the picture. Interpolation and storage techniques will allow the combining of video data editing functions heretofore impossible in analog systems. Two-way systems providing communications between user and originating sources will follow rapidly.

The consumer will benefit in other ways. Television receivers employing digital techniques will use digital frequency synthesizer tuners and the final signal will be received on a solid state picture tube. Print-out of various information as newspapers, financial reports, etc. will also be provided. Selection of channel and subject matter will multiply the variety of program material the user may enjoy.

Actual transmission (over the air) by digital means will require FCC rule changes and this stage will take many years since it will essentially obsolete present day TV receivers. On the other hand the reliability, simplicity, and performance of digital receivers will substantially improve consumer satisfaction and enjoyment of television. In the meantime, studios will become digital and conversion to analog signals will be required until rule changes are promulgated. □

You won't believe what we did to the TAPEX cartridge.

We threw out pressure pads for starters. Big deal? You bet it is. Because pads cause unnecessary wear on the tape and heads. With Tapex, you get longer life on both.

So now you ask, "how do you keep the tape on the head?" Easy. Tension is set on each Tapex Cartridge at the factory. And a unique stereo phase stabilizer keeps the tension just right during use.

This is just one way we've made Tapex a little better. Find out the rest. Write for details today.

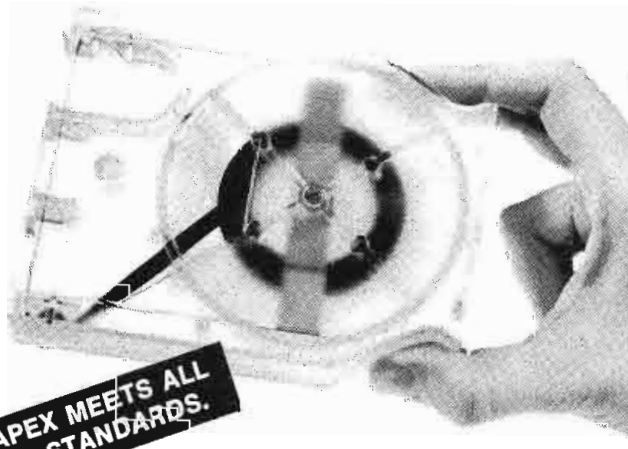

Tapex Corporation/P.O. Box 246/West Des Moines, Ia. 50265

YES! Please send me a detailed Tapex Cartridge flyer and price list.

Name _____

Address _____

City _____ State _____ Zip _____

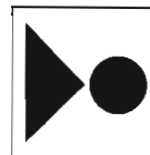

TAPEX
CORPORATION

BE-9

For More Details Circle (35) on Reply Card

IN A WORLD LOOKING FOR ANSWERS MAYBE DYNASCIENCES IS THE PLACE TO START

Dynasciences is quality. Dynasciences is
a complete line of Video Products.
Dynasciences is reliability.
Dynasciences is service.

Our line — not JUST a line — a Complete Line:

IMAGE ENHANCERS
EDITOR-PROGRAMMER
VIDEO PROCESSING AMPLIFIERS
DISTRIBUTION AMPLIFIERS
SYNC GENERATORS
VIDEO TEST EQUIPMENT
COLORIZER
BLACK BURST GENERATOR

*Soaring Tower
of United Nations Headquarters
Symbolized Man's Aspirations in Postwar World.*

SEE YOU AT NAEB - BOOTH NO. 1 & 2

DYNASCIENCES
CORPORATION

video products

TOWNSHIP LINE ROAD ● BLUE BELL, PA. 19422

Telephone: (215) 643-0250 ● Telex: 84-6358

Jungle Guides Needed

By Fred Moore

Station WJZ, Decatur, Ill.

Some people in our business are saying engineers are a bunch of shuffling bumblers who have no role in major decisions in their stations. Not so. The engineers I know are as articulate and current in our business as any other broadcaster.

The good management people know that if you don't talk to your technical guy ahead of, say, that next equipment purchase, things get complicated very fast around the station. Most managers already know this and save themselves gray hair by maintaining a rapport with engineering that serves them well during technical decisions.

It's no fun to watch managers who **don't** keep the channel open with their technical half. They're rather scarce, fortunately, but easy to spot. They have lots more wrinkles and are given to constant pacing when technical things are mentioned.

And Then One Day

Let's set up a hypothetical case. The manager is one of these rare ones. He is not a technical type and avoids that sort of thing like the plague. The need for a new console arises. The manager, feeling up to the decision without advice, buys one.

The day of arrival is quite festive at the station, and it is a beautiful beast sitting there amid packing foam and cardboard. It boasts twelve channels in, one out, with intercom, color coded knobs and integrated circuits. Our manager, the program director, and everyone in the office is very proud and each is eager to have it wired in.

But who's that lurking over in a corner looking very worried? It's our Chief Engineer. Upon questioning him, you find out just what's really got him down. The console won't **fit** where the old one is now. It doesn't have a second output

channel, and that's how the stock markets are recorded daily. There are two transmitters less than ten feet away and nobody asked the manufacturer about RFI in this console. You need six mic inputs and there are . . . only four? Is **that** what's bugging you, Chief?

And if you think the engineer is upset, wait until the manager is told that 26-hundred bucks was just the start of what this gem will run the company. And then tack on time involved in trying to fit this round peg into the scheme of things!

It's On The Air

Step one is breaking it to the announcers. We can hear it now. "Uh, hey, Ron would you mind doing your show from the production studio for a little while? Say about two weeks?" The air mistakes Ron will make with too few cart machines and the long reach to the start buttons in that studio will make radio history.

Step two would be to rip out the control room operating desk, a project engineers are known to have nightmares about. And on and on. For fear of really getting us all down, we leave out the really expensive part where our engineer has to add two more mic preamps, another output channel and other accommodations. When he's through, the board should be named after him instead of the manufacturer (as a tribute to his patience). Even months later, when all seems well after the storm, that old feeling comes right back one otherwise bright Monday morning when the manager bounds into the shop and asks, "Didn't I hear FM getting in the AM board on the way to work this morning, Rube?" It's enough to make you cry.

To some of you this may sound all too familiar, but happily, that day is fast disappearing. Most managers today know that he who

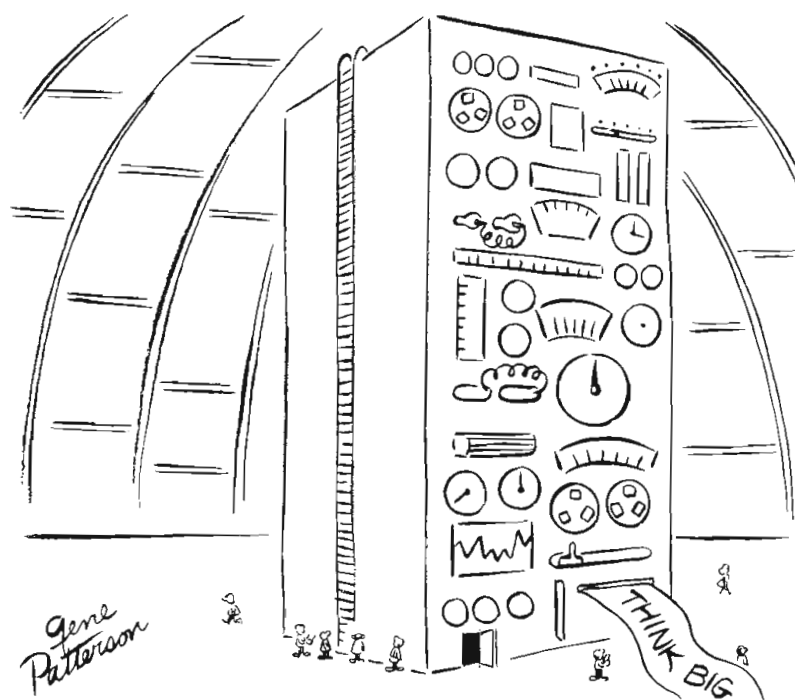



Bill Wertz, VP of WQLR, checks the chronometer, as Dennis Weidler is poised to put the station on the air. Pat Dyszkiewicz and Eric Toll watch.

Stanton. Brings on the new.

A new Station, and a new sound hits the air in Kalamazoo, Michigan. WQLR STEREO starts serving the market in June, 1972 with all new equipment and new programming. Every cartridge on every tonearm at WQLR is a Stanton. Vice President, Bill Wertz states, "We chose Stanton because we were starting fresh and we needed to impress the community with the quality of our sound from the very first on-the-air minute. Naturally, the well-documented reliability of Stanton's 500 series cartridges helped influence our choice."



Artie Altro makes the WOR-FM sound, while Eric Small, Sebastian Stone and Promotion Director, Kim Olian look over a new album.



Engineer Brian Morgan of WDRC AM/FM, gets ready for on-air playback.

Radio stations all over the nation specify Stanton.

For on-the-air use, Stanton 500 series cartridges have the ability to withstand rugged handling without any lessening of audio quality. They meet all standards for reliability and sound quality, both in on-air playback usage, and in the production of transfers. These characteristics, which assure high quality sound with minimum maintenance, make them ideally suited not only for professional use, but for home stereo systems as well.

You can enjoy the professional audio quality of Stanton Products whether your purpose involves broadcasting or home entertainment.

Write today for further information to Stanton Magnetics Inc., Terminal Drive, Plainview, New York 11803.



Scott Muni, WNEW-FM, cues in on a new release.



All Stanton cartridges are designed for use with all two and four-channel matrix derived compatible systems.

walks heavily into the technical jungle without a trusty guide may emerge later without his cherished audience and money. The one-man purchase decision just doesn't make it today. There are too many products and far too many features and technical considerations.

When The Votes Are In

At a recent NAB show, a company rep told me that their hospitality suite upstairs was for the managers. The display area downstairs was, he said, for engineers.

Both locations surely had their intended effect on that year's sales of broadcast gear. But leave it to the guy who poked around the equipment asking questions for a couple of hours to pull out the brochures and have the facts at hand when an equipment purchase decision is near.

Sure, station managers are concerned with costs. And, just as understandably, an engineer's first thoughts are likely to be about performance and reliability. That's

why the best decision on technical matters, including equipment buying, lies right on the fairway somewhere, not to close to either extreme. A vigorous discussion involving everyone concerned, be it programming, sales, engineering, management and any other areas affected almost always produces the smart choice.

Purchasing Checklist

Regarding equipment purchases, I use a short checklist for firming up my decisions before any conference. You may find it handy, too.

1. Are the stations now using the proposed equipment happy with the particular brand you are considering? A few letters or phone calls now may save much grief.
2. How does the price compare with others? What extras am I willing to pay for? What features can I do without to get a lower price?
3. How old is this model? Designs less than a year old give me the heebies.
4. Can it expand? Consoles may need extra inputs soon. Transmitters could require remote control or a stereo generator.
5. Compare the specs. Sounds basic but there may be a few surprises.
6. How good will the service be? A major factor here is how close the manufacturer is to you.
7. Is it compatible? Ever tried installing one company's remote control system on another's transmitter? Auugh!

Remember to get all the data you can. Then keep the channels open between all concerned. It keeps the "team decision" alive and well and making the right moves.



CONSOLE YOURSELF!

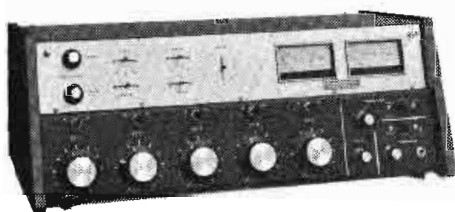

Model 5S11
Stereo

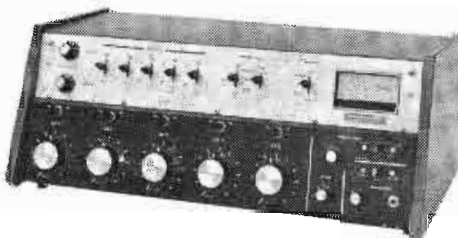

Model 5M11
Mono

SPOTMASTER IS HERE . . .

*with outstanding new audio consoles
from \$825*

Here are the audio consoles for stations whose standards are higher than their budgets. Look what you get:

- Model 5M11 Mono—11 HI/LO inputs into 5 mixers**
- Model 8M20 Mono—20 HI/LO inputs into 8 mixers**
- Model 5S11 Stereo—11 pairs of HI/LO inputs into 5 mixers**
- Model 8S14 Stereo—14 pairs of HI/LO inputs into 8 mixers**

- Electronic switching of input channels via FET's
- Low and high level preamps for each channel
- Top quality ladder attenuators (Daven or equiv.); carbon pots optional at lower cost in mono models
- Identical program and audition output channels for dual console capability
- Individual program, audition, monitor, cue and headphone amplifiers, plus mono mixdown amps in stereo models
- Solid state construction throughout; modular, plug-in circuitry; superb specs; complete with self-contained power supply
- Beautiful as well as functional; wood grain side panels

Write or call for details about the budget-pleasing prices:

BROADCAST ELECTRONICS, INC.

A Filmways Company

8810 Brookville Road, Silver Spring, Maryland 20910 • (301) 588-4983
TWX 710-825-0432

Moving?

**Send Your Change
Of Address To:**

**Broadcast Engineering
1014 Wyandotte
Kansas City, Mo. 64105**

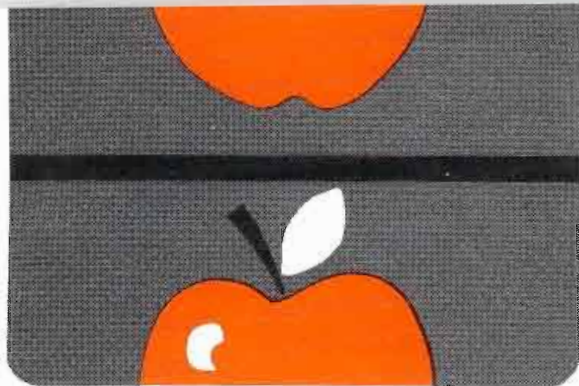

PICTURE ROLLS

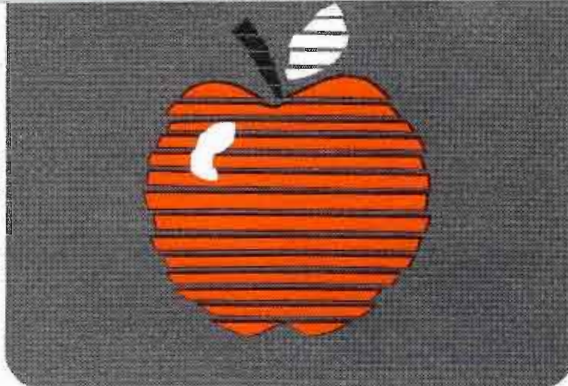

TEARING

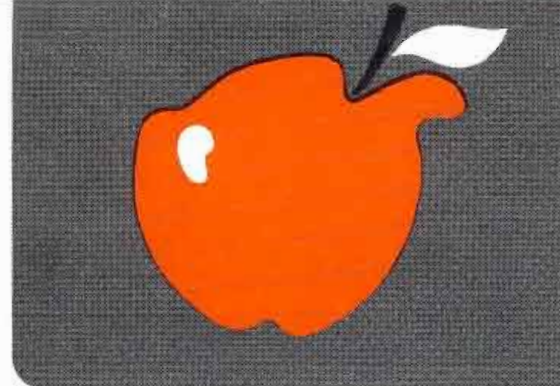

FLAGWAVING



HUE SHIFT

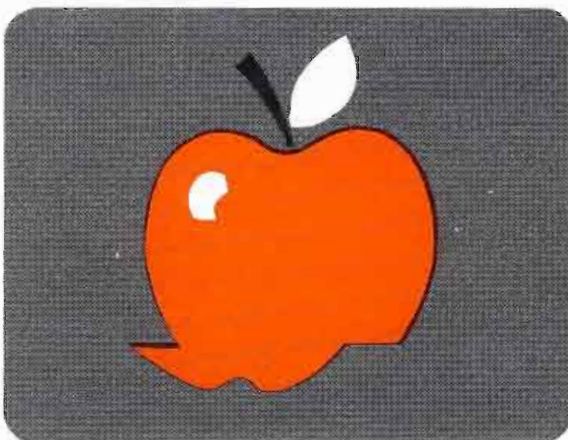

SKEW ERROR

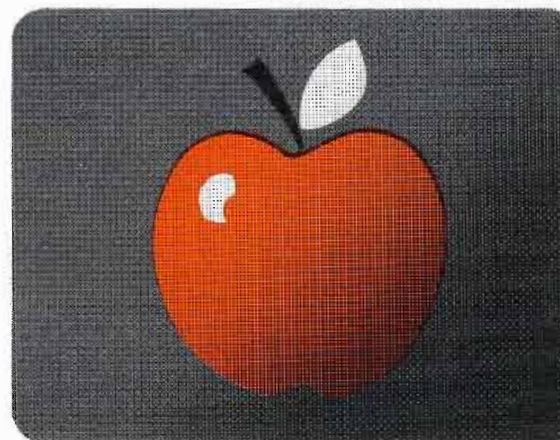

COLOR STREAKING

How do you like them apples?

Like 'em or not, them apples show composite errors in video signals which accumulate every time you use VTR equipment. Errors caused by changing tape geometries, varying tape speeds, fluctuating head velocities. But how do you get rid of the bad apples?

With a standalone Delta Series TBC from Television Microtime.

Delta TBCs give you broadcast quality from every VTR — 2-inch "quads," 1-inch helicals, 3/4-inch cassettes, 1/2-inch EIAJ — in monochrome, or direct or heterodyne NTSC color. And you can get them with standalone or built-in velocity error correction.

Delta accessories convert V-lock VTRs to H-lock operation and add automatic skew tension correction to low cost cassette and EIAJ VTRs. Our new full line brochure, *Meet The Compatibles*, describes over 20 different models . . . covers time base errors, the causes and the solutions. Use the coupon to send for your free copy. Or send for our special tape demonstration. We're available anytime to tell you how we can help solve time base problems.

Dear Sir,

I want to know more about time base error correction and Delta Series TBCs.

- Please send me your new brochure: *Meet The Compatibles*.
- I would like to see your tape demonstration.
- I want to talk with one of your representatives. My application is:

Name _____

Title _____

Company _____

Address _____

City, State, Zip _____



TELEVISION MICROTIME, INC.

1280 Blue Hills Ave., Bloomfield, Conn. 06002



For More Details Circle (38) on Reply Card

Read Those Specifications

By Dennis Ciapura
WLIF, Baltimore, Md.

Since it is virtually impossible to obtain a sample of each piece of new broadcast equipment purchased and "try-it-out" on the air, much of what we buy is purchased on the merits of the manufacturers' reputation and specifications.

Interpreting these specs is quite an ominous responsibility because a lot of dollars are usually at stake, both in the purchase price and the effects of the equipment on the air product. So, in this area of broadcast engineering we have an opportunity to inflict upon our operation a sort of economic double jeopardy; miss once and lose twice!

If one is to make sound purchasing decisions or accurately advise others in that capacity, it is obvious that a thorough understanding of how to interpret manufacturers' specs is essential. While broadcast equipment manufacturers are, as a group, among the most reputable and conscientious salesmen around, the ultimate responsibility for purchasing the best piece of equipment for a specific station lies with the station's engineering staff.

No matter how good the equipment is, if it is not utilized as it was intended to be, (in other words, if a poor purchasing decision was made)

optimum results will not be obtained. With this in mind, let's review each category of radio equipment and look into the specifications.

As with all equipment, mechanical construction as well as electrical specifications is important. The only mechanical specs normally given for consoles is the height, width, depth and weight, even though in most operations the "board" is the ever used and abused heart of the operation.

It is advisable to look at the "board" you plan to purchase "in person" if possible. It is very difficult to describe the mechanical construction of a console in specifications and certainly ten minutes of first-hand scrutiny is worth a thousand words. Keep the application in mind; a production console for some radio stations is not subjected to one thousandth the use that the on-air board is and a few dollars saved on this item might be used for a better quality main

(Continued on page 44)

**SPOTMASTER
REBUILDING
SERVICE**

**CLEANING
ADJUSTMENT
DIAGNOSIS
\$45**

We will thoroughly clean and adjust your 400 or 500 series SPOTMASTER® record/play unit for \$45.00. Delay model \$5 extra. Playback unit \$35.00. Any malfunctions or defective parts noted during preliminary testing will be corrected only after customer notification and approval. We are a franchised SPOTMASTER® dealer in new equipment, used equipment, and parts.

COMMUNICATION MEDIAS
P.O. BOX 54 / ALLENTOWN, PA. 18105
PHONE (215) 437-0607

Ship all equipment freight prepaid.
New accounts must enclose check with order.

For More Details Circle (39) on Reply Card

OMNIX

**Creative
Products
for Broad-
casting**

- Video Test Signal Generator
- Pulse DA's
- Video DA's
- Subcarrier DA's
- Audio Video Routing Switchers
- Video Title Inserters
- Title Edgers
- Colorizers
- Video Mixers
- Special Effects Generators

12234 W. Pico Blvd., Los Angeles, Calif. 90064
213 826-5605

For More Details Circle (40) on Reply Card



DIGITALS For computer age timing, counting and measuring.



ES 112 Digital Clock:

A six digit, 12 hour clock. Set to the second. Solid state, MSI components with printed circuit board. No moving parts. Silent, seven segment tubes. Built to last a lifetime. Three setting controls: Fast Advance, Slow Advance, Hold. **\$90.00**

Dimensions: 2 3/4" x 8" wide x 5 5/8" deep.
Case: Choice of Etched Aluminum or Walnut.
Electrical: 117 VAC 50/60 Hz 10 W max.
Options: R B P C K

ES 124 Digital Clock: Same clock specifications as ES 112 except displays up to 24 hours, and has provisions for 50 or 60 Hz operation. **\$90.00**

ES 500 Combination Six Digit Clock/Timer:

A 12 hour clock or timer. 5 controls: Start, Stop, Reset, Fast Advance, Slow Advance. Runs continuously to 12:59:59. Advances to 1:00:00 and continues as clock unless stopped or advanced. Same start, stop, and reset action as ES 400. **\$130.00**

Dimensions: 2 3/4" x 8" wide x 5 5/8" deep.
Case: Etched Aluminum
Electrical: 117 VAC 60 Hz 8 W max.
Options: R B P K



ES 510 Sixty minute timer:

A four digit timer (59:59). Start, stop and reset controls (Single pole, momentary, push-button). Runs continuously unless stopped or reset. If stopped, display holds time reading. When restarted continues with next count from last displayed figure. Reset while running or stopped. Returns display to all zeros. **\$110.00**

Dimensions: 2 3/4" x 6" wide x 5 5/8" deep.
Case: Etched Aluminum
Electrical: 117 VAC 60 Hz 8 W max.
Options: R B P Y Q K



ES 750 thru 769 Programmings Units:

Combines with standard ESE products on etched aluminum, 19" relay rack mounting panel (3 1/2" high). Single pole form A contact closure (1 Amp contact rating) for length of time program matches time. If control function involves count other than timing, products can be adapted. In most cases we provide interface between count input and event to be displayed.

Thumbwheel Programmer System

- ES 750/ES 112 & one 6 digit program \$265
- ES 751/ES 124 & one 6 digit program \$265
- ES 752/ES 500 & one 6 digit program \$295
- ES 753/ES 112 & two 4 digit programs \$315
- ES 754/ES 124 & two 4 digit programs \$315
- ES 755/ES 500 & two 4 digit programs \$345
- ES 756/ES 510 & one 4 digit program \$250
- ES 757/ES 300 & one 4 digit program \$285
- ES 758/ES 510 & two 4 digit programs \$300
- ES 759/ES 300 & two 4 digit programs \$335

Patchboard Programmer Systems*

- ES 760/ES 112 & one 6 digit program \$220
- ES 761/ES 124 & one 6 digit program \$220
- ES 762/ES 500 & one 6 digit program \$250
- ES 763/ES 112 & two 4 digit programs \$235
- ES 764/ES 124 & two 4 digit programs \$235
- ES 765/ES 500 & two 4 digit programs \$265
- ES 766/ES 510 & one 4 digit program \$225
- ES 767/ES 300 & one 4 digit program \$260
- ES 768/ES 510 & two 4 digit programs \$240
- ES 769/ES 300 & two 4 digit programs \$275

*An economy approach to providing the same programming functions as thumbwheel programmers listed.

ES 900 Series Modular Display Units

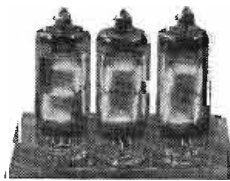

Priced from \$15.00 to \$79.00

Single Digit Modules — Vertical mounting board — Connector included.				Height	Width	Depth
	Height	Width	Depth			
ES 901	2"	.5"	2"	1.75"	1.8"	3.75"
ES 902/(7475)	2"	.5"	2"	1.75"	2.7"	3.75"
ES 903/(7475) (7490)	2"	.5"	2"	1.75"	3.6"	3.75"
ES 904/(7475) (74192)	2"	.5"	2"	1.75"	4.5"	3.75"
ES 905/(7490)	2"	.5"	2"	1.75"	5.4"	3.75"
ES 906/(74192)	2"	.5"	2"	1.75"	6.3"	3.75"
Multiple Digit Modules — Horizontal mounting — Connector optional.				Height	Width	Depth
	Height	Width	Depth			
ES 912/2 Digits	1.75"	1.8"	3.75"	1.75"	1.8"	3.75"
ES 913/3 Digits	1.75"	2.7"	3.75"	1.75"	2.7"	3.75"
ES 914/4 Digits	1.75"	3.6"	3.75"	1.75"	3.6"	3.75"
ES 915/5 Digits	1.75"	4.5"	3.75"	1.75"	4.5"	3.75"
ES 916/6 Digits	1.75"	5.4"	3.75"	1.75"	5.4"	3.75"
ES 917/7 Digits	1.75"	6.3"	3.75"	1.75"	6.3"	3.75"
ES 918/8 Digits	1.75"	7.2"	3.75"	1.75"	7.2"	3.75"
ES 922/2 Digits/(7475)	1.75"	1.8"	3.75"	1.75"	1.8"	3.75"
ES 923/3 Digits/(7475)	1.75"	2.7"	3.75"	1.75"	2.7"	3.75"
ES 924/4 Digits/(7475)	1.75"	3.6"	3.75"	1.75"	3.6"	3.75"
ES 925/5 Digits/(7475)	1.75"	4.5"	3.75"	1.75"	4.5"	3.75"
ES 926/6 Digits/(7475)	1.75"	5.4"	3.75"	1.75"	5.4"	3.75"
ES 927/7 Digits/(7475)	1.75"	6.3"	3.75"	1.75"	6.3"	3.75"
ES 928/8 Digits/(7475)	1.75"	7.2"	3.75"	1.75"	7.2"	3.75"
ES 932/2 Digits/(7475) (7490)	1.75"	1.8"	3.75"	1.75"	1.8"	3.75"
ES 933/3 Digits/(7475) (7490)	1.75"	2.7"	3.75"	1.75"	2.7"	3.75"
ES 934/4 Digits/(7475) (7490)	1.75"	3.6"	3.75"	1.75"	3.6"	3.75"
ES 935/5 Digits/(7475) (7490)	1.75"	4.5"	3.75"	1.75"	4.5"	3.75"
ES 936/6 Digits/(7475) (7490)	1.75"	5.4"	3.75"	1.75"	5.4"	3.75"
ES 937/7 Digits/(7475) (7490)	1.75"	6.3"	3.75"	1.75"	6.3"	3.75"
ES 938/8 Digits/(7475) (7490)	1.75"	7.2"	3.75"	1.75"	7.2"	3.75"
ES 942/2 Digits/(7490)	1.75"	1.8"	3.75"	1.75"	1.8"	3.75"
ES 943/3 Digits/(7490)	1.75"	2.7"	3.75"	1.75"	2.7"	3.75"
ES 944/4 Digits/(7490)	1.75"	3.6"	3.75"	1.75"	3.6"	3.75"
ES 945/5 Digits/(7490)	1.75"	4.5"	3.75"	1.75"	4.5"	3.75"
ES 946/6 Digits/(7490)	1.75"	5.4"	3.75"	1.75"	5.4"	3.75"
ES 947/7 Digits/(7490)	1.75"	6.3"	3.75"	1.75"	6.3"	3.75"
ES 948/8 Digits/(7490)	1.75"	7.2"	3.75"	1.75"	7.2"	3.75"
ES 952/2 Digits/(7475) (74192)	1.75"	1.8"	3.75"	1.75"	1.8"	3.75"
ES 953/3 Digits/(7475) (74192)	1.75"	2.7"	3.75"	1.75"	2.7"	3.75"
ES 954/4 Digits/(7475) (74192)	1.75"	3.6"	3.75"	1.75"	3.6"	3.75"
ES 955/5 Digits/(7475) (74192)	1.75"	4.5"	3.75"	1.75"	4.5"	3.75"
ES 956/6 Digits/(7475) (74192)	1.75"	5.4"	3.75"	1.75"	5.4"	3.75"
ES 962/2 Digits/(74192)	1.75"	1.8"	3.75"	1.75"	1.8"	3.75"
ES 963/3 Digits/(74192)	1.75"	2.7"	3.75"	1.75"	2.7"	3.75"
ES 964/4 Digits/(74192)	1.75"	3.6"	3.75"	1.75"	3.6"	3.75"
ES 965/5 Digits/(74192)	1.75"	4.5"	3.75"	1.75"	4.5"	3.75"
ES 966/6 Digits/(74192)	1.75"	5.4"	3.75"	1.75"	5.4"	3.75"

A prototype tool for custom digital instrumentation. Each module consists of a printed circuit board, a seven segment incandescent tube and decoder driver (7447). Many modules feature other TTL devices, as listed, to provide the following additional functions:

- Latch (7475)
- Decade Counter (7490)
- Programmable Up/Down Counter (74192)

A single 5V supply is the only power required for all modules.

ES 400 Three Digit Ten Minute Timer:

Three controls (Start, Stop, Reset). Runs continuously unless stopped. Displays up to 9:59. If stopped, display will hold time reading. Reset returns display to all zeros. Can be reset while running or stopped. If reset while running, timer will continue to run. **\$85.00**

Dimensions: 2 3/4" x 6" wide x 5 5/8" deep.
Case: Etched Aluminum
Electrical: 117 VAC 60 Hz 8 W max.
Options: R B P K

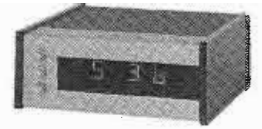

ES 300 One hundred minute up/down timer:

Four digit, one hundred minute timer (99:59) with six momentary push-button controls: Count Up, Count Down, Stop, Minutes Advance, Seconds Advance, Reset. Minutes and Seconds can be advanced simultaneously or independently, to pre-set for a specified countdown. Preset time will be automatically held until the timer is started. Counting can be activated up or down from that point or set back to zero. When "Stop" control is pressed, the four digit display is held. Counting direction (up or down) can be changed or time can be reset to zero without stopping the count. Continue to register elapsed time beyond the zero setting unless stopped. **\$145.00**

Dimensions: 2 3/4" x 8" wide x 5 5/8" deep. **Case:** Etched Aluminum
Electrical: 117 VAC 60 Hz 10 W max. **Options:** R B P Y Q K



ES 702 thru 718 Programming Units:

Includes comparator circuitry. User provides BCD information to compare to program. When info agrees with program, a single pole form A relay contact closure occurs (1 Amp contact rating). Contact closure is maintained for length of time external BCD information agrees with program.

Dimensions: 2 3/4" x 8" wide x 5 5/8" deep
Case: Etched Aluminum
Electrical: 117 VAC 60 Hz — Power requirements vary with number of digits.

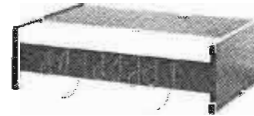

Patchboard

- ES 702 — 2 Digits \$64.00
- ES 703 — 3 Digits \$69.00
- ES 704 — 4 Digits \$74.00
- ES 705 — 5 Digits \$78.00
- ES 706 — 6 Digits \$82.00
- ES 707 — 7 Digits \$88.00
- ES 708 — 8 Digits \$92.00

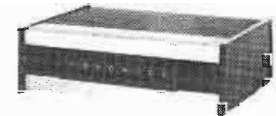

Thumbwheel

- ES 712 — 2 Digits \$110.00
- ES 713 — 3 Digits \$120.00
- ES 714 — 4 Digits \$130.00
- ES 715 — 5 Digits \$140.00
- ES 716 — 6 Digits \$150.00
- ES 717 — 7 Digits \$165.00
- ES 718 — 8 Digits \$180.00

Standard Options

... on many ESE digital products, allows a wide range of adaptability from the standard product line:

NOTE: When ordering, add these letter designations to the basic part number.

EXAMPLE:

ES 400 R P B
Basic Part Remote Panel BCD
Number Connector Mount Output

Designation:	Function:
R	Remote Connector
B	Parallel BCD Output (TTL)
P	Panel Mount
Y	Relay Closure
Q	Solid State Outputs
C	Crystal Time Base
K	Kit Available

KITS: Our K series kits allow you to build ESE digitals at much less than the price of an assembled unit. Includes illustrated instructions, parts list, schematic and parts. No special tools needed. Kits can be factory assembled for an additional charge.

Twelve Hour Digital Clock: ES 112K — All features of ES 112. **\$46.95** plus opt. alum. case **\$7.50/walnut \$12.00.**

Twenty Four Hour Digital Clock: ES 124K — Same as the ES 112 except tells time through 23:59:59. **\$46.95** plus opt. alum. case **\$7.50/walnut \$12.00.**

ID REMINDER: ES 200K — Opt. to ES112/124 Reminds operator 9 min. 45 sec. passed since last ID. Mounts on ES 112/124 board. Silent LED flash and opt. audio alarm. **Kits \$10.95/assembled \$16.95**

Crystal Time Base: ES 201K — Opt. addition to ES 112K, ES 124K, or ES 500K. Mounts on board. Accuracy .002%. **\$28.00**

Digital Multimeter: ES 210K — Sensitive, accurate, bipolar. Automatic polarity indicator. Displays ohms, volts or amps in five ranges. 100 Microvolts to 500 V. 100 Milliohms to 1 Megohm. 100 Nanoamps to 1 Amp. Optional probe. **\$77.00** plus **\$12.50** case.

40 MHz Digital Frequency Counters: ES 220K — 5 Digit line freq. time base (1 KHz resolution). **\$69.50** plus **\$10.00** case.

ES 221K — 6 Digit crystal time base (100 Hz resolution). Not damaged by high power transmission levels. One cable connection to trans. output. Pot for sensitivity adjustment. **\$109.50** plus **\$10.00** case.



10418 La Cienega • Inglewood, Ca. 90304

(213)674-3021

For More Details Circle (41) on Reply Card

MAXI OUTPUT MINI BUDGET

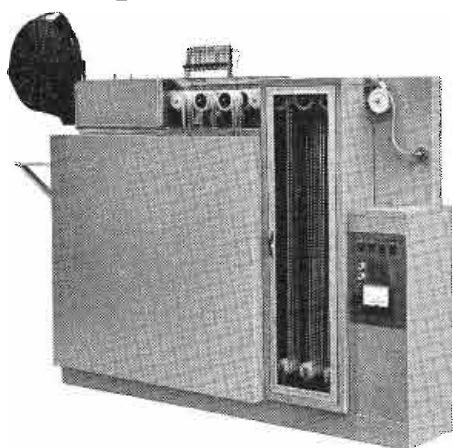

Little Max, the compact color film processor that performs quality, small volume processing for a small amount of money. Little Max fits the bill without bankrupting whoever foots the bill. Using 8, 16 and/or 35mm film, Little Max automatically processes with CR-100 chemistry in 15 minutes dry-to-dry, as well as the standard ME-4 Process in 28 minutes. And when it comes to quality, Little Max can stand shoulder-to-shoulder with the big guys. Small size. Small price. Big value. Little Max.

That's me

He's the
Personality
Processor

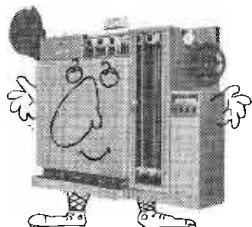

For further information call or write:
Marketing Department,



TECHNOLOGY INCORPORATED
HF PHOTO SYSTEMS DIVISION
mfr. of HOUSTON FEARLESS Products
11801 W. Olympic Blvd.,
Los Angeles, Calif. 90064 (213) 272-4331

LITTLE MAX

For More Details Circle (42) on Reply Card

(Continued from page 42)

console. For an automated station the exact reverse might be true. The human engineering aspects are also of prime importance. Knob size, spacing and location can mean a lot in terms of operator efficiency.

Digging In

If the selection of possible purchases is narrowed down by first finding the units most suitable mechanically, the electrical specifications of the "semi-finalists" can then be analyzed. Flexibility is a major item. How many inputs required? How many may be added later? How many inputs on one "pot"? Any studio engineer who has suffered through the experience of electronic tap dancing with a board that just ran out of pots as additional signal sources were added, is an expert in this area.

Serviceability is another consideration. How does the board "open-up"? Some of the better ones spread-eagle while others are a challenge to service.

The electrical specifications for fidelity and output capability often look very similar from one unit to the next, but there are pitfalls. Is the maximum output listed for driving one line or two? There can be a 3 dB difference, and in some operations this may be important. Also, check to see if the maximum output data is given for a maximum distortion level.

A good amplifier will be very clean right up to the clipping level. And look for overload capability. If the nominal output of the console is +8 dBm, the maximum output should be around +18 dBm to allow for transients 10 dB above the normal program level.

When looking at the signal to noise ratio, see if it is referred to maximum output or nominal output. There is usually a 10 dB difference here. The noise output is sometimes listed as a function of equivalent input noise in dBm. This is a very descriptive spec because it takes the gain of the console into account. The better units boast figures of about -120 dBm.

The distortion figures should be given for a range of input frequencies and output level for harmonic distortion specs. For example, less than 0.5 percent from 50-15000 Hz

at +8 dBm output. If an IM distortion spec is given, look for the low to high frequency ratio: the SMPTE standard is 4:1. If a 2:1 ratio is used, the distortion will look better in the spec than it actually is.

The frequency response of the console should be flat over the desired range and this spec should also be accompanied by an output level tag. And don't forget to check the monitor amplifier specification, too. If the maximum monitor output level is +33 dBm, this is only 2 Watts. How many speakers are you planning to drive?

Disc Equipment

Many engineers are confused by the variety of disc reproducing equipment available. Once again the application must be kept in mind. Starting speed may be of very little consequence at a classical music station with a slow, flowing format, but what a curse a slow starting turntable would be to Randy-Rock-Jock!

But Randy might not encounter a pianissimo in a year, so the low rumble spec that Mr. Classical engineer looks for won't concern the engineering staff at Randy's facility as much as the starting speed. A good turntable would have a rumble spec of about 40 dB below standard NAB zero level and wow and flutter figures of less than 0.2 percent. A fast table will reach full speed in one-tenth of a turn or less.

The electronic performance of the disc reproducing system is a many faceted situation. The pickup and pre-amp should be considered a system and the manufacturer's specs for these units analyzed accordingly. It must be remembered that there is no AGC system between the phono cartridge and the pre-amp, so the pre-amp must be able to handle the full dynamic range of the pickup's output. We have observed peaks as high as 26 dB above average program level on some of the newer records!

The pre-amp output noise, gain, maximum output capability and phono pickup output voltage must all be considered at the same time

(Continued on page 46)

YOU BE THE JUDGE!

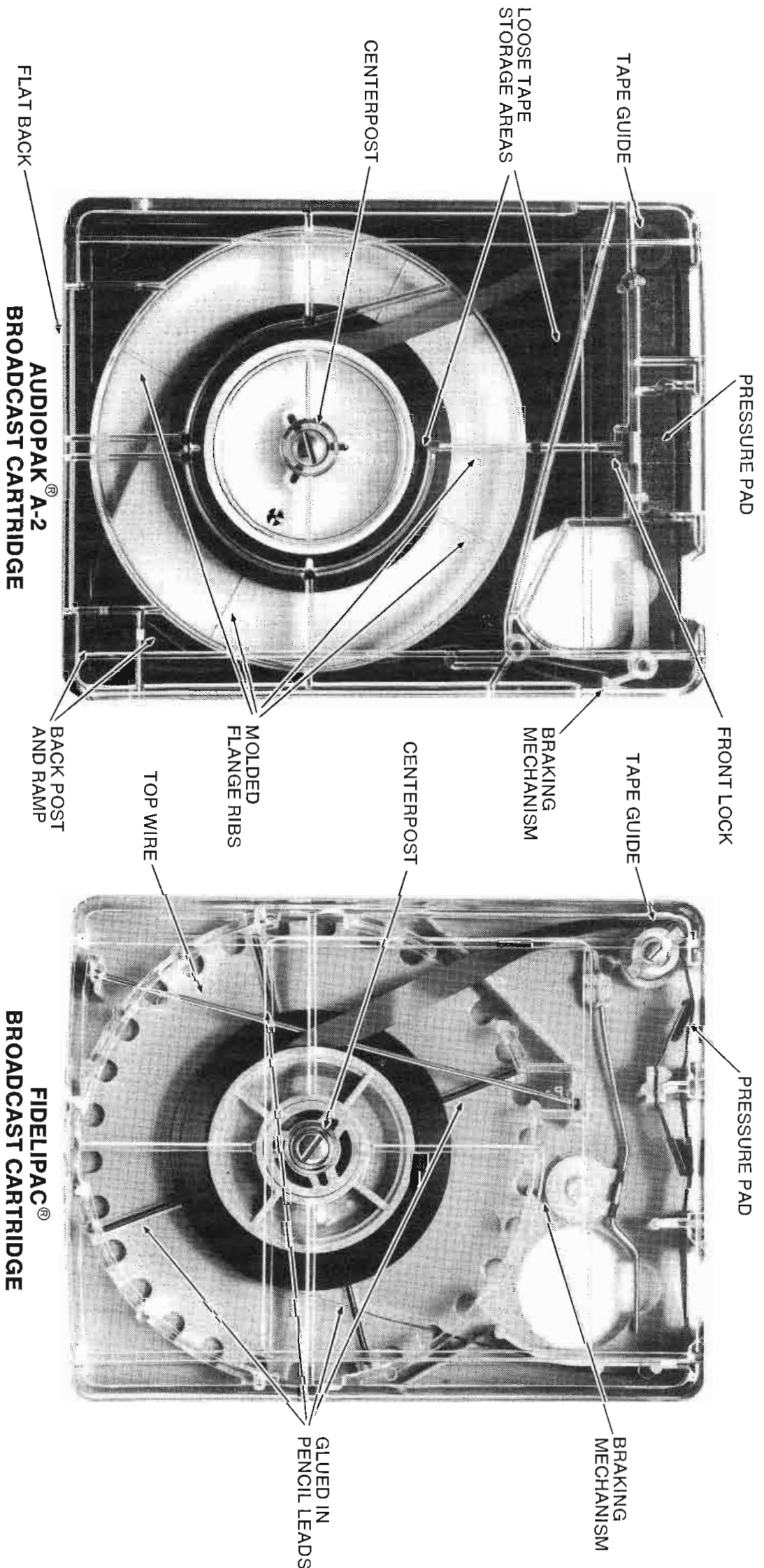

For your most critical stereo requirements, ask about our "new" Audiopak A-2SP Stereo Phase Broadcast Cartridge.

FOR MORE INFORMATION AND A FREE SAMPLE OF THE A-2, WRITE TO...
 AUDIO DEVICES, INC., A CAPITOL INDUSTRIES CO., 100 RESEARCH DRIVE, GLENBROOK, CONN. 06906 • MANUFACTURERS OF AUDIOTAPE®, AUDIOFILM® AND AUDIODISCS.®

For More Details Circle (43) on Reply Card

(Continued from page 44)

if we are to be sure that the disc reproducing system will not be clipping program peaks or running unnecessarily close to the residual noise level. Also bear in mind that the pre-amp output level controls are usually in the output circuits and cannot prevent overload of stages prior to these controls.

The usual frequency response and distortion criteria do, of course, also apply to the disc reproducing equipment. Remember that the phono pre-amp is also an equalizing device and has much more gain at low frequencies than at the high end. And since the response tapering R-C elements are usually in the feed-back circuit, there will be less feedback and more distortion at the bass end unless the open loop gain of the amplifier is high enough and/or the open loop distortion low enough to keep the non-linearity down to negligible levels. Look at the distortion vs. frequency specs to gauge performance in this area.

Phono pickup tracking ability

and mechanical tenacity are qualities which in practice are often found working at cross purposes. A very compliant stylus assembly will track well at low stylus pressure but may be too delicate for a fast paced top 40 operation. However, it may be just what the doctor ordered for the classical or "good music" guys on the next antenna down the street.

The tone arm is also part of our disc system and its specs should also be compatible with the other components chosen. It would do very little good to have a phono pickup that could track at $\frac{3}{4}$ gram mounted in an arm designed to operate at $1\frac{1}{2}$ grams or more. An extreme mis-match would be a very low mass tone arm with a low compliance pickup. In such a case, the low frequency response could actually show a measurable loss due to the fact that the stiff stylus would cause low frequency mechanical energy to move the entire tone arm assembly instead of the pickup's internal voltage generating ele-

ment alone.

Tape Systems

In analyzing spec sheets for tape equipment, one is very easily impressed by the level of fidelity afforded by modern tape machines. In fact, it is sometimes difficult to choose one deck as being better suited to our needs because they all look so good in the specs.

If we take a closer look at how the specs are written, we may begin to see where the differences are. Signal-to-noise ratio is always a lively tape topic, so let's start there.

Look to see if the noise level is referred to the standard NAB zero level or to 2 or 3 percent total harmonic distortion. Also inquire as to the bandwidth of the measurement. A tape deck will usually produce a somewhat lower noise reading when measured with a 15 kHz cut-off filter, as supersonic bias noise is removed.

Distortion can be minimized when the deck's bias is adjusted for

(Continued on page 48)

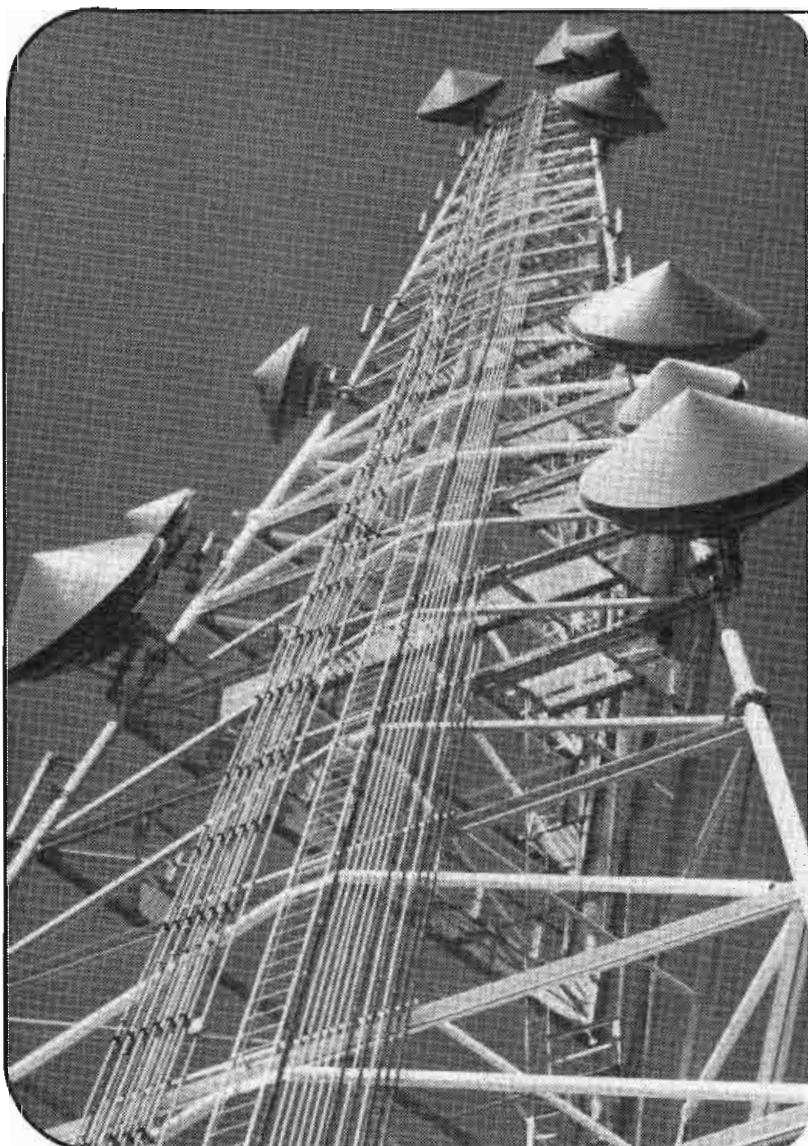

Stainless the big name in MICROWAVE TOWERS

- A single tower or a whole system of towers . . . count on Stainless to deliver.
- Whether it's a "one responsibility" package job to include site preparation, foundations, erection and towers . . . count on Stainless to deliver. The towers you need . . . on schedule.

Stainless Microwave Towers are serving as vital links for data transmission in the Telephone, Power, Pipe Line and Railroad Industries and Network interconnection for TV and ETV transmission.

We'll gladly discuss your tower requirements.

Stainless, inc.

North Wales, Pennsylvania 19454
Telephone (215) 699-4871
In Canada: Walcan Ltd., Toronto 12, Ontario.

For More Details Circle (44) on Reply Card

today EVERY frame in the TOP SHOWS...



...is indexed for ELECTRONIC editing

Today you need faster production, lower production costs and more sophisticated editing. There's only one answer... electronic indexing of all taped frames so that —

- ...scenes can be located automatically and rapidly.
- ...previewing and program planning can be both exacting and economical.
- ...edit points in final assembly can match editing decisions accurately to a single frame.

Because most shows develop their own editing standards, methods and techniques, equipment versatility is also important. The exceptional modularity of EECO Electronic Editing equipment provides for unequalled response to such individuality.



use EECO's new electronic "building-blocks"

Index tapes electronically with SMPTE Edit Code — put visual indexing on dubs and kine workprints — synchronize any two mag tapes (sprocketed or unsprocketed audio and quad or helical video) — edit electronically with single frame accuracy, dissolves, AB rolls and special effects.

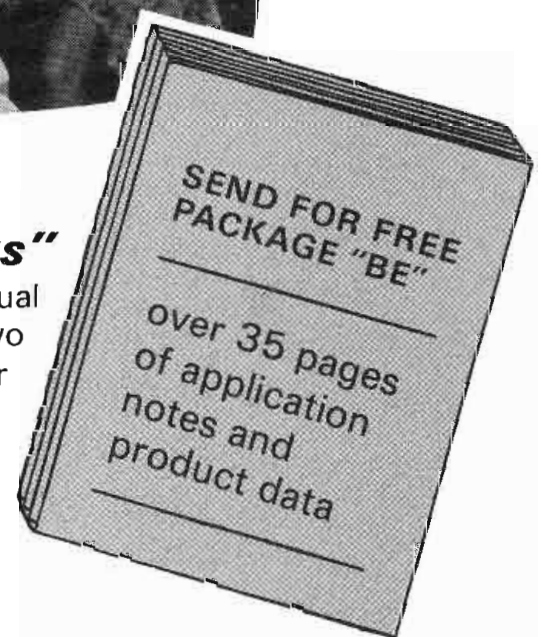

EECO

ELECTRONIC ENGINEERING COMPANY OF CALIFORNIA

1441 East Chestnut Avenue • Santa Ana, California 92701 • Phone: (714) 835-6000 • TWX 910-595-1550 • Telex 67-8420

For More Details Circle (45) on Reply Card

(Continued from page 46)

optimum performance with the tape used and will, of course, vary a bit from tape to tape, but the tape deck's amplifier distortion can be a limiting factor. Some of the newer decks boast amplifier distortion as low as 0.5 percent or less at 1 kHz, zero level.

Speed stability specs are also important and doubly so if your production operation requires multiple generations. Speed errors can be additive. Short term errors like wow and flutter are expressed as a percent, while long term error is sometimes called timing accuracy and can be expressed as a percent or in accumulated error in seconds per some unit of time (such as an hour or beginning-to-end of reel). It may be necessary to convert a percent spec to seconds of error to compare decks.

Cartridge equipment specs are similar to reel-to-reel, except that there are the usual flexibility considerations related to cueing facilities, etc. Like consoles and phono equipment, reel-to-reel and cart-

ridge tape equipment is subjected to the human (if not always humane) factor, and should be scrutinized mechanically to determine if the degree of ruggedness your operation requires is there.

AGC Amplifiers and Limiters

These units are probably the most difficult to compare specs on. Some of the equipment separates the audio range into bands and performs its control functions separately on each band, while other units employ multiple attack and release times keyed to the level of the incoming signals. Many others operate with a single attack and a single release characteristic. Once you have determined which control scheme is best suited to your facility, the more usual electrical specs can be reviewed.

When looking at the distortion figures, check to see if the data is given for levels below or above the threshold of limiting. Some manufacturers give a maximum distortion figure which will not be ex-

ceeded at any audio frequency and through the entire control range. Naturally, such a distortion spec will not be as impressive as a 1 kHz only figure taken at a low level.

If the AGC or limiter amplifier you require must feed a line, be sure to check the maximum output specification to see if the unit you choose can drive the line and any isolation and/or distribution network losses that may be required for your system.

Transmitting Equipment

Transmitting equipment has become more simple and more economical to operate with the introduction of new components and advanced circuitry. The specifications for most of the transmitters on the market today are quite impressive and sometimes similar as well. Therefore, once again we are inclined to take a closer look at the specs to see in what areas a particular model may excel.

(Continued on page 50)

HOW TO DELIVER AN FM SIGNAL WITH

SOCK!

It's easy to do. Not too expensive either. Good stereo demands low VSWR. Our circular polarized "Penetrator" antenna guarantees a VSWR of 1.1 to 1 before it's even mounted. And after installation it may be field trimmed to reproduce a VSWR value of 1.08 to 1. This provides a superior stereo signal.

The "Penetrator" will also increase your audience by penetrating difficult areas and by reaching more car receivers and small portables. It's the only circularized FM antenna with variable horizontal-to-vertical gain ratios. It delivers a signal with sock!

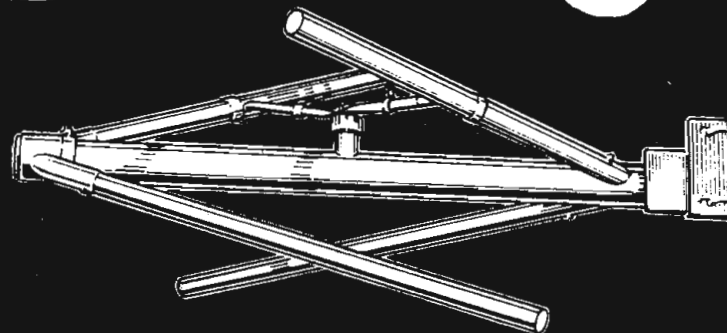
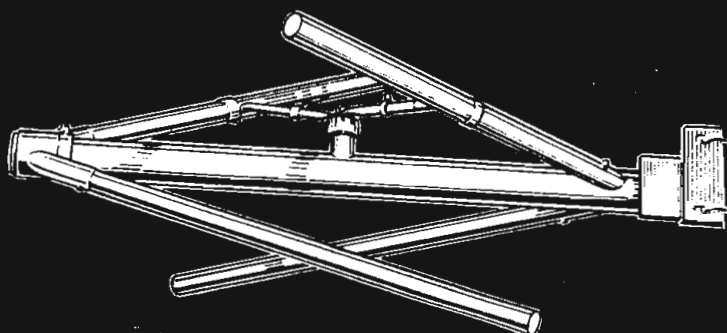

JAMPRO ANTENNA COMPANY
A DIVISION OF COMPUTER EQUIPMENT CORPORATION

PHONE (916) 383-1177

6939 Power Inn Road • Sacramento, CA 95828

For More Details Circle (46) on Reply Card

If you haven't seriously considered the new Setchell Carlson slim line demodulator



It's probably *our* fault.

It takes a great deal of time and expense to tell everyone in the industry about innovative new products, great low prices, and best value buys; consequently, there are probably still some people around who actually haven't seriously considered Setchell Carlson's new slim line demodulator! To those people we apologize...and we hope we're not too late to save you some money and give you a superior product at the same time.

After all, it's not your fault! How can you know that the all solid-state Setchell Carlson Demodulator is the only one in its price range with Automatic Fine Tuning unless we get the information to you? And how can you know it takes up only 3.5 inches of vertical rack space

or that its excellence of bandwidth characteristic produces outstanding monochrome and color picture quality? And, of course, you couldn't know about the four IF stages, high RF sensitivity, low noise, low chrominance/luminance delay, full chrominance signal level, regulated power supply, exclusive UNIT-IZED construction for easy maintenance, or attractive metal cabinet? **But most of all how could you possibly know all this is available at under \$350!...unless we tell you?**

Now that you know, simply circle the appropriate reader service card number for further information and literature, or for more rapid answers, see your S C Electronics dealer.



SC ELECTRONICS, INC.

A SUBSIDIARY OF AUDIOTRONICS CORPORATION

530 5th Ave. N.W. St. Paul, Minn. 55112, (612) 633-3131

For More Details Circle (47) on Reply Card

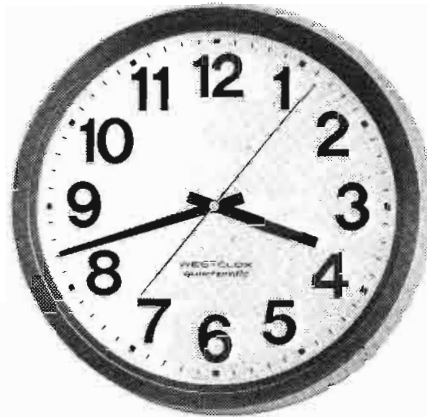

MODEL A
Super-legible black on white, woodhug case.

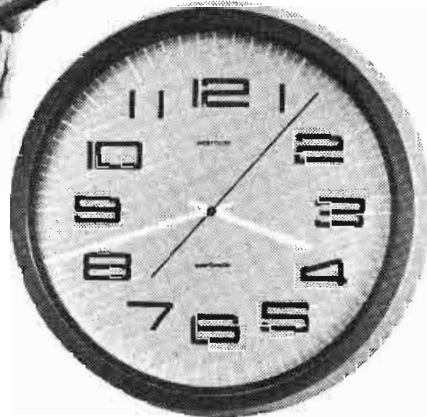

MODEL B
Contemporary black numerals on tan face, woodhug case.

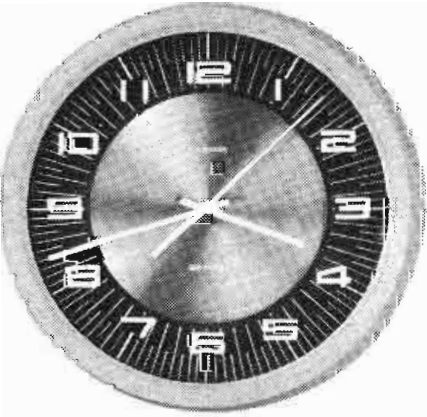

MODEL C
Decorator style, white numerals, black & bronze face, light gray case.

the miracle of quartz:

Cordless accuracy to one minute a year

Westclox Quartzmatic Clock only \$55⁰⁰

Precision quartz accuracy. Accurate to plus or minus one minute per year — less than 2/10 seconds a day.

Cordless convenience and portability. Runs on two ordinary "C" batteries.

Keeps you on time during power failures, or where no power plug is available.

Big 12" face with red sweep second hand. Easy to read—even at a distance.

Ideal for radio & T.V. stations, hospitals and labs, police and fire stations, transportation terminals, weather stations, homes and offices . . . anywhere!

One year Factory Guarantee from Westclox, division of General Time, world's foremost maker of precision timepieces.

This latest advance in quartz timekeeping technology is available NOW for only \$55.00 each in your choice of colors. Use this coupon or send your own purchase order.

Order the amazing Quartzmatic Clock today at this special price!

When checking the AM rigs, look for a good carrier shift spec. An AM transmitter which excels in this area has a good stiff power supply and, all other things being equal, is likely to sound better when run at high modulation levels because there will be less inter-modulation distortion. It is possible for two transmitters to have identical harmonic distortion characteristics and yet sound different. The manufacturers seldom give IM data, but the carrier shift spec is one clue. On a visual inspection look for a lot of iron in the modulation transformer, if there is one. A sharp rise in harmonic distortion at high modulation levels with low modulating frequencies can also indicate possibly less than spectacular IM performance.

Operating efficiency, tube types, construction, etc., all play a part in making the total transmitter the kind of beast it is or isn't going to be, but many of these considerations are subject to what the purchasing engineer feels is ideal for his station.

FM transmitter specs are a bit more complex, particularly if a stereo generator is to be employed. The FM transmitter itself is basically a huge RF amplifier and is usually broadband enough that most of the fidelity determining circuitry is in the stereo generator and exciter. Stereo separation data should include the modulating frequencies as should distortion data.

If a phase modulation system is employed, look closely at the low frequency audio performance. Also, check with the manufacturer to see if his signal to noise ratio data was taken with the exciter mounted in the transmitter. It is sometimes possible for the blowers to mechanically modulate the master oscillator and cause some deterioration of an otherwise excellent noise figure. Unless you are prepared to operate the exciter in a separate rack, this is something to be considered.

Frequency stability of both the main carrier and 19 kHz pilot is important, and these specs should be tagged with a temperature range. A transmitter installed at a remote antenna site may have to operate satisfactorily over quite a temperature span. □

GENERAL TIME SERVICE
A TALLEY INDUSTRIES COMPANY

AKRON 25 Ghent Rd., Ohio 44313
CHICAGO 206 N. Michigan Ave., Ill. 60601
DALLAS 400 S. Ervay St., Tex. 75201
LOS ANGELES 5404 Wilshire Blvd., Cal. 90036
NEW YORK 150 E. 47th St., N.Y. 10017
PHILADELPHIA 1214 Walnut St., Penna. 19107
PHOENIX 2047 E. Camelback Rd., Ariz. 85201
SAN FRANCISCO 540 Mission St., Cal. 94105

Please send me _____ Model "A," _____ Model "B," _____ Model "C" Quartzmatic Clocks.

_____ Send postpaid. My check or money order is enclosed.
_____ Send C.O.D. I'll pay shipping charges.

Name _____

Company _____

Address _____

City _____ State _____ Zip _____

(Add local sales tax where applicable)

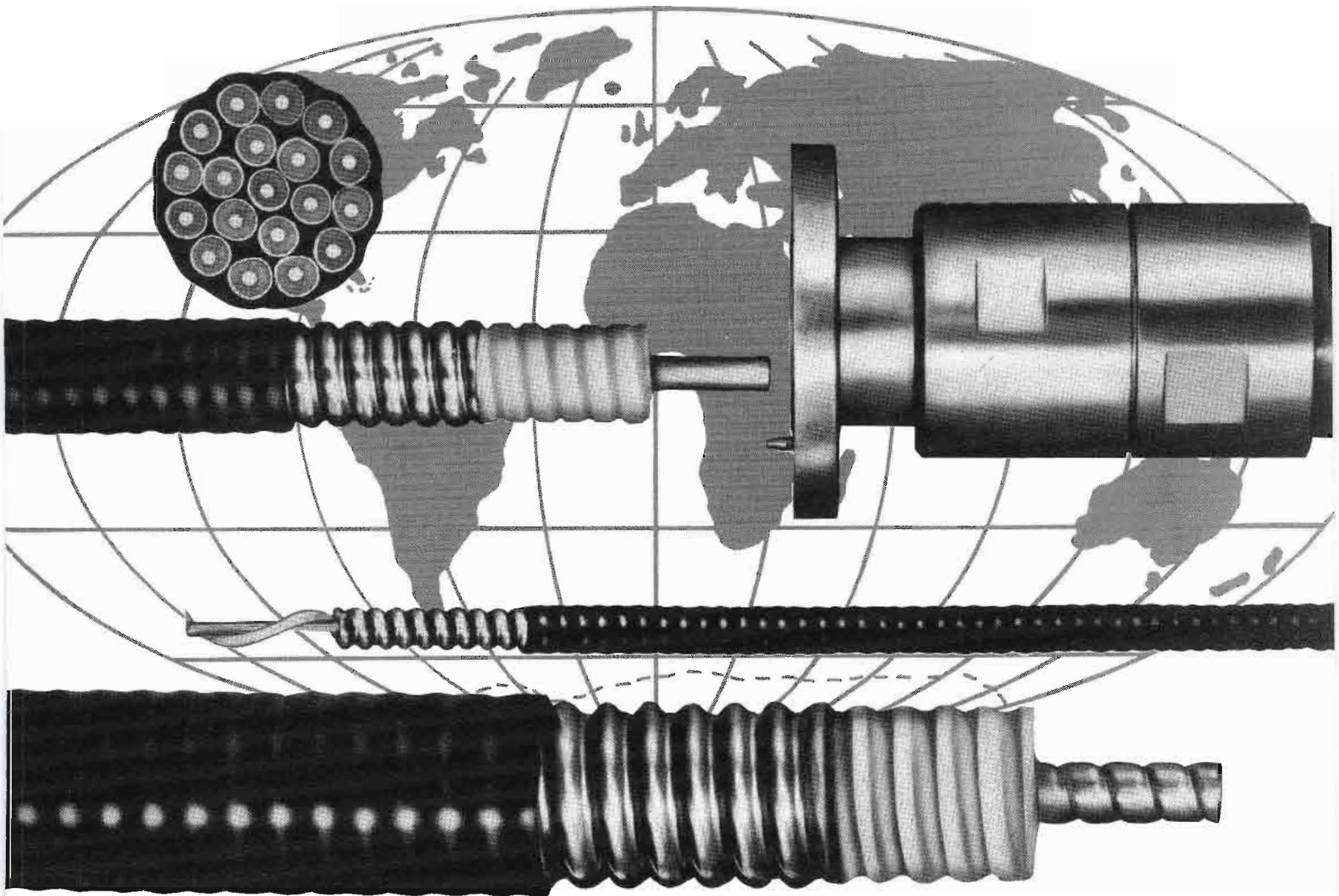

WORLD LEADERSHIP IN COAXIAL CABLES AND WAVEGUIDES

Since introducing its HELIAX[®] product line in 1954, ANDREW has become the world's largest independent producer of semi-flexible coaxial cables, waveguides and associated fittings used in radio frequency applications.

Eighteen years of innovation in product design and manufacturing technique, with emphasis on effective performance of installed systems have produced for ANDREW a position of world leadership, and for users of HELIAX cables and waveguides the assurance of superlative value in relation to cost.

With plants in the United States, Canada, Great Britain and Australia, ANDREW is well situated to provide prompt delivery service and competent assistance with problems, anywhere in the world.

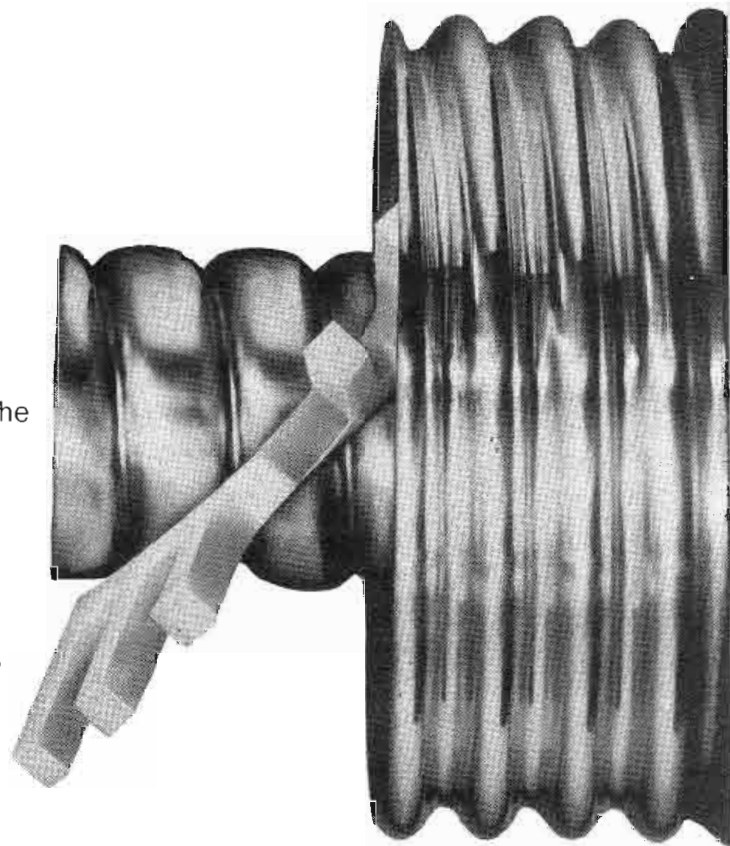

ANDREW

ANDREW CORPORATION 10500 W. 153rd St., Orland Park, IL, U.S.A. 60462

ANDREW ANTENNA SYSTEMS Lochgelly, Fife, Great Britain KY5 9HG

ANDREW ANTENNA COMPANY LTD. 606 Beech St., Whitby, Ontario, Canada

ANDREW ANTENNAS 171 Henty St., Reservoir, Victoria, Australia 3073

For More Details Circle (50) on Reply Card

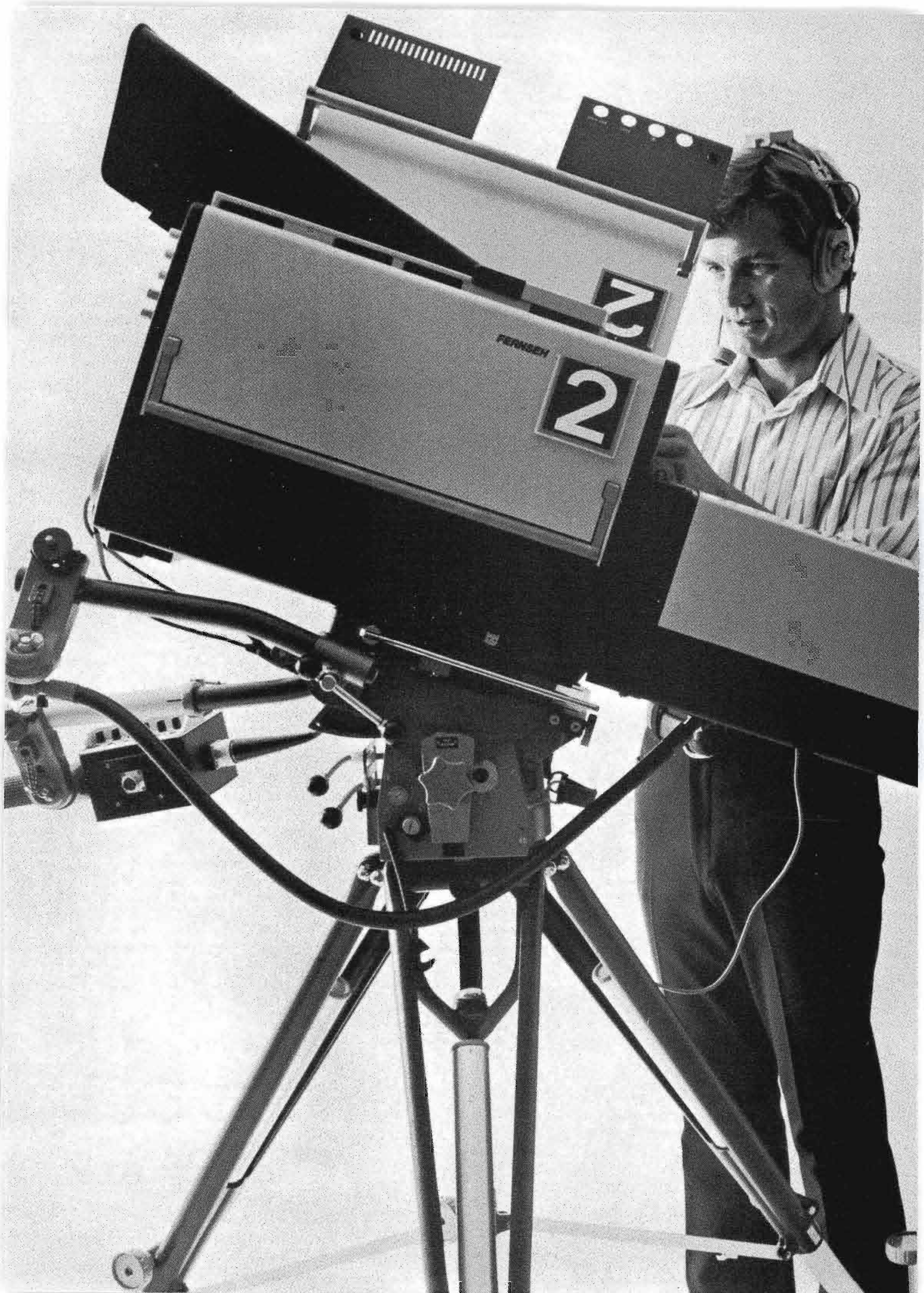

When we say interchangeability we mean interchangeability.

You can take one, or all, of the twenty modules and interchange them between cameras and maintain picture quality without additional adjustment, balancing, or fine tuning.

Our cameras were truly designed with interchangeability in mind.

You can take a module from one camera and put it in another camera. Or you can take a module from your parts stock and plug it in a camera. In fact, you can take a camera "shell" and put together a fully operative camera in about twenty minutes. The amount of time you save in adjustments and maintenance is remarkable.

Interchangeable modules are only a part of the Fernseh story. We have some other amazing features, too. For example, when you receive one of our cameras, it's ready for operation as soon as you unpack it. And, it'll perform to all specifications because each camera we make is pre-tested. We do something a little extra. We record actual performance characteristics for chromatic response and frequency response on each camera system.

There are a lot of things you should know about Fernseh cameras. Get detailed information by contacting your nearest Fernseh division representative at one of the offices listed below.

Chicago Headquarters

(312) 681-5000

Houston (713) 681-8461

Los Angeles (213) 649-4330

New York (516) 921-9000

Ramsey, N.J. (201) 825-1550

San Francisco (415) 583-9470

For More Details Circle (51) on Reply Card

**Robert Bosch
Corporation
Fernseh
Division**  the wings
of vision

The FCC Expects You To Know

By Ron Merrell

We've covered lottery before in "The FCC Expects You To Know" articles, but for those readers who missed it, let's have another crack at it.

For openers, the fines can be quite high. The most recent case involving an Indiana radio station was set at \$2,000. Obviously, that's quite a loss of revenue.

According to Section 73.122(b), lottery is defined this way: "...a program comes within the provisions of paragraph (a) of this section if in connection with such program a **prize** consisting of money or thing of value is awarded to any person whose selection is dependent in whole or in part upon **lot or chance**, if as a condition of winning or competing for such prize, such winner or winners are required to furnish (consideration) any money or thing of value or are required to have in their possession any product sold, manufactured, furnished or distributed by a sponsor of a program broadcast on the station in question. (See 18 U.S.C. 1304.)

Basically, it comes down to three elements, all of which must be present to constitute a lottery. These are: prize, consideration, and chance. As a broadcaster, you cannot broadcast a lottery or information about one.

Let's get back to that Indiana radio station and see how they were involved in a lottery.

This station broadcast information on a golf "contest". The listener could pick up a score card from a participating merchant, play 18 holes of golf on any course, have the professional at the course sign the scorecard, and mail it to the station. The winners were determined by having their cards drawn at random, without regard to the actual scores. The prizes were to total \$25,000.

Obviously, we have a prize offered. And there was chance, or lot, as the cards were drawn at random. But what about consideration?

This "contest" sounds safe enough, until we look for any possible qualification of consideration. If we go back to the contest requirements, we'll find that the listener had to play 18 holes of golf. And no course is going to let you play the holes for free! A green fee must be paid, and that amounted to consideration.

Unfortunately, there are further complications....other than fines. If we go back to that paragraph (a) mentioned earlier (under 73.122), we'll see why.

The Rule states: "An application for construction permit, license, renewal of license, or any other authorization for the operation of a broadcast station, will not be granted where the applicant proposes to follow or continue to follow

a policy or practice of broadcasting or permitting 'the broadcasting of any advertisement of or information concerning any lottery, gift enterprise, or similar scheme, offering prizes dependent in whole or in part upon lot or chance, or any list of the prizes drawn or awarded by means of any such lottery, gift enterprise, or scheme, whether said list contains any part or all of such prizes.' " Fortunately, the Rule continues by stating that the Commission will consider the facts in each case.

Check It Out

Naturally, the FCC expects you to know. If you have doubts about a proposed ad, call your FCC Field Office and ask them. And request a written answer. If the FCC sees a lottery in the offing, their written reply will: (1) show your integrity to the sponsor proposing the ad; (2) save you an awful lot of money; and (3) keep your record in good shape at renewal time.

By the way, you'll recall that the golf contest prize total was \$25,000. Actually, the figure was nearer \$6,000. So who can you trust? You might see the golf fees and you might not. But ask yourself what the merchants expect to get from the contest. In this case, it might well have been (1) to increase the course income from fees due to interest spurred by the contest, or (2) pro shops and sporting goods stores would get side effect business from the increased interest in golf, and it could have been (3) both of these.

Rocky Mountain Luck

On the other hand, not all lotteries come from outside sources. A Colorado station worked out a promotional scheme that went like this: Each letter of their call sign

Management Highlights

Here are two ways to lose money the hard way. But if you follow the article details, you avoid these pitfalls, and you will have a better record at renewal time.

Filmchain Projection Simplified



The new Bell & Howell Model 562 Optical/Magnetic Filmchain projector is delivered complete with a base which contains the projector controls and height adjustment to align the projector with TV camera or multiplexer. The projector is very much like the reliable 500 series design manual thread 16mm projector which is widely used in industry and education.

The Model 562 utilizes a synchronous motor, chain-driven film transport system including an automatic loop restorer to assist in providing picture and sound into the camera for transmission over closed circuit or antenna-signal distribution. The pedestal includes facility for easily installing remote operation from a control panel.

Other Features You'll Like

Optical or magnetic sound play back. Choose from a wide variety of standard lamps and Bell & Howell lenses to obtain the optimum lumen input to the camera. A special torque release lever is provided when using reels with small hubs.

Other Important Details

Projector reel arms are gear driven, which provides quiet, reliable operation and constant take-up torque. The "Stellite," 3-tooth shuttle and ground and polished aperture plate, provides careful film handling in the projector transport system.

Self-lubricated bearings and other fine engineering details provide long life. The 500 series product design is well known to the hundreds of Bell & Howell service stations across the country, providing a ready facility to service any projector when maintenance or repair is required.

A Final Thought

The instruction books and service manuals provide the details necessary for installation, both electrical and mechanical, as well as remote control. Contact Bell & Howell, Chicago, for technical literature and the name of the local sources who will help you select the best combination of lens, lamp and equipment to project 16mm films for TV program distribution or local display.

AUDIO VISUAL PRODUCTS DIVISION
7100 McCormick Road, Chicago, Illinois 60645



BELL & HOWELL

We simplify things. Life is complicated enough.

For More Details Circle (52) on Reply Card

New generation Strobe-Beacon meets all the latest FAA requirements... and then some.

The Dielectric Strobe-Beacon provides more than 200,000 candelas during the daytime, 16,000 candelas at twilight and 2,000 candelas at night, with automatic switching from one to the other guided by an extremely accurate and reliable calibrated photo cell. These amounts of luminous intensity conform exactly to the newest FAA standards.

Here are some of the extras you get from Dielectric — the people who specialize in high intensity warning systems for tall structures:

- Our control panel and power supply is in a convenient cabinet at ground level. All circuitry is solid state, of course, and is protected by lightweight but rugged and weatherproof housings.
- We offer a stand-by power supply and stand-by timer with automatic switch-over in case of failure.
- An optional remote control panel can be located at the studio which will indicate the mode of operation (daylight, twilight, night) as well as the type of failure, should there be one.

Free Brochure: We've just updated all technical literature. Like a copy? Circle our key number. Or, for a recommendation for your installation, including specifications and a price quote, write to Dielectric Communications, Raymond, Maine 04071 or phone (207) 655-4555.

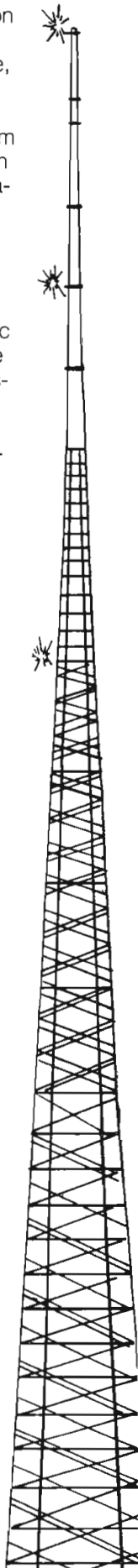

was printed on the bottom of cardboard pizza platters, and to win you must have a complete set of call sign letters. Only 30 platters were used for one of these letters, limiting the chance to win to that number.

With a Pizza Hut restaurant cooperating, it probably sounded like a fine promotional idea and a nice way to draw attention to the station's call letters. Of course the restaurant would benefit as well as the station.

But the Commission looked upon this as a lottery. Can you figure out why? Where are the basic elements? Prize, consideration, and chance?

Yes, prizes were given to 11 people who collected a complete set of pizza platters of the station call letters. **Consideration** was involved, because to compete, you must **buy** pizzas and take a **chance** on getting the complete set of letters.

The station contended that they did not "knowingly" broadcast a lottery. The Commission said that the station broadcast announcements of the contest and information on the prizes and the fact that one must buy a pizza to compete.

In this case, the station was fined \$500. And they were told that the low fine was based on the station's financial condition. Lottery fines usually start at \$1,000.

Excessive Power

Meanwhile, three stations have recently been fined from \$500 to \$1,000 for operating with excessive power. If you have your Rules handy, look this one up under 73.52(a).

In each case, the disturbing factors were that the logs showed operation with excessive power and that these violations were not for a few hours or for just a day or so. In other words, it's one thing to log readings, and it's quite something else to understand what the readings mean. Secondly, several consecutive days of operation with excessive power would seem to indicate that either no one at the station knew how to figure the power or there was a deliberate attempt to operate with excessive power.

We all know unfair inspections and a host of sometimes ridiculously interpreted Rules. But if you stop to think of what that inspecting engineer sees and must think in instances like these, you may come to understand why they are suspicious. But then, it should make you wonder about the relaxation of operator requirements. After all, even when it comes to figuring input and output power, the FCC expects you to know! □

BROADCAST Engineering Invites Your Comments And Your Ideas.

Address Correspondence To: 1014 Wyandotte Kansas City, Mo. 64105

Memo to Consulting Engineers

Broadcast Engineering's "Professional Services Section" is your most economical and effective way to display your Professional Card.

- **LOW MONTHLY RATES**
\$16 per monthly issue, 12 or more times
\$18.50 per monthly issue, 6-11 times
\$21 per monthly issue, 5 or less times
- **REACH ALL PROSPECTS**
Greater at-station circulation: FM, AM and educational radio; TV, ETV, CCTV and CATV; recording studios.
- **MORE AD SPACE**
Your Professional Card in BE is a full column wide!

Cablecasting Guidebook Available

The NCTA **Cablecasting Guidebook**, a 250-page compendium of cable television programming ideas, suggestions, and tips is now available.

The Guidebook includes programming information contributed by 178 large and small cable systems in 39 states and Canada. It contains descriptions of 525 program ideas actually used by cable operators.

The Guidebook, organized in loose leaf binder fashion, is available to NCTA members for \$15 per copy and to all others for \$30 per copy.

Included in the publication are entries under education, public access, community services, news, medical, sports, political programs, children's shows, entertainment, how-to-do-it and hobbies, and others. The Cablecasting Guidebook also includes listings of sources for free programs, program distributors, and a section on practical tips for setting up and managing a cablecasting operation.

The Guidebook was compiled by the NCTA staff under the direction of the association's Community Services Committee.

Orders, accompanied by check or money order, should be sent to Brian Owens, Cablecasting coordinator, NCTA, 918 16th St., NW, Wash. D.C.

"A Cable Television Profile, 1971-1972" (Technical Report No. T-7301), an analysis by the Technical Division of the Office of Chief Engineer of reports to the FCC by several thousand cable systems, may now be obtained from National Technical Information Service (NTIS), Port Royal Road, Springfield, Va. 22151.

The report had previously been available from the Technical Division.

The price is \$3.75 per copy for paper, and \$0.95 for microfiche.

Requests for orders should include the Report Number T-7301, PB221762, and title, "A Cable Television Profile, 1971-1972."

REQUIRE ACCURACY? ...THEN BUY BELAR MONITORS



The least you can afford is the best possible monitoring of your program material. The Belar TV Monitoring System (VHF or UHF) guarantees your getting what you need . . . accurately.

The Belar TVM-1 Modulation Monitor is the most accurate monitor available. Our advanced design starts where others leave off. TVM-1 Monitors both positive and negative modulation simultaneously and registers the higher of the two. Yes, it even tells you whether the modulation is positive or negative and calibration accuracy can be checked from the front panel modulation calibrator at any time.

The TVM-2 and TVM-3 Digital Frequency Monitors will measure TV visual carrier

and aural carrier independently or aural intercarrier. These monitors provide continuous monitoring with inhibited off-frequency alarm drivers, switch settable to either ± 500 or 1000 Hertz. It requires three successive errors to produce an alarm. This means no false alarms for you.

For remote control operations add the RFA-3 for off-air monitoring.

If your TV monitoring requirements include ease of operation, functional checks and ACCURACY, call or write today for more information. We know you'll make the right decision and BUY BELAR.

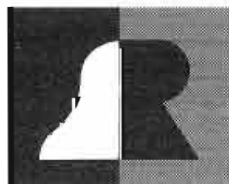

BELAR

ELECTRONICS LABORATORY, INC.

LANCASTER AVENUE AT DORSET, DEVON, PA. 19333
BOX 826 • (215) 687-5550

Where Accuracy Counts . . . Count On Belar

For More Details Circle (48) on Reply Card

WILKINSON HAS EVERYTHING

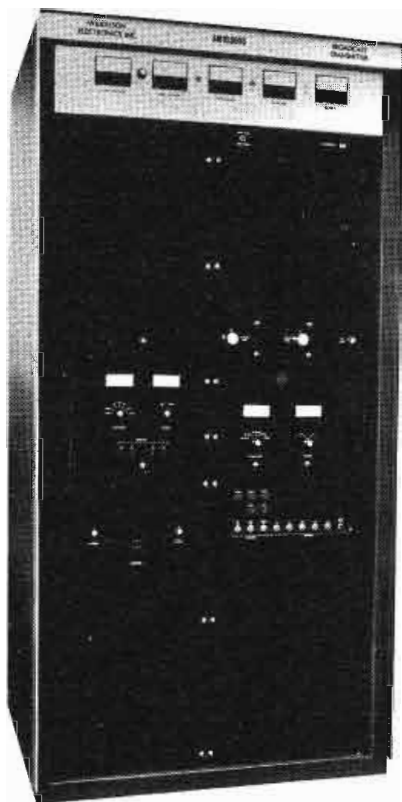

AM TRANSMITTERS - 250 W
1 KW - 5 KW - 10 KW - 50 KW

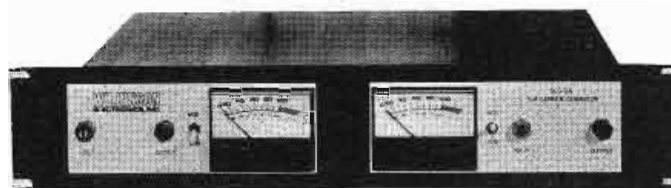

LIMITERS - Mono and Stereo

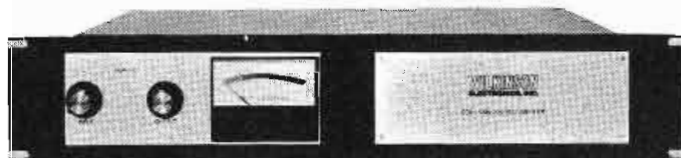

AGC AMPLIFIERS - Mono and Stereo



REMOTE AMPLIFIERS

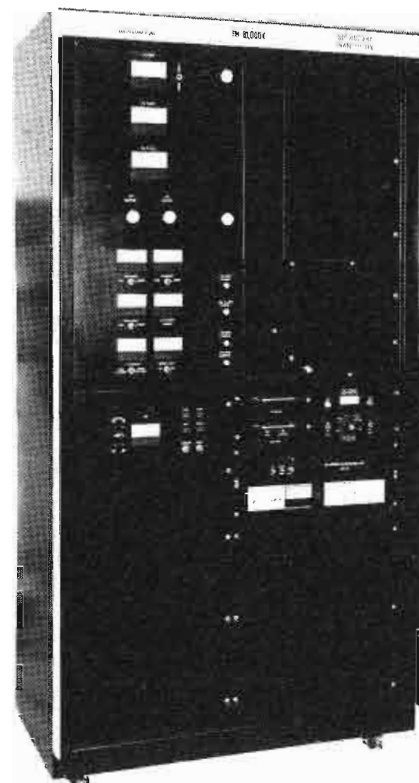

FM TRANSMITTERS 10W - 50W
250W - 1 KW - 2.5 KW - 5 KW
7.5 KW - 10 KW - 20 KW - 40 KW

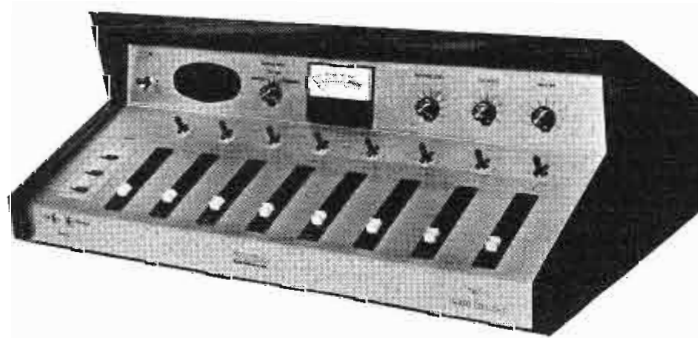

MONAURAL CONSOLES

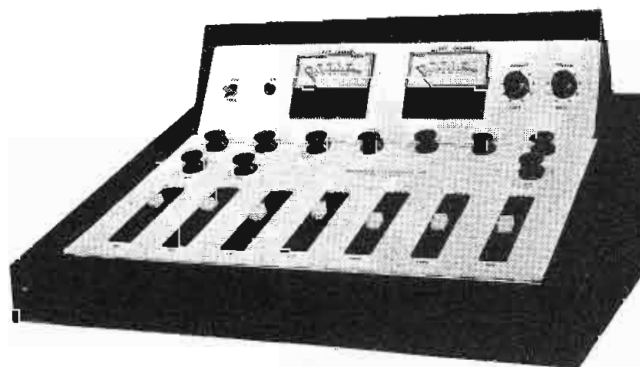

STEREO CONSOLES

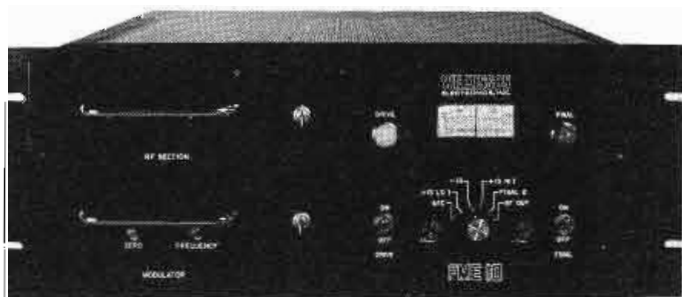

FM EXCITERS



STEREO GENERATORS

AND ALSO FROM WILKINSON . . . AM RF Amplifiers, line surge protectors, AM Monitors, field intensity meters, line amplifiers, monitor amplifiers, distribution amplifiers, FM receivers, antenna tuning units, phasers, dummy loads and silicon rectifiers.

WILKINSON
ELECTRONICS, INC.

1937 W. MacDADE BLVD., WOODLYN, PA. 19094

TELEPHONE (215) 874-5236/874-5237

For More Details Circle (49) on Reply Card

Manufacturer's Addresses

A

ABTO, Inc. 1926 Broadway New York N. Y. 10023
Accurate Sound Corp. Box 2159 Garland Tex. 75041
Acrodyne Industries 21 Commerce Drive Montgomeryville Pa. 18936
Admiral Corporation 3800 Cortland St. Chicago Ill. 60647
Advance Industries 2301 Bridgeport Drive Sioux City Ia. 51101
Advanced High Voltage Co., Inc. 14532 Arminta St. Van Nuys Calif. 91402
AEL Communications Corp., Subs. American Electronic Labs., Inc. Box 507 Lansdale Pa. 19446
Agfa-Gevaert Inc. 275 N. Street Teterboro N.J. 07608
Ailtech (Formerly: Microdot) 19535 E. Walnut Dr. City of Industry Calif. 91748
Air Space Devices Inc. Box 138 Paramount Calif. 90723
Aitken Communications Inc. 701 S. Tenth St. Taft Cal. 93268
Akai America, Ltd. 2139 East Del Amo Blvd. Compton Calif. 90220
AKG Division North Amer. Philips Corp. 100 East 42nd St. New York N.Y. 10017
Alco Electronic Products, Inc. 1551 Osgood St. North Andover Mass. 01845
Alcor Inc. 215 S. Tioga St. Ithaca N.Y. 14850
Alford Mfg. Co. 120 Cross St. Winchester Mass. 01890
A.L.I. Fire and Burglar Alarm Corp. Security Div. Box 775 Long Beach N. Y. 11561
Allen Avionics Inc. 255 E. 2nd St. Mineola N.Y. 11501
Allied Tower Company, Inc. Box 331 South Houston Tex. 77587
Alma Engineering Inc. 7990 Dagget St. San Diego Cal. 92111
Alpha Electronic Services Inc. 8431 Monroe Ave. Stanton Cal. 90680
Alpha Wire 711 Lidgerwood Ave. Elizabeth N.J. 07207
ALTEC 1515 S. Manchester Anaheim Cal. 92802
Alto Communications Inc. Broadcast Marketing Div. 6362 Hollywood Blvd. Hollywood Calif. 90028
Aluminum Hard Goods, Inc. Circle Ave. & Harrison St. Forest Park Ill. 60130
AMCO Engineering Co. 7333 W. Ainslie St. Chicago Ill. 60656
Ameco Inc. Box 13741 Phoenix Ariz. 85002
American Data Corp. an AIRPAX Company Box 5191 Huntsville Ala. 35805
American Electronics Lab., Inc. Box 552 Lansdale Pa. 19446
American Electronics, Inc. Box 458 Saint George S. C. 29477
American Pamcor Valley Forge Pa. 19481
American-Standard Industrial Products Div. 8111 Tireman Ave. Dearborn Mich. 48126
AMF Electrical Products Development Division 1025 N. Royal Street Alexandria Va. 22314
Amperex Corp. 75 Commerce Way Hackensack N.J. 07601
Amperex Electronic Corp. Electro-Optical Devices Div. Box 278 Slatersville R. I. 02876
Amperex Electronic Corp. 230 Duffy Ave. Hicksville N. Y. 11802
Ampex Corp. Audio-Video Systems Division 401 Broadway Redwood City Cal. 94063
Amphenol RF Division 33 E. Franklin St. Danbury Conn. 06810
Ampro Corp. 2220 Maplewood Ave. Willow Grove Pa. 19090
Anaconda Electronics 305 N. Muller St. Anaheim Cal. 92801
Ancha Electronics Inc. 370 W. Bennett Rd. Elk Grove Village Ill. 60007
Andrew Corp. 10500 W. 153rd St. Orland Park Ill. 60462
Andrews Tower Inc. 1420 Layton Ave. Ft. Worth Tex. 76117
Angenieux Corp. of America 440 Merrick Rd. Oceanside N.Y. 11572
Anixter-Pruzan CATV Division 1963 First Ave. Seattle Wash. 98134
Antenna Products Company Box 520 Mineral Wells Tex. 76067
Applied Electro Mechanics, Inc. 2350 Duke St. Alexandria Va. 22314
Applied Video Electronics, Inc. Box 25 Brunswick Ohio 44212
A&R Transmitters 705 Haverford Road Bryn Mawr Pa. 19010
Arriflex Company of America 25-20 Brooklyn-Queens Expwy. W. Woodside N.Y. 11377
Arvin Systems, Inc. 1771 Springfield St. Dayton Ohio 45403
Astrocom Electronics, Inc. Box 370 Oneonta N. Y. 13820
A-Tel-A-Matic 406 Jamestown Rd., Edgewater Park Beverly N.J. 08010
Atlantic Research Corp. Teleproducts Dept. 5390 Cherokee Ave. Alexandria Va. 22314
ATLAS Sound 10 Pomeroy Rd. Parsippany N.J. 07054
ATV Research 13th & Broadway Dakota City Neb. 68731
Audio Accessories Inc. 163 Water Street Keene, N.H. 03431
Audio Designs & Mfg. 16005 Sturgeon Roseville Mich. 48066
Audio Devices, Inc. 100 Research Drive Glenbrook Conn. 06906
Audio Distributor Inc. 2342 S. Division Ave. Grand Rapids Mich. 49507

Audio Engineering Co. 4112 Oak Lane Gary Ind. 46408
Audio Interface Systems, Inc. 2708 Fifth Ave. S. Irondale Ala. 35210
Audio Magnetics Corp. 14600 S. Broadway Gardena Cal. 90248
Audio Services, Inc. 26935 W. Eleven Mile Rd Southfield Mich. 48076
Audiotronics Corp. 7428 Bellaire Ave. North Hollywood Calif. 91605
Audio-Video Engineering Co. 65 Nancy Blvd. Merrick N. Y. 11566
Austin Insulator Div. Decca Radar Canada (1967) Ltd. 71 Selby Road Brampton Ont., Canada L6W 1K5
Autogram Corporation Box 456 Plano Tex. 75074
Automation Products Co. (International Industries, Inc.) Box 9882 Austin Tex. 78766
AVA Electronics Corp. 242 Pembroke Ave. Lansdowne Pa. 19050

B

Badger Meter, Inc. Electronics Div. 150 E. Standard Ave. Richmond Calif. 94804
Bailey Meter Company Subs. Babcock & Wilcox Co. 29801 Euclid Ave. Wickliffe Ohio 44092
Ball Bros. Research Corp. Miratel Division 1633 Terrace Drive St. Paul Minn. 55113
Bardwell & McAlister Div. of F & B/Ceco Industries 7269 Santa Monica Blvd. Hollywood Calif. 90046
Barker & Williamson, Inc. Canal St. Bristol Pa. 19007
Arnold Barnes Company 7616 LBJ Freeway, Suite 501 Dallas Tex. 75240
Beau Motor Division U.M.C. Electronics Co. 460 Sackett Point Rd. North Haven Conn. 06473
Belar Electronics Lab., Inc. Lancaster Avenue at Dorset Devon Pa. 19333
Belcom Electronics Mfg. Co. Box 267 Bellbrook Ohio 45305
Belden Corp. Electronic Division Richmond Ind. 47374
Bell & Howell Consumer Products Group 7235 N. Linder Ave. Skokie Ill. 60076
Bell P/A Prod. Corp. 1200 N. Fifth St. Columbus Ohio 43201
Bell Sound Studios Electro Sound Div. 237 West 54th St. New York N.Y. 10019
Berkey-Colortran Inc. 1015 Chestnut St. Burbank Cal. 91502
Beston Electronics Inc. No. 20 On The Mall Prairie Village Kans. 66208
Bethany International 5750 Bintliff Suite 201 Houston Tex. 77036
Beyer (Revox Corporation) 155 Michael Dr. Syosset N.Y. 11791
B & I Electronics, Inc. 128 Donaldson Center Greenville S. C. 29604
Bird Electronic Corp. 30303 Aurora Road Cleveland Ohio 44139
Birmingham Tape Cartridge Co., Inc. Box 217 Pinson Ala. 35126
Birnbach Co. Inc. P.O. Box 592 Freeport N.Y. 11520
B & K Instruments Inc. 5111 W. 164th St. Cleveland Ohio 44142
Blanchard Electronics Box 5 Kenansville N. C. 28349
Blonder-Tongue Labs. One Jake Brown Rd. Old Bridge N.J. 08857
Bogen Division Lear Siegler Inc. Box 500 Paramus N. J. 07652
Bogner Broadcast Equipment Corp. 99 W. Hawthorne Ave. Valley Stream N. Y. 11580
Boonton Electronics Rt. 287 Smith Rd. Parsippany N.J. 07054
Borg-Warner Corp. Ingersoll Prods. Div. 1000 W. 120th St. Chicago Ill. 60643
Boston Insulated Wire & Cable Co. 65 Bay St. Boston Mass. 02125
Bourns, Inc. BPMC Division 28151 Highway 74 Romoland Calif. 92380
Bradford Information Systems Box 65 Pompano Beach Fla. 33061
Brand-Rex Company Box 498 Williamantic Conn. 06226
Bristol Div. of Acco 40 Bristol St. Waterbury Conn. 06720
Broadcast Electronics 8810 Brookville Road Silver Spring Md. 20910
Broadcast Equipment Leasing Corp. Div. Anchor Leasing Corp. Grant Bldg. Pittsburgh Pa. 15219
Broadcast Prod. Co. Inc. Bcst. Division 3814 Everett St. Kensington Md. 20795
Broadcast Products Inc. 660 Lofstrand Lane Rockville Md. 20850
Broadcast Tower Service Box 448 Sioux Falls S. D. 57101
BSC Incorporated 8600 W. Sunnyside Ave. Chicago Ill. 60656
Bud Radio Inc. 4605 E. 355th St. Willoughby Ohio 44094
Bulova American Time Products 61-20 Woodside Ave. Woodside N.Y. 11377
Burke & James 333 W. Lake St. Chicago Ill. 60606
Burwen Laboratories 209 Middlesex Turnpike Burlington Mass. 01803

C

Cablewave Systems Inc. Subs. Phelps Dodge and Kabelmetal 60 Dodge Ave. North Haven Conn. 06473
California Instruments Co. 5150 Convooy St. San Diego Cal. 92111
Calvert Electronics Power Tube Div. 220 East 23rd St. New York N. Y. 10010

Camera Mart Inc. 456 West 55th St. New York N. Y. 10019
Canon USA, Inc. Optics Division 10 Nevada Drive Lake Success N. Y. 11040
Catel, a Div. of United Scientific Corp. 1030 W. Evelyn Ave. Sunnyvale Cal. 94086
CATV Equipment Co. 148D Mitchell Blvd. San Rafael Cal. 94903
CBS Labs 227 High Ridge Rd. Stamford Conn. 06905
CCA Electronics Corp. 716 Jersey Ave. Gloucester N.J. 08030
CCA RF Industries, Inc. Box 315 Westfield Mass. 01085
C-COR Electronics, Inc. 60 Decibel Road St. College Pa. 16801
Ceco Communications Inc. 2115 Avenue X Brooklyn N.Y. 11235
Central Dynamics Corp. 230 Livingston St. Northvale N.J. 07647
Century Strand, Inc. 5432 W. 102nd St. Los Angeles Calif. 90045
Cetec Inc. Subs. Computer Equipment Corp. 13035 Saticoy St. North Hollywood Calif. 91605
Channellock, Inc. S. Main St. Meadville Pa. 16335
CHESTER ELECTRONIC LABS., INC. GTE Information Systems Inc. Winthrop Road Chester Conn. 06412
Chiron Telesystems Systems Resources Corp. 223 Newtown Road Plainview N. Y. 11803
Christie Electric Corp. 3410 W. 67th St. Los Angeles Cal. 90060
Chrono-Log Corp. 2583 W. Chester Pike Broomall Pa. 19008
Cine Sonic Sound Inc. Box 996 New York N.Y. 10001
Clear-Corn Div. of Lumiere Productions, Inc. 759 Harrison St. San Francisco Calif. 94107
Cleveland Electronics, Inc. 17877 St. Clair Ave. Cleveland Ohio 44110
CMX Systems 635 Vaqueros Ave. Sunnyvale Calif. 94086
The CnB Studios 3415 Beresford Ave. Belmont Calif. 94002
Cohu, Inc. Electronics Division Box 623 San Diego Cal. 92112
Collins Radio Company Broadcast Division Building 406 Dallas Tex. 75207
Colorado Crystal Corp. 2303 West 8th St. Loveland Colo. 80537
Colorado Video Inc. Box 928 Boulder Colo. 80302
Columbia Broadcast Services Box 822 American City Bldg. Columbia Md. 21044
Columbia Electronic Cbl. 11 Cove St. New Bedford Mass. 02744
Comark Industries Inc. Box 196 Westfield Mass. 01085
Commercial Elect. 880 Maude Ave. Mountain View Calif. 94040
Comm. Radio Monitoring 103 S. Market Lee's Summit Mo. 64063
Comm/Scope Company Box 2406 Hickory N.C. 28601
Communication Medias Box 54 Allentown Pa. 18105
Compu/Net, Inc. 747 E. Green St. Pasadena Cal. 91101
Computer Image Corp. 933 N. LaBrea Los Angeles Cal. 90038

Computer Magnetics Corp. 6060 Shull St. Bell Gardens Calif. 90201
Comquip, Inc. 366 S. Maple Ave. Glen Rock N.J. 07452
Concept 70, A Div. of Dyma Engineering, Inc. Route 1 Box 51 Taos N. M. 87571
Conrac Corporation Cramer Division Mill Rock Road Old Saybrook Conn. 06475
Conrac Div. Conrac Corp. 600 North Rimsdale Ave. Covina Calif. 91722
Consolidated Video Systems 3300 Edward Ave. Santa Clara Calif. 95050
Contel Mfg. Div. of Continental Electronic Wholesale Corp. 1620 W. 32nd Place Hialeah Fla. 33012
Contender Corporation Box D Woodland Calif. 95695
Continental Electronics Mfg. Co. Box 17040 Dallas Tex. 75217
Control Concepts Corporation 411 N. Stonestreet Ave. Rockville Md. 20850
Conway Electronic Enterprises Limited 88-90 Arrow Rd. Weston Ont., Canada
Cook Electric Co. 6201 Oakton St. Morton Grove Ill. 60053
Cooke Engineering Co. 900 Slaters Lane Alexandria Va. 22314
Cosmicar Optical Co., Ltd. 424 Higashi-Oizumimachi, Nerima-ku Tokyo 177 Japan
Cramer Video and Audio Systems 120 Hampton Ave. Needham Heights Mass. 02194
Crown International Box 1000 Elkhart Ind. 46514
Cunningham Corp. Subs. of Gleason Works 10 Carriage St. Honeoye Falls N.Y. 14472
Custom Craft Designs 2135 Drexel St. West Hyattsville Md. 20783

D

Danscoll Ltd. 9721 Cote de Liesse Montreal 760 Que., Canada
Data Disc Inc. 686 W. Maude Ave. Sunnyvale Cal. 94086
Datapulse Div. of Systron-Donner 10150 Jefferson Culver City Cal. 90230
Datatek Corp. 1200 W. Chestnut St. Union N. J. 07083
Datatron, Inc. 1562 Reynolds Ave. Santa Ana Cal. 92707
Datavision, Inc. 15932 Shady Grove Rd. Gaithersburg Md. 20760
David Clark Co., Inc. 360 Franklin St. Worcester Mass. 01604
Davis & Sanford Co. Inc. 24 Pleasant St. New Rochelle N.Y. 10802
Defense Electronics Rockville Md. 20850
Delta-Benco-Cascade Ltd. 124 Bel- field Rd. Rexdale Ont., Canada M9W 1G1
Delta Electronics Inc. (N.C.) 145 Fayette St. Winston Salem N.C. 27101
Delta Electronics Inc. (Va.) Box 1508 Springfield Va. 22151
Delta Products, Inc. Box 1147 Grand Junction Colo. 81501

Denrad Mfg. Co. Inc. Drawer 326 Denison Tex. 75020
Denson Electronic Corp. P.O. Box 85, Longview Street Rockville Conn. 06066
Diamond Power Specialty Corp. Subs. Babcock & Wilcox Co. P.O. Box 415 Lancaster Ohio 43130
Diebold Incorporated 818 Mulberry Rd. SE Canton Ohio 44711
Dielectric Communications Div. of Sola Basic Route 121 Raymond Me. 04071
Display Systems Corp. 300 N. Griggs Midway Bldg., 1821 University Ave. W. St. Paul Minn. 55104
Ditch Witch Div. of Charles Machine Works, Inc. 100 Ash Street Perry Okla. 73077
Diversified Products Inc. 7625 E. 46th Place Tulsa Okla. 74145
D. N. Latus & Co., Inc. Airport Road Helena Mont. 59601
Dorado Systems 20698 Corsair Blvd. Hayward Calif. 94545
Dranetz Engineering Labs., Inc. 2385 S. Clinton Ave. South Plainfield N. J. 07080
D AND S CORLEY LIMITED 80 Galaxy Blvd. Rexdale, Ont. Canada
Duncan Electronics, Inc. 2865 Fairview Road Costa Mesa Cal. 92627
Duotone Co. Inc. Box 1168 South Miami Fla. 33134
Dyma Engineering, Inc. Route 1 Box 51 Taos N. M. 87571
Dynacool Mfg. Co., Inc. 1 Russell St. Saugerties N.Y. 12477
DYNAIR Electronics, Inc. 6360 Federal Blvd. San Diego Cal. 92114
Dynascan Corp. B & K Division 1801 W. Belle Plaine Ave. Chicago Ill. 60613
Dynasciences Corp. Video Products Div. Township Line Road Blue Bell Pa. 19422

E

Eastcoast Camera Center, Inc. 248 Lafayette St. New York N. Y. 10012
Eastman Kodak Co. 343 State St. Rochester N.Y. 14650
Econco Broadcast Service Inc. Rt. 2 Box 188 Woodland Calif. 95695
Edison Electronics, Div. of McGraw-Edison Co., Daven & Measurements Grenier Field Manchester N.H. 03103
Editel Productions 5610 Bois Franc Montreal 386 Que., Canada
Edwards Company, Inc. 90 Connecticut Ave. Norwalk Conn. 06856
Eico Elect. Inst. Co., Inc. 283 Malta Street Brooklyn N.Y. 11207
Eidson Electronic Co. Box 96 Temple Tex. 76501
EiE-Electronic Industrial Engineering A Division of RCA 7355 Fulton Ave. North Hollywood Calif. 91605
Eimac Div. Varian Associates 301 Industrial Way San Carlos Cal. 94070
Elektromesstechnik E M T Wilhelm Franz G M B H 5430 Wettingen (AG) Switzerland
Electrohome Ltd. 809 Wellington St. N. Kitchener Ont., Canada N2G 4J6

Electro Impulse, Inc. 116 Chestnut St. Red Bank N.J. 07701
Electromagnetic Sciences, Inc. Box 80508 - Chamblee Atlanta Ga. 30341
Electromagnetic Specialties 2417 Spring Hill Dr. Dallas Tex. 75228
Electronic Designers Inc. 84 Newtown Plaza Plainview N.Y. 11803
Electronic Engineering Co. of California 1441 E. Chestnut Ave. Santa Ana Calif. 92701
Electronic Inst. & Spec. 42 Pleasant St. Stoneham Mass. 02180
Electronic Lights Inc. 1701 N. Ashland Ave. Chicago Ill. 60622
Electronic Systems Engrg. Co. 120 1/2 N. Cleveland Cushing Okla. 74023
Electro-Voice Inc. Subs. of Gulton Industries, Inc. 639 Cecil St. Buchanan Mich. 49107
ELPA Marketing Industries, Inc. New Hyde Park N. Y. 11040
EMCEE Broadcast Products Div. of Electronics, Missiles & Communications, Inc. P.O. Box 116 White Haven Pa. 18661
Emerson Elec./Artolier Lighting & Sound Rittenhouse Div. Quaker Mtg. House Rd. Honeoye Falls N.Y. 14472
Enclosure Corp. 1701 Industrial Blvd. Pennsauken N.J. 08110
Engineering Associates R. R. 2 Arcanum Ohio 45304
Enterprise Electronics Corp. Box 1216 Enterprise Ala. 36330
Entron, Inc. 70-31 84th St. Glendale N. Y. 11227
Envirco Box 6468 Albuquerque N. M. 87107
Equipto 225 S. Highland Aurora Ill. 60507
ES Enterprises 10418 S. La Cienega Blvd. Inglewood Calif. 90304
ESC Electronics Corp. 534 Bergen Blvd. Palisades Park N. J. 07650
Essex International Inc. Communication & CATV Div. 6235 S. Harlem Ave. Chicago Ill. 60638
Essex International Inc. RBM Div. 131 Godfrey St. Logansport Ind. 46947
Eventide Clock Works Inc. Broadcast Products Div. 265 West 54th St. New York N. Y. 10019
E Z Way Prod. Inc. Box 17196 Tampa Fla. 33612

F

Fairchild/Robbins Fairchild Sound Equipment Corp. 75 Austin Blvd. Commack N. Y. 11725
F&B/Ceco Industries, Inc. 315 West 43rd St. New York N.Y. 10036
Feller Vacuum Form Studios 383 Canal Place Bronx N. Y. 10451
Fidelipac Division TelePro Industries, Inc. 3 Olney Ave. Cherry Hill N. J. 08034
Filmline Corp. 43 Erna Street Milford Conn. 06460
Fisher Berkeley Corp. 5800 Christie Ave. Emeryville Cal. 94608
Fluke, John, Mfg. Co. Inc. Box 7428 Seattle Wash. 98133

Fort Worth Tower Co., Inc. 5201 Bridge St., Box 8597 Ft. Worth Tex. 76112
Franz Vertriebs-gesellschaft m.b.H. POB 1520 D-763-Lahr-1 West Germany
Freeland Products Co. 3233 Conti St. New Orleans La. 70119
Fung Engineering Co. 111 Glenn Way Belmont Calif. 94002

G

GAF Corp. 140 W. 51 Street New York N.Y. 10020
Gately Electronics 57 W. Hillcrest Ave. Haverstown Pa. 19083
Gates Division of Harris-Intertype 123 Hampshire Street Quincy Ill. 62301
GBC Closed Circuit TV Corp. 74 Fifth Ave. New York N.Y. 10011
G.C. Electronics 400 S. Wyman St. Rockford Ill. 61101
General Cable Corp. 730 Third Ave. New York N.Y. 10017
General Devices Co., Inc. Vent-Rak Div. 525 S. Webster Ave. Indianapolis Ind. 46219
General Electric Co. Imaging Devices Operation Electronics Pk. Bdg. 6 Syracuse N. Y. 13201
General Electric Co. Mobile Radio Dept. Box 4197 Lynchburg Va. 24502
General Electric Company Tubes/MW Devices 316 E. Ninth St. Owensboro Ky. 42301
Gen. Electrodynamics 4430 Forest Lane Garland Tex. 75040
General Microwave Corp. 155 Marine St. Farmingdale N.Y. 11735
General Radio Co. 300 Baker Ave. Concord Mass. 01742
General Television Ntwk. 520 W. Eight Mile Rd. Ferndale Mich. 48220
General Time Service A Talley Industries Co. Box 4067 Mesa Ariz. 85201
Gibbs Mfg. & Research Co. 450 N. Main St. Janesville Wis. 53545
Gilbert Engineering Co. 3700 N. 36th St. Phoenix Ariz. 85019
Gotham Audio Corp. 741 Washington St. New York N.Y. 10014
Gould Inc. Instrument Systems Div. 3631 Perkins Ave. Cleveland Ohio 44114
GPL Div. Singer Gen. Pleasantville N.Y. 10570
Granger Assoc. 1601 California Ave. Palo Alto Cal. 94306
Grass Valley Group, Inc. P.O. Box 1114 Grass Valley Cal. 95945
Greenlee Tool Co. 2136 12th St. Rockford Ill. 61101
Grinnan Fixture Co. 16041 Georgetown St. N.E. Minerva Ohio 44657
GTE Lenkurt Incorporated 1105 County Road San Carlos Calif. 94070
GTE Sylvania Inc. Lighting Products Group 100 Endicott St. Danvers Mass. 01923
Gulf Telephone & Electronics Box 42130 Houston Tex. 77027
Gulton Industires, Inc. Recorder Systems Div. Route 2 & Middle Rd. East Greenwich R.I. 02818

H

Hannay Reels Clifford B. Hannay & Son Inc. 402 Main St. Westerlo N.Y. 12193
Hartley Prod. Corp. Barnert Place Ho Ho Kus N.J. 07423
Harwald Company 4900 Madison St. Skokie Ill. 60076
Harwood Mfg. Co. 1800 W. Fullerton Chicago Ill. 60614
Head Sound, Inc. 722 Brooks St. Ann Arbor Mich. 48103
Heath Co. Benton Harbor Mich. 49022
Heintz and Kaufman Ltd. 3650 Hayden Ave. Culver City Cal. 90230
Hewlett Packard Co. 1501 Page Mill Rd. Palo Alto Cal. 94304
Hickok Elect. Instrument 10514 Dupont Ave. Cleveland Ohio 44108
Hitachi Shibaden Corp. of America 58-25 Brooklyn Queens Exp. Woodside N.Y. 11377
Hokushin Elect. Co. 3-30-1, Shimomaru Ohta-ku, Tokyo Japan
Holland Electronics 842 East 94th St. Brooklyn N. Y. 11236
Hollingsworth Solderless Terminal Co. Nutt & French Creek Rds. Phoenixville Pa. 19460
Honeywell Inc. Test Instruments Div. 4800 E. Dry Creek Rd. Denver Colo. 80217
Hughes Aircraft Company Ind. Prod. Div.-Image Devices 2020 Ocean-side Blvd. Oceanside Calif. 92054
Hughey & Phillips Inc. 3050 N. California St. Burbank Cal. 91505
Hunt Chemical Corp., Philip A. Roosevelt Place Palisades Park N.J. 07650
Hy-Power Electronics Co. Box 38367 Dallas Tex. 75238

I

IGM Box 943, 3950 Home Rd. Bellingham Wash. 98225
Ikegami Tsushinki Co., Ltd. Export Department 1-11-1 Motoki, Kawasaki-ku Kawasaki-shi Kanagawa, Japan
Image Devices Incorporated Box 38-517 Miami Fla. 33138
Industrial Electric Reel 1509 Chicago St. Omaha Neb. 68102
Innovative Television Equipment, Inc. P.O. Box 681 Woodland Hills Cal. 91364
Inovonics 1630 Dell Ave. Campbell Calif. 95008
Instrument Laboratories 315 W. Walton Place Chicago Ill. 60610
Integral Data Devices Inc. 46 S. Bayles Ave. Port Washington N. Y. 11050
International Instrument Div. Sigma Instruments, Inc. 88 Marsh Hill Rd. Orange Conn. 06477
Interntl. Nuclear Corp. 608 Norris Ave. Nashville Tenn. 37204
International Tapetronics Corp. Box 241 Bloomington Ill. 61701
International Video Corp. 990 Al-manor Ave. Sunnyvale Cal. 94086
International Wire & Cable Co. 3500 McCart Fort Worth Tex. 76110

Irish Magnetic Recording Tape Div. Morhan Nat'l. Sales Co. Inc. 270-78 Newtown Road Plainview N. Y. 11803
ITT Electron Tube Div. Box 100 Easton Pa. 18042
ITT Electro-Optical Products Div. Box 7065 Roanoke Va. 24019
ITT General Controls 801 Allen Ave. Glendale Calif. 91201
ITT Jennings 970 McLaughlin Ave. San Jose Cal. 95116

J

Jamieson Film Co. 9171 King Arthur Drive Dallas Texas 75247
Jampro Antenna Co. Div. of Computer Equipment Corp. 6939 Power Inn Road Sacramento Cal. 95828
Janson Industries Box 8110 Canton Ohio 44711
Javelin Div. of Apollo Lasers 6357 Arizona Circle Los Angeles Calif. 90045
Jensen Sound Laboratories Div. Pempcor, Inc. 4310 Trans World Road Schiller Park Ill. 60146
Jensen Tools & Alloys 4117 N. 44th St. Phoenix Ariz. 85018
Joa Cartridge Service Box 7112 Philadelphia Pa. 19117
Johnson Electronics, Inc. P.O. Box 7 Casselberry Fla. 32707
Jones Int'l. Ltd. 880 Continental Bank Bldg. Englewood Colo. 80110
Jos. Schneider & Co. Optische Werke Div. P.O. Box 947 6550 Bad Kreuznach West Germany
Joslyn Electronic Sys. Box 817 Goleta Cal. 93017
Jud Williams Company Box 671 Winter Haven Fla. 33880

K

Kahn Research Lab. Inc. 966 Brush Hollow Road Westbury N.Y. 11590
Kaitronics Corporation Box 556 Belmont Calif. 94002
Kalart Victor Corp. Hultenius St. Plainville Conn. 06062
Kappa Networks, Inc. 165 Rosevelt Ave. Carteret N.J. 07008
Karex, Inc. Subs. of Rohm and Haas Co. 1262 Lawrence Station Rd. Sunnyvale Cal. 94086
Karg Laboratories, Inc. 44 N. Main St. South Norwalk Conn. 06854
Kato Engineering Co. 1415 First Ave. Mankato Minn. 56001
Kay Elemetrics Corp. 12 Maple Ave. Pine Brook N.J. 07058
Kenwood Electronics, Inc. 15777 S. Broadway Gardena Calif. 90248
Kliegl Bros. Lighting 32-32 48th Ave. Long Island City N.Y. 11101
Kline Iron & Steel Co. Tower Division Box 1013 Columbia S.C. 29202
Koss Corp 4129 N. Port Washington Ave. Milwaukee Wis. 53212
K'SON Corporation 250 E. Emerson Ave. Orange Calif. 92665

L

Lamb Laboratories 155 Michael Dr. Syosset N. Y. 11791
Lampkin Lab. Inc. Box 2048 Bradenton Fla. 33506
Lang Electronics Inc. 14 E. 39th St. New York N.Y. 10016
Lauderdale Electronic Labs 16 S.W. 13th St. Fort Lauderdale Fla. 33315
Leader Instruments Corp. 37-27 27th St. Long Island City N.Y. 11101
Lelectronic Res. Labs. Inc. 1423 Ferry Ave. BE Camden N.J. 08104
Lectrotech Inc. 5810 N. Western Ave. Chicago Ill. 60659
Lenco Inc. Electronics Division 319 W. Main St. Jackson Mo. 63755
Lenzar Optics Corp. 636 N. Federal Hwy. North Palm Beach Fla. 33408
Lerro Electrical Corp. 3125 N. Broad St. Philadelphia Pa. 19132
Liberty Industries 598 Deming Road Berlin Conn. 06037
LightNing Elimination Associates 9102 Firestone Blvd. Downey Calif. 90241
Lipps Inc. 1630 Euclid St. Santa Monica Cal. 90404
Lipsner-Smith Corp. 6735 N. Honore St. Chicago Ill. 60626
Listec TV Equip. Corp. 35 Cain Dr. Plainview N.Y. 11803
Logiconcepts, Inc. 3831 Catalina St. Los Alamitos Calif. 90720
The London Company 811 Sharon Drive Cleveland Ohio 44145
LPB Inc. 520 Lincoln Hwy. Frazer Pa. 19355
L-W Photo, Inc. 15451 Cabrito Road Van Nuys Cal. 91406

M

MacCarta 709 Railroad Ave. West Des Moines Iowa 50265
Machlett Laboratories Subs. of Raytheon Co. Inc. 1063 Hope St. Stamford Conn. 06907
MacKenzie Laboratories, Inc. 5507 N. Peck Road Arcadia Calif. 91006
Magnatech Corporation 3601 Park Center Blvd. Minneapolis Minn. 55416
Magna-Tech Electronic Co., Inc. 630 Ninth Ave. New York N.Y. 10036
Magnavox Company CATV Division 100 Fairgrounds Dr. Manlius N. Y. 13104
Magnecraft Electric Co. 5575 N. Lynch Ave. Chicago Ill. 60630
Magnetic Prod. Div. 3M Company 3M Center St. Paul Minn. 55101
Magnusonics Devices Inc. 124 Duffy Ave. Hicksville N.Y. 11801
P. R. Mallory & Co. Inc. Mallory Distributor Products Co. Box 1284 Indianapolis Ind. 46201
Marathon Broadcast Equip. 3 Electronics Ave. Danvers Ind. Pk. Danvers Mass. 01923
Marco Video Systems, Inc. 6114 North. 20th St. Philadelphia Pa. 19138
Marconi Electronics Inc. 500 Executive Blvd. Elmsford N.Y. 10523

Marconi Instruments 111 Cedar Lane Englewood N.J. 07631
Martel Electronics Inc. 2339 S. Cotner Ave. Los Angeles Calif. 90064
Marti Electronics P.O. Box 661, 1501 N. Main St. Cleburne Tex. 76031
Marubeni America Corp. Miida Electronics 2 Hammaraskjold Plaza New York N. Y. 10017
Mastertone Company 1105 Maple West Des Moines Iowa 50265
Matrix Systems Corp. 20426 Corisco St. Chatsworth Cal. 91311
Maze Corporation Box 6636 Birmingham Ala. 35210
McBee Laboratories 5151 Wisconsin Ave. NW Washington D. C. 20016
McCurdy Radio Ind. Inc. 1051 Clinton St. Buffalo N.Y. 14206
McMartin Industries 4500 South 76th St. Omaha Neb. 68127
Mediatech 824 Busse Highway Park Ridge Ill. 60068
Melcor Electronics Corp. 1750 New Highway Farmingdale N.Y. 11735
Memorex Corporation Audio-Video Group 1200 Memorex Drive Santa Clara Cal. 95052
Mercury Electronics 315 Roslyn Road Mineola N.Y. 11501
Metron Instruments 1051 S. Platte River Dr. Denver Colo. 80223
Michigan Magnetics 203 W. Third St. Vermontville Mich. 49096
Micro Communications, Inc. RFD 3, Grenier Field Manchester N.H. 03103
Microflect Co. Inc. 3575 25th St. S.E. Salem Ore. 97302
Micro-Trak Corporation (Formerly: Gray Research & Dev.) 620 Race St. Holyoke Mass. 01040
Microwave Assoc. Inc. South Ave., NW Industrial Prk. Burlington Mass. 01803
Miles Reproducer Co. 598 Broadway New York N.Y. 10012
Miller-Stephenson Chemical Co. Box 628 Danbury Conn. 06810
Minarik Elect. 224 E. Third St. Los Angeles Cal. 90013
Mincom Div. 3M Co. 300 South Lewis Rd. Camarillo Cal. 93010
MINNEAPOLIS MAGNETICS, INC. 8125 Pleasant Ave. S. Minneapolis Minn. 55420
Minnesota Mining & Mfg. Co. 3M Center St. Paul Minn. 55101
Modern Video Engineering Co. 1781 Fifth Street Muskegon Mich. 49440
Mole Richardson Co. 937 N. Sycamore Ave. Hollywood Cal. 90038
Moseley Assoc. Inc. 111 Castilian Drive Goleta Cal. 93017
Mosler Electronic Systems Div. 9 South St. Danbury Conn. 06810
Motorola Semiconduct Motorola Inc. 5005 E. McDowell Rd. Phoenix Ariz. 85008
Mountain West Alarm 4215 North 16th St. Phoenix Ariz. 85016
Multimetrix Industries Div. of Comstron Corp. 120-30 Jamaica Ave. Richmond Hill N.Y. 11418
Multronics, Inc. 12307 Washington Ave. Rockville Md. 20852

N

Nagra Magnetic Recorders, Inc. 19 W. 44th St. New York N.Y. 10036
Narda Microwave Corp., The 75 Commercial St. Plainview N.Y. 11803
Nasco Television Systems 947 Janesville Ave. Fort Atkinson Wis. 53538
National Electrolab Ltd. Box 68 Blaine Wash. 98230
Nemo Recording Labs Box 505 Times Sq. Sta. New York N.Y. 10036
Neumade Prod. Corp. 720 White Plains Rd. Scarsdale N.Y. 10583
Neve Inc., Rupert Berkshire Industrial Park Bethel Conn. 06801
Norelco, Philips Bcst. Equip. Corp. Subs. North American Philips Corp. One Philips Prkwy. Montvale N. J. 07645
North Amer. Electronics 723 Third Ave. West Birmingham Ala. 35204
North American Radio Corp. 3814 Marquis Dr., Suite 111 Garland Tex. 75042
Northlake Engineering, Inc. 999 Anita Ave. Antioch Ill. 60002
Norton Assoc. Inc. 10 Ditomas Court Copague N.Y. 11726
Nortronics Co., Inc. Recorder Care Div. 8101 Tenth Ave. N. Minneapolis Minn. 55427
Novatec Electronic Industries Ltd. 9721 Cote de Liesse Rd. Montreal 760 Que., Canada

O

OAK Industries Inc. CATV Division Crystal Lake Ill. 60014
Oaktron Industries Inc. 930 30th St. Monroe Wis. 53566
O'Connor Eng. Labs. Inc. Photographic Division 100 Kalmus Drive Costa Mesa Cal. 92627
Ohmite Mfg. Co. 3601 Howard St. Skokie Ill. 60076
OMNIX 12234 W. Pico Blvd. Los Angeles Calif. 90064
Onan 1400 73rd Avenue NE Minneapolis Minn. 55432
On-Guard Corp. of America 350 Gotham Parkway Carlstadt N.J. 07072
Orbit Radio and Video Box 1644 Louisville Ky. 40201
Otari of America, Ltd. 8295 S. La Cienega Blvd. Inglewood Calif. 90301

P

Pace Wire & Cable Corp. 3590 Oceanside Road Oceanside N. Y. 11572
Pacific Recorders and Engrg. Corp. 11760 Sorrento Valley Rd. San Diego Calif. 92121
Paillard Incorporated 1900 Lower Rd. Linden N.J. 07036
Palmer Films, Inc., W. A. 611 Howard St. San Francisco Cal. 94105
Panasonic Video Systems Div. Matsushita Electric Corp. of America Box 3980 Grand Central Sta. New York N.Y. 10017
Paso Sound Products Inc. 251 Park Ave. S. New York N.Y. 10010

Pentagon Industries, Inc. 4751 N. Olcott Ave. Chicago Ill. 60656
Peripheral Data Machines, Inc. (PER DATA) 102 New South Rd. Hicksville N.Y. 11801
Permadyne Electronics Corp. 2929 N. Southport Chicago Ill. 60657
Phelps Dodge Communications Co. Div. Phelps Dodge Industries Inc. Rte. 79 Marlboro N.J. 07746
Philips Broadcast Equipment Corp. Subs. North American Philips Corp. One Philips Prkwy. Montvale N.J. 07645
Photo Lab Inc. 3825 Georgia Ave. NW. Washington D.C. 20011
Photo-Pic Systems 100 Avenue of the Americas New York N.Y. 10013
Photo Research Div. of Kollmorgen Corp. 3000 N. Hollywood Way Burbank Cal. 91505
Plastoid Corporation 42-61 24th St. Long Island City N. Y. 11101
Polaroid 549 Technology Square Cambridge Mass. 02139
Polyline Corp. 2449 N. Western Ave. Chicago Ill. 60647
Potomac Instruments, Inc. 932 Philadelphia Ave. Silver Spring Md. 20910
Power-Optics Inc. Box 266 Fairview Village Pa. 19409
PRD Electronics, Inc. 6801 Jericho Turnpike Syosset N. Y. 11791
Precision Elect. Inc. 9101 King St. Franklin Park Ill. 60131
Precision Electrical Mfg. Div. Circuit Science Inc. 9628 6th Ave. N. Minneapolis Minn. 55441
Precision Laboratories Precision Cine Equipment Corp. 999 East 46th St. Brooklyn N.Y. 11203
Prestolite Company Port Huron Mich. 48060
Primo Co. Ltd. 1-25-6 Chome Mure Mitakashi, Tokyo Japan
Prodelin Inc. Box 131 Hightstown N.J. 08520
Profit Recovery Systems Div. of CPAC Box 25 Leicester N. Y. 14481
Pulse Dynamics Mfg. Corp. Fulton St. Colchester Ill. 62326
Pulse Techniques Inc. 1411 Palisade Ave. Teaneck N.J. 07666
Pulsecom 5714 Columbia Pike Falls Church Va. 22041

Q

QRK Electronic Prod. 1568 N. Sierra Vista Fresno Calif. 93703
Q-TV Sales & Distributing Corp. 342 W. 40th St. New York N.Y. 10018
Quad-Eight Electronics 11929 Vose St. North Hollywood Calif. 91605
Qualitape Inc. 101 Broadway Runnemedede N. J. 08078
Quasar Microsystems Inc. 448 Suffolk Ave. Brentwood N.Y. 11717
Quick-Set Inc. 3650 Woodhead Drive Northbrook Ill. 60062

R

Racine & Co., Inc., Jules 85 Executive Blvd. Elmsford N.Y. 10523
Radio Mfg. Co. (RMC) 4702 SW 75 Ave. Miami Fla. 33155

Radio Research Instrument Co., Inc. 3 Quincy St. Norwalk Conn. 06850
Ramko Research 3516-B LaGrande Blvd. Sacramento Calif. 95860
Rank Cintel, Electronic Systems Div. Rank Precision Industries Ltd. Watton Road Ware Herts., England SG12 0 AE
Rank Precision Industries 5437 Sheila St. Los Angeles Calif. 90040
Rank Precision Ind. Broadcast Div. 260 North Rt. 303 West Nyack N.Y. 10994
RAPID-Q Div. of Garron Electronics 1216 Kifer Rd. Sunnyvale Calif. 94086
Raytheon Company Raytheon Data Systems Co. 1415 Providence Turnpike Norwood Mass. 02062
RCA Corporation RCA Broadcast Equip., Comm. Sys. Div. Camden N.J. 08102
RCA Corporation RCA Electromagnetic & Aviation Systems Div. 8500 Balboa Blvd. Van Nuys Calif. 91409
RCA Corporation RCA Electronic Components 415 S. Fifth St. Harrison N.J. 07029
RCA Corporation RCA Missile & Surface Radar Div. Marne Hwy. & Borton Landing Rd. Moorestown N. J. 08057
RCA Corporation RCA Service Company Div. Cherry Hill Offices Camden N.J. 08101
Recordex Corporation 1300 Booth Ave. NW Atlanta Ga. 30318
Recortec Inc. 777 Palomar Ave. Sunnyvale Calif. 94086
Red Comet Inc. Box 272 Littleton Colo. 80120
Rek-O-Kut Inc. 1568 N. Sierra Vista Ave. Fresno Calif. 93703
Rex Rheostat & Co., Inc. 149 Babylon Turnpike Roosevelt N. Y. 11575
Reynolds/Leteron Co. 9830 San Fernando Rd. Pacoima Calif. 91331
RF Systems, Inc. 155 King St. Cohasset Mass. 02025
RHA Audio Communications Corp. 625 60th Street West New York N. J. 07093
RHG Elect Labs, Inc. 161 E. Industry Court Deer Park N.Y. 11729
R. H. Tyler Co. Div. of Weather Scan, Inc. Star Rte. Loop 132 & Hwy. 79 Olney Tex. 76374
Richmond Hill Laboratories Inc. 142 Central Ave. Clark N. J. 07066
Riker Communications Inc. 142 Central Ave. Clark N.J. 07066
Robert Bosch Corp. Fernseh Div. 2800 S. 25th Ave. Broadview Ill. 60153
Roberts Div. of Rheem Mfg. Co. 5922 Bowcroft St. Los Angeles Calif. 90016
Rodann Electronics Mfg. Co. 133 S. Brea Blvd. Brea Calif. 92621
Rodelco Corp. 356 A Comac Road Deer Park N.Y. 11729
Roh Corporation 150 Technology Park/Atlanta Norcross Ga. 30071
Rohde & Schwarz Sales Co. 111 Lexington Ave. Passaic N.J. 07055
Rohn Manufacturing Div. of Unarco Industries Inc. Box 2000 Peoria Ill. 61601

Roll-A-Reel 7386 Reading Road Cincinnati Ohio 45237
Rome Cable Div. Cyprus Mines Co. 421 Ridge St. Rome N.Y. 13440
RTI Research Technology Inc. 8260 Elmwood Ave. Skokie Ill. 60076
Rupert Neve Incorporated Berkshire Industrial Park Bethel Conn. 06801
Russco Electronics Mfg. Inc. 1070 Brookhaven Drive Clovis Cal. 93612
Rust Corp. 168 Tremont St. Everett Mass. 02149
F. B. Ryan Mfg. Co. Inc. Box 451 Chariton Iowa 50049
Ryder Magnetic Sales Corp. 1147 N. Vine St. Hollywood Cal. 90038

S

Sadelco, Inc. 299 Park Ave. Weehawken N. J. 07087
Howard W. Sams & Co., Inc. 4300 West 62nd St. Indianapolis Ind. 46268
Sansui Electronics Corp. 55-11 Queens Blvd. Woodside N. Y. 11377
Sarkes Tarzian Inc. Broadcast Equipment Div. East Hillside Dr. Bloomington Ind. 47401
Saxton Prod. Inc. 215 N. Route 303 Congers N.Y. 10920
SC Electronics, Inc. Subs. of Audio-ronics Corp. 530 Fifth Ave., N.W. St. Paul Minn. 55112
Scala Radio Corp. 1970 Republic Ave. San Leandro Cal. 94577
Schafer Electronics Corp. 75 Castilian Drive Goleta Calif. 93017
Schafer International 1355 Harbor Drive San Diego Calif. 92101
Schneider Corp. of America 154 Lodi St. Hackensack N.J. 07601
Schultz Inc., Albert 116 West 14 St. New York N.Y. 10011
Scientific Systems, Inc. Broadcast Equipment Div. 191 Westfield Ave. Clark N. J. 07066
Scintrex Inc. Communications Div. Amherst Industrial Park Tonawanda N.Y. 14150
Scott-Buttner Coastcom, Inc. 2346 Stanwell Drive Concord Calif. 94520
Scully/Metrotech Divs. of Dictaphone Corp. 475 Ellis St. Mountain View Cal. 94040
Seacor Inc. 598 Broadway Norwood N. J. 07648
Sencore Inc. 3200 Sencore Drive Sioux Falls S. D. 57107
Sennheiser Electronics Corp. 10 West 37th St. New York N. Y. 10018
Senstrol Division UMC Electronics Co. 460 Sackett Point Rd. North Haven Conn. 06473
Sentinel, Inc. 613 Easy St. Garland Tex. 75042
Sescom, Inc. Box 4155 Inglewood Calif. 90309
Shallco, Incorporated Hwy. 301 South, P.O. Box 1089 Smithfield N.C. 27577
Shintron Co. Inc. Video Products Div. 144 Rogers St. Cambridge Mass. 02142
Shively Laboratories, Inc. Route 302 Raymond Me. 04071

Shure Brothers Inc. 222 Hartrey Ave. Evanston Ill. 60204
Siemens Corporation 186 Wood Ave. S. Iselin N.J. 08830
SIMEX/COAST NAVIGATION SCHOOL Drawer Y - 418 E. Canon Perdido Santa Barbara Calif. 93102
Simpson Electric Co. 5200 W. Kinzie Chicago Ill. 60644
Singer Instrumentation Los Angeles Operation 3211 S. La Cienega Blvd. Los Angeles Calif. 90016
Singer Co., The Palo Alto Operation 3176 Porter Dr. Palo Alto Calif. 94304
Singer Co. Simulation Products Div. Colesville Rd. Binghamton N.Y. 13902
Singer Products Co., Inc. One World Trade Center Suite 2365 New York N.Y. 10048
Sitco Antenna Co. 10330 N.E. Marx Portland Ore. 97220
Skirpan Lighting Control Corp. 41-43 24th St. Long Island City N.Y. 11101
Soladyne International 7455 Convoy Court San Diego Calif. 92111
Solar Electronics Co. 901 N. Highland Ave. Hollywood Calif. 90038
Solitron Devices Inc. Semiconductor Div. 8808 Balboa Ave. San Diego Calif. 92123
Soll, Inc., Joseph M. 311 E. 72nd St. New York N.Y. 10021
Sony Corp. of America 47-47 Van Dam Street Long Island City N.Y. 11101
Soundolier, Inc. 9380 Watson Industrial Park St. Louis Mo. 63126
Soundscriber Corporation 680 Third Ave. West Haven Conn. 06515
Sparta Electronic Corp. 5851 Florin Perkins Rd. Sacramento Cal. 95828
Spectra Sonics 770 Wall Ave. Ogden Utah 84404
Spectrum Instruments, Inc. 35 Grand St. New Rochelle N. Y. 10801
Spencer-Kennedy Labs., Inc. 8 Gill St. Woburn Mass. 01801
Spindler & Sauppe, Inc. 13034 Saticoy St. North Hollywood Cal. 91605
Spin Physics, Inc. 11633 Sorrento Valley Rd. San Diego Calif. 92121
SPI-ITT Instruments Metrix Division P.O. Box 30 74010 Annecy France
Spotmaster Broadcast Electronics 8810 Brookville Rd. Silver Spring Md. 20910
Stainless, Incorporated Third & Montgomery Sts. North Wales Pa. 19454
Stancil-Hoffman Corp. 921 N. Highland Hollywood Calif. 90038
Standard Electric Time Div. of Johnson Service Co. 89 Logan St. Springfield Mass. 01101
Stanton Magnetics Inc. Terminal Drive Plainview N.Y. 11803
Stantron Division Wyco Metal Products 6914 Beck Ave. North Hollywood Calif. 91605
STEP Corporation P.O. Box 527 Havertown Pa. 19083
Sterling Television Presentations Inc. Sterling Communications Co. 120 East 23rd St. New York N. Y. 10010

Storeel Corp. 4993 New Peachtree Rd. Atlanta Ga. 30341
Superscope, Inc. 8150 Vineland Ave. Sun Valley Calif. 91352
Swager Tower Corp. Box 498 Fremont Ind. 46737
Switchcraft Inc. 5555 N. Elston Ave. Chicago Ill. 60630
Sylvania Comm. Electronic Box 268 Burlington Rd. Bedford Mass. 01730
Sylvania Semiconductor 100 Sylvan Road Woburn Mass. 01801
Systems Engineering Co., Inc. Box 49224 Atlanta Ga. 30329
Systems Marketing Corp. And Sono-Mag Corp. 1013 West Washington St. Bloomington Ill. 61701

T

Taber Mfg. & Engr. Co. 2081 Edison Ave. San Leandro Cal. 94577
TACO Technical Appliance Corp. A General Instrument Co. 1 Taco Street Sherburne N.Y. 13460
Taft Communication Systems, Inc. 5750 Bintliff Suite 201 Houston Tex. 77036
Tandberg of America Inc. 8 Third Avenue Pelham N.Y. 10803
Tape-Athon Corp. 502 S. Isis Inglewood Cal. 90301
Tapecaster TCM, Inc. Box 662 Rockville Md. 20851
Tapex Corporation Box 796 West Des Moines Iowa 50265
TASCAM Corporation 5440 McConnell Ave. Los Angeles Calif. 90066
Tasker Systems Div. of Whittaker Corp. 20131 Sunburst St. Chatsworth Cal. 91311
Taylor Instrument Consumer Prod. Div. Sybron Corp. Arden N.C. 28704
TDK Electronics Corp. 23-73 48th St. Long Island City N. Y. 11103
TEAC Corp of America 7733 Telegraph Rd. Montebello Cal. 90640
Tech Laboratories Inc. Bergen & Edsall Blvds. Palisades Park N.J. 07650
Technology Incorporated HF Photo Systems Div. 11801 W. Olympic Blvd. Los Angeles Calif. 90064
Tektronix Inc. Box 500 Beaverton Ore. 97005
Telatronics 924 Cost Ave. Stonewood W. V. 26301
TelComp Division Television and Computer Corp. 2385 Beryllium Rd. Scotch Plains N. J. 07076
Tele-Cine Inc. 18 Unqua Road Masapequa, L.I. N.Y. 11758
Telecommunications Industries Ltd. 414 N. Alfred St. Los Angeles Calif. 99048
Telectro Systems Corp. 96-18 43rd Ave. Corona N.Y. 11368
Teddyne Brown Engineering Co. Science & Engrg. Div. Research Park M.S. No. 15 Huntsville Ala. 35807
Teddyne Camera Systems 131 N. Fifth Ave. Arcadia Calif. 91006
Teddyne Isotopes Energy Systems Division 110 W. Timonium Rd. Timonium Md. 21093

TeleMation, Inc. Box 15068 Salt Lake City Utah 84115
Tele Measurements Inc. 145 Main Ave. Clifton N.J. 07014
Telemet Co. 185 Dixon Avenue Amityville N.Y. 11701
Teleng Inc. 405 Serrano Dr. Suite 4E San Francisco Calif. 94132
TELESTRATOR Industries 166 East Superior St. Chicago Ill. 60611
Telesync Corp. 20 Insley St. Demarest N.J. 07627
Television Equipment Associates P.O. Box 1391 Bayville N.Y. 11709
Television Microtime, Inc. Subs. Andersen Laboratories, Inc. 1280 Blue Hills Ave. Bloomfield Conn. 06002
Television Products Co. Inc. 9016 Aviation Blvd. Inglewood Calif. 90301
Television Technology Corp. 9150 B Brookville Rd. Silver Spring Md. 20910
Telex Communications Division 9600 Aldrich Ave. S. Minneapolis Minn. 55420
Telonic Industries Inc. Box 277 Laguna Beach Calif. 92652
Teltron, Inc. 940 Willow St. Pottstown Pa. 19464
Terminal Hudson Corp. Terminal Hudson Electronics 236 West 17th St. New York N. Y. 10011
Test & Measuring Instruments, Inc. a North American Philips Co. 224 Duffy Ave. Hicksville N. Y. 11802
Tetline Instruments Div. Roger Boatman & Associates, Inc. Box 5671 Titusville Fla. 32780
Texas Electronics Box 7225 Inwood Station Dallas Tex. 75209
Texas Instrument Components Group Box 5012 Dallas Tex. 75222
Texscan Corp. 2446 N. Shadeland Indianapolis Ind. 46219
Texwipe Co. Box 278 Hillsdale N. J. 07642
Theta-Corn of California AML Division 9320 Lincoln Blvd. Los Angeles Calif. 90045
Theta-Corn of California Cable Division Box 9728 Phoenix Ariz. 85020
Thomson-CSF Electron Tubes 50 Rockefeller Plaza New York N.Y. 10020
Thor Electronics Corp. 741 Livingston St. Elizabeth N.J. 07207
Time & Frequency Tech., Inc. 3000 Olcott St. Santa Clara Cal. 95051
Times Wire and Cable Sub. of Insilco Corp. 358 Hall Avenue Wallingford Conn. 06492
TM Systems, Inc. 25 Allen St. Bridgeport Conn. 06604
Topaz Electronics 3855 Ruffin Road San Diego Calif. 92123
Total Technology Box 828 Belmont Cal. 94002
TRACOR, Inc. Instruments Group 6500 Tracor Lane Austin Tex. 78721
Treise Engineering 1941 First St. San Fernando Cal. 91340
Trepac Corp. America 30 W. Hamilton Ave. Englewood N.J. 07631
Tri-Ex Tower Corp. 7182 Rasmussen Ave. Visalia Calif. 93277

CONTINENTAL BUILDS THE MOST AM TRANSMITTER FOR YOUR MONEY.

MOST EFFICIENT & MOST RELIABLE

Continental's unique modulation technique eliminates modulation transformers and reactors. More than 200 Continental standard AM broadcast transmitters are operating without the limitations of high power audio iron core components or the associated potential instabilities of plate modulation. Continental's Type 317C is still the most efficient, most reliable 50 KW AM transmitter available today.

MOST POPULAR

There are more Continental Type 317C 50 KW AM transmitters in service than any other single type 50 KW AM transmitter built by any manufacturer.

15 of the new Type 315/316F 5/10 KW AM transmitters were sold in the short period of May thru July, 1973.

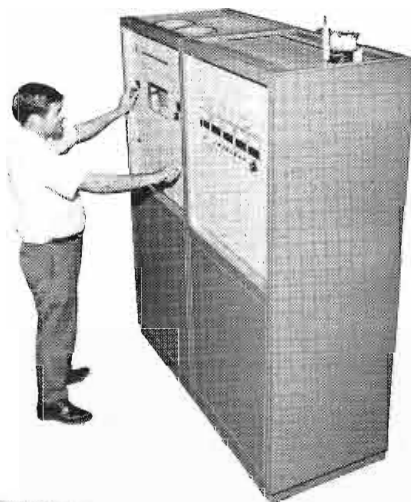

Type 315/316F
5/10 KW
transmitter uses
only two tubes.

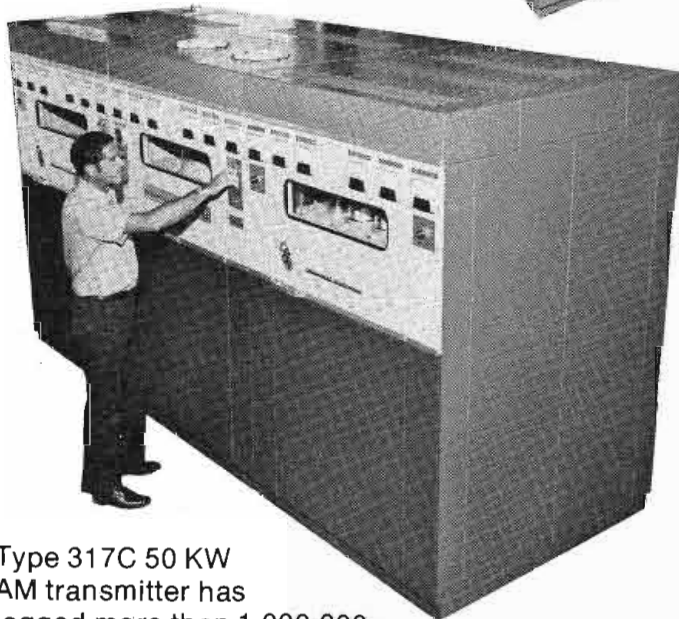

Type 317C 50 KW
AM transmitter has
logged more than 1,000,000
hours of air time.

For performance and reliability, it's Continental!

Continental Electronics 

CONTINENTAL ELECTRONICS MFG. CO. 4212 SOUTH BUCKNER BLVD.
MAIL ADDRESS: BOX 17040 DALLAS, TEXAS 75217 (214) 381-7161
CABLE ADDRESS: CONTRONICS TELEEX ADDRESS: 73-398

For More Details Circle (162) on Reply Card

Triplett Corporation 286 Harmon Rd.
Bluffton Ohio 45817
Tri-Tronics 829 Eighth St. Lillington
N.C. 27546
Trompeter Electronics 8936 Comanche
Ave. Chatsworth Cal. 91311
Troy Electronic Sales Co. 5810 N.
Western Ave. Chicago Ill. 60659
(Trusonic) ACS Inc. 335 S. Raymond
Ave. Pasadena Cal. 91105
TRW Electronic Supply Co. Div. of
TRW 414 N. 13th St. Philadelphia
Pa. 19108
TT Electronics, Inc. 2214 S. Barry Ave.
Los Angeles Calif. 90064
Turner Division Conrac Corporation
909 17th St. N.E. Cedar Rapids
Iowa 52402
TV Cable Supply Co., Inc. 1746 E.
Chocolate Ave. Hershey Pa. 17044

U

Ultra Audio Products Box 921 Beverly
Hills Cal. 90213
Union Connector Co., Inc. 149-A Bab-
ylon Turnpike Roosevelt N. Y.
11575
United Radio Supply Inc. 123 N.E. 7th
Portland Ore. 97232
United Recording Electronics Indus-
tries 11922 Valerio St. North Holly-
wood Cal. 91605
United Systems Corp. Subs. of Mon-
santo Co. 918 Woodley Rd. Dayton
Ohio 45403
Universal Media Corp. 2301 Industrial
Pkwy. W. Hayward Calif. 94545
Universal Research Labs 2501 United
Lane Elk Grove Village Ill. 60007
Up Right Scaffolds 1013 Pardee St.
Berkeley Cal. 94710
Upton Tools Inc. Box 4750 Rochester
N.Y. 14612
UREI a URC Company 11922 Valerio
St. North Hollywood Calif. 91605
Utility Tower Co. 3200 N.W. 38th St.,
P.O. Box 12027 Oklahoma City
Okla. 73112

V

Vaco Products Co. 510 N. Dearborn
St. Chicago Ill. 60610
Valad Electric Heating Corp. 71 Court-
landt St. Tarrytown N.Y. 10591
Varian Solid State Div. Micro-Link
Products 8 Salem Rd. Beverly Mass.
01915
Vicon Industries, Inc. 130 Central Ave.
Farmingdale N.Y. 11775
Victor Duncan, Inc. 11043 Gratiot
Ave. Detroit Mich. 48213
Video Aids Corp. of Colorado 112 W.
Fourth St. Loveland Colo. 80537
Video Data Systems, Inc. 657 Old Wil-
lets Path Hauppauge N.Y. 11787
Video Devices Co. 17000 Western
Ave. No. 6 Gardena Calif. 90247
Video Engineering Co. Inc. 356 West
40th St. New York N. Y. 10018
Video Sentry System 1080 Route 46
Clifton N.J. 07013
VIF International Box 1555 Mountain
View Cal. 94040
Vikoa Inc. 400 Ninth St. Hoboken N.J.
07030

Vikron 4918 West 35th St. Minneapo-
lis Minn. 55416
Virginia Panel Corporation Box 1106
Waynesboro Va. 22980
Viscount Industries Ltd. 105 East
69th Vancouver 15 B. C. Canada
Vista Systems, Inc. Box 15331 Los
Angeles Calif. 90015
Visual Communication Products Oper.
General Electric Co. No. 7 Electron-
ics Park Syracuse N.Y. 13201
Visual Educom Inc. DAGE Television
4333 S. Ohio St. Michigan City Ind.
46360
Visual Educom Inc. MTI Television
4333 S. Ohio St. Michigan City Ind.
46360
Visual Electronics Corp. 356 West
40th New York N. Y. 10018
Vital Industries Inc. 3700 NE 53rd
Ave. Gainesville Fla. 32601
Vitec Communications Ltd. 9721 Cote
de Liesse Rd. Montreal 760 Que.,
Canada
Vu-Data Corporation 7170 Convoy
Court San Diego Calif. 92111

W

Waber Electronics Inc. Div. SGL Indus-
tries, Inc. 300 Harvard Ave. West-
ville N. J. 08093
Waters Mfg. Inc. Longfellow Center
Wayland Mass. 01778
Weinschel Engineering Co. Box 577
Clopper Road Gaithersburg Md.
20760
Western Electronic Prods. Co. 107
Los Molinos San Clemente Calif.
92672
Westinghouse Electric Corp. Electric
Tube Div. Box 284 Elmira N.Y.
49502
Westinghouse Electric Corp. Westing-
house Bldg. Pittsburgh Pa. 15222
Wide Response 2926 Bently Ave. Los
Angeles Calif. 90064
Wilcam Photo Research Inc. 8619 Yo-
landa Ave. Northridge Calif.
91324
Wilkinson Electronics, Inc. 1937 W.
MacDade Blvd. Woodlyn Pa. 19094
Wilson Corp., H. 555 W. Taft Drive
South Holland Ill. 60473
World Video Inc. Box 117 Boyertown
Pa. 19512

X

Xcelite 118 Bank St. Orchard Park N.Y.
14127
ZERO-Impedance Systems, Inc. 2473
Hartnell Ave Redding Calif. 96001

Send Your
Industry News
to
Broadcast Engineering
1014 Wyandotte
Kansas City, Mo. 64105

1973 Broadcast Buyer's Guide

Broadcast Engineering's Reference Issue joins the Computer Age!

This 1973 annual issue, of Broadcast Industry Buyer's Guide and the Manufacturer's Address sections have been prepared for you by computer. We have taken this step so that we may continue to provide you with the most complete and latest information on products and services. Now that we can add and delete listings by computer we will be able to keep pace with the changes taking place in the industry. Not only will you have a better directory with this issue, you will continue to see improvements in the years to come.

Our only limitation is that we send questionnaires to all active manufacturers in the field. Some either fail to receive their listing notice or forget to send it in.

The result is almost 700 manufacturers in over 600 categories.

For CATV categories not listed in this section, see the CATV Buyer's Guide. It includes products especially designed for CATV use.

Red Listings

For the third time we are including red listings. A red listing under a category signifies that the manufacturer has an ad in this issue describing that product or service. In this way you will be able to immediately refer to specs and descriptions in categories of interest to you. Addresses of all manufacturers in this portion of the Guide are listed in the Manufacturers Address section.

Reader Service Card In This Issue Good For One Year

Amplifiers	66
Antennas	70
Automation	72
Cameras	74
Consoles	77
Generators	82
Lighting	85
Microphones	87
Monitors	89
Processors	92
Recorders	93
Switchers	97
Towers	99
Transmitters	100

Alarm, Fault

See Adv. Page

Moseley Assoc. Inc. 7
Trepac Corp. America 127

Aitken Communications Inc.
Atlantic Research Corp. Teleproducts Dept.
Badger Meter, Inc. Electronics Div.
Bird Electronic Corp.
Broadcast Products Inc.
Concept 70, A Div. of Dyma Engineering, Inc.
Gates Division of Harris-Intertype
Moseley Assoc. Inc.
National Electrolab Ltd.
Pulsecom
Rust Corp.
Scott-Buttner Coastcom, Inc.
TRACOR, Inc. Instruments Group
Trepac Corp. America

Alarm, Signal

See Adv. Page

B & I Electronics, Inc. 141
Moseley Assoc. Inc. 7
Sparta Electronic Corp. 8

Alpha Electronic Services Inc.
Atlantic Research Corp. Teleproducts Dept.
ATLAS Sound
Audio Engineering Co.
Belcom Electronics Mfg. Co.
B & I Electronics, Inc.
Broadcast Products Inc.
Concept 70, A Div. of Dyma Engineering, Inc.
Conrac Corporation Cramer Division
Delta Electronics Inc. (N.C.)
Diversified Products Inc.
Dorado Systems
Edwards Company, Inc.
Electronic Designers Inc.
Engineering Associates
Fisher Berkeley Corp.
P. R. Mallory & Co. Inc. Mallory Distributor Products Co.
Miles Reproducer Co.
Moseley Assoc. Inc.
National Electrolab Ltd.
On-Guard Corp. of America
Rodann Electronics Mfg. Co.
Rust Corp.
Scott-Buttner Coastcom, Inc.
Sparta Electronic Corp.
Tele-Cine Inc.
TM Systems, Inc.
Trepac Corp. America

Alarm, Teletype Receiver

Atlantic Research Corp. Teleproducts Dept.
B & I Electronics, Inc.
Systems Marketing Corp. And Sono-Mag Corp.
Trepac Corp. America

Alarm Systems, Burglar

See Adv. Page

Moseley Assoc. Inc. 7
Mountain West Alarm 137

A.L.I. Fire and Burglar Alarm Corp. Security Div.
AMF Electrical Products Development Division
Delta Products, Inc.
Diebold Incorporated
Diversified Products Inc.

Dorado Systems
Edwards Company, Inc.
Emerson Elec./Artolier Lighting & Sound Rittenhouse Div.
G.C. Electronics
P. R. Mallory & Co. Inc. Mallory Distributor Products Co.
Miles Reproducer Co.
Moseley Assoc. Inc.
Mountain West Alarm
On-Guard Corp. of America
Red Comet Inc.
Rodann Electronics Mfg. Co.
Telatronics

Alarm Systems, Fire

See Adv. Page

Moseley Assoc. Inc. 7
Mountain West Alarm 137

A.L.I. Fire and Burglar Alarm Corp. Security Div.
Aluminum Hard Goods, Inc.
AMF Electrical Products Development Division
Delta Products, Inc.
Diversified Products Inc.
Dorado Systems
Edwards Company, Inc.
Emerson Elec./Artolier Lighting & Sound Rittenhouse Div.
G.C. Electronics
P. R. Mallory & Co. Inc. Mallory Distributor Products Co.
Miles Reproducer Co.
Moseley Assoc. Inc.
Mountain West Alarm
On-Guard Corp. of America
Red Comet Inc.
Rodann Electronics Mfg. Co.
Telatronics

Alignment Projectors, TV

Tele Measurements Inc.

Amplifier, AF-AGC

See Adv. Page

Gates 10
Roh Corporation 124
Wilkinson Electronics, Inc. 58

ALTEC
Ampro Corp.
Belar Electronics Lab., Inc.
Broadcast Electronics
Broadcast Products Inc.
Burwen Laboratories
CBS Labs
CCA Electronics Corp.
C-COR Electronics, Inc.
Collins Radio Company Broadcast Division
Communication Medias
Edison Electronics, Div. of McGraw-Edison Co., Daven & Measurements
Fairchild/Robbins Fairchild Sound Equipment Corp.
Gately Electronics
Gates Division of Harris-Intertype
Inovonics
Marti Electronics
McCurdy Radio Ind. Inc.
Melcor Electronics Corp.
Neve Inc., Rupert
Pacific Recorders and Engrg. Corp.
Pulse Dynamics Mfg. Corp.
Quad-Eight Electronics
RCA Corporation RCA Broadcast Equip., Comm. Sys. Div.
Roh Corporation

Rupert Neve Incorporated
Spotmaster Broadcast Electronics
Stancil-Hoffman Corp.
Systems Marketing Corp. And Sono-Mag Corp.
Tele Measurements Inc.
Total Technology
Visual Communication Products Oper. General Electric Co.
Wilkinson Electronics, Inc.

Amplifier, AF Compressing

See Adv. Page

Gates 10

ALTEC
Ampro Corp.
Arnold Barnes Company
Belar Electronics Lab., Inc.
Bogen Division Lear Siegler Inc.
Broadcast Electronics
Broadcast Products Inc.
Burwen Laboratories
CBS Labs
CCA Electronics Corp.
Cetec Inc. Subs. Computer Equipment Corp.
Collins Radio Company Broadcast Division
Communication Medias
Fairchild/Robbins Fairchild Sound Equipment Corp.
Gately Electronics
Gates Division of Harris-Intertype
Inovonics
LPB Inc.
Magnatech Company
Marti Electronics
McCurdy Radio Ind. Inc.
Melcor Electronics Corp.
Neve Inc., Rupert
Pacific Recorders and Engrg. Corp.
Philips Broadcast Equipment Corp. Subs. North American Philips Corp.
Precision Elect. Inc.
Quad-Eight Electronics
RCA Corporation RCA Broadcast Equip., Comm. Sys. Div.
Roh Corporation
Rupert Neve Incorporated
Singer Products Co., Inc.
Sparta Electronic Corp.
Spectra Sonics
Spotmaster Broadcast Electronics
Stancil-Hoffman Corp.
Systems Marketing Corp. And Sono-Mag Corp.
TM Systems, Inc.
Total Technology
Ultra Audio Products
United Recording Electronics Industries
UREI a URC Company
Wilkinson Electronics, Inc.

Amplifier, AF General Purpose

See Adv. Page

Sparta Electronic Corp. 8

ALTEC
Amperex Corp.
Ampro Corp.
Atlantic Research Corp. Teleproducts Dept.
Audio Designs & Mfg.
Audio Distributor Inc.
Belar Electronics Lab., Inc.
Bell P/A Prod. Corp.
Bogen Division Lear Siegler Inc.
Bradford Information Systems
Broadcast Electronics
Broadcast Products Inc.
Burwen Laboratories
C-COR Electronics, Inc.

Central Dynamics Corp.
Cetec Inc. Subs. Computer Equipment Corp.
Collins Radio Company Broadcast Division
Communication Medias
Crown International
Custom Craft Designs
Danscoll Ltd.
Datatek Corp.
Denrad Mfg. Co. Inc.
Edison Electronics, Div. of McGraw-Edison Co., Daven & Measurements
Electronic Designers Inc.
Fairchild/Robbins Fairchild Sound Equipment Corp.
Fisher Berkeley Corp.
Gately Electronics
Gates Division of Harris-Intertype
General Electric Company Tubes/MW Devices
Head Sound, Inc.
Hewlett Packard Co.
Instrument Laboratories
Interntl. Nuclear Corp.
Marconi Electronics Inc.
Marti Electronics
McMartin Industries
Melcor Electronics Corp.
Micro-Trak Corporation (Formerly: Gray Research & Dev.)
Neve Inc., Rupert
Novatec Electronic Industries Ltd.
Pacific Recorders and Engrg. Corp.
Paso Sound Products Inc.
Permadynne Electronics Corp.
Philips Broadcast Equipment Corp. Subs. North American Philips Corp.
PRD Electronics, Inc.
Precision Elect. Inc.
Precision Laboratories Precision Cine Equipment Corp.
Pulse Dynamics Mfg. Corp.
Quad-Eight Electronics
Radio Mfg. Co. (RMC)
Ramko Research
RCA Corporation RCA Broadcast Equip., Comm. Sys. Div.
Roh Corporation
Rupert Neve Incorporated
Russco Electronics Mfg. Inc.
Sarkes Tarzian Inc. Broadcast Equipment Div.
Scientific Systems, Inc. Broadcast Equipment Div.
Sescom, Inc.
Shintron Co. Inc. Video Products Div.
Shure Brothers Inc.
Sparta Electronic Corp.
Spectra Sonics
Spotmaster Broadcast Electronics
Superscope, Inc.
Systems Engineering Co., Inc.
Systems Marketing Corp. And Sono-Mag Corp.
TelComp Division Television and Computer Corp.
Telex Communications Division
Tri-Tronics
Ultra Audio Products
United Recording Electronics Industries
Video Aids Corp. of Colorado
Visual Communication Products Oper. General Electric Co.
Wilkinson Electronics, Inc.

Amplifier, AF Peak Limiting AM

See Adv. Page

Gates 10
Marti Electronics 128D
Sparta Electronic Corp. 8
Wilkinson Electronics, Inc. 58

ALTEC
 Audio Designs & Mfg.
 Arnold Barnes Company
 Belar Electronics Lab., Inc.
 Broadcast Electronics
 Broadcast Products Inc.
 Burwen Laboratories
 CBS Labs
 CCA Electronics Corp.
 Cetec Inc. Subs. Computer Equipment Corp.
 Collins Radio Company Broadcast Division
 Communication Medias
 Electronic Systems Engrg. Co.
 Gates Division of Harris-Intertype
 Inovonics
 LPB Inc.
 Magnatech Company
 Marti Electronics
 Mastertone Company
 Melcor Electronics Corp.
 Neve Inc., Rupert
 Pacific Recorders and Engrg. Corp.
 Radio Mfg. Co. (RMC)
 RCA Corporation RCA Broadcast Equip., Comm. Sys. Div.
 Rupert Neve Incorporated
 Singer Products Co., Inc.
 Sparta Electronic Corp.
 Spectra Sonics
 Spotmaster Broadcast Electronics
 Systems Marketing Corp. And Sono-Mag Corp.
 Tele Measurements Inc.
 United Recording Electronics Industries
 UREI a URC Company
 Wilkinson Electronics, Inc.

Amplifier, AF Peak Limiting FM

See Adv. Page

Gates 10
 Marti Electronics 128D
 Sparta Electronic Corp. 8
 Wilkinson Electronics, Inc. 58

Arnold Barnes Company
 Belar Electronics Lab., Inc.
 Broadcast Electronics
 Broadcast Products Inc.
 Burwen Laboratories
 CBS Labs
 CCA Electronics Corp.
 Cetec Inc. Subs. Computer Equipment Corp.
 Collins Radio Company Broadcast Division
 Communication Medias
 Electronic Systems Engrg. Co.
 Gately Electronics
 Gates Division of Harris-Intertype
 Inovonics
 LPB Inc.
 Magnatech Company
 Marti Electronics
 Mastertone Company
 Pacific Recorders and Engrg. Corp.
 RCA Corporation RCA Broadcast Equip., Comm. Sys. Div.
 Singer Products Co., Inc.
 Sparta Electronic Corp.
 Spotmaster Broadcast Electronics
 Systems Marketing Corp. And Sono-Mag Corp.
 Tele Measurements Inc.
 United Recording Electronics Industries
 UREI a URC Company
 Wilkinson Electronics, Inc.

Amplifier, AF Remote

ALTEC
 Ampro Corp.
 Audio Designs & Mfg.
 Broadcast Electronics
 Central Dynamics Corp.
 Collins Radio Company Broadcast Division
 Communication Medias
 Gately Electronics
 Gates Division of Harris-Intertype
 LPB Inc.

Moseley Assoc. Inc.
 Nasco Television Systems
 Neve Inc., Rupert
 North American Radio Corp.
 Pulse Dynamics Mfg. Corp.
 Radio Mfg. Co. (RMC)
 RCA Corporation RCA Broadcast Equip., Comm. Sys. Div.
 Roh Corporation
 Rupert Neve Incorporated
 Sarkes Tarzian Inc. Broadcast Equipment Div.
 Scientific Systems, Inc. Broadcast Equipment Div.
 Sparta Electronic Corp.
 Spectra Sonics
 Spotmaster Broadcast Electronics
 Systems Engineering Co., Inc.
 TelComp Division Television and Computer Corp.
 Tele Measurements Inc.
 Tri-Tronics
 Ultra Audio Products
 Wilkinson Electronics, Inc.

Amplifier, AF Reverberation

ALTEC
 Communication Medias
 Concept 70, A Div. of Dyma Engineering, Inc.
 Dyma Engineering, Inc.
 Electronic Designers Inc.
 Fairchild/Robbins Fairchild Sound Equipment Corp.
 Gately Electronics
 Gotham Audio Corp.
 Melcor Electronics Corp.
 Neve Inc., Rupert
 Pacific Recorders and Engrg. Corp.
 Philips Broadcast Equipment Corp. Subs. North American Philips Corp.
 Pulse Dynamics Mfg. Corp.
 Quad-Eight Electronics
 Radio Mfg. Co. (RMC)
 Rupert Neve Incorporated
 Spectra Sonics
 Tele Measurements Inc.
 Television Equipment Associates
 Total Technology
 Troy Electronic Sales Co.
 Ultra Audio Products
 VIF International

Amplifier, AF Stereo

See Adv. Page

Sparta Electronic Corp. 8
 ALTEC
 Ampro Corp.
 Beyer (Revox Corporation)
 Collins Radio Company Broadcast Division
 Communication Medias
 Concept 70, A Div. of Dyma Engineering, Inc.
 Crown International
 Eico Elect. Inst. Co., Inc.
 Electronic Designers Inc.
 Fairchild/Robbins Fairchild Sound Equipment Corp.
 Gately Electronics
 Gates Division of Harris-Intertype
 Head Sound, Inc.
 Heath Co.
 Micro-Trak Corporation (Formerly: Gray Research & Dev.)
 Precision Elect. Inc.
 Pulse Dynamics Mfg. Corp.
 Radio Mfg. Co. (RMC)
 Ramko Research
 RCA Corporation RCA Broadcast Equip., Comm. Sys. Div.
 Roh Corporation
 Sansui Electronics Corp.
 Schultz Inc., Albert
 Sparta Electronic Corp.
 Superscope, Inc.
 Systems Engineering Co., Inc.
 Tele Measurements Inc.
 Telex Communications Division
 Tri-Tronics
 Wilkinson Electronics, Inc.

Amplifier, Bridging

See Adv. Page

Gates 10

Ameco Inc.
 American Data Corp. an AIRPAX Company
 Anaconda Electronics
 Atlantic Research Corp. Teleproducts Dept.
 Audio Designs & Mfg.
 Blonder-Tongue Labs.
 Burwen Laboratories
 CATV Equipment Co.
 C-COR Electronics, Inc.
 Cetec Inc. Subs. Computer Equipment Corp.
 Collins Radio Company Broadcast Division
 Communication Medias
 Computer Image Corp.
 Delta Electronics Inc. (N.C.)
 Delta Electronics Inc. (Va.)
 Denrad Mfg. Co. Inc.
 DYNAIR Electronics, Inc.
 Enterprise Electronics Corp.
 Fairchild/Robbins Fairchild Sound Equipment Corp.
 Gately Electronics
 Gates Division of Harris-Intertype
 Grass Valley Group, Inc.
 Head Sound, Inc.
 Interntl. Nuclear Corp.
 Kaitronics Corporation
 Magnavox Company CATV Division
 Mastertone Company
 Mincom Div. 3M Co.
 Neve Inc., Rupert
 Novatec Electronic Industries Ltd.
 OAK Industries Inc. CATV Division
 OMNIX
 Pulse Dynamics Mfg. Corp.
 Radio Mfg. Co. (RMC)
 Ramko Research
 RCA Corporation RCA Broadcast Equip., Comm. Sys. Div.
 RCA Corporation RCA Service Company Div.
 Riker Communications Inc.
 Roh Corporation
 Rupert Neve Incorporated
 Rust Corp.
 Scientific Systems, Inc. Broadcast Equipment Div.
 Spectra Sonics
 Spencer-Kennedy Labs., Inc.
 Systems Marketing Corp. And Sono-Mag Corp.
 TelComp Division Television and Computer Corp.
 TM Systems, Inc.
 Ultra Audio Products
 Vikoa Inc.
 Wilkinson Electronics, Inc.

Amplifier, Clamping'

See Adv. Page

Lenco Inc. 123
 Alma Engineering Inc.
 American Data Corp. an AIRPAX Company
 Ball Bros. Research Corp. Miratel Division
 Bell & Howell Consumer Products Group
 Beston Electronics Inc.
 Broadcast Electronics
 Central Dynamics Corp.
 Computer Image Corp.
 DYNAIR Electronics, Inc.
 Grass Valley Group, Inc.
 Interntl. Nuclear Corp.
 Kaitronics Corporation
 Lenco Inc. Electronics Division
 Marconi Electronics Inc.
 Melcor Electronics Corp.
 Mincom Div. 3M Co.
 OMNIX
 Raytheon Company Raytheon Data Systems Co.
 RCA Corporation RCA Broadcast Equip., Comm. Sys. Div.
 Spotmaster Broadcast Electronics
 Telemet Co.

Vital Industries Inc.

Amplifier, Compressing

See Adv. Page

Marti Electronics 128D

Audio Distributor Inc.
 Broadcast Electronics
 Burwen Laboratories
 Cetec Inc. Subs. Computer Equipment Corp.
 Communication Medias
 Electronic Systems Engrg. Co.
 Fairchild/Robbins Fairchild Sound Equipment Corp.
 Gately Electronics
 Gates Division of Harris-Intertype
 Head Sound, Inc.
 LPB Inc.
 Marti Electronics
 Melcor Electronics Corp.
 Novatec Electronic Industries Ltd.
 Precision Elect. Inc.
 RHG Elect Labs, Inc.
 Spotmaster Broadcast Electronics

Amplifier, DC

See Adv. Page

Moseley Assoc. Inc. 7

American Data Corp. an AIRPAX Company
 B & K Instruments Inc.
 Burwen Laboratories
 Cetec Inc. Subs. Computer Equipment Corp.
 Crown International
 Gately Electronics
 General Electric Company Tubes/MW Devices
 Head Sound, Inc.
 Hewlett Packard Co.
 Honeywell Inc. Test Instruments Div.
 Lectronic Res. Labs. Inc.
 Melcor Electronics Corp.
 Moseley Assoc. Inc.
 RCA Corporation RCA Broadcast Equip., Comm. Sys. Div.
 Rust Corp.
 Tele Measurements Inc.
 Test & Measuring Instruments, Inc. a North American Philips Co.

Amplifier, Distribution

See Adv. Page

American Data Corp. 131
 Bethany International 106
 Broadcast Electronics 34
 Danscoll Ltd. 116
 Dynasciences Corp. 37
 Fairchild/Robbins 17
 Gates 10
 Grass Valley Group, Inc. 3
 Lenco Inc. 123
 OMNIX 42
 Ramko Research 20
 Roh Corporation 124
 Taft Communication Systems, Inc. 106
 Telemet Co. IBC

Alcor Inc.
 Alma Engineering Inc.
 Ameco Inc.
 American Data Corp. an AIRPAX Company
 Ampro Corp.
 Anaconda Electronics
 Anixter-Pruzan CATV Division
 Applied Electro Mechanics, Inc.
 Atlantic Research Corp. Teleproducts Dept.
 Audio Designs & Mfg.
 AVA Electronics Corp.
 Ball Bros. Research Corp. Miratel Division
 Arnold Barnes Company
 Bell P/A Prod. Corp.

Beston Electronics Inc.
 Bethany International
 Blonder-Tongue Labs.
 Bradford Information Systems
 Broadcast Electronics
 Broadcast Prod. Co. Inc. Bcst. Division
 CATV Equipment Co.
 CBS Labs
 C-COR Electronics, Inc.
 Central Dynamics Corp.
 Cetec Inc. Subs. Computer Equipment Corp.
 Cleveland Electronics, Inc.
 Cohu, Inc. Electronics Division
 Communication Medias
 Computer Image Corp.
 Danscoll Ltd.
 Datatek Corp.
 Delta Electronics Inc. (N.C.)
 Delta Electronics Inc. (Va.)
 Dyma Engineering, Inc.
 DYNAIR Electronics, Inc.
 Dynasciences Corp. Video Products Div.
 Enterprise Electronics Corp.
 Fairchild/Robbins Fairchild Sound Equipment Corp.
 Gately Electronics
 Gates Division of Harris-Intertype
 GBC Closed Circuit TV Corp.
 Grass Valley Group, Inc.
 Head Sound, Inc.
 Hitachi Shibaden Corp. of America
 Interntl. Nuclear Corp.
 Javelin Div. of Apollo Lasers
 Kaitronics Corporation
 Lauderdale Electronic Labs
 Lenco Inc. Electronics Division
 LPB Inc.
 Magnavox Company CATV Division
 Marconi Electronics Inc.
 McCurdy Radio Ind. Inc.
 Melcor Electronics Corp.
 Mincom Div. 3M Co.
 Nasco Television Systems
 Neve Inc., Rupert
 Novatec Electronic Industries Ltd.
 OMNIX
 Pacific Recorders and Engrg. Corp.
 Philips Broadcast Equipment Corp.
 Subs. North American Philips Corp.
 PRD Electronics, Inc.
 Pulse Dynamics Mfg. Corp.
 Radio Mfg. Co. (RMC)
 Ramko Research
 RCA Corporation RCA Broadcast Equip., Comm. Sys. Div.
 RCA Corporation RCA Service Company Div.
 Riker Communications Inc.
 Robert Bosch Corp. Fernseh Div.
 Roh Corporation
 Rohde & Schwarz Sales Co.
 Rupert Neve Incorporated
 Sarkes Tarzian Inc. Broadcast Equipment Div.
 Scientific Systems, Inc. Broadcast Equipment Div.
 Shintron Co. Inc. Video Products Div.
 Singer Products Co., Inc.
 Spectra Sonics
 Spencer-Kennedy Labs., Inc.
 Spotmaster Broadcast Electronics
 Taft Communication Systems, Inc.
 Tasker Systems Div. of Whittaker Corp.
 TelComp Division Television and Computer Corp.
 TeleMation, Inc.
 Tele Measurements Inc.
 Telemet Co.
 Teleng Inc.
 Theta-Com of California Cable Division
 TV Cable Supply Co., Inc.
 Vicon Industries, Inc.
 Video Engineering Co. Inc.
 Visual Communication Products Oper. General Electric Co.
 Visual Educom Inc. DAGE Television
 Vital Industries Inc.
 Wilkinson Electronics, Inc.
 ZERO-Impedance Systems, Inc.

Amplifier, Keying

American Data Corp. an AIRPAX Company

Ball Bros. Research Corp. Miratel Division
 CBS Labs
 Central Dynamics Corp.
 Computer Image Corp.
 Grass Valley Group, Inc.
 RCA Corporation RCA Broadcast Equip., Comm. Sys. Div.
 Sarkes Tarzian Inc. Broadcast Equipment Div.
 Shintron Co. Inc. Video Products Div.
 Video Devices Co.
 Video Engineering Co. Inc.
 Vital Industries Inc.

Amplifier, Line

	See Adv. Page
Gates	10
Ramko Research	20
Roh Corporation	124
Sparta Electronic Corp.	8

American Data Corp. an AIRPAX Company
 Ampro Corp.
 Anixter-Pruzan CATV Division
 Audio Designs & Mfg.
 Blonder-Tongue Labs.
 Broadcast Electronics
 Burwen Laboratories
 C-COR Electronics, Inc.
 Central Dynamics Corp.
 Cetec Inc. Subs. Computer Equipment Corp.
 Collins Radio Company Broadcast Division
 Communication Medias
 Danscoll Ltd.
 Enterprise Electronics Corp.
 Fairchild/Robbins Fairchild Sound Equipment Corp.
 Gately Electronics
 Gates Division of Harris-Intertype
 Head Sound, Inc.
 Instrument Laboratories
 Magnavox Company CATV Division
 Marti Electronics
 Neve Inc., Rupert
 OAK Industries Inc. CATV Division
 OMNIX
 Pulse Dynamics Mfg. Corp.
 Quad-Eight Electronics
 Radio Mfg. Co. (RMC)
 Ramko Research
 RCA Corporation RCA Broadcast Equip., Comm. Sys. Div.
 RCA Corporation RCA Service Company Div.
 Riker Communications Inc.
 Robert Bosch Corp. Fernseh Div.
 Roh Corporation
 Rohde & Schwarz Sales Co.
 Rupert Neve Incorporated
 Sarkes Tarzian Inc. Broadcast Equipment Div.
 Scientific Systems, Inc. Broadcast Equipment Div.
 Shintron Co. Inc. Video Products Div.
 Singer Products Co., Inc.
 Spectra Sonics
 Spencer-Kennedy Labs., Inc.
 Spotmaster Broadcast Electronics
 Systems Marketing Corp. And
 Sono-Mag Corp.
 United Recording Electronics Industries
 Video Engineering Co. Inc.
 VIF International
 Wilkinson Electronics, Inc.
 ZERO-Impedance Systems, Inc.

Amplifier, Masking

Burwen Laboratories
 CBS Labs
 RCA Corporation RCA Broadcast Equip., Comm. Sys. Div.
 Tele Measurements Inc.

Amplifier, Mixing

Audio Designs & Mfg.
 Bell P/A Prod. Corp.
 Central Dynamics Corp.
 Cetec Inc. Subs. Computer Equipment Corp.
 Collins Radio Company Broadcast Division
 Fairchild/Robbins Fairchild Sound Equipment Corp.
 Grass Valley Group, Inc.
 Head Sound, Inc.
 Lauderdale Electronic Labs
 Novatec Electronic Industries Ltd.

QRK Electronic Prod.
 Roh Corporation
 Systems Engineering Co., Inc.
 Vital Industries Inc.
 ZERO-Impedance Systems, Inc.

Amplifier, Monitor

	See Adv. Page
Crown International	121
Gates	10
Marti Electronics	128D
Ramko Research	20
Sparta Electronic Corp.	8

Ampro Corp.
 Bell P/A Prod. Corp.
 Broadcast Electronics
 CCA Electronics Corp.
 Central Dynamics Corp.
 Cetec Inc. Subs. Computer Equipment Corp.
 Communication Medias
 Crown International
 Electronic Designers Inc.
 Fairchild/Robbins Fairchild Sound Equipment Corp.
 Gates Division of Harris-Intertype
 Head Sound, Inc.
 Magnatech Company
 Marti Electronics
 Mastertone Company
 Melcor Electronics Corp.
 National Electrolab Ltd.
 Novatec Electronic Industries Ltd.
 QRK Electronic Prod.
 Quad-Eight Electronics
 Radio Mfg. Co. (RMC)
 Ramko Research
 RCA Corporation RCA Broadcast Equip., Comm. Sys. Div.
 RCA Corporation RCA Service Company Div.
 Roh Corporation
 Russco Electronics Mfg. Inc.
 Sparta Electronic Corp.
 Spotmaster Broadcast Electronics
 Superscope, Inc.
 Video Engineering Co. Inc.
 Wilkinson Electronics, Inc.

Amplifier, Operational

Audio Designs & Mfg.
 Burwen Laboratories
 Computer Image Corp.
 Gately Electronics
 Head Sound, Inc.
 Hewlett Packard Co.
 Melcor Electronics Corp.
 Quad-Eight Electronics
 RCA Corporation RCA Broadcast Equip., Comm. Sys. Div.
 RCA Corporation RCA Service Company Div.
 Solitron Devices Inc. Semiconductor Div.
 Systems Engineering Co., Inc.
 Tektronix Inc.
 TelComp Division Television and Computer Corp.

Amplifier, Power

	See Adv. Page
Ceco Communications Inc.	140
Collins Radio Company	19
Head Sound, Inc.	141
Roh Corporation	124

Acrodyne Industries
 Ampro Corp.
 Audio Designs & Mfg.
 Arnold Barnes Company
 Bell P/A Prod. Corp.
 Bethany International
 Bogen Division Lear Siegler Inc.
 Broadcast Electronics
 California Instruments Co.
 C-COR Electronics, Inc.
 Ceco Communications Inc.
 Cetec Inc. Subs. Computer Equipment Corp.

Collins Radio Company Broadcast Division
 Continental Electronics Mfg. Co.
 Crown International
 Electronic Designers Inc.
 Fairchild/Robbins Fairchild Sound Equipment Corp.
 Fluke, John, Mfg. Co. Inc.
 Gates Division of Harris-Intertype
 Head Sound, Inc.
 McMartin Industries
 Melcor Electronics Corp.
 PRD Electronics, Inc.
 Precision Elect. Inc.
 Pulse Dynamics Mfg. Corp.
 Radio Mfg. Co. (RMC)
 RCA Corporation RCA Service Company Div.
 RHA Audio Communications Corp.
 RHG Elect Labs, Inc.
 Roh Corporation
 Spectra Sonics
 Spotmaster Broadcast Electronics
 Taft Communication Systems, Inc.
 Telex Communications Division
 Terminal Hudson Corp. Terminal Hudson Electronics
 ZERO-Impedance Systems, Inc.

Amplifier, Processing Video

	See Adv. Page
American Data Corp.	131
CBS Labs	135
Danscoll Ltd.	116
Dynasciences Corp.	37
Grass Valley Group, Inc.	3

Acrodyne Industries
 American Data Corp. an AIRPAX Company
 Ball Bros. Research Corp. Miratel Division
 Arnold Barnes Company
 CBS Labs
 Central Dynamics Corp.
 Computer Image Corp.
 Control Concepts Corporation
 Cramer Video and Audio Systems
 Danscoll Ltd.
 Dyma Engineering, Inc.
 Dynasciences Corp. Video Products Div.
 Enterprise Electronics Corp.
 Grass Valley Group, Inc.
 Marconi Electronics Inc.
 Mincom Div. 3M Co.
 OMNIX
 RCA Corporation RCA Broadcast Equip., Comm. Sys. Div.
 Robert Bosch Corp. Fernseh Div.
 Shintron Co. Inc. Video Products Div.
 Tektronix Inc.
 Video Engineering Co. Inc.

Amplifier, Pulse

	See Adv. Page
American Data Corp.	131
Danscoll Ltd.	116
Grass Valley Group, Inc.	3
Lenco Inc.	123
OMNIX	42

Acrodyne Industries
 Alma Engineering Inc.
 American Data Corp. an AIRPAX Company
 Applied Video Electronics, Inc.
 Ball Bros. Research Corp. Miratel Division
 Beston Electronics Inc.
 C-COR Electronics, Inc.
 Central Dynamics Corp.
 Cohu, Inc. Electronics Division
 Comark Industries Inc.
 Computer Image Corp.
 Danscoll Ltd.
 Datatek Corp.
 DYNAIR Electronics, Inc.
 Dynasciences Corp. Video Products Div.

General Electric Company Tubes/MW Devices
 Grass Valley Group, Inc.
 Hewlett Packard Co.
 Interntl. Nuclear Corp.
 Kaitronics Corporation
 Kay Elemetrics Corp.
 Lenco Inc. Electronics Division
 Marconi Electronics Inc.
 Nasco Television Systems
 OMNIX
 RCA Corporation RCA Broadcast Equip., Comm. Sys. Div.
 RHG Elect Labs, Inc.
 Robert Bosch Corp. Fernseh Div.
 Sarkes Tarzian Inc. Broadcast Equipment Div.
 Shintron Co. Inc. Video Products Div.
 TeleMation, Inc.
 Tele Measurements Inc.
 Telemet Co.
 Video Engineering Co. Inc.
 Viscount Industries Ltd.

Amplifier, Pulse Delay

See Adv. Page

Lenco Inc. 123

American Data Corp. an AIRPAX Company
 Beston Electronics Inc.
 Central Dynamics Corp.
 Grass Valley Group, Inc.
 Lenco Inc. Electronics Division
 OMNIX
 Television Equipment Associates

Amplifier, Remote

See Adv. Page

Sparta Electronic Corp. 8

Wilkinson Electronics, Inc. 58

Audio Engineering Co.
 Arnold Barnes Company
 Collins Radio Company Broadcast Division
 Communication Medias
 Dyma Engineering, Inc.
 Gates Division of Harris-Intertype
 Head Sound, Inc.
 Moseley Assoc. Inc.
 North American Radio Corp.
 Orbit Radio and Video
 Pulse Dynamics Mfg. Corp.
 RCA Corporation RCA Broadcast Equip., Comm. Sys. Div.
 Sparta Electronic Corp.
 Systems Engineering Co., Inc.
 Time & Frequency Tech., Inc.
 Wilkinson Electronics, Inc.

Amplifier, RF General Purpose

See Adv. Page

National Electrolab Ltd. 140

Acrodyne Industries
 AEL Communications Corp., Subs.
 American Electronic Labs., Inc.
 Ameco Inc.
 American Electronics Lab., Inc.
 Anixter-Pruzan CATV Division
 Belar Electronics Lab., Inc.
 Blonder-Tongue Labs.
 CCA Electronics Corp.
 C-COR Electronics, Inc.
 Comark Industries Inc.
 Enterprise Electronics Corp.
 Gates Division of Harris-Intertype
 General Electric Company Tubes/MW Devices
 General Radio Co.
 Hewlett Packard Co.
 Integral Data Devices Inc.
 Kay Elemetrics Corp.
 Lectronic Res. Labs. Inc.
 Magnatech Company
 McMartin Industries
 Microwave Assoc. Inc.
 National Electrolab Ltd.
 North American Radio Corp.
 OAK Industries Inc. CATV Division

PRD Electronics, Inc.
 RCA Corporation RCA Broadcast Equip., Comm. Sys. Div.
 RHG Elect Labs, Inc.
 Robert Bosch Corp. Fernseh Div.
 Rodelco Corp.
 Singer Instrumentation Los Angeles Operation
 Singer Co., The Palo Alto Operation
 Television Technology Corp.
 Time & Frequency Tech., Inc.
 TV Cable Supply Co., Inc.
 Video Engineering Co. Inc.
 Vikoa Inc.

Amplifier, RF Linear

Acrodyne Industries
 Arnold Barnes Company
 CCA Electronics Corp.
 C-COR Electronics, Inc.
 Comark Industries Inc.
 Continental Electronics Mfg. Co.
 Dyma Engineering, Inc.
 Gates Division of Harris-Intertype LPB Inc.
 Moseley Assoc. Inc.
 National Electrolab Ltd.
 North American Radio Corp.
 PRD Electronics, Inc.
 RHG Elect Labs, Inc.
 Robert Bosch Corp. Fernseh Div.
 Television Technology Corp.
 Wilkinson Electronics, Inc.

Amplifier, RF Peak Limiting

Belar Electronics Lab., Inc.
 CBS Labs
 Magnatech Company
 Microwave Assoc. Inc.
 RCA Corporation RCA Broadcast Equip., Comm. Sys. Div.
 RHG Elect Labs, Inc.
 Video Engineering Co. Inc.
 Wilkinson Electronics, Inc.

Amplifier, RF Power

See Adv. Page

Collins Radio Company 19

Acrodyne Industries
 Ailtech (Formerly: Microdot)
 American Electronics Lab., Inc.
 Amperex Electronic Corp.
 Belar Electronics Lab., Inc.
 Blonder-Tongue Labs.
 CCA Electronics Corp.
 C-COR Electronics, Inc.
 Collins Radio Company Broadcast Division
 Comark Industries Inc.
 Continental Electronics Mfg. Co.
 Eimac Div. Varian Associates
 EMCEE Broadcast Products Div. of Electronics, Missiles & Communications, Inc.
 Gates Division of Harris-Intertype
 Kay Elemetrics Corp.
 Lectronic Res. Labs. Inc.
 McMartin Industries
 Microwave Assoc. Inc.
 Moseley Assoc. Inc.
 National Electrolab Ltd.
 OAK Industries Inc. CATV Division
 PRD Electronics, Inc.
 RCA Corporation RCA Broadcast Equip., Comm. Sys. Div.
 RHG Elect Labs, Inc.
 Singer Products Co., Inc.
 Sparta Electronic Corp.
 Television Technology Corp.
 Video Engineering Co. Inc.
 Visual Communication Products Oper.
 General Electric Co.
 Wilkinson Electronics, Inc.

Amplifier, Sensing

Applied Electro Mechanics, Inc.
 Broadcast Prod. Co. Inc. Bcst. Division
 Mastertone Company
 Tele Measurements Inc.

Amplifier, Stabilizing

American Data Corp. an AIRPAX Company
 Ball Bros. Research Corp. Miratel Division
 CBS Labs
 Central Dynamics Corp.
 Dynasciences Corp. Video Products Div.
 General Radio Co.
 Grass Valley Group, Inc.
 Interntl. Nuclear Corp.
 Marconi Electronics Inc.
 RCA Corporation RCA Broadcast Equip., Comm. Sys. Div.
 Telemet Co.
 Vital Industries Inc.

Amplifier, Stereo Limiter

See Adv. Page

Gates 10

Broadcast Electronics
 Broadcast Products Inc.
 Burwen Laboratories
 CBS Labs
 Cetec Inc. Subs. Computer Equipment Corp.
 Collins Radio Company Broadcast Division
 Communication Medias
 Gately Electronics
 Gates Division of Harris-Intertype
 Mastertone Company
 Neve Inc., Rupert
 Rupert Neve Incorporated
 Spectra Sonics
 Spotmaster Broadcast Electronics
 UREI a URC Company
 Wilkinson Electronics, Inc.

Amplifier, TV Video

Acrodyne Industries
 AEL Communications Corp., Subs.
 American Electronic Labs., Inc.
 Alcor Inc.
 Alma Engineering Inc.
 American Data Corp. an AIRPAX Company
 American Pamcor
 Amperex Electronic Corp.
 Applied Electro Mechanics, Inc.
 Applied Video Electronics, Inc.
 AVA Electronics Corp.
 Ball Bros. Research Corp. Miratel Division
 Blonder-Tongue Labs.
 Catel, a Div. of United Scientific Corp.
 CBS Labs
 C-COR Electronics, Inc.
 Central Dynamics Corp.
 Cohu, Inc. Electronics Division
 Comark Industries Inc.
 Computer Image Corp.
 Control Concepts Corporation
 Cramer Video and Audio Systems
 Danscoll Ltd.
 Datatek Corp.
 Delta-Benco-Cascade Ltd.
 Delta Electronics Inc. (N.C.)
 DYNAIR Electronics, Inc.
 Dynasciences Corp. Video Products Div.
 Enterprise Electronics Corp.
 Fung Engineering Co.
 Gates Division of Harris-Intertype
 GBC Closed Circuit TV Corp.
 Grass Valley Group, Inc.
 Ikegami Tsushinki Co., Ltd. Export Department
 Integral Data Devices Inc.
 Interntl. Nuclear Corp.
 Kay Elemetrics Corp.
 Lenco Inc. Electronics Division
 Marconi Electronics Inc.
 Mincom Div. 3M Co.
 Nasco Television Systems
 OMNIX
 Philips Broadcast Equipment Corp. Subs. North American Philips Corp.
 Raytheon Company Raytheon Data Systems Co.
 RCA Corporation RCA Broadcast Equip., Comm. Sys. Div.

Richmond Hill Laboratories Inc.
 Riker Communications Inc.
 Sarkes Tarzian Inc. Broadcast Equipment Div.
 Shintron Co. Inc. Video Products Div.
 Singer Products Co., Inc.
 Spencer-Kennedy Labs., Inc.
 Tektronix Inc.
 Tele-Cine Inc.
 Teledyne Brown Engineering Co. Science & Engrg. Div.
 TeleMation, Inc.
 Telemet Co.
 Television Microtime, Inc. Subs.
 Andersen Laboratories, Inc.
 Vicon Industries, Inc.
 Video Engineering Co. Inc.
 Viscount Industries Ltd.
 Visual Communication Products Oper.
 General Electric Co.
 Visual Educom Inc. DAGE Television
 Vital Industries Inc.

Amplifier, Video Sweep

C-COR Electronics, Inc.
 Kay Elemetrics Corp.
 Leader Instruments Corp.
 Lectronic Res. Labs. Inc.
 RCA Corporation RCA Broadcast Equip., Comm. Sys. Div.

Amplifier, Zero Studio Delay

Television Equipment Associates
 Television Microtime, Inc. Subs.
 Andersen Laboratories, Inc.

Analyzers, Distortion

See Adv. Page

Crown International 121

ELPA Marketing Industries, Inc. 18

The London Company 14

Atlantic Research Corp. Teleproducts Dept.
 Barker & Williamson, Inc.
 Collins Radio Company Broadcast Division
 Crown International
 Dyma Engineering, Inc.
 ELPA Marketing Industries, Inc.
 General Radio Co.
 Heath Co.
 Hewlett Packard Co.
 Lectronic Res. Labs. Inc.
 The London Company
 Marconi Instruments
 RCA Corporation RCA Broadcast Equip., Comm. Sys. Div.
 Rohde & Schwarz Sales Co.
 Tektronix Inc.
 Vu-Data Corporation

Analyzers, Harmonic

See Adv. Page

ELPA Marketing Industries, Inc. 18

ELPA Marketing Industries, Inc.
 General Radio Co.
 Hewlett Packard Co.
 Lectronic Res. Labs. Inc.
 Marconi Instruments
 RCA Corporation RCA Broadcast Equip., Comm. Sys. Div.
 Rohde & Schwarz Sales Co.
 Tektronix Inc.
 Vu-Data Corporation

Analyzers, Intermodulation

Crown International
 Edison Electronics, Div. of McGraw-Edison Co., Daven & Measurements
 Heath Co.
 Rohde & Schwarz Sales Co.
 Tektronix Inc.

Analyzers, RF Network

PRD Electronics, Inc.
Rohde & Schwarz Sales Co.
Tektronix Inc.

Analyzers, Sideband

DYNAIR Electronics, Inc.
Enterprise Electronics Corp.
Marconi Instruments
RCA Corporation RCA Broadcast Equip., Comm. Sys. Div.
Rohde & Schwarz Sales Co.
Siemens Corporation
Singer Co., The Palo Alto Operation
Spectrum Instruments, Inc.
Tektronix Inc.
Telemet Co.

Analyzers, Spectrum

Ailtech (Formerly: Microdot)
ALTEC
B & K Instruments Inc.
Enterprise Electronics Corp.
General Radio Co.
Hewlett Packard Co.
Honeywell Inc. Test Instruments Div.
Kay Elemetrics Corp.
Marconi Instruments
Novatec Electronic Industries Ltd.
RCA Corporation RCA Broadcast Equip., Comm. Sys. Div.
Rohde & Schwarz Sales Co.
Singer Co., The Palo Alto Operation
Spectrum Instruments, Inc.
Spencer-Kennedy Labs., Inc.
Tektronix Inc.
Test & Measuring Instruments, Inc. a North American Philips Co.
Texscan Corp.

Analyzers, Video

Arnold Barnes Company
Colorado Video Inc.
Dynascan Corp. B & K Division
PRD Electronics, Inc.
RCA Corporation RCA Broadcast Equip., Comm. Sys. Div.
Rohde & Schwarz Sales Co.
Spencer-Kennedy Labs., Inc.
Tektronix Inc.
Video Engineering Co. Inc.

Antenna Alignment Systems, Microwave

Innovative Television Equipment, Inc.
Siemens Corporation

Antenna Sampling Systems

See Adv. Page
Moseley Assoc. Inc. 7
Sparta Electronic Corp. 8

Cablewave Systems Inc. Subs. Phelps Dodge and Kabelmetal
Moseley Assoc. Inc.
Multronics, Inc.
North American Radio Corp.
Sparta Electronic Corp.
Time & Frequency Tech., Inc.

Antenna Systems

See Adv. Page
Ceco Communications Inc. 140
Collins Radio Company 19
Jampro Antenna Co. 48
Mastertone Company 139

Admiral Corporation
Ameco Inc.
Andrew Corp.
Andrews Tower Inc.
AVA Electronics Corp.
Arnold Barnes Company
Bogner Broadcast Equipment Corp.
Cablewave Systems Inc. Subs. Phelps Dodge and Kabelmetal

Ceco Communications Inc.
Collins Radio Company Broadcast Division
Continental Electronics Mfg. Co.
Delta Electronics Inc. (Va.)
Electromagnetic Specialties
Enterprise Electronics Corp.
Gates Division of Harris-Intertype
Gulf Telephone & Electronics
Hy-Power Electronics Co.
Jampro Antenna Co. Div. of Computer Equipment Corp.
Mastertone Company
Micro Communications, Inc.
Microwave Assoc. Inc.
Multronics, Inc.
Phelps Dodge Communications Co. Div. Phelps Dodge Industries Inc.
Prodelin Inc.
RCA Corporation RCA Broadcast Equip., Comm. Sys. Div.
RF Systems, Inc.
Riker Communications Inc.
Robert Bosch Corp. Fernseh Div.
Scala Radio Corp.
Shively Laboratories, Inc.
Siemens Corporation
Singer Products Co., Inc.
Sitco Antenna Co.
Soll, Inc., Joseph M.
Sparta Electronic Corp.
TACO Technical Appliance Corp. A General Instrument Co.
Tri-Ex Tower Corp.
TV Cable Supply Co., Inc.
Video Engineering Co. Inc.
Visual Communication Products Oper. General Electric Co.

Antenna Tuning Units

See Adv. Page
Sparta Electronic Corp. 8

CCA Electronics Corp.
Collins Radio Company Broadcast Division
Jampro Antenna Co. Div. of Computer Equipment Corp.
Multronics, Inc.
North American Radio Corp.
Siemens Corporation
Sparta Electronic Corp.
Wilkinson Electronics, Inc.

Antennas, Directional System

See Adv. Page
Gates 10

Alford Mfg. Co.
Bogner Broadcast Equipment Corp.
Collins Radio Company Broadcast Division
Continental Electronics Mfg. Co.
Cook Electric Co.
Electromagnetic Specialties
Gates Division of Harris-Intertype
Innovative Television Equipment, Inc.
Jampro Antenna Co. Div. of Computer Equipment Corp.
Micro Communications, Inc.
Moseley Assoc. Inc.
Scala Radio Corp.
Sparta Electronic Corp.
TACO Technical Appliance Corp. A General Instrument Co.

Antennas, Dummy Load

See Adv. Page
Electro Impulse, Inc. 132

Bird Electronic Corp.
Collins Radio Company Broadcast Division
Continental Electronics Mfg. Co.
Dielectric Communications Div. of Sola Basic
Electro Impulse, Inc.
Gates Division of Harris-Intertype
Jampro Antenna Co. Div. of Computer Equipment Corp.
Marconi Electronics Inc.
Micro Communications, Inc.

North American Radio Corp.
Ohmite Mfg. Co.
RCA Corporation RCA Broadcast Equip., Comm. Sys. Div.
Rex Rheostat & Co., Inc.
Rohde & Schwarz Sales Co.
Shively Laboratories, Inc.
Siemens Corporation
Sparta Electronic Corp.
Wilkinson Electronics, Inc.

Antennas, Ice Warning System

See Adv. Page
Gates 10

Collins Radio Company Broadcast Division
Cook Electric Co.
Gates Division of Harris-Intertype
Jampro Antenna Co. Div. of Computer Equipment Corp.
Micro-Trak Corporation (Formerly: Gray Research & Dev.)

Antennas, Monitor

See Adv. Page
Moseley Assoc. Inc. 7

Moseley Assoc. Inc.
National Electrolab Ltd.
Phelps Dodge Communications Co. Div. Phelps Dodge Industries Inc.
Scala Radio Corp.
Video Engineering Co. Inc.

Antennas, Receiving FM

See Adv. Page
Gates 10
Jampro Antenna Co. 48

Anixter-Pruzan CATV Division
Catel, a Div. of United Scientific Corp.
Gates Division of Harris-Intertype
G.C. Electronics
Jampro Antenna Co. Div. of Computer Equipment Corp.
McMartin Industries
RCA Corporation RCA Broadcast Equip., Comm. Sys. Div.
RCA Corporation RCA Missile & Surface Radar Div.
RCA Corporation RCA Service Company Div.
RF Systems, Inc.
Saxton Prod. Inc.
Scala Radio Corp.
Siemens Corporation
TACO Technical Appliance Corp. A General Instrument Co.

Antennas, Receiving LF

Andrews Tower Inc.
Delta Electronics Inc. (Va.)
Fluke, John, Mfg. Co. Inc.
Time & Frequency Tech., Inc.

Antennas, Receiving MF

Delta Electronics Inc. (Va.)
Gulf Telephone & Electronics
Siemens Corporation
Singer Products Co., Inc.

Antennas, Receiving UHF

See Adv. Page
Gates 10

Ameco Inc.
American Electronics Lab., Inc.
American Pamcor
Andrew Corp.
Anixter-Pruzan CATV Division
Blonder-Tongue Labs.
Conway Electronic Enterprises Limited
EMCEE Broadcast Products Div. of Electronics, Missiles & Communications, Inc.
Gates Division of Harris-Intertype
G.C. Electronics

Lectronic Res. Labs. Inc.
Moseley Assoc. Inc.
Phelps Dodge Communications Co. Div. Phelps Dodge Industries Inc.
Prodelin Inc.
RF Systems, Inc.
Riker Communications Inc.
Robert Bosch Corp. Fernseh Div.
Rohde & Schwarz Sales Co.
Saxton Prod. Inc.
Scala Radio Corp.
Siemens Corporation
Sitco Antenna Co.
TACO Technical Appliance Corp. A General Instrument Co.
TV Cable Supply Co., Inc.
Video Engineering Co. Inc.

Antennas, Receiving VHF

See Adv. Page
Gates 10

Ameco Inc.
American Electronics Lab., Inc.
American Pamcor
Andrew Corp.
Anixter-Pruzan CATV Division
Blonder-Tongue Labs.
CATV Equipment Co.
Conway Electronic Enterprises Limited
EMCEE Broadcast Products Div. of Electronics, Missiles & Communications, Inc.
Gates Division of Harris-Intertype
G.C. Electronics
Lectronic Res. Labs. Inc.
Moseley Assoc. Inc.
Phelps Dodge Communications Co. Div. Phelps Dodge Industries Inc.
Prodelin Inc.
RF Systems, Inc.
Riker Communications Inc.
Robert Bosch Corp. Fernseh Div.
Rohde & Schwarz Sales Co.
Saxton Prod. Inc.
Scala Radio Corp.
Siemens Corporation
Sitco Antenna Co.
TACO Technical Appliance Corp. A General Instrument Co.
TV Cable Supply Co., Inc.
Video Engineering Co. Inc.

Antennas, Receiving Microwave

Andrew Corp.
Anixter-Pruzan CATV Division
Bogner Broadcast Equipment Corp.
Lectronic Res. Labs. Inc.
Mastertone Company
Narda Microwave Corp., The Prodelin Inc.
RF Systems, Inc.
Siemens Corporation
TACO Technical Appliance Corp. A General Instrument Co.

Antennas, Remote Indicator

Gates Division of Harris-Intertype
Moseley Assoc. Inc.
Potomac Instruments, Inc.

Antennas, Remote Pickup

Andrew Corp.
Andrews Tower Inc.
Cablewave Systems Inc. Subs. Phelps Dodge and Kabelmetal
CCA Electronics Corp.
Collins Radio Company Broadcast Division
Gates Division of Harris-Intertype
Magnatech Company
Mastertone Company
Moseley Assoc. Inc.
Phelps Dodge Communications Co. Div. Phelps Dodge Industries Inc.
RF Systems, Inc.
Scala Radio Corp.
Siemens Corporation
TACO Technical Appliance Corp. A General Instrument Co.

Antennas, STL

Andrew Corp.
CCA Electronics Corp.
Collins Radio Company Broadcast Division
Magnatech Company
Mastertone Company
Moseley Assoc. Inc.
Phelps Dodge Communications Co.
Div. Phelps Dodge Industries Inc.
Scala Radio Corp.

Antennas, Transmitting FM

See Adv. Page

Shively Laboratories, Inc. 119
Sparta Electronic Corp. 8

Arnold Barnes Company
Cablewave Systems Inc. Subs. Phelps Dodge and Kabelmetal
CCA Electronics Corp.
CCA RF Industries, Inc.
Collins Radio Company Broadcast Division
Electromagnetic Specialties
Gates Division of Harris-Intertype
Jampro Antenna Co. Div. of Computer Equipment Corp.
Magnatech Company
Mastertone Company
Micro Communications, Inc.
Phelps Dodge Communications Co.
Div. Phelps Dodge Industries Inc.
RCA Corporation RCA Broadcast Equip., Comm. Sys. Div.
Scala Radio Corp.
Shively Laboratories, Inc.
Siemens Corporation
Singer Products Co., Inc.
Sparta Electronic Corp.
TACO Technical Appliance Corp. A General Instrument Co.
Wilkinson Electronics, Inc.

Antennas, Transmitting LF

Andrews Tower Inc.
Continental Electronics Mfg. Co.
Delta Electronics Inc. (Va.)
Gates Division of Harris-Intertype
Jampro Antenna Co. Div. of Computer Equipment Corp.
Siemens Corporation

Antennas, Transmitting MF

Andrews Tower Inc.
Collins Radio Company Broadcast Division
Continental Electronics Mfg. Co.
Delta Electronics Inc. (Va.)
Gates Division of Harris-Intertype
Gulf Telephone & Electronics
Jampro Antenna Co. Div. of Computer Equipment Corp.
Marconi Electronics Inc.
RCA Corporation RCA Broadcast Equip., Comm. Sys. Div.
Shively Laboratories, Inc.
Siemens Corporation

Antennas, Transmitting UHF

See Adv. Page

Bogner Broadcast Equipment Corp. 35

Alford Mfg. Co.
Andrew Corp.
Bogner Broadcast Equipment Corp.
CCA Electronics Corp.
CCA RF Industries, Inc.
Collins Radio Company Broadcast Division
EMCEE Broadcast Products Div. of Electronics, Missiles & Communications, Inc.
Gates Division of Harris-Intertype
Jampro Antenna Co. Div. of Computer Equipment Corp.
Lectronic Res. Labs. Inc.
Marconi Electronics Inc.

Micro Communications, Inc.
Moseley Assoc. Inc.
Phelps Dodge Communications Co.
Div. Phelps Dodge Industries Inc.
Prodelin Inc.
RCA Corporation RCA Broadcast Equip., Comm. Sys. Div.
RF Systems, Inc.
Rohde & Schwarz Sales Co.
Scala Radio Corp.
Shively Laboratories, Inc.
Siemens Corporation
Sitco Antenna Co.
TACO Technical Appliance Corp. A General Instrument Co.
Visual Communication Products Oper. General Electric Co.

Antennas, Transmitting VHF

See Adv. Page

Bogner Broadcast Equipment Corp. 35

Alford Mfg. Co.
Bogner Broadcast Equipment Corp.
CCA Electronics Corp.
CCA RF Industries, Inc.
Collins Radio Company Broadcast Division
Dyma Engineering, Inc.
EMCEE Broadcast Products Div. of Electronics, Missiles & Communications, Inc.
Gates Division of Harris-Intertype
Jampro Antenna Co. Div. of Computer Equipment Corp.
Lectronic Res. Labs. Inc.
Marconi Electronics Inc.
Micro Communications, Inc.
Moseley Assoc. Inc.
Phelps Dodge Communications Co.
Div. Phelps Dodge Industries Inc.
Prodelin Inc.
RCA Corporation RCA Broadcast Equip., Comm. Sys. Div.
RF Systems, Inc.
Rohde & Schwarz Sales Co.
Scala Radio Corp.
Shively Laboratories, Inc.
Siemens Corporation
Singer Products Co., Inc.
Sitco Antenna Co.
TACO Technical Appliance Corp. A General Instrument Co.
Visual Communication Products Oper. General Electric Co.

Antennas, Transmitting Microwave

Andrew Corp.
Bogner Broadcast Equipment Corp.
Cablewave Systems Inc. Subs. Phelps Dodge and Kabelmetal
Collins Radio Company Broadcast Division
Jampro Antenna Co. Div. of Computer Equipment Corp.
Lectronic Res. Labs. Inc.
Mastertone Company
Microwave Assoc. Inc.
Moseley Assoc. Inc.
Prodelin Inc.
RF Systems, Inc.
Siemens Corporation
TACO Technical Appliance Corp. A General Instrument Co.

Antennas, VSWR Indicator

See Adv. Page

Gates 10

Bird Electronic Corp.
CCA Electronics Corp.
Collins Radio Company Broadcast Division
Delta Electronics Inc. (Va.)
Gates Division of Harris-Intertype
General Radio Co.
Jampro Antenna Co. Div. of Computer Equipment Corp.
Lectronic Res. Labs. Inc.
Micro Communications, Inc.
Moseley Assoc. Inc.

PRD Electronics, Inc.
Shively Laboratories, Inc.
Singer Products Co., Inc.

Arms, Tone

See Adv. Page

Gates 10
Micro-Trak Corporation 1288
Russco Electronics Mfg. Inc. 128
Sparta Electronic Corp. 8
Stanton Magnetics Inc. 39

Broadcast Electronics
Broadcast Products Inc.
CCA Electronics Corp.
Collins Radio Company Broadcast Division
Gates Division of Harris-Intertype
Lauderdale Electronic Labs
LPB Inc.
Micro-Trak Corporation (Formerly: Gray Research & Dev.)
QRK Electronic Prod.
RCA Corporation RCA Broadcast Equip., Comm. Sys. Div.
Rek-O-Kut Inc.
Russco Electronics Mfg. Inc.
Shure Brothers Inc.
Singer Products Co., Inc.
Sparta Electronic Corp.
Spotmaster Broadcast Electronics
Stanton Magnetics Inc.
Video Engineering Co. Inc.
Wilkinson Electronics, Inc.

Attenuators, Audio

See Adv. Page

Roh Corporation 124
Shallco, Incorporated 124
Sparta Electronic Corp. 8
Tech Laboratories Inc. 21
Waters Mfg. Inc. 117

Allen Avionics Inc.
ALTEC
Atlantic Research Corp. Teleproducts Dept.
Audio Designs & Mfg.
Audio Distributor Inc.
Burwen Laboratories
Cetec Inc. Subs. Computer Equipment Corp.
Collins Radio Company Broadcast Division
Duncan Electronics, Inc.
Edison Electronics, Div. of McGraw-Edison Co., Daven & Measurements
Fairchild/Robbins Fairchild Sound Equipment Corp.
General Radio Co.
Gotham Audio Corp.
Kay Elemetrics Corp.
Leader Instruments Corp.
Marconi Instruments
Neve Inc., Rupert
Ohmite Mfg. Co.
Quad-Eight Electronics
RCA Corporation RCA Broadcast Equip., Comm. Sys. Div.
Roh Corporation
Rohde & Schwarz Sales Co.
Rupert Neve Incorporated
Sennheiser Electronics Corp.
Shallco, Incorporated
Soundolier, Inc.
Sparta Electronic Corp.
Systems Engineering Co., Inc.
Tech Laboratories Inc.
Terminal Hudson Corp. Terminal Hudson Electronics
Texscan Corp.
TM Systems, Inc.
TRW Electronic Supply Co. Div. of TRW
Video Engineering Co. Inc.
Waters Mfg. Inc.
Weinschel Engineering Co.

Attenuators, Fixed

See Adv. Page

Shallco, Incorporated 124
Sparta Electronic Corp. 8
Tech Laboratories Inc. 21
Waters Mfg. Inc. 117

Allen Avionics Inc.
Ameco Inc.
Audio Distributor Inc.
Bird Electronic Corp.
Cetec Inc. Subs. Computer Equipment Corp.
Collins Radio Company Broadcast Division
Edison Electronics, Div. of McGraw-Edison Co., Daven & Measurements
Gates Division of Harris-Intertype
General Microwave Corp.
General Radio Co.
Holland Electronics
Kay Elemetrics Corp.
Lectronic Res. Labs. Inc.
Magnavox Company CATV Division
Narda Microwave Corp., The
PRD Electronics, Inc.
Radio Mfg. Co. (RMC)
RCA Corporation RCA Broadcast Equip., Comm. Sys. Div.
Riker Communications Inc.
Roh Corporation
Rohde & Schwarz Sales Co.
Shallco, Incorporated
Siemens Corporation
Singer Co., The Palo Alto Operation
Sparta Electronic Corp.
Tech Laboratories Inc.
Tektronix Inc.
Telonic Industries Inc.
Texscan Corp.
Trompeter Electronics
TV Cable Supply Co., Inc.
Video Engineering Co. Inc.
Waters Mfg. Inc.
Weinschel Engineering Co.

Attenuators, Impedance Matching

See Adv. Page

Shallco, Incorporated 124
Sparta Electronic Corp. 8
Tech Laboratories Inc. 21
Waters Mfg. Inc. 117

Allen Avionics Inc.
Barker & Williamson, Inc.
Cetec Inc. Subs. Computer Equipment Corp.
Collins Radio Company Broadcast Division
Edison Electronics, Div. of McGraw-Edison Co., Daven & Measurements
Electromagnetic Sciences, Inc.
General Radio Co.
Holland Electronics
Kay Elemetrics Corp.
Ohmite Mfg. Co.
PRD Electronics, Inc.
RCA Corporation RCA Broadcast Equip., Comm. Sys. Div.
Roh Corporation
Rohde & Schwarz Sales Co.
Shallco, Incorporated
Sparta Electronic Corp.
Tech Laboratories Inc.
Tektronix Inc.
Test & Measuring Instruments, Inc. a North American Philips Co.
Texscan Corp.
Video Engineering Co. Inc.
Waters Mfg. Inc.
Weinschel Engineering Co.

Attenuators, Microwave

See Adv. Page

Tech Laboratories Inc. 21

American Electronics Lab., Inc.
Electro Impulse, Inc.
General Microwave Corp.

General Radio Co.
Hewlett Packard Co.
Kay Elemetrics Corp.
Lectronic Res. Labs. Inc.
Marconi Instruments
Narda Microwave Corp., The
PRD Electronics, Inc.
Rohde & Schwarz Sales Co.
Siemens Corporation
Singer Co., The Palo Alto Operation
Tech Laboratories Inc.
Tektronix Inc.
Telonic Industries Inc.
Test & Measuring Instruments, Inc. a
North American Philips Co.
Texscan Corp.
Video Engineering Co. Inc.
Weinschel Engineering Co.

Attenuators, RF

See Adv. Page

Tech Laboratories Inc. 21

AEL Communications Corp., Subs.
American Electronic Labs., Inc.
Allen Avionics Inc.
Ameco Inc.
American Electronics Lab., Inc.
Anaconda Electronics
Anixter-Pruzan CATV Division
AVA Electronics Corp.
Bird Electronic Corp.
CATV Equipment Co.
Comark Industries Inc.
Edison Electronics, Div. of
McGraw-Edison Co., Daven &
Measurements
Electro Impulse, Inc.
Enterprise Electronics Corp.
General Microwave Corp.
General Radio Co.
Hewlett Packard Co.
Holland Electronics
Integral Data Devices Inc.
Kay Elemetrics Corp.
Lectronic Res. Labs. Inc.
Marconi Instruments
Matrix Systems Corp.
Narda Microwave Corp., The
OAK Industries Inc. CATV Division
PRD Electronics, Inc.
Riker Communications Inc.
Rohde & Schwarz Sales Co.
Shalco, Incorporated
Siemens Corporation
Singer Co., The Palo Alto Operation
Tech Laboratories Inc.
Telonic Industries Inc.
Test & Measuring Instruments, Inc. a
North American Philips Co.
Texscan Corp.
TV Cable Supply Co., Inc.
Video Engineering Co. Inc.
Weinschel Engineering Co.

Audio Stacks, Rebuilt or Rebuilding Services for VTR

See Adv. Page

**Computer Magnetics
Corp.** 105

Computer Magnetics Corp.

Automation, Camera Control

Ameco Inc.
Bristol Div. of Acco
Cunningham Corp. Subs. of Gleason
Works
Moseley Assoc. Inc.
Power-Optics Inc.
RCA Corporation RCA Broadcast
Equip., Comm. Sys. Div.
Robert Bosch Corp. Fernseh Div.
Tele-Cine Inc.
Trepac Corp. America
Video Engineering Co. Inc.

Automation, Color Corrector

Arnold Barnes Company
RCA Corporation RCA Broadcast
Equip., Comm. Sys. Div.

Robert Bosch Corp. Fernseh Div.

Automation, Data Processing

Broadcast Products Inc.
Central Dynamics Corp.
Lamb Laboratories
Mincom Div. 3M Co.
Quad-Eight Electronics
Sarkes Tarzian Inc. Broadcast
Equipment Div.
STEP Corporation
Systems Marketing Corp. And
Sono-Mag Corp.

Automation, Equipment Control

See Adv. Page

Audio Devices, Inc. 45
Autogram Corporation 18
**Grass Valley Group,
Inc.** 3
McBee Laboratories 114
Moseley Assoc. Inc. 7

Ampro Corp.
Atlantic Research Corp. Teleproducts
Dept.
Audio Devices, Inc.
Autogram Corporation
Bailey Meter Company Subs. Babcock
& Wilcox Co.
Broadcast Products Inc.
CCA Electronics Corp.
Central Dynamics Corp.
Chrono-Log Corp.
CMX Systems
Concept 70, A Div. of Dyma
Engineering, Inc.
Display Systems Corp.
Gates Division of Harris-Intertype
Grass Valley Group, Inc.
IGM
Magna-Tech Electronic Co., Inc.
Mastertone Company
McBee Laboratories
Mincom Div. 3M Co.
Moseley Assoc. Inc.
Quad-Eight Electronics
Radio Mfg. Co. (RMC)
RCA Corporation RCA Broadcast
Equip., Comm. Sys. Div.
Roh Corporation
Rust Corp.
Schafer Electronics Corp.
Sparta Electronic Corp.
STEP Corporation
Systems Marketing Corp. And
Sono-Mag Corp.
Tape-Athon Corp.
Telemet Co.
Trepac Corp. America
Visual Communication Products Oper.
General Electric Co.
Vitec Communications Ltd.

Automation, Film Chain

Central Dynamics Corp.
Mincom Div. 3M Co.
Quad-Eight Electronics
RCA Corporation RCA Broadcast
Equip., Comm. Sys. Div.
Robert Bosch Corp. Fernseh Div.
STEP Corporation
Vital Industries Inc.

Automation, Lighting Control

Berkey-Colortran Inc.
General Electric Company Tubes/MW
Devices
General Radio Co.
Skirpan Lighting Control Corp.
Video Engineering Co. Inc.

Automation, Program Control

See Adv. Page

Audio Devices, Inc. 45
Autogram Corporation 18
Collins Radio Company 19
ES Enterprises 43
Gates 10

**Grass Valley Group,
Inc.** 3
Sparta Electronic Corp. 8
**Systems Marketing
Corp.** 129
VIF International 128C

Aitken Communications Inc.
Aito Communications Inc. Broadcast
Marketing Div.
Ameco Inc.
American Data Corp. an AIRPAX
Company
Ampro Corp.
Audio Devices, Inc.
Autogram Corporation
Arnold Barnes Company
Broadcast Products Inc.
CCA Electronics Corp.
Central Dynamics Corp.
Chrono-Log Corp.
Collins Radio Company Broadcast
Division
Concept 70, A Div. of Dyma
Engineering, Inc.
Conrac Corporation Cramer Division
Datatron, Inc.
Display Systems Corp.
ES Enterprises
Gates Division of Harris-Intertype
Grass Valley Group, Inc.
IGM
Orbit Radio and Video
Quad-Eight Electronics
Radio Mfg. Co. (RMC)
RCA Corporation RCA Broadcast
Equip., Comm. Sys. Div.
Sarkes Tarzian Inc. Broadcast
Equipment Div.
Schafer Electronics Corp.
Schafer International
Sparta Electronic Corp.
STEP Corporation
Systems Marketing Corp. And
Sono-Mag Corp.
Tape-Athon Corp.
Tektronix Inc.
TeleMation, Inc.
Trepac Corp. America
VIF International
Visual Communication Products Oper.
General Electric Co.
Vital Industries Inc.

Automation, Program Logging

See Adv. Page

Autogram Corporation 18
Gates 10
Sparta Electronic Corp. 8
Video Sentry System 126

Aitken Communications Inc.
Alto Communications Inc. Broadcast
Marketing Div.
American Data Corp. an AIRPAX
Company
Ampex Corp. Audio-Video Systems
Division
Ampro Corp.
Atlantic Research Corp. Teleproducts
Dept.
Autogram Corporation
Broadcast Products Inc.
CCA Electronics Corp.
Central Dynamics Corp.
Collins Radio Company Broadcast
Division
Datatron, Inc.
Gates Division of Harris-Intertype
Grass Valley Group, Inc.
IGM
Mastertone Company
McBee Laboratories
Quad-Eight Electronics
Radio Mfg. Co. (RMC)
Sarkes Tarzian Inc. Broadcast
Equipment Div.
Schafer Electronics Corp.
Schafer International
Sparta Electronic Corp.
STEP Corporation
Systems Marketing Corp. And
Sono-Mag Corp.
Tape-Athon Corp.
Time & Frequency Tech., Inc.

Video Sentry System
Visual Communication Products Oper.
General Electric Co.
Vital Industries Inc.

Automation, Projector

Central Dynamics Corp.
Grass Valley Group, Inc.
Hokushin Elect. Co.
Magna-Tech Electronic Co., Inc.
Marconi Electronics Inc.
Skirpan Lighting Control Corp.
Spindler & Sauppe, Inc.

Automation, Switching

See Adv. Page

Audio Devices, Inc. 45
**Grass Valley Group,
Inc.** 3

American Data Corp. an AIRPAX
Company
Ampro Corp.
Atlantic Research Corp. Teleproducts
Dept.
Audio Devices, Inc.
Belcom Electronics Mfg. Co.
Broadcast Products Inc.
Central Dynamics Corp.
Chrono-Log Corp.
CMX Systems
Cohu, Inc. Electronics Division
Concept 70, A Div. of Dyma
Engineering, Inc.
Cunningham Corp. Subs. of Gleason
Works
Grass Valley Group, Inc.
IGM
Marconi Electronics Inc.
Quad-Eight Electronics
Radio Mfg. Co. (RMC)
Riker Communications Inc.
Sarkes Tarzian Inc. Broadcast
Equipment Div.
Schafer Electronics Corp.
STEP Corporation
Systems Marketing Corp. And
Sono-Mag Corp.
Tech Laboratories Inc.
TeleMation, Inc.
Telemet Co.
Trepac Corp. America
Video Engineering Co. Inc.
Visual Communication Products Oper.
General Electric Co.

Automation, Tape Control Cart

See Adv. Page

Audio Devices, Inc. 45
Autogram Corporation 18
Collins Radio Company 19
Gates 10
Sparta Electronic Corp. 8
**Systems Marketing
Corp.** 129
VIF International 128C

Aitken Communications Inc.
Alto Communications Inc. Broadcast
Marketing Div.
Ampex Corp. Audio-Video Systems
Division
Ampro Corp.
Audio Devices, Inc.
Autogram Corporation
Arnold Barnes Company
Broadcast Electronics
Broadcast Products Inc.
CCA Electronics Corp.
Central Dynamics Corp.
Collins Radio Company Broadcast
Division
Delta Electronics Inc. (N.C.)
Gates Division of Harris-Intertype
Grass Valley Group, Inc.
Mastertone Company
Mincom Div. 3M Co.
RCA Corporation RCA Broadcast
Equip., Comm. Sys. Div.
Schafer Electronics Corp.
Sparta Electronic Corp.
Spotmaster Broadcast Electronics

Systems Marketing Corp. And
Sono-Mag Corp.
Tapecaster TCM, Inc.
Telectro Systems Corp.
VIF International

Automation, Tape Control Reel

See Adv. Page

Audio Devices, Inc. 45
Collins Radio Company 19
Gates 10
Sparta Electronic Corp. 8
Systems Marketing
Corp. 129
VIF International 128C

Aitken Communications Inc.
Alto Communications Inc. Broadcast
Marketing Div.
Ampro Corp.
Audio Devices, Inc.
Autogram Corporation
Broadcast Products Inc.
CCA Electronics Corp.
Central Dynamics Corp.
CMX Systems
Collins Radio Company Broadcast
Division
Gates Division of Harris-Intertype
Grass Valley Group, Inc.
Mastertone Company
Mincom Div. 3M Co.
RCA Corporation RCA Broadcast
Equip., Comm. Sys. Div.
Schafer Electronics Corp.
Sparta Electronic Corp.
Systems Marketing Corp. And
Sono-Mag Corp.
Tape-Athon Corp.
Telectro Systems Corp.
VIF International
Wide Response

Automation, Transmitter Logging

See Adv. Page

Autogram Corporation 18
Gates 10
McBee Laboratories 114
Moseley Assoc. Inc. 7

Atlantic Research Corp. Teleproducts
Dept.
Autogram Corporation
Arnold Barnes Company
Broadcast Products Inc.
Central Dynamics Corp.
Collins Radio Company Broadcast
Division
Gates Division of Harris-Intertype
Marconi Instruments
Marti Electronics
McBee Laboratories
Moseley Assoc. Inc.
RCA Corporation RCA Broadcast
Equip., Comm. Sys. Div.
Rust Corp.
Systems Marketing Corp. And
Sono-Mag Corp.
Telectro Systems Corp.
Time & Frequency Tech., Inc.
Vital Industries Inc.

Automation, Video Tape Machine

Ampex Corp. Audio-Video Systems
Division
Broadcast Products Inc.
Central Dynamics Corp.
Display Systems Corp.
Mincom Div. 3M Co.
Orbit Radio and Video
RCA Corporation RCA Broadcast
Equip., Comm. Sys. Div.
Robert Bosch Corp. Fernseh Div.
TeleMation, Inc.

Blowers and Fans

AMCO Engineering Co.
American-Standard Industrial
Products Div.
Bud Radio Inc.

Collins Radio Company Broadcast
Division
Dynacool Mfg. Co., Inc.
Mole Richardson Co.
Terminal Hudson Corp. Terminal
Hudson Electronics

Bridge, Common Point

Collins Radio Company Broadcast
Division
Delta Electronics Inc. (Va.)
Gates Division of Harris-Intertype

Cabinets, Consoles and Racks

See Adv. Page

Borg-Warner Corp. 108
Broadcast Electronics 34
Dyma Engineering, Inc. 136
Gates 10
Micro-Trak Corporation 128B
Sparta Electronic Corp. 8
Stantron Division 128B

AMCO Engineering Co.
Anixter-Pruzan CATV Division
Audio Designs & Mfg.
Arnold Barnes Company
Borg-Warner Corp. Ingersoll Prods.
Div.
Broadcast Electronics
Bud Radio Inc.
CCA Electronics Corp.
Collins Radio Company Broadcast
Division
Concept 70, A Div. of Dyma
Engineering, Inc.
Dyma Engineering, Inc.
Enclosure Corp.
EQUIPTO
Gates Division of Harris-Intertype
General Devices Co., Inc. Vent-Rak
Div.

Grinnan Fixture Co.
Harwald Company
Lauderdale Electronic Labs
Mastertone Company
Micro-Trak Corporation (Formerly:
Gray Research & Dev.)
Multronics, Inc.
Neumade Prod. Corp.
North American Radio Corp.
Paso Sound Products Inc.
QRK Electronic Prod.
Quad-Eight Electronics
RCA Corporation RCA Broadcast
Equip., Comm. Sys. Div.
Rek-O-Kut Inc.
RTI Research Technology Inc.
Sarkes Tarzian Inc. Broadcast
Equipment Div.
Soundolier, Inc.
Sparta Electronic Corp.
Stantron Division Wyco Metal Products
Storeel Corp.
TeleMation, Inc.
Vicon Industries, Inc.
Video Engineering Co. Inc.
Waber Electronics Inc. Div. SGL
Industries, Inc.
Wilkinson Electronics, Inc.
Wilson Corp., H.

Cable, Camera

See Adv. Page

Boston Insulated Wire
& Cable Co. 120

Anixter-Pruzan CATV Division
Belden Corp. Electronic Division
Boston Insulated Wire & Cable Co.
Brand-Rex Company
Cramer Video and Audio Systems
Gates Division of Harris-Intertype
International Video Corp.
International Wire & Cable Co.
Robert Bosch Corp. Fernseh Div.
Rome Cable Div. Cyprus Mines Co.
Terminal Hudson Corp. Terminal
Hudson Electronics
Video Engineering Co. Inc.

Cable, Coaxial Flexible

See Adv. Page

Andrew Corp. 51
Cablewave Systems
Inc. 125
Sparta Electronic Corp. 8

Anaconda Electronics
Andrew Corp.
A-Tel-A-Matic
Belden Corp. Electronic Division
Blonder-Tongue Labs.
Brand-Rex Company
Cablewave Systems Inc. Subs. Phelps
Dodge and Kabelmetal
CATV Equipment Co.
Cohu, Inc. Electronics Division
Collins Radio Company Broadcast
Division
Columbia Electronic Cbl.
Comm/Scope Company
Cramer Video and Audio Systems
Dyma Engineering, Inc.
Essex International Inc.
Communication & CATV Div.
G.C. Electronics
General Cable Corp.
Gulf Telephone & Electronics
International Wire & Cable Co.
Jampro Antenna Co. Div. of Computer
Equipment Corp.
Javelin Div. of Apollo Lasers
Lamb Laboratories
Lectronic Res. Labs. Inc.
Mastertone Company
Pace Wire & Cable Corp.
Phelps Dodge Communications Co.
Div. Phelps Dodge Industries Inc.
Plastoid Corporation
Prodelin Inc.
RCA Corporation RCA Broadcast
Equip., Comm. Sys. Div.
Rome Cable Div. Cyprus Mines Co.
Saxton Prod. Inc.
Shively Laboratories, Inc.
Singer Products Co., Inc.
Soll, Inc., Joseph M.
Sparta Electronic Corp.
Spencer-Kennedy Labs., Inc.
Theta-Com of California Cable Division
Times Wire and Cable Sub. of Insilco
Corp.
Trompeter Electronics
TV Cable Supply Co., Inc.
Video Engineering Co. Inc.
Vikoa Inc.
Wilkinson Electronics, Inc.

Cable, Coaxial Rigid

See Adv. Page

Andrew Corp. 51
Cablewave Systems
Inc. 125

Ampro Corp.
Andrew Corp.
Anixter-Pruzan CATV Division
A-Tel-A-Matic
Cablewave Systems Inc. Subs. Phelps
Dodge and Kabelmetal
CATV Equipment Co.
CCA Electronics Corp.
Cohu, Inc. Electronics Division
Collins Radio Company Broadcast
Division
Comm/Scope Company
Dyma Engineering, Inc.
Essex International Inc.
Communication & CATV Div.
Gately Electronics
General Cable Corp.
Gulf Telephone & Electronics
Jampro Antenna Co. Div. of Computer
Equipment Corp.
Mastertone Company
Micro Communications, Inc.
Pace Wire & Cable Corp.
Phelps Dodge Communications Co.
Div. Phelps Dodge Industries Inc.
Plastoid Corporation
Prodelin Inc.
Quad-Eight Electronics
RCA Corporation RCA Broadcast
Equip., Comm. Sys. Div.

Rome Cable Div. Cyprus Mines Co.
Shively Laboratories, Inc.
Soll, Inc., Joseph M.
Sparta Electronic Corp.
Theta-Com of California Cable Division
Times Wire and Cable Sub. of Insilco
Corp.
TV Cable Supply Co., Inc.
Video Engineering Co. Inc.
Wilkinson Electronics, Inc.

Cable, Direct Burial

See Adv. Page

Cablewave Systems
Inc. 125

Anixter-Pruzan CATV Division
A-Tel-A-Matic
Brand-Rex Company
Cablewave Systems Inc. Subs. Phelps
Dodge and Kabelmetal
CATV Equipment Co.
Collins Radio Company Broadcast
Division
Columbia Electronic Cbl.
Comm/Scope Company
Essex International Inc.
Communication & CATV Div.
General Cable Corp.
Gulf Telephone & Electronics
Pace Wire & Cable Corp.
Phelps Dodge Communications Co.
Div. Phelps Dodge Industries Inc.
Plastoid Corporation
Rome Cable Div. Cyprus Mines Co.
Singer Products Co., Inc.
Spencer-Kennedy Labs., Inc.
Theta-Com of California Cable Division
Times Wire and Cable Sub. of Insilco
Corp.
TV Cable Supply Co., Inc.
Video Engineering Co. Inc.
Vikoa Inc.

Cable, Microphone

See Adv. Page

Sescom, Inc. 128

Sescom, Inc.

Cable, Shielded Audio

See Adv. Page

Sparta Electronic Corp. 8

Alpha Wire
Amphenol RF Division
A-Tel-A-Matic
Belden Corp. Electronic Division
Birnback Co. Inc.
Boston Insulated Wire & Cable Co.
Brand-Rex Company
Cetec Inc. Subs. Computer Equipment
Corp.
Collins Radio Company Broadcast
Division
Columbia Electronic Cbl.
Comm/Scope Company
Essex International Inc.
Communication & CATV Div.
Franz Vertriebs-gesellschaft m.b.H.
G.C. Electronics
General Cable Corp.
Gulf Telephone & Electronics
Lamb Laboratories
Nortronics Co., Inc. Recorder Care Div.
Pace Wire & Cable Corp.
Prestolite Company
RCA Corporation RCA Broadcast
Equip., Comm. Sys. Div.
Rome Cable Div. Cyprus Mines Co.
Saxton Prod. Inc.
Sescom, Inc.
Singer Products Co., Inc.
Sparta Electronic Corp.
Terminal Hudson Corp. Terminal
Hudson Electronics
Times Wire and Cable Sub. of Insilco
Corp.
Video Engineering Co. Inc.
Vikoa Inc.
Wilkinson Electronics, Inc.

Cable Laying Equipment

Anixter-Pruzan CATV Division
Contender Corporation
Ditch Witch Div. of Charles Machine Works, Inc.
Roll-A-Reel
F. B. Ryan Mfg. Co. Inc.
Terminal Hudson Corp. Terminal Hudson Electronics

Calibration Service, Instrument

Ameco Inc.
American Electronics Lab., Inc.
Bird Electronic Corp.
B & K Instruments Inc.
CBS Labs
Comm. Radio Monitoring
Eidson Electronic Co.
Honeywell Inc. Test Instruments Div.
Instrument Laboratories
National Electrolab Ltd.
Potomac Instruments, Inc.
Simpson Electric Co.
Tektronix Inc.

Camera Dollies, Stands and Tripods

Ameco Inc.
Anixter-Pruzan CATV Division
Comquip, Inc.
Cosmicar Optical Co., Ltd.
Cramer Video and Audio Systems
Davis & Sanford Co. Inc.
Diamond Power Specialty Corp. Subs. Babcock & Wilcox Co.
F&B/Ceco Industries, Inc.
Gates Division of Harris-Intertype
GBC Closed Circuit TV Corp.
Hitachi Shibaden Corp. of America
Image Devices Incorporated
Innovative Television Equipment, Inc.
International Video Corp.
Javelin Div. of Apollo Lasers
Listec TV Equip. Corp.
O'Connor Eng. Labs. Inc. Photographic Division
Paillard Incorporated
Panasonic Video Systems Div. Matsushita Electric Corp. of America
Philips Broadcast Equipment Corp. Subs. North American Philips Corp.
Precision Laboratories Precision Cine Equipment Corp.
Quick-Set Inc.
R. H. Tyler Co. Div. of Weather Scan, Inc.
Riker Communications Inc.
Sylvania Comm. Electronic Technology Incorporated HF Photo Systems Div.
Tele-Cine Inc.
TeleMation, Inc.
Television Products Co. Inc.
Victor Duncan, Inc.
Video Engineering Co. Inc.
Vikoa Inc.
Waber Electronics Inc. Div. SGL Industries, Inc.
Wilson Corp., H.

Camera Pan and Tilt Heads

Anixter-Pruzan CATV Division
Cramer Video and Audio Systems
Cunningham Corp. Subs. of Gleason Works
Davis & Sanford Co. Inc.
Gates Division of Harris-Intertype
Javelin Div. of Apollo Lasers
Listec TV Equip. Corp.
O'Connor Eng. Labs. Inc. Photographic Division
Technology Incorporated HF Photo Systems Div.
Tele-Cine Inc.
Victor Duncan, Inc.

Camera Remote Control Equipment

See Adv. Page

Moseley Assoc. Inc. 7

Anixter-Pruzan CATV Division
Arnold Barnes Company
Bristol Div. of Acco
Catel, a Div. of United Scientific Corp. Comquip, Inc.
Cunningham Corp. Subs. of Gleason Works
Diamond Power Specialty Corp. Subs. Babcock & Wilcox Co.
F&B/Ceco Industries, Inc.
Gates Division of Harris-Intertype
GBC Closed Circuit TV Corp.
Hitachi Shibaden Corp. of America
Ikegami Tsushinki Co., Ltd. Export Department
Innovative Television Equipment, Inc.
Listec TV Equip. Corp.
Moseley Assoc. Inc.
Philips Broadcast Equipment Corp. Subs. North American Philips Corp.
Power-Optics Inc.
RCA Corporation RCA Broadcast Equip., Comm. Sys. Div.
Robert Bosch Corp. Fernseh Div.
Sylvania Comm. Electronic
Tektronix Inc.
Tele-Cine Inc.
TeleMation, Inc.
Tele Measurements Inc.
TRACOR, Inc. Instruments Group
Trepac Corp. America
Vicon Industries, Inc.
Video Engineering Co. Inc.
Visual Educom Inc. DAGE Television
Visual Educom Inc. MTI Television

Cameras, Closed Circuit B&W

Admiral Corporation
Akai America, Ltd.
Ameco Inc.
Ampex Corp. Audio-Video Systems Division
Anixter-Pruzan CATV Division
A-Tel-A-Matic
ATV Research
Audiotronics Corp.
CATV Equipment Co.
Cohu, Inc. Electronics Division
Colorado Video Inc.
Commercial Elect.
Computer Image Corp.
Comquip, Inc.
Cramer Video and Audio Systems
Denson Electronic Corp.
Diamond Power Specialty Corp. Subs. Babcock & Wilcox Co.
Diebold Incorporated
F&B/Ceco Industries, Inc.
GBC Closed Circuit TV Corp.
Gen. Electrodynamics
GPL Div. Singer Gen.
Gulf Telephone & Electronics
Hitachi Shibaden Corp. of America
Ikegami Tsushinki Co., Ltd. Export Department
International Video Corp.
Javelin Div. of Apollo Lasers
Nasco Television Systems
Panasonic Video Systems Div. Matsushita Electric Corp. of America
Philips Broadcast Equipment Corp. Subs. North American Philips Corp.
RCA Corporation RCA Electromagnetic & Aviation Systems Div.
R. H. Tyler Co. Div. of Weather Scan, Inc.
Riker Communications Inc.
Robert Bosch Corp. Fernseh Div.
Sarkes Tarzian Inc. Broadcast Equipment Div.
Singer Co. Simulation Products Div.
Sony Corp. of America
Teledyne Brown Engineering Co. Science & Engrg. Div.
Teledyne Camera Systems
TeleMation, Inc.
Tele Measurements Inc.
Telesync Corp.
Teltron, Inc.
Video Engineering Co. Inc.
Visual Educom Inc. DAGE Television
Westinghouse Electric Corp. Electric Tube Div.

Cameras, Closed Circuit Color

See Adv. Page

Robert Bosch Corp. 52, 53

Akai America, Ltd.
Ameco Inc.
Ampex Corp. Audio-Video Systems Division
Anixter-Pruzan CATV Division
A-Tel-A-Matic
Arnold Barnes Company
CHESTER ELECTRONIC LABS., INC. GTE Information Systems Inc.
Cohu, Inc. Electronics Division
Commercial Elect.
Cramer Video and Audio Systems
Denson Electronic Corp.
F&B/Ceco Industries, Inc.
GBC Closed Circuit TV Corp.
GPL Div. Singer Gen.
Hitachi Shibaden Corp. of America
Ikegami Tsushinki Co., Ltd. Export Department
International Video Corp.
Norelco, Philips Bcst. Equip. Corp. Subs. North American Philips Corp.
Panasonic Video Systems Div. Matsushita Electric Corp. of America
Philips Broadcast Equipment Corp. Subs. North American Philips Corp.
RCA Corporation RCA Broadcast Equip., Comm. Sys. Div.
RCA Corporation RCA Electromagnetic & Aviation Systems Div.
R. H. Tyler Co. Div. of Weather Scan, Inc.
Robert Bosch Corp. Fernseh Div.
Singer Co. Simulation Products Div.
Sony Corp. of America
Teledyne Camera Systems
TeleMation, Inc.
Tele Measurements Inc.
Telesync Corp.
Video Engineering Co. Inc.
Westinghouse Electric Corp. Electric Tube Div.

Cameras, Film Chain

See Adv. Page

Gates 10

Anixter-Pruzan CATV Division
Arnold Barnes Company
CHESTER ELECTRONIC LABS., INC. GTE Information Systems Inc.
Cohu, Inc. Electronics Division
Commercial Elect.
Cramer Video and Audio Systems
Gates Division of Harris-Intertype
International Video Corp.
Marco Video Systems, Inc.
Norelco, Philips Bcst. Equip. Corp. Subs. North American Philips Corp.
Rank Cintel, Electronic Systems Div.
Rank Precision Industries Ltd.
RCA Corporation RCA Broadcast Equip., Comm. Sys. Div.
R. H. Tyler Co. Div. of Weather Scan, Inc.
Robert Bosch Corp. Fernseh Div.
Sarkes Tarzian Inc. Broadcast Equipment Div.
TeleMation, Inc.
Tele Measurements Inc.
Video Engineering Co. Inc.

Cameras, Film Cine

See Adv. Page

Comquip, Inc. 141

ABTO, Inc.
Arriflex Company of America
Camera Mart Inc.
Canon USA, Inc. Optics Division
Cohu, Inc. Electronics Division
Comquip, Inc.
Eastman Kodak Co.
F&B/Ceco Industries, Inc.
GAF Corp.
Image Devices Incorporated
Paillard Incorporated

Precision Laboratories Precision Cine Equipment Corp.
RCA Corporation RCA Broadcast Equip., Comm. Sys. Div.
R. H. Tyler Co. Div. of Weather Scan, Inc.
Robert Bosch Corp. Fernseh Div.
Teledyne Camera Systems
Tele Measurements Inc.
Victor Duncan, Inc.
Wilcam Photo Research Inc.

Cameras, Film Still

ABTO, Inc.
Burke & James
Eastman Kodak Co.
GAF Corp.
Paillard Incorporated
Philips Broadcast Equipment Corp. Subs. North American Philips Corp.
R. H. Tyler Co. Div. of Weather Scan, Inc.

Cameras, Image Motion Compensation

Dynasciences Corp. Video Products Div.
GBC Closed Circuit TV Corp.
GPL Div. Singer Gen.

Cameras, Surveillance

Anixter-Pruzan CATV Division
A-Tel-A-Matic
ATV Research
Audiotronics Corp.
Arnold Barnes Company
Cohu, Inc. Electronics Division
Comquip, Inc.
Cramer Video and Audio Systems
Diebold Incorporated
Eastman Kodak Co.
GBC Closed Circuit TV Corp.
Gen. Electrodynamics
Hitachi Shibaden Corp. of America
Javelin Div. of Apollo Lasers
Nasco Television Systems
Norelco, Philips Bcst. Equip. Corp. Subs. North American Philips Corp.
Panasonic Video Systems Div. Matsushita Electric Corp. of America
Power-Optics Inc.
Pulse Dynamics Mfg. Corp.
R. H. Tyler Co. Div. of Weather Scan, Inc.
Riker Communications Inc.
Singer Co. Simulation Products Div.
Tele-Cine Inc.
Teledyne Brown Engineering Co. Science & Engrg. Div.
Teledyne Camera Systems
TeleMation, Inc.
Telesync Corp.
Teltron, Inc.
Vicon Industries, Inc.
Victor Duncan, Inc.
Video Engineering Co. Inc.

Cameras, TV B&W Portable Broadcast

Ampex Corp. Audio-Video Systems Division
Anixter-Pruzan CATV Division
CATV Equipment Co.
Cohu, Inc. Electronics Division
Cramer Video and Audio Systems
Denson Electronic Corp.
Hitachi Shibaden Corp. of America
Ikegami Tsushinki Co., Ltd. Export Department
International Video Corp.
Philips Broadcast Equipment Corp. Subs. North American Philips Corp.
Riker Communications Inc.
Robert Bosch Corp. Fernseh Div.
Sony Corp. of America
Teledyne Camera Systems
TeleMation, Inc.
Tele Measurements Inc.
Teltron, Inc.
Video Engineering Co. Inc.
Visual Educom Inc. MTI Television

Cameras, TV B&W Studio Broadcast

Ameco Inc.
Anixter-Pruzan CATV Division
Arnold Barnes Company
Cohu, Inc. Electronics Division
Cramer Video and Audio Systems
Denson Electronic Corp.
GBC Closed Circuit TV Corp.
GPL Div. Singer Gen.
Hitachi Shibaden Corp. of America
Ikegami Tsushinki Co., Ltd. Export Department
International Video Corp.
Marconi Electronics Inc.
Maze Corporation
Norelco, Philips Bcst. Equip. Corp.
Subs. North American Philips Corp.
Philips Broadcast Equipment Corp.
Subs. North American Philips Corp.
Robert Bosch Corp. Fernseh Div.
Sarkes Tarzian Inc. Broadcast Equipment Div.
Sony Corp. of America
TeleMation, Inc.
Tele Measurements Inc.
Teltron, Inc.
Video Engineering Co. Inc.
Visual Educom Inc. DAGE Television

Cameras, TV Color Portable Broadcast

See Adv. Page

Akai America, Ltd. 5
Gates 10
Robert Bosch Corp. 52, 53

Akai America, Ltd.
Anixter-Pruzan CATV Division
Commercial Elect.
Cramer Video and Audio Systems
Editel Productions
F&B/Ceco Industries, Inc.
Gates Division of Harris-Intertype
GBC Closed Circuit TV Corp.
GPL Div. Singer Gen.
Ikegami Tsushinki Co., Ltd. Export Department
International Video Corp.
Norelco, Philips Bcst. Equip. Corp.
Subs. North American Philips Corp.
Philips Broadcast Equipment Corp.
Subs. North American Philips Corp.
RCA Corporation RCA Broadcast Equip., Comm. Sys. Div.
Robert Bosch Corp. Fernseh Div.
Sarkes Tarzian Inc. Broadcast Equipment Div.
TeleMation, Inc.
Tele Measurements Inc.

Cameras, TV Color Studio Broadcast

See Adv. Page

Gates 10
Robert Bosch Corp. 52, 53

Ameco Inc.
Ampex Corp. Audio-Video Systems Division
Anixter-Pruzan CATV Division
Arnold Barnes Company
CHESTER ELECTRONIC LABS., INC.
GTE Information Systems Inc.
Commercial Elect.
Cramer Video and Audio Systems
F&B/Ceco Industries, Inc.
Gates Division of Harris-Intertype
Hitachi Shibaden Corp. of America
Ikegami Tsushinki Co., Ltd. Export Department
International Video Corp.
Marconi Electronics Inc.
Maze Corporation
Norelco, Philips Bcst. Equip. Corp.
Subs. North American Philips Corp.
Philips Broadcast Equipment Corp.
Subs. North American Philips Corp.
RCA Corporation RCA Broadcast Equip., Comm. Sys. Div.
Robert Bosch Corp. Fernseh Div.
Sarkes Tarzian Inc. Broadcast Equipment Div.

Soll, Inc., Joseph M.
TeleMation, Inc.
Tele Measurements Inc.
Video Engineering Co. Inc.

Cameras, TV Remote Control Broadcast

Commercial Elect.
Cramer Video and Audio Systems
Gates Division of Harris-Intertype
International Video Corp.
Marconi Electronics Inc.
Norelco, Philips Bcst. Equip. Corp.
Subs. North American Philips Corp.
Philips Broadcast Equipment Corp.
Subs. North American Philips Corp.
Robert Bosch Corp. Fernseh Div.
Tele Measurements Inc.
Teltron, Inc.
Video Engineering Co. Inc.

Cartridge Machine, Dual Deck

See Adv. Page

International Tapetronics Corp. 128
Mastertone Company 139

Alto Communications Inc. Broadcast Marketing Div.
Ampro Corp.
Arnold Barnes Company
Broadcast Electronics
Broadcast Products Inc.
CCA Electronics Corp.
Cine Sonic Sound Inc.
Collins Radio Company Broadcast Division
Dyma Engineering, Inc.
Gates Division of Harris-Intertype
International Tapetronics Corp.
MacKenzie Laboratories, Inc.
Mastertone Company
McCurdy Radio Ind. Inc.
QRK Electronic Prod.
RAPID-Q Div. of Garron Electronics
RCA Corporation RCA Broadcast Equip., Comm. Sys. Div.
Schafer Electronics Corp.
Singer Products Co., Inc.
Spotmaster Broadcast Electronics
Systems Engineering Co., Inc.
Systems Marketing Corp. And Sono-Mag Corp.
Telectro Systems Corp.
Visual Electronics Corp.
Wilkinson Electronics, Inc.

Cartridge Machine, Multiple Deck

See Adv. Page

Broadcast Electronics 16, 34
Mastertone Company 139

Alto Communications Inc. Broadcast Marketing Div.
Ampro Corp.
Arnold Barnes Company
Blanchard Electronics
Broadcast Electronics
Broadcast Products Inc.
CCA Electronics Corp.
Cine Sonic Sound Inc.
Collins Radio Company Broadcast Division
Communication Medias
Dyma Engineering, Inc.
IGM
International Tapetronics Corp.
MacKenzie Laboratories, Inc.
Magnatech Company
Mastertone Company
QRK Electronic Prod.
Radio Mfg. Co. (RMC)
RAPID-Q Div. of Garron Electronics
RCA Corporation RCA Broadcast Equip., Comm. Sys. Div.
Singer Products Co., Inc.
Spotmaster Broadcast Electronics
Systems Engineering Co., Inc.
Systems Marketing Corp. And Sono-Mag Corp.
Telectro Systems Corp.

Telex Communications Division
VIF International
Visual Electronics Corp.
Wilkinson Electronics, Inc.

Cartridge Machine, Random Access

See Adv. Page

Gates 10
Mastertone Company 139
Sparta Electronic Corp. 8

Alto Communications Inc. Broadcast Marketing Div.
Ampro Corp.
Autogram Corporation
Broadcast Electronics
Broadcast Products Inc.
CCA Electronics Corp.
Cine Sonic Sound Inc.
Conrac Corporation Cramer Division
Gates Division of Harris-Intertype IGM
MacKenzie Laboratories, Inc.
Mastertone Company
RAPID-Q Div. of Garron Electronics
RCA Corporation RCA Broadcast Equip., Comm. Sys. Div.
Schafer Electronics Corp.
Singer Products Co., Inc.
Sparta Electronic Corp.
Spotmaster Broadcast Electronics
Systems Marketing Corp. And Sono-Mag Corp.
Telectro Systems Corp.
Telex Communications Division
VIF International
Wilkinson Electronics, Inc.

Cartridge Machine, Single Deck

See Adv. Page

Ampro Corp. 140
Broadcast Electronics 16, 34
Gates 10
Mastertone Company 139
RAPID-Q 134
Sparta Electronic Corp. 8

Alto Communications Inc. Broadcast Marketing Div.
Ampro Corp.
Arnold Barnes Company
Broadcast Electronics
Broadcast Products Inc.
CCA Electronics Corp.
Cine Sonic Sound Inc.
Collins Radio Company Broadcast Division
Communication Medias
Contel Mfg. Div. of Continental Electronic Wholesale Corp.
Dyma Engineering, Inc.
Gates Division of Harris-Intertype IGM
International Tapetronics Corp.
LPB Inc.
MacKenzie Laboratories, Inc.
Magnatech Company
Mastertone Company
McCurdy Radio Ind. Inc.
QRK Electronic Prod.
Radio Mfg. Co. (RMC)
RAPID-Q Div. of Garron Electronics
RCA Corporation RCA Broadcast Equip., Comm. Sys. Div.
Schafer Electronics Corp.
Schultz Inc., Albert
Singer Products Co., Inc.
Sparta Electronic Corp.
Spotmaster Broadcast Electronics
Systems Engineering Co., Inc.
Systems Marketing Corp. And Sono-Mag Corp.
Tapecaster TCM, Inc.
Telectro Systems Corp.
Telex Communications Division
Tri-Tronics
Visual Electronics Corp.
Wilkinson Electronics, Inc.

Cartridge Machine Alignment Tape

See Adv. Page

Sparta Electronic Corp. 8

Nortronics Co., Inc. Recorder Care Div.
Sparta Electronic Corp.

Cartridge Machine Rebuilding Services

See Adv. Page

Communication Medias 42

Communication Medias

Cartridge Reconditioning Services

See Adv. Page

Mastertone Company .. 139,141
Sparta Electronic Corp. 8

Birmingham Tape Cartridge Co., Inc.
Broadcast Electronics
Columbia Broadcast Services
Joa Cartridge Service
Lauderdale Electronic Labs
Marathon Broadcast Equip.
Mastertone Company
Qualitape Inc.
Sparta Electronic Corp.
Spotmaster Broadcast Electronics
Tapex Corporation
Telectro Systems Corp.

Cartridge Recording Services

See Adv. Page

Mastertone Company 141
Qualitape Inc. 137

Communication Medias
Mastertone Company
Pentagon Industries, Inc.
Qualitape Inc.
Radio Mfg. Co. (RMC)
Schultz Inc., Albert
Stanton Magnetics Inc.
Tapex Corporation
Telectro Systems Corp.

Cartridge Reloading Services

See Adv. Page

Qualitape Inc. 137
Qualitape Inc.

Cartridge Splice Finder

See Adv. Page

Birmingham Tape Cartridge Co., Inc. 140

Beau Motor Division U.M.C. Electronics Co.
Birmingham Tape Cartridge Co., Inc.
Broadcast Electronics
Broadcast Products Inc.
Communication Medias
Spotmaster Broadcast Electronics
Tapecaster TCM, Inc.
Telectro Systems Corp.

Cartridges, Magnetic Tape

See Adv. Page

Broadcast Electronics 34
BSC Incorporated 112
Fidelipac Division 122
Gates 10
Mastertone Company .. 139,141
Sparta Electronic Corp. 8
Tapex Corporation 36

Agfa-Gevaert Inc.
Audio Devices, Inc.
Audio Magnetics Corp.
Autogram Corporation

Broadcast Electronics
Broadcast Products Inc.
BSC Incorporated
CCA Electronics Corp.
Cine Sonic Sound Inc.
Collins Radio Company Broadcast
Division
Columbia Broadcast Services
Communication Medias
Conrac Corporation Cramer Division
Contel Mfg. Div. of Continental
Electronic Wholesale Corp.
Fairchild/Robbins Fairchild Sound
Equipment Corp.
Fidelipac Division TelePro Industries,
Inc.
Gates Division of Harris-Intertype
Gould Inc. Instrument Systems Div.
IGM
Joa Cartridge Service
Lauderdale Electronic Labs
MaCarta
Magnatech Company
Magnetic Prod. Div. 3M Company
Marathon Broadcast Equip.
Mastertone Company
Memorex Corporation Audio-Video
Group
QRK Electronic Prod.
Qualitape Inc.
Radio Mfg. Co. (RMC)
RCA Corporation RCA Broadcast
Equip., Comm. Sys. Div.
RCA Corporation RCA Electronic
Components
Schultz Inc., Albert
Singer Products Co., Inc.
Sparta Electronic Corp.
Spotmaster Broadcast Electronics
Systems Engineering Co., Inc.
Systems Marketing Corp. And
Sono-Mag Corp.
Tapecaster TCM, Inc.
Tapex Corporation
Telectro Systems Corp.
Telex Communications Division
Wilkinson Electronics, Inc.

Cartridges, Phono

See Adv. Page

Gates 10
Qualitape Inc. 137
Sparta Electronic Corp. 8
Stanton Magnetics Inc. 39

AKG Division North Amer. Philips
Corp.
Bell Sound Studios Electro Sound Div.
Bourns, Inc. BPMC Division
Broadcast Electronics
Broadcast Products Inc.
CCA Electronics Corp.
Collins Radio Company Broadcast
Division
Communication Medias
Duotone Co. Inc.
Electro-Voice Inc. Subs. of Gulton
Industries, Inc.
Gates Division of Harris-Intertype
Lauderdale Electronic Labs
LPB Inc.
Mastertone Company
QRK Electronic Prod.
Qualitape Inc.
RCA Corporation RCA Broadcast
Equip., Comm. Sys. Div.
Rek-O-Kut Inc.
Schultz Inc., Albert
Shure Brothers Inc.
Singer Products Co., Inc.
Sparta Electronic Corp.
Spotmaster Broadcast Electronics
Stanton Magnetics Inc.
Systems Engineering Co., Inc.
Terminal Hudson Corp. Terminal
Hudson Electronics
Wilkinson Electronics, Inc.

Cartridges, Stereo

See Adv. Page

Broadcast Electronics 34
Gates 10
Mastertone Company .. 139,141

Qualitape Inc. 137

Autogram Corporation
Broadcast Electronics
Broadcast Products Inc.
Collins Radio Company Broadcast
Division
Communication Medias
Electro-Voice Inc. Subs. of Gulton
Industries, Inc.
Fidelipac Division TelePro Industries,
Inc.
Franz Vertriebs-gesellschaft m.b.H.
Gates Division of Harris-Intertype
Lauderdale Electronic Labs
Marathon Broadcast Equip.
Mastertone Company
QRK Electronic Prod.
Qualitape Inc.
Rek-O-Kut Inc.
Sparta Electronic Corp.
Spotmaster Broadcast Electronics
Stanton Magnetics Inc.
Systems Marketing Corp. And
Sono-Mag Corp.
Tapex Corporation
Terminal Hudson Corp. Terminal
Hudson Electronics
Wilkinson Electronics, Inc.

Cartridges, Videotape

Anixter-Pruzan CATV Division
Audio Magnetics Corp.
Cramer Video and Audio Systems
International Video Corp.
K'SON Corporation
Magnetic Prod. Div. 3M Company
Mincom Div. 3M Co.
RCA Corporation RCA Broadcast
Equip., Comm. Sys. Div.
Schultz Inc., Albert
Tele Measurements Inc.

Cassette Machine, Dual Deck

Broadcast Products Inc.
Pentagon Industries, Inc.
Schafer International

Cassette Machine, Multiple Deck

Broadcast Products Inc.
Conrac Corporation Cramer Division
Pentagon Industries, Inc.
Schafer International

Cassette Machine, Random Access

Ampex Corp. Audio-Video Systems
Division
Broadcast Products Inc.
Conrac Corporation Cramer Division
Schafer International

Cassette Machine, Single Deck

Broadcast Products Inc.
Conrac Corporation Cramer Division
Mincom Div. 3M Co.
Schafer International
Telex Communications Division

Cassettes, Duplication

See Adv. Page

Qualitape Inc. 137
Qualitape Inc.

Character Generators

See Adv. Page

Broadcast Electronics 34
Video Data Systems,
Inc. 141

Ameco Inc.
American Data Corp. an AIRPAX
Company
Atlantic Research Corp. Teleproducts
Dept.
Broadcast Electronics
CBS Labs

Chiron Telesystems Systems
Resources Corp.
Chrono-Log Corp.
Communication Medias
Cooke Engineering Co.
Cramer Video and Audio Systems
Datavision, Inc.
Dyma Engineering, Inc.
Electronic Engineering Co. of California
Marconi Electronics Inc.
Nasco Television Systems
RCA Corporation RCA Broadcast
Equip., Comm. Sys. Div.
SPI-ITT Instruments Metrix Division
Spotmaster Broadcast Electronics
Sterling Television Presentations Inc.
Sterling Communications Co.
Tektronix Inc.
TeleMation, Inc.
TELESTRATOR Industries
Test & Measuring Instruments, Inc. a
North American Philips Co.
Time & Frequency Tech., Inc.
Video Data Systems, Inc.
Video Devices Co.
Video Engineering Co. Inc.
VIF International

Choppers

CCA Electronics Corp.
Comark Industries Inc.
RCA Corporation RCA Broadcast
Equip., Comm. Sys. Div.
Tektronix Inc.

Chroma Keyers

See Adv. Page

Danscoll Ltd. 116
Grass Valley Group,
Inc. 3
Shintron Co. Inc. 132
Telemet Co. IBC

Arnold Barnes Company
CBS Labs
Central Dynamics Corp.
Cramer Video and Audio Systems
Danscoll Ltd.
Grass Valley Group, Inc.
Shintron Co. Inc. Video Products Div.
Telemet Co.

Cleaner, Circuit Board

See Adv. Page

Miller-Stephenson
Chemical Co. 21

Miller-Stephenson Chemical Co.

Cleaner, Magnetic Tape Head

See Adv. Page

Miller-Stephenson
Chemical Co. 21

Ampex Corp. Audio-Video Systems
Division
Audio Magnetics Corp.
Broadcast Electronics
Communication Medias
Duotone Co. Inc.
Fairchild/Robbins Fairchild Sound
Equipment Corp.
G.C. Electronics
Javelin Div. of Apollo Lasers
Lauderdale Electronic Labs
P. R. Mallory & Co. Inc. Mallory
Distributor Products Co.
Mastertone Company
Miller-Stephenson Chemical Co.
Nortronics Co., Inc. Recorder Care Div.
Qualitape Inc.
Spotmaster Broadcast Electronics
Systems Marketing Corp. And
Sono-Mag Corp.
Telectro Systems Corp.
Television Equipment Associates
Texwipe Co.
VIF International

Clocks and Chronographs

See Adv. Page

Audio Devices, Inc. 45
ES Enterprises 43
General Time Service 50
Micro-Trak Corporation 128B

American Data Corp. an AIRPAX
Company
Audio Devices, Inc.
Bradford Information Systems
Broadcast Electronics
Broadcast Products Inc.
Bulova American Time Products
Cetec Inc. Subs. Computer Equipment
Corp.
Chrono-Log Corp.
Communication Medias
Cooke Engineering Co.
Edwards Company, Inc.
ES Enterprises
Gates Division of Harris-Intertype
General Time Service A Talley
Industries Co.
Harwood Mfg. Co.
IGM
Logiconcepts, Inc.
Micro-Trak Corporation (Formerly:
Gray Research & Dev.)
Racine & Co., Inc., Jules
Radio Mfg. Co. (RMC)
Spotmaster Broadcast Electronics
Standard Electric Time Div. of Johnson
Service Co.
Systems Marketing Corp. And
Sono-Mag Corp.
Tapecaster TCM, Inc.
TelComp Division Television and
Computer Corp.
Time & Frequency Tech., Inc.
Video Devices Co.
Video Engineering Co. Inc.
Visual Electronics Corp.

Clocks, Digital and Digital Driver

See Adv. Page

Audio Devices, Inc. 45
ES Enterprises 43
Micro-Trak Corporation 128B
Sparta Electronic Corp. 8

American Data Corp. an AIRPAX
Company
Applied Video Electronics, Inc.
Audio Devices, Inc.
Autogram Corporation
Broadcast Products Inc.
Bulova American Time Products
Chrono-Log Corp.
Conrac Corporation Cramer Division
Cooke Engineering Co.
Datatron, Inc.
ES Enterprises
Kaitronics Corporation
Mastertone Company
Micro-Trak Corporation (Formerly:
Gray Research & Dev.)
Orbit Radio and Video
PRD Electronics, Inc.
Quasar Microsystems Inc.
Sparta Electronic Corp.
Tapecaster TCM, Inc.
Test & Measuring Instruments, Inc. a
North American Philips Co.
Time & Frequency Tech., Inc.
United Systems Corp. Subs. of
Monsanto Co.
Video Devices Co.
Vitec Communications Ltd.

Clocks, Station Master Control

See Adv. Page

Audio Devices, Inc. 45

American Data Corp. an AIRPAX
Company
Audio Devices, Inc.
Arnold Barnes Company
Broadcast Products Inc.
Bulova American Time Products
Chrono-Log Corp.
Conrac Corporation Cramer Division

Dyma Engineering, Inc.
 ES Enterprises
 Gates Division of Harris-Intertype
 Kaitronics Corporation
 Micro-Trak Corporation (Formerly:
 Gray Research & Dev.)
 Quasar Microsystems Inc.
 Radio Mfg. Co. (RMC)
 Standard Electric Time Div. of Johnson
 Service Co.
 Systems Marketing Corp. And
 Sono-Mag Corp.
 Tapecaster TCM, Inc.
 Time & Frequency Tech., Inc.
 Vitec Communications Ltd.

Collimeters

See Adv. Page

Ramko Research 20

Ramko Research

Color Correction Equipment

Ampex Corp. Audio-Video Systems
 Division
 Arnold Barnes Company
 CBS Labs
 Datatek Corp.
 Marconi Electronics Inc.
 Philips Broadcast Equipment Corp.
 Subs. North American Philips Corp.
 Rank Cintel, Electronic Systems Div.
 Rank Precision Industries Ltd.
 Rank Precision Ind. Broadcast Div.
 Riker Communications Inc.
 Robert Bosch Corp. Fernseh Div.
 Television Equipment Associates

Colorizer --See Generators,
 Special Effect

Combiners, Power

See Adv. Page

Sparta Electronic Corp. 8

CCA Electronics Corp.
 Collins Radio Company Broadcast
 Division
 Comark Industries Inc.
 Dielectric Communications Div. of Sola
 Basic
 Narda Microwave Corp., The
 Shively Laboratories, Inc.
 Sparta Electronic Corp.

Common Point Bridge --See
 Bridge, Common Point

**Communication Systems, Land
 Mobile**

See Adv. Page

Moseley Assoc. Inc. 7

Alpha Electronic Services Inc.
 Andrew Corp.
 Andrews Tower Inc.
 Atlantic Research Corp. Teleproducts
 Dept.
 Belcom Electronics Mfg. Co.
 Cablewave Systems Inc. Subs. Phelps
 Dodge and Kabelmetal
 CCA Electronics Corp.
 Dyma Engineering, Inc.
 General Electric Co. Mobile Radio
 Dept.
 Miles Reproducer Co.
 Moseley Assoc. Inc.
 Paso Sound Products Inc.
 Phelps Dodge Communications Co.
 Div. Phelps Dodge Industries Inc.
 RCA Corporation RCA Broadcast
 Equip., Comm. Sys. Div.
 Scientific Systems, Inc. Broadcast
 Equipment Div.
 Scintrex Inc. Communications Div.
 Siemens Corporation
 Singer Products Co., Inc.

**Communication Systems,
 Microwave**

See Adv. Page

Moseley Assoc. Inc. 7

Acrodyne Industries
 Alcor Inc.
 Andrew Corp.
 Andrews Tower Inc.
 Atlantic Research Corp. Teleproducts
 Dept.
 Belcom Electronics Mfg. Co.
 Cablewave Systems Inc. Subs. Phelps
 Dodge and Kabelmetal
 Dyma Engineering, Inc.
 GTE Lenkurt Incorporated
 Moseley Assoc. Inc.
 Raytheon Company Raytheon Data
 Systems Co.
 RHG Elect Labs, Inc.
 Scientific Systems, Inc. Broadcast
 Equipment Div.
 Scott-Buttner Coastcom, Inc.
 Siemens Corporation
 Singer Products Co., Inc.
 Soladyne International
 Tele Measurements Inc.
 Theta-Com of California AML Division
 Varian Solid State Div. Micro-Link
 Products

**Communication Systems,
 Multiplex**

See Adv. Page

Moseley Assoc. Inc. 7

**Scott-Buttner
 Coastcom, Inc.** 12

Bethany International
 Catel, a Div. of United Scientific Corp.
 Dorado Systems
 GTE Lenkurt Incorporated
 Moseley Assoc. Inc.
 Raytheon Company Raytheon Data
 Systems Co.
 Scott-Buttner Coastcom, Inc.
 Siemens Corporation
 Singer Products Co., Inc.
 Taft Communication Systems, Inc.
 Trepac Corp. America

Communication Systems, STL

See Adv. Page

Moseley Assoc. Inc. 7

**Scott-Buttner
 Coastcom, Inc.** 12

Acrodyne Industries
 Alto Communications Inc. Broadcast
 Marketing Div.
 Andrews Tower Inc.
 Belcom Electronics Mfg. Co.
 Cablewave Systems Inc. Subs. Phelps
 Dodge and Kabelmetal
 CCA Electronics Corp.
 Comm/Scope Company
 David Clark Co., Inc.
 Dyma Engineering, Inc.
 GTE Lenkurt Incorporated
 Marti Electronics
 Mastertone Company
 Microwave Assoc. Inc.
 Moseley Assoc. Inc.
 Phelps Dodge Communications Co.
 Div. Phelps Dodge Industries Inc.
 RHG Elect Labs, Inc.
 Scott-Buttner Coastcom, Inc.
 Singer Products Co., Inc.
 Soladyne International
 Tele Measurements Inc.
 Trepac Corp. America
 Varian Solid State Div. Micro-Link
 Products

**Communication Systems,
 Teleprinter**

See Adv. Page

Moseley Assoc. Inc. 7

Atlantic Research Corp. Teleproducts
 Dept.
 Broadcast Products Inc.
 GTE Lenkurt Incorporated
 Moseley Assoc. Inc.
 Singer Products Co., Inc.
 Trepac Corp. America

Computer Equipment

See Adv. Page

Moseley Assoc. Inc. 7

Central Dynamics Corp.
 Compu/Net, Inc.
 Data Disc Inc.
 Datavision, Inc.
 Grass Valley Group, Inc.
 Hewlett Packard Co.
 Moseley Assoc. Inc.
 PRD Electronics, Inc.
 Raytheon Company Raytheon Data
 Systems Co.
 RCA Corporation RCA Missile &
 Surface Radar Div.
 Schafer Electronics Corp.
 STEP Corporation
 Systems Marketing Corp. And
 Sono-Mag Corp.
 Tektronix Inc.
 Union Connector Co., Inc.
 Visual Communication Products Oper.
 General Electric Co.

Connectors, Cable

Amphenol RF Division
 AVA Electronics Corp.
 Arnold Barnes Company
 Blonder-Tongue Labs.
 Enterprise Electronics Corp.
 G.C. Electronics
 General Radio Co.
 Gilbert Engineering Co.
 Hollingsworth Solderless Terminal Co.
 Magnavox Company CATV Division
 Phelps Dodge Communications Co.
 Div. Phelps Dodge Industries Inc.
 Switchcraft Inc.
 Systems Marketing Corp. And
 Sono-Mag Corp.
 Times Wire and Cable Sub. of Insilco
 Corp.
 TRW Electronic Supply Co. Div. of
 TRW
 Video Engineering Co. Inc.
 Wilkinson Electronics, Inc.

Console, Audio AM

See Adv. Page

**Audio Interface
 Systems, Inc.** 124
Broadcast Electronics 40
**Ceco Communications
 Inc.** 140
Collins Radio Company 19
Dyma Engineering, Inc. 136
Gates 10
Mastertone Company 139
Sparta Electronic Corp. 8
**United Recording
 Electronics
 Industries** 114
**Wilkinson Electronics,
 Inc.** 58

Accurate Sound Corp.
 Alto Communications Inc. Broadcast
 Marketing Div.
 AMCO Engineering Co.
 Ampro Corp.
 Audio Designs & Mfg
 Audio Distributor Inc.
 Audio Interface Systems, Inc.
 Autogram Corporation
 Arnold Barnes Company
 Blanchard Electronics
 Broadcast Electronics
 Broadcast Products Inc.
 CCA Electronics Corp.
 Ceco Communications Inc.
 Central Dynamics Corp.

Cetec Inc. Subs. Computer Equipment
 Corp.
 Collins Radio Company Broadcast
 Division
 Communication Medias
 Concept 70, A Div. of Dyma
 Engineering, Inc.
 Delta Electronics Inc. (Va.)
 Dyma Engineering, Inc.
 Electro-Voice Inc. Subs. of Gulton
 Industries, Inc.
 Fairchild/Robbins Fairchild Sound
 Equipment Corp.
 Gately Electronics
 Gates Division of Harris-Intertype
 Granger Assoc.
 IGM
 Ikegami Tsushinki Co., Ltd. Export
 Department
 Lauderdale Electronic Labs
 LPB Inc.
 Mastertone Company
 Maze Corporation
 McCurdy Radio Ind. Inc.
 McMartin Industries
 Neve Inc., Rupert
 Orbit Radio and Video
 Philips Broadcast Equipment Corp.
 Subs. North American Philips Corp.
 QRK Electronic Prod.
 Radio Mfg. Co. (RMC)
 Ramko Research
 RCA Corporation RCA Broadcast
 Equip., Comm. Sys. Div.
 Rupert Neve Incorporated
 Russco Electronics Mfg. Inc.
 Sarks Tarzian Inc. Broadcast
 Equipment Div.
 Scientific Systems, Inc. Broadcast
 Equipment Div.
 Singer Products Co., Inc.
 Sparta Electronic Corp.
 Spectra Sonics
 Spotmaster Broadcast Electronics
 Systems Engineering Co., Inc.
 TelComp Division Television and
 Computer Corp.
 Tele Measurements Inc.
 Tri-Tronics
 Ultra Audio Products
 United Radio Supply Inc.
 United Recording Electronics
 Industries
 UREI a URC Company
 Visual Communication Products Oper.
 General Electric Co.
 Visual Electronics Corp.
 Wilkinson Electronics, Inc.

Console, Audio FM

See Adv. Page

Ampro Corp. 139
**Audio Interface
 Systems, Inc.** 124
Broadcast Electronics 40
Collins Radio Company 19
Dyma Engineering, Inc. 136
Gates 10
LPB Inc. 120
Mastertone Company 139
Sparta Electronic Corp. 8
**United Recording
 Electronics
 Industries** 114
**Wilkinson Electronics,
 Inc.** 58

Accurate Sound Corp.
 Alto Communications Inc. Broadcast
 Marketing Div.
 AMCO Engineering Co.
 Ampro Corp.
 Audio Designs & Mfg.
 Audio Distributor Inc.
 Audio Interface Systems, Inc.
 Autogram Corporation
 Arnold Barnes Company
 Blanchard Electronics
 Broadcast Electronics
 Broadcast Products Inc.
 CCA Electronics Corp.
 Central Dynamics Corp.
 Cetec Inc. Subs. Computer Equipment
 Corp.

Collins Radio Company Broadcast Division
 Communication Medias
 Concept 70, A Div. of Dyma Engineering, Inc.
 Dyma Engineering, Inc.
 Fairchild/Robbins Fairchild Sound Equipment Corp.
 Gately Electronics
 Gates Division of Harris-Intertype
 Ikegami Tsushinki Co., Ltd. Export Department
 Lauderdale Electronic Labs LPB Inc.
 Mastertone Company
 Maze Corporation
 McCurdy Radio Ind. Inc.
 McMartin Industries
 Neve Inc., Rupert
 Orbit Radio and Video
 Philips Broadcast Equipment Corp. Subs. North American Philips Corp.
 QRK Electronic Prod.
 Radio Mfg. Co. (RMC)
 Ramko Research
 RCA Corporation RCA Broadcast Equip., Comm. Sys. Div.
 Rupert Neve Incorporated
 Scientific Systems, Inc. Broadcast Equipment Div.
 Singer Products Co., Inc.
 Sparta Electronic Corp.
 Spectra Sonics
 Spotmaster Broadcast Electronics
 Systems Engineering Co., Inc.
 TelComp Division Television and Computer Corp.
 Tele Measurements Inc.
 Tri-Tronics
 Ultra Audio Products
 United Radio Supply Inc.
 United Recording Electronics Industries
 UREI a URC Company
 Visual Communication Products Oper. General Electric Co.
 Visual Electronics Corp.
 Wilkinson Electronics, Inc.

Console, Audio Portable

See Adv. Page

Broadcast Electronics 34
Gates 10
Sparta Electronic Corp. 8

Alcor Inc.
 AMCO Engineering Co.
 American Electronics, Inc.
 Ampro Corp.
 Audio Designs & Mfg.
 Broadcast Electronics
 Broadcast Products Inc.
 CCA Electronics Corp.
 Central Dynamics Corp.
 Cetec Inc. Subs. Computer Equipment Corp.
 Collins Radio Company Broadcast Division
 Communication Medias
 Concept 70, A Div. of Dyma Engineering, Inc.
 Fairchild/Robbins Fairchild Sound Equipment Corp.
 Gately Electronics
 Gates Division of Harris-Intertype
 Head Sound, Inc.
 LPB Inc.
 Magnatech Company
 Mastertone Company
 Maze Corporation
 McCurdy Radio Ind. Inc.
 McMartin Industries
 Neve Inc., Rupert
 Orbit Radio and Video
 Philips Broadcast Equipment Corp. Subs. North American Philips Corp.
 Pulse Dynamics Mfg. Corp.
 QRK Electronic Prod.
 Radio Mfg. Co. (RMC)
 RCA Corporation RCA Broadcast Equip., Comm. Sys. Div.
 Rupert Neve Incorporated
 Russco Electronics Mfg. Inc.
 Scientific Systems, Inc. Broadcast Equipment Div.
 Sennheiser Electronics Corp.

Singer Products Co., Inc.
 Sparta Electronic Corp.
 Spectra Sonics
 Spotmaster Broadcast Electronics
 Superscope, Inc.
 Systems Engineering Co., Inc.
 TelComp Division Television and Computer Corp.
 Visual Communication Products Oper. General Electric Co.
 Wilkinson Electronics, Inc.

Console, Audio Recording

See Adv. Page

Audio Interface Systems, Inc. 124
Dyma Engineering, Inc. 136
Gates 10
Sparta Electronic Corp. 8
Wilkinson Electronics, Inc. 58

Accurate Sound Corp.
 Alcor Inc.
 ALTEC
 AMCO Engineering Co.
 Ampro Corp.
 Ancha Electronics Inc.
 Audio Designs & Mfg.
 Audio Distributor Inc.
 Audio Interface Systems, Inc.
 Autogram Corporation
 Blanchard Electronics
 Broadcast Prod. Co. Inc. Bcst. Division
 Broadcast Products Inc.
 CCA Electronics Corp.
 Central Dynamics Corp.
 Cetec Inc. Subs. Computer Equipment Corp.
 Collins Radio Company Broadcast Division
 Communication Medias
 Concept 70, A Div. of Dyma Engineering, Inc.
 Dyma Engineering, Inc.
 Elektromesstechnik E M T Wilhelm Franz G M B H
 Fairchild/Robbins Fairchild Sound Equipment Corp.
 Gately Electronics
 Gates Division of Harris-Intertype
 Gotham Audio Corp.
 Head Sound, Inc.
 IGM
 Lamb Laboratories
 Lang Electronics Inc.
 LPB Inc.
 Magnatech Company
 Magna-Tech Electronic Co., Inc.
 Maze Corporation
 McCurdy Radio Ind. Inc.
 McMartin Industries
 Nemo Recording Labs
 Neve Inc., Rupert
 Orbit Radio and Video
 Pacific Recorders and Engrg. Corp.
 Philips Broadcast Equipment Corp. Subs. North American Philips Corp.
 QRK Electronic Prod.
 Quad-Eight Electronics
 Radio Mfg. Co. (RMC)
 RCA Corporation RCA Broadcast Equip., Comm. Sys. Div.
 Rupert Neve Incorporated
 Scientific Systems, Inc. Broadcast Equipment Div.
 Singer Products Co., Inc.
 Sparta Electronic Corp.
 Spectra Sonics
 Systems Engineering Co., Inc.
 TASCAM Corporation
 TelComp Division Television and Computer Corp.
 Total Technology
 Ultra Audio Products
 United Radio Supply Inc.
 Visual Communication Products Oper. General Electric Co.
 Wilkinson Electronics, Inc.
 ZERO-Impedance Systems, Inc.

Console, Audio TV

See Adv. Page

Gates 10
Viscount Industries Ltd. 139,140

Alcor Inc.
 AMCO Engineering Co.
 Ampro Corp.
 Ancha Electronics Inc.
 Audio Designs & Mfg.
 Bradford Information Systems
 Broadcast Products Inc.
 Central Dynamics Corp.
 Cetec Inc. Subs. Computer Equipment Corp.
 Collins Radio Company Broadcast Division
 Communication Medias
 Concept 70, A Div. of Dyma Engineering, Inc.
 Cramer Video and Audio Systems
 Delta Electronics Inc. (Va.)
 Fairchild/Robbins Fairchild Sound Equipment Corp.
 Gately Electronics
 Gates Division of Harris-Intertype
 GBC Closed Circuit TV Corp.
 GPL Div. Singer Gen.
 IGM
 Ikegami Tsushinki Co., Ltd. Export Department
 Interntl. Nuclear Corp.
 Lang Electronics Inc.
 LPB Inc.
 Marconi Electronics Inc.
 Maze Corporation
 McCurdy Radio Ind. Inc.
 Neve Inc., Rupert
 Orbit Radio and Video
 Philips Broadcast Equipment Corp. Subs. North American Philips Corp.
 QRK Electronic Prod.
 Quad-Eight Electronics
 Radio Mfg. Co. (RMC)
 RCA Corporation RCA Broadcast Equip., Comm. Sys. Div.
 Riker Communications Inc.
 Rupert Neve Incorporated
 Sarks Tarzian Inc. Broadcast Equipment Div.
 Scientific Systems, Inc. Broadcast Equipment Div.
 Shintron Co. Inc. Video Products Div.
 Singer Products Co., Inc.
 Sparta Electronic Corp.
 Spectra Sonics
 Spotmaster Broadcast Electronics
 Systems Engineering Co., Inc.
 TelComp Division Television and Computer Corp.
 Tele Measurements Inc.
 Ultra Audio Products
 Vicon Industries, Inc.
 Viscount Industries Ltd.
 Visual Communication Products Oper. General Electric Co.
 Visual Electronics Corp.
 Vital Industries Inc.

Console, Stereo

See Adv. Page

Ampro Corp. 139
Audio Interface Systems, Inc. 124
Broadcast Electronics 40
Cetec Inc. 33
Collins Radio Company 19
Dyma Engineering, Inc. 136
Gates 10
LPB Inc. 120
Sparta Electronic Corp. 8
United Recording Electronics Industries 114
Wilkinson Electronics, Inc. 58

AMCO Engineering Co.
 Ampro Corp.
 Audio Designs & Mfg.
 Audio Interface Systems, Inc.

Autogram Corporation
 Arnold Barnes Company
 Blanchard Electronics
 Broadcast Electronics
 Broadcast Products Inc.
 CCA Electronics Corp.
 Central Dynamics Corp.
 Cetec Inc. Subs. Computer Equipment Corp.
 Collins Radio Company Broadcast Division
 Communication Medias
 Concept 70, A Div. of Dyma Engineering, Inc.
 Dyma Engineering, Inc.
 Fairchild/Robbins Fairchild Sound Equipment Corp.
 Gates Division of Harris-Intertype
 Head Sound, Inc.
 LPB Inc.
 Magnatech Company
 Mastertone Company
 Maze Corporation
 McMartin Industries
 Neve Inc., Rupert
 QRK Electronic Prod.
 Quad-Eight Electronics
 Radio Mfg. Co. (RMC)
 RCA Corporation RCA Broadcast Equip., Comm. Sys. Div.
 Rupert Neve Incorporated
 Sparta Electronic Corp.
 Spectra Sonics
 Spotmaster Broadcast Electronics
 Systems Engineering Co., Inc.
 United Recording Electronics Industries
 UREI a URC Company
 Visual Electronics Corp.
 Wilkinson Electronics, Inc.

Console, Video Portable

See Adv. Page

Danscoll Ltd. 116
Grass Valley Group, Inc. 3
Shintron Co. Inc. 132
Telemet Co. IBC
Vital Industries Inc. BC

Alcor Inc.
 AMCO Engineering Co.
 American Data Corp. an AIRPAX Company
 Ampex Corp. Audio-Video Systems Division
 Central Dynamics Corp.
 CHESTER ELECTRONIC LABS., INC.
 GTE Information Systems Inc.
 Cramer Video and Audio Systems
 Danscoll Ltd.
 Gately Electronics
 Gates Division of Harris-Intertype
 GBC Closed Circuit TV Corp.
 Grass Valley Group, Inc.
 Interntl. Nuclear Corp.
 Nasco Television Systems
 Orbit Radio and Video
 Philips Broadcast Equipment Corp. Subs. North American Philips Corp.
 RCA Corporation RCA Broadcast Equip., Comm. Sys. Div.
 R. H. Tyler Co. Div. of Weather Scan, Inc.
 Richmond Hill Laboratories Inc.
 Riker Communications Inc.
 Shintron Co. Inc. Video Products Div.
 Singer Co. Simulation Products Div.
 TeleMation, Inc.
 Telemet Co.
 Vicon Industries, Inc.
 Video Engineering Co. Inc.
 Viscount Industries Ltd.
 Vital Industries Inc.

Console, Video Studio

See Adv. Page

American Data Corp. 131
Danscoll Ltd. 116
Grass Valley Group, Inc. 3
Shintron Co. Inc. 132

Telemet Co. IBC
Viscount Industries Ltd. 139,140
Vital Industries Inc. BC

Alcor Inc.
 AMCO Engineering Co.
 Ameco Inc.
 American Data Corp. an AIRPAX Company
 Anixter-Pruzan CATV Division
 Applied Video Electronics, Inc.
 Central Dynamics Corp.
 CHESTER ELECTRONIC LABS., INC.
 GTE Information Systems Inc.
 Cramer Video and Audio Systems
 Danscoll Ltd.
 Gately Electronics
 Gates Division of Harris-Intertype
 GBC Closed Circuit TV Corp.
 GPL Div. Singer Gen.
 Grass Valley Group, Inc.
 Interntl. Nuclear Corp.
 Marconi Electronics Inc.
 Nasco Television Systems
 Orbit Radio and Video
 Panasonic Video Systems Div.
 Matsushita Electric Corp. of America
 Philips Broadcast Equipment Corp. Subs. North American Philips Corp.
 Quad-Eight Electronics
 RCA Corporation RCA Broadcast Equip., Comm. Sys. Div.
 R. H. Tyler Co. Div. of Weather Scan, Inc.
 Richmond Hill Laboratories Inc.
 Riker Communications Inc.
 Sarkes Tarzian Inc. Broadcast Equipment Div.
 Shintron Co. Inc. Video Products Div.
 Singer Products Co., Inc.
 Sylvania Comm. Electronic
 TeleMation, Inc.
 Telemet Co.
 Vicon Industries, Inc.
 Video Engineering Co. Inc.
 Viscount Industries Ltd.
 Visual Communication Products Oper. General Electric Co.
 Vital Industries Inc.

Converters

AEL Communications Corp., Subs. American Electronic Labs., Inc.
 Anixter-Pruzan CATV Division
 Berkey-Colortran Inc.
 Bristol Div. of Acco
 Bulova American Time Products
 Catel, a Div. of United Scientific Corp.
 CATV Equipment Co.
 C-COR Electronics, Inc.
 Fung Engineering Co.
 General Electric Company Tubes/MW Devices
 General Microwave Corp.
 Ikegami Tsushinki Co., Ltd. Export Department
 K'SON Corporation
 Lectronic Res. Labs. Inc.
 Magnavox Company CATV Division
 OAK Industries Inc. CATV Division
 Tasker Systems Div. of Whittaker Corp.
 Topaz Electronics
 TV Cable Supply Co., Inc.
 Video Engineering Co. Inc.

Counter-Timers

See Adv. Page

Audio Devices, Inc. 45
Danscoll Ltd. 116
ES Enterprises 43

Audio Devices, Inc.
 Autogram Corporation
 Bulova American Time Products
 Chrono-Log Corp.
 Conrac Corporation Cramer Division
 Cooke Engineering Co.
 Danscoll Ltd.
 ES Enterprises
 Fluke, John, Mfg. Co. Inc.
 Hewlett Packard Co.

Lectronic Res. Labs. Inc.
 Tapecaster TCM, Inc.
 Test & Measuring Instruments, Inc. a North American Philips Co.
 Time & Frequency Tech., Inc.
 United Systems Corp. Subs. of Monsanto Co.

Crystals, Quartz

Colorado Crystal Corp.
 Eidson Electronic Co.

Custom Control Services

See Adv. Page

Audio Services, Inc. 32

Audio Services, Inc

Cyclorama, Studio Drapery

Janson Industries

Decoder, Four Channel Stereo

Electro-Voice Inc. Subs. of Gulton Industries, Inc.
 Heath Co.
 Sansui Electronics Corp.

Data Transmitters

See Adv. Page

Moseley Assoc. Inc. 7

GTE Lenkurt Incorporated
 Moseley Assoc. Inc.
 Scott-Buttner Coastcom, Inc.
 Trepac Corp. America

Delay Cartridges, Audio

Communication Medias
 International Tapetronics Corp.
 Lauderdale Electronic Labs
 Marathon Broadcast Equip.
 Mastertone Company
 Qualitape Inc.
 Sparta Electronic Corp.

Delay Lines

See Adv. Page

ESC Electronics Corp. 137

Allen Avionics Inc.
 Amphenol RF Division
 Cablewave Systems Inc. Subs. Phelps Dodge and Kabelmetal
 Control Concepts Corporation
 Dynasciences Corp. Video Products Div.
 Edison Electronics, Div. of McGraw-Edison Co., Daven & Measurements
 ESC Electronics Corp.
 Eventide Clock Works Inc. Broadcast Products Div.
 Franz Vertriebs-gesellschaft m.b.H.
 Kappa Networks, Inc.
 Lectronic Res. Labs. Inc.
 Phelps Dodge Communications Co. Div. Phelps Dodge Industries Inc.
 Quad-Eight Electronics
 Tektronix Inc.
 Television Equipment Associates
 Television Microtime, Inc. Subs. Andersen Laboratories, Inc.
 Terminal Hudson Corp. Terminal Hudson Electronics
 Times Wire and Cable Sub. of Insilco Corp.
 United Recording Electronics Industries
 UREI a URC Company

Delay Measuring Set, Envelope

Arnold Barnes Company
 Datatek Corp.
 Dranetz Engineering Labs., Inc.
 Siemens Corporation
 Tektronix Inc.

Telemet Co.
 Test & Measuring Instruments, Inc. a North American Philips Co.

Delay Units, Video

See Adv. Page

ESC Electronics Corp. 137

Control Concepts Corporation
 Data Disc Inc.
 ESC Electronics Corp.
 Kappa Networks, Inc.
 Television Equipment Associates
 Television Microtime, Inc. Subs. Andersen Laboratories, Inc.

Demagnetizers, Bulk Tape

See Adv. Page

Broadcast Electronics 34
Fidelipac Division 122
Nortronics Co., Inc. 133
Sparta Electronic Corp. 8
Taber Mfg. & Engr. Co. 116

Beau Motor Division U.M.C. Electronics Co.
 Broadcast Electronics
 Broadcast Products Inc.
 Communication Medias
 Fairchild/Robbins Fairchild Sound Equipment Corp.
 Fidelipac Division TelePro Industries, Inc.
 Gates Division of Harris-Intertype
 G.C. Electronics
 Joa Cartridge Service
 Lauderdale Electronic Labs
 Marathon Broadcast Equip.
 Mastertone Company
 Minnesota Mining & Mfg. Co.
 Nortronics Co., Inc. Recorder Care Div.
 Radio Mfg. Co. (RMC)
 RCA Corporation RCA Broadcast Equip., Comm. Sys. Div.
 Recordex Corporation
 Scully/Metrotech Divs. of Dictaphone Corp.
 Shallco, Incorporated
 Sparta Electronic Corp.
 Spotmaster Broadcast Electronics
 Taber Mfg. & Engr. Co.
 VIF International

Demodulators

See Adv. Page

Gates 10
SC Electronics, Inc. 49
Telemet Co. IBC

Ameco Inc.
 Anixter-Pruzan CATV Division
 Audiotronics Corp.
 Arnold Barnes Company
 Belar Electronics Lab., Inc.
 Catel, a Div. of United Scientific Corp.
 Comark Industries Inc.
 Conrac Div. Conrac Corp.
 Cramer Video and Audio Systems
 DYNAIR Electronics, Inc.
 EiE-Electronic Industrial Engineering A Division of RCA
 Fung Engineering Co.
 Gates Division of Harris-Intertype
 Kahn Research Lab. Inc.
 National Electrolab Ltd.
 RCA Corporation RCA Broadcast Equip., Comm. Sys. Div.
 RHG Elect Labs, Inc.
 Riker Communications Inc.
 Rohde & Schwarz Sales Co.
 SC Electronics, Inc. Subs. of Audiotronics Corp.
 Scott-Buttner Coastcom, Inc.
 Siemens Corporation
 Telemet Co.
 Universal Media Corp.
 Video Engineering Co. Inc.

Detectors, Microwave

American Electronics Lab., Inc.
 Comark Industries Inc.
 General Electric Company Tubes/MW Devices
 General Microwave Corp.
 General Radio Co.
 Hewlett Packard Co.
 Lectronic Res. Labs. Inc.
 Microwave Assoc. Inc.
 Mosler Electronic Systems Div.
 Narda Microwave Corp., The
 PRD Electronics, Inc.
 RCA Corporation RCA Electromagnetic & Aviation Systems Div.
 Solitron Devices Inc. Semiconductor Div.
 Sylvania Semiconductor
 Test & Measuring Instruments, Inc. a North American Philips Co.
 Texscan Corp.
 Thomson-CSF Electron Tubes

Detectors, RF

Alford Mfg. Co.
 Anixter-Pruzan CATV Division
 Bird Electronic Corp.
 Blender-Tongue Labs.
 CCA Electronics Corp.
 Comark Industries Inc.
 General Microwave Corp.
 General Radio Co.
 Harwald Company
 Kaitronics Corporation
 Kay Elemetrics Corp.
 Lectronic Res. Labs. Inc.
 Microwave Assoc. Inc.
 Narda Microwave Corp., The
 National Electrolab Ltd.
 North American Radio Corp.
 RTI Research Technology Inc.
 Solitron Devices Inc. Semiconductor Div.
 Television Technology Corp.
 Telonic Industries Inc.
 Texscan Corp.
 Thomson-CSF Electron Tubes
 TV Cable Supply Co., Inc.

Detectors, Standing Wave

Bird Electronic Corp.
 Collins Radio Company Broadcast Division
 General Radio Co.
 Hewlett Packard Co.
 Lectronic Res. Labs. Inc.
 Micro Communications, Inc.
 Moseley Assoc. Inc.
 Mosler Electronic Systems Div.
 Narda Microwave Corp., The
 PRD Electronics, Inc.
 Rohde & Schwarz Sales Co.
 Telonic Industries Inc.
 Texscan Corp.

Detectors, Video Presence

See Adv. Page

Lenco Inc. 123

Colorado Video Inc.
 Comark Industries Inc.
 Cramer Video and Audio Systems
 Danscoll Ltd.
 Lenco Inc. Electronics Division
 Vicon Industries, Inc.

Diplexers

See Adv. Page

Scott-Buttner Coastcom, Inc. 12
Sparta Electronic Corp. 8

Alford Mfg. Co.
 Cablewave Systems Inc. Subs. Phelps Dodge and Kabelmetal
 CCA Electronics Corp.
 CCA RF Industries, Inc.
 Collins Radio Company Broadcast Division
 Comark Industries Inc.
 Continental Electronics Mfg. Co.

Electromagnetic Specialties
Ikegami Tsushinki Co., Ltd. Export
Department
Integral Data Devices Inc.
Jampro Antenna Co. Div. of Computer
Equipment Corp.
Micro Communications, Inc.
Microwave Assoc. Inc.
Multronics, Inc.
Narda Microwave Corp., The
Phelps Dodge Communications Co.
Div. Phelps Dodge Industries Inc.
RCA Corporation RCA Broadcast
Equip., Comm. Sys. Div.
Scott-Buttner Coastcom, Inc.
Shively Laboratories, Inc.
Sparta Electronic Corp.
Telonic Industries Inc.

Discs, Video

See Adv. Page

Computer Magnetics Corp.105

Computer Magnetics Corp.

Display Equipment, Titling

See Adv. Page

OMNIX 42
Video Data Systems, Inc.139

Arnold Barnes Company
CBS Labs
Data Disc Inc.
Datavision, Inc.
Display Systems Corp.
General Television Ntwk.
GPL Div. Singer Gen.
Ikegami Tsushinki Co., Ltd. Export
Department
Marconi Electronics Inc.
OMNIX
Photo Research Div. of Kollmorgen
Corp.
Reynolds/Leteron Co.
Robert Bosch Corp. Fernseh Div.
Shintron Co. Inc. Video Products Div.
Sterling Television Presentations Inc.
Sterling Communications Co.
Sylvania Comm. Electronic
Tektronix Inc.
Teledyne Brown Engineering Co.
Science & Engrg. Div.
TeleMation, Inc.
TELESTRATOR Industries
Telesync Corp.
Theta-Com of California AML Division
Ultra Audio Products
Video Data Systems, Inc.
Video Devices Co.
Video Engineering Co. Inc.
Westinghouse Electric Corp. Electric
Tube Div.
Wilson Corp., H.

Display Units, Digital

See Adv. Page

ES Enterprises 43

ES Enterprises

Display Units, Time-Temperature-ID

American Data Corp. an AIRPAX
Company
Autogram Corporation
Datavision, Inc.
Time & Frequency Tech., Inc.

Dividers, Frequency

Bulova American Time Products
General Electric Company Tubes/MW
Devices
Hartley Prod. Corp.
Total Technology

Dividers, Power

Alford Mfg. Co.
Bird Electronic Corp.
Collins Radio Company Broadcast
Division
Dielectric Communications Div. of Sola
Basic
Enterprise Electronics Corp.
Gates Division of Harris-Intertype
Jampro Antenna Co. Div. of Computer
Equipment Corp.
Lectronic Res. Labs. Inc.
Micro Communications, Inc.
Microwave Assoc. Inc.
Moseley Assoc. Inc.
Multronics, Inc.
Narda Microwave Corp., The
Phelps Dodge Communications Co.
Div. Phelps Dodge Industries Inc.
RCA Corporation RCA Broadcast
Equip., Comm. Sys. Div.
Scala Radio Corp.
Shively Laboratories, Inc.
Tektronix Inc.
Trompeter Electronics
Weinschel Engineering Co.

Dividers, Voltage

Burwen Laboratories
Edison Electronics, Div. of
McGraw-Edison Co., Daven &
Measurements
Enterprise Electronics Corp.
Fluke, John, Mfg. Co. Inc.
General Electric Company Tubes/MW
Devices
General Radio Co.
Hickok Elect. Instrument
ITT Jennings
Lectronic Res. Labs. Inc.
RCA Corporation RCA Electronic
Components
Shallco, Incorporated
Tech Laboratories Inc.

Dust Control Unit, Video

Enviroco
Liberty Industries

Edit Code Generator

Central Dynamics Corp.
Electronic Engineering Co. of California
Kaitronics Corporation
Quad-Eight Electronics
Recortec Inc.
Telemet Co.

Edit Code Receiver

Central Dynamics Corp.
Electronic Engineering Co. of California
Kaitronics Corporation
Telemet Co.

Editors, Audio Tape

Broadcast Electronics
Central Dynamics Corp.
ELPA Marketing Industries, Inc.
Marathon Broadcast Equip.
Nemo Recording Labs
Radio Mfg. Co. (RMC)
Spotmaster Broadcast Electronics

Editors, Film

CMX Systems
Comquip, Inc.
F&B/Ceco Industries, Inc.
Harwald Company
Kalart Victor Corp.
Lipsner-Smith Corp.
Neumade Prod. Corp.
Precision Laboratories Precision Cine
Equipment Corp.
RTI Research Technology Inc.
Victor Duncan, Inc.

Editors, Video Tape

See Adv. Page

Dynasciences Corp. 37
Electronic Engineering Co. of California 47
Video Aids Corp. of Colorado112

Ampex Corp. Audio-Video Systems
Division
Arnold Barnes Company
Central Dynamics Corp.
CMX Systems
Cramer Video and Audio Systems
Datatron, Inc.
Dynasciences Corp. Video Products
Div.
Electronic Engineering Co. of California
GBC Closed Circuit TV Corp.
Gotham Audio Corp.
Kaitronics Corporation
Nortronics Co., Inc. Recorder Care Div.
RCA Corporation RCA Broadcast
Equip., Comm. Sys. Div.
Robert Bosch Corp. Fernseh Div.
Tele-Cine Inc.
Telemet Co.
Video Aids Corp. of Colorado
Video Devices Co.
Video Engineering Co. Inc.

Enclosures, Module Card Tray

Bud Radio Inc.
Quad-Eight Electronics
Roh Corporation

Encoding Systems, Quad

CBS Labs
Electro-Voice Inc. Subs. of Gulton
Industries, Inc.
Gately Electronics
Sansui Electronics Corp.

Encoder, Color Video

See Adv. Page

Lenco Inc.123

American Data Corp. an AIRPAX
Company
Arnold Barnes Company
CHESTER ELECTRONIC LABS., INC.
GTE Information Systems Inc.
Computer Image Corp.
Cramer Video and Audio Systems
Gates Division of Harris-Intertype
Lenco Inc. Electronics Division
Marco Video Systems, Inc.
Marconi Electronics Inc.
Mincom Div. 3M Co.
RCA Corporation RCA Broadcast
Equip., Comm. Sys. Div.
Richmond Hill Laboratories Inc.
Robert Bosch Corp. Fernseh Div.
TeleMation, Inc.
Tele Measurements Inc.
Test & Measuring Instruments, Inc. a
North American Philips Co.
Video Engineering Co. Inc.

Encoder, Four Channel Stereo

Audio Designs & Mfg.
CBS Labs
Electro-Voice Inc. Subs. of Gulton
Industries, Inc.
Gately Electronics
Sansui Electronics Corp.

Enhancers, Stereo Phase

See Adv. Page

RAPID-Q 128A

RAPID-Q Div. of Garron Electronics

Enhancers, TV Image

See Adv. Page

Dynasciences Corp. 37

Grass Valley Group, Inc.

..... 3

OMNIX 42

Arnold Barnes Company
CBS Labs
Cohu, Inc. Electronics Division
Dynasciences Corp. Video Products
Div.
Gates Division of Harris-Intertype
Grass Valley Group, Inc.
OMNIX
Philips Broadcast Equipment Corp.
Subs. North American Philips Corp.
RCA Corporation RCA Broadcast
Equip., Comm. Sys. Div.
Robert Bosch Corp. Fernseh Div.
Shintron Co. Inc. Video Products Div.
Tele Measurements Inc.
Video Engineering Co. Inc.

Equalizers, Audio Emphasis

See Adv. Page

Pulse Techniques Inc.141

ALTEC
Audio Designs & Mfg.
Audio Distributor Inc.
Burwen Laboratories
CBS Labs
Central Dynamics Corp.
Cetec Inc. Subs. Computer Equipment
Corp.
Collins Radio Company Broadcast
Division
Communication Medias
Fairchild/Robbins Fairchild Sound
Equipment Corp.
Gately Electronics
Head Sound, Inc.
Lang Electronics Inc.
Maze Corporation
McCurdy Radio Ind. Inc.
Melcor Electronics Corp.
Micro-Trak Corporation (Formerly:
Gray Research & Dev.)
Neve Inc., Rupert
Novatec Electronic Industries Ltd.
Orbit Radio and Video
Pulse Techniques Inc.
Quad-Eight Electronics
Radio Mfg. Co. (RMC)
RCA Corporation RCA Broadcast
Equip., Comm. Sys. Div.
Roh Corporation
Rupert Neve Incorporated
Shallco, Incorporated
Spectra Sonics
Spectrum Instruments, Inc.
Systems Engineering Co., Inc.
TT Electronics, Inc.
Ultra Audio Products
United Recording Electronics
Industries
UREI a URC Company

Equalizers, Vertical Aperture

CBS Labs
Dynasciences Corp. Video Products
Div.
Grass Valley Group, Inc.
Mincom Div. 3M Co.
RCA Corporation RCA Broadcast
Equip., Comm. Sys. Div.
Robert Bosch Corp. Fernseh Div.
Video Engineering Co. Inc.

Equalizers, Video

See Adv. Page

Grass Valley Group, Inc. 3

Grass Valley Group, Inc.

Grass Valley Group, Inc. 3

Grass Valley Group, Inc.

Erasers, Magnetic --See also
Heads; Demagnetizers

See Adv. Page

Broadcast Electronics 34

Fidelipac Division122

Nortronics Co., Inc.133

Sparta Electronic Corp. 8
Taber Mfg. & Engr. Co. 116

Beau Motor Division U.M.C. Electronics Co.
 Broadcast Electronics
 Broadcast Products Inc.
 Collins Radio Company Broadcast Division
 Communication Medias
 Duotone Co. Inc.
 Fairchild/Robbins Fairchild Sound Equipment Corp.
 Fidelipac Division TelePro Industries, Inc.
 Gates Division of Harris-Intertype
 G.C. Electronics
 International Tapetronics Corp.
 Joa Cartridge Service
 Mastertone Company
 MINNEAPOLIS MAGNETICS, INC.
 Nortronics Co., Inc. Recorder Care Div.
 Precision Laboratories Precision Cine Equipment Corp.
 RCA Corporation RCA Broadcast Equip., Comm. Sys. Div.
 Recordex Corporation
 Recortec Inc.
 Schultz Inc., Albert
 Senstrol Division UMC Electronics Co.
 Shallco, Incorporated
 Sparta Electronic Corp.
 Spotmaster Broadcast Electronics
 Taber Mfg. & Engr. Co.

Exciters, AM

Arnold Barnes Company
 CCA Electronics Corp.
 Continental Electronics Mfg. Co.
 Gates Division of Harris-Intertype
 RCA Corporation RCA Broadcast Equip., Comm. Sys. Div.
 Siemens Corporation
 Wilkinson Electronics, Inc.

Exciters, FM

See Adv. Page

Gates 10
Sparta Electronic Corp. 8
Wilkinson Electronics, Inc. 58

American Electronics Lab., Inc.
 Arnold Barnes Company
 Belar Electronics Lab., Inc.
 CCA Electronics Corp.
 Collins Radio Company Broadcast Division
 Dyma Engineering, Inc.
 Fung Engineering Co.
 Gates Division of Harris-Intertype
 Granger Assoc.
 Magnatech Company
 Mastertone Company
 McMartin Industries
 North American Radio Corp.
 RCA Corporation RCA Broadcast Equip., Comm. Sys. Div.
 RHG Elect Labs, Inc.
 Rohde & Schwarz Sales Co.
 Siemens Corporation
 Singer Products Co., Inc.
 Sparta Electronic Corp.
 Wilkinson Electronics, Inc.

Exciters, SCA

See Adv. Page

Moseley Assoc. Inc. 7

American Electronics Lab., Inc.
 CCA Electronics Corp.
 Collins Radio Company Broadcast Division
 Dyma Engineering, Inc.
 Gates Division of Harris-Intertype
 Mastertone Company
 McMartin Industries
 Moseley Assoc. Inc.
 RCA Corporation RCA Broadcast Equip., Comm. Sys. Div.
 Sparta Electronic Corp.

Wilkinson Electronics, Inc.

Exciters, Stereo

See Adv. Page

Moseley Assoc. Inc. 7

American Electronics Lab., Inc.
 CCA Electronics Corp.
 Collins Radio Company Broadcast Division
 Dyma Engineering, Inc.
 Gates Division of Harris-Intertype
 Mastertone Company
 McMartin Industries
 Moseley Assoc. Inc.
 RCA Corporation RCA Broadcast Equip., Comm. Sys. Div.
 Sparta Electronic Corp.
 Wilkinson Electronics, Inc.

Film, Photographic

ABTO, Inc.
 Agfa-Gevaert Inc.
 Comquip, Inc.
 Eastman Kodak Co.
 F&B/Ceco Industries, Inc.
 GAF Corp.
 Image Devices Incorporated

Film Chain Light Level Control

Beston Electronics Inc.
 Gates Division of Harris-Intertype
 TeleMation, Inc.

Film Chain System

See Adv. Page

Bell & Howell 55

Ameco Inc.
 Arnold Barnes Company
 Bell & Howell Consumer Products Group
 Blonder-Tongue Labs.
 CHESTER ELECTRONIC LABS., INC.
 GTE Information Systems Inc.
 Cohu, Inc. Electronics Division
 Comquip, Inc.
 Cramer Video and Audio Systems
 Diamond Power Specialty Corp. Subs.
 Babcock & Wilcox Co.
 Gates Division of Harris-Intertype
 International Video Corp.
 Kalart Victor Corp.
 L-W Photo, Inc.
 Marco Video Systems, Inc.
 Marconi Electronics Inc.
 Philips Broadcast Equipment Corp.
 Subs. North American Philips Corp.
 Rank Cintel, Electronic Systems Div.
 Rank Precision Industries Ltd.
 RCA Corporation RCA Broadcast Equip., Comm. Sys. Div.
 R. H. Tyler Co. Div. of Weather Scan, Inc.
 Riker Communications Inc.
 Robert Bosch Corp. Fernseh Div.
 Sarkes Tarzian Inc. Broadcast Equipment Div.
 Singer Co. Simulation Products Div.
 Soll, Inc., Joseph M.
 TeleMation, Inc.
 Tele Measurements Inc.
 Video Engineering Co. Inc.
 Visual Communication Products Oper.
 General Electric Co.

Film Processing Chemicals, B&W

Eastman Kodak Co.
 GAF Corp.
 Harwald Company
 Hunt Chemical Corp., Philip A.
 RTI Research Technology Inc.

Film Processing Chemicals, Color

Eastman Kodak Co.
 GAF Corp.
 Harwald Company
 Hunt Chemical Corp., Philip A.

Norelco, Philips Bcst. Equip. Corp.
 Subs. North American Philips Corp.
 RTI Research Technology Inc.

Film Processing Services

Eastman Kodak Co.
 Jamieson Film Co.
 Lipsner-Smith Corp.
 Photo Lab Inc.
 Treise Engineering

Film Sound Transfer Equipment

See Adv. Page

Magna-Tech Electronic Co., Inc. 107

Magna-Tech Electronic Co., Inc.

Filters, Active

See Adv. Page

TT Electronics, Inc. 140

Alpha Electronic Services Inc.
 Head Sound, Inc.
 Multimetrics Industries Div. of Comstron Corp.
 Siemens Corporation
 Spectra Sonics
 Total Technology
 TT Electronics, Inc.
 United Recording Electronics Industries
 UREI a URC Company

Filters, Antenna

See Adv. Page

Gates 10

Ameco Inc.
 Anixter-Prusan CATV Division
 Barker & Williamson, Inc.
 Bird Electronic Corp.
 Continental Electronics Mfg. Co.
 Gates Division of Harris-Intertype
 G.C. Electronics
 Jampro Antenna Co. Div. of Computer Equipment Corp.
 Micro Communications, Inc.
 RCA Corporation RCA Broadcast Equip., Comm. Sys. Div.
 Telonic Industries Inc.
 TT Electronics, Inc.
 Video Engineering Co. Inc.

Filters, Audio

See Adv. Page

Pulse Techniques Inc. 141
Scott-Buttner Coastcom, Inc. 12
TT Electronics, Inc. 140

Broadcast Products Inc.
 ELPA Marketing Industries, Inc.
 Gately Electronics
 Multimetrics Industries Div. of Comstron Corp.
 Neve Inc., Rupert
 Novatec Electronic Industries Ltd.
 Pulse Techniques Inc.
 Quad-Eight Electronics
 Radio Mfg. Co. (RMC)
 Roh Corporation
 Rupert Neve Incorporated
 Scott-Buttner Coastcom, Inc.
 Solar Electronics Co.
 Spectra Sonics
 Spectrum Instruments, Inc.
 Total Technology
 TT Electronics, Inc.
 United Recording Electronics Industries
 UREI a URC Company

Filters, Noise

See Adv. Page

Burwen Laboratories 14

TT Electronics, Inc. 140

B & K Instruments Inc.
 Burwen Laboratories
 Central Dynamics Corp.
 Gately Electronics
 Multimetrics Industries Div. of Comstron Corp.
 Neve Inc., Rupert
 Novatec Electronic Industries Ltd.
 Quad-Eight Electronics
 Rupert Neve Incorporated
 Scott-Buttner Coastcom, Inc.
 Solar Electronics Co.
 TT Electronics, Inc.
 UREI a URC Company

Filters, Passive

See Adv. Page

Pulse Techniques Inc. 141
TT Electronics, Inc. 140

Bourns, Inc. BPMC Division
 Comark Industries Inc.
 ESC Electronics Corp.
 Gately Electronics
 Multimetrics Industries Div. of Comstron Corp.
 Multronics, Inc.
 Pulse Techniques Inc.
 Quad-Eight Electronics
 Scott-Buttner Coastcom, Inc.
 Solar Electronics Co.
 Telonic Industries Inc.
 Total Technology
 TT Electronics, Inc.
 UREI a URC Company

Filters, Sound Effect

See Adv. Page

Pulse Techniques Inc. 141

Evedite Clock Works Inc. Broadcast Products Div.
 Gately Electronics
 Neve Inc., Rupert
 Pulse Techniques Inc.
 Radio Mfg. Co. (RMC)
 Rupert Neve Incorporated
 TT Electronics, Inc.

Filters, Variable and Fixed Tuned

Gately Electronics
 Multimetrics Industries Div. of Comstron Corp.
 Multronics, Inc.
 Neve Inc., Rupert
 Rupert Neve Incorporated
 Scott-Buttner Coastcom, Inc.
 Spectra Sonics
 Television Equipment Associates
 Telonic Industries Inc.
 Total Technology
 TT Electronics, Inc.

Filters, Video

See Adv. Page

Scott-Buttner Coastcom, Inc. 12

Audio-Video Engineering Co.
 Comark Industries Inc.
 Datatek Corp.
 ESC Electronics Corp.
 Multimetrics Industries Div. of Comstron Corp.
 Scott-Buttner Coastcom, Inc.
 Tektronix Inc.
 Television Equipment Associates
 TT Electronics, Inc.

Frequency Standard

See Adv. Page

TRACOR, Inc. 135

TRACOR, Inc. Instruments Group

Generators, Audio Sine

See Adv. Page

ALTEC 126
ALTEC

Generators, Audio Sweep

See Adv. Page

ALTEC 127
Ailtech (Formerly: Microdot)
ALTEC
B & K Instruments Inc.
Conway Electronic Enterprises Limited
ELPA Marketing Industries, Inc.
Fairchild/Robbins Fairchild Sound
Equipment Corp.
Hewlett Packard Co.
Hickok Elect. Instrument
Radio Mfg. Co. (RMC)
Siemens Corporation
Telonic Industries Inc.
Test & Measuring Instruments, Inc. a
North American Philips Co.
Total Technology
United Recording Electronics
Industries
UREI a URC Company

Generators, Background Color

See Adv. Page

Danscoll Ltd. 116
Dynasciences Corp. 37
Grass Valley Group, Inc. 3
OMNIX 42

CBS Labs
Central Dynamics Corp.
Danscoll Ltd.
Dynasciences Corp. Video Products
Div.
Grass Valley Group, Inc.
OMNIX
Sarkes Tarzian Inc. Broadcast
Equipment Div.
Shintron Co. Inc. Video Products Div.
TeleMation, Inc.
Test & Measuring Instruments, Inc. a
North American Philips Co.
Video Data Systems, Inc.

Generators, Burst

See Adv. Page

Dynasciences Corp. 37
Lenco Inc. 123

Alpha Electronic Services Inc.
American Data Corp. an AIRPAX
Company
CBS Labs
Central Dynamics Corp.
Cohu, Inc. Electronics Division
Datapulse Div. of Systron-Donner
Dragnet Engineering Labs., Inc.
Dynasciences Corp. Video Products
Div.
Grass Valley Group, Inc.
Ikegami Tsushinki Co., Ltd. Export
Department
Lenco Inc. Electronics Division
OMNIX
Rohde & Schwarz Sales Co.
Shintron Co. Inc. Video Products Div.
Tektronix Inc.
TeleMation, Inc.
Test & Measuring Instruments, Inc. a
North American Philips Co.
Video Engineering Co. Inc.

Generators, Color Bar

See Adv. Page

OMNIX 42
American Data Corp. an AIRPAX
Company
Applied Electro Mechanics, Inc.
Arnold Barnes Company

CBS Labs
Cohu, Inc. Electronics Division
Dyma Engineering, Inc.
Dynascan Corp. B & K Division
Eico Elect. Inst. Co., Inc.
Engineering Associates
Heath Co.
Hickok Elect. Instrument
Ikegami Tsushinki Co., Ltd. Export
Department
Internatl. Nuclear Corp.
Leader Instruments Corp.
Lectrotech Inc.
Marconi Electronics Inc.
Marconi Instruments
Mincom Div. 3M Co.
OMNIX
RCA Corporation RCA Broadcast
Equip., Comm. Sys. Div.
RCA Corporation RCA Electronic
Components
Robert Bosch Corp. Fernseh Div.
Shintron Co. Inc. Video Products Div.
SPI-ITT Instruments Metrix Division
Tektronix Inc.
TeleMation, Inc.
Tele Measurements Inc.
Telemet Co.
Terminal Hudson Corp. Terminal
Hudson Electronics
Test & Measuring Instruments, Inc. a
North American Philips Co.
Troy Electronic Sales Co.
Video Engineering Co. Inc.

Generators, Color Sync

See Adv. Page

Lenco Inc. 123
Video Aids Corp. of Colorado 112

Ameco Inc.
American Data Corp. an AIRPAX
Company
Arnold Barnes Company
CBS Labs
Central Dynamics Corp.
Control Concepts Corporation
Cramer Video and Audio Systems
Danscoll Ltd.
Dyma Engineering, Inc.
Dynasciences Corp. Video Products
Div.
Grass Valley Group, Inc.
Lenco Inc. Electronics Division
Panasonic Video Systems Div.
Matsushita Electric Corp. of
America
RCA Corporation RCA Broadcast
Equip., Comm. Sys. Div.
RCA Corporation RCA Electronic
Components
Rohde & Schwarz Sales Co.
Tektronix Inc.
TeleMation, Inc.
Telemet Co.
Test & Measuring Instruments, Inc. a
North American Philips Co.
Video Aids Corp. of Colorado
Video Engineering Co. Inc.

Generators, Convergence

CBS Labs
Dynasciences Corp. Video Products
Div.
Lectrotech Inc.
Tektronix Inc.

Generators, Digital Sync

American Data Corp. an AIRPAX
Company
CBS Labs
Central Dynamics Corp.
Control Concepts Corporation
Electronic Designers Inc.
Lenco Inc. Electronics Division
Test & Measuring Instruments, Inc. a
North American Philips Co.

Generators, FM Subcarrier

See Adv. Page

Gates 10
Moseley Assoc. Inc. 7

American Electronics Lab., Inc.
Catel, a Div. of United Scientific Corp.
CCA Electronics Corp.
Collins Radio Company Broadcast
Division
Edison Electronics, Div. of
McGraw-Edison Co., Daven &
Measurements
Gates Division of Harris-Intertype
Leader Instruments Corp.
Magnatech Company
Marti Electronics
Mastertone Company
McMartin Industries
Moseley Assoc. Inc.
RCA Corporation RCA Broadcast
Equip., Comm. Sys. Div.
RCA Corporation RCA Electronic
Components
Rohde & Schwarz Sales Co.
Scott-Buttner Coastcom, Inc.
Singer Products Co., Inc.
Sparta Electronic Corp.
Tektronix Inc.
Test & Measuring Instruments, Inc. a
North American Philips Co.
Wilkinson Electronics, Inc.

Generators, NTSC Signal Test

See Adv. Page

Dynasciences Corp. 37

American Data Corp. an AIRPAX
Company
Arnold Barnes Company
CBS Labs
Dyma Engineering, Inc.
Dynasciences Corp. Video Products
Div.
Marconi Electronics Inc.
OMNIX
Rohde & Schwarz Sales Co.
Shintron Co. Inc. Video Products Div.
Tektronix Inc.
TeleMation, Inc.
Telemet Co.
Test & Measuring Instruments, Inc. a
North American Philips Co.
Video Engineering Co. Inc.

Generators, Powered (Electric Motor)

See Adv. Page

Onan 31

General Electric Company Tubes/MW
Devices
Kato Engineering Co.
Onan
Singer Products Co., Inc.

Generators, Powered (Gasoline Engine)

See Adv. Page

Onan 31

F&B/Ceco Industries, Inc.
Kato Engineering Co.
Mole Richardson Co.
Onan
Singer Products Co., Inc.
TV Cable Supply Co., Inc.

Generators, SCA

See Adv. Page

Gates 10
Moseley Assoc. Inc. 7

CCA Electronics Corp.
Gates Division of Harris-Intertype
Mastertone Company
McMartin Industries
Moseley Assoc. Inc.
Sparta Electronic Corp.

Tektronix Inc.
Wilkinson Electronics, Inc.

Generators, Signal AF

See Adv. Page

ALTEC 127

Ailtech (Formerly: Microdot)
ALTEC
Barker & Williamson, Inc.
Bulova American Time Products
Control Concepts Corporation
Conway Electronic Enterprises Limited
Datapulse Div. of Systron-Donner
Delta Electronics Inc. (N.C.)
Dragnet Engineering Labs., Inc.
Dyma Engineering, Inc.
Dynascan Corp. B & K Division
Eico Elect. Inst. Co., Inc.
ELPA Marketing Industries, Inc.
Fairchild/Robbins Fairchild Sound
Equipment Corp.
Gates Division of Harris-Intertype
General Radio Co.
Gibbs Mfg. & Research Co.
Heath Co.
Hewlett Packard Co.
Instrument Laboratories
Kay Elemetrics Corp.
Leader Instruments Corp.
Lectronic Res. Labs. Inc.
Marconi Instruments
Radio Mfg. Co. (RMC)
RCA Corporation RCA Broadcast
Equip., Comm. Sys. Div.
RCA Corporation RCA Electronic
Components
Roh Corporation
Rohde & Schwarz Sales Co.
Siemens Corporation
SPI-ITT Instruments Metrix Division
Terminal Hudson Corp. Terminal
Hudson Electronics
Test & Measuring Instruments, Inc. a
North American Philips Co.
Texscan Corp.
TM Systems, Inc.
Total Technology
United Recording Electronics
Industries
UREI a URC Company

Generators, Signal Dot Bar

See Adv. Page

OMNIX 42

American Data Corp. an AIRPAX
Company
Arnold Barnes Company
CBS Labs
Colorado Video Inc.
Control Concepts Corporation
Dyma Engineering, Inc.
Eico Elect. Inst. Co., Inc.
Grass Valley Group, Inc.
Heath Co.
Leader Instruments Corp.
Lectrotech Inc.
Marconi Electronics Inc.
Marconi Instruments
OMNIX
Philips Broadcast Equipment Corp.
Subs. North American Philips Corp.
RCA Corporation RCA Broadcast
Equip., Comm. Sys. Div.
RCA Corporation RCA Electronic
Components
Robert Bosch Corp. Fernseh Div.
Sencore Inc.
Shintron Co. Inc. Video Products Div.
SPI-ITT Instruments Metrix Division
Tektronix Inc.
TeleMation, Inc.
Tele Measurements Inc.
Telemet Co.
Troy Electronic Sales Co.
Video Engineering Co. Inc.

Generators, Signal Marker

Blonder-Tongue Labs.
Dynascan Corp. B & K Division
Eico Elect. Inst. Co., Inc.
Kay Elemetrics Corp.

Leader Instruments Corp.
Lectrotech Inc.
Marconi Instruments
RCA Corporation RCA Broadcast
Equip., Comm. Sys. Div.
RCA Corporation RCA Electronic
Components
SPI-ITT Instruments Metrix Division
Tektronix Inc.
Telonic Industries Inc.
Troy Electronic Sales Co.
Video Engineering Co. Inc.

Generators, Signal Pulse

Acrodyne Industries
Ailtech (Formerly: Microdot)
Atlantic Research Corp. Teleproducts
Dept.
B & K Instruments Inc.
Bulova American Time Products
Central Dynamics Corp.
Control Concepts Corporation
Datapulse Div. of Systron-Donner
Delta Electronics Inc. (Va.)
Dragnet Engineering Labs., Inc.
Dynasciences Corp. Video Products
Div.
Edison Electronics, Div. of
McGraw-Edison Co., Daven &
Measurements
F&B/Ceco Industries, Inc.
Hewlett Packard Co.
Kay Elemetrics Corp.
Leader Instruments Corp.
Lectronic Res. Labs. Inc.
Marconi Electronics Inc.
Marconi Instruments
Narda Microwave Corp., The
PRD Electronics, Inc.
RCA Corporation RCA Broadcast
Equip., Comm. Sys. Div.
Robert Bosch Corp. Fernseh Div.
Ryder Magnetic Sales Corp.
Spencer-Kennedy Labs., Inc.
Tasker Systems Div. of Whittaker
Corp.
Tektronix Inc.
Terminal Hudson Corp. Terminal
Hudson Electronics
Test & Measuring Instruments, Inc. a
North American Philips Co.
Trepac Corp. America
United Systems Corp. Subs. of
Monsanto Co.
Video Engineering Co. Inc.

Generators, Signal RF

Acrodyne Industries
Ailtech (Formerly: Microdot)
Blonder-Tongue Labs.
Boonton Electronics
C-COR Electronics, Inc.
Collins Radio Company Broadcast
Division
Conway Electronic Enterprises Limited
Delta Electronics Inc. (Va.)
Dynascan Corp. B & K Division
Edison Electronics, Div. of
McGraw-Edison Co., Daven &
Measurements
Eico Elect. Inst. Co., Inc.
Engineering Associates
Enterprise Electronics Corp.
General Radio Co.
Gibbs Mfg. & Research Co.
Heath Co.
Hewlett Packard Co.
Kay Elemetrics Corp.
Lampkin Lab. Inc.
Leader Instruments Corp.
Lectronic Res. Labs. Inc.
Marconi Electronics Inc.
Marconi Instruments
Narda Microwave Corp., The
PRD Electronics, Inc.
RCA Corporation RCA Broadcast
Equip., Comm. Sys. Div.
RCA Corporation RCA Electronic
Components
Rohde & Schwarz Sales Co.
Sadelco, Inc.
Siemens Corporation
Singer Instrumentation Los Angeles
Operation
Singer Co., The Palo Alto Operation

Spencer-Kennedy Labs., Inc.
SPI-ITT Instruments Metrix Division
Tasker Systems Div. of Whittaker
Corp.
Telonic Industries Inc.
Texscan Corp.
United Systems Corp. Subs. of
Monsanto Co.

Generators, Signal Square Wave

Acrodyne Industries
Ailtech (Formerly: Microdot)
American Data Corp. an AIRPAX
Company
Atlantic Research Corp. Teleproducts
Dept.
Bulova American Time Products
Conway Electronic Enterprises Limited
Datapulse Div. of Systron-Donner
Dynascan Corp. B & K Division
Edison Electronics, Div. of
McGraw-Edison Co., Daven &
Measurements
Eico Elect. Inst. Co., Inc.
General Radio Co.
Gibbs Mfg. & Research Co.
Heath Co.
Hewlett Packard Co.
Leader Instruments Corp.
Marconi Instruments
RCA Corporation RCA Broadcast
Equip., Comm. Sys. Div.
RCA Corporation RCA Electronic
Components
Rohde & Schwarz Sales Co.
SPI-ITT Instruments Metrix Division
Tektronix Inc.
TeleMation, Inc.
Tele Measurements Inc.
Telemet Co.
Terminal Hudson Corp. Terminal
Hudson Electronics
Test & Measuring Instruments, Inc. a
North American Philips Co.
Total Technology
Troy Electronic Sales Co.
United Recording Electronics
Industries
United Systems Corp. Subs. of
Monsanto Co.
UREI a URC Company
Weinschel Engineering Co.

Generators, Signal TV Synchronizing

American Data Corp. an AIRPAX
Company
Arnold Barnes Company
CBS Labs
Central Dynamics Corp.
Chrono-Log Corp.
Cleveland Electronics, Inc.
Cohu, Inc. Electronics Division
Colorado Video Inc.
Control Concepts Corporation
Cramer Video and Audio Systems
Dyma Engineering, Inc.
DYN AIR Electronics, Inc.
Dynasciences Corp. Video Products
Div.
Electronic Designers Inc.
Enterprise Electronics Corp.
GPL Div. Singer Gen.
Grass Valley Group, Inc.
Ikegami Tsushinki Co., Ltd. Export
Department
Internatl. Nuclear Corp.
Marconi Electronics Inc.
Marconi Instruments
Philips Broadcast Equipment Corp.
Subs. North American Philips Corp.
RCA Corporation RCA Broadcast
Equip., Comm. Sys. Div.
Richmond Hill Laboratories Inc.
Robert Bosch Corp. Fernseh Div.
Rohde & Schwarz Sales Co.
Shintron Co. Inc. Video Products Div.
Sylvania Comm. Electronic
Tektronix Inc.
TeleMation, Inc.
Tele Measurements Inc.
Telemet Co.
Test & Measuring Instruments, Inc. a
North American Philips Co.
Texscan Corp.

TRACOR, Inc. Instruments Group
Video Engineering Co. Inc.
Visual Educom Inc. DAGE Television
Visual Educom Inc. MTI Television

Generators, Signal VITS

American Data Corp. an AIRPAX
Company
CBS Labs
Electronic Designers Inc.
Marconi Instruments
Richmond Hill Laboratories Inc.
Rohde & Schwarz Sales Co.
Tektronix Inc.
TeleMation, Inc.
Tele Measurements Inc.
Telemet Co.
Test & Measuring Instruments, Inc. a
North American Philips Co.
Video Engineering Co. Inc.

Generators, Special Effect

	See Adv. Page
Danscoll Ltd.	116
DYN AIR Electronics, Inc.	118
Grass Valley Group, Inc.	3
OMNIX.....	42
Vital Industries Inc.	BC

Ameco Inc.
American Data Corp. an AIRPAX
Company
Applied Electro Mechanics, Inc.
Ball Bros. Research Corp. Miratel
Division
Central Dynamics Corp.
Cleveland Electronics, Inc.
Colorado Video Inc.
Cramer Video and Audio Systems
Danscoll Ltd.
DYN AIR Electronics, Inc.
Grass Valley Group, Inc.
Hitachi Shibaden Corp. of America
Internatl. Nuclear Corp.
Leader Instruments Corp.
Marconi Electronics Inc.
Modern Video Engineering Co.
OMNIX
Philips Broadcast Equipment Corp.
Subs. North American Philips Corp.
RCA Corporation RCA Broadcast
Equip., Comm. Sys. Div.
Richmond Hill Laboratories Inc.
Robert Bosch Corp. Fernseh Div.
Sarkes Tarzian Inc. Broadcast
Equipment Div.
Shintron Co. Inc. Video Products Div.
Singer Co. Simulation Products Div.
Tektronix Inc.
TeleMation, Inc.
Tele Measurements Inc.
Telemet Co.
TELESTRATOR Industries
Total Technology
Ultra Audio Products
Video Engineering Co. Inc.
Viscount Industries Ltd.
Vital Industries Inc.

Generators, Staircase

American Data Corp. an AIRPAX
Company
CBS Labs
Colorado Video Inc.
Control Concepts Corporation
Marconi Instruments
OMNIX
Richmond Hill Laboratories Inc.
Rohde & Schwarz Sales Co.
Tektronix Inc.
TeleMation, Inc.
Telemet Co.
Video Engineering Co. Inc.
VIF International

Generators, Stereo

	See Adv. Page
Moseley Assoc. Inc.	7

Sparta Electronic Corp. 8
Wilkinson Electronics,
Inc. 58

American Electronics Lab., Inc.
Catel, a Div. of United Scientific Corp.
CCA Electronics Corp.
Collins Radio Company Broadcast
Division
Fung Engineering Co.
Heath Co.
Leader Instruments Corp.
Mastertone Company
Moseley Assoc. Inc.
RCA Corporation RCA Electronic
Components
Rohde & Schwarz Sales Co.
Sparta Electronic Corp.
Test & Measuring Instruments, Inc. a
North American Philips Co.
Wilkinson Electronics, Inc.

Generators, Subcarrier

	See Adv. Page
Sparta Electronic Corp.	8

CBS Labs
CCA Electronics Corp.
Collins Radio Company Broadcast
Division
Control Concepts Corporation
Shintron Co. Inc. Video Products Div.
Sparta Electronic Corp.

Generators, Sync

	See Adv. Page
Ceco Communications Inc.	140
Control Concepts Corporation.....	110
Danscoll Ltd.	116
Dynasciences Corp.	37
Grass Valley Group, Inc.	3
Shintron Co. Inc.	132

American Data Corp. an AIRPAX
Company
Arnold Barnes Company
Bulova American Time Products
CBS Labs
Ceco Communications Inc.
Cohu, Inc. Electronics Division
Control Concepts Corporation
Cramer Video and Audio Systems
Danscoll Ltd.
Datapulse Div. of Systron-Donner
DYN AIR Electronics, Inc.
Dynasciences Corp. Video Products
Div.
Electronic Designers Inc.
Enterprise Electronics Corp.
Gates Division of Harris-Intertype
Gen. Electrodynamics
Grass Valley Group, Inc.
Hitachi Shibaden Corp. of America
Internatl. Nuclear Corp.
RCA Corporation RCA Broadcast
Equip., Comm. Sys. Div.
R. H. Tyler Co. Div. of Weather Scan,
Inc.
Rohde & Schwarz Sales Co.
Shintron Co. Inc. Video Products Div.
Tektronix Inc.
TeleMation, Inc.
Test & Measuring Instruments, Inc. a
North American Philips Co.
Video Aids Corp. of Colorado
Video Engineering Co. Inc.

Generators, Thermoelectric

	See Adv. Page
Teledyne Isotopes	128A

Teledyne Isotopes Energy Systems
Division

Generators, Time Code (Reader)

Scully/Metrotech Divs. of Dictaphone
Corp.

Generators, Video Carrier

Enterprise Electronics Corp.
Rohde & Schwarz Sales Co.
Tektronix Inc.
Test & Measuring Instruments, Inc. a
North American Philips Co.
TRACOR, Inc. Instruments Group
Video Engineering Co. Inc.

Generators, Video Sweep

Ailtech (Formerly: Microdot)
Leader Instruments Corp.
Lectrotech Inc.
Marconi Electronics Inc.
Marconi Instruments
RCA Corporation RCA Electronic
Components
Rohde & Schwarz Sales Co.
SPI-ITT Instruments Matrix Division
Tektronix Inc.
Telemet Co.
Telonic Industries Inc.
Test & Measuring Instruments, Inc. a
North American Philips Co.
Troy Electronic Sales Co.

Head Alignment Gauge

See Adv. Page

Sparta Electronic Corp. 8

Sparta Electronic Corp.

Head Cleaning Products, Video

Nortronics Co., Inc. Recorder Care Div.

Head Nest Rebuilding Services

Communication Medias
Mastertone Company
Nortronics Co., Inc. Recorder Care Div.
Radio Mfg. Co. (RMC)
Taber Mfg. & Engr. Co.

Headphones, Announcers Earpiece

Broadcast Electronics
Broadcast Products Inc.
Collins Radio Company Broadcast
Division
Communication Medias
Electro-Voice Inc. Subs. of Gulton
Industries, Inc.
Lauderdale Electronic Labs
Mastertone Company
Spotmaster Broadcast Electronics
Telex Communications Division
Wilkinson Electronics, Inc.

Headphones, Broadcast Monitoring

Beyer (Revox Corporation)
Broadcast Electronics
Broadcast Products Inc.
Collins Radio Company Broadcast
Division
Communication Medias
Conway Electronic Enterprises Limited
F&B/Ceco Industries, Inc.
Koss Corp
Lauderdale Electronic Labs
Mastertone Company
Maze Corporation
Pulse Dynamics Mfg. Corp.
Scintrex Inc. Communications Div.
Spotmaster Broadcast Electronics
Stanton Magnetics Inc.
Television Equipment Associates
Telex Communications Division
VIF International
Wilkinson Electronics, Inc.

Headphones, Mono

See Adv. Page

Broadcast Electronics 34
Sparta Electronic Corp. 8
Television Equipment
Associates..... 139

AKG Division North Amer. Philips
Corp.
Beyer (Revox Corporation)
Broadcast Electronics
Broadcast Products Inc.
Collins Radio Company Broadcast
Division
Communication Medias
Conway Electronic Enterprises Limited
David Clark Co., Inc.
F&B/Ceco Industries, Inc.
Gates Division of Harris-Intertype
G.C. Electronics
Gotham Audio Corp.
Heath Co.
Koss Corp
Lauderdale Electronic Labs
Magnatech Company
Mastertone Company
Paso Sound Products Inc.
RCA Corporation RCA Broadcast
Equip., Comm. Sys. Div.
R. H. Tyler Co. Div. of Weather Scan,
Inc.
Scintrex Inc. Communications Div.
Sennheiser Electronics Corp.
Singer Products Co., Inc.
Sparta Electronic Corp.
Spotmaster Broadcast Electronics
Stanton Magnetics Inc.
Superscope, Inc.
Systems Engineering Co., Inc.
Television Equipment Associates
Telex Communications Division
Terminal Hudson Corp. Terminal
Hudson Electronics
Victor Duncan, Inc.
Video Engineering Co. Inc.
VIF International
Wilkinson Electronics, Inc.

Headphones, Stereo

See Adv. Page

Broadcast Electronics 34
Sparta Electronic Corp. 8
Television Equipment
Associates..... 139

AKG Division North Amer. Philips
Corp.
Astrocom Electronics, Inc.
Beyer (Revox Corporation)
Broadcast Electronics
Broadcast Products Inc.
Collins Radio Company Broadcast
Division
Communication Medias
Conway Electronic Enterprises Limited
David Clark Co., Inc.
Duotone Co. Inc.
F&B/Ceco Industries, Inc.
Gates Division of Harris-Intertype
G.C. Electronics
Heath Co.
Koss Corp
Lauderdale Electronic Labs
Mastertone Company
Paso Sound Products Inc.
RCA Corporation RCA Broadcast
Equip., Comm. Sys. Div.
R. H. Tyler Co. Div. of Weather Scan,
Inc.
Sansui Electronics Corp.
Scintrex Inc. Communications Div.
Sennheiser Electronics Corp.
Sparta Electronic Corp.
Spotmaster Broadcast Electronics
Stanton Magnetics Inc.
Superscope, Inc.
Systems Engineering Co., Inc.
Television Equipment Associates
Telex Communications Division
Victor Duncan, Inc.
Video Engineering Co. Inc.
VIF International
Wilkinson Electronics, Inc.

Head, Contactor

Nortronics Co., Inc. Recorder Care Div.

Heads, Erase Magnetic

Broadcast Electronics
Broadcast Products Inc.

Cetec Inc. Subs. Computer Equipment
Corp.
Collins Radio Company Broadcast
Division
Communication Medias
ELPA Marketing Industries, Inc.
Gates Division of Harris-Intertype
Joa Cartridge Service
Lipps Inc.
Magnusonic Devices Inc.
Mastertone Company
Michigan Magnetics
MINNEAPOLIS MAGNETICS, INC.
Norton Assoc. Inc.
Nortronics Co., Inc. Recorder Care Div.
Precision Laboratories Precision Cine
Equipment Corp.
RCA Corporation RCA Broadcast
Equip., Comm. Sys. Div.
Recortec Inc.
Spin Physics, Inc.
Spotmaster Broadcast Electronics
Taber Mfg. & Engr. Co.

Heads, Film Stripe

Nortronics Co., Inc. Recorder Care Div.

Heads, Reconditioned or Reconditioning Services for Video

See Adv. Page

Computer Magnetics
Corp. 105

Computer Magnetics Corp.

Heads, Recorder Replacement

See Adv. Page

Broadcast Electronics 34
Computer Magnetics
Corp. 105
MINNEAPOLIS
MAGNETICS, INC. 108
Taber Mfg. & Engr.
Co. 136

Broadcast Electronics
Computer Magnetics Corp.
MINNEAPOLIS MAGNETICS, INC.
Nortronics Co., Inc. Recorder Care Div.
Taber Mfg. & Engr. Co.

Heads, Recording Magnetic

See Adv. Page

Taber Mfg. & Engr.
Co. 136

Broadcast Electronics
Broadcast Products Inc.
Cetec Inc. Subs. Computer Equipment
Corp.
Collins Radio Company Broadcast
Division
Communication Medias
Hitachi Shibaden Corp. of America
Joa Cartridge Service
Lipps Inc.
Magnusonic Devices Inc.
Mastertone Company
Michigan Magnetics
MINNEAPOLIS MAGNETICS, INC.
Norton Assoc. Inc.
Nortronics Co., Inc. Recorder Care Div.
RCA Corporation RCA Broadcast
Equip., Comm. Sys. Div.
Recordex Corporation
Spin Physics, Inc.
Spotmaster Broadcast Electronics
Taber Mfg. & Engr. Co.
Tapecaster TCM, Inc.
Video Engineering Co. Inc.
Vikron

Headset with Microphone

AKG Division North Amer. Philips
Corp.
Broadcast Products Inc.
Conway Electronic Enterprises Limited

David Clark Co., Inc.
Electro-Voice Inc. Subs. of Gulton
Industries, Inc.
Gates Division of Harris-Intertype
Hitachi Shibaden Corp. of America
Magnatech Company
Mastertone Company
Paso Sound Products Inc.
Pulse Dynamics Mfg. Corp.
RCA Corporation RCA Broadcast
Equip., Comm. Sys. Div.
R. H. Tyler Co. Div. of Weather Scan,
Inc.
Scintrex Inc. Communications Div.
Sennheiser Electronics Corp.
Telectro Systems Corp.
Television Equipment Associates
Telex Communications Division
Video Aids Corp. of Colorado
Video Engineering Co. Inc.
VIF International

Heater, Antenna Control

See Adv. Page

Gates 10

Collins Radio Company Broadcast
Division
Gates Division of Harris-Intertype
Mastertone Company
Micro-Trak Corporation (Formerly:
Gray Research & Dev.)
Valad Electric Heating Corp.
Wilkinson Electronics, Inc.

Heaters, Station Van

Precision Laboratories Precision Cine
Equipment Corp.
Valad Electric Heating Corp.

Hum Stop Coil, Video

See Adv. Page

Audio-Video
Engineering Co. 132

Audio-Video Engineering Co.
TeleMation, Inc.
Video Engineering Co. Inc.

Industrial TV --See also TV Systems, Closed Circuit

Alcor Inc.
Alma Engineering Inc.
American Data Corp. an AIRPAX
Company
Ampex Corp. Audio-Video Systems
Division
Anaconda Electronics
Applied Video Electronics, Inc.
ATV Research
Audiotronics Corp.
AVA Electronics Corp.
Ball Bros. Research Corp. Miratel
Division
Arnold Barnes Company
Berkey-Colortran Inc.
Blonder-Tongue Labs.
Boston Insulated Wire & Cable Co.
Bradford Information Systems
Catel, a Div. of United Scientific Corp.
Cohu, Inc. Electronics Division
Colorado Video Inc.
Comquip, Inc.
Cramer Video and Audio Systems
Diebold Incorporated
DYNAIR Electronics, Inc.
Gates Division of Harris-Intertype
GBC Closed Circuit TV Corp.
Gen. Electrodynamics
General Television Ntwk.
GPL Div. Singer Gen.
Gulf Telephone & Electronics
Hitachi Shibaden Corp. of America
Ikegami Tsushinki Co., Ltd. Export
Department
Internl. Nuclear Corp.
Janson Industries
Javelin Div. of Apollo Lasers
Jos. Schneider & Co. Optische Werke
Div.
Lerro Electrical Corp.

Nasco Television Systems
Orbit Radio and Video
Panasonic Video Systems Div.
Matsushita Electric Corp. of
America
Philips Broadcast Equipment Corp.
Subs. North American Philips Corp.
Precision Electrical Mfg. Div. Circuit
Science Inc.
RCA Corporation RCA Broadcast
Equip., Comm. Sys. Div.
Riker Communications Inc.
Robert Bosch Corp. Fernseh Div.
Rust Corp.
SC Electronics, Inc. Subs. of
Audiotronics Corp.
Scientific Systems, Inc. Broadcast
Equipment Div.
Shintron Co. Inc. Video Products Div.
Singer Co. Simulation Products Div.
Sylvania Comm. Electronic
Tasker Systems Div. of Whittaker
Corp.
Tektronix Inc.
Tele-Cine Inc.
Teledyne Brown Engineering Co.
Science & Engrg. Div.
TeleMation, Inc.
Tele Measurements Inc.
Teltron, Inc.
Video Engineering Co. Inc.
Vikoa Inc.
Visual Communication Products Oper.
General Electric Co.
Visual Educom Inc. DAGE Television
Visual Educom Inc. MTI Television
Vitec Communications Ltd.

Insulators, Antenna Base

See Adv. Page

Austin Insulator Div. 140

Austin Insulator Div. Decca Radar
Canada (1967) Ltd.

Insulators, Guy Strain

See Adv. Page

Austin Insulator Div. 141

Austin Insulator Div. Decca Radar
Canada (1967) Ltd.

Integrated Circuits --See also Semiconductors

American Electronics Lab., Inc.
A-Tel-A-Matic
Heintz and Kaufman Ltd.
Hewlett Packard Co.
P. R. Mallory & Co. Inc. Mallory
Distributor Products Co.
Melcor Electronics Corp.
Motorola Semiconduct Motorola Inc.
Raytheon Company Raytheon Data
Systems Co.
RCA Corporation RCA Broadcast
Equip., Comm. Sys. Div.
RCA Corporation RCA Electronic
Components
Solitron Devices Inc. Semiconductor
Div.
Terminal Hudson Corp. Terminal
Hudson Electronics
Texas Instrument Components Group
Thor Electronics Corp.
Visual Communication Products Oper.
General Electric Co.

Intercom Systems

See Adv. Page

Clear-Com 122
Video Aids Corp. of
Colorado 112

Bogen Division Lear Siegler Inc.
Central Dynamics Corp.
Clear-Com Div. of Lumiere
Productions, Inc.
Cramer Video and Audio Systems
David Clark Co., Inc.
Emerson Elec./Artolier Lighting &
Sound Rittenhouse Div.

Fisher Berkeley Corp.
G.C. Electronics
Heath Co.
Holland Electronics
McMartin Industries
Nasco Television Systems
Paso Sound Products Inc.
RCA Corporation RCA Broadcast
Equip., Comm. Sys. Div.
Roh Corporation
Sarkes Tarzian Inc. Broadcast
Equipment Div.
Shintron Co. Inc. Video Products Div.
Soundolier, Inc.
Systems Engineering Co., Inc.
Telectro Systems Corp.
Television Equipment Associates
Terminal Hudson Corp. Terminal
Hudson Electronics
Video Aids Corp. of Colorado
Visual Electronics Corp.

Isocouplers

See Adv. Page

Sparta Electronic Corp. 8

Sparta Electronic Corp.

ITFS System

Alford Mfg. Co.
Andrew Corp.
CHESTER ELECTRONIC LABS., INC.
GTE Information Systems Inc.
Cramer Video and Audio Systems
EMCEE Broadcast Products Div. of
Electronics, Missiles &
Communications, Inc.
RF Systems, Inc.
TeleMation, Inc.
Varian Solid State Div. Micro-Link
Products

Jack Panel Assemblies

See Adv. Page

Audio Devices, Inc. 45

A-Tel-A-Matic
Atlantic Research Corp. Teleproducts
Dept.
Audio Accessories Inc.
Audio Devices, Inc.
AVA Electronics Corp.
Central Dynamics Corp.
Collins Radio Company Broadcast
Division
Cooke Engineering Co.
Delta Electronics Inc. (Va.)
Gates Division of Harris-Intertype
Gulf Telephone & Electronics
Lectronic Res. Labs. Inc.
Mastertone Company
McCurdy Radio Ind. Inc.
Potomac Instruments, Inc.
RCA Corporation RCA Broadcast
Equip., Comm. Sys. Div.
Sarkes Tarzian Inc. Broadcast
Equipment Div.
Switchcraft Inc.
Systems Engineering Co., Inc.
Terminal Hudson Corp. Terminal
Hudson Electronics
Trompeter Electronics
Video Engineering Co. Inc.

Keyers, Video Insert

See Adv. Page

Grass Valley Group,
Inc. 3

Grass Valley Group, Inc.

Kits

ATV Research
Bardwell & McAlister Div. of F &
B/Ceco Industries
Comquip, Inc.
Eico Elect. Inst. Co., Inc.
Engineering Associates
ES Enterprises

Fairchild/Robbins Fairchild Sound
Equipment Corp.
Gately Electronics
G.C. Electronics
Heath Co.
Hollingsworth Solderless Terminal Co.
Hughey & Phillips Inc.
Lectronic Res. Labs. Inc.
Mole Richardson Co.
Oaktron Industries Inc.
PRD Electronics, Inc.
RCA Corporation RCA Broadcast
Equip., Comm. Sys. Div.
RCA Corporation RCA Electronic
Components
SPI-ITT Instruments Matrix Division
Terminal Hudson Corp. Terminal
Hudson Electronics
Texwipe Co.
TRW Electronic Supply Co. Div. of
TRW
Vaco Products Co.

Knobs, Control

See Adv. Page

Alco Electronic
Products, Inc. 10

Alco Electronic Products, Inc.
P. R. Mallory & Co. Inc. Mallory
Distributor Products Co.

Leased Broadcast Equipment

See Adv. Page

Broadcast Equipment
Leasing Corp. 137

Ampro Corp.
Broadcast Equipment Leasing Corp.
Div. Anchor Leasing Corp.
Broadcast Products Inc.
CBS Labs
Communication Medias
D AND S CORLEY LIMITED
International Tapetronics Corp.
Sparta Electronic Corp.
Tele-Cine Inc.
Wilkinson Electronics, Inc.

Lenses, Optical Fixed

See Adv. Page

Angenieux Corp. of
America 137
Comquip, Inc. 141

Angenieux Corp. of America
Arriflex Company of America
A-Tel-A-Matic
ATV Research
Canon USA, Inc. Optics Division
Comquip, Inc.
Cosmicar Optical Co., Ltd.
Cramer Video and Audio Systems
Cunningham Corp. Subs. of Gleason
Works
Denson Electronic Corp.
Eastcoast Camera Center, Inc.
F&B/Ceco Industries, Inc.
Gates Division of Harris-Intertype
GBC Closed Circuit TV Corp.
Image Devices Incorporated
Javelin Div. of Apollo Lasers
Jos. Schneider & Co. Optische Werke
Div.
Lenzar Optics Corp.
Rank Precision Industries
Rank Precision Ind. Broadcast Div.
RCA Corporation RCA Broadcast
Equip., Comm. Sys. Div.
R. H. Tyler Co. Div. of Weather Scan,
Inc.
Schneider Corp. of America
Tele-Cine Inc.
Tele Measurements Inc.
Vicon Industries, Inc.
Victor Duncan, Inc.
Video Engineering Co. Inc.
Visual Educom Inc. DAGE Television

Lenses, Optical Zoom

See Adv. Page

Angenieux Corp. of
America 137

Amperex Corp.
Angenieux Corp. of America
Arriflex Company of America
ATV Research
Canon USA, Inc. Optics Division
Comquip, Inc.
Cosmicar Optical Co., Ltd.
Cramer Video and Audio Systems
Cunningham Corp. Subs. of Gleason
Works
Denson Electronic Corp.
Eastcoast Camera Center, Inc.
F&B/Ceco Industries, Inc.
Gates Division of Harris-Intertype
GBC Closed Circuit TV Corp.
Hitachi Shibaden Corp. of America
Image Devices Incorporated
Javelin Div. of Apollo Lasers
Jos. Schneider & Co. Optische Werke
Div.
Lenzar Optics Corp.
Philips Broadcast Equipment Corp.
Subs. North American Philips Corp.
Rank Precision Industries
Rank Precision Ind. Broadcast Div.
RCA Corporation RCA Broadcast
Equip., Comm. Sys. Div.
R. H. Tyler Co. Div. of Weather Scan,
Inc.
Schneider Corp. of America
Tele-Cine Inc.
Tele Measurements Inc.
Vicon Industries, Inc.
Victor Duncan, Inc.
Video Engineering Co. Inc.
Visual Educom Inc. DAGE Television

Lighting, Preset Dimmer

Berkey-Colortran Inc.
Century Strand, Inc.
Cramer Video and Audio Systems
Janson Industries
Kliegl Bros. Lighting
Skirpan Lighting Control Corp.
Tele Measurements Inc.
Video Engineering Co. Inc.

Lighting, TV Controls

Berkey-Colortran Inc.
Century Strand, Inc.
Cramer Video and Audio Systems
F&B/Ceco Industries, Inc.
Janson Industries
Kliegl Bros. Lighting
Mole Richardson Co.
RCA Corporation RCA Broadcast
Equip., Comm. Sys. Div.
Skirpan Lighting Control Corp.
Tele Measurements Inc.
Ultra Audio Products
Utility Tower Co.
Video Engineering Co. Inc.
Waber Electronics Inc. Div. SGL
Industries, Inc.

Lighting, TV Portable System

Berkey-Colortran Inc.
Century Strand, Inc.
Comquip, Inc.
Cramer Video and Audio Systems
Gates Division of Harris-Intertype
GBC Closed Circuit TV Corp.
GTE Sylvania Inc. Lighting Products
Group
Harwood Mfg. Co.
Janson Industries
Kliegl Bros. Lighting
Mole Richardson Co.
R. H. Tyler Co. Div. of Weather Scan,
Inc.
Skirpan Lighting Control Corp.
TeleMation, Inc.
Tele Measurements Inc.
Union Connector Co., Inc.
Video Engineering Co. Inc.

Lighting, TV Studio System

Bardwell & McAlister Div. of F & B/Ceco Industries
 Berkey-Colortran Inc.
 Century Strand, Inc.
 Cramer Video and Audio Systems
 F&B/Ceco Industries, Inc.
 Gates Division of Harris-Intertype
 Janson Industries
 Kliegl Bros. Lighting
 Mole Richardson Co.
 RCA Corporation RCA Broadcast Equip., Comm. Sys. Div.
 R. H. Tyler Co. Div. of Weather Scan, Inc.
 Skirpan Lighting Control Corp.
 TeleMation, Inc.
 Tele Measurements Inc.
 Union Connector Co., Inc.
 Utility Tower Co.
 Video Engineering Co. Inc.

Lighting Hangers, Studio

See Adv. Page

Berkey-Colortran Inc. 130

Berkey-Colortran Inc.

Lighting Transformers

See Adv. Page

Austin Insulator Div. 139

Austin Insulator Div. Decca Radar Canada (1967) Ltd.

Lightning Arresters

Andrews Tower Inc.
 AVA Electronics Corp.
 Broadcast Tower Service
 Collins Radio Company Broadcast Division
 Cook Electric Co.
 G.C. Electronics
 General Electric Company Tubes/MW Devices
 Joslyn Electronic Sys.
 Siemens Corporation
 TV Cable Supply Co., Inc.
 Utility Tower Co.
 Vikoa Inc.

Lightning Protection Systems

Collins Radio Company Broadcast Division
 Cook Electric Co.
 General Electric Company Tubes/MW Devices
 LightNing Elimination Associates
 Wilkinson Electronics, Inc.

Lights, Studio Set

Berkey-Colortran Inc.
 Comquip, Inc.
 Cramer Video and Audio Systems
 F&B/Ceco Industries, Inc.
 GTE Sylvania Inc. Lighting Products Group
 Kliegl Bros. Lighting
 Mole Richardson Co.
 R. H. Tyler Co. Div. of Weather Scan, Inc.
 TeleMation, Inc.
 Union Connector Co., Inc.
 Video Engineering Co. Inc.

Lights, Tower Control

See Adv. Page

Hughey & Phillips Inc. 128C

Broadcast Tower Service
 Gates Division of Harris-Intertype
 Hughey & Phillips Inc.
 Jampro Antenna Co. Div. of Computer Equipment Corp.
 Mastertone Company
 Radio Mfg. Co. (RMC)

Lights, Tower Obstruction

See Adv. Page

Hughey & Phillips Inc. 128C
Sparta Electronic Corp. 8

Andrews Tower Inc.
 Broadcast Tower Service
 Collins Radio Company Broadcast Division
 Dielectric Communications Div. of Sola Basic
 Electronic Lights Inc.
 Fort Worth Tower Co., Inc.
 Gates Division of Harris-Intertype
 Hughey & Phillips Inc.
 Jampro Antenna Co. Div. of Computer Equipment Corp.
 Mastertone Company
 Rohn Manufacturing Div. of Unarco Industries Inc.
 Sparta Electronic Corp.
 Utility Tower Co.

Limiter Compressor

See Adv. Page

Gates 10
Pacific Recorders and Engrg. Corp. 22
Wilkinson Electronics, Inc. 58

Arnold Barnes Company
 Broadcast Electronics
 Burwen Laboratories
 CCA Electronics Corp.
 Cetec Inc. Subs. Computer Equipment Corp.
 Collins Radio Company Broadcast Division
 Communication Medias
 Franz Vertriebs-gesellschaft m.b.H.
 Gately Electronics
 Gates Division of Harris-Intertype
 Inovonics
 Magnatech Company
 Mastertone Company
 Neve Inc., Rupert
 Pacific Recorders and Engrg. Corp.
 Precision Elect. Inc.
 Roh Corporation
 Rupert Neve Incorporated
 Sparta Electronic Corp.
 Spectra Sonics
 Spotmaster Broadcast Electronics
 Wilkinson Electronics, Inc.

Line Surge Protector

C-COR Electronics, Inc.
 Collins Radio Company Broadcast Division
 Cook Electric Co.
 Gates Division of Harris-Intertype
 Mastertone Company
 Wilkinson Electronics, Inc.

Load Resistor, Coaxial

AVA Electronics Corp.
 Bird Electronic Corp.
 Electro Impulse, Inc.
 Lectronic Res. Labs. Inc.
 Micro Communications, Inc.
 Rohde & Schwarz Sales Co.
 Weinschel Engineering Co.

Maintenance Services, AM

See Adv. Page

Audio Devices, Inc. 45
Audio Services, Inc. 32

Audio Devices, Inc.
 Audio Services, Inc.
 Broadcast Tower Service
 Telatronics
 Tri-Tronics

Maintenance Services, Cartridge Tape

See Adv. Page

Audio Devices, Inc. 45
Joa Cartridge Service 130
Mastertone Company .. 139,141

Applied Video Electronics, Inc.
 Audio Devices, Inc.
 Broadcast Prod. Co. Inc. Bcst. Division
 Communication Medias
 Gates Division of Harris-Intertype
 Joa Cartridge Service
 Lauderdale Electronic Labs
 Liberty Industries
 Marathon Broadcast Equip.
 Mastertone Company
 RCA Corporation RCA Service Company Div.
 Sparta Electronic Corp.
 Taber Mfg. & Engr. Co.
 Tapex Corporation
 Tri-Tronics

Maintenance Services, FM

See Adv. Page

Audio Devices, Inc. 45
Audio Services, Inc. 32

American Electronics Lab., Inc.
 Audio Devices, Inc.
 Audio Services, Inc.
 Broadcast Tower Service
 Collins Radio Company Broadcast Division
 Fort Worth Tower Co., Inc.
 Liberty Industries
 RCA Corporation RCA Service Company Div.
 Soll, Inc., Joseph M.
 Telatronics
 Tri-Tronics
 Utility Tower Co.

Maintenance Services, Microwave

American Electronics Lab., Inc.
 Broadcast Tower Service
 Fort Worth Tower Co., Inc.
 Liberty Industries
 Microwave Assoc. Inc.
 Raytheon Company Raytheon Data Systems Co.
 RCA Corporation RCA Service Company Div.
 Telatronics
 Utility Tower Co.

Maintenance Services, TV

Alcor Inc.
 Angenieux Corp. of America
 Applied Video Electronics, Inc.
 Broadcast Tower Service
 Cramer Video and Audio Systems
 Fort Worth Tower Co., Inc.
 GBC Closed Circuit TV Corp.
 Liberty Industries
 RF Systems, Inc.
 Soll, Inc., Joseph M.
 Teledyne Brown Engineering Co. Science & Engrg. Div.
 Tele Measurements Inc.
 Television Technology Corp.
 Utility Tower Co.
 Visual Communication Products Oper. General Electric Co.

Meters, Antenna Base

See Adv. Page

Gates 10

Collins Radio Company Broadcast Division
 Gates Division of Harris-Intertype

Meters, Distortion

See Adv. Page

ELPA Marketing Industries, Inc. 18
The London Company 14

A-Tel-A-Matic
 Atlantic Research Corp. Teleproducts Dept.
 Collins Radio Company Broadcast Division
 Conway Electronic Enterprises Limited
 Dyma Engineering, Inc.
 ELPA Marketing Industries, Inc.
 Gates Division of Harris-Intertype
 Heath Co.
 Hewlett Packard Co.
 Hickok Elect. Instrument
 Lectronic Res. Labs. Inc.
 The London Company
 Marconi Instruments
 RCA Corporation RCA Broadcast Equip., Comm. Sys. Div.
 Vu-Data Corporation

Meters, Field Strength AM and FM

See Adv. Page

Delta Electronics Inc. (Va.) 138
Potomac Instruments, Inc. 12
Sparta Electronic Corp. 8

Collins Radio Company Broadcast Division
 Defense Electronics
 Delta Electronics Inc. (Va.)
 Engineering Associates
 Gates Division of Harris-Intertype
 Hickok Elect. Instrument
 Leader Instruments Corp.
 Lectronic Res. Labs. Inc.
 Narda Microwave Corp., The
 Potomac Instruments, Inc.
 RCA Corporation RCA Broadcast Equip., Comm. Sys. Div.
 Rohde & Schwarz Sales Co.
 Singer Instrumentation Los Angeles Operation
 Solar Electronics Co.
 Sparta Electronic Corp.
 SPI-ITT Instruments Matrix Division
 Terminal Hudson Corp. Terminal Hudson Electronics
 Wilkinson Electronics, Inc.

Meters, Field Strength TV-UHF

See Adv. Page

Potomac Instruments, Inc. 12

Ameco Inc.
 Anixter-Pruzan CATV Division
 Arnold Barnes Company
 Blender-Tongue Labs.
 CATV Equipment Co.
 Defense Electronics
 Edison Electronics, Div. of McGraw-Edison Co., Daven & Measurements
 Engineering Associates
 Fung Engineering Co.
 Leader Instruments Corp.
 Lectronic Res. Labs. Inc.
 Potomac Instruments, Inc.
 RCA Corporation RCA Broadcast Equip., Comm. Sys. Div.
 Rohde & Schwarz Sales Co.
 Sadelco, Inc.
 Sencore Inc.
 Singer Instrumentation Los Angeles Operation
 Terminal Hudson Corp. Terminal Hudson Electronics
 TV Cable Supply Co., Inc.
 Video Engineering Co. Inc.
 Vikoa Inc.

Meters, Flutter and Wow

See Adv. Page

ELPA Marketing Industries, Inc. 18

CCA Electronics Corp.
Conway Electronic Enterprises Limited
ELPA Marketing Industries, Inc.
Franz Vertriebs-gesellschaft m.b.H.
Gotham Audio Corp.
Kay Elemetrics Corp.
Leader Instruments Corp.
Lectronic Res. Labs. Inc.
Sentinel, Inc.
TASCAM Corporation

Meters, Frequency AF

Belar Electronics Lab., Inc.
B & K Instruments Inc.
Bulova American Time Products
CCA Electronics Corp.
Collins Radio Company Broadcast Division
Conway Electronic Enterprises Limited
Edison Electronics, Div. of McGraw-Edison Co., Daven & Measurements
Engineering Associates
General Electric Company Tubes/MW Devices
General Radio Co.
Hewlett Packard Co.
Hickok Elect. Instrument
Lampkin Lab. Inc.
Lectronic Res. Labs. Inc.
Marubeni America Corp. Miida Electronics
RCA Corporation RCA Broadcast Equip., Comm. Sys. Div.
Rohde & Schwarz Sales Co.
Siemens Corporation
Simpson Electric Co.
Singer Instrumentation Los Angeles Operation
SPI-ITT Instruments Metrix Division
Test & Measuring Instruments, Inc. a North American Philips Co.
Time & Frequency Tech., Inc.
United Systems Corp. Subs. of Monsanto Co.

Meters, Frequency RF

See Adv. Page

United Systems Corp. 25

Conway Electronic Enterprises Limited
Edison Electronics, Div. of McGraw-Edison Co., Daven & Measurements
Engineering Associates
ES Enterprises
General Electric Company Tubes/MW Devices
Heath Co.
Hewlett Packard Co.
Hickok Elect. Instrument
Lampkin Lab. Inc.
Lectronic Res. Labs. Inc.
Marubeni America Corp. Miida Electronics
Multronics, Inc.
Narda Microwave Corp., The
PRD Electronics, Inc.
Rohde & Schwarz Sales Co.
Siemens Corporation
Singer Instrumentation Los Angeles Operation
SPI-ITT Instruments Metrix Division
Test & Measuring Instruments, Inc. a North American Philips Co.
Time & Frequency Tech., Inc.
United Systems Corp. Subs. of Monsanto Co.

Meters, Frequency Calibrating

Bulova American Time Products
Edison Electronics, Div. of McGraw-Edison Co., Daven & Measurements
General Radio Co.
Lampkin Lab. Inc.
Lectronic Res. Labs. Inc.

Marubeni America Corp. Miida Electronics
Narda Microwave Corp., The
RCA Corporation RCA Broadcast Equip., Comm. Sys. Div.
Rohde & Schwarz Sales Co.
Singer Instrumentation Los Angeles Operation
Test & Measuring Instruments, Inc. a North American Philips Co.

Meters, Grind Dip

Conway Electronic Enterprises Limited
Edison Electronics, Div. of McGraw-Edison Co., Daven & Measurements
Leader Instruments Corp.

Meters, Intermodulation

Edison Electronics, Div. of McGraw-Edison Co., Daven & Measurements
Heath Co.
Rohde & Schwarz Sales Co.

Meters, Line Voltage

Alco Electronic Products, Inc.
Heath Co.
Hickok Elect. Instrument
Lectronic Res. Labs. Inc.
RCA Corporation RCA Electronic Components
Simpson Electric Co.
Terminal Hudson Corp. Terminal Hudson Electronics
Test & Measuring Instruments, Inc. a North American Philips Co.
Triplett Corporation

Meters, Panel Replacement

G.C. Electronics
General Microwave Corp.
Lectronic Res. Labs. Inc.
Minarik Elect.
Simpson Electric Co.
Triplett Corporation

Meters, Phase Angle

Collins Radio Company Broadcast Division
Conway Electronic Enterprises Limited
Dranetz Engineering Labs., Inc.
General Electric Company Tubes/MW Devices
Lectronic Res. Labs. Inc.
Neve Inc., Rupert
Potomac Instruments, Inc.
PRD Electronics, Inc.
RCA Corporation RCA Broadcast Equip., Comm. Sys. Div.
Rohde & Schwarz Sales Co.
Rupert Neve Incorporated
Siemens Corporation
Singer Instrumentation Los Angeles Operation
Time & Frequency Tech., Inc.

Meters, Power

Bird Electronic Corp.
Boonton Electronics
CCA Electronics Corp.
Collins Radio Company Broadcast Division
Dranetz Engineering Labs., Inc.
Electro Impulse, Inc.
Engineering Associates
General Microwave Corp.
Hickok Elect. Instrument
Lectronic Res. Labs. Inc.
Marconi Instruments
Narda Microwave Corp., The
National Electrolab Ltd.
PRD Electronics, Inc.
RCA Corporation RCA Broadcast Equip., Comm. Sys. Div.
Rohde & Schwarz Sales Co.
Siemens Corporation
Simpson Electric Co.
Terminal Hudson Corp. Terminal Hudson Electronics

Meters, Signal Level

Ameco Inc.
Siemens Corporation
Test & Measuring Instruments, Inc. a North American Philips Co.

Meters, Spectrum Analyzer

B & K Instruments Inc.
Dranetz Engineering Labs., Inc.
Marconi Electronics Inc.
Test & Measuring Instruments, Inc. a North American Philips Co.

Meters, Standing Wave

Bird Electronic Corp.
B & K Instruments Inc.
CCA Electronics Corp.
Collins Radio Company Broadcast Division
Delta Electronics Inc. (Va.)
General Radio Co.
Hewlett Packard Co.
Lectronic Res. Labs. Inc.
PRD Electronics, Inc.
RCA Corporation RCA Broadcast Equip., Comm. Sys. Div.
Rohde & Schwarz Sales Co.
SPI-ITT Instruments Metrix Division
Telonic Industries Inc.
Weinschel Engineering Co.

Meters, Video Noise

Vista Systems, Inc.

Meters, Volt Ohm

Alco Electronic Products, Inc.
Arnold Barnes Company
Conway Electronic Enterprises Limited
ES Enterprises
Heath Co.
Hickok Elect. Instrument
Instrument Laboratories
International Instrument Div. Sigma Instruments, Inc.
Leader Instruments Corp.
Marubeni America Corp. Miida Electronics
RCA Corporation RCA Broadcast Equip., Comm. Sys. Div.
RCA Corporation RCA Electronic Components
Simpson Electric Co.
SPI-ITT Instruments Metrix Division
Terminal Hudson Corp. Terminal Hudson Electronics
Test & Measuring Instruments, Inc. a North American Philips Co.
Triplett Corporation
United Systems Corp. Subs. of Monsanto Co.

Meters, VU

Audio Designs & Mfg.
Burwen Laboratories
Cetec Inc. Subs. Computer Equipment Corp.
Edison Electronics, Div. of McGraw-Edison Co., Daven & Measurements
Gately Electronics
G.C. Electronics
Hickok Elect. Instrument
Instrument Laboratories
International Instrument Div. Sigma Instruments, Inc.
Lectronic Res. Labs. Inc.
RCA Corporation RCA Broadcast Equip., Comm. Sys. Div.
Simpson Electric Co.
SPI-ITT Instruments Metrix Division
Systems Engineering Co., Inc.
Tapecaster TCM, Inc.
Terminal Hudson Corp. Terminal Hudson Electronics
Triplett Corporation
Vu-Data Corporation

Microphone Cable Tester

See Adv. Page

Sescom, Inc. 128

Sescom, Inc.

Microphone Stand and Boom

See Adv. Page

AKG Division 109 Sparta Electronic Corp. 8

AKG Division North Amer. Philips Corp.
ALTEC
Alto Communications Inc. Broadcast Marketing Div.
ATLAS Sound
Audio Distributor Inc.
Beyer (Revox Corporation)
Broadcast Electronics
Burwen Laboratories
CATV Equipment Co.
CCA Electronics Corp.
Century Strand, Inc.
Collins Radio Company Broadcast Division
Communication Medias
Comquip, Inc.
Cramer Video and Audio Systems
Custom Craft Designs
Dyma Engineering, Inc.
Electro-Voice Inc. Subs. of Gulton Industries, Inc.
F&B/Ceco Industries, Inc.
Gately Electronics
Gates Division of Harris-Intertype
G.C. Electronics
Image Devices Incorporated
Innovative Television Equipment, Inc.
Maze Corporation
Mole Richardson Co.
Norelco, Philips Bcast. Equip. Corp. Subs. North American Philips Corp.
Paso Sound Products Inc.
Philips Broadcast Equipment Corp. Subs. North American Philips Corp.
Primo Co. Ltd.
RCA Corporation RCA Broadcast Equip., Comm. Sys. Div.
RCA Corporation RCA Service Company Div.
R. H. Tyler Co. Div. of Weather Scan, Inc.
Schultz Inc., Albert
Scientific Systems, Inc. Broadcast Equipment Div.
Sennheiser Electronics Corp.
Shure Brothers Inc.
Singer Products Co., Inc.
Sparta Electronic Corp.
Spotmaster Broadcast Electronics
Tele Measurements Inc.
Television Products Co. Inc.
Terminal Hudson Corp. Terminal Hudson Electronics
Turner Division Conrac Corporation
Victor Duncan, Inc.
Video Engineering Co. Inc.
Wilkinson Electronics, Inc.

Microphones, Boom

See Adv. Page

AKG Division 109 Broadcast Electronics 34 Electro-Voice Inc. IFC Gates 10 Sparta Electronic Corp. 8

AKG Division North Amer. Philips Corp.
ALTEC
Beyer (Revox Corporation)
Broadcast Electronics
Broadcast Products Inc.
CATV Equipment Co.
Cetec Inc. Subs. Computer Equipment Corp.
Collins Radio Company Broadcast Division
Communication Medias
Comquip, Inc.
Cramer Video and Audio Systems

Denson Electronic Corp.
 Dyma Engineering, Inc.
 Electro-Voice Inc. Subs. of Gulton Industries, Inc.
 Gately Electronics
 Gates Division of Harris-Intertype
 G.C. Electronics
 Gotham Audio Corp.
 Image Devices Incorporated
 Innovative Television Equipment, Inc.
 Lauderdale Electronic Labs
 Mole Richardson Co.
 Nagra Magnetic Recorders, Inc.
 Norelco, Philips Bcst. Equip. Corp.
 Subs. North American Philips Corp.
 Paso Sound Products Inc.
 Philips Broadcast Equipment Corp.
 Subs. North American Philips Corp.
 RCA Corporation RCA Broadcast Equip., Comm. Sys. Div.
 Ryder Magnetic Sales Corp.
 Schultz Inc., Albert
 Sennheiser Electronics Corp.
 Shure Brothers Inc.
 Singer Products Co., Inc.
 Sparta Electronic Corp.
 Spotmaster Broadcast Electronics
 Tapecaster TCM, Inc.
 Tele Measurements Inc.
 Television Equipment Associates
 Telex Communications Division
 Terminal Hudson Corp. Terminal Hudson Electronics
 (Trusonic) ACS Inc.
 Turner Division Conrac Corporation
 Victor Duncan, Inc.
 Video Engineering Co. Inc.
 Wilkinson Electronics, Inc.

Microphones, Desk

See Adv. Page

AKG Division109
Broadcast Electronics 34
Comquip, Inc. 141
Gates 10
Sescom, Inc.128
Sparta Electronic Corp. 8

AKG Division North Amer. Philips Corp.
 ALTEC
 Audio Distributor Inc.
 Beyer (Revox Corporation)
 B & K Instruments Inc.
 Bogen Division Lear Siegler Inc.
 Broadcast Electronics
 Broadcast Products Inc.
 CATV Equipment Co.
 CCA Electronics Corp.
 Cetec Inc. Subs. Computer Equipment Corp.
 Collins Radio Company Broadcast Division
 Communication Medias
 Comquip, Inc.
 Cramer Video and Audio Systems
 Dyma Engineering, Inc.
 Electro-Voice Inc. Subs. of Gulton Industries, Inc.
 Gately Electronics
 Gates Division of Harris-Intertype
 G.C. Electronics
 Gotham Audio Corp.
 Javelin Div. of Apollo Lasers
 Lauderdale Electronic Labs
 Mastertone Company
 Nagra Magnetic Recorders, Inc.
 Norelco, Philips Bcst. Equip. Corp.
 Subs. North American Philips Corp.
 Paso Sound Products Inc.
 Philips Broadcast Equipment Corp.
 Subs. North American Philips Corp.
 Pulse Dynamics Mfg. Corp.
 RCA Corporation RCA Broadcast Equip., Comm. Sys. Div.
 R. H. Tyler Co. Div. of Weather Scan, Inc.
 Ryder Magnetic Sales Corp.
 Schultz Inc., Albert
 Sennheiser Electronics Corp.
 Sescom, Inc.
 Shure Brothers Inc.
 Singer Products Co., Inc.
 Sparta Electronic Corp.
 Spotmaster Broadcast Electronics

Superscope, Inc.
 Systems Engineering Co., Inc.
 Tapecaster TCM, Inc.
 TEAC Corp of America
 Tele Measurements Inc.
 Television Equipment Associates
 Terminal Hudson Corp. Terminal Hudson Electronics
 (Trusonic) ACS Inc.
 Turner Division Conrac Corporation
 Victor Duncan, Inc.
 Video Engineering Co. Inc.
 Wilkinson Electronics, Inc.

Microphones, Floor

See Adv. Page

AKG Division109
Broadcast Electronics 34
Gates 10
Sparta Electronic Corp. 8

AKG Division North Amer. Philips Corp.
 ALTEC
 Audio Distributor Inc.
 Beyer (Revox Corporation)
 B & K Instruments Inc.
 Bogen Division Lear Siegler Inc.
 Broadcast Electronics
 Broadcast Products Inc.
 CATV Equipment Co.
 CCA Electronics Corp.
 Cetec Inc. Subs. Computer Equipment Corp.
 Collins Radio Company Broadcast Division
 Communication Medias
 Cramer Video and Audio Systems
 Electro-Voice Inc. Subs. of Gulton Industries, Inc.
 Gately Electronics
 Gates Division of Harris-Intertype
 G.C. Electronics
 Gotham Audio Corp.
 Lauderdale Electronic Labs
 Mastertone Company
 Nagra Magnetic Recorders, Inc.
 Norelco, Philips Bcst. Equip. Corp.
 Subs. North American Philips Corp.
 Paso Sound Products Inc.
 Philips Broadcast Equipment Corp.
 Subs. North American Philips Corp.
 RCA Corporation RCA Broadcast Equip., Comm. Sys. Div.
 R. H. Tyler Co. Div. of Weather Scan, Inc.
 Ryder Magnetic Sales Corp.
 Schultz Inc., Albert
 Sennheiser Electronics Corp.
 Shure Brothers Inc.
 Sparta Electronic Corp.
 Spotmaster Broadcast Electronics
 Superscope, Inc.
 Tapecaster TCM, Inc.
 Tele Measurements Inc.
 Terminal Hudson Corp. Terminal Hudson Electronics
 (Trusonic) ACS Inc.
 Turner Division Conrac Corporation
 Victor Duncan, Inc.
 Video Engineering Co. Inc.
 VIF International
 Wilkinson Electronics, Inc.

Microphones, Hand Held

See Adv. Page

AKG Division109
Broadcast Electronics 34
Sparta Electronic Corp. 8

AKG Division North Amer. Philips Corp.
 ALTEC
 Audio Distributor Inc.
 Audiotronics Corp.
 Beyer (Revox Corporation)
 B & K Instruments Inc.
 Bogen Division Lear Siegler Inc.
 Broadcast Electronics
 Broadcast Products Inc.
 CATV Equipment Co.
 CCA Electronics Corp.
 Cetec Inc. Subs. Computer Equipment Corp.

Collins Radio Company Broadcast Division
 Communication Medias
 Cramer Video and Audio Systems
 Dyma Engineering, Inc.
 Electro-Voice Inc. Subs. of Gulton Industries, Inc.
 Gately Electronics
 Gates Division of Harris-Intertype
 G.C. Electronics
 Image Devices Incorporated
 Lauderdale Electronic Labs
 Mastertone Company
 Miles Reproducer Co.
 Nagra Magnetic Recorders, Inc.
 Norelco, Philips Bcst. Equip. Corp.
 Subs. North American Philips Corp.
 Paso Sound Products Inc.
 Philips Broadcast Equipment Corp.
 Subs. North American Philips Corp.
 Pulse Dynamics Mfg. Corp.
 RCA Corporation RCA Broadcast Equip., Comm. Sys. Div.
 R. H. Tyler Co. Div. of Weather Scan, Inc.
 Ryder Magnetic Sales Corp.
 Schultz Inc., Albert
 Sennheiser Electronics Corp.
 Shure Brothers Inc.
 Singer Products Co., Inc.
 Sparta Electronic Corp.
 Spotmaster Broadcast Electronics
 Superscope, Inc.
 Systems Engineering Co., Inc.
 Tapecaster TCM, Inc.
 TEAC Corp of America
 Tele Measurements Inc.
 Television Equipment Associates
 Telex Communications Division
 Terminal Hudson Corp. Terminal Hudson Electronics
 (Trusonic) ACS Inc.
 Turner Division Conrac Corporation
 Victor Duncan, Inc.
 Video Engineering Co. Inc.
 Wilkinson Electronics, Inc.

Microphones, Lavalier

See Adv. Page

AKG Division109
Broadcast Electronics 34
Gates 10
Sparta Electronic Corp. 8

AKG Division North Amer. Philips Corp.
 ALTEC
 Audiotronics Corp.
 Beyer (Revox Corporation)
 Bogen Division Lear Siegler Inc.
 Broadcast Electronics
 Broadcast Products Inc.
 CATV Equipment Co.
 CCA Electronics Corp.
 Cetec Inc. Subs. Computer Equipment Corp.
 Collins Radio Company Broadcast Division
 Communication Medias
 Comquip, Inc.
 Cramer Video and Audio Systems
 Electro-Voice Inc. Subs. of Gulton Industries, Inc.
 Gately Electronics
 Gates Division of Harris-Intertype
 G.C. Electronics
 Gotham Audio Corp.
 Image Devices Incorporated
 Lauderdale Electronic Labs
 Mastertone Company
 Miles Reproducer Co.
 Nagra Magnetic Recorders, Inc.
 Norelco, Philips Bcst. Equip. Corp.
 Subs. North American Philips Corp.
 Paso Sound Products Inc.
 Philips Broadcast Equipment Corp.
 Subs. North American Philips Corp.
 Pulse Dynamics Mfg. Corp.
 RCA Corporation RCA Broadcast Equip., Comm. Sys. Div.
 RCA Corporation RCA Electronic Components
 R. H. Tyler Co. Div. of Weather Scan, Inc.
 Ryder Magnetic Sales Corp.
 Schultz Inc., Albert

Sennheiser Electronics Corp.
 Shure Brothers Inc.
 Singer Products Co., Inc.
 Sparta Electronic Corp.
 Spotmaster Broadcast Electronics
 Superscope, Inc.
 Systems Engineering Co., Inc.
 Tapecaster TCM, Inc.
 Tele Measurements Inc.
 Television Equipment Associates
 Terminal Hudson Corp. Terminal Hudson Electronics
 (Trusonic) ACS Inc.
 Turner Division Conrac Corporation
 Victor Duncan, Inc.
 Video Engineering Co. Inc.
 Wilkinson Electronics, Inc.

Microphones, Parabolic and Shotgun

See Adv. Page

AKG Division109
Broadcast Electronics 34
Electro-Voice Inc.IFC
Sparta Electronic Corp. 8

AKG Division North Amer. Philips Corp.
 B & K Instruments Inc.
 Broadcast Electronics
 Communication Medias
 Comquip, Inc.
 Cramer Video and Audio Systems
 Electro-Voice Inc. Subs. of Gulton Industries, Inc.
 F&B/Ceco Industries, Inc.
 Image Devices Incorporated
 Lauderdale Electronic Labs
 Mastertone Company
 Nagra Magnetic Recorders, Inc.
 Radio Mfg. Co. (RMC)
 Ryder Magnetic Sales Corp.
 Schultz Inc., Albert
 Sennheiser Electronics Corp.
 Sparta Electronic Corp.
 Systems Engineering Co., Inc.
 Tapecaster TCM, Inc.
 Victor Duncan, Inc.
 Video Engineering Co. Inc.

Microphones, Wireless

See Adv. Page

Sparta Electronic Corp. 8

CHESTER ELECTRONIC LABS., INC.
 GTE Information Systems Inc.
 Communication Medias
 Comquip, Inc.
 Conway Electronic Enterprises Limited
 Cramer Video and Audio Systems
 F&B/Ceco Industries, Inc.
 Image Devices Incorporated
 Lauderdale Electronic Labs
 Miles Reproducer Co.
 North Amer. Electronics
 Orbit Radio and Video
 RCA Corporation RCA Broadcast Equip., Comm. Sys. Div.
 Ryder Magnetic Sales Corp.
 Schultz Inc., Albert
 Sennheiser Electronics Corp.
 Sparta Electronic Corp.
 Tele Measurements Inc.
 Television Equipment Associates
 Telex Communications Division
 (Trusonic) ACS Inc.
 Victor Duncan, Inc.
 Video Engineering Co. Inc.
 VIF International

Microwave Systems, STL

See Adv. Page

Mastertone Company139
Moseley Assoc. Inc. 7

Acrodyne Industries
 Andrew Corp.
 Broadcast Products Inc.
 CCA Electronics Corp.
 Collins Radio Company Broadcast Division
 Gates Division of Harris-Intertype

Magnatech Company
 Mastertone Company
 Maze Corporation
 Microwave Assoc. Inc.
 Moseley Assoc. Inc.
 Narda Microwave Corp., The
 North Amer. Electronics
 Radio Research Instrument Co., Inc.
 RCA Corporation RCA Broadcast
 Equip., Comm. Sys. Div.
 Sparta Electronic Corp.
 TeleMation, Inc.
 Tele Measurements Inc.
 Varian Solid State Div. Micro-Link
 Products
 Video Engineering Co. Inc.
 Wilkinson Electronics, Inc.

Microwave Systems, 2500 MHz

Alcor Inc.
 Andrew Corp.
 Broadcast Products Inc.
 CHESTER ELECTRONIC LABS., INC.
 GTE Information Systems Inc.
 Collins Radio Company Broadcast
 Division
 Cramer Video and Audio Systems
 EMCEE Broadcast Products Div. of
 Electronics, Missiles &
 Communications, Inc.
 General Electric Company Tubes/MW
 Devices
 Microwave Assoc. Inc.
 North Amer. Electronics
 RCA Corporation RCA Broadcast
 Equip., Comm. Sys. Div.
 Siemens Corporation
 Singer Co., The Palo Alto Operation
 TeleMation, Inc.
 Varian Solid State Div. Micro-Link
 Products
 Video Engineering Co. Inc.

Mixers --See also Consoles

	See Adv. Page
American Data Corp.	131
Audio Interface Systems, Inc.	124
Cetec Inc.	33
Collins Radio Company	19
Dyma Engineering, Inc.	136
Grass Valley Group, Inc.	3
OMNIX	42
Pulse Techniques Inc.	141
Russco Electronics Mfg. Inc.	128
Sparta Electronic Corp.	8

Alcor Inc.
 ALTEC
 American Data Corp. an AIRPAX
 Company
 Audio Designs & Mfg.
 Audio Interface Systems, Inc.
 Blanchard Electronics
 Broadcast Electronics
 Broadcast Products Inc.
 CCA Electronics Corp.
 Central Dynamics Corp.
 Cetec Inc. Subs. Computer Equipment
 Corp.
 Collins Radio Company Broadcast
 Division
 Communication Medias
 Comquip, Inc.
 Concept 70, A Div. of Dyma
 Engineering, Inc.
 Danscoll Ltd.
 Delta Electronics Inc. (N.C.)
 Dyma Engineering, Inc.
 Fairchild/Robbins Fairchild Sound
 Equipment Corp.
 Gately Electronics
 Gates Division of Harris-Intertype
 Gotham Audio Corp.
 Grass Valley Group, Inc.
 Head Sound, Inc.
 Lamb Laboratories
 Lang Electronics Inc.
 Magnatech Company
 McMartin Industries
 Melcor Electronics Corp.

Nasco Television Systems
 Neve Inc., Rupert
 North Amer. Electronics
 OMNIX
 Orbit Radio and Video
 Paso Sound Products Inc.
 PRD Electronics, Inc.
 Pulse Techniques Inc.
 QRK Electronic Prod.
 Quad-Eight Electronics
 Radio Mfg. Co. (RMC)
 Ramko Research
 RCA Corporation RCA Broadcast
 Equip., Comm. Sys. Div.
 Roh Corporation
 Rupert Neve Incorporated
 Russco Electronics Mfg. Inc.
 Ryder Magnetic Sales Corp.
 Schultz Inc., Albert
 Singer Products Co., Inc.
 Sparta Electronic Corp.
 Spotmaster Broadcast Electronics
 Superscope, Inc.
 Switchcraft Inc.
 Systems Marketing Corp. And
 Sono-Mag Corp.
 TASCAM Corporation
 TeleMation, Inc.
 Tele Measurements Inc.
 Video Engineering Co. Inc.
 Vital Industries Inc.
 Weinschel Engineering Co.

Mobile Communications Van, TV

Editel Productions
 Philips Broadcast Equipment Corp.
 Subs. North American Philips Corp.
 RCA Corporation RCA Broadcast
 Equip., Comm. Sys. Div.

Modulators, TV

Acrodyne Industries
 Ameco Inc.
 Anixter-Prizan CATV Division
 Catel, a Div. of United Scientific Corp.
 CCA Electronics Corp.
 Comark Industries Inc.
 Cramer Video and Audio Systems
 DYNAIR Electronics, Inc.
 EiE-Electronic Industrial Engineering A
 Division of RCA
 Gates Division of Harris-Intertype
 Hitachi Shibaden Corp. of America
 North Amer. Electronics
 Orbit Radio and Video
 RCA Corporation RCA Broadcast
 Equip., Comm. Sys. Div.
 Rohde & Schwarz Sales Co.
 TeleMation, Inc.
 Tele Measurements Inc.
 Telemet Co.
 Test & Measuring Instruments, Inc. a
 North American Philips Co.
 Video Engineering Co. Inc.

Monitors, AM System

	See Adv. Page
Gates	10
The London Company	25
Sparta Electronic Corp.	8
Time & Frequency Tech., Inc.	115

Arnold Barnes Company
 Belar Electronics Lab., Inc.
 Broadcast Products Inc.
 CCA Electronics Corp.
 Collins Radio Company Broadcast
 Division
 Dyma Engineering, Inc.
 Gates Division of Harris-Intertype
 The London Company
 Magnatech Company
 Mastertone Company
 McMartin Industries
 Melcor Electronics Corp.
 Metron Instruments
 National Electrolab Ltd.
 Neve Inc., Rupert
 RCA Corporation RCA Broadcast
 Equip., Comm. Sys. Div.
 Rupert Neve Incorporated
 Singer Products Co., Inc.

Sparta Electronic Corp.
 Systems Marketing Corp. And
 Sono-Mag Corp.
 Tele Measurements Inc.
 Time & Frequency Tech., Inc.
 Wilkinson Electronics, Inc.

Monitors, FM System

	See Adv. Page
Gates	10
The London Company	25
Sparta Electronic Corp.	8

Arnold Barnes Company
 Belar Electronics Lab., Inc.
 Broadcast Products Inc.
 CCA Electronics Corp.
 Collins Radio Company Broadcast
 Division
 Dyma Engineering, Inc.
 Gates Division of Harris-Intertype
 Karg Laboratories, Inc.
 Kenwood Electronics, Inc.
 The London Company
 Magnatech Company
 Mastertone Company
 McMartin Industries
 North American Radio Corp.
 RCA Corporation RCA Broadcast
 Equip., Comm. Sys. Div.
 Singer Products Co., Inc.
 Sparta Electronic Corp.
 Systems Marketing Corp. And
 Sono-Mag Corp.
 Tele Measurements Inc.
 Time & Frequency Tech., Inc.

Monitors, FM System SCA

	See Adv. Page
Gates	10

Belar Electronics Lab., Inc.
 Broadcast Products Inc.
 CCA Electronics Corp.
 Collins Radio Company Broadcast
 Division
 Dyma Engineering, Inc.
 Gates Division of Harris-Intertype
 Karg Laboratories, Inc.
 Magnatech Company
 Mastertone Company
 McMartin Industries
 Singer Products Co., Inc.
 Sparta Electronic Corp.
 Tele Measurements Inc.
 Time & Frequency Tech., Inc.

Monitors, Antenna Sampling

	See Adv. Page
Delta Electronics Inc. (Va.)	138
Potomac Instruments, Inc.	13

Delta Electronics Inc. (Va.)
 Potomac Instruments, Inc.
 Time & Frequency Tech., Inc.

Monitors, Frequency

	See Adv. Page
Belar Electronics Lab., Inc.	57
Gates	10
Sparta Electronic Corp.	8
Time & Frequency Tech., Inc.	115

Arnold Barnes Company
 Belar Electronics Lab., Inc.
 B & K Instruments Inc.
 CCA Electronics Corp.
 Collins Radio Company Broadcast
 Division
 Dyma Engineering, Inc.
 Eidson Electronic Co.
 ES Enterprises
 Gates Division of Harris-Intertype
 Lampkin Lab. Inc.
 Magnatech Company

Mastertone Company
 McMartin Industries
 Metron Instruments
 Narda Microwave Corp., The
 RCA Corporation RCA Broadcast
 Equip., Comm. Sys. Div.
 Sparta Electronic Corp.
 Time & Frequency Tech., Inc.
 Video Engineering Co. Inc.
 Wilkinson Electronics, Inc.

Monitors, Modulation

	See Adv. Page
Belar Electronics Lab., Inc.	57
Gates	10
The London Company	25
Sparta Electronic Corp.	8
Time & Frequency Tech., Inc.	115

Arnold Barnes Company
 Belar Electronics Lab., Inc.
 CCA Electronics Corp.
 Collins Radio Company Broadcast
 Division
 Dyma Engineering, Inc.
 Gates Division of Harris-Intertype
 Lampkin Lab. Inc.
 The London Company
 Magnatech Company
 Mastertone Company
 McMartin Industries
 Metron Instruments
 RCA Corporation RCA Broadcast
 Equip., Comm. Sys. Div.
 Singer Products Co., Inc.
 Sparta Electronic Corp.
 Tele Measurements Inc.
 Time & Frequency Tech., Inc.
 Video Engineering Co. Inc.
 Wilkinson Electronics, Inc.

Monitors, Phase

	See Adv. Page
Potomac Instruments, Inc.	13

Belar Electronics Lab., Inc.
 Collins Radio Company Broadcast
 Division
 Dranetz Engineering Labs., Inc.
 Gotham Audio Corp.
 Mastertone Company
 North American Radio Corp.
 Potomac Instruments, Inc.
 Sparta Electronic Corp.
 Time & Frequency Tech., Inc.

Monitors, Power

Bird Electronic Corp.
 Delta Electronics Inc. (Va.)
 Electro Impulse, Inc.
 General Microwave Corp.
 Lectronic Res. Labs. Inc.
 Melcor Electronics Corp.
 Narda Microwave Corp., The
 PRD Electronics, Inc.
 Sparta Electronic Corp.
 Systems Engineering Co., Inc.

Monitors, Program Audio

	See Adv. Page
Belar Electronics Lab., Inc.	57
Marti Electronics	128D

Audio Designs & Mfg.
 Autogram Corporation
 Belar Electronics Lab., Inc.
 Crown International
 Electro-Voice Inc. Subs. of Gulton
 Industries, Inc.
 Fairchild/Robbins Fairchild Sound
 Equipment Corp.
 Marti Electronics
 Neve Inc., Rupert
 Radio Mfg. Co. (RMC)
 Rupert Neve Incorporated

Scientific Systems, Inc. Broadcast Equipment Div.
Siemens Corporation
Sparta Electronic Corp.

Monitors, RF Level

General Microwave Corp.
North American Radio Corp.
Tektronix Inc.

Monitors, Stereo

See Adv. Page

Gates 10

Belar Electronics Lab., Inc.
Collins Radio Company Broadcast Division
Dyma Engineering, Inc.
Gates Division of Harris-Intertype
Kenwood Electronics, Inc.
Mastertone Company
McMartin Industries
Sparta Electronic Corp.
Systems Marketing Corp. And Sono-Mag Corp.
Ultra Audio Products

Monitors, Video B&W

See Adv. Page

Electrohome Ltd. 24

Anixter-Pruzan CATV Division
Audiotronics Corp.
Ball Bros. Research Corp. Miratel Division
Arnold Barnes Company
Belar Electronics Lab., Inc.
Cohu, Inc. Electronics Division
Conrac Div. Conrac Corp.
Cramer Video and Audio Systems
Cunningham Corp. Subs. of Gleason Works
Diebold Incorporated
Electrohome Ltd.
F&B/Ceco Industries, Inc.
Gates Division of Harris-Intertype
GBC Closed Circuit TV Corp.
GPL Div. Singer Gen.
Hitachi Shibaden Corp. of America
Ikegami Tsushinki Co., Ltd. Export Department
Javelin Div. of Apollo Lasers
Leader Instruments Corp.
North Amer. Electronics
Orbit Radio and Video
Panasonic Video Systems Div.
Matsushita Electric Corp. of America
Philips Broadcast Equipment Corp. Subs. North American Philips Corp.
Precision Electrical Mfg. Div. Circuit Science Inc.
Rank Cintel, Electronic Systems Div.
Rank Precision Industries Ltd.
RCA Corporation RCA Service Company Div.
R. H. Tyler Co. Div. of Weather Scan, Inc.
Richmond Hill Laboratories Inc.
Robert Bosch Corp. Fernseh Div.
SC Electronics, Inc. Subs. of Audiotronics Corp.
Siemens Corporation
Singer Co. Simulation Products Div.
Sony Corp. of America
Systems Engineering Co., Inc.
Tektronix Inc.
Tele-Cine Inc.
Teledyne Brown Engineering Co. Science & Engrg. Div.
TeleMation, Inc.
Tele Measurements Inc.
Video Engineering Co. Inc.
Visual Electronics Corp.

Monitors, Video Color

See Adv. Page

Electrohome Ltd. 24

Television Equipment Associates 141

Anixter-Pruzan CATV Division
Audiotronics Corp.
Ball Bros. Research Corp. Miratel Division
Arnold Barnes Company
Belar Electronics Lab., Inc.
CHESTER ELECTRONIC LABS., INC.
GTE Information Systems Inc.
Cohu, Inc. Electronics Division
Conrac Div. Conrac Corp.
Cramer Video and Audio Systems
Cunningham Corp. Subs. of Gleason Works
Dyma Engineering, Inc.
Electrohome Ltd.
F&B/Ceco Industries, Inc.
Gates Division of Harris-Intertype
Ikegami Tsushinki Co., Ltd. Export Department
Leader Instruments Corp.
Orbit Radio and Video
Panasonic Video Systems Div.
Matsushita Electric Corp. of America
Precision Electrical Mfg. Div. Circuit Science Inc.
Rank Cintel, Electronic Systems Div.
Rank Precision Industries Ltd.
RCA Corporation RCA Service Company Div.
R. H. Tyler Co. Div. of Weather Scan, Inc.
Richmond Hill Laboratories Inc.
Robert Bosch Corp. Fernseh Div.
SC Electronics, Inc. Subs. of Audiotronics Corp.
Siemens Corporation
Systems Engineering Co., Inc.
Tektronix Inc.
Tele-Cine Inc.
TeleMation, Inc.
Television Equipment Associates
Universal Media Corp.
Video Aids Corp. of Colorado
Video Engineering Co. Inc.
Visual Electronics Corp.
World Video Inc.

Monitors, Video Pulse Cross

Cramer Video and Audio Systems
Cunningham Corp. Subs. of Gleason Works
Electrohome Ltd.
Orbit Radio and Video
Precision Electrical Mfg. Div. Circuit Science Inc.
Systems Engineering Co., Inc.
Tektronix Inc.
Ultra Audio Products
Universal Media Corp.

Monitors, Waveform

Ball Bros. Research Corp. Miratel Division
California Instruments Co.
Cohu, Inc. Electronics Division
Colorado Video Inc.
Cramer Video and Audio Systems
Gates Division of Harris-Intertype
Ikegami Tsushinki Co., Ltd. Export Department
Leader Instruments Corp.
Marconi Instruments
North Amer. Electronics
Philips Broadcast Equipment Corp. Subs. North American Philips Corp.
Robert Bosch Corp. Fernseh Div.
Tektronix Inc.
Tele-Cine Inc.
Teledyne Brown Engineering Co. Science & Engrg. Div.
Tele Measurements Inc.
Ultra Audio Products
Video Engineering Co. Inc.
Vu-Data Corporation

Multiplexers

See Adv. Page

Collins Radio Company 19 Sparta Electronic Corp. 8

Alford Mfg. Co.
Collins Radio Company Broadcast Division
Comark Industries Inc.
Cramer Video and Audio Systems
Dorado Systems
Gates Division of Harris-Intertype
GPL Div. Singer Gen.
Ikegami Tsushinki Co., Ltd. Export Department
Kalart Victor Corp.
Marco Video Systems, Inc.
Micro Communications, Inc.
North Amer. Electronics
RCA Corporation RCA Broadcast Equip., Comm. Sys. Div.
R. H. Tyler Co. Div. of Weather Scan, Inc.
Sarkes Tarzian Inc. Broadcast Equipment Div.
Scott-Buttner Coastcom, Inc.
Shively Laboratories, Inc.
Solitron Devices Inc. Semiconductor Div.
Sparta Electronic Corp.
Tektronix Inc.
TeleMation, Inc.
Tele Measurements Inc.
Test & Measuring Instruments, Inc. a North American Philips Co.
Video Engineering Co. Inc.

Narrow Band FM Equipment

See Adv. Page

Moseley Assoc. Inc. 7

Acrodyne Industries
Edison Electronics, Div. of McGraw-Edison Co., Daven & Measurements
Moseley Assoc. Inc.
Scientific Systems, Inc. Broadcast Equipment Div.
Scintrex Inc. Communications Div.
Scott-Buttner Coastcom, Inc.
Singer Products Co., Inc.

Networks, Matching Audio

Allen Avionics Inc.
ALTEC
Cetec Inc. Subs. Computer Equipment Corp.
Collins Radio Company Broadcast Division
Edison Electronics, Div. of McGraw-Edison Co., Daven & Measurements
ESC Electronics Corp.
Gately Electronics
Quad-Eight Electronics
Roh Corporation
Tele Measurements Inc.
TT Electronics, Inc.

Networks, Matching RF

Alford Mfg. Co.
Allen Avionics Inc.
Collins Radio Company Broadcast Division
Comark Industries Inc.
Continental Electronics Mfg. Co.
Electro Impulse, Inc.
General Radio Co.
Hy-Power Electronics Co.
Integral Data Devices Inc.
Micro Communications, Inc.
Sparta Electronic Corp.
TT Electronics, Inc.

Networks, Mixing

See Adv. Page

Roh Corporation 124

Roh Corporation

Networks, Phasing -- See also Phasing Units

Allen Avionics Inc.
A-Tel-A-Matic
CCA Electronics Corp.

Collins Radio Company Broadcast Division
Comark Industries Inc.
Continental Electronics Mfg. Co.
Eventide Clock Works Inc. Broadcast Products Div.
Hy-Power Electronics Co.
Multronics, Inc.
RCA Corporation RCA Electromagnetic & Aviation Systems Div.
Sparta Electronic Corp.
Tele Measurements Inc.
TT Electronics, Inc.

Ohmmeters

Anixter-Pruzan CATV Division
Arnold Barnes Company
California Instruments Co.
Collins Radio Company Broadcast Division
Conway Electronic Enterprises Limited
Edison Electronics, Div. of McGraw-Edison Co., Daven & Measurements
Fluke, John, Mfg. Co. Inc.
Franz Vertriebs-gesellschaft m.b.H. Heath Co.
Hewlett Packard Co.
Hickok Elect. Instrument
ITT Jennings
Leader Instruments Corp.
Lectronic Res. Labs. Inc.
RCA Corporation RCA Broadcast Equip., Comm. Sys. Div.
RCA Corporation RCA Electronic Components
Rohde & Schwarz Sales Co.
Simpson Electric Co.
SPI-ITT Instruments Matrix Division
Triplett Corporation

Operating Impedance Bridge

Delta Electronics Inc. (Va.)
Dranetz Engineering Labs., Inc.
General Radio Co.
Rohde & Schwarz Sales Co.

Oscillator Transformers

Nortronics Co., Inc. Recorder Care Div.

Oscillators, AM

Ailtech (Formerly: Microdot)
Bulova American Time Products
CCA Electronics Corp.
Collins Radio Company Broadcast Division
Conway Electronic Enterprises Limited
Dyma Engineering, Inc.
Engineering Associates
Gates Division of Harris-Intertype
Gibbs Mfg. & Research Co.
Heath Co.
Hewlett Packard Co.
Instrument Laboratories
Kay Elemetrics Corp.
Leader Instruments Corp.
Marconi Instruments
RCA Corporation RCA Broadcast Equip., Comm. Sys. Div.
Rohde & Schwarz Sales Co.
Singer Products Co., Inc.
Test & Measuring Instruments, Inc. a North American Philips Co.
Trepac Corp. America

Oscillators, FM

Ailtech (Formerly: Microdot)
Belar Electronics Lab., Inc.
Bulova American Time Products
CCA Electronics Corp.
Collins Radio Company Broadcast Division
Conway Electronic Enterprises Limited
Gates Division of Harris-Intertype
Heath Co.
Kay Elemetrics Corp.
Leader Instruments Corp.
Marconi Electronics Inc.
Marconi Instruments
Microwave Assoc. Inc.
RCA Corporation RCA Broadcast Equip., Comm. Sys. Div.

Rohde & Schwarz Sales Co.
Singer Co., The Palo Alto Operation
Singer Products Co., Inc.
Test & Measuring Instruments, Inc. a
North American Philips Co.

Oscillators, Tone

Belcom Electronics Mfg. Co.
Bulova American Time Products
CCA Electronics Corp.
Cetec Inc. Subs. Computer Equipment
Corp.
Fairchild/Robbins Fairchild Sound
Equipment Corp.
Gates Division of Harris-Intertype
General Radio Co.
Neve Inc., Rupert
Quad-Eight Electronics
Radio Mfg. Co. (RMC)
Roh Corporation
Rupert Neve Incorporated
Total Technology
Trepac Corp. America

Oscillators, TV

Ailtech (Formerly: Microdot)
Heath Co.
Kay Elemetrics Corp.
Lectrotech Inc.
RCA Corporation RCA Broadcast
Equip., Comm. Sys. Div.
Riker Communications Inc.
Rohde & Schwarz Sales Co.
Tektronix Inc.

Oscilloscope Camera

Conway Electronic Enterprises Limited
Enterprise Electronics Corp.
Hewlett Packard Co.
Polaroid
SPI-ITT Instruments Metrix Division
Tektronix Inc.
Test & Measuring Instruments, Inc. a
North American Philips Co.

Oscilloscope Vector Display

Beston Electronics Inc.
Heath Co.
Lectrotech Inc.
Tektronix Inc.
Tele-Cine Inc.
Test & Measuring Instruments, Inc. a
North American Philips Co.
Ultra Audio Products

Oscilloscopes, Dual Trace

Arnold Barnes Company
Conway Electronic Enterprises Limited
Dynascan Corp. B & K Division
Eico Elect. Inst. Co., Inc.
Enterprise Electronics Corp.
Heath Co.
Hewlett Packard Co.
Hickok Elect. Instrument
Leader Instruments Corp.
Lectronic Res. Labs. Inc.
Lectrotech Inc.
Marconi Instruments
Marubeni America Corp. Miida
Electronics
RCA Corporation RCA Broadcast
Equip., Comm. Sys. Div.
SPI-ITT Instruments Metrix Division
Tektronix Inc.
Tele-Cine Inc.
Telonic Industries Inc.
Terminal Hudson Corp. Terminal
Hudson Electronics
Test & Measuring Instruments, Inc. a
North American Philips Co.
Troy Electronic Sales Co.

Oscilloscopes, Rack Type

Conway Electronic Enterprises Limited
Hewlett Packard Co.
Hickok Elect. Instrument
Lectronic Res. Labs. Inc.
Marubeni America Corp. Miida
Electronics

RCA Corporation RCA Broadcast
Equip., Comm. Sys. Div.
Robert Bosch Corp. Fernseh Div.
SPI-ITT Instruments Metrix Division
Tektronix Inc.
Tele-Cine Inc.
Terminal Hudson Corp. Terminal
Hudson Electronics
Test & Measuring Instruments, Inc. a
North American Philips Co.
Video Engineering Co. Inc.
Vu-Data Corporation

Oscilloscopes, Triggered Sweep

Conway Electronic Enterprises Limited
Dynascan Corp. B & K Division
Eico Elect. Inst. Co., Inc.
Enterprise Electronics Corp.
Heath Co.
Hewlett Packard Co.
Hickok Elect. Instrument
Leader Instruments Corp.
Lectronic Res. Labs. Inc.
Lectrotech Inc.
Marubeni America Corp. Miida
Electronics
RCA Corporation RCA Broadcast
Equip., Comm. Sys. Div.
Simpson Electric Co.
SPI-ITT Instruments Metrix Division
Tektronix Inc.
Tele-Cine Inc.
Test & Measuring Instruments, Inc. a
North American Philips Co.
Troy Electronic Sales Co.
Vu-Data Corporation

Oscilloscopes, Wideband

Conway Electronic Enterprises Limited
Eico Elect. Inst. Co., Inc.
Enterprise Electronics Corp.
Heath Co.
Hewlett Packard Co.
Hickok Elect. Instrument
Leader Instruments Corp.
Lectronic Res. Labs. Inc.
Lectrotech Inc.
Mercury Electronics
RCA Corporation RCA Broadcast
Equip., Comm. Sys. Div.
RCA Corporation RCA Electronic
Components
Simpson Electric Co.
SPI-ITT Instruments Metrix Division
Tektronix Inc.
Tele-Cine Inc.
Terminal Hudson Corp. Terminal
Hudson Electronics
Test & Measuring Instruments, Inc. a
North American Philips Co.
Troy Electronic Sales Co.
Vu-Data Corporation

Oscilloscopes with Plug-ins

California Instruments Co.
Conway Electronic Enterprises Limited
Enterprise Electronics Corp.
Hewlett Packard Co.
Lectronic Res. Labs. Inc.
SPI-ITT Instruments Metrix Division
Tektronix Inc.
Tele-Cine Inc.
Test & Measuring Instruments, Inc. a
North American Philips Co.

Patch Panel

See Adv. Page
Gates 10
Atlantic Research Corp. Teleproducts
Dept.
Audio Accessories Inc.
AVA Electronics Corp.
Arnold Barnes Company
Collins Radio Company Broadcast
Division
Comark Industries Inc.
Cooke Engineering Co.
Cramer Video and Audio Systems
Dielectric Communications Div. of Sola
Basic
Gates Division of Harris-Intertype

Micro Communications, Inc.
Mincom Div. 3M Co.
Phelps Dodge Communications Co.
Div. Phelps Dodge Industries Inc.
Potomac Instruments, Inc.
Quad-Eight Electronics
Sarkes Tarzian Inc. Broadcast
Equipment Div.
Shively Laboratories, Inc.
Terminal Hudson Corp. Terminal
Hudson Electronics
Trompeter Electronics
Video Engineering Co. Inc.
Virginia Panel Corporation

Phase Enhancer, Stereo

RAPID-Q Div. of Garron Electronics

Phasing Units -- See also Networks, Phasing

American Electronics Lab., Inc.
A-Tel-A-Matic
CCA Electronics Corp.
Collins Radio Company Broadcast
Division
Continental Electronics Mfg. Co.
Eventide Clock Works Inc. Broadcast
Products Div.
Hy-Power Electronics Co.
Multronics, Inc.
Radio Mfg. Co. (RMC)
RCA Corporation RCA Broadcast
Equip., Comm. Sys. Div.
Robert Bosch Corp. Fernseh Div.
Test & Measuring Instruments, Inc. a
North American Philips Co.
Wilkinson Electronics, Inc.

Power Supplies, AC

See Adv. Page
Sparta Electronic Corp. 8

Advanced High Voltage Co., Inc.
ALTEC
Ameco Inc.
American Data Corp. an AIRPAX
Company
Anaconda Electronics
Anixter-Pruzan CATV Division
A-Tel-A-Matic
Belcom Electronics Mfg. Co.
Bulova American Time Products
California Instruments Co.
C-COR Electronics, Inc.
Cetec Inc. Subs. Computer Equipment
Corp.
Collins Radio Company Broadcast
Division
David Clark Co., Inc.
Delta-Benco-Cascade Ltd.
Delta Electronics Inc. (N.C.)
Edison Electronics, Div. of
McGraw-Edison Co., Daven &
Measurements
Eico Elect. Inst. Co., Inc.
Engineering Associates
Enterprise Electronics Corp.
Essex International Inc. RBM Div.
F&B/Ceco Industries, Inc.
Fisher Berkeley Corp.
Fluke, John, Mfg. Co. Inc.
G.C. Electronics
General Electric Company Tubes/MW
Devices
Heath Co.
Ikegami Tsushinki Co., Ltd. Export
Department
Kato Engineering Co.
Lectronic Res. Labs. Inc.
Magnavox Company CATV Division
Melcor Electronics Corp.
Mole Richardson Co.
PRD Electronics, Inc.
Quad-Eight Electronics
Raytheon Company Raytheon Data
Systems Co.
RCA Corporation RCA Broadcast
Equip., Comm. Sys. Div.
Sparta Electronic Corp.
Systems Engineering Co., Inc.
Tektronix Inc.
Terminal Hudson Corp. Terminal
Hudson Electronics

Test & Measuring Instruments, Inc. a
North American Philips Co.
Topaz Electronics
TV Cable Supply Co., Inc.
Video Engineering Co. Inc.

Power Supplies, Precision

See Adv. Page
Roh Corporation 124

Advanced High Voltage Co., Inc.
ALTEC
American Data Corp. an AIRPAX
Company
A-Tel-A-Matic
Bristol Div. of Acco
Bulova American Time Products
Burwen Laboratories
Cetec Inc. Subs. Computer Equipment
Corp.
Collins Radio Company Broadcast
Division
Engineering Associates
Fluke, John, Mfg. Co. Inc.
Heath Co.
Hewlett Packard Co.
Lectronic Res. Labs. Inc.
Lectrotech Inc.
PRD Electronics, Inc.
Precision Laboratories Precision Cine
Equipment Corp.
Raytheon Company Raytheon Data
Systems Co.
RCA Corporation RCA Broadcast
Equip., Comm. Sys. Div.
Roh Corporation
Spectra Sonics
SPI-ITT Instruments Metrix Division
Tektronix Inc.
Test & Measuring Instruments, Inc. a
North American Philips Co.
Troy Electronic Sales Co.
Video Engineering Co. Inc.

Preamplifiers, Audio

See Adv. Page
Gates 10
Micro-Trak Corporation 128B
Roh Corporation 124
Russco Electronics
Mfg. Inc. 128
Sparta Electronic Corp. 8

Acrodyne Industries
Alcor Inc.
ALTEC
American Data Corp. an AIRPAX
Company
Ampro Corp.
Audio Designs & Mfg.
Autogram Corporation
Bell P/A Prod. Corp.
B & K Instruments Inc.
Bogen Division Lear Siegler Inc.
Bradford Information Systems
Broadcast Electronics
Burwen Laboratories
CCA Electronics Corp.
Cetec Inc. Subs. Computer Equipment
Corp.
Collins Radio Company Broadcast
Division
Communication Medias
Concept 70, A Div. of Dyma
Engineering, Inc.
Crown International
Danscoll Ltd.
David Clark Co., Inc.
Delta Electronics Inc. (N.C.)
Delta Electronics Inc. (Va.)
Denrad Mfg. Co. Inc.
Dyma Engineering, Inc.
DYNAIR Electronics, Inc.
Edison Electronics, Div. of
McGraw-Edison Co., Daven &
Measurements
Electronic Designers Inc.
Fairchild/Robbins Fairchild Sound
Equipment Corp.
Gately Electronics
Gates Division of Harris-Intertype
Head Sound, Inc.
Interntl. Nuclear Corp.
Lang Electronics Inc.

Leader Instruments Corp.
LPB Inc.
Marti Electronics
Mastertone Company
McCurdy Radio Ind. Inc.
McMartin Industries
Melcor Electronics Corp.
Micro-Trak Corporation (Formerly:
Gray Research & Dev.)
Neve Inc., Rupert
Orbit Radio and Video
Paso Sound Products Inc.
Philips Broadcast Equipment Corp.
Subs. North American Philips Corp.
PRD Electronics, Inc.
Precision Elect. Inc.
Precision Laboratories Precision Cine
Equipment Corp.
Pulse Dynamics Mfg. Corp.
QRK Electronic Prod.
Quad-Eight Electronics
Ramko Research
RCA Corporation RCA Broadcast
Equip., Comm. Sys. Div.
RCA Corporation RCA Electromagnetic
& Aviation Systems Div.
RHA Audio Communications Corp.
RHG Elect Labs, Inc.
Roh Corporation
Rupert Neve Incorporated
Russco Electronics Mfg. Inc.
Schafer Electronics Corp.
Schultz Inc., Albert
Scientific Systems, Inc. Broadcast
Equipment Div.
Sescom, Inc.
Shure Brothers Inc.
Sparta Electronic Corp.
Spectra Sonics
Spotmaster Broadcast Electronics
Stanton Magnetics Inc.
Superscope, Inc.
Systems Engineering Co., Inc.
Systems Marketing Corp. And
Sono-Mag Corp.
Tape-Athon Corp.
Telex Communications Division
Total Technology
United Recording Electronics
Industries
UREI a URC Company
Video Engineering Co. Inc.
VIF International
Visual Communication Products Oper.
General Electric Co.
Wilkinson Electronics, Inc.
ZERO-Impedance Systems, Inc.

Preamplifiers, Turntable

See Adv. Page
Broadcast Electronics 34
Micro-Trak Corporation 128B
Ramko Research 20
Russco Electronics
Mfg. Inc. 128
Sparta Electronic Corp. 8

Ampro Corp.
Autogram Corporation
Broadcast Electronics
Burwen Laboratories
CCA Electronics Corp.
Cetec Inc. Subs. Computer Equipment
Corp.
Communication Medias
Dyma Engineering, Inc.
Fairchild/Robbins Fairchild Sound
Equipment Corp.
Gately Electronics
Gates Division of Harris-Intertype
Head Sound, Inc.
Mastertone Company
Micro-Trak Corporation (Formerly:
Gray Research & Dev.)
Neve Inc., Rupert
Pulse Dynamics Mfg. Corp.
QRK Electronic Prod.
Quad-Eight Electronics
Radio Mfg. Co. (RMC)
Ramko Research
RCA Corporation RCA Broadcast
Equip., Comm. Sys. Div.
Rek-O-Kut Inc.
Roh Corporation
Rupert Neve Incorporated

Russco Electronics Mfg. Inc.
Sparta Electronic Corp.
Spotmaster Broadcast Electronics
Stanton Magnetics Inc.
Systems Engineering Co., Inc.
Video Engineering Co. Inc.
Wilkinson Electronics, Inc.

Preamplifiers, Video

Acrodyne Industries
Ameco Inc.
AMF Electrical Products Development
Division
C-COR Electronics, Inc.
Cramer Video and Audio Systems
Gen. Electrodynamics
Internatl. Nuclear Corp.
Kay Elemetrics Corp.
OMNIX
Philips Broadcast Equipment Corp.
Subs. North American Philips Corp.
RCA Corporation RCA Broadcast
Equip., Comm. Sys. Div.
RHG Elect Labs, Inc.
Riker Communications Inc.
Robert Bosch Corp. Fernseh Div.
Shintron Co. Inc. Video Products Div.
Tele Measurements Inc.
TV Cable Supply Co., Inc.
Video Engineering Co. Inc.

Pressurization Equipment, Transmission Line

Andrew Corp.
Anixter-Pruzan CATV Division
Cablewave Systems Inc. Subs. Phelps
Dodge and Kabelmetal
Collins Radio Company Broadcast
Division
Cook Electric Co.
Dielectric Communications Div. of Sola
Basic
Gates Division of Harris-Intertype
Jampro Antenna Co. Div. of Computer
Equipment Corp.
Micro Communications, Inc.
Prodelin Inc.
RCA Corporation RCA Broadcast
Equip., Comm. Sys. Div.
Soll, Inc., Joseph M.
Sparta Electronic Corp.
Wilkinson Electronics, Inc.

Probes, Oscilloscope

Conway Electronic Enterprises Limited
Dynascan Corp. B & K Division
Eico Elect. Inst. Co., Inc.
Enterprise Electronics Corp.
Heath Co.
Hewlett Packard Co.
Hickok Elect. Instrument
ITT Jennings
Leader Instruments Corp.
Lectronic Res. Labs. Inc.
Lectrotech Inc.
Mercury Electronics
RCA Corporation RCA Broadcast
Equip., Comm. Sys. Div.
RCA Corporation RCA Electronic
Components
Sencore Inc.
SPI-ITT Instruments Metrix Division
Tektronix Inc.
Terminal Hudson Corp. Terminal
Hudson Electronics
Test & Measuring Instruments, Inc. a
North American Philips Co.
Texscan Corp.
Troy Electronic Sales Co.
Vu-Data Corporation

Processors, Bleach Regeneration

Profit Recovery Systems Div. of CPAC

Processors, Film B&W

Comquip, Inc.
Eastman Kodak Co.
F&B/Ceco Industries, Inc.
Filmline Corp.
Photo-Pic Systems

Precision Laboratories Precision Cine
Equipment Corp.
Technology Incorporated HF Photo
Systems Div.
Treise Engineering

Processors, Film Color

See Adv. Page

Technology
Incorporated 44

Comquip, Inc.
F&B/Ceco Industries, Inc.
Filmline Corp.
Jamieson Film Co.
Photo-Pic Systems
Precision Laboratories Precision Cine
Equipment Corp.
Technology Incorporated HF Photo
Systems Div.
Treise Engineering

Processors, Pollution Control

Profit Recovery Systems Div. of CPAC

Processors, Silver Recovery Unit

Eastman Kodak Co.
Filmline Corp.
Photo-Pic Systems
Profit Recovery Systems Div. of CPAC
Technology Incorporated HF Photo
Systems Div.
Treise Engineering

Processors, VTR

Cramer Video and Audio Systems
Danscoll Ltd.
Mincom Div. 3M Co.
Television Microtime, Inc. Subs.
Andersen Laboratories, Inc.

Programmed Music

See Adv. Page

Cine Sonic Sound Inc. 137

Cine Sonic Sound Inc.

Programmers, Patchboard/Thumbwheel

See Adv. Page

ES Enterprises 43

ES Enterprises

Projectors, Film

See Adv. Page

Bell & Howell 55
Comquip, Inc. 141

ABTO, Inc.
Arriflex Company of America
Bell & Howell Consumer Products
Group
Christie Electric Corp.
Comquip, Inc.
Eastman Kodak Co.
F&B/Ceco Industries, Inc.
GAF Corp.
Gates Division of Harris-Intertype
Kalart Victor Corp.
Lipsner-Smith Corp.
Listec TV Equip. Corp.
L-W Photo, Inc.
Magna-Tech Electronic Co., Inc.
Paillard Incorporated
Palmer Films, Inc., W. A.
Philips Broadcast Equipment Corp.
Subs. North American Philips Corp.
Precision Laboratories Precision Cine
Equipment Corp.
Rank Cintel, Electronic Systems Div.
Rank Precision Industries Ltd.
RCA Corporation RCA Broadcast
Equip., Comm. Sys. Div.
R. H. Tyler Co. Div. of Weather Scan,
Inc.

Robert Bosch Corp. Fernseh Div.
TeleMation, Inc.
Video Engineering Co. Inc.
Wilcam Photo Research Inc.

Projectors, Film Cassette Loading

Comquip, Inc.
Hokushin Elect. Co.
Listec TV Equip. Corp.

Projectors, Film Rear

Christie Electric Corp.
F&B/Ceco Industries, Inc.
Kalart Victor Corp.
Video Engineering Co. Inc.
Wilson Corp., H.

Projectors, Slide

ABTO, Inc.
Christie Electric Corp.
Eastman Kodak Co.
F&B/Ceco Industries, Inc.
GAF Corp.
Gates Division of Harris-Intertype
Harwald Company
Kliegl Bros. Lighting
Listec TV Equip. Corp.
RCA Corporation RCA Broadcast
Equip., Comm. Sys. Div.
R. H. Tyler Co. Div. of Weather Scan,
Inc.
RTI Research Technology Inc.
Sarkes Tarzian Inc. Broadcast
Equipment Div.
Spindler & Sauppe, Inc.
TeleMation, Inc.
Telesync Corp.

Projectors, TV Large Screen

Comquip, Inc.
Cramer Video and Audio Systems
F&B/Ceco Industries, Inc.
GBC Closed Circuit TV Corp.
General Television Ntwk.
GPL Div. Singer Gen.
Hokushin Elect. Co.
Janson Industries
Kalart Victor Corp.
K'SON Corporation
Tele Measurements Inc.
Video Engineering Co. Inc.

Projectors, Video Test Slide

Photo Research Div. of Kollmorgen
Corp.
Robert Bosch Corp. Fernseh Div.
Spindler & Sauppe, Inc.

Quadraphonic Systems

Catel, a Div. of United Scientific Corp.
CBS Labs
Concept 70, A Div. of Dyma
Engineering, Inc.
Gately Electronics
Heath Co.
Neve Inc., Rupert
Rupert Neve Incorporated
Universal Research Labs
ZERO-Impedance Systems, Inc.

Radar, Weather

Radio Research Instrument Co., Inc.
Raytheon Company Raytheon Data
Systems Co.
RCA Corporation RCA Broadcast
Equip., Comm. Sys. Div.
RF Systems, Inc.
Tasker Systems Div. of Whittaker
Corp.

Radomes

See Adv. Page

Gates 10

Advance Industries
Andrew Corp.

Collins Radio Company Broadcast Division
 Gates Division of Harris-Intertype
 Jampro Antenna Co. Div. of Computer Equipment Corp.
 Magnatech Company
 Micro Communications, Inc.
 Prodelin Inc.
 RCA Corporation RCA Broadcast Equip., Comm. Sys. Div.
 RCA Corporation RCA Missile & Surface Radar Div.
 Shively Laboratories, Inc.
 Wilkinson Electronics, Inc.

Receivers, AM

Bell P/A Prod. Corp.
 Bogen Division Lear Siegler Inc.
 Conway Electronic Enterprises Limited
 Cooke Engineering Co.
 Heath Co.
 Ikegami Tsushinki Co., Ltd. Export Department
 Kahn Research Lab. Inc.
 Marconi Instruments
 National Electrolab Ltd.
 Potomac Instruments, Inc.
 Precision Elect. Inc.
 RCA Corporation RCA Electromagnetic & Aviation Systems Div.
 RHA Audio Communications Corp.
 RHG Elect Labs, Inc.
 Schultz Inc., Albert
 Siemens Corporation
 Singer Products Co., Inc.
 Terminal Hudson Corp. Terminal Hudson Electronics
 Wilkinson Electronics, Inc.

Receivers, Data

GTE Lenkurt Incorporated
 Trepac Corp. America
 Vitec Communications Ltd.

Receivers, EBS

Ball Bros. Research Corp. Miratel Division
 Mastertone Company
 McMartin Industries
 Tri-Tronics

Receivers, FM

Ameco Inc.
 Bell P/A Prod. Corp.
 Beyer (Revox Corporation)
 B & K Instruments Inc.
 Bogen Division Lear Siegler Inc.
 Catel, a Div. of United Scientific Corp.
 Cooke Engineering Co.
 Eico Elect. Inst. Co., Inc.
 GTE Lenkurt Incorporated
 Heath Co.
 Ikegami Tsushinki Co., Ltd. Export Department
 Lectronic Res. Labs. Inc.
 Marconi Instruments
 Marti Electronics
 McMartin Industries
 Paso Sound Products Inc.
 Permadyne Electronics Corp.
 Potomac Instruments, Inc.
 Precision Elect. Inc.
 RCA Corporation RCA Electromagnetic & Aviation Systems Div.
 RCA Corporation RCA Service Company Div.
 RHG Elect Labs, Inc.
 Sansui Electronics Corp.
 Schultz Inc., Albert
 Singer Products Co., Inc.
 Tandberg of America Inc.
 Terminal Hudson Corp. Terminal Hudson Electronics
 Wilkinson Electronics, Inc.

Receivers, HF

American Electronics Lab., Inc.
 Collins Radio Company Broadcast Division
 Conway Electronic Enterprises Limited
 Cooke Engineering Co.
 Engineering Associates

Heath Co.
 International Video Corp.
 Karg Laboratories, Inc.
 Marconi Electronics Inc.
 Marconi Instruments
 Narda Microwave Corp., The
 PRD Electronics, Inc.
 RHG Elect Labs, Inc.
 Rohde & Schwarz Sales Co.
 Siemens Corporation
 Singer Products Co., Inc.

Receivers, Multiplex

Belar Electronics Lab., Inc.
 Eico Elect. Inst. Co., Inc.
 GTE Lenkurt Incorporated
 Heath Co.
 Johnson Electronics, Inc.
 Karg Laboratories, Inc.
 McMartin Industries
 Moseley Assoc. Inc.
 Permadyne Electronics Corp.
 Precision Elect. Inc.
 RHG Elect Labs, Inc.
 Schultz Inc., Albert
 Singer Products Co., Inc.
 Superscope, Inc.
 Trepac Corp. America

Receivers, SCA

Belar Electronics Lab., Inc.
 Eico Elect. Inst. Co., Inc.
 Karg Laboratories, Inc.
 Marti Electronics
 Mastertone Company
 McMartin Industries
 Permadyne Electronics Corp.
 Scientific Systems, Inc. Broadcast Equipment Div.
 Singer Products Co., Inc.

Receivers, Time Signal

Arnold Barnes Company
 Catel, a Div. of United Scientific Corp.
 Electrohome Ltd.
 Lectronic Res. Labs. Inc.
 Radio Mfg. Co. (RMC)
 SIMEX/COAST NAVIGATION SCHOOL
 Singer Products Co., Inc.

Receivers, TV Color

Admiral Corporation
 Anixter-Pruzan CATV Division
 Audiotronics Corp.
 CHESTER ELECTRONIC LABS., INC.
 GTE Information Systems Inc.
 Cramer Video and Audio Systems
 Cunningham Corp. Subs. of Gleason Works
 Diamond Power Specialty Corp. Subs. Babcock & Wilcox Co.
 Electrohome Ltd.
 Heath Co.
 Panasonic Video Systems Div.
 Matsushita Electric Corp. of America
 Precision Electrical Mfg. Div. Circuit Science Inc.
 RCA Corporation RCA Service Company Div.
 SC Electronics, Inc. Subs. of Audiotronics Corp.
 Singer Co. Simulation Products Div.
 Soll, Inc., Joseph M.
 Sylvania Comm. Electronic
 Tele Measurements Inc.
 Video Aids Corp. of Colorado
 Video Engineering Co. Inc.

Receivers, TV Monochrome

Admiral Corporation
 Anixter-Pruzan CATV Division
 Audiotronics Corp.
 Cohu, Inc. Electronics Division
 Cramer Video and Audio Systems
 Cunningham Corp. Subs. of Gleason Works
 Heath Co.
 Nemo Recording Labs
 Panasonic Video Systems Div.
 Matsushita Electric Corp. of America

Precision Electrical Mfg. Div. Circuit Science Inc.
 Rank Precision Ind. Broadcast Div.
 SC Electronics, Inc. Subs. of Audiotronics Corp.
 Singer Co. Simulation Products Div.
 Sony Corp. of America
 Sylvania Comm. Electronic
 Telesync Corp.
 Video Engineering Co. Inc.

Recorder Care Kits, Video

See Adv. Page
Nortronics Co., Inc. 133
 Nortronics Co., Inc. Recorder Care Div.

Recorder Drive Motor Power Supply

See Adv. Page
Pacific Recorders and Engrg. Corp. 118
 Pacific Recorders and Engrg. Corp.

Recorder Replacement Motor

Beau Motor Division U.M.C. Electronics Co.
 Broadcast Products Inc.
 Mastertone Company
 Minarik Elect.
 Tapecaster TCM, Inc.
 Telectro Systems Corp.
 VIF International

Recorders, Audio Reel-to-Reel

See Adv. Page
Crown International 121
Mastertone Company 139
Scully/Metrotech 111
Tape-Athon Corp. 113

Ampex Corp. Audio-Video Systems Division
 Autogram Corporation
 Arnold Barnes Company
 Beyer (Revox Corporation)
 Broadcast Electronics
 Collins Radio Company Broadcast Division
 Communication Medias
 Crown International
 ELPA Marketing Industries, Inc.
 F&B/Ceco Industries, Inc.
 Gates Division of Harris-Intertype
 Image Devices Incorporated
 International Tapetronics Corp.
 Mastertone Company
 Nagra Magnetic Recorders, Inc.
 Norelco, Philips Bcst. Equip. Corp. Subs. North American Philips Corp.
 Pentagon Industries, Inc.
 Peripheral Data Machines, Inc. (PER DATA)
 Schafer Electronics Corp.
 Scully/Metrotech Divs. of Dictaphone Corp.
 Sparta Electronic Corp.
 Spotmaster Broadcast Electronics
 Systems Engineering Co., Inc.
 Tandberg of America Inc.
 Tape-Athon Corp.
 TASCAM Corporation
 TEAC Corp of America
 Telectro Systems Corp.
 Telex Communications Division
 Test & Measuring Instruments, Inc. a North American Philips Co.
 Victor Duncan, Inc.
 VIF International
 Wilkinson Electronics, Inc.

Recorders, Camera Tape to Film

Image Devices Incorporated
 Palmer Films, Inc., W. A.
 Teledyne Camera Systems
 Victor Duncan, Inc.

Recorders, Cassette

Astrocom Electronics, Inc.
 Audiotronics Corp.
 Cetec Inc. Subs. Computer Equipment Corp.
 Conrac Corporation Cramer Division
 Heath Co.
 Image Devices Incorporated
 K'SON Corporation
 P. R. Mallory & Co. Inc. Mallory Distributor Products Co.
 Martel Electronics Inc.
 Mincom Div. 3M Co.
 Panasonic Video Systems Div.
 Matsushita Electric Corp. of America
 Pentagon Industries, Inc.
 RAPID-Q Div. of Garron Electronics
 RCA Corporation RCA Broadcast Equip., Comm. Sys. Div.
 Recordex Corporation
 R. H. Tyler Co. Div. of Weather Scan, Inc.
 Sansui Electronics Corp.
 Schafer International
 Superscope, Inc.
 Tandberg of America Inc.
 Telectro Systems Corp.
 Telex Communications Division
 Terminal Hudson Corp. Terminal Hudson Electronics
 Test & Measuring Instruments, Inc. a North American Philips Co.
 Victor Duncan, Inc.

Recorders, Disc Magnetic

Ampex Corp. Audio-Video Systems Division
 CMX Systems
 Colorado Video Inc.
 Data Disc Inc.
 Dyma Engineering, Inc.
 Schultz Inc., Albert
 Systems Marketing Corp. And Sono-Mag Corp.
 TeleMation, Inc.

Recorders, Film Light

Magna-Tech Electronic Co., Inc.
 RCA Corporation RCA Broadcast Equip., Comm. Sys. Div.

Recorders, Film Magnetic

Cetec Inc. Subs. Computer Equipment Corp.
 Comquip, Inc.
 Magna-Tech Electronic Co., Inc.
 Precision Laboratories Precision Cine Equipment Corp.
 RCA Corporation RCA Broadcast Equip., Comm. Sys. Div.
 Stancil-Hoffman Corp.
 Tele-Cine Inc.
 Victor Duncan, Inc.

Recorders, Logging Magnetic

Alto Communications Inc. Broadcast Marketing Div.
 Broadcast Products Inc.
 CCA Electronics Corp.
 Gould Inc. Instrument Systems Div.
 Honeywell Inc. Test Instruments Div.
 Lang Electronics Inc.
 Magnatech Company
 Miles Reproducer Co.
 Philips Broadcast Equipment Corp. Subs. North American Philips Corp.
 Radio Mfg. Co. (RMC)
 RCA Corporation RCA Broadcast Equip., Comm. Sys. Div.
 Richmond Hill Laboratories Inc.
 Scully/Metrotech Divs. of Dictaphone Corp.
 Soundsciber Corporation
 Stancil-Hoffman Corp.
 Systems Marketing Corp. And Sono-Mag Corp.
 Tape-Athon Corp.
 Telectro Systems Corp.
 Test & Measuring Instruments, Inc. a North American Philips Co.

Recorders, Magnetic Tape Logging

Alto Communications Inc. Broadcast Marketing Div.
 Autogram Corporation
 B & K Instruments Inc.
 Broadcast Products Inc.
 CCA Electronics Corp.
 Collins Radio Company Broadcast Division
 Honeywell Inc. Test Instruments Div.
 Magnatech Company
 Mastertone Company
 Philips Broadcast Equipment Corp. Subs. North American Philips Corp.
 Radio Mfg. Co. (RMC)
 RCA Corporation RCA Broadcast Equip., Comm. Sys. Div.
 Schafer Electronics Corp.
 Scully/Metrotech Divs. of Dictaphone Corp.
 Singer Products Co., Inc.
 Soundscriber Corporation
 Sparta Electronic Corp.
 Stancil-Hoffman Corp.
 Systems Marketing Corp. And Sono-Mag Corp.
 Tape-Athon Corp.
 Telex Communications Division
 Test & Measuring Instruments, Inc. a North American Philips Co.

Recorders, Magnetic Tape Video

See Adv. Page

Ampex Corp. 26, 27

Akai America, Ltd.
 Alcor Inc.
 Ampex Corp. Audio-Video Systems Division
 Arvin Systems, Inc.
 Audiotronics Corp.
 BSC Incorporated
 CATV Equipment Co.
 Cramer Video and Audio Systems
 Diamond Power Specialty Corp. Subs. Babcock & Wilcox Co.
 F&B/Ceco Industries, Inc.
 GBC Closed Circuit TV Corp.
 General Television Ntwk.
 GPL Div. Singer Gen.
 Hitachi Shibaden Corp. of America
 Ikegami Tsuchinko Co., Ltd. Export Department
 International Video Corp.
 Javelin Div. of Apollo Lasers
 K' SON Corporation
 Mincom Div. 3M Co.
 Norelco, Philips Bcst. Equip. Corp. Subs. North American Philips Corp.
 Panasonic Video Systems Div.
 Matsushita Electric Corp. of America
 Philips Broadcast Equipment Corp. Subs. North American Philips Corp.
 Rank Cintel, Electronic Systems Div.
 Rank Precision Industries Ltd.
 RCA Corporation RCA Broadcast Equip., Comm. Sys. Div.
 R. H. Tyler Co. Div. of Weather Scan, Inc.
 Riker Communications Inc.
 Robert Bosch Corp. Fernseh Div.
 Singer Co. Simulation Products Div.
 Sony Corp. of America
 Video Engineering Co. Inc.

Recorders, Paper Logging and Graphic

Bristol Div. of Acco
 Collins Radio Company Broadcast Division
 Fluke, John, Mfg. Co. Inc.
 General Electric Company Tubes/MW Devices
 General Radio Co.
 Gould Inc. Instrument Systems Div.
 Gulton Industries, Inc. Recorder Systems Div.
 Heath Co.
 Honeywell Inc. Test Instruments Div.
 Lectronic Res. Labs. Inc.
 Rust Corp.
 Simpson Electric Co.

Systems Marketing Corp. And Sono-Mag Corp.
 Test & Measuring Instruments, Inc. a North American Philips Co.

Recorders, Program Logging

See Adv. Page

Video Sentry System126

Broadcast Products Inc.
 Central Dynamics Corp.
 Communication Medias
 Radio Mfg. Co. (RMC)
 Schafer Electronics Corp.
 Scully/Metrotech Divs. of Dictaphone Corp.
 Tandberg of America Inc.
 Tape-Athon Corp.
 Video Sentry System

Recorders, Tape Audio

See Adv. Page

Ampro Corp. 140
Broadcast Electronics 34
Comquip, Inc. 141
Crown International 121
Gates 10
Scully/Metrotech 111
Sparta Electronic Corp. 8
Tape-Athon Corp. 113

Accurate Sound Corp.
 Alcor Inc.
 Alto Communications Inc. Broadcast Marketing Div.
 Ampex Corp. Audio-Video Systems Division
 Ampro Corp.
 Arriflex Company of America
 Astrocom Electronics, Inc.
 Audio Distributor Inc.
 Audiotronics Corp.
 Arnold Barnes Company
 Bell & Howell Consumer Products Group
 Beyer (Revox Corporation)
 B & K Instruments Inc.
 Broadcast Electronics
 Broadcast Products Inc.
 CCA Electronics Corp.
 Cetec Inc. Subs. Computer Equipment Corp.
 Cine Sonic Sound Inc.
 Collins Radio Company Broadcast Division
 Communication Medias
 Comquip, Inc.
 Conrac Corporation Cramer Division
 Crown International
 Denson Electronic Corp.
 ELPA Marketing Industries, Inc.
 Gates Division of Harris-Intertype
 General Radio Co.
 IGM
 Inovonics
 International Tapetronics Corp.
 Lang Electronics Inc.
 Magnatech Company
 Magna-Tech Electronic Co., Inc.
 Martel Electronics Inc.
 Mastertone Company
 Miles Reproducer Co.
 Nagra Magnetic Recorders, Inc.
 Nemo Recording Labs
 Norelco, Philips Bcst. Equip. Corp. Subs. North American Philips Corp.
 Orbit Radio and Video
 Otari of America, Ltd.
 Paso Sound Products Inc.
 Pentagon Industries, Inc.
 Peripheral Data Machines, Inc. (PER DATA)
 Philips Broadcast Equipment Corp. Subs. North American Philips Corp.
 Radio Mfg. Co. (RMC)
 RCA Corporation RCA Broadcast Equip., Comm. Sys. Div.
 Recordex Corporation
 Roberts Div. of Rheem Mfg. Co.
 Ryder Magnetic Sales Corp.
 Schafer Electronics Corp.
 Schultz Inc., Albert

Scientific Systems, Inc. Broadcast Equipment Div.
 Scully/Metrotech Divs. of Dictaphone Corp.
 Singer Products Co., Inc.
 Soundscriber Corporation
 Sparta Electronic Corp.
 Spotmaster Broadcast Electronics
 Stancil-Hoffman Corp.
 Superscope, Inc.
 Systems Marketing Corp. And Sono-Mag Corp.
 Tandberg of America Inc.
 Tape-Athon Corp.
 TASCAM Corporation
 TEAC Corp of America
 Tele Measurements Inc.
 Telex Communications Division
 Terminal Hudson Corp. Terminal Hudson Electronics
 Victor Duncan, Inc.
 VIF International
 Wilkinson Electronics, Inc.

Recorders, Tape Audio Cartridge

See Adv. Page

Ampro Corp. 140
Broadcast Electronics 34
Collins Radio Company 19
Gates 10
International Tapetronics Corp. 128
RAPID-Q 134

Alto Communications Inc. Broadcast Marketing Div.
 Ampro Corp.
 Autogram Corporation
 Arnold Barnes Company
 Bell & Howell Consumer Products Group
 Broadcast Electronics
 Broadcast Prod. Co. Inc. Bcst. Division
 Broadcast Products Inc.
 CCA Electronics Corp.
 Cetec Inc. Subs. Computer Equipment Corp.
 Collins Radio Company Broadcast Division
 Communication Medias
 Conrac Corporation Cramer Division
 Contel Mfg. Div. of Continental Electronic Wholesale Corp.
 Dyma Engineering, Inc.
 Franz Vertriebs-gesellschaft m.b.H.
 Gates Division of Harris-Intertype IGM
 International Tapetronics Corp.
 Lang Electronics Inc.
 MaCarta
 MacKenzie Laboratories, Inc.
 Mastertone Company
 Maze Corporation
 Nemo Recording Labs
 Philips Broadcast Equipment Corp. Subs. North American Philips Corp.
 QRK Electronic Prod.
 RAPID-Q Div. of Garron Electronics
 RCA Corporation RCA Broadcast Equip., Comm. Sys. Div.
 Recordex Corporation
 Roberts Div. of Rheem Mfg. Co.
 Schafer Electronics Corp.
 Schultz Inc., Albert
 Singer Products Co., Inc.
 Sparta Electronic Corp.
 Spotmaster Broadcast Electronics
 Superscope, Inc.
 Systems Engineering Co., Inc.
 Systems Marketing Corp. And Sono-Mag Corp.
 Tandberg of America Inc.
 Tapecaster TCM, Inc.
 Tele Measurements Inc.
 Telex Communications Division
 Test & Measuring Instruments, Inc. a North American Philips Co.

Recorders, Time Base Corrector

Ampex Corp. Audio-Video Systems Division
 Cramer Video and Audio Systems

Recorders, Video Kinescope

Comquip, Inc.
 Palmer Films, Inc., W. A.
 Philips Broadcast Equipment Corp. Subs. North American Philips Corp.
 RCA Corporation RCA Broadcast Equip., Comm. Sys. Div.
 Teledyne Camera Systems
 Tele Measurements Inc.
 Video Engineering Co. Inc.

Recorders, Video Tape Clean Air Hood

Enviroco
 Liberty Industries
 RCA Corporation RCA Broadcast Equip., Comm. Sys. Div.
 Television Equipment Associates
 Video Engineering Co. Inc.

Recording Services, Audio Tape

See Adv. Page

The CnB Studios141

Accurate Sound Corp.
 Alto Communications Inc. Broadcast Marketing Div.
 Ampro Corp.
 Audio Magnetics Corp.
 Bell Sound Studios Electro Sound Div.
 Cine Sonic Sound Inc.
 The CnB Studios
 IGM
 Nemo Recording Labs
 Orbit Radio and Video
 Pentagon Industries, Inc.
 Qualitape Inc.
 Radio Mfg. Co. (RMC)
 Schafer Electronics Corp.
 Superscope, Inc.
 Tape-Athon Corp.
 Ultra Audio Products
 United Recording Electronics Industries

Recording Services, Videotape to Film

Cramer Video and Audio Systems
 Mediatech
 Palmer Films, Inc., W. A.

Recording Synchronizers

Electronic Engineering Co. of California
 Magna-Tech Electronic Co., Inc.
 Nagra Magnetic Recorders, Inc.
 Quad-Eight Electronics
 Ryder Magnetic Sales Corp.

Reels, Cable and Mike

See Adv. Page

Hannay Reels106

Hannay Reels Clifford B. Hannay & Son Inc.
 Industrial Electric Reel
 RCA Corporation RCA Broadcast Equip., Comm. Sys. Div.
 Roll-A-Reel
 Ryder Magnetic Sales Corp.

Reels, Magnetic Tape

See Adv. Page

Polyline Corp.137

Audio Devices, Inc.
 Audio Magnetics Corp.
 Broadcast Electronics
 Broadcast Products Inc.
 Collins Radio Company Broadcast Division
 Communication Medias
 Duotone Co. Inc.
 Fairchild/Robbins Fairchild Sound Equipment Corp.
 Lauderdale Electronic Labs.
 Magnetic Prod. Div. 3M Company
 Mastertone Company

Pentagon Industries, Inc.
Polyline Corp.
Qualitape Inc.
Recordex Corporation
Schafer Electronics Corp.
Spotmaster Broadcast Electronics
Wide Response
Wilkinson Electronics, Inc.

Reels, Video Tape

Audio Magnetics Corp.
Comquip, Inc.
Cramer Video and Audio Systems
Fairchild/Robbins Fairchild Sound
Equipment Corp.
Harwald Company
Magnetic Prod. Div. 3M Company
Polyline Corp.
Recordex Corporation
RTI Research Technology Inc.
Wide Response

Reflectors, Passive

Advance Industries
Andrews Tower Inc.
Collins Radio Company Broadcast
Division
Fort Worth Tower Co., Inc.
Microflex Co. Inc.
Rohn Manufacturing Div. of Unarco
Industries Inc.
Utility Tower Co.

Regulators, Voltage

California Instruments Co.
Collins Radio Company Broadcast
Division
General Electric Company Tubes/MW
Devices
General Radio Co.
Kato Engineering Co.
Lectronic Res. Labs. Inc.
Northlake Engineering, Inc.
Terminal Hudson Corp. Terminal
Hudson Electronics
Topaz Electronics
Total Technology
Video Engineering Co. Inc.

Remote Control Monitors, VIT

See Adv. Page

Telemet Co. IBC

Gates Division of Harris-Intertype
Telemet Co.
Video Engineering Co. Inc.

Remote Control Systems

See Adv. Page

Audio Devices, Inc. 45
Gates 10
Mastertone Company 139
Moseley Assoc. Inc. 7
Sparta Electronic Corp. 8

Alto Communications Inc. Broadcast
Marketing Div.
Ampro Corp.
Atlantic Research Corp. Teleproducts
Dept.
Audio Devices, Inc.
Belcom Electronics Mfg. Co.
Bristol Div. of Acco
CCA Electronics Corp.
Central Dynamics Corp.
CMX Systems
Collins Radio Company Broadcast
Division
Continental Electronics Mfg. Co.
Display Systems Corp.
Dorado Systems
Engineering Associates
Fairchild/Robbins Fairchild Sound
Equipment Corp.
Gates Division of Harris-Intertype
General Electric Company Tubes/MW
Devices
Magnatech Company
Magna-Tech Electronic Co., Inc.
Marti Electronics

Mastertone Company
Miles Reproducer Co.
Moseley Assoc. Inc.
National Electrolab Ltd.
North American Radio Corp.
Pulsecom
Ramko Research
RCA Corporation RCA Broadcast
Equip., Comm. Sys. Div.
RHA Audio Communications Corp.
Richmond Hill Laboratories Inc.
Roh Corporation
Rust Corp.
Ryder Magnetic Sales Corp.
Scott-Buttner Coastcom, Inc.
Sparta Electronic Corp.
Systems Marketing Corp. And
Sono-Mag Corp.
Tele-Cine Inc.
Telemet Co.
Trepac Corp. America
Video Engineering Co. Inc.
Wilkinson Electronics, Inc.

Remote Pickup Systems, Radio

See Adv. Page

Marti Electronics 128D
Moseley Assoc. Inc. 7
Sparta Electronic Corp. 8

CCA Electronics Corp.
Collins Radio Company Broadcast
Division
Marti Electronics
Mastertone Company
Miles Reproducer Co.
Moseley Assoc. Inc.
Pulse Dynamics Mfg. Corp.
Schafer Electronics Corp.
Sparta Electronic Corp.
Wilkinson Electronics, Inc.

Reverberation Systems

See Adv. Page

Sparta Electronic Corp. 8

AKG Division North Amer. Philips
Corp.
Audio Distributor Inc.
B & K Instruments Inc.
Fairchild/Robbins Fairchild Sound
Equipment Corp.
Franz Vertriebs-gesellschaft m.b.H.
Sparta Electronic Corp.
TASCAM Corporation

Rewinders, Film

Comquip, Inc.
F&B/Ceco Industries, Inc.
Harwald Company
Image Devices Incorporated
Kalart Victor Corp.
Neumade Prod. Corp.
Precision Laboratories Precision Cine
Equipment Corp.
RCA Corporation RCA Broadcast
Equip., Comm. Sys. Div.
RTI Research Technology Inc.

Rewinders, Tape

Bell Sound Studios Electro Sound Div.
Broadcast Products Inc.
Collins Radio Company Broadcast
Division
Fairchild/Robbins Fairchild Sound
Equipment Corp.
Marathon Broadcast Equip.
Neumade Prod. Corp.
Pentagon Industries, Inc.
Radio Mfg. Co. (RMC)
Ramko Research
RCA Corporation RCA Broadcast
Equip., Comm. Sys. Div.
Recordex Corporation
Recortec Inc.
Singer Products Co., Inc.
Sparta Electronic Corp.

Safety Devices, Ladder

Air Space Devices Inc.

Anixter-Pruzan CATV Division
Antenna Products Company
TV Cable Supply Co., Inc.

Scramblers, Speech

Kahn Research Lab. Inc.
Singer Products Co., Inc.
Trepac Corp. America

Screens, Projection Front

Comquip, Inc.
Eastman Kodak Co.
F&B/Ceco Industries, Inc.
Tele Measurements Inc.
Telesync Corp.
Video Engineering Co. Inc.

Screens, Projection Rear

F&B/Ceco Industries, Inc.
Tele Measurements Inc.
Video Engineering Co. Inc.
Wilson Corp., H.

Semiconductors, IC's

Amperex Electronic Corp.
Calvert Electronics Power Tube Div.
Ceco Communications Inc.
Hewlett Packard Co.
P. R. Mallory & Co. Inc. Mallory
Distributor Products Co.
Motorola Semiconduct Motorola Inc.
RCA Corporation RCA Electronic
Components
Solitron Devices Inc. Semiconductor
Div.
Terminal Hudson Corp. Terminal
Hudson Electronics
Texas Instrument Components Group
Thor Electronics Corp.

Semiconductors, Rectifier General

Amperex Corp.
Calvert Electronics Power Tube Div.
Ceco Communications Inc.
Collins Radio Company Broadcast
Division
General Electric Company Tubes/MW
Devices
Heintz and Kaufman Ltd.
P. R. Mallory & Co. Inc. Mallory
Distributor Products Co.
Motorola Semiconduct Motorola Inc.
RCA Corporation RCA Electronic
Components
Singer Products Co., Inc.
Solitron Devices Inc. Semiconductor
Div.
Sylvania Semiconductor
Terminal Hudson Corp. Terminal
Hudson Electronics
Texas Instrument Components Group
Thor Electronics Corp.
Westinghouse Electric Corp.

Semiconductors, Rectifier High Voltage Stack

Amperex Electronic Corp.
Calvert Electronics Power Tube Div.
Ceco Communications Inc.
Collins Radio Company Broadcast
Division
Heintz and Kaufman Ltd.
P. R. Mallory & Co. Inc. Mallory
Distributor Products Co.
Motorola Semiconduct Motorola Inc.
RCA Corporation RCA Electronic
Components
Singer Products Co., Inc.
Solitron Devices Inc. Semiconductor
Div.
Terminal Hudson Corp. Terminal
Hudson Electronics
Thor Electronics Corp.
Westinghouse Electric Corp.
Wilkinson Electronics, Inc.

Semiconductors, Rectifier Power

Amperex Corp.

Calvert Electronics Power Tube Div.
Ceco Communications Inc.
Collins Radio Company Broadcast
Division
General Electric Company Tubes/MW
Devices
Heintz and Kaufman Ltd.
P. R. Mallory & Co. Inc. Mallory
Distributor Products Co.
Motorola Semiconduct Motorola Inc.
RCA Corporation RCA Electronic
Components
Siemens Corporation
Singer Products Co., Inc.
Solitron Devices Inc. Semiconductor
Div.
Sylvania Semiconductor
Terminal Hudson Corp. Terminal
Hudson Electronics
Texas Instrument Components Group
Thor Electronics Corp.
Westinghouse Electric Corp.

Semiconductors, Rectifier Silicon Controlled-SCR

Amperex Corp.
Calvert Electronics Power Tube Div.
Ceco Communications Inc.
Collins Radio Company Broadcast
Division
General Electric Company Tubes/MW
Devices
Heintz and Kaufman Ltd.
Motorola Semiconduct Motorola Inc.
RCA Corporation RCA Electronic
Components
Siemens Corporation
Singer Products Co., Inc.
Solitron Devices Inc. Semiconductor
Div.
Terminal Hudson Corp. Terminal
Hudson Electronics
Texas Instrument Components Group
Thor Electronics Corp.
Westinghouse Electric Corp.
Wilkinson Electronics, Inc.

Semiconductors, Thyristor

Calvert Electronics Power Tube Div.
Ceco Communications Inc.
General Electric Company Tubes/MW
Devices
Heintz and Kaufman Ltd.
Motorola Semiconduct Motorola Inc.
RCA Corporation RCA Electronic
Components
Siemens Corporation
Singer Products Co., Inc.
Solitron Devices Inc. Semiconductor
Div.
Terminal Hudson Corp. Terminal
Hudson Electronics
Texas Instrument Components Group
Thor Electronics Corp.
Westinghouse Electric Corp.

Semiconductors, Transistor AF

Amperex Electronic Corp.
Calvert Electronics Power Tube Div.
Ceco Communications Inc.
Heintz and Kaufman Ltd.
P. R. Mallory & Co. Inc. Mallory
Distributor Products Co.
Motorola Semiconduct Motorola Inc.
Raytheon Company Raytheon Data
Systems Co.
RCA Corporation RCA Electronic
Components
Siemens Corporation
Singer Products Co., Inc.
Solitron Devices Inc. Semiconductor
Div.
Sylvania Semiconductor
Terminal Hudson Corp. Terminal
Hudson Electronics
Texas Instrument Components Group
Thor Electronics Corp.
Westinghouse Electric Corp.

Semiconductors, Transistor FET

Amperex Corp.
Calvert Electronics Power Tube Div.
Ceco Communications Inc.

Heintz and Kaufman Ltd.
P. R. Mallory & Co. Inc. Mallory
Distributor Products Co.
Motorola Semiconduct Motorola Inc.
RCA Corporation RCA Electronic
Components
Singer Products Co., Inc.
Solitron Devices Inc. Semiconductor
Div.
Terminal Hudson Corp. Terminal
Hudson Electronics
Texas Instrument Components Group
Thor Electronics Corp.
Westinghouse Electric Corp.

Semiconductors, Transistor General

Amperex Electronic Corp.
Calvert Electronics Power Tube Div.
CATV Equipment Co.
Ceco Communications Inc.
General Electric Company Tubes/MW
Devices
Motorola Semiconduct Motorola Inc.
Raytheon Company Raytheon Data
Systems Co.
RCA Corporation RCA Electronic
Components
Siemens Corporation
Singer Products Co., Inc.
Solitron Devices Inc. Semiconductor
Div.
Sylvania Semiconductor
Terminal Hudson Corp. Terminal
Hudson Electronics
Texas Instrument Components Group
Thor Electronics Corp.
Westinghouse Electric Corp.

Semiconductors, Transistor RF

Amperex Electronic Corp.
Calvert Electronics Power Tube Div.
Ceco Communications Inc.
Heintz and Kaufman Ltd.
Hewlett Packard Co.
Motorola Semiconduct Motorola Inc.
Raytheon Company Raytheon Data
Systems Co.
RCA Corporation RCA Electronic
Components
Siemens Corporation
Singer Products Co., Inc.
Solitron Devices Inc. Semiconductor
Div.
Sylvania Semiconductor
Terminal Hudson Corp. Terminal
Hudson Electronics
Texas Instrument Components Group
Thor Electronics Corp.
Westinghouse Electric Corp.

Shifters, Phase Microwave

Hewlett Packard Co.
Lectronic Res. Labs. Inc.
Micro Communications, Inc.
Microwave Assoc. Inc.
Narda Microwave Corp., The
Raytheon Company Raytheon Data
Systems Co.
Television Microtime, Inc. Subs.
Andersen Laboratories, Inc.
Weinschel Engineering Co.

Slow Scan TV Systems

ATV Research
Colorado Video Inc.
Cramer Video and Audio Systems
Gates Division of Harris-Intertype
Gen. Electrodynamics
Hughes Aircraft Company Ind. Prod.
Div.-Image Devices
Teledyne Brown Engineering Co.
Science & Engrg. Div.
Teltron, Inc.
Video Engineering Co. Inc.

Sound Effect Systems

Radio Mfg. Co. (RMC)
Universal Research Labs

Sound Systems, Outdoor

Alcor Inc.
ALTEC
Ancha Electronics Inc.
Applied Electro Mechanics, Inc.
ATLAS Sound
Audio Distributor Inc.
Bell P/A Prod. Corp.
Bogen Division Lear Siegler Inc.
Cetec Inc. Subs. Computer Equipment
Corp.
Concept 70, A Div. of Dyma
Engineering, Inc.
Electro-Voice Inc. Subs. of Gulton
Industries, Inc.
Head Sound, Inc.
Jensen Sound Laboratories Div.
Pemcor, Inc.
McMartin Industries
Paso Sound Products Inc.
Philips Broadcast Equipment Corp.
Subs. North American Philips Corp.
Pulse Dynamics Mfg. Corp.
Q-TV Sales & Distributing Corp.
RCA Corporation RCA Broadcast
Equip., Comm. Sys. Div.
Shure Brothers Inc.
Spectra Sonics
Terminal Hudson Corp. Terminal
Hudson Electronics
Ultra Audio Products

Sound Systems, Portable

Alcor Inc.
ALTEC
Ancha Electronics Inc.
Applied Electro Mechanics, Inc.
ATLAS Sound
Audio Distributor Inc.
Bell P/A Prod. Corp.
Bogen Division Lear Siegler Inc.
CCA Electronics Corp.
Cetec Inc. Subs. Computer Equipment
Corp.
Concept 70, A Div. of Dyma
Engineering, Inc.
Cramer Video and Audio Systems
Custom Craft Designs
Electro-Voice Inc. Subs. of Gulton
Industries, Inc.
F&B/Ceco Industries, Inc.
Gately Electronics
Head Sound, Inc.
Jensen Sound Laboratories Div.
Pemcor, Inc.
McMartin Industries
Neve Inc., Rupert
Paso Sound Products Inc.
Philips Broadcast Equipment Corp.
Subs. North American Philips Corp.
Pulse Dynamics Mfg. Corp.
Q-TV Sales & Distributing Corp.
RCA Corporation RCA Broadcast
Equip., Comm. Sys. Div.
Roberts Div. of Rheem Mfg. Co.
Rupert Neve Incorporated
Shure Brothers Inc.
Singer Products Co., Inc.
Spectra Sonics
Tape-Athon Corp.
Terminal Hudson Corp. Terminal
Hudson Electronics
Ultra Audio Products

Sound Systems, Studio

See Adv. Page

Broadcast Electronics 34
Crown International.....121
Sparta Electronic Corp. 8

Alcor Inc.
Ampro Corp.
Ancha Electronics Inc.
Audio Designs & Mfg.
Broadcast Electronics
CCA Electronics Corp.
Cetec Inc. Subs. Computer Equipment
Corp.
Cleveland Electronics, Inc.
Concept 70, A Div. of Dyma
Engineering, Inc.
Cramer Video and Audio Systems
Crown International
Delta Electronics Inc. (N.C.)

Edison Electronics, Div. of
McGraw-Edison Co., Daven &
Measurements
Electro-Voice Inc. Subs. of Gulton
Industries, Inc.
Fairchild/Robbins Fairchild Sound
Equipment Corp.
Gately Electronics
Gotham Audio Corp.
Jensen Sound Laboratories Div.
Pemcor, Inc.
Magna-Tech Electronic Co., Inc.
McMartin Industries
Melcor Electronics Corp.
Neve Inc., Rupert
Norelco, Philips Bcst. Equip. Corp.
Subs. North American Philips Corp.
Paso Sound Products Inc.
Philips Broadcast Equipment Corp.
Subs. North American Philips Corp.
Pulse Dynamics Mfg. Corp.
Quad-Eight Electronics
RCA Corporation RCA Broadcast
Equip., Comm. Sys. Div.
Rupert Neve Incorporated
Shure Brothers Inc.
Siemens Corporation
Singer Products Co., Inc.
Sparta Electronic Corp.
Spectra Sonics
Systems Engineering Co., Inc.
Total Technology
(Trusonic) ACS Inc.
Video Aids Corp. of Colorado

Sound Systems, Theater

Alcor Inc.
ALTEC
Ancha Electronics Inc.
ATLAS Sound
Audio Designs & Mfg.
Audio Distributor Inc.
Bell P/A Prod. Corp.
Bell Sound Studios Electro Sound Div.
Bogen Division Lear Siegler Inc.
Cetec Inc. Subs. Computer Equipment
Corp.
Concept 70, A Div. of Dyma
Engineering, Inc.
Delta Electronics Inc. (N.C.)
Electro-Voice Inc. Subs. of Gulton
Industries, Inc.
Fairchild/Robbins Fairchild Sound
Equipment Corp.
F&B/Ceco Industries, Inc.
Gately Electronics
Jensen Sound Laboratories Div.
Pemcor, Inc.
Melcor Electronics Corp.
Neve Inc., Rupert
Paso Sound Products Inc.
Philips Broadcast Equipment Corp.
Subs. North American Philips Corp.
Q-TV Sales & Distributing Corp.
Quad-Eight Electronics
RCA Corporation RCA Broadcast
Equip., Comm. Sys. Div.
RHA Audio Communications Corp.
Rupert Neve Incorporated
Shure Brothers Inc.
Spectra Sonics
(Trusonic) ACS Inc.

Speakers and Enclosures

See Adv. Page

Crown International.....121

Alcor Inc.
ALTEC
Ancha Electronics Inc.
ATLAS Sound
Bogen Division Lear Siegler Inc.
Broadcast Electronics
Cetec Inc. Subs. Computer Equipment
Corp.
Cleveland Electronics, Inc.
Collins Radio Company Broadcast
Division
Communication Medias
Crown International
Electro-Voice Inc. Subs. of Gulton
Industries, Inc.
G.C. Electronics
Gotham Audio Corp.
Hartley Prod. Corp.

Heath Co.
Jensen Sound Laboratories Div.
Pemcor, Inc.
Koss Corp
Micro-Trak Corporation (Formerly:
Gray Research & Dev.)
Oaktron Industries Inc.
Paso Sound Products Inc.
Philips Broadcast Equipment Corp.
Subs. North American Philips Corp.
Pulse Dynamics Mfg. Corp.
RCA Corporation RCA Broadcast
Equip., Comm. Sys. Div.
Sansui Electronics Corp.
Schultz Inc., Albert
Scientific Systems, Inc. Broadcast
Equipment Div.
Singer Products Co., Inc.
Soundolier, Inc.
Sparta Electronic Corp.
Spectra Sonics
Spotmaster Broadcast Electronics
Superscope, Inc.
Systems Engineering Co., Inc.
Tandberg of America Inc.
TEAC Corp of America
Tele Measurements Inc.
Terminal Hudson Corp. Terminal
Hudson Electronics
(Trusonic) ACS Inc.
Victor Duncan, Inc.

STL Equipment

See Adv. Page

Gates..... 10
Marti Electronics 128D
Moseley Assoc. Inc. 7

Acrodyne Industries
Alto Communications Inc. Broadcast
Marketing Div.
Andrews Tower Inc.
Belcom Electronics Mfg. Co.
CCA Electronics Corp.
Collins Radio Company Broadcast
Division
David Clark Co., Inc.
Dyma Engineering, Inc.
Electromagnetic Sciences, Inc.
Gates Division of Harris-Intertype
GTE Lenkurt Incorporated
Magnatech Company
Marti Electronics
Mastertone Company
Microwave Assoc. Inc.
Moseley Assoc. Inc.
Raytheon Company Raytheon Data
Systems Co.
RCA Corporation RCA Broadcast
Equip., Comm. Sys. Div.
RHG Elect Labs, Inc.
Richmond Hill Laboratories Inc.
Schafer Electronics Corp.
Scott-Buttner Coastcom, Inc.
Singer Products Co., Inc.
Sparta Electronic Corp.
Trepac Corp. America
Varian Solid State Div. Micro-Link
Products
Visual Communication Products Oper.
General Electric Co.
Wilkinson Electronics, Inc.

Studio Scenery

Feller Vacuum Form Studios
Janson Industries
Video Engineering Co. Inc.

Subcarrier Multiplex Equipment

See Adv. Page

Collins Radio Company..... 19
Moseley Assoc. Inc. 7
Scott-Buttner
Coastcom, Inc. 12

CCA Electronics Corp.
Collins Radio Company Broadcast
Division
Cook Electric Co.
Fung Engineering Co.
Moseley Assoc. Inc.
Scott-Buttner Coastcom, Inc.

Switchers

See Adv. Page

American Data Corp.131
Danscoll Ltd.116
Grass Valley Group, Inc. 3
OMNIX..... 42
Shintron Co. Inc.132
Telemet Co. IBC
Viscount Industries Ltd...... 139,140
Vital Industries Inc. BC

Alco Electronic Products, Inc.
 Alma Engineering Inc.
 American Data Corp. an AIRPAX Company
 Atlantic Research Corp. Teleproducts Dept.
 Audio Designs & Mfg.
 Ball Bros. Research Corp. Miratel Division
 Central Dynamics Corp.
 CHESTER ELECTRONIC LABS., INC. GTE Information Systems Inc.
 Cohu, Inc. Electronics Division
 Concept 70, A Div. of Dyma Engineering, Inc.
 Cramer Video and Audio Systems
 Cunningham Corp. Subs. of Gleason Works
 Danscoll Ltd.
 DYNNAIR Electronics, Inc.
 Dynasciences Corp. Video Products Div.
 Essex International Inc. RBM Div.
 Fairchild/Robbins Fairchild Sound Equipment Corp.
 Fung Engineering Co.
 Gates Division of Harris-Intertype
 GBC Closed Circuit TV Corp.
 Grass Valley Group, Inc.
 IGM
 Interntl. Nuclear Corp.
 Javelin Div. of Apollo Lasers
 Kay Elemetrics Corp.
 Marconi Electronics Inc.
 McCurdy Radio Ind. Inc.
 Nasco Television Systems
 Neve Inc., Rupert
 OMNIX
 RCA Corporation RCA Broadcast Equip., Comm. Sys. Div.
 R. H. Tyler Co. Div. of Weather Scan, Inc.
 Richmond Hill Laboratories Inc.
 Riker Communications Inc.
 Roh Corporation
 Rupert Neve Incorporated
 Sarkes Tarzian Inc. Broadcast Equipment Div.
 Seacor Inc.
 Shintron Co. Inc. Video Products Div.
 Sparta Electronic Corp.
 Systems Marketing Corp. And Sono-Mag Corp.
 TeleMation, Inc.
 Telemet Co.
 Theta-Com of California AML Division
 Total Technology
 Vicon Industries, Inc.
 Video Aids Corp. of Colorado
 Video Engineering Co. Inc.
 Vikoa Inc.
 Viscount Industries Ltd.
 Visual Educom Inc. DAGE Television
 Visual Electronics Corp.
 Vital Industries Inc.

Switches

See Adv. Page

Switchcraft Inc.110

Switchcraft Inc.

Switches, Coaxial

See Adv. Page

American Data Corp.131
Switchcraft Inc.110

Alford Mfg. Co.

American Data Corp. an AIRPAX Company
 American Electronics Lab., Inc.
 Amphenol RF Division
 Andrew Corp.
 A-Tel-A-Matic
 Atlantic Research Corp. Teleproducts Dept.
 Arnold Barnes Company
 Bird Electronic Corp.
 Blonder-Tongue Labs.
 Cablewave Systems Inc. Subs. Phelps Dodge and Kabelmetal
 CATV Equipment Co.
 Collins Radio Company Broadcast Division
 Comark Industries Inc.
 Delta Electronics Inc. (Va.)
 Dielectric Communications Div. of Sola Basic
 Electronic Inst. & Spec.
 Fung Engineering Co.
 Gates Division of Harris-Intertype
 General Microwave Corp.
 Integral Data Devices Inc.
 ITT Jennings
 Jampro Antenna Co. Div. of Computer Equipment Corp.
 Kay Elemetrics Corp.
 Lectronic Res. Labs. Inc.
 Magnecraft Electric Co.
 Matrix Systems Corp.
 Micro Communications, Inc.
 OAK Industries Inc. CATV Division
 Prodelin Inc.
 RCA Corporation RCA Broadcast Equip., Comm. Sys. Div.
 Rohde & Schwarz Sales Co.
 Shively Laboratories, Inc.
 Singer Products Co., Inc.
 Soll, Inc., Joseph M.
 Sparta Electronic Corp.
 Switchcraft Inc.
 Telonic Industries Inc.
 Terminal Hudson Corp. Terminal Hudson Electronics
 Texscan Corp.
 Trompeter Electronics
 Virginia Panel Corporation

Switches, Crossbar

See Adv. Page

American Data Corp.131
Switchcraft Inc.110

American Data Corp. an AIRPAX Company
 Atlantic Research Corp. Teleproducts Dept.
 Cablewave Systems Inc. Subs. Phelps Dodge and Kabelmetal
 CHESTER ELECTRONIC LABS., INC. GTE Information Systems Inc.
 Cramer Video and Audio Systems
 Cunningham Corp. Subs. of Gleason Works
 Delta Electronics Inc. (Va.)
 Integral Data Devices Inc.
 Interntl. Nuclear Corp.
 Marconi Electronics Inc.
 Matrix Systems Corp.
 RCA Corporation RCA Broadcast Equip., Comm. Sys. Div.
 Robert Bosch Corp. Fernseh Div.
 Rust Corp.
 Switchcraft Inc.
 Tape-Athon Corp.
 Trompeter Electronics
 Video Engineering Co. Inc.
 Viscount Industries Ltd.

Switching Systems

See Adv. Page

American Data Corp.131
Gates 10
Vital Industries Inc. BC

Alcor Inc.
 Alma Engineering Inc.
 American Data Corp. an AIRPAX Company
 Andrew Corp.
 Atlantic Research Corp. Teleproducts Dept.

Bradford Information Systems
 Broadcast Products Inc.
 Cablewave Systems Inc. Subs. Phelps Dodge and Kabelmetal
 Central Dynamics Corp.
 CHESTER ELECTRONIC LABS., INC. GTE Information Systems Inc.
 Cleveland Electronics, Inc.
 CMX Systems
 Cohu, Inc. Electronics Division
 Concept 70, A Div. of Dyma Engineering, Inc.
 Cramer Video and Audio Systems
 Cunningham Corp. Subs. of Gleason Works
 Danscoll Ltd.
 Datatek Corp.
 Delta Electronics Inc. (Va.)
 DYNNAIR Electronics, Inc.
 Fairchild/Robbins Fairchild Sound Equipment Corp.
 Gates Division of Harris-Intertype
 Grass Valley Group, Inc.
 Holland Electronics
 IGM
 Integral Data Devices Inc.
 Interntl. Nuclear Corp.
 International Video Corp.
 ITT General Controls
 Javelin Div. of Apollo Lasers
 Marco Video Systems, Inc.
 Marconi Electronics Inc.
 Mastertone Company
 Matrix Systems Corp.
 McCurdy Radio Ind. Inc.
 Multronics, Inc.
 Nasco Television Systems
 OMNIX
 Q-TV Sales & Distributing Corp.
 RCA Corporation RCA Broadcast Equip., Comm. Sys. Div.
 Richmond Hill Laboratories Inc.
 Riker Communications Inc.
 Robert Bosch Corp. Fernseh Div.
 Roh Corporation
 Sarkes Tarzian Inc. Broadcast Equipment Div.
 Schafer Electronics Corp.
 Soll, Inc., Joseph M.
 Switchcraft Inc.
 Systems Marketing Corp. And Sono-Mag Corp.
 Tasker Systems Div. of Whittaker Corp.
 Tech Laboratories Inc.
 TeleMation, Inc.
 Telemet Co.
 Trepac Corp. America
 Trompeter Electronics
 Vicon Industries, Inc.
 Video Engineering Co. Inc.
 Vikoa Inc.
 Virginia Panel Corporation
 Viscount Industries Ltd.
 Visual Electronics Corp.
 Vital Industries Inc.

Systems Research and Development

See Adv. Page

OMNIX..... 42

OMNIX

Tape, Magnetic Recording Audio

See Adv. Page

Birmingham Tape Cartridge Co., Inc.140
Qualitape Inc.137
Sparta Electronic Corp. 8

Agfa-Gevaert Inc.
 Alto Communications Inc. Broadcast Marketing Div.
 Ampex Corp. Audio-Video Systems Division
 Audio Devices, Inc.
 Audio Magnetics Corp.
 Bell & Howell Consumer Products Group
 Bell Sound Studios Electro Sound Div.
 Birmingham Tape Cartridge Co., Inc.
 Broadcast Electronics
 Broadcast Products Inc.

BSC Incorporated
 CCA Electronics Corp.
 Cine Sonic Sound Inc.
 Collins Radio Company Broadcast Division
 Columbia Broadcast Services
 Communication Medias
 Comquip, Inc.
 Crown International
 Duotone Co. Inc.
 Elecktromesstechnik E M T Wilhelm Franz G M B H
 Fairchild/Robbins Fairchild Sound Equipment Corp.
 Gates Division of Harris-Intertype
 Image Devices Incorporated
 Irish Magnetic Recording Tape Div. Morhan Nat'l. Sales Co. Inc.
 Karex, Inc. Subs. of Rohm and Haas Co.
 Lauderdale Electronic Labs
 Magnatech Company
 Magnetic Prod. Div. 3M Company
 P. R. Mallory & Co. Inc. Mallory Distributor Products Co.
 Mastertone Company
 Memorex Corporation Audio-Video Group
 Miles Reproducer Co.
 Otari of America, Ltd.
 Pentagon Industries, Inc.
 Philips Broadcast Equipment Corp. Subs. North American Philips Corp.
 Q-TV Sales & Distributing Corp.
 Qualitape Inc.
 RCA Corporation RCA Broadcast Equip., Comm. Sys. Div.
 RCA Corporation RCA Electronic Components
 Recordex Corporation
 Ryder Magnetic Sales Corp.
 Schafer Electronics Corp.
 Schultz Inc., Albert
 Singer Products Co., Inc.
 Soundscriber Corporation
 Sparta Electronic Corp.
 Spotmaster Broadcast Electronics
 Superscope, Inc.
 Systems Marketing Corp. And Sono-Mag Corp.
 Tape-Athon Corp.
 TDK Electronics Corp.
 Tele Measurements Inc.
 Victor Duncan, Inc.
 VIF International
 Wide Response
 Wilkinson Electronics, Inc.

Tape, Magnetic Recording Audio Cartridge

See Adv. Page

BSC Incorporated112
Gates 10
Joa Cartridge Service130
Mastertone Company141
Qualitape Inc.137

Alto Communications Inc. Broadcast Marketing Div.
 Audio Devices, Inc.
 Audio Magnetics Corp.
 Bell & Howell Consumer Products Group
 Bell Sound Studios Electro Sound Div.
 Birmingham Tape Cartridge Co., Inc.
 Broadcast Electronics
 Broadcast Prod. Co. Inc. Bcst. Division
 Broadcast Products Inc.
 BSC Incorporated
 Cine Sonic Sound Inc.
 Collins Radio Company Broadcast Division
 Columbia Broadcast Services
 Communication Medias
 Conrac Corporation Cramer Division
 Contel Mfg. Div. of Continental Electronic Wholesale Corp.
 Fairchild/Robbins Fairchild Sound Equipment Corp.
 Fidelipac Division TelePro Industries, Inc.
 Gates Division of Harris-Intertype
 IGM
 Irish Magnetic Recording Tape Div. Morhan Nat'l. Sales Co. Inc.

Joa Cartridge Service
 Lauderdale Electronic Labs
 Magnetic Prod. Div. 3M Company
 P. R. Mallory & Co. Inc. Mallory
 Distributor Products Co.
 Marathon Broadcast Equip.
 Mastertone Company
 Memorex Corporation Audio-Video
 Group
 Nemo Recording Labs
 Paso Sound Products Inc.
 QRK Electronic Prod.
 Q-TV Sales & Distributing Corp.
 Qualitape Inc.
 RCA Corporation RCA Broadcast
 Equip., Comm. Sys. Div.
 RCA Corporation RCA Electronic
 Components
 Recordex Corporation
 Schafer Electronics Corp.
 Schultz Inc., Albert
 Singer Products Co., Inc.
 Sparta Electronic Corp.
 Spotmaster Broadcast Electronics
 Superscope, Inc.
 Systems Engineering Co., Inc.
 Systems Marketing Corp. And
 Sono-Mag Corp.
 Tapecaster TCM, Inc.
 Tapex Corporation
 TDK Electronics Corp.
 Wilkinson Electronics, Inc.

Tape, Magnetic Recording Computer

Ampex Corp. Audio-Video Systems
 Division
 Audio Devices, Inc.
 Magnetic Prod. Div. 3M Company
 Memorex Corporation Audio-Video
 Group
 RCA Corporation RCA Broadcast
 Equip., Comm. Sys. Div.
 Systems Marketing Corp. And
 Sono-Mag Corp.
 TDK Electronics Corp.
 Wide Response

Tape, Magnetic Recording Test

See Adv. Page

Mastertone Company141
Nortronics Co., Inc.133

Ampex Corp. Audio-Video Systems
 Division
 Communication Medias
 Fidelipac Division TelePro Industries,
 Inc.
 G.C. Electronics
 International Tapetronics Corp.
 Mastertone Company
 Nortronics Co., Inc. Recorder Care Div.
 RCA Corporation RCA Broadcast
 Equip., Comm. Sys. Div.
 Schultz Inc., Albert
 Systems Marketing Corp. And
 Sono-Mag Corp.
 Taber Mfg. & Engr. Co.
 TASCAM Corporation
 Telectro Systems Corp.
 Victor Duncan, Inc.
 VIF International

Tape, Magnetic Recording Video

Ampex Corp. Audio-Video Systems
 Division
 Anixter-Pruzan CATV Division
 Audio Magnetics Corp.
 BSC Incorporated
 Columbia Broadcast Services
 Computer Image Corp.
 Comquip, Inc.
 Cramer Video and Audio Systems
 Diamond Power Specialty Corp. Subs.
 Babcock & Wilcox Co.
 GBC Closed Circuit TV Corp.
 Hitachi Shibaden Corp. of America
 Irish Magnetic Recording Tape Div.
 Morhan Nat'l. Sales Co. Inc.
 Javelin Div. of Apollo Lasers
 Karex, Inc. Subs. of Rohm and Haas
 Co.
 K'SON Corporation

Magnetic Prod. Div. 3M Company
 Memorex Corporation Audio-Video
 Group
 Panasonic Video Systems Div.
 Matsushita Electric Corp. of
 America
 Philips Broadcast Equipment Corp.
 Subs. North American Philips Corp.
 RCA Corporation RCA Broadcast
 Equip., Comm. Sys. Div.
 Recordex Corporation
 R. H. Tyler Co. Div. of Weather Scan,
 Inc.
 Robert Bosch Corp. Fernseh Div.
 Schultz Inc., Albert
 Sony Corp. of America
 TDK Electronics Corp.
 Tele Measurements Inc.
 Video Engineering Co. Inc.
 Wide Response

Tape, Recording Logging

Alto Communications Inc. Broadcast
 Marketing Div.
 Audio Devices, Inc.
 Broadcast Products Inc.
 Cine Sonic Sound Inc.
 IGM
 Lauderdale Electronic Labs
 Magnetic Prod. Div. 3M Company
 Philips Broadcast Equipment Corp.
 Subs. North American Philips Corp.
 Qualitape Inc.
 RCA Corporation RCA Broadcast
 Equip., Comm. Sys. Div.
 Richmond Hill Laboratories Inc.
 Schafer Electronics Corp.
 Singer Products Co., Inc.
 Soundscriber Corporation
 Sparta Electronic Corp.
 Stancil-Hoffman Corp.
 Systems Marketing Corp. And
 Sono-Mag Corp.
 Tape-Athon Corp.
 Telectro Systems Corp.
 Video Sentry System
 Wide Response

Tape Cart Loaders

See Adv. Page

**Birmingham Tape
 Cartridge Co., Inc.**140
Broadcast Electronics 34
Ramko Research 20

Birmingham Tape Cartridge Co., Inc.
 Broadcast Electronics
 Communication Medias
 Inovonics
 Lauderdale Electronic Labs
 Marathon Broadcast Equip.
 Qualitape Inc.
 Ramko Research
 Sparta Electronic Corp.
 Spotmaster Broadcast Electronics

Tape Cassettes

See Adv. Page

Audio Devices, Inc. 45

Audio Devices, Inc.

Tape Cleaners

Audio Magnetics Corp.
 Arnold Barnes Company
 Fairchild/Robbins Fairchild Sound
 Equipment Corp.
 Harwald Company
 Lauderdale Electronic Labs
 Lipsner-Smith Corp.
 Miller-Stephenson Chemical Co.
 Nortronics Co., Inc. Recorder Care Div.
 Recortec Inc.
 RTI Research Technology Inc.
 Taber Mfg. & Engr. Co.
 TEAC Corp of America
 Television Equipment Associates
 Virginia Panel Corporation

Tape Decks, Magnetic

Accurate Sound Corp.
 Alto Communications Inc. Broadcast
 Marketing Div.
 Ampro Corp.
 Astrocom Electronics, Inc.
 Beyer (Revox Corporation)
 Broadcast Electronics
 Broadcast Products Inc.
 BSC Incorporated
 CCA Electronics Corp.
 Cetec Inc. Subs. Computer Equipment
 Corp.
 CHESTER ELECTRONIC LABS., INC.
 GTE Information Systems Inc.
 Cine Sonic Sound Inc.
 Collins Radio Company Broadcast
 Division
 Communication Medias
 Comquip, Inc.
 Conrac Corporation Cramer Division
 Crown International
 Gates Division of Harris-Intertype
 Gould Inc. Instrument Systems Div.
 Honeywell Inc. Test Instruments Div.
 IGM
 International Tapetronics Corp.
 Lang Electronics Inc.
 Magnatech Company
 Mastertone Company
 Mincom Div. 3M Co.
 Otari of America, Ltd.
 Philips Broadcast Equipment Corp.
 Subs. North American Philips Corp.
 Q-TV Sales & Distributing Corp.
 Radio Mfg. Co. (RMC)
 RAPID-Q Div. of Garron Electronics
 RCA Corporation RCA Broadcast
 Equip., Comm. Sys. Div.
 Recordex Corporation
 Roberts Div. of Rheem Mfg. Co.
 Sansui Electronics Corp.
 Schafer Electronics Corp.
 Schultz Inc., Albert
 Scully/Metrotech Divs. of Dictaphone
 Corp.
 Singer Products Co., Inc.
 Soundscriber Corporation
 Sparta Electronic Corp.
 Spotmaster Broadcast Electronics
 Superscope, Inc.
 Systems Marketing Corp. And
 Sono-Mag Corp.
 Tape-Athon Corp.
 Tapecaster TCM, Inc.
 TASCAM Corporation
 TEAC Corp of America
 Telectro Systems Corp.
 Tele Measurements Inc.
 Telex Communications Division
 VIF International
 Wilkinson Electronics, Inc.

Tape Duplicators

Alcor Inc.
 Ampex Corp. Audio-Video Systems
 Division
 Audiotronics Corp.
 Bell Sound Studios Electro Sound Div.
 Broadcast Products Inc.
 Cetec Inc. Subs. Computer Equipment
 Corp.
 Cramer Video and Audio Systems
 Inovonics
 Lang Electronics Inc.
 Mastertone Company
 Orbit Radio and Video
 Pentagon Industries, Inc.
 Philips Broadcast Equipment Corp.
 Subs. North American Philips Corp.
 Recordex Corporation
 Recortec Inc.
 Schultz Inc., Albert
 Telectro Systems Corp.
 TeleMation, Inc.
 Telex Communications Division

Tape Racks, Cartridge

See Adv. Page

Broadcast Electronics 34
Fidelipac Division 122
Gates 10
Micro-Trak Corporation 128B

Sparta Electronic Corp. 8

Broadcast Electronics
 Broadcast Products Inc.
 CCA Electronics Corp.
 Collins Radio Company Broadcast
 Division
 Communication Medias
 Concept 70, A Div. of Dyma
 Engineering, Inc.
 Fairchild/Robbins Fairchild Sound
 Equipment Corp.
 Fidelipac Division TelePro Industries,
 Inc.
 Gates Division of Harris-Intertype
 Harwald Company
 Joa Cartridge Service
 Lauderdale Electronic Labs
 Mastertone Company
 Micro-Trak Corporation (Formerly:
 Gray Research & Dev.)
 Neumade Prod. Corp.
 QRK Electronic Prod.
 RTI Research Technology Inc.
 Sparta Electronic Corp.
 Spotmaster Broadcast Electronics
 Systems Engineering Co., Inc.
 Tapex Corporation
 Tele Measurements Inc.

Tape Recording Accessories

Ampex Corp. Audio-Video Systems
 Division
 Audio Devices, Inc.
 Broadcast Electronics
 Broadcast Products Inc.
 Electro-Voice Inc. Subs. of Gulton
 Industries, Inc.
 ELPA Marketing Industries, Inc.
 Fairchild/Robbins Fairchild Sound
 Equipment Corp.
 Fidelipac Division TelePro Industries,
 Inc.
 G.C. Electronics
 Lauderdale Electronic Labs
 Mastertone Company
 Micro-Trak Corporation (Formerly:
 Gray Research & Dev.)
 Nortronics Co., Inc. Recorder Care Div.
 Pacific Recorders and Engrg. Corp.
 Qualitape Inc.
 Ramko Research
 RCA Corporation RCA Broadcast
 Equip., Comm. Sys. Div.
 Recortec Inc.
 Scully/Metrotech Divs. of Dictaphone
 Corp.
 Sparta Electronic Corp.
 Spotmaster Broadcast Electronics
 Telectro Systems Corp.
 VIF International

Tape Splice Finders

See Adv. Page

Fidelipac Division 122

Broadcast Electronics
 Communication Medias
 Fidelipac Division TelePro Industries,
 Inc.
 Recortec Inc.
 Senstrol Division UMC Electronics Co.
 Spotmaster Broadcast Electronics

Tape Splicers

See Adv. Page

Comquip, Inc. 141
Fidelipac Division 122

Broadcast Electronics
 Collins Radio Company Broadcast
 Division
 Comquip, Inc.
 Duotone Co. Inc.
 ELPA Marketing Industries, Inc.
 Fairchild/Robbins Fairchild Sound
 Equipment Corp.
 Fidelipac Division TelePro Industries,
 Inc.
 G.C. Electronics
 Lauderdale Electronic Labs
 Nortronics Co., Inc. Recorder Care Div.
 Spotmaster Broadcast Electronics

Victor Duncan, Inc.

Tape Transport

Ampro Corp.
Broadcast Electronics
Broadcast Products Inc.
Cetec Inc. Subs. Computer Equipment Corp.
Cine Sonic Sound Inc.
Conrac Corporation Cramer Division
Cook Electric Co.
Gates Division of Harris-Intertype
Gould Inc. Instrument Systems Div.
IGM
International Tapetronics Corp.
Mastertone Company
Peripheral Data Machines, Inc. (PER DATA)
Radio Mfg. Co. (RMC)
Recordex Corporation
Sparta Electronic Corp.
Spotmaster Broadcast Electronics
Systems Marketing Corp. And Sono-Mag Corp.
Tape-Athon Corp.
Telectro Systems Corp.
VIF International

Telephone Tone Receivers

See Adv. Page

Trepac Corp. America130

Trepac Corp. America

Telephone Tone Transmitters

See Adv. Page

Trepac Corp. America130

Trepac Corp. America

Teletype Alarm Receiver

Atlantic Research Corp. Teleproducts Dept.
Audio Engineering Co.
Concept 70, A Div. of Dyma Engineering, Inc.
Trepac Corp. America

Termination Units

See Adv. Page

Electro Impulse, Inc.132

Electro Impulse, Inc.

Test Records

Ameco Inc.
CBS Labs
G.C. Electronics
Mastertone Company
RCA Corporation RCA Broadcast Equip., Comm. Sys. Div.

Test Sets, Multifunction

See Adv. Page

Roh Corporation124
Telemet Co. IBC

American Data Corp. an AIRPAX Company
CBS Labs
Conway Electronic Enterprises Limited
ELPA Marketing Industries, Inc.
OMNIX
Roh Corporation
Sadelco, Inc.
Telecommunications Industries Ltd.
Telemet Co.
Test & Measuring Instruments, Inc. a North American Philips Co.
TM Systems, Inc.

Test Slides, Video

Cramer Video and Audio Systems
D AND S CORLEY LIMITED
Marconi Electronics Inc.

RCA Corporation RCA Broadcast Equip., Comm. Sys. Div.
Telecommunications Industries Ltd.
Tele Measurements Inc.
Television Equipment Associates
Teltron, Inc.
Video Engineering Co. Inc.

Test Tapes, Audio

See Adv. Page

Sparta Electronic Corp. 8

Nortronics Co., Inc. Recorder Care Div.
Sparta Electronic Corp.

Testers, Semiconductor

Acrodyne Industries
American Electronics Lab., Inc.
Conway Electronic Enterprises Limited
Datatron, Inc.
Delta Electronics Inc. (N.C.)
Delta Electronics Inc. (Va.)
Eico Elect. Inst. Co., Inc.
Heath Co.
Hickok Elect. Instrument
Jud Williams Company
Leader Instruments Corp.
Lectronic Res. Labs. Inc.
Lectrotech Inc.
PRD Electronics, Inc.
Ramko Research
RCA Corporation RCA Broadcast Equip., Comm. Sys. Div.
RCA Corporation RCA Electronic Components
Rohde & Schwarz Sales Co.
Sencore Inc.
SPI-ITT Instruments Matrix Division
Tektronix Inc.
Terminal Hudson Corp. Terminal Hudson Electronics
Test & Measuring Instruments, Inc. a North American Philips Co.
Testline Instruments Div. Roger Boatman & Associates, Inc.
Triplett Corporation
Troy Electronic Sales Co.

Testers, Vacuum Tube

Conway Electronic Enterprises Limited
Eico Elect. Inst. Co., Inc.
Heath Co.
Hickok Elect. Instrument
Leader Instruments Corp.
Lectronic Res. Labs. Inc.
Lectrotech Inc.
RCA Corporation RCA Broadcast Equip., Comm. Sys. Div.
Sencore Inc.
Singer Products Co., Inc.
SPI-ITT Instruments Matrix Division
Terminal Hudson Corp. Terminal Hudson Electronics
Triplett Corporation

Textbooks, Communications

See Adv. Page

Jones Int'l. Ltd.138
Howard W. Sams & Co., Inc.119

Jones Int'l. Ltd.
Howard W. Sams & Co., Inc.

Time Announcers

See Adv. Page

Gates 10
Sparta Electronic Corp. 8

Ampro Corp.
ES Enterprises
Gates Division of Harris-Intertype
Mastertone Company
Schafer Electronics Corp.
Sparta Electronic Corp.
Stancil-Hoffman Corp.
Systems Marketing Corp. And Sono-Mag Corp.

Time Base Corrector, Helical Scan and Quad

See Adv. Page

Television Microtime, Inc. 41

Ampex Corp. Audio-Video Systems Division
Consolidated Video Systems
Cramer Video and Audio Systems
Television Microtime, Inc. Subs. Andersen Laboratories, Inc.

Timers, Program

See Adv. Page

American Data Corp.131
Danscoll Ltd.116
ES Enterprises43

American Data Corp. an AIRPAX Company
Ampro Corp.
Cooke Engineering Co.
Danscoll Ltd.
ES Enterprises
Standard Electric Time Div. of Johnson Service Co.
Tapecaster TCM, Inc.
Test & Measuring Instruments, Inc. a North American Philips Co.
Time & Frequency Tech., Inc.
Video Devices Co.

Tool Kits

See Adv. Page

Jensen Tools & Alloys137
Xcelite133

Anixter-Pruzan CATV Division
Automation Products Co. (International Industries, Inc.)
Channellock, Inc.
Greenlee Tool Co.
Heath Co.
Jensen Tools & Alloys
Systems Marketing Corp. And Sono-Mag Corp.
Terminal Hudson Corp. Terminal Hudson Electronics
Upton Tools Inc.
Vaco Products Co.
Western Electronic Prods. Co.
Xcelite

Tower Beacon Light Flashers

See Adv. Page

Hughey & Phillips Inc. 128C

Broadcast Tower Service
Collins Radio Company Broadcast Division
Electronic Lights Inc.
Hughey & Phillips Inc.
Jampro Antenna Co. Div. of Computer Equipment Corp.
Mastertone Company
Radio Mfg. Co. (RMC)
Rohn Manufacturing Div. of Unarco Industries Inc.
Utility Tower Co.

Tower Light Indicator Panels

See Adv. Page

Hughey & Phillips Inc. 128C
Moseley Assoc. Inc. 7

CCA Electronics Corp.
Collins Radio Company Broadcast Division
Hughey & Phillips Inc.
Mastertone Company
Moseley Assoc. Inc.

Tower Lighting Isolation Transformers

See Adv. Page

Hughey & Phillips Inc. 128C

Austin Insulator Div. Decca Radar Canada (1967) Ltd.
Collins Radio Company Broadcast Division
Hughey & Phillips Inc.
Mastertone Company
North American Radio Corp.

Tower Lights, High Intensity Obstruction

See Adv. Page

Dielectric Communications 56

Dielectric Communications Div. of Sola Basic

Towers, Antenna

See Adv. Page

Sparta Electronic Corp. 8
Stainless, Incorporated 46

Advance Industries
Allied Tower Company, Inc.
Andrews Tower Inc.
Antenna Products Company
Broadcast Tower Service
Collins Radio Company Broadcast Division
Dyma Engineering, Inc.
E Z Way Prod. Inc.
Fort Worth Tower Co., Inc.
Gates Division of Harris-Intertype
G.C. Electronics
Gulf Telephone & Electronics
Jampro Antenna Co. Div. of Computer Equipment Corp.
Kline Iron & Steel Co. Tower Division
Magnatech Company
Mastertone Company
Microflect Co. Inc.
RCA Corporation RCA Broadcast Equip., Comm. Sys. Div.
RF Systems, Inc.
Rohn Manufacturing Div. of Unarco Industries Inc.
Sparta Electronic Corp.
Stainless, Incorporated
Swager Tower Corp.
Tri-Ex Tower Corp.
Up Right Scaffolds
Utility Tower Co.

Towers, Antenna Receiving

Allied Tower Company, Inc.
Ameco Inc.
Andrews Tower Inc.
Anixter-Pruzan CATV Division
Antenna Products Company
Broadcast Tower Service
E Z Way Prod. Inc.
Gulf Telephone & Electronics
Microflect Co. Inc.
RF Systems, Inc.
Rohn Manufacturing Div. of Unarco Industries Inc.
Singer Products Co., Inc.
Stainless, Incorporated
Swager Tower Corp.
TV Cable Supply Co., Inc.
Up Right Scaffolds
Utility Tower Co.

Towers, Antenna Transmitting AM

See Adv. Page

Gates 10

Advance Industries
Allied Tower Company, Inc.
Alto Communications Inc. Broadcast Marketing Div.
Andrews Tower Inc.
Antenna Products Company

Broadcast Tower Service
CCA Electronics Corp.
Collins Radio Company Broadcast
Division
E Z Way Prod. Inc.
Fort Worth Tower Co., Inc.
Gates Division of Harris-Intertype
Jampro Antenna Co. Div. of Computer
Equipment Corp.
Kline Iron & Steel Co. Tower Division
Mastertone Company
Microflect Co. Inc.
RCA Corporation RCA Broadcast
Equip., Comm. Sys. Div.
Rohn Manufacturing Div. of Unarco
Industries Inc.
Siemens Corporation
Singer Products Co., Inc.
Sparta Electronic Corp.
Stainless, Incorporated
Swager Tower Corp.
Tri-Ex Tower Corp.
Up Right Scaffolds
Utility Tower Co.
Wilkinson Electronics, Inc.

Towers, Antenna Transmitting FM

See Adv. Page
Gates 10

Advance Industries
Allied Tower Company, Inc.
Alto Communications Inc. Broadcast
Marketing Div.
Andrews Tower Inc.
Antenna Products Company
Broadcast Tower Service
CCA Electronics Corp.
Collins Radio Company Broadcast
Division
E Z Way Prod. Inc.
Fort Worth Tower Co., Inc.
Gates Division of Harris-Intertype
Jampro Antenna Co. Div. of Computer
Equipment Corp.
Kline Iron & Steel Co. Tower Division
Magnatech Company
Mastertone Company
Microflect Co. Inc.
RCA Corporation RCA Broadcast
Equip., Comm. Sys. Div.
Rohn Manufacturing Div. of Unarco
Industries Inc.
Shively Laboratories, Inc.
Siemens Corporation
Singer Products Co., Inc.
Sparta Electronic Corp.
Stainless, Incorporated
Swager Tower Corp.
Up Right Scaffolds
Utility Tower Co.
Wilkinson Electronics, Inc.

Towers, Antenna Transmitting TV

See Adv. Page
Gates 10
Stainless, Incorporated 46

Advance Industries
Allied Tower Company, Inc.
Andrews Tower Inc.
Antenna Products Company
E Z Way Prod. Inc.
Fort Worth Tower Co., Inc.
Gates Division of Harris-Intertype
Jampro Antenna Co. Div. of Computer
Equipment Corp.
Kline Iron & Steel Co. Tower Division
Microflect Co. Inc.
RCA Corporation RCA Broadcast
Equip., Comm. Sys. Div.
Rohn Manufacturing Div. of Unarco
Industries Inc.
Shively Laboratories, Inc.
Siemens Corporation
Singer Products Co., Inc.
Sparta Electronic Corp.
Stainless, Incorporated
Swager Tower Corp.
Tri-Ex Tower Corp.
Up Right Scaffolds
Utility Tower Co.

Transformers, Audio

See Adv. Page
Sescom, Inc. 128

Sescom, Inc.

Translator Systems, High Power

See Adv. Page
**Television Technology
Corp.** 128C

Acrodyne Industries
CCA Electronics Corp.
D. N. Latus & Co., Inc.
EMCEE Broadcast Products Div. of
Electronics, Missiles &
Communications, Inc.
Jampro Antenna Co. Div. of Computer
Equipment Corp.
TeleMation, Inc.
Television Technology Corp.

Translator Systems, Low Power

See Adv. Page
Gates 10
**Television Technology
Corp.** 128C

Acrodyne Industries
CCA Electronics Corp.
Delta-Benco-Cascade Ltd.
D. N. Latus & Co., Inc.
EMCEE Broadcast Products Div. of
Electronics, Missiles &
Communications, Inc.
Gates Division of Harris-Intertype
Ikegami Tsushinki Co., Ltd. Export
Department
Jampro Antenna Co. Div. of Computer
Equipment Corp.
Marconi Electronics Inc.
RCA Corporation RCA Broadcast
Equip., Comm. Sys. Div.
RF Systems, Inc.
RHA Audio Communications Corp.
Rodelco Corp.
Rohde & Schwarz Sales Co.
Singer Products Co., Inc.
TeleMation, Inc.
Television Technology Corp.

Transmission Lines

See Adv. Page
Gates 10

Alto Communications Inc. Broadcast
Marketing Div.
Ameco Inc.
Andrew Corp.
Belden Corp. Electronic Division
Cablewave Systems Inc. Subs. Phelps
Dodge and Kabelmetal
CCA Electronics Corp.
Collins Radio Company Broadcast
Division
Columbia Electronic Cbl.
Comark Industries Inc.
Dyma Engineering, Inc.
Gates Division of Harris-Intertype
Jampro Antenna Co. Div. of Computer
Equipment Corp.
Lectronic Res. Labs. Inc.
Magnatech Company
Mastertone Company
Micro Communications, Inc.
Phelps Dodge Communications Co.
Div. Phelps Dodge Industries Inc.
Radio Mfg. Co. (RMC)
RCA Corporation RCA Broadcast
Equip., Comm. Sys. Div.
Shively Laboratories, Inc.
Siemens Corporation
Singer Products Co., Inc.
Soll, Inc., Joseph M.
Sparta Electronic Corp.
Wilkinson Electronics, Inc.

Transmission Sets

Atlantic Research Corp. Teleproducts
Dept.
Cablewave Systems Inc. Subs. Phelps
Dodge and Kabelmetal
GTE Lenkurt Incorporated
Lectronic Res. Labs. Inc.
RCA Corporation RCA Broadcast
Equip., Comm. Sys. Div.
United Recording Electronics
Industries
UREI a URC Company

Transmitter Kits

Gates Division of Harris-Intertype
Heath Co.
RCA Corporation RCA Broadcast
Equip., Comm. Sys. Div.

Transmitters, AM Carrier

See Adv. Page
**Ceco Communications
Inc.** 140

Arnold Barnes Company
Bristol Div. of Acco
CCA Electronics Corp.
Ceco Communications Inc.
Dyma Engineering, Inc.
GTE Lenkurt Incorporated
LPB Inc.
Mastertone Company
Radio Mfg. Co. (RMC)
RCA Corporation RCA Broadcast
Equip., Comm. Sys. Div.
Singer Products Co., Inc.
Sparta Electronic Corp.

Transmitters, AM Low Power

See Adv. Page
Gates 10
Sparta Electronic Corp. 8

Arnold Barnes Company
CCA Electronics Corp.
Collins Radio Company Broadcast
Division
Continental Electronics Mfg. Co.
Gates Division of Harris-Intertype
LPB Inc.
Mastertone Company
RCA Corporation RCA Broadcast
Equip., Comm. Sys. Div.
RHA Audio Communications Corp.
Singer Products Co., Inc.
Sparta Electronic Corp.

Transmitters, AM 250 Watt

See Adv. Page
Collins Radio Company 19
Gates 10
**Wilkinson Electronics,
Inc.** 58

American Electronics Lab., Inc.
A&R Transmitters
Arnold Barnes Company
CCA Electronics Corp.
Collins Radio Company Broadcast
Division
Gates Division of Harris-Intertype
Mastertone Company
Radio Mfg. Co. (RMC)
RCA Corporation RCA Broadcast
Equip., Comm. Sys. Div.
Singer Products Co., Inc.
Sparta Electronic Corp.
Wilkinson Electronics, Inc.

Transmitters, AM 500 Watt

See Adv. Page
Gates 10

American Electronics Lab., Inc.
A&R Transmitters
Arnold Barnes Company
CCA Electronics Corp.

Collins Radio Company Broadcast
Division
Gates Division of Harris-Intertype
Mastertone Company
RCA Corporation RCA Broadcast
Equip., Comm. Sys. Div.
Singer Products Co., Inc.
Sparta Electronic Corp.
Wilkinson Electronics, Inc.

Transmitters, AM 1 kw

See Adv. Page
Gates 10
Sparta Electronic Corp. 8
**Wilkinson Electronics,
Inc.** 58

American Electronics Lab., Inc.
A&R Transmitters
Arnold Barnes Company
CCA Electronics Corp.
Collins Radio Company Broadcast
Division
Contel Mfg. Div. of Continental
Electronic Wholesale Corp.
Gates Division of Harris-Intertype
Marconi Electronics Inc.
Mastertone Company
RCA Corporation RCA Broadcast
Equip., Comm. Sys. Div.
Siemens Corporation
Singer Products Co., Inc.
Sparta Electronic Corp.
Wilkinson Electronics, Inc.

Transmitters, AM 3 kw

See Adv. Page
Sparta Electronic Corp. 8

Sparta Electronic Corp.

Transmitters, AM 5 kw

See Adv. Page
**Continental Electronics
Mfg. Co.** 64
Gates 10
Sparta Electronic Corp. 8
**Wilkinson Electronics,
Inc.** 58

American Electronics Lab., Inc.
A&R Transmitters
Arnold Barnes Company
CCA Electronics Corp.
Collins Radio Company Broadcast
Division
Contel Mfg. Div. of Continental
Electronic Wholesale Corp.
Continental Electronics Mfg. Co.
Gates Division of Harris-Intertype
Mastertone Company
RCA Corporation RCA Broadcast
Equip., Comm. Sys. Div.
Siemens Corporation
Singer Products Co., Inc.
Sparta Electronic Corp.
Wilkinson Electronics, Inc.

Transmitters, AM 10 kw

See Adv. Page
Collins Radio Company 19
**Continental Electronics
Mfg. Co.** 64
Gates 10
Sparta Electronic Corp. 8
**Wilkinson Electronics,
Inc.** 58

American Electronics Lab., Inc.
A&R Transmitters
Arnold Barnes Company
CCA Electronics Corp.
Collins Radio Company Broadcast
Division
Contel Mfg. Div. of Continental
Electronic Wholesale Corp.
Continental Electronics Mfg. Co.
Gates Division of Harris-Intertype
Marconi Electronics Inc.

Mastertone Company
 RCA Corporation RCA Broadcast
 Equip., Comm. Sys. Div.
 Siemens Corporation
 Singer Products Co., Inc.
 Sparta Electronic Corp.
 Wilkinson Electronics, Inc.

Transmitters, AM 15 kw

See Adv. Page

Sparta Electronic Corp. 8
 Sparta Electronic Corp.

Transmitters, AM 25 kw

See Adv. Page

Gates 10
 American Electronics Lab., Inc.
 Arnold Barnes Company
 CCA Electronics Corp.
 Contel Mfg. Div. of Continental
 Electronic Wholesale Corp.
 Continental Electronics Mfg. Co.
 Gates Division of Harris-Intertype
 RCA Corporation RCA Broadcast
 Equip., Comm. Sys. Div.
 Siemens Corporation
 Singer Products Co., Inc.
 Sparta Electronic Corp.

Transmitters, AM 50 kw

See Adv. Page

Gates 10
Wilkinson Electronics, Inc. 58
 American Electronics Lab., Inc.
 Arnold Barnes Company
 CCA Electronics Corp.
 Continental Electronics Mfg. Co.
 Gates Division of Harris-Intertype
 Hy-Power Electronics Co.
 Marconi Electronics Inc.
 Nasco Television Systems
 RCA Corporation RCA Broadcast
 Equip., Comm. Sys. Div.
 Siemens Corporation
 Singer Products Co., Inc.
 Visual Communication Products Oper.
 General Electric Co.
 Wilkinson Electronics, Inc.

Transmitters, AM over 50 kw

See Adv. Page

Gates 10
 American Electronics Lab., Inc.
 A&R Transmitters
 Arnold Barnes Company
 CCA Electronics Corp.
 Continental Electronics Mfg. Co.
 Gates Division of Harris-Intertype
 Hy-Power Electronics Co.
 Marconi Electronics Inc.
 RCA Corporation RCA Broadcast
 Equip., Comm. Sys. Div.
 Siemens Corporation

Transmitters, AM to order

See Adv. Page

Collins Radio Company 19
Gates 10
 American Electronics Lab., Inc.
 Arnold Barnes Company
 CCA Electronics Corp.
 Collins Radio Company Broadcast
 Division
 Continental Electronics Mfg. Co.
 Gates Division of Harris-Intertype
 Hy-Power Electronics Co.
 North American Radio Corp.
 RCA Corporation RCA Broadcast
 Equip., Comm. Sys. Div.
 Singer Products Co., Inc.
 Sparta Electronic Corp.
 Wilkinson Electronics, Inc.

Transmitters, FM

See Adv. Page

Ceco Communications Inc. 140
Collins Radio Company 19
Gates 10
Sparta Electronic Corp. 8

American Electronics Lab., Inc.
 Arnold Barnes Company
 Bristol Div. of Acco
 CCA Electronics Corp.
 Ceco Communications Inc.
 Collins Radio Company Broadcast
 Division
 Dyma Engineering, Inc.
 Fung Engineering Co.
 Gates Division of Harris-Intertype
 GTE Lenkurt Incorporated
 Marconi Electronics Inc.
 Mastertone Company
 Miles Reproducer Co.
 North American Radio Corp.
 RCA Corporation RCA Broadcast
 Equip., Comm. Sys. Div.
 RCA Corporation RCA Electromagnetic
 & Aviation Systems Div.
 Singer Products Co., Inc.
 Soll, Inc., Joseph M.
 Sparta Electronic Corp.
 Wilkinson Electronics, Inc.

Transmitters, FM 10 Watt

See Adv. Page

Sparta Electronic Corp. 8
Wilkinson Electronics, Inc. 58
 American Electronics Lab., Inc.
 A&R Transmitters
 Arnold Barnes Company
 CCA Electronics Corp.
 Collins Radio Company Broadcast
 Division
 Gates Division of Harris-Intertype
 GTE Lenkurt Incorporated
 Magnatech Company
 Marti Electronics
 Mastertone Company
 McMartin Industries
 RCA Corporation RCA Broadcast
 Equip., Comm. Sys. Div.
 Rohde & Schwarz Sales Co.
 Singer Products Co., Inc.
 Sparta Electronic Corp.
 Wilkinson Electronics, Inc.

Transmitters, FM 50 Watt

See Adv. Page

Wilkinson Electronics, Inc. 58
 A&R Transmitters
 Arnold Barnes Company
 CCA Electronics Corp.
 Gates Division of Harris-Intertype
 Mastertone Company
 RCA Corporation RCA Broadcast
 Equip., Comm. Sys. Div.
 Rohde & Schwarz Sales Co.
 Singer Products Co., Inc.
 Wilkinson Electronics, Inc.

Transmitters, FM 100 Watt

A&R Transmitters
 Arnold Barnes Company
 CCA Electronics Corp.
 Gates Division of Harris-Intertype
 Marti Electronics
 Mastertone Company
 RCA Corporation RCA Broadcast
 Equip., Comm. Sys. Div.
 Singer Products Co., Inc.
 Wilkinson Electronics, Inc.

Transmitters, FM 250 Watt

See Adv. Page

Sparta Electronic Corp. 8

Wilkinson Electronics, Inc. 58

A&R Transmitters
 Arnold Barnes Company
 CCA Electronics Corp.
 Gates Division of Harris-Intertype
 Mastertone Company
 North American Radio Corp.
 Siemens Corporation
 Sparta Electronic Corp.
 Wilkinson Electronics, Inc.

Transmitters, FM 500 Watt

A&R Transmitters
 Arnold Barnes Company
 CCA Electronics Corp.
 Gates Division of Harris-Intertype
 Mastertone Company
 RCA Corporation RCA Broadcast
 Equip., Comm. Sys. Div.
 Singer Products Co., Inc.
 Sparta Electronic Corp.
 Wilkinson Electronics, Inc.

Transmitters, FM 1 kw

See Adv. Page

Gates 10
Sparta Electronic Corp. 8
Wilkinson Electronics, Inc. 58

American Electronics Lab., Inc.
 A&R Transmitters
 Arnold Barnes Company
 CCA Electronics Corp.
 Collins Radio Company Broadcast
 Division
 Fung Engineering Co.
 Gates Division of Harris-Intertype
 Marconi Electronics Inc.
 Mastertone Company
 North American Radio Corp.
 RCA Corporation RCA Broadcast
 Equip., Comm. Sys. Div.
 Siemens Corporation
 Singer Products Co., Inc.
 Sparta Electronic Corp.
 Wilkinson Electronics, Inc.

Transmitters, FM 2.5 kw

See Adv. Page

Gates 10
Wilkinson Electronics, Inc. 58

American Electronics Lab., Inc.
 Arnold Barnes Company
 Collins Radio Company Broadcast
 Division
 Gates Division of Harris-Intertype
 Mastertone Company
 North American Radio Corp.
 Sparta Electronic Corp.
 Wilkinson Electronics, Inc.

Transmitters, FM 3 kw

See Adv. Page

Gates 10
 American Electronics Lab., Inc.
 A&R Transmitters
 Arnold Barnes Company
 CCA Electronics Corp.
 Gates Division of Harris-Intertype
 Magnatech Company
 Mastertone Company
 RCA Corporation RCA Broadcast
 Equip., Comm. Sys. Div.
 Singer Products Co., Inc.
 Sparta Electronic Corp.

Transmitters, FM 5 kw

See Adv. Page

Gates 10
Wilkinson Electronics, Inc. 58

American Electronics Lab., Inc.
 A&R Transmitters
 Arnold Barnes Company
 CCA Electronics Corp.
 Collins Radio Company Broadcast
 Division
 Gates Division of Harris-Intertype
 Marconi Electronics Inc.
 Mastertone Company
 RCA Corporation RCA Broadcast
 Equip., Comm. Sys. Div.
 Singer Products Co., Inc.
 Sparta Electronic Corp.
 Wilkinson Electronics, Inc.

Transmitters, FM 7.5 kw

See Adv. Page

Gates 10
Wilkinson Electronics, Inc. 58

American Electronics Lab., Inc.
 A&R Transmitters
 Arnold Barnes Company
 CCA Electronics Corp.
 Gates Division of Harris-Intertype
 Mastertone Company
 Singer Products Co., Inc.
 Sparta Electronic Corp.
 Wilkinson Electronics, Inc.

Transmitters, FM 10 kw

See Adv. Page

Collins Radio Company 19
Gates 10
Wilkinson Electronics, Inc. 58

American Electronics Lab., Inc.
 A&R Transmitters
 Arnold Barnes Company
 CCA Electronics Corp.
 Collins Radio Company Broadcast
 Division
 Gates Division of Harris-Intertype
 Magnatech Company
 Marconi Electronics Inc.
 Mastertone Company
 RCA Corporation RCA Broadcast
 Equip., Comm. Sys. Div.
 Siemens Corporation
 Singer Products Co., Inc.
 Sparta Electronic Corp.
 Wilkinson Electronics, Inc.

Transmitters, FM 12 kw

See Adv. Page

Gates 10
 American Electronics Lab., Inc.
 A&R Transmitters
 Arnold Barnes Company
 CCA Electronics Corp.
 Gates Division of Harris-Intertype
 Sparta Electronic Corp.

Transmitters, FM 15 kw

See Adv. Page

Gates 10
 A&R Transmitters
 Arnold Barnes Company
 CCA Electronics Corp.
 Gates Division of Harris-Intertype
 RCA Corporation RCA Broadcast
 Equip., Comm. Sys. Div.
 Singer Products Co., Inc.
 Sparta Electronic Corp.
 Wilkinson Electronics, Inc.

Transmitters, FM 20 kw

See Adv. Page

Collins Radio Company 19
Gates 10
Wilkinson Electronics, Inc. 58

A&R Transmitters

Arnold Barnes Company
CCA Electronics Corp.
Collins Radio Company Broadcast
Division
Gates Division of Harris-Intertype
Magnatech Company
Mastertone Company
North American Radio Corp.
RCA Corporation RCA Broadcast
Equip., Comm. Sys. Div.
Singer Products Co., Inc.
Sparta Electronic Corp.
Wilkinson Electronics, Inc.

Transmitters, FM 25 kw

See Adv. Page

**American Electronics
Lab., Inc.** 15
Gates 10

American Electronics Lab., Inc.
A&R Transmitters
Arnold Barnes Company
CCA Electronics Corp.
Gates Division of Harris-Intertype
Wilkinson Electronics, Inc.

Transmitters, FM 40 kw

See Adv. Page

Collins Radio Company 19
Gates 10
**Wilkinson Electronics,
Inc.** 58

American Electronics Lab., Inc.
A&R Transmitters
Arnold Barnes Company
CCA Electronics Corp.
Collins Radio Company Broadcast
Division
Gates Division of Harris-Intertype
Mastertone Company
North American Radio Corp.
RCA Corporation RCA Broadcast
Equip., Comm. Sys. Div.
Singer Products Co., Inc.
Sparta Electronic Corp.
Wilkinson Electronics, Inc.

Transmitters, FM 50 kw

See Adv. Page

**American Electronics
Lab., Inc.** 15

American Electronics Lab., Inc.
A&R Transmitters
Arnold Barnes Company
CCA Electronics Corp.
Gates Division of Harris-Intertype
Singer Products Co., Inc.
Sparta Electronic Corp.
Wilkinson Electronics, Inc.

Transmitters, FM 100 kw

American Electronics Lab., Inc.
A&R Transmitters
Arnold Barnes Company
CCA Electronics Corp.
Gates Division of Harris-Intertype
Singer Products Co., Inc.

Transmitters, FM to order

See Adv. Page

Sparta Electronic Corp. 8

American Electronics Lab., Inc.
Arnold Barnes Company
CCA Electronics Corp.
Collins Radio Company Broadcast
Division
Gates Division of Harris-Intertype
North American Radio Corp.
RCA Corporation RCA Broadcast
Equip., Comm. Sys. Div.
Singer Products Co., Inc.
Sparta Electronic Corp.
Wilkinson Electronics, Inc.

Transmitters, TV

Acrodyne Industries
Arnold Barnes Company
CCA Electronics Corp.
CCA RF Industries, Inc.
Cramer Video and Audio Systems
DYNAIR Electronics, Inc.
Gates Division of Harris-Intertype
Ikegami Tsushinki Co., Ltd. Export
Department
Marconi Electronics Inc.
RCA Corporation RCA Broadcast
Equip., Comm. Sys. Div.
Soll, Inc., Joseph M.
Television Technology Corp.
Varian Solid State Div. Micro-Link
Products
Visual Communication Products Oper.
General Electric Co.

Transmitters, TV 1 Watt

Acrodyne Industries
Arnold Barnes Company
CCA Electronics Corp.
Cramer Video and Audio Systems
EMCEE Broadcast Products Div. of
Electronics, Missiles &
Communications, Inc.
Fung Engineering Co.
Gates Division of Harris-Intertype
GTE Lenkurt Incorporated
Orbit Radio and Video
RCA Corporation RCA Broadcast
Equip., Comm. Sys. Div.
Rohde & Schwarz Sales Co.
Television Technology Corp.
Varian Solid State Div. Micro-Link
Products

Transmitters, TV 10 Watt

Acrodyne Industries
Arnold Barnes Company
CCA Electronics Corp.
Cramer Video and Audio Systems
Delta-Benco-Cascade Ltd.
EMCEE Broadcast Products Div. of
Electronics, Missiles &
Communications, Inc.
Gates Division of Harris-Intertype
GTE Lenkurt Incorporated
RCA Corporation RCA Broadcast
Equip., Comm. Sys. Div.
Rodelco Corp.
Television Technology Corp.
Varian Solid State Div. Micro-Link
Products

Transmitters, TV 20 Watt

Acrodyne Industries
Arnold Barnes Company
CCA Electronics Corp.
Cramer Video and Audio Systems
EMCEE Broadcast Products Div. of
Electronics, Missiles &
Communications, Inc.
Gates Division of Harris-Intertype
RCA Corporation RCA Broadcast
Equip., Comm. Sys. Div.
Rodelco Corp.
Television Technology Corp.

Transmitters, TV 60 Watt

Acrodyne Industries
Arnold Barnes Company
CCA Electronics Corp.
Cramer Video and Audio Systems
EMCEE Broadcast Products Div. of
Electronics, Missiles &
Communications, Inc.
Gates Division of Harris-Intertype
RCA Corporation RCA Broadcast
Equip., Comm. Sys. Div.
Rodelco Corp.

Transmitters, TV 100 Watt

See Adv. Page

Gates 10

Acrodyne Industries
Arnold Barnes Company

CCA Electronics Corp.
Cramer Video and Audio Systems
Delta-Benco-Cascade Ltd.
EMCEE Broadcast Products Div. of
Electronics, Missiles &
Communications, Inc.
Gates Division of Harris-Intertype
RCA Corporation RCA Broadcast
Equip., Comm. Sys. Div.
Rodelco Corp.
Television Technology Corp.

Transmitters, TV 500 Watt

See Adv. Page

Gates 10

Acrodyne Industries
Arnold Barnes Company
CCA Electronics Corp.
EMCEE Broadcast Products Div. of
Electronics, Missiles &
Communications, Inc.
Gates Division of Harris-Intertype
Marconi Electronics Inc.
RCA Corporation RCA Broadcast
Equip., Comm. Sys. Div.
Siemens Corporation

Transmitters, TV 1 kw

See Adv. Page

Gates 10

Acrodyne Industries
Arnold Barnes Company
CCA Electronics Corp.
EMCEE Broadcast Products Div. of
Electronics, Missiles &
Communications, Inc.
Gates Division of Harris-Intertype
Marconi Electronics Inc.
RCA Corporation RCA Broadcast
Equip., Comm. Sys. Div.
Visual Communication Products Oper.
General Electric Co.

Transmitters, TV 2 kw

See Adv. Page

Gates 10

Arnold Barnes Company
CCA Electronics Corp.
Gates Division of Harris-Intertype
RCA Corporation RCA Broadcast
Equip., Comm. Sys. Div.

Transmitters, TV 5 kw

See Adv. Page

Gates 10

Arnold Barnes Company
CCA Electronics Corp.
Gates Division of Harris-Intertype
Marconi Electronics Inc.
RCA Corporation RCA Broadcast
Equip., Comm. Sys. Div.
Visual Communication Products Oper.
General Electric Co.

Transmitters, TV 6 kw

See Adv. Page

Gates 10

Arnold Barnes Company
CCA Electronics Corp.
Gates Division of Harris-Intertype
Philips Broadcast Equipment Corp.
Subs. North American Philips Corp.
RCA Corporation RCA Broadcast
Equip., Comm. Sys. Div.
Visual Communication Products Oper.
General Electric Co.

Transmitters, TV 10 kw

See Adv. Page

Gates 10

Arnold Barnes Company

CCA Electronics Corp.
CCA RF Industries, Inc.
Gates Division of Harris-Intertype
Marconi Electronics Inc.
Philips Broadcast Equipment Corp.
Subs. North American Philips Corp.
RCA Corporation RCA Broadcast
Equip., Comm. Sys. Div.
Siemens Corporation

Transmitters, TV 11 kw

See Adv. Page

Gates 10

Arnold Barnes Company
CCA Electronics Corp.
Gates Division of Harris-Intertype
Philips Broadcast Equipment Corp.
Subs. North American Philips Corp.
RCA Corporation RCA Broadcast
Equip., Comm. Sys. Div.
Visual Communication Products Oper.
General Electric Co.

Transmitters, TV 12 kw

See Adv. Page

Gates 10

Arnold Barnes Company
CCA Electronics Corp.
Gates Division of Harris-Intertype
Philips Broadcast Equipment Corp.
Subs. North American Philips Corp.
RCA Corporation RCA Broadcast
Equip., Comm. Sys. Div.

Transmitters, TV 15 kw

See Adv. Page

Gates 10

Arnold Barnes Company
CCA Electronics Corp.
CCA RF Industries, Inc.
Gates Division of Harris-Intertype
Marconi Electronics Inc.
Philips Broadcast Equipment Corp.
Subs. North American Philips Corp.
RCA Corporation RCA Broadcast
Equip., Comm. Sys. Div.
Visual Communication Products Oper.
General Electric Co.

Transmitters, TV 25 kw

See Adv. Page

Gates 10

Arnold Barnes Company
CCA Electronics Corp.
CCA RF Industries, Inc.
Gates Division of Harris-Intertype
Marconi Electronics Inc.
Philips Broadcast Equipment Corp.
Subs. North American Philips Corp.
RCA Corporation RCA Broadcast
Equip., Comm. Sys. Div.

Transmitters, TV 30 kw

See Adv. Page

Gates 10

Arnold Barnes Company
CCA Electronics Corp.
CCA RF Industries, Inc.
Gates Division of Harris-Intertype
Marconi Electronics Inc.
Philips Broadcast Equipment Corp.
Subs. North American Philips Corp.
RCA Corporation RCA Broadcast
Equip., Comm. Sys. Div.
Visual Communication Products Oper.
General Electric Co.

Transmitters, TV 35 kw

See Adv. Page

Gates 10

Arnold Barnes Company

CCA Electronics Corp.
Gates Division of Harris-Intertype
Marconi Electronics Inc.
RCA Corporation RCA Broadcast
Equip., Comm. Sys. Div.

Transmitters, TV 50 kw

See Adv. Page

Gates 10

Arnold Barnes Company
CCA Electronics Corp.
CCA RF Industries, Inc.
Gates Division of Harris-Intertype
Marconi Electronics Inc.
RCA Corporation RCA Broadcast
Equip., Comm. Sys. Div.

Transmitters, TV 55 kw

See Adv. Page

Gates 10

Arnold Barnes Company
CCA Electronics Corp.
CCA RF Industries, Inc.
Gates Division of Harris-Intertype
Marconi Electronics Inc.
Philips Broadcast Equipment Corp.
Subs. North American Philips Corp.
RCA Corporation RCA Broadcast
Equip., Comm. Sys. Div.
Visual Communication Products Oper.
General Electric Co.

Transmitters, TV 100 kw

See Adv. Page

Gates 10

Arnold Barnes Company
CCA Electronics Corp.
CCA RF Industries, Inc.
Gates Division of Harris-Intertype
Marconi Electronics Inc.
Visual Communication Products Oper.
General Electric Co.

Transmitters, TV Specify Power

See Adv. Page

Gates 10

CCA Electronics Corp.
Gates Division of Harris-Intertype
RCA Corporation RCA Broadcast
Equip., Comm. Sys. Div.
Visual Communication Products Oper.
General Electric Co.

Transmitters, TV to order

See Adv. Page

Gates 10

Acrodyne Industries
CCA Electronics Corp.
Gates Division of Harris-Intertype
Miles Reproducer Co.
RCA Corporation RCA Broadcast
Equip., Comm. Sys. Div.
Television Technology Corp.

Turnkey Equipment Installation Services

See Adv. Page

Audio Devices, Inc. 45
Audio Services, Inc. 32

Audio Devices, Inc.
Audio Services, Inc

Turntables, Phonograph

See Adv. Page

Broadcast Electronics 34
Gates 10
Gotham Audio Corp. 9
Micro-Trak Corporation 128B

Russco Electronics Mfg. Inc. 128
Sparta Electronic Corp. 8

AKG Division North Amer. Philips Corp.
Audio Distributor Inc.
Broadcast Electronics
Broadcast Products Inc.
CCA Electronics Corp.
Collins Radio Company Broadcast Division
Dyma Engineering, Inc.
Franz Vertriebs-gesellschaft m.b.H.
Gates Division of Harris-Intertype
Gotham Audio Corp.
Heath Co.
Lauderdale Electronic Labs LPB Inc.
Mastertone Company
McCurdy Radio Ind. Inc.
Micro-Trak Corporation (Formerly: Gray Research & Dev.)
QRK Electronic Prod.
Ramko Research
RCA Corporation RCA Broadcast Equip., Comm. Sys. Div.
Rek-O-Kut Inc.
Russco Electronics Mfg. Inc.
Sansui Electronics Corp.
Schultz Inc., Albert
Singer Products Co., Inc.
Sparta Electronic Corp.
Spotmaster Broadcast Electronics
Superscope, Inc.
Systems Engineering Co., Inc.
Video Engineering Co. Inc.
Wilkinson Electronics, Inc.

TV Systems, Closed Circuit

Admiral Corporation
AEL Communications Corp., Subs. American Electronic Labs., Inc.
Alcor Inc.
Ameco Inc.
American Data Corp. an AIRPAX Company
Ampex Corp. Audio-Video Systems Division
Anaconda Electronics
Anixter-Pruzan CATV Division
Applied Video Electronics, Inc.
A-Tel-A-Matic
ATV Research
Audiotronics Corp.
AVA Electronics Corp.
Ball Bros. Research Corp. Miratel Division
Arnold Barnes Company
Berkey-Colortran Inc.
Boston Insulated Wire & Cable Co.
Catel, a Div. of United Scientific Corp.
CHESTER ELECTRONIC LABS., INC.
GTE Information Systems Inc.
Cohu, Inc. Electronics Division
Colorado Video Inc.
Comquip, Inc.
Cramer Video and Audio Systems
Cunningham Corp. Subs. of Gleason Works
Danscoll Ltd.
Davis & Sanford Co. Inc.
Delta Electronics Inc. (N.C.)
Denson Electronic Corp.
DYNAIR Electronics, Inc.
F&B/Ceco Industries, Inc.
Gates Division of Harris-Intertype
GBC Closed Circuit TV Corp.
General Electric Company Tubes/MW Devices
Gen. Electrodynamics
General Television Ntwk.
Gulf Telephone & Electronics
Hitachi Shibaden Corp. of America
Ikegami Tsushinki Co., Ltd. Export Department
Internatl. Nuclear Corp.
International Video Corp.
Janson Industries
Javelin Div. of Apollo Lasers
K'SON Corporation
Lerro Electrical Corp.
Listec TV Equip. Corp.
Marconi Electronics Inc.
Mosler Electronic Systems Div.
Nasco Television Systems
Orbit Radio and Video

Panasonic Video Systems Div.
Matsushita Electric Corp. of America
Philips Broadcast Equipment Corp.
Subs. North American Philips Corp.
Precision Electrical Mfg. Div. Circuit Science Inc.
RCA Corporation RCA Broadcast Equip., Comm. Sys. Div.
RCA Corporation RCA Electromagnetic & Aviation Systems Div.
Riker Communications Inc.
Robert Bosch Corp. Fernseh Div.
Sarkes Tarzian Inc. Broadcast Equipment Div.
Singer Co. Simulation Products Div.
Soll, Inc., Joseph M.
Sylvania Comm. Electronic
Tasker Systems Div. of Whittaker Corp.
Tele-Cine Inc.
Teledyne Brown Engineering Co. Science & Engrg. Div.
TeleMation, Inc.
Tele Measurements Inc.
Telesync Corp.
Teltron, Inc.
TV Cable Supply Co., Inc.
Varian Solid State Div. Micro-Link Products
Vicon Industries, Inc.
Video Engineering Co. Inc.
Vikoa Inc.
Visual Communication Products Oper. General Electric Co.
Visual Educom Inc. DAGE Television
Visual Educom Inc. MTI Television
Vitec Communications Ltd.
Westinghouse Electric Corp. Electric Tube Div.

Vacuum Tubes, Camera Image-Orthicon

See Adv. Page

Amperex Electronic Corp. 1
RCA Corporation 23
Teltron, Inc. 8

Amperex Corp.
Amperex Electronic Corp.
Electro-Optical Devices Div.
Arnold Barnes Company
Calvert Electronics Power Tube Div.
Ceco Communications Inc.
General Electric Co. Imaging Devices Operation
General Electric Company Tubes/MW Devices
Heintz and Kaufman Ltd.
Hitachi Shibaden Corp. of America
Hughes Aircraft Company Ind. Prod. Div.-Image Devices
RCA Corporation RCA Electronic Components
Robert Bosch Corp. Fernseh Div.
Tele Measurements Inc.
Teltron, Inc.
Terminal Hudson Corp. Terminal Hudson Electronics
Thor Electronics Corp.
Video Engineering Co. Inc.
Visual Communication Products Oper. General Electric Co.

Vacuum Tubes, Camera Isocon

See Adv. Page

Teltron, Inc. 8

Teltron, Inc.

Vacuum Tubes, Camera Plumbicon

See Adv. Page

Amperex Electronic Corp. 1
RCA Corporation 23

Amperex Corp.
Amperex Electronic Corp.
Electro-Optical Devices Div.

Amperex Electronic Corp.
Arnold Barnes Company
Calvert Electronics Power Tube Div.
Ceco Communications Inc.
Cramer Video and Audio Systems
Gates Division of Harris-Intertype
Hitachi Shibaden Corp. of America
Philips Broadcast Equipment Corp.
Subs. North American Philips Corp.
RCA Corporation RCA Electronic Components
Tele Measurements Inc.
Teltron, Inc.
Terminal Hudson Corp. Terminal Hudson Electronics
Thor Electronics Corp.
Video Engineering Co. Inc.
Westinghouse Electric Corp.

Vacuum Tubes, Camera Silicon Array

See Adv. Page

Amperex Electronic Corp. 1
RCA Corporation 23

Amperex Electronic Corp.
Electro-Optical Devices Div.
Amperex Electronic Corp.
Arnold Barnes Company
Calvert Electronics Power Tube Div.
Ceco Communications Inc.
Cramer Video and Audio Systems
General Electric Co. Imaging Devices Operation
General Electric Company Tubes/MW Devices
Hughes Aircraft Company Ind. Prod. Div.-Image Devices
RCA Corporation RCA Electronic Components
Teltron, Inc.
Thomson-CSF Electron Tubes

Vacuum Tubes, Camera Telicon

See Adv. Page

Teltron, Inc. 8

Teltron, Inc.

Vacuum Tubes, Camera Vidicon

See Adv. Page

Amperex Electronic Corp. 1
RCA Corporation 23
Teltron, Inc. 8

Amperex Corp.
Amperex Electronic Corp.
Electro-Optical Devices Div.
Amperex Electronic Corp.
A-Tel-A-Matic
ATV Research
Arnold Barnes Company
Calvert Electronics Power Tube Div.
Ceco Communications Inc.
Cramer Video and Audio Systems
Gates Division of Harris-Intertype
GBC Closed Circuit TV Corp.
General Electric Co. Imaging Devices Operation
General Electric Company Tubes/MW Devices
Gen. Electrodynamics
Heintz and Kaufman Ltd.
Hitachi Shibaden Corp. of America
Hughes Aircraft Company Ind. Prod. Div.-Image Devices
ITT Electro-Optical Products Div.
Javelin Div. of Apollo Lasers
Philips Broadcast Equipment Corp.
Subs. North American Philips Corp.
RCA Corporation RCA Electronic Components
Siemens Corporation
Teltron, Inc.
Terminal Hudson Corp. Terminal Hudson Electronics
Texas Instrument Components Group
Thomson-CSF Electron Tubes
Thor Electronics Corp.
Video Engineering Co. Inc.

Visual Communication Products Oper.
General Electric Co.
Westinghouse Electric Corp. Electric
Tube Div.

Vacuum Tubes, Cathode Ray Oscilloscope

Amperex Electronic Corp.
Electro-Optical Devices Div.
Amperex Electronic Corp.
Calvert Electronics Power Tube Div.
Ceco Communications Inc.
Heintz and Kaufman Ltd.
Hughes Aircraft Company Ind. Prod.
Div.-Image Devices
Lectronic Res. Labs. Inc.
RCA Corporation RCA Electronic
Components
Terminal Hudson Corp. Terminal
Hudson Electronics
Thomson-CSF Electron Tubes
Thor Electronics Corp.
Video Engineering Co. Inc.

Vacuum Tubes, Cathode Ray TV Color

Amperex Corp.
Ceco Communications Inc.
General Electric Company Tubes/MW
Devices
RCA Corporation RCA Electronic
Components
Terminal Hudson Corp. Terminal
Hudson Electronics
Thomson-CSF Electron Tubes
Thor Electronics Corp.
Video Engineering Co. Inc.
Westinghouse Electric Corp. Electric
Tube Div.

Vacuum Tubes, Cathode Ray TV Monochrome

Amperex Corp.
Amperex Electronic Corp.
Electro-Optical Devices Div.
Ceco Communications Inc.
General Electric Company Tubes/MW
Devices
Hitachi Shibaden Corp. of America
RCA Corporation RCA Electronic
Components
Terminal Hudson Corp. Terminal
Hudson Electronics
Thor Electronics Corp.
Video Engineering Co. Inc.
Westinghouse Electric Corp. Electric
Tube Div.

Vacuum Tubes, Rectifier

Amperex Electronic Corp.
Calvert Electronics Power Tube Div.
Ceco Communications Inc.
General Electric Company Tubes/MW
Devices
Heintz and Kaufman Ltd.
Lectronic Res. Labs. Inc.
RCA Corporation RCA Electronic
Components
Terminal Hudson Corp. Terminal
Hudson Electronics
Westinghouse Electric Corp. Electric
Tube Div.

Vacuum Tubes, Translator

Calvert Electronics Power Tube Div.
Ceco Communications Inc.
General Electric Company Tubes/MW
Devices
Heintz and Kaufman Ltd.
Thomson-CSF Electron Tubes

Vacuum Tubes, Transmitting

See Adv. Page

Eimac Div. 11

Amperex Corp.
Amperex Electronic Corp.
Calvert Electronics Power Tube Div.
Ceco Communications Inc.

Collins Radio Company Broadcast
Division
Eimac Div. Varian Associates
Gates Division of Harris-Intertype
General Electric Company Tubes/MW
Devices
Heintz and Kaufman Ltd.
ITT Electron Tube Div.
Joa Cartridge Service
Lectronic Res. Labs. Inc.
Machlett Laboratories Subs. of
Raytheon Co. Inc.
Raytheon Company Raytheon Data
Systems Co.
RCA Corporation RCA Electronic
Components
Singer Products Co., Inc.
Terminal Hudson Corp. Terminal
Hudson Electronics
Thomson-CSF Electron Tubes
Thor Electronics Corp.

Vacuum Tubes, Transmitting Rebuilt

See Adv. Page

Freeland Products Co. 134

Ceco Communications Inc.
Econco Broadcast Service Inc.
Freeland Products Co.
Heintz and Kaufman Ltd.
Terminal Hudson Corp. Terminal
Hudson Electronics
Westinghouse Electric Corp. Electric
Tube Div.

Vector Display, Color

Beston Electronics Inc.
Lectrotech Inc.
Tele-Cine Inc.

Viewfinder for Closed Circuit Cameras

Javelin Div. of Apollo Lasers
Precision Electrical Mfg. Div. Circuit
Science Inc.
Video Engineering Co. Inc.
Visual Educom Inc. DAGE Television

Voltmeters, AC

A-Tel-A-Matic
Boonton Electronics
Bristol Div. of Acco
California Instruments Co.
Conway Electronic Enterprises Limited
Dragnet Engineering Labs., Inc.
Dynascan Corp. B & K Division
Eico Elect. Inst. Co., Inc.
Fluke, John, Mfg. Co. Inc.
General Electric Company Tubes/MW
Devices
Heath Co.
Hewlett Packard Co.
Hickok Elect. Instrument
Instrument Laboratories
International Instrument Div. Sigma
Instruments, Inc.
ITT Jennings
Leader Instruments Corp.
Lectronic Res. Labs. Inc.
Minarik Elect.
RCA Corporation RCA Broadcast
Equip., Comm. Sys. Div.
RCA Corporation RCA Electronic
Components
Rohde & Schwarz Sales Co.
Simpson Electric Co.
SPI-ITT Instruments Metrix Division
Terminal Hudson Corp. Terminal
Hudson Electronics
Test & Measuring Instruments, Inc. a
North American Philips Co.
Triplett Corporation
Vu-Data Corporation

Voltmeters, DC

A-Tel-A-Matic
B & K Instruments Inc.
Boonton Electronics
Bristol Div. of Acco
California Instruments Co.

Conway Electronic Enterprises Limited
Dynascan Corp. B & K Division
Eico Elect. Inst. Co., Inc.
Fluke, John, Mfg. Co. Inc.
General Electric Company Tubes/MW
Devices
General Microwave Corp.
Heath Co.
Hewlett Packard Co.
Hickok Elect. Instrument
International Instrument Div. Sigma
Instruments, Inc.
ITT Jennings
Leader Instruments Corp.
Lectronic Res. Labs. Inc.
Minarik Elect.
RCA Corporation RCA Broadcast
Equip., Comm. Sys. Div.
RCA Corporation RCA Electronic
Components
Rohde & Schwarz Sales Co.
Simpson Electric Co.
SPI-ITT Instruments Metrix Division
Terminal Hudson Corp. Terminal
Hudson Electronics
Test & Measuring Instruments, Inc. a
North American Philips Co.
Triplett Corporation
Vu-Data Corporation

Voltmeters, FET

Conway Electronic Enterprises Limited
Dynascan Corp. B & K Division
Eico Elect. Inst. Co., Inc.
Heath Co.
Hickok Elect. Instrument
Leader Instruments Corp.
RCA Corporation RCA Broadcast
Equip., Comm. Sys. Div.
Sencore Inc.
Simpson Electric Co.
Terminal Hudson Corp. Terminal
Hudson Electronics
Test & Measuring Instruments, Inc. a
North American Philips Co.
Triplett Corporation

Voltmeters, Vacuum Tube

Anixter-Pruzan CATV Division
Boonton Electronics
Conway Electronic Enterprises Limited
Dynascan Corp. B & K Division
Edison Electronics, Div. of
McGraw-Edison Co., Daven &
Measurements
Eico Elect. Inst. Co., Inc.
Heath Co.
Hewlett Packard Co.
Instrument Laboratories
Leader Instruments Corp.
Lectronic Res. Labs. Inc.
RCA Corporation RCA Broadcast
Equip., Comm. Sys. Div.
RCA Corporation RCA Electronic
Components
Rohde & Schwarz Sales Co.
Simpson Electric Co.
SPI-ITT Instruments Metrix Division
Terminal Hudson Corp. Terminal
Hudson Electronics
Test & Measuring Instruments, Inc. a
North American Philips Co.
Triplett Corporation
United Recording Electronics
Industries

Wattmeters

Ailtech (Formerly: Microdot)
Bird Electronic Corp.
Boonton Electronics
Conway Electronic Enterprises Limited
Eico Elect. Inst. Co., Inc.
General Electric Company Tubes/MW
Devices
General Microwave Corp.
Instrument Laboratories
Lectronic Res. Labs. Inc.
Micro Communications, Inc.
RCA Corporation RCA Broadcast
Equip., Comm. Sys. Div.
Rohde & Schwarz Sales Co.
Simpson Electric Co.
Singer Products Co., Inc.

Terminal Hudson Corp. Terminal
Hudson Electronics
Triplett Corporation

Waveguides

See Adv. Page

Andrew Corp. 51

Andrew Corp.
Cablewave Systems Inc. Subs. Phelps
Dodge and Kabelmetal
CCA Electronics Corp.
Comark Industries Inc.
Dielectric Communications Div. of Sola
Basic
Lectronic Res. Labs. Inc.
Micro Communications, Inc.
Narda Microwave Corp., The
RCA Corporation RCA Broadcast
Equip., Comm. Sys. Div.
RF Systems, Inc.
Test & Measuring Instruments, Inc. a
North American Philips Co.

Weather Instruments

Gates Division of Harris-Intertype
Mastertone Company
R. H. Tyler Co. Div. of Weather Scan,
Inc.
Taylor Instrument Consumer Prod.
Div. Sybron Corp.
TeleMation, Inc.
Texas Electronics

Wiring and Cabling Services

AEL Communications Corp., Subs.
American Electronic Labs., Inc.
Alpha Wire
Ancha Electronics Inc.
Applied Electro Mechanics, Inc.
Applied Video Electronics, Inc.
A-Tel-A-Matic
Audio Accessories Inc.
AVA Electronics Corp.
Belden Corp. Electronic Division
Boston Insulated Wire & Cable Co.
Cablewave Systems Inc. Subs. Phelps
Dodge and Kabelmetal
Concept 70, A Div. of Dyma
Engineering, Inc.
Enterprise Electronics Corp.
International Wire & Cable Co.
K'SON Corporation
Lerro Electrical Corp.
Pace Wire & Cable Corp.
RCA Corporation RCA Broadcast
Equip., Comm. Sys. Div.
Rex Rheostat & Co., Inc.
Saxton Prod. Inc.
Soil, Inc., Joseph M.
Systems Marketing Corp. And
Sono-Mag Corp.
Tech Laboratories Inc.
Telatronics
Teledyne Brown Engineering Co.
Science & Engrg. Div.
Terminal Hudson Corp. Terminal
Hudson Electronics
Times Wire and Cable Sub. of Insilco
Corp.
TV Cable Supply Co., Inc.
Union Connector Co., Inc.
Waber Electronics Inc. Div. SGL
Industries, Inc.

Reader Service
Card In Sept.
Good For 1 Year

We invite you to compare **CMC** for *quality, service and price*

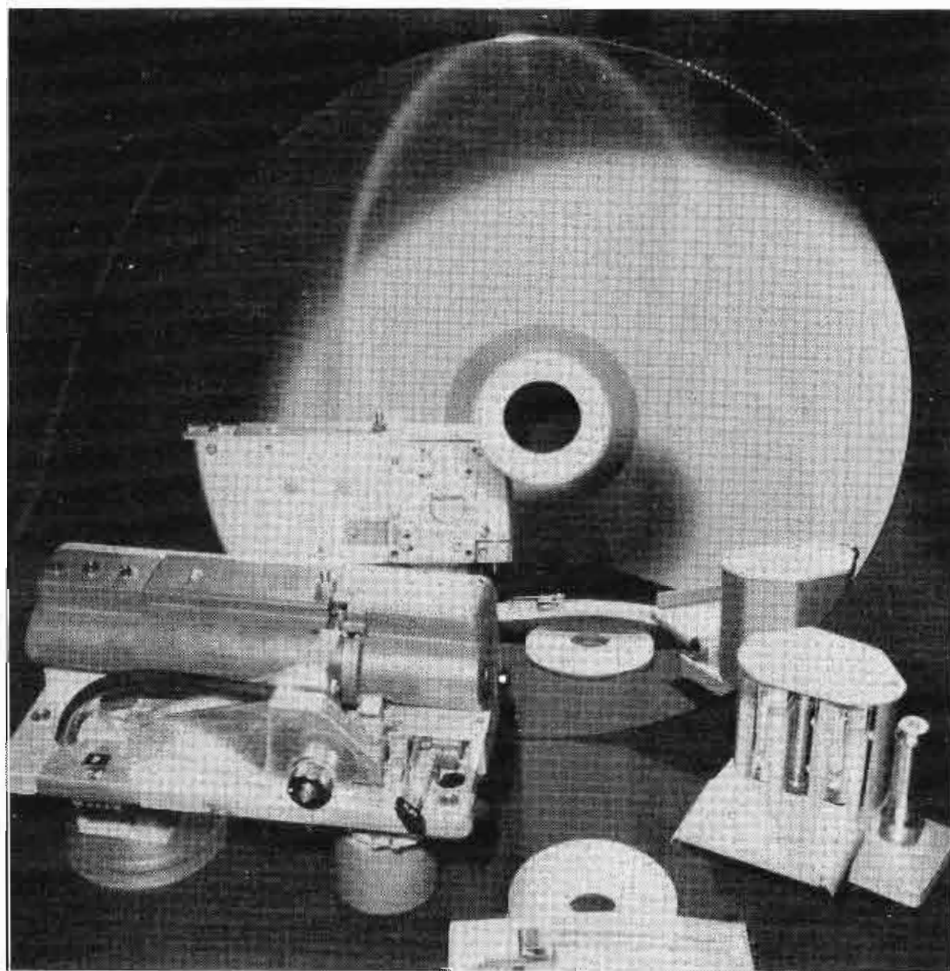

REFURBISHING

Mark X

video head assemblies

MAXIMUM

10 Day Turn-Around

REBUILDING

VTR

audio stacks

One Day Delivery

SUPPLYING

video discs and
heads for

Slo-Mo machines

24 Hour Delivery

Customer Satisfaction. That's the foundation for CMC's solid reputation in the broadcast industry. Our equipment and refurbishing services incorporate the highest standards of design and engineering excellence...for longer life, greater return on your investment. Prices? You can't do better anywhere. And delivery

service is unequalled in the industry.

By any standard—quality and service—we've got what it takes to give you the most for your money. Check the other suppliers. Discover what CMC has to offer. You will join the growing ranks of CMC satisfied customers.

Call or write today for complete specifications and price list.

Computer Magnetics Corp.

6060 SHULL STREET • BELL GARDENS, CALIFORNIA 90201
TELEPHONE (213) 927-3384

In Canada, contact:
Glentronix, Ltd.
160 Duncan Mill Road
Don Mills, Ontario
(416) 444-8497

UNMATCHED CAPABILITY

CHANNEL TWO TELEVISION COMPANY

KPRC TV

July 13, 1972

Mr. Morris T. Covington
Director of Research
Taft Communications Systems, Inc.
4808 San Felipe Road
Houston, Texas 77027

Dear Morris:

This long overdue letter will let you know how very pleased we are with the continuing good service from our Taft Audio Distribution Amplifiers.

As you know, I had six of these amplifiers on the test bench for six weeks and abused them in every way possible. I did not experience a single failure; in addition, they held their specifications in every way.

I had evaluated several "well-known" distribution amplifiers before I tested the Taft DA, and I knew then that this was the DA for us. It is right in every way: size, individual power supply, number of outputs and performance. After several months of hard and continuous service, I am still well pleased with all fifty two of them.

I will recommend your Model 5002 Audio Distribution Amplifier, and also your Model 4002 Monitor/Power Amplifier without a moment's hesitation.

Yours very truly,

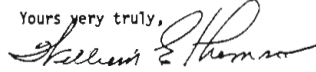

William E. Thomson
Audio Engineer



Note these unique features of the Taft Model 5002 Audio Distribution Amplifier:

- (1) 18 isolated 600 ohm outputs (80 db)
- (2) 20-20 KHZ ± 0.5 db, 0.5% total distortion (with "EQ" and "Rolloff" in flat position)
- (3) Equalization and Rolloff feature provided for signal conditioning before distribution
- (4) Input and outputs are balanced
- (5) 20 db gain (can be increased to 40 db)
- (6) Noise better than 80 db below 0 dbm signal
- (7) All integrated circuits for very efficient operation — units may be stacked without air spaces
- (8) Output level is continuously monitored
- (9) Two year parts and labor warranty

New Price: \$295.00 (includes input transformer — specify 150, 600 or 15K input impedance)

If you are interested in evaluating the 5002, call us collect or check the information card.

BETHANY INTERNATIONAL, INC.

5750 Bintliff, Suite 201
Houston, Texas 77036
Phone: (713) 783-1260

Formerly



COMMUNICATION SYSTEMS, INC.

For More Details Circle (55) on Reply Card

book review

Test Procedures

Basic Electronic Test Procedures is a step-by-step guide to all types of basic electronics measurements, using simple, inexpensive test instruments. The ability to make meaningful measurements and to put the resulting information to work is essential in any area of electronics. The job is much easier with an array of sophisticated instruments, but few have access to such expensive test equipment. However, the student or "pro" who really understands the reasoning behind each test doesn't need complex gear to accomplish his purpose. In fact, he can take useful readings with readily-available instruments.

In this new book, the mysteries usually associated with many electronics tests are unveiled. The author shows how to get accurate, meaningful measurements with ordinary VOMs, electronic meters, oscilloscopes, etc., by taking into consideration the errors inherent in most test instruments. The important thing is knowing —and understanding—the true nature of what is to be measured.

For example, it is surprising what can be done with the ohmmeter, allowing, of course for inaccuracies and

(Continued on page 108)

Portable Cable Reel

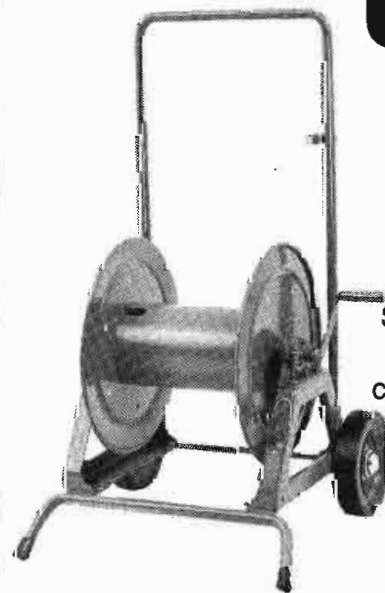

Handle up to 600 feet of $\frac{1}{2}$ " O.D. cable on this low-cost reel on wheels. Solid steel construction for years of service. Easy crank rewinding. Adjustable drag and brake control. Steel disc wheels with rubber tires.

Send for complete catalog of standard and custom-built reels to handle cable for broadcast equipment.



HANNAY REELS

CLIFFORD B. HANNAY & SON, INC., WESTERLO, NEW YORK 12193

For More Details Circle (56) on Reply Card

The state of the art in film sound just took a giant step forward. In Speed, Flexibility, Safety, and Ease of Operation. For sound transfers, looping, re-recording, double-system screening and telecine interlock.

Magna-Tech's new 600 Series is the reason. This versatile new system features electronic interlock, foolproof IC logic and improved mechanical and electrical design. Incorporating traditional Magna-Tech reliability and durability, the MTE 600 Series provides expanded capabilities and superior performance in any application from the most compact studio to the largest mixing complex.

Among its many features are:

- stepping motor sprocket drive
 - optical/electronic high-speed interlock system
 - local or remote advance/retard of individual films in interlock
 - operates at 6-times-sync speed through sprocket in interlock with Magna-Tech high-speed intermittent projector, via optical encoder
 - operates 10-times-sync speed in interlock with video tape recorder
 - operates local at sync and 10-times-speed through the sprocket
 - 115/220 volt—50 or 60 Hz operation
-
- flywheel accelerators for rapid start
 - film retracted from heads in all modes except sync speed forward
 - servo-controlled film take-up tension provides gentle handling of spliced tracks
 - automatic safety shutdown
-
- compatible with conventional interlock systems
 - multiple machine operation—as many as desired—in interlock via distribution amplifier
 - 6-buss interlock selector switch for studio delegation
 - can be cued on and off buss while running in interlock
-
- pushbutton-selected 16 or 35 speed and 24 or 25 frame rate, forward or reverse
 - local inching forward or reverse
 - plug-in head assemblies for play-only or erase/record/ play, interchangeable for 16, 35, 17½ and multi-tracks
 - multi-track pick-up recording with selective erase
 - 3000-foot (1000-meter) reel capacity

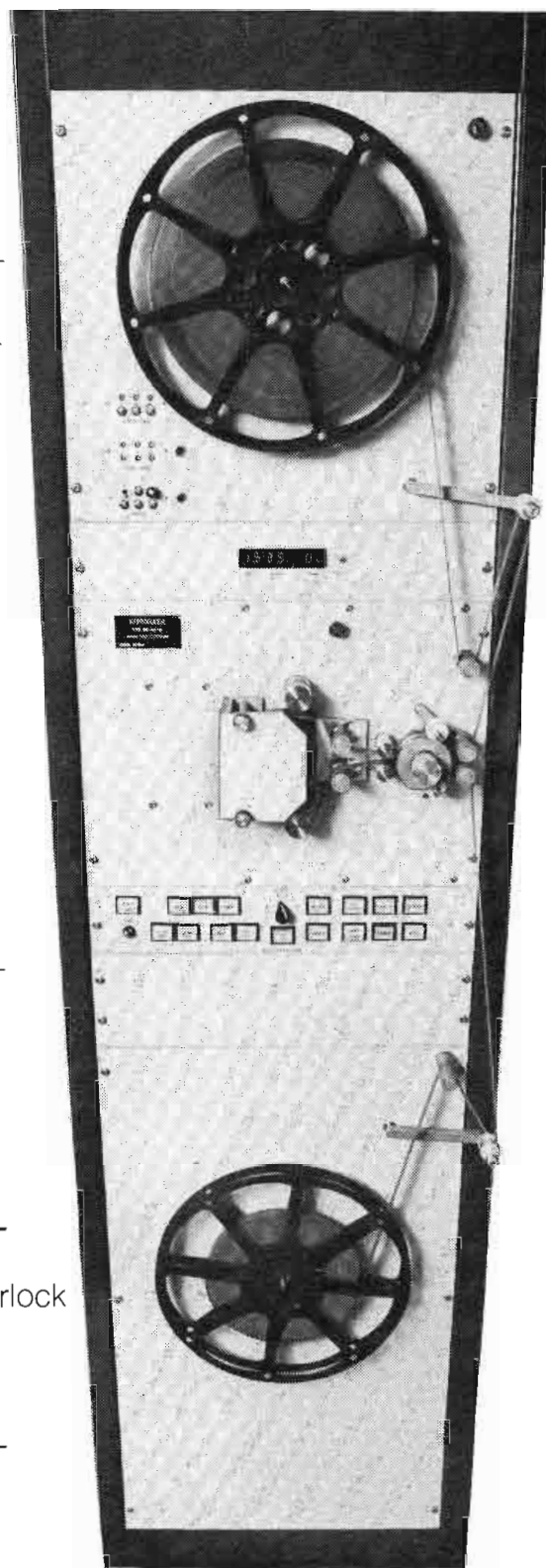

HIGH-SPEED ELECTRONIC INTERLOCK IS NOW A PRACTICAL REALITY

MAGNA-TECH ELECTRONIC CO., INC.

630 NINTH AVENUE/ NEW YORK, N.Y. 10036

- QUAD-EIGHT, 11929 VOSE ST., NORTH HOLLYWOOD, CA. 91605
- CINESOUND INTERNATIONAL LTD., IMPERIAL STUDIOS, MAXWELL ROAD, BOREHAMWOOD, ENGLAND
- MAGNA-TECHTRONICS (AUST) PTY., LTD., 49 WHITING ST., ARTARMON, N.S.W., AUSTRALIA 2064

For More Details Circle (57) on Reply Card

Countdown
to
shipment . . .
72 hours!
That's

INSTANT EMCOR®

MODULAR CABINETRY

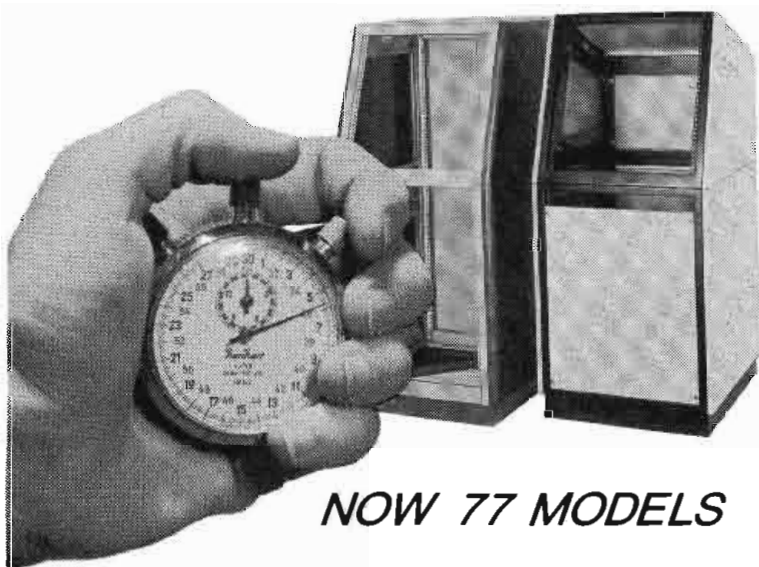

NOW 77 MODELS

When time is of the essence . . . and you need equipment enclosures "yesterday" . . . it's good to know you can count on INSTANT EMCOR to ship your requirements **within 3 days**. That's because we stockpile 77 models of our EMCOR I and EMCOR II series of modular enclosure frames—vertical, slope front, turret, desk and counter height, instrument, low silhouette and steel work/writing top . . . ready to go on 72 hour notice.

Plus — doors, drawers, shelves chassis guides, panels, you name it . . . literally thousands of components and accessories to meet virtually any equipment housing need.

That's INSTANT EMCOR — the enclosures you order "off-the-shelf."

Ingersoll Products, 1000 W. 120th St., Chicago, IL 60643

Ingersoll Products

For More Details Circle (58) on Reply Card



(Continued from page 106)

deceptions. The reader will learn the advantages, and more importantly, the disadvantages of resistance measurements in solid-state circuits. It's all a matter of understanding the circuit or component under test.

The book contains 416 pages and 178 illustrations. It is available through Tab Books, Blue Ridge Summit, Pa.

For More Details Circle (164) on Reply Card

Intrusion Alarms

The electronic security system plays an important role in offsetting the constant threat that exists to one's security. **Building & Installing Electronic Intrusion Alarms**, written by John E. Cunningham, explains how to select, construct, install, operate and maintain electronic intrusion alarms.

The book is divided into sixteen chapters, each dealing with a particular phase of electronic intrusion alarms. It discusses electromechanical intrusion alarms, sensors and switches, audio and vibration alarms, photoelectric intrusion alarms and proximity alarms.

Also covered are closed-circuit television, access control switches, telephone attachments, an automobile protection system and other commonly used types of intrusion alarms. To further assist the reader, an

(Continued on page 110)

MONO **STEREO**

<p>FLUTTER BAR RECONDITIONING</p>	<p>NON-POPPING GATE SPRING MODIFICATION</p>	<p>FOR OLDER MODELS: POLE PIECES CAPS W/GUIDES REPLACEMENT HEADS</p>
-----------------------------------	---	--

DIRECT REPLACEMENT HEADS

MMI HEADS EQUAL OR EXCEED ORIGINAL EQUIPMENT SPECS.

SEND US YOUR ASSEMBLY. We will ultrasonically clean everything — install new heads if yours cannot be relapped — replace any worn or missing minor hardware — adjust — test — ship back PRE-PAID your assembly (not some other).

36 HOUR SERVICE — LOANERS AVAILABLE

INSTALL YOURSELF. Buy MMI heads with complete written and pictorial instructions.

8125 PLEASANT AVE SO MINNEAPOLIS, MINN 55420
(612) 884-7393

For More Details Circle (59) on Reply Card

BROADCAST ENGINEERING

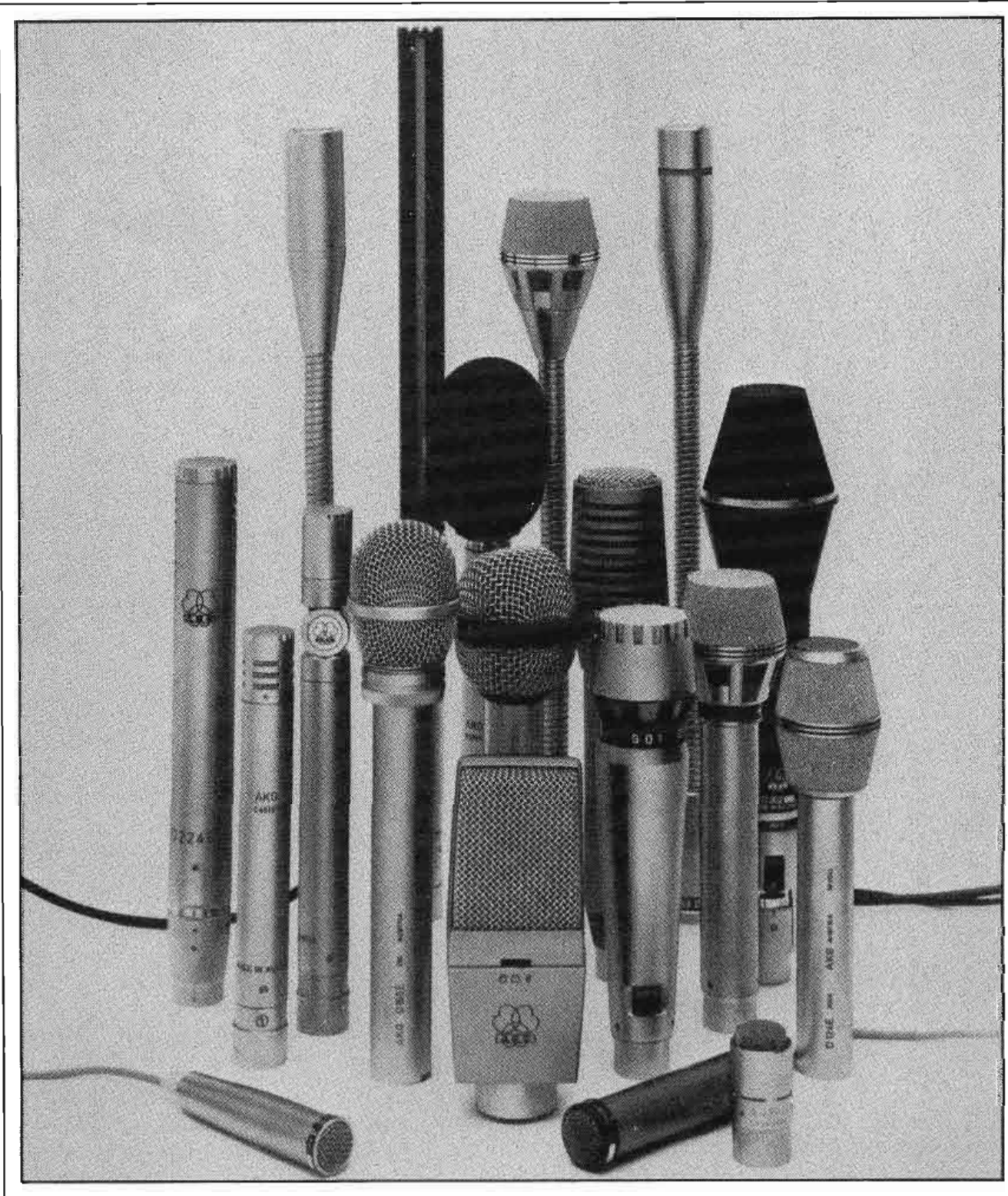

**PHONE
TODAY
FOR MORE
INFORMATION**

- CALIFORNIA, NO. (415) 937-1482
- CALIFORNIA, SO. (213) 559-2591
- COLORADO (303) 934-2123
- CONNECTICUT (203) 322-9202
- FLORIDA (305) 754-5475
- GEORGIA (404) 458-3616 (404) 451-3471
- ILLINOIS (312) 685-2338
- IOWA (712) 243-1626
- KANSAS (913) 648-5191
- MARYLAND (301) 622-0300
- MASSACHUSETTS (617) 873-8550
- MICHIGAN (313) 547-4771
- MINNESOTA (612) 926-3861
- MISSOURI (314) 428-0300
- NEW YORK, METRO. (212) 585-2027
- NEW YORK, UPSTATE (315) 437-2992
- OHIO (216) 333-9955
- OREGON (503) 292-9145
- TEXAS (713) 772-0961
- WASHINGTON (206) 284-1121
- PUERTO RICO (809) 765-4021

For your microphone requirements turn to AKG—the first choice of professional in recording, radio and TV broadcasting, sound reinforcement and entertainment.

- Studio Condenser Systems
- FET Condenser Systems
- Directional Dynamics
- Omni-directional Dynamics
- Lavalier
- Noise Cancelling Dynamics
- Shotgun Dynamics
- Dynamic Headphones



AKG MICROPHONES • HEADPHONES

DISTRIBUTED BY
NORTH AMERICAN PHILIPS CORPORATION
100 EAST 42nd STREET, NEW YORK, NEW YORK 10017

AKG WEST COAST REPRESENTATIVE: (213) 655-4433 NEW YORK OFFICE: (212) 697-3600



FOR COMPLETE
DESIGN FREEDOM IN CONTROL PANELS
SPECIFY

SWITCHCRAFT SWITCHES

①



PUSHBUTTON ACTION
ILLUMINATED LITTEL "MULTI-SWITCH." Virtually unlimited lighting effects and switching functions in one ultra-compact unit . . . enables you to design a cybernetically correct, error-reducing panel for your special applications. Single color or split-face lighting. Up to 6PDT in only .6 sq. in. panel space! 1 to 18 stations per row . . . can be ganged and coupled.

②

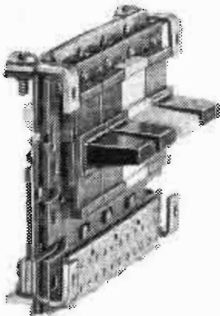

SLIDE ACTION
"MULTI-SLIDE" SWITCHES. New! A slide switch offering all 3 types of actuation: interlock, all-lock, non-lock. Speeds operator reaction while minimizing errors through slide-switch variety and visibility! 1 to 18 stations.

③

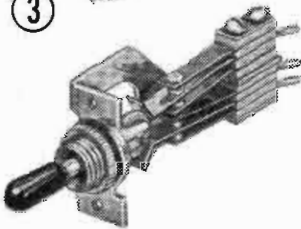

LEVER ACTION
Switchcraft offers the largest selection of illuminated and non-illuminated lever-type switches in the industry. Wide variety of sizes from miniaturized "Feather Lever" (featuring changeable push-on color knobs) to the industry standard "Telever"* telephone-type switches with field changeable functions. Specialized types to solve such problems as capacitance build up, need for switches with 1/2 lock and 1/2 non-lock functions, extra length bushings, etc.

*T.M.

WRITE FOR COMPLETE LEVER, SLIDE AND PUSHBUTTON SWITCH CATALOGS or see your Switchcraft Authorized Industrial Distributor for immediate delivery at factory prices.

SWITCHCRAFT[®]
INC.

5531 North Elston Avenue
Chicago, Illinois 60630

(Continued from page 108)

appendix contains a general listing of companies that supply alarms and accessories.

This easy-to-read book has been written for everyone who is interested in electronic security systems, whether he is a novice who wishes to build his own security system or a skilled technician who wants to enter the field of security electronics.

The book is available through Howard W. Sams & Co., Inc., Indianapolis, Ind.

For More Details Circle (165) on Reply Card

Transistor Audio Amplifiers

Today, the design of audio amplifiers requires a thorough understanding of transistor characteristics and the various circuit possibilities. Also, since a design is usually a compromise between several factors such as cost and performance, it is important to understand the basis of the performance requirements. **Transistor Audio Amplifiers**, written by P. Tharma, considers these aspects of design in detail, and is based on the work done by the audio application group of the Mullard Central Application Laboratory.

The first two chapters deal with transistor characteristics: following chapters over circuit design and measurements, and a final section of the book considers various applications and describes circuits to

(Continued on page 112)

New DSG*
superior performance
in a modular package

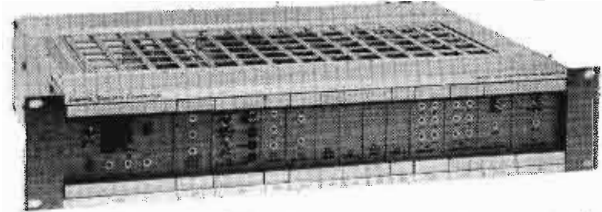

*Digital Sync Generator Model 800

Control Concepts Corporation introduces a new generation of low cost digital sync generators designed primarily for single line pulse distribution systems. The Model 800 plus CCC's Model 601 Master Sync Generator comprise a complete system which features:

- modular construction
- separate modules for programming pulses in 70 ns increments and for horizontal phase (9μs advance, 6μs delay in increments of 70 ns)
- zero to one line vertical phase advance
- optional modules-additional pulse and sub-carrier outputs; black burst; dot/grating

Price Basic unit: \$1800

Control Concepts Corporation

411 N. STONESTREET AVENUE
ROCKVILLE, MARYLAND 20850

For More Details Circle (62) on Reply Card

Ain't nobody else can give you an S/N ratio up to 72 dB. Nobody.

We call it the Scully 280-B Professional Recorder/Reproducer. Not a very fancy name. But it's so new, we haven't had time for anything else but a number.

Briefly, here are the high points, new electronics for up to 72 dB S/N ratio on full track .25" tapes. And a greater dynamic range than you've ever been used to.

Two-track quarter-inch and four track half-inch 280-B lays on a crisp, clean 69 dB on an NAB weighted basis.

We've built in some other choice features, too. Like an OPTAC™ optical motion sensing system that gets rid of deck plate sensor mechanisms. Plus a new mother-daughter board architecture for super easy maintenance.

The spec sheet has all the details.

For more information contact your Scully Distributor or write direct to Scully/Metrotech.



For More Details Circle (63) on Reply Card

Color Sync Gen

Video Aids New Color Genlock Sync Gen., Model 5000 Offers: *H, B, V, Dual Sync burst flag and subcarrier *Phase lock indicator *External Sync present indicator *Loop thru BNC video input *Low cost *Meets all NTSC/RS 170 requirements and specifications *No add-on options or accessories *MOS/LSI technology improves reliability by drastically reducing parts. *All output pulse widths are digitally controlled to eliminate drift from temperature and aging.

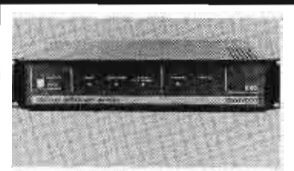

Meets all NTSC/RS 170 Specs. Color Genlock H, B, V, dual sync, burst flag and subcarrier. \$1244.00

"EDIT AID"™

EDIT-AID AR-1: Low-cost editor-programmer. Unit removes common editing errors that develop unless the video tape recorder operator presses his edit and stop pushbuttons at the exact split second. Can program edit-in and edit-out functions precisely at the same place automatically. With the exception of frame-by-frame editing for animation the edit-aid programmer accomplishes most precise editing needs. Can also be used for controlling projectors, recorders or other devices.

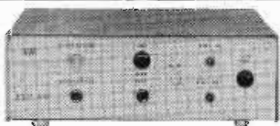

\$495.00
Helical and Quad
VTR editor-programmers

Party Lines

PARTY LINE PL1 & PLS-1: Intercom amplifier for use with Western Electric or VACC headsets (Low Z). Unit meets the need for audio intercommunication using a two-way headphone and microphone-type interconnect for audio and video engineers, technical directors, camera personnel etc. Model PLS-1 unit has a supply sufficient to handle up to ten single Model PL-1 units. Model PL-1 can be used without the PLS-1 master unit if 8 to 12 volts DC (negative ground) is available. Normally a party-line system would consist of one master PLS-1 unit and several single PL-1 units. Feature individual volume controls.

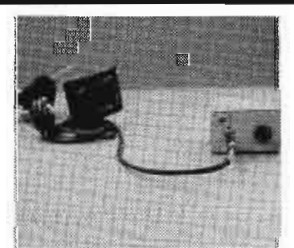

With Individual
Volume Controls
\$40.00

Now you can convert your Sony Trinitron^T to a high quality receiver/monitor for only \$129.00. *Video Aids Electro Optical Isolator Kit, Model A-1 Offers; *Low Cost *Easy Installation *Only 8 Wires To Connect *Light and Portable **Monitor/Receiver Flexibility At The Flick Of A Switch *The A-1 Features; Loop-Thru BNC input Connectors/Audio Connector *Isolation From Power Line *Switchable: Video/R.F.



VIDEO AIDS
Corp. of Colo.

112 West 4th St.
Loveland, Colorado 80537
(303 667-3301)

For More Details Circle (64) on Reply Card

(Continued from page 110)

illustrate the design principles. Particular attention is given to the extensive use of direct-coupled audio amplifier circuits. Noise and "acoustic roughness" due to non-linearity are considered in detail. The book contains 399 pages and includes 245 diagrams.

This book is available through the Van Nostrand Reinhold Co., New York.

For More Details Circle (166) on Reply Card

Solid State Experimental Designs

If you are a serious hobbyist or experimenter who is interested in the "why" and "how to" of solid-state circuit design then **Solid-State Circuits for Hobbyists & Experimenters**, by Jon L. Turino has valuable information for you.

It is a practical book that assists you in designing circuitry for a great many useful projects or adapting and modifying existing circuit designs to suit a specific purpose. Procedures of design are given, starting with "how" to explain your idea using a simple block diagram. The design procedures then progress from developing a single stage to combining several stages, adding a voltage source for power, and finally connecting an input.

This book is available through Howard W. Sams & Co., Inc., Indianapolis, Ind.

For More Details Circle (167) on Reply Card

Capitol/Audiopak[®] Broadcast Tape Cartridge

EVERYTHING IN AUDIO & VIDEO TAPE
AT THE RIGHT PRICE

BSC
INCORPORATED

8600 W. SUNNYSIDE AVE.
CHICAGO, ILL., 60656
(312) 625-0265

For More Details Circle (65) on Reply Card

BROADCAST ENGINEERING

Electronic editing so precise you might kiss tape splicing goodbye!



The new Tape-Athon 1001 Recorder/Reproducer has everything the professional studio demands in a precision instrument, plus some exciting innovations we've added to make the 1001 a must-see-it-before-you-invest. Here are the basics: dual capstan, closed loop tape drive for clean, even tape travel with minimum wow and flutter; tach-controlled motion sensing to eliminate tape breakage, stretching or spillage; newly designed tape head section for easy threading, fast lifting; illuminated push button controls, flush mounted.

Now for the innovations, take a look at this control panel.



With the Tape-Athon 1001 you can initiate a "balanced torque mode" on the tape drive by activating the PLAY (or FAST FORWARD) controls simultaneously with the REWIND control. Both drive motors are balancing against one another, allowing the user to manually move the reels in either direction without drag, skipping or tape stretching. You can actually move the tape so precisely for editing purposes that splicing is virtually eliminated.

Call for complete details and specifications on the professional's professional 1001 Recorder/Reproducer (also now available in Reproduce-Only, 14 Inch Reel, and Logger versions for the broadcast industry) or write to:

Tape-Athon Corp.

502 S. Isis, Inglewood, CA 90301 • Tel: (213) 776-6933

For More Details Circle (66) on Reply Card

The V11/21 Automatic Digital Logging System

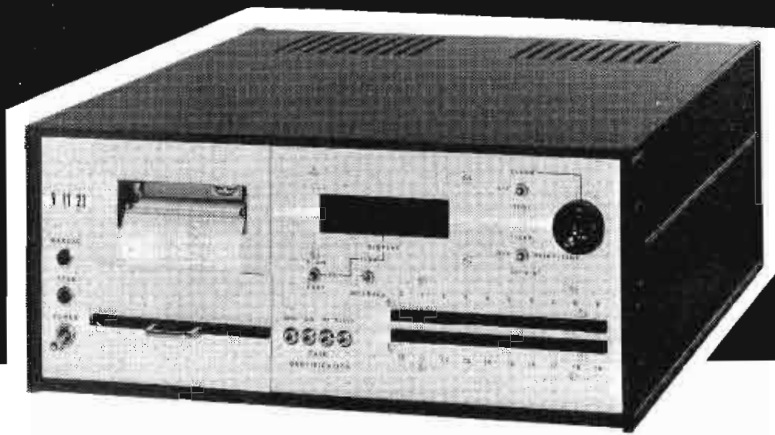

from the industry's Creative Product Innovators.

The V11/21 Automatic Digital Logger records and prints out all necessary meter readings, saves valuable engineering time and assures total accuracy.

Here's a complete, self-contained system, including a printer which can display and print-date identification, time, channel number and meter readings in volts, amps, watts, etc. The system is capable of sampling, measuring, displaying and

recording analog inputs from single or multiple sources, and is equipped with a real-time, solid state, 24-hour digital clock. Precise time can be displayed visually and also printed out.

This compact unit is only 7" high. Virtually maintenance free, it utilizes plug-in printed circuit cards for quick and easy replacement. Optional elements and equipment can be added for even greater versatility.

McBEE LABORATORIES

Special Electronic Equipment—for Broadcasting

5151 WISCONSIN AVENUE, N.W.
WASHINGTON, D.C. 20016
(202) 244-2345 (202) 244-5535

For More Details Circle (67) on Reply Card

Digital Logic

(Continued from page 33)

fastest form of logic available today. Its flexibility and good speed-power product make it very attractive for use in new designs.

Figure 10 shows the design of a basic ECL gate. The input circuitry is nothing more than a differential amplifier with one side biased to a constant voltage V_{BB} . V_{BB} then becomes the switching threshold for the other inputs. Whenever any input is above V_{BB} , the corresponding input transistor is turned on. This turns off the output transistor Q1, and turns on Q2. Only when all inputs are below V_{BB} will Q1 be on and Q2 off. Thus the output at Q1 is high only when all inputs are low and is low only when all inputs are high. This output represents the NOR function of the inputs.

By symmetry, the output at Q2 is seen to be the OR function. Providing complimentary outputs is another feature of flexibility of the ECL logic family.

Propagation delay times of from

(Continued on page 116)

a new am & fm broadcast console

The Mod One

modular for economy now,
flexible for the future!

Start with the format you need now, and expand later to meet new requirements. The Mod One console mother-board design accepts a wide selection of input modules and plug-in amplifier cards. 10 mixing positions, with up to 30 inputs. Modern vertical faders; silent operating switches; state-of-the-art circuitry.

Custom features and options with off-the-shelf availability. Monaural, stereo, or quadrasonic. Meets all FCC AM and FM standards.

Write for complete specifications. Available through better dealers throughout the USA.



UTE company

11922 Valerio Street, No. Hollywood, California 91605 (213) 764-1500

The New Standards

for frequency and
modulation monitors

Since TFT introduced its first instrument in 1971, TFT monitors have become the broadcast industry standards for reliability, accuracy and convenience. For example, in the past two years, more than 25 percent of the TV stations in the U.S. have installed TFT monitors. Plus many stations in foreign countries. What's more, TFT's new AM and FM monitors are meeting with the same kind of sales success.

And for good reasons: innovative design techniques . . . remote monitoring without an RF amplifier to avoid intermod products . . .

accurate digital display . . . proportional, oven-controlled master oscillator for exceptional frequency stability . . . far fewer calibrations . . . digitally settable plus and minus peak flashers to prevent ambiguity . . . built-in, 10MHz general purpose counter . . . and many more features you won't find in traditional monitors.

But prove it to yourself. Just ask anyone who owns one (a complete customer list is available on request). Then, let us demonstrate on your frequency. Contact your local TFT representative, or call us collect.

TV (UHF & VHF)



FCC Type Approval 3-187

AM

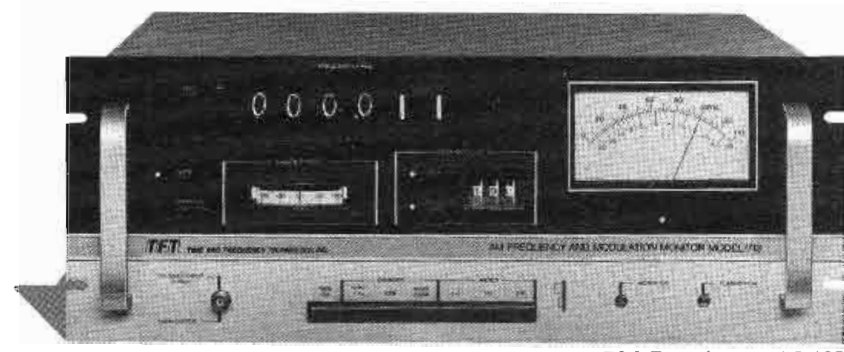

FCC Type Approval 3-195

FM

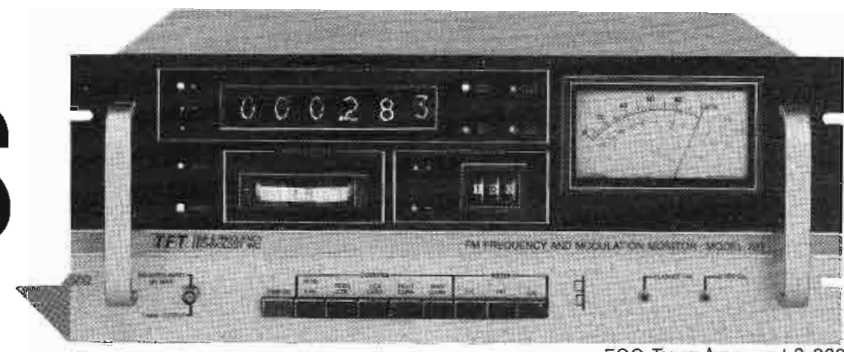

FCC Type Approval 3-202

TFT TIME AND FREQUENCY TECHNOLOGY, INC.
3000 OLCOTT STREET, SANTA CLARA, CA 95050 (408) 246-6365

For More Details Circle (69) on Reply Card

Change Sound to Silence with a **TABERASER**



This rugged, heavy duty bulk tape eraser wipes sound from all magnetic tapes, cartridges, cassettes and magnetic film stock; handling up to 2".

It erases with minimum residual noise because the field automatically diminishes at the end of each 30-second cycle. A thermal control and blower keeps the unit below 71° C. Priced at only \$395.00.

For the distributor in your area—Call or write:

TABER Manufacturing & Engineering Company
2081 Edison Ave. • San Leandro, Ca. 94577 • (415) 635-3831

For More Details Circle (70) on Reply Card

(Continued from page 114)

1-4 nsec and flip-flop toggle frequencies to 400 MHz make this family ideal for very high speed applications. Due to its popularity, the cost per gate is also decreasing and flexibility is increasing.

MOS Devices

MOS devices use the field effect transistor (FET) as a basic building block as opposed to the junction transistors used in the bi-polar technologies. An FET can be thought of as a switch. When it is turned off, very little current flows from the source to the drain. It then acts as an open switch. When it is turned on, the impedance from the source to drain drops by several orders of magnitude and the FET acts as a closed switch.

There are two basic types of FET's. The P-channel and the N-channel. For the P-channel devices, a negative voltage on the gate turns on the FET. N-channel devices are turned on by a positive potential.

Figure 11 shows the basic gate of a P-MOS device. (P-MOS means a logic device built with P-channel

(Continued on page 118)



Danscoll has a lot to offer...

Whether you're planning a new facility or adding to an existing one, Danscoll can supply many of your equipment requirements.

Production Switchers: Several standard models are available from 2 bus systems to 5 bus systems, such as our Video Tape Editing Switcher. Custom switchers are also available in larger formats. A wide variety of special effects options permits us to satisfy virtually any requirement.

Routing Switchers: Video and audio separate and combined and a wide variety of control formats including a unique remote controlled switcher using

a single control pair are available. Can be supplied in sizes from 5 x 5 and up.

Distribution Amplifiers: Both video and pulse with several models to suit various applications.

Specialty Products: VTR signal processors, sync generators, encoded chroma keyers, background generators, digital timers, switcher accessories and a range of audio products complete the line.

Send for literature on these and other products. Together, we could make a great team.

danscoll

9721 côte de liesse
montréal 760 canada
(514) 631 9884

Waters Attenuators

not just a pair, but a full house



Choosing professional audio controls involves complex compromises between noise, life, accuracy, and price. No one design can achieve all the alternatives. To satisfy all requirements, a full range of attenuator models is required, and that's what Waters offers: a complete line of attenuators, all of which feature MystR®—a proprietary conductive plastic resistance element.

MystR's glass-hard, smooth wiping surface achieves noise levels below $20\mu\text{V}$ (at least 100db down) over a trouble-free life of at least ten million operations.

Zero to 90db of truly "stepless" attenuation is achieved with Waters' computer-controlled curve-shaping technique which actually tailors the attenuator resistance element assuring superior tracking accuracy.

If you'd like to call our hand, send for Waters' Audio Attenuator brochure which describes their complete line of linear and rotary attenuators and pan pots. Use the coupon provided, or better yet, phone 617-358-2777 for immediate service.

WATERS MANUFACTURING, INC.
Boston Post Road
Wayland, Ma. 01778

I'd like further information on Waters attenuators and MystR® conductive plastic elements.

Send me your attenuator brochure and "The MystR Story"

I need additional information:

Name _____
Position _____
Company _____ Phone _____
Street _____ City _____
State _____ Zip _____

Multisync

"I wouldn't be without it!" —

Jack McCoy, Program Director at KCBO Radio in San Diego uses his Multisync.

Multisync gives continuously variable speed control of tape decks and turntables.

- Save that "61 second" spot.
- Balance "off speed" tapes.
- Sharpen your sound!

Ask the people who know—the people who use Multisync:

KCBO/San Diego, Calif. • WKTQ/Pittsburgh, Penn. • KROQ/L.A., Calif. • WMYQ/Miami, Fla. • WOKY/Milwaukee, Wisc. • KSLQ/St. Louis, Mo. • KOIL/Omaha, Nebraska • KBey/Kansas City, Kansas • KHJ/L.A., Calif. • WDRQ/Detroit, Mich. • WLQY/Fort Lauderdale, Fla. • Fanfare Recording/El Cajon, Calif. • Studio West/San Diego, Calif. • Caribou Ranch/Nederland, Col. • DiJobe Sound Recorders/Orange County, Calif. • Lee Furr Studio/Tucson, Ariz. • Studio East/Milwaukee, Wisc. • 24-16 Corp./Mexico City • Erwin Wasy Adv./L.A., Calif. • Emmitt Rhodes/Hawthorne, Calif. • Atlantic Records/N.Y. • Fred Arthur Productions/Denver, Col. • Las Vegas Recording Studio/Las Vegas, Nev.

Then call us, or write for further information: Pacific Recorders, the total equipment suppliers!



PACIFIC RECORDERS AND ENGINEERING CORPORATION
11760 SORRENTO VALLEY ROAD, SAN DIEGO, CALIFORNIA 92121
TELEPHONE (714) 453-3255 TELEX 695008

For More Details Circle (73) on Reply Card

(Continued from page 116)

FET's). As you can see, whenever any input is low (negative), it will turn on its FET. Since the FET acts like a low impedance the output goes to the higher level. Whenever all inputs are high, all input FET's will be turned off and the output will be pulled to the lower voltage (-13V). Thus all inputs high results in a low output. This is the NAND function.

Because of ease in processing, P-MOS devices are more readily available and are used more often than N-MOS. Much effort is currently being made to develop the N-MOS technology.

P-MOS is characterized by relatively long propagation delay times (typically 300 ns) and low flip-flop toggle frequency (2MHz). It has two important advantages, though, first is very low power consumption (typically .2 to 10 mW) and the ability to design many complex functions on one IC chip. P-MOS is a growing logic family.

While most devices used today are built for custom applications, there are developing lines of

New Color Special Effects Generators

- Self-contained version for console mounting
- Remote-controlled version for mounting in custom switcher panels

DYNAIR's new SE-70A and SE-70A-R Special Effects Generators allow basic effects to be easily and inexpensively added to any television system. These broadcast quality units operate equally well on color or monochrome signals, with either broadcast or industrial sync. A quality locking-type gear-driven effects mechanism is used, allowing effects to be easily implemented.

The units provide horizontal and vertical wipes, inserts from any corner with diagonal expansion, and internal and external keying and matting. The SE-70A is self-contained for console mounting and the SE-70A-R is an electrically identical remote-controlled unit, the control panel of which may be easily mounted in custom panels.

Available off-the-shelf . . . write today for complete information.

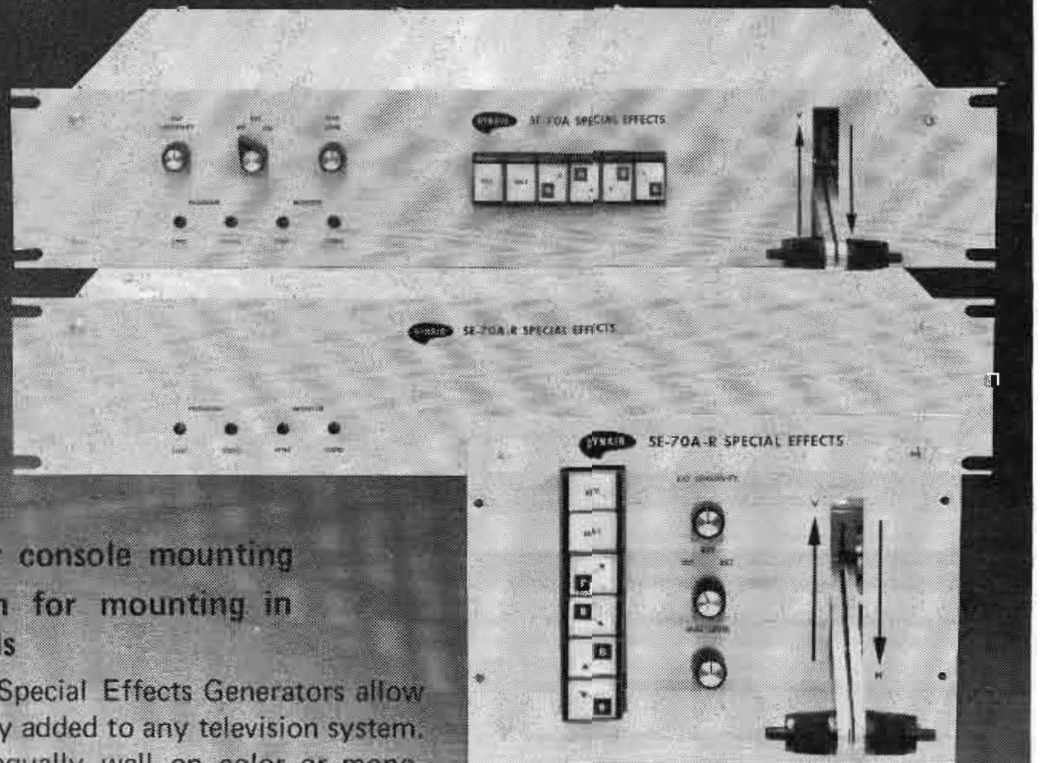

SE-70A: \$1095.00
SE-70A-R: \$1195.00

DYNAIR ELECTRONICS, INC.

8380 FEDERAL BOULEVARD
SAN DIEGO, CALIF. 92114 U.S.A.
TELEPHONE: 714-582-9211



**SHIVELY LABORATORIES
ANNOUNCES A NEW GENERATION
OF CIRCULARLY POLARIZED
FM ANTENNAS**

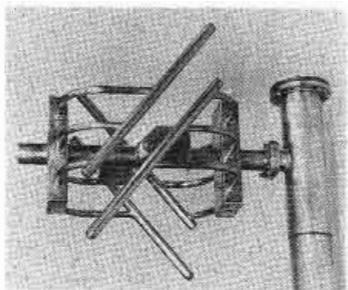

TYPE 6814 • 25 KW PER BAY

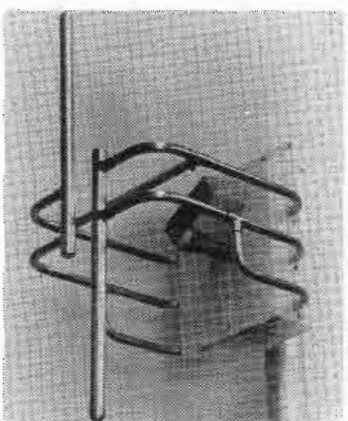

TYPE 6810 • 10 KW PER BAY

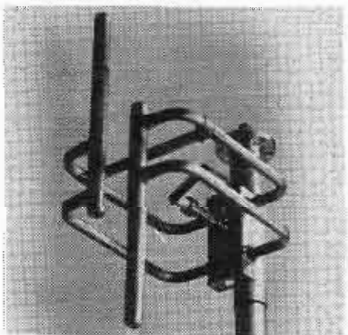

TYPE 6813 • 3 KW PER BAY

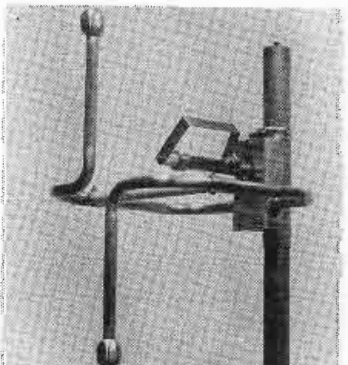

TYPE 6811 • 1 KW PER BAY

**RADOMES OR DEICERS
AVAILABLE FOR ALL MODELS**

WRITE FOR INFORMATION ON
ANTENNAS
TRANSMISSION LINE
FILTERS
RF LOADS
COAXIAL SWITCHES
POWER COMBINERS



**SHIVELY LABORATORIES,
INC.
RAYMOND, MAINE 04071
PHONE 207 655-3841**

For More Details Circle (75) on Reply Card

standard devices for off-the-shelf design.

The CMOS Design

CMOS is an extension or marriage of the P-channel and N-channel MOS technologies. Both P and N channel FET's are used in the design of a CMOS gate. The simple gate in Figure 12 illustrates the operation of a CMOS device. When any input is high, the series connection of P-channel FET's will be broken and at the same time, one of the parallel N-channel devices will be turned on. Thus the output will be pulled to the low (VSS) state.

Only when all inputs are low, will all the P-channel devices be on and thus the output pulled high. (Note that if all P-channel devices are on, then all the N-channel devices are off.) This then is the NOR logic function.

CMOS offers many design advantages. Extremely low power consumption (.01-1 mW), good noise immunity, and medium speed (around 50 ns propagation delay time) make this one of the fastest growing logic families in both use and number of new devices being developed. In areas where speed is unimportant and power-consumption crucial, CMOS seems to offer the best trade off of the logic families discussed. □

**GET
COMPLETE
DETAILS**

**Use Free Readers
Service Card.**

**Be sure to
include your
name and address.**

**What happened
when a group of
experts teamed up
to write this book?**

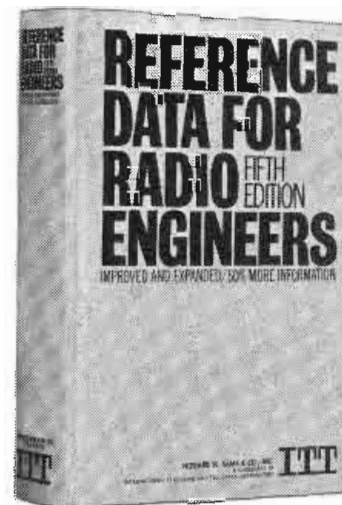

**They made it so
practical that
it's now in its
5th edition!**

This completely revised 5th Edition of the world famous Reference Data for Radio Engineers is the result of 5 years work by a broad group of practicing engineers, professors, government experts and the ITT staff. Its 1196 pages and 45 chapters bring you the very latest on transistors, electroacoustics, microminiature electronics, space communication, navigation aids, quantum electronics, reliability and life testing, etc.; information you need in your work. 1350 illustrations, charts, diagrams, tables, etc. Everything cross indexed for ready reference. Practical? Valuable? 400,000 radio engineers think so. Your money back if you don't agree with them.

Reference Data for Radio Engineers
No. 20678 \$20.00



HOWARD W. SAM'S & CO., INC.
4300 West 62nd Street
Indianapolis, Indiana 46268

Please send Reference Data for Radio Engineers. Check/money order enclosed for \$_____ for _____ copies @ \$20.00. (Include sales tax where applicable.) Canadian price slightly higher. **BE 093**

Name _____

Address _____

City _____

State _____ Zip _____

For More Details Circle (76) on Reply Card

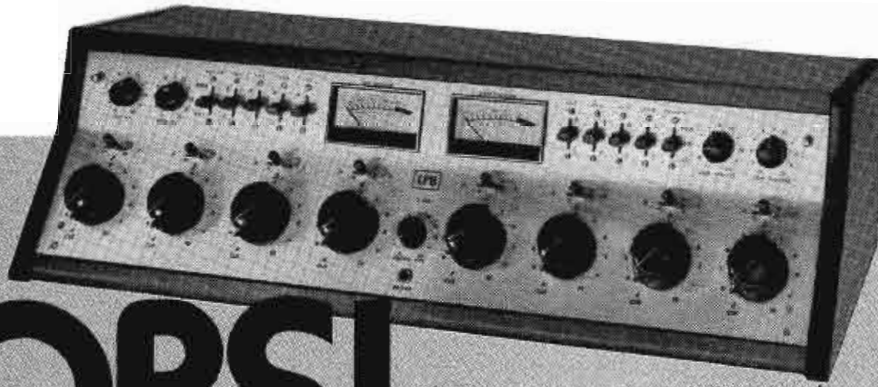

TOPS!

That's LPB's stereo S-13B console, our top-line audio control center. Features include:

- 18 stereo and 6 mono inputs.
- Step attenuator mixers.
- Telephone-type switches.
- Plug-in fiberglass circuits.
- Stereo 12 watt/channel monitor.
- Internal cue amp and speaker.
- All transformer input and output.

The features and quality of LPB's S-13B just can't be found in other consoles at comparable prices. Take a hard look at the S-13B before you make a mistake!

LPB has a complete line of mono consoles, too, and everything that goes with them. Call or write today for complete information.



LPB Inc.
520 Lincoln Highway, Frazer, Pa. 19355
(215) 644-1123

For More Details Circle (77) on Reply Card

NEW PRODUCTS

(Use circle number on reader service card for further information)

Tone Arms

Shure, Evanston, Illinois has announced the Shure-SME Model 3009 Series II Improved Tone Arm featuring reduction in the effective tone arm mass, and improved anti-skating control.

Other improvements in the Model 3009 Series II Improved include less overhang of the counterweight, making the new arm suitable for use with most turntables, and easier balance adjustment incorporating a rotating counterweight at the rear of the tone arm.

By reducing the effective mass of the Model 3009 Improved, the resultant resonant frequency of the tone arm/cartridge combination has

(Continued on page 122)

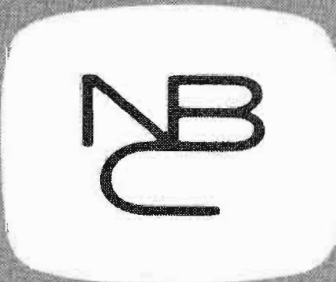

At NBC...

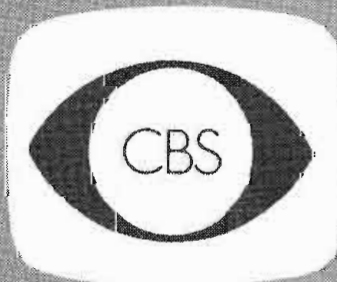

and CBS...

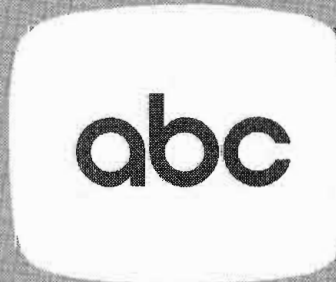

and ABC...

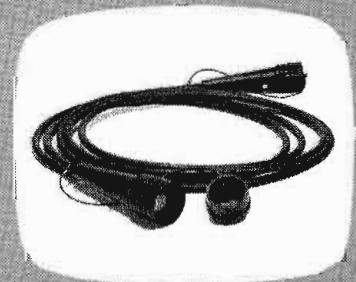

they use more BIW TV broadcast cable

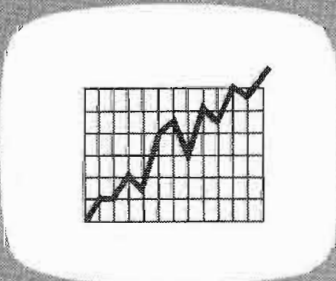

... than any other brand.



... and now a word from our sponsor:

The major networks prefer BIW TV cable for the same reasons local stations do. For one thing, they get proven reliability. BIW was the first TV cable manufacturer, has more experience than anybody else. We're now the supplier of cable for all TV cameras, plus accessory equipment for other studio cable and connector requirements. We also have both East and West Coast facilities for on-the-spot supply, service, and technical help. Write for literature. Or call.

Thanks for tuning in!

Boston Insulated Wire & Cable Company

65 Bay Street, Boston, Mass. 02125
Court Street, Plymouth, Mass. 02360 • Tel: 617-265-2102



Other Plants and Sales Offices in Los Angeles, Calif. 90061 • Tel: 213-532-9064
Hamilton, Canada • Tel: 416-529-7151; Kingston-upon-Thames, U.K. • Tel: 01-546-3384; Singapore • Tel: 374777

YEAR AFTER YEAR... CROWN EQUIPMENT PAYS FOR ITSELF

*with reliable performance
and superior audio quality*

STUDIO MONITOR AMPLIFIERS

All models have complete internal protection. IM distortion is better than 0.05% from 0.01 watt to full power. All units mount in a 19-inch rack. Three year warranties cover parts, labor and round-trip shipping.

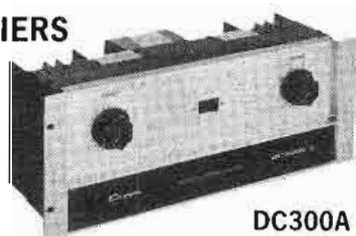

DC300A

delivers 150 watts RMS per channel into 8 ohms, or 600 watts output in monaural operation; height 7 inches.



D150

delivers 75 watts RMS per channel into 8 ohms; height 5 1/4 inches.



D60

delivers 30 watts RMS per channel into 8 ohms; height 1 3/4 inches.

26 YEARS EXPERIENCE IN BROADCAST AND PROFESSIONAL STUDIO EQUIPMENT. Every product is ruggedly constructed, rigorously tested and guaranteed to meet or exceed printed specifications. All circuits are outstanding for low noise and distortion, wide bandwidth and high frequency response.

DISTORTION ANALYZER

Model IMA tests audio equipment easily, quickly and accurately. Both intermodulation distortion analyzer and internal oscillators are enclosed in one compact unit. Even an inexperienced technician can take ten power level measurements in 5dB steps in just 60 seconds. The ranges are 100, 30, 10, 3, 1, 0.3, and 0.1%.

MAGNETIC TAPE EQUIPMENT.....IN THE PRODUCTION STUDIO

All models are designed to work 18 hours a day, 7 days a week for 10 years with three head replacements. Modular construction and plug-in circuit boards mean fast, easy field servicing. These precision instruments will make clean, accurate recordings years after the economical semi-pro decks are retired. All models handle 1/4-inch tape and 7-inch and 10 1/2-inch reels. All mount in 19-inch racks. Standard speeds are 15, 7 1/2 and 3 3/4 ips. There are individual record, erase and play heads for 1 to 4 channels. Over 40 standard models are available with numerous professional accessories.

CX822 Mastering Recorder

computer logic control for safe, rapid tape handling and editing ■ full remote control optional ■ TracSync available ■ each channel has two mixing inputs and individual bias adjust and equalizers ■ third-head monitor for meters or headphones with A/B switch



...IN THE CONTROL ROOM

SP722 Studio Player

simple tape transport system has only 9 moving parts ■ remote start/stop optional, automatic stop in play mode



...ON LOCATION

SX822 Recorder/Mixer

integral mixing facility simplifies setup ■ same tape transport system and meter monitoring as CX822 ■ two mic or line inputs per channel

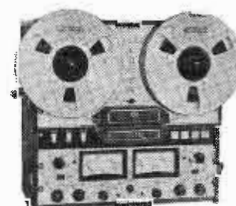

STUDIO TRANSDUCERS

Four models of superior quality speaker systems have advanced-design electrostatic elements for midrange and treble and acoustic suspension base woofers, for finest possible reproduction for the professional recording studio. Two models of excellent cone speakers provide fine sound for broadcast monitoring.

ES224

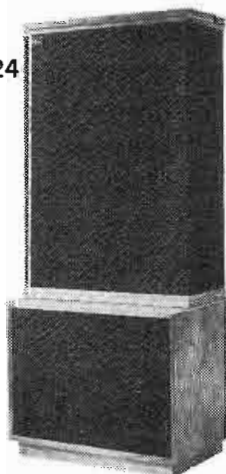

EXPORT DISTRIBUTORS

Canada:
Caldwell A/V Equipment
1080 Bellamy Road N.
Scarborough, Ontario

Europe:
Niles Christensen
382 Springfield Ave.
Summit, N.J. 07901

Latin America:
Telesco Int'l. Corp.
1044 Northern Blvd.
Roslyn, N.Y. 11576

For More Details Circle (79) on Reply Card



MADE ONLY
IN AMERICA

crown

cue clue:

GET A GOOD INTERCOM SYSTEM!

Clear-Com Portable Intercom System. For sound, lighting and camera crews. Designed specifically for the high noise level encountered in concerts, theaters, arenas, and TV and recording remotes. Clear-Com is a wired system. One main station powers up to 30 remote belt-pack stations. All stations are equipped with headphones and dynamic high-intensity noise-canceling microphones.

OTHER FEATURES INCLUDE:

- Interconnects with standard microphone cable, compatible with most audio/video systems.
- Call lights and cue buttons to cue operators who have removed headphones.
- Individual volume control at each station.

Full one-year warranty guarantees all components.



Write or call today:

CLEAR-COM DIVISION OF LUMIERE PRODUCTIONS, INC.
759 Harrison Street, San Francisco, CA 94107 (415) 989-1130

For More Details Circle (80) on Reply Card

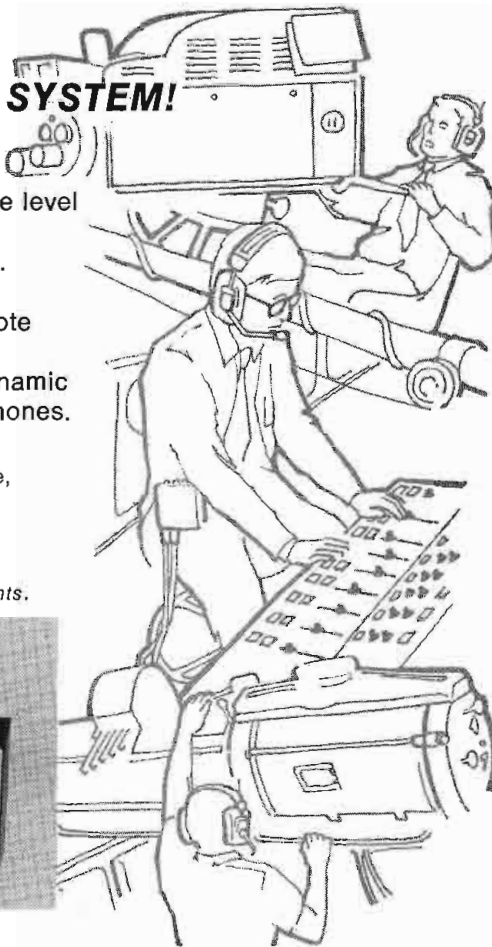

(Continued from page 120)

been increased, resulting in more positive tracking of warped records and less susceptibility to vibration. This was made possible by reducing the counterweight mass and incorporating a nonremovable cartridge shell. For anyone preferring a removable shell, there is the Model 3009/S2 Improved, with a slightly higher effective mass than the 3009 Improved.

For More Details Circle (168) on Reply Card

2-Meter Transceiver

One of the latest and hottest all solid state items off **Heathkits** bench is their completely new 2-meter transceiver and lineup of matching accessories.

The basic kit is called the HW-202, and it offers 36-channel capability, hitting it with a minimum of 10 Watts in such a way that the unit will continue to operate even into an infinite VSWR without failure.

Transmitter deviation is fully adjustable from 0 to 7.5 kHz, with instantaneous deviation limiting.

(Continued on page 124)

Here's Our Line...

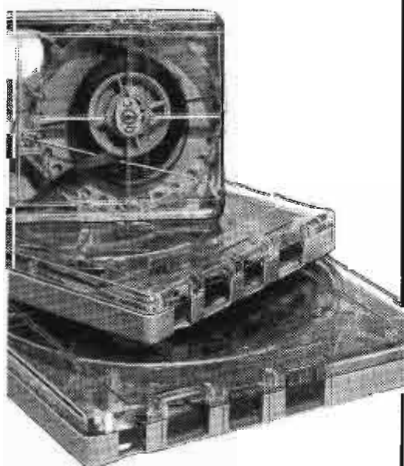

Fidelipac's Automatic Tape Cartridges: The standard of the industry with more in use than all other brands combined.

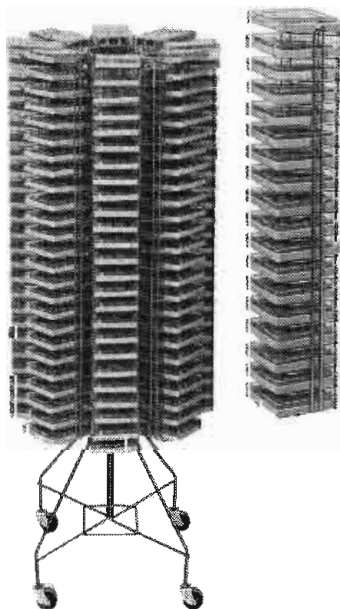

The convertible Cart-A-round Cartridge Storage Racks: Floor standing or wall mount.



New Cart-E-raise Demagnetizers: Hand held or Table Top Models. Plus blank tape, repair and splicing kits and splicing tape.

Want the complete line?
Contact your **Fidelipac**
Distributor or

FIDELIPAC®

3 Olney Avenue,
Cherry Hill, N. J. 08034
(609) 424-1234

Fidelipac is a registered
trademark of TelePro
Industries Incorporated



For More Details Circle (81) on Reply Card

LENCO ELECTRONICS

presents

The winning pair

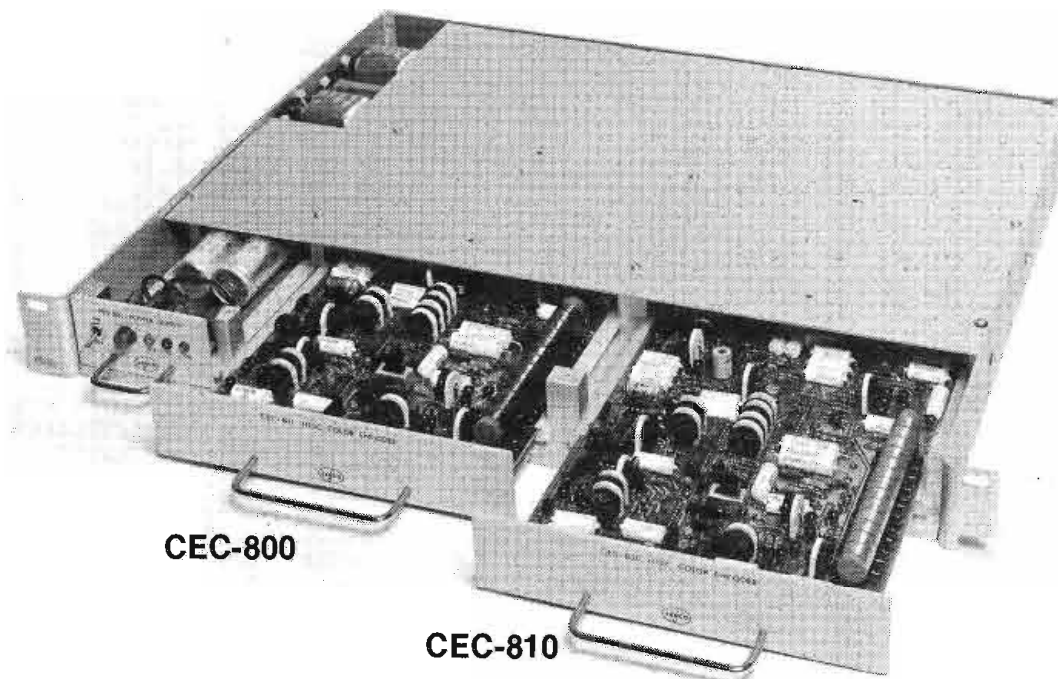

CEC-800

CEC-810

NTSC COLOR ENCODERS

The CEC-800 and CEC-810 Encoders are designed for maximum stability with simplified alignment. They can be used as a plug-in replacement for the R-Y, B-Y Encoder used in IVC's model 90 and model 150 color camera or as pictured, rack mounted in the PFM-801 frame, for use with any make or model R, G, B color camera. A green tie switch is included for alignment or monochrome operation. Horizontal aperture correction is "contours out of green". Chroma can be phased 360°. Encoders operate on RGB, sync, blanking, and subcarrier.

The CEC-800 can be aligned within 5%, using only a waveform monitor.

The CEC-810 has the added feature of an inbuilt color bar generator for internal, as well as monitor alignment.

CEC-800 Plug-In Module	\$995.00
CEC-810 Plug-In Module	\$1,195.00
PFM-801 Frame w/Power Supply, holds 2 Encoders	\$400.00

OTHER LENCO PRODUCTS

CSG-700	Color Sync Generator	PVA-100	Video Distribution Amplifier
CSL-710	Gen-Lock Generator	PVA-101	Video D.A. w/Differential Input
CSG-CO-1	Sync Changeover Switch	PVA-102	Video D.A. w/Breezeway Clamp
BB-500	Black Burst, Pattern Generator	PPA-110	Pulse Distribution Amplifier
CPA-200	Clamping-AGC Video Amplifier	PPA-111	Pulse D.A. w/Pulse Delay
VP-1	Video Presence Detector	PSA-120	Subcarrier Distribution Amplifier



LENCO ELECTRONICS

A DIVISION OF LENCO, INC.

PHONE [314] 243-2394 OR 243-3141 319 W. MAIN ST., JACKSON, MO. 63755

For More Details Circle (82) on Reply Card

AUDIO INTERFACE SYSTEMS BUILD

MORE CONSOLE FOR THE MONEY

M-52

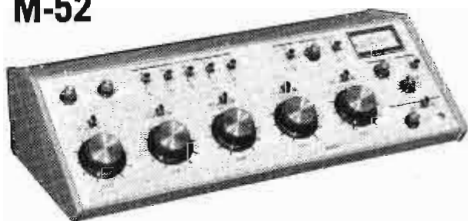

5 CH-MONO
DUAL OUTPUT

\$675

S-52

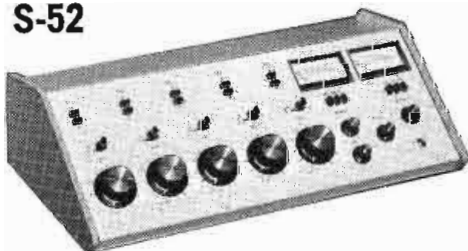

5 CH-STEREO

\$995

M-82



8 CH-MONO
DUAL OUTPUT

\$995

S-82



8 CH-STEREO

\$1895

M-41



4 CH-MONO

\$369



Audio Interface Systems, Inc.

(205) 595-6469 P.O. BOX 6911
2708 5th AVENUE S. • IRONDALE, ALA. 35210

For More Details Circle (83) on Reply Card

(Continued from page 122)

The unit is supplied with a push-to-talk ceramic mic. The receiver uses dual gate MOSFETS in the front end, an IC IF that completely limits with less than 10uV signal. It's dual conversion, with excellent impulse noise rejection.

This unit is far advanced from the "lunch bucket" days. Aside from its impressive specs, the accessories include a tone burst encoder accessible from the front panel, an AC power supply, a 40-Watt amp, a wattmeter, and base and mobile antenna. On our BE bench, we found that the HW-202 meets or exceeds the manual specs.

For More Details Circle (169) on Reply Card

Digital Sync Generator

Control Concepts Corporation, Rockville, Maryland, introduces a new generation of low cost digital sync generators designed primarily for single line pulse distribution systems. The Model 800 plus CCC's Model 601 Master Sync Generator

(Continued on page 126)

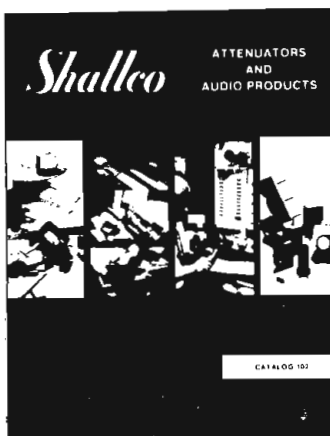

ATTENUATORS AND AUDIO PRODUCTS

The above catalog provides 16 pages of information, including applications, charts, tables, and a selection guide. Send for your copy today.

Shalleco

P. O. BOX 1089 HIGHWAY 301 SOUTH
SMITHFIELD, N. C. 27577

For More Details Circle (84) on Reply Card

ROH fits right in

***New Products
for '74**

Roh audio systems fit your needs, fit your budget, and always fit right in with existing equipment. Start with a single module or several. Then build from there. You'll be ahead in quality, performance and price.

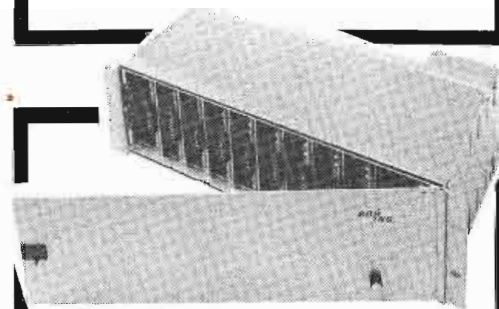

MODULES

Model	Description	Price
210	10 Watt Power Amplifier	60.00
*211	1x6 DA, Source Terminated Differential Outputs	90.00
*212	1x6 DA, Individual Transformer Outputs	130.00
213	12x1 Active Mixing Network	60.00
214	Microphone/Line Preamplifier	90.00
215	Program/Line Amplifier	75.00
216	4 Channel LDR Attenuator/Switch	75.00
217	4x1 Solid State Crosspoint Switch	110.00
218	Dual Channel Phono Tape Preamplifier	75.00
219	Audio Processing AGC Amplifier	150.00
220	Dual 10 Watt Single 30 Watt Power Amplifier	110.00
221	4 Stage Binary Tally Logic Driver	90.00
*222	Diode Matrix for cascading 221's	45.00
*223	6x1 Differential Input Active Mixing Network	75.00
*224	Dual Channel model of 214	150.00
*225	Dual Channel model of 215	130.00
*230	Generator, Volt Meter Test Set for 200 series systems	350.00

ENCLOSURES

201	10 Module Enclosure	190.00
202	9 Module Enclosure Accepts Model 205 Power Supply	230.00
203	3 Module Enclosure	130.00
204	2 Module Enclosure with Power Supply	170.00
250	1 Module Enclosure with Power Supply	110.00

Roh Corporation

150 Technology Park/Atlanta Suite 15
Norcross, Georgia 30071 Ph: 404/449-0873

For More Details Circle (85) on Reply Card

What you don't see

is also what you get.

When you look into our coaxial cables, the completeness of the line is the first thing that strikes you. It's unique. We're the only manufacturer to offer a coax to meet every need: copper corrugated, smooth aluminum, foam dielectric and air dielectric; both types with a choice of constructions in a wide range of sizes and continuous lengths. A check on the performance of these coaxial cables in the lab or in the field would present convincing evidence of a high degree of mechanical integrity and outstanding electrical characteristics. Request a quotation and a glance at price and delivery will be the clincher.

These qualities are obvious to anyone who cares to look for them but our coax customers get still more not so readily seen. For instance, fast reaction to your RFQ's and prompt, accurate, response to requests for technical data and assistance in system or subsystem design. Perhaps a custom cut length of coax or a special assembly, terminated and ready to slip into place is what you need. No problem. After-sales service is not an empty statement with us. It's an article of faith.

May we tell you more? Write for your copy of our new 64-page catalog today. Cablewave Systems Inc., 60 Dodge Avenue, North Haven, Connecticut 06473. (203) 239-3311.



Cablewave Systems Inc.

A Corporation owned by Phelps Dodge and Kabelmetal

For More Details Circle (86) on Reply Card

There are other things to do besides watching T.V. all day.

The VIDEO SENTRY is designed especially for the busy, cost conscious broadcaster. This system records both audio and video content of your T.V. programming and automatically superimposes time and date on each frame, second by second.

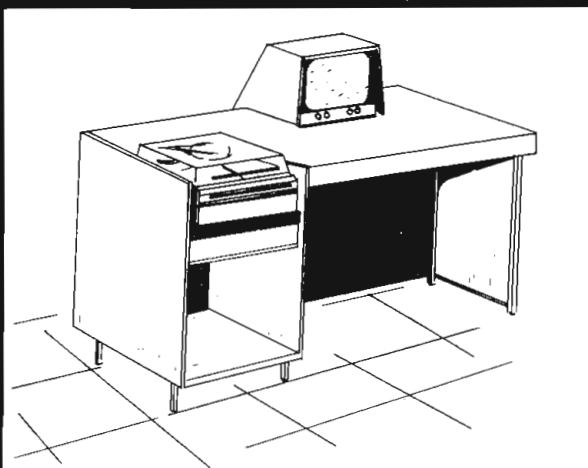

VIDEO SENTRY is ideal for:

- Program content studies
- Commercial verification
- Daily program logging

FEATURES:

- Automatic unattended operation
- Costs as little as .12 cents per minute for tape
- Keyboard, single frame stop action
- Perfect playback (no noise bars) in real time
- Up to 12 hours of programming on a single 1/2 inch width roll of video tape
- High speed search and playback

The VIDEO SENTRY includes:

- Recorder/Player
- T.V. Receiver/Monitor
- Headset/Speaker
- Custom Console Cabinet
- Electronic Video Clock with optional station I.D.
- One Roll Video Tape

Call or write:

VIDEO SENTRY SYSTEMS

1080 Route 46, Clifton, New Jersey 07013, (201) 777-7600

For More Details Circle (87) on Reply Card

(Continued from page 124)

comprise a complete system.

Specific features are: modular construction; separate modules for programming pulses in 70 ns increments and for horizontal phase (9µs advance, 6µs delay in increments of 70 ns). Zero or one line vertical phase advance. Optional modules - additional pulse and subcarrier outputs; black burst; dot/grating.

For More Details Circle (170) on Reply Card

Quad Console

Dyma Engineering has a new quadrasonic console designed specifically for broadcast application. In addition to the many normal human engineering features on DYMA consoles, the Custom Quad features simplified control of quadrasonic sources. It also provides mixing capabilities for conventional stereo signals and mono signals with pan control on many of the channels.

The console features peak flasher units for each of the four channels, peak flashers and total modulation indication, illuminated transmitter status indication, and digital clock and timer.

Many additional variations are offered.

For More Details Circle (171) on Reply Card

One Tube 2.5 kW Transmitter

Wilkinson Electronics, Inc., now has available a single tube transmitter representing a solid shift to solid state. With the exception of the 5CX1500 final amplifier, this 2.5 kW FM transmitter is all solid state.

Operating at 2.5 kW, the FM-2500E transmitter has at least another 250 Watts available. And it requires only 5¼ square feet of space.

The FM-2500E uses vacuum capacitor tuning and loading, and it requires no neutralization. Even the power supply is solid state.

For More Details Circle (172) on Reply Card

Video Discassette Recorder

Arvin Systems, Inc., demonstrated their new direct video animation device for attendees at the NCTA convention this year. Using the Arvin Video Discassette Re-

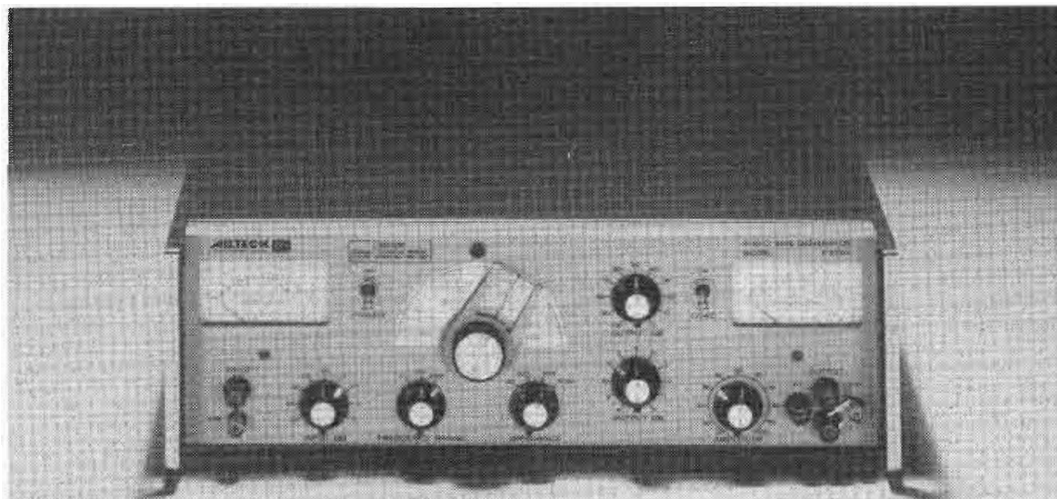

HIGH watts are a must for the effective testing of audio range devices. For such applications as measuring return loss, AILTECH's Model F370 Audio Sine Generator has all the specifications you'll ever need. Model F370 has a frequency range of 20 Hz to 20 KHz; a built-in voltmeter; 110 db control and impedances of 50 to 5000 ohms. If your requirements include input level metering and secondary metering, Model F370 has it all—for only \$625. Write today for information on the finest high watt audio sine generator built — AILTECH's **Model F370.**

AILTECH MODEL F370A AUDIO SINE GENERATOR

AILTECH 
A CUTLER-HAMMER COMPANY CONTROL

EAST COAST • 815 BROADHOLLOW ROAD • FARMINGDALE, NEW YORK 11735 • (516) 595-6471
WEST COAST • 19535 EAST WALNUT DRIVE • CITY OF INDUSTRY, CA. 91748 • (213) 965-4911

order, they demonstrated how animated ads could be built in a matter of minutes for advertising products or for use in designing unique animated promos.

Within the system, the image is recorded directly onto a flexible magnetic disc that can be played back immediately to check for timing and effects.

The Discassette demonstration included titling, freeze frames, and other special effects. This machine would be applicable to commercial and non-commercial TV, as well as cable TV and industrial TV.

For More Details Circle (173) on Reply Card

Professional Recorder/Reproducer

How about 72 dB signal/noise ratio? Scully/Metrotech is saying it about the new 280-B professional recorder/reproducer.

The 72 dB they claim is on full track .25" tapes, with a high dynamic range. The two-track quarter-inch and four-track 280B is designed to give a clean 69 dB on a NAB weighted basis.

The new unit includes an optical motion sensing system that eliminates deck plate sensor mechanisms. These units also are designed for easy maintenance.

For More Details Circle (174) on Reply Card

Antenna Monitor

Delta Electronics' new DAM-1 antenna monitor is designed to meet the requirements of the FCC Rules changes for monitoring antennas by remote control. It is a true digital instrument using integrated circuit and TTL techniques.

The unit reads phase and true current ratio for up to six towers with different reference towers and different powers for DA-2.

Specs include: phase accuracy at ± 1 degree; phase resolution at ± 0.1 degree; and ratio accuracy at ± 2 percent. Phase range is ± 180 degrees.

For More Details Circle (175) on Reply Card

Audio-Video Television Modulator

Dynair has introduced their Dyna-Mod II, representing an improvement on their industry

(Continued on page 128)

new

AUDIO or VIDEO LEVELS MONITORED AUTOMATICALLY

- SOLID STATE • COMPACT
- ACCURATE • RELIABLE

We Guarantee It For 5 Years



TREPAC MODEL 553 A/V AUDIO/VIDEO AUTOMATIC LINE PROGRAM ALARM senses variations of signal level, and provides automatic control of alarm or other associated equipment. It eliminates the need for continuous personal attention. The unit is activated whenever the audio or video line program level deteriorates below a preset threshold.

The output power "switches" either off or on as desired when level drops for a predetermined (adjustable) length of time. In the absence of a signal, the unit will "switch" off after a fixed duration. Whenever programming returns to its nominal level, the output control instantly "switches"

on. All "switching" is done automatically. Accurate time control predetermines wide range of timing intervals available. The time duration (or delay) is adjustable from 0.1 seconds to as long as 30 minutes, depending on your application. There are many more features that make the compact 553 A/V AUDIO/VIDEO AUTOMATIC LINE PROGRAM ALARM valuable in audio/video monitoring and control applications.

Write today for more information about the 553 A/V and how you may obtain a unit for free evaluation on your program lines. **WITHOUT OBLIGATION.**

TREPAC CORPORATION OF AMERICA

SOLID STATE ELECTRONICS FOR TELECOMMUNICATIONS

30 W. Hamilton Ave., Englewood, N.J. 07631 • Phone: 201/567-3810

For More Details Circle (89) on Reply Card

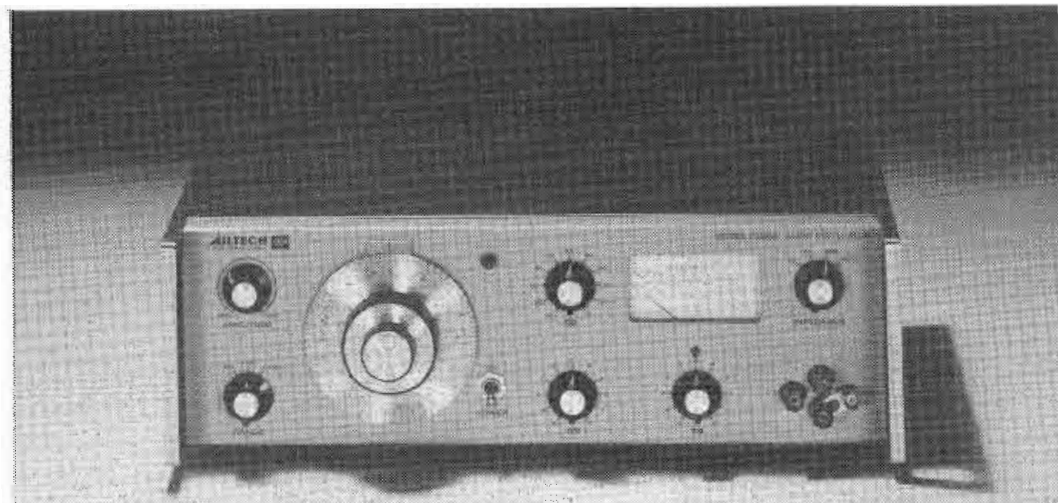

LOW distortion a requirement for the testing, monitoring, and maintenance of your broadcast instrumentation? AILTECH's Model F380A Audio Sine Generator has proof accuracy in one box. Total distortion is less than 0.1%; it has a built-in voltmeter, calibrated in volt and db; a balanced 150/600 ohm output; and a .20 Hz to 20 KHz frequency span. All that for only \$925. If you're interested in only the finest in broadcast test instrumentation, AILTECH's Model F380A can guarantee **proof of performance.**

AILTECH MODEL F380A AUDIO SINE GENERATOR

AILTECH CONTROL
A CUTLER-HAMMER COMPANY

EAST COAST • 815 BROADHOLLOW ROAD • FARMINGDALE, NEW YORK 11735 • (516) 595-6471
WEST COAST • 19535 EAST WALNUT DRIVE • CITY OF INDUSTRY, CA. 91748 • (213) 965-4911

Quality and economy can go together... we did it with Encore tape cartridge equipment



Encore Reproducer \$475

Some broadcasters want and need an economy line of tape cartridge equipment. We incorporated the best features of our premium line into Encore. We simplified systems, circuits and manufacturing techniques. And we created further economies by selling direct, with payment due when you order. We offer a 30-day guarantee of satisfaction plus a one year warranty. Call us collect today and find out why many broadcasters are finding quality and economy under the Encore name.

Encore Recorder/Reproducer \$630



Call 309-828-1381 collect for details on the Encore series

INTERNATIONAL TAPETRONICS CORPORATION
2425 South Main Street,
Bloomington, Illinois 61701

For More Details Circle (91) on Reply Card

(Continued from page 127)

tested Dyna-Mod unit.

The unit accepts separate audio and video inputs from which it generates a broadcast quality VHF television signal on a specified channel. It contains a sideband response filter and output amplifier which is designed assure performance in adjacent-channel color systems without the addition of external filters.

An optional envelope-delay correction filter also is available.

Maximum RF output is 500,000 microvolts with a second output providing a 10 dB reduction.

For More Details Circle (176) on Reply Card

Audio Consoles

Broadcast Electronics, an old line audio manufacturer, has developed a new line of mono and stereo consoles for the broadcaster.

The mono consoles have from 11 high/low inputs into 5 mixers up to 20 high/low inputs into 8 mixers.

On the stereo side, the new units offer from 11 pairs of high/low



Manufacturers of High Quality Products for the Broadcasting Industry.

- Audio Transformers
- Microphone Extension Cords
- Broadcast and Audio Accessories
- Paging Microphones
- New Microphone Cable Tester

Send for free catalogs
Sold through Electronic Distributors

100% AMERICAN

SESCOM, Inc.

Quality Engineered Sound Products
P.O. Box 4155, Inglewood, CA. 90309
(213) 678-4841

For More Details Circle (92) on Reply Card



We just feel like singing about RUSSCO's New STUDIO/MASTER 505 Audio-Mixer — LOOK! 5 mixing channels, 4 channels with built-in Preamps! Each adjustable for mic, phono or hi-level! Channel 5 has 5 hi-level push-button balanced inputs! Built-in Monitor Amp, cue-speaker, headset amplifier! Push-button key switching with LED indicators! Allen-Bradley Mod Pots! FET monitor muting and much more! Available in attractive cabinet or as a rack mount (in 5 1/2" space) model. Mod colors — maroon & black face, blue-grey cabinet! PRICES THAT START AT UNDER \$500!!!



RUSSCO STUDIO-PRO and CUE MASTER turntables offer the ultimate in rugged long-wear dependability and ease of operation . . . only 3 moving parts! No-slip starting and reliable Bodine synchronous motor. The finest professional engineering with prices starting at a low \$152.00



The perfect tone arm for the finest turntable! The RUSSCO TA-12 all metal anti-skating tone arm — only \$59.00



You get the most "headroom" for the money (+18 DBM) with RUSSCO's New "FIDELITY-PRO" and "FIDELITY-MASTER" phono pre-amps. 8 models stereo or mono to fit your needs, self-powered and featuring a unique "easy-service" case. Years ahead in engineering with economical prices starting at \$92.00



ELECTRONICS INCORPORATED
1070 Brookhaven, Clovis, Calif. 93612
Phone (209) 299-2167

For More Details Circle (93) on Reply Card

inputs into 5 mixers up to 14 pairs of high/low inputs into 8 mixers.

FET's are used for switching of the input channels, and there are low and high level preamps for each channel. Ladder attenuators are standard, but carbon pots are optional at lower cost on mono models.

Completely self-contained and solid state, these models have identical program and audition output channels for dual console capability.

Please note that requests for further information should be on

company stationery and mailed to: Broadcast Electronics, 8810 Brookville Road, Silver Spring, Md. 20910.

Video Monitors

SC Electronics, Inc., is now offering a line of 16 sq. inch video monitors in single or triple unit combinations. These monitors take up only 7 inches of vertical rack space.

These professional monitors have a horizontal resolution of 600 lines and are completely solid state. And

the easily removable chassis allows easy access and maintenance.

For More Details Circle (177) on Reply Card

Station Clock Timer System

Time And Frequency Technology, Inc. (TFT) has introduced a versatile clock timer system you can synchronize with any number of remote digital clocks, impulse clocks, event timers and synchronous motor clocks. It can impose time data on a video signal with a

(Continued on page 128B)



CHARGE-UP YOUR BATTERY

WITH
TELAN
thermoelectric
generators

GENERATOR OR BATTERY SYSTEM? There's really no need to choose between the two. TELAN can work *with* your battery system—charging for those peak loads. Power from 10 to several hundred watts. 12-24-48 VDC standard.

Operates on natural gas or propane.

TELEDYNE ISOTOPES

110 W. Timonium Rd. Timonium, Md. 21093 Phone: 301-252-8220 Telex: 87-780

For More Details Circle (94) on Reply Card

STEREO PHASÈ ENHANCER

MODEL
STE-100

DOES YOUR MONO-SUM (L+R) SIGNAL SUFFER FROM PHASE DISTORTION?

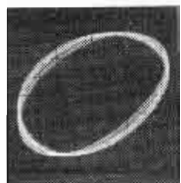

STE-100 INPUT

SEE WHAT THE STE-100
STEREO PHASE ENHANCER CAN
DO FOR YOUR STATION!



STE-100 OUTPUT

- Enhances Discrete Stereo Signals
- Affects Only Phase—No Signal Degradation
- Place Before Stereo Generator
- Fail-Safe Bypass
- \$795.00

FROM THE MAKERS OF RAPID-Q™ CARTRIDGE TAPE EQUIPMENT

GARRON ELECTRONICS INC.

1216 KIFER ROAD SUNNYVALE, CALIF. 94086 (408) 736-8737

(Continued from page 128A)

reported accuracy of one second per month.

Called Digit-Sync, the system requires only a single pair of shielded wires to transmit time data and power supply to auxiliary units.

In addition, serial time data can be sent over voice band channels or recorded on tape for time coding of information.

The system is expandable into virtually any size or complexity. And power failure protection is provided by a 12-Volt back-up battery.

For More Details Circle (178) on Reply Card

Audio Control Center

From Cetec comes the new series 10 audio control center for video, AM, FM, or stereo.

The control center series features 10 stereo mixing channels, two monitor amplifiers, 5-position monitor select, 26 stereo inputs (including 8 remotes), and conductive-plastic faders.

The series also offers separate

program, audition and cue outputs with individual channel assignment. All include redundant fail-safe power supplies.

For More Details Circle (179) on Reply Card

Computer Assisted Remote Control

Moseley Associates, Inc., is now producing computer assisted remote control systems that are fully digital for control, telemetry, and for automatic logging.

Their computer option is up to 30 parameters displayed simultaneously with tolerances on all channels.

The Moseley system can offer totally automated transmitter operation. This system includes a CRT readout of parameters.

For More Details Circle (180) on Reply Card

Color Sync Generator

Video Aids Corporation of Colorado® VACC's Model 5000 Color Genlock Sync Generator meets all NTSC/RS 170 requirements and

specifications.

No add-on options or accessories are needed to obtain phase lock. VACC's genlock provision permits synchronization from an entire video system to an external video source such as a VTR or remote line. Indicator lights automatically inform user when unit is on, when composite video or black burst is present at the input and when the Model 5000 is phase locked.

VACC's Model 5000 is housed in a rack-mount cabinet.

For More Details Circle (181) on Reply Card

Special Effects Video Quantizer

Colorado Video has available a unique unit that can be used for image processing, electronic art, or broadcast special effects.

Called the Video Quantizer, this unit (model 606A) is intended primarily for studio special effects production. The principle of operation involves the "slicing" of a normal video signal into eight dis-

CAN YOU FIND --



OURS

YOU



THEIRS

THE HAPPY ENGINEER



TONE ARMS



PRE-AMPS



TURNTABLES



STUDIO FURNITURE



CLOCK SYSTEMS



TAPE CART RACKS





WE CAN MAKE YOU HAPPY



MICRO-TRAK
620 RACE STREET
HOLYOKE, MASS. 01040

For More Details Circle (96) on Reply Card

LET'S TALK FACTS!

STANTRON'S Modular cabinet concept offers:

- FACT: Weight-load capacities to 3,035 pounds**
- FACT: Tapped panel mounting angles**
- FACT: Square-corner or ball-corner design**
- FACT: Eleven paint colors, smooth or textured**
- FACT: Front aluminum trim, two styles**

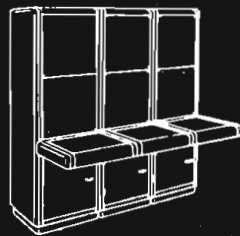
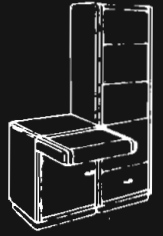
For additional facts about custom cabinets/enclosures without custom fabrication costs, write or call for our catalog.



STANTRON®
MODULAR ELECTRONIC CABINETS

6914 Beck Avenue
No. Hollywood, CA 91605
Phone (213) 875-0800
TWX 910-499-2177

DIVISION OF WYCO METAL PRODUCTS

For More Details Circle (97) on Reply Card

BROADCAST ENGINEERING

crete amplitude levels, with subsequent intermixture of these eight signals to achieve a wide range of visual effects.

Effects include: Keying, tone reduction, outlining, brightness, contouring, grey scale inversion, synthetic color generation, tinting, and even psychedelic pattern generation.

For More Details Circle (182) on Reply Card

Wide Range Function Generators

Aitech announces the release of a trio of function generators incorporating an independent yet integrated sawtooth generator.

The 505, 515, and 525 are now available with the capabilities built-in to generate sine waves, triangles, square waves, sawtooth waveforms, pulses, low-duty cycle pulses, tone bursts, swept sine, swept triangle, swept square waves, swept prb, haversines, mono pulses and waveforms, etc.

Each of the units additionally provides a built-in wideband summing amplifier; its "integrator" and sawtooth generator can be operated separately or together. All can be externally triggered, the main generator can be used as a VCG, trigger-gated, mixed, etc.

The main generator can be selected with top frequency of 5 MHz, 10 MHz or 20 MHz. The sawtooth

generator operates from 001 Hz (1000 sec) to 100 KHz. Sawtooth output is 0 to 1.5V into 50 Ohms (0 to 3V open circuit). This can be amplified X4 by the built-in amplifier.

The sawtooth generator can cause the main generator to sweep over a frequency range up to 1000:1, at all the rates mentioned.

For More Details Circle (183) on Reply Card

Directional Antenna Monitor

Potomac Instruments announces FCC type approval of the AM-19 (204) Antenna Monitor. This instrument is the first antenna monitor to be approved under the new rules adopted January 10, 1973.

The AM-19 (204) is a completely solid state device which provides direct readout of phase angle and loop current ratio. Unlike earlier phase monitors, this unit requires no operator adjustments other than tower selection by means of front panel push buttons. Directional arrays of up to twelve (12) towers and up to three (3) separate patterns can be monitored. Free of internal oscillators and mixers, the monitor exhibits an input level dynamic range of 32 dB (.5V rms to 20V rms) without the need for adjustable attenuators. Loop Current Ratio is displayed directly as a

(Continued on page 129)

VIF INTERNATIONAL®
CUSTOM AUTOMATION SYSTEMS. WE WILL SUPPLY ALL OR PART. INTEGRATE YOUR EXISTING TAPE TRANSPORTS, OR WE WILL SUPPLY MAKES AND MODELS OF YOUR CHOICE.

PO BOX 1555, MOUNTAIN VIEW, CALIF. 94040 • TELEPHONE (408) 739-9740.

For More Details Circle (98) on Reply Card

TRANSLATORS

DESIGNERS AND MANUFACTURERS OF VHF, UHF, FM
ALSO REPAIR PARTS AND UP DATING KITS FOR
ALL ADLER AND LITTON TRANSLATORS

FOR FULL INFORMATION:

Television Technology Corporation

9150-B Brockville Road, Silver Spring, Md. 20910

(301) 555-0770

For More Details Circle (99) on Reply Card

To Meet All
Federal Regulations*

**SPECIFY
& INSIST**

on
Hughey & Phillips

The leader in tower
obstruction lighting
and control systems.

* FCC — FAA and Nat'l. Elec.
Code Regulations



**300MM BEACONS
SINGLE AND DOUBLE
OBSTRUCTION LIGHTS**



**APPROVED
by the FAA**

TOWER LIGHTING ISOLATION TRANSFORMERS
750, 1750, 3500, 5000, 7500 Watts

FEATURING...

- HIGHER EFFICIENCY
- IMPROVED REGULATION
- FIBERGLAS INSULATION
- EPOXY ENCASED
- VERSATILE MOUNTING



CONTROL UNITS to meet
Standard or Special Requirements.

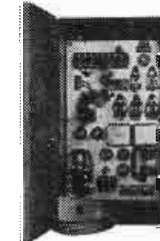

**LAMP FAILURE
ALARM SYSTEMS
FOR UNATTENDED
INSTALLATIONS**

**TUBELESS PHOTOELECTRIC
CONTROL UNITS**
Indoor or Outdoor
Many Sizes and Voltages

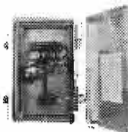

BEACON FLASHERS
Single and Multi-circuit
Indoor or Outdoor

FOR TALL TV TOWERS



**LAMP FAILURE
INDICATOR PANELS**

Request our exclusive **TALL TOWER**
Specification Guide.

HUGHEY & PHILLIPS, INC.

Manufacturers of
300mm Beacons, Obstruction Lights, photo-controls,
Beacon Flashers, Microwave Tower Hazard Light Control
and Lamp Failure Alarm Systems, Complete Kits for:
Tower Hazard Lighting, Deicers, & Talking Circuits, Tower
Lighting Isolation Transformers, Airport Runway Lighting

3050 N. California St., Burbank, California 91503

For More Details Circle (100) on Reply Card

MARTI... the name to remember for *remote pickup* and *studio-transmitter links*



RPU Transmitter

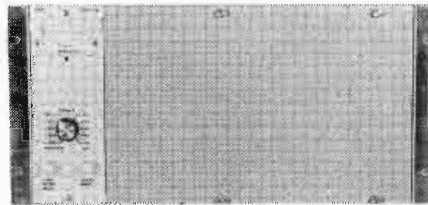

RPU Receiver

Radio Remote Pickup Equipment is versatile, dependable and an entree to profitable radio broadcasting. That is the acclaim given to Marti RPU Equipment by American Radio Broadcasters. "How did we ever operate a radio station without it?", is the comment most often heard after equipment has been purchased and put into service.

The progressive minded, community spirited broadcaster, can find many uses for Remote Pickup Equipment. He will do many more remotes than he is presently doing, simply because the equipment is available at a moment's notice. To coin an old cliché, "It doesn't cost—it pays."

RADIO REMOTE PICKUP

150 - 450 MHZ

FEATURES:

- *All Solid-State
- *Direct FM Modulator
- *Broadcast Quality—Continuous Duty
- *Four Audio Mixing Channels
- *Plug-in Modular Construction
- *I.F. Crystal Filter
- *Taut Band Meters

COMPLETE LINE OF ACCESSORIES AVAILABLE

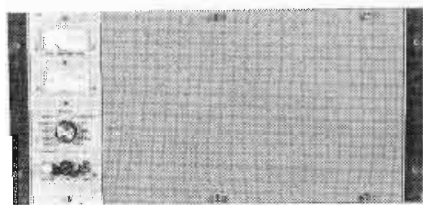

STL Transmitter

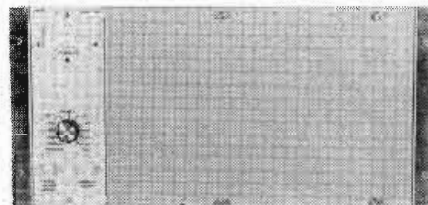

STL Receiver

Marti Electronics, Inc., has now been actively engaged in the design and manufacturing of Studio-Transmitter Link equipment for both AM and FM Broadcast, and Inter-City Relay Systems, for the past 9 years. Having well over 300 systems on the air and operating throughout the 50 United States and many more internationally, soundness of design, reliability and sound quality are a matter of record.

It is our earnest opinion that the only logical answer to increased telephone line costs, minimum "lost air" time, improved sound quality and a general reduction in operating costs lies in the use of STL, Remote Control and Telemetry equipment.

AURAL STUDIO-TRANSMITTER LINK INTER-CITY RELAY

AM - FM 950 MHZ MONO-STEREO

FEATURES:

- *All Solid-State
- *Direct FM Modulator
- *Field Proven Varactor Final
- *Plug-in Modular Construction
- *Solid-State Ovens
- *Hi-Accuracy Crystals

SYSTEM SPECIFICATIONS

Frequency Response: + or - .5 db. from 40 Hz to 15,000 Hz.
Distortion: 0.6% or less, 50 Hz to 15,000 Hz.
Signal To Noise: -65 db. or better. Ref. 400 Hz. Mod. 100%

CLA-40A COMPRESSOR/LIMITER AMPLIFIER

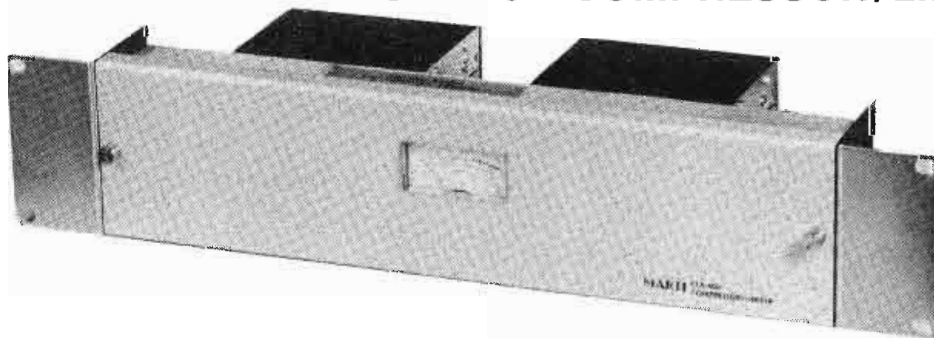

FEATURES:

- *Symmetrical or Asymmetrical Peak Limiting—Switchable
- *Pre-emphasized or Flat Audio Response—AM or FM—Switchable
- *Compress/Limit, Compress Only, Compress Limit Off—Switchable
- *Adjustable Negative and Positive Peaks
- *Well Shielded and Filtered for Strong RF Fields
- *Plug-in Modular Construction
- *Illuminated, Taut Band Meter reads Gain Reduction or Output Level in VU
- *40 DB Dynamic Range with less than 1% Distortion
- *Automatic Gain Control Built In
- *Solid-State
- *Selectable Release

The CLA-40/A Compressor/Limiter, is perhaps the most versatile audio processing device to be found on the market today. Combining the functions of Limiting, Compression, Expansion and Automatic Gain Control, the CLA-40/A fills a variety of requirements, formally accomplished by several different devices.

ALSO AVAILABLE:
Program/Line Amplifier*Monitor Amplifier

MARTI Electronics, Inc.

P. O. Box 661 1501 N. Main Cleburne, Texas 76031 (817) 645-4091

(Continued from page 128C)

percentage of reference tower current. Phase Angle is indicated in degrees and is independent of modulation effects.

Remote indications of Phase Angle and Loop Current Ratio are displayed on the RMP-19 (204) at the remote control point thereby eliminating the need to visit the transmitter within two hours after pattern change. The AM-19 (204) is the current production version of the very popular AM-19 which has a five year history of proven reliability.

The AM-19 is currently used by several hundred broadcasters with virtually every available type of wire and wireless remote control system. Separate normalized analog outputs are provided for each measured parameter without the need for line interface equipment.

For More Details Circle (184) on Reply Card

Noise and Signal Test Set

The new **TM SYSTEMS** Model 510 Test Set is a self contained battery operated transistorized unit measuring signal and VU levels from +23 dBm to -95 dBm, and noise from +113 dBm to -5 dBm.

Longitudinal balance is maintained in excess of 85,000 Ohms across the line while maintaining close tolerances when bridging or terminating lines under test. Frequencies are maintained flat from 30 Hz to 20 kHz as well as modified by active circuitry for C-MSG, High Pass, 3 kHz and 15 kHz weighting.

Provisions for external 48V DC operation is provided and 115/220 Volt power adapters are available. The Model 510 is packaged for ease of operation, portability and maintenance.

For More Details Circle (185) on Reply Card

Dynamic Noise Filter

Burwen Laboratories has taken no less than 40 operational amplifiers and combined them into a unique broadcast unit: a dynamic noise filter.

This unit is a automatically variable bandpass filter with a bandwidth that changes rapidly with each musical note. Its high and low frequency cutoffs are independently

controlled by the spectral content of the input signal. No signal encoding is required.

Burwen claims 100 dB dynamic range with flat response across the entire range.

For More Details Circle (186) on Reply Card

Digital Logging System

McBee Laboratories is now showing their model VII/21 automatic digital logger that records and prints out all the meter readings

you need.

In a complete, self-contained system the VII/21 contains a printer display and print date, time, channel number, and volts, amps, watts, etc. Also capable of sampling, measuring, and displaying analog inputs from single or multiple sources. The unit is equipped with a real time digital clock.

For More Details Circle (187) on Reply Card

(Continued on page 130)

"live" automation will improve productivity

Use the talents of your best people to their full capabilities. Staff members can actually be in production while they are "on-air" with live automation. The SMC SEQUENTIAL system permits scheduling up to 60 events (spots, music, talk, whatever) from as many as 10 different audio sources. Planned programming is significantly improved with your best talents being used constantly rather than on a "shift" basis.

Improve your "live" programming with this easy-to-operate SMC system that you can add to later for future growth. Phone or send for full facts today.

Send complete information on live automation with the SMC SEQUENTIAL!

Name _____

Station _____

Company _____

Address _____

Zip _____

the **COMPUTERCASTERS** from



SYSTEMS MARKETING CORPORATION

Phone: 309-829-6373
1015 W. Washington Street
Bloomington, Illinois 61701

SEQUENTIAL

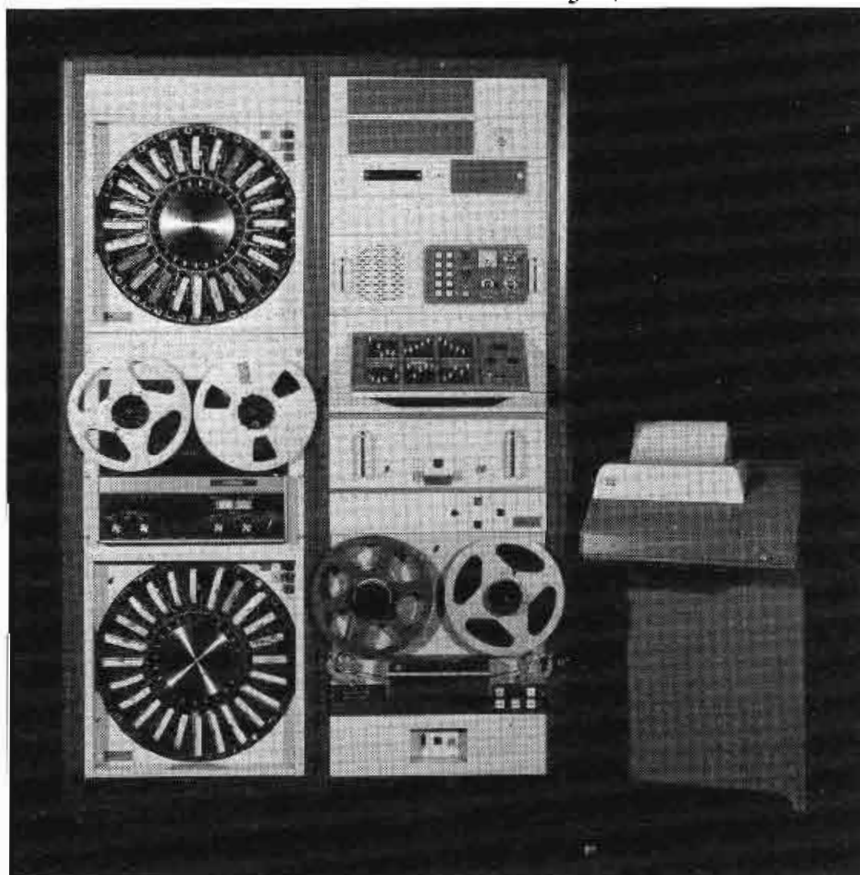

For More Details Circle (102) on Reply Card

AMT-G-HANGER

Supports your lights at any height. Adjustable from 0-80 pounds. Write to Berkey Colortran for more information.

Berkey Colortran
A DIVISION OF Berkey Photo Inc.
1015 Chestnut St. Burbank, CA 91502 • 213 843-1200

(Continued from page 129)

Turntable And Recorder Test Set

Elpa Marketing has a new recorder test unit - called the RTS-2 - that should be of interest to engineers in broadcasting, recording studios, testing labs, and service shops.

The RTS-2 is a pushbutton operated test instrument that includes a sine wave generator, millivoltmeter, wow and flutter bridge with expanded range, and a harmonic distortion meter with simplified measurements.

Elpa says the setup time is minimal and only two test leads are required.

For More Details Circle (188) on Reply Card

Portable Video Production Switcher

The new Richmond Hill Laboratories portable video production switcher is color capable, and features 12 effects nine inputs available.

The switcher follows the tradition

JOA CARTRIDGE SERVICE OFFERS DISTINCT ADVANTAGES YOU SHOULD KNOW ABOUT

Advantage ONE—NO MINIMUM

Cartridge Reconditioning

Advantage TWO—NO EXTRA CHARGE for

- (a) foam teflon-faced pressure pads
- (b) replacement of minor parts
- (c) visible splice
- (d) pretesting under actual broadcast conditions
- (e) 72 hour processing
- (f) Scotch heavy-duty lubricated tape

New Cartridges

Advantage THREE

Shipment from stock, of any standard size, or... "prompt shipment" of CUSTOM SIZE Fidelpac precision manufactured NAB cartridges.

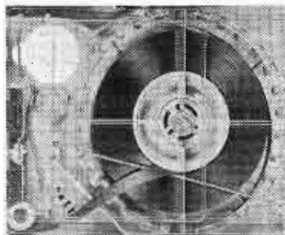

Advantage FOUR—24 or more shipped prepaid. Authorized distributor for NORTRONIC HEADS.

Phone or Write

JOA Cartridge Service
P.O. Box 7112, Phila., Penna. 19117
Area Code 215, 886 7993

For More Details Circle (104) on Reply Card

HALF THE COST
1/10 THE SIZE

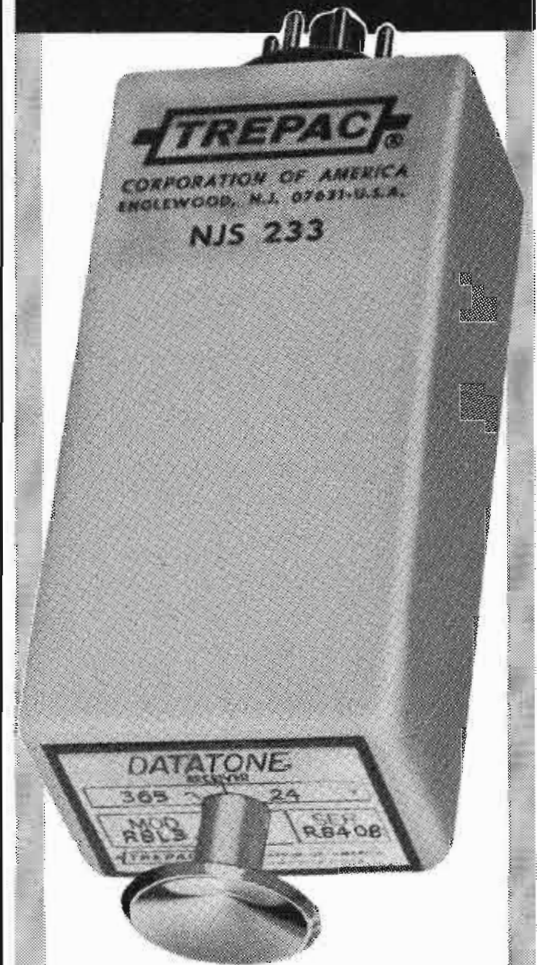

DATATONE[®] TRANSMITTERS RECEIVERS

- Transistorized • Miniaturized
- No tuning forks • Solid state
- No tuned reeds
- Low cost • Proven reliability
- Thousands in service
- Compatible with standard telephone operating practices

All plug-in sealed modules measure only 1½" x 1¾" x 4".

Freq. range: 300 Hz to 9999Hz.

SPECIFICATIONS

DATATONE TRANSMITTER: Designed to bridge a 600 ohm transmission line with less than 1 db loading and through contact closure deliver an undistorted tone signal level of 1 Milliwatt.

DATATONE RECEIVER: Designed to bridge a 600 ohm transmission line with less than 0.5 db loading, and close contacts or power an external relay load upon receiving a tone pulse from its companion transmitter.

Both units are rated for continuous operation over a temperature range of -30°C to +70°C from a 12/24/36/48 VDC supply. For complete technical data, call or write:

TREPAC
SOLID STATE ELECTRONICS FOR TELECOMMUNICATIONS
CORPORATION OF AMERICA
30 W. Hamilton Ave., Englewood, N. J. 07631
201-567-3810

For More Details Circle (105) on Reply Card

of Richmond Hill, and this one includes totally solid state video switches from Honeywell.

Because of the many features and options of the VPM-41, the switcher could well be used as a control room production switcher.

For More Details Circle (189) on Reply Card

Film Sound Transfer Equipment

Magna-Tech Electronic Company has introduced a new machine that is designed to add speed and flexibility in the operation of sound transfers, looping, re-recording, double system screening, and tele-cine interlock.

Using foolproof IC logic, this unit - called the MTE 600 series - features: stepping motor sprocket drive; optical/electrical high speed interlock; 10 times sync speed in interlock with video tape recorder; and it operates at 6 times sync speed through sprocket in interlock.

For More Details Circle (190) on Reply Card

Audio Routine Test System

Control Concepts Corporation, Rockville, Maryland, has introduced Model HS-4 Audio Routine Test System, which measures audio line quality in less than one minute.

Audio level, frequency response, total harmonic distortion and signal-to-noise ratio are all detected in a 16 second scan sequence and indicated by two meters.

For More Details Circle (191) on Reply Card

Dual Cue Recorder Control

Designed for use with EECO's BE450 Wide Range Synchronizer, the new BE460 Dual Cue Controller provides individual or simultaneous automatic cueing of two video or audio tape recorders.

The BE450 Wide Range Synchronizer, introduced in 1972, automatically synchronizes two mag tapes, whether quad or slant-track video, sprocketed or unsprocketed audio.

EECO's new BE460 Dual Cue Controller now replaces the BE420 Edit Code Reader, which required manual pre-roll parking of recorders prior to actual synchronization. The Dual Cue Controller provides pre-set and automatic location of

desired tape parking points.

The BE460's front panel dimensions are identical to those of the Synchronizer—4.9" high X 8.3" wide. These also match dimensions of other EECO mini "building block" modules in use for electronic indexing, synchronization and editing of video and audio tapes.

For More Details Circle (192) on Reply Card

Frequency Counter

United Systems is now offering

the Monsanto model 115A counter that will digitally read out from 5 Hz up to 150 MHz, with sensitivity on the high end at 50 mV. And unlike many counters, the 115A has three selectable gate times, with optional I.F. subtraction for use in communications.

Its input is one megohm shunted by 20 pf. The resolution is selectable at the front panel for 10 kHz, 100 Hz, and 10 Hz. The maximum input on this unit is 500 VDC plus

(Continued on page 132)

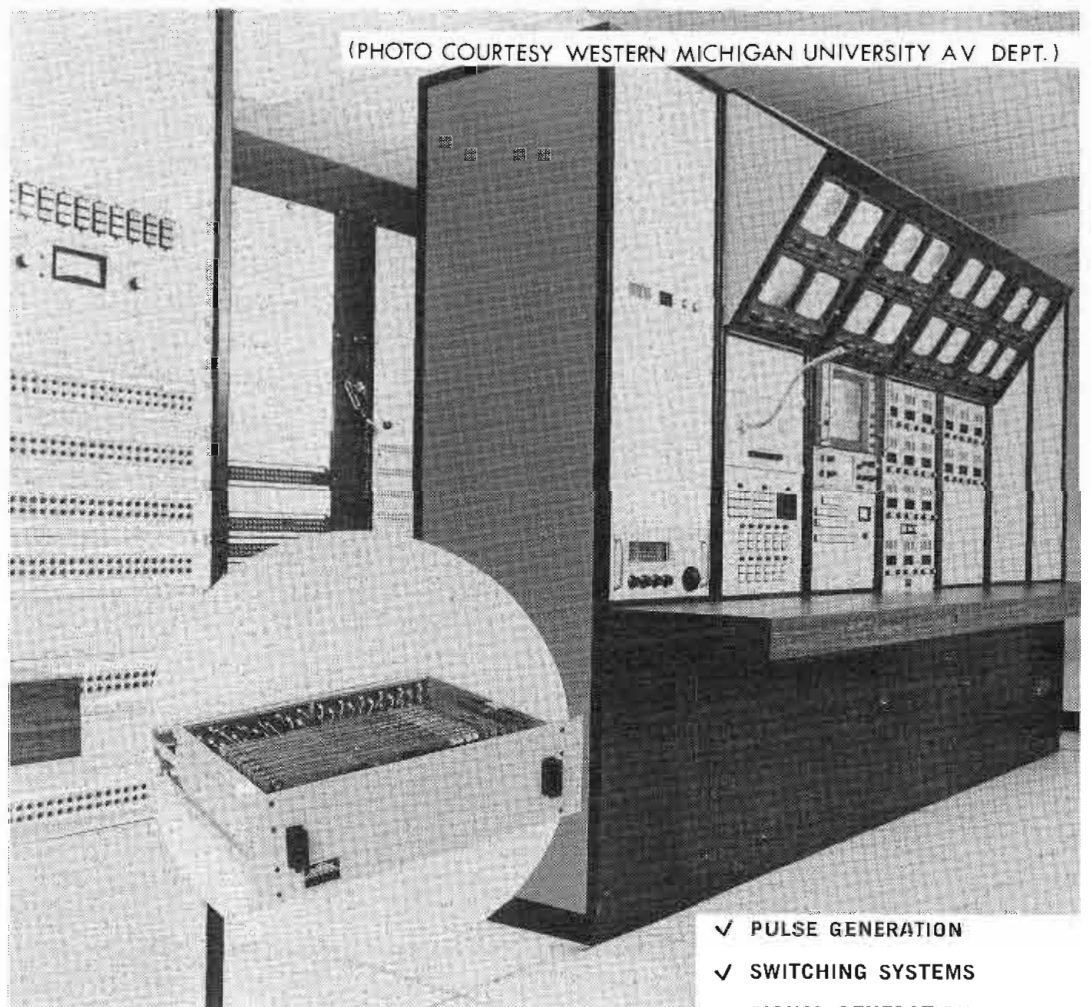

(PHOTO COURTESY WESTERN MICHIGAN UNIVERSITY AV DEPT.)

- ✓ PULSE GENERATION
- ✓ SWITCHING SYSTEMS
- ✓ SIGNAL GENERATION
- ✓ AUDIO DISTRIBUTION
- ✓ TIME EQUIPMENT
- ✓ VIDEO DISTRIBUTION
- ✓ PULSE DISTRIBUTION
- ✓ SYNC SYSTEMS
- ✓ PROCESSING AMPLIFIERS
- ✓ MIXING SYSTEMS



CHECK THE MANY ADVANTAGES OF

ADC "Custom Configured"

TELEVISION PRODUCTION AND ROUTING SWITCHING SYSTEMS DESIGNED TO MEET YOUR SPECIFIC REQUIREMENTS.



AMERICAN DATA CORPORATION

AN **AIRPAX** COMPANY

315 WYNN DRIVE, N.W. P.O. BOX 5191 HUNTSVILLE, ALABAMA 35806 TEL. 205-837-5180

For More Details Circle (106) on Reply Card

STOP GROUND-LOOP HUM!

VIDEO
HUM STOP COIL
HSC-1

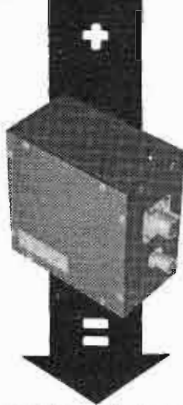
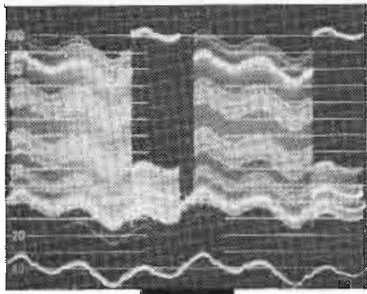

NEW!

NEW!

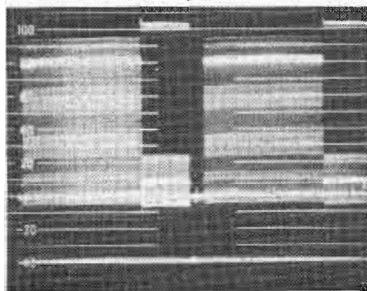

- Will **ELIMINATE HUM** and other INTERFERENCE in Video Lines caused by differences in Ground Potential!!

- For Color and Black & White
- FLAT — DC to 6.5 MHz.
- No Low-Freq. or Hi-Freq. Roll-off.
- No Differential Phase Distortion.
- No Differential Gain Distortion.
- No Envelope Delay.
- Reversible.
- Passive Device — Failure Free.
- Small Compact Package 4" x 4" x 2 1/4".
- Low Price.

\$110.—F.O.B. NY

ELIMINATES HUM & INTERFERENCE:

- **IN FIELD:** Betw. Remote Truck & Telco.
Betw. Remote Truck & Microwave
For Intertruck Hookup
For VTR Units
For Monitoring Lines
- **IN STUDIO:** Between Buildings
On long runs in Buildings
Between Studios & Transmitter
On incoming TELCO circuits
On Outgoing TELCO circuits

AUDIO-VIDEO ENGINEERING COMPANY
65 Nancy Blvd., Merrick, N.Y. 11566
Tel. (516) 546-4239

- Please send Add'tl. Inform. on HSC-1
- Please send me HSC-1 coil(s).
- Enclosed is remittance of
- Please Invoice on 10 day Free Trial

Name
Station or Co. Title
Address
City State Zip

For More Details Circle (107) on Reply Card

(Continued from page 131)

peak AC. Peak AC; 10 V at maximum sensitivity and 500 V at minimum sensitivity. Attenuation is continuously variable by a vernier control.

Options include 6, 7, or 8 digit displays, and BCD output. This last option is particularly useful for recording measurements with peripheral equipment. Complete interlocks are provided as necessary for proper acquisition of data without ambiguities. This unit was tested in the BE lab.

For More Details Circle (193) on Reply Card

Reorder Maintenance Kits

The Recorder Care Division of **Nortronics Company, Inc.**, exhibited their new Recorder Care Products at the 1973 CES Show.

Nortronics' 1973 CES Show exhibit was highlighted by four new inspection and cleaning kits designed for cassette, 8-track cartridge and reel-to-reel recorders and players. The company also showed their

THE ULTIMATE IN COLOR SWITCHERS MODEL 370 MARK II

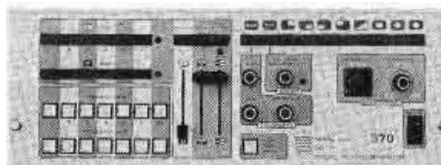

MODEL 370 CHROMATIC® SEG

Built-in features

- Colorizer
- Background Generator
- Burst Generator
- Elliptomat®/Joystick
- Matte/Key
- Vertical Interval Switching
- Automatic Take & Re-entry
- Complete Tally System
- \$2,496.00 List

Chromatic® SEGs 370, 366, 360, Sync. Generators, Gen-Locks, VDA, ADA, Keyers, Pointers, Moduline® Consoles.

SHINTRON

144 Rogers St. Cambridge, MA 02142
Phone: 617-491-8700

For More Details Circle (108) on Reply Card

DPTC-FM SERIES FM DRY LOADS

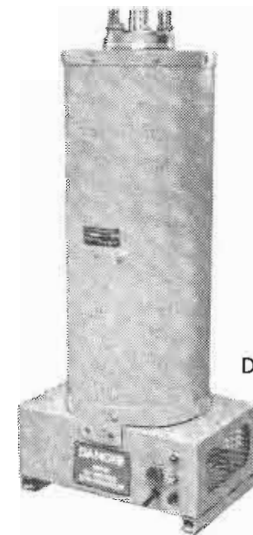

DPTC-10KFM

Model	Average Power	Connector	VSWR
DPTC-10KFM	10KW	3/8	1.2:1
DPTC-20KFM	20KW	3/8	1.2:1
DPTC-30KFM	30KW	3/8	1.2:1
DPTC-40KFM	40KW	3/8	1.2:1
DPTC-50KFM	50KW	6/8	1.2:1
DPTC-75KFM	75KW	6/8	1.25:1

Specifications:

Model DPTC-10KFM

Power Rating: 10,000 watts

Duty: Continuous

Frequency: 85-110 MHz

VSWR: 1.2:1

Weight: 37 pounds

Connector: 3/8 standard

Finish: Light Grey

Power Required: 110VAC 50/60Hz Std.

Ambient Temp. Range: -40° to 52°C

Dimensions: 38 h x 11 d x 16" w.

The new **Electro Impulse Dry FM Band Termination** will save the costs of water or expensive installations for other types of Loads.

Consisting of a practically indestructible resistive element in a stream of forced ambient air, the DPTC-10KFM will operate silently for just a few pennies a year... and we guarantee it for 2!

APPLICATION:

Highly dependable Termination for FM Transmitters. Requires only 110 VAC, 30 watts power.

UNIQUE WARRANTY

"This Termination is Unconditionally Guaranteed against defects in parts or workmanship for a period of 25 months, provided it is operated within recommended parameters."



116 CHESTNUT STREET
RED BANK, N.J. 07701
PHONE: 201-741-0404

For More Details Circle (109) on Reply Card

nothing like this RG59/U coax stripper/cutter

Meet No. 590 . . . designed specifically for RG59/U Coax Cable. With three-position lever in selected position, it cuts and strips:

- 1 Jacket, shielding, and dielectric cleanly from conductor.
- 2 Jacket and shielding only.
- 3 Jacket only.

With lever disengaged, it cuts through entire cable.

Cushion grips for comfort. Made in U.S.A. to highest standards.

Request Free
Tool Catalog

nationwide availability
through local distributors

XCELITE

XCELITE, INC.

118 Bank Street, Orchard Park, N.Y. 14127
In Canada contact Charles W. Pointon, Ltd.

For More Details Circle (110) on Reply Card

beat the heat with this handy little heat sink



This is No. 80, Xcelite's little gem for absorbing and dissipating heat when soldering fine wires or working close to delicate electronic components. Solder won't adhere to copper jaws because they're nickel plated. They're spring loaded to "stay put" and have a smooth surface to avoid marring or scratching.

Insulating cushion grips protect fingers. Made in U.S.A. to highest standards.

Request Free Tool Catalog

nationwide availability through local distributors

XCELITE

XCELITE, INC.

118 Bank Street, Orchard Park, N.Y. 14127
In Canada contact Charles W. Pointon, Ltd.

For More Details Circle (110) on Reply Card
September, 1973

QM-202 Professional Head Demagnetizer which safely and effectively removes residual magnetism from tape heads, rollers and guides, and thus protects expensive pre-recorded tapes.

Nortronics' new QM-211 Professional Bulk Eraser, designed to erase recorded tapes down to the level of virgin tape, was also shown.

Nortronics also exhibited their Broadcast Cartridge, Professional Cassette, 8-Track Cartridge and Reel-to-Reel Alignment tapes and their new QM-5 Video Recorder Care Kit for the total maintenance of video recorders.

For More Details Circle (194) on Reply Card

Master-Slave Clock System

The Quasar Electronic MASTER-SLAVE Clock System is designed for use where many stations are required to have the exact time reading.

The Quasar Electronic MASTER-SLAVE Clock System is dependent for accuracy on the Master Clock, which utilizes a highly accurate Crystal Oscillator.

The Master Clock can be calibrated to Station WWV for time upgrading. All Slaves display the same time as the Master Clock at all remote locations. The Modular Clock circuitry is built on plug-in P.C. boards for ease of maintenance. The Quasar System uses LED Displays, and battery backup, if a power failure occurs. The Master Clock can drive up to 50 slaves.

For More Details Circle (195) on Reply Card

Remote Control Monitors

The new Delta combination remote control unit provides for the control and digital remote readout of Model DAM-1 Antenna Monitor and up to 15 transmitter meter readings. On/raise and off/lower controls are also provided for 15 functions and 8 alarm indicators are provided on the remote unit.

The transmitter interface unit selects any one of 15 DC voltage inputs and the DAM-1 amplitude digital readout provides local display of transmitter or antenna readings. Digital data and control sig-

(Continued on page 134)

recording accessories for demanding professionals

Nortronics — world's leading manufacturer of magnetic heads — now offers professional recording accessories with the quality and reliability that broadcasters and recording studios demand.



PROFESSIONAL ALIGNMENT TAPES

First generation master recordings with the tests and tones required to check and adjust professional recorders. AT-120 for 1/4" Reel-to-Reel to NAB standards; AT-200 for Cassettes; AT-320 for Broadcast Cartridge Spot Announcers.



PROFESSIONAL DEMAGNETIZERS

QM-211 Bulk Eraser for erasing reel, cassettes and cartridges down to the level of virgin tape — QM-202 Professional Head Demagnetizer to remove residual magnetism from heads, capstans and guides.

VIDEO RECORDER CARE KIT

Model QM-5. All the professional accessories required to properly maintain video recorders. Products are completely effective and totally safe for all components in the video tape path.

Nortronics now offers industry's most complete line of recorder care products — a line that sells well and is uniquely profitable to sell. Contact our Sales Manager, Roger J. Czerniak for complete information.



RECORDER CARE DIVISION

NORTRONICS COMPANY, INC.

8101 Tenth Avenue North
Minneapolis, Minnesota 55427
Tel: (612) 544-0381

For More Details Circle (111) on Reply Card

nals are handled by a single voice grade telephone line by means of self-contained FSK modems.

The system provides the accuracy of digital transmission and readout of data with analog to digital conversion in the precision circuits of the DAM-1 Antenna Monitor.

For stations that do not require transmitter control and monitoring the DAML-1 and DAMR-1, remote control units are available for control and readout of the DAM-1 Antenna Monitor.

For More Details Circle (196) on Reply Card

Cameras With Automatic Iris

Cinema Products Corporation announces their CP-16 and CP-16/A camera models will accept the new Angenieux 9.5-95mm and 12-120mm zoom lenses — Both with built-in Angenieux-designed automatic iris. Exposure control is instant and precise with no "hunt-and-peek" time delays.

These improved and advanced Angenieux Automatic Iris zoom lens control systems are ideally suited for operation with ultra light-weight CP-16 camera models, and draw power from the same nicad battery pack powering the entire CP-16 camera system.

For More Details Circle (197) on Reply Card

Dual Section Distribution Amp

Shintron now has available a new addition to its line of distribution amplifiers. Called the model 338 Dual Section Pulse DA, this unit consists of two independent sections of 1 in, 6 out as well as the

capability of providing 1 in, 12 out.

Along with solving fan-out distribution problems, the 338 features automatic amplitude control, fast rise and fall time, high output isolation, and wide range input.

For More Details Circle (198) on Reply Card

Audio Control Center

Cetec, Inc., has announced the introduction of a new audio control center in their Langevin product line. The Series 10 is designed specifically for radio and TV broadcasters and incorporates a wide range of flexibilities with greatly simplified operational functions. Modern-day styling and economical pricing are also highlighted features of this new console.

Highlighted features include built-in stop-start switches for auxiliary sound sources, digital clock, panel mounted on-the-air light, contacts for remote microphone switching, cue speaker, fail safe auto-switched dual power supply and dual 10 Watt monitor amplifier.

Options include quadraphonic output, equalization and a mono version.

For More Details Circle (199) on Reply Card

Fully Automatic Hi Fi Analyzer

The practical automation of audio frequency performance measurements is the target of Radiometer's new BKF10 Automatic Distortion Analyzer.

This unique instrument is actually a complete audio performance test set. It incorporates a distortion meter, a sweepable AF oscillator, an amplitude response meter, and a

frequency indicator, all of which operate automatically.

This equipment simultaneously determines both distortion factor and frequency response, while the input signal is swept through the four frequency decades from 20 Hz to 20 kHz.

Results are continuously displayed on the front panel meters. In addition, recorder output signals allow both the distortion factor and the overall amplitude response to

SAVE ABOUT 50% OF POWER TUBE COSTS



IF YOU USE 3CX2500, 4CX5000, 4CX10000, 4CX15000 AND SIMILAR TYPES

Freeland Products offers expert reprocessing of certain types of thoriated filament tubes. Our service is backed by a warranty and over 30 years experience.

Send today for descriptive brochure and price list. Freeland reprocessing assures FULL AVERAGE EMISSION LIFE of new tubes—yet you'll save up to 50% of original cost!

Scores of Satisfied Customers

- | | | |
|------|------|------|
| WAOK | KHOU | WRUF |
| KBCL | WHAL | WSMB |
| KBHS | WHAS | WTAE |
| WBKH | WHB | WTIX |
| KCIJ | WIRK | KVOL |
| KCIM | WJCW | KWHI |
| WCCO | WJDX | WWST |
| WCMJ | WJLS | WPRS |
| WDAE | WKIZ | WVHI |
| WDAK | KLCN | WDSU |
| KELI | KLIV | KNXR |
| KFDA | WMRI | WHBC |
| WFOR | KOKE | WDWS |
| KGBC | KOMA | WBTM |
| KGUD | KPQ | WGAF |
| WGNV | WPLO | KMLB |
| KHOF | WQAM | KOAX |
| KHOM | WQMV | WOCN |

And Many More!

Freeland Products Co.

3233 Conti St. • New Orleans, La. 70119
504/822-9223

For More Details Circle (113) on Reply Card

BROADCAST ENGINEERING

RAPID-Q™

3000

CARTRIDGE TAPE EQUIPMENT

- RAPID-Q Adjustable Delayed Automatic Fast Forward Standard
- Modular Independent Units Single, Dual, or Triple Cases
- Rack or Desk Top Mount
- Superior Performance
- RECORD ■ PLAY ■ MONO ■ STEREO MODULAR UNITS

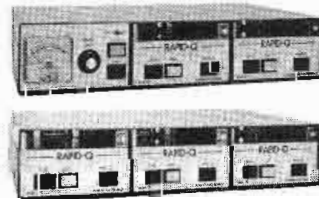

RAPID-Q

1216 KIFER ROAD SUNNYVALE, CALIF. 94086
(408) 736-8737

For More Details Circle (112) on Reply Card

be plotted as a function of frequency. Use of dual channel or X, Y, Y' type recorders permits the plots to be developed simultaneously. The result is a complete, hard copy, dual performance signature with one sweep of the frequency spectrum.

The built-in sweep oscillator supplies a pure signal. Total harmonic distortion is maintained at less than 0.01 percent throughout its frequency range.

For More Details Circle (200) on Reply Card

Professional Recording/Remaining

SON OF 36 GRAND, Model 501, is an expandable, modular professional recording/remixing console from **Auditronics, Inc.** of Memphis, designed to accommodate 24-track recording and quad mixdown. Expandable to 26 inputs with complete metering, expandable patching, and a full line of matching accessories. A distinctive full capacity system at a moderate price.

Up to 26 input channels, each for mic and line with the following: Linear motion fader; microphone gain trim; input on/off switch; solo tape track or input fader; two independent studio cue mixes; echo selectable from monitor channel or input position; echo level control; echo send to four echo chambers in any combination; four knob equalizer; low & high cut filter; equalizer in-out switch; monitor level control; monitor channel assignment L-C-R; monitor sync overdub switch; quad pan pot; quad source selector from monitor matrix or program; independent selection to main 16 output channels.

For More Details Circle (201) on Reply card

Professional Tape Deck Control Unit

Can you really have precise control over tape speed on tape decks? According to **Pacific Recorders and Engineering Corp.**, yes.

Pacific is in production on unit they call the Multisync MDA-1B. It's a self-contained rack mount or table top unit intended to supply drive motor power to professional

(Continued on page 136)

BIG TIME NETWORK TV STAR.

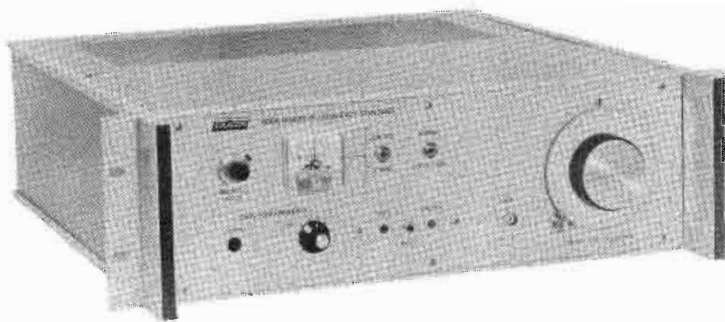

Tracor Model 600A Rubidium Frequency Standard. Used by NBC, ABC and CBS television networks. Price: \$7,700.

Only rubidium standard found in TV application. Compact, rugged, designed for color subcarrier generation. Utilizes stable quartz crystal oscillator whose frequency is controlled by the atomic resonance in the ground state of rubidium 87. Features continuous rotation phase shifter and built-in Time Scale Selector. Long-term stability is 3×10^{-11} . Write or call for full technical and application information.

Tracor

Industrial Instruments
6500 Tracor Lane • Austin, Texas 78721 • AC 512/926-2800

For More Details Circle (114) on Reply Card

Send only the best.

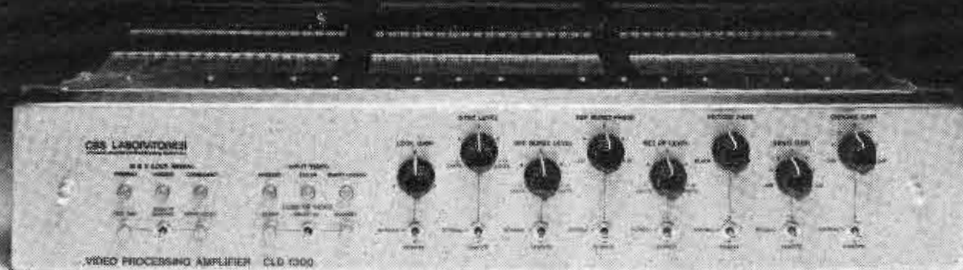

CBS Laboratories' new Video Processing Amplifier is an outstanding performer! For monochrome or composite color restructuring, CBS Laboratories CLD 1300 is the universal amplifier. High quality restoration is accomplished through individual controls of video, chroma, reference burst, sync and blanking.

In helical or quad tape use, the CLD 1300 actually improves quality dramatically. And the CLD 1300 can even be used simultaneously as a standby sync generator. From CBS Laboratories, of course.

CBS LABORATORIES

A Division of Columbia Broadcasting System, Inc.
227 High Ridge Road, Stamford, Connecticut 06905

tape decks for the purpose of varying tape speed under precise control.

The MDA-1B can give phasing delay effects, compensate for off speed tapes, tune tracks for recording non-tuneable instruments, offer

variable delay for double-tracking, and lengthen or shorten running time of broadcast tapes.

For More Details Circle (202) on Reply Card

Combining Network
Roh Corporation announces a

newly designed 6X1 active combining network which features differential inputs for use with 600 Ohm balanced circuitry. The unit is intended for use as a mixer maintaining source isolation.

This module is a new addition to the Roh 200 series modular audio equipment line and is compatible with the Company's several enclosure offerings.

Important module specifications: 10K Ohm balanced bridging inputs, 60 dB isolation between inputs, 50 dB minimum CMR for each input, unity to 20 dB voltage gain provided by potentiometer adjustment.

For More Details Circle (203) on Reply Card

Listen to the Sound of Performance

INOVONICS MODEL 360 is a completely self-contained solid state unit that enables you to gain new equipment performance from older tube type recorders.

It interfaces directly with Ampex 300, 350 and 351 tape transports and accommodates a wide variety of original equipment and replacement heads. Plug-in circuit cards combine advantages of both IC and discrete circuitry for unexcelled performance and trouble-free operation.

For the distributor in your area - Call or write:

TABER Manufacturing & Engineering Company

2081 Edison Ave.
San Leandro, Ca 94577
(415) 635-3831
Telex 337-714 Taber SNLO

1227 N. Vine St.
Hollywood, Ca 90038
(213) 464-5108
Telex 673-476 Taber LSA

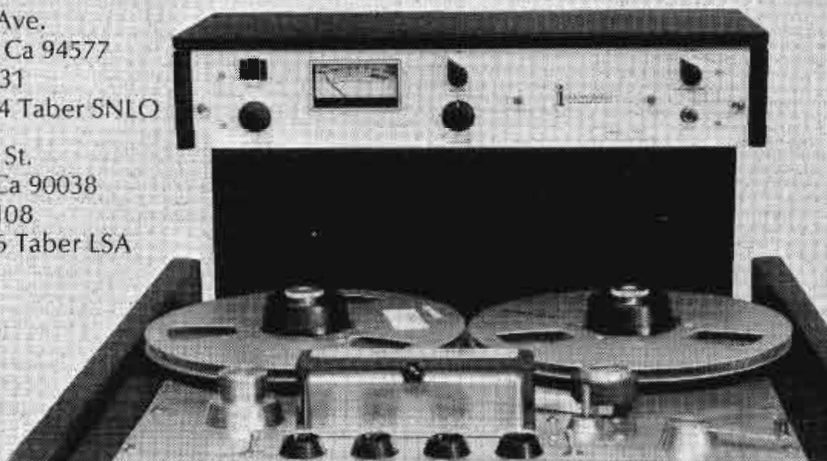

For More Details Circle (116) on Reply Card

Custom Camera Cases

The Arriflex Company of America announces the availability of two, customized Halliburton Camera Cases: One fitted for all Arriflex 16S Cameras, and the other for Arri 16BL cameras.

The case exteriors are made from heat-treated, hard aluminum alloys, formed and ribbed under tremendous pressure, to make a shell of exceptional rigidity. The cases use full length hinges and special latches designed to withstand the hard usage. Interiors are pre-cut foam, whose density is carefully matched to the purpose, and formed to surround and protect the camera completely against shock,

DYMA's Innovation

Matches

Your Imagination

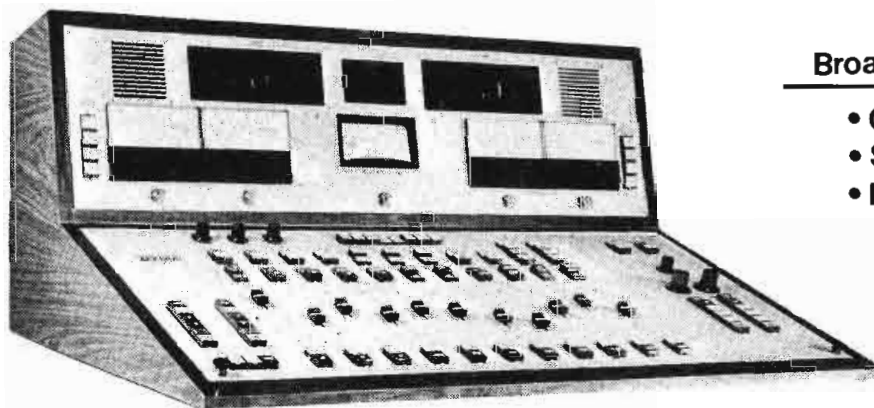

Broadcast Control Centers

- Custom Consoles
- Studio Cabinetry
- Design & Engineering

DYMA ENGINEERING
Route 1 Box 51
Taos, New Mexico 87571
505-758-2686

For More Details Circle (117) on Reply Card

moisture and dirt.

The Halliburton customized Case for the Arriflex 16S, measures overall 26" x 18" x 9" and weighs 15 lbs. It accepts the basic 16S, zoom and fixed focal length lenses, 2 400

ft. magazines, torque motor, and other small accessories.

The Case for the Arri 16BL, measures approximately 21½" x 17" x 12"; and weighs 18 lbs. The customized case accepts the 16BL camera with zoom lens, 2 400 ft. magazines, matte box and other small accessories.

For More Details Circle (204) on Reply Card

**Remote
Origination Link**

Communications Carriers, Inc., a subsidiary of International Microwave Corp., exhibited their RSL-13 system. It's a package of site to studio microwave link equipment that is designed to give the Cable operator the timeliness of news or sports shows that are possible when put on the line live.

The package includes a light weight, battery operated transmitter, a self powered repeater, and the studio receiver.

This system works in the 13 GHz STL (studio to transmitter link) band. The studio receiver terminal contains an antenna which can be mounted on remote operated pan and tilt head along with RF receiver terminal operating at 110 VAC. Battery packs for the transmitter and repeater are designed for a minimum of 10 hours of continuous use.

For More Details Circle (205) on Reply Card

**Reader Service
Card In Sept.
Good For 1 Year**

Color Encoder Board

Lenco Electronics announces a new NTSC Color Encoder board. Designed as a direct replacement for the encoder in IVC 150 and 90 color cameras, it can be rack mounted to encode any R.G.B. signal. The new encoder sells for under \$1,000.00.

For More Details Circle (206) on Reply Card

**ESC ELECTRONICS
LC DELAY LINES**

For the communication and TV Broadcast Industry, Contact ESC, America's oldest delay line specialists for your requirements in delay lines, LC filters or wide band video Transformers. Toll Free 800-631-0853 (except N.J.)

**ESC ELECTRONICS
Palisades Park, N.J. 07650**

For More Details Circle (125) on Reply Card

**USE OUR CASH
FOR YOUR NEW
EQUIPMENT**

You choose the equipment; we will lease it to you—3-4 or 5 years with option to buy.

**Broadcast Equipment
Leasing Co.**

DIVISION OF ANCHOR LEASING CORP.

Grant Building
Pittsburgh, Pa. 15219
Area Code 412-281-3768

For More Details Circle (126) on Reply Card

FREE ALARM CATALOG

Full line of professional burglar and fire alarm systems and supplies. 80 pages, 400 items. Off-the shelf delivery, quantity prices.



mountain west alarm
4215 n. 16th st., phoenix, az. 85016

For More Details Circle (118) on Reply Card



**Plastic Reels
FOR MAG TAPE**

Shipped from Inventory

Mfrs. of Amerline reels

**POLYLINE
CORP.** (312) 489-1757
2449 N. Western, Chgo. 60647

For More Details Circle (119) on Reply Card

**LARGEST LIBRARY OF PROGRAMMED
MUSIC** . . . furnished to radio and television stations, including CATV facilities, on a lease basis. Reel-to-Reel up to 14" (7", 10½", 14"). Also, cartridges (1 to 4 track) up to 8 hours. Fits all types of equipment. Your cartridges refilled, repaired and guaranteed to work. Write or call for complete information and prices.

CINE SONIC SOUND, P.O. Box 996, New York, N.Y. 10001, (212) 563-0540.

For More Details Circle (120) on Reply Card

FREE CATALOG

HARD-TO-FIND PRECISION TOOLS

Lists more than 1700 items—pliers, tweezers, wire strippers, vacuum systems, relay tools, optical equipment, tool kits and cases. Also includes four pages of useful "Tool Tips" to aid in tool selection.



JENSEN TOOLS
4117 N. 44th Street, Phoenix, Ariz. 85018

For More Details Circle (121) on Reply Card

angénieux service corporation of california
13381 BEACH AVE., VENICE, CALIF. 90291 • (213) 821-5080

**FACTORY SERVICE
CENTERS**

REPAIRS • PARTS
ACCESSORIES



angénieux corporation of america
440 MERRICK RD., OCEANSIDE, N.Y. 11572 • (516) 678-3520

For More Details Circle (122) on Reply Card

ON THE AIR

when the pressure's on... Qualitape's there

besides supplying our clients with:

- *reject free stereo-phased cartridges
- *reject free Audiopak A-2 cartridges
- *reject free custom length cartridges
- *cartridge reloading
- *Audio Devices ACETATE base tape

- *Audio Devices magnetic tape
- *Audio Devices magnetic film
- *magnetic tape accessories
- *high quality duplicator cassettes
- *high speed custom duplication

we are here to help you solve any of your tape problems and guarantee your peace of mind. if you are at all troubled call us. (609) 933-2500 (215) 629-1073

QUALITAPE 101 BROADWAY RUNNEMEDE, NEW JERSEY 08078

For More Details Circle (123) on Reply Card

TWO NEW TEST INSTRUMENTS FOR DIRECTIONAL ANTENNAS



**FSM-1
FIELD STRENGTH METER**
 Frequency: Any frequency in the AM band
 Field Strength Range: 100 μ V/m to 1V/m
 Power: Internal battery
 Calibration certificate supplied
 Size: 5-1/2" x 8" x 5" (closed); Weight: 4-3/4 lbs. with batteries

DAM-1 DIGITAL ANTENNA MONITOR

Frequency: Any frequency in the AM band; Phase Range: $\pm 180^\circ$;
 Phase Accuracy: $\pm 1.0^\circ$; Phase Resolution: $\pm 0.1^\circ$; Ratio Range: 0.100 to 2.000;
 Ratio Accuracy: $\pm 2.0\%$; Ratio Resolution: ± 0.001 ; Input Impedance: 50 or 75 ohms



Delta's new Field Strength Meter and Digital Antenna Monitor will help keep your directional antenna system within FCC specifications.

The DAM-1 Antenna Monitor meets the new FCC requirements for remote control. It is a true digital instrument using the latest integrated circuit and TTL techniques. Reads phase and true current ratio for up to six towers with different reference towers and different powers for DA-2. Monitors for larger arrays available on special order.

Delta also offers remote panels and interface units for controlling and reading the DAM-1 Phase Meter over multiconductor, two wire, UHF, or microwave circuits with no reduction in accuracy.

The FSM-1 Field Strength Meter is smaller and much simpler to operate than other field strength meters because it is fixed tuned to your frequency by plug-in modules. If you have to check more than one station, order the FSM-1 with additional frequency modules. For monitor point checks and extensive proof of performance work the FSM-1 will minimize errors and speed up field measurements.

DELTA ELECTRONICS, Department A
 5534 Port Royal Rd., Springfield, Va. 22151
 703/321-9845

DELTA ELECTRONICS



Exporter: DELTA ELECTRONICS, INC.
 International Division, 154 E Boston Post Rd.
 Mamaroneck, N. Y. 10543. Telex 1 37327, Art Rocke

For More Details Circle (127) on Reply Card

(Continued from page 137)

Function Generator

Ailtech announces as standard options and accessories a series of convenience features which can be included as part of any of its "Gold-Line Series 500" function generators.

The units can now be provided with built-in AM, rear-panel concurrent output connectors, plug-access to critical parts of the unit's integrator for phase-lock service, special grounding, special power, special mounting, etc.

The purpose of these features is to allow the user to specify and obtain custom features for his unit, without burdening the standard unit with special interest and cost-consuming characteristics. Further, these features can be obtained without complex ordering instructions/factory calls and so on.

For More Details Circle (207) on Reply Card

Hall Effect Generator

Interdesign, Inc., Sunnyvale, California announces the availability of an integrated Hall Effect

For
 Better
 Results
 Use
 Reader
 Service
 Card

For the **FIRST** time ever...

Jones CATV Dictionary

over 800 CATV definitions in both French and English

Now the CATV industry has its own comprehensive dictionary of technical terms in both English and French—the Jones Dictionary of CATV Terminology. Because of the smashing success of the English version, Jones Int'l., Ltd. has now published a second, greatly enlarged edition in two languages.

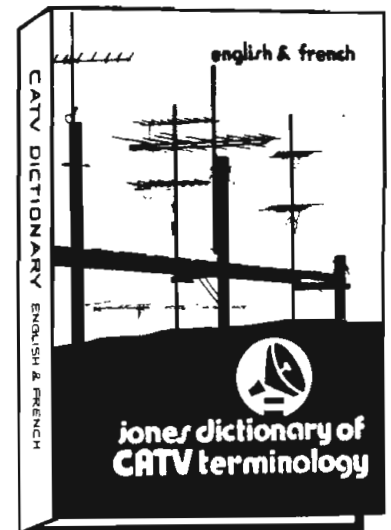

For your copy(ies) send check to:
 Jones Dictionary of CATV Terminology
 Jones Int'l., Ltd.
 880 Continental Bank Bldg.
 Englewood, Colo. 80110

ONLY \$19⁹⁵

For More Details Circle (128) on Reply Card

Generator in its Monochip series. The four terminal device is sensitive to magnetic fields and is used for switching, coupling and sensing.

On the same IC chip a large number of transistors and other components are available as well, so that the output of the Hall generator can be amplified, shaped or combined with other circuit functions.

The company's Monochip series contains three chips in sizes ranging from 110 to 300 integrated components. The components—including the Hall-effect generator—are interconnected with a customized metal layer which can be easily designed by the user.

For More Details Circle (208) on Reply Card

TV Monitoring

Marconi Instruments displayed selected instruments from its range of TV measuring equipment.

The major display was the new Automatic TV Broadcast Transmitter Monitoring System which

(Continued on page 140)

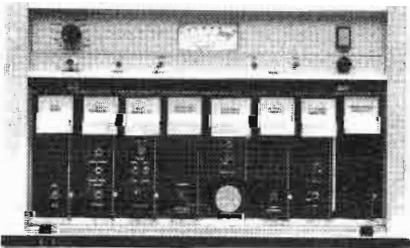

10 WATT FM

B-910 series

B-910 monaural exciter
\$1995

B-910 with stereo generator
\$3070

B-910 with stereo & sca
\$3520

B-910T 10 watt transmitter
\$2355

unique phase-lock •
direct fm modulation

precision frequency control •

full metering •

FCC type accepted •

McMartin

McMartin Industries Inc.
4500 South Seventy-sixth Street
Omaha, Nebraska 68127
(402) 331-2000 Telex 048-485

For More Details Circle (163) on Reply Card

September, 1973

exciter

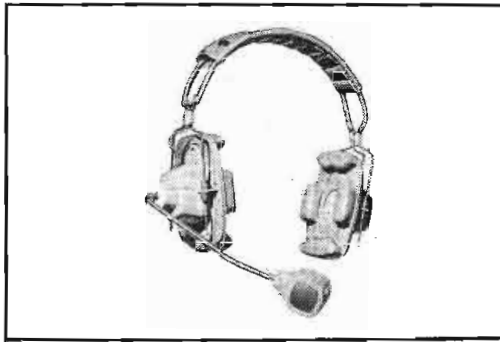

COMFORTABLE HEADSETS

Amplivox makes a headset which stands up to the rough and tumble handling of TV crews without sacrificing the light weight and comfort necessary for all-day use.

Interchangeable soft, ear enveloping foam cushions or ventilated foam cushions which eliminate ear perspiration and accommodate eyeglass frames.

Available single or double side + 300 OHM phone – 100 OHM carbon or noise cancelling carbon mike.
TELEVISION EQUIPMENT ASSOCIATES, Box 1391, BAYVILLE, N.Y. 11709, (516) 628-8068

For More Details Circle (129) on Reply Card

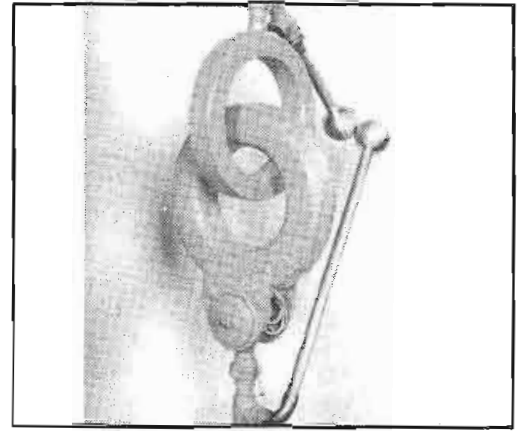

AUSTIN LIGHTING TRANSFORMER

A high quality efficient transformer providing low capacitance and excellent regulation. Specifically designed to minimize radio frequency losses. Also available as oil immersed unit for maximum isolation voltage. Load capability from 0.7 kVA to 15 kVA.
AUSTIN INSULATOR DIVISION, Decca Radar Canada (1967) Limited, 71 Selby Road, Brampton, Ontario L6W 1K5, Phone (416) 457-8720.

For More Details Circle (132) on Reply Card

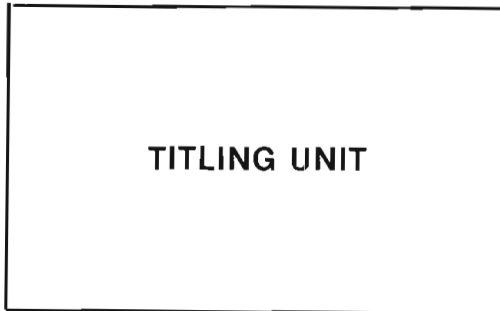

TITLING UNIT

Basic model includes: 2 pages of 8 lines of 16 "high resolution" characters. Will sync to composite video signal or accept separate sync input; keyboard; 2 character sizes; titles keyed into video signal; separate program/preview outputs; vertical interval page switching.

Expandable plug-in modules: 8 pages of memory; horizontal crawl; blinking characters; color backgrounds; character edging; audio tape storage. Priced from \$2500. VIDEO DATA SYSTEMS, 657 Old Willets Path, Hauppauge, N.Y. 11787, (516) 234-1010

For More Details Circle (130) on Reply Card

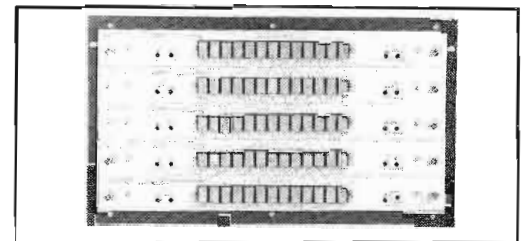

VIDEO/AUDIO ROUTING SWITCHER

The Model 1035 Routing switcher features Solid State Video switching, Solid State Video/Audio input and output circuitry, and full field expansion of inputs and outputs by addition of 12X1 individual plug in Cards. Available in Video, and Audio follow Video configurations. Prices are as follows: (Factory assembled)

INPUT		OUTPUT	VIDEO	AUDIO VIDEO
12	X	5	2330	2690
12	X	10	4910	5110
12	X	15	6560	7530
12	X	20	8890	10,220

DELIVERY: 6 Weeks. VISCOUNT INDUSTRIES LTD., 105 East 69th Ave., Vancouver 15, B.C. CANADA

For More Details Circle (133) on Reply Card

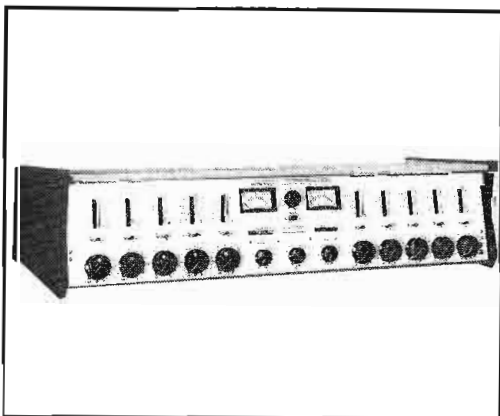

10 CHANNEL STEREO CONSOLE

AMPRO's AC-10-S is one of a new line of 6, 8 and 10 channel dual, stereo and mono consoles. Featuring heavy-duty telephone type switches, 4 switchable mic or high-level inputs to all faders, 4 muting relays with Programming Board and shielded PC board mixing bus, it's priced at \$3,695. Available from AMPRO CORPORATION, 2220 MAPLEWOOD AVENUE, WILLOW GROVE, PENNSYLVANIA 19090.

For More Details Circle (131) on Reply Card

ROTA-RAK MODEL 200 TAPE RACK

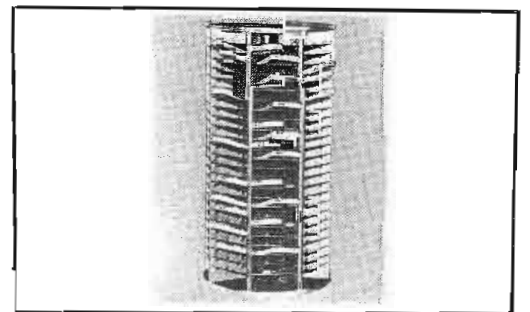

HOLDS 200 CARTRIDGES – DIMENSIONS 35" HIGH 19" IN DIAMETER – ROTATES ON BALL BEARINGS.

WE CARRY A COMPLETE LINE OF QUALITY BROADCASTING EQUIPMENT:

TRANSMITTERS – TOWERS – ANTENNAS – CONSOLES-TURNABLES – MICROPHONES – CARTRIDGE EQUIPMENT – REEL TO REEL. WRITE US FOR MORE INFORMATION. MASTERTONE COMPANY, 1105 MAPLE WEST DES MOINES, IOWA 50265 515-274-2551.

For More Details Circle (134) on Reply Card

assesses the picture quality by measurements on a VIT signal. This system comprises of two units an INSERTION ANALYZER, MODEL 2914, illustrated top unit, and DATA MONITOR, MODEL 2915. The Analyzer permits the simultaneous measurement of up to 24 parameters of a previously introduced VIT signal. Some of the basic parameters which may be measured are - the amplitudes of bar, sync and 2T pulses; chrominance/luminance gain, delay and crosstalk; luminance non linearity; noise; LF error; bar tilt; differential phase and gain. In the manual mode, these parameters are expressed in units of mV, nSecs, degrees or as a percentage and can be displayed on a 3½ digit panel

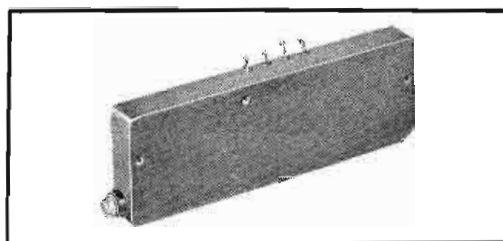

Variable Delay Line Makes Burst Phasing an Operational Adjustment

ESC Model 74-61 Variable delay line is supplied for video tape recorder correction of improper color phasing resulting from variations in quality of production tapes. Inserted between the colortec and proc amp burst routing the screw-driver control is made available for external quick adjustment. Price is \$67.00.

Details regarding use and specification are available from:

ESC ELECTRONICS CORP.
530 Bergen Blvd. Palisades Park, N.J. 07650

For More Details Circle (137) on Reply Card

NOW READY!
1973-74
CATALOG.

52 Pages-Transmitting Tube, Semi-Conductors, Broadcast Eqpt. (Most comprehensive in the Industry)

Write or phone:
212-646-6300
CECO COMMUNICATIONS, Inc.
2115 Ave. X
Brooklyn, N.Y. 11235

For More Details Circle (140) on Reply Card

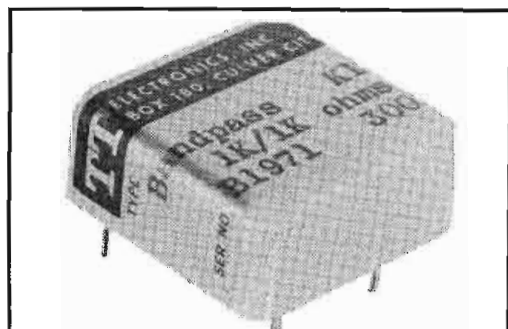

FILTERS

1,000,000 Standard Types
BANDPASS • BANDSTOP
LOWPASS • HIGHPASS

Select any Frequency from 3Hz to 100MHz such as

25Hz Cue Tone Notch, 50Hz Highpass, 15.75KHz CATV Bandpass, 300Hz Telephone Simulation Lowpass, 21Hz Bandpass, 18KHz Lowpass, 1KHz Notch, 4MHz Lowpass, 7.6KHz Lowpass.

TTElectronics, Inc. 2214 Barry Ave. Los Angeles, 90064, (213)478-8224

For More Details Circle (135) on Reply Card

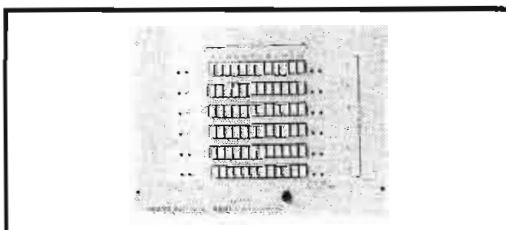

VIDEO/AUDIO ROUTING SWITCHER

The Model 1050 Routing switcher has solid state input and output circuitry to broadcast standards; is available in Video, Audio or Audio follow Video configurations. Switches 12 inputs to any number of outputs. Factory assembled prices are:

INPUT	OUTPUT	VIDEO	AUDIO	AUDIO VIDEO
12 X	3	\$1200	\$ 860	\$1490
12 X	6	1710	1370	2150
12 X	9	2380	1980	3000
12 X	12	2920	2520	3720

DELIVERY: 6 Weeks. **VISCOUNT INDUSTRIES LTD.,** 105 East 69th Avenue, Vancouver 15, B.C. CANADA

For More Details Circle (138) on Reply Card

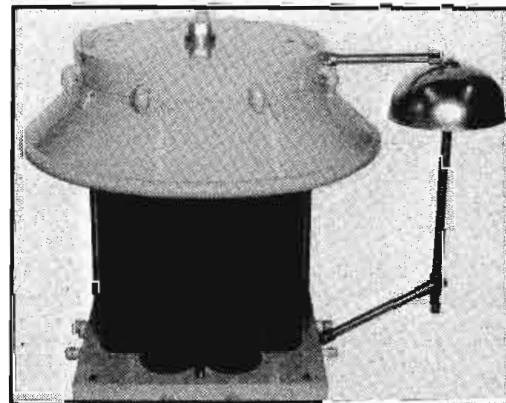

AUSTIN BASE INSULATOR

High quality insulator specifically designed for radio frequency use. Oil filled to prevent RF loss from condensation; low capacity, smooth finish minimizes leakage and flashover. Available for guyed or self supported towers. Working download to 2,500,000 lb. Working uplift to 455,000 lb. Working RF voltage to 100 kV RMS wet. **AUSTIN INSULATOR DIVISION, Decca Radar Canada (1967) Limited,** 71 Shelby Road, Brampton, Ontario L6W 1K5, Phone (416) 457-8720.

For More Details Circle (141) on Reply Card

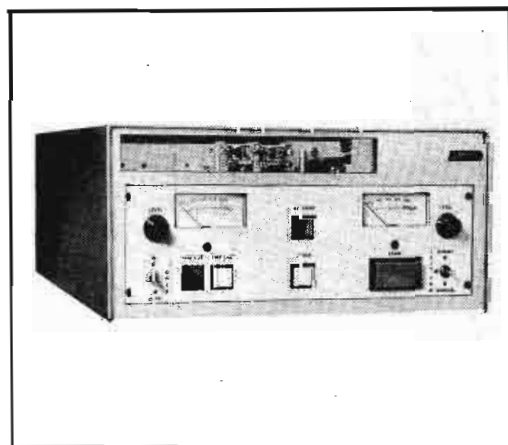

STEREO CARTRIDGE UNIT

AMPRO's Model 4500 SR Recorder-Reproducer is one 10 new units featuring heavy-duty direct drive 4" Beau Motor, self-aligning pinch roller, air-damped solenoid operation and die-cast deck and front panel. Accepts all NAB Type A, B and C Automatic Tape Cartridges. The Model 4500 SR costs \$1,375. Available from **AMPRO CORPORATION, 2220 MAPLEWOOD AVENUE, WILLOW GROVE, PENNSYLVANIA 19090.**

For More Details Circle (136) on Reply Card

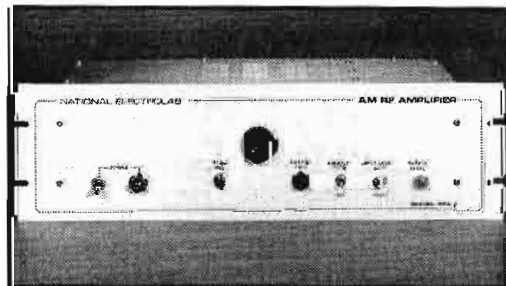

RELIABLE AM RF AMPLIFIER

The Model RFA-4 offers proven reliability in driving any AM modulation and frequency monitor. Standard features include a carrier-fail alarm, low distortion audio detector, 10v RF output for modulation monitor. Optional are a clipped RF output for a standard frequency counter, AGC or switchable RF input attenuator, and 10 kHz whistle filter. Available through Gates Radio & Collins.

NATIONAL ELECTROLAB LTD., P.O. Box 67, Blaine, Wash. 98230. In Canada: 1130 E. 7th Ave., Vancouver, B.C.

For More Details Circle (139) on Reply Card

BIRMINGHAM TAPE CARTRIDGE CO., INC.
P. O. BOX 217 - PINSON, ALABAMA 35126
JACK HERRING, Pres. - Ph. (205) 681-9637

NEW N.A.B. 300 & 350 FIDELIPAC CARTRIDGES

FASTEST RELOAD SERVICE CENTER

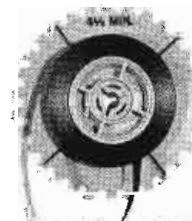

Join our hundreds of satisfied clients and purchase your New 300 & 350 Stereo Fidelipac Cartridges from the #1 Fidelipac Distributor in the U.S.A. and send your cartridges that need reloading to us. We have all parts for Fidelipac Carts. We are Distributors for the following: Fidelipac Carts, Racks, Erasers, Avery Labels, Rotex Labeling Tape, Scotch Tape and Cassettes. Write for free Brochures and prices. All Cartridges loaded with 156 Scotch Tape and guaranteed to perform like new. Top Quality and speedy service is our motto.

For More Details Circle (142) on Reply Card

meter. In the automatic mode, the digitized signal is passed to the data monitor.

The Data Monitor automatically scans each parameter in turn and compares the result to pre-programmed limits. When an out of limits condition occurs, a front panel LED is extinguished and alarms or necessary control action can be initiated.

CUSTOM TAPES FOR AUTOMATION



THE CnB STUDIOS

3415 BERESFORD AVENUE
BELMONT, CALIFORNIA 94002
415 / 592-6149

For More Details Circle (161) on Reply Card

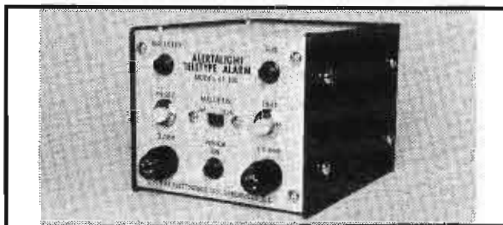

NEW ALERTALIGHT TELETYPE ALARM

THE MODEL ST104 TELETYPE ALARM HAS ALL SOLID STATE COMPONENTS AND INTEGRATED CIRCUITS; HIGHER ACCURACY AND RELIABILITY COUPLED WITH LONG LIFE; ALERTS STATION PERSONNEL TO NEWS BULLETINS, EMERGENCY WEATHER AND EBS SIGNALS. PRICE ONLY \$95. INCLUDES MOUNTING BRACKET AND CONNECTING CABLE; OPTIONS AVAILABLE. WRITE OR CALL:

B. I. ELECTRONICS
128 Donaldson Center
Greenville, S.C. 29604

(803) 277-2759

For More Details Circle (143) on Reply Card

CUSTOM CHARACTER GENERATORS

Custom displays created using video data systems standard modules to meet your unique requirements. All Units are EIA RS-170 compatible. Internal synchronization or external gen lock to studio sync. Loop through video available.

Color background, high resolution character matrix; keyboard interfaces and type interfaces "using standard audio tape recorder" are standard modules. Available in 5-1/4-inch rack mountable packages. Available in 30 days. VIDEO DATA SYSTEMS, 657 Old Willets Path, Hauppauge, N.Y. 11787, (516) 234-1010

For More Details Circle (144) on Reply Card

September, 1973

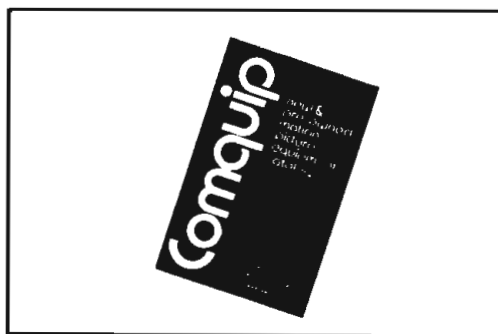

FREE Catalog

Lists over 300 top-brand items of professional movie cameras, lenses, battery belts, tripods, underwater equipment, audio recorders, microphones, sound gear, editors, rewinds, splicers, processors, projectors and much more. Includes new and pre-owned items fully guaranteed and at big savings. We also buy movie equipment for cash and accept trade-ins. **COMQUIP, INC. 366 S. MAPLE AVE., GLEN ROCK, N.J. 07452. Telephone (201) 444-3800**

For More Details Circle (145) on Reply Card

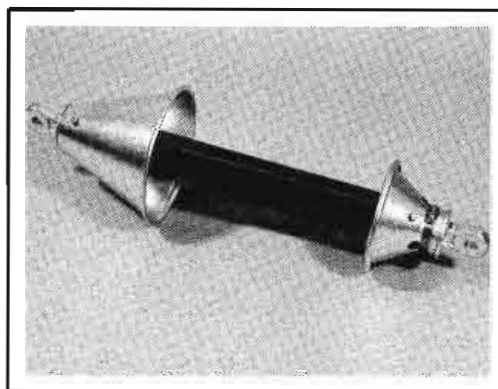

AUSTIN GUY STRAIN INSULATOR

High quality oil filled insulators specifically designed for high voltage radio frequency operation. Unique design provides long leakage path, low capacity, high internal dielectric strength and self cleaning surface. Range of insulators available for working loads from 6,000 lb. to 275,000 lb. with up to 150 kV R.F. working voltage. **AUSTIN INSULATOR DIVISION, Decca Radar Canada (1967) Limited, 71 Selby Road, Brampton, Ontario L6W 1K5, Phone (416) 457-8720.**

For More Details Circle (146) on Reply Card

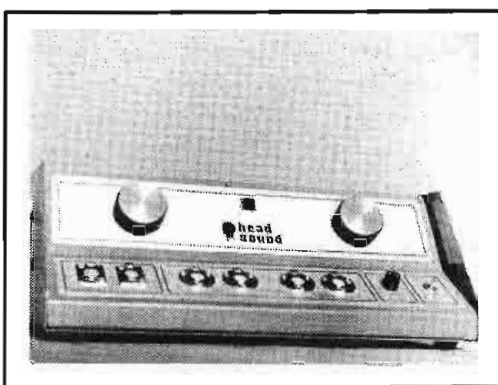

BASIC POWER AMPLIFIER

Enough of ho-hum black! The MODEL 2 is a blue and orange 2 channel power amplifier with self contained cooling, 2 handles, wrap-around self locking power cord; may be stacked or rack mounted, electronically protected against any improper inputs or outputs, overload recovery is instantaneous. Power output, 220 watts RMS at 8 ohms, 310 watts RMS at 4 ohms. 38 lbs. \$495. **HEAD SOUND, INC., 722 Brooks, Ann Arbor, MI. 48103.**

For More Details Circle (147) on Reply Card

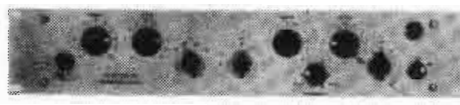

**PULTEC® EQUALIZERS
FILTERS
MIXERS**

Twenty years of capable, dependable service in radio & TV stations and recording studios. U.S. and overseas. Picture is Model EQP-1A3 \$496.00.

PULSE TECHNIQUES, INC. 1411 Palisade, Teaneck, N.J. 07666. Tel. (201) 837-2575 Cable: PULTEC, TEANECK, NEW JERSEY

For More Details Circle (148) on Reply Card



We have Everything the Tape Cartridge User Needs. TAPEX and Fidelipac Cartridge Rework, Tape Eraser, Tape Meter, Alignment Tape, Capstan Pressure Rollers, Time Announced Tape, Replacement Cartridge Heads, Rota Raks all sizes.

Write us for more information. **MASTERTONE CO., 1105 Maple W, Des Moines, IA 50265 515-274-2551.**

For More Details Circle (149) on Reply Card

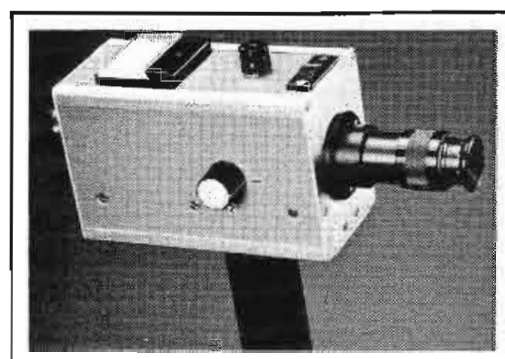

IRT COLOR MONITOR COMPARATOR

The IRT comparator is a simple auxiliary device for quick and accurate monitor balance by direct color comparison of the TV kine. The operator, looking through the device's ocular, will observe a direct view of the kine face and the illuminant-D reference. The operator adjusts the monitor's screen and gain controls for perfect monitor balance. **TELEVISION EQUIPMENT ASSOCIATES, BOX 1391, BAYVILLE, N.Y. 11709 (516) 628-8068**

For More Details Circle (150) on Reply Card

PROFESSIONAL SERVICES

VIR JAMES
CONSULTING RADIO ENGINEERS
Applications and Field Engineering
345 Colorado Blvd.
Phone: (Area Code 303) 333-5562
DENVER, COLORADO 80206
Member AFCCE

SMITH and POWSTENKO
Broadcasting and Telecommunications
Consultants

2000 N Street, N.W.
Washington, D.C. 20036
(202) 293-7742

CAMBRIDGE CRYSTALS
PRECISION FREQUENCY
MEASURING SERVICE
SPECIALISTS FOR AM-FM-TV
445 Concord Ave. Phone 876-2810
Cambridge, Mass. 02138

RALPH E. EVANS ASSOCIATES
Consulting Radio Engineers
AM - FM - TV - CATV - ITFS
3500 North Sherman Blvd.
MILWAUKEE, WISCONSIN 53216
Phone: 414-442-4210

CHU ASSOCIATES, INC.
Telecommunications Division
AM - FM - TV - CATV
Applications - Facilities Planning
Field Surveys and Proofs
Appraisals
800 Fesler St., El Cajon, Ca. 92020
(714) 442-9459
TWX 910 331 1178

SESCO, Inc.

47 NICHOLS AVENUE
P. O. BOX 518

(206) 378-2137

FRIDAY HARBOR,
WASHINGTON, 98250

Moving?
Send Your Change
Of Address To:
Broadcast Engineering
1014 Wyandotte
Kansas City, Mo. 64105

CLASSIFIED

Advertising rates in Classified Section are 15¢ per word, each insertion, and must be accompanied by cash to insure publication.

Each initial or abbreviation counts a full word. Upper case words, 30¢ each.

Minimum classified charge, \$2.00.

For ads on which replies are sent to us for forwarding, there is an additional charge of \$2.00 to cover department number, etc., which is printed in advertising copy, and processing of replies.

Classified columns are not open to advertising of any products regularly produced by manufacturers unless used and no longer owned by the manufacturer or a distributor.

TRAINING

PASS FCC EXAMS with Ameco books. Each book contains FCC questions plus simplified answers plus FCC-type exams and answers. 3rd class 75¢, 2nd class \$2.25, 1st class \$1.50. Free catalog. Ameco Publishing, 314G Hillside Ave., Williston Park, N.Y. 11596. 8-72-tf

FIRST PHONE through tape recorded lessons at home plus one week personal instruction in Washington, DC, Atlanta, Boston, Detroit, New Orleans, Minneapolis, Seattle, Denver, Portland, Los Angeles. Proven results. Our 17th year teaching FCC license courses. Bob Johnson Radio License Preparation, 1060D Duncan, Manhattan Beach, Calif. 80266. Phone 213-379-4461. 1-69-tf

PASS FCC first and second class exams with new 21 lesson, 450-page course. Starts with basic electricity. Over 600 FCC-type, multiple-choice questions and sample exams included. No previous technical knowledge required. Commercial Radio Operator Theory Course, #15-01. Only \$5.95. Ameco Publishing, 314G Hillside Ave., Williston Park, N.Y. 11596. 8-72-tf

EARN ELECTRONICS DEGREE, mainly by correspondence. F.C.C. license preparation included at your option. Accredited by Accrediting Commission of NHSC. G.I. Bill approved. Free brochure. Write: Dean, Grantham School of Engineering, 1505 N. Western, Hollywood, California 90027. 8-72-tf

FCC RADIO TELEPHONE OPERATORS LICENSE in six weeks. Classes (day & evening) in Atlanta, Dallas, Denver, Ft. Worth, Hartford, Houston, Memphis, Nashville, New Orleans, Oklahoma City, and San Antonio. For information contact Elkins Institute, 2727 Inwood Road, Dallas, Texas 75235, 214-357-4001. 5-73-tf

SERVICES

CRYSTAL & MONITOR SERVICE. Frequency change, repair or replacement of oven type broadcast crystals. Also frequency change and recalibration or repair of AM frequency monitors, and H-P FM monitors. Fast service at reasonable prices. 30 years experience! Call or write: Eidson Electronic Co. Box 96, Temple, Tx. 76501. Pho. 817 773-3901. 9-70-tf

CARTRIDGES SPOTLESSLY CLEANED, REBUILT AND RELOADED with Scotch 157. Like new at approximately half price. Also, BEST PRICES anywhere on new FIDELIPAC carts, 3M professional tape and other studio supplies. YOUR ORDER IS YOUR CHARGE ACCOUNT! Full guarantee. FREE CATALOGUE. Lauderdale Electronic Labs, 16 S.W. 13th Street, Ft. Lauderdale, Fla. 33315 (305) 525-0478. 4-73-6t

WANTED

WANTED: All surplus broadcast equipment especially clean A.M. & F.M. transmitters, contractors, capacitors. Surpluss Equipment Sales, 2 Thorncliffe Pk. Dr. Unit 28 Toronto 17, Ont; Canada. 1-73-tf

TUBES WANTED—All types—CeCo 2115 Avenue X, Brooklyn, N.Y. 11235, 212-646-6300-Anytime. 7-73-12X

WANTED AMPEX VR-1200 video tape recorder. Call 408-298-6676/Engineering KGSC-TV, San Jose, California. 9-73-1t

NON-PROFIT, EDUCATIONAL MEDIA corporation needs transmitting, production, and studio equipment for carrier current network, production facilities, and tentative FM station. Contact Free Media, Inc., Box 722 University Station, Lexington, Kentucky 40506 9-73-2t

HELP NEEDED. Building educational FM. Equipment donations gratefully accepted. Tax deductible. Approximately 3,000 watt (stereo) transmitter, transmission line, antenna, console, studio equipment, or anything else. WFPC, Eckerd College, St. Petersburg, Florida 33733. 9-73-1t

NEED 3-340 FT. GUYED TOWERS, ground wire, mesh, strap, etc. What do you have, how much, when and where? Box 4371, Inglewood, California 90309. 9-73-2t

WE ARE BUILDING an entire AM station from scratch. Need studio equipment. What do you have, how much, when and where? Box 4371, Inglewood, California 90309. 9-73-2t

EQUIPMENT FOR SALE

SURPLUS AUDIO PATCH PANELS. All Standard Configurations. Gulf Telephone & Electronics, Inc., P.O. Box 42130, Houston, Texas 77042. 7-72-tf

MOTORS FOR SPOTMASTERS
NEW Paps hysteresis synchronous motor HSZ 20.50-4-470D as used in series 400 and 500 machines. Price \$39.00 each prepaid, while they last. 90 day warranty. Terms check with order only, no COD's. Not recommended for Tapecaster series 600 or 700.

TAPECASTER TCM, INC., Box 662,
Rockville, Maryland 20851

1-72-TF

"NEW & USED TOWERS, Buy, Sell or Trade. Erect. Ground wire 85¢ lb. Bill Angle, 919-752-3040, Box 55, Greenville, N.C. 27834." 2-71-tf

ONE STOP for all your professional audio requirements. Bottom line oriented. F. T. C. Brewer Company, P.O. Box 8057, Pensacola, Florida 32505. 7-71-tf

QUALITY AUDIO CONSOLES are our specialty. Modern styling with slide potentiometers and "soft" audio switching. We manufacture 8 standard consoles at very competitive prices. However, we'll manufacture a custom system to your specifications if you prefer. Also plug-in audio modules including distribution amplifiers, preamplifiers, monitor amplifiers, etc. Write or phone for pricing and specifications. **SYSTEMS ENGINEERING COMPANY**, P.O. Box 49224, Atlanta, Ga. 30329. 404-482-2446. 2-73-12t

HELIAX-STYROFLEX. Large stock—bargain prices—tested and certified. Write for price and stock lists. Sierra Western Electric, Box 23872, Oakland, Calif. 94623. Telephone (415) 832-3527. 1-73-tf

EQUIPMENT FOR SALE CONT.

SURPLUS MICA AND VACUUM TRANSMITTING CAPACITORS. Large stock; immediate delivery. Price lists on request. SURCOM ASSOCIATES, 1147 Venice Blvd., Los Angeles, Ca. 90015 (213) 382-6985. 5-73-12t

NATIONAL TAPE CARTRIDGE SERVICE SPECIAL Pressure Sensitive Labels. Fits All Cartridges. Comes in 5 Colors. Write for FREE Sample. MASTERTONE COMPANY, 1105 Maple West Des Moines, Iowa 50265 515-274-2551 8-73-tf

NATIONAL TAPE CARTRIDGE SERVICE CARTRIDGES RECONDITIONED - NEW TAPE 12 Years Experienced Personnel. Write for new and reconditioned price sheet. Mastertone Co., 1105 Maple, Dept. B-E 1, West Des Moines, Iowa 515-274-2551 8-73-tf

CARTRIDGE TAPE EQUIPMENT—Rebuilt. New paint, heads, flywheel, pressure roller, belts, etc. Spotlessly clean and thoroughly tested. 30 day money-back guarantee, 90 day warranty. Also contact us for discounts on new equipment and accessories. AUTODYNE, Box 1004, Rockville, Maryland 20850. (301/762-7626). 7-72-tf

AM RADIO STATION 5,000 KW Eastern Arizona - substantial cash. KHIL, Willcox, Arizona, 384-2780 - 384-2367 8-73-4t

BUILD YOUR OWN TV AND RADIO PRODUCTION EQUIPMENT. Easy, inexpensive, (mostly IC). Plans or kits: Special Effects Generator, Automatic Logger, Vertical Interval Video Switcher, Solid State Lighting Board, Preset Audio-Video Board, Preset Lighting Board, Crystal Controlled Wireless Mikes with matching receivers. Subsonic Tone Control for audio tapes, 8MM SOF Cameras and Projectors, Distribution Amplifiers (Sync. Video, Audio), Audio Control Boards (Studio & Remote) Proc-Amp with compensation and regeneration for adapting Helical Scan VTR's to broadcast standards. PLUS specialized correspondence courses in Telephone Engineering (\$39.50), and Integrated Circuit Engineering (\$49.50). Plans from \$5.95 to \$15. SUPER CATALOG plus years updateing of new devices Air Mailed \$1.00. Don Britton Enterprises, PO Drawer G, Waikiki, Ha. 96815. 4-73-12t

FOR SALE: Random access unit for carousel Gates RA-1. Used seven months. In perfect condition. \$1200.00. WACL, Waycross, Georgia. 8-73-2t

NEW AND USED TOWERS 150 ft. & 1. 175 ft. Self Supporting Microwave Towers. 11 GHZ Antenna complete. 5 ft. X 8 ft. Reflector. AM FM and Communication Guyed Tower. Write DISCO, P.O. Box 1029, Bradenton, Florida 33505 or call 813-745-6285 8-73-3t

USED, Gates FMC-5 FM Antenna. Tuned to 104.1 MHZ with deicers. Best offer, inquire WIOF P.O. Box 2719, Waterbury, Connecticut 06720. 9-73 1t

"LARGE INVENTORY of parts for Westinghouse SHV2/10HV1 Transmitters. Very reasonable. Call 615-546-5581, extension 8." 9-73-1t

TWO RCA TK4I-C color camera chains, complete with tubes and lens, \$8000 each. Also extra cable and monitors. Matrix Mobile Television, Box 536, San Luis Obispo, Calif. 93406. 9-73 1t

TEXSCAN MODEL 9300A Sweep Spectrum Analyzer for sale complete with variable Impedance Bridge, connector adaptor kit, Harmonic markers and instruction manuals. Only one year old and just returned from factory for complete check up. \$3500.00. George Gardner, Box 38, Carlisle, Penna. 17013. 9-73 1t

EQUIPMENT FOR SALE CONT

PROFESSIONAL RECORDING AND TEST EQUIPMENT for recording studios and broadcasters-Altec, Ampex, 3M, GR, HP, Tektronix-new and used. Free equipment list or drop in. CHAS. E. WASHBURN CO., 6114-B SANTA MONICA BLVD., HOLLYWOOD, CALIF. 90038. 9-73 3t

HELP WANTED

MOVE UP from your present job in broadcast engineering. We handle all engineering jobs and openings coast to coast. Send full resume confidentially now. The AMPS Agency, 11661 San Vicente Blvd., Los Angeles, Calif. 90049 8-73-tf

WELL QUALIFIED TECHNICIAN needed for operation and maintenance of Ampex 1200B, Ampex 3000 and Norelco LDH cameras. Send resumes to Varicom, Inc., 485 West Milwaukee, Detroit, Michigan 48202. 8-73-2t

FAST-GROWING EXPORTER of broadcast equipment seeks man with technical knowledge of TV and radio equipment to head NYC staff. Should have extensive purchasing and management experience, with strong contacts among electronic suppliers. Broadcast Equipment Corporation, 777 Third Avenue, New York, N.Y. 10017 Phone (212) 758-7577 9-73-1t

CHIEF ENGINEER to maintain and operate remote color broadcast van as well as design additional units. Familiarity with CCTV/CATV gear through time base correction desirable. Awareness of world technical standards helpful. Must be highly motivated, well organized. Be able to accept COMPLETE responsibility for engineering operations for mid-west located independent production company. Our employees are aware of this ad. Submit brief resume. Write Box 289, Broadcast Engineering, 1014 Wyandotte St., Kansas City, Mo. 64105 9-73-1t

VIDEO ENGINEERS & TECHNICIANS Fully experienced in maintaining color cameras, 2", 1" and 1/2" VTRS using latest Tektronix test equipment. Excellent salaries for right men. Send resumes to: Phil Dewald, F&B/CECO of Calif., Inc., 7051 Santa Monica Blvd., Hollywood, Calif. 90038; Walter Druker, F&B/CECO Inc., 315 W. 43rd St., New York, N.Y. 10036 9-73-1t

ENGINEERING SUPERVISOR to help construct and operate new public radio station. At least two years experience in radio operations and maintenance required. Salary open. Resume to Director of Radio Services, WXXI-FM, 410 Alexander Street, Rochester, New York 14607. 9-73-1t

EXPERIENCED SALESMAN of sophisticated video systems to industrial, educational, medical markets or into broadcast and CATV industries. Excellent opportunity with one of the nation's leading suppliers representing top lines. High income potential with all fringes. Philadelphia area. Respond in confidence to Peirce-Phelps, Inc., 2000 N. 59th St., Philadelphia, Pa. 19131 (215) 477-9000 (Attention: Henry Grove) An Equal Opportunity Employer. 9-73 1t

ENGINEER/TECHNICIAN: Rapidly growing New York video house seeks experienced man for systems design and production equipment maintenance. Must have working knowledge of helical VTRs, color cameras, color processing, monitoring equipment, etc. Salary open. Call 212 586-3690 9-73-1t

POSITION OPEN IMMEDIATELY—Large, 110 Kw FM University Station seeks an engineer with at least three years experience. Duties include studio and transmitter maintenance. Excellent stereo equipped facility. Must have First Class license. Located in Midwest. Write Dept. #287, Broadcast Engineering, 1014 Wyandotte, Kansas City, Mo. 64105 9-73-1t

HELP WANTED CONT.

"CHRISTIAN TV STATION needs 1st Class Engineer with experience for maintenance UHF Transmitter 2" and 1" VTRs, etc. Send resume to P.O. Box 5421, Phoenix, Arizona 85010." 9-73-1t

ASSISTANT CHIEF ENGINEER for a large southern market AM-FM operation. This is a job with a future and an excellent opportunity for a young engineer to get a great start in a big market. 1st Phone and some experience required. Send resume, references and salary requirements to Box XXX, Broadcast Engineering, 1014 Wyandotte Street, Kansas City, Missouri 64105. 9-73-2t

WANTED: RADIO CHIEF ENGINEER AM-FM. Experienced in AM directionals, maintenance, AM-FM profs-station construction. Excellent salary and growth potential. Equal opportunity employer m/f. Write Box: 288 Broadcast Engineering, 1014 Wyandotte St., Kansas City, Mo. 64105. 9-73-1t

Reader
Service
Card
In This
Issue
Is Good
For
12 Months
And
You Can
Use It To
Renew
Your BE
Subscription

advertisers'

index

Ailtech/Cutler-Hammer	126, 127	Fidelipac Div. of Telepro Industries	122	Superior Continental Corp.	CE-8, CE-9
Akai Electric Co., Ltd.	5	Freeland Products Co.	134	Switchcraft, Inc.	110
Alco Electronic Products, Inc.	10	Gates Div., Harris-Intertype Corp.	10	Systems Marketing Corp.	129
American Data Corp.	131	General Time Corp.	50	TT Electronics	140
American Electronic Laboratories Broadcast Div.	15	Gotham Audio	9	Taber Manufacturing & Engineering Corp.	116, 136
Amperex	1	Grass Valley Group, Inc.	3	Taft Communications	106
Ampex Corporation	26-27	Clifford B. Hannay & Son, Inc.	106	Tape-Athon Corp.	113
Ampro Corporation	139, 140	Head Sound, Inc.	141	Tech Laboratories	21
Andrew Corporation	51	Hughey & Phillips, Inc.	128C	Technology Inc., HF Photo Systems Div.	44
Angenieux Corp. of America	137	Ingersoll Products, Div. of Borg-Warner	108	Teledyne Isotopes	128A
Audio Devices, Inc.	45	International Tapetronics Corp.	128	Telemet Company	Cover 3
Audio Interface Systems, Inc.	124	JOA Cartridge Service	130	Television Equipment Associates	139, 141
Audio Services, Inc.	32	Vir James Consulting Radio Engineers	142	Television Microtime, Inc.	41
Audio Video Engineering Co.	132	Jampro Antenna Co.	48	Television Technology Corp.	128C
Austin Insulator Div., Decca Radar Canada	139, 140, 141	Jensen Tools and Alloys	137	Teltron, Inc.	8
Autogram	18	Jones International Ltd.	138	Time & Frequency Technology	115
B&I Electronics, Inc.	140	Lenco, Inc.	123	Tracor Industrial Instruments Div.	135
B&K Instruments, Inc.	CE-11	The London Co.	14, 25	Trepac Corporation of America	127, 130
BSC Incorporated	112	Low Power Broadcast Co.	120	United Recording Electronics, Inc.	114
Belar Electronic Laboratory, Inc.	57	McBee Laboratories	114	United Systems Corp.	25
Bell & Howell	55	McMartin Industries	139	VIF International	128C
Berkey-Colortran	130	Magna-Tech Electronic Co., Inc.	107	Varian Associates - Eimac	11
Bethany International, Inc.	106	Marti Electronics	128D	Video Aids Corp. of Colorado	112
Birmingham Tape Cartridge Company Inc.	140	Mastertone, Inc.	139, 141	Video Data Systems	139, 141
Bogner Broadcast Equipment Corp.	35	Micro-Trak	128B	Video Sentry Systems	126
Robert Bosch Corporation	52-53	Miller-Stephenson Chemical Co.	21	Viscount Industries Ltd.	139, 140
Boston Insulated Wire & Cable Company	120	Mincom Div., 3M Company	CE-3	Vital Industries, Inc.	Cover 4
Broadcast Electronics, Inc.	16, 34, 40	Minneapolis Magnetics Inc.	108	Waters Manufacturing, Inc.	117
Broadcast Leasing	137	Mosely Associates, Inc.	7	Wilkinson Electronics, Inc.	58
Broadcast Tower Service	CE-4	Mountain West Alarm Supply Co.	137	Xcelite, Inc.	133
Burwen Laboratories	14	National Electrolab Associates Ltd.	140		
CBS Laboratories	135	North American Philips Corp.	109		
CnB Studios	141	Nortronics RCD	133		
Cablewave Systems, Inc.	125	Omnix	42, CE-5		
Cambridge Thermionic Corp.	142	Onan	31		
Ceco Communications	140	Pacific Recorders & Engineering Corp.	22, 118		
Cetec, Inc.	33	Philips Broadcast Equipment	CE-7		
Chu Associates, Inc.	142	Polyline Corporation	137		
Cine Sonic Sound	137	Potomac Instruments, Inc.	12, 13		
Clear-Com, Div. of Lumiere Productions, Inc.	122	Pulse Techniques, Inc.	141		
Collins Radio Company	19	Qualitape, Inc.	137		
Communications Medias	42	Quick-Set, Inc.	CE-10		
Computer Magnetics Corp.	105	RCA Electronic Components	23		
Comquip, Inc.	141	Ramko Research	20		
Continental Electronics	64	Rapid-Q	134, 128A		
Control Concepts Corp.	110	Robins/Fairchild	17		
Crown International	121	Roh Corporation	124		
Danscoll	116	Russco Electronics	128		
Delta Electronics	138	SC Electronics	49		
Dielectric Communications, Div. of Sola Basic	56	Howard W. Sams & Co., Inc.	119		
Dyma Engineering	136	Scott-Buttner/Coastcom	12		
Dynair Electronics, Inc.	118	Scully/Metrotech Div. of Dictaphone	111		
Dynasciences Corp.	37	Sesco, Inc.	142		
ES Enterprises	43	Sescom, Inc.	128		
ESC Electronics Corp.	137, 140	Shallco, Inc.	124		
Electro Impulse, Inc.	132	Shintron Company, Inc.	132		
Electrohome Ltd.	24	Shively Labs	119		
Electronic Engineering Co. of California	47	Smith & Powstenko	142		
Electro-Voice, Inc.	Cover 2	Sparta Electronic Corp.	8		
Elpa Marketing Industries	18	Spin Physics, Inc.	CE-6		
Ralph E. Evans Associates	142	Spotmaster	16, 34, 40		
		Stainless, Inc.	46		
		Stanton Magnetics, Inc.	39		
		Stantron Div., Wycoco Metal Products	128B		

**This may be
your last chance
to get up off
your big fat
complacency.**

Try this. Pick out one of our United Way agencies. Go out into the field with its workers. See for yourself the very real needs of the people it serves. The new and growing urgency of their problems.

Take a good hard look at the new things that the agency is doing to solve these problems. The new approaches. The new programs. The new money they take.

Then, when you pledge your Fair Share, you're bound to make it bigger. You will remember the faces and voices of those you are helping.

If you don't do it, it won't get done.

advertising contributed for the public good



BROADCAST EQUIPMENT SHOWCASE

For more than 20 years, Telemet has built precision products for the broadcast industry. Products designed for long life. To function with the ultimate of efficiency.

That's why each Telemet product undergoes extensive development and final field testing before it is available to the industry. The result: a long and growing list of satisfied customers.

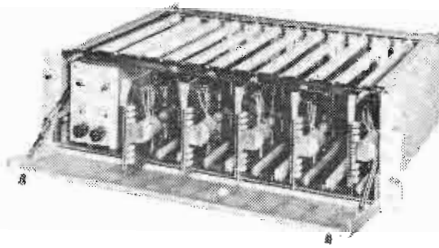

**Audio
DAs**

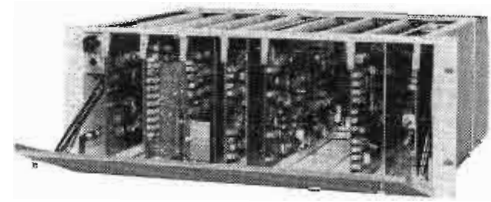

**VIT
Packages**

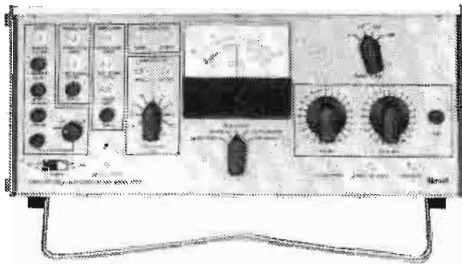

**Group Delay
Test Sets**

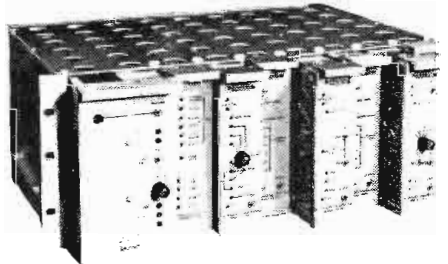

**Test
Sets**

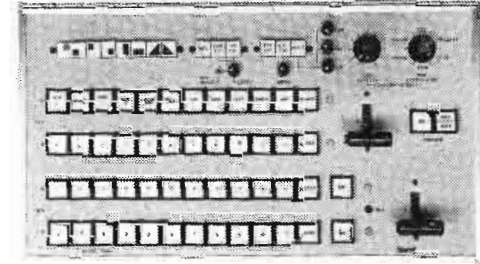

**Production
Switchers**

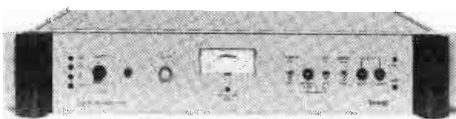

**Precision
Demodulators**



**Chroma
Keyers**

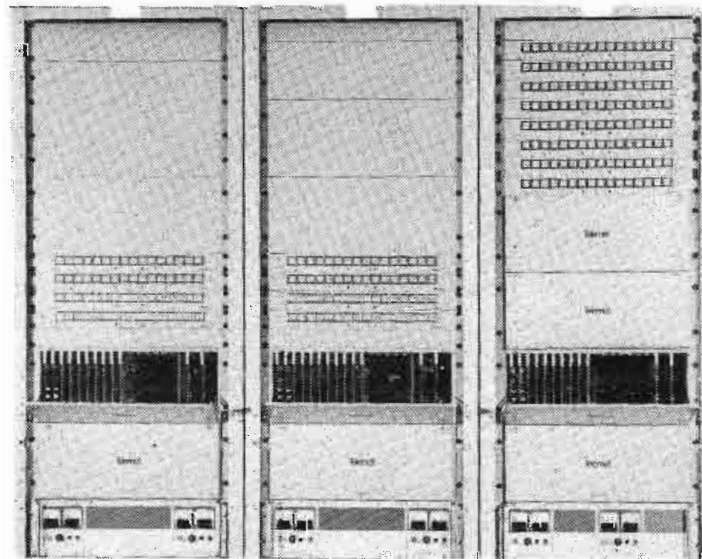

**Routing
Switchers**



better ideas for broadcasting
Telemet

A GEOTEL COMPANY

Amityville, New York 11701, (516) 541-3600

REGIONAL OFFICES

Chicago, Ill. (312) 627-6026 Houston, Tex. (713) 946-5796 Riverside, Calif. (714) 683-0641

For More Details Circle (2) on Reply Card

VIX-1

The Professional One

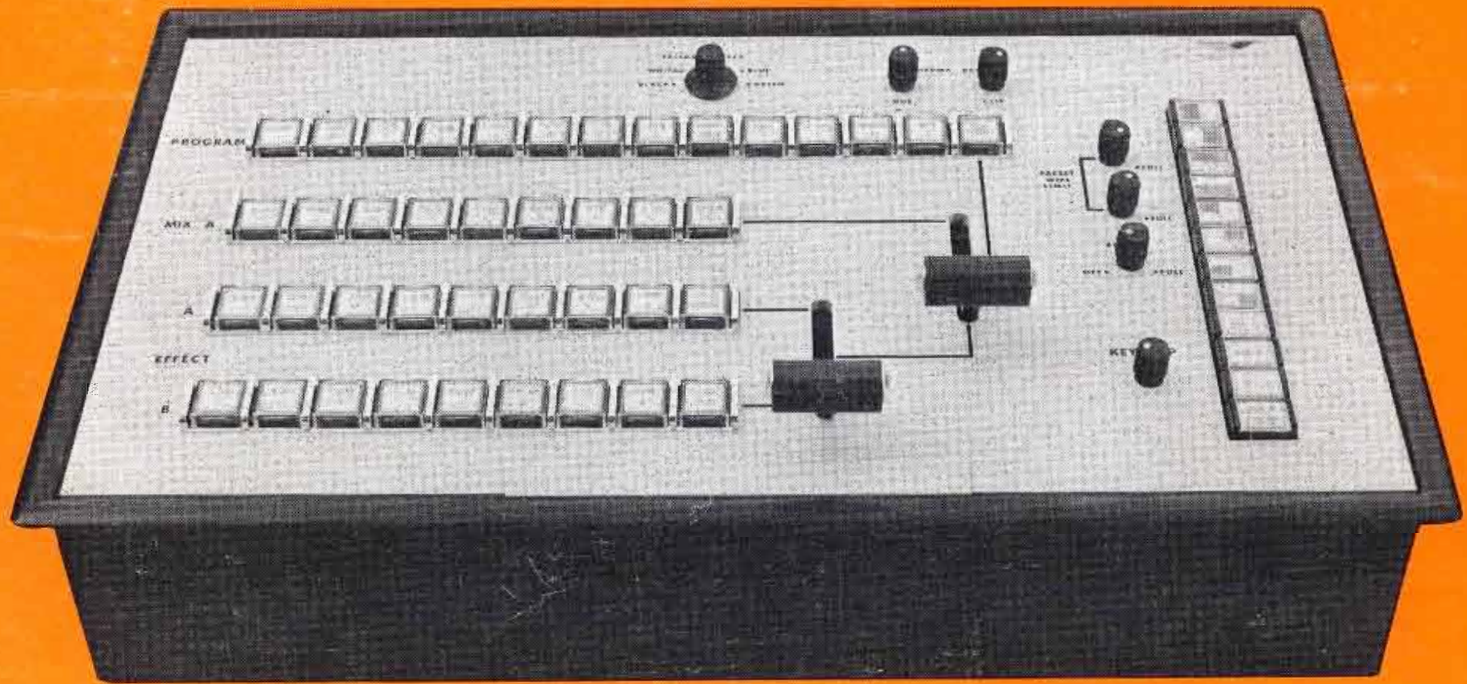

VIX-1

New performance standards in video switching. The VIX-1 is designed to fulfill the need for high quality production switchers where a medium number of source inputs are required while providing versatile production capability.

SALIENT FEATURES:

- No adjustments required
- Independent 13-input program bus
- 9 sources on mix-effects buses with tally functions
- 8 effects patterns with variable border
- 4 independent key sources
- Preset effects pattern limits
- Effects entry into mix
- Built-in black burst and color background generator with no adjustments
- Less than 10-inch rack mount electronics
- D.C. control cables to panel available in 25-foot increments

Price \$7,900.00

Options: Chroma key VCK-1 \$980.00
Audio-follow on program bus \$800.00
Video processor \$2,400.00

GOOD ENGINEERING IS VITAL

11 years of specialization. Designed, manufactured and delivered some of the world's largest and most complex integrated telecommunication systems.



VITAL INDUSTRIES, INC.

MAIN OFFICE: 3614 S.W. Archer Road, Gainesville, Fla. 32601 — Phone 904/378-1581

Fox Hill Rd., Lynchburg, Va. 24503 — Phone 804/384-7001 3620 Ridgewood Rd., N.W., Atlanta, Ga. 30327 — Phone 404/233-9459
7960 W. Beverly Blvd., Los Angeles, Calif. 90048 — Phone 213/653-9438 2644 N. Seventh St., Terre Haute, Ind. 47804 — Phone 812/466-3212

For More Details Circle (3) on Reply Card