

BROADCAST **engineering**

September, 1975/75 cents



'75 BUYER'S GUIDE ISSUE

Televising the President

Parallel FM transmitters

New Dimensions in Sound

Trendsetting technology blends with timeless elegance in every Ward-Beck console.

The latest high performance Series 460 modules feature totally balanced circuitry and state-variable techniques. Configurations are planned for operational ease and flexibility.

Ward-Beck continues to challenge contemporary standards with innovative designs that reveal new dimensions in the Art of Sound.



Tomorrow's Technology Today.

Ward-Beck Systems Ltd.,
841 Progress Avenue,
Scarborough, Ontario M1H 2X4
Telephone (416) 438-6550.
Telex 06-23469

Ward-Beck Systems Inc.,
290 Larkin Street,
Buffalo, N.Y. 14210

For More Details Circle (14) on Reply Card



Any Way You Look At It... Telemet's \$4,600 Sideband Analyzer Comes Up First!

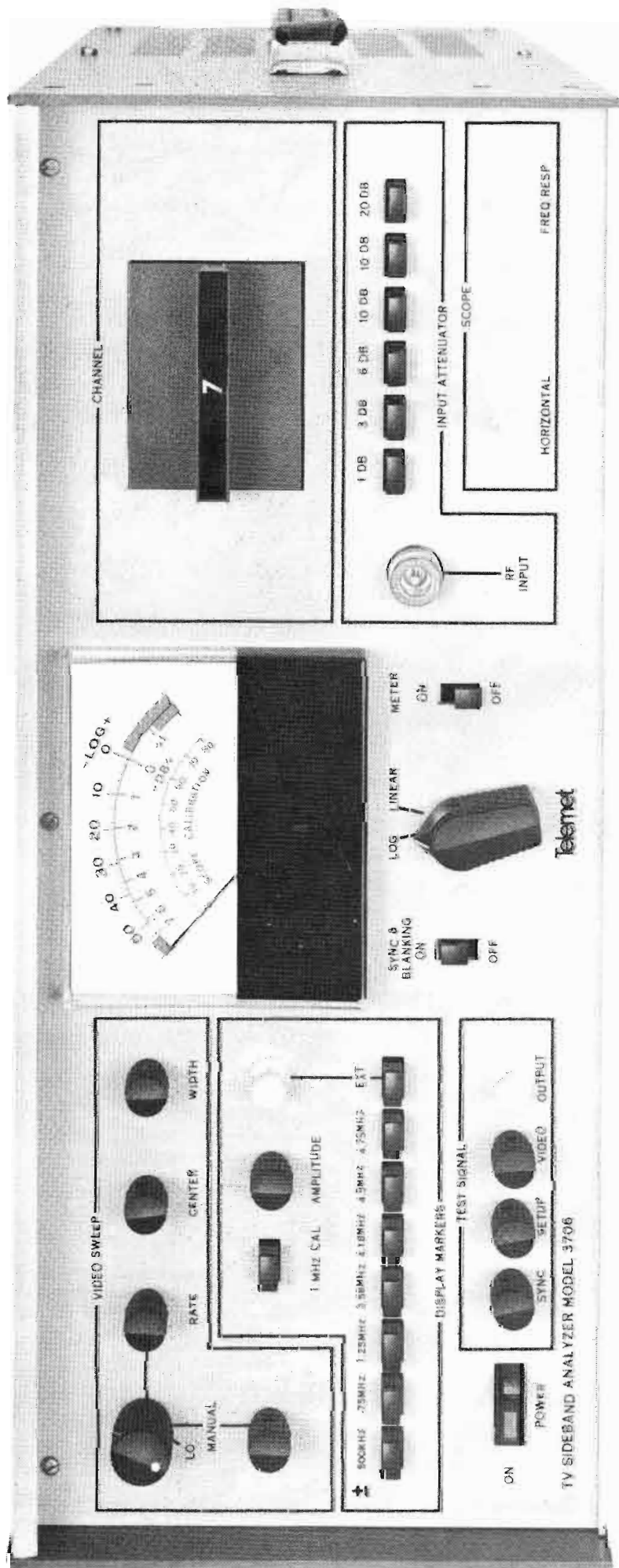

We've turned our 3706 on end so that you could see how much this sideband analyzer has going for you.

And check these features to see why broadcast engineers from coast-to-coast are insisting on buying Telemet's Sideband Analyzer:

- Single channel plug-in crystal controlled for frequency stability
- Crystal filtered dual conversion IF
- 50dB scope display
- Composite or noncomposite outputs
- H Sync & blanking internally generated
- Variable sweep rates including manual control
- Point to point response readout on front panel meter
- 7 discrete crystal markers at the required measuring frequencies
- 1 MHz crystal comb frequency markers across the sweep width

Best of all is its price: only \$4,600 for VHF channels; add another \$500 for the UHF to VHF Down Converter.

But this product is only part of the extensive Telemet line of video equipment. Get the whole story. Use the coupon below or call Your Telemet representative for information on:

- | | |
|---|-------------------------------|
| Video Test Signal Generators | Audio Monitors |
| Envelope Delay Test Set | Audio Distribution Amplifiers |
| Differential Phase and Gain Measuring Systems | Video Distribution Amplifiers |
| Remote Control Vertical Interval Test Sets | Pulse Distribution Amplifiers |
| Video Sweep Generators | Clamper Amplifiers |
| Modulators | Monoscope Generator |
| Demodulators—Fixed Frequency | Video Routing Switchers |
| Demodulators—Variable Tuned | Video Production Switchers |
| Video Signal Conditioners | Chroma Keyer—RGB |
| | Chroma Keyer Decoder—NTSC |

A GEOTEL COMPANY

Telemet

Amityville, New York 11701, (516) 541-3600
TWX 510-227-9850

O.K. Telemet send me the following:

- Information on Model 3706 Sideband Analyzer
- Complete Catalog
- Please put me on your Technical Bulletin Mailing List

Name _____

Title _____

Company _____

Address _____

City _____ State _____ Zip _____

Phone _____

For More Details Circle (18) on Reply Card

- 26 Televising The President.** Our Video Editor reports on the logistics and techniques of covering the President. *Joe Roizen.*
- 34 Parallel FM Transmitters.** Part three of a series with system ideas from an engineer who has built a number of parallel FM transmitter installations. *Tom Polino.*
- 69 1975 Buyer's Guide Directory.** Directory section continues to grow with this year's version. It includes a number of new and innovative product categories. Products with red listings refer to ads in other parts of the magazine. And remember that the Reader Service cards in this issue are good for one year.
- 126 TV Lighting: The Neglected Art.** Lighting notes for basic TV applications. *Ed Gallagher.*
- 134 Keep Those Milk Bottles Rolling.** Remember the good old days? If you don't, here's a report from an engineer who was there before we had blue bananas. *Phil Whitney.*
- 177 Manufacturer's and Supplier's Address Section.** We've expanded our address section to include addresses and telephone numbers of national sales offices. If the telephone number you need is not listed, refer to the number listed in the ad in this issue.

About the Cover

The shot was taken in a van using LIVE journalism in Boston. You'll find a number of new equipment categories as a result of this and other industry innovations. Photo courtesy of Philips Audio Video Systems Corp.

Departments

Direct Current	4
Industry news	8
SBE Journal.....	122
Cable Engineering	CE-1
People in the News	140
New Products	150
Classified Ads.....	186
Ad Index.....	188

EDITORIAL

Ronald N. Merrell, *Director*
Carl Babcoke, *Technical*
Pat Finnegan, *Maintenance*
Howard T. Head, *FCC Rules*
Robert A. Jones, *Facilities*
Walter Jung, *Solid State*

Cris Barnes, *Editorial Assistant*
H. G. Roesler, *Cartoonist*
Dudley Rose, *Graphic Designer*
Joe Roizen, *Video*
Archer Taylor, *CATV*
Dennis Ciapura, *Audio Editor*

CIRCULATION

Evelyn Rogers, *Manager*



ADVERTISING

Mike Kreiter, *Director*
Greg Garrison, *Production*
Regional Advertising Sales Offices on Advertisers' Index page

Broadcast Engineering is published monthly by Intertec Publishing Corp., 1014 Wyandotte Street, Kansas City, Missouri 64105. Telephone: (913) 888-4664

Broadcast Engineering is mailed free to qualified persons engaged in commercial and educational radio and television broadcasting. Non-qualified subscriptions in the U.S. are \$6.00 one year, \$10.00 two years, \$13.00 three years. Outside the USA add \$1.00 per year to cover postage. Single copy rate 75 cents. Back issues rate \$1.00. Adjustments necessitated by subscription termination at single copy rate.

Controlled Circulation postage paid at Indianapolis, Indiana.



Robert E. Hertel, *Publisher*

INTERTEC PUBLISHING CORP.
Subsidiary of HOWARD W. SAMS & CO., INC.

Copyright, 1975, Intertec Publishing Corp. All Rights Reserved: Material may not be reproduced or photocopied in any form without written permission of Publisher.

DIRECT CURRENT FROM D. C.



September, 1975/By Howard T. Head and Harold L. Kassens

Improvements Asked in TV Receiver Performance

A consortium consisting of the Corporation for Public Broadcasters (CPB), the Public Broadcasting Service (PBS), and several commercial broadcast trade associations has petitioned the FCC to amend its Rules governing TV receiver performance. Principal attention is being focused on the permissible noise figure at UHF, now established at 18 dB above $kT\Delta F$, which when you stop to think about it, is an awful lot of noise. The petition requests an immediate reduction, after exhausting inventories, to 14 dB to be followed within two years by phased reductions to 10 dB.

It is asserted that the cost to the public of the first reduction will be negligible, since this can be brought about almost entirely by improved quality control. The further reductions will require some type of solid state RF amplifier, but this approach is already being used in those receivers employing varactor tuning.

A companion request addresses itself to the need for an adequate antenna at UHF, and asks that the Commission require that wherever a VHF antenna is permanently affixed to a set, an effective UHF antenna also be permanently affixed. According to the petition many UHF antennas may be readily detached, lost in the shipping box, or simply not used by the viewer because he does not realize the need for the UHF antenna. Meanwhile the Commission continues its "taboo" study to determine the validity of the existing VHF taboos as well as the possibility of reducing or eliminating them.

The National Bureau of Standards (NBS) has also proposed a reduction in the primary AC power consumption of all TV receivers, with a goal of a 42% reduction in the case of color sets and a 48% reduction in monochrome. Most of the power consumption occurs in the horizontal deflection system, with wide angle deflection tubes requiring significant amounts of power.

Satellite Audio Feed Being Tested

RCA Global Communications and the Muzak Corporation have been granted temporary authority by the Commission to conduct a test and demonstration program of the feasibility of high-fidelity audio trans-

(Continued on page 6)

The New SPARTA Broadcast Equipment

VARIEITY SHOW



Sparta 703B Bows In Before US Audiences After Long Road Tour!

(Sacramento) — The 2.5 kW AM Model 703B by Sparta has been in continuous production for the foreign market since 1967! Now all-solid state

Stars Added to Brilliant Long-run 'Showcase' Sparta Productions!

(Super City, USA) — Famous SPARTA 'Showcase' furniture groups have been veteran supporting actors for 1000-Series audio consoles for years. The most recent productions of 'Showcase' studio furniture include CENTURION SERIES and 3000 SERIES in new functional designs. The same good looks and durability are built in

which made 'Showcases' curtain-call quality performers in control rooms around the world!

CUSTOM studio staging at mass production prices...Sparta 'Showcase' furniture groups are now show-stoppers for ALL THREE SPARTA CONSOLE LINES!!

Sparta 635 Headlines the FM Transmitter Cast!

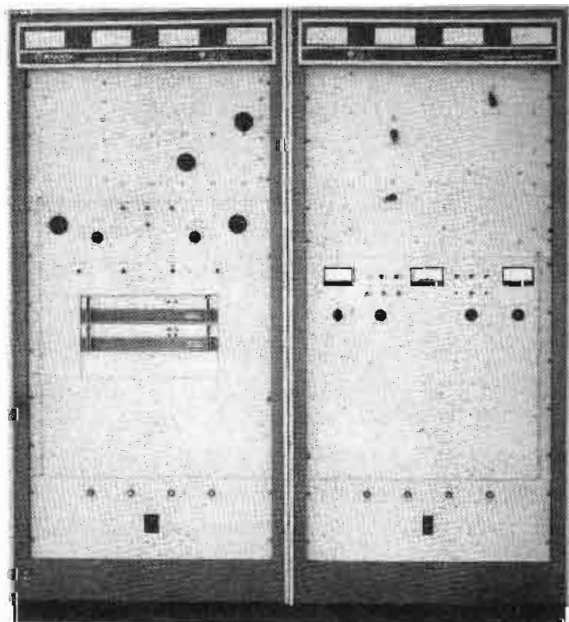

(Everywhere, USA) — The husky young star of the SPARTA FM transmitter line takes a bow for greatest 100 kW ERP economy, modular construction for modest installation cost!

35 kW power output through 3 1/8" line for economy...grounded grid design for utmost high power dependability without 'tweaking'. Modules of the Model 635 fit even small existing transmitter buildings, can be arranged for engineering advantage!

The SPARTA FM cast includes 250 Watt all-solid state Model 600B, the 601A, 602A, 605B, 610A and 625A FM Transmitters...specify your needs!

Get in line early, Model 635 will be playing to SRO audiences soon!!

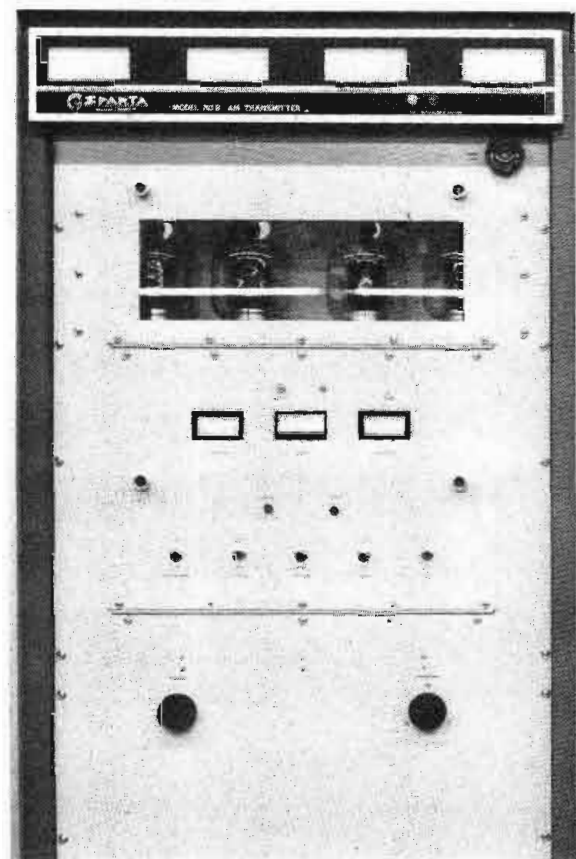

up to the finals, its suitability for the F.C.C. 2.5 kW AM power classification will make it the instant leader in economy and dependable performance!

Sparta AM transmitter productions also include the 701B, 705, 710, 715 and 725 models. Ask our prompter for information!

Look for sparkling action, great direction, and long LONG runs of these smash Sparta productions!

We're in the business of You.



5851 Florin-Perkins Road, Sacramento, Ca. 95828
(916) 383-5353 • Telex 377-488 • Cable SPARTA

For More Details Circle (19) on Reply Card

(Continued from page 4)

mission by satellite to a small earth terminal. A similar demonstration was held last year between Valley Forge, Pennsylvania and the Waldorf-Astoria Hotel in New York City. Locations for this year's test will include Westbury, New York; Miami Beach, Florida; San Diego, California; Seattle, Washington; and Oak Park (Chicago), Illinois.

The satellite to be used is the Canadian Anik II. Program material is to be transmitted within the range of audio frequencies 50 Hz to 15 kHz.

CATV 1977 Rebuild Deadline Cancelled

The Commission has cancelled the March 31, 1977 deadline by which all major market CATV systems operating prior to March 31, 1972 were required to reconstruct for compliance with the channel capacity and access provisions of the Commission's Rules. The action does not affect major market systems beginning operation on or after March 31, 1972, or the origination facilities requirement imposed on systems with more than 3500 subscribers. There was no relaxation of the requirement on older systems for effecting compliance with all other requirements of the technical standards by the 1977 date.

The requirements being relaxed include those for having twenty channel capacity, the provision for non-broadcast channels, two-way capability and public access channels. Commission Rule-Making is now under way to consider possible alternatives to the 1977 deadline. The Commission stressed its continuing commitment for fostering channel access services.

Short Circuits

The Commission has adopted rules for high intensity (strobe) lighting of tall antenna structures; the change will not be mandatory in the case of existing structures....The Commission has cancelled a fine of \$1,000 levied against a Virginia AM station, principally based on the charge of reading the remote antenna current meter during modulation....A New Mexico TV station under construction has been granted a waiver on the extension metering rules so as to permit the meters to be 184 feet from the transmitter rather than the 100 foot maximum imposed by the rules...slide and voice announcements on UHF and FM transmitters may now range up to 30 seconds; the previous limit was 20 seconds....The Commission has proposed to allow the use of FM microwave by TV translator stations...the 25th Annual Fall Broadcast Symposium of the IEEE Broadcast Group will be held in Washington on September 25-26; the program will honor FCC Commissioner Robert E. Lee, who has served more years as a Commissioner than a member of any other Federal Agency.

THE ADC 553

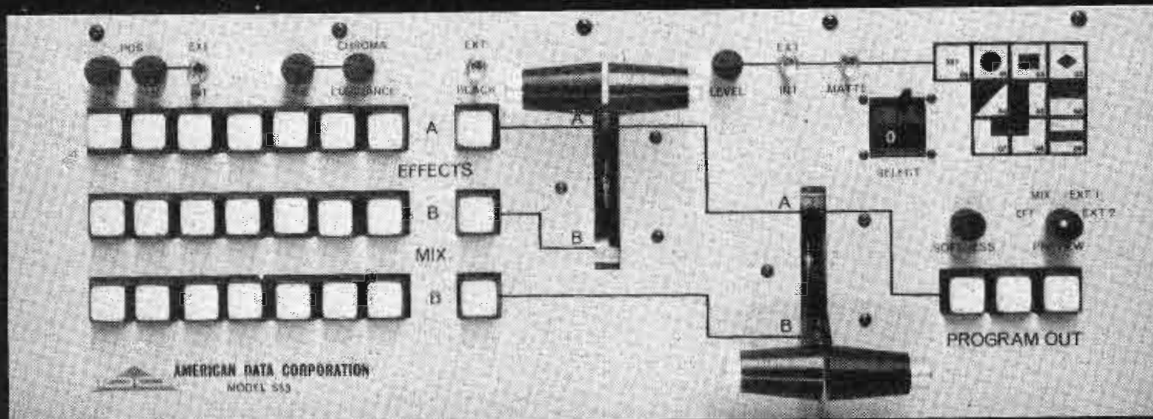

A TOTALLY NEW PACKAGE DESIGNED ESPECIALLY FOR:

- ★ THE LARGE MARKET
- ★ THE SMALL MARKET
- ★ THE MEDIUM MARKET
- ★ CABLE, CCTV, MOBILE
- ★ ONLY \$3,950

The ADC Model 553 Vertical Interval Color Production Switcher is designed to provide small studio and remote van operators with a broadcast quality switching system that incorporates the latest state-of-the-art advances. SOFT WIPE and LINEAR KEY are standard features, but a new development from ADC allows the combining of two 553 systems for a system of unmatched capability and economy.

The special effects generator provides nine wipes, including a circle, square, diamond, diagonal, H&V splits and corner inserts. In key mode, the special effects generator provides a choice of self or matte key on internal or external sources, and an external chroma keyer may be used on the external input. True SOFT WIPES are provided, with control for degree of softness. The keying system is LINEAR in nature so that edge crawl and key breakup are minimized.

The Model 553 is self-contained and designed to mount in a standard 19 inch console or rack housing. Input selector buttons are momentary contact, illuminated with relegendable lens caps. A blackburst and color background generator is included in the switcher to provide fades or wipes to any color or black, and in conjunction with the matte keyer, will provide colored insert keying.



AMERICAN DATA CORPORATION

AN **AIRPAX** COMPANY

315 WYNN DRIVE, N.W. P. O. BOX 5228 HUNTSVILLE, ALABAMA 35805 TEL. 205-837-5180

1729 WILMONT DRIVE
ATLANTA, GA. 30329
404-633-2100

5504 WATERWAY
ROCKVILLE, MD. 20853
301-460-1454

3250 WILSHIRE BL. STE900
LOS ANGELES, CA. 90010
213-387-7756

2908 MULBERRY
PASADENA, TX. 77502
713-941-7272

AIRPAX ELECTRONICS

Cambridge Division
Cambridge, Md.

Circuit Breakers & Switches
Controls Division
Ft. Lauderdale, Fla.

Tachometry & Control Instrumentation

For More Details Circle (20) on Reply Card

INDUSTRY NEWS

Commission adopts rules Permitting strobe lighting

The Commission has adopted rules permitting the use of high intensity (strobe) lighting of antenna structures as an alternative to the customary painting and red obstruction lighting.

The Commission recommended the action in a rulemaking notice released February 11, 1974, to conform with Federal Aviation Administration (FAA) standards for obstruction marking and lighting.

While comments in response to the rulemaking supported in principle the use of high intensity lighting systems for antenna structures, they expressed concern that the use of

strobe lighting, which was intended as an alternate to the current rule provisions, would become mandatory. This concern was based essentially on the fact that strobe lighting systems are far more costly than the current systems, that they are not always compatible with existing antenna structural designs and that in some instances the systems would be potential irritations or nuisances.

The Commission said it did not anticipate that adoption of the new rules would make obsolete the painting and red obstruction lighting standards now in effect, and it

did not intend to require existing structures to be converted to high intensity lighting.

The Commission pointed out that the revised rules would apply primarily to new structures where the FAA has determined that increased visibility was necessary to obviate the structure having a substantial adverse effect on the safe and efficient utilization of airspace. The rules would also be applicable to existing or proposed structures, the FCC said, where painting and red obstruction lighting have been specified initially but on request of the applicant the Commission approves the installation of high intensity lighting as an alternative.

**For Latest News
See
Direct Current page 4**

The MASTER CART from FIDELIPAC®

For the cleanest cart sound your station can broadcast, Master Cart is the answer. Engineered to use natural tape flow patterns that eliminate erratic tape behavior and assure repeatability both from cartridge to cartridge and usage to usage. Provides that added edge in stereo performance that conventional cartridges *can't* deliver. Fewer parts for simpler maintenance . . . and greater reliability.

For detailed information, contact your Fidelipac Distributor or



FIDELIPAC®

109 Gaither Drive • Mt. Laurel, NJ 08057
(609) 235-3511

* Trademark

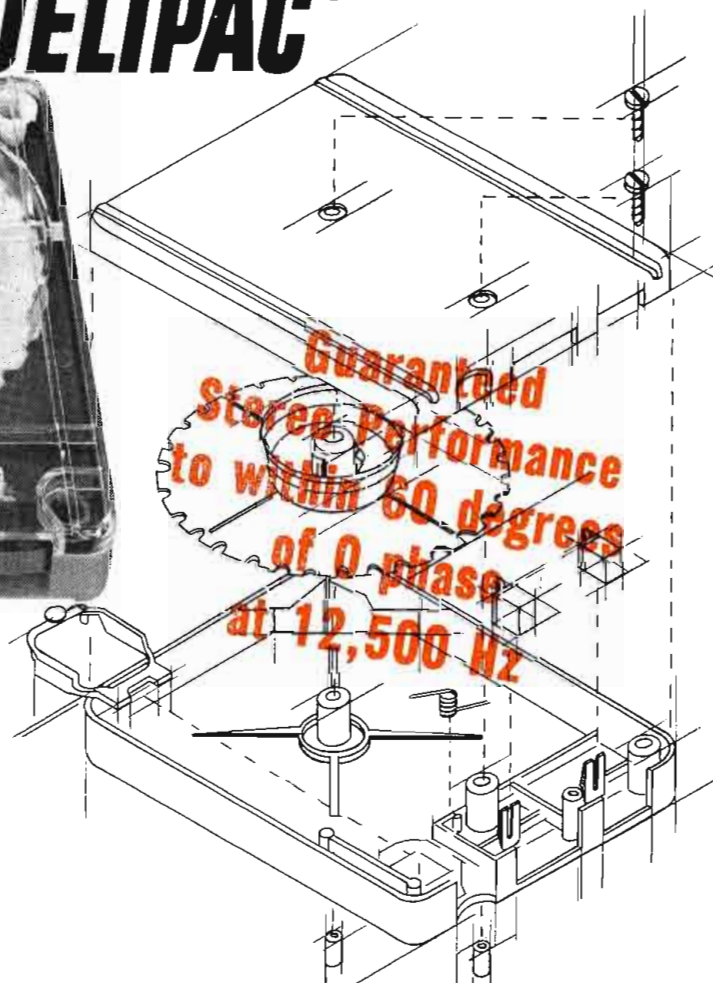
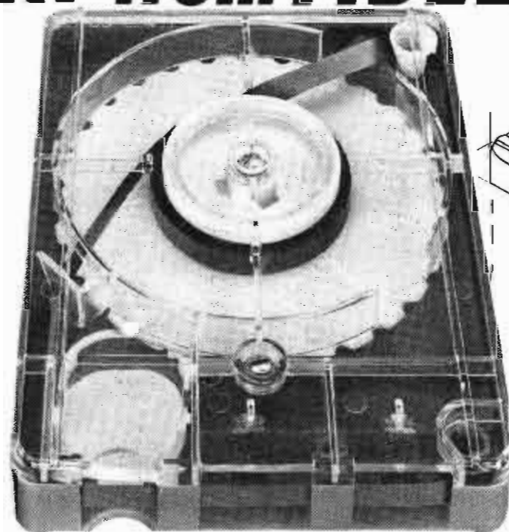

For More Details Circle (21) on Reply Card

AURAL STUDIO-TRANSMITTER AND REMOTE PICK-UP LINKS

All solid-state aural studio-transmitter and remote pickup links are available to fulfill almost every requirement. Moseley Associates, Inc., has pioneered many STL and remote pickup concepts — solid-state systems, true direct FM modulation, and composite operation (FM stereo on a single link) . . . just to name a few. Front-panel metering of all important parameters is included on all Moseley STL and remote pickup transmitters and receivers.

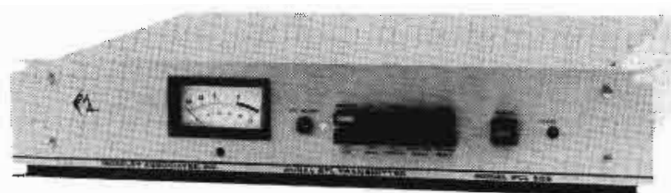

- AURAL STUDIO-TRANSMITTER LINKS**
 PCL-101 — AM Mono — 148 to 960 MHz
 PCL-505 — AM/FM Mono — 148 to 960 MHz
 FM Stereo (Dual)
 PCL-505/C — Composite Stereo — 148 to 960 MHz
 (Single Link for Stereo)

- AURAL REMOTE PICKUP LINKS**
 RPL-3 — 2 microphones, 1 line — 148 to 174 MHz
 RPL-4 — 2 microphones, 1 line — 450 to 470 MHz
 AMP-3 and AMP-4 Companion RF Power Amplifiers

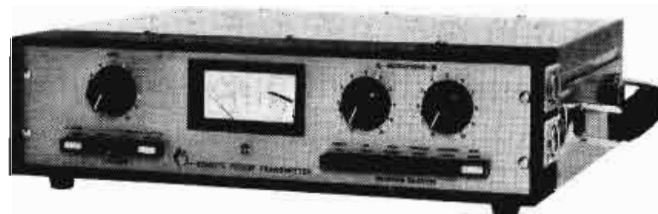

For More Details Circle (22) on Reply Card

TRANSMITTER REMOTE CONTROL SYSTEMS

Moseley Associates Remote Control Systems are field proven at numerous installations. Two basic types of systems are available — analog and digital. Both systems can be operated in either a wire or wireless mode.

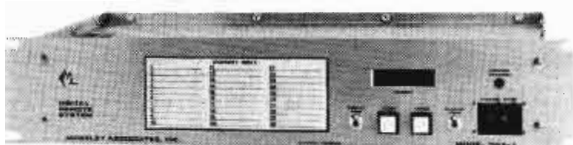

- ANALOG REMOTE CONTROL**
 ■ TRC-15A — 15 Channels — Push-button Channel Select
- DIGITAL REMOTE CONTROL**
 ■ DRS-1A Digital Remote System —
 Up to 30 Channels
 Companion 24-Channel Status Subsystem
 DLS-1 Digital Logging System Records up to 20 Parameters

- DCS-2 Digital Control System —
 Up to 90 Channels
 Multiple-Transmitter Site Operation
 Up to 60 Status Channels
 PLU-1 Parameter Logging Unit Records up to 20 Parameters
 Computer Option — Allows Computer-Assisted Operation, Even Full Automation

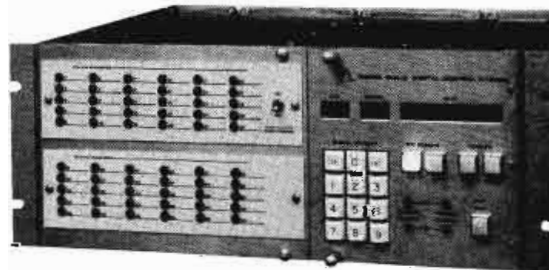

For More Details Circle (23) on Reply Card

OTHER MOSELEY PRODUCTS

- Full Remote Control Accessories ■ Full STL Accessories ■ FM Subcarrier Generators
 ■ Stereo Generators ■ Remote Pickup Accessories ■ FM Subcarrier Detectors



MOSELEY ASSOCIATES, INC.
 SANTA BARBARA RESEARCH PARK

111 CASTILIAN DRIVE
 GOLETA, CALIFORNIA 93017
 TELEPHONE (805) 968-9621
 TELEX 658448 CABLE: MOSELEY

For More Details Circle (24) on Reply Card



**The only full line
of FM monitors
made for remote**

State-of-the-art performance. It's made TFT a leader in AM and TV monitoring. And, now, it's available in a complete line of FCC type-approved FM monitors. Choose from two baseband units — Frequency and Modulation (Model 723) or Modulation Only (Model 734) — plus stereo and SCA!

Like all TFT monitors, the FM line is tailor-made for remote operation. For one thing, you don't need an RF amplifier to drive the baseband monitor. So, you get an exceptionally clean demodulated signal.

Furthermore, you don't have to give TFT monitors much after-installation attention. The Model 723, for example, doesn't need periodic calibration because its stability is ± 100 Hz per year. Other features that make TFT monitors ideal for remote include: digital (BCD) or optional analog logging outputs, and several alarm options: Carrier-Off, Loss-of-Modulation, and Off-Frequency.

Advanced design techniques are hallmarks of all TFT instruments. In the stereo monitor, for example,

phase lock loop circuits ensure superior, highly stable separation measurements. Another example is the use of crystal filters in the SCA monitor to provide excellent selectivity.

Frequency synthesizer design is another TFT advantage. And, the Model 723 can be calibrated directly against NBS, using a TFT Model 735 WWV Receiver.

In addition, the precise accuracy needed for measuring peak modulation is provided by digitally settable peak flashers that display plus and minus peaks simultaneously. This is standard, both on the baseband monitors and on the SCA unit.

All TFT monitors meet applicable FCC requirements, and baseband units have high level inputs for direct transmitter hook-up. This allows you to make all necessary proof-of-performance measurements.

For a demonstration on your frequency, call or write TFT at the address below. In Canada: Glentronix Ltd., Don Mills, Ontario.

FCC moves in On auction Programs

The Commission has ruled that auction programs broadcast over radio and television stations in which bids are placed via telephone calls to the stations, and from which stations receive proceeds from the sales made, constitute program-length commercials and are to be logged as commercial matter.

The ruling was a result of requests from several licensees and a communications counsel concerning the proper manner by which to classify auction programs for logging purposes.

Generally the programs in question:

- are broadcast live with a duration in excess of 15 minutes,
- have articles of merchandise sold by auction to the highest bidder who makes his bid by telephone call to the station,
- auction off articles received from various sources such as merchant donations in exchange for announcements made during the program advertising the name and location of the merchant, in trade-out transactions unrelated to the program, or from parties who furnish articles with joint participation by the station in the proceeds of the sale,
- result in the stations in all cases retaining all or part of the sale proceeds,
- may provide, in most cases, a form of entertainment by way of chats between announcer and bidders or by way of comments by the announcer referring to bids or the articles.

The Commission pointed out that in its Public Notice of January 31, 1974, on program-length commercials, the criteria for determining if a program falls within such a category is whether the commercial and noncommercial matter in the program is so "inextricably intermixed that it becomes impossible to draw a line between them."

The Commission said the pro-
(Continued on page 12)

TFT TIME AND FREQUENCY TECHNOLOGY, INC.
3000 OLCOTT STREET, SANTA CLARA, CA 95051 (408) 246-6365

For More Details Circle (25) on Reply Card

This is all you need to get moving with Dolby FM

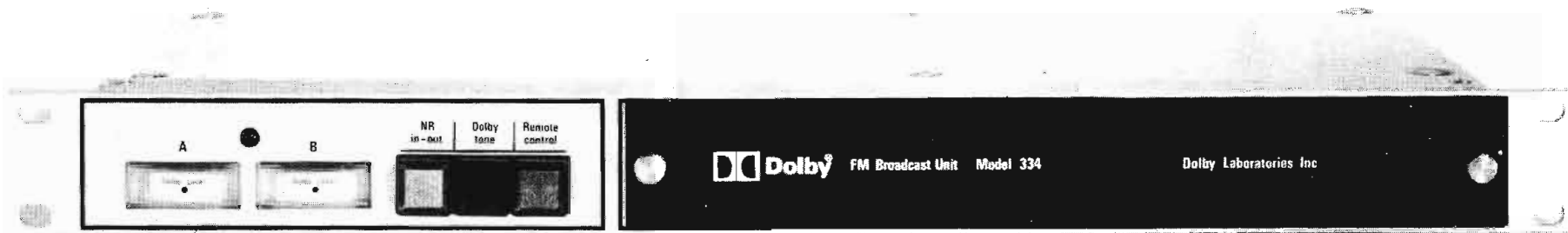

Remember the first time you came across Dolbyized cassettes? And how surprised you were that music could sound so good in such a convenient form?

Well, now the same principles are being used to improve FM broadcasting. The audible effect of the Dolby system as used in FM is a bit more subtle than with

cassettes. But the overall results are just as important. Dolby FM is cleaner, with sparkling high frequencies free of limiting. And, of course, noise is reduced, which often increases the area of good reception.

As of August 1975, over 100 US stations have purchased the Dolby Model 324 or

334 FM Broadcast Unit. The unit accurately compresses the signal in accordance with the Dolby B-Type characteristics and changes the effective transmission time-constant to 25 microseconds. This allows the station to reduce or eliminate any high frequency limiting required previously.

Akron OH	WAEZ 97.5	Cincinnati OH	WGUC 90.9	Edmond OK	KWHP 97.7	Los Angeles CA	KGBS 97.1	New York NY	WOXR 96.3	Seattle WA	KIXI 95.7
Albany NY	WHSB 106.5	Collegeville MN	KSJR 90.1	Fairmont NC	WFMO 100.9	Los Angeles CA	KIOO 100.3	New York NY	WRFM 105.1	Skokie IL	WCLR 101.9
Allentown PA	WFMZ 100.7	Columbus GA	WEIZ 100.1	Flint MI	WGMZ 107.9	Los Angeles CA	KPFK 90.7	Normal IL	WGLT 91.7	St. George SC	WPWR 95.9
Alta Vista VA	WKDE 105.5	Columbus OH	WCOL 92.3	Fort Wayne IN	WMEF 97.3	Lancaster PA	WDAC 94.5	Opportunity WA	KZUN 96.1	St. Louis MO	KCFM 93.7
Arlington TX	KAMC 94.9	Columbus OH	WOSU 98.7	Fort Worth TX	KWXI 97.1	Lexington VA	WLUR 91.5	Paterson NJ	WPAT 93.1	Stevens Point WI	WSPT 97.9
Baltimore MD	WAMR 106.5	Dayton OH	WTUE 104.7	Fresno CA	KPHD 95.5	Louisville KY	WCSN 99.7	Philadelphia PA	WMMR 93.3	Sylvania OH	WXEZ 105.5
Birmingham MI	WHNE 94.7	Dallas TX	KCHU 90.9	Gainesville GA	WDUN 106.7	Louisville KY	WLRS 102.3	Portland ME	WDOS 97.9	Topeka KS	KTPK 106.9
Boston MA	WROR 98.5	Dallas TX	KTLC 100.3	Grand Rapids MI	WZZM 95.7	Madison WI	WYXE 92.1	Richmond VA	WEZS 103.7	Tuscaloosa AL	WUOA 95.7
Boston MA	WBFB 105.7	Dallas TX	KVIL 103.7	Hanover NH	WDCR 99.3	Maine FL	WAIA 97.3	Rochester NY	WCMF 96.5	Utica NY	WOUR 96.9
Buffalo NY	WDCX 99.5	Dallas TX	KZEW 97.9	Hartford CT	WTIC 96.5	Manassas VA	WEZR 106.7	Rochester NY	WEZO 101.3	Washington DC	WAMU 88.5
Buffalo NY	WBEN 102.5	Denver CO	KBPI 105.9	Henrietta NY	WITR 89.7	Memphis TN	WKNO 91.1	Saline MI	WIOB 102.9	Washington DC	WASH 97.1
Carbondale IL	WSIU 91.9	Denver CO	KLZ 106.7	Houston TX	KILT 100.3	Miami FL	WAIA 97.3	Salt Lake City UT	KDAB 101.1	Washington DC	WGMS 107.3
Charlotte NC	WEZC 104.7	Detroit MI	WABX 99.5	Houston TX	KRLY 93.7	Minneapolis MN	KSJN 91.1	Salt Lake City UT	KSL 100.3	Washington DC	WHUR 96.3
Charlotte NC	WRQQ 95.1	Detroit MI	WOMC 104.3	Indianapolis IN	WNAF 93.1	Morgantown WV	WAJR 101.9	San Antonio TX	KEXL 104.5	Washington DC	WMAL 107.3
Chicago IL	WFMT 98.7	Detroit MI	WJZZ 105.9	Jackson MS	WSLI 96.3	New Orleans LA	WEZB 97.1	San Diego CA	KGB 101.5	Wilkes-Barre PA	WYZZ 92.9
Chicago IL	WLOO 100.3	Detroit MI	WMUZ 103.5	Kettering OH	WVUD 99.9	New Orleans LA	WNOW 101.1	San Francisco CA	KABL 98.1	Youngstown OH	WYSU 88.5
Cincinnati OH	WEBN 102.7	Detroit MI	WORS 105.1	Los Angeles CA	KBIG 104.3	New York NY	WNEW 102.7	Seattle WA	KIRO 100.7		

As listeners to these stations can hear for themselves, a Dolby FM signal is compatible. In fact, most people find it a better signal even when received on their normal equipment without Dolby decoding.

However, some listeners like to take advantage of every opportunity for improvement. If they use Dolby circuitry* during reception, they can bring the signal even closer to the quality of the original source material used at the station.

Naturally, the noise is reduced. But that's not all. Dolby compression is standardized, recoverable compression. By using Dolby encoding instead of the conventional high frequency limiting normally required during transmission, the station gives the listener at home the opportunity of recovering the full frequency range and dynamics of the signal. Furthermore, depending on the amount of limiting previously used, many stations find that Dolby encoding permits them to increase their level – which is good for both the listeners and the station.

If these prospects excite you, we think you will soon be wanting to check out the new Dolby Model 334 FM Broadcast Unit. \$1,350 and 1 3/4 inches of rack space are all you need to get moving with Dolby FM – an improvement we think both you and your listeners will appreciate.

Distributors

FTC Brewer Co, Pensacola, FL
Broadcast Communication Devices, Anaheim, CA
Broadcast Consultants Corp, Leesburg, VA
Collins Radio Group, Dallas, TX
Control Technology Inc, Fort Lauderdale, FL
HM Dyer Electronics, Farmington Hills, MI

La Salle Audio, Chicago, IL
Lebow Labs Inc, Brighton, MA
Pacific Recorders and Engineering Corp, San Diego, CA
Schafer Electronics Corp, Goleta, CA
Sparta Electronics Corp, Sacramento, CA
Whalin's Pro Audio Sales, Arlington, TX

Technical literature and reprints of papers describing these developments are available from our offices or distributors – or call in and see us on Booth 66-67 at NAFMB Atlanta 17-20 September.

*Some of the 50 Dolby licensees are already producing their new receiver models, and others have new designs in the pipeline.



Dolby Laboratories Inc

'Dolby' and the double-D symbol are trademarks of Dolby Laboratories Inc.

1133 Avenue of the Americas
New York NY 10036
Telephone (212) 489-6652
Telex 125797
Cables Dolbylabs New York

346 Clapham Road
London SW9
Telephone 01-720 1111
Telex 919109
Cables Dolbylabs London

(Continued from page 10)

grams in question appear to be either devoted to the dealers who furnish the merchandise or to the merchandise itself. Since the station broadcasting these auction programs receives proceeds from each sale, the station itself must be considered the sponsor of the program, the Commission said.

Therefore, it said, the entire program is a program-length commercial and should be logged as commercial matter.

NAB will sponsor Six regional Seminars

Six regional radio seminars, sponsored jointly by the National Association of Broadcasters and the Radio Advertising Bureau, will cover every aspect of day-to-day radio station operations.

The seminars will include separate sessions on sales, programming, publicity and promotion, legal problems, government relations, engineering and a two-and-a-half hour meeting with a Federal Communications Commissioner and top FCC staff members.

The series opens in Atlanta, Ga., Oct. 13-14 with follow-up sessions scheduled in Boston, Oct. 16-17; in New Orleans, Nov. 10-11; in Chicago, Nov. 13-14; in Denver, Nov. 17-18; and in San Francisco, Nov. 20-21.

The regional conventions, coupled with NAB-sponsored seminars for radio program directors, are designed to provide station managers with a broad spectrum of operational information.

One feature of the conventions is a presentation for general management entitled "Accelerating Radio Growth." NAB President Vincent T. Wasilewski and RAB President Miles David will discuss re-regulation, sales, profitability, and community service—all areas in which radio can achieve a continually improving future.

A special feature: an FCC Commissioner and top FCC staff members will conduct an afternoon-long

(Continued on page 14)

STOREROOL CORP.

THE SPACE-SAVING ENGINEERS

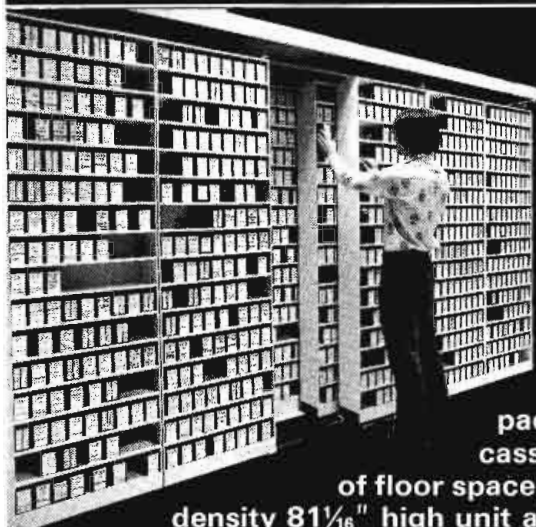

presents

THE ROOM STRETCHER

HERE IT IS! Storeel's space-age answer to your AMPEX ACR-25 storage problems. One high-impact ABS unit provides storage for 144 cassettes, yet requires only 7 1/4" x 24 1/4"

of floor space! Gliding on ball bearings, each high-density 81 1/16" high unit allows easy access to second, third, fourth or FIFTH bays (rear bay is stationary). Eze-Remove system facilitates handling of cassettes. Send your room dimensions for a NOW answer to your storage problems.

STOREROOL CORP.

4993 New Peachtree Road • Atlanta, Georgia 30341 • Telephone (404) 458-3280

For More Details Circle (26) on Reply Card

AUDIOWAVES

Programming by the numbers.

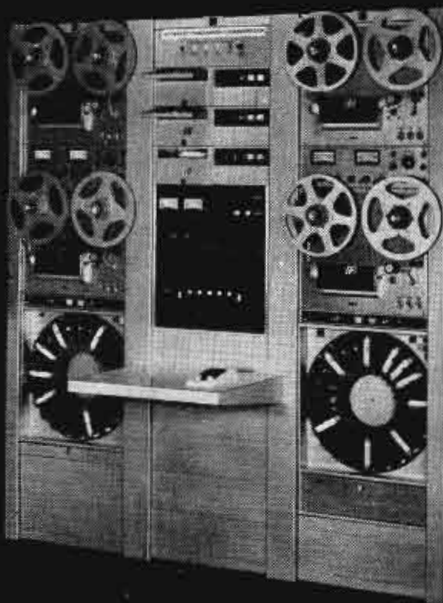

An RCA audio automation system lets you put up to a week's programming in operation by pressing one button.

Because of the latest digital approaches like an MOS memory and full use of FET's, you get a system that can program anywhere from 2000 up to 8000 random events. From up to 92 sources.

And RCA systems sound live because of our voice track synchronization, announceover and fadeout capabilities.

Your RCA representative can help you plan your system. RCA Broadcast Systems, Camden, N. J. 08102.

RCA

Microphones • Consoles • Tape and Transcription Equipment
Automation Systems • Amplifiers and Speakers

For More Details Circle (27) on Reply Card

a standard switcher from CDL?

only 120 day
delivery?

only \$34,000?*

that's right!

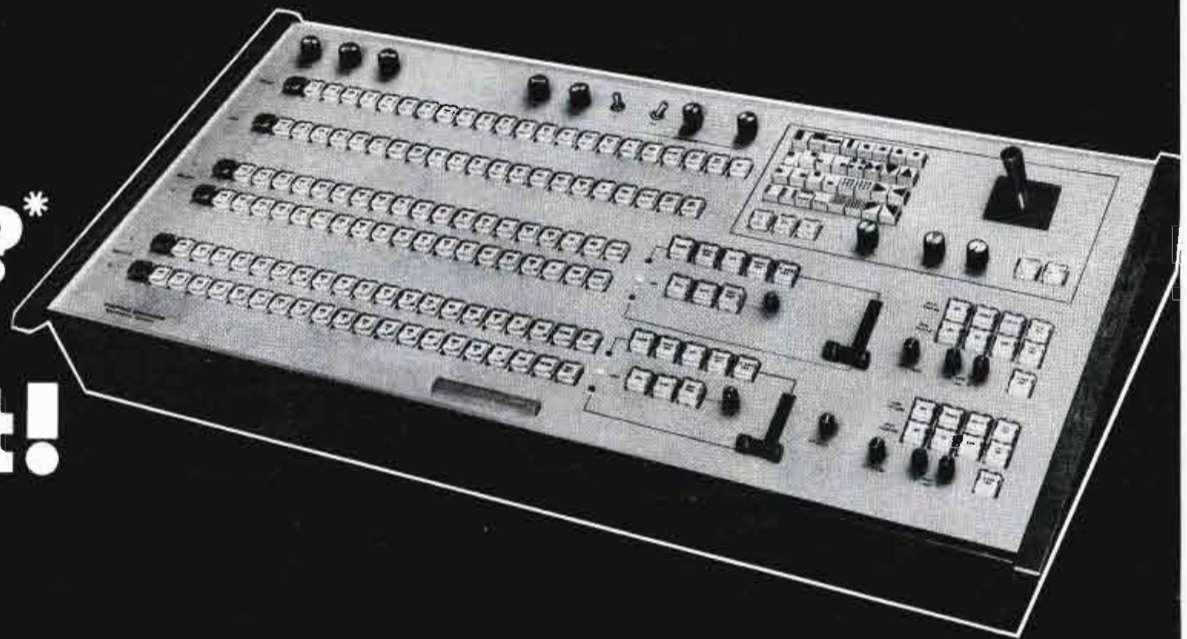

And in addition...
loaded with
"custom" features
and CDL Quality

it's the
VSP-1260S!

When you need a "Big" Video Production Switcher there are only a few manufacturers who make them. You've been accustomed to a "Big" delivery (6 months and longer), and at a "Big" price.

That's how it has been

Here's how it is NOW!

- We've taken your most wanted "Custom" options and made them STANDARD.
- Standardizing features and production have reduced costs, and delivery schedules to less than 4 months.
- The VSP-1260S also has all the other original features of Central Dynamics' VSP-1200 Series Switchers.

You get these most wanted "Custom" features:

- 20 inputs
- 8 Busses including 2 Mix/Effects, Preview/Key, Program AND 2 prewired Utility busses for a variety of applications.
- VK-2140 Encoded Chroma Keyer integrated and timed into switcher and including 4x1 input selector.
- Dual 2x1 Chroma Key Switcher to delegate VK-2140 or RGB Chroma Keyer to either M/E amplifier.
- 1 Key Border Module: can be used with either Mix/Effects bus.
- 32 Non-Repeating Effects Patterns
- Soft Edge Key
- Soft Edge Wipes and Vignettes
- Spotlight & Mask Keys
- Non-Add Insert on each M/E
- Fade to Black from nonsynchronous sources
- Automatic Color Black system

Following options can be added any time on a plug-in basis:

- RGB Chroma Keyer and input selector
- Utility Bus Control Panels
- Additional Key Border Module

To see the effects of VSP-1200 Series Switchers in color, request our "On-with-the-Show" Brochure.

You can also see the effects "Live". VSP-1200 Switchers are operating in most major cities across the country.



CENTRAL DYNAMICS LTD

Canada:

147 Hymus Blvd., Montreal, Que., H9R-1G1
514-697-0811

U.S.A.

230 Livingston Street, Northvale, N.J. 07647
201-767-1300

*U.S. Price

For More Details Circle (28) on Reply Card

(Continued from page 12)

The Mod One Is The Flexible One

Start With The Console Format You Need Now, Expand Later.

Modular design lets you select a wide range of input modules and plug-in amplifier cards as you grow. 10 mixing positions with up to 30 inputs. Modern vertical faders; silent operating switches; state-of-the-art circuitry.

Custom features and options with off-the-shelf availability. Monaural, stereo, or quad. Meets all FCC - AM and FM standards. UREI quality, of course.

Available through your UREI dealer.



11922 Valerio Street, No. Hollywood, California 91605 (213) 764-1500
 Exclusive export agent: Gotham Export Corporation, New York

session on "Today's FCC Problems". AM/FM duplication to continuous ascertainment, the short license renewal form and EEO requirements, automatic transmitters and program length commercials will be covered, followed by questions and suggestions from the audience.

Also featured at the two-day session:

"How to Avoid Legal Problems"—John Summers, NAB executive vice president and general counsel, will outline ways to avoid legal problems and provide tips on how to get out of trouble once it develops.

"Communicating with Your Congressman"—the positives and negatives of lobbying will be discussed by Donald Zeifang, NAB executive vice president for government relations; William Carlisle, a vice president on his staff, and a member of NAB's Small Market Radio Committee.

Bob Henabery, a nationally-known programming consultant, will be joined by a successful manager and a program director at each session, in a discussion of "Trends in FM Influencing Radio Today." Mr. David also will participate, discussing trends in FM sales.

There will be a session entitled "Solving Day-to-Day Management and Engineering Problems." A member of NAB's Radio Information Office Committee will play the role of a typical manager who calls in consultants from the general management and engineering fields to resolve such problems as common engineering errors or omissions that give rise to forfeitures.

Four separate sessions are devoted to sales:

"Finding and Training Salespeople"—a presentation in which Mr. David and Robert Alter, NAB executive vice president, cite a case history on the effective development of sales personnel and discuss successful recruiting and training.

"Co-op Advertising: The Plugged-Up Faucet"—a candid presentation by Ed Crimmins, an authority on

(Continued on page 16)

If we didn't make a better refurbished quad head than either Ampex or RCA and with a better price/performance ratio we'd have been out of it a long time ago. (And that's the truth)

Videomax began to make refurbished quad heads 5 years ago. We were convinced a better job could be done and that you should have a choice. We were also convinced that a small company of specialists could offer a better product than the large multi-product manufacturers. Nothing since has changed our minds or the minds of our **more than 600 customers.**

Today, no one in the business comes close to our level of cost/performance. No one in the business exceeds our warranty protection. No one in the business offers a wider variety of

refurbished Ampex and RCA heads. And no one, according to our long list of customers, has a more respected manufacturing and Q.C. history.

So, if you need a Mark X or a Mark III quad head in our "L" or "M" Series ... or an RCA High Band or Low Band quad head in our "M" Series ... contact Videomax.



Videomax, an ORROX company
154 San Lazaro Avenue
Sunnyvale, CA. 94086
(408) 739-5391

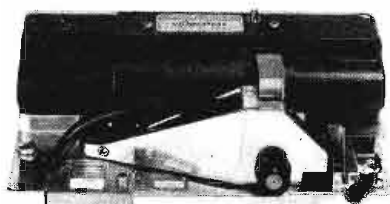

MARK X

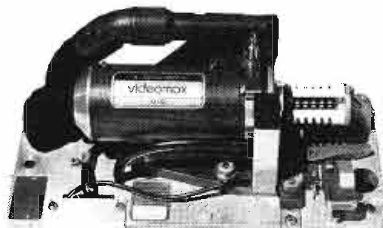

MARK III

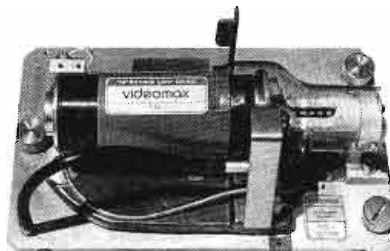

RCA LOW BAND

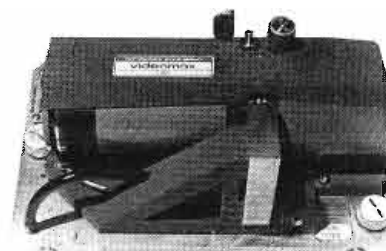

RCA HIGH BAND

SALES & SERVICES

New York Los Angeles Washington, D.C.
(212) 947-8031 (213) 980-7927 (301) 384-4733

For More Details Circle (30) on Reply Card



THE INFLATION FIGHTERS

World Video Color Monitors

CR 6700 17" Rack Mount Color Video Monitor. Designed for broadcast applications. All Controls mounted on front panel including pulse cross, underscan, R-G-B switches, screen and drive controls, dual inputs, internal-external sync and keyed back porch clamp. Utilizes only 15 3/4" of vertical rack space. Price: \$1,700.00



RK 6700 17" Rack Mount Color Video Monitor. A high quality utility monitor requiring only 15 3/4" of vertical rack space. Dual inputs, keyed back-porch clamp, internal-external sync. Controls conveniently mounted on front panel. Price: \$1,195.00



CR 6210 12" Rack Mount Color Video Monitor. Designed for broadcast applications. All controls easily accessible on front panel. Dual inputs, pulse-cross, keyed back porch clamp, underscan, R-G-B switches, screen and drive controls, internal-external sync. Convenient plug in modules for ease in servicing. Price: \$1,350.00

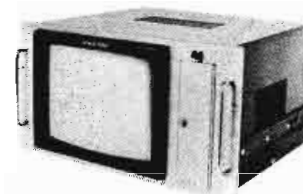

CB 6210 12" Cabinet Color Video Monitor. Convenient carrying handles for portability. All other features the same as the CR 6210. Price: \$1,350.00

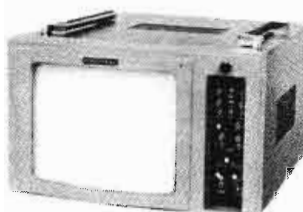

CDR 9000 Single or Dual Rack Mount 9" Color Video Monitors. Utilizing only 8 3/4" of vertical rack space. CDR 9000 equipped with mounting provisions for a WFM or vectorscope. Controls conveniently mounted on front panel. Dual inputs, underscan, and internal-external sync provided. Price: CDR 9000 \$ 950.00
CDR 9900 \$1,750.00

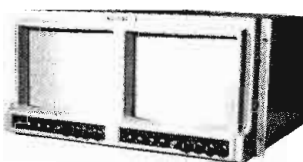

World Video also manufactures CCTV Color Monitors and Receiver/ Monitors in screen sizes from 5" to 19". Information available upon request.

All World Video color monitors are 100% solid state and utilize single-gun CRTs.



WORLD VIDEO, INC.

P. O. BOX 117, BOYERTOWN, PA., 19512
PHONE 215-367-6055

(Continued from page 14)

co-op advertising, on the basics required in tapping a revenue source with a \$3 billion potential.

"Know Radio Better to Sell Radio Better"—Mr. David and Mr. Alter review results of ARMS II, the All Radio Marketing Study that shows radio's power to reach every type of consumer group and deliver customers, and discuss audience measurements and the tailoring of research needs to specific markets.

"Standardization of Radio Rate Card Formats"—a report by Mr. Alter on efforts by an industry task force in developing suggestions to standardize rate card formats and make radio easier to buy.

Safety handbook Now available

A new 24-page folder featuring general safety awareness is offered by Onan, Minneapolis-based manufacturer of electric generating systems, automatic transfer switches and air-cooled industrial engines.

The 12-page, 8½ x 11" brochure is illustrated with descriptive cartoons which emphasize the safety points being made for each subject. The areas covered by the ONAN SAFETY HANDBOOK range from Flammable Liquids through Engine Safety, Generator Safety, Electric Shock Hazard to Recreational Vehicles, Welders and Portable Generator Sets. A list of Safety Do's and Don'ts is also provided.

The ONAN SAFETY HANDBOOK was prepared specifically for owners and operators of Onan Products (electric generating systems, air-cooled engines, transfer switches, welders, etc.) but is offered to all persons involved in an electro/mechanically hostile environment.

First copies of this new ONAN SAFETY HANDBOOK are available free upon request. Additional copies are \$1 each.

For a personal copy, write Onan Division, Onan Corporation, 1400 73rd Avenue NE, Minneapolis, Minnesota 55432.

**For Latest News
See
Direct Current page 4**

For More Details Circle (31) on Reply Card

TRI has solved the problem. We've engineered a simple, direct, interface with our EA-5 Editing System which opens up all sorts of creative possibilities.

Here's what you can now do with a Sony 2850:

- Preview edits
- Edit accurately to video or audio cues
- Edit with frame accuracy
- Search at up to 5 times play speed in either direction
- Interface the 2850 with other makes or models
- Adjust the edit point after preview

- Make your edit decisions with true still-frame assistance
- Control end insert point from the console
- Monitor audio and video at the console

Still another friendly message from TRI involves price. It doesn't take an arm and a leg to add the EA-5 to your existing VTRs. The cost? Less than \$6,000. Installation time? Less than an hour. Training period? It might take as long as a half hour.

A quick word to the needy, we're delivering right now.

Somehow the word got out.

For a "hands-on" demo, or more information, contact us or the best video distributor in your area.

Chances are he's our distributor.

Television Research International, Inc.
1003 Elwell Court
Palo Alto, California 94303
415/961-7475

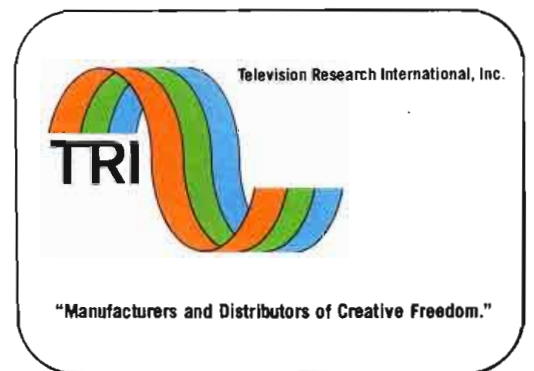

Here's a brief, friendly message for frustrated editors trying to make frame accurate edits on the Sony 2850 *U-Matic VTR.

Relax!



*U-Matic is the trademark of the Sony Corporation of America

For More Details Circle (32) on Reply Card

Anyway you look at them, Unimedia's SMT color monitors are good news! Professional quality . . . affordable prices.

The SMT Line is a complete family of one-gun color monitors, from 9-inch portables and rack models through 12, 15, 17, up to 19-inch rack-mount models. All share the same clean styling, single gun color tube picture quality, and blue-gun only set-up convenience. Professional options include pulse-cross, A-B input, external sync, switchable underscan, and tally-light features. Most are priced right around \$1,000. Some higher . . . some considerably less.

If you're a broadcaster, CCTV or Cable operator, or production studio operator you can share in the dollar savings inherent in Unimedia's simple, straightforward SMT design. Now you have a golden opportunity to replace obsolete monochrome models with new SMT color monitors at attractive prices. Or replace temperamental large-screen color jobs with SMT 12s, 15s, 17s, or even the new 19s. If you're starting a new facility, Unimedia monitors can save enough to buy you an additional piece of needed equipment.

And Unimedia SMT Color Monitors are professional in every sense of the word. Their long-term dependability is the result of engineered design simplicity and quality components. We've delivered over four thousand units to satisfied customers in the last four years. You'll find NTSC and RGB models. In the nine-inch line you'll choose from singles, duals, and combination models with waveform monitors, vectorscopes, or audio speaker-amplifiers. Or combine a color nine with a high resolution monochrome nine for camera focus and registration.

You really owe it to yourself to check out the complete Unimedia line before you install another monitor in your facility. Write . . . or phone today. Remember . . . saving money isn't all that bad!

**UNIMEDIA, 22525 Kingston Lane, Auburn, California 95603
Telephone: (916) 272-1971 Grass Valley**

**Grand color monitors...
Great dollar savings!**

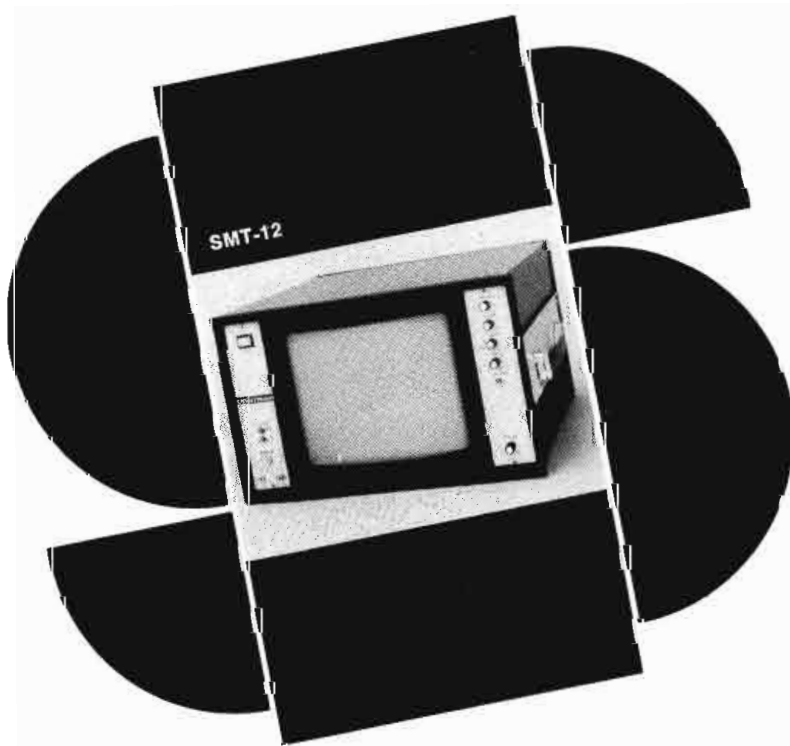

**unimedia
unimedia
unimedia
unimedia**

For More Details Circle (33) on Reply Card

NAB names committee For its 1976 convention

Ten prominent broadcasters have been named as members of the National Association of Broadcasters' Convention Committee to plan for next year's annual meeting in Chicago. All are members of NAB's Board of Directors.

Appointed as co-chairman were V. Kay Melia, general manager of KLOE, Goodland, Kans., and Robert D. Gordon, vice president and general manager, WCPO-TV, Cincinnati, O. Mr. Melia and Mr. Gordon are vice chairmen, respectively, of the NAB Radio and Television Boards.

Named to serve them were: Radio Board members John R. Anderson, president and general manager, WCCW, Traverse City, Mich.; Donald G. Jones, president, PSB Radio Group, Fond du Lac, Wis.; Frank W. McLaurin, vice president and general manager, KSRO, Santa Rosa, Cal.; Paul E. Reid, president and general manager, WHBH, Fitzgerald, Ga., and Virginia Pate Wetter, president and general manager, WASA, Havre de Grace, Md.

Television Board members named included: Thomas E. Bolger, president, WMTV, Madison, Wis.; Kathryn F. Broman, vice president, Springfield (Mass.) Television; and Daniel T. Pecaro, president, WGN Continental Broadcasting, Chicago.

Sony schedules several Fall video workshops

Sony Corporation of America has announced the schedule of video production workshops being sponsored by its dealers in cooperation with the company's Video Utilization Services Department.

Nine workshops are scheduled during the last four months of this year. Additional workshops will be announced.

The workshop dates and locations with the names of the sponsoring dealers include: Buffalo and Rochester, N.Y., October, 1975, Seneca Communications; Los Angeles, California, October, 1975, Hoffman Electronics; Tulsa, Oklahoma, October, 1975, Systa-Matics; Oakland, California, November, 1975, General Electronics; Los Angeles, California, November, 1975, Hoffman Electronics; Milwaukee, Wisconsin, December, 1975, Milwaukee Video; Phoenix, Arizona, December, 1975, Vidcom.

Interested parties in the scheduled areas can register for the video workshops by contacting the sponsoring dealers direct. Additional information can be obtained from Jeff Glasser, Sony Corporation of America, 700 West Artesia Blvd., Compton, California 90220.

You asked for so much, made so small for so much less.

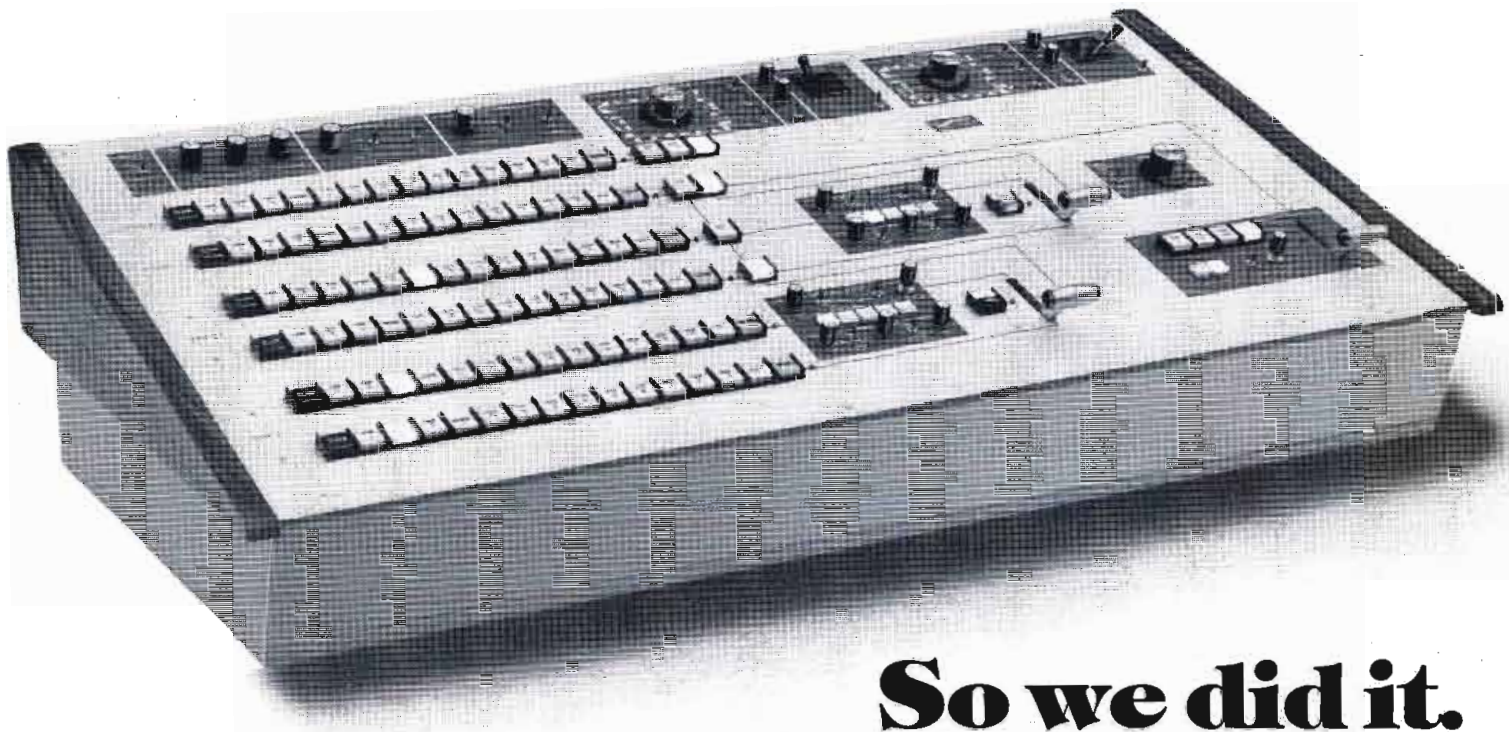

So we did it.

As usual, you're looking for the almost impossible. A full function video production switcher that fits your system and your budget. Of course, you want it fast. You're looking for the Ross RVS 16-6, the most sophisticated switcher in its price range. Packed with production capability: 16 inputs, 6 busses, colour black and background generator, downstream keyer, two independent effects groups each with 96 wipes, soft wipe, soft key, bordered wipe, spotlight, positioner and chroma key. State of the art C-Mos circuitry means reliability and low power consumption. And the compact electronics and power supply occupy only 7" of rack space.

Cost effective design gives you so much more for so much less...so much so, in fact, it can be considered a new generation. And when you sit down and use it you'll discover the human engineering that's so much a part of Ross switchers: ease of operation, logical procedures. You may have seen the Ross RVS 16-4; purchasers include the CBC, WGBH Boston and Global Television Los Angeles. The RVS 16-6 is the 4's big brother. It has been selected by ORTO, the Olympics Radio and Television Organization, a division of the CBC, for use at the 1976 Montreal Olympic games. Find out why. Here's a hint: Price approximately \$31,000 complete. Delivery time 90 days.



ROSS ROSS BROADCAST PRODUCTS LTD
14 IROQUOIS PLAZA
IROQUOIS ONTARIO K0E 1K0
(613) 652 4335

Distributed by
Glentronix Ltd.
160 Duncan Mills Road
Don Mills, Ontario M3B 1Z5
(416) 444-8497

For More Details Circle (34) on Reply Card

Harley will retire from NAEB

William G. Harley, president of the National Association of Educational Broadcasters for the past 16 years, has announced that he will retire from that position in November. The retirement will become effective November 16, the date of the annual meeting of the Board of Directors preceding the start of the Association's 51st annual Convention.

Harley has been the chief executive for the NAEB since the Association opened its Washington offices in 1960. At that time the former professor was on a year's leave of absence from the University of Wisconsin. During his 16-year tenure, Harley has been involved at the national level in virtually all major decisions and actions that have been taken in the educational

broadcasting movement; and, often has personally had the opportunity to initiate certain undertakings or to help shape the outcome of important developments in the field.

In announcing his retirement to chairman of the NAEB Board of Directors, Jack McBride, Harley stated, "As you know, my retirement carries out a planned withdrawal that began last November with the appointment of an executive director to take over the operational management of the Association and a consequent phasing down of my involvement in time and responsibilities. It also fulfills my promise to the Board and to various industry and foundation executives to stay at the helm until the transition from an institutional to an individual-based organization could be effected. Now that the new NAEB is well under way, it seems appropriate and timely to let younger leadership take over and guide the association in its new role and mission."

Let's talk it over—
broadcaster
to broadcaster.

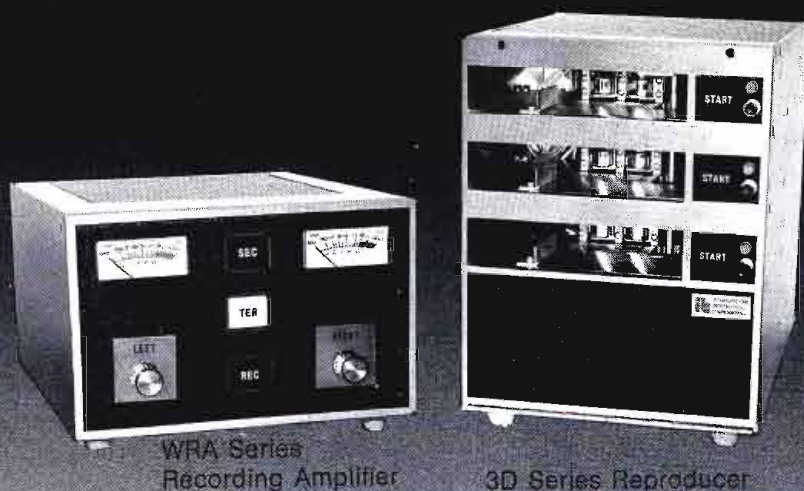

You want to know something about tape cartridge equipment . . . such as our 3D Series multi-reproducer and the WRA Series recording amplifier. Sure . . . you want to talk to an engineer who knows his equipment. But you also want to talk to someone who understands **your** problems as a broadcaster. We combine both. Our men are former broadcasters and engineers. You'll get straight answers as to which of our equipment will solve your problems best. We think you'll be pleasantly surprised at how much we can help. That's why we have a standing offer to any broadcaster with a question to call us **collect**. And after you buy, we're always as close as your phone. So, let's talk it over — broadcaster to broadcaster . . . today.

CALL 309-828-1381 COLLECT



INTERNATIONAL TAPETRONICS CORPORATION

2425 South Main Street • Bloomington, Illinois 61701

Marketed exclusively in Canada by McCurdy Radio Industries Ltd., Toronto

Distant signal Rule adopted

A rule prohibiting any cable television system from importing, via a distant television signal, a sports event that is being played within the television market in which the cable community is located has been adopted by the FCC.

The rule provides a 35-mile zone of protection into which distant telecast of the same game may not be imported by a cable system when the home team is playing at home and when the game is not available on a local television signal. The action amends Part 76 of the FCC rules.

Although directed primarily at professional and collegiate contests, the rule will apply to all sports telecast where the event is not exhibited on local conventional television stations.

The FCC said the rule was necessary "to maintain the totality of sports programming now made available to television viewers" and was consistent with the policy established by Congress with passage of PL 87-331, The Sports Broadcasting Act and PL 93-107, the Anti-blackout law.

Clean up your image with EEV camera tubes.



8572V 1 inch magnetic Vidicon
for use in color film
chain operation



P8130 to P8133 30mm Coaxial
Leddicon® series with internal
light bias. Replaces most integral
or separate mesh color camera
tubes. Available in standard layer
as well as extended red or green.



P856 4 1/2 inch Image Orthicon
for use as the luminance tube
in color cameras.



8134V1 1 inch electrostatic
focus Vidicon for color film
chain broadcast applications.
8480V1 1 1/2 inch tube for use
in luminance channel.

Clean, precise, consistent—EEV Leddicon® camera tubes are made to last. They can be used as replacements for Plumbicon® and Vistacon tubes.

Hundreds of stations in the USA and throughout the world use Leddicons to down costs and up quality.

From the same one-stop source you can also specify EEV Image Orthicons—we're the world's biggest makers—and Vidicons.

All EEV tubes are available for immediate delivery with fast service back-up. Contact us now for type lists and prices.



EEV NORTH AMERICA

ENGLISH ELECTRIC VALVE NORTH AMERICA LTD.

1 American Drive • Cheektowaga, NY 14225

(716) 632-5871 • TWX: (710) 523-1862

67 Westmore Drive • Rexdale, Ontario M9V 3Y6

(416) 745-9494 • Telex: 06 965864

A member of the GEC - English Electric Group of Companies

Leddicon™ is a registered trademark of English Electric Valve Company Limited
Plumbicon™ is a registered trademark of N. V. Philips of Holland

For More Details Circle (36) on Reply Card

GOODBYE, TRIPOD.

Hydro-Ped takes over

Suddenly the tripod is completely out-dated. It had to happen. The cumbersome, awkward, insecure mount had to go. In its place is the O'Connor 102 Hydro-Ped, a completely new concept in camera mounts. 4 times more rigid in torsion (panning) and 4 times more rigid in moment of mounting plate (tilting) than a comparable tripod. Levels hydraulically on any terrain.

Column raises or lowers quickly and easily.

Height adjustable from 30" to 60". Folds instantly to 9½" x 30" for easy, safe handling. Strong magnesium construction; wt. 19 lbs. Handles up to 100 lbs. Stop cursing your tripod. Start enjoying your Hydro-Ped.

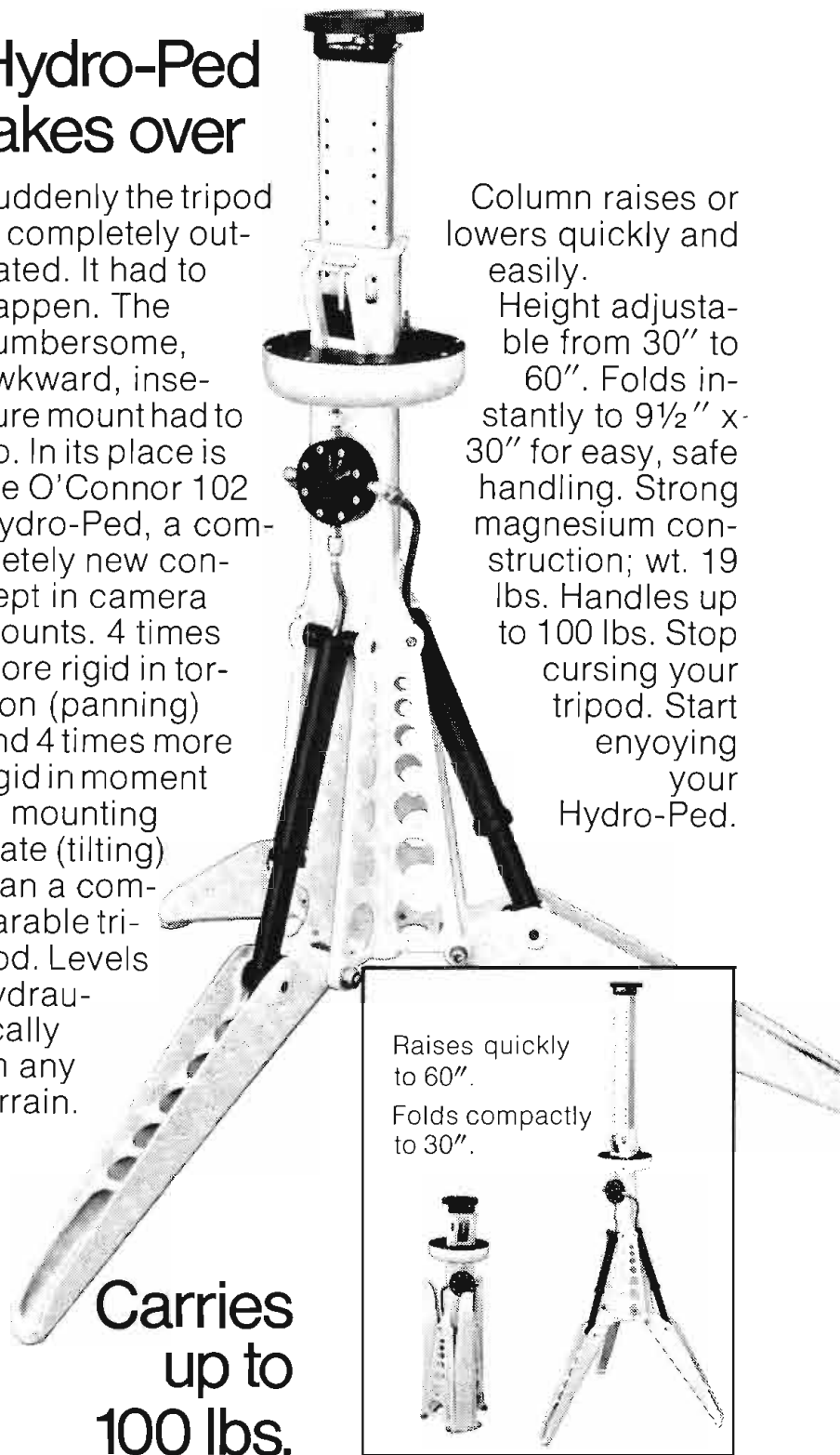

**Carries
up to
100 lbs.**

Raises quickly to 60".
Folds compactly to 30".

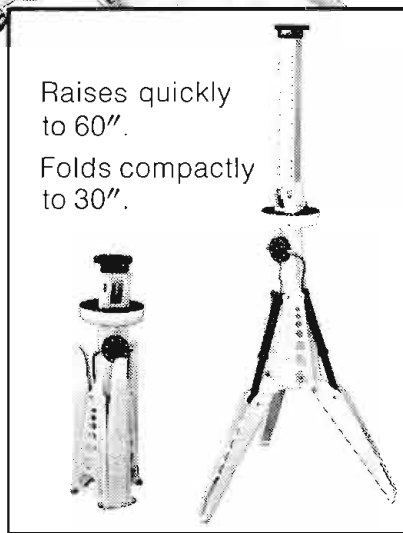

**O'CONNOR
HYDRO-PED**

O'Connor Engineering Laboratories, Inc.
100 Kalmus Dr., Costa Mesa, Calif. 92627

Send catalogs on () Hydro-Ped. () Fluid Head for camera weighing _____ lbs.

Name _____

Firm _____ Title _____

Address _____

City _____ State _____ Zip _____

NAB encourages The birth of New equipment

The National Association of Broadcasters urged the Federal Communications Commission to do away with outmoded regulations and free broadcasters to provide Americans with a system of completely automated radio and television service.

NAB said in comments responding to FCC's notice of inquiry that fully automatic electronic transmission systems are feasible and authorization by the Commission for their use would encourage "birth of a new generation of broadcast equipment."

The 75-page filing pointed out that U.S. broadcast equipment is one of man's "greatest achievements in the field of mass communications" but that its use has been "all too often impeded by rules and regulations designed to continue the regulatory umbilical cord."

"For over half a century," NAB said, "the industry has witnessed a steady pattern of technological development which has elevated broadcasting from an embryonic experimental effort to one of technical sophistication. Beginning with the advent of the vacuum tube, broadcasting equipment has progressed over those five decades from cumbersome motor-driven transmission devices to an all-electronic system which has an excellent performance record, requires a minimum of human supervision and is highly reliable."

On the other hand, it said, FCC rules and regulations "have not kept pace and the industry is still required to operate within a framework of reference which was developed when the Communications Act was originally adopted in 1934."

"As related to space, aviation and land mobile communications," NAB said, "the broadcasting industry has been left far behind in its endeavor to utilize modern techniques..."

"The industry has been attempt-

(Continued on page 24)

the original digital video tape timer

\$595.00
ALL MODELS

NOW DUAL SPEED

AVAILABLE
7.5 ips - 15 ips

NOW IVC KIT

+ DELIVERY: STOCK TO 30 DAYS



NEED A SWITCHING SYSTEM?

Let VAMCO custom design an Audio/Video Distribution System tailored to your needs. From the giant multi-city, tone-remote-controlled system installed across the **State of Oklahoma**—to the routing system pictured built for **WCCO Television**, Minneapolis—to the 10 x 1 expandable Audio/Video unit in a 1 3/4" rack frame—to **YOUR** special requirements. Systems are all solid state, bi-polar, vertical interval switching with full remote control capability and Audio break away features.

Basic Pricing: \$65 per Switchpoint
\$150 per Output Amplifier

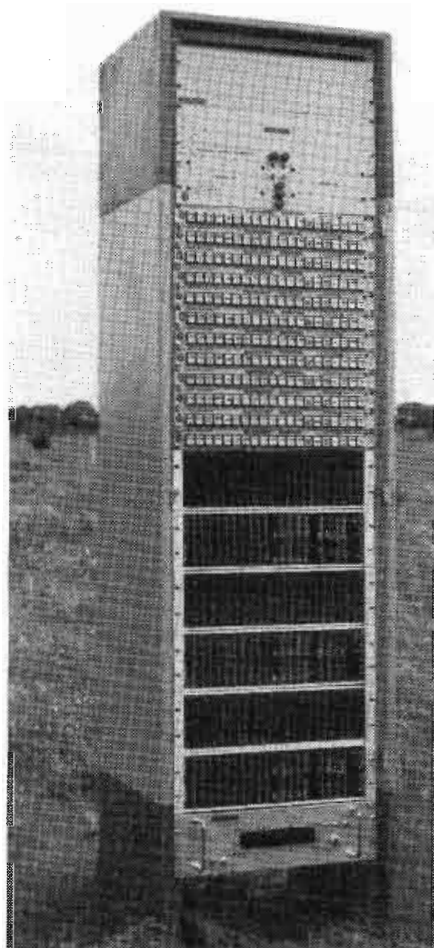

OTHER PRODUCTS AVAILABLE

Audio Distribution Switchers	Digital Timers
Video Distribution Switchers	Digital Clocks
Chroma Key Input Switcher	Custom Clock Systems
Composite Chroma Key Kit	Production Switchers



VAMCO ENGINEERING

Box 7512
Tulsa, Oklahoma 74105
(918) 252-4142, 747-7812

leadership through creativity in design

For More Details Circle (38) on Reply Card

(Continued from page 22)

ing to narrow the gap between technology and the Commission's rules through a case-by-case procedure which envisioned changes in specific rules as the situation demanded...

"The promulgation of new rules and regulations would result in the birth of a new generation of broadcast equipment...(and) provide the public with a program service transmitted through the finest equipment consistent with the state-of-the-art."

NAB said rules authorizing automated operations should be limited to three basic elements—frequency, power and modulation. Such issues as loudness, security and voltage standing wave ratios, it said, should be handled under present regulations since introduction of such matters are tantamount to reinventing the broadcast system and are areas having virtually no bearing on the matter relating to the development of rules and regulations for automatic transmission

systems."

In answer to questions posed by FCC in its notice of inquiry, the Association said:

• No technical operating or maintenance log keeping would be necessary since it would only be an "academic exercise and do little more than generate mountains of useless paper".

• An "automatic or electronic observer" device would sample the electronic operations of the transmission system and cut off service whenever an out-of-tolerance condition occurred.

• Each system would be programmed to start and stop automatically. In the case of AM stations required to change modes during a broadcast day, the system would be pre-programmed to make the required switching.

• The automatic equipment could be made "tamperproof" in the same way that broadcasters now safeguard unattended transmitters—by placing them in windowless cinder block enclosures surrounded by high wire fences with intrusion alarms.

Monroe Electronics' New DUAL-TONE EMERGENCY BROADCAST SYSTEMS MONITOR



WALL MOUNTED ENCLOSURE

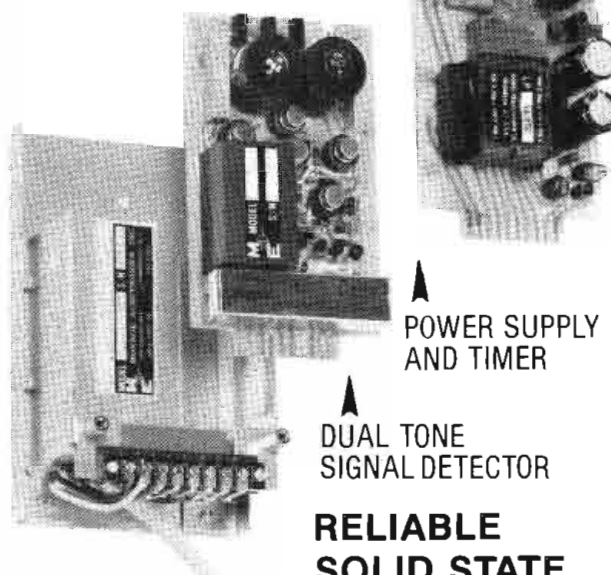

POWER SUPPLY AND TIMER

DUAL TONE SIGNAL DETECTOR

RELIABLE SOLID STATE

New System Designed To Meet New FCC Regulations

- Dual Tone Input
- Wide Dynamic Input Range
- Immune to Voice and Music
- Built-in Audible Alarm
- Relay Closure Output
- \$298.00

This monitor is tailored to FCC regulations covering the new Dual Tone Alert system. The unit accepts a dual tone input from any radio receiver or audio cable and provides an audible alarm and relay closure output when activated.

The Monroe unit is housed in a metal cabinet suitable for wall or panel mounting. It is furnished complete with power cord and internal audible alarm.

The EBS Monitor occupies 6½" x 4" x 2½", and weighs 2 pounds. Plug-in circuit cards, and ready access to test terminals make servicing fast and effective. A one year full warranty is furnished by the manufacturer. Parts availability and factory service exceeds 10 years.

Phone or write for full details.



MONROE ELECTRONICS, INC.

100 HOUSEL AVENUE, LYNDONVILLE, NEW YORK 14098

Area Code 716 765-2254

EIA revises its RS-170 standard

Revision of EIA RS-170, Standard for Monochrome Television Studio Facilities, prepared by Engineering Committee TR-4, to include color equipment and facilities (NTSC), is currently underway in Engineering Subcommittee TR-4.4.1 under the Chairmanship of Robert W. McAll, Northeast Regional Manager of Vital Industries of Gainesville, Florida.

Efforts to provide a Standard for TV Color equipment and systems similar to the Standard for Monochrome have yielded to date a preliminary specification drawing for the studio output video waveform. The drawing is available for industry comment from L. M. Rundlett, EIA Engineering Department, 2001 Eye St., N.W., Washington, D.C. 20006.

Persons desiring to participate in the work of this Subcommittee should contact McAll at 34 Autumn Lane, Hicksville, N.Y. 11801, Tel. (516) 735-0055.



SS 3159

The SS3159 stereo disc reproducer provides complete facilities for professional stereo reproduction of disc recordings. It is completely self-contained with SP10D turntable, tone arm, plug-in pickup cartridge, equalized preamplifiers, audio cue switching, power supply and pedestal assembly.

The turntable offers the highest quality, lowest noise operation available. It adds virtually nothing to the original sound as recorded on the disc. And with the advent of quadrophonic discs, it's imperative that vertical as well as horizontal "rumble" be reduced to a minimum.



FOR FURTHER INFORMATION CONTACT:

McCURDY RADIO INDUSTRIES INCORPORATED
1051 CLINTON STREET, BUFFALO, N.Y. 14206 (716) 854-6700, TWX 610-492-3219

EASTERN SALES OFFICE: P.O. BOX 86 SADDLE RIVER N.J., 07458, (201) 327-0750 TWX 610-492-3219

IN CANADA: McCURDY RADIO INDUSTRIES LIMITED
108 CARNFORTH ROAD, TORONTO, ONTARIO M4A 2L4 (416) 751-6262 TELEX: 06-963533

SS 7800

The SS7800 Series of modular audio consoles provides complete professional facilities for mixing and shaping today's complex audio material.

In addition to complete program mixing, monitoring and control, SS7800 Series consoles provide PA feeds and comprehensive Solo/Cue, Echo-Send/Receive, Fold-back and talkback system facilities. A full range of options is also available including Equalizers, Compressors, Program Assign with Pan, and Remote Controls.



For More Details Circle (40) on Reply Card



While the studio camera feeds the quad recorder in a mobile van parked outside, the Ikegami ENG camera is connected to a portable cassette unit and is recording the president for insertion on the news a few hours later. (Photo by Fred Gayton)

Televising the PRESIDENT

By Joe Roizen

The focal point of national attention on the individual who holds the highest political office in the land requires almost constant media coverage of every event in which he is involved.

On April 7, Gerald Ford came to address the luncheon gathering of over 2,000 delegates to the NAB convention in Las Vegas. He brought with him Betty Ford and Henry Kissinger as part of the presidential entourage.

To cover this speech by any of the members of the news media required special accreditation, which had to be applied for by filling out a form two days in advance. Surprisingly, two constitutional rights were abrogated in the application form as the indi-

vidual reporter had to indicate sex and race in appropriate slots. Presidential staff members explained that these questions had no bearing on acceptance, but were there for accelerated identification if and when that became necessary.

White House Planning

According to Bob Meade, the Presidential TV advisor, plans for the NAB speech were made about a month ahead, and an advance crew went to Las Vegas on Thursday to begin checking the facilities and make arrangements for the Monday noon speech. Another group came in on Saturday to take care of security checks, transportation arrangements and the like. While

yes it's TRUE... the PRICE of Cross-Pulse & Color monitors HAS DROPPED

Now you can convert any monitor to a cross-pulse monitor with VACC's new \$345.* model CPG-1 Cross Pulse Generator. Your monitor requires no modification. Circle the inquiry number for more information. At the same time you'll get a free copy of VACC'S Troubleshooting Chart. This handy wall chart has actual photos showing typical video conditions such as normal sync with and without burst, time-base errors, overshoot, clipped sync, and many more. VACC's chart is a valuable aid when adjusting and troubleshooting video problems using a cross-pulse monitor.

If a video monitor is needed, install a VACC Electro-optical Isolator in a Sony receiver. An electronic technician can install a model A-1 in a 12", 15" and 17" Sony receiver in less than an hour. Model A1-A should be installed in a KV1722 and all 19 inch Sony receivers. You add only one-half pound to your receiver and your Sony can be used as a high quality monitor or retained as a receiver by merely flipping a switch. Isolation is far superior to heavy transformer isolated monitors and you can connect up to 20 monitors without troublesome ground loops if all monitors have VACC isolators.

*domestic U.S.A. price

INFLATION FIGHTERS

Combine VACC's Electro-optical Isolator and Cross-Pulse Generator with a Sony receiver and discover how the price of color and cross-pulse monitors has dropped.

NEW! Electro-Optical DEMOD Kit

"EDIT AID"™

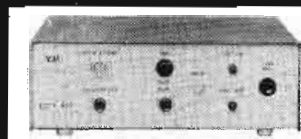

\$495.00 list
Helical and Quad
VTR editor-programmers

FASTER, almost GOOF-PROOF Genlocking



Model 5000 - \$1,495.00
With Option 0-1 - \$1,895.00

NEW
KEEP THOSE FLESH TONES...



phase shift checked **the VACC way**

WHEN USING SPECIAL-EFFECTS, SUPERS AND CHROMA KEYS
BY PAYING CLOSE ATTENTION TO PHASE SHIFT WITH A

BURST PHASE METER—VACC's model BPM-1 is a small compact unit which compares color burst phase of color cameras, VTR's processing amplifiers and time base correctors. The BPM-1 is an ideal substitute for most vectorscope needs. \$437.50

Party Lines

With Individual Volume Controls - \$45.00



VIDEO AIDS
Corp. of Colo.

112 West 4th St.
Loveland, Colorado 80537
(303 667-3301)

For More Details Circle (41) on Reply Card

they had adequate time to set up the Las Vegas speech, Mead admitted that they often work on much shorter notice and can get ready for a TV interview of the President in a matter of hours when necessary.

Regardless of whether television is used or not, the U.S. Navy provides two film crews that record every Presidential appearance for the national archives. Mead indi-

cated that the White House is now seriously considering the use of the newer electronic equipment to replace the film coverage. He said that while the early E.J. results were not up to adequate quality standards, he now feels that what he has seen recently, even under low light conditions, meets the requirements of Presidential archival coverage and it is just a matter of time before it is adopted.

Mead has no interest or jurisdiction over the type of television equipment used by the networks or local stations to cover his boss. He assumes they will do an adequate job to suit the occasion. He has watched Soviet television crews in Vladivostok and NHK operators in

Tokyo originating pool coverage of Ford visits to those cities. He was most impressed with the minicam coverage of the Martinique meeting between Ford and Giscard d'Estaing, particularly since all networks had ENG crews working there. He says he cooperated fully with all of them to give the President the most exposure possible.

One function that White House personnel do perform is to assign camera space on the basis of priority and need. The main camera stand for both film and TV is usually in a location that will not interfere with the audience's view of the Chief Executive.

In Las Vegas, this was a raised platform on the left side of the

A packed ballroom at the Las Vegas Hilton provides a forum for the President. The TAV camera with a long zoom lens zeros in on the President while Bob Pierpont of CBS keeps an eye on our BE photographer. (Photo by Donna Foster Roizen)



EIMAC tubes in all countries of the world

This is the new EIMAC X-2159 super-power tetrode, rated at 1.3 megawatts power output, 100% modulated. A second member of this family is the X-2170, rated at 600 kilowatts output, 100% modulated. These advanced tubes are ready—in stock now—for today's worldwide broadcast service.

For technical information on EIMAC products, contact the EIMAC Division of Varian, 301 Industrial Way, San Carlos, California 94070. Or any of the more than 30 Varian/EIMAC Electron Device Group Sales Offices throughout the world.



For More Details Circle (42) on Reply Card

STOP PLAYING DIRTY TAPES ON AIR

If you use video tape, you should be using the N.O.V.A. BLOCK.

REDUCES: Operation costs. Oxide Build-up. Head Clogging. Drop-outs

INCREASES: Tape Life. Head Life. Quality

For the first time video tape cleaning is done on your own video tape recorder regardless of the tape format you are using. The N.O.V.A. BLOCK cleans 1", 2", 3/4" U-matic, 1/2" and 1/4" formats.

Until now, tape cleaning has been expensive, time consuming, and in some formats virtually impossible. The N.O.V.A. BLOCK is not expensive and requires little time and effort for you to install. Yet the results are dramatic. Consistent usage of the N.O.V.A. BLOCK insures cleaner tapes time and again.

The N.O.V.A. BLOCK cleans tape on your VTR, taking advantage of proper tensions for your particular format. This eliminates the need for costly winding units and for dedicating time and space to a cleaning operation.

The N.O.V.A. BLOCK is a synthetic monocrystalline ceramic sapphire. The sapphire crystal is formed to have 4 chip-resistant cleaning edges, is very hard and consequently has a long life.

A N.O.V.A. BLOCK is installed on most recorders in such a manner as to make its use optional. In the 2" version the cleaning is done in a shuttle mode either "forward" or "rewind" by rethreading the tape outside of the original tape path and through the N.O.V.A. BLOCK. This means that while cleaning the tape there is no wear on the audio stack, control track head, female guide, or the erase head. Therefore, costs of maintenance and operation are reduced.



2"
N.O.V.A.
BLOCK
\$340



1/2"
N.O.V.A.
BLOCK \$100

2".....	\$340	1".....	\$240
3/4".....	\$140	1/2"-1/4".....	\$100
REPLACEMENT BLADES			
2" sapphires.....	\$150	1" sapphires.....	\$100
All other sapphires... \$68			

N*O*V*A Corporation
BOX 2121 • CANOGA PARK • CALIFORNIA • 91306

VTR MAKE _____

VTR MODEL _____

QUANTITY _____

Check Money Order C.O.D. Request

NAME _____

ADDRESS _____

STATE _____ ZIP _____

N.O.V.A. BLOCKS are patent pending

For More Details Circle (43) on Reply Card



Among the video and film cameras, an Akai ENG package is supervised by John Varnell. (Photo by Donna Foster Roizen)

ballroom in the Hilton Hotel. Except for those areas marked off by Eric Rosenberg, the White House press coordinator, the rest of the space is on a first come, first served basis (BE's photographer got there early and got a prime location). However, since the speech might appear on national TV, a special location was roped off in a front and center spot where the CBS crew, with their Ikegami and a Sony Portapak, were allowed to locate next to a TAV studio camera.

ENG And LIVE Journalism

Bob Dunn and Fred Gayton of CBS described their ENG operation. Their equipment is carried in regular-sized cases so they can move around in ordinary vehicles; they do not even need a station wagon. They have done this for the last two years, with the same equipment, and they feel it meets the special requirements of hot news. They claim their results are at least as good as news film and, of course, a lot faster. They can run the gear on batteries or local power when available. Once on location, start up time is an amazing 30 seconds, most of which is spent in waiting for the camera beams to

unfold. They need about 125 foot candles of light to make good pictures, and in this case, it was no problem as the President was well lit by one of the foremost experts in the field, Imero Fiorentino.

For the Ford NAB speech, Dunn and Gayton flew in for this event only. After the on-site recording, which was for network pool coverage, the U-matic tape was taken to Channel 5 (the CBS affiliate in Las Vegas) and edited on a Sony 2850, then dubbed to a quad through a CVS 504 digital TBC. While at the Hilton ballroom, and after the President's speech, a local CBS reporter was also used to make some pertinent commentary. This material was inserted into the Cronkite network news the same evening.

Dunn and Gayton are obviously proficient veterans who have been around television and video tape recording since its earliest days. They accompanied Nixon to Moscow with the ENG gear and had the plug pulled on them when a documentary they did in Russia annoyed the Soviets. They admitted that made a better story than what they already had on tape. Covering Ford in San Diego or Las Vegas was a snap compared to their other adventures.

DL42

It does more
than just reach.

It helps you to
better sound.
Every take.
Every day.
Anywhere.

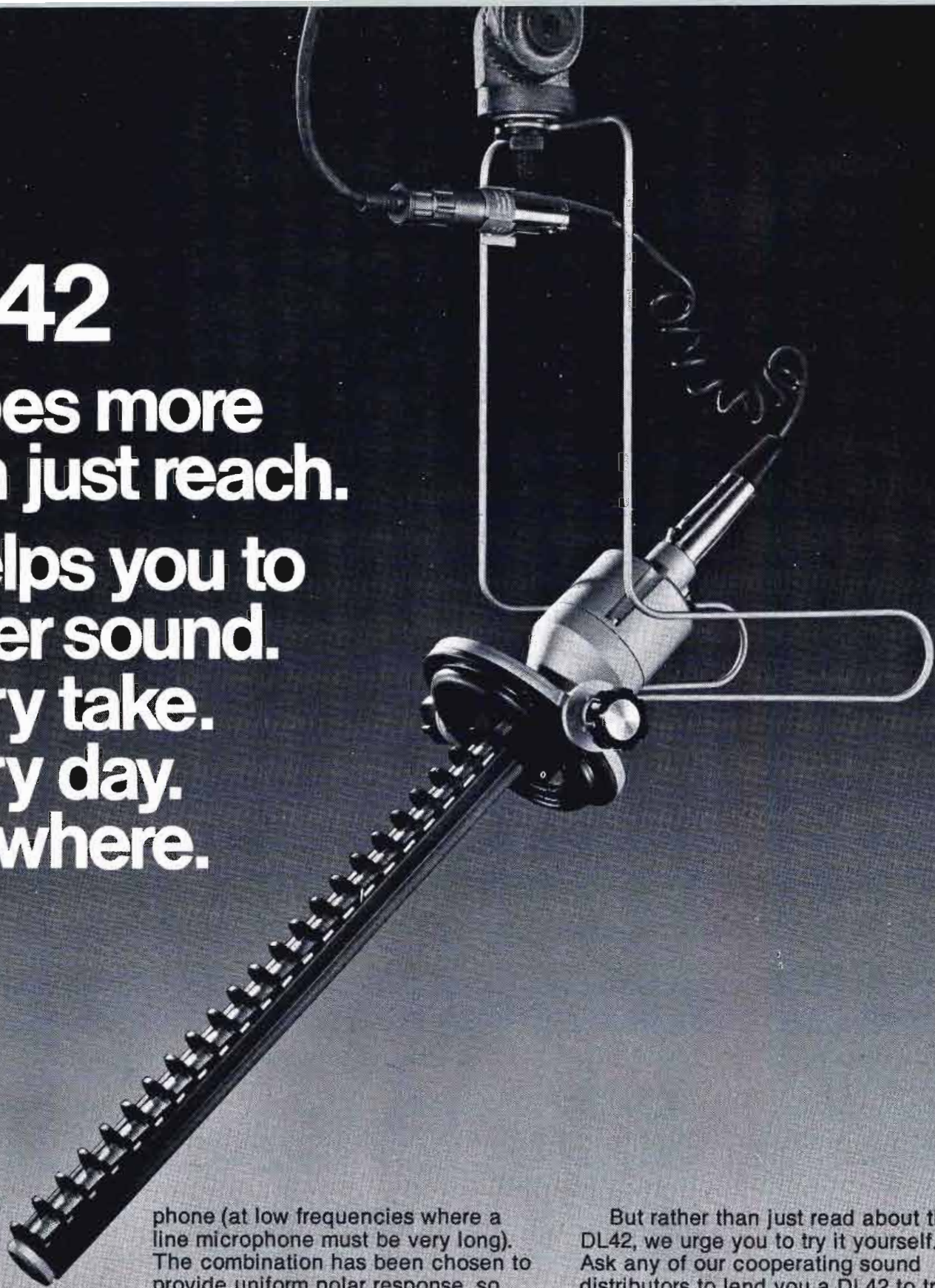

Since 1962 when the E-V Model 642 earned an Academy Award certificate for contributions to motion picture sound, there have been a lot of attempts to better this pioneering design.

Admittedly, some similar-appearing microphones were lighter and a bit smaller. But often it was at the expense of uniform polar response and wide range. Now there's a long reach microphone that's both smaller and lighter, yet maintains wide range response even off mike.

It's the E-V DL42.

Weight has been reduced to 1/4 of the 642... even less than most highly-directional condenser microphones. And size has been shaved wherever possible. The DL42 is a unique combination of line microphone (at the high frequencies) and cardioid micro-

phone (at low frequencies where a line microphone must be very long). The combination has been chosen to provide uniform polar response, so important to consistent sound quality. Off-mike pickups even sound good (although lower in level), a particular advantage to documentary units and free-wheeling shows where the unexpected is always happening.

The good pickup quality off axis has another practical benefit in the studio. Because maximum rejection is at the sides (where most of the noise comes from) you can work at a remarkable distance when necessary. So when a long shot is called for, the DL42 can be moved upward and cover the entire area with good quality and level. In fact the DL42 is more like a *super-super-cardioid*. And it covers with less racking and panning of the microphone than you ever needed before.

But rather than just read about the DL42, we urge you to try it yourself. Ask any of our cooperating sound distributors to lend you a DL42 to try on your next production. No cost or obligation to serious professional users. Write today for a DL42 technical data sheet. Good reach with good sound. We think you'll like what you hear.

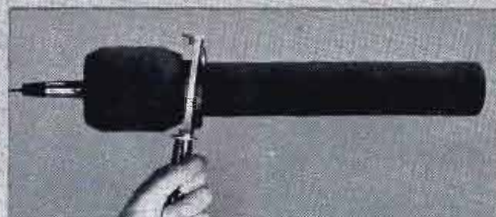

Electro-Voice[®]

For More Details Circle (44) on Reply Card

a **Gulton**
COMPANY

Network Coverage

The more sophisticated coverage of Ford's speech was done with three Norelco PC70 studio cameras provided by Trans American Video.

The cameras terminated in a large mobile van equipped with a production switcher, character generator and a pair of Ampex quads that could record and edit the program material.

TAV provided a live feed to CBS as well, so the network could record what they wanted. The recordings in the van were available for NBC, PBS or White House use. Since the TAV van was already at the NAB show, it was decided to offer this additional high quality coverage to satisfy the NAB convention committee requirements and as a courtesy to the White House.

As a last security measure, before the President's arrival at 12:45 p.m., the ballroom was cleared of all working personnel at 10:30 a.m. They were then allowed back in at 11:00 a.m., with a careful check of identity and a search of any equipment carried. Tape recorders and cameras were carefully scrutinized, even to the point of opening the battery compartments, or cassette sections to make sure that what was inside belonged there.

While Ford spoke, we counted three Portapak, quads and their associated seven color TV cameras committing the President's words and images to thin ribbons of plastic tape. Electronic Journalism never had it so good! □

Management Highlights

Following the President of the United States around the world to record what he says or does involves a rather diverse crew of people and a wide variety of equipment. Gerald Ford's visit to the NAB in Las Vegas afforded an opportunity to find out just what is involved.

To get the White House side, we interviewed Bob Mead, television advisor to the President. The networks involvement was described by the CBS Electronic News Gathering team of Bob Dunn and Fred Gayton, and the local coverage story came from Pete Wood, manager of production operations for Trans American Video.

The composite story describes a presidential speech which rated only a few minutes of network news time and a little more at the local level; however, the producers and equipment apply to similar events of greater prime time prominence.

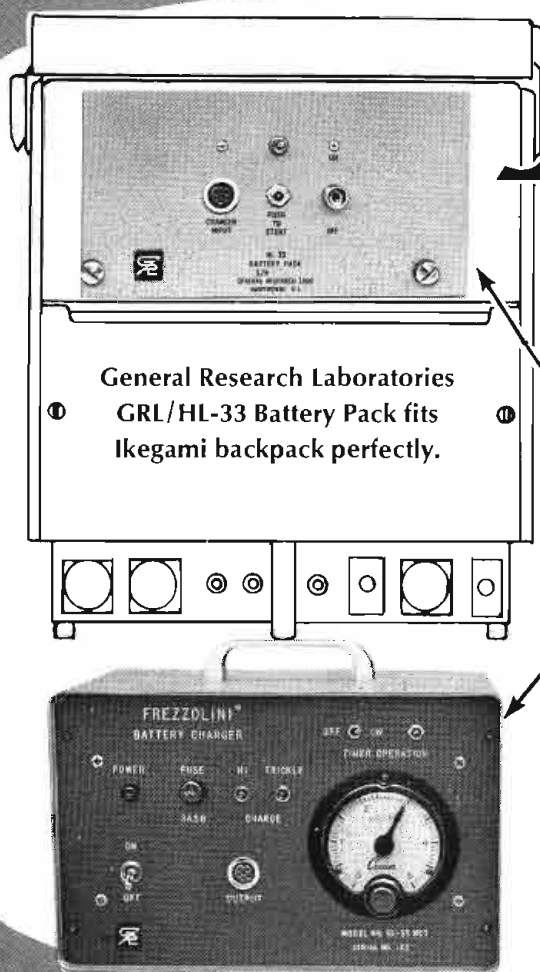

General Research Laboratories
GRL/HL-33 Battery Pack fits
Ikegami backpack perfectly.

World's standard
FREZZOLINI®

Model HL-33NC Battery Pack
LOWEST COST PORTABLE POWER WITH NiCad RELIABILITY
for Ikegami HL-33 or 35 backpack

GRL/HL-33NC Battery Pack. Mounted in case ready for use in Ikegami HL-33 or 35 backpack. NiCad reliability, 4AH, 24 "D" cells. Battery includes patented Charge Control Method. Rechargeable in less than 3 hours. . . . **User Net \$575.00**

GRL/HL-33NCT Charger. Single Channel Charger with built-in timer for automatic charging of GRL/HL-33 Battery in less than 3 hours. . . . **User Net \$812.50**

Delivery: 2 weeks from stock.

Made in U.S.A.

Call Jim Crawford, VP/Engng, at (201) 427-1160
General Research Laboratories



DIVISION OF
Frezzolini Electronics Inc.
7 Valley St., Hawthorne, N. J. 07506

Farinon Makes It...



Portable, Tunable and Superior

The new FV Portable Microwave Series for Video Transmission from 1.99 to 13.25 GHz

- **Tunable across the band without narrow-band preselection** — For example, the FV(13)P system for TV broadcasters is tunable from 12.7 to 13.25 GHz, with up to 12 crystal-referenced operating frequencies, with no filter changing.

- **Direct frequency-generation at output frequencies** — No energy-wasting, noise-producing multiplier stages.

- **Plug-in units provide baseband options** — Up to three subcarrier channels, clammers, video monitors, modulators and demodulators.

- **Up to 500-foot cable separation of RF and remote units at each end** — without video roll-off or need for equalization.

and these performance characteristics:

- **±.002% frequency stability**
- **60 dB signal-to-hum ratio from dc to 10 kHz**
- **70 dB signal-to-noise ratio from 10 kHz to 5 MHz**
- **1 watt RF output from 6.875 to 13.25 GHz;**
5 watts output from 1.990 to 2.110 GHz

Farinon Electric (DISC), 1691 Bayport Ave., San Carlos, CA 94070, U.S.A. Tel. (415) 593-8491. Telex 34-8491.

... in Canada: Farinon Electric of Canada, Ltd., 657 Orly Ave., Dorval, P.Q. H9P 1G1, Canada.

Tel. (514) 636-0974. Telex 05-82-1893.

Farinon

For More Details Circle (46) on Reply Card

Parallel FM transmitters

Part 3 of a series/By Tom Polino, Chief Engineer, KLVE, Los Angeles.

“Parallel Transmitters.” This descriptive phrase may bring forth many visions in the mind of an engineer. The dreams or nightmares that he forms may be the product of good or bad experience, no experience, or too much of the wrong input.

“To parallel or not to parallel: that is the issue.” I hope this article will help to shed some light on some questions that an engineer may have about parallel transmitters. It should be understood that this discussion will be about a system of achieving reliability and dependability in a station’s transmitting system. I am not advocating one manufacturer’s system over another. I will only state my experience with some configurations that I have installed and put together.

How About Costs?

The first and most important consideration in a new or modified transmitting system is cost. Exact cost breakouts are impractical since each case is unique. What is a major cost factor for one station may be of little importance to another. However, some overall cost trends do apply universally.

Without question it is more costly to buy a parallel transmitting system than a single transmitter of equal power. The price tag will increase even more with automatic switching options to enable half- and full-power operation with one transmitter down. The major part of this cost is in the RF switching system needed to accomplish these modes of operation. I have installed several systems, including one with automatic switching at KOAX, Dallas, and one with manual switching at KJOI, Los Angeles.

Going to ¼-power only cuts the field in half. That kind of cut in power is only noticed in fringe areas. If a station’s major audience is in its fringe area, these options are important. An RF switching capability is also very useful for maintenance and repair considerations.

So, a second cost consideration is that of maintenance. In the four installations I made, there were slight cost increases for maintenance over single transmitters, but in comparing a parallel system with a main-auxiliary system, there would be considerable savings in maintenance. These savings could be realized in a smaller spare-parts inventory and in the fact that the system is all new. There would be no need to keep a used-up main transmitter going as an auxiliary or alternate-main transmitter. The cost of final tubes is another consideration.

The cost differential depends on the individual transmitter’s power. Let’s take a hypothetical case of a dual 10-kW to give 20-kW TPO. Brand “A” 10-kW transmitter takes a smaller tube than the same brand’s 20-kW. The cost of a 10kW tube is about 70% of the 20-kW tube.

As you can see in this example, there would be no savings in the outright tube cost. However, this is not always the only consideration. I have a Sparta 3-kW transmitter whose two finals cost the same as a 3-kW single final, but the 1.5-kW finals last longer than other 3-kW final tubes I have used. Therefore, overall tube costs may be less, even if the parallel power tubes cost more than the single higher-powered final tube. A prospective buyer should take into account tube cost in dollars-per-hour of operation.

Power Consumption

Power consumption is slightly higher than for a single transmitter, due in part to the second-driver consumption and idle power such as relays, blower motors and tube filaments. These costs are really insignificant, especially in high-power transmitters. If this parallel system will replace an auxiliary system, total power consumption could most likely be the same or less than an auxiliary/main system’s total power consumption, depending on the equipment under consideration.

Something else to consider is a problem such as I had at KLVE in Los Angeles. It was necessary to double TPO and cut antenna gain to reach areas that were in the present antenna’s first null area. The cost of a new 20-kW transmitter was about \$28,000. That was just the transmitter. An auxiliary transmitting system would also be needed. KLVE had one 5-kW transmitter that was relatively new. A second used 10-kW transmitter like it was available for less than \$10,000. Six thousand dollars was spent on parts to upgrade the 5-kW to 10-kW and for a combiner and 10-kW reject load. The total cost for the complete transmitting system was not more than \$20,000.

Most important, use was made of a present transmitter whose price was listed for considerably more than its used value. In short, the possibility may exist in a transmitting plant that a relatively new lower-powered transmitter which has become obsolete before its time may be utilized. With careful use of a manufacturer’s catalog and a used-parts flyer, it may be possible to put a low-budget system together that has the reliability of a complete new system, for less than a new system of equal power.

Something else to consider is maximum available transmitter power. If the decision is made to go to a lower number of antenna bays and 40-to-50kW transmitter power output is needed, then parallel transmitters may be the only way (at any reasonable cost) to achieve this.

What’s Theory, What’s Fact?

Let’s assume that parallel transmitters might be the way to fly from a cost standpoint. What about physical considerations and actual operation? It’s well-known that theory and practicality run parallel paths, but they seldom come together completely.

A technical manual or math calculation will tell what parallel transmitters do when combined, what effects phasing and different

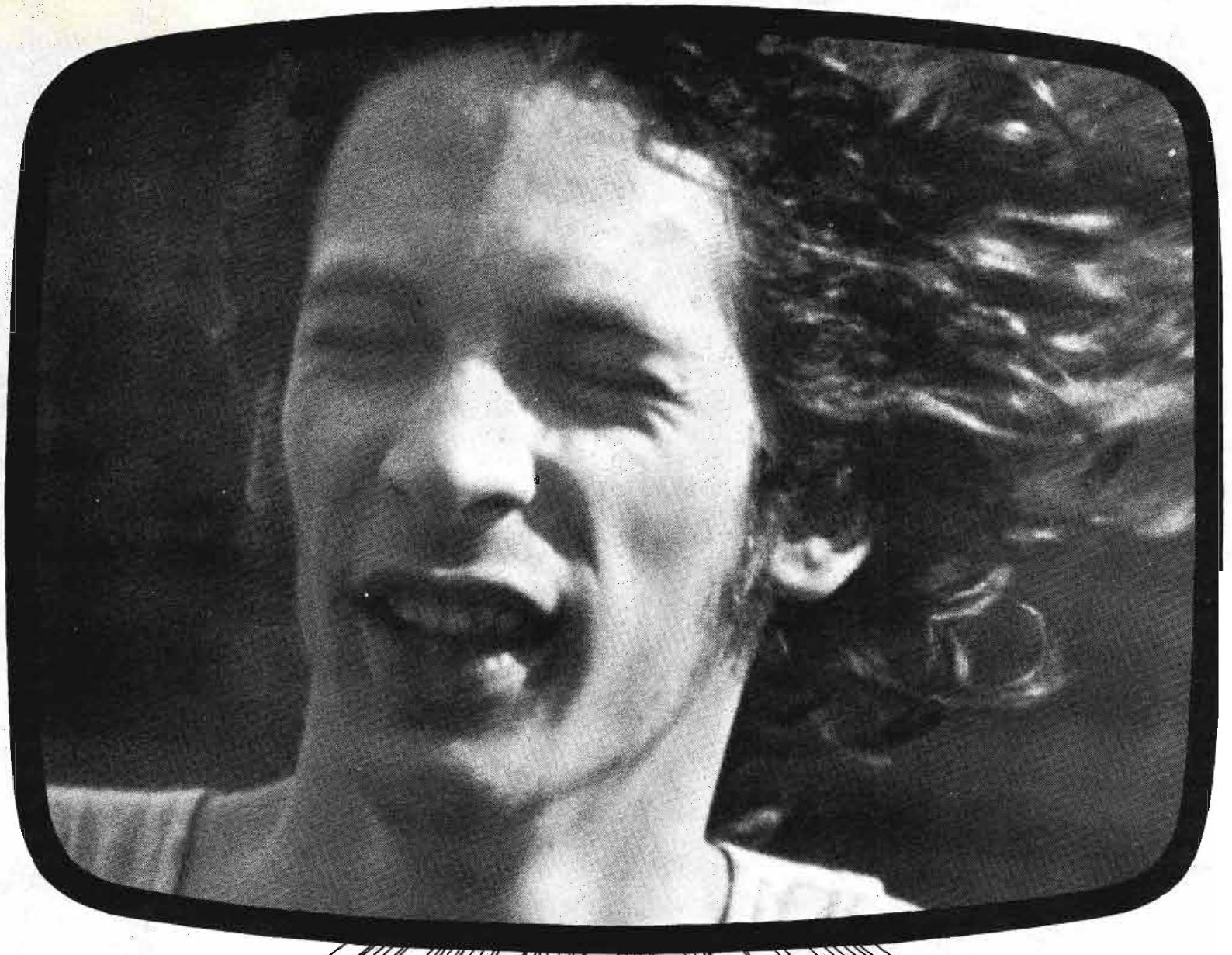

THE INFINITY CLOSE UP

Taylor Hobson's outside broadcast lenses give you an amazing narrow angle at infinity - 0.75° at $f/7$. Real agony and ecstasy in close up.

And with Taylor Hobson's plug in modular controls, twenty seconds is all you need to align your servo. They're fully interchangeable with manual control modules in a few seconds. And they cut down off air time. Meanwhile don't forget you've got Taylor Hobson after sales service to back you up.

Varotals designed for how you want them to perform. That's Taylor Hobson philosophy when it comes to zoom lenses. Ask about the range. All of it.

Send me details and specifications of the complete Taylor Hobson range of lenses

Name _____
Company _____
Address _____



In the USA post to:

RANK PRECISION INDUSTRIES INC
411 Jarvis Avenue,
Des Plaines,
Illinois 60018,
U.S.A.

For More Details Circle (47) on Reply Card

Elsewhere in the world post to:

**RANK OPTICS
TAYLOR HOBSON**
P.O. Box 64,
Stoughton Street,
Leicester LE2 0SP
England.

ELECTRONIC NEWS GATHERING

ANTENNA'S

OMNI-DIRECTIONAL

Four antenna array for omni-directional coverage. Provision for adding additional high gain antenna for troublesome paths.

MULTIPLE POLARIZATIONS

Capable of receiving Horizontal, Vertical, Right Circular and Left Circular polarizations.

SOLID STATE

Reliable Solid State polarization control permits fast on line switching.

REMOTELY CONTROLLED

Quadrant and Polarization remotely controllable via telcom lines.

LOW WIND LOAD

Module construction permits easy mounting and low wind profile.

TRANSMITTING ANTENNA

Transmitting antenna's is available with either fixed Right Circular Polarization or switchable circular polarization. Remotely controllable feeds for existing 2 and 4 ft. parabolic dish.



MICRO COMMUNICATIONS, INC.
GRENIER FIELD, R.F.D. #3
MANCHESTER, N.H. 03103
TEL: (603) 624-4351

"DESIGNED FOR BROADCASTERS USE"

"USED EXCLUSIVELY BY MAJOR NETWORKS"

"MANUFACTURERS OF HIGH POWER
RF COMPONENTS AND ANTENNAS"

For More Details Circle (48) on Reply Card

TPO's have on combined efficiency, and what effect 1/4-power operation has on field intensity. What cannot be put into absolute theory is, what do these graphs and efficiency figures physically mean to an



John Davis, consultant to KIQQ, is shown using an RF switch mode controller. The system will put either 25 kW or a 20 kW auxiliary rig on the air.

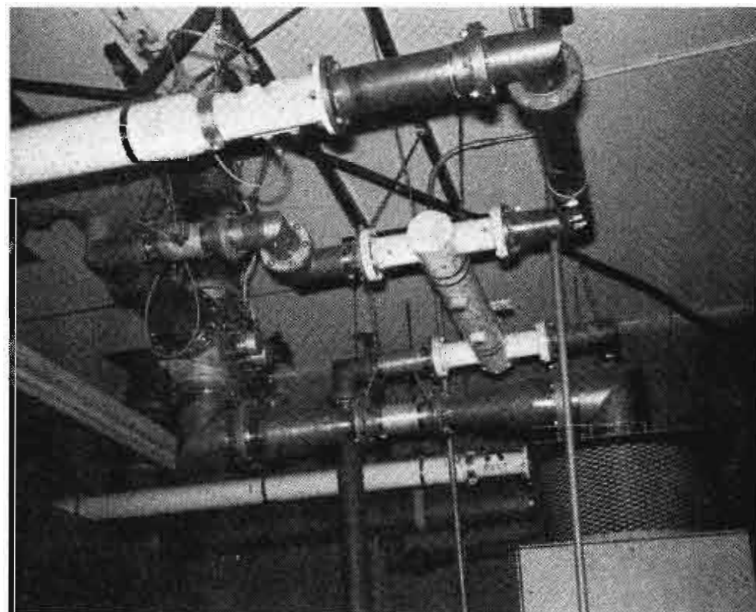

This is the combining system at KIQQ. The parallel transmitters drive a three-bay Jampro JHCP antenna. Redundancy was not a prime consideration in this system.

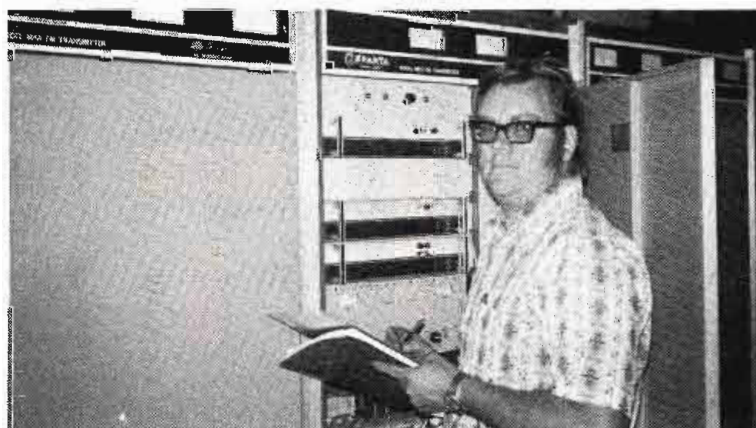

John Ehede, KEZL in San Diego, checks on his system that comes close to "take readings and forget it".

TIME ON YOUR HANDS?

BE SURE with the COOKE Digital Clock System

MASTER CLOCK SYSTEMS

Cooke's Master Clock Systems provide real time digital and/or analog display of the time of day in hours, minutes and seconds. Master units drive remote displays, impulse clocks, event timers, video numerical character generators, and other devices. These systems provide all control timing necessary for broadcast studio needs.

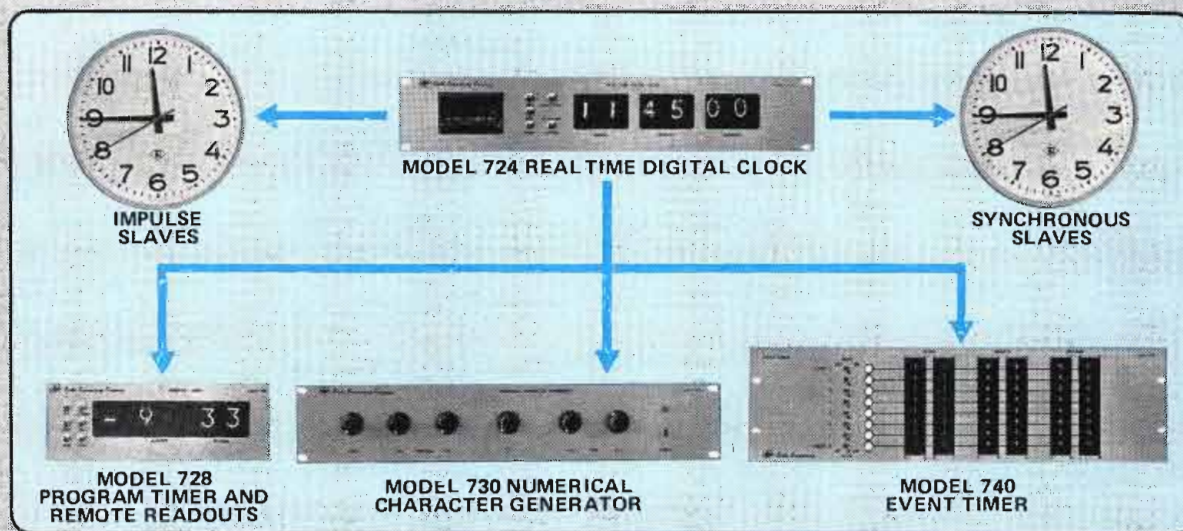

VIDEO/AUDIO PATCHING EQUIPMENT

COAXIAL

TWINAXIAL

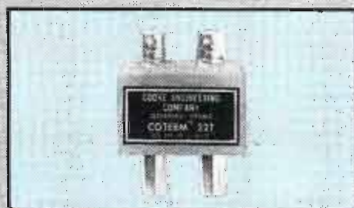

Cooke's Coaxial Patching equipment features flexibility of use, convenient installation, ease of maintenance, self-normalling and self-terminating capability. Excellent electrical properties make this equipment ideal for TV and communication patching. Analog signals up to 150 MHz, digital signals up to 10 nanoseconds pulse width, continuous power up to 50 watts and pulse power up to 1 kilowatt may be accommodated.

Cooke's TWINAXIAL balanced circuit patching equipment is ideal for uses where low level signals may be exposed to high level noise. Typical applications include video distribution, radio multiplex baseband, group and supergroup channels. TWINAXIAL jackfields have self terminating jacks that provide normal through circuits without patchcords. Circuits may also be monitored and tested without interruption.

VIDEO/AUDIO/PULSE DISTRIBUTION MODULES

Cooke's Dyna-Mites are a new series of broadcast quality audio, video and pulse distribution modules. Small and powerful, they have the exacting specifications and reliability for the most advanced studio use, and the economy for the smallest CCTV installation. All modules feature plug in construction with self-contained power supplies.



RMH 1-4 RACK MOUNT HOUSING



VDA 1-4 VIDEO DISTRIBUTION AMPLIFIER



ADA 1-6 AUDIO DISTRIBUTION AMPLIFIER



VEA-1 VIDEO EQUALIZATION AMPLIFIER



AMA-1 AUDIO MONITOR AMPLIFIER



APA-1 AUDIO PREAMPLIFIER



PDA 1-4 PULSE DISTRIBUTION AMPLIFIER

COOKE ENGINEERING COMPANY
 900 Slaters Lane, Alexandria, Va. 22314 • Phone: 703/548-3889 • Telex: 89-9454

Division of
 Dynatech Laboratories, Inc.

For More Details Circle (49) on Reply Card

engineer actually operating a parallel system? What constitutes a 90° phase shift? How much mis-tuning can be tolerated? What effect do different transmitter efficiencies have on the total combined efficiency? In a nutshell, how does a graph convert into a twist of a vernier on the plate tuning capacitor? Let's elaborate on some of the basic questions and look at some alternatives.

In practice, the extremes of full power and ¼-power are not always as bad as the figures seem to say. There is not a discernable difference in reception in the city-grade coverage area at ¼-power. The only noticeable difference is in the fringe areas. If this is a major factor, systems can be built to maintain half and even full power. A full-power system could use two antennas, a main antenna and an auxiliary antenna system with twice the gain (possibly the old antenna from a system) in that the TPO is being doubled.

I have seen switching systems work quite well. I have also had my headaches with burned-out coax switches, shorted or malfunctioning mode selectors and other switching-equipment malfunctions that made me wish I never had switches. A parallel system is, as its name implies, parallel and redundant, and should be designed with this in mind. Keep the system as simple as possible; avoid using equipment configurations that make the whole parallel system dependent on one item. The exception would be the antenna and transmission line which could be backed up with an auxiliary antenna system (again, possibly the old antenna).

One alternative to the antenna-redundancy problem is a parallel antenna system (Figure 1). Parallel antennas have some drawbacks. There are no means directly at hand to monitor the combining of the two parallel transmitters at the antenna. Any monitoring system would have to be calibrated against an arbitrary standard and would be subject to drift.

From KLVE's Mt. Wilson transmitting site where this system was used, it was found that there was a severe drop in field intensity at a remote point with relatively little phase shift between the transmitters. After inquiring into this

phenomenon, it was learned that the phase shift between the transmitters not only caused poor amplitude and phase addition of power at the antenna, but also caused a pseudo-beam-tilt in the antenna's vertical plane pattern. At this particular transmitting site this was a very serious problem.

System Stability

Questions most asked about a parallel system are about its stability. Once properly tuned, a parallel transmitting system needs only occasional "tweaking" to keep phase proper by correcting for tube age.

The Sparta 3-kW at KEZL in San Diego, for example, is so stable it is only necessary to retune slightly when the tubes are changed. Even though there is a difference in stability between grounded grids and regular pentodes, in reality it is not large enough to cause a significant impact on the parallel operation of these transmitters.

Actually, parallel transmitters are not new. Collins, for example, paralleled two 10-kW amplifiers with one driver to achieve 20-kW in their 830-series transmitters for years. True parallel redundant transmitters have two drivers and two amplifiers running independently except for the exciter and combiner.

When transmitters are combined the initial setup is the most important. At this time, each transmitter is tuned for optimum performance into a known load. Except for the phasing system, line lengths and output plumbing in each transmitter leg are kept to the same electrical length in each stage. When the two transmitters are fed into the combiner, one transmitter is usually done after the exciter power splitter with a ¼ wavelength of line, or with a 90° splitter, depending on the equipment manufacturer. Once optimum performance is achieved with this phase lag network, fine phase control, if needed, is usually achieved with a very slight off-resonance condition in any stage.

A high (Q) circuit like the driver plate or PA grid tuning is the most effective in producing the desired phase shift. This adjustment is usually so slight that it doesn't affect the operation of the indivi-

dual transmitter, and some manufacturers supply a Trombone line section to achieve this fine phase shift.

Once a transmitter is set up in this manner, it need never be done again, except for super-fine tweaking to compensate for tuning drift due to such things as tube age. Again, the amount of drift is dependent on the stability of the transmitters used in the system. When one transmitter has a tube replaced, all that need be done is to tune that transmitter to optimum performance as before, and make a fine tweak of one stage control to reestablish final parallel phase, if the original set-up was made properly.

Determining Power Output

Another question that might be asked is how one determines power output, direct or indirect. As in the single transmitter system, the same benefits apply to each method, when used with parallel transmitters.

If the indirect method is used, the difference, if any, in the actual transmitter efficiency is unnoticeable in the effect it has on the optimum combining of the transmitters. In practice, this efficiency stays fairly constant from new to fairly old tubes, constant enough that if one final should fail it is not at all necessary to replace the other final to insure good combining. Again, if the individual transmitters are kept tuned to resonance or optimum, tube age does not, to any noticeable degree, affect phase or combining efficiency.

In summary, there is no truth to the rumor that both PA or driver tubes have to be changed at the same time regardless of condition. This is true even when using the indirect method of determining power output. The phase and amplitude between the transmitters are controlled (for all practicality) by the individual transmitter tuning and are not substantially affected by reasonable tube age. The parallel systems on the market today are truly independent parallel transmitters in this respect.

A spare exciter and associated switching system should be considered in a parallel transmitting system. All switching is usually accomplished before the power split-

Fewer parts... fewer problems with **audiopak® A-2** broadcast cartridge

*Ribs are molded into the flange —
no pencil leads
to break and jam.*

*No top wire.
Reloading's easier.*



*Tape guide is
an integral part of
the cartridge base
— not glued in —
to insure accurate azimuth control.*

Try one free

In the broadcast cartridge world, the simpler the better. That's why the design of the audiopak A-2 eliminates parts that can give you trouble.

The lessons learned from our years of experience developing the world's leading 8-track cartridge have been applied to our audiopak A-2. The result is a more durable, more reliable broadcast cartridge. And because we manufacture the entire product — from tape to packaging — we can assure you of the highest possible quality control.

We're so sure we have the best product on the market, we want to prove it... at no cost to you. For

your free sample and more information on the audiopak A-2 broadcast cartridge, write on your company letterhead to: Capitol Magnetic Products, Division of Capitol Records, Inc., 1750 North Vine St., Los Angeles, Calif. 90028. Attention: Marketing Manager, Professional Products.



CAPITOL MAGNETIC PRODUCTS
A DIVISION OF CAPITOL RECORDS, INC.
LOS ANGELES, CALIFORNIA 90028
A MEMBER OF THE EMI GROUP



TM OF EMI LIMITED

LENCO

THE NAME THAT MEANS

QUALITY

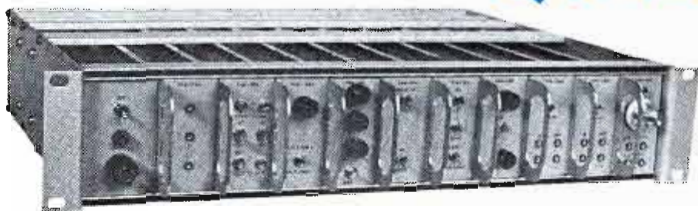

FOR:

- VIDEO TEST GENERATORS
- GEN-LOC SYNC GENERATORS
- NTSC ENCODERS
- DISTRIBUTION AMPLIFIERS
- BLACK AND WHITE CAMERAS

Quality With Reliability At A Reasonable Price.

Lenco offers a two year warranty, parts and labor, including surface transportation to and from the factory.



LENCO, INC., ELECTRONICS DIVISION
 319 W. Main St., Jackson, Mo. 63755
 (314) 243-3147 or (314) 243-2394

For More Details Circle (51) on Reply Card

PERFECT TIMING

Low Cost ESE Right On Timers

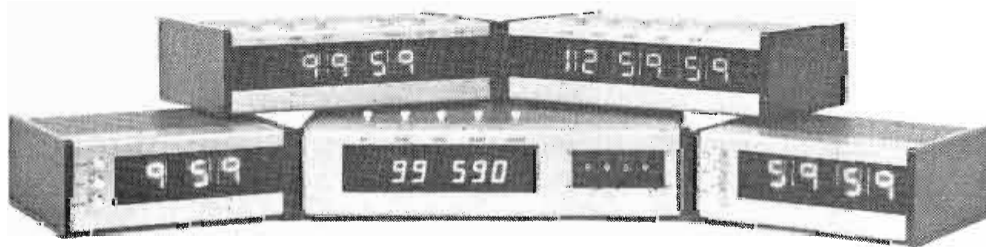

- ES-300:** Four digit incandescent display, one hundred minute timer (99:59) with six controls: Count Up, Count Down, Min-Set, Sec-Set, Stop, Reset. **\$168.00**
- ES-301:** Identical to ES-300 except with planar, gas discharge display. **\$185.00**
- ES-302:** Equivalent to ES-301 plus fast-set lever wheel programing. **\$238.00**
- ES-400:** Three digit ten minute timer (9:59) with Start, Stop, Reset. **\$ 98.00**
- ES-510:** Four digit sixty minute timer (59:59) with Start, Stop, Reset. **\$125.00**
- ES-500:** Six digit, twelve hour combination clock/timer with five controls: Start, Stop, Reset, Fast Advance, Slow Advance. **\$150.00**

STANDARD OPTIONS AVAILABLE: Kit; Slave; BCD Output; Remote Connector; 6' Remote Cable and Pushbutton Set; 220V A.C., 50Hz; 9" or 19" Front Panel 3 1/2" high; 3 Wire Cord and Molded Plug. Tenths of seconds are available on all timers except the ES-500. Relay Contact Closure at Zero and/or Stop at Zero available on ES-300, 301, and 302. Crystal Timebase available for ES-500. Custom options and special orders available.



WRITE, WIRE OR CALL TODAY

505 1/2 Centinela Avenue • Inglewood, California 90302 • (213) 674-3021

For More Details Circle (52) on Reply Card

ter, and has no effect on the phasing of the parallel transmitter itself. The exciters used should have equal power outputs.

The power dividing systems used in parallel transmitters are many and quite varied. Some systems require amplifiers to make up for loss in the divider, while other systems need amplifiers to get adequate power to drive two transmitters. The simplest system uses a two-to-one transformer and has very little loss, and therefore usually does not require extra amplification.

Most manufacturers are very willing to work around a buyer's specifications. In any future purchases I would make, I would specify a low-loss splitting system, keeping clear of all unnecessary equipment.

On the other end of the system is the combiner. This part of the system so far has caused no trouble whatsoever. However, one very important subpart is the reject load. It would be best to spend a little more money at the outset and get a load that will handle at least the full power output from one transmitter.

If the system under consideration has a switching system, the reject load can also serve as a testing load, when the system is bypassing the combiner in the single transmitter mode of operation.

Space requirements are another consideration; but, remember, parallel transmitters could replace a main and auxiliary system. Most parallel systems are fairly compact and require about the same room as a main-auxiliary transmitting system.

One final thought for a good parallel installation: a redundant source of power is needed. When the transmitters are installed, by all means continue the independence of the transmitters through to the AC power. Have separate circuits for each transmitter, and have the exciters and control circuits on a third separate circuit.

The pitfalls I have described are avoidable. The parallel transmitting system is a sound and viable solution to the space, power, and economic problems in a reliable transmitter installation. The basic system is one of the best available to get high reliability, ease of maintenance and a low overall operating cost. □

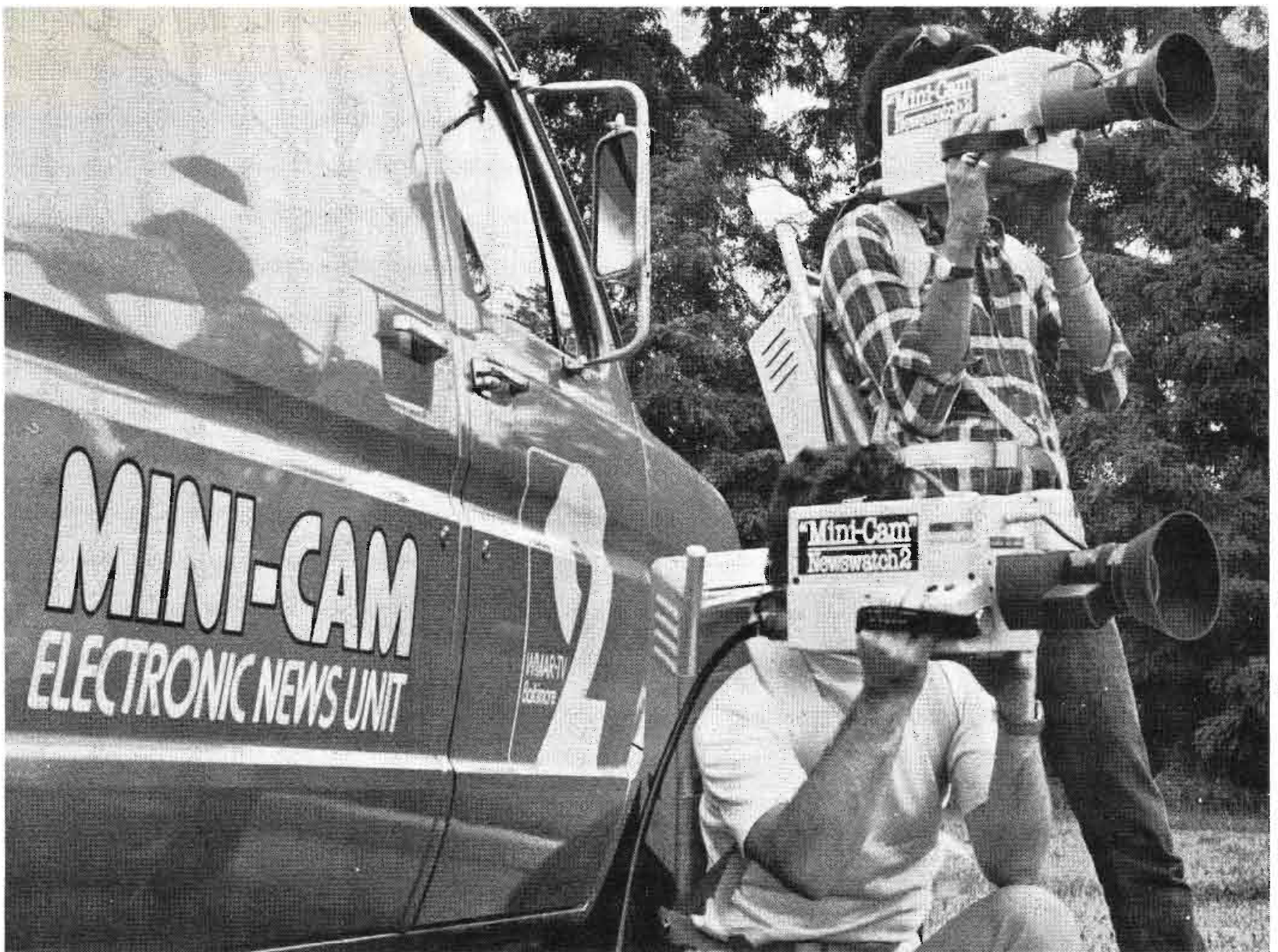

THE MINI-CAM THAT MAKES NEWS SAVES YOU THOUSANDS AT \$27,500

Imagine! A top broadcast quality TV minicamera for only \$27,500.00, including lens. That's around \$15,000.00 less than you would have to pay for a comparable camera.

Top quality features make the Asaca ACC-3000 camera the choice of United States TV stations from coast-to-coast . . . and across three continents. These light-weight, hand held cameras are the favorites of news departments (pictured above: news camera men from WMAR, Channel 2, Baltimore). Complete with camera head, view finder, lens, back pack, and control box (power supply pack).

Compare these features:

● Can use standard C mount lens

- Light-weight, camera is 12 lbs., back pack, 13 lbs.
- External sync Gen-lock possible
- Standard battery operates system 120 minutes
- Usable picture 2 minutes after power on, completely stable operation in 10 minutes
- Cable to 100 ft. for camera head to back pack, 6 ft. standard, back pack to control box 1000 ft. max., 100 ft. standard
- Three 2/3" picture taking tubes
- 450 TV line VBS
- S/N ratio: 45 db (rms) or more

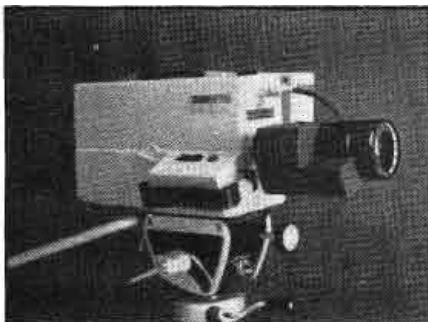

Asaca ACC-3000 camera is widely used by TV stations on remotes and in studio as a sub-camera, with or without tripod.

ASACA®

Asaca Corporation of America
 1289 Rand Road,
 Des Plaines, Illinois 60016
 Tel: (312) 298-4380
 Telex: 72-6351

FREE DEMONSTRATION

Asaca, 1289 Rand Rd., Des Plaines, Ill. 60016
 Yes, I want a FREE DEMONSTRATION.

NAME _____
 TITLE _____
 STATION _____
 ADDRESS _____
 CITY _____
 STATE _____ ZIP _____
 PHONE _____

For More Details Circle (53) on Reply Card

COASTCOM DELIVERS SPECIALIZED MULTIPLEX FOR BROADCAST NETWORKS

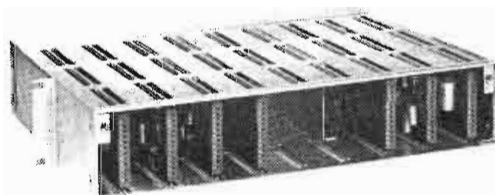

SBC 418 FM Program Audio Diplexer is made for the most demanding satellite and transcontinental broadcast networks where economical high quality program channels are needed in the 4 to 10 MHz range above the video spectrum.

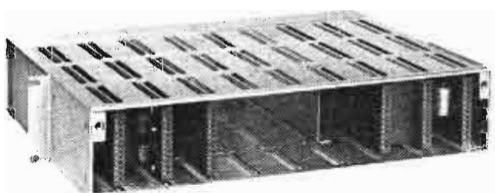

SBC 425 FM Multicarrier System puts unused video microwave base-band capacity to work by adding 24 separate voice channels or multiple program channels to a single subcarrier in the 6 to 10 MHz region on a satellite or video microwave link.

SBC 502 Wideband Multiplex makes multi-channel and multi-lingual program audio transmission a practical reality without major system modifications or excessive channel capacity loss. SBC 502 operates in the 12 to 52 kHz or 60 to 108 kHz spectrum on a full or half duplex basis and exceeds all current CCITT recommendations and ICSC satellite transmission practices.

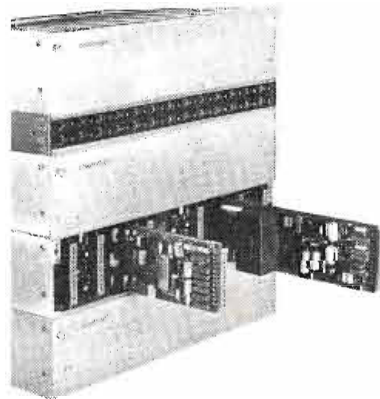

Coastcom specialized multiplex for network broadcast transmission delivers high quality performance over a broad spectrum of broadcast applications. For complete technical details and prices, contact Coastcom at 2346 Stanwell Drive, Concord, California USA 94520. Telephone 415 / 825-7500 or Cable: COASTCOM

COASTCOM

Multiplex Specialists

NAB seeks change In recording interviews

The NAB has urged the Federal Communications Commission to let radio stations that record and broadcast telephone conversations notify the other party **after** the conversation, not before.

Under the proposal, the conversation "could not be broadcast unless or until clear consent is given" by the other party to the call.

NAB said in comments supporting an idea originally proposed by Doubleday Broadcasting Co., Dallas, Tex., that radio thrives on spontaneity and "the vital sense of natural and unrestrained comment is severely encumbered if not lost entirely" when the party to a phone call knows of the recording in advance.

NAB said that present rules are "unduly restrictive and overly protective" and needlessly limits the licensee's flexibility in programming.

"The premise upon which the proposal is predicated is neither novel nor particularly innovative," NAB said, "...There is simply no grounds for distinguishing telephone conversations from other spontaneous recordings..."

Likening the proposed procedure to that used in television for the "Candid Camera" show and unrehearsed commercials, NAB said "the rights of the individual are no more abused by the hidden camera or hidden microphone than would be the case with an unexpected telephone call..."

"Spontaneity is the crucial element in each of those situations. Similarly, radio programs and promotions often require that extra spark that can only be found in the truly instantaneous and unrehearsed dialogue."

NAB handbook ready

Part I of the sixth edition of the **National Association of Broadcasters Engineering Handbook**—the first new edition of this classic work in fifteen years—is now being mailed to NAB members who have already placed orders for the book.

With 19 chapters, over 500 pages and hundreds of illustrations, reference data, graphs and charts, Part I of the **NAB Engineering Handbook** contains hundreds of solutions to engineering problems and suggestions for reducing costs and improving the efficiency of radio and television Engineering Departments.

This comprehensive handbook is designed to keep broadcasters informed about the most recent developments in broadcast engineering. Theory and mathematics are included, but the stress is on operational aspects. Every effort was made to avoid using the type of information that can be found in equipment manuals. The handbook was designed and organized around the everyday needs of a station. The book explores the phenomenal growth of broadcast technology including the latest technical advances,

(Continued on page 46)

Silent Partners



Now that the FCC have approved the use of a 25 microsecond characteristic on Dolby transmission, more and more FM stations will be taking advantage of this ruling to effect even better quality for their listeners.

Obviously now, more than ever, source quality is of paramount importance and in tape the Revox/Dolby B is the obvious answer.

Already most manufacturers of automated programming equipment have come to rely on Revox—such prestigious names as Schafer Electronics Corporation, CCA, Gates Division of Harris-Intertype, Sparta Electronics Corporation, IGM/NTI and SMC Systems Marketing Incorporated (Sonomag) all employ Revox tape recorders as an integral part of their installations.

If your application depends on ultra-reliable, high performance and outstanding signal to noise, shouldn't you be using Revox too?

"More proof that Revox delivers what all the rest only promise."

As for the Beyer DT109

microphone/headphones, they are in a class by themselves. Highly sensitive and capable of withstanding immensely high sound pressure without overload or distortion, they feature modular construction with a unique multi-pin plug in lead allowing separate wiring of left and right headphone channels, independently of the microphone.

Add featherweight comfort and effective ear sealing together with a wide frequency, true cardioid, broadcast quality microphone specially designed to work under extremes of temperature and humidity, and it is easy to understand why the DT109 has become so popular for live remote broadcasting, studio, film, television, disc jockey and language laboratory applications.

Together or separately, our remarkable Silent Partners will open your ears to recording and broadcasting possibilities you never knew existed.

Your nearest Revox/Beyer dealer will be delighted to arrange an introduction.

Once you have met them, you will wonder how you ever did without them.

Dolby is the trademark of Dolby Laboratories, Inc.
Illustrations may contain optional extras.

Revox Corporation in USA: 155 Michael Drive, Syosset, N.Y. 11791
Revox in England: Lamb House, Church Street, Chiswick, London W4 2PB.
Revox Canada.
Revox International: Regensdorf 8105 ZH
Althardstrasse 146, Switzerland.

Please tell me where I can see and buy Revox A77 Dolby B
 Revox Good used machines*
 Beyer DT109

Name _____
 Street _____
 City _____ State _____ Zip _____
 BSI *As and when available from our dealers

Watch those royalties!

The National Association of Broadcasters has urged Congress to reject as an unfair and unjustified windfall proposed legislation that would require broadcasters to pay a new record royalty for performing artists and record companies.

Testimony in opposition was

given at a House Judiciary Subcommittee hearing by Vincent T. Wasilewski, NAB president, and Wayne C. Cornils, Chairman of its Small Market Radio Committee.

Both emphasized that record companies and their artists already benefit handsomely from free over-

the-air exposure that promotes the sale of records and the artists themselves.

Wasilewski described broadcasters as a symbiotic third partner in the music business who, through air play of their work, have enabled record companies and performers to reap "staggering compensation." Any further assessment on broadcasters, he said, is unnecessary and unwarranted.

Noting that broadcasters already pay copyright fees for authors and composers, the NAB president said the one percent royalty for performers and record companies "flies directly in the face of trade practices, economic realities and the Constitution of the United States."

"We are asked to pay that one percent to an industry that is growing faster than the industry which fuels its growth," he said. "...It imposes an unreasonable burden on a symbiotic partner in the music industry and promises windfall profits for those for whom no need can be demonstrated."

Wasilewski presented statistics compiled by Dr. Frederic Stuart of Hofstra University on the relative sums received by composers, publishers, artists and record companies from the sale of recorded music played on the air. Stuart's estimates of revenue from a random sample of records, he said, show that composers received \$1.5 million; publishers \$1.2 million; artists \$4.2 million and record companies \$10 million.

The NAB president said the Constitution empowers Congress to afford authors and inventors copyright protection "to promote the progress of science and the useful arts." Broadcasters, he said, now pay 3.5% of their net advertising receipts for payment to publishers, lyricists and composers.

"Talent and creativity do not a copyright make," he said. "The 'performance rights amendment' does not belong in this copyright bill. It is recommended neither by the constitutional guidelines nor the economic market place."

"It would place an extremely heavy burden on all broadcasters, certainly including those of us in America's smaller markets," he said.

There are **2** *great* **CHIRON** *systems*

*providing titling...graphics
for television production*

CHIRON II **Electronic Graphics System,**

unquestionably the most advanced and versatile system available today...the one system that offers the highest character resolution and do-it-yourself capability for unlimited type font and logo preparation, plus more features than any other TV graphics equipment.

CHIRON III **Electronic Titling System,**

At a moderate price CHIRON III provides more flexibility and quality than higher priced units, including unlimited font and logo interchangeability, large message storage capability, and character resolution exceeded only by CHIRON II.

For complete information write:

CHIRON telesystems

A Division of The Computer Exchange Inc.

11 Grace Avenue, Great Neck, New York 11021 • 516 829-5666
851 Burlway Road, Burlingame, Calif. 94010 • 415 348-1144

For More Details Circle (55) on Reply Card

Spotmaster[®]

Tape Cartridge Machines



SERIES 2000



SERIES 3000



SERIES 4000



MULTI-DECKS

Audio Consoles



VERSA CONSOLE



50 SERIES MONO



100/200 SERIES
MONO AND STEREO



SLIDE-TYPE
MONO AND STEREO

Audio Amplifiers



CLE-500
SOUND BRITENER



CLE-FM
SOUND
BRITENER



CLA 20/40A
COMPRESSOR/
LIMITER
AMPLIFIER



BETMS-100/200
TURNTABLE
PRE-AMPLIFIERS

ACCESSORIES

Fault/Splice Detectors • Sequencers/Switchers • Remote Controls • Phase-Lok
Head Brackets • Distribution Amps • Monitor Amps • Telephone Answering
Systems • Tape • Tape Cartridges • Alignment Tapes • Test Tapes • Tape
Winders/Loaders • Delay Tape Cartridges • Rebuilding/Reconditioning Services
Maintenance Supplies/Cleaners • Heads • Demagnetizers • Erasers • Micro-
phones • Headphones • Turntables • Tape Cart Racks • Control Room Furni-
ture • Studio Clocks

BROADCAST ELECTRONICS INC.

— A FILMWAYS COMPANY —

8810 BROOKVILLE ROAD • SILVER SPRING, MARYLAND, 20910
PHONE 301-588-4983 • TWX 710-825-0432



For More Details Circle (56) on Reply Card

VISCOUNT 1150B PRODUCTION SWITCHER

**PROFESSIONAL...
and... AVAILABLE**

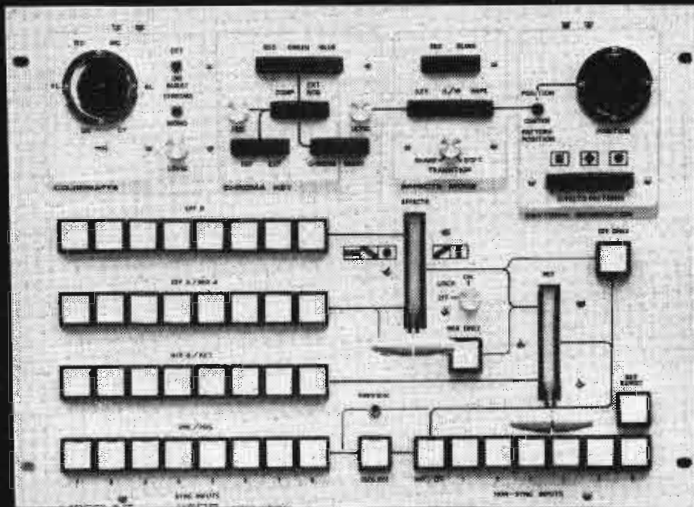

KEY FEATURES:

- * 14 inputs - 8 sync, 6 non
- * 4 busses
- * 27 std. wipe patterns
- * int., ext., chroma key
- * composite, ext. RGB
- * soft key, wipe of key
- * mix-blink on wipe-key
- * spot light effect
- * black burst, clr. mat. gen
- * 'on-air' inputs indication
- * full preview
- * colour timed, any path
- * vert. int. switching
- * processing amplifier
- * remote control panel

*** \$9250 - '1150B'**
(shown above)

also available:

\$7500 - '1150A'

VISCOUNT INDUSTRIES LTD.



105 EAST 69th AVENUE
VANCOUVER, BRITISH COLUMBIA
CANADA V5X 2W9
PHONE (604) 327-9446 TELEX (04) 508-605

NAB handbook

(Continued from page 42)

modern facilities and equipment and the most current engineering practices.

The **NAB Engineering Handbook** covers everything from FCC regulations on antenna structures to the fundamentals of wave propagation. It offers quick answers to questions on lightning protection, proof-of-performance techniques, FM multiplexing or video tape recording and can also be used to help estimate costs for installing or repairing equipment or for planning studio facilities.

The new **NAB Engineering Handbook** has been designed with a larger type in a double column format with 8½ by 11 inch pages. This edition features a gold-stamped post binder for the easy addition of updated loose leaf material. It is anticipated that Part II which will include an additional 60 pages will be mailed early in the new year.

The handbook was edited by George W. Bartlett, NAB vice president for engineering, and was assisted by Estelle Mallinoff of Mallinoff Associates, Washington, D.C. and Tim Paulson, assistant to NAB's director of broadcast management. Semline, Inc. of Braintree, Mass. is printing the book.

Burns Nugent, NAB executive vice president for station relations, said NAB's decision to edit and publish the book itself has kept the cost in line. NAB is offering the **NAB Engineering Handbook** to members for \$30 per copy. The retail price is \$45.

Another ad headache

Broadcasters have urged the Federal Communications Commission to reject as totally lacking in merit a suggestion that it ban the advertising of over-the-counter medications on television before 9 p.m. each day.

Opposition comments filed by the National Association of Broadcasters said Frank Bellotti, attorney general of Massachusetts, and other petitioners failed to submit any evidence that TV commercials contribute to drug abuse or deaths among children because there is none.

NAB cited studies and statistics to show that actually (1) the use of illegal drugs by teenage boys is less likely among heavy viewers of TV commercials than among light viewers and (2) TV's continuing educational efforts may have contributed to the continuing decline in childhood deaths from ingesting poisons.

NAB said the Bellotti petition contains "lofty statements and broad-brush assertions" that obviously are based on "falsehoods...misrepresentations and erroneous premises" and is "totally lacking in merit."

"The problems of drug abuse have given rise to recurrent exclamations that the advertisements of over-the-counter or non-prescription medications have created a 'pill popping' society destined to 'hard drug' addiction," NAB's comments said. "There is no scientific support for the alleged causal relationship between proprietary medicine advertisements and drug abuse or misuse."

For More Details Circle (57) on Reply Card

Take your code and shove it up your monitor



You know what the SMPTE Edit Code is for.

Now, imagine it displayed *right on your monitor* as you preview a video tape. That's what our new Video Character Generator does. With this new black box you can also add the code display to the video signal for playback on a small, helical recorder.

If you hold a single frame, the code readout is held stationary as well. You can move the code to any position on the monitor, make it large or small, and add or delete a background mask.



You can use the Video Character Generator to display on any number of monitors at once. And you can even use it to imprint the code on every frame of kine work prints.

Think of the possibilities. Think of how much editing you can now do easily with inexpensive equipment away from the studio.

Needless to say, there's a lot more we'd like to tell you. So write us or call us today. Ask for me, George Swetland, and charge the reverses.

EECO

1441 East Chestnut Avenue, Santa Ana, California 92701
Phone 714/835-6000

For More Details Circle (58) on Reply Card

CHECK... CONSIDER...

Do your cart machines, or the ones you're talking about buying, have these standard features:

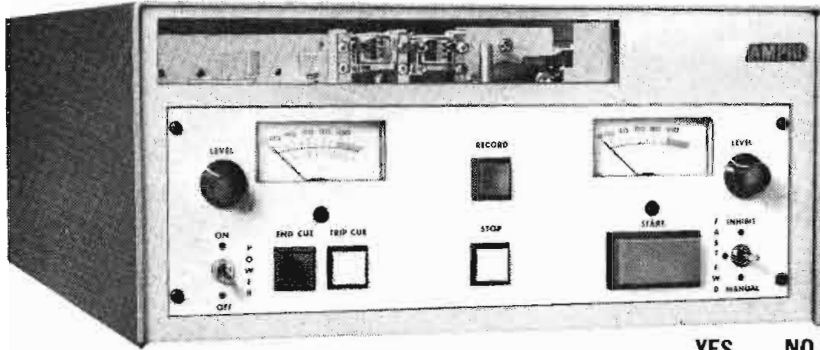

- | | | |
|---|--------------------------|--------------------------|
| Direct drive hysteresis synchronous motor | YES | NO |
| Self-aligning pinch roller with air-damped solenoid | <input type="checkbox"/> | <input type="checkbox"/> |
| Automatic record/playback meter switching | <input type="checkbox"/> | <input type="checkbox"/> |
| 100 kHz transformerless bias oscillator | <input type="checkbox"/> | <input type="checkbox"/> |
| No adjustment digital cue synthesizer and detector | <input type="checkbox"/> | <input type="checkbox"/> |
| Superior RF field immunity | <input type="checkbox"/> | <input type="checkbox"/> |
| +8dBm output, +22dBm clipping: 58dB s/n ref. 3% THD | <input type="checkbox"/> | <input type="checkbox"/> |

All 34 standard AMPRO models do! PLUS MUCH MORE. Available in 1/2 or 1/3 rack and desk configurations. Options include automatic fast forward with manual override and electronic splice finder. Priced from \$695.00 to \$1,945.00.

Ampro also produces a comprehensive line of 6, 8, 10 and 12 channel mono, dual mono, stereo and dual stereo/simulcast broadcast audio consoles. For complete details, call collect today or write:



AMPRO CORPORATION

850 PENNSYLVANIA BLVD., FEASTERVILLE, PA 19047 • (215) 322-5100

Professional Equipment for Broadcasting Professionals

See us in booth #1, NAFMB, Atlanta

For More Details Circle (59) on Reply Card

the **NEW McMARTIN FM TRANSMITTER • BF-3.5K**

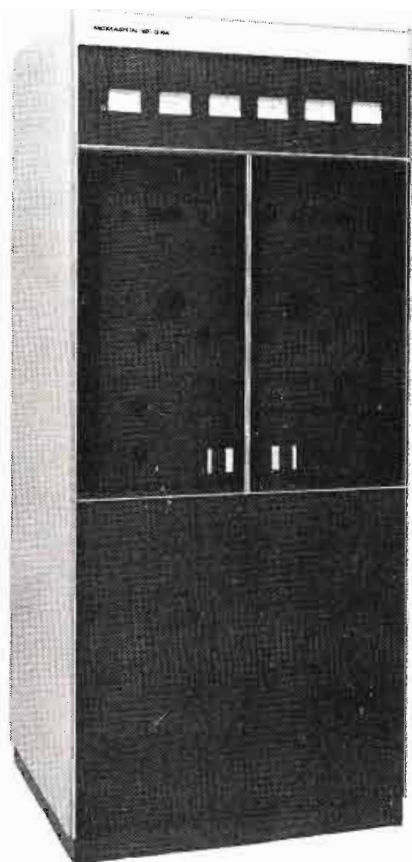

traditionally, McMARTIN engineering has supplied the AM/FM broadcaster with the finest professional equipment. The new BF-3.5K is one of those products.

excellent efficiency for power output levels from 2000 to 3500 watts.

the high performance solid state B-910 exciter, is the heart of the system

superb bandwidth characteristics and operating stability

optimum stereo and SCA performance – zero bias, grounded grid PA – no neutralization... no screen grid or bias voltage supplies are needed

standard features include illuminated pushbutton switch controls, output reflectometer, memory-type LED status indicators, built-in harmonic filter, remote control capability of metering and operating functions

McMartin

McMartin Industries, Inc. 4500 South 76th Street, Omaha, Nebraska 68127 (402) 331-2000

48

For More Details Circle (60) on Reply Card

Pan Am sports Will go helical

International Video Corporation has been selected by the Executive Committee of the Pan American Sports Organization to provide the videotape recording equipment for worldwide broadcast transmission of the 1975 Pan American Games to be held in Mexico City, October 12-26.

Ronald H. Fried, IVC's Executive Vice President, said six IVC-9000 videotape systems will be used exclusively to record and play back programming from the games, primarily via satellite, for viewing by audiences at convenient local times around the world.

The Pan American Sports Organization is leasing the television equipment which will later be delivered to customers in Latin America.

"This represents the first time in the history of videotape recording of world games that a new recording format has been accepted for mastering, editing and playback," Fried said.

The IVC-9000 recorders will be housed in a communications tower at a central location at the games and will be under the supervision of a broadcast pool that includes Televisa, the principal Mexican television network; Channel 13, Mexico City, the government-owned commercial channel; and personnel from the Secretariat of Communications and Transportation, the teleproduction arm of the Mexican government. Technical support for the project will be provided both by IVC and Telemation de Mexico S.A., IVC's distributor in that country. CBS Television will carry the games in the United States.

The Pan American Games are the second largest athletic event in the world, second only to the Olympic Games. Staged every four years, the games are sanctioned by the International Olympic Committee. They will be held at the site of the 1968 World Olympics in Mexico City.

The IVC-9000 two-inch, segmented helical scan broadcast videotape recorders were introduced two years ago and have gained widespread acceptance in teleproduction facilities around the world.

The Editor-In-Chief!

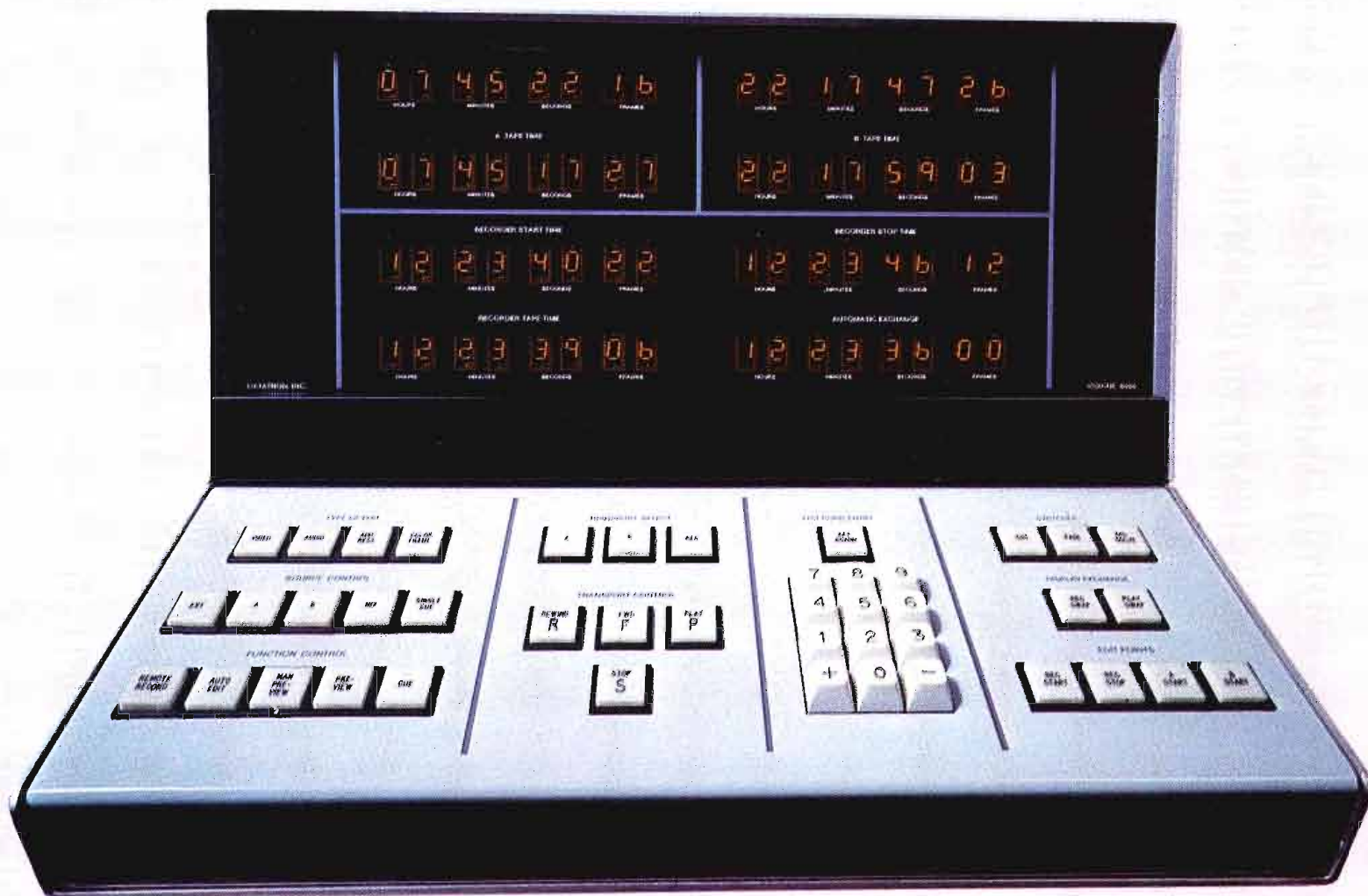

Now you can economically edit on helicals and automatically transfer in minutes to quads

The editing system you've been waiting for. Meet the Editor-In-Chief. Our thrifty new Vidicue 5050. It defies obsolescence. You can expand from two to three machines at will. Or move up in logical steps to a completely automatic on-line, off-line system where editing is done on low cost helicals and transferred in minutes to quads.

Easy to learn, and to operate too. Simple keyboard entry. Visual display of tape position and all edit points. Exclusive jam sync, eliminating forever the need to pre-record SMPTE edit code on tape. A/B rolls, color framing, special effects switching, time base correction. The works!

Yet this remarkable video tape editing system is priced far below competition. In fact, there is none.

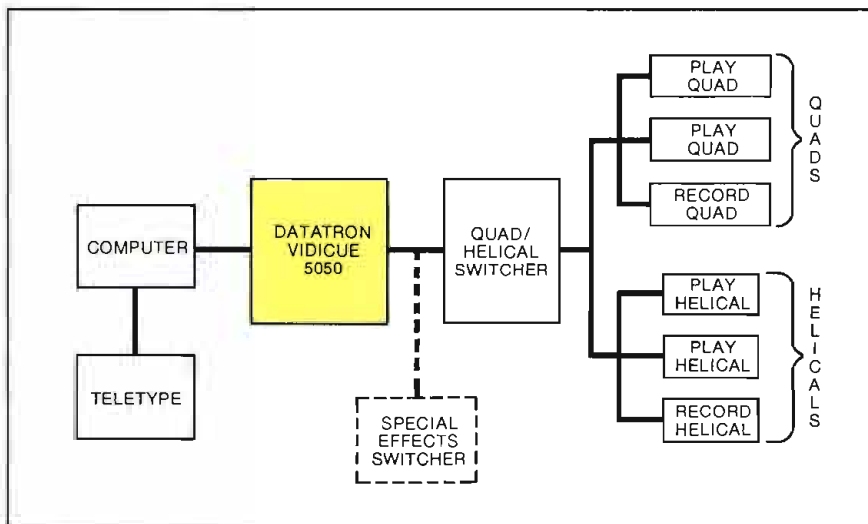

The importance of Jam-Sync.

Our exclusive jam-sync eliminates the need to pre-lay-down the SMPTE edit code on an entire length of fresh tape being used to assemble a show from other tapes. Instead, during pre-roll, the system time code generator is automatically set and sync'd so that time picks up exactly where it left off — to

the frame. This saves quad head wear. Tape wear, too. And is also a great time saver on stop-and-go live production by generating a continuous uninterrupted elapsed time on the tape.

Save your expensive quads for other jobs.

The block diagram tells the story. You can edit on-line or off-line. Do time consuming edits on low cost helicals. Edit event times are stored in the computer

and a punched tape prepared. Using this tape, a precisely edited show can be automatically transferred to quads in minutes.

Your quads have never had it so good. Or your pocketbook either. We'd like to tell you the whole story of our Editor-in-Chief. Why not write or phone today.

datatron, inc. EDITING SYSTEMS DIVISION

1562 Reynolds Ave., Santa Ana, California 92705 (714) 540-9330 • TWX 910-595-1589
Mailing Address: P.O. Box 11427, Santa Ana, California 92711

For More Details Circle (61) on Reply Card

NAB asks for review Of Pay Cable siphoning

The National Association of Broadcasters has petitioned the U.S. Court of Appeals for the District of Columbia to review new Federal Communications Commission rules governing pay-cable siphoning of movies and sports from free television.

NAB contends the new rules are an "unjustified relaxation" of those which now apply and could lead "inexorably to the very sort of siphoning" the original FCC rules were intended to prevent.

In an earlier filing with the FCC, NAB particularly objected to provisions of the new rule which would:

- Permit pay cable systems to show feature films over 10 years old if they have been shown in the same market during the previous three years.
- Permit pay cable to show feature films concurrent with their

contractual availability in the same market.

• Apply a complex formula for cable carriage of sports programs that fails to assure viewers of free TV "the same quality and quantity of sports events to which the public is accustomed."

NAB told the Commission these and other aspects of its new rules are "ripe for reconsideration", that they "contain the seeds" for even broader siphoning, and the Commission might well find itself having to "tell the burglar to leave after he's broken in."

Looking ahead

Man soon may be looking 10 times farther into the universe than ever before, thanks to a device developed by University of Arizona astronomers.

The instrument is a digital television system sensitive enough to detect individual photons of light coming into a telescope and record them for immediate information playback.

The device is basically a special television tube, called a silicon intensified target (SIT) tube. It is so sensitive it records the individual photons, or packets of light energy, as they enter the telescope. The system records 64,000 points of light at once, but soon may be expanded to record 1,000,000.

This information is then sent in digital form directly to a computer which immediately removes the image's "noise" (disturbance) and "cleans it up."

Until now image tubes have recorded information in only one dimension, while the UA device records objects in two dimensions. This advantage, along with the system's efficiency in recording and processing information, will allow astronomers to see objects 100 times fainter than previously possible.

PROFESSIONALS SPECIALIZE

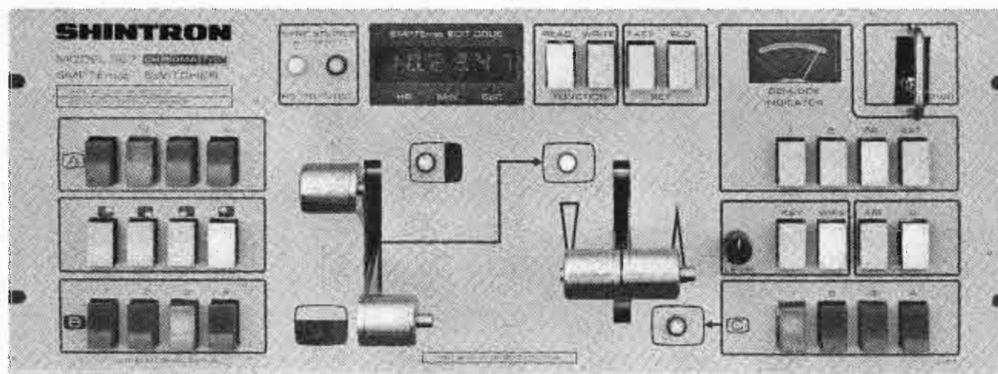

MODEL 367 SMPTEmat Switcher

- Color Switcher
- Color NTSC Genlock Sync Generator
- SMPTE Edit Code Reader/Generator
- Interface Panel

Post Production Switcher

▼ \$3,300 List

CHROMATIC DUET

▲ \$3,780 List

MODEL 370

Special Effects Generator

- 10 Basic Wipe Patterns
- Dissolve to Effects
- Built-in Color Background Generator
- Over 1000 Units Sold

Production Switcher

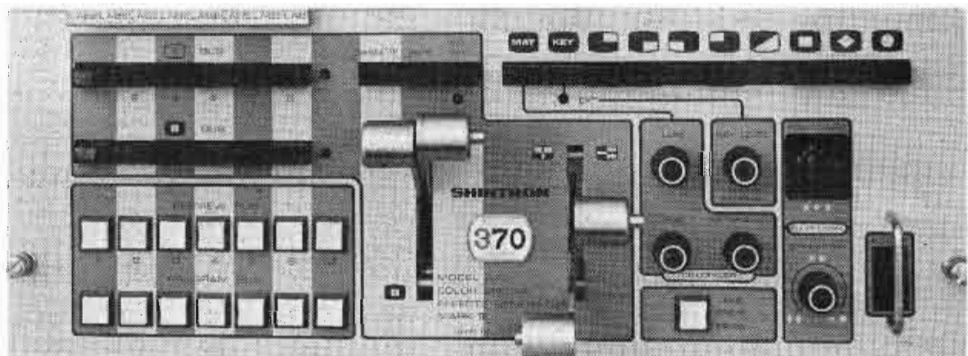

SHINTRON
Cambridge, MA 02142 (617) 491-8700

... The Precision People

Collins announces the next generation of FM transmitters. The Generation 4 line.

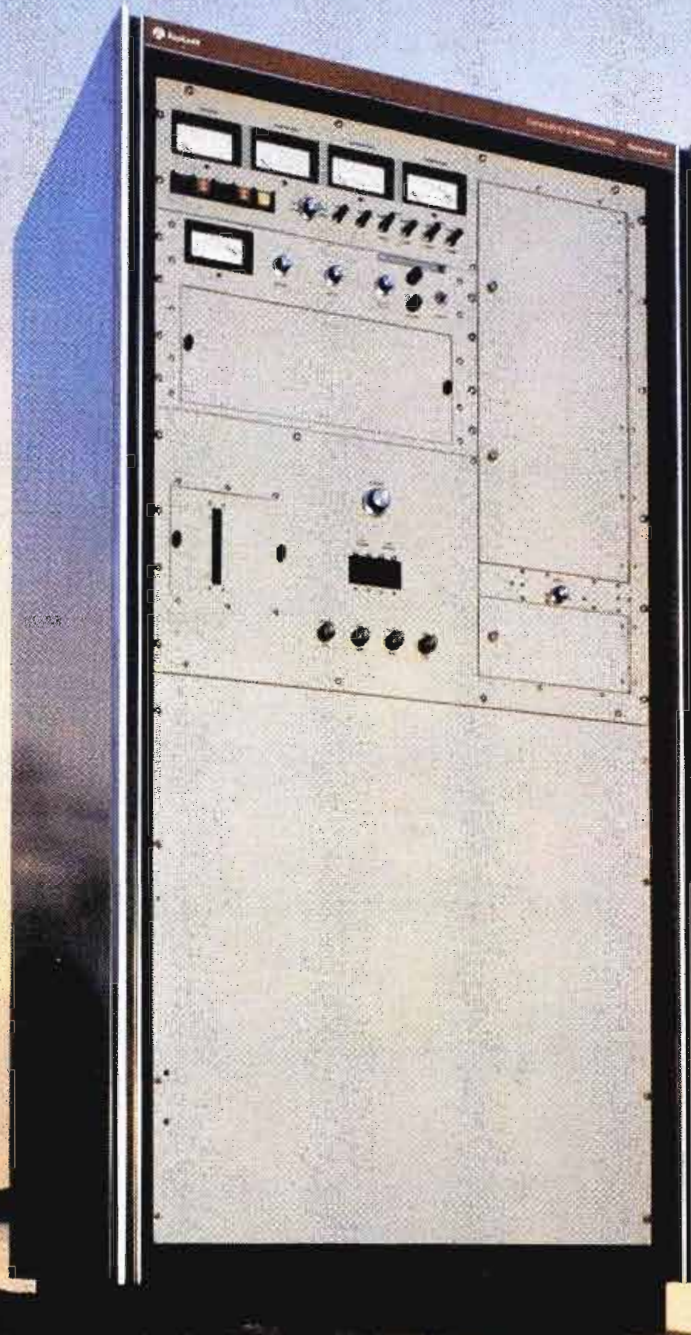

They're here now. Nine new FM transmitters from Collins. Named Generation 4™ because they're a full generation ahead of anything else on the market. And because every feature is the product of 4 decades of Collins broadcast experience.

At the heart of everything is Collins' new, field-proven Phase 4™ Exciter. The best FM exciter available today at any price. Just one part of a system designed to meet the requirements of today's new generation of radio audiophiles with discrete quad compatibility and stringent specifications on all the things that count, like intermod distortion.

Choices? Everything from the big 40 KW

831H-2, the 200 KW 831G-2B, and 2½-KW 831D-2, to the 10-watt 831A-2. And five more models in between. And they're available right now at prices that are going to be a pleasant surprise. With the same superior Collins quality you've come to expect. Backed with the same unexcelled 24-hour parts and field service.

Act now, while we're still able to hold our current pricing. Contact your local Collins Broadcast salesman. Or Broadcast Marketing, Collins Radio Group, Rockwell International, Dallas, Texas 75207. Phone 214-690-5574 or 214-690-5219.



For More Details Circle (63) on Reply Card

Beau...the best replacement motor for Ampex and Scully units.



More and more broadcasters are coming to UMC for Ampex and Scully replacement motors because they realize that the famed Beau inside-out design provides maximum performance as well as rugged construction and compact size. Beau motors are fully factory repairable, too. All standard tape speeds are available. Those are just a few of the reasons why all of the finest new broadcast cartridge machines incorporate the Beau hysteresis synchronous drive as original equipment.

Here's how to order Beau replacement drive motors, direct from the factory. 1) Specify tape speed. 2) Choose from the table below:

Type and Models	Beau Prices
Ampex — Model 440	\$180.00
Ampex — Models 350, 351, 354	\$195.00
Scully — Models 270, 275, 280, 282	\$180.00

Six page catalog available on request.

UMC® BEAU MOTOR DIVISION
UMC ELECTRONICS CO.

460 Sackett Point Rd. North Haven, CT 06473

For More Details Circle (64) on Reply Card

Your Comments and Ideas Are Welcome At Broadcast Engineering

Regional convention For New York SBE

The third annual regional convention and equipment exhibition of the Society of Broadcast Engineers chapters from central New York, northeastern Pennsylvania, and the Binghamton-Elmira area will be held October 17 at the Northway Inn, Seventh North Street, Syracuse, New York.

The three chapters originated the concept of the regional convention.

Equipment manufacturers have indicated that displays will include the latest developments in video tape and portable color cameras.

Convention chairman is Paul Barron, WCNY-TV/FM, Syracuse.

NAB border action

The Chairman of the Board and the President of the National Association of Broadcasters have asked the Secretary of State to "take appropriate action" to resolve difficulties encountered by advertisers on American radio and television stations whose signals are received in Canada.

In a letter to Dr. Henry Kissinger, Board Chairman Wilson C. Wearn (president, Multimedia Broadcasting Co., Greenville, S.C.) and President Vincent T. Wasilewski, said that Canadian cable systems, with the consent of their government, delete commercial advertising from U.S. television programs and substitute their own.

In addition, they said, the Canadian government has proposed legislation that would deny business deductions to Canadian businesses that purchase advertising on U.S. radio and television stations whose signals reach Canadian markets.

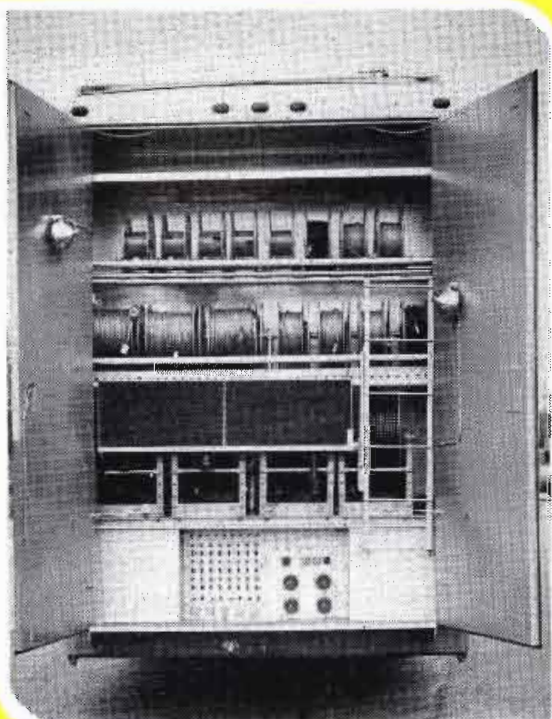

WRAP IT TO GO

Microphone cable, coaxial cable, power cable. Wrap 'em on Hannay reels to go wherever your mobile equipment must go. Hannay reels make cable handling faster, easier and safer to help you set up sooner and stow the cable quickly when the show is over. Choose the reels you need from a wide range of standard and custom models. Send for complete information on Hannay Reels for broadcast cable.



CLIFFORD B. HANNAY & SON, INC., WESTERLO, NEW YORK 12193

Reader

Service

Card

In This

Issue

Is Good

For

12 Months

For More Details Circle (65) on Reply Card

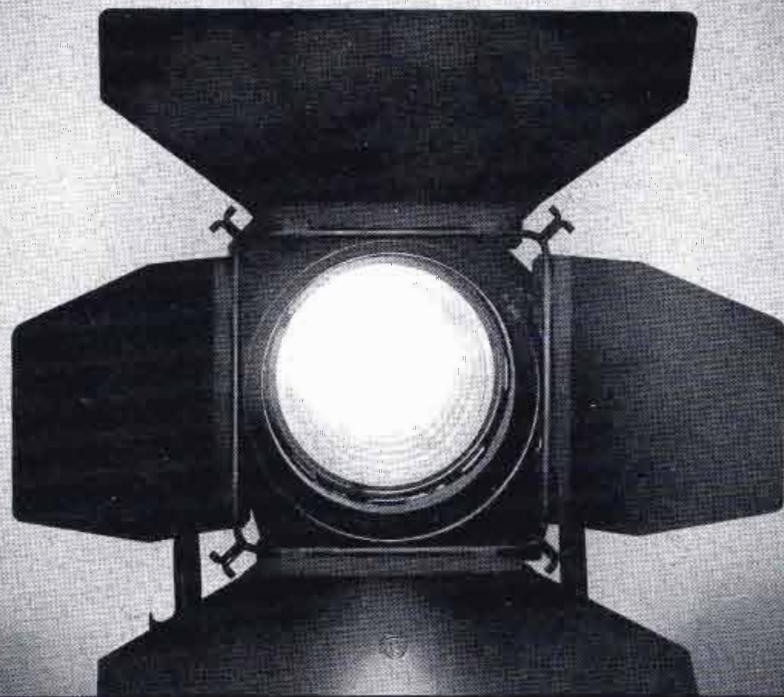

Introducing the dawn of a new era. Flicker-free HMI daylight.

Our new flicker-free Quartz-color daylight spotlights are now available in 575W, 1200W, 2500W and 4000W models. Each unit is complete with lamp, cable and the special flicker-free ballast.

What's more, Quartz-color radiates very little heat, uses power very sparingly (85 - 102 lumens per watt), and produces light like tomorrow's dawn.

The output efficiency of our 2500W model at

5600° K is equal to that of a 10,000W incandescent unit corrected to daylight. And that's a lot of light. In a system that doesn't weigh a ton or cost a fortune to operate. That's Ianiro Quartzcolor. The dawn of a new era in lighting.

For details, write Ed Gallagher, National Director of Television/Motion Picture Sales.

Strand Century Inc
20 Bushes Lane
Elmwood Park, NJ 07407
(201)791-7000 (212)947-2475



STRAND CENTURY INC

A COMPANY WITHIN THE RANK ORGANISATION

For More Details Circle (66) on Reply Card



VIDEO TEST SLIDES...

for fast, accurate camera alignment and consistently true color reproduction!

To assure accuracy and integrity, DSC test slides are produced in an ultra-modern laboratory in a controlled, separately air-conditioned, super clean "white room" environment. Unique, new production and analytical equipment specifically designed by DSC is used to meet the exacting tolerances required by the television industry.

In the interest of maintaining accuracy over long periods of time, all DSC test slides are distributed on a lease basis and are replaced at regular intervals. This method of distribution eliminates the use of obsolete test objects and every engineer knows that he is using only current test materials produced to the very latest standards. Leasing is more efficient and economical, too. Any broken or damaged slides are replaced at no cost to the user.

DSC test materials are widely used throughout Canada, the U.S.A. and in Asia and Europe. To join the Broadcasters, CATV systems, Universities and Manufacturers who are saving time and money aligning their equipment with precision-made DSC video test slides, write or telephone...

D and S Corley Limited

80 Galaxy Boulevard, Unit 3,
Rexdale, Ontario, Canada, M9W 4Y8
Telephone: (416) 678-0511



When in Toronto visit our new Laboratory by the International Airport.

For More Details Circle (67) on Reply Card

PERFECT TIMING

ESE 12 and 24 Hour Digital Clocks

THE ES 112 and ES 124 twelve and twenty-four hour, solid state, six digit clocks. Silent seven segment incandescent displays. Three easy to operate controls: Fast Advance, Slow Advance, and Hold. Built to deliver a lifetime of service. Available with the following options to provide an even wider range of applications. BCD Output; Crystal Timebase; Remote Connector with or without Six Foot Cable and Pushbutton set; 220V AC, 50Hz; Nine or Nineteen inch Anodized Aluminum Front Panel; Slave; Three Wire Cord with Molded Plug. Also available in Kit form. **Price \$130.00**



THE ES 142 and ES 144 twelve and twenty-four hour, MOS, solid state digital clock/thermometers. Display simultaneously: 6 digits of time (hours, minutes, seconds) and 3 digits of temperature (-50°F to +150°F) in planar, gas discharge displays .55" high. Units come equipped with Temperature Probe and six foot cord. With the exception of the Nine inch Front Panel the ES 142 and ES 144 are available with the same options as the ES 112 and ES 124. **Price \$225.00**

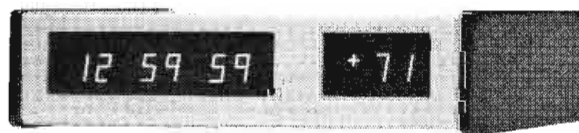

THE ES 132 and ES 134 twelve and twenty-four hour 12V D.C., MOS, solid state six digit clocks. LED display. Black anodized aluminum case. Available with same options as ES 112/124 plus A.C. operation with Crystal or Line Frequency Timebase. **\$200.00**



WRITE, WIRE OR CALL TODAY

505½ Centinela Avenue • Inglewood, California 90302 • (213) 674-3021

For More Details Circle (68) on Reply Card

NAB schedules Regional radio Conferences

The NAB and the Radio Advertising Bureau have announced a series of regional radio conferences jointly sponsored by the two organizations to be held this fall. The regional radio conventions will replace the NAB Fall Conferences and the RAB Management Meetings.

In what was termed "an historic first," Vincent Wasilewski and Miles David said in a joint statement that "these regional radio conventions will cover the entire spectrum of interest to broadcasters. They will include government relations, sales, general management, engineering, legal, FCC problems, and many other subjects. For the first time, a combined force of NAB and RAB will offer the radio broadcaster a program tailored to all of his needs. We believe these conferences will uniquely serve the needs of radio in a better way than has ever been done before. By combining the respective conferences, broadcasters will get the benefit of the activities of both organizations, but will only have to take the time to travel to a single meeting." Members of either NAB or RAB, whether or not they are members of both organizations, will be able to attend the Fall Regional Radio Conferences. Among the elements of the conventions will be the following:

- The Plugged Up Faucet—up to 3 billion dollars of co-op advertising, now largely denied to radio, can flow into radio stations. Ed Crimmins, the country's leading authority on co-op advertising, will discuss the practical problems of getting a piece of that business.
- How to Talk to Your Congressman—the do's and don'ts, the positives and negatives: what he will respond to positively and what he will respond to negatively.
- A session on General Management and Engineering.
- A session on Finding and Training a Salesperson.

(Continued on page 56)

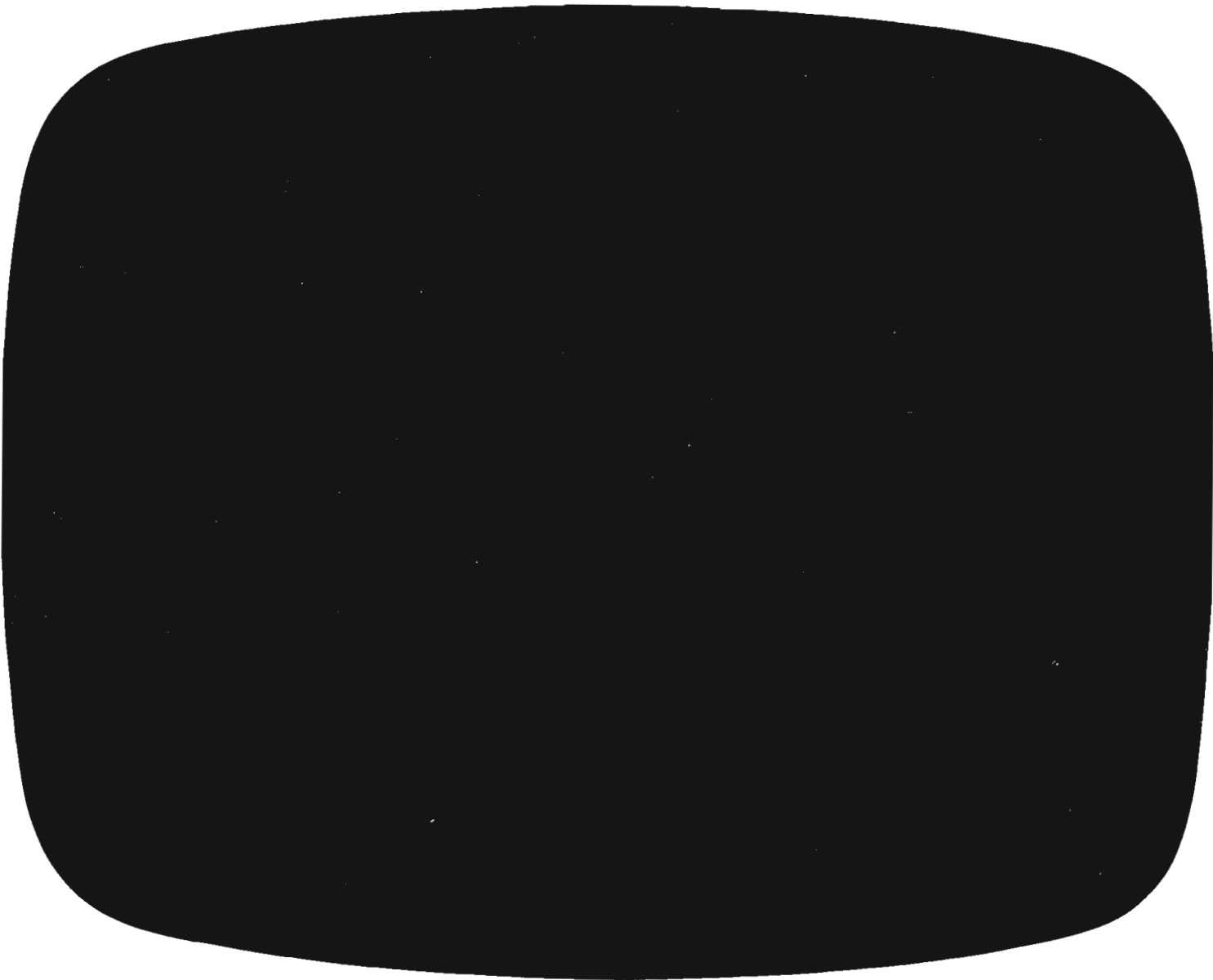

This is a picture of your picture.

(during a power failure)

Yours may be the finest broadcast facility around. But you aren't transmitting much of a signal when the power is off.

Admittedly, chances of a prolonged power failure aren't great. Yet they do happen.

That's where Onan standby power comes in.

It provides "insurance" against a crippling power outage.

It doesn't have to replace utility power totally. But it can keep you on the air.

It can keep heating and ventilating equipment working. Elevators running. Lighting in critical areas burning.

So when you're ready to talk seriously about standby power for your TV or radio station, remember this:

Onan is the world's number one builder of standby power plants.

Only Onan gives you total system responsibility for the engine, generator and load transfer controls. We build 'em, test 'em, install 'em and

certify that they will perform as rated. Only Onan warranties the complete system for 5 years.

Call your local Onan Distributor (in the Yellow Pages under Generators) or send coupon.

FREE STANDBY POWER BOOKLET BE-75

Onan
1400 73rd Avenue N.E.
Minneapolis, Minnesota 55432

Please send a copy of "Standby Power . . . who needs it?" to:



Name _____

Firm _____

Address _____

City _____ State _____ Zip _____



**ELECTRIC GENERATOR SETS •
LOAD TRANSFER CONTROLS • INDUSTRIAL ENGINES**

For More Details Circle (69) on Reply Card

Here's what's new in FM monitors



Frequency Monitor FF-80

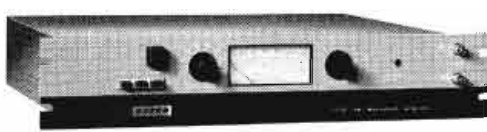

Modulation Monitor FT-80

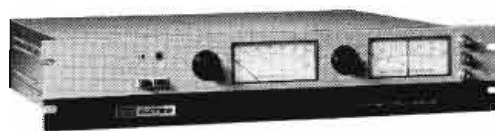

Stereo Monitor FS-80



SCA Monitor FC-80

- GREATER ACCURACY
- LONG TERM RELIABILITY
- COMPLETE FLEXIBILITY
- EASE OF OPERATION

These are just a few of the reasons it makes sense to contact the only major manufacturer of FM transmitters that also designs and builds FM monitors. To learn more about Harris' "new generation" of FM monitors, write Harris Corporation, Broadcast Equipment Division, 123 Hampshire Street, Quincy, Illinois 62301.



HARRIS
COMMUNICATIONS AND
INFORMATION HANDLING

For More Details Circle (70) on Reply Card

Now, in our corner the world heavyweight champions...

Introducing, from Quick-Set, the professional champs in television and microwave support equipment. We've acquired the Houston Fearless product line of studio pedestals, heads, tripods and dollies. These popular heavy duty units accommodate a complete range of studio/remote requirements.

Stability, smooth action and quality are the key ingredients in every Quick-Set product. This is why we can offer a lifetime guarantee against defects in materials and workmanship. We back this with worldwide distribution and service to give you the professional support you deserve.

Send for our complete catalog.



instrument positioning equipment

3650 Woodhead Drive, Northbrook, Illinois 60062
312/498-0700 Telex: 72-4362

For More Details Circle (71) on Reply Card

(Continued from page 54)

NAB conferences

- A session on Legal Problems—how to stay out of trouble, and how to get out of trouble if you're in it.
- A session on the latest in Audience Research and how it can help the radio station.
- A session on Future Formats for Radio.
- A session with an FCC Commissioner and members of the top staff to go over the great variety of issues before the FCC that affect radio: radio ascertainment, the short-form license renewal, political broadcasting in radio, problems of commercial regulations, fairness, etc.

The Regional Radio Conventions will be held on the following dates, which are the same as for the previously announced NAB Fall Conferences:

Oct. 13-14: Atlanta/Fairmont; Oct. 16-17: Boston/Marriott; Nov. 10-11: New Orleans/Monteleone; Nov. 13-14: Chicago/Pick Congress; Nov. 17-18: Denver/Brown Palace; and Nov. 20-21: San Francisco/Fairmont.

A separate seminar for radio program directors will be held on the first day of each convention. Details of that seminar will be announced in a separate release.

A television session will be held concurrently, but entirely separately, on the second day of the convention. The programming for the television sessions will be announced at a later date.

Commission extends Translator ad time

The Commission has extended from 20 to 30 seconds, the limitation on locally originated slide and voice announcements by UHF and FM translator stations.

The extended time would eliminate viewer confusion while not altering the rebroadcast nature of the translators, the FCC said.

The present rules permit UHF translators to transmit locally generated signals such as still photographs, slides and recorded announcements for a period not to exceed 20 seconds at intervals of no less than one hour. The rules also

(Continued on page 58)

INNOVATIONS in coaxial cables



guarantees mechanical and electrical performance.

The choice is yours at Cablewave Systems . . . 0.180" to 3 1/8" outer conductors of smooth wall aluminum or corrugated copper; dielectric insulators of air (extruded spiral polyethylene or special helix designs), foam polyethylene center conductors of copper or copper clad aluminum . . . each engineered to excel in its area of application whether it be phasing lines for broadcasting, microwave antenna feeders, or delay line applications and each with a full range of connectors and accessories.

By giving you the widest selection of cable types, connectors, sizes and lengths through new and patented manufacturing techniques, plus a complete selection of compatible connectors, you are assured of getting the ideal cable assembly for your specific application — there's no compromising. Cablewave Systems Inc., 60 Dodge Avenue, North Haven, Conn. 06473, 203-239-3311.

Call or write for catalog 401A and get all the details on our complete line of Coaxial Cables and accessories.

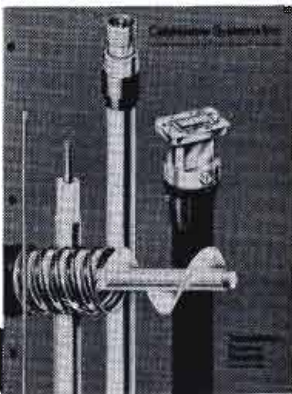

now, that's **INNOVATION**

Cablewave Systems Inc.

For More Details Circle (72) on Reply Card

AUDIOWAVES

Choice is the name of the game
in RCA audio tape equipment.

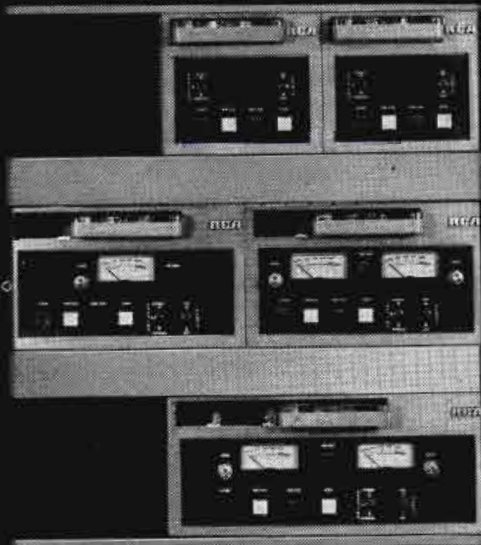

We don't think one or two kinds of tape recorder—or even three or four—are enough to be sure of meeting your particular needs.

So RCA offers more than 200 separate models: choose different speeds, choose from reel-to-reel or cartridge, choose mono or stereo, choose record/playback or playback only models. And choose a lot more from our extensive accessory list.

And if you choose to talk to your RCA representative about it, he can fill in the details. RCA Broadcast Systems, Camden, N. J. 08102.

RCA

Microphones • Consoles • Tape and Transcription Equipment
Automation Systems • Amplifiers and Speakers

For More Details Circle (73) on Reply Card

LIVE ELECTRONIC JOURNALISM

NURAD'S ENG ANTENNA SYSTEMS AND COMPONENTS FOR INSTANT REMOTE TV BROADCASTING ARE NOW AVAILABLE IN THE 2.0 GHZ, 7.0 GHZ, & 13.0 GHZ BANDS.

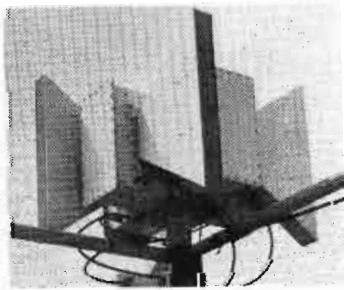

NURAD 2 GHZ QUAD
POLARIZED ANTENNA
INSTALLATION

NURAD QUAD POLARIZED MICROWAVE ANTENNA SYSTEMS ARE OPERATING OR WILL SOON BE IN SERVICE IN SOME THIRTY MAJOR METROPOLITAN AREAS.

NURAD

INCORPORATED

2165 DRUID PARK DRIVE

BALTIMORE, MARYLAND 21211
AREA CODE 301 - 462-1700

For More Details Circle (74) on Reply Card

Translators

(Continued from page 56)

permit the use of locally generated voice announcements on FM translators under the same general conditions.

In its Notice of Proposed Rule-making, issued in December 1972, the Commission said it recognized the contention of the National Translator Association (NTA) that a 20-second limitation had proved unworkable.

NTA stated that although at the time the rule was adopted television stations (the signals of which were rebroadcast by the translators) were using 20-second announcements, the general practice then changed to the use of 30-second announcements. As a result, it pointed out, when a translator station originated its own 20-second announcements there was a 10-second residual announcement from the primary station that appeared on the receivers of the translator viewers, causing confusion.

In adopting the 30-second period for UHF translators, the Commission said it would serve to eliminate the confusion to viewers and enhance the capacity of UHF television translator stations to acquire needed financial support. In the interest of consistency, the Commission also changed the FM translator time limit from 20 to 30 seconds.

NEPCON show opens October 7

Modern electronic devices have fascinated a whole generation of Americans because of their small size, compactness and ability to perform an amazing variety of functions. Equally interesting, however, are the techniques for manufacturing these devices and this will be the prime theme of a trade Show coming to the Chicago area, October 7-9. This Show is called NEPCON '75 CENTRAL. It will be held at the Arlington Park Exposition Center, in Arlington Heights, a suburb of Chicago near O'Hare International Airport.

NEPCON CENTRAL is the Midwest version of Shows also held in the Western and Eastern United

(Continued on page 60)

DELTA ELECTRONICS

THE AM BROADCASTER'S SINGLE SOURCE FOR . . .

- DIGITAL ANTENNA MONITORING
- TRANSMITTER/ANTENNA CONTROL
- MEASUREMENT/TEST INSTRUMENTS

Digital Antenna Monitoring

DAM-1 DIGITAL ANTENNA MONITOR – FCC type approved. Provides digital readout of amplitude, ratio and phase. Also available: DAMA-1 Base Current Adapter for remote digital readout of antenna base currents; DAMA-2 Analog Converter to Interface DAM-1 Monitor with existing analog remote control systems; DAMX-1 to extend capacity of DAM-1 to arrays up to 12 towers.

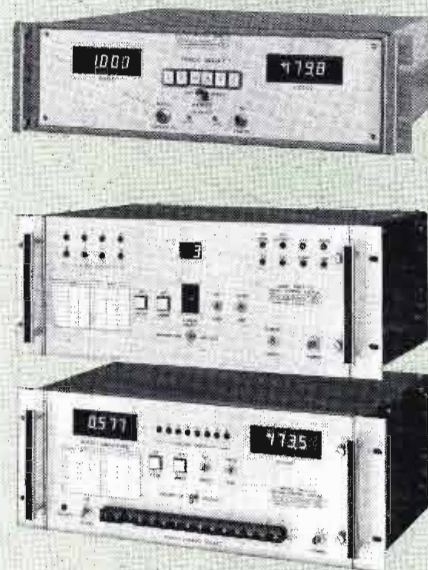

Transmitter/Antenna Remote Control

TMCS-1 TRANSMITTER/ANTENNA REMOTE CONTROL SYSTEM – Provides digital readout and control of the DAM-1 and transmitter over a single voice channel. Other systems available: DAMR-1/DAML-1 for digital readout and control of the DAM-1 only; DAMH-1 for use where the remote control point is close enough to the monitor to permit hardwired inter-connection.

Measurement/Test Instruments



OIB-1 OPERATING IMPEDANCE BRIDGE – For antenna system measurements under transmitter power. May also be used as a conventional bridge.

RG-1 RECEIVER/GENERATOR – Two-watt signal generator with a tracking detector. Built-in rechargeable battery power supply for full portability in making low power impedance measurements. For use with OIB-1 or other RF bridges.

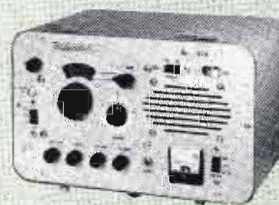

CPB-1 COMMON POINT IMPEDANCE BRIDGE – Monitors common point impedance continuously. Designed for permanent installation.

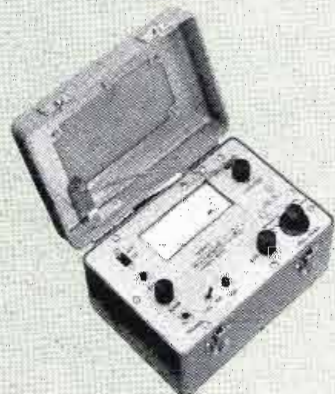

FSM-1 FIELD STRENGTH METER – Single frequency meter for simple, error-free, economical field strength measurements. Plug in modules for multi-frequency and harmonic measurements.

Other Products

TCT-() TOROIDAL CURRENT TRANSFORMER – Provides accurate, stable R. F. samples for phase and amplitude measurements. Available in three sensitivities. Also available: TCTR-1 Compensated Rectifier Circuit to provide DC voltage for remote current measurement when used with TCT-().

MJ-50 METER JACK – A make-before-break in line jack assembly that permits "hot" insertion of OIB-1 Bridge or Ammeters.

DELTA ELECTRONICS



5534 PORT ROYAL ROAD
SPRINGFIELD, VIRGINIA 22151
TELEPHONE: 703/321-9845 TWX: 710-831-0620

For More Details Circle (75) on Reply Card

PERFECT TIMING

The World's Finest Stopwatch:



Cronus

The world's finest most versatile hand held stopwatch because Cronus is actually four stopwatches in one! With Standard Start/Stop, Taylor/Sequential, Split and Event/Time-Out functions. All with 1/100 of a second timing resolution and 0.001% Quartz Crystal timebase accuracy. Dependable Solid State C/MOS Circuitry backed by a 2 year warranty. Your choice of timing ranges: 24 hours with the Cronus 1 and 60 minutes with the Cronus 2. And there's more...



Bright easy to read red LED's with Anti-reflective filter for high ambient light. Plus, the Low Battery Indicator lights when it's time to recharge the nickel cadmium Cronus 1 batteries or replace the AA disposable Cronus 2 batteries. Perfect timing under nearly any conditions with a temperature drift of $\pm 0.025\%$ from -40° to $+150^{\circ}$ F. All this in a compact, $4\frac{1}{2} \times 2\frac{1}{4} \times 1\frac{1}{4}$ inches, 6 ounces, water resistant, unbreakable plastic case. Want more? The Cronus 1 is available with an optional desk base which transforms it into either a desktop or portable 24 hour clock. Cronus.

CRONUS 1 \$185.00

CRONUS 2 \$125.00

505 1/2 CENTINELA AVENUE

• INGLEWOOD, CALIFORNIA 90302

• (213) 674-3021

For More Details Circle (76) on Reply Card

WRITE, WIRE OR CALL



NEPCON

(Continued from page 58)

States, Canada, Europe and Japan. NEPCON stands for the "National Electronic Packaging and Production Conference." The word "packaging" pertains to what engineers call "prototype development" of the physical model or "package" of an electronic device. It is this physical model which manufacturing departments follow in producing electronic devices in quantity.

A large number of booths at NEPCON '75 CENTRAL will display the latest machines, tools, materials, hardware, components, supplies and production and test equipment required to manufacture all the modern types of electronic circuits and equipment used today.

NAB convention

The Executive Committee of the National Association of Broadcasters has applauded the cooperation between NAB and the Radio Advertising Bureau.

The committee was particularly pleased with the exciting program developed by the two organizations for the Fall Regional Radio Conventions.

In addition to the Fall Regional Radio Conventions, the two organizations are currently involved in developing ways to increase radio's share of co-operative advertising dollars. RAB is making presentations to manufacturers, companies and agencies who engage in co-op advertising. NAB has retained the services of noted co-op authority, Edward C. Crimmins, to investigate current FTC guidelines.

Because of these efforts and the obvious benefits to all radio broadcasters, the committee urged the NAB staff to continue to work closely with RAB on other projects.

A subcommittee of NAB's Convention Committee, consisting of Radio Board chairman, Harold Krelstein, and vice chairman, V. Kay Melia, will investigate the possibility of programming a Radio Day at the 1976 Convention in cooperation with the Radio Advertising Bureau. The subcommittee plans will be presented to the full Convention Committee at their meeting in September in Chicago.

Change
Sound to
Silence
with a



TABERASER

This rugged, heavy duty bulk tape eraser wipes sound from all magnetic tapes, cartridges, cassettes and magnetic film stock; handling up to 2".

It erases with minimum residual noise because the field automatically diminishes at the end of each 30-second cycle.

A thermal control and blower keeps the unit below 71° C.

Available for 60Hz or 50Hz operation.

For the distributor in your area—Call or write:

TABER Manufacturing & Engineering Company
2081 Edison Ave. • San Leandro, Ca. 94577 • (415) 635-3831

For More Details Circle (77) on Reply Card

TV RECEIVING EARTH STATION

- Antenna meets all FCC requirements for both receive and transmit
- Gain 51dB at 3.95 GHz. G/T of 26 when using GaAs FET pre-amp with 3dB NF at 20° elevation. Video S/N 52dB minimum with 34dBw EIRP
- Double reflector feed system for superior cross polarization discrimination. (Much better than prime focus!)
- Antenna erectable without crane
- Guaranteed system performance



ANDREW

Andrew introduces a new complete earth station . . . 10 metre antenna, LNA, receiver, connecting and pressurizing systems . . . plus transportation to site, installation and checkout if you want it.

More than 40 Andrew earth station antennas are now in service in the Canadian domestic satellite system of TELESAT Canada. 100 Andrew earth station antennas will be used in the Alaska Small Earth Station Program.

Call or write for complete information.

ANDREW CORPORATION, 10500 W. 153rd St., Orland Park, IL, U.S.A. 60462 Telephone: (312) 349-3300
ANDREW ANTENNA COMPANY LTD., 606 Beech St., Whitby, Ontario, Canada L1N 5S2 Tel: (416) 668-3348
ANDREW ANTENNA SYSTEMS, Lochgelly, Fife, Great Britain KY5 9HG Telephone: (0592) 780561
ANDREW ANTENNAS, 171 Henty St., Reservoir, Victoria, Australia 3073 Telephone: (03) 460-1544
ANDREW ANTENAS LIMITADA, Caixa Postal 600, 18100 Sorocaba, São Paulo, Brasil Tel: Sorocaba 2-8900

For More Details Circle (78) on Reply Card



COMMUNICATION MEDIAS

P.O. BOX 54
ALLENTOWN, PA. 18105

DISTRIBUTORS OF:

**SPOTMASTER • FIDELIPAC • ROH •
RUSSCO • ELECTRO-VOICE • OTARI
• RAMKO • SCOTCH • STANTON •
NORTRONICS • SHURE • TELEX
• SENNHEISER • MAGNECORD •
AND VIKING**

Broadcast Component Distributors

**SALES • PARTS • SERVICE
• EQUIPMENT LEASING •**

**COMMUNICATION MEDIAS
PHONE (215) 437-0607**

For More Details Circle (79) on Reply Card

**On
the Air®**

with a full range of high reliability

TV TRANSLATORS

TV TRANSMITTERS

TV AMPLIFIERS

**@j acrodyne
industries, inc.**

21 Commerce Drive • Montgomeryville, Pa. 18936
(215) 368-2600 TWX 510-661-7265

For More Details Circle (80) on Reply Card

FCC proposes schedule For 2.5 kW stations

The Commission has proposed amending its fee schedule to specify filing and grant fees for stations with authorized power of 2.5 kW.

The Commission noted that on June 27 of this year it adopted rules that, among other things, provided for standard broadcast stations with authorized power of 2.5 kW as an intermediate step between the present 1kW and 5 kW classifications now specified by the rules.

It said its current fee schedule does not provide for applications for construction permits for new stations and major changes in existing stations that request facilities specifying 2.5 kW power.

It said therefore it proposed to charge a \$300 filing and a \$2,025 grant fee for applications for new daytime-only standard broadcast stations or for a major change in existing stations requesting 2.5 kW power.

For an application for an unlimited-time station (either new or major change) requesting a power of 2.5 kW, the filing and grant fees would be \$600 and \$4,050, respectively, the FCC said.

The action would amend Section 1.1111(a)(1) of the rules.

Midwest film and TV Seminar set for Oct. 16

First-hand exposure to new technical developments in the U.S. film and television industries will be featured at the third annual Midwest Seminar on Videotape and Film, to be held in Chicago, October 17-18.

Hands-on demonstrations of sophisticated film and tape editing equipment—from a multi-plate flat-bed film editing unit to the newest in videocassette editing hardware, will be available to Seminar participants.

A demonstration of electronic news gathering techniques by John D. Callaway of WTTW/Channel 11, Chicago, will illustrate how the portable production equipment and modern editing techniques of broadcast journalism apply to industrial and educational situations.

"SynthaVision," a computer-based system for generating complex film animation from flat artwork, will be demonstrated by its developer, Dr. Phillip S. Mittelman of Mathematical Applications Group, Inc. (MAGI), New York.

Joining Callaway and Mittelman as Seminar speakers will be an array of leaders in the A-V industry. They are, Tom Hope, publisher of Hope Reports; Elmer Friman of the Indiana University School of Medicine; Robert B. Montague of General Dynamics; Edward A. Reichard, Consolidated Film Industries; Robert B. Pfannkuch, Bell & Howell; Wilton R. Holm, Association of Motion Picture and Television Producers; and Jack B. Spatafora, educa-

(Continued on page 64)



Creation of the new Calibration Standard filled a need... the acceptance of Stanton's 681 TRIPLE-E is unprecedented!

It was no accident!

The Recording Industry needed a new calibration standard because it had been cutting discs with higher accuracy to achieve greater definition and sound quality.

So, the engineers turned to Stanton for a cartridge of excellence to serve as a primary calibration standard in recording system check-outs.

The result: the *new* calibration standard, The Stanton 681 TRIPLE-E.

The rest is history!

Major recording studios adopted it . . . as did many of the smaller producers. Radio stations across the world put the 681 TRIPLE-E on all of their turntables, both for on-the-air broadcasting and for disc-to-tape transfer.

And, audiophiles by their purchases have voted it the outstanding stereo cartridge available.

The Stanton 681 TRIPLE-E offers improved tracking

at all frequencies. It achieves perfectly flat frequency response beyond 20 kHz. Its ultra miniaturized stylus assembly has substantially less mass than previously, yet it possesses even greater durability than had been previously thought possible to achieve.

Each 681 TRIPLE-E is guaranteed to meet its specifications within exacting limits and each one boasts the most meaningful warranty possible. An individually calibrated test result is packed with each unit.

As Julian D. Hirsch of Hirsch-Houck Labs wrote in Popular Electronics Magazine in April, 1975: "When we used the cartridge to play the best records we had through the best speaker systems at our disposal, the results were spectacular".

Whether your usage involves recording, broadcasting, or home entertainment, your choice should be the choice of the professionals . . . the STANTON 681 TRIPLE-E.



Write today for further information to Stanton Magnetics, Terminal Drive, Plainview, New York 11803

For More Details Circle (81) on Reply Card

Seminar

(Continued from page 62)

tional TV director of the New Trier (Illinois) Township Schools.

The Seminar is devoted to stimulating the use of film and videotape as interrelated media in business, education, medicine, and other fields. A non-profit event, it is sponsored jointly by the Chicago Film Council, the Chicago Television Guild, and Chicago chapters of the Information Film Producers of America (IFPA) and the Society of Motion Picture and Television Engineers (SMPTE).

Reservations for the Seminar, and further infor-

mation, can be obtained by writing to Midwest Seminar on Videotape and Film, P.O. Box 11376, Chicago, Ill. 60611. Reservations are \$45 if made before Oct. 1, and include a party on Oct. 17 and lunch on Oct. 18. The Seminar will be held at the Holiday Inn near Chicago's O'Hare Airport.

Last year the Seminar drew participants from ten states and Canada.

NAB regional conventions Will aid directors

On the first day of the six Regional Radio Conventions sponsored by the National Association of Broadcasters and the Radio Advertising Bureau, NAB will hold a separate, concurrent seminar for radio program directors.

Burns Nugent, NAB executive vice president for station relations, said the seminars, to be conducted by Bob Henabery Associates of New York City, will deal with actual programming problems and solutions.

Mr. Nugent pointed out that the seminars are designed to provide program directors with an opportunity to meet with their counterparts, to profit from the experiences of prominent innovators, to share the successes of highly regarded programmers and to enhance their own professional opportunities.

The afternoon sessions will feature nationally-known management/program director teams.

The program directors and radio station managers

(Continued on page 66)

FOR ALL YOUR AUDIO/RF NEEDS

At Orange County we're much more than just product distributors—we're system designers who design for people. Contact us for "off-the-shelf" products or custom engineering. Or if you know where you are going but don't know what you need, ask us! You have a right to expect that we do everything—from design through complete installation.

AGC Amplifiers	Stereo & SCA Monitors
Compressing Amplifiers	Antenna & Phase Monitors
AM & FM Limiters	Frequency Monitors
Distribution Amplifiers	Phasing Units & Networks
Monitor Amplifiers	Audio Preamplifiers—
Power Amplifiers	All Types
Ice Warning Systems	Turntable Preamplifiers
FM, UHF, VHF Antennas	Radomes
Tone Arms	Tape & Cartridge Recorders
Cabinets, Consoles, Racks	Logging Recorders
Coaxial Cable-Rigid & Flexible	Voltage Regulators
Cartridge Machines	Remote Control Systems
AM & FM Consoles	Reverberation Systems
TV Consoles	Speakers & Enclosures
Recording Consoles	Studio Audio Systems
Custom Equipment & Systems	Audio Switchers
AM & FM Exciters	Audio Recording Tape
Stereo & SCA Exciters	Tape Cartridges
Equalizers—	Tape Duplicators
Fixed & Tunable	Mastering Devices
Stereo & SCA Generators	Cartridge Racks
Headphones	Cartridge Splice Finders
Intercom Systems	Test Tapes
Jackfields & Patch Panels	Active Audio Transformers
Limiters/Compressors	AM Transmitters,
AM & FM Maintenance Services	250w-50Kw
Microphones—All Types	FM Transmitters, 10w-50Kw
Microphone Splitters	Turntables & Accessories
STL Microwave Systems	Turnkey Equipment
AM & FM Monitors	Installation
	Systems Engineering
	Transmitting Vacuum Tubes

For information or service call us first

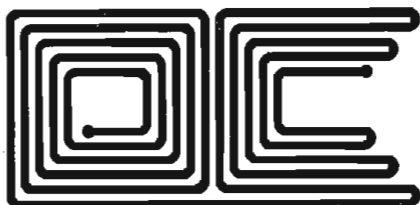

Serving Canada and the NW United States
ORANGE COUNTY ASSOCIATES
 1079 Autumnwood Drive
 Winnipeg, Manitoba, Canada R2J 1C6
 Phone (204) 475-1026

For More Details Circle (84) on Reply Card

Reader Service Cards In This Issue Are Good For One Year

Buyer's Guide Begins On Page 69

ALUMINUM KNOBS



Don't just take our beautiful KNURLED KNOBS for granted! They're different because they are completely machined, including the knurl and then carefully anodized. This takes a little more time and effort, but we think it's worth it. You'll agree too, when you see these knobs.

Call us today at (617) 685-4371 for samples and prices.

For More Details Circle (82) on Reply Card

MINIATURE TOGGLES

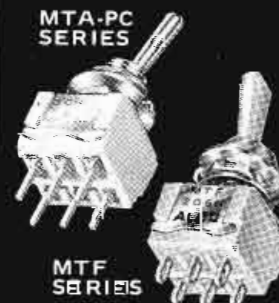

Switches with molded-in heat sink terminals. Fine silver contacts with gold finish for easy soldering. Internal and external voltage barriers between poles & terminals. Anti-push-in toggle. PC or wired terminals. Many lever options and styles. Rated 3 Amps @ 250VAC or 6 Amps @ 115VAC.

Call (617) 685-4371 for samples, prices & technical information.

ALCO ELECTRONIC PRODUCTS, INC.
 NO. ANDOVER, MASS. 01845 U.S.A.

Tel: (617) 685-4371 TWX: 710 342-0552

A SUBSIDIARY OF **AUGAT** INC.

For More Details Circle (83) on Reply Card

BROADCAST ENGINEERING

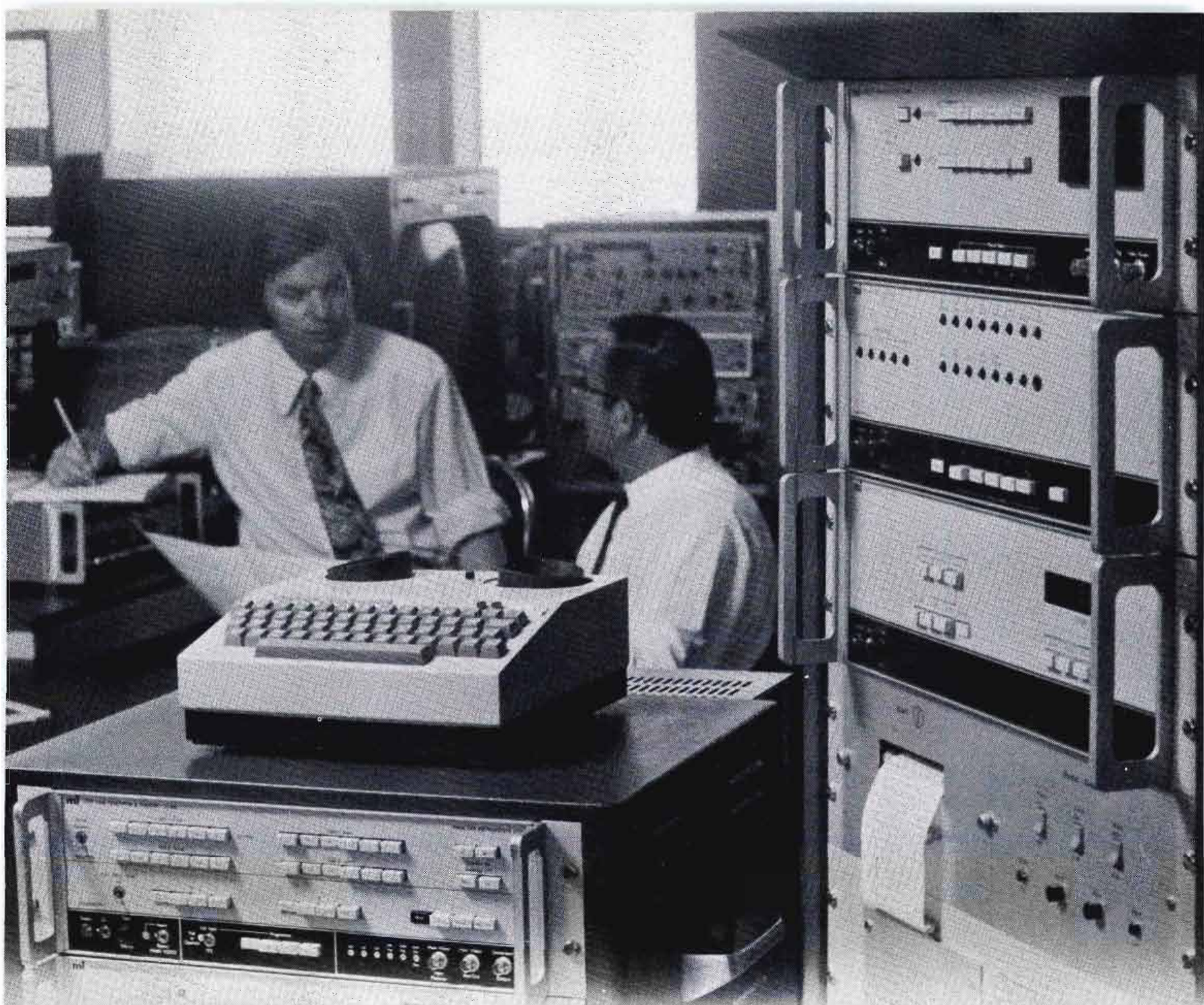

mi automatic TV monitoring sets free the engineers

Time was when highly trained transmission engineers had to waste their brains (and their time) watching a battery of waveforms and pictures — instead of concentrating on work more worthy of them.

Now the TV monitoring scene has been transformed. For TF2914 Insertion Signal Analyser, TF2915 Data Selector together form THE FIRST COMMERCIALY AVAILABLE AUTOMATIC TRANSMISSION MONITORING SYSTEM. In conjunction with a test line signal generator and inserter (such as **mi** TF2913), it will automatically cycle through the measurement of all the important parameters of the test line

signal from five separate inputs. Comparison with pre-selected limits is continuous, and an 'out of limits' fault can initiate executive action by automatic switching to standby, with remote alarm indication and simultaneous data transmission of fault location. Up to 16 parameters can also be measured manually by means of push-button selection and a self-contained digital voltmeter. Versions are available for all national and international standards. Systems are now operating in seven countries. Applications include broadcast monitoring, common carriers and satellite operations. Call **mi** and discuss your application.

mi **MARCONI INSTRUMENTS**
DIVISION OF MARCONI ELECTRONICS INC.

100 STONEHURST COURT, NORTHVALE, NEW JERSEY 07647 • TELEPHONE: (201) 767-7250 • TWX: 710-891-9752

For More Details Circle (85) on Reply Card

747R-1

NAB (Continued from page 64)

attending the conventions will attend a joint luncheon to hear Hugh Finnerty. Mr Finnerty's topic "Boss or Leader" is designed to encourage people to get the most out of themselves and others.

There also will be a red carpet reception at the conclusion of the meetings.

Guest broadcasters for NAB Program Directors' Seminars include:

Atlanta, Oct. 13—"The Creative Team," Warren Potash, manager, WBAP (Capital Cities) Fort Worth, Tex., and Bob Harper, program director, WKBW (Capital Cities), Buffalo, N.Y.

Boston, Oct. 16—"The News Team," Bill Scott, news director, WINS (Group W), New York; John Hultman, news director, WBBM (CBS), Chicago; and John Webster, program director, WERE (Atlantic), Cleveland.

New Orleans, Nov. 10—"The Management Team," Ed Newsome, manager, and Scott Burton, program director, KSD, St. Louis.

Chicago, Nov. 13—"The News Team," Frank Barnako, news director, WRC (NBC), Washington, D.C.; Lou Adler, news director, WCBS (CBS), New York; and Ed Ripley, program director, WJW (Storer), Cleveland.

Denver, Nov. 17—"The Management Team," Marty Greenberg, manager, WLS (ABC), Chicago, and John Gehron, program director, WLS.

San Francisco, Nov. 20—"The Creative Team," Paul Drew, national program director, and Harvey Mednick, national promotion director, RKO Radio, Los Angeles.

NAB petition FCC

The National Association of Broadcasters has petitioned the Federal Communications Commission to require cable television systems which provide aural origination programming to subscribers to carry the signals of all local radio stations where off-the-air signal reception is precluded by cable input.

It urged the Commission to initiate proceedings looking towards adoption of such a rule.

The proposed rule would apply to cable systems which provide aural programming other than retransmission of licensed broadcast radio stations. NAB pointed out that the rule would apply only where the cable input to the subscribers radio receiver prevented reception of off-the-air signals. NAB stated that cable systems should not be permitted to foreclose competition by depriving subscribers of access to over-the-air signals.

Recognizing that technical considerations may limit the number of useable cable channels, NAB said aural originations by cable systems should be permitted "only to the extent that they do not preclude the reception of any local signals."

Broadcast

quality
video switching
NOW under
\$30 per crosspoint.

Input-output configurations are virtually unlimited with this modular, building-block, solid-state, video switch. And . . . this flexibility comes at reduced cost.

Starting with a single 14-inch by 19-inch rack frame assembly, the user can build to a 20-input by 20-output configuration by selecting plug-in switching and amplifier modules. Using the appropriate modules, configurations such as 10-in by 5-out, 20-in by 10-out or other configurations can be assembled. Greater capacities can also be accommodated . . . just add.

Control? . . . DYN AIR has it all, from pushbuttons to computers. The 1400 Series plug-in switch modules accept control from 15 to 25 VDC or 5-volt negative logic steady state levels. With optional plug-in circuitry, encoded logic level signals can provide the control. A complete line of control hardware is available from us.

Performance is state-of-the-art. Using field effect transistor circuitry, the 1400 Series frequency response is flat within ± 0.1 dB to 8 MHz (± 0.5 dB to 12 MHz). Differential phase is less than 0.1 degree, and it is DC coupled. Top color performance for NTSC and PAL systems.

Best of all, users will really appreciate the economy. By specifying the initial and future capacity for the system, the buyer purchases only the hardware needed now without being penalized later. High reliability solid-state video switching costs can be cut below \$30 per crosspoint . . . less than competitive switching systems. Compatible with our Series 8100 Solid-State Audio Switching Equipment, the new 1400 Series offers, spec for spec, the lowest cost quality switching equipment available today!

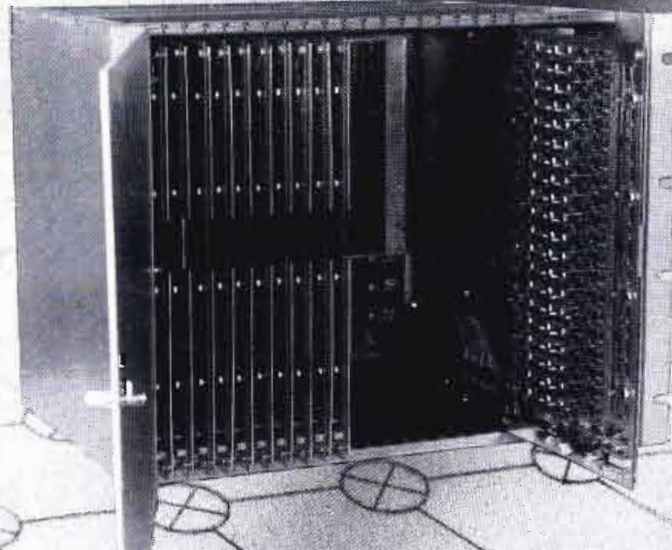

DYN AIR ELECTRONICS, INC.
6386 FEDERAL BLVD, SAN DIEGO, CALIF. 92114
TELEPHONE: 714-582-9211 TWX: 910-385-2040

DYN AIR

For More Details Circle (86) on Reply Card

Instrumentation Precision in Broadcast Terminal Products

TeleMation's *Precision* Line Terminal Equipment

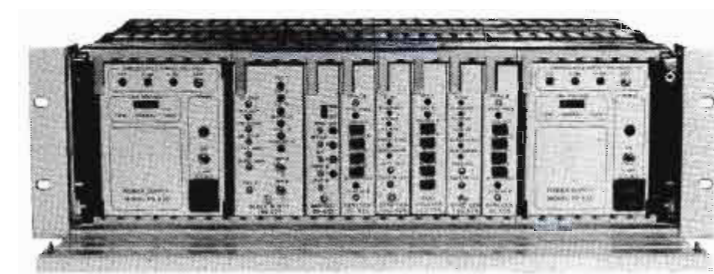

Within TeleMation's "525 Series" audio and video terminal product line, certain units are designated *precision* as distinguished from their *broadcast* counterparts. The *precision* designation is much more than a simple "marketing label". *Precision* is a demarcation assigned through TeleMation R&D that puts a particular product into a separate, unique attention category, from design concept through manufacture and quality-assurance verification. All this to assure the buyer that the product not only meets or surpasses all known competitive products in its performance parameters, but also that it is designed to operate for months and even years without need for periodic adjustment or any other routine maintenance. This philosophy and practice, then, take the *precision* units in the 525 Series terminal equipment into a quality/stability/reliability realm that is usually associated with instrumentation electronics.

TeleMation has used a number of design techniques in accomplishing the high performance and stability achieved by these products. For example, one-percent-tolerance resistors having a temperature coefficient of 20PPM/°C are generally used as gain-determining elements and wherever drift would affect stability. They provide both freedom from temperature drift and freedom from the effects of aging that are common to the less expensive resistors normally used in video products. Junction matching — each PN junction being matched with an NP junction to cancel the characteristic 2.2mv/°C drift of silicon junctions — is also employed to improve stability and prevent offset drift in DC-coupled outputs.

Feedback is extensively used in *precision* grade units as a means of insulating performance characteristics from the effects of component variables. Audio amplifiers are typically high-gain op-amps inside 100-dB feedback loops, while video amplifiers are typically transistor pairs inside 40-dB feedback loops. In these applications, a 2:1 change in the gain characteristic of any active component will have negligible effects on overall circuit performance.

The advantages of push-pull, cascode, and complementary symmetry circuits are exploited to provide low distortion, wide bandwidth, and high signal handling capability. Current-sourcing techniques are also employed as a means of minimizing distortion that otherwise can result from operating semiconductor junctions over wide current ranges.

TeleMation engineers also have successfully coped with capacitor leakage (another source of long-term drift) in the *precision* series designs. Capacitors are either operated with minimum DC voltage drop or the effects of increased leakage with age are otherwise eliminated, as in the TVA-524 and TVA-525 video distribution amplifiers where the capacitance of a small capacitor having extremely low leakage current is "amplified" by a high-gain op amp; the result—longer time constant, less tilt, and greatly improved long-term stability.

Our TVA-525 video distribution amplifier, whose performance characteristics are listed below, is a representative application of the quality and stability factors inherent in the *precision* series product.

TVA-525 PERFORMANCE SPECIFICATIONS

	TYPICAL	PUBLISHED
Differential Phase @ 3.58 or 4.43MHz	0.12°	0.2°
Differential Gain @ 3.58 or 4.43MHz	0.11%	0.2%
Frequency Response to 5.5MHz	0.05 dB	0.1 dB
Frequency Response to 10MHz	0.20dB	0.25dB
Hum and Noise	72dB	66dB
Distortion, 50Hz Squarewave DC Mode	.1%	<.15%
Distortion and Tilt, 50Hz		
Squarewave AC Mode	.20%	<.25%
Output return loss @ 5.5 MHz	38dB	35dB
Input return loss @ 5.5 MHz	43dB	40dB
Bounce and Overshoot DC Mode	1%	—
Bounce, AC Mode (Monotonic)	8 sec.	5 sec.
Overshoot, AC Mode	None	None
K Factor	.25%	0.5%
Input Offset Compensation Range	>3VDC	>2VDC
Common Mode Rejection, 60Hz	>70dB	>60dB
Common Mode Rejection, 5MHz	>43dB	>40dB

A functional schematic of this amplifier along with a product description is available on request. We suggest you compare this circuit to that of any competitive product. We feel you will agree that the stability and long-term quality performance intrinsic to our *precision* design will justify whatever small additional initial cost might be involved through including such quality electronic devices in your broadcast system.



TeleMation

P.O. BOX 15068, SALT LAKE CITY, UTAH 84115
(801) 487-5399, TELEX: 388-352

AFA's 1975 Buyer's Guide to TV Broadcast & Production Studio Design/Engineering

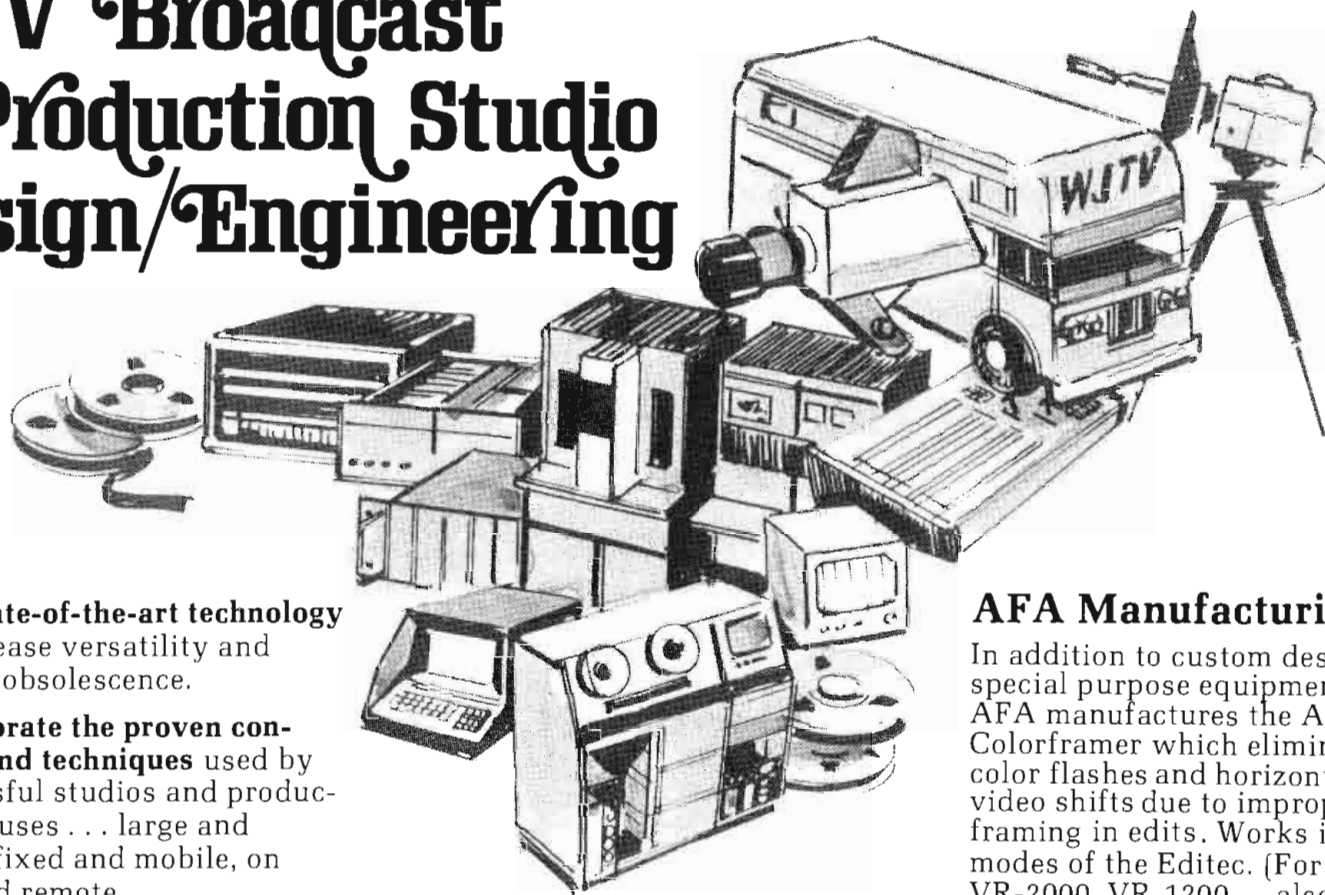

- 1** Use state-of-the-art technology to increase versatility and reduce obsolescence.
- 2** Incorporate the proven concepts and techniques used by successful studios and production houses . . . large and small, fixed and mobile, on line and remote.
- 3** Purchase the best equipment and instrumentation you can realistically afford, for greater reliability and production quality.
- 4** Stay away from lash-ups and make-dos . . . If you have a "special" need, have special purpose equipment and systems custom designed.
- 5** Consider the purchase of "pre-owned" and completely reconditioned quality equipment, such as our AMPEX (VR-2000, VR-1200, etc.) VTR's. (A pre-owned Rolls is better than anything but a new one.)
- 6** Realize as soon as possible, that you probably can't do all this without help.

CAVEAT EMTOR

(Let the Buyer Beware!)

With an everchanging state-of-the-art . . . with ever increasing demands for production sophistication . . . with the mind boggling proliferation of "new" equipment . . . **where do you start?**

By delegating the responsibility to AFA, you can optimize your capabilities.

AFA possesses the unique combination of experience and technological expertise to provide a broad variety of services such as:

- Facilities Planning
- System or "special purpose" equipment design
- Operation/Production Engineering
- Implementation & Procurement
- Installation Management

And AFA will provide consultation, design and/or implementation of any part or delivery of a complete turn-key operation, anywhere in the world.

Since we are not primarily a manufacturer, we can be objective about the merits and disadvantages of the various equipment available and can engineer a system to your specific needs.

Sophisticated production complex or basic and functional . . . AFA helps you put more in so you can turn more out. As your needs grow, the potential for expansion has been built-in. Quality, modularized, fundamental equipment can be added to at any time.

The sooner you get us involved, the more comprehensive our service can be.

AFA Manufacturing

In addition to custom designed, special purpose equipment, AFA manufactures the AF-103 Colorframer which eliminates color flashes and horizontal video shifts due to improper framing in edits. Works in all modes of the Editec. (For VR-2000, VR-1200 — also available for AVR-1, ACR-25.

Pre-Owned VTR's

Our previously owned, fully reconditioned AMPEX VR-2000 and VR-1200 VTR's are outstanding values as basic equipment or as back-up or additional units. We'll also recondition your present AMPEX VTR's. Naturally, we are interested in purchasing pre-owned units in any condition. Liberal prices offered.

Before you make any firm plans about new or established installations, contact AF Associates. Starting off right can make a big difference.

You'll hear lots of talk about the economics of Studio Design and Engineering.

AFA is doing something about it!

Call us or request our new brochure.

AFA

A.F. ASSOCIATES, INC.
415 Stevens Avenue
Ridgewood, New Jersey 07450
(201) 447-0096

For More Details Circle (88) on Reply Card

1975 BROADCAST BUYER'S GUIDE

This buyer's guide is a verified directory of communications equipment. Each year we send questionnaires to communications equipment manufacturers, asking them to tell us what they make and what equipment has been added to their listings since last year.

Every year the coverage of manufacturers grows. And each year we add categories to reflect new and diverse equipment recently introduced to the communications industry.

About The Red Listings

In each Buyer's Guide issue you'll find equipment categories that include manufacturers listed in red. Those red listings indicate that the manufacturer has an advertisement in this issue describing a product that fits in that equipment category. In this way, you can look up a category to see who makes such a unit and find (listed in red) those manufacturers who have advertised this unit in this issue. It's a service to both the manufacturer and reader, because the location of the ad also is listed in red.

In another section of this directory—within **Cable Engineering**—you will find product categories listed for equipment basically designed for closed circuit applications. So, if you can't find the category you need, try the CCTV Guide.

Reader Service Cards

At the bottom of each ad you will see a line that reads "For More Details Circle (00) On Reply Card". The number, of course is different for each ad. In order to get more information on a product advertised in this issue, turn to the back of this issue and locate our Reader Service cards. All you need to do is fill out your name and mailing address and circle the appropriate numbers from the ad(s). These cards are good for one year. In other words, if you are seeking product information several months after you have received this issue, you can still fill in one of these cards and send it in. Then product information will come to you directly from the manufacturer.

In fact, you can use this same system for getting more details about advertised products in any issue by taking a card from the issue where the ad appeared and sending it in.

Subscription Renewal

In each issue of Broadcast Engineering we include renewal cards. If you should stop receiving the magazine, all you need to do is tear off the free subscription card and mail it to us. And, if you need copies of issues you've missed, drop us a note and tell us which issues you want.

Also in this issue we have included a manufacturers and suppliers address list. Where telephone numbers are not included, we suggest you find the advertisers index and get the numbers directly from the ads.

NEW RINGBACK ANTENNA by Mark

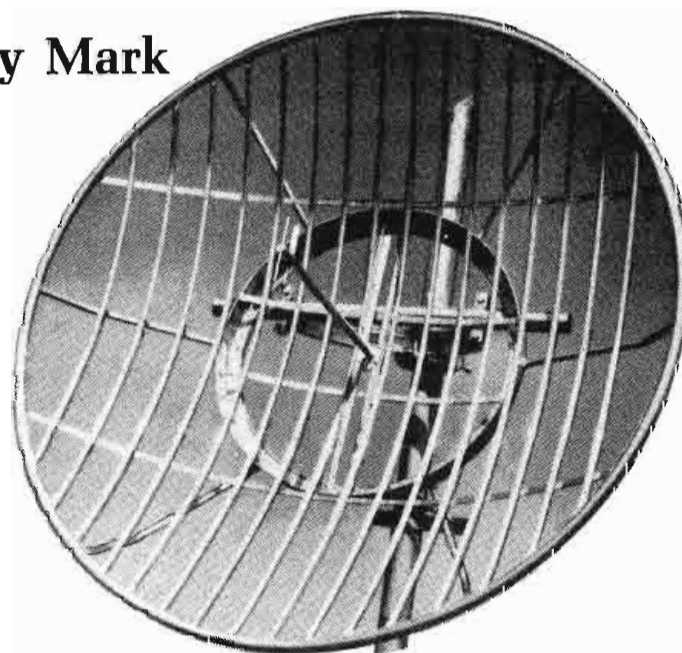

Simplifies Alignment • Speeds Installation

Low profile ringback frames available on all Mark Grid Parabolic Antennas. 3-point mounting greatly reduces path alignment and installation time.

Ringbacks further improve already extremely low wind loading characteristics of Mark Grid Antennas compared to solid dish type parabolics. Frequency range 400-900 MHz, 2GHz. Others available on special application. Nest 4 to a crate. Write:

ANIXTER-MARK
Originators of the grid antenna.

5439 W. Fargo
Skokie, Ill. 60076
(312) 675-1500

For More Details Circle (89) on Reply Card

Alarm, Fault

See Adv. Page

Moseley Assoc. Inc. 9

Badger Meter, Inc.
Belar Electronics Lab., Inc.
Bird Electronic Corp.
Broadcast Automation Assoc.
Beta Technology, Inc.
Concept 70
Datalogic-Rust Co.
Dragnet Engineering Labs., Inc.
Harris Corp. Broadcast Products Div.
Hughey & Phillips Inc.
Moseley Assoc. Inc.
National Electrolab Ltd.
Tracor, Inc. Instruments Group
Trepac Corp. America

Alarm, Signal

See Adv. Page

Audio Services, Inc. 163
B & I Electronics, Inc. 158
Moseley Assoc. Inc. 9

Alpha Electronic Services Inc.
Atlas Sound
Audio Services, Inc.
B & I Electronics, Inc.
Broadcast Automation Assoc.
Beta Technology, Inc.
Concept 70
Delta Electronics Inc. (N.C.)
Dorado Systems
Edwards Co., Inc.
Electronic Designers Inc.
Engineering Associates
Fisher Berkeley Corp.
P. R. Mallory & Co. Inc.
Miles Reproducer Co.
Moseley Assoc. Inc.
National Electrolab Ltd.
RHA Audio Communications Corp.
Rodann Electronics Mfg. Co.
Sparta Electronic Corp.
Tele-Cine Inc.
Trepac Corp. America

Alarm, Teletype

See Adv. Page

B & I Electronics, Inc. 158

Audio Services, Inc.
B & I Electronics, Inc.
Philips Test & Measuring Instruments, Inc.

Alarm, Teletype Receiver

See Adv. Page

Audio Services, Inc. 160, 163
B & I Electronics, Inc. 158
Moseley Assoc. Inc. 9

Audio Services, Inc.
B & I Electronics, Inc.
Moseley Assoc. Inc.
Systems Marketing Corp.
Trepac Corp. America

Alarm, Tower Light Failure --See Tower Light Failure Alarms

Alarm Systems, Burglar

Air Space Devices Inc.
AMF Electrical Products
A-Tel-A-Matic
Beta Technology, Inc.
Cine Sonic Sound Inc.

Communications 2000, Inc.
Delta Products, Inc.
Diebold Inc.
Dorado Systems
Edwards Co., Inc.
Emerson Electric/Artolier
G.C. Electronics
Heath Co.
P. R. Mallory & Co. Inc.
Microwave Assoc. Inc.
Miles Reproducer Co.
Mountain West Alarm
Red Comet Inc.
RHA Audio Communications Corp.
Rodann Electronics Mfg. Co.
SC Electronics, Inc.
Sinai-Johnson
Telatronics
Trepac Corp. America

Alarm Systems, Fire

Aluminum Hard Goods, Inc.
AMF Electrical Products
A-Tel-A-Matic
Communications 2000, Inc.
Delta Products, Inc.
Dorado Systems
Edwards Co., Inc.
Emerson Electric/Artolier
G.C. Electronics
Heath Co.
IGM
Microwave Assoc. Inc.
Miles Reproducer Co.
Mountain West Alarm
Red Comet Inc.
Rodann Electronics Mfg. Co.
Telatronics
Trepac Corp. America

Amplifier, AF-AGC

See Adv. Page

Comark Industries Inc. 161
Communication Medias 62
Martin Audio/Video 152
Opamp Lamps, Inc. 185
Orange County Corp. 64, 158
RCA Corp. 58
ROH Corporation 155
Russco Electronics Mfg. Inc. 142
Val-Tronics, Inc. 171
Wilkinson Electronics, Inc. 157

Allied Broadcast Equip.
Altec Sound Products
Belar Electronics Lab., Inc.
Broadcast Automation Assoc.
Broadcast Electronics
Collins Radio Group
Comark Industries Inc.
Communication Medias
Dyma Engineering, Inc.
Eventide Clock Works Inc.
Gately Electronics
General Electric Co. ISO Div.
Harris Corp. Broadcast Products Div.
Inovonics
Marti Electronics
Martin Audio/Video
McCurdy Radio Ind. Inc.
Microwave Assoc. Inc.
Modular Audio Products
Monroe Electronics, Inc.
Rupert Neve, Inc.
Opamp Lamps, Inc.
Orange County Corp.
Orban/Broadcast
QRK Electronic Products
Quad-Eight Electronics
RCA Corp. Broadcast Systems Div.
Richmond Sound Design, Ltd.

Robins/Fairchild
ROH Corporation
Russco Electronics Mfg. Inc.
Singer Products Co., Inc.
Sphere Electronics
Spotmaster
Stancil-Hoffman Corp.
Systems Marketing Corp.
Thompson-CSF Laboratories, Inc.
Total Technology
Val-Tronics, Inc.
Wilkinson Electronics, Inc.

Amplifier, AF Compressing

See Adv. Page

Broadcast Electronics 45
Communication Medias 62
LPB Inc. 152
Martin Audio/Video 152
Orange County Corp. 158
ROH Corporation 155

Allied Broadcast Equip.
Altec Sound Products
Automated Processes, Inc.
Belar Electronics Lab., Inc.
Bogen Div.
Broadcast Automation Assoc.
Broadcast Electronics
Broadcast Equipment & Supply Co.
Burwen Laboratories
Collins Radio Group
Communication Medias
Eventide Clock Works Inc.
Gately Electronics
Gotham Audio Corp.
Harris Corp. Broadcast Products Div.
Inovonics
Lauderdale Electronic Labs
LPB Inc.
Marti Electronics
Martin Audio/Video
McCurdy Radio Ind. Inc.
Microwave Assoc. Inc.
Modular Audio Products
Monroe Electronics, Inc.
Rupert Neve, Inc.
Opamp Lamps, Inc.
Orange County Corp.
Orban/Broadcast
Pacific Recorders and Engrg. Corp. Div. 47B
Philips Audio Video Systems Corp. Broadcast Equip. Div.
Precision Elect. Inc.
QRK Electronic Products
Quad-Eight Electronics
Ramko Research
RCA Corp. Broadcast Systems Div.
Richmond Sound Design, Ltd.
Robins/Fairchild
ROH Corporation
Shure Brothers Inc.
Sinai-Johnson
Singer Products Co., Inc.
Sparta Electronic Corp.
Spectra Sonics
Sphere Electronics
Spotmaster
Stancil-Hoffman Corp.
Systems Marketing Corp.
Thompson-CSF Laboratories, Inc.
Total Technology
Tri-Tronics Professional Electronics
Ultra Audio Products
United Recording Electronics Industries
UREI a URC Co.
Val-Tronics, Inc.
VIF International
Wilkinson Electronics, Inc.

Amplifier, AF General Purpose

See Adv. Page

Comark Industries Inc. 161
Martin Audio/Video 152
Opamp Lamps, Inc. 185
Orange County Corp. 64, 158
RCA Corp. 58
ROH Corporation 155
Russco Electronics Mfg. Inc. 142

Allied Broadcast Equip.
Altec Sound Products
Audio Designs & Mfg.
Audio Distributor Inc.
Automated Processes, Inc.
Belar Electronics Lab., Inc.
Bell P/A Prod. Corp.
Bogen Div.
Broadcast Automation Assoc.
Broadcast Electronics
C-COR Electronics, Inc.
Cetec Audio Div. Subs. Computer Equipment Corp.
Collins Radio Group
Comark Industries Inc.
Communication Medias
Communications Technology, Inc.
Cooke Engineering Co.
Crown International
Custom Craft Designs
Datatek Corp.
Dyma Engineering, Inc.
Electronic Designers Inc.
Fisher Berkeley Corp.
Frontier Engineering Corp.
Gately Electronics
General Electric Co. ISO Div.
General Electric Co. Tubes/MW Devices
Harris Corp. Broadcast Products Div.
Hewlett Packard Co.
Instrument Laboratories
Internatl. Nuclear Corp.
Lauderdale Electronic Labs
Marti Electronics
Martin Audio/Video
McMartin Industries, Inc.
Micro-Trak Corp.
Microwave Assoc. Inc.
Modular Audio Products
Monroe Electronics, Inc.
Rupert Neve, Inc.
Opamp Lamps, Inc.
Orange County Corp.
Pacific Recorders and Engrg. Corp. Div. 47B
Paso Sound Products Inc.
Permadyne Electronics Corp.
Philips Audio Video Systems Corp. Broadcast Equip. Div.
Precision Elect. Inc.
Pulse Dynamics Mfg. Corp. (PDMC)
Quad-Eight Electronics
Radio Mfg. Co. (RMC)
Ramko Research
RCA Corp. Broadcast Systems Div.
Richmond Sound Design, Ltd.
Robins/Fairchild
ROH Corporation
Russco Electronics Mfg. Inc.
Scientific Systems, Inc.
Senstrol Div.
Shure Brothers Inc.
Sinai-Johnson
Singer Products Co., Inc.
Sparta Electronic Corp.
Spectra Sonics
Sphere Electronics
Superscope, Inc.
Systems Engineering Co., Inc.
Systems Marketing Corp.
Telex Communications, Inc.
Tri-Tronics Professional Electronics
Ultra Audio Products

United Recording Electronics Industries
Val-Tronics, Inc.
Video Accessories Mfg. Co.
Video Aids Corp. of Colorado
Wilkinson Electronics, Inc.

Amplifier, AF Peak Limiting AM

See Adv. Page

Broadcast Electronics	45
LPB Inc.	152
Martin Audio/Video	152
Orange County Corp.	64,158
Wilkinson Electronics, Inc.	157

Allied Broadcast Equip.
Altec Sound Products
Audio Designs & Mfg.
Belar Electronics Lab., Inc.
Broadcast Automation Assoc.
Broadcast Electronics
Broadcast Equipment & Supply Co.
Burwen Laboratories
Collins Radio Group
Communication Medias
Eventide Clock Works Inc.
Gotham Audio Corp.
Harris Corp. Broadcast Products Div.
Inovonics
Lauderdale Electronic Labs
LPB Inc.
Marti Electronics
Martin Audio/Video
Mastertone Co., Inc.
Microwave Assoc. Inc.
Modular Audio Products
Rupert Neve, Inc.
Orange County Corp.
Pacific Recorders and Engrg. Corp. Div. 47B
QRK Electronic Products
Radio Mfg. Co. (RMC)
Ramko Research
RCA Corp. Broadcast Systems Div.
Singer Products Co., Inc.
Sparta Electronic Corp.
Spectra Sonics
Spotmaster
Systems Marketing Corp.
Thompson-CSF Laboratories, Inc.
United Recording Electronics Industries
UREI a URC Co.
Val-Tronics, Inc.
VIF International
Wilkinson Electronics, Inc.

Amplifier, AF Peak Limiting FM

See Adv. Page

Broadcast Electronics	45
LPB Inc.	152
Martin Audio/Video	152
Orange County Corp.	64,158
Wilkinson Electronics, Inc.	157

Allied Broadcast Equip.
Belar Electronics Lab., Inc.
Broadcast Automation Assoc.
Broadcast Electronics
Broadcast Equipment & Supply Co.
Collins Radio Group
Communication Medias
Dyma Engineering, Inc.
Gately Electronics
Gotham Audio Corp.
Harris Corp. Broadcast Products Div.
Inovonics
Lauderdale Electronic Labs
LPB Inc.
Marti Electronics
Martin Audio/Video
Mastertone Co., Inc.
Microwave Assoc. Inc.
Orange County Corp.
Orban/Broadcast
Pacific Recorders and Engrg. Corp. Div. 47B
QRK Electronic Products
Ramko Research
RCA Corp. Broadcast Systems Div.
Singer Products Co., Inc.

Sparta Electronic Corp.
Spotmaster
Systems Marketing Corp.
Thompson-CSF Laboratories, Inc.
United Recording Electronics Industries
UREI a URC Co.
Val-Tronics, Inc.
VIF International
Wilkinson Electronics, Inc.

Amplifier, AF Remote

See Adv. Page

LPB Inc.	152
Moseley Assoc. Inc.	9
Opamp Lamps, Inc.	185

Allied Broadcast Equip.
Altec Sound Products
American Electronics, Inc.
Audio Designs & Mfg.
Automated Processes, Inc.
Broadcast Electronics
Broadcast Equipment & Supply Co.
Collins Radio Group
Communication Medias
Dyma Engineering, Inc.
Frontier Engineering Corp.
Gately Electronics
LPB Inc.
Microwave Assoc. Inc.
Moseley Assoc. Inc.
Nasco Television Systems
Rupert Neve, Inc.
Opamp Lamps, Inc.
Orange County Corp.
Pulse Dynamics Mfg. Corp. (PDMC)
Radio Mfg. Co. (RMC)
Ramko Research
Richmond Sound Design, Ltd.
ROH Corporation
Scientific Systems, Inc.
Shure Brothers Inc.
Sparta Electronic Corp.
Spectra Sonics
Spotmaster
Tri-Tronics Professional Electronics
Ultra Audio Products
Wilkinson Electronics, Inc.

Amplifier, AF Reverberation

Altec Sound Products
Communication Medias
Concept 70
Dyma Engineering, Inc.
Electronic Designers Inc.
Gately Electronics
Gotham Audio Corp.
Micmix Audio Products, Inc.
Microwave Assoc. Inc.
Rupert Neve, Inc.
Opamp Lamps, Inc.
Orange County Corp.
Pacific Recorders and Engrg. Corp. Div. 47B
Philips Audio Video Systems Corp. Broadcast Equip. Div.
Pulse Dynamics Mfg. Corp. (PDMC)
Quad-Eight Electronics
Radio Mfg. Co. (RMC)
Ramko Research
Robins/Fairchild
Shure Brothers Inc.
Sound Dynamics, Inc.
Spectra Sonics
Total Technology
Tri-Tronics Professional Electronics

Amplifier, AF Stereo

See Adv. Page

Opamp Lamps, Inc.	185
Orange County Corp.	64,158
RCA Corp.	58

Allied Broadcast Equip.
Altec Sound Products
Ampro Corp.
Automated Processes, Inc.
Beyer (Revox Corporation)
Collins Radio Group
Communication Medias
Concept 70

Crown International
Dyma Engineering, Inc.
Eico Elect. Inst. Co., Inc.
Electronic Designers Inc.
Gately Electronics
Harris Corp. Broadcast Products Div.
Heath Co.
James B. Lansing Sound, Inc.
Micro-Trak Corp.
Nippon Electric Co., Ltd.
Opamp Lamps, Inc.
Orange County Corp.
Precision Elect. Inc.
Radio Mfg. Co. (RMC)
Ramko Research
RCA Corp. Broadcast Systems Div.
Revox Corp.
Robins/Fairchild
ROH Corporation
Sansui Electronics Corp.
Sinai-Johnson
Sound Dynamics, Inc.
Sparta Electronic Corp.
Superscope, Inc.
Telex Communications, Inc.
Tri-Tronics Professional Electronics
Val-Tronics, Inc.
Wilkinson Electronics, Inc.

Amplifier, Audio Loop

Communication Medias
Orange County Corp.
Pulse Dynamics Mfg. Corp. (PDMC)
Ramko Research
Tri-Tronics Professional Electronics

Amplifier, Bridging

See Adv. Page

Orange County Corp.	64,158
RCA Corp.	12

Allied Broadcast Equip.
Ameco Inc.
American Data Corp.
Audio Designs & Mfg.
Automated Processes, Inc.
Blonder-Tongue Labs.
C-COR Electronics, Inc.
Cetec Audio Div. Subs. Computer Equipment Corp.
Communication Medias
Communications Systems
Communications Technology, Inc.
Delta Electronics Inc. (N.C.)
Dynair Electronics, Inc.
Frontier Engineering Corp.
Gately Electronics
Grass Valley Group, Inc.
Internatl. Nuclear Corp.
Kaitronics Corp.
James B. Lansing Sound, Inc.
Mastertone Co., Inc.
Microwave Assoc. Inc.
Mincom Div. 3M Co.
Modular Audio Products
Rupert Neve, Inc.
Oak Industries, Inc.
Opamp Lamps, Inc.
Orange County Corp.
Radio Mfg. Co. (RMC)
Ramko Research
RCA Corp. Broadcast Systems Div.
RCA Corp. RCA Service Co. Div.
Richmond Hill Laboratories Ltd.
Richmond Sound Design, Ltd.
Robins/Fairchild
ROH Corporation
Scientific-Atlanta, Inc.
Scientific Systems, Inc.
Shure Brothers Inc.
Spectra Sonics
Superscope, Inc.
Systems Marketing Corp.
TeleMation, Inc.
Theta-Com
Tri-Tronics Professional Electronics
Ultra Audio Products
Vedco, Inc.
Video Accessories Mfg. Co.
Wilkinson Electronics, Inc.

Amplifier, Clamping

See Adv. Page

Central Dynamics	176
Telemet, a Geotel Co.	1

American Data Corp.
Ball Bros. Research Corp. Miratel Division
Broadcast Video Systems, Ltd.
Central Dynamics Corp.
Communications Technology, Inc.
Cooke Engineering Co.
Dynair Electronics, Inc.
Farinon Electric
Grass Valley Group, Inc.
Internatl. Nuclear Corp.
Kaitronics Corp.
Lenco Inc.
Marconi Electronics Inc.
Microwave Assoc. Inc.
Mincom Div. 3M Co.
Raytheon Data Systems Co.
RCA Corp. Broadcast Systems Div.
Richmond Hill Laboratories Ltd.
Telemet, a Geotel Co.
Vedco, Inc.

Amplifier, Compressing

See Adv. Page

Comark Industries Inc.	161
Communication Medias	62
LPB Inc.	152
Martin Audio/Video	152
Modular Audio Products	146
Orange County Corp.	64,158
RCA Corp.	58

Audio Distributor Inc.
Broadcast Electronics
Burwen Laboratories
Comark Industries Inc.
Communication Medias
Dolby Laboratories, Inc.
Gately Electronics
Gotham Audio Corp.
Harris Corp. Broadcast Products Div.
Lauderdale Electronic Labs
LPB Inc.
Marti Electronics
Martin Audio/Video
Mastertone Co., Inc.
Microwave Assoc. Inc.
Modular Audio Products
Opamp Lamps, Inc.
Orange County Corp.
Philips Audio Video Systems Corp. Broadcast Equip. Div.
Precision Elect. Inc.
Ramko Research
RCA Corp. Broadcast Systems Div.
Robins/Fairchild
Shure Brothers Inc.
Sinai-Johnson
Spotmaster
Tri-Tronics Professional Electronics

Amplifier, DC

See Adv. Page

Moseley Assoc. Inc.	9
Orange County Corp.	64,158

C-COR Electronics, Inc.
Crown International
Datalogic-Rust Co.
Gately Electronics
General Electric Co. Tubes/MW Devices
Hewlett Packard Co.
Microwave Assoc. Inc.
Modular Audio Products
Moseley Assoc. Inc.
Opamp Lamps, Inc.
Orange County Corp.
Paso Sound Products Inc.
Richmond Sound Design, Ltd.
Singer Products Co., Inc.
Tektronix Inc.

Amplifier, Distribution Audio

See Adv. Page

Broadcast Electronics 45
 Communication Medias 62
 Cooke Engineering Co. 37
 Lenco Inc. 40
 LPB Inc. 152
 Martin Audio/Video 152
 Opamp Lamps, Inc. 185
 Orange County Corp. 64
 Ramko Research 125
 RCA Corp. 58
 Scientific Systems 155, 164
 TeleMation, Inc. 67
 Telemet, a Geotel Co. 1
 Val-Tronics, Inc. 171
 Vamco Engineering 23
 Wilkinson Electronics, Inc. 157

- Allied Broadcast Equip.
 American Data Corp.
 Audio Designs & Mfg.
 Auditronics, Inc.
 Automated Processes, Inc.
 Bell P/A Prod. Corp.
 Broadcast Automation Assoc.
 Broadcast Electronics
 Broadcast Equipment & Supply Co.
 Beta Technology, Inc.
 C-COR Electronics, Inc.
 Communication Medias
 Communications Technology, Inc.
 Cooke Engineering Co.
 Datatek Corp.
 Dunlap-Clarke Electronics
 Dyma Engineering, Inc.
 Dynair Electronics, Inc.
 Frontier Engineering Corp.
 General Electric Co. ISO Div.
 Harris Corp. Broadcast Products Div.
 Industrial Sciences, Inc.
 Lauderdale Electronic Labs
 Lenco Inc.
 LPB Inc.
 Marconi Electronics Inc.
 Martin Audio/Video
 Mastertone Co., Inc.
 Microwave Assoc. Inc.
 Modular Audio Products
 Opamp Lamps, Inc.
 Orange County Corp.
 Pacific Recorders and Engrg. Corp. Div. 47B
 Philips Audio Video Systems Corp. Broadcast Equip. Div.
 Pulse Dynamics Mfg. Corp. (PDMC)
 Quad-Eight Electronics
 Ramko Research
 RCA Corp. Broadcast Systems Div.
 Richmond Hill Laboratories Ltd.
 Richmond Sound Design, Ltd.
 Robins/Fairchild
 ROH Corporation
 Roscor Corp.
 Scientific Systems, Inc.
 Senstrol Div.
 Shintron Co. Inc.
 Sound Dynamics, Inc.
 Spectra Sonics
 Spotmaster
 Systems Engineering Co., Inc.
 TeleMation, Inc.
 Telemet, a Geotel Co.
 Theta-Com
 Thompson-CSF Laboratories, Inc.
 Total Technology
 Tri-Tronics Professional Electronics
 Val-Tronics, Inc.
 Vamco Engineering
 Vedco, Inc.
 Video Accessories Mfg. Co.
 Vital Industries Inc.
 Ward-Beck Systems, Ltd.
 Wilkinson Electronics, Inc.

Amplifier, Distribution Video

See Adv. Page

Central Dynamics 176
 Cooke Engineering Co. 37
 Lenco Inc. 40
 TeleMation, Inc. 67
 Telemet, a Geotel Co. 1

Vamco Engineering 23

- American Data Corp.
 Applied Electro Mechanics, Inc.
 Applied Video Electronics, Inc.
 Ball Bros. Research Corp. Miratel Division
 Broadcast Video Systems, Ltd.
 Beta Technology, Inc.
 C-COR Electronics, Inc.
 Central Dynamics Corp.
 Cohu, Inc.
 Communications Systems
 Communications Technology, Inc.
 Cooke Engineering Co.
 Dage-MTI, Inc.
 Datatek Corp.
 Dyma Engineering, Inc.
 Dynair Electronics, Inc.
 Dynasciences Video Products
 Farinon Electric
 Frontier Engineering Corp.
 Grass Valley Group, Inc.
 Harris Corp. Broadcast Products Div.
 Hitachi Shibaden Corp. of America
 Industrial Sciences, Inc.
 Lenco Inc.
 Marconi Electronics Inc.
 Microwave Assoc. Inc.
 Nasco Television Systems
 Nemo Recording Labs
 Panasonic Video Systems Div.
 RCA Corp. Broadcast Systems Div.
 Rohde & Schwarz Sales Co.
 Roscor Corp.
 Ross Broadcast Products, Inc.
 Scientific-Atlanta, Inc.
 Scientific Systems, Inc.
 Shintron Co. Inc.
 Sinai-Johnson
 Systems Engineering Co., Inc.
 TeleMation, Inc.
 Telemet, a Geotel Co.
 Theta-Com
 Thompson-CSF Laboratories, Inc.
 Vamco Engineering
 Vedco, Inc.
 Vicon Industries, Inc.
 Video Accessories Mfg. Co.
 Viscount Industries Ltd.
 Vital Industries Inc.

Amplifier, FM

See Adv. Page

Martin Audio/Video 152

- AEL, Inc.
 Belar Electronics Lab., Inc.
 Communication Medias
 The Finney Co.
 Martin Audio/Video
 McMartin Industries, Inc.
 RHG Elect Labs, Inc.
 Superscope, Inc.
 Transcom Electronics, Inc.
 Val-Tronics, Inc.

Amplifier, Keying

Central Dynamics 176

- American Data Corp.
 Applied Electro Mechanics, Inc.
 Ball Bros. Research Corp. Miratel Division
 Broadcast Video Systems, Ltd.
 Central Dynamics Corp.
 Communications Technology, Inc.
 Grass Valley Group, Inc.
 Microwave Assoc. Inc.
 Richmond Hill Laboratories Ltd.
 Shintron Co. Inc.
 Thompson-CSF Laboratories, Inc.
 Video Devices Co.

Amplifier, Line

See Adv. Page

Communication Medias 62
 Modular Audio Products 146
 Opamp Lamps, Inc. 185
 Orange County Corp. 64
 Ramko Research 125
 ROH Corporation 155
 Senstrol Div. 167

TeleMation, Inc. 67

Wilkinson Electronics, Inc. 157

- Allied Broadcast Equip.
 Ameco Inc.
 American Data Corp.
 Audio Designs & Mfg.
 Automated Processes, Inc.
 Blonder-Tongue Labs.
 C-COR Electronics, Inc.
 Cetec Audio Div. Subs. Computer Equipment Corp.
 Collins Radio Group
 Communication Medias
 Communications Technology, Inc.
 Cooke Engineering Co.
 The Finney Co.
 Frontier Engineering Corp.
 Gately Electronics
 Harris Corp. Broadcast Products Div.
 Instrument Laboratories
 James B. Lansing Sound, Inc.
 Marti Electronics
 Microwave Assoc. Inc.
 Modular Audio Products
 Monroe Electronics, Inc.
 Nemo Recording Labs
 Rupert Neve, Inc.
 Oak Industries, Inc.
 Opamp Lamps, Inc.
 Orange County Corp.
 Pacific Recorders and Engrg. Corp. Div. 47B
 Philips Audio Video Systems Corp. Broadcast Equip. Div.
 Pulse Dynamics Mfg. Corp. (PDMC)
 Quad-Eight Electronics
 Radio Mfg. Co. (RMC)
 Ramko Research
 RCA Corp. RCA Service Co. Div.
 Richmond Hill Laboratories Ltd.
 Richmond Sound Design, Ltd.
 Robins/Fairchild
 ROH Corporation
 Senstrol Div.
 Shure Brothers Inc.
 Sparta Electronic Corp.
 Spectra Sonics
 Systems Engineering Co., Inc.
 Systems Marketing Corp.
 TeleMation, Inc.
 Total Technology
 Tri-Tronics Professional Electronics
 United Recording Electronics Industries
 Video Accessories Mfg. Co.
 VIF International
 Wilkinson Electronics, Inc.

Amplifier, Masking

- Burwen Laboratories
 Microwave Assoc. Inc.
 Richmond Hill Laboratories Ltd.
 Thompson-CSF Laboratories, Inc.

Amplifier, Microphone

See Adv. Page

Ramko Research 125

- Ramko Research

Amplifier, Mixing

See Adv. Page

Central Dynamics 176
 Modular Audio Products 146
 Orange County Corp. 64
 RCA Corp. 12

- Allied Broadcast Equip.
 American Data Corp.
 Applied Electro Mechanics, Inc.
 Audio Designs & Mfg.
 Automated Processes, Inc.
 Bell P/A Prod. Corp.
 Broadcast Video Systems, Ltd.
 Central Dynamics Corp.
 Cetec Audio Div. Subs. Computer Equipment Corp.
 Collins Radio Group
 Communications Technology, Inc.
 Dage-MTI, Inc.

- Dyma Engineering, Inc.
 Frontier Engineering Corp.
 Gotham Audio Corp.
 Grass Valley Group, Inc.
 Head Sound, Inc.
 James B. Lansing Sound, Inc.
 Lauderdale Electronic Labs
 Mastertone Co., Inc.
 McMartin Industries, Inc.
 Micro-Trak Corp.
 Microwave Assoc. Inc.
 Modular Audio Products
 Nemo Recording Labs
 Opamp Lamps, Inc.
 Orange County Corp.
 Panasonic Video Systems Div.
 Philips Audio Video Systems Corp. Broadcast Equip. Div.
 Pulse Dynamics Mfg. Corp. (PDMC)
 Quad-Eight Electronics
 Ramko Research
 RCA Corp. Broadcast Systems Div.
 Richmond Hill Laboratories Ltd.
 Richmond Sound Design, Ltd.
 Robins/Fairchild
 ROH Corporation
 Shure Brothers Inc.
 Sinai-Johnson
 TeleMation, Inc.
 Ultra Audio Products

Amplifier, Monitor

See Adv. Page

Broadcast Electronics 45
 Communication Medias 62
 Cooke Engineering Co. 37
 Orange County Corp. 64, 158
 Ramko Research 125
 RCA Corp. 58
 Russco Electronics Mfg. Inc. 142
 Wilkinson Electronics, Inc. 157

- Allied Broadcast Equip.
 American Data Corp.
 Automated Processes, Inc.
 Belar Electronics Lab., Inc.
 Bell P/A Prod. Corp.
 Broadcast Electronics
 Cetec Audio Div. Subs. Computer Equipment Corp.
 Communication Medias
 Communications Technology, Inc.
 Cooke Engineering Co.
 Crown International
 Dunlap-Clarke Electronics
 Dyma Engineering, Inc.
 Electronic Designers Inc.
 Frontier Engineering Corp.
 Harris Corp. Broadcast Products Div.
 James B. Lansing Sound, Inc.
 Lauderdale Electronic Labs
 Marti Electronics
 Mastertone Co., Inc.
 McMartin Industries, Inc.
 Microwave Assoc. Inc.
 Modular Audio Products
 Narda Microwave Corp
 National Electrolab Ltd.
 Nemo Recording Labs
 Opamp Lamps, Inc.
 Orange County Corp.
 Panasonic Video Systems Div.
 Philips Audio Video Systems Corp. Broadcast Equip. Div.
 QRK Electronic Products
 Quad-Eight Electronics
 Radio Mfg. Co. (RMC)
 Ramko Research
 RCA Corp. Broadcast Systems Div.
 RCA Corp. RCA Service Co. Div.
 Robins/Fairchild
 ROH Corporation
 Russco Electronics Mfg. Inc.
 Scientific Systems, Inc.
 Sparta Electronic Corp.
 Spotmaster
 Superscope, Inc.
 TeleMation, Inc.
 Tri-Tronics Professional Electronics
 Val-Tronics, Inc.
 Vedco, Inc.
 Video Accessories Mfg. Co.
 Ward-Beck Systems, Ltd.

Wilkinson Electronics, Inc.

Amplifier, Operational

See Adv. Page	
Modular Audio Products	146
Opamp Lamps, Inc.	185
Orange County Corp.	64
TeleMation, Inc.	67

American Electronics, Inc.
 Audio Designs & Mfg.
 Automated Processes, Inc.
 Frontier Engineering Corp.
 Gately Electronics
 Gotham Audio Corp.
 Microwave Assoc. Inc.
 Modular Audio Products
 Opamp Lamps, Inc.
 Orange County Corp.
 Quad-Eight Electronics
 RCA Corp. RCA Service Co. Div.
 Richmond Sound Design, Ltd.
 Singer Products Co., Inc.
 Tektronix Inc.
 TeleMation, Inc.
 Vedco, Inc.

Amplifier, Power

See Adv. Page	
Comark Industries Inc.	161
Martin Audio/Video	152
Modular Audio Products	146
Opamp Lamps, Inc.	185
Orange County Corp.	64,158
RCA Corp.	12
ROH Corporation	155
Senstrol Div.	167

Acrodyne Industries Inc.
 Allied Broadcast Equip.
 American Data Corp.
 Audio Designs & Mfg.
 Automated Processes, Inc.
 Belar Electronics Lab., Inc.
 Bell P/A Prod. Corp.
 Bethany International
 Bogen Div.
 Broadcast Electronics
 California Instruments Co.
 C-COR Electronics, Inc.
 Ceco Communications Inc.
 Collins Radio Group
 Comark Industries Inc.
 Communications Technology, Inc.
 Continental Electronics Mfg. Co.
 Crown International
 Dunlap-Clarke Electronics
 Electronic Designers Inc.
 Electro Sound, Inc.
 John Fluke Mfg. Co., Inc.
 Frontier Engineering Corp.
 James B. Lansing Sound, Inc.
 Lauderdale Electronic Labs
 Martin Audio/Video
 McMartin Industries, Inc.
 Modular Audio Products
 Nemo Recording Labs
 North American Radio Corp.
 Opamp Lamps, Inc.
 Orange County Corp.
 Paso Sound Products Inc.
 Philips Audio Video Systems Corp.
 Broadcast Equip. Div.
 PRD Electronics, Inc.
 Precision Elect. Inc.
 Pulse Dynamics Mfg. Corp. (PDMC)
 Quad-Eight Electronics
 Radio Mfg. Co. (RMC)
 Ramko Research
 RCA Corp. Broadcast Systems Div.
 RCA Corp. RCA Service Co. Div.
 Revox Corp.
 RHA Audio Communications Corp.
 Robins/Fairchild
 ROH Corporation
 Senstrol Div.
 Shure Brothers Inc.
 Sinai-Johnson
 Sound Dynamics, Inc.
 Spectra Sonics
 Superscope, Inc.

Telex Communications, Inc.
 Terminal Electronics Corp.
 TT Electronics, Inc.
 Vedco, Inc.

Amplifier, Processing Video

See Adv. Page	
Central Dynamics Corp.	176
TeleMation, Inc.	67

American Data Corp.
 Ball Bros. Research Corp. Miratel
 Division
 Broadcast Video Systems, Ltd.
 Central Dynamics Corp.
 Cohu, Inc.
 Communications Systems
 Communications Technology, Inc.
 Dage-MTI, Inc.
 Dyma Engineering, Inc.
 Dynasciences Video Products
 Fernesh Group Robert Bosch Corp.
 Grass Valley Group, Inc.
 Industrial Sciences, Inc.
 Lenco Inc.
 Marconi Electronics Inc.
 Microwave Assoc. Inc.
 Mincorn Div. 3M Co.
 RCA Corp. Broadcast Systems Div.
 Richmond Hill Laboratories Ltd.
 Roscor Corp.
 Ross Broadcast Products, Inc.
 Shintron Co. Inc.
 Tektronix Inc.
 TeleMation, Inc.
 Thompson-CSF Laboratories, Inc.
 Vital Industries Inc.

Amplifier, Pulse

See Adv. Page	
Central Dynamics Corp.	176
Cooke Engineering Co.	37
Telemet, a Geotel Co.	1

American Data Corp.
 Applied Video Electronics, Inc.
 Ball Bros. Research Corp. Miratel
 Division
 Broadcast Video Systems, Ltd.
 C-COR Electronics, Inc.
 Central Dynamics Corp.
 Comark Industries Inc.
 Communications Technology, Inc.
 Cooke Engineering Co.
 Datatek Corp.
 Dynair Electronics, Inc.
 Dynasciences Video Products
 Fernesh Group Robert Bosch Corp.
 Frontier Engineering Corp.
 General Electric Co. Tubes/MW
 Devices
 Grass Valley Group, Inc.
 Hewlett Packard Co.
 Industrial Sciences, Inc.
 Interntl. Nuclear Corp.
 Kaitronics Corp.
 Lenco Inc.
 Marconi Electronics Inc.
 Microwave Assoc. Inc.
 Nasco Television Systems
 Panasonic Video Systems Div.
 RCA Corp. Broadcast Systems Div.
 RHG Elect Labs, Inc.
 Richmond Hill Laboratories Ltd.
 Roscor Corp.
 Scientific Systems, Inc.
 Shintron Co. Inc.
 TeleMation, Inc.
 Telemet, a Geotel Co.
 Vedco, Inc.
 Vital Industries Inc.

Amplifier, Pulse Delay

See Adv. Page	
Central Dynamics Corp.	176
American Data Corp.	
Broadcast Video Systems, Ltd.	
Central Dynamics Corp.	

Cohu, Inc.
 Communications Technology, Inc.
 Grass Valley Group, Inc.
 Lenco Inc.
 Microwave Assoc. Inc.
 TeleMation, Inc.
 Television Equipment Associates
 Vedco, Inc.
 Video Accessories Mfg. Co.

Amplifier, Remote

See Adv. Page	
Broadcast Electronics	45
Martin Audio/Video	152
Moseley Assoc. Inc.	9
Orange County Corp.	64
Pulse Dynamics Mfg. Corp.	160
RCA Corp.	12
Wilkinson Electronics, Inc.	157

Allied Broadcast Equip.
 American Data Corp.
 Belar Electronics Lab., Inc.
 Broadcast Electronics
 Collins Radio Group
 Communication Medias
 Dyma Engineering, Inc.
 Martin Audio/Video
 Micro-Trak Corp.
 Microwave Assoc. Inc.
 Moseley Assoc. Inc.
 Nemo Recording Labs
 Orange County Corp.
 Orbit Radio and Video
 Pulse Dynamics Mfg. Corp. (PDMC)
 Ramko Research
 RCA Corp. Broadcast Systems Div.
 Shure Brothers Inc.
 Sparta Electronic Corp.
 Spotmaster
 Tri-Tronics Professional Electronics
 Wilkinson Electronics, Inc.

Amplifier, RF General Purpose

See Adv. Page	
Moseley Assoc. Inc.	9
Wilkinson Electronics, Inc.	157

Acrodyne Industries Inc.
 AEL Communications Corp.
 Allied Broadcast Equip.
 Ameco Inc.
 Amperex Electronic Corp.
 AVA Electronics Corp.
 Belar Electronics Lab., Inc.
 Blonder-Tongue Labs.
 C-COR Electronics, Inc.
 Comark Industries Inc.
 Fisher-Burke Broadcast Consultants
 General Electric Co. Tubes/MW
 Devices
 Hewlett Packard Co.
 Kay Elemetrics Corp.
 Lauderdale Electronic Labs
 McMartin Industries, Inc.
 Microwave Assoc. Inc.
 Moseley Assoc. Inc.
 National Electrolab Ltd.
 North American Radio Corp.
 Oak Industries, Inc.
 PRD Electronics, Inc.
 QRK Electronic Products
 RHG Elect Labs, Inc.
 Rodelco Corp.
 Rolane Sales Corp.
 Singer Instrumentation
 Singer Products Co., Inc.
 Television Technology Corp.
 Wide Band Engineering Co., Inc.
 Wilkinson Electronics, Inc.
 Winegard Television Systems

Amplifier, RF Linear

See Adv. Page	
Comark Industries Inc.	161
LPB Inc.	152
Moseley Assoc. Inc.	9

Wilkinson Electronics, Inc. 157

Acrodyne Industries Inc.
 AEL Communications Corp.
 Amperex Electronic Corp.
 AVA Electronics Corp.
 C-COR Electronics, Inc.
 Comark Industries Inc.
 Continental Electronics Mfg. Co.
 Fisher-Burke Broadcast Consultants
 Harris Corp. Broadcast Products Div.
 Heath Co.
 Lauderdale Electronic Labs
 LPB Inc.
 Microwave Assoc. Inc.
 Moseley Assoc. Inc.
 National Electrolab Ltd.
 North American Radio Corp.
 Orange County Corp.
 PRD Electronics, Inc.
 QRK Electronic Products
 RHG Elect Labs, Inc.
 Scientific Radio Systems, Inc.
 Sinai-Johnson
 Singer Products Co., Inc.
 Television Technology Corp.
 Transcom Electronics, Inc.
 Tranel Corp.
 Vitek Electronics Inc.
 Wilkinson Electronics, Inc.

Amplifier, RF Peak Limiting

See Adv. Page	
RCA Corp.	12

Belar Electronics Lab., Inc.
 Lauderdale Electronic Labs
 Microwave Assoc. Inc.
 RCA Corp. Broadcast Systems Div.
 Superscope, Inc.
 Thompson-CSF Laboratories, Inc.
 Wilkinson Electronics, Inc.

Amplifier, RF Power

See Adv. Page	
Comark Industries Inc.	161
Moseley Assoc. Inc.	9
Rolane Sales Corp.	160
Wilkinson Electronics, Inc.	157

Acrodyne Industries Inc.
 AEL, Inc.
 Ailtech
 Amperex Electronic Corp.
 Belar Electronics Lab., Inc.
 Blonder-Tongue Labs.
 CCA Electronics Corp.
 C-COR Electronics, Inc.
 Collins Radio Group
 Comark Industries Inc.
 Continental Electronics Mfg. Co.
 EIMAC Div. of Varian
 EMCEE Broadcast Products
 Fisher-Burke Broadcast Consultants
 General Electric Co. ISO Div.
 McMartin Industries, Inc.
 Microwave Assoc. Inc.
 Moseley Assoc. Inc.
 National Electrolab Ltd.
 North American Radio Corp.
 Oak Industries, Inc.
 PRD Electronics, Inc.
 Rohde & Schwarz Sales Co.
 Rolane Sales Corp.
 Scientific Radio Systems, Inc.
 Singer Products Co., Inc.
 Sintronic Corp.
 Sparta Electronic Corp.
 Television Technology Corp.
 Transcom Electronics, Inc.
 Wilkinson Electronics, Inc.
 Winegard Television Systems

Amplifier, Sensing

See Adv. Page	
Moseley Assoc. Inc.	9

Mastertone Co., Inc.
 Microwave Assoc. Inc.
 Moseley Assoc. Inc.

Amplifier, Stabilizing

See Adv. Page

Central Dynamics 176
ROH Corporation 155

Ball Bros. Research Corp. Miratel Division
Central Dynamics Corp.
Grass Valley Group, Inc.
Internatl. Nuclear Corp.
Lenco Inc.
Marconi Electronics Inc.
Microwave Assoc. Inc.
ROH Corporation
Telemet, a Geotel Co.

Amplifier, Stereo Limiter

See Adv. Page

Martin Audio/Video 152
Orange County Corp. 64
Wilkinson Electronics, Inc. 157

Allied Broadcast Equip.
Broadcast Automation Assoc.
Broadcast Electronics
Broadcast Equipment & Supply Co.
Collins Radio Group
Communication Medias
Gately Electronics
Gotham Audio Corp.
Harris Corp. Broadcast Products Div.
Inovonics
Lauderdale Electronic Labs
Martin Audio/Video
Mastertone Co., Inc.
Microwave Assoc. Inc.
Rupert Neve, Inc.
Orange County Corp.
Ramko Research
RCA Corp. Broadcast Systems Div.
Schafer Electronics Corp.
Spectra Sonics
Spotmaster
Thompson-CSF Laboratories, Inc.
Val-Tronics, Inc.
Wilkinson Electronics, Inc.

Amplifier, TV Video

See Adv. Page

Acrodyne Industries Inc. 62
Central Dynamics 176

Acrodyne Industries Inc.
AEL Communications Corp.
Amperex Electronic Corp.
AVA Electronics Corp.
Ball Bros. Research Corp. Miratel Division
Belar Electronics Lab., Inc.
Blonder-Tongue Labs.
Broadcast Video Systems, Ltd.
C-COR Electronics, Inc.
Central Dynamics Corp.
Comark Industries Inc.
Communications Technology, Inc.
Control Concepts Corp.
Dage-MTI, Inc.
Datatek Corp.
Delta Electronics Inc. (N.C.)
Dynair Electronics, Inc.
Frontier Engineering Corp.
Fung Engineering Inc.
General Electric Co. ISO Div.
Grass Valley Group, Inc.
Internatl. Nuclear Corp.
Kay Elemetrics Corp.
Lenco Inc.
Marconi Electronics Inc.
Microwave Assoc. Inc.
Mincom Div. 3M Co.
Nasco Television Systems
Nippon Electric Co., Ltd.
Panasonic Video Systems Div.
Raytheon Data Systems Co.
RCA/Community Telev. Systems
RCA Corp. Broadcast Systems Div.
Ross Broadcast Products, Inc.
Singer Products Co., Inc.
Tektronix Inc.
Tele-Cine Inc.
TeleMation, Inc.
Telemet, a Geotel Co.

Thompson-CSF Laboratories, Inc.
Vedco, Inc.
Vicon Industries, Inc.
Video Accessories Mfg. Co.

Amplifier, Video Sweep

C-COR Electronics, Inc.
Dage-MTI, Inc.
Kay Elemetrics Corp.
Microwave Assoc. Inc.

Amplifier, Zero Studio Delay

Lenco Inc.
Microwave Assoc. Inc.

Analysis Forms

Semline, Inc.

Analyzers, Distortion

See Adv. Page

Logitek Electronic Systems 162

Allied Broadcast Equip.
B & K Instruments Inc.
Collins Radio Group
Control Concepts Corp.
Crown International
Dyma Engineering, Inc.
ELPA Marketing Industries, Inc.
Heath Co.
Hewlett Packard Co.
Logitek Electronic Systems
The London Co.
Marconi Instruments
Potomac Instruments, Inc.
Rohde & Schwarz Sales Co.
Tektronix Inc.
Vu-Data Corp.

Analyzers, Harmonic

Control Concepts Corp.
ELPA Marketing Industries, Inc.
Hewlett Packard Co.
Marconi Instruments
Potomac Instruments, Inc.
Rohde & Schwarz Sales Co.
Singer Instrumentation
Tektronix Inc.
Vu-Data Corp.

Analyzers, Intermodulation

Allied Broadcast Equip.
Belar Electronics Lab., Inc.
Control Concepts Corp.
Crown International
Heath Co.
Marconi Instruments
Rohde & Schwarz Sales Co.
Tektronix Inc.
Theta-Com

Analyzers, RF Network

Ailtech
Comark Industries Inc.
Hewlett Packard Co.
PRD Electronics, Inc.
Rohde & Schwarz Sales Co.
Singer Instrumentation
Singer Products Co., Inc.
Tektronix Inc.
Wide Band Engineering Co., Inc.

Analyzers, Sideband

See Adv. Page

Telemet, a Geotel Co. 1

Ailtech
Marconi Instruments
Rohde & Schwarz Sales Co.
Spectrum Instruments, Inc.
Tektronix Inc.
Telemet, a Geotel Co.

Analyzers, Spectrum

Ailtech
Altec Sound Products
Amber Electro Design, Ltd.
Audio Designs & Mfg.
B & K Instruments Inc.
Hewlett Packard Co.
Kay Elemetrics Corp.
Marconi Instruments
Philips Test & Measuring Instruments, Inc.
Rohde & Schwarz Sales Co.
Singer Products Co., Inc.
Spectrum Instruments, Inc.
Systron-Donner
Tektronix Inc.
Texscan Corp.
Vitek Electronics Inc.

Analyzers, Video

See Adv. Page

Marconi Instruments 65

Ailtech
Colorado Video Inc.
Dynascan Corp.
Marconi Instruments
Rohde & Schwarz Sales Co.
Tektronix Inc.

Antenna Alignment Systems, Microwave

See Adv. Page

Micro Communications, Inc. 36
Nurad, Inc. 58

Innovative Television Equipment, Inc.
Micro Communications, Inc.
Nurad, Inc.
Power Waves, Inc.
Scientific-Atlanta, Inc.
Varian/Beverly

Antenna and Tower Guys

See Adv. Page

Philadelphia Resins Corp. 140

Antenna Products Co.
A-Tel-A-Matic
Collins Radio Group
Dyma Engineering, Inc.
G.C. Electronics
Philadelphia Resins Corp.
Stainless, Inc.
Swagger Tower Corp.
Triangle Towers & Antennas
Tri-Ex Tower Corp.
Unarco-Rohn
Utility Tower Co.

Antenna and Tower Installation and Services

See Adv. Page

Fisher-Burke Broadcast Consultants 124
Dave Hovey 185

Collins Radio Group
Communications 2000, Inc.
Fisher-Burke Broadcast Consultants
GEC-Marconi Electronics Ltd.
Harris Corp. Broadcast Products Div.
Dave Hovey General Contractor
Prodelin Inc.
RCA Corp. Broadcast Systems Div.
Stainless, Inc.
Swagger Tower Corp.
Triangle Towers & Antennas
Tri-Ex Tower Corp.
Unarco-Rohn
Utility Tower Co.

Antenna Sampling Systems

See Adv. Page

Moseley Assoc. Inc. 9

Cablewave Systems Inc.
Collins Radio Group
Delta Electronics Inc. (Va.)
Fisher-Burke Broadcast Consultants
Harris Corp. Broadcast Products Div.
Moseley Assoc. Inc.
Multronics, Inc.
North American Radio Corp.
Sparta Electronic Corp.

Antenna Systems

See Adv. Page

Micro Communications, Inc. 36

Andrew Corp.
Anixter-Mark
AVA Electronics Corp.
Bogner Broadcast Equipment Corp.
Cablewave Systems Inc.
Ceco Communications Inc.
Collins Radio Group
Communications 2000, Inc.
Continental Electronics Mfg. Co.
Delta Electronics Inc. (Va.)
Electromagnetic Specialties
The Finney Co.
Fisher-Burke Broadcast Consultants
G.C. Electronics
GEC-Marconi Electronics Ltd.
General Electric Co. ISO Div.
Harris Corp. Broadcast Products Div.
Jampro Antenna Co.
Mastertone Co., Inc.
Micro Communications, Inc.
Microwave Assoc. Inc.
Multronics, Inc.
Nurad, Inc.
Phelps Dodge Communications Co.
Prodelin Inc.
Radio Research Instrument Co., Inc.
RCA Corp. Broadcast Systems Div.
RCA Corp. Distributor & Special Products Div.
RF Systems, Inc.
Rohde & Schwarz Sales Co.
Scala Radio Corp.
Shively Laboratories, Inc.
Sinai-Johnson
Singer Products Co., Inc.
Sitco Antenna Co.
Sparta Electronic Corp.
Transcom Electronics, Inc.
Triangle Towers & Antennas
Tri-Ex Tower Corp.
Winegard Television Systems

Antenna Tuning Units

See Adv. Page

Micro Communications, Inc. 36
Val-Tronics, Inc. 160

CCA Electronics Corp.
Collins Radio Group
Continental Electronics Mfg. Co.
Dyma Engineering, Inc.
Fisher-Burke Broadcast Consultants
G.C. Electronics
Harris Corp. Broadcast Products Div.
Jampro Antenna Co.
Maury Microwave Corp.
Micro Communications, Inc.
Multronics, Inc.
Nippon Electric Co., Ltd.
North American Radio Corp.
RCA Corp. Broadcast Systems Div.
Sintronic Corp.
Sparta Electronic Corp.
Transcom Electronics, Inc.
Val-Tronics, Inc.
Wilkinson Electronics, Inc.

Antennas, Directional System

See Adv. Page
Micro Communications, Inc. 36

Alford Mfg. Co.
Antenna Products Co.
Bogner Broadcast Equipment Corp.
Collins Radio Group
Continental Electronics Mfg. Co.
Electromagnetic Specialties
The Finney Co.
Harris Corp. Broadcast Products Div.
Innovative Television Equipment, Inc.
Jampro Antenna Co.
Micro Communications, Inc.
Multronics, Inc.
Radio Research Instrument Co., Inc.
RCA Corp. Broadcast Systems Div.
RCA Corp. Distributor & Special Products Div.
RF Systems, Inc.
Rohde & Schwarz Sales Co.
Scala Radio Corp.
Shively Laboratories, Inc.
Sparta Electronic Corp.
Winegard Television Systems

Antennas, Dummy Load

See Adv. Page
Electro Impulse, Inc. 171
Micro Communications, Inc. 36

Bird Electronic Corp.
Coaxial Dynamics
Collins Radio Group
Continental Electronics Mfg. Co.
Dielectric Communications
Electro Impulse, Inc.
G.C. Electronics
Harris Corp. Broadcast Products Div.
Jampro Antenna Co.
Marconi Electronics Inc.
Maury Microwave Corp.
Micro Communications, Inc.
Narda Microwave Corp.
North American Radio Corp.
Ohmite Mfg. Co.
RCA Corp. Broadcast Systems Div.
Rex Rheostat & Co., Inc.
Rohde & Schwarz Sales Co.
Shively Laboratories, Inc.
Sparta Electronic Corp.
Val-Tronics, Inc.
Wilkinson Electronics, Inc.

Antennas, Ice Warning System

See Adv. Page
Orange County Corp. 64

Collins Radio Group
Harris Corp. Broadcast Products Div.
Jampro Antenna Co.
Micro-Trak Corp.
Orange County Corp.
RCA Corp. Broadcast Systems Div.
Val-Tronics, Inc.

Antennas, Monitor

See Adv. Page
Delta Electronics Inc. (Va.) 59
Moseley Assoc. Inc. 9
Potomac Instruments, Inc. 153

Belar Electronics Lab., Inc.
Collins Radio Group
Delta Electronics Inc. (Va.)
Fisher-Burke Broadcast Consultants
G.C. Electronics
Moseley Assoc. Inc.
National Electrolab Ltd.
Potomac Instruments, Inc.
Rohde & Schwarz Sales Co.
Scala Radio Corp.
Val-Tronics, Inc.

Antennas, Receiving FM

Anixter-Mark
Antenna Products Co.
Applied Video Electronics, Inc.
Belar Electronics Lab., Inc.
Catel
The Finney Co.
G.C. Electronics
Jampro Antenna Co.
McMartin Industries, Inc.
RCA Corp. Distributor & Special Products Div.
RCA Corp. RCA Service Co. Div.
RF Systems, Inc.
RMS Electronics, Inc.
Rohde & Schwarz Sales Co.
Saxton Prod. Inc.
Scala Radio Corp.
Scientific-Atlanta, Inc.
Sitco Antenna Co.
Winegard Television Systems

Antennas, Receiving LF

Anixter-Mark
Antenna Products Co.
Delta Electronics Inc. (Va.)
John Fluke Mfg. Co., Inc.
RCA Corp. Distributor & Special Products Div.
Rohde & Schwarz Sales Co.

Antennas, Receiving MF

Anixter-Mark
Antenna Products Co.
Belar Electronics Lab., Inc.
Delta Electronics Inc. (Va.)
RCA Corp. Distributor & Special Products Div.
Rohde & Schwarz Sales Co.
Singer Products Co., Inc.

Antennas, Receiving UHF

See Adv. Page
Micro Communications, Inc. 36
Moseley Assoc. Inc. 9
Nurad, Inc. 58
Rolane Sales Corp. 160

Acrodyne Industries Inc.
Anixter-Mark
Antenna Products Co.
Applied Video Electronics, Inc.
Blonder-Tongue Labs.
EMCEE Broadcast Products
The Finney Co.
G.C. Electronics
Heath Co.
Micro Communications, Inc.
Moseley Assoc. Inc.
Nurad, Inc.
Phelps Dodge Communications Co.
Prodelin Inc.
RCA Corp. Distributor & Special Products Div.
RF Systems, Inc.
RMS Electronics, Inc.
Rohde & Schwarz Sales Co.
Rolane Sales Corp.
Saxton Prod. Inc.
Scala Radio Corp.
Scientific-Atlanta, Inc.
Singer Products Co., Inc.
Sitco Antenna Co.
Winegard Television Systems

Antennas, Receiving VHF

See Adv. Page
Micro Communications, Inc. 36
Moseley Assoc. Inc. 9
Nurad, Inc. 58
Rolane Sales Corp. 160

Acrodyne Industries Inc.
Anixter-Mark
Antenna Products Co.
Applied Video Electronics, Inc.
Blonder-Tongue Labs.
EMCEE Broadcast Products

The Finney Co.
G.C. Electronics
Heath Co.
Micro Communications, Inc.
Moseley Assoc. Inc.
Nurad, Inc.
Phelps Dodge Communications Co.
Prodelin Inc.
RCA Corp. Distributor & Special Products Div.
RF Systems, Inc.
RMS Electronics, Inc.
Rohde & Schwarz Sales Co.
Rolane Sales Corp.
Saxton Prod. Inc.
Scala Radio Corp.
Scientific-Atlanta, Inc.
Sitco Antenna Co.
Winegard Television Systems

Antennas, Receiving Microwave

See Adv. Page
Anixter-Mark 69
Farinon Electric 33
Micro Communications, Inc. 36
Nurad, Inc. 58
TerraCom 127

Andrew Corp.
Anixter-Mark
Bogner Broadcast Equipment Corp.
Cablewave Systems Inc.
Farinon Electric
Mastertone Co., Inc.
Maury Microwave Corp.
Micro Communications, Inc.
Narda Microwave Corp.
Nurad, Inc.
Prodelin Inc.
RF Systems, Inc.
Rohde & Schwarz Sales Co.
Scientific-Atlanta, Inc.
Singer Products Co., Inc.
TerraCom

Antennas, Remote Indicator

Collins Radio Group
Potomac Instruments, Inc.
Scientific-Atlanta, Inc.
Teledata Systems, Inc.

Antennas, Remote Pickup

See Adv. Page
Micro Communications, Inc. 36
Moseley Assoc. Inc. 9

Andrew Corp.
Anixter-Mark
Belar Electronics Lab., Inc.
Bogner Broadcast Equipment Corp.
Collins Radio Group
Dyma Engineering, Inc.
Mastertone Co., Inc.
Micro Communications, Inc.
Moseley Assoc. Inc.
Nurad, Inc.
RF Systems, Inc.
Scala Radio Corp.
Scientific-Atlanta, Inc.
Wilkinson Electronics, Inc.

Antennas, STL

See Adv. Page
Micro Communications, Inc. 36
Moseley Assoc. Inc. 9
Nurad, Inc. 58

Andrew Corp.
Anixter-Mark
Cablewave Systems Inc.
Collins Radio Group
Contel Mfg.
Dyma Engineering, Inc.
Mastertone Co., Inc.
Micro Communications, Inc.
Moseley Assoc. Inc.
Nurad, Inc.

Scala Radio Corp.
Schafer Electronics Corp.
Singer Products Co., Inc.
Swager Tower Corp.
TerraCom
Wilkinson Electronics, Inc.

Antennas, Transmitting FM

See Adv. Page
Micro Communications, Inc. 36
Orange County Corp. 64

Allied Broadcast Equip.
Antenna Products Co.
Broadcast Automation Assoc.
Collins Radio Group
Dyma Engineering, Inc.
Electromagnetic Specialties
GEC-Marconi Electronics Ltd.
Harris Corp. Broadcast Products Div.
Jampro Antenna Co.
Mastertone Co., Inc.
Micro Communications, Inc.
Orange County Corp.
Phelps Dodge Communications Co.
RCA Corp. Broadcast Systems Div.
Rohde & Schwarz Sales Co.
Scala Radio Corp.
Schafer Electronics Corp.
Shively Laboratories, Inc.
Singer Products Co., Inc.
Sintronic Corp.
Sparta Electronic Corp.
Val-Tronics, Inc.
Wilkinson Electronics, Inc.

Antennas, Transmitting LF

See Adv. Page
Micro Communications, Inc. 36
Stainless, Inc. 120

Antenna Products Co.
Continental Electronics Mfg. Co.
Delta Electronics Inc. (Va.)
GEC-Marconi Electronics Ltd.
Jampro Antenna Co.
Micro Communications, Inc.
Stainless, Inc.

Antennas, Transmitting MF

Antenna Products Co.
Collins Radio Group
Continental Electronics Mfg. Co.
Delta Electronics Inc. (Va.)
GEC-Marconi Electronics Ltd.
Jampro Antenna Co.
Marconi Electronics Inc.
Rohde & Schwarz Sales Co.
Shively Laboratories, Inc.

Antennas, Transmitting UHF

See Adv. Page
Bogner Broadcast Equipment Corp. 159
CCA Electronics Corp. 168
Jampro Antenna Co. 128
Micro Communications, Inc. 36
Moseley Assoc. Inc. 9
Nurad, Inc. 58
Orange County Corp. 64
Rolane Sales Corp. 160

Acrodyne Industries Inc.
Alford Mfg. Co.
Andrew Corp.
Anixter-Mark
Antenna Products Co.
Bogner Broadcast Equipment Corp.
CCA Electronics Corp.
Collins Radio Group
EMCEE Broadcast Products
GEC-Marconi Electronics Ltd.
General Electric Co. ISO Div.
Harris Corp. Broadcast Products Div.
Jampro Antenna Co.
Marconi Electronics Inc.

Micro Communications, Inc.
Moseley Assoc. Inc.
Nurad, Inc.
Orange County Corp.
Phelps Dodge Communications Co.
Prodelin Inc.
RCA Corp. Broadcast Systems Div.
RF Systems, Inc.
Rohde & Schwarz Sales Co.
Rolane Sales Corp.
Scala Radio Corp.
Shively Laboratories, Inc.
Sitco Antenna Co.

Antennas, Transmitting VHF

	See Adv. Page
Bogner Broadcast Equipment Corp.	159
Micro Communications, Inc.	36
Moseley Assoc. Inc.	9
Orange County Corp.	64
Rolane Sales Corp.	160

Acrodyne Industries Inc.
Alford Mfg. Co.
Anixter-Mark
Antenna Products Co.
Bogner Broadcast Equipment Corp.
CCA Electronics Corp.
Collins Radio Group
Dyma Engineering, Inc.
EMCEE Broadcast Products
General Electric Co. ISO Div.
Harris Corp. Broadcast Products Div.
Jampro Antenna Co.
Marconi Electronics Inc.
Micro Communications, Inc.
Moseley Assoc. Inc.
Nurad, Inc.
Orange County Corp.
Phelps Dodge Communications Co.
Prodelin Inc.
RCA Corp. Broadcast Systems Div.
RF Systems, Inc.
Rohde & Schwarz Sales Co.
Rolane Sales Corp.
Scala Radio Corp.
Shively Laboratories, Inc.
Singer Products Co., Inc.
Sitco Antenna Co.

Antennas, Transmitting Microwave

	See Adv. Page
Anixter-Mark	69
Farinon Electric	33
Micro Communications, Inc.	36
Moseley Assoc. Inc.	9
Nurad, Inc.	58
TerraCom	127

Andrew Corp.
Anixter-Mark
Bogner Broadcast Equipment Corp.
Cablewave Systems Inc.
Collins Radio Group
Farinon Electric
Jampro Antenna Co.
Mastertone Co., Inc.
Micro Communications, Inc.
Microwave Assoc. Inc.
Moseley Assoc. Inc.
Nurad, Inc.
Prodelin Inc.
RF Systems, Inc.
Rohde & Schwarz Sales Co.
Scientific-Atlanta, Inc.
Singer Products Co., Inc.
TerraCom

Antennas, TV Earth Station

	See Adv. Page
Andrew Corp.	61

Andrew Corp.

Antennas, VSWR Indicator

	See Adv. Page
Micro Communications, Inc.	36
Moseley Assoc. Inc.	9

Bird Electronic Corp.
CCA Electronics Corp.
Collins Radio Group
Comark Industries Inc.
Delta Electronics Inc. (Va.)
Dyma Engineering, Inc.
Harris Corp. Broadcast Products Div.
Jampro Antenna Co.
Micro Communications, Inc.
Moseley Assoc. Inc.
Narda Microwave Corp
PRD Electronics, Inc.
Rohde & Schwarz Sales Co.
Shively Laboratories, Inc.
Singer Products Co., Inc.
Wide Band Engineering Co., Inc.

Arms, Tone

	See Adv. Page
LPB Inc.	152
McCurdy Radio Ind. Inc.	25
Orange County Corp.	64
Russco Electronics Mfg. Inc.	142
Sound Dynamics, Inc.	174

Allied Broadcast Equip.
Broadcast Automation Assoc.
Broadcast Electronics
Broadcast Equipment & Supply Co.
Camex Corp.
Collins Radio Group
Harris Corp. Broadcast Products Div.
Lauderdale Electronic Labs
LPB Inc.
Mastertone Co., Inc.
McCurdy Radio Ind. Inc.
Micro-Trak Corp.
Orange County Corp.
Professional Audio Service
QRK Electronic Products
Rek-O-Kut Inc.
Russco Electronics Mfg. Inc.
Schafer Electronics Corp.
Shure Brothers Inc.
Singer Products Co., Inc.
Sound Dynamics, Inc.
Sparta Electronic Corp.
Spotmaster
Stanton Magnetics Inc.
Systems Engineering Co., Inc.
Val-Tronics, Inc.
Wilkinson Electronics, Inc.

Attenuators, Audio

	See Adv. Page
Ampro Corp.	48
Shallco, Inc.	165
Tech Laboratories Inc.	169
Waters Mfg. Inc.	150

Allen Avionics Inc.
Allied Broadcast Equip.
Altec Sound Products
Ampro Corp.
Audio Designs & Mfg.
Audio Distributor Inc.
Automated Processes, Inc.
Burwen Laboratories
Collins Radio Group
Duncan Electronics, Inc.
Edison Electronics Div.
Gotham Audio Corp.
Harvey Radio
Kay Elemetrics Corp.
Kings Electronics Co., Inc.
Leader Instruments Corp.
Marconi Instruments
Rupert Neve, Inc.
Orange County Corp.
Quad-Eight Electronics
Robins/Fairchild
ROH Corporation
Rohde & Schwarz Sales Co.

Sennheiser Electronic
Shallco, Inc.
Shure Brothers Inc.
Sinai-Johnson
Sparta Electronic Corp.
Spectra Sonics
Tech Laboratories Inc.
Terminal Electronics Corp.
Texscan Corp.
Waters Mfg. Inc.
Weinschel Engineering Co.

Attenuators, Fixed

	See Adv. Page
Shallco, Inc.	165
Tech Laboratories Inc.	169

AEL Communications Corp.
Allen Avionics Inc.
Ameco Inc.
Audio Distributor Inc.
AVA Electronics Corp.
Bird Electronic Corp.
Collins Radio Group
Comark Industries Inc.
Edison Electronics Div.
The Finney Co.
Holland Electronics
Kay Elemetrics Corp.
Kings Electronics Co., Inc.
Narda Microwave Corp
Orange County Corp.
PRD Electronics, Inc.
Radio Mfg. Co. (RMC)
RMS Electronics, Inc.
Rohde & Schwarz Sales Co.
Shallco, Inc.
Sparta Electronic Corp.
Tech Laboratories Inc.
Tektronix Inc.
Telonic Altair
Texscan Corp.
Trompeter Electronics
Waters Mfg. Inc.
Weinschel Engineering Co.

Attenuators, Impedance Matching

	See Adv. Page
Shallco, Inc.	165
Tech Laboratories Inc.	169
Waters Mfg. Inc.	150

Allen Avionics Inc.
Ameco Inc.
Collins Radio Group
Edison Electronics Div.
Electromagnetic Sciences, Inc.
Holland Electronics
Kay Elemetrics Corp.
Narda Microwave Corp
Orange County Corp.
Rohde & Schwarz Sales Co.
Shallco, Inc.
Sparta Electronic Corp.
Tech Laboratories Inc.
Tektronix Inc.
Texscan Corp.
Waters Mfg. Inc.
Weinschel Engineering Co.
Wide Band Engineering Co., Inc.

Attenuators, Microwave

	See Adv. Page
Electro Impulse, Inc.	171
Shallco, Inc.	165
Tech Laboratories Inc.	169

Coaxial Dynamics
Comark Industries Inc.
Electro Impulse, Inc.
General Microwave Corp.
Hewlett Packard Co.
Kay Elemetrics Corp.
Kings Electronics Co., Inc.
Maury Microwave Corp.
Microwave Assoc. Inc.
Narda Microwave Corp
PRD Electronics, Inc.
Rohde & Schwarz Sales Co.
Shallco, Inc.
Singer Products Co., Inc.

Systron-Donner
Tech Laboratories Inc.
Tektronix Inc.
Telonic Altair
Texscan Corp.
Waters Mfg. Inc.
Weinschel Engineering Co.

Attenuators, RF

	See Adv. Page
Electro Impulse, Inc.	171
Micro Communications, Inc.	36
Shallco, Inc.	165
Tech Laboratories Inc.	169

AEL Communications Corp.
Allen Avionics Inc.
Ameco Inc.
AVA Electronics Corp.
Bird Electronic Corp.
Coaxial Dynamics
Comark Industries Inc.
Edison Electronics Div.
Electro Impulse, Inc.
General Microwave Corp.
Hewlett Packard Co.
Holland Electronics
Kahn Communications, Inc.
Kay Elemetrics Corp.
Kings Electronics Co., Inc.
Marconi Instruments
Micro Communications, Inc.
Microwave Assoc. Inc.
Narda Microwave Corp
Oak Industries, Inc.
PRD Electronics, Inc.
RCA Corp. Distributor & Special Products Div.
Rohde & Schwarz Sales Co.
Shallco, Inc.
Sinai-Johnson
Singer Products Co., Inc.
Systron-Donner
Tech Laboratories Inc.
Telonic Altair
Texscan Corp.
Waters Mfg. Inc.
Weinschel Engineering Co.
Winegard Television Systems

Audio Stacks, Rebuilt or Rebuilding Services for VTR

	See Adv. Page
Videomax Corp.	15

Computer Magnetics Corp.
Minneapolis Magnetics, Inc.
Taber Mfg. & Engr. Co.
Videomax Corp.

Automation, Camera Control

	See Adv. Page
Moseley Assoc. Inc.	9

Cunningham Corp.
Fernesh Group Robert Bosch Corp.
GEC-Marconi Electronics Ltd.
Moseley Assoc. Inc.
Power-Optics Inc.
Tele-Cine Inc.
Trepac Corp. America

Automation, Color Corrector

	See Adv. Page
Comark Industries Inc.	158

Comark Industries Inc.
Fernesh Group Robert Bosch Corp.
GEC-Marconi Electronics Ltd.
Rank Precision Industries
Television Equipment Associates
Thompson-CSF, Inc.
Thompson-CSF Laboratories, Inc.

Automation, Data Processing

See Adv. Page

Central Dynamics Corp.176
 Control Design Corp.....137
 Grass Valley Group, Inc. 3
 Moseley Assoc. Inc. 9
 Vital Industries Inc. BC

Broadcast Automation Assoc.
 Central Dynamics Corp.
 Control Design Corp.
 GEC-Marconi Electronics Ltd.
 Grass Valley Group, Inc.
 Hewlett Packard Co.
 Mincom Div. 3M Co.
 Moseley Assoc. Inc.
 Quad-Eight Electronics
 Revox Corp.
 Step Corp.
 Systems Marketing Corp.
 Vital Industries Inc.

Automation, Equipment Control

See Adv. Page

Central Dynamics Corp.176
 Grass Valley Group, Inc. 3
 IGM173
 Marconi Instruments 65
 Moseley Assoc. Inc. 9
 RCA Corp.12
 Telemedia Electronics.....161
 Val-Tronics, Inc.....171
 Vital Industries Inc. BC

Aitken Communications Inc.
 Allied Broadcast Equip.
 Audio Distributor Inc.
 Audio Services, Inc
 Autogram Corp.
 Avtel
 Broadcast Automation Assoc.
 Camex Corp.
 Central Dynamics Corp.
 Chrono-Log Corp.
 CMX Systems
 Communication Medias
 Concept 70
 Control Design Corp.
 ESE
 GEC-Marconi Electronics Ltd.
 General Electric Co. ISO Div.
 Grass Valley Group, Inc.
 IGM
 Magna-Tech Electronic Co., Inc.
 Marconi Instruments
 Mastertone Co., Inc.
 McBee Laboratories
 Mincom Div. 3M Co.
 Moseley Assoc. Inc.
 Orange County Corp.
 QRK Electronic Products
 Quad-Eight Electronics
 Radio Mfg. Co. (RMC)
 RCA Corp. Broadcast Systems Div.
 Richmond Hill Laboratories Ltd.
 Schafer Electronics Corp.
 Sparta Electronic Corp.
 Systems Marketing Corp.
 Tape-Athon Corp.
 Telemedia Electronics
 Trepac Corp. America
 Val-Tronics, Inc.
 Video Accessories Mfg. Co.
 Vital Industries Inc.

Automation, Film Chain

See Adv. Page

Central Dynamics Corp.176

Central Dynamics Corp.
 Fernesh Group Robert Bosch Corp.
 Mincom Div. 3M Co.
 Quad-Eight Electronics
 RCA Corp. Broadcast Systems Div.
 Thompson-CSF, Inc.

Automation, Lighting Control

Berkey-Colortran Inc.
 General Electric Co. Tubes/MW Devices
 Revox Corp.
 Richmond Hill Laboratories Ltd.
 Skirpan Lighting Control Corp.

Automation, Program Control

See Adv. Page

Audio Services, Inc.169
 Control Design Corp.....137
 Grass Valley Group, Inc. 3
 IGM173
 RCA Corp. 58
 Sparta Electronic Corp. 5
 Telemedia Electronics.....161
 Vital Industries Inc. BC

Aitken Communications Inc.
 Allied Broadcast Equip.
 Alto Communications Inc.
 American Data Corp.
 Audio Distributor Inc.
 Audio Services, Inc
 Autogram Corp.
 Avtel
 Broadcast Automation Assoc.
 Camex Corp.
 Central Dynamics Corp.
 Chrono-Log Corp.
 Collins Radio Group
 Concept 70
 Control Design Corp.
 Datatron, Inc.
 Dynasciences Video Products
 ESE
 General Electric Co. ISO Div.
 Grass Valley Group, Inc.
 IGM
 Nippon Electric Co., Ltd.
 Orange County Corp.
 Orbit Radio and Video
 QRK Electronic Products
 Quad-Eight Electronics
 Radio Mfg. Co. (RMC)
 RCA Corp. Broadcast Systems Div.
 Revox Corp.
 Richmond Hill Laboratories Ltd.
 Schafer Electronics Corp.
 Sparta Electronic Corp.
 Step Corp.
 Systems Marketing Corp.
 Tape-Athon Corp.
 Tektronix Inc.
 TeleMation, Inc.
 Telemedia Electronics
 Trepac Corp. America
 Val-Tronics, Inc.
 VIF International
 Vital Industries Inc.
 Ward-Beck Systems, Ltd.

Automation, Program Logging

See Adv. Page

Central Dynamics Corp.176
 Control Design Corp.....137
 Grass Valley Group, Inc. 3
 IGM173
 Moseley Assoc. Inc. 9

Allied Broadcast Equip.
 Autogram Corp.
 Broadcast Automation Assoc.
 Camex Corp.
 Central Dynamics Corp.
 Collins Radio Group
 Control Design Corp.
 Datatron, Inc.
 General Electric Co. ISO Div.
 Grass Valley Group, Inc.
 Harris Corp. Broadcast Products Div.
 IGM
 Mastertone Co., Inc.
 McBee Laboratories
 Moseley Assoc. Inc.
 Orange County Corp.
 Radio Mfg. Co. (RMC)

Revox Corp.
 Richmond Hill Laboratories Ltd.
 Schafer Electronics Corp.
 Sparta Electronic Corp.
 Systems Marketing Corp.
 Val-Tronics, Inc.
 Vital Industries Inc.

Automation, Projector

Central Dynamics176

Central Dynamics Corp.
 ESE
 Magna-Tech Electronic Co., Inc.
 Marconi Electronics Inc.
 RCA Corp. Broadcast Systems Div.
 Skirpan Lighting Control Corp.
 Spindler & Sauppe, Inc.

Automation, Switching

See Adv. Page

Central Dynamics Corp.176
 Control Design Corp.....137
 Grass Valley Group, Inc. 3
 RCA Corp.12
 Telemedia Electronics.....161
 Vital Industries Inc. BC

Allied Broadcast Equip.
 American Data Corp.
 Audio Services, Inc
 Avtel
 Broadcast Automation Assoc.
 Camex Corp.
 Central Dynamics Corp.
 Chrono-Log Corp.
 CMX Systems
 Concept 70
 Control Design Corp.
 Cunningham Corp.
 General Electric Co. ISO Div.
 Grass Valley Group, Inc.
 IGM
 Marconi Electronics Inc.
 Orange County Corp.
 Quad-Eight Electronics
 Radio Mfg. Co. (RMC)
 RCA Corp. Broadcast Systems Div.
 Revox Corp.
 Richmond Hill Laboratories Ltd.
 ROH Corporation
 Schafer Electronics Corp.
 Skirpan Lighting Control Corp.
 Systems Marketing Corp.
 Tech Laboratories Inc.
 TeleMation, Inc.
 Telemedia Electronics
 Trepac Corp. America
 Vital Industries Inc.

Automation, Tape Control Cart

See Adv. Page

Ampro Corp. 48
 Audio Services, Inc162
 Central Dynamics Corp.176
 Control Design Corp.....137
 IGM173
 RCA Corp. 58
 Sparta Electronic Corp. 5

Aitken Communications Inc.
 Allied Broadcast Equip.
 Ampro Corp.
 Audio Services, Inc
 Autogram Corp.
 Broadcast Automation Assoc.
 Broadcast Electronics
 Camex Corp.
 Central Dynamics Corp.
 Collins Radio Group
 Control Design Corp.
 Delta Electronics Inc. (N.C.)
 Dyma Engineering, Inc.
 Harris Corp. Broadcast Products Div.
 IGM
 Mastertone Co., Inc.
 Mincom Div. 3M Co.
 Orange County Corp.
 QRK Electronic Products
 RCA Corp. Broadcast Systems Div.

Schafer Electronics Corp.
 Sparta Electronic Corp.
 Spotmaster
 Systems Marketing Corp.
 Tapecaster TCM, Inc.
 Telectro Systems Corp.
 VIF International

Automation, Tape Control Reel

See Adv. Page

Control Design Corp.....137
 IGM173
 RCA Corp. 58

Aitken Communications Inc.
 Allied Broadcast Equip.
 Audio Services, Inc
 Autogram Corp.
 Broadcast Automation Assoc.
 Camex Corp.
 Central Dynamics Corp.
 Collins Radio Group
 Control Design Corp.
 IGM
 Mastertone Co., Inc.
 Mincom Div. 3M Co.
 Nemo Recording Labs
 Orange County Corp.
 Otari Corp.
 QRK Electronic Products
 RCA Corp. Broadcast Systems Div.
 Revox Corp.
 Schafer Electronics Corp.
 Sparta Electronic Corp.
 Systems Marketing Corp.
 Tape-Athon Corp.
 Telectro Systems Corp.
 Telemedia Electronics
 VIF International

Automation, Transmitter Logging

See Adv. Page

Grass Valley Group, Inc. 3
 Marconi Instruments 65
 Moseley Assoc. Inc. 9

Broadcast Automation Assoc.
 Collins Radio Group
 Datalogic-Rust Co.
 Grass Valley Group, Inc.
 Marconi Instruments
 McBee Laboratories
 Moseley Assoc. Inc.
 Orange County Corp.
 Philips Test & Measuring Instruments, Inc.
 Sinai-Johnson
 Systems Marketing Corp.
 Telectro Systems Corp.

Automation, Video Tape Machine

See Adv. Page

Central Dynamics Corp.176
 Grass Valley Group, Inc. 3

Ampex Corp.
 Avtel
 Broadcast Automation Assoc.
 Central Dynamics Corp.
 CMX Systems
 Dyma Engineering, Inc.
 Dynasciences Video Products
 Electronic Designers Inc.
 ESE
 Fernesh Group Robert Bosch Corp.
 GEC-Marconi Electronics Ltd.
 Grass Valley Group, Inc.
 Mincom Div. 3M Co.
 Nemo Recording Labs
 Orbit Radio and Video
 RCA Corp. Broadcast Systems Div.
 Recortec Inc.
 Systa-Matics, Inc.
 TeleMation, Inc.
 Telemedia Electronics

Battery Pack Chargers

See Adv. Page
Frezzolini Electronics, Inc. 32
Frezzolini Electronics, Inc.

Battery Packs, ENG

See Adv. Page
Frezzolini Electronics, Inc. 32
Frezzolini Electronics, Inc.

Blowers and Fans

AMCO Engineering Co.
American-Standard
Bellern Research Corp.
Collins Radio Group
Lauderdale Electronic Labs
Mole Richardson Co.
Optima Enclosures
Stantron Div.
Terminal Electronics Corp.

Bridge, Common Point

See Adv. Page
Delta Electronics Inc. (Va.) 59
Potomac Instruments, Inc. 153

Collins Radio Group
Delta Electronics Inc. (Va.)
Potomac Instruments, Inc.
Val-Tronics, Inc.

Cabinets, Consoles and Racks

See Adv. Page
Aderhold Construction Co. 185
Broadcast Electronics 45
Cooke Engineering Co. 37
Fisher-Burke Broadcast Consultants 124
Grinnan Fixture Co. 163
Orange County Corp. 64
Sparta Electronic Corp. 5
Storeel Corp. 12

Aderhold Construction Co.
AMCO Engineering Co.
Audio Designs & Mfg.
AVA Electronics Corp.
Broadcast Electronics
Collins Radio Group
Communications Systems
Concept 70
Control Design Corp.
Cooke Engineering Co.
Dyma Engineering, Inc.
EMCOR Ingersoll Products
Enclosure Corp.
Equipto
Fisher-Burke Broadcast Consultants
General Devices Co., Inc.
Grinnan Fixture Co.
Harris Corp. Broadcast Products Div.
Harvey Radio
Lauderdale Electronic Labs
Mastertone Co., Inc.
Micro-Trak Corp.
Neumade Prod. Corp.
Nippon Electric Co., Ltd.
North American Radio Corp.
Optima Enclosures
Orange County Corp.
Paso Sound Products Inc.
QRK Electronic Products
Quad-Eight Electronics
RCA Corp. Broadcast Systems Div.
Rek-O-Kut Inc.
Schafer Electronics Corp.
SGL Waber Electric
Shintron Co. Inc.
Sparta Electronic Corp.
Stantron Div.

Storeel Corp.
Systems Engineering Co., Inc.
Tektronix Inc.
TeleMation, Inc.
Telemedia Electronics
TRW Electronics Supply Co.
Vicon Industries, Inc.
Wilkinson Electronics, Inc.
H. Wilson Corp.

Cable, Camera

Asaca Corp. of America
Belden Corp.
Boston Insulated Wire & Cable Co.
Brand-Rex Co.
Fernesh Group Robert Bosch Corp.
GBC Closed Circuit TV Corp.
General Cable Corp.
General Electric Co. ISO Div.
Harris Corp. Broadcast Products Div.
Harvey Radio
International Video Corp.
Kings Electronics Co., Inc.
Panasonic Video Systems Div.
RCA Corp. Broadcast Systems Div.
Super 8 Sound, Inc.
TeleMation, Inc.
Terminal Electronics Corp.

Cable, Coaxial Flexible

See Adv. Page
Burwen Laboratories 57
Comark Industries Inc. 161
Orange County Corp. 64

Alpha Wire Corp.
Andrew Corp.
A-Tel-A-Matic
Belden Corp.
Blonder-Tongue Labs.
Brand-Rex Co.
Burwen Laboratories
Cablewave Systems Inc.
Collins Radio Group
Comark Industries Inc.
Comm/Scope Co.
Communications Systems
Essex International Inc.
The Finney Co.
GBC Closed Circuit TV Corp.
G.C. Electronics
General Cable Corp.
Harvey Radio
Jampro Antenna Co.
Javelin
Mastertone Co., Inc.
Orange County Corp.
Phelps Dodge Communications Co.
Plastoid Corp.
Prodelin Inc.
RCA Corp. Broadcast Systems Div.
Revox Corp.
Saxton Prod. Inc.
Shively Laboratories, Inc.
Sinai-Johnson
Singer Products Co., Inc.
Sparta Electronic Corp.
TeleMation, Inc.
Times Wire and Cable
Trompeter Electronics
Val-Tronics, Inc.
Wilkinson Electronics, Inc.

Cable, Coaxial Rigid

See Adv. Page
Burwen Laboratories 57
Comark Industries Inc. 161
Micro Communications, Inc. 36
Orange County Corp. 64

AEL Communications Corp.
Andrew Corp.
A-Tel-A-Matic
Burwen Laboratories
Cablewave Systems Inc.
Collins Radio Group
Comark Industries Inc.
Comm/Scope Co.
Dyma Engineering, Inc.
Essex International Inc.
Gately Electronics

General Cable Corp.
Jampro Antenna Co.
Mastertone Co., Inc.
Micro Communications, Inc.
Orange County Corp.
Phelps Dodge Communications Co.
Plastoid Corp.
Prodelin Inc.
RCA Corp. Broadcast Systems Div.
Shively Laboratories, Inc.
Singer Products Co., Inc.
Sparta Electronic Corp.
Times Wire and Cable
Val-Tronics, Inc.
Wilkinson Electronics, Inc.

Cable, Direct Burial

AEL Communications Corp.
Alpha Wire Corp.
A-Tel-A-Matic
Belden Corp.
Brand-Rex Co.
Cablewave Systems Inc.
Collins Radio Group
Comm/Scope Co.
Davis Mfg. Co.
Essex International Inc.
General Cable Corp.
Phelps Dodge Communications Co.
Plastoid Corp.
Sinai-Johnson
Singer Products Co., Inc.
Times Wire and Cable

Cable, Microphone

Alpha Wire Corp.
Belden Corp.
Collins Radio Group
G.C. Electronics
General Cable Corp.
Gotham Audio Corp.
Harvey Radio
Lauderdale Electronic Labs
Orange County Corp.
Revox Corp.
Saxton Prod. Inc.
Senstrol Div.
Sinai-Johnson
Singer Products Co., Inc.
Times Wire and Cable
Wilkinson Electronics, Inc.

Cable, Shielded Audio

Alpha Wire Corp.
A-Tel-A-Matic
Belden Corp.
Boston Insulated Wire & Cable Co.
Brand-Rex Co.
Broadcast Equipment & Supply Co.
Collins Radio Group
Comm/Scope Co.
Communications Systems
EMT Franz VGmbH
Essex International Inc.
G.C. Electronics
General Cable Corp.
Gotham Audio Corp.
Harvey Radio
Nortronics Co., Inc.
Orange County Corp.
Prestolite Wire Div.
Revox Corp.
Saxton Prod. Inc.
Senstrol Div.
Sinai-Johnson
Singer Products Co., Inc.
Sparta Electronic Corp.
Terminal Electronics Corp.
Times Wire and Cable
Wilkinson Electronics, Inc.

Cable Laying Equipment

Davis Mfg. Co.
Ditch Witch
Roll-A-Reel
Terminal Electronics Corp.

Cable Locators, Underground

Automation Products Co.
Instrument Laboratories
Scully/Metrotech
Tektronix Inc.

Cable Stripping Tools

See Adv. Page
Western Electronic Prods. Co. 150
Western Electronic Prods. Co.

Calibration Service, Instrument

See Adv. Page
Fisher-Burke Broadcast Consultants 124

Bird Electronic Corp.
B & K Instruments Inc.
Comm. Radio Monitoring
Fisher-Burke Broadcast Consultants
Instrument Laboratories
National Electrolab Ltd.
Potomac Instruments, Inc.
Sencore Inc.
Tektronix Inc.
Thompson-CSF Laboratories, Inc.

Camera Carrying Systems, Television Portapak

See Adv. Page
K & H Products, Ltd. 157
K & H Products, Ltd.

Camera Dollies, Stands and Tripods

See Adv. Page
O'Connor Eng. Labs, Inc. 22
Quick-Set Inc. 56
Television Products Co. Inc. 136
Victor Duncan, Inc. 139

Berkey-Colortran Inc.
Cohu, Inc.
Communications Systems
Comquip, Inc.
Cosmicar Optical Co., Ltd.
Davis & Sanford Co. Inc.
Editel Communications
GBC Closed Circuit TV Corp.
Harris Corp. Broadcast Products Div.
Harvey Radio
Image Devices Inc.
Innovative Television Equipment, Inc.
International Video Corp.
Javelin
Lauderdale Electronic Labs
Listec TV Equip. Corp.
O'Connor Eng. Labs. Inc.
Paillard Inc.
Panasonic Video Systems Div.
Quick-Set Inc.
RCA Corp. Broadcast Systems Div.
SGL Waber Electric
Smith-Beemish, Inc.
Sylvania Comm. Electronic
Systa-Matics, Inc.
Tele-Cine Inc.
Television Products Co. Inc.
R. H. Tyler Co.
Victor Duncan, Inc.

Camera Housing, Environmental

Asaca Corp. of America
Cohu, Inc.
Communications Systems
Cunningham Corp.
Dage-MTI, Inc.
GBC Closed Circuit TV Corp.
General Electric Co. ISO Div.
Nemo Recording Labs
Sinai-Johnson
Smith-Beemish, Inc.
Systa-Matics, Inc.

Camera Pan and Tilt Heads

See Adv. Page

Quick-Set Inc...... 56
Television Products Co. Inc. 136
Victor Duncan, Inc. 139

Asaca Corp. of America
 Cohu, Inc.
 Communications Systems
 Cunningham Corp.
 Dage-MTI, Inc.
 Davis & Sanford Co. Inc.
 Dyma Engineering, Inc.
 Editel Communications
 GBC Closed Circuit TV Corp.
 General Electric Co. ISO Div.
 Harris Corp. Broadcast Products Div.
 Image Devices Inc.
 Innovative Television Equipment, Inc.
 Javelin
 Listec TV Equip. Corp.
 Nemo Recording Labs
 O'Connor Eng. Labs. Inc.
 Paillard Inc.
 Power-Optics Inc.
 Quick-Set Inc.
 RCA Corp. Broadcast Systems Div.
 Roscor Corp.
 Sinai-Johnson
 Smith-Beemish, Inc.
 Systa-Matics, Inc.
 Tele-Cine Inc.
 Television Products Co. Inc.
 R. H. Tyler Co.
 Vicon Industries, Inc.
 Victor Duncan, Inc.

Camera Remote Control Equipment

See Adv. Page

Moseley Assoc. Inc. 9

Catel
 Cohu, Inc.
 Communications Systems
 Cunningham Corp.
 Dage-MTI, Inc.
 Fernesh Group Robert Bosch Corp.
 Innovative Television Equipment, Inc.
 Moseley Assoc. Inc.
 Panasonic Video Systems Div.
 Power-Optics Inc.
 Sinai-Johnson
 Smith-Beemish, Inc.
 Sylvania Comm. Electronic
 Tektronix Inc.
 Tele-Cine Inc.
 TeleMation, Inc.
 Trepac Corp. America
 Vicon Industries, Inc.

Cameras, Closed Circuit B&W

Akai America, Ltd.
 Asaca Corp. of America
 A-Tel-A-Matic
 ATV Research
 Cohu, Inc.
 Colorado Video Inc.
 Communications Systems
 Comquip, Inc.
 Dage-MTI, Inc.
 Denson Electronic Corp.
 Diebold Inc.
 Echo Science Corp.
 Editel Communications
 GBC Closed Circuit TV Corp.
 GEC-Marconi Electronics Ltd.
 General Electric Co. ISO Div.
 General Electric Co. Tubes/MW Devices
 Gen. Electrodynamics
 Harvey Radio
 Hitachi Shibaden Corp. of America
 Ikegami Electronics (USA) Inc.
 Javelin
 Lenco Inc.
 Lenzar Optics Corp.
 Maze Corp
 Panasonic Video Systems Div.
 Philips Audio Video Systems Corp.
 Broadcast Equip. Div.

RCA Corp. Distributor & Special Products Div.
 Roscor Corp.
 SC Electronics, Inc.
 Sinai-Johnson
 Sony Corp. of America VTR Div.
 Systa-Matics, Inc.
 TEAC Corp of America
 TeleMation, Inc.
 Teltron Inc.
 Temtron Electronics
 R. H. Tyler Co.
 Westinghouse Electronic Tube Divs.

Cameras, Closed Circuit Color

Akai America, Ltd.
 A-Tel-A-Matic
 Cohu, Inc.
 Commercial Electronics, Inc.
 Communications Systems
 Comquip, Inc.
 Denson Electronic Corp.
 Editel Communications
 Fernesh Group Robert Bosch Corp.
 GBC Closed Circuit TV Corp.
 GEC-Marconi Electronics Ltd.
 General Electric Co. ISO Div.
 General Electric Co. Tubes/MW Devices
 Harvey Radio
 Hitachi Shibaden Corp. of America
 Ikegami Electronics (USA) Inc.
 International Video Corp.
 Maze Corp
 Nemo Recording Labs
 Panasonic Video Systems Div.
 Philips Audio Video Systems Corp.
 Broadcast Equip. Div.
 Roscor Corp.
 Sony Corp. of America VTR Div.
 Systa-Matics, Inc.
 TEAC Corp of America
 Temtron Electronics
 R. H. Tyler Co.
 Westinghouse Electronic Tube Divs.

Cameras, Film Chain

Cohu, Inc.
 Commercial Electronics, Inc.
 Comquip, Inc.
 Fernesh Group Robert Bosch Corp.
 GBC Closed Circuit TV Corp.
 General Electric Co. ISO Div.
 General Electric Co. Tubes/MW Devices
 Harris Corp. Broadcast Products Div.
 Harvey Radio
 International Video Corp.
 Marco Video Systems, Inc.
 Maze Corp
 Nemo Recording Labs
 Nippon Electric Co., Ltd.
 Panasonic Video Systems Div.
 Philips Audio Video Systems Corp.
 Broadcast Equip. Div.
 Rank Precision Industries Rank Cintel Div.
 RCA Corp. Broadcast Systems Div.
 Roscor Corp.
 Systa-Matics, Inc.
 TeleMation, Inc.
 Temtron Electronics
 Thompson-CSF, Inc.
 Thompson-CSF Laboratories, Inc.
 R. H. Tyler Co.

Cameras, Film Cine

Arriflex Co. of America
 Canon USA, Inc. Optics Div.
 Comquip, Inc.
 Eastman Kodak Co.
 Fernesh Group Robert Bosch Corp.
 GAF Corp.
 General Electric Co. Tubes/MW Devices
 Image Devices Inc.
 Paillard Inc.
 Panasonic Video Systems Div.
 RCA Corp. Broadcast Systems Div.
 Super 8 Sound, Inc.
 Teledyne Camera Systems
 TeleMation, Inc.
 Thompson-CSF, Inc.
 Thompson-CSF Laboratories, Inc.

Victor Duncan, Inc.

Cameras, Film Still

Canon USA, Inc. Optics Div.
 Comquip, Inc.
 Eastman Kodak Co.
 GAF Corp.
 General Electric Co. Tubes/MW Devices
 Paillard Inc.
 Panasonic Video Systems Div.

Cameras, Image Motion Compensation

Dynasciences Video Products

Cameras, Surveillance

Asaca Corp. of America
 A-Tel-A-Matic
 ATV Research
 Cohu, Inc.
 Communications Systems
 Comquip, Inc.
 Dage-MTI, Inc.
 Diebold Inc.
 Eastman Kodak Co.
 Echo Science Corp.
 GEC-Marconi Electronics Ltd.
 General Electric Co. ISO Div.
 General Electric Co. Tubes/MW Devices
 Gen. Electrodynamics
 Harvey Radio
 Hitachi Shibaden Corp. of America
 Ikegami Electronics (USA) Inc.
 Image Devices Inc.
 Javelin
 Lenco Inc.
 Lenzar Optics Corp.
 Nemo Recording Labs
 Panasonic Video Systems Div.
 Philips Audio Video Systems Corp.
 Broadcast Equip. Div.
 Power-Optics Inc.
 RCA Corp. Distributor & Special Products Div.
 SC Electronics, Inc.
 Sinai-Johnson
 Systa-Matics, Inc.
 Tele-Cine Inc.
 Teledyne Camera Systems
 TeleMation, Inc.
 Teltron Inc.
 Vicon Industries, Inc.
 Victor Duncan, Inc.

Cameras, TV B&W Portable Broadcast

See Adv. Page

Asaca Corp. of America..... 41
Cramer Video..... 148
Lenco Inc...... 40
Martin Audio/Video 152
Sony Corp. of America..... IBC

Asaca Corp. of America
 Cohu, Inc.
 Communications Systems
 Comquip, Inc.
 Cramer Video
 Denson Electronic Corp.
 GEC-Marconi Electronics Ltd.
 General Electric Co. Tubes/MW Devices
 Harvey Radio
 Ikegami Electronics (USA) Inc.
 JVC Industries, Inc.
 Lenco Inc.
 Martin Audio/Video
 Maze Corp
 Sony Corp. of America VTR Div.
 TEAC Corp of America
 Teledyne Camera Systems
 Teltron Inc.

Cameras, TV B&W Studio Broadcast

See Adv. Page

Lenco Inc...... 40

Cohu, Inc.
 Dage-MTI, Inc.
 Denson Electronic Corp.
 GEC-Marconi Electronics Ltd.
 Harvey Radio
 Hitachi Shibaden Corp. of America
 Ikegami Electronics (USA) Inc.
 Lenco Inc.
 Marconi Electronics Inc.
 Maze Corp
 Philips Audio Video Systems Corp.
 Broadcast Equip. Div.
 Sony Corp. of America VTR Div.
 TeleMation, Inc.
 Teltron Inc.
 Temtron Electronics

Cameras, TV Color Portable Broadcast

See Adv. Page

Asaca Corp. of America..... 41
Cramer Video..... 148
Martin Audio/Video 152
Sony Corp. of America..... IBC

Akai America, Ltd.
 Ampex Corp.
 Asaca Corp. of America
 Commercial Electronics, Inc.
 Comquip, Inc.
 Cramer Video
 Editel Communications
 Fernesh Group Robert Bosch Corp.
 GBC Closed Circuit TV Corp.
 GEC-Marconi Electronics Ltd.
 Harris Corp. Broadcast Products Div.
 Harvey Radio
 Ikegami Electronics (USA) Inc.
 Image Devices Inc.
 International Video Corp.
 Martin Audio/Video
 Maze Corp
 Nippon Electric Co., Ltd.
 Philips Audio Video Systems Corp.
 Broadcast Equip. Div.
 RCA Corp. Broadcast Systems Div.
 Roscor Corp.
 Sony Corp. of America VTR Div.
 Systa-Matics, Inc.
 TEAC Corp of America
 Thompson-CSF, Inc.
 Thompson-CSF Laboratories, Inc.
 Victor Duncan, Inc.

Cameras, TV Color Studio Broadcast

See Adv. Page

Asaca Corp. of America..... 41
Cramer Video..... 148

Ampex Corp.
 Asaca Corp. of America
 Commercial Electronics, Inc.
 Cramer Video
 Fernesh Group Robert Bosch Corp.
 GEC-Marconi Electronics Ltd.
 Harris Corp. Broadcast Products Div.
 Harvey Radio
 Hitachi Shibaden Corp. of America
 Ikegami Electronics (USA) Inc.
 International Video Corp.
 Marconi Electronics Inc.
 Maze Corp
 Nippon Electric Co., Ltd.
 Panasonic Video Systems Div.
 Philips Audio Video Systems Corp.
 Broadcast Equip. Div.
 RCA Corp. Broadcast Systems Div.
 Roscor Corp.
 Sony Corp. of America VTR Div.
 Systa-Matics, Inc.
 Temtron Electronics
 Thompson-CSF, Inc.
 Thompson-CSF Laboratories, Inc.

Cameras, TV Hand Held

See Adv. Page

Asaca Corp. of America..... 41
Cramer Video.....148
Martin Audio/Video152
Sony Corp. of America..... IBC

- Akai America, Ltd.
- Ampex Corp.
- Asaca Corp. of America
- ATV Research
- Communications Systems
- Comquip, Inc.
- Cramer Video
- Editel Communications
- Fernesh Group Robert Bosch Corp.
- GBC Closed Circuit TV Corp.
- GEC-Marconi Electronics Ltd.
- Harvey Radio
- Ikegami Electronics (USA) Inc.
- Image Devices Inc.
- International Video Corp.
- JVC Industries, Inc.
- Martin Audio/Video
- Philips Audio Video Systems Corp.
- Broadcast Equip. Div.
- RCA Corp. Broadcast Systems Div.
- RCA Corp. Distributor & Special Products Div.
- Roscor Corp.
- Sinai-Johnson
- Sony Corp. of America VTR Div.
- Systa-Matics, Inc.
- TEAC Corp of America
- Thompson-CSF, Inc.
- Thompson-CSF Laboratories, Inc.
- R. H. Tyler Co.

Cameras, TV Remote Control Broadcast

See Adv. Page

Martin Audio/Video152

- Commercial Electronics, Inc.
- Fernesh Group Robert Bosch Corp.
- GEC-Marconi Electronics Ltd.
- General Electric Co. Tubes/MW Devices
- Harvey Radio
- International Video Corp.
- Marconi Electronics Inc.
- Martin Audio/Video
- Maze Corp
- Philips Audio Video Systems Corp.
- Broadcast Equip. Div.
- RCA Corp. Broadcast Systems Div.
- Smith-Beemish, Inc.
- Teltron Inc.
- Thompson-CSF, Inc.
- Thompson-CSF Laboratories, Inc.

Capacitors, Transmitting, Mica and Vacuum

- Surcom Associates

Cartridge Machine, Dual Deck

See Adv. Page

Ampro Corp...... 48
Broadcast Electronics 45
Communication Medias..... 62
Martin Audio/Video152
RCA Corp. 12

- Allied Broadcast Equip.
- Ampro Corp.
- Broadcast Automation Assoc.
- Broadcast Electronics
- Camex Corp.
- Cine Sonic Sound Inc.
- Collins Radio Group
- Communication Medias
- Control Design Corp.
- Dyma Engineering, Inc.
- Garron Electronics, Inc.
- Harris Corp. Broadcast Products Div.
- IGM
- MacKenzie Laboratories, Inc.
- Martin Audio/Video
- Mastertone Co., Inc.

- Maze Corp
- McCurdy Radio Ind. Inc.
- Orange County Corp.
- QRK Electronic Products
- Rapid-Q
- RCA Corp. Broadcast Systems Div.
- Singer Products Co., Inc.
- Spotmaster
- Systems Marketing Corp.
- Tapex Corp.
- Telectro Systems Corp.
- Visual Electronics Laboratories
- Wilkinson Electronics, Inc.

Cartridge Machine, Multiple Deck

See Adv. Page

Ampro Corp...... 48
Broadcast Electronics 45
Control Design Corp......137
Garron Electronics, Inc.170
IGM173
International Tapetronics Corp. 20
Martin Audio/Video152
Orange County Corp. 64
RCA Corp. 12
Sparta Electronic Corp. 5

- Allied Broadcast Equip.
- Ampro Corp.
- Broadcast Automation Assoc.
- Broadcast Electronics
- Broadcast Equipment & Supply Co.
- Camex Corp.
- Collins Radio Group
- Communication Medias
- Control Design Corp.
- Dyma Engineering, Inc.
- Garron Electronics, Inc.
- Harris Corp. Broadcast Products Div.
- IGM
- International Tapetronics Corp.
- MacKenzie Laboratories, Inc.
- Martin Audio/Video
- Mastertone Co., Inc.
- Maze Corp
- Orange County Corp.
- QRK Electronic Products
- Radio Mfg. Co. (RMC)
- Rapid-Q
- RCA Corp. Broadcast Systems Div.
- Schafer Electronics Corp.
- Singer Products Co., Inc.
- Sparta Electronic Corp.
- Spotmaster
- Systems Engineering Co., Inc.
- Systems Marketing Corp.
- Telectro Systems Corp.
- Telex Communications, Inc.
- Val-Tronics, Inc.
- VIF International
- Visual Electronics Laboratories
- Wilkinson Electronics, Inc.

Cartridge Machine, Random Access

See Adv. Page

Ampro Corp...... 48
IGM173
RCA Corp. 12

- Allied Broadcast Equip.
- Ampro Corp.
- Autogram Corp.
- Broadcast Automation Assoc.
- Broadcast Electronics
- Camex Corp.
- Cine Sonic Sound Inc.
- Control Design Corp.
- IGM
- MacKenzie Laboratories, Inc.
- Mastertone Co., Inc.
- Maze Corp
- Orange County Corp.
- QRK Electronic Products
- RCA Corp. Broadcast Systems Div.
- Schafer Electronics Corp.
- Singer Products Co., Inc.
- Sparta Electronic Corp.
- Spotmaster
- Systems Marketing Corp.

- Telectro Systems Corp.
- Telex Communications, Inc.
- Val-Tronics, Inc.
- VIF International
- Wilkinson Electronics, Inc.

Cartridge Machine, Single Deck

See Adv. Page

Ampro Corp...... 48
Broadcast Electronics 45
Communication Medias..... 62
Garron Electronics, Inc.170
LPB Inc.152
Martin Audio/Video152
Orange County Corp. 64
RCA Corp. 12
Sparta Electronic Corp. 5

- Allied Broadcast Equip.
- Ampro Corp.
- Audio Distributor Inc.
- Bell P/A Prod. Corp.
- Broadcast Automation Assoc.
- Broadcast Electronics
- Broadcast Equipment & Supply Co.
- Camex Corp.
- Cine Sonic Sound Inc.
- Collins Radio Group
- Communication Medias
- Communications Systems
- Contel Mfg.
- Control Design Corp.
- Dyma Engineering, Inc.
- Garron Electronics, Inc.
- Harris Corp. Broadcast Products Div.
- IGM
- International Tapetronics Corp.
- Lauderdale Electronic Labs
- LPB Inc.
- MacKenzie Laboratories, Inc.
- Martin Audio/Video
- Mastertone Co., Inc.
- Maze Corp
- McCurdy Radio Ind. Inc.
- Orange County Corp.
- QRK Electronic Products
- Radio Mfg. Co. (RMC)
- Rapid-Q
- RCA Corp. Broadcast Systems Div.
- Rek-O-Kut Inc.
- Schafer Electronics Corp.
- Sharp Electronics Corp.
- Singer Products Co., Inc.
- Sparta Electronic Corp.
- Spotmaster
- Superscope, Inc.
- Systems Engineering Co., Inc.
- Systems Marketing Corp.
- Tapecaster TCM, Inc.
- Tapex Corp.
- Telectro Systems Corp.
- Telex Communications, Inc.
- Val-Tronics, Inc.
- Visual Electronics Laboratories
- Wilkinson Electronics, Inc.

Cartridge Machine Alignment Tape

See Adv. Page

Broadcast Electronics 45
Fidelipac154

- Allied Broadcast Equip.
- Ampro Corp.
- Audio Distributor Inc.
- Broadcast Electronics
- Broadcast Equipment & Supply Co.
- Fidelipac
- Harris Corp. Broadcast Products Div.
- IGM
- Joa Cartridge Service
- Lauderdale Electronic Labs
- Mastertone Co., Inc.
- Nortronics Co., Inc.
- Orange County Corp.
- Professional Audio Service
- Sparta Electronic Corp.
- Spotmaster
- Taber Mfg. & Engr. Co.
- Tapecaster TCM, Inc.
- Tapex Corp.
- Val-Tronics, Inc.

Cartridge Machine Rebuilding Services

See Adv. Page

Ampro Corp...... 48
Broadcast Electronics 45

- Ampro Corp.
- Broadcast Electronics
- Communication Medias
- Harris Corp. Broadcast Products Div.
- Orange County Corp.
- Spotmaster

Cartridge Machine, Stereo

Cartridge Reconditioning Services

See Adv. Page

Broadcast Electronics 45
Joa Cartridge Service162

- Allied Broadcast Equip.
- Birmingham Tape Cartridge Co., Inc.
- Broadcast Electronics
- Harris Corp. Broadcast Products Div.
- Joa Cartridge Service
- Lauderdale Electronic Labs
- Mastertone Co., Inc.
- Professional Audio Service
- Re-Play Video Cartridge Service
- Sparta Electronic Corp.
- Spotmaster
- Tapex Corp.
- Telectro Systems Corp.

Cartridge Recording Services

- Cine Sonic Sound Inc.
- Communication Medias
- Lauderdale Electronic Labs
- Mastertone Co., Inc.
- Nemo Recording Labs
- Pentagon Industries, Inc.
- Professional Audio Service
- Radio Mfg. Co. (RMC)
- Tapex Corp.
- Telectro Systems Corp.

Cartridge Reloading Services, Audio

- Allied Broadcast Equip.
- Broadcast Electronics
- Cine Sonic Sound Inc.
- Harris Corp. Broadcast Products Div.
- Joa Cartridge Service
- Lauderdale Electronic Labs
- Mastertone Co., Inc.
- Orange County Corp.
- Professional Audio Service
- Re-Play Video Cartridge Service
- Sparta Electronic Corp.
- Spotmaster
- Tapex Corp.

Cartridge Reloading Services, Video

- Re-Play Video Cartridge Service

Cartridge Splice Finder

See Adv. Page

Ampro Corp...... 48
Broadcast Electronics 45
Orange County Corp. 64

- Allied Broadcast Equip.
- Ampro Corp.
- Birmingham Tape Cartridge Co., Inc.
- Broadcast Automation Assoc.
- Broadcast Electronics
- Broadcast Equipment & Supply Co.
- Communication Medias
- Dyma Engineering, Inc.
- Electro Sound, Inc.
- Joa Cartridge Service
- Orange County Corp.
- Professional Audio Service
- RCA Corp. Broadcast Systems Div.
- Spotmaster

Tapecaster TCM, Inc.
Telectro Systems Corp.
UMC Electronics Co.
Val-Tronics, Inc.

Cartridges, Magnetic Tape

	See Adv. Page
Aristocart Div.	157
Broadcast Electronics	45
Capitol Magnetic Products	39
Communication Medias.....	62
Fidelipac	8, 154
Joa Cartridge Service	162
LPB Inc.	152
Orange County Corp.	64
Sound Dynamics, Inc.	174
Val-Tronics, Inc.....	160

Allied Broadcast Equip.
Ampex Corp.
Aristocart Div.
Audio Distributor Inc.
Audio Magnetics Corp.
Autogram Corp.
Broadcast Automation Assoc.
Broadcast Electronics
Broadcast Equipment & Supply Co.
BSC Inc.
Camex Corp.
Capitol Magnetic Products
Cine Sonic Sound Inc.
Collins Radio Group
Communication Medias
Contel Mfg.
Dyma Engineering, Inc.
Fidelipac
Fuji Photo Film USA, Inc. Magnetic Products Dept.
Gould Inc.
Harris Corp. Broadcast Products Div.
Harvey Radio
IGM
Joa Cartridge Service
Lauderdale Electronic Labs
LPB Inc.
MacKenzie Laboratories, Inc.
Mastertone Co., Inc.
Memorex Corp. Audio-Video Group
Orange County Corp.
Professional Audio Service
Radio Mfg. Co. (RMC)
RCA Corp. Broadcast Systems Div.
Schafer Electronics Corp.
Sinai-Johnson
Singer Products Co., Inc.
Sound Dynamics, Inc.
Sparta Electronic Corp.
Spotmaster
Systems Engineering Co., Inc.
Systems Marketing Corp.
Tapecaster TCM, Inc.
Tapex Corp.
Telectro Systems Corp.
Telex Communications, Inc.
3M Co. Magnetic Audio/Video Prod. Div.
Val-Tronics, Inc.
Wilkinson Electronics, Inc.

Cartridges, Phono

	See Adv. Page
Communication Medias.....	62
LPB Inc.	152
McCurdy Radio Ind. Inc.	25
Orange County Corp.	64
Stanton Magnetics Inc.	63

Allied Broadcast Equip.
Broadcast Automation Assoc.
Broadcast Electronics
Broadcast Equipment & Supply Co.
Camex Corp.
Collins Radio Group
Communication Medias
Duotone Co. Inc.
Electro-Voice Inc.
Gotham Audio Corp.
Harris Corp. Broadcast Products Div.
Harvey Radio
Lauderdale Electronic Labs

LPB Inc.
Mastertone Co., Inc.
McCurdy Radio Ind. Inc.
Orange County Corp.
Philips Audio Video Systems Corp. Audio Div.
Professional Audio Service
QRK Electronic Products
RCA Corp. Broadcast Systems Div.
Rek-O-Kut Inc.
Shure Brothers Inc.
Singer Products Co., Inc.
Sparta Electronic Corp.
Spotmaster
Stanton Magnetics Inc.
Systems Engineering Co., Inc.
Val-Tronics, Inc.
Wilkinson Electronics, Inc.

Cartridges, Stereo

	See Adv. Page
Aristocart Div.	157
Communication Medias.....	62
Fidelipac	8
Orange County Corp.	64
Sound Dynamics, Inc.	174
Stanton Magnetics Inc.	63

Allied Broadcast Equip.
Aristocart Div.
Autogram Corp.
Broadcast Automation Assoc.
Broadcast Electronics
Capitol Magnetic Products
Cine Sonic Sound Inc.
Collins Radio Group
Communication Medias
Electro-Voice Inc.
EMT Franz VGmbH
Fidelipac
Harris Corp. Broadcast Products Div.
Harvey Radio
Lauderdale Electronic Labs
Mastertone Co., Inc.
Orange County Corp.
Professional Audio Service
RCA Corp. Broadcast Systems Div.
Rek-O-Kut Inc.
Shure Brothers Inc.
Sound Dynamics, Inc.
Sparta Electronic Corp.
Spotmaster
Stanton Magnetics Inc.
Systems Marketing Corp.
Tapex Corp.
Wilkinson Electronics, Inc.

Cartridges, Videotape

Ampex Corp.
Audio Magnetics Corp.
Fuji Photo Film USA, Inc. Magnetic Products Dept.
Harvey Radio
International Video Corp.
J. D. Ivey Corp.
Mincom Div. 3M Co.
Nemo Recording Labs
Panasonic Video Systems Div.
RCA Corp. Broadcast Systems Div.
Recortec Inc.
Re-Play Video Cartridge Service
Sony Corp. of America VTR Div.
3M Co. Magnetic Audio/Video Prod. Div.

Cassette Machine, Dual Deck

Broadcast Automation Assoc.
Cetec Audio Div. Subs. Computer Equipment Corp.
Cine Sonic Sound Inc.
Garron Electronics, Inc.
Pentagon Industries, Inc.
Rapid-Q
Schafer International

Cassette Machine, Multiple Deck

Broadcast Automation Assoc.
Conrac Corp. Cramer Div.
Control Design Corp.
Garron Electronics, Inc.
Pentagon Industries, Inc.
Rapid-Q

Schafer International

Cassette Machine, Random Access

	See Adv. Page
Telemedia Electronics.....	161

Ampex Corp.
Broadcast Automation Assoc.
Conrac Corp. Cramer Div.
Control Design Corp.
Garron Electronics, Inc.
Rapid-Q
Schafer International
Telemedia Electronics

Cassette Machine, Single Deck

Broadcast Automation Assoc.
Broadcast Equipment & Supply Co.
Communications Systems
Conrac Corp. Cramer Div.
Garron Electronics, Inc.
Heath Co.
Lauderdale Electronic Labs
Mincom Div. 3M Co.
Otari Corp.
Rapid-Q
Schafer International
Sharp Electronics Corp.
Superscope, Inc.
Systa-Matics, Inc.
TEAC Corp of America
Telex Communications, Inc.

Cassettes, Duplication

Allied Broadcast Equip.
Audio Distributor Inc.
Capitol Magnetic Products
Cine Sonic Sound Inc.
Conrac Corp. Cramer Div.
Control Design Corp.
Dolby Laboratories, Inc.
J. D. Ivey Corp.
Lauderdale Electronic Labs
Mastertone Co., Inc.
Memorex Corp. Audio-Video Group
Nemo Recording Labs
Orange County Corp.
Otari Corp.
Pentagon Industries, Inc.
Recortec Inc.
Roscor Corp.

Character Generators

	See Adv. Page
Central Dynamics Corp.	176
Chiron Telesystems.....	44
Cooke Engineering Co.	37
EECO	47
TeleMation, Inc.	166
Video Data Systems, Inc.	171

Central Dynamics Corp.
Chiron Telesystems
Chrono-Log Corp.
Communication Medias
Communications Systems
Cooke Engineering Co.
Datametrics
Datavision Video Products
Echo Science Corp.
EECO
Kaitronics Corp.
Kansas State Network, Inc.
Nasco Television Systems
RCA Corp. Broadcast Systems Div.
Sinai-Johnson
SPI-ITT Metrix Instruments Div.
Tektronix Inc.
TeleMation, Inc.
Thompson-CSF Laboratories, Inc.
Ultra Audio Products
Video Accessories Mfg. Co.
Video Data Systems, Inc.
Video Devices Co.
VIF International

Choppers

Comark Industries Inc.
Tektronix Inc.

Chroma Keyer-Decoders

	See Adv. Page
Telemet, a Geotel Co.....	1

Telemet, a Geotel Co.

Chroma Keyers

	See Adv. Page
Broadcast Video Systems, Ltd.	122
Central Dynamics Corp.	176
Telemet, a Geotel Co.....	1
Vamco Engineering	23

American Data Corp.
Broadcast Video Systems, Ltd.
Central Dynamics Corp.
Dynair Electronics, Inc.
Dynasciences Video Products
Grass Valley Group, Inc.
RCA Corp. Broadcast Systems Div.
Richmond Hill Laboratories Ltd.
Roscor Corp.
Ross Broadcast Products, Inc.
Telemet, a Geotel Co.
Thompson-CSF Laboratories, Inc.
Vamco Engineering
Video Accessories Mfg. Co.
Viscount Industries Ltd.

Cleaner, Circuit Board

G.C. Electronics
Lauderdale Electronic Labs
Miller-Stephenson Chemical Co., Inc.
Orange County Corp.

Cleaner, Magnetic Tape Head

	See Adv. Page
Broadcast Electronics	45
Strand Century, Inc.	53

Allied Broadcast Equip.
Ampex Corp.
Audio Distributor Inc.
Audio Magnetics Corp.
Broadcast Electronics
Broadcast Equipment & Supply Co.
Communication Medias
Duotone Co. Inc.
Fidelipac
G.C. Electronics
Harvey Radio
Joa Cartridge Service
Lauderdale Electronic Labs
P. R. Mallory & Co. Inc.
Mastertone Co., Inc.
Memorex Corp. Audio-Video Group
Miller-Stephenson Chemical Co., Inc.
Nortronics Co., Inc.
Orange County Corp.
Professional Audio Service
Revox Corp.
Saxton Prod. Inc.
Sound Dynamics, Inc.
Spotmaster
Strand Century, Inc.
Systems Engineering Co., Inc.
Systems Marketing Corp.
TEAC Corp of America
Telectro Systems Corp.
Television Equipment Associates
Texwipe Co.
Tri-Tronics Professional Electronics
VIF International

Clocks and Chronographs

	See Adv. Page
Audio Services, Inc.	169
Broadcast Electronics	45
Cooke Engineering Co.	37
ESE	54
Telemedia Electronics.....	161

Vamco Engineering 23

Allied Broadcast Equip.
American Data Corp.
Audio Services, Inc.
Broadcast Automation Assoc.
Broadcast Electronics
Broadcast Equipment & Supply Co.
Chrono-Log Corp.
Chronotron Systems, Inc.
Communication Medias
Cooke Engineering Co.
Dyma Engineering, Inc.
ESE
Frontier Engineering Corp.
General Time Service
Harwood Mfg. Co.
Heath Co.
IGM
Lauderdale Electronic Labs
Orange County Corp.
Jules Racine & Co., Inc.
Radio Mfg. Co. (RMC)
Radio Time Service
Rohde & Schwarz Sales Co.
Sparta Electronic Corp.
Spotmaster
Standard Electric Time
Systems Marketing Corp.
Tapecaster TCM, Inc.
Telemedia Electronics
Vamco Engineering
Video Accessories Mfg. Co.
Video Devices Co.
Visual Electronics Laboratories

Clocks, Digital and Digital Driver

See Adv. Page
Audio Services, Inc. 169
Control Design Corp. 137
Cooke Engineering Co. 37
ESE 40, 54
Telemedia Electronics. 161
Vamco Engineering 23

American Data Corp.
Applied Video Electronics, Inc.
Audio Services, Inc.
Autogram Corp.
Barco U.S.
Broadcast Automation Assoc.
Beta Technology, Inc.
Camex Corp.
Chrono-Log Corp.
Communications 2000, Inc.
Control Design Corp.
Cooke Engineering Co.
Datametrics
Datatron, Inc.
ESE
Frontier Engineering Corp.
Harris Corp. Broadcast Products Div.
Heath Co.
IGM
Kaitronics Corp.
Lauderdale Electronic Labs
Mastertone Co., Inc.
Orange County Corp.
Orbit Radio and Video
Pacific Recorders and Engrg. Corp.
Div. 47B
PRD Electronics, Inc.
Rek-O-Kut Inc.
Rohde & Schwarz Sales Co.
Sparta Electronic Corp.
Stancil-Hoffman Corp.
Systems Engineering Co., Inc.
Systron-Donner
Tapecaster TCM, Inc.
Telemedia Electronics
Time & Frequency Tech., Inc.
Total Technology
Transel Corp.
United Systems Corp.
Vamco Engineering
Video Accessories Mfg. Co.
Video Devices Co.

Clocks, Station Master Control

See Adv. Page
Audio Services, Inc. 169
Cooke Engineering Co. 37
Vamco Engineering 23

American Data Corp.
Audio Services, Inc.
Broadcast Automation Assoc.
Beta Technology, Inc.
Chrono-Log Corp.
Chronotron Systems, Inc.
Cooke Engineering Co.
Datametrics
Dyma Engineering, Inc.
ESE
Frontier Engineering Corp.
Kaitronics Corp.
Orange County Corp.
Radio Mfg. Co. (RMC)
Radio Time Service
Rohde & Schwarz Sales Co.
Schafer Electronics Corp.
Standard Electric Time
Systems Marketing Corp.
Tapecaster TCM, Inc.
Time & Frequency Tech., Inc.
Vamco Engineering
Video Accessories Mfg. Co.
Video Devices Co.

Collimeters

See Adv. Page
Electro Impulse, Inc. 171
**Television Equipment
Associates. 159**

Electro Impulse, Inc.
Lauderdale Electronic Labs
Orange County Corp.
Ramko Research
Television Equipment Associates

Color Correction Equipment

See Adv. Page
Comark Industries Inc. 158
**Television Equipment
Associates. 159**
**Thompson-CSF
Laboratories, Inc. 121**

Ampex Corp.
Comark Industries Inc.
Datatek Corp.
Editel Communications
Fernesh Group Robert Bosch Corp.
Marconi Electronics Inc.
Rank Precision Industries Rank Cintel
Div.
Rank Precision Industries
Television Equipment Associates
Thompson-CSF Laboratories, Inc.

**Colorizer --See Generators,
Special Effect**

Combiners, Power

See Adv. Page
Comark Industries Inc. 161
Electro Impulse, Inc. 171
**Micro Communications,
Inc. 36**

AEL, Inc.
AVA Electronics Corp.
CCA Electronics Corp.
Collins Radio Group
Comark Industries Inc.
Continental Electronics Mfg. Co.
Dielectric Communications
Electro Impulse, Inc.
Harris Corp. Broadcast Products Div.
Micro Communications, Inc.
Narda Microwave Corp.
North American Radio Corp.
Shively Laboratories, Inc.
Sparta Electronic Corp.

**Common Point Bridge --See
Bridge, Common Point**

**Communication Systems, Land
Mobile**

See Adv. Page
Moseley Assoc. Inc. 9

Allied Broadcast Equip.
Alpha Electronic Services Inc.
Atlantic Research Corp.
Avtel
Dyma Engineering, Inc.
Editel Communications
Electro-Voice Inc.
GEC-Marconi Electronics Ltd.
General Electric Co. Mobile Radio
Dept.
Image Devices Inc.
Microwave Assoc. Inc.
Miles Reproducer Co.
Moseley Assoc. Inc.
Paso Sound Products Inc.
Phelps Dodge Communications Co.
RCA Corp. Broadcast Systems Div.
RHA Audio Communications Corp.
Scientific Systems, Inc.
Scintrex Inc. Communications Div.
Singer Instrumentation
Singer Products Co., Inc.
Transcom Electronics, Inc.
Victor Duncan, Inc.

**Communication Systems,
Microwave**

See Adv. Page
Comark Industries Inc. 161
Farinon Electric 33
Moseley Assoc. Inc. 9
TerraCom 127
Varian/Beverly 185

Acrodyne Industries Inc.
Atlantic Research Corp.
Cablewave Systems Inc.
Coastcom
Collins Radio Group
Comark Industries Inc.
Communications Carriers, Inc.
Dyma Engineering, Inc.
Farinon Electric
Farinon Electric of Canada, Ltd.
GEC-Marconi Electronics Ltd.
GTE Lenkurt, Inc.
Microwave Assoc. Inc.
Moseley Assoc. Inc.
Narda Microwave Corp.
North American Radio Corp.
Raytheon Data Systems Co.
RHG Elect Labs, Inc.
Singer Products Co., Inc.
Tepco Corp.
TerraCom
Theta-Com
Transcom Electronics, Inc.
Varian/Beverly

**Communication Systems,
Multiplex**

See Adv. Page
Comark Industries Inc. 161
Moseley Assoc. Inc. 9
TerraCom 127

Atlantic Research Corp.
Bethany International
Beta Technology, Inc.
Camex Corp.
Catel
Coastcom
Collins Radio Group
Comark Industries Inc.
Communications 2000, Inc.
Dorado Systems
Farinon Electric of Canada, Ltd.
GEC-Marconi Electronics Ltd.
GTE Lenkurt, Inc.
Image Devices Inc.
Moseley Assoc. Inc.
Raytheon Data Systems Co.
Singer Products Co., Inc.
TerraCom
Transcom Electronics, Inc.
Trepac Corp. America

Communication Systems, STL

See Adv. Page
Marti Electronics 119
Moseley Assoc. Inc. 9
Orange County Corp. 64

Acrodyne Industries Inc.
Cablewave Systems Inc.
Camex Corp.
Coastcom
Collins Radio Group
Comm/Scope Co.
Dyma Engineering, Inc.
Farinon Electric
Farinon Electric of Canada, Ltd.
GTE Lenkurt, Inc.
Ikegami Electronics (USA) Inc.
Marti Electronics
Mastertone Co., Inc.
Microwave Assoc. Inc.
Moseley Assoc. Inc.
North American Radio Corp.
Orange County Corp.
RHG Elect Labs, Inc.
Singer Products Co., Inc.
Tepco Corp.
TerraCom
Trepac Corp. America
Varian/Beverly

**Communication Systems,
Teleprinter**

See Adv. Page
Moseley Assoc. Inc. 9

Broadcast Automation Assoc.
General Electric Co. Mobile Radio
Dept.
GTE Lenkurt, Inc.
Moseley Assoc. Inc.
Transcom Electronics, Inc.
Trepac Corp. America

Compensators, Dropout

Communications Systems
Mincom Div. 3M Co.
RCA Corp. Broadcast Systems Div.

Computer Equipment

See Adv. Page
Central Dynamics 176
Moseley Assoc. Inc. 9

Central Dynamics Corp.
Compu/Net, Inc.
Data Disc Inc.
Datavision Video Products
General Electric Co. ISO Div.
Gould Inc.
Grass Valley Group, Inc.
Hewlett Packard Co.
IGM
Moseley Assoc. Inc.
Nippon Electric Co., Ltd.
PRD Electronics, Inc.
Raytheon Data Systems Co.
Recortec Inc.
Schafer Electronics Corp.
Step Corp.
Systems Marketing Corp.
Tektronix Inc.
Transcom Electronics, Inc.

Connectors, Cable

Ameco Inc.
AMP Special Industries
Amphenol RF Div.
A-Tel-A-Matic
AVA Electronics Corp.
Blonder-Tongue Labs.
Broadcast Equipment & Supply Co.
Cambridge Products Corp.
The Finney Co.
G.C. Electronics
Gotham Audio Corp.
Harvey Radio
Hollingsworth Solderless Terminal Co.
Kings Electronics Co., Inc.
L R C Electronics
Maury Microwave Corp.
Phelps Dodge Communications Co.

Rex Rheostat & Co., Inc.
 RMS Electronics, Inc.
 Saxton Prod. Inc.
 Switchcraft Inc.
 Systems Marketing Corp.
 Theta-Corn
 Times Wire and Cable
 Trompeter Electronics
 TRW Electronics Supply Co.
 Union Connector Co., Inc.
 Vaco Products Co.
 Weinschel Engineering Co.
 Wilkinson Electronics, Inc.

Console, Audio AM

	See Adv. Page
Ampro Corp.....	48
Auditronics, Inc.....	133
Broadcast Electronics	45
Dyma Engineering, Inc.....	165
LPB Inc.	152
Martin Audio/Video	152
McCurdy Radio Ind. Inc.	25
Opamp Lamps, Inc.	185
Orange County Corp.	64
Pulse Dynamics Mfg. Corp.	160
Quantum Audio Labs, Inc.	171
Ramko Research	125
RCA Corp.	58
Ross Broadcast Products, Inc.	19
Russco Electronics Mfg. Inc.	142
Sparta Electronic Corp.	5
Sphere Electronics	170
UREI.....	14
Val-Tronics, Inc.....	171
Vamco Engineering	23
Ward-Beck Systems, Ltd.....	IFC
Wilkinson Electronics, Inc.	157

Accurate Sound Co.
 Allied Broadcast Equip.
 AMCO Engineering Co.
 Ampro Corp.
 Audio Designs & Mfg.
 Audio Distributor Inc.
 Auditronics, Inc.
 Autogram Corp.
 Broadcast Automation Assoc.
 Broadcast Electronics
 Broadcast Equipment & Supply Co.
 Camex Corp.
 Ceco Communications Inc.
 Cetec Audio Div. Subs. Computer Equipment Corp.
 Collins Radio Group
 Communication Medias
 Concept 70
 Contel Mfg.
 Dyma Engineering, Inc.
 Fisher-Burke Broadcast Consultants
 Frontier Engineering Corp.
 Gately Electronics
 General Electric Co. ISO Div.
 Gotham Audio Corp.
 Grinnan Fixture Co.
 Harris Corp. Broadcast Products Div.
 Lauderdale Electronic Labs
 LPB Inc.
 Martin Audio/Video
 Mastertone Co., Inc.
 Maze Corp
 McCurdy Radio Ind. Inc.
 McMartin Industries, Inc.
 Rupert Neve, Inc.
 Opamp Lamps, Inc.
 Orange County Corp.
 Orbit Radio and Video
 Pacific Recorders and Engrg. Corp. Div. 47B
 Pulse Dynamics Mfg. Corp. (PDMC)
 QRK Electronic Products
 Quad-Eight Electronics
 Quantum Audio Labs, Inc.
 Radio Mfg. Co. (RMC)
 Ramko Research

RCA Corp. Broadcast Systems Div.
 Rek-O-Kut Inc.
 Robins/Fairchild
 Ross Broadcast Products, Inc.
 Russco Electronics Mfg. Inc.
 Schafer Electronics Corp.
 Scientific Systems, Inc.
 Shure Brothers Inc.
 Singer Products Co., Inc.
 Sound Dynamics, Inc.
 Sparta Electronic Corp.
 Spectra Sonics
 Sphere Electronics
 Spotmaster
 Willi Studer America, Inc.
 Systems Engineering Co., Inc.
 Tri-Tronics Professional Electronics
 Ultra Audio Products
 United Radio Supply Inc.
 United Recording Electronics Industries
 UREI a URC Co.
 Val-Tronics, Inc.
 Vamco Engineering
 Visual Electronics Laboratories
 Ward-Beck Systems, Ltd.
 Wilkinson Electronics, Inc.

Console, Audio FM

	See Adv. Page
Ampro Corp.....	48
Auditronics, Inc.....	133
Broadcast Electronics	45
Dyma Engineering, Inc.....	165
LPB Inc.	152
Martin Audio/Video	152
McCurdy Radio Ind. Inc.	25
Opamp Lamps, Inc.	185
Orange County Corp.	64
Pulse Dynamics Mfg. Corp.	160
Quantum Audio Labs, Inc.	171
Ramko Research	125
RCA Corp.	58
Ross Broadcast Products, Inc.	19
Russco Electronics Mfg. Inc.	142
Sparta Electronic Corp.	5
Sphere Electronics	170
UREI.....	14
Val-Tronics, Inc.....	171
Vamco Engineering	23
Ward-Beck Systems, Ltd.....	IFC
Wilkinson Electronics, Inc.	157

Accurate Sound Co.
 Allied Broadcast Equip.
 AMCO Engineering Co.
 Ampro Corp.
 Audio Designs & Mfg.
 Audio Distributor Inc.
 Auditronics, Inc.
 Autogram Corp.
 Broadcast Automation Assoc.
 Broadcast Electronics
 Camex Corp.
 Cetec Audio Div. Subs. Computer Equipment Corp.
 Collins Radio Group
 Communication Medias
 Concept 70
 Contel Mfg.
 Dyma Engineering, Inc.
 Fisher-Burke Broadcast Consultants
 Frontier Engineering Corp.
 Gately Electronics
 General Electric Co. ISO Div.
 Gotham Audio Corp.
 Grinnan Fixture Co.
 Harris Corp. Broadcast Products Div.
 Lauderdale Electronic Labs
 LPB Inc.
 Martin Audio/Video
 Mastertone Co., Inc.
 Maze Corp
 McCurdy Radio Ind. Inc.
 McMartin Industries, Inc.

Rupert Neve, Inc.
 Opamp Lamps, Inc.
 Orange County Corp.
 Orbit Radio and Video
 Pacific Recorders and Engrg. Corp. Div. 47B
 Pulse Dynamics Mfg. Corp. (PDMC)
 QRK Electronic Products
 Quad-Eight Electronics
 Quantum Audio Labs, Inc.
 Radio Mfg. Co. (RMC)
 Ramko Research
 RCA Corp. Broadcast Systems Div.
 Rek-O-Kut Inc.
 Robins/Fairchild
 Ross Broadcast Products, Inc.
 Russco Electronics Mfg. Inc.
 Schafer Electronics Corp.
 Scientific Systems, Inc.
 Shure Brothers Inc.
 Singer Products Co., Inc.
 Sound Dynamics, Inc.
 Sparta Electronic Corp.
 Spectra Sonics
 Sphere Electronics
 Spotmaster
 Willi Studer America, Inc.
 Systems Engineering Co., Inc.
 Tri-Tronics Professional Electronics
 Ultra Audio Products
 United Radio Supply Inc.
 United Recording Electronics Industries
 UREI a URC Co.
 Val-Tronics, Inc.
 Vamco Engineering
 Visual Electronics Laboratories
 Ward-Beck Systems, Ltd.
 Wilkinson Electronics, Inc.

Console, Audio Portable

	See Adv. Page
Ampro Corp.....	48
Audio Designs & Mfg.	129
Auditronics, Inc.....	133
Broadcast Electronics	45
Dyma Engineering, Inc.....	165
LPB Inc.	152
Martin Audio/Video	152
McCurdy Radio Ind. Inc.	25
Opamp Lamps, Inc.	185
Orange County Corp.	64
Pulse Dynamics Mfg. Corp.	160
Quantum Audio Labs, Inc.	171
RCA Corp.	58
Ross Broadcast Products, Inc.	19
Russco Electronics Mfg. Inc.	142
Sparta Electronic Corp.	5
Sphere Electronics	170
Val-Tronics, Inc.....	171
Ward-Beck Systems, Ltd.....	IFC
Wilkinson Electronics, Inc.	157

Allied Broadcast Equip.
 AMCO Engineering Co.
 American Electronics, Inc.
 Ampro Corp.
 Audio Designs & Mfg.
 Audio Distributor Inc.
 Auditronics, Inc.
 Automated Processes, Inc.
 Broadcast Automation Assoc.
 Broadcast Electronics
 Broadcast Equipment & Supply Co.
 BSC Inc.
 Central Dynamics Corp.
 Cetec Audio Div. Subs. Computer Equipment Corp.
 Collins Radio Group
 Communication Medias
 Concept 70
 Dyma Engineering, Inc.
 Frontier Engineering Corp.
 Gately Electronics
 General Electric Co. ISO Div.

Gotham Audio Corp.
 Harris Corp. Broadcast Products Div.
 Harvey Radio
 Head Sound, Inc.
 Lauderdale Electronic Labs
 LPB Inc.
 Martin Audio/Video
 Mastertone Co., Inc.
 Maze Corp
 McCurdy Radio Ind. Inc.
 McMartin Industries, Inc.
 Nemo Recording Labs
 Rupert Neve, Inc.
 Opamp Lamps, Inc.
 Orange County Corp.
 Orbit Radio and Video
 Phillips Audio Video Systems Corp.
 Broadcast Equip. Div.
 Pulse Dynamics Mfg. Corp. (PDMC)
 QRK Electronic Products
 Quad-Eight Electronics
 Quantum Audio Labs, Inc.
 Radio Mfg. Co. (RMC)
 Ramko Research
 RCA Corp. Broadcast Systems Div.
 Revox Corp.
 Richmond Sound Design, Ltd.
 Robins/Fairchild
 Ross Broadcast Products, Inc.
 Russco Electronics Mfg. Inc.
 Scientific Systems, Inc.
 Sennheiser Electronic
 Shure Brothers Inc.
 Sinai-Johnson
 Singer Products Co., Inc.
 Sound Dynamics, Inc.
 Sparta Electronic Corp.
 Spectra Sonics
 Sphere Electronics
 Spotmaster
 Willi Studer America, Inc.
 Superscope, Inc.
 Systems Engineering Co., Inc.
 Total Technology
 Tri-Tronics Professional Electronics
 Val-Tronics, Inc.
 Video Accessories Mfg. Co.
 Ward-Beck Systems, Ltd.
 Wilkinson Electronics, Inc.
 H. Wilson Corp.

Console, Audio Recording

	See Adv. Page
Ampro Corp.....	48
Auditronics, Inc.....	133
Broadcast Electronics	45
Martin Audio/Video	152
McCurdy Radio Ind. Inc.	25
Opamp Lamps, Inc.	185
Orange County Corp.	64
Quantum Audio Labs, Inc.	171
Ramko Research	125
RCA Corp.	58
Ross Broadcast Products, Inc.	19
Russco Electronics Mfg. Inc.	142
Sound Dynamics, Inc.	174
Sparta Electronic Corp.	5
Sphere Electronics	170
Ward-Beck Systems, Ltd.....	IFC

Accurate Sound Co.
 Allied Broadcast Equip.
 Altec Sound Products
 AMCO Engineering Co.
 Ampro Corp.
 Audio Designs & Mfg.
 Audio Distributor Inc.
 Auditronics, Inc.
 Autogram Corp.
 Automated Processes, Inc.
 Broadcast Automation Assoc.
 Broadcast Electronics
 BSC Inc.
 Camex Corp.
 Cetec Audio Div. Subs. Computer Equipment Corp.
 Collins Radio Group
 Communication Medias

Concept 70
 Dyma Engineering, Inc.
 Frontier Engineering Corp.
 Gately Electronics
 General Electric Co. ISO Div.
 Gotham Audio Corp.
 Grinnan Fixture Co.
 Harris Corp. Broadcast Products Div.
 Harvey Radio
 Head Sound, Inc.
 Lang Electronics Inc.
 Lauderdale Electronic Labs
 Magna-Tech Electronic Co., Inc.
 Martin Audio/Video
 Maze Corp
 McCurdy Radio Ind. Inc.
 McMartin Industries, Inc.
 Nemo Recording Labs
 Rupert Neve, Inc.
 Opamp Lamps, Inc.
 Orange County Corp.
 Orbit Radio and Video
 Pacific Recorders and Engrg. Corp.
 Div. 47B
 QRK Electronic Products
 Quad-Eight Electronics
 Quantum Audio Labs, Inc.
 Radio Mfg. Co. (RMC)
 Ramko Research
 RCA Corp. Broadcast Systems Div.
 Revox Corp.
 Richmond Sound Design, Ltd.
 Robins/Fairchild
 Ross Broadcast Products, Inc.
 Russco Electronics Mfg. Inc.
 Scientific Systems, Inc.
 Shure Brothers Inc.
 Sinai-Johnson
 Singer Products Co., Inc.
 Sound Dynamics, Inc.
 Sparta Electronic Corp.
 Spectra Sonics
 Sphere Electronics
 Spotmaster
 Willi Studer America, Inc.
 Systems Engineering Co., Inc.
 TEAC Corp of America
 TeleMation, Inc.
 Total Technology
 Tri-Tronics Professional Electronics
 Ultra Audio Products
 United Radio Supply Inc.
 Val-Tronics, Inc.
 Ward-Beck Systems, Ltd.
 Wilkinson Electronics, Inc.

Console, Audio TV

See Adv. Page

Ampro Corp.....	48
Audio Designs & Mfg.	129
Central Dynamics Corp.	176
LPB Inc.	152
Rupert Neve, Inc.	138
Orange County Corp.	64
Quantum Audio Labs, Inc.	171
RCA Corp.	58
Sphere Electronics	170

Allied Broadcast Equip.
 AMCO Engineering Co.
 Ampro Corp.
 Audio Designs & Mfg.
 Auditronics, Inc.
 Automated Processes, Inc.
 Broadcast Automation Assoc.
 BSC Inc.
 Central Dynamics Corp.
 Cetec Audio Div. Subs. Computer Equipment Corp.
 Collins Radio Group
 Communication Medias
 Concept 70
 Dyma Engineering, Inc.
 Frontier Engineering Corp.
 Gately Electronics
 General Electric Co. ISO Div.
 Gotham Audio Corp.
 Harris Corp. Broadcast Products Div.
 Interntl. Nuclear Corp.
 Lang Electronics Inc.
 LPB Inc.
 Marconi Electronics Inc.
 Maze Corp

McCurdy Radio Ind. Inc.
 McMartin Industries, Inc.
 Rupert Neve, Inc.
 Opamp Lamps, Inc.
 Orange County Corp.
 Orbit Radio and Video
 Pacific Recorders and Engrg. Corp.
 Div. 47B
 Philips Audio Video Systems Corp.
 Broadcast Equip. Div.
 Quad-Eight Electronics
 Quantum Audio Labs, Inc.
 Radio Mfg. Co. (RMC)
 Ramko Research
 RCA Corp. Broadcast Systems Div.
 Rek-O-Kut Inc.
 Robins/Fairchild
 Scientific Systems, Inc.
 Shintron Co. Inc.
 Sinai-Johnson
 Singer Products Co., Inc.
 Sound Dynamics, Inc.
 Sparta Electronic Corp.
 Spectra Sonics
 Sphere Electronics
 Systems Engineering Co., Inc.
 TeleMation, Inc.
 Tri-Tronics Professional Electronics
 Ultra Audio Products
 Vicon Industries, Inc.
 Visual Electronics Laboratories
 Ward-Beck Systems, Ltd.

Console, Stereo

See Adv. Page

Ampro Corp.....	48
Auditronics, Inc.....	133
Broadcast Electronics	45
Dyma Engineering, Inc.....	165
LPB Inc.	152
Martin Audio/Video	152
McCurdy Radio Ind. Inc.	25
Opamp Lamps, Inc.	185
Orange County Corp.	64
Quantum Audio Labs, Inc.	171
Ramko Research	125
RCA Corp.	58
Ross Broadcast Products, Inc.	19
Russco Electronics Mfg. Inc.	142
Sparta Electronic Corp.	5
UREI.....	14
Val-Tronics, Inc.....	171
Ward-Beck Systems, Ltd.....	IFC
Wilkinson Electronics, Inc.....	157

Allied Broadcast Equip.
 AMCO Engineering Co.
 Ampro Corp.
 Audio Designs & Mfg.
 Auditronics, Inc.
 Autogram Corp.
 Automated Processes, Inc.
 Broadcast Automation Assoc.
 Broadcast Electronics
 Broadcast Equipment & Supply Co.
 BSC Inc.
 Camex Corp.
 Cetec Audio Div. Subs. Computer Equipment Corp.
 Collins Radio Group
 Communication Medias
 Concept 70
 Dyma Engineering, Inc.
 Fisher-Burke Broadcast Consultants
 Frontier Engineering Corp.
 Gotham Audio Corp.
 Harris Corp. Broadcast Products Div.
 Head Sound, Inc.
 Lauderdale Electronic Labs
 LPB Inc.
 Martin Audio/Video
 Mastertone Co., Inc.
 Maze Corp
 McCurdy Radio Ind. Inc.
 McMartin Industries, Inc.
 Nemo Recording Labs
 Rupert Neve, Inc.

Opamp Lamps, Inc.
 Orange County Corp.
 Pacific Recorders and Engrg. Corp.
 Div. 47B
 QRK Electronic Products
 Quad-Eight Electronics
 Quantum Audio Labs, Inc.
 Radio Mfg. Co. (RMC)
 Ramko Research
 RCA Corp. Broadcast Systems Div.
 Rek-O-Kut Inc.
 Richmond Sound Design, Ltd.
 Robins/Fairchild
 Ross Broadcast Products, Inc.
 Russco Electronics Mfg. Inc.
 Schafer Electronics Corp.
 Sinai-Johnson
 Sound Dynamics, Inc.
 Sparta Electronic Corp.
 Spectra Sonics
 Sphere Electronics
 Spotmaster
 Willi Studer America, Inc.
 Systems Engineering Co., Inc.
 Telex Communications, Inc.
 Tri-Tronics Professional Electronics
 United Recording Electronics Industries
 UREI a URC Co.
 Val-Tronics, Inc.
 Visual Electronics Laboratories
 Ward-Beck Systems, Ltd.
 Wilkinson Electronics, Inc.

Console, Video Portable

See Adv. Page

American Data Corp.	7
Central Dynamics Corp.	13
Rupert Neve, Inc.	138
Orange County Corp.	64
RCA Corp.	58
Shintron Co. Inc.	50
Telemet, a Geotel Co.....	1
Viscount Industries Ltd.....	46
Vital Industries Inc.....	BC

AMCO Engineering Co.
 American Data Corp.
 Avtel
 Central Dynamics Corp.
 Communications Systems
 Dynasciences Video Products
 Echo Science Corp.
 Gately Electronics
 GBC Closed Circuit TV Corp.
 Grass Valley Group, Inc.
 Industrial Sciences, Inc.
 Interntl. Nuclear Corp.
 Maze Corp
 Nasco Television Systems
 Rupert Neve, Inc.
 Orange County Corp.
 RCA Corp. Broadcast Systems Div.
 Richmond Hill Laboratories Ltd.
 Shintron Co. Inc.
 Systems Engineering Co., Inc.
 TeleMation, Inc.
 Telemet, a Geotel Co.
 R. H. Tyler Co.
 Ultra Audio Products
 Vicon Industries, Inc.
 Video Accessories Mfg. Co.
 Viscount Industries Ltd.
 Vital Industries Inc.
 H. Wilson Corp.

Console, Video Studio

See Adv. Page

American Data Corp.	7
Ampro Corp.....	48
Central Dynamics Corp.	13,176
Rupert Neve, Inc.	138
RCA Corp.	58
Ross Broadcast Products, Inc.	166
Shintron Co. Inc.	50
Telemet, a Geotel Co.....	1

Vamco Engineering	23
Viscount Industries Ltd.....	46
Vital Industries Inc.....	BC
Ward-Beck Systems, Ltd.....	IFC

AMCO Engineering Co.
 American Data Corp.
 Ampro Corp.
 Avtel
 Broadcast Video Systems, Ltd.
 Central Dynamics Corp.
 Communications Systems
 Dage-MTI, Inc.
 Dynasciences Video Products
 Echo Science Corp.
 Gately Electronics
 GBC Closed Circuit TV Corp.
 General Electric Co. ISO Div.
 Grass Valley Group, Inc.
 Industrial Sciences, Inc.
 Interntl. Nuclear Corp.
 Marconi Electronics Inc.
 Nasco Television Systems
 Rupert Neve, Inc.
 Nippon Electric Co., Ltd.
 Orbit Radio and Video
 Panasonic Video Systems Div.
 RCA Corp. Broadcast Systems Div.
 Richmond Hill Laboratories Ltd.
 Ross Broadcast Products, Inc.
 Shintron Co. Inc.
 Singer Products Co., Inc.
 Sylvania Comm. Electronic Systems Engineering Co., Inc.
 Telemet, a Geotel Co.
 R. H. Tyler Co.
 Vamco Engineering
 Vicon Industries, Inc.
 Video Accessories Mfg. Co.
 Video Concepts, Inc.
 Viscount Industries Ltd.
 Vital Industries Inc.
 Ward-Beck Systems, Ltd.
 H. Wilson Corp.

Controllers, Equipment, Network Tone Activated

Audio Services, Inc

Converters

See Adv. Page

Telemet, a Geotel Co.....	1
---------------------------	---

AEL Communications Corp.
 Berkey-Colortran Inc.
 Biomation Corp.
 Catal
 Fernesh Group Robert Bosch Corp.
 The Finney Co.
 Fung Engineering Inc.
 General Electric Co. Tubes/MW Devices
 Marconi Electronics Inc.
 Narda Microwave Corp
 Oak Industries, Inc.
 Philips Test & Measuring Instruments, Inc.
 Telemedia Electronics
 Telemet, a Geotel Co.
 Topaz Electronics

Counter-Timers

See Adv. Page

Audio Services, Inc	169
Cooke Engineering Co.....	37
ESE	40
Vamco Engineering	23

American Data Corp.
 Audio Services, Inc
 Autogram Corp.
 Broadcast Electronics
 Chrono-Log Corp.
 Conrac Corp. Cramer Div.
 Control Concepts Corp.
 Cooke Engineering Co.
 Dana Laboratories, Inc.
 Dyma Engineering, Inc.
 EIP, Inc.
 ESE

John Fluke Mfg. Co., Inc.
Gotham Audio Corp.
Harris Corp. Broadcast Products Div.
Hewlett Packard Co.
Holland Electronics
Lauderdale Electronic Labs
Pacific Recorders and Engrg. Corp.
Div. 47B
Philips Test & Measuring Instruments,
Inc.
Power Waves, Inc.
Simpson Electric Co.
Spotmaster
Systron-Donner
Tapecaster TCM, Inc.
Tektronix Inc.
Telemidia Electronics
Transel Corp.
United Systems Corp.
Vamco Engineering
Video Accessories Mfg. Co.

Couplers, Hybrid

See Adv. Page
Electro Impulse, Inc. 171
Micro Communications, Inc. 36

Arvin Systems, Inc.
Coaxial Dynamics
Comark Industries Inc.
Electro Impulse, Inc.
Maury Microwave Corp.
Micro Communications, Inc.
Microwave Assoc. Inc.
Narda Microwave Corp
Saxton Prod. Inc.
Shively Laboratories, Inc.
Wide Band Engineering Co., Inc.

Crystals, Quartz

Eidson Electronic Co.
Permadyne Electronics Corp.
Sinai-Johnson

Custom Control Systems

See Adv. Page
Aderhold Construction Co. 185
A. F. Associates, Inc. 68
Central Dynamics Corp. 13
Fisher-Burke Broadcast Consultants 124
Moseley Assoc. Inc. 9
Orange County Corp. 64
Wilkinson Electronics, Inc. 157

Aderhold Construction Co.
A. F. Associates, Inc.
American Data Corp.
Audio Services, Inc.
Central Dynamics Corp.
Communications 2000, Inc.
Control Concepts Corp.
Datalogic-Rust Co.
Dyma Engineering, Inc.
Echo Science Corp.
Imero Fiorentino Associates, Inc.
Fisher-Burke Broadcast Consultants
IGM
Moseley Assoc. Inc.
Orange County Corp.
Richmond Sound Design, Ltd.
Scientific Systems, Inc.
Sparta Electronic Corp.
Telemidia Electronics
Total Technology
Video Accessories Mfg. Co.
Wilkinson Electronics, Inc.

Cyclorama, Studio Drapery

Imero Fiorentino Associates, Inc.
Janson Industries

Decoder, Four Channel Stereo

Electro-Voice Inc.

Lauderdale Electronic Labs
Sansui Electronics Corp.

Decoders, Tone

See Adv. Page
Audio Services, Inc. 160
Central Dynamics Corp. 176

Alpha Electronic Services Inc.
Audio Services, Inc.
Central Dynamics Corp.
Electronic Designers Inc.
IGM
Monroe Electronics, Inc.
Orange County Corp.
Teledata Systems, Inc.
Telemidia Electronics
Trepac Corp. America
Val-Tronics, Inc.
Video Accessories Mfg. Co.

Decoders, Tone, EBS

See Adv. Page
Audio Services, Inc. 163

Audio Services, Inc

Data Transmitters

See Adv. Page
Moseley Assoc. Inc. 9
TerraCom 127

Audio Services, Inc
Catel
Coastcom
Communications 2000, Inc.
Delta Electronics Inc. (Va.)
GEC-Marconi Electronics Ltd.
GTE Lenkurt, Inc.
Moseley Assoc. Inc.
North American Radio Corp.
Teledata Systems, Inc.
TerraCom
Transcom Electronics, Inc.
Trepac Corp. America

Delay Cartridges, Audio

See Adv. Page
Broadcast Electronics 45

Allied Broadcast Equip.
Broadcast Electronics
Communication Medias
Fidelipac
International Tapetronics Corp.
Joa Cartridge Service
Lauderdale Electronic Labs
Mastertone Co., Inc.
Orange County Corp.
Professional Audio Service
Revox Corp.
Sound Dynamics, Inc.
Sparta Electronic Corp.

Delay Lines

See Adv. Page
Television Equipment Associates 159

Allen Avionics Inc.
Altec Sound Products
Avtel
B & K Instruments Inc.
Broadcast Video Systems, Ltd.
Cablewave Systems Inc.
Control Concepts Corp.
Dynasciences Video Products
Edison Electronics Div.
EMT Franz VGmbH
ESC Electronics Corp.
Eventide Clock Works Inc.
GEC-Marconi Electronics Ltd.
Gotham Audio Corp.
Kappa Networks, Inc.
Lexicon, Inc.
Maury Microwave Corp.
Phelps Dodge Communications Co.

Quad-Eight Electronics
Ramko Research
Singer Products Co., Inc.
Tasker Systems
Tektronix Inc.
Television Equipment Associates
Thomson-CSF Electron Tubes
Times Wire and Cable
United Recording Electronics
Industries
UREI a URC Co.
Walther M. A. Andersen & Assoc., Inc.

Delay Measuring Set, Envelope

See Adv. Page
Telemet, a Geotel Co. 1

Datatek Corp.
Dragnet Engineering Labs., Inc.
Rohde & Schwarz Sales Co.
Tektronix Inc.
Telemet, a Geotel Co.
Television Equipment Associates

Delay Units, Video

See Adv. Page
Television Equipment Associates 159

Control Concepts Corp.
Data Disc Inc.
Dynasciences Video Products
Edison Electronics Div.
ESC Electronics Corp.
Kappa Networks, Inc.
Television Equipment Associates
Walther M. A. Andersen & Assoc., Inc.

Demagnetizers, Bulk Tape

See Adv. Page
Broadcast Electronics 45
Fidelipac 154
Sound Dynamics, Inc. 174
Taber Mfg. & Engr. Co. 60

Allied Broadcast Equip.
Audio Distributor Inc.
Broadcast Automation Assoc.
Broadcast Electronics
Broadcast Equipment & Supply Co.
Collins Radio Group
Communication Medias
Fidelipac
G.C. Electronics
Harvey Radio
International Tapetronics Corp.
Joa Cartridge Service
Lauderdale Electronic Labs
Mastertone Co., Inc.
Nortronics Co., Inc.
Orange County Corp.
Professional Audio Service
Radio Mfg. Co. (RMC)
Recordex Corp.
Robins/Fairchild
Shalloco, Inc.
Sound Dynamics, Inc.
Sparta Electronic Corp.
Spotmaster
Taber Mfg. & Engr. Co.
TEAC Corp of America
UMC Electronics Co.
Val-Tronics, Inc.
VIF International

Demodulators

See Adv. Page
Comark 158, 161
Moseley Assoc. Inc. 9
TeleMation, Inc. 67
Telemet, a Geotel Co. 1

Belar Electronics Lab., Inc.
Catel
Coastcom
Comark Industries Inc.

Conrac Div. Conrac Corp.
Dynair Electronics, Inc.
Fung Engineering Inc.
Harris Corp. Broadcast Products Div.
Kahn Communications, Inc.
Marconi Instruments
Moseley Assoc. Inc.
Philips Test & Measuring Instruments, Inc.
RCA/Community Telev. Systems
RHG Elect Labs, Inc.
Rohde & Schwarz Sales Co.
SC Electronics, Inc.
Scientific-Atlanta, Inc.
Sinai-Johnson
TeleMation, Inc.
Telemet, a Geotel Co.
Unimedia Corp.
Video Aids Corp. of Colorado
World Video Inc.

Detectors, Microwave

Amperex Electronic Corp.
Comark Industries Inc.
General Electric Co. Tubes/MW Devices
General Microwave Corp.
Hewlett Packard Co.
Kay Elemetrics Corp.
Maury Microwave Corp.
Microwave Assoc. Inc.
Narda Microwave Corp
PRD Electronics, Inc.
Singer Products Co., Inc.
Systron-Donner
Texscan Corp.
Thomson-CSF Electron Tubes
Weinschel Engineering Co.

Detectors, RF

See Adv. Page
Moseley Assoc. Inc. 9
Potomac Instruments, Inc. 153

Alford Mfg. Co.
Bird Electronic Corp.
Blonder-Tongue Labs.
CCA Electronics Corp.
Coaxial Dynamics
Comark Industries Inc.
General Microwave Corp.
Kaitronics Corp.
Kay Elemetrics Corp.
Leader Instruments Corp.
Micro Communications, Inc.
Microwave Assoc. Inc.
Moseley Assoc. Inc.
Narda Microwave Corp
North American Radio Corp.
Potomac Instruments, Inc.
PRD Electronics, Inc.
Singer Products Co., Inc.
Systron-Donner
Television Technology Corp.
Telonic Altair
Texscan Corp.
Thomson-CSF Electron Tubes
Tri-Tronics Professional Electronics
Vitek Electronics Inc.
Wide Band Engineering Co., Inc.

Detectors, Standing Wave

See Adv. Page
Moseley Assoc. Inc. 9

Bird Electronic Corp.
Collins Radio Group
Comark Industries Inc.
Hewlett Packard Co.
Maury Microwave Corp.
Micro Communications, Inc.
Moseley Assoc. Inc.
Narda Microwave Corp
PRD Electronics, Inc.
Rohde & Schwarz Sales Co.
Telonic Altair
Texscan Corp.
Weinschel Engineering Co.
Wide Band Engineering Co., Inc.

Detectors, Video Presence

Colorado Video Inc.
Comark Industries Inc.
Dynasciences Video Products
Lenco Inc.
Richmond Hill Laboratories Ltd.
Vicon Industries, Inc.
Vitek Electronics Inc.
Wide Band Engineering Co., Inc.

Differential Phase/Gain Measuring Sets

See Adv. Page

Telemet, a Geotel Co. 1

Datatek Corp.
Telemet, a Geotel Co.

Digitizers, Color Video

Biomation Corp.
Nippon Electric Co., Ltd.
TeleMation, Inc.

Diplexers

See Adv. Page

Coastcom 42
Comark Industries Inc. 161
**Micro Communications,
Inc.** 36

Alford Mfg. Co.
CCA Electronics Corp.
Coastcom
Collins Radio Group
Comark Industries Inc.
Continental Electronics Mfg. Co.
Electromagnetic Specialties
Jampro Antenna Co.
Micro Communications, Inc.
Microwave Assoc. Inc.
Multronics, Inc.
Narda Microwave Corp.
North American Radio Corp.
Phelps Dodge Communications Co.
RCA/Community Telev. Systems
RCA Corp. Broadcast Systems Div.
Shively Laboratories, Inc.
Singer Products Co., Inc.
Sparta Electronic Corp.
Telonic Altair
Wide Band Engineering Co., Inc.

Discs, Video

See Adv. Page

**Computer Magnetics
Corp.** 131

Ampex Corp.
Barco U.S.
Chiron Telesystems
Colorado Video Inc.
Computer Magnetics Corp.
Echo Science Corp.
Glentronix, Ltd.
Nippon Electric Co., Ltd.

Display Equipment, Titling

Chiron Telesystems
Comquip, Inc.
Datavision Video Products
General Television Ntwk.
Photo Research Div. of Kollmorgen
Corp.
RCA Corp. Broadcast Systems Div.
Reynolds/Leteron Co.
Sylvania Comm. Electronic
Tektronix Inc.
TeleMation, Inc.
Thompson-CSF Laboratories, Inc.
Ultra Audio Products
Video Data Systems, Inc.
Video Devices Co.
Westinghouse Electronic Tube Divs.

Display Units, Digital

See Adv. Page

Moseley Assoc. Inc. 9

Audio Services, Inc.
Ball Bros. Research Corp. Miratel
Division
Barco U.S.
Datavision Video Products
ESE
G.C. Electronics
General Microwave Corp.
Ikegami Electronics (USA) Inc.
Moseley Assoc. Inc.
SC Electronics, Inc.
Simpson Electric Co.
Tektronix Inc.
Total Technology
Video Accessories Mfg. Co.
Video Data Systems, Inc.

Display Units, Time- Temperature-ID

Ameco Inc.
Audio Services, Inc.
Autogram Corp.
Control Design Corp.
IGM
Total Technology
Video Accessories Mfg. Co.
Video Data Systems, Inc.

Dividers, Frequency

Control Concepts Corp.
General Electric Co. Tubes/MW
Devices
Hartley Prod. Corp.
Microwave Assoc. Inc.
Total Technology
Video Accessories Mfg. Co.

Dividers, Power

See Adv. Page

Moseley Assoc. Inc. 9

Alford Mfg. Co.
AVA Electronics Corp.
Bird Electronic Corp.
Collins Radio Group
Dielectric Communications
Jampro Antenna Co.
Maury Microwave Corp.
Micro Communications, Inc.
Microwave Assoc. Inc.
Moseley Assoc. Inc.
Multronics, Inc.
Narda Microwave Corp.
North American Radio Corp.
Phelps Dodge Communications Co.
PRD Electronics, Inc.
Scala Radio Corp.
Shively Laboratories, Inc.
Singer Products Co., Inc.
Tektronix Inc.
Trompeter Electronics
Weinschel Engineering Co.
Wide Band Engineering Co., Inc.

Dividers, Voltage

John Fluke Mfg. Co., Inc.
General Electric Co. Tubes/MW
Devices
Hickok Elect. Instrument
ITT Jennings
Shallco, Inc.
Tech Laboratories Inc.

Dust Control Unit, Video

Enviroco
Liberty Industries

Edit Code Generator

See Adv. Page

**Central Dynamics
Corp.** 176

Automated Processes, Inc.

Beta Technology, Inc.
Central Dynamics Corp.
CMX Systems
Datametrics
Datatron, Inc.
EECO
Kaitronics Corp.
Quad-Eight Electronics
Recortec Inc.
Shintron Co. Inc.
Smith-Beemish, Inc.
Television Research International
Video Accessories Mfg. Co.

Edit Code Receiver

See Adv. Page

**Central Dynamics
Corp.** 176

Automated Processes, Inc.
Beta Technology, Inc.
Central Dynamics Corp.
Datametrics
Datatron, Inc.
EECO
Kaitronics Corp.
Shintron Co. Inc.
Smith-Beemish, Inc.
Television Research International
Video Accessories Mfg. Co.

Editors, Audio Tape

See Adv. Page

Central Dynamics 176
Sound Dynamics, Inc. 174

Broadcast Electronics
Central Dynamics Corp.
Comquip, Inc.
Datatron, Inc.
ELPA Marketing Industries, Inc.
Fidelipac
Harvey Radio
Lauderdale Electronic Labs
Nemo Recording Labs
Radio Mfg. Co. (RMC)
Sound Dynamics, Inc.

Editors, Film

CMX Systems
Comquip, Inc.
Kalart Victor Corp.
Lipsner-Smith Corp.
Magnasync/Moviola Corp.
Neumade Prod. Corp.
Smith-Beemish, Inc.
Super 8 Sound, Inc.
Victor Duncan, Inc.

Editors, Video Tape

See Adv. Page

**Central Dynamics
Corp.** 176
Convergence Corp. 174
Datatron, Inc. 49
Sony Corp. of America IBC
**Television Research
International** 17
**Video Aids Corp. of
Colorado** 27

Ampex Corp.
Beta Technology, Inc.
Central Dynamics Corp.
CMX Systems
Convergence Corp.
Datatron, Inc.
Dynasciences Video Products
EECO
ELPA Marketing Industries, Inc.
Gotham Audio Corp.
Harvey Radio
Kaitronics Corp.
RCA Corp. Broadcast Systems Div.
Recortec Inc.
Rohde & Schwarz Sales Co.
Smith-Beemish, Inc.
Sony Corp. of America VTR Div.
Tele-Cine Inc.
Telemedia Electronics
Television Research International

Video Accessories Mfg. Co.
Video Aids Corp. of Colorado
Video Concepts, Inc.
Video Devices Co.

Enclosures, Module Card Tray

Monroe Electronics, Inc.
Orange County Corp.
Quad-Eight Electronics
Robins/Fairchild
ROH Corporation

Encoding Systems, Quad

Collins Radio Group
Electro-Voice Inc.
Gately Electronics
Sansui Electronics Corp.

Encoder, Color Video

See Adv. Page

Lenco Inc. 40

Amtron Corp.
Chiron Telesystems
Cohu, Inc.
Communications Systems
Fernesh Group Robert Bosch Corp.
Lenco Inc.
Marco Video Systems, Inc.
Marconi Electronics Inc.
Mincom Div. 3M Co.
Panasonic Video Systems Div.
Philips Test & Measuring Instruments,
Inc.
TeleMation, Inc.
Thompson-CSF Laboratories, Inc.

Encoder, Four Channel Stereo

Collins Radio Group
Electro-Voice Inc.
Gately Electronics
Sansui Electronics Corp.

Encoders, Tone

See Adv. Page

Lenco Inc. 40

Alpha Electronic Services Inc.
Audio Services, Inc.
Bogen Div.
Electronic Designers Inc.
IGM
Lenco Inc.
Monroe Electronics, Inc.
Orange County Corp.
Schafer Electronics Corp.
Teledata Systems, Inc.
Trepac Corp. America
Video Accessories Mfg. Co.

Encoder-Decoders, EBS

See Adv. Page

**Alpha Electronic
Services Inc.** 156
Audio Services, Inc. 163, 164
**Monroe Electronics,
Inc.** 24

Alpha Electronic Services Inc.
Audio Services, Inc.
Monroe Electronics, Inc.

Enhancers, Stereo Phase

See Adv. Page

Garron Electronics, Inc. 165

Garron Electronics, Inc.
Rapid-Q
Schafer Electronics Corp.

Enhancers, TV Image

See Adv. Page

A. F. Associates, Inc. 68
Telemet, a Geotel Co. 1

A. F. Associates, Inc.
 Cohu, Inc.
 Dynasciences Video Products
 Fernesh Group Robert Bosch Corp.
 Roscor Corp.
 Syste-Matics, Inc.
 Telemet, a Geotel Co.
 Thompson-CSF Laboratories, Inc.

Equalizers, Audio Emphasis

See Adv. Page

Broadcast Electronics 45
 Modular Audio Products 146
 Orange County Corp. 64, 158
 Pulse Techniques Inc. 156
 Senstrol Div. 167
 Sound Dynamics, Inc. 174

Allied Broadcast Equip.
 Altec Sound Products
 Audio Designs & Mfg.
 Audio Distributor Inc.
 Auditronics, Inc.
 Automated Processes, Inc.
 Bell P/A Prod. Corp.
 B & K Instruments Inc.
 Broadcast Electronics
 Broadcast Equipment & Supply Co.
 Burwen Laboratories
 Cetec Audio Div. Subs. Computer Equipment Corp.
 Collins Radio Group
 Communication Medias
 ESC Electronics Corp.
 Gately Electronics
 Gotham Audio Corp.
 Harvey Radio
 Lang Electronics Inc.
 Lauderdale Electronic Labs
 Maze Corp
 McCurdy Radio Ind. Inc.
 Micro-Trak Corp.
 Modular Audio Products
 Rupert Neve, Inc.
 Orange County Corp.
 Orban/Parasound, Inc.
 Orbit Radio and Video
 Pulse Techniques Inc.
 Quad-Eight Electronics
 Radio Mfg. Co. (RMC)
 Ramko Research
 Robins/Fairchild
 ROH Corporation
 Senstrol Div.
 Shallco, Inc.
 Shure Brothers Inc.
 Sinai-Johnson
 Sound Dynamics, Inc.
 Spectra Sonics
 Spectrum Instruments, Inc.
 Sphere Electronics
 Super 8 Sound, Inc.
 Systems Engineering Co., Inc.
 Thompson-CSF Laboratories, Inc.
 Total Technology
 TT Electronics, Inc.
 Ultra Audio Products
 United Recording Electronics Industries
 UREI a URC Co.
 Val-Tronics, Inc.

Equalizers, Vertical Aperature

Burwen Laboratories
 Dynasciences Video Products
 ESC Electronics Corp.
 Fernesh Group Robert Bosch Corp.
 Mincom Div. 3M Co.
 Panasonic Video Systems Div.
 Thompson-CSF Laboratories, Inc.

Equalizers, Video

See Adv. Page

Cooke Engineering Co. 37
 Orange County Corp. 64
 Pulse Techniques Inc. 156
 Telemet, a Geotel Co. 1
 Television Equipment Associates 159

Communications Technology, Inc.
 Cooke Engineering Co.
 Datatek Corp.
 ESC Electronics Corp.
 Grass Valley Group, Inc.
 Kappa Networks, Inc.
 Lenco Inc.
 Maze Corp
 Orange County Corp.
 Pulse Techniques Inc.
 Richmond Hill Laboratories Ltd.
 RMS Electronics, Inc.
 Telemet, a Geotel Co.
 Television Equipment Associates
 Thompson-CSF Laboratories, Inc.

Erasers, Magnetic --See also Heads; Demagnetizers

See Adv. Page

Broadcast Electronics 45
 Fidelipac 154
 Taber Mfg. & Engr. Co. 60

Allied Broadcast Equip.
 Broadcast Automation Assoc.
 Broadcast Electronics
 Collins Radio Group
 Communication Medias
 Comquip, Inc.
 Duotone Co. Inc.
 Fidelipac
 Garner Electronics
 G.C. Electronics
 Harvey Radio
 International Tapetronics Corp.
 Joa Cartridge Service
 Lauderdale Electronic Labs
 Mastertone Co., Inc.
 Minneapolis Magnetics, Inc.
 Nortronics Co., Inc.
 Professional Audio Service
 Recordex Corp.
 Robins/Fairchild
 Shallco, Inc.
 Sound Dynamics, Inc.
 Sparta Electronic Corp.
 Spotmaster
 Super 8 Sound, Inc.
 Taber Mfg. & Engr. Co.
 Tapex Corp.
 TEAC Corp of America
 UMC Electronics Co.
 Val-Tronics, Inc.
 Victor Duncan, Inc.
 VIF International

Exciters, AM

See Adv. Page

Orange County Corp. 64

AEL, Inc.
 Allied Broadcast Equip.
 CCA Electronics Corp.
 Collins Radio Group
 Continental Electronics Mfg. Co.
 Harris Corp. Broadcast Products Div.
 Kahn Communications, Inc.
 Maze Corp
 Orange County Corp.
 RCA Corp. Broadcast Systems Div.
 Singer Products Co., Inc.
 Sintronic Corp.
 Transcom Electronics, Inc.
 Wilkinson Electronics, Inc.

Exciters, FM

See Adv. Page

Collins Radio Group 51
 Orange County Corp. 64

AEL, Inc.
 Allied Broadcast Equip.
 Camex Corp.
 CCA Electronics Corp.
 Collins Radio Group
 Dyma Engineering, Inc.
 Fung Engineering Inc.
 Harris Corp. Broadcast Products Div.
 Mastertone Co., Inc.
 Maze Corp
 McMartin Industries, Inc.

Narda Microwave Corp
 North American Radio Corp.
 Orange County Corp.
 RCA Corp. Broadcast Systems Div.
 Rohde & Schwarz Sales Co.
 Singer Products Co., Inc.
 Sintronic Corp.
 Sparta Electronic Corp.
 Transcom Electronics, Inc.
 Val-Tronics, Inc.
 Wilkinson Electronics, Inc.

Exciters, SCA

See Adv. Page

Moseley Assoc. Inc. 9
 Orange County Corp. 64

AEL, Inc.
 Allied Broadcast Equip.
 Camex Corp.
 CCA Electronics Corp.
 Collins Radio Group
 Dyma Engineering, Inc.
 Harris Corp. Broadcast Products Div.
 Mastertone Co., Inc.
 Maze Corp
 McMartin Industries, Inc.
 Moseley Assoc. Inc.
 Orange County Corp.
 RCA Corp. Broadcast Systems Div.
 Sintronic Corp.
 Sparta Electronic Corp.
 Wilkinson Electronics, Inc.

Exciters, Stereo

See Adv. Page

Moseley Assoc. Inc. 9
 Orange County Corp. 64

AEL, Inc.
 Allied Broadcast Equip.
 Camex Corp.
 CCA Electronics Corp.
 Collins Radio Group
 Dyma Engineering, Inc.
 Harris Corp. Broadcast Products Div.
 Mastertone Co., Inc.
 Maze Corp
 McMartin Industries, Inc.
 Moseley Assoc. Inc.
 Orange County Corp.
 RCA Corp. Broadcast Systems Div.
 Sintronic Corp.
 Sparta Electronic Corp.
 Val-Tronics, Inc.
 Wilkinson Electronics, Inc.

Film, Photographic

Agfa-Gevaert Inc.
 Comquip, Inc.
 Eastman Kodak Co.
 GAF Corp.
 Image Devices Inc.

Film Chain Light Level Control

Beston Electronics Inc.
 International Video Corp.
 Sony Corp. of America VTR Div.
 The Zei-Mark Corp.

Film Chain System

See Adv. Page

Buhl Optical Co. 167

Bell & Howell Audio Visual Div.
 Blonder-Tongue Labs.
 Buhl Optical Co.
 Cohu, Inc.
 Communications Systems
 Comquip, Inc.
 Fernesh Group Robert Bosch Corp.
 GBC Closed Circuit TV Corp.
 General Electric Co. ISO Div.
 International Video Corp.
 Marco Video Systems, Inc.
 Marconi Electronics Inc.
 Philips Audio Video Systems Corp.
 Broadcast Equip. Div.
 Rank Precision Industries Rank Cintel Div.

Rank Precision Industries
 RCA Corp. Broadcast Systems Div.
 Roscor Corp.
 Syste-Matics, Inc.
 TeleMation, Inc.
 Thompson-CSF, Inc.
 R. H. Tyler Co.
 The Zei-Mark Corp.

Film Processing Chemicals, B&W

Eastman Kodak Co.
 GAF Corp.
 Philip A. Hunt Chemical Corp.
 RMS Electronics, Inc.

Film Processing Chemicals, Color

Agfa-Gevaert Inc.
 Eastman Kodak Co.
 GAF Corp.
 Philip A. Hunt Chemical Corp.

Film Processing Services

Eastman Kodak Co.
 GAF Corp.
 Lipsner-Smith Corp.
 W. A. Palmer Films, Inc.
 Photo Lab Inc.
 Super 8 Sound, Inc.

Film Sound Transfer Equipment

Comquip, Inc.
 Magna-Tech Electronic Co., Inc.
 W. A. Palmer Films, Inc.
 Quad-Eight Electronics
 Super 8 Sound, Inc.
 Victor Duncan, Inc.

Filters, Active

See Adv. Page

Comark Industries Inc. 161
 Pulse Techniques Inc. 156
 TT Electronics, Inc. 171

Alpha Electronic Services Inc.
 Comark Industries Inc.
 Crown International
 Gotham Audio Corp.
 Lauderdale Electronic Labs
 Multimetrics Industries
 Nagra Magnetic Recorders, Inc.
 Orange County Corp.
 Pulse Techniques Inc.
 Richmond Sound Design, Ltd.
 ROH Corporation
 Shure Brothers Inc.
 Spectra Sonics
 Total Technology
 TT Electronics, Inc.
 United Recording Electronics Industries
 UREI a URC Co.

Filters, Antenna

See Adv. Page

Micro Communications, Inc. 36

Ameco Inc.
 Bird Electronic Corp.
 Coaxial Dynamics
 Collins Radio Group
 Comark Industries Inc.
 Continental Electronics Mfg. Co.
 The Finney Co.
 G.C. Electronics
 Harris Corp. Broadcast Products Div.
 Jampro Antenna Co.
 Micro Communications, Inc.
 Microwave Assoc. Inc.
 North American Radio Corp.
 Shively Laboratories, Inc.
 Telonic Altair
 TT Electronics, Inc.
 Wide Band Engineering Co., Inc.

Filters, Audio

See Adv. Page

Comark Industries Inc.161
Pulse Techniques Inc......156
TT Electronics, Inc.171

Allen Avionics Inc.
Audio Designs & Mfg.
Autogram Corp.
Broadcast Automation Assoc.
Burwen Laboratories
Coastcom
Comark Industries Inc.
Crown International
Electro-Voice Inc.
ELPA Marketing Industries, Inc.
Gately Electronics
Gotham Audio Corp.
Lauderdale Electronic Labs
Monroe Electronics, Inc.
Multimetrics Industries
Rupert Neve, Inc.
Orange County Corp.
Pulse Techniques Inc.
Quad-Eight Electronics
Radio Mfg. Co. (RMC)
RCA Corp. Broadcast Systems Div.
Richmond Sound Design, Ltd.
ROH Corporation
Rohde & Schwarz Sales Co.
Shure Brothers Inc.
Sound Dynamics, Inc.
Spectra Sonics
Spectrum Instruments, Inc.
Total Technology
TT Electronics, Inc.
United Recording Electronics Industries
UREI a URC Co.

Filters, Noise

See Adv. Page

Comark Industries Inc.161
Pulse Techniques Inc......156
TT Electronics, Inc.171

B & K Instruments Inc.
Burwen Laboratories
Comark Industries Inc.
ESC Electronics Corp.
The Finney Co.
Gately Electronics
G.C. Electronics
Gotham Audio Corp.
Lauderdale Electronic Labs
Multimetrics Industries
Rupert Neve, Inc.
Orange County Corp.
Pulse Techniques Inc.
Quad-Eight Electronics
Shure Brothers Inc.
Simpson Electric Co.
Tektronix Inc.
Topaz Electronics
TT Electronics, Inc.

Filters, Passive

See Adv. Page

Pulse Techniques Inc......156
TT Electronics, Inc.171

Allen Avionics Inc.
Ameco Inc.
Audio-Video Engineering Co.
Coaxial Dynamics
Comark Industries Inc.
ESC Electronics Corp.
The Finney Co.
Gately Electronics
Kappa Networks, Inc.
Lauderdale Electronic Labs
Microwave Assoc. Inc.
Multimetrics Industries
Multronics, Inc.
Orange County Corp.
Pulse Techniques Inc.
Quad-Eight Electronics
ROH Corporation
Shively Laboratories, Inc.
Shure Brothers Inc.
Singer Products Co., Inc.
Telonic Altair

Total Technology
TT Electronics, Inc.
UREI a URC Co.
Wide Band Engineering Co., Inc.

Filters, Sound Effect

Audio Designs & Mfg.
Gately Electronics
Rupert Neve, Inc.
Orange County Corp.
Pulse Techniques Inc.
Radio Mfg. Co. (RMC)
Richmond Sound Design, Ltd.
Spectrum Instruments, Inc.
TT Electronics, Inc.

Filters, Variable and Fixed Tuned

See Adv. Page

TT Electronics, Inc.171

Ameco Inc.
Coaxial Dynamics
The Finney Co.
Gately Electronics
Gotham Audio Corp.
Microwave Assoc. Inc.
Multimetrics Industries
Multronics, Inc.
Rupert Neve, Inc.
North American Radio Corp.
Orange County Corp.
Power Waves, Inc.
Pulse Techniques Inc.
Quad-Eight Electronics
ROH Corporation
Shure Brothers Inc.
Spectra Sonics
Spectrum Instruments, Inc.
Systron-Donner
Television Equipment Associates
Telonic Altair
Total Technology
TT Electronics, Inc.
UREI a URC Co.

Filters, Video

See Adv. Page

Television Equipment Associates.....159
TT Electronics, Inc.171

Audio-Video Engineering Co.
Coastcom
Comark Industries Inc.
Datatek Corp.
ESC Electronics Corp.
Kappa Networks, Inc.
Multimetrics Industries
Orange County Corp.
Tektronix Inc.
Television Equipment Associates
Temtron Electronics
Theta-Com
TT Electronics, Inc.
The Zei-Mark Corp.

Framer, Color

A. F. Associates, Inc.
Video Accessories Mfg. Co.

Frequency Standard

Ailtech
Control Concepts Corp.
ESE
John Fluke Mfg. Co., Inc.
Gotham Audio Corp.
Hewlett Packard Co.
Multimetrics Industries
Rohde & Schwarz Sales Co.
Tracor, Inc. Instruments Group

Generators, Audio Sine

Altec Sound Products
Amber Electro Design, Ltd.
Automated Processes, Inc.
Collins Radio Group
Control Concepts Corp.
Control Design Corp.
Dynascan Corp.

Heath Co.
Instrument Laboratories
Leader Instruments Corp.
Marconi Instruments
Multimetrics Industries
Philips Test & Measuring Instruments, Inc.
Potomac Instruments, Inc.
RCA Corp. Distributor & Special Products Div.
Rek-O-Kut Inc.
Rohde & Schwarz Sales Co.
Sinai-Johnson
SPI-ITT Metrix Instruments Div.
Tektronix Inc.
Total Technology
Transel Corp.
United Systems Corp.

Generators, Audio Sweep

Ailtech
Altec Sound Products
Amber Electro Design, Ltd.
B & K Instruments Inc.
Dyma Engineering, Inc.
Hewlett Packard Co.
Hickok Elect. Instrument
Leader Instruments Corp.
Marconi Instruments
Philips Test & Measuring Instruments, Inc.
Radio Mfg. Co. (RMC)
Rohde & Schwarz Sales Co.
Telonic Altair
Total Technology
Transel Corp.
United Recording Electronics Industries

Generators, Background Color

American Data Corp.
Applied Electro Mechanics, Inc.
Central Dynamics Corp.
Communications Technology, Inc.
Dynasciences Video Products
Grass Valley Group, Inc.
Lenco Inc.
Philips Test & Measuring Instruments, Inc.
Richmond Hill Laboratories Ltd.
Ross Broadcast Products, Inc.
Shintron Co. Inc.
TeleMation, Inc.
Thompson-CSF Laboratories, Inc.
Video Accessories Mfg. Co.
Video Data Systems, Inc.

Generators, Burst

See Adv. Page

TeleMation, Inc. 67

Alpha Electronic Services Inc.
American Data Corp.
Applied Electro Mechanics, Inc.
Central Dynamics Corp.
Communications Technology, Inc.
Control Concepts Corp.
Dranetz Engineering Labs., Inc.
Dynasciences Video Products
Grass Valley Group, Inc.
Lenco Inc.
Philips Test & Measuring Instruments, Inc.
Richmond Hill Laboratories Ltd.
Rohde & Schwarz Sales Co.
Shintron Co. Inc.
Tektronix Inc.
TeleMation, Inc.
Thompson-CSF Laboratories, Inc.
Video Accessories Mfg. Co.
Video Aids Corp. of Colorado

Generators, Color Bar

See Adv. Page

TeleMation, Inc. 67

American Data Corp.
Cohu, Inc.
Dynascan Corp.
Eico Elect. Inst. Co., Inc.
Engineering Associates
Ferness Group Robert Bosch Corp.

General Electric Co. ISO Div.
Heath Co.
Hickok Elect. Instrument
Internatl. Nuclear Corp.
Leader Instruments Corp.
Lectrotech Inc.
Lenco Inc.
Marconi Electronics Inc.
Mincom Div. 3M Co.
Philips Test & Measuring Instruments, Inc.
RCA Corp. Distributor & Special Products Div.
Sencore Inc.
Sinai-Johnson
SPI-ITT Metrix Instruments Div.
Tektronix Inc.
TeleMation, Inc.
Telemet, a Geotel Co.
Thompson-CSF Laboratories, Inc.
Ultra Audio Products
Video Data Systems, Inc.

Generators, Color Sync

See Adv. Page

TeleMation, Inc. 67

American Data Corp.
Central Dynamics Corp.
Communications Technology, Inc.
Control Concepts Corp.
Dyma Engineering, Inc.
Dynasciences Video Products
Grass Valley Group, Inc.
Lenco Inc.
Panasonic Video Systems Div.
Philips Test & Measuring Instruments, Inc.
RCA Corp. Broadcast Systems Div.
RCA Corp. Distributor & Special Products Div.
Richmond Hill Laboratories Ltd.
Rohde & Schwarz Sales Co.
Roscor Corp.
Tektronix Inc.
TeleMation, Inc.
Telemet, a Geotel Co.
Thompson-CSF Laboratories, Inc.
Video Aids Corp. of Colorado
Video Concepts, Inc.

Generators, Convergence

American Data Corp.
Barco U.S.
Dynasciences Video Products
Lectrotech Inc.
Lenco Inc.
Philips Test & Measuring Instruments, Inc.
Richmond Hill Laboratories Ltd.
Tektronix Inc.

Generators, Cross Pulse

See Adv. Page

Video Aids Corp. of Colorado 27

Control Concepts Corp.
Tektronix Inc.
Video Aids Corp. of Colorado
Video Concepts, Inc.

Generators, Digital Sync

See Adv. Page

Central Dynamics 178
TeleMation, Inc. 67

American Data Corp.
Central Dynamics Corp.
Communications Technology, Inc.
Control Concepts Corp.
Electronic Designers Inc.
Grass Valley Group, Inc.
Lenco Inc.
RCA Corp. Broadcast Systems Div.
Richmond Hill Laboratories Ltd.
Rohde & Schwarz Sales Co.
TeleMation, Inc.
Thompson-CSF Laboratories, Inc.

Generators, FM Subcarrier

See Adv. Page

Moseley Assoc. Inc. 9

- AEL, Inc.
- Allied Broadcast Equip. Camex Corp.
- Catel
- CCA Electronics Corp.
- Coastcom
- Collins Radio Group
- Dyma Engineering, Inc.
- Leader Instruments Corp.
- Marti Electronics
- Mastertone Co., Inc.
- McMartin Industries, Inc.
- Moseley Assoc. Inc.
- Orange County Corp.
- RCA Corp. Broadcast Systems Div.
- RCA Corp. Distributor & Special Products Div.
- Singer Products Co., Inc.
- Sintronix Corp.
- Sparta Electronic Corp.
- Tektronix Inc.
- Wilkinson Electronics, Inc.

Generators, Monoscope

See Adv. Page

Telemet, a Geotel Co. 1

- Telemet, a Geotel Co.

Generators, NTSC Signal Test

See Adv. Page

Lenco Inc. 40
 Telemet, a Geotel Co. 1
 Video Aids Corp. of Colorado 27

- American Data Corp.
- Asaca Corp. of America
- Dynasciences Video Products
- Lenco Inc.
- Marconi Electronics Inc.
- Marconi Instruments
- Philips Test & Measuring Instruments, Inc.
- Richmond Hill Laboratories Ltd.
- Rohde & Schwarz Sales Co.
- Shintron Co. Inc.
- Tektronix Inc.
- TeleMation, Inc.
- Telemet, a Geotel Co.
- Thompson-CSF Laboratories, Inc.
- Video Aids Corp. of Colorado
- VIF International

Generators, Powered (Electric Motor)

- General Electric Co. Tubes/MW Devices
- Singer Products Co., Inc.

Generators, Powered (Gasoline Engine)

See Adv. Page

Onan 55
 Val-Tronics, Inc. 171

- Comquip, Inc.
- Mole Richardson Co.
- Onan
- Singer Products Co., Inc.
- Val-Tronics, Inc.

Generators, SCA

See Adv. Page

Moseley Assoc. Inc. 9
 Orange County Corp. 64
 Wilkinson Electronics, Inc. 157

- AEL, Inc.
- Allied Broadcast Equip. Camex Corp.
- CCA Electronics Corp.

- Collins Radio Group
- Harris Corp. Broadcast Products Div.
- Leader Instruments Corp.
- Mastertone Co., Inc.
- McMartin Industries, Inc.
- Moseley Assoc. Inc.
- Orange County Corp.
- Singer Products Co., Inc.
- Sparta Electronic Corp.
- Tektronix Inc.
- Wilkinson Electronics, Inc.

Generators, Signal AF

- Ailtech
- Altec Sound Products
- Amber Electro Design, Ltd.
- Control Concepts Corp.
- Control Design Corp.
- Delta Electronics Inc. (N.C.)
- Dragnet Engineering Labs., Inc.
- Dyna Engineering, Inc.
- Dynascan Corp.
- Edison Electronics Div.
- Eico Elect. Inst. Co., Inc.
- Heath Co.
- Hewlett Packard Co.
- Instrument Laboratories
- Kay Elemetrics Corp.
- Leader Instruments Corp.
- Multimetrix Industries
- Opamp Lamps, Inc.
- Philips Test & Measuring Instruments, Inc.
- Potomac Instruments, Inc.
- Radio Mfg. Co. (RMC)
- RCA Corp. Distributor & Special Products Div.
- Rohde & Schwarz Sales Co.
- Sinai-Johnson
- Spectra Sonics
- SPI-ITT Metrix Instruments Div.
- Terminal Electronics Corp.
- Texscan Corp.
- Total Technology
- Transel Corp.
- United Recording Electronics Industries

Generators, Signal Dot Bar

See Adv. Page

TeleMation, Inc. 67

- Barco U.S.
- Colorado Video Inc.
- Control Concepts Corp.
- Dyma Engineering, Inc.
- Eico Elect. Inst. Co., Inc.
- Fernesh Group Robert Bosch Corp.
- Grass Valley Group, Inc.
- Heath Co.
- Leader Instruments Corp.
- Lectrotech Inc.
- Lenco Inc.
- Philips Test & Measuring Instruments, Inc.
- RCA Corp. Distributor & Special Products Div.
- Richmond Hill Laboratories Ltd.
- Sencore Inc.
- Sinai-Johnson
- SPI-ITT Metrix Instruments Div.
- Tektronix Inc.
- TeleMation, Inc.
- Telemet, a Geotel Co.
- Thompson-CSF Laboratories, Inc.

Generators, Signal Marker

- Blonder-Tongue Labs.
- Dynascan Corp.
- Eico Elect. Inst. Co., Inc.
- Leader Instruments Corp.
- Lectrotech Inc.
- RCA Corp. Distributor & Special Products Div.
- Sencore Inc.
- SPI-ITT Metrix Instruments Div.
- Tektronix Inc.

Generators, Signal Pulse

- Ailtech
- B & K Instruments Inc.
- Control Concepts Corp.

- Delta Electronics Inc. (Va.)
- Dragnet Engineering Labs., Inc.
- Dynasciences Video Products
- Edison Electronics Div.
- Fernesh Group Robert Bosch Corp.
- GEC-Marconi Electronics Ltd.
- Hewlett Packard Co.
- Leader Instruments Corp.
- Lenco Inc.
- Marconi Electronics Inc.
- Nagra Magnetic Recorders, Inc.
- Narda Microwave Corp
- Philips Test & Measuring Instruments, Inc.
- RCA Corp. Distributor & Special Products Div.
- Richmond Hill Laboratories Ltd.
- Rohde & Schwarz Sales Co.
- Ryder Magnetic Sales Corp.
- Systron-Donner
- Tasker Systems
- Tektronix Inc.
- Trepac Corp. America
- Vitek Electronics Inc.

Generators, Signal RF

See Adv. Page

Delta Electronics Inc. (Va.) 59
 Modular Audio Products 146
 Potomac Instruments, Inc. 153

- Ailtech
- Blonder-Tongue Labs.
- Boonton Electronics
- Collins Radio Group
- Delta Electronics Inc. (Va.)
- Dynascan Corp.
- Edison Electronics Div.
- Eico Elect. Inst. Co., Inc.
- Engineering Associates
- General Microwave Corp.
- Heath Co.
- Hewlett Packard Co.
- Lampkin Lab. Inc.
- Leader Instruments Corp.
- Marconi Instruments
- Modular Audio Products
- Multimetrix Industries
- Narda Microwave Corp
- Philips Test & Measuring Instruments, Inc.
- Potomac Instruments, Inc.
- PRD Electronics, Inc.
- RCA Corp. Distributor & Special Products Div.
- Rohde & Schwarz Sales Co.
- Sadelco, Inc.
- Sencore Inc.
- Sinai-Johnson
- Singer Instrumentation
- SPI-ITT Metrix Instruments Div.
- Tasker Systems
- Telonic Altair
- Texscan Corp.
- United Systems Corp.
- Weinschel Engineering Co.

Generators, Signal Square Wave

- Ailtech
- Amber Electro Design, Ltd.
- Dynascan Corp.
- Edison Electronics Div.
- Eico Elect. Inst. Co., Inc.
- Heath Co.
- Hewlett Packard Co.
- Leader Instruments Corp.
- Lenco Inc.
- Multimetrix Industries
- Philips Test & Measuring Instruments, Inc.
- RCA Corp. Distributor & Special Products Div.
- Rohde & Schwarz Sales Co.
- Sinai-Johnson
- SPI-ITT Metrix Instruments Div.
- Systron-Donner
- Tektronix Inc.
- Terminal Electronics Corp.
- Total Technology
- Transel Corp.

- United Recording Electronics Industries
- United Systems Corp.
- Weinschel Engineering Co.

Generators, Signal TV Synchronizing

See Adv. Page

TeleMation, Inc. 67

- American Data Corp.
- Colorado Video Inc.
- Communications Technology, Inc.
- Control Concepts Corp.
- Dage-MTI, Inc.
- Dyma Engineering, Inc.
- Dynair Electronics, Inc.
- Dynasciences Video Products
- Echo Science Corp.
- Electronic Designers Inc.
- Fernesh Group Robert Bosch Corp.
- Grass Valley Group, Inc.
- Interntl. Nuclear Corp.
- Lenco Inc.
- Marconi Electronics Inc.
- Philips Test & Measuring Instruments, Inc.
- Rohde & Schwarz Sales Co.
- Shintron Co. Inc.
- Sylvania Comm. Electronic
- Tektronix Inc.
- TeleMation, Inc.
- Telemet, a Geotel Co.
- Texscan Corp.
- Thompson-CSF Laboratories, Inc.
- Video Aids Corp. of Colorado

Generators, Signal VITS

See Adv. Page

Telemet, a Geotel Co. 1

- American Data Corp.
- Electronic Designers Inc.
- Lenco Inc.
- Marconi Instruments
- Philips Test & Measuring Instruments, Inc.
- Rohde & Schwarz Sales Co.
- Tektronix Inc.
- Telemet, a Geotel Co.

Generators, Special Effect

See Adv. Page

Central Dynamics 176
 Chiron Telesystems 44
 Shintron Co. Inc. 50
 TeleMation, Inc. 67
 Vamco Engineering 23

- American Data Corp.
- Ball Bros. Research Corp. Miratel Division
- Broadcast Video Systems, Ltd.
- Central Dynamics Corp.
- Chiron Telesystems
- Colorado Video Inc.
- Communications Technology, Inc.
- Dage-MTI, Inc.
- Dynair Electronics, Inc.
- Dynasciences Video Products
- Grass Valley Group, Inc.
- Industrial Sciences, Inc.
- Interntl. Nuclear Corp.
- Leader Instruments Corp.
- Marconi Electronics Inc.
- Panasonic Video Systems Div.
- Richmond Hill Laboratories Ltd.
- Roscor Corp.
- Shintron Co. Inc.
- Sinai-Johnson
- Tektronix Inc.
- TeleMation, Inc.
- Total Technology
- R. H. Tyler Co.
- Ultra Audio Products
- Universal Research Labs
- Vamco Engineering
- Video Accessories Mfg. Co.
- Viscount Industries Ltd.

Generators, Staircase

- American Data Corp.

Colorado Video Inc.
Lenco Inc.
Philips Test & Measuring Instruments, Inc.
Richmond Hill Laboratories Ltd.
Rohde & Schwarz Sales Co.
Tektronix Inc.
TeleMation, Inc.
Telemet, a Geotel Co.
Thompson-CSF Laboratories, Inc.
Ultra Audio Products

Generators, Stereo

See Adv. Page
Logitek Electronic Systems.....164
Moseley Assoc. Inc. 9
Orange County Corp. 64
Orban/Parasound, Inc.185
Wilkinson Electronics, Inc......157

AEL, Inc.
Allied Broadcast Equip.
Broadcast Automation Assoc.
Camex Corp.
Catel
CCA Electronics Corp.
Collins Radio Group
Edison Electronics Div.
Fung Engineering Inc.
Harris Corp. Broadcast Products Div.
Heath Co.
Leader Instruments Corp.
Logitek Electronic Systems
The London Co.
Mastertone Co., Inc.
Maze Corp
McMartin Industries, Inc.
Moseley Assoc. Inc.
Orange County Corp.
Orban/Broadcast
Orban/Parasound, Inc.
Philips Test & Measuring Instruments, Inc.
RCA Corp. Distributor & Special Products Div.
Rohde & Schwarz Sales Co.
Sencore Inc.
Sintronic Corp.
Sparta Electronic Corp.
Val-Tronics, Inc.
Wilkinson Electronics, Inc.

Generators, Subcarrier

See Adv. Page
Moseley Assoc. Inc. 9
Allied Broadcast Equip.
Ameco Inc.
American Data Corp.
ATV Research
Broadcast Automation Assoc.
Camex Corp.
CCA Electronics Corp.
Cohu, Inc.
Collins Radio Group
Communications Technology, Inc.
Control Concepts Corp.
Grass Valley Group, Inc.
Harris Corp. Broadcast Products Div.
Lenco Inc.
Maze Corp
McMartin Industries, Inc.
Moseley Assoc. Inc.
Orange County Corp.
Philips Test & Measuring Instruments, Inc.
Richmond Hill Laboratories Ltd.
Rohde & Schwarz Sales Co.
Shintron Co. Inc.
Sintronic Corp.
Sparta Electronic Corp.
TeleMation, Inc.
Tracor, Inc. Instruments Group

Generators, Sync

See Adv. Page
Lenco Inc...... 40
TeleMation, Inc...... 67

Video Aids Corp. of Colorado 27

American Data Corp.
Broadcast Video Systems, Ltd.
Ceco Communications Inc.
Central Dynamics Corp.
Cohu, Inc.
Colorado Video Inc.
Communications Systems
Communications Technology, Inc.
Control Concepts Corp.
Dynamics Video Products
Electronic Designers Inc.
GBC Closed Circuit TV Corp.
Grass Valley Group, Inc.
Hitachi Shibaden Corp. of America
Interntl. Nuclear Corp.
Lenco Inc.
Maze Corp
Nagra Magnetic Recorders, Inc.
Philips Test & Measuring Instruments, Inc.
Richmond Hill Laboratories Ltd.
Rohde & Schwarz Sales Co.
Shintron Co. Inc.
Systa-Matics, Inc.
Tektronix Inc.
TeleMation, Inc.
Telemet, a Geotel Co.
Thompson-CSF Laboratories, Inc.
R. H. Tyler Co.
Video Aids Corp. of Colorado
Video Concepts, Inc.

Generators, Thermoelectric

See Adv. Page
Teledyne Energy Systems.....155

Mastertone Co., Inc.
Teledyne Energy Systems

Generators, Time Code (Reader)

See Adv. Page
Central Dynamics Corp.176

Beta Technology, Inc.
Central Dynamics Corp.
Chrono-Log Corp.
CMX Systems
Datametrics
Datatron, Inc.
EECO
Kaitronics Corp.
Recortec Inc.
Scully/Metrotech
Stancil-Hoffman Corp.
Systron-Donner
Tektronix Inc.
Telemet, a Geotel Co.
VIF International

Generators, Tone

See Adv. Page
Control Design Corp......137

Allied Broadcast Equip.
Alpha Electronic Services Inc.
Audio Services, Inc
Autogram Corp.
Control Design Corp.
Edison Electronics Div.
Gotham Audio Corp.
IGM
Lauderdale Electronic Labs
Mastertone Co., Inc.
Multimetrix Industries
Opamp Lamps, Inc.
Orange County Corp.
Shure Brothers Inc.
Singer Instrumentation
Telemedia Electronics
Total Technology
Transel Corp.
Trepac Corp. America
Video Accessories Mfg. Co.

Generators, Tone, EBS

Audio Services, Inc

Generators, Video Carrier

See Adv. Page
Lenco Inc...... 40
Ameco Inc.
Electronic Designers Inc.
Lenco Inc.
Philips Test & Measuring Instruments, Inc.
Rohde & Schwarz Sales Co.
Tektronix Inc.
Theta-Com
Tracor, Inc. Instruments Group

Generators, Video Sweep

See Adv. Page
Lenco Inc...... 40
Telemet, a Geotel Co...... 1

Ailtech
Datatek Corp.
Leader Instruments Corp.
Lectrotech Inc.
Lenco Inc.
Marconi Instruments
Philips Test & Measuring Instruments, Inc.
RCA Corp. Distributor & Special Products Div.
Rohde & Schwarz Sales Co.
SPI-ITT Metrix Instruments Div.
Tektronix Inc.
Telemet, a Geotel Co.
Telonic Altair
Texscan Corp.

Graph Paper

Semline, Inc.

Head Alignment Gauge

Ampro Corp.
Broadcast Equipment & Supply Co.
Fidelipac
Harris Corp. Broadcast Products Div.
Joa Cartridge Service
Lauderdale Electronic Labs
Mastertone Co., Inc.
Nagra Magnetic Recorders, Inc.
Orange County Corp.
Professional Audio Service
Sound Dynamics, Inc.
Sparta Electronic Corp.

Head Cleaning Products, Video

Lauderdale Electronic Labs
Memorex Corp. Audio-Video Group
Nortronics Co., Inc.
Orange County Corp.
VIF International

Head Nest Rebuilding Services

See Adv. Page
International Electro-Magnetics148
Minneapolis Magnetics, Inc.148

Accurate Sound Co.
Communication Medias
International Electro-Magnetics
Lipps Inc.
Mastertone Co., Inc.
Minneapolis Magnetics, Inc.
Radio Mfg. Co. (RMC)
Taber Mfg. & Engr. Co.

Headphones, Announcers Earpiece

See Adv. Page
Broadcast Electronics 45
David Clark Co., Inc......163
Orange County Corp. 64
Sound Dynamics, Inc.174
Television Equipment Associates.....159

Allied Broadcast Equip.
Broadcast Automation Assoc.
Broadcast Electronics
David Clark Co., Inc.
Collins Radio Group
Communication Medias
Dyma Engineering, Inc.
Electro-Voice Inc.
Image Devices Inc.
Lauderdale Electronic Labs
Mastertone Co., Inc.
Nemo Recording Labs
Orange County Corp.
Pulse Dynamics Mfg. Corp. (PDMC)
Rek-O-Kut Inc.
Revox Corp.
Sound Dynamics, Inc.
Systems Engineering Co., Inc.
Television Equipment Associates
Telex Communications, Inc.
Wilkinson Electronics, Inc.

Headphones, Broadcast Monitoring

See Adv. Page
David Clark Co., Inc......163
Communication Medias..... 62
Orange County Corp. 64
Sound Dynamics, Inc.174
Television Equipment Associates.....159

Allied Broadcast Equip.
Beyer (Revox Corporation)
Broadcast Automation Assoc.
Broadcast Electronics
Broadcast Equipment & Supply Co.
David Clark Co., Inc.
Collins Radio Group
Communication Medias
Harvey Radio
Image Devices Inc.
Koss Corp
Lauderdale Electronic Labs
Mastertone Co., Inc.
Maze Corp
Nemo Recording Labs
Orange County Corp.
Philips Audio Video Systems Corp.
Broadcast Equip. Div.
Pulse Dynamics Mfg. Corp. (PDMC)
Rek-O-Kut Inc.
Revox Corp.
Scintrex Inc. Communications Div.
Sound Dynamics, Inc.
Stanton Magnetics Inc.
Systems Engineering Co., Inc.
Television Equipment Associates
Telex Communications, Inc.
Val-Tronics, Inc.
VIF International
Wilkinson Electronics, Inc.

Headphones, Mono

See Adv. Page
Broadcast Electronics 45
Val-Tronics, Inc......160

Allied Broadcast Equip.
Bell & Howell Audio Visual Div.
Beyer (Revox Corporation)
Broadcast Automation Assoc.
Broadcast Electronics
Collins Radio Group
Communication Medias
G.C. Electronics
Harvey Radio
Heath Co.
Image Devices Inc.
Koss Corp
Lauderdale Electronic Labs
Mastertone Co., Inc.
Nemo Recording Labs
Orange County Corp.
Paso Sound Products Inc.
Philips Audio Video Systems Corp.
Audio Div.
Philips Audio Video Systems Corp.
Broadcast Equip. Div.
Professional Audio Service
Rek-O-Kut Inc.
Revox Corp.
Ryder Magnetic Sales Corp.

Scintrex Inc. Communications Div.
Sennheiser Electronic
Singer Products Co., Inc.
Sound Dynamics, Inc.
Sparta Electronic Corp.
Stanton Magnetics Inc.
Superscope, Inc.
Systems Engineering Co., Inc.
Television Equipment Associates
Telex Communications, Inc.
Terminal Electronics Corp.
Val-Tronics, Inc.
Victor Duncan, Inc.
VIF International
Wilkinson Electronics, Inc.

Headphones, Stereo

	See Adv. Page
Broadcast Electronics	45
Communication Medias.....	62
LPB Inc.	152
Val-Tronics, Inc.....	160

Allied Broadcast Equip.
Beyer (Revox Corporation)
Broadcast Automation Assoc.
Broadcast Electronics
Collins Radio Group
Communication Medias
Duotone Co. Inc.
Dyma Engineering, Inc.
G.C. Electronics
Harvey Radio
Heath Co.
Image Devices Inc.
Koss Corp
Lauderdale Electronic Labs
LPB Inc.
Mastertone Co., Inc.
Nemo Recording Labs
Orange County Corp.
Philips Audio Video Systems Corp.
Audio Div.
Philips Audio Video Systems Corp.
Broadcast Equip. Div.
Professional Audio Service
Rek-O-Kut Inc.
Revox Corp.
Ryder Magnetic Sales Corp.
Sansui Electronics Corp.
Scintrex Inc. Communications Div.
Sennheiser Electronic
Singer Products Co., Inc.
Sound Dynamics, Inc.
Sparta Electronic Corp.
Stanton Magnetics Inc.
Super 8 Sound, Inc.
Superscope, Inc.
Systems Engineering Co., Inc.
Television Equipment Associates
Telex Communications, Inc.
R. H. Tyler Co.
Val-Tronics, Inc.
Victor Duncan, Inc.
VIF International
Wilkinson Electronics, Inc.

Heads, Audio Stack

	See Adv. Page
Computer Magnetics Corp.	131

Computer Magnetics Corp.

Head, Contactor

Nortronics Co., Inc.
TEAC Corp of America

Heads, Erase Magnetic

Broadcast Automation Assoc.
Broadcast Electronics
Communication Medias
Joa Cartridge Service
Lauderdale Electronic Labs
Lipps Inc.
Magna-Tech Electronic Co., Inc.
Magnusonic Devices Inc.
Mastertone Co., Inc.
Minneapolis Magnetics, Inc.
Norton Assoc. Inc.
Nortronics Co., Inc.

Orange County Corp.
Professional Audio Service
Sound Dynamics, Inc.
Spin Physics, Inc.
Spotmaster
Taber Mfg. & Engr. Co.

Heads, Film Stripe

Lipps Inc.
Magna-Tech Electronic Co., Inc.
Norton Assoc. Inc.
Nortronics Co., Inc.
Victor Duncan, Inc.

Heads, Reconditioned or Reconditioning Services for Audio

	See Adv. Page
International Electro-Magnetics	148
Minneapolis Magnetics, Inc.	148

Accurate Sound Co.
Audio Distributor Inc.
Broadcast Automation Assoc.
Computer Magnetics Corp.
Electro Sound, Inc.
International Electro-Magnetics
Lipps Inc.
Minneapolis Magnetics, Inc.
Norton Assoc. Inc.
Sound Dynamics, Inc.
Taber Mfg. & Engr. Co.
Victor Duncan, Inc.

Heads, Reconditioned or Reconditioning Services for Video

	See Adv. Page
Computer Magnetics Corp.	131
Videomax Corp.	15

Ampex Corp.
Computer Magnetics Corp.
Glentronix, Ltd.
International Video Corp.
Spin Physics, Inc.
Taber Mfg. & Engr. Co.
Videomax Corp.

Heads, Recorder Replacement

	See Adv. Page
Broadcast Electronics	45
Communication Medias.....	62
Computer Magnetics Corp.	131
International Electro-Magnetics	148
Joa Cartridge Service.....	162
Minneapolis Magnetics, Inc.	148
Videomax Corp.	15

Allied Broadcast Equip.
Broadcast Automation Assoc.
Broadcast Electronics
Broadcast Equipment & Supply Co.
Communication Medias
Computer Magnetics Corp.
Electro Sound, Inc.
Glentronix, Ltd.
International Electro-Magnetics
Joa Cartridge Service
Lauderdale Electronic Labs
Lipps Inc.
Minneapolis Magnetics, Inc.
Norton Assoc. Inc.
Nortronics Co., Inc.
Orange County Corp.
Professional Audio Service
Sound Dynamics, Inc.
Spin Physics, Inc.
Spotmaster
Taber Mfg. & Engr. Co.
Tapex Corp.
Val-Tronics, Inc.
Videomax Corp.

VIF International

Heads, Recording Magnetic

	See Adv. Page
Broadcast Electronics	45
Communication Medias.....	62
Computer Magnetics Corp.	131
International Electro-Magnetics	148
Joa Cartridge Service.....	162
Minneapolis Magnetics, Inc.	148
Sound Dynamics, Inc.	174

Allied Broadcast Equip.
Broadcast Automation Assoc.
Broadcast Electronics
Collins Radio Group
Communication Medias
Computer Magnetics Corp.
Electro Sound, Inc.
Glentronix, Ltd.
Hitachi Shibaden Corp. of America
International Electro-Magnetics
Joa Cartridge Service
Lauderdale Electronic Labs
Lipps Inc.
Magna-Tech Electronic Co., Inc.
Magnusonic Devices Inc.
Mastertone Co., Inc.
Minneapolis Magnetics, Inc.
Nagra Magnetic Recorders, Inc.
Norton Assoc. Inc.
Nortronics Co., Inc.
Orange County Corp.
Professional Audio Service
Recordex Corp.
Sound Dynamics, Inc.
Spin Physics, Inc.
Spotmaster
Taber Mfg. & Engr. Co.
Tapecaster TCM, Inc.
Val-Tronics, Inc.
Videomax Corp.
Vikron

Heads, Video Recorder

	See Adv. Page
Computer Magnetics Corp.	131
Videomax Corp.	15

Asaca Corp. of America
Computer Magnetics Corp.
Glentronix, Ltd.
International Video Corp.
RCA Corp. Broadcast Systems Div.
Spin Physics, Inc.
Taber Mfg. & Engr. Co.
Videomax Corp.

Headset with Microphone

	See Adv. Page
David Clark Co., Inc.	163
Communication Medias.....	62
Orange County Corp.	64
Revox Corp.	43
Television Equipment Associates.....	159

Allied Broadcast Equip.
Audio Distributor Inc.
Broadcast Automation Assoc.
David Clark Co., Inc.
Communication Medias
Electro-Voice Inc.
Hitachi Shibaden Corp. of America
Lauderdale Electronic Labs
Mastertone Co., Inc.
Nemo Recording Labs
Orange County Corp.
Philips Audio Video Systems Corp.
Audio Div.
Philips Audio Video Systems Corp.
Broadcast Equip. Div.
Pulse Dynamics Mfg. Corp. (PDMC)
Revox Corp.
Scintrex Inc. Communications Div.
Sennheiser Electronic

Systems Engineering Co., Inc.
Telectro Systems Corp.
Television Equipment Associates
Telex Communications, Inc.
R. H. Tyler Co.
Val-Tronics, Inc.
Video Aids Corp. of Colorado
VIF International

Heat Exchangers

Bird Electronic Corp.
Electro Impulse, Inc.
Harris Corp. Broadcast Products Div.

Heater, Antenna Control

Collins Radio Group
Harris Corp. Broadcast Products Div.
Mastertone Co., Inc.
Micro-Trak Corp.
Orange County Corp.
Valad Electric Heating Corp.

Heaters, Station Van

Valad Electric Heating Corp.

Hum Stop Coil, Video

	See Adv. Page
Audio-Video Engineering Co.	172

Audio-Video Engineering Co.
Systa-Matics, Inc.
TeleMation, Inc.

Industrial TV --See also TV Systems, Closed Circuit

Ampex Corp.
ATV Research
AVA Electronics Corp.
Ball Bros. Research Corp. Miratel Division
Berkey-Colortran Inc.
Blonder-Tongue Labs.
Boston Insulated Wire & Cable Co.
Broadcast Electronics
Buhl Optical Co.
Catel
Colorado Video Inc.
Communications Technology, Inc.
Communications 2000, Inc.
Comquip, Inc.
Dage-MTI, Inc.
Diebold Inc.
Dynair Electronics, Inc.
Echo Science Corp.
Fernesh Group Robert Bosch Corp.
General Electric Co. ISO Div.
Gen. Electrodynamics
General Television Ntwk.
Hitachi Shibaden Corp. of America
Ikegami Electronics (USA) Inc.
Internatl. Nuclear Corp.
International Video Corp.
Janson Industries
Javelin
Lenco Inc.
Lenzar Optics Corp.
Modtek
Nasco Television Systems
Orbit Radio and Video
Panasonic Video Systems Div.
Philips Audio Video Systems Corp.
Broadcast Equip. Div.
SC Electronics, Inc.
Jos. Schneider & Co. Optische Werke Div.
Scientific Systems, Inc.
Sony Corp. of America VTR Div.
Sylvania Comm. Electronic
Tektronix Inc.
Tele-Cine Inc.
Teltron Inc.
Varian/Beverly

Janson Industries
Javelin
Lenco Inc.
Lenzar Optics Corp.
Modtek
Nasco Television Systems
Orbit Radio and Video
Panasonic Video Systems Div.
Philips Audio Video Systems Corp.
Broadcast Equip. Div.
SC Electronics, Inc.
Jos. Schneider & Co. Optische Werke Div.

Scientific Systems, Inc.
Sony Corp. of America VTR Div.
Sylvania Comm. Electronic
Tektronix Inc.
Tele-Cine Inc.
Teltron Inc.
Varian/Beverly

Isolators, Electro-Optical

	See Adv. Page
Video Aids Corp. of Colorado	27

Video Aids Corp. of Colorado

Insulators, Antenna Base

Continental Electronics Mfg. Co.
Decca Austin Insulators
Utility Tower Co.

Insulators, Guy Strain

Continental Electronics Mfg. Co.
Decca Austin Insulators
Utility Tower Co.

**Integrated Circuits --See also
Semiconductors**

Amperex Electronic Corp.
A-Tel-A-Matic
English Electric Valve North America
Ltd.
General Electric Co. ISO Div.
Harvey Radio
Heintz and Kaufman Ltd.
Hewlett Packard Co.
P. R. Mallory & Co. Inc.
Microwave Assoc. Inc.
Motorola Semiconduct
Raytheon Data Systems Co.
RCA Corp. Distributor & Special
Products Div.
Temtron Electronics
Terminal Electronics Corp.
Texas Instrument Components Group
Thor Electronics Corp.

Intercom Systems

See Adv. Page
David Clark Co., Inc.163
Orange County Corp. 64

Atlas Sound
Audio Designs & Mfg.
Bethany International
Bogen Div.
David Clark Co., Inc.
Clear-Com
Electro-Voice Inc.
Emerson Electric/Artolier
Fernesh Group Robert Bosch Corp.
Fisher Berkeley Corp.
G.C. Electronics
Harvey Radio
Heath Co.
Holland Electronics
McMartin Industries, Inc.
Nasco Television Systems
Orange County Corp.
Paso Sound Products Inc.
ROH Corporation
Scientific Systems, Inc.
Sinai-Johnson
Systems Engineering Co., Inc.
Telectro Systems Corp.
TeleMation, Inc.
Television Equipment Associates
Terminal Electronics Corp.
Video Aids Corp. of Colorado
Visual Electronics Laboratories

Isocouplers

See Adv. Page
**Video Aids Corp. of
Colorado 27**

Allied Broadcast Equip.
Collins Radio Group
Mastertone Co., Inc.
RCA Corp. Broadcast Systems Div.
Sintronic Corp.
Sparta Electronic Corp.
Val-Tronics, Inc.
Video Aids Corp. of Colorado

ITFS System

See Adv. Page
Varian/Beverly 185

Acrodyne Industries Inc.
Alford Mfg. Co.
EMCEE Broadcast Products

RF Systems, Inc.
Varian/Beverly

Jack Panel Assemblies

See Adv. Page
Cooke Engineering Co. 37
Orange County Corp. 64

Allied Broadcast Equip.
A-Tel-A-Matic
Audio Accessories Inc.
Audio Designs & Mfg.
Audio Distributor Inc.
Audio Services, Inc
AVA Electronics Corp.
Broadcast Automation Assoc.
Collins Radio Group
Cooke Engineering Co.
Delta Electronics Inc. (Va.)
Dyma Engineering, Inc.
Harris Corp. Broadcast Products Div.
Harvey Radio
Mastertone Co., Inc.
McCurdy Radio Ind. Inc.
Orange County Corp.
Potomac Instruments, Inc.
RCA Corp. Broadcast Systems Div.
Rex Rheostat & Co., Inc.
Switchcraft Inc.
Systems Engineering Co., Inc.
Terminal Electronics Corp.
Trompeter Electronics
Union Connector Co., Inc.

Jacks, Meter Line

See Adv. Page
**Delta Electronics Inc.
(Va.) 59**
Delta Electronics Inc. (Va.)

Keyers, Video Insert

See Adv. Page
**Broadcast Video
Systems, Ltd.122**
Central Dynamics.176

Broadcast Video Systems, Ltd.
Central Dynamics Corp.
Chiron Telesystems
Communications Technology, Inc.
Grass Valley Group, Inc.
Panasonic Video Systems Div.
Roscor Corp.
Shintron Co. Inc.
Video Accessories Mfg. Co.
Video Devices Co.

Kits

See Adv. Page
Opamp Lamps, Inc.185

ATV Research
Eico Elect. Inst. Co., Inc.
Engineering Associates
ESE
Imero Fiorentino Associates, Inc.
Gately Electronics
G.C. Electronics
Heath Co.
Hughes & Phillips Inc.
Lauderdale Electronic Labs
Mole Richardson Co.
Oaktron Industries Inc.
Opamp Lamps, Inc.
RCA Corp. Distributor & Special
Products Div.
Recortec Inc.
Robins/Fairchild
SPI-ITT Metrix Instruments Div.
Terminal Electronics Corp.
Texwipe Co.
TRW Electronics Supply Co.
Vaco Products Co.

Knobs, Control

Alco Electronic Products, Inc.
G.C. Electronics
P. R. Mallory & Co. Inc.
Quad-Eight Electronics
Singer Products Co., Inc.

**Lamps, Stage and Studio
Replacement**

See Adv. Page
Sitler's Supplies, Inc.175

GTE Sylvania Inc. Lighting Products
Group
Lauderdale Electronic Labs
Sitler's Supplies, Inc.

Leased Broadcast Equipment

See Adv. Page
Ampro Corp. 48

Allied Broadcast Equip.
Ampro Corp.
Audio Services, Inc
Broadcast Automation Assoc.
Broadcast Equipment Leasing Corp.
Broadcast Equipment & Supply Co.
Collins Radio Group
Communication Medias
Comquip, Inc.
Control Design Corp.
D and S Corley Ltd.
Editel Communications
Fujinon Optical, Inc.
Gotham Audio Corp.
Harris Corp. Broadcast Products Div.
International Tapetronics Corp.
Lauderdale Electronic Labs
Orange County Corp.
RCA Corp. Broadcast Systems Div.
Schafer Electronics Corp.
Sintronic Corp.
Smith-Beemish, Inc.
Sparta Electronic Corp.
Spectra Sonics
Tele-Cine Inc.
Thompson-CSF Laboratories, Inc.
Wilkinson Electronics, Inc.

Lenses, Optical Fixed

See Adv. Page
Anixter-Mark185
Canon USA, Inc.135
Victor Duncan, Inc.139

Angenieux Corp. of America
Anixter-Mark
Arriflex Co. of America
A-Tel-A-Matic
ATV Research
Buhl Optical Co.
Canon USA, Inc. Optics Div.
Cohu, Inc.
Communications Systems
Comquip, Inc.
Cosmicar Optical Co., Ltd.
Cunningham Corp.
Dage-MTI, Inc.
Denson Electronic Corp.
Fujinon Optical, Inc.
General Electric Co. ISO Div.
Harvey Radio
Image Devices Inc.
Javelin
Lenzar Optics Corp.
Maze Corp
Panasonic Video Systems Div.
Power-Optics Inc.
Schneider Corp. of America
Jos. Schneider & Co. Optische Werke
Div.
Sinai-Johnson
Smith-Beemish, Inc.
Tele-Cine Inc.
TeleMation, Inc.
R. H. Tyler Co.
Vicon Industries, Inc.
Victor Duncan, Inc.

Lenses, Optical Fixed Relay

See Adv. Page
Canon USA, Inc.135
Comquip, Inc.162

Angenieux Corp. of America
Canon USA, Inc. Optics Div.
Comquip, Inc.
Fernesh Group Robert Bosch Corp.
Fujinon Optical, Inc.
Lenzar Optics Corp.
Smith-Beemish, Inc.

Lenses, Optical Zoom

See Adv. Page
Anixter-Mark185
Canon USA, Inc.135
**Rank Precision
Industries 35**
Victor Duncan, Inc.139

Angenieux Corp. of America
Anixter-Mark
Arriflex Co. of America
ATV Research
Buhl Optical Co.
Canon USA, Inc. Optics Div.
Cohu, Inc.
Communications Systems
Comquip, Inc.
Cosmicar Optical Co., Ltd.
Cunningham Corp.
Dage-MTI, Inc.
Denson Electronic Corp.
Fujinon Optical, Inc.
General Electric Co. ISO Div.
Harvey Radio
Image Devices Inc.
Javelin
Lenzar Optics Corp.
Listec TV Equip. Corp.
Maze Corp
Panasonic Video Systems Div.
Rank Precision Industries
Schneider Corp. of America
Jos. Schneider & Co. Optische Werke
Div.
Sinai-Johnson
Smith-Beemish, Inc.
Tele-Cine Inc.
TeleMation, Inc.
R. H. Tyler Co.
Vicon Industries, Inc.
Victor Duncan, Inc.

Lighting, Preset Dimmer

Berkey-Colortran Inc.
Janson Industries
Kliegl Bros. Lighting
Richmond Hill Laboratories Ltd.
Skirpan Lighting Control Corp.
Strand Century, Inc.

Lighting, TV Controls

Berkey-Colortran Inc.
Communications Systems
Janson Industries
Kliegl Bros. Lighting
Maze Corp
Mole Richardson Co.
Richmond Hill Laboratories Ltd.
SGL Waber Electric
Skirpan Lighting Control Corp.
Strand Century, Inc.
Utility Tower Co.

Lighting, TV Portable System

See Adv. Page
Strand Century, Inc. 53

Berkey-Colortran Inc.
Communications Systems
Comquip, Inc.
GTE Sylvania Inc. Lighting Products
Group
Harwood Mfg. Co.
Janson Industries
Kliegl Bros. Lighting
Maze Corp
Mole Richardson Co.

Richmond Hill Laboratories Ltd.
Skirpan Lighting Control Corp.
Smith-Beemish, Inc.
Strand Century, Inc.
Super 8 Sound, Inc.
R. H. Tyler Co.
Union Connector Co., Inc.
Victor Duncan, Inc.

Lighting, TV Studio System

See Adv. Page
Strand Century, Inc. 53

Bardwell & McAlister
Berkey-Colortran Inc.
Communications Systems
Comquip, Inc.
Imero Fiorentino Associates, Inc.
Harris Corp. Broadcast Products Div.
Image Devices Inc.
Janson Industries
Kliegl Bros. Lighting
Lauderdale Electronic Labs
Maze Corp
Mole Richardson Co.
Richmond Hill Laboratories Ltd.
Skirpan Lighting Control Corp.
Strand Century, Inc.
R. H. Tyler Co.
Union Connector Co., Inc.
Utility Tower Co.
Victor Duncan, Inc.

Lighting Hangers, Studio

Berkey-Colortran Inc.
Maze Corp
Mole Richardson Co.
Richmond Hill Laboratories Ltd.
Strand Century, Inc.
Victor Duncan, Inc.

Lighting Transformers

Decca Austin Insulators
Harris Corp. Broadcast Products Div.

Lightning Arresters

See Adv. Page
Wilkinson Electronics, Inc. 157

AVA Electronics Corp.
Collins Radio Group
Communications 2000, Inc.
Cook Electric Co.
Dyma Engineering, Inc.
G.C. Electronics
General Electric Co. Tubes/MW Devices
MCG Electronics Inc.
RMS Electronics, Inc.
Saxton Prod. Inc.
Utility Tower Co.
Wilkinson Electronics, Inc.

Lightning Protection Systems

See Adv. Page
Wilkinson Electronics, Inc. 157

Collins Radio Group
Communications 2000, Inc.
Cook Electric Co.
General Electric Co. Tubes/MW Devices
Lightning Elimination Assoc., Inc.
MCG Electronics Inc.
Singer Products Co., Inc.
Sintronic Corp.
Topaz Electronics
Wilkinson Electronics, Inc.

Lights, HMI Ballast

Strand Century, Inc.

Lights, On Air

See Adv. Page
Fidelipac 154
Fidelipac

Lights, Portable, Battery and AC

Strand Century, Inc.

Lights, Portable, Kit

Strand Century, Inc.

Lights, Studio Set

See Adv. Page
Sitler's Supplies, Inc. 175
Strand Century, Inc. 53

Bardwell & McAlister
Berkey-Colortran Inc.
Comquip, Inc.
GTE Sylvania Inc. Lighting Products Group
Kliegl Bros. Lighting
Lauderdale Electronic Labs
Maze Corp
Mole Richardson Co.
Revox Corp.
Richmond Hill Laboratories Ltd.
Sitler's Supplies, Inc.
Strand Century, Inc.
R. H. Tyler Co.
Union Connector Co., Inc.
Victor Duncan, Inc.

Lights, Tower Control

See Adv. Page
Flash Technology Corp. of America 144
Hughey & Phillips Inc. 161

Collins Radio Group
Flash Technology Corp. of America
Hughey & Phillips Inc.
Jampro Antenna Co.
Lauderdale Electronic Labs
Mastertone Co., Inc.
Radio Mfg. Co. (RMC)
Triangle Towers & Antennas
Utility Tower Co.

Lights, Tower Flasher --See Tower Beacon Light Flashers

Lights, Tower Obstruction

See Adv. Page
Flash Technology Corp. of America 144

Crouse Hinds Lighting Products Div.
Flash Technology Corp. of America
Fort Worth Tower Co., Inc.
Harris Corp. Broadcast Products Div.
Hughey & Phillips Inc.
Jampro Antenna Co.
Lauderdale Electronic Labs
Mastertone Co., Inc.
Sparta Electronic Corp.
Swager Tower Corp.
Triangle Towers & Antennas
Unarco-Rohn
Utility Tower Co.

Limiter Compressor

See Adv. Page
LPB Inc. 152
Orange County Corp. 64, 158
Orban/Parasound, Inc. 185
Sound Dynamics, Inc. 174
Val-Tronics, Inc. 171

Allied Broadcast Equip.
Automated Processes, Inc.
Broadcast Automation Assoc.
Broadcast Electronics
Camex Corp.

Collins Radio Group
Communication Medias dbx, Inc.
Dyma Engineering, Inc.
EMT Franz VGmbH
Gately Electronics
Gotham Audio Corp.
Harris Corp. Broadcast Products Div.
Harvey Radio
Inovonics
LPB Inc.
Mastertone Co., Inc.
Modular Audio Products
Rupert Neve, Inc.
Opamp Lamps, Inc.
Orange County Corp.
Orban/Broadcast
Orban/Parasound, Inc.
Pacific Recorders and Engrg. Corp. Div. 47B
Precision Elect. Inc.
QRK Electronic Products
Ramko Research
RCA Corp. Broadcast Systems Div.
Robins/Fairchild
Sound Dynamics, Inc.
Sparta Electronic Corp.
Spectra Sonics
Spotmaster
UREI a URC Co.
Val-Tronics, Inc.
VIF International
Wilkinson Electronics, Inc.

Line Surge Protector

See Adv. Page
Boston Sound & Power Systems 169
Telecommunications Industries Ltd. 145

Boston Sound & Power Systems
C-COR Electronics, Inc.
Collins Radio Group
Cook Electric Co.
Dyma Engineering, Inc.
Harris Corp. Broadcast Products Div.
Mastertone Co., Inc.
MCG Electronics Inc.
Orange County Corp.
Philips Test & Measuring Instruments, Inc.
Sintronic Corp.
Telecommunications Industries, Inc.
Telecommunications Industries Ltd.
Temtron Electronics
Topaz Electronics
Wilkinson Electronics, Inc.

Load Resistor, Coaxial

AVA Electronics Corp.
Bird Electronic Corp.
Coaxial Dynamics
Collins Radio Group
Electro Impulse, Inc.
Maury Microwave Corp.
Micro Communications, Inc.
Narda Microwave Corp
PRD Electronics, Inc.
Rohde & Schwarz Sales Co.
Weinschel Engineering Co.

Maintenance Services, AM

See Adv. Page
Fisher-Burke Broadcast Consultants 124
Orange County Corp. 64

Applied Video Electronics, Inc.
Atlantic Research Corp.
Collins Radio Group
Fisher-Burke Broadcast Consultants
North American Radio Corp.
Orange County Corp.
RCA Corp. Broadcast Systems Div.
Telatronics
Triangle Towers & Antennas
Tri-Tronics Professional Electronics

Maintenance Services, Cartridge Tape

Allied Broadcast Equip.
Broadcast Electronics
Communication Medias
Joa Cartridge Service
Lauderdale Electronic Labs
Liberty Industries
Mastertone Co., Inc.
Professional Audio Service
RCA Corp. Broadcast Systems Div.
RCA Corp. RCA Service Co. Div.
Sparta Electronic Corp.
Spotmaster
Taber Mfg. & Engr. Co.
Tapex Corp.

Maintenance Services, FM

See Adv. Page
Fisher-Burke Broadcast Consultants 124
Orange County Corp. 64

Applied Video Electronics, Inc.
Atlantic Research Corp.
Collins Radio Group
Fisher-Burke Broadcast Consultants
Fort Worth Tower Co., Inc.
Liberty Industries
North American Radio Corp.
Orange County Corp.
RCA Corp. Broadcast Systems Div.
RCA Corp. RCA Service Co. Div.
Telatronics
Television Technology Corp.
Triangle Towers & Antennas
Tri-Tronics Professional Electronics
Utility Tower Co.

Maintenance Services, Microwave

See Adv. Page
Fisher-Burke Broadcast Consultants 124

Atlantic Research Corp.
Collins Radio Group
Comark Industries Inc.
Farinon Electric
Farinon Electric of Canada, Ltd.
Fisher-Burke Broadcast Consultants
Fort Worth Tower Co., Inc.
Liberty Industries
Microwave Assoc. Inc.
Raytheon Data Systems Co.
RCA Corp. RCA Service Co. Div.
Telatronics
Utility Tower Co.

Maintenance Services, TV

See Adv. Page
Fisher-Burke Broadcast Consultants 124

Angenieux Corp. of America
Applied Video Electronics, Inc.
Atlantic Research Corp.
Comark Industries Inc.
Fisher-Burke Broadcast Consultants
Fort Worth Tower Co., Inc.
General Electric Co. ISO Div.
Liberty Industries
Orange County Corp.
RCA Corp. Broadcast Systems Div.
RF Systems, Inc.
Telemedia Electronics
Television Technology Corp.
Utility Tower Co.

MDS Equipment, 2150 MHz

Varian/Beverly

Meters, Antenna Base

Collins Radio Group
Delta Electronics Inc. (Va.)

Meters, Antenna Impedance

See Adv. Page

Potomac Instruments, Inc. 153

Potomac Instruments, Inc.

Meters, Burst Phase

See Adv. Page

Video Aids Corp. of Colorado 27

Broadcast Video Systems, Ltd.
Beta Technology, Inc.
Control Concepts Corp.
Dragnet Engineering Labs., Inc.
Video Aids Corp. of Colorado

Meters, Distortion

Allied Broadcast Equip.
A-Tel-A-Matic
Collins Radio Group
Control Concepts Corp.
Crown International
Dyma Engineering, Inc.
ELPA Marketing Industries, Inc.
Harris Corp. Broadcast Products Div.
Heath Co.
Hewlett Packard Co.
Hickok Elect. Instrument
The London Co.
Marconi Instruments
Maze Corp
Potomac Instruments, Inc.
Val-Tronics, Inc.

Meters, Field Strength AM and FM

See Adv. Page

Delta Electronics Inc. (Va.) 59

Potomac Instruments, Inc. 153

Allied Broadcast Equip.
Arvin Systems, Inc.
Collins Radio Group
Delta Electronics Inc. (Va.)
Engineering Associates
Harris Corp. Broadcast Products Div.
Hickok Elect. Instrument
Leader Instruments Corp.
Maze Corp
Narda Microwave Corp
Potomac Instruments, Inc.
Rohde & Schwarz Sales Co.
Singer Instrumentation
Sparta Electronic Corp.
SPI-ITT Metrix Instruments Div.
Terminal Electronics Corp.
Val-Tronics, Inc.
Wilkinson Electronics, Inc.

Meters, Field Strength TV-UHF

See Adv. Page

Delta Electronics Inc. (Va.) 59

Potomac Instruments, Inc. 153

AEL Communications Corp.
Ameco Inc.
Arvin Systems, Inc.
B & K Instruments Inc.
Blonder-Tongue Labs.
Castle TV Tuner Service, Inc.
Delta Electronics Inc. (Va.)
Engineering Associates
The Finney Co.
Fung Engineering Inc.
Leader Instruments Corp.
Maze Corp
Potomac Instruments, Inc.
Rohde & Schwarz Sales Co.
Sadelco, Inc.
Sencore Inc.
Sinai-Johnson
Singer Instrumentation

Terminal Electronics Corp.
Texscan Corp.

Meters, Flutter and Wow

CCA Electronics Corp.
ELPA Marketing Industries, Inc.
EMT Franz VGmbH
Gotham Audio Corp.
Kay Elemetrics Corp.
Leader Instruments Corp.
Nagra Magnetic Recorders, Inc.
Rank Precision Industries
TEAC Corp of America
Val-Tronics, Inc.

Meters, Frequency AF

Audio Designs & Mfg.
Belar Electronics Lab., Inc.
B & K Instruments Inc.
CCA Electronics Corp.
Collins Radio Group
Engineering Associates
ESE
General Electric Co. Tubes/MW Devices
Heath Co.
Hewlett Packard Co.
Hickok Elect. Instrument
Lampkin Lab. Inc.
Rohde & Schwarz Sales Co.
Simpson Electric Co.
Singer Instrumentation
SPI-ITT Metrix Instruments Div.
Temtron Electronics
United Systems Corp.

Meters, Frequency RF

Belar Electronics Lab., Inc.
Dynascan Corp.
Edison Electronics Div.
EIP, Inc.
Engineering Associates
ESE
General Electric Co. Tubes/MW Devices
General Microwave Corp.
Heath Co.
Hewlett Packard Co.
Hickok Elect. Instrument
Lampkin Lab. Inc.
Narda Microwave Corp
Power Waves, Inc.
PRD Electronics, Inc.
Rohde & Schwarz Sales Co.
Singer Instrumentation
Singer Products Co., Inc.
SPI-ITT Metrix Instruments Div.
Systron-Donner
United Systems Corp.
Val-Tronics, Inc.

Meters, Frequency Calibrating

B & K Instruments Inc.
Lampkin Lab. Inc.
Narda Microwave Corp
Philips Test & Measuring Instruments, Inc.
Power Waves, Inc.

Meters, Grind Dip

Edison Electronics Div.
Harvey Radio
Heath Co.
Leader Instruments Corp.
Singer Products Co., Inc.

Meters, Intermodulation

Control Concepts Corp.
Edison Electronics Div.
Heath Co.
Marconi Instruments

Meters, Line Voltage

Alco Electronic Products, Inc.
Dragnet Engineering Labs., Inc.
Gralex Industries
Harvey Radio
Heath Co.
Hickok Elect. Instrument

Philips Test & Measuring Instruments, Inc.

RCA Corp. Distributor & Special Products Div.
Sencore Inc.
Simpson Electric Co.
Terminal Electronics Corp.
Triplett Corp.

Meters, Modulation

See Adv. Page

Logitek Electronic Systems 167

Logitek Electronic Systems

Meters, Panel Replacement

A-Tel-A-Matic
Conrac Corp. Cramer Div.
G.C. Electronics
General Microwave Corp.
Gralex Industries
Harvey Radio
Simpson Electric Co.
Triplett Corp.

Meters, Phase Angle

B & K Instruments Inc.
Collins Radio Group
Control Concepts Corp.
Dragnet Engineering Labs., Inc.
General Electric Co. Tubes/MW Devices
Rupert Neve, Inc.
Potomac Instruments, Inc.
PRD Electronics, Inc.
Singer Instrumentation
SPI-ITT Metrix Instruments Div.

Meters, Power

See Adv. Page

Electro Impulse, Inc. 171

Ailtech
A-Tel-A-Matic
Bird Electronic Corp.
B & K Instruments Inc.
Boonton Electronics
CCA Electronics Corp.
Coaxial Dynamics
Collins Radio Group
Dragnet Engineering Labs., Inc.
Electro Impulse, Inc.
Engineering Associates
General Microwave Corp.
Hickok Elect. Instrument
Narda Microwave Corp
National Electrolab Ltd.
PRD Electronics, Inc.
Rohde & Schwarz Sales Co.
Simpson Electric Co.
Singer Products Co., Inc.
Systron-Donner
Terminal Electronics Corp.

Meters, Signal Level

Ameco Inc.
Audio Designs & Mfg.
Belar Electronics Lab., Inc.
Broadcast Video Systems, Ltd.
Echo Science Corp.
Edison Electronics Div.
G.C. Electronics
Pulse Dynamics Mfg. Corp. (PDMC)
Quad-Eight Electronics
Sadelco, Inc.
Singer Instrumentation

Meters, Spectrum Analyzer

Ailtech
Altec Sound Products
Amber Electro Design, Ltd.
Audio Designs & Mfg.
B & K Instruments Inc.
Marconi Instruments
Rohde & Schwarz Sales Co.
Texscan Corp.

Meters, Standing Wave

Bird Electronic Corp.
B & K Instruments Inc.
CCA Electronics Corp.
Coaxial Dynamics
Collins Radio Group
Delta Electronics Inc. (Va.)
G.C. Electronics
Hewlett Packard Co.
Micro Communications, Inc.
Narda Microwave Corp
PRD Electronics, Inc.
Rohde & Schwarz Sales Co.
SPI-ITT Metrix Instruments Div.
Telonic Altair
Tranrel Corp.
Weinschel Engineering Co.

Meters, Tape -- See Tape Meters

Meters, Video Level

Video Aids Corp. of Colorado

Meters, Video Noise

Ailtech
Rohde & Schwarz Sales Co.
Sinai-Johnson

Meters, Volt Ohm

California Instruments Co.
Dana Laboratories, Inc.
Dynascan Corp.
ESE
G.C. Electronics
Heath Co.
Hewlett Packard Co.
Hickok Elect. Instrument
Instrument Laboratories
International Instrument Div.
Leader Instruments Corp.
RCA Corp. Distributor & Special Products Div.
Rohde & Schwarz Sales Co.
Sencore Inc.
Simpson Electric Co.
Sinai-Johnson
SPI-ITT Metrix Instruments Div.
Systron-Donner
Tektronix Inc.
Television Equipment Associates
Terminal Electronics Corp.
Triplett Corp.
United Systems Corp.

Meters, VU

Audio Designs & Mfg.
Edison Electronics Div.
Gately Electronics
G.C. Electronics
Gotham Audio Corp.
Harvey Radio
Hickok Elect. Instrument
Instrument Laboratories
International Instrument Div.
Pulse Dynamics Mfg. Corp. (PDMC)
Quad-Eight Electronics
Simpson Electric Co.
Sintronic Corp.
SPI-ITT Metrix Instruments Div.
Systems Engineering Co., Inc.
Tapecaster TCM, Inc.
Terminal Electronics Corp.
Total Technology
Triplett Corp.
United Systems Corp.
Vu-Data Corp.
Ward-Beck Systems, Ltd.

Microphone Boom Reconditioning Services

Television Products Co. Inc.

Microphone Cable Tester

Image Devices Inc.
Orange County Corp.
Senstrol Div.

Microphone Stand and Boom

	See Adv. Page
Electro-Voice Inc.	31
LPB Inc.	152
Orange County Corp.	64

Allied Broadcast Equip.
 Altec Sound Products
 Atlas Sound
 Audio Distributor Inc.
 Beyer (Revox Corporation)
 Birmingham Tape Cartridge Co., Inc.
 Bogen Div.
 Broadcast Automation Assoc.
 Broadcast Electronics
 Broadcast Equipment & Supply Co.
 Collins Radio Group
 Communication Medias
 Comquip, Inc.
 Custom Craft Designs
 Electro-Voice Inc.
 Gately Electronics
 G.C. Electronics
 Gotham Audio Corp.
 Harris Corp. Broadcast Products Div.
 Harvey Radio
 Image Devices Inc.
 Lauderdale Electronic Labs
 LPB Inc.
 Maze Corp.
 Mole Richardson Co.
 Nemo Recording Labs
 Orange County Corp.
 Paso Sound Products Inc.
 Philips Audio Video Systems Corp.
 Audio Div.
 Philips Audio Video Systems Corp.
 Broadcast Equip. Div.
 RCA Corp. Broadcast Systems Div.
 RCA Corp. RCA Service Co. Div.
 Rek-O-Kut Inc.
 Revox Corp.
 Sennheiser Electronic
 Shure Brothers Inc.
 Singer Products Co., Inc.
 Sony Corp. of America VTR Div.
 Sparta Electronic Corp.
 Strand Century, Inc.
 Tapex Corp.
 Television Products Co. Inc.
 Terminal Electronics Corp.
 Turner Div. Conrac Corp.
 R. H. Tyler Co.
 Victor Duncan, Inc.
 Wilkinson Electronics, Inc.

Microphones, Boom

	See Adv. Page
Broadcast Electronics	45
Electro-Voice Inc.	31
Martin Audio/Video	152
Orange County Corp.	64
RCA Corp.	58
Sound Dynamics, Inc.	174

Allied Broadcast Equip.
 Altec Sound Products
 Applied Video Electronics, Inc.
 Beyer (Revox Corporation)
 Broadcast Automation Assoc.
 Broadcast Electronics
 Broadcast Equipment & Supply Co.
 Camex Corp.
 Collins Radio Group
 Communication Medias
 Comquip, Inc.
 Denson Electronic Corp.
 Dyma Engineering, Inc.
 Electro-Voice Inc.
 Gately Electronics
 G.C. Electronics
 Gotham Audio Corp.
 Harris Corp. Broadcast Products Div.
 Harvey Radio
 Image Devices Inc.
 Lauderdale Electronic Labs
 Martin Audio/Video
 Maze Corp.
 Mole Richardson Co.
 Nemo Recording Labs
 Orange County Corp.
 Paso Sound Products Inc.
 Philips Audio Video Systems Corp.
 Audio Div.

Philips Audio Video Systems Corp.
 Broadcast Equip. Div.
 RCA Corp. Broadcast Systems Div.
 Rek-O-Kut Inc.
 Revox Corp.
 Ryder Magnetic Sales Corp.
 Sennheiser Electronic
 Shure Brothers Inc.
 Singer Products Co., Inc.
 Sound Dynamics, Inc.
 Sparta Electronic Corp.
 Spotmaster
 Strand Century, Inc.
 Willi Studer America, Inc.
 Television Equipment Associates
 Telex Communications, Inc.
 Terminal Electronics Corp.
 Turner Div. Conrac Corp.
 Val-Tronics, Inc.
 Victor Duncan, Inc.
 Wilkinson Electronics, Inc.

Microphones, Desk

	See Adv. Page
Broadcast Electronics	45
Communication Medias.....	62
LPB Inc.	152
Martin Audio/Video	152
Orange County Corp.	64
RCA Corp.	12
Sound Dynamics, Inc.	174

Allied Broadcast Equip.
 Altec Sound Products
 Applied Video Electronics, Inc.
 Audio Distributor Inc.
 Beyer (Revox Corporation)
 B & K Instruments Inc.
 Bogen Div.
 Broadcast Automation Assoc.
 Broadcast Electronics
 Broadcast Equipment & Supply Co.
 Camex Corp.
 Collins Radio Group
 Communication Medias
 Communications Systems
 Comquip, Inc.
 Dyma Engineering, Inc.
 Electro-Voice Inc.
 Gately Electronics
 G.C. Electronics
 Gotham Audio Corp.
 Harris Corp. Broadcast Products Div.
 Harvey Radio
 Image Devices Inc.
 Lauderdale Electronic Labs
 LPB Inc.
 Martin Audio/Video
 Mastertone Co., Inc.
 Maze Corp.
 Nemo Recording Labs
 Orange County Corp.
 Paso Sound Products Inc.
 Philips Audio Video Systems Corp.
 Audio Div.
 Philips Audio Video Systems Corp.
 Broadcast Equip. Div.
 Professional Audio Service
 RCA Corp. Broadcast Systems Div.
 Rek-O-Kut Inc.
 Revox Corp.
 Ryder Magnetic Sales Corp.
 Sennheiser Electronic
 Senstrol Div.
 Shure Brothers Inc.
 Sinai-Johnson
 Singer Products Co., Inc.
 Sony Corp. of America VTR Div.
 Sound Dynamics, Inc.
 Sparta Electronic Corp.
 Spotmaster
 Superscope, Inc.
 Systems Engineering Co., Inc.
 Tapex Corp.
 TEAC Corp of America
 Television Equipment Associates
 Terminal Electronics Corp.
 Turner Div. Conrac Corp.
 R. H. Tyler Co.
 Val-Tronics, Inc.
 Victor Duncan, Inc.
 Wilkinson Electronics, Inc.

Microphones, Floor

	See Adv. Page
Broadcast Electronics	45
Martin Audio/Video	152
Orange County Corp.	64
RCA Corp.	58
Sound Dynamics, Inc.	174

Allied Broadcast Equip.
 Altec Sound Products
 Applied Video Electronics, Inc.
 Audio Distributor Inc.
 Beyer (Revox Corporation)
 B & K Instruments Inc.
 Bogen Div.
 Broadcast Automation Assoc.
 Broadcast Electronics
 Broadcast Equipment & Supply Co.
 Camex Corp.
 Collins Radio Group
 Communication Medias
 Communications Systems
 Electro-Voice Inc.
 Gately Electronics
 G.C. Electronics
 Gotham Audio Corp.
 Harris Corp. Broadcast Products Div.
 Harvey Radio
 Image Devices Inc.
 Lauderdale Electronic Labs
 Martin Audio/Video
 Mastertone Co., Inc.
 Maze Corp.
 Nemo Recording Labs
 Orange County Corp.
 Paso Sound Products Inc.
 Philips Audio Video Systems Corp.
 Audio Div.
 Philips Audio Video Systems Corp.
 Broadcast Equip. Div.
 Professional Audio Service
 RCA Corp. Broadcast Systems Div.
 Rek-O-Kut Inc.
 Revox Corp.
 Ryder Magnetic Sales Corp.
 Sennheiser Electronic
 Shure Brothers Inc.
 Sinai-Johnson
 Sound Dynamics, Inc.
 Sparta Electronic Corp.
 Spotmaster
 Willi Studer America, Inc.
 Superscope, Inc.
 Tapex Corp.
 Terminal Electronics Corp.
 Turner Div. Conrac Corp.
 R. H. Tyler Co.
 Val-Tronics, Inc.
 Victor Duncan, Inc.
 VIF International
 Wilkinson Electronics, Inc.

Microphones, Hand Held

	See Adv. Page
Broadcast Electronics	45
Communication Medias.....	62
Martin Audio/Video	152
Orange County Corp.	64
RCA Corp.	12
Sound Dynamics, Inc.	174

Allied Broadcast Equip.
 Altec Sound Products
 Applied Video Electronics, Inc.
 Audio Distributor Inc.
 Beyer (Revox Corporation)
 B & K Instruments Inc.
 Bogen Div.
 Broadcast Automation Assoc.
 Broadcast Electronics
 Broadcast Equipment & Supply Co.
 Califone International, Inc.
 Collins Radio Group
 Communication Medias
 Communications Systems
 Comquip, Inc.
 Dyma Engineering, Inc.
 Electro-Voice Inc.
 Gately Electronics
 G.C. Electronics
 Gotham Audio Corp.
 Harris Corp. Broadcast Products Div.
 Harvey Radio

Image Devices Inc.
 Lauderdale Electronic Labs
 Martin Audio/Video
 Mastertone Co., Inc.
 Maze Corp.
 Miles Reproducer Co.
 Nemo Recording Labs
 Orange County Corp.
 Panasonic Video Systems Div.
 Paso Sound Products Inc.
 Philips Audio Video Systems Corp.
 Audio Div.
 Philips Audio Video Systems Corp.
 Broadcast Equip. Div.
 Professional Audio Service
 Pulse Dynamics Mfg. Corp. (PDMC)
 RCA Corp. Broadcast Systems Div.
 Rek-O-Kut Inc.
 Revox Corp.
 Ryder Magnetic Sales Corp.
 Sennheiser Electronic
 Shure Brothers Inc.
 Sinai-Johnson
 Singer Products Co., Inc.
 Sound Dynamics, Inc.
 Sparta Electronic Corp.
 Spotmaster
 Willi Studer America, Inc.
 Superscope, Inc.
 Systems Engineering Co., Inc.
 Tapex Corp.
 TEAC Corp of America
 Television Equipment Associates
 Telex Communications, Inc.
 Terminal Electronics Corp.
 Turner Div. Conrac Corp.
 R. H. Tyler Co.
 Val-Tronics, Inc.
 Victor Duncan, Inc.
 Wilkinson Electronics, Inc.

Microphones, Lavalier

	See Adv. Page
Broadcast Electronics	45
Martin Audio/Video	152
RCA Corp.	58
Sound Dynamics, Inc.	174

Allied Broadcast Equip.
 Altec Sound Products
 Beyer (Revox Corporation)
 Birmingham Tape Cartridge Co., Inc.
 Bogen Div.
 Broadcast Automation Assoc.
 Broadcast Electronics
 Broadcast Equipment & Supply Co.
 Collins Radio Group
 Communication Medias
 Communications Systems
 Comquip, Inc.
 Electro-Voice Inc.
 Gately Electronics
 G.C. Electronics
 Gotham Audio Corp.
 Harris Corp. Broadcast Products Div.
 Harvey Radio
 Image Devices Inc.
 Lauderdale Electronic Labs
 Martin Audio/Video
 Mastertone Co., Inc.
 Miles Reproducer Co.
 Nemo Recording Labs
 Orange County Corp.
 Paso Sound Products Inc.
 Philips Audio Video Systems Corp.
 Audio Div.
 Philips Audio Video Systems Corp.
 Broadcast Equip. Div.
 Professional Audio Service
 RCA Corp. Broadcast Systems Div.
 Rek-O-Kut Inc.
 Revox Corp.
 Ryder Magnetic Sales Corp.
 Sennheiser Electronic
 Senstrol Div.
 Shure Brothers Inc.
 Sinai-Johnson
 Singer Products Co., Inc.
 Sony Corp. of America VTR Div.
 Sound Dynamics, Inc.
 Sparta Electronic Corp.
 Spotmaster
 Superscope, Inc.
 Systems Engineering Co., Inc.
 TEAC Corp of America
 Television Equipment Associates

Terminal Electronics Corp.
Turner Div. Conrac Corp.
R. H. Tyler Co.
Val-Tronics, Inc.
Victor Duncan, Inc.
VIF International
Wilkinson Electronics, Inc.

Microphones, Mixer

See Adv. Page
Broadcast Electronics 45
Martin Audio/Video 152
Quantum Audio Labs, Inc. 171

Allied Broadcast Equip.
Ampro Corp.
Broadcast Electronics
Broadcast Equipment & Supply Co.
Cetec Audio Div. Subs. Computer Equipment Corp.
Collins Radio Group
Communication Medias
Communications Systems
Comquip, Inc.
G.C. Electronics
Gotham Audio Corp.
Harvey Radio
Heath Co.
Lauderdale Electronic Labs
Martin Audio/Video
Maze Corp.
Nagra Magnetic Recorders, Inc.
Nemo Recording Labs
Orange County Corp.
Panasonic Video Systems Div.
Paso Sound Products Inc.
Quantum Audio Labs, Inc.
RCA Corp. Broadcast Systems Div.
Rek-O-Kut Inc.
Revox Corp.
Richmond Sound Design, Ltd.
Senstrol Div.
Shintron Co. Inc.
Shure Brothers Inc.
Soundsciber Corp.
Spotmaster
Superscope, Inc.
Switchcraft Inc.
Systems Engineering Co., Inc.
Total Technology
Val-Tronics, Inc.
Victor Duncan, Inc.
Wilkinson Electronics, Inc.

Microphones, Parabolic and Shotgun

See Adv. Page
RCA Corp. 12

Allied Broadcast Equip.
Audio Distributor Inc.
B & K Instruments Inc.
Broadcast Electronics
Communication Medias
Comquip, Inc.
Electro-Voice Inc.
Harvey Radio
Image Devices Inc.
Lauderdale Electronic Labs
Mastertone Co., Inc.
Nemo Recording Labs
Orange County Corp.
Philips Audio Video Systems Corp. Audio Div.
Radio Mfg. Co. (RMC)
RCA Corp. Broadcast Systems Div.
Rek-O-Kut Inc.
Ryder Magnetic Sales Corp.
Sennheiser Electronic
Sparta Electronic Corp.
Superscope, Inc.
Systems Engineering Co., Inc.
Victor Duncan, Inc.
VIF International

Microphones, Splitter

See Adv. Page
Orange County Corp. 64

Communication Medias
Harvey Radio

Nemo Recording Labs
Orange County Corp.
Richmond Sound Design, Ltd.
Senstrol Div.

Microphones, Wireless

See Adv. Page
Comrex Corp. 156
LPB Inc. 152
Television Equipment Associates 159

Allied Broadcast Equip.
Applied Video Electronics, Inc.
Audio Distributor Inc.
Broadcast Equipment & Supply Co.
Communication Medias
Comquip, Inc.
Comrex Corp.
Edcor Div. of P.A.C.
GEC-Marconi Electronics Ltd.
Harvey Radio
Image Devices Inc.
Lauderdale Electronic Labs
LPB Inc.
Miles Reproducer Co.
Nemo Recording Labs
Orange County Corp.
Orbit Radio and Video
Paso Sound Products Inc.
Revox Corp.
Ryder Magnetic Sales Corp.
Sennheiser Electronic
Sparta Electronic Corp.
Television Equipment Associates
Telex Communications, Inc.
Val-Tronics, Inc.
Vega Elect. Div.
Victor Duncan, Inc.
VIF International

Microwave Systems, STL

See Adv. Page
Micro Communications, Inc. 36
Moseley Assoc. Inc. 9

Broadcast Automation Assoc.
Collins Radio Group
Communications Carriers, Inc.
Farinon Electric
Farinon Electric of Canada, Ltd.
GTE Lenkurt, Inc.
Harris Corp. Broadcast Products Div.
Ikegami Electronics (USA) Inc.
Mastertone Co., Inc.
Maze Corp.
Micro Communications, Inc.
Microwave Assoc. Inc.
Moseley Assoc. Inc.
Narda Microwave Corp.
Nippon Electric Co., Ltd.
Nurad, Inc.
Radio Research Instrument Co., Inc.
Singer Products Co., Inc.
Sparta Electronic Corp.
Swagger Tower Corp.
Tepco Corp.
TerraCom
Val-Tronics, Inc.
Varian/Beverly
Wilkinson Electronics, Inc.

Microwave Systems, 2500 MHz

See Adv. Page
Micro Communications, Inc. 36
Varian/Beverly 185

Broadcast Automation Assoc.
Collins Radio Group
EMCEE Broadcast Products
General Electric Co. Tubes/MW Devices
Micro Communications, Inc.
Microwave Assoc. Inc.
Nurad, Inc.
Singer Products Co., Inc.
Swagger Tower Corp.
Varian/Beverly

Mixers --See also Consoles

See Adv. Page
Auditronics, Inc. 133
Broadcast Electronics 45
Central Dynamics 176
Martin Audio/Video 152
Orange County Corp. 64,158
Pulse Dynamics Mfg. Corp. 160
Pulse Techniques Inc. 156
Quantum Audio Labs, Inc. 171
Ramko Research 125
Russco Electronics Mfg. Inc. 142
Sound Dynamics, Inc. 174
Sparta Electronic Corp. 5
UREI 14
Ward-Beck Systems, Ltd. IFC

Allied Broadcast Equip.
Altec Sound Products
Ampro Corp.
Audio Designs & Mfg.
Auditronics, Inc.
Bogen Div.
Broadcast Automation Assoc.
Broadcast Electronics
Central Dynamics Corp.
Cetec Audio Div. Subs. Computer Equipment Corp.
Collins Radio Group
Communication Medias
Concept 70
Dage-MTI, Inc.
Delta Electronics Inc. (N.C.)
Dyma Engineering, Inc.
Gately Electronics
Gotham Audio Corp.
Grass Valley Group, Inc.
Harvey Radio
Head Sound, Inc.
Heath Co.
Industrial Sciences, Inc.
Lang Electronics Inc.
James B. Lansing Sound, Inc.
Lauderdale Electronic Labs
Martin Audio/Video
Maze Corp.
McMartin Industries, Inc.
Nagra Magnetic Recorders, Inc.
Nasco Television Systems
Nemo Recording Labs
Rupert Neve, Inc.
Nippon Electric Co., Ltd.
Orange County Corp.
Orbit Radio and Video
Pacific Recorders and Engrg. Corp. Div. 47B
Paso Sound Products Inc.
Pulse Dynamics Mfg. Corp. (PDMC)
Pulse Techniques Inc.
QRK Electronic Products
Quad-Eight Electronics
Quantum Audio Labs, Inc.
Radio Mfg. Co. (RMC)
Ramko Research
Revox Corp.
Richmond Hill Laboratories Ltd.
Richmond Sound Design, Ltd.
Robins/Fairchild
ROH Corporation
Russco Electronics Mfg. Inc.
Ryder Magnetic Sales Corp.
Shure Brothers Inc.
Singer Products Co., Inc.
Sound Dynamics, Inc.
Sparta Electronic Corp.
Sphere Electronics
Spotmaster
Superscope, Inc.
Switchcraft Inc.
Systems Marketing Corp.
TEAC Corp of America
TeleMation, Inc.
R. H. Tyler Co.
UREI a URC Co.
Ward-Beck Systems, Ltd.
Weinschel Engineering Co.
Wilkinson Electronics, Inc.

Mobile Communications Van, TV

A. F. Associates, Inc.

Comquip, Inc.
Editel Communications
GEC-Marconi Electronics Ltd.
International Video Corp.
Microwave Assoc. Inc.
Philips Audio Video Systems Corp. Broadcast Equip. Div.
TerraCom
Thompson-CSF, Inc.

Modulators, TV

See Adv. Page
Rolane Sales Corp. 160
Telemet, a Geotel Co. 1

Acrodyne Industries Inc.
Ameco Inc.
Belar Electronics Lab., Inc.
Catel
CCA Electronics Corp.
Communication Medias
Communications Systems
Dynair Electronics, Inc.
EMCEE Broadcast Products
GEC-Marconi Electronics Ltd.
Harris Corp. Broadcast Products Div.
Lenco Inc.
Nemo Recording Labs
Orbit Radio and Video
Philips Test & Measuring Instruments, Inc.
RCA/Community Telev. Systems
Rohde & Schwarz Sales Co.
Rolane Sales Corp.
Roscor Corp.
Scientific-Atlanta, Inc.
Sinai-Johnson
Telemedia Electronics
Telemet, a Geotel Co.

Monitors, AM System

See Adv. Page
Belar Electronics Lab., Inc. 165
CCA Electronics Corp. 171
Orange County Corp. 64
Telemet, a Geotel Co. 1
Time & Frequency Tech., Inc. 10
Val-Tronics, Inc. 160

Ailtech
Allied Broadcast Equip.
Belar Electronics Lab., Inc.
Broadcast Automation Assoc.
CCA Electronics Corp.
Collins Radio Group
Dyma Engineering, Inc.
Harris Corp. Broadcast Products Div.
The London Co.
Mastertone Co., Inc.
Maze Corp.
McMartin Industries, Inc.
National Electrolab Ltd.
Rupert Neve, Inc.
North American Radio Corp.
Orange County Corp.
RCA Corp. Broadcast Systems Div.
Singer Products Co., Inc.
Sparta Electronic Corp.
Systems Marketing Corp.
Telemet, a Geotel Co.
Time & Frequency Tech., Inc.
Val-Tronics, Inc.

Monitors, FM System

See Adv. Page
Belar Electronics Lab., Inc. 165
Orange County Corp. 64
Time & Frequency Tech., Inc. 10
Val-Tronics, Inc. 160

Ailtech
Allied Broadcast Equip.
Belar Electronics Lab., Inc.
Broadcast Automation Assoc.
CCA Electronics Corp.
Collins Radio Group
Dyma Engineering, Inc.

Harris Corp. Broadcast Products Div.
The London Co.
Mastertone Co., Inc.
Maze Corp
McMartin Industries, Inc.
Miles Reproducer Co.
North American Radio Corp.
Orange County Corp.
RCA Corp. Broadcast Systems Div.
Singer Products Co., Inc.
Sparta Electronic Corp.
Systems Marketing Corp.
Time & Frequency Tech., Inc.
Val-Tronics, Inc.

Monitors, FM System SCA

See Adv. Page

Harris Corp. 56
Orange County Corp. 64
Time & Frequency
Tech., Inc. 10

Allied Broadcast Equip.
Belar Electronics Lab., Inc.
Broadcast Automation Assoc.
CCA Electronics Corp.
Collins Radio Group
Dyma Engineering, Inc.
Harris Corp. Broadcast Products Div.
Mastertone Co., Inc.
Maze Corp
McMartin Industries, Inc.
Orange County Corp.
RCA Corp. Broadcast Systems Div.
Singer Products Co., Inc.
Sparta Electronic Corp.
Time & Frequency Tech., Inc.
Val-Tronics, Inc.

Monitors, Antenna Sampling

See Adv. Page

Delta Electronics Inc.
(Va.) 59
Orange County Corp. 64
Potomac Instruments,
Inc. 153

Allied Broadcast Equip.
Belar Electronics Lab., Inc.
Collins Radio Group
Delta Electronics Inc. (Va.)
Fisher-Burke Broadcast Consultants
Harris Corp. Broadcast Products Div.
Orange County Corp.
Potomac Instruments, Inc.
Val-Tronics, Inc.
Wide Band Engineering Co., Inc.

Monitors, Directional Antenna

See Adv. Page

Delta Electronics Inc.
(Va.) 59
Orange County Corp. 64
Potomac Instruments,
Inc. 153

Allied Broadcast Equip.
Belar Electronics Lab., Inc.
Delta Electronics Inc. (Va.)
Harris Corp. Broadcast Products Div.
Micro Communications, Inc.
Orange County Corp.
Potomac Instruments, Inc.
Val-Tronics, Inc.

Monitors, Frequency

See Adv. Page

Belar Electronics Lab.,
Inc. 165
CCA Electronics Corp. 171
Harris Corp. 56
Orange County Corp. 64
Time & Frequency
Tech., Inc. 10

Ailtech
Allied Broadcast Equip.
Belar Electronics Lab., Inc.

B & K Instruments Inc.
Broadcast Automation Assoc.
CCA Electronics Corp.
Collins Radio Group
Eidson Electronic Co.
ESE
GEC-Marconi Electronics Ltd.
Harris Corp. Broadcast Products Div.
Lampkin Lab. Inc.
Mastertone Co., Inc.
McMartin Industries, Inc.
Narda Microwave Corp
Orange County Corp.
RCA Corp. Broadcast Systems Div.
Singer Instrumentation
Sparta Electronic Corp.
Time & Frequency Tech., Inc.
Val-Tronics, Inc.
Video Accessories Mfg. Co.
Wilkinson Electronics, Inc.

Monitors, Modulation

See Adv. Page

CCA Electronics Corp. 171
Harris Corp. 56
Orange County Corp. 64
Time & Frequency
Tech., Inc. 10
Wilkinson Electronics,
Inc. 157

Allied Broadcast Equip.
Belar Electronics Lab., Inc.
Broadcast Automation Assoc.
CCA Electronics Corp.
Collins Radio Group
Dyma Engineering, Inc.
Harris Corp. Broadcast Products Div.
Lampkin Lab. Inc.
The London Co.
Marconi Instruments
Mastertone Co., Inc.
Maze Corp
McMartin Industries, Inc.
Orange County Corp.
RCA Corp. Broadcast Systems Div.
Singer Products Co., Inc.
Sparta Electronic Corp.
Time & Frequency Tech., Inc.
Tranrel Corp.
Val-Tronics, Inc.
Wilkinson Electronics, Inc.

Monitors, Phase

See Adv. Page

Orange County Corp. 64
Val-Tronics, Inc. 171

Allied Broadcast Equip.
Belar Electronics Lab., Inc.
Collins Radio Group
Delta Electronics Inc. (Va.)
Dranetz Engineering Labs., Inc.
Dyma Engineering, Inc.
Harris Corp. Broadcast Products Div.
Mastertone Co., Inc.
North American Radio Corp.
Orange County Corp.
Potomac Instruments, Inc.
Sparta Electronic Corp.
Val-Tronics, Inc.

Monitors, Power

See Adv. Page

Moseley Assoc. Inc. 9

Ailtech
Bird Electronic Corp.
Coaxial Dynamics
Conrac Corp. Cramer Div.
Delta Electronics Inc. (Va.)
Dranetz Engineering Labs., Inc.
Electro Impulse, Inc.
General Microwave Corp.
Harris Corp. Broadcast Products Div.
Maze Corp
Moseley Assoc. Inc.
Narda Microwave Corp
Orange County Corp.
PRD Electronics, Inc.
Sencore Inc.

Sparta Electronic Corp.
Systems Engineering Co., Inc.
Wide Band Engineering Co., Inc.

Monitors, Program Audio

See Adv. Page

Modular Audio
Products 146
Orange County Corp. 64, 158
Telemet, a Geotel Co. 1

Allied Broadcast Equip.
Altec Sound Products
Amber Electro Design, Ltd.
Audio Designs & Mfg.
Audio Distributor Inc.
Autogram Corp.
Automated Processes, Inc.
Belar Electronics Lab., Inc.
Cetec Audio Div. Subs. Computer
Equipment Corp.
Communications Technology, Inc.
Crown International
Electro-Voice Inc.
GEC-Marconi Electronics Ltd.
Harris Corp. Broadcast Products Div.
James B. Lansing Sound, Inc.
Lauderdale Electronic Labs
Marti Electronics
Maze Corp
Modular Audio Products
Rupert Neve, Inc.
Orange County Corp.
Radio Mfg. Co. (RMC)
Revox Corp.
Robins/Fairchild
Scientific Systems, Inc.
Sparta Electronic Corp.
Telemet, a Geotel Co.
Vedco, Inc.

Monitors, RF Level

Bird Electronic Corp.
Electro Impulse, Inc.
Fisher-Burke Broadcast Consultants
General Microwave Corp.
Harris Corp. Broadcast Products Div.
Narda Microwave Corp
North American Radio Corp.
Tektronix Inc.
Wide Band Engineering Co., Inc.

Monitors, Stereo

Collins Radio Group
Lauderdale Electronic Labs
Mastertone Co., Inc.
Maze Corp
Sparta Electronic Corp.
Systems Marketing Corp.

Monitors, TV System

See Adv. Page

Electrohome Ltd. 141
Marconi Instruments 65
World Video Inc. 16

Belar Electronics Lab., Inc.
Electrohome Ltd.
Marconi Instruments
World Video Inc.

Monitors, Video B&W

See Adv. Page

Electrohome Ltd. 141
Sony Corp. of America IBC
Unimedia Corp. 18
Video Aids Corp. of
Colorado 27
World Video Inc. 16

Asaca Corp. of America
Ball Bros. Research Corp. Miratel
Division
Barco U.S.
Belar Electronics Lab., Inc.
Broadcast Electronics
Beta Technology, Inc.
Cohu, Inc.

Communications Systems
Comquip, Inc.
Conrac Div. Conrac Corp.
Cunningham Corp.
Diebold Inc.
Dyma Engineering, Inc.
Editel Communications
Electrohome Ltd.
Fernesh Group Robert Bosch Corp.
GBC Closed Circuit TV Corp.
General Electric Co. ISO Div.
Harvey Radio
Hitachi Shibaden Corp. of America
Ikegami Electronics (USA) Inc.
Javelin
Leader Instruments Corp.
Maze Corp
Modtek
Orbit Radio and Video
Panasonic Video Systems Div.
RCA Corp. Broadcast Systems Div.
RCA Corp. RCA Service Co. Div.
Roscor Corp.
SC Electronics, Inc.
Sinai-Johnson
Sony Corp. of America VTR Div.
Systa-Matics, Inc.
Systems Engineering Co., Inc.
Tektronix Inc.
Tele-Cine Inc.
Thompson-CSF, Inc.
R. H. Tyler Co.
Ultra Audio Products
Unimedia Corp.
Video Aids Corp. of Colorado
World Video Inc.

Monitors, Video Color

See Adv. Page

Electrohome Ltd. 141
Sony Corp. of America IBC
Unimedia Corp. 18
Video Aids Corp. of
Colorado 27
World Video Inc. 16

Amtron Corp.
Asaca Corp. of America
Ball Bros. Research Corp. Miratel
Division
Barco U.S.
Belar Electronics Lab., Inc.
Beta Technology, Inc.
Cohu, Inc.
Communications Systems
Comquip, Inc.
Conrac Div. Conrac Corp.
Dyma Engineering, Inc.
Editel Communications
Electrohome Ltd.
Fernesh Group Robert Bosch Corp.
GBC Closed Circuit TV Corp.
General Electric Co. ISO Div.
Harris Corp. Broadcast Products Div.
Harvey Radio
Ikegami Electronics (USA) Inc.
Leader Instruments Corp.
Maze Corp
Orbit Radio and Video
Panasonic Video Systems Div.
RCA Corp. Broadcast Systems Div.
RCA Corp. RCA Service Co. Div.
Roscor Corp.
SC Electronics, Inc.
Sharp Electronics Corp.
Sony Corp. of America VTR Div.
Systa-Matics, Inc.
Systems Engineering Co., Inc.
Tektronix Inc.
Tele-Cine Inc.
Thompson-CSF, Inc.
R. H. Tyler Co.
Unimedia Corp.
Video Aids Corp. of Colorado
World Video Inc.

Monitors, Video Pulse Cross

See Adv. Page

Video Aids Corp. of
Colorado 27

Amtron Corp.
Dyma Engineering, Inc.

Electrohome Ltd.
Orbit Radio and Video
Panasonic Video Systems Div.
Systa-Matics, Inc.
Systems Engineering Co., Inc.
Tektronix Inc.
Ultra Audio Products
Unimedia Corp.
Video Aids Corp. of Colorado
World Video Inc.

Monitors, Waveform

American Data Corp.
Ball Bros. Research Corp. Miratel
Division
Colorado Video Inc.
Harris Corp. Broadcast Products Div.
Ikegami Electronics (USA) Inc.
Leader Instruments Corp.
Maze Corp.
Rohde & Schwarz Sales Co.
Systa-Matics, Inc.
Tektronix Inc.
Tele-Cine Inc.
Ultra Audio Products
Vu-Data Corp.

Multicarrier Systems, FM

See Adv. Page

Coastcom 42

Coastcom

Multiplexers

See Adv. Page

Buhl Optical Co. 167
Coastcom 42
Moseley Assoc. Inc. 9

Alford Mfg. Co.
Buhl Optical Co.
Coastcom
Cohu, Inc.
Collins Radio Group
Comark Industries Inc.
Communications 2000, Inc.
Comquip, Inc.
Dorado Systems
GTE Lenkurt, Inc.
Kalart Victor Corp.
Marco Video Systems, Inc.
Maze Corp.
Micro Communications, Inc.
Moseley Assoc. Inc.
RCA Corp. Broadcast Systems Div.
Shively Laboratories, Inc.
Sparta Electronic Corp.
Tektronix Inc.
TeleMation, Inc.
TerraCom
TT Electronics, Inc.
R. H. Tyler Co.
The Zei-Mark Corp.

Narrow Band FM Equipment

See Adv. Page

Moseley Assoc. Inc. 9

Coastcom
McMartin Industries, Inc.
Moseley Assoc. Inc.
Scintrex Inc. Communications Div.
Singer Products Co., Inc.
Transcom Electronics, Inc.

Network Joiners

See Adv. Page

ESE 132

ESE

Networks, Matching Audio

Allen Avionics Inc.
Altec Sound Products
Collins Radio Group
Edison Electronics Div.
Fisher-Burke Broadcast Consultants
Gately Electronics

Orange County Corp.
Quad-Eight Electronics
TT Electronics, Inc.

Networks, Matching RF

Alford Mfg. Co.
Allen Avionics Inc.
Collins Radio Group
Comark Industries Inc.
Continental Electronics Mfg. Co.
Edison Electronics Div.
Electro Impulse, Inc.
ESC Electronics Corp.
Fisher-Burke Broadcast Consultants
Micro Communications, Inc.
Multronics, Inc.
Narda Microwave Corp.
North American Radio Corp.
Sparta Electronic Corp.
TT Electronics, Inc.
Wide Band Engineering Co., Inc.

Networks, Mixing

Cetec Audio Div. Subs. Computer
Equipment Corp.
Orange County Corp.
Quad-Eight Electronics
Robins/Fairchild
ROH Corporation

Networks, Phasing --See also Phasing Units

See Adv. Page

Orange County Corp. 64

AEL, Inc.
Allen Avionics Inc.
A-Tel-A-Matic
Collins Radio Group
Comark Industries Inc.
Continental Electronics Mfg. Co.
Fisher-Burke Broadcast Consultants
Multronics, Inc.
North American Radio Corp.
Orange County Corp.
Sintronic Corp.
Sparta Electronic Corp.
TT Electronics, Inc.

Noise Reduction Systems

See Adv. Page

Dolby Laboratories,
Inc. 11

Dolby Laboratories, Inc.

Ohmmeters

California Instruments Co.
Collins Radio Group
EMT Franz VGmbH
ESE
John Fluke Mfg. Co., Inc.
G.C. Electronics
Heath Co.
Hewlett Packard Co.
Hickok Elect. Instrument
ITT Jennings
Leader Instruments Corp.
Philips Test & Measuring Instruments,
Inc.
RCA Corp. Distributor & Special
Products Div.
Rohde & Schwarz Sales Co.
Sencore Inc.
Simpson Electric Co.
Sinai-Johnson
SPI-ITT Metrix Instruments Div.
Triplett Corp.
United Systems Corp.

Operating Impedance Bridge

Delta Electronics Inc. (Va.)
Dragnet Engineering Labs., Inc.
Rohde & Schwarz Sales Co.
Val-Tronics, Inc.

Oscillator Transformers

Nortronics Co., Inc.

TT Electronics, Inc.

Oscillators, AM

Ailtech
CCA Electronics Corp.
Collins Radio Group
Engineering Associates
John Fluke Mfg. Co., Inc.
Heath Co.
Hewlett Packard Co.
Instrument Laboratories
Leader Instruments Corp.
Marconi Instruments
Microwave Assoc. Inc.
Modular Audio Products
Philips Test & Measuring Instruments,
Inc.
Rohde & Schwarz Sales Co.
Singer Products Co., Inc.
Trepac Corp. America

Oscillators, FM

Ailtech
Belar Electronics Lab., Inc.
CCA Electronics Corp.
Collins Radio Group
John Fluke Mfg. Co., Inc.
Heath Co.
Kay Elemetrics Corp.
Leader Instruments Corp.
Marconi Instruments
Microwave Assoc. Inc.
Rohde & Schwarz Sales Co.
Singer Products Co., Inc.

Oscillators, Tone

See Adv. Page

Opamp Lamps, Inc. 185

Allied Broadcast Equip.
Audio Designs & Mfg.
Audio Services, Inc.
Cetec Audio Div. Subs. Computer
Equipment Corp.
Dyma Engineering, Inc.
Electronic Designers Inc.
IGM
Microwave Assoc. Inc.
Monroe Electronics, Inc.
Rupert Neve, Inc.
Opamp Lamps, Inc.
Pulse Dynamics Mfg. Corp. (PDMC)
Quad-Eight Electronics
Radio Mfg. Co. (RMC)
Robins/Fairchild
Spectra Sonics
Sphere Electronics
Telemedia Electronics
Total Technology
Trepac Corp. America
Video Accessories Mfg. Co.

Oscillators, TV

Ailtech
ATV Research
Heath Co.
Kay Elemetrics Corp.
Lectrotech Inc.
Marconi Instruments
Microwave Assoc. Inc.
Rohde & Schwarz Sales Co.
Tektronix Inc.

Oscilloscope Camera

Comquip, Inc.
Hewlett Packard Co.
Lenzar Optics Corp.
Philips Test & Measuring Instruments,
Inc.
SPI-ITT Metrix Instruments Div.
Tektronix Inc.
Vu-Data Corp.

Oscilloscope Vector Display

Beston Electronics Inc.
Dynascan Corp.
Heath Co.
Lectrotech Inc.
Sencore Inc.
Tektronix Inc.

Tele-Cine Inc.
Ultra Audio Products

Oscilloscopes, Dual Trace

Comquip, Inc.
Dynascan Corp.
Eico Elect. Inst. Co., Inc.
Heath Co.
Hewlett Packard Co.
Hickok Elect. Instrument
Leader Instruments Corp.
Lectrotech Inc.
Philips Test & Measuring Instruments,
Inc.
RCA Corp. Distributor & Special
Products Div.
Sencore Inc.
Sinai-Johnson
SPI-ITT Metrix Instruments Div.
Tektronix Inc.
Tele-Cine Inc.
Telonic Altair
Texscan Corp.
Vu-Data Corp.

Oscilloscopes, Rack Type

California Instruments Co.
Hewlett Packard Co.
Hickok Elect. Instrument
Philips Test & Measuring Instruments,
Inc.
SPI-ITT Metrix Instruments Div.
Tektronix Inc.
Tele-Cine Inc.
Vu-Data Corp.

Oscilloscopes, Triggered Sweep

Dynascan Corp.
Eico Elect. Inst. Co., Inc.
Heath Co.
Hewlett Packard Co.
Hickok Elect. Instrument
Leader Instruments Corp.
Lectrotech Inc.
Philips Test & Measuring Instruments,
Inc.
RCA Corp. Distributor & Special
Products Div.
Sencore Inc.
Simpson Electric Co.
Sinai-Johnson
SPI-ITT Metrix Instruments Div.
Tektronix Inc.
Tele-Cine Inc.
Vu-Data Corp.

Oscilloscopes, Wideband

Eico Elect. Inst. Co., Inc.
Heath Co.
Hewlett Packard Co.
Hickok Elect. Instrument
Leader Instruments Corp.
Lectrotech Inc.
Philips Test & Measuring Instruments,
Inc.
RCA Corp. Distributor & Special
Products Div.
Sencore Inc.
Simpson Electric Co.
SPI-ITT Metrix Instruments Div.
Tektronix Inc.
Tele-Cine Inc.
Vu-Data Corp.

Oscilloscopes with Plug-ins

Comquip, Inc.
Hewlett Packard Co.
Philips Test & Measuring Instruments,
Inc.
SPI-ITT Metrix Instruments Div.
Tektronix Inc.
Tele-Cine Inc.

Patch Panel

See Adv. Page

Cooke Engineering Co. 37
LPB inc. 152
Orange County Corp. 64

Allied Broadcast Equip.
 Audio Accessories Inc.
 Audio Designs & Mfg.
 Audio Services, Inc.
 AVA Electronics Corp.
 Berkey-Colortran Inc.
 Broadcast Equipment & Supply Co.
 Collins Radio Group
 Comark Industries Inc.
 Cooke Engineering Co.
 Dielectric Communications
 Harris Corp. Broadcast Products Div.
 LPB Inc.
 Micro Communications, Inc.
 Mincom Div. 3M Co.
 Orange County Corp.
 Phelps Dodge Communications Co.
 Potomac Instruments, Inc.
 Quad-Eight Electronics
 Rex Rheostat & Co., Inc.
 Shively Laboratories, Inc.
 Skirpan Lighting Control Corp.
 Strand Century, Inc.
 Switchcraft Inc.
 Terminal Electronics Corp.
 Trompeter Electronics
 Union Connector Co., Inc.

Phase Enhancer, Stereo

Allied Broadcast Equip.
 Broadcast Automation Assoc.
 Dyma Engineering, Inc.
 Garron Electronics, Inc.
 Rapid-Q
 Sound Dynamics, Inc.
 Val-Tronics, Inc.

**Phasing Units --See also
 Networks, Phasing**

See Adv. Page

Orange County Corp. 64

AEL, Inc.
 A-Tel-A-Matic
 Collins Radio Group
 Comark Industries Inc.
 Continental Electronics Mfg. Co.
 Eventide Clock Works Inc.
 Fisher-Burke Broadcast Consultants
 Multronics, Inc.
 North American Radio Corp.
 Orange County Corp.
 Radio Mfg. Co. (RMC)
 Sintronic Corp.
 TT Electronics, Inc.
 Wilkinson Electronics, Inc.

**Plans, Broadcast Equipment
 Construction**

Don Britton Enterprises

Power Supplies, AC

See Adv. Page

**Modular Audio
 Products 146
 Opamp Lamps, Inc. 185
 Orange County Corp. 64,158
 TeleMation, Inc. 67**

Advanced High Voltage Co., Inc.
 AEL Communications Corp.
 Altec Sound Products
 Ameco Inc.
 A-Tel-A-Matic
 California Instruments Co.
 C-COR Electronics, Inc.
 Cetec Audio Div. Subs. Computer
 Equipment Corp.
 Collins Radio Group
 Delta Electronics Inc. (N.C.)
 Eico Elect. Inst. Co., Inc.
 Engineering Associates
 The Finney Co.
 Fisher Berkeley Corp.
 John Fluke Mfg. Co., Inc.
 G.C. Electronics
 General Electric Co. Tubes/MW
 Devices
 Heath Co.
 Modular Audio Products
 Mole Richardson Co.

Nagra Magnetic Recorders, Inc.
 Opamp Lamps, Inc.
 Orange County Corp.
 Philips Test & Measuring Instruments,
 Inc.
 Quad-Eight Electronics
 Raytheon Data Systems Co.
 Sparta Electronic Corp.
 Systems Engineering Co., Inc.
 Tektronix Inc.
 TeleMation, Inc.
 Terminal Electronics Corp.
 Theta-Com
 Topaz Electronics
 Transcom Electronics, Inc.
 Wilmore Electronics Co., Inc.

Power Supplies, Precision

See Adv. Page

**Modular Audio
 Products 146
 Opamp Lamps, Inc. 185
 TeleMation, Inc. 67**

Advanced High Voltage Co., Inc.
 Altec Sound Products
 A-Tel-A-Matic
 Bristol Div.
 Collins Radio Group
 Dynascan Corp.
 Engineering Associates
 G.C. Electronics
 Head Sound, Inc.
 Heath Co.
 Hewlett Packard Co.
 Lectrotech Inc.
 Modular Audio Products
 Nagra Magnetic Recorders, Inc.
 Opamp Lamps, Inc.
 Philips Test & Measuring Instruments,
 Inc.
 Raytheon Data Systems Co.
 Sencore Inc.
 Sinai-Johnson
 Spectra Sonics
 Tektronix Inc.
 TeleMation, Inc.

Power Supplies, Standby

Wilmore Electronics Co., Inc.

Preamplifiers, Audio

See Adv. Page

**Cooke Engineering Co. 37
 LPB Inc. 152
 Modular Audio
 Products 146
 Opamp Lamps, Inc. 185
 Orange County Corp. 64,158
 Russco Electronics
 Mfg. Inc. 142
 Senstrol Div. 167
 Val-Tronics, Inc. 160**

Allied Broadcast Equip.
 Altec Sound Products
 American Data Corp.
 Audio Designs & Mfg.
 Autogram Corp.
 Automated Processes, Inc.
 Bell P/A Prod. Corp.
 B & K Instruments Inc.
 Bogen Div.
 Broadcast Electronics
 Burwen Laboratories
 Cetec Audio Div. Subs. Computer
 Equipment Corp.
 Collins Radio Group
 Communication Medias
 Communications Technology, Inc.
 Comquip, Inc.
 Concept 70
 Cooke Engineering Co.
 Crown International
 Delta Electronics Inc. (N.C.)
 Delta Electronics Inc. (Va.)
 Dyma Engineering, Inc.
 Dynair Electronics, Inc.
 Electronic Designers Inc.
 Electro Sound, Inc.
 Gately Electronics

G.C. Electronics
 General Electric Co. ISO Div.
 Gotham Audio Corp.
 Harris Corp. Broadcast Products Div.
 Interntl. Nuclear Corp.
 Lang Electronics Inc.
 James B. Lansing Sound, Inc.
 Lauderdale Electronic Labs
 Leader Instruments Corp.
 LPB Inc.
 Mastertone Co., Inc.
 Maze Corp
 McCurdy Radio Ind. Inc.
 McMartin Industries, Inc.
 Micro-Trak Corp.
 Modular Audio Products
 Nagra Magnetic Recorders, Inc.
 Rupert Neve, Inc.
 Opamp Lamps, Inc.
 Orange County Corp.
 Orbit Radio and Video
 Pacific Recorders and Engrg. Corp.
 Div. 47B
 Paso Sound Products Inc.
 Philips Audio Video Systems Corp.
 Audio Div.
 Precision Elect. Inc.
 Pulse Dynamics Mfg. Corp. (PDMC)
 QRK Electronic Products
 Quad-Eight Electronics
 Ramko Research
 RCA Corp. Broadcast Systems Div.
 RHA Audio Communications Corp.
 Richmond Sound Design, Ltd.
 Robins/Fairchild
 ROH Corporation
 Russco Electronics Mfg. Inc.
 Schafer Electronics Corp.
 Scientific Systems, Inc.
 Senstrol Div.
 Shure Brothers Inc.
 Sinai-Johnson
 Sound Dynamics, Inc.
 Sparta Electronic Corp.
 Spectra Sonics
 Sphere Electronics
 Spotmaster
 Stanton Magnetics Inc.
 Superscope, Inc.
 Systems Engineering Co., Inc.
 Systems Marketing Corp.
 Tape-Athon Corp.
 Telex Communications, Inc.
 Total Technology
 Tri-Tronics Professional Electronics
 United Recording Electronics
 Industries
 UREI a URC Co.
 Val-Tronics, Inc.
 VIF International
 Wilkinson Electronics, Inc.

Preamplifiers, Turntable

See Adv. Page

**Broadcast Electronics 45
 LPB Inc. 152
 McCurdy Radio Ind.
 Inc. 25
 Micro-Trak Corp. 164
 Modular Audio
 Products 146
 Opamp Lamps, Inc. 185
 Orange County Corp. 64,158
 Ramko Research 125
 Russco Electronics
 Mfg. Inc. 142
 Senstrol Div. 167
 Val-Tronics, Inc. 160
 Wilkinson Electronics,
 Inc. 157**

Allied Broadcast Equip.
 Audio Designs & Mfg.
 Audio Distributor Inc.
 Automated Processes, Inc.
 Broadcast Automation Assoc.
 Broadcast Electronics
 Broadcast Equipment & Supply Co.
 Camex Corp.
 Collins Radio Group
 Communication Medias
 Dyma Engineering, Inc.
 Gately Electronics
 Grinnan Fixture Co.

Harris Corp. Broadcast Products Div.
 Lauderdale Electronic Labs
 LPB Inc.
 Mastertone Co., Inc.
 Maze Corp
 McCurdy Radio Ind. Inc.
 McMartin Industries, Inc.
 Micro-Trak Corp.
 Modular Audio Products
 Rupert Neve, Inc.
 Opamp Lamps, Inc.
 Orange County Corp.
 Professional Audio Service
 Pulse Dynamics Mfg. Corp. (PDMC)
 QRK Electronic Products
 Quad-Eight Electronics
 Radio Mfg. Co. (RMC)
 Ramko Research
 Rek-O-Kut Inc.
 Robins/Fairchild
 ROH Corporation
 Russco Electronics Mfg. Inc.
 Senstrol Div.
 Shure Brothers Inc.
 Sound Dynamics, Inc.
 Sparta Electronic Corp.
 Spotmaster
 Stanton Magnetics Inc.
 Systems Engineering Co., Inc.
 Tri-Tronics Professional Electronics
 Val-Tronics, Inc.
 Wilkinson Electronics, Inc.

Preamplifiers, Video

See Adv. Page

**Wilkinson Electronics,
 Inc. 157**

AMF Electrical Products
 C-COR Electronics, Inc.
 Dage-MTI, Inc.
 Fernesh Group Robert Bosch Corp.
 Interntl. Nuclear Corp.
 Lenco Inc.
 Maze Corp
 Microwave Assoc. Inc.
 Wilkinson Electronics, Inc.

**Pressurization Equipment,
 Transmission Line**

Allied Broadcast Equip.
 Andrew Corp.
 Cablewave Systems Inc.
 Collins Radio Group
 Dielectric Communications
 General Cable Corp.
 Harris Corp. Broadcast Products Div.
 Jampro Antenna Co.
 Micro Communications, Inc.
 Prodelin Inc.
 Sparta Electronic Corp.
 Wilkinson Electronics, Inc.

Probes, Oscilloscope

Dynascan Corp.
 Eico Elect. Inst. Co., Inc.
 Heath Co.
 Hewlett Packard Co.
 Hickok Elect. Instrument
 ITT Jennings
 Leader Instruments Corp.
 Lectrotech Inc.
 Philips Test & Measuring Instruments,
 Inc.
 RCA Corp. Distributor & Special
 Products Div.
 Sencore Inc.
 SPI-ITT Metrix Instruments Div.
 Tektronix Inc.
 Terminal Electronics Corp.
 Texscan Corp.
 Vu-Data Corp.

Processors, Bleach Regeneration

CPAC Div. of CPAC

Processors, Film B&W

See Adv. Page

**Jamieson Film Co. 126
 Technology, Inc. 154**

Comquip, Inc.
Eastman Kodak Co.
Filmline Corp.
Jamieson Film Co.
Technology, Inc.

Processors, Film Color

See Adv. Page
Jamieson Film Co......126
Technology, Inc......154

Comquip, Inc.
Eastman Kodak Co.
Filmline Corp.
Jamieson Film Co.
Technology, Inc.

Processors, Pollution Control

CPAC Div. of CPAC

Processors, Silver Recovery Unit

CPAC Div. of CPAC
Eastman Kodak Co.
Filmline Corp.
Technology, Inc.

Processors, VTR

Dynasciences Video Products
Mincom Div. 3M Co.

Production Systems, AM or FM Remote or Studio

See Adv. Page
Moseley Assoc. Inc. 9

Allied Broadcast Equip.
Ampro Corp.
Audio Designs & Mfg.
Broadcast Electronics
Broadcast Equipment & Supply Co.
Control Design Corp.
Imero Fiorentino Associates, Inc.
Fisher-Burke Broadcast Consultants
Harris Corp. Broadcast Products Div.
Mastertone Co., Inc.
Maze Corp
Moseley Assoc. Inc.
Robins/Fairchild
Sparta Electronic Corp.
Tri-Tronics Professional Electronics
Val-Tronics, Inc.

Programmed Music

Allied Broadcast Equip.
Cine Sonic Sound Inc.
The CnB Studios
Control Design Corp.
Schafer Electronics Corp.
Sinai-Johnson
Tape-Athon Corp.
VIF International

Programmer/Comparators

See Adv. Page
ESE132
Telemedia Electronics.....161

ESE
Telemedia Electronics

Programmers, Patchboard/Thumbwheel

See Adv. Page
ESE132

Communication Medias
ESE
Harris Corp. Broadcast Products Div.
JGM
Recortec Inc.
Schafer Electronics Corp.
Telemedia Electronics

Projector Lamps

GTE Sylvania Inc. Lighting Products Group
Sitler's Supplies, Inc.
Strand Century, Inc.

Projectors, Film

Allied Broadcast Equip.
Arriflex Co. of America
Bell & Howell Audio Visual Div.
Canon USA, Inc. Optics Div.
Communications Systems
Comquip, Inc.
Eastman Kodak Co.
Fernesh Group Robert Bosch Corp.
GAF Corp.
GBC Closed Circuit TV Corp.
Harris Corp. Broadcast Products Div.
Kalart Victor Corp.
L-W International
Magna-Tech Electronic Co., Inc.
Paillard Inc.
W. A. Palmer Films, Inc.
Rank Precision Industries Rank Cintel Div.
RCA Corp. Broadcast Systems Div.
Super 8 Sound, Inc.
Systa-Matics, Inc.
TeleMation, Inc.
R. H. Tyler Co.
The Zei-Mark Corp.

Projectors, Film Cassette Loading

Comquip, Inc.
RCA Corp. Broadcast Systems Div.

Projectors, Film Rear

Comquip, Inc.
Kalart Victor Corp.

Projectors, Slide

Buhl Optical Co.
Communications Systems
Comquip, Inc.
Eastman Kodak Co.
GAF Corp.
Harris Corp. Broadcast Products Div.
Kliegl Bros. Lighting
Listec TV Equip. Corp.
Spindler & Sauppe, Inc.
Systa-Matics, Inc.
TeleMation, Inc.
R. H. Tyler Co.
The Zei-Mark Corp.

Projectors, TV Large Screen

Comquip, Inc.
GBC Closed Circuit TV Corp.
General Television Ntwk.
Janson Industries
Kalart Victor Corp.
Sony Corp. of America VTR Div.

Projectors, Video Test Slide

Fernesh Group Robert Bosch Corp.
Photo Research Div. of Kollmorgen Corp.
Spindler & Sauppe, Inc.

Prompters

Listec TV Equip. Corp.
Ultra Audio Products

Proof Workbook (For FCC test requirements)

Intertec Publishing Corp.

Quadraphonic Systems

Admiral Group, Rockwell Int'l.
Audio Designs & Mfg.
Belar Electronics Lab., Inc.
Catel
Cetec Audio Div. Subs. Computer Equipment Corp.

Concept 70
Dyma Engineering, Inc.
Gately Electronics
Heath Co.
Rupert Neve, Inc.
Orange County Corp.
Quad-Eight Electronics

Radar, Weather

Enterprise Electronics Corp.
GEC-Marconi Electronics Ltd.
Microwave Assoc. Inc.
Radio Research Instrument Co., Inc.
Raytheon Data Systems Co.
RF Systems, Inc.

Radomes

See Adv. Page
Micro Communications, Inc. 36
Nurad, Inc. 58
Orange County Corp. 64

Andrew Corp.
Collins Radio Group
GEC-Marconi Electronics Ltd.
Harris Corp. Broadcast Products Div.
Jampro Antenna Co.
Micro Communications, Inc.
Nurad, Inc.
Orange County Corp.
Prodelin Inc.
Shively Laboratories, Inc.
Triangle Towers & Antennas
Wilkinson Electronics, Inc.

Receivers, AM

Admiral Group, Rockwell Int'l.
Allied Broadcast Equip.
Bell P/A Prod. Corp.
Bogen Div.
Collins Radio Group
Electronic Designers Inc.
Heath Co.
Kahn Communications, Inc.
Lauderdale Electronic Labs
Marconi Instruments
McMartin Industries, Inc.
Orange County Corp.
Precision Elect. Inc.
RHA Audio Communications Corp.
RHG Elect Labs, Inc.
Singer Products Co., Inc.
Val-Tronics, Inc.
Wilkinson Electronics, Inc.

Receivers, Data

GTE Lenkurt, Inc.
Transcom Electronics, Inc.
Trepac Corp. America

Receivers, EBS

See Adv. Page
Alpha Electronic Services Inc......156
Monroe Electronics, Inc......24
Val-Tronics, Inc......160

Allied Broadcast Equip.
Alpha Electronic Services Inc.
Audio Services, Inc
Collins Radio Group
Mastertone Co., Inc.
McMartin Industries, Inc.
Monroe Electronics, Inc.
Radio Mfg. Co. (RMC)
Val-Tronics, Inc.
Wilkinson Electronics, Inc.

Receivers, FM

See Adv. Page
Wilkinson Electronics, Inc.157

Admiral Group, Rockwell Int'l.
Allied Broadcast Equip.

Altec Sound Products
Ameco Inc.
Bell P/A Prod. Corp.
Beyer (Revox Corporation)
B & K Instruments Inc.
Bogen Div.
Catel
Collins Radio Group
Eico Elect. Inst. Co., Inc.
Electronic Designers Inc.
GTE Lenkurt, Inc.
Heath Co.
Lauderdale Electronic Labs
Marconi Instruments
McMartin Industries, Inc.
Miles Reproducer Co.
Orange County Corp.
Permadyne Electronics Corp.
Precision Elect. Inc.
RCA Corp. RCA Service Co. Div.
Revox Corp.
RHG Elect Labs, Inc.
Sansui Electronics Corp.
Scientific Radio Systems, Inc.
Singer Products Co., Inc.
Superscope, Inc.
Temtron Electronics
Transcom Electronics, Inc.
Tri-Tronics Professional Electronics
Val-Tronics, Inc.
Wilkinson Electronics, Inc.

Receivers, HF

B & K Instruments Inc.
Collins Radio Group
Engineering Associates
Heath Co.
Kahn Communications, Inc.
Marconi Electronics Inc.
Marconi Instruments
Narda Microwave Corp
RHG Elect Labs, Inc.
Rohde & Schwarz Sales Co.
Scientific Radio Systems, Inc.
Singer Products Co., Inc.
Transcom Electronics, Inc.

Receivers, Microwave

See Adv. Page
Farion Electric 33
Tepeco Corp.166
TerraCom127
Varian/Beverly185

Farion Electric
Farion Electric of Canada, Ltd.
Narda Microwave Corp
RHG Elect Labs, Inc.
Scientific-Atlanta, Inc.
Tepeco Corp.
TerraCom
Varian/Beverly
Weinschel Engineering Co.

Receivers, Multiplex

See Adv. Page
Moseley Assoc. Inc. 9

Admiral Group, Rockwell Int'l.
Allied Broadcast Equip.
Altec Sound Products
Beta Technology, Inc.
Dynair Electronics, Inc.
Eico Elect. Inst. Co., Inc.
GTE Lenkurt, Inc.
Heath Co.
Lauderdale Electronic Labs
McMartin Industries, Inc.
Moseley Assoc. Inc.
Permadyne Electronics Corp.
Precision Elect. Inc.
Singer Products Co., Inc.
Superscope, Inc.
TEAC Corp of America
Transcom Electronics, Inc.
Trepac Corp. America

Receivers, SCA

See Adv. Page
Moseley Assoc. Inc. 9

Allied Broadcast Equip.
Contel Mfg.
Eico Elect. Inst. Co., Inc.
Mastertone Co., Inc.
McMartin Industries, Inc.
Moseley Assoc. Inc.
Orange County Corp.
Permadyne Electronics Corp.
Pulse Dynamics Mfg. Corp. (PDMC)
Singer Products Co., Inc.
Val-Tronics, Inc.

Receivers, Time Signal

See Adv. Page

**Time & Frequency
Tech., Inc. 10**

Catel
Electrohome Ltd.
Radio Mfg. Co. (RMC)
Simex/Coast Navigation School
Time & Frequency Tech., Inc.
Total Technology
Video Accessories Mfg. Co.

Receivers, TV Color

Admiral Group, Rockwell Int'l.
Conrac Div. Conrac Corp.
Electrohome Ltd.
Harvey Radio
Heath Co.
Image Devices Inc.
Maze Corp
Nemo Recording Labs
Panasonic Video Systems Div.
RCA Corp. RCA Service Co. Div.
SC Electronics, Inc.
Sharp Electronics Corp.
Sony Corp. of America VTR Div.
Sylvania Comm. Electronic
Systems Engineering Co., Inc.

Receivers, TV Monochrome

Admiral Group, Rockwell Int'l.
Conrac Div. Conrac Corp.
Electrohome Ltd.
Harvey Radio
Heath Co.
Maze Corp
Nemo Recording Labs
Panasonic Video Systems Div.
SC Electronics, Inc.
Sony Corp. of America VTR Div.
Sylvania Comm. Electronic
Systems Engineering Co., Inc.

**Receivers, 162.55 MHz
Weather**

Admiral Group, Rockwell Int'l.
Catel
Scientific Radio Systems, Inc.

Recorder Amplifiers

See Adv. Page

**International
Tapetronics Corp. 20**

International Tapetronics Corp.

Recorder Care Kits, Video

Nortronics Co., Inc.

**Recorder Carrying Systems,
Videotape Portable**

See Adv. Page

K & H Products, Ltd. 157

K & H Products, Ltd.

**Recorder Drive Motor Power
Supply**

Maze Corp
Pacific Recorders and Engrg. Corp.
Div. 47B
VIF International

**Recorder Reconditioning,
Videotape**

A. F. Associates, Inc.
International Video Corp.
RCA Corp. Broadcast Systems Div.

**Recorder Replacement
Electronics**

See Adv. Page

Accurate Sound Co. 149
Inovonics 175
Sound Dynamics, Inc. 174

Accurate Sound Co.
Inovonics
Sound Dynamics, Inc.

Recorder Replacement Motor

See Adv. Page

UMC Electronics Co. 52

Broadcast Automation Assoc.
Broadcast Electronics
Lauderdale Electronic Labs
Mastertone Co., Inc.
Maze Corp
Sound Dynamics, Inc.
Tapecaster TCM, Inc.
Telectro Systems Corp.
UMC Electronics Co.
VIF International

**Recorder Tape Tension Controls,
VTR**

See Adv. Page

Avtel 147
Recortec Inc. 159

Avtel
Recortec Inc.

Recorder Tape Tension Gages

See Adv. Page

Sound Dynamics, Inc. 174
Tentel 169

Sound Dynamics, Inc.
Tentel

Recorders, Audio Reel-to-Reel

See Adv. Page

Communication Medias 62
**International
Electro-Magnetics 148**
LPB Inc. 152
Martin Audio/Video 152
Orange County Corp. 64
RCA Corp. 58,12
Revox Corp. 43
Scully/Metrotech 123

Allied Broadcast Equip.
Ampex Corp.
Ampro Corp.
Audio Distributor Inc.
Autogram Corp.
Beyer (Revox Corporation)
Broadcast Automation Assoc.
Broadcast Equipment & Supply Co.
Camex Corp.
Collins Radio Group
Communication Medias
Comquip, Inc.
Control Design Corp.
Crown International
Electro Sound, Inc.
ELPA Marketing Industries, Inc.
Fisher-Burke Broadcast Consultants
Gotham Audio Corp.
Harris Corp. Broadcast Products Div.
Harvey Radio
Heath Co.
IGM
Image Devices Inc.
International Electro-Magnetics
International Tapetronics Corp.

Lauderdale Electronic Labs
LPB Inc.
Martin Audio/Video
Mastertone Co., Inc.
Maze Corp
Minneapolis Magnetics, Inc.
Nagra Magnetic Recorders, Inc.
Orange County Corp.
Otari Corp.
Pentagon Industries, Inc.
Philips Audio Video Systems Corp.
Broadcast Equip. Div.
RCA Corp. Broadcast Systems Div.
Revox Corp.
Schafer Electronics Corp.
Scully/Metrotech
Sound Dynamics, Inc.
Sparta Electronic Corp.
Spotmaster
Willi Studer America, Inc.
Super 8 Sound, Inc.
Superscope, Inc.
Systems Engineering Co., Inc.
Tapecaster TCM, Inc.
Tapex Corp.
TEAC Corp of America
Telectro Systems Corp.
Telex Communications, Inc.
Val-Tronics, Inc.
Victor Duncan, Inc.
VIF International
Wilkinson Electronics, Inc.

Recorders, Camera Tape to Film

Comquip, Inc.
Image Devices Inc.
W. A. Palmer Films, Inc.
Super 8 Sound, Inc.
Teledyne Camera Systems
Victor Duncan, Inc.

Recorders, Cassette

See Adv. Page

Sony Corp. of America IBC

Admiral Group, Rockwell Int'l.
Allied Broadcast Equip.
Audio Distributor Inc.
Califone International, Inc.
Cetec Audio Div. Subs. Computer
Equipment Corp.
Comquip, Inc.
Conrac Corp. Cramer Div.
Control Design Corp.
Garron Electronics, Inc.
Harvey Radio
Heath Co.
Image Devices Inc.
Lauderdale Electronic Labs
Mincom Div. 3M Co.
Minneapolis Magnetics, Inc.
Orange County Corp.
Otari Corp.
Pentagon Industries, Inc.
Philips Test & Measuring Instruments,
Inc.
Rapid-Q
Recordex Corp.
Sansui Electronics Corp.
SC Electronics, Inc.
Schafer International
Sharp Electronics Corp.
Sony Corp. of America VTR Div.
Super 8 Sound, Inc.
Superscope, Inc.
Telectro Systems Corp.
Telex Communications, Inc.
R. H. Tyler Co.
Victor Duncan, Inc.

Recorders, Cassette, Video

See Adv. Page

Sony Corp. of America IBC

Communications Systems
Comquip, Inc.
J. D. Ivey Corp.
Maze Corp
Nemo Recording Labs
Nippon Electric Co., Ltd.
Panasonic Video Systems Div.
Philips Audio Video Systems Corp.
Broadcast Equip. Div.

RCA Corp. Broadcast Systems Div.
Sony Corp. of America VTR Div.
Super 8 Sound, Inc.
Systa-Matics, Inc.
TeleMation, Inc.
Telemedia Electronics

Recorders, Disc Magnetic

See Adv. Page

Data Disc Inc. 163

Ampex Corp.
Colorado Video Inc.
Data Disc Inc.
Echo Science Corp.
Super 8 Sound, Inc.
Systems Marketing Corp.

Recorders, Film Light

Magna-Tech Electronic Co., Inc.
Super 8 Sound, Inc.

Recorders, Film Magnetic

Comquip, Inc.
Image Devices Inc.
Magna-Tech Electronic Co., Inc.
Quad-Eight Electronics
Stancil-Hoffman Corp.
Super 8 Sound, Inc.
Tele-Cine Inc.
Victor Duncan, Inc.

Recorders, Logging Magnetic

See Adv. Page

Orange County Corp. 64

Allied Broadcast Equip.
Broadcast Automation Assoc.
Control Design Corp.
Gould Inc.
Harvey Radio
IGM
Lang Electronics Inc.
Maze Corp
Miles Reproducer Co.
Orange County Corp.
Radio Mfg. Co. (RMC)
Scully/Metrotech
Sinai-Johnson
Soundscriber Corp.
Stancil-Hoffman Corp.
Super 8 Sound, Inc.
Systems Marketing Corp.
Tape-Athon Corp.
Telectro Systems Corp.
VIF International

**Recorders, Magnetic Tape
Logging**

See Adv. Page

LPB Inc. 152
Scully/Metrotech 123

Allied Broadcast Equip.
Autogram Corp.
B & K Instruments Inc.
Broadcast Automation Assoc.
Cine Sonic Sound Inc.
Collins Radio Group
Control Design Corp.
Echo Science Corp.
Harris Corp. Broadcast Products Div.
IGM
LPB Inc.
Mastertone Co., Inc.
Maze Corp
Nagra Magnetic Recorders, Inc.
Orange County Corp.
Philips Test & Measuring Instruments,
Inc.
Radio Mfg. Co. (RMC)
Revox Corp.
Schafer Electronics Corp.
Scully/Metrotech
Singer Products Co., Inc.
Sound Dynamics, Inc.
Soundscriber Corp.
Sparta Electronic Corp.
Stancil-Hoffman Corp.
Super 8 Sound, Inc.

Systems Marketing Corp.
Tape-Athon Corp.
Telectro Systems Corp.
Telex Communications, Inc.
Val-Tronics, Inc.
Video Memory Corp.
VIF International

Recorders, Paper Logging and Graphic

See Adv. Page

Moseley Assoc. Inc. 9

Biomation Corp.
B & K Instruments Inc.
Bristol Div.
Collins Radio Group
Control Design Corp.
Datalogic-Rust Co.
John Fluke Mfg. Co., Inc.
General Electric Co. Tubes/MW
Devices
Gould Inc.
Heath Co.
Moseley Assoc. Inc.
Philips Test & Measuring Instruments,
Inc.
Rohde & Schwarz Sales Co.
Simpson Electric Co.
Systems Marketing Corp.
Vitek Electronics Inc.

Recorders, Program Logging

See Adv. Page

RCA Corp. 12

Allied Broadcast Equip.
Applied Video Electronics, Inc.
Broadcast Automation Assoc.
Camex Corp.
Communication Medias
IGM
Miles Reproducer Co.
Orange County Corp.
Otari Corp.
Radio Mfg. Co. (RMC)
RCA Corp. Broadcast Systems Div.
Roscor Corp.
Schafer Electronics Corp.
Scully/Metrotech
Stancil-Hoffman Corp.
Tape-Athon Corp.
Telectro Systems Corp.
Val-Tronics, Inc.
VIF International

Recorders, Tape Audio

See Adv. Page

Communication Medias..... 62
International
Electro-Magnetics 148
Orange County Corp. 64
RCA Corp. 12
Revox Corp. 43
Scully/Metrotech 123

Accurate Sound Co.
Allied Broadcast Equip.
Ampex Corp.
Ampro Corp.
Applied Video Electronics, Inc.
Arriflex Co. of America
Audio Distributor Inc.
Bell & Howell Audio Visual Div.
Beyer (Revox Corporation)
B & K Instruments Inc.
Broadcast Automation Assoc.
Broadcast Electronics
Broadcast Equipment & Supply Co.
Camex Corp.
Cetec Audio Div. Subs. Computer
Equipment Corp.
Cine Sonic Sound Inc.
Collins Radio Group
Communication Medias
Comquip, Inc.
Control Design Corp.
Crown International
Denson Electronic Corp.
Electro Sound, Inc.
ELPA Marketing Industries, Inc.

Gotham Audio Corp.
Harris Corp. Broadcast Products Div.
Harvey Radio
IGM
Image Devices Inc.
Inovonics
International Electro-Magnetics
International Tapetronics Corp.
Lang Electronics Inc.
Lauderdale Electronic Labs
Magna-Tech Electronic Co., Inc.
Mastertone Co., Inc.
Maze Corp
Miles Reproducer Co.
Minneapolis Magnetics, Inc.
Nagra Magnetic Recorders, Inc.
Nemo Recording Labs
Orange County Corp.
Orbit Radio and Video
Otari Corp.
Pentagon Industries, Inc.
Philips Audio Video Systems Corp.
Broadcast Equip. Div.
Radio Mfg. Co. (RMC)
RCA Corp. Broadcast Systems Div.
Recordex Corp.
Revox Corp.
Ryder Magnetic Sales Corp.
SC Electronics, Inc.
Schafer Electronics Corp.
Scully/Metrotech
Sharp Electronics Corp.
Sinai-Johnson
Singer Products Co., Inc.
Sound Dynamics, Inc.
Soundscriber Corp.
Sparta Electronic Corp.
Spotmaster
Stancil-Hoffman Corp.
Willi Studer America, Inc.
Superscope, Inc.
Systems Engineering Co., Inc.
Systems Marketing Corp.
Tapex Corp.
TEAC Corp of America
Telectro Systems Corp.
Telex Communications, Inc.
Val-Tronics, Inc.
Victor Duncan, Inc.
VIF International
Wilkinson Electronics, Inc.

Recorders, Tape Audio Cartridge

See Adv. Page

Ampro Corp..... 48
Broadcast Electronics 45
Communication Medias..... 62
Garron Electronics, Inc. 170
International
Tapetronics Corp. 20
Martin Audio/Video 152
Orange County Corp. 64
RCA Corp. 58,12
Val-Tronics, Inc..... 171

Allied Broadcast Equip.
Ampro Corp.
Audio Distributor Inc.
Autogram Corp.
Bell & Howell Audio Visual Div.
Bell P/A Prod. Corp.
Broadcast Automation Assoc.
Broadcast Electronics
Broadcast Equipment & Supply Co.
Camex Corp.
Cetec Audio Div. Subs. Computer
Equipment Corp.
Cine Sonic Sound Inc.
Collins Radio Group
Communication Medias
Contel Mfg.
Control Design Corp.
Dyma Engineering, Inc.
EMT Franz VGmbH
Garron Electronics, Inc.
Harris Corp. Broadcast Products Div.
IGM
Image Devices Inc.
International Tapetronics Corp.
Lang Electronics Inc.
Martin Audio/Video
Mastertone Co., Inc.
Maze Corp
Nemo Recording Labs
Orange County Corp.

QRK Electronic Products
Rapid-Q
RCA Corp. Broadcast Systems Div.
Recordex Corp.
Rek-O-Kut Inc.
Roscor Corp.
Schafer Electronics Corp.
Sharp Electronics Corp.
Singer Products Co., Inc.
Sparta Electronic Corp.
Spotmaster
Superscope, Inc.
Systems Engineering Co., Inc.
Systems Marketing Corp.
Tapecaster TCM, Inc.
Tapex Corp.
Telectro Systems Corp.
Telex Communications, Inc.
Val-Tronics, Inc.
Wilkinson Electronics, Inc.

Recorders, Time Base Corrector

Ampex Corp.
Communications Systems
Harvey Radio
RCA Corp. Broadcast Systems Div.
Roscor Corp.

Recorders, Video Kinescope

Comquip, Inc.
W. A. Palmer Films, Inc.
Teledyne Camera Systems

Recorders, Video Slow Motion

Ampex Corp.
Data Disc Inc.
International Video Corp.
Javelin
Panasonic Video Systems Div.
TEAC Corp of America
Video Memory Corp.

Recorders, Videotape Cartridge

See Adv. Page

Cramer Video..... 148

Communications Systems
Comquip, Inc.
Cramer Video
Harvey Radio
Hitachi Shibaden Corp. of America
Image Devices Inc.
International Video Corp.
JVC Industries, Inc.
Nemo Recording Labs
Panasonic Video Systems Div.
Philips Audio Video Systems Corp.
Broadcast Equip. Div.
RCA Corp. Broadcast Systems Div.
Sinai-Johnson
Sony Corp. of America VTR Div.

Recorders, Videotape Clean Air Hood

Enviroco

Recorders, Videotape Helical

See Adv. Page

Cramer Video..... 148
Martin Audio/Video 152
Sony Corp. of America..... IBC
Telemedia Electronics..... 161

Akai America, Ltd.
Ampex Corp.
Communications Systems
Comquip, Inc.
Cramer Video
Echo Science Corp.
Fernesh Group Robert Bosch Corp.
GBC Closed Circuit TV Corp.
Hitachi Shibaden Corp. of America
Ikegami Electronics (USA) Inc.
International Video Corp.
Javelin
JVC Industries, Inc.
Martin Audio/Video
Maze Corp
Nemo Recording Labs

Nippon Electric Co., Ltd.
Panasonic Video Systems Div.
Philips Audio Video Systems Corp.
Broadcast Equip. Div.
Rank Precision Industries Rank Cintel
Div.
Roscor Corp.
Sinai-Johnson
Sony Corp. of America VTR Div.
Telemedia Electronics
Video Memory Corp.

Recorders, Videotape Quad

See Adv. Page

A. F. Associates, Inc. 68
Cramer Video..... 148
Martin Audio/Video 152

A. F. Associates, Inc.
Ampex Corp.
Asaca Corp. of America
Comquip, Inc.
Cramer Video
Martin Audio/Video
Maze Corp
Nippon Electric Co., Ltd.
RCA Corp. Broadcast Systems Div.

Recording Services, Audio Tape

Accurate Sound Co.
Allied Broadcast Equip.
Alto Communications Inc.
Audio Magnetics Corp.
Cine Sonic Sound Inc.
The CnB Studios
J. D. Ivey Corp.
Lauderdale Electronic Labs
Mastertone Co., Inc.
Nemo Recording Labs
Orbit Radio and Video
W. A. Palmer Films, Inc.
Pentagon Industries, Inc.
Professional Audio Service
Radio Mfg. Co. (RMC)
Ryder Magnetic Sales Corp.
Schafer Electronics Corp.
Superscope, Inc.
Tape-Athon Corp.
United Recording Electronics
Industries

Recording Services, Videotape to Film

J. D. Ivey Corp.
Nemo Recording Labs
W. A. Palmer Films, Inc.

Recording Synchronizers

EECO
Magna-Tech Electronic Co., Inc.
Nagra Magnetic Recorders, Inc.
Quad-Eight Electronics
Ryder Magnetic Sales Corp.

Reels, Cable and Mike

See Adv. Page

**Clifford B. Hannay &
Son, Inc. 52**

Clifford B. Hannay & Son, Inc.
Industrial Electric Reel, Inc.
Roll-A-Reel
Ryder Magnetic Sales Corp.

Reels, Magnetic Tape

See Adv. Page

R S Corp. 185

Allied Broadcast Equip.
Audio Distributor Inc.
Audio Magnetics Corp.
Broadcast Automation Assoc.
Capitol Magnetic Products
Collins Radio Group
Communication Medias
Duotone Co. Inc.
Harvey Radio
Lauderdale Electronic Labs

Mastertone Co., Inc.
 Memorex Corp. Audio-Video Group
 Nemo Recording Labs
 Pentagon Industries, Inc.
 Professional Audio Service
 Recordex Corp.
 Rek-O-Kut Inc.
 R S Corp.
 Schafer Electronics Corp.
 Spotmaster
 TEAC Corp of America
 3M Co. Magnetic Audio/Video Prod.
 Div.
 Wilkinson Electronics, Inc.

Reels, Video Tape

See Adv. Page

R S Corp.185

Audio Magnetics Corp.
 Comquip, Inc.
 Harvey Radio
 Lauderdale Electronic Labs
 Memorex Corp. Audio-Video Group
 Nemo Recording Labs
 Panasonic Video Systems Div.
 Recordex Corp.
 R S Corp.
 Sony Corp. of America VTR Div.
 Studio Tape Exchange
 3M Co. Magnetic Audio/Video Prod.
 Div.

Reflectors, Passive

Collins Radio Group
 Fort Worth Tower Co., Inc.
 Unarco-Rohn
 Utility Tower Co.

Regulators, Voltage

See Adv. Page

Orange County Corp. 64

California Instruments Co.
 Collins Radio Group
 General Electric Co. Tubes/MW
 Devices
 Northlake Engineering, Inc.
 Orange County Corp.
 Temtron Electronics
 Terminal Electronics Corp.
 Topaz Electronics
 Total Technology

Remote Broadcast Cue Systems

See Adv. Page

Comrex Corp.156

Comrex Corp.

Remote Control Monitors, VIT

See Adv. Page

Teledata Systems, Inc.151
Telemet, a Geotel Co. 1

Marconi Instruments
 Teledata Systems, Inc.
 Telemet, a Geotel Co.

Remote Control Systems

See Adv. Page

Audio Services, Inc.162
Broadcast Electronics 45
Central Dynamics176
Control Design Corp.137
Delta Electronics Inc.
 (Va.) 59
Marti Electronics 119
Moseley Assoc. Inc. 9
Nurad, Inc. 58
Orange County Corp. 64,158
Pulse Dynamics Mfg.
Corp.160
Ramko Research125
TerraCom127
Val-Tronics, Inc.160

Allied Broadcast Equip.
 Alpha Electronic Services Inc.
 Audio Services, Inc
 Bristol Div.
 Broadcast Electronics
 Central Dynamics Corp.
 Collins Radio Group
 Continental Electronics Mfg. Co.
 Control Design Corp.
 Datalogic-Rust Co.
 Delta Electronics Inc. (Va.)
 Dorado Systems
 Dyma Engineering, Inc.
 Engineering Associates
 ESE
 Fisher-Burke Broadcast Consultants
 GEC-Marconi Electronics Ltd.
 General Electric Co. Tubes/MW
 Devices
 Harris Corp. Broadcast Products Div.
 Logitek Electronic Systems
 Magna-Tech Electronic Co., Inc.
 Marti Electronics
 Mastertone Co., Inc.
 Maze Corp
 McBee Laboratories
 Miles Reproducer Co.
 Moseley Assoc. Inc.
 North American Radio Corp.
 Nurad, Inc.
 Orange County Corp.
 Pulse Dynamics Mfg. Corp. (PDMC)
 Ramko Research
 Robins/Fairchild
 ROH Corporation
 Ryder Magnetic Sales Corp.
 Sparta Electronic Corp.
 Systems Marketing Corp.
 Tele-Cine Inc.
 Teledata Systems, Inc.
 TerraCom
 Trepac Corp. America
 Val-Tronics, Inc.
 Video Accessories Mfg. Co.
 Video Concepts, Inc.
 Wilkinson Electronics, Inc.

Remote Pickup Receivers

See Adv. Page

Farinon Electric 33
Marti Electronics119
Moseley Assoc. Inc. 9

Farinon Electric
 Marti Electronics
 Moseley Assoc. Inc.

Remote Pickup Systems, Radio

See Adv. Page

Marti Electronics119
Moseley Assoc. Inc. 9
TerraCom127
Val-Tronics, Inc.171

Allied Broadcast Equip.
 Camex Corp.
 Collins Radio Group
 Dyma Engineering, Inc.
 Marti Electronics
 Mastertone Co., Inc.
 Maze Corp
 McMartin Industries, Inc.
 Miles Reproducer Co.
 Moseley Assoc. Inc.
 Nagra Magnetic Recorders, Inc.
 Pulse Dynamics Mfg. Corp. (PDMC)
 Schafer Electronics Corp.
 Sparta Electronic Corp.
 TerraCom
 Val-Tronics, Inc.
 Wilkinson Electronics, Inc.

Remote Pickup Transmitters

See Adv. Page

Farinon Electric 33
Marti Electronics119
Moseley Assoc. Inc. 9

Farinon Electric
 Marti Electronics
 Moseley Assoc. Inc.

Reverberation Systems

See Adv. Page

Micmix Audio
Products, Inc.130
Orange County Corp. 64
Val-Tronics, Inc.160

Audio Distributor Inc.
 Bell P/A Prod. Corp.
 B & K Instruments Inc.
 Dyma Engineering, Inc.
 EMT Franz VGmbH
 Gotham Audio Corp.
 Micmix Audio Products, Inc.
 Opamp Lamps, Inc.
 Orange County Corp.
 Orban/Parasound, Inc.
 Philips Audio Video Systems Corp.
 Audio Div.
 Quad-Eight Electronics
 Robins/Fairchild
 Shure Brothers Inc.
 Sparta Electronic Corp.
 Systems Engineering Co., Inc.
 TEAC Corp of America
 Total Technology
 Tri-Tronics Professional Electronics
 Val-Tronics, Inc.

Rewinders, Film

Comquip, Inc.
 Image Devices Inc.
 Kalart Victor Corp.
 Neumade Prod. Corp.
 Super 8 Sound, Inc.

Rewinders, Tape

See Adv. Page

Audico, Ltd.166

Allied Broadcast Equip.
 Audico, Ltd.
 Broadcast Automation Assoc.
 Lauderdale Electronic Labs
 Neumade Prod. Corp.
 Orange County Corp.
 Pentagon Industries, Inc.
 Radio Mfg. Co. (RMC)
 Ramko Research
 Recordex Corp.
 Recortec Inc.
 Singer Products Co., Inc.
 Sparta Electronic Corp.
 Systems Engineering Co., Inc.
 Ultra Audio Products

Safety Devices, Ladder

Air Space Devices Inc.
 Antenna Products Co.
 Triangle Towers & Antennas
 Unarco-Rohn

Scramblers, Speech

Kahn Communications, Inc.
 Singer Products Co., Inc.

Screens, Projection Front

Comquip, Inc.
 Eastman Kodak Co.
 Raven Screen Corp.

Screens, Projection Rear

Raven Screen Corp.
 H. Wilson Corp.

Semiconductors, IC's

See Adv. Page

C. M. Levit Electronics162

Amperex Electronic Corp.
 A-Tel-A-Matic
 Calvert Electronics Inc.
 Ceco Communications Inc.
 English Electric Valve North America
 Ltd.
 G.C. Electronics

Harvey Radio
 Hewlett Packard Co.
 JSH Electronics, Inc.
 C. M. Levit Electronics
 P. R. Mallory & Co. Inc.
 Microwave Assoc. Inc.
 Motorola Semiconduct
 Opamp Lamps, Inc.
 RCA Corp. Distributor & Special
 Products Div.
 Terminal Electronics Corp.
 Texas Instrument Components Group
 Thor Electronics Corp.

Semiconductors, Rectifier General

See Adv. Page

C. M. Levit Electronics162

Amperex Electronic Corp.
 A-Tel-A-Matic
 Calvert Electronics Inc.
 Ceco Communications Inc.
 Collins Radio Group
 Electronic Devices, Inc.
 English Electric Valve North America
 Ltd.
 General Electric Co. Tubes/MW
 Devices
 Heintz and Kaufman Ltd.
 JSH Electronics, Inc.
 C. M. Levit Electronics
 P. R. Mallory & Co. Inc.
 Microwave Assoc. Inc.
 Motorola Semiconduct
 RCA Corp. Distributor & Special
 Products Div.
 Singer Products Co., Inc.
 Temtron Electronics
 Terminal Electronics Corp.
 Texas Instrument Components Group
 Thor Electronics Corp.

Semiconductors, Rectifier High Voltage Stack

See Adv. Page

C. M. Levit Electronics162
Wilkinson Electronics,
Inc.157

Amperex Electronic Corp.
 A-Tel-A-Matic
 Calvert Electronics Inc.
 Ceco Communications Inc.
 Collins Radio Group
 Electronic Devices, Inc.
 English Electric Valve North America
 Ltd.
 Heintz and Kaufman Ltd.
 JSH Electronics, Inc.
 C. M. Levit Electronics
 P. R. Mallory & Co. Inc.
 Microwave Assoc. Inc.
 Motorola Semiconduct
 RCA Corp. Distributor & Special
 Products Div.
 Singer Products Co., Inc.
 Terminal Electronics Corp.
 Thor Electronics Corp.
 Wilkinson Electronics, Inc.

Semiconductors, Rectifier Power

See Adv. Page

C. M. Levit Electronics162

Amperex Electronic Corp.
 A-Tel-A-Matic
 Calvert Electronics Inc.
 Ceco Communications Inc.
 Collins Radio Group
 Electronic Devices, Inc.
 English Electric Valve North America
 Ltd.
 General Electric Co. Tubes/MW
 Devices
 Heintz and Kaufman Ltd.
 JSH Electronics, Inc.
 C. M. Levit Electronics
 P. R. Mallory & Co. Inc.
 Microwave Assoc. Inc.
 Motorola Semiconduct

RCA Corp. Distributor & Special Products Div.
Singer Products Co., Inc.
Terminal Electronics Corp.
Texas Instrument Components Group
Thor Electronics Corp.

Semiconductors, Rectifier Silicon Controlled-SCR

See Adv. Page

C. M. Levit Electronics162

Amperex Electronic Corp.
A-Tel-A-Matic
Calvert Electronics Inc.
Ceco Communications Inc.
Collins Radio Group
English Electric Valve North America Ltd.
G.C. Electronics
General Electric Co. Tubes/MW Devices
Heintz and Kaufman Ltd.
JSH Electronics, Inc.
C. M. Levit Electronics
Microwave Assoc. Inc.
Motorola Semiconduct
RCA Corp. Distributor & Special Products Div.
Singer Products Co., Inc.
Terminal Electronics Corp.
Texas Instrument Components Group
Thor Electronics Corp.
Wilkinson Electronics, Inc.

Semiconductors, Thyristor

See Adv. Page

C. M. Levit Electronics162

Amperex Electronic Corp.
A-Tel-A-Matic
Calvert Electronics Inc.
Ceco Communications Inc.
English Electric Valve North America Ltd.
G.C. Electronics
General Electric Co. Tubes/MW Devices
Heintz and Kaufman Ltd.
JSH Electronics, Inc.
C. M. Levit Electronics
Motorola Semiconduct
RCA Corp. Distributor & Special Products Div.
Singer Products Co., Inc.
Terminal Electronics Corp.
Texas Instrument Components Group
Thor Electronics Corp.

Semiconductors, Transistor AF

See Adv. Page

C. M. Levit Electronics162

Amperex Electronic Corp.
A-Tel-A-Matic
Calvert Electronics Inc.
Ceco Communications Inc.
G.C. Electronics
Heintz and Kaufman Ltd.
JSH Electronics, Inc.
C. M. Levit Electronics
P. R. Mallory & Co. Inc.
Microwave Assoc. Inc.
Motorola Semiconduct
Raytheon Data Systems Co.
RCA Corp. Distributor & Special Products Div.
Singer Products Co., Inc.
Temtron Electronics
Terminal Electronics Corp.
Texas Instrument Components Group
Thor Electronics Corp.

Semiconductors, Transistor FET

See Adv. Page

C. M. Levit Electronics162

A-Tel-A-Matic
Calvert Electronics Inc.
Ceco Communications Inc.

G.C. Electronics
Harvey Radio
Heintz and Kaufman Ltd.
JSH Electronics, Inc.
C. M. Levit Electronics
P. R. Mallory & Co. Inc.
Microwave Assoc. Inc.
Motorola Semiconduct
RCA Corp. Distributor & Special Products Div.
Singer Products Co., Inc.
Temtron Electronics
Terminal Electronics Corp.
Texas Instrument Components Group
Thor Electronics Corp.

Semiconductors, Transistor General

See Adv. Page

C. M. Levit Electronics162

Amperex Electronic Corp.
A-Tel-A-Matic
Calvert Electronics Inc.
Ceco Communications Inc.
G.C. Electronics
General Electric Co. Tubes/MW Devices
Harvey Radio
Hewlett Packard Co.
JSH Electronics, Inc.
C. M. Levit Electronics
Microwave Assoc. Inc.
Motorola Semiconduct
Raytheon Data Systems Co.
RCA Corp. Distributor & Special Products Div.
Singer Products Co., Inc.
Temtron Electronics
Terminal Electronics Corp.
Texas Instrument Components Group
Thor Electronics Corp.

Semiconductors, Transistor RF

See Adv. Page

C. M. Levit Electronics162

Amperex Electronic Corp.
A-Tel-A-Matic
Calvert Electronics Inc.
Ceco Communications Inc.
English Electric Valve North America Ltd.
G.C. Electronics
Heintz and Kaufman Ltd.
Hewlett Packard Co.
JSH Electronics, Inc.
C. M. Levit Electronics
Microwave Assoc. Inc.
Motorola Semiconduct
Raytheon Data Systems Co.
RCA Corp. Distributor & Special Products Div.
Singer Products Co., Inc.
Terminal Electronics Corp.
Texas Instrument Components Group
Thor Electronics Corp.

Sensors, Tone

See Adv. Page

Control Design Corp.....137

Allied Broadcast Equip.
Audio Services, Inc.
Communication Medias
Control Design Corp.
Monroe Electronics, Inc.
Orange County Corp.
Telemedia Electronics
Val-Tronics, Inc.
Video Accessories Mfg. Co.

Set-up Trucks

Editel Communications
Harris Corp. Broadcast Products Div.
Storeel Corp.

Shifters, Phase Microwave

Hewlett Packard Co.
Maury Microwave Corp.

Micro Communications, Inc.
Microwave Assoc. Inc.
Narda Microwave Corp
Raytheon Data Systems Co.
Singer Products Co., Inc.
Systron-Donner
Weinschel Engineering Co.

Slow Scan TV Systems

See Adv. Page

Colorado Video Inc.....170

ATV Research
Colorado Video Inc.
Communications Systems
Gen. Electrodynamics
Nemo Recording Labs
Teltron Inc.

Sound Effect Systems

Gotham Audio Corp.
IGM
MacKenzie Laboratories, Inc.
Orange County Corp.
Pacific Recorders and Engrg. Corp. Div. 47B
Radio Mfg. Co. (RMC)
Richmond Sound Design, Ltd.
Total Technology
Universal Research Labs

Sound Systems, Automatic Level Control

Allied Broadcast Equip.
Nemo Recording Labs
Orange County Corp.
Robins/Fairchild
Shure Brothers Inc.

Sound Systems, Outdoor

Altec Sound Products
Bell P/A Prod. Corp.
Bogen Div.
Concept 70
Ecor Div. of P.A.C.
Electro-Voice Inc.
G.C. Electronics
Head Sound, Inc.
Heath Co.
Jensen Sound Laboratories
James B. Lansing Sound, Inc.
Maze Corp
McMartin Industries, Inc.
Microwave Assoc. Inc.
Nemo Recording Labs
Orange County Corp.
Paso Sound Products Inc.
Philips Audio Video Systems Corp. Broadcast Equip. Div.
Pulse Dynamics Mfg. Corp. (PDMC)
Robins/Fairchild
Shure Brothers Inc.
Sinai-Johnson
Spectra Sonics
Terminal Electronics Corp.
Ultra Audio Products

Sound Systems, Portable

Altec Sound Products
Applied Electro Mechanics, Inc.
Audio Distributor Inc.
Automated Processes, Inc.
Bell P/A Prod. Corp.
Bogen Div.
Comquip, Inc.
Concept 70
Custom Craft Designs
Ecor Div. of P.A.C.
Electro-Voice Inc.
Gately Electronics
Harvey Radio
Head Sound, Inc.
Heath Co.
James B. Lansing Sound, Inc.
Maze Corp
McMartin Industries, Inc.
Modular Audio Products
Nagra Magnetic Recorders, Inc.
Nemo Recording Labs
Rupert Neve, Inc.
Orange County Corp.

Paso Sound Products Inc.
Pulse Dynamics Mfg. Corp. (PDMC)
QRK Electronic Products
Robins/Fairchild
Sharp Electronics Corp.
Shure Brothers Inc.
Sinai-Johnson
Singer Products Co., Inc.
Spectra Sonics
Tape-Athon Corp.
Terminal Electronics Corp.
Ultra Audio Products

Sound Systems, Studio

See Adv. Page

Orange County Corp.158

Allied Broadcast Equip.
Altec Sound Products
Ampro Corp.
Audio Designs & Mfg.
Broadcast Electronics
Concept 70
Crown International
Delta Electronics Inc. (N.C.)
Dolby Laboratories, Inc.
Dyma Engineering, Inc.
Ecor Div. of P.A.C.
Electro-Voice Inc.
Fisher-Burke Broadcast Consultants
Gately Electronics
Gotham Audio Corp.
Heath Co.
Jensen Sound Laboratories
James B. Lansing Sound, Inc.
Magna-Tech Electronic Co., Inc.
Maze Corp
McMartin Industries, Inc.
Nemo Recording Labs
Rupert Neve, Inc.
Orange County Corp.
Paso Sound Products Inc.
Philips Audio Video Systems Corp. Broadcast Equip. Div.
Pulse Dynamics Mfg. Corp. (PDMC)
QRK Electronic Products
Quad-Eight Electronics
Rek-O-Kut Inc.
Robins/Fairchild
ROH Corporation
Scientific Systems, Inc.
Shure Brothers Inc.
Singer Products Co., Inc.
Sparta Electronic Corp.
Spectra Sonics
Systems Engineering Co., Inc.
Total Technology
Video Aids Corp. of Colorado

Sound Systems, Theater

Altec Sound Products
Audio Designs & Mfg.
Audio Distributor Inc.
Bell P/A Prod. Corp.
Bogen Div.
Cetec Audio Div. Subs. Computer Equipment Corp.
Comquip, Inc.
Concept 70
Delta Electronics Inc. (N.C.)
Dolby Laboratories, Inc.
Ecor Div. of P.A.C.
Electro Sound, Inc.
Electro-Voice Inc.
Gately Electronics
Heath Co.
James B. Lansing Sound, Inc.
Magna-Tech Electronic Co., Inc.
Maze Corp
Rupert Neve, Inc.
Orange County Corp.
Paso Sound Products Inc.
Quad-Eight Electronics
Richmond Sound Design, Ltd.
Robins/Fairchild
ROH Corporation
Shure Brothers Inc.
Spectra Sonics
Ward-Beck Systems, Ltd.

Speakers and Enclosures

See Adv. Page

Orange County Corp. 64,158

RCA Corp. 58
Sound Dynamics, Inc. 174

Allied Broadcast Equip.
 Altec Sound Products
 Amperex Electronic Corp.
 Atlas Sound
 Audio Designs & Mfg.
 Audio Distributor Inc.
 Bogen Div.
 Camex Corp.
 Cetec Audio Div. Subs. Computer
 Equipment Corp.
 Collins Radio Group
 Communication Medias
 Comquip, Inc.
 Crown International
 Ecor Div. of P.A.C.
 Electro-Voice Inc.
 G.C. Electronics
 Gotham Audio Corp.
 Harris Corp. Broadcast Products Div.
 Hartley Prod. Corp.
 Heath Co.
 Jensen Sound Laboratories
 Koss Corp.
 James B. Lansing Sound, Inc.
 Maze Corp.
 Micro-Trak Corp.
 Oaktron Industries Inc.
 Orange County Corp.
 Paso Sound Products Inc.
 Philips Audio Video Systems Corp.
 Audio Div.
 Philips Audio Video Systems Corp.
 Broadcast Equip. Div.
 Professional Audio Service
 Pulse Dynamics Mfg. Corp. (PDMC)
 RCA Corp. Broadcast Systems Div.
 Rek-O-Kut Inc.
 ROH Corporation
 Sansui Electronics Corp.
 Shure Brothers Inc.
 Sinai-Johnson
 Singer Products Co., Inc.
 Sound Dynamics, Inc.
 Sparta Electronic Corp.
 Superscope, Inc.
 Systems Engineering Co., Inc.
 TEAC Corp of America
 Terminal Electronics Corp.
 Victor Duncan, Inc.

STL Equipment

See Adv. Page
Marti Electronics 119
Micro Communications, Inc. 36
Moseley Assoc. Inc. 9
Orange County Corp. 64
Tepco Corp. 166
Val-Tronics, Inc. 160

Camex Corp.
 Coastcom
 Collins Radio Group
 Contel Mfg.
 Dolby Laboratories, Inc.
 Dyma Engineering, Inc.
 Electromagnetic Sciences, Inc.
 Farinon Electric
 Farinon Electric of Canada, Ltd.
 General Electric Co. ISO Div.
 GTE Lenkurt, Inc.
 Harris Corp. Broadcast Products Div.
 Ikegami Electronics (USA) Inc.
 Marti Electronics
 Mastertone Co., Inc.
 Maze Corp.
 Micro Communications, Inc.
 Microwave Assoc. Inc.
 Moseley Assoc. Inc.
 Nurad, Inc.
 Orange County Corp.
 Raytheon Data Systems Co.
 RCA Corp. Broadcast Systems Div.
 RHG Elect Labs, Inc.
 Singer Products Co., Inc.
 Sparta Electronic Corp.
 Tepco Corp.
 Trepac Corp. America
 Val-Tronics, Inc.
 Varian/Beverly
 Wilkinson Electronics, Inc.

Stopwatches, Digital

See Adv. Page
ESE 60

Studio Design and Construction

See Adv. Page
Aderhold Construction Co. 185
A. F. Associates, Inc. 68
Fisher-Burke Broadcast Consultants 124

Aderhold Construction Co.
 A. F. Associates, Inc.
 Fisher-Burke Broadcast Consultants

Studio Scenery

Imero Fiorentino Associates, Inc.
 Janson Industries

Studio Systems, Audio

See Adv. Page
A. F. Associates, Inc. 68
LPB Inc. 152
Orange County Corp. 64

Accurate Sound Co.
 A. F. Associates, Inc.
 Allied Broadcast Equip.
 Ampro Corp.
 Audio Designs & Mfg.
 Audio Services, Inc.
 Auditronics, Inc.
 Automated Processes, Inc.
 Broadcast Electronics
 Camex Corp.
 Cetec Audio Div. Subs. Computer
 Equipment Corp.
 Communication Medias
 Eventide Clock Works Inc.
 Fisher-Burke Broadcast Consultants
 Gotham Audio Corp.
 Harris Corp. Broadcast Products Div.
 LPB Inc.
 Magna-Tech Electronic Co., Inc.
 McMartin Industries, Inc.
 Modular Audio Products
 Nemo Recording Labs
 Opamp Lamps, Inc.
 Orange County Corp.
 Philips Audio Video Systems Corp.
 Broadcast Equip. Div.
 Quad-Eight Electronics
 Robins/Fairchild
 ROH Corporation
 Sparta Electronic Corp.
 Spectra Sonics
 Spotmaster
 Systems Engineering Co., Inc.
 Total Technology

Subcarrier Multiplex Equipment

See Adv. Page
Colorado Video Inc. 170
Moseley Assoc. Inc. 9
Tepco Corp. 166

Allied Broadcast Equip.
 Camex Corp.
 CCA Electronics Corp.
 Coastcom
 Collins Radio Group
 Colorado Video Inc.
 Farinon Electric
 Farinon Electric of Canada, Ltd.
 Fung Engineering Inc.
 GEC-Marconi Electronics Ltd.
 GTE Lenkurt, Inc.
 Harris Corp. Broadcast Products Div.
 McMartin Industries, Inc.
 Moseley Assoc. Inc.
 Orban/Broadcast
 Sinai-Johnson
 Tepco Corp.
 TerraCom

Switchers --See also Console Listings

See Adv. Page
Broadcast Electronics 45
Central Dynamics Corp. 13,176
Dynair Electronics, Inc. 66
Orange County Corp. 158
Shintron Co. Inc. 50
Telemet, a Geotel Co. 1
Vamco Engineering 23
Viscount Industries Ltd. 46
Ward-Beck Systems, Ltd. IFC

Alco Electronic Products, Inc.
 American Data Corp.
 Audio Designs & Mfg.
 Auditronics, Inc.
 Ball Bros. Research Corp. Miratel
 Division
 Bethany International
 Broadcast Electronics
 Camex Corp.
 Central Dynamics Corp.
 Communications Systems
 Communications Technology, Inc.
 Computer Image Corp.
 Comquip, Inc.
 Concept 70
 Cunningham Corp.
 Dyma Engineering, Inc.
 Dynair Electronics, Inc.
 Dynasciences Video Products
 Echo Science Corp.
 Fung Engineering Inc.
 Grass Valley Group, Inc.
 Holland Electronics
 Industrial Sciences, Inc.
 Internatl. Nuclear Corp.
 Javelin
 Kay Elemetrics Corp.
 Marconi Electronics Inc.
 Maze Corp.
 McCurdy Radio Ind. Inc.
 Nasco Television Systems
 Rupert Neve, Inc.
 Orange County Corp.
 RCA Corp. Broadcast Systems Div.
 Richmond Hill Laboratories Ltd.
 Richmond Sound Design, Ltd.
 Robins/Fairchild
 ROH Corporation
 Ross Broadcast Products, Inc.
 Seacor Inc.
 Shintron Co. Inc.
 Sparta Electronic Corp.
 Systems Engineering Co., Inc.
 Systems Marketing Corp.
 TeleMation, Inc.
 Telemet, a Geotel Co.
 Total Technology
 R. H. Tyler Co.
 Vamco Engineering
 Vedco, Inc.
 Vicon Industries, Inc.
 Video Accessories Mfg. Co.
 Video Aids Corp. of Colorado
 Viscount Industries Ltd.
 Visual Electronics Laboratories
 Ward-Beck Systems, Ltd.

Switches

See Adv. Page
Alco Electronic Products, Inc. 64
Comark Industries Inc. 161

Alco Electronic Products, Inc.
 American Switch Corp.
 AMP Special Industries
 Amperex Electronic Corp.
 Comark Industries Inc.
 Edison Electronics Div.
 G.C. Electronics
 Harvey Radio
 Lauderdale Electronic Labs
 Magnecraft Electric Co.
 Richmond Hill Laboratories Ltd.
 Seacor Inc.
 Shallco, Inc.
 Switchcraft Inc.

Systems Engineering Co., Inc.
 Tech Laboratories Inc.
 TRW Electronics Supply Co.

Switches, Coaxial

See Adv. Page
Cooke Engineering Co. 37
Micro Communications, Inc. 36

Alford Mfg. Co.
 Amphenol RF Div.
 Andrew Corp.
 A-Tel-A-Matic
 Bird Electronic Corp.
 Blonder-Tongue Labs.
 Collins Radio Group
 Comark Industries Inc.
 Cooke Engineering Co.
 Delta Electronics Inc. (Va.)
 Dielectric Communications
 Electronic Inst. & Spec.
 Fung Engineering Inc.
 General Microwave Corp.
 Harvey Radio
 ITT Jennings
 Jampro Antenna Co.
 Kay Elemetrics Corp.
 Magnecraft Electric Co.
 Micro Communications, Inc.
 Microwave Assoc. Inc.
 Narda Microwave Corp
 Oak Industries, Inc.
 Prodelin Inc.
 RCA/Community Telev. Systems
 Dynasciences Video Products
 Richmond Hill Laboratories Ltd.
 Rohde & Schwarz Sales Co.
 Shively Laboratories, Inc.
 Singer Products Co., Inc.
 Sparta Electronic Corp.
 Systron-Donner
 Telonic Altair
 Terminal Electronics Corp.
 Texscan Corp.
 Trompeter Electronics
 Vitek Electronics Inc.
 Wide Band Engineering Co., Inc.

Switches, Crossbar

See Adv. Page
Dynair Electronics, Inc. 66

Communications 2000, Inc.
 Cunningham Corp.
 Delta Electronics Inc. (Va.)
 Dynair Electronics, Inc.
 Fernesh Group Robert Bosch Corp.
 Internatl. Nuclear Corp.
 ITT Jennings
 Orange County Corp.
 Richmond Hill Laboratories Ltd.
 Trompeter Electronics
 Viscount Industries Ltd.

Switching Systems

See Adv. Page
A. F. Associates, Inc. 68
American Data Corp. 7
Central Dynamics Corp. 13,176
Dynair Electronics, Inc. 66
Orange County Corp. 64,158
Quantum Audio Labs, Inc. 171
Shintron Co. Inc. 50
Telemet, a Geotel Co. 1
Vamco Engineering 23
Ward-Beck Systems, Ltd. IFC

A. F. Associates, Inc.
 American Data Corp.
 Andrew Corp.
 Audio Services, Inc.
 Broadcast Automation Assoc.
 Broadcast Video Systems, Ltd.
 Central Dynamics Corp.
 CMX Systems
 Communications Technology, Inc.
 Communications 2000, Inc.

Concept 70
 Cunningham Corp.
 Datalogic-Rust Co.
 Datatek Corp.
 Delta Electronics Inc. (Va.)
 Dyma Engineering, Inc.
 Dynair Electronics, Inc.
 Fernesh Group Robert Bosch Corp.
 Grass Valley Group, Inc.
 GTE Lenkurt, Inc.
 Holland Electronics
 IGM
 Industrial Sciences, Inc.
 Internatl. Nuclear Corp.
 Javelin
 Marco Video Systems, Inc.
 Marconi Electronics Inc.
 Mastertone Co., Inc.
 Maze Corp
 McCurdy Radio Ind. Inc.
 Multronics, Inc.
 Nasco Television Systems
 Orange County Corp.
 Quantum Audio Labs, Inc.
 RCA Corp. Broadcast Systems Div.
 Richmond Hill Laboratories Ltd.
 Richmond Sound Design, Ltd.
 Robins/Fairchild
 ROH Corporation
 Ross Broadcast Products, Inc.
 Schafer Electronics Corp.
 Shintron Co. Inc.
 Systems Marketing Corp.
 Tech Laboratories Inc.
 Tektronix Inc.
 TeleMation, Inc.
 Telemet, a Geotel Co.
 Trepac Corp. America
 Trompeter Electronics
 Vamco Engineering
 Vicon Industries, Inc.
 Video Concepts, Inc.
 Viscount Industries Ltd.
 Visual Electronics Laboratories
 Vital Industries Inc.
 Ward-Beck Systems, Ltd.

Synchronizers, Audio/Video

Ampex Corp.
 Automated Processes, Inc.
 Datametrics
 EECO
 Magna-Tech Electronic Co., Inc.
 Nagra Magnetic Recorders, Inc.
 Quad-Eight Electronics
 TeleMation, Inc.

Synchronizer, Digital Video

Consolidated Video Systems
 Datametrics
 EECO
 Magna-Tech Electronic Co., Inc.
 Nippon Electric Co., Ltd.
 TeleMation, Inc.

Systems Research and Development

See Adv. Page
Comark Industries Inc.161
Fisher-Burke Broadcast Consultants.....124

Ameco Inc.
 Audio Designs & Mfg.
 Audio Services, Inc
 Comark Industries Inc.
 Communications 2000, Inc.
 Comquip, Inc.
 Control Concepts Corp.
 Fisher-Burke Broadcast Consultants
 GEC-Marconi Electronics Ltd.
 Lauderdale Electronic Labs
 Lenco Inc.
 PRD Electronics, Inc.
 Richmond Hill Laboratories Ltd.
 Telemet, a Geotel Co.
 Tepco Corp.
 Universal Research Labs

Tape, Magnetic Recording Audio

See Adv. Page
Broadcast Electronics 45
Communication Medias..... 62
Martin Audio/Video152
Orange County Corp. 64

Agfa-Gevaert Inc.
 Allied Broadcast Equip.
 Ampex Corp.
 Audio Distributor Inc.
 Audio Magnetics Corp.
 Birmingham Tape Cartridge Co., Inc.
 Broadcast Automation Assoc.
 Broadcast Electronics
 BSC Inc.
 Capitol Magnetic Products
 Cine Sonic Sound Inc.
 Collins Radio Group
 Communication Medias
 Communications Systems
 Comquip, Inc.
 Dolby Laboratories, Inc.
 Duotone Co. Inc.
 Fuji Photo Film USA, Inc. Magnetic Products Dept.
 GEC-Marconi Electronics Ltd.
 Harvey Radio
 Image Devices Inc.
 Irish Magnetic Recording Tape
 Joa Cartridge Service
 Karex, Inc.
 Lauderdale Electronic Labs
 P. R. Mallory & Co. Inc.
 Martin Audio/Video
 Mastertone Co., Inc.
 Maxell Corp. of America
 Memorex Corp. Audio-Video Group
 Nemo Recording Labs
 Orange County Corp.
 Otari Corp.
 Pentagon Industries, Inc.
 Professional Audio Service
 Recordex Corp.
 Roscor Corp.
 Ryder Magnetic Sales Corp.
 Sinai-Johnson
 Singer Products Co., Inc.
 Soundscriber Corp.
 Sparta Electronic Corp.
 Spotmaster
 Studio Tape Exchange
 Super 8 Sound, Inc.
 Superscope, Inc.
 Systems Engineering Co., Inc.
 Systems Marketing Corp.
 Tapex Corp.
 3M Co. Magnetic Audio/Video Prod. Div.
 Val-Tronics, Inc.
 Victor Duncan, Inc.
 VIF International
 Wilkinson Electronics, Inc.

Tape, Magnetic Recording Audio Cartridge

See Adv. Page
Fidelipac154
Orange County Corp. 64

Allied Broadcast Equip.
 Ampex Corp.
 Aristocart Div.
 Audio Distributor Inc.
 Audio Magnetics Corp.
 Birmingham Tape Cartridge Co., Inc.
 Broadcast Automation Assoc.
 Broadcast Electronics
 BSC Inc.
 Capitol Magnetic Products
 Cine Sonic Sound Inc.
 Collins Radio Group
 Communication Medias
 Contel Mfg.
 Dyma Engineering, Inc.
 Fidelipac
 Fuji Photo Film USA, Inc. Magnetic Products Dept.
 Harvey Radio
 Irish Magnetic Recording Tape
 Joa Cartridge Service
 Lauderdale Electronic Labs
 P. R. Mallory & Co. Inc.
 Mastertone Co., Inc.

Memorex Corp. Audio-Video Group
 Nemo Recording Labs
 Orange County Corp.
 Professional Audio Service
 Recordex Corp.
 Rek-O-Kut Inc.
 Sinai-Johnson
 Singer Products Co., Inc.
 Sound Dynamics, Inc.
 Sparta Electronic Corp.
 Spotmaster
 Superscope, Inc.
 Systems Engineering Co., Inc.
 Systems Marketing Corp.
 Tapecaster TCM, Inc.
 Tapex Corp.
 3M Co. Magnetic Audio/Video Prod. Div.
 Val-Tronics, Inc.
 Wilkinson Electronics, Inc.

Tape, Magnetic Recording Computer

Ampex Corp.
 Asaca Corp. of America
 Fuji Photo Film USA, Inc. Magnetic Products Dept.
 Memorex Corp. Audio-Video Group
 Systems Marketing Corp.

Tape, Magnetic Recording Test

See Adv. Page
Broadcast Electronics 45

Allied Broadcast Equip.
 Ampex Corp.
 Broadcast Electronics
 Communication Medias
 Fidelipac
 G.C. Electronics
 Harvey Radio
 Lauderdale Electronic Labs
 Mastertone Co., Inc.
 Nortronics Co., Inc.
 Professional Audio Service
 Systems Engineering Co., Inc.
 Systems Marketing Corp.
 Taber Mfg. & Engr. Co.
 Tapex Corp.
 TEAC Corp of America
 Telectro Systems Corp.
 Val-Tronics, Inc.
 Victor Duncan, Inc.
 VIF International

Tape, Magnetic Recording Video

See Adv. Page
Martin Audio/Video152
Studio Tape Exchange168
Television Equipment Associates.....159
The Video Tape Co.149

Ampex Corp.
 Audio Magnetics Corp.
 BSC Inc.
 Communications Systems
 Comquip, Inc.
 Fuji Photo Film USA, Inc. Magnetic Products Dept.
 GEC-Marconi Electronics Ltd.
 Harvey Radio
 Hitachi Shibaden Corp. of America
 Image Devices Inc.
 International Video Corp.
 Irish Magnetic Recording Tape
 Javelin
 Karex, Inc.
 Martin Audio/Video
 Maxell Corp. of America
 Memorex Corp. Audio-Video Group
 Nemo Recording Labs
 Panasonic Video Systems Div.
 Recordex Corp.
 Roscor Corp.
 Sony Corp. of America VTR Div.
 Studio Tape Exchange
 Systems Engineering Co., Inc.
 TEAC Corp of America
 Television Equipment Associates
 3M Co. Magnetic Audio/Video Prod. Div.

R. H. Tyler Co.
 The Video Tape Co.

Tape, Recording Logging

Allied Broadcast Equip.
 Broadcast Automation Assoc.
 Capitol Magnetic Products
 Cine Sonic Sound Inc.
 Lauderdale Electronic Labs
 Maze Corp
 Memorex Corp. Audio-Video Group
 Orange County Corp.
 Singer Products Co., Inc.
 Soundscriber Corp.
 Sparta Electronic Corp.
 Stancil-Hoffman Corp.
 Systems Engineering Co., Inc.
 Systems Marketing Corp.
 Telectro Systems Corp.
 3M Co. Magnetic Audio/Video Prod. Div.

Tape, Time Announced

Camex Corp.
 Communication Medias
 Harris Corp. Broadcast Products Div.
 IGM
 Tape-Athon Corp.
 Tapex Corp.

Tape Cart Loaders

See Adv. Page
Audico, Ltd.166
Broadcast Electronics 45
Ramko Research125

Allied Broadcast Equip.
 Audico, Ltd.
 Birmingham Tape Cartridge Co., Inc.
 Broadcast Electronics
 Cine Sonic Sound Inc.
 Communication Medias
 Electro Sound, Inc.
 Lauderdale Electronic Labs
 Maze Corp
 Orange County Corp.
 Ramko Research
 RCA Corp. Broadcast Systems Div.
 Re-Play Video Cartridge Service
 Spotmaster
 Systems Engineering Co., Inc.

Tape Cassette Loaders

See Adv. Page
Audico, Ltd.166
 Audico, Ltd.

Tape Cassettes

Allied Broadcast Equip.
 Audio Magnetics Corp.
 Capitol Magnetic Products
 Cine Sonic Sound Inc.
 Communications Systems
 Conrac Corp. Cramer Div.
 Fuji Photo Film USA, Inc. Magnetic Products Dept.
 Harvey Radio
 Image Devices Inc.
 Irish Magnetic Recording Tape
 Joa Cartridge Service
 Karex, Inc.
 Mastertone Co., Inc.
 Maxell Corp. of America
 Minneapolis Magnetics, Inc.
 Nemo Recording Labs
 Orange County Corp.
 Philips Audio Video Systems Corp. Broadcast Equip. Div.
 RCA Corp. Broadcast Systems Div.
 Recordex Corp.
 Simpax International
 Sinai-Johnson
 Studio Tape Exchange
 Super 8 Sound, Inc.
 Systems Engineering Co., Inc.
 3M Co. Magnetic Audio/Video Prod. Div.
 R. H. Tyler Co.

Tape Cleaners

See Adv. Page	
Nova Corp.	30
Television Equipment Associates	159

Allied Broadcast Equip.
Audio Magnetics Corp.
G.C. Electronics
Harvey Radio
Lauderdale Electronic Labs
Miller-Stephenson Chemical Co., Inc.
Nortronics Co., Inc.
Nova Corp.
Orange County Corp.
Recortec Inc.
Systems Engineering Co., Inc.
TEAC Corp of America
Television Equipment Associates
3M Co. Magnetic Audio/Video Prod. Div.
R. H. Tyler Co.
Ultra Audio Products

Tape Conditioners, Video

See Adv. Page	
Nova Corp.	30
Recortec Inc.	172

Nova Corp.
Recortec Inc.
Television Equipment Associates

Tape Deck and Turntable Speed Control

Lauderdale Electronic Labs
Orange County Corp.
Orbit Radio and Video
Pacific Recorders and Engrg. Corp. Div. 47B
Val-Tronics, Inc.

Tape Decks, Magnetic --See also Cartridge Machine listings

See Adv. Page	
Ampro Corp.	48
Orange County Corp.	64

Accurate Sound Co.
Allied Broadcast Equip.
Ampro Corp.
Beyer (Revox Corporation)
Broadcast Automation Assoc.
Broadcast Electronics
Camex Corp.
Cetec Audio Div. Subs. Computer Equipment Corp.
Cine Sonic Sound Inc.
Collins Radio Group
Communication Medias
Comquip, Inc.
Conrac Corp. Cramer Div.
Control Design Corp.
Crown International
ELPA Marketing Industries, Inc.
Garron Electronics, Inc.
Glenburn Corp.
Gotham Audio Corp.
Gould Inc.
Heath Co.
IGM
International Tapetronics Corp.
Lang Electronics Inc.
Lauderdale Electronic Labs
Mastertone Co., Inc.
Minneapolis Magnetics, Inc.
Nemo Recording Labs
Orange County Corp.
Otari Corp.
Pacific Recorders and Engrg. Corp. Div. 47B
QRK Electronic Products
Radio Mfg. Co. (RMC)
Rapid-Q
Recordex Corp.
Revox Corp.
Sansui Electronics Corp.
Schafer Electronics Corp.
Scully/Metrotech
Sharp Electronics Corp.
Singer Products Co., Inc.

Soundsciber Corp.
Sparta Electronic Corp.
Spotmaster
Superscope, Inc.
Systems Engineering Co., Inc.
Systems Marketing Corp.
Tape-Athon Corp.
Tapecaster TCM, Inc.
Tapex Corp.
TEAC Corp of America
Telectro Systems Corp.
Telex Communications, Inc.
VIF International
Wilkinson Electronics, Inc.

Tape Duplicators

See Adv. Page	
Cramer Video	148
International Electro-Magnetics	148
Orange County Corp.	64

Allied Broadcast Equip.
Ampex Corp.
Audio Distributor Inc.
Avtel
Broadcast Automation Assoc.
Cetec Audio Div. Subs. Computer Equipment Corp.
Cine Sonic Sound Inc.
Cramer Video
Dolby Laboratories, Inc.
Electro Sound, Inc.
Garner Electronics
International Electro-Magnetics
Lang Electronics Inc.
Lauderdale Electronic Labs
Mastertone Co., Inc.
Maze Corp
Minneapolis Magnetics, Inc.
Nemo Recording Labs
Orange County Corp.
Orbit Radio and Video
Pentagon Industries, Inc.
Philips Audio Video Systems Corp. Broadcast Equip. Div.
Recordex Corp.
Recortec Inc.
SC Electronics, Inc.
Systems Engineering Co., Inc.
Telectro Systems Corp.
Telex Communications, Inc.

Tape Evaluators, Video

See Adv. Page	
Recortec Inc.	173
Television Equipment Associates	159

Auratone
Kaitronics Corp.
Recortec Inc.
Television Equipment Associates

Tape Mastering Devices

See Adv. Page	
Orange County Corp.	64
RCA Corp.	12

Auratone
Electro Sound, Inc.
Orange County Corp.
RCA Corp. Broadcast Systems Div.
Scully/Metrotech
VIF International

Tape Meters

See Adv. Page	
Tentel	169

Communication Medias
Communications 2000, Inc.
Nagra Magnetic Recorders, Inc.
Tapex Corp.
Tentel
Video Accessories Mfg. Co.

Tape Racks, Cartridge

See Adv. Page	
Broadcast Electronics	45
Fidelipac	154
Orange County Corp.	64
Sparta Electronic Corp.	5
Storeel Corp.	12

Allied Broadcast Equip.
Audio Distributor Inc.
Audio Magnetics Corp.
Auratone
Broadcast Automation Assoc.
Broadcast Electronics
Collins Radio Group
Communication Medias
Concept 70
Dyma Engineering, Inc.
Fidelipac
Joa Cartridge Service
Lauderdale Electronic Labs
Mastertone Co., Inc.
Micro-Trak Corp.
Neumade Prod. Corp.
Orange County Corp.
Professional Audio Service
QRK Electronic Products
RCA Corp. Broadcast Systems Div.
RMS Electronics, Inc.
Simpac International
Sound Dynamics, Inc.
Sparta Electronic Corp.
Spotmaster
Storeel Corp.
Systems Engineering Co., Inc.
Tapex Corp.
Val-Tronics, Inc.

Tape Recording Accessories

See Adv. Page	
Fidelipac	154
RCA Corp.	12

Allied Broadcast Equip.
Ampex Corp.
Ampro Corp.
Broadcast Automation Assoc.
Broadcast Electronics
Capitol Magnetic Products
Comquip, Inc.
Control Design Corp.
Electro Sound, Inc.
Electro-Voice Inc.
ELPA Marketing Industries, Inc.
Fidelipac
G.C. Electronics
Harvey Radio
Lauderdale Electronic Labs
Mastertone Co., Inc.
Micro-Trak Corp.
Nagra Magnetic Recorders, Inc.
Nemo Recording Labs
Nortronics Co., Inc.
Orange County Corp.
Professional Audio Service
Ramko Research
RCA Corp. Broadcast Systems Div.
Recortec Inc.
Revox Corp.
Robins/Fairchild
Scully/Metrotech
Sparta Electronic Corp.
Spotmaster
Super 8 Sound, Inc.
Systems Engineering Co., Inc.
Tapex Corp.
TEAC Corp of America
Telectro Systems Corp.
3M Co. Magnetic Audio/Video Prod. Div.
Videomax Corp.
VIF International

Tape Splice Finders

See Adv. Page	
Broadcast Electronics	45
Orange County Corp.	64

Allied Broadcast Equip.
Ampro Corp.
Broadcast Automation Assoc.
Broadcast Electronics

Communication Medias
IGM
Joa Cartridge Service
Lauderdale Electronic Labs
Orange County Corp.
Recortec Inc.
Spotmaster
Systems Engineering Co., Inc.
Tapecaster TCM, Inc.

Tape Splicers

Allied Broadcast Equip.
Audio Distributor Inc.
Broadcast Electronics
Collins Radio Group
Duotone Co. Inc.
Electro Sound, Inc.
ELPA Marketing Industries, Inc.
Fidelipac
G.C. Electronics
Joa Cartridge Service
Lauderdale Electronic Labs
Mastertone Co., Inc.
Nagy Research Products
Nortronics Co., Inc.
Orange County Corp.
Panasonic Video Systems Div.
Professional Audio Service
Revox Corp.
Robins/Fairchild
Spotmaster
Systems Engineering Co., Inc.
Victor Duncan, Inc.

Tape Transport

Allied Broadcast Equip.
Ampro Corp.
Broadcast Automation Assoc.
Broadcast Electronics
Camex Corp.
Cine Sonic Sound Inc.
Conrac Corp. Cramer Div.
Cook Electric Co.
Crown International
Gould Inc.
IGM
Individualized Instruction Inc.
International Tapetronics Corp.
Mastertone Co., Inc.
Maze Corp
Minneapolis Magnetics, Inc.
Nagra Magnetic Recorders, Inc.
Nemo Recording Labs
Orange County Corp.
Radio Mfg. Co. (RMC)
Recordex Corp.
Schafer Electronics Corp.
Sparta Electronic Corp.
Spotmaster
Systems Engineering Co., Inc.
Systems Marketing Corp.
Tape-Athon Corp.
Telectro Systems Corp.
Telex Communications, Inc.
VIF International

Telephone Answering Equipment

See Adv. Page	
Broadcast Electronics	45

Broadcast Electronics
Spotmaster

Telephone Tone Receivers

See Adv. Page	
Audio Services, Inc.	160

Audio Services, Inc.
Comark Industries Inc.
Electronic Designers Inc.
Monroe Electronics, Inc.
Orange County Corp.
Teledata Systems, Inc.
Trepac Corp. America
Video Accessories Mfg. Co.

Telephone Tone Transmitters

Audio Services, Inc.
Comark Industries Inc.
Ikegami Electronics (USA) Inc.

50 men who can put you in touch with some of the best workers in the country.

If you're looking for hard-working, skilled men and women to help your company grow, people trained or educated to work within their disabilities, write to the Director of Vocational Rehabilitation in your state.

ALABAMA:

Mr. George Hudson
Director, Vocational Rehabilitation
State Board of Education
2129 E. South Blvd., Montgomery, Ala. 36111

ALASKA:

Mr. Leslie F. James
Director, Office of Vocational Rehabilitation
Dept. of Education, Pouch F
Alaska Office Bldg., Juneau, Alaska 99801

ARIZONA:

Mr. Thomas G. Tyrrell
Chief, Rehabilitation Services Bureau
Dept. of Economic Security
1535 W. Jefferson, Phoenix, Ariz. 85007

ARKANSAS:

Mr. E. Russell Baxter
Commissioner of Rehabilitation Service
Dept. of Social and Rehabilitative Services
P.O. Box 3781, Little Rock, Ark. 72203

CALIFORNIA:

Mr. Alan C. Nelson
Director, Dept. of Rehabilitation
California Human Relations Agency
714 P Street, Sacramento, Calif. 95814

COLORADO:

Dr. Parnell McLaughlin
Director, Division of Rehabilitation
State Dept. of Social Services
916 Social Services Bldg., Denver, Colo. 80203

CONNECTICUT:

Dr. James S. Peters, II
Associate Commissioner
Conn. Division of Vocational Rehabilitation
600 Asylum Ave., Hartford, Conn. 06105

DELAWARE:

Mr. Don Kappes, Acting Director
Vocational Rehabilitation Service
Dept. of Labor, 1500 Shallcross Ave.
P.O. Box 1190, Wilmington, Del. 19899

FLORIDA:

Mr. Craig Mills
Director, Division of Vocational Rehabilitation
725 S. Bronough St., Room 254
Tallahassee, Florida 32304

GEORGIA:

Mr. Nathan Nolan
Director, Division of Vocational Rehabilitation
Dept. of Human Resources
47 Trinity Ave., Atlanta, Georgia 30334

HAWAII:

Mr. Kuniji Sagara
Administrator, Vocational Rehabilitation
Dept. of Social Services
P.O. Box 339, Honolulu, Hawaii 96809

IDAHO:

Mr. Ray W. Turner
Director, Vocational Rehabilitation Services
State Board for Vocational Education
1501 McKinney, Boise, Idaho 83704

ILLINOIS:

Mr. Alfred Slicer
Director, Division of Vocational Rehabilitation
State Bd. of Vocational Ed. & Rehabilitation
623 E. Adams St., Springfield, Ill. 62706

INDIANA:

Mr. Walter Penrod
Executive Officer, Rehabilitation Services Bd.
1012 Illinois Building
17 W. Market St., Indianapolis, Ind. 46204

IOWA:

Mr. Jerry L. Starkweather, Director
Div. of Rehabilitation Ed. & Services
State Board of Public Instruction
801 Bankers Trust Bldg., Des Moines, Iowa 50309

KANSAS:

Mr. Frank F. Hoge, Acting Director
Division of Vocational Rehabilitation
6th Floor, State Office Bldg.
Topeka, Kansas 66612

KENTUCKY:

Mr. Ben F. Coffman
Asst. Superintendent for Rehabilitation
State Board of Education, State Office Bldg.
High Street, Frankfort, Ky. 40601

LOUISIANA:

Mr. A. Gus Landry
Director, Division of Vocational Rehabilitation
State Board of Education
P.O. Box 44371, Baton Rouge, La. 70804

MAINE:

Mr. C. Owen Pollard
Director, Bureau of Rehabilitation Services
Dept. of Health and Welfare
32 Winthrop St., Augusta, Maine 04330

MARYLAND:

Mr. J. Leo Delaney, Asst. State Superintendent
State Board of Vocational Education
P.O. Box 8717, Friendship International Airport
Baltimore, Maryland 21240

MASSACHUSETTS:

Mr. Russell E. O'Connell, Commissioner
Massachusetts Rehabilitation Commission
296 Boylston St., Boston, Mass. 02116

MICHIGAN:

Dr. Ralf A. Peckham
Dir. for Vocational Rehabilitation Services
P.O. Box 1016, Lansing, Mich. 48904

MINNESOTA:

Mr. August W. Gehrke, Asst. Commissioner
Division of Vocational Rehabilitation
1745 University Ave., St. Paul, Minn. 55104

MISSISSIPPI:

Mr. John Webb
Dir., Division of Vocational Rehabilitation
1304 Walter Sillers State Office Bldg.
P.O. Box 1698, Jackson, Miss. 39205

MISSOURI:

Mr. William H. Keith, Coordinator
Section of Vocational Rehabilitation
State Board of Education, Farm Bureau Bldg.
1616 Missouri Blvd., Jefferson City, Mo. 65101

MONTANA:

Mr. J. C. Carver, Administrator
Rehabilitative Services Division
Dept. of Social and Rehabilitation Services
506 Power Block, Helena, Montana 59601

NEBRASKA:

Mr. Garry D. Cartwright, Asst. Commissioner
and Director, Division of Rehabilitation Services
233 South 10th St., Lincoln, Neb. 68508

NEVADA:

Mr. Delbert E. Frost, Administrator
Rehabilitation Division, State Dept. of Health,
Welfare, and Rehabilitation
308 N. Curry St., Carson City, Nev. 89701

NEW HAMPSHIRE:

Mr. Bruce Archambault
Chief, Vocational Rehabilitation Division
105 Loudon Rd., Bldg. 3, Concord, N.H. 03301

NEW JERSEY:

Mr. Arthur J. Sinclair, Director
New Jersey Rehabilitation Commission
Dept. of Labor and Industry
John Fitch Plaza, Trenton, N.J. 08625

NEW MEXICO:

Dr. Robert A. Swanson
Asst. Superintendent for Vocational Rehab.
Dept. of Education, P.O. Box 1830
Santa Fe, N.M. 87501

NEW YORK:

Mr. Adrian Levy, Assoc. Commissioner
The State Education Dept.
Office of Vocational Rehabilitation
99 Washington Ave., Albany, N.Y. 12210

NORTH CAROLINA:

Mr. Claude A. Myer, Administrator
Division of Vocational Rehabilitation
Dept. of Human Resources, 620 N. West St.
P.O. Box 26053, Raleigh, N.C. 27611

NORTH DAKOTA:

Mr. James O. Fine, Director
N.D. Division of Vocational Rehabilitation
1025 N. Third St., Bismarck, N.D. 58501

OHIO:

Mr. Denver L. White, Administrator
Ohio Rehabilitation Services Commission
4656 Heaton Rd., Columbus, Ohio 43229

OKLAHOMA:

Mr. Lowell E. Green, Administrative Asst.
Division of Rehabilitative and Visual Services
P.O. Box 25352, Oklahoma City, Okla. 73125

OREGON:

Mr. Norm Silver, Administrator
State Vocational Rehabilitation Division
Dept. of Human Resources
680 Cottage St., N.E., Salem, Oregon 97310

PENNSYLVANIA:

Mr. John A. Hagan, Director
Bureau of Vocational Rehabilitation
Labor and Industry Bldg.
7th and Forster Sts. Harrisburg, Penn. 17120

RHODE ISLAND:

Mr. Edward Carley
Chief, Division of Vocational Rehabilitation
40 Fountain St., Providence, R.I. 02903

SOUTH CAROLINA:

Dr. Dill D. Beckman, Commissioner
Vocational Rehabilitation Dept.
400 Wade Hampton State Office Bldg.
Columbia, S.C. 29201

SOUTH DAKOTA:

Mr. Ben F. Hins
Director, Division of Vocational Rehabilitation
200 West Pleasant Dr., Pierre, S.D. 57501

TENNESSEE:

Mr. O. E. Reece, Asst. Commissioner
Division of Vocational Rehabilitation
Suite 1400—1808 West End Bldg.
Nashville, Tenn. 37203

TEXAS:

Mr. Jess Irwin, Jr., Commissioner
Texas Rehabilitation Commission
1600 W. 38th St., Austin, Texas 78705

UTAH:

Dr. Harvey C. Hirschi, Administrator
Division of Rehabilitation Services
1200 University Club Bldg.
136 E. South Temple, Salt Lake City, Utah 84111

VERMONT:

Mr. Richard W. Hill
Director, Vocational Rehabilitation Division
Agency of Human Services
56 State St., Montpelier, Vt. 05602

VIRGINIA:

Mr. Don W. Russell, Commissioner
State Dept. of Vocational Rehabilitation
4615 W. Broad St., P.O. Box 11045
Richmond, Va. 23230

WASHINGTON:

Mr. Peter M. Jamero, Asst. Secretary
Vocational Rehabilitation Services Division
Dept. of Social and Health Services
P.O. Box 1788, Olympia, Wash. 98504

WEST VIRGINIA:

Mr. Thorold S. Funk, Director
Division of Vocational Rehabilitation
State Board of Vocational Education, P&G Bldg.
2019 Washington East, Charleston, W. Va. 25305

WISCONSIN:

Mr. Adrian E. Towne, Administrator
Division of Vocational Rehabilitation
Dept. of Health and Social Services
1 West Wilson St., Room 685
Madison, Wis. 53702

WYOMING:

Mr. L. Owen Barnett, Administrator
Division of Vocational Rehabilitation
State Office Bldg., Room 305
Cheyenne, Wyo. 82001



Monroe Electronics, Inc.
Orange County Corp.
Trepac Corp. America

Teletype Noise Reducer Cabinets

Dyma Engineering, Inc.

Termination Units

See Adv. Page
Micro Communications, Inc. 36

Bird Electronic Corp.
Electro Impulse, Inc.
Holland Electronics
Hollingsworth Solderless Terminal Co.
Micro Communications, Inc.
RMS Electronics, Inc.
Systron-Donner

Test Chart Pattern Illuminators

See Adv. Page
Television Equipment Associates..... 159

Television Equipment Associates

Test Charts, Camera

ATV Research
GEC-Marconi Electronics Ltd.
Harris Corp. Broadcast Products Div.
Image Devices Inc.
RCA Corp. Broadcast Systems Div.
Telecommunications Industries Ltd.

Test Records

B & K Instruments Inc.
G.C. Electronics
Gotham Audio Corp.
Lauderdale Electronic Labs
Mastertone Co., Inc.
Shure Brothers Inc.

Test Sets, Multifunction

See Adv. Page
Val-Tronics, Inc...... 160

Ailtech
Amber Electro Design, Ltd.
American Data Corp.
Control Concepts Corp.
ELPA Marketing Industries, Inc.
Kay Elemetrics Corp.
Lenco Inc.
ROH Corporation
Sadelco, Inc.
Singer Instrumentation
Singer Products Co., Inc.
Systron-Donner
Telecommunications Industries Ltd.
Telemet, a Geotel Co.
Thompson-CSF Laboratories, Inc.
Val-Tronics, Inc.

Test Sets, Vertical Interval

American Data Corp.
Broadcast Video Systems, Ltd.
Lenco Inc.
Telemet, a Geotel Co.

Test Slides, Video

See Adv. Page
D and S Corley Ltd. 54
Television Equipment Associates..... 159

D and S Corley Ltd.
Marconi Electronics Inc.
Telecommunications Industries Ltd.
Television Equipment Associates
Teltron Inc.

Test Tapes, Audio

See Adv. Page
Broadcast Electronics 45
Fidelipac 154
Orange County Corp. 64
Sound Dynamics, Inc. 174

Allied Broadcast Equip.
Ampex Corp.
Ampro Corp.
Audio Distributor Inc.
Broadcast Electronics
Fidelipac
Gotham Audio Corp.
Harvey Radio
Lauderdale Electronic Labs
Mastertone Co., Inc.
Nortronics Co., Inc.
Orange County Corp.
Professional Audio Service
Sound Dynamics, Inc.
Sparta Electronic Corp.
Taber Mfg. & Engr. Co.
Tapex Corp.
TEAC Corp of America
VIF International

Testers, Semiconductor

Biomation Corp.
Datatron, Inc.
Delta Electronics Inc. (N.C.)
Dynascan Corp.
Eico Elect. Inst. Co., Inc.
Harvey Radio
Heath Co.
Hickok Elect. Instrument
Leader Instruments Corp.
Lectrotech Inc.
PRD Electronics, Inc.
RCA Corp. Distributor & Special Products Div.
Rohde & Schwarz Sales Co.
Sencore Inc.
Simpson Electric Co.
Sinai-Johnson
SPI-ITT Metrix Instruments Div.
Tektronix Inc.
Terminal Electronics Corp.
Testline Instruments, Inc.
Triplett Corp.

Testers, Tape Recorder

Amber Electro Design, Ltd.
ELPA Marketing Industries, Inc.
Fidelipac
Marconi Instruments
Maze Corp

Testers, Vacuum Tube

Dynascan Corp.
Eico Elect. Inst. Co., Inc.
Heath Co.
Hickok Elect. Instrument
Leader Instruments Corp.
Lectrotech Inc.
Sencore Inc.
Sinai-Johnson
Singer Products Co., Inc.
SPI-ITT Metrix Instruments Div.
Terminal Electronics Corp.
Triplett Corp.

Textbooks, Communications

Audio Distributor Inc.
Jones Int'l. Ltd.
Howard W. Sams & Co., Inc.

Time Announcers

See Adv. Page
Control Design Corp...... 137

Allied Broadcast Equip.
Camex Corp.
Control Design Corp.
ESE
IGM
Mastertone Co., Inc.
Rek-O-Kut Inc.
Schafer Electronics Corp.

Sparta Electronic Corp.
Stancil-Hoffman Corp.
Systems Marketing Corp.
Tape-Athon Corp.

Time Base Corrector, Helical Scan and Quad

See Adv. Page
Microtime, Inc. 134

Ampex Corp.
Communications Systems
Consolidated Video Systems
Edutron, Inc.
Harvey Radio
International Video Corp.
Kansas State Network, Inc.
Microtime, Inc.
Roscor Corp.
Systa-Matics, Inc.

Timers, Program

See Adv. Page
Cooke Engineering Co. 37
ESE 40
Vamco Engineering 23

Allied Broadcast Equip.
American Data Corp.
Audio Services, Inc.
Conrac Corp. Cramer Div.
Cooke Engineering Co.
Dyma Engineering, Inc.
Dynasciences Video Products
ESE
Gotham Audio Corp.
IGM
Pacific Recorders and Engrg. Corp. Div. 47B
Recortec Inc.
Standard Electric Time
Tapecaster TCM, Inc.
Telemedia Electronics
Total Technology
Vamco Engineering
Video Accessories Mfg. Co.
Video Concepts, Inc.
Video Devices Co.
VIF International

Timers, Videotape

See Adv. Page
Control Design Corp...... 137
Recortec Inc. 154
Vamco Engineering 23

Control Design Corp.
Dynasciences Video Products
ESE
Recortec Inc.
Telemedia Electronics
Vamco Engineering
Video Accessories Mfg. Co.
Video Concepts, Inc.

Titling Systems

See Adv. Page
Chiron Telesystems..... 44
Video Data Systems, Inc...... 171

Chiron Telesystems
Communications Systems
Datavision Video Products
Reynolds/Leteron Co.
Systa-Matics, Inc.
Vicon Industries, Inc.
Video Accessories Mfg. Co.
Video Data Systems, Inc.

Tool Kits

A-Tel-A-Matic
Automation Products Co.
Channellock, Inc.
G.C. Electronics
Heath Co.
Image Devices Inc.
Jensen Tools & Alloys

Lauderdale Electronic Labs
Nagra Magnetic Recorders, Inc.
P. K. Neuses Inc.
Systems Marketing Corp.
Terminal Electronics Corp.
Upton Tools Inc.
Vaco Products Co.
Western Electronic Prods. Co.

Tower Beacon Light Flashers

See Adv. Page
Flash Technology Corp. of America 144
Hughey & Phillips Inc. 161
SSAC Precision Products, Inc. 168

Collins Radio Group
Crouse Hinds Lighting Products Div.
Flash Technology Corp. of America
Harris Corp. Broadcast Products Div.
Hughey & Phillips Inc.
Jampro Antenna Co.
Mastertone Co., Inc.
Radio Mfg. Co. (RMC)
SSAC Precision Products, Inc.
Triangle Towers & Antennas
Unarco-Rohn
Utility Tower Co.

Tower Guys --See Antenna and Tower Guys

Philadelphia Resins Corp.

Tower Installation and Services - -See Antenna and Tower Installation and Services

Tower Light Failure Alarms

See Adv. Page
Hughey & Phillips Inc. 161

Crouse Hinds Lighting Products Div.
Harris Corp. Broadcast Products Div.
Hughey & Phillips Inc.
Utility Tower Co.

Tower Light Indicator Panels

See Adv. Page
Hughey & Phillips Inc. 161

Collins Radio Group
Crouse Hinds Lighting Products Div.
Fisher-Burke Broadcast Consultants
Hughey & Phillips Inc.
Mastertone Co., Inc.

Tower Lighting Isolation Transformers

See Adv. Page
Hughey & Phillips Inc. 161

Collins Radio Group
Decca Austin Insulators
Fisher-Burke Broadcast Consultants
Harris Corp. Broadcast Products Div.
Hughey & Phillips Inc.
Jampro Antenna Co.
Mastertone Co., Inc.
North American Radio Corp.

Tower Lights, High Intensity Obstruction

See Adv. Page
Flash Technology Corp. of America 144

Crouse Hinds Lighting Products Div.
Dielectric Communications
Flash Technology Corp. of America
Harris Corp. Broadcast Products Div.
Lauderdale Electronic Labs
Triangle Towers & Antennas



Let us send you 33 proven ways to conserve energy in your business

Frederick B. Dent
Secretary of Commerce

These 33 ways to save energy will also save you money. You will find them in a free booklet we have just gotten together with the help of businessmen like yourself. Because it is based on actual company case histories, almost any business is sure to find some ways to save money from this comprehensive list.

And if you send for our "33 Ways" booklet, we will send you something else: "How to Start An Energy Management Program." It is filled with all the basic information you will need to get your energy savings plan underway. Like how to organize management resources. How to conduct an energy audit. How to set energy conservation goals. And how to involve your employees and community.

The energy crisis is now a serious reality. But it is something that we all can do something about. One of the best ways to start is to send for these two booklets.

savEnergy



To: U.S. DEPARTMENT OF COMMERCE
Office of Energy Programs • Washington, D.C. 20230

Please send me your two free booklets on "33 Money-Saving Ways to Conserve Energy" and "How to Start an Energy Management Program."

Name _____

Title _____

Company _____

Address _____

City _____ State _____ ZIP _____

Type of Business _____

Towers, Antenna

See Adv. Page

Stainless, Inc. 120
Val-Tronics, Inc. 160

Allied Broadcast Equip.
 Allied Tower Company, Inc.
 Andrews Tower Inc.
 Antenna Products Co.
 Collins Radio Group
 Dyma Engineering, Inc.
 E-Z Way Products, Inc.
 Fort Worth Tower Co., Inc.
 G.C. Electronics
 Harris Corp. Broadcast Products Div.
 Jampro Antenna Co.
 Kline Iron & Steel Co.
 Mastertone Co., Inc.
 RF Systems, Inc.
 Sparta Electronic Corp.
 Stainless, Inc.
 Swager Tower Corp.
 Triangle Towers & Antennas
 Tri-Ex Tower Corp.
 Unarco-Rohn
 Up-Right, Inc.
 Utility Tower Co.
 Val-Tronics, Inc.

Towers, Antenna Receiving

See Adv. Page

Stainless, Inc. 120

Allied Tower Company, Inc.
 Andrews Tower Inc.
 Antenna Products Co.
 E-Z Way Products, Inc.
 RF Systems, Inc.
 Singer Products Co., Inc.
 Stainless, Inc.
 Swager Tower Corp.
 Triangle Towers & Antennas
 Tri-Ex Tower Corp.
 Unarco-Rohn
 Up-Right, Inc.
 Utility Tower Co.

Towers, Antenna Transmitting AM

See Adv. Page

Stainless, Inc. 120
Val-Tronics, Inc. 160

Allied Broadcast Equip.
 Allied Tower Company, Inc.
 Andrews Tower Inc.
 Antenna Products Co.
 Collins Radio Group
 E-Z Way Products, Inc.
 Fort Worth Tower Co., Inc.
 Harris Corp. Broadcast Products Div.
 Jampro Antenna Co.
 Kline Iron & Steel Co.
 Mastertone Co., Inc.
 RCA Corp. Broadcast Systems Div.
 Singer Products Co., Inc.
 Sparta Electronic Corp.
 Stainless, Inc.
 Swager Tower Corp.
 Triangle Towers & Antennas
 Tri-Ex Tower Corp.
 Unarco-Rohn
 Up-Right, Inc.
 Utility Tower Co.
 Val-Tronics, Inc.
 Wilkinson Electronics, Inc.

Towers, Antenna Transmitting FM

See Adv. Page

Val-Tronics, Inc. 160

Allied Broadcast Equip.
 Allied Tower Company, Inc.
 Andrews Tower Inc.
 Antenna Products Co.
 Collins Radio Group
 E-Z Way Products, Inc.
 Fort Worth Tower Co., Inc.
 Harris Corp. Broadcast Products Div.

Jampro Antenna Co.
 Kline Iron & Steel Co.
 Mastertone Co., Inc.
 RCA Corp. Broadcast Systems Div.
 Shively Laboratories, Inc.
 Singer Products Co., Inc.
 Sparta Electronic Corp.
 Stainless, Inc.
 Swager Tower Corp.
 Triangle Towers & Antennas
 Unarco-Rohn
 Up-Right, Inc.
 Utility Tower Co.
 Val-Tronics, Inc.
 Wilkinson Electronics, Inc.

Towers, Antenna Transmitting TV

See Adv. Page

Stainless, Inc. 120
Val-Tronics, Inc. 160

Allied Tower Company, Inc.
 Andrews Tower Inc.
 Antenna Products Co.
 Fort Worth Tower Co., Inc.
 Harris Corp. Broadcast Products Div.
 Jampro Antenna Co.
 Kline Iron & Steel Co.
 RCA Corp. Broadcast Systems Div.
 Shively Laboratories, Inc.
 Singer Products Co., Inc.
 Sparta Electronic Corp.
 Stainless, Inc.
 Swager Tower Corp.
 Triangle Towers & Antennas
 Tri-Ex Tower Corp.
 Unarco-Rohn
 Up-Right, Inc.
 Utility Tower Co.
 Val-Tronics, Inc.

Transformers, Audio

See Adv. Page

Modular Audio Products 146
Orange County Corp. 64,158

Altec Sound Products
 Electro-Voice Inc.
 Gotham Audio Corp.
 Modular Audio Products
 Northlake Engineering, Inc.
 Opamp Lamps, Inc.
 Orange County Corp.
 Quad-Eight Electronics
 Revox Corp.
 Senstrol Div.
 Shure Brothers Inc.

Transformers, RF Sampling

See Adv. Page

Delta Electronics Inc. (Va.) 59

Delta Electronics Inc. (Va.)
 Harris Corp. Broadcast Products Div.
 Val-Tronics, Inc.

Translator Repair Parts

See Adv. Page

Television Technology Corp. 168

Acrodyne Industries Inc.
 Television Technology Corp.
 Tepco Corp.

Translator Systems, High Power

See Adv. Page

Acrodyne Industries Inc. 62
Rolane Sales Corp. 160
Television Technology Corp. 168
Tepco Corp. 166

Acrodyne Industries Inc.
 EMCEE Broadcast Products
 Jampro Antenna Co.
 D. N. Latus & Co., Inc.
 Nippon Electric Co., Ltd.
 Rolane Sales Corp.
 Television Technology Corp.
 Tepco Corp.
 Thompson-CSF, Inc.

Translator Systems, Low Power

See Adv. Page

Acrodyne Industries Inc. 62
Rolane Sales Corp. 160
Television Technology Corp. 168
Tepco Corp. 166

Acrodyne Industries Inc.
 Contel Mfg.
 Dyma Engineering, Inc.
 EMCEE Broadcast Products
 Harris Corp. Broadcast Products Div.
 Ikegami Electronics (USA) Inc.
 Jampro Antenna Co.
 D. N. Latus & Co., Inc.
 Marconi Electronics Inc.
 Nippon Electric Co., Ltd.
 RF Systems, Inc.
 Rodelco Corp.
 Rohde & Schwarz Sales Co.
 Rolane Sales Corp.
 Scientific-Atlanta, Inc.
 Singer Products Co., Inc.
 Television Technology Corp.
 Tepco Corp.
 Thompson-CSF, Inc.

Transmission Lines

See Adv. Page

Micro Communications, Inc. 36
Val-Tronics, Inc. 171

Allied Broadcast Equip.
 Andrew Corp.
 Belden Corp.
 Broadcast Automation Assoc.
 Cablewave Systems Inc.
 Collins Radio Group
 Comark Industries Inc.
 Continental Electronics Mfg. Co.
 Dyma Engineering, Inc.
 The Finney Co.
 Harris Corp. Broadcast Products Div.
 Jampro Antenna Co.
 Mastertone Co., Inc.
 Maury Microwave Corp.
 Micro Communications, Inc.
 Phelps Dodge Communications Co.
 Radio Mfg. Co. (RMC)
 RCA Corp. Broadcast Systems Div.
 Saxton Prod. Inc.
 Shively Laboratories, Inc.
 Singer Products Co., Inc.
 Sparta Electronic Corp.
 Val-Tronics, Inc.
 Wilkinson Electronics, Inc.

Transmission Sets

Cablewave Systems Inc.
 GTE Lenkurt, Inc.
 United Recording Electronics Industries

Transmitter Kits

Harris Corp. Broadcast Products Div.
 Heath Co.
 McMartin Industries, Inc.

Transmitters, AM Carrier

See Adv. Page

LPB Inc. 152
Val-Tronics, Inc. 171

Allied Broadcast Equip.
 Bristol Div.
 Broadcast Automation Assoc.

CCA Electronics Corp.
 Ceco Communications Inc.
 Dyma Engineering, Inc.
 GEC-Marconi Electronics Ltd.
 GTE Lenkurt, Inc.
 LPB Inc.
 Mastertone Co., Inc.
 Maze Corp.
 North American Radio Corp.
 Orange County Corp.
 Radio Mfg. Co. (RMC)
 Singer Products Co., Inc.
 Sparta Electronic Corp.
 Tapex Corp.
 Val-Tronics, Inc.

Transmitters, AM Low Power

See Adv. Page

LPB Inc. 152

Ailtech
 Allied Broadcast Equip.
 Bogen Div.
 CCA Electronics Corp.
 Collins Radio Group
 GEC-Marconi Electronics Ltd.
 Ikegami Electronics (USA) Inc.
 LPB Inc.
 Mastertone Co., Inc.
 North American Radio Corp.
 Orange County Corp.
 RHA Audio Communications Corp.
 Singer Products Co., Inc.
 Sparta Electronic Corp.

Transmitters, AM 250 Watt

See Adv. Page

Orange County Corp. 64

AEL, Inc.
 Allied Broadcast Equip.
 Bogen Div.
 CCA Electronics Corp.
 Collins Radio Group
 GEC-Marconi Electronics Ltd.
 Harris Corp. Broadcast Products Div.
 Mastertone Co., Inc.
 McMartin Industries, Inc.
 Orange County Corp.
 Radio Mfg. Co. (RMC)
 RCA Corp. Broadcast Systems Div.
 Singer Products Co., Inc.
 Sintronic Corp.
 Sparta Electronic Corp.
 Wilkinson Electronics, Inc.

Transmitters, AM 500 Watt

See Adv. Page

Orange County Corp. 64

AEL, Inc.
 Allied Broadcast Equip.
 CCA Electronics Corp.
 Collins Radio Group
 GEC-Marconi Electronics Ltd.
 Harris Corp. Broadcast Products Div.
 Mastertone Co., Inc.
 McMartin Industries, Inc.
 Orange County Corp.
 RCA Corp. Broadcast Systems Div.
 Singer Products Co., Inc.
 Sintronic Corp.
 Sparta Electronic Corp.
 Wilkinson Electronics, Inc.

Transmitters, AM 1 kw

See Adv. Page

Orange County Corp. 64
Sparta Electronic Corp. 5
Wilkinson Electronics, Inc. 157

AEL, Inc.
 Allied Broadcast Equip.
 CCA Electronics Corp.
 Collins Radio Group
 Contel Mfg.
 GEC-Marconi Electronics Ltd.
 Harris Corp. Broadcast Products Div.
 Kahn Communications, Inc.

Think of what just one company can do to stop pollution. We have.

**WHAT
INDUSTRY
IS DOING
TO STOP
POLLUTION**



Keep America Beautiful, Inc.
99 Park Avenue
New York, New York 10016

Please send me a free copy of
"What industry is doing to stop pollution."

Name _____

Street _____

City _____

State _____ Zip _____

Twenty years ago some farsighted businessmen had an idea. To establish an organization to combat littering. They called it Keep America Beautiful, Inc.

Since then, KAB, Inc. has led a national movement to stop not just littering. But pollution as well. A movement that involves

almost 70 million Americans.

To show you what companies like yours are doing to fight pollution, we've put together this folder, "What industry is doing to stop pollution."

It's a special way to celebrate our first twenty years.

People start pollution. People can stop it.



A Public Service of
This Magazine &
The Advertising Council

Keep America Beautiful
99 Park Avenue, New York, New York 10016



Marconi Electronics Inc.
 Mastertone Co., Inc.
 McMartin Industries, Inc.
 Orange County Corp.
 RCA Corp. Broadcast Systems Div.
 Singer Products Co., Inc.
 Sintronic Corp.
 Sparta Electronic Corp.
 Val-Tronics, Inc.
 Wilkinson Electronics, Inc.

Transmitters, AM 2.5 kw

See Adv. Page

Orange County Corp. 64
 Sparta Electronic Corp. 5

Orange County Corp.
 Sparta Electronic Corp.

Transmitters, AM 3 kw

See Adv. Page

Orange County Corp. 64

CCA Electronics Corp.
 GEC-Marconi Electronics Ltd.
 Harris Corp. Broadcast Products Div.
 Orange County Corp.
 RCA Corp. Broadcast Systems Div.
 Singer Products Co., Inc.
 Sparta Electronic Corp.
 Wilkinson Electronics, Inc.

Transmitters, AM 5 kw

See Adv. Page

Continental Electronics
 Mfg. Co. 163,167
 Orange County Corp. 64
 Wilkinson Electronics,
 Inc. 157

AEL, Inc.
 CCA Electronics Corp.
 Collins Radio Group
 Contel Mfg.
 Continental Electronics Mfg. Co.
 GEC-Marconi Electronics Ltd.
 Harris Corp. Broadcast Products Div.
 Mastertone Co., Inc.
 Orange County Corp.
 RCA Corp. Broadcast Systems Div.
 Singer Products Co., Inc.
 Sintronic Corp.
 Sparta Electronic Corp.
 Val-Tronics, Inc.
 Wilkinson Electronics, Inc.

Transmitters, AM 10 kw

See Adv. Page

Continental Electronics
 Mfg. Co. 167,163
 Orange County Corp. 64
 Wilkinson Electronics,
 Inc. 157

AEL, Inc.
 CCA Electronics Corp.
 Collins Radio Group
 Contel Mfg.
 Continental Electronics Mfg. Co.
 GEC-Marconi Electronics Ltd.
 Harris Corp. Broadcast Products Div.
 Marconi Electronics Inc.
 Mastertone Co., Inc.
 Orange County Corp.
 RCA Corp. Broadcast Systems Div.
 Singer Products Co., Inc.
 Sintronic Corp.
 Sparta Electronic Corp.
 Wilkinson Electronics, Inc.

Transmitters, AM 15 kw

See Adv. Page

Orange County Corp. 64

Collins Radio Group
 GEC-Marconi Electronics Ltd.
 Harris Corp. Broadcast Products Div.

Orange County Corp.
 Singer Products Co., Inc.
 Sparta Electronic Corp.

Transmitters, AM 25 kw

See Adv. Page

CCA Electronics Corp. 174
 Orange County Corp. 64

AEL, Inc.
 CCA Electronics Corp.
 Contel Mfg.
 Continental Electronics Mfg. Co.
 GEC-Marconi Electronics Ltd.
 Harris Corp. Broadcast Products Div.
 Orange County Corp.
 Singer Products Co., Inc.
 Sparta Electronic Corp.

Transmitters, AM 50 kw

See Adv. Page

CCA Electronics Corp. 174
 Continental Electronics
 Mfg. Co. 164
 Orange County Corp. 64
 Wilkinson Electronics,
 Inc. 157

AEL, Inc.
 CCA Electronics Corp.
 Continental Electronics Mfg. Co.
 GEC-Marconi Electronics Ltd.
 General Electric Co. ISO Div.
 Harris Corp. Broadcast Products Div.
 Marconi Electronics Inc.
 Nippon Electric Co., Ltd.
 North American Radio Corp.
 Orange County Corp.
 RCA Corp. Broadcast Systems Div.
 Singer Products Co., Inc.
 Sintronic Corp.
 Wilkinson Electronics, Inc.

Transmitters, AM over 50 kw

AEL, Inc.
 CCA Electronics Corp.
 Continental Electronics Mfg. Co.
 GEC-Marconi Electronics Ltd.
 Harris Corp. Broadcast Products Div.
 Marconi Electronics Inc.
 Nippon Electric Co., Ltd.
 North American Radio Corp.
 Orange County Corp.
 RCA Corp. Broadcast Systems Div.
 Singer Products Co., Inc.

Transmitters, AM to order

AEL, Inc.
 CCA Electronics Corp.
 Collins Radio Group
 Continental Electronics Mfg. Co.
 Fisher-Burke Broadcast Consultants
 GEC-Marconi Electronics Ltd.
 Harris Corp. Broadcast Products Div.
 Nippon Electric Co., Ltd.
 North American Radio Corp.
 Orange County Corp.
 Singer Products Co., Inc.
 Sparta Electronic Corp.
 Transcom Electronics, Inc.
 Wilkinson Electronics, Inc.

Transmitters, FM

See Adv. Page

Val-Tronics, Inc. 171

AEL, Inc.
 Ailtech
 Allied Broadcast Equip.
 Bristol Div.
 Broadcast Automation Assoc.
 CCA Electronics Corp.
 Ceco Communications Inc.
 Collins Radio Group
 Dyma Engineering, Inc.
 Fung Engineering Inc.
 GEC-Marconi Electronics Ltd.
 GTE Lenkurt, Inc.
 Harris Corp. Broadcast Products Div.

Ikegami Electronics (USA) Inc.
 Image Devices Inc.
 Marconi Electronics Inc.
 Mastertone Co., Inc.
 Maze Corp.
 McMartin Industries, Inc.
 Miles Reproducer Co.
 Nippon Electric Co., Ltd.
 North American Radio Corp.
 Orange County Corp.
 RCA Corp. Broadcast Systems Div.
 Singer Products Co., Inc.
 Sintronic Corp.
 Sparta Electronic Corp.
 Tapex Corp.
 Thompson-CSF, Inc.
 Val-Tronics, Inc.
 Wilkinson Electronics, Inc.

Transmitters, FM 10 Watt

See Adv. Page

Collins Radio Group 51
 LPB Inc. 152
 Orange County Corp. 64
 Wilkinson Electronics,
 Inc. 157

AEL, Inc.
 Ailtech
 Allied Broadcast Equip.
 CCA Electronics Corp.
 Collins Radio Group
 GEC-Marconi Electronics Ltd.
 GTE Lenkurt, Inc.
 Harris Corp. Broadcast Products Div.
 LPB Inc.
 Mastertone Co., Inc.
 McMartin Industries, Inc.
 Orange County Corp.
 RCA Corp. Broadcast Systems Div.
 Rohde & Schwarz Sales Co.
 Singer Products Co., Inc.
 Sintronic Corp.
 Sparta Electronic Corp.
 Wilkinson Electronics, Inc.

Transmitters, FM 50 Watt

See Adv. Page

Orange County Corp. 64

AEL, Inc.
 Ailtech
 Allied Broadcast Equip.
 CCA Electronics Corp.
 GEC-Marconi Electronics Ltd.
 Harris Corp. Broadcast Products Div.
 Mastertone Co., Inc.
 Orange County Corp.
 Rohde & Schwarz Sales Co.
 Singer Products Co., Inc.
 Sintronic Corp.
 Wilkinson Electronics, Inc.

Transmitters, FM 100 Watt

See Adv. Page

Orange County Corp. 64
 Wilkinson Electronics,
 Inc. 157

AEL, Inc.
 CCA Electronics Corp.
 GEC-Marconi Electronics Ltd.
 Harris Corp. Broadcast Products Div.
 Mastertone Co., Inc.
 Orange County Corp.
 Singer Products Co., Inc.
 Sintronic Corp.
 Wilkinson Electronics, Inc.

Transmitters, FM 250 Watt

See Adv. Page

Orange County Corp. 64
 Sparta Electronic Corp. 5
 Wilkinson Electronics,
 Inc. 157

AEL, Inc.
 Allied Broadcast Equip.
 CCA Electronics Corp.

GEC-Marconi Electronics Ltd.
 Harris Corp. Broadcast Products Div.
 Mastertone Co., Inc.
 North American Radio Corp.
 Orange County Corp.
 Singer Products Co., Inc.
 Sintronic Corp.
 Sparta Electronic Corp.
 Wilkinson Electronics, Inc.

Transmitters, FM 500 Watt

See Adv. Page

Orange County Corp. 64

CCA Electronics Corp.
 Collins Radio Group
 GEC-Marconi Electronics Ltd.
 Harris Corp. Broadcast Products Div.
 Mastertone Co., Inc.
 Orange County Corp.
 RCA Corp. Broadcast Systems Div.
 Singer Products Co., Inc.
 Sparta Electronic Corp.
 Wilkinson Electronics, Inc.

Transmitters, FM 1 kw

See Adv. Page

Orange County Corp. 64
 Wilkinson Electronics,
 Inc. 157

AEL, Inc.
 Allied Broadcast Equip.
 CCA Electronics Corp.
 Collins Radio Group
 Fung Engineering Inc.
 GEC-Marconi Electronics Ltd.
 Harris Corp. Broadcast Products Div.
 Marconi Electronics Inc.
 Mastertone Co., Inc.
 North American Radio Corp.
 Orange County Corp.
 RCA Corp. Broadcast Systems Div.
 Singer Products Co., Inc.
 Sintronic Corp.
 Sparta Electronic Corp.
 Wilkinson Electronics, Inc.

Transmitters, FM 2.5 kw

See Adv. Page

Collins Radio Group 51
 Orange County Corp. 64
 Sparta Electronic Corp. 5
 Wilkinson Electronics,
 Inc. 157

AEL, Inc.
 Allied Broadcast Equip.
 CCA Electronics Corp.
 Collins Radio Group
 GEC-Marconi Electronics Ltd.
 Harris Corp. Broadcast Products Div.
 Mastertone Co., Inc.
 North American Radio Corp.
 Orange County Corp.
 Singer Products Co., Inc.
 Sintronic Corp.
 Sparta Electronic Corp.
 Wilkinson Electronics, Inc.

Transmitters, FM 3 kw

See Adv. Page

Orange County Corp. 64
 Sparta Electronic Corp. 5

AEL, Inc.
 CCA Electronics Corp.
 GEC-Marconi Electronics Ltd.
 Harris Corp. Broadcast Products Div.
 Mastertone Co., Inc.
 Orange County Corp.
 RCA Corp. Broadcast Systems Div.
 Singer Products Co., Inc.
 Sintronic Corp.
 Sparta Electronic Corp.
 Val-Tronics, Inc.



JOHNNY CASH WOULD LIKE TO THANK YOU.

I'd like to tell you about a boy named Bobby. It is a true story. Bobby is retarded. There is nothing that gives joy to parents more than to hear the doctor say their baby is a perfect child. But, what happens when fate does not go your way? Of all the problems people have to face, perhaps mental retardation is one of the hardest.

Yet with special care and love, children like Bobby are being helped. They are getting the care they need through the agencies and programs of your United Way . . . and your United Way is working, thanks to you. This year I'd like to ask all my friends and every parent of a child who has been blessed to give your fair share pledge.

Let's keep it working for children like Bobby and thousands of others, the United Way.



A new United Way film, starring Johnny Cash, entitled "God's Children", is available for free viewing by contacting your local United Way or writing to United Way of America, 801 North Fairfax Street, Alexandria, Virginia 22314.

Thanks to you it's working



The United Way



advertising contributed for the public good

Transmitters, FM 3.5 kw

See Adv. Page

McMartin Industries, Inc. 48

McMartin Industries, Inc.

Transmitters, FM 5 kw

See Adv. Page

Orange County Corp. 64
Sparta Electronic Corp. 5
Wilkinson Electronics, Inc. 157AEL, Inc.
CCA Electronics Corp.
Collins Radio Group
GEC-Marconi Electronics Ltd.
Harris Corp. Broadcast Products Div.
Marconi Electronics Inc.
Mastertone Co., Inc.
Orange County Corp.
RCA Corp. Broadcast Systems Div.
Singer Products Co., Inc.
Sintronic Corp.
Sparta Electronic Corp.
Wilkinson Electronics, Inc.**Transmitters, FM 7.5 kw**

See Adv. Page

Orange County Corp. 64
Sparta Electronic Corp. 5
Wilkinson Electronics, Inc. 157AEL, Inc.
CCA Electronics Corp.
Collins Radio Group
GEC-Marconi Electronics Ltd.
Harris Corp. Broadcast Products Div.
Mastertone Co., Inc.
Orange County Corp.
Singer Products Co., Inc.
Sintronic Corp.
Sparta Electronic Corp.
Wilkinson Electronics, Inc.**Transmitters, FM 10 kw**

See Adv. Page

Orange County Corp. 64
Sparta Electronic Corp. 5
Wilkinson Electronics, Inc. 157AEL, Inc.
CCA Electronics Corp.
Collins Radio Group
GEC-Marconi Electronics Ltd.
Harris Corp. Broadcast Products Div.
Marconi Electronics Inc.
Mastertone Co., Inc.
Nippon Electric Co., Ltd.
Orange County Corp.
RCA Corp. Broadcast Systems Div.
Singer Products Co., Inc.
Sintronic Corp.
Sparta Electronic Corp.
Val-Tronics, Inc.
Wilkinson Electronics, Inc.**Transmitters, FM 12 kw**

See Adv. Page

Orange County Corp. 64AEL, Inc.
CCA Electronics Corp.
Collins Radio Group
GEC-Marconi Electronics Ltd.
Harris Corp. Broadcast Products Div.
Orange County Corp.
Singer Products Co., Inc.
Sintronic Corp.**Transmitters, FM 15 kw**

See Adv. Page

Orange County Corp. 64CCA Electronics Corp.
Collins Radio Group
GEC-Marconi Electronics Ltd.
Harris Corp. Broadcast Products Div.
Orange County Corp.
Singer Products Co., Inc.
Sintronic Corp.
Sparta Electronic Corp.**Transmitters, FM 20 kw**

See Adv. Page

Orange County Corp. 64
Sparta Electronic Corp. 5
Wilkinson Electronics, Inc. 157CCA Electronics Corp.
Collins Radio Group
GEC-Marconi Electronics Ltd.
Harris Corp. Broadcast Products Div.
Mastertone Co., Inc.
North American Radio Corp.
Orange County Corp.
RCA Corp. Broadcast Systems Div.
Singer Products Co., Inc.
Sintronic Corp.
Sparta Electronic Corp.
Val-Tronics, Inc.
Wilkinson Electronics, Inc.**Transmitters, FM 22.5 kw**

See Adv. Page

Collins Radio Group 51

Collins Radio Group

Transmitters, FM 25 kw

See Adv. Page

Orange County Corp. 64
Sparta Electronic Corp. 5
Wilkinson Electronics, Inc. 157AEL, Inc.
CCA Electronics Corp.
Collins Radio Group
Harris Corp. Broadcast Products Div.
Orange County Corp.
Singer Products Co., Inc.
Sintronic Corp.
Sparta Electronic Corp.
Wilkinson Electronics, Inc.**Transmitters, FM 35 kw**

See Adv. Page

Sparta Electronic Corp. 5

Sparta Electronic Corp.

Transmitters, FM 40 kw

See Adv. Page

Collins Radio Group 51
Orange County Corp. 64
Sparta Electronic Corp. 5AEL, Inc.
CCA Electronics Corp.
Collins Radio Group
GEC-Marconi Electronics Ltd.
Harris Corp. Broadcast Products Div.
Mastertone Co., Inc.
North American Radio Corp.
Orange County Corp.
RCA Corp. Broadcast Systems Div.
Singer Products Co., Inc.
Sintronic Corp.
Sparta Electronic Corp.
Wilkinson Electronics, Inc.**Transmitters, FM 50 kw**

See Adv. Page

Orange County Corp. 64
Wilkinson Electronics, Inc. 157AEL, Inc.
GEC-Marconi Electronics Ltd.
Harris Corp. Broadcast Products Div.
North American Radio Corp.
Orange County Corp.
Singer Products Co., Inc.
Sintronic Corp.
Sparta Electronic Corp.
Wilkinson Electronics, Inc.**Transmitters, FM 100 kw**

See Adv. Page

Sparta Electronic Corp. 5GEC-Marconi Electronics Ltd.
Harris Corp. Broadcast Products Div.
North American Radio Corp.
Orange County Corp.
Singer Products Co., Inc.
Sparta Electronic Corp.**Transmitters, FM to order**

See Adv. Page

Sparta Electronic Corp. 5AEL, Inc.
CCA Electronics Corp.
Collins Radio Group
Fisher-Burke Broadcast Consultants
GEC-Marconi Electronics Ltd.
Harris Corp. Broadcast Products Div.
North American Radio Corp.
Orange County Corp.
Rohde & Schwarz Sales Co.
Singer Products Co., Inc.
Sintronic Corp.
Sparta Electronic Corp.
Transcom Electronics, Inc.
Wilkinson Electronics, Inc.**Transmitters, TV**Acrodyne Industries Inc.
CCA Electronics Corp.
Dynair Electronics, Inc.
GEC-Marconi Electronics Ltd.
General Electric Co. ISO Div.
Harris Corp. Broadcast Products Div.
Ikegami Electronics (USA) Inc.
Marconi Electronics Inc.
RCA Corp. Broadcast Systems Div.
Television Technology Corp.
Thompson-CSF, Inc.
Varian/Beverly**Transmitters, TV Microwave**

See Adv. Page

Farinon Electric 33
Tepco Corp. 166
TerraCom 127
Varian/Beverly 185Acrodyne Industries Inc.
Ailtech
EMCEE Broadcast Products
Farinon Electric
Farinon Electric of Canada, Ltd.
GEC-Marconi Electronics Ltd.
GTE Lenkurt, Inc.
Microwave Assoc. Inc.
Narda Microwave Corp
RCA Corp. Broadcast Systems Div.
Tepco Corp.
TerraCom
Thompson-CSF, Inc.
Varian/Beverly**Transmitters, TV 1 Watt**Acrodyne Industries Inc.
CCA Electronics Corp.
EMCEE Broadcast Products
Fung Engineering Inc.
GEC-Marconi Electronics Ltd.GTE Lenkurt, Inc.
Harris Corp. Broadcast Products Div.
Orbit Radio and Video
Rohde & Schwarz Sales Co.
Television Technology Corp.
Varian/Beverly**Transmitters, TV 10 Watt**Acrodyne Industries Inc.
CCA Electronics Corp.
EMCEE Broadcast Products
GEC-Marconi Electronics Ltd.
GTE Lenkurt, Inc.
Harris Corp. Broadcast Products Div.
Rodelco Corp.
Rolane Sales Corp.
Television Technology Corp.
Varian/Beverly**Transmitters, TV 20 Watt**Acrodyne Industries Inc.
CCA Electronics Corp.
EMCEE Broadcast Products
GEC-Marconi Electronics Ltd.
Harris Corp. Broadcast Products Div.
Rodelco Corp.
Rolane Sales Corp.
Television Technology Corp.**Transmitters, TV 60 Watt**Acrodyne Industries Inc.
EMCEE Broadcast Products
GEC-Marconi Electronics Ltd.
Harris Corp. Broadcast Products Div.
Rodelco Corp.
Rolane Sales Corp.**Transmitters, TV 100 Watt**Acrodyne Industries Inc.
CCA Electronics Corp.
EMCEE Broadcast Products
GEC-Marconi Electronics Ltd.
Harris Corp. Broadcast Products Div.
Rodelco Corp.
Rolane Sales Corp.
Television Technology Corp.**Transmitters, TV 500 Watt**Acrodyne Industries Inc.
CCA Electronics Corp.
EMCEE Broadcast Products
GEC-Marconi Electronics Ltd.
Harris Corp. Broadcast Products Div.
Marconi Electronics Inc.**Transmitters, TV 1 kw**Acrodyne Industries Inc.
CCA Electronics Corp.
EMCEE Broadcast Products
GEC-Marconi Electronics Ltd.
General Electric Co. ISO Div.
Harris Corp. Broadcast Products Div.
Marconi Electronics Inc.
Nippon Electric Co., Ltd.**Transmitters, TV 2 kw**Acrodyne Industries Inc.
CCA Electronics Corp.
EMCEE Broadcast Products
GEC-Marconi Electronics Ltd.
Harris Corp. Broadcast Products Div.**Transmitters, TV 5 kw**CCA Electronics Corp.
GEC-Marconi Electronics Ltd.
General Electric Co. ISO Div.
Harris Corp. Broadcast Products Div.
Marconi Electronics Inc.**Transmitters, TV 6 kw**CCA Electronics Corp.
GEC-Marconi Electronics Ltd.
General Electric Co. ISO Div.
Harris Corp. Broadcast Products Div.

THE BILL OF RIGHTS DOES NOT EXCLUDE HANDICAPPED CHILDREN

Why should our school systems?

Less than half our handicapped children are getting the education they need to achieve their full potential as human beings.

Yet they have the same right to education as the rest of our children.

For information or help, write:

**CLOSER LOOK, BOX 1492,
WASHINGTON, D.C. 20013**

U.S. Department of Health, Education & Welfare, U.S. Office of Education
Bureau of Education for the Handicapped

Transmitters, TV 10 kw

CCA Electronics Corp.
GEC-Marconi Electronics Ltd.
Harris Corp. Broadcast Products Div.
Marconi Electronics Inc.
Nippon Electric Co., Ltd.

Transmitters, TV 11 kw

CCA Electronics Corp.
GEC-Marconi Electronics Ltd.
General Electric Co. ISO Div.
Harris Corp. Broadcast Products Div.

Transmitters, TV 12 kw

CCA Electronics Corp.
GEC-Marconi Electronics Ltd.
Harris Corp. Broadcast Products Div.

Transmitters, TV 15 kw

See Adv. Page

CCA Electronics Corp.168

CCA Electronics Corp.
GEC-Marconi Electronics Ltd.
General Electric Co. ISO Div.
Harris Corp. Broadcast Products Div.
Marconi Electronics Inc.
RCA Corp. Broadcast Systems Div.

Transmitters, TV 25 kw

See Adv. Page

CCA Electronics Corp.168

CCA Electronics Corp.
GEC-Marconi Electronics Ltd.
Harris Corp. Broadcast Products Div.
Marconi Electronics Inc.
RCA Corp. Broadcast Systems Div.

Transmitters, TV 30 kw

See Adv. Page

CCA Electronics Corp.168

CCA Electronics Corp.
GEC-Marconi Electronics Ltd.
General Electric Co. ISO Div.
Harris Corp. Broadcast Products Div.
Marconi Electronics Inc.
Nippon Electric Co., Ltd.
RCA Corp. Broadcast Systems Div.

Transmitters, TV 35 kw

See Adv. Page

CCA Electronics Corp.168

CCA Electronics Corp.
GEC-Marconi Electronics Ltd.
Harris Corp. Broadcast Products Div.
Marconi Electronics Inc.
RCA Corp. Broadcast Systems Div.

Transmitters, TV 50 kw

See Adv. Page

CCA Electronics Corp.168

CCA Electronics Corp.
GEC-Marconi Electronics Ltd.
Harris Corp. Broadcast Products Div.
Marconi Electronics Inc.
Nippon Electric Co., Ltd.
RCA Corp. Broadcast Systems Div.

Transmitters, TV 55 kw

See Adv. Page

CCA Electronics Corp.168

CCA Electronics Corp.
GEC-Marconi Electronics Ltd.
General Electric Co. ISO Div.
Harris Corp. Broadcast Products Div.
Marconi Electronics Inc.
RCA Corp. Broadcast Systems Div.

Transmitters, TV 100 kw

See Adv. Page

CCA Electronics Corp.168

CCA Electronics Corp.
GEC-Marconi Electronics Ltd.
General Electric Co. ISO Div.
Harris Corp. Broadcast Products Div.
Marconi Electronics Inc.
RCA Corp. Broadcast Systems Div.

Transmitters, TV Specify Power

See Adv. Page

CCA Electronics Corp.168

Acrodyne Industries Inc.
CCA Electronics Corp.
GEC-Marconi Electronics Ltd.
General Electric Co. ISO Div.
Harris Corp. Broadcast Products Div.

Transmitters, TV to order

Acrodyne Industries Inc.
CCA Electronics Corp.
GEC-Marconi Electronics Ltd.
Harris Corp. Broadcast Products Div.
Television Technology Corp.

Turnkey Equipment Installation Services

See Adv. Page

A. F. Associates, Inc. 68
Orange County Corp. 64

AEL Communications Corp.
A. F. Associates, Inc.
Ameco Inc.
Applied Video Electronics, Inc.
Atlantic Research Corp.
Audio Designs & Mfg.
Audio Services, Inc
Avtel
Broadcast Automation Assoc.
Beta Technology, Inc.
CCA Electronics Corp.
EMCEE Broadcast Products
Farinon Electric
Farinon Electric of Canada, Ltd.
Fisher-Burke Broadcast Consultants
GEC-Marconi Electronics Ltd.
Grinnan Fixture Co.
GTE Lenkurt, Inc.
Harris Corp. Broadcast Products Div.
International Video Corp.
Magna-Tech Electronic Co., Inc.
Microwave Assoc. Inc.
Nippon Electric Co., Ltd.
Orange County Corp.
Pacific Recorders and Engrg. Corp.
Div. 47B
RCA/Community Telev. Systems
RCA Corp. Broadcast Systems Div.
Roscor Corp.
Spectra Sonics
TeleMation, Inc.
Theta-Com
Ultra Audio Products

**Turntable Speed Control --See
Tape Deck and Turntable
Speed Control**

Turntables, Phonograph

See Adv. Page

Broadcast Electronics 45
LPB Inc.152
Martin Audio/Video152
**McCurdy Radio Ind.
Inc. 25**
Orange County Corp. 64
**QRK Electronic
Products160**
**Russco Electronics
Mfg. Inc.142**
Sound Dynamics, Inc.174
Sparta Electronic Corp. 5

Val-Tronics, Inc.....171

Admiral Group, Rockwell Int'l.
Allied Broadcast Equip.
Audio Distributor Inc.
Broadcast Automation Assoc.
Broadcast Electronics
Broadcast Equipment & Supply Co.
Camex Corp.
Collins Radio Group
Dyma Engineering, Inc.
ELPA Marketing Industries, Inc.
EMT Franz VGmbH
Glenburn Corp.
Gotham Audio Corp.
Grinnan Fixture Co.
Harris Corp. Broadcast Products Div.
Heath Co.
Lauderdale Electronic Labs
LPB Inc.
Martin Audio/Video
Mastertone Co., Inc.
McCurdy Radio Ind. Inc.
Micro-Trak Corp.
Orange County Corp.
Orbit Radio and Video
Philips Audio Video Systems Corp.
Audio Div.
Philips Audio Video Systems Corp.
Broadcast Equip. Div.
QRK Electronic Products
Ramko Research
RCA Corp. Broadcast Systems Div.
Rek-O-Kut Inc.
Russco Electronics Mfg. Inc.
Sansui Electronics Corp.
Schafer Electronics Corp.
Sinai-Johnson
Singer Products Co., Inc.
Sintronic Corp.
Sound Dynamics, Inc.
Sparta Electronic Corp.
Spotmaster
Stanton Magnetics Inc.
Systems Engineering Co., Inc.
Val-Tronics, Inc.
Wilkinson Electronics, Inc.

TV Systems, Closed Circuit

AEL Communications Corp.
A. F. Associates, Inc.
Ameco Inc.
American Data Corp.
Applied Video Electronics, Inc.
A-Tel-A-Matic
Atlantic Research Corp.
ATV Research
AVA Electronics Corp.
Ball Bros. Research Corp. Miratel
Division
Berkey-Colortran Inc.
Boston Insulated Wire & Cable Co.
Catel
Ceco Communications Inc.
Colorado Video Inc.
Communications Technology, Inc.
Communications 2000, Inc.
Comquip, Inc.
Cunningham Corp.
Dage-MTI, Inc.
Davis & Sanford Co. Inc.
Delta Electronics Inc. (N.C.)
Denson Electronic Corp.
Dynair Electronics, Inc.
Echo Science Corp.
Fernesh Group Robert Bosch Corp.
GBC Closed Circuit TV Corp.
General Electric Co. ISO Div.
General Electric Co. Tubes/MW
Devices
Gen. Electrodynamics
General Television Ntwk.
Hitachi Shibaden Corp. of America
Ikegami Electronics (USA) Inc.
Interntl. Nuclear Corp.
International Video Corp.
Janson Industries
Javelin
Lenzar Optics Corp.
Marconi Electronics Inc.
Nasco Television Systems
Nippon Electric Co., Ltd.
Orbit Radio and Video
Panasonic Video Systems Div.
Philips Audio Video Systems Corp.
Broadcast Equip. Div.
RCA Corp. Broadcast Systems Div.

SC Electronics, Inc.
Sinai-Johnson
Sylvania Comm. Electronic
Systa-Matics, Inc.
Tele-Cine Inc.
TeleMation, Inc.
Telemedia Electronics
Teltron Inc.
Temtron Electronics
Varian/Beverly
Vicon Industries, Inc.
Westinghouse Electronic Tube Divs.
The Zei-Mark Corp.

Vacuum Tubes, Camera Image-Orthicon

See Adv. Page

**English Electric Valve
North America Ltd. 21**

Calvert Electronics Inc.
Ceco Communications Inc.
Dage-MTI, Inc.
English Electric Valve North America
Ltd.
Fernesh Group Robert Bosch Corp.
General Electric Co. ISO Div.
General Electric Co. Tubes/MW
Devices
Heintz and Kaufman Ltd.
JSH Electronics, Inc.
C. M. Levit Electronics
RCA Corp. Distributor & Special
Products Div.
Teltron Inc.
Temtron Electronics
Terminal Electronics Corp.
Thor Electronics Corp.

Vacuum Tubes, Camera Isocon

Calvert Electronics Inc.
Ceco Communications Inc.
Dage-MTI, Inc.
English Electric Valve North America
Ltd.
JSH Electronics, Inc.
C. M. Levit Electronics
Teltron Inc.
Thor Electronics Corp.

Vacuum Tubes, Camera Leddicon

See Adv. Page

Calvert Electronics Inc.....175
**English Electric Valve
North America Ltd. 21**

Calvert Electronics Inc.
English Electric Valve North America
Ltd.

Vacuum Tubes, Camera Plumbicon

See Adv. Page

Calvert Electronics Inc.....175

Amperex Electronic Corp.
Electro-Optical Devices Div.
Amperex Electronic Corp.
Calvert Electronics Inc.
Ceco Communications Inc.
Dage-MTI, Inc.
GBC Closed Circuit TV Corp.
Hitachi Shibaden Corp. of America
International Video Corp.
JSH Electronics, Inc.
C. M. Levit Electronics
RCA Corp. Distributor & Special
Products Div.
TeleMation, Inc.
Teltron Inc.
Temtron Electronics
Terminal Electronics Corp.
Thor Electronics Corp.

Vacuum Tubes, Camera Silicon Array

Amperex Electronic Corp.
Electro-Optical Devices Div.

Amperex Electronic Corp.
Calvert Electronics Inc.
Ceco Communications Inc.
Dage-MTI, Inc.
English Electric Valve North America
Ltd.
GBC Closed Circuit TV Corp.
General Electric Co. ISO Div.
General Electric Co. Tubes/MW
Devices
Gen. Electrodynamics
International Video Corp.
JSH Electronics, Inc.
C. M. Levit Electronics
RCA Corp. Distributor & Special
Products Div.
TeleMation, Inc.
Teltron Inc.
Temtron Electronics
Thomson-CSF Electron Tubes
Thor Electronics Corp.
Westinghouse Electronic Tube Divs.

Vacuum Tubes, Camera Telicon

Calvert Electronics Inc.
Ceco Communications Inc.
JSH Electronics, Inc.
C. M. Levit Electronics
Teltron Inc.
Thor Electronics Corp.

Vacuum Tubes, Camera Vidicon

See Adv. Page

Calvert Electronics Inc.....175
**English Electric Valve
North America Ltd. 21**

Amperex Electronic Corp.
Electro-Optical Devices Div.
Amperex Electronic Corp.
A-Tel-A-Matic
ATV Research
Calvert Electronics Inc.
Ceco Communications Inc.
Dage-MTI, Inc.
English Electric Valve North America
Ltd.
General Electric Co. ISO Div.
General Electric Co. Tubes/MW
Devices
Gen. Electrodynamics
Heintz and Kaufman Ltd.
Hitachi Shibaden Corp. of America
International Video Corp.
Javelin
JSH Electronics, Inc.
C. M. Levit Electronics
RCA Corp. Distributor & Special
Products Div.
TeleMation, Inc.
Teltron Inc.
Temtron Electronics
Terminal Electronics Corp.
Texas Instrument Components Group
Thor Electronics Corp.
Westinghouse Electronic Tube Divs.

Vacuum Tubes, Camera Vikon

Calvert Electronics Inc.
Ceco Communications Inc.
Dage-MTI, Inc.
JSH Electronics, Inc.
C. M. Levit Electronics
Teltron Inc.
Thor Electronics Corp.

Vacuum Tubes, Camera Vistacon

See Adv. Page

Calvert Electronics Inc.....175

Calvert Electronics Inc.

Vacuum Tubes, Cathode Ray Oscilloscope

See Adv. Page

Calvert Electronics Inc.....175
C. M. Levit Electronics 162

Amperex Electronic Corp.
Electro-Optical Devices Div.
Amperex Electronic Corp.
Calvert Electronics Inc.
Ceco Communications Inc.
English Electric Valve North America Ltd.
Heintz and Kaufman Ltd.
JSH Electronics, Inc.
C. M. Levit Electronics
RCA Corp. Distributor & Special Products Div.
Temtron Electronics
Terminal Electronics Corp.
Thor Electronics Corp.

Vacuum Tubes, Cathode Ray TV Color

See Adv. Page

C. M. Levit Electronics162

Calvert Electronics Inc.
Ceco Communications Inc.
General Electric Co. Tubes/MW Devices
JSH Electronics, Inc.
C. M. Levit Electronics
RCA Corp. Distributor & Special Products Div.
Temtron Electronics
Terminal Electronics Corp.
Thor Electronics Corp.
Westinghouse Electronic Tube Divs.

Vacuum Tubes, Cathode Ray TV Monochrome

See Adv. Page

C. M. Levit Electronics162

Amperex Electronic Corp.
Electro-Optical Devices Div.
Calvert Electronics Inc.
Ceco Communications Inc.
Dage-MTI, Inc.
General Electric Co. Tubes/MW Devices
JSH Electronics, Inc.
C. M. Levit Electronics
RCA Corp. Distributor & Special Products Div.
Temtron Electronics
Terminal Electronics Corp.
Thor Electronics Corp.
Westinghouse Electronic Tube Divs.

Vacuum Tubes, Rectifier

See Adv. Page

C. M. Levit Electronics162

Amperex Electronic Corp.
Calvert Electronics Inc.
Ceco Communications Inc.
EIMAC Div. of Varian
English Electric Valve North America Ltd.
General Electric Co. Tubes/MW Devices
Heintz and Kaufman Ltd.
JSH Electronics, Inc.
C. M. Levit Electronics
RCA Corp. Distributor & Special Products Div.
Temtron Electronics
Thomson-CSF Electron Tubes
Thor Electronics Corp.
Val-Tronics, Inc.
Westinghouse Electronic Tube Divs.

Vacuum Tubes, Rectifier, Solid State Replacement

Electronic Devices, Inc.

Vacuum Tubes, Translator

See Adv. Page

Calvert Electronics Inc.....175
EIMAC..... 29
C. M. Levit Electronics162

Amperex Electronic Corp.

Calvert Electronics Inc.
Ceco Communications Inc.
EIMAC Div. of Varian
General Electric Co. Tubes/MW Devices
Heintz and Kaufman Ltd.
JSH Electronics, Inc.
C. M. Levit Electronics
Nippon Electric Co., Ltd.
Temtron Electronics
Thomson-CSF Electron Tubes
Thor Electronics Corp.

Vacuum Tubes, Transmitting

See Adv. Page

Calvert Electronics Inc.....175
EIMAC..... 29
C. M. Levit Electronics162
Orange County Corp.64

Allied Broadcast Equip.
Amperex Electronic Corp.
Calvert Electronics Inc.
Ceco Communications Inc.
Collins Radio Group
EIMAC Div. of Varian
English Electric Valve North America Ltd.
General Electric Co. Tubes/MW Devices
Heintz and Kaufman Ltd.
ITT Electron Tube Div.
JSH Electronics, Inc.
C. M. Levit Electronics
Machlett Laboratories
Nippon Electric Co., Ltd.
Orange County Corp.
Raytheon Data Systems Co.
RCA Corp. Distributor & Special Products Div.
Singer Products Co., Inc.
Temtron Electronics
Thomson-CSF Electron Tubes
Thor Electronics Corp.
Val-Tronics, Inc.
Westinghouse Electronic Tube Divs.

Vacuum Tubes, Transmitting Rebuilt

See Adv. Page

Freeland Products Co.174

Ceco Communications Inc.
Econco Broadcast Service Inc.
Freeland Products Co.
Heintz and Kaufman Ltd.
C. M. Levit Electronics
Temtron Electronics
Thor Electronics Corp.
Westinghouse Electronic Tube Divs.

Vector Display, Color

Beston Electronics Inc.
Lectrotech Inc.
Tele-Cine Inc.
Ultra Audio Products
Video Aids Corp. of Colorado

Viewfinder for Closed Circuit Cameras

Ceco Communications Inc.
Communications Systems
Dage-MTI, Inc.
Javelin
R. H. Tyler Co.

Voltmeters, AC

A-Tel-A-Matic
B & K Instruments Inc.
Boonton Electronics
Bristol Div.
California Instruments Co.
Dana Laboratories, Inc.
Dranetz Engineering Labs., Inc.
Dynascan Corp.
Eico Elect. Inst. Co., Inc.
John Fluke Mfg. Co., Inc.
General Electric Co. Tubes/MW Devices
Gralex Industries

Harvey Radio
Heath Co.
Hewlett Packard Co.
Hickok Elect. Instrument
Instrument Laboratories
International Instrument Div.
ITT Jennings
Leader Instruments Corp.
Lectrotech Inc.
Philips Test & Measuring Instruments, Inc.
RCA Corp. Distributor & Special Products Div.
Rohde & Schwarz Sales Co.
Simpson Electric Co.
SPI-ITT Metrix Instruments Div.
Systron-Donner
Triplett Corp.
United Systems Corp.

Voltmeters, DC

A-Tel-A-Matic
B & K Instruments Inc.
Bristol Div.
California Instruments Co.
Dana Laboratories, Inc.
Dynascan Corp.
Eico Elect. Inst. Co., Inc.
ESE
John Fluke Mfg. Co., Inc.
General Electric Co. Tubes/MW Devices
Gralex Industries
Harvey Radio
Heath Co.
Hewlett Packard Co.
Hickok Elect. Instrument
International Instrument Div.
ITT Jennings
Leader Instruments Corp.
Lectrotech Inc.
Philips Test & Measuring Instruments, Inc.
RCA Corp. Distributor & Special Products Div.
Rohde & Schwarz Sales Co.
Simpson Electric Co.
SPI-ITT Metrix Instruments Div.
Systron-Donner
Tektronix Inc.
Triplett Corp.
United Systems Corp.

Voltmeters, FET

B & K Instruments Inc.
Dynascan Corp.
Eico Elect. Inst. Co., Inc.
Harvey Radio
Heath Co.
Hickok Elect. Instrument
Leader Instruments Corp.
Lectrotech Inc.
Philips Test & Measuring Instruments, Inc.
RCA Corp. Distributor & Special Products Div.
Sencore Inc.
Simpson Electric Co.
SPI-ITT Metrix Instruments Div.
Triplett Corp.
United Systems Corp.

Voltmeters, Vacuum Tube

Boonton Electronics
Dynascan Corp.
Eico Elect. Inst. Co., Inc.
Gralex Industries
Harvey Radio
Heath Co.
Hewlett Packard Co.
Instrument Laboratories
Leader Instruments Corp.
RCA Corp. Distributor & Special Products Div.
Rohde & Schwarz Sales Co.
Simpson Electric Co.
SPI-ITT Metrix Instruments Div.
Triplett Corp.
United Recording Electronics Industries

Wattmeters

See Adv. Page

Micro Communications, Inc. 36

Ailtech
Bird Electronic Corp.
Boonton Electronics
Coaxial Dynamics
Dielectric Communications
Eico Elect. Inst. Co., Inc.
Electro Impulse, Inc.
General Electric Co. Tubes/MW Devices
General Microwave Corp.
Instrument Laboratories
Micro Communications, Inc.
Philips Test & Measuring Instruments, Inc.
Rohde & Schwarz Sales Co.
Simpson Electric Co.
Singer Products Co., Inc.
SPI-ITT Metrix Instruments Div.
Tranrel Corp.
Triplett Corp.

Waveguides

See Adv. Page

Comark Industries Inc.161
Micro Communications, Inc. 36
Tepco Corp.166

Allied Broadcast Equip.
Andrew Corp.
Cablewave Systems Inc.
Comark Industries Inc.
Dielectric Communications
Maury Microwave Corp.
Micro Communications, Inc.
Microwave Assoc. Inc.
RCA Corp. Broadcast Systems Div.
RF Systems, Inc.
Shively Laboratories, Inc.
Singer Products Co., Inc.
Systron-Donner
Tepco Corp.

Weather Instruments

See Adv. Page

ESE 54
LPB Inc.152
Texas Electronics170

Ameco Inc.
Collins Radio Group
ESE
Heath Co.
Lauderdale Electronic Labs
LPB Inc.
Mastertone Co., Inc.
Taylor Instrument
Texas Electronics
R. H. Tyler Co.

Wiring and Cabling Services

AEL Communications Corp.
Alpha Wire Corp.
Ameco Inc.
Applied Video Electronics, Inc.
A-Tel-A-Matic
Audio Accessories Inc.
AVA Electronics Corp.
Belden Corp.
Boston Insulated Wire & Cable Co.
Cablewave Systems Inc.
Concept 70
Dyma Engineering, Inc.
Orange County Corp.
Prestolite Wire Div.
RCA Corp. Broadcast Systems Div.
Rex Rheostat & Co., Inc.
SGL Waber Electric
Switchcraft Inc.
Systems Marketing Corp.
Tech Laboratories Inc.
Telatronics
Times Wire and Cable
Union Connector Co., Inc.

MARTI . . . THE NAME TO REMEMBER . . .

STEREO STUDIO-TRANSMITTER LINKS INTER-CITY RELAY

Stereo - Mono 950 MHZ FM - AM



STL Transmitter

The Stereo STL with
"Built-in Backup."

Dual Channel System (Stereo) \$4160.00
Single Channel System (Mono) \$2290.00

Antenna or Transmission line cost not included.

FEATURES: • All Solid-State • Direct FM Modulator • Field Proven Varactor Final • Plug-in Modular Construction • Solid-State Ovens • Hi-Accuracy Crystals

Why STL?

1. No "lost air" time due to cut, wet or electrically charged telephone lines.
2. Better Sound Quality Than a Class AAA telephone line.
3. EVENTUAL COST REDUCTION in operating expense.
4. Complete control of entire broadcast system.

Why Dual Channel?

1. A Dual-Channel costs less than a Composite.
2. Better Reliability than a Composite. "Built in Backup."
3. Greater Channel Separation than a Composite.
4. Less Signal Drive Required to Receivers means additional system Fade Margin.
5. Less Test Equipment Necessary and more Positive System Diagnosis.
6. Stereo Generator is away from Studio and Unauthorized Tampering.
7. Stereo Generator and Broadcast Transmitter Compatibility without Interface.
8. Having a Dual-Channel STL is like having a Spare Link.
9. Two Remote Control and Two Sub-Carrier Capability.

Why MARTI?

1. Channel Separation more than 65 db.
2. Channel Response matched to 0.25 db.
3. Distortion less than 0.5%.
4. All Solid State.
5. A Simple, True Direct FM Plug-in Modulator.
6. Complete accessibility to modules without removal from rack.
7. The Marti System Delivers Top Performance with Transmitter manufacturer's Stereo Generator.
8. Marti STL Systems Log over TWO MILLION (2,000,000) Broadcast Hours each Year.
9. AVAILABLE FROM STOCK.

DIGITAL REMOTE CONTROL

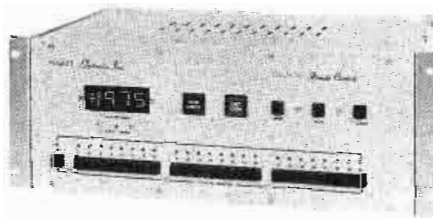

DRC-24 Studio Unit

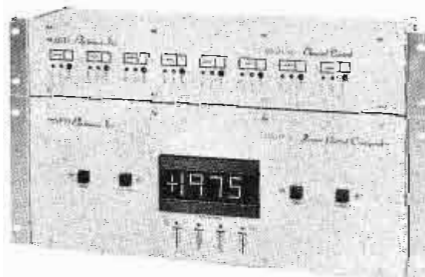

DRT-24 Transmitter Unit

8 - Channel — \$2350.00
16 - Channel — \$2650.00
24 - Channel — \$2950.00

FEATURES: • Single Button, Direct Channel Select • Exceeds All FCC Requirements for Accuracy of Antenna System Data • Studio and Transmitter Units Phase Locked to Common Clock • Telemetry Accuracy 0.1% • Basic 8-Channel System Expandable to 16 or 24 Channels • Status/Tolerance Limit Alarm • Fully Digital for Radio Circuit or Wire-Line Operation • Plug-in Modules for FSK Frequency Change • Adaptable to Multiple Transmitter Control From Multiple Control Points • Status Indication (Optional)

• Compatible with Composite or Dual STL Systems

The Marti DRC-24 is a completely Digital Remote Control, Telemetry and status/alarm system, providing the **ultimate in accuracy, simplicity, and speed of operation.** Channel selection is accomplished simply by pressing a **single** button. The data for the selected channel is then read from the large digital panel display. Raise/Lower commands can be given for the selected channel by pressing the Raise or Lower button.

The integrity of the entire digital process is assured by validation of received data transmission by checking proper start, parity, and stop bits, a **feature found in the most sophisticated data processing equipment.** This advanced design feature **virtually eliminates the possibility of error in channel selection, command and telemetry data.**

RADIO REMOTE PICKUP 150 - 450 MHZ



RPU
Transmitter

\$975.00 (150 MHZ)
\$1145.00 (450 MHZ)

FEATURES: • All Solid-State • Direct FM Modulator • Broadcast Quality — Continuous Duty • Four Audio Mixing Channels • Plug-in Modular Construction • I.F. Crystal Filter • Taut Band Meters

Radio Remote Pickup Equipment is versatile, dependable and an entree to profitable radio broadcasting. That is the acclaim given to Marti RPU Equipment by American Radio Broadcasters. "How did we ever operate a radio station without it?", is the comment most often heard after equipment has been purchased and put into service.

The progressive minded, community spirited broadcaster, can find many uses for Remote Pickup Equipment. He will do many more remotes than he is presently doing, simply because the equipment is available at a moment's notice. To coin an old cliché, "It doesn't cost — it pays."

Add Color to Your Remotes . . .

PORTABLE BROADCAST REMOTE PICKUP TRANSMITTER

Model RPT-1

\$495.00 (150 MHZ)

FEATURES: • Portable operation on internal rechargeable nickel-cadmium battery. Total weight only 5¼ lbs. • All Solid-State • Built-in battery charger • Dual frequency operation (One crystal included) • Meter indicates battery condition and modulation • Whip antenna mounted directly on unit • Broadcast-quality Compressor/Limiter handles toughest remote pickup conditions • Two microphone inputs (one push-to-talk) and one Hi-Level input each with individual mixing gain control

COMPLETE LINE OF ACCESSORIES AVAILABLE

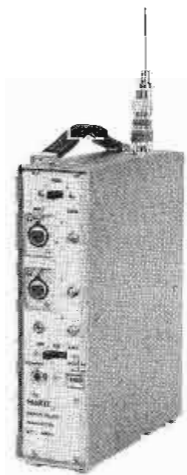

MARTI Electronics, Inc.

P.O. BOX 661 • 1501 N. MAIN
CLEBURNE, TEXAS 76031
817/645-9163

For More Details Circle (90) on Reply Card

Commission sets its Fall Meeting dates

The Commission recently announced the second phase in its series of regional meetings with the public and broadcasters. Meetings will be held in Boston on October 7, in Denver November 18 and in San Francisco November 20 and 21.

FCC Chairman Richard E. Wiley, Commissioner Benjamin L. Hooks,

other Commissioners and key FCC staff personnel will attend all meetings.

Previous regional meetings have been held in Chicago, Atlanta and Washington, D.C.

The Boston meetings are for the public and broadcasters from Maine, New Hampshire, Vermont,

Massachusetts, Connecticut, Rhode Island, New York, New Jersey and Pennsylvania. The public meeting will be held in the New England Life Hall in Copley Square downtown Boston, and the broadcaster meeting at the Boston Marriott Hotel.

The Denver meetings are for the public and broadcasters from Colorado, New Mexico, Utah, Wyoming, Idaho and Montana. Both meetings will be held at the Brown Palace Hotel.

The San Francisco meetings are for broadcasters and the public from California, Nevada, Oregon and Washington. The Cox Broadcasting Corp., parent company of the licensee of KTVU-TV, Oakland, invited the Commission to use its studio and facilities to conduct the San Francisco public meeting. It will be an experimental television phone-in meeting broadcast in prime time from 8 to 10 P.M., PS November 20. On November 21, broadcasters will meet at the Fairmont Hotel.

Chairman Wiley said the Commission would continue its series of regional meetings throughout the United States as long as broadcasters and the public continued to show an interest. He said taking government to the people and of Washington in this fashion led to a better understanding between broadcasters, the public and regulatory agencies.

He said these informal conferences helped improve regulatory processes and provided a constructive aid to broadcasters in the development of responsive programming.

STAINLESS for AM/FM?

YOU BET!

Many people think of Stainless as only tall tower specialists, but we are also experts in AM/FM. We supply as many radio towers as anyone else—and have for a long time.

Whether you require a single 200 foot AM tower like WMMM in Westport, Connecticut, an 8 tower array like KULF in Houston, or even a 2000 foot tower, our standards of excellence in engineering, workmanship and materials are always consistent and our prices are always competitive.

So if AM or FM is your field, think of Stainless for your tower—and call us.



Stainless, inc.

North Wales, Pa. 19454
Telephone (215) 699-4871
TWX 510-661-8097

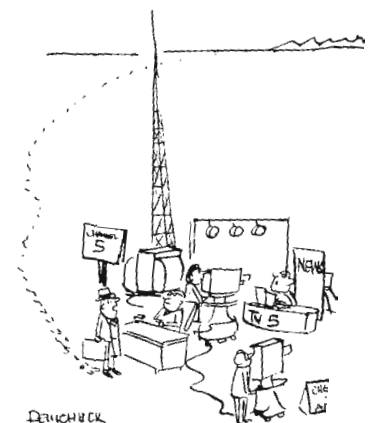

"Yes, I'll go along with you're sure out of the high frict."

For More Details Circle (91) on Reply Card



Introducing a Color Corrector for Electronic News Gathering.

Electronic News Gathering makes tough demands upon the broadcaster. Color imbalance and colorimetry problems are frequently encountered. Matching remote camera shots to indoor studio programs or assembling tapes from different locations or cameras is "chancy" at best. Often that fast-breaking story doesn't allow for camera rebalancing!

Thomson-CSF Laboratories now provides a solution to such difficult encoded signal color problems. With the Model 5500A Color Corrector, you'll be able to rebalance and match video signals *after* encoding. It can be used either after the play-back tape machine or following the microwave receiver during live coverage. In most cases, a noticeably improved color picture will result. For ease of operation, a Remote Control unit is included as standard equipment.

As an added feature, an optional automatic Sensor unit is also available to control the Color Corrector for telecine use.

Whether for Electronic News Gathering, tape production or telecine use, the Thomson-CSF Laboratories Color Corrector System should be working for you. Interested? Give us a call.



THOMSON-CSF LABORATORIES, INC.

37 Brownhouse Road, Stamford, Connecticut 06902
(203) 327-7700 / TWX (710) 474-3346

For More Details Circle (92) on Reply Card



Let's hear it For Virginia Doss

Those who have received mail from SBE National recently, may have noticed that Assistant Secretary Virginia Doss has suddenly become Vincent Flanders. Virginia has finally decided to retire and dedicate her attention to her regular full-time job at WRTV. It's fitting to use this column to thank her on behalf of all SBE members for the terrific job she's done. In the past years she's singlehandedly processed inquiries and applications for membership and for new chapters, done all of the membership billing, and organized the election process of national officers at NAB.

The list goes on, but the torch has now passed to another Assistant Secretary—Vincent Flanders. He may be reached at the same address: SBE, P.O. Box 88123, Indianapolis, Indiana 46202, but at a different telephone number: (317) 842-0836.

SBE will introduce the new Assistant Secretary in the next issue of *The Signal* and review some of the old and new responsibilities which he will be taking on at headquarters.

Convention Changes

Chapters 1, 2 and 22 have had a date change for their upcoming regional convention. It will still be held in Syracuse at the Northway Best Western Inn, but on the 17th of October, not the 24th as reported last month.

Meanwhile, there's been an addition to the convention roster. Chapter 15 in New York will be holding a regional convention on the 19th and 20th of October (Sunday and Monday) in Hempstead, New York, at the Holiday Inn Hotel. We

understand that's about a half hour from downtown New York City.

The Chapter has more than doubled the amount of floor space they had available at last year's convention, and 50 to 60 exhibitors are expected. The tentative program is to present most of the technical papers in the morning and reserve the afternoons for exhibitors. Although not all the speakers have been confirmed yet, the chairmen currently plan to have a report on "absolute state-of-the-art and solid state," as well as a panel discussion with five or six top management people on "how to get and keep competent engineering help." Sunday night will feature a sit-down prime rib dinner with a special guest speaker. For complete details call either of the co-chairmen: Lyn Snyder, P.O. Box 182, Floral Park, New York 11001, (212) 347-2940, or Larry Strasser, WTFM, 173-15 Long Island Expressway, Fresh Meadows, New York 11365, (212) 357-8000.

(Continued on page 124)

TWO NEW COX BOXES! FROM MICHAEL COX ELECTRONICS

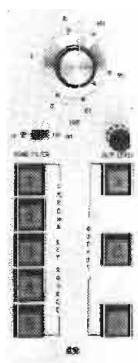

TYPE 231
ENCODED
CHROMA KEYSER
FROM \$2470.*



TYPE DKM150
DOWNSTREAM
KEYER
\$2070.*

Derives a high quality keying signal from encoded video using comb filter decoding techniques. Provides an input to the external key on any video switcher or can be used with our 150 DKM downstream keyer. With available options the 231 becomes a "Stand Alone", downstream chromakeyer, complete with it's own effects key and 5 input vertical interval switcher for selecting chroma key source.

The most versatile downstream keyer in the industry.

- Cut a key in and out of program
- Dissolve a key in and out of program
- Fade to black

Why not expand your video production facilities with these versatile, economical boxes? They can be added to any system in minutes with a few **BNC'S**.

Distributed exclusively in North America by:

broadcast video systems ltd.

1050 McNICOLL AVE., UNIT 9, AGINCOURT, ONTARIO M1W 2L8 Tel. (416) 497-1020

• F.O.B. TORONTO, CANADA
CANADIAN F.S.T. NOT INCLUDED

For More Details Circle (93) on Reply Card

It's all in the family



The new Scully 284B-8:
1-inch 8 channel master
recorder with DC Servo
and 14" reels.

The new Scully 284B:
1/4" or 1/2" recorder with
1-4 channels and 14" reels.

**The new multi-purpose
Scully 280B:**
up to 11.5" reels with AC motors
or DC Servo capstan drive.

Scully's new 280B family of innovative audio tape recorders has a list of improvements and features that won't quit. As a result, Scully can handle any recording assignment you have. Just take a look.

- **Optional DC capstan servo**
- **Speeds to 30 in/sec.**
- **Transports up to 14" reels**
- **New direction sensing control logic**
- **Functionally illuminated controls**
- **1/4" full-track to 1-inch 8-track recorders**
- **Innovative low-noise electronics**
- **Common components for interchangeability**

- **14" reels for 30 in/sec. mix-downs**
- **Variable Speed accessory with L.E.D. exact speed read-out**

Scully makes it easy for you, including sales and service which is available from over 200 distributors throughout the world. For all the facts, write, Telex or phone.

▶ **Scully | Metrotech**

Division of Dictaphone

475 Ellis Street

Mountain View, California 94043

(415) 968-8389 TLX 34-5524

Scully and Metrotech are trade marks of Dictaphone Corporation, Rye, New York.



SBE CHAPTERS IN PROFILE

The summer season has provided time to become better acquainted with some of the Chapters around the country, since the vacation months tend to cut down on the frequency of meetings.

The following groups were interviewed last month, and others are invited to contribute a "past-to-present" account of their Chapter as background for future columns. These sketches should be sent to Angela Keynon, SBE Editorial Office, 2000 N Street, N.W., Suite 210, Washington, D.C. 20036.

Chapter 16: Seattle, Wash.

Seattle's Chapter 16 is an outgrowth of an elite group of the chief engineers of six FM stations which are located on Cougar Mountain, an isolated high point east of Seattle. To make a long story short, each of the six chiefs had a key to every other site, along with a license

for authorized thievery in case of need. In other words, they helped each other, with the complete agreement of the owners...but that's a different story. These six friends started a weekly luncheon get-together to share latest news and information. It was a natural thing for them to expand and formalize the group when, in 1963, SBE called upon charter members to help form Chapters. Walt Jamison and John Maxson of this group were charter members, and the half dozen men became the nucleus around which the Chapter was built.

A mailing list was set up to include the chief of each operating station in the Puget Sound area, and invitations to attend meetings went out on a regular basis. Costs were out-of-pocket, and the meetings were so interesting that the original six grew to an average attendance of 25, with about 20% of these having become SBE members by the end of the year. Attendance increased to an average of 30, but it was still largely radio-oriented. Then the gavel went to Bob Ingalls, a TV man, and the TV

group was able to enjoy the opportunity of sharing information on a professional basis. In the nine years of monthly meetings, Chapter 16's success has been a result of careful planning and extra effort on the part of officers and program specialists.

FCC Cooperation

One point might be worth a story of its own. It is the unique spirit of cooperation between the Seattle Field Engineering Office of the FCC and the Seattle SBE. From the first meeting, Bob Dietsch, Engineer in Charge of the Seattle FCC Office, has been an honorary member of the Chapter. His five-minute review of FCC actions during previous months has been a regular feature at the meetings, and, best of all, Bob and the members feel that it's important to have an informal meeting-ground where the FCC man and the broadcaster do not feel like adversaries.

Attendance at Seattle's monthly meetings now averages around 45 people. Meetings are held every second Wednesday of the month at

(Continued on page 138)

INSTANT RELIEF

FROM:

DESIGN,
CONSTRUCTION,
INSTALLATIONS,
MAINTENANCE, or
PROOF of PERFORMANCE

FB FISHER - BURKE

Broadcast Consultants
P.O. BOX 2468 • PHOENIX, ARIZONA 85003 • (602) 257-0225

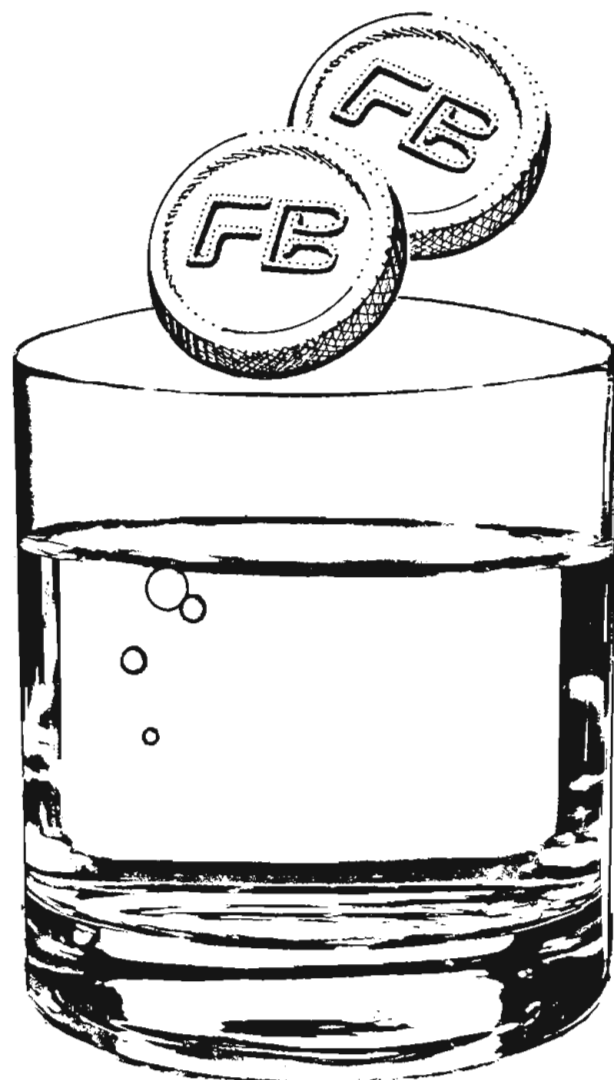

For More Details Circle (95) on Reply Card

Our new E series audio equipment will improve your sound and cut your costs . . . or your money back!

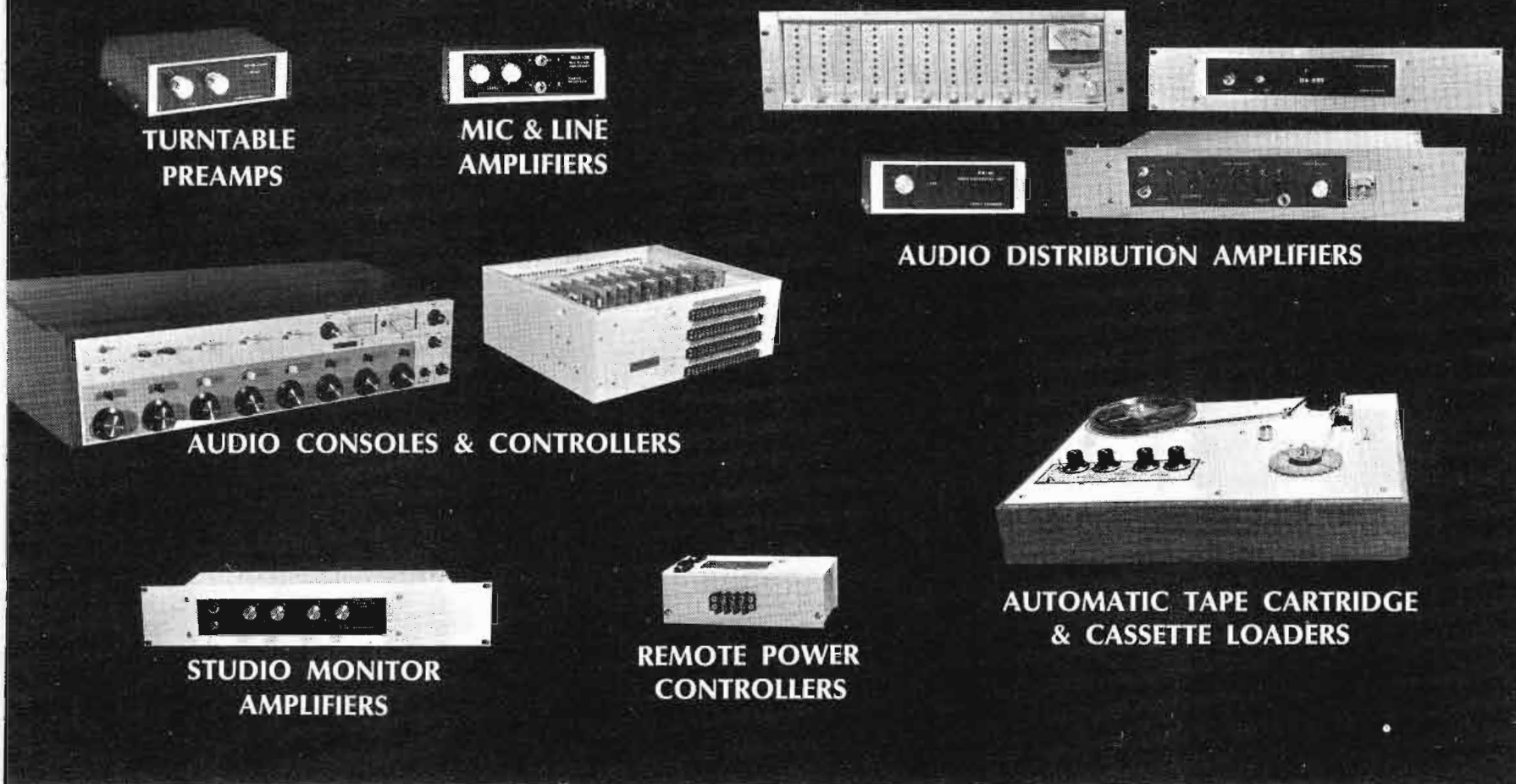

**TURNTABLE
PREAMPS**

**MIC & LINE
AMPLIFIERS**

AUDIO DISTRIBUTION AMPLIFIERS

AUDIO CONSOLES & CONTROLLERS

**STUDIO MONITOR
AMPLIFIERS**

**REMOTE POWER
CONTROLLERS**

**AUTOMATIC TAPE CARTRIDGE
& CASSETTE LOADERS**

TEN DAY FREE EVALUATION AND 2 YEAR GUARANTEE INSURE YOUR UNCOMPROMISED SATISFACTION

TURNTABLE PREAMPS

Preamps costing almost 3 times more will not compare with these units. RIAA/NAB equalized ± 1 db, 0.5MV sensitivity at 1KHz for +4dbm out, balanced outputs, -75db s/n at 10mv in, 0.05% distortion, +21dbm max. out. Internal power supply.

MP-8E Mono \$86 SP-8E Stereo \$137

MIC & LINE AMPLIFIERS

Dual function and superb performance. Inputs for mic and line, ± 0.5 db response 10Hz-20KHz, 67db gain on mic channel(s) +26db gain on line inputs. Balanced inputs & outputs, +21dbm out max, 0.1% distortion. Internal power supply.

MLA-1E Mono \$98
MLA-2E Dual Mono/Stereo \$139

AUDIO DISTRIBUTION AMPLIFIERS

From 1 in/6 out to 20 in/80 out in one small package. Whatever your distribution requirements we have an answer. All units meet or exceed the following specifications: Balanced bridging/matching inputs, balanced 600ohm outputs, ± 0.5 db response 10Hz-20KHz, ± 3 db 5Hz-40KHz, 26db gain, +21dbm out. max. capability, 0.1% or less distortion, outputs isolated by 80db, hum and noise 90db down referenced to +21dbm out. Internal power supplies.

DA-6/E Table top. 1 in/6 out. \$131
DA-6R/E Rack mount. 1 in/6 out. \$149
DA-6BR/E Rack mount. 1 in/6 out. Individual level controls for each output. \$165
DA-6RS/E Rack mount. 1 in/6 out stereo or 2 in/12 out mono. \$229
DA-16BR/E Rack mount. 1 in/8 out stereo or 2 in/16 out mono. Individual output level controls, selectable metering & headphone monitoring. \$287
DA-2080/E Rack mount main frame with protected

power supply, metering & headphone monitor. Will accept up to 10 slide in modules. Each module has 2 inputs & 8 outputs. Individual output level controls & selectable meter switch. Up to 20 in/80 out.

DA-2080/E Main Frame \$150
DA-2080/E Modules 2 in/8 out \$135 ea.

AUDIO CONSOLES & CONTROLLERS

Our new series 35 audio controller introduces a new concept in audio mixing. Allows separation of controls from the audio functions. Controls can be placed in any convenient location in the studio, while electronics may be mounted anywhere for easy maintenance & hookup. Remote DC control for completely unaffected audio.

This versatility gives you a custom designed console at a standard production model cost.

Features include; 8 channels, mono, dual channel mono, stereo, dual channel stereo, or combinations; paralleling 2 units for quad, fail safe power supply & plug in interchangeable cards.

Performance specifications are; 0.3% or less distortion, 124dbm equivalent noise on low level channels, approximately 25w power consumption, -70db crosstalk, balanced bridging/matching inputs & response within ± 2 db 20Hz-20KHz. Series 35 audio controllers start at \$1200.

AUTOMATIC TAPE CARTRIDGE AND CASSETTE LOADERS

So easy to use & accurate that our largest winder competitor has been using one of these to load their own carts.

Eliminates guesswork. Set the dials to the length desired. The exact amount of tape is fed onto the cart or cassette hub and then shuts off automatically. Also has exclusive torque control for proper tape pack on different size hubs. Winds at 30 IPS.
ACL-25/E \$185

Winders also come in higher speed models (ACL-60 series). Same operation as above but winds at 60 IPS. Accepts 14" pancakes.

ACL-60T/E (tone stop only) \$266
ACL-60B/E (Blank tape loader) \$331
ACL-60BT/E (for both prerecorded and blank tape) \$375

STUDIO MONITOR AMPLIFIERS

Exceptional reproduction! Internal muting. ± 2 db response from 20Hz-40KHz. 25w music power, 20w RMS into 8 ohms. Hum & noise 65db below rated outputs.

Distortion less than 0.25% at less than 20w out, 1% or less at 20w. Works into 4-16ohms. Balanced bridging inputs, variable bass contour, internal overload & short circuit protection.

SMA-50/E Table top (mono) \$125
SMA-500/E Rack mount (mono) \$142
SMA-1000/E Rack mount (stereo-40w) \$196

REMOTE POWER CONTROLLERS (DUAL)

Safe, transient free means of controlling 110V/AC. Turntables, on the air lights, etc.

PR-2 (toggle switch on/off) \$39
PR-2B (momentary contact actuation) \$54

Give us a call or write today for further details. You'll be money and performance ahead.

CALL COLLECT — (916) 392-2100

WRITE — 3516-C LaGrande Boulevard
Sacramento, California 95823

RAMKO RESEARCH

Lighting for television

By Ed Gallagher

One of the most important functions of a television production is good lighting. For many years the 'Art of Lighting for Television' has been one of the most neglected functions.

Television stations have spent millions of dollars over the years for the best in electronic, and transmission equipment to get on the air and to replace outdated equipment. Hundreds of thousands of dollars have been spent on highly skilled technical personnel to train in the operation and maintenance of this equipment. Very little attention has been given to the actual needs of the lighting equipment required for each individual station's studio use.

There are probably no more than 25 to 30 truly qualified lighting directors in the United States

today. A number of these men are independents and a few work in local television stations throughout the country. Most, however, are to be found in the television networks on both the East and West Coasts. That leaves the largest percentage of the television stations throughout the country to get by as best they can.

These television stations have accomplished their lighting needs by having a chief engineer, a cameraman or any one of several technical assistants do the lighting for their individual facilities. Most of these people have never had any formal training in the art of lighting. In many instances the lighting will consist of an individual climbing a ladder, aiming whatever fixture is hanging there towards the

set, and proceeding to the next fixture. Thus there becomes a general illumination of a set with a few if any designed lighting specifics.

It is very important to realize that the television receiver or monitor is, in reality, a flat rectangular surface which, by definition, has length and width. There is no visible depth. Television is a three-dimensional world and the only way to get the third dimension "depth" is through lighting.

There are six basic functions which I will discuss. These are: key lighting, back lighting, fill lighting, base lighting, set lighting and special effects.

Key lighting is a spotlight de-

(Continued on page 128)

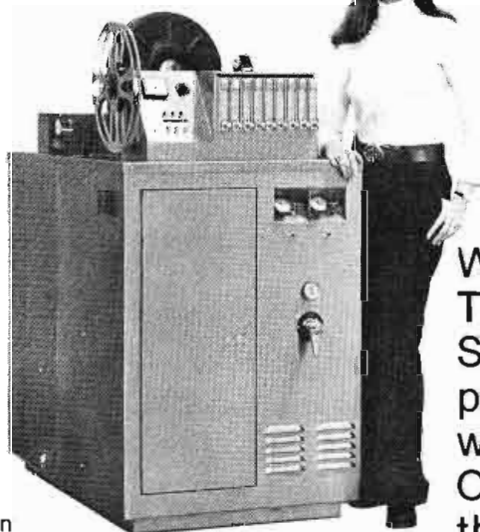

Jamieson
Compact Model

Jamieson No.1 in TV!

Why is the Jamieson Processor No. 1 in TV? The best answer is from someone who owns one. Someone you know owns a Jamieson. Probably a lot of people you know. Why not ask them about it? The best way to get an unbiased appraisal of its performance. Or ask us...we'll be more than happy to tell you about the Jamieson Processors and give you references.

JAMIESON'S ADVANCED DESIGN TECHNOLOGY FEATURES

- Film advance virtually tension-free. The demand top-overdrive film transport uses no clutches, floating rollers or film sprockets.
- Smaller machines take only half the floor space.
- Solution volumes reduced 15 times over open-tank designs.
- Temperature in primary solutions is controlled to an accuracy of a few hundredths of a degree.
- The elliptical shape of the tube protects the film and provides high induced turbulence.



JAMIESON FILM COMPANY

6911 FOREST PARK ROAD • DALLAS, TEXAS 75235
PHONE: 214-350-1283 • TELEX: 73-0932

Please send information on Jamieson Processors and a list of some users.

Name _____ Title _____

Firm _____ Phone _____

Address _____ City _____

State _____ Zip _____ JAMIESON FILM COMPANY

BED

6911 Forest Park Rd. Dallas, TX 75235



**QUICK SET-UP TIME
FOR REMOTE OPERATION**



**COMPLETE REMOTE
SIMPLEX SYSTEMS**



**TRIPOD MOUNTED
DUPLX CONFIGURATION**

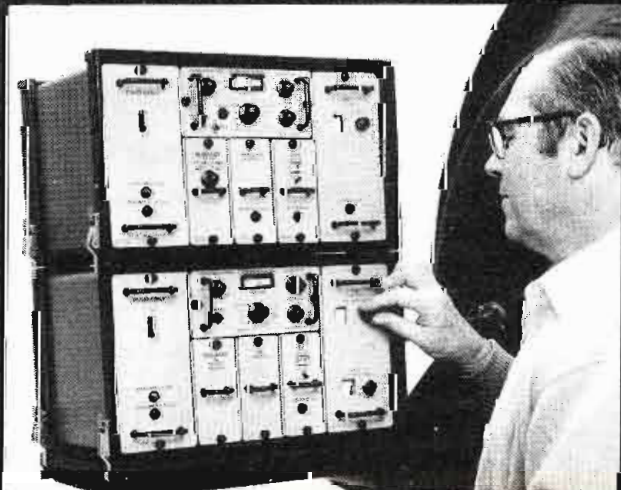

TCM-6 SERIES PORTABLE MICROWAVE RADIO ... the accepted standard

- All Frequency Bands, 1.7 to 15 GHz • Continuous Frequency Tuning • .005% Stability • Built-In Test • Automatic Fault Indication
- All Mounting Configurations • Solid-State Modular Design • Internal Sub-Carrier Program Channels

This universal remodulating microwave radio gives high quality performance for up to 1200 FDM voice channels, NTSC video, or high bit rate digital data transmission. Major common carriers and many other leading communicators are using the TCM-6 Series in rapidly increasing numbers.

The TCM-6 Series has been designed for easiest possible operation, testing, and servicing. Quick and simple maintenance stems from a built-in test system, automatic fault isolation indication, plug-in modules and detachable boards. The comprehensive maintenance manual includes a complete list of locally available parts. High reliability is afforded through simple design, high derating of parts, and rugged construction.

TerraCom TCM-6 Series Microwave Radio is available for simplex, duplex, hot standby and diversity operation. Convertible mounting configurations allow rack installation, simplex or duplex tripod mounting, stacking, or vehicular mounting. In each configuration, the RF Unit plug-in modules can be remoted hundreds of feet in weatherproof enclosures at the antenna—eliminating waveguide.

Our customers praise our service. At TerraCom you can rely on personal attention, quick resolution, and fast turnaround. Write or call Bruce Jennings: 9020 Balboa Avenue, San Diego, California 92123, (714) 278-4100. For More Details Circle (98) on Reply Card



Lighting

(Continued from page 126)

signed to illuminate the subject and to make it stand out from the background. It is the main source of illumination.

The key light should be placed either to the left or to the right of the subject. As it illuminates the subject from that side, it should cast a harsh shadow on the other side. It is essential that a key light be a lensed fixture, commonly called a fresnel.

The light output from a fresnel is much more controllable than an open-faced fixture. It is important that the key light be a focusing fixture capable of having its beam adjusted from a narrow spot to a wide flood. This allows for very good control of the light output. A key light in most applications is either a 5,000, a 2,000, or a 1,000 Watt fresnel.

An important accessory to the key light is a barndoor. Barndoors come in 4 and 8 leaf configurations and allow a relatively sharp edge to cut off unwanted light.

Back lighting is illumination applied behind the subject. The function of the back light is to create the illusion of depth. The back light highlights the subject's head area and shoulder area. The characteristics of a back light should be the same as those for a key light. Again, it is important to use barndoors with a back light so that the spill lighting can be controlled. A back light many times is closer to the subject than the key light. This will allow the use of a smaller wattage fixture to be used.

Fill lighting is lighting designed to fill in the shadow areas created by the key light. The fill light is used to control contrast range which would be much too great if only key lighting was used. A fill light fixture in most applications is a scoop, which is generally 14 to 18 inches in diameter and uses 1,000, 1,500 and 2,000 Watt lamps.

A scoop has a very soft edge and usually is not controllable in that it neither has barndoors nor has a necessity to be a focusing unit. Since a scoop has a very soft edge, it blends in with other fixtures very

nicely.

The object of base lighting is to use the ambient light level up to a usable intensity. Base lighting, like fill lighting, uses a noncontrollable light source, usually a scoop.

Set lighting is the proper illumination of an individual set, the cyclorama or any background. In most set lighting applications, either a scoop or a cyclorama fixture is used to illuminate the set or cyclorama. On small sets or where the lighting grid is below 14 feet, most applications use scoops. When a studio grid is 14 feet or greater, the cyclorama fixture is used to illuminate the cyclorama from top to bottom as evenly as possible. When illumination from the floor upward is required, a strip light or ground row is used.

A cyclorama strip is a group of usually 500 or 1,000 Watt lamps grouped together on a horizontal plane in one circuit, two circuit or three circuit configurations.

Special effects lighting utilizes a fixture designed specifically to pro-

(Continued on page 130)

Trouble-Free UHF Antennas

from America's only exclusive antenna manufacturer

- Safe power ratings from 30 KW-120KW
- Omni-directional patterns with power gains to 48.
- Exceptionally low VSWR (1.05) for crisp, sharp TV pictures.

Jampro's time proven Zig Zag UHF TV antennas have many advantages over competitive brands.

First, with our ultra simple feed system, our antenna provides extremely high power capability, which insures trouble-free service.

Second, there are no interbay feed cables. Single or dual 6 1/8" coaxial lines allow 60 and 120 KW power handling with ease.

Third, plastic radomes give unaffected service in salt or corrosive environments, as well as snow and ice.

Fourth, every antenna is pattern-tested on our mile-long test range before shipment to meet your most stringent requirements.

Call us for a quotation today.

JAMPRO ANTENNA COMPANY
A SUBSIDIARY OF CETEC CORPORATION

Phone (916) 383-1177 • 6939 Power Inn Road, Sacramento, California 95828

J

A

M

P

R

O



**For TV Sound
at its very best...**

Audio Designs NEW TV 32 Broadcast Production Console

Stringent electronic specifications Flexibility for expansion

ADM's all-new TV 32 Consoles are engineered to meet the most exacting requirements for television production. They are modular, multi-input (up to 32) by 4 submaster busses, TV Studio and Production Center units that will professionally handle any program material in large or small stations.

These full-featured, floor standing consoles incorporate the latest audio production philosophies into broadcast parameters. They are skillfully engineered to provide the professional broadcaster with the most demanded features. TV 32 Series Consoles offer exceptional flexibility for future expansion by plugging in additional modular components. Chances are one of our "stock" units will meet your requirements. If not we will be glad to design a custom console tailored to your exact needs.

ADM is a leading producer of highest quality professional audio consoles. Our key people have had impressive studio broadcast experience, and all of their expertise has been applied to our consoles.

An all-inclusive 5-Year Warranty covers parts and labor, and back-up technical assistance is always available from the factory. Write for Technical Brochure detailing all of the important features of ADM consoles.

BC-5 Broadcast Production Consoles

A table-top version of the TV 32 using the same high quality components. Allows for future expansion through the choice of modular plug-in components.

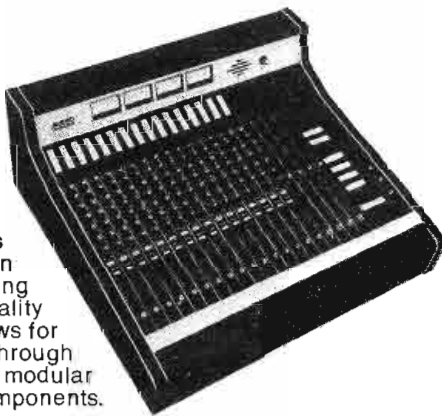

AUDIO DESIGNS AND
MANUFACTURING, INC.

16005 Sturgeon
Roseville, Michigan 48066
Phone: (313) 778-8400, Cable: AUDEX

AMPEX

DISTRIBUTED OUTSIDE U.S.A.

BY AMPEX INTERNATIONAL OPERATIONS, INC.



For More Details Circle (100) on Reply Card

Lighting

(Continued from page 128)

ject shapes or patterns on a given surface. A fixture used for special effects lighting is a Lekolight. This unit comes in lamp configurations utilizing 500, 1,000, and 2,000 Watt lamps.

Having now discussed six basic functions of lighting and the fixtures used to obtain these functions, let us now look at the practical applications.

For most basic lighting applications, the triangular approach to lighting is used. This is to place a key light on one side of the subject, a fill light on the other side and a back light directly behind the subject. If one were to draw a straight line between each of these fixtures—key light, fill light, back light and back-to-key light, a triangle would be formed with its subject being the enclosed area.

The key light should be at a 45 degree angle to the subject, allowing the subject to look straight toward the camera without looking directly into the key light. This will

allow a small shadow area to be created under the subject's chin.

The fill light is generally at 30 degrees to the subject. This allows the shadow area created by the key light to be filled in so that there is an adequate contrast ratio. In most applications, a fill light is placed on a light lift or a pantograph-type design device so that it may be raised or lowered to the desired height.

Back lighting is generally 45 to 60 degrees to the given subject. This allows for proper illumination of the head and shoulder area. By having the back light at an angle of 45 to 60 degrees, it eliminates spill light going directly into the lens of the camera.

A base light is utilized in the same general area as a fill light. A base light is generally at a 15 to 20 degree angle to the subject.

The set light, or cyclorama light, is generally 4 to 6 feet from the set or cyclorama, and is utilized to illuminate the set or cyc areas desired. Special effects are then used as an application is required.

It is difficult to determine what

the required lighting levels for any specific area needs to be. It is usually based on the foot candle requirements of individual cameras. Generally speaking, for color applications the light levels will be between 200 and 300 foot candles.

Since most television stations today utilize only color cameras, there is one more important characteristic which must be met in lighting. The Kelvin temperature must remain constant. This is achieved through the use of Tungsten Halogen lamps. The Tungsten Halogen (or quartz) lamp does not blacken as do incandescent lamps, thus its temperature remains constant throughout its life. The standard Kelvin temperature, which is used in the television industry, is 3,200 degrees. Kelvin temperature, by definition, is the actual temperature at which a filament in a lamp burns. As a lamp burns at a higher degree Kelvin than 3,200, the bluer the light spectrum will appear. If the Kelvin temperature goes below 3,200 degrees, the spectrum will appear red.

(Continued on page 132)

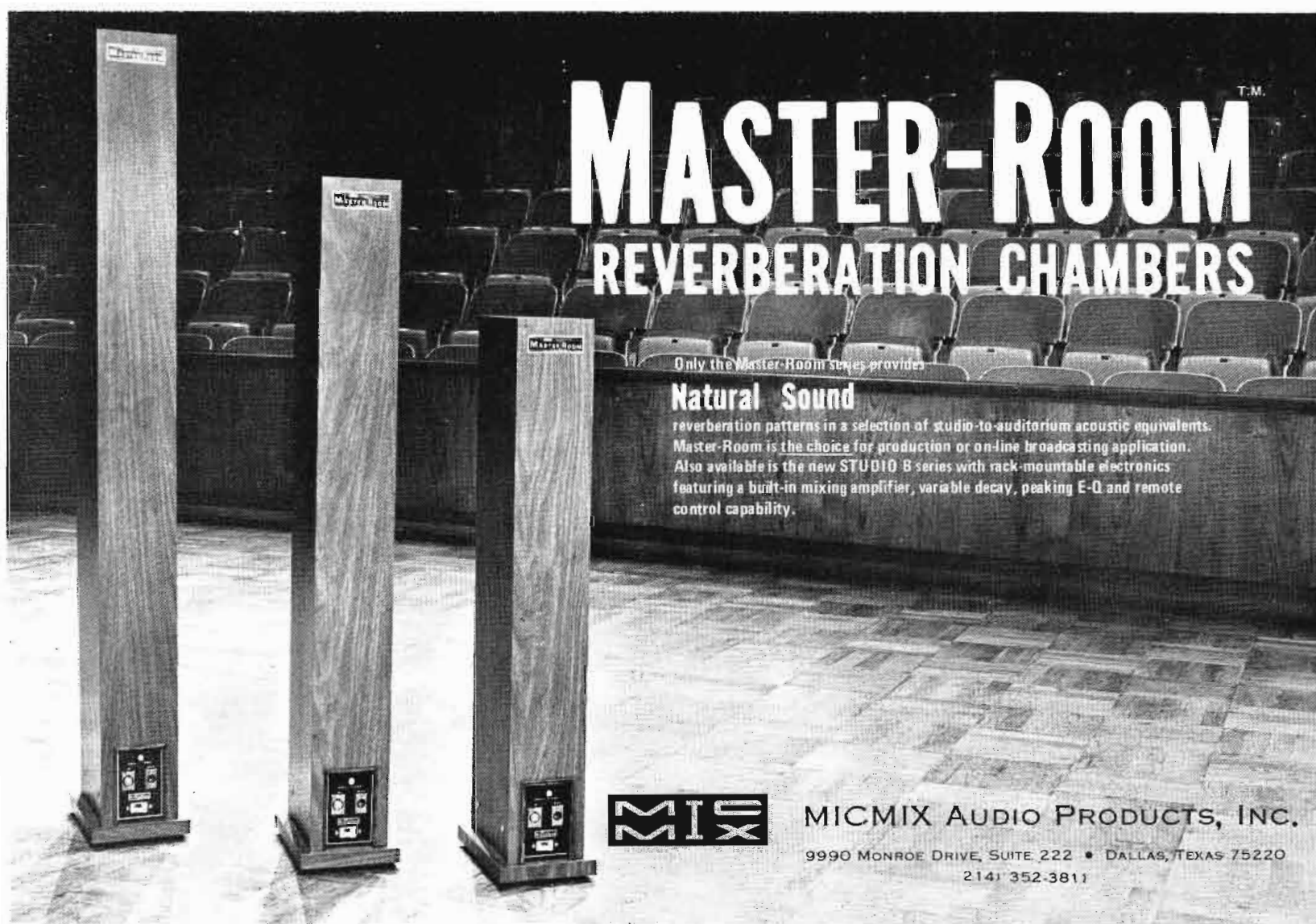

MASTER-ROOM^{T.M.}
REVERBERATION CHAMBERS

Only the Master-Room series provides
Natural Sound
reverberation patterns in a selection of studio-to-auditorium acoustic equivalents.
Master-Room is the choice for production or on-line broadcasting application.
Also available is the new STUDIO B series with rack-mountable electronics
featuring a built-in mixing amplifier, variable decay, peaking E-Q and remote
control capability.

MIX MICMIX AUDIO PRODUCTS, INC.
9990 MONROE DRIVE, SUITE 222 • DALLAS, TEXAS 75220
214/352-3811

For More Details Circle (101) on Reply Card

CMC is matching product excellence with the best delivery service in the TV industry.

COMPUTER MAGNETICS CORPORATION has emerged as a major source of quality video tape equipment.

We are a specialty company providing the TV industry with technically superior products, refurbishing capabilities, and very fast delivery.

For refurbishing **MARK X Video Head Assemblies**, our turn-around time is normally within one week. Our turn-around time for **MARK XX Video Head Assemblies** is two weeks maximum. **VIDEO DISCS** and **HEADS** for Slow-Motion applications are in stock and ready to ship. **AUDIO STACKS** are rebuilt with superior quality heads, and they are in stock for **IMMEDIATE** delivery. Our **dual track AUDIO** record/playback heads are used for producing stereo sound or bi-lingual tracks on the same tape. We also manufacture special **HEADS** for high speed duplication, and for digital applications.

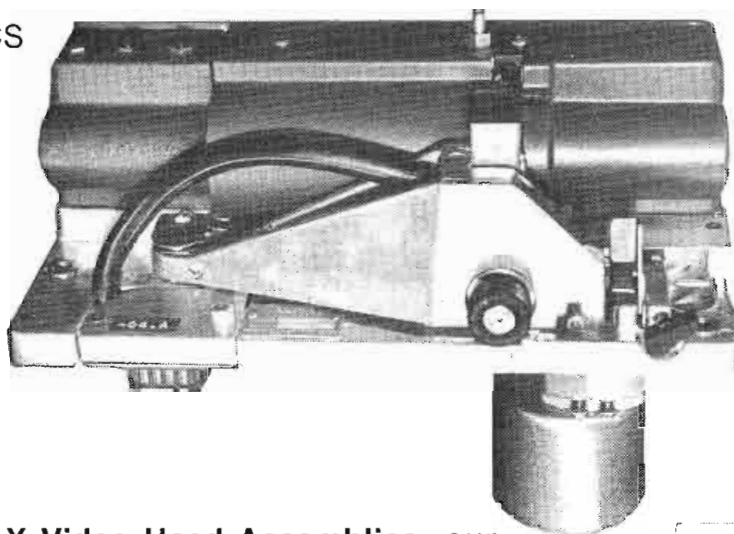

In CMC, we believe our business is to produce quality merchandise, to provide excellent service, and to improve our manufacturing technology in order to maintain a competitive pricing. Back in the old days, a craftsman was proud of his profession. We still are!

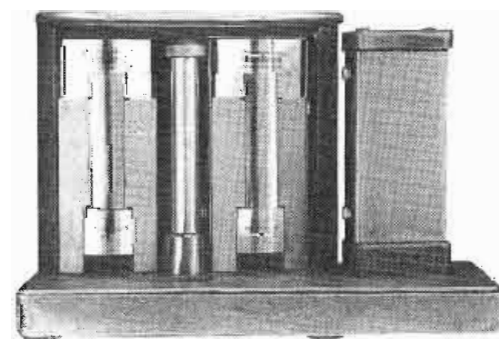
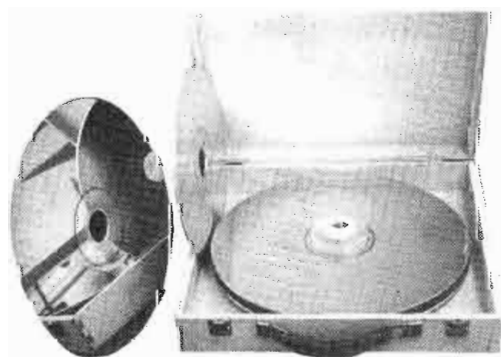
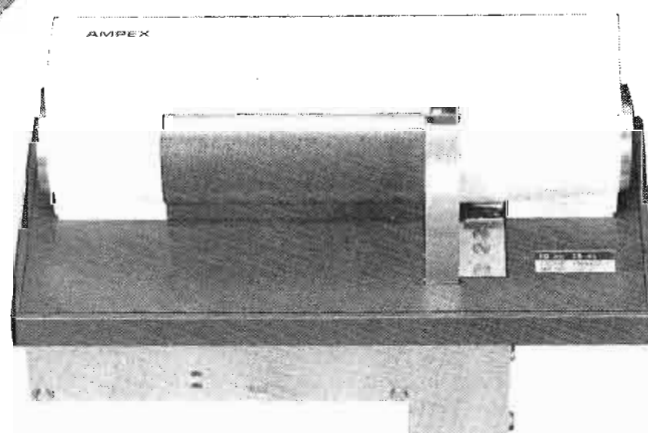

For more information, please write:

In U.S.A.
Computer Magnetics Corp.
125 W. Providencia Ave.
Burbank, Calif. 91502
(213) 843-6674

In Canada
Glentronix, Ltd.
160 Duncan Mill Rd.
Don Mills, Ontario, Canada
(416) 444-8497

In Australia
Air Programs International
60 Bathurst St.
Sydney NSW 2000 Australia
26-1498

For More Details Circle (102) on Reply Card

Lighting

(Continued from page 130)

Dimming is another important function in a television studio. It allows each of the different fixtures to have its light intensities blended together to give a much more appealing result in the final production.

Not only are dimmers used to balance the light, they are also used to paint the light and create mood. It is important to realize that if the key light is kept full up, the skin tones will remain constant. With this in mind, the fill lighting can now be dimmed to create dramatic effect as well as the base light and back lights. Interesting visual effects are created by dimming the colored cyclorama lights and by raising the intensities of the ground rows to create horizons.

If an individual, be he a cameraman or a technician, would take these few basics and apply them to his own needs, not only once, but several times, the lighting for those sets should improve. Nobody will become a trained lighting director

from just reading an article; however, this article was written to give people who have no knowledge of lighting a starting point. □

Commission Allocations table

The FCC has amended a footnote in its Table of Frequency Allocations to reflect the current status of UHF-TV translator stations licensed to operate in the 806-890 MHz land mobile band.

The footnote (NG63) currently sets forth certain conditions under which UHF-TV translator stations, holding valid licenses to operate in the band as of November 15, 1971, may continue to operate, with protection from the land mobile service, for the balance of their license terms. The footnote stipulates, however, that upon license renewal, such translator stations will become secondary with respect to the land mobile service.

Since these translator licenses are valid for three years, all UHF-TV

translator stations now operating in the 806-890 MHz band have renewed their licenses at least once since the rules became effective.

Therefore, the FCC said, all translator stations in this band now are operating on a secondary basis to the land mobile service and the footnote needs to be amended to reflect this current situation.

Accordingly, Footnote NG63 to the Table of Frequency Allocations, Section 2.106 of the rules, has been amended. The rule change becomes effective September 25.



"I said...can you slow down the transmitter room exhaust fan?"

PERFECT TIMING

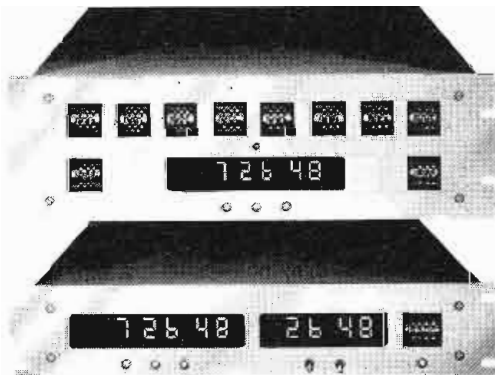

Programmer/Comparators and Network Joiners

Whether your station is based in New York, Honolulu or anywhere in between, perfect timing of station breaks and commercial time-outs is essential. To meet your exacting timing requirements ESE now offers two precision timing components.

To fulfill the needs of Network Broadcasters ESE has designed a complete line of Programmer/Comparators. Rugged thumbwheel programmers coupled with a reliable ESE clock or timer to provide a single pole contact closure (1 Amp contact rating) for the length of time program matches display. In addition ESE P/C's are available with a 10 second preroll cuing lite.

Write, Wire or Call Today: 505½ Centinela Avenue



To meet the needs of Affiliates ESE has designed the Network Joiner. A solid-state Re-programmable memory united with an ESE clock or timer to provide as many user-programmed single pole contact closures as needed. Supplied with manual override and mode selection to provide maximum programming flexibility.

The Programmer/Comparator and the Network Joiner are furnished on a 19" aluminum relay rack mounting panel. The prices of Programmer/Comparators start at \$305. The price of the 10 program P/C shown above is \$1100. The base price of the Network Joiner is \$1000. Custom options and special orders are available.

Inglewood, California 90302 • (213) 647-3021

For More Details Circle (103) on Reply Card

SEPTEMBER, 1975

CABLE engineering

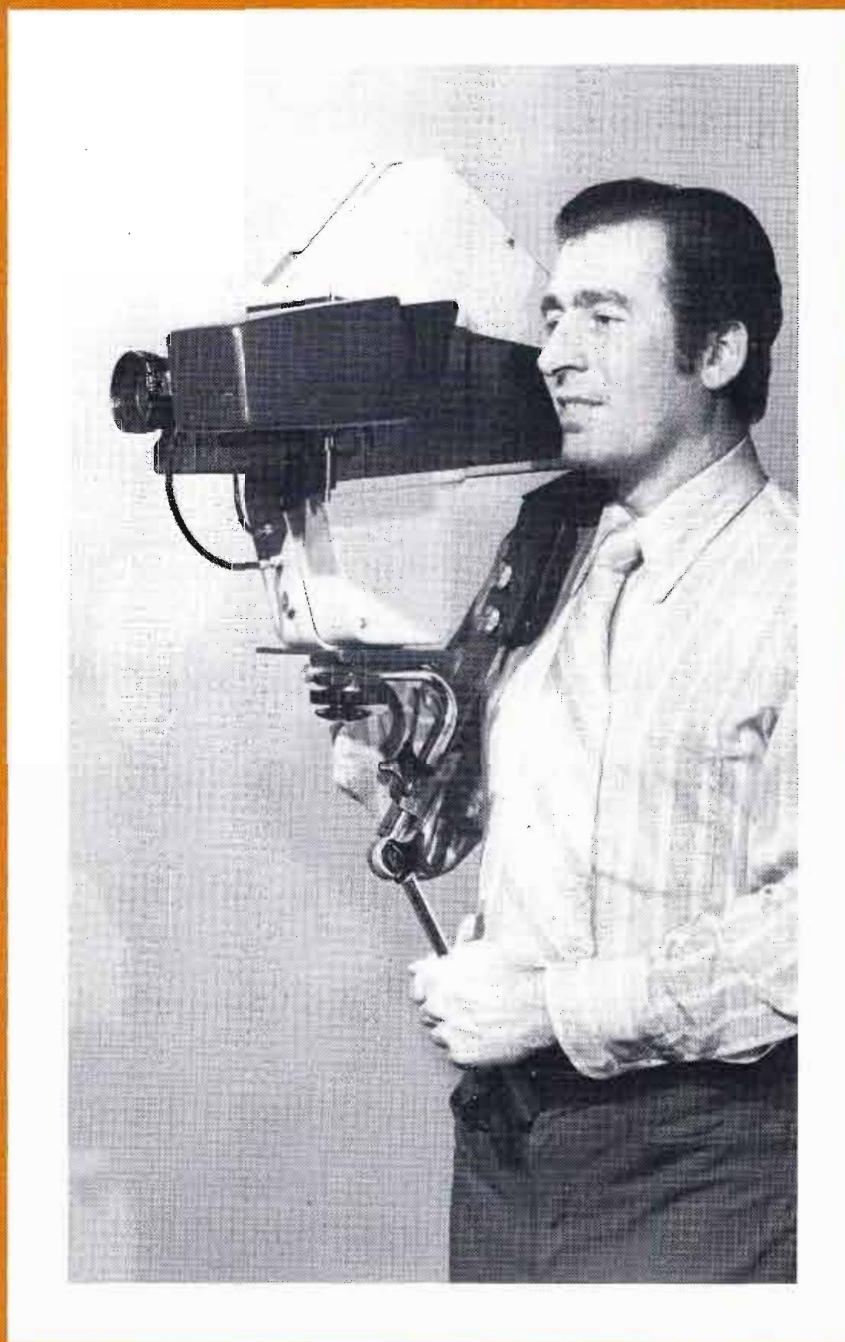

1975 CCTV BUYER'S GUIDE

WITH TODAY'S TIGHT MONEY, OUR \$3,500 TBC LOOKS BETTER THAN EVER!



Even when money was "easy come, easy go," management gloried in saving bucks. Today, they insist on it.

So, you who are on the verge of recommending the purchase of a TBC, ought to know you can still include one in your budget. A darned good one. It's the KSN Signal Master. And it does such a superior job eliminating flag and jitters (often better than many \$12,000 units), we guarantee its performance. You can feel confident that the Signal Master offers the kind of quality you want. For about \$8,000 less than you thought you'd have to pay.

Go ahead. Specify a KSN Signal Master in your budget. Save yourself a lot of maintenance headaches. Save management some pretty substantial bucks. And watch them glory!



SIGNAL MASTER **TIME BASE CORRECTOR** **Kansas State Network**

The incredible KSN Signal Master. Only \$3,500 F.O.B. Wichita, Kansas. SEND FOR A FREE BROCHURE. Write KSN, Box 333, Wichita, Kansas 67201

For More Details Circle (104) on Reply Card

CCTV product directory

Amplifiers Station, Modular

Ameco, Inc.
 Anaconda Elect.
 Anixter-Pruzan
 Broadcast Elect., Inc.
 Buckeye Telephone &
 Supply Co.
 C-COR Elect., Inc.
 Environmental Comm., Inc.
 GTE Sylvania
 Jerrold Elect. Corp.
 Lindsay Specialty Prods. Ltd.
 Magnavox
 Teleng Inc.
 Theta-Com of Calif.
 TV Cable Supply Co., Inc.

Amplifiers, Bridging

Ameco, Inc.
 Anaconda CATV
 Anixter-Pruzan
 Buckeye Telephone &
 Supply Co.
 C-COR Elect., Inc.
 Davco Elect. Corp.
 Delta-Benco-Cascade Ltd.
 Echo Science Corp.
 Elect. Indust. Eng., Inc.
 Entron, Inc.
 Environmental Comm., Inc.
 GTE Sylvania
 Jerrold Elect. Corp.
 Lindsay Specialty Prods. Ltd.
 Magnavox
 Maspro Co., Inc.
 Rohde & Schwarz Sales Co.
 Telaudio Centre
 Teleng Inc.
 Temtron Elect.
 Theta-Com of Calif.
 TV Cable Supply Co., Inc.
 Ultra Audio Prods.
 Video Eng. Co., Inc.

Amplifiers, Broadband

AEL Comm. Corp.
 Ameco, Inc.
 Anaconda Elect.
 Anixter-Pruzan
 Antsco Corp.
 B&K Instr., Inc.
 Blonder-Tongue Labs., Inc.
 Cerro Comm.
 C-COR Elect., Inc.
 Davco Elect. Corp.
 Delta-Benco-Cascade Ltd.
 Elect. Indust. Eng., Inc.
 Entron, Inc.
 Environmental Comm., Inc.
 GTE Sylvania
 Jerrold Elect. Corp.
 JFD Systems Div.
 Kay Elemetrics Corp.
 Lindsay Specialty Prods. Ltd.
 Magnavox
 Radiation Devices Co.
 RMS Elect., Inc.
 Sitco Antenna Co.
 Teleng Inc.
 Temtron Elect.
 Theta-Com of Calif.
 Tocom, Inc.
 TV Cable Supply Co., Inc.
 Winegard Co.

Amplifiers, Distribution

Ameco, Inc.
 Amer. Data Corp.
 Anaconda CATV
 Anixter-Pruzan
 AVA Elect. & Machine Corp.
 Ball Bros. Research Corp.
 Beaver Elect. Ltd.
 Blonder-Tongue Labs., Inc.
 Broadcast Automation Assoc.
 Broadcast Elect., Inc.
 C-COR Elect., Inc.
 Cerro Comm.
 Cohu, Inc.
 Delta-Benco-Cascade Ltd.
 Davco Elect. Corp.
 Dynair Elect., Inc.
 Dynasciences Corp.
 GTE Sylvania
 Hitachi Shibaden Corp.
 of Amer.
 Magnavox
 Radiation Devices Co.
 Rohde & Schwarz Sales Co.
 Telemation, Inc.
 Temtron Elect.
 Video Eng. Co., Inc.
 Viscount Indust. Ltd.
 Visual Educom Inc.
 Vital Indust. Inc.
 Winegard Co.

Amplifiers, Distribution Pulse

Amer. Data Corp.
 Anixter-Pruzan
 Ball Bros. Research Corp.
 Cohu, Inc.
 Dynascience Corp.
 Telemation, Inc.
 Telemet
 Temtron Elect.
 Video Eng. Co., Inc.
 Vital Indust. Inc.

Amplifiers, Line Extender

Able Comm. & Elect.
 Ameco, Inc.
 Anaconda CATV
 Anixter-Pruzan
 AVA Elect. & Machine Corp.
 Buckeye Telephone &
 Supply Co.
 Cascade Elect. Ltd.
 C-COR Elect., Inc.

Davco Elect. Corp.
 Delta-Benco-Cascade Ltd.
 Elect. Indust. Eng., Inc.
 Entron, Inc.
 Environmental Comm., Inc.
 GTE Sylvania
 Jerrold Elect. Corp.
 Lindsay Specialty Prods. Ltd.
 Magnavox
 MPI Co.
 Radiation Devices Co.
 Riker Video
 Teleng Inc.
 Temtron Elect.
 Theta-Com of Calif.
 TV Cable Supply Co., Inc.
 Vital Indust. Inc.
 Winegard Co.

Amplifiers, Processing

Ameco, Inc.
 Anixter-Pruzan
 Ball Bros. Research Corp.
 CBS Labs.
 C-COR Elect., Inc.
 Dynasciences Corp.
 Environmental Comm., Inc.
 Scientific-Atlanta, Inc.
 Telemation, Inc.
 Television Microtime, Inc.
 Video Eng. Co., Inc.
 Vital Indust. Inc.

Amplifiers, RF

AEL Comm. Corp.
 Ameco, Inc.
 Anixter-Pruzan
 AVA Elect. & Machine Corp.
 B&K Instr., Inc.
 Broadcast Automation Assoc.
 C-COR Elect., Inc.
 Cerro Comm.
 Davco Elect. Corp.
 Elect. Indust. Eng., Inc.
 Environmental Comm., Inc.
 Jerrold Elect. Corp.
 JFD Systems Div.
 Kay Elemetrics Corp.
 KLM Elect.
 Leaming Indust. Corp.
 Magnavox
 RMS Elect., Inc.
 Rohde & Schwarz Sales Co.
 Sitco Antenna Co.
 Tocom, Inc.
 TV Cable Supply Co., Inc.

Amplifiers, Subcarrier

Ameco, Inc.
 Amer. Data Corp.
 Anixter-Pruzan
 Cohu, Inc.
 Davco Elect. Corp.
 Delta-Benco-Cascade Ltd.
 Dynasciences Corp.
 Magnavox
 Telemation, Inc.
 Video Eng. Co., Inc.
 Vital Indust. Inc.

Amplifiers, Trunk

AEL Comm. Corp.
 Ameco, Inc.
 Anaconda CATV
 Anixter-Pruzan
 Buckeye Telephone &
 Supply Co.
 Cascade Elect. Ltd.
 C-COR Elect., Inc.
 Davco Elect. Corp.
 Delta-Benco-Cascade Ltd.
 Elect. Indust. Eng., Inc.
 Entron, Inc.
 Environmental Comm., Inc.
 GTE Sylvania
 Jerrold Elect. Corp.
 Magnavox
 Teleng Inc.
 Temtron Elect.
 Theta-Com of Calif.
 TV Cable Supply Co., Inc.

Amplifiers, Two-Way

AEL Comm. Corp.
 Ameco, Inc.
 Anaconda CATV
 Anixter-Pruzan
 AVA Elect. & Machine Corp.
 Buckeye Telephone &
 Supply Co.
 Cascade Elect., Inc.
 Davco Elect. Corp.
 Delta-Benco-Cascade Ltd.
 Elect. Indust. Eng., Inc.
 Entron, Inc.
 Environmental Comm., Inc.
 GTE Sylvania
 Jerrold Elect. Corp.
 Lindsay Specialty Prods. Ltd.
 Magnavox
 Scientific-Atlanta, Inc.
 Teleng Inc.
 Theta-Com of Calif.



VP12

PLOW MODULE

Today, More Than Ever...
DITCH WITCH VIBRATORY PLOWS
 Make \$ense!



R200

In many situations, trenching isn't necessary to make underground installations. Vibratory plowing installs materials directly into the ground quickly and efficiently. And since no trench is dug, there's no trench to fill up. Vibratory plowing is extremely effective when working in areas that already are landscaped, because turf damage is minimized. Ditch Witch offers the most complete line of vibratory plowing equipment available. The compact VP12 "service" plow, is a completely self-contained plow for making service installations. Vibratory plow modules are available for the four Modularmatic models in power ranges from 30-HP to 100-HP. And the king of all vibratory plows is the Ditch Witch R200, the big, rugged 195-HP model designed specifically for cross country work. Ditch Witch vibratory plow equipment can help you do more work in less time and lower overall construction costs. And, today, more than ever, that makes sense.



"Ask the man you see wearing this emblem how Ditch Witch Makes Sense for you!"

Ditch Witch . . . equipment from 7- to 195-HP.

CHARLES MACHINE WORKS, INC.

P. O. Box 66
 Perry, Oklahoma 73077®



Tocom, Inc.
TV Cable Supply Co., Inc.
Video Aids Corp. of Colo.

Antenna Baluns

Anixter-Pruzan
Antsco Corp.
AVA Elect. & Machine Corp.
Beaver Elect. Ltd.
Blonder-Tongue Labs., Inc.
Cablewave Systems Inc.
Davco Elect. Corp.
Delta-Benco-Cascade Ltd.
Gates Radio
Hy-Gain Elect. Corp.
Jampro Antenna Co.
JFD Systems Div.
KLM Elect.
Lindsay Specialty Prods. Ltd.
Maspro Co., Inc.
Rohde & Schwarz Sales Co.
Scala Radio Corp.
Scientific-Atlanta, Inc.
Sitco Antenna Co.

Antennas, Broadband

Advance Indust., Inc.
Anixter-Pruzan
Cablewave Systems, Inc.
C-COR Elect., Inc.
Cush Craft Corp.
Davco Elect. Corp.
Gates Radio
Hy-Gain Elect. Corp.
Jampro Antenna Co.
Jerrold Elect. Corp.
JFD Systems Div.
KLM Elect.
Lindsay Specialty Prods. Ltd.
RD Systems, Inc.
RMS Elect., Inc.
Rohde & Schwarz Sales Co.
Scala Radio Corp.
Scientific-Atlanta, Inc.
Sitco Antenna Co.
TACO Div.
TV Cable Supply Co., Inc.
Winegard Co.

Antennas, FM

Advance Indust., Inc.
Anixter-Pruzan
Beaver Elect. Ltd.
Blonder-Tongue Labs., Inc.
Broadcast Automation Assoc.
Cablewave Systems, Inc.
Cush Craft Corp.
Davco Elect. Corp.
Ft. Worth Tower Co., Inc.
Gates Radio
Hy-Gain Elect. Corp.
Jampro Antenna Co.
Jerrold Elect. Corp.
KLM Elect.
Lindsay Specialty Prods. Ltd.
Maspro Co., Inc.
RF Systems, Inc.
Riker Video
RMS Elect., Inc.
Rohde & Schwarz Sales Co.
Saxton Prods., Inc.
Scala Radio Corp.
Scientific-Atlanta, Inc.

Sitco Antenna Co.
Sparta Elect. Corp.
TACO Div.
TV Cable Supply Co., Inc.
Winegard Co.

Antennas, Single Channel

Advance Indust., Inc.
Anixter-Pruzan
Beaver Elect. Ltd.
Blonder-Tongue Labs., Inc.
Cablewave Systems Inc.
C-COR Elect., Inc.
Cush Craft Corp.
Davco Elect. Corp.
Gates Radio
Hy-Gain Elect. Corp.
Jampro Antenna Co.
Jerrold Elect. Corp.
JFD Systems Div.
KLM Elect.
Lindsay Specialty Prods. Ltd.
Maspro Co., Inc.
Radiation Devices Co.
RF Systems, Inc.
Riker Video
RMS Elect., Inc.
Scala Radio Corp.
Scientific-Atlanta, Inc.
Sitco Antenna Co.
TACO Div.
TV Cable Supply Co., Inc.
Winegard Co.

Antennas, VHF-UHF

Advance Indust., Inc.
Anixter-Pruzan
Beaver Elect. Ltd.
Blonder-Tongue Labs., Inc.
Cablewave Systems Inc.
C-COR Elect., Inc.
Cush Craft Corp.
Davco Elect. Corp.
Gates Radio
Hy-Gain Elect. Corp.
Jampro Antenna Co.
Jerrold Elect. Corp.
JFD Systems Div.
KLM Elect.
Lindsay Specialty Prods. Ltd.
Radiation Devices Co.
RCA Corp.
RF Systems, Inc.
Riker Video
RMS Elect., Inc.
Rohde & Schwarz Sales Co.
Saxton Prods., Inc.
Scala Radio Corp.
Scientific-Atlanta, Inc.
Sitco Antenna Co.
Soladyne Internatl., Inc.
TACO Div.
TV Cable Supply Co., Inc.
Winegard Co.

Attenuators

Kay Elemetrics CE-8

Audio Equipment

Able Comm. & Elect.
Amer. Data Corp.
Anixter-Pruzan

B&K Instr., Inc.
Broadcast Automation Assoc.
Broadcast Elect., Inc.
CBS Labs.
Coastcom
Comspace Corp.
Davco Elect. Corp.
Electrohome, Ltd.
Electro-Voice, Inc.
Fairchild MOD
F&B/Ceco of Calif., Inc.
Gates Radio
Gotham Audio Corp.
Kay Elemetrics Corp.
McGraw-Edison Co.
Nelson-Hershfield Elect.
Noram Comm. Ltd.
Rohde & Schwarz Sales Co.
Soladyne Internatl., Inc.
Sparta Elect. Corp.
Tapecaster TCM
Telaudio Centre
Tele-Cine Inc.
Telemation, Inc.
Telemet
Television Equipment Assoc.
Television Microtime Inc.
Ultra Audio Prods.
Video Eng. Co., Inc.
VIF Internatl.
Visual Elect. Labs.
Vital Indust. Inc.

Automatic Programming Equipment

Ameco, Inc.
Amer. Data Corp.
Anixter-Pruzan
Broadcast Automation Assoc.
Broadcast Elect., Inc.
Concise Instr. Design Ltd.
Davco Elect. Corp.
Dynasciences Corp.
Gates Radio
Jerrold Elect. Corp.
Phasecom Corp.
Sparta Elect. Corp.
Spectra-Vision Corp.
Tape-Athon Corp.
Techno Prods. Co.
Telemation, Inc.
Television Microtime Inc.
Video Data Systems, Inc.
VIF Internatl.
Vital Indust. Inc.

Background Music Equip.

Tape-Athon Corp.

Cable Accessories

Alpha Wire Corp.
Ameco, Inc.
Amer. Technology Co., Inc.
Anixter-Pruzan
Antsco Corp.
AVA Elect. & Machine Corp.
Beaver Elect. Ltd.
Belden Corp.
Boston Insulated Wire & Cable Co., Ltd.
British Insulated Callender's Cables Ltd.

Buckeye Telephone & Supply Co.
Cablewave Systems Inc.
Cerro Comm.
Comm/Scope Corp.
Davco Elect. Corp.
Entron, Inc.
Essex Elect. Systems
General Cable Corp.
Gilbert Eng. Co., Inc.
Jampro Antenna Co.
Jerrold Elect. Corp.
Kay Elemetrics Corp.
LRC Elect., Inc.
Noram Comm. Ltd.
Panduit Corp.
Preform Line Prods. Co.
Prodelin Inc.
RMS Elect., Inc.
Sigmaform Corp.
Soladyne Internatl., Inc.
Southern Telephone Supply Co.
Telsta/General Cable Apparatus Div.
Temtron Elect.
Theta-Com of Calif.
Tocom, Inc.
TV Cable Supply Co., Inc.
Utility Tool Corp.
Utility Tower Co.
Westay Co.
Winegard Co.

Cable Burial Equipment

Ditch Witch CE-4
Anixter-Pruzan
Buckeye Telephone & Supply Co.
Cleveland Trenchers Div.
Davco Elect. Corp.
Davis Mfg.
Ditch Witch
Terra Equipment Co.

Cable Coaxial, Line

Alpha Wire Corp.
Anaconda CATV
Anixter-Pruzan
Berkshire Electric Cable Co.
Blonder-Tongue Labs., Inc.
Boston Insulated Wire and Cable Co., Ltd.
Brand-Rex Co.
British Insulated Callender's Cables Ltd.
Broadcast Automation Assoc.
Cerro Comm.
Copperweld Corp.
Davco Elect. Corp.
General Cable Corp.
Noram Comm. Ltd.
Phelps Dodge Comm. Co.
Prodelin Inc.
Saxton Prods., Inc.
Times Wire & Cable Co.

Cable Coaxial, Drop

Alpha Wire Corp.

Your Amperex distributor has the replacement tube that will restore your Plumbicon* TV camera to its original performance...

...or even better!

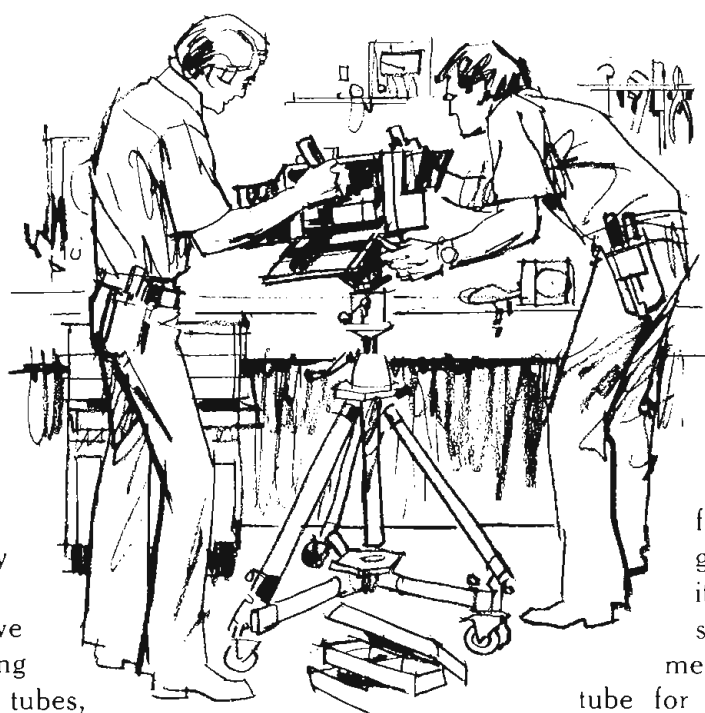

Let's face it — even Plumbicon TV camera tubes wear out and eventually have to be replaced to restore your camera's original picture quality. If we learned anything on the way to selling over 30,000 Plumbicon TV camera tubes, we learned how important Service is to the telecaster. Especially when it's related to availability! No TV camera-user can afford to shut down his operation while "waiting for parts." Plumbicon replacement tubes are instantly available, at all times, through local distributors and through Amperex factory sales representatives. And Plumbicon tube distributors (your own local businessmen) are carefully selected for their ability to support Plumbicon TV camera systems with on-the-spot customer support and on-the-spot customer service.

No doubt it was picture quality that motivated you to select a Plumbicon CCTV camera originally. Today, when business conditions, more than ever, demand absolute peak performance

from every system, you can upgrade your camera's picture quality dramatically, simply by substituting a direct plug-in replacement, broadcast-grade Plumbicon tube for the industrial-grade Plumbicon tube now in your camera.



The broadcast-grade tube is the direct descendant of our original Plumbicon that revolutionized color TV broadcasting...and won an Emmy award from the Broadcast Industry. As a matter of fact, contemporary Plumbicon tubes outperform the original Plumbicon by a wide margin with such important improvements as Higher Resolution and Modulation Depth, Extended-Red Response and Minimum Lag.

Genuine Amperex Plumbicon tubes are available through selected Amperex Distributors. For the name of the Plumbicon Distributors nearest you, write: Electro-Optical Devices Division, Amperex Electronic Corporation, Slatersville, Rhode Island 02876. Telephone: 401-762-3800.

Amperex®

TOMORROW'S THINKING IN TODAY'S PRODUCTS

A NORTH AMERICAN PHILIPS COMPANY

*Trademark of N.V. Philips of The Netherlands

For More Details Circle (106) on Reply Card

Anaconda CATV
Anixter-Pruzan
Berkshire Electric Cable Co.
Blonder-Tongue Labs., Inc.
Brand-Rex Co.
British Insulated Callender's
Cables Ltd.
Cerro Comm.
Copperweld Corp.
Davco Elect. Corp.
General Cable Corp.
Noram Comm. Ltd.
Saxton Prods., Inc.
Times Wire & Cable Co.

Cable Locators, Underground

Anixter-Pruzan
Davco Elect. Corp.
Scully/Metrotech

Cable, Messenger Wire

Alpha Wire Corp.
Anixter-Pruzan
Belden Corp.
Berkshire Electric Cable Co.
Brand-Rex Co.
Buckeye Telephone &
Supply Co.
Cerro Comm.
Copperweld Corp.
Davco Elect. Corp.
General Cable Corp.
Noram Comm. Ltd.
Phelps Dodge Comm. Co.
Southern Telephone
Supply Co.
Systems Wire & Cable, Inc.
TV Cable Supply Co., Inc.

Camera Tubes

Amperex **CE-6**

Cameras, B/W

Ameco, Inc.
Ampex Corp.
Anixter-Pruzan
Audiotronics Corp.
Avtel Corp.
Cohu, Inc.
Davco Elect. Corp.
Diamond Power Specialty
Corp.
Echo Science Corp.
F&B/Ceco of Calif., Inc.
Gates Radio
GBC Closed Circuit TV Corp.
GPL-TV
Hitachi Shibaden Corp.
of Amer.
Int. Video Corp.
Javelin Elect. Co.
Jerrold Elect. Corp.
JFD Systems Div.
K'Son Corp.
Nelson-Hershfield Elect.
Noram Comm. Ltd.
Panasonic VTR/CCTV
Phillips Bcst. Equip. Corp.
Sony Corp. of Amer.
Southern Telephone
Supply Co.

Telaudio Centre
Telemation, Inc.
Temtron Elect.
R. H. Tyler Co.
Video Eng. Co., Inc.
Visual Educom Inc.

Cameras, Color

Ampex Corp.
Anixter-Pruzan
Avtel Corp.
Cohu, Inc.
Commercial Elect. Inc.
Davco Elect. Corp.
Diamond Power Specialty
Corp.
F&B/Ceco of Calif., Inc.
Gates Radio
GBC Closed Circuit TV Corp.
Hitachi Shibaden Corp.
of Amer.
Int. Video Corp.
Magnavox
The Magnavox Co.,
Video Systems
Noram Comm. Ltd.
Panasonic VTR/CCTV
Phillips Bcst. Equip. Corp.
RCA Corp.
Sony Corp. of Amer.
Southern Telephone
Supply Co.
Telaudio Centre
Tele-Cine Inc.
Telemation, Inc.
Temtron Elect.
Video Eng. Co., Inc.

Cameras, Industrial CCTV

Ampex Corp.
Anixter-Pruzan
Cohu, Inc.
Davco Elect. Corp.
Echo Science Corp.
GBC Closed Circuit TV Corp.
Hitachi Shibaden Corp.
of Amer.
Int. Video Corp.
Javelin Elect. Co.
The Magnavox Co.,
Video Systems
Noram Comm. Ltd.
Stereotronics Television Co.
Telemation, Inc.
Temtron Elect.
Video Eng. Co., Inc.
Visual Educom Inc.

Channel Preamps

Ameco, Inc.
Anixter-Pruzan
Beaver Elect. Ltd.
C-COR Elect., Inc.
Davco Elect. Corp.
Delta-Benco-Cascade Ltd.
Entron, Inc.
Environmental Comm., Inc.
Fung Eng. Co.
Jerrold Elect. Corp.
JFD Systems Div.

Lindsay Specialty Prods. Ltd.
TV Cable Supply Co., Inc.
Winegard Co.

Character Generators

Anixter-Pruzan
Datavision Inc.
Davco Elect. Corp.
GBC Closed Circuit TV Corp.
Interand Corp.
Kansas State Network, Inc.
Laird Telemedia, Inc.
Metrodata Corp.
MSI Television
Systron-Donner Corp.
Telemation, Inc.
Telemet
Video Data Systems, Inc.
Video Eng. Co., Inc.
VIF Internatl.

Colorizers

Amer. Data Corp.
Anixter-Pruzan
Dynasciences Corp.
Laird Telemedia, Inc.
Metrodata Corp.
Telemation, Inc.
Telemet
Television Microtime Inc.
Video Eng. Co., Inc.
Vital Indust. Inc.

Consoles & Accessories

Alma Eng.
Anixter-Pruzan
Avtel Corp.
Beston Elect.
Broadcast Automation Assoc.
Broadcast Elect., Inc.
Cohu, Inc.
Fairchild MOD
F&B/Ceco of Calif., Inc.
GBC Closed Circuit TV Corp.
GPL-TV
Int. Video Corp.
Javelin Elect. Co.
Nelson-Hershfield Elect.
Noram Comm. Ltd.
Panasonic VTR/CCTV
Shintron Co. Inc.
Sparta Elect. Corp.
Telaudio Centre
Telemation, Inc.
Television Microtime Inc.
Ultra Audio Prods.
Video Eng. Co., Inc.
Visual Educom Inc.
Vital Indust. Inc.

Converters

Able Comm. & Elect.
AEL Comm. Corp.
Ameco, Inc.
Anixter-Pruzan
C-COR Elect., Inc.
Comspace Corp.
Davco Elect. Corp.
Delta-Benco-Cascade Ltd.
Elect. Indust. Eng., Inc.

Entron, Inc.
Environmental Comm., Inc.
F&B/Ceco of Calif., Inc.
Fung Eng. Co.
GTE Sylvania
Jerrold Elect. Corp.
JFD Systems Div.
K'Son Corp.
Lindsay Specialty Prods. Ltd.
Magnavox
Maspro Co., Inc.
Oak Indust.
Phasecom Corp.
RMS Elect., Inc.
Teleng Inc.
Terado Corp.
Tomco Comm. Inc.
TV Cable Supply Co., Inc.

Delay Units

Anixter-Pruzan
Broadcast Automation Assoc.
McGraw-Edison Co.
Television Equipment Assoc.
Television Microtime Inc.

Demodulators

Ameco, Inc.
Anixter-Pruzan
Audiotronics Corp.
Catel
Coastcom
Davco Elect. Corp.
Dynair Elect., Inc.
Elect. Indust. Eng., Inc.
Environmental Comm., Inc.
F&B/Ceco of Calif., Inc.
Fung Eng. Co.
Jerrold Elect. Corp.
JFD Systems Div.
Leaming Indust. Corp.
Nelson-Hershfield Elect.
Radiation Devices Co.
Rohde & Schwarz Sales Co.
SC Elect., Inc.
Telemet
Video Eng. Co., Inc.

Directional Couplers

Ameco, Inc.
Amer. Technology Co., Inc.
Anaconda CATV
Anixter-Pruzan
Antsco Corp.
AVA Elect. & Machine Corp.
Beaver Elect. Ltd.
Blonder-Tongue Labs., Inc.
Buckeye Telephone &
Supply Co.
C-COR Elect., Inc.
Cerro Comm.
Davco Elect. Corp.
Delta-Benco-Cascade Ltd.
Dolphin Comm. Corp.
Entron, Inc.
Environmental Comm., Inc.
Jampro Antenna Co.
Jerrold Elect. Corp.
Lindsay Specialty Prods. Ltd.
Magnavox
MPI Co.
RMS Elect., Inc.

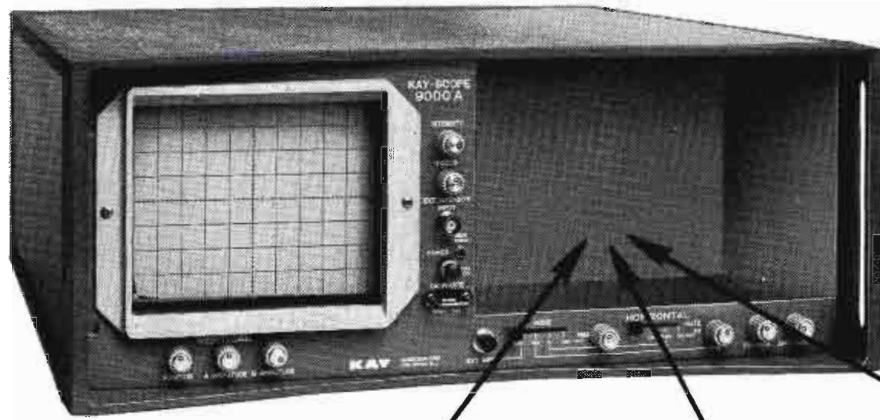

KAY's modular CATV test set.

The new Kay Series 9000 CATV test set offers a completely new approach to system testing: a basic storage scope main frame with low cost plug-ins for summation sweep testing, spectrum analysis, loss and return loss measurements and bench alignment.



The P9020A/VHF Summation Sweep Receiver — features 40 db post amp. — 42 db attenuator, markers, detector and tilt control. Also built-in +15 db mv reference signal.

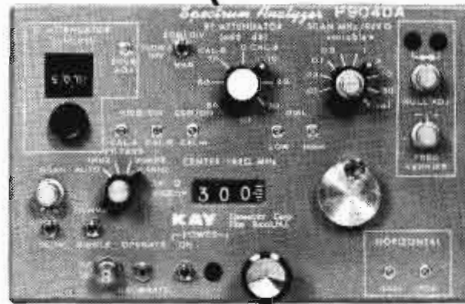

The P9040 Spectrum Analyzer features phase locked 1 KHz resolution in 1 — 300 MHz frequency range with 72 db dynamic range from +20 dbmv 75 ohm.

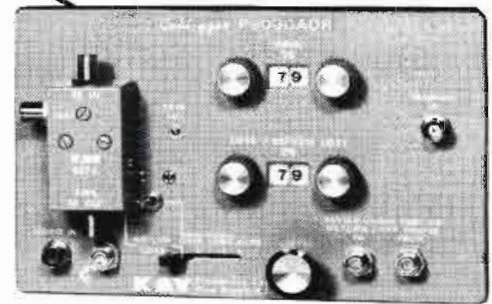

The 9030 measures gain/loss and return loss of active and passive device. Includes attenuators, electronic switch bridge and detector.

New KAY HALF-RACK Sweep Generator Series



Model	Frequency Range	Sweep Width	RF Output	Flatness	Distortion	Price (plus markers)
9054	50 KHz-110 MHz	0-110 MHz	1V RMS	± .25 db	>35 db down	\$ 995.
9059	.5-300 MHz	0-300 MHz	1V RMS	± .25 db	>30 db down	845.
9060	.5-500 MHz	.5-500 MHz	1V RMS	± .3 db	>35 db down	1150.
9062	1-1000 MHz	.5-1000 MHz	.5V RMS	± .25 db	>30 db down	1350.
9063	1-1500 MHz		.5V RMS		>30 db down	1590.

Band 1: 1-900 MHz Band 1: 500 KHz-1000 MHz Band 1: ± .25 db
 Band 2: 800-1500 MHz Band 2: 200 KHz-700 MHz Band 2: ± 3 db

KAY Attenuators

- High Accuracy
- Low VSWR
- Minimal Insertion Loss
- 75 Ohm

DC-12.4 GHz
Sliding Block
132 db



\$395.

Miniature
DC-2 GHz
Rotary
70 db



\$125.

Miniature
DC-1 GHz
In-Line Toggle
132 db



\$145.

Noise Figure Meters • Gain-Loss, Return Loss Bridges
LIN/LOG Amplifiers • RF Detectors
1 GHz Electronic Switch • Test Equipment

KAY Elemetrics Corp

Maple Avenue, Pine Brook, New Jersey 07058/Phone (201) 227-2000

For More Details Circle (228) on Reply Card

Rohde & Schwarz Sales Co.
Southern Telephone Supply
Co.
Theta-Com of Calif.
Tocom, Inc.
TV Cable Supply Co., Inc.

Drop Cables

Aberdeen Co.
Alpha Wire Corp.
Anaconda CATV
Anixter-Pruzan
Belden Corp.
Buckeye Telephone &
Supply Co.
Canada Wire & Cable
Co., Ltd.
Cerro Comm.
Comm/Scope Corp.
Copperweld Corp.
Davco Elect. Corp.
Essex Elect. Systems
General Cable Corp.
Noram Comm. Ltd.
Southern Telephone
Supply Co.
Theta-Com of Calif.
TV Cable Supply Co., Inc.

Encoder, Video

Amer. Data Corp.
Anixter-Pruzan
Cohu, Inc.
Commercial Elect. Inc.
Telemation, Inc.
Video Eng. Co., Inc.

Equalizers

Ameco, Inc.
Anaconda Elect.
Anixter-Pruzan
B&K Instr., Inc.
Broadcast Automation Assoc.
Buckeye Telephone &
Supply Co.
C-COR Elect., Inc.
Davco Elect. Corp.
Delta-Benco-Cascade Ltd.
Dynair Elect., Inc.
F&B/Ceco of Calif., Inc.
Jerrold Elect Corp.
Lindsay Specialty Prods. Ltd.
Magnavox
Telemet
Theta-Com of Calif.
TV Cable Supply Co., Inc.
Video Eng. Co., Inc.

Feeder & Trunk Cables

Alpha Wire Corp.
Anaconda CATV
Anixter-Pruzan
Buckeye Telephone &
Supply Co.
Cerro Comm.
Comm/Scope Corp.
Davco Elect. Corp.
Jerrold Elect. Corp.
Noram Comm. Ltd.
Southern Telephone
Supply Co.
Theta-Com of Calif.

TV Cable Supply Co., Inc.

Field Strength Meters

Ameco, Inc.
Anixter-Pruzan
B&K Instr., Inc.
Beaver Elect. Ltd.
Blonder-Tongue Labs., Inc.
Cascade Elect. Ltd.
Davco Elect. Corp.
Delta-Benco-Cascade Ltd.
Fung Eng. Co.
Jerrold Elect. Corp.
McGraw-Edison Co.
Potomac Instr., Inc.
Radiation Devices Co.
Riker Video
Rohde & Schwarz Sales Co.
Sadelco, Inc.
Sencore Inc.
Temtron Elect.
Vikoa, Inc.

Film Chain Equipment

Anixter-Pruzan
Avtel Corp.
Cohu, Inc.
Commercial Elect. Inc.
Comspace Corp.
Davco Elect. Corp.
Eastman Kodak
F&B/Ceco of Calif., Inc.
Gates Radio
GPL-TV
Kalart Victor Corp.
Laird Telemedia, Inc.
L-W Photo, Inc.
Noram Comm. Ltd.
Philips Bcst. Equip. Corp.
RCA Corp.
Spindler & Sauppe, Inc.
Telaudio Centre
Telemation, Inc.
Temtron Elect.
R. H. Tyler Co.
Video Eng. Co., Inc.

FM Processing Equipment

Anixter-Pruzan
Catel
CBS Labs.
Davco Elect. Corp.
Environmental Comm., Inc.
Fung Eng. Co.
Jerrold Elect. Corp.

Generators, Carrier

Ameco, Inc.
Anixter-Pruzan
Blonder-Tongue Labs., Inc.
C-COR Elect., Inc.
Davco Elect. Corp.
Delta-Benco-Cascade Ltd.
Fung Eng. Co.
Jerrold Elect. Corp.
McGraw-Edison Co.
Rohde & Schwarz Sales Co.
Southern Telephone
Supply Co.
Telemation, Inc.
Telemet
Teleng Inc.

Theta-Com of Calif.

Generators, Character

GBC Closed Circuit TV Corp.

Generators, Special Effects

Amer. Data Corp.
Anixter-Pruzan
Ball Bros. Research Corp.
Dynair Elect., Inc.
Dynamics Corp.
GBC Closed Circuit TV Corp.
Hitachi Shibaden Corp.
of America
Interand Corp.
Telemation, Inc.
Telemet
Video Eng. Co., Inc.
Viscount Indust. Ltd.
Visual Educom Inc.
Vital Indust. Inc.

Generators, Sync

Amer. Data Corp.
Anixter-Pruzan
CBS Labs.
Cohu, Inc.
Commercial Elect. Inc.
Comspace Corp.
Davco Elect. Corp.
Dynascan Corp.
Dynamics Corp.
Echo Science Corp.

Entron, Inc.
F&B/Ceco of Calif., Inc.
Hitachi Shibaden Corp.
of Amer.
Panasonic VTR/CCTV
Rohde & Schwarz Sales Co.
Telemation, Inc.
Telemet
Television Microtime Inc.
TV Cable Supply Co., Inc.
Video Aids Corp. of Colo.
Video Eng. Co., Inc.
Visual Educom Inc.
Vital Indust. Inc.

Generators, Test

Kay Elemetrics **CE-8**

Ameco, Inc.
Amer. Data Corp.
Anixter-Pruzan
B&K Instr., Inc.
CBS Labs.
Dix Hills Elect., Inc.
Dynascan Corp.
Kay Elemetrics Corp.
McGraw-Edison Co.
Rohde & Schwarz Sales Co.
Telemet
Theta-Com of Calif.
Video Eng. Co., Inc.

Headend Buildings

Anixter-Pruzan
Beaver Elect. Ltd.

THE SPACE-SAVING ENGINEERS

Bring all your film/
tape storage (and
transportation)
problems to
Storeel. Our
problem-solving
engineers are
dedicated solely
to the broadcast
industry. Flexible
systems custom-
engineered for
VTR, spots, car-
toons, feature
films, RCA car-
tridges, Ampex
cassettes, 1" tape
cartridges; plus
FM audio
cassettes.



If it needs to be stored, it deserves Storeel.
ILLUSTRATED CATALOG UPON REQUEST.

STORROOL

CORP.
4993 New Peachtree Rd. • Atlanta, Ga. 30341 • (404) 458-3280

For More Details Circle (107) on Reply Card

Ft. Worth Tower Co., Inc.
Microwave Systems Co.
Noram Comm. Ltd.
Steffen, Inc.
Walker-Parkersburg

Headend Controls

Ameco, Inc.
Anixter-Pruzan
Cascade Elect. Ltd.
Davco Elect. Corp.
Elect. Indust. Eng., Inc.
Jerrold Elect. Corp.
Phasecom Corp.
Scientific-Atlanta, Inc.

Headend Systems

Ameco, Inc.
Anixter-Pruzan
Avtel Corp.
Cascade Elect. Ltd.
Davco Elect. Corp.
Dynair Elect., Inc.
Eastman Kodak Co.
Elect. Indust. Eng., Inc.
Entron, Inc.
Fung Eng. Co.
Jerrold Elect. Corp.
Metrodata Corp.
Phasecom Corp.
Scientific-Atlanta, Inc.
TV Cable Supply Co., Inc.

Hum Stop Coils

Anixter-Pruzan

Lenses, TV Camera

Angenieux Corp. of Amer.
Anixter-Pruzan
Cohu, Inc.
Cunningham Corp.
Davco Elect. Corp.
F&B/Ceco of Calif., Inc.
GBC Closed Circuit TV Corp.
Int. Video Corp.
Javelin Elect. Co.
Noram Comm. Ltd.
Panasonic VTR/CCTV
Rank Precision Indust. Inc.
RCA Corp.
Southern Telephone
Supply Co.
Stereotronics Television Co.
Tele-Cine Inc.
Video Eng. Co., Inc.

Lights, Studio

Anixter-Pruzan
Berkey Colortran, Inc.
F&B/Ceco of Calif., Inc.
GBC Closed Circuit TV Corp.
Alan Gordon Enterprises, Inc.
Kliegl Bros. Lighting
Co., Inc.
Noram Comm. Ltd.
RCA Corp.
Telaudio Centre
Video Eng. Co., Inc.
Vital Indust. Inc.

Meters, RF Volts

Anixter-Pruzan
B&K Instr., Inc.
Davco Elect. Corp.
Fung Eng. Co.
Radiation Devices Co.
Rohde & Schwarz Sales Co.

Microwave Relay Equip.

Anixter-Pruzan
Buckeye Telephone &
Supply Co.
Environmental Comm., Inc.
Ft. Worth Tower Co., Inc.
GTE Sylvania
Innovative Television
Equip., Inc.
Microwave Systems Co.
PRD Elect., Inc.
Prodelin Inc.
RCA Corp.
Soladyne Internatl., Inc.

Mixers

Ameco, Inc.
Amer. Data Corp.
Anixter-Pruzan
Davco Elect. Corp.
McGraw-Edison Co.
Shure Bros., Inc.

Modulators, Audio

Able Comm. & Elect.
Ameco, Inc.
Anixter-Pruzan
Blonder-Tongue Labs., Inc.
Catel
Coastcom
Davco Elect. Corp.
Dynair Elect., Inc.
Elect. Indust. Eng., Inc.
Fung Eng. Co.
Jerrold Elect. Corp.
Leaming Indust. Corp.
Noram Comm. Ltd.
Phasecom Corp.
Video Eng. Co., Inc.

Modulators, Video

Ameco, Inc.
Anixter-Pruzan
Blonder-Tongue Labs., Inc.
Catel
Davco Elect. Corp.
Dynair Elect., Inc.
Elect. Indust. Eng., Inc.
F&B/Ceco of Calif., Inc.
Fung Eng. Co.
Hitachi Shibaden Corp.
of Amer.
Jerrold Elect. Corp.
JFD Systems Div.
Nelson-Hershfield Elect.
Noram Comm. Ltd.
Phasecom Corp.
Rohde & Schwarz Sales Co.
Telemet
Tocom, Inc.
Video Eng. Co., Inc.

Monitor Conversion Kits (For Receivers)

Anixter-Pruzan

Monitors, Video

Anixter-Pruzan
Audiotronics Corp.
Ball Bros. Research Corp.
Beston Elect. Inc.
Broadcast Elect., Inc.
Comspace Corp.
Conrac Corp.
Davco Elect. Corp.
Electrohome, Ltd.
F&B/Ceco of Calif., Inc.
GBC Closed Circuit TV Corp.
Hitachi Shibaden Corp.
of Amer.
Javelin Elect. Co.
Jerrold Elect. Corp.
Magnavox
The Magnavox Co.,
Video Systems
Nelson-Hershfield Elect.
Noram Comm. Ltd.
Panasonic VTR/CCTV
RCA Corp.
SC Elect., Inc.
Shintron Co. Inc.
Southern Telephone
Supply Co.
Tele-Cine Inc.
Ultra Audio Prods.
Video Aids Corp. of Colo.
Video Eng. Co., Inc.
Visual Educom Inc.
Vital Indust. Inc.
World Video, Inc.

Monitors, Waveform

Amer. Data Corp.
Anixter-Pruzan
Avtel Corp.
Ball Bros. Research Corp.
Beston Elect. Inc.
B&K Instr., Inc.
Rohde & Schwarz Sales Co.
Telaudio Centre
Ultra Audio Prods.
Video Eng. Co., Inc.
Visual Educom Inc.

Non-Duplications Switchers

Alaun Engineering
Amer. Data Corp.
Anixter-Pruzan
Avtel Corp.
Davco Elect. Corp.
Phasecom Corp.
RCA Corp.
Rich Labs., Inc.
Rust Corp.
Telemation, Inc.

Optical Multiplexer

Anixter-Pruzan
Cohu, Inc.
Eastman Kodak Co.
Int. Video Corp.
Laird Telemedia, Inc.
Telemation, Inc.
Video Eng. Co., Inc.

Pedestals

Aberdeen Co.
Anixter-Pruzan

Buckeye Telephone
& Supply Co.
Davco Elect. Corp.
F&B/Ceco of Calif., Inc.
General Cable Corp.
Jerrold Elect. Corp.
Innovative Television
Equipment Inc.
Int. Video Corp.
Noram Comm. Ltd.
RCA Corp.
Southern Telephone
Supply Co.
Tele-Cine Inc.
TV Cable Supply Co., Inc.
Video Eng. Co., Inc.

Pole Line Hardware

Aberdeen Co.
Anixter-Pruzan
Buckeye Telephone &
Supply Co.
A. B. Chance Co.
Davco Elect. Corp.
General Cable Corp.
GTE Sylvania
Noram Comm. Ltd.
Preform Line Prods. Co.
Reliable Electric
Southern Telephone
Supply Co.
Telsta/General Cable
Apparatus Div.
TV Cable Supply Co., Inc.
Utilities Service Co.
Westay Co.

Power Couplers

Ameco, Inc.
Anaconda CATV
Anixter-Pruzan
Beaver Elect. Ltd.
British Insulated Callender's
Cables Ltd.
Entron, Inc.
Jerrold Elect. Corp.
Theta-Com of Calif.

Power Supplies

Alma Eng.
Ameco, Inc.
Anaconda CATV
Anixter-Pruzan
Beaver Elect. Ltd.
British Insulated Callender's
Cables Ltd.
Buckeye Telephone &
Supply Co.
Cerro Comm.
Davco Elect. Corp.
Delta-Benco-Cascade Ltd.
Dynascan Corp.
Entron, Inc.
GTE Sylvania
Jerrold Elect. Corp.
Magnavox
Maspro Co., Inc.
MSI Television
Sawyer Indust., Inc.
Soladyne Internatl., Inc.
Sola Electric
Southern Telephone
Supply Co.

Systron-Donner Corp.
 Terado Corp.
 Tocom, Inc.
 Tomco Comm. Inc.
 TV Cable Supply Co., Inc.
 Wilmore Elect. Co., Inc.

Preamps, Single Channel

Ameco, Inc.
 Anixter-Pruzan
 Beaver Elect. Ltd.
 C-COR Elect., Inc.
 Davco Elect. Corp.
 Delta-Benco-Cascade Ltd.
 Entron, Inc.
 Environmental Comm., Inc.
 Jerrold Elect. Corp.
 JFD Systems Div.
 Maspro Co., Inc.
 Riker Video
 Tomco Comm. Inc.
 TV Cable Supply Co., Inc.
 Winegard Co.

Recorders, Audio

Ampex Corp.
 Anixter-Pruzan
 Audiotronics Corp.
 B&K Instr., Inc.
 Broadcast Automation Assoc.
 Broadcast Elect., Inc.
 Davco Elect. Corp.
 F&B/Ceco of Calif., Inc.
 Gotham Audio Corp.
 Noram Comm. Ltd.
 RCA Corp.
 Scully/Metrotech
 Sparta Elect. Corp.
 Tape-Athon Corp.
 Tellaudio Centre
 Video Eng. Co., Inc.

VIF Internatl.

Recorders, Video Tape

Ampex Corp.
 Anixter-Pruzan
 Avtel Corp.
 Davco Elect. Corp.
 Diamond Power Specialty Corp.
 Echo Science Corp.
 F&B/Ceco of Calif., Inc.
 GBC Closed Circuit TV Corp.
 Hitachi Shibaden Corp. of Amer.
 Int. Video Corp.
 3M Co., Mincom Div.
 Noram Comm. Ltd.
 Panasonic VTR/CCTV
 RCA Corp.
 Sony Corp. of America
 Southern Telephone Supply Co.
 Telemation, Inc.
 R. H. Tyler Co.
 Video Eng. Co., Inc.

Scramblers, Unscramblers

Anixter-Pruzan
 Techno Prods. Co.

Signal Corrector (Video)

Anixter-Pruzan
 Telemet
 Television Equip. Assoc.
 Video Eng. Co., Inc.
 Television Microtime Inc.

Signal Processor

Ameco, Inc.
 Anixter-Pruzan

Davco Elect. Corp.
 Delta-Benco-Cascade Ltd.

Signal Strength Meter

Ameco, Inc.
 Anixter-Pruzan
 Beaver Elect. Ltd.
 Blonder-Tongue Labs., Inc.
 Davco Elect. Corp.
 Echo Science Corp.
 Fung Eng. Co.
 McGraw-Edison Co.
 Radiation Devices Co.
 Winegard Co.

Spectrum Analyzers

Kay Elemetrics **CE-8**

Splitting & Mixing Networks

Ameco, Inc.
 Anixter-Pruzan
 AVA Elect. & Machine Corp.
 Beaver Elect. Ltd.
 Cerro Comm.
 C-COR Elect. Corp.
 Delta-Benco-Cascade Ltd.
 Dolphin Comm. Corp.
 Entron, Inc.
 Jerrold Elect. Corp.
 JFD Systems Div.
 Magnavox
 Maspro Co., Inc.
 MPI Co.
 TV Cable Supply Co., Inc.

Sweep Systems

Kay Elemetrics **CE-8**
 Anixter-Pruzan

Avantek, Inc.
 Jerrold Elect. Corp.
 Kay Elemetrics Corp.
 Noram Comm. Ltd.
 Rohde & Schwarz Sales Co.
 Systron-Donner Corp.
 Theta-Com of Calif.

Switchers

Alma Eng.
 Amer. Data Corp.
 Anixter-Pruzan
 Ball Bros. Research Corp.
 Beston Elect. Inc.
 Cablewave Systems, Inc.
 Cohu, Inc.
 Cunningham Corp.
 Davco Elect. Corp.
 Dynair Elect., Inc.
 Dynasciences Corp.
 Echo Science Corp.
 F&B/Ceco of Calif., Inc.
 GBC Closed Circuit TV Corp.
 Jerrold Elect. Corp.
 Kay Elemetrics Corp.
 Matrix Systems Corp.
 Noram Comm. Ltd.
 Philips Bcst. Equip. Corp.
 RCA Corp.
 Rohde & Schwarz Sales Co.
 Rust Corp.
 Shintron Co. Inc.
 Telemation, Inc.
 Telemet
 Video Aids Corp. of Colo.
 Video Eng. Co., Inc.
 Viscount Indust. Ltd.
 Vital Indust. Inc.

Systems Research & Development

Ameco, Inc.

INSTANT

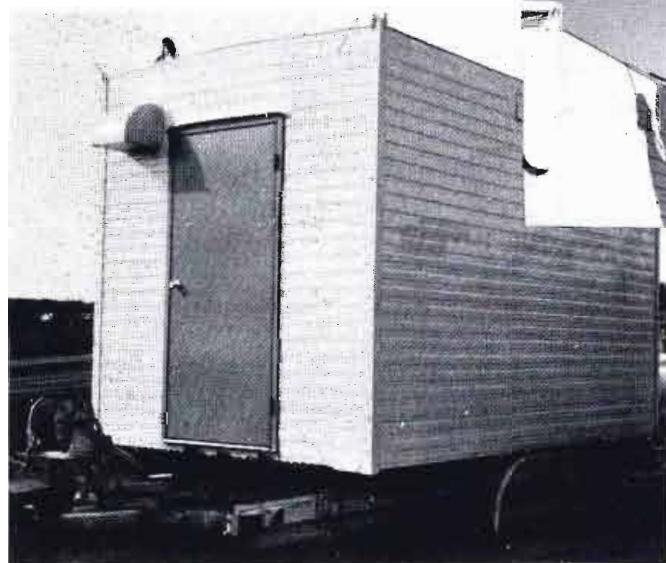

The Head-End Building that is installed on site in minutes... BACK IT UP... SLIDE IT OFF... BOLT IT DOWN! These factory fabricated buildings have been engineered and designed as the most modern and economical way to house CATV and micro-wave electronic equipment. Specially constructed to withstand the rigors of all climatic conditions and provide a dust-free and temperature controlled housing for the electronic equipment. Mobilt Head-End Buildings fulfill all requirements with a minimum of time and expense. Many options are available in size, outside finish, wiring and ventilation. There's one exactly suited to your system requirement...

TOWERS ...

Every tower is individually engineered to fit each system's unique requirements... and at economical prices. Absolutely no compromise in design, fabrication or erection of any Fort Worth Tower. We have never lost a tower to the wind, although some have gone through a number of hurricanes. For example, the Cablecom General tower at Biloxi, Mississippi recently bore the brunt of a devastating blow... without damage. Get the most for your money. Next time specify a Fort Worth Tower Co. tower.

New and larger facilities to serve you better.



See us at the NCTA Convention, BOOTHS 54,55
Fort Worth Tower Co., Inc.

P.O. BOX 8597/1901 E. LOOP 820 SOUTH/FORT WORTH, TEXAS 76112
 FORT WORTH PH. (817)457-3060 • DALLAS PH. (214)AN 4-2822

For More Details Circle (108) on Reply Card

Beaver Elect. Ltd.
C-COR Elect., Inc.
Davco Elect. Corp.
Echo Science Corp.
Int. Video Corp.
Noram Comm. Ltd.
Radiation Devices Co.
Rosner Television
Systems, Inc.
Stereotronics Television Co.
Techno Prods. Co.

Tape & Film Racks

Storeel **CE-9**

Tap-offs

Ameco, Inc.
Anixter-Pruzan
AVA Elect. & Machine Corp.
Beaver Elect. Ltd.
Buckeye Telephone &
Supply Co.
Cerro Comm.
Davco Elect. Corp.
Delta-Benco-Cascade Ltd.
Entron, Inc.
Jerrold Elect. Corp.
JFD Systems Div.
Magnavox
Maspro Co., Inc.
MPI Co.
Preform Line Prods. Co.
Riker Video
RMS Elect., Inc.
Southern Telephone Supply
Co.
Theta-Com of Calif.
TV Cable Supply Co., Inc.
Winegard Co.

Taps, Directional

Aberdeen Co.
Ameco, Inc.
Amer. Technology Co., Inc.
Anaconda CATV
Anixter-Pruzan
Antsco Corp.
AVA Elect. & Machine Corp.
Beaver Elect. Ltd.
Buckeye Telephone &
Supply Co.
C-COR Elect., Inc.
Cerro Comm.
Davco Elect. Corp.
Delta-Benco-Cascade Ltd.
Dolphin Comm. Corp.
Echo Science Corp.
Entron, Inc.
GTE Sylvania
Jerrold Elect. Corp.
JFD Systems Div.
Lindsay Specialty Prods. Ltd.
Magnavox
RMS Elect., Inc.
Southern Telephone
Supply Co.
Theta-Com of Calif.
Tocom, Inc.
TV Cable Supply Co., Inc.
Winegard Co.

Time Base Correctors

Kansas State Network ... **CE-2**
Ampex Corp.

Anixter-Pruzan
Dynasciences Corp.
GTE Sylvania
Int. Video Corp.
Kansas State Network, Inc.
Telemation, Inc.
Television Microtime Inc.
Video Eng. Co., Inc.
VIF Internatl.

Title Edgers

Anixter-Pruzan
Telemation, Inc.
Video Eng. Co., Inc.
Vital Indust. Inc.

Title Inserters

Amer. Data Corp.
Anixter-Pruzan
Datavision Inc.
Interand Corp.
Kansas State Network, Inc.
Laird Telemedia, Inc.
MSI Television
Telemation, Inc.
Telemet
Video Data Systems, Inc.
Video Eng. Co., Inc.
Vital Indust. Inc.

Towers & Accessories

Ft. Worth Tower **CE-11**

Advance Indust., Inc.
Allied Tower, Inc.
Andrews Tower, Inc.
Anixter-Pruzan
Beaver Elect. Ltd.
Buckeye Telephone &
Supply Co.
Copperweld Corp.
Davco Elect. Corp.
E-Z Way Prods., Inc.
Ft. Worth Tower Co., Inc.
Gates Radio
Grasis Fabricating Co.
Halline Utility Equip.
Jampro Antenna Co.
McCabe-Power Body Co.
Microflect Co., Inc.
Path Prods. Inc.
RCA Corp.
Rohn Mfg.
Soladyne Internatl., Inc.
Stainless, Inc.
Swager Tower Corp.
Tiner Comm. Service, Inc.
Tri-Ex Tower Corp.
TV Cable Supply Co., Inc.
Up-Right Scaffolds
Utility Tower Co.

Tower Service

Ft. Worth Tower **CE-11**

Advance Indust., Inc.
Allied Tower Co., Inc.
Ft. Worth Tower Co., Inc.
Noram Comm. Ltd.
Rohn Mfg.
Stainless, Inc.
Swager Tower Corp.
Tiner Comm. Service, Inc.
Tri-Ex Tower Corp.

Trucks, Ladder & Bucket

Buckeye Telephone &
Supply Co.
A. B. Chance Co.
General Cable Corp.
Halline Utility Equip.
McCabe-Power Body Co.
Telsta/General Cable
Apparatus Div.
Time Mfg. Co.
Utility Body Co.
Van Ladder, Inc.

Two-Way Home Terminal Equip.

Anixter-Pruzan
AVA Elect. & Machine
Corp.
Cascade Elect. Ltd.
Catel
Elect. Indust. Eng., Inc.
Jerrold Elect. Corp.
K'Son Corp.
Magnavox
RMS Elect., Inc.
Television Audience
Response System Div.
Tocom, Inc.

Video Equip. & Accessories

Amer. Data Corp.
Anixter-Pruzan
Audio-Video Eng. Co.
Avtel Corp.
Beston Elect. Inc.
CBS Labs.
Cunningham Corp.
Data Disc, Inc.
Davco Elect. Corp.
Diamond Power Specialty
Corp.
Dynair Elect., Inc.
Dynasciences Corp.
Echo Science Corp.
Electrohome, Ltd.
F&B/Ceco of Calif., Inc.
Gates Radio
GBC Closed Circuit TV
Corp.
Hitachi Shibaden Corp.
of Amer.
Innovative Television
Equip., Inc.
Interand Corp.
Int. Video Corp.
Javelin Elect. Co.
Kalart Victor Corp.
The Magnavox Co.,
Video Systems
Noram Comm. Ltd.
Panasonic VTR/CCTV
Philips Bcst. Equip. Corp.
RCA Corp.
Riker Video
Rohde & Schwarz Sales Co.
Saxton Prod., Inc.
Shintron Co. Inc.
Sony Corp. of Amer.
Spectra-Vision Corp.
Stereotronics Television Co.
Techno Prods. Co.
Telaudio Centre
Tele-Cine Inc.
Telemation, Inc.

Telesync Corp.
Television Equip. Assoc.
Television Microtime Inc.
Temtron Elect.
Ultra Audio Prods.
Video Aids Corp. of Colo.
Video Eng. Co., Inc.
Visual Elect. Labs.

Video Equip. & Editor

Anixter-Pruzan
Dynasciences Corp.
Echo Science Corp.
F&B/Ceco of Calif., Inc.
GBC Closed Circuit TV Corp.
Hitachi Shibaden Corp.
of Amer.
3M Co., Mincom Div.
Panasonic VTR/CCTV
RCA Corp.
Spectra-Vision Corp.
Telemation, Inc.
Telemet
Telesync Corp.
Video Aids Corp. of Colo.
Video Eng. Co., Inc.

Video Tape

Ampex Corp.
Anixter-Pruzan
Davco Elect. Corp.
GBC Closed Circuit TV Corp.
Hitachi Shibaden Corp.
of Amer.
Int. Video Corp.
3M Co., Magnetic
Audio/Video Prods. Div.
Memorex Corp.
Noram Comm. Ltd.
Telemation, Inc.
Temtron Elect.
Video Eng. Co., Inc.

VTR Heads

Ampex Corp.
Anixter-Pruzan
GBC Closed Circuit TV Corp.
Hitachi Shibaden Corp.
of Amer.
Int. Video Corp.
Noram Comm. Ltd.
Spin Physics, Inc.
Video Eng. Co., Inc.

Weather Units

Ameco, Inc.
Anixter-Pruzan
Avtel Corp.
Buckeye Telephone &
Supply Co.
Catel
Concise Instr. Design Ltd.
Davco Elect. Corp.
Kansas State Network, Inc.
Laird Telemedia, Inc.
MSI Television
Soladyne Internatl., Inc.
Telestrator Indust., Inc.
Texas Elect., Inc.
Texas Instr. Inc.
R. H. Tyler Co.

Manufacturer's address list

A

Aberdeen Company
P.O. Box 2663
Culver City, Cal. 90230

Able Comm. & Elect.
P.O. Box 236
Palm Harbor, Fla. 33563

Advance Indust., Inc.
Lunar Comm.
2301 Bridgeport Dr.
P.O. Box 1410
Sioux City, Ia. 51102

AEL Comm. Corp.
Subs. of Amer. Elect. Labs.
P.O. Box 507
Lansdale, Pa. 19446

Akai Amer., Ltd.
2139 E. Del Amo Blvd.
Compton, Cal. 90220

Alaun Engineering
515 South Palm
Alhambra, Cal. 91802

Allied Tower Co., Inc.
P.O. Box 331
809 Kansas St.
S. Houston, Tex. 77587

Alma Engineering
7990 Dagget St.
San Diego, Cal. 92111

Alpha Wire Corp.
711 Ledgerwood Ave.
Elizabeth, N.J. 07207

Ameco, Inc.
2960 Grand Ave.
P.O. Box 13741
Phoenix, Ariz. 85002

Amer. Data Corp.
An Airpax Co.
315 Wynn Dr.
P.O. Box 5228
Huntsville, Ala. 35805

Amer. Technology Co., Inc.
3630 W. Clarendon St.
Phoenix, Ariz. 85019

Amperex
Slatersville, R.I.
02876

Ampex Corporation
Audio-Video Systems Div.
401 Broadway
Redwood City, Cal. 94063

Anaconda CATV
7465 Lampson Ave.
Garden Grove, Cal. 92641

Andrew Corp.
10500 W. 153rd St.
Orland Park, Ill. 60462

Andrews Tower, Inc.
1420 Layton Ave.
Ft. Worth, Tex. 76117

Angenieux Corp. of
Amer., Inc.
440 Merrick Rd.
Oceanside, N.Y. 11572

Anixter-Pruzan
1963 1st Ave. South
Seattle, Wash. 98134

Antsco Corporation
Antsco Antenna Access.
17 West Sierra Madre Blvd.
P.O. Box 188
Sierra Madre, Cal. 91024

Audiotronics Corp.
Video Systems Div.
7428 Bellaire Ave.
N. Hollywood, Cal. 91605

Audio-Video Eng. Co.
65 Nancy Blvd.
Merrick, N.Y. 11566

AVA Elect. & Machine Corp.
242 Pembroke Ave.
Lansdowne, Pa. 19050

Avantek, Inc.
3175 Bowers Ave.
Santa Clara, Cal. 95051

Avtel Corp.
44 Railroad Ave.
Glen Head, N.Y. 11545

B

Ball Brothers Research Corp.
Miratel Drive
1633 Terrace Dr.
St. Paul, Minn. 55113

Beaver Elect. Ltd.
70 Ronson Dr.
Rexdale, Ontario
Canada M9W-1B8

Belden Corp.
Richmond, Ind. 47374

Berkey Colortran, Inc.
1015 Chestnut St.
Burbank, Cal. 91502

Berkshire Elect. Cable Co.
River Rd.
Leeds, Mass. 01053

Beston Elect. Inc.
9024 W. 51st Terr.
Shawnee, Kans. 66203

B & K Instruments, Inc.
5111 W. 164th St.
Cleveland, Ohio 44142

Blonder-Tongue Labs., Inc.
One Jake Brown Rd.
Old Bridge, N.J. 08857

Boston Insulated Wire
and Cable Co., Ltd.
9545 Cote De Liesse
Dorval, Quebec
Canada H9P 1A5

Brand-Rex Co.
P.O. Box 498
Willimantic, Conn. 06226

British Insulated
Callender's Cables Ltd.
P.O. Box 5
21 Bloomsburg St.
London WC1B 3Qn, England

Broadcast Automation Assoc.
5199 N.E. 12th Ave.
Ft. Lauderdale, Fla. 33308

Broadcast Elect., Inc.
8810 Brookville Rd.
Silver Spring, Md. 20910

Buckeye Telephone
& Supply Co.
1250 Kinnear Rd.
Columbus, Ohio 43221

C

Cablewave Systems Inc.
60 Dodge Ave.
North Haven, Conn. 06473

Cambridge Prods., Corp.
101 Foley St.
Somerville, Mass. 02145

Canada Wire &
Cable Co., Ltd.
147 Laird Dr.
Toronto, Ontario, Canada

Cascade Cable Constr., Inc.
P.O. Box 677
Wenatchee, Wash. 98801

Cascade Elect. Ltd.
1111 C Street
Bellingham, Wash. 98225

Catel
Div. of United Scientific
1030 W. Evelyn
Sunnyvale, Cal. 94086

CBS Laboratories
227 High Ridge Rd.
Stamford, Conn. 06905

C-COR Elect., Inc.
60 Decibel Rd.
State College, Pa. 16801

Reader

Service

Card

In This

Issue

Is Good

For

12 Months

Cerro Comm.
Div. of Cerro Corp.
Halls Mill Rd.
Freehold, N.J. 07728

A. B. Chance Co.
210 N. Allen St.
Centralia, Mo. 65240

Cleveland Trencher Div.
20100 St. Clair Ave.
Cleveland, Ohio 44117

Coastcom
2346 Stanwell Dr.
Concord, Cal. 94520

Cohu, Inc.
Electronics Div.
P.O. Box 623
San Diego, Cal. 92112

Collins Radio Co.
1200 N. Alma Rd.
Richardson, Tex. 75080

Commercial Elect. Inc.
880 Maude Ave.
Mountain View, Cal. 94040

Comm/Scope Corp.
P.O. Box 2406
15 N. Center St.
Hickory, N.C. 28601

Comspace Corp.
350 Great Neck Rd.
Farmingdale, N.Y. 11735

Concise Inst. Design Ltd.
260 Geary Ave.
Toronto, 170, Ontario,
Canada

Conrac Corp.
Conrac Div.
600 N. Rimsdale Ave.
Covina, Cal. 91722

Consolidated Video Systems
3300 Edward Ave.
Santa Clara, Cal. 95050

Copperweld Corp.
Copperweld Bimetallics Div.
Box 1000
Glassport, Pa. 15045

Coral
7700 River Rd.
North Bergen, N.J. 07047

Cunningham Corp.
10 Carriage St.
Honeoye Falls, N.Y. 14472

Cush Craft Corp.
621 Hayward St.
Manchester, N.H. 03103

D

Data Disc, Inc.
686 W. Maude Ave.
Sunnyvale, Cal. 94086

Datavision Inc.
15932 Shady Grove Rd.
Gaithersburg, Md. 20760

Davco Elect. Corp.
2150 E. Harrison St.
Batesville, Ark. 72501

Davis Manufacturing
1500 S. McLean Blvd.
P.O. Box 1801
Wichita, Kans. 67213

Delts-Benco-Cascade Ltd.
124 Belfield Rd.
Rexdale,
Ontario, Canada M9W1G1

Diamond Power
Specialty Corp.
P.O. Box 415
East Main Pike
Lancaster, Ohio 43130

Ditch Witch
The Charles
Machine Works, Inc.
P.O. Box 66
Perry, Okla. 73077

Dix Hills Elect., Inc.
25 N. Mall
Plainview, N.Y. 11803

Dolphin Comm. Corp.
181 Church St.
Pughkeepsie, N.Y. 12502

Dynair Elect., Inc.
6360 Federal Blvd.
San Diego, Cal. 92114

Dynascan Corp.
1801 W. Belle Plaine Ave.
Chicago, Ill. 60613

Dynasciences Corp.
Scientific Systems Div.
Township Line Rd.
Blue Bell, Pa. 19422

E

Eastman Kodak Co.
343 State St.
Rochester, N.Y. 14650

Echo Science Corp.
An Arvin Systems, Inc. Co.
485 E. Middlefield Rd.
Mountain View, Cal. 94040

Electrohome, Ltd.
809 Wellington North
Kitchener, Ontario, Canada

Elect. Indust.
Engineering, Inc.
A Div. of RCA Corp.
7355 Fulton Ave.
N. Hollywood, Cal. 91605

Electro-Voice, Inc.
Subs. of Gulton Ind. Inc.
600 Cecil St.
Buchanan, Mich. 49107

Entron, Inc.
70-31 84th St.
Glendale, N.Y. 11227

Environmental Comm., Inc.
Cable Television
Components Div.
2718 S. Grand Ave.
Santa Ana, Cal. 92705

Essex Elect. Systems
6235 S. Harlem Ave.
Chicago, Ill. 60638

Essex Internatl., Inc.
Comm. and CATV Div.
6235 S. Harlem Ave.
Chicago, Ill. 60638

E-Z Way Prods., Inc.
Commercial Div.
13155 Nebraska Ave.
P.O. Box 17196
Tampa, Fla. 33612

F

Fairchild MOD
423 National Ave.
Mountain View, Cal. 95111

F&B/Ceco of Calif., Inc.
7051 Santa Monica Blvd.
Hollywood, Cal. 90038

Ft. Worth Tower Co., Inc.
5201 Bridge St.
P.O. Box 8597
Ft. Worth, Tex. 76112

Fung Engineering Co.
111 Glenn Way
Belmont, Cal. 94002

G

Gamco Indust., Inc.
317 Cox St.
Roselle, N.J. 07203

Gates Radio
123 Hampshire Street
Quincy, Ill. 62301

GBC Closed Circuit TV Corp.
74 Fifth Ave.
New York, N.Y. 10011

General Cable Corp.
500 W. Putnam Ave.
Greenwich, Conn. 06830

Gilbert Eng. Co., Inc.
3700 N. 36th Ave.
Phoenix, Ariz. 85019

Gotham Audio Corp.
741 Washington Street
New York, N.Y. 10014

Alan Gordon Enterprises, Inc.
5362 Cahuenga Blvd.
N. Hollywood, Cal. 91601

GPL-TV, Link Div.
The Singer Co.
Binghamton, N.Y. 13902

Grasis Fabricating Co.
5601 Gardner Ave.
Kansas City, Mo. 64120

GTE Sylvania
CATV Operations
114 S. Oregon
El Paso, Tex. 79901

H

Halline Utility Equip.
P.O. Box 5854
St. Louis, Mo. 63134

Hatichi Shibaden
Corp. of Amer.
58-25 Brooklyn-Queens
Expwy.
Woodside, N.Y. 11377

Hy-Gain Elect. Corp.
8601 N.E. Hwy. 6
Lincoln, Neb. 68507

I

Innovative Television
Equip., Inc.
P.O. Box 681
Woodland Hills, Cal. 91634

Interand Corp.
Telestrator Div.
450 East Ohio St.
Chicago, Ill. 60611

Int. Indust., Inc.
P.O. Box 9882
Austin, Tex. 78766

Int. Video Corp.
990 Alamanor Ave.
Sunnyvale, Cal. 94086

ITT Aerospace/Optical Div.
3700 E. Pontiac St.
Ft. Wayne, Inc. 46803

ITT Cannon Electric
666 E. Dyer Rd.
Santa Ana, Cal. 92702

J

Jampro Antenna Co.
Computer Equip. Corp.
6939 Power Inn Rd.
Sacramento, Cal. 95828

Javelin Elect. Co.
Div. of Apollo Lasers, Inc.
6357 Arizona Circle
Los Angeles, Cal. 90045

Jerrold Elect. Corp.
CATV Systems Div.
200 Witmer Rd.
Horsham, Pa. 19044

JFD Systems Div. of
Riker Comm.
142 Central Ave.
Clark, N.J. 07066

JVC Indust., Inc.
50-36 56th Rd.
Maspeth, N.Y. 11378

K

Kalart Victor Corp.
Hultenius St.
Plainville, Conn. 06062

Kansas State Network, Inc.
833 N. Main
P.O. Box 333
Wichita, Kans. 67203

Kay Elemetrics Corp.
12 Maple Ave.
Pine Brook, N.J. 07058

Kliegl Bros.
Lighting Co., Inc.
32-32 48th Ave.
L.I.C., N.Y. 11101

KLM Electronics
1600 Decker Ave.
San Martin, Cal. 95046

K'Son Corporation
250 E. Emerson Ave.
Orange, Cal. 92665

L

Laird Telemedia, Inc.
2125 S.W. Temple
Salt Lake City, Utah 84115

Leaming Indust. Corp.
3740 Campus Dr.
Newport Beach, Cal. 92660

Lindsay Specialty Prods. Ltd.
50 Mary W.
Lindsay, Ontario, Canada

LRC Elect., Inc.
901 S. Ave.
Horseheads, N.Y. 14845

L-W Photo, Inc.
15451 Cabrito Rd.
Van Nuys, Cal. 91406

M

Magnavox
CATV Div.
100 Fairgrounds Dr.
Manlius, N.Y. 13104

The Magnavox Co.
Video Systems
1700 Magnavox Way
Ft. Wayne, Ind. 46804

Maspro Co., Inc.
Asada, Nissin,
Nagoya-shigai, Japan

Matrix Systems Corp.
9411 Lurline Ave.
Chatsworth, Cal. 91311

McCabe-Power Body Co.
8900 Frost Ave.
St. Louis, Mo. 63134

McGraw-Edison Co.
Edison Elect.
Grenier Field
Manchester, N.H. 03103

3M Company
Magnetic Audio/Video
Prod. Div.
3M Center, Bldg. 224-61
St. Paul, Minn. 55101

3M Company
Mincom Div.
300 S. Lewis Rd.
Camarillo, Cal. 93010

Memorex Corp.
Audio-Video Group
1200 Memorex Dr.
Santa Clara, Cal. 95052

Metrodata Corp.
1250 Mercer
Seattle, Wash. 98109

Microflect Co., Inc.
3575 25th St., S.E.
Salem, Ore.

Microwave Systems Co.
15860 W. 5th Ave.
Golden, Colo. 80401

Mid-State Comm., Inc.
40 N. 7th Ave.
Beech Grove, Ind. 46107

MPI Company
1524 Frankford Ave.
Philadelphia, Pa. 19125

MSI Television
4788 S. State St.
Salt Lake City, Utah 84107

N

Nelson-Hershfield Elect.
1848 W. Campbell Ave.
Phoenix, Ariz. 85015

Noram Comm. Ltd.
70 Ronson Dr.
Rexdale, Ont.,
Canada M9W 1B8

O

Oak Indust. Inc.
Crystal Lake, Ill. 60014

Operations International
15860 W. 5th Ave.
Golden, Colo. 80401

P

Panasonic VTR/CCTV
of Matsushita
Elect. Corp. of Amer.
P.O. Box 3980
Grand Central Station
New York, N.Y. 10017

Panduit Corp.
17301 Ridgeland Ave.
Tinley Park, Ill. 60477

Path Products Inc.
P.O. Box 399
Jacksonville, Tex. 75766

Phasecom Corp.
13130 S. Yukon Ave.
Hawthorne, Cal. 90250

Phelps Dodge Comm. Co.
441 Sawmill River Rd.
Yonkers, N.Y. 10702

Philips Bcst. Equip. Corp.
One Philips Parkway
Montvale, N.J. 07645

Plastoid Corp.
42-61 24th St.
L.I.C., N.Y. 11101

Potomac Instr., Inc.
932 Philadelphia Ave.
Silver Spring, Md. 20910

PRD Elect., Inc.
1200 Prospect Ave.
Westbury L.I., N.Y. 11590

Preform Line Prods. Co.
5349 St. Clair Ave.
Cleveland, Ohio 44103

Prodelin Inc.
P.O. Box 131
Hightstown, N.J. 08520

Pyramid Indust. Inc.
2612 W. Encanto Blvd.
Phoenix, Ariz. 85009

Q

Quick-Set Inc.
3650 Woodhead Dr.
Northbrook, Ill. 60062

R

Radiation Devices Co.
P.O. Box 8450
Baltimore, Md. 21234

Rank Precision Indust. Inc.
260 N. Tr. 303
W. Nyack, N.Y. 10994

RCA Corporation
Comm. Systems Div.
Front & Cooper Sts.
Building 2-5
Camden, N.J. 08102

Reliable Electric
11333 W. Addison
Franklin Pk., Ill. 60131

RF Systems, Inc.
155 King St.
Cohasset, Mass. 02025

Rich Laboratories, Inc.
105 Pasatiempo Dr.
Santa Cruz, Cal. 95060

Riker Video
142 Central Ave.
Clark, N.J. 07066

RMS Elect., Inc.
50 Antin Place
Bronx, N.Y. 10462

Rohde & Schwarz Sales Co.
111 Lexington Ave.
Passaic, N.J. 07055

Rohn Manufacturing
Div. of Unarco Indust., Inc.
P.O. Box 2000
Peoria, Ill. 61601

Rosner Television
Systems, Inc.
250 W. 57 St.
New York, N.Y. 10019

Rust Corp.
168 Tremont St.
Everett, Mass. 02149

S

Sadelco, Inc.
299 Park Ave.
Weehawken, N.J. 07087

Sawyer Indust., Inc.
Glenronics Div.
748 E. Alosta Ave.
Glendora, Cal. 91740

Saxton Prods., Inc.
215 N. Route 303
Congers, N.Y. 10920

Scala Radio Corp.
1970 Republic Ave.
San Leandro, Cal. 94577

SC Elect., Inc.
530 Fifth Ave., N.W.
New Brighton, Minn. 55112

Scientific-Atlanta, Inc.
Box 13654
Atlanta, Ga. 30324

Scully/Metrotech
Div. of Dictaphone Corp.
475 Ellis St.
Mountain View, Cal. 94040

Sencore Inc.
3200 Sencore Dr.
Sioux Falls, S.D. 57107

Shintron Co. Inc.
144 Rogers St.
Cambridge, Mass. 02142

Shure Bros., Inc.
222 Hartrey Ave.
Evanston, Ill. 60204

Sigmaform Corp.
2401 Walsh Ave.
Santa Clara, Cal. 95050

Sitco Antenna Co.
10330 N.E. Marx St.
P.O. Box 20456
Portland, Ore. 97220

Soladyne Internatl., Inc.
7455 Convoy St.
San Diego, Cal. 92111

Sola Electric
Div. of Sola Basic Indust.
1717 Busse Rd.
Elk Grove Village,
Ill. 60007

Sony Corp. of America
474-47 Van Dam St.
L.I.C., N.Y. 11101

Southern Telephone
Supply Co.
5978 Peachtree Rd., N.E.
Chamblee, Atlanta, Ga. 30341

Sparta Elect. Corp.
5851 Florin-Perkins Rd.
Sacramento, Cal. 95828

Spectra-Vision Corp.
1528 Belfield Ave.
Philadelphia, Pa. 19141

Spindler & Sauppe, Inc.
13034 Saticoy St.
N. Hollywood, Cal. 91605

Spin Physics, Inc.
11615 Sorrento Valley Rd.
San Diego, Cal. 92121

Stainless, Inc.
Third Street
N. Wales, Pa. 19454

Steffen, Inc.
623 W. 7th St.
Sioux City, Ia. 51103

Stereotronics Television Co.
13720 Riverside Dr.
Sherman Oaks, Cal. 91403

Storeel Corp.
4993 New Peachtree Rd.
Atlanta, Ga. 30341

Swager Tower Corp.
P.O. Box 656
Fremont, Ind. 46737

Systa-Matics Inc.
510 N. Sheridan
Tulsa, Okla. 74115

Systems Wire & Cable, Inc.
3500 S. 30th St.
Phoenix, Ariz. 85040

Systron-Donner Corp.
One Systron Dr.
Concord, Cal. 94518

T

TACO Div.
1 Taco St.
Sherburne, N.Y. 13460

Tape-Athon Corp.
P.O. Box 814
Inglewood, Cal. 90301

Tapecaster TCM
P.O. Box 662
12326 Wilkins Ave.
Rockville, Md. 20851

Techno Prods. Co.
7405 Greenbush Ave.
N. Hollywood, Cal. 91605

Telaudio Centre
634 S. Victory Blvd.
Burbank, Cal. 91502

Tele-Cine Inc.
294 E. Shore Dr.
Massapequa, N.Y. 11758

Telemation, Inc.
Broadcast Sales
P.O. Box 15068
Salt Lake City, Utah 84115

Telemet
185 Dixon Ave.
Amityville, N.Y. 11701

Teleng Inc.
405 Serrando Dr.
Suite 4E
San Francisco, Cal. 94132

Telesync Corp.
20 Insley St.
Demarest, N.J. 07627

Television Audio
Response System Div.
Cable-Television
Components Div.
271 S. Grand Ave.
Santa Ana, Cal. 92705

Television Equip. Assoc.
P.O. Box 1391
Bayville, N.Y. 11709

Television Microtime, Inc.
1280 Blue Hills Ave.
Bloomfield, Conn. 06002

Telsta/General
Cable Apparatus Div.
P.O. Box 666
Westminister, Colo. 90030

Temtron Elect.
138-91 Francis Lewis Blvd.
Rosedale, N.Y. 11422

Terado Corp.
1068 Raymond Ave.
St. Paul, Minn. 55108

Terra Equip. Co.
1270 Townline Rd.
Mundelein, Ill. 60060

Texas Elect., Inc.
P.O. Box 7225
Inwood Station
Dallas, Tex. 75209

Texas Instr. Inc.
34 Forest St.
Attleboro, Mass. 02703

Theta-Com of Calif.
CATV Division
P.O. Box 9728
Phoenix, Ariz. 85020

Tidel Comm. Corp.
121 Washington St.
Poughkeepsie, N.Y. 12602

Time Mfg. Co.
7601 Imperial Dr.
Waco, Tex. 76710

Times Wire & Cable Co.
Subs. Insilco Corp.
358 Hall Ave.
Wallingford, Conn. 06492

Tiner Comm. Service, Inc.
P.O. Box 232
Ankeny, Ia. 50021

Tocom, Inc.
P.O. Box 47066
Dallas, Tex. 75247

Tomco Comm. Inc.
2134 Old Middlefield Way
Mountain View, Cal. 94040

Tri-Ex Tower Corp.
7182 Rasmussen Ave.
Visalia, Cal. 93277

Trompeter Elect., Inc.
8936 Comanche Ave.
Chatsworth, Cal. 91311

TV Cable Supply Co., Inc.
1746 E. Chocolate Ave.
Hershey, Pa. 17033

R. H. Tyler Co.
Loop 132 & Hwy. 79
Onley, Tex. 76374

U

Ultra Audio Prods.
Box 921
Beverly Hills, Cal. 90213

Up-Right Scaffolds
1013 Pardee St.
Berkeley, Cal. 94710

Utilities Service Co.
P.O. Box 627
Allentown, Pa. 18105

Utility Body Co.
901 Gilman St.
Berkeley, Cal. 94710

Utility Tool Corp.
Town Street
E. Haddam, Conn. 06423

Utility Tower Co.
3200 Northwest 38th
P.O. Box 12027
Oklahoma City, Okla. 73112

V

Van Ladder, Inc.
Box 709
Spencer, Ia. 51301

Video Aids Corp. of Colo.
112 W. Fourth St.
Loveland, Colo. 80537

Video Data Systems, Inc.
657 Old Willets Path
Hauppauge, N.Y. 11787

Video Eng. Co., Inc.
Riggs Rd. at
First Place, N.E.
Washington, D.C. 20011

VIF International
P.O. Box 1555
Mountain View, Cal. 94042

Viscount Indust. Ltd.
105 E. 69th Ave.
Vancouver 15, B.C.,
Canada

Visual Educom Inc.
Dage Television
4333 S. Ohio St.
Michigan City, Ind. 46360

Visual Elect. Labs.
10 Robert St.
Clifton, N.J. 07014

Vital Indust. Inc.
TV Broadcast Equip.
3700 N.E. 53rd Ave.
Gainesville, Fla. 32601

W

Walker-Parkersburg
Dept. CV
Box 1828
Parkersburg, W. Va. 26101

Wavetek, Indiana, Inc.
66 North 1st Ave.
Beech Grove, Ind. 46107

Westay Co.
P.O. Box 573
Cupertino, Cal. 95014

Wilmore Elect. Co., Inc.
P.O. Box 2973
Durham, N.C. 27705

Winegard Co.
3000 Kirkwood
Burlington, Ia. 52601

World Video, Inc.
Box 117
13 E. Philadelphia Ave.
Boyertown, Pa. 19512

Z

Zeil-Mark Corp.
P.O. Box 182
Brookfield Ctr., Conn. 06805

NUMBER ONE



SON AND GRANDSONS



SON 52 inputs
26 mixing positions

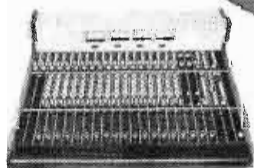

GRANDSON 36 inputs
18 mixing positions



GRANDSON II 48 inputs
24 mixing positions

For years, the Auditronics family of consoles has produced sound leaders. From New York to Bangkok.

Our Son and Grandsons deliver faultless performances night after night. In front of the most hardened authorities.

Yet our success is no mystery. In both recording and the broadcast industry, Auditronics has become a standard for craftsmanship and technology. A reputation won on the firing line.

Think about it. And don't make a sound without calling us first.
Leasing/Financing Plans Available.

INTERNATIONAL DEALERS: J-Mar Electronics, Ltd., Toronto, Canada/Studio Equipment, Paris, France/
Syntec Electronic Distributors, Sydney, Australia.

 **auditronics, inc.**
P.O. Box 12637 • Memphis, Tenn. 38104 • 901/276-6338

For More Details Circle (109) on Reply Card

Keep those milk bottles rolling!

By Phil Whitney

Most of the surviving "old timers" in broadcasting have a barrel full of stories about unique problems and amusing incidents in the years of the art's development. Many tell their stories, a few write about them, and at least one has gone happily to the bank many times as a result of our "bloopers". On the other hand, many of the great and humorous incidents have been lost because they were never set down in print.

Here, we recount a few of those happenings in the life of one of the old timers, told with a chuckle for those in the business where, "you can't take it back after you've said it".

Today's DJ's enjoy advantages yesterday's performers didn't have before we appropriated the European tape recorder in 1945. An-

nouncers were open to all sorts of unpredictable errors which began to disappear with the appearance of the first paper and iron oxide tape.

A few may remember the entangled days of the fine steel wire which wrapped itself around everything and everyone in the control room. A knot on the head was often the result of the chair casters becoming clogged with wire.

The Penguin And the Pranksters

Many years ago announcers were dressed as though they were on television without a camera. Management seemed to believe that being properly dressed for the job somehow resulted in a more professional performance, so announcers were placed in the center of a large studio, clad in a tuxedo, totally at the mercy of the control room

operator. Here he became the sitting duck for the pranksters who were present at every station.

Thoroughness was more important than brevity, so frequent Press Radio newscasts of fifteen minutes or more duration were daily occurrences for the penguin-like personalities armed with a sheaf of news stories in one hand and with hand cupped to ear, bellowing into carbon, crystal or condenser microphones.

It was an unfortunate preparation for the writer to begin in a station with more than one prankster. In fact we had a full club of them, and their main objective was breaking up the announcer.

One of the favorite tricks was to quietly sneak up behind an announcer and set fire to the handful of news he held, usually when he

(Continued on page 136)

640 Series Digital TBC

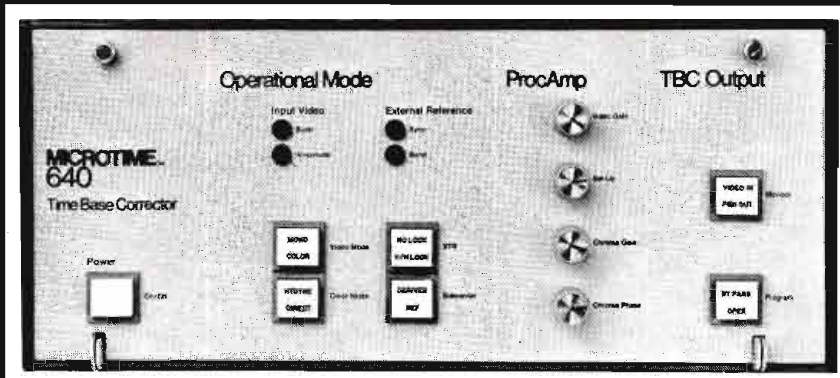

Reliability of second generation digital design from the TBC pioneers

Simple front panel operation

Lowest cost full capacity digital TBC

Unique Features include:
High speed bi-polar memory
Standalone or 3.58 feedback heterodyne
Optional plug-in DOC

MICROTIME

Microtime, Inc.
1280 Blue Hills Avenue
Bloomfield, Connecticut 06002
(203) 242-4242 TWX 710-425-2390

For More Details Circle (110) on Reply Card

HOW TO GET A SECOND CAMERA WITHOUT PAYING FOR IT.

Economic realities being what they are, improving your camera setup often boils down to a battle of program quality versus pocketbook: For some assignments, you want the mobility and compactness of a hand-held camera. For others, the long focal length and high zoom ratio of a first-rate mobile. And sometimes, of course, the virtues of both. But what can you do on a one-camera budget?

Logical question. For which we have a logical—and economical—answer: Canon Versatility Packages. A family of two-lens systems which give you both capabilities, plus a quick, positive attach/detach system that's the closest thing to two cameras for the price of one.

Take our Plumbicon* Package, for instance. When you need compactness and high mobility, there's the PV10x12B—the world's most popular electronic news gathering lens. Featuring an 18" minimum object distance and a 55.4° wide angle, it's the lightest professional 10:1 around. One of the smallest of its type, the PV10x12B features remote CCU iris control with manual override, and fully-motorized variable-speed zoom.

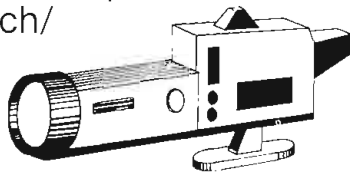

Where applications require a longer focal length, there's the other half of the Package: our PV34x24B-DZ for 25mm and the P34x32 for 30mm. A mouthful of numbers which add up to the most versatile remote lenses available today. The basic lens is a 24-400mm automatic iris f/1.8 with built-in double zoom that yields a long, long 800mm. Thanks to its continuous, stepless magnification, you can operate at maximum light efficiency while tailoring the focal length precisely to your needs. Vary field of view from 29.8° to 0.9°, controlled by the cameraman on the air, with no blanking periods or cumbersome supplementary lens insertions. And work to a minimum object distance of just 1.8 meters. Mounted on a rugged, lightweight camera base plate with a universal head fitting, either lens is easily attached and detached from the camera.

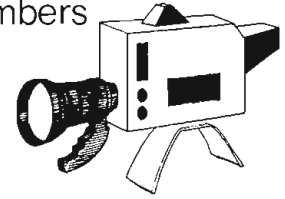

The Canon Plumbicon Versatility Package comes complete with all controls, accessories, and protective cases. Like the other Versatility Packages we offer for other formats, it's a great way to keep your cameramen happy. Without upsetting your controller. For more information, please write or call.

Canon®

Canon U.S.A. Inc.

Head Office, 10 Nevada Drive,
Lake Success, N.Y. 11040

457 Fullerton Avenue, Elmhurst, Ill. 60126

123 Paularino Avenue East,

Costa Mesa, Ca. 92626

Canon Optics & Business Machines

Canada, Ltd.

3245 American Drive,

Mississauga, Ontario, L4V 1B8, Canada

Canon Amsterdam N.V.

Industrial Products Division

De Boelelaan 8, Amsterdam, Netherlands

* © N.V. Philips of Holland



For More Details Circle (111) on Reply Card

Bottles

(Continued from page 134)

had gone some three minutes into a fifteen-minute newscast. Memories are still fresh of the racing thoughts regarding what could be said during the remaining twelve minutes.

Please Turn Off The Bottle Machine

Then there were bottle rollers. For the modern reader, we should explain that a milk bottle was a round glass object, rather large and with embossed lettering on one side. When rolled on a hard surface, such as a tiled floor, these missiles made a loud, recurring sound in the stillness of a studio.... ka-BUMP, ka-BUMP....

The staff jokers would start the bottle rolling after the studio announcer had established himself in the monologue. The bottle rolled slowly from one end of the studio to the other, and the studio always seemed endless. The result was disconcerting to an announcer concentrating on the news. Then when concentration disappeared, the following words became disconnected

and listeners had difficulty following the trend in the news. If the trick was less than totally effective on the first try, it was repeated, until one day the announcer either broke up, or down.

The President Said What??

All attempts at a breakup had been resisted until someone bribed the control operator. One well-remembered day the item of the moment concerned a speech which the President had delivered. The story began...."Today in Washington, President Roosevelt said..." The ka-BUMP began. Turning to the control room, the signal to cut the microphone was given and in a loud voice the announcer screamed..."Get that D—N bottle out of here". Appearances had been misleading. The control man had NOT cut the microphone and for two weeks people were stopping us on the streets and asking why the President would say a thing like that.

Some "Flighty" Competition

More than a few in our industry

have worked for the "boss" who is by nature suspicious of "the competition". He is frequently convinced that "they" are out to get him. When we lost our program each evening at 6 for a few days, this boss was totally convinced that "they" were doing it. The program left the studio in good condition, but in the middle of the 6 o'clock news it would disappear at the transmitter. So a posse of station employees was formed, armed with shotguns, just in case. The three miles of telephone line were patrolled by employees in cars with radios.

When the program stopped, everyone looked skyward. There they were. Blackbirds, thousands of them, perching on the top wire of the open line, after having a heavy supper of grain from a nearby wheatfield. The top wire sagged until it touched the bottom and the program went South. Of course, there were many puns about the "flighty" competition, but the only remedy was a daily shotgun patrol along the line until the grain was harvested. □

Television Products Company

For years, most of the major network studios have considered anything but pneumatic pedestals obsolete. The tough requirements of day-to-day use has proven TVP Pedestals to be reliable, flexible and maintenance free.

Our superior pneumatic counter-balance system is used in all of these. With this, cameras float on telescoping columns that glide on ball-bearing races. Camera height can be raised or lowered at the touch of a finger... smoothly.

And without lead weights, there's less weight to have to push around.

The 360° steering is adjustable from crabbing to tracking at the touch of a foot pedal. This mechanism has been specially designed for quiet operation.

You won't find 8-inch tires on most pedestals, but they're standard equipment on ours. Bigger is better: not only do they roll easier, but they'll transmit less vibration to the camera.

If you're worried about maintenance, you'll be glad to know that we've used sealed ball bearings wherever possible. The air system requires only one-point lubrication, once a year. And everything is designed for easy access.

Compare these three with any other pedestals available—you'll find them a very attractive combination of quality and price.

9016 Aviation Blvd. Inglewood, CA 90301

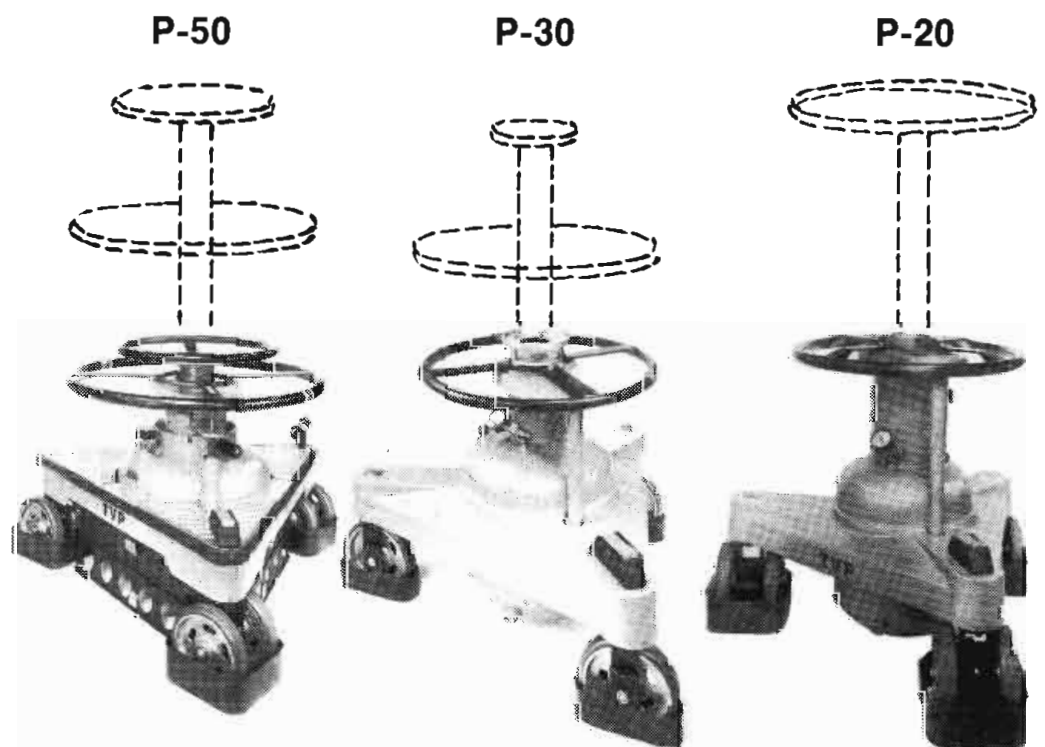

	P-50	P-30	P-20
Column Range	36"	30"	20"
Min/Max Height*	21" to 57"	25" to 55"	30 ⁵ / ₈ " to 50 ⁵ / ₈ "
Load Capacity	300 lbs.	100 lbs.	285 lbs.

*Measured from the top of the pan-head' mount to the floor.

For More Details Circle (112) on Reply Card

AM, FM, SW BROADCAST MODULAR PROGRAM AUTOMATION

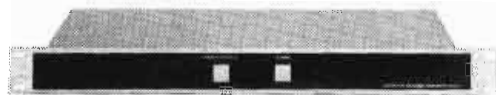

CD25G 25 Hz TONE GENERATOR

For production studio use to insert the standard 25 Hz automation actuating tone. Starts tape transport and actuates muting to eliminate bias pops and other start-up noises. Tone button applies 25 Hz tone and stops transport at end of tone.

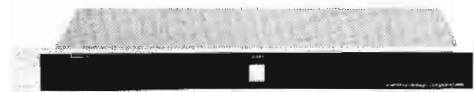

CD25S 25 Hz TONE SENSOR

Senses the presence of pre-recorded 25 Hz tones on audio material and provides automation control functions. Features tone removal filter, adjustable delayed stop contacts, and fixed tone alarm for automatic tape rewind.



CD60T TIME ANNOUNCE CONTROL UNIT

Adds versatility to your automation system by using two cartridge machines or reel-to-reel transports for automatic time announcements. Contains its own internal IC clock. Power failure interlock disables time announcement until clock reset.

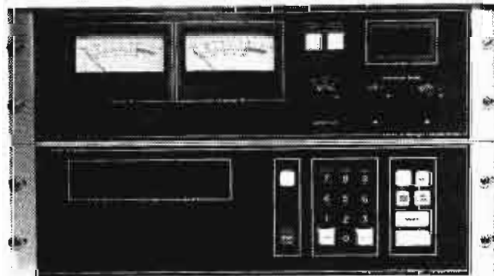

CD28AS SEQUENCER

Low cost way to start automation with easy and economic expansion at a later date. Uses keyboard entry for simplicity of programming. Eighty events of pre-programming provide ample storage for most formats.



CD12C TIME PROGRAM CONTROLLER

Provides 10 programmable exact time points per hour for real time control of CD28AS and CD28 APM plus digital clock display. 8 relay function outputs for time announcements, transmitter on/off control and other functions. Crystal time base and battery backup.

CDRMD REMOTE CONTROLLER

Provides full entry remote control for traffic department or control room access to automation system. Allows complete programming with display of next-to-run or program-entry.



Control Design provides the total modular approach to AM, FM and Short Wave program automation. Our individual modules may be used alone, assembled into complete automation systems, or used with existing equipment to update and expand automatic programming. All Control Design equipment is manufactured to the highest standards for excellent reliability and easy maintenance. Easily obtained solid state devices are used with printed circuit construction, socket mounted integrated circuits and quick disconnect interface connectors. All equipment is covered by a one year full warranty.

CD24R MULTIPLE CARTRIDGE MACHINE

The CD24R cartridge machine (shown above) is simple and reliable — so reliable it is used by the U.S. Government for flight training. Provides six second access to any one of 24 cartridges.

CD28APM AUDIO CONTROLLER AND PROGRAMMER

The CD28 family of audio controllers is perfect for your new automation system, or for use with present audio sources. Features 2000 pre-programmed events (expandable to 8000) 12 audio sources (expandable to 96), full random select for 9 multiple cartridge players. Accessories include remote control, logging and computer interfaces.

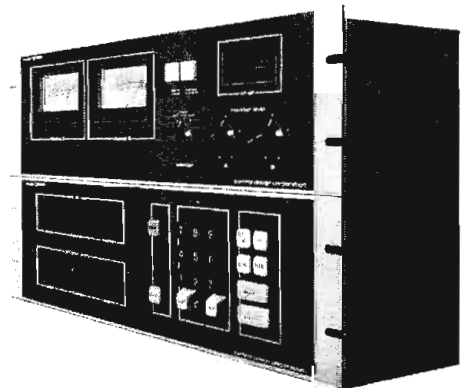

**control
design
corporation**

205 S. Whiting St. • Alexandria
Virginia 22304 USA
TEL. 703-751-5650
TELEX 899149 • CODECOR

WRITE OR TELEX FOR BROCHURES AND TECHNICAL SPECIFICATIONS

(Continued from page 124)

the Norselander Restaurant, and guests are always welcome to attend. It is a point of interest that no Chapter dues are assessed, and the Seattle SBE asks only that its guests become national members as quickly as possible. They believe in SBE and want it to grow as a productive organization, gaining strength every year.

Chapter 26: Chicago, Illinois

The Chicago Chapter held its first organizational meeting in September, 1969, under the leadership of Ron Lask who was then at the University of Illinois Medical Center TV facility. Lew Wetzel, SBE President, was also on hand. The three network 0 & 0's were represented along with leading independent and educational TV stations, equipment suppliers, and the closed-circuit studios of both the Circle Campus and Medical Centers of the University of Illinois.

Meetings are scheduled once a month on various days to give everyone an opportunity to attend. Attendance at meetings averaged 250 per year until 1974 when it went over 400 and the 1975 projection is for over 500. The meetings are also held at different locations so that members can see a wide variety of installations and equipment. The Chapter cooperates with the local SMPTE chapter in an effort to avoid meeting conflicts, and if either group arranges a particularly good program, a joint meeting is often arranged. Everyone is welcome to attend the meetings, and some occasions are specifically used to invite spouses and friends to meet people and see interesting sidelights of a broadcast engineer's work. Some of the places meetings have been held include: the world's tallest building, the Planetarium, a record mastering and pressing plant, the largest ITV operation, Telco, and, of course, a variety of radio and TV stations and production houses.

Chapter 33: Southwestern, Ohio

During an interview with Mark

Erhardt, Chapter 33's secretary, he mentioned that this group had actually been meeting for some time before they received their permanent charter in August, 1974. Seems that John McNally, current chairman, had requested from SBE National a list of members in the area, and called around to see if anyone would be interested in getting together. So this group was well under way when they finally decided to make it official. Erhardt adds that since 1974, the membership has grown by 100 percent.

The Chapter tries to rotate its meetings during the second week of the month to accommodate different work schedules so that everyone will have a chance to attend at least some of the sessions. Also, since the Chapter represents the Cincinnati-Dayton area, the members have chose a half-way point in Fairfield, Ohio, for their gatherings. Notices are usually mailed prior to each meeting to let everyone know of pending business, what the presentation will be, and a little background on the evening's speaker.

(Continued on page 144)

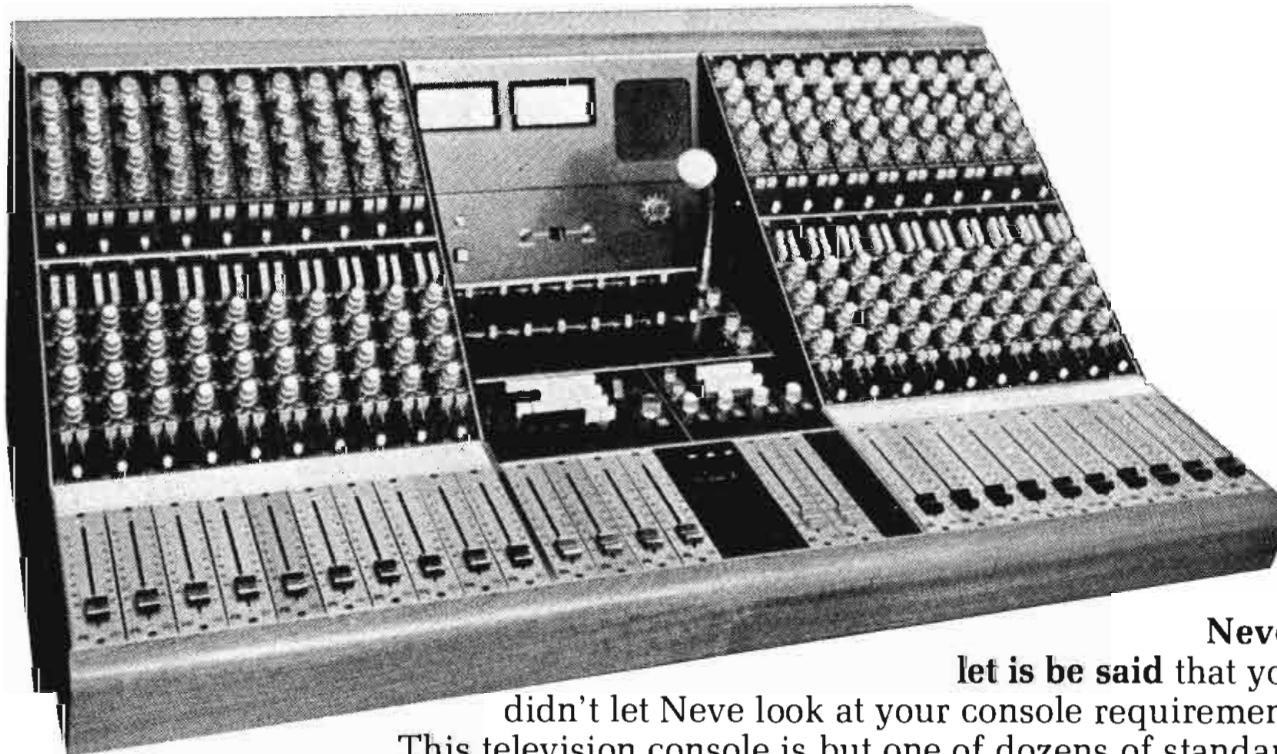

Never let is be said that you didn't let Neve look at your console requirement. This television console is but one of dozens of standard console designs for various applications. From the most modest studio to the largest of network facilities, Neve probably has a standard console to satisfy your Radio or TV requirement. If it doesn't exactly match — we'll modify. Of course, we also build many custom consoles. Call us. You'll be pleased with the prices and you'll be buying the best.

Rupert Neve Incorporated, Berkshire Industrial Park, Bethel, Connecticut 06801 Tel: (203) 744-6230, Telex: 969638
Rupert Neve Incorporated, Suite 614 1800 N. Highland Ave., Hollywood, California 90028 Tel: (213) 465-4822
Rupert Neve of Canada, Ltd., 2717 Rena Road, Malton, Ontario L4T 3K1, Canada Tel: (416) 677-6611
Rupert Neve & Company Ltd., Cambridge House, Melbourn, Royston, Hertfordshire, SG8 6AU England, Tel: (0763) 60776
Rupert Neve GmbH, 6100 Darmstadt Bismarckstrasse 114 West Germany, Tel: (06151) 81764

For More Details Circle (114) on Reply Card

NEVE

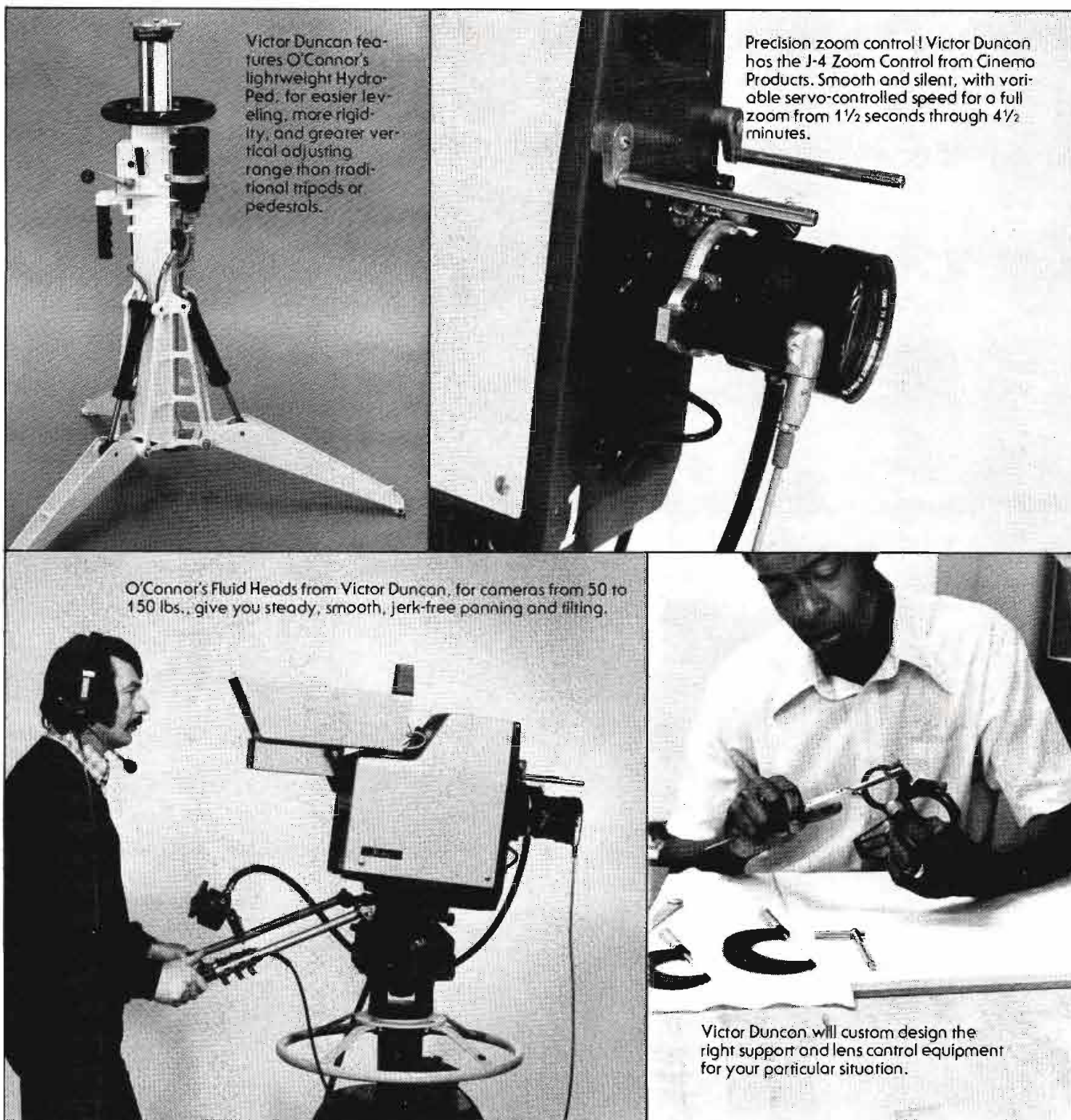

Victor Duncan features O'Connor's lightweight Hydra-Ped, for easier leveling, more rigidity, and greater vertical adjusting range than traditional tripods or pedestals.

Precision zoom control! Victor Duncan has the J-4 Zoom Control from Cinema Products. Smooth and silent, with variable servo-controlled speed for a full zoom from 1½ seconds through 4½ minutes.

O'Connor's Fluid Heads from Victor Duncan, for cameras from 50 to 150 lbs., give you steady, smooth, jerk-free panning and tilting.

Victor Duncan will custom design the right support and lens control equipment for your particular situation.

Videotaping filmstyle

Smooth, silent zooms, jerk-free pans and tilts, location shooting, and a myriad of other attributes once solely in the realm of film, are now equally at home with videorape. And Victor Duncan, Inc., having served the motion picture industry with rentals, sales and service for fifteen years, now makes it possible for the video industry to enjoy these qualities even more with equipment customized by Victor Duncan for video cameras.



VICTOR DUNCAN, INC.
Rentals, Sales, Service
 676 N. St. Clair, Chicago, Illinois 60611, (312) 321-9406
 2659 Fondren, Dallas, Texas 75206, (214) 369-1165
 11043 Gratiot, Detroit, Michigan 48213, (313) 371-4920

Help us help you! Write for information on your specific needs.

- O'Connor Fluid Heads J-4 Zoom Control
 O'Connor Hydro-Ped

Name _____

Firm _____

City _____

State _____ Zip _____

Corporate Director of Sales
VICTOR DUNCAN, INC.
 2659 Fondren, Dallas, Texas 75206, (214) 369-1165

The check and double check people!

For More Details Circle (115) on Reply Card

PHILLYSTRAN®

... manufactured from
impregnated KEVLAR* fiber

GUYS THAT OUTLAST THE TOWER

- NON-INTERFERENCE
- MINIMUM STRETCH
- MAINTENANCE-FREE

If you are looking for guys that eliminate the usual problems of RFI . . . and guys that never need to be replaced during the life of the tower, then PHILLYSTRAN is the answer.

Call or write for additional information.

* duPont registered trademark

© PHILLYSTRAN . . .
proprietary resin
impregnation process of
Philadelphia Resins Corp.

**PHILADELPHIA
RESINS CORPORATION**

20 Commerce Drive, Montgomeryville, Pa. 18936
Phone: (215) 855-8450 • Telex: 846-342



Commission amends Double-billing rules

The FCC has proposed amending its rules prohibiting fraudulent (double) billing, and has proposed new rules pertaining to distortion of audience ratings ("hypoing") and licensee-conducted contests.

The Commission said despite having cautioned licensees for years against these practices, the activities have continued, and complaints have indicated, may be increasing.

Fraudulent Billing

In 1965, the Commission adopted rules prohibiting fraudulent billing practices by broadcast licensees with the rules being amended in 1970.

The Commission stated that in recent years, however, a number of instances had come to its attention in which licensees had engaged in "network clipping"—falsely certifying to their networks that they had broadcast certain network programs in their entirety when, in fact, stations had deleted portions of the network programs or had not carried the programs at all.

Accordingly, in 1973, the Commission issued a Public Notice entitled "Clipping of Radio and Television Network Programs." It cautioned licensees it considers falsely certifying that network material—whether advertising, program content or other material—has been carried to be a use of a licensed facility for fraudulent purposes, and raises serious questions as to the licensee's qualifications to hold a broadcast authorization.

The Commission also stated similar questions were raised when a licensee furnished false information regarding the broadcast of programs supplied by any other party with which the licensee has entered into a contract or any other agreement obligating the licensee to provide specified information concerning the broadcast of program matter supplied by that party.

Examples include commercial announcements sold by a syndicator or program packager that the licensee has agreed to broadcast as consideration for receiving the right to broadcast and where sports clubs or leagues which make available play-by-play broadcasts of their teams in consideration of the stations' agreements to carry the broadcasts in full, including commercial matter.

The FCC has proposed to amend its fraudulent billing rules to include such types of agreements and materials. The Commission invited comment on a revised Public Notice giving examples of the applicability of the amended fraudulent billing rules.

"Hypoing"

In an effort to gain an advantage over competitors some licensees and permittees have engaged in special promotions during or preceding a rating period to temporarily increase a station's rating and thus create a false impression that the rating is larger than it is. These promotions have included contests, special

(Continued on page 14)

The eyes of the world are upon us.

Around the world, more people now look to Electrohome for excellence in video equipment than ever before.

We manufacture solid state video monitors in monochrome and color to NTSC and PAL standards for broadcast, educational, industrial, commercial, medical, security and data applications.

The reason for such wide-spread acceptance is two-fold: a standard of quality and a record of service to our customers that have earned our products top rating around the world.

For complete information, contact Electrohome Limited at one of these offices:

**Kitchener, Ontario, Canada N2G 4J6
519/744-7111 Telex 069-5449**

**9314 West 122nd Street, Palos Park, Illinois 60464
312/361-4636**

**2991 Grace Lane, Costa Mesa, California 92626
714/545-6991**

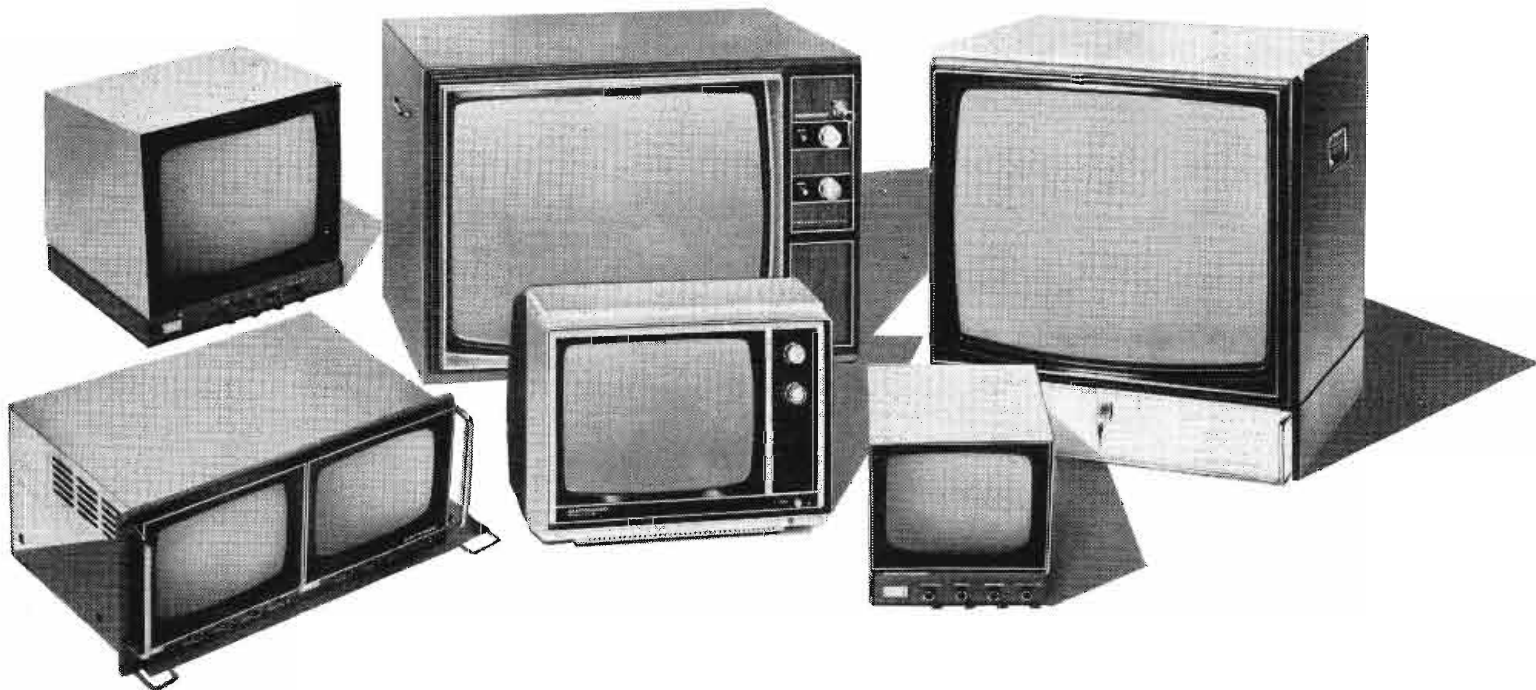

ELECTROHOME

... an extra degree of excellence in video equipment for every application.

Distributed in:

Austria	Denmark	Greece	Malaysia	Norway	Spain	United States
Australia	Eire	Hong Kong	Mexico	Philippines	Sweden	United Kingdom
Belgium	Finland	Italy	Netherlands	Portugal	Switzerland	Venezuela
Canada	France	Japan	New Zealand	South Africa	Thailand	West Germany

For More Details Circle (117) on Reply Card

**RELAX
LOVER**



**DEPEND ON
RUSSCO!**

RUSSCO engineers design the broadcast equipment that works for you—Solid state stereo and mono 5-channel audio mixers, amplifiers and preamps, the finest turntables and precision tone arms. Using modern, trouble-free technology and RUSSCO-RUGGED construction, we bring you products you can really depend on. There's just no other name to consider for Top Quality and Economy!



RUSSCO

ELECTRONICS INCORPORATED

1070 BROOKHAVEN, CLOVIS, CALIF. 93612 Ph. (209) 299-2167

For More Details Circle (118) on Reply Card

Hypoing

(Continued from page 140)

give-aways rewarding the public for tuning to a station and substantially increased advertised campaigns timed with a rating period.

In addition, some licensees have engaged in promotions designed to cause members of the public to state falsely, when approached by a rating service, that they prefer, regularly listen to, or view a particular station. Also some stations have issued false or misleading claims of their station's popularity or coverage area based on audience ratings that themselves may be accurate.

Noting that programs are determined at least in part on the ratings, with distortion and proper use of these ratings bearing directly on the public interest, the Commission said it was desirable to incorporate a new section prohibiting these practices.

Distorted ratings

The Commission said the proposed rules would define clearly the practices it believed contrary to the public interest, and would widen the range of sanctions it could impose for such practices, including monetary forfeiture.

It stressed that distortion of ratings is a serious violation of a licensee's responsibilities, and where the violation appeared to require stronger measures than forfeitures, it intended to take them.

The Commission also said it proposed to issue a Public Notice setting forth examples of how the amended "hypoing" rules would apply to specific situations and invited comments on the Notice.

Licensee-Conducted Contests

The FCC said a recurring problem in recent years has been the failure of some licensees to assure that their contests are conducted with due regard for the public interest despite a Public Notice issued in 1974 dealing with contests that were not fairly conducted or were falsely or misleadingly advertised.

The proposed rules would require licensees who conduct broadcast contests—any arrangement in which a prize is offered to the public—to take steps to assure they are promoted and conducted properly.

Under the proposal, licensees must fully disclose to its audiences the material terms of the contest, and must conduct the contest substantially as announced.

It said the standards were high since contests were particularly susceptible to abuse, but noted that abuses could be prevented by diligent licensee attention to the planning and conduct of contests.

Where a licensee's only connection with a contest is to advertise it for another, however, the Commission said the licensee's responsibility was the same as for commercial announcements in general—to take all reasonable measures to eliminate any false, misleading or deceptive matter.

The Commission has invited comments on the three rulemaking notices which proposed amending Part 73 and the three Public Notices by August 29, with reply comments due September 29.

YOU ASKED FOR IT. AND HERE IT IS.

Announcing the first COMPLETE FM Proof Manual ever offered.

Here's everything you need to comply with the FCC's annual proof-of-performance test. Every procedure, every detail is spelled out *step-by-step* in simple, concise language—all reviewed by the FCC. You save time, money, headaches—and you're sure of doing it right the first time.

Broadcast Engineering's FM Proof-of-Performance Manual includes *all* required logging forms for pulling *both* mono and stereo proofs. A complete chapter on FCC Rules. Dozens of helpful troubleshooting tips and time-saving measurement and logging techniques. Detailed procedures on how to *pre-test* your station before pulling the Proof. And more.

Your FM Proof Manual shows you

- how to prepare the test equipment
- how to connect the test equipment
- an efficient method of measurement and a look at the performance requirements
- how to use the data summary sheet and evolve the graphs
- how to comply fully with FCC rules and standards
PLUS...you get individual *replaceable* forms for completing the equipment performance tests.

All this in one package. And all for \$6.95

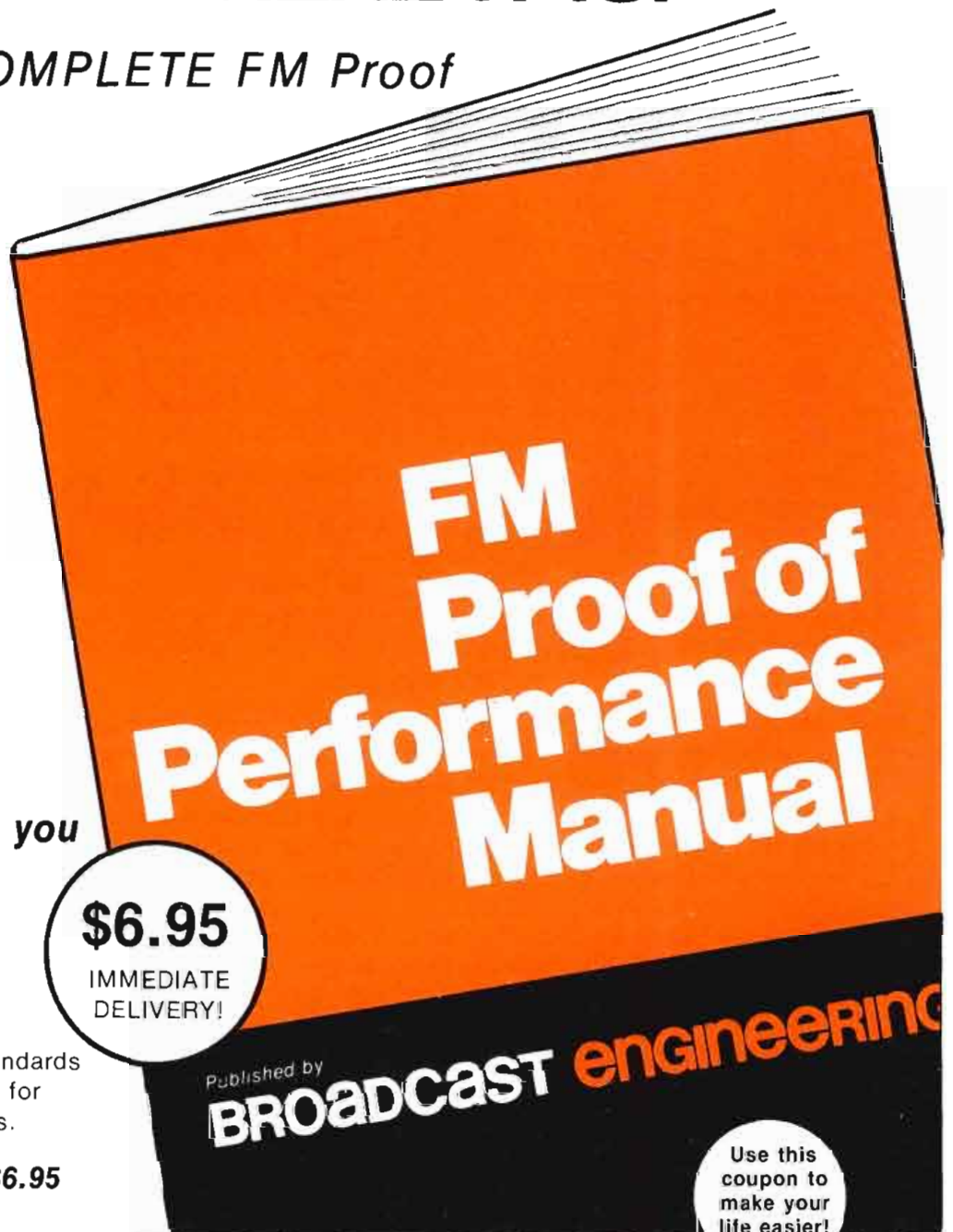

SPECIAL OFFER!

Order Both Manuals AND SAVE!

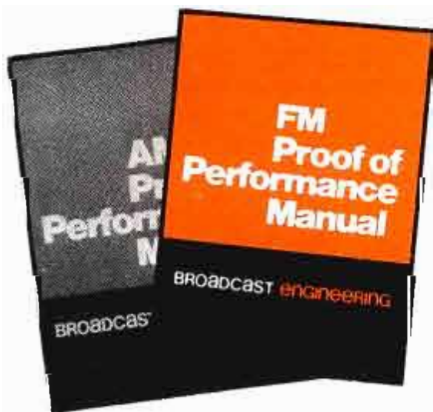

ONLY \$12 for both!

Over 1,000 AM Manuals
now in use

**Volume discounts available
on request.**

BROADCASTENGINEERING®

1014 Wyandotte St., Kansas City, Mo. 64105

- Please send me _____ copies of the FM Proof-of-Performance Manual @ \$6.95 each
- Please send me _____ copies of the AM Proof-of-Performance Manual @ \$6.95 each
- Please send me _____ sets of the FM and AM Proof-of-Performance Manuals @ \$12 for BOTH.

My check or money order is enclosed

Please bill me

Name _____

Address _____

City _____

State _____ ZIP _____

NOTE: Broadcast Engineering pays the postage on all orders!

High Intensity Lights MARK YOUR TOWER!

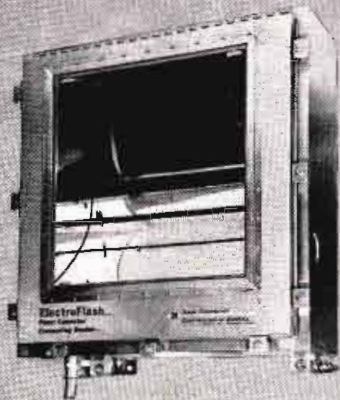

No More Painting or Red Lights

INTRODUCING THE FTB-205 BEACON

FAA APPROVED

Flash Technology Corporation of America continues to lead in innovation and technology in the flash beacon field. Our new FTB-205 Beacon reduces the number of enclosures required (each beacon contains an integral power supply within its enclosure eliminating the need for a separate unit), it is smaller in size, and lighter in weight — all important considerations when mounted on a structure.

Since we offer a self-contained unit, the number of enclosures to be mounted on the structure is equal to the number of beacons required by the FAA.

Only two input power connections plus two connections for control and monitoring are required for each beacon.

The FTB-205 Beacon continues to offer previous Electro Flash features:

- A unique optical system with a sharp lower beam cutoff to reduce downward radiation (Pat. No. 3,737,645).
- An effective extended flash duration during nighttime operation (Pat. No. 3846750).
- Only 2 wires are required for all control and monitoring functions.
- Contacts available to drive a remote failure alarm.
- 3 operational intensities for 24-hour operation; 200,000 effective candelas daytime, 20,000 twilight, and 4,000 for nighttime operation.
- Lowest power input requirements.
- Regional service available.

Over 50 operational systems on tall structures from Canada to Florida prove the reliability and quality of the ElectroFlash Beacon System.

We would be pleased to assist in your design planning for specific installations and provide additional information on our FTB-105 or 205 series beacons.

Do It With Confidence

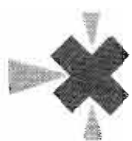

FLASH TECHNOLOGY

CORPORATION of AMERICA

111 LOCK STREET, NASHUA, NEW HAMPSHIRE 03060

TEL. (603) 883-0521

For More Details Circle (119) on Reply Card



SOCIETY OF BROADCAST ENGINEERS, INC.
P. O. Box 66123 Indianapolis, Indiana 46206

(Continued from page 138)

CHAPTER MEETINGS

Chapter 1: Binghamton, N.Y.

Chapter 1 held its annual picnic and election of officers on June 10th at the Newtown Battlefield Reservation. This was an informal meeting so that the Chapter could welcome families and prospective members. Last year's officers were all re-elected. Bill Sitzman, Jr., Independent Broadcast Consultants, Inc., Box R, Freeville, New York 13068, (607) 273-2970.

Chapter 15: New York, N.Y.

Jerry Budelman, from the Audio Systems Technology Group of the CBS Technology Center (no longer affiliated with CBS Labs), spoke on SQ broadcasting techniques July 10th. His explanation of four-channel operation procedures was followed by a discussion of the merits and adaptability of the system to those used currently in existing stations.

A schedule of fall meetings lists September 11th, Byron Fincher, from RCA, who will speak on RCA's new AM stereo system device that is presently being tested by two stations in North America—WBAL in Baltimore and XETRA in Tijuana. On October 9th, Ed Karl, district manager of radio sales for Harris Corporation, will give a talk on their new solid AM transmitter. Jonn Lyons, WWRL, 41-30 58th Street, Woodside, New York 11377, (212) 335-1600.

Chapter 22: Central, New York

Representatives Jerry Quest and Ralph Dahm, from Shure Brothers, Inc., spoke on the subject of microphones. This presentation included a discussion of pickup patterns, impedance, and proximity effects; problems such as noise, wind blast, pop suppression, and phasing; and techniques of distance miking, miking a lectern, and lavalier use. Mort Miller, WNYS-TV, P.O. Box 9, Syracuse, New York 13214, (315) 446-4780.

Chapter 26: Chicago, Illinois

The July meeting of Chapter 26 featured John Wentworth, of RCA, speaking on digital techniques. A large group was on hand at the NBC studios for this fascinating presentation. J. Grinnell, secretary/treasurer recommends that all Chapters present this program. On August 6th, the group met at the Sears Tower where the topic of the day was proof-of-

performance tests for radio and TV, featuring the Tektronix spectrum analyzer along with other techniques.

Members will meet at the D'Arcy Advertising Agency in the Standard Oil Building on September 23. The topic will be electronic journalism, and the Ikegami camera system will be displayed. The October meeting is expected to be held at the newly opened Tektronix Service Center in Rolling Meadows, Illinois. Bob Churchill, SBE, 121 West Wacker Drive, Room 755, Chicago, Illinois 60601. (312) 729-5215.

Chapter 32: Tuscon, Arizona

Friday, June 27th, Chapter 32 was conducted through Tuscon's and the University of Arizona's newest FM station by Gene Stough, director of programs and engineering supervisor of KUAT-AM-FM-TV, who provided the narrative. On July 30, after a feast of "pancakes—all you can eat for 79c" the members held their annual election of officers. H. J. "Bart" Paine, Chief Television Engineer, University of Arizona, College of Medicine, Tuscon, Arizona 85724, (602) 882-6644.

Alexandria, Virginia/ Washington, D.C.

The June 25th meeting was held at WDCA where a tour of the facilities was conducted by Don Doty, chief engineer. The next meeting will also be a tour, at WETA which will include a demonstration by Landy Associates of a high-resolution monitor and the Ikegami hand-held camera. Charles F. Riley, Tele-Color Productions, 708 N. West Street, Alexandria, Virginia 22314, (703) 683-3203.

San Diego, California

San Diego met June 25th to hear Jack Williams, owner of Pacific Records, speak on "The New Generation of Professional Audio Tape Recorders." The July 23rd meeting was held at the California State University. The program for that evening was spectrum analyzer concepts, and their use by AM, FM, and television stations, presented by Dan Harris and R. Thompson of Hewlett Packard. Bill Montgomery, SBE, 6841 Convoy Court, San Diego, California 92111. (714) 556-8080.

**SBE Journal
Begins
On Page 122**

DYNAIR adds chroma keyer line

Technicolor's Chromatech line of linear chroma keyers and exclusive rights have been acquired for an undisclosed sum by DYNAIR Electronics, Inc., San Diego, according to Robert Vandeland, Vice President of Marketing for DYNAIR.

"This advanced technology will permit DYNAIR to accelerate its move into more professional color

applications. The program was started by the introduction of entirely new distribution switching systems at the recent NAB Show," said Vandeland.

DYNAIR Electronics, Inc. is an eighteen year old organization specializing in television switching, distribution and processing equipment.

POWERLINE PROTECTORS USING THE

TII 3-ELECTRODE

- Protects equipment from powerline surges
- Includes instant-acting TII 3-Electrode Gas Tube, thermal cut-out and fuse
- Available in many convenient packages

Model TII-412 for in-equipment use.

Model TII-410, standard. Cover included.

Model TII-411 with 3-prong line cords. Cover included.

Model TII-425 for standard 3-prong 117 vac receptacle.

Model TII-422 with Hubbel Twist-Lock connectors. Cover included.

TII Powerline Protectors prevent surge from entering via the AC feed... a major source of damaging overvoltages and junction destruction.

Take advantage of the full protection of TII 3-Electrode Gas Tube Arresters on the AC side of transformers, power supplies and all other ac-powered equipment. A wide range of convenient wiring arrangements are available both with and without leads.

Write for complete details to:



TELECOMMUNICATIONS INDUSTRIES, INC.

1375 Akron St., Copiague, N.Y. 11726 • (516) 842-5000 • Telex 144631

More than 11 trouble-free years and over 2,000,000 tubes in service.

Licensed by Western Electric Co. and M.O. Valve Co. Worldwide patents and patents pending.

In Canada: TII Canada, P.O. Box 6120, Station A, Toronto, Canada M5W 1P5

For More Details Circle (120) on Reply Card

For All Your Console Components

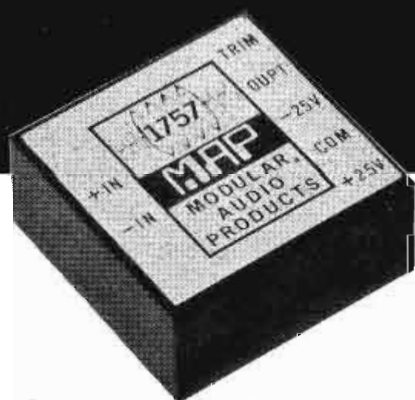

from this...

- **Audio Operational Amplifiers**
 - Single Channel
 - Dual Channel
 - Booster
- **PC Card Amplifiers**
 - Microphone Preamplifiers
 - Tape and Phono Preamplifiers
 - Line Amplifiers
 - Mixer Amplifiers
 - Power Amplifiers
 - Power Supply Modules
- **Panel Mounted Assemblies**
 - Equalizers
 - Compressor—Limiter
 - Precision Test Oscillator
 - Stereo Broadcast Console
 - Input Modules
 - Recording Console Input Modules
- **Rack Mounted Equipment**
 - Graphic Equalizer
 - Studio Monitor
 - Power Supply
- **Accessories**
 - Mounting Racks for Card Amplifiers
 - Input and Output Transformers
 - Connectors and Sockets

...to this



MAP MODULAR
AUDIO PRODUCTS, Inc.

A UNIT OF MODULAR DEVICES, INC.

1385 Lakeland Ave., Airport International Plaza
Bohemia, New York 11716 516-567-9620

Noncommercial rules Reflect local needs

The FCC has proposed that noncommercial educational broadcasters be required to ascertain the problems and needs of their communities of license and other communities they serve or propose to serve, program to meet those needs and document their ascertainment and programming efforts.

These requirements would apply to all applicants for new construction permits, for changes in facilities where the proposed field intensity contours encompass a new area equal to or greater than 50 percent of the area within presently authorized contours and renewal applicants.

The action was in response to a notice of proposed rulemaking released September 11, 1973. In that notice, the Commission said that while no formal ascertainment requirements, as specified by the FCC's 1971 Primer on Ascertainment of Community Problems by Broadcast Applicants, have been imposed on noncommercial broadcasters, there was no question concerning their responsibilities and obligations to determine the problems and needs of their communities and to program in such a way as to meet those needs.

(The Primer requires all commercial broadcast applicants to determine the demographics and composition of the city of license. Within six months of filing the application, the principals and management level employees must interview community leaders representing a cross-section of the community.

During the same time a random sample survey of the general public must be taken either by the principals, management or nonmanagement level personnel, or a professional research firm. The applicant must then list the problems and needs ascertained and, based on its evaluation, determine which problems it proposes to treat and what programs it will broadcast to deal with those problems.)

The FCC said the ascertainment documentation requirements it has proposed for commercial renewal applicants "provide the best means of bringing pertinent ascertainment information to the attention of the Commission and the public. It therefore proposed to impose the same documentation approach on non-commercial applicants. It requested further comment on its proposed requirements as well as on rule and form changes.

Interview Format

The Commission said the format of community leader interviews prescribed in the Primer was somewhat restrictive for noncommercial ascertainment. It said it was intended that the consultations be face-to-face contacts with the interviewees specifically advised of the purpose of the conversation. Since the Primer was adopted, the FCC said it had allowed commercial licensees to conduct their leader surveys by other means such as joint meetings, and telephone inter-

views.

The Commission said it intended to allow the non-commercial licensee "considerable flexibility in planning its leader survey" and would accept a broad range of methods—group meetings, on-the-air interviews, town hall settings, chance encounters, and telephone interviews.

"In fact," the FCC said, "we encourage noncommercial applicants to experiment with a variety of methods and view this freedom as a proving ground for methods which might at a later date be applied in the commercial context."

The Commission also proposed to extend to non-commercial applicants the requirement that they conduct a random sample of their community of licenses and those other communities within their service area that they serve or propose to serve.

At the same time, comments were invited on other possible options for conducting the general public survey. These include a monthly call-in program inviting members of the public to discuss community problems and needs, or semi-annual public meetings discussing these issues.

Once During Licence Term

This survey, the FCC said, could be conducted once during each license term or for nonrenewal applicants during the six-month period preceding the filing of their applications.

The survey could be conducted by principals, management-level employees, nonmanagement-level employees, volunteers, or a professional research or survey service. Noncommercial applicants would be required to demonstrate that a random sample of the general public of the community had been contacted.

The Commission said it would be inappropriate to require noncommercial applicants to ascertain the instructional needs of their communities and service areas. It said ascertainment did not have a role to play in the planning of instructional programs since most, if not all, instructional programs were presented in coordination with educational institutions.

(Instructional programming is designed to be used by any level of educational institution in the regular instructional program of the institution. Examples are in-school, in-service for teachers, and college credit courses.)

The Commission said that if a licensee provides only instructional programming, no ascertainment of community problems and needs would be necessary.

The Commission said it did not view the difference between radio and television to be significant enough to justify separate ascertainment standards although they did justify different types of programming to meet the ascertained needs. Radio, for example, may make considerable use of short duration vignettes rather than 15 or 30 minute programs.

Class D Distinction

The Commission said, however, that a valid distinction could be drawn between Class D 10-watt FM

Dynatel™

Automatic Tension Corrector

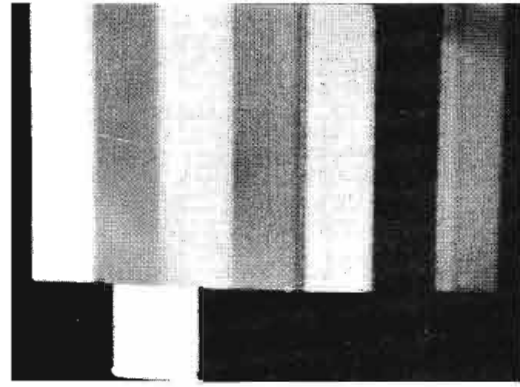

Program this

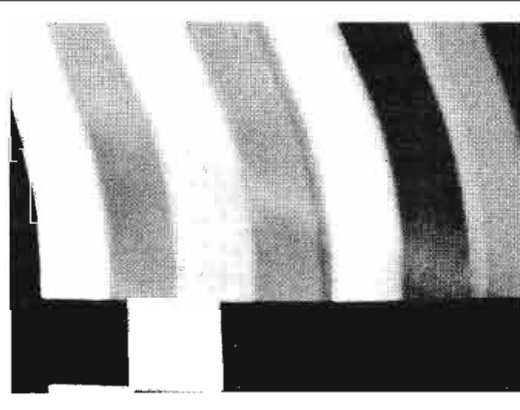

Not this

A simple modification for U-matic VTR's

Automatically reduces picture skewing or flag-waving; corrects tension in both play and record

Eliminates major cause of tape damage

Circuitry on plug-in printed circuit board for easy field installation

Extends playback dynamic range to twice that of conventional machines

Avtel

Avtel
1280 Blue Hills Avenue
Bloomfield, Connecticut 06002
(203) 242-4242 TWX 710-425-2390

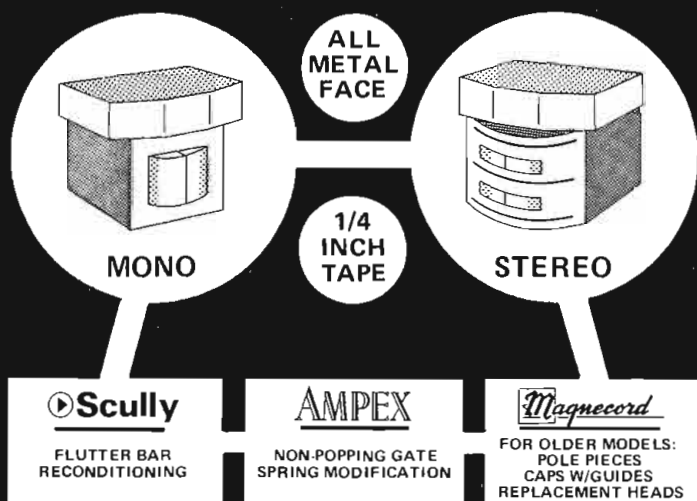

DIRECT REPLACEMENT HEADS

MMI HEADS EQUAL OR EXCEED ORIGINAL EQUIPMENT SPECS.

SEND US YOUR ASSEMBLY. We will ultrasonically clean everything — install new heads if yours cannot be relapped — replace any worn or missing minor hardware — adjust — test — ship back PRE-PAID your assembly (not some other).

36 HOUR SERVICE — LOANERS AVAILABLE

INSTALL YOURSELF. Buy MMI heads with complete written and pictorial instructions.



For More Details Circle (123) on Reply Card

CRAMER SPECIALS

Panasonic	NV 5110 Cartridge Players	\$ 735
	NV 5120 Cartridge Play/Rec.	945
	NV 2110 3/4" Cassette Player	795
IVC	800A 1" B/W Play/Rec.	3149
	760 1" B/W Play/Rec.	2730
	700 1" B/W Play/Rec.	1575
	150 Color Camera	12,706
	40M B/W Camera	1725
Magnavox	CV220 Color Camera	2700
	CV 330 Color Camera	2665
Shibaden	FPC 1000 Color Camera	6600
	FP 100 C B/W Camera	795
Sony	AVC 3200 DX B/W Camera Ensemble	699
	AV 8400 C 1/2" Color Portable	1300
Pentagon	S-1000 Cassette Slave	1995
	C-320 Cassette to Cassette	1670
	C-1340 Cassette Duplicator	1313
	CM-1200 Cassette Duplicator	697

Call Toll Free 800-225-3768

Cramer Video

120 Hampton Ave.
Needham, MA 02194

148

For More Details Circle (124) on Reply Card

Noncommercial

(Continued from page 147)

noncommercial radio stations and those of greater power. These stations primarily are licensed to or connected with educational institutions, colleges, junior colleges and high schools. Their service area is very limited in that they place a city grade signal out only about one mile. Accordingly, the FCC said it would exempt 10-watt licensees from the requirements of ascertainment. Instead, it said it would rely on the established channels of communication within the educational institutions to assure that these licensees are responsive to the needs of their audiences.

Small Market Exemption

The proposed small market exemption was designed to test the proposition that a broadcaster in a small community knows thoroughly the problems and needs of his town. Since the broadcaster's chief obligation is to his community of license, and population data on communities is readily available, the Commission proposed to use the community of license rather than the service areas as its point of reference. It specifically invited comment on whether a community of 10,000 or less was an appropriate cutoff.

The Commission said it proposed to extend the same small market exemption to noncommercial licensees and invited comments on all aspects of the proposal, including the cutoff figure.

iem
INTERNATIONAL
ELECTRO-MAGNETICS

MAGNETIC HEADS

- HEAD RECONDITIONING
- NEW REPLACEMENT HEADS FOR MOST PROFESSIONAL RECORDERS

(BOTH DOMESTIC AND FOREIGN)

TAPE TRANSPORTS

- MASTER STUDIO RECORDER
- ECONOMY STUDIO RECORDER
- MASTER HI-SPEED PLAYBACK
- HI-SPEED SLAVE DUPLICATOR
- LOW SPEED QC OR LOGGER

SEND FOR COMPLETE BULLETINS

For More Details Circle (125) on Reply Card

NEW PRODUCTS

Production Switcher

Telemet, one of the Geotel Companies, has announced a totally new TV broadcast production switcher, Model 7960, which was previewed at NAB in Las Vegas. The 7960 combines the latest in production effects, a modularly expandable package, and features highest reliability, state-of-the-art integrated circuitry design throughout, assuring the standards of performance and dependability expected from every product bearing the Telemet name.

Model 7960 is a 4 bus switcher with re-entry and an independent preview option. The control panel is available in 3 standard configurations: 9, 15 or 21 inputs. Custom panels are available with up to 29 inputs, additional key, preview and program busses, machine control, audio breakaway, etc.

For More Details Circle (229) on Reply Card

Distribution Amplifiers

Dynasciences Video Products has announced the 4000 Series of distribution amplifiers, which provide an economical means of combining up to 10 video and/or pulse distribution amplifiers in a single, standard-sized rack.

Model 4000 rack provides 2 loop-through input with 5 output connectors for each amplifier. Model 410 is the common power supply for all plug-in modules.

The plug-in module, Model 420, provides five 75-ohm output signals from one bridging input signal with minimum differential gain and phase error. The VDA's also have provision for high frequency peaking to compensate for long cable runs.

Model 450 plug-in module is interchangeable with Model 420 without rack modification.

For More Details Circle (230) on Reply Card

Downstream Keyer

Broadcast Video Systems LTD. announces a versatile downstream keyer from **Michael Cox Electronics LTD.** Housed in a single 1 3/4" rack unit, Model 150DKM consists of a special effects switch module, a 4X1 crosspoint module, a mix amp and power supply. A 10 conductor DC control cable connects the electronics to the remote control panel.

September, 1975

Let Accurate Sound Update Your Old Ampex Recorders

Nucleus SC-100 Tape Recording Electronics



- *All Solid State
- *"Plug for plug" replacement for Ampex 300, 350, 351 models
- *Low noise
- *Self Contained power supply
- *Highly reliable

Now you can update your old Ampex recorder to our all new solid state electronics. No more changing tubes. No need to change bias and EQ settings to compensate for aging tubes. This unit is complete and ready to plug in. The electronics are fully adjustable to accommodate a variety of head stacks. Write for complete specifications. \$550.00.

Accurate Sound Company will allow \$100.00 trade-in on your old Ampex 351 style electronics or \$50.00 on any other style electronics.



ACCURATE SOUND COMPANY

114 5th Avenue,
Redwood City, California 94063
415/365-2843

Send for our 18 page illustrated catalog with new and used equipment listings. As well as services i.e., head rebuilding, recorder systems rebuilding, turn-key studio installation and lease/purchase program.

For More Details Circle (126) on Reply Card

Announcing VTC-1000



All-new Mastering Video Tape \$160.00 per hour*

From the Video Tape Company—the firm that promptly supplies any of your video tape needs! Prices lower than all competition—including Program Duplicating Stock @ \$125.00 per hr./ Spot Duplicating Stock @ \$1.00 per min.* — (22 min. max. length) 100% guaranteed. VTC-1000 promises: low dropouts hi signal-to-noise excellent color performance extended headwear exceptional durability each reel tested end-to-

end. Lowest prices. Guaranteed quality. And immediate, personal attention to every video tape product or service you need.*And we'll pay the freight anywhere in the continental U.S. with each order of 6 or more reels! (In California, add 6% for sales tax.)
Call collect: (213) 985-1666

	THE VIDEO TAPE CO.	4212 Lankershim Blvd. N. Hollywood, Ca. 91602 Keith Austin, Pres.
	Mail this coupon today for free price-and-information brochure.	
Name _____		
Title _____		
Company and/or Channel _____		
City _____		
State _____		Zip _____
BE-75S		

For More Details Circle (127) on Reply Card

149

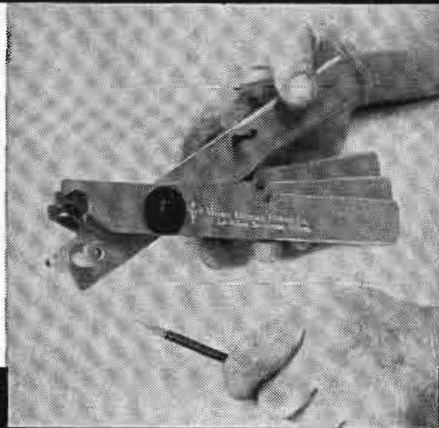

NEW MODEL CX-1

COAXIAL CABLE STRIPPER

Developed and used by NASA ■ Prepares cable for connectors in 10 seconds ■ Adjusts for stripping requirements of all standard co-ax connectors ■ Close-tolerance adjustment prevents nicked conductors ■ With removable inserts, accepts cable from .075" to .435" OD.

PRICE \$44.50 F.O.B. San Clemente
Specify cable O.D. when ordering

Western Electronic Products Co.
107 Los Molinos, San Clemente, Calif. 92672

For More Details Circle (128) on Reply Card

The unit is designed for installation anywhere in a television system where there is a requirement to key a caption into a video feed or fade video to black.

Other features of the 150DKM include: output can be previewed before going to line; separate key and caption inputs for use with border generators; stripped sync from program video available on rear panel for locking up caption camera if required.

For more Details Circle (231) on Reply Card

Video Production Switcher

Ross Broadcast Products has developed RVS16-6, its newest full function video production switcher. Designed for mobile or studio fixed applications, the unit's features include: 16 inputs, 6 busses, built-in color black and background generator, downstream keyer, two independent effects groups each with 96 wipe patterns, soft wipe, soft key, bordered wipe, spotlight, positioner and chroma keyer. State-of-the-art C-Mos circuitry reportedly assures low power consumption and high reliability. The compact electronics and power supply package requires only 7" of rack space.

For More Details Circle (232) on Reply Card

1-Inch Video Tape System

Three versions of the new 1-inch **Fernseh** video tape recording system recently introduced at the 1975 Montreux (Switzerland) Exhibition will be available in the United States, in early 1976, it was announced by Fernseh Group of **Robert Bosch Corporation**.

The BCN System presented in Montreux is a 1-inch magnetic tape recording system using the 2-head helical scanning technique (segmented field). It features full broadcast studio quality, and is designed for all applications.

It consists of four basic units which can be combined into three compatible equipment versions.

- The BCN 20: A portable battery-powered version that weighs only 48.5 lbs. and offers full broadcast studio quality and a recording time of 52 minutes. This machine is equipped with an automatic assembling system permitting an "on-air" tape to be produced immediately by assembling the recorded takes.

- The BCN 40: Designed for use in both mobile units and studios, it consists of tape deck and electronics unit and weighs 143 lbs. This compact recorder also provides integrated electronic editing facilities, a time code reader and processor, digital remote-control transmission and computer-aided editing. Its recording time is 95 minutes.

- The BCN 50: By adding a processor to the BCN 40 unit, the recorder becomes a professional broadcast studio machine providing recording and playback and the generation of an "on-air" signal. It weighs 220 lbs. The machine can be extended by monitoring equipment mounted at eye level. It is equipped with either a black/white or color monitor, an oscilloscope and/or vectorscope.

For More Details Circle (233) on Reply Card

Rack Mounted Coaxial Wattmeter

Model 4527 is a new **Bird Electronic Corp.**, Thruline® RF Directional Wattmeter for the measurement of forward or reflected CW power with the additional feature of an RF sampling output for frequency analysis on a scope, spectrum analyzer or frequency counter.

The wattmeter is designed for ± 5% power measurement from 100 milliwatts to 1000 Watts from 2 to 200 MHz and up to 500 Watts from 200 to 512 MHz, using the same standard plug-in elements in discrete



A professional makes even the toughest jobs seem easy

That's the way it is with Waters professional audio attenuators. They feature glass-hard MystR® conductive plastic elements and slip rings as well as precious metal contacts. What's more, Waters computer-controlled curve-shaping technique assures superior tracking.

Result: smooth, quiet, long-life performance under the most grueling service conditions.

You'll find Waters complete line of professional audio controls meets every need — linear or rotary motion — mono, stereo, or quad. Two standard impedance values are now available, 600 or 10,000 ohms.

If you're into mixing, you ought to get the complete story on Waters audio controls. Write today, or call us at 617-358-2777.

It's the professional way.

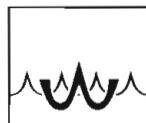

WATERS MANUFACTURING, INC.
Longfellow Center, Wayland, MA 01778 617-358-2777



For More Details Circle (129) on Reply Card

bands and power-levels as cataloged with the famous model 43. No plug-in elements are needed for RF analysis: The sample signal is available from a BNC output port at about 53dB below the main signal level in the precision built-in section of 50-Ohm line (10-512 MHz). Below 10 MHz the coupling decreases gradually to -70dB.

THRULINE model 4527 has a low insertion VSWR of 1.05 max. A major feature resulting in this low VSWR value is the use of the patented QC Quick-Change Connectors, which permit mating with male or female N, BNC, TNC, UHF, C, SC, HN, GR Type 874 and 7/8" EIA lines without the need for performance-degrading adapters.

For More Details Circle (234) on Reply Card

Digital Remote System

A totally digital remote control system has been developed by **Moseley Associates, Inc.** The DRS-1 digital remote system has a 10-channel control/telemetry capability, with each channel providing one telemetry and two command functions. The system can be field expanded to 20 or 30-channel capability. A 24-channel status/alarm subsystem is optional.

Model DLS-1 digital logging system is a companion unit providing automatic recording of up to 20 parameters, plus time of day. The system records parameters at preset time intervals when an out-of-tolerance condition occurs, or when manually initiated. Interconnection requirements are a single voice-grade line; audible command and telemetry in the 300 Hz to 2600 Hz range.

Also available as an option is a completely wireless radio (STL) system made possible by the addition of an interior subcarrier generator and demodulator for command information. Subaudible telemetry is available with the DRS-1.

For More Details Circle (235) on Reply Card

Portable Reverberation Unit

The **AKG BX-10** is a truly portable two-channel reverberation unit designed to provide both the quality and operating features required in studio applications. The unit is based on the extremely successful Torsion Transmission Line principle used in the larger well-known AKG BX-20.

Independent decay-time adjustment, high and low frequency equalization and reverberation/dry signal mixing are provided for each of the two electronically and acoustically separate channels. Decay-time is adjusted silently through motional feed-

NEED EQUIPMENT?

ALLIED IS YOUR BEST SOURCE

FOR NEW OR USED BROADCAST EQUIPMENT

(WE ARE LISTED IN OVER 125 CATEGORIES IN THIS ISSUE)

MOST MAJOR BRANDS • FAST SERVICE

LARGE INVENTORY • SATISFACTION GUARANTEED

FINANCING AVAILABLE ON \$500 OR MORE

contact ALLIED before you buy or trade

317-982-8596

IF YOU ARE NOT RECEIVING OUR MONTHLY CATALOG

CALL OR WRITE

ALLIED BROADCAST EQUIPMENT

124 South 6th Street

Richmond, Indiana 47374

For More Details Circle (130) on Reply Card

TRANSMITTER REMOTE CONTROL

No other remote control system has enough DIGIT\$ to display the full price except:

TELEDATA SYSTEMS
DIGITEL® X10

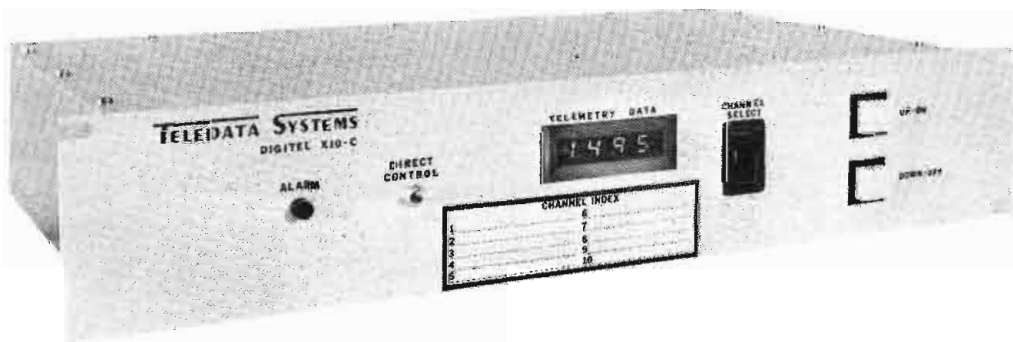

- Fully Digital
- 10 Channels
- No Stepper

- Wire or Wireless
- Optional BCD Word Inputs
- 3½ Inches of Rack Space

- All Accessories Available

Please Contact John Webster, 805-685-2317

TELEDATA SYSTEMS, INC.,

108 Aero Camino, Goleta Ca. 93017

IN CANADA: Orange County Corp., 1079 Autumnwood Dr., Winnipeg, Man., R2J 1C6

For More Details Circle (131) on Reply Card

LPB

*won't do a
thing for the
hiccups...*

LPB is a manufacturer and distributor of Studio and Broadcast equipment at low, low prices. It's worth your time to find out more, so call Dick Crompton or Ted Davey or write

LPB[®]

LPB Inc.
520 Lincoln Highway
Frazer, Pa. 19355
(215) 644-1123

See us at Booths 91 & 92,
NAFMB, Atlanta

For More Details Circle (132) on Reply Card

back, enabling adjustment during program material. Reverberation/dry signal mixing enables reverberation to be added to dry signal without the need for a "reverb return" mixing section in the mixing desk.

The unit may be rack mounted in the control room or used as a portable system. Its unique two-point suspension makes it impervious to acoustic feedback and mechanical vibration. There is no need to "lock-down" the system for transport, nor any need for adjustments after transport.

For More Details Circle (236) on Reply Card

Transient Suppressor

A radio frequency interference/voltage transient suppressor for 120 Volt power lines is now available from **Boston Sound & Power Systems**. The unit features 70 dB attenuation in the RF band, suppresses all voltages above 130 Volts RMS, and can withstand peak current transients to 2000 Amps. Maximum current delivered is 12 Amps.

Available with 4 or 8 standard outlets, the product plugs into a normal wall or equipment rack outlet for operation. Devices to be protected plug into the unit.

A full 5-year warranty on all parts and labor is included.

For More Details Circle (237) on Reply Card

News Info System

An easy, low cost way to add up-to-the-minute news and other material to air time is the new INFO SYSTEM from **SMC**. It consists of an SMC DT-1 encoder with a CRT video terminal installed in the newsroom. Information entered on the encoder keyboard is instantly transmitted to the video unit.

Up to nine video terminals in separate control rooms can be hooked up to the system. Late news flashes, current weather or promo material is displayed simultaneously in all rooms.

The INFO SYSTEM can also be used for an in-station paging system to summon personnel for phone calls, messages, etc.

For More Details Circle (238) on Reply Card

Equalization Filter Set

The **UREI** Model 529 Room Equalization Filter Set is an "Attenuate-Only" version of their popular Model 527-A Graphic Equalizer. The 529 has 27 $\frac{1}{3}$ octave active filters that each provide up to 15 dB of attenuation to adjust for a desired house curve. They are centered on standard ISO frequencies making the 529 compatible with all current room equalization measuring equipment.

Filters combine properly for minimum ripple and phase shift. "Band end" tunable high pass and low pass filters attenuate 18 dB per octave. Gain is adjustable to +20 dB to make up for average level lost in equalization. The 529 is completely self contained with built-in power supply.

An accessory security cover (529 SC) may be added to prevent unauthorized tampering or accidental mis-adjustments.

For More Details Circle (239) on Reply Card

Aural Studio-Transmitter Link

Model PCL-505 aural studio-transmitter link has been announced by **Moseley Associates, Inc.** Available in the 148-174 MHz, 215-240 MHz, 300-330 MHz, 450-470 MHz and 890-960 MHz bands, model PCL-505 has replaced models PCL-202, PCL-303, PCL-303/C and PCL-404 STL's.

Direct FM modulation, a technique pioneered by Moseley Associates, is employed in the PCL-505 transmitter. A new approach to AFC circuit design enables a 100% duty cycle, improving AFC locking capability and providing frequency stability of better than 0.0005%. Model PCL-505 accepts one program feed, monaural or stereo, and two additional subcarriers. Also considered in the design of the unit was quadra-

MARTIN

THE WORLD'S LARGEST
ELECTRONIC EVERYTHING HOUSE
FOR THE PROFESSIONAL

The biggest "in-stock" inventory of professional audio/video equipment, parts and accessories—anywhere.

The Everything House has everything for the professional... broadcast, audio, video, sound reinforcement and hi-fi stereo components.

Quality products from over 200 leading manufacturers*... what you want, when you want it!

Consult Martin's specialists about installation... service... systems design... and sales for all your audio/video needs.



*Such as: AKG, Altec, Ampex, Crown, DBX, Do'loy, J. B. Lansing, 3M, Shure, Neumann, Sony, Scully, McIntosh, Urei

Call or write for
a free catalog

MARTIN

Audio/Video

320 West 46th Street, N.Y.C. 10036
(212) 541-5900

For More Details Circle (133) on Reply Card

BROADCAST ENGINEERING

ANTENNA IMPEDANCE MEASUREMENTS WITH INTERFERENCE IMMUNITY

The Model SD-31 Synthesizer/Detector

Is...

NEW

... designed for antenna impedance measurements in presence of strong interference ■ High-level oscillator compatible with General Radio 916 Series, 1606 Series, and Delta OIB-1 Impedance Bridges ■ Special coherent detector circuit rejects interfering signals during measurements ■ Crystal controlled frequency, variable in 500 Hz steps from 100.0 kHz to 1999.5 kHz ■ Receiver for detector can be external or optional built-in RX-31 ■ Powered by rechargeable batteries ■ Self-contained portable package ■ Field proven ■ Versatile — can use as an RF signal generator for troubleshooting antenna systems; as a variable frequency oscillator for antenna site survey; or other applications requiring a precise frequency source ■ Price: \$1250 complete with RX-31 Receiver — \$995 without Receiver.

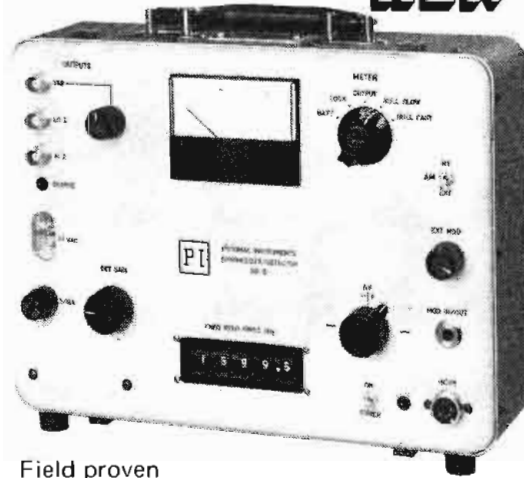

CONTACT US FOR DETAILS.

POTOMAC INSTRUMENTS

932 PHILADELPHIA AVE.
SILVER SPRING, MD. 20910
(301) 589-3125

For More Details Circle (134) on Reply Card

Audio Cassette Storage System

Engineered to fit specific FM station problems and physical locations, the audio cassette "Room Stretcher" from Storeel Corporation is now in production. The product provides storage for 400 cassettes in a compatible unit measuring 84"H, 22-3/8"W, 4-5/8"D. Custom engineering is offered free of charge.

For More Details Circle (240) on Reply Card

Recorder Electronics Unit

A replacement tape record electronics unit with features not found even on new recorders has been introduced by Inovonics, Inc.

Model 375 Tape Recording Electronics features full remote control and three-speed equalization. It has a "linearized" recording amplifier and phase-corrected reproduce circuitry for low distortion.

An optional sync reproduce amplifier has independent equalization for optimum performance in both playback modes.

The Model 375 plugs directly into most Ampex recorders and is easily adaptable to most other machines.

For More Details Circle (241) on Reply Card

phonic stereo. The PCL-505/C has the capability of accepting a quadraphonic stereo signal.

For More Details Circle (258) on Reply Card

Computer Managed ENG Editing

CMX Systems, California based developer of computer managed video editing systems, has introduced a new system specifically designed and priced for electronic news gathering.

The CMX System/40, dubbed The News Editor, utilizes the basic technology of the company's prior computer managed editing systems. The News Editor features frame accurate editing, jogging (frame advance), slow motion (20%), edit storage in computer memory, re-edit and auto-assembly and the ability to read time codes in fast modes. The system's media format involves the widely used Sony U-Matic VCR series.

The System/40 is offered in four basic configurations. News editors may opt for a basic system which includes a rack mounted computer, CMX Monitor Control and 2 or 3 Sony 2850 U-Matic VCRs. A 3 VCR system may be expanded to full CMX System/50 capability.

For More Details Circle (259) on Reply Card

AGAIN & AGAIN POTOMAC INSTRUMENTS IS



First FCC Approved Antenna Monitor AM-19(204)

First Harmonic Reading Standard Broadcast Field Strength Meter FIM-41

First Digital Antenna Monitor AM-19D(210)

First Frequency Synthesized RF Bridge Source and Coherent Detector SD-31

First Solid State VHF Combination Field Strength Meter & RF Generator FIM-71

And Other FIRSTS to be Announced

CONTACT US NOW FOR DESCRIPTIVE LITERATURE ON OUR COMPLETE LINE OF BROADCAST INSTRUMENTATION.

POTOMAC INSTRUMENTS

932 PHILADELPHIA AVE.
SILVER SPRING, MD. 20910
(301) 589-3125

For More Details Circle (135) on Reply Card

FIDELIPAC® ACCESSORIES & CARTRIDGES

CART-A-ROUND CARTRIDGE STORAGE RACKS

Each WR-25 Modular Rack holds 25 Type A Cartridges . . . eight can be mounted on our Mobile Carousel Base to make up the MR-200.

WR-25 \$13.25
MR-200 \$145.95

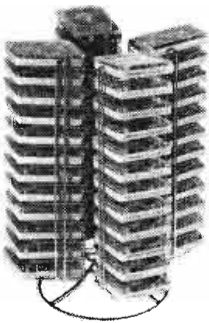
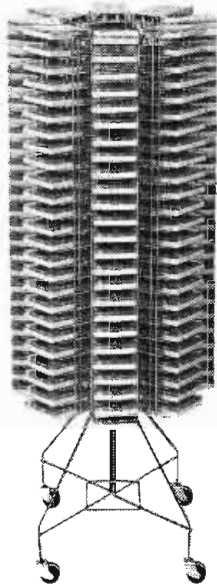

TABLE TOP CARTRIDGE RACK

Model TR-96 holds 96 Type A cartridges, Model TR-48 holds 48.

TR-96 \$73.85
TR-48 \$38.55



STUDIO ON AIR LIGHT

brilliant red lettering on jet black background can be seen even in the brightest ambient light conditions. \$29.95



CART-E-RASE DEMAGNETIZER

can be used for erasing cartridges, reel-to-reel tape, film sound stripping, etc. \$34.50



ALIGNMENT PROBLEM?

Keep your cart equipment in perfect working order with:

- 350 STA Alignment Cartridge \$38.50
- 350 STF Wow and Flutter Cartridge \$24.50
- 350 STQ Cue Test Cartridge \$35.00
- Head Insertion Gage \$3.35
- Height Gage \$12.95
- Right Angle Zenith Gage \$21.75

Contact your Fidelipac Distributor or



FIDELIPAC®

109 Gaither Drive, Mt. Laurel, NJ 08057
(609) 235-3511

® Trademark

For More Details Circle (136) on Reply Card

Automatic Release Cartridge Machine

Broadcast Electronics, Inc. announces the introduction of a new line of Spotmaster automatic release tape cartridge machines. Designated as the Series 3000, these new machines in-

corporate an automatic release deck and other features never before available in this type of machine. The Series 3000 is of advanced design with all performance specifications exceeding present and proposed NAB standards. Power consumption is very low—less than 45 Watts—so there is no excessive heat to damage tapes and cartridges.

Quality construction is used throughout the Series 3000 with a rugged machined deck, gold-plated connectors, plug-in electronics, high efficiency direct-drive motor, maximum noise suppression and a massive air-damped solenoid. Standard features include FET switching, transformer output, and remote control connectors. Stereo units are equipped with the unique Spotmaster Phase-lok III head bracket—the only head bracket with an independent azimuth adjustment to assure extremely tight control of stereo phasing.

A full range of Series 3000 models is available including mono and stereo, record/playback/delay, all cartridge sizes and desk or rack mounting. Options include all tape

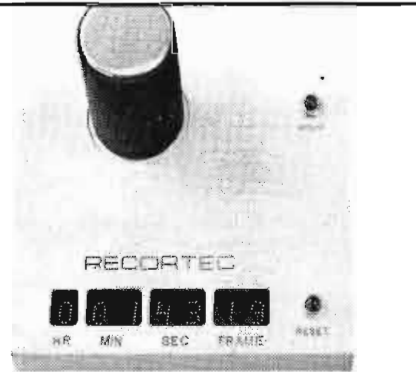

TAPE TIMER

All Ampex and RCA 2 inch Video Tape Recorders can be equipped with a Recortec Video Tape Timer. Gives bright LED display in hours, minutes, seconds and frames. Installs with one bolt. Remote display unit available.

Most units priced at \$560 including power supply.

Recortec, Inc., 777 Palomar Avenue, Sunnyvale, Ca. 94086. Tel: (408) 735-8821.

For More Details Circle (137) on Reply Card

A COMPLETE COLOR FILM LAB FOR LITTLE SPACES AND LITTLE BUDGETS



Owning a color film lab isn't as expensive as you think.

You don't need a lot of volume to justify owning Little Max. And you don't need a lot of space either.

In fact, it fits any 7' by 10' space. That's tiny, compared to most color processors.

And the price is tiny, too.

But there's no skimping on quality. You get superb results from Little Max.

For the full story on improved film budget and production efficiency, contact us today.

11801 West Olympic Blvd., Los Angeles, CA 90064. (213) 479-3941.
TWX 910-342-6899, Cable: TECHINCLA. In Canada, Braun Electric Ltd., Ontario.

Houston Fearless®
PROCESSORS



Technology Incorporated

For More Details Circle (138) on Reply Card

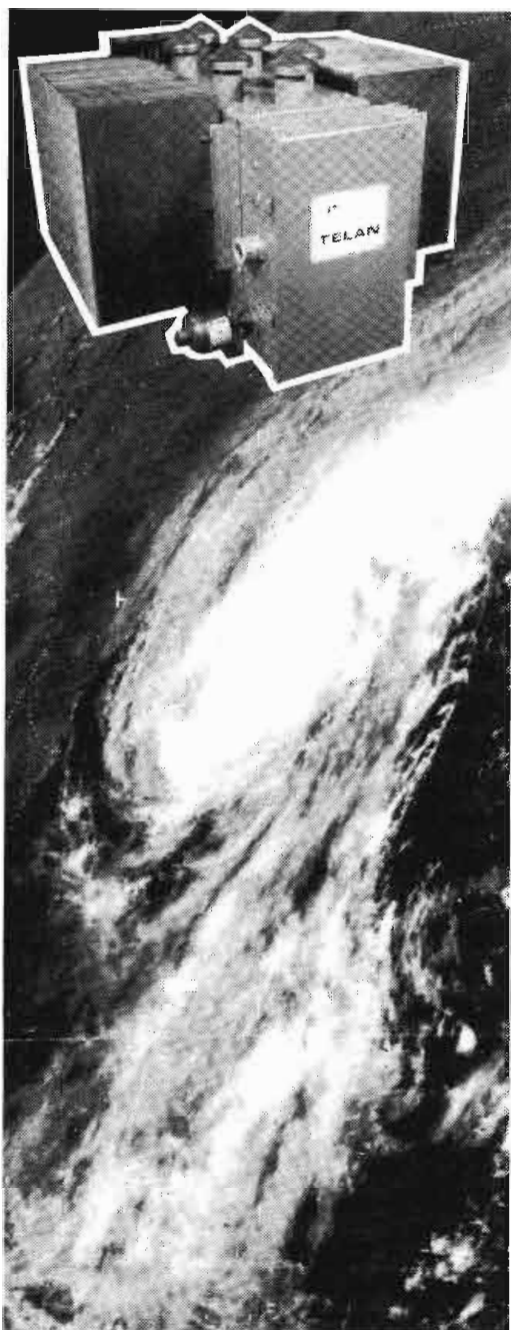

RELIABILITY

IF YOU COULD SEE UNDER THE CLOUD COVER OF HURRICANE CARMEN, SEPTEMBER 7, 1974, YOU WOULD FIND THE TELAN THERMOELECTRIC GENERATOR IN OPERATION.

TELAN

GAS FUELED THERMOELECTRIC GENERATORS

- Safe, low temperature catalytic combustion — No flame-out
- No moving parts — high reliability
- Weather proof — simple operation
- Amperage and voltage to your needs
- Constant power

TELEDYNE
ENERGY SYSTEMS

110 W. Timonium, Rd., Timonium, Md. 21093
Phone: 301-252-8220 Telex: 87-780

For More Details Circle (139) on Reply Card

speeds, secondary and tertiary cue tones, fast forward and various operating voltages. A tape splice/fault detector is also available as an accessory.

For More Details Circle (242) on Reply Card

Tape Cleaning

New from **The Video Tape Company**, North Hollywood, (Calif.), The Tape Saver, a revolutionary sapphire-bladed module for tape cleaning on Recortec or other machines.

Unlike the more traditional use of industrial razor blades and other configurations of steel blades for tape burnishing, this four-edged sapphire blade will not destroy tape by tearing or cutting during the cleaning process. Each edge remains razor-sharp for 4000 reels, removing loose oxide, dust, imbedded foreign particles, loose binding and backing materials.

Equipped with a vacuum system for continuous blade cleaning and cap screw for easy blade rotation. The Tape Saver will not loosen tape binding or cause tape to shed. Mini-vacuum chamber prevents the re-deposit of foreign matter during the cleaning process.

For More Details Circle (243) on Reply Card

Wireless Microphone

Television Equipment Associates has announced "The Director", a new wireless microphone in the 450 MHz frequency, which is a legal frequency for broadcasters under FCC rules.

The equipment reportedly has been designed to provide maximum reliability and minimum interference from "dead spots". Due to high operating frequency combined with efficient output from the transmitter and high

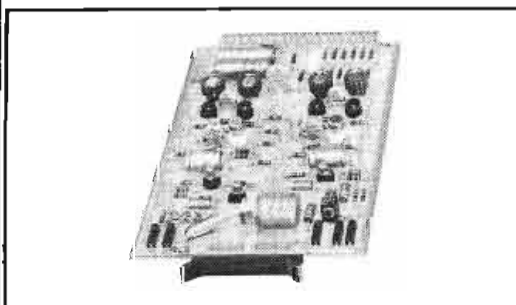

AUDIO DISTRIBUTION AMPLIFIERS

SCIENTIFIC SYSTEMS Model SA-200 Audio Distribution Amplifier is one of a complete line of Audio Processing Modules. The D.A. has six source terminate balanced 600 ohm outputs, providing high output line isolation. Output is a maximum of +24dbm. Input is transformer isolated, and gain is variable 0- to 20db. All silicon devices are used and are socket mounted for ease of maintenance in the field. The SA-200 card costs \$170.00, and is available in various card frame configurations with Power Supplies from **SCIENTIFIC SYSTEMS, INC.**, 48 Windjammer Court, Toms River, New Jersey 08753, 201-255-2230.

For More Details Circle (140) on Reply Card

ROH

ADDS*

POWER TO FLEXIBILITY
1-300 WATTS
1-20 CHANNELS
MODULAR CONSTRUCTION
POWER AMPLIFIERS



* Model 230
Dual Channel
1W/Ch., 4-50 ohms
3W/Ch., 8 ohms

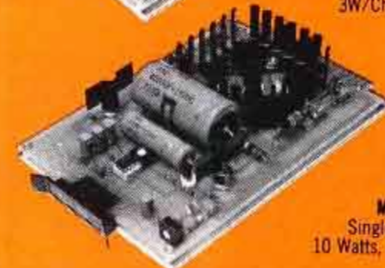

Model 210
Single Channel
10 Watts, 4-8 ohms



Model 220
Dual Channel
10W/Ch., 4-8 ohms
30W Bridge, 8 ohms



Models 202, 203, 204
1, 3, and 10 module powered enclosures
include plug in power supplies and barrier
block module termination.



* Model 271
Single Channel 100 Watts, 4-16 ohms



* Model 272
Dual Channel
100W/Ch., 4-16 ohms
300W Bridge, 70.7V Line

25 modules, 4 enclosures
and the necessary accessories from
a single source,

Write today for additional information
Roh Corporation

107 Technology Park/Atlanta
Norcross, Georgia 30071 404/449-0873

For More Details Circle (141) on Reply Card

Finally... an EBS encoder/decoder in a compact package at an affordable price!

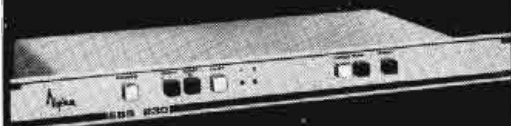

THE ALPHA
EBS-230
ONLY **\$295**

We've broken the price and size barrier with our new two-tone EBS-230. It's priced at one-third less than some competitive models and combines both encoder and decoder in a package that's half the size of anything on the market. Check these outstanding features:

- Low profile--1 1/4" high x 19" wide, rack-mountable
- Versatile--program channel loop-through standard
- Output--three modes: balanced, unbalanced, floating
- Higher output level-- +12 dBm
- Adjustment controls for both tones, front panel accessible
- Built-in step attenuator--0, 20 or 40 dB
- Self-test feature
- Meets all proposed FCC specifications*

You're assured of quality and reliability when you buy the EBS-230. We've been in the "tone" business for more than a decade, and our advanced thick-film hybrid circuitry offers the ultimate in stability.

Don't wait. The new FCC regulations on two-tone attention systems go into effect on January 15, 1976. Be ready for them with the lowest-cost, smallest-profile and most versatile unit available--the Alpha EBS-230.

Alpha also offers a separate encoder with remote capability and a decoder--the EBS-210 and EBS-220--at comparably low prices.

Write or call us today for complete technical specifications.

*Like all other EBS equipment manufacturers, Alpha is awaiting FCC type acceptance finalization.



Alpha Electronic Services, Inc.
8431 Monroe Ave., Stanton, CA 90680
(714) 821-4400

For More Details Circle (142) on Reply Card

receiver sensitivity, the user is said to find a reduction in interference from man-made sources such as electrical machines, vehicle ignition and other radio frequency sources.

A sturdy spring-loaded plug is supplied for microphone input, and a wide range of dynamic and electret mics can be used. The transmitter can supply power for several types of electret lavalier mics. The transmitter case is a metal extrusion and fits either into a shirt pocket or can be worn on the belt in the leather case provided.

The receiver is optionally line or battery powered, and provides either line or mic level output.

For More Details Circle (244) on Reply Card

Delay/Echo Unit

Revox Corporation is offering a delay/echo unit that incorporates an endless loop cassette that can be used with any Revox A77 tape deck by removing the deck plate and reel turntables and attaching a cassette mounting plate. The changeover takes less than 10 minutes.

Applications include: automatic message repeating; continuous short-term program monitoring; time delay of programmable machinery; tape echo. For the last application, the variable speed control unit may be used to extend the range of available time delay.

For More Details Circle (245) on Reply Card

Pro Recorder

Telex Communications, Inc. announced that their new professional series 1400 recorders/reproducers are now available. According to Telex, these open reel machines combine the

SOLID-STATE

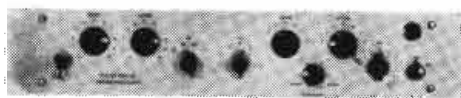

PULTEC® EQUALIZERS FILTERS MIXERS

Twenty years of capable, dependable service in radio & TV stations and recording studios. U.S. and overseas. Picture is Model EQP-1A3

PULSE TECHNIQUES, INC. 1411 Palisade,
Teaneck, N.J. 07666. Tel. (201) 837-2575
Cable: PULTEC, TEANECK, NEW JERSEY

For More Details Circle (143) on Reply Card

COMREX

"Specialists In Remote Broadcast
Audio Transmission"

450MHz Wireless Microphone System

The Comrex 450MHz Wireless Microphone system is designed specifically for use with sound cameras in news and sports coverage.



Features:

Crystal Control, Rechargeable Batteries, Dual Automatic Modulation Control, Crystal Bandpass Filter

Specifications:

Transmitter Model 450TA
Frequency Range: 450-451 MHz
Power Output: 100mW Microphone:
Any low impedance dynamic
Size: 3" x 5" x 1"

Receiver Model 450RA

Sensitivity: 1 microvolt
Antenna: Flexible rod
Output: -50 dBm @ 150 ohms
Size: 3" x 5" x 1"

Cue System

The Comrex 26 CRA/CTA Cue System provides remote transmission of Cue/program/instruction from the production control center to floor crew, field technician and talent.

Features:

High level Headphone Output
Operates on Replaceable 9 V Battery
Crystal Control FM

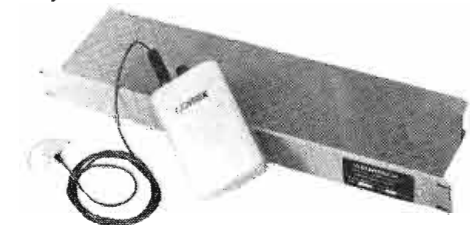

Specifications:

Receiver Model 26CRA
Frequency Range: 26.1 - 26.48 Mhz
Audio Output: 500 mW into 8 ohms
Antenna: Headphone cable
Size: 3" x 5" x 1"

Transmitter Model 26CTA

Frequency Range: 26.1 - 26.48 MHz
Power Output: 1 W into 50 ohms
Deviation: ± 5 KHz
Size: 1-3/4" relay rack (19")
Audio Input: 6000 ohms bridging
(0 dBm @ 600 ohms)
Power Supply: 117 V 60 Hz

56 Union Avenue
Sudbury, Massachusetts 01776 U.S.A.
(617) 358-4042

COMREX

For More Details Circle (144) on Reply Card

We guarantee
the unique
individually tested

ARISTOCART

will deliver
a consistently higher
standard of voice and
music reproduction
than you'll get from
any other cartridge on
the market.

SPECIFICALLY:

Aristocart's exclusive internal guidance system delivers reel-to-reel fidelity — 20Hz to 15kHz — for the life of the tape. Phase stability is better than 90° to 12.5kHz with any properly aligned machine. Wow and flutter have been minimized.

Every Aristocrat cartridge is factory tested before shipment for phase and frequency response. We replace at our expense any cartridge which fails to perform within areas indicated.

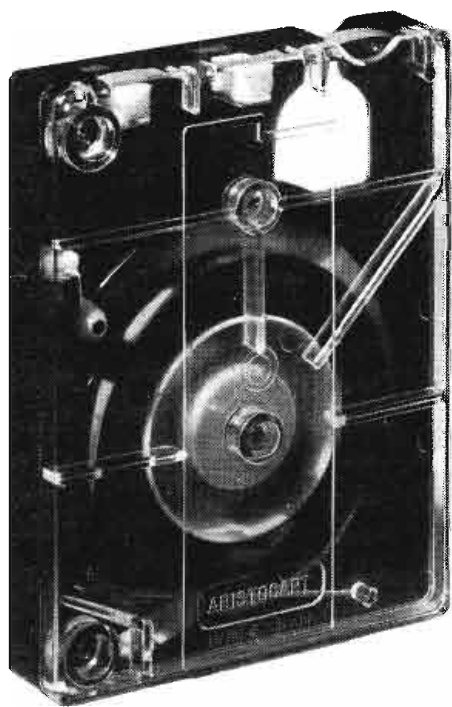

believe your own ears

Switch to

ARISTOCART

A DIVISION OF WESTERN BROADCASTING LTD.
505 Burrard Street, Vancouver, Canada V7X 1M6
Tel.: (604) 687-2844

Distributors: U.S.A. — McCurdy Radio Industries Inc., Buffalo N.Y. — IGM, Bellingham, Wash. CANADA — McCurdy Radio Industries Ltd., Toronto, Ont. — L. A. Varah Ltd., Vancouver, B.C. GREAT BRITAIN — Selkirk Communications Limited, London, Eng. AUSTRALIA — Syntec Electronic Distributors, Pty., Castle Cove, N.S.W.

For More Details Circle (145) on Reply Card
September, 1975

latest state of the art with the rugged dependability of their old Magnecord broadcast recorders.

Like the Magnecords, the 1400 series is built on a rugged, die cast aluminum main frame. But it has a completely new DC servo drive system that assures a timing accuracy of less than 3 seconds deviation per 30 minutes of operation, regardless of line voltage variations. Units are available in full, half and quarter track head configurations and operate at 3-3/4, 7-1/2 and 15 ips.

Solid state logic controls all tape transport functions. The amplifier provides balanced and unbalanced inputs and outputs. At 15 ips the specifications state frequency response of 35 Hz - 22 kHz ± 2dB and S/N at 60 dB. The 1400 series is equipped with a dual tap transformer for 110-130 VAC and 220-260VAC 50 or 60 Hz. Remote control stations are optional.

For More Details Circle (246) on Reply Card

**Modular Pro
Audio Console**

GRANDSON II, model 110-8, is a new expandable, completely modular professional recording/remixing/on-air audio control console from **Audi-ronics, Inc.** Designed for budget 8 track and 16 track recording/remixing and on-air applications, the free standing unit is expandable to 24 mixing positions—48 inputs—in only 50" width.

It offers complete metering, two echo send/receive channels, talkback communications, separate control room and studio monitoring, either 8 or 16 channel monitor matrix, test oscillator, simultaneous stereo and 8 channel outputs, two independent

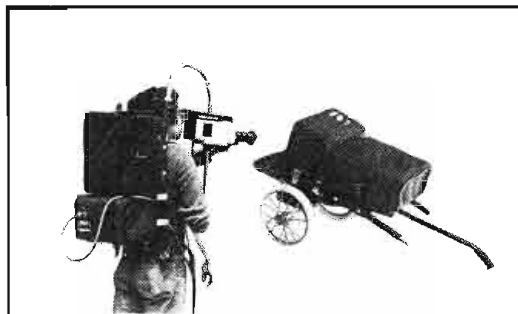

VCR CARRYING SYSTEM

The PB-3800 is a special Porta-Brace designed to accommodate the new portable color VCR units (Sony VO-3800, TEAC VT-1000). Incorporating the patented Porta-Brace cantilevered camera arm, the PB-3800 features two Cordura nylon padded cases for both the cassette deck and DXC-1600 CCU, and a heavy-duty padded waistbelt. The WB-2 is a lightweight, collapsible, two-wheeled cart designed to carry the Porta-Brace with video equipment mounted. Twelve inch semi-pneumatic wheels insure stable movement over any surface. **K AND H PRODUCTS, LTD.**, Box 246, North Bennington, VT 05257 (802) 442-9118.

For More Details Circle (146) on Reply Card

**WILKINSON
ELECTRONICS
MAKES**

- A 10 WATT FM TRANSMITTER
- A 100 WATT FM TRANSMITTER
- A 250 WATT FM TRANSMITTER
- A 1 KW FM TRANSMITTER
- A 2.5 KW FM TRANSMITTER
- A 5 KW FM TRANSMITTER
- A 7.5 KW FM TRANSMITTER
- A 10 KW FM TRANSMITTER
- A 20 KW FM TRANSMITTER
- A 25 KW FM TRANSMITTER
- A 50 KW FM TRANSMITTER
- AN FM RELAY RECEIVER
- A STEREO GENERATOR
- AN SCA GENERATOR
- A BIG STEREO CONSOLE
- A LITTLE STEREO CONSOLE
- A 1 KW AM TRANSMITTER
- A 5 KW AM TRANSMITTER
- A 10 KW AM TRANSMITTER
- A 50 KW AM TRANSMITTER
- A MONAURAL AUDIO CONSOLE
- AN AM MODULATION MONITOR
- AN AM RF AMPLIFIER
- A MONO LIMITING AMPLIFIER
- A STEREO LIMITING AMPLIFIER
- A MONAURAL AGC AMPLIFIER
- A STEREO AGC AMPLIFIER
- A TURNTABLE PREAMPLIFIER,
MONAURAL & STEREO
- A MONITORING AMPLIFIER
- A REMOTE AMPLIFIER
- A DISTRIBUTION AMPLIFIER
- A LINE AMPLIFIER
- LIGHTNING PROTECTORS
- SILICON RECTIFIER STACKS
- CUSTOM PRODUCTS

**WILKINSON
ELECTRONICS, INC.**

Telephone: (215) 497-5100

701 Chesnut St.
Trainer, Pa. 19013
CABLES WILEC

For More Details Circle (147) on Reply Card 157

tough & juicy

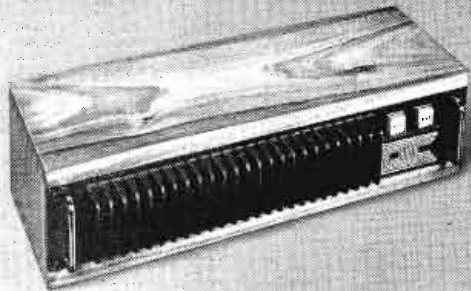

The Orange County 200 Series Amplifier. It's reliable. It's accurate. It satisfies the most exacting standards of broadcast and sound recording.

A unique circuit compares input and output signals, and drives a "tilt lamp" to provide instantaneous indication of distortion, phase shift, peak clipping or load fault. Handy in multi-channel systems.

The Orange County amplifier couples high continuous power output with excellent protection.

Short circuited output and difficult loads are no problem for the 200 Series.

A specialized power transformer is capable of providing several times the normal power requirements. The output power circuit, a high current, high voltage operational amplifier, represents a new dimension in power circuit design. Various high impedance or professional balanced input configurations are available and the tamper-proof housing can be rack mounted or supplied with walnut cabinet or durable portable case.

Orange County 200 Series Amplifier, for professional monitor applications. Tough. Models from 75 to dual 200 Watts. Juicy.

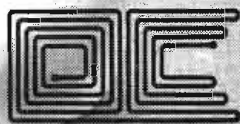

The Orange County Electronics Corporation Ltd.
1079 Autumnwood Drive, Winnipeg
Manitoba, Canada R2J 1C6
Phone (204) 475-1026

Manufacturers of: Monitor Amplifiers, Monitor Speakers, Audio Switches and Systems, Power Supplies, Limiters, Compressors, Expanders, Equalizers, Remote Control Systems, Active Input and Output Transformers, Universal Audio Preamplifier Modules.

For More Details Circle (148) on Reply Card

headphone cue foldback circuits, and a full line of matching accessories including a plug-in patch bay.

A full capacity production system at a moderate price, GRANDSON II, eliminates the need for jury rigged consoles to handle 8 track recording and can be expanded to full 16 track capability.

For More Details Circle (247) on Reply Card

Helical Editing Control System

Television Research International, Inc., has introduced a new helical editing control system which interfaces the company's EA-5 editing system with the Sony VO 2850 3/4" Cassette U-Matic format. The system enables editors to intermix Sony VO 2850's with any other helical VTR.

This new development holds promise to the rapidly growing world of Electronic News Gathering where the Sony 2850 and the portable Sony 3800 have enjoyed considerable acceptance and use. News editors can now edit with frame precision accuracy and much, much more.

The new system consists of the conventional EA-5 Editing Console plus an auxiliary console to accommodate and control the Sony interface. In addition to the standard editing features of the Sony VO 2850, the system features preview edits, accurate editing to video or audio cues, frame accurate editing, search at up to 5 times play speed in either direction, VO 2850 interface with other helical VTR's, adjustable point after preview, edit decisions made with true still-frame assistance, control of insert point from the console and the ability to monitor audio and video at the console.

For More Details Circle (248) on Reply Card

COMARK ...MORE THAN DEMODULATORS!

DIPLEXERS • POWER COMBINERS/SPLITTERS • FILTERS—HI POWER • SWITCHES • AMPLIFIERS • WAVEGUIDE AND CO-AXIAL TRANSMISSION LINE COMPONENTS • SYSTEM DESIGN

BROADCAST CONSULTING

MICROWAVE LINKS

(2, 6 & 12 GHz)

Video, Audio, Digital Traffic

For a "hot line" to one of our staff of experienced RF experts call—(413) 568-1870. ...Dedicated to solving your RF problems...

COMARK INDUSTRIES, INC.

P.O. Box 196

Westfield, Mass. 01085

For More Details Circle (149) on Reply Card

ALERTALIGHT

The industries most complete line of teletype alarm systems.

MODEL 105D WEATHER TELETYPE ALARM

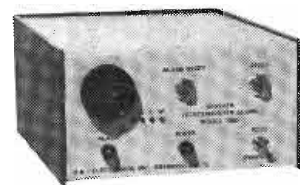

Designed to respond only to the emergency weather signals (Letters A, Letters W) transmitted by the National Weather Service. This new alarm instrument saves energy and paper by utilizing two operation modes: automatic-on and manual off, permitting optional static position operation. Solid state — reliable.

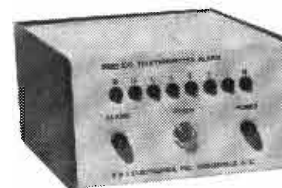

MODEL 106C BULLETIN TELETYPE ALARM

This instrument features single-word-code accuracy by responding only to the pre-coded 8 bit word B-U-L-L-E-T-I-N. Operating on level 5 for broadcasters and level 8 for newspapers allows versatile application to all media: Newspaper, wire service, radio, T.V., Designed for ultimate response accuracy.

MODEL ST104-5A TELETYPE INTERFACE

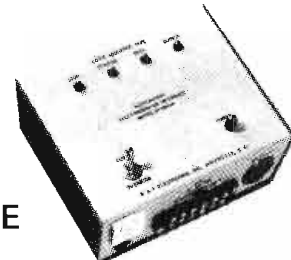

This unit is designed to interface between the Teletype and our ALERTALIGHT alarm units, and allows response to urgents, bulletings & EBS. Other features include automatic-on and manual reset permitting energy and paper saving options found in our more advanced models.



MODEL ST104 TELETYPE ALARM

This solid state instrument responds to signal bells 5 and 10 derived from news wire service, and may be modified with our 5A interface to respond to 3 and 4 bells. The outstanding reliability and accuracy of this unit has made it the standard with hundreds of broadcasters.



ELECTRONICS

Manufacturers of fine instruments for over a decade.

For more information write or phone:
B & I ELECTRONICS, INC.
128 Donaldson Center
Greenville, S. C. 29604
Phone (803) 277-5985

For More Details Circle (150) on Reply Card

BROADCAST ENGINEERING

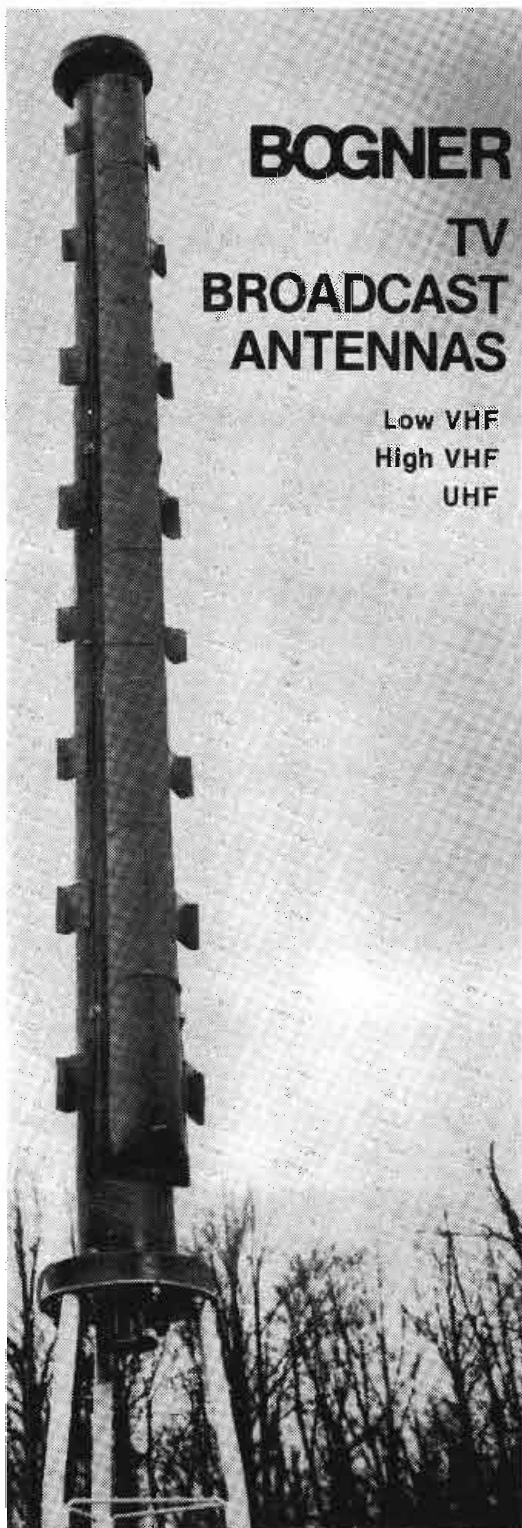

BOGNER TV BROADCAST ANTENNAS

Low VHF
High VHF
UHF

Omnidirectional and directional, high gain rugged slot and dipole arrays. Available in 9 standard horizontal patterns, choice of vertical patterns...with power gains to over 100 and power ratings of 3 KW, 10 KW, or 30 KW. Hundreds of Bogner Antennas have been providing continuous service in urban and remote areas since 1965. Write for free catalog and price list, including all required electrical mechanical and structural data.

BOGNER BROADCAST EQUIPMENT

CORP. 156 HAVEN AVENUE
PORT WASHINGTON, N.Y. 11050
TEL: (516) 883-2911

For More Details Circle (151) on Reply Card
September, 1975

Film Processor Problem Sensor

Photosense, a new electronic system that instantaneously reports any malfunction in a film processor, is now being marketed by **HF Photo Systems Division** of Technology Incorporated.

Sensors detect any breakdown or extraordinary situation in the processor and announce the condition by a flashing light in a display window, together with an audio-alarm. The unit contains a "Fail Safe" backup lamp system to insure 100% protection against faulty monitoring. Photosense can be mounted remotely for convenience of supervision.

Functions most commonly monitored by Photosense include temperatures, film breaks and film speed, power; flow of hypo, developer and water wash; hypo, water, developer and air pressures, re-exposure lamp and pre-hardener temperatures.

The Photosense is available in standard 6, 8, or 12 event window display cabinets or may be ordered with more event windows, depending upon the user's requirements.

For More Details Circle (249) on Reply Card

Follow Spotlight

A follow spotlight that requires no lenses has been introduced by **Berkey Colortran, Inc.**, a division of Berkey Photo, Inc. Dubbed the **Colorspot[®]**, the new radically designed light represents the "first significant design innovation in a follow spotlight in 35 years," according to Peter T. Coe, Berkey Colortran president.

The Colorspot is fitted with a high quality aluminized nickel substrate optical projection mirror, and develops 800,000 beam candlepower

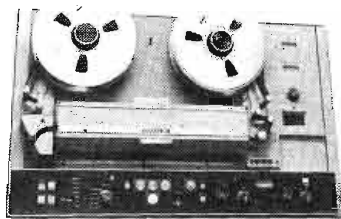

CONSTANT TENSION KIT

All models of Ampex and RCA two inch VTR's can be upgraded to constant tension tape handling performance with Recortec's R-MOD. The easily installed kit provides improved head and tape life, faster search, automatic end of reel sensing, unrestricted remote control even in tape shuttling operations and many other improvements. R-MOD provides outstanding performance improvement at a reasonable price.

Recortec, Inc., 777 Palomar Avenue, Sunnyvale, Ca. 94086. Tel.: (408) 735-8821.

For More Details Circle (152) on Reply Card



TELEVISION EQUIPMENT ASSOC.

THE MAGNETEK TAPE CLEANER/EVALUATOR

for 2" and 1" video tape — removes 70% of video drop-out. The Evaluator read-out produces a **3-pen** profile of video drop-out, control track damage and audio track damage.

For more details, circle () in reply card.

MATTHEY

Video Delays, Pulse Delays and Low-Pass Video Filters. Matthey Chroma Corrector to adjust phase and delay and Matthey Automatic Video Equalizer.

For more details, circle () in reply card.

THE DIRECTOR WIRELESS MICROPHONE

at 450 MHz, dedicated to the broadcast industry's requirements for news and sports.

For more details, circle () in reply card.

THE SPORTSCASTER HEADSET

Dynamic or Noise-Cancelling Dynamic Microphone — independently wired 'phones.

For more details, circle () in reply card.

INTERCOM HEADSETS

Carbon and Noise-Cancelling Carbon Microphones — single and double 'phones.

For more details, circle () in reply card.

COLOR MONITOR COMPARATOR

For balancing color monitors.

For more details, circle () in reply card.

T-M TEST SLIDES AND TEST PATTERN ILLUMINATOR

For more details, circle () in reply card.

Television Equipment Associates, Inc.

BILL PEGLER 516 • 628-8068

Box 1391

BAYVILLE, N. Y. 11709

For More Details Circle (153) on Reply Card

NETCOM IS:



- A versatile telephone type tone decoder/equipment controller
- Available in models compatible with the AP or UPI radio network tone transmissions
- Compatible with other broadcast applications where equipment must be controlled via decoded telephone type tones
- Available now from . . .

THE INNOVATORS AT



3140 E. Jefferson
Detroit, Mich. 48207
(313) 567-0555

TWX: 810-221-1267

For More Details Circle (154) on Reply Card

Remote Broadcast

Complete Line of Remote
Broadcasting Equipment
Using Standard Telephone Lines

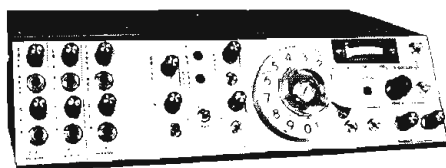

- ✦ Direct Distance Dialing
- ✦ Built in Voice Couplers
- ✦ Line Lock Features
- ✦ Many Options & Accessories
- ✦ Single & Multi
Channel Mixers
- ✦ Consoles
- ✦ AC/DC
- ✦ Sports Network System

Ask For Catalog
Unconditional 5 year guarantee



PULSE DYNAMICS MFG. CORP.
P. O. Box 355
Colchester, Illinois 62326
(309) 776-4544, 776-4575

For More Details Circle (155) on Reply Card

with a 1kW tungsten-halogen lamp in a 9° field. Equipped with a five-color boomerang, an optional 9° x 20° spread lens, curtain shutters and iris, the Colorspot is capable of throws from 30 to 100 feet.

A joystick control permits rapid lamp access and optical alignment, while a newly-designed precision socket assures proper lamp positioning. The Colorspot is 35" long, 32" wide and is adjustable from 57" to 71" in height. The unit weighs 114 lbs. with the spread lens and 110 lbs. without.

For More Details Circle (250) on Reply Card

Test Records

The CBS Technical Series Professional Test Records have been revised and reissued. Produced at the recording research laboratory of the **CBS Technology Center** (the recently-organized successor to the former CBS Laboratories Division), the new line has been expanded to include a total of nine unique recordings.

The needs of varied users have been anticipated—engineers, quality control specialists, audio display centers, service technicians and audiophiles.

The new line of records includes the following: STR 100, Stereophonic Frequency Test Record; STR 101, Seven Steps to Better Listening; STR 112, Square Wave, Tracking and Intermodulation Test Record; STR 120, Wide Range Pickup Response Test Record; STR 130, RIAA Frequency Response Test Record; STR 140, RIAA Pink Noise Acoustical Test Record; STR 151, Broadcast Test Record; STR 170, 318 Microsecond Frequency Response Test Record; STR 1100, SQ Quadraphonic Test Record.

For More Details Circle (251) on Reply Card

For the best buy
in microphones its

BEYER

from

Val-tronics, Inc.

Penn Park Building
Pittston, Pa. 18640
(717) 655-5937

a complete line of

Headphones - Tape Cartridges - Remote Control
Systems - Antennas - Pre Amps - Reverb Units -
EBS Receivers - AM-FM and Stereo Monitors -
Studio Transmitter Links - Towers - Antenna
Tuning Units - Test Equipment.

For More Details Circle (156) on Reply Card

T V T R A N S L A T O R S

ONE WATT VHF
TEN WATT VHF
100 WATT VHF

ONE WATT UHF
TEN WATT UHF
20 WATT UHF
100 WATT UHF
1000 WATT UHF

AMPLIFIERS, MODULATORS,
ANTENNA SYSTEMS
ALL AVAILABLE
FROM

ROLANE SALES CORPORATION
1 DuPont Street So.
Plainview, N.Y. 11803

TELEPHONE
(516) 433-6311

For More Details Circle (157) on Reply Card

"INSTANT START" "RELIABLE"

Who can ask for
anything more?



Outstanding for 30 yrs.

Contact your local ORK dealer or inquire direct.



ELECTRONIC PRODUCTS, INC.
1568 North Sierra Vista, Fresno, California 93707
Phone (209) 251-4213

For More Details Circle (158) on Reply Card

TME CINE-MATIC II

Video Cassette Playback System

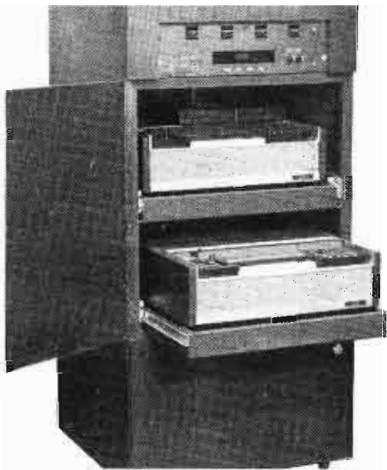

Low cost, fully automatic. The CINE-MATIC II will playback multi-hour programs up to eight times per day on selected days of the week...all Automatically.

- Four Digit Clock
- Instant Switchover. No loss of program during switch.
- Four Digital Time Selectors each with a programmable Day Selector.
- Automatically Switches to and from External Audio/Video Inputs.
- Complete System with R. F. Modulator
- Systems available with up to eight Video Cassette Players.



AUTOMATIC DIGITAL PROGRAMMER

The TME Model 1020 Series Digital Programmers provide all control and timing signals to automate Videocassette machines for multiple playback. This series is available in models to control from two to eight players.

NEW PRODUCTS

TME Model 412 Digital Clock: 0.4 inch led readout—Rackmount—only 1¾ inches high. Introductory Price only \$99.

TME Model 104 Automatic Digital Cue-Toner: Provides precise timing sequences and generates tones for automatically cueing tapes. Can be used with all Automation Systems. This model includes digital readout for time and tone frequency and an external frequency measuring input. Price \$395.



TeleMedia Electronics

1548 W. Winton Avenue,
Hayward, California 94545
(415) 783-3311

Digital Microwave Filter

Tunable microwave filters from **Power Waves, Inc.** yield a response of a fixed tuned filter but with the versatility of a continuously tunable filter. The filter may be provided in as many as 10 poles in which each pole is tuned in steps to yield a contiguous tuning response or selected bands. Because of the stepped tuning, time-delay characteristics can be maintained as in a fixed tuned filter. Reportedly, there is no degradation of response with frequency tuning.

For More Details Circle (252) on Reply Card

Automatic Programmer For The ACR-25

A computer interface accessory for ACR-25 cassette recorders used in automated television stations was demonstrated by **Ampex Corporation.**

The computerized device, the Automation Data Accessory (ADA), is designed to automatically program and control the operation of the Ampex ACR-25 cassette recorder.

Charles A. Steinberg, Ampex vice president - general manager of the audio-video systems division, said the ADA system represents a significant step towards helping broadcasters realize the full operational and economic potential of the automated studio.

ADA integrates the ACR-25 into the automated operation by acting as a kind of bilingual translator, receiving and storing information from the cassette recorder and transmitting it to the host computer.

If a scheduled cassette is missing, the computer will recognize the error and the ADA will display a warning light. As the scheduled cassettes are played and the remaining number of



DEMODULATOR

The CI-2400B Demodulator bridges the gap between the simple diode and an expensive receiver, with many of the features of the higher priced units. For the ultimate in stability a "flat response" is obtained using patented VIDEO CORRECTION. The Chopper, which is the only active circuit, is compatible with Automatic Correctors (such as the Tek 1440).

Price: \$1,195.00 Delivery: 45 Days ARO
COMARK INDUSTRIES, INC.
P.O. Box 196
Westfield, Mass. 01085
(413) 568-1870

For More Details Circle (160) on Reply Card

To Meet All
Federal Regulations*

SPECIFY & INSIST

on
Hughey & Phillips

The leader in tower
obstruction lighting
and control systems.

* FCC — FAA and Nat'l. Elec.
Code Regulations



**300MM BEACONS
SINGLE AND DOUBLE
OBSTRUCTION LIGHTS**



**APPROVED
by the FAA**

TOWER LIGHTING ISOLATION TRANSFORMERS
750, 1750, 3500, 5000, 7500 Watts

FEATURING...

- HIGHER EFFICIENCY
- IMPROVED REGULATION
- FIBERGLAS INSULATION
- EPOXY ENCASED
- VERSATILE MOUNTING



CONTROL UNITS to meet
Standard or Special Requirements.



**LAMP FAILURE
ALARM SYSTEMS
FOR UNATTENDED
INSTALLATIONS**

**TUBELESS PHOTOELECTRIC
CONTROL UNITS**
Indoor or Outdoor
Many Sizes and Voltages



BEACON FLASHERS
Single and Multi-circuit
Indoor or Outdoor

FOR TALL TV TOWERS



**LAMP FAILURE
INDICATOR PANELS**

Request our exclusive **TALL TOWER**
Specification Guide.

HUGHEY & PHILLIPS, INC.

Manufacturers of
300mm Beacons, Obstruction Lights, photo-controls,
Beacon Flashers, Microwave Tower Hazard Light Control
and Lamp Failure Alarm Systems, Complete Kits for:
Tower Hazard Lighting, Deicers, & Talking Circuits, Tower
Lighting Isolation Transformers, Airport Runway Lighting

3050 N. California St., Burbank, California 91505

For More Details Circle (161) on Reply Card

For More Details Circle (159) on Reply Card
September, 1975

**JOA CARTRIDGE SERVICE
OFFERS DISTINCT ADVANTAGES
YOU SHOULD KNOW ABOUT**

Advantage ONE—NO MINIMUM

Cartridge Reconditioning

*Advantage TWO—NO EXTRA
CHARGE for*

- (a) foam teflon-faced pressure pads
- (b) replacement of minor parts
- (c) visible splice
- (d) pretesting under actual broadcast conditions
- (e) 72 hour processing
- (f) Scotch heavy-duty lubricated tape

New Cartridges

Advantage THREE

Shipment from stock, of any standard size, or... "Prompt shipment" of CUSTOM SIZE Fidelipac precision manufactured NAB cartridges with TIME indicated on REEL.

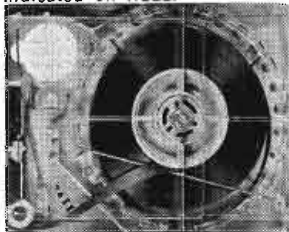

Advantage FOUR—24 or more shipped prepaid.

Authorized distributor for NORTRONIC HEADS.

Phone or Write

JOA Cartridge Service

P.O. Box 7112, Phila., Penna. 19117
Area Code 215, 886 7993

For More Details Circle (162) on Reply Card

**RADIOMETER
COPENHAGEN**

**automatic
distortion
analyzer**

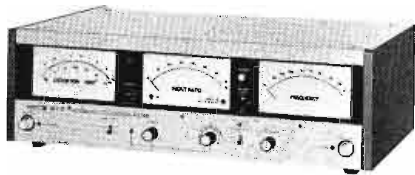

A unique instrument providing automatic simultaneous measurement and recording of distortion and amplitude response vs frequency.

- Low distortion sweep generator.
- Automatic distortion meter.
- Automatic frequency response.
- Outputs for automatic recording.

Contact us for complete information.



THE LONDON COMPANY

811 SHARON DRIVE
CLEVELAND, OHIO 44145
Tel. (216) 871-8900

221A

For More Details Circle (163) on Reply Card

cassettes is reduced, another warning light advises when there is a need to reload.

When it is time to re-stock the ACR-25 with fresh cassettes, the machine's random-access feature simplifies the procedure. Cassettes can be quickly loaded in any sequence into any available bin by the operator. ADA will identify each cassette and its location so that the computer can schedule it. This reduces the manual operational requirements of the ACR-25 to merely loading and unloading.

For More Details Circle (253) on Reply Card

Digital Transmission Multimeter

Model 430 digital transmission multimeter from **Warettek**, is used to test the characteristics of telephone lines. Key tests made are noise, level and frequency. Line resistance and capacitance, loop current, station battery and AC power influence also are measured. All measurements are made from one input connection, with pushbutton control and digital display of measurement.

Signal level (-70 to +15 dBm, 50 kHz bandwidth) and noise metallic (+80 to 0 dBm) are measured with selectable termination impedances and bridging. Built-in C-message, 3 kHz flat and 15 kHz flat filter weighting are provided for noise measurement. Noise-to-ground is measured from +120 to +40 dBm. Single frequencies up to 20 kHz are measured. Voltage is measured to 200V (Vac over 10 kHz bandwidth), resistance to 200 k Ω , current to 200 mA and capacitance to 2 μ F.

Dial-and-holding of remote signal sources or quiet terminations, damping, 60 Hz suppression, noise monitor speaker, out-of-range indicator for noise and level measurements, auto-

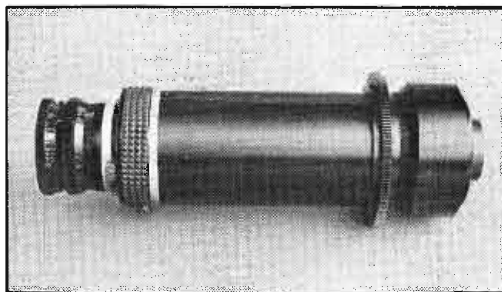

NEW PRODUCT

FIXED LENS RELAY SYSTEM. Adapts 35mm motion picture and S-L-R lenses to Plumbicon TV cameras. Permits wider angle, macro and special effects shots not possible with zoom lenses. Provides direct relationship to 35mm cinematography in lens angles and shooting techniques. No light loss or vignetting. Mounts supplied for Editel, Fernseh, Phillips, RCA and other cameras. For information call or write: **COM-QUIP, INC.**, 366 So. Maple Ave., Glen Rock, N.J. 07452. (201) 444-3800.

For More Details Circle (164) on Reply Card

SYSTEM 1 IS:

- An automation assisted cartridge control system for the "live" station
- Adaptable to full automation when the need arises
- Capable of controlling the air play of cartridges at the studio from a remote broadcast location freeing studio personnel for other duties during remotes
- A means of using your normal on-air control room as an extra production studio during remotes
- A whole lot more
- Available from...

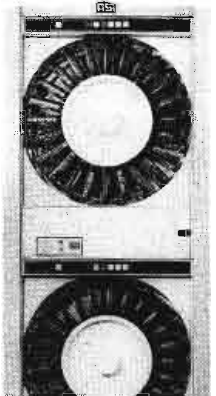

THE INNOVATORS AT



3140 E. Jefferson
Detroit, Mich. 48207
(313) 567-0555

AUDIO SERVICES INC.
TWX: 810-221-1267

For More Details Circle (165) on Reply Card

**NOW... get all your
ELECTRON TUBES and
SEMICONDUCTORS
from one source...
and get them fast!**

**C.M. Levit Electronics
(212)
777-5517**

America's top brands shipped to you on the day your order is received. Immediate attention—overnight delivery. Big savings, too!

YOURS FREE

THE MOST COMPLETE
ELECTRONIC TUBE AND
SEMICONDUCTOR CATALOGUES
—A VIRTUAL PURCHASING
DIRECTORY OF ACTIVE
COMPONENTS



C.M. Levit Electronics

200 Park Avenue South
New York, NY 10003
Phone: (212) 777-5517
Cable Address: "LECIMEX"
NEW YORK
TELEX: 422509

For More Details Circle (166) on Reply Card

There's no one system for every communications/noise problem



(So we offer many.)

We turn off noise and turn on voice messages. In noisy, remote areas, dependable voice communications can be critical. Clark Systems offer reliable solutions.

From missile sites to theaters, construction jobs to shipyards, our Intercom Systems help you hear while suppressing ambient noise.

Because your communications problems vary, so do our Intercom Systems, modules and headsets. We'll customize one to solve your voice message problem.

Call or write today.

from "the quiet people" at

David Clark COMPANY
INCORPORATED

360 Franklin St., Worcester, Mass. 01604

For More Details Circle (167) on Reply Card

RECORD CABINETS



Model GS 2412

24" wide x 12" deep x 84" high
Capacity 750 12" Records **\$89.50**

Model GS 3612

36" wide x 12" deep x 84" high
Capacity 1125 12" Records **\$119.50**

Model GS 4812

48" wide x 12" deep x 84" high
Capacity 1500 12" Records **\$149.50**

You may deduct 5% when cash accompanies order. Call or write us regarding your requirements for cabinets or equipment. We will design and build a complete turnkey station for you.

Phone 216-862-2323

GRINNAN FIXTURE Co.

16041 Georgetown Street, N.E.
Minerva, Ohio 44657

For More Details Circle (168) on Reply Card
September, 1975

matic ranging on all other measurements, and battery power are standard features.

For More Details Circle (254) on Reply Card

Portable Color TV Camera

A new portable color television camera that offers features comparable to studio cameras, and which can operate up to 200 feet from its backpack, has been introduced by **International Video Corporation**.

Michael A. Moscarello, IVC president and chief executive officer, said the IVC-7000P offers performance identical to the IVC-7000 studio camera. Both cameras use 1-inch Plumbicon[®] tubes and provide 675 lines of resolution and a signal-to-noise ratio of 51 dB, among the best specifications of any available camera. The IVC-7000P, less lens, weighs 14 pounds. The companion backpack weighs 17 pounds.

The camera with its backpack is fully automatic and completely self-contained, yet provides full production control at the backpack if needed. It can be used in a studio as well as on location and can be tripod-mounted.

The backpack operated up to 2,100 feet from the base station on minicable, 3,000 feet on standard cable, 5,000 on triax and further on microwave.

For More Details Circle (255) on Reply Card

Orderwire Panels

Coastcom recently introduced its new 770 Series Orderwire Panels that provide for voice communication during installation, lineup and maintenance of microwave radio relay systems. This versatile series can be

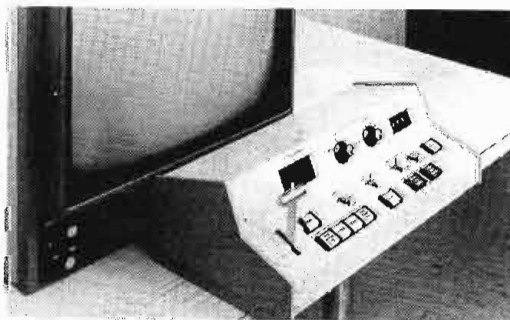

BROADCAST DISC RECORDER

The BDR 500 is a reliable, easily transportable slow motion disc recorder. It records and plays back 30 seconds of broadcast quality NTSC, PAL or SECAM color video.

Data Disc's experience with the head/disc interface offers the broadcast industry high quality at a competitive price. Standard features include continuously variable or switchable fixed rates on record and playback, slide file capability, and preset/reset address control.

DATA DISC, INCORPORATED, 686 W. Maude Avenue, Sunnyvale, California; (408)732-7330.

For More Details Circle (169) on Reply Card

QUALITY TALKS FOR WENE

Endicott, New York

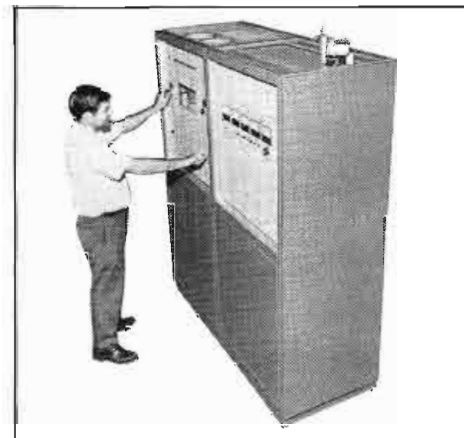

Continental's new 5/10 kW AM transmitter is setting records for acceptance. It has performance and efficiency, with the cleanest sound around. Listen to Continental: quality talks.

Continental Electronics

CONTINENTAL ELECTRONICS MFG. CO.
BOX 17040 DALLAS, TEXAS 75217

For More Details Circle (170) on Reply Card

TEL•ALERT IS:



- A low cost, efficient method to alert control room personnel when bulletin or EBS transmissions move on a remotely located teletype.
- Available now from . . .

THE INNOVATORS AT



3140 E. Jefferson
Detroit, Mich. 48207
(313) 567-0555

TWX: 810-221-1267

For More Details Circle (171) on Reply Card

QUALITY TALKS FOR WHAS

Louisville, Kentucky



Continental's 317C is the best measure for any 50 kW AM transmitter purchase. Performance, 125% positive modulation and reserve power capabilities are unbeatable. Today's best sound in 50 kW AM is Continental.

Continental Electronics

CONTINENTAL ELECTRONICS MFG. CO.
BOX 17040 DALLAS, TEXAS 75217

For More Details Circle (172) on Reply Card

ASI'S EBS EQUIPMENT WILL BE:



- A two tone encoder and decoder system compatible with the new FCC rules
- Low cost
- High quality
- Available in plenty of time to meet the FCC's compliance deadline
- A product of . . .

THE INNOVATORS AT



3140 E. Jefferson
Detroit, Mich. 48207
(313) 567-0555

TWX: 810-221-1267

For More Details Circle (173) on Reply Card

164

used in conjunction with any message or video microwave radio.

The basic orderwire panel, designated as the SBC 770, contains an audio amplifier, volume control, speaker, headset jacks, a 3.0 KHz speech-plus filter, and a push-to-talk button. Seven additional features are offered as standard options.

The SBC 771 includes the basic SBC 770 orderwire panel and an SSB multiplex channel. This combination provides an orderwire channel in any 4 KHz slot between 4 KHz and 60 KHz.

The third unit in this series, the SBC 774, includes the basic SBC 770 and a duplex FM channel. This assembly provides an orderwire channel at any frequency between 1.0 MHz and 15.0 MHz. Highly immune to baseband noise and adjacent tones, the SBC 774 orderwire can be applied to a baseband along with radar, video, message, multiplexed "T" carrier or other types of signals.

For More Details Circle (256) on Reply Card

Digital Multimeter

Model 334 digital multimeter from Hickok Electrical Instrument Company is designed for continuous operation in service, laboratory and testing applications. It has 5 ranges of AC and DC voltage and current and 6 ranges of ohms, and features 3½ digit resolution, automatic decimal point, automatic polarity, and automatic overrange indication.

Automatic polarity eliminates the need to reverse leads if a DC voltage is negative, and the overrange indication is nondeceptive; if any input exceeds the maximum reading of 1999, the display shows two flashing bars and three zeros.

For More Details Circle (257) on Reply Card

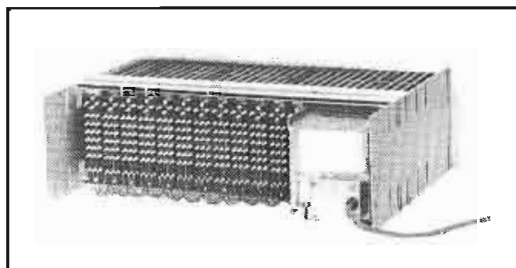

AUDIO DISTRIBUTION AMPLIFIER PACKAGE

The SA-200 DA, is available in two basic packages. Shown is the wiring side of the 12 card frame which contains a Dual Regulated Power Supply and rear mounted Terminal Boards for ease of installation. Provides 12 Inputs and 72 Outputs at a cost of \$2,495.00. Other products include: Custom Audio Consoles, Studio Intercom Systems, Studio Monitor Systems, Video and Pulse Distribution Amplifiers Systems. **SCIENTIFIC SYSTEMS, INC.**, 48 Windjammer Court, Toms River, New Jersey 08753, 201-255-2230.

For More Details Circle (174) on Reply Card

RADIOMETER
COPENHAGEN

stereo generator

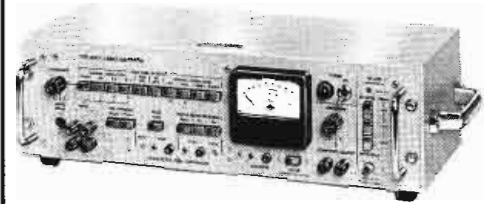

Exceptionally stable and complete stereo signals with push button selection of all combinations.

- World famous Model SMG1
- Both composite and RF outputs.
- Extremely low distortion.
- Excellent channel separation throughout audio range.

Price \$ 1195

THE LONDON COMPANY
811 SHARON DRIVE
CLEVELAND, OHIO 44145
Tel. (216) 871-8900

221D

For More Details Circle (175) on Reply Card

6400 6401

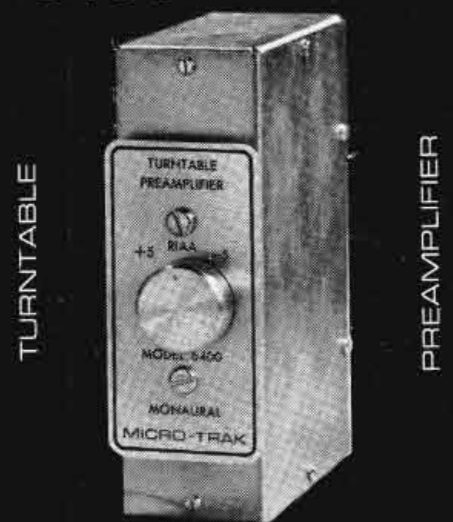

Model 6400-Monaural **Model 6401-Stereo**
Gain: 44 dB at 1000 Hz. Adjustable (5 mv. input provides 0 dBm output)
Frequency Response: Three selectable curves. RIAA/NAB. +5 dB at 15K Hz. For brilliance. -5 dB at 15K Hz. For scratch filtering. (See curves on previous page)
Total Harmonic Distortion: Less than 0.5% at 0 dBm output.
Signal to Noise Ratio: Better than 60 dB (equivalent to -104 dBm input noise)
Input Impedance: 47,000 OHMS unbalanced
Output Impedance: 600 OHM balanced or unbalanced. (As supplied) 150 OHMS balanced or unbalanced internally selectable.
Output Level: 0 dBm adjustable + 15 dBm maximum
Power Requirements: 115 VAC 50-60 Hz. 2 watts
Dimensions: 4¼ depth x 2¼ width x 6 high
Terminations: Input — RCA style phono jacks
Output — barrier type screw terminal strip
Mounting: May be face mounted on turntable, panel or cabinet. May be bracket mounted to side wall or floor of cabinet. Brackets provided.
Weight: 3 lbs.

MICRO-TRAK CORPORATION
FORMERLY ORBIT RESEARCH
HOLYOKE, MASSACHUSETTS 01040 U.S.A.

For More Details Circle (176) on Reply Card

Sound Reduction Door Catalog

The Jamison Door Company has made available an illustrated catalog featuring Jamisonic® sound reduction doors. A detailed listing of door construction, design, features and a guide for architectural specification are included in the catalog.

Available in single and double swinging, horizontal and vertical sliding models, the doors are rated from STC52 to STC65. The doors are filled with Polysonic insulation and are manufactured in accordance with the latest ASTM standard, E90-70.

For More Details Circle (260) on Reply Card

Power Supply Line

A new family of Class 83 series-regulated DC power supplies, featuring dual and triple outputs typically required for computer, EDP, process control, electronic measuring, telemetry and other instrumentation, is introduced by Sola Electric Division of Sola Basic Industries.

The line features split bobbin transformer design that provides input/output isolation tested at 1000 Megohms DC, 2500 VAC, and assures full isolation between independent outputs.

Each output has individual manual adjustment for both output voltage and current limiting. Reverse voltage protection and short circuit protection with automatic return are built in, and overvoltage protection is optional.

Input voltages are 120 and 240 VAC, with tolerance for $\pm 10\%$ variation. Input frequency ranges from 47 to 420 Hz. Combined line/load regulation is 0.05%. Output ripple is 0.01% RMS, and output noise is held to 0.01% RMS.

The units are designed for either series or parallel operation, and equipped for remote sensing and programming. Operating temperatures range from 0°C. to +55°C. without derating, and reach -20°C to +80°C. with minor derating.

All components are mounted on an open L-shaped heat-sink chassis for convection cooling. Chassis is pre-drilled for screw or bolt mounting in either vertical or horizontal position.

For More Details Circle (261) on Reply Card

Portable Multimeter

Tekelec, Inc. has just announced the availability of its transfective liquid crystal display as a no additional cost option on its TA355 3½ digit portable multimeter. The display combines the best qualities of both a transmissive liquid crystal display and a reflective liquid crystal display.

THE QUADZILLION MODEL 7x10⁻²⁵

HAS A ZILLION INPUTS,
A ZILLION OUTPUTS,
A ZILLION CONTROLS...
...TAKES A ZILLIPLUS TO RUN IT!

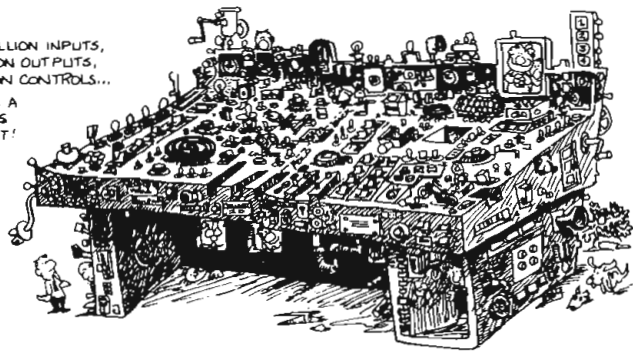

WHY WOULDN'T IT BE THE ULTIMATE BROADCAST CONSOLE?

DYMA KNOWS!!

RT. 1, Box 51, TADS, NEW MEXICO 87371 PHONE (505) 768-2686

For More Details Circle (177) on Reply Card

Rigged for Silent Running

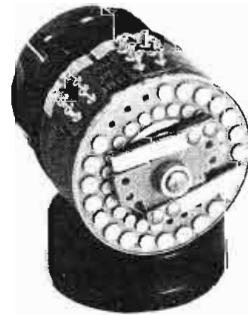

Shallco

Beneath the surface, Shallco attenuators quietly raise and lower signals for broadcast applications.

Request Catalog 102

SHALLCO, INC. P. O. BOX 1089
SMITHFIELD, N. C. 27577
919/934-3135

For More Details Circle (178) on Reply Card

A "SOUND" COMPETITIVE EDGE!

The **STE-100 STEREO PHASE ENHANCER...**
can minimize "Phase nulling" in "Mono-sum" signals,
and ensure your "Sound quality" in todays competitive markets!!!



GARRON ELECTRONICS, 1216 Kifer Rd, Sunnyvale, CA, 94086, Call (408) 736-8737

For More Details Circle (179) on Reply Card

ask about our new am | fm | tv monitors



Call or Write ARNO MEYER

BELAR ELECTRONICS LABORATORY, INC.

Lancaster Avenue at Dorset, Devon, Pa. 19333 Box 827
(215) 687-5550

For More Details Circle (180) on Reply Card

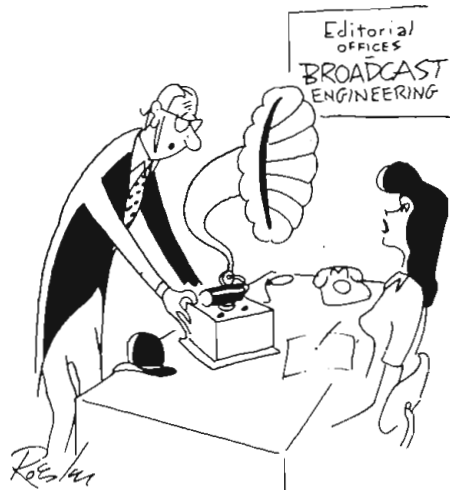

"I'D LIKE TO SEE YOUR
'NEW PRODUCTS' EDITOR."

The TA355 offers 5 functions, 25 ranges, automatic polarity, automatic decimal indication, 100 microvolt AC and DC voltage sensitivity, plus 100 nanoamps sensitivity on AC and DC current functions and .1 Ohm/digit on the resistance function. Basic accuracy of the TA355 is .05% of full scale plus or minus 1 digit.

Other features include: rocker type switch for selection of either of 2 reading rates or HOLD reading; interlocked pushbutton range and function selection; automatic decimal indication; illuminated function indicators and input protection to 1000 volts. The instrument has a rugged, molded cyclocac case.

Options include: internal rechargeable nickel cadmium batteries and built-in battery charger/AC power

supply; fully isolated parallel BCD output with separate connector; "Touch 'N Hold" probe which permits readings to be made without fear of short circuits while reading the display; and a high voltage probe for extending the instrument's range up to 50,000 Volts.

For More Details Circle (281) on Reply Card

Tape-to-Tape Editor

The Dynasciences Model 1100 Auto-Controller has been designed to operate with the Model 1000 Editor-Programmer. It was developed to minimize and simplify repetitive operations involved in video tape editing, thereby saving time and reducing operator errors.

The important feature of the Auto-Controller is that the tape editor can focus attention on the tasks of selecting and refining the location of edit points, while minimizing the distractions of performing and monitoring the mechanics of shuttling tapes back and forth.

For More Details Circle (262) on Reply Card

Digital Clock/Thermometer

ES142 digital clock/thermometer from ESE displays 12 or 24 hour time in 6 digits, and Fahrenheit or centigrade temperature in 3 digits, from -50°F to +150°F. The .55-inch displays are planar gas discharge.

Included is a temperature probe and 25 feet of cable, which connects to the rear of the unit. The unit is enclosed in an aluminum case with simulated walnut sides and top.

For More Details Circle (263) on Reply Card

Full featured Video Production Switcher

Ross RVS 16-4 video production switcher provides full function versatility in a compact economical package. New circuit design concepts achieve ultra reliable high quality performance.

Human engineering puts the logic back into operational procedures. Practical for mobile or fixed studio applications. Price approximately \$18,000 US complete, delivery 4-6 weeks. Ross Broadcast Products Ltd. Distributed by Glentronix Ltd., 160 Duncan Mills Road, Don Mills, Ontario M3B 1Z5, telephone (416) 444 8497.

For More Details Circle (182) on Reply Card



TITLING UNIT—NEW PRICE

The TCG-1432A Character Generator, including built-in monitor and 8-page memory, is now listed at a new package-price - \$3,190. Unit features sync generator with genlock, separate program and preview outputs, and exceptional character clarity (120-element matrix) and brightness (keyed into video signal). Total of 64 characters - 32 characters by 16 lines. Output meets EIA RS-170 standard, and unit automatically sync-locks to any RS-170 video source.

Other optional add-ons - at comparably good prices - include color-background generator with custom-designed patterns, a digital clock and an audio-tape memory coupler.

TeleMation, Inc., P.O. Box 15068, Salt Lake City, Utah 84115 (801) 487-5399.

For More Details Circle (184) on Reply Card

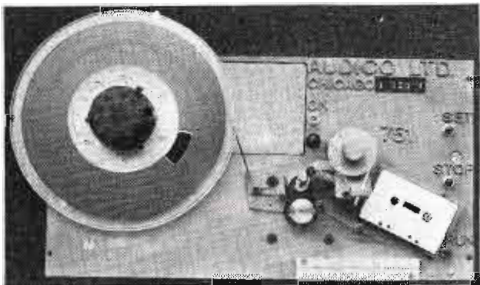

High Precision Tape Loader for Cartridge or Cassette

The 751 is the fastest semi-automatic blank cassette loading machine available. At its operating speed of 135 I.P.S., only 34 seconds are required to load a C-60. One operator using two 751's can load over 1,000 C-60's per shift. Specifications: Extreme Accuracy ($\pm 2''$ per 100'); Absolute Repeatability ($\pm 1/2''$ per 100'); Calibration Directly in Minutes & Seconds; Single Button Calibration; Continuous Readout of Tape Loaded; Complete Tension Adjustments; Precision Dynamic Braking; No Spill Zeor Tension Stopping; C-120 Capability; Loading from Pancake or Reel; Q Tone Kit and Remote Calibration Available; List Price \$1,335 F.O.B. Chicago. Also available: Tape Duplicators and Cartridge Winders. **Audico Ltd.**, 7345 W. Wilson, Chicago, Ill. 60656, (312) 867-6881.

For More Details Circle (183) on Reply Card



A new microwave receiver line by Tepco. Covers 2 GHz, 7 GHz, and 13 GHz bands. Other equipment available - VHF 1 watt and 10 watt translators, microwave transmitters, and microwave audio subcarrier equipment. Custom designed waveguide fittings also available. For FREE information write



Tepco Corporation
P.O. Box 680
Rapid City, S. Dak.
57701

Phone 605/343-7200

For More Details Circle (185) on Reply Card

Stereo Analyzer

A new plug-in unit extends the measurement capability of the R-O-R 300 System to stereo equipment and stereo transmission channels. Model 306 stereo analyzer plugs into the standard mainframe of the 300 System.

Measurements of phase and level difference between the two channels are displayed as a plot v.s. frequency while discrete values of phase and level are available from a digital readout. An accessory generator and power splitter unit provide a well isolated dual signal source for stereo transmission tests.

Phase difference measurements are made with an accuracy better than ± 0.5 degrees and a resolution of ± 0.25 degrees. Level difference and absolute level accuracy are better than ± 0.25 dB. The operating frequency range of the Model 306 is 40

Hz to 20 kHz.

The other tests normally made on audio equipment and program channels are completed with the R-O-R Model 302 Analyzer. The unit from **R-O-R Associates Limited** measures frequency response, harmonic distortion and weighted noise.

For More Details Circle (264) on Reply Card

VHF/FM Receiver

The NOAA VHF radio weather system receiver and receiver for the White House office of telecommunications policy has been designated the government-operated radio system for communicating attack or disaster warnings directly to the general public. **Scientific Radio Systems** Model SR-401 is operative on 162.40 and 162.55 MHz, and is being supplied to NOAA's national weather service, municipalities, radio broadcast stations, farm organizations, and others.

In addition to direct monitoring of the system broadcast, Model SR-401 includes tone alerts for disaster warnings, and alarms for loss of transmitter carrier, modulation, and frequency drift. The unit features an internal rechargeable battery with automatic switchover from AC. A field strength meter is optional.

For More Details Circle (265) on Reply Card

Professional Tape Deck

Revox Corporation announces a new version of its tape deck which features speeds of 7½ and 15 ips for professional applications and is equalized as per NAB.

Other features include balanced line inputs 1.55 V for peak level modulation (514nW/m). Levels preset, without mixing facility.

Balanced line output preset to 1.55 V cannon XLR type connectors. Output for loudspeakers, unbalanced lines and adjustable headphone outputs are also provided. Tape tension is adjustable for work with self supporting tape stacks.

For More Details Circle (266) on Reply Card

Bi-Polar Power Supply

A new high output current bi-polar power supply, with output current capability of ±4 amps is available from **Modular Audio Products**, a unit of Modular Devices, Inc.

Known as Model 7000, it operates off 115 VAC, 60 Hz input power, and provides adjustable DC voltages from ± 14 to ± 16 V at 4 amps. The unit provides crowbar over-voltage protection (limiting the output to 18 Volts

QUALITY TALKS FOR CJOB

Winnipeg, Manitoba

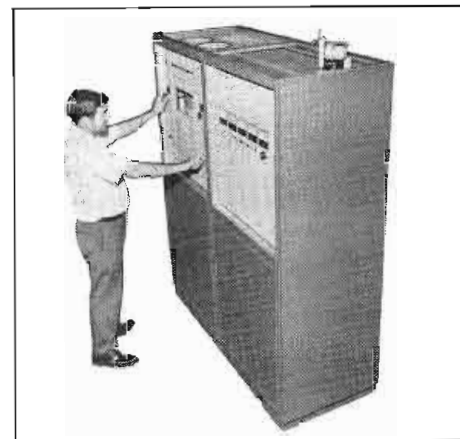

Continental's new 5/10 kW AM transmitter is setting records for acceptance. It has performance and efficiency, with the cleanest sound around. Listen to Continental: quality talks.

Continental Electronics

CONTINENTAL ELECTRONICS MFG. CO.
BOX 17040 DALLAS, TEXAS 75217

For More Details Circle (189) on Reply Card

RADIOMETER COPENHAGEN

modulation meters

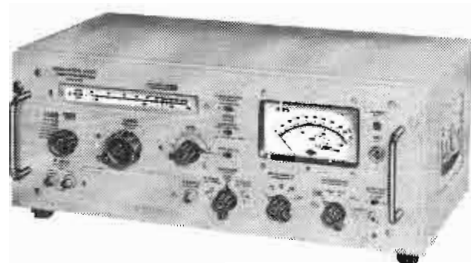

Accurate and easy measurements of AM modulation and FM deviation on RF carriers to 1 GHz.

- Narrow band and wide band models.
- Automatic level control.
- High resolution for residual AM and incidental FM measurements.
- Low internal distortion.

Contact us for complete information.

THE LONDON COMPANY
811 SHARON DRIVE
CLEVELAND, OHIO 44145
Tel. (216) 871-8900

221B

For More Details Circle (187) on Reply Card

September, 1975

BUHL

A FILM CHAIN WITHOUT A DEDICATED CAMERA

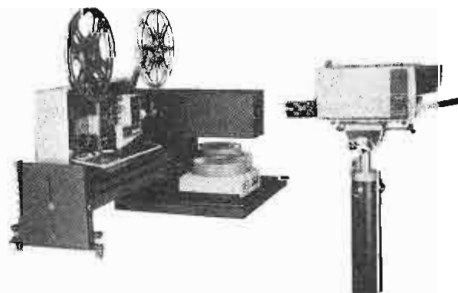

MOBILE MULTIPLEXER!

Save the high cost of an extra color camera. Studio camera adapts to film chain use in seconds.

Use standard TV zoom lens

Input: Two 35mm slide projectors in dissolve mode plus 16mm or Super-8

Mobile Multiplexer saves studio space

At \$975.00, outperforms units at twice the price!

For complete technical details--- Contact Buhl.

BUHL OPTICAL
1009 Beach Avenue
Pittsburgh, Pa. 15233
Phone 412-321-0076

BUHL

For More Details Circle (188) on Reply Card

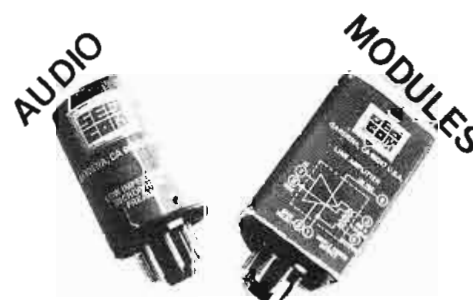

BUILD YOUR OWN

Mixers, Consoles, or add on to old equip.

10 different MODELS

Mic (Low-Z, Hi-Z), Mag. Phono, NAB Tape, Active Equalizer, Line Amp, Power Amp.

From \$16.50 to \$43.50 Pro-NET

Order Today from your nearest SESCOM dealer or factory direct.

Send for NEW CATALOG over 280 items for AUDIO Users



"QUALITY ENGINEERED SOUND PRODUCTS"

TELEPHONE (214) 701-3511

P.O. BOX 500, GARDENA, CALIFORNIA 90247 U.S.A.

For More Details Circle (190) on Reply Card

167

\$55 YOU CAN GET
3M 400
1/2 HOUR
MASTER QUALITY
 ea. delivered **2" VIDEO TAPE**
CLEANED, EVALUATED
AND REPROCESSED

FOR ALL YOUR VIDEOTAPE NEEDS:

Call Nancy: (212) 265-3740
 366 West 46th Street
 New York, NY 10036

Call Renée: (213) 985-3303
 11555 Ventura Blvd.
 Studio City, Ca 91604

Studio Tape Exchange Inc.



QUALITY & SERVICE AT THE LOWEST PRICES

For More Details Circle (191) on Reply Card

SOLID STATE TOWER FLASHERS

Zero voltage switching increases lamp life 5 to 10 times. Properly mounted, the totally encapsulated FS154 handles 1500 watts at 120VAC. Two lamps can be flashed alternately by adding FA154 auxilliary package.

The rugged FS154 offers:

- High current rating: 12 amps
- 120 amp surge capability
- Full AC operation Low cost



PRECISION PRODUCTS INC.

P.O. Box 395, Liverpool, N.Y. 13088
 Phone 315-457-9610



Size: 2" x 2" x 3/4"

For More Details Circle (192) on Reply Card

TRANSLATORS

DESIGNERS AND MANUFACTURERS OF VHF, UHF, FM
 ALSO REPAIR PARTS AND UP DATING KITS FOR ALL
 ADLER, LITTON AND KEITH ANDERSON TRANSLATORS
 SOLAR POWERED TRANSLATORS NOW AVAILABLE.

Television Technology Corporation

9150-B Brookville Road, Silver Spring, Md. 20910
 (301) 565-0770

For More Details Circle (193) on Reply Card



Typical measured Pattern #21
 Peak hor. power gain 3.38
 CCA patented TV antennas can provide you with the exact pattern you require — normally at no extra cost and at a minimum of tower loading! We can prove its pattern at our mile long test site!

YOUR BEST COMBINATION FOR UHF-TV COVERAGE

Send this advertisement for more information

CCA ELECTRONICS CORP.
 716 Jersey Ave.
 Gloucester City, N.J. 08030

A Subsidiary of CCA Industries

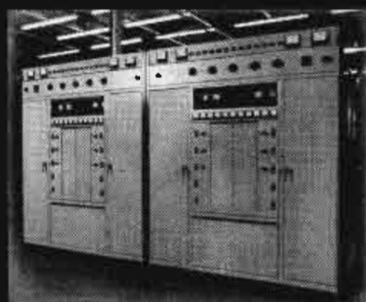

CCA UHF-TV transmitters have been in service for over 10 years in more than 40 locations. From 15 kw to 110 kw. No other company can match our reliability.

For More Details Circle (194) on Reply Card

maximum): foldback type current limiting; and inter-locked output protection.

Other features include remote sensing, resettable power line circuit breaker, an overload indicator, and front panel voltage adjusting controls.

The Model 7000 measures 5" x 8-9/16" x 12 1/4", and is designed for bench or rack mounting. A separate rack panel is available for mounting one or two units in a standard 19" rack, 5" high. Delivery is from stock to 60 days.

For More Details Circle (267) on Reply Card

Function Generators

Wavetek announces the first instruments in the new 180 series function generator, Models 180, 184 and 185. These three instruments all include internal sweep capability. The 2 MHz Model 180 features sine, triangle, square and DC outputs plus a true TTL pulse output.

Internal sweep over a three decade range further enhances the versatility of the 180. The Model 184 and 185 generators operate to 5 MHz. The Model 184 has sine, square, triangle, pulse and DC outputs with full symmetry control. Clean low-level signals are available due to the 60 dB step attenuator.

Trigger, gated and sweep modes are selectable, as well as normal cw operation.

For More Details Circle (268) on Reply Card

Stereo Generator

The Moseley Associates all new solid-state Model SCG-9 Stereo Generator offers the FM broadcaster a composite stereo signal of high quality at an affordable price. Although intended primarily as a companion unit to the Moseley Associates line of composite stereo aural studio-transmitter links, it may also be used with most direct FM exciters.

The Model SCG-9 Stereo Generator requires a minimum of adjustments. The Model SCG-9 Stereo Generator features advanced solid-state techniques, a peak-reading dB meter which accurately reads total output of the generator, mode selection (stereo/monaural), compact construction, and ease of maintenance provided by numerous test points.

For More Details Circle (269) on Reply Card

Sine/Square Wave Generator

A fast rising square wave for testing transient response and low distortion sine wave are among the

features of the LAG-26 generator being offered by **Leader Instruments Corp.** The new product is said to be ideal for audio and supersonic frequency range testing through provisions for modulation and distortion checks via the square/sine wave outputs.

The product has a sine wave output range of 20Hz-200kHz at 0-5Vrms with ± 1 dB flatness and with distortion at less than 0.5% below 20kHz. Square wave output is 20Hz-20kHz in the 0-10Vp-p voltage range with 0.5 μ s rise time.

LAG-26 also synchronizes signals from an external source and has a calibration accuracy of $\pm 3\%$. Output impedance is 600 Ω unbalanced and the frequency range is in 4 decade bands.

For More Details Circle (270) on Reply Card

Dial-Up Teleprinter

"A much-used addition to your computer work force" is an apt description of the **RCA Service Company** model 33ASR teleprinter featuring dial-up capabilities. The model 33ASR, which is now in stock and ready for immediate delivery, is equipped with the 101C data set. It is compatible with and comparable to

the Bell System's "Data-Phone" + service and Western Union's TWX service. The RCA Model 33ASR automatically recognizes the calls of both.

Information such as invoices, sales orders, personnel records and freight bills can be transmitted cross-country via telephone lines at half the cost of a phone call and in less time than by mail. Questions about transmittals can be answered on the spot either by typing the reply or by the alternate voice communications of the 33ASR's built-in phone.

The 33ASR operates on the eight-level ASCII code, thereby "speaking" the same language as most computers and other business machines. Other features include automatic, unattended operation, operator selectable, half or full duplex, automatic reader, automatically-triggered answer-back and an optional "tape-on, tape-off." Sprocket (pin) models for business forms or friction-feed models are both available.

For More Details Circle (271) on Reply Card

Video Trimmer

Video switchers frequently develop errors due to path length variations as a result of aging of discrete components, temperature variations in

VIDEO HELP!

Tape tension is the "pulse" of your video recorder/player. **TENDEL** has a tension gage designed for your application to provide a fast, accurate measurement of the tension with the machine "in operation."

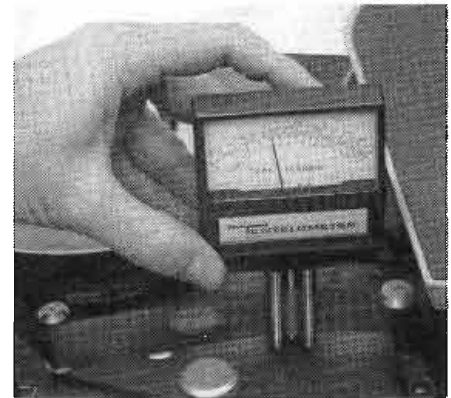

TENSION PROBLEMS SHOW UP AS:

- **Interchangeability problems** between two or more recorder/players.
- **Horizontal time base instability** which causes flagging and picture distortion.
- **Premature headwear and tape wear** due to high tension.

Approved by **Ampex, I.V.C., and Sony**, (Great for **U-Matics**).

From \$179. Send for additional information or call today.

TENDEL (408) 377-6588
50 Curtner Avenue
Campbell, California 95008

For More Details Circle (197) on Reply Card

SYNCRON IS:

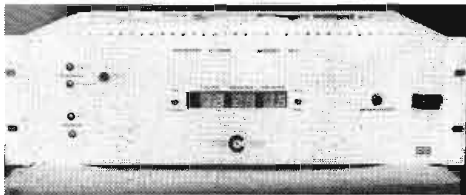

- A highly reliable, low cost Master Clock System capable of synchronizing digital, simplex, synchronous and pulse type clock devices
- An FSK data transmission system
- An accurate multi-readout by-directional digital timer system
- A multi-readout electronic thermometer
- A programmable event timer
- A whole lot more
- Available from . . .

THE INNOVATORS AT



3140 E. Jefferson
Detroit, Mich. 48207
(313) 567-0555

TWX: 810-221-1267

For More Details Circle (195) on Reply Card

BOSTON SOUND & POWER SYSTEMS IS HIGH REL

Reliability is the key to reducing overhead. Our radio frequency interference/voltage transient suppressors reduce your headaches and extend the life of your valuable equipment with performance upon which you can depend. All models are backed by a FULL FIVE YEAR parts, labor and air shipping warranty. That means we've built in reliability. We've also built in ease of handling. There's no need to modify your equipment. Simply plug our suppressor into any standard 115 volt outlet. Then plug the equipment to be protected into the suppressor. An entire equipment rack can be protected from the line riding nuisance of radio frequency interference and the destructive forces of voltage transients with a single suppressor unit.

Model 101A equipt with four 115 volt standard outlets at 15 amps. \$105
Model 101X equipt with eight 115 volt standard outlets at 15 amps. \$125

BOSTON SOUND & POWER SYSTEMS

Three Fredith Rd., Weymouth, Mass. 02189
Tel: 617-335-6406

Contact our staff for information regarding any noise problem.

For More Details Circle (196) on Reply Card

IF YOU NEED ATTENUATORS YOU NEED THIS CATALOG!



AUDIO AND RF ATTENUATORS TO MEET ANY REQUIREMENT

Here in one compact and informative 24 page booklet is all the data you need to select a Precision Audio and RF Attenuator for your application.

Reference Charts, Circuit Diagrams, Types and Uses, Current and Voltage Ratio Tables, Ratings, Etc., make this a handy and invaluable reference.

SEND FOR YOUR FREE COPY TODAY.

TECH LABS, INC.

Bergen & Edsall Blvds.
Palisades Park, N.J. 07650
Tel.: (201) 944-2221

For More Details Circle (198) on Reply Card

RAPID-Q^{T.M.} CART MACHINES

RQ 71 Series for all size cartridges

Custom 3000 Series for "A" size cartridges

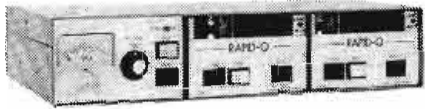

- Record/Playback
- Playback Only
- Single Units
- Multiple Units
- Monaural
- Stereo

Automatic fast-forward standard

GARRON ELECTRONICS, INC.
1216 Kifer Road
Sunnyvale, California 94086
(408) 736-8737

For More Details Circle (199) on Reply Card

FM/SCA/TV

Transmit still TV pictures on the 67 kHz subcarrier channel for:

- instructional programming
- community services
- storecasting

Contact us for hardware specifications.

cv

Colorado Video Inc.
P. O. Box 928
Boulder, CO 80302
(303) 444-3972
TWX 910-940-3248
COLO VIDEO BDR

Pioneers in compressed video

For More Details Circle (200) on Reply Card

the equipment and interconnecting cables, compact component changes through failures, or frequency response adjustments during maintenance or line-up.

The Matthey Video Trimmer, from **Television Equipment Associates**, reportedly can eliminate these problems without the necessity of whittling cable. Delay time is infinitely variable from 3 to 9 ns, which is the equivalent of 2- to 6-feet of coaxial cable. Model UN3/9, also known as the "Rubber Coax", has 75 Ohm impedance and flat loss is less than 0.1 dB at 100 kHz.

For More Details Circle (272) on Reply Card

Transient Clipper

AEL Communications Corporation (AELCC), subsidiary of American Electronic Laboratories, Inc. (AEL), announces the introduction of its Model TZ-1, Transient Clipper.

Utilization of the unit in a cable system prevents component damage by protecting the system from transients generated by power company switching, lightning, short circuit, or improper test and operating procedures. Laboratory and system environment tests have proved the unit provides excellent protection.

Digital Air Temperature

The Announcer's Friend



- Indoor and Outdoor Sensors
- Walnut-Finish Console
- Gold Anodized Panel
- Multi-Sensor Selector
- Remote to Any Distance
- 1/2" Sperry 7-Segment Display
- Slaves Available

Send for Spec. Sheet, Model 309.
Money Back Guarantee.

Also, a complete line of Weather Instruments, Recorders and Controllers.

(214) 631-2490
Texas Electronics, Inc.
P. O. Box 7225B
Dallas, Texas 75209

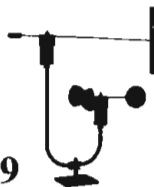

For More Details Circle (201) on Reply card

Transient Clipper, Model TZ-1, is designed for use in 30 or 60-Volt cable systems and is easily connected to the output winding of the power supply.

For More Details Circle (273) on Reply Card

Videocassette Demonstration Tape

Buhl Optical, Video Products Division, Pittsburgh, Pa. announces the availability of the new "Take One" videocassette demonstration tape.

The tape is produced using two standard Kodak Ektagraphic E slide projectors, an electronic dissolve unit, a Panasonic color camera and Buhl's Mobile Multiplexer.

The Mobile Multiplexer is "a film chain without a dedicated camera", which allows the user to switch the video camera from film chain to studio use in seconds.

"Take One" shows how the MM interfaces audio visual and video operations.

For More Details Circle (274) on Reply Card

Audio Cleaner

Audio Pro, a new professional cleaner specially formulated for use with all audio equipment, is now available from **Audiotechniques, Inc.**, Stamford, Ct.

ALPHA

SERIES



THE BEGINNING OF A NEW ERA IN PROFESSIONAL QUALITY MIXING CONSOLES.

Remotes or a permanent system, the new Alpha series mixers have more features than we have space to tell you about them.

Write us or circle the number. We'll send complete information on the compact Alpha.

Good things come in small packages. From the Console Company...

Sphere
ELECTRONICS

EASTERN REP.
SPHERE AUDIO SALES
478 DEVENS DRIVE
BRENTWOOD, TENN. 37027
(615) 794-0155 (NASHVILLE)

20201 X PRAIRIE AVE.
CHATSWORTH, CALIF. 91311
(213) 349-4747

For More Details Circle (202) on Reply Card

According to Audiotechniques' president, Hamilton Brosious, the new cleaner has been extensively field tested by audio equipment manufacturers with excellent results.

Audio Pro was designed to penetrate iron oxide buildup on tape recorder heads, capstans and guides, as well as for general cleanup of tape decks, electronic panels, mike stands, keyboards, and consoles.

For More Details Circle (275) on Reply Card

Open Reel Duplicating System

The new Model SRR2250-8, open reel-to-reel duplicating system for 1/2 track stereo or 1/2 track mono is available from **Pentagon**.

The system is designed for high speed tape duplicating providing broadcast quality tapes. This easy-to-operate system is available with

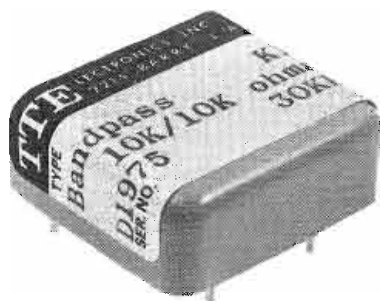

FILTERS

1,000,000 Standard Types
**BANDPASS • BANDSTOP
 LOWPASS • HIGHPASS**

Select any Frequency from 3Hz to 100MHz such as

25Hz Cue Tone Notch, 50Hz Highpass, 15.75KHz CATV Bandpass, 300Hz Telephone Simulation Lowpass, 21Hz Bandpass, 18KHz Lowpass, 1KHz Notch, 4MHz Lowpass, 7.6KHz Lowpass.

TTElectronics, Inc. 2214 Barry Ave. Los Angeles, 90064, (213)478-8224

For More Details Circle (203) on Reply Card

For the best buy in tape recorders its

REVOX

from
Val-tronics, Inc.

Penn Park Building
 Pittston, Pa. 18640
 (717) 655-5937
 a complete line of

AM-FM Transmitters—Consoles—Turntables—AM Phase Monitors—Emergency Power Generators—Transmission Line—Tubes AGC and Distribution Amplifiers—Cartridge Recorders—Tape AM-FM-TV Limiters—Remote Pick Up Automation Systems.

For More Details Circle (204) on Reply Card



"I'M AFRAID THE F.C.C. WON'T LIKE OUR STATE EMERGENCY BROADCAST SYSTEM."

Four Professional Mixing Consoles

for the price of one.



THE QM-8A.

- Recording
- Production
- Mixdown
- Remotes

Quantum Audio Labs

1905 Riverside Dr.
 Glendale, Calif. 91201
 (213) 841-0970

For More Details Circle (205) on Reply Card

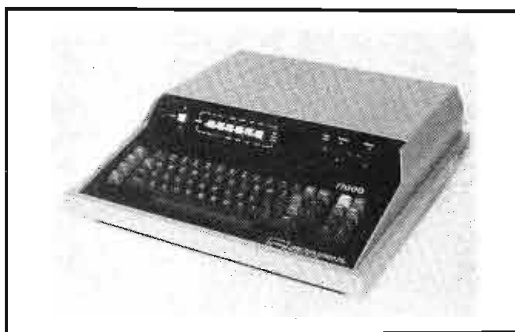

TITLING UNIT

Basic T-1000 - \$2,695.00, includes 2 character sizes, separate program / preview outputs, 2 page memory, 7 x 9 character matrix, keyed titles, blink, one or two line window, vertical interval page switching, full editing.

Broadcast version - non-composite video. Expansion modules to 16 pages of memory, horizontal crawl, vertical roll, high resolution 10 x 14 font, black borderline, and more.

Video Data Systems, Inc. 657 Old Willets Path, Hauppauge, New York, 11787 (516) 234-1010.

For More Details Circle (206) on Reply Card

SOLID STATE AM MONITORS ACCURATE @ 125%



- Positive and Negative Peaks Read Simultaneously
- Digital Frequency Display Unaffected by Modulation
- Flashers and Meters "Remoteable"
- Both Monitors Can Mount In One 5 1/4" Space

CCA ELECTRONICS CORPORATION

716 JERSEY AVE., GLOUCESTER CITY N. J. 08030 • Phone: (609) 456-1716

For More Details Circle (207) on Reply Card

- **DUMMY LOADS**
100 to 1.5 Million Watts Average Power
- **FM/LOW TV DRY LOADS TO 75KW**
- **AM/VHF DRY LOADS TO 200KW**
- **COAXIAL WATER LOADS**
- **DIRECTIONAL COUPLERS** UP TO 6-1/8 EIA LINE
- **RF POWER METERS** IN LINE/TERMINATING
- **RF ATTENUATORS**
- **RF DRY BALUNS**
- **RF CALORIMETERS**

Electro IMPULSE, INC.

OUR 26th YEAR OF GROWTH

116 CHESTNUT ST., RED BANK, N.J. 07701
 TELEPHONE: 201-741-0404

For More Details Circle (208) on Reply Card

STOP GROUND-LOOP HUM!

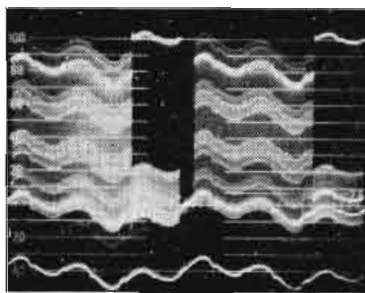

\$140
F.O.B. N.Y.

NEW!

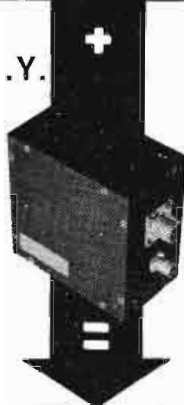

NEW!

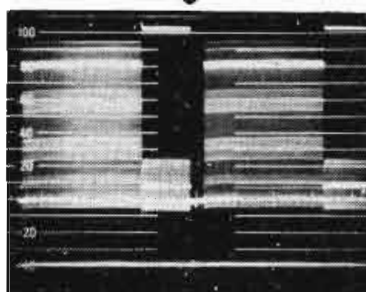

VIDEO HUM STOP COIL HSC 1

Will ELIMINATE HUM and other INTERFERENCE in Video Lines caused by differences in Ground Potential

- For Color and Black and White.
- FLAT-DC to 6.5 MHz.
- No Low-Freq. or Hi-Freq. Roll-off.
- No Differential Phase Distortion.
- No Differential Gain Distortion.
- No Envelope Delay.
- Passive Device - Failure Free-Low Price.
- Small Compact Package 4" x 4" x 2-1/4".

ELIMINATES HUM AND INTERFERENCE:

IN STUDIO

Between Buildings
On long runs in Buildings
Between Studio and Transmitter
On Incoming Telco circuits
On Outgoing Telco circuits

IN FIELD

Betw. Remote Truck and Telco
Betw. Remote Truck and Microwave
For Intertruck Hookup
For VTR Units
For Monitoring Lines

Available on 10 day free trial

AUDIO-VIDEO ENGINEERING COMPANY
65 Nancy Blvd., Merrick, N.Y. 11566
Tel. (516) 546-4239

For More Details Circle (209) on Reply Card

optional fully automatic rewind of the master deck. Features include acutrack metering, track selection, bias monitor indicator lights, pull out circuit cards, response 40-15,000 Hz for 7 1/2 ips masters. Price: \$6,675.00, includes one slave.

For More Details Circle (276) on Reply Card

Modular Mixer

TEAC Corporation of America has introduced another unit in its TAS-CAM Series, the model 5, an 8-in. 4-out mixer of modular construction.

Each input channel features a low impedance, balanced mic input, pan, an LED overload indicator, two bands of selectable equalization, solo, a direct output and cue and echo send.

Volume averaging meters for the four program busses are complemented with LED peak indicators. In addition, a fifth meter can be switched to monitor either the cue or echo send level.

There is an independent monitor mix facility which allows the user to monitor one mix while simultaneously recording another.

The unit also features receive patch points on every input module, four buss inputs, and four auxiliary outputs in parallel with the line outputs. A built-in test tone oscillator is provided, and the new unit is also capable of interfacing with a companion mixer for additional inputs.

For More Details Circle (277) on Reply Card

Video Delay

Television Equipment Associates is introducing a new video delay package from Matthey Printed Products which will accommodate any delay from 10 to 2,120 ns.

The product consists of a 5 1/4" Vero card frame which accepts eight cards and is supplied with BNC connectors in and out. A ± 4 ns. vernier is supplied on the front panel of each card.

Matthey equalized video delay PC modules can be fitted to the card to accommodate any video delay from 10 to 2,120 ns. equalized to 5.5 MHz and padded to 3 dB.

For More Details Circle (278) on Reply Card

50-Watt Op Amp

The power operational amplifier SM-100K from **OPAMP Labs** offers dual 50-Watts rms or mono 100-Watts rms over the DC through audio range. Unit consists of panel chassis with hardware, two 440KR power amplifiers, 536 power supply, PC-SM100 convertible stereo 50-Watt or mono 100-Watt PC board, and all necessary components. SM100K kit priced at \$175.00; the wired unit (SM-100W) at \$255.00.

For More Details Circle (279) on Reply Card

Digital Multimeter

MOS circuitry is used throughout in this new **Philips** multimeter in order to combine low cost with high reliability and accuracy. During the lifetime of the instrument, designated the PM2522, the specified accuracies are, in fact, guaranteed and there is no need to recalibrate.

In order to make the lifetime accuracy as high as possible (0.2 percent on DC voltage) the PM2522 uses a unique analog-to-digital conversion technique which eliminates the need for filters and rejects series-mode signals down to 0.1 percent of their original value. Together with the common mode rejection of 100 dB and high (10 MOhm) input impedance, this ensures that specified accuracies are maintained, even under unfavorable measurement conditions.

State-of-the-art techniques are also found on the front panel. The 3 1/2 digit LED display is easy to read and has an automatic decimal point as well as polarity and overrange indication.

For More Details Circle (280) on Reply Card



Still the industry's MOST POPULAR

VIDEO TAPE CONDITIONER

- Cleans and winds tapes
- Prolong tape life and reduce dropouts
- Hundreds installed worldwide
- Leasing program available

RECORTEC, INC. 777 PALOMAR AVE. SUNNYVALE, CA. 94086 TEL: (408) 735-8821 TWX: 910 339 9367

For More Details Circle (210) on Reply Card

NAB schedules Fall seminars

The National Association of Broadcasters announced that this Fall it will hold one day seminars for television station executives in six cities around the country.

The morning session will focus on "Television Today" and will include a discussion of television issues by a member of Congress and a Federal Communications Commissioner. Delegates will also participate in discussions covering current TV issues—legislative and regulatory, sales, news, programming, promotion and public relations.

The afternoon session entitled "The Mind Stretchers—A Look at the 1990 Time Capsule" will be devoted to a discussion of "Television Tomorrow." During this session, the television executives will hear predictions and viewpoints from scientists, economists, former and current distinguished broadcasters, manufacturers, regulators and legislators. These leading experts will give their views on the effect of cable, pay television, multiple distribution systems and other engineering advances, programming and future regulation and legislation on TV's future. Their views will be presented on audio tape and a discussion will follow.

Among those participating in the afternoon session will be Dr. Robert Adler, vice president, Zenith Radio Corp., Chicago, Ill.; former Federal Communications Commissioner

Kenneth Cox, Haley, Bader & Potts communications law firm, Washington, D.C.; Dr. Herbert Elion, senior staff member, Arthur D. Little research firm, Cambridge,

Mass.; former National Cable Television Association President David Foster; Henry W. Harris, president, Cox Cable, Inc., Atlanta, Ga.; Irvin
(Continued on page 174)

IGM has just RAMmed the automation industry a giant step forward

- with our new RAM 4000 event random access memory unit—works with any system, operates as a main-brain, or expands your existing system.
- with our new PAL Printed Automatic Logging package—works with any system or live studio operation, provides fully buffered, verified FSK printed English-text logging.

- with our new Go-Cart—the first innovative multiple cartridge handler in years—42 cart capacity expandable to 78, high-speed access under micro-processor control, optional back-to-back playback from the same machine, all at the lowest per cartridge cost in the industry!

- with Instacart—the first and only time-proven instant random access cartridge handler—ask anyone!

Surprising new capabilities at surprisingly realistic prices— from IGM, automatically...

the best there is!

Call or write today for full details

IGM

a division of NTI
4041 Home Rd.
Bellingham, WA
98225
(206) 733-4567



For More Details Circle (211) on Reply Card

Still the industry's MOST DESIRED

VIDEO TAPE EVALUATOR



- Tape evaluation at 16 times speed
- World wide customer base
- Standard in the industry
- Leasing program available

RECORTEC, INC. 777 PALOMAR AVE. SUNNYVALE, CA. 94086 TEL: (408) 735-8821 TWX: 910 339 9367

For More Details Circle (212) on Reply Card

(Continued from page 173)

Kahn, former Teleprompter president, New York, N.Y.; Clair R. McCollough former president, The Steinman Stations, Lancaster, Pa.; former Federal Communications Commission Chairman Newton Minow, Sidley & Austin communi-

cations law firm, Chicago, Ill.; Joseph L. Stern, president, Stern Telecommunications Corp., New York, N.Y.; Sol Taishoff, chairman, Broadcasting Publications, Washington, D.C. and Jack Valenti, president, Motion Picture Association of America, Washington, D.C.

The one-day seminars replace NAB's traditional Fall Conferences. During both the morning and afternoon sessions emphasis will be on discussion and questions and answers. To stimulate maximum participation and a free flow of ideas, attendance will be limited and on a pre-registration basis. Further information and registration forms will be mailed to NAB members shortly.

The seminars will be held in: Atlanta, October 14, Riviera Hyatt House; Boston, October 17, Marriott; New Orleans, November 11, Monteleone; Chicago, November 14, Pick-Congress; Denver, November 18, Brown Palace; San Francisco, November 21, Fairmont.

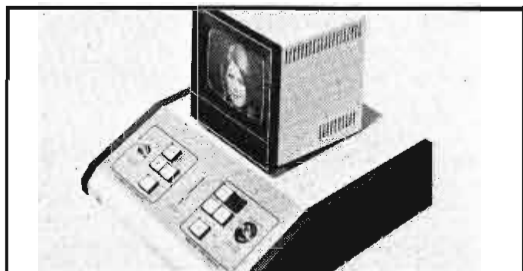

NEW EDITING SYSTEM INTERFACES WITH CASSETTE EQUIPMENT

Here's a unique approach to electronic editing. The ECS-1, with dual joystick controls, interfaces with the Sony 2850 recorder, as well as IVC 1" models 700/800/900 and the Sony 1/2" model 8650. This design provides bi-directional variable speed tape motion control for playback and record VTR's, enables precision editing by counting control track pulses. Desk top and rack configurations include repeatable preview in still frame and real time with automatic recue, 9" monitor and digital interlock logic. Options include a programmable end insert timer and a multiple source selection switcher. **CONVERGENCE CORP., 4400 CAMPUS DR., NEWPORT BEACH, CA. 92660 (714) 549-3146.**

For More Details Circle (213) on Reply Card

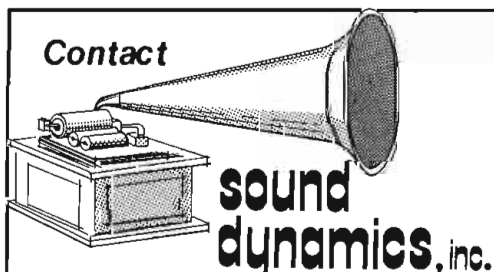

Contact

sound dynamics, inc.

for detailed information on Fidelipac®

Sound Dynamics represents major manufacturers of audio equalizers, cartridge accessories, editing equipment, headsets, limiters, magnetic tape heads, microphones, mixing consoles, recorders, recorder electronics, reproducers, speakers, tape degaussers, tape tension gauges, test tapes, tone-arms and turntables.

P.O. Box 1335 • Sunnyvale, Ca. 94088 • Tele: (408) 926-3588

For More Details Circle (214) on Reply Card

50 KW AM
with conventional high level modulation and air cooling.

CCA AM/FM TRANSMITTERS ARE WITHOUT COMPARISON

Send this advertisement for more information

CCA ELECTRONICS CORPORATION
716 Jersey Avenue
Gloucester City, N. J. 08030
(609) 456-1716

25KW FM
air cooled transmitter with independent 3 KW driver and one power amplifier tube.

You are cordially invited to visit our plant and watch the AM 50,000 go through its paces!

For More Details Circle (215) on Reply Card

Notice:

All Companies Red Listed For Page 185 Have Been Moved To Page 191

SAVE ABOUT 50% OF POWER TUBE COSTS

NEW:
3,000 HOUR WARRANTY!



IF YOU USE 3CX2500, 4CX5000, 4CX10000, 4CX15000 AND SIMILAR TYPES

Freeland Products offers expert reprocessing of certain types of thoriated filament tubes. Our service is backed by a warranty and over 30 years experience.

Send today for descriptive brochure and price list. Freeland reprocessing assures FULL AVERAGE EMISSION LIFE of new tubes—yet you'll save up to 50% of original cost!

Scores of Satisfied Customers

WAOK	KHOU	WRUF
KBCL	CJRC	WSMB
KALB	WHAS	WTAE
WBKH	WHB	WTIX
KCIJ	WIRK	KVOL
KCIM	WJCW	KWHI
WCCO	WJDX	WWST
WCMI	WJLS	WPRS
WDAE	WAMX	KNOE
KCMO	KLCN	WGSO
WSAV	KLIV	WMPS
KFDA	WMRI	WHBC
WFOR	KOKE	WDWS
KGBC	KOMA	WBTM
WGAC	KHYM	WGAF
KEEL	WPLO	KMLB
KUPK	WQAM	KOAX
WERC	WQMV	WROB

And Many More!

Freeland Products Co.
3233 Conti St. • New Orleans, La. 70119
504/822-9223

For More Details Circle (216) on Reply Card

BROADCAST ENGINEERING

Radio license Renewal Bill

Introduction in Congress of a radio license renewal bill will be a major effort of the National Association of FM Broadcasters during the coming months, according to an announcement made today by Abe Voron, NAFMB Executive Director.

"All of the renewal bills which have so far been introduced are broadcast license renewal bills and continue the practice of lumping

together radio and television," said Mr. Voron. "Radio and television are very, very different services and businesses and it's completely illogical for them to be regulated as if they were identical. For too long radio has suffered by being dragged along behind TV's besieged wagon and our preliminary contacts with members of Congress indicate that Congress recognizes the differences between radio and TV and would be sympathetic to legislation governing radio only," Mr. Voron further stated.

"We will be discussing details of a radio license renewal bill with key members of Congress during the coming weeks," said Mr. Voron, "and we expect to have some specifics to announce at NAFMB's National Radio Broadcasters Conference & Exposition in Atlanta this coming September 17th through 20th."

"The Association of Public Radio Stations will join NAFMB in this effort," Mr. Voron stated, "and we expect the support of other radio-oriented organizations."

Notice:

**All Companies
Red Listed For
Page 185
Have Been Moved
To Page 191**

SAVE AT SITLER'S

G.E. & SYLVANIA STAGE - STUDIO & PROJECTOR LAMPS

PLEASE DON'T GIVE US LAMP ORDERS
AT LIST. WE'D RATHER GIVE YOU

42% TO 45% OFF

COMPARE SITLER'S PRICES:

TV PRODUCTION LAMP NUMBER	LIST PRICE	6 TO 23 (42% OFF)	24 & UP (45% OFF)
Q1000T3/4CL (FCM)	\$14.10	\$ 8.18	\$ 7.75
FAD	13.80	8.00	7.59
Q1000TS/4 (FHM)	15.00	8.70	8.25
Q1000PS52/4 (DKZ)	25.00	14.50	13.75
Q1500PS52/4 (DKX)	36.00	20.88	19.80
Q2000T11/4CL (CYX)	49.25	28.57	27.09
DXW	20.20	11.72	11.11
1M/T12/2	18.50	10.73	10.17
Q1500T4/4CL (F0B)	25.75	14.93	14.16
Q1000T3/1CL (FFT)	25.25	14.64	13.89
500T20/64	18.50	10.73	10.17
750T20P/SP (BFE)	17.15	9.95	9.43
Q500T3/4 (FDN)	14.45	8.38	7.95
Q500T3/4CL (FDF)	15.25	8.85	8.39
Q1000/4CL/P (EGJ)	31.00	17.98	17.05
DTJ	23.25	13.49	12.79
FAY	32.45	18.82	17.85
FBE	32.70	18.97	17.98
FBX	14.20	8.24	7.81
FCX	20.80	12.06	11.44
Q1000/4CL (FEL)	27.00	15.66	14.85
750T24/16 (DVH/EDG)	15.75	9.13	8.66
Q1000/4 (FCV)	30.25	17.54	16.64
Q2000T8/4CL (FEY)	49.25	28.56	27.09
DYA	22.45	13.02	12.35
FBY	21.00	12.18	11.55

Many other numbers in stock. All transportation pre-paid on \$100.00 or more net orders. Lamp orders may be assorted for best price. Minimum order \$25.00 net. ORDER TODAY. OR WRITE FOR OUR COMPLETE PRICE SHEET!

Sitler's SUPPLIES, INC.

P.O. Box 10-A
Washington, Iowa 52353

Please send:
(Quantity) (Lamp No.) (Net Due)

_____ \$ _____
_____ \$ _____

NAME _____

ADDRESS _____

CITY _____

STATE _____

ZIP _____

For More Details Circle (217) on Reply Card
September, 1975

We are stocking distributors for the top lines of professional broadcast audio equipment. Check our Fall, '75 catalog for all your requirements.

Broadcast Equipment & Supply Co.

P.O. Box 3141
Bristol, Tennessee 37620
(615) 968-7342

For More Details Circle (218) on Reply Card

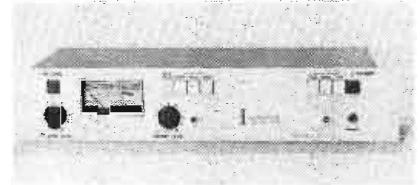

RECORDER ELECTRONICS UNIT HAS "BETTER-THAN-NEW" FEATURES

A replacement tape record electronics unit with features not found even on new recorders has been introduced by Inovonics, Inc., of Campbell, California.

Model 375 Tape Recording Electronics features full remote control and three-speed equalization. It has a "linearized" recording amplifier and phase-corrected reproduce circuitry for low distortion.

An optional sync reproduce amplifier has independent equalization for optimum performance in both playback modes.

The Model 375 plugs directly into most Ampex recorders and is easily adaptable to most other machines. The price of the unit is \$690. For more information, contact: INOVONICS, INC., 1630 Dell Avenue, Campbell, Ca. 95008. (408) 374-8300.

For More Details Circle (219) on Reply Card

CALVERT BROADCAST CAPABILITY

- **Camera Tubes**
Plumbicon* Vistacon
Leddicon Vidicon
- **Transmitting Tubes**
TV-AM-FM-Translator
- **Microwave Tubes**
Klystron UHF
Traveling Wave Tube
- **Special Tubes**
Photo Multiplier
CRT Instrumentation

Broadcast product availability
at lowest cost.

EIMAC RCA EEV AMPEREX VARIAN

For literature and FREE Metric
System Guide make this
Toll-Free call: 800-221-6845.

BROADCAST/CATV/CCTV Division
CALVERT ELECTRONICS, INC.
220 East 23rd St., New York, N.Y. 10010
(212) 679-1340

*Reg. Trademark N.V. Philips of the Netherlands

For More Details Circle (220) on Reply Card

Central Dynamics... Recognized Throughout The World for Leadership in Television Broadcast Equipment

Video Switchers

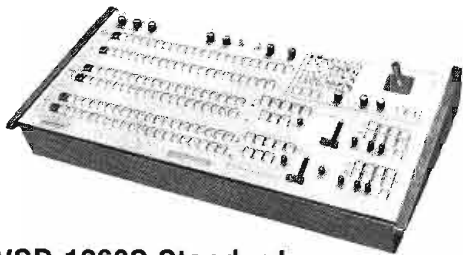

VSP-1260S Standard Video Production Switcher

A New Standard from CDL; 8 Busses, 20 inputs, Key Border, Non-Repeating patterns, Soft Key, Soft Wipe, plus integrated and timed encoded Chroma Keyer with 2x1 Dual Chroma Keyer Selector. RGB Keyer optional.

Circle 1 on Reader Service Card.

VSP-1270: Three MIX & EFF Amplifiers. For the most demanding production requirements.

The CDL VSP-1200 Series Switchers also include models VSP-1240 and VSP-1250 with 1 and 2 MIX/EFF Amplifiers.

Circle 2 on Reader Service Card.

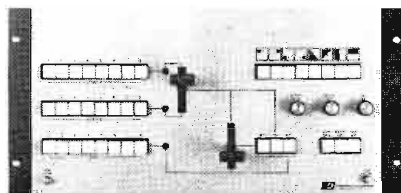

CDL's New VS-10 Video Production Switcher

Eight-input, 3 bus vertical interval switcher designed for small mobile, CCTV and CATV applications.

Circle 3 on Reader Service Card.

MCS-829/PTS-121 Master Control Switcher

15 or 20 inputs, including a MIX & EFF Amplifier, and Preset/Prelisten bus. Also included is PTS-121 17-event memory including pre-programmable transitions.

Circle 4 on Reader Service Card.

VA-2181 Processing Amplifier

Used with studio production and master control switching systems. Has master fade to black of synchronous and non-synchronous signals.

Circle 5 on Reader Service Card.

Digital-Sync Decoder

One delay adjustment for all pulses including subcarrier. Also operates as a master generator with subcarrier input reference.

Circle 6 on Reader Service Card.

Tape Editing Systems

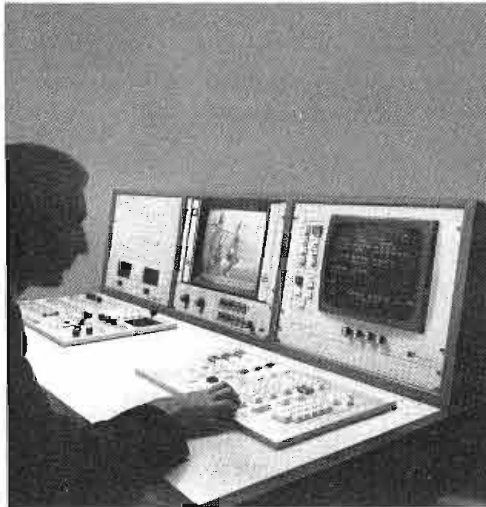

PEC-102 Computer Controlled VTR Editing System

A state-of-the-art system using SMPTE Time Code, controls up to 8 machines, (Quad, Helical and multi-track audio) Edit File stores up to 600 edit sequences.

Circle 7 on Reader Service Card.

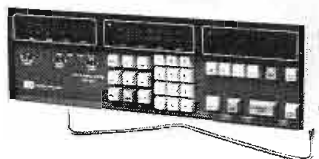

EDS-200 Tape Editing System

Uses SMPTE Time Code. Use with Helical or Quad video tape machines.

Circle 8 on Reader Service Card.

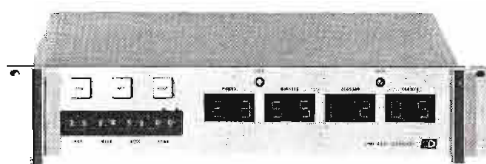

SMPTE Time Code Generator

The original identification and information source for the videotape.

Circle 9 on Reader Service Card.

SMPTE Time Code Reader

Identifies the tape and any segment of the tape down to a single frame on a numerical readout.

Circle 10 on Reader Service Card.

Character Generator

Inserts Time Code or User Bits into video. Can be used with Time Code Generator or Reader.

Circle 11 on Reader Service Card.

Automation

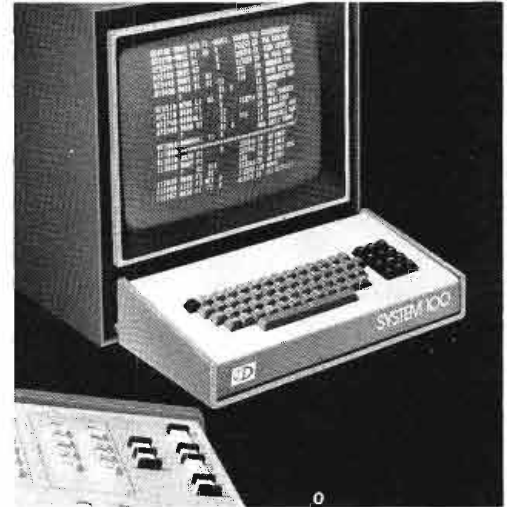

SYSTEM 100

Computer controlled automation system for Technical Operations that communicates directly with either BCS or BIAS business systems, and stores and retrieves the schedule with entry error checking, makes automatic time corrections, performs complicated audio/video switching sequences, assigns machines, verifies material, and prints the "As-Aired" log.

Circle 12 on Reader Service Card.

Also ask us about our complete line of production and TV Terminal Equipment including:

- Video and Pulse Distribution Amplifiers
- Encoded Chroma Keyer
- RGB Chroma Keyer
- VTR Input & Distribution Switchers
- Machine Delegation & Control
- Station Audio/Video Routing Switchers
- Pulse Assignment Systems
- Machine Assignment Systems

Circle 13 on Reader Service Card.



CENTRAL DYNAMICS LTD

Canada:

147 Hymus Blvd., Montreal, Que., H9R-1G1
514-697-0811

U.S.A.

230 Livingston Street, Northvale, N.J. 07647
201-767-1300

Manufacturer's Addresses

A

- Accurate Sound Co.**, 114 5th Ave., Redwood City, Calif. 94063
Ron Newdell - (415) 365-2843
- Acrodyne Industries Inc.**, 21 Commerce Drive, Montgomeryville, Pa. 18936
John Parke - (215) 368-2600
- Aderhold Construction Co.**, 3384 Peachtree Rd. N.E., Atlanta, Ga. 30326
- Admiral Group, Rockwell Int'l.**, 1701 E. Woodfield Rd., Schaumburg, Ill. 60172
- Advanced High Voltage Co., Inc.**, 14532 Arminta St., Van Nuys, Calif. 91402
- AEL Communications Corp.**, Box 507, Lansdale, Pa. 19446
- AEL, Inc.**, Box 552, Lansdale, Pa. 19446
- A. F. Associates, Inc.**, 415 Stevens Ave., Ridgewood, N. J. 07450
Arnold P. Ferolito - (201) 447-0096
- Agfa-Gevaert Inc.**, 275 N. Street, Teterboro, N.J. 07608
- Ailtech**, 19535 E. Walnut Dr., City of Industry, Calif. 91748
- Air Space Devices Inc.**, Box 197, Paramount, Calif. 90723
- Aitken Communications Inc.**, 701 S. Tenth St., Taft, Cal. 93268
- Akai America, Ltd.**, 2139 East Del Amo Blvd., Compton, Calif. 90220
- Alco Electronic Products, Inc.**, 1551 Osgood St., North Andover, Mass. 01845
Thomas J. Clark - (617) 685-4371
- Alford Mfg. Co.**, 120 Cross St., Winchester, Mass. 01890
- Allen Avionics Inc.**, 255 E. 2nd St., Mineola, N.Y. 11501
- Allied Broadcast Equip.**, 124 S. 6th St., Richmond, Ind. 47374
Jim Jones - (317) 962-8596
- Allied Tower Company, Inc.**, Box 331, South Houston, Tex. 77587
- Alpha Electronic Services Inc.**, 8431 Monroe Ave., Stanton, Cal. 90680
Miss Cherie McNeil, Mkt. Mgr. - (714) 821-4400
- Alpha Wire Corp.**, 711 Lidgerwood Ave., Elizabeth, N.J. 07207
- Altec Sound Products**, 1515 S. Manchester, Anaheim, Calif. 92803
- Aito Communications Inc.**, 6362 Hollywood Blvd., Hollywood, Calif. 90028
- Aluminum Hard Goods, Inc.**, Circle Ave. & Harrison St., Forest Park, Ill. 60130
- Amber Electro Design, Ltd.**, 1064 Chemin du Golf, Montreal, Canada H3E 1H4
- AMCO Engineering Co.**, 7333 W. Ainslie St., Chicago, Ill. 60656
- Ameco Inc.**, Box 13741, Phoenix, Ariz. 85002
- American Data Corp.**, Box 5228, Huntsville, Ala. 35805
H. Bjorklund - (205) 837-5180
- REGIONAL SALES OFFICES**
Dwight Wilcox, 5504 Waterway, Rockville, Md. 20853, (301) 460-1454
Bob Munzner, 21 W. 127 Tee Lane, Itasca, Illinois 60143, (312) 773-3180.
Bill Wiseman, 3250 Wilshire Blvd., Suite 900, Los Angeles, California 90010, (213) 387-7756.
Joe Ryan, 1729 Wilmont Drive, Atlanta, Georgia 30329, (404) 633-2100.
Maurice DuPont, 11636 P.M. Favier, Montreal Nord H1G3Y2, (514) 322-4564.
Russ Trevillian, 2908 Mulberry, Pasadena, Texas 77502, (713) 941-7272.
- American Electronics, Inc.**, Box 903-904, Saint George, S. C. 29477
- American-Standard**, Box 76, Dearborn, Mich. 48121
- American Switch Corp.**, 134 Water St., Wakefield, Mass. 01880
- AMF Electrical Products**, 1025 N. Royal St., Alexandria, Va. 22314
- AMP Special Industries**, Valley Forge, Pa. 19482
- Amperex Electronic Corp., Electro-Optical Devices Div.**, Box 278, Slatersville, R. I. 02876
Raleigh E. Utterback, (401) 762-3800.
- REGIONAL SALES OFFICES**
Robert L. Manahan, 3760 Cahuenga Blvd., N. Hollywood, Ca. 91604, (213) 762-2118.
Ralph E. Johnson, 175 Scott St., Elk Grove Village, Ill. 60007, (312) 593-8220.
Robert A. Raboin, Providence Pike, Slatersville, R.I. 02876, (401) 762-3800.
- Amperex Electronic Corp.**, 230 Duffy Ave., Hicksville, N. Y. 11802
- Ampex Corp.**, 401 Broadway, Redwood City, Cal. 94063
- Amphenol RF Div.**, 33 E. Franklin St., Danbury, Conn. 06810
- Ampro Corp.**, 850 Pennsylvania Blvd., Feasterville, 19047 19090
Harry N. Larkin, (215) 322-5100.
- Amtron Corp.**, Box 21043, San Jose, Calif. 95151
- Andrew Corp.**, 10500 W. 153rd St., Orland Park, Ill. 60462
H. L. "Woody" Woodbury - (312) 349-3300
- Andrews Tower Inc.**, 1420 Layton Ave., Ft. Worth, Tex. 76117
- Angenieux Corp. of America**, Box 340, Ronkokoma, N.Y. 11779
Mr. Ken Rice, (516) 567-1800.
- REGIONAL SALES OFFICES**
Bob Jagemann, 13381 Beach Avenue, Venice, California 90291, (213) 821-5080.
- Anixter-Mark**, 5439 W. Fargo, Skokie, Ill. 60076
Edward N. Lamarre, (312) 675-1500.
- Antenna Products Co.**, Box 520, Mineral Wells, Tex. 76067
- Applied Electro Mechanics, Inc.**, 2350 Duke St., Alexandria, Va. 22314
- Applied Video Electronics, Inc.**, Box 25, Brunswick, Ohio 44212
- Aristocart Div.**, 1960-505 Burrard St., Vancouver, B. C., Canada V7X 1C4 (See "Western Broadcasting Co. Ltd., Aristocart Division")
- Arriflex Co. of America**, 25-20 Brooklyn-Queens Expwy. W., Woodside, N.Y. 11377
- Arvin Systems, Inc.**, 1771 Springfield St., Dayton, Ohio 45403
- Asaca Corp. of America**, 1289 Rand Rd., Des Plaines, Ill. 60016
T. Shigezaki, 1289 Rand Rd., Des Plaines, Ill. 60016, (312) 298-4380
C. Miller, P.O. Box 333, Londonderry, N.H. 03053, (603) 434-0731
- A-Tel-A-Matic**, 406 Jamestown Rd., Beverly, N.J. 08010
- Atlantic Research Corp.**, 5390 Cherokee Ave., Alexandria, Va. 22314
- Atlas Sound**, 10 Pomeroy Rd., Parsippany, N.J. 07054
- ATV Research**, 13th & Broadway, Dakota City, Neb. 68731
- Audico, Ltd.**, 7345 W. Wilson, Chicago, Ill. 60656
John Landsell, President - (312) 867-6881
- Audio Accessories Inc.**, 163 Water Street, Keene, N.H. 03431
- Audio Designs & Mfg.**, 16005 Sturgeon, Roseville, Mich. 48066
Murray Shields - (313) 778-8400
- Audio Distributor Inc.**, 2342 S. Division Ave., Grand Rapids, Mich. 49507
- Audio Magnetics Corp.**, 234 W. 146th St., Gardena, Calif. 90248
- Audio Services, Inc.**, 3140 E. Jefferson, Detroit, Mich. 48207
James A. Zinser - (313) 567-0555
- Audio-Video Engineering Co.**, 65 Nancy Blvd., Merrick, N. Y. 11566
R. Drucker - (516) 546-4239
- Auditronics, Inc.**, 207 Summit St., Memphis, Tenn. 38104
Bob Ward - (901) 276-6338
- REGIONAL SALES OFFICES**
Bill Hamilton, Philadelphia, Pa., (215) 328-9889
Bill Brock, Nashville, Tn. (615) 794-7529
- Auratone**, Box 580, Del Mar, Calif. 92014
- Autogram Corp.**, Box 456, Plano, Tex. 75074
- Automated Processes, Inc.**, 789 Park Ave., Huntington, N.Y. 11743
- Automation Products Co.**, Box 9882, Austin, Tex. 78766
- AVA Electronics Corp.**, 242 Pembroke Ave., Lansdowne, Pa. 19050
- Avtel**, 1280 Blue Hills Ave., Bloomfield, Conn. 06002
(continued)

John S. Larkworthy - (203) 242-4242

B

- Badger Meter, Inc.**, 150 E. Standard Ave., Richmond, Calif. 94804
- Ball Bros. Research Corp., Miratel Division**, 1633 Terrace Drive, St. Paul, Minn. 55113
- Barco U.S.**, 2525 Hyperion Ave., Los Angeles, Calif. 90027
- Bardwell & McAlister**, 7269 Santa Monica Blvd., Hollywood, Calif. 90046
- Belar Electronics Lab., Inc.**, Lancaster Ave. at Dorset, Devon, Pa. 19333
Jesse Maxenchs - (215) 687-5550
- Belden Corp.**, Box 1327, Richmond, Ind. 47374
- Bell & Howell, Audio Visual Div.**, 7100 McCormick Rd., Chicago, Ill. 60645
- Bell P/A Prod. Corp.**, 1200 N. Fifth St., Columbus, Ohio 43201
- Bellern Research Corp.**, 5069 Kings Hwy., Saugerties, N.Y. 12477
- Berkey-Colortran Inc.**, 1015 Chestnut St., Burbank, Cal. 91502
- Beston Electronics Inc.**, 9024 W. 51st Terr., Shawnee, Kansas 66203
- Bethany International**, 5750 Bintliff Suite 201, Houston, Tex. 77036
- Beyer (Revox Corporation)**, 155 Michael Dr., Syosset, N.Y. 11791
- B & I Electronics, Inc.**, Box 8813, Greenville, S. C. 29604
Don Tompkins - (803) 277-5985
- Biomation Corp.**, 10411 Bubb Rd., Cupertino, Calif. 94014
- Bird Electronic Corp.**, 30303 Aurora Rd., Cleveland, Ohio 44139
- Birmingham Tape Cartridge Co., Inc.**, Box 217, Pinson, Ala. 35126
- B & K Instruments Inc.**, 5111 W. 164th St., Cleveland, Ohio 44142
- Blonder-Tongue Labs.**, One Jake Brown Rd., Old Bridge, N.J. 08857
- Bogen Div.**, Box 500, Paramus, N. J. 07652
- Bogner Broadcast Equipment Corp.**, 156 Haven Ave., Port Washington, N. Y. 11050
Leonard H. King - (516) 561-9130
- Boonton Electronics**, Rt. 287 Smith Rd., Parsippany, N.J. 07054
- Boston Insulated Wire & Cable Co.**, 65 Bay St., Boston, Mass. 02125
- Boston Sound & Power Systems**, 3 Fredith Rd., Weymouth, Mass. 02189
Richard L. White - (617) 335-6406
- Brand-Rex Co.**, Box 498, Williamantic, Conn. 06226
- Bristol Div.**, 40 Bristol St., Waterbury, Conn. 06720
- Don Britton Enterprises**, Drawer G, Waikiki, Hawaii 96815

Broadcast Automation Assoc., 5199 N.E. 12th Ave., Oakland Park, Fla. 33308

Broadcast Electronics, 8810 Brookville Road, Silver Spring, Md. 20910
Tom Creighton - (301) 588-4983

Broadcast Equipment Leasing Corp., 3612 Blvd. of Allies, Pittsburgh, Pa. 15213

Broadcast Equipment & Supply Co., Box 3141, Bristol, Tenn. 37620
Cliff Droke - (615) 968-7342

Broadcast Video Systems, Ltd., 1050 McNicoll Ave., Unit 9, Agincourt, Ont., Canada M1W 2L8
Bert G. Verwey - (416) 497-1020

BSC Inc., 8600 W. Sunnyside Ave., Chicago, Ill. 60656

Buhl Optical Co., 1009 Beech Ave., Pittsburgh, Pa. 15233
Irv Stapsy - (412) 321-0076

Burwen Laboratories, 209 Middlesex Turnpike, Burlington, Mass. 01803

Beta Technology, Inc., 94 Verdi St., Farmingdale, N.Y. 11735

C

Cablewave Systems Inc., 60 Dodge Ave., North Haven, Conn. 06473

William P. Meola - (203) 239-3311
REGIONAL SALES OFFICES
Rufus Baldwin, 790 Lucerne Drive, Sunnyvale, Ca. 94086, (408) 735-8500

Califone International, Inc., 5922 Bowcroft St., Los Angeles, Calif. 90016

California Instruments Co., 5150 Convooy St., San Diego, Cal. 92111

Calvert Electronics Inc., 220 East 23rd St., New York, N. Y. 10010
Fred M. Samuel - (212) 679-1340

Cambridge Products Corp., 101 Foley St., Somerville, Mass. 02145

Camex Corp., 6362 Hollywood Blvd., Hollywood, Calif. 90028

Canon USA, Inc., Optics Div., 10 Nevada Dr., Lake Success, N. Y. 11040

Jack Keyes - (516) 488-6700
REGIONAL SALES OFFICES
Harry Hirai, 123 Paularino Avenue E., Costa Mesa, Ca. 92626, (714) 979-6000

T. Sakurai, 3245 American Drive, Mississauga, Ontario L4V 1B8, (416) 678-2730
Matt Miyazaki, 457 Fullerton Avenue, Elmhurst, Ill. 60126, (312) 833-3070

John Reed, Gebouw 70, (P.O. Box 7760), Schiphol Oost, Holland

Capitol Magnetic Products, 1750 North Vine St., Los Angeles, Calif. 90028

Larry Hockemeyer - (213) 462-6252
REGIONAL SALES OFFICES
Tony Sanchirico, 1370 Avenue of the Americas, New York, N.Y. 10019, (212) 757-7470
Richard Dunlavy, 6401 Gross Point Road, Niles, Illinois 60648, (312) 775-7101
Bud LaGrandeur, 3116 West Avenue 32, Los Angeles, California 90065, (213) 255-5103

Castle TV Tuner Service, Inc., 5710 N. Western Ave., Chicago, Ill. 60645

Catel, 1400 D Stierlin Rd., Mt. View, Calif 94043

CCA Electronics Corp., 716 Jersey Ave., Gloucester, N.J. 08030
Robert D. Sidwell - (609) 456-1716

C-COR Electronics, Inc., 60 Decibel Road, St. College, Pa. 16801

Ceco Communications Inc., 2115 Avenue X, Brooklyn, N.Y. 11235

Central Dynamics Corp., Box 116, Northvale, N.J. 07647
Robert G. Hueffed, Vice President - (201) 767-1300

REGIONAL SALES OFFICES
Dick DeBeradinis, 230 Livingston Street, Northvale, New Jersey 07647, (201) 767-1300
Bob Faulkner, 331 W. Northwest Highway, Palatine, Ill. 60067, (312) 991-4720
Paul Welcome, The Madison Bldg. - Suite 219, 15130 Ventura Boulevard, Sherman Oaks, Ca. 91403, (213) 789-0574

Cetec Audio Div., Subs. Computer Equipment Corp., 13035 Saticoy St., North Hollywood, Calif. 91605

Channellock, Inc., S. Main St., Meadville, Pa. 16335

Chiron Telesystems, 11 Grace Ave., Great Neck, N. Y. 11021

Joseph Scheuer, VP/Mktg.; David Bukler, Eastern Regional Sls. Mgr. (516) 829-5666

REGIONAL SALES OFFICES
David Siegel, 851 Burlway Rd., Burlingame, Calif. 94010, (415) 348-1144

Chrono-Log Corp., 2 W. Park Rd., Havertown, Pa. 19083

Chronotron Systems, Inc., 230 Mineola Blvd., Mineola, N.Y. 11501

Cine Sonic Sound Inc., Box 996, New York, N.Y. 10001

David Clark Co., Inc., 360 Franklin St., Worcester, Mass. 01604
Robert Murphy - (617) 756-6216

Clear-Com, 759 Harrison St., San Francisco, Calif. 94107

CMX Systems, 635 Vaqueros Ave., Sunnyvale, Calif. 94086

The CnB Studios, 3415 Beresford Ave., Belmont, Calif. 94002

Coastcom, 2346 Stanwell Drive, Concord, Calif. 94520
Cliff Hopper - (415) 825-7500

Coaxial Dynamics, 13110 Enterprise, Cleveland, Ohio 44135

Cohu, Inc., Box 623, San Diego, Cal. 92112

Collins Radio Group, Mail Station 406-240, Dallas, Tex. 75207

D. A. Senter, Mkt. Mgr. - (214) 690-5574

Colorado Video Inc., Box 928, Boulder, Colo. 80302

Glen Southworth, Pres. - (303) 444-3972

REGIONAL OFFICES
John Fitzgerald, 13844 Peyton Dr., Dallas, Texas 75240, (214) 233-5497
Darrell Bevan, 1562 Devonshire Ave., Westlake Village, Calif. 91361, (213) 889-3653

Comark Industries Inc., Box 196, Westfield, Mass. 01085

Ernest P. Hodur, (413) 568-1870

Commercial Electronics, Inc., 880 Maude Ave., Mountain View, Calif. 94040

Comm. Radio Monitoring, 103 S. Market, Lee's Summit, Mo. 64063

Comm/Scope Co., Box 2406, Hickory, N.C. 28601

Communication Medias, Box 54, Allentown, Pa. 18105
Bill Davies - (215) 437-0607

Communications Carriers, Inc., Box 642, Greenwich, Conn. 06830

Communications Systems, 3500 De Pauw Blvd., Suite 3000, Indianapolis, Ind. 46268

Communications Technology, Inc., 3070 Leeman Ferry Rd., Huntsville, Ala. 35801

Communications 2000, Inc., 6584 Interstate 85, Norcross, Ga. 30071

Compu/Net, Inc., 8616 La Tijera, Los Angeles, Calif. 90045

Computer Image Corp., 2475 W. 2nd Ave., Denver, Colo. 80223

Computer Magnetics Corp., 125 W. Providencia Ave., Burbank, Calif. 91502
Ignatius Tsu, Pres. - (213) 843-6674

Comquip, Inc., 366 S. Maple Ave., Glen Rock, N.J. 07452

John Schlageter - (201) 444-3800

Comrex Corp., 56 Union Ave., Sudbury, Mass. 01776

Lynn Distler - (617) 358-4042

Concept 70, Route 1 Box 51, Taos, N. M. 87571

Conrac Corp., Cramer Div., Mill Rock Road, Old Saybrook, Conn. 06475

Conrac Div., Conrac Corp., 600 North Rimsdale Ave., Covina, Calif. 91722

Consolidated Video Systems, 3300 Edward Ave., Santa Clara, Calif. 95050

Contel Mfg., 1620 W. 32nd Place, Hialeah, Fla. 33012

Continental Electronics Mfg. Co., Box 17040, Dallas, Tex. 75217

Vernon Collins - (214) 381-7161

Control Concepts Corp., 411 N. Stonestreet Ave., Rockville, Md. 20850

Control Design Corp., 205 S. Whiting St., Alexandria, Va. 22304

Eric Wright, Int'l. Sales Mgr. William J. Bridges - (703) 751-5650

Convergence Corp., 4400 Campus Dr., Newport Beach, Calif. 92660

Dennis Christensen, Pres.; Gary Beeson, VP - (714) 549-3146

Cook Electric Co., 6201 Oakton St., Morton Grove, Ill. 60053

Cooke Engineering Co., 900 Slaters Lane, Alexandria, Va. 22314

Jesse F. Lancaster Mkt. Mgr. (703) 548-3889

Cosmicar Optical Co., Ltd., 424 Higaishi Oizumi, Nerima-Ku, Tokyo, Japan 177

CPAC, Div. of CPAC, 2364 Leicester Rd., Leicester, N. Y. 14481

Cramer Video, 120 Hampton Ave., Needam, Mass. 02194

Bill Hall - (617) 449-2100

Crouse Hinds, Lighting Products Div., Box 131, Syracuse, N.Y. 13201

Crown International, Box 1000, Elkhart, Ind. 46514

Cunningham Corp., 10 Carriage St., Honeoye Falls, N.Y. 14472

Custom Craft Designs, 2135 Drexel St., West Hyattsville, Md. 20783

D

Dage-MTI, Inc., 4333 S. Ohio St., Michigan City, Ind. 46360

Dana Laboratories, Inc., 2401 Campus Drive, Irvine, Calif. 92664

Data Disc Inc., 686 W. Maude Ave., Sunnyvale, Cal. 94086

Thomas P. Quinn - (408) 732-7330
REGIONAL SALES OFFICES
Frank Iazzetta, 249 Saw Mill River Road, Elmstord, New York 10523, (914) 592-8658

Leonard D. Mayers, 9125 Telegraph Rd., Suite B, Detroit, Michigan 48239, (313) 535-2110

James Willoughby, 686 W. Maude Avenue, Sunnyvale, California 94086, (408) 732-7330
Martin Fitzgerald, 5 Barlow Lane, Suite 6A, Westwood, Massachusetts 02090, (617) 329-6373
Kurt Zimmerman, 21253 Chagall Road, Topanga, California 90290, (213) 883-8413

Datalogic-Rust Co., Box 273, Everett, Mass. 02149

Datametrics, 340 Fordham Road, Wilmington, Mass. 01887

Datatek Corp., 1200 W. Chestnut St., Union, N. J. 07083

Datron, Inc., Box 11427, Santa Ana, Cal. 92707

Robert J. Ricci - (714) 540-9330

Datavision Video Products, 15932 Shady Grove Rd., Gaithersburg, Md. 20760

Davis Mfg. Co., 1500 S. McLean Blvd., Wichita, Kans. 67213

Davis & Sanford Co. Inc., 24 Pleasant St., New Rochelle, N.Y. 10802

dbx, Inc., 296 Newton St., Waltham, Mass. 02154

Decca Austin Insulators, 71 Selby Road, Brampton Ont., Canada L6W 1K5

Delta Electronics Inc. (N.C.), 145 Fayette St., Winston Salem, N.C. 27101

Delta Electronics Inc. (Va.), Box 1508, Springfield, Va. 22151

Joseph Novack - (703) 321-9845

Delta Products, Inc., Box 1147, Grand Junction, Colo. 81501

Denson Electronic Corp., Box 85, Rockville, Conn. 06066

Diebold Inc., 818 Mulberry Rd. SE, Canton, Ohio 44711

Dielectric Communications, Route 121, Raymond, Me. 04071

Ditch Witch, P.O. Box 66, Perry, Okla. 73077

Dwaine Doldsberry - (405) 336-4404

Dolby Laboratories, Inc., 1133 Ave. of the Americas, New York, N.Y. 10036

Morley Kahn - (212) 489-6652

Dorado Systems, 20956 Corsair Blvd., Hayward, Calif. 94545

Dranetz Engineering Labs., Inc., 2385 S. Clinton Ave., South Plainfield, N. J. 07080

D and S Corley Ltd., 80 Galaxy Blvd., Rexdale, Ont., Canada

David Corley - (416) 678-0511

Duncan Electronics, Inc., 2865 Fairview Road, Costa Mesa, Calif. 92626

Victor Duncan Inc., (See listing under "V")

Dunlap-Clarke Electronics, 230 Calvary St., Waltham, Mass. 02154

Duotone Co. Inc., Box 1168, South Miami, Fla. 33134

Dyma Engineering, Inc., Route 1 Box 51, Taos, N. M. 87571
Carroll Cunningham - (505) 758-2686
REGIONAL SALES OFFICES
W. Cunningham, 505½ Centinela, Inglewood, Calif. 90302, (213) 674-2806

Dynair Electronics, Inc., 6360 Federal Blvd., San Diego, Cal. 92114
Robert A. Jacobs - (714) 582-9211
REGIONAL SALES OFFICES
Doug Buterbaugh, 6360 Federal Blvd., San Diego, Ca. 92114

Dynasciences Corp., 1801 W. Belle Plaine Ave., Chicago, Ill. 60613

Dynasciences Video Products, Township Line Road, Blue Bell, Pa. 19422

E

Eastman Kodak Co., 343 State St., Rochester, N.Y. 14650

Echo Science Corp., 485 E. Middlefield Rd., Mountain View, Calif. 94043

Econco Broadcast Service Inc., Rt. 2 Box 188, Woodland, Calif. 95695

Ecor Div. of P.A.C., 3030 Red Hill Ave., Costa Mesa, Calif. 92626

Edison Electronics Div., Grenier Field, Manchester, N.H. 03103

Editel Communications, 5610 Bois Franc, Montreal, Que., Canada H4S 1A9

Edutron, Inc., 3700-B2 N.E. 53rd Ave., Gainesville, Fla. 32601

Edwards Co., Inc., 90 Connecticut Ave., Norwalk, Conn. 06856

EECO, 1441 E. Chestnut Ave., Santa Ana, Calif. 92701
George R. Swetland - (714) 835-6000

Eico Elect. Inst. Co., Inc., 283 Malta Street, Brooklyn, N.Y. 11207

Eidson Electronic Co., Box 96, Temple, Tex. 76501

EIMAC, Div. of Varian, 301 Industrial Way, San Carlos, Cal. 94070

EIMAC, Div. Varian, (see "Varian Assoc.")

EIP, Inc., 3230 Scott Blvd., Santa Clara, Calif. 95051

Electrohome Ltd., 809 Wellington St. N., Kitchener, Ont., Canada N2G 4J6
Bruce Ellis - (519) 744-7111

Electro Impulse, Inc., Box 870, Red Bank, N.J. 07701
Mark Rubin - (201) 741-0404

Electromagnetic Sciences, Inc., Box 80508, Atlanta, Ga. 30341

Electromagnetic Specialties, 2417 Spring Hill Dr., Dallas, Tex. 75228

Electronic Designers Inc., 84 Newtown Plaza, Plainview, N.Y. 11803

Electronic Devices, Inc., 21 Gray Oaks Ave., Yonkers, N.Y. 10710

Electronic Inst. & Spec., 42 Pleasant St., Stoneham, Mass. 02180

Electro Sound, Inc., 725 Kifer Rd., Sunnyvale, Calif. 94086

Electro-Voice Inc., 639 Cecil St., Buchanan, Mich. 49107
Marc Johnson, V.P. Mkt. - (616) 695-6831

ELPA Marketing Industries, Inc., New Hyde Park, N. Y. 11040

EMCEE Broadcast Products, P.O. Box 116, White Haven, Pa. 18661

EMCOR Ingersoll Products, 1000 W. 120th St., Chicago, Ill. 60643

Emerson Electric/Artolier, Quaker Mtg. House Rd., Honeoye Falls, N.Y. 14472

EMT Franz VGmbH, Box 1520, D-763 Lahr, W. Germany

Enclosure Corp., 4529 Adams Circle, Cornwell Heights, Pa. 19020

Engineering Associates, R. R. 2, Arcanum, Ohio 45304

English Electric Valve North America Ltd., 1 American Drive, Cheektowaga, N.Y. 14225
Richard Betts - (716) 632-5871
Canadian Office: 67 Westmore Drive, Unit #1, Rexdale, Ont., Canada - George Morron - (416) 745-9494
REGIONAL SALES OFFICES
Donald E. Rose, 14001 40th Place N.E., Seattle, Washington 98155, (206) 363-2200
Daniel T. Green, 3 Buckingham Road, Natick, Massachusetts 07610, (617) 653-8300
Kevin A. Joyce, 1207 E. Wayne South, South Bend, Indiana 46615 (219) 232-2101

Enterprise Electronics Corp., Box 1216, Enterprise, Ala. 36330

Envirco, Box 6468, Albuquerque, N. M. 87107

Equipto, 225 S. Highland, Aurora, Ill. 60507

ESC Electronics Corp., 534 Bergen Blvd., Palisades Park, N. J. 07650

ESE, 505 1/2 Centinela, Inglewood, Calif. 90302
Bob Mayers, Pres. - (213) 674-3021

Essex International Inc., 6235 S. Harlem Ave., Chicago, Ill. 60638

Eventide Clock Works Inc., 265 West 54th St., New York, N. Y. 10019

E-Z Way Products, Inc., Box 22845, Tampa, Fla. 33622

F

Farinon Electric, 1691 Bayport Ave., San Carlos, Calif. 94070
Kenneth A. O'Neil - (415) 592-4120
REGIONAL SALES OFFICES
Richard O. Schlack, P.O. Box 148, Somerville, New Jersey 08876, (201) 526-2669
Arthur J. Joseph, 710 No. Post Oak Rd., Suite 222, Houston, Texas 77024, (713) 688-5569/5560
John H. Eastman, P.O. Box 125, Fair Play, South Carolina 29643, (803) 882-6391

Farinon Electric of Canada, Ltd., 657 Orly Ave., Dorval, Que., Canada H9P 1G1

Fernesh Group, Robert Bosch Corp., 279 Midland Ave., Saddle Brook, N.J. 07662

Fidelipac, 109 Gaither Dr., Mt. Laurel, N.J. 08057
Gene Bidun - (609) 235-3511

Filmline Corp., 43 Erna Street, Milford, Conn. 06460

The Finney Co., 34 W. Interstate St., Bedford, Ohio 44146

Imero Fiorentino Associates, Inc., 10 West 66th St., New York, N. Y. 10023

Fisher Berkeley Corp., 5800 Christie Ave., Emeryville, Cal. 94608

Fisher-Burke Broadcast Consultants, Box 2468, Phoenix, Ariz. 85003
David J. Fisher - (602) 257-0225

Flash Technology Corp. of America, 111 Lock St., Nashua, N. H. 03060
Donald Rowe - (603) 883-0521

John Fluke Mfg. Co., Inc., Box 43210, Mountlake Terrace, Wash. 98043

Fort Worth Tower Co., Inc., Box 8597, Ft. Worth, Tex. 76112
T. W. Moore, Betty Moore, Fred Moore - (817) 457-3060 - (214) 264-2822

Freeland Products Co., 3233 Conti St., New Orleans, La. 70119
William T. Freeland - (504) 822-9223

Frezzolini Electronics, Inc., 7 Valley St., Hawthorne, N. J. 07506
James Crawford - (201) 427-1160

Frontier Engineering Corp., Box 265, Florham Park, N.J. 07932

Fuji Photo Film USA, Inc., Magnetic Products Dept., 350 5th Ave., New York, N. Y. 10001

Fujinon Optical, Inc., 420 West End Ave., New York, N.Y. 10024

Fung Engineering Inc., 551 Taylor Way, Belmont, Calif. 94002

G

GAF Corp., 140 W. 51 Street, New York, N.Y. 10020

Garner Electronics, 4200 No. 48th St., Lincoln, Nebr. 68504

Garron Electronics, Inc., 1216 Kifer Rd., Sunnyvale, Calif. 94086
Ron Eigenmann - (408) 736-8737

Gately Electronics, 57 W. Hillcrest Ave., Haverstown, Pa. 19083

GBC Closed Circuit TV Corp., 74 Fifth Ave., New York, N.Y. 10011

G.C. Electronics, 400 S. Wyman St., Rockford, Ill. 61101

GEC-Marconi Electronics Ltd., Marconi House, Chemsford, Essex, England CM1 1PL

General Cable Corp., 500 West Putnam Ave., Greenwich, Conn. 06830

General Devices Co., Inc., Box 19188, Indianapolis, Ind. 46219

General Electric Co., ISO Div., EP # 7, Rm. 301, Syracuse, N. Y. 13201

General Electric Co., Mobile Radio Dept., Box 4197, Lynchburg, Va. 24502

General Electric Co., Tubes/MW Devices, 316 E. Ninth St., Owensboro, Ky. 42301

Gen. Electrodynamics, 4430 Forest Lane, Garland, Tex. 75040

General Microwave Corp., 155 Marine St., Farmingdale, N.Y. 11735

General Television Ntwk., 520 W. Eight Mile Rd., Ferndale, Mich. 48220

General Time Service, Box 4067, Mesa, Ariz. 85201

Glenburn Corp., 4 North St., Waldwick, N.J. 07463

Glentronix, Ltd., 160 Duncan Mills Rd., Don Mills, Ont., Canada M3B 1O5

Gotham Audio Corp., 741 Washington St., New York, N.Y. 10014

Gould Inc., 3631 Perkins Ave., Cleveland, Ohio 44114

Gralex Industries, 155 Marine St., Farmingdale, N. Y. 11735

Grass Valley Group, Inc., P.O. Box 1114, Grass Valley, Cal. 95945
Robert E. Lynch - (916) 273-8421
REGIONAL SALES OFFICES
Tom Sleeman, 1644 Tullie Circle, NE, Suite 102, Atlanta, Georgia 30329, (404) 634-0521
Gordon Sweeley, 4419 Van Nuys Boulevard, Suite 307, Sherman Oaks, Ca. 91403, (213) 990-6172
Louis Swift, 810 West Bristol Street, Suite E, Elkhart, Indiana 46514, (219) 264-0931
Robert Webb, Station Plaza East, Great Neck, New York 11021, (516) 487-1311
Bill Buford, P.O. Box 482, Mabank, Texas 75147 (214) 887-1181

Grinnan Fixture Co., 16041 Georgetown St. N.E., Minerva, Ohio 44657
John F. Grinnan - (216) 862-2323

GTE Lenkurt, Inc., 1105 County Road, San Carlos, Calif. 94070

GTE Sylvania Inc., Lighting Products Group, 100 Endicott St., Danvers, Mass. 01923

H

Clifford B. Hannay & Son, Inc., 402 Main St., Westerlo, N.Y. 12193
George Hannay - (518) 797-3791

Harris Corp., Broadcast Products Div., 123 Hampshire Street, Quincy, Ill. 62301
J. M. Engle, Jr. - (217) 222-8200
REGIONAL SALES OFFICES - RADIO
Neil Arveschoug, P.O. Box W, Oak Harbor, Washington 98277, (206) 675-1574
Robert Gorjance, 3320 Ivy Lane, Racine, Wisconsin 53402, (414) 639-7689
Galen L. Hassinger, 1479 19th Avenue, Waverly, Nebraska 68462, (402) 786-2431
London England, 4019 Richmond Avenue, Houston, Texas 77027, (713) 623-6655
Robert Hallenbeck, 11 Ridgecrest, Latham, New York 12110, (518) 785-9144
Ed Huber, Route 3, Rinehart Rd., Bellville, Ohio 44813, (419) 886-4444
Ed Karl, 120 E. 34th Street, New York, New York 10016, (212) 889-0793
E. R. (Red) Lowder, 7209 Stonehaven Drive, Columbia, S.C. 29209, (803) 776-2059
Curt Lutz, P.O. Box 45107, Tulsa, Okla. 74145, (918) 251-8808
James Miller, 413 20th Court N.E., Birmingham, Alabama 35215, (205) 853-9443
David Orienti, 56 S. Crestview Drive, R.R. 5, Box 240D, Adrian, Michigan 49221, (517) 423-4560
Charles B. Patterson, P.O. Box 1173, Maryland Heights, Mo. 63043, (314) 434-7727
Ivey Raulerson, P.O. Box 958, McClenny, Florida 32063, (904) 259-6475
Dan Roberts, 10521 Malvasia Way, Rancho Cordova, California 95670, (916) 363-8264
Dick Sawicki, 701 G Greenhaven Drive, Greensboro, N.C. 27406, (919) 855-1146
Robert Switzer, 1945 Figueroa, Los Angeles, California 90007, (213) 747-7129 (continued)

Paul Timpe, 730 Federal Bldg.,
1522 K St., N.W., Washington,
D.C. 20005, (202) 223-5508

REGIONAL OFFICES TV

Vern Killion, 4019 Richmond Ave-
nue, Houston, Texas 77027, (713)
623-6655

Bill Culbertson, P.O. Box 2927,
Rocky River, Ohio 44116, (216)
333-6890

George I. Hardy, 1745 Tully Circle,
N.E., Atlanta, Georgia 30329, (404)
636-0906

Tom O'Hara, 1945 S. Figueroa,
Los Angeles, California 90007,
(213) 747-7129

Lew Page, 730 Federal Bldg., 1522
K St., N.W., Washington, D.C.
20005, (202) 223-5508

Vern Russell, 1810 North Ridge
Avenue, Arlington Heights, Ill.
60004, (312) 255-9230

Dave Spindle, 130 E. 34th Street,
New York, New York 10016, (212)
889-0790

Hartley Prod. Corp., 56 N. Summit St.,
Tenafly, N.J. 07670

Harvey Radio, 23 W. 45th St., New
York, N.Y. 10036

Harwood Mfg. Co., 1800 W. Fullerton,
Chicago, Ill. 60614

Head Sound, Inc., 722 Brooks St., Ann
Arbor, Mich. 48103

Heath Co., Benton Harbor, Mich.
49022

Heintz and Kaufman Ltd., 3650 Hay-
den Ave., Culver City, Cal. 90230

Hewlett Packard Co., 1501 Page Mill
Rd., Palo Alto, Calif. 94304

Hickok Elect. Instrument, 10514 Du-
pont Ave., Cleveland, Ohio 44108

Hitachi Shibaden Corp. of America,
58-25 Brooklyn Queens Exp.,
Woodside, N.Y. 11377

Holland Electronics, 970 E. 92nd St.,
Brooklyn, N. Y. 11236

**Hollingsworth Solderless Terminal
Co.**, Nutt & French Creek Rds.,
Phoenixville, Pa. 19460

Dave Hovey, General Contractor, Rt. 1,
Box 113, Coffeeville, Miss. 38922

Dave Hovey - (601) 675-2956

Hughey & Phillips Inc., 3050 N. Cali-
fornia St., Burbank, Cal. 91505

C. E. Stephens - (213) 849-1104

Philip A. Hunt Chemical Corp., Roose-
velt Place, Palisades Park, N.J.
07650

I

IGM, Box 943, Bellingham, Wash.
98225

Steve Grayson - (206) 733-4567

Ikegami Electronics (USA) Inc.,
29-19 39th Ave., Long Island City,
N.Y. 11101

Image Devices Inc., Box 680730,
Miami, Fla. 33138

Individualized Instruction Inc., 1901
Walnut, Oklahoma City, Okla.
73105

Industrial Electric Reel, Inc., 1125
Jackson St., Omaha, Neb. 68102

Industrial Sciences, Inc., Box 296, Cor-
nelia, Ga. 30531

Innovative Television Equipment, Inc.,
P.O. Box 681, Woodland Hills, Cal.
91364

Inovonics, 1630 Dell Ave., Campbell,
Calif. 95008

Jim Wood - (408) 374-8300

Instrument Laboratories, 315 W. Wal-
ton Place, Chicago, Ill. 60610

International Electro-Magnetics, Box
7, Palatine, Ill. 60067

Tony Pretto - (312) 358-4622

International Instrument Div., 88
Marsh Hill Rd., Orange, Conn.
06477

Interntl. Nuclear Corp., 608 Norris
Ave., Nashville, Tenn. 37204

International Tapetronics Corp., Box
241, Bloomington, Ill. 61701

Fred Harkness - (309) 828-1381

International Video Corp., 990 Al-
manor Ave., Sunnyvale, Cal. 94086

Intertec Publishing Corp., 1014
Wyandotte Street, Kansas City, Mo.
64105

Irish Magnetic Recording Tape,
270-78 Newtown Road, Plainview,
N. Y. 11803

ITT Electron Tube Div., Box 100, Eas-
ton, Pa. 18042

ITT Jennings, 970 McLaughlin Ave.,
San Jose, Cal. 95116

J. D. Ivey Corp., Box 2751, Orlando,
Fla. 32802

J

Jamieson Film Co., 6911 Forest Park
Rd., Dallas, Texas 75235

Jack Cobb - (214) 350-1283

REGIONAL SALES OFFICES

Bob O'Neill, 6575 Rutger Rd.,
East Syracuse, N.Y. 13057, (315)
437-8792

Art Blose, 254 N. Arlington Ave.,
Harrisburg, Pa. 17109, (717) 652-
6371

Harvey Hooper, P.O. Box 2099,
Wichita, Kansas 67201, (316) 263-
1111

Jack Hannah, P.O. Box 2099,
Wichita, Kansas 67201, (316) 263-
1111

Tom Meade, P.O. Box 2099,
Wichita, Kansas 67201, (316) 263-
1111

George Lopez, P.O. Box 2099,
Wichita, Kansas 67201, (316) 263-
1111

Jampro Antenna Co., 6939 Power Inn
Road, Sacramento, Cal. 95828

Ross Shelton - (916) 383-1177

Janson Industries, Box 8110, Canton,
Ohio 44711

Javelin, 6357 Arizona Circle, Los An-
geles, Calif. 90045

Jensen Sound Laboratories, 4310
Trans World Road, Schiller Park, Ill.
60146

Jensen Tools & Alloys, 4117 N. 44th
St., Phoenix, Ariz. 85018

Joa Cartridge Service, Box 7112,
Philadelphia, Pa. 19117

Alma Moskat, Pres. - (215) 886-
7993

Jones Int'l. Ltd., 880 Continental Bank
Bldg., Englewood, Colo. 80110

JSH Electronics, Inc., Box 2898,
Culver City, Calif. 90230

JVC Industries, Inc., 50-36 56th Rd.,
Maspeth, N.Y. 11378

K

K & H Products, Ltd., Box 246, North
Bennington, Vt. 05257

Myles Kuwahara - (802) 442-9118

Kahn Communications, Inc., Box 72,
Freeport, N.Y. 11520

Kaitronics Corp., 870 Mahler Rd., Bur-
lingame, Calif. 94010

Kalart Victor Corp., Hultenius St.,
Plainville, Conn. 06062

Kansas State Network, Inc., Box 333,
Wichita, Kans. 67201

Larry Proffitt - (316) 265-5631

Kappa Networks, Inc., 165 Roosevelt
Ave., Carteret, N.J. 07008

Karex, Inc., 1262 Lawrence Station
Rd., Sunnyvale, Calif. 94086

Kay Elemetrics Corp., 12 BE Maple
Ave., Pine Brook, N.J. 07058

Kings Electronics Co., Inc., 40 Marble-
head Rd., Tuckahoe, N.Y. 10707

Kliegl Bros. Lighting, 32-32 48th
Ave., Long Island City, N.Y. 11101

Kline Iron & Steel Co., Box 1013, Co-
lumbia, S.C. 29202

Koss Corp., 4129 N. Port Washington
Ave., Milwaukee, Wis. 53212

L

Lampkin Lab. Inc., Box 9048, Braden-
ton, Fla. 33506

Lang Electronics Inc., 14 E. 39th St.,
New York, N.Y. 10016

James B. Lansing Sound, Inc., 3249
Casitas Ave., Los Angeles, Calif.
90039

D. N. Latus & Co., Inc., Box 1720,
Helena, Mont. 59601

Lauderdale Electronic Labs, 16 S.W.
13th St., Fort Lauderdale, Fla.
33315

Leader Instruments Corp., 151 Du-
Pont St., Plainview, N.Y. 11803

Lectrotech Inc., 5810 N. Western
Ave., Chicago, Ill. 60659

Lenco Inc., 319 W. Main St., Jackson,
Mo. 63755

Richard N. Lawrence - (314) 243-
3147

Lenz Optics Corp., 210 Brant Rd.,
Lake Park, Fla. 33403

C. M. Levit Electronics, 200 Park Ave.
S., New York, N.Y. 10003

Michel Levit - (212) 777-5517

Lexicon, Inc., 60 Turner St., Waltham,
Mass. 02154

Liberty Industries, 598 Deming Rd.,
Berlin, Conn. 06037

Lightning Elimination Assoc., Inc.,
9102 Firestone Blvd., Downey, Calif.
90241

Lipps Inc., 1630 Euclid St., Santa
Monica, Cal. 90404

Lipsner-Smith Corp., 6735 N. Honore
St., Chicago, Ill. 60626

Listec TV Equip. Corp., 35 Cain Dr.,
Plainview, N.Y. 11803

Logitek Electronic Systems, Box
25304, Houston, Texas 77005

The London Co., 811 Sharon Drive,
Cleveland, Ohio 44145

Dr. Steven A. Firstenberg - (216)
871-8900

REGIONAL SALES OFFICES

Ron Evenson, 424-A A Avenue,
Lake Oswego, Oregon 97034, (503)
635-2818

Mark Daly, 2313 A McKelvey Rd.,
Maryland Hts., Missouri 63043,
(314) 878-8953

Ed Pitcher, 11811 Moonmist,
Houston, Texas 77072, (713) 521-
0125

Ed Pitcher, 2750 Northaven, Ste.
108, Dallas, Texas 75229, (214)
241-1960 or 241-1961

Don Moulton, Reg. Mgr., 9415
Doral Court, Apt. 10, Louisville,
Ky. 40220, (502) 491-2255

Ed Pitcher, 11445 Bard Ave. Apt.
208N, Baton Rouge, Louisiana
70815, (504) 343-2497

Jim McKenna, 10568 Kingston,
Huntington Woods, Michigan
48070 (313) 544-0636

Mark Daly, 4049 Pennsylvania
Ave. Ste. 308, Kansas City, Mis-
souri 64111, (816) 753-1900

Tom Miller, 8370 Capwell, Oak-
land, Calif. 94621, (415) 562-3833

Tom Miller, 309 North Victory,
Burbank, Calif. 91502, (213) 841-
0430

LPB Inc., 520 Lincoln Hwy., Frazer, Pa.
19355

Richard H. Crompton - (215) 644-
1123

REGIONAL SALES OFFICES

William F. Jamison, P.O. Box
9005, Baltimore, Md. 21222, (301)
284-8730

Richard W. Burden, Suite 216,
20944 Sherman Way, Canoga Park,
California 91303, (213) 340-4590

L R C Electronics, 901 South Ave.,
Horseheads, N.Y. 14845

L-W International, 6416 Variel Ave.,
Woodland Hills, Calif. 91364

M

Machlett Laboratories, 1063 Hope St.,
Stamford, Conn. 06907

MacKenzie Laboratories, Inc., 5507
N. Peck Road, Arcadia, Calif. 91006

Magnasync/Moviola Corp., 5539 Riv-
erton Ave., North Hollywood, Calif.
91601

Magna-Tech Electronic Co., Inc., 630
Ninth Ave., New York, N.Y. 10036

Magnecraft Electric Co., 5575 N.
Lynch Ave., Chicago, Ill. 60630

Magnusonic Devices Inc., 290 Duffy
Ave., Hicksville, N.Y. 11801

P. R. Mallory & Co. Inc., Box 1284,
Indianapolis, Ind. 46201

Marco Video Systems, Inc., 6114
North 20th St., Philadelphia, Pa.
19138

Marconi Electronics Inc., 100 Stone-
hurst Ct., Northvale, N. J. 07647

Marconi Instruments, 100 Stonehurst
Ct., Northvale, N. J. 07647

Tony Ramsden - (201) 767-7250

Marti Electronics, Box 661, Cleburne,
Tex. 76031

Robert E. Richards - (817) 645-
9163

Martin Audio/Video, 320 W. 46th St.,
New York, N.Y. 10036

Larry Grossberg, VP - (212) 541-
5900

Mastertone Co., Inc., 1105 Maple,
West Des Moines, Iowa 50265

Maury Microwave Corp., 8610 Helms
Ave., Cucamonga, Calif. 91730

Maxell Corp. of America, 130 West
Commercial Ave., Moonachie, N. J.
07074

Maze Corp, Box 6636, Birmingham,
Ala. 35210

McBee Laboratories, 5151 Wisconsin
Ave. NW, Washington, D. C. 20016

McCurdy Radio Ind. Inc., 1051 Clinton
St., Buffalo, N.Y. 14206

Ron Mitchell - (716) 854-6700

REGIONAL SALES OFFICES

Cliff Rogers, P.O. Box 86, Saddle
River, N.J. 07458, (201) 327-0750

MCG Electronics Inc., 279 Skidmore Rd., Deer Park, N.Y. 11729

McMartin Industries, Inc., 4500 South 76th St., Omaha, Neb. 68127
Jim Lucy - (402) 331-2000

Memorex Corp., Audio-Video Group, 1200 Memorex Drive, Santa Clara, Cal. 95052

Micrim Audio Products, Inc., 9990 Monroe Dr., Suite 222, Dallas, Texas 75220

J. R. Saul - (214) 352-3811
REGIONAL SALES OFFICES
David Hawkins, 27-31 Bryanston Street, London W1H 7AB England, 935-0141
K. Nakano, 1-47 Sasazuka, Shibuya-Ku, Tokyo, Japan, 460-6052
E. C. Sloss, P.O. Box 165, North Sydney 2060 Australia, 406-4627

Micro Communications, Inc., RFD 3, Grenier Field, Manchester, N.H. 03103

T. J. Vaughan - (603) 624-4351

Microtime, Inc., 1280 Blue Hills Ave., Bloomfield, Conn. 06002

John Larkworthy, VP-mktg.; Dave Acker, VP-Eng.; Neal Owens, Mgr., Adv./Promotion; Richard H. McLean, National Sales Mgr. - (203) 242-4242

REGIONAL SALES OFFICES:
DeWitt C. Smith III, Philadelphia Pa., (215) 355-6642
D. J. Solie, Los Angeles, Ca., (213) 884-6269
For Southeast: Neal Owens, (203) 242-4242
For Midwest & Canada: Richard H. McLean, (203) 242-4242

Micro-Trak Corp., 620 Race St., Holyoke, Mass. 01040

William Stacy - (413) 536-3551

Microwave Assoc. Inc., South Ave., NW Industrial Prk., Burlington, Mass. 01803

Miles Reproducer Co., 598 Broadway, New York, N.Y. 10012

Miller-Stephenson Chemical Co., Inc., Box 628, Danbury, Conn. 06810

Mincom Div., 3M Co., 300 South Lewis Rd., Camarillo, Cal. 93010

Minneapolis Magnetics, Inc., 8125 Pleasant Ave. S., Minneapolis, Minn. 55420

Frank Zeman - (612) 884-7393

Modtek, 8810 Brookville Rd., Silver Spring, Md. 20910

Modular Audio Products, 1385 Lakeland Ave., Bohemia, N. Y. 11716

Rick Belmont - (516) 567-9620

Mole Richardson Co., 937 N. Sycamore Ave., Hollywood, Cal. 90038

Monroe Electronics, Inc., 100 Housel Ave., Lindenville, N.Y. 14098

Ken O'Brien (VP Sales) - (716) 765-2254

Moseley Assoc. Inc., 111 Castilian Drive, Goleta, Cal. 93017

John E. Leonard Jr. - (805) 968-9621

Motorola Semiconduct, 5005 E. McDowell Rd., Phoenix, Ariz. 85008

Mountain West Alarm, 4215 North 16th St., Phoenix, Ariz. 85016

Multimetrix Industries, 120-30 Jamaica Ave., Richmond Hill, N.Y. 11418

Multronics, Inc., 12307 Washington Ave., Rockville, Md. 20852

N

Nagra Magnetic Recorders, Inc., 19 W. 44th St., Room 715, New York, N.Y. 10036

Nagy Research Products, Box 289, McLean, Va. 22101

Narda Microwave Corp., 75 Commercial St., Plainview, N.Y. 11803

Nasco Television Systems, 947 Janesville Ave., Fort Atkinson, Wis. 53538

National Electrolab Ltd., Box 68, Blaine, Wash. 98230

Nemo Recording Labs, Box 505 Times Sq. Sta., New York, N.Y. 10036

Neumade Prod. Corp., 720 White Plains Rd., Scarsdale, N.Y. 10583

P. K. Neuses Inc., 1401 Rohlwing Rd., Rolling Meadow, Ill. 60008

Rupert Neve, Inc., Berkshire Industrial Park, Bethel, Conn. 06801

R. D. Titcomb - (203) 744-6230

REGIONAL SALES OFFICES

Tore B. Nordahl, 2717-9 Rena Road, Malton, Ontario, (416) 677-6611

Gary R. Carruthers, Suite 614, 1800 N. Highland Ave., Hollywood, Ca. 90028, (213) 465-4822

Nippon Electric Co., Ltd., P. O. Box 1, Takanawa, Tokyo, Japan

North American Radio Corp., 3814 Marquis Dr., Suite 111, Garland, Tex. 75042

Northlake Engineering, Inc., 999 Anita Ave., Antioch, Ill. 60002

Norton Assoc. Inc., 10 Ditomas Court, Copaugue, N.Y. 11726

Nortronics Co., Inc., 8101 Tenth Ave. N., Minneapolis, Minn. 55427

Nova Corp., Box 2121, Canoga Park, Calif. 91306

Kim Forrest

Nurad, Inc., 2165 Druid Park Dr., Baltimore, Md. 21211

Leslie K. Lear - (301) 462-1700

O

Oak Industries, Inc., Crystal Lake, Ill. 60014

Oaktron Industries Inc., 930 30th St., Monroe, Wis. 53566

O'Connor Eng. Labs. Inc., 100 Kalmus Drive, Costa Mesa, Cal. 92627

Ohmite Mfg. Co., 3601 Howard St., Skokie, Ill. 60076

Onan, 1400 73rd Avenue NE, Minneapolis, Minn. 55432

Robert Wakelield, V.P. - (612) 574-5000

Opamp Lamps, Inc., 1033 N. Sycamore Ave., Los Angeles, Calif. 90038

B. J. Losmandy - (213) 934-3566

Optima Enclosures, 2166 Mountain Industrial Blvd., Tucker, Ga. 30084

Orange County Corp., 1079 Autumnwood Dr., Winnipeg, Man., Canada R2J 1C6

Morton D. Larsen - (204) 475-1026

Orban/Broadcast, 271 Columbus Ave., San Francisco, Calif. 94133

Eric Small - (415) 421-3894

Orban/Parasound, Inc., 680 Beach St., San Francisco, Calif. 94109

Orbit Radio and Video, Box 1644, Louisville, Ky. 40201

Otari Corp., 981 Industrial Rd., San Carlos, Calif. 94070

P

Pacific Recorders and Engrg. Corp., Div. 47B, 11760 Sorrento Valley Rd., San Diego, Calif. 92121

Paillard Inc., 1900 Lower Rd., Linden, N.J. 07036

W. A. Palmer Films, Inc., 611 Howard St., San Francisco, Cal. 94105

Panasonic Video Systems Div., Box 1501, Secaucus, N.J. 07094

Paso Sound Products Inc., 251 Park Ave. S., New York, N.Y. 10010

Pentagon Industries, Inc., 4751 N. Olcott Ave., Chicago, Ill. 60656

Permadyne Electronics Corp., 2929 N. Southport, Chicago, Ill. 60657

Phelps Dodge Communications Co., Rt. 79, Marlboro, N.J. 07746

Philadelphia Resins Corp., 20 Commerce Dr., Montgomeryville, Pa. 18936

David P. Kollock - (215) 855-8450

REGIONAL SALES OFFICES

John C. McGuckin, 4141 Veterans Memorial Boulevard, Metairie, La 70002, (504) 887-3639

Philip T. Gibson, Tension Member Technology Div., 15161 Golden West Circle, Building 6 South, Westminster, Ca. 92683, (714) 898-5641

George T. Kollock, 3030 Bridgeway, Sausalito, Ca. 94965, (415) 332-4670

Philips Audio Video Systems Corp., Audio Div., 91 McKee Dr., Mahway, N. J. 07430

Philips Audio Video Systems Corp., Broadcast Equip. Div., 91 McKee, Mahwah, N. J. 07430

Philips Test & Measuring Instruments, Inc., 400 Crossways Park Dr., Woodbury, N. Y. 11797

Photo Lab Inc., 3825 Georgia Ave. NW., Washington, D.C. 20011

Photo Research, Div. of Kollmorgen Corp., 3000 N. Hollywood Way, Burbank, Cal. 91505

Plastoid Corp., 42-61 24th St., Long Island City, N. Y. 11101

Potomac Instruments, Inc., 932 Philadelphia Ave., Silver Spring, Md. 20910

David G. Harry - (301) 589-3125

Power-Optics Inc., Box 266, Fairview Village, Pa. 19409

Power Waves, Inc., Box 1353, Asbury Park, N. J. 07712

PRD Electronics, Inc., 6801 Jericho Turnpike, Syosset, N. Y. 11791

Precision Elect. Inc., 9101 King St., Franklin Park, Ill. 60131

Prestolite Wire Div., 3529 24th St., Port Huron, Mich. 48060

Prodelin Inc., Box 131, Hightstown, N.J. 08520

Professional Audio Service, Box 1953, Fort Worth, Texas 76101

Pulse Dynamics Mfg. Corp., (PDMC), Box 355, Colchester, Ill. 62326

R. D. Zimmer - (309) 776-4544/4575

Pulse Techniques Inc., 1411 Palisade Ave., Teaneck, N.J. 07666

E. R. Shenk - (201) 837-2575

Q

QRK Electronic Products, 1568 N. Sierra Vista, Fresno, Calif. 93703

Carl Hammett - (209) 251-3008 or 4213

Quad-Eight Electronics, 11929 Vose St., North Hollywood, Calif. 91605

Quantum Audio Labs, Inc., 1905 Riverside Dr., Glendale, Calif. 91201

John Pritchett, Pres. - (213) 841-0970

Quick-Set Inc., 3650 Woodhead Drive, Northbrook, Ill. 60062

Mark Stolman, V.P. Mkt. & Sls. - (312) 498-0700

R

Jules Racine & Co., Inc., 85 Executive Blvd., Elmsford, N.Y. 10523

Radio Mfg. Co. (RMC), 4702 SW 75 Ave., Miami, Fla. 33155

Radio Research Instrument Co., Inc., 3 Quincy St., Norwalk, Conn. 06850

Radio Time Service, Box 6613, Tucson, Ariz. 85733

Ramko Research, 3516-C LaGrande Blvd., Sacramento, Calif. 95823

L. R. Kohleid - (916) 392-2100

Rank Precision Industries, Rank Cintel Div., Watton Road, Ware, England SG12 OAE

Rank Precision Industries, 411 Jarvis ave, Des Plaines, Ill. 60018

Rapid-Q, 1216 Kifer Rd., Sunnyvale, Calif. 94086

Raven Screen Corp., 124 East 124th St., New York, N.Y. 10035

Raytheon Data Systems Co., 1415 Providence Turnpike, Norwood, Mass. 02062

RCA/Community Telev. Systems, 7355 Fulton Ave., North Hollywood, Calif. 91605

RCA Corp., Broadcast Systems Div., Front and Cooper Streets, Camden, N.J. 08102

REGIONAL SALES OFFICES

P. G. Walters - P. Higginbotham, 3395 Northeast Expressway, Atlanta, Ga. 30341, (404) 455-3400

D. Forbes, 3409 Executive Centre Dr., Suite 213, Austin, Texas 78731, (512) 345-2224 & 5

A. Nobo, Office Park Bldg. #10, Office Park Circle, Birmingham, Ala. 35223, (205) 871-1155

J. F. Morse, Wellesley Office Park, 40 Williams Street, Boston: Wellesley, Mass. 02181, (617) 237-6050

R. J. Newman, 330 Primrose Rd., Suite 305, Burlingame, Calif. 94010, (415) 343-2741

N. J. Hudak - R. C. Tyrrell, Bldg. 2-2, Front & Cooper Sts., Camden, N.J. 08102, (609) 963-8000

L. White, 6230 Fairview Rd., Suite 104, Charlotte, N.C. 28210, (704) 366-0626

O. G. Bjerke - F. Timberlake, 120 S. Riverside Plaza, Gateway II Bldg., Suite 1400, Chicago, Ill. 60606, (312) 782-0700

C. E. Raasch, 11430 Hamilton Ave., Cincinnati, Ohio 45231, (513) 825-1550

E. H. Hoff - G. McClanathan - L. Pinski, 8700 Stemmons Freeway, Dallas Texas 75247, (214) 638-6200

J. H. Butts, 2695 Alcott St., Suite 231-S, Denver, Colo. 80211, (303) 433-8484

(continued)

- J. L. Preston, 24333 Southfield Rd., Suite 209, Detroit: Southfield, Mich. 48075, (313) 357-0080
H. W. Dover - C. Cookson, RCA Corp., Suite 531, 6363 Sunset Blvd., Hollywood Calif. 90028, (213) 461-9171
J. L. Ayers, RCA Broadcast Sales, Bldg. Q-1, 2511 East 46th Street, Indianapolis, Ind. 46205, (317) 546-4001
F. C. Fitch, 2747 Art Museum Drive, Suite 5, Jacksonville, Fla. 32207, (904) 398-4588
G. Thursby, Kansas City Area: 5750 West 95th St., Suite 111, Overland Park, Kansas 66207, (913) 642-3185, 6, 7
C. Koriwchak, 761 N. Washington Road, Nationwide Office Bldg., McMurray, Pa. 15317, (412) 941-5570
W. G. Eberhart, 4601 Excelsior Blvd., Suite 307, Minneapolis, Minn. 55416, (612) 920-6395, 6
R. F. Varda - J. P. Shipley - C. J. Gaydos, 1133 Avenue of the Americas, 3rd Floor, New York, N.Y. 10036, (212) 598-5900
D. B. Freeman, Noah's Ark, Suite 340, St. Charles, Mo. 63301, (314) 723-2525 & 946-7755
B. Lloyd, 408 Second Ave., West, Seattle, Washington 98119, (206) 285-2375
R. S. Emch - R. C. Parkhill, Washington, D.C. Area: 1901 North Moore St., Arlington, Virginia 22209, (703) 558-4212
R. E. Giles, 3900 RCA Blvd., Palm Beach Gardens, West Palm Beach, Fla. 33410 (305) 622-1100
- RCA Corp., Distributor & Special Products Div.,** Cherry Hill Offices, Camden, N.J. 08101
- RCA Corp., RCA Service Co. Div.,** Cherry Hill Offices, Camden, N.J. 08101
- Recordex Corp.,** 1300 Booth Ave. NW, Atlanta, Ga. 30318
- Recortec Inc.,** 777 Palomar Ave., Sunnysvale, Calif. 94086
Ron Troxell - (408) 735-8821
- Red Comet Inc.,** Box 272, Littleton, Colo. 80120
- Rek-O-Kut Inc.,** 1568 N. Sierra Vista Ave., Fresno, Calif. 93703
- Re-Play Video Cartridge Service,** 315 Thornberry Court Dr., Pittsburgh, Pa. 15237
- Revox Corp.,** 155 Michael Dr., Syosset, N. Y. 11791
Michael J. Noakes - (516) 364-1900
- Rex Rheostat & Co., Inc.,** 149 Babylon Turnpike, Roosevelt, N. Y. 11575
- Reynolds/Leteron Co.,** 9830 San Fernando Rd., Pacoima, Calif. 91331
- RF Systems, Inc.,** 155 King St., Cohasset, Mass. 02025
- RHA Audio Communications Corp.,** 625 60th Street, West New York, N. J. 07093
- RHG Elect Labs, Inc.,** 161 E. Industry Court, Deer Park, N.Y. 11729
- Richmond Hill Laboratories Ltd.,** 1240 Ellesmere Rd., Scarborough, Ont., Canada M1P 2X4
- Richmond Sound Design, Ltd.,** Box 65507, Vancouver, B. C., Canada V5N 5K5
- RMS Electronics, Inc.,** 50 Antin Place, Bronx, N. Y. 10462
- Robins/Fairchild,** 75 Austin Blvd., Commack, N. Y. 11725
- Rockwell International,** (see Collins Radio Group)
- Rodann Electronics Mfg. Co.,** 133 S. Brea Blvd., Brea, Calif. 92621
- Rodelco Corp.,** 356 A Comac Road, Deer Park, N.Y. 11729
- ROH Corporation,** 107 Technology Park, Norcross, Ga. 30071
James B. Godwin - (404) 449-0873
- Rohde & Schwarz Sales Co.,** 14 Gloria Lane, Fairfield, N.J. 07006
- Rolane Sales Corp.,** 1 Du Pont St. So., Plainview, N.Y. 11803
Wayne D. Freeman - (516) 433-6210
- Roll-A-Reel,** 7386 Reading Road, Cincinnati, Ohio 45237
- Roscor Corp.,** 6160 Oakton, Morton Grove, Ill. 60053
- Ross Broadcast Products, Inc.,** 14 Iroquois Plaza, Iroquois, Ont., Canada KOE 1K0
Tom Pressley - (613) 652-4335
- R S Corp.,** 1241 Rand Road, Des Plaines, Ill. 60616
John Kaiser - (312) 297-0955
- Rupert Neve, Inc.,** (See listing under "N")
- Russco Electronics Mfg. Inc.,** 1070 Brookhaven Drive, Clovis, Cal. 93612
Russell C. Friend - (209) 299-2167
- Ryder Magnetic Sales Corp.,** 1147 N. Vine St., Hollywood, Cal. 90038
- S**
- Sadelco, Inc.,** 299 Park Ave., Weehawken, N. J. 07087
- Howard W. Sams & Co., Inc.,** 4300 West 62nd St., Indianapolis, Ind. 46268
- Sansui Electronics Corp.,** 55-11 Queens Blvd., Woodside, N. Y. 11377
- Saxton Prod. Inc.,** 215 N. Route 303, Congers, N.Y. 10920
- SC Electronics, Inc.,** 530 Fifth Ave., N.W., St. Paul, Minn. 55112
- Scala Radio Corp.,** 1970 Republic Ave., San Leandro, Cal. 94577
- Schafer Electronics Corp.,** 75 Castilian Drive, Goleta, Calif. 93017
- Schafer International,** 1355 Harbor Drive, San Diego, Calif. 92101
- Schneider Corp. of America,** 154 Lodi St., Hackensack, N.J. 07601
- Jos. Schneider & Co., Optische Werke Div.,** P.O. Box 947, 6550 Bad Kreuznach, West Germany
- Scientific-Atlanta, Inc.,** 3845 Pleasantdale Rd., Atlanta, Ga. 30340
- Scientific Radio Systems, Inc.,** 367 Orchard St., Rochester, N.Y. 14606
- Scientific Systems, Inc.,** 48 Windjammer Ct., Toms River, N. J. 08753
Douglas Fink - (201) 255-2230
- Scintrex Inc., Communications Div.,** Amherst Industrial Park, Tonawanda, N.Y. 14150
- Scully/Metrotech,** 475 Ellis St., Mountain View, Cal. 94040
Homer Hull - (415) 968-8389
- REGIONAL SALES OFFICES**
William Shute, 1005 8th Ave. South, Nashville, Tenn. 37203, (615) 244-1546
Gareth Nelson, 3434 W. Peterson, Chicago, Ill. 60645 (312) 583-7878
(continued)
- Gerald Terdiman,** 285 County Road, Tenally, New Jersey 07670, (201) 568-4414
Chuck Broneer, 548 South Kingsley, Los Angeles, Calif. 90020, (213) 387-4252
- Seacor Inc.,** 598 Broadway, Norwood, N. J. 07648
- Semline, Inc.,** 180 Wood Rd., Braintree, Mass. 02184
- Sencore Inc.,** 3200 Sencore Drive, Sioux Falls, S. D. 57107
- Sennheiser Electronic,** 10 West 37th St., New York, N. Y. 10018
- Senstrol Div.,** 460 Sackett Point Rd., North Haven, Conn. 06473
- Sescom, Inc.,** 12931 Budlong Ave., Gardena, Calif. 90247
Franklin J. Miller - (213) 770-3510
- SGL Waber Electric,** 300 Harvard Ave., Westville, N. J. 08093
- Shallco, Inc.,** Hwy. 301 South, P.O. Box 1089, Smithfield, N.C. 27577
M. D. Sutton - (919) 934-3135
- Sharp Electronics Corp.,** 10 Keystone Place, Paramus, N.J. 07652
- Shintron Co. Inc.,** 144 Rogers St., Cambridge, Mass. 02142
(617) 491-8700
- REGIONAL SALES OFFICES**
Western Office: Ronald Scaggs, 1234 Uppingham, Thousand Oaks, Ca. 91360, (805) 492-5422
- Shively Laboratories, Inc.,** Route 302, Raymond, Me. 04071
- Shure Brothers Inc.,** 222 Hartrey Ave., Evanston, Ill. 60204
- Simex/Coast, Navigation School,** Drawer Y - 418 E. Canon Perdido, Santa Barbara, Calif. 93102
- Simpac International,** 369 San Miguel Dr., Ste. 365, Newport Beach, Calif. 92660
- Simpson Electric Co.,** 853 Dundee Ave., Elgin, Ill. 60120
- Sinai-Johnson,** Box 5218, Redwood City, Calif. 94063
- Singer Instrumentation,** 5340 Alla Rd., Los Angeles, Calif. 90066
- Singer Products Co., Inc.,** One World Trade Center Suite 2365, New York, N.Y. 10048
- Sintronic Corp.,** 705 Haverford Ave., Bryn Mawr, Pa. 19010
- Sitco Antenna Co.,** Box 20456, Portland, Ore. 97220
- Sitler's Supplies, Inc.,** Box 10-B, Washington, Iowa 52353
Wm. C. Sitler - (319) 653-2123
- Skirpan Lighting Control Corp.,** 41-43 24th St., Long Island City, N.Y. 11101
- Smith-Beemish, Inc.,** Box 596, Farmingdale, N.Y. 11735
- Sony Corp. of America, VTR Div.,** 9 W. 57th St., New York, N.Y. 10019
Richard F. O'Brien, V.P., and Don Thorkelson, 9 West 57th Street, New York, New York 10019, (212) 371-5800
- REGIONAL SALES OFFICES**
Roy Raymond, 47-47 Van Dam Street, Long Island City, New York 11101, (212) 361-8600
Lee Manning, 20 Perimeter Park, Suite 109, Atlanta, Georgia 30341, (404) 451-7501
Robert Vavra, 6801 West Jarvis Street, Niles, Illinois 60648, (312) 792-3600
(continued)
- Mike Fleming,** 230 West Hill Place, Crocker Industrial Park, Brisbane, California 94005, (415) 467-4900
Robert Mueller, 700 West Artesia Boulevard, Compton, California 90220, (213) 537-4300
Max Harris, 10616 Galaxie Avenue, Ferndale, Michigan 48220, (313) 548-9325
Bill Harlow, 9004 Ambassador Row, Dallas, Texas 75247, (214) 631-3431
- Sound Dynamics, Inc.,** Box 1335, Sunnysvale, Calif. 94088
Ron Golick - (408) 926-3588
- Soundscriber Corp.,** Simm Lane, New Town, Conn. 06470
- Sparta Electronic Corp.,** 5851 Florin Perkins Rd., Sacramento, Cal. 95828
Jack J. Lawson - (916) 383-5353
- Spectra Sonics,** 770 Wall Ave., Ogden, Utah 84404
- Spectrum Instruments, Inc.,** Box 97, Hartsdale, N.Y. 10530
- Sphere Electronics,** 20201A Prairie, Chatsworth, Calif. 91311
Don McLaughlin - (213) 349-4747
- Spindler & Sauppe, Inc.,** 13034 Saticoy St., North Hollywood, Cal. 91605
- Spin Physics, Inc.,** 11633 Sorrento Valley Rd., San Diego, Calif. 92121
- SPI-ITT, Metrix Instruments Div.,** P.O. Box 30, 74010 Annecy, France
- Spotmaster,** 8810 Brookville Rd., Silver Spring, Md. 20910
- SSAC Precision Products, Inc.,** Box 395, Liverpool, N.Y. 13088
Dick Shutt - (315) 457-9610
- Stainless, Inc.,** Third & Montgomery Sts., North Wales, Pa. 19454
Jess C. Rodriguez - (215) 699-4871
- Stancil-Hoffman Corp.,** 921 N. Highland, Hollywood, Calif. 90038
- Standard Electric Time,** 89 Logan St., Springfield, Mass. 01101
- Stanton Magnetics Inc.,** Terminal Drive, Plainview, N.Y. 11803
Joseph S. Woodstock - (516) 681-0415
- Stantron Div.,** 6914 Beck Ave., North Hollywood, Calif. 91605
- Step Corp.,** 8699 W. Chester Pkwy., Upper Darby, Pa. 19082
- Stocker & Son, Inc.,** 34 Suydam Lane, Bayport, N. Y. 11705
- Storeel Corp.,** 4993 New Peachtree Rd., Atlanta, Ga. 30341
William O. Kirkpatrick - (404) 458-3280
- Strand Century, Inc.,** 20 Bushes Lane, Elmwood Park, N. J. 07407
Ed Gallagher - (201) 791-7000
- Willi Studer America, Inc.,** 3916 Broadway, Buffalo, N.Y. 14227
- Studio Tape Exchange,** 366 W. 46th St., New York, N.Y. 10036
Spencer Manning (Film), Nancy Gordan (Video Tape) - (212) 265-3740
- Super 8 Sound, Inc.,** 95 Harvey St., Cambridge, Mass. 02140
- Superscope, Inc.,** 8150 Vineland Ave., Sun Valley, Calif. 91352
- Surcom Associates,** 1147 Venice Blvd., Los Angeles, Calif. 90015

Swager Tower Corp., Box 656, Fremont, Ind. 46737
Switchcraft Inc., 5555 N. Elston Ave., Chicago, Ill. 60630
Sylvania Comm. Electronic, Box 268 Burlington Rd., Bedford, Mass. 01730
Systa-Matics, Inc., 510 N. Sheridan Rd., Tulsa, Okla. 74115
Systems Engineering Co., Inc., Box 49224, Atlanta, Ga. 30329
Systems Marketing Corp., 1013 West Washington St., Bloomington, Ill. 61701
Systron-Donner, 10 Systron Dr., Concord, Calif. 94518

T

Taber Mfg. & Engr. Co., 2081 Edison Ave., San Leandro, Cal. 94577
Robert H. Kearns - (415) 635-3831
REGIONAL SALES OFFICES
Bryant Ellis, 1227 N. Vine St., N. Hollywood, Ca. 90038
Tape-Athon Corp., 502 S. Isis, Inglewood, Cal. 90301
Tapecaster TCM, Inc., Box 662, Rockville, Md. 20851
Tapex Corp., Box 246, West Des Moines, Iowa 50265
Tasker Systems, 20131 Sunburst St., Chatsworth, Cal. 91311
Taylor Instrument, Arden, N.C. 28704
TEAC Corp of America, 7733 Telegraph Rd., Montebello, Cal. 90640
Tech Laboratories Inc., Bergen & Edsall Blvds., Palisades Park, N.J. 07650
Kenton K. Garrison - (201) 944-2221
Technology, Inc., 11801 W. Olympic Blvd., Los Angeles, Calif. 90064
Derrill Macho - (213) 479-3941
Tektronix Inc., Box 500, Beaverton, Ore. 97077
Telatronics, 924 Cost Ave., Stone-wood, W. V. 26301
Tele-Cine Inc., 18 Unqua Road, Massapequa, L.I., N.Y. 11758
Telecommunications Industries, Inc., 1375 Akron St., Copiague, N.Y. 11726
Don Worden - (516) 842-5000
Telecommunications Industries Ltd., 6335 Homewood Ave., Suite 204, Los Angeles, Calif. 90028
Telectro Systems Corp., 96-18 43rd Ave., Corona, N.Y. 11368
Teledata Systems, Inc., 108 Aero Camino, Goleta, Calif. 93017
John Webster - (805) 685-2317
Teledyne Camera Systems, 131 N. Fifth Ave., Arcadia, Calif. 91006
Teledyne Energy Systems, 110 W. Timonium Rd., Timonium, Md. 21093
Paul I. Bessert - (301) 252-8220, Telex 87-780, Cable Telises
TeleMation, Inc., Box 15068, Salt Lake City, Utah 84115
Don Smith - (801) 487-5399
Telemedia Electronics, 1548 W. Win-ton, Hayward, Calif. 94544
Joseph W. Hilson - (415) 783-3311
Telemet, a Geotel Co., 185 Dixon Ave., Amityville, N.Y. 11701

(continued)

Ken Schwenk - (516) 541-3600, TWX 510-227-9850
REGIONAL SALES OFFICES
Northeast: Robert Griffiths, East-hill RFD #3, Brewster, N.Y. 10509, (914) 279-3231
Midwest: Earl Platt, 12992 Cedar Rd., Cleveland Heights, Ohio 44118, (216) 321-7523
Southwest: Lee Caput, 13620 Littlecrest Drive, Dallas, Texas 75234, (214) 241-0928
Robert B. Daines, 1261 El Curtola, Walnut Creek, Calif. 94595, (415) 938-8887
In Southeast Region, contact home office for sales information. Telemet Amityville, N.Y., Tel: (516) 541-3600

Television Equipment Associates, Box 1391, Bayville, N.Y. 11709
Bill Pegler - (516) 628-8068

Television Microtime, Inc., (see "Microtime, Inc.")

Television Products Co. Inc., 9016 Aviation Blvd., Inglewood, Calif. 90301
Bill Weisner - (213) 776-3276

Television Research International, 1003 Elwell Ct., Palo Alto, Calif. 94303
Ron De Pinto - (415) 961-7475

Television Technology Corp., 9150 B Brookville Rd., Silver Spring, Md. 20910

Dr. Byron St. Clair - (301) 565-0770

Telex Communications, Inc., 9600 Aldrich Ave. S., Minneapolis, Minn. 55420

Telonic Altair, Box 277, Laguna Beach, Calif. 92652

Teltron Inc., Box 416, Douglassville, Pa. 19518

Temtron Electronics, 138-69 Francis Lewis Blvd., Rosedale, N.Y. 11422

Tentel, 50 Curtner Ave., Campbell, Calif. 95008

Wayne B. Graham - (408) 377-6588
REGIONAL SALES OFFICES

Robert Cook, Noresco Mfg. Co. Inc., 100 Floral Parkway, Toronto, Ontario, Canada, (416) 249-7316
Brian Horman, Regent House, 63 Kingsway, South Melbourne, Australia, 61-3801

Ampex Video and Professional Audio, Worldwide, most countries consult local Phone Listing

Tepeco Corp., Box 680, Rapid City, S. D. 57701

Don White, V.P. - (605) 343-7200

Terminal Electronics Corp., 1421 Pinewood St., Rahway, N.J. 07065

TerraCom, 9020 Balboa Ave., San Diego, Calif. 92123

Bruce Jennings - (714) 278-4100

Testline Instruments, Inc., Box 5686, Titusville, Fla. 32780

Texas Electronics, Box 7225, Dallas, Tex. 75209

David DeGraff - (214) 631-2490

Texas Instrument, Components Group, Box 5012, Dallas, Tex. 75222

Texscan Corp., 2446 N. Shadeland, Indianapolis, Ind. 46219

Texwipe Co., Box 278, Hillsdale, N. J. 07642

Theta-Com, Box 9728, Phoenix, Ariz. 85068

Thomson-CSF Electron Tubes, 750 Bloomfield Ave., Clifton, N. J. 07015

Thomson-CSF, Inc., 75 Rockefeller Plaza, New York, N.Y. 10019
Thomson-CSF Laboratories, Inc., 37 Brownhouse, Stamford, Conn. 06902

John Camarda - (203) 327-7700

REGIONAL SALES OFFICES

John Camarda, 37 Brownhouse Road, Stamford, Conn. 06902, (203) 327-7700

Thomas F. Hindle, 37 Brownhouse Road, Stamford, Conn. 06902, (203) 327-7700

Harvey Caplan, 4233 Barcelos Drive, St. Louis, Mo. 63129, (314) 487-2450

James A. Smith, P.O. Box 36, La Canada, Calif. 91011, (213) 790-4393

Thor Electronics Corp., 741 Livingston St., Elizabeth, N.J. 07207

3M Co., Magnetic Audio/Video Prod. Div., 3M Center, St. Paul, Minn. 55101

Time & Frequency Tech., Inc., 3000 Olcott St., Santa Clara, Cal. 95051
Frank Stolten, Marketing, (408) 246-6365

Times Wire and Cable, 358 Hall Avenue, Wallingford, Conn. 06492

Topaz Electronics, 3855 Ruffin Road, San Diego, Calif. 92123

Total Technology, 1346 Bayport Ave., San Carlos, Calif. 94070

Tracor, Inc., Instruments Group, 6500 Tracor Lane, Austin, Tex. 78721

Transcom Electronics, Inc., Box 9, La Mesa, Calif. 92041

Transel Corp., 4180-5 N. Elmhurst Dr., Indianapolis, Ind. 46226

Trepac Corp. America, 30 W. Hamilton Ave., Englewood, N.J. 07631

Triangle Towers & Antennas, Box 705, Louisburg, N. C. 27549

Tri-Ex Tower Corp., 7182 Rasmussen Ave., Visalia, Calif. 93277

Triplett Corp., 286 Harmon Rd., Bluff-ton, Ohio 45817

Tri-Tronics, Professional Electronics, 829 Eighth St., Lillington, N.C. 27546

Trompeter Electronics, 8936 Coman-che Ave., Chatsworth, Cal. 91311

TRW Electronics Supply Co., 414 N. 13th St., Philadelphia, Pa. 19108

TT Electronics, Inc., 2214 S. Barry Ave., Los Angeles, Calif. 90064

Joseph F. Sodaro - (213) 478-8224

Turner Div., Conrac Corp., 909 17th St. N.E., Cedar Rapids, Iowa 52402

R. H. Tyler Co., Loop 132 & Hwy. 79, Olney, Tex. 76374

U

Ultra Audio Products, Box 921, Beverly Hills, Cal. 90213

UMC Electronics Co., 460 Sackett Point Rd., North Haven, Conn. 06473

C. E. Collett - (203) 288-7731

REGIONAL SALES OFFICES

G. M. Burkhardt, 3232 Midvale Ave., Los Angeles, Calif. 90034, (213) 475-1677

Unarco-Rohn, Box 2000, Peoria, Ill. 61601

Unimedia Corp., Rt. 2, Box 2574E, Au-burn, Calif. 95603

Morey McFarren - (916) 272-1971

(continued)

REGIONAL SALES OFFICES

Gilles Vrignaud, 43 Rainside Road, Don Mills, Ontario M3A 3L9, (416) 445-5650

Union Connector Co., Inc., 149-A Bab-ylon Turnpike, Roosevelt, N. Y. 11575

United Radio Supply Inc., Box 14040, Portland, Ore. 97214

United Recording Electronics Indus-tries, 11922 Valerio St., North Hol-lywood, Cal. 91605

United Recording Electronics In-dustries, (see "UREI listing")

United Systems Corp., Box 458, Day-ton, Ohio 45401

Universal Research Labs, 2501 United Lane, Elk Grove Village, Ill. 60007

Up-Right, Inc., 1013 Pardee St., Berkeley, Cal. 94710

Upson Tools Inc., Box 4750, Roches-ter, N.Y. 14612

UREI, a URC Co., 11922 Valerio St., North Hollywood, Calif. 91605

DeWitt F. Morris - (213) 764-1500

Utility Tower Co., Box 12027, Ok-lahoma City, Okla. 73112

V

Vaco Products Co., 510 N. Dearborn St., Chicago, Ill. 60610

Valad Electric Heating Corp., 160 Wil-ley St., Tarrytown, N.Y. 10591

Val-Tronics, Inc., Penn Park Bldg., Pitt-ston, Pa. 18640

Milan Krupa - (717) 655-5937

REGIONAL SALES OFFICES

Glenn W. Winter, 1847 Radnor Rd., York, Pa. 17402, (717) 741-1543

Vamco Engineering, Box 7512, Tulsa, Okla. 74105

Gene Randall Jr. - (918) 252-4142

Varian Associates, Electron De-vice Group, 611 Hansen Way, Palo Alto, Calif. 94303

Ben Allgood - (415) 493-4000

REGIONAL SALES OFFICES

Ted Tucker, 6650 Powers Ferry Rd., NW, Suite 100, Atlanta, Ga. 30339, [404] 252-0045

Wm. Cohan, 400 Totten Pond Rd., Bldg. #1, Waltham, Ma 02154, (617) 890-4560

Wm. Polich, 205 West Touhy Avenue, Park Ridge, Ill. 60068, (312) 825-6686

H. N. Andreassen, P.O. Box 689, 558 So. Central Expressway, Suite 202, Richardson, TX 75080, (214) 235-2385

R. Petticrew, 10 Southmoor Circle, Dayton Oh. 45429, (513) 298-7318

Wm. Myers, 2901 Wilshire Blvd., Suite 102, Santa Monica, Ca. 90403, (213) 828-5588

George Korb, 25 Route 22, Spring-field, N.J. 07081, (201) 376-6600

H. Cray, 306 Fellowship Road, Mount Laurel, N.J. 08057, (609) 235-6800

S. Kerr, 7117 Third Avenue, Suite 106, Scottsdale, Az. 85251, (602) 947-5461

W. Boiko, 4940 El Camino Real, Los Altos, Ca. 94022, (415) 968-7630

H. Breese, 115 Twin Oaks Drive, Syracuse, N.Y. 13206, (315) 437-2568

H. Tribble, 4701 Lydell Road, Cheverly, Md. 20781, (301) 773-7010

Varian/Beverly, 8 Salem Rd., Beverly, Mass. 01915

Vedco, Inc., 2320 N. Woodlawn Ave., Metairie, La. 70001

Vega Elect. Div., 9900 Baldwin Pl., El Monte, Calif. 91731

Vicon Industries, Inc., 130 Central Ave., Farmingdale, N.Y. 11775

Victor Duncan, Inc., 2659 Fondren Drive, Dallas, Texas 75206
Norman L. Bleicher - (214) 369-1165

REGIONAL SALES OFFICES

Victor Duncan, Inc./Detroit, Ray Hautala, 11043 Gratiot Avenue, Detroit, Mi. 48213, (313) 371-4920
Victor Duncan, Inc./Dallas, Ginny Hart, 2659 Fondren Drive, Dallas, Tx. 75206, (214) 369-1165
Victor Duncan, Inc./Chicago, Sam Irwin, 676 N. St. Clair St., Chicago Ill. 60611, (312) 321-9406

Video Accessories Mfg. Co., Box 7512, Tulsa, Okla. 74105

Video Aids Corp. of Colorado, 112 W. Fourth St., Loveland, Colo. 80537
Christie Smith - (303) 667-3301

REGIONAL SALES OFFICES

Dick Turchen, Int'l. Sls., Mgr., 601 S. Main St., Spring Valley, N.Y. 10977, (914) 356-3700

Video Concepts, Inc., 3715 Lomita Blvd., Torrance, Calif. 90505

Video Data Systems, Inc., 657 Old Willets Path, Hauppauge, N.Y. 11787
Gerald Goldman - (516) 234-1010

Video Devices Co., 1320 Grand Ave., San Marcos, Calif. 92029

Videomax Corp., 154 San Lazaro Ave., Sunnyvale, Calif. 94086
(408) 739-5391

REGIONAL SALES OFFICES

Sidney B. McCollum, 552 Wyndham Road, Teaneck, New Jersey 07666, (212) 947-8031
Bill H. Seidel, 7020 Delco Avenue, Canoga Park, California 91306, (213) 980-7927
William E. Fitts, 13708 Stoner Drive, Silver Spring, Md. 20904, (301) 384-4733

Video Memory Corp., 3070 Kenneth St., Santa Clara, Calif. 95050

The Video Tape Co., 4212 Lankershim Blvd., N. Hollywood, Calif. 91602
Keith Austin - (213) 985-1666

VIF International, Box 1555, Mountain View, Calif. 94042

Vikron, 4918 West 35th St., Minneapolis, Minn. 55416

Viscount Industries Ltd., 105 East 69th, Vancouver, B.C., Canada V5X 2W9
Al G. Gerrebos - (604) 327-9446

Visual Electronics Laboratories, 10 Robert St., Clifton, N.J. 07014

Vital Industries Inc., 3700 NE 53rd Ave., Gainesville, Fla. 32601

Nubar Donoyan - (904) 378-1581
REGIONAL SALES OFFICES
Morrell Beavers, 2644 North 7th St., Terre Haute, Indiana, (812) 466-3212
Gordon Peters, P.O. Box 912, Arlington, Texas 76010, (817) 261-6855
N. Donoyan, 3620 Ridgewood Rd. N.W., Atlanta, Ga. 30327, (404) 233-9459
Eric King, Foxhill Road, Lynchburg, Va. 24503, (804) 384-7001
Robert McAll, 34 Autumn Lane, Hicksville, N.Y. 11801, (516) 735-0055.
(continued)

West Coast, 7960 W. Beverly Blvd., Los Angeles, California 90048, (213) 653-9438

Vitek Electronics Inc., 200 Wood Ave., Middlesex, N.J. 08846

Vu-Data Corp., 7170 Convoy Court, San Diego, Calif. 92111

W

Walther M. A. Andersen & Assoc., Inc., 4 Main St. Ext., Tariffville, Conn. 06081

Ward-Beck Systems, Ltd., 841 Progress Ave., Scarborough, Ont., Canada M1H 2X4
William McFadden - (416) 438-6550

Waters Mfg. Inc., Longfellow Center, Wayland, Mass. 01778
Howard A. Daziel - (617) 358-2777

Weinschel Engineering Co., P.O. Box 577, Gaithersburg, Md. 20760

Western Broadcasting Co. Ltd., Aristocart Division, #12-825 McBride Blvd., New Westminster, B.C. V3L 5B5

Western Electronic Prods. Co., 107 Los Molinos, San Clemente, Calif. 92672
Ellen Schriber - (714) 492-4677

Westinghouse, Electronic Tube Divs., Westinghouse Circle, Horseheads, N.Y. 14845

Wide Band Engineering Co., Inc., Box 21652, Phoenix, Ariz. 85036

Wilkinson Electronics, Inc., 701 Chestnut St., Trainer, Pa. 19013
William Shaw - (215) 497-5100

Wilmore Electronics Co., Inc., Box 2973, Durham, N.C. 27705

H. Wilson Corp., 555 W. Taft Drive, South Holland, Ill. 60473

Winegard Television Systems, 3000 Kirkwood, Burlington, Iowa 52601

World Video Inc., Box 117, Boyertown, Pa. 19512
John A. Taylor III - (215) 367-6055

XYZ

The Zei-Mark Corp., Box 182, Brookfield Center, Conn. 06805

Let's help each other.

the good neighbor.

The American Red Cross
advertising contributed for the public good

American Business, you answered our "Help Wanted" ad loud and clear.



The response was overwhelming. Corporate gifts. Payroll deduction plans. Your executives using their business know-how to insure accountability and efficiency that makes it possible for 93 cents of every United Way dollar raised to go into direct services. To help the forgotten. The aged. The sick. The poor. To help the helpless help themselves. That's the United Way. And thanks to you it's working.

**Thanks to you
it's working.
The United Way.**

©The United Way 1974.

A Public Service of This Magazine & The Advertising Council



BUILD A BETTER STUDIO

Call Aderhold Construction Company. A complete team of professional designers, architects, builders and engineers. No problem too large or too small. 404/233-5413.



Aderhold Construction Company

3384 Peachtree Rd. NE / Atlanta, Georgia 30326

For More Details Circle (221) on Reply Card

angénieux service corporation of california
13381 BEACH AVE., VENICE, CALIF. 90291 • (213) 821-5080



FACTORY SERVICE CENTERS
REPAIRS • PARTS
ACCESSORIES

angénieux corporation of america
ISLIP AIRPORT, BOX 340, RONKONKOMA, N.Y. 11779 • (516) 567-2424

For More Details Circle (222) on Reply Card

empty
tape reels and boxes
for your audio/video needs

36 types in stock



RS corp. GET CATALOG — RBE 175
1291 Rand Rd., DesPlaines, IL 60016 312/297-0955

For More Details Circle (223) on Reply Card

DAVE HOVEY GENERAL CONTRACTOR
Route 1, Box 113 Phone A/C 601-675-2956
COFFEEVILLE, MS. 38922

- Tower Construction •
- Antenna & Wave Guide Repair & Installation •

For More Details Circle (224) on Reply Card

FREE CATALOG & AUDIO APPLICATIONS



CONSOLES
KITS & WIRED
AMPLIFIERS
MIC, EQ, ACN,
LINE, TAPE, DISC,
POWER
OSCILLATORS
AUDIO
TAPE BIAS
POWER SUPPLIES

OPAMP LABS, INC.
1033 N. SYCAMORE AVE.
LOS ANGELES, CALIF. 90038
(213) 934-3566

For More Details Circle (225) on Reply Card

OPTIMOD 8000
Something New In FM
Signal Processing

Urban/Broadcast,
271 Columbus Avenue
San Francisco, Ca. 94133 (415) 421-3894

For More Details Circle (226) on Reply Card

NAB urges Commission to Restrict cable leapfrogging

The National Association of Broadcasters has urged the Federal Communications Commission to maintain strict leapfrogging rules for cable TV as "absolutely necessary" in preserving the present system of local television service.

It also urged the Commission to reconsider its proposed rule which would permit cable systems to import by distant signals sporting events that compete with those being broadcast by local TV stations.

NAB's reply comments said rules limiting "leapfrogging"—the reaching out by cable beyond the closest independent stations to bring in more distant signals—should be retained and applied to all cable systems to assure local TV service in the public interest.

It said deletion of the rules as advocated by the National Cable Television Association (NCTA) could lead to creation of independent "super stations" carried by cable from coast to coast—"the antithesis of local service."

NAB said cable has "let the cat out of the bag" by stating frankly that its interest lies primarily in importing signals from independent stations in cities that "are the home of professional sports teams in basketball, hockey and baseball whose televised games are generally originated by one or more of the independent stations in the market."

NAB said NCTA's arguments for abandoning the leapfrogging rules are "literally incredible...rife with fallacious reasoning."

For example, it said, NCTA says that while the rules were designed to regulate cable's relay of distant signals, they have "actually permitted and encouraged most potential cable systems to select stations from the very largest markets." Having determined that the rules are "ineffective," NAB said, NCTA then proclaims them to be "invalid."

"Presumably," the NAB comments said, "if NCTA found a malfunctioning traffic signal at a busy intersection, it would conclude that the policy underlying the regulation of rights-of-way at busy intersections—the protection of life and property—is invalid."

"Obviously, NCTA's approach barely even qualifies as sophistry. It is simply fallacious."

"NCTA has utilized fallacious logic to deduce from false premises that the leapfrogging rules have no public interest rationale. It has presented not the slightest reason for the Commission to depart from its well-established policy."

- ITFS/MDS Transmitters and Receivers
- Microwave Path Survey Equipment
- Low-Cost FM Microwave Receivers for Satellite Terminals

varian MICRO-LINK[®]
beverly, mass. (617) 922-6000

For More Details Circle (227) on Reply Card

**America. It only works
as well as we do.**

The National Commission on  Productivity, Washington, D.C.

PROFESSIONAL SERVICES

VIR JAMES
CONSULTING RADIO ENGINEERS
Applications and Field Engineering
Computerized Frequency Surveys
345 Colorado Blvd.
Phone: (Area Code 303) 333-5562
DENVER, COLORADO 80206
Member AFCCE

RALPH E. EVANS ASSOCIATES
Consulting Telecommunications Engineers
AM-FM-TV-CATV-ITFS
3500 North Sherman Boulevard
MILWAUKEE, WISCONSIN 53216
PHONE: (414) 442-4210 Member AFCCE

SMITH and POWSTENKO
Broadcasting and Telecommunications
Consultants
2000 N Street, N. W.
Washington, D. C. 20036
(202) 293-7742

Joseph & Donna ROIZEN
VIDEO CONSULTANTS
International TV Systems
Marketing/Technical Writing
800 Welch Rd., Suite 354
Palo Alto, Ca. 94304
Tel: (415) 326-6103

Midwest Engineering Associates
Consulting Engineers
F. W. Hannel, P.E.
BSEE; MSEE
7304 N. Oxford, Peoria, Illinois 61614
(309) 691-3426

Applied Video Electronics, Inc.
STUDIO SYSTEMS DESIGN AND INSTAL-
LATION ENGINEERING. REFURBISHING/
MODIFYING COLOR CAMERAS AND
QUADRUPLEX VIDEO TAPE RECORDERS.
Post Office Box 25
Brunswick, Ohio 44212
Phone [216] 225-4443

W. H. BRADLEY, P.E.
Consulting Radio Engineer
Engineering Applications
& Field Engineering
Phone: 918-245-5444
300 West 41 Street,
SAND SPRINGS, OKLAHOMA, 74063

Oscar Leon Cuellar
Consulting Engineer
1563 South Hudson
(303) 756-8456
DENVER, Colorado 80222
Member AFCCE

P.H. LEE ASSOCIATES, INC.
Over 36 Years in Communications
And Broadcast Engineering
AM-FM-TV Frequency Measurements
P.O. Box 1575
Thousand Oaks, Calif. 91360
(805) 492-5055 (213) 889-7769

PROFESSIONAL SERVICES

TELECOMMUNICATIONS
AND
BROADCAST CONSULTANTS
Tabcon Inc.
Sales / Programing / Management / Engineering
Field Services
4425 East 31st St.
Tulsa, Okla. 74135
918-742-5410

HAROLD D. RUSSELL
Consulting Radio Engineer
Over 30 years experience with the
Federal Communications Commission
1711 Macon Street
McLean, Virginia 22101
703 356-4739

McCLANATHAN & ASSOCIATES
Consulting Engineers
APPLICATIONS & FIELD ENGINEERING
TURNKEY INSTALLATIONS—RADIO & TV
P.O. Box 750
PORTLAND, OREGON 97207
Phone: 503/246-8080

CLASSIFIED

Advertising rates in Classified Section are 15¢ per word, each insertion, and must be accompanied by cash to insure publication.

Each initial or abbreviation counts a full word. Upper case words, 30¢ each.

Minimum classified charge, \$2.00.

For ads on which replies are sent to us for forwarding, there is an additional charge of \$2.00 per insertion, to cover department number, etc., which is printed in advertising copy, and processing of replies.

Classified columns are not open to advertising of any products regularly produced by manufacturers unless used and no longer owned by the manufacturer or a distributor.

WANTED

WANTED: All surplus broadcast equipment especially clean A.M. & F.M. transmitters, contactors, capacitors. Surpluss Equipment Sales. Clark & Potomac Phase monitors. 2 Thorncliffe Pk. Dr. Unit 28 Toronto 17, Ont; Canada 1-73-tf

WANTED: Education Public Broadcast Station needs surplus broadcast equipment, 1 or 1.5 kw FM transmitter, and studio equipment. Tax exempt status. Contact Boulder Community Broadcast Association, 885 Arapahoe, Boulder, Colorado 80302. 6-75-6t

WANTED: PRE 1926 RADIOS AND TUBES, ESPECIALLY IN NEW CONDITION. STATE MAKE, MODEL, CONDITION AND PRICE WANTED. AUGUST J. LINK, SURCOM ASSOCIATES, 1147 VENICE BLVD., LOS ANGELES, CALIFORNIA 90015. 8-75-tf

LBH ENTERPRISES buys and sells quality used broadcast equipment (AM-FM-TV). LBH ENTERPRISES, 3521 S.W. 42nd Ave., Gainesville, FL 32608. 9-75-1t

WANTED: Television High Band, Low Power, VHF Transmitter. Also three Orthican type color camera. 315-853-6825. 9-75-1t

WANTED: 2 Norelco PC 70 cameras, GE-PE250's, other color cameras. Also want your excess stock of lead oxide tubes, such as XQ1020, XQ1023, XQ1070, etc., other camera tubes. Do you have transmitting tubes such as 6181, SRL7C, 7007, 6166, 6076, 4CX5000A and other types? Immediate cash paid. Reply to: T.D.I., 138-69 Francis Lewis Blvd., Rosedale, N.Y. 11422. Toll free # is (800) 221-8376. 9-75-1t

WANTED (CONT.)

WANTED: Church needs radio & TV production equipment. Tax deductible. Contact Dave Willis, 9th & O Baptist Church, 2921 Taylor Blvd., Louisville, Ky. (502) 637-2519. 9-75-1t

PRODUCTS WANTED: NY based national TV marketing specialist looking for products. We offer marketing and technical expertise. Smith-Beemish, Inc., P.O. Box 591, Farmingdale, N.Y. 11735 (516) 420-0986. 9-75-3t

OPTICAL SYSTEMS MFG: management oriented partner and venture capital needed for development of optical products for the Medical, TV, and Motion Picture Industry. Write: Dept. 334, Broadcast Engineering, 1014 Wyandotte St., Kansas City, Mo. 64105. 9-75-1t

WANTED: T.V. maintenance Engineer for community cable T.V. station. Send resume to General Manager, Crystal Video Ltd., 301 South Brady St., DuBois, Pa. 15801. 9-75-1t

EQUIPMENT FOR SALE

ONE STOP FOR ALL YOUR PROFESSIONAL AUDIO REQUIREMENTS. Bottom line oriented. F.T.C. Brewer Company, P.O. Box 8057, Pensacola, Florida 32505. 7-71-tf

HELIAX-STYROFLEX. Large stock — bargain prices—tested and certified. Write for price and stock lists. Sierra Western Electric. Box 23872, Oakland, Calif. 94623. Telephone (415) 832-3527. 1-73-tf

REBUILT CARTRIDGE TAPE EQUIPMENT. Spotlessly clean and thoroughly tested. 30 day moneyback guarantee, ONE YEAR warranty. Also, **REPAIR AND RECONDITIONING SERVICES** for cartridge equipment by factory trained technicians. Send for complete information: AUTODYNE, Box 1004, Rockville, Md. 20850, (301) 762-7626. 1-75-tf

MOTORS FOR SPOTMASTERS

NEW Paps hysteresis synchronous motor HSZ 20.50-4-470D as used in series 400 and 500 machines. Price \$49.00 each prepaid, while they last. 90 day warranty. Terms check with order only, no COD's. Not recommended for Tapecaster series 600 or 700.

TAPECASTER TCM, INC., Box 662
Rockville, Maryland 20851 1-72-tf

BUILD YOUR OWN TV AND RADIO PRODUCTION EQUIPMENT. Easy, inexpensive, (mostly IC). Plans or kits: Special Effects Generator, Automatic Logger, Vertical Interval Video Switcher, Solid State Lighting Board, Preset Audio-Video Board, Preset Lighting Board, Crystal Controlled Wireless Mikes with Matching receivers. Subsonic Tone Control for audio tapes, 8MM SOF Cameras and Projectors, Distribution Amplifiers (Sync. Video, Audio), Audio Control Boards (Studio & Remote) Proc-Amp with compensation and regeneration for adapting Helical Scan VTR's to broadcast standards. PLUS specialized correspondence courses in Telephone Engineering (\$39.50). and Integrated Circuit Engineering (\$49.50). Plans from \$5.95 to \$15. SUPER CATALOG plus years updateing of new devices Air Mailed \$1.00. Don Britton Enterprises PO Drawer G, Waikiki, Ha. 96815. 5-74-24t

MICA AND VACUUM transmitting capacitors. Large stock; immediate delivery. Price lists on request. SURCOM ASSOCIATES, 1147 Venice Blvd., Los Angeles, Cal. 90015 (213) 382-6985. 6-75-tf

STODDART RADIO interference-field intensity meters. Stoddart NM-22A, 150KHZ-32MHZ. Complete - \$2,195, less antennas - \$1,595. Stoddart NM-30A, 20-400MHZ. Complete - \$1,295. Stoddart NM-52A, 375-1000MHZ. Complete - \$1,495, less antennas - \$1,095. All are in excellent condition and calibrated prior to shipment. Surcom Associates, (213) 382-6985. 6-75-tf

FULL LINE TUNING and phasing components available, including contactors, also large supply separate contacts for E. F. Johnson contactors. Write: Geleco Electronics, Ltd., #2 Thorncliffe Park Drive, Unit 28, Toronto 17, Canada. Phone: (416) 421-5631. 2-75-tf

EQUIPMENT FOR SALE (CONT.)

SPOTMASTER EQUIPMENT AND PARTS now in Texas from Sales Southwest 4002 Houston Highway, Victoria, Texas 77901. 512-578-4323. 4-75-6t

SPOTMASTER, FIDELIPAC, RUSSCO, ROH, ELECTRO-VOICE, OTARI, RAMKO, SCOTCH, STANTON, NORTONICS, SHURE, SENNHEISER, TELEX, MAGNECORDER, and VIKING are all items distributed and serviced by COMMUNICATION MEDIAS/BROADCAST EQUIPMENT DISTRIBUTORS, P.O. Box 54, Allentown, Pa. 18105. 215-437-0607. "Sudden Service" our specialty. 6-75-12t

CCA AM250-D TRANSMITTER—Excellent condition. Low hours, used as auxiliary. May be heard on the air. \$2900.00 FOB, San Bernardino. La Vern Garton, 714-885-6555. 6-75-4t

WHATEVER YOUR EQUIPMENT NEEDS — new or used — check us first. We specialize in broadcast equipment. Send \$1.00 for our complete listings. Broadcast Equipment & Supply Co., Box 3141, Bristol, Tenn. 37620. 3-75-tf

MAGNECORDER PT6-A RECORDERS. Rebuilt units and new and used Magnecord, Telex, Viking, and Spotmaster parts. Huge supply, lowest prices. **REBUILT CARTRIDGE TAPE EQUIPMENT.** Spotlessly clean and thoroughly tested. 30 day moneyback guarantee. **ONE YEAR** warranty. **REPAIR AND RECONDITIONING SERVICES** for cartridge equipment by factory trained technicians. Send for complete information: AUTODYNE, Box 1004, Rockville, Md. 20850, (301) 762-7626. 8-75-tf

CCA—AM 250-D transmitter. Excellent condition. On air now as auxiliary. \$2900.00. LaVern Garton, 714-885-6555. 7-75-5t

GATES SOLIDSTATESMAN FM LIMITER, 1970, FACTORY RECONDITIONED, \$350, WRAR-FM, 804-443-4321. 8-75-3t

CHARACTER GENERATORS: DEMO/TRADE-IN EQUIPMENT AVAILABLE—MODELS INCLUDE D-2400, D-1500, D-1032, DT-1, AND MG-1. ALL WARRANTED—REASONABLY PRICED. FIRST COME BASIS. CONTACT: ANTHONY MATTIA, DATAVISION VIDEO PRODUCTS, 3M COMPANY, 15932 SHADY GROVE ROAD, GAITHERSBURG, MARYLAND 20760, (301) 948-0460. 8-75-3t

FOR SALE: Heliac-Cable HJ-7-50 1-5/8 inch. Used four months. Due to antenna conversion, over 300 feet on reel ready for shipment. Price \$3.00 FOB. Contact Bill Pruden, P.O. Box 1076, Roanoke Rapids, N.C. Telephone (919) 537-1023. 7-75-5t

AMPEX 1200B OHM Color Videotape Recorder/ Reproducer with Electronic Editor Mark III. Excellent Condition. Best Offer or Trade. Windsor Total Video, 652 First Avenue, New York, N.Y. 10016, (212) 725-8080. 9-75-1t

RAZOR BLADES. Single Edge, Tape Editing, \$23/M, Flyer, RALTEC, 25885 Highland, Cleveland, Ohio 44143. 9-75-6t

529' STAINLESS, INC. guyed, galvanized tower; RCA Custom TFU36JDA(L) Antenna for Channel 15; 580' 6-1/8" 75 ohm Universal Transmission Line and all connections. Will sell as package or separately. Priced to sell - 25% of new prices. Box 52103, Lafayette, La. 70501 or (318) 232-8120. 9-75-1t

RCA TT50AH TELEVISION TRANSMITTER presently operating channel 11. Good condition and may be inspected. Sideband filter available. Contact Chief Engineer, WBAL-TV, 3800 Hooper Ave., Baltimore, Md. 301-467-3000. 9-75-2t

RCA stock number 96522 mica capacitors for TTU-1B transmitters. 17 new available. Lot at \$40.00. Inquire KLOC Broadcasting Company, Modesto, California 95352. 9-75-1t

ANDREW 6GHZ band, 6ft. Microwave dishes with pipe clamps, waveguide, and connectors. Used only 1 year. Lot at \$550.00. Inquire KLOC Broadcasting Company, Modesto, California 95352. 9-75-1t

CBS AUDIMAX 4440A. Must sell. One year old. Also willing to sell ITA-AMF-1A AM frequency monitor. Scott Shannon (803) 536-1580. 9-75-5t

QUALITY used Television and Radio equipment. LBH ENTERPRISES, 3521 S.W. 42nd Ave., Gainesville, Fl. 32608. 9-75-1t

EQUIPMENT FOR SALE (CONT.)

RCA TR-3 Hi band tape machine, color ATC, Linelock. Good condition. \$14,000. WEMT-TV, Bangor, Maine 04401. 9-75-2t

IVC 200 COLOR CAMERA AND ENCODER. VERY GOOD CONDITION. \$10,000.00. P.O. BOX 480, BRIDGEPORT, W. VA. 26330. PHONE (304) 842-3558, or TWX (710) 935-1142. 9-75-1t

FOR SALE: Good used 5 kW AM Transmitter traded in on Continental 315F. Call Dick Floyd or Vernon Collins (214) 381-7161. 9-75-1t

AMPEX 3000 PORTABLE 2" VIDEOTAPE RECORDER used by advertising agency; approximately 75 hours; excellent condition; maintained by resident engineer and Ampex personnel; also spare new head and accessory case, \$30,000 firm. Mary Wolka (313) 872-3540. 9-75-2t

TWO 3M DROPOUT COMPS. with VR-1200 Interfacing Kits; Two Envirazones Model EV II 10050; One Ampex VR-1001A, lowband monochrome VTR with spare head. WKTU, P.O. Box 2, Utica, NY 13503 (315) 733-0404. 9-75-1t

RCA TR-22 COLOR VTR'S (2) in excellent condition, complete with books, spare heads. Low cost highband conversions available. Call or write with your offer for one or both. Ellis Feinstein, KMED-TV, Medford, Oregon 97501 (503) 773-7373. 9-75-1t

BROADCAST CRYSTALS for AM, FM or TV transmitters. Frequency change, repair or replacement of oven types. Also new vacuum types for RCA, Gates, Collins, etc. transmitters. Quality products, reasonable prices and better delivery! Don't be without a spare crystal. Frequency change and service for AM and FM frequency monitors. Over 30 years in the business. Eidson Electronic Co., Box 96, Temple, Texas, 76501. Phone (817) 773-3901. 12-74-tf

COMPLETE AUTOMATION SYSTEM—MOR MUSIC PACKAGE: Gates SP-10, 2 Scullys, ATC-55, more, and 420 hours MOR music. See and hear in operation til mid-November. Replacement value over \$25,000, asking \$10,000. KBUR-FM, Box 70, Burlington, Ia. 52601. 319-752-2701. 9-75-1t

AMPEX VR7100 Video Recording System, including CC324 Camera, 4 lenses, tripod, microphone. \$650.00. Call G. Hall 217-789-5576. Write R.R. 1, Pl. Plains, Ill. 62677. 9-75-2t

19 INCH EQUIPMENT RACKS: Have 5 six foot standard equipment racks. AC wired and blowers. At give away prices. J. Brooks, 728 Stillwater Dr., Valdosta, Ga. 31601, (912) 242-1086. 9-75-1t

3 NORELCO PC-70 COLOR CAMERAS. EXCELLENT PHYSICAL AND ELECTRICAL CONDITION. CAMERA CHAINS CONSIST OF: (2) ANGENIEUX 10x18 LENS, (1) ANGENIEUX 18x1 LENS. ALL LENS MANUALLY CONTROLLED. (3) 200' LENGTHS TV81 CAMERA CABLE. CONTOURS AND ENCODERS. WRITE: DEPT. 335, BROADCAST ENGINEERING, 1014 WYANDOTTE ST., KANSAS CITY, MO. 64105. 9-75-1t

CBS VOLUMAX 4000 Peak Limiter, excellent condition, \$450.00. SPARTA 800C R/pb Cart Machine, like new, \$685.00. Sound Dynamics, Inc., P.O. Box 1335, Sunnyvale, CA 94088, (408) 926-3588. 9-75-1t

SERVICES

FREQUENCY MEASURING SERVICE—WE'RE #2—MONITOR REPAIRS—MOBILE UNIT— covers Northern 2/3 Ill., Eastern Iowa, Eastern Minn., Southern 2/3 Wis., Western Mich., and Western Ind., monthly. Radio Aids, 528 Ravine Ave., Lake Bluff, Illinois 60044, (312) 234-0953 2-74-tf

BROADCAST CRYSTALS for AM, FM or TV transmitters. Frequency change, repair or replacement of oven types; also new vacuum types. Quality products, reasonable prices and better delivery! Don't be without a spare crystal. Repair of G.R. 1931-A/B modulation monitors and frequency change of AM and FM frequency monitors. Over 30 years in the business. Eidson Electronic Co., Box 96, Temple, Texas 76501. Phone (817) 773-3901. 12-74-tf

SERVICES (CONT.)

COMMERCIAL RADIO MONITORING CO. Precision frequency measurements since 1932. Local and mobile service covering entire midwest plus. Test instruments, counters, monitors repaired and certified. Lee's Summit, Mo. 64063. (816) 524-3777. 9-74-tf

SPOTMASTER PARTS—24 hour service. Repairs and rebuilding of your Spotmaster equipment. Franchised Spotmaster repair service. 90 day warranty. COMMUNICATION MEDIAS/BROADCAST COMPONENT DISTRIBUTORS, P.O. Box 54, Allentown, Pa. 18105, 215-437-0607. 6-75-12t

CAMERA TUBES...ALL TYPES EXCEPT ORTHICONS CAN NOW BE RECONDITIONED AT AN UNBELIEVABLE PRICE, LEAD OXIDE TYPES \$300.00, VIDICONS FROM \$35 TO \$200.00. ALL RECONDITIONED TUBES COME WITH 500 HOUR WARRANTY. FOR DETAILS WRITE: RODONCO ENGINEERING, CAMERA TUBE DIV., 4020 STAPLETON DR., BLOOMINGTON, IND. 47401. 8-75-tf

HELP WANTED

NOTE: Employment ads which violate Equal Opportunity Employment provisions will not be accepted.

MOVE UP from your present job in broadcast engineering. We handle all engineering jobs and openings coast to coast. Send full resume confidentially now. The AMPS Agency, 6331 Hollywood Blvd., Suite 623, Los Angeles, Calif. 90028. Tel: (213) 462-7301. 8-73-tf

FIELD SERVICE ENGINEER

Extensive travel, all benefits. Experience in color video and switching systems preferred. Contact: Mr. Buzan, **Vital Industries, Inc., 3700 N.E. 53rd Ave., Gainesville, Fla. 32601. Phone 904/378-1581.**

EXCELLENT OPPORTUNITY for a video and audio systems sales engineer with a major communications distributor in Southwestern Ohio. Technical knowledge helpful. Write giving background to: Dept. 337, Broadcast Engineering, 1014 Wyandotte St., Kansas City, Mo. 64105. 9-75-1t

TV TECHNICAL SPECIALIST—With background in electronics and experience in commercial or educational TV. Capable of maintenance and operations of equipment in TV studio and closed-circuit distribution system. Good salary & benefits. Equal Opportunity Employer. Submit (prior to Oct. 1, 1975) resume including salary history: Dr. Joseph S. Gardiner, Instructional Resources Center, State University College, Oneonta, New York 13820. 9-75-1t

UHF-TV TRANSMITTER engineer wanted. Eastern market. Solid background in transmitter maintenance required. Studio and film chain maintenance experience desirable. Good salary. Write: Dept. 336, Broadcast Engineering, 1014 Wyandotte St., Kansas City, Mo. 64105. 9-75-1t

MUSIC DEPARTMENT—STATE UNIVERSITY OF NEW YORK AT BUFFALO. Technical Specialist to maintain and repair Music Department electronic equipment and to record Department concerts. Send resumes to William K. Wachob, Music Department, 111 Baird Hall, SUNY at Buffalo, Buffalo, New York 14214. Equal Opportunity/Affirmative Action Employer. 9-75-1t

TRAINING

PASS FCC first and second class exams with new 21 - lesson, 450-page course. Starts with basic electricity. Over 600 FCC-type, multiple-choice questions and sample exams included. No previous technical knowledge required. Commercial Radio Operator Theory Course, #15-01. Only \$5.95. Ameco Publishing, 275G Hillside Ave., Williston Park, N.Y. 11596. 8-72-tf

TRAINING (CONT.)

EARN YOUR ELECTRONICS DEGREE by correspondence, G. I. Bill approved. For free brochure, write Grantham School of Engineering, Information Desk, 2000 Stoner Avenue, Los Angeles, Calif. 90025. 8-72-tf

FIRST PHONE in six to twelve weeks through tape recorded lessons at home plus one week personal instruction in Boston, Philadelphia, Detroit, Atlanta, Kansas City, Seattle or Los Angeles. Our twentieth year teaching FCC license courses. Bob Johnson Radio License Preparation, 1201 Ninth, Manhattan Beach, Calif. 90266, Telephone 213-379-4461. 8-75-tf

BROADCAST ENDORSEMENT and third phone preparation on cassettes. Illustration book includes current FCC-type exams. Radio License Preparation, 1201 Ninth, Manhattan Beach, Calif. 90266. 8-75-tf

FOR 38 YEARS, Industry leader, Don Martin School of Communications trains for 1st phone license, in just five weeks! Call collect for details, 213-462-3281, or write, Don Martin School, 7080 Hollywood Blvd., Hollywood, CA 90028, Now! 8-75-tf

PASS FCC EXAMS with Ameco books. Each book contains FCC questions plus simplified answers plus FCC-type exams and answers. 3rd class includes broadcast endorsement \$1.00, 2nd class \$2.25, 1st class \$1.50. Free catalog. Ameco Publishing, 275G Hillside Ave., Williston Park, N.Y. 11596. 8-72-tf

BROADCAST ENGINEERING: Radio communications course in FCC First class Licensing. Six to eight week sessions with comprehensive, personal instruction in a suburban setting. Local housing available. Well proven instructor and method. Not to be confused with a straight "question and answer" method. Attend the only course of this nature in the entire Northeast. Call collect: Tutoring Services, 281 Silver Lane, East Hartford, CT 06118, at (203) 569-2302. 9-75-1t

BROADCAST ENDORSEMENT AND THIRD PHONE—A complete course on cassette. Includes current FCC type exams and manual. Also includes basics of broadcast techniques. Prepared by chief engineer WMOA AM-FM. \$24.99 from S.S.E., Box 224, Marietta, Ohio 45750. 9-75-1t

SITUATION WANTED

TV TRANSMITTER ENGINEER—two years experience will relocate, want opportunity to become TV chief engineer, resume on request. 1306 Walnut, Cadillac, Mich. 49601. 9-75-1t

**If you
don't do it,
it won't
get done.**

GIVE THE UNITED WAY



A.F. Associates, Inc.	68
Accurate Sound Company	149
Acrodyne Industries, Inc.	62
Aderhold Construction Company	191
Alco Electronic Products, Inc.	64
Allied Broadcast Equipment	151
Alpha Electronic Services, Inc.	156
American Data Corporation	7
Amperex Electronic Corporation	CE-6
Ampro Corporation	48
Andrew Corporation	61
Angenieux Corp. of America	191
Anixter-Mark	69
Aristocart Div., Western Broadcasting Ltd.	157
Asaca Corporation of America	41
Audico Ltd.	166
Audio Designs & Manufacturing	129
Audio Services, Inc.	160, 162, 163, 164, 169
Audio-Video Engineering	172
Auditronics, Inc.	133
Avtel Div. of Television Microtime	147
B & I Electronics	158
Belar Electronics Laboratory, Inc.	165
Bogner Broadcast Equipment Corp	159
Boston Sound & Power Systems	169
Broadcast Electronics, Inc.	45
Broadcast Equipment & Supply Co.	175
Broadcast Video Systems Ltd.	122
Buhl Optical Company	167
CCA Electronics Corp.	168, 171, 174
Cablewave Systems, Inc.	57
Calvert Electronics, Inc.	175
Canon Video	135
Capitol Magnetic Products	39
Central Dynamics Ltd.	13, 176
Chiron Telesystems	44
David Clark	163
Coastcom	42
Colorado Video, Inc.	170
Comark Industries	158, 161
Communication Medias	62
Computer Magnetics Corp.	131
Comquip, Inc.	162
Comrex Corporation	156
Continental Electronic Mfg. Co., Inc.	163, 164, 167
Control Design Corporation	137
Convergence Corporation	174
Cooke Engineering	37
Cramer Video	148
D and S Corley Ltd.	54
Data Disc	163
Datatron, Inc.	49
Delta Electronics, Inc.	59
Ditch Witch Trenchers	CE-4
Dolby Laboratories	11
Victor Duncan, Inc.	139
Dyma Engineering	165
Dynair Electronics, Inc.	66
EECO	47
ES Enterprises	40, 54, 60, 132
EIMAC, Division of Varian	29
Electrohome Ltd.	141
Electro Impulse, Inc.	171
Electro-Voice, Inc.	31
English Electric Valve North America Ltd.	21
Farinon	33
Fidelipac	8, 154
Fisher/Burke Consultants	124
Forth Worth Tower Company	CE-11
Flash Technology Corp. of America	144
Freeland Products Company	174
Frezzolini Electronics, Inc.	32
Garron Electronics, Inc.	165, 170
The Grass Valley Group	3
Grinnan Fixture Company	163
Clifford B. Hannay & Son, Inc.	52
Harris Corp., Broadcast Equip. Div.	56
Dave Hovey General Contractor	191
Hughey & Phillips	161
IGM - NTL	173
Inovonics	175
International Electro-Magnetics	148
International Tapetronics Corp.	20
JOA Cartridge Service	162
Jamieson Film Company	126
Jampro Antenna Company	128
K and H Products, Ltd.	157
Kay Elemetrics Corporation	CE-8
Kansas State Network	CE-2
LPB Inc.	152
Lenco, Inc.	40
The London Company	162, 164, 167
C. M. Levit Electronics	162
McCurdy Radio Industries, Inc.	25
McMartin Industries, Inc.	48
Marconi Instruments	65
Marti Electronics	119
Martin Audio/Video Corporation	152
MICMIX Audio Products	130
Micro Communications, Inc.	36
Micro-Trak Corporation	164
Minneapolis Magnetics, Inc.	148
Modular Audio Products	146
Monroe Electronics, Inc.	24
Moseley Associates, Inc.	9
Rupert Neve Incorporated	138
NOVA Corporation	30
Nurad, Inc.	58
O'Connor Engineering Labs	22
Onan	55
Opamp Labs, Inc.	191
Orange County Corporation	64, 158
Orban/Broadcast	191
Philadelphia Resins Corp.	140
Potomac Instruments, Inc.	153
Pulse Dynamics Mfg. Corp	160
Pulse Techniques, Inc.	156
QRK Electronic Products, Inc.	160
Quantum Audio Labs, Inc.	171
Quick-Set, Inc.	56
RCA-CESD	12, 58
Ramko Research	125
Rank Optics	35
Recording Supply Corp.	191
Recortec, Inc.	154, 159, 172, 173
Revox Corporation	43
Rockwell International	51
Roh Corporation	155
Rolane Sales Corporation	160
Ross Broadcast Products (Glentronix Ltd.)	19, 166
Russco Electronics, Inc.	42
SSAC Precision Products, Inc.	168
Scientific Systems, Inc.	155, 164
Scully/Metrotech	123
Sescom, Inc.	167
Shalco, Inc.	165
Shintron Company, Inc.	50
Sitler's Supplies, Inc.	175
Sony Corporation of America	Cover 3
Sound Dynamics, Inc.	174
Sphere Electronics	170
Sparta Electronic Corporation	5
Spotmaster	45
Stainless, Inc.	120
Stanton Magnetics, Inc.	63
Storeel Corporation	12, CE-9
Strand Century, Inc.	53
Studio Tape Exchange, Inc.	168
TT Electronics	171
Taber Mfg. & Eng. Co.	60
Tech Labs, Inc.	169
Technology Incorporated, H. F. Photo Systems Div.	154
Telecommunications Industries, Inc.	145
Teldata Systems, Inc.	151
Teledyne Energy Systems	155
Telemation, Inc.	67, 166
Telemedia Electronics	161
Telemet	1
Television Equipment Associates	159
Television Microtime, Inc.	134
Television Products Company, Inc.	136
Television Research International	17
Television Technology Corp.	168
Tentel	169
Tepco Corporation	166
TerraCom	127
Texas Electronics, Inc.	170
Thomson-CSF	121
Time & Frequency Technology, Inc.	10
UMC Electronics Company	52
Unimedia	18
United Recording Electronics, Inc.	14
Val-Tronics, Inc.	160, 171
Vamco Engineering	23
Varian Micro-Link	191
Video Aids Corp. of Colorado	27
Video Data Systems, Inc.	171
The Video Tape Company	149
Videomax Corporation	15
Viscount Industries	46
Vital Industries, Inc.	Cover 4
Ward-Beck Systems, Ltd.	Cover 2
Waters Manufacturing, Inc.	150
Western Electronic Products Company	150
Wilkinson Electronics, Inc.	157
World Video, Inc.	16

The whole point of ENG is the point of the Sony U-matic format.

Fast, easy, economical news gathering.

That's the whole point of ENG.

Fast, easy, economical operation.

That's the whole point of Sony's 3/4" U-matic® videocassette equipment.

Cassettes and ENG were made for one another. They're a perfect match.

But only Sony can give your ENG all the speed and savings of both cassette recording and cassette editing.

Our all-cassette system consists of two editing units, an editing controller, portable recorder,

Trinicon® color camera, and camera control unit.

Operating savings? Huge. Because, unlike film, videotape is erasable, reusable, instantly replayable. And there is no processing.

Which means no processing delays. No chemicals to dispose of. No processing costs of any kind.

No wonder Sony ENG equipment is already making news at ABC, CBS, NBC, and over 200 local stations across the nation.

For the whole exciting story, write Sony Corporation of America, Video Information Center Dept. 224-C, Box 1594, Trenton, N. J. 08607.

SONY®

The complete ENG system.

For More Details Circle (15) on Reply Card

For Demonstration Only Circle (16) on Reply Card





**VIMAX
27**

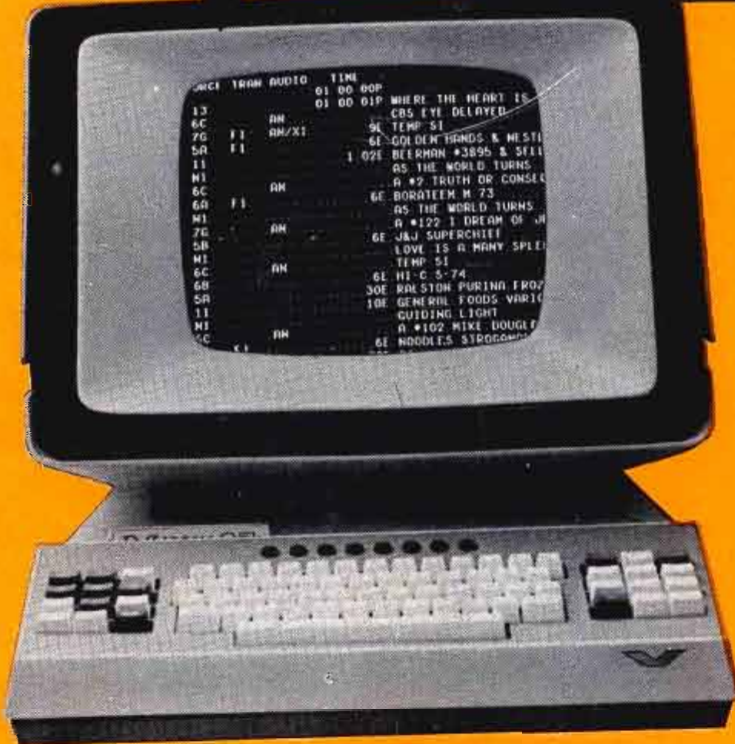
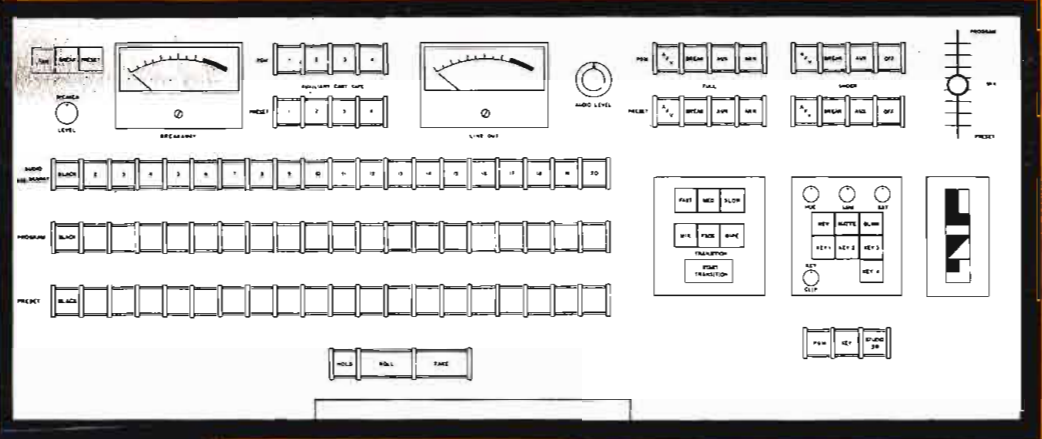

the Vital way to tv automation

- New modular computer concept
- Extremely versatile, fast and reliable
- Easy operation with no computer training
- Standard and custom formats available
- 64 characters per line
- 27 events displayed at one time
- Full editing capabilities
- Multiple pre-rolls without time restrictions
- Full transition capability including fades, dissolves, pattern wipes and inserts
- Complete logging facilities for management and FCC purposes
- Manual override always "hot"
- Power failure protection
- Complete plant communications with auxiliary monitors
- Full spectrum of equipment can be controlled in any configuration and quantity
- Events on-air — by real, elapse, duration or cue time, plus manual
- Two automation systems in one: on-air plus 8 programmable selections for microwave switching, VTR's into record, etc.
- Optional mass data storage available for advanced scheduling from 27 events to one year

Several stations in America now enjoy daily use of the Vital Automation System. Write for your brochure describing our VIMAX-27 system.

Make Vital Industries, Inc. your single responsible source for your total system needs.

MORRELL BEAVERS Midwest
2644 N. Seventh St., Terre Haute, Ind. 47804
Phone 812/466-3212

ROBERT McALL Northeast
34 Autumn Lane, Hicksville, N.Y. 11801
Phone 516/735-0055

GORDON PETERS Southwest
P.O. Box 912, Arlington, Texas 76010
Phone 817/261-6855

ERIC KING
Fox Hill Road, Lynchburg, Va. 24503
Phone 804/384-7001

RICHARD RODGERS West Coast
7960 W. Beverly Blvd., Los Angeles, Ca. 90048
Phone 213/653-9438

GOOD ENGINEERING IS VITAL



VITAL INDUSTRIES, INC.

MAIN OFFICE: 3700 N.E. 53rd Ave., Gainesville, Fla. 32601 - Phone 904/378-1581

For More Details Circle (17) on Reply Card