

JUNE 1982

TEN DOLLARS

BROADCAST COMMUNICATIONS

THE INTERNATIONAL
JOURNAL OF
BROADCAST TECHNOLOGY

(USPS 536830)

THE DIRECTORY

OF BROADCAST
EQUIPMENT,
SERVICES,
& SUPPLIERS

1982

40-MEYER- 1UPC2M
500067808
UNITED SATELLITE CORP
MR. RAYM. MEYERS
4160 SW 75TH AVE
MIAMI FL 33155**
2

ADM[®]

The Audio Company

ST Series II

High marks in everything

The ratings are in on our ST Series AM/FM Broadcast Consoles—and they're number one. They rate high for versatility, reliability and overall excellence.

But we know that even the finest products can be made better—that's why we've introduced the new ST Series II. These new consoles incorporate even more features to insure greater capability and performance.

The new ST consoles offer a series of modular frames that can be equipped to meet your specific needs. A wide range of input, output and signal processing modules is available to cover your present requirements and provide for future expansion.

At ADM we're never content to stand still—the new ST Series II consoles are impressive proof of that. We're so confident of their excellence that they're backed by an exclusive 5-year warranty.

Contact us now! ADM Technology, Inc.—*The Audio Company*—
1626 E. Big Beaver Road, Troy, MI 48084, Phone (313) 524-2100.
TLX 23-1114.



West Central Sales
(817) 467-2990

West Coast Sales
(415) 945-0181

Main Office
and
East Coast Sales
(313) 524-2100

Rocky Mountain Sales
(801) 486-8822

JUNE 1982

BROADCAST COMMUNICATIONS

THE INTERNATIONAL JOURNAL OF BROADCAST TECHNOLOGY

BEHIND THE SCENES

COMING ATTRACTIONS AT A GLANCE

SEPTEMBER

Satellite Applications Review

Energy-Efficient Facility Design ★

RTNDA Preview



Ad Performance Study

BONUS DISTRIBUTION

★ Supplemental mailing to all current CP Holders in the U.S.

RTNDA, Las Vegas, September 30-October 2

AD CLOSING DATE
AUGUST 16

OCTOBER

High-Definition Television

Resurrecting AM Stereo

Fall SMPTE Preview

Improving TV Audio

And featuring the fourth quarterly installment of

ACCESS

TO CABLE COMMUNICATIONS

BONUS DISTRIBUTION

Fall SMPTE, New York, November 7-12

AES, New York

AD CLOSING DATE:
SEPTEMBER 17

NOVEMBER

The Automated Newsroom



Computer Business Systems

Radio Automation Update

AD CLOSING DATE:
OCTOBER 15

NOTE — Behind the Scenes is a special promotional insert bound only in those complimentary copies of BROADCAST COMMUNICATIONS distributed to advertisers, prospective advertisers and advertising agencies.

The ideal advertising medium combines **Readership with Buying Activity.**

OVERALL RESULTS
McGraw-Hill Advertising Performance Study
February, 1982 Edition

AVERAGE SCORES — SIZE AND COLOR

Advertiser	Number of Ads	Attracted Attention	Began To Read	Read Half or More	Action Taken or Planned					
					Planned or Took 1 or More Actions	Evaluated Ad Info for Future Needs	Filed Ad	Shown it to/ Discussed it with Others	Re-quested More Infor-mation	Recom-mended/ Specified Purchase
Fractional Page Ads.....	20	49%	25%	15%	57%	32%	13%	5%	8%	2%
1 Page Ads	26	63	31	20	61	33	14	8	9	3
2 Page Ads	1	83	43	32	59	21	13	11	7	9
Black & White	24	50	26	15	58	32	13	6	10	3
2 Color	10	58	31	19	61	35	16	7	8	2
4 Color	13	71	33	22	59	33	14	8	8	4
Average — All Ads	47	58%	29%	18%	59%	33%	14%	7%	9%	3%

AVERAGE SCORES — PRODUCT GROUPS

Advertiser	Number of Ads	Attracted Attention	Began To Read	Read Half or More	Action Taken or Planned					
					Planned or Took 1 or More Actions	Evaluated Ad Info for Future Needs	Filed Ad	Shown it to/ Discussed it with Others	Re-quested More Infor-mation	Recom-mended/ Specified Purchase
Video Products.....	26	59%	28%	17%	58%	29%	15%	8%	9%	3%
Audio Products.....	18	58	32	20	63	38	12	6	9	2
Audio/Video Products.....	3	43	23	11	48	27	11	3	10	1
Average — All Ads	47	58%	29%	18%	59%	33%	14%	7%	9%	3%

Here's proof positive.

Your advertising in

BROADCAST COMMUNICATIONS
THE INTERNATIONAL JOURNAL OF BROADCAST TECHNOLOGY

*enjoys extraordinary readership and recall,
and generates specific buying activity.*

For a copy of the complete research report, write or call:

BROADCAST COMMUNICATIONS
4121 West 83rd Street; Suite 132
Prairie Village, KS 66208
(913) 642-6611

ADDA CORPORATION

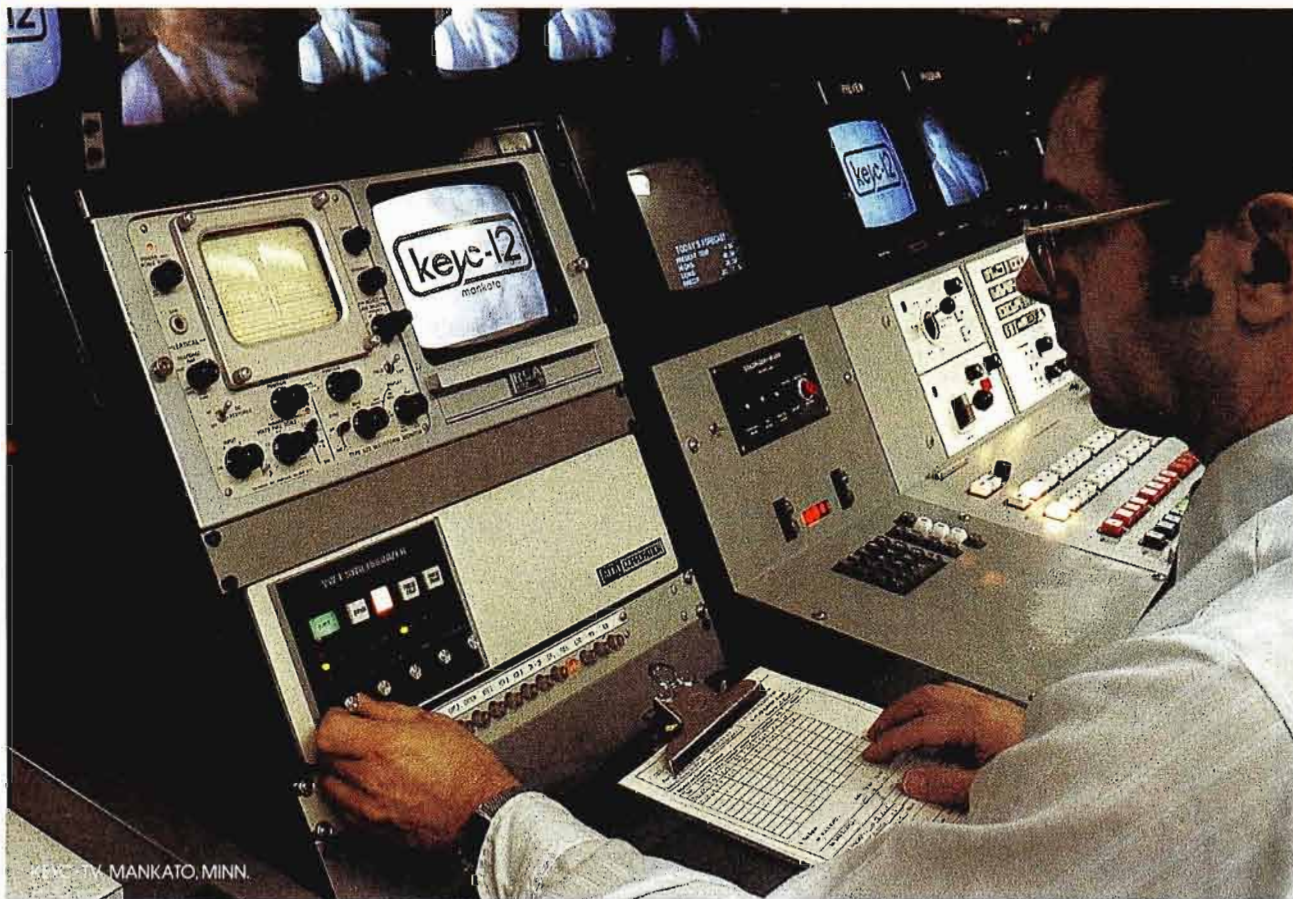

Why the Networks' TBC Is Getting Popular in Smaller Markets.

In less than five years, our VW series has become the broadcast industry's basis for comparison in time base correction and frame synchronization. The ADDA VW is standard equipment for 3 of the 4 networks, as well as O and O's.



The affiliates and independents have been watching, listening and making up their minds. More and more of them, even in the medium and smaller markets, are ordering the VW-1 (for 3/4" VTR's) and the VW-2 (for 3/4" and 1" VTR's).

The way we see it, the reasons for this trend are clear:

- Superior digital signal processing
- Unequaled reliability
- Infinite correction window
- Full-bandwidth electronic freeze frame
- Frame synchronization (The VW can take raw external feeds and let you switch them synchronously with studio material.)
- Meets RS-170A

Of course, the VW costs more than some of its competitors. The ultimate usually does. But the difference buys you a great deal more; and the difference may well be less than you think, because prices are lower now.

The best way to understand the difference between the VW and everything else is to watch a side-by-side comparison on your own premises. Call us for a demo. We'll be happy to show you why the VW is a TBC for everybody's market.

Affordable Excellence

ADDA CORPORATION

1671 Dell Avenue
Campbell, California 95008
(408) 379-1500

Fine Tuner. \$950



Barco has a reputation for quality products. And in the AVD-33 video tuner, which permits television monitors to receive off-the-air signals, Barco quality looks better than ever.

In the AVD-33, Barco engineers have built a tuner you can rely on featuring:

- advanced digital search tuning
- 20-channel memory
- 2 video and audio outputs
- all channels, including mid and upper band
- bi-directional sequential channel selection

A fine tuner at a fine price. Barco's AVD-33.

Available from Elector, exclusive U.S. distributor of Barco communications products.

In the U.S.
Elector U.S.
5128 Calle del Sol,
Santa Clara, CA 95050
Phone: 408/727-1506
Telex: 0236/0172335



In Canada
Electro & Optical Systems Ltd.
31 Progress Court,
Scarborough
Ontario M16 3V5
Phone: 416/439-9333
Telex: 021/06525431



Circle (2) on Action Card

BROADCAST COMMUNICATIONS

THE INTERNATIONAL JOURNAL OF BROADCAST TECHNOLOGY

President & Publisher Michael D. Kreiter

Vice President/Editorial Director Ron Merrell

Vice President/Managing Editor Michael Scheibach

International Video Editor Joe Roizen

Video Production Editor Glen Pensinger

Radio Editor Peter Burk

Audio Editor Larry Titus

Acoustics Editor Eric Neil Angevine

News Technology Editor Phillip Keirstead

Programming Editor Ed Shane

Computer Editor Bryan Boyle

Radio Station Editor Robert A. Jones

Satellite Editor Raymond Meyers

Facilities Editor Morris Courtright

Foreign Correspondent Mike Townley

Art Director Mary Christoph

Circulation/Business Manager Jean Girardin

Ad Production Manager Debbie Gutschenritter

Association Affiliation

Radio-Television News Directors Association

American Society of Television Cameramen

Broadcasters Promotion Association

Society of Broadcast Engineers

Advertising Sales Offices

Home Office: Debbie Gutschenritter, Ad Production Mgr.
P.O. Box 12268, Overland Park, KS 66212; (913) 642-6611

Eastern Region: Stan Osborn, Vice President/Sales
46 Post Road East, Westport, CT 06880; (203) 226-7419

Charles C. Horner, District Sales Manager
P.O. Box 175, Greenlawn, NY 11740; (516) 757-7863

Central Region: Roy Henry, Vice President/Sales
2469 E. 98th Street, Indianapolis, IN 46280; (317) 846-7026

Western Region: Dennis Triola, Vice President/Sales
2680 Bayshore Frontage Road, Suite 207, Mountain View, CA 94043
(415) 969-3000

Europe: Tomislav F. Marjanović, European Sales Representative
Wilhelmstrasse 52 E, D-6200 Wiesbaden, Fed. Republic of Germany
Tel. (0 6121) 30 26 14

BROADCAST COMMUNICATIONS is published monthly by Globecom Publishing Limited, 4121 West 83rd Street, Suite 132, Prairie Village, KS 66208.

All material in this magazine is copyrighted © 1982 by Globecom Publishing Limited. All rights reserved.

SUBSCRIPTIONS: BROADCAST COMMUNICATIONS is mailed free to qualified persons. Non-qualified subscriptions in the United States are \$36.00 for one year. Subscription rates outside the United States are \$50.00 for one year. Back-issues rate is \$5.00. Allow 8 weeks for new subscriptions. Allow 8 weeks delivery for change of address.

Controlled-circulation postage paid at Shepherdsville, Kentucky.

BPA Member, Business Publications Audit of Circulation

Postmaster: Please send 3579 forms to P.O. Box 809, Mineola, NY 11501.



Globecom Publishing Limited

BROADCAST COMMUNICATIONS/JUNE 1982

Get the Edge on price, performance and features

CMX hones THE EDGE with the addition of Internal Memory, Re-edit and List Ripple to its six-point advantage.

When we at CMX set out to build an advanced medium-scale editing system we took a look at the best competition had to offer. We then applied our 11 years of leadership in building editing systems to produce THE EDGE™, a system that is superior in every respect. Check these six key points and we think you'll agree.



The Human EDGE. Veteran editors and beginners alike quickly adapt to THE EDGE because its

SMART KEYS™ and layered screens take you easily through the editing process as you direct it. You set your own pace. Frame accurate time code or pulse count editing lets you concentrate on creativity and increase your productivity dramatically.



The Technical EDGE. Simple plug-in modularity makes THE EDGE expandable. Going from two to three

machines? Add a card. Expanding to a floppy disk? Add a card. Forget about stringing out black boxes. Also, servicing has been human-engineered with built-in diagnostics that trouble shoot on the spot. Information on the screen will tell you the story. No more long waits for service calls.



The CMX EDGE.

With the internal event memory, which features re-editing, list rippling, event deletion and list scrolling, you can essentially do your off-line editing with THE EDGE and build a CMX Edit Decision List. And this can all be done on a cuts-only system, if desired. Through the availability of a variety of optional techniques, such as using THE EDGE audio/video dissolver or auto-transition control of a production switcher, you can complete

your final auto-assembly on THE EDGE. If it's a highly sophisticated finished production that requires numerous special effects, you may wish to complete it from THE EDGE EDL on a 340X system. It's this flexibility of choices that gives you the most cost effective solution to your editing needs.



The VTR EDGE.

The EDGE speaks very quietly to VTR's and they respond gently. Only CMX knows how to engineer smooth-as-silk VTR interfaces. And that

includes 1-inch, 3/4-inch, and 1/2-inch machines from the major manufacturers. Mix and match them on your system.

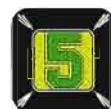

The Protective EDGE. Last year's EDGE becomes this year's with a quick, easy update to incorporate any new features. It's just like our 340X. It's built to grow with you. It's protection against obsolescence.



The Dollar EDGE. The most important consideration in computing the true cost of an

editing system is what your bottom line is going to be a few years hence. By then you'll have expanded your system into its final configuration. You can get THE EDGE in a two-machine system for \$13,250.* The complete system, a fully-featured three machine system including A/V dissolver and floppy disk, costs about \$23,400.* That's many thousands less than competitors. That's the most you'll ever spend.

Call or write us for more information. It costs less to own or lease the very best—and to get the EDGE.

CMX
ORROX
The World Standard for Editing

Circle (3) on Action Card

Orrox Corporation 3303 Scott Blvd., Santa Clara, CA 95050 (408) 988-2000 Telex 910-338-0554

*U.S. Domestic

TM Orrox Corporation

BROADCAST COMMUNICATIONS

THE INTERNATIONAL JOURNAL OF BROADCAST TECHNOLOGY

THE DIRECTORY

38

General Index

An index of all categories in The Directory. The index will direct you to the page where you can find the complete listing of companies that manufacture products in that category. Major categories are listed alphabetically, and sub-headings of major categories also are arranged alphabetically. For example, test equipment is divided into three major categories: generators; measuring instruments; and measuring/monitoring meters. Sub-categories include everything from stereo generators and acoustic analyzers to antenna base meters.

Advertisers in this issue are highlighted in the General Index under the categories which correspond to the products featured in their ads. There is also a reference to the page on which the ad is located.

46

Product Directory

A comprehensive and up-to-date listing of all major broadcast equipment and service categories, including U.S., Canadian, and foreign manufacturers who responded to our requests for directory information. With few exceptions, most manufacturers re-verified their listings within the past four months, making The Directory as current as possible.

114

Manufacturers

Mailing addresses for companies listed in the equipment and services categories are included along with company sales contacts. Several new additions have been

made for companies in the U.S., Canada, and from manufacturers around the world. Regional and international sales offices are included for companies advertising in this issue.

163

Suppliers Showcase

A special suppliers advertising section designed to put you in direct contact with equipment suppliers around the country.



168

Dealers and Distributors

A comprehensive guide to dealers, distributors, independent representatives, and importers/exporters. These listings are arranged alphabetically by state. This section includes complete mailing addresses, telephone numbers, and sales contacts.

The product lines carried are also listed with each entry.

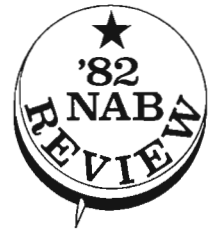

Feature

190

NAB '82 Unveils A Record Number of New Products

Part 2 of a two-part review of the hottest products at this year's NAB convention.

Departments

8 On-the-Air

With cable continuing to gain momentum at the expense of the broadcast industry, broadcasters are renewing the fight over copyright protection while, at the same, trying to plan strategies to capitalize on the new technologies.

10 World Update

The Society of Broadcast Engineers has taken the lead in efforts to establish an effective certification procedure for broadcast engineers.

26 Newsmakers

205 SBE Monthly Log
206 Advertisers Index

Cover—Cover design by Mary Christoph.

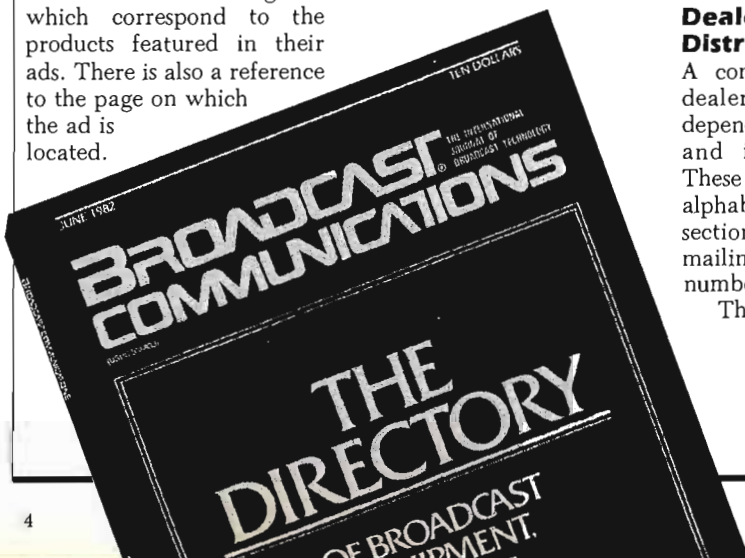



NEW!

THE 1680 SERIES

Built on the solid reputation of the 1600 Series for reliability and ease of operation ...with nearly double the production power!



Circle (4) on Action Card

THE GRASS VALLEY GROUP, INC.®

P.O. BOX 1114 GRASS VALLEY CALIFORNIA 95945 USA • TEL: (916) 273-8421 TWX: 910-530-8280

A TEKTRONIX COMPANY

Offices: *Eastern Regional:* 499 Thornall St, Edison, NJ 08817, (201) 549-9600 • *Southeastern District:* 1644 Tullie Circle N.E., Ste 102, Atlanta, GA 30329 (404) 321-4318 • *Midwestern Regional:* 810 West Bristol St, Elkhart, IN 46514 (219) 264-0931 • *Northwestern District:* 3585 North Lexington Ave, Ste 238, Arden Hills, MN 55112 (612) 483-2594 • *Southwestern District:* 316 Seminary South Office Bldg, Fort Worth, TX 76115 (817) 921-9411 • *Western District:* 1032 Elwell Court, Ste 244, Palo Alto, CA 94303 (415) 968-6680 • *Western Regional:* 21243 Ventura Blvd, Ste 206, Woodland Hills, CA 91364 (213) 999-2303

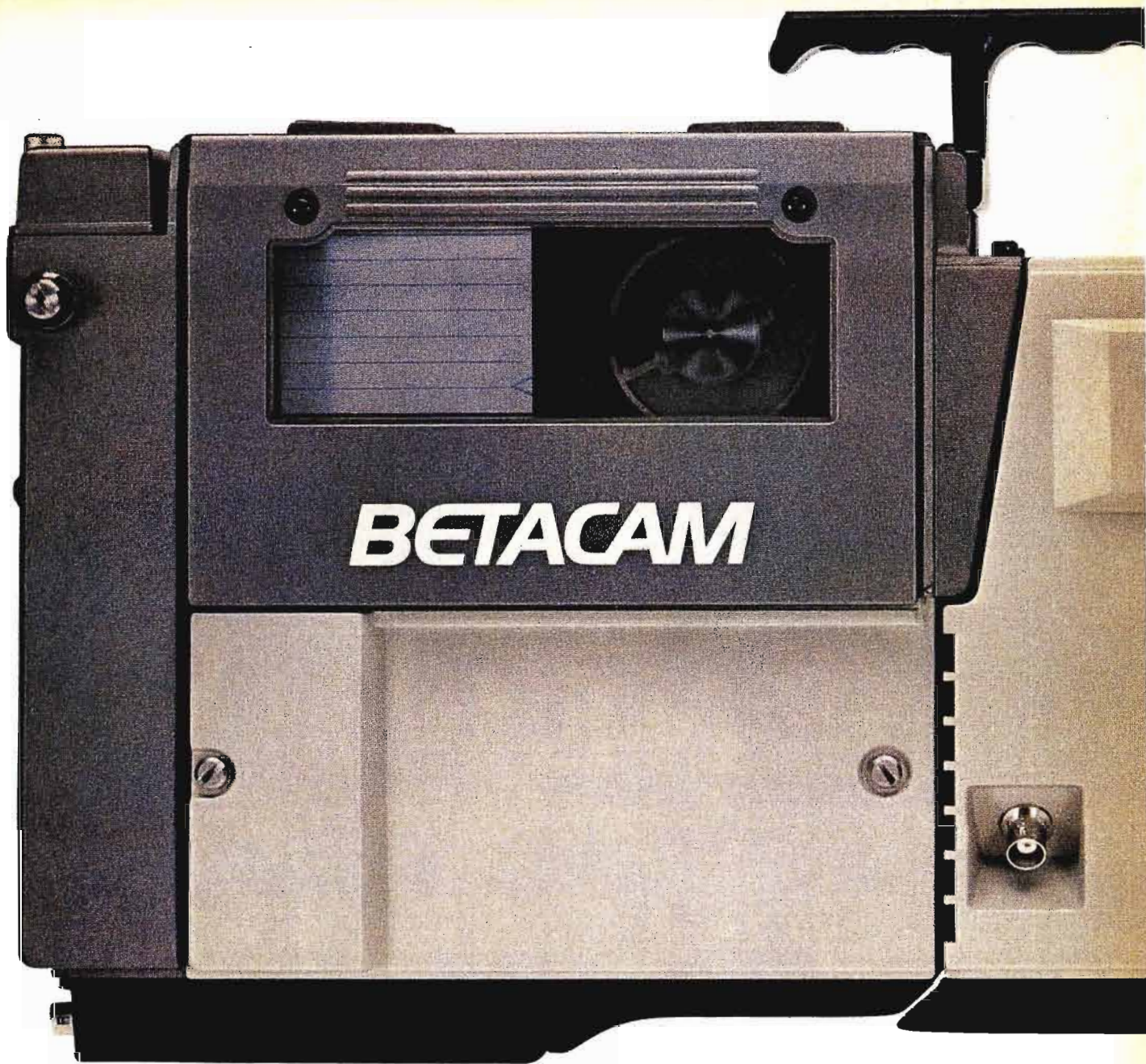

HOW TO LOSE WEIGHT, TAKE BETTER

SONY INTRODUCES THE BETACAM SYSTEM

When we designed the innovative Sony half-inch ENG system, we didn't do it halfway.

So our Betacam™ camera/recorder is 30% lighter than its nearest competitor. And more than 40% smaller. A big difference when you're rushing to cover a story.

But not only have we trimmed pounds and inches, we've saved you dollars and cents. In fact, the entire system is so competitively priced, you might want to buy

two of our camera/recorders rather than one of the heavier, bulkier units around. Then, obviously, you'll be able to cover twice as much news.

The Betacam camera section employs a High-Band SMF Tricon® single-tube pickup system. As a result, it has a dramatically improved picture, with better resolution and more sensitivity than conventional one-tube cameras.

And since it has 60% fewer components than three-tube cameras, the cost of maintaining it is low.



SAVE MONEY, AND PICTURES.

(Of course, there will always be applications where you prefer a three-tube camera. So you'll be delighted to know that Sony also offers a three-tube Betacam.)

The Betacam recorder also provides superior performance, with better picture clarity and a higher signal-to-noise ratio, even when compared to $\frac{3}{4}$ " machines. It records for 20 minutes on a Beta L-500 cassette, and runs for a full hour on the low-power, rechargeable battery contained in the unit. And both cassettes and batteries are inexpensive and readily available.

A separate playback unit completes the Betacam system. It's the only interface you need for existing post-production equipment. So nothing is made obsolete.

Naturally, there are many other refinements and innovations. So to request more information, call 1-800-526-0890. Or in New Jersey, (201) 256-4512, ext. B1.

Sony Betacam. Like so many other Sony Broadcast products, it seems revolutionary today. And will be indispensable tomorrow.

SONY[®]

Broadcast

Sony is a registered trademark of Sony Corp.

Circle (5) on Action Card

ON-THE-AIR

RON MERRELL

NAB seeks review of cable copy royalties

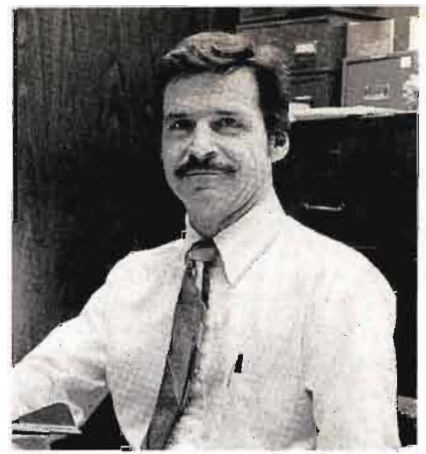

The subject of cable copy royalty fees will be argued again and again in this decade. Perhaps the day will even come when programming and event coverage is so competitive that fairness will at last prevail.

For now, the NAB has asked the full U.S. Court of Appeals for the District of Columbia Circuit to change a recent appellate decision on cable copyright royalty fees. Back in April, a three-judge panel upheld the Copyright Royalty Tribunal's decision concerning 1978 fees, which awarded 3.25 percent to commercial television and nothing to commercial radio.

NAB said the court's opinion recognized broadcasters' copyright interest, but manages "to take away the kernel, and leave them only the husk." The court agreed with three critical arguments to the Tribunal: (1) that broadcasters hold copyrights to sports broadcasts; (2) that broadcasters hold copyrights to broadcast day compilations (the arrangement of the various programs of a broadcast day in a particular order); and (3) that broadcasters who own exclusive licenses for certain syndicated programs hold the copyright to the extent of the licenses.

The NAB noted that the court remanded to the Tribunal for consideration of National Public Radio's entitlement to 0.25 percent. "It is anomalous and incorrect to characterize NAB's entitlement to royalties for sports telecasts and compilations as *de minimis* (minimal), when an award of only one-quarter of one percentage point is already the subject of a remand."

The royalty situation has gone a long way toward erasing the battle lines between cable and commercial TV. But when the money muscle of cable out pulls the networks on program and event buys, a royalty re-think will be in order.

Meanwhile, the competition will improve the product of both, peaking before direct broadcast satellites elbow in for their piece of the pie.

Will DBS sell?

Most U.S. households would be interested in having a satellite dish or antenna to receive multi-channel televi-

sion programs regularly. That's according to a national survey conducted last October by Frank N. Magid Associates, an Iowa research firm.

The dish antennas would receive TV programs beamed nationwide via direct broadcast satellites (DBS). If the dish cost \$300, the survey found that 46 percent of the sample would purchase one: 26 percent would be very likely and another 20 percent would be somewhat likely to spend the money.

These public attitude studies were conducted for United States Satellite Broadcasting Company (USSB) of St. Paul, Minnesota, a company affiliated with Hubbard Broadcasting. USSB is one of a number of applicants to the FCC for a DBS license. USSB proposes to beam free (advertiser-supported) high-quality programming from two satellites to homes equipped with receiver dishes throughout the country. In addition, USSB would feed its programming to a network of independent member television stations.

The study of the national market potential of a 30-channel DBS system showed that 52 percent who already have cable and 61 percent who do not have cable are interested in a home satellite dish for DBS.

A new information age

"We are indeed entering a new age of information in this decade, one that may prove to be as significant as those in which motion pictures, recorded music, radio, and television entered our lives."

So commented James H. Rosenfield, executive vice president for the CBS Broadcast Group, when he addressed a Financial Analysts Federation in March. "CBS is positioning itself," said Rosenfield, "to capitalize on the opportunities created by the development of technologies creating new electronic pathways to the home. It is also committed to make broadcasting, and particularly, network broadcasting, the centerpiece of our efforts to maintain our position as the nation's leading supplier of entertainment and information.

"Yet these clear goals that we have established, and clear commitments we have maintained, have nonetheless not

always been clearly understood. Some have misinterpreted our wide-ranging development efforts in the new media as signaling some doubts about the future of network broadcasting. Nothing could be further off the mark.

"Cable television is one of the fastest-growing of these new pathways, and it is a business in which CBS is committed to play a larger role in its function as the premier provider of entertainment and information. The CBS/Fox joint venture we recently announced will help us play that role in both subscriber-supported and advertiser-supported cable. Similarly, there will be more new pathways for information and data, through broadcast means and telephone networks. That is why we are working to develop teletext, which we are testing in Los Angeles, and videotex, which we will be testing in a joint effort with AT&T in New Jersey.

"Far ahead in the future, we see the emergence of direct broadcast satellite and high-definition TV, and we are taking innovative steps to participate in their development."

Summing up, Rosenfield said, "Yet with all these new pathways, there will only be one way to reach virtually every American household at the same time with the same message. There will be only one conduit available to the advertiser that will be able to reach into all the communities of the nation, reach all ages and income groups with the impact of sight, sound, and motion. . . ." This, of course, is the television network and its affiliated stations.

It's only a matter of time

Already, cable TV vertical-interest programming is getting more sets turned on. But cable is still in search of its prime-time leader, even though it's not necessary. Cable and commercial TV *do* compete for the same dollars now; however, in the future cable's vertical-interest programming is likely to siphon more from newspapers and magazines than from commercial TV. Together, they will give the viewer even more variety than we have now. Only a group of DBS/broadcast networks could derail the momentum of the current broadcast/cable express.

**Enter a
new dimension
Quality Videotapes.
Price and Delivery.**



Midwest



Together, They Bring
A Whole New Dimension of Professionalism
and Dependability to Video Production.
Midwest Corporation is the nation's largest single-source
supplier of video production equipment and supplies, with
more than 10,000 different items in stock, ready for
immediate delivery.

We stock the complete line of Scotch® Brand Videotapes
from 3M. And we can get them to you ... FAST!
If you need technical assistance in selecting the type of
3M videotape that's best for you, call on the Midwest
experience in supplying quality Scotch® Videotapes
to every phase of the recording industry.
Best of all, Midwest's prices are competitive with
anyone in the field. So you not only get the best
quality and service in the industry, you get the
best deal, too!

3M and Midwest. Together, we take you
to a new dimension of quality and
service.

Take a trip to a new dimension. For
complete information on
Midwest's full line of equipment and
supplies, call toll-free
today.

1-800-543-1584

1021 W. 8th Street
Cincinnati, OH 45203
513-651-1904



A UNR Company
Authorized Distributor of
3M Magnetic Products

Cincinnati, OH 513-651-1904
Columbus, OH 614-476-2800
Cleveland, OH 216-447-9745
Detroit, MI 313-689-9730
Indianapolis, IN 317-251-5750
Louisville, KY 502-491-2888
Nashville, TN 615-331-5791
Lexington, KY 606-277-4994
Charleston, WV 304-722-2921
Virginia Beach, VA 804-464-6256
Washington, DC 301-577-4903
Charlotte, NC 704-399-6336
Miami, FL 305-592-5355

Circle (6) on Action Card

SBE leads certification effort

The Society of Broadcast Engineers (SBE), meeting in Dallas in conjunction with the National Association of Broadcasters, has pledged a continuing leadership involvement in certification, including the development of an entry-level examination and a new thrust in the area of frequency coordination.

Jim Wulliman, national SBE certification chairman, moderated an NAB panel discussion on certification and reported that more than 1,750 broadcast engineers have been certified under the SBE program. The SBE certification program has completed its first five-year period of operation and is now processing renewals from the original group of senior broadcast engineers who have been certified.

The recent FCC action, dropping the Radiotelephone First Class license, has prompted broadcasters and broadcast associations to suggest that the SBE reconsider an entry-level certification program, said Wulliman.

"The entry-level certification program, as proposed by the SBE Certification Committee, will consist of an entry-level exam containing questions on (1) electronic fundamentals, (2) FCC rules pertaining to operating tolerances, and (3) safety.

Wulliman said that several hundred questions will be stored in a computer, which will randomly select 50 questions

for each exam. Each exam will be different.

The certificate holder will be recognized as a broadcast technologist.

"It is the desire of the committee to hold the fees down to about the present \$30 level if outside support can be obtained to meet the increased budget requirements of the expanded program," said Wulliman.

The Certification Committee has developed a five-year budget plan which will require support from NAB and/or other broadcast organizations to meet the start-up expenses of the expanded program.

"Our program will seek support for one half of the first year expenses, decreasing each year until the program is self-supporting," he said, adding that the SBE board voted to subsidize the program until December 31, 1982, and set an introductory fee of \$10 for the broadcast technologist certificate only.

"The SBE Certification Program offers the best method of identifying those broadcast engineers who are truly qualified, and also pointing the way for those who are entering the field, through the progressive levels of realistic certification from broadcast technologist through senior broadcast engineer," he noted.

Richard Rudman, an SBE member and chairman of the Southern Califor-

nia Frequency Coordinating Committee, was appointed by SBE president Ron Arendall to chair a newly-created SBE National Frequency Coordinating Committee.

Rudman sees the SBE role in frequency coordination as "one of an informational conduit."

"I believe that it can become a useful tool for the SBE to market itself," said Rudman, who envisions SBE chapters as possibly becoming publishers of the data base for frequency coordination.

"By getting involved in frequency coordination, the individual SBE chapters will own a data base and mailing list," said Rudman.

Rudman's Southern California frequency coordinating effort, which has gained much industry recognition, now has moved into the area of television microwave coordination.

Rudman termed frequency coordinating as "enlightened peer pressure" and continued that its existence is to "raise awareness level, but we're not policemen."

His warning is "don't copy" the Southern California effort. Every area of the country has its varied problems and "you must mold it to your area."

Announcement was made at the annual SBE meeting of the re-election of Ron Arendall of Indianapolis, Ind., as president of SBE for the 1982-83 term. Arendall is manager of engineering at WTHR-TV in Indianapolis.

Other officers gaining re-election include Doyle Thompson of Atlanta, Ga., director of engineering of The Weather Channel, vice president; Brad Dick of Lawrence, Kan., director of engineering at KANU/KFKU, secretary; and Ed Karl of Manchester, Mo., engineer in charge of KMOX-TV in St. Louis, treasurer.

Board members re-elected to their positions include Len Ballard of Tulsa, Okla., director of engineering for Swanson Broadcasting; Ray Benedict of Dayton, Ohio, engineering manager of WHIO-TV; Hugh Cleland of Liverpool, N.Y., chief engineer, WCNY-TV/FM in Syracuse; and Roger Johnson of Phoenix, Ariz., chief engineer of KOY Radio.

New board members elected to serve for the 1982-83 term are Robert Klein of Lexington, Ken., director of engineering at Kentucky Educational Television; and Jack McKain of Kansas

Continued on page 12

Entry-level certification added

An entry level of certification has been added to the Society of Broadcast Engineers' Certification Program. This class of certification is called Broadcast Technologist and is valid for a period of five years. It can be obtained in either of two ways:

- By holders of a valid FCC First Class Operator license who meet the service requirement; or
- By achieving a passing grade on the required proficiency examination. There is no experience requirement to be eligible for the Broadcast Technologist examination.

The SBE national office is now accepting applications for the Broadcast Technologist certification. For a copy of the application and Program of Certification booklet, write to the Certification Secretary, Society of Broadcast Engineers, P.O. Box 50844, Indianapolis, IN 46250.

SBE is still receiving requests for the recertification material from the engineers whose certification expired January 1, 1982. Some of these engineers stated they were not aware that their certification had expired. In order to be fair to everyone, SBE will extend the deadline for applying for Recertification until December 31, 1982. Anyone who has not applied by that date, will be deleted from the certification records in the national office.

TV test equipment from the inventors of the Plumbicon® tube.

At long last a new, reliable source of TV test equipment. One that offers fast, predictable delivery. One with a name all the world trusts—Philips. Four quick examples:

PM5565 Waveform Monitor

Enjoy the luxury of examining one line and one field at a time. On top of this, there's a convenient front probe input so you can use the monitor as a troubleshooting oscilloscope.

PM5567 Vectorscope

If you want more accurate decoding and the ability to have an external reference from composite video signals, choose our vectorscope.

Both waveform monitor and vectorscope mount side by side, fit all existing hardware and use less power than the competition.

PM5539 Color Analyzer

Take it on a quick trip through your studio or control room and adjust all monitors to the same color temperature in a matter of minutes.

With four different memories, there's no problem in quickly calibrating four different phosphors.

Variable full-scale, from less than set up to more than reference white, allows measurement of color tracking as a function of APL.

PM5534 Color Pattern Generator

Our universal pattern contains all the signals needed to verify overall system operation—directly from the picture. No wonder virtually every set manufacturer uses our pattern for their TV set alignment.

Of course our TV test equipment line doesn't end here. Today Philips offers a wide range of equipment including sync and pattern generators, VITS generators and analyzers, and TV modulators and demodulators.

For nationwide sales and service information call 800-631-7172, except in Hawaii, Alaska and New Jersey. In New Jersey call collect (201) 529-3800, or contact Philips Test and Measuring Instruments, Inc., 85 McKee Drive, Mahwah, New Jersey 07430.



Philips, of course.



**Test & Measuring
Instruments**

PHILIPS

Circle (7) on Action Card

**PNEUMATICALLY
OPERATED
TELESCOPIC
MASTS**

**Convenient
Compact
Portable**



- ENG
- Fixed or Mobile Radio Communications
- Field Strength Measurements
- Camera or Microphone Support
- Noise Level Measurements
- Temporary Flood-lighting
- Environmental Sensors
- Sizes Available:
Retracted 5.5 to 15 ft.
Extended 50 to 92 ft.

For details contact:

Allen Osborne Associates
5195 N. Douglas Fir Rd.
Calabasas, CA 91302
(213) 888-2772
TWX: 910-494-1710

U.S. Distributor for
Hilomast Ltd., Essex, England

Circle (8) on Action Card

City, Mo., director of engineering at KCMO-TV/AM-FM.

Roger Johnson, chairman of the Chapter Liaison Committee, urged the formation of a committee of past presidents to chart a five- or 10-year plan for the SBE.

"We have been asked to look at the activity of the Society and come up with a five-year plan," said Bob Flanders, a past president, who added that the committee hopes to offer the officers of the SBE a "path to go down" similar to a five-year business plan.

The committee has already begun its work; it is hoped that the plan will be drafted in time for the fall board meeting. Flanders, Jim Wulliman, Jim Hurley, Bob Wehrman, Bob Jones, and Lou Wetzel will serve on the committee.

Johnson also announced the establishment of two national awards to be announced at the 1983 convention. Awards will be given for "best membership growth" and "best newsletter, judged on both content and form."

A highlight of the annual SBE membership meeting was the presentation of a surprise award to Jim Wulliman for his leadership, direction, and continuing efforts in the area of certification.

Wallace E. Johnson of Washington, D.C., an SBE member and current executive director of ABES, was presented a Fellow Award. A special award to John Battison for his early activities as chairman of the steering committee and first president of the SBE, was also announced.

Canadian show set for Toronto

The largest gathering in the field of Canadian broadcasting will meet at the Toronto Sheraton Centre Hotel, November 13-16, 1982. Sponsored jointly by the Canadian Association of Broadcasters (CAB), Central Canada Broadcast Engineers (CCBE), and the Central Canada Broadcasters' Association (CCBA), "Perspectives '83" (the theme of the convention) will focus on the business and technological future of radio and television. In addition to presentations and workshops, convention delegates will witness Canada's first National Electronic Hardware and Software Trade Exhibition.

To commemorate this event, the CAB will launch the first edition of a new publication, the *CAB Yearbook and Directory*. Theorists and practitioners representing the domestic and international broadcast business community, technical experts, and government

legislators will contribute to the editorial content.

A section of this bilingual periodical will include a listing of CAB members and associated industries, with selected photographs of personnel featured.

For further information, contact Dave Hamilton, (416) 446-5546.

ABC plans new pay TV service

American Broadcasting Companies Inc. (ABC) has announced plans to provide a national program distribution service—The Home View Network (HVN)—that would utilize a unique combination of broadcast and video recording technology to deliver quality programming, including motion pictures, on a subscription basis to the viewing public.

Through the ABC-owned and participating affiliated stations of the ABC Television Network, HVN will transmit programming in scrambled form during overnight hours for automatic videocassette recording in HVN homes. The scrambled tape would then be played back at the viewer's convenience through a decoder developed by Sony, which will be compatible with virtually all VCRs.

Applications were made to the Federal Communications Commission by ABC for expedited authorization to offer the service through its five owned television stations and those affiliated stations who subsequently elect to participate in HVN. Sony also filed an application for FCC approval of its encoding and decoding system for use in conjunction with the new service.

HVN will offer approximately eight feature-length movies new to the service each month, as well as cultural, theatrical, children's, educational, and other special-interest programming.

The Home View Network will transmit the program service during early morning hours when most stations do not offer programming (2:00 a.m.—6:00 a.m. in the Eastern and Pacific Time Zones and 1:00 a.m.—5:00 a.m. in the Central Mountain Time Zones). HVN will broadcast at least five nights a week and will program up to three hours a night, depending on the length of the programs.

According to ABC, the Home View Network will provide a new, convenient alternative for consumers, one that will use an already existing national distribution system. Thus, HVN will be able to enter, relatively quickly, many markets not presently served by pay cable, STV or MDS.

Continued on page 14

MORE THAN A PORTABLE

Acquisition plus studio-type control makes the Ampex VPR-20B your professional portable.

If you need more than just a portable acquisition recorder, choose the improved Ampex VPR-20B. When you go into the field for realism and immediacy, you'll know you've got it. Right the first time with videotape you've already reviewed, edited and played back—on location, ready to air.

It's the VPR-20B's exclusive dual-cue editing that gives it studio-type control in the field. From instant reviews with precise return to the next edit point, to total control when replacing undesired material with mid-segment, color-frame accurate edits. You can now have it all in one easy-to-use portable.

With the VPR-20B you also get top quality audio and video every time. The built-in video confidence and color stabilizer features play the picture back from the tape into the camera viewfinder, or any color monitor,

during recording. So you'll know that the picture you see is the one you've got! And, unlike other portables, the VPR-20B has a simple plug-in AC power pack which replaces the battery. You can forget about bulky external power supplies.

Most of all, the VPR-20B is backed by the unique worldwide service and support that Ampex is known for. So before your next field production, find out more from your Ampex representative. Or write Ampex Corporation, Audio-Video Systems Division, 401 Broadway, Redwood City, CA 94063 (415) 367-2011.

AMPEX TOOLS FOR TOMORROW

Ampex Corporation • One of The Signal Companies 

Circle (9) on Action Card

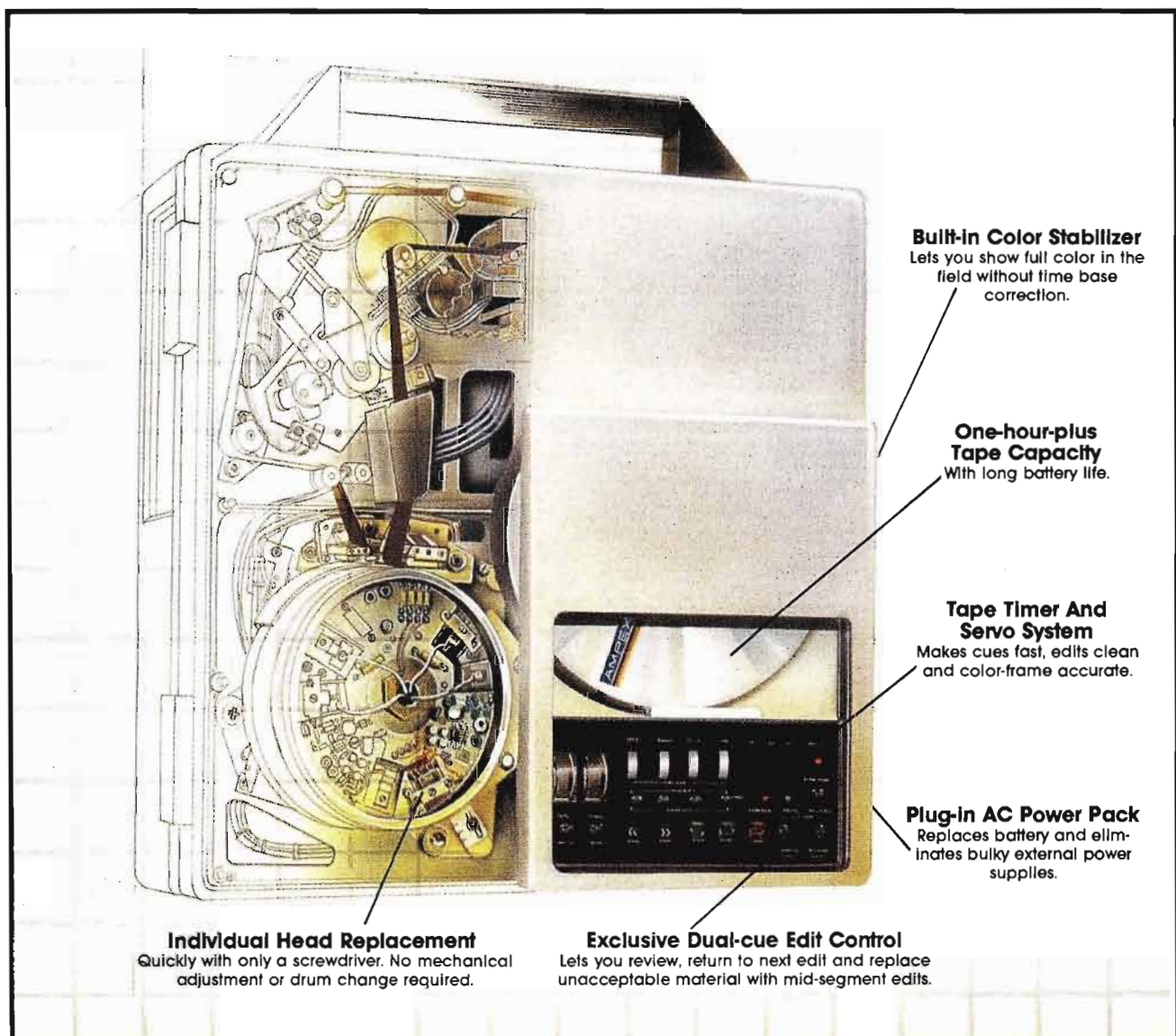

Built-in Color Stabilizer
Lets you show full color in the field without time base correction.

One-hour-plus Tape Capacity
With long battery life.

Tape Timer And Servo System
Makes cues fast, edits clean and color-frame accurate.

Plug-in AC Power Pack
Replaces battery and eliminates bulky external power supplies.

Individual Head Replacement
Quickly with only a screwdriver. No mechanical adjustment or drum change required.

Exclusive Dual-cue Edit Control
Lets you review, return to next edit and replace unacceptable material with mid-segment edits.

ABC Inc. will be responsible for the programming and marketing aspects of HVN. The technical equipment for HVN will be purchased from Sony. This innovative technology will encode the HVN program before transmission, enabling participating ABC affiliated stations to broadcast HVN selections with the same equipment they use for all other network programs. The subscriber needs only a special Sony decoder and any videocassette recorder. The program will be automatically

recorded in scrambled form by the subscriber's videocassette recorder and can be played back for viewing only by HVN homes equipped with the special Sony decoder. This unique feature of the HVN system provides maximum security against unwarranted use. Addressability has been built into the Sony decoders for potential pay-per-view usage.

HVN is expected to be offered to consumers at a monthly subscription of \$19.95 plus an initial installation

charge. Homes without videocassette recorders may lease a VCR through HVN for \$29.95 per month or may buy one through the service at a cost comparable to the lowest retail price.

The Company will initiate a technical field test of HVN this summer. HVN is scheduled to start in early 1983.

NAB argues for cable legislation

In hearings before the Senate Commerce Subcommittee on Communications, NAB president Vincent T. Wasilewski asked for the "opportunity to compete fairly, equitably, and openly with cable." The Subcommittee is considering cable legislation sponsored by Senator Barry Goldwater (R-Ariz.).

Wasilewski cited three goals for broadcasters with respect to cable: fair and equitable access to programming; open entry for broadcasters into the cable industry; and deregulation of broadcasting to achieve regulatory parity with cable. "S. 2172 is a positive step toward realization of these goals," he stated.

"Legislation now pending in the House, H.R. 5949, embodies provisions designed to resolve both the copyright and communications policy issues presented by cable carriage of broadcast signals," Wasilewski continued, referring to the cable copyright compromise reached by NAB, the National Cable Television Association, and the Motion Picture Association of America. "We very much want to secure prompt House passage of H.R. 5949 and urge you to act favorably on it when it comes before you," he added.

Goldwater's bill would prohibit imposition of cable-broadcast cross-ownership restrictions, a provision heartily endorsed by NAB, allowing broadcasters to participate fully in cable.

Wasilewski warned the Subcommittee that their provision allowing the FCC to decide signal carriage issues "is clearly inadequate." "By leaving the Commission free rein, it does no more than perpetuate the greatest infirmity of the present scheme—uncertainty," he told them. Instead, Wasilewski urged the subcommittee to refrain from adopting any statutory provisions that might be "inconsistent" with the House cable copyright compromise legislation. "I could not emphasize too strongly the desire of NAB to see such a definitive resolution of the signal carriage issue," he added.

Continued on page 16

Think of us as your mike expert.



The 635A – Perfect design from the start

The Electro-Voice 635A is probably the most widely used broadcast microphone currently available. Yet it was introduced back in 1967! There are microphone companies that haven't been around as long as the 635A! What makes a microphone continue to be the broadcasters' favorite after 15 years in the field?

The 635A was designed to be used anywhere. Its screw-machined steel case and mechanically nested parts set standards for durability and ruggedness that the competition still strives for. It was the first omnidirectional microphone designed to have a shaped, rather than flat, frequency response. A rolled off bass response combined with a slightly rising high end make it perfect for vocal

reproduction. And it was the first microphone of its type to feature an elastomer encased head capsule for reduced handling noise and additional protection from severe mechanical shock.

Despite all the technological advances in the broadcast, recording and sound reinforcement industries, the 635A continues to be the "audio man's screwdriver"—a microphone tool that can be used anytime, anywhere, for almost anything. When a product is designed right to start with, there's no need for it to become obsolete. All Electro-Voice professional microphones are designed with the same goal in mind. That's why people think of Electro-Voice as their microphone expert.



EV Electro-Voice[®]
a gulton company

600 Cecil Street, Buchanan, Michigan 49107
In Canada
Electro-Voice Div of Gulton Industries (Canada) Ltd.,
345 Herbert St., Gananoque, Ontario K7G 2V1.

Circle (10) on Action Card

Progress by Design

Videotek's philosophy is to progressively design & refine the quality, function, and reliability of our products, and to provide equally aggressive service-after-the-sale.

Videotek's state-of-the-art TSM-5A Waveform Monitor and VSM-5A Vectorscope reflect this on-going commitment, with such innovative features as Internal Graticule CRT for precise parallax-free signal analysis, and Non-Glare Shields to eliminate distracting ambient light. TSM-5A also includes selectable 1H mode for easy one-line viewing, and 0.5 μ s/div. scan rate for the most accurate time-base measurements.

Our popular Studio 12 picture monitor includes, as standard equipment, the features found on monitors costing twice as much: A-B Split Screen, Selective H-AFC, High Voltage Regulation, ACC-Defeat, Preset Controls, Pulse Cross, Underscan, External Sync plus more.



(all available in PAL standard.)

In only 7 years, Videotek has become an industry leader. We design and build more sizes and configurations of color monitors than anyone—worldwide! And our 1981 "Distinguished Video Industries Service Award" stands as a testimonial to our commitment to your needs.

Now that's Progress...by Design.



**VIDEOTEK
INC.**

Circle (11) on Action Card

Business Hotline

PHILIPS TEST & MEASURING—Philips Test & Measuring Instruments has established field operations in Plano, Texas, to cover Northern Texas, Oklahoma, and Arkansas. Morris Jones has been given the responsibility to initiate field efforts within this new territory.

AUDIO PLUS VIDEO—Audio Plus Video International recently opened a West Coast international standards conversion facility at 1438 North Gower Street in Hollywood, California. Shellie Yaseen heads the new operation.

WESTERN BROADCAST SYSTEMS—Ross Video has appointed Western Broadcast Systems as its exclusive distributor for Northern California, Oregon, and Washington. WBS, based in Cupertino, California, specializes in video and audio broadcast-quality products. Other products distributed include Leitch Video, MCI/Quantel, Ampex, and Crown International.

TELEIMAGE—Teleimage has been named the official television production company for the Century IV Celebration, Philadelphia's 300th anniversary

celebration being held throughout 1982. Located in Bala Cynwyd, Pa., Teleimage is one of the largest television production facilities in the Philadelphia area.

EECO—EECO Inc. has written and published a comprehensive booklet explaining the early development and technical operation as well as the latest advances in SMPTE/EBU longitudinal and vertical interval time code. The booklet, entitled *SMPTE/EBU Longitudinal and Vertical Interval Time Code*, is offered free of charge. For your copy, write to EECO Inc., Video Products Marketing, 1601 E. Chestnut Avenue, Santa Ana, CA 92701; or call (714) 835-6000.

HARRIS BROADCAST PRODUCTS—KTTV-TV, Los Angeles, is upgrading its satellite facilities with Harris equipment valued at more than \$825,000. The station currently employs a Harris 9-meter satellite dish for receive service, and has purchased the necessary equipment to add uplink capabilities to that antenna. The Metromedia station has also purchased a new Harris 9-meter uplink system to be used for additional transmit capabilities.

BROADCAST MARKETING ASSOCIATES—Richard Reilly, president of

BMA, San Jose, California, has announced the sale of four Dubner Computer Graphic Systems to KOMO-TV, Seattle, Washington; KTVA-TV, Anchorage, Alaska; One Pass Video, San Francisco; and Video Post and Transfer, Dallas. BMA is a distributor of high-technology video and audio equipment with offices in Seattle, Los Angeles, and headquarter offices in San Jose.

CONTINENTAL ELECTRONICS—The Shield of the Egyptian Organization of Broadcasting and Television Federation (OBTF) has been awarded to Continental Electronics Mfg. Co. of Dallas in recognition of Continental's outstanding work and cooperation with OBTF during 1981. The award recognizes Continental's on-site engineering and installation work for two OBTF projects. Continental is a leader in the design and manufacture of high-power radio frequency transmitters and related equipment for communications, radio broadcast, radar, linear accelerator, fusion, and other scientific research applications.

SONY BROADCAST PRODUCTS—Cox Broadcasting Corporation, owner and operator of television stations, *Continued on page 20*

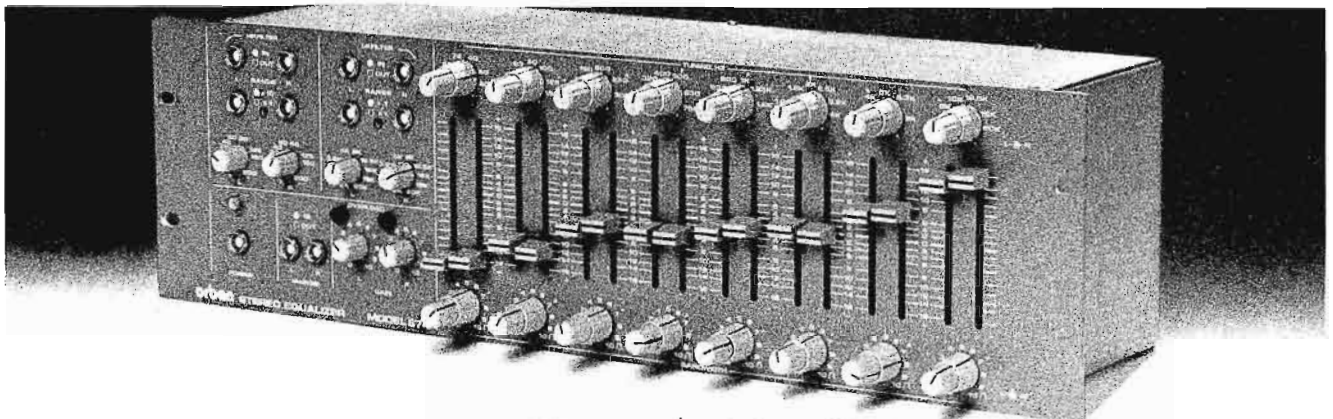

The Dream Equalizer: Now Mono Or Stereo

When we introduced our 672A "dream equalizer" in 1979, we had an instant hit. Audio professionals loved its versatility and clean sound. Eight parametric EQ bands (with reciprocal curves) were combined with wide-range tunable 12 dB/octave highpass and lowpass filters. The result: an amazingly powerful and useful machine. A cost-saving one too, because the outputs of both filters are available to perform a full electronic crossover function.

The 672A now has a stereo twin—the new 674A, with all the power of two 672A's in a space-saving 5¼" rackmount package. Naturally, both equalizers are built to full Orban professional standards. That means industrial-quality construction and components, RFI suppression, a heavy-duty roadworthy chassis, and comprehensive backup support.

For complete information on the popular 672A and the brand new stereo 674A, contact your nearest Orban dealer.

orban Orban Associates Inc. 645 Bryant St.
San Francisco, Ca. 94107 (415) 957-1067

Continental quality, performance & service offers you a new strength in AM & FM radio broadcast equipment.

NOW! Continental Electronics offers you a new strength in radio broadcast equipment: AM and FM transmitters from 1 kW to 50 kW; transmitter coupling and phasing equipment; antennas, antenna systems and accessories; transmission line and accessories; studio audio equipment; remote studio equipment; STL and transmitter remote control equipment; test and monitoring equipment; 24-hour parts and professional field service for Collins and Continental transmitters.

Since its founding in 1946, Continental Electronics has pioneered many advances in rf transmitter and systems technology at power levels from kilowatts to megawatts; for radio broadcast, communications, radar and scientific research applications. Continental medium and short wave transmitters have achieved a world-wide reputation for quality components and

construction; circuit innovations and unique, easy-to-operate designs which produce superior performance.

Call your local Continental sales representative whenever you need product data, information or service. Learn first-hand how we can meet your radio broadcast equipment requirements.

Continental is ready to offer you a new strength in professional service and quality equipment.

Continental Electronics Mfg. Co.
Box 270879 Dallas, TX 75227
Phone: (214) 381-7161

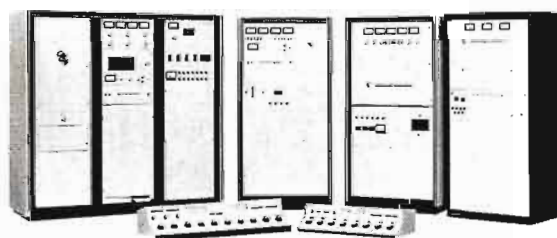
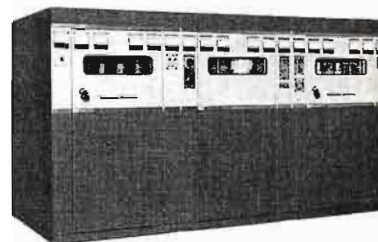
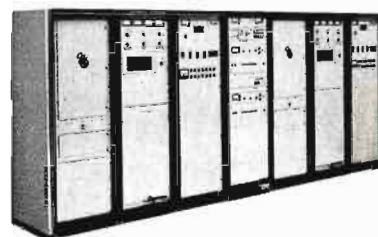

NORTHEAST
MARK F. HUTCHINS
 P.O. BOX 13
 GREENLAND, NH 03840
 (603) 436-4059

KEITH A. LEACH
 P.O. BOX 16
 NEWTON, NJ 07860
 (201) 383-8797

SOUTHEAST
RAY C. EVANS
 P.O. BOX 143
 ALCOA, TN 37701
 (615) 970-2572

DAVE HULTSMAN
 2280 ROCKCREEK TRAIL
 BIRMINGHAM, AL 35226
 (205) 822-1078

MIDWEST
JOHN D. ABDNOUR
 P.O. BOX 575
 STREATOR, IL 61364
 (815) 672-8585

LLOYD W. COLLINS
 ROUTE 3, BOX 106
 HOLTS SUMMIT, MO 65043
 (314) 896-5791

JIM LITTLEJOHN
 670 NORTH BRANCH RD.
 MAPLE PLAIN, MN 55359
 (612) 479-2633

SOUTHWEST
STEVE H. SCHOTT
 P.O. BOX 2008
 PLANO, TX 75074
 (214) 423-3644

NORTHWEST
TOM T. CAUTHERS
 1215 SE 73rd AVE.
 PORTLAND, OR 97215
 (503) 254-2818

WEST
STEVE KEATING
 7225 HOLLYWOOD BLVD.
 SUITE 105
 HOLLYWOOD, CA 90046
 (213) 851-6380

*Canada, Arizona, New Mexico, Utah, Hawaii and Puerto Rico are handled from the Home Office in Dallas, Texas.

Continental Electronics



Circle (13) on Action Card

IF IT WERE YOUR JOB TO GET THIS ON TAPE, WHAT TAPE WOULD YOU GET IT ON?

For the first time, mankind will set foot on a surface other than earth. It's a moment that transcends science and politics. A moment that will be seen and reseen all over the world for as long as mankind exists.

But there are no guarantees at a moment like this. And the stakes are just as high for failure as they are for success. So nothing is left to chance.

That's why Scotch® Video Tape was there when the Moon Walk was first recorded. And again when the Space Shuttle Landing was first recorded. And again when the U.S.-Russia Hockey Game was first recorded.

The Papal Tour of America. The Return of the Hostages. The Eruption of Mount St. Helens. Whenever there was one chance to get it, chances are they got it on Scotch Video Tape.

So whether your production is important to the world or just important to you, why take chances? Get it on the one tape you know will get it right.

Magnetic A/V Products Division/3M.

Moon Walk
July 20, 1969





HISTORY IS RECORDED ON SCOTCH® VIDEO TAPE.

3M hears you...

3M

Circle (14) on Action Card

radio stations, and cable systems in 23 states, has ordered approximately \$750,000 worth of videotape recording equipment from Sony Broadcast Products Company. Combined with 1981 purchases of Sony equipment, the new order brings the total amount of video equipment Cox has purchased from Sony Broadcast to approximately \$2 million.

The latest order slated for 1982 delivery includes 23 Sony BVU-800 U-matic videocassette recorders with built-in editing capability. The order also includes nine BVU-50 portable U-matic recorders; six BVU-110 U-matic recorders; and one BVP-250, two BVP-330s, and three BVP-300 cameras.

LOGICA—Television South West

(TSW) is the first commercial television broadcaster in the U.K. to buy the Flair videographics system from Logica. Flair will provide additional facilities to the existing TSW graphics department, and will be used for the production of maps and charts as well as special effects.

ECCO INC.—Lake Systems Corporation, with offices in Newton, Mass., and North Haven, Conn., has been appointed distributor for ECCO's computer controls for video production. Lake Systems is responsible for distributing ECCO equipment in the six New England states.

FILM/VIDEO EQUIPMENT SERVICE CO.—Film/Video Equipment Service Co. of Denver, Colorado, has established a professional optical department to provide expert lens service and repair for all makes of professional cine, ENG/EFP, and studio broadcast lenses, such as Angenieux, Canon, Zeiss, Cooke, Schneider, Fujinon, JVC/Tamron, etc. For more information, contact Ron Cotty at Film/Video, 1875 South Pearl St., Denver, CO 80210; or circle number 328 on the Action Card.

SATCOM TECHNOLOGIES—SatCom Technologies' new 7-meter earth station antenna (model 700CH) has been type accepted by PBS. PBS recently purchased five antennas, which will be used to provide programming via satellite to PBS television broadcasting stations around the country.

ALLEN AVIONICS—Allen Avionics has issued catalog 15V containing the firm's expanded line of video and pulse delay lines, video filters, and equalizers. This catalog introduces a complete rack-mountable series of video delay lines, with the capability of replacing up to 1,450 feet of cable. Delay units are available with slide switches or in strappable versions. Catalogs are available from Allen Avionics, 224 East 2nd Street, Mineola, NY 11501; or phone (516) 248-8080.

SPERBER COMMUNICATIONS—A new firm has been formed to guide STV, MDS, CATV, MATV, LPTV, and satellite TV companies from start-up through maturity in optimizing their technical operations and product line development. Sperber Communications, located in Santa Monica, California, will provide comprehensive services for new market launches, existing markets, subcontractor organizations, vendors, and manufacturers. Martin Sperber, most recently with National Subscription TV in Los Angeles, is the founder and president of the company. For more information, contact Sperber Communications, 313 Alta Avenue, Santa Monica, CA 90402; (213) 393-5127. **BC**

RTNDA NEWSLINE

Convention set for Las Vegas

Ted Turner, Mark Fowler, David Brinkley, and Tom Pettit are among the headliners already on the program for the RTNDA convention in Las Vegas, September 30-October 2.

Turner, chairman of the board and president of Turner Broadcasting System Inc., and founder of the Cable News Network, will be the keynote speaker when the convention opens in Caesars Palace.

RTNDA president-elect and conference program chairman Dean Mell, news director, KHQ, Spokane, said he was delighted that Turner had accepted the invitation to keynote the convention. "His experience in cable news and his insight into the future of electronic news are having an undeniable influence on communications in this country," Mell said.

ABC newsman David Brinkley, a former RTNDA convention keynoter, has been named recipient of the RTNDA Paul White award, and his acceptance speech will close the three-day conference. Jack Hogan, RTNDA's immediate past president and chairman of the Paul White Award Committee, said, in announcing Brinkley's selection, "I am delighted to have had a hand in formally recognizing David Brinkley's outstanding journalistic achievements and the part he played in making news broadcasting the primary source of information for most Americans."

FCC chairman Mark Fowler and NBC's Tom Pettit are luncheon speakers. Fowler has taken a leadership role in efforts to persuade Congress to repeal government regulation of the content of broadcast news—the so-called fairness doctrine and the equal opportunities provisions of the Communications Act. He is perhaps RTNDA's staunchest current ally in the association's long fight to achieve full First Amendment rights for news broadcasters.

Pettit was covering the Senate in Washington for NBC News when he was tapped for the number-two news job at 30 Rockefeller Plaza, executive vice president of NBC News.

Each day of the convention will focus on a major area of concern for radio and television news directors. The first day will be devoted to news content, the second to technology, and the third to management.

Exhibits chairman Eddie Barker reports that the entire exhibit hall in Caesars Palace has been reserved! Bob Vaughn, director of conference planning for RTNDA, is now trying to locate additional space in the hotel for more exhibits. In any event, there will be far more exhibits this year than ever before. Plans are being made to use some of the computers on display to expedite the elections and the handling of resolutions during the business session the second day of the convention.

Convention registrations are now being accepted at RTNDA headquarters at 1735 DeSales St., N.W., Washington, DC 20036. Pre-registration for members is \$160, and for non-members \$175. Rooms at Caesars Palace can be reserved at a special convention rate of \$55 single or double occupancy. Room reservations should be made directly with the hotel, Caesars Palace, 3570 Las Vegas Boulevard, Las Vegas, NV 89109, not with the RTNDA headquarters.

Watch this column for more RTNDA convention news—and get your registration and reservation in early!

Give or take a few pennies, and using some conservative assumptions (18hr/day, 5 year full depreciation), that's all it costs to replace your current audio processor with an Orban OPTIMOD-AM, -FM, or -TV. And get an *immediate* improvement in on-air audio quality. An improvement that pays off every minute of every hour of every operating day.

OPTIMODs are fully adjustable to program requirements. Their patented technology has literally revolutionized audio processing in the last six years, and yields a cleaner, brighter, louder sound unmatched at any price.

And their superior sound is complemented by Orban quality and service—a well-established, industry-respected commitment that protects your investment.

Money may be tight. But particularly in trying economic times, the winners are

those who compete the hardest and deliver the best-sounding product to their audience. OPTIMODs are lethal competitive weapons. And, at 13¢/hr, very sound investments.

Can you afford not to go with an OPTIMOD?

For further information, see your local Orban Broadcast Products dealer, or call us Toll Free (800) 227-4498. In California (415) 957-1067.

orban

Orban Associates Inc.
645 Bryant Street
San Francisco, CA 94107
Telex: 17-1480
Cable: ORBANAUDIO

Better audio for 13¢/hour.



Circle (16) on Action Card for OPTIMOD-AM
Circle (17) on Action Card for OPTIMOD-FM
Circle (18) on Action Card for OPTIMOD-TV

**NEVER BEFORE HAS
THIS VITAL
COMPONENT BEEN SO
SUCCESSFULLY
INTEGRATED INTO A
1" VIDEO RECORDER.**



SONY INTRODUCES A 1" VIDEO RECORDER TAILORED TO THE PEOPLE WHO USE IT: THE BVH-2000.

Because Sony probably has more experience selling and servicing 1" VTRs than anyone else, we're in an unequalled position to understand the wishes of 1" video users.

And now, Sony announces with fulfillment for the broadcast industry: the new BVH-2000 1" video recorder.

WHY "BVH-2000" WILL MEAN DIFFERENT THINGS TO DIFFERENT PEOPLE.

In broadcast recording, there is no such thing as one typical situation.

That's why there's no one single BVH-2000.

The BVH-2000 actually allows you to "design" the VTR you need for your own particular applications and budget.

You can choose among three different control panels—ranging from a basic model to one with virtually every possible feature and function.

And the tape transport system, signal system, and control section can either be combined into a single unit, or separated easily and installed in a 19" rack or console.

The BVH-2000 also gives you far greater latitude in setting up your entire recording system. Various remote-control connectors enable you to interface your system in a variety of ways for studio, mobile, and editing configurations. Direct interface with U-matic[®] and Betacam[™] is possible, too. The BVH-2000



Plug-in time base corrector (optional).

also has an optional plug-in time base corrector.

What's more, the BVH-2000's lighter weight and smaller size (almost 50% less than its predecessor) make it as ideal on the road as it is in the studio.

And because of the ever-increasing number of applications requiring longer program times, the BVH-2000 provides up to 2 hours of tape time.

A VTR THAT LEADS THE SIMPLE LIFE.

In the BVH-2000, unlike most other VTRs, microprocessors are used to their full advantage. All data necessary for servo control are channeled into a central processing unit, making the operator's control over all systems and functions simpler and more precise.

Life is made simpler yet by the fact that every necessary function control, metering facility, and electronic module is accessible from the front.

Even the way the tape moves through the recorder has been simplified. One innovation—an extremely precise servo mechanism



The BVH-2000 (shown with Type-III control panel).



Front access to all electronic circuits and modules.

—permits the entrance and exit guide posts to move about 10mm away from the drum during threading. The result is the easiest threading system ever in a 1" video recorder.

THE MOST ARTICULATE VTR EVER BUILT.

The BVH-2000 removes much of the mystery from maintenance, too. It literally tells you about malfunctions—usually well before you'd notice them yourself—through a microprocessor-governed self-diagnostic system.

The system includes various alarm functions and numerous checks to confirm that everything is working properly. Most defects can be easily found—allowing for far less complicated maintenance and repairs, and reducing downtime considerably.

And because the best way to simplify maintenance is by lessening the need for it, the Sony BVH-2000 has been designed to be virtually maintenance-free down to the last detail. For example, only brushless DC motors are used, and all incandescent lamps have been replaced with high-brightness LED's.

Other welcome advances include a greatly expanded dynamic tracking range (from reverse at normal speed to forward at 3 times normal); programmed play (allowing you to vary playback speed across a range of ±20% of normal speed); and video and audio confidence.

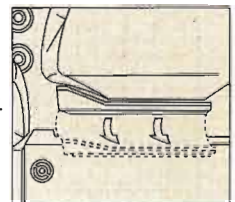
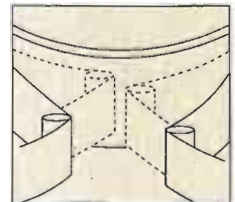

To simplify threading, guide posts automatically move away from drum, and audio head cover opens.

Remarkably, these are only some of the Sony BVH-2000's innovations. All of them add up to form the answer to virtually every need ever expressed by the users of 1" video.

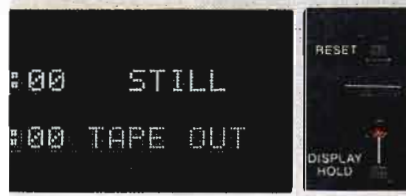

Display board for self-diagnostics and other data-processing functions.

To find out how it can answer yours, write Sony Broadcast, 9 West 57th St., New York, NY 10019. Or call us in New York/New Jersey at (201) 368-5085; in Chicago at (312) 860-7800; in Los Angeles at (213) 537-4300; in Atlanta at (404) 451-7671; or in Dallas at (214) 659-3600.

SONY
Broadcast

Circle (28) on Action Card

Sony and U-matic are registered trademarks and Betacam is a trademark of Sony Corp. © 1982 Sony Corp. of America, 9 W. 57th St., New York, N.Y. 10019.

PERFECT TIMING



780 SERIES

RAM TIME

PROGRAMMERS \$1200 to \$1500

When programming more than eight events, the 780 Series RAM Time Programmers are the most cost-effective way of dealing with the problem. They are flexible, easy to use, and provide 32 events (expandable to 96) in 5 1/4 inches of rack space.

780 Series units operate from the power line, with a backup crystal time base and 72 hour battery/charger as an integral part of the equipment.

The front panel consists of:

- An eight digit real time display when day selection is required as on the ES 781, 784, 785, seven digits for ES 780, and six digits for the others.
- A two digit display of "Next Event" number.
- An eight digit display of "Next Event Time" when ES 780, 781, or 782 is specified, and a six digit display when ES 783, 784, 785, 786 or 787 is specified, and a four digit display when ES 788 or 789 is specified.
- All displays are .3 inch red light emitting diodes.
- Controls, mounted below the displays, consisting of:

An "Active-Disable" Switch used when it is necessary to preempt the program temporarily.

Time Setting Controls—All recessed to avoid accidental bumping.

"Display"—The displays can be observed by actuating this control during a power outage. The unit will continue to operate, but the displays will be blanked to conserve battery energy.

"Event Select"—A two decade thumbwheel, used to set the event number when entering or reading data in the memory.

"Event Time Select"—An eight or six or four decade thumbwheel, used to enter the event time in the memory. The number of thumbwheels will be determined by the part number of the unit specified.

"Enter"—This pushbutton is actuated to enter data into the memory.

"Run-Read/Enter"—A two position switch, placed in the "Run" position for normal operation, and in the "Read/Enter" position whenever entering data or reading data.

STANDARD UNITS

EIGHT DIGITS OF PROGRAMMING CAPABILITY:

ES 780—10 Days, 10 Outputs, Hours, Minutes, Seconds

ES 781—100 Days, Hours, Minutes, Seconds

ES 782—16 Outputs, Hours, Minutes, Seconds

SIX DIGITS OF PROGRAMMING CAPABILITY:

ES 783—Hours, Minutes, Seconds

ES 784—100 Days, Hours, Minutes

ES 785—100 Days, Minutes, Seconds

ES 786—16 Outputs, Hours, Minutes

ES 787—16 Outputs, Minutes, Seconds

FOUR DIGITS OF PROGRAMMING CAPABILITY:

ES 788—Hours, Minutes

ES 789—Minutes, Seconds

The size of the unit is 5 1/4" High x 19" Wide x 10" Deep—Relay Rack construction, totally enclosed, with a screen top.

ES 782, 786 and 787 have 16 isolated outputs. Any of the 32 events can be programmed to activate any of the 16 outputs. ES 780 has 10 outputs. The other units have a single output.

ES 784, 788 and 789 have a one minute contact closure. The others have a one second contact closure. Contacts are single pole, form A, reed type, and have a one amp rating.

THE 780 SERIES AS A MASTER CLOCK

By adding the ES 167 Serial Time Code Generator and using a more accurate crystal, the 780 Series Ram Time Programmers can serve the dual functions of Master Clock and 96 event programmable timer.

750 SERIES

THUMBWHEEL

PROGRAMMER/

COMPARATORS \$310 to \$390

When programming up to eight time events, the 750 Series is recommended. Thumbwheel switches are set to compare the time information from an ESE Clock or Timer.

An output (event) occurs each time the thumbwheel switch setting agrees with the time display.

One set of thumbwheels is required for each event. The standard 750 Series units are enclosed in a 3 1/2 inch high relay rack panel and chassis.

STANDARD UNITS

ES 750—ES 112 and one 6 Digit Program

ES 751—ES 124 and one 6 Digit Program

ES 753—ES 112 and two 4 Digit Programs (Hrs & Min)

ES 754—ES 124 and two 4 Digit Programs (Hrs & Min)

ES 756—ES 510 and one 4 Digit Program (Min & Sec)

ES 758—ES 510 and two 4 Digit Programs (Min & Sec)

ES 760

\$620

ATS CLOCK

The ES 760 is a six digit, 24 hour, programmable clock.

On the front panel are a six digit display of time, in hours, minutes and seconds, and two sets of four thumbwheels.

An internal comparator is fed "Clock Time" and "Thumbwheel Time," and when these two agree, a reed relay contact closure occurs, which is brought to a rear-mounted connector. The connector also provides four line parallel BCD time information.

If normal power is interrupted, ES 760 will automatically switch to its internal battery and crystal time base.

Mechanical: 3 1/2" High x 19" Wide x 8" Deep.

PRESETTABLE TAPE TIMERS

ES 1296

\$195

For Off-Air taping, or operating tape recorders when nobody is there, ESE has created ES 1296.

ES 1296 is a six digit, twelve hour clock with LED displays and a programmable, 300 watt, 117V AC outlet on the rear.

There are four push-button controls (Fast, Slow, Set and Reset) and a four position selector switch. The Fast and Slow controls are used to set time of day and recorder start time.

When setting the recorder start time, the Set control is used in addition to the Fast and Slow controls, to set the time to the nearest minute. A rear-mounted four position switch is used to pre-set the start time as far ahead as 96 hours.

Once the rear outlet is activated, it will remain on for 66 minutes.

The **Record Duration** option allows the user to select one of four time intervals for recording. These four time intervals are either 16, 33, 66 and 138 minutes, or 33, 66, 138 and 250 minutes.

An additional option is **Sequential Turn-on**, for those machines that require Power, Play, Record in sequence.

A **Manual Override Switch** can be provided as an option, so that the user may operate his machine at any time without disconnecting from the ES 1296.



ESE Masters provide a means of keeping all time displays in the system in agreement, through the use of a Serial Time Code. Only one pair of wires is needed to distribute the time code to all remote serial input displays.

An ESE Master Clock System can operate digital displays, clocks with sweep second hands, printers and, in addition, tell your computer what time it is.

Twelve hours of standby battery operation is standard in ES 160, 160/1 and 190.

MASTER CLOCKS

ES 180 Mounted in a 5 1/4" relay rack panel and chassis, displays six digits of time information on 3" LED displays, in 12 hour format.

ES 160 has three second per month accuracy. Its standard output is serial BCD, CMOS compatible, and can drive ES 161, 166, 171, 991 or 993 Remote Displays without buffering. All inputs and outputs are through rear-mounted connectors.

Dimensions: 5 1/4" High x 19" Wide x 15" Deep. \$1050

ES 160/1 One second per month version of ES 160. \$1225

ES 190 The ultimate in accuracy? Similar to ES 160, with special circuits for receiving and decoding a 1000 Hz tone at the start of each minute. The decoder output resets the seconds' counters in the clock each minute except the first minute of every hour. These tones are transmitted by radio station WWV, with an oscillator accuracy of ± 1 part in 10¹¹. ES 190 has an antenna and internal WWV receiver with audio-output. Displays are .3" red LEDs. Serial output drives ES 161, 166, 171, 991 and 993 Remote Displays.

Dimensions: 5 1/4" High x 19" Wide x 15" Deep. \$1225

ES 192/194 The most economical Masters. ES 192 (12 Hr) and ES 194 (24 Hr) are constructed using ES 112 or ES 124 digital clocks and adding the ES 167 Serial Time Code Generator to provide the output needed to drive Remote Serial Displays ES 161, 166, 171, 991 and 993. Displays are .6" incandescent type.

Dimensions: 2 1/4" High x 8" Wide x 6" Deep. \$325

ES 196 TIME AND TEMPERATURE MASTER Basically the same as ES 192, but with gas discharge displays, panel mounting end separate serial BCD outputs for time and temperature. Displays 12 hour and "F" format.

Dimensions: 3 1/4" High x 19" Wide x 8" Deep. \$766

ACCESSORIES

ES 161 REMOTE DIGITAL DISPLAY Decodes serial time data and displays six digits of time on .55" Gas Discharge Displays, in either 12 or 24 hour format.

Dimensions: 8" Wide x 2 1/4" High x 6" Deep. \$165

ES 162 IMPULSE DRIVER Plugs into the ES 160 chassis, can drive 20 Impulse Clocks. Designed so that, if power fails, impulse always comes on with the same polarity when power is restored. \$200

ES 164 REMOTE DIGITAL IMPULSE DISPLAY Similar to the ES 161 except that the ES 164 derives its count command from the ES 162 Impulse Driver, or any impulse clock drive circuits already installed.

Dimensions: 8" Wide x 2 1/4" High x 6" Deep. \$244

ES 166 JUMBO 1" CLOCK DISPLAY Features six digits of one inch gas discharge displays in 12 or 24 hour format. Receives serial time code input from any ESE Master Clock or ES 167.

Dimensions: 10 1/2" Wide x 4 1/2" High x 6 1/2" Deep. \$254

ES 167 SERIAL TIME CODE GENERATOR An integral part of ES 160, 190, 192/194 and 196 Master Clocks, this unit can be added to many other ESE products, including ES 112, 124, 182, 184, 992, 994, 750, 751, 753, 754 and all 780 Series Time Programmers. Drives ES 161, 166, 171, 991 or 993 Remote Displays. \$146

ES 168 TEMPERATURE SLAVE Receives serial code from ES 196, displays it on .55" Gas Discharge Displays.

Dimensions: 8" Wide x 2 1/4" High x 6" Deep. \$146

ES 171 CONSOLE MOUNT REMOTE DISPLAY Receives the serial time code generated by any ESE Master Clock, or any ESE product containing the ES 167 serial time code generator, and displays it on bright red .3" LEDs.

Dimensions: 2 1/4" High x 4 1/2" Wide x 4" Deep. \$158

ES 1548 CONSOLE MOUNT TEMPERATURE DISPLAY In the same case as ES 171, receives the serial code from ES 196 and displays it on bright red .3" LEDs.

Dimensions: 2 1/4" High x 4 1/2" Wide x 4" Deep. \$158

IMPULSE CLOCK When a sweep second hand is desired, specify the 3201.003 "Extra Flat" Impulse Clock. It has a 12 inch dial protected by a glass cover and metal bezel and is approximately one inch thick. As many as twenty impulse clocks can be driven by a Master Clock which has ES 162 as an accessory. \$195

ES 991 4 DIGIT SERIAL INPUT SLAVE Decodes serial time data and displays four digits of time on large 2" gas discharge displays.

Dimensions: 10 1/2" Wide x 4 1/2" High x 6 1/2" Deep. Desk Top Case. \$325

ES 993 6 DIGIT SERIAL INPUT SLAVE Features four digits of 2" high gas discharge displays, and two digits (Seconds) of 1" gas discharge displays. Receives serial time code input from any ESE Master Clock or ES 167.

Dimensions: 5" High x 12" Wide x 3" Deep (Wall Mount). \$449



ES 253 SMPTE TIME CODE READER: is an eight-digit SMPTE Time Code Reader displaying Hours, Minutes, Seconds and Frames. \$454

ES 254 SMPTE TIME CODE READER: is a bi-directional, multi-speed eight-digit reader, displaying Hours, Minutes, Seconds and Frames on .4" red LED displays. \$675

ES 255 is a bi-directional, multi-speed, eight-digit SMPTE Code Reader, that can add the information to a video stream for recording time code on the video portion of a tape, or for displaying it on a monitor. Reading speed is 1/20 to 20 times playback speed. \$995

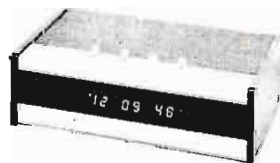

SMPTE TIME CODE GENERATOR: ES 261 is a pre-settable, eight-digit SMPTE/Time Code Generator, capable of Drop Frame or Non-Drop Frame operation. \$750

ES 112/124

DIGITAL CLOCK \$165

ES 112 (12 hr.) and ES 124 (24 hr.) are solid state, six digit clocks. Can drive 80 Series end 90 Series slaves. Displays are incandescent filament, 6" high.
Dimensions: 2 1/2" High x 8" Wide x 6" Deep.



ES 142/144

DIGITAL CLOCK THERMOMETER \$300

ES 142 (12 hr.) and ES 144 (24 hr.) are solid state digital clock/thermometers. Six digits of time (hours, minutes, seconds) and 3 digits of temperature (-50°F to +150°F or -45°C to +66°C) in gas discharge displays. 55" high. Temperature sensor on 25 ft. cable included.
Dimensions: 2 1/2" High x 10" Wide x 6" Deep.

ES 240/241

ES 240 DIGITAL THERMOMETER is calibrated for °F and °C. Displays are planar gas discharge, .55" high. \$195
Dimensions: 2 1/2" High x 8" Wide x 6" Deep.

ES 241 DIGITAL THERMOMETER is calibrated for °F and °C, alternating between the two every four seconds. Displays are planar gas discharge, .55" high. \$236

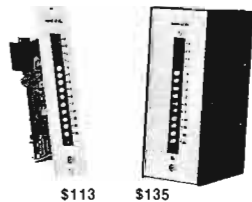

\$113 \$135

ES 211/214

DYNAMIC AUDIO LEVEL INDICATOR

The ES 214 is a highly accurate audio level indicator which is designed to simulate the action of a conventional VU-Meter but with superior dynamic characteristics. The LED meter is live to one hundred times faster in responding to complex waveforms than the mechanical meter without sacrificing the familiar meter "movement".

SPECIFICATIONS

Number of Indicators: 14 LED Lamps in 3 colors.

Scale: +4, +3, +2, +1 dB—Red
 0 dB—Yellow
 -1, -2, -3, -5, -7, -10,
 -15, -20, -25 dB—Green

Input Impedance: 2200 ohms at maximum sensitivity, 6800 ohms at +8dBm "House Level", 10,000 ohms at minimum sensitivity.
Input Circuit: Transformer isolated, balanced bridging.

Frequency Response: 20-20 KHz ± 1 dB (all modes).

Rise Times: Less than 250 MicroSec (Peak Mode), less than 25 Millisec (Fast Averaging Mode). Approximately 300 Millisec (Optional VU Standard).

Fall Time: (All Modes) About 300 MicroSec from full scale.

Modes of Operation: Peak Reading, Fast Averaging (Apparent Loudness), Slow Averaging (USA VU-Standard).



70 SERIES

CONSOLE MOUNT CLOCKS AND TIMERS

ES 172 SIX DIGIT, 12 HOUR CLOCK: Three setting controls—Fast Advance, Slow Advance and Hold. \$158

ES 174 SIX DIGIT, 24 HOUR CLOCK: Otherwise identical to the ES 172 \$158

ES 370 FOUR DIGIT, ONE HUNDRED MINUTE UP/DOWN TIMER: Six controls—Count Up, Count Down, Stop, Minutes Advance, Seconds Advance, Reset. \$201

ES 371 UP/DOWN TIMER: Similar to the ES 370 except with Leverwheel Preset capability for faster setting of the desired time. \$319

ES 570 FOUR DIGIT, SIXTY OR 100 MINUTE TIMER: Select 60 or 100 minute mode on rear connector. Start, Stop and Reset controls. Runs continuously unless stopped. Reset will return all displays to zero. Unit will run if reset while running or will stay at zero if reset when stopped. \$158

ES 572 SIX DIGIT, 12 HOUR CLOCK OR TIMER: Five controls—Start, Stop, Reset, Fast Advance, Slow Advance. Will run continuously to 12:59:59. Advances to 1:00:00 and continues as clock unless stopped or advanced. \$192

ES 574: A 24 hour version of ES 572. \$192

ES 575: Exactly like ES 570, with the addition of a "freeze" button. When the button is released, the display "catches up" with the correct elapsed time. \$192

Dimensions: 2.16" High x 4.5" Wide x 4.13" Deep.

80 SERIES

JUMBO CLOCKS AND TIMERS

Large, bright 1" gas discharge displays provide effortless long distance viewing from 40 feet.

ES 182 SIX DIGIT, 12 HOUR CLOCK: Three rear-mounted setting controls—Fast Advance, Slow Advance, and Hold. \$272

ES 184 SIX DIGIT, 24 HOUR CLOCK: Otherwise identical to the ES 182 \$272

ES 390 FOUR DIGIT, 100 MINUTE UP/DOWN TIMER: Similar to ES 360, except that leverwheel preset is used. \$416

ES 580 FOUR DIGIT, 60 MINUTE TIMER: Displays minutes and seconds. Rear connector allows remote wiring of three momentary SPST controls—Start, Stop and Reset. Reset returns all displays to zero, and timer will continue to run from zero if reset while running.

ES 381 UP/DOWN TIMER: Similar to ES 360, except that leverwheel preset is used. \$416

ES 580 FOUR DIGIT, 60 MINUTE TIMER: Displays minutes and seconds. Rear connector allows remote wiring of three momentary SPST controls—Start, Stop and Reset. Reset returns all displays to zero, and timer will continue to run from zero if reset while running.

80 Series slaves are also compatible with other ESE clocks and timers: ES 112/124, 301, 302 and 510 \$228

Dimensions: 4.45" High x 10.38" Wide x 6.58" Deep.

90 SERIES

2 INCH DISPLAYS—VIEWABLE AT 60 FEET

ES 391—Presettable Up/Down Timer: 100 Minute Range—Displays Minutes and Seconds, uses Leverwheel Preset. Controls are Count Up, Count Down, Stop, Reset and Preset. \$487

Dimensions: 4.45" High x 10.38" Wide x 6.58" Deep.

ES 580—Sixty Minute Timer: Displays Minutes and Seconds. Rear-mounted connector provides for wiring to user's single pole, momentary, push-button controls: Start, Stop and Reset. Reset returns all displays to zero, and timer will continue to run from zero if reset while counting. \$228

Dimensions: 4.45" High x 10.38" Wide x 6.58" Deep.

ES 992/994—6 Digit Clocks: ES 992 (12 Hr) and ES 994 (24 Hr)—Hours and Minutes on Two Inch Gas Discharge Displays, Seconds on One Inch Gas Discharge Displays. Three top-mounted setting controls—Fast Advance, Slow Advance and Hold. \$449

Dimensions: 5" High x 12" Wide x 3 1/2" Deep.



ES 562/564

SIX DIGIT CLOCK/TIMER WITH MEMORY \$313

ES 562/564 is a combination six digit clock and 24 hour timer with memory, allowing the user to set the clock to the correct time of day, switch to timer mode, then switch back to time of day by pushing one button; time of day will be correctly displayed. In hours, minutes and seconds. Five pushbutton controls are mounted on the top of the unit, near the front of the desk-top case. When panel mounting is specified, they will be mounted on the front panel, below the display. The controls may also be removed, through two rear-mounted five pin connectors (Option R or Option D). These controls are Clock, Fast/Start, Slow/Stop, Timer and Hold.

Display: Six digits of .55" Planar Gas Discharge Display.



ES 280

AUDIO TIME CODE GENERATOR/READER

The ES 280 is a 10 Digit Audio Time Code Generator/Reader, capable of laying down a serial BCD time code on audio tape in the Generator Mode, and recovering and displaying it in Digital form in the Reader Mode. The code has been designed by ESE. It is not a standard code, such as SMPTE or IRIG. The frequencies used to produce the code have been selected to be compatible with cartridge machines as well as other tape recording and playback equipment. Amplitude adjustment assures the right amount of signal for the particular machine being used.



ES 510L

FOUR DIGIT 60 MINUTE TIMER \$158

ES 510 is a four digit, sixty minute timer (59:59) with Start, Stop and Reset controls. If stopped, display will hold time reading and when restarted will continue with next count from last displayed figure. If reset while running, timer will continue to run. ES 510 can drive 80 Series and 90 Series Slaves.

Dimensions: 2 1/2" High x 6" Wide x 6" Deep.

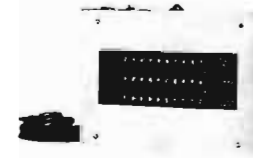

ES 203/205 \$ 89

ES 203/205 is a 20 input Timer/Source Interface. It was designed to provide a simple means of connecting a variety of sources such as carts and turntables to the remote input of ESE Timers. The most common application for this product is resetting either an ES 400 or ES 510 Timer each time a source is started.

The 20 inputs are divided into ten DC voltage inputs and ten contact closure inputs. Activation of any one of these inputs will cause an output which will momentarily reset an ESE timer.

Mechanical: Aluminum Case 8" x 6" x 2".

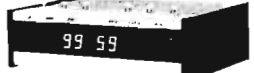

ES 301/302

100 MINUTE UP/DOWN TIMERS \$234 \$302

ES 301 is a four digit, one hundred minute timer (99:59) with six controls: Count Up, Count Down, Stop, Minutes Advance, Seconds Advance, Reset. Counting can be activated up or down or set back to zero. When "Stop" control is pressed, the four digit display is held. Counting direction (up or down) can be changed or time can be reset to zero without stopping the count. The ES 301 can drive 80 Series and 90 Series Slaves. Displays are gas discharge, .55" high.



With the ES 302, the user can preset times much faster than with the ES 301, because lever-wheel type switches are used for the preset feature. The ES 302 can drive 80 Series and 90 Series Slaves.

Dimensions: ES 301: 2 1/2" High x 8" Wide x 6" Deep.
 ES 302: 2 1/2" High x 10" Wide x 6" Deep.



ES 206

VIDEO TIME AND DATE GENERATOR \$475

The ES 206 has been designed to allow the addition of Time and Date information to a video signal. Two rear-mounted video jacks permit "looping" the video information through the 206 to add the data.



ES 270

IRIG B TIME CODE READER \$350

The ES 270 TIME CODE READER has been designed to be an economical solution to the problem of receiving and displaying IRIG B.

Nine digits (Days, Hrs, Min, Sec) of time are shown on bright red LED's, .3" character height.

ES 270 comes in a rack mounting enclosure, 1 1/2" High, 19" Wide and 10" Deep.

The power requirement is 117V AC, 50/60 Hz, 230V AC, 50 Hz is available as an option.



142 Sierra Street El Segundo, CA 90245
 (213) 322-2136

Circle (152) on Action Card

CHIEF ENGINEER-

"Thank God, it works. We've tried everything and we're really pleased."

DIRECTOR-

"It's a wonderful sense of security for a director to have access to the people he works with."

TALENT-

"Without the Comrex, I would have been lost."

Are you entirely satisfied with your ENG communications?

We've just finished talking with every Comrex Cue System user and, after talking with them, what we can't understand is why every station who does ENG, EFP, sports, or live studio programming hasn't at least considered our Cue System.

The Comrex Cue System is an RF system that goes in a van, helicopter, press box, studio control room, etc., and sends both program and instructions to small, rugged, pocket receivers.

Give us a call. We're happy to tell you more or to send it out on a free ten day trial.

COMREX

P.O. Box 269 60 Union Avenue
Sudbury, Massachusetts 01776
TEL: 617-443-8811 TWX: 710 347-1049



Circle (20) on Action Card

NEWSMAKERS

Vincent Wasilewski, president of the National Association of Broadcasters, has announced his intention to resign sometime during 1982. Wasilewski joined NAB in October 1949 and has served as president since January 1965. Wasilewski, who will be 60 this December 17, is one of the industry's more respected and forceful figures.

Sterling Davis was hired as production manager and Ray Jacobs was named director of administration of Cox-owned KTVU, San Francisco/Oakland. Davis will be responsible for the supervision of both the film and floor departments, and will serve as the facilities supervisor. Prior to joining KTVU, Davis was chief engineer of Telemation Production in Seattle.

John Ridall has been appointed general manager of Viacom Cablevision in Dayton, Ohio. Ridall was formerly director of marketing for Viacom Cablevision in Cleveland.

John Dimling, Jr., has been named executive director of the Broadcast Rating Council. Dimling assumed the position June 1, following the retirement of Hugh Beville, Jr..

Jim Noeldner joined Katz Communications' sales office in Seattle. Noeldner came to Katz from KAPY Radio, Port Angeles, where he was a sales manager.

Jonathan Klein is the new general sales manager of WBZ-TV, Boston. Klein, formerly vice president and general manager of KDKA Radio, will be responsible for WBZ-TV's national and local sales force.

Peter Rainger, deputy director of engineering for the BBC, has been elected a Fellow of the Royal Society "for his major contributions to the development of electronic techniques used in television." Rainger joined the BBC as a graduate engineer in 1951. He helped develop the first electronic standards converters as well as Ceefax, from which teletext has developed. More recently he has played a leading role in the formulation of the standard format for digital video signals which was agreed upon by the CCIR.

Anna Mae Sokusky is the new director, CBS Radio Stations News Service. She replaces Joseph Durso, Jr., who has been appointed news director at WBBM-AM in Chicago.

Fran Wilkinson, an executive with an extensive background in radio sales, has joined the RKO Radio Networks as western region sales manager in the Los Angeles sales office. Wilkinson comes to RKO from Blair Radio, where he was sales manager for the firm's L.A. office.

Sheldon Cooper has been named president of Tribune Productions, a newly formed subsidiary of Tribune Company Broadcasting Inc. Cooper was formerly the president and general manager of WGN Television.

Andrea Cetera has assumed the post of vice president, market strategy, at Viacom Enterprises. Prior to joining Viacom a year ago, Cetera was director of research and client services for Petry Television.

Elliott Klein was elected vice president of the Phoenix Metropolitan Chapter of the Arizona Broadcasters Association. Klein is director of engineering at KNIX, Tempe.

Continued on page 30

Ampex Announces the Practical End of Video Jitters.



Video Jitters can drive you up a wall.

It happens when you've repeated an edit over and over. You want it perfect. Now, everything's cued up just right. You hit the edit button, and what do you get? A glitch. A shaky picture. A sour stomach. Video Jitters.

The culprit is stiction—friction build-up so bad that the tape actually jerks across the heads and scanner. Humid conditions can make it worse.

But not if you use Ampex 196 One-Inch Broadcast Video Tape.

Every batch of Ampex 196 has to pass the toughest test in the industry—stiction-free operation at the extreme environments of 90% RH and 90° F, to guarantee that you have consistent stiction-free operation under all conditions.

Ampex 196. Less friction, because who needs it?

Ampex 196 One-Inch Video Tape.

AMPEX

Ampex Corporation • One of The Signal Companies

I want to end the Video Jitters with Ampex 196 One-Inch Broadcast Video Tape.

Please send me more information on your 196 Video Tape.

NAME _____
TITLE _____
COMPANY _____
ADDRESS _____
CITY _____ STATE _____ ZIP _____
PHONE (____) _____

Send to:

Ampex Corporation, Magnetic Tape Division
401 Broadway MS 22-02, Redwood City, CA 94063

BC

Circle (21) on Action Card

THE NEW OF VIDEO.

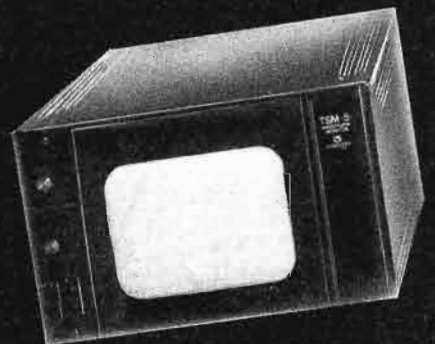
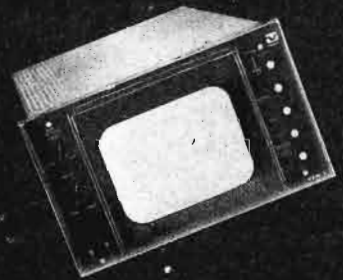
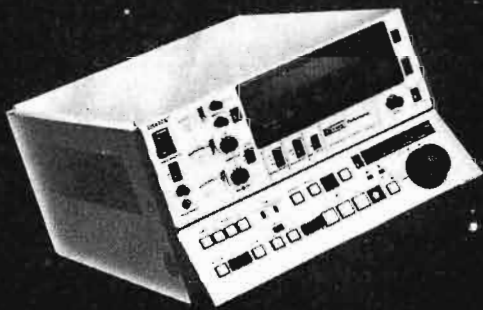

WORLD

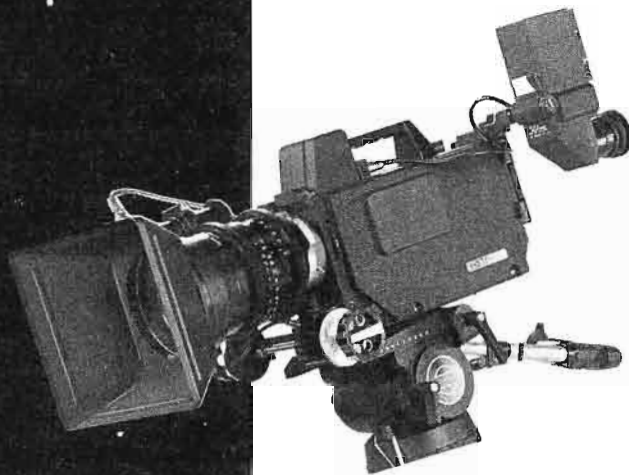

CAMERA MART, THE SOURCE FOR EVERYTHING IN TODAY'S NEW WORLD OF VIDEO TECHNOLOGY.

At Camera Mart, we're keeping pace with the rapidly advancing science of video technology to give you the most sophisticated state-of-the-art equipment available.

In the new world of video, equipment is more flexible, more versatile, more accurate than ever before, with capabilities far ahead of just a year ago.

At Camera Mart we can give you entire video systems: cameras, sound, lighting, editing...plus the expertise of our trained technical staff to help you put together the system that's exactly right for your needs, TV broadcasting, field production, fixed or mobile installations, ENG/electronic cinematography, you name it.

Whether you want to buy, rent or lease, see what's been happening in video research and development. See how much more you can have with the latest advanced video systems at Camera Mart.

*Products Shown:
Sony BVU-800 Broadcast Cassette VTR, Ikegami HL-79
ENG/EP Camera, Videotek TSM-5 Wave Form Monitor,
Videotek VSM-5 Vectorscope, Ikegami EC-35 Electronic
Cinematography Camera, Quantel DPE 5000 Digital
Effects System, Panasonic NV-8500 VHS Editing Recorder,
Microtime T-120 Time Base Corrector.*

The Camera Mart, Inc.

456 W. 55th St., New York 10019 • (212) 757-6977/Telex: 1-2078
Video Department: 800 Tenth Ave.
Sales • Service • Rental

Circle (22) on Action Card

THE ELECTRONIC NEWSROOM IS HERE TO STAY!

THE PROVEN SYSTEM IS AVAILABLE TODAY!

FROM INTEGRATED TECHNOLOGY, INC.

- IT is the only computer systems company that is totally devoted to broadcast news applications!
- IT is the manufacturer of the only electronic newsroom system with a proven performance of around-the-clock operation for more than 18 months without crash!
- IT leads the industry in the number of new systems developed exclusively for the broadcast news market!
- IT has the capability for the volume production of its exclusive design, and performance proven systems, now!

CALL OR WRITE FOR DETAILS TODAY

INTEGRATED TECHNOLOGY, INC.

Specializing in computer management systems for the broadcast newsroom.

9644 View High Drive
Kansas City, Missouri 64134
816/763-2286 • 913/677-1041

NEWSMAKERS

Lou Zacche, named vice president of advertising and promotion for Abell Communications, will direct the advertising, promotion, and design activities for Abell's television and radio stations, as well as its direct marketing and program syndication efforts.

Peter Vincelette joined the Insilco Broadcast Group of Florida as general manager of WYOR, Miami. Vincelette had been vice president and general manager of WJYE-FM, Buffalo.

Linda Farrell moved from KOCO-TV, Oklahoma City, to KOA-TV, Denver, where she became news anchor. Farrell has worked as a producer, writer, reporter, anchor, and news director in the Oklahoma City area.

Mary Murano has been appointed northeast region affiliate marketing manager for Rainbow Programming Services. Her responsibilities include developing, planning, and executing affiliate launches; ongoing marketing programs; and follow-through activities for all systems within the district. Prior to joining Rainbow, she was manager of advertising and promotion at Showtime Entertainment.

Business Moves

Herb Lee, formerly in industrial video sales for Peirce-Phelps, Video Systems Division, has been promoted to broadcast/teleproduction salesman for the Washington, D.C., area. Also at Peirce-Phelps, James Wesley Boslough has joined the company as systems engineer. Boslough has more than 20 years of broadcast and technical engineering experience.

Bruce Hall recently joined Bonneville Satellite Corporation as director of operations. Hall is responsible for the operations of Bonneville Satellite's leased and owned satellite facilities and services.

Michael O. Felix has been appointed general manager of Ampex Corporation's Advanced Technology Division. Felix will direct the company's extensive research and development programs in his new position.

Howard McClure has been named vice president of marketing at Townsend Associates. McClure joins Townsend Associates from Fernseh, where he was director of product management and applications engineering.

Richard Teichman was recently appointed senior vice president of Electronics, Missiles & Communications Inc. (EMCEE). In his new position, Teichman will be responsible for many phases of the company's operations, including general administration, training, and data processing.

John Robbins, new manager of production and product support at Quad-Eight Electronics, has an extensive background in professional and consumer audio manufacturing and in FM broadcasting. His new responsibilities will cover both standard and custom products at Quad-Eight.

Michael Montag, formerly European regional sales manager for Telemation International, has been appointed head of the newly formed Microtime Europe Limited, a wholly owned subsidiary of Microtime Inc., located in the United Kingdom. The new company will provide sales and service support to Microtime's dealers and customers in Europe, the Middle East, and Africa. Also at Microtime,

Continued on page 32

Another "state of the art" camera from Philips...

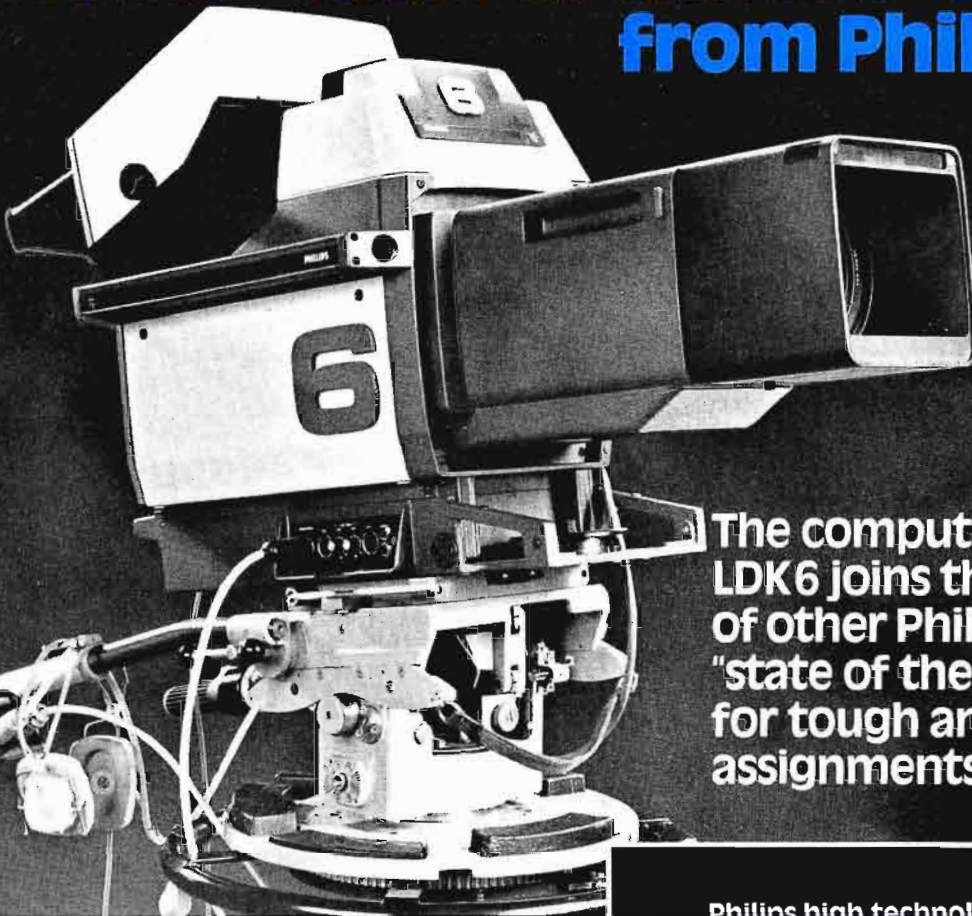

The computer controlled LDK6 joins the family of other Philips cameras... "state of the art" cameras for tough and specialized assignments.

A new era has been launched with the all new LDK6 field and studio triax camera with "distributed intelligence" to control, report and diagnose. These features now mean the operator can concentrate on creative camerawork.

For the first time, individual microcomputer and data communication facilities in each of the main system units provide an unequalled degree of intelligence within the system.

Other unique features include:

- Simultaneous multi camera computer controlled setup... partial or automatic.
- Diagnostics for on line anticipatory, and off line on-demand fault indication.
- Digital scan correction for spectacular reduction in corner errors.
- Wide Band RGB video over triax.
- Multiple camera settings can be stored and recalled instantaneously during production.
- 4 lens memories to automatically adjust for different lens parameters including back focus.
- Built-in diascope so standard lenses can be used including LDK5/25 lenses.
- Either 25mm or 30mm Plumbicons® can be selected.
- Two-wire data bus permits easy and economical expansion.

LDK5B and 25B are rugged and reliable high quality cameras. The all triax LDK5B has become a standard for tough remote requirements, and continues to be the first choice for quality field productions. The multi-core LDK25B is a first line studio camera... and surprisingly affordable.

LDK14S and SL EFP/Studio cameras are ready for any shoot out and comparison of automatic features... and require only a simple adapter for triax conversion. The LDK14SL with Low Output Capacitance diode gun Plumbicons® offers an unusually high S/N Ratio (57dB) and higher resolution.

LDK44 is a new modular 3-in-1 versatile and economical broadcast quality ENG/EFP/Studio camera. No other camera offers the features and flexibility at such a low price.

Philips high technology "workhorse" cameras continue to be the choice of demanding broadcasters for quality pictures, reliability, flexibility and low cost of ownership.



For your present or future camera requirements, put yourself behind any one of these Philips LDK cameras and compare... quality, reliability, ease of operation, flexibility, and cost of ownership. Call or write for full details.



CENTRAL DYNAMICS CORPORATION

The U.S. Broadcast Company for **CDL** ■ **PHILIPS** ■ **American Data**
900 Corporate Drive, Mahwah, NJ 07430 201-529-1550

Circle (24) on Action Card

THE TRUE MEASURE OF PERFORMANCE

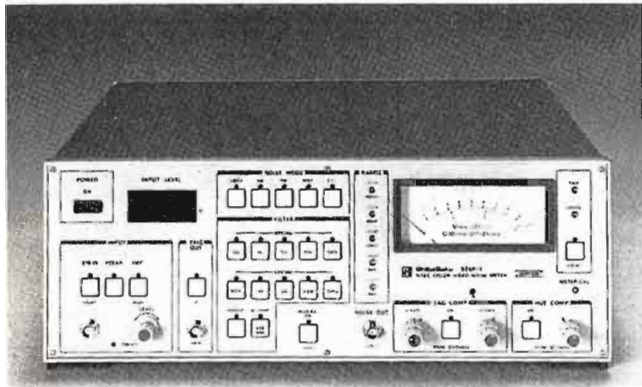

ASACA/SHIBASOKU 925R Color Video Noise Meter

The versatile 925R accurately measures both luminance and chrominance noise generated from TV transmission equipment, TV cameras, VTR's, videotape and videodisks. Connected to a general purpose interface bus (IEEE-488), it gives you complete receive/transmit capabilities. You can receive measurement start, mode and filter selection commands and transmit measurement data through the bus. You can expand the 925R into a fully automated system by using a desk-top computer with the SHIBASOKU TG-7 TV Test Signal Generator, U705 Noise Test Unit and 531 Interface Unit.

- Tests equipment under actual operating conditions.
- Separates AM/PM chrominance noise and measures each.
- Features HP/LP filters and weighting network for frequency analysis.
- Provides V/H sag compensation, hue compensation, and VTR head balance.
- Logs digital data; may be used as a digital video level meter.
- Available in NTSC; PAL B, M, N; and SECAM systems.

Measure your performance with the best. **ASACA/SHIBASOKU 925R.** The world standard in color video noise measurement.

For complete specifications, write:



ASACA/SHIBASOKU CORP. OF AMERICA
12509 Beatrice Street, Los Angeles, California 90066
Sales, Service: (800) 423-6347 • (213) 827-7144

Circle (83) on Action Card

NEWSMAKERS

Stephen Kreinik was named director of engineering; Gary Armour was named western regional manager; and Stephen Krant was named south central regional manager.

David Osedach was recently appointed video products sales manager for Audiotronics International, located in North Hollywood, California. Osedach will have full responsibility for the marketing of both CCTV and data display customers in the international markets, excluding Europe.

Jamie McMahan has been promoted to director of marketing for the Broadcast Division of Data Communications Corporation.

Larry Lamoray joined Audiotronics as international marketing manager. Lamoray was formerly with MCI Inc., serving both the engineering and marketing departments.

Bill Culbertson is the new manager of southern broadcast sales at RCA Commercial Communications Systems Division. Based in Camden, New Jersey, Culbertson is responsible for an organization selling RCA's line of radio and television studio and transmitting systems throughout the southern states.

Gary Hinderliter has been named director, customer services, at CMX/Orox. In his new position, Hinderliter will supervise the company's technical publications, training, and field service activities. He joined the company in 1978, and was most recently central region field service supervisor.

Peter Maguire, the new head of Valtec's Kansas City office, is responsible for developing new business opportunities for Caltec fiber-optic cable and telecommunications in North Dakota, South Dakota, Nebraska, Colorado, Kansas, Oklahoma, Texas, Louisiana, Missouri, Iowa, Minnesota, Illinois, and Wisconsin.

Richard Moen was recently appointed general sales manager for McM Martin Industries. Moen will also continue his former responsibilities as eastern regional sales manager for McM Martin broadcast products.

Russell Farrell was promoted to OEM sales manager for Altec Lansing's industrial/professional sound products line. He was formerly Altec's district manager for New England.

Nathaniel (Nat) Ostroff, the former principal founder of Acrodyne Industries, joined Comark Communications as a member of the board of directors and as an operating vice president. Ostroff will head the company's new high-technology research and engineering division in Colmar, Pennsylvania.

Dr. Albert A. Comparini has been named vice president of operations for Andersen Laboratories. Dr. Comparini will be responsible for product development, materials, and manufacture of electronic systems for Anderson Laboratories, a subsidiary of Andersen Group Inc. He had been director of operations for Andersen Laboratories since 1979. He joined the firm in 1977 as engineering manager.

James "Jay" Samples is the new midwest regional sales manager for Capscan Cable Company. He will be responsible for Capscan sales and service activities throughout Tennessee, Kentucky, Ohio, Illinois, Indiana, Michigan, Minnesota, and Iowa. **BC**

The next generation in editing systems.

Mach One® Series II.

Mach One from Fernseh has always been the fastest videotape editor on the market. The easiest-to-use.

And because it's software-based, we can make it more powerful with software changes.

That's exactly what we've done with the new Mach One Series II—the second-generation system.

Powerful new features.

Series II has all the features of the original Mach One. Plus six important new features that not only let you edit faster than ever, but give you unique capabilities and conveniences.

Dual-channel audio control. This exclusive feature gives you complete and independent control over two separate audio tracks in addition to the video channel.

Variable speed control. You can select any of 16 shuttle-jog speeds in either direction—all the way from freeze frame to maximum VTR speed.

Programmable slow motion.

Once you've selected a speed, it's displayed on the screen and you can program it in the edit list (for example, "half-speed at two minutes in, three-quarter-speed at three minutes in," and so forth). The programmed sequence is then completely repeatable.

Updated edit list formatting.

Mach One Series II gives you 6-digit alphanumeric reel numbers, audio channel 1 and 2 entry, additional events displayed on the screen, and other edit list features.

Cluster-event programming.

A Mach One exclusive. This powerful feature lets you program extremely complicated multiple events, known as "elements," in a "cluster" and treat them as a single event. For example, a complex series of switcher wipes, dissolves, or keys—together with digital video effects—can be quickly put together and previewed or recorded *in one pass* rather than event-at-a-time.

Screen highlighting. We've made the Series II edit screen easier to work with. Now it brightens the edit line you're working on and simultaneously dims the rest of the screen. It's easy

on the eyes, easy on the nerves, and never lets you lose your place—even for a second.

The editor's editor.

Mach One Series II in your editing room will give you speed and ease of operation that translates into creativity and profits.

You need the new generation in computer-assisted editing for your post production. And the new generation is exclusively Mach One Series II.

Your local Fernseh office is anxious to get you full details. Call them. Or get in touch with us directly: Fernseh Inc., the Video Corporation of Bell & Howell and Robert Bosch, P.O. Box 15068, Salt Lake City, UT 84115. (801) 972-8000.

From now on,
look to Fernseh.

FERNSEH

Circle (100) on Action Card

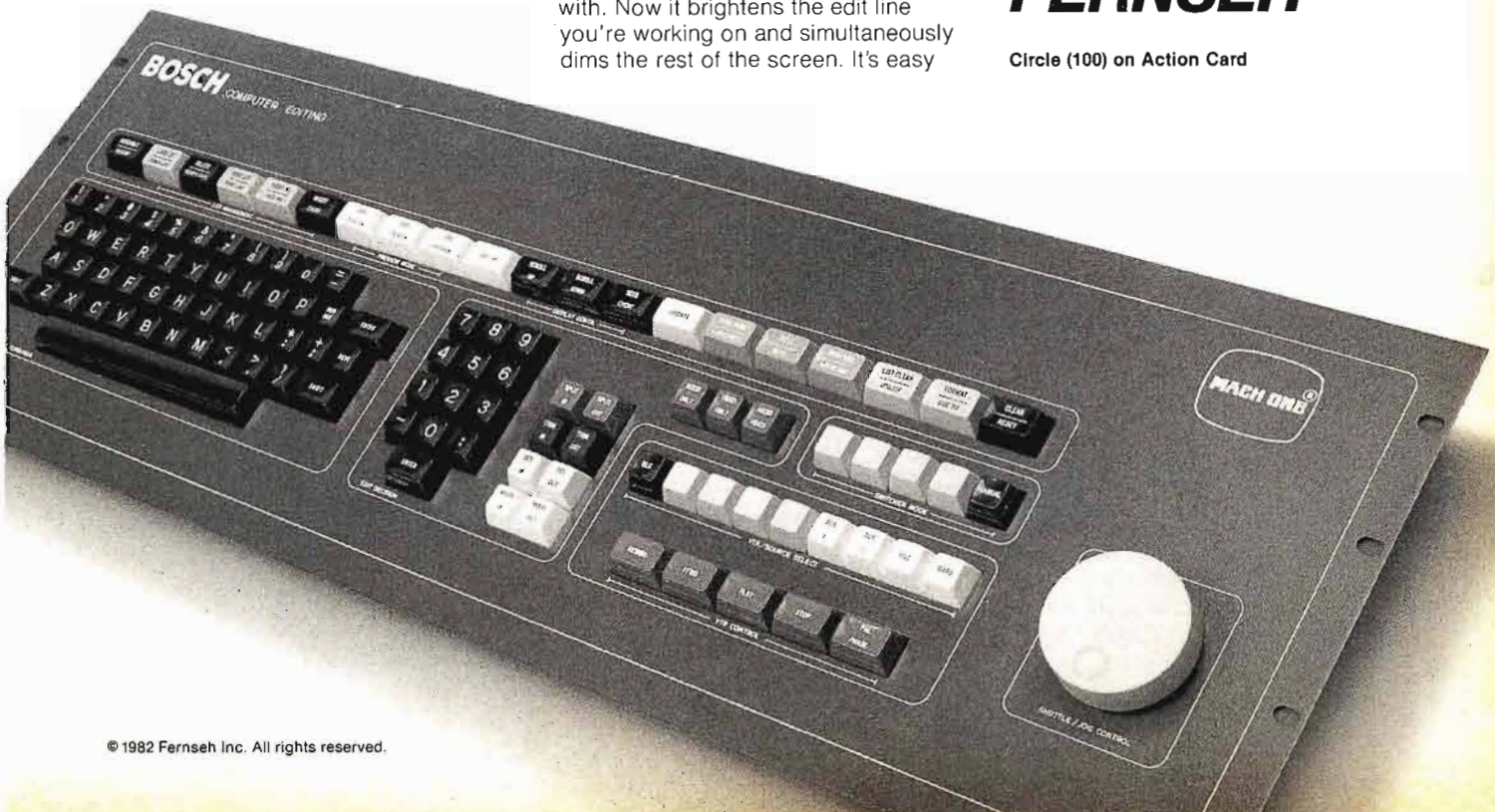

INTRODUCING THE XC EVERYONE ELSE OUT AGAIN.

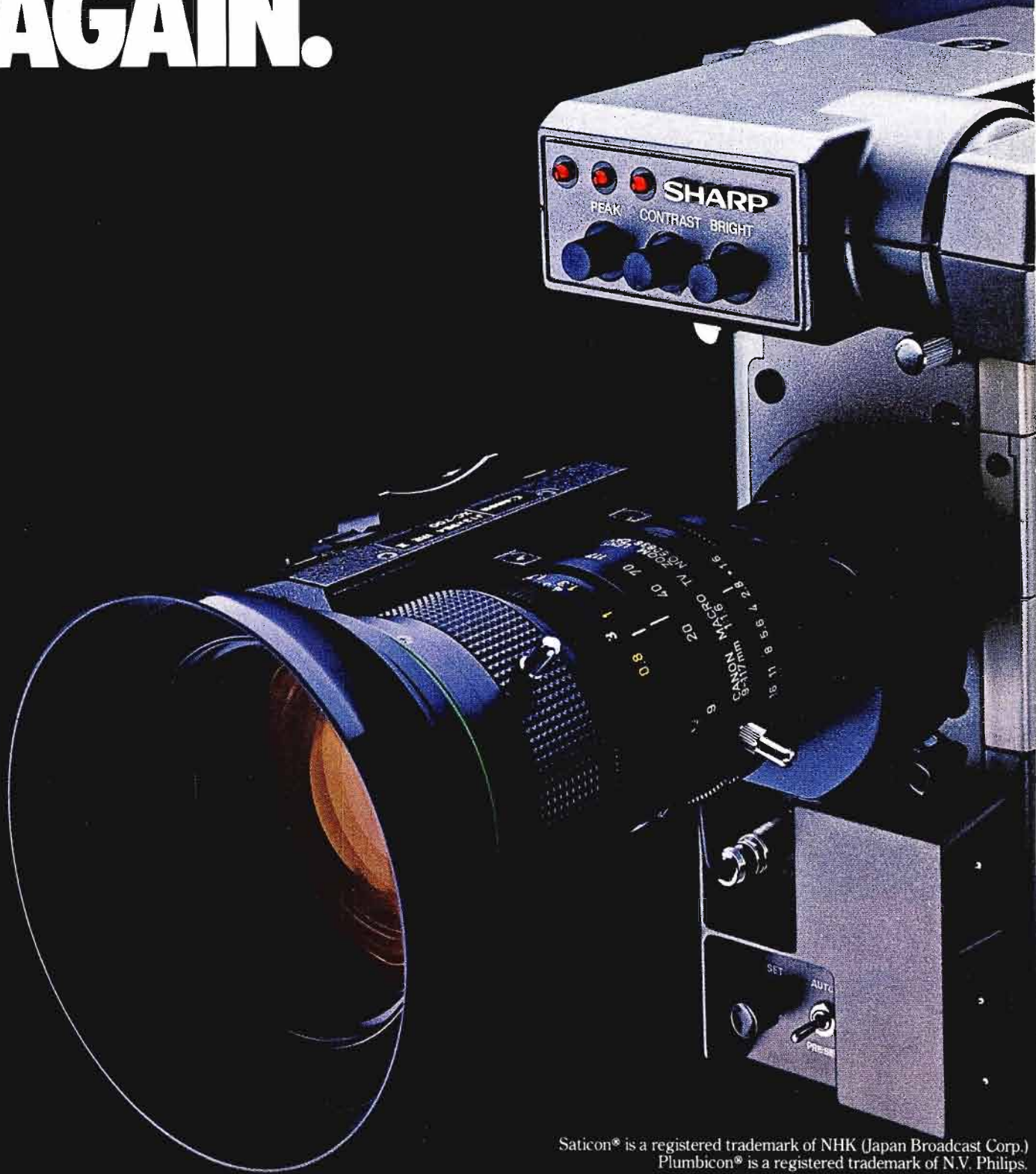

Saticon® is a registered trademark of NHK (Japan Broadcast Corp.)
Plumbicon® is a registered trademark of N.V. Philips.

-800. SHARP® TAKES OF THE PICTURE.



While everyone else is introducing a mid-priced camera, Sharp introduces a whole new generation.

The Saticon II Generation.

The Sharp XC-800 is the first camera priced under \$13,000 with Saticon II Tubes.

That means it's the first camera in its class that combines Saticon® strengths with a Plumbicon® plus.

So unlike conventional Saticons, you get substantially less highlight sticking, even when you pan across bright lights.

And you still get the higher resolution and depth of modulation Saticons are known for.

But that's just the beginning.

Pound for pound, feature for feature, nothing comes close to the new Sharp XC-800. It's lightweight and perfectly balanced.

And while we're proud of our new on-board computer, and newly designed Remote Operations Panel with serial data transmission and black stretch, the name of our game is more than just features.

It's reliability.

That's what the pros were looking for when we introduced the original XC-700, the first mid-priced camera that didn't perform like a mid-priced camera.

In fact, it performed so well, there are over a thousand of them out in the field today.

And it's been so successful, it's encouraged a rash of new mid-priced cameras.

We encourage you to compare any of them with the new Sharp XC-800.

Between the Saticon II breakthrough and everything else, nobody offers more camera for the money. For more information, contact your local dealer, or write: Sharp Electronics Corporation, Professional Products, 10 Sharp Plaza, Paramus, New Jersey 07652.



FROM SHARP MINDS
COME SHARP PRODUCTS

Circle (27) on Action Card

The Quantel DLS 6030.

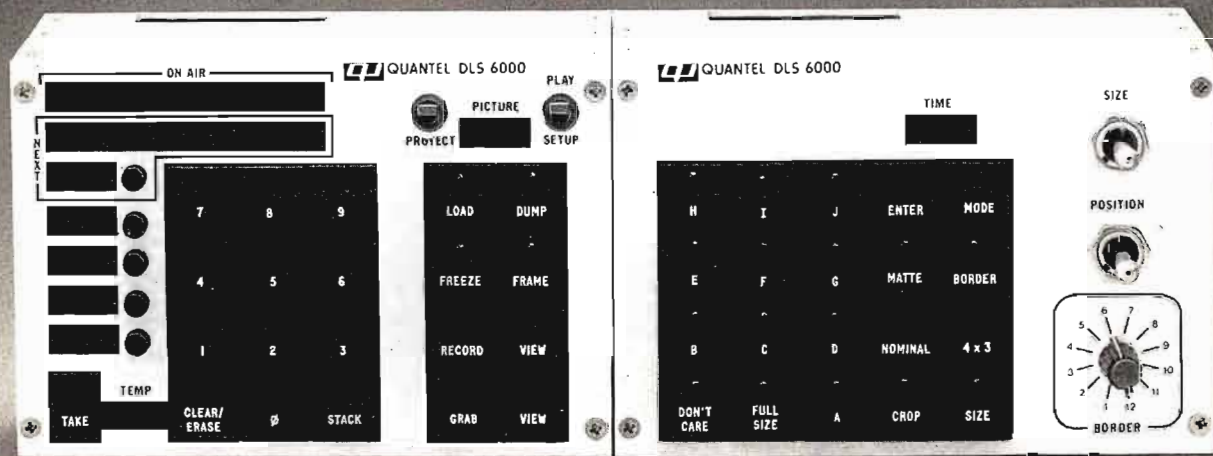

Every other way to store stills is obsolete.

Introducing the state-of-the-art in electronic still-storage—the Quantel DLS 6030 digital library system.

Obviously it stores still pictures. Up to 800 on each small Winchester disk drive. And with the quality that is a hallmark of Quantel. But the DLS 6030 goes far beyond still-storage.

It is the only electronic still-store with production effects capabilities. So now you can compress still pictures to any size. Crop them to remove unwanted material. Position them anywhere you want. Put borders around them. And dissolve from one shot to the next.

You can even build up totally new pictures—composites or montages—from existing material.

And you can always retain your “originals” in their pristine state.

The DLS 6030 lets you browse through its disk library to select the pictures you need, and gives you unprecedented facilities for on-air editing, previewing, and presentation.

Off-loading? You can dump all the pictures—in digital form—onto

standard videotape. Then reload at the remote site via any VTR. The transfer is digital, so there's no generation loss.

Because Quantel's technology is leading-edge, the DLS 6030 is small—about one-quarter the size of still-stores using older technology—and draws far less power. So it's ideal for mobile operations as well as the studio.

There's nothing else like it. See for yourself. Call your local MCI/Quantel representative. Or get in touch with us directly at 415/856-6226. Micro Consultants, Inc., P.O. Box 50810, Palo Alto, California 94303.



MCI/QUANTEL
The digital video people.

MCI/Quantel is a trademark of Micro Consultants, Inc.

Circle (101) on Action Card

JUNE 1982

TEN DOLLARS

BROADCAST COMMUNICATIONS

THE INTERNATIONAL JOURNAL OF BROADCAST TECHNOLOGY

THE DIRECTORY

OF BROADCAST
EQUIPMENT
SERVICES
& SUPPLIERS

1982

GENERAL INDEX

ALARMS

CARRIER 46
 FAULT 46
 TOWER LIGHT 46
 WARNING SYSTEMS 46
 TFT Inc., see ad on page 77

AM PHASING & BRANCHING SYSTEMS

CSP Inc., see ad on page 196
 Continental Electronics, see ad on page 17
 Cosmin Electronics, see ad on page 139

AMPLIFIERS, AUDIO

CLAMPING AMP 46
 Telemet, see ad on page 85
 COMPRESSION AMP 46
 ATI-Audio Tech. Inc., see ad on page 142
 Inovonics, see ad on page 126
 Processing Plus, see ads on pages 162, 164
 DISTRIBUTION 46
 ATI-Audio Tech. Inc., see ad on page 142
 BSM Systems, see ad on page 176
 Broadcast Technology, see ad on page 193
 Di-tech, see ad on page 57
 Processing Plus, see ads on pages 162, 164
 RTS Systems, see ads on pages 126, 128
 Telemet, see ad on page 85
 LINE AMP 46
 ATI-Audio Tech. Inc., see ad on page 142
 Broadcast Technology, see ad on page 193
 Processing Plus, see ads on pages 162, 164
 MIKE AMP 46
 ATI-Audio Tech. Inc., see ad on page 142
 Processing Plus, see ads on pages 162, 164
 MIXER AMP 48
 MONITOR AMP 48
 Di-tech, see ad on page 57
 PEAK LIMITING, AM 48
 Inovonics, see ad on page 126
 Processing Plus, see ads on pages 162, 164
 PEAK LIMITING, FM 48
 Inovonics, see ad on page 126
 Processing Plus, see ads on pages 162, 164
 POWER AUDIO AMP 48
 ATI-Audio Tech. Inc., see ad on page 142
 Broadcast Technology, see ad on page 193
 PROCESSING AMP 48
 ATI-Audio Tech. Inc., see ad on page 142
 Broadcast Technology, see ad on page 193
 Inovonics, see ad on page 126
 REMOTE AUDIO AMP 50

AMPLIFIERS, VIDEO

DISTRIBUTION AMP 50
 Di-tech, see ad on page 57
 Dynair, see ads on pages 127, 129, 131
 Graham-Patten Systems, see ad on page 176
 Multidyne Electronics, see ad on page 178
 Sigma Electronics, see ad on page 178
 Telemet, see ad on page 85
 ISOLATION AMP 50
 Telemet, see on page 85
 PULSE AMP 50
 Di-tech, see ad on page 57
 Graham-Patten Systems, see ad on page 176
 Telemet, see ad on page 85
 PROC AMP 50
 Processing Plus, see ads on pages 162, 164
 PULSE DELAY 50
 STABILIZING AMP 50
 SWEEP AMP 50
 VIDEO AMP 54
 ZERO STUDIO DELAY AMP 50

AMPLIFIER, RF

PEAK LIMITING 50

Inovonics, see ad on page 126
 POWER AMPLIFIER 52

ANIMATION SYSTEMS & SERVICES

Multidyne Electronics, see ad on page 178
 Spectra Computer, see ad on page 115
 UMC Electronics, see ad on page 196
 Videomedia, see ad on Inside Back Cover

ANTENNA ACCESSORIES & SERVICES

ALIGNMENT SYSTEMS, MICROWAVE 52
 BASE INSULATOR 52
 Racal-Decca Canada, see ad on page 130
 BALUNS 52
 CURRENT CONTROLLERS 52
 Delta Electronics, see ad on page 71
 CURRENT METER 52
 Delta Electronics, see ad on page 71
 DIPLEXER 52
 DUMMY LOADS 52
 EARTH TERMINAL POSITIONER 52
 GUY STRAIN INSULATOR 52
 Racal-Decca Canada, see ad on page 130
 HEATER CONTROLS 52
 ICE WARNING SYSTEM 52
 INSTALLATION SERVICES 52
 PHASING/BRANCHING SYSTEM 52
 CSP Inc., see ad on page 196
 Cosmin Electronics, see ad on page 139
 Geleco Electronics, see ad on page 202
 RADOMES 52
 REMOTE INDICATORS 52
 SAMPLING SYSTEMS 52
 CSP Inc., see ad on page 196
 Delta Electronics, see ad on page 71
 Geleco Electronics, see ad on page 202
 STATIC DRAIN RESISTOR 52
 Racal-Decca Canada, see ad on page 130
 TELESCOPING MAST 52
 Allen Osborne, see ad on page 12
 TRANSFER SWITCH 52
 Delta Electronics, see ad on page 71
 TUNING UNITS 52
 CSP Inc., see ad on page 196
 Cosmin Electronics, see ad on page 139
 VSWR METERS 54
 WAVEGUIDES 54

ANTENNA MASTS, ENG

Allen Osborne, see ad on page 12

ANTENNAS, RECEIVING

EARTH TERMINAL DISHES 54
 FM ANTENNA 54
 MICROWAVE 54
 MF ANTENNA 54
 REMOTE PICKUP 54
 STL ANTENNA 54
 UHF ANTENNA 54
 VHF ANTENNA 54

ANTENNAS, TRANSMITTING

AM ANTENNAS (See also Towers) 54
 AM DIRECTIONAL SYSTEMS 54
 CIRCULARLY POLARIZED FM 56
 Continental Electronics, see ad on page 17
 CIRCULARLY POLARIZED TV 56
 EARTH TERMINAL DISHES 56
 MICROWAVE 56
 MICROWAVE PORTABLE 56
 REMOTE FOR RADIO 56
 STL 56
 TV UHF 56
 TV VHF 56

ARCHITECTURAL/ACOUSTIC DESIGN & CONSTRUCTION

Rees Associates, see ad on page 174

ATTENUATORS

AUDIO 56
 Tech Labs, see ad on page 151
 FIXED 56
 Tech Labs, see ad on page 151
 IMPEDANCE MATCHING 56
 Tech Labs, see ad on page 151
 MICROWAVE 56
 RADIO FREQUENCY (RF) 56
 Tech Labs, see ad on page 151
 VIDEO 58
 Tech Labs, see ad on page 151

AUTOMATED REMOTE CONTROLS

Image Video Ltd., see ad on page 173

AUTOMATION CONTROLS & SYSTEMS

ATS Systems 58
 Asaca, see ads on pages 32, 121
 QEI, see ad on page 171
 TFT Inc., see ad on page 77
 BUSINESS SYSTEMS & SERVICES 58
 CART SYSTEM, RANDOM SELECT, AUDIO 58
 Deltamod, see ad on page 135
 Image Video, see ad on page 173
 CART SYSTEM, RANDOM SELECT, VIDEO 58
 DATA PROCESSING 58
 LIGHTING (See Lighting Controls & Services) 58
 LOGGING 58
 TFT Inc., see ad on page 77
 MASTER CONTROL, CUSTOM 58
 Image Video, see ad on page 173
 PROGRAM CONTROL, AUDIO 58
 Deltamod, see ad on page 135
 Image Video Ltd., see ad on page 173
 PROGRAM CONTROL, VIDEO 58
 Image Video Ltd., see ad on page 173
 PROJECTOR/FILM CHAIN CONTROL 58
 REEL-TO-REEL CONTROLLER 58

BATTERIES & ACCESSORIES

BATTERY BELTS 58
 Alexander Mfg., see ad on page 124
 Cine 60, see ad on page 45
 Perrott Engineering, see ad on page 93
 BATTERY CHECKER 60
 Perrott Engineering, see ad on page 93
 BATTERY PACKS/ENG 60
 Alexander Mfg., see ad on page 124
 Cine 60, see ad on page 45
 Perrott Engineering, see ad on page 93
 BATTERY PACKS/LIGHTING 60
 Alexander Mfg., see ad on page 124
 Cine 60, see ad on page 45
 Perrott Engineering, see ad on page 93
 BATTERY CHARGERS 60
 Alexander Mfg., see ad on page 124
 Perrott Engineering, see ad on page 93
 BATTERY PACK/TEST INSTRUMENT 60

BLOWERS & FANS

..... 60

BRIDGES, COMMON POINT

Delta Electronics, see ad on page 71

BUZZ TONE ELIMINATORS

..... 60

CABINETS, CONSOLES AND EQUIPMENT RACKS

Dynair, see ads on pages 127, 129, 131

CABLE & ACCESSORIES & SERVICES

AUDIO CABLE 60
 CABLING & WIRING SERVICES 60
 CAMERA CABLE 60

COAX, FLEXIBLE	60
CSP Inc., see ad on page 196	
CONNECTORS	62
FIBER OPTIC CABLES	62
GUY WIRES (See Also Towers & Accessories)	62
HEAVY DUTY, AC/DC POWER	62
MICROPHONE CABLE	62
TRANSMISSION LINES, PRESSURIZED	62
CSP Inc., see ad on page 196	
CALIBRATION SERVICES (See Test Equipment & Services)	
CAMERA MOUNTS, CARRYING SYSTEMS & ACCESSORIES	
AIRBORNE MOUNTING/ STABILIZING	62
CARRYING SYSTEM	62
William Bal Corp., see ad on page 170	
K & H Products, see ad on page 201	
DOLLIES & TRIPODS	62
K & H Products, see ad on page 201	
Listec, see ad on page 119	
PAN & TILT HEADS	62
Listec, see ad on page 119	
Sachtler Corp. of Am., see ad on page 181	
PEDESTALS	62
REMOTE CONTROLS	62
STABILIZED CARRYING SYSTEM	62
TEST CHARTS	62
CAMERA/RECORDER COMBINATION	62
CAMERAS, FILM	62
CAMERAS, VIDEO	
CCD	64
CCTV	64
Sharp Electronics, see ad on pages 34-35	
FILM CHAIN CAMERA	64
ENG/HANDHELD	64
The Camera Mart, see ad on pages 28-29	
Central Dynamics/Philips, see ad on page 31	
Victor Duncan, see ad on page 172	
Hitachi, see ad on page 55	
Sharp Electronics, see ad on pages 34-35	
Sony, see ad on pages 6-7	
FIELD CAMERA	64
CEI, see ad on page 87	
Central Dynamics/Philips, see ad on page 31	
Ikegami, see ad on page 63	
STUDIO CAMERA	64
CEI, see ad on page 87	
The Camera Mart, see ad on pages 28-29	
Central Dynamics/Philips, see ad on page 31	
Victor Duncan, see ad on page 172	
Ikegami, see ad on page 63	
CAMERA, VIDEO	64
DIGITAL REMOTE CONTROL SYSTEM	
Hitachi, see ad on page 55	
CAPACITORS, TRANSMITTING	64
Surcom Associates, see ad on page 147	
CART MACHINES & SERVICES	
SINGLE DECK	64
Pacific Recorders & Engr., see ad on page 47	
UMC Electronics, see ad on page 196	
DUAL DECK	64
TRIPLE DECK	64
UMC Electronics, see ad on page 196	
MULTIPLE DECK	64
UMC Electronics, see ad on page 196	
RANDOM ACCESS (See also Automation Controls, Audio)	64
UMC Electronics, see ad on page 196	
REBUILDING SERVICES	64

RECORD ONLY	64
Pacific Recorders & Engr., see ad on page 47	
STEREO	64
Pacific Recorders & Engr., see ad on page 47	
UMC Electronics, see ad on page 196	
CARTRIDGES (TAPE) ACCESSORIES & SERVICES	
ALIGNMENT TAPES	64
DELAY CARTS	64
MONO CARTS	64
Aristocart, see ad on page 116	
Capitol Magnetic Prod., see ad on page 143	
Fidelipac, see ad on page 175	
UMC Electronics, see ad on page 196	
STEREO CARTS	66
Aristocart, see ad on page 116	
Capitol Magnetic Prod., see ad on page 143	
Fidelipac, see ad on page 175	
UMC Electronics, see ad on page 196	
RECONDITIONING SERVICES	66
RELOADING SERVICES	66
STORAGE RACKS & CABINETS	66
CARTRIDGES, PHONO	66
CASES, PORTABLE EQUIPMENT	66
William Bal Corp., see ad on page 170	
K & H Products, see ad on page 201	
CASSETTE MACHINES	
SINGLE DECK	66
DUAL DECK	66
MULTIPLE DECK	66
DUPLICATION MACHINE	66
CAVITY	66
Varian, see ad on page 99	
CHARACTER GENERATOR	66
For-A Corporation, see ad on page 118	
Laird Telemedia, see ad on page 123	
Multidyne Electronics, see ad on page 178	
Videomedia, see ad on Inside Back Cover	
CHOKES	66
CHOPPERS	66
CHROMA KEYS	66
CHROMA KEYS/DECODER	66
Telemet, see ad on page 85	
CLOCKS & COUNTERS	
COUNTER, DOWN	66
ESE, see ad on pages 24-25	
COUNTER, UP	66
ESE, see ad on pages 24-25	
COUNTER, UP/DOWN	66
ESE, see ad on page 24-25	
Laird Telemedia, see ad on page 123	
STATION CLOCKS	68
ESE, see ad on pages 24-25	
True Time Instruments, see ad on page 173	
COILS, RF	68
Geteco Electronics, see ad on page 202	
COLLIMETER	68
COLOR CORRECTOR	68
COMBINER, POWER	68
COMMUNICATIONS SYSTEMS	
ENG	68
Comrex, see ad on page 26	

Marti Electronics, see ad on page 174	
LAND MOBILE	68
MICROWAVE	68
MULTIPLEX	68
STL SYSTEMS	68
Moseley Associates, see ad on page 117	
TFT Inc., see ad on page 77	
TSL SYSTEMS	68
Marti Electronics, see ad on page 174	
TFT Inc., see ad on page 77	
COMPARATOR, TIME	68
COMPARATOR, VIDEO	68
COMPUTERS	68
COMPUTER SYSTEMS & SERVICES	
BUSINESS/ACCOUNTING	68
NEWSROOM	68
Integrated Technology, see ad on page 30	
TRAFFIC/PROGRAMMING	68
Di-tech, see ad on page 57	
WEATHER	68
CONSOLES, AUDIO	
BROADCAST MONO	70
ADM Technology, see ad on IFC	
Autogram, see ad on page 150	
Continental Elec, see ad on page 17	
Dyma Engineering, see ad on page 191	
Finntek, see ad on page 132	
Howe Audio, see ad on page 145	
LPB Inc., see ad on page 153	
Logitek, see ad on page 200	
Pacific Recorders & Engr., see ad on page 47	
Processing Plus, see ads on pages 162, 164	
Siemens (foreign), see ad on page 31	
Ward-Beck Systems, see ad on Back Cover	
BROADCAST MONO MODULAR	70
ADM Technology, see ad on IFC	
Autogram, see ad on page 150	
Dyma Engineering, see ad on page 191	
Finntek, see ad on page 132	
Howe Audio, see ad on page 145	
Pacific Recorders & Engr., see ad on page 47	
Quantum Audio, see ad on page 192	
Siemens (foreign), see ad on page 31	
Ward-Beck Systems, see ad on Back Cover	
BROADCAST STEREO	70
ADM Technology, see ad on IFC	
Autogram, see ad on page 150	
Continental Elec., see ad on page 17	
Dyma Engineering, see ad on page 191	
Finntek, see ad on page 132	
LPB Inc., see ad on page 153	
MCI Inc., see ad on page 85	
Pacific Recorders & Engr., see ad on page 47	
Processing Plus, see ads on pages 162, 164	
Quantum Audio, see ad on page 192	
Siemens (foreign), see ad on page 31	
Ward-Beck Systems, see ad on Back Cover	
BROADCAST STEREO MODULAR	70
ADM Technology, see ad on IFC	
Autogram, see ad on page 150	
Dyma Engineering, see ad on page 191	
Elektroimpex, see ad on page 149	
Finntek, see ad on page 132	
Howe Audio, see ad on page 145	
Logitek, see ad on page 200	
MCI Inc., see ad on page 83	
Pacific Recorders & Engr., see ad on page 47	
Quantum Audio, see ad on page 192	
Siemens (foreign), see ad on page 31	
Ward-Beck Systems, see ad on Back Cover	
PORTABLE FOR REMOTES	70
Audy Instruments, see ad on page 121	
Autogram, see ad on page 150	
BSM Systems, see ad on page 176	
Dyma Engineering, see ad on page 191	
Finntek, see ad on page 132	
Processing Plus, see ads on page 162, 164	
Satt Electronics, see ad on page 95	

Continued on page 40

WHERE TO FIND IT

RECORDING STUDIO 72	COUPLERS, HYBRID 74	DIVIDERS, POWER 76
ADM Technology, see ad on IFC	CONVERTERS, A-D, D-A 74	DROPOUT COMPENSATOR 76
Autogram, see ad on page 150	CRT DISPLAYS & CONTROLLERS 74	EARTH TERMINALS, RECEIVE ONLY 76
Elektroimpex, see ad on page 149	Di-tech, see ad on page 57	EARTH TERMINALS, RECEIVE/TRANSMIT 76
Finntek, see ad on page 132	CRYSTALS 74	EDIT CODE GENERATOR 76
LPB Inc., see ad on page 153	CUE SYSTEMS, REMOTE 74	ESE, see ad on pages 24-25
MCI Inc., see ad on page 83	Comrex, see ad on page 26	Videomedia, see ad on Inside Back Cover
Pacific Recorders & Engr., see ad on page 47	DECODERS	EDIT CODE RECEIVER 76
Quantum Audio, see ad on page 192	CLOSED CAPTIONING 74	ESE, see ad on pages 24-25
Siemens (foreign), see ad on page 31	TFT Inc., see ad on page 77	Videomedia, see ad on Inside Back Cover
Ward-Beck Systems, see ad on Back Cover	COMB 74	EDITOR, AUDIO 78
ROUTING 72	TFT Inc., see ad on page 77	EDITOR, FILM 78
BSM Systems, see ad on page 176	DIGITAL SYNC 74	EDITORS, VIDEO
Di-tech, see ad on page 57	TFT Inc., see ad on page 77	CCTV/INDUSTRIAL 78
H.M. Dyer Electronics, see ad on page 199	STEREO 74	Datatron, see ad on page 73
Dynair, see ads on pages 127, 129, 131	TFT Inc., see ad on page 77	Fernseh, see ad on page 33
Finntek, see ad on page 132	STV, PAY TV 74	Swiderski, see ad on page 151
HEDCO, see ad on page 120	Gorman Redlich Mfg., see ad on page 183	ENG/FIELD PRODUCTION 78
Image Video, see ad on page 173	TFT Inc., see ad on page 77	CMX Systems, see ad on page 3
Siemens (foreign), see ad on page 31	STEREO 74	Datatron, see ad on page 73
Telemet, see ad on page 85	TFT Inc., see ad on page 77	Fernseh, see ad on page 33
TV PRODUCTION 62	STV, PAY TV 74	Swiderski, see ad on page 151
ADM Technology, see ad on IFC	Gorman Redlich Mfg., see ad on page 183	Videomedia, see ad on Inside Back Cover
Autogram, see ad on page 150	TFT Inc., see ad on page 77	STUDIO PRODUCTION 78
Elektroimpex, see ad on page 149	TONE 74	CMX Systems, see ad on page 3
Finntek, see ad on page 132	Gorman Redlich Mfg., see ad on page 183	Datatron, see ad on page 73
Howe Audio, see ad on page 145	TFT Inc., see ad on page 77	Fernseh, see ad on page 33
LPB Inc., see ad on page 153	STV, PAY TV 74	Swiderski, see ad on page 151
MCI Inc., see ad on page 83	Gorman Redlich Mfg., see ad on page 183	Videomedia, see ad on Inside Back Cover
Pacific Recorders & Engr., see ad on page 47	TFT Inc., see ad on page 77	STUDIO PRODUCTION 78
Quantum Audio, see ad on page 192	TONE, EBS 74	CMX Systems, see ad on page 3
Siemens (foreign), see ad on page 31	Gorman Redlich, see ad on page 183	Datatron, see ad on page 73
Ward-Beck Systems, see ad on Back Cover	TFT Inc., see ad on page 77	Fernseh, see ad on page 33
CONSOLES, VIDEO	UMC Electronics, see ad on page 196	Swiderski, see ad on page 151
CCTV/EDUCATIONAL 72	DEGAUSSER 74	Videomedia, see ad on Inside Back Cover
Crosspoint Latch, see ad on page 91	Fluxcom, see ad on page 137	STUDIO PRODUCTION 78
MASTER CONTROL 76	UMC Electronics, see ad on page 196	CMX Systems, see ad on page 3
Crosspoint Latch, see ad on page 91	DE-ESSERS 74	Datatron, see ad on page 73
Grass Valley Group, see ad on page 5	DELAY, AUDIO TAPE 74	Fernseh, see ad on page 33
Image Video Ltd., see ad on page 173	DELAY LINES, AUDIO 74	Swiderski, see ad on page 151
Industrial Sciences, see ad on page 177	DELAY LINES, VIDEO 76	Videomedia, see ad on Inside Back Cover
Siemens (foreign), see ad on page 31	Allen Avionics, see ad on page 169	EFFECTS SYSTEM, DIGITAL VIDEO 78
Videomedia, see ad on Inside Back Cover	Anders, see ad on page 139	The Camera Mart, see ad on pages 28-29
PORTABLE PRODUCTION 72	DELAY MACHINE, TALK SHOW 76	ELECTROMAGNETICS FOR KLYSTRON TUBES 78
Asaca, see ads on pages 32, 121	Comex Systems, see ad on page 197	ENCODERS
Crosspoint Latch, see ad on page 91	DEMODULATORS, OPTICAL 76	CLOSED CAPTIONING 78
Dyma Engineering, see ad on page 191	DEMODULATORS, VIDEO 76	TFT Inc., see ad on page 77
Grass Valley Group, see ad on page 5	R.E. Instruments, see ad on page 195	COLOR VIDEO 78
Industrial Sciences, see ad on page 177	Telemet, see ad on page 85	Asaca, see ads on pages 32, 121
Siemens (foreign), see ad on page 31	DETECTORS	TFT Inc., see ad on page 77
Videomedia, see ad on Inside Back Cover	MICROWAVE 76	TONE 78
POST PRODUCTION 72	QUADRATURE DISTORTION 76	TFT Inc., see ad on page 77
Crosspoint Latch, see ad on page 91	RF DETECTOR 76	EBS 78
Grass Valley Group, see ad on page 5	VIDEO PRESENCE 76	Gorman-Redlich, see ad on page 183
Siemens (foreign), see ad on page 31	Di-tech, see ad on page 57	TFT Inc., see ad on page 77
Videomedia, see ad on Inside Back Cover	DE-TUNING UNITS 76	ENHANCERS, VIDEO IMAGE 78
ROUTING 72	DIGITAL VIDEO ANALYZER 76	Asaca, see ads on pages 32, 121
AVL Digital Ltd., see ad on page 125	DIGITIZER, COLOR 76	ENHANCERS, STEREO PHASE 78
Di-tech, see ad on page 57	DIPLEXER (See Antenna Accessories)	EQUALIZERS
H.M. Dyer Electronics, see ad on page 199	CSP Inc., see ad on page 196	AUDIO 78
Dynair, see ads on pages 127, 129, 131	DISCS, VIDEO 76	Orban Associates, see ads on pages 16, 21
HEDCO, see ad on page 120	DISPLAY UNITS, TIME, TEMP, ID (See also Character / Animation Generator) 76	Processing Plus, see ads on pages 162, 164
Image Video Ltd., see ad on page 173	DISCS, VIDEO 76	VERTICAL APERTURE VIDEO 78
Telemet, see ad on page 85	DISCS, VIDEO 76	Broadcast Technology, see ad on page 193
STUDIO PRODUCTION 72	DISCS, VIDEO 76	Dynair, see ads on pages 127, 129, 131
Crosspoint Latch, see ad on page 91	DISCS, VIDEO 76	EQUIPMENT BUILDINGS, PREFABRICATED 80
Grass Valley Group, see ad on page 5	DISCS, VIDEO 76	EQUIPMENT CARRYING SYSTEMS
Industrial Sciences (ISI), see ad on page 177	DISCS, VIDEO 76	CASES 80
Siemens (foreign), see ad on page 31	DISCS, VIDEO 76	Wm. Bal Corp., see ad on page 170
Videomedia, see ad on Inside Back Cover	DISCS, VIDEO 76	
STUDIO PRODUCTION WITH DIGITAL EFFECTS 74	DISCS, VIDEO 76	
Grass Valley Group, see ad on page 5	DISCS, VIDEO 76	
Industrial Sciences, see ad on page 177	DISCS, VIDEO 76	
Siemens (foreign), see ad on page 31	DISCS, VIDEO 76	
CONSULTING SERVICES 74	DISCS, VIDEO 76	
David Green, see ad on page 133-134	DISCS, VIDEO 76	
Magna-Tech, see ad on page 75	DISCS, VIDEO 76	
Processing Plus, see ads on pages 162, 164	DISCS, VIDEO 76	
Rees Associates, see ad on page 174	DISCS, VIDEO 76	

CASES WITH WHEELS	80
DOLLIES	80
EXCITERS	
AM EXCITER	80
AM STEREO	80
Motorola, see ad on page 89	
Processing Plus, see ads on pages 162, 164	
FM EXCITER	80
QEI Corp., see ad on page 171	
FM STEREO	80
QEI Corp., see ad on page 171	
SCA EXCITER	80
FIBER-OPTIC TRANSMISSION SYSTEM	80
R.E. Instruments, see ad on page 195	
Telemet, see ad on page 85	
FIBER OPTIC FOTOR	80
FIELD VIDEO SETUP MODULE	80
FILM & ACCESSORIES & SERVICES	
8mm/16mm	80
DUBBING SYSTEMS	80
Magna-Tech, see ad on page 75	
REWINDERS	80
SOUND TRANSFER	80
TO VIDEOTAPE TRANSFER	80
FILM CHAIN LIGHT CONTROL	80
FILM CHAIN SYSTEMS (See also Projectors, Cameras)	80
Laird Telemedia, see ad on page 123	
FILTERS	
ACTIVE	82
ANTENNA	82
NOISE	82
PASSIVE	82
VARIABLE/FIXED	82
VIDEO	82
FRAME STORE SYNCHRONIZERS	82
Adda Corporation, see ad on page 1	
FRAME/FIELD STORE, DIGITAL	82
MCI/Quantel, see ad on page 36	
FRAMES & RACKS	82
FURNITURE & CABINETRY, STUDIO	82
GENERATORS	
AF	82
BACKGROUND COLOR	82
Asaca, see ads on pages 32, 121	
BURST	82
COLOR PATTERN	84
Philips Test & Measuring, see ad on page 11	
COLOR SYNC	84
Asaca, see ads on pages 32, 121	
CONVERGENCE	84
RF	84
Asaca, see ads on pages 32, 121	
R.E. Instruments, see ad on page 195	
SUBCARRIER, FM	84
SCA	84
QEI Corp., see ad on page 171	
SPECIAL EFFECTS	84
STEREO (See also Test Equipment)	84
SYNC, TV	84
Asaca, see ads on pages 32, 121	
TIME CODE	84
ESE, see ad on pages 24-25	
Videomedica, see ad on Inside Back Cover	
TONE	84

Asaca, see ads on pages 32, 121	
TONE, EBS	84
Gorman-Redlich, see ad on page 183	
TFT Inc., see ad on page 77	
GENERATOR, ELECTRIC POWER	84
GRAPHIC EQUALIZER	84
HEAD DEGAUSSERS	84
HEADS, AUDIO & ACCESSORIES/SERVICES	
ALIGNMENT GAUGES	84
Tentel, see ad on page 197	
CLEANERS	84
ERASE	86
Saki Magnetics, see ad on page 132	
PLAYBACK	86
Saki Magnetics, see ad on page 132	
UMC Electronics, see ad on page 196	
RECORD	86
Saki Magnetics, see ad on page 132	
UMC Electronics, see ad on page 196	
FILM STRIPE	86
RECONDITIONING SERVICES	86
HEADS, VIDEO ACCESSORIES/SERVICES	
REPLACEMENT HEADS	86
REFURBISHING SERVICES	86
HEADPHONES	
ANNOUNCERS EARPIECE	86
MONO	86
STEREO	86
WITH ANNOUNCERS MIKE	86
HEAT EXCHANGERS	86
HEATERS FOR VANS	86
HELICOPTER ENG SYSTEMS	86
HELICOPTER STABILIZERS	86
HELICOPTERS	86
HUM STOP COIL	86
IDENTIFICATION SYSTEMS, VIDEO	86
IMAGE REPOSITIONER	88
INTEGRATED CIRCUITS (See also Semiconductors & ICs)	88
INTERCOM SYSTEMS	88
Broadcast Technology, see ad on page 193	
INVERTERS	88
ISOCOUPERS	88
ISOLATOR	88
JACK PANELS	88
Audio Accessories, see ad on page 88	
Broadcast Systems, see ads on 88, 170	
Comad, see ads on pages 164, 166	
JACK PANELS, WIRED	88
Audio Accessories, see ad on page 88	
Broadcast Systems, see ads on 88, 170	
Comad, see ads on pages 164, 166	
KEYERS, VIDEO INSERT	88

KNOBBS, CONTROL	90
LENS FILTERS	90
LENSES, FIXED	90
Angenieux, see ad on page 101	
Canon, see ad on page 59	
Fujinon Inc., see ad on page 69	
Schneider TV Lenses, see ad on page 141	
LENSES, PROJECTION	90
LENSES, ZOOM	90
Angenieux, see ad on page 101	
Canon, see ad on page 59	
Fujinon Inc., see ad on page 69	
Schneider TV Lenses, see ad on page 141	
LIGHTING ACCESSORIES	
CONNECTOR PLUGS	90
FADER CONTROLS	90
TRANSFORMERS	90
LIGHTING: CONTROLS, FIXTURES, LAMPS	
CONTROL BOARD/CONSOLE	90
FILTERS & GELS	90
HANGERS, STUDIO	90
LAMPS, REPLACEMENT	90
LIGHTS, HMI	90
LIGHTS, PORTABLE/ENG.	90
Cine 80, see ad on page 45	
LIGHTS, STUDIO	90
PATCH PANEL	92
LIGHTS, STUDIO WARNING	92
LIGHTS, TOWER (See Tower Lights & Accessories)	
LIGHTNING ARRESTORS	92
LIGHTNING PROTECTION SYSTEMS	92
LIMITER/COMPRESSOR, AM	92
Inovonics, see ad on page 126	
Orban Associates, see ads on pages 16, 21	
Processing Plus, see ads on pages 162, 164	
LIMITER/COMPRESSOR, FM	92
Inovonics, see ad on pages 126	
Orban Associates, see ads on pages 16, 21	
Processing Plus, see ads on pages 162, 164	
LIMITER/COMPRESSOR, TV	92
Orban Associates, see ads on pages 16, 21	
LINE SURGE PROTECTORS	92
LOAD RESISTORS, COAXIAL	92
LOUDSPEAKERS, CONTROL ROOM	92
LOUDSPEAKERS, RECORD STUDIO	92
LOW FREQUENCY EXTENDERS	92
MACHINE ASSIGNMENT SYSTEMS	92
Image Video Ltd., see ad on page 173	
Moseley Associates, see ad on page 117	
MAINTENANCE SERVICES	
AM SERVICES	92
Processing Plus, see ads on pages 162, 164	
FM SERVICES	94
Processing Plus, see ads on pages 162, 164	

Continued on page 42

WHERE TO FIND IT

TV SERVICES	94	Videotek, see ad on page 15		PRODUCTION/POST- PRODUCTION SERVICES	102
MICROWAVE	94	PULSE CROSS	98	PROJECTORS	
TOWER SERVICES	94	Asaca, see ads on pages 32, 121		FILM CHAIN	102
MDS SYSTEMS	94	Siemens (foreign), see ad on page 31		Laird Telemedia, see ad on page 123	
METERS (See <i>Test Equipment</i>)		Videotek, see ad on page 15		Magna-Tech, see ad on page 75	
MIXERS, MICROPHONE	94	RECEIVER/MONITORS	98	LARGE SCREEN TV	102
Satt Electronics, see ad on page 95		WAVEFORM (See also <i>Test Equipment</i>)	98	GE VDEO, see ad on page 81	
MICROPHONES & ACCESSORIES		Philips Test & Measuring, see ad on page 11		Image Magnification, see ad on page 201	
BOOMS & STANDS	94	Videotek, see ad on page 15		SLIDE	102
FLEXIBLE/MOBILE HOLDER	94	MULTICARRIER SYSTEMS	98	PROMPTERS	102
(For Consoles)	94	MULTIPLEXER	98	Listec, see ad on page 119	
HAND HELD	94	MUSIC PRODUCTION SERVICES	98	PULSE ASSIGNMENT SYSTEMS	
Electro-Voice, see ad on page 14		MUSIC PROGRAM SERVICES	98	102
LAPEL MIKE	94	NETWORKS		RF COMPONENTS	102
LAVALIER MIKE	94	AUDIO MATCHING	98	CSP Inc., see ad on page 196	
PARABOLIC & SHOTGUN	96	MIXING	98	Cosmin Electronics, see ad on page 139	
Geleco Electronics, see ad on page 202		PHASING	98	READER FOR TIME CODE IN VERTICAL INTERVAL	102
MICROPHONES, WIRELESS	96	RF MATCHING	98	ESE, see ad on pages 24-25	
Comrex, see ad on page 26		NEWS SERVICE	98	RECEIVERS	
Micron, see ad on page 163		NOISE REDUCTION SYSTEMS, AUDIO	98	AM RECEIVERS	102
MICROPHONE SPLITTER	96	Deltamod, see ad on page 135		TFT Inc., see ad on page 77	
Sescom, see ad on page 147		Processing Plus, see ads on pages 162, 164		DATA	102
MOBILE UNITS (See <i>Vans</i>)		NOISE REDUCTION SYSTEMS, VIDEO	98	EARTH STATION	102
MODULATION CONTROLLER	96	Asaca, see ads on pages 32, 121		EBS RECEIVER	102
Delta Electronics, see ad on page 71		OSCILLATORS, TONE	98	Gorman-Redlich, see ad on page 183	
MODULATORS, TV	96	OSCILLOSCOPES (See <i>Test Equipment</i>)		TFT Inc., see ad on page 77	
Asaca, see ads on pages 32, 121		PATCH PANELS	100	FM RECEIVER	102
Telemet, see ad on page 85		Audio Accessories, see ad on page 88		Gorman-Redlich, see ad on page 183	
MONITORS, AUDIO & RF		PHASE CONTROLLER, AUTOMATIC	100	TFT Inc., see ad on page 77	
AM SYSTEM	96	Geleco Electronics, see ad on page 202		STL	102
TFT Inc., see ad on page 77		PHASE CONVERTERS	100	TFT Inc., see ad on page 77	
ANTENNA	96	PHASE CORRECTOR, CART	100	TSL	102
Delta Electronics, see ad on page 71		Howe Audio, see ad on page 145		TFT Inc., see ad on page 77	
BASE CURRENT/ANT SAMPLING	96	POWER CONTROLLER	100	TIME (WWW)	102
DIRECTIONALS	96	Delta Electronics, see ad on page 71		True Time Instruments, see ad on page 173	
FM SYSTEM	96	POWER SUPPLIES	100	WEATHER, VHF	102
QEI Corp., see ad on page 171		PREAMPLIFIERS		Gorman-Redlich, see ad on page 183	
FREQUENCY	96	MICROPHONE	100	RECEIVER, TV AURAL	102
Belar Electronics, see ad on page 152		ATI-Audio Technologies, see ad on page 142		RECORDER PARTS & ACCESSORIES	
TFT Inc., see ad on page 77		Broadcast Technology, see ad on page 193		CAPSTAN ASSEMBLY	102
MODULATION	96	Processing Plus, see ads on pages 162, 164		CARE KITS	103
Belar Electronics, see ad on page 152		MODULES, FOR CONSOLES	100	DRIVE MOTOR POWER SUPPLY	103
QEI Corp., see ad on page 171		STEREO	100	ELECTRONICS	103
R.E. Instruments, see ad on page 195		ATI-Audio Technologies, see ad on page 142		Inovonics, see ad on page 126	
TFT Inc., see ad on page 77		Broadcast Technology, see ad on page 193		UMC Electronics, see ad on page 196	
PHASE MONITOR	96	Processing Plus, see ads on pages 162, 164		HEADS (See <i>Heads</i>)	
POWER MONITOR	96	RTS Systems, see ads on pages 126, 128		MOTORS	103
PROGRAM MONITOR	96	TURNTABLE	100	UMC Electronics, see ad on page 196	
Real World Technologies, see ad on page 122		ATI-Audio Technologies, see ad on page 142		SERVO MODIFICATIONS	103
RF LEVEL	96	Broadcast Technology, see ad on page 193		SPEED CONTROLS	103
R.E. Instruments, see ad on page 195		Processing Plus, see ads on pages 162, 164		SYNCHRONIZERS	103
SCA MONITOR	96	RTS Systems, see ads on pages 126, 128		TAPE DECK CABINETS	103
TFT Inc., see ad on page 77		VIDEO	100	TAPE DECKS	103
TV AURAL	96	PROCESSORS, AUDIO	100	TENSION CONTROLS	103
MONITORS, VIDEO		ATI-Audio Technologies, see ad on page 142		Inovonics, see ad on page 126	
B&W RACK	96	Broadcast Technology, see ad on page 193		TRANSPORT SERVICES	103
Asaca, see ads on pages 32, 121		Processing Plus, see ads on pages 162, 164		VELOCITY ERROR CORRECTORS	103
Siemens (foreign), see ad on page 31		Sescom, see ad on page 147		RECORDERS, AUDIO TAPE	
Videotek, see ad on page 15		RECORDER PARTS & ACCESSORIES		CARTRIDGE (See <i>Cart Machines</i>)	
B&W STANDALONE	96	CAPSTAN ASSEMBLY	102	CASSETTE (See <i>Cassette Machines</i>)	
Siemens (foreign), see ad on page 31		CARE KITS	103	DIGITAL	103
Videotek, see ad on page 15		DRIVE MOTOR POWER SUPPLY	103	FILM RECORDER	103
COLOR RACK	96	ELECTRONICS	103	Magna-Tech, see ad on page 75	
Asaca, see ads on pages 32, 121		Inovonics, see ad on page 126		LOGGING	103
Victor Duncan, see ad on page 172		UMC Electronics, see ad on page 196			
Siemens (foreign), see ad on page 31		HEADS (See <i>Heads</i>)			
Videotek, see ad on page 15		MOTORS	103		
COLOR STANDALONE	98	UMC Electronics, see ad on page 196			
Asaca, see ads on pages 32, 121		SERVO MODIFICATIONS	103		
Victor Duncan, see ad on page 172		SPEED CONTROLS	103		
Siemens (foreign), see ad on page 31		SYNCHRONIZERS	103		
		TAPE DECK CABINETS	103		
		TAPE DECKS	103		
		TENSION CONTROLS	103		
		Inovonics, see ad on page 126			
		TRANSPORT SERVICES	103		
		VELOCITY ERROR CORRECTORS	103		

REEL: ONE & TWO TRACK	103
MCI Inc., see ad on page 83	
Studer ReVox, see ad on page 128	
REEL: FOUR TRACK	103
REEL: MULTI-TRACK	103
MCI Inc., see ad on page 83	
RECORDERS, VIDEOTAPE	
1/4-INCH	103
1/2-INCH	103
Ampex, see ad on page 13	
The Camera Mart, see ad on pages 28-29	
3/4-INCH	103
Ampex, see ad on page 13	
The Camera Mart, see ad on pages 28-29	
Victor Duncan, see ad on page 172	
US JVC Corp., see ad on page 51	
1-INCH	103
Ampex, see ad on page 13	
The Camera Mart, see ad on pages 28-29	
Victor Duncan, see ad on page 172	
Sony, see ad on pages 22-23	
EXTENDED PLAY KIT	103
Merlin Engineering, see ad on page 194	
QUAD	104
LOGGING	104
RECONDITIONED MACHINES	104
SLOW MOTION REPLAY	104
RECORDING SERVICES AUDIO	104
RECORDS	
AUDIO TEST	104
SOUND EFFECTS	104
REELS	
AUDIO TAPE	104
CABLE & MIKE (See Cables)	
VIDEOTAPE	104
REGULATORS, VOLTAGE	104
RECTIFIERS	
POWER (Semiconductor)	104
SCR	104
STACKS	104
Electronic Devices, see ad on page 137	
TUBES (See Tubes)	
REMOTE CONTROL SYSTEMS, AM & FM	104
Delta Electronics, see ad on page 71	
Moseley Associates, see ad on page 117	
QEI Corp., see ad on page 171	
TFT Inc., see ad on page 77	
REMOTE CONTROL SYSTEMS, VIDEO	104
Moseley Associates, see ad on page 117	
TFT Inc., see ad on page 77	
REMOTE PICKUP SYSTEMS	104
Marti Electronics, see ad on page 174	
REPEAT COILS	104
RETICULE	
SAFE AREA/TITLE	104
REVERBERATION UNITS	104
REWINDERS, TAPE (See Tape Accessories)	
SAFE AREA GENERATORS	104
SATELLITE DISTRIBUTION SERVICES	104
SCRAMBLERS	105

SEMICONDUCTORS	105
CeCo Communications, see ad on page 81	
SCREENS	
FRONT PROJECTION	105
REAR PROJECTION	105
SENSORS, TONE	105
Processing Plus, see ads on pages 162, 164	
SLIDES, TEST	105
SLOW SCAN TV SYSTEMS	105
SOLAR CELLS, PHOTOVOLTAIC	105
SOUND SYSTEMS	
LEVEL CONTROL	105
PORTABLE	105
STUDIO	105
SPEECH RECOGNITION SYSTEMS	105
SPEECH SYNTHESIS SYSTEMS	105
STL EQUIPMENT/SYSTEMS	105
Moseley Associates, see ad on page 117	
TFT Inc., see ad on page 77	
STV EQUIPMENT	105
Dynacom Electronics, see ad on page 172	
STANDARDS CONVERTERS/SERVICES	105
STILL/SLIDE STORE, ELECTRONIC	105
MCI/Quantel, see ad on page 36	
SCA EQUIPMENT	105
QEI Corp., see ad on page 171	
TFT Inc., see ad on page 77	
STUDIO DESIGN SERVICES	105
Magna-Tech, see ad on page 75	
Rees Associates, see ad on page 174	
Siemens (foreign), see ad on page 31	
SWITCHES, COAXIAL	105
Geleco Electronics, see ad on page 202	
SWITCHES, VIDEO ACTIVATED	106
Geleco Electronics, see ad on page 202	
SWITCHER LIGHTING KIT	106
Dynair, see ads on pages 127, 129, 131	
SWITCHERS, CROSSBAR	106
SWITCHERS, ROUTING	106
AVL Digital Ltd, see ad on page 125	
Broadcast Technology, see ad on page 193	
Di-tech, see ad on page 57	
H.M. Dyer Electronics, see ad on page 199	
Dynair, see ads on pages 127, 129, 131	
HEDCO, see ad on page 120	
Image Video Ltd., see ad on page 173	
Siemens, see ad on page 97	
Telemet, see ad on page 85	
SWITCHERS, VIDEO	
(See Consoles, Video)	

SYNCHRONIZERS, AUDIO-VIDEO	106
SYNCHRONIZERS, DIGITAL VIDEO (See Frame Store)	
SYNTHESIZERS, STEREO	106
SYSTEMS DESIGN, AUDIO	106
MCI Inc., see ad on page 83	
SYSTEMS DESIGN, VIDEO	106
Central Dynamics Corp., see ad on page 31	
Magna-Tech, see ad on page 75	
TAPE-FILM INTERLOCK	106
Magna-Tech, see ad on page 75	
TAPE, AUDIO (See also Cartridges)	
CARTRIDGE	106
Aristocart, see ad on page 116	
Capitol Magnetic Prod., see ad on page 143	
Fidelipac, see ad on page 175	
CASSETTE	106
LOGGING	106
OPEN REEL	106
TEST TAPE	106
TAPE, AUDIO ACCESSORIES	
CLEANERS	107
DEMAGNETIZERS	107
LOADERS	107
MOTION CONTROLS	107
REWINDERS	107
SPLICERS	107
SPLICE FINDERS	107
TAPE, VIDEO	
CASSETTES	107
Ampex, see ad on page 27	
3M Company, see ad on pages 18-19	
Midwest Corporation, see ad on page 9	
CARTRIDGES	107
Ampex, see ad on page 27	
3M Company, see ad on pages 18-19	
Midwest Corporation, see ad on page 9	
OPEN REEL	107
Ampex, see ad on page 27	
3M Company, see ad on pages 18-19	
Midwest Corporation, see ad on page 9	
TAPE, VIDEO ACCESSORIES	
CARRYING & SHIPPING CASES	107
DEMAGNETIZERS	107
EVALUATOR	107
Recortec, see ad on page 179	
REWINDERS	107
SPINDLE HEIGHT GAUGE	107
Tentel, see ad on page 197	
TAPE CLEANER	107
Recortec, see ad on page 179	
TENSION GAUGE	107
Tentel, see ad on page 197	
TELECINE	107
Laird Telemedia, see ad on page 123	

Continued on page 44

WHERE TO FIND IT

GENERAL INDEX, Pages 38-45

WHO MAKES IT

PRODUCT DIRECTORY, Pages 46-113

WHERE TO BUY IT

MANUFACTURERS, Pages 114-162

DEALERS/DISTRIBUTORS, Pages 168-189

WHERE TO FIND IT

Magna-Tech, see ad on page 75
Marconi Electronics, see ad on page 49

TELECONFERENCE SYSTEM, AUTOMATIC AUDIO/VIDEO 107

TELECONFERENCING SYSTEMS 107

TELEPHONE EQUIPMENT

EQUALIZERS 107
HYBRID FILTER/AMP 107
TONE RECEIVERS 107
TONE TRANSMITTERS 107

TELETEXT SYSTEMS 107

TERMINAL EQUIPMENT 108
DI-tech, see ad on page 57

TEST EQUIPMENT GENERATORS

AUDIO SINE 108
AUDIO SWEEP 108
COLOR BAR 108
Philips Test & Measuring, see ad on page 11
CROSS PULSE 108
DOT/BAR 108
FUNCTION 108
MARKER 108
NTSC SIGNAL TEST 108
PULSE 108
RF SIGNAL 108
R.E. Instruments, see ad on page 195
SQUARE WAVE 108
STAIRCASE 108
STEREO 108
VIDEO SWEEP 108
Rohde & Schwarz (for.), see ad on page 25
VITS 108
VITS INSERTER 108

TEST EQUIPMENT: MEASURING/INSTRUMENTS

ACOUSTIC ANALYZER 108
AUDIO SYSTEM ANALYZER 108
R.E. Instruments, see ad on page 195
BURST PHASE METER 108
COLOR ANALYZER 108
Philips Test & Measuring, see ad on page 11
DELAY MEASURING SETS 108
Rohde & Schwarz (for.), see ad on page 25
Telemet, see ad on page 85
DEMOD TESTER 109
Telemet, see ad on page 85
DIFFERENTIAL PHASE/GAIN SETS 109
FIELD STRENGTH METER, AM/FM 109
Potomac Instruments, see ad on page 130
FIELD STRENGTH METER, TV 109
Potomac Instruments, see ad on page 130
FREQUENCY COUNTER 109
HARMONIC DISTORTION ANALYZER 109
INSERTER/READER VIT 109
INTERMOD DISTORTION ANALYZER 109
Rohde & Schwarz (for.), see ad on page 25
INTERVAL TIMER, V&H 109
MONITORS (See Monitors, Audio and Monitors, Video)
MULTI-PHASE VIRS Inserter 109
OSCILLOSCOPES 109
Rohde & Schwarz (for.), see ad on page 25
PHASE ANGLE METER 109
SIDE BAND ANALYZER 109
Telemet, see ad on page 85
SPECTRUM ANALYZER 109
R.E. Instruments, see ad on page 195
Rohde & Schwarz (for.), see ad on page 25
VSWR & POWER METER 109
VIDEO ANALYZER 109
Rohde & Schwarz (for.), see ad on page 25
VIDEO LINE OUTPUT DISPLAY 109
WAVEFORM MONITORS 109
The Camera Mart, see ad on pages 28-29
Victor Duncan, see ad on page 172

Videotek, see ad on page 15

WOW & FLUTTER METER 109
R.E. Instruments, see ad on page 195

VECTORSCOPE 109
The Camera Mart, see ad on pages 28-29
Victor Duncan, see ad on page 172
Philips Test & Measuring, see ad on page 11
Videotek, see ad on page 15

TEST EQUIPMENT: MEASURING/ MONITORING METERS

ANTENNA BASE METER 109
Delta Electronics, see ad on page 71

COHERENT DETECTOR 109

DIGITAL MULTIMETER 109

DIGITAL PANEL METER 109

IC TESTER 109

MODULAR TEST SET 109
Telemet, see ad on page 85

IMPEDANCE BRIDGE 109

PEAK PROGRAM 109
ESE, see ad on pages 24-25
Inovonics, see ad on page 126

RF METER 109
R.E. Instruments, see ad on page 195

SEMICONDUCTOR TESTER 110

VIDEO LEVEL METER 110

VIDEO NOISE METER 110

VOLTMETER, AUDIO 110

VTVM 110

VU METER 110

WATTMETER 110
R.E. Instruments, see ad on page 195

TIME BASE CORRECTORS 110
Adda Corporation, see ad on page 1
Camera Mart, see ad on pages 28-29
Harris Video, see ad on page 79

TIME CODE GENERATOR

VERTICAL INTERVAL 110
ESE, see ad on pages 24-25

TIME COMPRESSOR

AUDIO 110
Integrated Sound, see ad on page 45

TIMERS, BLANKING INTERVAL 110
ESE, see ad on pages 24-25

TIMERS, PROGRAM (See also Clocks & Counters) 110
ESE, see ad on pages 24-25

TIMERS, VIDEO TAPE 110
ESE, see ad on pages 24-25
Laird Telemedia, see ad on page 123

TITLING SYSTEMS (See also Character Generators) 110
For-A Corporation, see ad on page 118
Laird Telemedia, see ad on page 123

TOOL KITS 110

TOWER LIGHTS & ACCESSORIES

FLASHERS 110
FLASHERS, HIGH INTENSITY 110
ISOLATION TRANSFORMERS 110
Racal-Decca Canada, see ad on page 130
LAMPS, REPLACEMENT 110
LIGHT FAILURE ALARM (See Alarms)
LIGHT INDICATOR PANELS 110

TOWERS 110
Stainless, see ad on page 198

TOWER SERVICES 111

TRANSFORMERS

AUDIO 111
Sescom, see ad on page 147

FILAMENT 111

ISOLATION 111
North Hills Electronics, see ad on page 200

MODULATION 111

PLATE 111

RF SAMPLING 111

TORODIAL CURRENT 111
Delta Electronics, see ad on page 71
Geleco Electronics, see ad on page 202

TRANSFORMER VIDEO/DATA LINE 111

TRANSLATORS

HIGH POWER 111
EMCEE, see ad on page 53

LOW POWER 111
EMCEE, see ad on page 53

TRANSMISSION LINES (See Cables)

TRANSMISSION LINES, SUPERVISION SYSTEMS 111
CSP Inc., see ad on page 196

TRANSMITTER MODULATION CONTROLLER 111
Delta Electronics, see ad on page 71

TRANSMITTER OUTPUT CONTROLS 111

TRANSMITTERS, AM

500 WATTS & UNDER 111
500 WATTS & OVER, SOLID-STATE 111
1,000 to 2,500 WATTS 111
Continental Electronics, see ad on page 17
5,000 to 7,500 WATTS 111
Continental Electronics, see ad on page 17
Siemens, see ad on page 97
10,000 to 20,000 WATTS 111
Continental Electronics, see ad on page 17
Siemens, see ad on page 97
OVER 20,000 WATTS 111
Continental Electronics, see ad on page 17
Siemens, see ad on page 97

TRANSMITTERS, FM

500 WATTS & UNDER 111
QEI Corporation, see ad on page 171
500 WATTS & OVER, SOLID-STATE 111
QEI Corporation, see ad on page 171
1,000 to 2,500 WATTS 112
Continental Electronics, see ad on page 17
QEI Corporation, see ad on page 171
5,000 to 7,500 WATTS 112
Continental Electronics, see ad on page 17
QEI Corporation, see ad on page 171
10,000 to 20,000 WATTS 112
Continental Electronics, see ad on page 17
Siemens, see ad on page 97
OVER 20,000 WATTS 112
Continental Electronics, see ad on page 17

TRANSMITTERS, TV

LOW POWER UHF 112
EMCEE, see ad on page 53
LOW POWER VHF 112
EMCEE, see ad on page 53
HIGH POWER UHF 112
HIGH POWER VHF 112

TRANSMITTERS, MICROWAVE 112

TRANSMITTERS, SHORTWAVE 112
Continental Electronics, see ad on page 17

TUBES

CRT MONITOR	112
CRT OSCILLOSCOPE	112
RECEIVER TYPES	112
CeCo Communications, see ad on page 81	
Vacuum Tube Industries, see ad on page 150	
RECTIFIER TUBES	112
Vacuum Tube Industries, see ad on page 150	
SOLID-STATE REPLACEMENT	112
CeCo Communications, see ad on page 81	
Electronic Devices, see ad on page 137	
TRANSMITTER TUBES, AM/FM	112
Calvert Electronics, see ad on page 65	
CeCo Communications, see ad on page 81	
Geleco Electronics, see ad on page 202	
Vacuum Tube Industries, see ad on page 150	
Varian, see ad on page 99	
TRANSMITTER TUBES, KLYSTRONS	112
EEV Inc., see ad on page 67	
TRANSMITTER TUBES, VHF	112
Varian, see ad on page 99	
VIDEO CAMERA PICKUP	112
Calvert Electronics, see ad on page 65	
CeCo Communications, see ad on page 81	
TUNERS, FM	112
TUNERS, VIDEO	112
Elector, see ad on page 2	
TURNKEY INSTALLATION SERVICES	112
TURNKEY TV FACILITY	113
TURNTABLES & ACCESSORIES	
PHONO CARTRIDGES (See Cartridges, Phono)	
TONE ARM	113
TURNTABLE	113
SPEED CONTROLS	113
VANS & MOBILE UNITS	
ENG/RENG REMOTE	113
Siemens, see ad on page 97	
VIDEO PRODUCTION	113
Siemens, see ad on page 97	
VANS WITH LADDERS	113
VIDEO CONTROLLER	113
VIDEO LINE OUTPUT DISPLAY	113
VIDEOTAPE DUPLICATION	113
WEATHER GRAPHIC SYSTEM	113
Spectra Computer Sys., see ad on page 115	
WEATHER INSTRUMENTS	113
ESE, see ad on pages 24-25	
WEATHER RADAR SYSTEMS	113
WEATHER RECEIVERS (See Receivers)	
WEATHER SERVICES	113
WIRE (See Cable)	
WIRING SERVICES (See Cable)	

WHERE TO FIND IT

GENERAL INDEX, Pages 38-45

WHO MAKES IT

PRODUCT DIRECTORY, Pages 46-113

WHERE TO BUY IT

MANUFACTURERS, Pages 114-162

DEALERS/DISTRIBUTORS, Pages 168-189



TDM-8000
Audio Time
Compressor

TDM-8200
Stereo Slave



NEW FROM INTEGRATED SOUND SYSTEMS

The TDM-8000 Audio Time Compressor features proprietary patented technology that achieves performance appropriate for first run movies, video taped segments, records, commercials for TV and AM/FM radio, and related applications.

An exclusive, state of the art, intelligent splicing system (pat. pending) is one of the major innovations of the system. The audio signal is analyzed in digital form, but the program signal remains in the analog domain throughout the

process. This insures the lowest possible distortion and minimum listening fatigue.

Its ability to process complex program material, such as speaking voice over ambient noise or singers with accompaniment, without intermodulation distortion or the need to band limit the program is unique.

This makes the TDM-8000 the most versatile on the market.

And now with the new TDM-8200 Stereo Slave you can do it all in stereo.

INTEGRATED
Sound Systems, inc.

29-50 Northern Blvd., Long Island City, N.Y. 11101, Telex: 968020

Circle (153) on Action Card

CINE 60 SUN-GUN

Beautifully Simple

Beautiful . . . because it's fresnel-soft and uniform — ideal for video. And simple because . . . if 250 Watts is too much, change to 150 Watts. Need more? Go to 350 Watts. Want to go really light? Use 100 Watts (12V.). Outdoors, swing-in the built-on Daylight Filter: You color correct instantly! Indoors, swing away the Filter and you have tungsten light! Never a need to readjust camera color controls here! For focus, vary the beam from 8 to 14 Ft. For power, choose from 20 Sun-Gun Powerbelts and Powerpaks. And, to make it beautifully simple . . . we put it all together for you in any one of 17 Portable Sun-Gun Kits. See your dealer or send for data, today.



CINE 60

INCORPORATED
630 Ninth Ave. 6430 Sunset Blvd.
New York, N.Y. 10036 Hollywood, CA. 90028
(212) 586-8782 (213) 461-3046

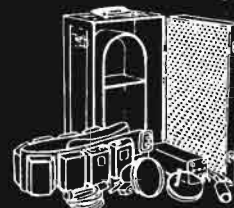

Circle (154) on Action Card

PRODUCT DIRECTORY

ALARMS

CARRIER

Belar Electronic Labs
Bird Electronic
Cinetronics
Coastcom
GTE Products Corp.
Jerrold Div., Gen. Instrument Corp.
Jenel Corporation Consulting Engineers
McMartin Industries
Moseley Associates
Potomac Instruments
Rivers Associates Inc.
Telcom Research

FAULT

Belar Electronic Labs
Bird Electronics
CSI
Cat Systems
Coastcom
Dranetz Engr. Labs
Ear Systems, Inc.
Image Video
Jenel Consulting Engineers
Marconi Instruments Ltd.
Modulation Associates
Moseley Associates
Pinzone Communications
Rivers Associates Inc.
Telcom Research
Trepac Corp. of America
Video Aids of Colorado
Zercom Corp.

TOWER LIGHT

AEG-Telefunken
Abroyd Construction
Allied Tower
Coastcom
Flash Technology
Harris Corp., Broadcast Products
Hughey & Phillips
LeBlanc & Royle
Communications Inc.
Moseley Associates
Potomac Instruments
SSAC Inc.
Sharepoint Systems
Trepac Corp. of America
UNR-Rohn
World Tower

WARNING SYSTEMS

TFT Inc.

AM PHASING & BRANCHING SYSTEMS

Andrew Corp.
BES Electronics Ltd.
CSI Electronics
CSP Inc.
Continental Electronics Mfg.
Cosmin Electronics
Delta Electronics
Elcom Specialty Products
Gelco Electronics Ltd.
Harris Corporation, Broadcast Products Division
Multiphase Consulting

AMPLIFIERS, AUDIO

CLAMPING AMP

ATI Audio Technologies Incorporated
AVL Digital Ltd.
Central Dynamics Ltd.
Di-tech

Dynamic Technology Ltd.
Elektroimpex
International Nuclear
Leader Broadcast Systems
Multidyne Electronics
Orange County
Sait Electronics

COMPRESSING AMP

ATI Audio Technologies Incorporated
Amek TAC
Aphex Systems
Applied Technology
Audio & Design Recording
Audix Limited
Bogen Division / Lear Siegler
Broadcast Electronics
Circuit Research
Coastcom
dbx, Inc.
Dukane Corp.
Dyma Engineering
Elcom Bauer
Elcom Specialty Products
Elektroimpex
Fisher Berkeley
Gregg Laboratories
Harrison Systems
I T I Electronics
Inovonics
LPB
Leader Broadcast Systems
McCurdy Radio Industries
McMartin Industries
Modular Audio Products
Modulation Associates
Moseley Associates
NTP Elektronik A/S
Georg Neumann GwBH
Rupert Neve
Opamp Labs
Orban Associates
Orange County
Processing Plus
ProTech Audio Corporation
Pyramid Loudspeaker
Ramko Research
Richmond Sound Design
Roh Corporation
Sait Electronics
Sescom
Shure Brothers
Sontec Electronics
Spectra Sonics
T M Systems
TOA Electronics
Trident
Tweed Audio
Valley People

DISTRIBUTION

ADM Technology
ALICE (Stancoil Ltd.)
ATI Audio Technologies Inc.
AVL Digital Ltd.
Allied Broadcast
American Data
Aphex Systems
Arrakis Systems
Audio & Design Recording
Audironics
Audisar
Audix Ltd.
Bayly Engineering Ltd.
BGW Systems
BSM Systems
Bell Audio Systems
Bogen Division / Lear Siegler
Bonneville Productions
Robert Bosch GmbH
Brabury Broadcast Systems
Don Britton Eng.
Broadcast Audio Corp.
Broadcast Electronics
Broadcast Technology
David H. Brothers Co.
C-Cor Electronics
Catel
Central Dynamics Ltd.
Channelmatic
Comprehensive Video Supply
Conifer Corp.
D - B Electronics
Datatek
Datatronic
Datum

Di-tech
Philip Drake Electronics
Dyma Engineering
Dynair Electronics
Dynamic Technology Ltd.(82)
Edcor
Elektroimpex
Farrtronics Limited
Fernseh, Inc.
Finney
HEDCO/Hughes Electronic Devices Corp.
IGM Communications
Industrial Sciences, Inc. (ISI)
Inovonics
International Nuclear Corp.
J.V. Electronics Inc.
Javelin Electronics
Jerrold Division, General Instrument Corp.
Johnson Electronics
LPB Inc.
Leader Broadcast Systems
Leitch Video
Link Electronics
Logitek
McCurdy Radio Industries
McMartin Industries
Magnavox CATV
Merrill Cable Equipment Corp. (CATV Electronics)
Micro - Trak Corporation
Modular Audio Products
Modulation Associates
Multidyne Electronics
NTP Elektronik A/S
George Neumann GwBH
Rupert Neve
RTS Systems
Radio Systems, Inc.
Norcom Manufacturing
Opamp Labs
Pacific Recorders
Pro Bel Ltd.
Processing Plus
ProTech Audio Corporation
Pye TVT
RMS Electronics
RTS Systems
Radio Systems
Ramko Research
Richmond Sound Design
Rockwell International
Roh Corporation
Rohde & Schwarz
Russco
Sait Electronics
Scantex Laboratories
Scientific-Atlanta
Scientific Systems
Sescom
Shintron
Siemens Osterreich A/S
Sigma Electronics
Sontec Electronics
Sound Systems
Spectra Sonics
Straight Wire Audio
Studer ReVox America
Teac Corp. of America
Telemet
Television Equipment Associates
Texscan
Thomson-CSF Broadcast
Tweed Audio USA, Inc.
Ultra Audio Pixtec
Vamco Engineering
Versa-Count
Vital Industries
Ward-Beck Systems

LINE AMP

ADM Technology
AEG-Telefunken
(Bayly Engineering)
ALICE (Stancoil Ltd.)
Amplica
Aphex Systems
Arrakis Systems
ATI Audio Technologies Incorporated
Audisar
Audix Limited
BGW Systems
Bell Audio Systems
Bogen Division / Lear Siegler
Bonneville Productions

Brabury Broadcast Systems
Broadcast Audio Corp
Broadcast Electronics
Broadcast Technology
David H. Brothers Co.
C-Cor Electronics
Central Dynamics Ltd.
Michael Cox
D - B Electronics, Inc.
Datatek
Datatronic
Datum
Philip Drake Electronics
Dukane Corp.
Dyma Engineering
Ear Systems Inc.
Elektroimpex
Enertec Schlumberger
Finney
Fisher Berkeley
Full Compass Systems
HEDCO
Howe Audio
IGM Communications
I T I Electronics
International Nuclear Corp.
J.V. Electronics Inc.
Javelin Electronics
Jensen Transformers
Johnson Electronics
Leader Broadcast Systems
Link Electronics
McCurdy Radio Industries
McMartin Industries
Magnavox CATV Systems
Merrill Cable Equipment Corp. (CATV Electronics)
Micro - Trak Corporation
Modular Audio Products
Modulation Associates
Multidyne Electronics
NTP Elektronik A/S
Georg Neumann GwBH
Rupert Neve
Norton Assoc.
Opamp Labs
Panasonic, Professional Audio Division
Potomac Marine & Aviation
Processing Plus
ProTech Audio Corporation
Pye TVT
Quad-Eight Electronics
RTS Systems
Radio Systems, Inc.
Ramko Research
Research Systems Tech.
Richard Sound Design
Roh Corporation
Rohde & Schwarz
Sait Electronics
Sandar Electronics A/S
Scantex Laboratories
Scientific Systems
Sescom
Siemens Osterreich AG
Sontec Electronics
Sound Systems
Spectra Sonics
Sphere
Straight Wire Audio
Studer Revox America
TM Systems
Teac Corp. of America
Telex Communications, Inc.
Tweed Audio
Ultra Audio Pixtec
Valley People
Vidaire Elec. Mfg.
Video Aids of Colorado

MIKE AMP

ADM Technology
AEG-Telefunken
AKG Acoustics
ALICE (Stancoil Ltd.)
ATI Audio Technologies Incorporated
Amek TAC
Arrakis Systems
Audio & Design Recording
Audisar
Audix Limited
BMS Systems
Bayly Engineering Ltd.
Beyer Dynamic

Continued on page 48



the trendsetters

Unquestionably the industry's standard of excellence in broadcast equipment

Most manufacturers meet industry standards; we exceed them. Our TOMCAT cartridge recorders/reproducers and BMX series of broadcast consoles deliver trendsetting on-line performance in broadcasting systems worldwide, from Boston to L.A., Australia to Great Britain.

TOMCAT: simply the world's finest. Innovative design assures superb sound quality, reliability, and low noise operation. Our Maxtrax™ wide-track fixed azimuth heads yield more signal, lowest phase error.

BMX, Series II: the ultimate in high performance mixing consoles. These compact units feature proven RF immunity and CMOS remote control flexibility, plus a choice of 10, 14, 22,

and 26 input mainframe configurations. A new mix module is now available to offer two mix-minus busses for telephone talk shows. All this in a no-nonsense panel layout! See why TOMCAT and BMX series have made us the industry trademark. Call or write today for free information on our complete line of equipment.



pacific recorders & engineering corporation
 11100 Roselle St. San Diego, CA 92121
 (714) 453-3255

SOUTHEAST REGIONAL OFFICE

Three Maryland Farms
 Suite 340
 Brentwood, Tennessee 37027
 (615) 373-3313

Circle (29) on Action Card

WHO MAKES IT

Bell Audio Systems
 Bogen Division / Lear Siegler, Inc.
 Brabury Broadcast Systems
 Broadcast Audio Corp.
 Broadcast Electronics
 Broadcast Technology
 David H. Brothers, Co.
 Central Dynamics Ltd.
 Cinetronics
 Continental Electronics
 D-B Electronics
 Datatek
 Datatronix
 Dukane Corp.
 Dyma Engineering
 Dynair Electronics
 Ear Systems Inc.
 Edcor
 Elektroimpex
 Full Compass Systems
 Gregg Laboratories
 Howe Audio
 IGM Communications
 I T I Electronics
 International Nuclear Corp.
 Ivie Electronics
 Jensen Transformers
 Johnson Electronics
 Leader Broadcast Systems
 McCurdy Radio Industries
 McMartin Industries
 Micro-Trak
 Modular Audio Products
 NTP Elektronik A/S
 Georg Neumann GwBH
 Rupert Neve
 Opamp Labs
 Paso Sound Products
 Processing Plus
 ProTech Audio Corporation
 Quad-Eight Electronics
 RTS Systems
 Radio Systems, Inc.
 Ramko Research
 Research Systems Tech.
 Richard Sound Design
 Roh Corporation
 Salt Electronics
 Scantex Laboratories
 Scientific Systems
 Sescom
 Shure Brothers
 Siemens Osterrelch AG
 Sontec Electronics
 Sound Systems
 Spectra Sonics
 Straight Wire Audio
 TOA Electronics
 Tapco
 Telex Communications, Inc.
 Transist-O-Sound
 Tweed Audio
 Vidair Elec. Mfg.

MIXER AMP

ADM Technology
 ALICE (Stancoil Ltd.)
 ATI Audio Technologies
 Incorporation
 Altec Corp.
 Amek TAC
 Applied Technology
 Arrakis Systems
 Audisar
 Audix Ltd.
 Belar Electronic Labs
 Bell Audio Systems, Inc.
 Beyer Dynamic
 Bogen Division / Lear
 Siegler, Inc.
 Don Britton Ent.
 Broadcast Electronics
 Broadcast Technology
 David H. Brothers, Co.
 Central Dynamics Ltd.
 Cinetronics
 Continental Electronics Mfg.
 Michael Cox
 Datatronix
 Phillip Drake Electronics
 Dukane Corp.
 Dyma Engineering
 Ear Systems Inc.
 Edcor
 Elektroimpex
 Full Compass Systems
 Hallikainen and Friends
 Howe Audio

IGM Communications
 International Nuclear Corp.
 Ivie Electronics
 Johnson Electronics
 Leader Broadcast Systems
 Logitek Electronic Systems, Inc.
 McCurdy Radio Industries
 McMartin Industries
 Micro-Trak Corporation
 Modular Audio Products
 Georg Neumann GwBH
 Richmond Sound Design
 Rupert Neve
 Opamp Labs
 Paso Sound Products
 ProTech Audio Corporation
 Pye TVT
 Quad-Eight Electronics
 RTS Systems
 Ramko Research
 Richard Sound Design
 Roh Corporation
 Salt Electronics
 Scantex Laboratories
 Scientific Systems
 Sescom
 Shure Brothers
 Siemens Osterreich AG
 Sontec Electronics
 Sound & Light Co.
 Sound Systems
 Spectra Sonics
 Sphere
 Straight Wire Audio
 Studer ReVox America
 TOA Electronics
 Tapco
 Tape-Athon Corp.
 Teac Corp. of America
 Transist-O-Sound
 Tweed Audio
 Ultra Audio Pixtec
 Vidair Elec. Mfg.

MONITOR AMP

AEG-Telefunken
 (Bayly Engineering)
 ALICE (Stancoil Ltd.)
 ATI Audio Technologies
 Incorporated
 Altec Corp.
 American Data
 Arrakis Systems
 Audionics of Oregon
 Audisar
 AVL Digital
 BGW Systems
 BSM Systems
 Belar Electronic Labs
 Bogen Division / Lear
 Siegler, Inc.
 Broadcast Audio Corp.
 Broadcast Electronics
 Broadcast Technology
 David H. Brothers, Co.
 Bryston Mfg. Ltd.
 Cetec Broadcast Group
 Conex Electro Systems
 Continental Electronics Mfg.
 Crown International
 D-B Electronics
 Datatek
 Datatronix
 Di-tech
 Phillip Drake Electronics
 Dukane Corp.
 Dyma Engineering
 Elektroimpex
 EV/Tapco
 Fernseh, Inc.
 Hallikainen and Friends, Inc.
 Howe Audio
 IGM Communications
 I T I Electronics
 Industrial Sciences, Inc.
 International Nuclear Corp.
 Ivie Electronics
 Jerrold Division, General
 Instrument Corp.
 Kudelski S.A.
 Leader Broadcast Systems
 Logitek
 McCurdy Radio Industries
 McMartin Industries
 Merlin Engineering
 Micro-Trak Corporation
 Modular Audio Products
 Multidyne Electronics

Georg Neumann
 Opamp Labs
 Panasonic, Professional Audio
 Division
 ProTech Audio Corporation
 RTS Systems
 Radio Systems
 Ramko Research
 Roh Corporation
 Rohde & Schwarz
 Russco
 Sait Electronics
 Scientific Systems
 Sescom
 Siemens Osterreich AG
 Sound Systems
 Spectra Sonics
 Straight Wire Audio
 Studer International AG
 Studer ReVox America
 TM Systems
 TOA Electronics
 Tweed Audio
 Ultra Audio Pixtec
 VIF International
 Video Aids of Colorado
 Videotek
 Ward-Beck Systems
 World Video

PEAK LIMITING, AM

ADM Technology
 Applied Technology
 ATI-Audio Technologies Inc.
 Audio & Design Recording
 Belar Electronic Labs
 Bogen Division/Lear Siegler
 Broadcast Electronics
 Cetec Broadcast Group
 Circuit Research Labs
 Continental Electronics Mfg.
 Delta Electronics
 Dorrough Electronics
 Dyma Engineering
 EMT Franz
 Elcom Bauer
 Elcom Special Products
 Enertec Schlumberger
 Gregg Laboratories
 Harris Corporation, Broadcast
 Products Division
 IGM Communications
 Inovonics
 Kahn Communications
 LPB Inc.
 Leader Broadcast Systems
 McMartin Industries
 Modular Audio Products
 Moseley Associates
 NTP Elektronik A/S
 Orange County
 Orban Associates
 Processing Plus
 Salt Electronics
 Siemens Osterreich AG
 Sontec Electronics
 Spectra Sonics
 Thomson-CSF Broadcast
 Valley People

PEAK LIMITING, FM

ADM Technology
 Applied Technology
 Audio & Design Recording
 ATI-Audio Technologies Inc.
 Bogen Division/Lear Siegler
 Broadcast Electronics
 Cetec Broadcast Group
 Circuit Research Labs
 Continental Electronics Mfg.
 Dorrough Electronics
 Dyma Engineering
 EMT Franz
 Elcom Bauer
 Gregg Laboratories
 IGM Communications
 Inovonics
 Kahn Communications
 LPB Inc.
 McMartin Industries
 Modular Audio Products
 Modulation Sciences
 Moseley Associates
 NTP Elektronik A/S
 Orange County
 Orban Associates
 Processing Plus

Pye TVT
 Rohde & Schwarz
 Salt Electronics
 Siemens AG Osterreich
 Sontec Electronics
 Spectra Sonics
 Thomson-CSF Broadcast
 Tweed Audio
 Valley People

POWER AUDIO AMP

AEG-Telefunken
 (Bayly Engineering)
 ATI-Audio Technologies Inc.
 Altec Corp.
 American Data
 Argos Products
 Audionics of Oregon
 Audisar
 Audix Limited
 AVL Digital
 BGW Systems, Inc.
 Bell Audio Systems, Inc.
 Bogen Division / Lear
 Siegler, Inc.
 Broadcast Electronics
 David H. Brothers, Co.
 Bryston
 Central Dynamics Ltd.
 Cetec Broadcast Group
 Cinetronics
 Conex Electro Systems
 Crown International
 D-B Electronics
 Philip Drake Electronics
 Dukane Corp.
 Dyma Engineering
 Dynair Electronics, Inc.
 EV/Tapco
 Electro-Voice
 Elektroimpex
 Eurig USA
 Fisher Berkeley
 Fostex
 Hammond Industries
 Heath Company
 Howe Audio
 IGM Communications
 Integrated Sound Systems
 Ivie Electronics
 Johnson Electronics
 Kimian Sales, Inc.
 Kintek
 Leader Broadcast Systems
 Logitek
 McCurdy Radio Industries
 McMartin Industries
 Micro-Trak
 Modular Audio Products
 Multidyne Electronics
 Opamp Labs
 Panasonic, Professional Audio
 Division
 ProTech Audio
 Pye TVT
 QSC Audio Products
 RTS Systems
 Radio Systems
 Ramko Research
 Roh Corporation
 Rohde & Schwarz
 Russco
 Sait Electronics
 Scientific Systems
 Sharp Electronics
 Shure Brothers
 Siemens AG Osterreich
 Spectra Sonics
 John M. Sullivan Assoc.
 Stanton Magnetics
 Studer International AG
 Studer ReVox America
 TOA Electronics
 Tape-Athon/Cavox Stereo
 Productions
 Teac Corp. of America
 Telex Comm., Inc.
 Ultra Audio Pixtec
 VIF International

PROCESSING AMP

ATI Audio Technologies Inc.
 Aphex Systems
 Applied Technology
 Audio & Design Recording
 Audionics of Oregon

Continued on page 50

Marconi deserves an Oscar

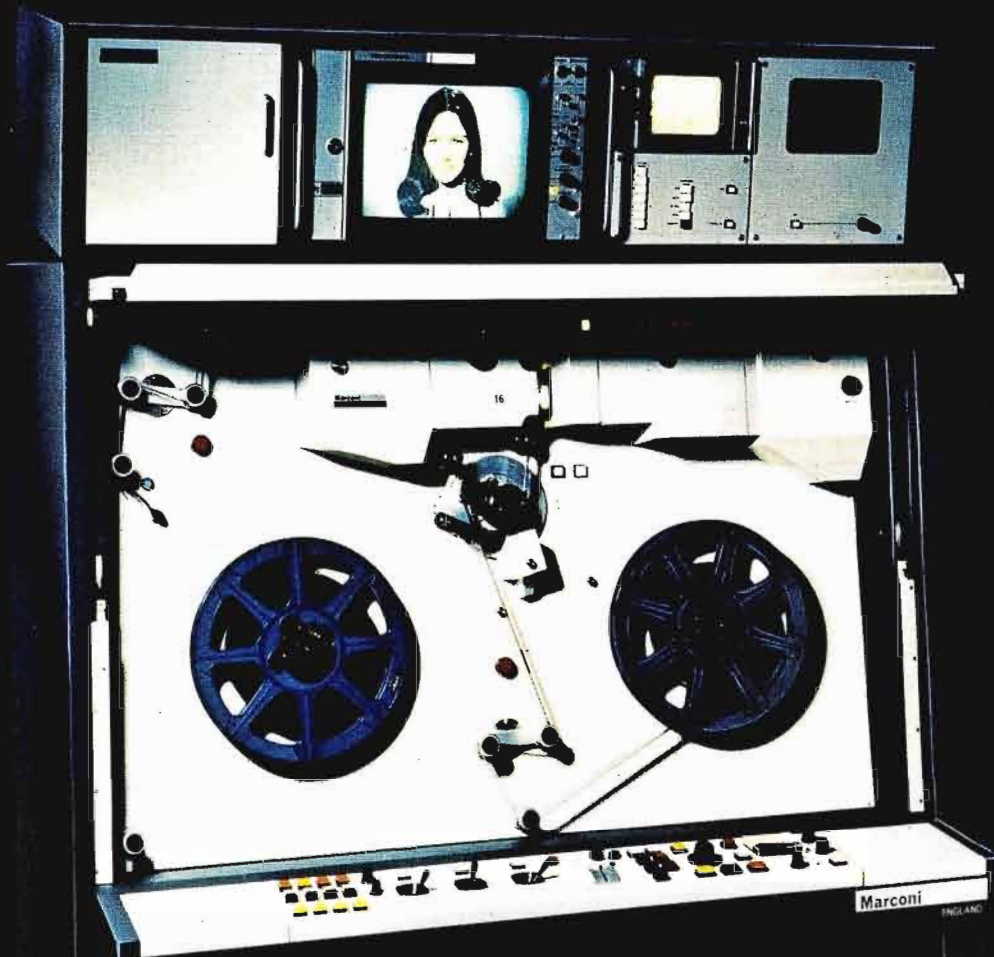

Smooth, silent, reliable.

The New Marconi Line Array Telecine B3410

For a remarkable contribution to film in TV, Marconi's new Line Array Telecine B3410 fully deserves its great reputation.

The unique combination of full digital processing with micro-processor control and CCD sensors means exceptional picture quality, shorter set-up times, rapid change of TV standards, long life and minimum maintenance. No tubes, no replacements!

Also offering fast change of film gauge and full resolution cinemscope, this most outstanding newcomer is available for swift delivery at a highly competitive price.

For full details contact: Marconi Electronics Inc. (John White or Simon Frazer)

Tel: (201) 767-7250 or A.F. Associates Inc. (Lou Siracusano or Bill Ebell)

Tel: (201) 767-1000.



Marconi Electronics Inc./A.F. Associates Inc.

100 Stonehurst Court, Northvale, New Jersey 07647, U.S.A. Tel. 767-7250. Telex. 710-991-9752.

Circle (30) on Action Card

BGW Systems
Broadcast Electronics
Central Dynamics Ltd
Circuit Research Labs
Composit Video
dbx, Inc.
Delta Electronics
Dorrrough Electronic
Gregg Laboratories
Harris, Broadcast Products
IGM Communications
Inovonics
Jerrold Division, General
Instrument Corp.
Kahn Communications
Leader Broadcast Systems
McCurdy Radio Industries
McMartin Industries
Modular Audio Products
Moseley Associates
Opamp Labs
Orange County
Orban Associates
Processing Plus
ProTech Audio
RTS Systems
Siemens AG Osterreich
Spectra Sonics
Straight Wire Audio
Telex Communications, Inc.
Ward-Beck Systems

REMOTE AUDIO AMP

Arrakis Systems
ATI Audio Technologies
Incorporated
AVL Digital Ltd.
BGW Systems, Inc.
BSM Systems
Bogen Division/Lear Siegler
Don Britton Ent.
Broadcast Electronics
Dyma Engineering(82)
Elektroimpex
HEDCO
Hallikainen & Friends
IGM Communications(82)
International Nuclear Corp.
Kahn Communications
Leader Broadcast Systems
Logitek
McCurdy Radio Industries
McMartin Industries
Micro-Trak
Modular Audio Products
Moseley Associates, Inc.
NTP Electronik A/S(82)
Opamp Labs
Ramko Research(82)
Richard Sound Design
Rohde & Schwarz
Scantex Laboratories
Sescom
Siemens AG Osterreich
Sound Systems
Spectra Sonics
Straight Wire Audio
T M Systems
Transist-O-Sound
Tweed Audio
Ultra Audio Pixtec
Vital Industries

AMPLIFIERS, VIDEO

DISTRIBUTION AMP

AVA Electronics
AVL Digital Ltd.
American Data
Amplica, Inc.
Apert-Herzog
BSM Systems
Blonder-Tongue Labs
Robert Bosch GmbH
Don Britton Ent.
Broadcast Video Systems
David H. Brothers Co.
C-Cor Electronics
Canter-Redman Technologies
Corp.
Channelmatic
Comad Communications
Composite Video
Comprehensive Video Supply
Conifer Corp.
Crow of Reading Ltd.

Datatek
Delta Systems
DI-tech
Dyma Engineering
Dynair Electronics
Dynamic Technology Ltd.
Elektroimpex
Fernseh, Inc.
Finney
Fung Eng. Labs Inc.
GBC Closed-Circuit Corp.
Graham-Patten Systems
Grass Valley Group
HEDCO/Hughes Electronic
Devices Corporation
Ikegami Electronics
Kuge Video Limited
Industrial Sciences, Inc. (ISI)
International Nuclear Corp.
Javelin Electronics
Jerrold Div., Gen. Instrument Corp.
Lang Video Systems
Leitch Video
Lenco
Link Electronics
Magnavox CATV Systems
Marconi Electronics Inc.
Merrill Cable Equipment
Multidyne Electronics
NEC America
Opamp Labs
Panasonic
Phase Video Inc.
Pro-Bel
QSI Systems
RMS Electronics Inc.
Rohde & Schwarz
Russco
Sandar Electronics A/S
Scantex Laboratories, Inc.
Scientific-Atlanta
Shintron
Sierra Audio
Sigma Electronics
John M. Sullivan Associates
Telemet
Television Equipment
Associates
Texscan
Thomson-CSF
Vamco Engineering
Vidair Elec. Mfg.
Video Aids of Colorado
Video Masters
Vidicraft
Viscount Industries
Vital Industries

ISOLATION AMP

Telemet

PULSE AMP

AVL Digital
American Data
Amplica
Broadcast Video Systems
C-Cor Electronics
Central Dynamics Ltd.
Crow of Reading Ltd.
Datatek
Delta Systems
Dyma Engineering
Dynair Electronics
Dynamic Technology Ltd.
Elektroimpex
Fernseh, Inc.
GBC Closed-Circuit TV
Graham-Patten Systems
Grass Valley Group
HEDCO/Hughes Electronic
Devices Corp.
Harris Corp., Broadcast Products
Industrial Sciences Inc. (ISI)
International Nuclear Corp.
Javelin Electronics
Jerrold Div., Gen. Instrument Corp.
Lang Video Systems
Leitch Video
Lenco
Link Electronics
Multidyne Electronics
NEC America
Opamp Labs
Panasonic Industrial
Phase Video Inc.
Pro-Bel
QSI Systems

Rohde & Schwarz
Sandar Electronics A/S
Shintron
Sigma Electronics
John M. Sullivan Associates
Telemet
Television Equipment Assoc.
Thomson-CSF
Video Aids of Colorado

PULSE DELAY

American Data
Robert Bosch GmbH
Broadcast Video Systems
Central Dynamics Ltd.
Comad Communications
Crow of Reading Ltd.
Delta Systems
DI-tech, Inc.
Dyma Engineering
Dynair Electronics
Fernseh, Inc.
Graham-Patten Systems
Grass Valley Group
Industrial Sciences, Inc. (ISI)
International Nuclear Corp.
Jerrold Division, General
Instrument Corp.
Koss Company
Leitch Video
Lenco
Link Electronics
Pro-Bel
Sandar Electronics A/S
Sigma Electronics
Telemet
Television Equipment
Associates
Videomedia

PROC AMP

Adwar Video
Automation Techniques
Broadcast Video Systems
Canter-Redman Technologies
Corporation
Central Dynamics Ltd.
Composite Video
Michael Cox
Crow of Reading Ltd.
Delta Systems
Dyma Engineering
Fernseh, Inc.
Grass Valley Group
Industrial Sciences, Inc. (ISI)
Jerrold Division, General
Instrument Corp.
Leitch Video
Lenco
NEC America, Broadcast
Equipment
Processing Plus
Rohde & Schwarz
Siegel-Electronics
Sigma Electronics
John M. Sullivan Associates
Tektronix
Vidicraft
Videomedia

STABILIZING AMP

Don Britton Ent.
Composite Video
Michael Cox
Crow of Reading Ltd.
Delta Systems
Dyma Engineering
International Nuclear Corp.
Javelin Electronics
Jerrold Division, General
Instrument Corp.
Leitch Video
Telemet
Thomson-CSF

SWEEP AMP

Crow of Reading Ltd.
Jerrold Division, General
Instrument Corp.
Lenco
Rohde & Schwarz

VIDEO AMP

AVA Electronics
AVL Digital Ltd.
Advanced Analog Systems
Adwar Video

American Data
Amplica
Robert Bosch GmbH
David H. Brothers, Co.
Michael Cox
Comad Communications
Crow of Reading Ltd.
Datatek
Datum
Delta Systems
Dyma Engineering
Dynair Electronics
Dynamic Technology Ltd.
Fernseh, Inc.
GBC Closed-Circuit TV
Graham-Patten Systems
Grass Valley Group
HEDCO
Ikegami Electronics
Industrial Sciences, Inc.
International Nuclear Corp.
Javelin Electronics
Jerrold Div., Gen. Instrument Corp.
Lang Video Systems
Leitch Video
Lenco
Link Electronics
Magnavox CATV Systems, Inc.
Marconi Electronics, Inc.
Multidyne Electronics
Opamp Labs
Panasonic
Phase Video Inc.
Pro-Bel Ltd.
Rohde & Schwarz
Siegel-Electronics
Thomson-CSF
Videcom Engineering
Video Masters
Videomedia

ZERO STUDIO DELAY AMP

C-M-C Technology Corp.
Orange County
Television Equipment
Associates
Videomedia

AMPLIFIER, RF

PEAK LIMITING

ADM Technology
ATI Audio Technology, Inc.
Amek TAC
Amplica
Aphex Systems
Applied Technology
Audio & Design Recording
Bogen Division/Lear Siegler
Broadcast Audio Corp.
Broadcast Electronics
Circuit Research Labs
Continental Electronics Mfg.
Dorrrough Electronics
Dyma Engineering
Elcom Bauer
Elektroimpex
Gregg Laboratories
Harris Corporation, Broadcast
Products Division
Harrison Systems
IGM Communications
Inovonics
Javelin Electronics
Jerrold Division, General
Instrument Corp.
Kahn Communications
Leader Broadcast Systems
McMartin Industries
Microwave Power Devices
Modular Audio Products
Modulation Sciences
Moseley Associates
Georg Neumann GwBH
Opamp Labs
Orange County
Orban Associates
Quad-Eight Electronics
Spectra Sonics
TM Systems
Thomson-CSF Broadcast
VIF International
Valley People

Continued on page 52

GAIN VIDEOCONFIDENCE!TM

NEW JVC CR-4700U

PORTABLE 3/4" U TAPEHANDLER



Here's something really new in a portable 3/4" U videocassette recorder: JVC's exclusive VideoConfidence™ head. Now you can be absolutely confident that you're getting on tape what you see in the camera monitor...because you review as you record!

The picture you see in the monitor is fed to it from the tape a split second

after recording. What you get is what you see.

There's no other portable 3/4" U VCR with this feature.

But that's not all the CR-4700U offers. It has SMPTE time code capability to speed post-production editing. Head switching is in the vertical interval to eliminate undesirable switching points. There's microprocessor-based logic for full remote control. You can do assemble editing in the field with the automatic editing function.

And how about a video S/N ratio of better than 46dB! No other portable 3/4" U VCR has so many valuable features.

See it NOW at your JVC dealer. For more information write

JVC COMPANY OF AMERICA
Prof. Video Div., Dept. BCD 6/82
41 Slater Drive, Elmwood Park, NJ 07407
JVC CANADA INC., Scarborough, Ont.

For faster action, call toll-free
800-821-7700, Ext. 7005.
(In Missouri: 800-892-7655, Ext. 7005.)

WARNING TO PURCHASERS: The unauthorized recording of copyrighted broadcast programming for commercial purposes is copyright infringement.

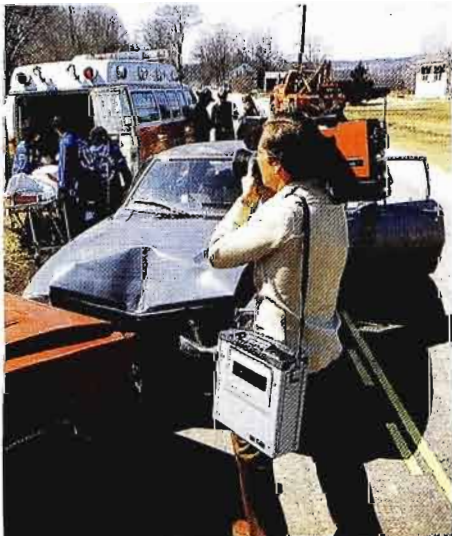

JVC[®]

JVC COMPANY OF AMERICA
Professional Video Division

Circle (31) on Action Card

POWER AMPLIFIER

ATI Audio Technologies Inc.
Altec Corp.
Amplica
Arrakis Systems
Audisar
Ayburn Electronics
BGW Systems
Bayly Engineering Ltd.
Bell Audio Systems
Bogen Division/Lear Slegler
Broadcast Electronics
Broadcast Technology
David H. Brothers, Co.
Bryston Mfg. Ltd.
C-Cor Electronics
California Instrument
Crown International
Crowder Communications
Dukane Corp.
Dynair Electronics
Dyma Engineering
Edcor
Elektroimpex
Elicon
Enertec Schlumberger
EV/Tapco
Hammond Industries
Harris Corporation, Broadcast
Products Division
Howe-Yin Research Corp.
IGM Communications
Integrated Sound
Ivle Electronics
Jerrold Division, General
Instrument Corp.
Johnson Electronics, Inc.
Kirmian Sales, Inc.
Leader Broadcast Systems
Logitek
McCurdy Radio Industries
McMartin Industries
Magnavox CATV Systems, Inc.
Merrill Cable Equipment Corp.
Micro-Trak
Microwave Power Devices
Modular Audio Products
Moseley Associates, Inc.
Opamp Labs
Panasonic, Professional
Audio Division
Paso Sound Products
Hans Pilsch
RF Technology
Ramko Research
Rockwell International
Roh Corporation
Scientific Radio Systems, Inc.
Sescom, Inc.
Sharp Electronics
Sierra Audio
Spectra Sonics
Studer International AG
Studer ReVox America
John M. Sullivan Assoc., Inc.
TOA Electronics
Tape-Athon Corp.
Tascam
Television Technology
Tapco
Triple Crown Electronics
Ultra Audio Pixtec
VIF International
Varian Associates
Varian, MCSD
Versa - Count
Vidair Electronics
Wilkinson Electronics

ANIMATION SYSTEMS & SERVICES

American Image Productions
Ampex
Animation Video (Division of
Convergence Corporation)
Aurora Imaging Systems
Autographics, Inc.
Cinetron Computer Systems
Computer Graphics Lab
Computer Image
Dubner Computer Systems
Elcon

English Electric Valve
Fernseh
The Graphic Express
Grove Video
Ikegami Electronics
Interand
Jatex Inc.
Lyon Lamb
MCI/Quantel
MPB Technologies
Precision/Echo Science
Spectra Computer Systems
Standard Communications
Starex, Inc.
E.J. Stewart
Texscan Corp.
Via Video
Weathercaster
Frank Woolley & Company

ANTENNA ACCESSORIES & SERVICES

ALIGNMENT SYSTEMS, MICROWAVE

Antennas for Communications Inc.
Atlas Tower Corp.
Compucon
GC Electronics
Gabriel Electronics
Grant Tower
Harris Corp., Broadcast Products
ITE Innovative TV Equipment
Innovative Television
Jenel Consulting Engineers
LeBlanc & Royle
Communications Towers
M/A-COM Video Systems
Micro Communications
Moseley Associates
Fred Nudd Company
Nurad
Swager Tower Corporation
TBC Pye Ltd.
Tayburn Electronics
UNR-Rohn
Utility Tower
V & B Tower Construction

BASE INSULATOR

Continental Electronics Mfg.
Daburn Electronics & Cable
Grant Tower
LeBlanc & Royle Comm. Towers
Fred A. Nudd Corporation
Racal-Decca Canada,
Insulators Division
UNR-Rohn
Utility Tower
World Tower Company

BALUNS

Barker & Williamson Inc.
Blonder-Tongue Laboratories
Electro Impulse
The Finney Company
Marshall Electronics
North Hills Electronics
RMS Electronics Inc.
Rohde & Schwarz
Scala Electronic Corporation
Shively Laboratories
Sitco Antennas
Thomson-CSF
Vidair Elec. Mfg.

CURRENT CONTROLLERS

Delta Electronics

CURRENT METER

Delta Electronics

DIPLEXER

Blonder-Tongue Laboratories
Cetec Antennas
Comark Communications
Continental Electronics Mfg.
CSP Inc.
Cosmin Electronics
Dielectric Communications
Elcom Specialty Products
GTE Products Corp.
Harris Corporation, Broadcast
Products Division

McMartin Industries
Micro Communications
Moseley Associates
Mu-Del Electronics
NEC America
Nurad
Phelps Dodge Communications
Company
Rohde & Schwarz
Shively Laboratories
Swintek Enterprises, Inc.
Technology for Communications
International
Tennaplex Systems Ltd.
Thomson-CSF
Townsend Associates
UTE Microwave
Varian Associates, MCSD
Varian, MCSD

DUMMY LOADS

AEG-Telefunken
(Bayly Engineering)
AVA Electronics
Antenna Technology
Barker & Williamson
Bird Electronic
CSP Inc.
Coaxial Dynamics
Comark Communications
Continental Electronics Mfg.
Dielectric Communications
Dyma Engineering
Elcom Bauer
Elcom Specialty Products
Electro Impulse, Inc.
GC Electronics
Geleco Electronics Ltd.
Harris Corporation, Broadcast
Products Division
McMartin Industries
Marconi Electronics, Inc.
Micro Communications
Moseley Associates
Narda Microwave Corp.
Northland Communications
Phelps Dodge Communications
Rex Rheostat & Company
Rockwell International
Rohde & Schwarz
Shively Laboratories
Thomson-CSF
Varian Associates, MCSD
Varian, MCSD
Vidair Elec. Mfg.
Wilkinson Electronics

EARTH TERMINAL POSITIONER

Andrew Corp.
Antennas for Communications Inc.
Don Britton Ent.
Comtech Antenna Corp.
Elcon
Harris, Broadcast Products
Lang Video Systems
Microdyne Corp.
Scientific-Atlanta

GUY STRAIN INSULATOR

Racal-Decca Canada

HEATER CONTROLS

McMartin Industries
Fred Nudd Corporation
Thomson-CSF
Wilkinson Electronics

ICE WARNING SYSTEM

Bird Electronic Corp.
Harris, Broadcast Products
McMartin Industries
Thomson-CSF
Shively Laboratories

INSTALLATION SERVICES

Abroyd Construction
Andrew Corporation
Antennas for Communications
CSP Inc.
Comark Communications
Dyma Engineering
GTE Products Corp.
Gabriel Electronics Inc.
Grant Tower
Harris Corp., Broadcast Products
Kline Iron and Steel Co.
LeBlanc & Royle Comm. Towers

McMartin Industries
Microdyne Corp.
Multiphase Consulting
Fred A. Nudd Corporation
Nurad
Potomac Marine & Aviation
RCA Service Company
Radiotechniques
Rohde & Schwarz
SWR
Soil Inc.
Swager Tower Corporation
TBC Pye Ltd.
Tennaplex Systems Ltd.
UNR-Rohn
Utility Tower

PHASING/BRANCHING SYSTEM

CSP Inc.

RADOMES

AEL (American Electronic
Laboratories)
Andrew Corporation
Anixter-Mark
Antenna Technology
Cablewave Systems
Cetec Antennas
Continental Electronics Mfg.
Elcom Specialty Products
Gabriel Electronics Inc.
Grant Tower
Harris, Broadcast Products
LeBlanc & Royle Comm. Towers
McMartin Industries
Micro Communications
Nurad
Phelps Dodge Company
Shively Laboratories
Thomson-CSF
Wilkinson Electronics

REMOTE INDICATORS

Atlas Sound
Coaxial Dynamics
Delta Electronics
Harris Corp., Broadcast Products
McMartin Industries
Nurad
Potomac Marine & Aviation
Shively Labs
Thomson-CSF
Video Aids of Colorado
Wilkinson Electronics

SAMPLING SYSTEMS

CSP Inc.
Continental Electronics Mfg.
Delta Electronics
Elcom Specialty Products
Geleco Electronics Ltd.
Harris Corp., Broadcast Products
McMartin Industries

Static Drain Resistor

Racal-Decca Canada

TELESCOPING MAST

Allen Osborne Associates

TRANSFER SWITCH

Antenna Technology
Bird Electronic
Comark Communications
CSP Inc.
Delta Electronics
Dielectric Communications
Geleco Electronics Ltd.
ITT Jennings
McMartin Industries
Marshall Electronics
Micro Communications
Multronics, Inc.
SWR
Shively Laboratories
Soil Inc.
Technology for Communications
International
Tennaplex Systems Ltd.
Transco Products
Varion MCSD
Video Aids of Colorado

TUNING UNITS

CSP Inc.
Continental Electronics Mfg.

Continued on page 54

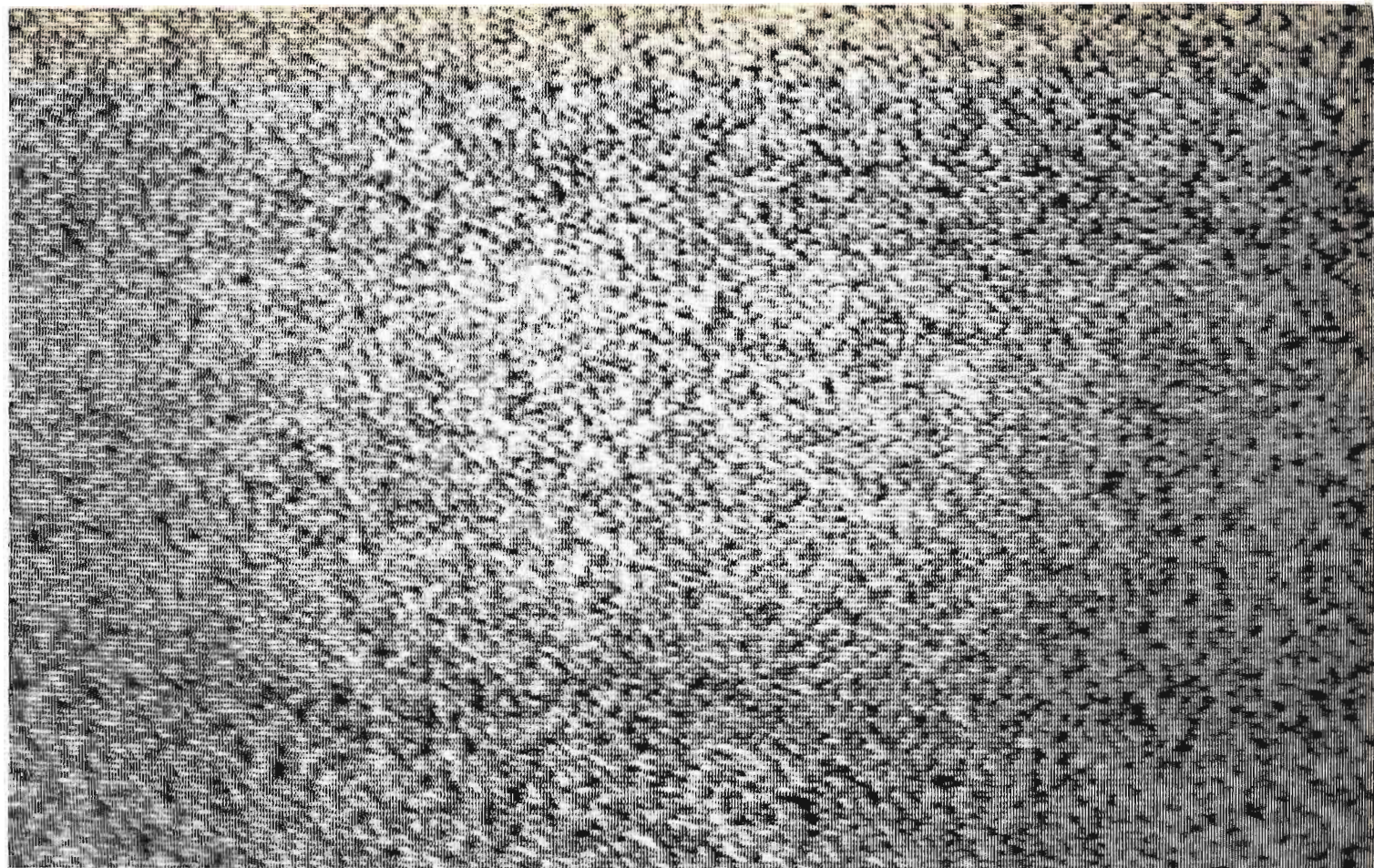

The next time your air monitor goes dead, tell your audience about your bargain low-power television equipment

The high cost of low price equipment

No broadcast equipment is a bargain when it's off the air. So EMCEE[®] Broadcast Products builds its translators, LPTV transmitters and other hardware without cutting corners or costs. Frankly, that often means prices that appear higher. But it also means the proven higher reliability that EMCEE hardware has provided since 1960.

Oldies but goodies

This higher reliability is no blue-sky claim, either. Many EMCEE HRV-1 1 watt translators are still doing a full broadcast day's work eighteen years after installation. EMCEE HTU-100 100 watt translators are still going strong after seventeen years on site. And the list goes on. Because through three generations of low-power television equipment, value and reliability have always come before cost.

Lasting value

This value and reliability comes from higher rated components that loaf along at operating values. From human engineered front panel metering for immediate status of operating para-

eters. And from innovations such as the industry's first use of pre-correction to improve linearity and extend final tube life. And the industry's only remote interrogator. A complete translator/transmitter status monitor that reduces the number of trips and hours necessary to keep isolated installations operating efficiently.

Valuable support

But technology alone isn't the source of EMCEE reliability. It comes from the Applications and Field Engineering Departments that supply design, installation and total turnkey services without additional charges. It comes from the expertise of our tower crew. And it comes from our special inventory of emergency hardware and a 24-hour number that can help you solve small problems before they become bigger ones.

A fourth generation of reliability

The next generation of EMCEE low-power television equipment is now in the breadboard stage. Like the three previous generations, it won't be the least expensive hardware available.

Which leaves you with two choices. Pay the price of reliability when you buy. Or when your air monitor goes dead.

*It's not just how it works.
But how long it works.*



EMCEE
BROADCAST PRODUCTS

a division of
**ELECTRONICS, MISSILES
& COMMUNICATIONS, INC.**

P.O. Box 68
White Haven, PA 18661
Call toll free: 800-233-6193
(In PA: 717-443-9575)
TWX: 510-655-7088
Ans: EMCEE WHH

Equipment manufactured in U.S.A.
® EMCEE Broadcast Products
© 1982 EMCEE Broadcast Products

Circle (32) on Action Card

Delta Electronics
Elcom Bauer
Elcom Specialty Products
Geleco Electronics Ltd.
Harris Corporation, Broadcast
Products Division
McMartin Industries
Micro Communications
SWR
Scientific Radio Systems
TBC Pye Ltd.
Tennaplex Systems Ltd.
Thomson-CSF

VSWR UNITS

Bird Electronic
Coaxial Dynamics
Comark Communications
Continental Electronics Mfg.
Dielectric Communications
Dyma Engineering
Elcom Specialty Products
Electro Impulse Laboratory
Harris Corporation, Broadcast
Products Division
McMartin Industries
Micro Communications
Northland Communication
Rohde & Schwarz
SWR
Scientific Radio Systems
Shively Laboratories
TBC Pye Ltd.
Tennaplex Systems Ltd.
Thomson-CSF
Vidaire Electronics

WAVEGUIDES

AEL (American Electronic
Laboratories)
Andrew Corporation
Anixter-Mark
Antenna Technology
Antennas for Communications Inc.
Cablewave Systems
Comark Communications
Dielectric Communications
Gabriel Electronics Inc.
Grant Tower
LeBlanc & Royle
Communications, Inc.
Micro Communications
Narda Microwave Corp.
Nurad
Prodelin
SWR
UNR-Rohn

ANTENNA MASTS, ENG

Abroyd Construction
Copperweld Biometallics Group
Cortland Cable Co.
ENG Corp.
Harris Corporation
Kindwall Corp.
Kline Iron & Steel Co.
LeBlanc & Royle Communications
Allen Osborne Assoc.
Swagger Tower Corp.
TMD Div. - Will Burt
Tennaplex Systems Ltd.(82)
Wolf Coach Inc.

ANTENNAS, RECEIVING

EARTH TERMINAL DISHES

AEG-Telefunken
Andrew Corporation
Anixter-Mark
Antenna Technology
Antennas for Communications Inc.
Blonder-Tongue Laboratories
California Microwave
Comtech Antenna Corp.
Comtech Data
Conifer
Crowder Communications
Dyma Engineering
Fort Worth Tower
Gabriel Electronics
Gardner Communications
Grant Tower

Harris Corporation,
Broadcast Products
Hughes Aircraft Co.,
Microwave Comm. Products
Kathrein-Werke KG
Lang Video Systems
Lindsay Specialty Products
Marcom Communication Systems
Microdyne Corporation
Microwave Associates
Modulation Associates
Moseley Associates
NEC America, Broadcast
Equipment
Prodelin
SatCom Technologies
Scientific-Atlanta
SED Systems
Satcom, Inc.
Television Technology
TerraCom
Thomson-CSF
United States Tower

FM ANTENNA

AEG-Telefunken
Anderson Scientific
Anixter-Mark
Blonder-Tongue Labs
Cotel
Comark Communications
Elcom Specialty Products
The Finney Company
G.C. Electronics
Gorman Redlich Mfg. Co.
Grant Tower
Harris Corporation, Broadcast
Products Division
Johnson Electronics
Kathrein-Werke KG
LeBlanc & Royle
Communications Towers
Lindsay Specialty Products
McMartin Industries
Micro Communications
Phelps Dodge
Communications
Potomac Instruments
RMS Electronics
Rohde & Schwarz
Scala Electronic Corporation
Scientific-Atlanta
Sitco Antennas
Television Technology
Tennaplex Systems Ltd.
Tepco
Thomson-CSF
Vidaire Elect. Mfg.
Wilkinson Electronics
World Tower

MICROWAVE

AEG-Telefunken
Andrew Corporation
Anixter-Mark
Antenna Technology
Antennas for Communications
Bogner Broadcast Equipment
Don Britton Enterprises
Cablewave Systems
Conifer
Farinon
GTE Products Corp.
Gabriel Electronics
Harris Corporation, Broadcast
Products Division
Ikegami Electronics
Lang Video Systems
LeBlanc & Royle
Communications, Inc.
Micro Communications
Microwave Associates
Moseley Associates
Multitenna Corp. of America
Narda Microwave Corp.
NEC America
Nurad
Prodelin
RF Technology
Tayburn
Tennaplex Systems, Ltd.
Terracom
Texscan
Wilkinson Electronics
World Tower

MF ANTENNA

AEG-Telefunken
Grant Tower
LeBlanc & Royle
Communications Towers
G.E. McKay Co.
McKay Dymek Company
Thomson-CSF

REMOTE PICKUP

AEG-Telefunken
Anixter Mark
Antenna Technology
Belar
Gorman-Redlich
Grant Tower
Harris Corporation, Broadcast
Products Division
McMartin Industries
M/A-COM Video Systems
Martl
Moseley Associates
Motorola Communications
& Electronics
NEC America Inc.
Nurad
Phelps Dodge Communications
Company
RF Technology
Scala Electronic Corporation
Tayburn Electronics
Wilkinson Electronics

STL ANTENNA

AEG-Telefunken
Andrew Corporation
Anixter Mark
Cablewave Systems
Elcom Specialty Products
Gabriel Electronics
Harris Corporation, Broadcast
Products Division
Lindsay Specialty Products Ltd.
McMartin Industries
M/A-COM Video Systems
Micro Control Associates
Moseley Associates
NEC America Inc.
Nurad
Phelps Dodge Communications
RF Technology
Rockwell International
Scala Electronic Corporation
Tayburn Electronics
Wilkinson Electronics
World Tower

UHF ANTENNA

AEG-Telefunken
Andrew Corp.
Anixter-Mark
Blonder-Tongue Labs
Bogner Broadcast
Comark Communications
Conifer
Crowder Communications
EMCEE Broadcast Products
The Finney Company
G.C. Electronics
Gorman-Redlich
Kathrein-Werke KG
Lindsay Specialty Products
Micro Communications
Phelps Dodge Communications
Prodelin
RMS Electronics
Rohde & Schwarz
Scala Electronic Corporation
Scientific-Atlanta, Phoenix Div.
Sitco Antennas
John M. Sullivan Assoc., Inc.
TBC Pye Ltd.
Television Technology
Tennaplex Systems Ltd.
Thomson-CSF
Velec Sefat
Vidaire Electronics Mfg.

VHF ANTENNA

AEG-Telefunken
Barker & Williamson
Blonder-Tongue Labs
Bogner Broadcast
Conifer
Crowder Communications
EMCEE Broadcast Products
The Finney Company

G.C. Electronics
Gorman-Redlich
Grant Tower
Kathrein-Werke KG
Lindsay Specialty Products
Micro Communications
Phelps Dodge Communications
Potomac Instruments
RMS Electronics
Rohde & Schwarz
Scala Electronic Corporation
Scientific-Atlanta, Phoenix Div.
Sitco Antennas
John M. Sullivan Assoc., Inc.
Swintek Enterprises, Inc.
TBC Pye Ltd.
Television Technology
Tennaplex Systems Ltd.
Tepco
Thomson-CSF
Velec Sefat
Vidaire Electronics

ANTENNAS, TRANSMITTING

AM ANTENNAS

AEG-Telefunken
(Bayly Engineering)
Abroyd Construction
Allied Tower
Atlas Tower Cord
Barker & Williamson
Cetec Broadcast Group
Continental Electronics Mfg.
Cortland Cable Co.
Cosmin Electronics
Dyma Engineering
Elcom Specialty Products
Grant Tower
Harris Corporation, Broadcast
Products Division
Kathrein-Werke AG
Kline Iron & Steel Co.
LeBlanc & Royle
Communications, Inc.
McMartin Industries
Magnum Towers
Marconi Electronics, Inc.
Multiphase Consulting
Fred A. Nudd Corporation
Rockwell International
Stainless
Swagger Tower Corporation
TBC Pye Ltd.
Technology for Communications
International
Thomson-CSF
UNR-Rohn
United States Tower
Utility Tower
V & B Tower
Wilkinson Electronics
World Tower Company

AM DIRECTIONAL SYSTEMS

AEG-Telefunken
(Bayly Engineering)
Allied Tower
Atlas Tower Corp.
CSP Inc.
Cetec Broadcast Group
Continental Electronics Mfg.
Cosmin Electronics
Delta Electronics
Dyma Engineering
Elcom Specialty Products
Grant Tower
Harris Corporation, Broadcast
Products Division
Harrison Systems
LeBlanc & Royle
Communications Towers
McMartin Industries
Multiphase Consulting
Swagger Tower Corporation
TBC Pye Ltd.
Technology for Communications
International
Thomson-CSF
UNR-Rohn
V & B Tower
World Tower

Continued on page 56

**“I want a world-class camera
I can take a mile from the van,
and still get 57 dB S/N and
600-line resolution.”**

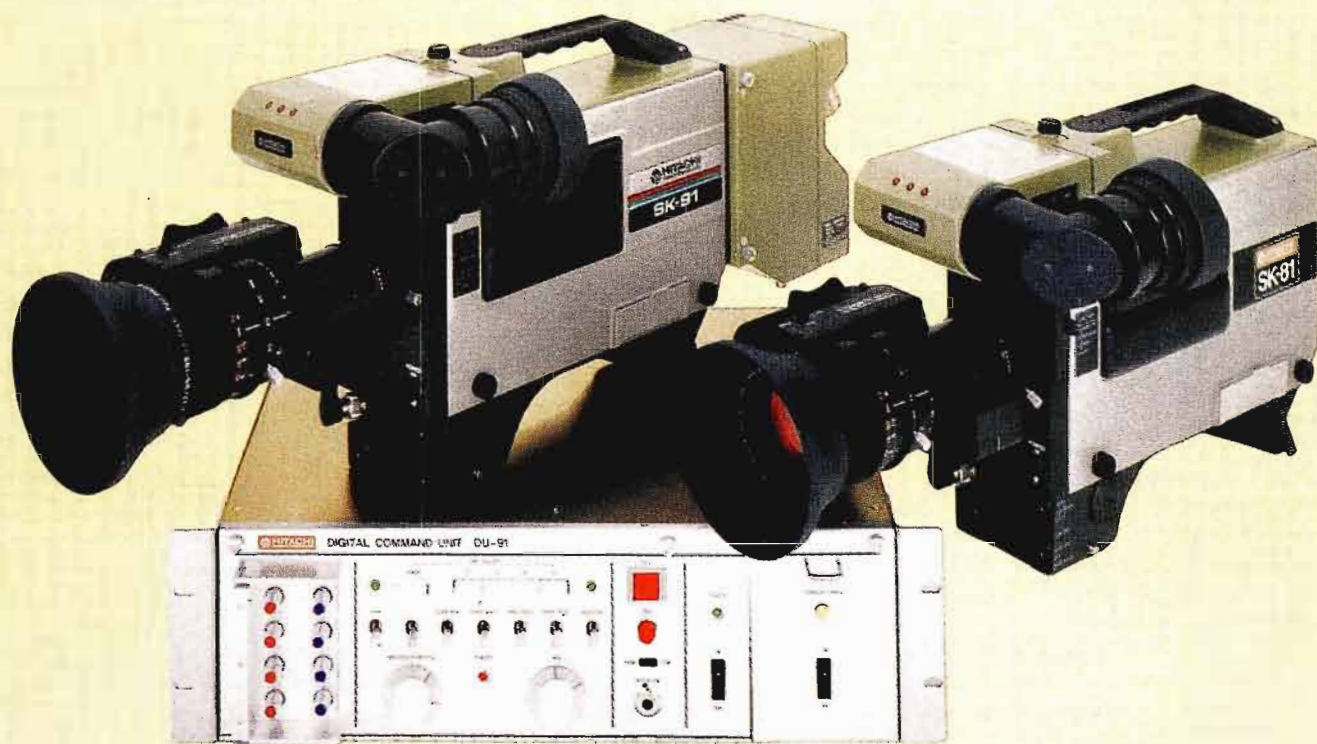

HITACHI HEARD YOU.

Then you're looking for broadcast-quality. Then you're looking for lightweight equipment you can carry unencumbered by anything but a lightweight triax cable.

Well, Hitachi heard you. Because now our Hitachi SK-91 and SK-81 can both be connected to our triax DU-91 Digital Command System by up to 6,000 feet of cable.

The SK-91 is an example of the lengths Hitachi will go to give you the camera your craft and courage demand. Though just 9.7 pounds, including its 1.5-inch viewfinder, this \$33,000 camera has been hailed as a bargain by perfectionists. And it's I.B.A. and C.B.C. accepted.

Its shock-mounted optical system—with Saticons® Plumicons® or Diode Guns®—gives you up to 57 dB S/N and 600-line resolution. All in an incredibly tough

magnesium alloy package.

It has an auto-iris closure. A +9/18 dB high-grain switch. Horizontal and vertical blanking widths adjustable over a wide range. An auto black balance control as well as an auto white balance control.

The SK-81 gives you just a shade less performance for \$22,000. The DU-91 at \$18,900 lets you get great pictures with either the SK-91 or SK-81 whether you're shooting at the low-light levels of a coal mine or going to the top of the world. Who from? Who else? Hitachi Denshi America, Ltd., 175 Crossways Park West, Woodbury, NY 11797. (516) 921-7200. Offices also in Chicago, Los Angeles, Atlanta, Cincinnati, Dallas, Denver, Seattle and Washington, D.C.

Circle (33) on Action Card

CIRCULARLY POLARIZED FM

AEG-Telefunken
Bogner Broadcast Equipment
Broadcast Electronics, Inc.
Cetec Antennas
Comark Communications
Continental Electronics Mfg.
Dielectric Communications
Dyma Engineering
Elcom Specialty Products
Harris Corporation, Broadcast Products Division
Kathrein Werke KG
McMartin Industries
Micro Communications
Phelps Dodge Communications
RCA Broadcast Systems
Rockwell International
Rohde & Schwarz
Shively Laboratories
Simplicity Tool Co.
Sitco Antennas
TBC Pye Ltd.
Tennaplex Systems Ltd.
Tepco
Thomson-CSF

CIRCULARLY POLARIZED TV

AEG-Telefunken
Andrew Corp.
Bogner Broadcast Equipment
Cetec Antennas
Harris Corporation, Broadcast Products Division
Kathrein Werke KG
Micro Communications
Nurad
RCA Broadcast Systems
SWR
Shively Laboratories
Sitco Antennas
TBC Pye Ltd.
Tennaplex Systems Ltd.
Thomson-CSF

EARTH TERMINAL DISHES

AEG-Telefunken
Andrew Corporation
Anixter-Mark
Antenna Technology
Antennas for Communications
Comtech Antenna Corp.
Crowder Communications
Gabriel Electronics
Gardiner Communications
Harris Corporation, Broadcast Products Division
Lang Video Systems
Microdyne Corp.
Microwave Associates
Moseley Associates
NEC America
Prodelin
SatCom Technologies
Standard Communications
Scientific-Atlanta
SED Systems
Thomson-CSF

MICROWAVE

AEG-Telefunken
Alford Mfg. Co.
Andrew Corporation
Anixter-Mark
Antenna Technology
Antennas for Communications Inc.
Bogner Broadcast Equipment
David H. Brothers, Co.
Cablewave Systems
Cetec Broadcast Group
Farinon Video/Harris Corp.
Gabriel Electronics
Harris Broadcast Microwave
Harris Corporation, Broadcast Products Division
Ikegami Electronics
LeBlanc & Royle
Communications Towers
Marcom Communication Systems
Micro Communications
Microdyne Corporation
Microwave Associates
Moseley Associates
Multitenna Corp. of America
NEC America
Narda Microwave Corp.
Nurad

Prodelin
RF Technology
Tayburn Electronics
Tennaplex Systems
TerraCom

MICROWAVE PORTABLE

AEG-Telefunken
Andrew Corp.
Anixter-Mark
Antenna Technology
ENG Helicopter Satellites Ltd.
Farinon Video/Harris Corp.
Harris Broadcast Microwave
Harris Corporation, Broadcast Products Division
Ikegami Electronics
M/A-COM Video Systems
Micro Communications Inc.
Moseley Associates
NEC America
Nurad
RF Technology
Tayburn Electronics
Tennaplex Systems Ltd.
TerraCom
Thomson-CSF

REMOTE FOR RADIO

AEG-Telefunken
Andrew Corp.
Anixter-Mark
Belar
Cetec Broadcast Group
Delta Electronics
Harris Corporation
McMartin Industries
Moseley Associates
Motorola
Rockwell International
Scala Electronic Corporation
Swager Tower Corporation
Swintek Enterprises
Wilkinson Electronics

STL

AEG-Telefunken
Andrew Corp.
Anixter Mark
Broadcast Electronics
Cablewave Systems
Cetec Broadcast Group
Continental Electronics Mfg.
Elcom Specialty Products
Gabriel Electronics
Grant Tower
Harris Broadcast Microwave
Harris Corporation, Broadcast Products Division
International Microwave Corp.
Lindsay Specialty Products Ltd.
McMartin Industries
M/A-COM Video Systems
Micro Control Associates
Moseley Associates
NEC America, Inc.
Nurad
Phelps Dodge Communications
RF Technology
Scala Electronic Corporation
Swager Tower Corporation
Tayburn Electronics
Tenaplex Systems Ltd.
Wilkinson Electronics
World Tower

TV UHF

AEG-Telefunken
AEL (American Electronic Laboratories)
Acrodyne
Alford Mfg. Co.
Andrew Corporation
Anixter-Mark
Bogner Broadcast Equipment
Cetec Antennas
Comark Communications
Crowder Communications
EMCEE Broadcast Products
The Finney Company
GTE Products Corp.
Harris Corporation, Broadcast Products Division
Kathrein-Werke AG
Larcam Communication Equipment
Lindsay Specialty Products
Marcom Communication Systems

Marconi
Micro Communications
Nurad
Phelps Dodge
Pye TVT
RCA Broadcast
Rohde & Schwarz
SWR
Scala Electronic
Scientific-Atlanta, Phoenix Div.
Shively Laboratories
Simplicity Tool
Sitco Antennas
TBC Pye Ltd.
Television Technology
Tennaplex Systems Ltd.
Thomson-CSF
Townsend Associates
Velec Sefat

TV VHF

AEG-Telefunken
AEL (American Electronic Laboratories)
Acrodyne
Alford Mfg. Co.
Anixter-Mark
Bogner Broadcast Equipment
Cetec Antennas
Comark Communications
Crowder Communications
EMCEE Broadcast Products
The Finney Company
GTE Products Corp.
Harris Corporation
Kathrein-Werke AG
Larcam Communications Inc.
Marcom Communication Systems
Marconi Electronics, Inc.
Micro Communications
Nady Systems
Nurad
Phelps Dodge
Prodelin
Pye TVT
RCA Broadcast
Rohde & Schwarz
SWR
Scala Electronic
Scientific-Atlanta, Phoenix Div.
Shively Laboratories
Simplicity Tools
Sitco Antennas
TBC Pye Ltd.
Television Technology
Tennaplex Systems Ltd.
Tepco
Thomson-CSF
Townsend Associates
Velec Sefat

ARCHITECTURAL/ ACOUSTIC DESIGN & CONSTRUCTION

Jamieson and Associates
Frank Rees Associates

ATTENUATORS

AUDIO
ADM Technology
AEG-Telefunken
(Bayly Engineering)
Aphex Systems Ltd.
Audio Technology
Audionics
Audisar
Broadcast Audio Associates
Composite Video
Comprehensive Video Supply
Datatronix
Electro Controls
Electro Impulse
Electroline TV Equipment
Leader Instruments
Leader Broadcast Systems
McCurdy Radio Industries
NTP Electronik AIS
Georg Neumann GwBH
Orange County
Potomac Instruments
Potomac Marine & Aviation

ProTech Audio Corporation
Richard Sound Design
Roh Corporation
Sescom
Siemens AG Osterreich
Shalico
Shure Brothers
Spectra Sonics
Tech Labs
Tektronix
Television Specialist Inc.
Trompeter Electronics
Valley People
Waters Manufacturing

FIXED

AVA Electronics
Barker & Williamson
Bird Electronic
Electro Impulse
Electroline TV Equipment
The Finney Company
I T I Electronics, Inc.
Leader Broadcast Systems
Mu-Del Electronics
Narda Microwave Corp.
North Hills Electronics
RMS Electronics
Sescom, Inc.
Shalico
Spectra Sonics
TM Systems
Tech Labs
Tektronix
Television Specialist Inc.
Texscan Corp.
Trompeter Electronics
Whirlwind Music

IMPEDANCE MATCHING

AVL Digital
CSP Inc.
Electro Impulse, Inc.
Electroline TV Equipment
Geleco Electronics Ltd.
Leader Broadcast Systems
Marconi Instruments Ltd.
Micro Communications
Mu-Del Electronics
Narda Microwave Corp.
North Hills Electronics
Sescom
Shalico
Shure Brothers
Tech Labs
Tektronix
Texscan Corp.
VIZ Manufacturing
Valley People
Vidair Elec. Mfg.
Whirlwind Music

MICROWAVE

Electroline TV Equipment
Harris Corporation, Broadcast Products Division
Harris Corporation, PRD Electronics Div.
Marconi Instruments Ltd.
Moseley Associates
Narda Microwave Corp.
North Hills Electronics
Nurad
Television Specialist Inc.
Texscan Corp.
Wavetek Indiana

RADIO FREQUENCY (RF)

AVA Electronics
Bird Electronic
Compac
Development Corp.
Dielectric Communications
Electro Impulse, Inc.
Electroline TV Equipment
Harris Corporation - PRD Electronics, Div.
Jerrold Division, General Instrument Corp.
Magnavox CATV Systems, Inc.
Magnavox Cable Equipment
Marconi Instruments Ltd.
Merrill Cable Equipment Corp.
Moseley Associates
Mu-Del Electronics
Narda Microwave Corp.

Continued on page 58

Imagine The Features That Will Answer Your Present And Future Needs ... Then Call **Di-Tech**

Audio/video routing switchers come in many different shapes and sizes, offering a variety of features. Since your requirements change from year to year, shouldn't you select the one that fits today's budget AND can meet your present and future needs? Then try **Di-Tech**. We've got that small 4 x 1 matrix switcher and the 200 x 200 switchers. We've even got a selection of in-between sizes for audio only, video only or audio follow video with 1, 2 or 3 channels of audio per input.....

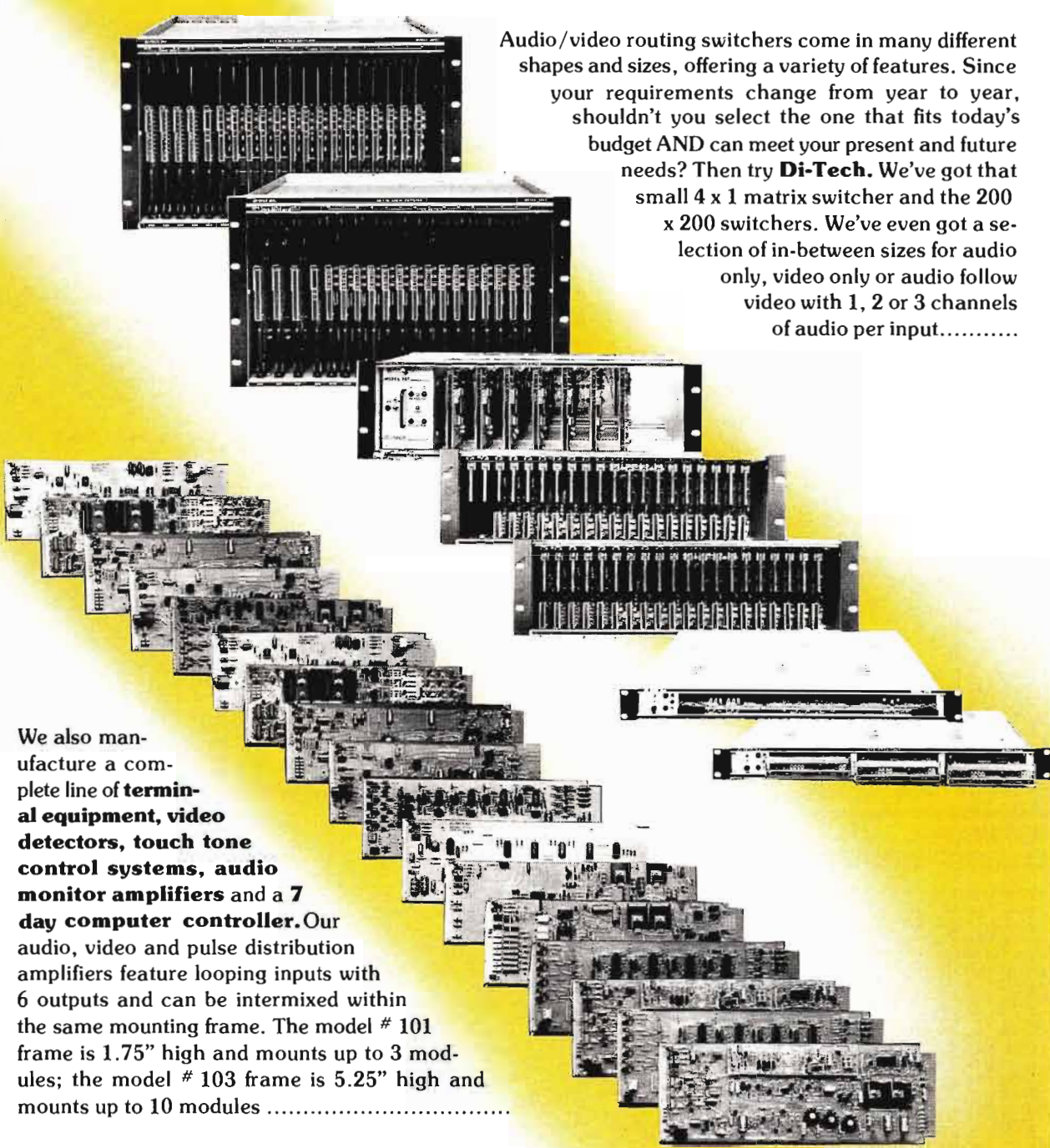

We also manufacture a complete line of **terminal equipment, video detectors, touch tone control systems, audio monitor amplifiers** and a **7 day computer controller**. Our audio, video and pulse distribution amplifiers feature looping inputs with 6 outputs and can be intermixed within the same mounting frame. The model # 101 frame is 1.75" high and mounts up to 3 modules; the model # 103 frame is 5.25" high and mounts up to 10 modules

Whatever your present or future needs are, call **Di-Tech** for the high quality, reliable, easy-to-operate answer.



di-tech

our **NEW**, bigger location:
48 JEF RYN BOULEVARD
DEER PARK, N.Y. 11729
TEL. # (516) 667-6300

Circle (34) on Action Card

North Hills Electronics
RHG Electronics
Rohde & Schwarz
Sadeco, Inc.
Tech Labs
Television Specialist Inc.
Texscan Corp.
Thomson-CSF
Trompeter Electronics
Triple Crown Electronics
Wavetek Indiana

VIDEO

AVA Electronics Corp.
AVL Digital
Aphex Systems
Comprehensive Video Supply
Electroline TV Equipment
Harris Corporation, PRD
Electronics
North Hills Electronics
Rohde & Schwarz
Shallco
Tech Labs
Tektronix
Television Specialist Inc.
Vidaire Electronics Mfg. Corp.

AUTOMATED REMOTE CONTROLS

American Data
Audio Kinetics
Don Britton Ent.
CAT Systems
Channelmatic
Cox Data Services
Delta Electronics
Dynair Electronics
Dynamic Technology Ltd.
Hallikainen & Friends
Harris Corporation, Broadcast
Products Division
Image Video Limited
Key Video Ltd.
M/A-COM Video Systems
The Management
Moseley Associates
Potomac Instruments
ProTech Audio
Rank Cintel Ltd.
Recortec Inc.
Scientific-Atlanta
Teknekron Controls
Telcom Research
Thomson-CSF
Video Specialties
Video Tape Systems
Vital Industries

AUTOMATION CONTROLS & SYSTEMS

ATS SYSTEMS

Asaca/Shibasoku
Broadcast Electronics
Consolidated Electronics Ind.
Delta Electronics
Hallikainen and Friends
Harris Corporation, Broadcast
Products Division
McMartin Industries
Moseley Associates
Multiphase Consulting
Potomac Instruments
ProTech Audio
QEI Corp.
Sharepoint Systems
TFT Inc.

BUSINESS SYSTEMS & SERVICES

Automated Business Concepts
Automation Electronics, Inc.
BIAS / Data
BIC Computers
Bonneville Data Systems
Cetec Broadcast Group
Chase Media
Columbine Systems
Computer Business Systems
Computer Concepts

Computer Management Systems
Consolidated Electronic Ind.
Cox Data Services
Custom Business Systems, Inc.
Data Communications Corp.
Groton Computer
Harris Corporation, Broadcast
Products Division
IGM Communications
Jefferson Data Systems
Jenel Corp. Consulting Engineers
Kaman Sciences
The Management
Marketron
Matrix Information Systems
NEAS
Nidus Broadcast Systems
Printer Terminal Communications
Corp.
Research Technology Int'l.
Radio Computing Services
Solid State Logic
Station Business Systems

CART SYSTEM, RANDOM SELECT, AUDIO

Autogram
Automated Broadcast Controls
Broadcast Electronics
David H. Brothers, Co.
Central Dynamics Ltd.
Cetec Broadcast Group
Consolidated Electronic Industries
Deltamod
Harris Corporation, Broadcast
Products Division
IGM Communications
International Tapetronics
MacKenzie Laboratories
Microprobe Electronics Inc. (MEI)
Nidus Broadcast Systems
Sono-Mag
UMC Electronics
UREI
VIF International
Vital Industries

CART SYSTEM, RANDOM SELECT, VIDEO

Automatic Techniques
Robert Bosch GmbH
Central Dynamics
Fernseh Inc.
NEAS
RCA Broadcast
Recortec
UREI
Vital Industries

DATA PROCESSING

Automated Business Concepts
Automation Electronics, Inc.

BIAS / Data
BIC Computers
Bonneville Data Systems
Central Dynamics Ltd.
Cetec Broadcast Group
Chase Media, Inc.
Columbine Systems, Inc.
Computer Concepts
Computer Management Systems
Cox Data Services
Custom Business Systems, Inc.
Data Communications
Fernseh
Groton Computer, Inc.
Jefferson Data Systems
Kaman Sciences
McInnis-Skinner & Assoc.
The Management
Marcom Communication Systems
Matrix Information Systems
NEAS
Nidus Broadcast Systems
Radio Computing Services
Station Business Systems
TVNS
Telesource Communication
Services
Weatherscan International

LIGHTING

(See *Lighting Controls & Services*)
Berkey Colortran
Dynamic Technology Ltd.
Electronics Diversified, Inc.
Kliegl Bros.

Leedal
Matthews Studio Equipment
Panoak Lighting Systems
SSAC Inc.
Skirpan Lighting Control Corp.
Strand Century

LOGGING

American Data
Autogram Corp.
Automated Broadcast Controls
Broadcast Electronics
David H. Brothers Co.
Cat Systems
Central Dynamics Ltd.
Cetec Broadcast Group
Channelmatic
Chase Media, Inc.
Columbine Systems Inc.
Computer Management Systems
Computer Systems
Consolidated Electronic Ind.
Data Communications Corp.
Dynamic Technology Ltd.
Elektrolmpex
Hallikainen and Friends
Harris Corporation, Broadcast
Products Division
IGM Communications
Kudelski SA Switzerland
The Management
Marketron, Inc.
Matrix Information Systems
Moseley Associates
NEAS
Neal Ferrograph (USA) Inc.
Nidus Broadcast Systems
Potomac Instruments
QSI Systems
Sono-Mag
Station Business Systems
TFT
Telcom Research
Telex Communications
Vital Industries

MASTER CONTROL, CUSTOM

Image Video Ltd.

PROGRAM CONTROL, AUDIO

Amek TAC
American Data
Basys Inc.
Don Britton Enterprises
Broadcast Electronics
David H. Brothers, Co.
C-M-C Technology Corp.
Central Dynamics Ltd.
Century 21 Programming
Cetec Broadcast Group
Channelmatic
Consolidated Electronic Industries
Michael Cox
Crosspoint Latch
Data Communications Corp.
Deltamod
Di-tech
Elektrolmpex
Grass Valley
Harris Corporation, Broadcast
Products Division
Harrison Systems
IGM Communications
Image Video Limited
Kintek
McCurdy Radio Industries
The Management
Marcom Communication Systems
Microprobe Electronics
Modulation Associates
NEAS
Rupert Neve
Nidus Broadcast Systems
Orban Associates
Pro Tech Audio
Quad-Eight Electronics
Rivers Associates
Rohde & Schwarz
Siemens AG Osterreich
Sharepoint Systems
Solid-State Logic
Sono-Mag
Standard Telephone UND Radio
AG
Station Business Systems
VIF International
Video Specialties

Video Tape Systems
Vital Industries

PROGRAM CONTROL, VIDEO

American Data
AVL Digital Ltd.
BFE KG
Basys, Inc.
Robert Bosch GmbH
Don Britton Ent.
C-M-C Technology Corp.
Central Dynamics Ltd.
Channelmatic
Michael Cox
Crosspoint Latch
Data Communications Corp.
Di-tech
Dynamic Technology Ltd.
Grass Valley Group
Image Video Limited
Industrial Sciences Inc. (ISI)
Javelin Electronics
Marcom Communication Systems
Microtime
NEAS
Panasonic Video Systems
Panoak Lighting Systems
Rohde & Schwarz
Siemens AG Osterreich
Station Business Systems
Tech Electronics
Torpy Controls & Engineering
Video Aids of Colorado
Video Specialties
Video Tape Systems
Videomedea
Vital Industries

PROJECTOR / FILM CHAIN CONTROL

American Data
Central Dynamics Ltd.
Cox Data Services
Data Communications Corp.
Fernseh
Grass Valley
Kaitronics Corp.
NEAS
RCA Broadcast Systems
Rank Cintel
Vital Industries

REEL-TO-REEL CONTROLLER

American Data
Audio Kinetics
The BTX Corporation
Broadcast Electronics
C-M-C Technology Corp.
Central Dynamics Ltd.
Cetec Broadcast Group
Consolidated Electronic Industries
Cox Data Services
Data Communications Corp.
IGM Communications
Leader Broadcast Systems
The Management
Microprobe Electronics
NEAS
PWH Electronics Limited
ProTech Audio
Rivers Associates
Solid-State Logic
Sono-Mag
Studer ReVox America
John M. Sullivan Associates
Tape-Athon / Cavox Stereo Prod.
United Research Lab
VIF International
Vital Industries

BATTERIES & ACCESSORIES

BATTERY BELTS

Adwar Video
Alexander Mfg. Co.
Anton/Bauer
Calvert Electronics
Christie Electric
Cine 60
Cinema Products
Comprehensive Video Supply
Frezzolini Electronics
Kapco Communications

Continued on page 60

40 to 1

Canon PV40 x 13.5B IE: THE OLYMPIAN

Canon moves you a giant step forward with a 40X broadcast quality zoom lens. An incredible new lens that allows you to cover a stadium at wide angle or fill the frame with the quarterback's eyes.

Never before has a single lens provided this much flexibility and sensitivity, with remarkably little change in effective aperture throughout its entire 13.5mm-540mm* range. Built-in extenders let you go all the way to 1080mm and each lens is diascoped-equipped for modern microprocessor-



controlled cameras.

We call it The Olympian. Not only because it is ideally suited for sports coverage but also because of the dedication and team effort required of our optical and electronic engineers in making this lens a reality.

Enlarge a dollar bill forty times and it covers an area twenty feet long and eight feet wide. Now think about what you could do with the Canon PV 40 x 13.5B IE!

*1" cameras. Also available in 30mm plumbicon.



Canon®

Optics Division

Canon USA, Inc., Head Office: One Canon Plaza, Lake Success, N.Y. 11042 (516) 488-6700

Dallas Office: 11311 Stemmers Freeway, Suite 1, Dallas, Texas 75229 (214) 620-2641 Chicago Office: 140 Industrial Drive, Elmhurst, Ill. 60126 (312) 833-3070

West Coast Office: 123 Paularino Avenue East, Costa Mesa, Ca. 92626 (714) 979-6000

Canon Canada, Inc., 3245 American Drive, Mississauga, Ontario L4V1B8, Canada (416) 678-2730

© 1982 Canon U.S.A., Inc.

Circle (35) on Action Card

Nalpak Sales
One Pass Video
Optical & Textile
PAG Group
Panasonic
Panoak/Ba Lighting Systems
Perrott Engineering
Portable Energy Products
Strand Century
Swintek Enterprises, Inc.
Tascam
Videomedia
Yardney

BATTERY CHECKER

Perrott Engineering

BATTERY PACKS / ENG

Alexander Mfg. Co.
Anton / Bauer
Calvert Electronics
Christie Electric Corporation
Cine 60 Inc.
Cinema Products
Comprehensive Video Supply
Film / Video Equipment
Frezzolini
Gould, Inc.
Harris Corporation, Broadcast
Products Division
Ikegami Electronics
Kapco Communications
Microwave Associates
Multiplier Industries
Nalpak Sales
One Pass Video
Optical & Textile
PAG Group
Panasonic
Perrott Engineering Labs
Portable Energy Products
Sharp Electronics
Sony Corporation of America
U.S. JVC Corporation
Videomedia
Yardney Electric

BATTERY PACKS / LIGHTING

Adwar Video
Alexander Mfg. Co.
Anton / Bauer
Walter S. Brewer Co.
Calvert Electronics
Christie Electric Corporation
Cine 60 Inc.
Cinema Products
Comprehensive Video Supply
Film / Video Equipment
Frezzolini Electronics
Gould, Inc.
Harwood Mfg. Co.
Kapco Communications
LTM Corporation of America
Multiplier Industries Corp.
Nalpak Sales
Panoak/B-W Lighting Systems
One Pass Video
Optical & Textile
PAG Group
Panasonic
Panoak Lighting Systems
Perrott Engineering Labs
Portable Energy Products
Smith - Victor Sales Corp.
John M. Sullivan Associates
Teledyne Big Beam
Videomedia
Yardney

BATTERY CHARGERS

Alexander Manufacturing
Anton / Bauer
Beyer Dynamic
Brabury Electronics Ltd.
Calvert Electronics
Christie Electric Corporation
Cine 60 Inc.
Cinema Products
Cinetronics
Comprehensive Video Supply
Dynamote
Farinon Video/Harris Corp.
Film / Video Equipment
Frezzolini Electronics
G.C. Electronics
Gould Inc.
Harris Corporation, Broadcast
Products Division

Harwood Mfg., Co.
Ikegami Electronics
Kapco Communications
M/A-COM Video Systems
Multiplier Industries
Nalpak Labs
Panoak/B-W Lighting Systems
North Wind Power Co.
One Pass Video
Optical & Textile
PAG Group
Panasonic
Perrott Engineering Labs
Portable Energy Products
Sharp Electronics
Sony Corporation of America
John M. Sullivan Associates
Swintek Enterprises
Teledyne Big Beam
Vanner Inc.
U.S. JVC Corporation
Videomedia
Yardney

BATTERY PACK/ TEST INSTRUMENT

Tektronix

BLOWERS & FANS

Amco Engineering Co.
Bud Industries
Comark Communications
Electro Impulse Laboratory, Inc.
Ripley Co.
Stantron Division / Wyco Metal
Products
Winsted Corp.

BRIDGES, COMMON POINT

CSP Inc.
Continental Electronics Mfg.
Delta Electronics
Harris Corporation, Broadcast
Products Division
Potomac Instruments
Texscan Corp.

BUZZ TONE ELIMINATORS

Merlin Engineering
Orange County
John M. Sullivan Associates

CABINETS, CONSOLES, & EQUIPMENT RACKS

A&S Case Co. Inc.
AEG-Telefunken
(Bayly Engineering)
Advance Products
Amco Engineering
Anvil Cases
Auidix Limited
Brabury Electronics Ltd.
Broadcast Electronics, Inc.
Bud Industries
Calzone Case Co.
Cases Inc.
Centro
Cetec Broadcast Group
Compac Development Corp.
Dell Technical Vehicles
Dyma Engineering
Electro Acoustics Designs
Emcor Products
Enclosure Corp.
Environmental Container
Systems
Equipto
Fiberbill
Forecast Media Installations
GKM Manufacturing
GTE Products Corp.

Grinnan Fixtures
HSC Inc.
Hammond Industries
Harris Corporation, Broadcast
Products Division
IGM Communications
Javelin Electronics
Leedal
Lee-Ray Industries
McCurdy Radio Industries
Micro-Trak
Neumade Products
Paso Sound Products
ProTech Audio
Rack Techniques
Research Technology Int'l.
Ruslang Corp.
Sait Electronics
Scientific-Atlanta,
Optima Division
Shintron
Spectra Sonics
Stantron Division, Wyco
Metal Products
Thermodyne International Ltd.
Thomson-CSF
Wallach & Associates
Winsted
Vector Electronic

CABLE & ACCESSORIES & SERVICES

AUDIO CABLE
AEG-Telefunken
Alpha Wire Corporation
Audicon, Inc.
Bi-tronics
Boston Insulated Wire & Cable
Brand-Rex
Broadcast Electronics
David H. Brothers Co.
Cinetronics
Comprehensive Video Supply
Connect-Air International
Daburn Electronics & Cable
Dyma Engineering
Elektrolmplex
Emcor Products
G.C. Electronics
Galite
Hammond Industries
Harris Corporation, Broadcast
Products Division
Hartley Products
Javelin Electronics
Leader Broadcast Systems
McCurdy Radio Industries
McMartin Industries
Marshall Electronics
Miles Associates, Div. Miles Air
Products Ltd.
Mohawk Wire & Cable Corp.
Georg Nuemann GwBH
PAG Group
Pirelli Cable Corp.
RMS Electronics
Rockwell International
Rohde & Schwarz
Scientific-Atlanta
Sescom, Inc.
Shure Brothers
Spectra Sonics
John M. Sullivan Associates
Tascam
Teac Corp. of America
Times Fiber Communications
Vidaire Electronics Mfg.
Wireworks Corporation

CABLING & WIRING SERVICES

AEG-Telefunken
A.F. Associates
AVA Electronics
Audicon
Audio Accessories
Boston Insulated Wire & Cable
Brabury Broadcast Systems
Brand-Rex
Cinetronics
Connect-Air International
Crow of Reading Ltd.
Daburn Electronics & Cable
Dell Technical Vehicles

Dynamic Technology Ltd.
Ear Systems Inc.
East Coast Video
Edcor
Electro - Acoustic Designs
Emcor Products
G.C. Electronics
GTE Products Corp.
Galite
Graham-Patten Systems
Image Devices Incorporated
McCurdy Radio Industries
Marshall Electronics
Fred Nudd Corporation
PAG Group
Pirelli Cable Corp.
ProTech Audio
Radiotechniques
Rex Rheostat & Co., Inc.
Sait Electronics
Scientific-Atlanta
Spectra Sonics
Thomson-CSF
Union Connector Co.
Whirlwind Music

CAMERA CABLE

AEG-Telefunken
Artel Communications Corp.
Bi-tronics
Robert Bosch GmbH
Boston Insulated Wire & Cable
Brand-Rex
Comprehensive Video Supply
Connect-Air International
Crow of Reading Ltd.
Daburn Electric & Cable Corp.
Emcor Products
G.B.C.
Galite
Harris Corporation, Broadcast
Products Division
Ikegami Electronics
Image Devices Incorporated
Javelin Electronics
Marshall Electronics
Mohawk Wire & Cable Corp.
PAG Group
Panasonic
Pirelli Cable Corp.
RMS Electronics
John M. Sullivan Associates
Thomson-CSF
Times Fiber Communications
Videomedia

COAX, FLEXIBLE

AEG-Telefunken
AVA Electronics
Alpha Wire
Andrew Corp.
Anixter-Mark
Belden
Bi-tronics
Blonder - Tongue Labs, Inc.
Robert Bosch GmbH
Boston Insulated Wire & Cable
Brand-Rex
Broadcast Electronics, Inc.
David H. Brothers, Co.
CCS Cable
CSP Inc.
Cableware Systems
Compac
Comprehensive Video Supply
Connect-Air International
Continental Electronics Mfg.
Crow of Reading Ltd.
Daburn Electronics & Cable
Emcor Products
The Finney Company
Gabriel Electronics
Harris Corporation, Broadcast
Products Division
Image Devices Incorporated
Javelin Electronics
LeBlanc & Royle Communications
McMartin Industries
M/A-COM Video Systems
Marshall Electronics
Micro Communications
Micro Control Associates
Mohawk Wire & Cable Corp.
Nurad
PAG Group
Phelps Dodge Communications

Continued on page 62

The brightness you need to show it big

General Electric (U.S.A.)* Professional Large Screen Video Projection

With General Electric's (U.S.A.) exclusive sealed light valve and sealed Xenon lamp system, in both color and monochrome General Electric (U.S.A.) Professional Large Screen Video Projectors, you can depend on sharp pictures from 2 to 25 feet wide. New high brightness models allows the room lighting viewers need to take notes and refer to written material.

The color projectors reproduce every color accurately, with the convenience of inherent color registration. General Electric's (U.S.A.) exclusive single gun, single optical path light valve system eliminates the need for manual color convergence.

Portable and flexible, the projectors are being used for a wide variety of applications, including front and rear projection. Our applications experts will tell you whether yours can be added to the growing list, which includes:

Education: Medical, dental, engineering, computer science instruction.

Business: Sales meetings, industrial training, product presentations, real-time display of computer-generated data, teleconferences.

Aerospace and Defense: Situation displays, simulator training.

Entertainment: Theatre television, closed-circuit TV events, overflow crowds, special effects.

Television Production: Backgrounds for news programs, special effects, data display, program previewing.

Call or write: General Electric Company (U.S.A.), Video Display Equipment Operation, Electronics Park 6-206, Syracuse, NY 13221 U.S.A., Phone: (315) 456-2152.



NEWS BACKGROUND at WTMJ-TV, Milwaukee, is displayed rear screen by General Electric (U.S.A.) projector.

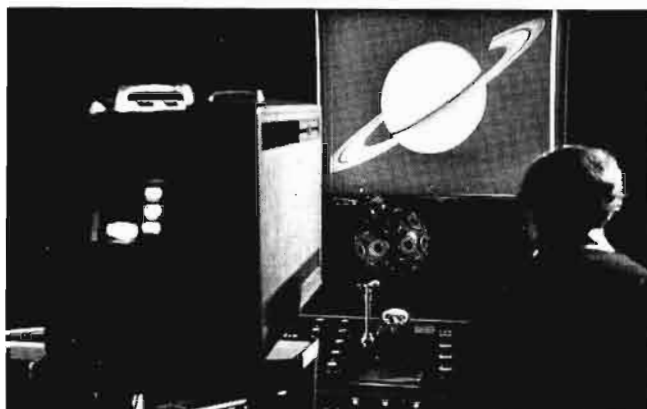

SELL-OUT CROWDS at Fiske Planetarium, Boulder, watched live NASA transmission presented by General Electric (U.S.A.) projector.

GE (U.S.A.) Professional Large Screen Television Projector Specifications

COLOR PROJECTORS

Model	Light Output in Lumens			Resolution* in TV Lines per Picture Height		Input Power Req.		Scan Standards***	Video Input**
	Open Gate, Min.	Modulated TV, Min.	Modulated TV, Typ.	Min. Horiz.	Min. Vert.	Watts	Volt-Amps.		
PJ 5000	550	220	280	750	300	1200	1600	525 li./60 fps; 625 li./50 fps	(1)
PJ 5050	1250	500	650	750	300	1600	2150	525 li./60 fps; 625 li./50 fps	(1)
PJ 5800	550	200	280	750	600	1200	1600	875 lines, 60 fps	(2)
PJ 5850	1250	500	650	750	600	1600	2150	875 lines, 60 fps	(2)
PJ 5100	550	200	280	750	650	1200	1600	1023 lines, 60 fps	(2)
PJ 5150	1250	500	650	750	650	1600	2150	1023 lines, 60 fps	(2)

MONOCHROME PROJECTORS

PJ 7000	1000	600	750	800	400	1000	1350	525 li./60 fps; 625 li./50 fps	(3)
PJ 7050	1700	1000	1250	800	400	1000	1350	525 li./60 fps; 625 li./50 fps	(3)
PJ 7055	3300	2000	2400	800	400	1500	2000	525 li./60 fps; 625 li./50 fps	(3)
PJ 7800	1000	600	750	800	650	1000	1350	875 lines, 60 fps	(3)
PJ 7850	1700	1000	1250	800	650	1000	1350	875 lines, 60 fps	(3)
PJ 7855	3300	2000	2400	800	650	1500	2000	875 lines, 60 fps	(3)
PJ 7100	1000	600	750	800	750	1000	1350	1023 lines, 60 fps	(3)
PJ 7150	1700	1000	1250	800	750	1000	1350	1023 lines, 60 fps	(3)
PJ 7155	3300	2000	2400	800	750	1500	2000	1023 lines, 60 fps	(3)

Line Power, All Projectors: 117 or 240 v., $\pm 10\%$, 50/60 Hz

*Resolution measurements made with wide-band video input.

**Video Input Key: (1) NTSC or RGB. (2) RGB. (3) Wide-Band.

***For use at other scanning rates, contact General Electric (U.S.A.) (VDEO) for special application/model information.

GENERAL  **ELECTRIC**
U.S.A.

*Not connected with the English company of a similar name.

Circle (36) on Action Card

Pirelli Cable Corp.
 Prodelin, Inc.
 RMS Electronics
 Scala Electronic Corp.
 Scientific-Atlanta
 John M. Sullivan Associates
 Tascam
 Tepco
 Thomson-CSF
 Times Fiber Communications
 Times Wire & Cable
 Trompeter Electronics
 Utility Tower
 Videomedia
 Whirlwind Music
 Wilkinson Electronics

CONNECTORS

AKG Acoustics
 AMP Inc.
 AMP Special Industries
 AVA Electronics
 Adwar Video
 Alpha Wire
 Andrew Corp.
 Anixter-Mark
 Bardwell & McAlister
 Bayly Engineering
 Blrd Electronic
 Blonder - Tongue Labs, Inc.
 Boston Insulated Wire & Cable
 Broadcast Electronics
 CSP Inc.
 Cablewave Systems
 Cambridge Products Corp.
 Ceco Communications
 Comark Communications
 Compac Development Corp.
 Comprehensive Video Supply
 Connect-Air International
 Continental Electronics Mfg.
 Daburn Electronics & Cable
 Emcor Products
 Gilbert Engineering
 G.C. Electronics
 GTE Products Corp.
 Galite
 The Finney Company
 Harris Corporation, Broadcast
 Products Division
 Image Devices Incorporated
 Javelin Electronics
 Jerrold Division, General
 Instrument Corp.
 Kings Electronics
 LRC Electronics
 LTM Corporation of America
 LeBlanc & Royle Communications
 McMartin Industries
 Magnavox CATV Systems
 Marconi Instruments Ltd.
 Marshall Electronics
 Micro Communications
 Micro Control Associates
 Millen Components
 Mohawk Wire & Cable
 Neutrik Products
 Nurad
 PAG Group
 Panoak Lighting Systems
 Phelps Dodge Communications
 Pirelli Cable Corp.
 Prodelin
 Pyramid Industries
 RMS Electronics
 SGL Waber Electric
 Switchcraft
 Tascam
 Tepco Corp.
 Thomson-CSF
 Trompeter Electronics
 Union Connector
 VIZ Manufacturing
 Vidaire Electronics Mfg.
 Whirlwind Music

FIBER OPTIC CABLES

AEG-Telefunken
 Artel Communications
 Andrew Corporation
 Robert Bosch GmbH
 Boston Insulated Wire & Cable
 Brand-Rex
 Connect-Air International
 Delta Systems
 Emcor Products
 Foundation Electronic Instruments
 Galite

LaCroy Research Systems
 M/A-COM Video Systems
 Mohawk Wire & Cable
 Moseley Associates
 NEC America, Broadcast
 Equipment
 Pirelli Cable Corp.
 Thomson-CSF
 Times Fiber Communications
 Valtec Corporation

GUY WIRES

(See Also Towers & Accessories)
 Abroyd Construction
 Allied Tower
 Copperweld Bimetallics Group
 Cortland Cable Co.
 Emcor Products
 G.C. Electronics
 Image Devices Incorporated
 LeBlanc & Royle Communications
 Fred Nudd Corporation
 Philadelphia Resins
 RMS Electronics
 Thomson-CSF
 UNR-Rohn
 Utility Tower
 VIF International
 World Tower

HEAVY DUTY, AC / DC POWER

AEG-Telefunken
 Alpha Wire Corp.
 California Instruments
 Cine 60 Inc.
 Daburn Electronics & Cable
 Emcor Products
 Galite
 Pirelli Cable Corp.
 Tech Theatre Inc.
 Thomson-CSF
 Transector Systems

MICROPHONE CABLE

AEG-Telefunken
 AKG Acoustics
 AKG Akustische u. Kino-Gerate
 Alpha Wire
 Audio-Technica US Inc.
 Beyer Dynamics
 Bi-tronics
 Brand-Rex
 Broadcast Electronics
 David H. Brothers Co.
 Comprehensive Video Supply
 Connect-Air International
 Daburn Electronics & Cable
 Dyma Engineering
 Emcor Products
 G.C. Electronics
 Galite
 Hammond Industries
 Harris Corporation, Broadcast
 Products Division
 McMartin Industries
 Marshall Electronics
 Miles Associates, Div. Miles Air
 Products Ltd.
 Mohawk Wire & Cable Corp.
 Georg Neumann GwBH
 Panasonic
 Pirelli Cable Corp.
 Shure Brothers
 John M. Sullivan Associates
 Tascam
 Teac Corp. of America
 Telex Comm. Inc.
 Vidaire Electronics Mfg.
 Wireworks Corporation

TRANSMISSION LINES, PRESSURIZED

AEG-Telefunken
 Andrew Corp.
 Anixter-Mark
 Antennas for Communications
 CSP Inc.
 Cablewave Systems
 Cetec Broadcast Group
 Comark Communications
 Continental Electronics Mfg.
 Copperweld Bimetallics Group
 Dielectric Communications
 Emcor Products
 Gabriel Electronics
 Harris Corporation, Broadcast
 Products Division
 LeBlanc & Royle Communications

McMartin Industries
 Micro Communications
 Moseley Associates
 Phelps Dodge Communications
 Pirelli Cable Corp.
 Prodelin
 S.W.R. Inc.
 Shively Laboratories
 Television Technology
 Thomson-CSF
 Wilkinson Electronics

CALIBRATION SERVICES

(See Test Equipment & Services)

CAMERA MOUNTS, CARRYING SYSTEMS & ACCESSORIES

AIRBORNE MOUNTING/STABILIZING
 Arriflex
 ENG Helicopter Satellites Ltd.
 Feathercam
 M/A-COM Video Systems

CARRYING SYSTEM
 Anvil Cases
 William Bai Corporation
 Calvert Electronics
 Cine 60 Inc.
 Cinema Products
 Feathercam
 Fiberbilt
 Harris Corporation, Broadcast
 Products Division
 Image Devices Incorporated
 Innovative Television
 K and H Products, Ltd.
 Lee-Ray Industries
 Listec TV Equipment

DOLLIES & TRIPODS
 Arriflex
 Bardwell & McAlister
 Calvert Electronics
 Calzone Case Co.
 Cinema Products
 Comprehensive Video Supply
 Davis & Sanford
 Elektrolimpex
 Elicon
 Feathercam
 Alan Gordon Enterprises
 Gruber Products
 Harris Corporation, Broadcast
 Products Division
 Karl Heltz Inc.
 ITE (Innovative
 Television Equipment)
 K & H Products
 Lee-Ray Industries
 Listec TV Equipment
 Matthews Studio Equipment
 Miller Professional Equipment
 O'Connor Engineering
 One Pass Video
 Optical & Textile Ltd.
 PAG Group
 Quick - Set
 Sachtler Corp. of America
 Smith-Victor
 Strand Century
 John M. Sullivan Associates
 Telescript
 Television Products Co.
 Triple SMFC Corp.

PAN & TILT HEADS
 Arriflex
 David H. Brothers Co.
 Calvert Electronics
 Cinema Products
 Cohu, Electronics Division
 Comprehensive Video Supply
 Davis & Sanford
 Electro & Optical Systems
 Elektrolimpex
 Elicon
 Feathercam, Inc.
 G.B.C.

Harris Corporation, Broadcast
 Products Division
 Karl Heltz, Inc.
 ITE (Innovative
 Television Equipment)
 Image Devices Incorporated
 Javelin Electronics
 KB Systems
 Listec TV Equipment
 Miller Professional Equipment, Inc.
 Motorola Communications
 and Electronics
 O'Connor Engineering Labs
 Optical & Textile Ltd.
 PAG Group
 Panasonic
 Peerless Sales
 Quick Set
 Sachtler Corp. of America
 Smith - Victor Sales Corp.
 John M. Sullivan Associates
 Tele-Cine
 Telescript

PEDESTALS
 Bardwell & McAlister
 Calvert Electronics
 Elektrolimpex
 Elicon
 Feathercam
 Harris Corporation
 ITE (Innovative
 Television Equipment)
 Lee Ray Industries
 Listec TV Equipment
 Matthews Studio Equipment
 O'Connor Engineering
 One Pass Video
 Sachtler Corp. of America
 Telescript
 Television Products Company

REMOTE CONTROLS
 A.F. Associates
 Bayly Engineering
 David H. Brothers, Co.
 Cinema Products
 Cinetronics
 Comark Communications
 Crow of Reading Ltd.
 Elicon
 Feathercam, Inc.
 Harris Corporation, Broadcast
 Products Division
 Image Devices Incorporated
 Javelin Electronics
 Listec TV Equipment
 M/A-COM Video Systems
 Motorola Communications
 and Electronics
 Panasonic
 Potomac Marine & Aviation
 Tele-Cine
 Videomedia

STABILIZED CARRYING SYSTEM
 Anvil Cases Inc.
 Arriflex
 Cinema Products
 Feathercam
 Image Devices Incorporated
 K and H Products Ltd.
 Lee Ray Industries
 M/A-COM Video Systems
 Tele-Cine

TEST CHARTS
 Porta-Pattern Telecommunications

CAMERA/RECORDER COMBINATION

Fernseh (Bosch)
 Hitachi
 Ikegami Electronics
 Panasonic
 RCA
 Sony Corp. of America

CAMERAS, FILM

Aaton Cameras
 Arriflex

Continued on page 64

Outstanding Outdoors

Camera location 3 behind home plate is no place to tear down a camera. Especially if the director wants to punch it up on air to catch the next pitch. That's just one reason why the rock-steady, works-every-time HK-357A is an outstanding choice for production in the field.

Beyond its reputation for legendary Ikegami reliability, the HK-357A has a lot more to recommend it as the ideal field camera. For example, its crisp, high resolution picture, signal-to-noise ratio of better than 53 dB, and superb colorimetry.

What's more the camera really shows off when it's time to set up. Use of the optional microproces-

sor control brings into play Ikegami's Emmy award-winning digital techniques for automatic setup. Simply press one button and the computer automatically refreshes all set up and registration adjustments in about 45 seconds. No chip charts blowing in the wind, no tweaking. Just unpack, plug-in, auto-setup, and shoot.

Hook up is a simple matter too. Choose the triax option and you can position the camera as far as a mile from the van with absolutely no compromise in picture quality as compared to multicore. And for versatility, our triax camera interfaces with TV-81 multicore at the flip of a switch.

Field test an HK-357A to see why Ikegami is the choice of so many networks, major market stations, and independent producers.



Ikegami HK357A

Ikegami Electronics (USA) Inc., 37 Brook Avenue
Maywood, NJ 07607; (201) 368-9171
Northeast: (201) 368-9171 West Coast: (213) 534-0050
Southwest: (713) 445-0100 Southeast: (813) 884-2046
Canada: (201) 368-9179
Circle (37) on Action Card



Cinema Products
Compro Productions
Feathercam
Fernseh
Frezzolini
G.B.C.
Alan Gordon Enterprises
Image Devices Incorporated
Team Electronics
Wide Range Electronics

CAMERAS, VIDEO

CCD
English Electric Valve
Fairchild CCD Imaging
NEC America, Broadcast
Equipment
Panasonic
Teknekron Controls
Thompson-CSF

CCTV
ATV Research
Adwar Video
Robert Bosch GmbH
David H. Brothers, Co.
Cinema Products
Cohu, Inc., Electronics Division
Commercial Electronics, Inc. (CEI)
Compro Productions
Dage-MTI
Elektroimpex
Fernseh
GBC Closed-Circuit TV
Hitachi Denshi American Ltd.
Ikegami
Javelin Electronics
Link Electronics
Motorola
Nytone Electronics Corp.
Oktel
Panasonic Video Systems
Philips Broadcast
RCA Broadcast Systems
Sharp Electronics
Thomson-CSF
Toshiba International
U.S. JVC Corporation
Video Masters
Westinghouse Electric

FILM CHAIN CAMERA
Adwar Video
Robert Bosch GmbH
Cinema Products
Cohu, Electronics Division
Fernseh
Harris Corporation, Broadcast
Products Division
Hitachi Denshi America
Ikegami
Image Devices Incorporated
Marconi Electronics
NEC America
Nytone Electronics
Philips Broadcast
RCA Broadcast Systems
Rank Cintel
Sharp Electronics
Thomson-CSF
Toshiba International
U.S. JVC Corporation

ENG / HANDHELD
Adwar Video
Ampex
Robert Bosch GmbH
CEI
Cinema Products
Fernseh
Frezzolini Electronics
Hitachi Denshi American Ltd.
Ikegami
Javelin Electronics
NEC America
Panasonic Video Systems
Philips Broadcast
Pye TVT
RCA Broadcast Systems
Sharp Electronics
Sony Corporation of America
Swintek Enterprises
Thomson-CSF Broadcast
Toshiba America
U.S. JVC Corporation

FIELD CAMERA
Ampex
Robert Bosch GmbH
CEI
Cinema Products
Fernseh
Harris Corporation, Broadcast
Products Division
Hitachi Denshi America
Ikegami
International Video Corp.
Link Electronics
Marconi
NEC America
Panasonic Video Systems
Philips Broadcast
Pye TVT
RCA Broadcast Systems
Sharp Electronics
Sony Corporation of America
Thomson-CSF Broadcast
Toshiba America
U.S. JVC Corporation

STUDIO CAMERA
Ampex
Robert Bosch GmbH
CEI
Cinema Products
Fernseh
Harris Corporation, Broadcast
Products Division
Hitachi Denshi America
Ikegami
International Video Corp.
Marconi Electronics
NEC America
Panasonic Video Systems
Philips Broadcast
Pye TVT
RCA Broadcast Systems
Sharp Electronics
Thomson-CSF Broadcast
Toshiba America
U.S. JVC Corporation

CAMERA, VIDEO DIGITAL REMOTE CONTROL SYSTEM

Anton/Bauer
Bayly Engineering
David H. Brothers Co.
Cinema Products

CAPACITORS, TRANSMITTING

BES Electronics
Calvert Electronics
Ceco Communications
Comad Communications
English Electric Valve
ITT Jennings
Mallory Capacitor
Surcom Associates
Thomson-CSF

CART MACHINES & SERVICES

SINGLE DECK
Amilon
Ampro/Scully
Audi-Cord
BASF Limited
Broadcast Electronics
Century 21 Programming
Cetec Broadcast Group
Consolidated Electronic Industries
Contel
Continental Electronics Mfg.
D - B Electronics
Elcom-Bauer
Harris Corporation, Broadcast
Products Division
IGM Communications
ITC/3M
International
Electro - Magnetics

International Tapetronics
Leader Broadcast Systems
Pacific Recorders
Ramko Research
Singer Products Company
Sono-Mag
Tapecaster TCM, Inc.
Telex Communications
UMC Electronics
UREI

DUAL DECK
Amilon
Ampro/Scully
Aristocart, Div. of Weston
Broadcasting
Audi-Cord
Broadcast Electronics
Century 21 Programming
Cetec Broadcast Group
Consolidated Electronic Ind.
D - B Electronics, Inc.
Harris Corporation, Broadcast
Products Division
IGM Communications
International
Electro-Magnetics
International Tapetronics
Leader Broadcast Systems
MacKenzie Laboratories
Ramko Research
Sono-Mag
UREI

TRIPLE DECK
Amilon
Ampro/Scully
Audi-Cord
Broadcast Electronics
Calico Video
Century 21 Programming
Cetec Broadcast Group
Consolidated Electronic Ind.
D - B Electronics
Harris Corporation, Broadcast
Products Division
IGM Communications
ITC/3M
International
Electro-Magnetics
International Tapetronics
Leader Broadcast Systems
MacKenzie Laboratories
Ramko Research
Singer Products Company
Sono-Mag
UMC Electronics

MULTIPLE DECK
Amilon
Audi-Cord
Broadcast Electronics
Century 21 Programming
Cetec Broadcast Group
Consolidated Electronic Ind.
D - B Electronics
Harris Corporation, Broadcast
Products Division
IGM Communications
International
Electro-Magnetics
MacKenzie Laboratories
Ramko Research
Sono-Mag
Tapecaster TCM, Inc.
UMC Electronics

RANDOM ACCESS
(See Also Automation Controls Audio)
Audi-Cord
Broadcast Electronics
Calico Video
Century 21 Programming
Cetec Broadcast Group
Consolidated Electronic Ind.
IGM Communications
International Tapetronics
Microprobe Electronics
Singer Products Company
Sono-Mag
UMC Electronics
VIF International

REBUILDING SERVICES
Aristocart
Audi-Cord
Audio Path

Broadcast Electronics
Century 21 Programming
Ear Systems Inc.
Harris Corporation, Broadcast
Products Division
IGM Communications
Leader Broadcast Systems
The Management
RCA Service Company
Tapecaster TCM, Inc.

RECORD ONLY
Century 21 Programming
Cetec Broadcast Group
Consolidated Electronic Ind.
Contel
Harris Corporation, Broadcast
Products Division
International Tapetronics
MacKenzie Laboratories
Pacific Recorders &
Engineering
Ramko Research
Tapecaster TCM
Telex Communications

STEREO
Ampro/Scully
Audi-Cord
Broadcast Electronics
David H. Brothers, Co.
Century 21 Programming
Cetec Broadcast Group
Consolidated Electronic Ind.
Continental Electronics
D - B Electronics
Harris Corporation, Broadcast
Products Division
IGM Communications
ITC/3M
International Tapetronics
MacKenzie Laboratories
The Management
Pacific Recorders & Engineering
Ramko Research
Tapecaster TCM, Inc.
Telex Communications
UMC Electronics

CARTRIDGES (TAPE), ACCESSORIES & SERVICES

ALIGNMENT TAPES
Aristocart, Division of
Weston Broadcasting
Broadcast Electronics, Inc.
Continental Recordings
Fidelipac Corp.
Harris Corporation
IGM Communications
Marathon Products Corp.
Nortronics
United Research Lab Corp.

DELAY CARTS
Broadcast Electronics
Capitol Magnetic Products
Cetec Broadcast Group
Consolidated Electronic Ind.
Continental Recordings
D - B Electronics
Fidelipac
3M Company, Magnetic
AV Products Division
Marathon Products
Procart
Tapecaster TCM, Inc.
Western Broadcasting

MONO CARTS
Aristocart
Broadcast Electronics
Capitol Magnetic Products
Century 21 Programming
Continental Electronics Mfg.
Consolidated Electronics Ind.
Continental Recordings
D - B Electronics
Fidelipac
Harris Corporation, Broadcast
Products Division
IGM Communications

Continued on page 66

Crosstown or cross country, call Calvert first.

You'll get the lowest price in America *and* overnight delivery.

TRANSMITTING TUBES

3B28 14.00	4CX350F 125.00	575A 29.00	6696A 2850.00
3CW20000A3 1480.00	4CX1000A 370.00	673 45.00	6697A 3000.00
3CW20000A7 1585.00	4CX1000K 502.00	805 65.00	ML7007A 3750.00
3CX1000A7 527.00	4CX1500A 584.00	807 8.50	7237A 553.00
3CX1500A7 465.00	4CX1500B 470.00	810 69.00	7527 130.00
3CX2500A3 432.00	4CX3000A 871.00	813 45.00	7527A 165.00
3CX2500F3 469.00	4CX5000A 1025.00	828 88.00	8008 18.00
3CX3000A1 432.00	4CX10000D 1175.00	833A 85.00	8122 98.00
3CX3000A7 601.00	4CX15000A 1500.00	833A (U.S.A.) 185.00	8791 375.00
3CX3000F1 516.00	4CX20000A 1495.00	866A 7.25	8791VI 387.00
3CX3000F7 610.00	4CX35000C 5525.00	866AX 38.00	8792 680.00
3CX10000A3 1130.00	4CX40000G 7075.00	872A 18.00	8792VI 690.00
3CX10000A7 1440.00	4X150A 50.00	4055VI 165.00	8806 2500.00
3CX10000U7 2045.00	4X500A 320.00	5762 545.00	8807 2660.00
3CX15000A3 1387.00	4-65A 65.00	5867A 135.00	8873 191.00
3CX15000A7 1340.00	4-125A 75.00	5879 4.80	8874 191.00
3CX20000A7 1873.00	4-250A 90.00	5924A 825.00	8875 191.00
3-400Z 90.00	4-400A 95.00	5933 19.00	8890 2600.00
3-500Z 99.00	4-400AX 165.00	6076 695.00	8891 3375.00
4CV35000A 2625.00	4-400B 130.00	6076A 650.00	8916 3375.00
4CX250B 57.00	4-400C 95.00	6146A 8.95	8976 2832.00
4CX250BC 71.00	4-500A 221.00	6146B 8.95	8977 2600.00
4CX250K 126.00	4-1000A 420.00	6155 75.00	8984 6300.00
4CX250R 95.00	5CX1500A 650.00	6156 90.00	8985 1650.00
4CX300A 184.00	5CX3000A 900.00	6161 550.00	8986 1275.00
4CX300Y 205.00	5-500A 260.00	6166A (7007) 2640.00	8988 2900.00
4CX350A 99.00	9C25 9200.00	6181 3486.00	9007 3800.00



GET 'EM WHILE THEY'RE HOT!

TEN OF THE MOST POPULAR TUBES NOW DISCOUNTED BELOW DISTRIBUTOR COST!

Limited to extent of inventory on hand.

TUBE	SALE PRICE	ADV. AT	DIST. COST	SUGG. RESALE
3CX1500A7	\$421.	\$465.	\$425.	\$574.
3CX2500A3	415.	432.	432.	583.
3CX3000A1	415.	432.	432.	583.
3CX3000F1	480.	516.	491.	663.
3CX15000A7	1325.	1340.	1340.	1675.
4CX1000A	345.	370.	365.	493.
4CX3000A	825.	871.	830.	1037.
4CX5000A	995.	1025.	1000.	1250.
4CX10000D	1015.	1069.	1200.	1500.
4CX35000C	5325.	5525.	5600.	7000.

RCA CAMERA TUBES

PART NO.	PRICE	PART NO.	PRICE	PART NO.	PRICE	PART NO.	PRICE
BC4390 series	1955.00	BC4592 series	2238.00	BC4992 series	2350.00	BC7735	240.00
BC4391 series	2222.00	BC4593R	2444.00	BC4993R	2555.00	BC8134	766.00
BC4392 series	2350.00	BC4594 series	2444.00	BC4994 series	2555.00	BC8134B	766.00
BC4393R	2555.00	BC4809	750.00	5820A/L	3295.00	8480	1350.00
BC4394 series	2555.00	BC4809B	750.00	7295C	2950.00	BC8480	1915.00
BC4396 series	2400.00	BC4908 series	1955.00	7389C	3050.00	BC8507	275.00
BC4532U	1375.00	BC4909	2050.00			BC8541	255.00

NEW CUSTOMERS—we accept telephone orders. Inquire about our convenient Net 30 terms. Prices and items subject to change or withdrawal without prior notice.

TOLL FREE EAST COAST **800-526-6362**

7 DAYS—24 HOUR EMERGENCY PHONE SERVICE

TOLL FREE WEST COAST **800-421-7549**

CALVERT ELECTRONICS, INC.

Circle (38) on Action Card **ONE BRANCA ROAD, EAST RUTHERFORD, NJ 07073**
800-526-6362 • 201-460-8800 • TWX 710-989-0116/ERFD • TELEX 4990274

West Coast: 1355 Redondo Avenue, Suite 6, Long Beach, CA 90804 ■ 213-498-3504/3184

England: Imperial House, Victoria Rd., Chelmsford, Essex CM1 1NY ■ Telephone: 0245 358585 ■ Telex: 995849

3M Company, Magnetic A/V Products Division
Marathon Products
Procart
Ramko Research
Singer Products Company
Tapecaster TCM, Inc.
UMC Electronics
Western Broadcasting

STEREO CARTS

Aristocart
Broadcast Electronics
Capitol Magnetic Products
Century 21 Programming
Continental Electronics Mfg.
Consolidated Electronics Ind.
Continental Recordings
D. B. Electronics
Fidelipac
Harris Corp., Broadcast Products
IGM Communications
3M Co., Magnetic A/V Products
Marathon Products
Ortoton Manufacturing
Procart
Ramko Research
Singer Products Company
Tapecaster TCM, Inc.
UMC Electronics
Western Broadcasting

RECONDITIONING SERVICES

Aristocart
Broadcast Electronics
Capitol Magnetic Products
Century 21 Programming
Colorado Magnetics
The Management
Marathon Products
RCA Service Co.
Re-Play Video Cartridge Service
Sound Dynamics
Tapecaster TCM
United Research Lab. Co.
Western Broadcasting

RELOADING SERVICES

Aristocart
Capitol Magnetic Products
Colorado Magnetics
Consolidated Electronic Ind.
Leader Broadcast Systems
Marathon Products
Re-Play Video Cartridge Service
Western Broadcasting

STORAGE RACKS & CABINETS

Advance Products
Anvil Cases
Aristocart
Broadcast Electronics
CSP Inc.
Cetec Broadcast Group
Consolidated Electronic Ind.
Continental Electronics Mfg.
Continental Recordings
Display Media
Dyma Engineering
Equipto
Fidelipac
Harris Corp., Broadcast Products
IGM Communications
Leader Broadcast Systems
Leadal
Marathon Products Corp.
Micro-Trak Corporation
Neumade Products
RMS Electronics Inc.
Research Technology Int'l.
Ruslang
See Hear Industries
Stantron
Storeel Corporation
Tascam
Videomedia
Western Broadcasting
Winsted Corporation

CARTRIDGES, PHONO

AKG Acoustics
AKG Akustische u. Kino-Geräte
The Astatic Corp.
Audio-Technica US, Inc.
David H. Brothers, Co.

Cetec Broadcast Group
Continental Recordings
Fidelipac Corp.
IGM Communications
Ortofon A/S
Panasonic, Professional Audio Division
Shure Brothers
Sonic Research
Stanton Magnetics
VIF International
Vidair Electronics Mfg.

CASES, PORTABLE EQUIPMENT

William Bai Corporation

CASSETTE MACHINES

SINGLE DECK

AIWA
Amilon
Audiotronics
BASF Limited
Bell Audio Systems
Edco Products
Eumig USA
Fernseh
IGM Communications
Javelin Electronics
Neal Ferrograph (USA)
Pentagon Industries, Inc.
Ramko Research
Sharp Electronics
Studer ReVox America
Tascam
Teac Corp. of America
Telex Communications
Tiffen Mfg. Corp.

DUAL DECK

Amilon
Fernseh
Leader Broadcast Systems
Pentagon Industries, Inc.
Sharp Electronics
Tape-Athon / Cavox Stereo Prod.

MULTIPLE DECK

Amilon
Fernseh
Otari Corp.
Pentagon Industries, Inc.
Tape-Athon / Cavox Stereo Prod.
VIF International

DUPLICATION MACHINE

David H. Brothers Co.
Lyrec Manufacturing A/S
Master Digital Inc.
Otari Corp.
Pentagon Industries
Ramko Research
See Hear Industries
Sharp Electronics
Tape
Telex Communications
Valentino Production Music
Triple I Inc.
United Research Lab. Co.

CAVITY

Varian Associates

CHARACTER GENERATOR

AVL Digital
Adwar Video
Aston Electronic Designs Ltd.
Aurora Systems
Autographics
BEI (Beston)
Robert Bosch GmbH
The BTX Corporation
C-M-C Technology Corp.
Chrono-log Corporation
Chyron Corporation
Comad Communications
Computer Video Systems

Michael Cox
Datametrics-Dresser
Datatron
Datum
Dubner Computer Systems
Dynamic Technology Ltd.
Dynaquip Electron Devices Ltd.
EECO Incorporated
EEV
Elektroimpex
Fernseh
For-A Corporation
Interand
Knox Video Products
Laird Telemedia
Lang Video Systems
Logica
MCI/Quantel
3M Company
MPB Technologies
McInnis Skinner & Assoc.
Multidyne Electronics
Portac
Potomac Marine & Aviation
Pro-Bel
QSI Systems
Quanta Corporation
RCA Broadcast Systems
Shintron
Television Graphics
Texscan
Thomson-CSF Broadcast
Tore Seem
Torpey Controls & Engineering
United Media
Unitel
Velec Sefat
Video Data Systems
Videomedia

CHOKES

CSP Inc.
Cinetronics
Peter W. Dahl Co.
Millen Components
North Hills Electronics
Wilkinson Electronics

CHOPPERS

T M Systems

CHROMA KEYS

American Data
Robert Bosch GmbH
Broadcast Video Systems
Central Dynamics Ltd.
Cezar International
Michael Cox
Crosspoint Latch Corp.
Crow of Reading Ltd.
Dytek
EchoLab
Grass Valley Group
Image Video Limited
Industrial Sciences, Inc. (ISI)
International Nuclear Corp.
Marcom Communication Systems
NEC America
Panasonic Video Systems
RCA Broadcast
Shintron
Telemet
Thomson-CSF Broadcast
Vamco
Videomedia
Vital Industries

CHROMA KEYS DECODER

Barco Electronic
Broadcast Video Systems
Michael Cox
Crow of Reading Ltd.

Faroudja Laboratories
Image Video Limited
Link Electronics
RCA Broadcast Systems
Siegel-Electronics
Thomson-CSF
Videomedia

CLOCKS & COUNTERS

COUNTER, DOWN

Applied Technology
BEI (Beston Electronics)
Broadcast Aids
Broadcast Electronics
C-M-C Technology Corp.
Cinetronics
Chrono-log Corporation
ESE
Harris Corporation, Broadcast Products Division
IGM Communications
Image Video Limited
KB Systems
Leader Broadcast Systems
McCurdy Radio Industries
Nationwide Electronic Systems
QSI Systems
Standard Electric Time Corp.
Thomson-CSF
Torpey Controls & Engineering
Vamco Engineering

COUNTER, UP

Applied Technology
Autocue Products Ltd.
BG Engineering
Broadcast Aids
Broadcast Electronics
Chrono-log Corporation
Cinetronics
Datametrics
Dynaquip Electron Devices Ltd.
ESE
Harris Corporation, Broadcast Products Division
IGM Communications
Image Video Limited
KB Systems
McCurdy Radio Industries
Nationwide Electronic Systems
Norcom Manufacturing
Pacific Recorders
PWH Electronics Limited
QSI Systems
Radio Systems
Ramko Research
Sharepoint Systems
Standard Electric Time Corp.
Tapecaster TCM
Thomson-CSF
Torpey Controls & Engineering
Vamco Engineering

COUNTER, UP / DOWN

ADM Technology
Applied Technology
Autocue
Broadcast Aids
Broadcast Electronics
CSP Inc.
Chrono-log Corporation
Datametrics
Dynaquip Electron Devices
ESE
Harris Corporation, Broadcast Products Division
IGM Communications
Image Video Limited
Jatex Inc.
KB Systems
Kajaani Oy
Laird Telemedia
Leader Broadcast Systems
Logitek Electronic Systems
McCurdy Radio Industries
Multidyne Electronics
Nationwide Electronic Systems
QSI Systems
Rangertone Research Inc.
Standard Electric Time Corp.
Tapecaster TCM
Thomson-CSF
Torpey Controls & Engineering

Continued on page 68

EEV high efficiency UHF klystrons pay for themselves...in 1 to 3 years!

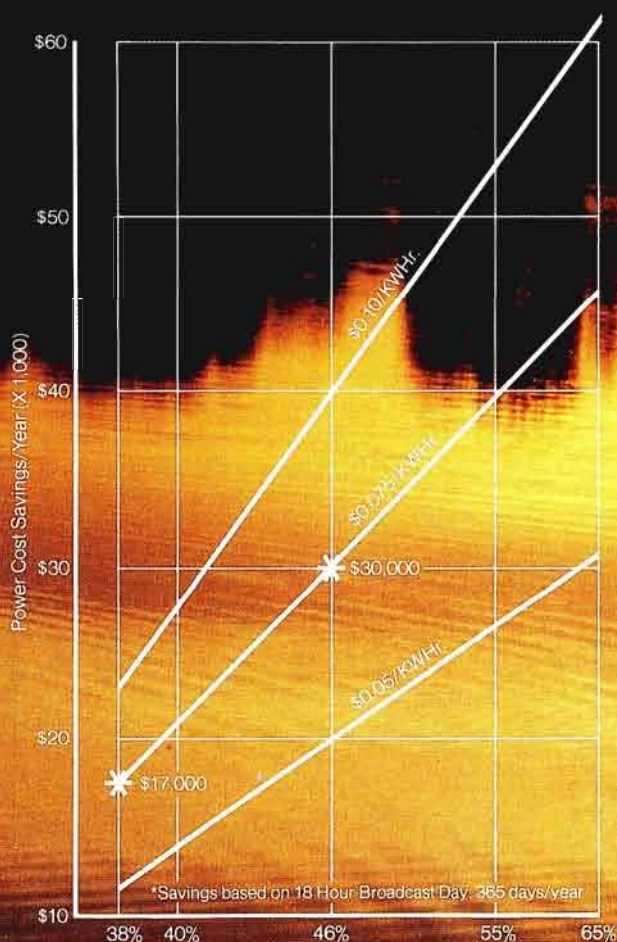

Annual Power Cost Savings using EEV 55KW high efficiency klystron vs. older generation 30% efficiency klystron

These are the facts.

- Over 70 EEV 55KW high efficiency external cavity klystron installations made during the past three years.
 - These klystrons are operating from 38% to 46% efficiency vs. average of 30% efficiency for older generation klystrons.
 - Annual power cost savings from \$17,000 to \$30,000 for single tube installations.*
 - Existing transmitters upgraded with new EEV klystrons operating from 38% to 40% Eff.
 - New transmitter installations with EEV klystrons operating from 40% to 46% Eff.
 - Life and reliability proven by 1400 installations worldwide logging over 9,000,000 hours/year.
 - EEV 55kw high efficiency klystrons available for UHF channels 14 to 78.
 - Development work being completed to attain 55%-65% efficiencies for external cavity klystrons with modulating anode or grid pulsing vs. klystron's intrinsic 46% efficiency.
- With these facts you can predict your power cost savings when you install EEV's 55KW high efficiency external cavity klystron.



Start now.

Specify EEV for your existing or new transmitter or

Convert and upgrade your internal cavity klystron system to EEV's external cavity klystron.

Every week you delay installing an EEV 55KW high efficiency klystron can represent an additional 4400KW to 7500KW on your power bill.

*Based on an 18 Hour Broadcast Day and \$0.75/KWHr.



EEV, INC.

7 Westchester Plaza, Elmsford, NY 10523, 914-592-6050, Telex 646180

In Canada: EEV CANADA, LTD., 67 Westmore Drive, Rexdale, Ontario, M9V 3Y6, 416-745-9494, Telex 06-989363

In Europe: English Electric Valve Co. Ltd., Chelmsford, England CM1 2QU Tel: 0245 61777, Telex 851-99103

Circle (39) on Action Card

Wide Range Electronics
Vamco Engineering

STATION CLOCKS

Autocue
Beaveronics
Broadcast Aids
Broadcast Electronics
Continental Electronics Mfg.
D-B Electronics
Datametrics
Datum
Dukane Corp.
Dynaquip Electron Devices
EEV
ESE
Glentronix Ltd.
Greg Laboratories
IGM Communications
Leader Broadcast Systems
Leitch Video
McCurdy Radio Industries
Multidyne Electronics
Nationwide Electronic Systems
QSI Systems
Ramko Research
Sharepoint Systems
Standard Electric Time Corp.
Torpey Controls & Engineering
True Time Instruments, Div. of
Kinometrics

COILS, RF

Geleco Electronics

COLLIMETER

Optical & Textile
Ramko Research

COLOR CORRECTOR

Angenieux
Robert Bosch GmbH
Broadcast Video Systems
Corporate Communications
Consultants
Michael Cox
Crow of Reading Ltd.
Dubner Computer System
For-A Corp. of America
Harris Corp., Broadcast Products
Ikegami
Kollmorgen, Photo Research Div.
Marcom Communication Systems
Marconi Electronics
Phase Video Inc.
RCA Broadcast Systems
Rank Cintel
Scantex Laboratories, Inc.
Siegel-Electronics
John M. Sullivan Assoc., Inc.
Television Equipment Associates
Thomson-CSF-Broadcast
Videomedia

COMBINER, POWER

Aydin Monitor Systems
Broadcast Electronics
Comark Communications
Continental Electronics
Elcom Specialty Products
Harris Corporation, Broadcast
Products Division
McMartin Industries
Marconi Electronics, Inc.
Micro Communications
Microwave Power Devices
Mu-Del Electronics
Sait Electronics
Shively Laboratories
Television Technology
Tennaplex System Ltd.
Thomson-CSF

COMMUNICATIONS SYSTEMS

ENG
Comrex
Martl Electronics

LAND MOBILE

AEG-Telefunken (Bayly Engr.)
AEL (Am. Elec. Labs)
American Laser Systems
American Microsignal
Artel Communications
Centro
Communications Control Center
Compucon Inc.
Dell Technical Vehicles
ENG Helicopter Satellites, Ltd.
GTE Products Corp.
Harris Corp., Broadcast Products
Microwave Power Devices
Moseley Associates
Motorola Comm. and Elec.
Nady Systems
Northland Communications
Penn Beth Marketing
Phelps Dodge Communications
Printer Terminal Communications
RCA Broadcast Systems
Radiotechniques
Regency
Rivers Associates
Scientific Radio Systems
Setcom
Sonar Radio
Standard Communications
Swintek Enterprises
Texscan Corp.

MICROWAVE

AEG-Telefunken
Bayly Engineering)
AEL (American Electronic
Laboratories)
Aydin Microwave
CALDATACOM
Centro
Coastcom
Compucon
Datum
Dell Technical Vehicles
ENG Helicopter Satellite Ltd.
Farinon Video/Harris Corp.
GTE Products Corp.
Harris Broadcast Microwave
Harris Corporation, Broadcast
Products Division
Hughes Aircraft, Microwave
Communications Products
International Microwave Corp.
Lang Video Systems
M/A-COM Video Systems
Microwave Power Devices
Moseley Associates
Motorola Communications
and Electronics
NEC America
Nurad
RF Technology
Radiotechniques
Standard Telephon und Radio
Tayburn
Television Technology
Terracom
Texscan Corp.

MULTIPLEX

AEG-Telefunken (Bayly Engr.)
Artel Communications
Aydin Microwave
Broadcast Electronics
CALDATACOM
Coastcom
Foundation Electronic Instruments
GTE Products Corp.
Grass Valley Group
Johnson Electronics, Inc.
International Microwave Corp.
Javelin Electronics
Harris Corp./Farinon Video
Kalart Victor Corporation
M/A-COM Video Systems
Modulation Associates
Moseley Associates
Motorola C & E

Optical & Textile
Potomac Marine & Aviation
Radiotechniques
C.N. Rood BV
Siemens

STL SYSTEMS

AEG-Telefunken (Bayly Engr.)
Artel Communications
Aydin Microwave
Broadcast Electronics
CALDATACOM
Cetec Broadcast Group
Coastcom
Compucon, Inc.
Comsearch, Inc.
Continental Electronics
Farinon Video/Harris Corp.
GTE Products Corp.
Harris Broadcast Microwave
International Microwave Corp.
McMartin Industries
M/A-COM Video Systems
Micro Control Associates
Moseley Associates
RF Technology
Radiotechniques
C.N. Rood B.V.
Telemet
Television Technology
Wold Communications

TSL SYSTEMS

Martl Electronics
TFT Inc.

COMPARATOR, TIME

Datum
ESE
True Time Instruments

COMPARATOR, VIDEO

Angenieux Corp. of America
Autogram
Michael Cox
Leitch Video
Mead Data Central
C.N. Rood BV
Video Aids of Colorado

COMPUTERS

Automated Business Concepts
The Broadcast Center
Cetec Broadcast Group
Chase Media
Computer Business Systems
Computer Management Systems
Cox Data Systems
Data Communications
EEG Enterprises
Elicon
Harris Corporation, Broadcast
Products Division
Kaman Sciences
McInnis/Skinner & Associates
Mead Data Central
Nidus Broadcast Systems
Ortoton Manufacturing
Salt Electronics
Station Business Systems
Telesource Communication
Services
Video Specialties
Weather Services Int'l

COMPUTER SYSTEMS & SERVICES

BUSINESS/ACCOUNTING
Automated Business
Concepts
BIC Computers
The Broadcast Center
Jim Cason Electronics
Cetec Broadcast Group
Chase Media
Columbine Systems
Computer Business Systems

Computer Concepts
Computer Management Systems
Consolidated Electronic Ind.
Cox Data Services
Custom Business Systems
Data Communications
Grotton Computer
Harris Corporation, Broadcast
Products Division
IGM Communications
Jefferson Data Systems
Kaman Sciences
Marketron
Mead Data Central
NEAS
NET Enterprises
Nidus Broadcast Systems
Patrick Computer Systems
Radio Computing Services
Research Technology Int'l
Southwestern Programming
Service
Station Business Systems
Teknektron Controls
Telmar Media Systems

NEWSROOM

BEI (Beston Electronics)
BIC Computers
Basy's Inc.
Chase Media
Data Communications
Harris Corporation, Broadcast
Products Division
Integrated Technology
Jefferson Data Systems
Kaman Sciences/BCS
Logica
McInnis-Skinner & Associates
Mead Data Central
New England Digital Corp.
Radio Computing Services
Spectra Computer Systems
Station Business Systems
SynSat International
TVNS
Texscan/MSI Corp.

TRAFFIC/PROGRAMMING

Automated Business Concepts
BIC Computers
The Broadcast Center
Cetec Broadcast Group
Chase Media
Columbine Systems
Computer Business Systems
Computer Concepts
Computer Management Systems
Consolidated Electronic Ind.
Cox Data Services
Custom Business Systems
Data Communications
Grotton Computer
Harris Corporation, Broadcast
Products Division
IGM Communications
Jefferson Data Systems
Kaman Sciences/BCS
The Management
Marketron, Inc.
Mead Data Central
NEAS
Nidus Broadcast Systems
Patrick Computer Systems
Radio Computing Services
Salt Electronics
Station Business Systems
Vital Industries

WEATHER

Aurora Systems
Computer Video Systems
Information Processing Systems
McInnis-Skinner & Associates
Mead Data Central
New England Digital Corp.
Spectra Computer Systems
SynSat International
Technology Service
Texscan/MSI Corp.
Weather Services Int'l
Weatherscan International

Continued on page 70

STUDIO OR STADIUM, FUJINON'S NEW BCTV LENSES PLAY ALL THE ANGLES.

From super-wide to ultra-tele, in the studio or the stadium, Fujinon BCTV lenses are the clear winners . . . from any angle.

NEW. Fujinon's P28x15 ESM — the super studio lens. It gives you a wall-to-wall 15mm wide angle and a maximum aperture of F/2.2 which is maintained out to ten times. Even at 420mm, the F/4.2 allows you to keep your lighting levels reasonable. And for the tightest shots, the built-in 1.7X extender takes you to 714mm. Naturally, it has a built-in diascope for near instant computer setup. But range and speed do not reveal the incredibly sharp, bright, high contrast image the new 28X delivers. Its superior resolution and color performance place it ahead of any lens in its class.

NEW. Fujinon's P17x16.5 ESM — the standard studio lens. With a zoom range from 16.5 to 280mm, an aperture which will remain flat at F/2.1 out to 217mm and built-in 1.5X and 2X extenders, here's the lens destined to be the industry workhorse for years to come. Simply put, it offers virtually every performance and operating feature — including built-in diascope — you're likely to need.

Not new. Fujinon's P30x20 ESM — the super field lens. Whether picking up the clearest shot of the space shuttle lifting off or a concert stage from the back of the top balcony, it goes out farther and flatter to deliver outstanding images . . . especially under lighting conditions that leave other lenses in the dark. Total zoom range, with the built-in 2X extender

is an incredible 20 to 1240mm. The F/2.2 aperture remains flat from 20 to 418mm — and at 620mm is giving you F/3.2. No wonder the 30X lens is acknowledged by the industry as the finest field zoom available.

For more information on the newest

and finest BCTV lenses, and why they are the best performance investment for your new or existing cameras, contact Fujinon. Large format zoom lenses are another reason why the world sees itself more clearly through the eyes of Fujinon.

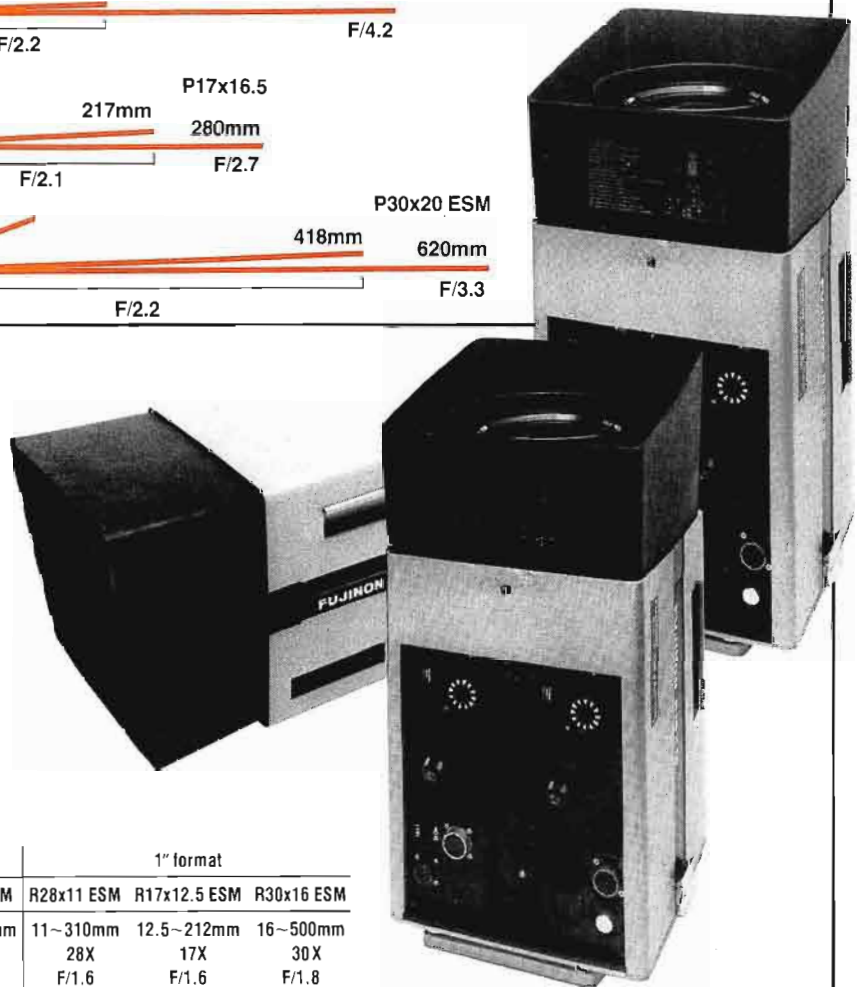
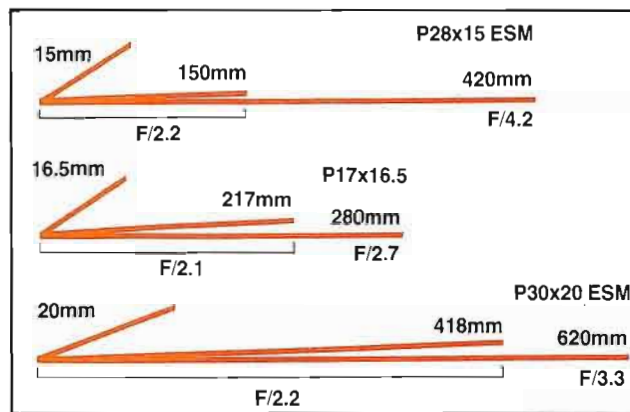

Specifications:	1 1/4" format			1" format		
	P28x15 ESM	17x16.5 ESM	30x20 ESM	R28x11 ESM	R17x12.5 ESM	R30x16 ESM
Focal Length	15~420mm	16.5~280mm	20~620mm	11~310mm	12.5~212mm	16~500mm
Zoom Ratio	28X	17X	30X	28X	17X	30X
Max. Aperture	F/2.2	F/2.1	F/2.2	F/1.6	F/1.6	F/1.8
M.O.D.	.95m	.75m	2.5m	.95m	.75m	2.5m
Range Extender	1.7X	1.5X, 2X	2X	1.7X	1.5X, 2X	2X



FUJINON INC. 672 White Plains Road, Scarsdale, New York 10583
(914) 472-9800 Telex: 131642

118 Savarona Way, Carson, California 90746
(213) 532-2861 Telex: 194978

Circle (40) on Action Card

CONSOLES, AUDIO

BROADCAST MONO

ADM Technology
ALICE (Stancoil Ltd.)
Amek TAC
Ampro/Scully
Arrakis
AudiTronics
AudiX Limited
Autogram
Broadcast Audio Assoc.
Broadcast Audio Corp.
Broadcast Electronics
Broadcast Technology
Cetec Broadcast Group
Coherent Communications
Continental Electronics Mfg.
Datatronix
Dyma Engineering
Elcom-Bauer
Elektroimpex
Enertec Schlumberger
EV-Tapco
Farrtronics
Finntek
Full Compass Systems
Greg Laboratories
Hallikainen and Friends Inc.
Harris Corporation, Broadcast Products Division
Harrison Systems
Howe Audio
IGM Communications
Industrial Sciences Inc.
LPB Inc.
Leader Broadcast Systems
Logitek
MBI Broadcast Systems
MCI Inc.
McCurdy Radio Industries
McMartin Industries
Micro - Trak Corporation
Modular Audio Products
Georg Neumann GmbH
Opamp Labs
Rupert Neve
Pacific Recorders
Processing Plus
ProTech Audio Corporation
Quad Eight
Quantum Audio
RCA Broadcast Systems
Ramko Research
Richmond Sound Design
C.N. Rood BV
Russco
SATT Electronics
Sait Electronics
Scantex Laboratories
Siemens AG Osterreich
Singer Products Company
Solid State Logic
Sontec Electronics
Sound Dynamics
Spectra Sonics
Sphere Electronics
Studer International
Studer ReVox America
Tangent Systems
Tascam, Div. of Teac
TOA Electronics
Tramec Electronics
Trident
Tweed Audio USA
UMC Electronics
UREI
Ultra Audio Pixtec
VIF International
Ward - Beck Systems Ltd.
Yamaha International

BROADCAST MONO MODULAR

ADM Technology
ALICE (Stancoil Ltd.)
Amco Engineering
Amek TAC
Arrakis Systems
AudiTronics
AudiX Limited
Autogram Corp.
Automated Processes
BFE KG
Broadcast Audio Assoc.
Broadcast Audio Corp.
Broadcast Electronics

Broadcast Technology
Cetec Broadcast Group
Coherent Communications
Custom Audio Elect
Datatronix
Dyma Engineering
Electro-Voice/E.V. Tapco
Elektroimpex
Enertec Schlumberger
Farrtronics
Finntek
Full Compass Systems
Greg Laboratories
Hallikainen and Friends
Harris, Broadcast Products
Harrison Systems
IGM Communications
LPB Inc.
Leader Broadcast Systems
Listec
Logitek Electronic Systems
McCurdy Radio Industries
MBI Broadcast Systems
MCI
McMartin Industries
Micro - Trak Corporation
Modular Audio Products
Georg Neumann GmbH
Opamp Labs
Rupert Neve
ProTech Audio Corporation
Quad Eight Elec.
Quantum Audio
RCA Broadcast Systems
Ramko Research
Richmond Sound Design
C.N. Rood BV
Sait Electronics
Scantex Laboratories
Siemens AG Osterreich
Solid State Logic
Sontec Electronics
Spectra Sonics
Sphere
Studer International
Studer Revox America
Tangent Systems Inc.
Trak Audio
Tramec Electronics
Trident
Tri Tec Systems Inc.
Tweed Audio USA
UMC Electronics
UREI
VIF International
Ward - Beck Systems Ltd.

BROADCAST STEREO

ADM Technology
ALICE (Stancoil Ltd.)
Amek TAC
Ampro / Scully
Arrakis Systems
Audio Interface Inc.
AudiTronics
AudiX Limited
Audy Instruments, Inc.
Autogram Corp.
Broadcast Audio Assoc.
Broadcast Electronics
Broadcast Technology
Cetec Broadcast Group
Coherent Communications
Continental Electronics Mfg.
Datatronix
Dyma Engineering
EV-Tapco
Elcom-Bauer
Elektroimpex
Enertec Schlumberger
Farrtronics
Finntek Limited
Full Compass Systems
Greg Laboratories
Harris Corporation, Broadcast Products Division
Harrison Systems
Howe Audio
IGM Communications
Integrated Sound, GLI Div.
LPB Inc.
Leader Broadcast Systems
Logitek Electronic Systems
McCurdy Radio Industries
McMartin Industries
MBI Broadcast Systems
MCI
Micro - Trak Corporation
Modular Audio Products
Georg Neumann GmbH
Opamp Labs
Rupert Neve
Pacific Recorders
ProTech Audio Corporation
Quad-Eight Electronics
Quantum Audio
RCA Broadcast Systems
Ramko Research
Richmond Sound Design
Rohde & Schwarz

Micro - Trak Corporation
Modular Audio Products
Opamp Labs
Rupert Neve
Pacific Recorders
Panasonic, Professional Audio Division
Processing Plus
ProTech Audio Corporation
Pye TVT
Quad Eight Electronics
Quantum Audio
RCA Broadcast Systems
Radio Systems Inc.
Ramko Research
Richmond Sound Design
Rohde & Schwarz
C.N. Rood BV
Russco
SATT Electronics
Sait Electronics
Scantex Laboratories
Siemens AG Osterreich
Singer Products Company
Solid State Logic
Sontec Electronics
Soundcraft Electronics
Spectra Sonics
Sphere Electronics
Studer International
Studer ReVox America
John M. Sullivan Associates
TOA Electronics
Tangent Systems
Tascam, Div. of Teac
Tramec Electronics
Trident (USA) Inc.
Tweed Audio USA
UMC Electronics
UREI
VIF International
Ward - Beck
Wilkinson Electronics
Yamaha International

BROADCAST STEREO MODULAR

ADM Technology
ALICE (Stancoil Ltd.)
Amco Engineering Co.
Amek TAC
Arrakis Systems
AudiTronics
AudiX Limited
Audy Instruments
Autogram Corp.
Automated Processes
BFE KG
Broadcast Audio Corp.
Broadcast Electronics
Broadcast Technology
Cetec Broadcast Group
Coherent Communications
Custom Audio Elect
Datatronix
Dyma Engineering
Electro-Voice/EV Tapco
Elektroimpex
Enertec Schlumberger
Farrtronics
Greg Laboratories
Harris, Broadcast Products
Harrison Systems
Howe Audio
IGM Communications
Kajaani Oy
LPB Inc.
Leader Broadcast Systems
Listec
Logitek Electronic Systems
McCurdy Radio Industries
McMartin Industries
MBI Broadcast Systems
MCI
Micro - Trak Corporation
Modular Audio Products
Georg Neumann GmbH
Opamp Labs
Rupert Neve
Pacific Recorders
ProTech Audio Corporation
Quad-Eight Electronics
Quantum Audio
RCA Broadcast Systems
Ramko Research
Richmond Sound Design
Rohde & Schwarz

C.N. Rood BV
Sait Electronics
Scantex Laboratories
Siemens AG Osterreich
Solid State Logic
Sontec Electronics
Soundcraft Electronics
Spectra Sonics
Sphere Electronics
Studer Revox America
TOA Electronics
Tangent Systems Inc.
Tascam, Div. of Teac
Trak Audio
Tramec Electronics
Trident
Tri Tec Systems Inc.
Tweed Audio USA
UMC Electronics
UREI
VIF International
Ward - Beck
Westrex

PORTABLE FOR REMOTES

ADM Technology
AEG-Telefunken
(Bayly Engineering)
ALICE (Stancoil Ltd.)
ATI Audio Technologies Inc.
Amek TAC
Applied Technology
Arrakis Systems
Audio Processing Systems
AudiTronics
AudiX Limited
Audy Instruments
BSM Systems
Don Britton Ent.
Broadcast Audio Assoc.
Broadcast Electronics
Cetec Broadcast Group
Coherent Communications
Comrex Corp.
Continental Electronics Mfg.
Crosspoint Latch
Custom Audio Electronics
Datatronix
Dyma Engineering
ENG Helicopter Satellite Ltd.
EV-Tapco
Electro-Voice
Enertec Schlumberger
Environmental Container Systems
Farrtronics
Full Compass Systems
Hallikainen & Friends
Harris Corporation, Broadcast Products Division
Harrison Systems
IGM Communications
Integrated Sound
LPB Inc.
Leader Broadcast Systems
Listec TV Equipment
Logitek
McCurdy Radio Industries
McMartin Industries
MBI Broadcast Systems
MCI
Micro - Trak
Modular Audio Products
Moseley Associates
Rupert Neve
Georg Neumann
Opamp Labs
Panasonic, Professional Audio Division
Processing Plus
ProTech Audio Corporation
Quad Eight Electronics
RTS Systems
Ramko Research
Richmond Sound Design
C.N. Rood BV
Russco
SATT Electronics
Sait Electronics
Scantex Laboratories
Sescom
Shure Brothers
Siemens AG Osterreich
Sontec Electronics
Sound Dynamics
Soundcraft Electronics
Spectra Sonics

Continued on page 72

DELTA BROADCAST PRODUCTS

AMC-1/FMC-1



The **Modulation Controllers** are the only modulation controlling systems that provide a completely closed loop around the transmitter. The sampling of actual modulation levels after the PA output network assures precise adjustment for optimum modulation levels. The AMC-1/FMC-1 also keep a digital count of positive and negative overmodulation bursts for both present and previous one minute periods.

DAM-1

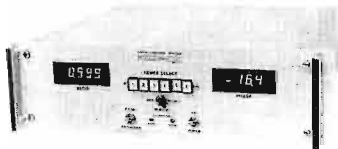

The **Digital Antenna Monitor** couples pushbutton ease of operation with digital accuracy. The DAM-1 will accept RF samples from up to 12 towers (with an auxiliary panel) and features $\pm 1^\circ$ phase and $\pm 2\%$ current ratio accuracies. Remote panels and other accessories are available.

AAM-1

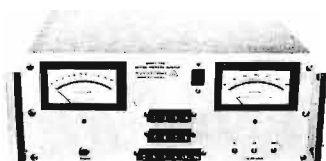

The **Analog Antenna Monitor** gives stable phase and ratio readings even in high RF fields. Separate phase and ratio mirrored-scale meters assure accurate meter indications.

RCS-1V

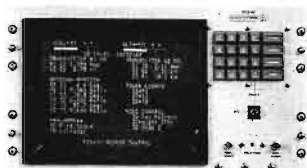

The **RCS-1V Remote Control System** combines microprocessor technology with simplified operation. Features include direct interface boards for antenna monitors, patented remote modulation bargraph, automatic logging, and synthesized speech telephone interface. The modular design allows the customer to plug in additional input or control boards to expand remote control capabilities even after the system is operating in the field.

APC-1



The **Automatic Power Controller** is your insurance against citations for over- and under-power operation. The APC-1 continuously monitors the transmitter output power, and makes automatic power adjustments with the transmitter loading control. This assures proper power adjustment at all times.

6730-E
6740-B

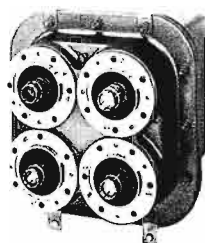

Designed to switch two transmitters from antenna to dummy load, the 6730E interfaces with 1 5/8 inch coaxial cable. For 3 1/8" lines, the 6740-B transfer switch is used. Either manually or remote controlled, the **Transfer Switch** is fully interlocked and can be wired to existing equipment to prevent "hot" switching.

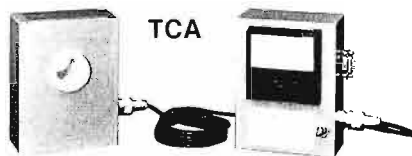

State of the art antenna current metering has arrived in the **TCA Ammeter Systems**. Accurate, Modulation-free, temperature stable current indications are found in the TCA. Models include single and dual scale meters.

TCT

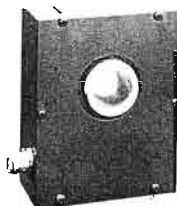

Delta's **Toroidal Current Transformers** provide accurate sampling current and phase values without the problems associated with sampling loops. Three output voltage ranges are available, as well as high voltage models for high-power facilities.

OIB-1



OIB-3

The **Operating Impedance Bridge** measures the impedance of networks, radiators, and the like while they operate under full power. VSWR as well as complex impedances of up to $400 \pm j300$ ohms can be measured.

The **OIB-3 Operating Impedance Bridge** provides extended resistance and reactance ranges, measuring up to $1000 \pm j900$ ohms. The bridge has a built-in carrying case and RF amplifier for improved nulling.



RG-3

The **Receiver/Generator** combines a two-watt RF output and a correlation detector circuit that virtually eliminates interference problems. The RG-3 can be used in conjunction with any conventional impedance bridge including the OIB series.

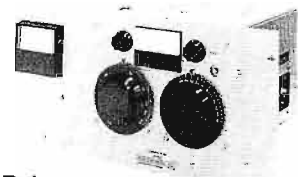

CPB-1

The **Common Point Impedance Bridge** is designed for permanent installation; and allows continuous monitoring of the common point, thus facilitating network adjustment. This model can be provided with one of Delta's TCA ammeters mounted in the front panel.

DELTA ELECTRONICS



5730 GENERAL WASHINGTON DRIVE
P.O. Box 11268 • ALEXANDRIA, VIRGINIA 22312
TELEPHONE: 703-354-3350 TWX: 710-832-0273

Circle (41) on Action Card

Sphere Electronics
 Studer International
 Studer ReVox America
 TOA Electronics
 Tascam, Div. of Teac
 Tramec Electronics
 Trident
 Tweed Audio USA
 Ultra Audio Pixtec
 VIF International
 Zercom Corp.

RECORDING STUDIO

ALICE (Stancoil Ltd.)
 Amco Engineering Co.
 Amek TAC
 Arrakis Systems
 Audio Processing Systems
 Audiotronics
 Audix Ltd.
 Audy Instruments
 Autogram Corp.
 BFE KG
 Don Britton Ent.
 Broadcast Electronics
 Broadcast Technology
 Cetec Broadcast Group
 Datatronix
 EV-Tapco
 Electro-Voice
 Elektroimpex
 Enertec Schlumberger
 Finntek Limited
 Harris Corporation
 Harrison Systems
 IGM Communications
 Kajaani Oy
 LPB Inc.
 Logitek Electronic Systems
 McCurdy Radio Industries
 MBI Broadcast Systems
 MCI Inc.
 Micro-Trak Corp.
 Modular Audio Products
 Rupert Neve
 Georg Neumann GmbH
 Opamp Labs
 Panasonic, Professional Audio Div.
 ProTech Audio Corporation
 Pye TVT
 Pyramid Loudspeakers
 Quad Eight Electronics
 RCA Broadcast Systems
 Ramko Research
 Richmond Sound Design
 Russco
 Sait Electronics
 Sandar
 Siemens AG Osterreich
 Sierra Audio
 Singer Products Company
 Solid State Logic
 Sontec Electronics
 Soundcraft Electronics
 Spectra Sonics
 Sphere Electronics
 Studer International
 Studer ReVox America
 Tascam, Div. of Teac
 Technicobel
 Tri Tec Systems Inc.
 Trident (USA) Inc.
 Tweed Audio USA
 VIF International
 Ward-Beck Systems
 Westrex

ROUTING

ALICE (Stancoil Ltd.)
 Arrakis Systems
 Audix Limited
 Audy Instruments
 Bogen Division / Lear Siegler
 Broadcast Technology
 Communications Control Centers
 Michael Cox
 Crosspoint Latch
 Datatek
 Di-tech
 Dyma Engineering
 Dynalr
 Edco Products
 Elektroimpex
 Enertec Schlumberger
 Full Compass Systems
 Hallikainen & Friends
 Harrison Systems

HEDCO/Hughes Electronic Devices Corp.

Image Video Limited
 Industrial Sciences Inc. (ISI)
 International Nuclear
 Key Video Ltd.
 McCurdy Radio Industries
 Modular Audio Products
 Rupert Neve
 Pro-Bel
 ProTech Audio Corporation
 Richmond Sound Design
 Roh Corporation
 Sait Electronics
 Scantex Laboratories
 Siemens AG Osterreich
 Spectra Sonics
 TBC Pye Ltd.
 Technicobel
 Trident (USA)
 Tri Tec Systems Inc.
 Tweed Audio USA
 Ultra Audio Pixtec
 Viscount Industries

TV PRODUCTION

ADM Technology
 ALICE (Stancoil Ltd.)
 Altha Video & Elec. Corp.
 Amco Engineering Co.
 Amek TAC
 Arrakis Systems
 Audiotronics
 Audix Limited
 Audy Instruments
 Autogram Corp.
 BFE KG
 Don Britton Eng.
 Broadcast Audio Corp.
 Broadcast Technology
 Cetec Broadcast Group
 Coherent Communications
 Michael Cox
 Crosspoint Latch
 Datatronix
 Dyma Engineering
 ENG Helicopter Satellite Ltd.
 EV-Tapco
 Elektroimpex
 Enertec Schlumberger
 Farrtronics
 Finntek Limited
 Full Compass Systems
 General TV Network
 Hallikainen and Friends
 Harrison Systems
 Industrial Sciences Inc. (ISI)
 Kajaani Oy
 LPB Inc.
 Listec TV Equipment
 Logitek Electronic Systems
 MBI Broadcast Systems
 MCI Inc.
 McCurdy Radio Industries
 McMartin Industries
 Marcom Communication Systems
 Micro - Trak Corporation
 Modular Audio Products
 Rupert Neve
 Georg Neumann
 Opamp Labs
 ProTech Audio Corporation
 Quad-Eight Electronics
 Ramko Research
 Richmond Sound Design
 Russco
 SATT Electronics AB
 Sait Electronics
 Scantex Laboratories
 Siemens AG Osterreich
 Solid State Logic
 Spectra Sonics
 Sphere Electronics
 Studer International
 Studer ReVox America
 Technicobel
 Tri Tec Systems Inc.
 Trident (USA) Inc.
 Tweed Audio USA
 UREI
 Ultra Audio Pixtec
 Ward-Beck Systems

CONSOLES, VIDEO

CCTV/EDUCATIONAL
 AVL Digital Ltd.
 Altha Video & Elect. Corp.
 American Data
 Angenieux
 Beaveronics
 Robert Bosch GmbH
 Central Dynamics
 Centro
 Convergence
 Michael Cox
 Crosspoint Latch
 Delta Systems
 Dyma Engineering
 Electrohome
 Elektroimpex
 G.B.C. Closed Circuit TV
 Grass Valley Group
 Industrial Sciences Inc. (ISI)
 Javelin Electronics
 Kalart Victor Corporation
 Lang Video Systems
 Marcom Communication Systems
 Motorola Communications
 & Electronics
 Ross Video
 Sandar Electronics A/S
 Shintron
 Tech Electronics
 Telemet
 Texscan/MSI Corp.
 Thomson-CSF
 U.S. JVC Corporation
 Viscount Industries
 Vital Industries

MASTER CONTROL

AVL Digital Ltd.
 Altha Video & Elect. Corp.
 American Data
 BFE KG
 Robert Bosch GmbH
 Broadcast Video Systems
 Central Dynamics
 Centro
 Michael Cox
 Crosspoint Latch
 Crow of Reading Ltd.
 Delta Systems
 Dyma Engineering
 Grass Valley Group
 Image Video Limited
 Industrial Sciences (ISI)
 International Nuclear
 Javelin Electronics
 NET Enterprises
 Rohde & Schwarz
 Ross Video
 Thomson-CSF
 Vital Industries

PORTABLE PRODUCTION

AVL Digital Ltd.
 Adwar Video
 American Data
 Ampex
 Asaca/Shibasoku
 BFE KG
 Beaveronics
 Broadcast Video Systems
 Central Dynamics
 Centro
 Convergence
 Michael Cox
 Crosspoint Latch
 Crow of Reading Ltd.
 Datatron
 Delta Systems
 Dyma Engineering
 ENG Helicopter Satellite Ltd.
 Echolab, Inc.
 Electro & Optical Systems
 Environmental Container Systems
 General TV Network
 Image Video Limited
 Industrial Sciences, Inc. (ISI)
 Kaitronics Corp.
 Lang Video Systems
 NEC America
 NET Enterprises
 Panasonic
 Quantum Audio Labs
 Rohde & Schwarz
 Ross Video

Shintron
 Sony
 Thomson-CSF
 Toshiba International
 U.S. JVC Corporation
 Videcom Engineering
 Videomedia
 Viscount Industries
 Vital Industries
 Winsted Corporation

POST PRODUCTION

Adwar Video
 Altha Video & Elect. Corp.
 American Data
 BCB Electronic Sales
 Beaveronics
 Robert Bosch GmbH
 Central Dynamics Ltd.
 Michael Cox
 Crosspoint Latch
 Crow of Reading Ltd.
 Delta Systems
 Dyma Engineering
 Echolab, Inc.
 General TV Network
 Grass Valley Group
 Harris Corporation
 Industrial Sciences (ISI)
 Lang Video Systems
 NET Enterprises
 Quantum Audio Labs
 Ross Video
 Scantex Laboratories
 Shintron
 Solid State Logic
 Thomson-CSF
 Unemco International
 Viscount Ind.
 Vital Industries
 Winsted Corp.

ROUTING

AVL Digital
 Altha Video & Elect. Corp.
 American Data
 BFE KG
 Robert Bosch GmbH
 Broadcast Video Systems
 Channelmatic
 Michael Cox
 Crosspoint Latch
 Crow of Reading Ltd.
 Datatek Corp.
 Delta Systems
 Dyma Engineering
 Dynair Electronics
 Fernseh Inc.
 Grass Valley Group
 HEDCO
 Image Video Ltd.
 Industrial Sciences (ISI)
 International Nuclear
 Key Video Ltd.
 Lang Video Systems
 NEC America
 NET Enterprises
 Pro-Bel
 Sandar Electronics A/S
 Scantex Laboratories
 TBC Pye Ltd.
 Telemet
 Thomson-CSF
 Viscount Ind.
 Vital Industries

STUDIO PRODUCTION

Adwar Video
 Altha Video & Elect. Corp.
 American Data
 Ampex
 BFE KG
 Beaveronics
 Robert Bosch GmbH
 Broadcast Video Systems
 Central Dynamics Ltd.
 Convergence
 Michael Cox
 Crosspoint Latch
 Crow of Reading Ltd.
 Datatron
 Delta Systems
 Dyma Engineering
 Dytek
 Echolab Inc.
 General TV Network

Continued on page 74

THE WORD IS OUT!

Vanguard Helps Editors Learn Procedures

CP/I ASSIGNABLE COAXIAL
INTERFACING

HELPING EDITORS LEARN
PROCEDURES

SYNC ROLL WITH EFFECTS
(SRE)

SPECIAL FUNCTION CON-
TROL (SFC)

LIST MANAGEMENT,
RIPPLE TEXT EDIT, CLEAN-IT AND
BLOCK MOVES

CHECKERBOARD, PREVIEW, SEQUEN-
TIAL AND CONTINUOUS
ROLL AUTOMATIC
ASSEMBLY

CMX 300/340X COM-
PATIBLE EDL

LAST EDL EVENT
ON CRT

CLIENT I/D IN
HEADER

SMART SCAN SLOW MOTION EDITING OPTION

EDIT LIST COMMENTS

COLOR FRAME PHASE ON CRT

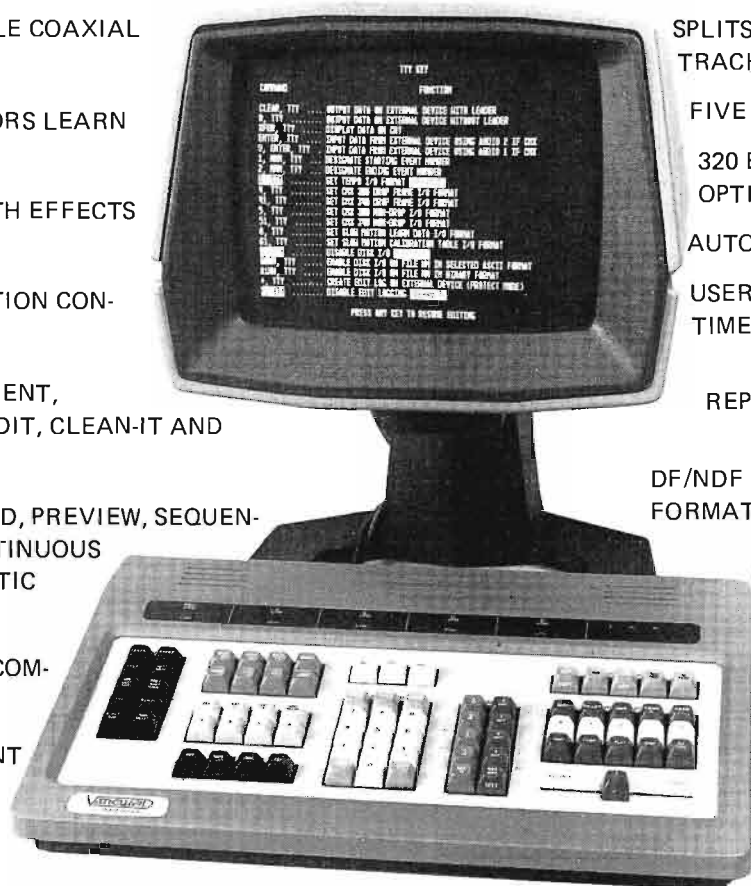

SPLITS WITH TWO AUDIO
TRACKS

FIVE VTR ROLL

320 EVENTS MEMORY
OPTIONAL 500 EVENTS

AUTO SCROLL OF THE EDL

USER DEFINABLE REACTION
TIME, POST ROLL, PREROLL

REPLAY

DF/NDF CONVERSION AND MIXED
FORMAT READING

SCRATCH PAD MEMORY
WITH MATH FUNCTIONS

ASSIGNABLE RECORD/
PLAY CONFIGURATION
OF ANY DECK

HIGH SPEED FLOPPY
DISK

DUAL VARASCAN CON-
TROL OPTION

SMPTE/CTL READING

ENGLISH ERROR MESSAGES

ON THE FLY EDITING CAPABILITIES

datatron, inc.

VIDEO SYSTEMS DIVISIONS

2942 Dow Ave., Tustin, California 92680

(714) 544-9970 • TWX 910-595-1589

Circle (42) on Action Card

Grass Valley Group
Harris Corporation
Ikegami Electronics
Image Video Limited
Industrial Sciences (ISI)
International Nuclear
3M Company
MCI / Quantel
Marcom Communication Systems
NEC America
NET Enterprises
Panasonic
Piher
Pye TVT
Quantum Audio Labs
RCA
Ross Video Ltd.
Russco
Siemens
Selttech
Shintron
Strand Century
Thomson-CSF
Viscount Industries
Vital Industries
Winsted Corporation

STUDIO PRODUCTION WITH DIGITAL EFFECTS

Altha Video & Elect. Corp.
American Data
Ampex
Robert Bosch GmbH
Central Dynamics Ltd.
Convergence
Crow of Reading Ltd.
Delta Systems
Dyma Engineering
Grass Valley Group
Industrial Sciences (ISI)
Marcom Communication Systems
Master Digital Inc.
NEC America
NET Enterprises
Pye TVT
Ross Video
Thomson-CSF
Vital Industries

CONSULTING SERVICES

AVC
Action Video Inc.
Aderhold Construction Co.
Angenieux Corp. of America
Bonneville Satellite Corp.
Robert Bosch GmbH
Walter S. Brewer Co.
Don Britton Ent.
The Broadcast Center
Broadcast Aids Inc.
Candex Pacific
Canter-Redman Technologies
Jim Cason Electronics
Centro
Compucon
Computer Management Systems
Comsearch
Corporate Communications
Consultants
Crosspoint Latch
Crowder Communications
3D Video
Davis Electronics
John J. Davis & Associates
Dell Technical Vehicles
Deltamod
Dyma Engineering
Dynamic Technology
East Coast Video Systems
Electro-Acoustic Designs
Electro Controls
Elektroimpex
Ellcon
Engineering Associates
G. A. Gilbreath Associates
Graham-Patten Systems
General TV Network
The Graphic Express
Harris Corporation
Hoppmann Corp.
Imero Fiorentino Associates
Interface Video Systems Inc.
Jamieson and Associates

Jenel Consultants
Kitchen Productions
Lighting Elimination Associates
McCurdy Radio Industries
MBI Broadcast Systems
The Management
Master Digital Inc.
Kenneth R. Meades
Merlin Engineering
Midwest Corp.
Multiphase Consulting
Musicues Corp.
NET Enterprises
L.E. Nelson Corp.
Panoak Lighting Systems
Potomac Marine & Aviation
Processing Plus
Pyramid Loudspeaker Corp.
R.A.V.E./Reliable Audio Video
Enterprises
Radiotechniques
Rees Associates Inc.
Rivers Associates
Rosner Television Systems
Scantex Laboratories
Shane Media Services
Siemens AG Osterelch
Sierra Audio
Shafer Associates
Soll Inc.
Spectrum Instruments
Spencer Broadcast
Standard Telephon Und Radio
AG
TVNS
Technology Service Corp.
Telecommunications Systems
Teleconcepts In
Communications
Television Technology
Thomson-CSF
Video-Ink
Albert Walsh & Associates
Weather Services Int'l

COUPLERS, HYBRID

AVA Electronics
Alford Mfg. Co.
Coaxial Dynamics
Comrex Corp.
Dielectric Communications
Harris Corporation, Broadcast
Products Division
Howe Audio Marketing
Magnavox CATV Systems
Micro Communications
Narda Microwave Corp.
North Hills Electronics
RMS Electronics
RTS Systems
Scientific-Atlanta, Phoenix
Division
Shively Laboratories
Vidair Electronics Mfg.
Wide Band Engineering

CONVERTERS, A-D, D-A

Apert-Herzog
Computer Labs, Div. of Analog
Devices, Inc.
Consolidated Electronic Ind.
Datei-Intersil
Eagle Comtronics
Electroline TV Equipment
Global Video Comm. Corp.
Grove Video
ILC Data Device
Jerrold Division, General
Instruments Corp.
Johnson Electronics
Moseley Associates, Inc.
Potomac Marine & Aviation
Scientific-Atlanta, Phoenix
Division
Tektronix
Thomson-CSF
Vidair Electronics Mfg.

CRT DISPLAYS & CONTROLLERS

Ann Arbor Terminals, Inc.
Dynair Electronics
EEV Inc.
Electrohome Ltd.
Harrison Systems
Harris Corporation
IGM Communications
Lexicon, Inc.
Moseley Associates, Inc.
Tektronix
Theatre Techniques Inc.
World Video Inc.

CRYSTALS

Calvert Electronics
Edison Electronic Co.
Elcom Specialty Products
Elektroimpex
Harris Corporation, Broadcast
Products Division
Moseley Associates
Motorola Communications
& Electronics
Thomson-CSF
Wilkinson Electronics

CUE SYSTEMS, REMOTE

Autocue
Cetec Vega
Channelmatic
Coastcom
Comrex
Consolidated Elec. Ind.
D'San Corporation
Edcor
IGM Communications
Leader Broadcast Systems
Modulation Associates
Monroe Electronics
Motorola Comm. & Elec.
Nady Systems
Panoak Lighting Systems
ProTech Audio Corporation
RTS Systems
Roh Corporation
Swintek Enterprises
Television Equipment Associates
Thomson-CSF
Unemco International
Video Tape Systems

DECODERS

CLOSED CAPTIONING
Barco Video Systems
EEG Enterprises Inc.
NET Enterprises
Unitel

COMB

Amtron Corp.
Barco Video Systems
Broadcast Video Systems
Canter-Redman Technologies
Michael Cox
Faroudja Laboratories
QSI Systems
Rohde & Schwarz
Siegel Electronics
TTE Inc.
Thomson-CSF

DIGITAL SYNC

Central Dynamics Ltd.
Crosspoint Latch
Digital Video Systems
Jerrold Division, General
Instrument Corp.
Rohde & Schwarz
Thomson-CSF

STEREO

Rohde & Schwarz

C.N. Rood B.V.

STV, PAY TV
Blonder-Tongue Laboratories
Dynacom Electronics
Fung Eng. Labs., Inc.
Oak Communications, CATV
Division
Satcom Inc.

TONE

AEG-Telefunken
(Bayly Engineering)
American Microsignal
Cetec Vega
Channelmatic
Communications Control Centers
Deltamod
Di-tech
Frequency Devices
Gorman-Redlich
IGM Communications
Jatex Inc.
McMartin Industries
Modulation Associates
Monroe Electronics
Potomac Marine & Aviation
Rivers Associates
Rohde & Schwarz
Texscan/MSI
Trec Corp. of America
UMC Electronics

TONE, EBS

Broadcast Electronics
ESE
Emergency Alert Receiver
Gorman-Redlich Mfg. Co.
International Nuclear Corp.
Johnson Electronics
McMartin Industries
ProTech Audio
Rivers Associates
Rohde & Schwarz
UMC Electronics

DEGAUSSER

R. B. Annis Co.
Comprehensive Video Supply
Fidelipac
Fluxcom
Garner Industries
IGM Communications
Nalpak Sales
Nortronics
Research Technology Int'l.
Rohde & Schwarz
Sonar
United Research Lab Corp.
UMC Electronics

DE-ESSERS

ATI Audio Technologies Inc.
Audio & Design Recording
Datatronix
IGM Communications
Georg Neumann
Valley People

DELAY, AUDIO TAPE

Fidelipac
IGM Communications

DELAY LINES, AUDIO

AKG Acoustics
AKG Akustische u. Kino-Gerate
Advanced Analog Systems
Allen Avionics
Audio & Design Recording
Broadcast Technology
Comex Systems
DeltaLab Research
EMT Franz

Continued on page 76

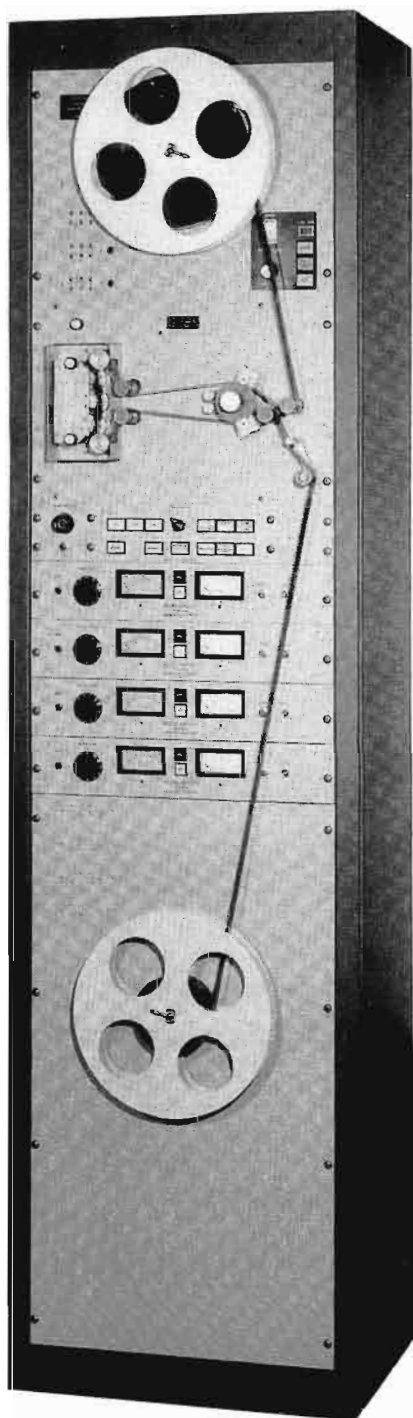

MAGNA-TECH

THE SOUND HEARD AROUND THE WORLD

**Magnetic Film
Recorders and Reproducers
for Television and Film
Sound Post-Production**

HIGH SPEED

Telecine Magnetic Followers
Video Tape-Film Interlock
Electronic Looping
Dubbing Systems
16 and 35mm Electronic Projectors
Total Facility Engineering

WORLDWIDE SALES OFFICES

Paris
Hi-Fidelity Services
4 Rue Semard
75009 Paris, France

Sydney
Magna-Techtronics (Aust.)
PO Box 150
Crows Nest NSW 2064
Australia — Telex 24655

Johannesburg
General Optical Co., Ltd.
15 Hulbert Road
Johannesburg 2001,
South Africa

Rome
Alberto Sciarretta
Via Siria 24
Rome Italy 00179
Tel: 794-3618

Brussels
A.R.C.
Rue de Boisdé Linthout 45
1200 Brussels Belgium

Hong Kong
Paul Yang and Associates
901 Star House
3 Salisbury Road
Kowloon, Hong Kong

Bombay
Capt. P.K. Vishwanath
234/4 Rama Baug,
Deodhar Road
Bombay 400 019, India

Kehl
Zenon GmbH
Postfach 1743
Hauptstrasse 128
Kehl am/Rhein West Germany
Tel: 07851/2991
Telex: 753537

London
Branch & Appleby
42 High Street
Harrow-on-the-Hill
Middlesex HA1 3LL,
England

Kuala Lumpur
Kinematronika Sdn. Bhd.
2852, Jalan Selangor/
Persekutuan,
Federal Hill
Kuala Lumpur, Malaysia

Caracas
Cine Materiales srl
Apartado Postal 61.098
Caracas 106 Venezuela

MAGNA-TECH ELECTRONIC CO., INC.

630 Ninth Avenue, New York, N.Y. 10036

Telephone (212) 586-7240

Telex 126191

Cables "Magtech"

Circle (43) on Action Card

ESC Electronics
Elektrolmex
Eventide Inc.
Hammond Industries
IGM Communications
Industrial Research Products
Klark-Teknik Research
Leader Broadcast Systems
Lexicon
MXR Innovations
ProTech Audio Corporation
Spectra Sonics
T M Systems, Inc.
TT Electronics, Inc.
UREI
URSA Major, Inc.

DELAY LINES, VIDEO

Allen Avionics
American Data
Anders Inc.
Andersen Laboratories
Broadcast Video Systems
Michael Cox
ESC Electronics
Eagle Contronics
Fairchild CCD Imaging
Faroudja Laboratories
Grass Valley Group
Leitch Video
Lnk Electronics
Listec TV Equipment
NEC America
Rohde & Schwarz
Sandar Electronics A/S
TT Electronics
Television Equipment Assoc.
Thomson-CSF

DELAY MACHINE, TALK SHOW

Comrex

DEMODULATORS, OPTICAL

Artel Communications Corp.
Foundation Electronic
Instruments
Telemet
Times Fiber Communications

DEMODULATORS, VIDEO

Artel Communications Corp.
Barco Video Systems
Blonder-Tongue Laboratories
Cotel
Comark Communications
EEG Enterprises
Electro & Optical Systems
Fung Engineering Labs
Harris Corp. Broadcast Products
Javelin Electronics
Jerrold Div., Gen. Instrument
Lang Video Systems
Lenco Inc.
Optek Inc.
Phasecom
Hans Plisch
QSI Systems
R. E. Instruments
Rohde & Schwarz
Scientific-Atlanta
TL Systems
Tektronix
Telemet
Television Technology
Thomson-CSF
Townsend Associates
Triple Crown Electronics
Videomedia
Vevec Safat
Videotek

DETECTORS

MICROWAVE
Coaxial Dynamics, Inc.
GTE Products Corp.
Gralex
Harris Corporation,
PRD Electronics Div.
Marconi Instruments Ltd.
Metrifast
Moseley Associates
Narda Microwave
Varian Associates
Vevec Safat

QUADRATURE DISTORTION
Rohde & Schwarz
Telemet
Vevec Safat

RF DETECTOR
Bird Electronic Corp.
Coaxial Dynamics
Comark Communications
Harris Corporation, Broadcast
Products Division
Harris Corporation, PRD
Electronics Division
Moseley Associates
Potomac Instruments
Rohde & Schwarz
Telemet
Television Technology
Texscan Corp.
Vevec Safat
Vitek Electronics
Wavetek Indiana
Wide Band Engineering

VIDEO PRESENCE
AVL Digital
Channematic
Michael Cox
DI-tech
Graham-Patten Systems
International Microwave
Javelin Electronics
Portac
Rivers Associates
Telemet
Vidicraft
Video Aids of Colorado

DE-TUNING UNITS

BES Electronics
CSP Inc.
Dyma Engineering

DIGITAL VIDEO ANALYZER

Amtron Corp.
Apert-Herzog
NET Enterprises
Rohde & Schwarz
Tektronix

DIGITIZER, COLOR

Alford Mfg. Co.
Amtron Corporation of America
Aurora Systems
Grove Video
Gralex
Technology Service Corp.
Thomson-CSF

DIPLEXER

(See Antenna Accessories)

DISCS, VIDEO

Ampex
Arvin Echo
Eigen Video
Grove Video

Oktel Corporation
Precision/Echo Science
Tele Concepts In Communications
Thomson-CSF
U.S. JVC Corporation
Videomedia

DISPLAY UNITS, (TIME TEMP, ID)

(See Also Character Generators)
BEI (Beston Electronics Inc.)
Channematic
Cherry Elec. Prod. Corp.
Chrono-log Corporation
Cinema Products
Computer Video Systems
Datum
Gralex
Grove Video
EEV Inc.
ESE
Harris Corporation, Broadcast
Products Division
IGM Communications
Jatex Inc.
Kajaani Oy
Logitek
Multidyne Electronics
QSI Systems
Texscan/MSI Corp.
Thomson-CSF
Torpey Controls
Unitel
Vamco Engineering
Vevec Safat
Visual Methods

DIVIDERS, POWER

CSP Inc.
Comark Communications
Comtech Data
Cosmin Electronics
Crowder Communications
Dielectric Communications
Elcom-Bauer
Gardiner Communications
Harris Corporation, Broadcast
Products Division
Micro Communications
Moseley Associates
Mu-Del Electronics
Narda Microwave Corp.
North Hills Electronics
Phelps Dodge Communications
Rohde & Schwarz
SED Systems
Scala Electronic
Shively Laboratories, Inc.
Television Technology
Thomson-CSF
Trompeter Electronics
Vevec Safat
Wide Band Engineering

DROPOUT COMPENSATOR

Merlin Engineering
NEC America
One Pass Video
RCA Broadcast Systems
Siegel-Electronics
Studer ReVox America
John M. Sullivan Assoc., Inc.
Thomson-CSF
Video I-D
Videomedia

EARTH TERMINALS, RECEIVE ONLY

AEG-Telefunken
Ampica, Inc.
Anixter-Mark
Automation Techniques
Aydin Microwave
Blonder-Tongue Laboratories

Bonneville Satellite Corp.
California Microwave
Comad Communications
Compucon
Comtech Data Corp.
Conifer
Crowder Communications
Electrohome Ltd.
Gabriel Electronics
Gardiner Communications
Harris Corporation, Broadcast
Products Division
International Microwave
Lang Video Systems
Lindsay Specialty Products
M/A-COM Video Systems
Microdyne
Microwave Communications
Products
Modulation Associates
NEC America
Pinzone Communications
RF Technology
Rohde & Schwarz
SED Systems
Satcom Inc.
Scientific-Atlanta
Standard Communications
TL Systems
Television Technology
Thomson-CSF
Triple Crown Electronics
Vevec Safat
Wold Communications

EARTH TERMINALS, RECEIVE/TRANSMIT

AEG-Telefunken
Anixter-Mark
Aydin Microwave
Bonneville Satellite Corp.
California Microwave
Comad Communications
Compucon
Comtech Data Corp.
Crowder Communications
Harris Corporation, Broadcast
Products Division
Hughes Television Network
M/A-COM Video Systems
Microdyne Corp.
Modulation Associates
SED Systems
Scientific-Atlanta
Thomson-CSF
Varian Associates
Wold Communications

EDIT CODE GENERATOR

Aston Electronic Designs Ltd.
The BTX Corporation
C-M-C Technology Corp.
Coherent Communications
Control Video Corporation
Datametrics
Datatron
Datum
EECO Incorporated
ESE
For-A Corp. of America
Gray Engineering Labs
Jatex Inc.
Kaitronics
NET Enterprises
Shintron
Skotel Corporation
Telcom Research
Unemco International
United Media
Videomedia

EDIT CODE RECEIVER

The BTX Corporation
C-M-C Technology Corp.
Coherent Communications
Control Video Corporation
Convergence

Continued on page 78



BROADCAST EXPERTISE...

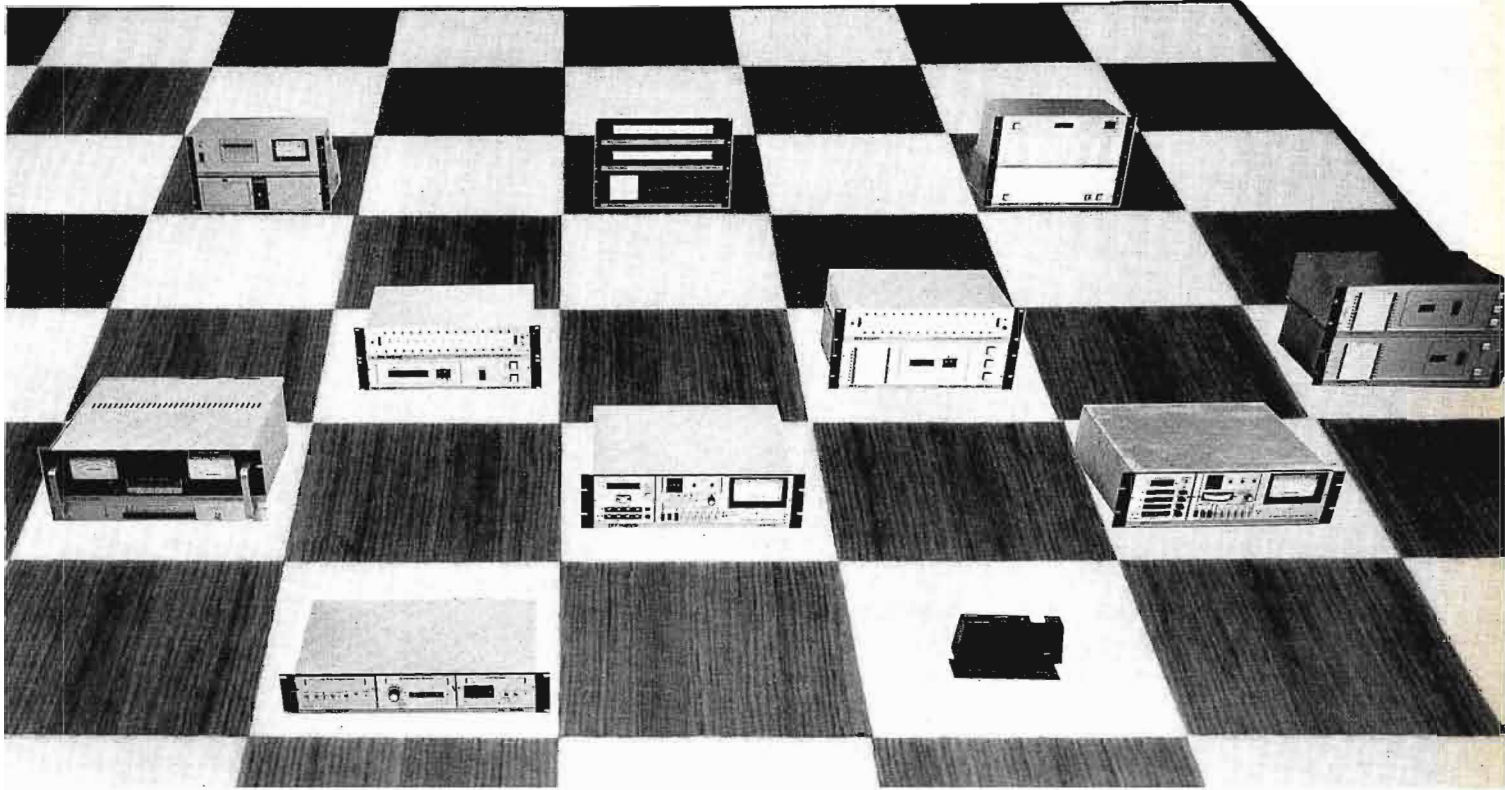

ACROSS THE BOARD!

Since 1970, TFT, Inc. has been a pioneer in state-of-the-art broadcast technology. As such, we have been able to always keep one move ahead in cost-effective design to provide reliable, versatile and innovative products to the broadcast industry.

TFT was the first to use frequency synthesized circuits in its full line of AM, FM, TV, stereo and SCA **Modulation Monitors**. TFT concepts in **Remote Control Systems** now allow expansion all the way to micro-processor based data logging, display and

alarm systems. In the relatively new field of **Studio Transmitter Links**, TFT has made major contributions through the use of IF modulation transmitters and pulse counting discriminators to improve both S/N ratio and stereo performance.

Even in the **Emergency Broadcast System (EBS)**, TFT has taken a leadership role in the development of both EBS generators and receivers.

Now, it's your move! Call or write TFT today for full facts on their winning product lines.

(TIME & FREQUENCY TECHNOLOGY)



3090 OAKMEAD VILLAGE DR.
SANTA CLARA, CA 95051
(408) 727-7272 TWX 910-338-0584

Circle (44) on Action Card

Datametrics
Datatron
Datum
Dynaquip Electron Devices Ltd.
EECO Incorporated
ESE
Electro & Optical Systems
For-A Corp. of America
Gray Engineering Labs Inc.
Jatex
Kaltronics
Shintron
Skotel Corporation
Steenbeck
Telcom Research
Thomson-CSF
Torpey Controls & Engineering
Unemco International
United Media

EDITOR, AUDIO

The BTX Corporation
Control Video Corp.
Datatron
EECO Inc.
Editall Corp.
Jatex
Leader Broadcast Systems
Musiciens
Quad-Eight Electronics
Scantex Laboratories
Steenbeck
United Media

EDITOR, FILM

CMX Systems/Orrox
Cinema Products
Compro Productions
Datatron
J&R Film Co., Inc.
K B Systems
Kalart Victor Corporation
Leedal
3M Company, Video Products
Magnasync / Moviola
Mobile Visual Productions
Neumade Products
New Earth TV Works
PAG Films Ltd.
Paulmar
Research Technology Int'l.
Scantex Laboratories
Steenbeck
Thomson-CSF
Unidek Film Editing Systems
Videomedia
The Virginia Company

EDITORS, VIDEO

CCTV / INDUSTRIAL
Adwar Video
BCB Electronic Sales
CMX/Orrox
Cezar International, Ltd.
Cinema Products
Control Video Corp.
Convergence
Michael Cox
Datatron
EMS Inc.
General Television Network
Harris Video Systems
Jatex
Javelin Electronics
3M Company
Panasonic Industrial
Portac
Sait Electronics
Sony Corp. of America
Thomson-CSF
U.S. JVC Corporation
Unemco International
United Media
Videomedia/S.E.D.

ENG / FIELD PRODUCTION

CMX Systems/Orrox.
Cezar International
Control Video Corp.
Michael Cox

Crow of Reading Ltd.
Harris Video Systems
Panasonic
Sony
US JVC Corporation
Video I-D
Videomedia

STUDIO PRODUCTION

Adwar Video
Ampex
BCB Electronic Sales Ltd.
BTX Corp.
Robert Bosch GmbH
Television Systems Div.
Cezar International, Ltd.
CMX / Orrox
Compro Productions
Control Video Corp.
Convergence
Michael Cox
Crow of Reading Ltd.
Datatron
EECO Incorporated
Fernseh
General Television Network
Harris Corp.,
Broadcast Products Div.
Interface Video Systems
Jatex
3M Company
Microvision
New Earth Television Work
System, Ltd.
Panasonic
RCA Broadcast Systems
Scantex Laboratories
Thomson-CSF
Tore Seem
Unemco International
United Media Inc.
U.S. JVC Corp.
Video I-D
Videomedia

EFFECTS SYSTEM, DIGITAL VIDEO

Adda Corporation
Adwar Video
Ampex
Aurora Systems
Robert Bosch GmbH
Television Systems Div.
Broadcast Video Systems
Central Dynamics Ltd.
Colorado Video
Convergence
Data Communications
Digital Video Systems
The Grass Valley Group
Grove Video
Harris Video Systems
Interand
MCI/Quantel
NEC America Inc.
Broadcast Equipment
Precision/Echo Science
Quantel Limited
Texscan/MSI Corporation
Thomson-CSF
Video I-D
Videomedia
Vital Industries

ELECTROMAGNETICS FOR KLYSTRON TUBES

Thomson-CSF
Varian Associates

ENCODERS

CLOSED CAPTIONING
EEG Enterprises
Logica

COLOR VIDEO

Asaca/Shibasoku
Broadcast Video Systems
Cezar International
Cohu, Electronics Division

Michael Cox
Fernseh
For-A Corporation
Grove Video
Harris Corporation, Broadcast
Products Division
Ikegami
Jatex
Jerrold Div., General Instrument
Lenco
Marcom Communication Systems Ltd.
Marconi Electronics, Inc.
MPB Technologies
QSI Systems
Siegel - Electronics
Thomson-CSF
Videomedia

PHONE

AEG-Telefunken
(Bayly Engineering)
American Microsignal
Bogen Division / Lear
Sieglar, Inc.
Cetec Vega
Channematic
Comex Systems
Communications Control Centers
Deltamod
Di-tech
Edcor
Frequency Devices
Gorman Redlich
IGM Communications
McMartin Industries
Monroe Electronics, Inc.
Motorola Communications &
Elect.
Rivers Associates, Inc.
Trepac Corporation of America

EBS

Broadcast Electronics
ESE
Gorman-Redlich Mfg. Co.
International Nuclear Corp.
Johnson Electronics
McMartin Industries
Rivers Associates

ENHANCERS, VIDEO IMAGE

Adwar Video
Asaca/Shibasoku
Robert Bosch GmbH
Cohu, Electronics Division
Composite Video
Consolidated Video
Crow of Reading Ltd.
Edutron
Faroudja Laboratories
Fernseh Inc.
Grove Video
Harris Video Systems
Ikegami
Lectrotech, Inc.
Listec Television Equipment Corp.
Microtime
Pleacar, Inc.
Siegel - Electronics
Simon Associates
John M. Sullivan Associates
Thomson-CSF
Video I-D
Video Optics
Video Products/3M
Vidicraft

ENHANCERS, STEREO PHASE

ATI Audio Technologies Inc.
Audiolincs of Oregon
Kintek
Howe Audio Marketing
Rupert Neve
Orange County

EQUALIZERS

AUDIO
ADM Technology

AEG-Telefunken,
(Bayly Engineering)
ATI Audio Technologies Inc.
Amek TAC
American Data
Apex Systems Ltd.
Audio & Design Recording
Audio Processing Systems
Audisar
Audix Ltd.
Bogen Division / Lear
Sieglar, Inc.
Broadcast Electronics
Broadcast Technology
C-Cor Electronics
Composite Video
Continental Electronics Mfg.
Crown International
Datatronix
Dolby Labs
Dukane Corp.
Dyma Engineering
Electro-Voice/EV Tapco
Electroline Television Equipment
Elektroimpex
Enertec Schlumberger
Farrtronics
Frequency Devices
Georg Neumann GwBH
Hammond Industries
Harrison Systems
IBX Inc.
IGM Communications
Integrated Sound GLI Div.
International
Electro-Magnetics, Inc.
Ivlie Electronics
Kahn Communications
Kintec
Klark-Teknik Research Ltd.
Leader Broadcast Systems, Inc.
Lævers Rich Equipment Ltd.
MXR Innovations, Inc.
McCurdy Radio
McMartin Industries
Modular Audio Products
NTP Electronics A/S
Rupert Neve
Georg Neumann
Opamp Labs
Orban Associates
Processing Plus
ProTech Audio Corporation
Pulse Techniques Inc. (Pultec)
Quad-Eight Electronics
Ramko Research
Research Systems Tech., Inc.
Richard Sound Design
C.N. Rood B.V.
SAE
Sescom, Inc.
Shure Brothers
Siemens Ag Osterreich
Sontec Electronics
Sound & Light Co.
Spectra Sonics
Spectrum Instruments
Sphere Electronics
John M. Sullivan Associates
Superex Electronics Corp.
TOA Electronics
TTE Inc.
Tascam, Div. of Teac
Tri Tec Systems Inc.
Tweed Audio USA, Inc.
UREI
Valley People
VIF International
Ward-Beck Systems
White Instruments

VERTICAL APERTURE
Electroline Television Equipment
Thomson-CSF

VIDEO

AVL Digital Ltd.
Allen Avionics
American Data
Robert Bosch GmbH
CMC technology Corporation
Cohu, Electronics, Div.
C-Cor Electronics
Composite Video
Michael Cox
DataTek

Continued on page 80

For Pal/SECAM heterodyne VTRs

The advantages of component-coding in a proven, digital TBC

Now only \$11,670 — with 16 line memory!

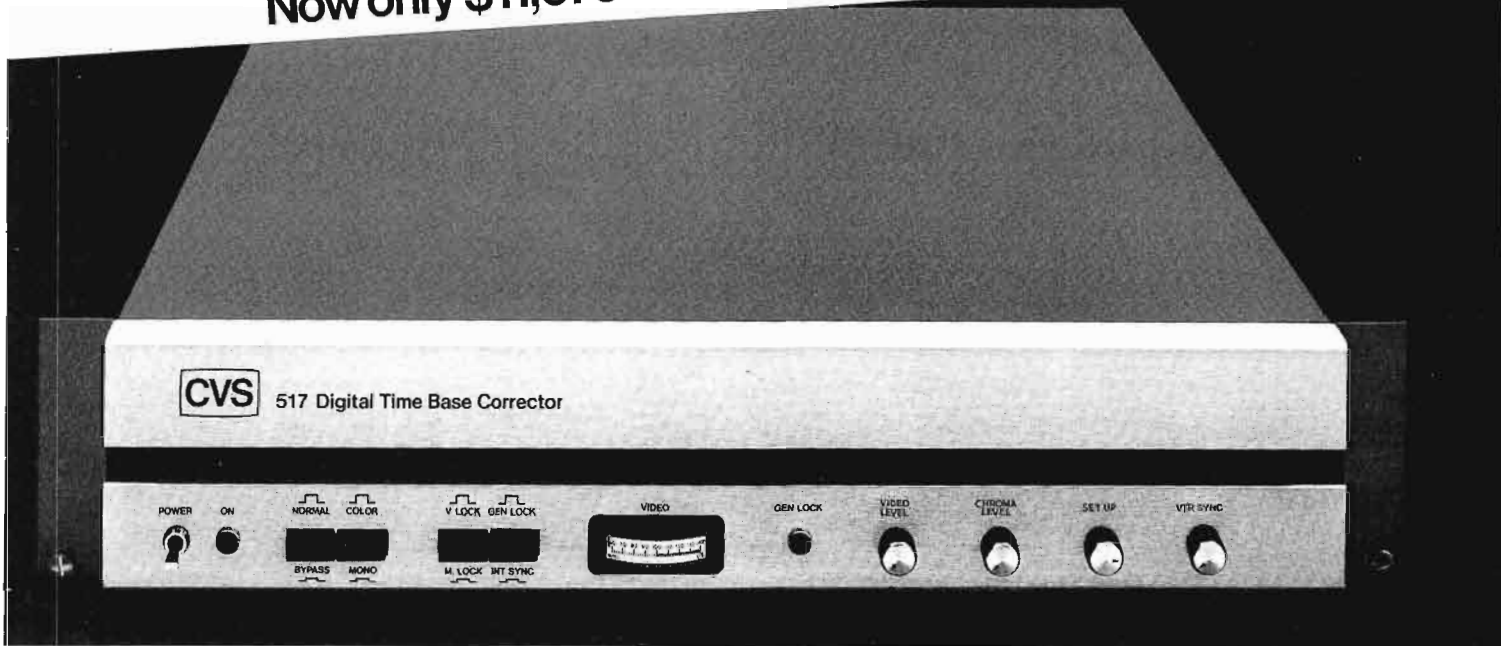

Recently, many experts have called for a digital standard based on component coding.

At Harris, we agree. We've been using it in our digital time base correctors since 1976 when, as Consolidated Video Systems, we introduced the CVS 517.

Today, the CVS 517 is acknowledged as the most versatile and effective TBC available — proven in over 500 installations.

The 517's unique architecture processes the video signal in *component* form instead of in *composite* form. This component coding technique results in a system that is inherently immune to color phasing problems and horizontal picture shift, or "cycle jump."

In addition, you receive real benefits in your day-to-day operation:

- Inherent immunity to color subcarrier editing problems.

- Excellent time base correction because there is no need to track the jittering subcarrier.
- Improved odd field and rough edit processing.
- Chroma noise reduction of 3db, without degradation of the luminance component.
- Better signal-to-noise ratio than composite systems with the same bit rate.

What's more, the CVS 517 features, as standard equipment: one-cable gen-lock, a DOC and a full proc amp with auto preset controls.

Plug-in options include: SECAM; Dub-to-Hiband for mains lock heterodyne-to-direct VTR dubs; 16 line memory; and an adjustable Image Enhancer/Noise Reducer with coring.

For details and a demonstration, contact your Authorized HVS Distributor, or the HVS office nearest you.

Be sure to ask for our free booklet about the basics of time base correction.



HARRIS



COMMUNICATION AND
INFORMATION PROCESSING

HARRIS CORPORATION Harris Video Systems
1255 East Arques Avenue, Sunnyvale, CA 94086 (408) 737-2100

Circle (45) on Action Card

DI-tech, Inc.
 Dynair Electronics, Inc.
 Dynamic Technology Ltd.
 Electroline Television Equipment
 GBC Closed Circuit TV Corp.
 The Grass Valley Group
 HEDCO
 Industrial Sciences Inc. (ISI)
 International Nuclear Corp.
 Javelin Electronics
 Leitch Video
 Lenco
 Link Electronics
 Multidyne Electronics
 Opamp Labs
 Pro Bel Ltd.
 Superex Electronics Corp.
 Telemet, Div. of Geotel
 Television Equipment Associates
 Thomson-CSF
 TTE Inc.
 Vital Industries

EQUIPMENT BUILDINGS PREFABRICATED

Fort Worth Tower Co.
 Harris Corporation
 Portatronics

EQUIPMENT CARRYING SYSTEMS

CASES
 A&S Case Co.
 Adwar Video
 Anvil Cases
 William Bal Corporation
 Bardwell & McAllister
 David H. Brothers, Co.
 Calzone Case Co.
 Cases Inc.
 Comprehensive Video Supply
 Environmental Containers
 Systems Inc.
 Excalibur Industries
 Fiberbilt
 The Great American Market
 Harris Corp./Farinon Video
 Impact Case Sales Limited
 K&H Products
 Leader Broadcast Systems
 Lowel-Light Mfg. Co.
 Nalpak Sales
 O'Connor Engineering Labs
 Panasonic
 Panoak Lighting Systems
 Portatronics
 Research Technology Int'l.
 See Hear Industries
 Sharp Electronics
 Simon Associates
 Thermodyne International Ltd.

CASES WITH WHEELS
 A&S Case Co.
 Adwar Video
 Anvil Cases
 William Bal Corporation
 Bardwell & McAllister
 Calzone Case Co.
 Cases Inc.
 Environmental Container
 Systems Inc.
 Excalibur Industries
 Fiberbilt
 The Great American Market
 K&H Products
 Leader Broadcast Systems
 Nalpak Sales
 PAG Group
 Portatronics
 Schuessler Case
 Sharp Electronics
 John M. Sullivan Associates
 Thermodyne International Ltd.

DOLLIES
 Adwar Video
 Anvil Cases
 Bardwell & McAllister

Bretford Mfg.
 Comprehensive Video Supply
 Excallbur Industries
 Fiberbilt
 GKM Manufacturing Corp.
 Gruber Products
 Harris Corporation
 K&H Products
 Leader Broadcast Systems
 Lee-Ray Industries
 PAG Group
 Portatronics
 Roll-A-Reel Co.
 Stantron Div. of Wyco
 Metal Products
 John M. Sullivan Associates

EXCITERS

AM EXCITER
 Acrodyne
 Bayly Engineering
 Comad Communications
 Continental Electronics Mfg.
 Elcom Specialty Products
 Harris Corporation, Broadcast
 Products Division
 LPB Inc.
 McMartin Industries
 Rohde & Schwarz GmbH & Co. KG
 Rohde & Schwarz
 Singer Products Inc.
 Scientific-Atlanta
 TBC Pty. Ltd.
 Thomson-CSF
 Tramec Electronics
 Versa - Count
 Wilkinson Electronics

AM STEREO
 Belar Electronic Labs
 Comad Communications
 Continental Electronics Mfg.
 Elcom Specialty Products
 Harris Corporation, Broadcast
 Products Division
 Kahn Communications
 McMartin Industries
 Motorola Inc. Special Products
 Processing Plus
 Rohde & Schwarz GmbH & Co. KG
 Rohde & Schwarz
 Tramec Electronics

FM EXCITER
 AEG-Telefunken
 (Bayly Engineering)
 Acrodyne
 Broadcast Electronics
 Cetec Broadcast Group
 Comad Communications
 Continental Electronics Mfg.
 CSI Inc.
 Crowder Communication
 Elcom Bauer
 Harris Corporation, Broadcast
 Products Division
 LPB Inc.
 McMartin Industries
 Moseley Associates
 NEC America, Inc.
 Broadcast Equipment
 QEI Corp.
 RCA Broadcast Systems
 Rockwell International
 Rohde & Schwarz
 C.N. Rood B.V.
 Singer Products Inc.
 Scientific-Atlanta
 Solid Electronics Laboratories
 TBC Pty. Ltd.
 Thomson-CSF
 Tramec Electronics
 Versa - Count
 Wilkinson Electronics

FM STEREO
 AEG-Telefunken
 (Bayly Engineering)
 Broadcast Electronics
 Comad Communications
 Continental Electronics Mfg.
 Crowder Communications
 Elcom Specialty Products
 Elcom Bauer
 Fung Engineering Labs Inc.

Harris Corporation, Broadcast
 Products Division
 LPB Inc.
 McMartin Industries
 Marconi Electronics, Inc.
 Moseley Associates
 NEC America Inc.
 Broadcast Equipment
 Orban Associates
 Pyramid Loudspeaker
 QEI Corp.
 RCA Broadcast Systems
 Rohde & Schwarz GmbH
 & Co KG
 Rohde & Schwarz
 C.N. Rood B.V.
 Singer Products Inc.
 Solid Electronics Laboratories
 TBC Pty. Ltd.
 Thomson-CSF
 Tramec Electronics
 Versa - Count

SCA EXCITER
 Broadcast Electronics
 Cetec Broadcast Group
 Comad Communications
 Continental Electronics Mfg.
 Elcom Specialty Products
 Elcom Bauer
 Harris Corporation, Broadcast
 Products Division
 McMartin Industries
 Moseley Associates
 QEI Corp.
 Rohde & Schwarz
 C.N. Rood B.V.,
 Solid Electronics Laboratories
 Versa - Count

FIBER-OPTIC TRANSMISSION SYSTEM

AEG-Telefunken
 (Bayly Engineering)
 American Laser Systems
 Ariel Communications
 Belden
 Robert Bosch GmbH,
 Television Systems Div.
 Catel, Div. of United Scientific
 Foundation Electronic Instruments
 GTE Products Corp.
 The Grass Valley Group
 ILC Data Device Corp.
 LeCroy Research System
 M/A-COM Video Systems
 Moseley Associates
 NEC America Inc.
 R. E. Instruments
 Standard Telephon UND Radio
 Telemet, Div. of Geotel
 Thomson-CSF
 Times Fiber Communications

FIBER OPTIC FOTOR

Tektronix

FIELD VIDEO SETUP MODULE

Altha Video & Elect. Corp.
 Cinema Products
 Lang Video Systems
 One Pass Video
 Porta-Pattern Telecommunications
 John M. Sullivan Associates

FILM & ACCESSORIES & SERVICES

8mm/16mm
 Buhl Optical Co.
 Compro Productions
 The Durafilm Co.
 Eastman Kodak
 Goldberg Bros. Inc.

Houston Pearlless 76 Inc.
 J&R Film Co. Inc.
 K B Systems
 Leo Diner Film
 Magna-Tech Electronic Co., Inc.
 Magnasync/Moviola
 Mobile Visual Productions
 Optical & Textile
 PAG Films Ltd.
 W.A. Palmer Films
 Paulmar Inc.
 Rangertone Research Inc.
 Rank Cintel
 Schuessler Case
 Starex Inc.
 Unidek Film Editing Systems
 The Zei-Mark Corp.

DUBBING SYSTEMS
 Magna-Tech

REWINDERS
 Goldberg Bros. Inc.
 J&R Film Co., Inc.
 K B Systems
 Kalart Victor Corporation
 Kinetronics Corporation
 Lipsner-Smith
 Magnasync/Moviola
 Neumade Products
 PAG-Group
 Paulmar Inc.
 Research Technology, Int'l.
 Sigma Film Equipment

SOUND TRANSFER
 Eastman Kodak
 Image Transform
 K B Systems
 Leo Diner Films
 Lipsner Smith Co.
 Magna-Tech Electronic
 Magnasync/Moviola
 Multi-Track Magnetics
 PAG-Films Ltd.
 W.A. Palmer Films, Inc.
 Rangertone Research Inc.
 Rank Cintel
 E.J. Stewart Inc.

TO VIDEOTAPE TRANSFER
 Adwar Video
 Cinema Products
 Eastman Kodak
 Image Transform, Inc.
 Interface Video Systems, Inc.
 Leo Diner Films
 Lipsner Smith, Co.
 One Pass Video
 Magnasync/Moviola
 Mobile Visual Productions
 Multi-Track Magnetics
 W.A. Palmer Films
 Piclear Inc.
 Quad Eight
 Rank Cintel
 E.J. Stewart, Inc.
 Thomson-CSF
 Video Dub
 The Zei-Mark Corp

FILM CHAIN LIGHT CONTROL

BEI (Beston Electronics)
 Elicon
 Industrial Sciences Inc. (ISI)
 Laird Telemedia, Inc.
 Lipsner Smith, Co.
 The Zei-Mark Corp.

FILM CHAIN SYSTEMS

(See Also Projectors and Cameras)
 Robert Bosch GmbH
 Television Systems Div.
 Buhl Optical
 Cohu, Electronics Division
 Fernseh Inc.
 Global Video Comm. Corp.

Continued on page 82

**SAVE MONEY
CHECK OUR
MONTHLY
SPECIALS**

**Serving the industry
Since 1922
World's largest
franchised distributor
of electronic tubes
Serving over 5,000 stations**

**FREE GIFTS
FIND OUT
HOW TO QUALIFY
PHONE OR WRITE**



**BROADCAST
TUBES**



WE WILL NOT BE UNDERSOLD

**TRANSMITTING
TUBES**

3B28.....	\$ 10.00
3CW20000A3.....	1400.00
3CW20000A7.....	1495.00
3CX1000A7.....	500.00
3CX1500A7.....	460.00
3CX2500A3.....	426.00
3CX2500F3.....	390.00
3CX3000A1.....	420.00
3CX3000A7.....	540.00
3CX3000F1.....	495.00
3CX3000F7.....	602.00
3CX10000A3.....	1062.00
3CX10000A7.....	1420.00
3CX15000A3.....	1350.00
3CX15000A7.....	1330.00
3CX20000A7.....	1855.00
3-400Z.....	82.00
3-500Z.....	88.00
4CV35000A.....	2165.00
4CX250B.....	55.00
4CX250BC.....	68.00
4CX250K.....	120.00
4CX250R.....	87.00
4CX300A.....	175.00
4CX350A.....	105.00
4CX350F.....	118.00
4CX1000A.....	365.00
4CX1000K.....	450.00
4CX1500A.....	579.00
4CX1500B.....	460.00
4CX3000A.....	862.00
4CX5000A.....	1018.00
4CX10000D.....	1175.00
4CX15000A.....	1400.00
4CX20000A.....	1475.00
4CX35000C.....	5520.00
4CX40000G.....	6722.00
4X150A.....	49.50
4X500A.....	320.00
4-65A.....	62.00
4-125A.....	70.00
4-250A.....	90.00
4-400A C.....	88.00
4-400AX.....	160.00
4-400B.....	110.00
4-500A.....	192.00
4-1000A.....	415.00
5CX1500A.....	620.00

**TRANSMITTING
TUBES**

5-500A.....	225.00
575A.....	27.00
673.00.....	35.00
802.....	27.50
805.....	50.00
807.....	5.50
810.....	60.00
813.....	40.00
816.....	5.25
828.....	80.00
833A.....	80.00
866A.....	6.80
872A.....	15.50
889RA.....	1775.00
891R.....	2220.00
892R.....	2200.00
4055V I.....	105.00
5762.....	910.00
5879.....	4.00
5924A.....	795.00
5933.....	15.25
6076.....	540.00
6076A.....	625.00
6146A.....	7.25
6146B.....	7.50
6155.....	70.00
6156.....	70.00
6161.....	395.00
6166A(7007).....	2220.00
6696A.....	2790.00
6697A.....	2900.00
ML7007A.....	3390.00
7237A.....	525.00
7527.....	110.00
7527A.....	160.00
8008.....	16.00
8122.....	82.00
8791VI.....	405.00
8792VI.....	725.00
8873.....	185.00
8874.....	185.00
8875.....	185.00
8890.....	2400.00
8891.....	3300.00
8916.....	3100.00
8985.....	1600.00
8986.....	1225.00

CAMERA TUBES

BC4390 series.....	\$1820
BC4391 series.....	2140
BC4392 series.....	2270
BC4393R.....	2460
BC4394.....	2460
BC4532U.....	1325
BC4592 series.....	2195
BC4593R.....	2350
BC4594 series.....	2350
BC4809.....	720
BC4809B.....	720
BC4908 series.....	1875
BC4909.....	1955
BC4992 series.....	2280
BC4993R.....	2460
BC4994 series.....	2460
5820A L.....	3060
7295C.....	2835
7389C.....	2855
BC7735.....	240
BC8134.....	810
BC8134B.....	775
8480.....	1315
BC8480.....	1945
BC8507.....	270
BC8541.....	270

VIDICONS FOR CCTV

20PE11.....	26.25
20PE13A.....	26.25
20PE14.....	28.35
20PE19/S4097.....	28.35
20PE20/S4097A.....	28.35
4532U.....	285.00
7262A.....	30.35
7735A.....	30.85
7735B.....	165.00
8134.....	294.00
8507.....	150.00
8507A.....	245.00
8541.....	40.00
8541B.....	50.00
8758A.....	45.00
8823.....	30.00
8844.....	26.25
8929.....	30.00
S4075.....	279.50
S4076.....	318.50
S4092.....	299.00
S4102.....	305.00
S4113.....	344.00
S4119.....	403.00
S4140.....	403.00

**AIR SYSTEM
SOCKETS**

SK-300.....	470.00
SK-300A.....	325.00
SK-310.....	380.00
SK-400.....	235.00
SK-410.....	32.00
SK-500.....	336.00
SK-510.....	32.50
SK-600.....	47.00
SK-600A.....	46.25
SK-602.....	68.00
SK-602A.....	72.00
SK-607.....	56.00
SK-610.....	52.00
SK-610A.....	60.00
SK-611.....	41.00
SK-612.....	72.00
SK-620A.....	59.00
SK-630A.....	61.00
SK-640.....	34.00
SK-650.....	35.00
SK-1300.....	319.00
SK-1310.....	336.00
SK-1320.....	366.00
SK-1400A.....	430.00
SK-1420.....	570.00
SK-1470A.....	555.00
SK-1490.....	522.00
SK-1500A.....	984.00
SK-1510A.....	1149.00
SK-1920.....	19.00
SK-2200.....	76.00
SK-2210.....	64.00
SK-2220.....	292.00
SK-655.....	36.00
SK-660.....	37.00
SK-660A.....	35.00
SK-700.....	216.00
SK-710.....	207.00
SK-711A.....	207.00
SK-712A.....	207.00
SK-740.....	72.00
SK-760.....	72.00
SK-761.....	72.00
SK-770.....	80.00
SK-800B.....	240.00
SK-810B.....	260.00
SK-820.....	565.00
SK-830A.....	540.00
SK-831.....	286.00
SK-840.....	340.00
SL-860.....	207.00

**AIR SYSTEM
SOCKETS**

SK-890B.....	234.00
SK-900.....	283.00

CHIMNEYS

SK-3096.....	25.00
SK-316.....	25.00
SK-406.....	57.00
SK-416.....	27.00
SK-506.....	85.00
SK-516.....	105.00
SK-606.....	10.00
SK-626.....	10.00
SK-636B.....	29.00
SK-646.....	58.00
SK-656.....	58.00
SK-806.....	31.00
SK-816.....	27.00
SK-906.....	44.00
SK-1306.....	37.00
SK-1406.....	32.00
SK-1426.....	35.00
SK-2216.....	48.00

**SOLID STATE
REPLACEMENTS
FOR VACUUM
TUBE RECTIFIERS**

ASSR-1010 575A.....	35.00
ASSR-1011 673.....	50.00
ASSR-1013 866A, 866AX, 3B28.....	9.00
ASSR-1014 872A, 872AX, 4B32.....	30.00
ASSR-1015 8008, 8008XE.....	35.00

RECEIVING TUBES

Complete lines of major brands at 75 to 80% off list.

SEMICONDUCTORS

Full lines of Sylvania (ECG), RCA (SK), and GE replacement semiconductors

Wholesale tube prices to broadcasters • One source for all your electronic needs • Off the shelf, overnight delivery: call 24 hrs. a day, 7 days a week, 1-800-221-0860. POLICY STATEMENT: Terms: Rated firms — Net 30 Days. Others: Furnish Trade References — 2% Discount if payment accompanies order. All shipments F.O.B. Brooklyn, usually within 24 hours of order. Emergency Shipments Our Specialty. All products carry Standard Factory Guarantee. All Prices Subject to Change Without Notice.



COMMUNICATIONS, INC., 2115 Avenue X, Brooklyn, New York 11235

Phone: (212) 646-6300 / Toll Free: (800) 221-0860

Telex: 235125 Cable: CeCo Tubes

Circle (46) on Action Card

Harris Corp.
Broadcast Products Div.
Ikegami
Image Devices
Kalart Victor Corporation
Laird Telemedia
Lipsner Smith Co.
Magnasync/Moviola Corp.
Marconi
NEC America
Nytone Electronics Corporation
Phillips Broadcast Group
RCA Broadcast Systems
Radmar
Rangertone Research
Rank Cintel
RCA Broadcast Systems
Video I-D
Westrex
Zei-Mark Corporation

FILTERS

ACTIVE
ADM Technology
ATI Audio Technologies Inc.
Amek TAC
Aphex Systems
Audio & Design Recording
Composite Video
dbx Inc.
Dyma Engineering
Electroline Television Equipment
Elektroimpex
Frequency Devices
Ivie Electronics
ILC Data Device Corp.
Lipsner Smith Co.
Georg Neumann GwbH
Rupert Neve
Georg Neumann
Potomac Marine & Aviation
Quad-Eight Electronics
Research Systems Tech., Inc.
Richard Sound Design
C.N. Rood B.V.
Sescom, Inc.
Sontec Electronics
Spectrum Instruments
Spectra Sonics
TT Electronics
VIF International
White Instruments

ANTENNA

Alford Mfg. Co.
Antennas for Communications
Bird Electronics
Coaxial Dynamics
Continental Electronics Mfg.
Dielectric Communications
Dyma Engineering
Elcom-Bauer
Electroline Television Equipment
The Finney Company
Harris Corporation, Broadcast
Products Division
Kathrein-Werke AG
Lipsner Smith Co.
Micro Communications
Phelps Dodge Communications
RMS Electronics
Rohde & Schwarz
Shively Laboratories
Triple Crown Electronics
TT Electronics
VTE Microwave Inc.
Vidaire Electronics Mfg.

NOISE

Audio & Design Recording
Beaveronics
Broadcast Video Systems
Computer Business Systems
Electroline Television Equipment
Fernseh
Frequency Devices
Lightning Elimination Associates
Lipsner Smith Co.
Jatex
Nurad Inc.
Ramko Research
Rohde & Schwarz
C.N. Rood B.V.
Spectra Sonics
TT Electronics

Vidaire Electronics Mfg.

PASSIVE

AEG-Telefunken,
(Bayly Engineering)
AMP Inc.
AVL Digital Ltd.
Allen Avionics
Altec Lansing
Anderson Laboratories
Antennas for Communications
Audio & Design Recording
Audio-Video Engineering Co.
Bird Electronics
Blonder-Tongue Laboratories
Coastcom
Coaxial Dynamics
Comark Communications, Inc.
Compac Development Corp.
EFI
ESC Electronics
Electroline Television Equipment
The Finney Company
ILC Data Device Corp.
Jerrold Div.,
General Instrument
Lightning Elimination Assoc.
Lipsner Smith Co.
Modulation Associates
Mu-Del Electronics
North Hills Electronics
Phelps Dodge Communications
Potomac Instruments
Potomac Marine & Aviation
Quad-Eight Electronics
C.N. Rood B.V.
Sescom
Shure Brothers
Tepco Corp.
TT Electronics
Vitek Electronics
White Instruments

VARIABLE / FIXED

ADM Technology
Audio & Design Recording
Barker & Williamson Inc.
Coaxial Dynamics
ESC Electronics
Frequency Devices
ILC Data Device Corp.
International Microwave Corp.
Lipsner Smith Co.
North Hills Electronics
Potomac Instruments
ProTech Audio
Pulse Techniques Inc. (Pultec)
Quad-Eight Electronics
Richard Sound Design
Research Systems Tech. Inc.
Sescom
Spectrum Instruments
Texscan Corp.
TT Electronic Inc.
White Instruments Inc.

VIDEO

AVL Digital Ltd.
Allen Avionics
Anderson Labs
Audio-Video Engineering Co.
Broadcast Video Systems
Catei
Datatek
ESC Electronics
Faroudja Laboratories
ILC Data Device Corp.
Lipsner Smith Co.
Modulation Associates.
Rohde & Schwarz
TT Electronics, Inc.
Thomson-CSF
Tiffen Mfg. Corp.
Vidaire Electronics Mfg.

FRAME STORE SYNCHRONIZERS

Adda Corporation
Apert-Herzog
Arvin Echo
Asaca/Shibasoku
BCB Electronic Sales Ltd.
Digital Video Systems
ECCO Inc.

Harris Video Systems
Harris Corp.,
Broadcast Products Div.
MCI/Quantel
Microtime
NEC America Inc.
Broadcast Equipment
Quantel Ltd.
RCA Broadcast Systems
Thomson-CSF

FRAME / FIELD STORE, DIGITAL

Adda Corporation
Apert-Herzog
Arvin Echo
Asaca/Shibasoku
Aurora Systems
Robert Bosch GmbH,
Television Systems Div.
Colorado Video
Digital Video Systems
Eigen Video
Fernseh Inc.
Grove Video
Harris Corp., Broadcast Products
Harris Video Systems
Logica
MCI/Quantel
Merlin Engineering
Microtime
MPB Technologies
NEC America, Inc.
Broadcast Equipment
Phase Video Inc.
Quantel Ltd.
RCA Broadcast Systems
Rohde & Schwarz
Thomson-CSF
Vital Industries

FRAMES & RACKS

Amco Engineering
Artel Communications Corp.
Bayly Engineering
Bud Industries
Broadcast Electronics
Cases Inc.
Centro Corp.
David H. Brothers Co.
Digital Video Systems
Dell Technical Vehicles
Dyma Engineering
Dynair
Enclosure Corp.
Encor Products
GBC Closed Circuit TV Corp.
GF Business Equipment
GKM Manufacturing Corp.
Grinnan Fixture
HSC Incorporated
Hammond Industries
Micro-Trak
Modular Audio Products
Panoak/B-W Lighting System
Research Technology Int'l.
Stantrom
Straight Wire Audio
Vector Electronic Co.
Winsted Corp.
Wyco Metal Prod.

FURNITURE & CABINETRY, STUDIO

Amco Engineering
AudiTronics
Bretford Mfg.
Broadcast Audio Corp.
David H. Brothers Co.
Bud Industries
Calzone Case Co.
Centro Corp.
Dell Technical Vehicles
Dyma Engineering
Dynamic Technology Ltd.
Electro-Acoustic Designs
Emcor Products/GF Business
Equipment
Encor Products

The Graphic Express
Grinnan Fixture
HSC Incorporated
Hammond Industries
Harris Corp.
Broadcast Products Div.
IGM Communications
Kreonite
Leader Broadcast Systems
Leedal
McCurdy Radio Industries
Mirco-Trak
Pacific Recorders & Engineering
Panoak Lighting Systems
Rack Techniques
Rangertone Research Inc.
Research Technology Int'l.
Ruslang Corp.
Strantron, Div. of Wyco
Uniset Corp.
Winsted Corporation

GENERATORS

AF
Amber Electro Design
Audisair
Bald Mountain Lab
CMC Technology Corp.
California Instruments
Comex Systems
Elektroimpex
Georg Neumann GwbH
Kajaani Oy
Leader Broadcast Systems
Leader Instruments
Modular Audio Products
Georg Neumann
Opamp Labs
Potomac Instruments
Potomac Marine & Aviation
Quad-Eight Electronics
Rohde & Schwarz
Sescom
Siemens AG Osterreich
Spectra Sonics
Tektronix
VIZ Mfg. Co.
White Instruments Inc.
Xedit Corporation

BACKGROUND COLOR

American Data
Asaca/Shibasoku
Automation Techniques
Beaveronics
Robert Bosch GmbH
Broadcast Video Systems
C-M-C Technology Corp.
Cezar International
Michael Cox
Crosspoint Latch Corp.
Crow of Reading Ltd.
Elektroimpex
Graham-Patten Systems
The Grass Valley Group
Harris Corporation, Broadcast
Products Division
Image Video Limited
Industrial Sciences, Inc. (ISI)
International Nuclear Corp.
Lang Video Systems
Lenco
Shintron
John M. Sullivan Associates
Texscan/MSI Corporation
Thomson-CSF
Vital Industries

BURST

American Data
Automation Techniques, Inc.
Robert Bosch GmbH
Don Britton Ent.
Broadcast Video Systems
Michael Cox
C-M-C Technology Corp.
Canter-Redman Technologies
Crosspoint Latch
Crow of Reading Ltd.
Dynair Electronics
Fernseh Inc.
Graham-Patten Systems
Harris Corporation, Broadcast
Products Division

Continued on page 84

Profitable in-house production starts with the right system.

Designed by MCI.

Time was when you could get by on in-house production with a couple of beat-up tape recorders and a turntable. But audiences and advertisers of today are demanding more. And that means a total production system that allows you to do everything from overdubbing and track bouncing to live multitrack recording. Now the company that has equipped more award winning studios than any other has designed a Total Production Package priced within your budget. You get an 8-track recorder, 2-track recorder and a studio quality console with

10 microphone and 5 stereo line inputs. Plus remote control, an accurate spot timer, 10 programmable "search and find" memories, variable speed and dozens of other features designed to make your job easier and your product better. MCI even offers a comprehensive user training program in the creative use and the maintenance of this system.

Contact your nearest MCI dealer today about the quality design (and current price advantages) of MCI's new Total Production Package. Your advertisers will love you for it.

Circle (48) on Action Card

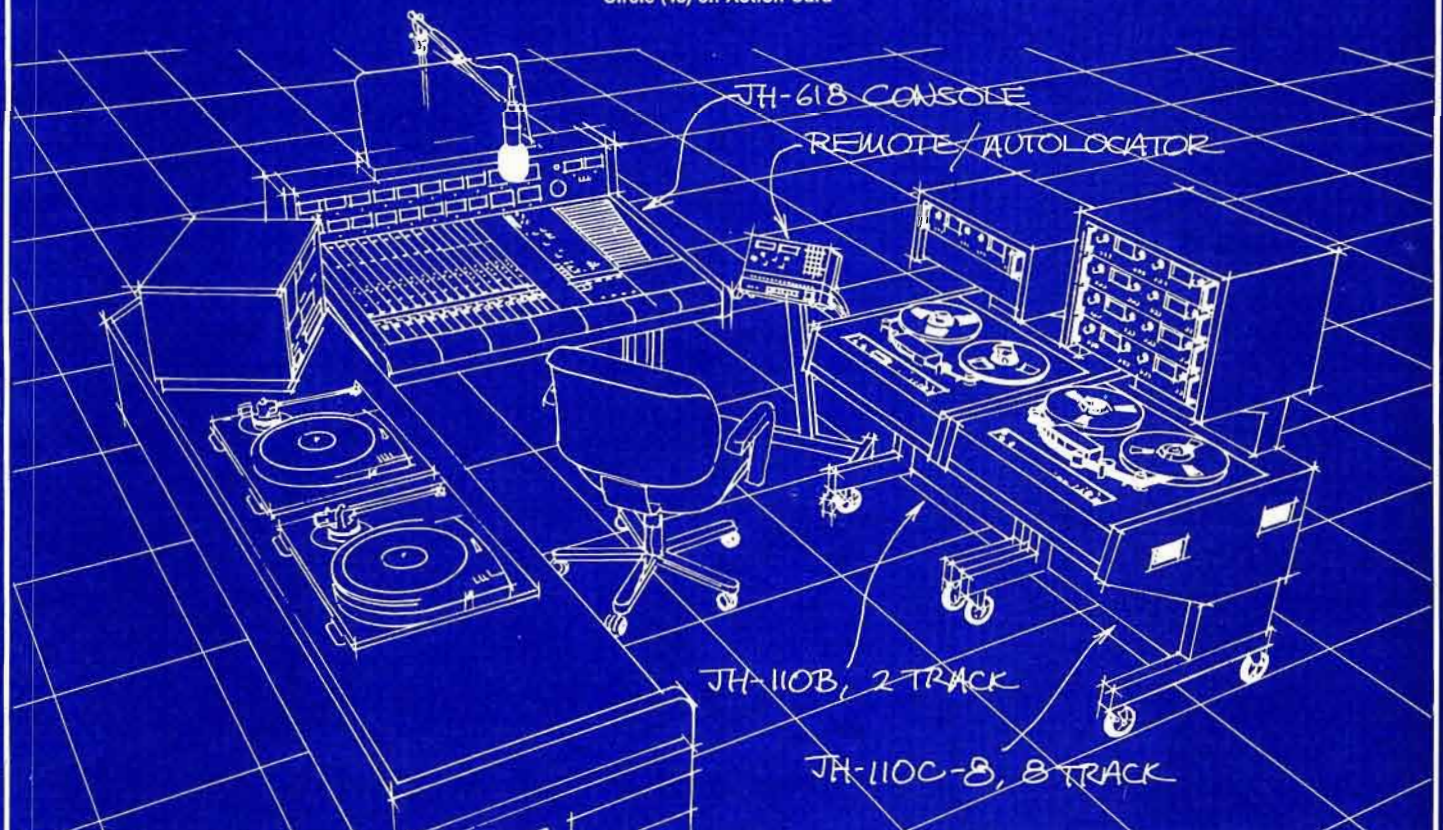

SPECIFICATION			CONTROL			DWG.		
		TITLE						REV.
		BROADCAST AUDIO PRODUCTION SYSTEM						
DRAWN	AM	DATE	SHT	DWG.	DWG. No.		B	
CHECKED	DM		OF	SIZE	233			
APPROVED	gl		3	A				

Industrial Sciences, Inc. (ISI)
International Nuclear Corp.
Jatex Inc.
Leader Instruments Corp.
Leitch Video
Lenco
Marconi Electronics, Inc.
Multidyne Electronics
NTP Elektronik A/S
Philips Test & Measuring
QSI Systems
Thomson-CSF
Video Aids of Colorado
Vital Industries

COLOR PATTERN

Philips Test & Measuring

COLOR SYNC

Asaca/Shibasoku
Aston Electronic Developments
Robert Bosch GmbH
Broadcast Video Systems
Michael Cox
Crosspoint Latch Corp.
Crow of Reading Ltd.
Dynair Electronics
ECHOlab, Inc.
Elektroimpex
Fernseh Inc.
Graham-Patten Systems
The Grass Valley Group
Harris Corp., Broadcast Products
Ikegami
Industrial Sciences Inc. (ISI)
Lang Video Systems
Leader Instruments Corp.
Leitch Video
Lenco
Link Electronics
3M Company
Marconi Electronics, Inc.
Multidyne Electronics
Panasonic
Phase Video Inc.
Philips Test & Measuring
QSI Systems
Rohde & Schwarz
Shintron
Siegel - Electronics
Sigma Electronics
John M. Sullivan Associates
Tektronix
Thomson-CSF
Viscom Engineering
Video Aids of Colorado

CONVERGENCE

Amtron Corp.
Crow of Reading
Harris Corporation, Broadcast
Products Division
Leader Instruments Corp.
Lectrotech
Leitch Video
Lenco
Multidyne Electronics
Philips Test & Measuring
Rohde & Schwarz
Sigma Electronics
Tektronix
Teimet
VideoMedia

RF

ATV Research
Asaca/Shibasoku
Boonton Electronics Corp.
Delta Electronics
John Fluke Mfg. Co., Inc.
Javelin Electronics
Lang Video Systems
Leader Instruments
Marshall Electronics
Moseley Associates
Motorola Communications & Elect.
Potomac Instruments
Rohde & Schwarz
John M. Sullivan Associates
Thomson-CSF
VIZ Mfg. Co.
Wavelek Indiana

SYNC, TV

Asaca/Shibasoku
Aston Electronic Developments
Automation Techniques, Inc.

Broadcast Video Systems
Cinetronics
Michael Cox
Crosspoint Latch Corp.
Crow of Reading Ltd.
Digital Video Systems
Dynair Electronics
Echo Lab
Fernseh
Fortel
Graham-Patten Systems
The GBC Closed Circuit TV Corp.
Grass Valley Group
Harris Corp., Broadcast Products
Ikegami
Industrial Sciences Inc. (ISI)
Lang Video Systems
Leader Instruments
Leitch Video
Lenco
Link Electronics
Marconi Electronics
Multidyne Electronics
Philips Test & Measuring
Philips Broadcast Group
QSI Inc.
Rohde & Schwarz
Shintron
Sigma Electronics
Tektronix
Telemet
Thomson-CSF
Video Aids of Colorado
Viscount Industries

SUBCARRIER, FM

ATV Research
Broadcast Electronics
Catel (Division of United Scientific)
Cetec Broadcast Group
Harris Corp. Broadcast Products
Leader Broadcast Systems, Inc.
McMartin Industries
Micro Control Associates
Modulation Assoc.
Moseley Associates, Inc.
Philips Test & Measuring
Rohde & Schwarz
C.N. Rood B.V.
Solid Electronics Laboratories
Tektronix
Tepco

SCA

Broadcast Electronics
Cetec Broadcast Group
Comad Communications
Continental Electronics Mfg.
Harris Corp., Broadcast Products
McMartin Industries
Moseley Associates
QEI Corp.
Rohde & Schwarz
C.N. Rood B.V.
Solid Electronics Laboratories
Swintek Enterprises
Versa-Count

SPECIAL EFFECTS

American Data
Asaca/Shibasoku
Aurora Systems
Beaveronics
Broadcast Video Systems
Central Dynamics Ltd.
Colorado Video
Convergence
Michael Cox
Crosspoint Latch Corp.
Crow of Reading Ltd.
Digital Video Systems
Dubner Computer Systems
Dynair Electronics, Inc.
Echo Lab
Graham-Patten Systems
Grass Valley Group
Grove Video
Industrial Sciences Inc. (ISI)
Interand
Lang Video Systems
3M Video Products
MCI/Quantel
NEC America Inc.
Panasonic
RAVE/Reliable Audio Video
Enterprises
Shintron

Tech Theatre Inc.
Thomson-CSF
Vital Industries
Video Associates Labs
Viscom Engineering
Viscount Ind.

STEREO

(See Also Test Equipment)
BPI Audio Text Instruments
Broadcast Electronics
Comad Communications
Continental Electronics Mfg.
Harris Corporation, Broadcast
Products Division
Kintek
Leader Instruments
Leader Broadcast Systems
McMartin Industries
Moseley Associates
Orban Associates
Potomac Instruments
Pyramid Loudspeaker Corp.
Rohde & Schwarz
C.N. Rood B.V.
Solid Electronics Laboratories
Sound Technology
Tektronix
Versa-Count

TIME CODE

Ampex
Audio Kinetics
The BTX Corporation
Robert Bosch GmbH
Broadcast Video Systems
C-M-C Technology Corp.
Chrono-log Corporation
Control Video Corporation
Datametrics Dresser
Datatron Inc./
Video Systems Div.
Datum
Dynamic Technology Ltd.
Dynaquip Electron Devices Ltd.
E & O Systems, Ltd.
EECO Incorporated
ESE
Gray Engineering Laboratories
Jatex
Kaitronics
Kudelski SA
Multidyne Electronics
Multi-Track Magnetics
Panasonic
Philips Broadcast Group
QSI Systems
Recortec
Shintron
Skotel Corporation
Telcom Research
Thomson-CSF
Torpey Controls & Engineering
True Time Instruments
United Media, Inc.

TONE

American Microsignal Corp.
Asaca/Shibasoku
Audisar
Bald Mountain Lab
Bogen Division/Lear Slegler, Inc.
Broadcast Electronics
C-M-C Technology Corp.
Cetec Vega
Channelmatic
Comex Systems
Communications Control Centers
Conex Electro Systems
Deltamod
Gorman Redlich
Leader Broadcast Systems
Link Electronics
McMartin Industries
Modular Audio Products
Modulation Associates
Motorola Communications & Elect.
Multidyne Electronics
Opamp Labs
Potomac Marine & Aviation
Rivers Associates Inc.
Sescom
Siemens AG Osterreich
Teac Corp. of America
Triplett Corp.
Trepac Corporation of America
VIF International

TONE, EBS

Bald Mountain Lab
Broadcast Electronics
ESE
Gorman-Redlich Mfg. Co.
McMartin Industries
Rivers Associates Inc.

GENERATORS, ELECTRIC POWER

AEG-Telefunken
California Instruments
Dell Technical Vehicles
Dynamote
E-N-G Corp.
Gralex
Harris Corp., Broadcast
Products Div.
North Wind Power
Onan Corp.
RTS Systems
Teledyne Energy Systems
Vanner

GRAPHIC EQUALIZERS

Audio & Design Recording
Datatronix
Harrison Systems
IGM Communications
Integrated Sound
International Electro Magnetics
MXR Innovations Inc.
Opamp Labs
Orban Associates
Pulse Techniques
Quad-Eight Electronics
Spectra Sonics
John M. Sullivan Associates
White Instruments

HEAD DEGAUSSERS

R.B. Anns Co.
Comprehensive Video Supply
IGM Communications
Kudelski S.A.
Leavers Rich Equipment Ltd.
Marathon Products
Nortronics
Research Technology Int'l.
Saki Magnetics
Spectra Sonics
United Research Lab. Corp.
Wide Range Electronics

HEADS, AUDIO & ACCESSORIES/ SERVICES

ALIGNMENT GAUGES
Aristocart
Broadcast Electronics
D-B Electronics
Fidelipac
Harris Corporation, Broadcast
Products Division
IGM Communications
Image Devices Incorporated
Merlin Engineering
Multi-Track Magnetics
Nortronics
Studer ReVox America
Tapecaster TCM, Inc.
Telex Communications
UMC Electronics

CLEANERS

Allsop
Broadcast Electronics
Chemtronics
Comprehensive Video Supply
Electro-Acoustic Designs
Fidelipac
IGM Communications

Continued on page 86

Telemet

Video Broadcast and Test Equipment

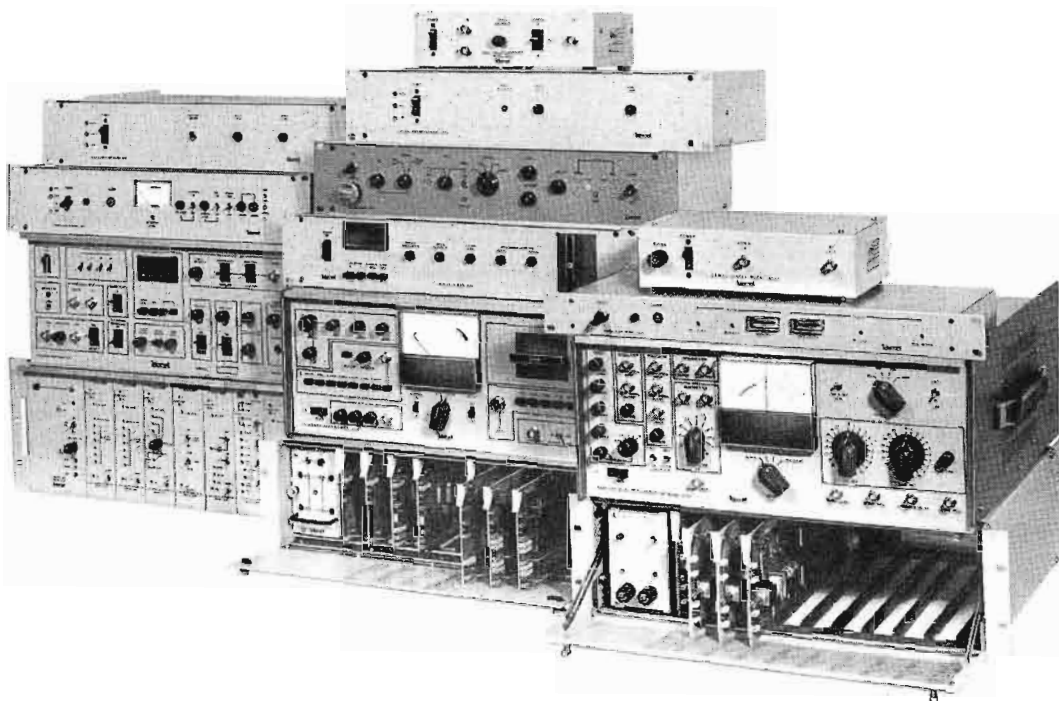

AV Routing Switcher, 7934 is the latest in the state of the art circuitry. Both manual or computer control options available.

Envelope Delay Measurement Set, 3705 measures the envelope delay of video frequencies for compliance with FCC requirements.

Sideband Analyzer, 3706 shows with a calibrated response curve if sideband attenuation and frequency response meet FCC requirements. (model 3709, for deeper resolution and spectrum analysis).

Broadcast Demodulator, 4501 accurately demodulates the transmitted signal to show the true video signal being broadcast.

Demod Tester, 4503-A1 quickly checks the broadcast signal demodulator for flatness of frequency response.

Modulator, 4420 is a state of the art cable TV modulator with VSB saw filter, digital display, very low noise and FCC TV transmitter specs.

Broadcast Demodulator, 3710 is a comprehensive demodulator with both synchronous and envelope detection, built-in self tester, digital display, multiplexed outputs and other convenience features.

Video and Pulse Distribution System, (3300 series). Features Video DA's with frequency equalization; Pulse DA's with variable delay.

Clamper Amplifier, 3203-F clamps high levels of hum on balanced and unbalanced lines. Equalizes for cable loss up to 10 dB.

Fiber Optics Video Transmission System, 4210 has audio sub-carrier. Provides interference-free video and aural transmissions for STL and ENG applications.

Modular Test Set, 3538 provides up to 8 EIA standard video test signals. Special purpose modules also available.

Audio DA System, 6910. Each DA card provides 6 balanced, or 12 unbalanced 600 ohm outputs. 10 cards per frame with power supply.

NTSC Chroma Keyer Decoder, 4706-A1 decodes the NTSC signal with no apparent H delay for RGB keying.

Isolation Amplifier, 5300. An active device that negates hum caused by ground loops on unbalanced video transmission cable.

Over 175 products and accessories available

Telemet

A Geotel Company

185 Dixon Avenue, Amityville, L.I., New York 11701 (516) 842-2300 TWX 510-227-9850

Eastern Area Office—(914) 279-3231

Circle (47) on Action Card

Image Devices Incorporated
Leader Broadcast Systems
Marathon Products Co.
Nortronics
RMS Electronics
Tascam, Div. of Teac
The Texwipe Co.
VIF International

ERASE

R.B. Annis Co.
Bogen Electronic GwBH
Broadcast Electronics
Brush Magnetic Heads
Century 21 Programming
D-B Electronics
Harris Corp. Broadcast
Products Div.
IGM Communications
Image Devices Incorporated
International
Electro-Magnetics Inc.
Elektrolmpex
Leader Broadcast Systems
Magna Tech Electronic Co.
Michigan Magnetics
Minneapolis Magnetics
Multi-Track Magnetics
Neal-Ferrograph
Norton Associates
Nortronics, Recorder Care Div.
Saki Magnetics
Sonar Radio Corp.
Studer ReVox America
Taber Mfg. & Eng. Co.
Tapecaster TCM, Inc.
Tascam, Division of Teac
United Research Lab Corp.
VIF International
Vikron
Woelke Magnet Bandtechnik GmbH

PLAYBACK

Audi-Cord
Bogen Electronic GmbH
Broadcast Electronics
Brush Magnetic Heads
Century 21 Programming
D-B Electronics
Elektrolmpex
IGM Communications
International
Electro-Magnetics Inc.
Magna Tech Electronic Co.
Michigan Magnetics
Minneapolis Magnetics
Multi-Track Magnetics
Neal-Ferrograph
Nortronics, Recorder Care Div.
Norton Associates
Saki Magnetics
Studer Revox America, Inc.
Taber Mfg. & Eng. Co.
Tapecaster TCM Inc.
Tascam, Division of Teac
UMC Electronics
United Research Lab Corp.
VIF International
Vikron
Woelke Magnet Bandtechnik GmbH

RECORD

Audi-Cord
Bogen Electronic GmbH
Broadcast Electronics
Brush Magnetic Heads
Century 21 Programming
D-B Electronics
Elektrolmpex
IGM Communications
International
Electro-Magnetics Inc.
Leader Broadcast Systems
Magna Tech Electronic Co.
Michigan Magnetics
Minneapolis Magnetics
Multi-Track Magnetics
Neal-Ferrograph
Nortronics, Recorder Care Div.
Norton Associates
Saki Magnetics
Studer ReVox America
Taber Mfg. & Eng. Co.
Tapecaster TCM, Inc.
Tascam, Division of Teac
UMC Electronics
United Research Lab Corp.

Vikron
VIF International
Woelke Magnet Bandtechnik GmbH

FILM STRIPE

Brush Magnetic Heads
International
Electro-Magnetics Inc.
Leader Broadcast Systems
Magna Tech Electronic Co.
Multi-Track Magnetics
Norton Associates
Vikron

RECONDITIONING SERVICES

Accurate Sound
Broadcast Electronics
Brush Magnetic Heads
CMC Technology
D-B Company
International
Electro-Magnetics Inc.
Leader Broadcast Systems
Merlin Engineering
Michigan Magnetics
Minneapolis Magnetics
Norton Associates
Saki Magnetics
Sound Dynamics
Taber Mfg. & Eng. Co.
Tascam, Division of Teac
United Research Lab Corp.

HEADS, VIDEO & SERVICES

REPLACEMENT HEADS

Bogen Electronic GmbH
Brush Magnetic Heads
C-M-C Technology Corp.
Image Devices Incorporated
International Electro Magnetics
Minneapolis Magnetics
Nortronics, Recorder Care Div.
Panasonic
RCA Broadcast Systems
Ramko Research
Saki Magnetics
Spin Physics
John M. Sullivan Associates
Taber Mfg. & Eng.
Thomson-CSF
UMC Electronics
Videomagnetics
Vikron Inc.
Woelke Magnet Bandtechnik GmbH

REFURBISHING SERVICES

Ampex
Bogen Electronic GmbH
Brush Magnetic Heads
CMC Technology Corporation
International Electro Magnetics
Minneapolis Magnetics
RCA Broadcast Systems
Saki Magnetics
Spin Physics
Taber Mfg. & Eng.
Videomagnetics

HEADPHONES

ANNOUNCERS EARPIECE

Audlosears
Beyer Dynamics
Eugene Beyer Elektrotechnische
Fabrik GmbH & Co.
Broadcast Electronics, Inc.
David H. Brothers Co.
Burns Auditorics
Elektrolmpex
Harris Corporation, Broadcast
Products Division
IGM Communications
Integrated Sound GLI Div.
Kimlan Sales
Norcom Manufacturing
R-Columbia Products
Setcom Corporation
Sennheiser Electronic Corp.
Shure Brothers
Stanton Magnetics
Television Equipment Associates

Telex Communications, Inc.
Vidaire Elec. Mfg.

MONO

AKG Acoustics
AKG A Kustische u. Kino-Gerate
Audiotronics
Beyer Dynamic
Eugene Beyer Elektrotechnische
Fabrik GmbH & Co.
Robert Bosch GmbH
Broadcast Electronics
David H. Brothers Co.
Burns Auditorics
Clear Com Intercom Systems
D-B Electronics
Edcor
Elektrolmpex
Harris Corporation, Broadcast
Products Division
IGM Communications
Image Devices Incorporated
Kimlan Sales Inc.
Miles Associates, Div. Miles Air
Products Ltd.
Neal-Ferrograph
R-Columbia Products
Sennheiser Elect Corp.
Setcom Corporation
Shure Brothers
Superex Electronics Corp.
Swintek Enterprises
Television Equipment Assoc.
Telex Communications, Inc.
Vidaire Elec. Mfg.

STEREO

AKG Acoustics
AKG Akustische u. Kino-Gerate
Audio-Technica US Inc.
Audiotronics
Eugene Beyer Elektrotechnische
Fabrik GmbH & Co.
Beyer Dynamic
Broadcast Electronics
David H. Brothers Co.
Burns Auditorics
David Clark Co.
Clear Com Intercom Systems
D-B Electronics
Elektrolmpex
Fostex
G.C. Electronics
Harris Corporation, Broadcast
Products Division
IGM Communications
Kimlan Sales Inc.
Koss Corporation
Miles Associates
Neal Ferrograph (USA) Inc.
North American Soar Corp.
R-Columbia Products
SAE
Sennheiser Electronic Corp.
Setcom
Setcom Corporation
Shure Brothers
Stanton Magnetics
Studer ReVox America
Superex Electronics Corp.
Swintek Enterprises
Tascam, Div. of Teac
Television Equipment Assoc.
Telex Communications, Inc.
VIF International
Vidaire Electronics Mfg.

WITH ANNOUNCERS MIKE

AKG Acoustics
AKG Akustische u. Kino-Gerate
Audiosears
Beyer Dynamic
Eugene Beyer Elektrotechnische
Fabrik GmbH & Co.
Robert Bosch GmbH
Broadcast Electronics
David H. Brothers Co.
Burns Auditorics
Clear-Com Intercom Systems
Electro-Voice
Elektrolmpex
Hammond Industries
Harris Corporation, Broadcast
Products Division
IGM Communications
Koss Corp.

Miles Associates, Div. Miles Air
Products Ltd.
Pro Tech Audio
R-Columbia Products
RTS Systems
Sennheiser Electronic Corp.
Setcom Corporation
Shure Brothers
Superex Electronics Corp.
Television Equipment Assoc.
Telex Communications

HEAT EXCHANGERS

Electro Impulse Laboratory Inc.
Harris Corporation, Broadcast
Products Division
Micro Communications
Shively Laboratories
Thomson-CSF(81)
Trelse Engineering

HEATERS FOR VANS

Dell Technical Vehicles
Harris Corp., Broadcast
Products Div.
John M. Sullivan Associates

HELICOPTER ENG SYSTEMS

Bell Helicopter Textron
Commerce Airborne Corp.
ENG Helicopter Satellite Ltd.
Feathercam, Inc.
Harris Broadcast Microwave
Harris Corp./Farlon Video
Lang Video Systems
Lee Ray Industries
M/A-COM Video Systems
NEC America Inc.
Broadcast Equipment
Nurad Inc.
R.F. Technology Inc.
Tayburn Electronics

HELICOPTER STABILIZERS

Arriflex
Cinema Products
ENG Helicopter Satellite Ltd.
Feathercam, Inc.
Gralex
Sfena

HELICOPTERS

Bell Helicopter
ENG Helicopter-Satellite Ltd.
Hughes Helicopters

HUM STOP COIL

Crow of Reading Ltd.
North Hills Electronics
Video Aids of Colorado

IDENTIFICATION SYSTEMS, VIDEO

CMC Technology Corp.
AVL Digital Ltd.
CMC Technology Corp.
Comprehensive Video Supply
Michael Cox
Datatek
Di-tech
Dynamic Technology Ltd.
Fernseh
Gray Engineering Laboratories
Lang Video Systems

Continued on page 88

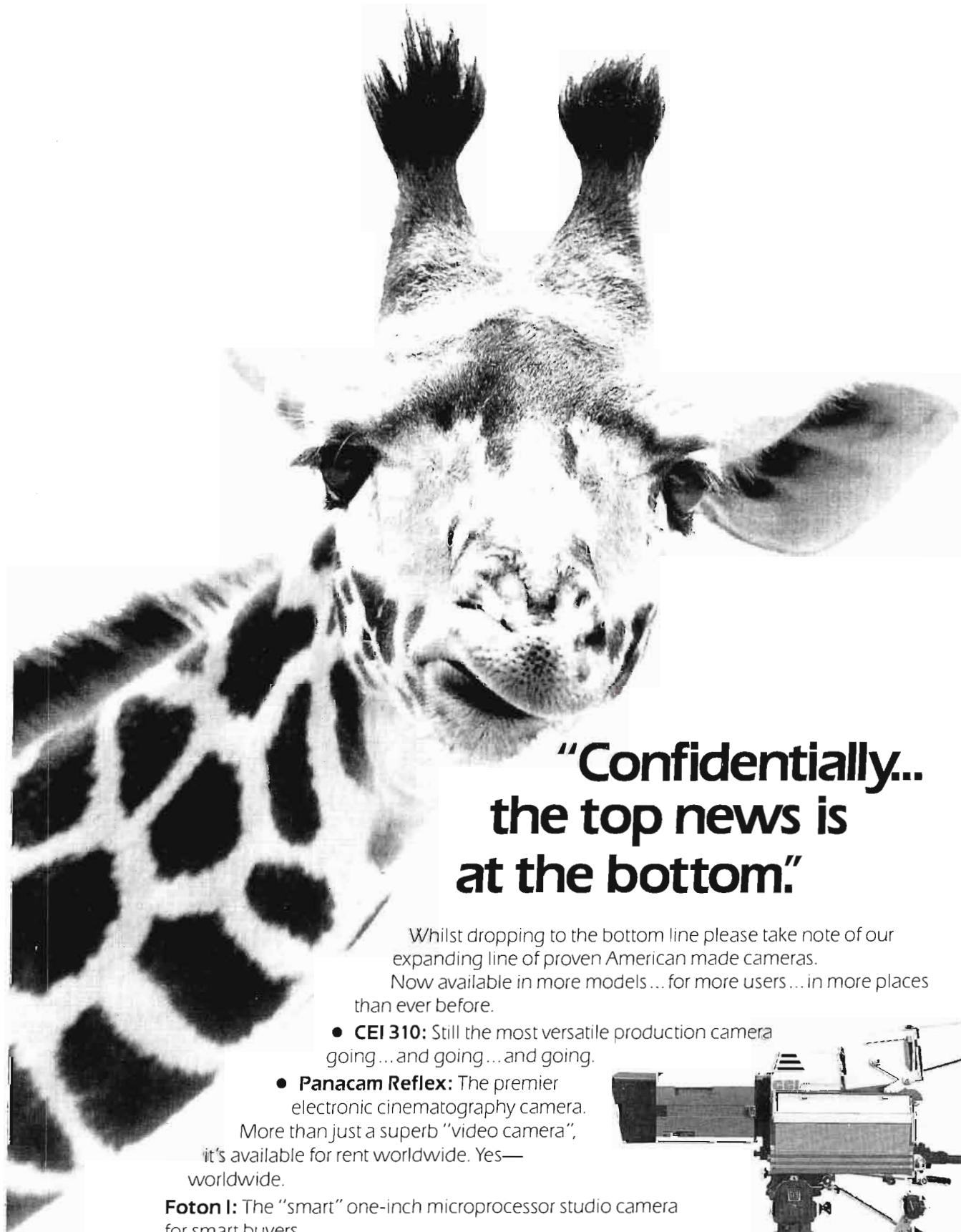

"Confidentially... the top news is at the bottom."

Whilst dropping to the bottom line please take note of our expanding line of proven American made cameras.

Now available in more models... for more users... in more places than ever before.

- **CEI 310:** Still the most versatile production camera going... and going... and going.
- **Panacam Reflex:** The premier electronic cinematography camera. More than just a superb "video camera", it's available for rent worldwide. Yes—worldwide.

Foton I: The "smart" one-inch microprocessor studio camera for smart buyers.

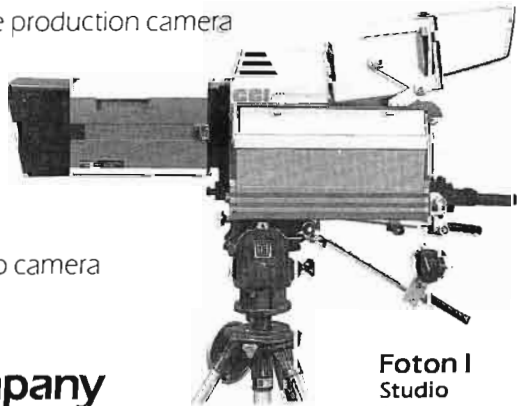

**Foton I
Studio
Camera**

CEI...now a PANAVISION company

880 MAUDE AVENUE/MOUNTAIN VIEW, CA 94043-4089/(415) 969-1910/TELEX: 348-436

Circle (49) on Action Card

WHO MAKES IT



BSI BJ-240 PREWIRED AUDIO JACK PANEL

- 48 TIP-RING-SLEEVE JACKS (2 rows, 24 per row) PREWIRED TO REAR TERMINAL STRIP.
- JACK PANEL MAY BE USED AS 24 CIRCUIT TIP-RING-SLEEVE OR 12 CIRCUIT TIP-SLEEVE AT CUSTOMER OPTION.
- TIP & RING NORMALS WIRED TO TERMINAL STRIP FOR "NORMAL-THRU" SELECTIONS.
- JACK PANEL EASILY REMOVED FROM FRONT OF UNIT FOR CLEANING WITHOUT REMOVING UNIT FROM RACK.
- HIGH QUALITY ADC JACK PANEL WITH REPLACEABLE DESIGNATION STRIPS.
- VERY RUGGED CONSTRUCTION.
- REMOVABLE CABLE STRAIN RELIEF BARS.
- LARGE TERMINAL STRIP WITH OVERSIZED TERMINALS FOR EASE OF WIRING.
- SUPERIOR CROSSTALK ISOLATION.
- ALL AUDIO GROUND CIRCUITS INSULATED FROM CHASSIS.
- DIMENSIONS: 3.5" HIGH, 15.75" DEEP, 19.0" WIDE.
- AVAILABLE FROM STOCK.
- PRICE: \$545.00

NATIONAL WATS: 800/531-5232

TEXAS WATS: 800/252-9792

BROADCAST SYSTEMS INC.

8222 JAMESTOWN AUSTIN TEXAS 78758

Circle (50) on Action Card

audio accessories

audio-line

AUDIO ACCESSORIES, INC. / MILL ST. / MARLOW, NH 03456

Manufacturers of Audio-Line™ Jack Panels, Patch Cords, Telephone Jacks and Pre-Wired Jack Panels

Custom and Standard Pre-Wired Jack Panels

- Wired to connectors, "Christmas Tree" type terminal blocks, screw terminal barrier strips, or numbered pigtail
- 11 panel sizes: 1.156" x 19" to 14" x 19"
- 1 to 14 rows per panel
- 1/4" audio jacks: 16 to 26 jacks per row
- Miniature audio jacks: 32 to 52 jacks per row
- Belden 9451 or 8723 shielded cable

Telephone
603/446-3335

Serving the broadcast industry since 1946

Circle (51) on Action Card

Nytone Electronics Corp.
QSI Systems
Torpey Controls & Engineering
Visual Methods

IMAGE REPOSITIONER

Adda Corporation
Grove Video
Interand
MCI/Quantel
NEC America Inc.
Broadcast Equipment
Video Aids of Colorado

INTEGRATED CIRCUITS

(See Also ICs and Semiconductors)
AEG-Telefunken
(Bayly Engineering)
AEL-American Electronic Laboratories
Apex Systems
Calvert Electronics
Cherry Elec. Prod. Corp.
Cherry Semiconductor
Cool Light
Datel-Intersil
Fairchild CCD Imaging
Javelin Electronics
Logica
Motorola
Narda Microwave
NEC America Inc.
Broadcast Equipment
Thomson-CSF

INTERCOM SYSTEMS

AEG-Telefunken
Alice (Stancoil Ltd.)
Auxid Ltd.
Bell Audio Systems
Bogen Division / Lear Siegler Inc.
Brabury Electronics Ltd.
David H. Brothers Co.
Broadcast Technology
Cetec Vega
Clear-Com Intercom Systems
Communications Co. Inc.
Communications Control Centers
Comprehensive Video Supply
Crosspoint Latch
Datatronic
Phillip Drake Electronics
Dukane Corp.
Dyma Engineering
Dynamote Corp.
ENG Helicopter Satellite Ltd.
Edcor
Elektroimpex
Enertec Schlumberger
Farrtronics Limited
Fisher Berkeley Corp.
G.C. Electronics
GTE Products Corp.
Harris Corporation, Broadcast Products Division
H. M. Electronics
International Electro - Magnetics
Leader Broadcast Systems
Link Electronics
McCurdy Radio Industries
Minicom
Rupert Neve
PAG Group
Paso Sound Products
ProTech Audio Corporation
R-Columbia Products
RTS Systems
Richmond Sound Design
Roh Corporation
Salt Electronics
Setcom Corporation
Sharepoint Systems
Siemens Ag Osterreich
Singer Products Co.
Standard Telephon UND Radio
Swintek Enterprises, Inc.
TOA Electronics
Telectro Systems Corp.
Television Equipment Assoc.

Telex Communications
Thomson-CSF
Tweed Audio USA
Vamco Engineering
Velec Sefat
Vidaire Electronics Mfg.
Video Aids of Colorado
Ward-Beck Systems
World Video

INVERTERS

Advance Conversion Devices Co.
Don Britton Ent.
Comprehensive Video Supply
Vanner Inc.

ISOCOUPERS

Artel Communications Corp.
CSP Inc.
Continental Electronics Mfg.
Harris Corporation, Broadcast Products Division
McMartin Industries
Moseley Associates
Shively Laboratories
Video Aids of Colorado

ISOLATOR

Harris Corporation
UTE Microwave Inc.
Varian MCSD
Video Aids of Colorado

JACK PANELS

ADM Technology
Audio Accessories Inc.
Broadcast Electronics, Inc.
Broadcast Systems
Broadcast Technology
Bud Industries
CSP Inc.
Comad Communications
Continental Electronics Mfg.
Crow of Reading
Datatronic
Dell Technical Vehicles
Dielectric Communications
Dynamic Technology Ltd.
Dynatech Data Systems
Electro-Acoustic Design
Elektroimpex
Farrtronics Limited
G.C. Electronics
Harris Corp., Broadcast Products
Image Video Limited
Leader Broadcast Systems
Link Electronics
McCurdy Radio Industries
McMartin Industries
Rupert Neve
Panoak/B-W Lighting Systems
Potomac Instruments
Potomac Marine & Aviation
Ramko Research
Rex Rheostat & Co. Inc.
Rockwell International
Shively Laboratories
Sphere
Switchcraft
TM Systems
Trompeter Electronics
Union Connector
Victor Electronic Co.
Ward-Beck Systems

JACK PANELS, WIRED

Audio Accessories
Broadcast Systems
Comad Communications

KEYERS, VIDEO INSERT

American Data
Beaveronics

Continued on page 90

SIX REASONS WHY MOTOROLA'S AM STEREO SYSTEM IS GETTING SUCH GOOD RECEPTION.

Motorola's C-QUAM® (Compatible Quadrature) AM Stereo System is attracting the attention of broadcasting executives.

Probably because no other AM Stereo system has all that the C-QUAM system offers:

- 1) Full modulation capability over the whole range the FCC allows (from +125% to -100%).
- 2) No monaural distortion increase.
- 3) Full coverage in monaural and stereo.
- 4) Causes no clicks or pops.
- 5) Full frequency response.
- 6) Lease plan.

These and other C-QUAM system features are completely explained in our free brochure "AM Stereo. The Answer to the Marketplace Decision." Send in the coupon for your own copy. Or call Dick Harasek, Motorola, Inc. P.O. Box 95334, Schaumburg, Illinois 60195 (312) 576-3591.

Dick Harasek
Manager, Advanced Technology Products
Motorola, Inc. P.O. Box 95334
Schaumburg, Illinois 60195

Please send me a copy of your free brochure: "AM Stereo. The Answer to the Marketplace Decision."

Name _____

Title _____

Station/Group _____

Address _____

ZIP _____

**MOTOROLA
AM STEREO
THE ANSWER
TO THE
MARKETPLACE
DECISION**



MOTOROLA A World Leader in Electronics

©1982 Motorola Inc. Motorola, C-QUAM, and (M) are registered trademarks of Motorola, Inc.

Circle (52) on Action Card

Robert Bosch GmbH, Television Systems Div.
Don Britton Ent.
Broadcast Video Systems
Control Video Corporation
Michael Cox
Crosspoint Latch
Dynair Electronics
Graham-Patten Systems
Image Video Limited
Industrial Sciences Inc. (ISI)
International Nuclear Corp.
Key Video Ltd.
Link Electronics
Rohde & Schwarz
Siegel Electronics
Thomson-CSF
Torpey Controls & Engineering
Video Associates Labs
Videomedia
Vital Industries

KNOB'S CONTROL

Alco Electronic Products
Buhl Optical Co.
Electronic Instrument & Specialty Corp.
G.C. Electronics
Selco Products
Sescom, Inc.
VIZ Mfg. Co.

LENS FILTERS

Angenieux Corp. of America
David H. Brothers Co.
Century Precision Cine/Optics
Harris Corporation
Schneider Corp. of Am.
Tiffen Manufacturing
Tele-Cine Inc.
The Zei-Mark Corp.

LENSES, FIXED

ATV Research
Angenieux
Arriflex
Robert Bosch GmbH
David H. Brothers Co.
Buhl Optical
Canon USA
Century Precision Cine/Optics
Cinema Products
Comprehensive Video Supply
D.O. Industries Inc.
Etablissements Pierre Angenieux
Fujinon Inc.
GBC Closed Circuit TV Corp.
Harris Corp -Broadcast Products Div.
Karl Heitz Inc.
Javelin Electronics
Lenzar Optics
Panasonic
Power Optics
Rank Precision
Rank Taylor Hobson
Jos Schneider GmbH
The Schneider Corp. of Am.
Tele-Cine Inc.
Visual Methods
The Zei-Mark Corp.

LENSES, PROJECTION

Buhl Optical
DO Industries Inc.
Rangertone Research
Jos Schneider
Tele Cine Corp.
The Zei-Mark Corp.

LENSES, ZOOM

ATV Research
Angenieux Inc.

Arriflex
Robert Bosch GmbH
David H. Brothers Co.
Buhl Optical
Canon USA
Century Precision Cine/Optics
Cinema Products
Comprehensive Video Supply
Crow of Reading
D.O. Industries Inc.
Etablissements Pierre Angenieux
Frezzolini Electronics
Fujinon Inc.
GBC Closed Circuit TV
Harris Corp. Broadcast Products Div.
Javelin Electronics
Kalart Victor
Lenzar Optics
One Pass Video
Panasonic
Power Optics
Rank Precision
Rank Taylor Hobson
Jos. Schneider GmbH & Co.
The Schneider Corp. of Am.
Sharp Electronics
Tele-Cine Inc.
Visual Methods

LIGHTING ACCESSORIES

CONNECTOR PLUGS

AVA Electronics
Bardwell & McAllister
Belden Communications
Walter S. Brewer Co.
Colortran
Electro Controls
Electronics Diversified, Inc.
G.C. Electronics
GTE Products Corp.
Kliegl Bros.
L.E. Nelson Corp.
LTM Corp. of America
Olesen
Packaged Lighting Systems
Panoak Lighting Systems & Supply
Research Technology Int'l.
Rex Rheostat & Co.
Strand Century
John M. Sullivan Associates
Union Connector Co., Inc.
Whirlwind Music

FADER CONTROLS

Belden Communications
Walter S. Brewer Co.
CAE Inc.
Colortran
Duncan Electronics
Dynamic Technology Ltd.
Electro Controls
Electronics Diversified Inc.
Hammond Industries
Kliegl Brothers
LE Nelson Corp.
Olesen
Packaged Lighting Systems
Panoak Lighting Systems
Skirpan Lighting Control Corp.
Strand Century
John M. Sullivan Associates
Theater Techniques

TRANSFORMERS

Belden Communications
Peter W. Dahl
Harris Corporation, Broadcast Products Division
L. E. Nelson Corp.
Olesen
Packaged Lighting Systems
Panoak/B-W Lighting Systems
World Tower

LIGHTING: CONTROLS, FIXTURES, LAMPS

CONTROL BOARD/CONSOLE
AEG-Telefunken
Alco Electronics

AVAB America
Bardwell & McAllister
Belden Communications
Walter S. Brewer Co.
Don Britton Ent.
CAE, Inc.
Colortran
Custom Audio Electronics
Dynamic Technology Ltd.
Electro Controls
Electronics Diversified, Inc.
The Great American Market
Hammond Industries
Kliegl Brothers
LTM Corp. of America
Matthews Studio Equipment
L.E. Nelson Corp.
Olesen
Osram Sales Corp.
Packaged Lighting Systems
Panoak Lighting Systems & Supply
Rainko Products
Siemens
Skirpan Lighting Control Corp.
Strand Century
Tech Theatre Inc.
Theater Techniques Inc.
Thorn Lighting Limited
Ultra Audio Pixtec

FILTERS & GELS

AEG-Telefunken
Bardwell & McAllister
Belden Communications
Walter S. Brewer Co.
Colortran
Cool Light
Electro Controls
Electronics Diversified Inc.
Kliegl Bros.
LTM Corp. of America
Matthews Studio Equipment
L.E. Nelson Corp.
Olesen
Packaged Lighting Systems
Panoak Lighting Systems & Supply
Smith - Victor Sales Corp.
Strand Century
John Sullivan Associates
Tech Theatre Inc.
Tiffen

HANGERS, STUDIO

AEG-Telefunken
Automatic Devices
Bardwell & McAllister Inc.
Walter S. Brewer Co.
Colortran
Electro Controls
Electronics Diversified
Image Devices Incorporated
Kliegl Brothers
LTM Corp. of America
Matthews Studio Equipment
L.E. Nelson Corp.
Olesen
Packaged Lighting Systems
Panoak Lighting Systems & Supply
Smith - Victor Sales Corp.
Strand Century
Syracuse Scenery & Stage Lighting

LAMPS, REPLACEMENT

AEG-Telefunken
Alco Electronic Products
Bardwell & McAllister
Belden Communications
Walter S. Brewer Co.
Cinema Products
Cool Light
Dynamic Technology Ltd.
Electro Controls
Electronics Diversified
Frezzolini Electronics
GTE Products Corp.
Lighting Products Group
Grand Tower
Image Devices Incorporated
Kliegl Brothers
LTM Corp. of America
Lowel - Light
L.E. Nelson Corp.
Fred A. Nudd

Olesen
Packaged Lighting Systems
Panoak Lighting Systems & Supply
Smith - Victor Sales Corp.
John M. Sullivan Associates
Strand Century
Teledyne Big Beam

LIGHTS, HMI

AEG-Telefunken
Arriflex
Bardwell & McAllister
Belden Communications
Cine 60 Inc.
Cinema Products
Electro Controls
Electronics Diversified
The Great American Market
Image Devices Incorporated
Kliegl Bros.
LTM Corp. of America
Nalpak Sales
L.E. Nelson Corp.
Olesen
Osram Sales
PAG Power Ltd.
Panoak Lighting Systems & Supply
Strand Century

LIGHTS, PORTABLE / ENG

AEG-Telefunken
Arriflex
Bardwell & McAllister
Belden Communications
CAE Inc.
Cine 60 Inc.
Cinema Products
Colortran
Comprehensive Video Supply
Cool Light
Custom Audio Electronics
Dynamic Technology Ltd.
Electro Controls
Frezzolini Electronics
GTE Products Corp. -
Lighting Products Group
The Great American Market
Harris Corporation, Broadcast Products Division
Harwood Mfg. Co.
Kapco Communications
Kliegl Brothers
LTM Corp. of America
Lowel - Light Mfg., Inc.
L.E. Nelson Corp.
Olesen
PAG-Power Ltd.
Packaged Lighting Systems
Panoak Lighting Systems & Supply
Strand Century
Teledyne Big Beam
Video I-D

LIGHTS, STUDIO

AEG-Telefunken
Arriflex
Avab America
Bardwell & McAllister Inc.
Belden Communications
Walter S. Brewer Co.
Broadcast Electronics Inc.
CAE Inc.
Cine 60 Inc.
Cinema Products
Colortran
Comprehensive Video Supply
Cool Light
Custom Audio Electronics
Dynamic Technology Ltd.
Electro Controls
Electronics Diversified, Inc.
Frezzolini Electronics
GTE Products Corp. -
Lighting Products Group
The Great American Market
Harris Corporation, Broadcast Products Division
Harwood Mfg. Co.
Kliegl Brothers
LTM Corp. of America
Leedal
Lowel - Light Mfg., Inc.
Mole-Richardson

Continued on page 92

A RANGE OF VIDEO SWITCHERS

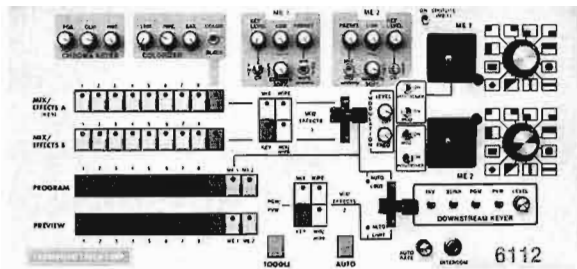

6112

The only switcher in its class to offer two fully independent MIX EFFECTS systems, with each M/E having its own pattern generator and positioner. This nine input, four bus unit includes the following standard features: downstream keyer, pattern modulator, spot-lite, colorizer, toggle or "take preview", automatic or manual mix and wipe operations, variable soft wipes, adjustable borders, internal or external keying on each M/E, intercom, loop-thru video inputs, preset of mix or wipes, black burst output, and a blanking processor. There is also a plug-in optional chroma keyer available. All inputs accept synchronous, non-synchronous, composite, non-composite, monochrome or color signals and go thru dual back porch clamping.

Price \$7,950.00 PAL \$8,950.00

Options

- Encoded chroma keyer (plug-in board) **\$1,050.00**
- RGB chroma keyer (plug in board) **\$1,050.00**
- Slimline control panel (4 inches) **\$250.00**

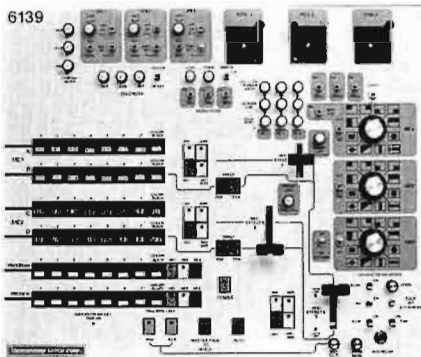

6139

Eight input production switcher with three fully independent Mix Effects Systems. Each ME has its own pattern generator and positioner and each one is capable of double re-entry. Chroma keyer (either encoded or RGB), downstream keyer with matte, blink, invert and edge or external border. Downstream keyer may be previewed. Five video signals can be displayed at the same time. Downstream fade to black. Quad split. Field expandable to 24 inputs with additional pattern selector.

Plug in Option

- Genlock
- Two chroma keyers (RGB or encoded)
- Dual Colorizer (instead of one chroma keyer)

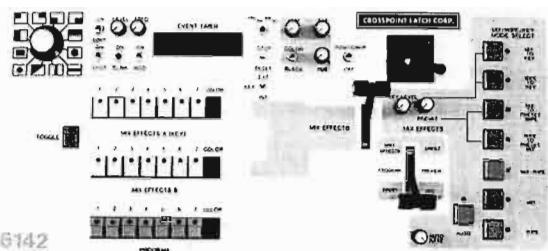

6142

6142

The 6142 is a three bus, eight input completely self-contained switcher. This unit features dual fader handles which permit the operator to dissolve to an effect. The mix effects system features double re-entry along with 12 patterns, variable soft, 24 hour event timer, internal or external keying, pattern modulator, blink key, colorizer, toggle, spot lite, positioner, mix or wipe to key, preset of mix and wipes, blanking processor, loop thru video inputs, dual back porch clamps and black burst output.

Price: \$5,245.00 PAL \$6,245.00

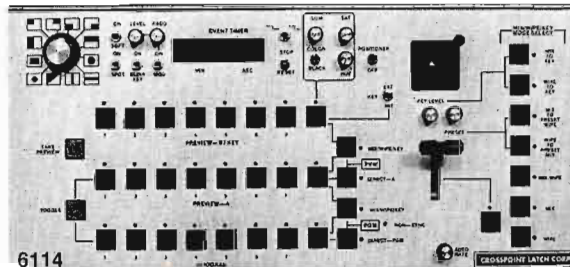

6114

6114

The 6114 is a broadcast quality, eight input, three bus video switcher. It features 12 patterns, positioner, event timer, pattern modulator, soft wipe, spot lite, blink key, toggle, take preview, automatic or manual mix and wipe blanking processor, non-sync lamp, loop through video inputs and a blackburst output.

Price: \$4,680 PAL \$5,680

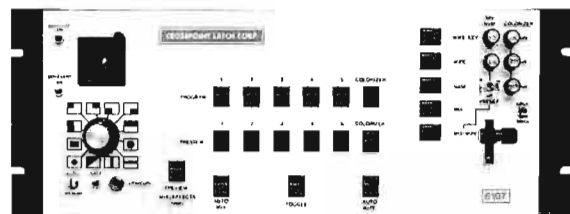

6107

The 6107 is a broadcast quality switcher. Though there are only 2 buses it is possible to preview and/or preset a mix or effect without disturbing the program output. The special mix-wipe function provides a combination mix and wipe (for instance, a dissolve within a circle pattern), which normally requires at least three buses. It also features 12 patterns, soft wipes, built-in intercom amplifiers, and colorizer, toggle and blackburst output.

Price: \$3,800. PAL \$4,800.

CROSSPOINT LATCH CORP.

95 Progress Street • Union, N.J. 07083 • Tel. (201) 688-1510 • Telex: 181160

Circle (53) on Action Card

WHO MAKES IT

NET Enterprises
L.E. Nelson Corp.
Olesen
Osram Sales
Packaged Lighting Systems
Panoak Lighting Systems & Supply
Smith - Victor Sales Corp.
Strand Century
Syracuse Scenery & Stage Lighting
Teledyne Big Beam
Theatre Techniques Inc.

PATCH PANEL
AEG-Telefunken
Bardwell & McAlister
Belden Communications
Walter S. Brewer Co.
Colortran
Electro Controls
Electronics Diversified
Kliegl Bros.
L.E. Nelson
Olesen
One Pass Video
Osram Sales
Packaged Lighting Systems
Panoak Lighting Systems & Supply
Rex Rheostat & Co.
Skirpan Lighting Control Corp.
Strand Century
John M. Sullivan Associates
Theatre Techniques Inc.
Union Connector Co. Inc.
Videomedia

LIGHTS, STUDIO WARNING

Broadcast Electronics
Comprehensive Video Supply
Continental Electronics Mfg.
Electro Controls
Fidellipac
GTE Products Corp.
Grant Tower
McMartin Industries
John M. Sullivan Associates
UNR-Rohn
World Tower

LIGHTS, TOWERS

(See Tower Lights & Accessories)

LIGHTNING ARRESTORS

Continental Electronics Mfg.
Delta Lightning Arrestors
Dyma Engineering
EEV
English Electric Valve
Grant Tower
Lightning Elimination Associates
MCG Electronics Inc.
McMartin Industries
Multiplier Industries
Fred A. Nudd Corporation
Thomson-CSF
TransTector Systems
Vidair Electronics Mfg.
World Tower

LIGHTNING PROTECTION SYSTEMS

Abroyd Construction
C-Cor Electronics
ComSonic Inc.
Continental Electronics Mfg.
EEV Inc.
EFI
The Great American Market
Lightning Elimination Associates
MCG Electronics
RMS Electronics

SGL Waber Electric
Thomson-CSF
Topaz Electronics
TransTector Systems
Wilkinson Electronics
World Tower

LIMITER / COMPRESSOR, AM

Applied Technology
ATI Audio Technologies Inc.
Audio Design & Recording
Bogen Division/Lear Siegler, Inc.
Broadcast Electronics
Cetec
Circuit Research Labs
Continental Electronics Mfg.
dbx Inc.
Delta Electronics
Dorrough Electronics
EMT Franz
Elcom Bauer
Elcom Specialty Products
Elektrolmplex
Harris Corporation
IGM Communications
Inovonics Incorporated
Kahn Communications
Leader Broadcast Systems
LPB
McMartin Industries
Modular Audio Products
Moseley Associates
NTP Elektronik A/S
Rupert Neve
Orban Associates
Pacific Recorders
Processing Plus
Pyramid Loudspeaker
QEI
RCA Broadcast
C.N. Rood B.V.
Spectra Sonics
Thomson-CSF
Tramec Electronics
Valley People
VIF International

LIMITER / COMPRESSOR, FM

Applied Technology Corp.
Audio Design & Recording
ATI Audio Technologies Inc.
Bogen Division/Lear Siegler, Inc.
Broadcast Electronics
Circuit Research Labs
Continental Electronics Mfg.
dbx Inc.
Delta Electronics
Dolby Laboratories
Dorrough Electronics
Elcom Bauer
Harris Corp., Broadcast Products
IGM Communications
Inovonics Inc.
Kajaani Oy
LPB
Leader Broadcast Systems
Marti
McMartin Industries
Modular Audio Products
Modulation Sciences
Moseley Associates
NTP Elektronik A/S
Rupert Neve
Orban Associates
Pacific Recorders
Processing Plus
QEI
Rohde & Schwarz GmbH
Siemens Ag Osterreich
Spectra Sonics
Thomson-CSF
Tramec Electronics
VIF International
Valley People

LIMITER / COMPRESSOR, TV

Orban Associates

LINE SURGE PROTECTORS

AEG-Telefunken
(Bayly Engineering)
C-Cor Electronics
Comad Communications
Computer Business Systems
ComSonic Inc.
Continental Electronics Mfg.
Delta Electronics
EEV Inc.
EFI
Elcom-Bauer
Harris Corporation, Broadcast Products Division
IGM Communications
Lightning Elimination Associates
McMartin Industries
MCG Electronics
PTS Electronics
SGL Waber Electric
The Superior Electric Co.
Television Technology Corp.
Thomson-CSF
Topaz Electronics
TransTector Systems
Video Aids of Colorado

LOAD RESISTORS, COAXIAL

AEG-Telefunken
(Bayly Engineering)
Ava Electronics Corporation
Barker & Williamson Inc.
Bird Electronic
Coaxial Dynamics
Dielectric Communications
Electro Impulse Laboratory, Inc.
Magnavox CATV Systems
North Hills Electronics
Phelps Dodge Communications
Pyramid Industries Inc.
Pyramid Loudspeaker Corp.
Shively Labs
Thomson-CSF
Trompeter Electronics
Wide Band Engineering

LOUDSPEAKERS, CONTROL ROOM

Altec Corp.
Argos Products Co. Inc.
Audisar
Audio-Technica U.S.
Auernheimer Labs and Co.
BGW Systems
Bayly Engineering
Barco Electronic
Bogen Division/Lear Siegler, Inc.
Broadcast Audio Corp.
Broadcast Electronics
Cetec Gauss
Continental Electronics Mfg.
D-B Electronics
Electro-Voice
Elektrolmplex
Dukane Corp.
Fostex
Hartley Products Corp.
IGM Communications
Integrated Sound, GLI Div.
JBL
Koss Corp.
McCurdy Radio Industries
McMartin Industries
Merlin Engineering Works
NET Enterprises
Neal Ferrograph (USA) Inc.
Panasonic, Professional Audio Div.
Pyramid Loudspeaker
Rohde & Schwarz GmbH
Russco
Shure Brothers
Siemens AG Osterreich
Sierra Audio Corp.
Singer Products Company
Spectra Sonics
Studer International AG

John M. Sullivan Associates
Telectro Systems
Teledyne Acoustic Research (AR)
VIF International
Video I-D

LOUDSPEAKERS, RECORD STUDIO

Altec Corp.
Argos Products Co. Inc.
Audio-Technica U.S.
Audisar
Auernheimer Labs and Co.
BGW Systems
Barco Electronic
Bogen Division/Lear Siegler, Inc.
Broadcast Audio Corp.
D-B Electronics
Electro-Voice
Elektrolmplex
Fostex
IGM Communications
JBL
Koss Corp.
McMartin Industries
Panasonic, Professional Audio Div.
Pyramid Loudspeaker
Russco
Siemens AG Osterreich
Shure Brothers
Sierra Audio Corp.
Spectra Sonics
Studer International AG
Studer ReVox America
Telectro Systems
Teledyne Acoustic Research (AR)

LOW FREQUENCY EXTENDERS

Comrex Corporation
dbx Inc.
Hartley Products Corp.
Integrated Sound GLI Div.
Kahn Communications
Klntek Corp.
McCurdy Radio Industries
C.N. Rood B.V.
Sierra Audio Corp.

MACHINE ASSIGNMENT SYSTEMS

Broadcast Electronics
Datatek Corp.
Dynamic Technology Ltd.
Kaitronics
NEC America Inc.
Torpey Controls & Engineering Ltd.

MAINTENANCE SERVICES

AM SERVICES
AEG-Telefunken
Abroyd Construction
Atlas Tower Corp.
Burden Associates
CSP Inc.
Jim Cason Electronics
Davis Electronics
John J. Davis & Assoc.
Global Communications
Grant Tower
Harris Corp. Broadcast Products Div.
Harrison Systems
IGM Communications
Image Devices Incorporated
Leader Broadcast Systems
LeBlanc & Royle Communications
Multiphase Consulting
Processing Plus
RCA Service Company
Radlotechniques
Swager Tower Corp.
Tramec Electronics

Continued on page 94

PERROTT

ENGINEERING LABS, INC.

7201 Lee Highway
Falls Church, VA 22046
(703) 528-5861 (703) 532-0700

MINICHARGERS® AND MINIPACKS™ FOR ALL YOUR POWER NEEDS!

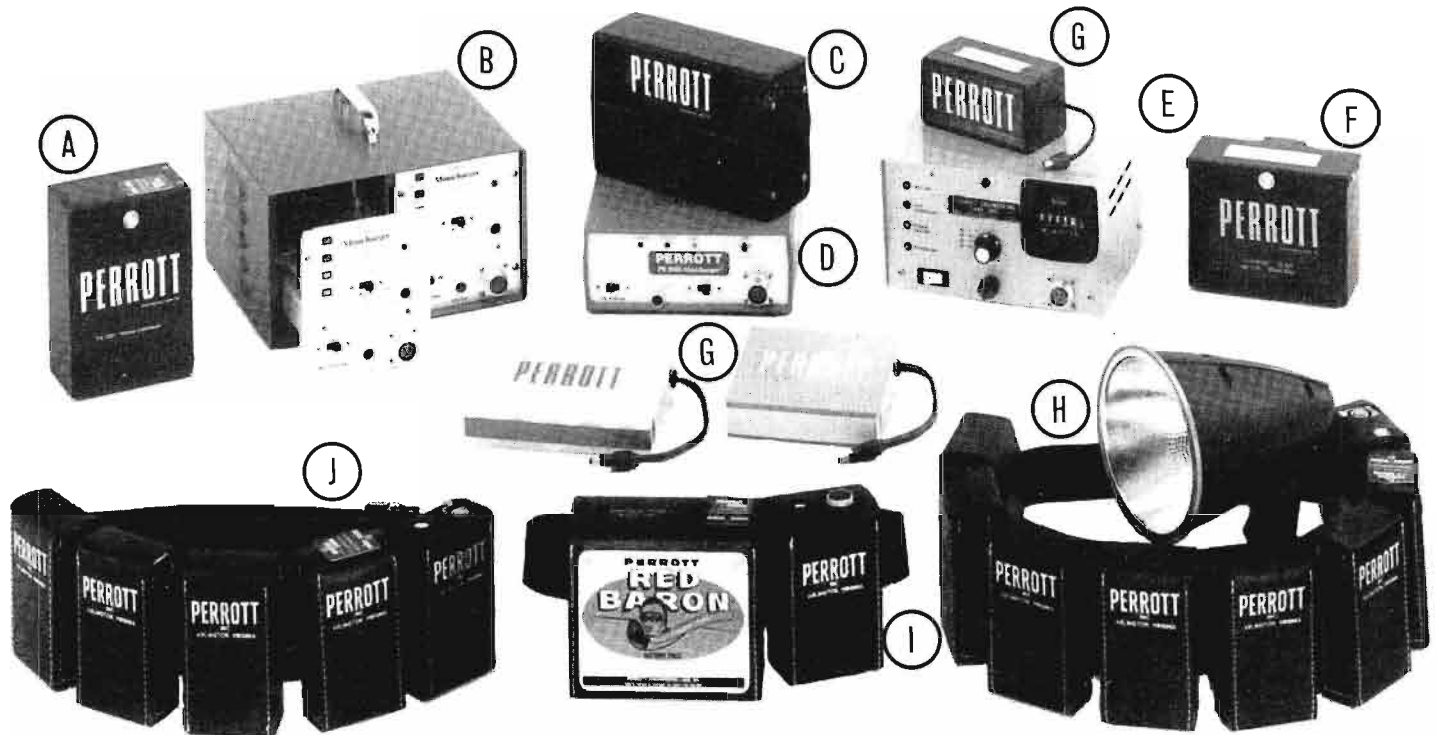

- A** Innovative and a real value—the Gemini™ battery/charger duo in ni-cad or silver.
- B** The compact lightweight PE 100 Minicharger® is available singly or in multiples up to 8 units.
- C** Our 8AH ni-cad pack operates the Ampex VPR 20 recorder for over an hour. It can be charged in an hour with our KWIK-CHARGER™.
- D** PERROTT'S™ long awaited KWIK-CHARGER™ the *ultimate* fast charger for ni-cads. One hour troublefree charging.
- E** The Nicadomatic Analyzer™ provides a read out of your battery's condition. Another product designed to save you \$.

- F** PERROTT'S™ popular KWIK-KLIP® packs in ni-cad and silver for ENG and EFP. Known worldwide for their power and flexibility.
- G** Our VTR battery packs in 4AH ni-cad, 8AH silver and 3AH lead acid are industry favorites.
- H** PERROTT'S™ 30 volt sun gun leather units provide power for a 250 watt lighting system or video camera. Also available in shoulder pack.
- I** The *legendary* favorite — our lightweight silver 12AH leather battery belt for maximum performance.
- J** PERROTT'S™ leather 4AH and 7AH ni-cad belts for film and video are acclaimed for reliability.

PERROTT'S™ continued high standards in equipment design and engineering have resulted in our 25 year reputation for reliable products.

Circle (54) on Action Card

OTT PERROTT PE
PERROTT PERROTT
TO PERROTT PERROTT
PERROTT PERROTT
ROTT PERROTT PERROTT
T PERROTT PERROTT
ROTT PERROTT PERROTT

POWER

LET US KNOW YOUR NEEDS

CALL US COLLECT (703) 528-5861

Utility Tower
World Tower Company

FM SERVICES

AEG-Telefunken
Abroyd Construction
Atlas Tower Corp.
Burden Associates
Jim Cason Electronics
Crowder Communications Ltd.
Davis Electronics
John J. Davis & Assoc.
Electro-Acoustic Designs
Image Devices Incorporated
Global Communications
Grant Towers
Harris Corp., Broadcast Products Div.
Harrison Systems
IGM Communications
Leader Broadcast Systems
LeBlanc & Royle Communications
Micro Communications
Multiphase Consulting
Processing Plus
RCA Service Company
Radiotechniques
Rohde & Schwarz GmbH
Swager Tower Corp.
Tramec Electronics
Utility Tower
World Tower Company

TV SERVICES

AEG-Telefunken
Abroyd Construction
Atlas Tower Corp.
Broadcast Aids Inc.
Jim Cason Electronics
Cinema Products
Comark Communications
Cohu, Electronics Div.
Crowder Communications
Davis Electronics
John J. Davis & Assoc.
Grant Towers
Harris Corp., Broadcast Product Div.
Harrison Systems
Image Devices Incorporated
Global Communications
LeBlanc & Royle Communications Inc.
Micro Communications
Radiotechniques
RCA Service Company
Rohde & Schwarz
Swager Tower Corp.
Utility Tower
Velec Sefat
Videocon Engineering
Videomagnetics
World Tower Company

MICROWAVE

AEG-Telefunken
Abroyd Construction
Andrew Corp.
Atlas Tower Corp.
Davis Electronics
John J. Davis & Associates
Gabriel Electronics
Grant Towers
Harris Corp., Broadcast Products Div.
Image Devices Incorporated
International Microwave Corp.
Jatex Inc.
Leader Broadcast Systems
LeBlanc & Royle Communications Inc.
M/A-COM Video Systems
Motorola Communications & Elect.
Multiphase Consulting
Nurad Inc.
RCA Service Company
R.F. Technology
Radiotechniques
Swager Tower Corp.
Utility Tower
Velec Sefat
World Tower Company

TOWER SERVICES

AEG-Telefunken
Abroyd Construction

Atlas Tower Corp.
Davis Electronics
John J. Davis & Assoc.
Gabriel Electronics
Grant Tower
Harris Corp., Broadcast Products Div.
Image Devices Incorporated
M/A-COM Video Systems
Multiphase Consulting
Fred A. Nudd Corporation
LeBlanc & Royle Communications Inc.
RCA Service Co.
Swager Tower Corp.
Utility Tower
World Tower Company

MDS SYSTEMS

Bogner Broadcast Equipment
Comad Communications
Compucon Inc.
Comsearch
Conifer
Dynacom Electronics Ltd.
EMCEE Broadcast Products
Lindsay Specialty Products Ltd.
Micro Communications
Oak Communications, CATV Division
Standard Communications
Texscan

METERS

(See Test Equipment)

MIXERS, MICROPHONE

AKG Akustische u. Kino-Gerate
ATI Audio Technologies Inc.
Amek TAC
Applied Technology
Audisar
Audix Limited
Audio-Technica U.S.
Avab America
Bill Audio Systems
Bogen Division / Lear Siegler
Broadcast Electronics, Inc.
Cinetratics
Coherent Communications
Creative Trade
Crown International
Georg Neumann GwBH
Edcor
Electro-Voice
Elektrolmpex
EV-Tapco
Foundation Electronic Instruments
H.M. Electronics
Hallikainen & Friends
Hammond Industries
Howe Audio
IGM Communications
Industrial Research Products
Integrated Sound Systems, Inc.
Ivle Electronics
LTM Corp. of America
MBI Broadcast Systems, Inc.
McCurdy Radio Industries
McMartin Industries
Micro-Trak
Rupert Neve
Northland Communications
PAG-Group
Panasonic, Professional Audio Div.
Paso Sound Products
ProTech Audio
Quad-Eight Electronics
Quantum Audio Labs
RTS Systems
Ramko Research
Richmond Sound Design
Russco
Satt Electronics AB
Sescom Inc.
Shure Brothers
Sontec Electronics
Spectra Sonics
Sphere

Stancoll Ltd.
Stellovox
Studer International AG
Studer ReVox America
Teac Corp. of America
Transist-O-Sound
Ultra Audio Plitex
Vidaire Electronics Mfg.
Video I-D
Videomedia
Ward-Beck Systems

MICROPHONES & ACCESSORIES

BOOMS & STANDS

AKG Acoustics
AKG Akustische u. Kino-Gerate
Accurate Sound
Allen Gordon Enterprises
The Astatic Corporation
Atlas Sound
Audio-Technica US Inc.
Beyer Dynamics
Eugene Beyer Elektrotechnische Fabrik GmbH & Co.
Bogen Division / Lear Siegler
Broadcast Electronics, Inc.
David H. Brothers Co.
Cinema Products
Continental Electronics Mfg.
Creative Trade, CTAB AB
D - B Electronics
Elektrolmpex
Fidellpac Corp.
G.C. Electronics
Hammond Industries
Harris Corporation
Karl Heitz Inc.
McCurdy Radio Industries
NET Enterprises
Neal Ferrograph (USA) Inc.
Northland Communications
Georg Neumann GwBH
Paso Sound Products
Sennheiser Electronic Corp.
Shure Brothers
Singer Products Co. Inc.
Strand Century
Studer International AG
John M. Sullivan Associates
Turner, Division of Telex Communications, Inc.
Vidaire Elec. Mfg.

FLEXIBLE / MOBILE HOLDER (FOR CONSOLES)

AKG Acoustics
AKG Akustische u. Kino-Gerate
Atlas Sounds
Beyer Dynamics
Creative Trade, CTAB AB
Eugene Beyer Elektrotechnische Fabrik GmbH & Co.
Bogen Division / Lear Siegler
Broadcast Electronics
Continental Electronics Mfg.
Harris Corporation
Neal Ferrograph (USA) Inc.
Georg Neumann
R-Columbia Products
Sescom
Shure Brothers
Studer International AG

HAND HELD

AIWA
AKG Acoustics
AKG Akustische u. Kino-Gerate
ARG Products Co. Inc.
The Astatic Corporation
Audio-Technica US, Inc.
Audiotronics
Eugene Beyer Elektrotechnische Fabrik GmbH & Co.
Beyer Dynamics
Bogen Division / Lear Siegler
Broadcast Electronics, Inc.
David H. Brothers Co.
Cetec Vega
Continental Electronics Mfg.
Creative Trade, CTAB AB
Electro-Voice
Elektrolmpex
Eumig USA

Fidellpac Corp.
G.C. Electronics
Hammond Industries
Harris Corporation, Broadcast Products Division
Leader Broadcast Systems
Nady Systems
George Neumann GwBH
Northland Communications
PAG-Group
Panasonic Canada-Video Systems
Panasonic Professional Audio Division
Paso Sound Products
RMS Electronics
Sennheiser Elect. Corp.
Shure Brothers
Sony
Standard Communications
Studer International AG
Studer Revox America, Inc.
John Sullivan Associates
Swintek Enterprises, Inc.
TOA Electronics
Tascam, Div. of Teac
Telex Communications
Turner, Division of Telex Communications, Inc.
Vidaire Electronics Mfg.
Video I-D

LAPEL MIKE

AIWA
AKG Acoustics
AKG Akustische u. Kino-Gerate
Audio-Technica US Inc.
Audiotronics
Beyer Dynamics
Eugene Beyer Elektrotechnische Fabrik GmbH & Co.
Bogen Division / Lear Siegler
Broadcast Electronics
David H. Brothers Co.
Coherent Communications
Creative Trade, CTAB AB
Crown International
Electro-Voice
Eumig USA
Fidellpac Corp.
G.C. Electronics
Harris Corporation
Micron Audio Prod.
Northland Communications
PAG-Group
Panasonic Canada-Video Systems
Panasonic Professional Audio
Sennheiser Elect. Corp.
Shure Brothers
Standard Communications
Superex Electronics Corp.
Swintek Enterprises
Telex Communications
Turner, Division of Telex Communications, Inc.
Vidaire Electronics Mfg. Corp.
Video I-D

LAVALIER MIKE

AIWA
AKG Acoustics
AKG Akustische u. Kino-Gerate
Altec Lansing
The Astatic Corporation
Audio-Technica US Inc.
Audiotronics
Beyer Dynamics
Eugene Beyer Elektrotechnische Fabrik GmbH & Co.
Bogen Division / Lear Siegler
Broadcast Electronics
David H. Brothers Co.
Cetec Vega
Coherent Communications
Comprehensive Video Supply
Creative Trade, CTAB AB
Crown International
Dukane Corp.
Edcor
Electro-Voice
Eumig USA
Fidellpac Corp.
G.C. Electronics
Harris Corporation
Micron Audio Prod. Ltd.
Nady Systems
George Neumann GwBH

Continued on page 96

SAM82

Dimensions: 17.5 x 3.2"

Weight: 17.6 lbs

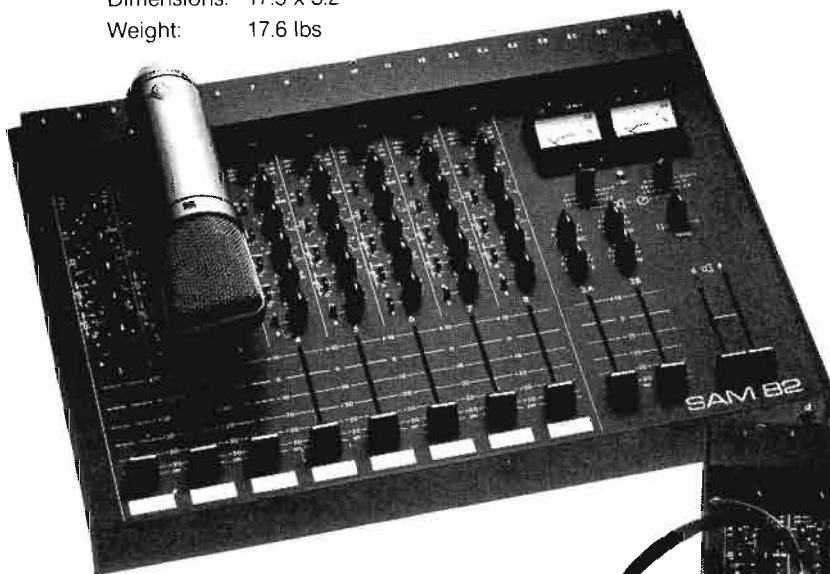

STUDIO AUDIO MIXERS

SAM42

Dimensions: 11.3 x 10.4 x 3.1"

Weight: 8.5 lbs



(ac and dc operated)

Made in Sweden by

SATT
Electronics

P.O. Box 32006

S-126 11 Stockholm/Sweden

Phone: +46 (8) 81 01 00 Telex: 10884 SATTEL S

International distribution:

Australia: G.E. Direct Marketing, Melbourne **Benelux:** Trans-Tec BV, Rotterdam **Denmark:** AEG Dansk Elektricitets A/S, Copenhagen **Finland:** Sähköliikkeiden OY, Vantaa **France:** Publison Audio Professional, Paris **Japan:** Hoei Sangyo Co Ltd, Tokyo **Middle East:** AATC, Amman/Jordan **Norway:** Siving Benum A/S, Oslo **Switzerland:** Biesse Elettronica SA, Lugano **United Kingdom:** AKG Acoustics Ltd, London **USA:** Martin Audio Video Corp., New York **West Germany:** BFE KG, Mainz **Yugoslavia, Czechoslovakia, Bulgaria, Romania, Greece:** C Stavrinidis, Paudex/Switzerland

I am interested in SAM 82/SAM 42

Company _____

Name _____

Address _____

Postal code _____

Country _____

Telephone _____ BC 6/82

Circle (55) on Action Card

WHO MAKES IT

NET Enterprises
Northland Communications
PAG-Group
Panasonic Canada-Video Systems
Panasonic Professional Audio
Paso Sound Products
Sennheiser
Shure Brothers
Sony
Studer International AG
Swintek Enterprises
Telex Communications
Turner, Division of Telex Communications, Inc.
Vidalre Elec. Mfg.

PARABOLIC & SHOTGUN
AKG Acoustics
AKG Akustische u. Kino-Gerate
Audio-Technica US Inc.
Eugene Beyer Elektrotechnische Fabrik GmbH & Co.
Beyer Dynamics
Bogen Division / Lear Siegler
David H. Brothers Co.
Coherent Communications
Comprehensive Video Supply
Electro-Voice
Fidelipac Corp.
Gelco Electronics Ltd.
Georg Neumann GwBH
PAG - Group
Sennheiser Electronic Corp.

MICROPHONES, WIRELESS

AEG-Telefunken
Beyer Dynamic Inc.
Eugene Beyer Elektrotechnische Fabrik GmbH & Co.
Cetec Vega
Coherent Communications
Comrex Corporation
Edcor
Alan Gordon Enterprises
H. M. Electronics
Micron Audio Prod. Ltd.
Nady Systems
Paso Sound Products
R-Columbia Products
Ken Schaffer Group
Sennheiser Electronic Corp.
Spectra Sonics
Swintek Enterprises, Inc.
Telex Communications

MICROPHONE SPLITTER

Beyer Dynamics
Harris Corp., Broadcast Products
Neal Ferrograph (USA) Inc.
Georg Neumann
Ramko Research
Sescom
Straight Wire Audio
Wireworks
Whirlwind Music Dist.

MOBILE UNITS

(See Vans)

MODULATION CONTROLLER

Delta Electronics

MODULATORS, TV

Asaca/Shibasoku
Aston Electronic Designs Ltd.
Automation Techniques Inc.
ATV Research
Barco Video Systems
Don Britton Ent.
Catel
Comtec Data Corp.
Crowder Communications
Crow of Reading Ltd.
Dynair Electronics

Fung Eng. Labs Inc.
GTE Products Corp.
Gardiner Communications Corp.
Harris Corp., Broadcast Products Div.
Javelin Electronics
Letrotech Inc.
Marshall Electronics
Panasonic
Phasecom
Rohde & Schwarz
Scientific-Atlanta
TL Systems
Telemet
Television Technology Corp.
Thomson-CSF
Times Fiber Communications
Triple Crown Electronics
UHF Associates

MONITORS, AUDIO & RF

AM SYSTEM
BES Electronics
Belar
CSP Inc.
Comad Communications
Continental Electronics Mfg.
Delta Electronics
Gorman Redlich
Harris Corporation, Broadcast Products Division
Motorola Inc., Special Products
Potomac Instruments
ProTech Audio
Rohde & Schwarz
Rohde & Schwarz GmbH
Singer Products Co. Inc.
TFT
Wavetk Indiana

ANTENNA
Comad Communications
Delta Electronics
Gorman Redlich Mfg. Co.
Harris Corporation
Potomac Instruments

BASE CURRENT / ANT SAMPLING

BES Electronics Ltd.
Belar
CSP Inc.
Continental Electronics Mfg.
Cosmin Electronics
Delta Electronics
Geleco Electronics
Gorman Redlich
Potomac Instruments
Thomson-CSF

DIRECTIONALS

BES Electronics Ltd.
Belar
CSP Inc.
Coaxial Dynamics
Continental Electronics Mfg.
Cosmin Electronics
Delta Electronics
Gorman-Redlich Mfg. Co.
Harris Corporation, Broadcast Products Division
Micro Communications
Potomac Instruments
Thomson-CSF

FM Systems
Broadcast Electronics
Rohde & Schwarz

FREQUENCY

Alltech
Belar
Broadcast Electronics, Inc.
Cetec Broadcast Group
Comad Communications
Continental Electronics Mfg.
Eidson Electronic
Global Specialties Corp.
Harris Corporation, Broadcast Products Division
McMartin Industries
Motorola
Philips Test & Measuring
Rohde & Schwarz
Rohde & Schwarz GmbH

Singer Products Co. Inc.
TFT Inc.
Tektronix
Thomson-CSF
True Time Instruments
Versa-Count
Wavetek Indiana

MODULATION

Belar
Broadcast Electronics
Cetec Broadcast Group
Comad Communications
Continental Electronics Mfg.
Harris Corp., Broadcast Products
Javelin Electronics
Kudelski S.A. Switzerland
McMartin Industries
Marconi Instruments Ltd.
Motorola Communications & Elect. QEI Corp.
R. E. Instruments
Scientific-Atlanta
Singer Products Co. Inc.
TFT Inc.
Thomson-CSF
Versa-Count
Wavetek Indiana

PHASE MONITOR

Belar
CSP Inc.
Continental Electronics Mfg.
Delta Electronics
Dranetz Eng. Labs
Gorman-Redlich Mfg. Co.
Javelin Electronics
Jerrold Div., General Instrument
Kajaani Oy
Marconi Instruments Ltd.
Potomac Instruments
Pro Tech Audio
Selco Products
Thomson-CSF
Video Aids of Colorado

POWER MONITOR

B & I Electronics
Belar
Bird Electronic
Bogen Division / Lear Siegler
Coaxial Dynamics
Delta Electronics
Harris Corporation, Broadcast Products Division
Marconi Instruments Ltd.
Moseley Associates
Narda Microwave
Potomac Instruments
ProTech Audio
SGL Waber Electric
Sierra Audio Corp.
Thomson-CSF

PROGRAM MONITOR

Belar
Bogen Division / Lear Siegler
Harris Corp., Broadcast Products
ProTech Audio
Real World Technologies
Roh Corp.
Russco
Thomson-CSF
Ultra Audio Pixtec
Videotek
Video Aids of Colorado
World Video

RF LEVEL

B & I Electronics
Belar
Bird Electronic
Coaxial Dynamics
Delta Electronics
Harris Corporation, Broadcast Products Division
Jerrold Div., General Instru.
Marconi Instruments Ltd.
Moseley Associates
Potomac Instruments
R. E. Instruments
Rohde & Schwarz
Sadeco Inc.
Thomson-CSF

SCA MONITOR

Belar
Broadcast Electronics
David H. Brothers Co.
Cetec Broadcast Group
Comad Communications
Continental Electronics Mfg.
Harris Corporation
McMartin Industries
Rohde & Schwarz
Singer Products Co. Inc.
Swintek Enterprises
TFT Inc.
Thomson-CSF
Versa-Count

TV AURAL

Comad Communications
Comrex Corp.

MONITORS, VIDEO

B & W RACK

ATV Research
Adwar Video
Amtron Corp.
Asaca Corporation
Audiotronics Corp.
Barco Video Systems
Robert Bosch GmbH
David H. Brothers Co.
Cinema Products
Cohu, Electronics Division
Conrac Corp.
Crow of Reading Ltd.
Electrohome Ltd.
Elektroimpex
Fernseh Inc.
G.B.C. Closed Circuit TV Corp.
Harris Corp. Broadcast Products Div.
Ikegami
Javelin Electronics
Lenco
Link Electronics
Motorola Communications & Elect.
NET Enterprises
Panasonic
Rohde & Schwarz
Rohde & Schwarz GmbH
Team Electronics
Tektronix
Telemation
Thomson-CSF
Velee Sefat
Videcom Engineering
Video I-D

B & W STANDALONE

Amtron Corp.
ATV Research
Audiotronics Corp.
Barco Video Systems
Robert Bosch GmbH Television
Cinema Products
Cohu, Electronics Division
Conrac Corporation
Crow of Reading
Electrohome Ltd.
Elektroimpex
Fernseh Inc.
G.B.C. Closed Circuit TV Corp.
Ikegami
Javelin Electronics
Lenco
Link Electronics
Motorola Comm. & Elect.
Panasonic
Rohde & Schwarz
Rohde & Schwarz GmbH
Team Electronics
Tektronix
Thomson-CSF
Velee Sefat
Video Aids of Colorado
Videcom Engineering
Visual Methods Inc.

COLOR RACK

Adwar Video
Amtron Corporation of America
Asaca/Shibasoku
Autocue Products
Barco Video Systems

Continued on page 98

SIEMENS

A solide solution...

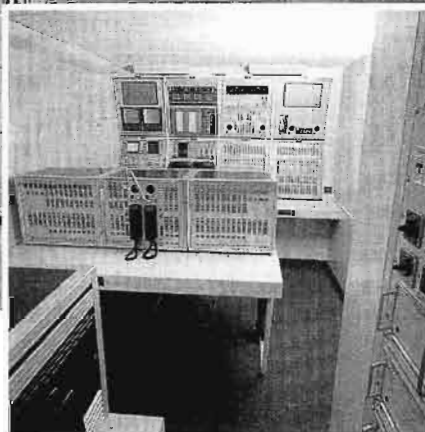
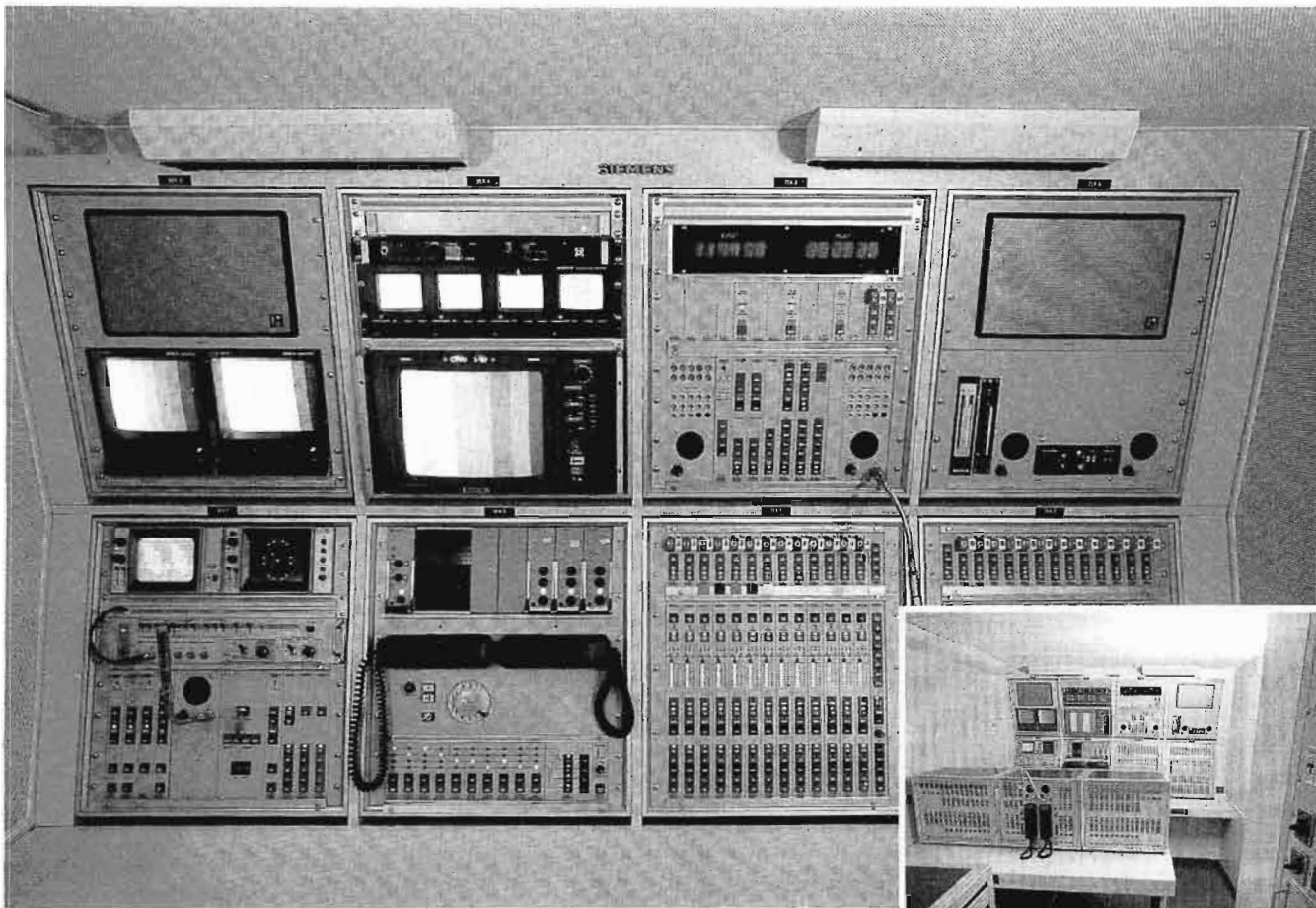

Siemens: a synonym for years of experience in sound control and studio engineering. Development, planning, manufacture and mounting of complete radio and television studios, intercommunications systems, microprocessor-controlled signal routing systems, sound control desks for all purposes and sizes, professional and semi-professional TV and radio transmission vans, speech and sound transmission systems of

digital technique, peripheral modules for switch room and control desk applications.

For further details on sound control and studio engineering, please contact

Siemens AG Österreich
Division Ton- und Studiotechnik
A-1031 Vienna, P.O.B. 326
Phone (0222) 73 45 11/103
Tx 1 33603

Sound control equipment – for Eurovision – OB van EW 11

Circle (56) on Action Card

Robert Bosch GmbH
Cinema Products
Conrac
Crow of Reading Ltd.
Elector
Electro & Optical Systems
Electrohome
Elektroimpex
Fernseh Inc.
Hitachi
Ikegami
Lenco
Link Electronics
NET Enterprises
Panasonic
Pye TVT
Rohde & Schwarz
Rohde & Schwarz GmbH
Shintron
Sony Corporation of America
Team Electronics
Tektronix
Thomson-CSF
Velec Sefat
Videocom Engineering
Video I-D
Videotek Inc.
World Video

COLOR STANDALONE
Amtron Corporation of America
Asaca/Shibasoku
ATV Research
Autocue Products
Barco Video Systems
Robert Bosch GmbH
Broadcast Video Systems
Canter-Redman Technologies Corp.
Cinema Products
Conrac
Crow of Reading Ltd.
Elector
Electro & Optical Systems
Electrohome
Elektroimpex
Fernseh Inc.
Ikegami
Hitachi
Lectrotech Inc.
Lenco
Link Electronics
Panasonic
Pye TVT
Rohde & Schwarz
Rohde & Schwarz GmbH
Shintron
Sony
Team Electronics
Tektronix
Velec Sefat
Videocom Engineering
Video Aids of Colorado
Video I-D
World Video

PULSE CROSS
Adwar Video
Amtron Corporation of America
Asaca/Shibasoku
Autocue Products Ltd.
Barco
Robert Bosch GmbH
Cinema Products
Conrac
Crow of Reading
Elector
Electrohome
Fernseh Inc.
Ikegami
Lenco
Link Electronics
Panasonic
Rohde & Schwarz
Shintron
Tektronix
Videocom Engineering
Video Aids of Colorado
Video I-D
Videotek Inc.
World Video

RECEIVER / MONITORS
ATV Research
Adwar Video
Amtron Corporation
BCB Electronic Sales
Barco Electronic

Conrac
Crowder Communications
Crow of Reading Ltd.
Elector
Electro & Optical Systems
Electrohome
Lectrotech
Panasonic
Rohde & Schwarz
Team Electronics
Thomson-CSF
U.S. JVC Corporation
Videocom Engineering
Video Aids of Colorado
Video I-D
Videotek Inc.
World Video

WAVEFORM
(See Also Test Equipment)
Amtron Corporation
Broadcast Video Systems
Michael Cox
Cinema Products
Crow of Reading Ltd.
Elektroimpex
Hitachi
Image Devices Incorporated
Lectrotech
Lenco
Marconi Instruments Ltd.
Rohde & Schwarz
Tektronix
Thomson-CSF
Ultra Audio Pixtec
Video I-D
Videotek Inc.

MULTICARRIER SYSTEMS

Aydn Microwave
Coastcom
Calzone Case Co.
GTE Lenkurt Incorporated
Modulation Associates
Moseley Associates
C.N. Rood BV
Valtec Corporation

MULTIPLEXER

ATV Research
Alford Mfg. Co.
Artel Communications Corp.
Aydn Microwave
Aydn Monitor Systems
Bayly Engineering
Buhl Optical
CSP Inc.
Coastcom
Cohu, Electronics Division
Comark Communications
Dielectric Communications
Fernseh Inc.
GTE Lenkurt Incorporated
GTE Products Corp.
Ikegami Electronics
Kalart Victor
Laird Telemedia
Micro Communications
Modulation Associates
Mu-Del Electronics
North Hills Electronics
Nytone Electronics Corp.
C.N. Rood BV
Shively Laboratories
Thomson-CSF
Zei-Mark Corporation

MUSIC PRODUCTION SERVICES

American Image Productions
Emil Ascher Music
BPI
The Broadcast Center
Century 21 Programming
The CnB Studios
CVE Recording
Columbia Special Products
Continental Recordings

DeWolfe Music Library
Kitchen Productions
Musicues
Network Production Music
Parasound Inc.
Real Radio Co.
Ken Schaffer Group
Tape-Athon / Cavox Stereo
Productions
Valentino Inc.

MUSIC PROGRAM SERVICES

Emil Ascher Music
BPI (Broadcast Programming
International)
The CnB Studios
CVE Recording
Century 21 Programming
Chase Media Inc.
Computer Management Systems
Concept Productions
DeWolfe Music Library
Drake-Chenault
KalaMusic
Kimian Sales Inc.
Kitchen Productions
Live Sound
Mighty Minute Programs
Musicues
Radio Computing Services
Real Radio Company
Sacred Sounds
Shane Media Services
Tape-Athon / Cavox Stereo
Productions
VIF International
Valentino Inc.
Video Data Systems

NETWORKS

AUDIO MATCHING
Bayly Engineering Ltd.
Leader Broadcast Systems
McCurdy Radio Industries
Sescom
Siemens AG Osterreich
TM Systems
TTE Inc.
Vidaire Electronics Mfg.

MIXING
Michael Cox
Leader Broadcast Systems
McCurdy Radio Industries
Modular Audio Products
NET Enterprises
ProTech Audio Corporation
Siemens AG Osterreich
Straight Wire Audio

PHASING
BES Electronics
CSP Inc.
Continental Electronics
Elcom-Bauer
Harris Corporation
Leader Broadcast Systems
McCurdy Radio Industries
NET Enterprises
Siemens AG Osterreich
TTE Inc.
Thomson-CSF

RF MATCHING
BES Electronics
Bayly Engineering
CSP Inc.
Continental Electronics
Dielectric Communications
Elcom Bauer
Harris Corporation
North Hills Electronics
S.W.R.
Siemens AG Osterreich
TTE Inc.
Texscan Corp.
Thomson-CSF
Wide Band Engineering

NEWS SERVICES

The Associated Press
United Press International

NOISE REDUCTION SYSTEMS, AUDIO

ADM Technology
AEG-Telefunken
(Bayly Engineering)
ATI-Audio Technologies Inc.
Advanced Analog Systems, Inc.
Aphex Systems
Applied Technology Corp.
Audio & Design Recording
Audiomics of Oregon
Briel & Kjaer Instruments
Coastcom
Composite Video
dbx Inc.
Deltamod
Dolby Laboratories
EMT Franz
GTE Products Corp.
Harris Corporation, Broadcast
Products Division
IGM Communications
Inovonics
Integrex
Kintek
Leader Broadcast Systems
MXR Innovations
McCurdy Radio Industries
Micmix Audio Products
Modulation Associates
NEC America
NET Enterprises
Opamp Labs Inc.
Processing Plus
Ramko Research
Sierra Audio
Straight Wire Audio
Tascam, Div. of Teac
Valley People

NOISE REDUCTION SYSTEMS, VIDEO

Asaca/Shibasoku
Composite Video
Crow of Reading Ltd.
Digital Video Systems
Faroudja Laboratories
Fernseh, Inc.
Fortel
GTE Products Corp.
Harris Corporation
Microtime
NEC America
NET Enterprises
Phillips Broadcast Group
Siegel - Electronics
Thomson-CSF

OSCILLATORS, TONE

Audisar
Broadcast Electronics
Broadcast Technology
Briel & Kjaer
CMC Technology Corp.
Channelomatic
Datatronix
Deltamod
Frequency Devices
Gorman-Redlich
Leader Broadcast Systems
McCurdy Radio Industries
Multidyne Electronics
Opamp Labs Inc.
Potomac Marine & Aviation
ProTech Audio Corporation
Rohde & Schwarz
Spectra Sonics
Sphere
Tektronix

Continued on page 100



EIMAC cavities cover 54 to 970 MHz at power levels to 30 kW —our design or yours

Varian EIMAC has complete cavity design and production capability. We make sure that tube and cavity are compatible. If it isn't an off-the-shelf-item, we have the designers and engineers for any specific job.

EIMAC has expertise in all disciplines including pulse, CW, FM, and TV. We match tube, power,

bandwidth and operating mode to achieve optimum performance.

More information on EIMAC cavities and tubes is available in our Cavity Capability brochure from Varian EIMAC. Or for prompt consideration of your special design requirements, contact Product Manager, Var-

ian EIMAC, or the nearest Varian Electron Device Group sales office. Call or write today.

Electron Device Group
Varian EIMAC
 301 Industrial Way
 San Carlos, California 94070
 415 592-1221

Varian A.G.
 Steinhauserstrasse
 CH-6300 Zug, Switzerland
 Tel: (042) 23 25 75
 Telex: 78 841

EIMAC Cavity	Matching EIMAC Tube	Tuning Range (MHz)	Power Output
CV-2200	4CX20,000A	86-108	30 kW
CV-2220	3CX1500A7	86-108	1.5 kW
CV-2225	4CX3500A	86-108	5 kW
CV-2240	3CX10,000U7	54-88	10 kW†
CV-2250	3CX10,000U7	170-227	10 kW†
CV-2400	8874	420-450	300/1250 W*
CV-2800	3CX400U7	850-970	225 W
CV-2810	3CX400U7	910-970	190 W

*pulsed power

†peak sync, or 2.5 kW combined in translator service



Circle (57) on Action Card

OSCILLOSCOPES

(See Test Equipment)

PATCH PANELS

ADM Technology
Audio Accessories, Inc.
Audironics
Bayly Engineering Ltd.
Brabury Broadcast Systems
Broadcast Electronics
Broadcast Technology
Continental Electronics
Crow of Reading Ltd.
Datatronix
Dell Technical Vehicles
Dielectric Communications
Dyma Engineering
Dynamic Technology Ltd.
Dynatech Data Systems
Electro-Acoustic Designs
Elektroimpex
Farrtronics
Harris Corporation, Broadcast Products Division
Kings Electronics
Link Electronics
McCurdy Radio Industries
McMartin Industries
Micro Communications
Panoak Lighting Systems
Phelps Dodge Communications
Potomac Instruments
Rex Rheostat & Co., Inc.
S.W.R.
Shively Laboratories
Siemens AG Osterreich
Sphere
Strand Century
Switchcraft
Tascam, Div. of Teac
Theatre Technologies Inc.
Thomson-CSF
Trompeter Electronics
Union Connector Co., Inc.
Vector Electronic
Videomedia
Wireworks

PHASE CONTROLLER, AUTOMATIC

California Instruments
Delta
Micro Communications
NEC America
Rohde & Schwarz
Thomson-CSF

PHASE CONVERTERS

California Instruments
Kay Industries
Thomson-CSF
Wilkinson Electronics

PHASE CORRECTOR, CART

Howe Audio Productions

POWER CONTROLLER

Delta Electronics

POWER SUPPLIES

AEL (Am. Elec. Labs)
AKG Acoustics
AKG Akustische u. Kino-Gerate
Advance Conversion Devices
Alpha Technologies
Anton/Bauer
Beyer Dynamic
California Instruments
Catel
Christie Electric Corp.
Cinema Products

Cinetronics
Coastcom
Comprehensive Video Supply
Crowder Communications
Peter W. Dahl Co., Inc.
Dukane Corp.
Dynamote
Dynascan
Elektroimpex
Frequency Devices
GTE Products Corp.
Glassman High Voltage
Gould Inc./Instruments Div.
Harris Corp. Broadcast Products
Keithley Instruments
McCurdy Radio Industries
Microwave Power Devices
Modular Audio Products
Motorola Comm. & Elec.
Georg Neumann GwBH
North Wind Power Co.
Nova Electric Mfg. Co.
Opamp Labs, Inc.
PTS Electronics
Potomac Marine & Aviation Power Products
ProTech Audio Corporation
Sait Electronics
Siemens AG Osterreich
Sorenson
Spectra Sonics
Systron Donner
Sytron Inc.
Teledyne Energy Systems
Tepco Corp.
Thomson-CSF
Vanner
Varian, MCSD
Vidair Electronics Mfg. Corp.

PREAMPLIFIERS

MICROPHONE

ADM Technology
AKG Acoustics
ATI Audio Technologies Incorporated
Amek TAC
Arrakis Systems
Audio & Design Recording
Audiolincs of Oregon
Audisar
AudiX Ltd.
Bayly Engineering Ltd.
Bell Audio Systems, Inc.
Bogen Division / Lear Siegler
Broadcast Electronics, Inc.
Broadcast Technology
Bruel & Kjaer Instruments
Cetec Broadcast Group
Comad Communications
Continental Electronics Mfg.
Datatek
Datatronix
Dukane Corp.
Dyma Engineering
Edcor
Elektroimpex
EV-Tapco
Full Compass Systems
Georg Neumann GwBH
Gregg Laboratories
Hammond Industries
Harris Corporation, Broadcast Products Division
I T I Electronics
Leader Broadcast Systems
MXR Innovations, Inc.
McCurdy Radio Industries
Micro - Trak Corporation
Miles Assoc., Div. of Miles Air Products Ltd.
Modular Audio Products
Rupert Neve
Opamp Labs Inc.
Paso Sound Products
Processing Plus
ProTech Audio Corporation
Quad-Eight Electronics
RTS Systems
Ramko Research
Richmond Sound Design
Roh Corporation
Russo
Sait Electronics
Sescom Inc.
Shure Brothers
Siemens AG Osterreich

Sontec Electronics
Shure Brothers
Siemens Ag Osterreich
Spectra Sonics
Sphere
Straight Wire Audio
TOA Electronics
Tri Tec Systems Inc.
Valley People

MODULES, FOR CONSOLES

ADM Technology
ALICE (Stancoll Ltd.)
Amek TAC
Arrakis Systems
Audio Technology
AudiX Ltd.
Bogen Division / Lear Siegler
Broadcast Electronics, Inc.
Broadcast Technology
Datatronix
Dyma Engineering
Elektroimpex
Georg Neumann GwBH
Howe Audio
Leader Broadcast Systems
McCurdy Radio Industries
McMartin
Micro - Trak Corporation
Modular Audio Products
Rupert Neve
Georg Neumann
Opamp Labs Inc.
ProTech Audio Corporation
Quad-Eight Electronics
Richard Sound Design
Roh Corporation
Sait Electronics
Sescom
Siemens Ag Osterreich
Sontec Electronics
Spectra Sonics
Sphere Electronics
Straight Wire Audio
TOA Electronics
Telex Communications
Tri Tec Systems Inc.
Ward-Beck Systems

STEREO

ADM Technology
ATI Audio Technologies Incorporated
Arrakis Systems
Audio Technology
Audiolincs of Oregon
Audisar
AudiX Ltd.
Broadcast Electronics
Bryston
Comad Communications
Continental Electronics Mfg.
Crown International
Dyma Engineering
Ear Systems Inc.
Elektroimpex
Full Compass Systems
Georg Neumann GwBH
Harris Corporation, Broadcast Products Division
Integrated Sound Systems
Leader Broadcast Systems
Logitek Electronic Systems
MXR Innovations
McCurdy Radio Industries
Micro - Trak Corporation
Rupert Neve
Georg Neumann
Panasonic, Professional Audio Div.
Processing Plus
ProTech Audio Corporation
RTS Systems
Ramko Research
Richmond Sound Design
Roh Corporation
Rohde & Schwarz
Rohde & Schwarz GmbH
C.N. Rood B.V.
Russo
Sait Electronics
Sescom, Inc.
Siemen Ag Osterreich
Sontec Electronics
Sphere
Stanton Magnetics
Straight Wire Audio
Teac Corp. of America

Telex Communications, Inc.
Valley People
Vidair Electronics Mfg. Corp.

TURNTABLE

ADM Technology
ALICE (Stancoll Ltd.)
Applied Technology
Arrakis Systems
ATI Audio Technologies Inc.
Audio Path
Audio Technology
Audiolincs of Oregon
Audisar
AudiX Ltd.
Bogen Division / Lear Siegler
Broadcast Audio Assoc.
Broadcast Electronics
Bryston
Cetec Broadcast Group
Comad Communications
Continental Electronics Mfg.
Crown International Inc.
D-B Electronics
Datatronix
Dyma Engineering
Full Compass Systems
Gregg Laboratories
Hammond Industries
Harris Corporation, Broadcast Products Division
Howe Audio
Leader Broadcast Systems
Logitek Electronic Systems
LPB Inc.
MXR Innovations
McCurdy Radio Industries
McMartin Industries
Micro-Trak Corporation
Opamp Labs Inc.
Processing Plus
ProTech Audio Corporation
RTS Systems
Radio Systems
Ramko Research
Research Systems Tech.
Russo
Sescom
Sontec Electronics
Stanton Magnetics
Straight Wire Audio
Tweed Audio USA Inc.
Vidair Electronics Mfg.

VIDEO

Acrodyne
Blonder-Tongue Laboratories
Comad Communications
Crow of Reading Ltd.
International Nuclear Corp.
Opamp Labs Inc.
Rohde & Schwarz
Thomson-CSF

PROCESSORS, AUDIO

ATI Audio Technologies Inc.
Aphex Systems Ltd.
Applied Technology Corp.
Audio & Design
Audio Path
Broadcast Electronics
Circuit Research Coastcom
Comad Communications
Composite Video
Deltamod
Dyma Engineering
Eventide Inc.
Greg laboratories
IGM Communications
Inovonics
Integrated Sound
Kahn Communications
Labs Inc.
Lexicon
MXR Innovations
Modulation Sciences
Orban Associates
Processing Plus
ProTech Audio
Pyramid Loudspeaker Corp.
Richmond Sound Design
Sontec Electronics
Spectra Sonics
Trident (USA)

Continued on page 102



IMPROVE YOUR IMAGE

with
angēnieux

Angenieux has developed for your needs, the complete modular lens systems. With selectable attachments, we cover—from the widest wide angle to the super telephoto with the same basic lens.

These systems cover studio lenses with outstanding optical quality as well as durable, lightweight, compact ENG, EFP and field lenses.

Whatever your format, $\frac{1}{2}$ " , $\frac{3}{4}$ " , 1" , 1 $\frac{1}{4}$ " ,
if you're thinking about purchasing a good lens
then why not consider—the very best.

angēnieux inc.

120 DERRY RD., HUDSON, N.H., 03051 • (603) 880-1710
13381 BEACH AVE., VENICE, CA 90291 • (213) 821-5080
190 DON PARK RD., MARKHAM, ONT. L3R-2V8 • (416) 475-5454

Circle (58) on Action Card

VIF International
URSA Major
Valley People

PRODUCTION/ POST-PRODUCTION SERVICES

Action Video
BCB Electronic Sales Ltd.
Bonneville Productions
The Broadcast Center
Center City Video
Compro
Dolphin Productions
Golden Egg
Interface Video Systems
Imero Fiorentino Assoc.
Bernie Krause/Gary Remal
LTI Productions
Leo Diner Films
McQ Productions
Master Digital Inc.
Mobile Visual Productions
NET Enterprises
New Earth Television Works
Systems Ltd.
Oak Communications Inc.
Satellite Systems
Optical Radiation
Quantum Audio Labs
R.A.V.E./Reliable Audio Video
Enterprises
Rank Precision Industries, Inc.
(Cintel Div.)
K.L. Rubel & Assoc., Ltd.
Smith-Mattlingly Productions Ltd.
E.J. Stewart Inc.
Teleconcepts in Communications
Television Assoc. Inc.
Television Production Services
Television International
Operations, Ltd.
Trans-American Video
Unidek Film Editing Systems
Valentino Inc.
Vipro Program Services
Video Workshop

PROJECTORS

FILM CHAIN
Buhl Optical
Crow of Reading Ltd.
Eastman Kodak
Harris Corporation, Broadcast
Products Division
Ikegami Electronics
Image Devices Incorporated
Kalart Victor Corporation
Laird Telemedia
L-W International
Mobile Visual Productions
Multi-Track Magnetics
Rangertone Research
Rank Precision Industries
(Cintel Div.)
Spendler & Sauppe
Westrex
The Zei-Mark Corp.

LARGE SCREEN TV
Advent Corp.
Barco Electronic
Canter Redman Technologies Corp.
Conrac
Eidophor Ltd.
Electro
Electrohome Ltd.
General Electric Co. - Video
Display Equipment Operation
Image Magnification Inc.
Kalart Victor Corporation
Link Electronics
Panasonic
Tele Concepts in Communications

SLIDE
Buhl Optical
Crow of Reading Ltd.
Datatron
Eastman Kodak
The Great American Market

Harris Corporation, Broadcast
Products Division
Interand
Kalart Victor
Laird Telemedia
Mobile Visual Productions
Optical Radiation
Rank Cintel
Rangertone Research
Research Technology Int'l.
Spendler & Sauppe
The Zei-Mark Corp.

PROMPTERS

Autocue Products Ltd.
BEI (Beston Electronics)
Cinema Products
D'San Corporation
Listec Television Equipment Corp.
Q-TV
Telescript
Texscan/MSI Corporation

PULSE ASSIGNMENT SYSTEMS

Audico Inc.
Central Dynamics
Leitch Video
Lenco
Thomson-CSF

RF COMPONENTS

Andrew Corp.
BES Electronics
Calvert Electronics
Catel
Coaxial Dynamics
Compac Development Corp.
CSP Inc.
Delta Electronics
Elcom-Bauer
Gralex
Jerrold Div.
Magnecraft Electric Co.
Marconi Instruments Ltd.
Marshall Electronics
Micro Communications
Motorola
Mu-Del Electronics
North Hills Electronics
Nurad Inc.
Phelps Dodge Communications
Rohde & Schwarz
S.W.R.
Scientific Atlanta Phoenix Div.
Shively Labs
TL Systems
Texscan
Thompson-CSF
Tramec Electronics
UTE Microwave
Varian MCS-D
Varian Associates

READER FOR TIME CODE IN VERTICAL INTERVAL

BTX Corporation
Control Video Corp.
Datatron
Dynamic Technology Ltd.
EEO Inc.
Gray Engineering Labs
Skotel Corp.
Telcom Research

RECEIVERS

AM RECEIVER
TFT Inc.

DATA
AEG-Telefunken
Aydin Microwave
Catel (Division of United Scientific)

Datum Inc.
Johnson Electronics
Radio Data Systems
Technology Service Corp.

EARTH STATION

AEG-Telefunken
Andersen Scientific
Anixter Mark
Automation Techniques
Aydin Microwave
Blonder-Tongue Labs
California Microwave
Coastcom
Comad Communications
ComTech Data
Conifer
Crowder Communication
Gardiner Communications
Harris Corp., Broadcast Products
Hughes Aircraft Co.,
M/A-COM Video Systems
International Microwave Corp.
Microdyne Corporation
Modulation Associates
NEC America
Oak Communications Inc.
Satellite Systems
Rohde & Schwarz
SED Systems
Satcom Inc.
Satvision
Scientific-Atlanta
Standard Communications
TL Systems
TerraCom-Loral
Triple Crown Electronics
United States Tower
Velec Sefat

EBS RECEIVER

AEG-Telefunken
Automation Techniques
Broadcast Electronics
Emergency Alert Receiver
Gorman-Redlich Mfg. Co.
Harris Corp., Broadcast Products
International Nuclear Corp.
Johnson Electronics
McMartin Industries
Radio Systems Inc.
Rivers Associates Inc.
TTF Inc.

FM RECEIVER

AEG-Telefunken
Audix Ltd.
Bogen Division / Lear Siegler
Catel
Comad Communications
Electra Co., Div. of Masco
Emergency Alert Receiver Inc.
Gorman Redlich Mfg. Co.
McMartin Industries
Micro Communications
Paso Sound Products
Pyramid Loudspeaker Corp.
R - Columbia Products
Regency Electronics
Rohde & Schwarz
Scientific Atlanta Phoenix Div.
H.H. Scott
Sharp Electronics
Studer International AG
Studer ReVox America
Swintek Enterprises
TFT Inc.
Triple Crown Electronics

MICROWAVE

AEG-Telefunken
Automation Techniques
Aydin Microwave
Cablewave Systems
Conifer Corp.
Datum
Farinon Video/Harris Corp.
Harris Broadcast Microwave
Harris Corp., Broadcast Products
International Microwave Corp.
M/A-COM Video Systems
Marconi Instruments Ltd.
Moseley Associates
NEC America
Nurad Inc.
R.F. Technology
RHG Electronics

Satvision
Tayburn Electronics
Teppo Corp.
Terracom - Loral
Visual Methods Inc.

RECEIVER/GENERATOR

Delta Electronics

SCA
AEG-Telefunken
Bogen Division/Lear Siegler
David H. Brothers Co.
Comad Communications
Continental Electronics Mfg.
Emergency Alert Receiver Inc.
Harris Corp., Broadcast Products
Johnson Electronics
McMartin Industries
Moseley Associates
Radio Data Systems, Inc.
Rohde & Schwarz
TFT Inc.

STL

AEG-Telefunken
Artel Communications
Aydin Microwave
Broadcast Electronics
Cablewave Systems
Comad Communications
Continental Electronics Mfg.
Harris Corp./Farinon Video
International Microwave Corp.
McMartin Industries
M/A-COM Video Systems
Martí
Micro Control Associates, Inc.
Moseley Associates
Phelps Dodge Communications
R.F. Technology
RHG Electronics
Swintek Enterprises
TFT Inc.
Tayburn Electronics
Versa-Count

TSL

TFT Inc.

TIME (WWW)

AEG-Telefunken
Catel
ESE
McKay Dymek Company
Scientific Radio Systems
Teppo Corp.
True Time Instruments

WEATHER, VHF

AEG-Telefunken
Alden Electronic Impulse
& Recording Equipment
Catel
Electra, Div. of Masco
Emergency Alert Receiver
Gorman Redlich
Kudelski S.A. Switzerland
Heath Company
Motorola Communications & Elec.
Regency Electronics
Scientific Radio Systems

RECEIVER, TV AURAL

Rohde & Schwarz

RECORDER PARTS & ACCESSORIES

CAPSTAN ASSEMBLY
Broadcast Electronics
Century 21 Programming
Consolidated Electronic Ind.
Leader Broadcast Systems
Merlin Engineering
Neal-Ferroglyph
Studer ReVox America
Telectro Systems
UMC Electronics
VIF International

CARE KITS

Allsop
R. B. Annis Co.
Broadcast Electronics
Century 21 Programming
Chemtronics
Fidelipac
G.C. Electronics
Harris Corp., Broadcast
Products Div.
Leader Broadcast Systems
Marathon Products
Merlin Engineering
Neal-Ferrograph
Nortronics
PAG - Group
Studer ReVox America
Teac Corp. of America
The Texwipe Company

DRIVE MOTOR POWER SUPPLY

Broadcast Electronics
Century 21 Programming
Consolidated Electronic Ind.
Leader Broadcast Systems
Merlin Engineering
Neal-Ferrograph
Studer ReVox America

ELECTRONICS

Audi-Cord
Broadcast Electronics
Brush Magnetic Heads
Consolidated Electronic Ind.
Inovonics
Leader Broadcast Systems
Merlin Engineering
Neal-Ferrograph
Sontec Electronics
Studer ReVox America
Taber Mfg. & Eng.
Teac Corp. of America
UMC Electronics
United Research Lab Corp.
Videomagnetics
VIF International
Westrex

HEADS (See Heads)**MOTORS**

Audi-Cord
Broadcast Electronics
Brush Magnetic Heads
Century 21 Programming
Consolidated Electronic Ind.
International Electro-Magnetics
Leader Broadcast Systems
Merlin Engineering
Neal-Ferrograph
Studer ReVox America
Taber Mfg. & Eng. Co.
Telectro Systems
UMC Electronics
United Research Lab Corp.
VIF International

SERVO MODIFICATIONS

Consolidated Electronic Ind.
Inovonics
Marconi Electronics
Merlin Engineering
Multi-Track Magnetics
Recortec
Studer ReVox America
Video Associates Labs

SPEED CONTROLS

Cherry, Semiconductor
Consolidated Electronic Ind.
Leader Broadcast Systems
Merlin Engineering
Multi-Track Magnetics
Neal-Ferrograph
Studer ReVox America
Unemco International

SYNCHRONIZERS

Audiotronics
The BTX Corporation
Consolidated Electronic Ind.
EECO Incorporated
Kudelski S.A. Switzerland
Leader Broadcast Systems
Merlin Engineering
Multi-Track Magnetics

Neal-Ferrograph
Skotel Corporation
Studer International AG
Studer ReVox America
Telcom Research
Tiffen Manufacturing Corp.

TAPE DECK CABINETS

Broadcast Electronics
Consolidated Electronic Industries
Ear Systems Inc.
Grinnan Fixture
Leader Broadcast Systems
Micro-Trak
Merlin Engineering
Otari Corp.
Sound Dynamics
Studer ReVox America
UMC Electronics
Winsted Corp.

TAPE DECKS

AEG-Telefunken
Amilon Corp.
Ampro-Scully
Audi-Cord
Broadcast Electronics
David H. Brothers Co.
Century 21 Programming
Consolidated Electronic Industries
International Electro-Magnetics
Kudelski S.A.
Leader Broadcast Systems
Merlin Engineering
Neal-Ferrograph
Rupert Neve
Panasonic, Professional Audio Div.
Sound Dynamics
Studer ReVox America
Tascam, Div. of Teac
Telectro Systems
Telex Communications
Triple I Inc.
UMC Electronics
United Research Lab Corp.
VIF International

TENSION CONTROLS

Broadcast Electronics
Consolidated Electronic Industries
Inovonics
K B Systems
Merlin Engineering
Recortec
UMC Electronics
VIF International

TRANSPORT SERVICES

Century 21 Programmer
Consolidated Electronic Industries
Leader Broadcast Systems
Merlin Engineering
Neal-Ferrograph
Recortec
Sound Dynamics
Taber Mfg. & Eng.
VIF International

VELOCITY ERROR CORRECTORS

CMC Technology Corporation
Consolidated Electronic Industries
Merlin Engineering
Studer International AG

RECORDERS, AUDIO TAPE**CARTRIDGE (See Cart Machines)****CASSETTE (See Cassette Machines)****DIGITAL**

Amiton Corp.
Comex Systems
Consolidated Electronic Industries
3M Company, Video Products
MCI
Master Digital Inc.
Panasonic, Professional Audio Div.
Rangertone Research Inc.
Sony

FILM RECORDER

Enertec Schlumberger
Kudelski S.A. Switzerland

Magna-Tech Electronic Co.
Magnasync/Moviola
Multi-Track Magnetics
Rangertone Research
Rank Cintel Ltd.
Westrex

LOGGING

Amilon Corp.
Amplex
Ampro-Scully
Broadcast Electronics
David H. Brothers Co.
Consolidated Electronic Industries
Continental Electronics Mfg.
Dictaphone Corporation
Elektroimpex
IGM Communications
International Electro Magnetics
Kudelski S.A. Switzerland
Leader Broadcast Systems
Magnasync/Moviola
Nagra Magnetic Recorders
Neal-Ferrograph (USA), Inc.
Otari
QSI Systems
Singer Products Co. Inc.
Soundscriber Magnetic
Recording Co. Inc.
The Stancil-Hoffman Corporation
Studer ReVox America
Telectro Systems
Telex Communications

REEL: ONE & TWO TRACK

Accurate Sound
Amplex
Ampro / Scully
BASF Limited
David H. Brothers Co.
Cetec Broadcast Group
Consolidated Electronic Industries
Continental Electronics Mfg.
Electro Sound
Elektroimpex
Enertec Schlumberger
IGM Communications
ITC/3M
Kudelski S.A. Switzerland
Leader Broadcast Systems
Lyrec Manufacturing A/S
Magna-Tech Electronic Co.
MCI
Microprobe Electronics
Micro-Trak
Nagra Magnetic Recorders
Neal-Ferrograph (USA) Inc.
Rupert Neve
Northland Communications
Otari
Pacific Recorders
Panasonic, Professional Audio Div.
Ramko Research
RCA Broadcast
L. J. Scully Manufacturing Corp.
Singer Products Co. Inc.
Sono-Mag
Sound Dynamics
Soundscriber Magnetic Recording
Stancil Corp.
Stillavox
Studer International AG
Studer ReVox America
Tascam, Div. of Teac
Telex Communications
United Research Lab Corp.
VIF International

REEL: FOUR TRACK

Accurate Sound
Amplex
Ampro / Scully
Consolidated Electronic Industries
Continental Electronics Mfg.
IGM Communications
Kudelski S.A. Switzerland
Lyrec Manufacturing A/S
Microprobe Electronics, Inc.
MCI Inc.
Nagra Magnetic Recorders
Neal-Ferrograph (USA) Inc.
Rupert Neve
Northland Communications
Otari
Ramko Research
S.J. Scully
Singer Products Co. Inc.

Stancil Hoffman
Stillavox
Studer International AG
Studer ReVox America
Tascam, Div. of Teac
Telex Communications, Inc.
United Research Lab Corp.
VIF International

REEL: MULTI-TRACK

Accurate Sound
Ampro / Scully
Consolidated Electronic Industries
Continental Electronics Mfg.
Dictaphone Corporation
Leader Broadcast Systems, Inc.
Lyrec Manufacturing A/S
MCI Inc.
Rank Cintel Ltd.
Rupert Neve
Otari
Sierra Audio Corp.
Singer Products Co. Inc.
Soundcraft Electronics
Stancil - Hoffman
Stillavox
Studer International AG
Studer ReVox America
Tascam, Div. of Teac
Telex Communications, Inc.
Trident (USA) Inc.
United Research Lab Corp.
VIF International

RECORDERS, VIDEOTAPE

1/4 - INCH
Fernseh
Hitachi
Ikegami
Technicolor

1/2 - INCH

Action Video Inc.
Adwar Video
Canter Redman Technologies Corp.
Feathercam Inc.
Ikegami Electronics
Javelin Electronics
Merlin Engineering
NET Enterprises
Panasonic
QSI Systems
RCA
Sharp Electronics
Sony Corp. of America
US JVC Corporation
Video I-D

3/4 - INCH

Action Video Inc.
Adwar Video
Merlin Engineering
NET Enterprises
Panasonic
RCA
Recortec
Sony Corporation of America
US JVC Corporation
Video I-D
Video Masters

1 - INCH

A.F. Associates
Adwar Video
Amplex
BCB Electronic Sales Ltd.
Robert Bosch GmbH
Fernseh Inc.
Hitachi
International Video Corp.
3M Company, Video Products
Marconi Electronics
Merlin Engineering Works
NEC America
Philips Broadcast Group
RCA Broadcast Systems
Sony Corporation of America
Video Masters

Extended Play Kit
Marconi Electronics

Continued on page 104

Merlin Engineering Works
Recortec

QUAD

A.F. Associates
Ampex
Robert Bosch GmbH
Marconi
Merlin Engineering
RCA Broadcast Systems
Recortec
Video Masters

LOGGING

David H. Brothers Co.
Fernseh Inc.
Merlin Engineering
QSI Systems

RECONDITIONED MACHINES

A.F. Associates
Merlin Engineering Works

SLOW MOTION REPLAY

Ampex
Arvin Echo
Brabury Broadcast Systems
Elgen Video
Fernseh Inc.
Javelin Electronics
Marconi Electronics
Merlin Engineering Works
NEC America, Broadcast
Equipment
NET Enterprises
Oktel Corporation
Panasonic
RCA Broadcast Systems
Television Graphics
U.S. JVC Corporation

RECORDING SERVICES, AUDIO

Accurate Sound
American Image Productions
Bonneville Productions
CVC Recording
Century 21 Programming
Command Productions
Compact Video
Compro Productions
Continental Recordings
Highland Labs
Master Digital Inc.
Musicues
W.A. Palmer Films, Inc.
Real Radio Company
Richmond Sound Design
See Hear Industries
Sierra Audio
John M. Sullivan Assoc., Inc.
Tape
Tuesday Productions
Video Workshop
9 West Recording Studio

RECORDS

AUDIO TEST

Audio-Technica US, Inc.
Briel & Kjaer Instruments
Leader Broadcast Systems
Ortofon A/S
Shure Brothers

SOUND EFFECTS

Emil Ascher Music
Century 21 Programming
Columbia Special Products (CBS
Records)
Comprehensive Video Supply
Leader Broadcast Systems
Tech Theatre Inc.
Valentino Inc.

REELS

AUDIO TAPE

Broadcast Electronics, Inc.
Continental Electronics
Dictaphone

D'San Corporation
ENG Corp.
Hannay Reels
Harris Corporation, Broadcast
Products Division
Leader Broadcast Systems
3M Mag A/V Products Division
Pan Canada Magnetics Ltd.
Plastic Reel Corp.
Polyline Corp.
See Hear Industries
The Stancil-Hoffman Corporation
Studer ReVox America
Tascam, Div. of Teac
VIF International

CABLE & MIKE

(See Cables)

VIDEOTAPE

Calico Video
Fuji Magnetic Tape Division
Goldberg Bros. Inc.
J&R Film Co., Inc.
Javelin Electronics
3M Mag A/V Products Division
Panasonic
Plastic Reel Corp.
Polyline Corp.
RCA Service Company
Re-Play Video Cartridge Service
Schuessler Case
See Hear Industries

REGULATORS VOLTAGE

AEG-Telefunken
(Bayly Engineering)
California Instruments
Cinetronics
Continental Electronics
DTE Superior Electric Co.
Lightning Elimination Associates
MCG Electronics
Motorola
Spectra Sonics
The Superior Electric Co.
Sytron Inc.
Thomson-CSF
Topaz Electronics
TransTector Systems
Vidaltre Electronics

RECTIFIERS

POWER (SEMICONDUCTOR)

AEG-Telefunken
(Bayly Engineering)
Amperex Electronics
Calvert Electronics
Ceco Communications
Electronic Devices
GTE Products Corp.
Motorola
RCA Distributor & Special
Products
Thomson-CSF

SCR

AEG-Telefunken
(Bayly Engineering)
Amperex Electronics
Calvert Electronics
Ceco Communications
Comprehensive Video Supply
Electronic Devices
Motorola
RCA Distributor & Special
Products
Thomson-CSF

STACK

Amperex Electronics
Calvert Electronics
Ceco Communications
Electronic Devices

TUBES (See Tubes)

REMOTE CONTROL SYSTEMS, AM-FM

Bayly Engineering
Broadcast Electronics
Channematic
Comad Communications
Communication Control
Centers Inc.
Delta Electronics
Harris Corporation
Hallikainen & Friends
Micro Control Assoc.
Monroe Electronics
Moseley Associates
Potomac Instruments
Rohde & Schwarz
C.N. Rood B.V.
Soll Inc.
TFT Inc.
Tayburn
Torpey Controls & Engineering
Tramec Electronics
Video Specialties
Zercom Corp.

REMOTE CONTROL SYSTEMS, VIDEO

Advanced Analog Systems
Airborne Video Systems Corp.
Altha Video & Elect. Corp.
American Data
Asaca/Shibasoku
David H. Brothers
CALDATACOM
Cat Systems
Channematic
Cinema Products
Cohu, Electronics Division
Communications Control Centers
Control Video Corporation
Michael Cox
Crow of Reading Ltd.
Delta Electronics
DI-tech
Dynair Electronics
Dynamic Technology Ltd.
Fernseh Inc.
GBC Closed-Circuit TV
Harris Corporation, Broadcast
Products Division
Image Video Limited
Javelin Electronics
Jenel Corp. Consulting Engineers
Micro Control Associates
Monroe Electronics
Moseley Associates
NEC America
Panasonic
Phillips Broadcast Group
PWH Electronics Limited
Rohde & Schwarz
Soll Inc.
Tayburn Electronics
TFT Inc.
Thomson-CSF
Torpey Controls & Engineering
United Media
Vamco Engineering
Video Specialties
Video Tape Systems

REMOTE PICKUP SYSTEMS

Altha Video & Elect. Corp.
Broadcast Electronics
Centro
Comrex Corporation
Farinon Video/Harris Corp.
Harris Broadcast Microwave
Harris Corporation, Broadcast
Products Division
Kaitronics
Lang Video Systems
McCurdy Radio Industries
McMartin Industries
Marti

Micro Control Associates
Micro-Trak
Moseley Associates
Motorola Communications
and Electronics
Nady Systems
Norcom Manufacturing
Northland Communications
R F Technology
Rivers Associates
Sound Dynamics
Tayburn

REPEAT COILS

ITI Electronics Inc.
Video Aids of Colorado

RETICULE SAFE AREA/TITLE

Amtron Corp.
CMC Technology Corp.
Gray Engineering Labs
Porta-Pattern Telecommunications

REVERBERATION UNITS

AKG Acoustics
AKG Akustische u. Kino-Gerate
Advanced Analog Systems
Audicon Inc.
Audio & Design
Comex Systems
Deltalab Research
EMT Franz
EV-Tapco
Eventide Inc.
IGM Communications
Klark-Teknik Research Ltd.
Leader Broadcast Systems
Lexicon
Micmix Audio Products
Orban Associates
ProTech Audio Corporation
Quad Eight
Sony
Ursa Major
VIF International

REWINDERS, TAPE

(See Tape Accessories)

SAFE AREA GENERATORS

Asaca/Shibasoku
Broadcast Video Systems
CMC Technology
Crow of Reading Ltd.
Gray Engineering Labs

SATELLITE DISTRIBUTION SERVICES

AEG-Telefunken
American Satellite Company
Bonneville Satellite Corp.
California Microwave
Catel (Division of United Scientific)
Centro
Comad Communications
Compucon Inc.
Comtec Data Corp.
Crowder Communications Ltd.
Global Video Comm. Corp.
Modulation Associates
New Earth Television Works
Oak Satellite Corp.
RCA Americom
SED Systems
Satvision
Scientific-Atlanta, Phoenix Div.
Telecommunications System
Tuesday Productions
Video Tape Systems

Western Union Telegraph
Wold Communications

SCRAMBLERS

AEG-Telefunken
(Bayly Engineering)
Don Britton Ent.
CALDATACOM
Coherent Communications
Crowder Communications
Dynamac Electronics Ltd.
Dynamic Technology
Eagle Comtronics
Fung Eng. Labs, Inc.
Magnavox CATV Systems
Microtime
Motorola Communications
and Electronics
Oak Satellite Corp.
QSI Systems
Scientific Radio Systems
Swintek Enterprises
Torpey Controls & Engineering
Video Tape Systems

SEMICONDUCTORS

Calvert Electronics
Ceco Communications
Cherry Semiconductor
Dynamic Technology Ltd.
Electronic Devices
Fairchild CCD Imaging
Harris Corporation, Broadcast
Products Division
Levit Electronics
Motorola
RCA Distributor & Special
Products
Thomson-CSF
Transecter Systems
Varian Associates

SCREENS

FRONT PROJECTION
Bretford Mfg.
Eastman Kodak
Da-Lite Screen
Electrohome
Hoppmann Corporation
Raven Screen Corp.
Research Technology Int'l.
The Screen Works
Simon Associates
Tech Theatre Inc.
Wilcox - Lange Inc.

REAR PROJECTION
Da-Lite
Hoppmann Corporation
Raven Screen Corp.
Research Technology Int'l.
The Screen Works
Simon Associates
Tech Theatre Inc.
Uni-Set Corp.
Wilcox - Lange Inc.

SENSORS, TONE

Don Britton Ent.
Century 21 Programming
Channelmatic
Coney Electro Systems
IGM Communications
Leader Broadcast Systems
Monroe Electronics
Potomac Marine & Aviation
Processing Plus
ProTech Audio Corporation
Rivers Associates
WIF International

SLIDES, TEST

D & S Corley Ltd.
Porta - Pattern Telecommunications
Thomson-CSF

SLOW SCAN TV SYSTEMS

David H. Brothers Co.
Colorado Video
Interand
Javelin Electronics
NEC America, Broadcast
Equipment

SOLAR CELLS, PHOTOVOLTAIC

AEG-Telefunken
Bayly Engineering
Motorola
North Wind Power Co.
Teledyne Energy Systems
Television Technology

SOUND SYSTEMS

LEVEL CONTROL
ATI Audio Technologies Inc.
Audio & Design Recording
Audix Ltd.
Bogen Division / Lear Siegler
Circuit Research Labs
EV-Tapco
Elektroimpex
Leader Broadcast Systems
MXR Innovations
McCurdy Radio Industries
Micro-Trak
ProTech Audio Corporation
Sait Electronics
Siemens AG Osterreich
Spectra Sonics
Swintek Enterprises
Tele Concepts in Communications
Telectro Systems Corp.
Vidaire Elec. Mfg.

PORTABLE
Amek TAC
Argos Products
Atlas Sound
Audio & Design Recording
Audix Ltd.
Auratone
Bogen Division / Lear Siegler
David H. Brothers Co.
Cetec Vega
Coherent Communications
Dukane Corp.
EV-Tapco
Electro-Acoustic Design
Elektroimpex
Hoppmann Corp.
Ivie Electronics
Kudelski SA Switzerland
Harrison Systems
Leader Broadcast Systems
MXR Innovations
Micro-Trak
Northland Communications
Paso Sound Products
Perma Power Electronics
ProTech Audio Corporation
Sait Electronics
Shure Brothers
Spectra Sonics
TOA Electronics
Telectro Systems Corp.
Video Masters

STUDIO
Audio & Design Recording
Audix Limited
Auratone
Bogen Division / Lear Siegler
Dukane Corp.
EV-Tapco
Electro-Acoustic Design
Elektroimpex
Fostex
Harrison Systems
Hartley Products
Hoppmann Corp.
Klipsch & Associates
Leader Broadcast Systems

MXR Innovations
McCurdy Radio Industries
Micro-Trak
Perma Power Electronics
ProTech Audio Corporation
Richmond Sound Design
Sait Electronics
Siemens AG Osterreich
Sony
Spectra Sonics
TOA Electronics
Ultra Audio Pixtec
Video Masters

SPEECH RECOGNITION SYSTEMS

Heuristics
Logica
NEC America, Broadcast
Equipment
New England Digital Corp.

SPEECH SYNTHESIS SYSTEMS

Comex Systems
Delta Electronics
National Semiconductor
R F Technology
Telesensory Systems
Texas Instruments
Video Specialties

STL EQUIPMENT SYSTEMS

AEG-Telefunken
(Bayly Engineering)
Artel Communications Corp.
Aydin Microwave
Broadcast Electronics
Catel (Division of United Scientific)
Cetec Broadcast Group
Coastcom
Comad Communications
Continental Electronics
Farinon Video/Harris Corp.
GTE Lenkurt Incorporated
Harris Broadcast Microwave
Harris Corporation, Broadcast
Products Division
IGM Communications
International Microwave Corp.
Jenel Corp. Consulting Engineers
McMartin Industries
M/A-COM Video Systems
Martl
Micro Control Associates
Moseley Associates
RF Technology
RHG Electronics
Rockwell International
C.N. Rood B.V.
Singer Products Company
Studer ReVox America
TFT Inc.
Tayburn Electronics
Telecommunications System
Telcom Research
Terracom
Tramec Electronics
Versa - Count

STV SYSTEMS

Blonder-Tongue Laboratories
Comtech Antenna Corp.
Confier Corp.
Dynamac Electronics Ltd.
The Finney Co.
Oak Communications

STANDARDS CONVERTERS/SERVICES

Audio Plus Video

Broadcast Video Systems
Canter-Redman Technologies Corp.
Michael Cox
Fernseh Inc.
Global Video Comm. Corp.
MCI / Quantel
OKI Electric Overseas Corp.
Quantel Ltd.
Thomson-CSF

STILL / SLIDE STORE, ELECTRONIC

Adda Corporation
Ampex
Arvin Echo
Digital Video Systems
Eigen Video
Fernseh Inc.
Grove Video
Harris Corporation, Broadcast
Products Division
Harris Video Systems
Logica
Lyon Lamb
MCI / Quantel
Oklet Corporation
Precision/Echo Science
Quantel Ltd.
Thomson-CSF

SCA EQUIPMENT

Belar
Bogen Division / Lear Siegler
Broadcast Electronics
Comad Communications
David H. Brothers Co.
Elcom Specialty Products
Harris Corporation
IGM Communications
Johnson Electronics
McMartin Industries
Micro Control Associates
Moseley Associates
Printer Terminal Communications
Rivers Associates
Rohde & Schwarz
C.N. Rood BV
Solid Electronics
Swintek Enterprises
TFT Inc.
TOA Electronics

STUDIO DESIGN SERVICES

AVC
Aderhold Construction Co.
Averline Acoustical Consultants
Crow of Reading Ltd.
Dyma Engineering
East Coast Video
Electro-Acoustics Design
Harris Corporation
Kenneth R. Meades
Jamleson and Associates
Jenel Consultants Corp.
Leader Broadcast Systems
L.E. Nelson Corp.
Panoak Lighting System
Radiotechniques
Rees Associates
Siemens AG Osterreich
Soll Inc.
Richmond Sound Design
Straight Wire Audio
Syracuse Scenery & Stage Lighting
Thomson-CSF
Uni-Set Corp.

SWITCHES, COAXIAL

AEG-Telefunken
Ava Electronics Corporation
Barker & Williamson
Bird Electronic
CSP Inc.
Channelmatic Inc.
Comark Communications Inc.

Continued on page 106

Compac Development Corp.
Comtec Data Corp.
Continental Electronics
Crow of Reading Ltd.
Delta Electronics
Dielectric
Dow-Key
Elec. Instrument & Specialty Corp.
Harris Corp., Broadcast Products
ITT Jennings
Magnecraft Electric Co.
Marshall Electronics
Micro Communications
Phelps Dodge Communications
RMS Electronics Inc.
Rohde & Schwarz
S.W.R.
Shively Laboratories
Sigma Electronics
Thomson-CSF
Transco Products
Vidaire Electronics
Vital Industries
Wide Band Engineering

SWITCHES, VIDEO ACTIVATED

AVL Digital Ltd.
Channelmatic
Michael Cox
Dynamic Technology Ltd.
Panasonic
Rohde & Schwarz
Video Aids of Colorado
Vital Industries

SWITCHER LIGHTING KIT

Dynair

SWITCHERS, ROUTING

American Data
AVL Digital Ltd.
Audix Limited
Broadcast Video Systems
Broadcast Technology
Channelmatic
Communications Control Centers Inc.
Michael Cox
Crow of Reading Ltd.
Datek Corp.
Delta Systems
Dielectric Communications
Di-tech
Dynair Electronic
HEDCO
Industrial Sciences Inc.
Key Video Ltd.
Lenco Inc.
McCurdy Radio Industries
NEC America
NTP Elektronik AIS
Opamp Lab Inc.
Pacific Recorders & Engineering
Pro Bel Ltd.
Richmond Sound Design
Scandex Laboratories
Telemet
Thomson-CSF
Viscount Ind.
Vital Industries

SWITCHERS, CROSSBAR

AEG-Telefunken
Alco Electronic Products
Ava Electronics
Robert Bosch GmbH
Central Dynamics Ltd.
Channelmatic
Cherry Elec. Prod. Corp.
Communications Control Centers Inc.
Michael Cox
Datatron
Delta Electronics
Delta Systems
Dynair Electronics
ITT Jennings
Industrial Sciences Inc. (ISI)
Javelin Electronics

NTP Elektronik A/S
Pacific Recorders
Rohde & Schwarz GmbH
Rohde & Schwarz Sales
Siemens AG Osterreich
Shintron
Standard Telephon und Radio
Telemet
Thomson-CSF
Unemco International
Vital Industries

SWITCHERS, VIDEO

(See Consoles, Video)

SYNCHRONIZERS, AUDIO - VIDEO

Adda Corporation
Ampex
Audio Kinetics
Auditronics
The BTX Corporation
California Instruments
Control Video Corp.
Datatron
Digital Video Systems
EECO Incorporated
Harris Corporation, Broadcast
Products Division
Harris Video Systems
Leader Broadcast Systems
MCI Inc.
MCI/Quantel
Microtme
Multi-Track Magnetics
NEC America
Perfectone Products SA
Philips Broadcast Group
Rohde & Schwarz GmbH
Rohde & Schwarz Sales
Skotel Corporation
Studer International AG
Studer ReVox America
Telcom Research
Thomson-CSF

SYNCHRONIZERS, DIGITAL VIDEO

(See Frame Store)

SYNTHESIZERS, STEREO

The BTX Corporation
Catel
Elcom Bauer
Elcom Specialty Products
IGM Communications
Orban Associates
Rohde & Schwarz GmbH
Rohde & Schwarz Sales
Studer International
Telemet

SYSTEM DESIGN, AUDIO

Accurate Sound
Alice Stancoil Ltd.
Amek TAC
Audix
Aydin Microwave
C-Cor Electronics
Centro
Coastcom
Comad Communications
Crosspoint Video Ltd.
Dell Technical Vehicles
Dukane Corp.
Dyma Engineering
ENG Helicopter Satellite Ltd.
East Coast Video
Electro Acoustic Designs
Elektroimpex
G. A. Gilbreath
Graham-Patten Systems
Harris Corporation

Harrison Systems
Happmann Corp.
Jenel Consultants Corp.
Kintek
Leader Broadcast Systems
Link Electronics
MCI
McCurdy Radio Industries
The Management
Kenneth R. Meades
Multiphase Consulting
Multi-Track Magnetics
Opamp Labs Inc.
Pacific Recorders & Engr.
Perfectone Products SA
ProTech Audio
Radiotechniques
Richmond Sound Design
Rohde & Schwarz
C.N. Rood B.V.
Scantex Laboratories
Siemens AG Osterreich
Soll Inc.
Spectra Sonics
Straight Wire Audio
Tascam, Div. of Teac
Ultra Audio Pixtec

SYSTEM DESIGN, VIDEO

A.F. Associates
Altha Video & Elect. Corp.
Aydin Microwave
Robert Bosch GmbH
C-Cor Electronics
Canter-Redman Technologies Corp.
Central Dynamics Ltd.
Centro
Cinema Products
Cohu, Electronics Division
Crosspoint Video Ltd.
Crow of Reading Ltd.
Dell Technical Vehicles
Delta Systems
Dyma Engineering
Dynamic Technology Ltd.
ENG Helicopter Satellite Ltd.
East Coast Video
Graham-Patten Systems
Harris Corp., Broadcast Products
Happmann Corp.
Interand
Jatex
Javelin Electronics
Jenel Consultants Corp.
Link Electronics
Kenneth R. Meades
Multi-Track Magnetics
Panoak Lighting Systems
QSI Systems
Rohde & Schwarz
Rosner Television Systems
Sandar Electronics A/S
Scantex Laboratories
Siegel Electronics
Soll Inc.
Thomson-CSF
Ultra Audio Pixtec
Video-Ink
Vital Industries

TAPE-FILM INTERLOCK

Magna-Tech

TAPE, AUDIO

(See Also Cartridges)

CARTRIDGE
Ampex, Magnetic Tape Division
Aristocart
Audio Magnetics
BASF Limited
Broadcast Electronics
Capitol Magnetic Products
Century 21 Programming
Colorado Magnetics
Consolidated Electronic Inc.
Fidelipac
Fuji Photo Film USA Inc.
3M Mag A/V Products Division
Marathon Products
Memorex
Pan Canada Magnetics Ltd.
Procart

Ramko Research
See Hear Industries
Tape-Athon Corp
Team Electronics
Telectro Systems Corp.
UMC Electronics

CASSETTE

Agfa-Gevaert
Ampex, Magnetic Tape Division
Audio Magnetics
BASF Limited
Capitol Magnetic Products
Colorado Magnetics
Fidelipac Corp.
Fuji Photo Film USA Inc.
3M Mag A/V Products Division
Maxell Corp. of America
Memorex
Pan Canada Magnetics Ltd.
RKO Tape
Recortec
See Hear Industries
TDK Electronics
Tape-Athon Corp.
Team Electronics
Telectro Systems Corp.
Video I-D

LOGGING

Ampex, Magnetic Tape Division
Colorado Magnetics
Consolidated Electronic Ind.
Dictaphone Corporation
Elektroimpex
Fidelipac Corp.
Leavers Rich Mfg. Co. Inc.
3M Mag A/V Products Division
Magnasync/Moviola
Marathon Products
Memorex
Pan Canada Magnetics Ltd.
Soundscriber Magnetic Recording
The Stancil-Hoffman Corporation
Telectro Systems

OPEN REEL

Agfa-Gevaert
Ampex, Magnetic Tape Division
BASF Limited
Broadcast Electronics
Century 21 Programming
Colorado Magnetics
Consolidated Electronic Ind.
Elektroimpex
Fidelipac
Leavers Rich Equipment Ltd.
3M Mag A/V Products Division
Maxell Corp. of America
Memorex
Pan Canada Magnetics Ltd.
RKO Corp.
Recortec
See Hear Industries
Studer ReVox America
TDK Electronics
Tape-Athon Corp.
Team Electronics
Telectro Systems Corp.
VIF International
Video I-D

TEST TAPE

Ampex, Magnetic Tape Division
Aristocart
Audio/Tek Inc.
BASF Limited
BPI Audio Test Instruments
Broadcast Electronics
Colorado Magnetics
Consolidated Electronic Ind.
Datatronix
Fidelipac
IGM Communications
Kudelski S.A.
3M Magnetic A/V Products
Magnetic Reference Laboratories
Marathon Prod. Co.
Memorex
Nortronics
Radiotechniques
Sound Dynamics
Standard Tape Laboratory, Inc.
Studer ReVox America
TDK Electronics
Team Electronics
VIF International
Video I-D

TAPE, AUDIO ACCESSORIES

CLEANERS

Allsop
Audio Magnetics
Audio-Technica U.S.
Broadcast Electronics
Chemtronics
Dictaphone Corporation
Fidelipac
Fuji Photo Film USA Inc.
IGM Communications
Marathon Products
Merlin Engineering Works
NOVA Corp.
Nortronics
Pan Canada Magnetics Ltd.
RMS Electronics
Recortec
Studer ReVox America
TDK Electronics
Teac Corp. of America
Texwipe
United Research Lab Corp.
Vidalre Electronics
Xedit Corporation

DEMAGNETIZERS

R. B. Annis Co.
Broadcast Electronics
Dictaphone
Fidelipac Corp.
Garner Ind.
IGM Communications
Magnefax International
Marathon Products
Nalpak Sales
Neal Ferrograph (USA)
Nortronics
PAG-Group
Soundscriber Magnetic Recording
TDK Electronics
Taber
Tape
Teac Corp. of America
UMC Electronics

LOADERS

Audico
Audio/Tek Inc.
Merlin Engineering Works
Otari Corporation
Recortec
See Hear Industries
Tapecaster TCM

MOTION CONTROLS

Merlin Engineering Works
Television Graphics
United Research Lab Corp.

REWINDERS

Audico
D-B Electronics
Dictaphone Corporation
K B Systems
Merlin Engineering Works
Neumade
See Hear Industries
Tape
Tapecaster TCM Inc.

SPLICERS

Audico
Broadcast Electronics
D-B Electronics
Dictaphone Corporation
Fidelipac
Goldberg Bros. Inc.
ITC/3M
J&R Film Co., Inc.
Leader Broadcast Systems
Marathon Products
Neal Ferrograph (USA)
Nortronics
Plastic Reel Corp.
Studer ReVox America
Vidaire Electronics Mfg. Corp.
Xedit Corporation

SPLICE FINDERS

Broadcast Electronics
Consolidated Electronic Ind.

Harris Corporation, Broadcast
Products Division
IGM Communications
ITC/3M
Nortronics
UMC Electronics

TAPE, VIDEO

CASSETTES

Adwar Video
Agfa-Gevaert
Ampex
Audico
Audio/Tek
BASF Limited
Ceco Communications
E.I. Dupont De Nemours & Co.
Fidelipac Corp.
Fuji Photo Film USA, Inc.
Fuji Magnetic Tape Div.
Lyrec Manufacturing A/S
3M Mag A/V Products Division
Maxell Corp. of America
Memorex
Merlin Engineering
Otari
Panasonic
Polyline Corp.
RKO Corp.
Recortec
Research Technologies Int'l.
See Hear Industries
Sony
Studer ReVox America
TDK Electronics
Team Electronics
U.S. JVC Corporation
Video Cassette Services
Video I-D
Videotape Exchange

CARTRIDGES

Agfa - Gevaert
Ampex
Audio/Tek
BASF Limited
Calico Video
Ceco Communications
Fidelipac Corp.
3M Mag A/V Products Division
Memorex
Merlin Engineering
Panasonic
Re-Play Video
Tape
Team Electronics
Videotape Exchange

OPEN REEL

Adwar Video
Agfa - Gevaert
Ampex
BASF Limited
Calico Video
Ceco Communications
Fidelipac Corp.
Fuji Photo Film USA, Inc.
3M Mag A/V Products Division
Maxell Corp.
Memorex
Otari
Panasonic Video Systems
Studer ReVox America
TDK Electronics
Team Electronics
Videotape Exchange

TAPE, VIDEO ACCESSORIES

CARRYING & SHIPPING CASES

A & S Case Company
Adwar Video
Amaray Sales
Anvil Cases
David H. Brothers Co.
Display Media
Environmental Container Systems
Excalibur Industries
Fiberbilt
Impact Cases Inc.
Innovative Concepts
3M Mag A/V Products Division

Nalpak Sales
Neumade Products
Plastic Reel Corp.
Reliance Plastics & Packaging
Research Technology, Int'l.
Schuessler Case
See Hear Industries
Winsted Corporation

DEMAGNETIZERS

Garner Industries

EVALUATOR

Asaca/Shibasoku
Chyron Telesystems
Merlin Engineering Works
Recortec
Research Technology Int'l.
Television Equipment Associates

SPINDLE HEIGHT GAUGE

Tentel

REWINDERS

Audico
Merlin Engineering Works
Neumade Products
Ramko Research
Recortec
Research Technology Int'l.

TAPE CLEANER

Adwar Video
Allsop
Asaca/Shibasoku
Audico
Audio-Technica U.S.
G.C. Electronics
Merlin Engineering Works
NOVA Corporation
PAG-Group
Panasonic
Recortec
Research Technology Int'l.
TDK Electronics
Texwipe
Xedit Corporation

TENSION GAUGE

Adwar Video
BCB Electronic Sales
Leavers Rich Equipment Ltd.
Merlin Engineering Works
Tentel

TELECINE

Laird Telemedia
Magnasync/Moviola Corp.
Marconi Electronics
Multi-Track Magnetics
Piclear Inc.
Rangertone Research Inc.
Rank Cintel Ltd.
Westrex
Thomson-CSF
The Zel-Mark Corp.

TELECONFERENCE SYSTEM, AUTOMATIC AUDIO/VIDEO

Altha Video & Elect. Corp.
Centro
Dyma Engineering
Happmann Corp.
Interand Corp.
Misar Industries
Telectra Systems Corp.

TELECONFERENCING SYSTEMS

Artel Communications Corp.
Audix Limited
Bonnevillle Satellite Corp.
Centro
Comrex Corporation
David Brothers Co.
GE VDEO
GTE Products
Hoppmann Corp.

Interand Corp.
Microdyne Corp.
Misar Industries
NEC America
NET Enterprises
Sharp Electronics
Tele Concepts In Communications

TELEPHONE EQUIPMENT

EQUALIZERS

AEG-Telefunken
(Bayly Engineering)
Audio & Design
Coastcom
Comrex
GTE Products
ITI Electronics
Kahn Communications
McCurdy Radio Industries
NTP Elektronik A/S
Radiotechniques
C.N. Rood B.V.
Rusoco
T M Systems
Telemet
White Instruments Inc.

HYBRID FILTER / AMP

AEG-Telefunken
(Bayly Engineering)
Alice Stancoil Ltd.
Coastcom
Comrex
GTE Products
Greg Laboratories
IGM Communications
ITI Electronics
McCurdy Radio Industries
Northland Communications
Potomac Marine & Aviation
RTS Systems
Studer International
Studer ReVox America
T M Systems
Thomson-CSF
Western Broadcasting

STONE RECEIVERS

AEG-Telefunken
(Bayly Engineering Ltd.)
American MicroSignal
Don Britton Ent.
Cetec Vega
Channelmatic
Frequency Devices
GTE Products
Potomac Marine & Aviation
T M Systems
Trepac Corp. of America

STONE TRANSMITTERS

AEG-Telefunken
American MicroSignal
Bayly Engineering Ltd.
Don Britton Ent.
Cetec Vega
Channelmatic
Frequency Devices
GTE Products
Potomac Marine & Aviation
T M Systems
Trepac Corp. of America
Triplett Corporation

TELETEXT SYSTEMS

AEG-Telefunken
Antlope Videotex Systems
Aston Electronic Design Ltd.
Barco Electronics
Barda Electronics
Computer Video Systems
Consolidated Electronic Ind.
Dynamic Technology Ltd.
EEG Enterprises
Electro & Optical Systems
Logica
Oak Communications
Rohde & Schwarz
Torpey Controls & Engineering
Untel
Video Data Systems

Continued on page 108

TERMINAL EQUIPMENT

Di-tech
Graham-Patten Systems
Harris Corporation
HEDCO

TEST EQUIPMENT: GENERATORS

AUDIO SINE

Amalgamated Wireless
Amber Electro Design
Asaca/Shibasoku
Audisar
BPI Audio Test Instruments
Bald Mountain Lab
Broadcast Electronics, Inc.
Briel & Kjaer Instruments
CMC Technology Corp.
California Instruments
Dynascan
Frequency Devices
Global Specialties
Hickok
Kajaanl Oy
Leader Instruments Corp.
Link Electronics
Marconi Instruments Ltd.
Multidyne Electronics
Neal Ferrograph (USA)
Opamp Labs Inc.
Phillips Test & Measuring
Potomac Instruments
Rohde & Schwarz
Sescom
Spectra Sonics
Teac Corp. of America
Tektronix
Ultra Audio Pixtec
Viz Manufacturing

AUDIO SWEEP

Amalgamated Wireless
Amber Electro Design
Asaca/Shibasoku
Audisar
Briel & Kjaer Instruments
CMC Technology Corp.
Dynascan
Global Specialties Corp.
Leader Instruments Corp.
Marconi Instruments Ltd.
Tektronix
UREI
Viz Manufacturing

COLOR BAR

AVL Digital Ltd.
Automation Techniques
Asaca/Shibasoku
Robert Bosch GmbH
Broadcast Video Systems
CMC Technology Corp.
Canter-Redman Technologies Corp.
Michael Cox
Crosspoint Latch
Crow of Reading Ltd.
D and S Corley
Dynascan
Elektroimpex
Hickok
Industrial Sciences Inc. (ISI)
Lang Video Systems
Leader Instruments Corp.
Lectrotech
Leitch Video
Lenco
Link Electronics
Marconi Electronics
Multidyne Electronics
QSI Systems
Panasonic
Rohde & Schwarz
Sencore
Sigma Electronics
Tektronix
Telemet
Thomson-CSF
Ultra Audio Pixtec
Videomedia
Visual Information Institute
Viz Manufacturing
World Video

CROSS PULSE

AVL Digital Ltd.
Amtron Corp.
Asaca/Shibasoku
Robert Bosch GmbH
Crow of Reading Ltd.
Dynascan
Lenco
Rohde & Schwarz
Thomson-CSF
Video Aids of Colorado

DOT / BAR

AVL Digital Ltd.
Asaca/Shibasoku
Broadcast Video Systems
Canter-Redman Technologies Corp.
Crow of Reading Ltd.
Dynascan
Hickok
Leader Instruments Corp.
Lectrotech
Leitch Video
Lenco
Link Electronics
Marconi Electronics
Phillips Test & Measuring
Sencore
Sigma Electronics
Tektronix
Telemet
Thomson-CSF
Ultra Audio Pixtec
Visual Information Institute
World Video

FUNCTION

Amber Electro Design Inc.
Asaca/Shibasoku
Audisar
Briel & Kjaer Instruments
Dynascan
Global Specialties Corporation
Heath Company
Hickok
Leader Instruments Corp.
Marconi Instruments Ltd.
Phillips Test & Measuring
Tektronix
Thomson-CSF
Viz Manufacturing

MARKER

Amtron Corp.
Asaca/Shibasoku
Ballantine Laboratories
Dynascan
Phillips Test & Measuring
Tektronix
Texscan Corp.
Thomson-CSF
Viz Manufacturing

NTSC SIGNAL TEST

Asaca/Shibasoku
Broadcast Video Systems
Canter-Redman Technologies Corp.
Cezar International
Dynascan
Lang Video Systems
Leader Instruments Corp.
Leitch Video
Link Electronics
Marconi Instruments Ltd.
Multidyne Electronics
Rohde & Schwarz
Sigma Electronics
Tektronix
Ultra Audio Pixtec
Vidicraft
Video Aids of Colorado
Videomedia
Visual Information Institute
World Video

PULSE

Asaca/Shibasoku
Audioco Inc.
Broadcast Video Systems
Briel & Kjaer Instruments
Dynascan
Elektroimpex
Global Specialties
Leitch Video
Lenco Inc.
Link Electronics
Marconi Instruments Ltd.

North American Soar Corp.

Rohde & Schwarz
Systron Donner
Tektronix
Thomson-CSF
Video Aids of Colorado
Videomedia
Viz Manufacturing
Xedit Corporation

RF SIGNAL

Asaca/Shibasoku
Delta Electronics
John Fluke Mfg. Co. Inc.
Dynascan
Harris Corp., Broadcast Products
Harris Corporation - PRD
Electronics Div.
Heath Company
Lang Video Systems
Leader Instruments Corp.
Marconi Instruments Ltd.
Motorola
Narda Microwave Corp.
Potomac Instruments
R. E. Instruments
Rohde & Schwarz
Sadelco
Sound Technology
Systron Donner
Texscan Corp.
Triple Crown Electronics
Videomedia
Viz Manufacturing
Wavetek Indiana

SQUARE WAVE

Amber Electro Design
Asaca/Shibasoku
BPI Audio Test Instruments
California Instruments
D and S Corley
Dynascan
Global Specialties
Hickok
Leader Instruments Corp.
Leitch Video
Link Electronics
Marconi Instruments Ltd.
Rohde & Schwarz
Tektronix
Telemet
Thomson-CSF
Visual Information Institute
Viz Manufacturing
Wavetek Indiana Inc.

STAIRCASE

AVL Digital Ltd.
Asaca/Shibasoku
Robert Bosch GmbH
Broadcast Video Systems
Canter-Redman Technologies Corp.
Dynascan
Lang Video Systems
Leader Instruments Corp.
Leitch Video
Lenco
Link Electronics
Rohde & Schwarz
Tektronix
Telemet
Thomson-CSF
Ultra Audio Pixtec
Visual Information Institute
World Video

STEREO

Asaca/Shibasoku
Leader Instruments
McMartin Industries
Marconi Instruments Ltd.
Rohde & Schwarz

VIDEO SWEEP

AVL Digital Ltd.
Asaca/Shibasoku
Datatek
Dynascan
Leader Instruments Corp.
Lenco
Lectrotech Inc.
Link Electronics
Phillips Test & Measuring
Rohde & Schwarz
Tektronix
Telemet

Texscan Corp.

Thomson-CSF
Ultra Audio Pixtec
Visual Information Institute
Viz Manufacturing

VITS

AVL Digital Ltd.
Asaca/Shibasoku
Elektroimpex
Lenco
Link Electronics
Rohde & Schwarz
Sencore
Tektronix
Telemet
Thomson-CSF
Video Aids of Colorado

VITS INSERTER

Asaca/Shibasoku
Elektroimpex
Link Electronics
Marconi Instruments Ltd.
Rohde & Schwarz
Tektronix
Thomson-CSF
Video Aids of Colorado

TEST EQUIPMENT: MEASURING INSTRUMENTS

ACOUSTIC ANALYZER

Amber Electro Design Ltd.
David H. Brothers Co.
Briel & Kjaer Instruments
Communications Co. Inc.
Crown International
Eventide Clockworks
Inovonics
Ivie Electronics
Klark Teknik Research Ltd.
Neutrik Products
Ortofon A/S
Telectro Systems Corp
White Instruments

AUDIO SYSTEM ANALYZER

Amber Electro Design Ltd.
Asaca/Shibasoku
BPI Audio Test Instruments
Bald Mountain Lab
Barker & Williamson
Briel & Kjaer
Crown International
Eventide Inc.
Hammond Industries
Inovonics
Ivie Electronics
Klark Teknik Research
Leader Instruments Corp.
Neal Ferrograph (USA)
Neutrik Products
Ortofon A/S
Potomac Instruments
R. E. Instruments
Rohde & Schwarz
Sound Technology
Spectra Sonics
Tektronix

BURST PHASE METER

Asaca/Shibasoku
Ortofon A/S
Rohde & Schwarz
Video Aids of Colorado

COLOR ANALYZER

Phillips Test & Measuring

DELAY MEASURING SETS

Asaca/Shibasoku
Briel & Kjaer Instruments
Datatek
Hirschmann Electric
Hitachi Denshi America
Ivie Electronics
Klark Teknik Research
Marconi Instruments Ltd.
Phillips Test & Measuring
Rohde & Schwarz
Telectro Systems Corp.
Telecommunications Technology
Telemet

DEMOD TESTER

R. E. Instruments
Tektronix

DIFFERENTIAL PHASE / GAIN SETS

Amtron Corporation
Asaca/Shibasoku
Bruel & Kjaer Instruments
Crow of Reading Ltd.
Hammond Industries
Harris Corporation, PRD Elec.
Hewlett - Packard
Hirschmann Electric
Lectrotech
Link Electronics
Phillips Test & Measuring
Potomac Instruments
Rohde & Schwarz
Tektronix
Telecommunications Technology
Telemet

FIELD STRENGTH METER, AM / FM

Anritsu America
Broadcast Electronics
Continental Electronics
Harris Corporation
Kathrein-Werke KG
McMartin Industries
Potomac Instruments
Rohde & Schwarz
Sadelfco Inc.
Texscan Corp.
Vidale Electronics Mfg. Corp.

FIELD STRENGTH METER, TV

Anritsu America
Asaca/Shibasoku
Kathrein-Werke KG
Leader Instruments
Lectrotech
PTS Electronics
Potomac Instruments
Rohde & Schwarz
Sadelfco
Texscan Corp.

FREQUENCY COUNTER

Alltech
Anritsu America
Ballantine Laboratories
Dynascan Corp.
Belar Electronic Labs
Coaxial Dynamics Inc.
EIP Microwave, Inc.
John Fluke Mfg. Co. Inc.
Glentronix
Global Specialties Corporation
Hammond Industries
Heath Company
Leader Instruments Corp.
Lectrotech
Marconi Instruments Ltd.
Motorola
North American Soar Corp.
Ortofon A/S
Phillips Test & Measuring
Sencore
Systron Donner
TFT Inc.
Tektronix
Telecommunications Technology
Texscan Corp.
Triplett
Viz Manufacturing
Xedit Corporation

HARMONIC DISTORTION ANALYZER

Amalgamated Wireless
Amber Electro Design Ltd.
Asaca/Shibasoku
BPI Audio Test Instruments
Broadcast Electronics
Bruel & Kjaer Instruments
Dranetz Eng. Labs
Elektroimpex
Heath Company
Leader Instruments Corp.
Ortofon A/S
Potomac Instruments
Radiometer Electronics
Sescom
Sound Technology
Tektronix
Telecommunications Technology
Woeike Magnetbandtechnik GmbH

INSERTER / READER VIT

Asaca/Shibasoku
Crow of Reading Ltd.
Harris Corporation
Link Electronics
Tektronix

INTERMOD DISTORTION ANALYZER

Amalgamated Wireless
Amber Electro Design Ltd.
BPI Audio Test Instruments
Broadcast Electronics
Bruel & Kjaer Instruments
Heath Company
Otofon A/S
Potomac Instruments
Sound Technology
Tektronix

INTERVAL TIMER, V & H

A.F. Associates
Anritsu America
Broadcast Video Systems Ltd.
D'San Corporation
Global Specialties Corporation
Nationwide Electronic Systems
Standard Electric Time Corp.
World Video

MONITORS

(See Monitors, Audio; Monitors, Video)

MULTI-PHASE/VIRS INSERTER

Tektronix
Video Aids of Colorado

OSCILLOSCOPES

Ballantine Laboratories
Bruel & Kjaer Instruments
Dynascan
Gould Instruments Division
Heath Company
Hewlett - Packard
Hickok
Hitachi Denshi America
Leader Instruments Corp.
Lectrotech
Motorola
North American Soar Corp.
Phillips Test & Measuring
Rohde & Schwarz
Scientific-Atlanta, Phoenix Div.
Sencore
Tektronix
Texscan Corp.
Viz Manufacturing
Wavetek Indiana

PHASE ANGLE METER

Bruel & Kjaer Instruments
Delta Electronics
Dranetz Eng. Labs
Hewlett - Packard
Potomac Instruments
Western Broadcasting

SIDEBAND ANALYZER

Tektronix
Rohde & Schwarz

SPECTRUM ANALYZER

Alltech
Amber Electro Design Ltd.
Anritsu America
Applied Technology
Bruel & Kjaer Instruments
Crown International
Eventide Inc.
Glentronix
Ivie Electronics
Klark Teknik Research
Marconi Instruments Ltd.
Motorola
NTP Elektronik A/S
Phillips Test & Measuring
Photo Research, Kollmorgan Corp.
R. E. Instruments
Scientific-Atlanta
Spectrum Instruments
Systron Donner
Tektronix
Texscan Corp.
Wavetek Indiana

VSWR & POWER METER

Bird Electronic
Boonton Electronics
Coaxial Dynamics
Delta Electronics

Dielectric Communications

Electro Impulse Inc.
Marconi Instruments Ltd.
Motorola
Narda Microwave Corp.
Sadelfco Inc.
Texscan Corp.
Vidaire Electronics
Viz Manufacturing

VIDEO ANALYZER

Rohde & Schwarz

VIDEO LINE OUTPUT DISPLAY

Broadcast Video Systems

WAVEFORM MONITORS

Amtron Corporation
Anritsu America
Broadcast Video Systems
Bruel & Kjaer Instruments
Canter-Redman Technologies
Michael Cox
Crow of Reading Ltd.
Elektroimpex
Leader Instruments Corp.
Lectrotech
Lenco
Marconi Instruments Ltd.
Motorola
Rohde & Schwarz
Sencore
Tektronix
Television Graphics
Ultra Audio Pixtec
Videcom Engineering
Videotek
Woeike Magnetbandtechnik GmbH

WOW & FLUTTER METER

Asaca/Shibasoku
BPI Audio Test Instruments
Broadcast Electronics
Bruel & Kjaer Instruments
Fidelipac
Hammond Industries
Leader Instruments Corp.
Neal Ferrograph (USA)
Ortofon A/S
Potomac Instruments
R. E. Instruments
Radiometer Electronics
Sound Technology
Woeike Magnetbandtechnik GmbH
Xedit Corporation

VECTORSCOPE

Amtron Corporation
Broadcast Video Systems
Crow of Reading Ltd.
Leader Instruments Corp.
Lectrotech
Tektronix
Television Graphics
Ultra Audio Pixtec
Videcom Engineering
Video I-D
Videotek

**TEST EQUIPMENT:
MEASURING /
MONITORING METERS****ANTENNA BASE METER**

Antenna Base Meter
Continental Electronics
Delta Electronics
Gorman-Redlich

COHERENT DETECTOR

Image Devices Incorporated
Potomac Instruments

DIGITAL MULTIMETER

Ballantine Laboratories
Biddle Instruments
Dynascan
Elektroimpex
John Fluke Mfg. Co. Inc.
G.C. Electronics
Global Specialties Corp.
Hickok
Keithley Instruments
Leader Instruments Corp.
Motorola
North American Soar Corp.

Sencore
Tektronix
Triplett
Vidaire Elec. Mfg.
Viz Manufacturing

DIGITAL PANEL METER

Ballantine Laboratories
Delta Electronics
Gralex

GRID DIP METER

Barker & Williamson
Image Devices Incorporated

IC TESTER

Datatron
Dynascan
John Fluke Mfg. Co. Inc.
G.C. Electronics
Global Specialties Corporation
Keithley Instruments
Orban Associates
Vidaire Elec. Mfg.

IMPEDANCE BRIDGE

Biddle Instruments
Boonton Electronics
Delta Electronics
HEDCO
Harris Corporation - PRD
Leader Instruments Corp.
Marconi Instruments Ltd.
Potomac Instruments
Radiometer Electronics
Sadelfco, Inc.
Sencore
Texscan Corp.
Wide Band Engineering

LINE VOLTAGE METER

Audio Technology
Biddle Instruments
Gralex Industries
Image Devices Incorporated
International Instruments
Motorola Communications
Paladin
Sencore
Triplett
Viz Manufacturing

MODULAR TEST SET

Telemet

PEAK PROGRAM

Alice Stancoll Ltd.
Applied Technology Corp.
Audio Technology
Broadcast Technology
Michael Cox
Crow of Reading Ltd.
Dorough Electronics
ESE
Elektroimpex
Inovonics
Logitek
McCurdy Radio Industries
Micmix Audio
NTP Elektronik A/S
Ramko Research
Selco Products
Siemens AG Osterlech
Tweed Audio USA

POWER

Audio Technology
Bird Electronic
Boonton Electronics
Coaxial Dynamics
Dranetz
Electro Impulse Laboratory, Inc.
Gralex Industries
Harris, PRD Electronics Div.
Image Devices Incorporated
Leader Instruments Corp.
Marconi Instruments Ltd.
Paladin
Photo Research
T M Systems

RF METER

Ballantine Laboratories
Barker & Williamson
Bird Electronic
Boonton Electronics
Coaxial Dynamics

Continued on page 110

Delta Electronics
Electro Impulse Inc.
Fung Eng. Labs. Inc.
Harris Corp. PRD Electronics Div.
Marconi Instruments Ltd.
Motorola
R. E. Instruments
Sadelco Inc.
T M Systems
Triplett
Vitek Electronics
Viz Manufacturing

SEMICONDUCTOR TESTER
Dynascan
Heath Company
Keithley Instruments
Leader Instruments
PTS Electronics
Sencore
Tektronix

VIDEO LEVEL METER
Asaca/Shibasoku
Link Electronics
Rohde & Schwarz
Vidicraft

VIDEO NOISE METER
Asaca/Shibasoku
Lenco
Link Electronics
Rohde & Schwarz
Sadelco Inc.
Tektronix
Video Aids of Colorado

VOLTMETER, AUDIO
Amber Electro Design Ltd.
Asaca/Shibasoku
Audio Technology
BPI Audio Test Instruments
Bald Mountain Lab
Ballantine Laboratories
Bayly Engineering
Boonton Electronics
Broadcast Technology
Bruel & Kjaer Instruments
dbx Inc.
Elektroimpex
John Fluke Mfg. Co., Inc.
Global Specialties Corp.
Heath Company
Image Devices Incorporated
Leader Broadcast Systems
Motorola
Neal Ferrograph USA
Ortofon A/S
Potomac Instruments
Rohde & Schwarz
Rycom Instruments
Sencore
Viz Manufacturing

VTVM
B & K Precision Product
Group/Dynascan Corp.
Ballantine Laboratories
Heath Company
ITT Jennings
Motorola
Triplett
Vidaire Electronics
Viz Manufacturing

VU METER
ADM Technology
ATI-Audio Technologies Inc.
Applied Technology Corp.
Audio Technology
Bald Mountain Lab
Broadcast Electronics
Dorrough Electronics
ESE
Elektroimpex
Logitek
McCurdy Radio Industries
NTP Electronik A/S
Potomac Marine & Aviation
Ramko Research
Roh Corp.
Rohde & Schwarz
Selco Products
Siemens AG Osterrelch
Spectra Sonics
T M Systems
Triplett

Ward-Beck Systems Ltd.

WATTMETER
AEG-Telefunken (Bayly Engr.)
Audio Technology
Barker & Williamson
Bird Electronic
Coaxial Dynamics
Dielectric Communications
Marconi Instruments Ltd.
Micro Communications
Motorola
North American Soar Corp.
R. E. Instruments
Rohde & Schwarz
Triplett
Viz Manufacturing

TIME BASE CORRECTORS

Adda Corporation
Adwar Video
Ampex
Automation Techniques
BCB Electronic Sales
Don Britton Ent.
Digital Video Systems
Eigen Video
For-A Corporation
Fortel Inc.
Harris Video Systems
MCI/Quantel
Marconi Electronics
Merlin Engineering Works
Microtime
NEC America
NET Enterprises
Phase Video Inc.
Phillips
RCA Broadcast
Siegel Electronics
Sony
TBC Pty. Ltd.
Video Data Systems
Video I-D
Video Tape Systems

TIME CODE GENERATOR, VERTICAL INTERVAL

EECO Inc.

TIME COMPRESSOR, AUDIO

Deltalab Research
Eventide Inc.
Harris Corporation
IGM Communications
Integrated Sound

TIMERS, BLANKING INTERVAL

Broadcast Video Systems
For-A Corp. of America
Harris Corporation, Broadcast
Products Division
Lexicon Inc.
Standard Electric Time Corp.
Tektronix
V.S.C.
World Video

TIMERS, PROGRAM

(See Also Clocks & Counters)

Applied Technology
Audico
Automation Techniques
B G Engineering
Broadcast Aids
Broadcast Electronics
Channelmatic
Michael Cox
Datum
D'San Corporation
Dynaquip Electron Devices Ltd.
ESE

Harris Corporation, Broadcast
Products Division
IGM Communications
Image Video Limited
Jatex Inc.
Kajaani Oy
Logitek
The Management
Nationwide Electronic Systems
Neal Ferrograph (USA)
Pacific Recorders
QEI Systems
Radio Systems
Sharepoint Systems
Standard Electric Time Corp.
Tapecaster TCM, Inc.
Tentel
Torpey Controls & Engineering Ltd.
Vamco Engineering
Video Tape Systems

TIMERS, VIDEO TAPE

Convergence
Michael Cox
Dynamic Technology Ltd.
Dynaquip Electron Devices Ltd.
ESE
Electro & Optical Systems
For-A Corp. of America
G.B.C.
Jatex Inc.
Merlin Engineering Works
Panasonic Video Systems
QSI Systems
Recortec
Standard Electric Time Corp.
Tentel
Vamco Engineering
Video Tape Systems

TITLING SYSTEMS

(See Also Character Generators)

Aurora Systems
Autographics Inc.
Beston Elect. Inc. (BEI)
Robert Bosch GmbH
CMC Technology Corp.
Chyron Telesystems
Comprehensive Video Supply
Computer Video Systems
Michael Cox
Crow of Reading Ltd.
Elicon
Fernseh Inc.
For-A Corp. of America
Interand
Knox Video Products
Laird Telemedia
McInnis-Skinner & Assoc.
PAG Group
Reynolds/Leteron
Shintron
Television Graphics
Thomson-CSF
Unitel
Velec Sefat
Video Associates Labs

TOOL KITS

AVA Electronics Corp.
The Will Burt Company
Comprehensive Video Supply
The Cooper Group
Kline Iron & Steel
Nalpak Sales
PAG Group
Pace Inc.
Paladin Corporation
SSAC
UNR-Rohn
Vidaire Electronics Mfg.

TOWER LIGHTS & ACCESSORIES

FLASHERS
AEG-Telefunken
Abroyd Construction
Allied Tower
Calvert Electronics

Elcom Bauer
Flash Technology
Hughey & Phillips
LeBlanc & Royle
Communications Towers Inc.
Osram Sales
SSAC
Swager Tower Corporation
Tech Theatre Inc.
Teledyne Big Beam
UNR-Rohn
United States Tower
Utility Tower
World Tower

FLASHERS, HIGH INTENSITY

AEG-Telefunken
Allied Tower
Calvert Electronics
EG&G, Electro Optics
Flash Technology Corp. of America
LeBlanc & Royle
Communications Inc.
Osram Sales
SSAC
Swager Tower Corporation
Teledyne Big Beam
UNR-Rohn
Utility Tower

ISOLATION TRANSFORMERS

AEG-Telefunken
Abroyd Construction
Allied Tower
BES Electronics
CSP Inc.
Peter Dahl Company
Decca Austin Insulators
Flash Technology
Hughey & Phillips
LeBlanc & Royle
Communications Inc.
MCG Electronics, Inc.
North Hills Electronics
Swager Tower Corporation
UNR-Rohn
Utility Tower
World Tower

LAMPS, REPLACEMENT

AEG-Telefunken
Abroyd Construction
Allied Tower
Atlas Tower Corp.
Flash Technology Corp. of America
Grant Tower
Hughey & Phillips
LeBlanc & Royle
Communications Towers
Fred Nudd Corp.
Swager Tower Corporation
Teledyne Big Beam
UNR-Rohn
Utility Tower
World Tower

LIGHT FAILURE ALARM

(See Alarms)

LIGHT INDICATOR PANELS

AEG-Telefunken
Abroyd Construction
Allied Tower
B & I Electronics
CSP Inc.
Flash Technology Corporation
of America
Grasis
Hughey & Phillips
UNR-Rohn

TOWERS

Abroyd Construction
Allied Tower Company
Aluma Tower Company
Atlas Tower Corp.
The Will Burt Company, TND Div.
Cetec Broadcast Group
Continental Electronics
Cortland Cable Co.
E-N-G Corporation
E-Z Way Products
Fort Worth Tower
Grant Tower
Grasis Corporation

Harris Corporation, Broadcast Products Division
 Kline Iron and Steel Co.
 LeBlanc & Royle Communications Inc.
 McMartin Industries
 Magnum Towers
 Microflex
 Motorola
 North Wind Power
 Fred A. Nudd Corporation
 Allen Osborne Assoc.
 Stainless
 Stevens Tower Co.
 Swager Tower Corporation
 Telex Communications
 Tri-ex Tower
 TMD Division, The Will Burt Co.
 UNR-Rohn
 United States Tower
 Up-Right Inc.
 Utility Tower
 V & B Tower Company
 Wilkinson Electronics
 World Tower Company

TOWER SERVICES

Abroyd Construction
 Angle Steel Erectors
 Antennas for Communications Inc.
 Atlas Tower Corp.
 The Will Burt Company
 EMCEE Broadcast Products
 Fort Worth Tower
 Gabriel Electronics
 Grant Tower
 Grasis Corporation
 Kline Iron and Steel Co.
 LeBlanc & Royle Communications Inc.
 Magnum Towers
 Microflex
 Fred A. Nudd Corporation
 Soll Inc.
 Stainless
 Stevens Tower Co.
 Swager Tower Corporation
 Tri-ex Tower
 UNR-Rohn
 United States Tower
 Utility Tower
 V & B Tower Company
 World Tower Company

TRANSFORMERS

AUDIO
 Altec Lansing
 Audisar
 Bogen Division / Lear Siegler
 Broadcast Technology
 Cletronics Inc.
 Consolidated Electronic Ind.
 Peter W. Dahl Co.
 Dyma Engineering
 Elektroimpex
 Enertec Schlumberger
 Harris Corporation, Broadcast Products Division
 ITI Electronics, Inc.
 Jensen Transformers
 Marconi Instruments Ltd.
 Modular Audio Products
 Modulation Associates
 Northland Communications
 Opamp Labs Inc.
 ProTech Audio Corporation
 Sescom
 Shure Brothers
 Siemens AG Osterreich
 Spectra Sonics
 TTE Inc.
 Tramec Electronics
 Tri Tec Systems Inc.
 Vidaire Electronics Mfg. Corp.

FILAMENT
 Peter W. Dahl Co.
 Cletronics
 Tramec Electronics

MODULATION
 Peter W. Dahl Co.
 Cletronics Inc.
 Tramec Electronics

PLATE
 Peter W. Dahl Co.
 Cletronics
 Tramec Electronics

RF SAMPLING
 BES Electronics
 CSP Inc.
 Coaxial Dynamics
 Peter Dahl Company
 Delta Electronics

TOROIDAL CURRENT
 BES Electronics
 CSP Inc.
 Cletronics
 Peter Dahl Company
 Delta Electronics
 Millen Components

TRANSFORMER VIDEO/DATA LINE ISOLATION
 North Hills Electronics

TRANSLATORS

HIGH POWER
 AEG-Telefunken
 Acrodyne Industries
 Anderson Scientific
 EMCEE Broadcast Products
 Harris Corporation, Broadcast Products Division
 Hans Plisch
 Larcam Communications Inc.
 Rodelco
 Rohde & Schwarz
 TBC Pty. Ltd.
 Television Technology
 Thomson-CSF
 Townsend Associates
 Velec Sefat
 Versa-Count

LOW POWER
 AEG-Telefunken
 Acrodyne Industries
 Anderson Scientific
 Crowder Communications
 EMCEE Broadcast Products
 Harris Corporation, Broadcast Products Division
 Howe-Yin Research Company
 D. N. Latus & Co., Inc.
 NEC America
 Hans Plisch
 Rodelco
 Rohde & Schwarz
 TBC Pty. Ltd.
 Television Technology
 Tepco
 Thomson-CSF
 Townsend Associates
 Triple Crown Electronics
 United States Tower
 Velec Sefat
 Versa-Count

TRANSMISSION LINES

(See Cables)

TRANSMISSION LINES, SUPERVISION SYSTEMS

Catel (Division of United Scientific Corp.)
 Fernseh Inc.
 Grass Valley
 GTE Lenkurt Incorporated
 LeBlanc & Royle Communications
 LeCroy Research Systems
 Times Wire & Cable
 Telemet
 Valtec Corporation

TRANSMITTER MODULATION CONTROLLER

AEG-Telefunken

Circuit Research Labs
 Continental Electronics
 Delta Electronics
 GTE Products
 Kahn Communications
 Moseley Associates
 Thomson-CSF

TRANSMITTER OUTPUT CONTROLS

AEG-Telefunken
 Cat Systems
 Delta Electronics
 Hallikainen & Friends
 Moseley Associates
 Orban Associates
 Sharepoint Systems
 Singer Broadcast Products
 Thomson-CSF

TRANSMITTERS, AM

500 WATTS & UNDER
 AEG-Telefunken
 Cetec Broadcast Group
 Comad Communications
 Dyma Engineering
 Elcom-Bauer
 Harris Corporation, Broadcast Products Division
 LPB Inc.
 McMartin Industries
 Microwave Power Devices
 Nautel Maine
 Radio Systems Inc.
 Singer Broadcast Products
 TBC Pty. Ltd.
 Thomson-CSF
 Tramec Electronics
 Triple Crown Electronics
 Wilkinson Electronics

500 WATTS & OVER, SOLID-STATE
 AEG-Telefunken
 Comad Communications
 Dyma Engineering
 Elcom-Bauer
 Harris Corporation, Broadcast Products Division
 McMartin Industries
 Microwave Power Devices
 Nautel Maine
 Singer Broadcast Products
 TBC Pty. Ltd.
 Thomson-CSF
 Tramec Electronics
 Wilkinson Electronics

1,000 TO 2,500 WATTS
 AEG-Telefunken
 CSI Electronics
 Cetec Broadcast Group
 Comad Communications
 Continental Electronics
 Dyma Engineering
 Elcom-Bauer
 Harris Corporation, Broadcast Products Division
 McMartin Industries
 Marconi
 Microwave Power Devices
 NEC America
 Nautel Maine
 Singer Broadcast Products
 TBC Pty. Ltd.
 Thomson-CSF
 Tramec Electronics
 Wilkinson Electronics

5,000 TO 7,500 WATTS
 AEG-Telefunken
 CSI Electronics
 Cetec Broadcast Group
 Comad Communications
 Continental Electronics
 Dyma Engineering
 Elcom-Bauer
 Elcom Specialty Products
 Harris Corporation, Broadcast Products Division
 McMartin Industries
 Marconi
 Microwave Power Devices

NEC America
 Nautel Maine
 RCA Broadcast Systems
 Siemens AG
 Singer Broadcast Products
 TBC Pty. Ltd.
 Thomson-CSF
 Tramec Electronics
 Wilkinson Electronics

10,000 TO 20,000 WATTS
 AEG-Telefunken
 CSI Electronics
 Cetec Broadcast Group
 Comad Communications
 Continental Electronics
 Dyma Engineering
 Elcom-Bauer
 Elcom Specialty Products
 Harris Corporation, Broadcast Products Division
 McMartin Industries
 Marconi
 NEC America
 Nautel Maine
 Siemens AG
 Singer Broadcast Products
 TBC Pty. Ltd.
 Thomson-CSF
 Tramec Electronics
 Wilkinson Electronics

OVER 20,000 WATTS
 AEG-Telefunken
 (Bayly Engineering Ltd.)
 CSI Electronics
 Comad Communications
 Continental Electronics
 Dyma Engineering
 Elcom-Bauer
 Elcom Specialty Products
 Harris Corporation, Broadcast Products Division
 McMartin Industries
 Marconi Electronics, Inc.
 Siemens AG
 Singer Broadcast Products
 Thomson-CSF
 Tramec Electronics
 Wilkinson Electronics

TRANSMITTERS, FM

500 WATTS & UNDER
 AEG-Telefunken
 (Bayly Engineering)
 Anderson Scientific
 Broadcast Electronics
 CSI Electronics
 Cetec Broadcast Group
 Comad Communications
 Crowder Communications
 Dyma Engineering
 Elcom-Bauer
 Elcom Specialty Products
 Harris Corporation, Broadcast Products Division
 LPB Inc.
 McMartin Industries
 Microwave Power Devices
 Nady Systems
 NEC America
 QEI Corp.
 Rohde & Schwarz
 C.N. Rood B.V.
 Singer Broadcast Products
 Solid Electronics Labs
 TBC Pty. Ltd.
 Thomson-CSF
 Tramec Electronics
 Triple Crown Electronics
 Versa-Count
 Wilkinson Electronics

500 WATTS & OVER, SOLID-STATE
 AEG-Telefunken
 (Bayly Engineering)
 Broadcast Electronics, Inc.
 Comad Communications
 Dyma Engineering
 Elcom-Bauer
 Elcom Specialty Products
 Harris Corporation, Broadcast Products Division

Continued on page 112

McMartin Industries
Microwave Power Devices
NEC America
QEI Corp.
Rohde & Schwarz
Singer Broadcast Products
TBC Pty. Ltd.
Thomson-CSF
Tramec Electronics
Wilkinson Electronics

1,000 TO 2,500 WATTS

AEG-Telefunken
(Bayly Engineering Ltd.)
Broadcast Electronics
CSI Electronics
Cetec Broadcast Group
Comad Communications
Continental Electronics
Dyma Engineering
Elcom Bauer
Elcom Specialty Products
Harris Corporation, Broadcast Products Division
McMartin Industries
Marcom Communication Systems Ltd.
Marconi Electronics
Microwave Power Devices
NEC America
QEI Corp.
Rohde & Schwarz
Singer Broadcast Products
TBC Pty. Ltd.
Thomson-CSF
Tramec Electronics
Wilkinson Electronics

5,000 TO 7,500 WATTS

AEG-Telefunken
(Bayly Engineering)
Broadcast Electronics
Cetec Broadcast Group
Comad Communications
Continental Electronics
Dyma Engineering
Elcom Bauer
Elcom Specialty Products
Harris Corporation, Broadcast Products Division
McMartin Industries
Marcom Communication Systems
Microwave Power Devices
NEC America
QEI Corp.
RCA Broadcast Systems
Rohde & Schwarz
Singer Broadcast Products
TBC Pty. Ltd.
Thomson-CSF
Tramec Electronics
Wilkinson Electronics

10,000 TO 20,000 WATTS

AEG-Telefunken
(Bayly Engineering)
Broadcast Electronics
CSI Electronics
Cetec Broadcast Group
Comad Communications
Continental Electronics
Dyma Engineering
Elcom Bauer
Elcom Specialty Products
Harris Corporation, Broadcast Products Division
Larcan Communications Inc.
McMartin Industries
Marcom Communication Systems
NEC America
QEI Corp.
RCA Broadcast Systems
Rohde & Schwarz
Singer Broadcast Products
TBC Pty. Ltd.
Thomson-CSF
Tramec Electronics
Wilkinson Electronics

OVER 20,000 WATTS

AEG-Telefunken
Broadcast Electronics
CSI Electronics
Cetec
Comad Communications
Continental Electronics
Dyma Engineering
Elcom Bauer

Elcom Specialty Products
Harris Corporation, Broadcast Products Division
Larcan Communications Inc.
McMartin Industries
NEC America
RCA Broadcast Systems
Singer Broadcast Products
Thomson-CSF
Tramec Electronics
Wilkinson Electronics

TRANSMITTERS, TV

LOW POWER, UHF

AEG-Telefunken
(Bayly Engineering)
Acrodyne Industries
Anderson Scientific
Comad Communications
Comark Communications Inc.
Crowder Communications
EMCEE Broadcast Products
Harris Corporation, Broadcast Products Division
Hirschmann Electric
Marconi
Microwave Power Devices
NEC America
Rodelco Electronics Corp.
Rohde & Schwarz
Satcom Inc.
Swintek Enterprises
TBC Pty. Ltd.
Television Technology
Thomson-CSF
Townsend Associates
Triple Crown Electronics
United States Tower
Visual Methods, Inc.

LOW POWER VHF

AEG-Telefunken
Acrodyne Industries
Comad Communications
Crowder Communications
EMCEE Broadcast Products
Harris Corporation, Broadcast Products Division
Howe-Yin Research
Microwave Power Devices
Nady Systems
Rodelco Electronics
Rohde & Schwarz
Swintek Enterprises
TBC Pty. Ltd.
Television Technology
Thomson-CSF
Townsend Associates
Triple Crown Electronics
Visual Methods

UHF HIGH POWER

AEG-Telefunken
Acrodyne Industries
Comad Communications
Comark Communications Inc.
Harris Corp., Broadcast Products
Marcom Communication Systems Ltd.
Marconi Electronics Inc.
Microwave Power Devices
NEC America
Philips Broadcast
RCA Broadcast Systems
Rodelco Electronics
Rohde & Schwarz
Singer Broadcast Products
TBC Pty. Ltd.
Thomson-CSF
Townsend Associates
Varian MCS D

VHF HIGH POWER

AEG-Telefunken
Acrodyne Industries
Comad Communications
Comark Communications Inc.
Harris Corp., Broadcast Products
Larcan Communications Inc.
Marcom Communication Systems Ltd.
Marconi
Microwave Power Devices
NEC America
RCA Broadcast Systems
Rodelco Electronics
Rohde & Schwarz

Singer Broadcast Products
TBC Pty. Ltd.
Thomson-CSF
Townsend Associates

TRANSMITTERS, MICROWAVE

AEG-Telefunken
Aydin Microwave
Datum
EEV
Farinon Video/Harris
Hughes Aircraft Company
International Microwave
M/A-COM Video Systems
Moseley Associates
Nurad
RF Technology
Tayburn Electronics
Terracom
Thomson-CSF
Varian, MCS D
Velec Sefat
Visual Methods

TRANSMITTERS, SHORTWAVE

Continental Electronics

TUBES

CRT MONITOR

Auditronics
Amperex
Calvert Electronics
EEV
GBC Closed Circuit TV Corp.
Levit Electronics, Inc.
Team Electronics
Thomson-CSF

CRT OSCILLOSCOPE

Amperex
Calvert Electronics
EEV
Levit Electronics
RCA Electro-Optics
Texscan
Thomson-CSF

RECEIVER TYPES

AEG-Telefunken
Amperex
David H. Brothers Co.
Calvert Electronics
CeCo Communications
EEV
Levit Electronics
RCA Distributor & Special Products
RF Gain
Team Electronics
Varian Associates

RECTIFIER TUBES

AEG-Telefunken
Amperex
Calvert Electronics
CeCo Communications
EEV
Levit Electronics
RCA Distributor & Special Products
RF Gain
Team Electronics
Thompson-CSF
Varian Associates
Westinghouse Electric Corp.

SOLID-STATE REPLACEMENT

AEG-Telefunken
Amperex
Calvert Electronics
Electronic Devices
Microwave Power Devices

TRANSMITTER TUBES, AM/FM

AEG-Telefunken
Amperex
Broadcast Electronics
Calvert Electronics

Ceco Communications
Comad Communications
EEV
Econco Broadcast Service
Elcom-Bauer
Freeland Products Co.
Harris Corporation
Levit Electronics
RCA Distributor & Special Products
RCA Electro-Optic Devices
RF Gain
Team Electronics
Thomson-CSF
Vacuum Tube Industries
Varian, MCS D
Westinghouse Electric Corp.

TRANSMITTER TUBES, KLYSTRONS

AEG-Telefunken
Amperex
Calvert Electronics
EEV
Harris Corporation
NEC America
Thomson-CSF
Vacuum Tube Ind. Inc.
Varian Assoc.
Varian, MCS D

TRANSMITTER TUBES, VHF

AEG-Telefunken
Amperex
Calvert Electronics
EEV
Econco Broadcast Service
Harris Corporation
RCA Electro-Optic Devices
Thomson-CSF
Vacuum Tube Industries
Varian Associates

VIDEO CAMERA PICKUP

ATV Research
Amperex
Robert Bosch GmbH
David H. Brothers Co.
Calvert Electronics
Ceco Communications
EEV
English Electric Valve
GBC Closed Circuit TV
Harris Corporation
Hitachi
Levit Electronics
Link Electronics
Panasonic
Philips
RCA Electro-Optic Devices
Team Electronics
Thomson-CSF

TUNERS, FM

Bill Audio Systems
Bogen Division / Lear Siegler
Catal
Crown International
Johnson Electronics
McMartin Industries
Paso Sound Products
Pyramid Loudspeaker Corp.
H. H. Scott
Sharp Electronics
Singer Products Company
Studer International AG
Studer ReVox America

TUNERS, VIDEO

Barco (Elector)

TURNKEY INSTALLATION SERVICES

AEG-Telefunken
A.F. Associates
Alice Stancoil Ltd.
Altha Video & Elect. Corp.
Amek Systems & Controls
Andrew Corporation
Antennas for Communications Inc.
Audix
Aydin Microwave
Braybury Electronics

Burden Associates
 Canter-Redman Technologies Corp.
 Jim Cason Electronics
 Central Dynamics
 Centro
 Comad Communications
 Comark Communications Inc.
 Compact Video
 Computer Management Systems
 Crowder Communications
 Davis Electronics
 John J. Davis & Assoc.
 Delta Systems
 Dynacom Electronics Ltd.
 Dynamic Technology
 EEG Enterprises
 EMCEE Broadcast Products
 Electro - Acoustic Designs
 Elektrolmpex
 Gabriel Electronics
 Global Communications
 Harris Corporation
 Harrison Systems
 Hoppmann Corporation
 Immad Broadcast Services Ltd.
 Jamieson and Associates
 Jatex
 Jenel Consultants
 Jerrold Div., Gen. Instrument Corp.
 Larcam Communications Inc.
 Leader Broadcast Systems
 LeBlanc & Royle
 Link Electronics
 McCurdy Radio Industries
 M/A-COM Video Systems
 MBI Broadcast Systems
 Microdyne Corporation
 Midwest Corp.
 Multi-Track Magnetics
 Multiphase Consulting
 National TeleConsultants
 L.E. Nelson
 Rupert Neve
 Pacific Recorders & Engr.
 Professional Electronics Co.
 RCA Broadcast Systems
 RCA Service Company
 Radio Systems
 Radiotechniques
 Rohde & Schwarz
 Rosner Television Systems
 Sait Electronics
 Sat Vision
 Siemens AG Osterreich
 Soil Inc.
 Standard Telephon und Radio
 Strand Century
 Studer International
 Swager Tower Corp.
 TBC Pty. Ltd.
 Telecommunications Systems
 Thomson-CSF
 Townsend Associates
 Tramec Electronics
 Ultra Audio Pixtec
 United States Tower
 Valley People
 Vaitec Corporation
 Velec Sefat
 Video Masters
 World Tower Company

TURNKEY TV FACILITY

AEG-Telefunken
 A.F. Associates
 Aderhold Construction
 Altha Video & Elect. Corp.
 BFE KG
 CSP Inc.
 Central Dynamics
 Centro
 Crowder Communications
 Dynacom Electronics Ltd.
 General Television Network
 Global Communications
 Graham-Patten Systems
 Harris Corporation, Broadcast
 Products Division
 Harrison Systems
 Immad Broadcast Services
 Jenel Consultants
 LeBlanc & Royle Comm. Inc.
 Merlin Engineering Works
 Midwest Corp.
 Multi-Track Magnetics

L.E. Nelson
 RCA Broadcast Systems
 Rohde & Schwarz
 Rosner
 Soil Inc.
 Siemens AG Osterreich
 Strand Century
 Thomson-CSF
 Ultra Audio Pixtec

TURNTABLES & ACCESSORIES

PHONO CARTRIDGES
(See Cartridges, Phono)

TONE ARMS
 Audio-Technica US, Inc.
 Broadcast Electronics
 Cart-Align Research
 Cetec Broadcast Group
 Continental Electronics
 D - B Electronics
 Elektrolmpex
 Fidelipac Corp.
 Harris Corporation, Broadcast
 Products Division
 IGM Communications
 LPB Inc.
 McCurdy Radio Industries
 Micro-Trak
 Panasonic, Professional Audio Div.
 Ramko Research
 Russo
 Shure Brothers
 Westrex

TURNTABLE

AIWA
 Bogen Division / Lear Slegler
 Broadcast Electronics
 David H. Brothers Co.
 Cetec Broadcast Group
 Continental Electronics
 D - B Electronics
 Elektrolmpex
 EMT - Franz
 Harris Corporation, Broadcast
 Products Division
 IGM Communications
 LPB Inc.
 McCurdy Radio Industries
 McMartin Industries
 Micro-Trak Corporation
 Panasonic, Professional Audio Div.
 RCA Broadcast Systems
 Radio Systems
 Ramko Research
 Russo
 H.H. Scott
 Sharp Electronics
 Stanton Magnetics Inc.
 Studer International AG
 Studer ReVox America

SPEED CONTROLS

Broadcast Electronics
 Harris Corporation, Broadcast
 Products Division
 McCurdy Radio Industries

VANS & MOBILE UNITS

ENG/RENG REMOTE
 A.F. Associates
 Altha Video & Elect. Corp.
 Audix Limited
 Robert Bosch GmbH
 Brabury Broadcast Systems
 Brabury Electronics
 Centro
 ComCoach Corporation
 Compact Video Systems
 Compro
 Crow of Reading Ltd.
 Dell Technical Vehicles
 Dynamic Technology
 E-N-G Corporation
 Farinon Video/Harris
 The Gerstenslager Company
 Harris Broadcast Microwave
 Harris Corporation, Broadcast
 Products Division
 Hughes Television Network
 Jenel Consulting Engineers

Link Electronics
 M/A-COM Video Systems
 Marconi
 Midwest Corporation
 NET Enterprises
 One Pass Video
 Phillips Broadcast Group
 RCA Broadcast Systems
 R F Technology
 Rack Techniques
 Sait Electronics
 Siemens AG Osterreich
 Standard Telephon und Radio
 Studer International AG
 Tayburn Electronics
 Television Engineering
 Thomson-CSF
 Van Ladder
 Video Masters
 Videomedia
 Videosystems International
 Wold Communications
 Wolf Coach Inc.

VIDEO PRODUCTION

A.F. Associates
 Altha Video & Elect. Corp.
 Robert Bosch GmbH
 Brabury Broadcast Systems
 Brabury Electronics
 Centro
 ComCoach Corporation
 Compact Video Systems
 Compro Productions
 Crow of Reading Ltd.
 Dell Technical Vehicles
 Dynamic Technology
 E-N-G Corporation
 The Gerstenslager Company
 Harris Corporation, Broadcast
 Products Division
 Hughes Television Network
 Interface Video Systems
 Jenel Consulting Engineers
 Lang Video Systems
 Link Electronics
 Marcom Communication Systems
 Marconi
 Midwest Corporation
 Mobile Visual Productions
 NET Enterprises
 One Pass Video
 Phillips Broadcast Group
 RCA Broadcast Systems
 RCA Service Company
 Rosner Television Systems
 Sait Electronics
 Siemens AG Osterreich
 Soil Inc.
 Standard Telephon und Radio
 Television Engineering
 Thomson-CSF
 Video I-D
 Video Masters
 Videomedia
 Videosystems International
 Wold Communications
 Wolf Coach Inc.

VANS WITH LADDERS

Brabury Broadcast Systems
 Centro
 Compact Video
 Crow of Reading Ltd.
 Dell Technical Vehicles
 Dynamic Technology
 E-N-G Corporation
 Harris Corporation
 Kindwall Corp.
 Midwest Corporation
 NET Enterprises
 Phillips Broadcast Group
 Rosner Television Systems
 Television Engineering
 Thomson-CSF
 Van Ladder
 Videosystems International
 Wolf Coach Inc.

VIDEO CONTROLLER

BCB Electronic Sales
 BTX Corp.
 CMC Technology Corp.
 Cezar International
 Channelmatic
 Control Video

Convergence
 Crow of Reading Ltd.
 Jatex Inc.
 Javelin Electronics
 MPB Technologies
 Microtime
 Panasonic
 Rohde & Schwarz
 Tech Electronics

VIDEO LINE OUTPUT DISPLAY

Broadcast Video Systems
 Datum
 Javelin Electronics

VIDEOTAPE DUPLICATION

Video Dub Inc.

WEATHER GRAPHIC SYSTEM

Spectra Computer Systems

WEATHER INSTRUMENTS

Arvin-Diamond
 ESE
 Computer Video Systems
 Harris Corp., Broadcast Products
 Heath Company
 Information Processing Systems
 Kudelski SA Switzerland
 Merrill Cable Equipment Corp.
 Nagra Magnetic Recorders
 North Wind Power
 Taylor Instrument
 Texas Electronics
 Texscan
 Viz Manufacturing
 Weatherscan International

WEATHER RADAR SYSTEMS

AEG-Telefunken
 Alden Elec. & Impulse Recording
 Calvert Electronics
 Computer Video Systems
 Enterprise Electronics
 Okiel Corporation
 Sperry Marine Systems
 Technology Service
 Varian Associates
 Weathermaton
 Weatherscan International

WEATHER RECEIVERS

(See Receivers, Weather)

WEATHER SERVICES

Arvin Echo
 BEI (Beston Electronics)
 Computer Video Systems
 Connect Air International
 McInnis-Skinner & Associates
 Mesomet
 Spectra Computer Systems
 Synsat International
 Station Program Resources
 Telesource Communication Services
 Texscan
 Weather Services International
 Weatherscan International
 Weathermaton

WIRE *(See Cable)*

WIRING SERVICES

(See Cable)

DIRECTORY OF MANUFACTURERS AND SERVICE COMPANIES

A

ADDA CORPORATION
1671 Dell Ave.
Campbell, CA 95008 (408) 379-1500

Regional Sales Offices:
ADDA CORPORATION
No. 7 Pitman Avenue
Wakefield, MA 01880 (617) 245-4602
Contact: Frank Alioto, Reg. Sls. Mgr.
ADDA CORPORATION
1966 E. 38th St.
Brooklyn, NY 11234 (212) 375-4064
Contact: Marty Frange, Reg. Sls. Mgr.
ADDA CORPORATION
13952 Chelmsford Walk
Westminster, CA 92683 (714) 891-3364
Contact: Sheila Holmes, Reg. Sls. Mgr.
ADDA CORPORATION
9517 Moody Park Circle
Overland Park, KS 66212 (913) 631-1500
Contact: Emerson Ray, Reg. Sls. Mgr.
ADDA CORPORATION
30310 Woodgate Dr.
Southfield, MI 48076 (313) 332-1500
Contact: Dick Strauss, Reg. Sls. Mgr.
ADDA CORPORATION
2693 Twigg Circle
Marletta, CA 30067 (404) 953-1500
Contact: Duane Tuttle, Reg. Sls. Mgr.

ADM TECHNOLOGY INC.
1626 E. Big Beaver Road
Troy, MI 48084 (313) 778-8400
Sales Contact: Murray Shields, VP/Sales

Regional Sales Offices:
ADM TECHNOLOGY INC.
P.O. Box 912
Arlington, TX 76010 (817) 467-2990
Contact: Gordon Peters, Sales Rep.
ADM TECHNOLOGY INC.
2118 26th Ave.
San Francisco, CA 94116 (415) 664-2400
Contact: Ron Webb, Sales Rep.

AEG-TELEFUNKEN, Bayly Engineering Ltd.
167 Hunt St.
Ajax, Ontario
Canada L1S 1P6 (416) 683-8200
Sales Contact: Bill Lindsay, Sales Manager

AEG-TELEFUNKEN
Theodor-Stern-Kei
6000 Frankfurt/Main
West Germany (0611) 600
Sales Contact: Hans Gissel, Dr. Eng.

AEL-AMERICAN ELECTRONIC LABORATORIES INC.
P.O. Box 552
Lansdale, PA 19446 (215) 822-2929
Sales Contact: A. Rosset, Adv. Mgr.

A.F. ASSOCIATES INC.
100 Stonehurst Ct.
Northvale, NJ 07647 (201) 767-1000
Sales Contact: Bill Ebell, Mktg. Mgr.

AIWA AMERICA INC.
35 Oxford Drive
Moonachie, NJ 07074 (201) 440-5220
Sales Contact: Robert Fisher, Nat'l. Sls. Mgr.

AKG ACOUSTICS INC.
77 Selleck St.
Stamford, CT 06902 (203) 348-2121
Sales Contact: Peter Wellikoff, Nat'l. Sls. Mgr.

AKG Akustische u. Kino-Gerate GEs.m.b. H
A-1150 Vienna,
Brunnhildengasse 1 (0222) 956517
Sales Contact: Ing. H. Sicheritz, Int'l Sls. Mgr.

AMP INC.
P.O. Box 3608
Harrisburg, PA 17105 (715) 564-0100
Sales Contact: Robert Steele, VP Ind. Sls.

AMP SPECIAL INDUSTRIES
(A subsidiary of AMP Incorporated)
Valley Forge, PA 19482 (215) 647-1000
Sales Contact: Joseph Maher, Gen. Sls. Mgr.

A & S CASE COMPANY
1111 North Gordon Street
Hollywood, CA 90038 (213) 466-6181
Sales Contact: Jan Alejandro, Sales Mgr.

ATI-AUDIO TECHNOLOGIES INC.
328 W. Maple Ave.
Horsham, PA 19044 (215) 443-0330
Sales Contact: Ed M. Mullin, V.P.

Regional Sales Offices:
AUDIOTECHNIQUES
652 Glenbrook Road
Stamford, CT 06906 (203) 359-2312
Contact: Michael Faulkner
ALLIED BROADCAST EQPT.
635 South E Street
Richmond, IN 47374 (317) 962-8596
Contact: Roy Ridge
AVC SYSTEMS INC.
1517 E. Lake St.
Minneapolis, MN 55407 (612) 729-8305
AUDIO DISTRIBUTORS INC.
2342 Division Ave., S.
Grand Rapids, MI 49507 (616) 452-1596
BROADCAST COMM. PRODUCTS
8179 Second Ave.
Leyden, CO 80401 (303) 424-3231
Contact: Greg Pine
BROADCAST EQPT. & SUPPLY CO.
P.O. Box 3141
Bristol, TN 37620 (615) 878-2531
DOUG BROWN ENTERPRISES
1703 E. Skelly Drive
Tulsa, OK 74105 (918) 747-3618
Contact: Doug Brown
COMAD COMMUNICATIONS
91 Kelfield Street, Unit 5
Rexdale, Ontario M9W 5A3 (416) 245-1734
Contact: Emil Adamyk
CRAMER VIDEO/AUDIO SYSTEMS
120 Hampton Ave.
Needham, MA 02194 (617) 449-2100
Contact: Jim Ritterman
CROUSE-KIMZEY CO.
P.O. Box 9830
Ft. Worth, TX 76107 (800) 433-2105
Contact: Mark Bradford
FLANNER AND HAFOS
2500 N. Mayfair Rd.
Milwaukee, WI 53226 (414) 259-9665
Contact: John Loeper
FULL COMPASS SYSTEMS
6729 Seybold Road
Madison, WI 53719 (608) 271-1100
Contact: Jonathan Lipp
GRAY COMM. CONSULTANTS INC.
5401 Southern Comfort Blvd.
Tampa, FL 33614 (813) 885-1411
DAVID GREEN BROCST. CONSULTANTS
P.O. Box 590
Leesburg, VA 32075 (703) 777-8660
Contact: David Green
H.M. HOLZBERG ASSOC.
P.O. Box 322
Totowa, NJ 07511 (201) 256-0455
Contact: Herb Holzberg
MARTIN AUDIO/VIDEO CORP.
423 W. 55th Street
New York, NY 10019 (212) 541-5900
Contact: Michael Bogen
NORTHEAST BROADCAST LABS
15 Charles St.
South Glen Falls, NY 12801 (518) 793-2181
Contact: Bill Bingham
OAKWOOD AUDIO LABS
652 King Edward Street
Winnipeg, Manitoba R3H 0P2 (204) 786-6715
PINEWAY ELECTRONICS

1875 Leslie Street, Unit 3
Don Mills, Ontario M3B 2M5 (416) 449-1343
PRO COM SYSTEMS
5001 Baum Blvd.
Pittsburgh, PA 15213 (412) 621-1950
SAVCO INC.
Box 427
Richardson, TX 75080 (214) 234-1841
SINGER PRODUCTS CO. INC.
875 Merrick Ave.
Westburg, NY 11590 (516) 333-2000
SONICS ASSOCIATES
237 Oxmoor Circle
Birmingham, AL 35209 (205) 942-9631
WESTEC AVI INC.
1841 Broadway
New York, NY 10023 (212) 586-1662
WILTRONIX INC.
16850 Oakmont Ave.
Washington Grove, MD 20880 (301) 258-7676
AUDIOMEDIA ASSOCIATES
P.O. Box 29264
New Orleans, LA 70189 (504) 586-0140
Contact: Corey Meyer
PRO AUDIO GENERAL STORE
1378 Northwest 100th Ave.
Coral Springs, FL 33065 (305) 752-0330
MARCOM
P.O. Box 66507
Scotts Valley, CA 95066 (408) 438-4273
Contact: Marty Jackson
RIGGINS ELECTRONIC SALES
3272 East Willow St.
Long Beach, CA 90806
Contact: George Riggins
PRS INC.
Professional Recording & Sound
1616 Soldiers Field Road
Boston, MA 02135 (617) 254-2110
Contact: Peter Engel

ATV RESEARCH
13th & Broadway
Dakota City, NE 68731 (402) 987-3771
Sales Contact: M.H. Shadbolt, Pres.

AVA ELECTRONICS CORP.
4000 Bridge St.
Drexel Hill, PH 19026 (215) 284-2500
Sales Contact: Joseph Roos, Dir. of Mktg.

AVAB AMERICA
967 Howard St.
San Francisco, CA 94103 (415) 421-3562
Sales Contact: Rodger Payne, Vice President

AVL DIGITAL LTD.
70 Milner Ave., Unit 5
Scarborough, Ont. M1S 3P8 (416) 298-6220
Sales Contact: M. Porteous, President

Regional Offices:
WESTRONIC ENGINEERING SALES
Seven W. 7th Ave.
Vancouver, B.C. V5Y 1L4 (604) 872-0636
Contact: G. English
WESTRONIC ENGINEERING SALES
7056A Farrell Rd. S.E.
Calgary, Alta. T2H 0T2 (403) 253-5585
Contact: E. Muldowan
WESTERN BROADCAST SYSTEMS
10707 Amulet Pl.
Cupertino, CA 95014 (408) 749-0900
Contact: H. Hull
UNITED PACIFIC CORP.
40 S. 900 E., Suite 9B
Salt Lake City UT 84102 (801) 486-7512
Contact: R. Rask

AATON CAMERAS INC.
1697 Broadway
New York City, NY 10019 (212) 541-8181
Sales Contact: Carolyn Brooks, Mgr.

ABROYD CONSTRUCTION, Division of Dahmer Steel Limited
68 Shirley Avenue
P.O. Box 460
Kitchener, Ontario N2G 4A6 (519) 744-2293
Sales Contact: A.J. Nightingale, P.Eng., G. Mgr.

ACCURATE SOUND CORPORATION
114 5th Avenue
Redwood City, CA 94063 (415) 365-2843
Sales Contact: Ronald M. Newdell, Pres.

ACHRO-VIDEO INTERNATIONAL SALES

55 Virginia Avenue
 West Nyack, NY 10994 (914) 358-5504
 Sales Contact: Nick Glade

ACRODYNE

516 Township Line Road
 Blue Bell, PA 19422 (215) 542-7000
 Sales Contact: Marketing Dept.

ADCOM COMMUNICATIONS

555 W. 57th St.
 New York, NY 10019 (212) 265-1760
 Sales Contact: Al Leon

ACTION VIDEO INC.

28475 Greenfield Rd.
 Southfield, MI 48076 (313) 559-7970
 Sales Contact: Barry M. Grant, Pres.

ADERHOLD CONSTRUCTION COMPANY

3384 Peachtree Road NE
 Atlanta, GA 30326 (404) 233-5413
 Sales Contact: J. H. Aderhold, Pres.

ADVANCE CONVERSION DEVICES CO.

109 Eighth Street
 Passaic, NJ 07055 (201) 778-0707
 Lynda M. Schmidt, Sales Mgr.

THE ADVANCE PRODUCTS CO.

Central at Wabash
 P.O. Box 2178
 Wichita, KS 67201 (316) 263-4231
 Sales Contact: Paul Keek, Sales Mgr.

ADVANCED ANALOG SYSTEMS INC.

790 Lucerne Dr.
 Sunnyvale, CA 94086 (408) 730-9786
 Sales Contact: Robert Frosthalm, Dir. of Mkt.

ADVANCED VIDEO COMMUNICATIONS

49 S. Washington
 Hinsdale, IL 60521 (312) 323-7464
 Sales Contact: Mike Vergauwen, VP Sales

ADVENT CORPORATION

195 Albany Street
 Cambridge, MA 02139 (617) 661-9500
 Sales Contact: Wait Henry, Video Prod. Mgr.

ADWAR VIDEO CORP.

100 5th Avenue
 New York, NY 10011 (212) 691-0976
 Sales Contact: Marty Amrani, Prod. Mgr.

AGFA-GEVAERT AG

5090 Leverkusen 1
 Fed Republic of Germany

AGFA-GEVAERT

275 North Street
 Teterboro, NJ 07608 (201) 288-4100
 Sales Contact: Ruth Hladyk, Adv. Coord.

AIRBORNE VIDEO SYSTEMS INC.

7525 Hayvenhurst Place
 Van Nuys, CA 91406 (213) 781-1622
 Sales Contact: Arnold Condon, Pres.

ALCO ELECTRONIC PRODUCTS INC.

1551 Osgood Street

No. Andover, MA 01845 (617) 685-4371
 Sales Contact: C. Czapski, Nat'l Sales Mgr.

ALDEN ELECTRONIC & IMPULSE RECORDING EQUIPMENT CO. INC.

Washington St.
 Westboro, MA 01581 (617) 366-8851
 Sales Contact: Richard J. Boire, Manager
 Weather Systems Sales

ALEXANDER MFG. CO.

1511 S. Garfield Place
 Mason City, IA 50401 (515) 423-8955
 Sales Contact: Georgia Franks, Co. Mgr.

Regional Offices:

ALEXANDER MFG. CO.
 425 S. Elm
 Palatine, IL 60067 (312) 359-1153
 Contact: Bill Sapp
 ALEXANDER MFG. CO.
 P.O. Box 1053
 Pompano Beach, FL 33061 (305) 781-1181
 Contact: Charlie Stinson
 ALEXANDER MFG. CO.
 47 Lenape Dr.
 Montville, NJ 07045 (201) 263-1888
 ALEXANDER MFG. CO.
 P.O. Box 28880
 San Diego, CA 92128 (714) 485-5509
 Contact: Bill Sapp, Jr.
 ALEXANDER MFG. CO.
 2020 S. Onelda, Suite 204
 Denver, CO 80224 (303) 758-3051
 Contact: Stan Rubenstein
 ALEXANDER MFG. CO.
 P.O. Box 1512
 Bellevue, WA 98009 (206) 455-0773
 Contact: Bob Hudson

Continued on page 116



**The Best
 Price - Fonts - Graphics**



SPECTRA COMPUTER SYSTEMS

391 CHIPETA WAY - RESEARCH PARK SALT LAKE CITY, UTAH 84108

801-581-5478

Circle (59) on Action Card

WHERE TO BUY IT

ALEXANDER MFG. CO.
6004 Olinger Blvd.
Minneapolis, MN 55436
Contact: Paul Ohlin
ALEXANDER MFG. CO.
P.O. Box 367
Mequon, WI 53092
Contact: Dave Barquist
ALEXANDER MFG. CO.
2217 A Dunwin Dr.
Mississauga, Ont.
Canada L5L1X1
Contact: Ed Irving

(612) 929-6924

(414) 241-3020

(416) 828-7100

ALFORD MFG. CO.
15 Sixth Rd.
Woburn, MA 01801
Sales Contact: F. Abel, Pr. Eng.

(617) 935-8610

ALICE (STANCOIL LTD)
38 Alexandra Road
Windsor, Berkshire,
U.K.
Sales Contact: John L. Andrews, Joint M.D.

07535-51056

ALLEN AVIONICS
224 E. 2nd Street
P.O. Box 350
Mineola, NY 11501
Sales Contact: Lester Jacobson

(516) 248-8080

(516) 747-5450

ALLEN AVIONICS
201 Town & Country Village
Palo Alto, CA 94301
Contact: John Sessoms
ALLEN AVIONICS
11500 Stemmons Freeway -113
Dallas, TX 75229

(415) 323-5414

(214) 243-7261

Contact: Bob Braden
ALLEN AVIONICS
3 Eva Lane
Plainview, NY 11803
Contact: Bob Pizzutiello
ALLEN AVIONICS
4155 Live Oak, Suite 110
Arcadia, CA 91006
Contact: Van Gott
ALLEN AVIONICS
622 Gardenia Court
Golden, CO 80401
Contact: Pauline Tucker
ALLEN AVIONICS
2110 Wilkinson Place
Alexandria, VA 22306
Contact: Jim Muller
ALLEN AVIONICS
4130 Linden Ave., Suite 155
Dayton, OH 45432
Contact: Griff Ashby
ALLEN AVIONICS
13540 N.W. Mill Creek Dr.
Portland, OR 97229
Contact: Don Lain
ALLEN AVIONICS
3525 W. Peterson Ave., Suite T7
Chicago, IL 60659
Contact: Irv Hirsch
ALLEN AVIONICS
P.O. Box 864
Anoka, MN 55303
Contact: Ken Huagen
ALLEN AVIONICS
1980 N. Atlantic Ave., Suite 831
Cocoa Beach, FL 32931
Contact: Foster Reynolds
ALLEN AVIONICS
2 Evergreen Rd.
Natick, MA 01760
Contact: Bill Everson
ALLEN AVIONICS
P.O. Box 1660
Cherry Hill, NJ 08034
Contact: Don White
ALLEN AVIONICS
98 Fairview Crescent
Rochester, NY 14617
Contact: Jim Welch

(516) 931-1414

(213) 445-9728

(303) 279-7796

(703) 768-1660

(513) 252-5627

(503) 643-5588

(312) 588-4535

(612) 421-3395

(305) 784-4700

(617) 655-6080

(609) 428-4544

(716) 244-1100

ALLEN OSBORNE ASSOCIATES
5195 N. Douglas Fir Road
Calabasas, CA 91302
Sales Contact: Lois Osborne, Mgr., Sales

(213) 888-2772

THE ALLEN PRODUCTS COMPANY
160 Wampus Lane
Milford, CT 06460
Sales Contact: R.L. Bailer, V.P., Mktg.

(203) 874-2563

ALLIED TOWER CO.
12450 Old Galveston Road
Webster, TX 77598
Sales Contact: Charles White, Sales Mgr.

(713) 486-7691

ALLISON RESEARCH INC.
P.O. Box 40288 - 2817 Erica Pl.
Nashville, TN 37204
Sales Contact: Norman Baker, V.P.

(615) 385-1760

ALLSOP INC.
P.O. Box 23
Bellingham, WA 98227
Sales Contact: Jeffrey V. Heininger, Nat'l. Sls. Manager

(206) 734-9090

ALPHA TECHNOLOGIES
D-6, 1305 Fraser
Bellingham, WA 98225
Sales Contact: John Dooyeweerd, Mktg. Mgr.

(604) 430-1476

(206) 671-7703

ALPHA VIDEO & ELECTRONICS CO.
28 East Mall Plaza
Carnegie, PA 15106
Sales Contact: Henry B. Lassige, Pres.

(412) 923-2070

ALPHA WIRE CORPORATION
711 Lidgerwood Ave., P.O. Box 711
Elizabeth, NJ 07207
Sales Contact: Mike Klakis, Mktg. Mgr.

(201) 925-8000

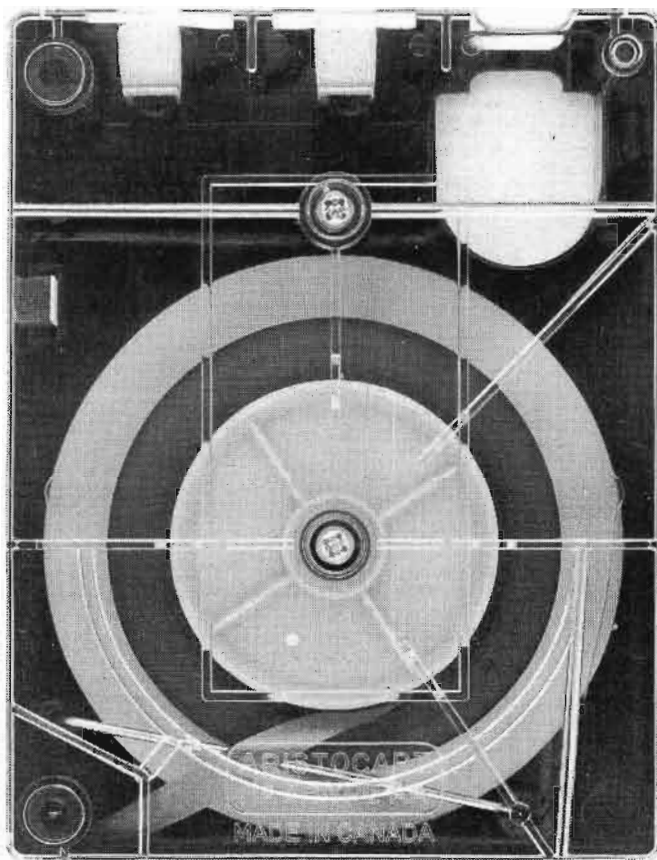

ARISTOCART

no other NAB cartridge meets these exacting standards

We designed the ARISTOCART cartridge 10 years ago. Its features have been widely copied but it continues to outperform competing products because we alone take the trouble to check each unit we ship for phase stability and frequency response in conformity with NAB specifications.

our guarantee

If any ARISTOCART cartridge should fail to meet NAB AM/FM performance specifications on a properly aligned cart machine, we will replace it at our sole expense.

MANUFACTURED BY ARISTOCART DIV. WESTERN BROADCASTING LTD., 505 BURRARD ST., VANCOUVER, B.C., CANADA V7X 1M6 TEL: (604) 687-2844 TELEX: 04-54639

ALTEC CORP., Sound Products Division
 1515 S. Manchester Ave.
 Anaheim, CA 92803 (714) 774-2900
Sales Contact: Gary Rilling, VP Comm. Sls.

ALUMA TOWER COMPANY
 1639 Old Dixie Highway
 P.O. Box 2806 (305) 567-3423
 Vero Beach, FL 32960 Telex: 803405
Sales Contact: T.E. Gottry, VP

AMALGAMATED WIRELESS
 P.O. Box 96
 Sydney, Australia North Ryde 2113

AMARAY SALES CORPORATION
 2251 Grant Road
 Los Altos, CA 94022 (415) 968-2840
Sales Contact: Ron Garrett, Pres.

AMBER ELECTRO DESIGN INC.
 4810 Jean Talon West
 Montreal Canada H4P 2N5 (514) 735-4105
Sales Contact: Wayne Jones, President

AMCO ENGINEERING CO.
 3801 N. Rose Street
 Schiller Park, IL 60176 (312) 671-6670
Sales Contact: R.C. Komarek, Dir. of Mktg.

AMDAX CORPORATION
 160 Wilbur Place
 New York, NY 11716 (516) 567-7887
Sales Contact: John J. Egan, VP Mktg.

AMEK SYSTEMS & CONTROLS LTD.
TOTAL AUDIO CONCEPTS LTD.
 Islington Mill,
 James Street Salford M3 5HW 061/834 6747
 England TELEEX: 668127
Sales Contact: Nick Franks, Director

AMERICAN DATA CORPORATION
 401 Winn Drive
 Huntsville, AL 35805 (205) 837-5180
Sales Contact: Ed Miller, Nat'l. Sales Mgr.
 (See listing for Central Dynamics Corporation)

AMERICAN IMAGE PRODUCTIONS
 Box 23355 (800) 251-2058
 Nashville, TN 37202 (615) 329-1988

AMERICAN LASER SYSTEMS
 106 James Fowler Road
 Goleta, CA 93117 (805) 967-0423
Sales Contact: Jackie Parker, Mktg. Mgr.

AMERICAN MICROSIGNAL CORP.
 8431 Monroe Ave.
 Stanton, CA 90680 (714) 761-1222
Sales Contact: Beth Phipps

AMERICAN SIGN & INDICATOR
 P.O. Box 2727
 Spokane, WA 99220 (509) 535-4101
Sales Contact: Edmond Bruneau, Brcst. Mgr.

AMERICAN SATELLITE COMPANY
 1801 Research Blvd.
 Rockville, MD 20850 (301) 251-8300
Sales Contact: Bruce McClelland, Dir. Mk. Ser.

AMILON CORP.
 49-12 30th Avenue
 Woodside, NY 11377 (212) 274-1794
Sales Contact: L. Rosenblatt, Sales Mgr.

AMNET
 P.O. Box 3600 CFS
 Champaign, IL 61820 (217) 398-2400

AMPEREX ELECTRONIC CORPORATION
 Providence Pike, P.O. Box 98
 Slatersville, RI 02876 (401) 762-3800

Continued on page 118

MICROPROCESSORS = MACRO RESULTS

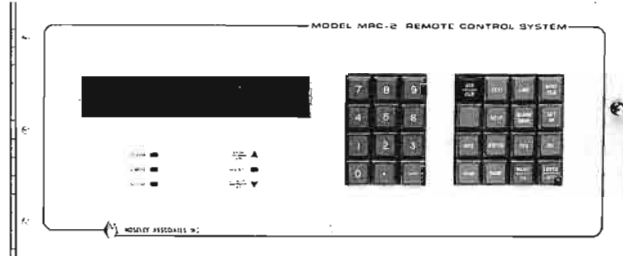

MRC-2

- MICROPROCESSOR BASED
- 99 REMOTE SITES AVAILABLE
- 32 CONTROL LINES
- 32 TELEMETRY CHANNELS

Leading Moseley's ever-growing family of microprocessor-based remote and supervisory control systems, the MRC-2 offers the user the most flexible and complete method of controlling and monitoring up to 99 remote sites available. With dual data link capability, 32 control lines, 32 status, and 32 telemetry channels standard; expansion capabilities allow for up to six data links, up to 255 control lines, and 255 status and 255 telemetry channels. User-defined dual upper and dual lower telemetry limits alarm when exceeded. Status channels can be programmed to alarm on rising, falling, or rising and falling waveforms. The MRC-2 offers a choice of six calibration modes for telemetry inputs; all setup data is preserved in non-volatile memory. Multiple CRTs, Loggers, and Automatic Control Units for automatic transmitter operation are available at both command and remote terminals.

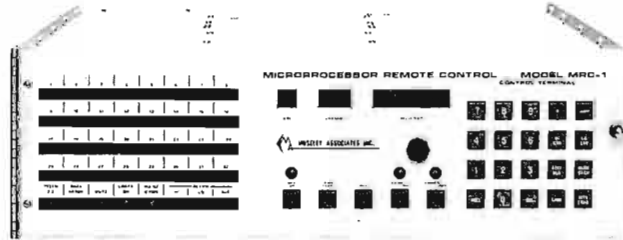

MRC-1

- 64 COMMAND OUTPUTS
- 9 REMOTE TERMINALS
- 32 TELEMETRY CHANNELS
- 32 CONTROL LINES

Closely following the MRC-2 in performance, Moseley's MRC-1 is the leading Microprocessor Control System in the industry today. Up to 64 command outputs at each of up to nine remote terminals gives the user outstanding system flexibility. System setup is tailored by the individual user. Telemetry channels may be keyboard-calibrated for linear, indirect power, or direct power scaling. The MRC-1 features modular design, upper and lower telemetry limits, automatic telemetry muting, and a set of 32 LEDs that display all status inputs from any site simultaneously. In case of extended shutdown, the Moseley Memory Option stores setup data for up to ten years. Optional CRT and Logging terminals simplify operator interface with the MRC-1. The Multiple Direct Command options offers ten preselected command functions to give the operator quick control of critical parameters at any site.

For further information please contact our Marketing Department.

M MOSELEY ASSOCIATES, INC.
 A Flow General Company . Santa Barbara Research Park

111 Castilian Drive . . . Goleta, California 93117
 (805) 968-9621 . Telex: 658-448 . Cable: MOSELEY

Circle (61) on Action Card

WHERE TO BUY IT

Sales Contact: Robert E. Carlin, Gen. Sls. Mgr.

AMPEX CORPORATION
401 Broadway
Redwood City, CA 94063 (415) 367-2011

Regional Sales Offices:
AMPEX CORPORATION
500 Rodier Dr.
Glendale, CA 91201 (213) 240-5000
Contact: Tom Nielsen, Reg. Mgr.
AMPEX CORPORATION
10435 No. Tantau Ave.
Cupertino, CA 95014 (408) 255-4800
Contact: Russ Ide, Reg. Mgr.
AMPEX CORPORATION
3135 Chestnut, Suite 101
Atlanta, GA 30340 (404) 451-7112
Contact: Paul Hansil, Reg. Mgr.
AMPEX CORPORATION
2201 Lunt Ave.
Elk Grove Village, IL 60007 (312) 593-6000

Contact: Mike D'Amore, Reg. Mgr.
AMPEX CORPORATION
10215 Fernwood Rd.
Bethesda, MD 20034 (301) 530-8800
Contact: Frank Rush, Reg. Mgr.
AMPEX CORPORATION
75 Commerce Way
Hackensack, NJ 07601 (201) 489-7400
Contact: Al Slater, Reg. Mgr.
AMPEX CORPORATION
Esmerelda 345, 10th Floor
Cosilla de Correo 5403
1035 Buenos Aires, Argentina 49-4159
Contact: Hector J. Salonio, Reg. Mgr.
AMPEX CORPORATION
4 Carlotta St.
Artamon, NSW, Australia (02) 439-4077
Contact: Greg Nixon, Reg. Mgr.
AMPEX CORPORATION
Rua: Visconde de Piraja
595 Gr. 1102
Ipanema, CEP. 22410

Rio de Janeiro, R.J., Brasil 274-8122
Contact: Weldon Squyres, Reg. Mgr.
AMPEX CORPORATION
132 East Drive
Bramalea, Ontario Can. (416) 791-3100
Contact: Jean-Louis Major, Reg. Mgr.
AMPEX CORPORATION
Avenida 40A, No. 13-09, Of. 1103
Bogota, Colombia 285-0517
Contact: Dave Peterson, Reg. Mgr.
AMPEX CORPORATION
Apartado Postal -13-615
Division del Norte -1832
Mexico, 13 D.F., Mexico 539-6870
Contact: Miguel Hernandez, Reg. Mgr.
AMPEX CORPORATION
Apartado Postal -13-615
Division del Norte -1832
Mexico, 13 D.F., Mexico 539-6870
Contact: Miguel Hernandez, Reg. Mgr.
AMPEX CORPORATION
P.O. Box 7056 (Rissneleden 8)
S-172 07 Sundbyberg, Sweden 08 / 28 29 10
Contact: Willy Bjorklund, Reg. Mgr.
AMPEX CORPORATION
Rue de Romont 29
1701 Fribourg, Switzerland (037) 81 31 11
Contact: Gerd Baumhof, Reg. Mgr.
AMPEX CORPORATION
Acre Road
Reading RG2 0QR, Berkshire, England (0734) 85200
Contact: Willie Scullion, Reg. Mgr.
AMPEX CORPORATION
21 Rue De Dome
92100 Boulogne, France 609-91-55
Contact: Michel Candelier, Reg. Mgr.
AMPEX CORPORATION
Walter Kolb Strasse 9 - 11
6000 Frankfurt (Main) 70
West Germany 60581
Contact: Elmar Sadeler, Reg. Mgr.
AMPEX CORPORATION
1801-1805 Star House
3 Salisbury Road
Kowloon, Hong Kong 678051
Contact: Allen Lee, Reg. Mgr.
AMPEX CORPORATION
Via Riccardo Gigante, 4
00143 Roma, Italy 06 / 54 69 91
Contact: Dick Crippa, Reg. Mgr.
AMPEX CORPORATION
New Belle Mode Bldg.
3 - 3 Kojimachi
Chiyoda - ku, Tokyo Japan 102 (03)264-7331
Contact: H. Wakamatsu, Reg. Mgr.
AMPEX CORPORATION
Toshiba Ampex Co., Ltd.
555 Toriyama-cho, Kohuku-ku
Yokohama, Japan 222 045-471-9041
Contact: K. Ohashi, President

AMPLICA

950 Lawrence Dr.
Newbury Park, CA 91320 (805) 498-9671
Sales Contact: N. Pena, Mgr. Mkt. Services

AMPRO/SCULLY

2693 Philmont Ave.
Huntington Valley, PA 19006 (215) 947-7000
Sales Contact: John Cyr, Sales Mgr.

AMTEL SYSTEMS

29-16 Connel Court
Toronto, Ontario
Canada M8Z 5T7 (416) 251-3355
Sales Contact: Peter McDonald

AMTRON CORPORATION

5620 Freedom Blvd.
P.O. Box 1150
Aptos, CA 95003 (408) 688-4445
Sales Contact: Bill Widera, Gen. Manager

ANDERS INC.

77 Wolcott Road
Simsbury, Ct. 06070 (203) 658-7666
Sales Contact: Roger A. Grover, VP/Mktg.

ANDERSEN LABORATORIES INC.

1280 Blue Hills Ave.
Bloomfield, CT 06002 (203) 242-0761
Sales Contact: Robert Jacobs, Dir. of Mktg.



Strong Character.

The VTW-300 Video Typewriter from FOR-A CORP. presents a host of professional features that, until now, have only been available in character generators costing twice as much—or more. And a complete system of outboard interface components are also available.

- 24 by 24 dot matrix format
- Full 8-page memory
- Auto-centering function
- Roll and Crawl functions
- Spanish character keyboard, Edge and Wipe controls available.
- Floppy disc-drive available
- Background and Title Colorizer available. Works with all C.G.'s!

FOR-A®
Innovations in Video

FOR-A CORP. of AMERICA, 1680 Vine Street, Suite 201
Los Angeles, California 90028 • (213) 467-8412

ANDERSON SCIENTIFIC

Box 800
 Black Hawk, SD 57718 (605) 787-4224
 Sales Contact: Keith V. Andersen

ANDREW CORPORATION

10500 W. 153rd St.
 Orland Park, IL 60462 (312) 349-3300
 Sales Contact: John Pryjma, Mgr., Cable Sls.

ANGENIEUX INC.

120 Derry Road (603) 880-1710
 Hudson, NH 03051 (603) 889-2116
 Sales Contact: Bern Levy, Mkt. Mgr.-Film & TV

Regional Sales Offices:**ANGENIEUX INC.**

13381 Beach Avenue (213) 821-5080
 Venice, CA 90291
 Contact: Bill Turner, Manager

ANGENIEUX INC.

190 Don Park Road (416) 495-5454
 Markham, Ontario L-R 2V8
 Contact: Tank Sum, Manager

ETS. P. ANGENIEUX

42570 Saint-Heand (33) 77-30-4210
 France

ANGEVINE ACOUSTICAL CONSULTANTS

7349 Davis Road
 West Falls, NY 14170 (716) 652-0282
 Sales Contact: Eric Neil Angevine

WHERE TO FIND IT

GENERAL INDEX, Pages 38-45

WHO MAKES IT

PRODUCT DIRECTORY, Pages 46-113

ANGLE STEEL ERECTORS

P.O. Box 55
 Greenville, NC 27834 (919) 752-7323
 Sales Contact: Bill Angle, Jr., Owner

ANIXTER-MARK

2180 S. Wolf Rd.
 Des Plaines, IL 60018 (312) 298-9420
 Sales Contact: E. Lamarre, VP/Mktg. Services

ANN ARBOR TERMINALS INC.

6175 Jackson Road
 Ann Arbor, MI 48103 (313) 663-8000
 Sales Contact: Sarah Freeman, Mktg. Mgr.

R. B. ANNIS CO.

1101 N. Delaware St.
 Indianapolis, IN 46202 (317) 637-9282
 Sales Contact: R.B. Annis, Owner

ANRITSU AMERICA INC.

128 Bauer Drive
 Oakland, NJ 07436 (201) 337-1111
 Sales Contact: Paul Young, Sales Mgr.

ANTENNAS FOR COMMUNICATIONS INC.

486 Cypress Road
 Ocala, FL 32672 (904) 687-4121
 Sales Contact: Kevin B. McWhinney,
 Marketing Manager

ANTENNA TECHNOLOGY CORP.

895 Central Florida Parkway
 Orlando, FL 32809 (305) 851-1112
 Sales Contact: Eugene P. Augustine, Pres.

ANTIOPE VIDEOTEX SYSTEMS INC.

1725 K Street NW #703
 Washington, DC 20006 (202) 861-0020

ANTON/BAUER

66 Center Street
 Shelton, CT (203) 735-3305
 Sales Contact: Joseph Lantowski, Manager

ANVIL CASES INC.

4128 Temple City Blvd.
 Rosemead, CA 91770 (213) 575-8514
 Sales Contact: R. Hoopes, Prod. Mgr.

APERT-HERZOG CORP.

7007 Realm Dr., B3
 San Jose, CA 95119 (408) 225-1425
 Sales Contact: Bill Nichols, Dir. Mktg.

APHEX SYSTEMS LTD.

7801 Melrose Ave.
 Los Angeles, CA 90046 (213) 655-1411
 Sales Contact: Paula Lintz, Mktg. Dir.

APPLIED TECHNOLOGY CORPORATION

27106 46th Avenue South
 Kent, WA 98031 (206) 854-1004

ARGOS PRODUCTS CO. INC.

600 S. Sycamore St.
 Genoa, IL 60135 (815) 784-5118
 Sales Contact: Ron Evers, VP-Sales

ARISTOCART, DIV. WESTERN BROADCASTING CO. LTD.

17-825 McBride Blvd.
 New Westminster, BC (604) 522-2711
 Canada V3L 5B5 (604) 687-2844
 Sales Contact: D. Kalmokoff, Mgr.

Regional Sales Offices:**BROADCAST SUPPLY WEST**

2711 Locust Avenue W.
 Tacoma, WA 98466 (206) 565-2301

Continued on page 120

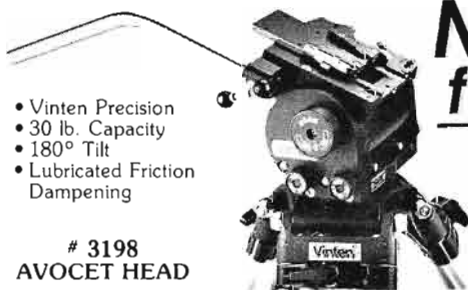

- Vinten Precision
- 30 lb. Capacity
- 180° Tilt
- Lubricated Friction Dampening

3198
AVOCET HEAD

NEW!
for '82

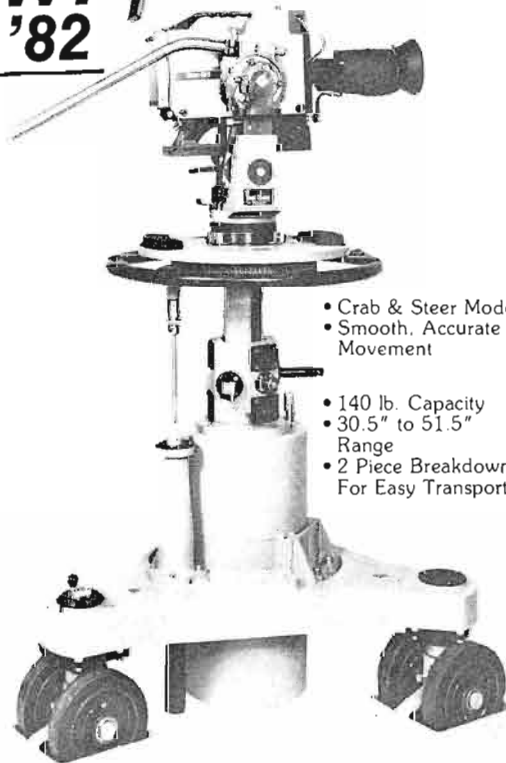

- Crab & Steer Modes
- Smooth, Accurate Movement

- 140 lb. Capacity
- 30.5" to 51.5" Range
- 2 Piece Breakdown For Easy Transport

VINTEN
 # 3197 TEAL PEDESTAL

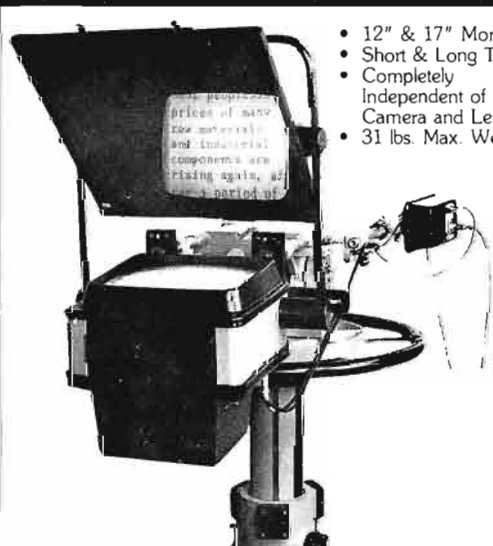

- 12" & 17" Monitors
- Short & Long Tables
- Completely Independent of Camera and Lens
- 31 lbs. Max. Weight

DIGIVISION MONITOR PROMPTING

Call or write for
 complete information
 and catalog...

Listec

**Listec
 Television
 Equipment
 Corporation**

39 Cain Drive
 Plainview,
 New York 11803
 (516) 694-8963
 Telex: 640470

**Listec (West)
 Corp.**

1619 Cosmic Way
 Glendale,
 California 91201
 (213) 247-9247
 Telex: 182686

WHERE TO BUY IT

IGM COMMUNICATIONS
Box 943
Bellingham, WA 98225 (206) 733-4567
DAVID GREEN ASSOCIATES
21 N. Wirt (703) 777-8660
Leesburg, VA 22075

ARRAKIS SYSTEMS
1713 Willox Court
Fort Collins, CO 80524 (303) 221-2918
Sales Contact: Michael Palmer, President

ARRIFLEX CORP.
500 Route 303
Blauvelt, NY 10523 (914) 353-1400
Sales Contact: R. Schriebman, Sls. Mgr.

ARTEL COMMUNICATIONS CORP.
P.O. Box 100
West Side Station
Worcester, MA 01602 (617) 752-5690
Sales Contact: David Felner, Sls. Mgr.

ARVIN-DIAMOND
4490 Old Columbus Rd NW
Carroll, OH 43112 (614) 756-9211
Sales Contact: John Saurenman, Sls. Mgr.
Dick Richards,
Manager, CATV Products

ASACA/SHIBASOKU CORP. OF AMERA
12509 Beatrice Street
Los Angeles, CA (213) 827-7144
Sales/Service (800) 423-6347

Sales Contact: Alan Davis, Dir. of Mktg.
Susan Grossinger, Office
Manager

Regional Sales Offices:
VIDEOSONICS
Portland, OR 97214 (503) 232-4632
Sales Contact: Bill Achatz, President
RIA INC.
Salt Lake City, UT 84115 (801) 484-1701
Sales Contact: Bob Bacon, President
E.M.C.
Isell, NJ 07001 (201) 634-5310
Sales Contact: Paul Backer
COLOR VIDEO SERVICES
Prior Lake, MN 55372 (612) 447-4453
Sales Contact: Mike Barsness
TELEVISION ASSOCIATES
Mountain View, CA 94040 (415) 967-6040
Sales Contact: Barry Rubin, Sales Mgr.
LAKE SYSTEMS
Newton, MA 02160 (617) 244-6881
Sales Contact: Frank De Mayo, VP
ASSOCIATED SYSTEMS
Manchester, NH 03108 (603) 472-2297
Sales Contact: Churchill Miller
G.P. ENTERPRISES
Arlington, TX 76014 (817) 467-0051
Sales Contact: Gordon Peters
TRITRONICS
Burbank, CA 91505 (800) 423-3640
Sales Contact: Michael Purdy, President
MIDWEST CORPORATION
Virginia Beach, VA 23455 (804) 464-6256
Sales Contact: Fred Wood, Sales Mgr.
MIDWEST CORPORATION
Miami, FL 33122 (305) 592-5355
Sales Contact: Lloyd Hicks, Sales Mgr.
MIDWEST CORPORATION
Cincinnati, OH 45203 (513) 651-1904
Sales Contact: Jay Adrick, Sales Mgr.

EMIL ASCHER MUSIC INC.
630 Fifth Avenue
New York, NY 10020 (212) 581-4504
Sales Contact: R. Sandler, Gen. Mgr.

THE ASTATIC CORPORATION
P.O. Box 120
Conneaut, OH 44030 (216) 593-1111
Sales Contact: Emory W. Talso, Jr.,
CSD Sales Manager

ASTON ELECTRONIC DEVELOPMENTS LTD.
125-127 Deepcut Bridge Road
Deepcut, Camberley Surrey (02516) 6221
England Telex: 858813
Sales Contact: John Waitford, Sls. Mgr.

ATLAS SOUND
10 Pomeroy Road
Parsippany, NJ 07054 (201) 887-7800
Sales Contact: D. Chambers, Dist. Sls. Mgr.

ATLAS TOWER CORPORATION
P.O. Box 972
Vinita, OK 74301 (918) 256-7883
Sales Contact: Richard Bell, VP Oper.

AUDICON INC.
1200 Beachwood Avenue
Nashville, TN 37212 (615) 256-6900
Sales Contact: Claude Hill, Pres.

AUDICO INC.
219 Crossen Ave.
Elk Grove, IL 60007 (312) 640-1030
Sales Contact: Bill Hinkle, President

AUDI-CORD CORPORATION
1845 W. Hovey Ave.
Normal, IL 61761 (309) 452-9461
Sales Contact: Carl L. Martin, Pres.

AUDIO ACCESSORIES INC.
Mill Street
Marlow, NH 03456 (603) 446-3335
Sales Contact: David Hall, GM

AUDIO KINETICS (UK) LTD.
Kinetic House

TransPath I

Your Door to a
Revolutionary
Routing System

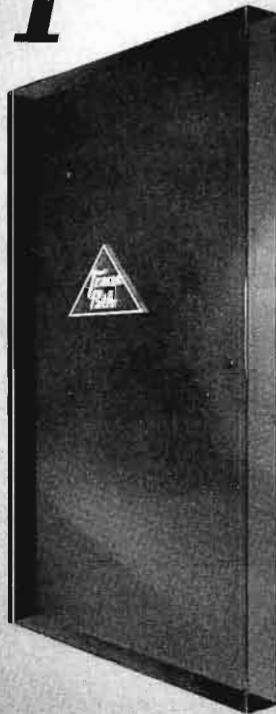

TransPath I is the first routing system to condense a switching matrix using the 3-stage concept. Central processing, using state-of-the-art components, allows unheard-of flexibility. A master terminal provides bus control or diagnostic information in parallel with individual remote panels. The system is equipped for either numeric or alpha-numeric displays.

TransPath offers multiple level switching with both AFV and breakaway operation, and all paths are virtually transparent. Input and output monitoring and redundant central processing are unique features incorporated in each 100 x 100 basic matrix, all contained in 29RU.

With sources constantly increasing and rack space at a premium, TransPath offers an innovative approach. Think about it.

Complete Descriptive Information is Available—
Give Us a Call

HUGHES ELECTRONIC DEVICES CORP.
P. O. Box 1985, Grass Valley, CA 95945 • 916/273-9524

HEDCO

Circle (64) on Action Card

THE TRUE MEASURE OF PERFORMANCE

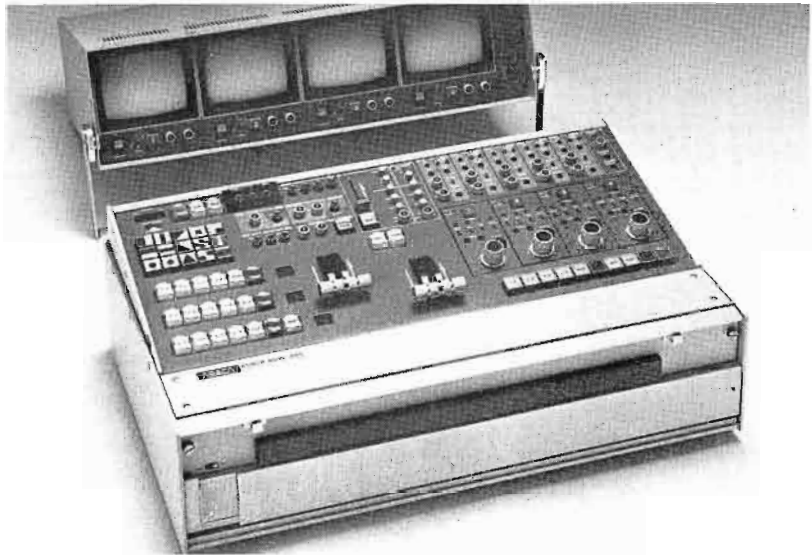

ASACA/SHIBASOKU Portable Production Systems

Here's portability plus, in 2 compact systems that give you true field mobility with full broadcast quality and capability. Our ASW 100 and ASW 200 production systems are multi-function units capable of performing all operations required for portable field production. Combined with optional monitors and power packs, they give you a van-full of equipment in 2 airline size suitcases you can take anywhere.

ASW 100/200 production systems are lightweight and rugged, with excellent manipulation and performance characteristics. They may be used with up to 4 cameras, with total remote control capability. Other components connect quickly and easily. Both systems perform full monitoring, switching and remote camera control functions. They may be used with any ENG/EFP camera on a variety of power sources.

- **Vertical interval switcher** has mix fader and wipe patterns with positioning and timing functions for super special effects.
- **Automatic camera phase control** adjusts sync and color phase for each camera instantly, precisely, automatically, continuously.
- **Remote controls** for all camera functions including iris, master pedestal, R.B. gain, R.B. pedestal and tally.
- **VTR remote controls** for stop, play, record.
- **System synchronization** with built-in sync generator and gen-lock capability to any internal or external source.
- **Preview monitoring** for each camera, line and VTR.
- **Cable compensator** for lengths up to 1,000 feet.
- **Downstream keyer** with specially designed generator for colorizing both background and characters.
- **Intercom** and tally system.

Measure your performance with the best.

ASACA/SHIBASOKU ASW 100/200. Compact systems with giant capabilities.



ASACA/SHIBASOKU CORP. OF AMERICA
12509 Beatrice Street, Los Angeles, California 90066
Sales, Service: (800) 423-6347 • (213) 827-7144

Circle (65) on Action Card

Verulam Road
St. Albans, Herts AL3 4DH 0727 32191
Sales Contact: *Charlie Day, Sls. Mgr.*

AUDIO MAGNETICS CORP
2602 Michelson Drive (800) 854-0131
Bruine, CA 92714 (714) 833-0020
Sales Contact: *T. Vali, VP Mktg. & Sls.*

AUDIO-TECHNICA U.S., INC.
1221 Commerce Dr.
Stow, OH 44224 (216) 686-2600
Sales Contact: *Charlie Winkler, Nat. Sls. Mgr.*

AUDIO TECHNOLOGY
1169 Tower Rd.
Schaumburg, IL 60195 (312) 885-0066
Sales Contact: *William Griffis, Sls. Mgr.*

AUDIO & DESIGN RECORDING, INC.
P.O. Box 786
Bremerton, WA 98310 (206) 275-5009
(Toll Free) (800) 426-6170
Sales Contact: *Nigel Branwell, Vice Pres.*

AUDIO & DESIGN RECORDING LTD.
16 North Street
Reading, Berks.
England (0734) 53411
Contact: *Dave McVittie, Sales Mgr.*

AUDIO INTERFACE INC.
P.O. Box 7369
Van Nuys, CA. 91409 (213) 704-5962
Sales Contact: *Anthony Sukanuma, Pres.*

AUDIO PROCESSING SYSTEMS INC.
40 Landsdowne St.
Cambridge, MA 02139 (617) 354-1144
Sales Contact: *Stephen W. Crump, President*

AUDIO/TEK INC.
502-D Vandell Way
Campbell, CA 95008 (408) 378-5586
Sales Contact: *Robert W. Kratt, Pres.*

AUDIO KINETICS (UK) LTD.
Kinetic House, Verulam Road
St. Albans, Herts,
England 0727 32191
Sales Contact: *Charlie Day, Sales Mgr.*

AUDIO-PATH ENGINEERING INC.
316 E. El Camino Dr.
Phoenix, AZ 85020 (602) 995-1666
Sales Contact: *Janene Spencer, Sales*

AUDIO PLUS VIDEO INTERNATIONAL
100 Stonehurst Court
Northvale, NJ 07647 (201) 767-3800
Sales Contact: *Noel Copley, Sales Dir.*

AUDIO-TECHNICA U.S. INC.
1221 Commerce Dr.
Stow, OH 44224 (216) 686-2600
Sales Contact: *Charlie Winkler, Nat. Sls. Mgr.*

AUDIO TECHNOLOGY
1169 Tower Rd.
Schaumburg, IL 60195 (312) 885-0066
Sales Contact: *William Griffis, Sales Mgr.*

AUDIO VIDEO ENGINEERING CO.
65 Nancy Blvd.
Merrick, NY 11566 (516) 546-4239
Sales Contact: *Rolf Drucker, Owner*

AUDIOMARKETING LTD.
652 Glenbrook Rd.
Stamford, CT 06906 (800) 243-2598 (Toll Free)

AUDIONICS OF OREGON
5687 S.E. Int'l Way
Suite "F"

Continued on page 122

WHERE TO BUY IT

Milwaukee, Oregon 97222 (503) 652-1854
Sales Contact: Charles Wood, Pres.

AUDIOSEARS CORP.
2 South St.
Stamford, NY 12167 (607) 652-7305
Sales Contact: David Hartwell, Sales Mgr.

AUDITRONICS INC.
3750 Old Getwell Rd.
Memphis, TN 38118 (901) 362-1350
Sales Contact: James F. Woodworth, Sls. Mgr.

AUDISAR
P.O. Box 1561
Bellevue, WA 98009 (206) 454-2040

Sales Contact: R.E. Munger, Owner

AUDIOTRONICS
7428 Bellaire Ave.
P.O. Box 3997
North Hollywood, CA 91609 (213) 765-2645

AUDIX LTD.
Station Road
Wenden
Saffron Walden,
Essex. (0799) 40888
Sales Contact: Ray Moore, Brdcast Sls. Mgr.

AUDY INSTRUMENTS INC.
235 Lafayette St.

P.O. Box 2054
Salem, MA 01970 (617) 744-5320
Sales Contact: Alan Kennedy, Sls. Mgr.

AUERNHEIMER LABS AND CO.
4561 E. Florence Ave.
Fresno, CA USA 93725 (209) 442-1048
Sales Contact: Curly Auernheimer, Owner

AURATONE CORP.
P.O. Box 698
Coronado, CA 92118 (714) 297-2820
Sales Contact: H. E. Wilson, V.P. Sales

AURORA SYSTEMS
185 Berry Street
Suite 143
San Francisco, CA 94107 (415) 777-2288
Sales Contact: Jesse Blount, VP Mktg.

AUTOCUE PRODUCTS LTD.
Autocue House, 265 Merton Road
London SW18 5JS 01-870 0104
Sales Contact: James Lucas, Dir.

AUTOGRAM CORPORATION
631 J. Place
P.O. Box 456
Plano, TX 75074 (214) 424-8585
Sales Contact: Ernest T. Ankele, Jr., Pres.

AUTOGRAPHICS INC.
6335 Homewood Ave.
Hollywood, CA 90028 (213) 464-2244
Sales Contact: Jull Humphreys, VP Operations

AUTOMATED BUSINESS CONCEPTS,
A Div. of Cetec Corp.
7204 Clairemont Mesa Blvd.
San Diego, CA 92111 (714) 560-1647
Sales Contact: Frank W. Crane, Mktg. Mgr.

AUTOMATIC DEVICES COMPANY
2121 S. 12th St.
Allentown, PA 18103 (215) 797-6000
Sales Contact: Donald Heller, V.P.-Sales

AUTOMATION ELECTRONICS INC.
1001 South St.
Lafayette, IN 47905 (317) 423-2572
Sales Contact: Larry Zaiser, Pres.

AUTOMATION TECHNIQUES INC.
1846 North 106 East Avenue
Tulsa, OK 74116 (918) 836-2584
Sales Contact: Frank Tackett, Sales Rep.

AYDIN MICROWAVE
75 E. Trimble Rd.
San Jose, CA 95131 (408) 946-5600
Sales Contact: Bruce Jennings, VP-Mktg.

AYDIN MONITOR SYSTEMS
502 Office Center Drive
Ft. Washington, PA 19034 (215) 646-8100
Sales Contact: Don E. Mahoney, V.P., Sales

B

BASF LIMITED, AUDIO VIDEO
2 - 4 Fitzroy Street
London W1P 6AD UK 01 637 8971

BCB ELECTRONIC SALES LTD.
98 Healey Rd., Box 315
Bolton, Ontario
Canada L0P 1A0 (416) 857-0790, 0791
Sales Contact: R.H. Cook, Pres.

BEI (BESTON ELECTRONICS INC.)
P.O. Box 937 (913) 764-1900
Olathe, KS 66061 (800) 255-6226
Sales Contact: Rod Herrling, Sales Mgr.



Big monitors up here, little meters down there . . .
with the production personnel's visual preoccupation,
is it any wonder audio quality
suffers?

The ^{uni}VUer puts it all together!

Dynamic bar graph display over monitor video!

- 2-channel for stereo monitoring
- Display size and position variable
- Selectable PPM/VU ballistics
- Peak flasher
- Adjustable silence sense
- Transparent to monitor video
- **RACK MOUNT OR PORTABLE**
- Compatible with European standards
- Master control monitoring
- Editing suites
- Production control rooms
- VTR bridges
- Boss' office
- Anywhere in the program monitoring chain
- **ENG/EFP — in line with monitor video return provides camera operator with audio CONFIDENCE**

See you in Dallas NAB booth 2621

THE REAL WORLD TECHNOLOGIES GROUP, INC.

Santa Ana, CA (714) 957-1061
Technology Development Services by
Microsystems Institute



Circle (66) on Action Card

B E S ELECTRONICS LIMITED
 3212 Wharton Way
 Mississauga, Ontario
 Canada, L4X 2C1 (416) 624-5624
Sales Contact: W. R. Onn, President/GM

BG ENGINEERING
 4411 Red Maple Ct.
 Concord, CA 94521 (415) 680-1349
Sales Contact: Bob Kearns, G.M.

BGW SYSTEMS INC.
 13130 South Yukon Avenue
 Hawthorne, CA 90250 (213) 973-8090
Sales Contact: Irwin Laskey, Sales Mgr.

B & I ELECTRONICS
 Bldg. 128 Donaldson Center
 Greenville, SC 29605 (803) 277-5985
Sales Contact: Don M. Tompkins, President

BIC COMPUTERS
 Box 619
 Moberly, MO 65270 (816) 263-5800
Sales Contact: Richard Womack, Exec. VP

B & K PRECISION PRODUCT GROUP / DYNASCAN CORP.
 6460 W. Cortland Street
 Chicago, IL 60635 (312) 889-9087
Sales Contact: Myron Bond, V.P. / Mktg.

BPI (Broadcast Programming Internat'l.)
 P.O. Box 547 (800) 426-9082 (toll free)
 Bellingham, WA 98009 (206) 676-1400
Sales Contact: Bill Wolkey or Jane Kindred, Prog. Conslts.

BPI AUDIO TEST INSTRUMENTS
 7853 Balboa Ave.

San Diego, CA 92111 (714) 279-3344
Sales Contact: Ray Yankowski, Sales Mgr.

BSM SYSTEMS
 Box 8081
 Manito Stn.
 Spokane, WA 99203 (509) 448-0697
Sales Contact: Bruce Morse, Owner

THE BTX CORPORATION
 12 Huron Drive
 Natick, MA 01760 (617) 653-6811
Sales Contact: John Sullivan, Sales

WILLIAM BAL CORP.
 947 Newark Ave.
 P.O. Box 875
 Elizabeth, NJ 07207 (201) 354-9625
 TELEX: 844280
Sales Contact: Les Weinstock

BALD MOUNTAIN LAB
 230 Bellevue Rd.
 Troy, NY 12180 (518) 279-9753
Sales Contact: Bob Henry, Owner

BALLANTINE LABORATORIES
 P.O. Box 97
 90 Fanny Road
 Boonton, NJ 07005 (201) 335-0900
Sales Contact: Roger A. Stagnol, Mktg. Serv. Manager

BARCO ELECTRONIC
 TH Sevenslaan 706
 8720 Kuurne Belgium 56 21 77 24
Sales Contact: N. Lietaert, Prod. Mgr.

BARDA ELECTRONIC INC.
 5180 Queen Mary Road, Room 410

Montreal H3W 3E7
 P.Q., Canada (514) 486-1186
Sales Contact: Serge Regnault, President

BARDWELL & McALISTER INC.
 7051 Santa Monica Bl.
 Hollywood, CA 90038 (213) 466-9361
Sales Contact: Sharon Evans, Sales Mgr. Barry Seybert, Systems Sales

BARKER & WILLIAMSON INC.
 10 Canad Street
 Bristol, PA 19007 (215) 788-5581
Sales Contact: Elmer R. Bush, V.P.

BASYS INC.
 4960 Hamilton Ave.
 San Jose, CA 95130 (408) 866-8117
Sales Contact: Peter Kolstad, President

BAYLY ENGINEERING LTD
 167 Hunt Street
 Ajax, Ontario
 Canada L1S 1P6 (416) 683-8200
Sales Contact: Ed Pilchuk, Nat'l. Acct. Mgr. Comm. Productions & Systems

BEAVERONICS INC.
 8 Haven Avenue
 Port Washington, NY 11050 (516) 883-4414
Sales Contact: John Busharis, V.P.-Marketing

BELAR ELECTRONICS LABORATORY INC.
 P.O. Box 826
 Devon, PA 19333 (215) 687-5550
Sales Contact: Arno M. Meyer, Pres.

Continued on page 124

CONGRATULATIONS!!!

WE CONGRATULATE THE
 NATION'S BROADCASTERS
 ON THEIR CONTRIBUTIONS AND
 ACCOMPLISHMENTS TOWARD MAKING...

THE 1980's
 "A DECADE
 OF
 DEREGULATION!"

LAIRD TELEMEDIA INC.®
 2424 SOUTH 2570 WEST • 801 972-5900
 SALT LAKE CITY, UTAH 84119

INTRODUCING THE MODEL 7200 COMMUNICATOR

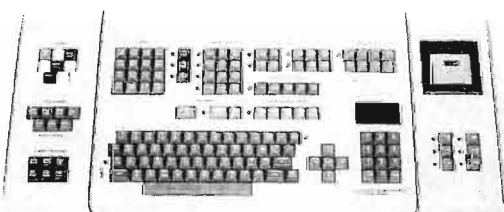

- HIGH RESOLUTION FONT (35 n sec.)
- BASIC SINGLE STROKE CONTROL
- GRAPHICS AND 3 CHARACTER SIZES
- 8 COLORS—CHARACTERS & BACKGROUND
- MIXED CHARACTER SIZES—BY LINE
- AUTO CENTERING BY PAGE OR LINE
- DISC AND/OR TAPE STORAGE
- MULTIPLE KEYBOARD CAPABILITY
- BUILT-IN VIDEO KEYS
- FULL BORDER OR DROP SHADOW

LAIRD TELEMEDIA INC.®
 2424 SOUTH 2570 WEST • 801 972-5900
 SALT LAKE CITY, UTAH 84119

WHERE TO BUY IT

BELDEN COMMUNICATIONS

534 W. 25th Street
New York, NY 10036 (212) 691-1910
Sales Contact: Paula Boxer, Sls. Mgr.

BELL AUDIO SYSTEMS INC.

994 Freeway Drive North, Bldg No. 6
Columbus, Ohio 43229 (614) 846-2766
Sales Contact: Thomas A. Curran, Pres.

BELL HELICOPTER TEXTRON

Box 482
Fort Worth, TX 76101 (817) 280-2142
Sales Contact: Robert Edholm, Mgr.,
Mktg. Development

BEYER DYNAMIC INC.

5-05 Burns Avenue
Hicksville, NY 11801 (516) 935-8000
Sales Contact: Paul Murphy, Gen. Mgr.

BEYER DYNAMIC

Theresienstrasse 8
D-7100 Heilbronn
West Germany (7131) 617.0
Sales Contact: Klaus Wischgoll, Tech. Dir.

EUGENE BEYER ELEKTROTECHNISCHE FABRIK GMBH & CO.

P.O.B. 1320
D-7100 Heilbronn (07131) 8 23 48
Sales Contact: Mr. Muller-Tolk, Mkt. & Sls. Mgr.

JAMES G. BIDDLE CO.

510 Township Line Road
Blue Bell, PA 19422 (215) 646-9200
Sales Contact: R.E. Voeks, Adv. Mgr.

BIDDLE INSTRUMENTS

510 Township Line Road
Blue Bell, PA 19422
Sales Contact: R.E. Voeks, Sls. Mgr.

BIRD ELECTRONIC CORP.

30303 Aurora Road
Cleveland (Solon), OH 44139 (216) 248-1200
Sales Contact: John R. Ittel, Brcdst. Sls. Mgr.

BI-TRONICS INC.

P.O. Box 125
Tuckahoe, NY 10707 (212) 585-1645
Sales Contact: J. Schwartz, Pres.

BLONDER-TONGUE LABS INC.

1 Jake Brown Road
Old Bridge, NJ 08857 (201) 679-4000 ext. 349
Sales Contact: Ted Zdzienicki, Tech. Writer

BOGEN DIVISION/LEAR SIEGLER INC.

Box 5000
Paramus, NJ 07652 (201) 343-5700
Sales Contact: Joseph A. Palmieri, V.P. Mktg.

BOGEN ELECTRONIC GMBH

Potsdamer Chaussee 80
D 700 Berlin 38 (030) 8004204
Sales Contact: Dr. Helmut Becker, Mgr.

BOGNER BROADCAST EQUIPMENT CORP.

401 Railroad Avenue
Westbury, NY 11590 (516) 997-7800
Sales Contact: Steven Weinstein, Mktg. Mgr.

BONNEVILLE BROADCAST CONSULTANTS

274 County Road
Tenafly, NJ 07670 (201) 567-8800
Sales Contact: Marlin Taylor, Pres.

BONNEVILLE DATA SYSTEMS

165 Social Hall Avenue
Salt Lake City, UT 84111 (801) 237-2454
Sales Contact: Nancy Coffeen, Mktg. Asst.

BONNEVILLE PRODUCTIONS

130 Social Hall Ave.
Salt Lake City, UT 84111 (801) 237-2400
Sales Contact: Mike Collett, V.P./Prod.

BONNEVILLE SATELLITE CORPORATION

130 Social Hall Ave. (801) 237-2450
Salt Lake City, UT 84111
Sales Contact: Bruce R. Hough, VP/IGM

BOONTON ELECTRONICS CORP.

P.O. Box 122
Parsippany, NJ 07005 (201) 887-5110
Sales Contact: W.F. White, Mktg. Mgr.

ROBERT BOSCH GmbH, Television Systems Division

Robert Bosch Strasse 7
6100 Dormstadt,
West Germany 06151 808-1
Sales Contact: Hans Goeller, Sales Dir.

BOSTON INSULATED WIRE & CABLE CO.

65 Bay Street
Boston, MA 02125 (617) 265-2102
Sales Contact: Richard Kruger, Mktg. Mgr.
TV Products

BRABURY ELECTRONICS LTD.

Smitham Bridge Hungerford
Berkshire, U.K. (04886) 3511
Sales Contact: Roger Daymond, Sls. Mgr.

BRAND-REX COMPANY

Electronic and Industrial Cable Div.

Your batteries can be born again.

Alexander rechargeable
nickel-cadmium batteries
can be discharged,
overcharged, and otherwise
abused and still be brought
back to life. That's why
producers and stations all
over the country are

switching to genuine
Alexander replacement
packs for ENG and EFP
equipment.

If dead batteries are driving
your crews to distractions,
get current — with
Alexander!



ALEXANDER

ALEXANDER MFG. CO.
1511 SO. GARFIELD PL.
MASON CITY IOWA 50401/515-423-8955

REPLACEMENT BATTERY PACKS AND CHARGERS FOR
PORTABLE CAMERAS, VTRS, VOICE RECORDERS, COMMUNICATIONS EQUIPMENT

Circle (68) on Action Card

P.O. Box 498
Willimantic, CT 06226 (203) 423-7771
Sales Contact: Ed Cronin

BRETFORD MFG. INC.
9715 Soreng
Schiller Park, IL (312) 678-2545
Sales Contact: Andrew Tess, Sales Mgr.

WALTER S. BREWER CO. INC.
2216 East 56th Place
Tulsa, OK 74105 (918) 749-9894
Sales Contact: Walter S. Brewer, Pres.

DON BRITTON ENTERPRISES
P.O. Drawer G
Waikiki, HI 96815 (808) 395-7458
Sales Contact: Bob Larson, Sls. Mgr.

BROADCAST AIDS INC.
20 Red Rose Drive
Levittown, PA 19056 (215) 547-7133
Sales Contact: John Bostwick, Pres.

BROADCAST AUDIO CORPORATION
11306 Sunco Drive
Rancho Cordova, CA 95670 (916) 635-1048
Sales Contact: Dale A. Tucker, Mktg. Mgr.

THE BROADCAST CENTER
325 John Knox Rd.
Suite F-160
Tallahassee, FL 32303 (904) 385-6161
Sales Contact: Bob Harris, Pres.

BROADCAST COMMUNICATION PRODUCTS
P.O. Box 204
Golden, CO 80401 (303) 424-3231
Sales Contact: Greg Pine, President

BROADCAST ELECTRONICS INC.
4100 N. 24th Street
P.O. Box 3606
Quincy, IL 62305 (217) 224-9600
Sales Contact: Joseph M. Engle,
National Sales Manager

BROADCAST EQUIPMENT
396 Attwell Drive
Rexdale, Ontario, Canada (416) 675-7500
M9W 5C3 Telex: 06-989302

BROADCAST SERVICES INC.
2877 Kalakaua Ave.
Honolulu, HI 96815 (808) 521-6311/537-4452
Sales Contact: Ernest Nearman, Sls. Eng.

BROADCAST SYSTEMS
8222 Jamestown Drive (800) 531-5232
Austin, TX 78758 in TX. (800) 252-9792
Sales Contact: Don Forbes

BROADCAST TECHNOLOGY INC.
33 Comac Loop
Ronkonkoma, NY 11779 (516) 588-6565
Sales Contact: Don Richter, Mktg. Mgr.

BROADCAST VIDEO SYSTEMS LTD.
1050 McNicoll Ave.
Unit 15
Agincourt, Ontario M1W 2L8 (416) 497-1020
Sales Contact: Bert Verwey, Gen. Mgr.

BRUEL & KJAER INSTRUMENTS
185 Forest St.
Marlboro, MA 01752 (617) 481-7000
Sales Contact: Simon Jepsen, Reg. Mgr.

BRUMAC INDUSTRIES
5261 Business Dr.
Huntington Beach, CA 92649 (714) 891-2505
Sales Contact: Carl Bode, V.P. Marketing

**BRUSH MAGNETIC HEADS DIV.,
FORGFLO CORP.**
3rd & Reagan St.
P.O. Box 638
Sunbury, PA 17801 (717) 286-5611
Sales Contact: Robert I. Trachtenberg, VP

BRYSTON MANUFACTURING LTD.
57 A Westmore Drive
Rexdale Ontario
Canada M9V3Y6
Sales Contacts:
Brian Russell (CAN) (416) 746-1800
John Russell (US) (802) 223-6159

BUD INDUSTRIES INC.
4605 E. 355th St.
Willoughby, OH 44094 (216) 946-3200
Sales Contact: Blair Haas, Sales Mgr.

BUHL OPTICAL
1009 Beech Avenue
Pittsburgh, PA 15233 (412) 321-0076
Sales Contact: Irv Stapsy, Pres.

BURDEN ASSOCIATES
20944 Sherman Way
Canoga Park, CA 91303 (213) 340-4590
Sales Contact: Richard Burden, Mgr.

THE WILL BURT CO.
169 S. Main St.

Continued on page 126

For maintenance technicians, no practice is perfect!

Too much routine studio maintenance is enough to turn off any good technician. They'd prefer to spend their time on more pressing problems, rather than just practicing their skills on routine chores. And that's what makes the AVL Digital Routing Switcher perfect for busy maintenance departments. It's routine-maintenance free. No practice is necessary!

With AVL Digital, constant fine-tuning and regular adjustments are chores of the past. That can save time and money for the department. The system is reliable and simple... just install it and turn it on for dependable control switching performance.

AVS 100 switchers are available from stock in standard configurations such as 10 x 10 and 20 x 20, or virtually any size, made to order. There's a full range of 'audio

follow video', 'video only' and 'audio only' systems available.

Building an AVL system to meet specific needs is as simple as it is to maintain!

Give your technicians a break from the regular maintenance practice. The AVL Digital Routing Switcher is a perfect start.

For more details on AVS 100 Switchers, options, sizes and other quality AVL Digital products, please contact...



AVL DIGITAL LTD.
70 Milner Avenue, Unit 5
Scarborough, Ontario Canada M1S 3P8
Telephone: (416) 298-6220
Tlx: 06-963533 Twx: 610-4923219



Circle (69) on Action Card

PHONO PRE

Our Model 405 Professional Phono Preamplifier offers high performance in a unique package: +27 dBm balanced output at .003% THD, -72 dB SNR, and 70 dB channel separation. Compact, self-contained, the 405 may be used free standing or in single or tandem rack mount. Let us tell you more about our distinguished high definition Phono Preamplifier. Call or write RTS Systems for details.

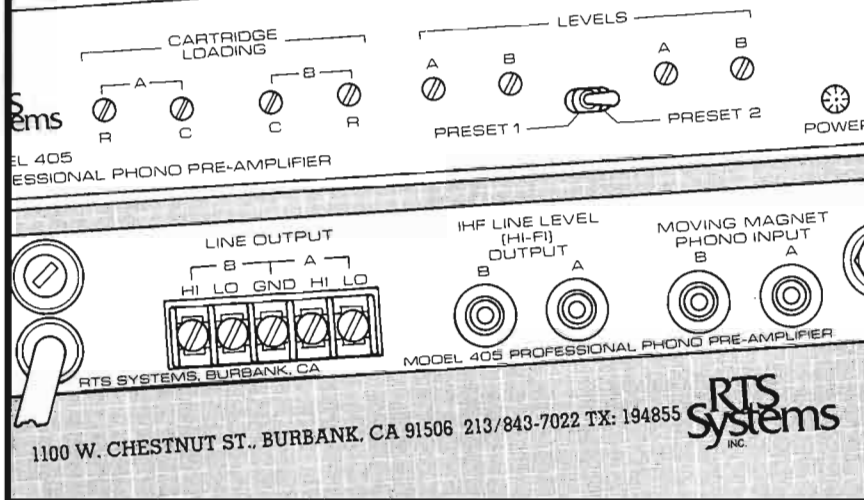

1100 W. CHESTNUT ST., BURBANK, CA 91506 213/843-7022 TX: 194855

RTS Systems
INC.

Circle (70) on Action Card

WHERE TO BUY IT

Orville, OH 44667 (216) 682-7013
Sales Contact: H. Featherstone, VP

THE WILL BURT CO., TMD DIVISION
249 W. Henry St.
Wooster, OH 44691 (216) 262-7010
Sales Contact: William R. Trimmer, Plant Mgr.

C

CAE INC.
P.O. Box 430
10087 Industrial Dr.
Hamburg, MI 48139 (313) 231-9373
Sales Contact: John Malek, Mktg. Mgr.

CAT SYSTEMS
Box 440
Rye Beach, NH 03871 (212) 988-0658
Sales Contact: Joe Soll

C-COR ELECTRONICS INC.
60 Delibel Road
State College, PA 16801 (814) 238-2461
Sales Contact: Gerry Groff, Inside Sales

CCS CABLE
Plant 5707
5707 W. Buckeye Rd.
Phoenix, AZ 85043 (602) 272-6855
Mail: P.O. Box 14710
Phoenix, AZ 85063
Sales Contact: Bill Terrill, Mgr. Sls. Serv.

CEI (COMMERCIAL ELECTRONICS INC.)
880 Maude Ave.
Mt. View, CA 94043-4089 (415) 969-1910
Sales Contact: Len Adler, Dir. of Mktg.

Regional Sales Offices:

CEI
137 E. 25th Street
Floor 9
New York, NY 10010 (212) 685-4390
Contact: Harvey Ray, Eastern Sls. Mgr.

CEI
4357 N. Lowell Avenue
Chicago, IL 60641 (312) 725-8181
Contact: Jim Comella, Midwest Sls. Mgr.

CEI
880 Maude Avenue
Mountain View, CA 94043 (415) 969-1910
(714) 540-2317
Contact: Jim Irvine, Int'l Mktg. Mgr.

CMC TECHNOLOGY CORPORATION
733 N. Pastoria Ave.
Sunnyvale, CA 94086 (408) 245-3342
Sales Contact: William E. Fitts, Dir. of Mkt.

CMX SYSTEMS/ORROX CORPORATION
3303 Scott Blvd.
Santa Clara, CA 94086 (408) 988-2000
Sales Contact: Allan J. Behr, VP/IGM

Regional Offices:

CMX SYSTEMS/ORROX CORP.
3303 Scott Blvd.
Santa Clara, CA 95050 (408) 988-2000
Contact: Darrell Vincent, W. Reg. Field Sls. Mgr.

CMX SYSTEMS/ORROX CORP.
1301 W. 22nd St., Suite 501
Oakbrook, IL 60521 (312) 325-8488
Contact: Doug Hutton, Cent. Reg. Field Sls. Mgr.

CMX SYSTEMS/ORROX CORP.
Contact: Murray Bevilz, E. Reg. Field Sls. Mgr.

THE CnB STUDIOS
3415 Beresford Avenue
Belmont, CA 94002 (415) 592-6149
Sales Contact: Carole Thompson, Sales/Mgr.

CSI ELECTRONICS INC.
18248 East Rogers Circle
Boca Raton, FL 33431 (305) 737-5626
Sales Contact: Bernard Gelman, President

CSP INC.
203 Airport Rd.

Get the most from your AM signal...

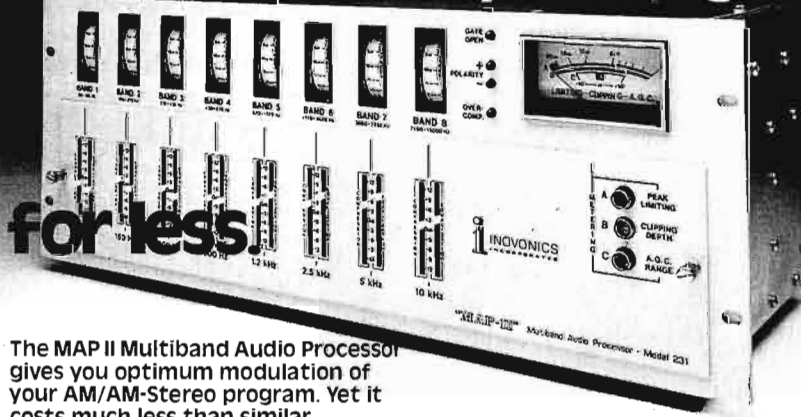

The MAP II Multiband Audio Processor gives you optimum modulation of your AM/AM-Stereo program. Yet it costs much less than similar systems.

Discriminate Compression
Only MAP II offers you independent compression and equalization for each of eight bands. Input level is held constant by a slow, gain-riding A.G.C.

Inaudible Phase Optimization
Program phase is silently "rotated" for maximum positive modulation.

Absolute Peak Control
A unique integrated peak controller combines a hard clipper with a low-distortion peak limiter.

Convenient Operation
Features include selectable low- and high-pass filters, "proof" mode, and built-in pink-noise generator.

Call or write today for more information.

Inovonics Inc.

503-B Vandell Way
Campbell, CA 95008

Telephone
(408) 374-8300



Circle (71) on Action Card

Doylestown, PA 18901 (800) 523-6010
Sales Contact: David C. Gorman, President

CABLEWAVE SYSTEMS INC.
60 Dodge Ave.
North Haven, CT 06473 (203) 239-3311
Sales Contact: William Meola,
Broadcast Sales Mgr.

CALDATACOM
293 Quinhill Ave.
Los Altos, CA 94022 (415) 941-2259
Sales Contact: D.J. Edwonds, V.P. Mktg.

CALICO VIDEO
8955 Thwin Rd.
Stockton, CA 95209 (209) 952-3333

CALIFORNIA INSTRUMENTS,
Division of Amstar Tech. Products Co., Inc.
5150 Convoy Street Telex: 695047
San Diego, CA 92111 (714) 279-8620
Sales Contact: L.E. Thompson, V.P. Mktg.

CALIFORNIA MICROWAVE INC.
990 Almanor Ave.
Sunnyvale, CA 94086 (408) 732-4000
Sales Contact: Mike Tooley, Mktg. Mgr.

CALVERT ELECTRONICS INC.
One Branca Road (201) 460-8800
East Rutherford, NJ 07073 (800) 526-6362
Sales Contact: Larry Broome, Sales Mgr.

Regional Sales Offices:
CALVERT ELECTRONICS INC.
1355 Redondo Ave., Suite 6
Long Beach, CA 90804 (213) 498-3504
Contact: Jane Stack, West Coast Sls. Mgr.
CALVERT ELECTRONICS, INC.
Imperial House - Victoria Rd.
Chelmsford, Essex
England Cm1ny 0245 358585
Contact: Peter Butcher, Europena Ophs.

CALZONE CASE COMPANY
P.O. Box 862
17 Butler St.
South Norwalk, CT 06856 (203) 853-7907
Sales Contact: Michael Macari, Jr.,
Dir. of Mktg./Sales

CAMBRIDGE PRODUCTS CORP.
244 Woodland Ave. (800) 243-8814
Bloomfield, CT 06002 (203) 243-1761
Sales Contact: Joyce Johnson, Sales Admin.

CANDEX PACIFIC
693 Veterans Blvd.
Redwood City, CA 94063 (415) 364-8427
Sales Contact: Sherman Duck, V.P.

CANON USA INC.
1 Canon Plaza
Lake Success, NY 11042 (516) 488-6700
Sales Contact: John J. Keyes, Vice Pres.

CANTER-REDMAN TECHNOLOGIES CORP.
321 West 44th Street
New York, NY 10036 (212) 245-5505
Sales Contact: Quentin Nelson, VP, Mktg.

CAPITOL MAGNETIC PRODUCTS
6902 Sunset Blvd.
Hollywood, CA 90028 (213) 461-2701
Sales Contact: Larry Hockemeyer,
Bud Jackson, VP/Int'l Sls.

CART-ALIGN RESEARCH
316 E. El Camino Dr.
Phoenix, AZ (602) 995-1666
Sales Contact: Janene Spencer, Sales Mgr.

J.I. CASE, LIGHT EQUIPMENT DIV.
P.O. Box 9228
Wichita, KS 67277 (316) 945-0111
Sales Contact: Steve Barber, Mktg. Serv. Mgr.

CASES INC.
1745 W. 134th St.
Gardena, CA 90249 (213) 770-4444
Sales Contact: Wayne Nall, VP Mktg.

JIM CASON ELECTRONICS.
5213A Trentwood Drive
P.O. Box 1254
New Bern, NC 28560 (919) 638-5956
Sales Contact: Jim Cason, Owner

CATEL-DIVISION OF UNITED SCIENTIFIC CORPORATION
4800 Patrick Henry Dr.
Santa Clara, CA 95054 (408) 988-7722
Sales Contact: Frank A. Genochio, Pres.

CECO COMMUNICATIONS INC.
2115 Ave. X (800) 221-0860
Brooklyn, NY 11239 (212) 646-6300
Sales Contact: Tony Ianna, Brd. Mgr.

CENTER CITY VIDEO INC.
1503-05 Walnut Street
Philadelphia, PA 19102 (215) 568-6010
Sales Contact: Jordan Schwartz, Chairman

CENTRAL DYNAMICS CORPORATION
(Central Dynamics, Philips, American Data)
900 Corporate Drive
Mahwah, NJ 07430 (201) 529-1550
Sales Contact: John L. Barker, President

Regional Sales Offices:
CENTRAL DYNAMICS CORPORATION
331 West Northwest Hwy.
Palatine, IL 60067 (312) 991-4720
Contact: Jim Gardner, Reg. Mgr.
CENTRAL DYNAMICS CORPORATION
3760 Cahuenga Blvd. West
No. Hollywood, CA 91604 (213) 766-8184
Contact: M. Hart/D. Cadora, Reg. Mgrs.
CENTRAL DYNAMICS CORPORATION
570 Taxter Road, Suite 570
Elmsford, NY 10523 (914) 592-5440
Contact: Dick DeBeradinis, Reg. Sls. Mgr.
CENTRAL DYNAMICS
801 Howard Grove Road
Davidson, MD 21035 (301) 956-3065
Contact: Bob Mahoney, Reg. Manager
CENTRAL DYNAMICS
(American Data headquarters)
401 Wynn Drive
Huntsville, AL 35805 (205) 837-5180
Contact: Bob Munzner, Reg. Manager
CENTRAL DYNAMICS
P.O. Box 27324
Indianapolis, IN 46227 (317) 784-3000
Contact: Jim Gardner, Reg. Manager
CENTRAL DYNAMICS
Rt. 2, 801 E. Woodglen
Lewisville, TX 75067 (817) 455-2214
Contact: Mike Mackin, Reg. Manager

CENTRAL DYNAMICS LTD.
147 Hymus Blvd.
Pointe Claire, Quebec
Canada H9R 1G1 (514) 697-0810

CENTRO CORPORATION
9516 Chesapeake Drive
San Diego, CA 92123 (714) 560-1578
Sales Contact: Jon Munderloh, President

CENTURY 21 PROGRAMMING
4340 Beltwood Parkway (800) 527-5959
Dallas, TX 75234 or (214) 934-2121
Sales Contact: Tom McIntyre, President

CENTURY PRECISION CINE/OPTICS
10661 Burbank Blvd.
No. Hollywood, CA 91601 (213) 766-3715
Sales Contact: Ken Skuban, Mktg. Admin.

CETEC ANTENNAS
6939 Power Inn Road
Bow 2842 5
Sacramento, CA 95828 (916) 383-1177

Continued on page 128

Video Switcher



SERIES 1500 6 x 1 Passive Video Switcher provides a simple and economical means of manually switching one of six sources to one output.

Auxiliary switching contacts are included for user wiring of additional switching functions such as audio and control circuits.

- ★ Reliable operation
- ★ Auxiliary switch contacts for audio or control circuits
- ★ Lighted push button option
- ★ Legendable buttons

DYNAIR

5275 Market St., San Diego, CA 92114
Phone 714/263-7711
TWX 910/335-2040

Circle (72) on Action Card

Distribution Amplifier



SERIES 1500 1 in, 4 out Video Distribution Amplifiers provide high quality performance in color and high resolution monochrome systems.

Precision hybrid video operational amplifiers provide ± 0.5 dB frequency response to 10 MHz, +1, -2 dB at 30 MHz, and 0.25%/0.25 $^\circ$ differential phase/gain.

- ★ High thermal stability
- ★ Front panel adjustment and test points
- ★ Self-contained with internal power supply

DYNAIR

5275 Market St., San Diego, CA 92114
Phone 714/263-7711
TWX 910/335-2040

Circle (73) on Action Card

TX6 AUDIO DA

Our Model 416 is a super high-performance 1 by 6 audio distribution amplifier with balanced differential input and six transformer coupled outputs—each driven by a separate amplifier with independent level control. Super specifications and a rack-mountable compact package make this amplifier perfect for any distribution need. For more about this versatile amplifier, call or write RTS.

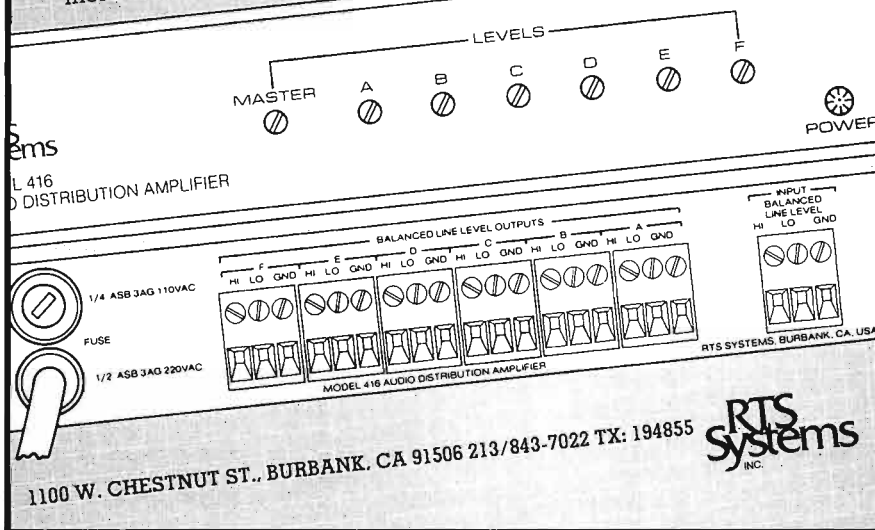

1100 W. CHESTNUT ST., BURBANK, CA 91506 213/843-7022 TX: 194855

Circle (74) on Action Card



Revox PR99. Not just another pretty faceplate.

Before you buy a compact audio recorder, be sure to compare what you're getting on the inside. Look at the chassis, the headblock, the motors, the switches, the PC boards, and the wiring. When you do, you'll notice a difference between the PR99 and everything else in its price range. The PR99 looks better because it must adhere to stricter standards of quality. Standards that have made Studer Revox the world's most respected name in audio recording.

PR99 features: • Balanced and floating line in and line out • Calibrate/uncalibrate switches • Servo controlled capstan motor • Edit mode switch • Tape dump • Self sync • Optional remote control and vari-speed • Cabinet, console, and rack mount versions.

STUDER REVOX
AMERICA, INC.

STUDER REVOX OF AMERICA, INC. • 1425 Elm Hill Pike • Nashville, TN 37210 • (615) 254-5651

Circle (75) on Action Card

WHERE TO BUY IT

Sales Contact: Bill Cunningham, Product Mgr.

CETEC BROADCAST GROUP

1110 Mark Avenue
Carpinteria, CA 93013 (800) 235-5715
Sales Contact: Jerry R. Clements,
National Sales Mgr.
Tony Mezey, Prod. MGR.

CETEC GAUSS

9130 Glenoaks Blvd. (213) 875-1900
Sun Valley, CA 91352 Telex: 194989
Sales Contact: Jim Williams, Sales Mgr.

CETEC VEGA

P.O. Box 5348
El Monte, CA 91731 (213) 442-0782
Sales Contact: Ken Bourne, Dir. of Mktg.

CEZAR INTERNATIONAL LTD.

1026 W. Maude Ave., Suite 302
Sunnyvale, CA 94086 (408) 733-1436
Sales Contact: Al Paz, Mktg. Dir.

CHANNELMATIC INC.

821 Tavern Road
Alpine, CA 92001 (714) 445-2691
Sales Contact: Bill Killion, Pres.

CHASE MEDIA INC.

5284 South 320 West, Suite C - 166
Salt Lake City, Utah 84107 (801) 261-1383
Sales Contact: Steve Vaughn, Sales Mgr.

CHEMTRONICS INC.

681 Old Willets Path
Hauppauge, NY 11788 (516) 582-3322
Sales Contact: Scott Friedman, Sales Mgr.

CHERRY ELECTRICAL PRODUCTS CORP.

3600 Sunset Ave.
Waukegan, IL 60085 (312) 689-7600
Sales Contact: Frank Amendola, Dir. Mkt. Dev.

CHERRY SEMICONDUCTOR CORP.

2000 South County Trail
East Greenwich, RI 02818 (401) 884-3000
Sales Contact: Richard A. Hogberg, Reg. S. Mgr.

CHRISTIE ELECTRIC CORPORATION

20665 Manhattan Place (800) 421-2955
Torrance, CA 90501 (213) 320-0808
Sales Contact: Diane Church, Sls. Coord.

CHRONO-LOG CORPORATION

2 West Park Road
Havertown, PA 19083 (215) 853-1130
Sales Contact: David Biberman, Mktg. Mgr.

CHYRON CORPORATION

265 Spagnoli Rd.
Melville, NY 11747 (516) 249-3296
Sales Contact: David Buckler, Dir. Sales

CINE 60 INC.

630 9th Ave.
New York, NY 10036 (212) 586-8782
Sales Contact: Don F. Civitillo, Mktg. Mgr.

Regional Sales Offices:

CINE 60 INC.
6430 Sunset Blvd.
Hollywood, CA 90028 (213) 461-3046
Sales Contact: Evan Green, Mgr.

CINEMA PRODUCTS CORPORATION

2037 Granville Ave. (213) 478-0711
Los Angeles, CA 90025 or 477-1972
Sales Contact: Ed Clare, Nat'l. Sls. Mgr.

CINEMILLS CORP.

3500 W. Magnolia Ave.
Burbank, CA 91505 (213) 841-5930

CINETRON COMPUTER SYSTEMS

6700 I-85 North
Norcross, GA 30093 (404) 448-9463

Sales Contact: Gene Nottingham, VP

CINETRONICS
8610 Oakdale Ave.
Canoga Park, CA 91306 (213) 709-4694
Sales Contact: Dieter Steinmaier, Owner

CIRCUIT RESEARCH LABS INC.
3204 S. Fair Ln.
Tempe, AZ 85282 (602) 894-0077
Sales Contact: Jack Stuart, Mktg. Mgr.

CLEAR-COM INTERCOM SYSTEMS
1111 17th St.
San Francisco, CA 94107 (415) 861-6666
Sales Contact: Edward M. Fitzgerald, Sales Dir.

DAVID CLARK COMPANY
360 Franklin St.
Worcester, MA 01604 (617) 756-6216
Sales Contact: George R. Conlon, Prod. Mgr.

CLETRONICS INC.
1684 Medina Rd.
Medina, OH 44256 (216) 239-1351
Sales Contact: James Riffe, Pres.

COASTCOM
2312 Stanwell Drive
Concord, CA 94520 (415) 825-7500
Sales Contact: Jim Fisher, Dir. Mktg.

COAXIAL DYNAMICS INC.
13110 Enterprise Ave.
Cleveland, OH 44135 (216) 267-2233
Sales Contact: R.J. Scott, VP, Mktg.

COHERENT COMMUNICATIONS INC.
13756 Glenoaks Bl.
Sylmar, CA 91342 (213) 362-2566
Sales Contact: Ivan Kruglak, Pres.

COHU INC., ELECTRONICS DIVISION
5725 Kearny Villa Road
San Diego, CA 92123 (714) 277-6700
Sales Contact: Julian J. Pec, App. Sls. Eng.

COLORTRAN INC.
1015 Chestnut St.
Burbank, CA 91506 (213) 843-1200
Sales Contact: C. Cambuzzi, Market Mgr.

COLORADO MAGNETICS
P.O. Box 713
Colorado Springs, CO 80901 (303) 596-0684
Sales Contact: Larry Wilson, Owner

COLORADO VIDEO
Box 928
Boulder, CO 80306 (303) 444-3972
Sales Contact: Jim Dole, Sls. Mgr.

COLUMBIA SPECIAL PRODUCTS
51 West 52 Street
New York, NY 10019 (212) 975-5073
Sales Contact: John M. Franks, Gen. Mgr.

COLUMBINE SYSTEMS INC.
P.O. Box 740
Golden, CO 80401 (303) 279-4000
Sales Contact: Barbara Krichbaum, Mktg. Rep.
Martha Freeman, Mktg. Rep.

COMAD COMMUNICATIONS LTD.
91 Kelfield St., Unit 5
Rexdale, Ontario M9W 5A3 (416) 245-1734
Sales Contact: Emil Adamyk, President
Regional Sales Office:
COMAD INC.
P.O. Box 10667
Pensacola, FL 32504 (904) 434-9782

COMARK COMMUNICATIONS INC.
P.O. Box 267
Southwick, MA 01077 (413) 569-5939
Sales Contact: Dick Fiore, Salesman

COMEX SYSTEMS
Executive Drive
Hudson, NH 03051 (603) 889-8564
Sales Contact: T.H. Sullivan, Gen. Mgr.

COMMAND PRODUCTIONS
P.O. Box 26348
San Francisco, CA 94126 (415) 332-3161
Sales Contact: Warren Weagant, Pres.

COMMERCE AIRBORNE CORPORATION
16425 Hart Street
Suite 104 (213) 785-5409 or 785-5400
Sales Contact: Tom J. Storli, President

COMMUNICATIONS CO. INC.
3490 Noell St
San Diego, CA 92110 (714) 297-3262
Sales Contact: Victor M. Hall, Sls. Mgr.

COMMUNICATIONS CONTROL CENTERS
1710 Stierlin Road
Mountain View, CA 94043 (415) 964-5250
Sales Contact: Eric Campbell, Dir., Sls & Mktg.

COMPAC DEVELOPMENT CORP.
279 Skidmore Rd.
Deer Park, NY 11729 (516) 667-3933
Sales Contact: K. Wicks, Asst. Sales Mgr.

COMPACT VIDEO SALES
1104 W. Chestnut
Burbank, CA 91506 (213) 843-3232
Sales Contact: Oscar Wilson, Pres.

COMPACT VIDEO SERVICES
2813 W. Alameda Avenue
Burbank, CA 91505 (213) 843-3232
Sales Contact: John W. Gardner
John Brandon

COMPOSITE VIDEO
1218 N. Blackwelder
Okalhoma City, OK (405) 236-4449
Sales Contact: Mike Janko, Pres.

COMPREHENSIVE VIDEO SUPPLY
565 Kingston Road
London SW20 8SA 01-542 1171
Sales Contact: C. Rhodes, Mktg. Mgr.

COMPRO PRODUCTIONS
2080 Peachtree Industrial Court
Suite 114
Atlanta, GA 30341 (404) 455-1943
Sales Contact: Susan Bodiford,
Sls. & Mktg. Rep.

COMPUCON INC.
P.O. Box 401229
Dallas, TX 75240
13749 Neutron Road
Dallas, TX 75234 (214) 233-4380
Sales Contact: Becky Shipman, Sls. Rep.

COMPUTER BUSINESS SYSTEMS INC.
167 Moore Rd.
Weymouth Industrial Park
Weymouth, MA 02189 (617) 337-7799
Sales Contact: Richard White, Dir.

COMPUTER CONCEPTS CORPORATION
8001 W. 63rd
Overland Park, KS 66202 (800) 255-6350
Sales Contact: Greg Dean, President

COMPUTER GRAPHICS LAB
Wheatley Road
Old Westbury, NY 11568

COMPUTER IMAGE CORP.
2475 West 2nd Avenue
Denver, CO 80223 (303) 934-5801
Sales Contact: Pete Freyschlag

Continued on page 130

Balanced Equalizer



SERIES 1500 Balanced Equalizing Amplifiers provide high quality video transmission through 124 ohm cable runs.

High performance 24 dB post-equalization for cable runs to 3,000 ft. — 7,500 ft. when used with pre-equalizer.

- ★ Front panel adjustments and test points
- ★ Two outputs
- ★ High thermal stability
- ★ Self-contained with internal power supply

DYNAIR

5275 Market St., San Diego, CA 92114
Phone 714/263-7711
TWX 910/335-2040

Circle (76) on Action Card

Unbalanced Equalizer



SERIES 1500 Unbalanced Equalizing Amplifiers provide high quality video transmission through 75 ohm cable.

High performance 24 dB post-equalization for cable runs to 3,000 feet.

- ★ Differential/grounded inputs
- ★ Front panel adjustments and test points
- ★ Two outputs
- ★ High thermal stability
- ★ Self-contained with internal power supply

DYNAIR

5275 Market St., San Diego, CA 92114
Phone 714/263-7711
TWX 910/335-2040

Circle (77) on Action Card

Racal-Decca Canada Inc.

INSULATORS DIVISION

- **GUY STRAIN INSULATORS**
- **BASE INSULATORS***
- **ISOLATION TRANSFORMERS**
- **TRANSFORMER ENCLOSURES,
STATIC DRAIN RESISTORS,
CUSTOM DESIGNED
INSULATORS**

* Base Insulators can be adapted for direct mounting of Isolation Transformers

RACAL
The Electronics Group

71 Selby Road, Brampton, Ontario L6W 1K5, Canada
Telephone (416) 457-8720 Telex: 06-97699 Cables: Decradar Toronto

Circle (78) on Action Card

NEW FM AND TV FIELD STRENGTH METER FIM-71

- Accurate — Direct Reading — Volts or dB ■ 45 MHz to 225 MHz — Continuous Tuning ■ Peak or Averaging Detector (switch selectable) ■ Wide or Narrow IF Bandwidth (switch selectable) ■ 20 dB or 60 dB Meter Range (switch selectable) ■ AM or FM Demodulator (switch selectable) ■ Calibrated Dipole Antenna, Mounted on Case for Near-Ground Measurements or Removable for TASO Measurements ■ 140 dB Measurement Range (1 μ V to 10 V) ■ 4½-Inch, Mirrored Scale, Taut-Band Meter
- Front Panel Speaker
- Recorder Output
- Rugged, Portable Package ■ Calibrated Signal Generator, 45 MHz to 225 MHz
- Battery or External Power ■ Use as Signal Source/Selective Voltmeter for Insertion Loss Measurements of Filters, etc. ■ Measures FM Harmonics to -80 dB



CONTACT US FOR DETAILS.

POTOMAC INSTRUMENTS

932 PHILADELPHIA AVE.
SILVER SPRING, MD. 20910
(301) 589-2662

Circle (79) on Action Card

WHERE TO BUY IT

COMPUTER LABS, Div. of Analog Devices
505 Edwardia Drive
Greensboro, NC 27409 (919) 292-6427
Sales Contact: Ed Graves, Prod. Mkt. Mgr.

COMPUTER MANAGEMENT SYSTEMS INC.
6610 North Shadeland Ave.
Indianapolis, IN 46220 (317) 842-1830
Sales Contact: Myron Keeney, VP

COMPUTER VIDEO SYSTEMS INC.
3678 West 2150 South Unit No. 2
Salt Lake City, UT 84120 (801) 974-5380
(800) 453-8822
Sales Contact: Randy Wegner, Dir. of Mktg.

COMREX CORPORATION
60 Union Avenue
P.O. Box 269
Sudbury, MA 01776 (617) 443-8811
Sales Contact: Lynn Distler, Sls. Mgr.

COMSEARCH INC.
11503 Sunrise Valley Drive
Reston, VA 22091 (703) 620-6300
Sales Contact: Jerry Schulman, VP

COMSONICS INC.
P.O. Box 1106
Harrisonburg, VA 22801 (703) 434-5965
Sales Contact: Carl Hensley, Gen. Sls. Mgr.

COMTECH ANTENNA CORP.
3100 Communications Rd.
St. Clour, FL 32769-4692 (305) 892-6111
Sales Contact: Glenn Higgins, VP

COMTECH DATA CORPORATION
350 N. Hayden Road
Scottsdale, AZ 85257 (602) 949-1155
Sales Contact: R. L. Miller, Eng. Mgr.-Video

CONCEPT PRODUCTIONS
801 D Riverside Avenue
Roseville, CA 95678 (916) 782-7754
Sales Contact: Dick Wagner, President

CONEX ELECTRO SYSTEMS INC.
P.O. Box 1342
1602 Carolina St.
Bellingham, WA 98227 (206) 734-4323
Sales Contact: Bill Hamelin

CONIFER CORPORATION
P.O. Box 1025
1000 N. Roosevelt
Burlington, IA 52601 (319) 752-3607
Sales Contact: Jim Clark, Sales Mgr.

CONNECT-AIR INTERNATIONAL INC.
50 37th St. Northeast (206) 939-4880
Auburn, WA 98002 or (206) 772-5033 (Seattle)
Sales Contact: Sales Office

**CONRAC CORPORATION,
CONRAC DIVISION**
600 No. Rimsdale Ave.
Covina, CA 91722 (213) 966-3511
Sales Contact: John McClimont, Dir. of Mktg.

CONSOLIDATED ELECTRONIC INDUSTRIES INC
15A Anderson Rd., Thornburg
Vic, 3051 Australia (03) 440791
Sales Contact: P. Robinson, Mktg. Mgr.

CONTEL MANUFACTURING
1620 W. 32nd Place
Hialeah, FL 33012 (305) 822-1421
Sales Contact: Frank Mestre

CONTINENTAL ELECTRONICS MFG. CO.
P.O. Box 270879
Dallas, TX 75227 (214) 381-7161
Sales Contact: Vernon Collins, VP Dom. Mktg.

Regional Sales Offices:

CONTINENTAL ELECTRONICS MFG. CO.
107 Breakfast Hill Rd.
Greenland, NH 03840 (603) 436-4059
Contact: Mark Hutchins, Dist. Sales Mgr.
CONTINENTAL ELECTRONICS MFG. CO.
P.O. Box 16
Newton, NJ 07860 (201) 383-8797
Contact: Kelth A. Leach, Dist. Sales Mgr.
CONTINENTAL ELECTRONICS MFG. CO.
P.O. Box 143
Alcoa, TN 37701 (615) 970-2572
Contact: Ray C. Evans, Dist. Sales Mgr.
CONTINENTAL ELECTRONICS MFG. CO.
2280 Rockcreek Trail
Birmingham, AL 35226 (205) 822-1078
Contact: Dave Hultsman, Dist. Sales Mgr.
CONTINENTAL ELECTRONICS MFG. CO.
P.O. Box 575
Streator, IL 61364 (815) 672-8585
Contact: John Abdour, Dist. Sales Mgr.
CONTINENTAL ELECTRONICS MFG. CO.
670 N. Branch Rd.
Maple Plain, MN 55359 (612) 479-2633
Contact: Jim Littlejohn, Dist. Sales Mgr.
CONTINENTAL ELECTRONICS MFG. CO.
Route 3, Box 106
Holts Summit, MO 65043 (314) 896-5791
Contact: Lloyd W. Collins, Dist. Sales Mgr.
CONTINENTAL ELECTRONICS MFG. CO.
P.O. Box 2008
Plano, TX 75074 (214) 423-3644
Contact: Steve H. Schott, Dist. Sales Mgr.
CONTINENTAL ELECTRONICS MFG. CO.
215 SE 73rd Ave.
Portland, OR 97215 (503) 254-2818
Contact: Tom Cauthers, Dist. Sales Mgr.
CONTINENTAL ELECTRONICS MFG. CO.
P.O. Box 158
Ventura, CA 93002 (805) 653-6747
Contact: Steve Keating, Dist. Sales Mgr.

CONTINENTAL RECORDING INC.

210 South Street
Boston, MA 02111 (617) 426-3131
Sales Contact: Dan Flynn, Pres.

CONTROL VIDEO CORP.

578 Division St.
Campbell, CA 95008 (408) 866-7447
Sales Contact: Michael Goddard, Mktg. Mgr.

CONVERGENCE CORPORATION

1641 McGaw
Irvine, CA 92714 (714) 549-3146
Sales Contact: Richard Moscarello,
Dir. of Domestic Sales
Donald Lefebvre,
Dir. of Int'l Mktg.

COOL LIGHT CO., INC.

5723 Auckland Ave.
No. Hollywood, CA 91601 (213) 761-6116
Sales Contact: Florence Tucker, Adm. Coord.

THE COOPER GROUP

P.O. Box 30100
Raleigh, NC 27622 (919) 781-7200
Sales Contact: E.R. Lawrence, Gen. Sls. Mgr.

COPPERWELD BIMETALLICS GROUP

Robinson Plaza Two
Pittsburgh, PA 15205 (412) 777-3000

CORPORATE COMM. CONSULTANTS INC.

4250 Veterans Memorial Highway
Holbrook, NY 11741 (516) 737-0903
Sales Contact: Mr. Armand B. Sarabia, Pres.

CORTLAND CABLE COMPANY

P.O. Box 352
171 Post Watson ST.
Cortland, NY 13045 (607) 753-8276
Sales Contact: John Dower, Sls. Mgr.

COSMIN ELECTRONICS

4214 San Pedro
San Antonio, TX 78212 (512) 736-6116
(215) 847-2044
Sales Contact: Jim Lucy, VP Sales

COX DATA SERVICES

5600 Roswell Road, N.E.
Suite 100 Prado North
Atlanta, GA 30342 (404) 256-5200
Sales Contact: Lou Kaib, Manager

MICHAEL COX ELECTRONICS LTD.

Hanworth Trading Estate
Hampton Road West
FELTHAM MIDDX 01-898 609 112/3/4
Sales Contact: Susan Bell, Sales Mgr.

CREATIVE ELECTRONICS

1417 N. Selfridge
Clawson, MI 48017 (313) 435-8916
Sales Contact: Carl W. Vette, Pres.

CREATIVE TRADE, CTAB AB

Knutsgatan 6
S-265 00 ASTORP Sweden 46 42/515 21-597 56
Sales Contact: Mrs. Sarah Rosander,
Marketing Manager

CROSSPOINT LATCH

95 Progress Street
Union, NJ 07083 (201) 688-1510
Sales Contact: H. George Pires, Pres.
Michael Molinaro,
Eastern Reg. Sls. Mgr.

Regional Sales Offices:

CROSSPOINT LATCH CORP.
209 Bass Rd.
Chattanooga, TN 37421 (615) 894-3247
Contact: George Cudabac, S. Reg. Sls. Mgr.

CROSSPOINT VIDEO LIMITED

64 Shorting Court
Shorting Rd.
Scarborough, Ontario
Canada (416) 298-6199
Sales Contact: Arthur W. Critchley, Pres.

CROW OF READING LTD.

P.O. Box 36
Reading RG1 2NB, (0734) 595025
England Telex: 847056
Sales Contact: Mike Angelou, Mktg. Mgr.

CROWDER COMMUNICATIONS LTD.

4312 Norfolk Street
Burnaby, BC
Canada (604) 437-4433
Sales Contact: Peter Crowder, President

CROWN INTERNATIONAL

1718 W. Mishawaka Rd.
Elkhart, IN 46517 (219) 294-5571
Sales Contact: Murray Young, Adv. Mgr.

CUE RECORDING

1156 Ave. of the Americas
New York, NY 10036 (212) 921-9221

CURRENT COMMUNICATIONS

#114-5910 No. 6 Rd.
Richmond, BC Canada V6V 1Z1 (604) 270-9544
Sales Contact: Reinhild Burchardt, Sls. Mktg.

CUSTOM BUSINESS SYSTEMS

P.O. Box 67
Reedsport, OR 97467 (503) 271-3684
Sales Contact: Steve Kenagy, VP/Mktg.

D**3-D VIDEO CORPORATION**

4605 Lankershim Blvd.
North Hollywood, CA 91602 (213) 769-6752
Sales Contact: James F. Butterfield, Mgr.

D-B ELECTRONICS INC.

7851 Airpark Drive No. 201
Gaithersburg, MD 20760 (301) 977-7048
Sales Contact: David R. Durst, President

Continued on page 132

Switch, Distribute, Equalize

with DYNNAIR'S SERIES 1500

- ★ 6 x 1 Video Switcher
- ★ 1 x 4 Video Distribution Amp
- ★ Unbalanced Equalizing Amp
- ★ Balanced Equalizing Amp
- ★ Balanced Pre-Equalizing Amp
- ★ Rack Mounting Frame
- ★ Blank Modules
- ★ Desk Mount Kit
- ★ Switcher Lighting Kit

Convenience engineered for simple installation, the Series 1500 shares mounting accessories.



Rack Mounting Frame provides space for three Series 1500 modules in standard 19-inch equipment racks.

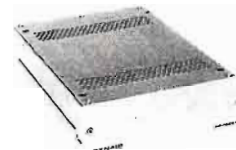

Blank module fills one unused space in Series 1500 Rack Mounting Frame and is a convenient housing for installer furnished customs.

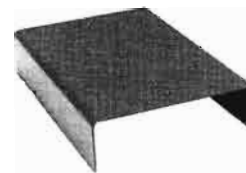

Desk Mount Kit for one Series 1500 unit.



Video Switcher Lighting Kit. Calculator-style plug-in transformer with 6-foot cable.

DYNNAIR

5275 Market St., San Diego, CA 92114
Phone 714/263-7711
TWX 910/335-2040

Circle (80) on Action Card

Audio for Broadcast-Film Sound-Production-TV

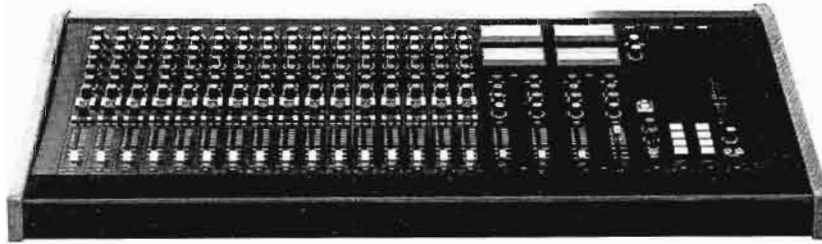

Tell us what you require!
We build it!
We install it!
We document it!
OR
You design it - we build it!

Finntek Limited

P.O. Box 235 • Riverton, Utah 84065 • 801-254-6398

Circle (81) on Action Card

40,000 MPH*

*40,000 MILES PER HEAD of tape travel — routine performance for Saki premium quality audio heads. We are the world's leading manufacturer of professional long-life audio and instrumentation heads. **Ask about our 2-track, 1/2 inch format.**

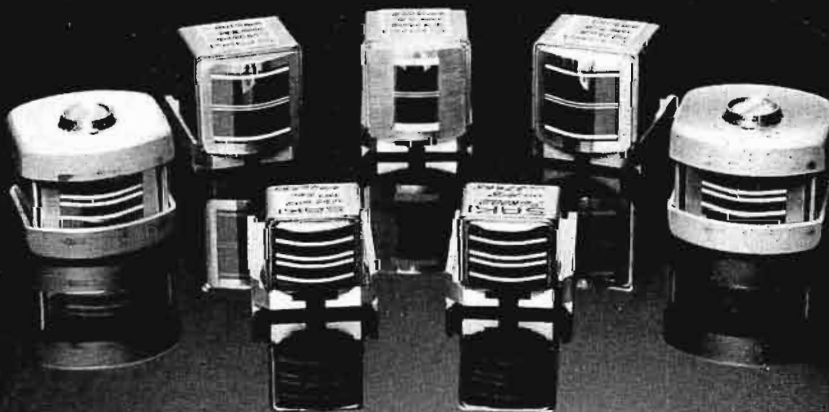

SAKI MAGNETICS, INC.

8850 HAYDEN PLACE, CULVER CITY, CALIFORNIA 90230 • TEL: (213) 544-3225 • FAX: (213) 544-3226 • TWX: 910-328-6100

Circle (82) on Action Card

WHERE TO BUY IT

dbx INCORPORATED
71 Chapel Street
Newton Center, MA 02195 (617) 964-3210
Sales Contact: David W. Roubush,
National Sales Mgr.

D. O. INDUSTRIES INC.
317 E. Chestnut St.
E. Rochester, NY 14445 (716) 385-4920
Sales Contact: Geri Drooz, Advtg. Mgr.

D AND S CORLEY LIMITED
80 Galaxy Blvd., Unit 3
Rexdale Ontario M9W 4Y8 (416) 675-3511
Sales Contact: Richard Corley, VP Research

DABURN ELECTRONICS & CABLE CORP.
70 Oak St.
Norwood, NJ 07648 (201) 768-5400
Sales Contact: Ira M. Lash, Sales Mgr.

DAGE-MTI INC.
208 Wabash St.
Michigan City, IN 46360 (219) 872-5514
Sales Contact: Paul Thomas, Nat'l. Sls. Mgr.

PETER W. DAHL CO. INC.
4007 Fort Blvd.
El Paso, TX 79930 (915) 566-5365
Sales Contact: P.W. Dahl, President

DA-LITE SCREEN COMPANY
P.O. Box 137
3100 State Road 15 North
Warsaw, IN 46580 (219) 267-8101
Sales Contact: Martin Olsen, Sales Mgr.

DATA COMMUNICATIONS CORP.
3000 Directors Row
Memphis, TN 38131 (901) 345-3544
Sales Contact: Nancy Jefferies, Sls. Mgr.

DATAMETRICS INC.
340 Fordham Road
Wilmington, MA 01887 (617) 658-5410
Sales Contact: Walter Hickman, Prod. Mgr.

DATATEK CORP.
1121 Bristol Rd.
Mountainside, NJ 07092 (201) 654-8100
Sales Contact: Bob Rainey, Mktg. Mgr.

DATATRONIX INC.
2100 Reston Ave.
Reston, VA 22091 (703) 620-5300
Sales Contact: David Brooks,
Dir., Audio Systems

DATATRON INC.
2942 Dow Avenue
Tustin, CA 92680 (714) 544-9970
Sales Contact: Roger Bailey,
Dir., Video Marketing

DATEL-INTERSIL INC.
11 Cabot Boulevard
Mansfield, MA 02048 (617) 339-9341
Sales Contact: Ted Petit, X221, App. Eng.

DATUM INC.
1363 S. State College Blvd.
Anaheim, CA 92806 (714) 533-6333
Sales Contact: Lester Turner, Sr. Staff Eng.

JOHN J. DAVIS & ASSOCIATES
P.O. Box 128
Sierra Madre, CA 91024 (213) 355-6909
Sales Contact: John J. Davis, Pres.

DAVIS ELECTRONICS CO.
P.O. Box 128
Sierra Madre, CA 91024 (213) 355-6909
Sales Contact: John J. Davis, Pres.

Continued on page 135

DELL TECHNICAL VEHICLES LTD.
Empress Road, Bevols Valley
Southampton SO2 0JY Hampshire (0703) 26982
Sales Contact: *J. Robinson, Tech. Sls. Mgr.*
M. Dickson, Mgr. Dir.

DELTA ELECTRONICS INC.
5730 General Washington Drive (703) 354-3350
Alexandria, VA 22312 TWX: 710-832-0273
Sales Contact: *Bob Bousman, Brd. Prod. Sls.*

DELTALAB RESEARCH INC.
27 Industrial Ave.
Chelmsford, MA 01824 (617) 256-9034
Sales Contact: *Wayne A. Morris,*
National Sales Mgr.
Wayne Morris, Reg. Sls. Mgr.

DELTA LIGHTNING ARRESTORS
Box 1084
Big Spring, TX 79720 (915) 267-5268
Sales Contact: *Mike Craddock*

DELTA SYSTEMS
Hermann-Loens-Str. 3
6074 Roedermark
West Germany 06074-90097
Sales Contact: *Richard Losch, Gen. Mgr.*

DELTAMOD CORPORATION
2823 Ninth Street
Berkeley, CA 94710 (415) 548-4858
Sales Contact: *Steve Sutter, Engr. Mgr.*

DE WOLFE MUSIC LIBRARY INC.
25 W. 45th St.
New York, NY 10036 (212) 586-6673
Sales Contact: *Larry Kessler, VP*

F. R. DICKINSON JR. INC.
9 Westinghouse Plaza
Bloomfield, New Jersey 07208 (201) 429-8996
Sales Contact: *F. R. Dickinson, Pres.*

DICTAPHONE CORPORATION
120 Old Post Road
Rye, NY 10580 (914) 967-7300
Sales Contact: *Arthur E. Kemp,*
Mktg. Support Mgr.

DIELECTRIC COMMUNICATIONS
Tower Hill Road
Raymond, ME 04071 (207) 655-4555
Sales Contact: *Stanley Thomas, V.P. Mktg.*

DIGITAL VIDEO SYSTEMS INC.
716 Gordon Baker Road
Willowdale, Ontario M2H 3B4 (416) 499-4826

LEO DINER FILMS INC.
350 Golden Gate Avenue
San Francisco, CA 94102 (415) 775-3664
Sales Contact: *Roy E. Diner, V.P. / Gen. Mgr.*

DISPLAY MEDIA INC.
3729 N. Ravenswood
Chicago, IL 60613 (312) 477-3827
Sales Contact: *Richard Moellerine, Pres.*

DI-TECH INC.
48 Jefryn Blvd.
Deer Park, NJ 11729 (516) 667-6300
Sales Contact: *Tony Bolletino, Dir. of Mktg.*

DOLBY LABORATORIES INC.
731 Sansome St.
San Francisco, CA 94111 (415) 392-0300
Sales Contact: *Tim Prouty, Prod. Mgr.*

DOLBY LABORATORIES
346 Clapham Road
London, UK SW9 9AP 01-720 1111
Telex: 919109
Sales Contact: *Peter Seaggar, Int'l. Sls. Mgr.*

DOLPHIN PRODUCTIONS INC.
140 E. 80th St.
New York, NY 10021 (212) 628-5930
Sales Contact: *Allan Stanley, Pres.*

DORROUGH ELECTRONICS
5221 Collier Place
Woodland Hills, CA 91364 (213) 999-1132
Sales Contact: *Kay Dorrough, PT*

DOW-KEY DIV. OF KILOVAC CORP.
P.O. Box 4422
Santa Barbara, CA 93103 (805) 684-4560
Sales Contact: *Jack L. Dysart, Prod. Mgr.*

PHILIP DRAKE ELECTRONICS LTD.
23 Redan Place
London UK W2 4SA 01-221-1476
Contact: *David Bower, Sales Mgr.*

DRAKE-CHENAULT
P.O. Box 1629
Canoga Park, CA 91304 (213) 883-7400
Sales Contact: *Ron Harrison, VP/Sales*

DRANETZ ENG. LABS., INC.
1000 New Durham Road
Edison, NJ 08817 (201) 287-3680
Sales Contact: *A.W. Orlacchio, V.P. Sales*

D'SAN CORPORATION
25-30 163rd St.
Flushing, NY 11358 (212) 746-8857
Sales Contact: *O.S. Swarth, Pres.*

DUBNER COMPUTER SYSTEMS
158 Linwood Plaza
Fort Lee, NJ 07024 (201) 592-6500
Sales Contact: *Harvey Dubner, President*

DUKANE CORP.
Communications Systems Div.
2900 Dukane Drive
St. Charles, IL 60174 (312) 584-2300
Sales Contact: *Don Coil, Admin. Asst.*

E.I. DUPONT DE NEMOURS & CO. INC.
MAGNETIC PRODUCTS DIVISION
Dupont Airport Site
Wilmington, DE 19898 (302) 999-4251
Sales Contact: *E.R. Buckley, Mktg. Mgr.*

THE DURAFILM COMPANY
137 North La Brea Avenue
Hollywood, CA 90036 (213) 936-1156
Sales Contact: *Madelon Cohen, President*

DYMA ENGINEERING INC.
P.O. 1697
213 Pueblo Del Sur
Taos, NM 87571 (505) 758-8686
Sales Contact: *W. Cunningham, VP*

DYNACOM ELECTRONICS LTD.
590 Commerce Park Drive
Suite 125
Marietta, GA 30060 (404) 428-3100
Sales Contact: *Robert W. Payne, Jr.,*
Director of Marketing

DYNAIR ELECTRONICS INC.
5275 Market Street
San Diego, CA 92114 (714) 263-7711
Sales Contact: *Robert Jacobs, Gen. Sls. Mgr.*

DYNA-METRICS INC.
4646 Mission Gorge Place
San Diego, CA 92120 (714) 583-8890
Sales Contact: *John Peterson, Pres.*

DYNAMIC TECHNOLOGY LIMITED
Zonal House, Alliance Road
Acton, London W3 0BA UK 01 993-2401
Sales Contact: *Derek Tugwell, Mngng. Dir.*

Continued on page 136

**DELTAMOD
CNR-6**

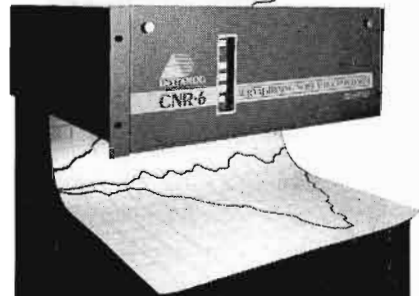

State of the Art Capabilities for Broadcast Cart Machines

DOLBY** Noise Reduction

- Advanced Dolby C-type NR in exclusive professional format
- 20dB of quality noise reduction without audible side effects
- Anti-saturation circuitry for reduced IM distortion
- Spectral skewing immunizes NR to machine and tape errors

Full Automation

- Automatically intermix carts of all formats
- No sacrifice of cue-track functions or FSK logging
- No operator adjustments or controls
- Full manual remote control

Compatible Matrixing

- Dramatic restoration of high frequencies for mono audience
- Prevents obsolescence when AM, television convert to stereo
- Stable thin-film matrix never needs alignment or nulling
- Matrixing and NR separately defeatable

Test Functions

- Built-in test set simplifies tape machine maintenance
- Precision LED meters
- Modulated Dolby tone oscillator
- Multi-frequency azimuth tone
- Phase and separation meters
- Quality new carts, check alignment—instantly



2823 NINTH ST.
BERKELEY
CA 94710
(415) 548-4858

* "Deltamod" and "CNR-6" are trademarks of Deltamod Corporation
** "Dolby" and the double-D are registered trademarks of Dolby Laboratories.

Circle (91) on Action Card

WHERE TO BUY IT

DYNAQUIP ELECTRON DEVICES LTD.
3515 Mainway
Burlington, Ontario,
Canada L7M 1A9 (416) 335-3700
Sales Contact: D. Evertz, Pres.

DYNAMOTE CORPORATION
1200 W. Nickerson
Seattle, WA 98119 (206) 282-1000
Sales Contact: Faith Adams, Marketing

E

EECO
1601 E. Chestnut Ave.
Santa Ana, CA 92701 (714) 835-6000
Sales Contact: Karen Mills, Prod. Spec.
(Ampex is master distributor worldwide.)

EEG ENTERPRISES INC.
1 Rome Street
Farmingdale, NY 11735 (516) 293-7472
Sales Contact: Bill Posner, V.P. Sales

EEV INC.
7 Westchester Plaza
Elmsford, NY 10523 (914) 592-6050
TELEX: 646180
Sales Contact: A. Sayers, Exec. Asst. Pres.

Regional Sales Offices:

EEV INC.
2073 Arleen Court
Schaumburg, IL 60194 (312) 843-8417
Contact: Chuck Bocan, Sales Mgr.

EEV INC.
207 Vern Lane
Buffalo, NY 14227 (716) 681-1970
Contact: Rick Bossert, Sales Mgr.

EEV INC.
Route 1
Anna, TX 75003 (214) 837-2464
Contact: Bob Knowles, Sales Mgr.

EEV INC.
Suite 100E, 15 Dunwoody Park
Atlanta, GA 30338 (404) 394-9201
Contact: Harry Kozicki, Sales Mgr.

EEV INC.
19001 40th Pl., N.E.
Seattle, WA 98155 (206) 363-2200

EEV CANADA, LTD.
67 Westmore Drive
Rexdale, Ontario M9V 3Y6 (416) 745-9494
Contact: D. Clissold, Gen. Mgr.

EFI
316 E. El Camino
Phoenix, AZ 85020 (602) 995-1666
Sales Contact: Janene Spencer, Sls. Mgr.

E G & G, ELECTRO-OPTICS
35 Congress St.
Salem, MA 01970 (617) 745-3200
Sales Contact: George J. Mandeville, Jr.,
Prod. Mgr.

EIP MICROWAVE INC.
2731 North First St.
San Jose, CA 95134 (408) 946-5700
Sales Contact: Richard A. Bush, VP - Sales

EMCEE BROADCAST PRODUCTS
P.O. Box 68
White Haven, PA 18661 (717) 443-9575
Sales Contact: David Parmelee,
Sls. & Mktg. Manager

EMI SOUND AND VISION EQUIPMENT
252 Blyth Road
Hayes, Middlesex UK

EMS UNEMCO INTERNATIONAL INC.
1392 Borregas Ave.
Sunnyvale, CA 94086 (408) 734-0163
Sales Contact: Lee Marvin, V.P.

ENG HELICOPTER SATELLITES LTD.
9919 Carter Road

Bethesda, MD 20817 (301) 469-8109
Sales Contact: Alex Carey, President

E-N-G CORPORATION
1009A Shary Cir.
Concord, CA 94518 (415) 798-4060
Sales Contact: J. Harris, Pres.

ESC ELECTRONICS CORPORATION
534 Bergen Blvd.
Palisades Park, NJ 07650 (201) 947-0400
Sales Contact: S. Packer, Pres.

ESE
142 Sierra St.
El Segundo, CA 90245 (213) 322-2136
Sales Contact: Bob Mayers, V.P.

EVITAPCO
3810 - 148th Street
Redmond, WA 98052 (202) 883-3510
Sales Contact: Jim Lopnow, Mkt. Dev. Mgr.

E-Z WAY PRODUCTS INC.
P.O. Box 22845
Tampa, FL 33622 (813) 677-7144
Sales Contact: Cyril B. Rogers, Pres.

EAGLE COMTRONICS INC.
4562 Waterhouse Rd.
Clay, NY 13041 (315) 622-3402
(800) 448-7474
Sales Contact: Doc D'Alfonso, Sales Mgr.

EAR SYSTEMS INC.
1807 Old Shay Court
Columbus, OH 43229 (614) 882-5205
Sales Contact: Larry Reynolds, Pres.

EAST COAST VIDEO SYSTEMS INC.
548 Broadway
New York, NY 10012 (212) 431-7453
Sales Contact: Rich Bisignano, Pres.

EASTMAN KODAK COMPANY
343 State Street
Rochester, NY 14650 (716) 724-4000

ECHO LAB
175 Bedford Road
Burlington, MA 01803 (617) 273-1512
Sales Contact: Ted Whittaker, Sales Mgr.

ECHO SCIENCE CORPORATION
485 E. Middlefield Road
Mountain View, CA 94043 (415) 961-7145
Sales Contact: George Elsasser, Dir. of Mktg.

ECONCO BROADCAST SERVICE
1318 Commerce Ave.
Woodland, CA 95695 (916) 662-7553
Sales Contact: John Sullivan, Owner

EDCOR
16782 Hale Ave.
Irvine, CA 92714 (714) 556-2740
Sales Contact: J. E. Morrison, VP Mktg.

EDITALL CORP.
P.O. Box 17435
Dulles Int'l. Airport
Washington, D.C. 20041 (703) 471-1766
Sales Contact: David Lane, Tech. & Mktg. Dir.

EDITEL
729 North Highland Avenue
Hollywood, CA 90038 (213) 931-1821

EDNALITE CORPORATION
200 North Water St.
Peekskill, NY 10566 (914) 737-4100
Sales Contact: Corinne Cohen, Sales Mgr.

EIDOPHOR LTD.
Althardstrasse 70

CH-8105 Regensdorf,
Switzerland 018421111
Sales Contact: Mr. A. Schmid, Deputy SM

EIDSON ELECTRONIC CO.
P.O. Box 3751
Temple, TX 76501 (817) 773-3901

EIGEN VIDEO
P.O. Box 848
Nevada City, CA 95959 (916) 272-3461
Sales Contact: John Romanko, Sales Mgr.

EIMAC DIVISION, VARIAN ASSOCIATES
301 Industrial Way
San Carlos, CA 94070 (415) 592-1221
Sales Contact: Nearest Varian Sales Office

ELCOM-BAUER
6991 Warehouse Way
Sacramento, CA 95826 (916) 381-3750
Sales Contact: Paul E. Gregg, Pres.

ELCOM SPECIALTY PRODUCTS
2810 Redding Ave. No. E
Sacramento, CA 95820 (916) 453-0859
Sales Contact: Paul E. Gregg, Pres.

ELECTOR
5128 Calle Del Sol
Santa Clara, CA 95050 (408) 727-1506
Sales Contact: Guido Govaert, Sales Mgr.

ELECTRA CO., DIV. OF MASCO CORP. OF INDIANA
300 E. County Line Road
Cumberland, IN 46229 (317) 894-1440
Sales Contact: Richard T. Murphy,
Manager, Mktg. Servs.

ELECTRO-ACOUSTIC DESIGNS
5131 West Chester Pike
Edgemont, PA 19028 (215) 356-4700
Sales Contact: Kenneth Tankel, Dir. of Eng.

ELECTRO-VOICE INC., E-VITAPCO
600 Cecil St.
Buchanan, MI 49107 (616) 695-6831
Sales Contact: Bob Cook, Nat. Sls. Mgr.

Regional Sales Offices:

E-VITAPCO INC.
3810 148th Ave., NE
Redmond, WA 98052 (206) 881-9555
Contact: Ken Bell, Plant Mgr.

ELECTRO-VOICE INC.
186 Buffalo Ave.
Freeport, NY 11520 (516) 546-9632
Contact: Jay Kahn, Reg. Sales Mgr.

ELECTRO-VOICE INC.
9550 Warner Avenue
Fountain Valley, CA 92708 (714) 964-3097
Contact: John Gunnerson, Reg. Sls. Mgr.

ELECTRO-VOICE INC.
Chicago, IL (312) 634-0228
Contact: Milt Neifach, Reg. Sls. Mgr.

ELECTRO-VOICE INC.
P.O. Box 3297
8234 Doe Avenue
Visalia, CA 93277 (209) 625-1330
Contact: Dennis Ehrlicke, Manager

ELECTRO-VOICE INC.
P.O. Box 3297
8234 Doe Avenue
Visalia, CA 93277 (209) 625-1330
Contact: Dennis Ehrlicke, Manager

ELECTRO CONTROLS INC.
2975 South 300 West
Salt Lake City, UT 84115 (801) 487-9861
Sales Contact: Hyrum Mead, Sales Mgr.
Will Wiggins, TV Sales Mgr.

ELECTRO IMPULSE LABORATORY
116 Chestnut St.
P.O. Box 870
Red Bank, NJ 07701 (201) 741-0404
Sales Contact: Mark Rublin, Pres.

ELECTROHOME LIMITED
809 Wellington St., N.
Kitchener, Ontario
Canada N2G 4J6 (519) 744-7111
Sales Contact: Don Leach, Sales Mgr.

ELECTRO & OPTICAL SYSTEMS LTD.

31 Progress Court
Scarborough, Ontario
M1G 3V5 (416) 439-9333
Sales Contact: Maurice Evans

ELECTROLINE TELEVISION EQUIP. INC.

8750 - 8th Avenue
St. Michel
Montreal Quebec
Canada H1Z 2W4 (514) 725-2471
Sales Contact: John Amann, Mktg. Dir.

ELECTRONIC DEVICES INC.

21 Gray Oaks Ave.
Yonkers, NY 10710 (914) 965-4400
Sales Contact: Dennis Dean, Sales Mgr.

ELECTRONICS DIVERSIFIED INC.

1675 NW 216th
Hillsboro, OR 97123 (503) 645-5533
Sales Contact: Greg Long, Dir., Sales Mgr.

ELECTRONIC INSTRUMENT & SPECIALTY CORP.

42 Pleasant Street
Stoneham, MA 02180 (617) 438-5300
Sales Contact: William K. Crawford, VP, Mktg.

ELEKTROIMPEX

P.O. Box 296, Budapest
Hungary 1392 1-129-430,328-300

ELICON

273 Viking Avenue
Brea, CA 92621-3881 (714) 990-6647
Sales Contact: Peter A. Regla, Dir. of Mktg.

EMCOR PRODUCTS

1600 4th Ave., NW
Rochester, MN 55901 (507) 289-3371
Sales Contact: Gary Ellis, Sales Mgr.

EMERGENCY ALERT RECEIVER INC.

One West 30th Street
New York City, NY 10001 (212) 695-4767
Sales Contact: Jack H. Bergman, Pres.

EMIL ASCHER MUSIC INC.

630 Fifth Avenue
New York, NY 10111 (212) 581-4504
Sales Contact: Robert Sandler, Gen. Mgr.

EMT FRANZ GMBH

P.O. Box 15 20
D-7630 Lahr 0 78 25/10 11
Sales Contact: Frank Hirsch, Dr.rer.nat.

ENCLOSURE CORP.

4529 Adams Circle
Cornwells Hts., PA 19020 (215) 638-9550
Sales Contact: R.D. Edelman, Pres.

ENERTEC SCHLUMBERGER

296 Avenue Napoleon Bonaparte
92500 Rueil Malmaison
(France) (1) 732-9223
Sales Contact: Jean Schwob, Sales Mgr.

ENGINEERING ASSOCIATES

7567 Rt. 49A East
Arcanum, OH 45304 (513) 692-5641
Sales Contact: Charles C. Little, Jr.

ENGLISH ELECTRIC VALVE CO. LTD.

Waterhouse Lane
Chelmsford, Essex CM 1 2QU, UK (0245) 61777
Sales Contact: Dave Farrar
Light Conversion Marketing Manager

ENTERPRISE ELECTRONICS CORP.

P.O. Box 1216
Enterprise, AL 36331 (205) 347-3478
Sales Contact: C.P. Jeter, Gen. Mgr.

ENVIRONMENTAL CONTAINER SYSTEMS

P.O. Box 188
Grants Pass, OR 97526 (503) 476-8871
Sales Contact: Tom Helman, Sys. Analyst

EQUIPTO

225 S. Highland Ave.
Aurora, IL 60507 (312) 859-1000
Sales Contact: Jeff Vaughn, Sales Prom. Mgr.

ESCOA

737 A-1 Werne Drive
Lexington, KY 40504 (606) 252-3536
Sales Contact: Ron Eigenmann

EUMIG (USA) INC.

Lake Success Business Park
225 Community Drive
Great Neck, NY 11020 (516) 466-6533
Sales Contact: Tom Bensen

EVENTIDE CLOCKWORKS INC.

265 W. 54th Street TWX: 710-581-2593
New York, NY 10019 (212) 581-9290
Sales Contact: Suzanne Langle, Mktg.

EXCALIBUR INDUSTRIES

12427 Foothill Blvd.
Lake View Terrace, CA 91342 (213) 899-2547
Sales Contact: John A. Gresch, Dir. of Mktg.

F**F&B/CECO INC.**

315 West 43rd Street
New York City, NY 10036 (212) 974-4600
Sales Contact: Walter Druker, Exec. VP

FAIRCHILD CCD IMAGING

4001 Miranda Avenue (415) 493-8003
Palo Alto, CA 94304 (415) 493-8001
Sales Contact: Neil Madonick, Prod. Mktg.

FANTASEE LIGHTING

404 N. River
Uppilanti, MI 48197 (313) 482-6565
Sales Contact: Stefan Graf, Pres.

FARINON GmbH

Diesterweggasse 29
1140 Wein, Austria

FARINON VIDEO

1680 Bayport Avenue
San Carlos, CA 94070 (415) 595-3500
Sales Contact: Cliff Fields, Nat'l. Sis. Mgr.

FAROUJIA LABORATORIES

946 Benicia Ave.
Sunnyvale, CA 94086 (408) 245-1492
Sales Contact: Isabell Faroudja, Admin. Asst.

FARRTRONICS LTD.

151 Bentley St., Unit 1
Markham, Ontario
Canada L3R 3X9 (416) 495-6720
Sales Contact: Norm Farr, Ron Smith,
or Mark Thornton

FEATHERCAM INC.

7240 Valjean Ave.
Van Nuys, CA 91406 (213) 989-5222
Sales Contact: John Carroll, President

FENWAL INC.

400 Main St.
Ashland, MA 01721 (617) 881-2000
Sales Contact: A.F. Cichy, Sales Mgr.

FERNSEH INC.

P.O. Box 15068
Salt Lake City, UT 84115 (801) 972-8000
Sales Contact: A. R. Pignoni, VP Brdcast. Sales

Continued on page 138

**NOTHING TO
BURN CUT!**



**SOLID STATE
RECTIFIER TUBES**

Replace vacuum and gas rectifiers with filamentless, dependable EDI SOLID-TUBE® silicon solid-state rectifiers for all these advantages: No filament or transformer. Greater reliability. Constant output. Long life. No warm up. No heat. Proved in use. Meets or exceeds tube ratings. Lower cost. Full range of replacements.

Write for a complete list of equivalent tube types, general information, and costs. Application advice also available.



SEND TODAY

**electronic
devices inc.**

21 GRAY OAKS AVE., YONKERS, N.Y. 10710
(914) 965-4400. TWX 710 560-0021

Circle (84) on Action Card

**THE OPTEK MODEL 8000A—
once IS enough!**

- The **ONLY** Bulk Tape Degausser capable of degaussing up to 2" high coercivity VIDEO tape in less than 30 seconds with only **ONE** erasure!
- The **#1** continuous-duty degausser in the industry.

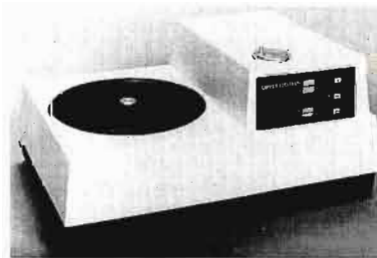

manufactured by:
FLUXCOM, INC.
1390 N. McCan Street
Anaheim, CA 92806
(714) 630-8280

Circle (155) on Action Card

WHERE TO BUY IT

Regional Sales Offices:

FERNSEH INC.
6300 Arizona Circle
Los Angeles, CA 90045 (213) 641-1636
FERNSEH INC.
279 Midland Ave.
Saddlebrook, NJ 07662 (201) 797-7400
Contact: John Webb, Regional Sales
FERNSEH INC.
7921 Jones Branch Drive, Suite 275
McLean, VA 22102 (703) 790-5570
Contact: A. Schoenberg, Regional Sales
FERNSEH INC.
3436 North Kennicott Drive
Arlington Heights, IL 60004 (312) 577-9780
Contact: Dave Spindle, Regional Sales
FERNSEH INC.
13620 Littlecrest Drive
Dallas, TX 75234 (214) 241-6044
Contact: Lee Caput, Regional Sales
FERNSEH INC.
2300 West 2300 South
Salt Lake City, UT (801) 972-8000
Contact: Ron Ferguson, Regional Sales

FIBERBILT

IKELHEIMER-ERNST, INC.

601 West 26th Street
New York, NY 10001 (212) 675-5820
Sales Contact: Fred Abeles, Sales

FIDELIPAC CORPORATION

P.O. Box 808
Morrestown, NJ 08057 (609) 235-3511
Sales Contact: Arthur Constantine, VP/Sales
Regional Sales Offices:
350 authorized distributors world wide.
Contact factory for your nearest distributor.

THE FINNEY CO.

34 West Interstate St.
Bedford, OH 44146 (216) 232-6161
Sales Contact: Tom Corpus, Sales Mgr.

FINNTEK LIMITED

12797 South, 2230 West
P.O. Box 235
Riverton, UT 84065 (801) 254-6398
Sales Contact: Lenna M. Welland, VP

FISHER BERKELEY CORP.

Christle & Powell
Emeryville, CA 94608 (415) 655-9696
Sales Contact: Art Tilley, Sales Mgr.

FLASH TECHNOLOGY

55 Lake St. TLX: 943481
Nashua, NH 03060 (603) 883-6500
Sales Contact: David Bowman, Sales Engineer

JOHN FLUKE MFG. CO. INC.

P.O. Box C9090 (800) 426-0361
Everett, WA 98206 (206) 356-5400
Sales Contact: Don Tuttle

FLUXCOM INC.

1390 N. McCan Street
Anaheim, CA 92806 (714) 630-8280
Sales Contact: Robert Morison, Mktg. Mgr.

FOR-A CORPORATION OF AMERICA

1680 N. Vine Street, Suite 201
Los Angeles, CA 90028 (213) 467-8412
Sales Contact: Tad Hlrota, Sales Mgr., VP

FORECAST MEDIA INSTALLATIONS

70 Carpenter Ave. (516) 671-8492
Sea Cliff, NY 11579 (516) 676-6437
Sales Contact: Jerry Hahn, Sales Consultant

FORT WORTH TOWER COMPANY

1901 E. Loop 820 S.
P.O. Box 8597
Fort Worth, TX 76112 (817) 457-3060
Sales Contact: Betty Moore, Sec.-Treas.

FORTEL INCORPORATED

6649 Peachtree Industrial Blvd.
Norcross, GA 30092 (404) 449-4343

Sales Contact: Marilyn Hopkins

FOUNDATION ELECTRONIC INSTRUMENTS

1794 Courtwood Crescent
Ottawa, Ont.
Canada K2C 2B5 (613) 226-4000
Sales Contact: A.J. Szanto, Mktg.

FREELAND PRODUCTS CO.

Rt. 7, Box 628
Covington, LA 70433 (504) 893-1243
Sales Contact: W.T. Freeland, Owner

FREQUENCY DEVICES INC.

25 Locust St.
Haverhill, MA 01830 (617) 374-0761
Sales Contact: John Maguire, App. Eng.

FREZZOLINI ELECTRONICS INC.

7 Valley Street
Hawthorne, NJ 07506 (201) 427-1160
Sales Contact: Jack Zink, Sales Mgr.

FUJI PHOTO FILM USA, INC.

350 Fifth Ave.
New York, NY 10118 (212) 736-3335
Sales Contact: Al Bedross, Nat'l Sales Mgr.

FUJI PHOTO FILM (Europe) GmbH

Berliner Allee 8
4000 Dusseldorf
Fed. Republic of Germany

FUJINON INC.

672 White Plains Road
Scarsdale, NY 10583 (914) 472-9800
Sales Contact: Jack Dawson

FULL COMPASS SYSTEMS

6729 Seybold Rd.
Madison, WI 53719 (800) 356-5811
Sales Contact: Jonathan, Lipp (608) 271-1100
(in Wisconsin)

FUNG ENGINEERING LABS INC.

425 Harbor Blvd.
P.O. Box 235
Belmont, CA 94002 (415) 592-8434
Sales Contact: Pamela J. Lee, Sales Mgr.

G

G. C. ELECTRONICS

400 S. Wyman St.
Rockford, IL 61101 (815) 968-9661
Sales Contact: Robert Reynolds, Sales Admin.

GKM MANUFACTURING CORP.

47 Bridgewater St.
Brooklyn, NY 11222 (212) 338-4114
Sales Contact: John D'Augelli, Sales Mgr.

GTE LENKURT INC.

1105 County Road
San Carlos, California 94070 (415) 595-3000
Sales Contact: John Stockford, Nat'l. Sls. Mgr.

GYR PRODUCTS, ODETICS INC.

1335 S. Claudina St.
Anaheim, CA 92805 (714) 772-1000
Sales Contact: Terry Tetirick,
National Sales Mgr.

GABRIEL ELECTRONICS INC.

P.O. Box 626
Scarborough, ME 04074 (207) 883-5161
Sales Contact: Don Crisman, Mktg. Mgr.

GALITE INC.

P.O. Box 50
Wallingford, CT 06492 (203) 265-7126
Sales Contact: Arthur J. Harvey, Sales Eng.

GARDINER COMMUNICATIONS CORP.

1980 So. Post Oak Road
Suite 2040
Houston, TX 77056-3869 (713) 961-7348
Sales Contact: Doug Smith, VP Sls. Mgr.

GARNER INDUSTRIES

4200 N. 48th
Lincoln, NE 68504 (402) 464-5911
Sales Contact: Bruce A. Alderman, Sales Mgr.

GELECO ELECTRONICS LIMITED

2 Thorncliffe Park Drive, Unit 28
Toronto, Ont. M4H 1H2 (416) 421-5631
Sales Contact: Gerald Lee, President

Regional Sales Office:

Geleco Electronics
1809 North 107th Street, Unit 3-201
Seattle, WA 98133 (206) 362-0403
Contact: P. J. Lee, Manager

GENERAL CABLE CO.—CATV DIV.

One Woodbridge Center
P.O. Box 700 (800) 526-4385
Woodbridge, NJ 07095 in NJ (201) 636-5500
Sales Contact: Richard L. Schwager

GENERAL ELECTRIC

Video Equipment Systems Operation

Building 6 - Room 206
Electronics Park
P.O. Box 4840
Syracuse, NY 13221 (315) 456-2562
Sales Contact: J.P. Gundersen, Mgr. of Mktg.

GENERAL TELEVISION NETWORK

13225 Capital Ave.
Oak Park, MI 48237 (313) 548-2500
Sales Contact: R. Hippler, Pres.

THE GERSTENSLAGER COMPANY

1425 E. Bowman Street
Wooster, OH 44691
Sales Contact: W. Baehr, Dir. of Eng.

GILBERT ENGINEERING CO. INC.

P.O. Box 23189
Phoenix, AZ 85063 (602) 245-1050
Sales Contact: R. Spann, President

G. A. GILBREATH ASSOCIATES

6357 Lawton Avenue
Las Vegas, NV 89107 (702) 878-8313
Sales Contact: Keith Smith, Sales Manager

GLASSMAN HIGH VOLTAGE INC.

P.O. Box 551
Whitehouse Station, NJ 08889 (201) 534-2226
Sales Contact: John Belden, Sales Mgr.

GLETRONIX LTD.

160 Duncan Mill Road
Don Mills, Ontario
M3B 1Z5 Canada (416) 444-8497
Sales Contact: Tom Pressley

GLOBAL SPECIALTIES CORPORATION

70 Fulton Terrace
New Haven, CT 06509 (203) 624-3103

GLOBAL VIDEO COMMUNICATIONS CORP.

744 West Church Street
Orlando Florida 32805 (305) 423-8299
Sales Contact: Cathy Malatesta

GOLDBERG BROTHERS INC.

3535 Larimer St.
Denver, CO 80217 (303) 892-1250
Sales Contact: Seymour Goldberg, V.P.

GOLDEN EGG

1373 Westwood Blvd.
Los Angeles, CA 90024 (213) 475-0817
Sales Contact: Ron Cutler, Pres.

ANDERS INC.

THE WORLDWIDE CHOICE
WHERE PERFORMANCE COUNTS

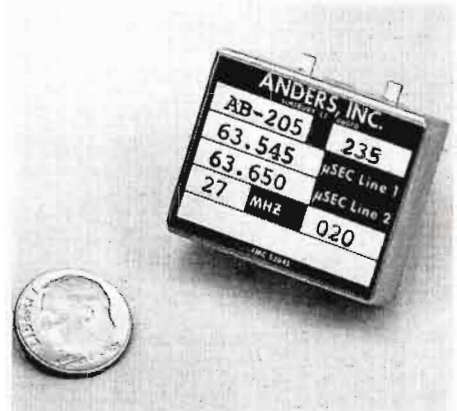

- I say, it's an outstanding delay line.
- Une ligne à retard extraordinaire.
- Geweldige vertragslijn.
- Das ist eine sehr gute verzögerung linie.

77 Wolcott Rd., Simsbury, CT 06070
(203) 658-7666

Circle (85) on Action Card

COSMIN ELECTRONICS

Producers of
Heavy duty
RF Components

RF Systems
Phasors
Antenna
Tuning Units

Sales

P.O. Box 222
Pipersville, PA
18947

Headquarters

4214 San Pedro
San Antonio, TX
78212

(215) 847-2044

Circle (86) on Action Card

ALAN GORDON ENTERPRISES
1430 Cahuenga Blvd.
Hollywood, CA 90028 (213) 466-3561
Sales Contact: Ted Lane

GORMAN REDLICH MFG. CO.
6 Curtis St.
Athens, OH 45701 (614) 593-3150
Sales Contact: James Gorman, Owner

GOULD INC.
2050 Cabot Blvd. West
Langhorne, PA 19047 (215) 752-0555
Sales Contact: Robert T. Hanson

GOULD INC., INSTRUMENTS DIV.
35129 Curtis Blvd.
Eastlake, OH 44094 (216) 361-3315
Sales Contact: Henry Berek, Nat'l. Sls. Mgr.

GRAHAM-PATTEN SYSTEMS
P.O. Box 1960
Grass Valley, CA 95945 (916) 273-8412
Sales Contact: Merv Graham, Pres.

GRALEX INDUSTRIES
155 Marine St.
Farmingdale, NY 11735 (516) 694-3600 x234
Sales Contact: Cary Ratner, Sls. Mgr.

GRANT TOWER INC.
13064 Wisner Avenue
Grant, MI 49327 (616) 834-5665
Sales Contact: Walt Knoch, Office Mgr.

THE GRAPHIC EXPRESS CORPORATION
7969 Engineer Rd. Suite 201
San Diego, CA 92111 (714) 565-2146

GRASIS CORPORATION
P.O. Box 1039
Kansas City, MO. 64141 (816) 483-1100
Sales Contact: J.W. Sebeuen, VP Sls. & Mk.

THE GRASS VALLEY GROUP INC.
13024 Bitney Springs Rd.
P.O. Box 1114
Grass Valley, CA 95945 (916) 273-8421
Sales Contact: Len Dole, Int'l Sls. Mgr.

Regional Sales Offices:

THE GRASS VALLEY GROUP, INC.
Station Plaza East
Great Neck, NY 11021 (516) 487-1311
Contact: Danny Antonellis, Reg. Mgr.

THE GRASS VALLEY GROUP, INC.
1644 Tullie Circle NE
Atlanta, GA 30329 (404) 321-4318

THE GRASS VALLEY GROUP, INC.
810 West Bristol Street
Elkhart, IN 46514 (219) 264-0931

THE GRASS VALLEY GROUP, INC.
3585 N. Lexington Ave. -238
Arden Hills, MN 55112 (612) 483-2594

THE GRASS VALLEY GROUP, INC.
316 Seminary So. Office Bldg.
Ft. Worth, TX 76115 (817) 921-9411

THE GRASS VALLEY GROUP, INC.
21243 Ventura Blvd. -206
Woodland Hills, CA 91364 (213) 999-2303
Contact: Tom Sleeman, Reg. Mgr.

GRAY ENGINEERING LAB INC.
504 W. Chapman Ave., Suite P
Orange, CA 92668 (714) 997-4151
Sales Contact: Tom C. Clark, Sales Mgr.

THE GREAT AMERICAN MARKET
21133 Costanzo St.
Woodland Hills, CA 91364 (213) 883-8182
Sales Contact: Joe Tawil, Owner

GREGG LABORATORIES
2120 E. Howell Ave., Suite 505
Anaheim, CA 92806 (714) 937-1100
Sales Contact: Scott J. Rubenstein, Mktg. Dir.

GRINNAN FIXTURE COMPANY
16041-Georgetown St. N.E.
Minerva, OH 44657 (216) 862-2323
Sales Contact: John Grinnan, Owner

GROTON COMPUTER INC.
19 Fort Hill Rd.
Groton, CT 06340 (203) 445-2325
Sales Contact: R. H. Salews, Sls. Mgr.

GROVE VIDEO CORPORATION
16851 Oakmont Avenue
Gaithersburg, MD 20877 (301) 840-5801
Sales Contact: P.K. Edwards, President

GRUBER PRODUCTS CO.
P.O. Box 7350
Toledo, OH 43615 (419) 531-4900
Sales Contact: D.B. Skilliter, Pres.

GRUNDIG AG
Geschäftsbereich Electronic
Wurzburgerstrasse 150
8510 Furth
Fed. Republic of Germany

H

HM ELECTRONICS INC.
6151 Fairmount Ave.
San Diego, CA 92120 (714) 280-6050
Sales Contact: R. Dale Scott, Nat. Sls. Mgr.

HSC INCORPORATED
2932 River Road
P.O. Box 155
River Grove, IL 60171 (312) 452-5551
Sales Contact: Paul F. Bergetz, Sls. Mgr.

HALLIKAINEN & FRIENDS INC.
101 Suburban Road
San Luis Obispo, CA 93401 (805) 541-0200
Sales Contact: Harold Hallikainen, Pres.

HAMMOND INDUSTRIES INC.
8000 Madison Pike
Madison, AZ 35758 (205) 772-9626
Sales Contact: Paul Twist, VP Sales

**HARRIS CORPORATION,
BROADCAST PRODUCTS DIVISION**
P.O. Box 4290
Quincy, IL 62305-4290 (217) 222-8200
Sales Contact: Ken Schwenk, Dir. of Dom. Sls.

**HARRIS CORPORATION
BROADCAST MICROWAVE**
1680 Bayport Avenue
San Carlos, CA 94070 (415) 595-3500
Sales Contact: Cliff Fields, Natl. Sls. Mgr.

**HARRIS CORPORATION/
FARINON VIDEO**
1680 Bayport Ave.
San Carlos, CA 94070 (415) 595-3500
Sales Contact: Cliff Fields, Dom. Sls. Mgr.

**HARRIS CORPORATION -
PRD ELECTRONICS DIV.**
1200 Prospect Ave.
Westbury, NY 11590 (516) 364-0400
Sales Contact: Jeffrey Price, Sales Admin.

HARRIS VIDEO SYSTEMS
1255 E. Arques Ave.
Sunnyvale, CA 94086 (408) 737-2100
Sales Contact: Frank Santucci, Nat. Sls. Mgr.

Regional Sales Offices:

HARRIS VIDEO SYSTEMS
1421 West 1st Street
Pella, IA 50219 (515) 628-9389

Contact: Clay Selthun, Midwest Reg. Mgr.
HARRIS VIDEO SYSTEMS

Continued on page 140

WHERE TO BUY IT

P.O. Box 229
Hazel Green, AL 35750 (205) 828-5308
Contact: Bob Ridge, So. Reg. Mgr.
HARRIS VIDEO SYSTEMS
1255 E. Arques Ave.
Sunnyvale, CA 94086 (408) 737-2100
Contact: Mike Lang, Western Reg. Mgr.

HARRISON SYSTEMS INC.

P.O. Box 22964
Nashville, TN 37202 (615) 834-1184
Sales Contact: Brad Harrison & Eric Johnson
Marketing Reps.

HARRISON SYSTEMS LTD.

6117 - 63rd Ave.
Riverdale, MD 20840 (301) 699-1606
Sales Contact: Ray Harrison, Pres.

HARTLEY PRODUCTS CORPORATION

P.O. Box 316
Ramsey, NJ 07446 (201) 327-4443
Sales Contact: R. Schmetterer, Pres.

HARWOOD MFG. CO.

Subsidiary Elgin Nat'l. Ind. Inc.
1800 W. Fullerton Ave.
Chicago, IL 60614 (312) 929-1100
Sales Contact: Ben S. Rubin, Dir. of Mktg. Sls.

THE HEATH COMPANY

Benton Harbor, MI 49022 (616) 982-3443
Sales Contact: Coy Clement

KARL HEITZ INC.

979 Third Avenue
New York, NY 10022 (212) 421-5220
Sales Contact: Chris Salmon, Mktg. Mgr.

HEURISTICS

1285 Hammerwood Ave.
Sunnyvale, CA 94022 (408) 734-8532
Sales Contact: Barry J. Schiffman, Pres.

HICKOK ELECTRICAL INSTRUMENT CO.

10514 Dupont Ave.
Cleveland, OH 44108 (216) 541-8060
Sales Contact: Tom Hayden, Mktg. Mgr.

HIGH-LITE CORP.

23 Selwyn Dr.
Greenville, SC 29615 (803) 268-7702
Sales Contact: Wayne P. Comstock, Pres.

RICHARD HIRSCHMANN ELECTRIC

A - 6830 Rankweil-Brederis
Austria

HITACHI DENSHI AMERICA LTD.

175 Crossways Park West
Woodbury, NY 11797 (516) 921-7200
Sales Contact: J. Breitenbucher, Reg. Sls. Mgr.

HOPPMAN CORPORATION

5410 Port Royal Road
P.O. Box 1463
Springfield, VA 22151 (703) 321-8800
Sales Contact: Carl H. Way, Mgr., Comm. Div.

HOUSTON FEARLESS 76 INC.

833 E. Walnut
Carson, CA 90746 (213) 538-4930
Sales Contact: Tom Bowman, Mgr. Sls./Mktg.

HOWE AUDIO MARKETING/

Howe Audio Productions Inc.
3085-A Bluff St.
Boulder, CO 80301 (800) 525-7520
(303) 444-4693 - 442-3231
Sales Contact: Greg Pine, Sales Mgr.

Regional Sales Offices:

HOWE AUDIO MARKETING
316 East El Camino Dr.
Phoenix, AZ 85020 (602) 242-2211
Contact: Chuck Spencer, Spencer Broadcast
HOWE AUDIO MARKETING
P.O. Box 204
Golden, CO 80401 (303) 424-3231

Contact: Greg Pine, President
HOWE AUDIO MARKETING
845 Hornby St. No. 204
Vancouver, BC, Canada V6Z 1V1 (604) 685-6043

HOWE-YIN NORTH

1998 Republic Avenue
San Leandro, CA 94577 (415) 483-7792
Sales Contact: Stephen T. Nicol, VP

HUGHES ELECTRONIC DEVICES CORP.

(HEDCO)
P.O. Box 1985
Grass Valley, CA 95945 (916) 273-9524
Sales Contact: Bob Wincentsen, VP Mktg.

Regional Sales Offices:

HOLZBERG ASSOCIATES
P.O. Box 322
Totowa, NJ 07511 (201) 256-0455
H.M. DYER ELECTRONICS INC.
31185 Ten Mile Rd.
Farmington Hills, MI 48024 (313) 478-2157
THE GENE SUDDUTH CO.
845 39th S.E.
Paris, TX 75460 (214) 784-6676
GRUNDER & ASSOCIATES
2019 W. 49th Terrace
Westwood Hills, KS 66205 (913) 831-0188
DIDIER/DENVER
P.O. Box 1599
Evergreen, CO 80439 (303) 674-6000
BOWDISH & ASSOCIATES
4432 Ensenada
Woodland Hills, CA 91364 (213) 704-6324
VICA & ASSOCIATES
4622 Emberline Court
Stone Mountain, GA 30083 (404) 292-7506
VIDEO COMMUNICATIONS CORP.
1400 Coleman Avenue
Suite B-22
Santa Clara, CA 95050 (408) 988-2968
NUCOM ASSOCIATES
19940 NW Ballinger Way
Seattle, WA 98155 (206) 364-9911

HUGHES AIRCRAFT COMPANY

Microwave Communications Products
3100 Fujita Street
P.O. Box 2999
Torrance, CA 90509 (213) 517-6100
Sales Contact: L.E. Stanley, Mgr. Mktg.

HUGHES HELICOPTERS INC.

Centinela Avenue & Teale St.
Culver City, CA 90230 (213) 305-3055
Sales Contact: Norman S. Jacobson,
No. Am. Sales Mgr.

HUGHES TELEVISION NETWORK

4 Penn Plaza
New York, NY 10001 (212) 563-8929
Sales Contact: Bill Page,
Dir., Sales Dev.

HUGHEY & PHILLIPS INC.

P.O. Box 6729
Burbank, CA 91510-6729 (213) 849-1104
Sales Contact: C.E. Stephens, Sales Mgr.

HUNT CHEMICAL

Roosevelt Place
Palisades Park, NJ 07650 (201) 944-4000
Sales Contact: E. Materazzi, Dir. of Sales

IGM COMMUNICATIONS

4041 Home Road
Bellingham, WA 98226 (206) 733-4567
Sales Contact: Nick Solberg, Tech. Mktg. Mgr.

ILC DATA DEVICE CORPORATION

105 Wilbur Place
Bohemia, NY 11716 (516) 567-5600
Sales Contact: Bill Henry, Reg. Mgr.

ITE INNOVATIVE TELEVISION EQUIP.

P.O. Box 681

Woodland Hills, CA 91365 (213) 888-9421
Sales Contact: B. Rosenberg, Pres.

ITI ELECTRONICS INC.

369 Lexington Ave.
Clifton, NJ 07011 (201) 546-3900
Sales Contact: Fred W. Belghaus, Sales Eng.

ITT JENNINGS DIVISION

970 McLaughlin Avenue
San Jose, CA 95122 (408) 292-4025
Sales Contact: R.W. Neibaur, Dir. Bus. Dev.

IKEGAMI ELECTRONICS (USA) INC.

37 Brook Avenue
Maywood, NJ 07607-1195 (201) 368-9171
Sales Contact: Herman Schloss,
VP, Sales/Marketing

Regional Sales Offices:

IKEGAMI ELECTRONICS
330 N. Belt Place East
Houston, TX 77060 (713) 445-0100
Contact: Leonard Wolff, Reg. Sls. Mgr.
IKEGAMI ELECTRONICS
3445 Kashiwa Street
Torrance, CA 90505 (213) 534-0050
Contact: Jerry Kraus, Reg. Sls. Mgr.
IKEGAMI ELECTRONICS
552 So. Lee St.
Americus, GA 31709 (912) 924-0061
Contact: Bud Mills, Reg. Sls. Mgr.
IKEGAMI ELECTRONICS
37 Brook Avenue
Maywood, NJ 07607 (201) 368-9171
Contact: John Chow, Reg. Sls. Mgr.
IKEGAMI ELECTRONICS
1411-C Shady Creek
St. Louis, MO 63141 (314) 878-6290
Contact: Harvey Caplan, Reg. Sls. Mgr.

IMAGE DEVICES INC.

1825 NE 149th St.
Miami, FL 33181 (305) 945-1111
Sales Contact: David Haylock, Pres.

IMAGE MAGNIFICATION INC.

739 Airway Circle
New Smyrna Beach, FL 32069 (904) 427-5294
Sales Contact: Robert Becker, VP Sales

IMAGE RESOURCE CORP.

2260 Townsgate Rd.
Westlake Village, CA 91361 (805) 496-3317
Sales Contact: M. Walker, Sales Mgr.

IMAGE TRANSFORM INC.

4142 Lankershim Blvd.
N. Hollywood, CA 91602 (213) 985-7566
Sales Contact: Dick Lebre, V.P. / Sls.

IMAGE VIDEO LIMITED

700 Progress Avenue, Unit 16
Scarborough, Ont., Canada (416) 438-3940
Sales Contact: Joseph Costa, Jr.

IMERO FIORENTINO ASSOCIATES

44 West 63rd Street
New York, NY 10023 (212) 787-3050
Sales Contact: Laurie Goldstein, Oper. Mgr.

IMMAD BROADCAST SERVICES LTD.

186 Queen St. West
Toronto Canada M5V 1Z1 (416) 598-0260
Sales Contact: S. Pumple, Pres. Telex: 0622634

IMPACT CASES INC.

150 Ferrier Street, Unit 3&4
Markham, Ontario L3R 3K3 (416) 475-7107
Sales Contact: L. Pugh, Ex. Administrator

INDUSTRIAL RESEARCH PRODUCTS INC.

321 N. Bond Street
Elk Grove Village, IL 60007 (312) 439-3600
Sales Contact: Roger M. Carroll, Mkt. Mgr.

INDUSTRIAL SCIENCES INC. (ISI)

P.O. Box 1495
3521 SW 42nd Ave. in FL (904) 373-6783

Gainesville, FL 32602 (800) 874-7590
Sales Contact: Robert Hansen, Dir. of Mktg.

INFORMATION PROCESSING SYSTEMS OF CALIFORNIA INC.

70 Glenn Way
Belmont, CA 94002 (415) 592-1742
Sales Contact: Larry Niswander, Mk. Mgr.

INMARK CORPORATION

38 Brushwood Rd.
Stamford, CT 06903 (203) 322-5272
Sales Contact: Lars Giers, Sales Mgr.

INNOVATIVE CONCEPTS INC.

2284 Ringwood Ave.
San Jose, CA 95131 (408) 262-6680
Sales Contact: Robert Sheehy, Nat. Sis. Mgr.

INNOVATIVE TELEVISION EQUIPMENT

P.O. Box 681
Woodlawn Hills, CA 91365 (213) 888-9421
Sales Contact: Bert I. Rosenberg, Pres.

INOVONICS INC.

503-B Vandell Way
Campbell, CA 95008 (408) 374-8300
Sales Contact: Brian Fogerty, Nat'l. Sis. Mgr.

INTEGRATED SOUND SYSTEMS

29-50 N. Blvd.
Long Island City, NY 11101 (212) 729-8400
Sales Contact: Mike Klasco

INTEGRATED TECHNOLOGY

9644 View High Drive
Kansas City, MO 64134 (816) 763-2286
Sales Contact: George Arneson, President

INTEGREX INC.

P.O. Box 747
Havertown, PA 19083 (215) 627-0966
Sales Contact: R. Tucker, Sales Dir.

INTERAND CORPORATION

666 North Lake Shore Drive
Chicago, IL 60611 (312) 943-1200
Sales Contact: Dr. Leonard Reiffel, Pres.

INTERFACE VIDEO SYSTEMS INC.

1333 New Hampshire Ave., NW LL-200
Washington, DC 20036 (202) 861-0500
Sales Contact: Terril Symonds Grow,
Sales, Marketing

INTERAND CORPORATION

666 N. Lake Shore Dr.
Chicago, IL 60611 (312) 943-1200
Sales Contact: E.K. Lunkenheimer, VP/Sales

INTERLAKE AUDIO INC.

580 F Dobbie St.
Winnipeg, Manitoba
Canada R2K 1G4 (204) 668-4864
Sales Contact: Paul Nagle, Sales Mgr.

INTERNATIONAL ELECTRO-MAGNETICS

350 N. Eric Drive
Palatine, IL 60067 (312) 358-4622
Sales Contact: Tony Pretto, Sales Mgr.

Continued on page 142

WHERE TO FIND IT

GENERAL INDEX, Pages 38-45

WHO MAKES IT

PRODUCT DIRECTORY, Pages 46-113

WHERE TO BUY IT

MANUFACTURERS, Pages 114-162

DEALERS/DISTRIBUTORS, Pages 168-189

WHY BUY TWO LENSES WHEN THIS ONE WILL DO?



Schneider 14X ENG/EFP lens zooms from super wide angle to long telephoto.

Changing lenses to handle changing conditions could cost you a once-in-a-lifetime shot. And that's why you should know about the Schneider 14X ENG/EFP lens. It gives you two-lens versatility in an economical one-lens package.

It can power zoom from 9mm-126mm. Or with the built-in 2X extender from 18mm-252mm. With the 6.3mm-9mm aspheric lens attachment, it can power zoom on the super wide angle shots. And, when the action calls for close and tight, it's got macro focusing.

The Schneider 14X is designed to bring out the best in Ampex, CEI, Fernseh, Hitachi, Ikegami, JVC, NEC, Panasonic, Philips, RCA, Sharp, Sony, Thomson and Toshiba 2/3" cameras. Lightweight, compact, ruggedly constructed, and weather resistant, it comes with a complete line of accessories. Superb European optics combined with excellent f/1.7 sensitivity bring back crisp, clear pictures even under low light level conditions.

In addition, Schneider offers the 14X lens in a 1/2-inch format for the new one-piece VCR cameras such as RCA Hawkeye, Panasonic and Sony. Schneider broadcast lenses are available throughout the United States and Canada from: **TELE-CINE CORP.**, 400 Crossways Park Drive, Woodbury, NY 11797; (516) 496-8500.

Schneider 14X ENG/EFP

Tele-Cine Corp. is a subsidiary of Schneider Corporation of America.

Circle (87) on Action Card

WHERE TO BUY IT

INTERNATIONAL INSTRUMENTS

88 Marsh Hill Rd.
Orange, CT 06477 (203) 795-4711
Sales Contact: D.R. Lynch, V.P. Sales

INTERNATIONAL MICROWAVE CORP.

33 River Road
Cos Cob, CT 06807 (203) 661-6277
Sales Contact: Tony Acri, Sales Mgr.

INTERNATIONAL NUCLEAR CORPORATION

608 Norris Ave.
Nashville, TN 37204 (615) 254-3365
Sales Contact: Raymond L. Weiland, Pres.

INTERNATIONAL TAPETRONICS CORPORATION

2425 S. Main St.
P.O. Box 241
Bloomington, IL 61701 (309) 828-1381
Sales Contact: Chuck Kelly, Sales Mgr.

INTERNATIONAL VIDEO CORPORATION

455 West Maude Avenue
Sunnyvale, CA 94086 (408) 738-3900
Sales Contact: Fielding Hodges, Nat. Sls. Mgr.

IONIC INDUSTRIES INC.

128 James Street
Morristown, NJ 07960 (201) 539-1040
Sales Contact: Alfred Mayer, Pres.

IVIE ELECTRONICS INC.

500 W. 1200 S.
Orem, UT 84057 (801) 224-1800
Sales Contact: Glen Meyer, Sales Mgr.

J

J&R FILM CO. INC.

6820 Romaine St.
Los Angeles, CA 90038 (213) 467-3107
Sales Contact: Joe Paskal, President

J.V. ELECTRONICS INC.

151 Bentley Str., Unit 2
Markham - Ont. L3R 3X9 (416) 475-8166
Sales Contact: John Visser, Pres.

JAMIESON AND ASSOCIATES

4130 IDS Tower
Minneapolis, MN 55402 (612) 333-4581
Sales Contact: Raymond Johnson, VP

JAMIESON FILM CO.

6901 Forest Park Road
Dallas, TX 75235 (800) 527-2299
Sales Contact: Oscar Garza, V.P. Mktg.

THE JANSON INDUSTRIES

Box 6090

Canton, OH 44706 (216) 455-7029
Sales Contact: Richard W. Janson, Gen. Mgr.

JATEX INC.

2626 Freewood Dr.
Dallas, TX 75220 (214) 358-0200
Sales Contact: Lee Phillips, Nat'l. Sls. Mgr.
Bill Eason, Jr., President

JAVELIN ELECTRONICS INC.

19831 Magellan Drive
Torrance, CA 90502 (800) 421-2716
Sales Contact: Louis Yates, Sales Consultant

JEFFERSON DATA SYSTEMS

501 Archdale Dr.
Charlotte, NC 28210 (704) 525-3901
Sales Contact: Mike Jones, VP

JENEL CONSULTANTS CORPORATION

9550 Forest Lane
Suite 400
Dallas, TX 75243 (214) 343-1229
Sales Contact: Elmer Smalling, Pres./Chmn.

JENSEN TRANSFORMERS

10735 Burbank Blvd.
North Hollywood, CA 91601 (213) 876-0059
Sales Contact: Dave Hill

JERROLD DIVISION, GENERAL INSTRUMENT CORP.

2200 Byberry Road
Hatboro, PA 19040 (215) 674-4800
Sales Contact: Jack Forde, V.P. Sales

IRV JOEL & ASSOCIATES

528 River Road
Teaneck, NJ 07666 (201) 692-0010

JOHNSON ELECTRONICS INC.

P.O. Box 7
Casselberry, FL 32707 (305) 339-2111
Sales Contact: Joseph M. Lutz, Pres.

K

K B SYSTEMS

10407 62nd Place West
Everett, WA 98204 (206) 355-8740
Sales Contact: Kay Vincent, Sales Mgr.

K & H PRODUCTS LTD.

Box 246
N. Bennington, VT 05257 (802) 442-9118
Sales Contact: Margie Robertson, Sales

KAHN COMMUNICATIONS INC.

839 Stewart Avenue
Garden City, NY 11530 (516) 222-2221
Sales Contact: Leonard R. Kahn, Pres.

KAJAANI OY ELECTRONICS DIV.

Nuaskatu 11
SF-87400 Kajaani 40
Finland *358 86 37311
Sales Contact: Veikko Hjerppe, Mark. Mgr.

KAITRONICS CORP.

1540 Gilbreth Road
Burlingame, CA 94010 (415) 697-9102
Sales Contact: Paul Tarrohaychik,
VP, Broadcast Products

KALAMUSIC

Suite 600
Industrial State Bank Building (616) 385-5110
Kalamazoo, MI 49007
Sales Contact: David Goldsmith, Nat. Sls. Mgr.

KALART VICTOR CORPORATION

Hultenius Street
Plainville, CT 06062 (203) 747-1663
Sales Contact: J.J. Costag, Sales Mgr.

KAMAN SCIENCES/KBS

1500 Garden of the Gods Road
Colorado Springs, CO 80933 (303) 599-1601
Sales Contact: George T. Beattie, Mgr. Mktg.

KAPCO COMMUNICATIONS

1270 Jarvis Ave.
Elk Grove Village, IL 60007 (312) 437-5900
Sales Contact: Ken Rubel, Pres.

KATHREIN-WERKE KG

P.O. Box 260
D - 8200 Rosenheim 2 08031/184-1
Sales Contact: G. Winkler, Expt. Mgr.

KAY ELEMETRICS CORP.

12 Maple Avenue
Pine Brook, NJ 07058 (201) 227-2000
Sales Contact: Stephen Crump, Sls. Mgr.

KAY INDUSTRIES INC.

604 North Hill Street
South Bend, IN 46617 (219) 234-0171
Sales Contact: Aaron Katz, Pres.

KEITHLEY INSTRUMENTS INC.

28775 Aurora Rd.
Cleveland, OH 44139 (216) 248-0400
Sales Contact: Ronald Ruiz, Nat. Sls. Mgr.

KEY VIDEO LTD.

70 Milner Ave., Unit 5
Scarborough,
Ontario M1S 3P8 (416) 298-6199
Sales Contact: A.W. Critchley, Pres.

KILOVAC CORPORATION

P.O. Box 4422 BC
Santa Barbara, CA 93103 (805) 684-4560
Sales Contact: Jack L. Dysart, Prod. Mgr.

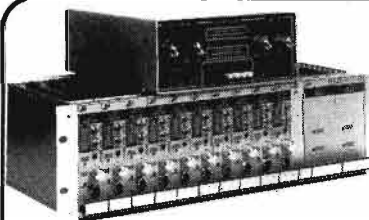

AUDIO PROCESSORS
MODULAR COMPRESSOR - DA

FREE DETAILED BROCHURES

Micro Amp Series by

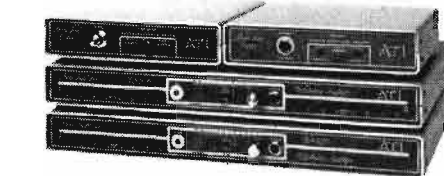

DISTRIBUTION AMPLIFIERS



PHONO
PREAMPLIFIERS

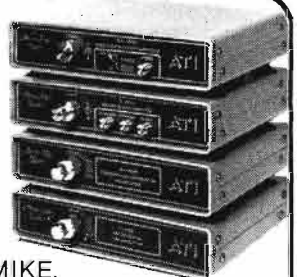

DUAL MIKE,
LINE, & POWER AMPLIFIERS
RACK MOUNTING



AUDIO
TECHNOLOGIES
INCORPORATED

328 MAPLE AVENUE
HORSHAM, PA. 19044
(215) 443-0330

Circle (88) on Action Card

KIMIEN SALES INC.

P.O. Box 503
 1804 Sycamore St.
 Atlantic, IA 50022 (712) 243-1626
Sales Contact: Robert C. Willms, President

KINDWALL CORPORATION

P.O. Box 1557 (800) 831-5051
 Spencer, IA 51301 (712) 262-5810
Sales Contact: Ron Kindwall, Pres.

KINETRONICS CORPORATION

42 Sherwood Terrace
 Lake Bluff, IL 60044 (312) 295-5600
Sales Contact: R. Nadolny, V.P. Sales

KINGS ELECTRONICS CO. INC.

40 Marbledale Rd.
 Tuckahoe, NY 10707 (914) 793-5000
Sales Contact: F. Della Ialono, Sales Mgr.

KINTEK INC., DIV. OF dbx INC.

61 Chapel St.
 Newton, MA 02195 (617) 969-2520
Sales Contact: Dan Taylor, Mktg. Dir.

WHERE TO FIND IT

GENERAL INDEX, Pages 38-45

WHO MAKES IT

PRODUCT DIRECTORY, Pages 46-113

WHERE TO BUY IT

MANUFACTURERS, Pages 114-162

DEALERS/DISTRIBUTORS, Pages 168-189

KITCHEN PRODUCTIONS INC.

619 W. Ridgecrest Blvd.
 Suite D
 Ridgecrest, CA 93555 (714) 375-2753
Sales Contact: Edward Tipler, Eng.

KLARK-TEKNIK RESEARCH LTD.

Walter Nash Road West
 Coppice Trading Estate
 Kidderminster, Worcs.,
 England (0562) 741515

KLIEGL BROS.

32-32 48th Avenue
 Long Island City, NY 11101 (212) 786-7474
Sales Contact: Michael F. Connell, Dir. of Sls.

KLINE IRON AND STEEL COMPANY

P.O. Box 1013
 Columbia, SC 29202 (803) 779-7080
Sales Contact: J.R. Trotter, Sales Mgr.

KLIPSCH & ASSOCIATES INC.

P.O. Box 688
 Hope, AK 71801 (501) 777-6751
Sales Contact: Chuck Mulhearn, Nat. Sls. Mar.

KNOX VIDEO PRODUCTS

5001-J Forbes Blvd.
 Lanham, MD 20706-4499 (301) 459-2106
Sales Contact: Paula Bowen, Mktg. Mgr.

KOSS CORPORATION

4129 N. Port Washington Ave.
 Milwaukee, WI 53212 (414) 964-5000
Sales Contact: Jeff Martin, Sales Mgr.

KRAUSE, BERNIE & GARY REMAL

c/o Parasound

680 Beach ST., Suite 414
 San Francisco, CA 94109 (415) 673-4544
Sales Contact: Betsy Zeger, Dir. of Sales

KREONITE INC.

715 E. 10th Street
 P.O. Box 2099
 Wichita, KS 67201 (316) 263-1111
Sales Contact: Lu Wasmoen, Mktg. V.P.

KUDELSKI S.A.

CH-1033
 Cheseaux-sur-Lausanne
 Switzerland (021) 91 21 21
Sales Contact: J.P. Kolopp, Adv. Mgr.

L**LPB INC.**

28 Bacton Hill Road
 Frazer, PA 19355 (215) 644-1123
Sales Contact: Harry N. Larkin, VP, Mktg.

Regional Sales Offices:

R.W. BURDEN ASSOCIATES
 20944 Sherman Way
 Canoga Park, CA 91303 (213) 340-4590
 Contact: Richard W. Burden
 M.S.C. ELECTRONICS LTD.
 254 Wildcat Road
 Downsview, Ontario M3J 2N5 (416) 661-4180
 Contact: David LaFrenais, Pres.

LRC ELECTRONICS INC.

901 South Ave.
 Horseheads, NY 14845 (607) 739-3844
Sales Contact: John W. McQuaid

Continued on page 144

THE CHOICE IS YOURS!



THE AUDIOPAK A-2 OR THE STEREO PHASED AA-3 BROADCAST CARTRIDGE

**Capitol Audiopak Broadcast Cartridges—
for stations who care how they sound.**

Both Audiopak carts offer extremely low wow and flutter; a positive brake system which stops the tape, not the hub, assuring accurate cueing. Unsurpassed reliability is assured because we manufacture the tape and all other components in the cartridge. Moreover, all carts are 100% tested before shipping.

The AA-3 offers excellent stereo phase stability. It's loaded with Capitol's own Q17 HOLN tape which extends frequency response and headroom to provide studio sound quality.

CAPITOL MAGNETIC PRODUCTS
 A Division of Capitol Records, Inc.
 6902 Sunset Blvd.
 Hollywood, California 90028

©1980 CAPITOL RECORDS, INC.



Circle (89) on Action Card

WHERE TO BUY IT

THE LRS DISTRIBUTING COMPANY

29 Stonehenge Circle
Baltimore, MD 21208 (301) 484-7750
Sales Contact: *Bucky Buchman, V.P.*

LTI PRODUCTIONS

22530 W. 8 Mile Rd.
Southfield, MI 48034 (313) 353-3355
Sales Contact: *Barry Grant, V.P.*

LTM CORPORATION OF AMERICA

1160 N. Las Palmas Ave.
Hollywood, CA 90038 (213) 460-6166
Sales Contact: *Gilles Galerne, Gen. Mgr.*

L-W INTERNATIONAL

6416 Variel Ave.
Woodland Hills, CA 91367 (213) 348-8614
Sales Contact: *Pat Smith, MGr. Mktg.*

LAIRD TELEMEDIA INC.

2424 South 2570 West
Salt Lake City, UT 84119 (801) 972-5900
Sales Contact: *David Klemm, Sales Mgr.*

LANG VIDEO SYSTEMS CORP.

2405 De La Cruz Blvd.
Santa Clara, CA 95050 (408) 988-2311
Sales Contact: *Mel Lang, President*

LARCAN COMMUNICATIONS EQUIPMENT

396 Attwell Dr.
Rexdale, Ont. M9W 5C3 (416) 675-7517
Sales Contact: *P. Balodis, Mktg. Dir.*

D.N. LATUS & CO. INC.

7 Placer, Box 1720
Helena, MT 59601 (406) 442-3940
Sales Contact: *D.N. Latus, Pres.*

LEADER BROADCAST SYSTEMS INC.

195 W. 7th Avenue
Vancouver, British Columbia, (604) 685-6043
Canada V5Y 1L8 Cables: LEADERTAPE
Sales Contact: *Michael K. Leader, Pres.*
Dave James, Tech. Dir.

LEADER INSTRUMENTS CORP.

380 Oser Avenue
Hauppauge, NY 11787 (516) 231-6900
Sales Contact: *Robert Sparks, Nat'l. Dir. of Sls.*

LEBLANC ROYLE COMM. TOWERS LTD.

514 Chartwell Rd.
P.O. Box 880
Oakville, Ontario
Canada L6J 5C5 (416) 844-1242
Sales Contact: *Jim Willson, Dir. of Sls & Mktg.*

LECTROTECH INC.

5810 N. Western Ave.
Chicago, IL 60659 (312) 769-6262
Sales Contact: *W. Grossman, Sales Mgr.*

LECROY FIBEROPTICS SYSTEMS DIV.

1234 E. Joppa Road
Towson, MD 21204 (301) 296-7670
Sales Contact: *J.B. Mroz, Mktg. Mgr.*

LECROY RESEARCH SYSTEMS

700 South Main Street
Spring Valley, NY 10977 (914) 425-2000
Sales Contact: *Dean Bogert, Appl. Eng.*

LEEVERS-RICH EQUIPMENT LTD.

319 Trinity Road
Wandsworth, London
SW18 3SL England 01-874-9054
Sales Contact: *W.A. Costello, Managing Dir.*

LEE-RAY INDUSTRIES INC.

38 E. 1st Ave.
Mesa, AZ 85202 (602) 962-6806
Sales Contact: *Sales Dept.*

LEITCH VIDEO OF AMERICA

825 K. Greenbriar Circle
Chesapeake, VA 23320 (804) 424-7920
Sales Contact: *John Walter, Pres. & GM*

LEITCH VIDEO LIMITED

705 Progress Ave., Unit 46
Scarborough, Ontario
Canada M1H 2X1 (416) 438-5060
Sales Contact: *Mr. John Walter, Gen. Mgr.*

LEMO U.S.A. INC.

P.O. Box 6626
335 Tesconi Circle
Santa Rosa, CA 95406 (707) 523-0600
Sales Contact: *Bob Wersen, Gen. Mgr.*

LENCO INC., ELECTRONIC DIV.

300 N. Maryland St.
Jackson, MO 63755 (314) 243-3147
Sales Contact: *Andy Leonard, Asst. Sls. Mgr.*

LENZAR OPTICS CORP.

1006 West 15th St.
Riviera Beach, FL 33404 (305) 844-0263
Sales Contact: *H.B. Ganther, VP*

LEVIT ELECTRONICS INC.

200 Park Avenue South
New York, NY 10003 (212) 777-5517
Sales Contact: *Michael Levit, Mktg.*

LEXICON INC.

60 Turner St.
Waltham, MA 02154 (617) 891-6790
Sales Contact: *Virginia Casale, Mktg. Admin.*

LIGHTNING ELIMINATION ASSOC. INC.

12516 Lakeland Road
Santa Fe Springs, CA 90670 (213) 944-0916
Sales Contact: *Hal Proppe, VP Mktg.*

LIGHTING PRODUCTS GROUP GTE PRODUCTS CORPORATION

100 Endicott Street
Danvers, MA 01923 (800) 221-3333
Sales Contact: *GTE Product Info. Center*

LINDSAY SPECIALTY PRODUCTS LTD.

50 Mary Street W.
Lindsay, Ontario,
Canada K9V 4S7 (705) 324-2196
Sales Contact: *Bob Barkwell, Sales Rep.*

LINK ELECTRONICS

North Way
Andover, Hampshire,
England SP10 5AJ 0264 61345
Sales Contact: *J. Willson, Sales Dir.*

LIPSNER-SMITH COMPANY

4700 Chase Ave.
Lincolnwood, IL 60646 (312) 675-8473
Sales Contact: *Tom Tisch, VP*

LISTEC TELEVISION EQUIPMENT CORP.

39 Cain Drive
Plainview, NY 11803 (516) 694-8963
Sales Contact: *Joanne Camarda, Manager*
Regional Sales Offices:

LISTEC TELEVISION EQUIPMENT CORP.
4529 San Fernando Road, Unit A
Glendale, CA 91204 (213) 247-9247

LIVE SOUND INC.

1741 N. Ivar -118
Hollywood, CA 90028 (213) 462-3351
Sales Contact: *Agnes F. Peterson, Pres.*

LOGICA

666 Third Avenue
New York, NY 10017 (212) 599-0828
Sales Contact: *Dick Lutz, Mktg. Mgr.*

LOGITEK ELECTRONIC SYSTEMS INC.

3320 Bering Drive in TX, collect (713) 782-4592
Houston, TX 77057 (800) 231-5870
Sales Contact: *Scott Hochberg, Pres.*

Regional Sales Offices:

LOGITEK ELECTRONIC SYSTEMS
Box 322
Totowa, NJ 07511 (201) 256-0455
Contact: *Herb Holzberg, Rep.*
LOGITEK ELECTRONIC SYSTEMS
5914 Maple
Houston, TX 77074 (713) 774-3314
Contact: *Bernie Giesler, Rep.*
LOGITEK ELECTRONIC SYSTEMS
1314 Iturbide Street
Laredo, TX 78040 (512) 723-6913
Contact: *Richard Reyes, Export Rep.*

LOWEL-LIGHT MFG. INC.

475 10th Avenue
New York, NY 10018 (212) 947-0950
Sales Contact: *Art Kramer, Sales Mgr.*
Amy Carter, Ass't. Sls. Mgr.

LYON LAMB VIDEO ANIMATION SYSTEMS

8255 Beverly Blvd.
Suite 202
Los Angeles, CA 90048 (213) 655-0606
Sales Contact: *Kimberly Mitchell*

LYON METAL PRODUCTS INC.

P.O. Box 671
Aurora, IL 60507 (312) 892-8941
Sales Contact: *O.J. Henderson, Nat'l. Sls. Mgr.*

LYREC MANUFACTURING A/S

Hollandsvej 12
DK-2800 Lyngby 02 87 63 22
Denmark TLX: 37568 Lyrec DK
Sales Contact: *Johan Von Schoultz, Sls. Mgr.*

M

3M COMPANY, Mincom Division

3M Center Bldg. 23-5E
St. Paul, MN 55101 (612) 733-7603

3M - Mag A/V Products Division

3M Center - Bldg. 223-5N
St. Paul, MN 55144 (612) 733-7980
Sales Contact: *C. Devore, Sls / Service Analyst*

Regional Sales Offices:

3M 5531 Minnesota Drive
Anchorage, Alaska 99502 (907) 276-2363
Would be Handled thru Int'l. Div.
3M 2860 Bankers Industrial Drive
Atlanta, GA 30360 (404) 447-7000
3M
115 4th Avenue
Needham Hts., MA 02194 (617) 449-0300
3M
6850 South Harlem Ave.
(Bedford Park)
Argo, IL 60501 (312) 496-6500
3M
4835 Para Drive
Cincinnati, Ohio 45237 (513) 242-2313
3M
12200 Brookpark Road
Cleveland, OH 44130 (216) 267-1800
3M
2121 Santa Anna Avenue
Dallas, TX 75228 (214) 324-8100
3M
23923 Research Drive
Farmington, MI 48024 (313) 477-5000

WHERE TO FIND IT

GENERAL INDEX, Pages 38-45

WHO MAKES IT

PRODUCT DIRECTORY, Pages 46-113

WHERE TO BUY IT

MANUFACTURERS, Pages 114-162

DEALERS/DISTRIBUTORS, Pages 168-189

3M
126 West Elm Court
Burbank, CA 91502 (213) 848-5534
3M
2880 Ualena Street
Honolulu, Hawaii 96819 (808) 841-0147
Would be handled through Int'l. Div.
3M
6023 South Garfield Ave.
Los Angeles, CA 90040 (213) 726-6300
3M
15 Henderson Drive
All Mail: P.O. Box 76
West Caldwell, NJ 07006 (201) 575-2000
3M
5698 Rising Sun Ave.
Philadelphia, PA 19120 (215) 728-5300
3M
10725 Baur Boulevard
All Mail: P.O. Box 510
St. Louis, MO 63166 (314) 997-8500
3M
320 Shaw Road
South San Francisco, CA 94080 (415) 761-1155
3M
100 Andover Park West
Andover Industrial Park
Seattle, WA 98188 (206) 244-7200
3M
3130 Lexington Avenue South
Eagan, MN 55121 (612) 733-5961
All Mail: P.O. Box 3211
St. Paul, MN 55133
3M
1101 - 15th St. N.W.
Washington, D.C. 20005 (202) 331-6964
3M
International Operations
Magnetic A/V Products Division
Bldg. 220 - 5E
St. Paul, MN 55101 (612) 733-2908

MIA-COM VIDEO SYSTEMS
63 Third Avenue
Burlington, MA 01803 (617) 272-3100

MBI BROADCAST SYSTEMS LTD.
69 Ship Street
Brighton, England
BN1 1AE (0273) 24928
Sales Contact: Michael Fabricant, Dir.

MCG ELECTRONICS INC.
160 Brook Ave.
Deer Park, NY 11729 (516) 586-5125
Sales Contact: Michael J. Coyle, Pres.

MCI INC.
1400 West Commercial Boulevard
Ft. Lauderdale, FL 33309 (305) 491-0825
Sales Contact: Dennis Sindrey, Sales Mgr.

Regional Sales Offices

AUDIO INDUSTRIES
1419 N. La Brea Avenue
Hollywood, CA 90028 (213) 851-4111

AUDIOTECHNIQUES
652 Glenbrook Road
Stamford, CT 06906 (203) 359-2313

CONTROL TECHNOLOGY
2322 Davle Blvd.
Ft. Lauderdale, FL 33312 (305) 792-7791

MCI INC./NASHVILLE OFFICE
1717 Elm Hill Pike, Suite B-9
Nashville, TN 37210 (615) 366-0333

MILAM AUDIO COMPANY
1470 Valle Vista Blvd.
Pekin, IL 61554 (309) 346-3161

PACIFIC RECORDER & ENGINEERING
11100 Roselle Street
San Diego, CA 92121 (714) 453-3255

PRO AUDIO GENERAL STORE
1378 NW 100th Avenue
Coral Springs, FL 33065 (305) 752-0330

PRO AUDIO SYSTEMS
11057 8th Avenue NE
Seattle, WA 98125 (206) 367-6800

RECORDING STUDIO EQUIPMENT
18917 NE 5th Avenue
N. Miami Beach, FL 33160 (305) 949-8918

SOUTHWEST PROFESSIONAL AUDIO
1500 Summit Street
Austin, TX 78741 (512) 443-4567
STUDIOWORKS
1018 Central Avenue
Charlotte, NC 28204 (704) 375-1053

MCI LTD.
MCI House, 54 - 56 Stanhope Street
London, UK NW1 3EX 01-388-7867 / 8

MCI/QUANTEL
2483 E. Bayshore, #100
P.O. Box 50810
Palo Alto, CA 94303 (415) 856-6226
Sales Contact: Don Prather, V.P. Sales

Regional Sales Offices:

MCI/QUANTEL
2971 Flowers Road, Suite 106
Atlanta, GA 30341 (404) 457-1266
Contact: Paul Fletcher, Dist. Mgr.

MCI/QUANTEL
300 Broad Street, No. 500
Stamford, CT 06901 (203) 348-4104
Contact: David Dever, Dist. Mgr.

MCI/QUANTEL
33701 Oak Point Circle
Farmington Hills, MI 48018 (313) 553-2360
Contact: Mr. Larry Blehl

MCI/QUANTEL
23416 Kittridge
Canoga Park, CA 91307 (213) 999-5965
Contact: Mr. Chuck Martin

MCI/QUANTEL
23711 107th Place, West
Edmonds, WA 98020 (206) 546-6264
Contact: Mr. Tom McGowan

MCI/QUANTEL
2225 Madison Street, No. 105
Arlington, TX 76011 (817) 261-0007
Contact: Mr. Gary Young

MICHAEL VIDEO SALES, INC.
2421 LewisvilleClemmons Rd.
Continued on page 146

Nobody's perfect ... but we'll help you get close.

Howe Series 2000 Phase Chaser™



OP2005

Phase errors in stereo cart machines, stereo reel-to-reel machines, stereo-to-mono dubs, and more can now be corrected inexpensively and effectively.

The revolutionary Howe Series 2000 Phase Chaser™ is one neat little package that can be placed in the audio chain in any of several locations to correct phase error between left and right channels.

The Howe Series 2000 Phase Chaser™ is not expensive, just essential.

Get your facility in phase for as low as \$800.

Phase Chaser™ is a trademark of Howe Audio



OP2020



OP2022



OP2023



For further information contact:
Howe Audio Marketing
3085-A Bluff Street
Boulder, CO 80301
(800) 525-7520 or (303) 442-3231



howe audio productions, inc.
P.O. Box 383, Boulder, CO 80306

Circle (90) on Action Card

WHERE TO BUY IT

Clemmons, NC 27012
Contact: Mr. Paul Michael
CAMERA MART
456 W. 55th Street
New York, NY 10019 (212) 757-6977
Contact: Mr. Leo Rosenberg
PROFESSIONAL PRODUCTS
4964 Fairmont
Bethesda, MD 20014 (301) 657-2141
Contact: Mr. Chuck Motta
LANDY ASSOCIATES
1890 E. Marilton Pike (Rt. 70)
Cherry Hills, NJ 08003 (609) 424-4860
Contact: Mr. Jim Landy
VICTOR DUNCAN
2659 Fondren
Dallas, TX 75206 (214) 389-1185
Contact: Mr. Bill Reiter
VICTOR DUNCAN
32380 Howard Street
Madison Heights, MI 48071 (313) 589-1900
Contact: Mr. Larry Walker
VICTOR DUNCAN
661 North LaSalle
Chicago, IL 60610 (312) 943-7300
Contact: Mr. Bob Coleman
SKAGGS VIDEO SALES
5181 Amelia Earhart Dr.
Salt Lake City, UT 84116 (801) 539-1420
Contact: Mr. Sam Kichas
OMEGA VIDEO, INC.
14326 Isis Avenue
Lawndale, CA 90260 (213) 679-9021
Contact: Mr. David Riegler
WESTERN BROADCAST SYS.
10707 Amulet Place
Cupertino, CA 95014 (408) 749-0900
Contact: Mr. Homer E. Hull
BENNETT ENGR. ASSOC., INC.
5005 S. 91st Avenue
Mercer Island, WA 98040 (206) 232-3550
Contact: Mr. Stanton Bennett
NORTEC WEST
325 West 5th Avenue
Vancouver, BC V5R 1J6 (604) 872-8525
Contact: Mr. Bob Whitehouse
NORTEC WEST
7056 B. Farrell Road
Calgary, AL T2H 0T2 (403) 252-8141
Contact: Mr. Ron Hill
ELECTRO & OPTICAL SYSTEMS
31 Progress Court
Scarsborough, ON M1G 3V5 (416) 439-9333
Contact: Mr. Maurice Evans, Mr. Michael Paul
TECKNOMERICA, S.A.
Fujlyama No. 72
Col. Las Aguilas
Mexico, 20 D.F. (905) 593-2046
Contact: Ing. Jorge Ibarra
PHI
Apartado 65600
Carcacas, 1066a 011-(582) 562-1403
Contact: Mr. Renato Micheluz

MEI MICROPROBE ELECTRONICS
Suite 1532 A, 875 N. Michigan Ave.
Chicago, IL 60611 (312) 440-3111
Sales Contact: David E. Collins, Pres.

MPB TECHNOLOGIES
P.O. Box 160
21051 North Service Road
Ste-Anne-De-Belleveue, Quebec
Canada H9X 3L5 (514) 457-2035
Sales Contact: Mr. R.J. Clark, VP Dlg. Prod.

MSI TELEVISION
4788 South State St.
Salt Lake City, UT 84107 (801) 262-8475
Sales Contact: Ann Newman, CATV Sls. Mgr.

MXR INNOVATIONS INC.
740 Driving Park Ave.
Rochester, NY 14613 (716) 254-2910
Sales Contact: Joel Silverman, Nat. Sls. Mgr.

MACKENZIE LABORATORIES INC.
5507 Peck Road
P.O. Box 3029
Arcadia, CA 91006 (213) 579-0440
Sales Contact: G.W. Keleher, VP

MAGNASYNC/MOVIOLA CORPORATION
5539 Riverton Ave.
North Hollywood, CA 91601 (213) 763-8441
Sales Contact: A. Madsen, Prod. Line Mgr.

MAGNA-TECH ELECTRONIC CO. INC.
630 Ninth Avenue
New York, NY 10036 (212) 586-7240
Sales Contact: R. Eberenz, VP

MAGNAVOX CATV SYSTEMS INC.
100 Fairgrounds Dr.
Manlius, NY 13104 (315) 682-9105
Sales Contact: Bob Finnerty, Sales Admin.

MAGNECRAFT ELECTRIC
5575 North Lynch Ave.
Chicago, IL 60630 (312) 282-5500
Sales Contact: D. Cooper, Ad Mgr.

MAGNEFAX INTERNATIONAL INC.
Route 1 Box 764
Rogers, AR 72756 (501) 925-1818
Sales Contact: Dennis W. Tallakson, Pres.

MAGNETIC REFERENCE LABORATORY INC.
229 Polaris Avenue, Suite 4
Mountain View, CA 94043 (415) 965-8187
Sales Contact: Jenny Foster, Secretary

MAGNESONICS SALES & MFG. CO.
3740E Transport
Ventura, CA 93003 (805) 642-3092
Sales Contact: D.P. Grosslight

MAGNUM TOWERS INC.
9370 Elder Creek Road
Sacramento, CA 95826 (916) 381-5053
Sales Contact: Alexander M. Perchevitch, GM

MALLORY CAPACITOR COMPANY
3029 E. Washington Street
Indianapolis, IN 46206 (317) 636-5353
Sales Contact: Frank Vendely, Dir. of Sales

THE MANAGEMENT
P.O. Box 111
Aled, TX 76008 (817) 441-8045
Sales Contact: Pete Charlton, Owner

MARATHON PRODUCTS CORPORATION
334 West Boylston St.
West Boylston, MA 01583 (617) 853-0988
Sales Contact: B. Bagdasarian, Treas.

MARCONI COMMUNICATION SYSTEMS LTD.
Marconi House
Chelmsford, U.K. CM1 1PL
Sales Contact: P.A.T. Turrall,
Overseas Sales Mgr.

MARCONI ELECTRONICS, Broadcast & Communications Division
100 Stonehurst Court
Northvale, NJ 07647 (201) 767-7250
Sales Contact: John B. White,
Mgr., Comm. & Broadcast

MARCONI INSTRUMENTS LTD.
Long Acres Stalbins
Hertfordshire (0727) 59292
AL4 0JN, UK TELEX 23350
Cable: Measure Test, St. Albans
Sales Contact: Mr. B. Briggs, Sales Mgr.

MARKETRON INC.
2180 Sand Hill Road
Suite 250
Menlo Park, CA 94025 (415) 854-5301
Sales Contact: Michael D. Rooney, Sales Mgr.

MARTI ELECTRONICS INC.
1501 N. Main, Box 661
Cleburne, TX 76031 (817) 645-9163
Sales Contact: Geo. Marti, Pres.

MARSHALL ELECTRONICS INC.
P.O. Box 2027
Culver City, CA 90230 (213) 836-4288
Sales Contact: L. Marshall, V.P.

MASTER DIGITAL INC.
202 Main Street
Venice, CA 90291 (213) 399-7764
Sales Contact: Paul Addis, Nat. Sls. Mgr.

MATRIX DIV./LEEDAL INC.
1918 S. Prairie Ave.
Chicago, IL 60616 (312) 842-6588
Sales Contact: T. Zimmerman, Adv. Dir.

MATTHEWS STUDIO EQUIPMENT INC.
2405 Empire Avenue
Burbank, CA 91504 (213) 843-6715
Sales Contact: Ron Prociw, Sales Mgr.

MAXELL CORPORATION OF AMERICA
60 Oxford Drive
Moonachie, NJ 07074 (201) 440-8020
Sales Contact: Jim Ringwood, Nat'l. Sales Mgr.

McCURDY RADIO INDUSTRIES LTD.
108 Carnforth Road
Toronto, Ontario,
Canada, M4A 2L4 (416) 751-6262
Sales Contact: Stan Maruno, Sales Mgr.

McINNIS-SKINNER & ASSOCIATES
6529 N. Classen Blvd.
Oklahoma City, OK 73116 (405) 848-4246
Sales Contact: Ron Hudson, Mktg. Dir.

McKAY DYMEK COMPANY
111 So. College Ave.
P.O. Box 5000 (800) 854-7769
Claremont, CA 91711 (714) 621-6711
Sales Contact: Joseph Priske, Pres.

McMARTIN INDUSTRIES INC.
4500 S. 76th Street
Omaha, NE 68127 (402) 331-2000
Sales Contact: K. Jones, Broadcast Oper. Mgr.

MCQ TELEPRODUCTIONS
P.O. Box 1676
San Mateo, CA 94401 (415) 348-1344
Sales Contact: Lon McQuillin, Pres.

MEAD DATA CENTRAL
200 Park Avenue
New York, NY 10017 (212) 883-8560
Sales Contact: H.E. Heilesen, VP Mktg.

KENNETH R. MEADES
P.O. Box 3831
Beverly Hills, CA 90212 (213) 771-0636
Sales Contact: Kenneth R. Meades,
Owner-Manager

MEMOREX CORP.
Professional Products Group
P.O. Box 1000
Santa Clara, CA 95052 (408) 987-1000
Sales Contact: J. Higgins, Video Prod. Mgr.

MERLIN ENGINEERING WORKS
1880 Embarcadero
Palo Alto, CA 94303 (415) 856-0900
Sales Contact: J. Streets, Pres.

MERRILL CABLE EQUIPMENT CORP.
P.O. Box 13741
2629 N. 24th Dr.
Phoenix, AZ 85002 (602) 271-9181
Sales Contact: Thomas Helsler, Dir./Mktg.

MESOMET INC.
35 E. Wacker Dr.
Chicago, IL 60601 (312) 263-5921
Sales Contact: C.M. Poe, VP

METRIFAST

51 South Denton Avenue
New Hyde Park, NY 11040 (516) 328-3333
Sales Contact: Mr. Herbert Arum, Mktg. Mgr.

MICHIGAN MAGNETICS INC.

203 W. Third St.
Vermontville, MI 49096 (517) 726-0590
Sales Contact: B.L. Killinger, Mkt. Dir.

MICMIX AUDIO PRODUCTS INC.

2995 Ladybird Lane
Dallas, TX 75220 (214) 352-3811
Sales Contact: Bill Allen, President

MICRO COMMUNICATIONS INC.

Grenier Field
P.O. Box 4365
Manchester, NH 03108 (603) 624-4351
Sales Contact: T.J. Vaughan, Marketing
Howard Bouldry, GM

MICRO CONTROL ASSOCIATES INC.

Box 694
Cleburne, TX 76031 (817) 295-7771
Sales Contact: Robert Richards, Pres.

MICRODYNE CORPORATION

P.O. Box 7213
491 Oak Road
Ocala, FL 32672 (904) 687-4633
Sales Contact: Thomas H. Kidd, Sls. Eng.

MICROFLECT CO. INC.

3575 25th St. S.E.
Salem, OR 97302 (503) 363-9267
Sales Contact: Harvey B. Wilson, Sales Mgr.

MICRO PRODUCTS INC.

13239 Northup Way
Bellevue, WA 98005 (206) 747-6010
Sales Contact: Sheryl Paulsen,
Mktg./Sales Mgr.

MICRON AUDIO PRODUCTS LTD.

210 Westlake Drive
Valhalla, NY 10595 (914) 761-6520
Sales Contact: Paul Tepper

Regional Sales Offices:

MICRON AUDIO PRODUCTS LTD.
1619 Broadway
New York, NY 10019 (212) 247-6517
Contact: C. Schietinger

MICRON AUDIO PRODUCTS LTD.
1600 Broadway
New York, NY 10019 (212) 582-7360
Contact: J. Welsberg

MICRON AUDIO PRODUCTS LTD.
6370 Santa Monica Blvd.
Hollywood, CA 90038 (213) 466-3238
Contact: K. Scuban

MICRON AUDIO PRODUCTS LTD.
4210 Lankershim Blvd.
N. Hollywood, CA 91602 (213) 980-9891
Contact: M. Chaitlinsky

MICRON AUDIO PRODUCTS LTD.
20440 Tiara Street
Woodland Hills, CA 91367 (213) 992-818
Contact: M. Metaxis

MICRON AUDIO PRODUCTS LTD.
10 Mt. Auburn St.
Watertown, MA 02172 (617) 923-0166
Contact: D. Talamas

MICRON AUDIO PRODUCTS LTD.
1848 Briarwood Rd. NE
Atlanta, GA 30329 (404) 325-3676
Contact: F. Willard

MICRON AUDIO PRODUCTS LTD.
2000 Lakewood Way - Bldg. - 4
Atlanta, GA 30315 (404) 622-1311
Contact: B. Anderson

MICRON AUDIO PRODUCTS LTD.
Audio Lane
New Haven, CT 06519 (203) 777-5301
Contact: B. Anderson

MICRON AUDIO PRODUCTS LTD.
7006 So. Alton Way, Bldg. B
Englewood, CO 80112 (303) 740-9031

MICROPROBE ELECTRONICS INC./MEI

875 N. Michigan Avenue

Suite 1532A
Chicago, IL 60611 (312) 440-3111
Sales Contact: David Collins, President

MICROTIME INC.

1280 Blue Hills Avenue
Bloomfield, CT 06002 (203) 242-4242

MICRO-TRAK CORPORATION

620 Race St.
Holyoke, MA 01040 (413) 536-3551
Sales Contact: W. Stacy, Pres.

MICROTRAN COMPANY INC.

145 E. Mineola Avenue
P.O. Box 236
Valley Stream, NY 11582 (516) 561-6050
Sales Contact: Walter Benscher, VP/Sales

MICROWAVE POWER DEVICES

330 Oser Avenue
Hauppauge, NY 11788 (516) 231-1400
Sales Contact: Richard J. Sheloff, VP Mktg.

MIDCOM INC.

2231 E. Division
Arlington, TX 76011 (817) 640-4573
Sales Contact: Mike Simpson, Owner

MIDWEST CORPORATION

Communications Systems Division
1021 W. 8th Street
Cincinnati, OH 45203 (513) 651-1904
Sales Contact: Jay Adrick, Branch Mgr.

Regional Sales Offices:

MIDWEST CORPORATION
3331 NW 82nd Ave.
Miami, FL 33122 (305) 592-5355
Contact: Lloyd Hicks, Sales Mgr.

MIDWEST CORPORATION
2815 Chrisman St., Suite E
Charlotte, NC 28208 (704) 399-6336
Contact: John Abrams, Sales Manager

MIDWEST CORPORATION
4720B Boston Way
Lanham, MD 20801 (301) 577-4903
Contact: Ed Somerville, Branch Mgr.

MIDWEST CORPORATION
1395 Air Rail Ave.
Virginia Beach, VA 23455 (804) 464-6256
Contact: Fred Wood, Sales Manager

MIDWEST CORPORATION
4410 Westerville Rd.
Columbus, OH 43229 (614) 476-2800
Contact: Fred Higbie, Branch Manager

MIDWEST CORPORATION
7500 Wall Street
Cleveland, OH 44125 (216) 447-9745
Contact: Brad Nogar, Sales Mgr.

MIDWEST CORPORATION
1328 Wheaton Ave.
Troy, MI 48084 (313) 689-9730
Contact: Mike Wolschen, Branch Mgr.

MIDWEST CORPORATION
8455 keystone Crossing, Suite 101
Indianapolis, IN 46240 (317) 251-5750
Contact: Steve Brant, Branch Mgr.

MIDWEST CORPORATION
1804 Cargo Court
Louisville, KY 40299 (502) 491-2888
Contact: Jerry Willingham, Branch Mgr.

MIDWEST CORPORATION
2035 Regency Road
Lexington, KY 40503 (606) 277-4994
Contact: Terry Hollinger, Sales Mgr.

MIDWEST CORPORATION
300 First Ave.
Nitro, WV 25143 (304) 722-2921
Contact: Dave Foglesong, Sales Mgr.

MIGHTY MINUTE PROGRAMS

840 Battery St.
San Francisco, CA 94111 (415) 788-1211
Sales Contact: Andrew Meblin, Partner
Lou Hummel, Sales Mgr.

MILES ASSOCIATES, DIV. MILES**AIR PRODUCTS LTD.**

240 Birmingham Street
Toronto, Ontario

Continued on page 148

NOW!FROM **SESCOM**

ORDER YOUR

FAVORITE AUDIO ACCESSORIES

BY MAIL

SEND FOR YOUR FREE COPY OF OUR 1982 CATALOG

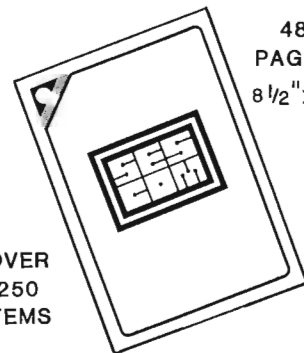

48
PAGES
8 1/2" X 11"

OVER
250
ITEMS

WITH TECHNICAL DATA & USE DIAGRAMS
INCLUDING DIRECT BOXES, MIC-SPLITTERS,
SIGNAL PROCESSING, AUDIO MODULES,
TRANSFORMERS & MANY OTHER ACCESSORIES

USE YOUR VISA OR MASTER CARD

Most Shipments From Stock
Shipments Via UPS, UPS Blue, Air etc.



SESCOM, INC.
RETAIL SALES DIVISION
1111 Las Vegas Blvd. North
Las Vegas, NV 89101-1197 U.S.A.
(702)384-0983 (800)634-3457
TWX (910)397-8996

Circle (92) on Action Card

CDE CORNELL-DUBILIER

**Transmitting
Mica Capacitors**



**STOCK DELIVERY
ON MOST RATINGS**

**ITT JENNINGS
VACUUM CAPACITORS**

SURCOM ASSOCIATES

305 Wisconsin Avenue
Oceanside, California 92054
(714) 722-6162

Circle (93) on Action Card

WHERE TO BUY IT

Canada, M8V 2C8 (416) 251-1705
Sales Contact: Don W. Adams, Sales Mgr.

MILLEN COMPONENTS, DIV. OF E.I.&S.
42A Pleasant Street
Stoneham, MA 02180 (617) 438-6951
Sales Contact: William K. Crawford, VP, Mktg.

MILLER PROFESSIONAL EQUIPMENT
10816 Burbank Boulevard
North Hollywood, CA 91601 (213) 766-9451
Sales Contact: Eva Princetich, VP

MINICOM
P.O. Box 302
Walnut Creek, CA 94596 (415) 932-8134
Sales Contact: Peter Giddings, Mktg. Dir.

MINNEAPOLIS MAGNETICS INC.
7178 Shady Oak Road
Eden Prairie, MN 55344 (612) 944-7660
Sales Contact: Ron Floding, Dir. of Oper.

MISAR INDUSTRIES
1477 E. Warner Avenue
Santa Ana, CA 92705 (714) 540-2477
Sales Contact: Dennis Christensen, VP-Mktg.

MOBILE VISUAL PRODUCTIONS
5251 Lampson Ave.
Garden Grove, CA 92645 (714) 894-3133
Sales Contact: Matthew Williams, Prod./Dir.

MODULATION ASSOCIATES INC.
897 Independence Avenue, 3-F
Mountain View, CA 94043 (415) 962-8000
Sales Contact: J. Walter Johnson, Assoc.

MODULATION SCIENCES INC.
99 Myrtle Ave.
Brooklyn, NY 11201 (212) 625-7333
Sales Contact: Eric Small, VP

MODULAR AUDIO PRODUCTS
50 Orville Drive
Bohemia, NY 11716 (516) 567-9620
Sales Contact: J. Brick, President

MOHAWK WIRE AND CABLE CORP.
9 Mohawk Drive
Leominster, MA 01453 (617) 537-9961
Sales Contact: Wm. Kirkland, Nat. Sls. Mgr.

MONROE ELECTRONICS INC.
100 Housel Avenue
Lyndonville, NY 14098 (716) 765-2254
Sales Contact: Donald L. Pritchard, Sls. Mgr.

MOSELEY ASSOCIATES INC.
111 Castilian Drive
Goleta, CA 93117 (805) 968-9621
Sales Contact: Chuck Rockhill, Mktg. Mgr.

MOTOROLA COMMUNICATIONS AND ELECTRONICS INC.
1301 E. Algonquin Road
Schaumburg, IL 60196 (312) 397-1000
Sales Contact: A. Sundry, VP/Gen. Mgr.
Eric A. Landan, Reg. Sls. Mgr.

MOTOROLA INC.
1244 1/2 Remington
Schaumburg, IL 60195 (312) 576-3591
Sales Contact: Dick Harasek, Mgr., Special Products

MOTOROLA SEMICONDUCTOR PRODUCTS
P.O. Box 20912 M370
Phoenix, AZ 85036 (602) 244-6900
Sales Contact: Brian Hilton

MU-DEL ELECTRONICS INC.
2426 Linden Lane
Silver Spring, MD 20910 (301) 587-6087
Sales Contact: I. Kuzminsky, Pres.

MULTIDYNE ELECTRONICS
P.O. Box 528
Locust Valley, NY 11560 (516) 671-7278
Sales Contact: Vincent Jachetta, Pres.

MULTIPHASE CONSULTING
4209 Lamarre Drive
Fairfax, VA 22030 (703) 273-1960
Sales Contact: H.I. Stewart, Manager

MULTIPLIER INDUSTRIES CORP.
464 South 10th Avenue
P.O. Box 29
Mount Vernon, NY 10550 (914) 699-0990
Sales Contact: Jack Lepore, Sales Mgr.

MULTITENNA CORPORATION OF AMERICA
P.O. Box 67
Valley Stream, NY 11582 (516) 997-7800
Sales Contact: D. King, Marketing Mgr.

MULTI-TRACK MAGNETICS INC.
3 Industrial Avenue Telex: 64-2718
Upper Saddle River, NJ 07458 (201) 327-9400
Sales Contact: Nancy C. Salvatore, National Sales Manager

MULTRONICS INC.
730 W. McNab Road
Fort Lauderdale, FL 33309 (305) 974-0300
Sales Contact: Stephen Fried, Sls. Mgr.

MUSICUES
1156 Ave. of the Americas
New York, NY 10036 (212) 921-9221
Sales Contact: A. Rosen, Dir.

N

NEAS
Wilkes-Barre/Scranton Airport
Avoca, PA 18641 (717) 826-1616
Sales Contact: George Eustis, Mgr.

NEC AMERICA, INC. BROADCAST EQUIPMENT DIVISION
130 Martin Lane
Elk Grove Village, IL 60007 (312) 640-3792
Sales Contact: Robert Curwin, Nat'l. Sales Dir.

N.O.V.A. CORPORATION
5801 Uplander Way
Culver City, CA 90230 (213) 641-2046
Sales Contact: B. Seidel, President

NOVA ELECTRIC MFG. CO.
263 Hillside Ave.
Nutley, NJ 07110 (201) 661-3434
Sales Contact: K. Novitch, Sls. Mgr.

NTP ELECTRONIK A/S
Theklavej 44
DK 2400 Copenhagen NV, Denmark (+45) 10 1222
Sales Contact: A. Mulstrup, Expt. Mgr.

NALPAK SALES
3928 S. Sepulvga Blvd.
Culver City, CA 90230 (213) 391-8181
Sales Contact: Robert S. Kaplan, Sls. Mgr.

NADY SYSTEMS INC.
1145 65th St.
Oakland, CA 94608 (415) 652-2411
Sales Contact: Phil Maselli, Dir. of Mktg.

NAGRA MAGNETIC RECORDERS INC.
19 West 44th St., Rm. 715
New York City, NY 11105 (212) 840-0999
Sales Contact: Dom Notto, VP Sales, GM

THE NARDA MICROWAVE CORP.
75 Commercial Street
Plainville, NY 11803 (516) 349-9600

Sales Contact: J. Coppola, Sls. Mgr.
NATIONAL SEMICONDUCTOR
2900 Semiconductor Drive
Santa Clara, CA 95051 (408) 737-5000

NATIONAL TELECONSULTANTS
3330 Barham Blvd., Suite 201
Los Angeles, CA 90068 (213) 851-8866
Sales Contact: Charles Phelan, Mgr. Dir.

NATIONWIDE ELECTRONIC SYSTEMS INC.
1536 Brandy Parkway
Streamwood, IL 60103 (312) 289-8820
Sales Contact: E. Cartwright, Sales

NAUTEL MAINE INC.
RR 1 Tantalton
Nova Scotia, Canada
BOJ 3J0 (902) 823-2233
Sales Contact: D.A. Wilcox, Mgr. Sls. Div.

NEAL FERROGRAPH (USA) INC.
652 Glenbrook Road
Stamford, CT 06906 (203) 348-1045
Sales Contact: Richard Chilvers, Sales Mgr.

NEAL-FERROGRAPH
Simonside Works, South Shields,
Tyne & Wear, NE 34 9NX,
England (0632) 566321
Sales Contact: Tom Batey, Comm. Dir.

L.E. NELSON CORP. LIGHTING/FACILITY DESIGN CONSULTANTS
1209 Park Circle
Las Vegas, NV 89102 (702) 384-7811
Sales Contact: L.E. Nelson, Pres.

NET ENTERPRISES INC.
2715 Packard Road
Ann Arbor, MI 48104 (313) 971-0031
Sales Contact: Donald J. Frehe, VP Sls./Mktg.

NETWORK PRODUCTION MUSIC LIBRARY
4429 Morena Blvd.
San Diego, CA 92117 (714) 272-2011
Sales Contact: Robert Skomer

NEUMADE PRODUCTS CORP.
720 White Plains Rd.
Scarsdale, NY 10583 (914) 725-4900
Sales Contact: R.N. Jones, VP

GEORG NEUMANN GMBH
Charlottenstr. 3
1000 Berlin 61
Germany (030) 251 40 91
Sales Contact: Dirk Rowehl, VP Sales

NEUTRIK PRODUCTS
77 Selleck St.
Stamford, CT 06902 (203) 348-2121
Sales Contact: Peter Wellikoff, Natl. Sls. Mgr.

NEVE ELECTRONICS INTERNAT'L. LTD.
Cambridge House Melbourn
Royston Herts,
England SG86AU (0) 763-60776, TLX: 81381
Sales Contact: D.A. Tilsley, Dir.

RUPERT NEVE INCORPORATED
Berkshire Industrial Park
Bethel, CT 06801 (203) 744-6230
Sales Contact: Anthony H. Langley Mktg. Mgr.

NEW EARTH TELEVISION WORKS SYSTEM, LTD.
P.O. Box 1281
Santa Cruz, CA 95061 (408) 476-8336
Sales Contact: Taylor Barcroft, Publ.

NEW ENGLAND DIGITAL CORP.
Main Street
Norwich, VT 05055 (802) 649-5183

Sales Contact: Bradley Naples

NEWMAN/LUSTIG & ASSOC.

1050 North State Street
Chicago, IL 60610 (312) 642-5364
Sales Contact: Michael Hazard

NEWSCAN/McINNIS-SKINNER & ASSOC.

6529 N. Classen Blvd.
Oklahoma City, OK 73116 (405) 848-4246
Sales Contact: Ron Hudson, Mktg. Dir.

NIDUS BROADCAST SYSTEMS

4010 Youngfield
Wheat Ridge, CO 80033 (303) 422-6889
Sales Contact: Bill Myers, Pres.

NORCOM MANUFACTURING

P.O. Box 804
Brainerd, MN 56401 (218) 829-9675
Sales Contact: John Thomas, Pres.

NORTH AMERICAN SOAR CORP.

1126 Cornell Avenue
Cherry Hill, NJ 08002 (609) 488-1060
Sales Contact: Bob Liska

NORTHLAND COMMUNICATIONS CORP.

P.O. Box 804
Brainerd, MN 56401 (218) 829-9675
Sales Contact: John H. Thomas, Pres.

NORTH HILLS ELECTRONICS INC.

Alexander Place
Glen Cove, NY 11542 (516) 671-5700
Sales Contact: Herb Marx, Mkt. Mgr.

NORTHLAND COMMUNICATIONS CORP.

P.O. Box 804
Brainerd, MN 56401 (218) 829-9675

Sales Contact: John H. Thomas, Pres.-Sales

NORTH WIND POWER CO.

P.O. Box 550
Moretown, VT 05660 (802) 496-2955
Sales Contact: Al Russell, Sales Mgr.

NORTHWEST MONITORING SERVICE

P.O. Box 1042
Pendleton, OR 97801 (503) 276-2281
Sales Contact: J.H. Platz, Partner

NORTON ASSOCIATES INC.

10 Ditomas Ct.
Copiague, NY 11726 (516) 842-4666
Sales Contact: R.S. Norton, Pres.

NORTRONICS, RECORDER CARE DIVISION

8101 Tenth Avenue North
Minneapolis, MN 55427 (612) 545-0401
Sales Contact: Ken Lubitz, Nat'l. Sales Mgr.

FRED A. NUDD CORPORATION

1743 Route 104, Box 475
Ontario, NY 14519 (315) 524-2531
Sales Contact: Rick Nudd, V.P./G.M.

NURAD INC.

2165 Druid Park Drive
Baltimore, MD 21211 (301) 462-1700
Sales Contact: Leslie K. Lear, Dir. of Mktg.

NYTONE ELECTRONICS CORPORATION

2424 South 900 West
Salt Lake City, UT 84119 (801) 973-4090
Sales Contact: George Sansom, Salesman

O

OAK COMMUNICATIONS INC.

Satellite Systems
16935 West Bernardo Drive
Rancho Bernardo, CA 92127 (714) 485-9880
Sales Contact: E.M. Keys, Sr. VP, Adm. & Dev.

OAK COMMUNICATIONS CATV DIV.

P.O. Box 517
Crystal Lake, IL 60014 (815) 459-5000
Sales Contact: M.L. Coburn, Mgr. Corp. Comm.

OAK SATELLITE CORPORATION

16935 West Bernardo Drive
Rancho Bernardo, CA 92127 (714) 485-9880
Sales Contact: Herb McKee, Mktg. Mgr.
Satellite Systems Division

OCEAN REALM VIDEO SYSTEMS

3514 S. Dixie Hwy.
Miami, FL 33133 (305) 443-8803
Sales Contact: Richard Stewart, Pres.

O'CONNOR ENGINEERING LABS

100 Kalmus Dr.
Costa Mesa, CA 92626 (714) 979-3993
Sales Contact: Debbie Thomason, Sales

OKI ELECTRIC OVERSEAS CORP.

One University Plaza
Hackensack, NJ 07601 (201) 646-0011
Sales Contact: Jim Tate, Mgr. Imp/Exp.

OKTEL CORPORATION

490 Division Street
Campbell, CA 95008 (408) 374-1811
Sales Contact: Fred L. Bones, VP Sales

Continued on page 150

**AUDIO SYSTEMS FOR
TV, RADIO AND RECORDING
STUDIOS**

Manufactured by
LEL
ML

Exported by
elektroimpex
BUDAPEST

H - 1392 Budapest P.O.B. 296
Telex: ELIMP - H 22-5771

Circle (94) on Action Card

AUTOGRAM

Specialists in radio station studio control consoles

- top quality
- modular input/output flexibility for mono or stereo operation
- AC-6: six channel
- AC-8: eight channel
- IC-10: ten channel

For information, contact:



AUTOGRAM CORPORATION
MAILING ADDRESS: BOX 456, PLANO, TEXAS 75074
PLANT: 631 J PLACE, PLANO. (214) 424-8585

Circle (95) on Action Card

REBUILT POWER AMPLIFIER TUBES

- New Tube Warranty
- Guaranteed Satisfaction
- Off Shelf Delivery
- Fraction of New Price

PARTIAL LIST OF TYPES:

125A	5666	6423F	7804
207	5667	6424	7805
356	5668	6425	7806
889	5669	6425F	7807
880	5671	6426	8333
889RA	5681	6427	8386
891	5682	6576	8388
891R	5770	6696	8461
892	5771	6697	8550
892R	5891	6800	8680
895	5918	6801	8752
1089	5919	6803	8795
BR1121	5936	6804	22789
BR1176	6398	6920	23185
5604	6420	7255	23431
5606	6421F	7479	23454
5619	6422	7480	4CX5000
5658	6423	7560	4CX35000

- Duds Purchased Or Rebuilt
- Send For Quote

VACUUM TUBE INDUSTRIES

35 Pequit St., Canton, Mass. 02021
617 — 828-1650

Circle (96) on Action Card

WHERE TO BUY IT

OLESEN

1535 Ivär Avenue
Hollywood, CA 90028 (213) 461-4631
Sales Contact: Marge Romans, Mktg. Dir.

ONAN CORPORATION

1400 73rd Avenue N.E.
Minneapolis, MN 55432 (612) 574-5000
Sales Contact: Ken Lorch, Adm. Adv. & Prom.

ONE PASS VIDEO

900 Third Street
San Francisco, CA 94107 (415) 777-5777
Sales Contact: Larry G. Kingen,
Sls. & Mktg. Director

OPAMP LABS INC.

1033 North Sycamore Avenue
Los Angeles, CA 90038 (213) 934-3566
Sales Contact: B. Losmandy, Mgr.

OPTEK INC.

1360 N. McCan St.
Anaheim, CA 92806 (714) 630-8280
Sales Contact: Roger Knipp, Eng.

OPTICAL RADIATION CORP.

1300 Optical Drive
Azusa, CA 91702 (213) 969-3344
Sales Contact: Glenn Berggren, VP Mktg.

OPTICAL & TEXTILE LTD.

22-26, Victoria Road
New Barnet, Herts.
EN4 9PH England (01) 449-2199
Sales Contact: Geoffrey Choppell, Gen. Mgr.

OPTIMA DIVISION, SCIENTIFIC-ATLANTA

2166 Mountain Industrial Blvd.
Tucker, GA 30084 (404) 939-6340
Sales Contact: Jeannie LaBour, Sls, Superv.

OPTICOM

1587 West 8th Ave.
Vancouver, B.C. Can (604) 734-4511
Sales Contact: David Boyd, Pres.

ORANGE COUNTY ELECTRONICS INT'L, INC.

c/o Parsound Inc.
680 Beach Street, Suite 414
San Francisco, CA 94109 (415) 673-4544

ORBAN ASSOCIATES INC.

645 Bryant St.
San Francisco, CA 94107 (415) 957-1067
Sales Contact: Jesse Maxenchs, Mktg. Mgr.
Broadcast Products
Sid Goldstein, Mktg. Mgr., Pro-Audio Products

ORROX CORPORATION (CMX SYSTEMS)

3303 Scott Blvd.
Santa Clara, CA 95050 (408) 988-2000
Sales Contact: J. Behr, Dir. Marketing

ORTOFON MANUFACTURING A/S

Mosedalvej 11B
DK 2500 Valby, Denmark (01) 462422
Sales Contact: Peter Haussmann, Sales Mgr.

OSRAM SALES CORP.

P.O. Box 7062
R.D. No. 3 Jeanne Dr. (914) 564-6300
Newburgh, NY 12550 (800) 431-9980
Sales Contact: Jim Malicki, Sales Mgr.

OTARI CORPORATION

2 Davis Drive
Belmont, CA 94002 (415) 592-8311
Sales Contact: Michael Bernard,
National Sales Manager

P

PAG FILMS LTD.

565 Kingston Road
London SW20 8SA (01) 543-3131
Sales Contact: A. Lavender, Man. Dir.

PTS ELECTRONICS

5233 S. Hwy 37
P.O. Box 272
Bloomington, IN 47402 (812) 824-9331
Sales Contact: J.A. Hamilton, Sales Mgr.

PWH ELECTRONICS LIMITED

P.O. Box 435
Station E
Toronto, Ontario
Canada M6H 4E3 (416) 533-6331
Sales Contact: Paul W. Hunter, Pres.

PACE INTERNATIONAL CORP.

3727 S. Robertson Blvd.
Culver City, CA 90230 U.S.A. (213) 839-1188
Sales Contact: Robert Kreiman, Pres.

PACE INC.

9893 Brewers Ct.
Laurel, MD 20810 (301) 490-9860
Sales Contact: Al Rosenthal, Mktg. Mgr.

PACIFIC COAST MARKETING

20 S. Santa Cruz Ave., Suite 309
Los Gatos, CA 95030 (408) 395-7021
Sales Contact: Larry Maguire

PACIFIC RECORDERS & ENGINEERING CORP.

11100 Roselle St.
San Diego, CA 92121 (714) 453-3255
Sales Contact: Michael Uhl, Sales Rep.

PACKAGED LIGHTING SYSTEMS, INC.

Grant Street - P.O. Box 285
Walden, NY 12586 (914) 778-3515
Sales Contact: Lillian Hillzen, President

PALADIN CORPORATION

31332 Via Colinas, Suite 106
Westlake Village, CA 91362 (213) 991-4970
Sales Contact: Ronald J. Vogel, V.P. Sales

W.A. PALMER FILMS, INC.

611 Howard Street
San Francisco, CA 94105 (415) 986-5961
Sales Contact: John Corso, Gen. Mgr.

PAN CANADA MAGNETICS LIMITED

1072 Rangeview Road
Port Credit, Ont.
Canada L5E 1H3 (416) 278-9851
Sales Contact: John Williams, Sales Mgr.

PANASONIC CANADA— VIDEO SYSTEMS DEPARTMENT

5770 Ambler Drive
Mississauga, Ontario L4W 2T3 (416) 624-5010
Sales Contact: Robert Qualle, Asst. Mgr.

PANASONIC, VIDEO SYSTEMS DIVISION

One Panasonic Way
Secaucus, NJ 07094 (201) 348-7000
Sales Contact: M. Washington, Nat. Sls. Mgr.

PANASONIC COMPANY, PROFESSIONAL AUDIO DIV.

50 Meadowland Parkway
Secaucus, NJ 07095 (201) 348-7470
Sales Contact: Paul Ackel, Sales Eng. Mgr.

PANOAK B-W LIGHTING SYSTEMS

7610 East 46th Street
P.O. Box 45162
Tulsa, OK 74145 USA (918) 664-1111
Sales Contact: L.S. Bostic, Gen. Mgr.

PARASOUND INC.
680 Beach St., Suite 414
San Francisco, CA 94109 (415) 673-4544

PARSONS MFG. CORP.
1055 O'Brien Dr.
Menlo Park, CA 94025 (415) 324-4726
Sales Contact: C.E. Plummer, V.P.

PASO SOUND PRODUCTS INC.
14 First Street
Pelham, NY 10803 (914) 738-4800
Sales Contact: Paul Mastrangelo, VP

PATRICK COMPUTER SYSTEMS INC.
11 Plymouth
Winnipeg, Manitoba, Canada
Sales Contact: Bob Sutherland, President

PAULMAR INC.
3316 Commercial Avenue
Northbrook, IL 60062 (312) 498-1020
Sales Contact: Robert Menary, Pres.

PEERLESS SALES COMPANY
1950 Hawthorne Ave.
Melrose Park, IL 60160 (312) 865-8870
Sales Contact: Walter Karus, Mgr. Cust. Serv.

PENNBETH MARKETING INC.
906 Grand Av., Suite 730
Kansas City, MO 64106 (816) 474-3555
Sales Contact: J.W. Kilker III, Pres.

PENTAGON INDUSTRIES INC.
4751 N. Olcott
Chicago, IL 60656 (312) 867-9200
Sales Contact: H. Sheaffer, Dir. of Sales

PERFECTONE PRODUCTS S.A.
Ringstrasse 3, Portmoos
2560 Nidau
Bienne, Switzerland
Sales Contact: Ms. M. Beuchat

THE PERF-FIX COMPANY
12381 Wilshire Blvd., Suite 203
Los Angeles, CA 90025 (213) 820-5827
Sales Contact: Diane Stanfield, Pres.

PERMAFILM INTERNATIONAL CORP.
305 East 46th Street
New York, NY 10017 (212) 755-1121

PERMA POWER ELECTRONICS INC.
5615 West Howard Avenue
Chicago, IL 60648 (312) 647-9414
Sales Contact: Norman A. Ackerman, VP Mktg.

PERROTT ENGINEERING LABS INC.
7201 Lee Highway
Falls Church, VA 22046 (703) 532-0700/528-5861
Sales Contact: William D. Mallon, VP/Sales

PHASE VIDEO INC.
12 South Main Street
Haydenville, MA (413) 268-7952
Sales Contact: Tony Vecchione
Joel Ratmanský

PHASECOM CORPORATION
6365 Arizona Circle
Los Angeles, CA 90045 (213) 641-3501
Sales Contact: William A. Lasky, Sales Mgr.

PHELPS DODGE COMMUNICATIONS CO.
Rte. 79
Marlboro, NJ 07746 (201) 462-1880
Sales Contact: Saul Esocoff, Mgr. Spec. Prod.

PHILADELPHIA RESINS CORPORATION
20 Commerce Drive
Montgomeryville, PA 18936 (215) 855-8450
Sales Contact: Rosely N. Stronski, Sales Adm.

PHILIPS BROADCAST GROUP
900 Corporate Dr.
Mahwah, NJ 07430
Sales Contact: Warren Anderson
(See listing for Central Dynamics Corporation)

PHILIPS TEST & MEASURING INSTRUMENTS
85 McKee Drive
Mahwah, NJ 07430 (800) 631-7172
Sales Contact: Hans Toorens, Prod. Mgr.

PHOTO RESEARCH DIVISION KOLLMORGEN CORPORATION
3000 N. Hollywood Way
Burbank, CA 91505 (213) 843-6100
Sales Contact: Mrs. M.L. Woolsey, Sales Mgr.

PICLEAR INC.
180 East Prospect Avenue
Mamaroneck, NY 10543 (914) 698-0258
Sales Contact: Richard Sassenberg, Pres.

PINZONE COMMUNICATIONS PROD. INC.
10142 Fairmount Road
Newbury, OH 44065 (304) 296-4493
Sales Contact: Basil F. Pinzone, Jr., Pres.

PIRELLI CABLE CORP. Special Cable Division
P.O. Box 50
2 Tower Drive
Wallingford, CT 06492 (203) 265-7126
Sales Contact: Arthur J. Harvey, Sales Rep.

PLASTIC REEL CORP. OF AMERICA
46 Passaic St.
Wood Ridge, NJ 07075 (201) 933-9125
Sales Contact: Pat Baccarella, V.P.

HANS H. PLISCH
D-6806 Viernheim,
Grosser Stellweg 13
West Germany 06204/2031
Sales Contact: Mr. Dresel, Sales Mgr.

POLYLINE CORP.
1233 Rand Road
Des Plaines, IL 60016 (312) 298-5300
Sales Contact: Ray Kaiser, Sls. Mgr.

PORTABLE ENERGY PRODUCTS
1875 So. Pearl St.
Denver, CO 80210 (303) 778-8616
Sales Contact: Dean Schneider, Pres.

PORTAC INC.
108 Aero Camino
Goleta, CA 93117 (805) 968-2120
967-2170
Sales Contact: B.E. Hooper, Pres.

PORTA-PATTERN TELECOMMUNICATIONS INDUSTRIES LTD.
P.O. Box 945
6822 Santa Monica Blvd.
Los Angeles, CA 90038 (213) 461-3561
Sales Contact: Ed Riles, Pres.

PORTATRONICS
2329 Verna Court
San Leandro, CA 94577 (415) 483-6862
Sales Contact: Charlie Brown, Sales Mgr.

POTOMAC INSTRUMENTS INC.
932 Philadelphia Ave.
Silver Spring, MD 20910 (301) 589-2662
Sales Contact: David G. Harry, VP/Mktg.

POTOMAC MARINE & AVIATION INC. ELECTRONICS DIVISION
1400 North Uhle Street
Arlington, VA 22201 (703) 525-2626
Sales Contact: R. Barnack, Pres.

Continued on page 152

NEW! Book VIDEOTAPE EDITING

Videotape Editing-Communications With Pictures And Sound answers every videotape editing question:
When to (and when not to) use a dissolve or wipe? How to cut? How to use complex sync role editing and audio editing? How to affect the mood and pace of a show? Why and how to perform computer editing without losing creative control? It even takes the mystery out of time code and user bits.

Beginning editors, experienced pros, film editors and media managers will all appreciate **Videotape Editing**. This new book is your guide through the world of videotape editing including time code and computer assistance.

Videotape Editing-Communications With Pictures And Sound By Michael D. Sheffer
• 165 pp. • 144 illus. • 6"X9" • Hardbound
\$32.20 (\$34.00 in U.S.)
Order Today!
Brochure Available
(312) 364-1900 Ext. 825
Major Credit Cards Accepted

SE Swiderski Electronics
Audio/Video Engineers
1200 Greenleaf Ave. • Elk Grove Village, IL 60007 • (312) 364-1900

Circle (97) on Action Card

IF YOU NEED ATTENUATORS YOU NEED THIS CATALOG!



AUDIO AND RF ATTENUATORS TO MEET ANY REQUIREMENT

Here in one compact and informative 24 page booklet is all the data you need to select a Precision Audio and RF Attenuator for your application.

Reference Charts, Circuit Diagrams, Types and Uses, Current and Voltage Ratio Tables, Ratings, Etc., make this a handy and invaluable reference.

SEND FOR YOUR FREE COPY TODAY.

TECH LABS, INC.

Bergen & Edsall Blvds.
Palisades Park, N.J. 07650
Tel.: (201) 944-2221

Circle (98) on Action Card

WHERE TO BUY IT

POWER OPTICS INC.
1055 W. Germantown Pike
Fairview Village, PA 19409
Sales Contact: Larry Green

POWER PRODUCTS
Div. of Computer Products Inc.
2801 Gateway Drive
Pompano Beach, FL 33060 (305) 974-2442
Sales Contact: Gene Zuch, Dir. Mktg.

PRECISION/ECHO SCIENCE CORP.
485 E. Middlefield Rd.
Mountain View, CA 94086 (415) 961-7145
Sales Contact: Donna Wotton, Mktg. Adm.

PRINTER TERMINAL COMM. CORP.
124 Tenth Street
P.O. Box 535
Ramona, CA 92065 (714) 789-5200
Sales Contact: Daniel L. Gillum, President

PRO-BEL LTD.
Acre Road,
Reading
Berks RG2 OPR UK 0734-866123
Sales Contact: Derek Owen, Dir.

PROCART
7012 27th St. W.
Tacoma, WA 98466 (206) 565-4546
Sales Contact: Tim Schwieger, Sls. Supervisor

PROCESSING PLUS
59 Brookside Road
P.O. Box 3303
Wescosville, PA 18106 (215) 398-3377
(800) 523-9396
Sales Contact: David Van Allen, Pres.

PRODELIN INC.
Box 131
Hightstown, NY 08520 (609) 448-2800
Sales Contact: Derek Munnery, Sls. Mgr.

PROFESSIONAL ELECTRONICS CO. INC.
1594 State St.
Woodlawn Plaza
Schenectady, NY 12304 (518) 374-1515
Sales Contact: Jerry Kolins, Pres.

PROTECH AUDIO CORPORATION
Flowerfield, Bldg. No. 1
St. James, NY 11780 (516) 584-5855

PULSE TECHNIQUES INC.
151 West Clinton Avenue
Bergenfield, NJ 07621 (201) 385-1232
Sales Contact: E.R. Shenk, Sls. Mgr.

PYE TVT LIMITED
P.O. Box 41
Coldhams Lane
Cambridge, UK CB13JU (0223) 45115
Telex: 81103

PYRAMID INDUSTRIES INC.
P.O. Box 1929
Phoenix, AZ 85063 (602) 269-6431
Sales Contact: Paul Rhodes, V.P.

PYRAMID LOUDSPEAKER CORP.
P.O. Box 192
Flushing, NY 11352 (212) 762-1300
Sales Contact: R. Sequerra, President

Q

QEI CORPORATION
Route 73
Kresson, NJ 08053 (609) 767-8052
Sales Contact: Bill Hoelzel, VP/Mktg.

Q-TV
33 West 60th St.
New York, NY 10023 (212) 765-4200
Sales Contact: George Andros, V.P.

QSC AUDIO PRODUCTS INC.
1926 Placentia Avenue
Costa Mesa, CA 92627 (714) 645-2540
Sales Contact: Barry Andrews, Pres.

QSI SYSTEMS INC.
12 Linscott Road
Woburn, MA 01888 (617) 938-1403
Sales Contact: Alfred J. Smilgs, Pres.

QUAD-EIGHT ELECTRONICS
11929 Vose St.
No. Hollywood, CA 91605 (213) 764-1516
Sales Contact: Bill Windsor, VP

QUANTA CORPORATION
2440 South Progress Drive
Salt Lake City, UT 84119 (801) 974-0992
Sales Contact: Roy Romijn, VP

QUANTEL LIMITED
Kenley House, Kenley Lane
Kenley, Surrey CR2 5YR
England (01) 668-4151
Contact: M.J. Maidens, Int. Mktg. Mgr.

QUANTUM AUDIO LABS INC.
1905 Riverside Drive
Glendale, CA 91201 (213) 841-0970
Sales Contact: Andrew C. Thompson, Sls. Mgr.

QUICK-SET INC.
3650 Woodhead Drive

Northbrook, IL 60062 (312) 498-0700
Sales Contact: John Andre, Sls. Mgr.

R

R-COLUMBIA PRODUCTS CO. INC.
2008 St. Johns Ave.
Highland Pk., IL 60035 (312) 432-7915
Sales Contact: I. Rozak, Pres.

R.A.V.E./RELIABLE AUDIO VIDEO ENTERPRISES
71 Glenn Way, Suite No. 6
Belmont, CA 94002 (415) 595-3750
Sales Contact: Rhode Roberts

RCA BROADCAST SYSTEMS
Front & Cooper Streets
Camden, NJ 08102 (609) 338-3000

RCA DISTRIBUTOR & SPECIAL PRODUCTS DIVISION
2000 Clements Bridge Road
Deptford, NJ 08096 (609) 541-3636
Sales Contact: H.L. Craton, Div. VP/Sales

RCA ELECTRO-OPTIC DEVICES
New Holland Avenue
Lancaster, PA 17604 (717) 397-7661
Sales Contact: W. Dennen, Dir. Public Affairs

RCA SERVICE COMPANY
Bldg. 204-2 Broadcast Service
Rt. 38 Cherry Hill, NJ 08358 (609) 338-5924
Sales Contact: Edw. B. Campbell, Mktg. Mgr.

RE:DB COMPANY
A Div. of PIERCE INDUSTRIES INC.
3120 East Pico Blvd.
Los Angeles, CA 90023 (213) 264-7855
Sales Contact: Mickey Epstein, Mktg. Mgr.

R. E. INSTRUMENTS
31029 Center Ridge Road
Westlake, OH 44145 (216) 871-7617
Sales Contact: Bruce Gravens, Sls. Mgr.

RF TECHNOLOGY INC.
145 Woodward Ave.
S. Norwalk, CT 06854 (203) 866-4283
Sales Contact: James A. Smith, Dir. of Mktg.
Carol A. Knox, Marketing Coor.

RHG ELECTRONICS LABORATORY INC.
161 E. Industry Ct.
Deer Park, NY 11729 (516) 242-1100
Sales Contact: Sls. Department

RKO TAPE CORP.
3 Fairfield Crescent
West Caldwell, NJ 07006 (201) 575-8484
Sales Contact: Stan Bauer, VP/Mktg. & Sls.

RMS ELECTRONICS INC.
50 Antin Place
Bronx, NY 10462 (212) 892-6700
Sales Contact: Seymour Goldberg, Nat. S. Mgr.

RTS SYSTEMS INC.
1100 West Chestnut Street
Burbank, CA 91506 (213) 843-7022
Sales Contact: Bob Tourkow, Sales

RACAL-DECCA CANADA INC. INSULATORS DIVISION
71 Selby Road
Brampton, Ontario (416) 457-8720
Sales Contact: P.H.J. Warr, Sales/Mktg.

**When accuracy Counts... Count on Belar
for AM/FM/TV MONITORS**

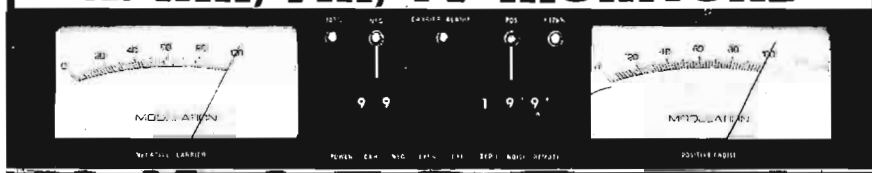

BELAR
AM MODULATION MONITOR

BELAR CALL ARNO MEYER (215) 687-5550
ELECTRONICS LABORATORY, INC.
LANCASTER AVENUE AT DORSET, DEVON, PA. 19333 • BOX 826 • (215) 687-5550

Circle (99) on Action Card

RACK TECHNIQUES CORP

904 Westwood
Addison, IL 60510 (312) 628-0870
Sales Contact: James B. Michaelsen, Pres.

RADIO COMPUTING SERVICES INC.

2 Dean Drive
Tenafly, NJ 07670 (201) 567-3263
Sales Contact: Andrew Economos, Pres.

RADIO DATA SYSTEMS INC.

669 North 10th West
Centerville, UT (801) 298-3322
Sales Contact: Miller R. (Mo) Gardner, Pres.

RADIOMETER ELECTRONICS

811 Sharon Drive
Westlake, OH 44145 (216) 871-7617
Sales Contact: Jerold Bush, V.P. / Gen. Mgr.

RADIO SYSTEMS INC.

5131 West Chester Pike
Edgemont, PA 19028 (215) 356-4700
Sales Contact: Daniel Braverman, Pres.

RADIOTECHNIQUES

402 Tenth Avenue
Haddon Heights, NJ 08035 (609) 546-1841
Sales Contact: Ed Schober, Pres.

RADMAR INC.

1282 Old Skokie Road
Highland Park, IL 60035 (312) 831-9000
Sales Contact: John Holliday, V.P. / Mktg.

RAINBO PRODUCTS

404 N. River
Ypsilanti, MI 48197 (313) 482-6591
Sales Contact: Stefan Graf, Pres.

RAMKO RESEARCH

11355 A Folsom Blvd.
Rancho Cordova, CA 95670 (916) 635-3600
Sales Contact: Ray Kohfeld, Pres.

RANGERTONE RESEARCH INC.

509 Madison Ave.
New York, NY 10022 (212) 753-5430
115 Roosevelt Ave.
Belleville, NJ 07102 (201) 751-6833
Sales Contact: George P. Zazzali, Pres.

RANK CINTEL LTD.

Watton Rd.
Ware, Hertfordshire, UK SG12 OAE (0920) 3939
Sales Contact: Alan McIlwaine, Mktg. Mgr.

RANK PRECISION INDUSTRIES INC.

260 N. Route 303
West Nyack, NY 10994 (914) 353-1914

RANK TAYLOR HOBSON

P.O. Box 36
Guthlaxton Street
Leicester, U.K. LE2 0SP
Sales Contact: B. H. Newman
Sales Manager

RAVEN SCREEN CORP.

124 East 124th Street
New York, NY 10035 (212) 534-8408-8409
Sales Contact: Fred Rose, President

REAL RADIO COMPANY

127 Glen Summer Road
Pasadena, CA 91105 (213) 795-4900
Sales Contact: John Price, Pres.

REAL WORLD TECHNOLOGIES GROUP

2714 W. Keller
Suite 1
Santa Ana, CA 92704 (714) 957-1061
Sales Contact: Ray Terrill

RECORDER CARE, Div. of Nortronics

8175 Lewis Rd.
Minneapolis, MN 55427 (612) 545-0401
Sales Contact: Ken Lubitz, Nat'l. Sls. Mgr.

RECORDING SUPPLY CO.

1233 Rand Road
Des Plaines, IL 60016 (312) 297-0955
Contact: Tom Franke

RECORTEC INC.

475 Ellis Street
Mountain View, CA 94043 (415) 962-0220
Sales Contact: Sidney B. McCollum,
National Sales Manager

REDDING RADIO

A Division of SJ Industries, Inc.
Box 344
Fairfield, CT 06430 (914) 561-4769
Sales Contact: S. Deale, Dir. of Sls.

REES ASSOCIATES INC.

4200 Perimeter Center Drive, S. 245
Oklahoma City, OK 73112 (405) 946-9800
Sales Contact: Harry Munyon, Sr. Assoc.

REGENCY ELECTRONICS

7707 Records St.
Indianapolis, IN 46226 (317) 545-4281
Sales Contact: Roger Praimi, Nat. Sls. Mgr.

Continued on page 154

4 Models—8 and 10 mixer dual stereo with rotary or linear faders • Transformer Balanced Inputs and Outputs • 3 Inputs Per Mixer—internal pads allows mic/line selection on the same mixer • Two 4-Input Auxiliary Input Selectors—may be assigned to any mixer • Pre-fader Pushbutton Cue—in addition to normal CCW fader cue position • LED Status Indicators—color coded to aid in instant identification of function selectors • Momentary or Continuous Remote Control Contacts—internally selectable, also controls optional digital timer reset/start • Full Metering Capability—two meters standard, up to four meters and/or digital clocks and timers optionally available, all meters provided with LED peak indicators • Gain Selectable Microphone Preamps—provided with center tap access for phantom condenser microphone power, processor input/output port with buffer amplifier for outboard compressors, limiters, etc. • Programmable Muting Logic—internal pin-programmed matrix allows any selection of monitor and cue muting for the first five mixer positions • Pushbutton Aural Phase Test • Announcer's Microphone Intercom-Air Selector • Full Dual Channel Operation— independent program and audition assignment push-buttons • Five Monitor Driver Outputs—four muted, one non-muted • All Mixers Switch-Selectable to Mono or Stereo • Ground-Plane Techniques Used Throughout for Increased RF Immunity • Selectable Internal or External Master Level Controls • Accessories and Options—mono mixdown, high impedance (cassette) line input plug-ins, reference oscillator/line input plug-in, additional microphone input plug-ins, digital clock, digital timer, linear faders.



LPB®

citation series Everything you want in an audio console

LPB Inc. • 28 Bacton Hill Road • Frazer, PA 19355 • (215) 644-1123

Manufacturers and Distributors of Broadcast Equipment since 1960

© 1981 LPB Inc.

WHERE TO BUY IT

RELIANCE PLASTICS & PACKAGING DIV.
225 Belleville Ave.
Bloomfield, NJ 07003 (201) 748-2222
Sales Contact: *Marion Burleigh, Sales Mgr.*

RESEARCH SYSTEMS TECHNOLOGY INC.
33447 Kelly Road
Fraser, MI 48026 (313) 296-1540

RESEARCH TECHNOLOGY INTERNATIONAL
4700 Chase Ave. (800) 323-7520
Lincolnwood, IL 60646 (312) 677-3000
Sales Contact: *Tom Boyle, Nat'l. Sls. Mgr.*

REX RHEOSTAT & CO. INC.
149 Babylon Turnpike
Roosevelt, NY 11575 (516) 379-1030
Sales Contact: *Richard W. Wolpert, Sls. Mgr.*

REYNOLDS/LETERON CO.
6704 Valjean Ave.
Van Nuys, CA 91406 (213) 994-1194
Sales Contact: *R. Plowman, Nat'l. Sales Mgr.*

RICHMOND SOUND DESIGN LTD.
1234 W. 6th Ave.
Vancouver, B.C. V6H 1A5 (604) 734-1217
Sales Contact: *C.B. Richmond, Pres.*

RIGGINS ELECTRONIC SALES
3272 E. Willow
Long Beach, CA 90806 (213) 598-7007
Sales Contact: *George Riggins, Owner*

RIPLEY CO. INC.
46 Nooks Hill Road
Cromwell, CT 06416 (203) 635-2200
Sales Contact: *Robert Clark, Sales Mgr.*

RIVERS ASSOCIATES INC.
47 Berry St. Extension
Fitchburg, MA 01420 (617) 342-8965
Sales Contact: *Norman L. Rivers, Pres.*

RODELCO ELECTRONICS CORP.
356 A Comac Rd.
Deer Park, NY 11729 (516) 643-5110
Sales Contact: *J. Rodgers, Gen. Mgr.*

ROH CORPORATION
3603 Clearview Place
Atlanta, GA 30340 (404) 455-7940
Sales Contact: *Jerry Levy, Mktg. Mgr.*

**C.N. ROOD B.V.,
BROADCASTING EQUIPMENT DIV.**
P.O. Box 42
2280 AA Rijswijk ZH
The Netherlands (070) 99 63 60
Sales Contact: *M.N.J. Moors, Pres.*

ROSNER TELEVISION SYSTEMS INC.
250 West 57 Street
New York, NY 10107 (212) 246-2850
Sales Contact: *C. Klehne, Sales Mgr.*

ROSS VIDEO LIMITED
9 Plaza Drive
Iroquois, Ontario
Canada K0E 1K0 (613) 652-4889
Sales Contact: *Jim Millard, Mktg. Coord.*

ROHDE & SCHWARZ
14 Gloria Lane
Fairfield, NJ 07006 (201) 575-0750

Regional Sales Offices:
PROGRESSIVE MARKETING
Fullerton, CA 92635 (714) 879-7940
Contact: *Len Dozler, Pres.*
G.P. ENTERPRISES
Arlington, TX 76014 (814) 467-0051
Contact: *Gordon Peters, Pres.*
PUS, INC.
Boston, MA 02135 (617) 254-2101
Contact: *Stergio Marino, Pres.*
RADFORD ASSOC.
Atlanta, GA 30319 (404) 237-6097
Contact: *Lew Radford, Pres.*
DELCOM CORP.
St. Louis, MO 63141 (314) 432-1164

ROHDE & SCHWARZ GMBH & CO. KG
P.O.B. 80 14 69
D-8000 Munich 80
Federal Republic of Germany (089) 41 29-1
Sales Contact: *R. Goebel*

Regional Sales Offices:
OTON R. KLEIN S.A. 362-7770, 7806, 7357
Carlos Calvo 225/29 pioneer-baires
(1102 Buenos Aires) 18 739
P.O.B. 568 (klein ar)
1000 Capital Federal
JACOBY MITCHELL PTY. LTD. 267-2622
18-26 Commonwealth St. acobsydney
Sydney, N.S.W. 2000 aa 26372
RHODE & SCHWARZ-TEKTRONIX GmbH
Sonleithnergasse 20-24 626141
A-1100 Wien

BUSINESS INTERNATIONAL 133933 (rus a)
257555, 257121
146/A, New Bally Rd. sony
P.O. B 727 760 (sms dac)

Dacca-2
ELECTRONIQUE GENERALE S.P.R.L. 7352193
Rue des Aduatiques, 71-75 roelectron
B-1040 Bruxelles 23241 b
SISTEMAS ELECTRONICOS HOEHNE LTDA.
Calle Teniente Oquendo 141
Casilla 5075

La Paz
HOOS MAQUINAS MOTORES S.A. 228-2566
Rua Paula Souza 79-4 and. maqulmotor
(01027 Sao Paulo)
Caixa Postal 7500 1122260 (hoos br)
01000-Sao Paulo

SERVICE STATION: V.M.E.I. LENIN 665784
Kw. Dervenitsa
Bl.II, Et.V, Room 2534 22576
1156-Sofia

RUSINT ELECTRONICS & SALES 829-3944
Canada Ltd.
25 D, Northside Rd. 053-3662
Nepean/Ottawa K2H 8S1

ORBIS OY 538 066
P.O.B. 15 orbis
(SF-00421 Helsinki 42) 123 134 (orbis sf)
Kalannitie 52
SF-00420 Helsinki-42

RHODE & SCHWARZ France 6872506
45/46, Place de la Loire ruselec
Sillc 190 204477 (ruselec f)
F-94563 Rungis Cedex

AVELEY ELECTRIC LTD. 3978771
Roebuck Rd. avel london
Chessington, Surrey KT9 1LP 928479
E. NASSOS, 3613047 (a.m.)
Engineering Comp. 3625500 (p.m.)

68, E. Benaki St. nasseof
Athinal 219340 (stec gr)
SCHMIDT & CO., (H.K.) Ltd. 5-455644
28th Floor Wing on Centre schmidtco
Hongkong 74766 (schmc nx)

R&S-Service/Station:
FOTO-OPTIKA 173841
Visegradi u. 60
H-1132 Budapest 226019
MAGNUS THORGEIRSSON H.F. 15054, 13725
Borgartun 20 pfaff
IS-121 Reykjavik 2068 (pfaff is)

TOSHNIWAL BROS.; PVT. LTD. 221565,
3E/8, Jhandewalan Extension 523597
New Delhi-110055 vlygantre
31-2886 (tbpl In)

J. MCKEEVER & COMP. LTD. 681604, 681582
Canal House — Northumberland Rd.
Dublin-4 5608
ROJE TELECOMUNICAZIONI, S.p.A.
Via Sant' Anatalone 15 4154141,-3
I-20147 Milano rojetele

DIPL-ING, ADOLF ZIHLER 431-8485
Okamoto 5 — chome 11 — 9
(Kobe 658) 5622150 (zihler j)
Port, P.O.B. 586
Kobe 651-01

ENGINEERING & SALES CO. LTD. 26815, 26386
Moi Ave., Bank House engsales
P.O.B. 46658, 30349 22030 (nalrobl)
Nairobi

MYASA,
Maquinarla y Accesorios, S.A. 5162512
Alfonso Reyes 15 azuma
Mexico-11 D.F. 1774217 (myasame)

RHODE & SCHWARZ Nederland B.V.
Postbus 233 (3600 AE Maarssen) 60324
Maarssenbroeksedijk 6A
NL-3606 AN Maarssen 70339 (rsned nl)

ELEKON (OVERSEAS) LTD. 780019
7—9 Kirk St. elkonlit
P.O.B. 5146 2910
Auckland-2 (elekon nz)

MORGENSTIERNE & CO. A/S 356110
Konghellegate 3 morof
P.B. 6688 Rodelokka 11719
N-10 10 Oslo-5

IMPORTADORA JANSSEN Y CIA, LTDA.
Moneda 1160—9 721776, 723956
Cusilla 13570, Correo 21 oroco
Santiago de Chill 94489 (oroco ku)

HANSEATICA CIA. LTDA. 2624207
Calle 15 No. 68D-78 2601291
Ap. Aereo 14467 hanseatlca
Bogota D.E. 044-790 (hans-co)

CHRIS RADIOVISION LTD. 66 121
23 Crete Str. radovlison
P.O.B. 1989 2395 (radovlison)
Nicosia
R&S SERVICE:ZENIT 4142461, 68, 74
A.s. Kirova 26

P.O.B. 88 122781
CS-15000 Praha 5
SERVICE STATION: KSNP-OTPV 549233
Kancelarske Stroje, n.p.
Radlicka 2 121988

CS-15046 Praha 5 — Smichov
TAGE OLSEN A/S 658111
Ballerup BYVEJ222 topocen
DK-2750 Ballerup 35293 (toas dk)

SUMINISTROS TECNICOS LTDA. 396-002,395-670
Sumisquis y Tulcan 1511 sumittec
P.O.B. 4492 3083361 pbccgye ed
Guayaquil (para sumittec)

GENERAL INDUSTRIAL & COMM. PVT. LTD. CO.
Ras Desta Damtew Ave., 41400, 41280
Kidane Beyene Bldg. gicomco
P.O.B. 2240 21192 (gic addis)
Addis Ababa

TELEC ELECTRONICS & MACHINERY LTD.
415, Mahboob Chambers, 512648
Abdullah Haroon Rd. 514894
P.O.B. 7430 3lco
Saddar-Karachi-0301 2690 (elco pk)

ESTEMAC PERUANA S.A. 455530, 456597
Avda. Petit Thousars 4620 estemac
Casilla Correo 224 25385 (pu)
Lima-18 (Miraflores)

R&S-Service-THM EXIMPOL S.A. 74901
ul. Stawki 2, pietro 28
PL-00-950 Warszawa 814640
SERVICE STATION: INCO 674081
ul. Tarnogajska 11/13

PL-50-950 Wroclaw 0712357
SOC. COM. MATTOS TAVARES LDA. 614880-82
R. Gregorio Lopes ustamante
Lote 1513-1 (Restelo) 12220 (matali p)

P-1400 Lisboa
Apartado 2171
P-1104 Lisboa Codex
R&S-SERVICE/STATION:
I.C.E. 333583
Calea Floreasca Nr. 169
R-72321 Bucuresti-2 10076

ASSOC. TECHN. SERVICES (PTE.) LTD. 913722
5th Floor, Maritime Bldg. ateads
Collyer Quay 21297 (patspor rs)
Singapore-1

WHERE TO FIND IT

GENERAL INDEX, Pages 38-45

WHO MAKES IT

PRODUCT DIRECTORY, Pages 46-113

WHERE TO BUY IT

MANUFACTURERS, Pages 114-162

DEALERS/DISTRIBUTORS, Pages 168-189

S.A. ELECTRO-MEDICAL (PTY.) LTD. 21-7431
Stand Gen. House, 10th Floor
215 Proes Street (Pretoria 0002)
P.O.B. 1784
Pretoria
0001
REMA LEO HAAG S.A. 4423900
Jose Abascal 18 rema
Madrid-3 42838 (rema a)
TELEINSTRUMENT AB 380370
Maltesholmavagen 138
Box 490 11347
S-16204 Vallingby
ROSCHI TELECOMMUNICATION AG. 442711
Giacomettistrasse 15/III
P.O.B. 63 32137 (ch)
CH-3000 Bern-31
B. GRIMM & CO. R.O.P. 2524081
1643/4, New Phetburi Rd. thalgrimm
G.P.O.B. 66 2614
Bangkok (thalgrim th)
ELECTRONIK SERVIS VE 441546
Muhendislik Koll. Stl. 447651
Necatibey Caddesi No. 90/II rapid
Karakoy-Istanbul 23353 (mse tr)
ROHDE & SCHWARZ 575-0750
Sales Co., Inc. rohdeschwarzusa
14 Gloria Lane 133310
Fairfield, New Jersey 07006
Equilab C.A. 516271, 516317, 516159
Edificio Titania-4 Piso, Entr. C equilab
Plaza la Estrella — San Bernardino 21860
Apdo. 60497 (equilx)
Caracas 106
R&S-SERVICE/STATION
Nacional 11-602858
Goce Dalceva 44
Y-11070 Novi Beograd 12940

ROLL-A-REEL CO.
7881 Reading Rd.
P.O. Box 37381
Cincinnati, OH 45222 (513) 761-8500
Sales Contact: Sales Dept.

K.L. RUBEL AND ASSOC. LTD.
5221 N. Elston Ave.
Chicago, IL 60630 (312) 545-2544
Sales Contact: Kenneth Rubel, Pres.

RUSLANG CORP.
320 Dewey Street
Bridgeport, CT 06605 (203) 384-1266
Sales Contact: Frank Ruskay, President

RUSSCO ELECTRONICS MFG. INC.
5690 E. Shields Ave.
Fresno, CA 93727 (209) 291-5591
Sales Contact: Barbara Gaudin, Sales Mgr.

RYCOM INSTRUMENTS INC.
9351 East 59th St.
Raytown, MO 64133 (816) 353-2100
Sales Contact: C.L. Jasper, Mktg. Mgr.

S

SAE
701 E. Macy St.
Los Angeles, CA 90012 (213) 489-7600
Sales Contact: Warren Pompei, V.P. Sales

SAIT ELECTRONICS
Chaussee De Ruisbroek 66
B - 1190 Bruxelles
(Belgique) 32 2 376 20 30
Sales Contact: J. Ryckmans
B. de Laminne

SED SYSTEMS INC.
SATELLITE COMMUNICATIONS GROUP
P.O. Box 1464
Saskatoon, Sask S7K 3P7 (306) 664-1825
Sales Contact: Neta Howard, Mktg. Assist.

SFENA CORPORATION
2617 Aviation Pkwy.
Grand Prairie, TX 75051 (214) 988-8000
Sales Contact: Stan Frazer, Mktg. Rep. Eng.

SGL WABER ELECTRIC
300 Harvard Avenue
Westview, NJ 08093 (609) 456-5400
Sales Contact: Carol H. Welch, Mktg. Coop.

SSAC INC.
P.O. Box 395
Liverpool, NY 13088 (315) 622-1000
Sales Contact: R. Shutt, VP Mktg.

S.W.R. INC.
P.O. Box 215
Goffstown, NH 03045 (603) 497-3000
Sales Contact: Jack L. Kruger, Pres.

SACHTLER CORP. OF AMERICA
400 Oser Avenue TELEX: 140 107
Hauppauge, NY 11788 (516) 231-0033
Sales Contact: Eric Falkenberg, Exec. VP

SACRED SOUNDS
11635 Richmond St.
Riverside, CA 92505 (714) 785-4567
Sales Contact: Lee McIntyre, Owner

SADELCO INC.
75 West Forest Ave.
Englewood, NJ 07631 (201) 569-3323
Sales Contact: Thomas W. Sadel,
National Sales Manager

SAKI MAGNETICS
8650 Hayden Place TWX 910-328-6100
Culver City, CA 90230 (213) 559-6704
Sales Contact: Trevor, J. Boyer, Sales Mgr.

SANDAR ELECTRONICS
P.O. Box 132
3201 Sandefjord, Norway 033 / 67222
Sales Contact: Ingrid Evensen

SATCOM INC.
1756-E Junction Avenue
San Jose, CA 95112 (408) 286-6000
Sales Contact: S. Erik Jenstad, VP & Gen. Mgr.

SATCOM TECHNOLOGIES INC.
2912 Pacific Dr.
Norcross, GA 30071 (404) 448-2116
Sales Contact: David Speed, VP

SATT ELECTRONICS AB
Box 32006
S-126 11 Stockholm
Sweden 468 81 01 00
Sales Contact: Ulf Ekendahl, Sls. Eng.

SATELLITE SYNDICATED SYSTEMS, INC.
P.O. Box 45684
Tulsa, OK 74145 (918) 481-0881
Sales Contact: Selman M. Kremer,
VP/Sales & Mktg.

SCALA ELECTRONIC CORP.
P.O. Box 4580
Medford, OR 97501 (503) 779-6500
Sales Contact: Ellis Feinstein, VP/Gen. Mgr.

SCANTEX LABORATORIES INC.
1 Westmount Square
Suite 1200
Montreal Quebec
Canada H3Z 2Z7 (514) 626-8943
Sales Contact: L. Solomon, VP Mktg.

KEN SCHAFER GROUP
10 E. 49th
New York, NY 10017 (212) 371-2335
Sales Contact: Ritchie Fliegler

SCHNEIDER CORPORATION OF AMERICA
185 Willis Avenue (516) 747-5100
Mineola, NY 11501 (212) 895-3366
Sales Contact: Dave Paskin, VP

JOS. SCHNEIDER GmbH & CO.
P.O. Box 947
D-6550 Bad Kreuznach
Germany Federal Republic 0671 6010
Sales Contact: K. H. Heb, Sls. Mgr.

Regional Sales Offices:
MAGNA-TECHNICS (AUST.) PTY Ltd.
MTA House
14 Whiting Street
Artarmon N.S.W. 2064
Australia 438 3377 Telex: 24655
EVERSHED POWER OPTICS LTD.
Bridge Wharf
Bridge Road
Chertsey, Surrey KT16 8LJ
United Kingdom 0044-9328-61181
TELEQUIP (PTY) LTD.
P.O. Box 23587
2044 Joubert Park
Johannesburg, South Africa
TELE-CINE-INC.
5434 Merrick Road (516) 798-2828
Massapequa L.I. N.Y. 11758
USA & Canada Telex: 5 102246138

SCHUESSLER CASE CO. INC.
P.O. Box 39066
Chicago, IL 60639 (312) 227-0027
Sales Contact: Paul H. Kreft, Pres.

SCIENTIFIC-ATLANTA
P.O. Box 105600
Atlanta, GA 30348 (404) 441-4000
Sales Contact: John Feight,
Mgr., Mktg. Comm.

SCIENTIFIC ATLANTA PHOENIX DIV.
P.O. Box 21007
2920 E. Elwood (602) 268-8744
Phoenix, AZ 85282 (800) 528-3211
Sales Contact: D. Taylor, Dir. Mktg.
T. Kruger, Sales Eng.

SCIENTIFIC RADIO SYSTEMS
367 Orchard Street
Rochester, NY 14606 (716) 458-3733
Sales Contact: Robt. L. Phillips,
Domestic Mktg. Mgr.

SCIENTIFIC SYSTEMS INC.
92 Westwood Drive
Toms River, NJ 08753 (201) 255-2230
Sales Contact: Douglas Fink, Sales Mgr.

H.H. SCOTT INC.
20 Commerce Way
Woburn, MA 01801 (617) 933-8800

SCOTT INSTRUMENT LABORATORIES
533 Main Street
Action, MA 01720 (617) 263-3263
Sales Contact: Robert W. Hayes, Sales Eng.

MICHAEL SCOTT CO. INC.
P.O. Box 384
Wellesley Hills, MA 02181 (617) 235-0102
Sales Contact: Michael Scott, Pres.

THE SCREEN WORKS LTD
WILCOX-LANGE INC.
3925 N. Pulaski Road
Chicago, IL 60641 (312) 588-8380
Sales Contact: Ieva Kalits, Sales Mgr.

L.J. SCULLY MANUFACTURING CORP.
138 Hurd Avenue
Bridgeport, CT 06604 (203) 368-2332
Sales Contact: R.J. Havanec, V.P.

SEE HEAR INDUSTRIES
717 E. Actesia Blvd.
Carson, CA 90746 (213) 516-0315
Sales Contact: Ray Salobs

SELCO PRODUCTS CO.
7580 Stage Rd. (213) 921-0681

Continued on page 156

WHERE TO BUY IT

Buena Park, CA 90621 (714) 521-8673
Sales Contact: Wm. J. Wilkinson, Gen. Mgr.
Steve Inge, Inside Sales

SELTECH

16 York Road
Maidenhead, Berkshire SL6 1SF
United Kingdom (0628) 36315-36714

SENCORE INC.

3200 Sencore Drive
Sioux Falls, SD 57107 (605) 339-0100
Sales Contact: James Smith, Nat'l. Acct. Mgr.

SENNHEISER ELECTRONIC CORP.

10 W. 37th St.
New York, NY 10018 (212) 239-0190
Sales Contact: Tony Tudisco, Nat. Sales Mgr.

SENNHEISER ELECTRONIC KG

3002 Wedemark 2
Fed. Rep. of Germany

SESCOM INC.

1111 Las Vegas Blvd. North
Las Vegas, NV 89101-1197 U.S.A. (702) 384-0993
Sales Contact: Franklin J. Miller, Pres.

SETCOM CORPORATION

1400 Stierlin Road
Mountain View, CA 94043 (415) 965-8020
Sales Contact: Warren G. Wettenstein, Mktg.

SHALLCO INC.

Smithfield Industrial Park
P.O. Box 1089
Smithfield, NC 27577 (919) 934-3135
Sales Contact: M.D. Sutton, Mgr. Mkt. — Eng.

SHANE MEDIA SERVICES

7703 Windswept
Houston, TX 77063 (713) 461-9958
Sales Contact: Pam Shane

SHARP ELECTRONICS CORPORATION

Professional Products Division
10 Sharp Plaza, P.O. Box 588
Paramus, NJ 07652 (201) 265-5548
Sales Contact: Robert Garbutt, Gen. Mgr.

Regional Sales Offices:

SHARP ELECTRONICS CORPORATION
20600 South Alameda Street
Carson, CA 90810 (213) 637-9488
Contact: Ron Colgan, Sis. Mgr.
SHARP ELECTRONICS CORPORATION
6478 Interstate 85
Norcross, GA 30093 (404) 448-5230
Contact: Jim Freeman, Sales Mgr.

SHINTRON CO. INC.

144 Rogers Street
Cambridge, MA 02142 (617) 491-8700
Sales Contact: William K. Warnke, Sales Dept.

SHIVELY LABORATORIES

11 Harrison Rd.
Bridgton, ME 04009 (207) 647-3327
Sales Contact: Charles Peabody, V.P. Manu.

SHURE BROTHERS INC.

222 Hartrey Ave.
Evanston, IL 60204 (312) 866-2200
Sales Contact: Glen Schrader, VP, Sales

SIEGEL ELECTRONICS

P.O. Box 33421
San Diego, CA 92103 (714) 295-4995
Sales Contact: Eric Siegel, Pres.

SIEMENS AG

St.-Martin-Str. 76
D-8000 Munchen 80
Federal Republic of Germany (089) 4133-4564
Sales Contact: Mr. Ruckerbauer, Leader of
Transmitter Dept., TV

SIEMENS AG OSTERREICH

A-1031 Vienna P.O.B. 326
Gollnergasse 15,
Australia (0222) 72 93-0
Sales Contact: Dipl. Ing. Wanda, Director

SIERRA AUDIO CORPORATION

621 So. Glenwood Place (213) 843-8115
Burbank, CA TLX: 691138Bubk
Sales Contact: Vencil Wells, Gen. Mgr.

SIGMA ELECTRONICS INC.

1830 State Street
E. Petersburg, PA 17520 (717) 569-2681
Sales Contact: Kent Porter, VP Mktg.

SIGMA FILM EQUIPMENT LTD.

Churchill Industrial Estate
Lancing, West Sussex 09063-66909
United Kingdom BN15 8TZ
Sales Contact: J.P. Seabourne, Dir.

SIMON ASSOCIATES

20 Sunnyside Ave., Suite B
Mill Valley, CA 94941 (415) 381-0835
Sales Contact: Tim Simon, Pres.

SIMPLICITY TOOL CO.

10330 N.E. Marx Street
Portland, OR 97220 (503) 253-2000
Sales Contact: G. Berliner, Mgr.

SINGER BROADCAST PRODUCTS INC.

Box 5500
Cherry Hill, NJ 08034 (609) 424-1500

SINGER PRODUCTS CO. INC.

875 Merrick Ave.
Holbrook, NY 11590 (516) 683-3000 x602
Sales Contact: J. Biccocchi, Gen. Mgr. Broad.

SITCO ANTENNAS

10330 N.E. Marx St.
Portland, OR 97220 (503) 253-2000
Sales Contact: G. Berllner, Pres.

SKIRPAN LIGHTING SYSTEMS

1100 W. Chestnut Street
Burbank, CA 91506 (213) 843-3232
Sales Contact: Robert Slutske, Dir. Mktg.

SKOTEL CORPORATION

1445 Provencher Blvd., Suite 204
Brossard, Quebec
J4W 1Z3 Canada (514) 465-8990
Sales Contact: Stephen Scott, Pres.

SMITH-MATTINGLY PRODUCTIONS

2560 Huntington Ave., Suite 303
Alexandria, VA 22303 (703) 960-2175
Sales Contact: Jennifer Ciacclo, Dir. of Oper.

SMITH-VICTOR CORPORATION

301 North Colfax Street
Griffith, IN 46319 (219) 924-6136
Sales Contact: Bruce McCullough, Sales Mgr.

SMOKE SIGNAL BROADCASTING

31336 Via Colinas
Westlake Village, CA 91362 (213) 889-9340
Sales Contact: Jim Alliday, Natl. Sis. Mgr.

SOLID ELECTRONICS LABORATORIES

4-9 Fairfield Road
Havertown, PA 19083 (215) 446-4799
Sales Contact: S.J. Hemphill, Owner

SOLID STATE LOGIC LTD.

Churchfields Road
Stonesfield, Oxford OX7 2PS
England (44) 099 389 8282
Sales Contact: Bill Aitken, Sales Mgr.

SOLL INC.

401 E. 74th St.
New York, NY 10021 (212) 988-0290
Sales Contact: Joe Soll, Pres.

SONAR RADIO CORPORATION

3000 Stirling Road
Hollywood, FL 33021 (305) 981-8800
Sales Contact: Bernard E. Klein, Pres.

SONDOR EXPORT AG

Dachslerenstrasse II
CH-8702 Zollikon 01 65 80 90
Switzerland 11/81 — 01/391 80 90
Sales Contact: Hans-Jurgen Schreier, Sales

SONIC RESEARCH INC.

27 Sugar Hollow Rd.
Danbury, CT 06810 (203) 792-8822
Sales Contact: Ronald E. Wilcox,
Nat. Sales & Mktg. Mgr.

SONO VIDEO INC.

2881 Le Corbusier
Chomedey, Laval
Quebec, Canada H7S 1Z4 (514) 335-0113

SONO-MAG CORPORATION

1833 W. Hovey Avenue
Normal, IL 61761 (309) 452-5313
Sales Contact: Stephen S. Sampson, Exe. VP

SONTEC ELECTRONICS

Audio Drive
Goldbond, VA 24094 (703) 626-7256
Sales Contact: Burgess Macneal, Mktg. Mgr.

SONY BROADCAST LTD.

City Wall House
Basing View, Basingstoke
Hampshire RG21 2LA United Kingdom

SONY BROADCAST PRODUCTS COMPANY

9 W. 57th Street
New York, NY 10019 (212) 371-5800

SORENSEN COMPANY

676 Island Pond Road
Manchester, NH 03103 (603) 668-4500
Sales Contact: Roy Allman, Nat. Sis. Mgr.

SOUND TECHNOLOGY INC.

1400 Dell Avenue
Campbell, CA 95008 (408) 378-6540
Sales Contact: Sonny Funke, Nat'l. Sis. Mgr.

SOUNDCRAFT ELECTRONICS LTD.

5-8 Great Sutton St.
London EC1V 0BX (01) 251-3631
Sales Contact: P. Dudderidge, Mktg. Dir.

SOUND DYNAMICS INC.

P.O. Box 32055
San Jose, CA 95152 (408) 926-3588
Sales Contact: Ron Golick, Gen. Mgr.

SOUNDCRIBER MAGNETIC

RECORDING CO. INC.
85 Willow Street
New Haven, CT 06511 (203) 624-5179
Sales Contact: Lawrence A. Acampora, G. Mgr.

THE SOUND & LIGHT CO.

1169 Tower Rd.
Schaumburg, IL 60195 (312) 885-2341
Sales Contact: Jim Hildebrandt, Pres.

SOUTHWESTERN PROGRAMMING SERVICE

1014 South Toltec
Mesa, AZ 85204 (602) 892-2343
Sales Contact: Jim Gaspar, Owner

SPECTRA COMPUTER SYSTEMS

391 Chipeta Way

Salt Lake City, UT 84108 (801) 581-5478
Sales Contact: Steven Root, Pres.

SPECTRA SONICS

3750 Airport Road
Ogden, UT 84403 (801) 392-7531
Sales Contact: Mr. Gregory D. Dilley, Eng. Sls.

SPECTRUM INSTRUMENTS INC.

P.O. Box 97
Hartsdale, NY 10530 (914) 428-4975
Sales Contact: J. McClean, Sales Mgr.

SPENCER BROADCAST INC.

316 E. El Camino Drive
Phoenix, AZ 85020 (602) 242-2211
Sales Contact: Janene Spencer, Sls. Dir.

SPERRY MARINE SYSTEMS

630 Gaiennie St.
New Orleans, LA 70130 (504) 525-7127
Sales Contact: Doug Golf, Dist. Mgr.

SPHERE ELECTRONICS INC.

20201 A. Prairie
Chatsworth, CA 91311 (213) 349-4747
Sales Contact: David Holmes, Sales Mgr.

SPINDLER & SAUPE

13034 Saticoy Street
N. Hollywood, CA 91605 (213) 764-1800
Sales Contact: Sarah Calkins, Mktg. Coord.

SPIN PHYSICS INC.

3099 Science Park Rd.
San Diego, CA 92121 (714) 453-5410
Sales Contact: Wm. W. Heywood, VP, Sales

STAINLESS INC.

3rd & Montgomery Avenue
North Wales, PA 19454 (215) 699-4871
Sales Contact: Jess Rodriguez, V.P. / Sls.

STANCIL CORPORATION

921 No. Highland Ave.
Hollywood, CA 90038 (213) 464-7461
Sales Contact: Mike Custer, VP.

STANDARD COMMUNICATIONS CORP.

108 W. Victoria
Carson, CA 90009 (213) 532-5300
Sales Contact: Mark Thomas, Dir. of Mktg.

STANDARD ELECTRIC TIME CORP.

357 Cottage St.
Springfield, MA 01104 (413) 732-1141
Sales Contact: Howard Weed, Sls, Mgr.

STANDARD TAPE LABORATORY INC.

26120 Eden Landing Road, No. 5
Hayward, CA 94545 (415) 786-3546
Sales Contact: Frank G. Lennert, Pres.

STANDARD TELEPHON UND RADIO AG

Friesenberg Strasse 75
CH 8055 Zurich (01) 465-2111
Sales Contact: K. Haering, Exp. Mgr.

STANTON MAGNETICS INC.

200 Terminal Drive
Plainview, NY 11803 (516) 349-0200
Sales Contact: Pete Bidwell, Prof. Sls. Mgr.

STANTRON DIV. OF WYCO METAL PROD.

6900-18 Beck Ave.
North Hollywood, CA 91605 (213) 875-0800
Sales Contact: Guy A. Tessier, VP/Sales

STAR CASE MFG. CO. INC.

15525 S. 70th Court
Orland Park, IL 60462 (312) 429-6200
Sales Contact: Dennis R. Toma, Pres.

STAREX INC.

655 Schuyler Ave.

P.O. Box 248
Kearny, NJ 07032 (201) 997-1555
Sales Contact: Stanley A. Asinof, Pres.

STATION BUSINESS SYSTEMS

Div. Control Data Corp.
600 West Putnam Avenue
Greenwich, CT 06830 (800) 243-5300
Sales Contact: J. Neil Smith, VP (203) 622-2400

STATION PROGRAM RESOURCES

6117 Blue Circle Drive
Minnetonka, MN (612) 935-4454
Sales Contact: Jack Hansen, Pres.

STEENBECK INC.

9045 Eton Avenue, Suite A
Canoga Park, CA 91304 (213) 998-4033
Sales Contact: Ted Diamond, Sales Mgr.

STELLAVOX

Jardillets 18
CH-2068 Hauterive (NE)
Switzerland (038) 33 42 33
Sales Contact: Georges Quellet, Propriet or

STEVENS TOWER COMPANY

P.O. Box 281
Laurel, MS 39440 (601) 425-5145
Sales Contact: Robert L. Stevens, Owner

E.J. STEWART INC.

525 Mildred Ave.
Primos, PA 19018 (215) 626-6500
Sales Contact: Hal Lipman, Gen. Mgr.

STOREEL CORPORATION

2050-C Carroll Ave., Ste. 2,
P.O. Box 80523
Atlanta, GA 30341 (404) 458-3280
Sales Contact: Ruth E. Schaeffer, President

STRAIGHT WIRE AUDIO CORP.

2523 Willson Boulevard
Arlington, VA 22201 (703) 522-7780
Sales Contact: Bill Sacks, Chief Engineer

STRAND CENTURY INC.

5432 W. 102 St.
Los Angeles, CA 90045 (213) 776-4600
Sales Contact: Bob Schiller, VP Mktg.

STANDARD TELEPHON AND RADIO AG

Friesenbergstrasse 75
CH 8055 Zurich, Switzerland (01) 214 2111
Sales Contact: K. Haering, Exp. Mgr.

STUDER INTERNATIONAL AG

Professional Audio Equipment
CH-8105 Regensdorf
Althardstrasse 150 01 840 29 60
Switzerland Telex 58489 stui ch
Sales Contact: Mister E. Sporri, Man. Dir.

STUDER REVOK AMERICA INC.

1425 Elm Hill Pike
Nashville, TN 37210 (615) 254-5651
Sales Contact: Bruno Hochstrasser, Pres.

Regional Sales Offices:

STUDER REVOK AMERICA
155 Avenue of the America
New York, NY 10013 (212) 255-4462
Sales Contact: Fred Layn, Regional Manager
Thomas Mintner, Reg. Manager

STUDER REVOK AMERICA

14046 Burbank Blvd.
Van Nuys, CA 91401 (213) 780-4234
Sales Contact: Bill Van Doren, Reg. Manager

STUDER REVOK AMERICA

111 South Drive
Barrington, IL 60010 (312) 381-4559
Sales Contact: Brian Tucker, Reg. Manager

JOHN M. SULLIVAN ASSOCIATES INC.

341 Marrett Road
Lexington, MA 02173 (617) 861-7472
861-0238
Sales Contact: John M. Sullivan, Pres.

SUPEREX ELECTRONICS

151 Ludlow St.
Yonkers, NY 10705 (914) 965-6906
Sales Contact: Michael Solomon, Mktg. Dir.

THE SUPERIOR ELECTRIC COMPANY

383 Middle St.
Bristol, CT 06010 (203) 582-9561
Sales Contact: J. McMahon, Sales Eng.

SURCOM ASSOCIATES INC.

305 Wisconsin Ave.
Oceanside, CA 92054 (714) 722-6162
Sales Contact: August J. Link, Pres.

SWAGER TOWER CORPORATION

P.O. Box 656
Fremont, IN 46737 (219) 495-5165
Sales Contact: Dan J. Swager, VP

RICHARD SWETTENHAM ASSOC.

38 Mount Pleasant
London Wc1 (01) 837-5873
Sales Contact: R. Swettenham/D. Comper

SWINTEK ENTERPRISES INC.

1180 Aster Ave. -J
Sunnyvale, CA 94086 (408) 249-5594
Sales Contact: Billy Williams, Sales Mgr.

SWITCHCRAFT INC.

5555 N. Elston Ave.
Chicago, IL 60630 (312) 792-2700
Sales Contact: Fred Fitzpatrick, Prod. Mgr.

SYNSAT INTERNATIONAL INC.

4104 Linden Hills Blvd.
Minneapolis, MN 55410 (612) 925-2633
Sales Contact: John Uldrich, Pres.

SYRACUSE SCENERY & STAGE LIGHTING CO., INC.

1423 North Salina St.
Syracuse, NY 13208 (315) 474-2474
Sales Contact: Christine Logan, V.P.

SYSTEM ASSOCIATES

5801 Uplander Way
Culver City, CA 90230 (213) 641-2042
Sales Contact: Walter A. Shubin, V.P.
Billy H. Seidel

SYSTEMS COMMUNICATIONS CABLE

P.O. Box 21007
Phoenix, AZ 85036 (602) 268-8744
Sales Contact: Earl Langenberg, Sls. Eng.

SYSTRON DONNER

2700 Systron Dr.
Concord, CA 94518 (415) 676-5000

SYTRON INC.

1340 Bodwell
Manchester, NH 03103 (603) 627-3655
Sales Contact: Erl Sexton, Pres.

T

TBC PTY. LTD.

6 Chilvers Road, Thornleigh. N.S.W. 2120
Australia (02) 848-8777
Sales Contact: Bert Heys, Mktg. Mgr.

TDF

21 / 27 rue Barbes
Montrouge 92120, France

TDK ELECTRONICS CORP.

12 Harbor Port Drive
Port Washington, NY 11050 (516) 625-0100
Sales Contact: Ed Pessara, Video Tape Mgr.

Continued on page 158

WHERE TO BUY IT

TFT INC.

3090 Oakmead Village Drive
Santa Clara, CA 95051 (408) 727-7272
Sales Contact: Joe Wu, Pres.

Regional Sales Offices:

1355 Jeanette Way
Southampton, PA 18966 (215) 322-8911
Contact: Tom Creighton

MARCOM

P.O. Box 66507
Scotts Valley, CA 95066 (408) 438-4273
Contact: Martin Jackson, Ted Tripp

MARCOM

216 Westlake Ave. North
Seattle, WA 98109 (206) 621-9633
Contact: Bill Wolfenbarger

MARCOM

21243 Ventura Blvd.
Suite 145
Woodland Hills, CA 91364 (213) 703-0381
Contact: Doug Howland

DIDIER/DENVER

NM, KS, NE (Radio and TV)
MT, WY, ID, UT, CO (TV Only)
P.O. Box 1599
Evergreen, CO 80439 (303) 674-6000
Contact: Herb Didier, Steve Didier

HALL ELECTRONICS

MT, WY, ID, UT, CO
(Radio Only)
P.O. Box 5031
Boise, ID 83705 (208) 376-1663
Contact: Larry Hall

PARCOM

4260 Raintree Drive
Southlake, TX 76092 (817) 481-7221
Contact: DArryl Parker

EMMONS ASSOCIATES

1121 Riverwood Drive
Burnsville, MN 55337 (612) 890-8920
Contact: Keth Emmons

DYER ELECTRONICS

31185 Ten Mile Rd.
Farmington Hills, MI 48024 (313) 478-2157
Contact: Mike Dyer, Leo Rymarz

RALPH L. HUCABY

1331 Otter Creek Rd.
Nashville, TN 37215 (615) 373-0231
EME I, INC.

EME I, INC.

112 Buena Vista
High Point, NC 27260 (919) 869-3335
Contact: George Gold

EME IV

107 Richneck Dr.
Williamsburg, VA 23185 (804) 253-0171
Contact: Ken Ward

ROSCOM, INC.

P.O. Box 1208
Roswell (Atlanta), GA 30077 (404) 992-2700
Contact: Bob Stewart, Ken Wilson

BEATTIE & ASSOCIATES

3317 Barrow Hill Trail
Tallahassee, FL 32308 (904) 893-1382
Contact: Bob Beattie

HOLZBERG ASSOCIATES

P.O. Box 322
Totowa, NJ 07512 (201) 256-0455
Contact: Herb Holzberg

WILTRONIX, INC.

16850 Oakmont Ave.
P.O. Box 364
Washington Grove, MD 20880-0364 (301) 258-7676
Contact: Dwight L. Wilcox, Dave Wilcox

MSC ELECTRONICS LTD.

254 Wildcat Rd.
Downsview, Ontario
Canada M3J 2N5 (416) 661-4180
Contact: David La Frenais, Anthony Sharpe

ELECTREX COMPANY

(Central/South Amer., P.R.)

18680 N.E. 2nd Ave.
Miami, FL 33179 (305) 651-5752
Contact: Ben Ostrovsky

GUARANTEED RADIO SUPPLY

(Mexico)
1314 Iturbide St.
Laredo, TX 78040 (512) 723-3331
Contact: Richard Reyes

TL SYSTEMS

1101 E. Chestnut St., Suite C
Santa Ana, CA 92701 (714) 547-1981
Sales Contact: Ted Laffleur, Pres.

TM SYSTEMS INC.

25 Allen St.
Bridgeport, CT 06604 (203) 366-4571
Sales Contact: I. Shuldman, Mgr.

TOA ELECTRONICS INC.

480 Carlton Court
S. San Francisco, CA 94080 (415) 588-2538
Sales Contact: Terry Green, Mktg. Mgr.

TTE INC.

2214 So. Barry Ave.
Los Angeles, CA 90064 (213) 478-8224
Sales Contact: S. Sodaro, Mgr.

TVNS (Television News Support)

World Trade Center
Suite 250R
San Francisco, CA 94111 (415) 982-3073
Sales Contact: J. Cheney, Pres.

TABER MFG. & ENG. CO.

2081 Edison Ave.
San Leandro, CA 94577 (415) 635-3831
Sales Contact: Bob Kearns, Gen. Mgr.

TANGENT SYSTEMS INC.

2005 E. University Dr.
Phoenix, AZ 85034 (602) 267-0653
Sales Contact: Thomas M. Scott, Sls. Mgr.

TAPCO, Div. of Electro-Voice

3810 148th Avenue NE
Redmond, WA 98052 (206) 883-3510
Sales Contact: Ferdinand Boyce, Mkt. Mgr.

TAPE

2065 Peachtree Industrial Ct.
Suite 215
Chamblee, GA 30341 (404) 458-8273

TAPE-ATHON CORP./CAVOX STEREO PROD.

502 S. Isis Ave.
Inglewood, CA 90301 (213) 776-6933
Sales Contact: Blair Hunnicutt, Sls. Mgr.

TAPECASTER TCM INC.

Box 662
Rockville, MD 20851 (301) 881-8888
(800) 638-0977
Sales Contact: Paul L. Shore, Pres.

TAPESWITCH CORPORATION

100 Schmitt Blvd.
Farmingdale, NY 11735 (516) 694-6312
Sales Contact: K. C. Torrens, Sls. Mgr.

TAYBURN ELECTRONICS

6106 Avenida Encinas
Carlsbad, CA 92008 (714) 438-5444
Sales Contact: Greg Rowley, Mktg. Mgr.

TAYLOR INSTRUMENT

(SYBRON CORPORATION)
Arden, NC 28704 (704) 684-8111
Sales Contact: Sales Department

TEAC CORP. OF AMERICA

TASCAM Production Products Division
7733 Telegraph Rd.
Montebello, CA 90640 (213) 726-0303
Sales Contact: Bill Mohrhoff, Natl. Sls. Mgr.

David G. Oren, Marketing Manager

TECH ELECTRONICS INC.

6000 Peachtree Rd., N.E.
Atlanta, GA 30341 (404) 455-7626
Sales Contact: Roby Price, Gen. Mgr.

TECH LABORATORIES INC.

Bergen & Edsall Blvds.
Palisades Park, NJ 07650 (201) 944-2221
Sales Contact: A. Konrad, Pres.

TECHNOLOGY FOR COMMUNICATIONS

INTERNATIONAL
1625 Stierlin Road
Mountain View, CA 94043 (415) 961-9180
Sales Contact: Lawrence J. Blum, VP Mktg.

TECHNOLOGY SERVICE CORPORATION

2950 31st St.
Santa Monica, CA 90405 (213) 450-9755
Sales Contact: Ray Durand, Manager

TECHNICOBEL

8 rue de la Croix - Martre
BP 26 91122
Palaiseau, France

TECH THEATRE

4724 Main Street
Lisle, IL 60532 (312) 971-0855
Sales Contact: Gary Timm, V.P.

TEKTRONIX INC.

P.O. Box 500
Beaverton, OR 97077 (503) 644-0161

TELCOM RESEARCH

1163 King Road
Burlington, Ontario
Canada (416) 681-2450
Sales Contact: Tom Banting

TELECOMMUNICATIONS SYSTEMS

910 17th St. N.W., Suite 319
Washington, DC 20006 (202) 223-4449
Sales Contact: R.G. Gould, P.E., Pres.

TELECOMMUNICATIONS TECHNOLOGY

555 Del Ray Avenue
Sunnyvale, CA 94086 (408) 735-8080
Sales Contact: Glenn Patterson, V.P. / Mktg.

TELECONCEPTS IN COMMUNICATIONS INC.

145 E. 49th St.
New York, NY 10017 (212) 355-7113
Sales Contact: James W. Johnson, Pres.

TELE-CINE CORPORATION

400 Crossways Park Drive
Woodbury, NY 11797 (516) 496-8500
Sales Contact: Robert Jones, Mgr. of Sales

TELECTRO SYSTEMS CORP.

96-18 43rd Avenue
Corona, NY 11368
Sales Contact: Harry Sussman, Pres.

TELEDYNE ACOUSTIC RESEARCH (AR)

10 American Drive
Norwood, MA 02062 (617) 769-4200
Sales Contact: Rick Sands, Dir. of Sales

TELEDYNE BIG BEAM

290 East Prairie St.
P.O. Box 518
Crystal Lake, IL 60014 (815) 459-6100
Sales Contact: C.J. Ortmeier, Exec. VP

TELEDYNE ENERGY SYSTEMS

110 W. Timonium Road
Timonium, MD 21093, U.S.A. (301) 252-8220
Sales Contact: Paul Bessert, Prod. Mktg. Mgr.

TELE-MEASUREMENTS INC.

145 Main Avenue
Clifton, NJ 07014 (201) 473-8822

WHERE TO FIND IT

GENERAL INDEX, Pages 38-45

WHO MAKES IT

PRODUCT DIRECTORY, Pages 46-113

WHERE TO BUY IT

MANUFACTURERS, Pages 114-162

DEALERS/DISTRIBUTORS, Pages 168-189

Sales Contact: W.E. Endres, Pres.
D. Cook, VP/Sales

TELECTRO SYSTEMS CORP.

96-18 43rd Avenue
Corona, NY 11368 (212) 651-8900
Sales Contact: Harry Sussman, Pres.

TELEMET, DIV. OF GEOTEL INC.

185 Dixon Avenue
Amityville, NY 11701 (516) 842-2300
Sales Contact: Joseph L. Cali, Jr.,
Customer Service Mgr.

Regional Sales Offices:

TELEMET, DIV. OF GEOTEL, INC.
Easthill RFD #3
Brewster, NY 10509 (914) 279-3231
Contact: Robert G. Griffilths, VP/Sales

TELESCO INTERNATIONAL CORP.

125 Mineola Avenue
Roslyn Heights, NY 11577 (516) 484-3822
Sales Contact: Gerald Lanier, President

TELESCRIPT INC.

20 Insley Street
Demarest, NJ 07627 (201) 567-2220
Sales Contact: Bob Swanson, Gen. Mgr.

TELESENSORY SYSTEMS

3408 Hillview Avenue
Palo Alto, CA 94304 (415) 856-8255
Sales Contact: Alan Yatagai

TELESOURCE COMMUNICATION SERVICES

730 East Highland
Phoenix, AZ 85014 (602) 265-1232
Sales Contact: Michael D. Rich, Mgr.

TELEVISION ASSOCIATES INC.

2410 Charleston Road
Mountain View, CA 94043 (415) 967-6040
Sales Contact: Ann Callahan, Prod. Sales
Dave Taylor, Equipment Sales

TELEVISION ENGINEERING CORPORATION

580 Goddard Ave.
Chesterfield, MO 63017 (314) 532-4700
Sales Contact: Sharon Sokup, Sls. Admin.

TELEVISION GRAPHICS, CO.

555 Broad St.
Glen Rock, NJ 07452 (201) 444-2911
Sales Contact: Charlie or Chuck Diehl, Ownr.

TELEVISION EQUIPMENT ASSOCIATES

Box 260
South Salem, NY 10590 (914) 763-8893
Sales Contact: Bill Pegler, President

TELEVISION INTERNATIONAL OPERATIONS LTD.

9-11 Windmill Street
London W1P 1HF, UK (01) 637-2477
Sales Contact: Joe Vick, Sales Dir.

TELEVISION PRODUCTS CO. INC.

9016 Aviation Blvd.
Inglewood, CA 90301 (213) 776-3276

TELEVISION PRODUCTION SERVICES CORP.

381 Horizon Drive
Edison, NJ 08817 (201) 287-3626
Sales Contact: R.J. Burks, Producer

TELEVISION TECHNOLOGY CORP.

5970 West 60th Ave.
Arvada, CO 80003 (303) 423-1652
Sales Contact: B.W. St. Clair, President

TELEX COMMUNICATIONS INC.

9600 Aldrich Ave. South
Minneapolis, MN 55420 USA (612) 884-4051
884-7517
Sales Contact: Don Meeen, Dir. Mktg.,

TELMAR MEDIA SYSTEMS INC.

90 Park Avenue
New York, NY 10016 (212) 949-4640
Sales Contact: Harry Appel, Sr. VP

TENNAPLEX SYSTEMS LTD.

34 Bentley Ave.
Ottawa, Ontario (613) 226-5870
Canada K2E 6T8 Telex: 053-4962
Sales Contact: Manfred Muenzel, Sls. Mgr.

TENTEL CORP.

1506 Dell Ave.
Campbell, CA 95008 (408) 379-1881
Sales Contact: Sales Engineering

TEPCO CORP.

P.O. Box 680
Rapid City, SD 57709 (605) 343-7200
Sales Contact: Jerry Johnson, Sales Mgr.

TERRACOM—LORAL CORP.

9020 Balboa Ave.
San Diego, CA 92123 (714) 278-4100
Sales Contact: Mike Mulcay, V.P. Mktg.

TEXAS ELECTRONICS

5529 Redfield Street
Dallas, TX 75235 (214) 631-2490
Sales Contact: Secretary

TEXAS INSTRUMENTS

P.O. Box 2250 MS 84
Dallas, Texas (214) 995-6611

TEXSCAN CORPORATION

2446 N. Shadeland Ave.
Indianapolis, IN 46219 (317) 357-8781
Sales Contact: Alan Whitlock, Sales Mgr.

TEXSCAN/MSI CORPORATION

3855 South 500 West, Suite "S"
Salt Lake City, UT 84115 (801) 262-8475
Sales Contact: Dennis Gourley, Mktg. Mgr.

THE TEXWIPE COMPANY

650 E. Crescent
P.O. 575
Upper Saddle River, NJ 07458 (201) 327-5577

THEATRE SERVICE & SUPPLY CORP.

1792 Union Ave.
Baltimore, MD 21211 (301) 467-1225
Sales Contact: Richard Antisdell, Pres.

THEATER TECHNIQUES INC.

60 Connolly Pkwy.
Hamden, CT 06514 (203) 281-6111
Sales Contact: F. Lindauer, Pres.

THERMODYNE INTERNATIONAL LTD.

10850 S. Alameda
Long Beach, CA 90810 (213) 603-1976
Sales Contact: Walter Wolf, Pres.

THOMSON-CSF, DIV. TUBES ELECTRONIQUES

38 Rue Vauthier
92102 Boulogne Billancourt Cedex (1) 604.81.75
France
Sales Contact: Mrs. J. Bidault, Pub. Rel.

THOMSON-CSF, ELECTRON TUBE DIVISION

301 Route Seventeen North
Rutherford, NJ 07071 (201) 438-2300
Sales Contact: John Mulroe, Prod. Sls. Mgr.

THOMSON-CSF, LABORATOIRE GENERAL DES TELECOMMUNICATIONS

51 Boulevard de la Republique
78400 Charou, France

THOMSON-CSF DIVISION, RADIODIFFUSION TELEVISION

94, Rue du Fosse Blanc 92231
Gennevilliers, France (1) 790.65.49
Sales Contact: M. Jean Wolf, Rel. Publiques

THOMSON-CSF BROADCAST INC.

37 Brownhouse Road
Stamford, CT 06902 (203) 327-7700
Sales Contact: Richard T. Sanford, Nat. S. Mgr.

THOMSON CSF EQUIPMENT & SYSTEMS LTD.

Hunting House, Central Way
Feltham, Middlesex TW14 OVD 01 751 6241
Sales Contact: Steve Rolls, Sls. Eng.

THOMSON-CSF

23 rue de Courcelles
75008 PARIS (1) 563 12.12
Sales Contact: Mrs. C. Durussel

THORN LIGHTING LIMITED

Angel Road Works
402 Angel Road
London N18 3AJ, UK 01-807-9011

TIFFEN MANUFACTURING

90 Oser Ave.
Hauppauge, NY 11788 (516) 273-2500
Sales Contact: Tom Grosso, Sales

TIMES FIBER COMMUNICATIONS INC.

358 Hall Avenue
P.O. Box 384
Wallingford, CT 06492 (203) 265-8500

TOPAZ INC.

3855 Ruffin Road
San Diego, CA 92123 (714) 571-5622
Sales Contact: Mr. Rob Britton, Dir. of Sls.

TORE SEEM

Box 10 N 1344
Haslum, Norway (02) 53 39 75

TORPEY CONTROLS & ENGINEERING LTD.

2220 Midland Ave., Unit 98
Scarborough, Ontario
Canada M1P 3E6 (416) 298-7788
Sales Contact: R. Torpey, Pres.

TOSHIBA AMERICA INC.

292 Gibraltar Dr.
Sunnyvale, CA 94086 (408) 734-9172

TOWNSEND ASSOCIATES INC.

Mainline Drive, P.O. Box 1122
Westfield, MA 01086 (413) 562-5055
Sales Contact: Howard McClure, VP/Mktg.

TRAMEC ELECTRONICA S.R.L.

San Lorenzo 2646
1636 Olivos-Provincia De BS.AS.
Argentina TELEEX: 26144
Sales Contact: Mr. Lirio A. Pereyra, Gen. Mgr.

TRANS-AMERICAN VIDEO, INC.

1541 North Vine Street
Hollywood, CA 90028 (213) 466-2141

TRANSCO PRODUCTS INC.

4241 Glencoe Avenue
Marina Del Rey, CA 90291 (213) 822-0800
Sales Contact: J.D. Fricke, Dir. of Mktg.

TRANSIST-O-SOUND

728 Yosemite Drive
Indianapolis, IN 46217 (317) 787-8491
Sales Contact: Bill/Maxine Landrum, Owners

TRANSTECTOR SYSTEMS

E. 5250 Seltice Hwy.
P.O. Box 1299

Continued on page 160

WHERE TO BUY IT

Post Falls, ID 83854 (800) 635-2537
Sales Contact: Edward Bellamy, Nat. Sls. Mgr.

TREISE ENGINEERING

1941 First St.
San Fernando, CA 91340 (213) 365-3124
Sales Contact: Bill Juden, Sales/Field Tech.

TREPAC CORPORATION OF AMERICA

30 W. Hamilton Ave.
Box 471
Englewood, NJ 07631 (201) 567-3810
Sales Contact: H.S. Gutshall, Mktg. Mgr.

TRIDENT (U.S.A.) INC.

652 Glenbrook Road
Stamford, CT 06906 (203) 357-8337
Sales Contact: Mark Terry, Sales Mgr.

TRI-EX TOWER CORP.

7182 Rasmussen Ave.
Visalia, CA 93277 (209) 625-9400
Sales Contact: Mr. Donald Hills, Sales Mgr.

TRIPLE S MFG. CORP.

351 Crosby Ave.
Pat, NJ 07502 (201) 942-3532
Sales Contact: Harry Scala, Pres.

TRIPLETT CORPORATION

One Triplett Drive
Bluffton, OH 45817 (419) 358-5015
Sales Contact: Stanley F. Naylor, Adv. Mgr.

TRI TEC SYSTEMS

1324 Motor Parkway
Hauppauge, NY 11787 (516) 234-6090
Sales Contact: Jack Jenkins, V.P. Sales

TROMPETER ELECTRONICS INC.

8936 Comanche Ave.
Chatsworth, CA (213) 882-1020
Sales Contact: P. Cox, Sales Admin.

TRUE TIME INSTRUMENTS

3243 Santa Rosa Ave.
Santa Rosa, CA 95401 (707) 528-1230
Sales Contact: Victor Kunkel, App. Engr.

TUESDAY PRODUCTIONS

4429 Morena Blvd.
San Diego, CA 92117 (714) 272-7660
Sales Contact: Bo Donovan, VP

TWEED AUDIO USA INC.

12-Ilex Drive
Newbury Park, CA 91320 (805) 499-4764
Sales Contact: Kirsh Mustafa

U

UHF ASSOCIATES

5625 State Farm Dr. -4
Rohnert Park, CA 94928 (707) 584-7844
Sales Contact: M. Sides, Mgr.

UMC ELECTRONICS CO.

460 Sackett Point Road
North Haven, CT 06473-0307 (203) 288-7731
Sales Contact: A. Z. Sawala, Nat'l. Sales Mgr.

Regional Sales Office:

UMC ELECTRONICS
26311 Marina Road
San Juan Capistrano, CA 92675 (714) 495-4047
Contact: Gerry Burkhardt, Western Reg. Sls. Mgr.

UNR-ROHN

P.O. Box 2000
Peoria, IL 61656 (309) 697-4400
Sales Contact: Lisa Rhodes, Adv. Coord.

UREI

8460 San Fernando Road
Sun Valley, CA 91352 (213) 767-1000
Sales Contact: Ray Combs, Sr. V.P.

URSA MAJOR INC.

Box 18 / 50 Trapelo Rd.
Belmont, MA 02178 (617) 489-0303
Sales Contact: Gerard Abeles, V.P., Mktg.

UTE MICROWAVE INC.

3500 Sunset Avenue
Asbury Park, NJ 07712 (201) 922-1009
Sales Contact: L.H. Nilson, Gen. Mgr.

ULTRA AUDIO PIXTEC

Div. of Audio Int'l Inc.
P.O. Box 921
Beverly Hills, CA 90213 USA (213) 276-2726
Sales Contact: Ricky Beck, Sales Mgr.

UNEMCO INTERNATIONAL INC.

2102 Ringwood Avenue
San Jose, CA 95131 (408) 946-5076
Sales Contact: R.A. Piper, Dir. of Market Development

UNION CONNECTOR CO. INC.

149 Babylon Turnpike
P.O. Box H
Roosevelt, NY 11575 (516) 623-7461
Sales Contact: Richard W. Wolpert, Pres.

UNI-SET CORPORATION

449 Ave. A
Rochester, NY 14621 (716) 544-3820
Sales Contact: Ronald Kniffin, Pres.

UNITED MEDIA INC.

4075 Leaverton Court
Anaheim, CA 92807 (714) 630-8020
Sales Contact: Mr. Robert J. Ricci, Pres.

UNITED PRESS INTERNATIONAL

220 E. 42nd St.
New York, NY 10017 (212) 850-8600
Sales Contact: Gordon Rice, VP, Broadcasting

UNITED RESEARCH LAB. CORP.

16 East 52 Street
New York, NY 10022 (212) 751-4663
Sales Contact: George Adams, Pres.

UNITED STATES TOWER COMPANY

P.O. Box 1438
Miami, OK 74354 (918) 540-1574
Sales Contact: Dan Weathers, VP

UNITEL

80, rue d'Arcueil
94250 Gentilly, France 588.33.13
Sales Contact: A. Thevenot, Comm. Dir.

UP-RIGHT INC.

1013 Pardee Street
Berkeley, CA 94710 (415) 843-0770
Sales Contact: Tony Armas, Sales Mgr.

US JVC CORP.

41 Slater Drive
Elmwood Park, NJ 07407 (201) 794-3900
Sales Contact: Daniel Roberts, VP

Regional Sales Offices:

U.S. JVC CORPORATION
41 Slater Drive
Elmwood Park, NJ 07407 (201) 794-3900
Contact: Steve Martin, Reg. Sls. Mgr.
U.S. JVC CORPORATION
2250 Lively Blvd.
Elk Grove, IL 60007 (312) 364-9300
Sales Contact: Doug DiGiacomo, Reg. Sls. Mgr.
U.S. JVC CORPORATION
407 Garden Oaks Blvd.
Houston, TX 77018 (713) 694-0866
Sales Contact: Ed Spalding, Branch Manager
U.S. JVC CORPORATION
1011 West Artesia Blvd.

Compton, CA 90220 (213) 537-6020
Sales Contact: Logan Enright, Reg. Sls. Mgr.

UTAH SCIENTIFIC INC.

2276 So. 2700 West
Salt Lake City, UT 84119 (801) 973-6840
Sales Contact: Lyle O. Keys, Pres.

UTILITY TOWER COMPANY

3200 N.W. 38th
P.O. Box 12369
Oklahoma City, OK 73157 (405) 946-5551
Sales Contact: R.G. Nelson, Mgr.

V

VIF INTERNATIONAL

P.O. Box 1555
Mtn. View, CA 94042 (408) 739-9740
Sales Contact: N.L. Mackechnle, Pres.

VIZ MANUFACTURING COMPANY

335 E. Price Street
Philadelphia, PA 19144 (215) 844-2626
Sales Contact: F.H. Tribolet, Dir. of Marketing

VACUUM TUBE INDUSTRIES, INC.

35 Pequit St.
Canton, MA 02021 (617) 828-1650
Sales Contact: Gene Tosti, Gen. Mgr.

VALENTINO PRODUCTION LIBRARY

151 W. 46th St.
New York, NY 10036 (212) 246-4675
Sales Contact: T. Valentino, Pres.

VALLEY PEOPLE INC.

P.O. Box 40306
2820 Erica Place
Nashville, TN 37204 (615) 383-4737
Sales Contact: Liz Clark, Sales Mktg. Coord.

VALTEC CORPORATION

99 Hartwell St.
West Boylston, MA 01583 (617) 835-6082
Sales Contact: Stephen Lang, Senior Mktg. Specialist

VAMCO ENGINEERING INC.

11104 E. 56th St.
Tulsa, OK 74145 (918) 252-5448
Sales Contact: E. Sudduth, V.P. / Mktg.

VANNER INC.

2136 Eakin Road
Columbus, OH 43223 (614) 272-6263
Sales Contact: Albert Ekegren, Pres.

VARIAN ASSOCIATES INC.

611 Hansen Way
Palo Alto, CA 94303 (415) 493-4000 x2011/2797
Sales Contact: Merlin J. Bowen, Prod. Mgr.

Regional Sales Offices:

VARIAN ASSOCIATES
83 Second Avenue
Burlington, MA 01803 (617) 272-8532
VARIAN ASSOCIATES
205 W. Touhy Avenue
Park Ridge, IL 60068 (312) 825-6686
VARIAN ASSOCIATES
314 South Missouri
Suite 209
Clearwater, FL 33516 (813) 446-8513
VARIAN ASSOCIATES
13531 N. Central Expressway
Suite 2343
Dallas, TX 75243 (214) 235-2385
VARIAN ASSOCIATES
4130 Lindon Avenue
Suite 255
Dayton, OH 45432 (513) 258-3930
VARIAN ASSOCIATES
500 Wynn Drive, N.W.
Suite 302
Huntsville, AL 35805 (205) 837-9225

VARIAN ASSOCIATES
2901 Wilshire Blvd.
Suite 205
Santa Monica, CA 90403 (213) 828-5588
VARIAN ASSOCIATES
(Metropolitan New York)
25 Commerce Drive
Cranford, NJ 07016 (201) 276-9050
VARIAN ASSOCIATES
(Philadelphia)
304 Harper Drive
Moorestown, NJ 08057 (609) 235-6800
TWX: 710-897-1871
VARIAN ASSOCIATES
7345 E. Earll Dr.
Suite 30
Scottsdale, AZ 85251 (602) 947-5461
VARIAN ASSOCIATES
375 Distel Circle
Suite C-4
Los Altos, CA 94022 (415) 968-7630
VARIAN ASSOCIATES
6489 Ridings Road
Syracuse, NY 13206 (315) 437-2568
VARIAN ASSOCIATES
United Finance Bldg.
Suite No. 4
1600 Watson Blvd.
Warner Robins, GA 31093 (912) 922-2202
VARIAN ASSOCIATES
(Washington D.C.)
4701 Lydell Road
Cheverly, MD 20781 (301) 773-7010
VARIAN, MCS DIVISION
3200 Patrick Henry Dr.
Santa Clara, CA 95050 (408) 496-6273
Sales Contact: M. Wytshyn, Mktg. Mgr.
A. Smith, Sales Mgr.
VARIABLE SPEECH CONTROL
29-50 Northern Blvd.
L.I.C., NY 11101 (212) 729-8400
Sales Contact: Paul Friedman, Sales Mgr.
VECTOR ELECTRONIC COMPANY
12460 Gladstone Ave.
Sylmar, CA 91342 (213) 365-9661
Sales Contact: F.L. Hill, VP Mktg.
VELEC SEFAT
278, chaussee F. Forest
59200 Tourcoing (20) 94 92 77
Sales Contact: Mr. D. Knockaert
VERSA-COUNT
553 Lively Blvd.
Elk Grove, IL 60007 (312) 593-0208
VIA VIDEO
10115 S. DeAnza Blvd.
Cupertino, CA 95014 (408) 996-2055
Sales Contact: Dennis Bowman,
National Mktg. Mgr.
VIDAIRE ELECTRONICS MFG. CORP.
150 Buffalo Ave.
P.O. Box 788
Freeport, NY 11520 (516) 623-6696
Sales Contact: Fred Schulz, Asst. Sales Mgr.
VIDECOM ENGINEERING INC.
P.O. Box 308, County Road 652
Mattawan, MI 49071 (616) 668-3375
Sales Contact: John Lepley, Chief Eng.
VIDEO AIDS OF COLORADO
1930 Central Avenue
Boulder, CO 80301 (303) 443-4950
Sales Contact: Mike Borsuk, Dir., Mktg.
VIDEO ASSOCIATES LABS
2304 Hancock Dr. #1-F

WHERE TO BUY IT

MANUFACTURERS, Pages 114-162
DEALERS/DISTRIBUTORS, Pages 168-189

Austin, TX 78756 (512) 459-5684
Sales Contact: Mike Dyer, Dir. of Ops.

VIDEO CASSETTE SERVICES
711 W. 17th Street, Suite J-6
Costa Mesa, CA 92627 (714) 548-3242
Sales Contact: J. Beazley, Pres.

VIDEO DATA SYSTEMS
Corporate - 205 Oser Ave.
Hauppauge, NY 11787 (516) 231-4400
Nat. Sales - 7001 S. 900 E.
Salt Lake City, UT 84047 (801) 566-3635
Sales Contact: Barry Kenyon, Sales Dir.

VIDEO DUB INC.
423 West 55th Street
New York, NY 10019 (212) 582-9550
Sales Contact: Donald Buck, Pres.

VIDEO I-D INC.
105 Muller Road
Washington, IL 61571 (309) 444-4323
Sales Contact: Sam B. Wagner, Pres.

VIDEO-INK
5184 North Lovers Lane
Milwaukee, WI 53225 (414) 462-7010
Sales Contact: John Kompas

VIDEO MASTERS
P.O. Box 1963
Kansas City, MO 64141 (816) 474-8530
Sales Contact: Virgil Jones, VP/Systems

VIDEO MASTERS
7471 Melrose Avenue, Suite 22
Los Angeles, CA (213) 655-1177
Sales Contact: Terry Rangno, Owner/Oper.

VIDEOMAGNETICS INC
155 San Lazaro (312) 830-2428
Sunnyvale, CA 94086 (408) 737-8300
Sales Contact: Sam DePino, V.P., Mktg.

VIDEOMEDIA/S.E.D. INC.
250 N. Wolfe Road
Sunnyvale, CA 94086 (408) 733-6500
Sales Contact: Hank Wilks, Gen. Sls. Mgr.

VIDEO OPTICS INC.
1916 Old Middlefield Way
Mtn. View, CA 94043 (415) 965-4298
Sales Contact: James Fadely, Pres.

VIDEO PRODUCTS / 3M
Bldg. 223-5E 3M Center
St. Paul, MN 55144 (612) 733-8132
Sales Contact: Bob Landingham, Nat. Sls. Mgr.

VIDEO SPECIALTIES
11535 Sorrento Valley Rd.
San Diego, CA 92121 (714) 450-1067
Sales Contact: John Russell, Pres.

VIDEOSYSTEMS INTERNATIONAL
1425 Dorchester Boul. O.
Montreal, Quebec
Canada (514) 879-1692
Sales Contact: Costa Babalis, Gen. Mgr.

VIDEOTAPE EXCHANGE INC.
855 Ave. of the Americas
New York, NY 10001 (212) 695-6644
Sales Contact: Joseph Lincci, V.P.

VIDEO TAPE SYSTEMS INC.
Box 70
Fountainville, PA 18923 (215) 345-0750
Sales Contact: DeWitt Smith, Pres.

VIDEOTEK INC.
125 North York St.
Pottstown, PA 19464 (215) 327-2292
Sales Contact: Peter H. Choi, VP Mktg.

Regional Sales Offices:
VIDEOTEK, INC.
9625 North 21st Drive
Phoenix, AZ 85021 (602) 997-7523
Sales Contact: Jim Mauger, Branch Mgr.

VIDEO WORKSHOP
468 Forest Ave.
Portland, ME 04101 (207) 774-7798
Sales Contact: Eric Jurgenson, Chief Eng.

VIDICRAFT INC.
0704 SW Bancroft St. TWX: 910-464-5156
Portland, OR 97201 (503) 223-4884
Sales Contact: Tim Johnson, Mktg. Mgr.

VIKRON INC.
520 Blanding Woods Road So.
St. Croix Falls, WI 54024 (715) 483-3233
Sales Contact: Jim Campeau, Sls. Eng.
Don Puls, General Manager

VIPRO PROGRAM SERVICES
645 N. Michigan Ave.
Chicago, IL 60611 (312) 664-7111
Sales Contact: Don Frehe, Dir.

THE VIRGINIA COMPANY
P.O. Box 2167
303 Depot St. N.W.,
Christiansburg, VA 24073 (703) 382-4135
Sales Contact: Ike Jeanes, Owner

VISCOUNT INDUSTRIES LTD.
105 East 69th Avenue
Vancouver, B.C. V5X 2W9
Canada (604) 327-9446
Sales Contact: A. Gerrebos, Gen. Mgr.

VISUAL INFORMATION INSTITUTE INC.
P.O. Box 33
Xenia, Ohio 45385-0033 (513) 376-4361
Sales Contact: John Harshbarger, Pres.

VISUAL METHODS INC.
35 Charles Street
Westwood, NJ 07675 (201) 666-3950
Sales Contact: T. Sandin, Pres.

VITAL INDUSTRIES INC.
3700 NE 53rd Avenue
Gainesville, FL 32601 (904) 378-1581
Sales Contact: Christopher Donoyan, Pres.

VITEK ELECTRONICS INC.
4 Gladys Court
Edison, NJ 08817 (201) 287-3200
Sales Contact: Robert Gelssler, President
Paul Ellman, Dir. of Mktg.

W

WALLACH & ASSOCIATES INC.
P.O. Box 18167
Cleveland, OH 44118 (216) 575-0765
Sales Contact: Chas. Wallach, Pres.

WALMORE ELECTRONICS
11 - 15 Betterton St.
Drury Lane, UK WC2H 9BS

ALBERT J. WALSH & ASSOCIATES
The Commons West
638 Newtown-Yardley Rd.
Newtown, PA 18940 (215) 968-0707

WARD-BECK SYSTEMS LTD.
841 Progress Avenue
Scarborough, Ontario M1H 2X4 (416) 438-6550
Sales Contact: Richard W. Chalk,
Canadian Sales Mgr.

Regional Sales Offices:
WARD-BECK SYSTEMS

Continued on page 162

WHERE TO BUY IT

4012 Mendenhall Drive
Dallas, TX 75234 (214) 247-5999
Sales Contact: Duke McLane, U.S. Sales Rep.
WARD-BECK SYSTEMS
755 Washington Street
Annisquam, MA 01930 (617) 283-7507
Sales Contact: Bill McFadden, U.S. Sales Rep.

WATERS MANUFACTURING INC.
Longfellow Center
Wayland, MA 01778 (617) 358-2777
Sales Contact: Skip Slason, Sis. Mgr.

WAVETEK INDIANA INC.
5808 Churchman
Beech Grove, IN 46107 (317) 787-3332
Sales Contact: John Duval, Sales Mgr.

1982 MVP*

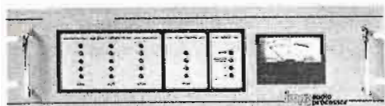

*MOST VALUABLE PROCESSOR

● PROCESSING PLUS
imp3
audio processor

High quality processing of your audio doesn't have to be expensive! Call or write today for price and complete specifications on the totally unique IMP-3!

processing **PLUS**

59 brookside road • p. o. box 3303
wescosville, pennsylvania 18106

**CALL TOLL-FREE
1-800-523-9396**

IN PA. CALL COLLECT: (215) 398-3377

WEARHOUSE INC.
10766 Tucker St.
Beltsville, MD 20705 (301) 937-4843
Sales Contact: Sam Waterworth, Sales Mgr.

WEATHER SERVICES INTERNAT'L. CORP.
131 The Great Rd.
P.O. Box B
Bedford, MA 01730 (617) 275-5300
Sales Contact: Michael S. Leavitt, VP

WEATHERMATION INC.
190 NO. State Street
Chicago, IL 60601 (312) 263-6921
Sales Contact: W. V. Smith, Pres.

WEATHERSCAN INTERNATIONAL
2445 N.W. 39th
Oklahoma City, OK 73112 (405) 521-9230
Sales Contact: R. Dale Leinew, Exec. VP

WESTERN UNION TELEGRAPH CO.
1 Lake St.
Upper Saddle River, NJ (201) 825-5306
Sales Contact: J.J. Albert, Ex. Plm.

WESTINGHOUSE ELECTRIC CORP.
Westinghouse Circle
Horseheads, NY 14845 (607) 796-3211
Sales Contact: R.R. Kaemmerer, Mktg. Mgr.

WESTREX
2629 W. Olive Ave.
Burbank, CA 91505 (213) 846-3394
Sales Contact: R.L. Bennett, Sales Mgr.

WHIRLWIND MUSIC DIST. INC.
P.O. Box 1075
Rochester, NY 14603 (716) 663-8820
Sales Contact: Bob Martin, Sales Mgr.

WHITE INSTRUMENTS INC.
P.O. Box 698
Austin, TX 78767 (512) 892-0752
Sales Contact: Emory Straus, Mktg. Mgr.

WIDE BAND ENGINEERING CO. INC.
P.O. Box 21652
Phoenix, AZ 85036 (602) 254-1570
Sales Contact: S. Ticknor, Sec./Pres.

WIDE RANGE ELECTRONICS CORP.
2119 Schuetz Road
St. Louis, MO 63141 (314) 567-5366
Sales Contact: Otto Rauhut, Pres.

WILCOX-LANGE INC.
3925 N. Pulaski Road
Chicago, IL 60641 (312) 588-8380
Sales Contact: K.P. Kallman, Gen. Mgr.

WILKINSON ELECTRONICS INC.
5970 W. 60th Ave.
Arvada, CO 80003 (303) 423-1652

WILL-BURT CO., TMD DIVISION
249 W. Henry St.
Wooster, OH 44691 (216) 262-7010
Sales Contact: Willis M. Patterson, Sales Mgr.

WINSTED CORPORATION
9801 James Circle
Minneapolis, MN 55431 (612) 888-1957
Sales Contact: G.R. Hoska, Sales Mgr.

WIREWORKS CORPORATION
380 Hillside Ave.
Hillside, NJ 07205 (201) 686-7400
Sales Contact: Angela DiCicco, Cust. Rel.

**WOELKE MAGNETBANDTECHNIK
GMBH & CO KG**
Woelke-Strasse 2-3
D-8069 Schwellenkirchen 08444/394
Sales Contact: Mr. C. Weber, Man. Dir.

ROBERT WOLD COMPANY
11661 San Vicente Blvd.
Los Angeles, CA 90049 (213) 820-2668
Sales Contact: Robert E. Wold, VP-Sales

WOLF COACH INC.
7 'B' Street - Auburn Ind. Park
Auburn, MA 01501 (617) 791-1950
Sales Contact: Richard Wolf, Gen. Mgr.

FRANK WOOLLEY & CO. INC.
529 Franklin St.
Reading, PA 19602 (215) 374-8335
Sales Contact: David L. Parke, VP

WORLD TOWER COMPANY INC.
P.O. Box 405
Mayfield, KY 42066 (502) 247-3649
Sales Contact: M.N. Sholar, Pres./Owner

WORLD VIDEO INC.
P.O. Box 117
Boyertown, PA 19512 (215) 367-6055
Sales Contact: John A. Taylor, III, VP Mktg.

XY & Z

XEDIT CORPORATION
133 So. Terrace Ave.
Mt. Vernon, NY 10550 (914) 668-0388
Sales Contact: Dan Brlstein, Sales Dir.

YAMAHA INTERNATIONAL CORP.
6600 Orangethorpe Ave.
Buena Park, CA 90620 (714) 522-9011

YARDNEY ELECTRIC CORP.
82 Mechanic St.
Pawcatuck, CT 02891 (203) 599-1100
Sales Contact: J. Houlihan, Mgr. Applications and Special Products

THE ZEI-MARK CORP.
P.O. Box 182
Brookfield Center, CT 06805 (203) 355-0008
Sales Contact: Richard Zettler, Pres.

ZERCOM CORPORATION
P.O. Box 84
Zercom Drive
Merrifield, MN 56465 (218) 765-3151
Sales Contact: Jeff Zernov, Pres.

WHERE TO FIND IT GENERAL INDEX, Pages 38-45

WHO MAKES IT PRODUCT DIRECTORY, Pages 46-113

WHERE TO BUY IT MANUFACTURERS, Pages 114-162; DEALERS/DISTRIBUTORS, Pages 168-189

SUPPLIER SHOWCASE®

A special advertising section featuring North America's top dealers, distributors, independent representatives, and importers/exporters. When it's time to buy... call these companies **FIRST!**

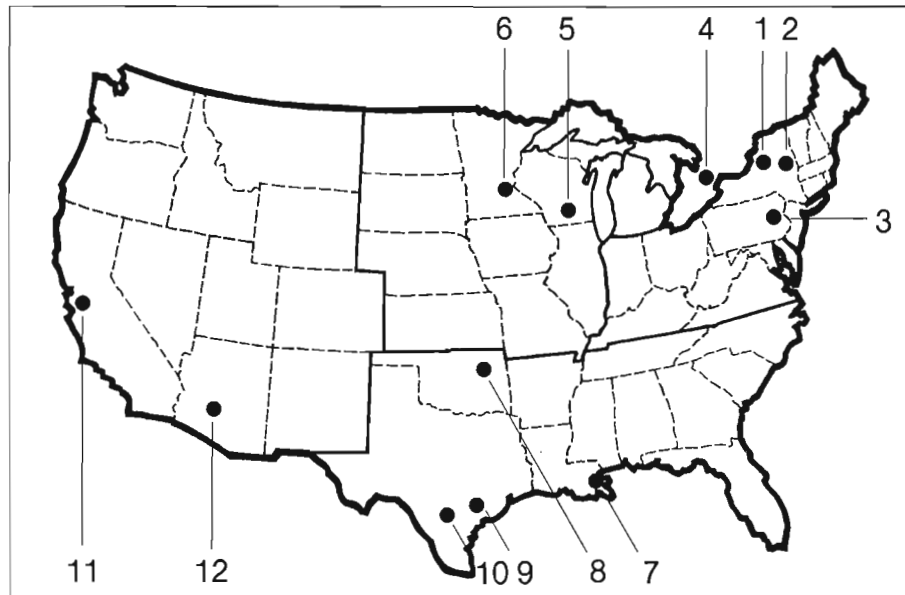

EAST

1. Micron Ltd.
(914) 761-6520
Valhalla, NY
SEE AD ON PAGE 163

2. Northeast Broadcast Labs Inc.
(518) 793-2181
South Glen Falls, NY
SEE AD ON PAGE 164

3. Processing Plus Inc.
(215) 398-3377
Wescosville, PA
SEE AD ON PAGE 164

NORTH/MIDWEST

4. Comad Communications, Limited
(416) 245-1734
Rexdale, Ontario Canada
SEE ADS ON PAGES 164, 166

5. Full Compass Systems
(608) 271-1100
Madison, Wisconsin
SEE AD ON PAGE 166

6. Todd Communications
(612) 941-0556
Minneapolis, MN
SEE AD ON PAGE 165

SOUTH

7. Audiomedia Associates
(504) 586-0140
New Orleans, LA
SEE AD ON PAGE 167

8. Delcom
(918) 494-9500
Tulsa, OK
SEE AD ON PAGE 165

9. Giesler Broadcasting Supply Inc.
(713) 774-3314
Houston, TX
SEE AD ON PAGE 166

10. Linrose Electronics
(512) 342-8849
San Antonio, TX
SEE AD ON PAGE 167

WEST

11. Marcom
(408) 438-4273
Scotts Valley, CA
SEE AD ON PAGE 167

12. Spencer Broadcast
(602) 242-2211
Phoenix, AZ
SEE AD ON PAGE 168



micron ltd.

For those who hear the difference

The MICRON Wireless Microphone System was designed to meet the needs of broadcasters, film makers and related professionals. We offer a variety of systems that give you the freedom and confidence never before available with a wireless microphone.

There's a MICRON system to fit your specific needs because you deserve the best.

MICRON AUDIO PRODUCTS

210 Westlake Drive • Valhalla, NY 10595 • (914) 761-6520

Circle (102) on Action Card



The Comad CJF-1 Prewired Audio Jackfield.

If you've counted the jacks in the photo, you've discovered the total price of the CJF-1. Not bad for a 24-position prewired jackfield. Shielded, twisted-pair wire connects the 24 ADC tip-ring-sleeve jacks to a swivel-mounted terminal block with room for 120 connectors. The standard single unit rack mounting strip is hinged on the left side for easy access to the wiring. Four different lengths of cable harness are available, so that up to four separate terminal blocks can be neatly mounted into a pair of optional mounting bars. If 24 jacks isn't enough for you, the 48-jack CJF-2 jackfield with a normalized wiring configuration is also available. Its price is \$495. (We'll let you figure out the cost per jack.)



Comad, Inc.
P.O. Box 10667
Pensacola, FL 32504
904/434-9782

Circle (103) on Action Card

processing⁺PLUS

audio processing and broadcast electronics
59 brookside road • box 3303
wescosville, pennsylvania 18106

BROADCAST EQUIPMENT DIV.

A COMPLETE LINE OF BROADCAST AUDIO AND RF EQUIPMENT

Product lines include: Aphex Aural Exciter, Scotch/3M, Nortronic, Stanton, BE, Fidelipac, Rusco, Unarco-Rohn, Phelps-Dodge and the IMP-3 Audio Processor

AUDIO ENGINEERING DIV.

AUDIO SPECIALISTS CONCERNED WITH ON-AIR QUALITY! WE OFFER:

- * AM/FM system planning
- * AM stereo consultation
- * Audio quality upgrading
- * Complete and comprehensive engineering consultation

CALL TOLL-FREE 1-800-523-9396

IN PA. CALL COLLECT: (215) 398-3377

Circle (106) on Action Card

GO WITH THE PROS...

CHECKLIST:

- | | |
|-------------------------|------------------|
| ✓ Bald Mountain Lab | ✓ Moseley |
| ✓ Broadcast Electronics | ✓ Marti |
| ✓ Cablewave Systems | ✓ Micro-Trak |
| ✓ Delta Electronics | ✓ Orban |
| ✓ Dielectric Products | ✓ Otari |
| ✓ ESE Timers & Clocks | ✓ Phelps-Dodge |
| ✓ Electro-Voice | ✓ Potomac Instr. |
| ✓ Fidelipac | ✓ QRK |
| ✓ Gorman-Redlich | ✓ QEI |
| ✓ Inovonics | ✓ Revox |
| ✓ LPB | ✓ Sennheiser |
| ✓ Marathon | ✓ Shure |
| | ✓ UREI |

Broadcast Equipment Distributor

for a complete line card, call or write for catalog and information



Circle (105) on Action Card

SHANE MEDIA SERVICES

7703 Windswept
Houston, TX 77063
713-461-9958

- Market Positioning Analysis*
- Programming and Music Consultation*
- Seminars for Management Professionals*

Circle (26) on Action Card

BROADCAST COMMUNICATIONS/JUNE 1982

WHO DESIGNED, ENGINEERED AND CONSTRUCTED THE FIRST LPTV STATION IN AMERICA?

TODD COMMUNICATIONS

CALL 612/941-0556
6545 CECILIA CIRCLE
MINNEAPOLIS, MN 55435

25 YEARS OF BROADCAST SYSTEM DESIGN
AND CONSTRUCTION
IN THE UPPER MIDWEST

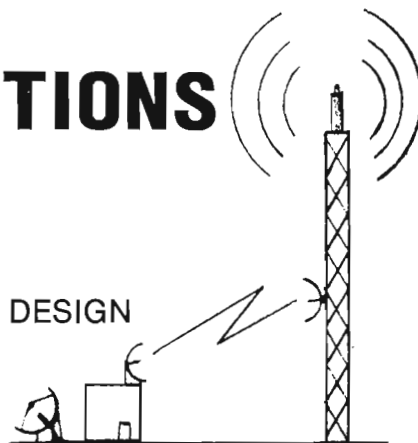

Circle (108) on Action Card

PUZZLED?

WITH THE PIECES IN A SYSTEM?

We're the most complete systems
Company you've ever seen.

- Video Equipment
- System Design
- Turnkey Installations
- Remote Trucks

WE MAKE THE PIECES TOO!

- AE-3 Automated
A/B Rolls
- VO-5850D —
A VTR with extras.

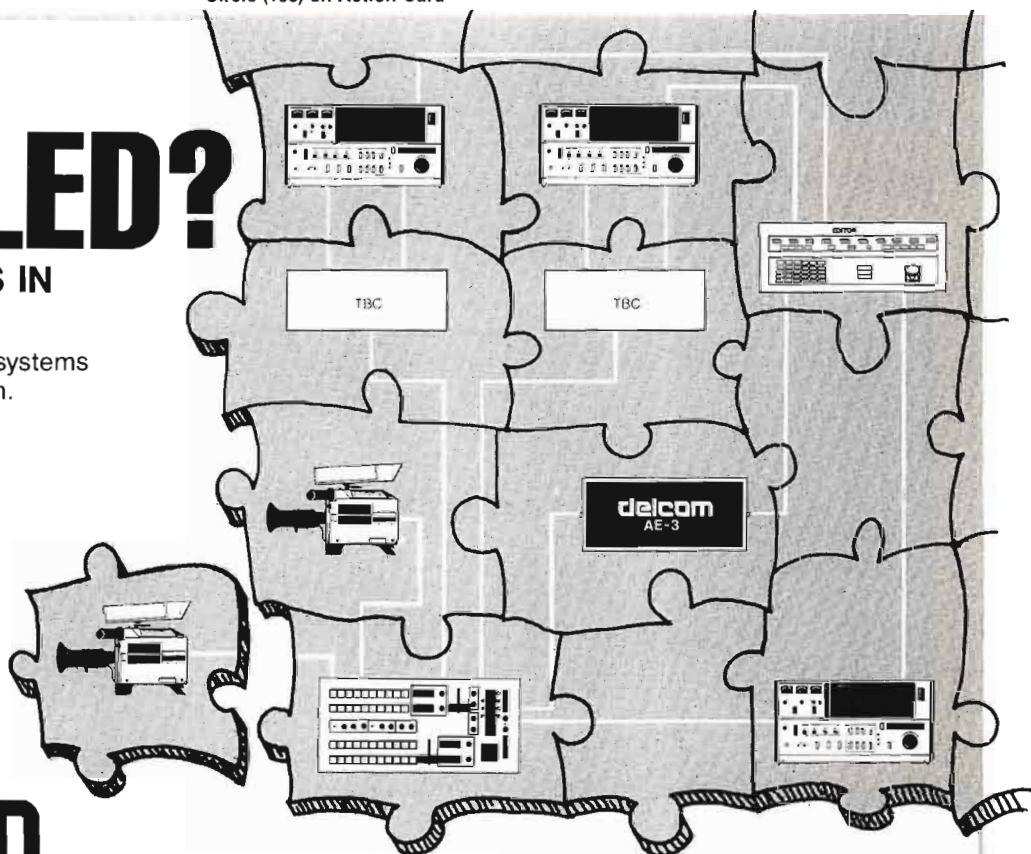

delcom

The leading edge in television

Tulsa 918-494-9500

800-331-5461

St. Louis 314-432-1164

Oklahoma City 405-942-1339

Circle (110) on Action Card

**G
B
S****GIESLER
BROADCASTING
SUPPLY INC.**

713-774-3314

**FOR: PROFESSIONAL SERVICE
PROFESSIONAL ADVICE
PROFESSIONAL PRODUCTS**

AMPEX	INOVONICS
AMPRO/SCULLY	JBL
ANIXTER-MARK	LOGITEK
AUDIOLAB	MARTI
AUDIO-TECHNICA	MCI
AUDITRONICS	MICRO-TRAK
AUTOGRAM	MOSELEY
BELAR	NORTRONICS
BIRD	ORBAN
BROADCAST ELECTRONICS	OTARI
CABLEWAVE	PHELPS DODGE
CAPITAL (AUDIOPAK)	POTOMAC

OVER 20 YEARS EXPERIENCE

CRL	REVOX
CSP	RUSLANG
DB PRODUCTS	RUSSCO
dbx	SCALA
DELTA	SENNHEISER
DIELECTRIC PRODUCTS	STL
ELECTROVOICE	SHURE
ELECTRO IMPULSE	STANTON
ESE	TECHNICS
FIDELIPAC	TEXAS ELECTRONICS
GORMAN-REDLICH	UMC
HALLIKAINEN	UREI

713-774-3314

5914 MAPLE HOUSTON, TEXAS 77074

Circle (109) on Action Card

166

CALL US LAST**HELLO,
FULL COMPASS?
HELP!!!****When you need advice and
the best price on Audio Gear
— The only number you need
to know is 800-356-5844.**

Circle (107) on Action Card

eight cable lengths**eight equalizing amps**

Everytime you've needed a specific amount of equalization, you've needed a separate distribution amplifier.

No more.

A single Comad DVE-1 Equalizing Amplifier has **eight individually adjustable outputs**, each capable of independently equalizing any video signal up to 1000 feet of cable.

And at \$600, it costs substantially less than eight amps — and only takes up one space in your equipment rack.

Save space. Save money. And do the job. You can't do much better than that.

**Comad, Inc.**
P.O. Box 10667
Pensacola, FL 32504
904 434-9782

Circle (104) on Action Card

BROADCAST COMMUNICATIONS/JUNE 1982

69 LINES

**of the most respected
equipment
in the broadcast
industry.**

Serving Texas, the Gulf Coast
and Mexico with radio and
television broadcasting
equipment.

For the best products, prices
and service call —

**Toby Tobias or
Richard Reyes**
(512) 342-8849

Linrose Electronics Corp.
202 W. Nakoma
San Antonio, TX 78216

Circle (111) on Action Card

audiomedia associates

*The Gulf South's
Premier Broadcast Supply House.*

- **AM-FM Broadcast Transmitters**
- **QEI Automatic Transmission Systems**
- **Turnkey Installation Specialists**

Educational and Package Discounts Available
College & Public Radio Bids Invited

Corey Meyer
(504) 586-0140
P. O. Box 29264
New Orleans, LA 70189

OTARI

LPB

orban

CCA



Circle (112) on Action Card

WHAT A PAIR!

PROCESSOR

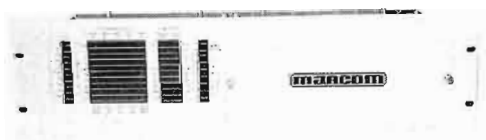

Model 82

- Format Addressable Processing™
- Pulse Duration Modulator (PDM)
Gain Control
- "Feed Forward" Controlled
Compressors
- "Paralimiter"™2 Designed Limiters
- Final Limiter With "Floating Release
Threshold"
- Simple Design

STEREO GENERATOR



Model SC-203

- Channel Separation 70dB Typical
- 95dB Signal to Noise Ratio
- Test Tone Generator
- Optional SCA Generator
- Optional Digital Overshoot Corrector

MARCOM

P.O. Box 66507 • Scotts Valley, CA 95066
(408) 438-4273

Circle (113) on Action Card

**DEALERS/DISTRIBUTORS
INDEPENDENT REPRESENTATIVES
IMPORTERS/EXPORTERS**

ALABAMA

LEE ASSOCIATES MID - SOUTH

LINE: Sound and vibration test equipment.

817 Wheeler Ave.
Huntsville, AL 35801
(205) 533-5896

Contact: S. J. Shelley

SIGNAL ENG. & SALES, INC.

LINE: Video equipment, audio and RF.

716-S. 23rd St.
P.O. Box 10167
Birmingham, AL 35202
(205) 328-6431

Contact: Louis H. Pfan, Pres.

ALASKA

**ALASKA ELECTRONICS
SUPPLY, INC.**

LINE: Electronic components, supplies, test instruments serving the industrial, communications and MRO markets.

5401 Fairbanks Street
Suites 1 & 2
Anchorage, AK 99502
(907) 272-9416

Contact: Harry J. Lang, President

HARRY J. LANG & ASSOCIATES

LINE: McMartin, Fluke, Ampex, Pulsecom.

1371 Hillcrest Drive #303
Anchorage, Alaska 99503
(907) 279-5741

Contact: Harry J. Lang, Owner

NVS SYSTEMS, INC.

LINE: Acrodyne, Barco, Conrac, Hitachi, Sony, Telex, Tektronix.

8300 King Street
Anchorage, Alaska 99502
(907) 349-3523

Contact: Jack O. Smith, President

ARIZONA

**CHAMBERS ELECTRONIC
COMMUNICATIONS**

LINE: Professional sound and com-

munications products: Altec, JBL, Yamaha, Phillips, etc.

313 South 36th St.
Phoenix, Arizona 85013
(602) 275-5496

Contact: Dave Holland, Sls. Engr.

IMC

LINE: Wind power systems.

2515 E. Thomas, Suite 17
Phoenix, AZ 85016
(602) 957-8624

Contact: Karen Berry, V.P.

JENSEN TOOLS, INC.

LINE: Tools & tool kits, test equipment.

1230 S. Priest Dr.
Tempe, Arizona 85281
(602) 968-6241

Contact: Tom Fenzel, Sls. Mgr.

**PROFESSIONAL AUDIO
DISTRIBUTORS**

LINE: Broadcast audio.

P.O. Box 2468
Phoenix, Arizona 85003
(602) 931-4956

Contact: L. Bollinger, Sls. Mgr.

ROH'S, INC.

LINE: Sony, Panasonic, JVC, Conrac, Microtime, HME, Setchell-Carlson, CVI, ProTech, ITE, Shure, Electro-Voice, Dukane.

4553 E. Broadway
Tucson, Arizona 85711
(602) 795-8573

Contact: William D. Roh,
President

SPENCER BROADCAST, INC.

LINE: Ampex, audio tape, videotape; Annixter Mark, M/W antennas; Audiopak, broadcast cartridges, tape; Audio-Path Engineering, audio equipment; Broadcast Electronics, audio/RF equipment; Cablewave, coax, & accessories; EFI, power line filters; Fidellipac, broadcast cartridges, accessories; Magnetic Reference Laboratory, audio alignment tapes; Orban Broadcast, AM/FM Opt/Mod; Scala, M/W antennas; Stanton, audio cartridges, styli, preamps; STL, alignment tapes; Technics Professional, turntables, recorders; Xedit, audio/video splicing blocks, accessories; complete systems design & construction capabilities & consulting services.

2338 W. Royal Palm
Phoenix, AZ 85021
(602) 242-2211

Contact: Janene Spencer,
Sales Director
SEE AD ON PAGE 168

VIDEO ASSIST

LINE: Video rentals.
P.O. Box 34433
Phoenix, AZ 85067
(602) 234-0909

Technics

E.F.I.

**BROADCAST
ELECTRONICS**



R.F.



AUDIO/VIDEO

STANTON
THE CHOICE OF THE PROFESSIONALS™

**AUDIO-PATH
Engineering, Inc.**

SENNHEISER

SPENCER BROADCAST

**Sales and Full Engineering Services
Offering AMPEX Thru XEDIT**

60 major lines for the Broadcaster, and growing

For further information, contact Chuck Spencer.

SPENCER BROADCAST
2338 W. Royal Palm, Phoenix, AZ 85021
(602) 242-2211

We Service What We Sell

"Competitive Pricing"

Contact: Richard Andresano,
General Manager

ARKANSAS

STANLEY COMMUNICATIONS COMPANY

LINE: Video and audio equipment and accessories.

3600 West 69th
Little Rock, Arkansas 72209
(501) 562-9200

Contact: K. White, VP/Gen. Mgr.

CALIFORNIA

AUDIO KINETICS, INC.

LINE: Audio Kinetics time code synchronizers and custom operating programs.

5721 Laurel Canyon Bl.
North Hollywood, CA 91607
(213) 980-5717
(800) 423-3666

Contact: Charles Flynn, Mktg. Dir.

AUTOGRAPHICS, INC.

LINE: Character generators & video equipment.

6335 Homewood Ave.
Hollywood, California 90028
(213) 464-2244

Contact: L. C. Rheinstein, Pres.

AUTOMATED BUSINESS CONCEPTS

Div. of Cetec Corp.

LINE: Business and accounting systems.

1110 Mark Ave.
Carpinteria CA 93013
(805) 684-7686
Contact: Frank Crane, Mktg. Mgr.

BARRETT ASSOCIATES, INC.

LINE: Full line of new and reconditioned (guaranteed) audio & RF equipment. Accepts trade-in equipment. CSI, JBL, 3M, Bird, LPB, Belar, Marti, Leader, Beyer, Electro-Voice, etc.

800 Grand Avenue
W. Bldg. Ste. C-1
Carlsbad, CA 92008
(714) 729-4957
(714) 729-4958

Contact: W. Barrett Mayer, Pres.

BIRNS & SAWYER, INC.

LINE: Lights, tripods and fluid heads, film & video camera accessories, sound equipment, lens filters.

1026 N. Highland Avenue
Hollywood, CA 90038
(213) 466-8211

Contact: Bill Sutphin, Sales VP

BROADCAST AUDIO CORP.

LINE: JBL loudspeakers.

11306 Sunco Drive
Rancho Cordova, CA 95670
(916) 635-1048

Contact: Dale A. Tucker,
Marketing Manager

BROADCAST CARTRIDGE SERVICE, INC.

LINE: Aristocart, Capitol/Audlopak, Fidelipac, 3M, Simpac.

15131 Triton Lane

Suite 108
Huntington Beach, CA 92649
(714) 898-7224
Contact: Bryant Ellis, President

BROADCAST COMMUNICATIONS DEVICES INC.

LINE: Panasonic, Hitachi, Ikegami, Conrac, Tektronix, JVC.

2990 E. La Jolla Street
Anaheim, CA 92806
(714) 630-8150

Contact: Randy Lucio, Oper. Mgr.

BROADCAST MARKETING ASSOCIATES

LINE: Computer graphic systems, digital standards converter, routing switchers, machine control systems, VTRs, cameras, monitors, text equipment.

2211 C Fortune Dr.
San Jose, CA 95131
(408) 946-2236

Contact: Richard Reilly, Pres.

RICHARD W. BURDEN ASSOCIATES

LINE: LPB, Dorrough Electronics, Catal.

20944 Sherman Way, -213
Canoga Park, CA 91303
(213) 340-4590

Contact: Richard W. Burden,
President

CALICO VIDEO CO., INC.

LINE: Videotape sales (all formats), TCR-100 video carts (new), REMFG'D

reloaded, 1" & 2", U-matic sales & service.

8955 Thornton Road
Stockton, CA 95209
(209) 952-3333

Contact: Hugh Sangster, President

CARA PACIFIC SALES

LINE: Microphones - Brand - MILAB (Sweden).

P.O. Box 9339
Marina Del Rey, CA 90291
(213) 821-7898

Contact: Bill Cara, Owner

THE C n B STUDIOS

LINE: Music libraries for automated radio stations.

3415 Beresford Ave.
Belmont, California
(415) 592-6149

Contact: A. Thompson,
Owner / Mgr.

COAST RECORDING EQUIPMENT SUPPLY, INC.

LINE: Ampex, BGW, Crown, AKG, Shure, Electro-Voice, Neumann.

6114 Santa Monica Blvd.
Hollywood, CA 90038
(213) 462-6058

Contact: Jerry Cabbage, Pres.

CHESTER COLEMAN GREAT AMERICAN BROADCAST CO.

P.O. Box 5053
2284 S. Victoria Ave.
Ste. 2-B

Continued on page 170



Video Delay Lines

ALLEN AVIONICS Video & Pulse Delay Lines replace 75 ohm coaxial cable, provide a more suitable method of achieving precise short delays. The units reduce size, weight, installation costs, save time & effort in making delay changes.

Part No.	Delay Range (Nano-Sec.)	Delay Steps (Nano-Sec.)	Method of Variation	Maximum Insertion Loss (at 100 KHz (db)	Amplitude Flatness At Any Delay Setting 100 KHz to 5.5 MHz (db)	Max. Rise Time (Nano-Sec.)	Package Size (Inches)
VAR005	3-7	Continuous	Trimmer	.20	.2 Max.	N.A.	3 5/8 x 1 1/2 x 1 1/4
VAR011	0-11	Continuous	Trimmer & Toggle	.20	.25	N.A.	4 3/8 x 2 3/8 x 1 1/16
VP0010	0-10.5	.5	Toggle	.15	.2	3	4 3/8 x 2 3/8 x 1 1/16
VP0127	0-127	1.0	Toggle	.15	.3	14	4 3/8 x 2 3/8 x 1 1/16
VP0255	0-255	1.0	Toggle	.15	.3	16	4 3/8 x 2 3/8 x 1 1/16
VP0317	0-317.5	2.5	Toggle	.15	.3	20	4 3/8 x 2 3/8 x 1 1/16
VP0635	0-635	5.0	Toggle	*.50	.4	25	4 1/16 x 3 1/16 x 2 1/16
VP1100	0-1100	10.0	Rotary	1.25	.4	30	4 1/16 x 3 1/16 x 2 1/16
VP1270	0-1270	10.0	Toggle	*3.00	.4	30	4 1/16 x 3 1/16 x 2 1/16
VP2075	0-2075	25.0	Toggle	*3.00	.5	40	7 3/8 x 4 1/16 x 2 3/16
VS0315	0-315	5.0	Strap	.25	.4	28	4 x 2 x 1 1/4
VS0635	0-635	5.0	Strap	.60	.5	33	5 x 2 x 1 1/4
VS1275	0-1275	5.0	Strap	1.25	.5	33	5 x 3 x 1 1/4
VS2075	0-2075	25.0	Strap	2.50	.5	40	6 1/2 x 3 1/2 x 2

RACK MOUNTABLE UNITS

VRM0255	0-255	1.0	Slide Switch	.40	.4 Max.	20	1 1/8 x 4 1/8 x 4
VRM0637	0-637.5	2.5	Slide Switch	*1.00	.4	28	1 1/8 x 4 1/8 x 6
VRM1275	0-1275	5.0	Slide Switch	*3.00	.4	33	1 1/8 x 4 1/8 x 9
VRM2270	0-2270	10.0	Slide Switch	*3.00	.5	40	1 1/8 x 4 1/8 x 9
VRS0317	0-317.5	2.5	Strap	.40	.5	26	1 1/8 x 4 1/8 x 4
VRS0635	0-635	5.0	Strap	.75	.5	35	1 1/8 x 4 1/8 x 6
VRS1270	0-1270	10.0	Strap	1.50	.5	37	1 1/8 x 4 1/8 x 9
VRS2260	0-2260	20.0	Strap	3.00	.5	40	1 1/8 x 4 1/8 x 9

*±.2db variation at any delay setting.

NEW!

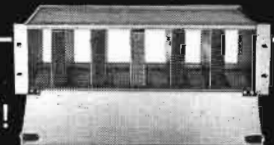

RACK MOUNTABLE VIDEO & PULSE DELAY LINES

A complete Rack Mountable series of Video & Pulse Delay Lines, with the capability of replacing up to 1450 feet of cable, is now being marketed by Allen Avionics. (See listing in table at left.)

Impedance: 75 ohms.

Pulse Distortion: Less than 4% with an input pulse rise time of 20 nanoseconds.

Working Voltage: 50 volts maximum. 100 volts maximum for Rack Mountable series.

Return Loss: 20db minimum. 15db minimum for VP2075, VS2075 and Rack Mountable series.

Delay Tolerance: 5% or 1 nanosecond, whichever is greater.

CALL/WRITE

For Video Delay Lines & Filters Catalog

ALLEN AVIONICS, INC.

224 EAST SECOND ST., MINEOLA, NY 11501
Phone: 516-248-8080

**NEED ANY OF THIS EQUIPMENT?
NOW???**

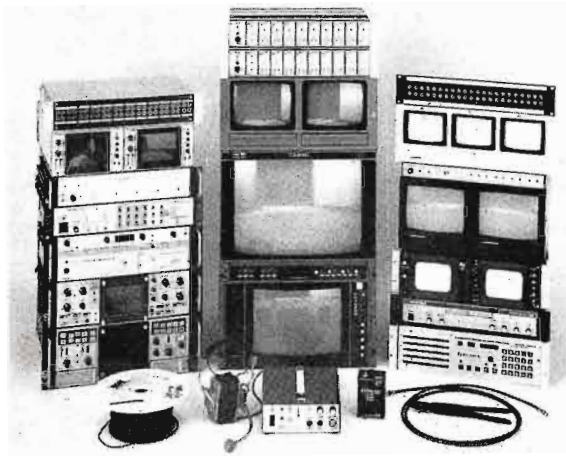

CALL BSI!

WE HAVE THESE ITEMS, AND MORE. **IN STOCK** ... READY FOR IMMEDIATE SHIPMENT.
CALL US TODAY ON OUR WATS LINE AND WE WILL SHIP TOMORROW

NATIONAL WATS: 800/531-5232

TEXAS WATS: 800/252-9792

BROADCAST SYSTEMS INC.

8222 JAMESTOWN, AUSTIN, TEXAS 78758

Circle (115) on Action Card

BAL'S ROAD CASE

\$75.00*
(in stock)



• Rugged A.T.A. design • Steel latches & hinge • Attractive grey color • Carry-on or ship by air/surface

Size: 19 x 14 x 6 inside; refer to P/N M82-0011
All shipments UPS prepaid. Allow 3 weeks for delivery.
Other larger sizes available. *Mail check or inquiry to:*

william BAL corporation
SINCE 1898

947 Newark Avenue, P.O. Box 875 BC
Elizabeth, New Jersey 07207
(201) 354-9625; Telex 844280

Circle (116) on Action Card

Ventura, CA 93003
(805) 656-FM96
Contact: Chester Coleman, GM

CINEMILLS CORP.

LINE: Strand Century, Inepo HMI lights, Veam connectors, Lee camera filters, Lee filters, Dayma HMI bulbs, hand held & line frequency meters.

3500 W. Magnolia Ave.
Burbank, CA 91505
(213) 843-4560

COMMUNICATIONS COMPANY, INC.

LINE: Altec, JBL, McMartin, Shure, EV, Vega, Yamaha.

3940 Noell Street
San Diego, CA 92110
(714) 297-3261

Contact: Victor M. Hall, President

COMMUNICATIONS CONTROL CENTERS, INC.

LINE: Thomson-CSF TV Transmitters, JAI closed circuit TV.

1568 N. Sierra Vista Ave.
Fresno, CA 93703
(209) 251-4213

Contact: Robt. D. Sidwell, VP-Sales

3D VIDEO CORPORATION

LINE: 3D TV Processors

4605 Lankershim Blvd.
N. Hollywood, CA 91602
(213) 769-6752

Contact: J. Butterfield, Gen. Mgr.

DAVIS ELECTRONICS

LINE: Remote control & monitoring system. STL, antennas, custom audio equipment.

P.O. Box 128
Sierra Madre, CA 91024
(213) 355-6909

Contact: John J. Davis, Pres.

LEO DINER FILMS, INC.

350 Golden Gate Ave.
San Francisco, CA 94102
(415) 775-3664

Contact: Roy E. Diner, VP-Gen. Mgr.

THE DURAFILM COMPANY

LINE: Film preservation, maintenance, restoration, services, machinery & chemicals.

137 N. LaBrea Ave.
Hollywood, CA 90036
(213) 936-1156

Contact: Madelon Caten, Pres.

EDDIE EGAN & ASSOC.

LINE: Studio vinyl tile for video stages.

156 S. Robertson Blvd.
Los Angeles, CA 90048
(213) 272-9282

Contact: Eddie Edgan, President

ELECTOR

LINE: Exclusive North American distributors for Barco Communications products, Barco Electronic products, and the Hi-Beam Projector.

5128 Calle Del Sol
Santa Clara, CA 95050
(408) 727-1506

Contact: Guido Govaert, Sls. Mgr.
SEE AD ON PAGE 2

GENERAL ELECTRONIC SYSTEMS, INC.

LINE: Sony, Conrac, Convergence, JVC, Panasonic, Altec, Dynair, 3M Minicom, Tektronix.

1440 San Pablo Ave.
Berkeley, CA 94702
(415) 527-7700

*Contact: R. Lindhelm, President
J. Harris, Mgr., Video Sls.*

ALAN GORDON ENT., INC.

LINE: Bell & Howell film cameras & minicams - MK-IV, director's view finder, NCEII Animation Motors - NAC animation Video System, Neilson-Hordell animation stands.

1430 Cahuenga Blvd.
Hollywood, CA 90028
(213) 466-3561

Contact: Ted Lane, Sls. Mgr.

THE GRAPHIC EXPRESS

LINE: News sets, animation, and graphics for news.

7969 Engineer Rd.
Suite 201
San Diego, California 92111
(714) 565-2146

Contact: D. Hoogenakker, Nat'l. Product Director

GREAT AMERICAN BROADCAST CO.

LINE: Broadcast automation custom systems, application consultants.

P.O. Box 5053
2284 S. Victoria Ave.,
Ste. 2 - B
Ventura, CA 93003
(805) 656-3696

Contact: Chester Coleman

HARRY'S VIDEO MART

LINE: Magnavox, Quasar, Panasonic, Pan Industrial, Sharp, Showtime Video Ventures, RCA, Hitachi.

647 W. Foothill Blvd.
Upland, CA 91786
(714) 981-8971
(213) 332-3235

Contact: Leigh Adams, Mgr.

IMAGE ELECTRONICS

LINE: Control Video, Quanta, Utah Scientific, JVC, Animation Video.

5801 Uplander Way
Culver City, CA 90230
(213) 641-7733

Contact: John Leveck, President

INNOVATIVE TELEVISION EQUIPMENT

P.O. Box 681
Woodland Hills, CA 91365
(213) 888-9421

Contact: B.I. Rosenberg, Pres.

INTERFACE DATA SYSTEMS

LINE: Digital Equipment Corporation's complete line of computer products, Plessey, Control Data, Emulex, MDB.

2990 E. LaJolla Street
Anaheim, CA 92806
(714) 630-8155

Contact: Tim Clark, Sls. Mgr.

INTERNATIONAL EQUIPMENT REPRESENTATIVES

LINE: Electronic broadcast equipment.

6920 Miramar Road, Ste. 307
San Diego, CA 92121
(714) 695-1850

Contact: Alejandro Rodriguez, Sales Manager

KAITRONICS CORP.

1540 Gilbreth Road
Burlingame, CA 94010
(415) 697-9102

Contact: Paul Tarradaychik, VP

R.H. KEARNS INC.

LINE: Broadcast cartridge digital tape timer.

4411 Red Maple Court
Concord, CA 94521
(415) 680-1349

Contact: *Bob Kearns, President*

KITCHEN PRODUCTIONS, INC.

LINE: Television Technology, Scala, Acrodyne, Wilkinson, Tepco, Blonder Tongue, Lindsay, Rohn, Triple Crown, Andrew, Anlxtar Mark, Prodelin.

619 W. Ridgecrest Blvd.
Suite D
Ridgecrest, CA 93555
(714) 375-2753
(714) 375-5690

Contact: *Shauna Wooley, Consultant*

LEASAMETRIC

LINE: Rental/lease, telecommunications test equipment.

1164 Triton Drive
Foster City, CA 94404
(415) 574-4441

Contact: *Susan Simmons, Corporate Communications Manager*

L. P. MARKETING

LINE: Otari, dbx, Orban, AKG, Infinity, SAE, Monster Cable.

2036 Livingston St.
Oakland, CA 94606
(415) 532-5600

Contact: *Larry Petersen, Pres.*

LEMO U.S.A. INC.

LINE: High-performance cylindrical coaxial, triaxial, multicontact and environmentally sealed connectors.

335 Tesconi Circle
P.O. Box 6626
Santa Rosa, CA 95406
(707) 523-0600

Contact: *Steve Haussler, Service Manager*

DAVID LINT ASSOC., INC.

Broadcast equipment. Equipment for recording studios and tape duplication facilities.

3350 Scott Blvd.
Bldg. 5
Santa Clara, CA
(408) 727-0964

Contact: *David Lint, President*
Igor Koxlov, Director

LIVE SOUND, INC.

1741 N. Ivar
Suite 101
Hollywood, CA 90028
(213) 462-3351

Contact: *Ken Rayzor, Sales*

MARCOM

LINE: Importers of C.N. Rood B.V., JNS Electronics, Clyde Electronics. Complete audio/video/teleconferencing and broadcast facilities, including engineering, installation and financing.

4865 Scotts Valley Dr.
P.O. Box 66507
Scotts Valley, CA 95066
(408) 438-4273

Contact: *Marty Jackson, Pres.*

SEE AD ON PAGE 167

MARSHALL ELECTRONICS

LINE: Mogami superflexible audio & video cable. Also connectors & cable assemblies for recording & broadcast.

P.O. Box 2027
Culver City, California 90230

(213) 836-4288

Contact: *L. Marshall, VP Mktg.*

MARTEL ELECTRONICS

LINE: Uher tape recorders and microphones.

970-A E. Orangethorpe Ave.
Anaheim, CA 92801
(714) 871-7102

Contact: *Ron Smith, Manager*

KENNETH R. MEADES

LINE: A/V consulting services, recording, designing & engineering, audio-video systems.

P.O. Box 3831
Beverly Hills, CA 90212
(213) 464-8166

Contact: *Kenneth R. Meades, Owner, Mgr.*

MEL AUDIO VIDEO, INC.

LINE: Tape recorders, tape, microphones, sound processing.

1122 E. Chevy Chase Dr.
Glendale, California 91205
(213) 245-7708

Contact: *Bryant Ellis, Manager*

C. H. MICHEL

LINE: Broadcast and industrial television, audio, and optical equipment and supplies.

13400 Mullholland Dr.
Beverly Hills, CA 90210
(213) 274-4903

Contact: *Charles H. Michel, Owner*

MILLER PROFESSIONAL EQUIPMENT, INC.

LINE: Universal fluid heads & tripods.

10816 Burbank Blvd.
North Hollywood, CA 91601
(213) 766-9451

Contact: *Eva. L. Pincetich, V.P.*

NTI AMERICA, INC.

1680 N. Vine St.
Los Angeles, CA 90028
(213) 462-8945

Contact: *George Nakaki, Sls. Mgr.*

OLESEN

LINE: Lighting and production supplies for stage, television and cinema.

1535 Ivar Ave.
Hollywood, CA 90028
(213) 461-4631

ALLEN OSBORNE ASSOCIATES

LINE: Telescoping pneumatic masts.

5195 N. Douglas Fir Road
Calabasas, CA 91302
(213) 888-2772

Contact: *Allen W. Osborne, Pres.*

SEE AD ON PAGE 12

PACIFIC COAST MARKETING

LINE: Amber Electro Design, Gorman-Redlich, Hallikainen & Friends, Leader Instruments, QEI, Ramko Research, Technics.

20 S. Santa Cruz Ave.,
Suite 309
Los Gatos, CA 95030
(408) 395-7021

Contact: *Larry Maguire*

PALADIN CORPORATION

LINE: Wire strippers, desoldering tools, wire cutters and voltage testing equipment.

31332 Via Colinas, Suite 106
Westlake Village, CA 91362

Continued on page 172



FM MONITOR/TEST SET (691)

FM EXCITER

STEREO GENERATOR

SCA GENERATOR

SOLID STATE TRANSMITTERS

150 WATT FM

300 WATT FM

500 WATT FM

1000 WATT FM

3.5KW FM TRANSMITTER

FM ATS

AM MODULATION MONITOR

QEI CORPORATION

ROUTE 73

KRESSON, N.J. 08053

(609) 767-8052

VICTOR DUNCAN Sells VIDEO EQUIPMENT
VICTOR DUNCAN Rents VIDEO EQUIPMENT
VICTOR DUNCAN Services VIDEO EQUIPMENT

CHICAGO (312) 943-7300
 661 N. LaSalle, Chicago, IL 60610
 DALLAS (214) 369-1165
 2659 Fondren, Dallas, TX 75206
 DETROIT (313) 589-1900
 32380 Howard, Madison Hgts., MI 48071



VICTOR DUNCAN, INC.

"The Check and Double Check People"

Circle (118) on Action Card

END STV PIRACY

low cost Dynacom system

Whether you're going into STV for the first time or you have an existing system that's letting you be robbed blind, check out the new, secure Dynacom system.

We have provided "ticket module" decoders to small market clients and fully addressable systems to larger markets.

Call Robert Payne today at (404) 428-3100, and start STV paying off for you.



Dynacom Electronics Limited
 590 Commerce Park Drive
 Marietta, GA 30060

Circle (119) on Action Card

WHERE TO BUY IT

(213) 991-4970
 Contact: Ronald Vogel, VP, SIs.

PANEL COMPONENTS CORP.

LINE: Fuses, fuseholders, voltage selectors, primary circuit connectors, RFI power line filters, cords & cordsets with international product safety approvals.

335 Tesconi Circle
 P.O. Box 6626
 Santa Rosa, CA 95406
 (707) 523-0600

Contact: Steve Haussler,
 Service Manager

PENNY & GILES CONDUCTIVE PLASTICS LTD.

1640 Fifth St.
 Suite 201
 Santa Monica, CA 90401
 (213) 393-0014

Contact: Rachel Smedley,
 Manager

PROCAM, INC.

LINE: Aaton camera system; FTG (Oskar Heiler) fluid heads & tripods; SFAT recording, editing, mixing, studios.

905 North Cole Avenue
 Hollywood, CA 90038
 (213) 464-2125

Contact: Regis Laderriere, Pres.

QUINTEK, INC.

LINE: Audio Kinetics Ltd. tape locators and synchronizers for audio/video. Advanced music systems -digital delay lines & disc mastering delay lines.

4721 Laurel Canyon Blvd.
 #209, N. Hollywood, CA 91607
 (213) 980-5717

Contact: Rodney Pearson,
 President

RIGGINS ELECTRONIC SALES

LINE: Audio consoles, cartridge machines, transmitters, turntables, reel to reel recorders, microphones, tape cartridges, tone arms, replacement styli, studio furniture, studio accessories.

3272 E. Willow St.
 Long Beach, California 90806
 (213) 598-7007

Contact: G. E. Riggins, Owner

SAS COMPANY

LINE: All professional audio equipment lines.

5219 Craner Ave.
 North Hollywood, CA
 (213) 466-5474

Contact: Gil Reyes, C.E.O.

SAECO INTERNATIONAL

LINE: Ampex, Grundig, JVC, Hitachi, OKI, Tektronics, Grass Valley, RCA, Comprehensive, NEC, Panasonic, Crosspoint Latch, Shintron, Strand Century, Videotek, Sony, JBL.

1122 E. Chevy Chase Dr.
 Glendale, CA 91205
 (213) 245-7708
 Tlx Twx: 910-497-2091

Contact: L.M. Bleakley, SIs. Mgr.

SAWYER CAMERA & INSTRUMENT CO.

LINE: 3M Scotch Videotape, Sony videotape, Majestic videotape, Mole-Richardson lights, Hitachi cameras & accessories.

6820 Santa Monica Blvd.
 Los Angeles, CA 90038

(213) 466-6111
 Contact: Alan Colberg, SIs. Mgr.

SEE HEAR INDUSTRIES

717 E. Actesia Blvd.
 Carson, CA 90746
 (213) 516-0315

Contact: Ray Salobs

SIERRA AUDIO CORP.

LINE: Custom acoustical consultation, construction services, monitor system.

721 So. Glenwood Pl.
 Burbank, CA 91506
 (213) 843-8115

Contact: Kent Duncan, Pres.

SIMON ASSOCIATES

LINE: Entre, Osram, Spectra, Tough Traveler, ColourTronics, Silver Grabber, Classic Cases, Port-A-Screen.

20 Sunnyside
 Suite B
 Mill Valley, CA 94941
 (415) 381-0835

Contact: Tim Simon, President

SIMPAC CORP.

5472 Kenilworth Dr.
 Huntington Beach, CA 92649
 (714) 846-0765

Contact: Paul J. Burns, Dist.

R. E. SNADER AND ASSOCIATES, INC.

LINE: 3M, Quanta, Tektronix, Microtime, JVC, Panasonic, Sigma, ISI, Gray, Fortel, Laird.

35 Reed Blvd.
 Mill Valley, CA 94941
 (415) 381-3300

Contact: Bob Snader, President

SOUND GENESIS

LINE: Consoles, tape machines, mikes, signal processing, amplifiers, intercom to PL systems, synchronizers, speaker systems and components, turntables, accessories.

2001 Bryant Street
 San Francisco, CA 94110
 (415) 285-8900

Contact: Ron Webb,
 Broadcast Sales Mgr.

SOUND INVESTMENT ENTERPRISES

LINE: Audio amplifiers, microphones, tape recorders, speakers, signal processing, cable & connectors, consoles, intercoms, headphones, recording tape, duplicators.

P.O. Box 4139
 31121 Via Colinas
 Suite 1003
 Thousand Oaks, CA 91359
 (213) 991-3400

Contact: Howard Parker, Owner

STEENBECK, INC.

LINE: Film editing equipment. Film to tape transfer equipment.

9045 Eton Ave.
 Suite A
 Canoga Park, CA 91304
 (213) 998-4033

Contact: Ted J. Diamond,
 Sales Manager

STUDIO FILM & TAPE, INC.

LINE: Reprocessed 2" Quad Video tape; New & reprocessed 1" and 3/4" tape. New 1/2" VHS and Beta Tape. Reprocessing facility available to evaluate 2" and 1" tape for reuse by user.

6670 Santa Monica Blvd.

Hollywood, CA 90038
(213) 466-8101
(800) 421-4496 outside of CA.
Contact: *Sherrie Finholt or
Bill Ferree,
Videotape Reps*

STUDIO MAINTENANCE SERVICE, INC.
LINE: Trident Audio Developments, Ltd. ADC Products (audio & video connectors).

12458-60 Magnolia Bl.
North Hollywood, CA 91607
(213) 877-3311
Contact: *David Michaels, Pres.*

SUDAMERICANA ELECTRONICS CO. (SAECO)
LINE: Ampex Broadcast, Hitachi Broadcast, JVC, Grass Valley, Tektronix, Grundig, RCA CCTV, video vans, studio lighting, earth station receivers.

1122 E. Chevy Chase Dr.
Glendale, CA 91205
(213) 245-7708
TLX TWX: 910-497-2091
Contact: *Lock Bleackley, Sls. Mgr.*

SURCOM ASSOCIATES
LINE: Transmitting capacitors
305 Wisconsin Ave.
Oceanside, California 92054
(714) 722-6162
Contact: *A. J. Link, Mgr./Owner*
SEE AD ON PAGE 147

SYSTEM ASSOCIATES
5801 Uplander Way
Culver City, CA 90230
(213) 641-2042
Contact: *Walter A. Shubin, VP
Billy H. Seidel, President*

TELAUDIO CENTRE
LINE: UAP, Panasonic, Microtime, Crosspoint Latch, Hitachi, Datatek, For-A, Teatronics.
P.O. Box 921
Beverly Hills, CA 90213
(213) 276-2726
Contact: *L. D. Mazzini, Sales Mgr.*

TEKNEKRON CONTROLS, INC. (T.C.I.)
2121 Auston Way
Berkeley, CA 94704
(415) 843-8227
Contact: *Claudia Kelly*

TELEVISION ASSOCIATES, INC.
LINE: Sharp, Ikegami, Listec, Asaca, Shlntron, Sony, Sony Broadcast, RCA, Ampex, 3M, Memorex, JVC, Panasonic, CVS, Anvil, Bratford, Calsonks, Canon, Christie, Cine-60, Colortran, NEC, Shure.

2410 Charleston Rd.
Mt. View, CA 94043
(415) 967-6040
Contact: *Ann Callahan, Prod. Sls.
Dave Taylor, Equip. Sls.*

BRIAN TRANKLE & ASSOC.
LINE: Audio Technica, E. M. Long Assoc., Lexicon, Quantum Audio Labs, Edcor, Renkus-Heinz, UREI, Panasonic Pro-Audio Division.

820 Black Mountain Rd.
Hillsborough, CA 94010
(415) 344-1133
Contact: *Brian F. Trankle, Owner*

TRITRONICS, INC.
LINE: Video/audio professional systems, plus related accessories & components.

2921 West Alameda Ave.
Burbank, CA 91505
(213) 843-2170
(800) 423-3640 Nat'l. Wats Line
CALIF. (800) 232-2141
Contact: *Chuck Huber, Sls. Adm.*

VIDEO LOGIC SERVICES INT'L
LINE: TV equipment, radio (commercial and private).
P.O. 1434
Los Gatos, CA 95030
(408) 356-1031
Contact: *James B. Sullivan, Pres.*

VIDEO SYSTEMS NETWORK, INC.
LINE: All major brands.
12530 Beatrice St.
Los Angeles, CA 90066
(213) 870-1231
Contact: *C. M. Brainard, V.P.*

THE VIDEO TAPE COMPANY
10545 Burbank Blvd.
N. Hollywood, CA 91601
(213) 985-1666
Contact: *Dick Millais, Dir. of Mktg.*

VIDEOTAPE PRODUCTS, INC.
1414 Sixth Street
Santa Monica, CA 90401
(213) 394-0282
Contact: *Dick Marzec, Pres.*

WESTERN BROADCAST SYSTEMS
LINE: Leitch Video, Ross Video, MCI/Quantel, Ampex Pro Audio, Ampex Tape, Conrac, Audtronic, Crown, Lexicon, CEI.
10707 Amulet Place
Cupertino, CA 95014
(408) 749-0900
Contact: *Homer Hull, Pres.*

WESTLAKE AUDIO, INC.
LINE: Audtronic, Otari, BTX, Soundcraft; all microphone lines, RTS systems; HME mikes.
6311 Wilshire Blvd.
Los Angeles, CA 90048
(213) 655-0303
Contact: *John Carey, Sls. Mgr.*

COLORADO
BROADCAST COMMUNICATION PRODUCTS
3085-A Bluff St.
Boulder, CO 80301
(303) 442-3231
Contact: *Greg Pine or Quin Morrison, Sales Managers*

CEC, INC.
LINE: Wide-band spectrum analyzers, RF components, signal & sweep generators, counters, oscilloscopes, amplifiers, modulation and deviation meters.
1602 South Parker Road
Denver, Colorado 80231
(303) 751-3252
Contact: *R. T. Seery, Sales Eng.*
Continued on page 174

WHERE TO FIND IT
GENERAL INDEX,
Pages 38-45
WHO MAKES IT
PRODUCT DIRECTORY,
Pages 46-113

CUSTOM & STANDARD BROADCAST EQUIPMENT

- Master Control Switchers
- Machine Assignment Systems
- Audio/Video Routing Switchers (10 x 1 up to 250 x 250)
- Custom Automated Systems
- Master Control Automation



Custom-designed Master Control

Modular design
Readily available components
Easy maintenance
Microprocessor control for large systems

We can design a system for your specific requirements



IMAGE VIDEO LIMITED

700 Progress Avenue, Scarborough, Ontario, Canada M1H 2Z7
Telephone: (416) 438-3940 Telex: 065-25392

Circle (156) on Action Card

We make a nice couple!

NEED TIME?

It's yours, accurately, from N.B.S. and TRUE TIME. We can supply time into your computer, onto your recorder, in visual or audio formats. Synchronization of time is available with any of several interfaces for downstream equipment or "stand alone" use. Our 2 year warranty and years of experience are your assurance of long life and dependability. Call Vic at:

TRUE TIME INSTRUMENTS
3243 Santa Rosa Ave.
Santa Rosa, CA 95401
(707) 528-1230 Telex 172853

Circle (121) on Action Card

Live Remotes

Marti's RPT15 Transmitter has the power to bring difficult remotes back **LIVE**.

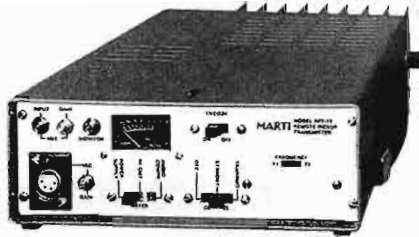

VHF-UHF
Model RPT15
Transmitter

Delivering the maximum allowable (15 watts) power for aircraft ENG, the RPT15 produces outstanding results with traffic reports, mobile units and fixed remotes — and with clean broadcast-quality audio and continuous-duty operation. Built-in encoding permits operation with Marti Mobile Repeaters and Automatic Repeaters in wide coverage systems.

RPT15 FEATURES:

- ★ Type accepted on all VHF-UHF RPU channels
- ★ 15 watts continuous output
- ★ Dual frequency capability
- ★ Sub audible encoder
- ★ Built-in metering
- ★ Built-in AC supply
- ★ FM Compressor-Limiter
- ★ Mixing mic and line inputs

MARTI MARTI Electronics, Inc.
1501 N. Main • P.O. Box 661
Cleburne, Texas 76031
(817) 645-9163 • Telex 794 835

Circle (122) on Action Card

Specializing in
broadcast facility
planning and design.

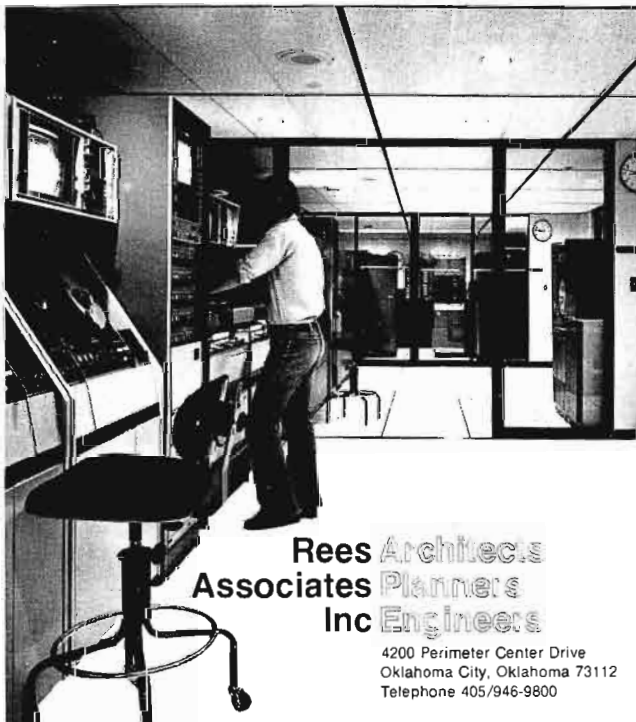

Rees Architects
Associates Planners
Inc Engineers

4200 Perimeter Center Drive
Oklahoma City, Oklahoma 73112
Telephone 405/946-9800

Circle (123) on Action Card

WHERE TO BUY IT

COLORADO MAGNETICS

LINE: Audiopak, Fidelpac, Audiolab, Aristocart, Audio Technica, Ampex.
P.O. Box 713
Colorado Springs, CO 80901
(303) 596-0684
Contact: Larry Wilson, Owner

COLUMBINE SYSTEMS, INC.

LINE: Data processing for the broadcast industry.
Seven Jackson Building
Level 3
Plaza of the Presidents
Golden, CO 80401
(303) 279-4000
Contact: Sue Thompson,
VP/Marketing

DAVIS AUDIO VISUAL, INC.

LINE: Conrac, JVC, Panasonic, Scotch, Videotek.
1801 Federal Blvd.
Denver, CO 80204
(303) 455-1122
Contact: David Marr, Video Mgr.

DIDIER / DENVER, INC.

LINE: Acrodyne, Adda Corporation, Central Dynamics Ltd., Leitch Video, Tektronix, Time & Frequency Technology, Etc.
P.O. Box 1599
Evergreen, CO 80439
(303) 674-6000
Contact: Herb Didier, Pres.

FILM / VIDEO EQUIPMENT SERVICE CO.

LINE: Cinema Products Corp., Swintek, Kangaroo Video Pack, Universal, O'Connor, Peter Lisand, Karl Heltz, Sennhelsler, Matthews, Lowel, Fujinon warranty repair.
1875 S. Pearl St.
Denver, CO 80210
(303) 778-8616
Contact: Dean Schneider, Pres.

GENERAL SOUND & ELECTRONICS

LINE: Altec, Electro-Voice, Soundolier, Toa, Alphone, Shure, Clear-Com, HME, Orban, Matreco Davis, BGW, AKG, Special Instruments Lab., University.
1369-A West Byers Place
Denver, CO 80223
(303) 744-1768
Contact: Jim Husky, President

HIGHLAND ASSOCIATES, INC.

LINE: Antennas, consoles, transmitters, microphones, turntables, tape recorders.
Box 99
Broomfield, Colorado 80020
(303) 466-3851
Contact: Mrs. H. S. Broughall,
President

McLOUD & RAYMOND CO.

LINE: Professional audio tape products, microphones, mixers, headphones.
1562 South Parker Road #336
Denver, Colorado 80231
(303) 751-5305
Contact: W. Cliff McCloud, Pres.

CONNECTICUT

JOHN B. ANTHONY CO.

LINE: AKG, Amber, AVS, Bozak, Cartalign, dbx, Eumlq, HME, Kenwood Car & Home, Micron, Orban, Otari, Sheffield Labs, Stanton, UREI & Consilium Industri AB.

992 High Ridge Road
Stamford, CT 06905
(203) 322-9202, (212) 585-2027
Contact: John B. Anthony, Pres.

AUDIOTECHNIQUES

LINE: MCI tape machine and consoles, Dolby, UREI, Crown, Lexicon, Neuman, AKG.
652 Glenbrook Rd.
Stamford, CT 06903
(203) 359-2312
Contact: Mike Faulkner, V.P.

COMET SALES

LINE: Fixed & variable ceramic vacuum capacitors
38 Brushwood Lane
Stamford, CT 06903
(203) 322-5272
Contact: H. Ripperger, Sales Coord.

CONCORD COMMUNICATIONS

LINE: Video equipment, audio equipment, lighting accessories, video services.
970 High Ridge Rd.
Stamford, CT 06905
(203) 322-9322
Contact: Alan Rich, VP

DENSON ELECTRONICS CORP.

LINE: Video equipment.
P.O. Box 85
Rockville, CT 06066
(203) 875-5198
Contact: A. C. Denson, President

GLOBAL COMMUNICATIONS AND ENGINEERING, INC.

LINE: TV, AM, FM transmitters, towers, antennas, audio / visual equip., "Turn-key" installations & services.
914 White Plains Rd.
Trumbull, CT 06611
(203) 261-2068
Contact: R. M. Read, Pres.

INMARK CORPORATION

LINE: Comet vacuum capacitors, Weber Circuit Breakers for equipment.
147 West Cedar St.
Norwalk, CT 06854
(203) 866-8474
Contact: Jacquelyn E. Nette, Dir.

NATIONAL VIDEO SERVICES, INC.

LINE: JVC, Panasonic, RCA, NEC, Sony, Lenco, Barco.
3 Pembroke Road
Danbury, CT 06810
(203) 792-3862
Contact: G. Johnstone, Pres.

NEUTRIK PRODUCTS

77 Selleck St.
Stamford, CT 06902
(203) 248-2121
Contact: Richard Pavich, Mkt. Mgr.

REDDING RADIO

A Division of
SJ Industries, Inc.
LINE: Redding Radio microphone call-letter plates, telephone coupling devices, 3M tape, Stanton cartridges/stylus, Shure cartridges/stylus/microphones, Electro-Voice mikes.
Box 344
Fairfield, CT 06430
Contact: Sascha Deale, VP/Mktg.

**STATION BUSINESS SYSTEMS
Div. Control Data Corp.**

LINE: BAT1700 billing, accounting, and traffic systems; music playlist & inventory systems; media cartridge inventory system; program package inventory system; and Newscom automated newsroom system for broadcast. Also subscriber processing & accounting systems for cable.

600 West Putnam Avenue
Greenwich, CT 06830
(203) 622-2400
Contact: Joe Barbieri, VP, Sales

DISTRICT OF COLUMBIA

COMEX CORPORATION

LINE: JVC professional video, Teracom microwave, Shively FM antenna, Ikegami CCTV.

P.O. Box 17011
Dulles Int'l Airport
Washington, D.C. 20041
(703) 471-4215
Contact: Jack Rickel, President

FLORIDA

AVS PROFESSIONAL

LINE: Tape machines, consoles, microphones, signal processing, accessories, supplies, monitor speakers, amplifiers, turntables: all audio equipment.

5484 Jct. Port Ind. Blvd.
Tampa, Florida 33614
(813) 884-1461
Contact: Michael Poles, Sales Eng.

**ALEXANDER BATTERY
SALES, INC.**

LINE: Batteries; nicad, alkaline & mercury & cell cells.

P.O. Box 1053
Pompano Beach, FL 33061
(800) 327-1190
Contact: Charles Stinson, GM

BAA INTERNATIONAL, INC.

LINE: Amplifiers, cart machines, audio consoles, carts, mikes, limiters, compressors, open reel recorders, turntables, STL systems.

1229 NE 37th St.
Ft. Lauderdale, Florida 33334
(305) 564-4422
Contact: K. Cameron, VP, Eng.

BENCNIK ASSOCIATES

LINE: McMartin, Teac Tascam, Lexicon, Telex, MacKenzie, Soundoller, Eastern Acoustic Works.

1627 E. Silver Springs Blvd.
Suite F
Ocala, Florida 32670
(904) 732-9775
Contact: W.L. Bencsik, Pres.

**BROADCAST AUTOMATION
ASSOCIATES**

LINE: Transmitters, consoles, cart machines, antennas, transmission line.

300 S. 6th St.
Ft. Pierce, FL 33450
(305) 464-5465
Contact: Ron Crider, Pres.

**BROADCAST
INTERNATIONAL, INC.**

LINE: Lexicon Model 1200, dbx, Otari, Phelps Dodge, Orban, Stanton, Eastern Acoustic Works, Technics, West Penn, Scotch, CSI, LPB, Belar.

1229 NE 37th St.
Ft. Lauderdale, FL 33334
(305) 564-4422
(305) 945-0635 MIA.
Contact: Ken Cameron, V.P., Eng.

CONTROL TECHNOLOGY INC.

LINE: MCI Audltronics, Technics, Orban, Eventide, JBL, Electro-Voice, UREI, Moseley.

2322 Davie Blvd.
Ft. Lauderdale, FL 33312
(305) 587-2716 or (800)
327-4121
Contact: James Woodworth,
President

CRESCENDO ASSOCIATES

LINE: AB Systems, Allen & Heath, Audio-Technics, dbx, Deltalab, ETA lighting, EXR, Mic-Mix, Nady Wireless, Furman Sound, Goldline Analyzers, Otari Corp., Roland Studio Systems, Rainbo lighting, Littlelight lighting.

9766 Deer Run Drive
Ponte Vedra Beach, FL 32082
(904) 285-6732
Contact: Patty Hall, Office Mgr.

DESIGN LINE, INC.

LINE: Berkey Colorfran, Skirpan, Rosco, GE, Sylvania, Norelco, Strand, EDI.

P.O. Box 260007
Tampa, Florida 33685
(813) 886-5073 or 886-5581
Contact: S.M. Goldman, GM

ELECTREX COMPANY

LINE: AKG, Ampex, Bird, CSI Electronics, Ramko, TFT, BE, Cableware, Elmac, Audlopac, Atlas, Lexicon, Optoelectronics, Regency, Otari, Fidellpac, 3-M, Marti, Micro-Trak, Nortronic, Orban, Phelps Dodge, Russco, Shure, Stanton, Technics, Telex.

18680 NE 2 Avenue
Miami, Florida 33179
(305) 651-5752, Tlx: 51-4733
Contact: Ben Ostrovsky, Pres.

P. R. FERMAINTT

LINE: AM-FM-TV transmitters, towers, antenna, trans-line, ptasors, monitors.

1031 Southwest 74 Court
Miami, Florida 33144
(305) 261-4755
Contact: Owner

FERMCO ELECTRONICS, INC.

LINE: Radio broadcasting & television equipment (transmitters, antenna, audio eqpt).

1031 SW 74 Court
Miami, FL 33144
(305) 261-4755
Contact: P.R. Fermaintt, Pres.

FLORIDA VIDEO SYSTEMS

LINE: Sony, Sony Broadcast, Microtime, Sharp, Quanta, Videotek, Crosspoint, Convergence.

Continued on page 176

FIDELIPAC cartridges use tape for only sound reasons.

Somebody else's
reasons are
highly unsound.

Magnetic tape is sacred at Fidelipac. That's why we only use it to record and reproduce audio. Not to do jobs it was never intended to do. Like act as part of the cartridge brake. Induce drag. Or increase tape tension.

Fidelipac cartridges use a brake on the reel assembly. Not on the tape surface. Which means no stretched or broken tape, feathering or dropout. And far less wear and abrasion to critical tape surfaces.

Now you decide. Do you want a cartridge designed for sound reasons? Or for reasons that are highly unsound?

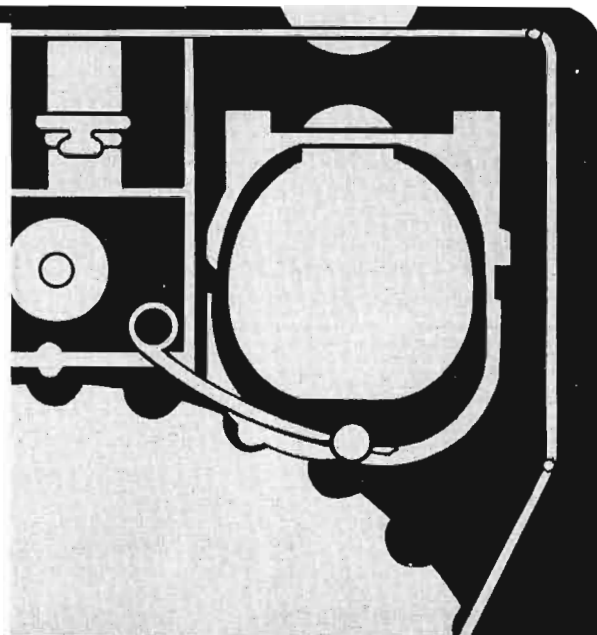

**FIDELIPAC[®]
BROADCAST TAPE CARTRIDGES**

Fidelipac Corporation
109 Gaither Drive • Mt. Laurel, NJ 08057 • USA
TWX/TELEX 710-897-0254 FIDELIPAC MTLR
609-235-3511

Who knows more about tape cartridges than Fidelipac?

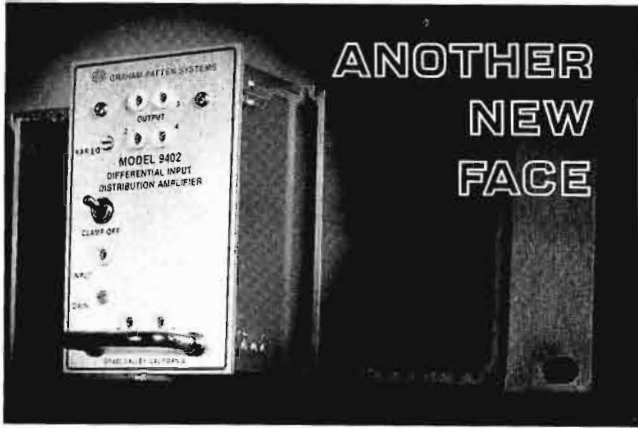

ANOTHER NEW FACE

GRAHAM-PATTEN SYSTEMS

INTRODUCES THE MODEL 9402 A Versatile New DA Featuring

**Differential Input
Switchable Clamping
Optional Cable Equalization
(fixed or variable)**

And, like our already popular 9401 video/pulse DA, it fits in any Grass Valley Group, inc. standard 900 tray.



GRAHAM-PATTEN SYSTEMS, INC.
P. O. BOX 1960, GRASS VALLEY, CA 95945
[916] 273-8412

Circle (125) on Action Card

AUDIO ROUTING SWITCHERS REMOTE BROADCAST UNITS AUDIO DISTRIBUTION AMPLIFIERS

BSM Systems product line is growing — offering RBU; Audio DA's and our new routing switcher. Same high quality at a price you can afford. Replace patch bays and eliminate a multitude of problems for your engineer.

RBU FEATURES:

- 2 Mike Channel
- 1 Tape Channel
- AC or Battery
- Rugged Case
- Studio Talk Back
- Removable Lid

Price: \$489

ROUTING SWITCHER FEATURES:

- 10x10 Routing Switcher
- BCD Controlled.

MONO \$1995
STEREO \$2995

For complete information on the RBU-Audio DA's and our new routing switcher, call or write:

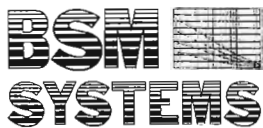

BSM SYSTEMS
P. O. Box 8081
Spokane, Washington
(509) 448-0697

Circle (126) on Action Card

WHERE TO BUY IT

14422 NW 7th Ave.
Miami, Florida 33168
(305) 688-6618

Contact: *Phil Dubs, VP Sls.*

**GLOBAL VIDEO
COMMUNICATIONS CORP**
744 West Church St.
Orlando, FL 32805

(305) 423-8356

Contact: *David Antoniak, Pres.
Larry Cunningham, GM*

MART HALLER, INC.

LINE: Bird wattmeters, communication towers, insulators, isolation transformers, antennas, tubes, crystals, transmitter parts, test equipment.

305 Palermo Avenue
Coral Gables, Florida 33134
(305) 444-4617 & 4618

Contact: *Edwin F. Haller*

IMAGE DEVICES INC.

1825 NE 149 St.
Miami, FL 33181
(305) 945-1111

Contact: *Steve Ciffone,
Rental Manager*

LAUDERDALE ELECTRONIC LABS

LINE: Radio & TV broadcast equipment.

16 SW 13th St.
Ft. Lauderdale, FL 33315
(305) 764-7755
(800) 327-3793

Contact: *Russ Novak, Sales Mgr.*

LITA BROADCASTING DIST.

LINE: Audio-Pak, Fidellpac, Broadcast Electronics, Eimac audio equipment; STL transmitters, antennas, transmission systems, tapes, transmitting tubes.

7154 N.W. 72th St.
Miami, FL 33166
(305) 887-1223

Contact: *Luis Endara, Owner
Rudy Estripeaut,
Sales Manager*

MEDIA CONCEPTS, INC.

LINE: JVC, Shure, Video Data Systems, Comprehensive Video, Cable Works, DuPont, Ampex, 3M, Maxell, RDK, Fuji, GBC, Edutron, Welt, Smith-Victor, Lowell, Quikset, MGA, Aquastar, Magnavox, Sylvania, MCI, Vico, and others.

559 49th St. So.
St. Petersburg, FL 33707
(813) 321-2122, 821-2122

Contact: *Bob Skldmore, Pres.*

MIDWEST COMMUNICATIONS SYSTEMS DIVISION

LINE: Hitachi, Panasonic, Conrac, JVC, Digital Video, Edutron, Lenco, Ampex Vicon, Videotek, 3M.

3331 NW 82 Ave.
Miami, FL 33122
(305) 592-5355

Contact: *Lloyd Hicks, Sls. Mgr.*

OVERSEAS, INC.

LINE: Radio broadcasting equipment.

444 Brickell Avenue
Suite 51-140
Miami, FL 33131
(305) 371-4046

Contact: *J.E. Cifuentes, Pres.*

PHOTOMART

LINE: Cinema Products, Frezzolini, Cine 80, Chiles, Colortran, Smith Victor Lowell, Strand Century, EV, Shure, etc.

6327 South Orange Ave.
Orlando, FL 32809
(305) 851-2780

Contact: *Charles Sutyak, Sales
Tony Delia, Sales*

PRO AUDIO GENERAL STORE, INC.

LINE: MCI recorders, Auditorics, dbx, A&DR, MRL, Otari, EXR, DeltaLab, EV, Ruslang.

1378 N.W. 100th Ave.
Coral Springs, FL 33065
(305) 752-0330

Contact: *Bill Shute, Pres.*

R & H ASSOCIATES

LINE: NEC America, Crest Electronics, Lee-Ray, Cinema Products.

1245 Hercules Ave.
Clearwater, FL 33515
(813) 442-7505

Contact: *Frank Fitzhenry, Pres.*

RECORDING STUDIO EQUIPMENT CO.

LINE: Full line of audio equipment.

14205 N.E. 18th Ave.
No. Miami, FL 33182
(305) 945-9774

Contact: *Seth Snyder, Sales Mgr.*

SOUTHEAST ELECTRONICS

LINE: Panasonic, Sony, JVC, Microtime, Videotek, 3M, American Data.

1125 Rosselle St.
P.O. Box 41308
Jacksonville, Florida 32203
(904) 356-3007

Contact: *James N. Overton, V.P.*

SUN VIDEO COMMUNICATIONS

LINE: Sony, Panasonic, Microtime, 3M, Tektronix, Fuji, JVC, Quanta, Mincom.

8100 Ulmerton Road
Largo, Florida 33541
(813) 536-9424

Contact: *Dave Smith, V.P.*

GEORGIA

C. M. ALLEN CO., INC.

LINE: Hand tools.

6145 Barfield Rd. NE
Suite 190
Atlanta, GA 30328
(404) 256-0610

Contact: *Charles Allen, Pres.*

BCA, INC.

P.O. Box 2606
312 Highway 74 South
Peachtree City, GA 30269

Contact: *Ron Baker*

BROADCAST COMMUNICATIONS ASSOC.

LINE: Moseley, Orban, Auditorics, LPB, Cablewave, Phelps Dodge.

P.O. Box 2606
Peachtree City, GA 30269
(404) 487-9559

DOMINTER, INC.

LINE: Audio visual and video equipment, communication systems design & installation.

6000 Peachtree Rd., N.E.
Atlanta, GA 30341

(404) 455-7626
Contact: D. B. Fincannon, Pres.

EME II, INC.
LINE: Digital effects, monitors, cameras, test equipment.
2522 Tanglewood Rd.
Decatur, GA 30033
(404) 325-0165
Contact: Pete Scarborough, Pres.

ELREP SALES
LINE: Mikes, test & monitoring equipment, open reel recorders.
1874 Forge St.
Tucker, Georgia 30084
(404) 938-7108
Contact: M. B. VanDeKreke, Pres.

FIDELICOM, INC.
LINE: Audio test equipment, real time analyzers; Sound Technology; Ivie Electronics.
P.O. Box 80644
Atlanta, Georgia 30366
(404) 458-3616 & 451-3471
Contact: Mort Liebman, Pres.

BEN GARVIN ELECTRONICS
LINE: Broadcast professional tape carts equipment; supplies to AM-FM-TV professional audio accounts; (main line) Fidelipac professional tape carts & supplies, reel to reel tape.
2878 Dunnington Cr. NE
Atlanta, GA 30341
(404) 938-1594
Contact: Ben Garvin, Owner

REGISTER DATA SYSTEMS
LINE: Computer broadcast business systems, using Tandy (Radio Shack) and Texas Instruments.
P.O. Box 1246
Perry, GA 31069
(912) 987-2501
Contact: Lowell Register, Pres.

SIBONEY AUDIO VISUAL
LINE: Audio visual equipment.
1760 Tully Circle N.E.
Atlanta, Georgia 30329
(404) 329-9200
Contact: Mark Henderson, Reg. Mgr.

MAITLAND K. SMITH, INC.
LINE: Test equipment, radio receivers.
2321 Fourth Street, Suite 210
Tucker, Georgia 30084
(404) 939-2053
Contact: Bob M. Tyler, President

STANCO COMMUNICATIONS PRODUCTS, INC.
2615 Shallowford Rd. N.E.
Atlanta, GA 30345
(404) 636-3096
Contact: Marvin Boaz, V.P.

STOREEL CORPORATION
LINE: High-density storage systems for videotapes, cassettes, cartridges and film.
2050-C Carroll Ave., Ste. 2
P.O. Box 80523
Atlanta, GA 30341
(404) 458-3280
Contact: Ruth E. Schaeffer, Pres.

TECHNICAL INDUSTRIES, INC.
LINE: Sony, Panasonic, Harris Video, Convergence, Maxell, Strand Century, Ikegami, ITE, Cezar, 3M.
6000 Peachtree Rd., N.E.
Atlanta, Georgia 30341
(404) 455-7610
Contact: Ed Matthews, V.P.

VISUAL SYSTEMS COMPANY
LINE: Hitachi, JVC, Panasonic, ISI, ITE, Conrac, Videotek, Dynair, Strand Century, Video Data Systems, Lenco.
3870 N. Peachtree Rd.
Atlanta, GA 30341
(404) 457-1388
Contact: Dale A. Schonmeyer, Pres.

HAWAII

THE AUDIO VISUAL COMPANY
LINE: Sony, JVC, Singer, Kodak, Sharp, B&O, MGA.
1071 South Beretania St.
Honolulu, Hawaii 96814
(808) 533-3848
Contact: Daniel H. Iki, V.P.

BROADCAST SERVICES, INC.
LINE: Moseley Associates, Econo Tubes, Micro-Trak and Autogram consoles, Fidelipac, Elmac, QRK
2877 Kalakaua Ave.
Honolulu, Hawaii 96815
(808) 521-6311
Contact: Alan Roycroft, Pres.

JOHN J. HARDING CO., LTD.
LINE: Ampex, Orban, Altec, Vicon, RCA Solid State Div., Inovonics, Broadcast Electronics, Allison Research, Philips AV systems.
2825 Ualena Street
Honolulu, Hawaii 96819
(808) 836-0941
Contact: Bob Edmondson,
Sales Manager

OMEGA PACIFIC
LINE: Acrodyne, Conrac, Hitachi, Scala, CDL.
570 Auahi St., -204
Honolulu, Hawaii 96813
(808) 533-7655
Contact: Mark Morrison, Owner

IDAHO

AMSCO (AMERICAN MEDIA SUPPLY CO.)
LINE: Full line of broadcast equipment.
P.O. Box 44
Rexburg, ID 83440
(208) 356-0360
Contact: Joe Perry, Sls. Mgr.

ILLINOIS

ADVANCED VIDEO COMMUNICATIONS
LINE: Sony, Hitachi, etc.
49 S. Washington Blvd.
Hinsdale, IL 60521
Continued on page 178

isi 200 SERIES PRODUCTION SWITCHERS

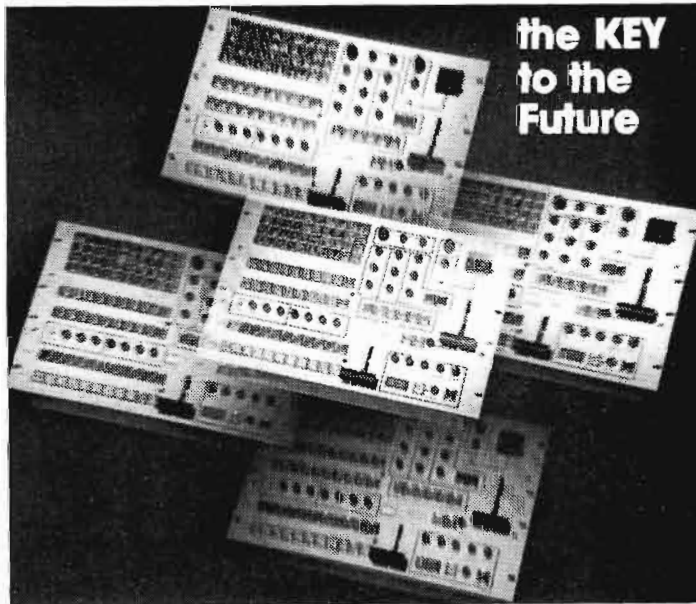

PolyKey® Effect System

200 Series Features:

The 200 Series is an advanced, state-of-the-art production switching system, offering one, two or three PolyKey® Effects (PKE) Systems. Each PKE has a 5 level processor with the following features:

- 4 input busses
- Manual or auto transitions
- Video key plus title key over/under
- Black/white/color border edging
- Chroma key standard
- Rotary and spin wipes

Every 200 Series switcher also has a Downstream Transition Unit which includes:

- "Flip-flop" mixer with cut bar
- Fade-to-black with pulse processing
- DSK with border edging and color
- Pointer Generator



INDUSTRIAL SCIENCES, INC.
3521 S.W. 42nd Avenue
P.O. Box 1495
Gainesville, Florida 32602
U.S.A.

TELEPHONE
Outside U.S.A. 01 (904) 373-6782
In Florida (904) 373-6783
Sales (800) 874-7590
Service (800) 874-7874

CABLE
TWX 810-825-2307



MULTIDYNE CQ-4

Very low cost graphics-character generator. Features, too numerous to list, include RS232C computer interface, dynamic character reprogramming, 2 character sizes, capability to type only in the vertical interval, audio generation, etc. Prices start under \$1,000.

VPDA-2 VIDEO-PULSE EQUALIZING D.A.

The most useful distribution amplifier in the industry!

It cancels common-mode hum up to 10 volts, distributes video, pulses or subcarrier in six outputs. It has a feedback clamp and a signal operated light. It equalizes up to 2500' of cable within 1% with a single control.

Portable units work on 117/230V AC, switch selectable, and give low D.C. warning when used with external battery. Rackmounted units can be single or dual. Typical distortion is .1 degree diff. phase .25% diff. gain.

Prices start at \$650.

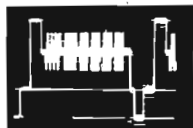
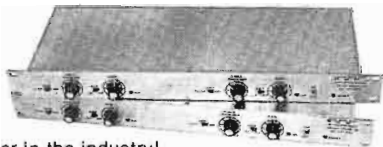

Typical response after 2000' of 8281 cable equalization.

MULTIDYNE ELECTRONICS

P.O. Box 528
Locust Valley, NY 11560
(516) 671-7278

Circle (128) on Action Card

SIGMA Video D.A.s are available "off the shelf"...



...but every unit is 100% lab tested, aged and calibrated.

VDA 100A

- 1 loop-thru input, 6 outputs
- ± 0.2 dB to 10 MHz
- Self contained power supply
- Rack mountable up to 3 in FR3-100



SIGMA ELECTRONICS INC.

1830 STATE STREET
EAST PETERSBURG, PA 17520
(717) 569-2681

Circle (129) on Action Card

WHERE TO BUY IT

(312) 323-7464

Contact: Mike Vergauwen, VP Sales

ALLIED BROADCAST EQUIPMENT

LINE: Audio and RF broadcast equipment.

3405 W. Balmoral
Chicago, IL 60625
(312) 784-2257

Contact: Tom Harley

ANCHA ELECTRONICS

LINE: Pulse generators and distribution equipment, switchers, audio and video distribution, routing switchers, SMPTE time code generators, black and white and color monitors, audio consoles, and tape equipment.

189 Gordon St.
Eik Grove Village, IL 60007
(312) 437-7712

Contact: F. Geyer, TV Sales Mgr.

AUDIO RESOURCES, INC.

LINE: Crown International, dbx, Ivl Electronics, Electro-Voice, Otari Corp. Orban Associates, Micmix Audio Products, Tapco.

825 N. Cass Ave., Suite 205
Westmont, Illinois 60559
(312) 655-1180

Contact: Wayne Hrabak, Pres.

BEHREND'S, INC.

541 N. Franklin
Chicago, IL 60610
(312) 527-3060

Contact: Jack Behrend, Pres.

COLUMBIA VIDEO SYSTEMS

LINE: Video equipment, lighting, microphones, cabinets, consoles, headphones.

The Columbia Building
1741 Second St.
Highland Park, IL 60035
(312) 433-6010

Contact: Gene R. Kahn, V.P. Mk.

VICTOR DUNCAN, INC.

LINE: Full line of broadcast equipment.
200 E. Ontario
Chicago, IL 60611
(312) 321-9406

JOSEPH ELECTRONICS, INC.

LINE: Sony & Panasonic exact replacement parts, test equipment.

8830 N. Milwaukee Ave.
Niles, IL 60648
(312) 297-4200

KAPCO COMMUNICATIONS

LINE: Video editing / processing systems, consulting on CCTV systems.

5221 N. Elston Ave.
Chicago, IL 60630
(312) 545-2544

Contact: Kenneth Rubel, Pres.

WILLIAM M. LINZ ASSOC., INC.

LINE: Telex, Bogen, Mohawk wire, Pomona, SGL Waber.

821 Skokie Blvd.
Northbrook, Illinois 60062
(312) 498-9600

Contact: Bill Linz, Pres.

MESOMET, INC.

LINE: Color radar, satellite receivers, lightning detectors, weather data computer, forecasts consulting to management.

35 E. Wacker Drive
Chicago, IL 60601
(312) 263-5921

Contact: Dr. Walter Lyons, Pres.

NEWMAN / LUSTIG & ASSOCIATES

1050 N. State Street
Chicago, Illinois
(312) 642-5364

Contact: Michael Lustig, Partner

OTTAWA EQUIPMENT CO.

LINE: Microwave General, Phelps Dodge, Broadcast Electronics, Aiphone Intercoms, Cablewave Systems, Fidelipac, Micro Communications.

6838 N. Ottawa Avenue
Chicago, Illinois 60631
(312) 774-5115

Contact: Gordon Du Vall, Pres.

THEODORE PAPPAS & ASSOC.

LINE: Tape recorders, signal processing equipment, professional microphones, radio horns, micro computer system, speakers, parametric equalizers.

5218 W. Diversey Ave.
Chicago, IL 60639
(312) 685-2338

Contact: Terry DeRouin, Pres.

PAULMAR, INC.

3316 Commercial Ave.
Northbrook, IL 60062
(312) 498-1020

Contact: R. Menary, Pres.

GEORGE PETITT CO., INC.

LINE: Communications, meters & test equip., MATV, PA horns, mike stands, frequency meters, crystals, logic probes, switches, turntables & speakers.

5300 A McDermott Drive
Berkeley, Illinois 60163
(312) 261-0342

Contact: George Pettitt, President

POLYLINE CORPORATION

LINE: Reel-to-reel tape, cassettes, C-10 -C-90; leader and splicing tape; empty reels & boxes.

1233 Rand Road
Des Plaines, IL 60016
(312) 298-5300

ROSCOR CORPORATION

LINE: Ikegami, Sony, Panasonic, JVC, Hitachi, Quanta, Control Video, Convergence Corp., Harris Video Systems.

6160 W. Oakton St.
Morton Grove, IL 60053
(312) 539-7700

Contact: S. A. Detch, V.P.

ROSE GROUP

LINE: JBL, Teac-Tascam, Maxell, UREI, Deltalabs, Sound Technology, Soundcraftmen.

3333 Commercial Ave.
Northbrook, IL 60062
(312) 291-2260

Contact: Bill Steffey, V.P.

SCHUESSLER CASE CO., INC.

P.O. Box 39066
Chicago, IL 60639
(312) 227-0027

Contact: P.H. Kreft, Pres.

SONO-MAG CORPORATION

LINE: Exporter for products of Audicord Corporation.

1833 West Hovey Avenue
Normal, IL 61761
(309) 452-5313

Contact: Stephen S. Sampson, Exec. VP

STEFFEY MARKETING ASSOCIATES

LINE: AKG, Tascam, JBL, Sound Technology, MXR, Standard Communications.

3575 Commercial Ave.
Northbrook, IL 60062
(312) 480-3575

Contact: Bill Steffey, President

SWIDERSKI ELECTRONICS INCORPORATED

LINE: Hitachi Denshi America, Fernseh, Conrac, Microtime, Ampex Professional Audio, Audiotronics, Electro Voice, Shure Brothers, Convergence Corp., Dynair Electronics, O'Connor Engineering, Quick Set, Arvin Echo, Sony Corp. of America, Panasonic, US JVC Corp.

1200 Greenleaf Avenue
Elk Grove Village, IL 60007
(312) 364-1900

Contact: J. Swiderski III,
Vice President

SEE AD ON PAGE 151

TECH THEATRE, INC.

4724 Main St.
Lisle, Illinois 60532
(312) 971-0855

Contact: Gary Timm, V.P.

WIDL VIDEO

LINE: Maxell, Switchcraft, Belden, Amphenol, Memorex, Vaco and 3M.

5245 W. Diversey
Chicago, IL 60639
(312) 622-9606

Contact: Sophie Wrublik, Sales Mgr.
Jerry O'Connell, Sls. Desk

INDIANA

ADVANCED VIDEO COMMUNICATIONS

LINE: Video equipment.

49 S. Washington
Hinsdale, IN 60521
(312) 323-7464

Contact: Clarence Norris, Pro. Mgr.

ALLIED BROADCAST EQUIPMENT

LINE: Audio and RF broadcast equipment.

635 South E Street
Richmond, IN 47374
(317) 962-8596

Contact: D. Burns, Sls. Mgr.

COMMUNICATION SYSTEMS

LINE: Panasonic, Sony, Vicon, Ampex tape.

1142 E. Mishawaka Ave.
South Bend, Indiana 46615
(219) 289-6709, 289-3664

Contact: Frank Bogaert, Sls. Mgr.

CONSUMER SATELLITE SYSTEMS, INC.

LINE: TVRO receivers, satellite antennas, LNA's, feedhorns, cable, remote lifts, down converters & CCTV.

6206 La Pas Trail
Indianapolis, IN 46268
(317) 299-0020

Contact: Jon Powell, President
Mike Schroeder, G.M.

DA-LITE SCREEN COMPANY, INC.

LINE: Projectors, tripods, screens, rear projection systems.

3100 State Road 15 North
Warsaw, Indiana 46580
(219) 267-8101

Contact: E. J. Danch, Ad. Dir.

INDIANAPOLIS VIDEO, INC.

LINE: Hitachi, JVC, Sony, Lenco, Microtime, 3M Mincom.

8720 Robbins Road
Indianapolis, Indiana 46268
(317) 293-3313

Contact: W.T. Blackwell, Sales Mgr.

MAISH SALES

LINE: Taco/Jerrold, Aiphone Intercom, McGohan, Remeo Wire, Sound Technology.

500 S. Madison St.
Box 548
Mulberry, Indiana 46058
(317) 296-2322

Contact: Charles Maish, Owner

JON POWELL & ASSOCIATES, INC.

LINE: Vicon, Panasonic, Sanyo, Robot, Solfan.

P.O. Box 68635
Indianapolis, Indiana 46268
(317) 848-7777

Contact: Jon Powell, Gen Mgr.

SMITH-VICTOR SALES CORP.

301 N. Colfax
Griffith, IN 46319

(219) 924-6136

Contact: Bruce McCullough,
Mktg. Director

SUKUP & COX, INC.

LINE: Sanyo, Astatic, Kalatel, Gyyr.
2060 East 54th St.
Indianapolis, IN 46220
(317) 253-5501

Contact: Ronald M. Cox, V.P.

IOWA

KIMIA SALES, INC.

LINE: Recorders, intercoms, speakers, horns, mikes, amplifiers.

P.O. Box 503
1804 Sycamore St.
Atlantic, Iowa 50022
(712) 243-1626

Contact: Robert C. Willms, Pres.

SITLER'S SUPPLIES, INC.

LINE: No. 2610.
702 E. Washington
Washington, IA 52353
(319) 653-2123

Contact: Wm. C. Sitler, Pres.

WINEGARD COMPANY

3000 Kirkwood St.
Burlington, IA 52601
(319) 753-0121

Contact: Jos. Ridge, Sls. Mgr.

Continued on page 180

NEW One Inch Video Tape Evaluator



- Full Cycle Clean & Evaluate 2.7 minutes
- Fast Clean & Rewind Cycle 1.8 minutes
- Ruggedized for 24 Hour Operation
- Proven Safety and Reliability for Tapes

RECORTEC

Recortec installed its first Video Tape Evaluator (VTE) over 12 years ago! Now, we have combined all our industry experience and customer feedback into a new design with all the desirable features at an unbeatable price.

The new VTE-101 provides a built-in diagnostic panel for ease of calibration and a microprocessor controlled printer to provide more meaningful outputs. Our VTE's have been known to pay for themselves faster than originally estimated. Why not order yours now? Satisfaction guaranteed! To find out more, call Sid McCollum, our National Sales Manager.

475 Ellis Street Mtn. View, CA 94043
Tel (415) 962-0220 TWX 910 339 5022

KANSAS

DYTEC / SOUTH, INC.

LINE: Line test and measuring equipment.

8245 Nieman Road, Suite 123
Lenexa, Kansas 66214
(913) 888-0215

Contact: Bert Saunders, Sales Eng.

MIDTEC ASSOCIATES

LINE: Microwave equipment, including satellite-TV.

7702 Mize
DeSota, KS 66018
(913) 441-6565

Contact: Gary Yantis, President

RADIO SUPPLY CO.

LINE: Videotape and recorders; test equipment, broadcast and camera tubes and accessories.

131 Laura, P.O. Box 1220
P.O. Box 1220
Wichita, KS 67201
(316) 267-5213

Contact: Jeff Felzien, CSTV Mgr.

STEVE SMITH AUDIO VISUAL

LINE: Sony Video Products, Shintron, Bell & Howell Filmchain, Electronic Systems Products.

P.O. Box 1216
623 Kansas Ave.
Topeka, Kansas 66601
(913) 235-3481

Contact: L. Heilman, Sls. Mgr.

THEATRICAL SERVICES, INC.

LINE: Manufacturers of studio lighting distribution equipment, studio cycloramas, curtains and scrims; distributors of studio and location lighting equipment for video or film; and design and installation of studio lighting and control systems.

128 South Washington
Wichita, Kansas 67202
(316) 263-4415

Contact: M. Hostetter, V.P.

KENTUCKY

BRUCE DAWSON & ASSOCIATES

LINE: NEC Broadcast, Barco monitors.

Central American Terminal -
Bowman Field
Louisville, KY 40205
(502) 456-6666

Contact: Bruce L. Dawson, Owner

CENTURY SOUND & RECORDING

LINE: Speaker systems, boards, amplifiers, microphones, tape, recorders.

3029 Oregon St.
Paducah, KY 42001
(502) 554-2722

Contact: Thomas F. Morris, Owner

LOUISIANA

AUDIOMEDIA ASSOCIATES

LINE: Orban, Otari, Ampro/Scully, LPB, CCA, Potomac Instruments, UREI, Cablewave, Phelps Dodge. Transmitters, AM & FM audio consoles & studio equipment, audio processing equipment, turnkey installation services.

4657 Michoud Blvd.

P.O. Box 29264
New Orleans, LA 70189
(504) 586-0140

Contact: Corey G. Meyer, Owner

BASS ELECTRONICS, INC.

LINE: CCTV - specialized voice communication, pro sound.

1591 S. Elaine Drive
Baton Rouge, LA 70815
Contact: Haywood Bass, Pres.

FREELAND PRODUCTS CO.

LINE: Rebuilt transmitter tubes.

Rt. 7 Box 628
Covington, LA 70433
(504) 893-1243

Contact: W.T. Freeland, Owner

FUTURE VIDEO PRODUCTS LTD.

LINE: Panasonic, JVC, Scotch, Sony, Beiden, Amperex, Sanyo, Hitachi.

7130 Millford Ind. Rd.
Baltimore, MD 21208
(301) 484-1449

Contact: David Snyder, Pres.

HOME AND COMMERCIAL SOUND

LINE: Technics, Vanderstein, Hafler, Onkyo, Tascam, Electro-Voice, B&W Meridian Mirage, Audio Research, RGR, 3D, Stax, GLI, BGW, Concord, Linear Power.

4773 Convention Street
(Florida & Foster)
Baton Rouge, LA 70806
(504) 924-1001

Contact: Paul Kadair, Pres.

MAINE

MAINE VIDEO SYSTEMS, INC.

LINE: Sony, Panasonic, JVC, Strand Century, Microtime, RCA, Electro-Voice, Quicksat, KTH, Bretford, Sharp.

468 Forest Avenue
Portland, Maine 04101
(207) 773-2355

Contact: Jim Marshall, Sls. Dir.

MARYLAND

ASSOCIATED SALES REPRESENTATIVES, INC.

LINE: Audio Technica USA (microphones), HME (wireless microphones), Otari Corp (pro tape recorders, audio duplicators), Quantum Audio Labs (broadcast & studio audio boards), Tape Athon Corp. (background), TOA Electronics (audio amps, mixer boards, wireless mikes), UREI (audio signal processors, 10 oct & 4 1/2 oct. eq. on-air boards, power amps, studio monitor speakers).

8969 B Yellow Brick Road
Balto, MD 21237
(301) 574-0550
TELEX 908313

(aus back asr bal)

Contact: Philip Walter, Pres.

DAVID H. BROTHERS CO., INC.

LINE: Amperex, Bogen Div., White Instr., Audio-Technica, Telex Comm. Div., H.O.M.E. Inc.

19 Old Court Road
Baltimore, MD 21208
(301) 764-7189

Contact: Alan Brothers, Pres.

FUTURE VIDEO PRODUCTS LTD.

LINE: Panasonic JVC, Scotch, Sony, Beiden, Amperex, Sanyo, Hitachi.

7130 Millford Ind. Rd.
Baltimore, MD 21208
(301) 484-1449

Contact: David Snyder, Pres.

INTERNATIONAL SOUND CORP.

LINE: Panasonic, JVC, Scotch, Sony, Beiden, Amperex, Sanyo, Hitachi.

7130 Millford Industrial Road
Pikesville, MD 21208
(301) 484-2244

Contact: Harold Snyder, Pres.

THE LRS DISTRIBUTING COMPANY

LINE: Professional tape, blank cassettes.

29 Stonehenge Circle
Baltimore, Maryland 21208
(301) 484-7750

Contact: Bucky Buchman, V.P.

MUSIC / SOUND DIST.

LINE: Microphones, blank tape, cartridges, amplifiers, tuners, turntables, cassette decks, video recorders, cameras.

7 C Aylesbury Rd.
Timonium, MD 21093
(301) 252-9081

Contact: Bob Dawson, Div. Mgr.

PROFESSIONAL PRODUCTS, INC.

LINE: Sony, JVC, Panasonic, 3M, Systems Concepts Convergence, Harris.

4964 Fairmont Avenue
Bethesda, MD 20014
(301) 657-2141

Contact: Carter Kaufmann, Ex. V.P.

R. & R. LIGHTING CO., INC. & VOX CAM ASSOCIATES, LTD.

LINE: Theatrical, film, studio and stage lighting equipment. Renting and sales.

813 Silver Spring Ave.
Silver Spring, MD 20910
(301) 589-4711
(301) 589-5377

Contact: Bernard Robertson II, VP

SEL - TRONICS, INC.

LINE: Test equipment, patch panels, RF connectors, RF switch matrix, cabinet racks; Trompeter Electronics, Equipco Electronics.

721 Ellsworth Drive
Silver Spring, MD 20910
(301) 589-3391

Contact: Jules Joslow, Treas.

SHAFER ASSOCIATES, INC.

9501 Briar Glen Way
Gaithersburg, MD 20760
(301) 869-4477

Contact: Dr. Edw. Shafer, Pres.

TAUB SALES, INC.

12244 Veins Mill Rd.
Wheaton, MD 20906
(301) 942-3100

Contact: Morton Taub, Pres.

THEATRE SERVICE & SUPPLY

LINE: Lighting, studio cyclorama curtains & tracks, scenic supplies, light bulbs.

1792 Union Ave.
Baltimore, MD 21211
(301) 467-1225

Contact: R. Antsdel, Pres.

WILTRONIX, INC.

LINE: Leitch Video, NEC Broadcast, Ross Video, TFT.

16850 Oakmont Avenue
P.O. Box 364
Washington Grove, MD 20880
(301) 258-7676

Contact: D. L. Wilcox, Pres.

MASSACHUSETTS

ALCO ELECTRONIC PRODUCTS, INC.

LINE: Miniature and sub-miniature switches, knobs, lights, relays, mini oil-light controls.

1551 Osgood Street
No. Andover, MA 01845
(617) 685-4371

Contact: Jay Webster, Ad. Mgr.

CRAMER VIDEO, INC.

LINE: Ampex, Sony, Panasonic, Hitachi, Ivie, 3M, JVC, Scully, Sharp, Raytheon, Amperex, Sanyo.

120 Hampton Ave.
Needham, MA 02194
(617) 449-2100

Contact: Don Mulhern, Ex. VP

CRIMSON CAMERA TECHNICAL SALES, INC.

LINE: Photographic, audio visual and video equipment and supplies.

325 Vassar St.
Cambridge, MA 02139
(617) 868-5150

Contact: Helen Anderson, Sales Manager

INDUSTRIAL COMPONENTS CORPORATION

LINE: Audio equipment, electronic parts, wire & cable, test equipment.

2551 Boston Road
P.O. Box 668
North Wilbraham, MA 01095
(413) 596-3854

Contact: Stephen R. Welch, V.P.

LAKE SYSTEMS CORPORATION

LINE: Broadcast and production audio and video hardware.

55 Chapel Street
Newton, MA 02160
(617) 244-6881

Contact: Bill Dwyer, President

MALCO ELECTRONICS, INC.

LINE: Sony, Panasonic, JVC, Ikegami, Sharp, Videotek.

5 Wolcott Ave.
Lawrence, MA 01843
(617) 685-4383

Contact: Bob Lamm, Video Mgr.

PROFESSIONAL VIDEO SYSTEMS/PROFESSIONAL RECORDING SOUNDS (PVS/PRS)

LINE: PVS, video equipment and telecommunications systems: PRS-Otari, Orban, Optimod, EYEI, Eventide, dbx, Neumann, Sennheiser, Crown, Cumlif, BE, Ampex, Technics, Runisa.

1616 Soldiers Field Rd.
Boston, MA 02135
(617) 254-2101

Contact: Kip Johnson, Sls. Mgr.

PIPER ASSOCIATES, INC.

LINE: Communications, video, audio, computer.

33 Marsh Rd. - Box 226
Needham, MA 02192

(617) 449-1144
Contact: Jim Piper, Pres.

MICHAEL SCOTT CO., INC.
LINE: Professional and commercial sound equipment.
P.O. Box 384
Wellesley Hills, MA 02181
(617) 235-0102
Contact: Michael Scott, Pres.

VF SALES, INC.
LINE: Audio equipment.
181 Worcester Rd.
Nabick, MA 01760
(617) 237-6544
Contact: Victor Faucon, Pres.

F. M. VALENTI, INC.
LINE: Panasonic CCTV, Comprehensive Video, Smith Victor, Echolab, Hitachi, Maxell, Knox, Sharp, Visual Methods, Zeimark.
16 Saddle Club Rd.
Lexington, MA 02173
(617) 861-0089
Contact: Fran Valenti, Pres.

MICHIGAN

AUDIO DISTRIBUTORS, INC.
Ampex, Audiotronics, Broadcast Electronics, Crown, ESE, EV, IVIE, Moseley, Otari, QEI, Shure, Sony, UREI.
2342 S. Division
Grand Rapids, MI 49507
(616) 453-0510
Contact: Dave Veldsma, Pres.

CM SALES
LINE: Otari, dbx, Studiomaster, Soundcraft, Hitachi Denshi, AudioTechnica, Calzone, Cetec Gauss, AB Systems.
2221 Lakeshore
W. Bloomfield, MI 48033
(313) 626-2397
Contact: Casey McWilliams,
President

CRUSE COMMUNICATIONS CO.
LINE: DVS, Sony, Panasonic, Colortran, Sharp, Cezar, American Data, 3M tape, 3M Mincom, Videomedia, Videotek.
4903 B Dawn Ave.
East Lansing, MI 48823
(517) 332-3579
Contact: William H. Cruse, Pres.

VICTOR DUNCAN, INC.
32380 Howard
Madison Heights, MI 48071
(313) 589-1900
SEE AD ON PAGE 172

H. M. DYER ELECTRONICS, INC.
LINE: Video and audio distribution, amplification, processing, etc. Video switching, video delays, studio and video routing, RF monitoring, transmitter controls, digital effects.
31185 Ten Mile Rd.
Farmington Hills, MI 48024
(313) 478-2157
Contact: Mike Dyer, Pres.
SEE AD ON PAGE 199

FANTASEE LIGHTING
LINE: Rainbo, Teatronics, Altman, GE, Lee filters, PyroTech, Genie towers, Atlas Stands.

404 N. River
Ypsilanti, MI 48197
(313) 482-6565
Contact: Stefan Gray, Pres.

GENERAL TELEVISION NETWORK
LINE: Sony, JVC, Panasonic, 3M, Microtime, Ikegami.
13225 Capital Avenue
Oak Park, Michigan 48237
(313) 548-2500
Contact: R. Hippler, Pres.

NORWOOD SCROGGS COMPANY
LINE: Electronic components: heat sinks, caps, ferrites, keyboards, power supplies, cabinets, magnetic shielding, RFI/EMI filters, PC boards attenuators, square/rotary switches.
2221 Arbor Hills Rd.
Jackson, MI 49201
(517) 750-1170
Contact: Woodie Scroggs, Owner

O'HARA ASSOCIATES
LINE: Audio equipment, AC/DC power supplies, FET preamps.
36500 Weideman Drive
Mt. Clemens, MI 48043
(313) 791-7140
Contact: Bob O'Hara, Mgr.

RAACO MARKETING
LINE: Nortronics, H-M Electronics, Sony Professional.
4379 Orion Road
P.O. Box 410
Rochester, MI 48063
(313) 652-2520
Contact: R.E. Ridderhoff, VP

SOUND SOLUTIONS, INC.
LINE: NEC, Broadcast Electronics, miscellaneous audio lines.
7641 19 Mile Rd.
Sterling Hts., MI 48077
(313) 739-7020
Contact: Dave Hill, Pres.

THALNER ELECTRONICS
LINE: Sony, Panasonic, JVC, Hitachi, CMX, Ikegami, Fernseh, ISI, Sharp, Harris and Dynair.
7235 Jackson Road
Ann Arbor, MI 48103
(313) 761-4506
Contact: Karl Couyoumjian,
Sales Manager

VIDICOM ENGINEERING INC.
LINE: Video production equipment and services for business & industry.
P.O. Box 308
County Road 652
Mattawan, MI 49071
(616) 668-3375
Contact: John Lepley, Sales Mgr.

WEBSTER COMMUNICATIONS
LINE: Communications equipment.
115 Bellarmine
Rochester, MI 48063
(313) 375-0420
(800) 521-2333
Contact: Roger Webster, Owner

WOLF ASSOCIATES
LINE: Television lighting equipment, dimmer control systems, lighting distribution equipment. (Strand Century)
Continued on page 182

sachtler video 25

the state-of-the-art
video fluid head
designed to supporting your
ENG- and EFP-cameras

Now ready to go into operation.

sachtler video 25

featuring:

Center of Gravity Compensation
4 step Dynamic Counterbalancing Control
2 times 7-step on/off drag control for pan and tilt
Touch & Go wedge plate

The rock-steady, silky-smooth cameramen's
fluid head, doing everything in
news gathering and field-production.

The all-in-one-piece camera support system.

Call or write:

Sachtler Corporation of America

400 Oser Ave., Hauppauge NY 11788

Phone: (516) 231 0033

a subsidiary of

Sachtler gmbh, Dieselstraße 16, D-8046 Garching

Phone: (089) 3204041, Telex: 5215340

or your nearest sachtler-distributor.

AMPEX - BOSCH -
HITACHI - IKEGAMI
- IVC - JVC - LINK -
MARCONI - NEC - PANASONICS -
PHILIPS - RCA - SHARP - SONY -
THOMSON - TOSHIBA
...and other fine makes
of professional cameras.



17200 W. 10 Mile Road
Suite 205
Southfield, MI 48076
(313) 552-8595
Contact: Stan Wolf, Owner

MINNESOTA

AVC SYSTEMS

LINE: Otari, Scully, Ampex, Ampro, JBL, Altec, Electro-Voice, Shure, AKG, Russco, UREI, Tascam, Tangent, Tapco, Stanton, Scotch, BGW, 3M, Telex, Revox, Technics.

1517 East Lake St.
Minneapolis, MN 55407
(612) 729-8305

Contact: Michael Siegel, Sls.

EMMONS ASSOCIATES, INC.

LINE: Broadcasting and production equipment.

1121 Riverwood Drive
Burnsville, Minnesota 55337
(612) 890-8920

Contact: Keith Emmons, Pres.

KODO ASSOCIATES, INC.

9031 Penn Ave. S.
Minneapolis, MN 55431
(612) 881-1255

Contact: Kodo Kawamura, Pres.

METEOROLOGICAL APPLICATIONS

LINE: Color radar systems, computer graphics for weather, lightning location and display systems.

511 Eleventh Ave. South
Minneapolis, MN 55415
(612) 333-1424

Contact: Dr. Walker Lyons, Pres.

MINNEAPOLIS MAGNETICS

LINE: Audio heads: Scully, Ampex, Revox. Cart heads.

7178 Shady Oak Road
Eden Prairie, MN 55344
(612) 944-7660

Contact: Ron Floding,
Dir. of Operations

PAUL OHLIN SALES CO.

LINE: Alexander Mfg. NiCad batteries, Marden crystals.

6004 Olinger Blvd.
Minneapolis, MN 55436
(612) 929-6924

Contact: Paul Ohlin, Owner

T. R. PITTS CO.

LINE: Various, CATV.

501 West 5th St.
P.O. Box 57
Winona, MN 55987
(507) 452-2629

Contact: T. R. Pitts, Owner

SKOR, INC.

1821 University Ave.
St. Paul, MN 55104
(612) 645-6461

Contact: H. E. Kurzweg, Pres.

SYNSAT COMMUNICATIONS

LINE: NVG weather satellite receiving system, MED-weather forecast, Vektorn fish & game forecasts.

5202 Grandview Lane
Minneapolis, MN 55436
(612) 927-0641

Contact: John Uldrich, President

TODD COMMUNICATIONS, INC.

LINE: Ikegami, Sony, Harris Video Systems, 3M, Panasonic, Lenco, Fernseh, Tektronix, Videomedia.

6545 Cecilia Circle
Minneapolis, MN 55435
(612) 941-0556

Contact: Wayne Mayer,
Director of Video
SEE AD ON PAGE 165

TODD COMMUNICATIONS R.F. Division

LINE: Scientific Atlanta, Emcee, Bogner, Microwave Associates, Cablewave, Andrew, Anlter Mark, Allied Tower.

6545 Cecilia Circle
Minneapolis, MN 55435
(612) 941-0556

Contact: Tom Uppman, Gen. Mgr.

VIDEO MIDWEST, INC.

LINE: Convergence, Hitachi, JVC, Microtime, Sony Video Products, Sony Professional, Quanta.

434 Stinson Blvd.
Minneapolis, MN 55427
(612) 379-3300

Contact: Jon Larson, Rental Mgr.

THE WINSTED CORPORATION

LINE: Editing consoles, tape & video storage systems, dubbing and post production consoles.

8127 Pleasant Ave. So.
Minneapolis, MN 55420
(612) 888-1957

Contact: G. R. Hoska, Sls. Mgr.

MISSISSIPPI

TRANSVOLT-INC.

LINE: Parker suppressors, voltage spike damage.

1840 Capitol Towers
Jackson, MS 39201
(601) 362-2697

Contact: Bill Fulgham, Eng.

MISSOURI

DYTEC/SOUTH INC.

LINE: Test equipment, component amplifiers, mixers, oscillators & antennas, A/D-D/A converters.

11657 Adie Road
Maryland Hts., MO 63043
(314) 569-2990

Contact: H. Crain, Pres.

ELECTRONIC VIDEO SUPPLY

1856 S. Stewart
Springfield, MO 65804
(417) 881-4766

Contact: Larry Welbern, Pres.

LINES VIDEO SYSTEMS

Div. Lines Music Co.

LINE: Video equipment.
Jefferson at McDaniel Sts.
Springfield, MO 65806
(800) 641-4674
(417) 862-5533

Contact: Bud Lines, V.P.

NATIONAL AUDIO CO., INC.

LINE: Apex audio & video tapes, Fidelity broadcast tape cartridges, Telex cassette copiers, Edlall splicing & editing supplies.

Box 3657, G.S.
1911 S. Stewart
Springfield, MO 65808
(417) 883-5377

Contact: Steve Stepp, Pres.

RADONICS ELECTRONICS

LINE: RCA, Panasonic, Videotek, Amtron, Scotch.

4445 Gustine
St. Louis, MO 63116
(314) 481-2222

Contact: Harry Knapp, Salesman

TELEVISION ENGINEERING CORP.

LINE: Ikegami Broadcast, Conrac, Auditronics, Broadcast Electronics, BTX, Kaitronics, ISI, JVC, ITE, Microdyne, BAL, Videotek, Tektronix, Thomson-CSF, Colortran, Scully.

580 Goddard Ave.
Chesterfield, MO
(314) 532-4700

Contact: Sharon Sokup,
Sales Administrator

VIDEO MASTERS, INC.

LINE: Sony Industrial, Sony Broadcast, JVC, HVS, Hitachi Denshi, Lenco, Quanta, CMX, 3M Tape, 3M, Datavision-Mincom, Videotek, Tektronix.

1616 Broadway
P.O. Box 1963
Kansas City, MO 64141
(816) 474-8530

Contact: Virgil Jones, VP

MONTANA

HOLM - JAMES DIST., INC.

LINE: Sony video, Panasonic video, Shure, Bogen, Videotek, Telex.

P.O. Box 2487
320 6th Street
Great Falls, Montana 59403
(406) 761-2420

Contact: R. E. Holm, Mgr.

NEBRASKA

ATV RESEARCH

LINE: CCTV cameras, monitors, modulators (RF), camera & modulator kits.

13th & Broadway
Dakota City, NE 68731
(402) 987-3771

Contact: Mel Shadbolt, Pres.

TODD COMMUNICATIONS

LINE: Ikegami, Sony, Harris video systems, 3-M, Panasonic, Lenco, Fernseh, Tektronix, Video-Media.

120 S. 41st St.
Omaha, NE 68131
(402) 551-7600

Contact: Gordon Berry, Reg. Mgr.

VIDEO ASSOCIATES, INC.

LINE: Panasonic, Sony, Microtime, Convergence, ITE, Zenith, Vicon, Javelin, Hitachi, Brettford.

10135 "J" Street
Omaha, NE 68127
(402) 331-1883

Contact: John G. Petersen, Pres.

NEVADA

AC & DC, INC.

LINE: Lighting equipment and accessories.

3049 Rigel Ave. Bldg. C-S10
Las Vegas, NV 89102
(702) 871-4777

Contact: John L. Murray,
General Manager

THE VIDEO CENTER, INC.

LINE: Video equipment and accessories.

4310 Paradise Road
Las Vegas, NV 89109
(702) 732-3201

Contact: Philip Larschan, Pres.

NEW HAMPSHIRE

ASSOCIATED SYSTEMS

LINE: Electronic test equipment, monitors, data terminals, generators, video displays.

P.O. Box 5211
Manchester, NH 03108
(603) 472-2297

Contact: C.S. Miller

NEW JERSEY

9 WEST RECORDING STUDIO

Box 547
9 Westinghouse Plaza
Bloomfield, NJ 07003
(201) 429-8996

Contact: Frank R. Dickinson, Jr.,
President

AVTEC INDUSTRIES, INC.

LINE: Ikegami, Hitachi, Sony, Grass Valley, NEC.

39 Industrial Ave.
Teterboro, NJ 07608
(201) 288-6130

Contact: Oscar E. Kraut,
VP Mktg. & Sls.

CALVERT ELECTRONICS INC.

LINE: Eimac, RCA, Amperex, GE, Quick Set, others.

1 Branca Road
E. Rutherford, NJ 07073
(800) 526-6362
(201) 460-8800

Contact: Larry Broome, Sls. Mgr.
SEE AD ON PAGE 65

COMPREHENSIVE VIDEO SUPPLY CORP.

LINE: Video cameras, monitors, VTRs, amplifiers, lighting systems, systems monitors, synchronizers, dollies and stands, switches, transmission cable, full video lines.

148 Veterans Drive
Northvale, NJ 07647
(201) 767-7990
(800) 526-0242

Contact: H. E. Dunn, Sales Mgr.

CONRAC CORPORATION

LINE: Complete video installation, design, and service.

32 Fairfield Place
West Caldwell, NJ 07006
(201) 575-8000

Contact: Len Blascovich, Prod. Mgr.

DAYSTRONG INTERNATIONAL

LINE: Cablewave Systems, Phelps Dodge, Fidellpac, Dielectric, American Data, Grass Valley.

1707 - 76th Street
North Bergen, NJ 07047
(201) 868-6937

Contact: M. E. Arrue, Gen. Mgr.

FRANK R. DICKINSON, JR., INC.

LINE: Motor & capstan assembly rebuilding.

Box 547
9 Westinghouse Plaza
Bloomfield, NJ 07003
(201) 429-8996

H. M. HOLZBERG ASSOC., INC.
 LINE: NEC America, TFT Inc., HEDCO, Dynatech Systems, Terracom, Logitek, Elcom-Bauer, Shively, Roh, Orban Associates, Audiographics, digital mix effects, TV cameras, flame synchronizers, STL, remote pickup, microwave, transmitters, studio equipment, towers, monitors, remote control, patches panels.
 P.O. Box 322
 Totowa, NJ 07511
 (201) 256-0455
 Contact: Herb Holzberg, Pres.

KOPPE RADEN CORP.
 LINE: Cameras, monitors, VTRs, switchers, audio recorders, test equipment.
 10 Stuyvesant Ave.
 Lyndhurst, New Jersey 07071
 (201) 460-0800
 Contact: Saul Raden, President,

LSI AVIONIC SYSTEMS CORP.
 LINE: Eidophor large screen television projectors.
 32 Fairfield Place
 West Caldwell, NJ 07006
 (201) 575-8000
 Contact: Len Blascovich, Prod. Mgr.

LANDY ASSOCIATES, INC.
 LINE: Ikegami, Ampex, Conrac, Datatek, Leitch Video, O'Connor, JVC, Panasonic, Peter Lisand, Quick Set, RTS Systems, Recortec, Porta-Pattern, Kotel, Tektronix, Thomson-CSF, Videotek, Vinten, Image Video, etc.
 1890 E. Marlton Pike
 Cherry Hill, NJ 08003
 (609) 424-4660
 Contact: Jim E. Landy, Pres.

NEUTRIK PRODUCTS
 LINE: Connectors, audio equipment.
 91 McKee Drive
 Mahwah, NJ 07430
 (201) 529-3800
 Contact: Paul Roland, Asst. Tech. Mgr.

NORTH AMERICAN SOAR CORP.
 LINE: Electronic test and measuring equipment.
 1126 Cornell Ave.
 Cherry Hill, NJ 08002
 (609) 488-1060
 Contact: Lys Grebla, Oper. Mgr.

OKI ELECTRIC OVERSEAS CORPORATION
 One University Plaza
 Hackensack, NJ 07601
 (201) 646-0011
 Contact: Jim Tate, Mgr.

RCA SERVICE COMPANY
 Bldg., 204-Z
 Technical Services Rt. 38
 Cherry Hill, NJ 08358
 (609) 338-5924
 Contact: Edward B. Campbell, Manager

ROHDE & SCHWARZ SALES CO.
 14 Gloria Lane
 Fairfield, NJ 07006
 (201) 575-0750

SHEA SALES
 LINE: Distortion analyzers, low-distortion audio generators, tape tester audio DA's, audio control consoles, routing switchers, audio accessories.
 552 Prospect St.
 Maplewood, NJ 07040
 (201) 762-2382
 Contact: Tom Shea, Pres.

SONNY SIMBERKOFF ASSOCIATES, INC.
 LINE: Shure microphones, mixers, phono cartridges; Beckman digital multimeters; Hitachi oscilloscopes; ECS crystals; Waters faders.
 71 Valley St.
 So. Orange, NJ 07079
 (201) 763-7900
 Contact: D.C. Miller, Pres.

STYLIST SYSTEMS, INC.
 LINE: Microtime, Tectronix, Videotek, Fernseh, Jerrold, Ikegami, Dynair, Altec, JBL, Ivie, Strand Century.

39 Industrial Ave.
 Teterboro, NJ 07608
 (201) 288-6130
 Contact: Mr. James Gore, Pres.

SYMCO, INC.
 LINE: NEC, Hitachi, Comprehensive, Echolab, Smith-Victor, Dage/MTI, For-A, Panoak.
 26 Lurline Dr.
 Millington, NJ 07946
 (201) 647-6262
 Contact: Frank Colotta, Pres.

T.V.G.
 LINE: Rental broadcast and production equipment.
 555 Broad St.
 Glen Rock, NJ 07452
 (201) 444-2911
 Contact: C. Diehl

TELE-MEASUREMENTS, INC.
 145 Main Avenue
 Clifton, NJ 07014
 (201) 473-8822
 Contact: W.E. Endres, Pres.
 D. Cook, VP Sales

TELEVISION PRODUCTION SERVICES
 30 West Maple Avenue
 Bound Brook, NJ 08805
 (201) 469-5743
 Contact: R. S. Burks
 Exec. Prod./Dir.

THOR ELECTRONICS CORP.
 LINE: Electronic components.
 321 Pennsylvania Ave.
 P.O. Box 707
 Linden, NJ 07036
 (201) 486-3300
 Contact: A. Crudele, Pres.

VALIANT UNIVERSAL VIDEO
 LINE: Video accessories and supplies.
 195 Bonhomme Street
 Hackensack, NJ 07602
 (800) 631-0867
 (201) 487-6340 In NJ
 Contact: S. Goldstein, Sls. Mgr.

VIDEO RENTALS, INC.
 100 Stonehurst Ct.
 Northvale, New Jersey 07647
 (201) 767-1006
 Contact: Bill C. Ebell, Pres.

VISION-SOUND PROFESSIONAL AUDIO, INC.
 LINE: Harrison Systems, recording & post-production consoles; Studer Revox, tape recording equipment.
 110 Grand Avenue
 Englewood, NJ 07631
 (201) 871-4101
 (800) 526-4710 E. of Ohio
 Contact: Michael Salafia, Pres.

NEW MEXICO

DYMA ENGINEERING
 LINE: Ikegami, RTS, Videotek, Ross, BE, Video Data, Lenco, Ampex.
 213 Pueblo Del Sur
 P.O. Box 1697
 Taos, NM 87571
 (505) 758-8686
 Contact: C. Cunningham, Pres.
 SEE AD ON PAGE 191

NEW YORK

ADCOM COMM., INC.
 LINE: Videomedia Z-8, Hamsepic, EMS, Sony, JVC, Quanta.
 555 West 57th St.
 New York, NY 10019
 (212) 265-1760
 Contact: Richard Alexander,
 Sales Manager

ADWAR VIDEO CORPORATION
 LINE: Video equipment, microphones, lighting, transfers, editing, dubbing, modifications.
 100 Fifth Avenue
 New York, NY 10011
 (212) 691-0976
 Contact: Jon Burris, Salesman

Continued on page 184

WEATHER RADIO
Model CRW



Price \$380.00

Sensitivity .28 microvolts for 12 dB quieting. All 3 frequencies. Alert tone demutes receiver, closes relay and gates audio to 600 ohm rear terminals. Another set of rear terminals has continuous 600 ohm audio output. Double conversion crystal controlled, crystal filter in first I.F., ceramic filter in second I.F. Dual gate MOS FET front end. 50 ohm coaxial input. Adjacent channel (j25 KHz) down 70 dB. 19" rack mount, 3 1/2" H, all metal enclosure. In stock—available for immediate delivery.

EBS EQUIPMENT
Required for L.P.T.V.

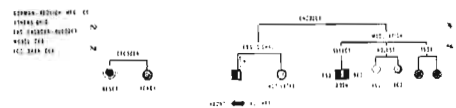

- Model CEB Encoder-Decoder **Price \$380.00**
- Model CE Encoder **265.00**
- Model CD Decoder **205.00**
- Encoder FCC Type Accepted Decoder FCC Certified
- Exceeds FCC Specifications
- Receiver can be supplied to drive Decoder. **\$100.00**

All interconnections to the EBS equipment are made through a barrier terminal block. No special connectors necessary. In stock—available for immediate delivery.

GORMAN REDLICH MFG. CO.

6 CURTIS STREET • ATHENS, OHIO 45701 • (614) 593-3150

Circle (131) on Action Card

Circle (132) on Action Card

WHERE TO BUY IT

ALBA VIDEO CENTER

LINE: VTR, VCR, TV, cameras, SEG, TBC, etc.

172 Madison Ave.
New York City, NY
(212) 886-0305

ARRIFLEX CORPORATION

LINE: ARRI daylight HMI lights, Arriflex motion picture equipment, Arriflex fluid head tripods.

500 Route 303
Blauvelt, NY 10913
(914) 353-1400

Contact: R. Schreiber, Sales Mgr.

EMIL ASCHER, INC.

LINE: Background music library.

630 Fifth Ave.
Suite 660

New York, NY 10111
(212) 581-4504

Contact: Lauri Levinson
Robert Aster, Sls. Mgr.

AUDIO VIDEO CORPORATION

LINE: Sony, Panasonic, DVS, Convergence, ISI, Quanta, Ikegami, 3M.

213 Broadway
Menands (Albany), NY 12204
(518) 449-7213

Contact: Ted Klarsfeld, Gen. Mgr.

DAVID BAIN ASSOCIATES

LINE: Broadcast Electronics, Potomac Instruments, Moseley Assoc., Fidelipac, Audiopak, ESE, Beyer, Shure, Nortronics, Cablewave Systems, Television Equip. Assoc., Dictaphone, Stanton Magnetics, Belar Labs, Inovonics Inc., Eventide Clockworks, Micro-Trak, Audio-Technica.

P.O. Box 1014
Port Washington, NY 11050
(516) 883-4818

Contact: David Bain, President

BARBIZON ELECTRIC CO.

LINE: Mole-Richardson lighting equipment; GE, Sylvania, Osram, Thorn, Chicago Miniature, lamps and sockets; Rosco and Lee Color Media.

426 W. 55th St.
New York, NY 10019
(212) 586-1620

Contact: Sidney Bloom, Pres.

BELDEN COMM., INC.

LINE: Lee filters, Color Media, Strand Century/laniro lighting, Lowell light location equipment, Matthews, Colortran; Dagmar, Sylvania & Osram bulbs.

534 W. 25th St.
New York, NY 10001
(212) 691-1910

Contact: Michael Sheppard, Pres.

BI-TRONICS, INC.

LINE: Mogami cable.

76 Main St.
Box 125
Tuckahoe, NY 10707
(212) 585-1645

Contact: Joel H. Schwartz, Pres.

BOYNTON STUDIO, INC.

LINE: AKG, Ampex, Atlas, Banner, Crown, dbx, EV, Inovonics, Micro-Trak, Orban, Ramsa, Sennhelsler, Shure, Stanton, Revox, Tascam.

Melody Pines Farm
Morris, NY 13808
(607) 263-5695

Contact: Fred Hohman, Tech. Sls.

BURNS AUDIOTRONICS, INC.

LINE: Mikes, amps, recorders.

5-05 Burns Ave.

Hicksville, New York 11801
(516) 935-8000

Contact: Norm Wieland, V.P.

THE CAMERA MART, INC.

LINE: Ikegami, Panasonic, Sharp, Microtime, Videotek, JVC, Ronford, Listec, Peter Lisand, Oconor, Sony, Sigma, For-A, RTS, Clear Com.

456 West 55th Street
New York, NY 10019
(212) 757-6977

Contact: Shelly Brown, Gen. Mgr.
SEE AD ON PAGES 28-29

CECO COMMUNICATIONS, INC.

LINE: Transmitting tubes, receiving tubes, camera tubes, CRT tubes, picture tubes, monitor tubes, serial conductors.

2115 Ave. X
Brooklyn, NY 11239
(212) 646-6300
(800) 221-0860

Contact: Tony Ianna, Brcdst. Mgr.
SEE AD ON PAGE 81

CITYWIDE SALES

LINE: Sennhelsler, Audio Technica, Ortofon, trade only.

1689 - 46th St.
Brooklyn, NY 11204
(212) 435-5100

Contact: Morty Fogel, Mkt. Mgr.

DALIS INDUSTRIAL ELECTRONICS

LINE: Belden wire & cable, Potter & Brumfield relays, Switchcraft connectors, Premier metal, Bud metal, Amphenol connectors, Dialight, etc.

35-35 24th Street
Long Island City, NY 11106
(212) 361-1100

Contact: Daniel Oberman, G.M.

BERNARD DARMSTEDTER ASSOC., INC.

LINE: Microphone and sound reinforcement

41 R. Oswego St.
Baldwinsville, NY 13027
(315) 638-1261

Contact: Bernard Darmstedter, Pres.

DOLPHIN PRODUCTIONS, INC.

140 East 80th Street
New York, NY 10021
(212) 628-5930

Contact: CeCe Lazarescu

D'SAN CORPORATION

25-30 163 St.
Flushing, NY 11358
(212) 746-8857

Contact: O. Swarth, Pres.

ERCONA CORPORATION

LINE: Fuses, fuseholders, plugs & connectors, headphones, microphones, lenses.

2492 Merrick Road
Bellmore, New York 11710
(516) 781-2770

Contact: M. Kandell, Sales Mgr.

F&B/CECO, INC.

315 West 43rd St.
New York, NY 10036
(212) 974-4600

Contact: Walter Druker, VP

RF GAIN, LTD.

LINE: Elmac, RCA, Machlett, Amperex, National Electron Tubes, CTC, Motorola, Philips, Acrlan, Amperex, Thomson-CSF, RF power transistor.

100 Merrick Rd.

Rockville Centre, NY 11570
(800) 645-2322

NY State: (516) 536-8868

GOTHAM AUDIO CORP.

LINE: Neumann, EMT, Telefunken, Fabec/TTM K&H.

741 Washington St.
New York, NY 10014
(212) 741-7411

Contact: Russ Hamm, VP

HAL - STAN ASSOCIATES

LINE: Police & fire flashlights.

160 New York Ave.
N. Babylon, NY 11703
(516) 587-9384

Contact: S. C. Rothschild, Partner

LAWRENCE K. HANER ASSOC., INC.

LINE: Power supplies, cable assemblies, switches, attenuators, filters, transformers, relays & triac devices.

900 Walt Whitman Rd.
Melville, NY 11747
(516) 423-2444

Contact: Larry Haner, Pres.

KARL HEITZ, INC.

LINE: Photographic equipment (still, cine, video).

979 Third Ave.
New York, NY 10022
(212) 421-5220

Contact: Christa Salmon,
Adv. Manager

J B VIDEO SALES

LINE: TV cameras, film chains, production switchers, time lapse VTR.

Box 77
Amawalk, NY 10501
(914) 245-1955

Contact: Joe Bottali, Pres.

LCA SALES CO.

LINE: Closed-circuit TV systems, master antenna systems, cable TV, commercial sound products, professional audio products.

76 Main St.
Tuckahoe, NY 10707
(914) 961-4700

Contact: Joel H. Schwartz,
Partner

LEVIT ELECTRONICS, INC.

LINE: Electron tubes & semi-conductors.

200 Park Avenue South
New York, NY 10003
(212) 777-5517

Contact: Michel Levit, Exec. VP

LEWIS & DUNNIGAN CO., INC.

LINE: Steel towers, coax cable, microwave shorrange, 2-way radio, headphones, microphones, antennas, cabinets.

104 Jamesville Road
Syracuse, NY 13214
(315) 446-5522

Contact: Dick Dunnigan, Pres.

LISTEC TV EQUIPMENT

LINE: W. Vinten Ltd. camera mounting equipment, Digivision monitor prompter, Electrohome video monitors.

39 Cain Drive
Plainview, NY 11803
(516) 694-8963

Contact: Joanne Camarda,
Manager

MPCS VIDEO, INC.

LINE: Sony, JVC, Panasonic, Ikegami, RCA, Quasar, Magnavox, 3M, TDK, Fuji.

514 W. 57th St.
New York City, NY 10019
(212) 586-3690

Contact: Paul Wilson, V.P.-Sales

MARTIN AUDIO - VIDEO CORP.

LINE: More than 300 professional audio & video lines.

423 W. 55th St.
New York, NY 10019
(212) 541-5900

Contact: Mike Bogen

MICRON AUDIO PRODUCTS

LINE: Micron wireless microphone systems, Diversity receiving systems, VHF antenna systems, Tram lavalier microphone systems.

210 Westlake Drive
Valhalla, NY 10595
(914) 761-6520

Contact: Paul Tepper, Pres.
SEE AD ON PAGE 163

MICROPHONICS

LINE: Sennheiser microphones, headphones & accessories. Importer-exporter of tubes, cable, phono cartridges, styl. Audio-Technica cartridges styl, Omtofon cartridges & styl, electronic tubes.

P.O. Box 37
Brooklyn, NY 11204
(212) 438-6400

Contact: Joseph Schwartz,
Sales Manager

MURA CORPORATION

LINE: Panel and indicating meters, potentiometers, IF transformers and coils, microphones, multi-testers, speakers, submini and mini lamps.

177 Cantiague Rock Rd.
Westbury, NY 11590
(516) 935-3640

Contact: William Mercurio, VP

NAGRA MAGNETIC RECORDERS INC.

19 W. 44th St.
New York, NY 10036
(212) 840-0999

Contact: Dom Notto, VP

NORTHEAST BROADCAST LAB, INC.

P.O. Box 1176
15 Charles St.
S. Glens Falls, NY 12801
(518) 793-2181

Contact: Bill Bingham, Pres.
SEE AD ON PAGE 164

PINZ SALES CORP.

LINE: Soundolier, Pickering, AIWA, Weatheralert.

570 Yonkers Ave.
Yonkers, NY 10704
(914) 423-4747

Contact: Ben Pinz, Pres.

PROFESSIONAL ELECTRONICS COMPANY

LINE: Harris, JVC, RCA, Panasonic, Sony, 3M, Dynair, Videodata, Videotek, Crosspoint, Lenco, Tektronix, Telex.

1594 State St.
Woodlawn Plaza
Schenectady, NY 12304
(518) 374-1515

Contact: Jerry H. Kolins, Pres.

JULES RACINE & CO., INC.

LINE: Stopwatches, chronographs, stop clocks.

85 Executive Blvd.
Elmsford, NY 10523
(914) 592-4760

Contact: Roger B. Smith, VP

KOPPE RADEN CORP.

LINE: Audio video broadcast communications equip. & supplies.

34 South Broadway
White Plains, NY 10601
(914) 682-8038

Contact: Lorraine Raden, VP

RAVEN SCREEN CORP.

LINE: Projection screens.

124 East 124th St.
New York, NY 10035
(212) 534-8408

Contact: Martin Soss, Pres.

ALAN SARFATY & ASSOC., INC.

26 Margaret Court
Great Neck, NY 11024
(516) 466-6770

Contact: Alan Sarfaty, Pres.

THE KEN SCHAFER GROUP

LINE: Eventide Clockworks; Redcom; Tamaphone, Swintek, Standard, Cetec-Vega.

10 E. 49th St.
3rd Floor
New York, NY 10017
(212) 371-2335

Contact: Paul Auerbach,
Dir. of Sales

SIGMUND LONDON, INC.

27-16 41 Avenue
Long Island City, NY 11101
(212) 786-1800

Contact: Stephen London, Treas.

SINGER PRODUCTS

LINE: Wide line of broadcast products for all applications.

875 Merrick Avenue
Holbrook, NY 11590
(516) 683-3000, ext. 602

Contact: J. Bicocchi,
GM/Broadcast

SOS PHOTO CINE OPTICS

LINE: Hajnal snorkel lenses, Lowel lights, Strand Century, Bardwell & McAlister light and grip equipment, animation equip. & supplies, motion picture cameras, lenses and editing equipment, Nagra recorders, projectors, S-8-16mm, 35mm. Used equipment of all types.

315 West 43rd St.
New York, NY 10036
(212) 974-4600

Contact: Hy Roth, VP Sales

TAPE CITY, INC.

LINE: Sony, Panasonic, JVC, RCA, Quasar, 3M, RDK.

404 Park Ave. South
New York City, NY 10016
(212) 679-1606

Contact: Andy Wander, Sls. Mgr.

TEAM ELECTRONICS, INC.

LINE: RCA, Amperex, GE, Toshiba, Hitachi, Panasonic, EEV, Ampex, Scotch, 3M.

24-16 Queens Plaza South
Long Island City, NY 11101
(212) 937-9200

Contact: Fred M. Samuel, Pres.

TELE-CINE, INC.

(A subsidiary of Schneider Corp. of America)

LINE: Exclusive distributor Schneider television Lenses, ENG, EFP, Studio, field, diascope Lenses— $\frac{1}{2}$ ", $\frac{3}{4}$ ", 1", 1 $\frac{1}{4}$ ".

400 Crossways Park Drive
Woodbury, NY 11758
(516) 496-8500

Contact: Bob Jones, Sls. Mgr.
SEE AD ON PAGE 141

TELESCO INTERNATIONAL

LINE: Radio and television studio and transmitting equipment.

125 Mineola Avenue
Roslyn Heights, NY 11577
(516) 484-3822

Contact: Gerald Lainer, Pres.

TELEVISION EQUIPMENT ASSOCIATES

LINE: Matthew, Rocal Acoustics, Elcom, Link.

Box 393
South Salem, NY 10590-0393
(914) 763-8893

Contact: Bill Pegler, Pres.

TEMTRON ELECTRONICS, LTD.

LINE: Transmitting tubes, camera pick up tubes, studio lamps, semiconductors.

15 Main St.
East Rockaway, NY 11518
(516) 599-6400

Contact: Ed Kramer, VP Mktg.

TESCO ASSOCIATES

LINE: Test equipment, scopes, generators, cabinets, batteries, recorders.

2002 Teall Ave.
Syracuse, NY 13206
(315) 463-4566

Contact: Ted Hendel, Owner

UNISTAGE, INC.

LINE: Yamaha, JBL, Eventide, Crown, AKG, Orban, Anvil, Clearcom, dbx, Spectrasonics.

330 Genesee St.
Buffalo, NY 14204
(716) 853-6500

Contact: Robert Lovejoy
Mgr. Pro-Sound

VIDEO COMPONENTS, INC.

LINE: Video accessories.

601 S. Main St.
Spring Valley, NY 10977
(914) 356-3700

Contact: Dick Turchen, Pres.

WESTEC AUDIO VIDEO INC.

LINE: Ampro/Scully, Audltronics, BTX, ATI, ESE, Fidellpac, RTS, Orban, Spectra Sonics.

1841 Broadway
Suite 1203
New York, NY 10023
(212) 586-1662

Contact: R. Maitland, Pres.
S. Lane, Op./Sales Mgr.

ZELLAN ENTERPRISES LTD.

LINE: Aaton, Angenieux, Century-Precision, Cooke, Harrison, Lowel, Tiffen, Zeiss, Sachtler.

250 West 57th Street
Room 414
New York, NY 10019
(212) 245-1598

Contact: Les Zellan, President

NORTH CAROLINA**ANGLE STEEL ERECTORS**

LINE: Towers, lighting, painting, ground systems

P.O. Box 55
Greenville, NC 27834
(919) 752-7323

Contact: William Angle Jr., Owner

BROADCAST SERVICES CO.

LINE: Audltronics, Broadcast Electronics, Electro-Voice, Revox, Electro-Impulse, Fidellpac, Audlopak, Sennheiser, Russco, Cablewave, Phelps-Dodge.

Route 3 Box 45E
Four Oaks, NC 27524
(919) 934-9590

Contact: Neal Davis, Owner

JIM CASON ELECTRONICS

5213A Trentwood Dr.
P.O. Box 1254
New Bern, NC 28560
(919) 638-5956

Contact: James L. Cason, III,
Owner

DOUG COOK & ASSOCIATES

LINE: Broadcast-professional.

6300 Carmel Road
Charlotte, NC 28211
(704) 542-6510
(800) 438-6040

Contact: Al Ellinson, Doug Cook
or Jim Claffin.

EME, INC.

LINE: Amber, Dage/MTI, Lightning Elimination Associates, NEC America, Terracom, TFT.

112 Buena Vista
High Point, NC 27260
(919) 869-3335

Contact: George W. Gold, Pres.

KIRKMAN ELECTRONICS, INC.

LINE: JVC, 3M, Videotek, Fortel, Anton Bauer, ESP, Bogen, Quick-Set, Lowel, Anvil, AKG, Tektronix, Comprehensive, Shure.

901 W. 2nd Street
P.O. Drawer K
Salem Station
Winston-Salem, NC 27108
(919) 722-9131

Contact: Read Clark, Mgr., Video

SOUTHEASTERN SIGHT & SOUND

LINE: Sony, Panasonic, JVC, Hitachi, HVS, Convergence, Strand Century.

P.O. Box 27786
Raleigh, NC 27611
(919) 828-2311

Contact: Lynn Irwin, Gen. Mgr.
Howard Rothstein,
VP/Mktg.

SOUTHERN COASTAL MARKETING SERVICES, INC.

LINE: RF & studio equipment for radio stations.

6300 Carmel Road
Charlotte, NC 28211
(704) 542-6543

Contact: Bob Cauthen, Gen. Mgr.

NORTH DAKOTA**AUDIO VISUAL, INC.**

LINE: JVC, Hitachi, Convergence,

Microtime, Lenco, 3M, Panasonic, Shlntron.

1818 East Broadway
Bismarck, ND 58501
(701) 258-6360

Contact: Joe Stoebner, Sls. Mgr.

OHIO**CARTWRIGHT COMMUNICATIONS CO.**

LINE: Two-way radio communications & accessories.

7812 Red Sky Dr.
Cincinnati, OH 45242
U.S. (800) 543-8614
OH (800) 582-2641

Contact: W. Y. Cartwright, Pres.

GRINNAN FIXTURE COMPANY

LINE: Loudspeakers, mikes & accessories, monitors, preamps, audio recorders, STL and SCA equipment, tape accessories, AM and FM transmitters, turnkey installation services, vans and mobile units.

16041 Georgetown St., N.E.
Minerva, Ohio 44657
(216) 862-2323

Contact: John F. Grinnan, Owner

KAVCO INC.

LINE: Over 600 lines of audio and video products. Complete turnkey systems for master control, studio control, editing suites, mobile vans, etc.

3931 Image Dr.
Dayton, OH 45414
(513) 898-2003

Contact: John Ellis, Sales Coord.

KLOPF AUDIO / VIDEO COMPANY

LINE: JVC, Sony, Panasonic, Hitachi, CEI, Rauland, 3M, NEC.

3381 Successful Way
Dayton, Ohio 45414
(513) 236-5500

Contact: Bill Kane, Sales Coord.

MIDWEST CORPORATION**Communications Systems Div.**

LINE: Ikegami, Hitachi, DVS, Sony, JVC, Panasonic, Quanta, 3M, Videotek, NEC, Scientific Atlanta, Microwave Associates, Lenco, Tektronix, Grass Valley, Ampex, Audltronics, Control Video, Cezar Int., Crosspoint Latch, Echo Lab, ITE, O'Conner, Quick Set, Eudtron, CVS, RTS.

1021 W. 8th Street
Cincinnati, OH 45203
(513) 651-1904

Contact: Jay Adrick, Branch Mgr.
SEE AD ON PAGE 9

R.E. INSTRUMENTS

LINE: Fiber optics, fiber-optic transmitters/receivers, digital modulators, demodulators.

31029 Center Ridge Road
Westlake, OH 44145
(216) 871-7617

Contact: Bruce Gravens, Mkt.
Sales Manager

OKLAHOMA**WALTER S. BREWER CO., INC.**

LINE: Electro Controls (lighting control systems), Bardwell & McAliston (lighting fixtures), Thorn Lighting (quartz lamps), Rosco (color materials).

2216 E. 56th Pl.
Tulsa, OK 74105
(918) 749-9894

Contact: Walter S. Brewer, Pres.

Continued on page 186

WHERE TO BUY IT

DOUG BROWN ENTERPRISES, INC.

LINE: Audio equipment, supplies, turn-key design and installation services.

1703 East Skelly Drive
Tulsa, OK 74105
(918) 747-3618

Contact: D. C. Brown, Pres.

DELCOM CORP.

LINE: Hitachi, Sony, Panasonic, ISI, Convergence, Microtime, Harris, For-A, Quanta, Laird.

6019 S. 66 E. Ave.
Tulsa, OK 74145
(918) 494-9500

Contact: Sam Pate, President

SATELLITE SYNDICATED SYSTEMS

LINE: WTBS, Atlanta.

8252 South Harvard - 74136
P.O. Box 45684
Tulsa, OK 74145
(918) 481-0881

Contact: Sel Kremer

OREGON

VIDEO BROKERS, INC.

10110 SW Numbus Ave. B-1
Portland, OR 97223
(503) 620-9021

Contact: Van M. Faulk, Sls. Eng.

VIDEOSONICS, INC.

LINE: Television systems equipment & design.

821 S.E. 14th Ave.
Portland, OR 97214
(503) 232-4632

Contact: George Morfin, Sls. Mgr.

PENNSYLVANIA

A B & T SALES CORP.

LINE: Speakers, amplifiers, receivers, and blank tape.

1000 Valley Forge
Circle-109B
King of Prussia, PA 19406
(215) 265-2028

Contact: Milt Dienes, Pres.

ALCARE COMM., INC.

LINE: Scott Time Lapse Weather Scan Box in addition to television programming.

1503-05 Walnut St.
Philadelphia, PA 19102
(215) 568-6010

Contact: Frank Beazley, Chrmn.

ALPHA VIDEO ELECTRONICS

LINE: Cameras, monitors, test equipment, VTRs, character generators, TBC, mikes, switchers.

28 East Mall Plaza
Carnegie, PA 15106
(412) 279-6169

Contact: H. B. Lasslge, Pres.

AUDIO INNOVATORS, INC.

LINE: The professional audio division of Audio Innovators Inc. carries more than 75 lines of pro audio equipment and accessories.

216 Blvd. of Allies
Pittsburgh, PA 15222
(412) 621-1950

Contact: M. J. Wilson, Op. Mgr.

BROADCOM T.M.

LINE: Cartridge machines; amplifiers;

equalizers; audio delay equipment; transmitters; mixers; studio furniture; noise reduction systems; turntables; headphones; mikes; monitoring devices.

Tilghman at Jefferson
Allentown, PA 18102
(215) 437-0607

Contact: Bill Davies

BRUSH MAGNETIC HEADS

3rd & Reagan Streets
P.O. Box 638
Sunbury, PA 17801
(717) 286-5611

Contact: Bob Trachtenberg, VP

CERCONE VINCENT ASSOCIATES

LINE: Strand Century, Mole-Richardson, Bardwell & McAllister, Lowell, Teatronics, GE, Osram, Clear-Com, Matthews, Uni-Set, Rosco, Lee, Union Connector, Anvil Cases.

2741 Noblestown Road
Pittsburgh, PA 15205
(412) 922-0901

Contact: Mark McGinnis, Sales

GEORGE M. CONNEEN CO., INC.

LINE: Wire & cable, microphones, monitor speakers, PA & pro sound speaker systems, audio amps, audio consoles, EQ.

P.O. Box 251
Springfield, PA 19064
(215) 544-5884

Contact: George Conneen, Sales

GRUVER RECORDING & SERVICE CO.

LINE: Used broadcast equipment, cassette tapes, NICad batteries, beautiful music and special format services.

214 N. Chestnut St.
Palmyra, PA 17078
(717) 838-6973

Contact: Gary L. Gruver, Owner

JOA CARTRIDGE SERVICE

LINE: Fidelipac, Capitol tape cartridges; 3M, Nortronics products at discount prices.

448 E. Hancock St.
Lansdale, PA 19446
(215) 362-8796

LERRO ELECTRICAL CORP.

LINE: VTRs, cameras, monitors, editing systems, character generators, battery/charges systems, mobile TV vans, professional audio and video equipment.

3125 N. Broad Street
Philadelphia, PA 19132
(215) 223-8200

Contact: Louis Lerro

LOFSTROM ELECTRONICS, INC.

LINE: Advance, Fujii, Hitachi Denshi, Jatech, Jerrold, JVC, Panasonic, Sound-oliver, Video Data, Winsted, World Video.

Empire Building
Glassport, PA 15045
(412) 461-2116 or
(412) 672-2554

Contact: Tom Mossbarger, Sales
David Owens, Sls. Engr.

ROBERT MEYERS ASSOCIATES

613 W. Cheltenham Ave.
Melrose Park, PA 19126
(215) 224-1663

RICHARD S. PASS ASSOCIATES, INC.

LINE: Swintek, Protech Audio, White Instruments, Mohawk Wire & Cable, Soundoller, AB Systems Design, ATS Cases, Minicom, Trutone Electronics, Ikegami Electronics (black & white only).

27 Oxford Drive
Langhorne, PA 19047
(215) 757-6100 or
(703) 370-9888

Contact: Richard Pass, President

PIERCE-PHELPS, INC.

LINE: CCTV, audio/visual equipment and supplies.

2000 N. 59th St.
Philadelphia, PA 19131
(215) 879-7171

Contact: Frank Brady, Sales Mgr.

PROCESSING PLUS

LINE: Distributor of broadcast equipment, audio processing specialist, and audio engineering consultants. IMP-3, Aphex, Fidelipac, Scotch 3M.

59 Brookside Road
P.O. Box 3303
Wescosville, PA 18106
(215) 398-3377
(800) 523-9396

Contact: Allan Winkler, VP/Sales

SEE ADS ON PAGES 162, 164

RABAL ASSOC., INC.

LINE: Video delay lines (1H & 2H), tape cleaners.

Box 114
Huntingdon Valley, PA 19006
(215) 947-4825

Contact: Allen S. Katz, Pres.

RO-CEL ELECTRONICS, INC.

LINE: Altec, JBL, Crown, E-V, AKG, Bi-Amp.

731 Butler St.
Pittsburgh, PA 15223
(412) 781-2326

Contact: Don Rosenberger, V.P.

TONER CABLE EQUIPMENT

LINE: Specialize in earth stations, towers, antennas, headends and apartment house amplifiers.

969 Horsham Road
Horsham, PA 19044
(800) 523-5947
In Pa call (800) 492-2512

VAL-TRONICS

Penn Park Bldg.
Pittston, PA 18641
(717) 655-5937

Contact: Milan J. Krupa,
Sales Manager

RHODE ISLAND

WRH BROADCAST SUPPLY

5 Industrial Way
Riverside, RI 02915
(401) 434-6272

Contact: Warren Hartwell, Pres.

TENNESSEE

AUDICON MARKETING GROUP

LINE: AKG, Ampro, Audifad, Barth, Beyer, BGW, dbx, Dolby, Eela, JBL, Lexicon, MCI, Raindirk, Scully, Sennheiser, Woelke.

1200 Beechwood Avenue
Nashville, TN 37212
(615) 256-6900

Contact: Claude Hill, President

AUDIO ARCHITECTS, INC.

LINE: Sound Workshop, Tascam, Otari, JBL, Audio & Design Recording, Tangent, Ursa Major, AKG.

112 Space Park Drive
Nashville, TN 37211
(615) 331-3247

Contact: Allen Rumbaugh,
Sales Manager

BARRY TRADING COMPANY

LINE: FM antennas, transmitters

P.O. Box 609
Lebanon, TN 37087
(615) 444-0305

Contact: William O. Barry, Owner

BROADCAST DISTRIBUTORS

LINE: 80 leading lines of audio & radio equipment.

3800 Keith St., N.W.
Cleveland, TN 37311
(615) 472-8200

Contact: Thos. Duncan, Mgr.

BROADCAST EQUIPMENT & SUPPLY CO., INC.

LINE: Broadcast Electronics, E-V, Shure, Russco, Ampro, LPB, Switchcraft, Teac, Revox, Stanton, Micro-Trak, Fidelipac.

Rt. 1-Weaver Pike
Bluff City, Tennessee 37618
(800) 251-0487 or
(615) 878-2531

Contact: Clifton Droke, Sls. Mgr.

PHASE AUDIO

LINE: Audio equipment, Auditratics, JBL.

151 N. Angelus
Memphis, TN 38104
(901) 726-1900

Contact: Bill Kenner, Sls. Mgr.

JOHN W. GARDNER, INC. D/B/A/ T.H.E. Co.

LINE: White Instruments, dbx, Dorrough, Sony Microphones, Eventide, Eastern Acoustics, AB Systems, Standard Wire & Cable.

28 Music Square East
Nashville, TN 37203
(615) 320-0807

Contact: Sales Manager

REDWOOD MARKETING GROUP

LINE: Redwood Research param equalizer, R. Barth KG audios, V311, Musicoder, Woelke test and measuring equipment. Heads.

820 Redwood Drive
Nashville, TN 37220
(615) 331-4743

Contact: Terry L. Hill, Mktg. Dir.

VALLEY PEOPLE, INC.—RETAIL

LINE: Otari, Sound Workshop, Auditratics, Lexicon, BTX, Fostex, Dolby, UREI, Crown, JBL.

2820 Erica Place
P.O. Box 40306
Nashville, TN 37204
(615) 383-4737

Contact: Bob Todranc, Exec. VP

TEXAS

ABADON / SUN., INC. dba ASI

LINE: Crown, JBL, AKG, Ampex, Auratone, dbx, Eventide, HME, Lexicon, MRL, Neotek, Orban, Quantium, Sennheiser, Soundcraft, Tascam, Teac, Technics, UREI, White.

P.O. Box 6520

San Antonio, Texas 78209
(512) 824-8781
Contact: Galen Carol, Pres.

BOB AMOS & ASSOCIATES, INC.
LINE: Sennheiser; Frazier monitors.
P.O. Box 3247

Irving, Texas 75061
(214) 827-8232, 252-1161
Contact: Bob Amos, Pres.

BRADENCO CORP.
LINE: Marconi Instruments, Kings Electronics, Allen Avionics, JFW, Western Microwave.
11500 Stemmons Fwy. #107
Dallas, Texas 75229
(214) 243-7261
Contact: Robert Braden, Pres.

BROADCAST SYSTEMS, INC.
LINE: Conrac, Tektronix, Philips, Vinten, 3M, Dielectric, Cetec Antennas, Videotek, Microtime, RTS, Farrtronics, HME, Dynatech, Moseley, Belar, Thomson-CSF, Gray Engineering, Myat, Electrohome. Approximately 80 other product lines of television support equipment.
8222 Jamestown Drive
A103
Austin, TX 78758
(512) 836-6011
(800) 531-5232
In Texas (800) 252-9792
Contact: Cary Fitch, Sls. Mgr.
SEE ADS ON PAGES 88, 170

CFA/MEDIA SPECIALTIES, INC.
LINE: Strand Century, dimming/fixtures; Lowel, portable lighting; Union Connector, connectors; Matthews, grip equipment; Paramount sound, sound systems; Rosco and Lee, filters, Cam-Lok, connectors; Oshram, lamps; Sylvania, lamps.
P.O. Box 34567
San Antonio, TX 78233
or
8234 Vicar
San Antonio TX 78218
(512) 657-5997
Contact: Marlene D. Hart, Sales
T.L. Folsom, Pres.

CAMPION SALES CO., INC.
LINE: Shure, Tape-Athon, Robline, Gold Line, Audio Magnetics.
P.O. Box 1830
Richardson, Texas 75080
(214) 238-8145
Contact: R. M. Campion, Pres.

COMPUCON
LINE: Consultant
P.O. Box 401229
Dallas, Texas 75240
(214) 233-4380
Contact: D. Coupe, Mgr.

CROUSE - KIMZEY COMPANY
LINE: Broadcast studio equipment.
3507 West Vickery
Fort Worth, Texas 76107
(817) 737-9911
Contact: M. Bradford, Sales Mgr.

VICTOR DUNCAN, INC.
LINE: Sony, JVC, Panasonic, Panavision, Barco, Fernseh, Tektronix.
2659 Fondren
Dallas, TX 75206
(214) 369-1165
Contact: Bill Ludwig, Sls. Mgr.
SEE AD ON PAGE 172

EIDSON ELECTRONIC CO.
LINE: AM, FM & TV crystals for frequency control.
P.O. Box 3751
Temple, Texas 76501
(817) 773-3901
Contact: M. Eidson, Mgr.

GIESLER BROADCASTING SUPPLY
LINE: Ampex, Scully, Autogram, Broadcast Electronics, Cablewave, dbx, Fidelipac, Logitek, Moseley, Orban, Potomac Instruments, QEI, UREI, CSP.
9440-L Harwin Dr
Houston, TX 77036
(713) 974-6205
Contact: Bernie Giesler, Pres.
SEE AD ON PAGE 166

GUARANTEE RADIO SUPPLY
LINE: Ampro/Scully, ITC, Ampex, Singer, JVC, Sony, Eimac, Ampex, Autogram, Ramko, TFT, Logitek, Scotch 3M.
1314 Iturbide
Laredo, TX 78040
(512) 723-6913
Contact: R. A. Reyes, Exec. V.P.

INDUSTRIAL AUDIO / VIDEO, INC.
LINE: Sony, JVC, Ikegami, Scotch, Conrac, Tektronix, ISI, Shlntron, Harris Video Systems, CMX Orrox, JBL, RTS, AKG, Shure, EV.
2617 Bissonnet
Houston, Texas 77005
(713) 524-1956
Contact: David Patton, Pres.

JBS ENTERPRISES, INC.
LINE: Communication, radio & pager batteries, VTR; biomedical batteries; AMT.
7817 Charter Oak Ct.
Ft. Worth, Texas 76179
(817) 236-7606
Contact: James B. Schusler, Owner

LINROSE ELECTRONICS CORPORATION
202 West Nakoma
San Antonio, Texas 78216
(512) 342-8849
Gordon W. Tobias, President

MEDIA SPECIALTIES, INC.
LINE: Ianiro, Strand Century, Paramount Sound Systems, Osram, Sylvania, Lee Filters, Rosco Sharp.
P.O. Box 34567
San Antonio, TX 78233
(512) 657-5997
Contact: Thos. L. Folsom, Pres.

MICRO CONTROL ASSOC., INC.
P.O. Box 694
Cleburne, TX 76031
(817) 295-7771
Contact: Robt. E. Richards, Pres.

MIDCOM, INC.
LINE: AKG, Audio Interconnect, Audio Services, BGW, Belden, Beyer, Blamp, Cerwin Vega, Cetec Vega, Clearcom Countryman, Crown, Crown PZM, dbx, Editall, Electro-Voice, Emcor, Eventide, HME, ITC, Interface Elec., Ivie, JBL, Kenwood, Lexicon, MXR, Micmix, Mohawk, Orange County, Orban, Quantum, RTS, Sennheiser, Setcom, Shure, Sony, Soundcraft, Sound Workshop, Star Cases, Switchcraft, Studer Revox, Tannox, Technics, Tram, UREI, White Inst.

2231 E. Division
Arlington, Texas 76011
(817) 461-2211
Contact: Mike Simpson, Pres.

MZB & ASSOCIATES
LINE: Video products and installation systems, cameras, etc.
4203 Beltway
Dallas, TX 75234
(214) 233-5535
Contact: Richard W. Bock, VP

PROFESSIONAL AUDIO SERVICES
LINE: Fidelipac, Stanton, Nortronic, 3M, Ampex, Electro-Voice, Audiotape, Audiolab, Editall.
P.O. Box 1953
Ft. Worth, Texas 76101
(817) 536-6254
Contact: Jeanie, Telephone Sales

SAVCO
LINE: Audio, video, RF—most lines.
P.O. Box 427
Richardson, Texas 75080
(214) 234-1841
Contact: N. Hughes, Gen. Mgr.

SPECTRUM PLANNING, INC.
1850 N. Greenville
Richardson, TX 75081
(214) 699-3536
Contact: G.L. Armes, Exec. VP

THE GENE SUDDUTH CO., INC.
LINE: Central Dynamics, Leitch Video, Knox Video, Audiotronics, Howe Audio, Datatek, Skotek.
P.O. Box 1116
Paris, TX 75460
(214) 785-5727
Contact: Gene Sudduth, Owner

TENICKI & ASSOCIATES
LINE: Otari, Orban, Ransa, Audio-Technica, URSA-Major, Cetec Gauss, AB Systems, Soundcraft, GLI, RSS, CAE.
5719 Kirby - Suite 17
Houston, Texas 77005
(713) 528-2005
Contact: Randy Tenicki, Pres.

WESTBROOK AUDIO, INC.
LINE: Otari, Sound Workshop, Amek, dbx, Crown, Delta-Lab, Neumann, AD&R.
11836 Judd Court, Suite 336
Dallas, Texas 75243
(214) 699-1203
Contact: Paul R. Westbrook, Pres.

WHALIN'S PRO AUDIO SALES
LINE: ADC Products, UREI, Electro-Voice, Shure.
2910 Buena Vista
Arlington, Texas 76010
(817) 640-0261
Contact: Louis D. Whalin, Owner

UTAH

J. E. HALL CO.
LINE: Pro & consumer sound, Edcor, Emilar, JBL, Intermagnetics, Niko, Shakespeare.
220 E. 3900 South #10
Salt Lake City, Utah 84107
(801) 268-3263
Contact: J. E. Hall, Owner

SKAGGS VIDEO SALES
LINE: Ikegami, Conrac, Tektronix, Panasonic, 3M, Sony Broadcast, etc.
4865 Wiley Post Way
Salt Lake City, Utah 84116
(801) 539-1420
Contact: Sam N. Kichas, Gen. Mgr.

TV SPECIALISTS, INC.
LINE: Panasonic (professional, UHS, CCTV), Sharp, Sony, Edutron, Kloss, MGA.
180 East 21st South
Salt Lake City, Utah 84115
(801) 486-5757
Contact: Ted Bollinger, Sls Mgr.

VIRGINIA

ALPHA AUDIO
LINE: Sonex-Sound absorbing anechoic wedge foam. Broadcast equipment consultation, design and fabrication services from concept to completion.
2049 W. Broad St.
Richmond, VA 23220
(804) 358-3852
Contact: Dave Jones, Prod. Mgr.
Eric Johnson, G.M.

BROADCAST ENGINEERS & EQUIPMENT REPS
LINE: Professional broadcast equipment for AM and FM radio.
P.O. Box 4777
Richmond, VA 23229
(804) 747-1212
Contact: Melvyn Lieberman, Mgr.

BOB DIX, INC.
LINE: Cetec, Singer, Moseley, Otari, Belar, ITC, Technics, dbx, Crown, JBL, Orban, TFT, Revox, Cablewave, Andrew, CRL, Urei, Sennheiser, Shure, Fidelipac, Eventide, Scully, Potomac, Bird, Delta.
P.O. Box 31
Marion, Virginia 24354
(703) 783-2001
Contact: Bob Dix, President

DAVID GREEN BROADCAST CONSULTANTS CORP.
LINE: 135 lines of broadcast equipment. Finance and lease plans available.
P.O. Box 590
Leesburg, Virginia 22075
(703) 777-6500, 8660
Contact: David Green, President
Art Reed, Tech.
Engineering Specialist
SEE INSERT, PAGES 133-134

MULTIPHASE CONSULTING
LINE: AM / FM studio and transmission equipment and consulting.
4209 Lamarre Drive
Fairfax, VA 22030
(703) 273-1960
Contact: H. I. Stewart, Partner

WASHINGTON

ALLIED BROADCAST EQUIPMENT
LINE: Audio and RF broadcast equipment.
31003 - A 18th Ave. S.
Federal Way, WA 98003
(800) 426-4254
(800) 562-0062
Contact: Cal Vandegrift
Continued on page 188

ARVA - HUDSON, INC.

LINE: Microwave, two-way radio, RF test equipment, Ni-Cad batteries.

P.O. Box 1512
Bellvue, WA 98009
(206) 455-0773

Contact: Bob Hudson, Pres.

BENNETT ENGINEERING ASSOC., INC.

LINE: Broadcast station equipment, audio, video, transmitters and accessories for AM/FM and TV.

P.O. Box 76
Mercer Island, WA 98040
(206) 232-3550

Contact: S. D. Bennett, Pres.

BROADCAST SUPPLY WEST

LINE: Wide range of broadcast studio equipment, everything from microphones to sound reinforcement.

7012 27th St. W.
Tacoma, Washington 98466
(206) 565-2301

National Watts (800) 426-8434
Contact: Tim Schwiager, Sls. Sup.

CUSTOM VIDEO SYSTEMS, INC.

LINE: Sony Broadcast, Harris Video Systems, Sharp, Sony, Panasonic, JVC, Ikegami, Convergence, O'Connor, Grass Valley, Tektronix.

17521 15th Ave. N.E.
Seattle, Washington 98155
(206) 365-5400

Contact: Al Harwood, President

FLEEHART & SULLIVAN, INC.

LINE: AmpereX, Comprehensive Video, Knox, Shure Bros., JVC Pro Video, GE CCTV, Remeo Wire, Thalner, Smith Victor, Ross, B&K Dynascan, Telux, ITT.

P.O. Box 77008
10109 Aurora Avenue N.
Seattle, Washington 98133
(206) 522-1533

Contact: Don Dussault, Sls. Mgr.

NORTHSHORE MARKETING,

LINE: Audio Technica, Crown International, EXR, JBL, Lexicon, Orban, Otari, UREI, Sound Workshop, MicMix, Ivie.

1800 NE 75th St.
Seattle, WA 98115
(206) 524-8672

Contact: Lewis Barrett, Sls. Mgr.

NORTH WEST INDUSTRIES

LINE: Video equipment (GE, Conrac, RCA, Zenith).

5518 Empire Way So.
Seattle, WA 98118
(206) 722-7400

Contact: J. Stanton Keck, Pres.

PUGET SOUND AUDIO

LINE: Otari, Quantum, Neumann, HME, dbx, Crown, Lexicon, E-V, Technics, Urei, Tascam, Sennheiser, Mic-Mix, JBL.

5105 N. 46th
Tacoma, WA 98407
(206) 759-4701

Contact: Rob Denbrook, Sls. Mgr.

WEST VIRGINIA

C. R. V. SYSTEMS, INC.

LINE: Comprehensive Video, JVC, Panasonic, ISI, Lenco, PLS Sharp, Jatex, ITE, Knox, World Video.

860 Adams Ave.
Huntington, WV 25704
(304) 525-2633

Contact: Stuart Underwood, Pres.

WISCONSIN

AVONIX VIDEO SYSTEMS

21675 Doral Rd.
Waukesah, Wisconsin 53186
(414) 784-1800

Contact: Warren Ribbecky,
Sales Representative

ELECTRONIC INDUSTRIES, INC.

LINE: Broadcast audio AM/FM, RF.
19 E. Irving Avenue
Oshkosh, WI 54901
(800) 558-0222

Contact: Bud Tedlie, Bdcst. Sales

ELECTRONIC PRODUCTS, INC.

LINE: RF test equipment, towers, land mobile equipment and accessories.

140 N. Avenue
Hartland, WI 53029
(414) 367-2929 or
(800) 558-2331 (WATS)

Contact: David Barquist, V.P.

FULL COMPASS SYSTEMS

LINE: Otari, Ampex Tape, Technics, EV, Tapco, Shure, Tascam, ClearCom, Ramsa, Crown, dbx, AKG, Sennheiser, Sony, Vega, HME.

6729 Seybold Rd.
Madison, WI 53719
(608) 271-1100

Contact: Jonathan Lipp, Pres.
SEE AD ON PAGE 166

TODD COMMUNICATIONS

LINE: Ikegami, Sony, Harris video systems, 3-M, Panasonic, Lenco, Fernseh, Tektronix, Videomedia.

1122 Queens Way West
Nekoosa, WI 54457
(517) 325-2573

Contact: Howard Dougherty,
Regional Manager
SEE AD ON PAGE 165

VIDEO IMAGES

LINE: Hitachi, Sony, Panasonic, JVC, Microtime, Fernseh, ISI, Crosspoint Latch, Sharp, Acrodyne, Scientific-Atlanta.

12200 W. Adler Ln.
W. Allis (Milwaukee),
WI 53214
(414) 475-0111

Contact: John Fuchs, V.P.

CANADA

AKG ACOUSTICS

LINE: Microphones & accessories, reverberation units, power supply unit, time delay units.

200 Consumers Rd. - 105
Willowdale, Ontario M2J 4R4
(416) 494-1453

Contact: Carlo Roletti, Sales Mgr.

BCB ELECTRONIC SALES LTD.

LINE: Videomedia, Technicolor, Cezar International, Tentel, Hitachi, Digital Video Systems, Automated Systems Int.

98 Healey Rd., Box 315
Bolton, Ontario, L0P 1A0.
(416) 857-0790,0791

Contact: R.H. Cook, President

B E S ELECTRONICS LIMITED

LINE: Audio recorders, antenna accessories & services, transmission cable

3212 Wharnton Way
Mississauga, Ontario
L4X 2C1 Canada

(416) 624-5624

24 Hr. Emerg. No. 276-0276

Contact: W. Onn, Pres. & Gen. Mgr.

B.S.R. (CANADA) LTD.

LINE: dbx & Otari.

26 Clairville Drive
Rexdale, Ontario M9V 4B3
(416) 675-2425

Contact: R.W. (Rod) Marsh,
Prod. Manager

CALDWELL EQUIPMENT

LINE: Wide array of audio and video equipment.

1080 Bellamy Road North
Scarborough, Ontario
M1H 1H2 Canada
(416) 438-6230

Contact: Jim Smith, President

CAMARTRON COMMUNICATIONS, INC.

LINE: Commercial Electronics, NEC America, Allen Avionics.

236 Yorkland Blvd.
Willowdale, Ontario
M2J 1R5 Canada
(416) 494-6978

Contact: Ken Snowden, Pres.

CARR MCLEAN LIMITED

LINE: Library, audio visual, archival supplies, furniture, shelving.

461 Horner Ave.
Toronto, Ontario, M8W 4X2
(416) 252-3371

Contact: W.G. Carr, Sales Mgr.

CAVECO EQUIPMENT LTD.

1121 Bellamy Rd. North
Unit 10
Scarborough, Ont. M1H 3B9
(416) 438-6230

Contact: Jim Smith, Pres.

CECOM COMMUNICATION PRODUCTS

1015 Matheson Blvd.
Unit -3
Mississauga, Ont. L4W 2V3
(416) 624-9392

Contact: T. Rankine

CECOM ELECTRONICS LTD.

1015 Matheson Blvd.
Unit 3
Mississauga, Ont. L4W 2V3
(416) 624-3420-21

Contact: Cecil Son Hing, Pres.

COMAD COMMUNICATIONS LIMITED

LINE: McMartin, Townsend, ESE, ITE, Knox Video, Studer Revox, Shure, Shively.

91 Kelfield St., Unit 5
Rexdale, Ontario
M9W 5A3 Canada
(416) 245-1734

Contact: Emil Adamyk, Pres.

CROWDER COMMUNICATIONS LTD.

LINE: Satellite turo equipment, rebroadcast equipment, system engineering.

4312 Norfolk St.
Burnaby, British Columbia
V5G 4J9 Canada
(604) 437-4433

Contact: J.G. Edwards, V.P.
Finance & Marketing

EEV CANADA LTD.

LINE: Specialized electron tubes, solid-state devices.

67 Westmore Drive
Rexdale Ontario
Canada M9V 3Y6
(416) 745-9494

Contact: D. Clissold, Gen. Mgr.

ELECTRO & OPTICAL SYSTEMS LIMITED

31 Progress Court
Scarborough, Ontario
Canada M1G 3V5
(416) 439-9333

Contact: Maurice Evans

GERR ELECTRO - ACOUSTICS

LINE: Midas, Sound Workshop, HME, Lexicon, TRS, Otari.

363 Adelaide Street East
Toronto, Ontario,
Canada M5A 1N3
(416) 868-0528

Contact: Robt. Snelgrove, Pres.

GLETRONIX (U.S.) INC.

LINE: Video & pulse delay lines, NTSC & RGB monitors, video production, routing & master control switchers, time code equipment, video & audio patchfields, camera test charts, slides, film & transparencies, tape synchronizer, video & audio head refurbishing, oscilloscopes & waveform monitors, automatic tape degaussers, logic analyzer board, tape conditions, evaluators & tape timers, side band analyzers, clock drivers & clocks, machine control equipment temperature equipment, cable strippers.

160 Duncan Mill Road
Don Mills, Ontario M3B 1Z5
(416) 444-8497

Contact: Debra Carter

GRAYGALE ENTERPRISES LTD.

LINE: Hughey & Phillips Inc., tower obstruction lighting & related products.

P.O. Box 1581
Kitchener, Ontario
N2G 4P2
(519) 884-5351

Contact: Winn Nightingale, Pres.

GOULD MARKETING CO. LTD.

LINE: Loudspeakers, audio equalizers, amplifiers, tape players, recorders, duplicators, mixers.

6445 Cote de Liesse Road
Montreal, Quebec
H4T 1E5 Canada
(514) 342-4441

Contact: Kevin G. Knoll,
Prod. Mgr.

EARTH STATION TECH. INC. (E.S.T.)

LINE: Elpro transmitters, Elpro translators, E.S.T. receiver stations, Andrew antennas.

#114 - 5910 No. 6 Road
Richmond, B.C.
Canada V6V 1Z1
(604) 270-9544
Telex: 04-357745

Contact: Sonny Kosuljandic, GM

IMMAD BROADCAST SERVICES

LINE: TV & FM RF components, combiners, diplexers, filters, antennas, video distribution equip., turnkey, installation & testing services for studio, transmitters and antennas.

233 Carlaw Ave.

Toronto, Ontario Canada
M4M 3E9
(416) 465-2463
Contact: N. Brian Everett, G.M.

J-MAR ELECTRONICS LTD.

LINE: Audio equipment.
6 Banigan Dr.
Toronto, Ontario M4H 1E9
(416) 421-9080
Contact: Chris Brooks, Sales Mgr.

R.C. KAHNERT SALES LTD.

15 Bunty Lane
Willowdale, Ontario
Canada M2K 1W4
(416) 221-7755
Contact: R.C. Kahnert, Pres.

LEADER BROADCAST SYSTEMS INC.

LINE: Audio products, mixers, recorders, studio systems.
195 W. 7th Avenue
Vancouver B.C.
Canada V5Y 1L8
(604) 685-6043
Contact: Michael K. Leader, Pres.

LUMITROL LTD.

LINE: Colortran, Stanley ASH Theatrical, Rual Industries, Larcen, Sylvania, Phillips, Hubbell.
5 Walker Ave.
Toronto, Ontario
M4V 1G3 Canada
(416) 921-6060
(416) 921-6688
Contact: Bruce Whitehead, Pres.

MSC ELECTRONICS

LINE: BEI, Broadcast Electronics, Capitol/Audiopak, Comark, EMCEE, Evershed Power Optics, Howell/Shively Labs, LEA, LPB, NEC, Orban, QEI, Rankcenter, Roh Corp., Telemet, TFT, UMC Electronics.
254 Wildcat Road
Downsview, Ont.
Canada M3J 2N5
(416) 661-4180
Contact: David La Frenais, Pres.

NATIONAL ELECTROLAB LTD.

LINE: RF test equipment, signal generators, spectrum analyzers, solid-state analyzers, time & frequency receivers, oscilloscopes, general test equipment.
1536 Columbia St.
North Vancouver, BC
V7J 1A4 Canada
(604) 985-0511
Contact: E. J. Frazier, Pres.

NATIONAL ELECTRONIC AGENCIES LIMITED

LINE: Hitachi professional broadcast ENG/EPF video camera equipment; Microtime, TBCs, image enhancers; Video Data production titlers, broadcast video products; Lenco; Cine 60; Crosspoint Latch switchers; E-V products, Hitachi oscilloscopes.
2137 Commercial Drive
Vancouver, British Columbia
V5N 4B3 Canada
(604) 253-3192
Contact: Chuck Spencer, Tech. Sup.

NORBEC VIDEO LTD.

LINE: Cameras, U-matic recorders, VHS recorders, time base correctors, monitors, tape.
4315 Girouard Ave.
Montreal, Quebec

Canada H4A-3E5
(514) 481-3483
Contact: Roger J. Archambault, President

NORTEC WEST LIMITED

LINE: Ampex Audio, Spotmaster, Audiotronics, Inovonics, Revox, Conrac, CEI, Convergence, Leitch, Moseley, Fernseh, Quantel.
325 West 5th Avenue
Vancouver, B.C.
V5Y 1J6 Canada
(604) 872-8525
Contact: R. Whitehouse, Pres.

OPTICOM DISTRIBUTORS LTD.

LINE: Cosmicar, Computar, Tokina, Smith-Victor, Universal, Fluid Head, Fujinon, Opticom Motorized Zoom Lenses, Kowa, Peter Lisand, Davis & Sanford.
301-1589 W. 8th Ave.
Vancouver,
British Columbia V6J 1T5
(604) 734-4511
Contact: David Boyd, Pres/Owner

RACAL (CANADA) LIMITED

LINE: Radio communications products (non domestic).
1806 Woodward Drive
Ottawa, Ontario
K2C 0P7 Canada
(613) 225-4640
Contact: A.H. Blow, Gen. Mgr.

RADIO SERVICE, INC.

2500 Bates Rd.
Montreal, Quebec
H3S 1A6 Canada
(514) 342-4503
TLX 055-60070
Contact: M. Vallee, Brdcast. Mgr.

RUSINT ELECTRONICS & SALES CANADA LTD.

LINE: Measuring, monitoring and transmission equipment for TV, FM broadcasting; Interference simulators and RFI suppression filters; test equipment for telecommunication including fibre optics; radio communication and monitoring equipment and systems.
25 D Northside Road
Nepean, Ontario
Canada
(613) 829-3944
Contact: R. Pauk, Sales TV & FM Broadcast Equipment

A. C. SIMMONDS & SONS LTD.

LINE: Antenna Specialists Co., Acoustic Research, Cetec Vega, Sound Guard, Shure, SME, RKO Tape Corp., Midland International, Schroff.
975 Dillingham Rd.
Pickering Ontario
L1W 3B2 Canada
(416) 839-8041
Contact: W. B. Campion, Mkt. Mgr., Prof. Audio

SMYTH SOUND EQUIPMENT

LINE: Grado, Ikegami, KEF, UREI.
595 rue Parc Industriel
Longueuil, Quebec
J4H 3V7 Canada
(514) 679-5490
Contact: Michel Girard, Sls. Mgr.

SONO VIDEO INC.

LINE: Sony Broadcast, Sony Industrial, Microtime, Ikegami, Shintron, Technics, Ampex Audio.
1010 Berlier St.
Chomedey, Laval,

Quebec, Canada
H7L 3R9
(514) 677-5861 or 384-4546
Contact: Serge Shanks, VP
Daniel Langelier

TENNAPLEX SYSTEMS LTD.

LINE: Broadcasting antennas and combiners systems.
34 Bentley Ave.
Ottawa, Ontario
Canada K2E 6T8
(613) 226-5870
Telex :053-4962
Contact: Marvin Crouch, Pres.

TRI-TEL ASSOCIATES LTD.

LINE: Maxell, Stanton, Denon, Onkyo, Thorens.
105 Sparks Ave.
Willowdale, Ont.
M2H 2S5
(416) 499-5044
Contact: Hank Gruenstein, VP

TURNELLE VIDEO INC.

LINE: Broadcast and industrial video products; audio products; surveillance products.
1050 Baxter Rd.
Ottawa, Canada K2C 3P1
(613) 829-8790
Contact: J.P. Clermont, Sls. Mgr.

UNITED VIDEO LTD.

LINE: Color cameras, video recorders, b/w cameras, switchers & sync gen., editing systems, production & test equipment, lighting systems, time base correctors, videotape, audio equipment, CCTU, processing equipment.
1230 Old Innes Rd., Unit 409
Ottawa, Ont K1B 3V3
(613) 741-5554
Contact: Dino DiMarino, Pres.

WESTRONIC ENGINEERING SALES LTD.

LINE: McCurdy Radio Industries Ltd., AVL Digital Ltd., Studer-Revox, Aristocart, Declibel Products, Arco Solar, IGM, McCurdy Telecommunica-

tions Ltd., L.M. Ericsson Ltd., Station Business Systems.
7 West 7th Ave.
Vancouver, B.C. Canada
(604) 872-0636
Contact: Rod Maddison, Prod. Mgr.

INTERNATIONAL

BFE kg

LINE: Audio and video studio products, OB vans, turnkey.
6500 Mainz-Gonsenheim
Fed. Republic of Germany
Contact: K.K. Feldweg, President

CROW OF READING LTD.

P.O. Box 36
Reading RG1 2NB
England 44
0734-595-025
TELEX: 847056
Contact: Mike Angelou, Marketing Manager

JOERGEN ANDERSEN INGENIOER&IRMA

LINE: Video equipment for broadcast and independent stations, total product range from cameras to VTRs.
Produktionsvej 1,
2600 Glostrup
Denmark
(02) 9188 88
Contact: A. Lillevang, Sales Mgr.

MALDWIN BOWDEN INTERNATIONAL LTD.

69 Ship Street
Brighton, England
BN1 1AE
(0273) 24928
Contact: Michael Fabricant, Dir.

OPTICAL AND TEXTILE LTD.

22-26 Victoria Road
New Barnet
Hertfordshire England
(01) 441-0098
(01) 441-2199
Contact: Bernard Bush, Sls. Mgr.

MISS ANYTHING? If you missed the category you were looking for, turn to the General Index on page 38. This index will tell you WHERE TO FIND IT: the page that the category is listed on, and all advertisements in this issue which feature products in this category.

FIND SOMETHING? If you found the right product and are interested in making a sales contact, use this section as a guide to dealers, distributors, and reps, or turn to the alphabetical listing of Manufacturers and Service Companies.

Tell them you read it in THE DIRECTORY.



NAB '82 unveils a record number of new products

PART 2

The 1982 version of the NAB convention has been committed to memory, but not yet laid to rest. If your memory isn't so good (or if you didn't make it to the convention), this second in a series of NAB review articles will fill in the blanks.

With a record number of exhibitors showing this year, it was necessary to split our coverage into two issues. This way you'll have a more complete record of what was introduced at the convention.

Meanwhile, this convention won't be laid to rest until the next one comes 'round. There were too many major issues that were left hanging. Take teletext, for example. It's another victim of the FCC's marketplace concept. Instead of affecting a standard, they sidestepped the issue.

AM stereo is another example. We may never know who had the best system. In this case we may just see who can bring the greatest influence to the marketplace.

Other standards were at issue, but their immediate impact will be of much less importance. Still, equipment manufacturers were offering both improved products at improved prices. Business was as brisk as it was serious.

As we return once more to the exhibit hall, remember that this issue is the annual Directory of Equipment, Services & Suppliers. The Action Cards can be used throughout the next 12 months. If you need further information on any of the ads or products described in this issue, circle the appropriate numbers on the Action Card, put a stamp on it, and drop it in the mail.

AKG ACOUSTICS—Microphones, reverberation units, headphones, and

phono cartridges were on display at the AKG booth. Among this company's professional products are "Golden Diaphragm" stereo condenser microphones, polydirectional studio condenser microphones, modular condenser microphone system, prepolarized condenser microphone series, the "Performing Arts Series" microphones, exclusive two-way dynamic microphones, dynamic microphones, paging and communications microphones, and torsional transmission line reverberation systems.

AKG's completely modular C-450 condenser microphone system comprises a basic preamplifier with interchangeable capsules, and accessories, each with different characteristics.

Circle (273) on Action Card

ACCURATE SOUND—Staying on top of the state-of-the-art in high-speed duplication is Accurate Sound's way of doing business. This year they introduced the System 200 high-speed duplicator.

The System 200 offers a crystal-referenced design, a servo-controlled capstan, and the unit is very compact. This system design eliminates the capstan-idler and the need for mechanical brakes. Tape duplication speeds available are 60, 120 and 240 inches per second.

The master can be either ¼-inch or ½-inch tape, and in either two or four channels. According to the company, tape duplication speed accuracy is down to 0.08 percent maximum, and flutter is listed at below 0.15 percent RMS.

Slave units can handle 150-mil cassettes or ¼-inch reel-to-reel tapes.

Circle (274) on Action Card

ALLIED BROADCAST EQUIPMENT—This company offers a comprehensive line of radio broadcast equipment.

Circle (275) on Action Card

AMBER ELECTRO DESIGN—The hottest product at the Amber Electro booth was the model 3501 distortion and noise measuring system. Successor to the popular 3500, this new instrument provides the highest performance distortion measurement commercially available with typical system (oscillator and analyzer) level of 0.0005% (-106 dB). It is also an extremely sensitive true RMS noise meter able to measure to -120 dBm with and without weighting. Comprehensive filtering allows compliance with FCC, NAB, IHF, and other standards.

Circle (276) on Action Card

AMCO ENGINEERING—New from Amco were economy EMI cabinets designed to meet FCC/EMI regulations. Also shown was a new line of computer desk cabinets and consoles.

Circle (277) on Action Card

AMPEREX—Amperex showed their full line of Plumbicon® television camera tubes, ranging in size from the hybrid ½-inch Diode Gun™ 80XQ to the 30mm high-resolution Diode Gun Frog Head 45XQ. This includes the ⅜-inch ENG XQ1427, the ⅝-inch EFP Diode Gun XQ3427, the XQ1070, XQ1080, and XQ2070 Diode Gun 1-inch families, and the 30mm XQ1410/1415 family.

Circle (278) on Action Card

ANGENIEUX—Angenieux unveiled their new 15x9 all-weather 9-135mm, f/1.5 zoom lens with diascope for

compact audio console!



The INTERNATIONAL is an 8 channel audio mixer that fits in everywhere, especially where space is limited...announce booths, news studios, eng. editing suites and remote locations.... it takes only 5½ inches of vertical rack space.

Unit features slide fader w/cue on all eight channels.

Channel module features switchable mike/line operation.

Available in mono, dual mono and stereo models; 16 in-mono out, 8 in-dual mono out and 16 in-stereo out.

DYMA

ENGINEERING

(505) 758-8686

P.O. Box 1697

213 Pueblo del Sur
Taos, New Mexico 87571

Circle (133) on Action Card

automatic ENG/EFP cameras. This lens features a new diascope design for precise registration even under field conditions.

With a photometric factor of 1.1 and an aperture of $f/1.5$, this lens is unique in the ENG/EFP field. In addition to its low light level capability, a built-in 2X range extender turret allows instant changing of the focal length range from 9-135mm to 18-270mm. Further versatility is achieved by the use of front optical attachments giving the lens an extreme focal length range of 7.2mm to 450mm. Minimum object distance of this new lens is 31 inches. At 270mm FL, the smallest object that will fill the screen is only 18x24.

Circle (279) on Action Card

ANTIOPE VIDEOTEX—The Antiope exhibit this year leaned toward exhibiting the established Antiope teletext operations in Los Angeles, San Francisco, and elsewhere. Their booth had a series of U.S. made color TV receivers, arranged in a pseudo living-room with comfortable couches. Visitors to the booth could pick up the remote control units, and call up teletext pages from CBS' Extravision, NBC's Tempo, KCET's NOW Electronic Magazine, and KPIX's Direct Vision. The teletext signals were brought in by phone line, and updated on a three-hour sequence.

Tony Barnett, president, and Marvin Segel, marketing manager, of Antiope & Telematics Corporation, agreed that teletext was still in the investigative phase among broadcasters. The standards dilemma in the teletext field still inhibits any major purchases, except among those avant-garde stations that want to experiment with this new medium.

However, Segel did find a very high interest by current users of Antiope equipment, in the new Unitel DRCS (soft-alphabet) equipment now operating in NTSC. This was the first display of a new keyboard editing console that does the finer graphics Antiope is capable of. The show equipment will go to KCET in Los Angeles for a few weeks, then on to the NCTA show in Las Vegas.

Circle (280) on Action Card

APERT-HERZOG—This company, located in San Jose, California, displayed digital video processing equipment and the new TDAC-1. The TDAC-1 (travelling digital-to-analog converter) is an 8-bit digital-to-analog converter in a probe for observation of address ramp functions, video waveforms, etc.

Circle (281) on Action Card

AGFA-GAVAERT—This New Jersey company displayed their ¼-inch U-Matic cassettes dubbed the KCA-60, KCA-30, and KCS-20 Mini. The company also showed their ½-inch videocassettes, the Beta L500, and the VHS T120. Other tapes included their Studio Mastering Tape designed for SMPTE lock-up.

Circle (282) on Action Card

ARRIFLEX—A complete line of ARRI daylight HMI lights and accessories were exhibited at this booth. Included in this line are the 200W AC/DC portable HMI light; AC lights in 575- to 6000-watt sizes for 120V/220V AC operation; a complementary system for distribution boxes, various outputs, and voltages; and shipping and storage cases.

Circle (283) on Action Card

ARVIN/DIAMOND—Arvin/Diamond introduced the Sat-Weather System, which provides direct conversion of weather data to color video, including satellite-generated infrared signals.

Circle (284) on Action Card

AUBURN INSTRUMENTS—Auburn Instruments featured their new MC/1 two-wire machine control system which eliminates cumbersome and time-consuming wiring of multi-conductor cables and connectors, and makes delegation of control possible with simple single-pole switching. The MC/1's basic features include 8 commands, 8 return tallies and DC power on a two-wire bus; two 4-button remote units which combine to control 8 functions; master/slave and gang start capabilities; and reliable opto-isolated machine interface (relays optional).

Circle (285) on Action Card

BGW SYSTEMS—The BGW 250 and 750 Series power amps employ fully modular construction, fool-proof speaker protection, and one-piece construction. According to the company, the 250 Series uses three times as many output devices as the competition, enabling it to last three times longer. The 750 uses a heavy-duty rear-mounted two-speed industrial fan to move large volumes of air in from the back, over the internal circuitry and up through exhaust ports.

Circle (286) on Action Card

THE BTX CORPORATION—The new BTX Shadow is a fully intelligent interface for audio, video, and film transports. It provides the production and post-production industries with

Continued on page 192

new capabilities for complete, economical, multi-machine control.

Circle (287) on Action Card

WILLIAM BAL CORPORATION—A new design in heavy-duty shipping cases for video cameras and player/recorders was the highlight at this booth. Several cases are available. Also, the company has complete in-house design service for custom-case interiors.

Circle (288) on Action Card

BASYS—Peter Kolstad and company

were showing a full line, including News Fury, Cart Fury and Clip Fury. The Basys booth was a mob scene. In fact, all the newsroom computer vendors were enjoying heavy traffic.

Basys just sold a big system to KRON-TV in San Francisco, and apparently word of that sale has changed the company's image as a network-only vendor. In fact, Basys is developing some revised formats for KRON to meet the specific needs of a large-market TV station.

Circle (289) on Action Card

BEAVERONICS—Beaveronics markets three standard video production switching systems: the J&D 712, the BI-154, and the BI-156. With the appropriate options, the user can customize these switchers to meet specific requirements. In the case of the BI-154 and BI-156 systems, most of the options can either be ordered initially or added at a later date since, for many of them, removable control panel cover plates and wired rack frames easily accommodate this modular expansion when desired.

Circle (290) on Action Card

BELDEN—Belden is the sole distributor of Lee Filters color media. Lee Filters are made from a tough polyester base, and they offer excellent consistency. They will not only stand up to the hottest quartz lights, but will always retain the highest degree of optical clarity. Lee Filters are available for immediate delivery through Belden's dealers across the U.S. and Canada.

Circle (291) on Action Card

BELL HELICOPTER—Being shown in the Bell Helicopter was a TV system specially designed for operation in the noisy environment of an airborne helicopter.

Circle (292) on Action Card

BIRD ELECTRONIC—Bird introduced the Digital Hi-Power wide-range RF Calorimeter (1000 W to 80 kW). Conveniently portable, it measures RF power quickly with precision, after simple set-up. Other advantages include automatic processing of all sensor inputs, displaying of power directly without charts or calculations, and accuracy of $\pm 3\%$ of reading.

Circle (293) on Action Card

BRITISH VIDEOTEX & TELETEX—The British have been among the leaders in the development of teletext and videotex systems, and this booth provided American broadcasters an opportunity see these systems first-hand. This display featured Logica's new Context teletext system, as well as Jasmin Electronics' new JTS4 teletext generation system.

Circle (294) on Action Card

BROADCAST AUDIO—There was no lack of excitement at this booth because Broadcast Audio introduced the System 14 digitally-controlled audio console. Digital slide faders and digitally controlled CMOS high-resolution logarithmic audio attenuators reduce signal paths, and do not exhibit the disadvantages associated with VCAs.

Also on display was the Broadcast Audio line of accessory amplifiers: the



Developing An Industry Standard

Quantum Audio Labs' newly designed concept of cost effectiveness within a modular broadcast production/on-air console now offers sophisticated simplicity, along with excelled engineering design.

If you've heard it on radio/TV, you've probably heard it through Quantum.

Please send me further details and full technical specifications.

Name _____ Position: _____

Studio/Company _____

Address _____

Phone: (____) _____



QUANTUM
AUDIO LABS, INC.

1905 RIVERSIDE DRIVE
GLENDALE, CALIFORNIA 91201
PHONE: (213) 841-0970

Circle (134) on Action Card

BA-235/435 monitor amplifier; the BA-6x4 distribution amplifier; and the BA-205/405 phono preamplifier.

Circle (295) on Action Card

BROADCAST SYSTEMS—Shown for the first time at NAB was the Broadcast Systems pre-wired audio patch panel. This new product greatly simplifies the proper installation of audio circuits to a patch panel removing hours of tedious on-site labor previously required in wiring up patch panels and "T" blocks, as well as providing a professional looking, easy-to-maintain audio jack field installation.

Circle (296) on Action Card

BROADCAST TECHNOLOGY—Highlighted was the new DC Controlled Equalizer. The EG3501 and EG3502, when used together, form a 10-band graphic equalizer. Either card can be used as a 5-band graphic with center frequency points 2 octaves apart. Both offer differential bridging inputs and are capable of driving 600-ohm loads differentially to +26 dBm.

Also new was the model VU3722, a VU and peak level indicator that consists of 20 LED segments in a 1.5-inch by 3.375-inch panel. The electronics that drive the VU3722 bridge a 600-ohm line differentially and can be

adjusted for 0 VU from -20 to +8 dBm.

Both the DC Controlled Equalizer and the VU and Peak Level Indicator—as well as other units in the line—are designed to be used with their new self-powered, rack mount enclosure.

Circle (297) on Action Card

BROADCAST VIDEO SYSTEMS—The EV4060 color signal monitor shown at this booth offers many attractive features, including full broadcast specifications; A-B inputs with buffered video output; and sharp, high-brightness trace. The EV4060 is switchable between waveform and vector display; mounts beside all popular half-rack pix monitors; and is ideal for mobile and studio applications. The EV4060 is available now, and is priced at \$4500 (FOB Buffalo, New York).

Circle (298) on Action Card

CMC TECHNOLOGY—This California-based company offers quad video head refurbishing services. CMC refurbishes Ampex Mark XX, Mark XV, Mark X, Mark III, and RCA High-Band. And, the company offers refurbishment of these units in either Alfesin or Ferrite materials.

Circle (299) on Action Card

CABLEWAVE SYSTEMS—Among their transmission lines, Cablewave was showing the FLC 7/8-inch foam coaxial cable that's been designed for lower attenuation than previous foam coax cables. These cables have low loss characteristics that are almost as low as those for air dielectric. Of course the FLC cables don't require pressurization.

Circle (300) on Action Card

CENTRO—Vans aren't just vans any more. Centro is proof of that. When Centro builds a van they spend as much time on rebuilding the vehicle as they do setting it up for the electronics. Van ride and handling characteristics are modified to accommodate the new configuration the van will have when it is completely outfitted with EFP and ENG equipment. Centro also installs their own custom air conditioning system because the original van design does not call for cooling the equipment racks that will be installed.

Circle (301) on Action Card

JOHN CHILES—New at this booth was an on-board-type battery pack which complements almost all existing industrial and professional cameras not utilizing on-board packs. Variable voltage and amp ranges provide for the

Continued on page 194

At Broadcast Technology There's A Lot More Behind Us!

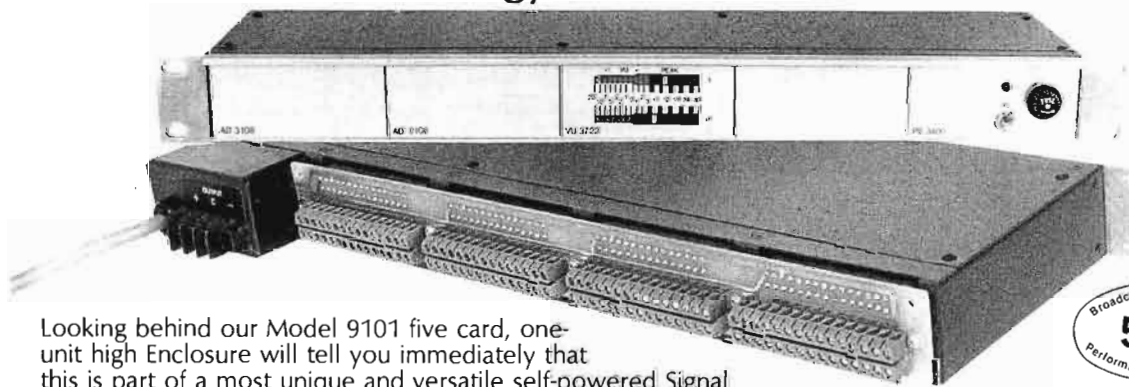

Looking behind our Model 9101 five card, one-unit high Enclosure will tell you immediately that this is part of a most unique and versatile self-powered Signal Processing System with barrier type terminals. By simply plugging in any of the BTI Series 3000 Cards, the system becomes a D.A., Switcher, an Intercom, an Equalizer, one or more Line, Power, or Pre-Amplifiers. The VU/Peak Level Indicators provide continuous in-line displays of VU and Peak information over a wide range of "0 VU" for all system configurations.

What's behind Broadcast Technology is more than meets the eye. We are seasoned audio professionals who are committed to technical excellence in the design and manufacture of audio components and systems.

There is also more behind our products as evidenced by our exclusive 5 Year Performance Warranty.

Look at us, and then look behind us. You'll find a lot more at Broadcast Technology.



broadcast technology inc.

33 Comac Loop, Ronkonkoma, NY 11779 (516) 588-6565

Circle (135) on Action Card

proper adaptation to all camera makes and models. John Chiles also introduced a new modular-type battery system which can be custom engineered to meet individual requirements concerning amphere hours and voltage specifications.

Circle (302) on Action Card

CHRISTIE ELECTRIC—The 20-minute miracle was the talk of the Christie booth. They were referring to their "burping" charger-and-battery system that gives a full recharge in under 20

minutes with longer battery life for NiCad batteries. The burping is accomplished with reflex negative pulses interjected between the positive pulses. By doing this, Christie finds they can use larger charging currents all the way to a full charge, thus cutting down the charge time. They also displayed a new AC/DC KS1 camera-mounted power supply.

Circle (303) on Action Card

CLEAR-COM—System II intercoms feature increased station capability,

higher output levels, and a very stable side tone. The system will operate from 12 volts on remote assignments. They also showed a new custom line of double muff headsets, the CC-75B and the CC-240B.

Circle (304) on Action Card

COLORADO VIDEO—This manufacturer of video instruments for data acquisition, processing, transmission and display introduced Compressed Video, the transmission of still pictures over ordinary telephone circuits. The term "compressed video" refers to frequency or bandwidth compression, and the process involves stretching out the picture in time, so that approximately one minute is required to transmit a single image.

Circle (305) on Action Card

COLORGRAPHICS WEATHER SYSTEMS—The LiveLine System III from Colorgraphics is an ultra high-resolution weather graphics computer system featuring one of the highest picture resolutions in the industry: 760 x 480. This system combines in one package weather animations, the first national and regional radar pictures in full color, and automatic weather updates from WSI. Color digital weather satellite pictures are also automatically ingested and displayed.

The System III stores 100 graphics at any time on an 11-megabyte hard disc system. Over 4,000 color choices in high resolution are user-selectable. Automatic sequencing permits recall live on the air of any selection of graphics, radar, and weather satellite pictures.

The LiveLine System III is available for delivery 30 days after order. The complete system price is \$39,900, including delivery and training.

Circle (306) on Action Card

COLORTRAN—A new high-efficiency spotlight family was introduced by Colortran. Called the 1 kW and 2 kW Fresnels, the units represent a new advance in performance in compact, professional lighting equipment. The Fresnels are designed in manual- and pole-operated versions, and employ a new steel and aluminum construction to provide maximum cooling and structural strength.

Circle (307) on Action Card

COMPREHENSIVE VIDEO—Comprehensive's new ULTRA-BOOM allows the user to vary camera height, pan, and tilt simultaneously in one smooth, continuous motion. This is made possible by ULTRA-BOOM's counter-balanced parallelogram design



Record, play and dub complete sporting events and full-length movies ... non-stop.

Record and playback up to 2 hours, 40 minutes on any standard Sony BVH 1000, 1100, and 1100A or Ampex VPR-1C, VPR-2 and VPR-2B Type C VTR with the Merlin ME 238 conversion kit.

Extended play time allows most full-length movies and sporting events to be recorded on a single 12½" reel. Ideal for master playback when dubbing to small format machines as well as for cable and broadcast automated programming.

MERLIN

1880 Embarcadero, Palo Alto, CA 94303

Call Toll Free — 800-227-1980 (California — Call Collect 415-856-0900)

CANADA

Electro & Optical Systems, Ltd., 3015 Kennedy Rd., Scarborough, Ont. M1V 1E7 (416)439-9333

AUSTRALIA

Advanced Automation, Pty. Ltd., 6 Dansie St., Greenslopes, Brisbane 4120 (07)397-2611

EUROPE

Tomislav Marjanovic, Wilhelmstr 52E, D-6200 Wiesbaden, Germany (06121) 30 26 14

U.K.

F.W.O. Bauch Ltd., 49 Theobald St., Boreham Wood, WD6 4RZ 01-953 0091

Circle (136) on Action Card

which is invaluable for getting "above the crowd", to achieve dramatic camera movement effects in commercial productions, to create "dolly shots" while remaining stationary, and many other applications. The ULTRA-BOOM mounts on tripod or camera truck.

Circle (308) on Action Card

COMPUTER GRAPHICS—IMAGES®, an Image Manipulation and Graphics Enhancement System, was one of the hits among the graphics crowd. IMAGES is a computer-based graphics system which allows an artist to draw directly in an electronic medium, maintaining the precision, comfort, and quality of conventional methods, while providing the speed, versatility, and processing power of a computer-controlled video medium.

Circle (309) on Action Card

COMTECH DATA—The emphasis at the Comtech booth was their satellite equipment lineup. Among a variety of products, the company showed their new model 650 satellite video receiver with a 24-channel LED readout, an agile cable modulator dubbed the CDM

1155 (it handles 59 channels), and their 5-meter satellite earth terminals for both audio and video receive installations. The dishes are easily convertible to circular polarization and/or 12/14 GHz.

Circle (310) on Action Card

CONRAC—Conrac showed a full line of professional broadcast color and monochrome video monitors for studio and teleproduction applications. Among the featured monitors was the 6100 Series master color monitors. These top-of-the-line monitors feature automatic stability of color temperature reference, precise colorimetry, and switchable comb filter. The series was designed to satisfy the most critical demands for signal evaluation in broadcasting and teleproduction.

Circle (311) on Action Card

CONTRO VIDEO—The hottest product at this booth was the new Lightfinger™, a microprocessor-based, multiple-machine, SMPTE time code editing system that is completely controlled through an interactive CRT. The system starts out as a two-machine editor, but is expandable into a data-

based multi-machine system that controls time base correctors, color correctors, audio mixers, and every other remoteable parameter required in high-level editing.

What's unique about Lightfinger is the CRT itself, which serves as the control panel. By utilizing the CRT control, Lightfinger gives the editor all of the capabilities of a computerized editing system, without the large, complicated, and cumbersome keyboard. Unnecessary functions are eliminated from the CRT, being displayed only as they are necessary for a particular editing procedure.

Circle (312) on Action Card

CUSTOM BUSINESS SYSTEMS—The CBSI broadcast business computer system is designed especially to handle the requirements of radio stations. It uses heavy-duty, business-quality, American-made Wang computers in either floppy-diskette or hard-disc configurations. Both versions can assemble and print a 24-hour program log for a busy station in less than 10 minutes, maintaining separation, proper dayparting, desired rotation, and

Continued on page 196

re TESTING & FIBER OPTICS

High Purity, RF Signals, FM & AM Stereo and Audio Analysis.

WOW & FLUTTER SYSTEM —

AUDIO ANALYZER —

Display Complete Audio Analysis
Freq., Voltage, TIM, IM,
THD, Stereo Separation, etc.

FM/AM STEREO GENERATOR —

RF SIGNAL GENERATOR —



Manual & Semi-automatic Systems available.

Optical terminal equipment with advanced digital video and audio capabilities.

Studio quality in audio & video to NTSC7 standard.

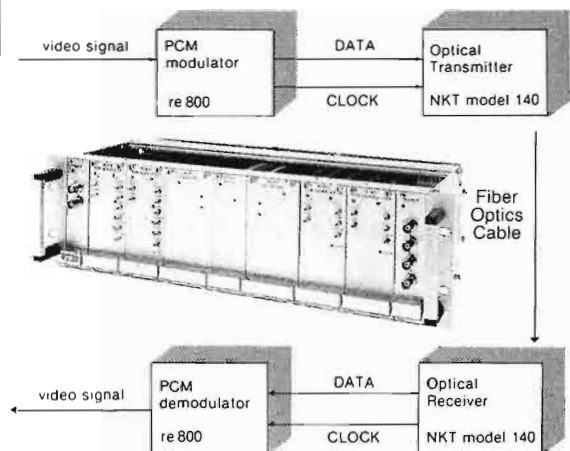

Presently operating with high quality fiber optics cable system.

For details contact our Engineering Applications Department:

re RE-INSTRUMENTS U.S.

31029 Center Ridge Road, Westlake, Ohio 44145

(216) 871-7617

Circle (137) on Action Card

SPECIFY C.S.P.

Your Complete Source For:

AM Antenna Phasing/Branching Systems

RF Components and Accessories

Diplexers, Sampling Systems, Transmission Line, Tuning Units

Quality, Service, Experience

Call or write:

C.S.P. Inc.

203 Airport Road • Doylestown, PA 18901
 Phone: 800-523-6010 • In Pennsylvania: 215-345-7386

Circle (138) on Action Card

We stand out from the crowd.

Thanks to the unique design of the patented Beau pancake motor, our Type 100 Recorder/Reproducer gives you *space* economy (it's only 3 5/8" high and stackable) and *power* economy, too. Also cool-running and compact, there's the inexpensive Beaucart II Reproducer.

Simple design means greater efficiency. Our versatile Model SFE-1 Automatic Splice Finder and Bulk Eraser combines *two* machines in *one*.

A common-sense approach makes Beau-Master Stereo Console and its companion Beau-Pro easy to operate—with the performance you demand.

Simple functional design makes UMC stand out from the crowd.



UMC Electronics Company
 460 Sackett Point Road
 North Haven, Connecticut 06473
 Phone (203) 288-7731

Outside Connecticut, toll free, (800) 243-6178

UMC[®]

Circle (139) on Action Card

numerous priority levels. CBSI allows locally designed and easily changeable TAP plans and dayparts, spot clusters and fill orders, package billing, or rate per spot.

Circle (313) on Action Card

dbx INCORPORATED—The two newest additions to the dbx line were unveiled at the NAB convention: the model 610 Autographic Computerized Room Equalizer and the model 907 Stereo/Gated Compressor Slave.

The model 610 is a microprocessor-controlled room equalization system designed for professional applications like broadcast or recording studio monitor equalization and fixed or portable sound reinforcement system equalization. The model 610, using its own calibrated microphone, pink noise generator, real time analyzer, and digitally-controlled filters, can automatically equalize an area for flat or specified response in less than 15 seconds.

The model 907 Stereo Gated Compressor Slave is designed to work with the model 903 compressor/limiter. While the 903/907 combination offers all of the features of the 903, it adds a sophisticated high-speed release gate and true dual RMS-detected stereo compression.

Circle (314) on Action Card

DATAMETRICS—On display in this booth were SMPTE time code generators, readers, character generators, vertical interval tune code readers, and generators.

Circle (315) on Action Card

DATATEK—One of the features of the Datatek booth was the Identification of Source (IDS) system which is made up of a family of plug-in modules designed to insert identification codes into a line in the vertical interval of a television signal; to read the codes, generate alphanumeric characters, and key the source ID characters into the active portion of the signal for display on picture monitors. A deleter module can be used to delete the vertical code where desired. The family of IDS modules include the D-657 encoder, D-658 reader, D660 deleter, and D-659 alphanumeric display unit.

Circle (316) on Action Card

DELCOM—The hot product at the Delcom booth was the AE-3 auto effects interface. The AE-3 auto effects interface combines the editing capabilities of the Convergence ECS-103 with the special effects of the ISI 902 production switcher, resulting in greatly expanded post-production techniques. All equip-

ment retains its original abilities, as well as automatic transitions, while requiring no modification.

Circle (317) on Action Card

DIGITAL COMMUNICATIONS—M/A-COM DCC Inc. of Germantown, Maryland, presented the MAESTRO™ digital audio satellite receiver. This is a complete 3-meter satellite terminal designed for the reception of high-quality digital audio channels for radio networking. MAESTRO™ users can select from multiple 15 kHz circuits; all channels are useable for stereo. The 3-meter system is totally integrated and can be installed without any extensive ground preparation or technical know-how. Each system is made of a 3-meter antenna, receive feed, and pedestal; 120°K low noise amplifier; microstrip down converter; digital program terminal (DPT); and interconnecting cables and connectors.

Circle (318) on Action Card

DOLBY LABORATORIES—Dolby unveiled a new line of audio noise reduction modules for the Sony BVH 1000 and 1100, and Ampex VPR-2 1-inch VTRs. These modules incorporate improved record-play electronics with two channels of Dolby A-type noise reduction, into a single package requiring no modifications to the VTR.

Circle (319) on Action Card

DUBNER COMPUTER SYSTEMS—Animation systems were very popular at this year's show, and Dubner exhibited one of the impressive systems. The CBG-2 is a sophisticated computer graphics system that produces broadcast-quality color images and animation sequences. The CBG combines into a single system the power of a character generator, a painting system, a frame storage device, and a digital video effects generator.

A new feature of the CBG system is the ability to rotate an image with perspective around any point in space. The resulting image, when viewed as part of an animation sequence, gives the enhanced sense of depth and three-dimensionality generally associated with a digital effects generator.

The CBG-2 system is available immediately. The price of the system ranges from \$76,000 to \$100,000.

Circle (320) on Action Card

VICTOR DUNCAN—Victor Duncan is a full-service company, supplying a wide range of broadcast equipment. Their expert staff can work with you to design the system you need. And they also

Continued on page 198

TENTEL GAGES

DO THINGS EVEN THE FACTORY GAGES DON'T DO!

FOR U-MATIC, BETA, VHS AND 1" TYPE "C" RECORDERS ...

TENTEL GAGES ARE SO EASY TO USE EVEN NON-TECHNICAL PERSONS CAN DIAGNOSE PENDING PROBLEMS.

The TENTELOMETER Tape Tension Gage will help if you want to prevent problems with:

- Interchange
- Hooking and flagging
- Tape destruction

The TENTEL Spindle Height (TSH) Gage will help if you want to prevent problems with:

- Tape edge damage
- Cassette binding
- Tape destruction

TENTEL is ready to help with your video recorder service needs. Thousands of service engineers rely on TENTEL daily!

Send for the TENTEL Tape Tips Guide or call us TOLL FREE (800) 538-6894. In California call (408) 379-1881.



TENTEL
1506 Dell Avenue
Campbell, CA 95008

Circle (142) on Action Card

TALK SHOWS SAVE MORE ^ MONEY TODAY

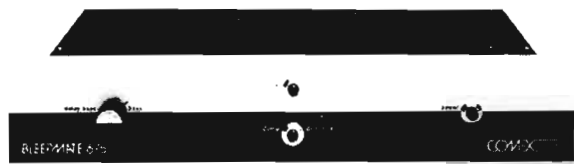

**NEW DIGITAL DELAY
BLEEPMATE™ 675/II**
fixed, 6 second delay

\$1,625

BLEEPMATE™ 675
3 or 6 second delay
operator selectable

\$1,940*

***We've held the price line!**
Both units available for immediate delivery.
Order from your favorite distributor or
Systems.

COMEX
SYSTEMS

2 Columbia Drive
Amherst, New Hampshire 03131 (603) 889-8564
A Division of The Successor Corporation

Circle (143) on Action Card

feature a rental department. For more information, contact one of their three offices, located in Dallas, Chicago, and Detroit.

Circle (321) on Action Card

EEC ENTERPRISES—Closed captioning was demonstrated in this booth. EEG has a deep line of captioning equipment that includes the encoder disc reader model MCZ-210, the tele-copy-floppy model MCZ-TC, and the dual computer model MCZ-DP. The company

also has a new line of video decoders and test encoders to go along with their Line 21 Simple Encoder.

Circle (322) on Action Card

EG&G—EG&G, Electro-Optics, based in Salem, Mass., displayed aircraft avoidance lighting systems for towers and other tall structures. These systems (high-intensity, capacitor-discharge, xenon-strobe type) are approved to FAA Advisory Circular AC150/5345-43.

Circle (323) on Action Card

EASTMAN KODAK—"FutureVision" was the theme of the two-story exhibit presented by Eastman Kodak. The ground floor featured Kodak's latest in film and video technologies, including the Eastman color high-speed negative film 5293/7293.

Due to the film's broad latitude, it can be exposed at very low light levels, creating many opportunities for originating programs at locations which were impractical or impossible to use before. It also presents opportunities for reduced lighting, power, and associated costs.

In the 16mm format, the high-speed film provides new magazine and documentary crews with opportunities for traveling lighter and moving faster, in addition to recording images at extremely low light levels.

Circle (324) on Action Card

ECHO SCIENCE—Echo Sciences' latest television tool, The Frame Bank, was introduced. Retaining all the same features of its predecessor, the EFS-1A, it has been made even more productive, reliable, and economical. Also introduced was the Image Maker, a high-band, color disc recording system that uses state-of-the-art electronics and an exclusive Discassete recording medium to perform a number of professional television production tasks from still frame storage to special effects. The Image Maker's functions include variable speed operation from freeze frame to real time, random access of as many as 512 frames on line, and the ability to preset 64 locations.

Circle (325) on Action Card

ELECTRO IMPULSE—This company displayed high-power RF loads, attenuators, baluns, and wattmeters.

Circle (326) on Action Card

EVENTIDE CLOCKWORKS—One of the more popular attractions at NAB '81 was Eventide's Timesqueeze™. And at this year's show, Eventide produced another winner with Timesqueeze Jr.™. The new Timesqueeze Jr. is an economical solution to time compression for television broadcasters, commercial producers, and filmmakers. The running time of audio, video, and film program material can be altered without editing or deleting material. Modular in design, this system consists of the PTC960 Precision Tape Controller and the H949 Harmonizer. And making time changes is simple: enter the percentage of time change desired on front-panel thumb-wheel switches on the PTV960, and Timesqueeze Jr. does the rest. When the H949 is not being used for time compression, the har-

**OVER ONE MILLION FEET!
AND STILL GOING STRONG!**

**OVER ONE MILLION FEET OF
COMMUNICATIONS TOWER CONSTRUCTION
... WE'VE DONE IT!**

This represents a tremendous financial investment by our customers, demonstrating their solid confidence in **STAINLESS**.
To our TV, AM/FM, CATV, military and microwave customers worldwide, past and present... **THANKS** for your confidence and your business.
NOW ON TO THE NEXT MILLION FEET, and a chance to serve **YOU**.
Call us soon, and discover what a difference our one million feet of experience can make to **YOU!**

The Tower People
Stainless, inc.
North Wales, PA 19454 U.S.A.
Phone: (215) 699-4871
TWX: 510-661-8097

CO182

Circle (141) on Action Card

monizer, by itself, is a superb audio production tool—for pitch change, delay and reverb, flanging, repeat, and time reversal. Timesqueeze Jr. provides full 15 kHz bandwidth and 96 dB dynamic range. The system provides all the control signals that are needed for operation with most 1-inch VTRs, film chains, and audio tape recorders. Units to be controlled must be specified when ordering.

Circle (327) on Action Card

FARRTRONICS—The M81 intercom system was shown by Farrtronics. This system, designed for television or radio use, features self-contained amplifiers in each station; line-level, direct audio switching with a cross-connect point; and totally passive matrix. The system connects to matrix via standard 25 pair cable and connectors. Each station is powered separately, with this decentralized approach allowing for maximum reliability. Interfaces are available.

FILM/VIDEO EQUIPMENT—This company's featured products were the Wide Eye I and Wide Eye II wide-angle adapters for video lenses. The Wide Eye I has a conversion factor of 6.4, and the Wide Eye II has a conversion factor of 5.1. These adapters can, for example, change the focal length of a 10-140 zoom lens to either a 6.4mm or a 5.1mm wide-angle lens. They are excellent for use in news or production.

Circle (328) on Action Card

FINNTEK—This company, located in Riverton, Utah, displayed audio consoles, audio test generators, and video test generators.

Circle (329) on Action Card

FLASH TECHNOLOGY—This company specializes in obstruction lighting. Featured at NAB was an obstruction

warning beacon system controller for use as part of an FAA L-856 obstruction lighting system. The ElectroFlash™ Controller SC-205 controls flashing operation of beacons, monitors flashing operation of beacons, activates a remote failure alarm, offers optional output and test functions by addition of plug-in modules, and mounts in conventional rack cabinet.

Circle (330) on Action Card

GARNER INDUSTRIES—Garner premiered its 1100 tape erasers, featuring a one-pass, endless belt operation that allows complete erasures at the rate of 13 reels per minute. Made of heavy-duty aluminum, the Garner 1100 has an internal fan for heat dissipation and an automatic thermal cutoff switch to prevent overheating. The eraser carries Garner's one-year guarantee.

Circle (331) on Action Card

GENERAL ELECTRIC—Two new families of GE Quartzline® tungsten halogen lamps for Fresnel spotlights used in studio, theater, and display lighting were announced, both having longer life and/or higher light output, plus more constant color and light output throughout life than the incandescent lamps they can replace.

Circle (332) on Action Card

THE GERSTENSLAGER COMPANY—As the networks begin to replace portions of their remote fleets now 15 to 18 years old, Wayne Bayer in the Gerstenslager booth was looking forward to one of their better years for broadcast vehicles. Already under construction is one W-33798 curb-side expandable, semi-trailer style unit for NBC with four similar units for CBS in the engineering phase. Also in the works for CBS is one of the V-5138S modular body units in which cable operators have been showing a lot of interest.

Circle (333) on Action Card

GLENTRONIX—Introduced by Glentronix was the model PC12 precision impulse clock, designed to operate with Torpey Controls & Engineering model CLK-2 and CLK-5 clock drivers. Features of the model PC12 include low power consumption, super-quiet movement, and jump second hand. It is resettable without being removed from the wall, and is designed to operate on standard 12 V alternate polarity pulse systems.

Circle (334) on Action Card

GORMAN REDLICH—Updated versions of the company's EBS encoders and decoders were shown. All equipment is in stock and available for immediate delivery. Prices are as follows: model C.E.B. encoder/decoder, \$345; model C.E. encoder, \$250; model C.D. decoder, \$195; modified AM/FM tunable receiver, \$100. Encoders are FCC type-accepted.

Circle (335) on Action Card

GOTHAM AUDIO—Included in this display were Neumann microphones, EMT Broadcast equipment and reverberation units, Digiphon audio storage systems, Telefunken tape machines, Telcom noise reduction systems, TTM frames, and NTP meters.

Circle (336) on Action Card

GREAT AMERICAN MARKET—New at NAB was STARSTROBE 2, a new version of the popular STARSTROBE. STARSTROBE 2 features a rugged, attractive, contoured housing, and a durable, clear molded one-piece lens cap. The cap is secured to the body by two set screws so that it can be easily removed and colored with lamp dip or gel. The new unit also incorporates an electronic circuit that operates on most AC dimmers as well as the main line. The unit's variable speed rate is designed to strobe at approximately 60

Continued on page 200

- Audio Follow Video
- 2-Channel Audio
- Rack Mount 19" x 1-3/4"
- BNC Connectors - Video
- TRW Multiple Connector - Audio
- Centralab Switches - Interlocking
- Bifurcated Silver Contacts
- Legend Strip
- Unswitched Video Terminated - 75 OHMS
- Unswitched Audio Easily Terminated
- No Signal Loss
- No Signal Degradation
- Cross Talk Better Than -60db
- No Power Required
- Simple Construction - Long Life

THE IDEAL WAY TO SWITCH MONITOR FEEDS

IN A PROBLEM-FREE, ECONOMICAL MANNER.

10 x 1 PASSIVE SWITCHER

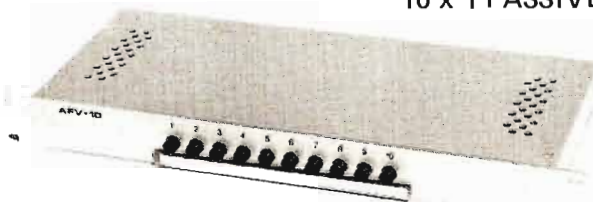

LOW COST
\$295.00

Model AFV - 10

H.M. DYER Electronics, Inc.

31185 Ten Mile Road Farmington Hills, Michigan 48024 Telephone (313) 478-2157

Circle (148) on Action Card

SPILL COFFEE IN OUR FADERS!

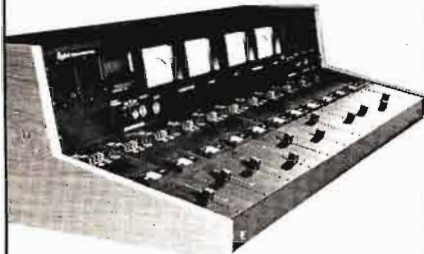

Our revolutionary new slide faders, made by P&G, literally deflect dust, dirt and spills to keep our boards running smoothly and quietly. Just one more way Logitek keeps you out front, year-in, year-out!

CALL TOLL-FREE 800-231-5870
(Texas call collect 713-782-4592)

We'll tell you about our full line of top-quality consoles, preamps, amplifiers and accessories!

Logitek Electronic Systems, Inc.
3320 BERING DRIVE □ HOUSTON, TEXAS 77057

Circle (144) on Action Card



Ground Isolation Problems In VIDEO/DATA LINES?

Your answer: **NORTH HILLS** ultra-wideband isolation transformers.

We have a comprehensive line of standard models, designed for —

- 75 ohm coax and 124 ohm balanced video lines with flat frequency and linear phase characteristics over video range.
- High-frequency 50 and 75 ohm coax pulse transmission systems in 1:1 and 50 to 75 ohm adapter versions.
- 10 kV isolation in public utility data transmission with 6 kHz to 2.5 MHz bandwidth in 75 ohm coax, 124 ohm balanced line and hybrid versions.

North Hills
Electronics, INC.
GLEN COVE, N.Y. 11542 • 516-671-5700

Circle (145) on Action Card

flashes per minute when 120 volts are applied. Lowering the voltage will slow the flash rate.

Circle (337) on Action Card

DAVID GREEN BROADCAST CONSULTANTS—Being shown in the David Green booth was the Composite Processor from Modulation Sciences. This unit delivers up to 6 dB more RMS modulation with less audible distortion per unit loudness than compressor/limiters. Even a station with the latest integrated compressor/limiter/stereo generator can add significantly to its loudness.

Circle (338) on Action Card

GREGG LABORATORIES—Gregg Laboratories has developed an all-new AM audio processing system which will solve bandwidth reduction problems, as well as loudness and audio quality problems faced by broadcasters. The 2540 AM audio broadcast processor is offered to the broadcaster as a complete AM broadcast audio processing system available in one complete package. The 2540 includes a broad-band gain control, band-limiting filters, specialized equalization, a symmetry synthesizer, a five-band compressor, a five-band clipper, low-pass filters, a transmitter phase/amplitude corrector, and two line amplifiers. The system may be divided in two using the optional main-frame to house the broad-band gain control in the event an STL is utilized. The 2540 is in stock and ready for immediate delivery.

Circle (339) on Action Card

HM ELECTRONICS—Well known in the field of wireless microphones, HME's Dynamic Expansion Systems were featured, including the 22E, 25E, 22EF, and the 25EF. The sound quality of these systems comes from a new approach to the compansion technique for noise reduction. Unique signal processing in the transmitters softly compresses the input signal, providing optimum modulation. A companion expansion circuit is included in the receivers, which precisely tracks the transmitter compression, resulting in an undistorted, virtually noise-free dynamic range of 100 dB.

Circle (340) on Action Card

HARRISON SYSTEMS—Well-known for their music recording consoles, Harrison Systems introduced the TV-3 series mixing console as a new solution to TV stereo sound. The TV-3 offers VCA grouping and automation in several variations as options.

Conductive VCA faders, full functions, automation control, three-band

equalization, filtering, and patch point and phase reversal switching are all available on the TV-3.

Harrison also unveiled the DS-1, a versatile, multi-channel audio-level metering system. Based on a powerful Z8000™ high-resolution color videographics processor, this new metering system offers a practical, cost-effective addition to a pointer or discrete bar graph audio-level metering system.

Circle (341) on Action Card

HOWE AUDIO/BCP—The Howe Series 2000 Phase 0 Chaser is an electronically controlled, precision, time-delay network which corrects for the relative phase-errors between the left and right channels of a stereo audio signal. This provides for optimum combining of left-plus-right signals for monaural compatibility. No other audio parameter is affected.

The Series 2000 features a dual-response, error-correction feedback loop having a long-term correction of phase of plus or minus 360 degrees and instantaneous correction to plus or minus 20 degrees. (This accurately characterizes stereo tape cartridge playback conditions). Measurements are at 10 kHz. Other features include a voltage-controlled time-delay network modeled to within 1% of "real world" time delay errors; and a wideband phase-error detector accurate to within 0.5% at all frequencies from 20 Hz to 20 KHz.

The Howe Series 2000 is available as a module for multiple use (either for individual tape playback systems or connected in series to achieve greater phase-correction range).

Circle (342) on Action Card

HUGHES HELICOPTERS—The Hughes' 300C/ENG helicopter drew the attention of crowds of exhibit viewers. Described as the most cost-effective ENG system available, Hughes offers it under the industry's best warranty.

Circle (343) on Action Card

IGM COMMUNICATIONS—IGM's brochure at their exhibit booth asked, "Are you ready for the new satellite music service?" Their answer: "We are." As sales representative Nick Solberg explained, "The equipment doesn't know what it's listening to," so it can interface with satellite, live assist, or other automation equipment.

There were no new showings by IGM, so the company concentrated on its reliable Instacart and the Go-Cart 24, 42, and 78 cartridge players, claiming the fastest access time in the automation industry.

Another feature at the IGM exhibit was the "Basic A" programming controller. Since the "Basic A" is programmed in simple English, it allows the station program director more flexibility than he has achieved with other automation controllers, the company says.

Circle (344) on Action Card

IMAGE VIDEO—This Canadian company offered several products, including routing switchers, master control switchers, machine assignment systems, and automation systems. Image Video custom designs switchers and control systems for television and radio.

Circle (345) on Action Card

INTERNATIONAL TAPETRONICS—This company returned with their standard line of audio tape recorders, but the Series 99 underwent some modifications since the last NAB convention, and the 99B includes these improvements: a bottoming solenoid that's easier to adjust; a less complicated, easier to adjust splice locator; lower THD and better response electronics; a higher slew rate; an improved erase coil; azimuth control routing; and a more accurate splice detector filter.

ITC claims theirs is the only totally compatible system for automatic azimuth/phase control. The 99B includes a built-in test generator that allows stand alone evaluation.

Circle (346) on Action Card

JBL (JAMES B. LANSING SOUND)—A variety of JBL monitor speakers for stations and recording studios were on display, and one of the featured products was their JBL 4411 control monitor. It's a three-way system with the drivers arranged in a closure cluster to permit close-in monitoring. The monitor includes a high-frequency dome radiator, mid-frequency driver, and a low-frequency driver. The 4411 could set the standard for today's compact studio monitors.

Circle (347) on Action Card

JAMIESON & ASSOCIATES—This Minneapolis-based firm offers consulting information, including development of business plans, A/V and media usage planning, and satellite communication; facility design services including the planning, design and equipment specification of broadcast and non-broadcast facilities, radio stations, training spaces, theaters, etc.; and consultive and production services in all major media formats.

JATEX—The Jatex VSEC-62TMX A/B roll editing controller has recently been

expanded to a full computer-assisted system that will operate on Jatex Scene-Dex time code or on SMPTE code. Regardless of the time code chosen by the purchasing agency, the VSEC-62TMX delivers such standard features as interface to any 1/2-inch, 3/4-inch, 1-inch, or 2-inch editing player/recorder with no VTR modification or kits; three separate and independent transport controls; self-contained VTR status display (no CRT needed); return to edit; random access search; auto tag; LAP time display; and more.

Circle (348) on Action Card

JEFFERSON DATA SYSTEMS—Jefferson Data was showing its enhanced System 90 traffic, sales, and accounting system. Emphasis is on fast delivery of data for quick response to availability requests and inquiries regarding accounts payable. Jefferson Data also showed a station-rep interface and an automatic switching interface for other manufacturers.

The folks from Charlotte, N.C., did not bring their ENP electronic newsroom system, although Bill Ballard was on hand to talk to the many interested parties. ENP is now being used to produce all news shows for WBTV, Charlotte.

Circle (349) on Action Card

KAMAN SCIENCES—Kaman has complete computer systems for television and radio in the areas of sales, traffic, billing, accounting, film inventory and amortization, cartridge and news inventory programs.

Circle (350) on Action Card

KINGS ELECTRONICS—Kings Electronics manufactures connectors, panels, and accessories for the broadcast industry.

Circle (351) on Action Card

KLIEGL BROTHERS—The Entertainer introduced by Kliegl is a portable memory lighting control console which provides proportional patching of dimmers to 12, 24, 36, or 48 group masters, and up to 48 memories within a simple two-scene preset system. Playback functions provide flash button operation of memorized "looks," and chase and latch functions with level controls. Other features include simultaneous manual and group controller operation, and optional library storage and hard copy printer.

Circle (352) on Action Card

LTM CORP. OF AMERICA—Highlighted at this booth was the Micro Set Lighting System (MSL) 250 which

Continued on page 202

IMI TRU COLOR PROJECTION TV

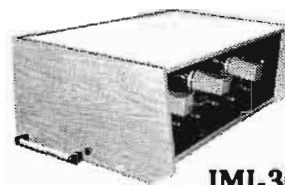

IMI-3000

LARGE SCREEN COLOR DISPLAY

10FT. UP TO 25FT.
DIAG. PICTURE SIZE

WIDE ANGLE VIEWING
ON STANDARD OR
REAR SCREENS

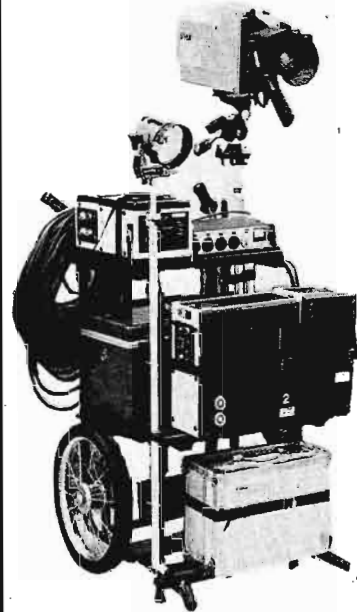

IMAGE MAGNIFICATION INC.

739 Airway Circle,
New Smyrna Beach Fla. 32069

(904) 427-5294

Circle (146) on Action Card



PORTA-BRACE™ "GRIP" THE ALL-PURPOSE CART

CALL FOR CATALOG
OF CARTS, CASES, & BACKPACKS



K and H Products, Ltd.
Box 246, North Bennington
Vermont 05257 802-442-9118

Circle (147) on Action Card

utilizes fiber optics. The MSL 250 System is in three parts: the power supply (ballast), the light box, and the Cable Micro Lights (CML).

Circle (353) on Action Card

LW INTERNATIONAL—Exhibited by LW International was the Athena 6000 telecine projector for on-line and film-to-tape transfer.

Circle (354) on Action Card

LAIRD TELEMEDIA—Film chain and previously introduced character-generator products were on display in Laird Telemedia's booth, but the attention was centered on this year's new introduction, the 7200 COMMUNICATOR character generator. This is their first high-resolution generator with features such as 4 resident fonts out of 128 available, 35ns resolution, 32 resident colors out of 32,000 possible, dual 8-inch disc drives and a 100-row resident memory.

Circle (355) on Action Card

LARCAN COMMUNICATIONS—Larcan, formerly known as Canadian General Electric, came to NAB '82 with a new 30 kW low-band TV transmitter

and a new 25 kW FM transmitter.

Circle (356) on Action Card

LeBLANC & ROYLE COMMUNICATIONS—This is one of the largest companies in Canada engaged in the design, manufacture, and erection of communications towers. LeBlanc & Royle also installs microwave antennas, broadcast antennas, and transmission lines.

Circle (357) on Action Card

LEITCH VIDEO—Leitch Video manufactures NTSC video synchronizing equipment, NTSC video calibration test generators, video/pulse processing, equalizing, and distribution amplifiers, master clock systems, and PAL/SECAM equipment. Among their products is the SPG-130N, an NTSC source synchronizing pulse generator. The SPG-130N is used primarily as a slave generator at picture source locations.

Circle (358) on Action Card

LEXICON—The Lexicon model 1200 audio time compressor provides a significant new capability: it allows you to play back recorded audio tape or videotape and film faster or slower without altering the original pitch.

With this remarkable audio processor, you can speed recorded materials up or slow them down, and get broadcast-quality sound, free of distortion. The 1200 makes it "pushbutton easy" to shrink or expand recorded material to meet allotted time requirements. Time-consuming editing and expensive re-takes are eliminated.

Circle (359) on Action Card

LOWEL-LIGHT—Lowel-Light featured the new Lowel DP, a 1,000-watt focusing spotlight. This new fixture, an updated version of the popular Lowel D light, features a 7:1 (150 to 1,050 foot candle) focussing range, built-in receptacle for new Lowel DP umbrella and gel frame, improved 4-way barndoor system, and a comfortable new pan/tilt handle.

Circle (360) on Action Card

McINNIS-SKINNER & ASSOCIATES—The jubilant folks at McInnis-Skinner arrived at the NAB fresh from announcing the first sale of their NEWSCAN newsroom computer system to WBNS-TV in Columbus, Ohio.

The firm showed both NEWSCAN and their popular WEATHERSCAN system. The graphics for WEATHERSCAN have been improved, and the product is getting almost as much attention as a graphics system as it is in its primary role as a means to illustrate TV weather.

Circle (361) on Action Card

MATTHEWS STUDIO EQUIPMENT—New from Matthews was the Video Matth-Pak, an assortment of Matthews equipment designed for effective video lighting control. The Matth-Pak offers video lighting control to the professional with the maximum of ease. Three cases, portable and lightweight in design, permit the mobility required in today's location video lighting.

Also new this year were additions to the Matthews Tuplic Crane, a portable, lightweight crane system designed for video applications.

MAXELL CORP. OF AMERICA—Maxell introduced a high-quality one-inch broadcast tape that is expected to be widely used at production houses as well as by television station engineers. The new tape is characterized by high signal-to-noise ratio; low chroma noise; low dropout rate; high color stability; and excellent audio quality. The new Maxell tape will be available in a shelf box and plastic shipper. It will be ready in commercial quantities by mid summer and will come in three lengths: 30, 60, and 90 minutes.

Circle (362) on Action Card

MEAD DATA CENTRAL—NEXIS is a computer-assisted information retrieval service that provides instant access to the full texts of stories from leading newspapers, magazines, wire services, newsletters, and other information services. This firm was showing its enhanced on-line data retrieval system. Mead brought its new "VBIQ" terminal with soft-touch keyboard.

Circle (363) on Action Card

MICRO COMMUNICATIONS—Circular waveguide transmission line developed for UHF-TV was featured at the Micro Communications booth. Some noteworthy features of the new transmission line are greater efficiency than either coax or rectangular waveguide, and the cylindrical shape reduces drag coefficient which lowers the wind load.

Circle (364) on Action Card

MICRO CONTROL—The booth included a line of studio to transmitter links and subcarrier equipment. The STL system is a wideband composite/narrowband single and dual-channel capacity operating on 10 watts. The frequency models available include 900 MHz, 215-235 MHz, 300-325 MHz, 450-470 MHz, and 1.2 GHz. The subcarrier system includes the PLG-10 generator, and the PLR-10 receiver, using PLL circuitry.

Circle (365) on Action Card

MICRODYNE—New from Microdyne

BROADCAST COMMUNICATIONS/JUNE 1982

ANTENNA PHASING COMPONENTS SYSTEMS



GCR-501

GCST-1,2,3 & 5

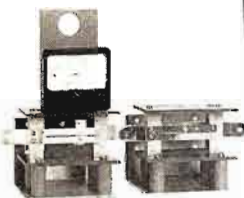
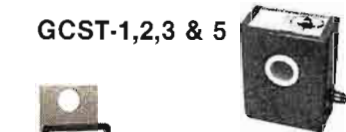

GMJ-100

GELECO ELECTRONICS LIMITED

Geleco Canada address:
2 Thorncliffe Park Drive, Unit 28
Toronto, Canada. M4H 1H2
(416) 421-5631

Geleco U.S.
U.S. Western Office:
1809-North 107th St., Unit 3-201
Seattle, Wash. 98133
(206) 362-0403

Circle (157) on Action Card

was the model 1100-TVX X-24 B-2 electronically tuned satellite TV receiver complete with internal polarization switching and two audio demodulators. This frequency-synthesized, 24-channel receiver can be tuned manually using front panel controls, or remotely via a BCD interface. A front-panel digital display indicates the locally or remotely selected channel. Unique threshold circuitry (patent pending) is a standard feature that assures optimum FM demodulator C/N performance. Other features include automatic antenna polarization selection; digital channel display, and optional audio subcarrier demodulators. The receiver is also available with switchable IF bandwidths and automatic video polarity reversal.

Circle (366) on Action Card

MODULATION SCIENCES—Eric Small burst on the NAB scene in Dallas with a new company that was promoting and selling a legal composite processor. According to Small, it's a new type of processor which delivers up to 6 dB more loudness while still complying with FCC regulations, and it produces less audible distortion per unit loudness than standard limiter/compressors.

Circle (367) on Action Card

NADY SYSTEMS—The newest addition to their product line is the Nady Wireless Communicator System, comprised of three units: the RT-201, a miniature push-to-talk two-way transceiver that attaches to the body and allows hands-free communication between two or more parties; the T-201, a miniature transmitter with the same housing and circuitry as the RT-201; and the R-1000, a miniature pocket FM receiver that is compatible with the RT-201 and T-201 systems.

Circle (368) on Action Card

NORTRONICS—Unveiled this year was the PF-208 Professional Head Degausser. It is designed with a super high-flux coil-core to demagnetize heavy duty 2-inch tape heads and guides. With a peak magnetic field strength of 1000 gauss, the PF-208 is one of the most powerful handheld degaussers currently on the market.

Circle (369) on Action Card

FRED NUDD COMPANY—This company designs, manufactures, and installs broadcast and communications towers and monopoles. Fred Nudd also provides tower repair, modification, and engineering services.

OAK COMMUNICATIONS—This California-based company offers

subscription television equipment, technology, and expertise to UHF station owners across the U.S. The licensing agreement calls for Oak to install, service, and maintain the STV equipment; prepare technical and business manuals; train STV operators and servicemen; and provide additional technical know-how as required.

Circle (370) on Action Card

O'CONNOR ENGINEERING—Displayed with O'Connor's camera support equipment, the Hydro-Ped model 102-B gives the cameraman several advantages over traditional tripods. The Hydro-Ped levels and locks hydraulically on any terrain up to 40°. The center column is hydraulically adjustable from 30 to 60 inches, and is hydraulically balanced so that it can handle its own weight and the weight of the camera and head up to 100 pounds on the column. The Hydro-Ped weighs only 29 pounds and folds to 30 inches long with a single centered handle.

Circle (371) on Action Card

PEP INC.—PEP demonstrated their new line of premium ENG power packs featuring the heavy-duty and lightweight on-board batteries, and the new 3-pound HAC3 on-board adapter.

Circle (372) on Action Card

QEI—The QEI model 691 FM monitor offers several features in a single 10½-inch-high, standard rack-mount unit. When combined with a single-trace oscilloscope, the model 691 becomes a spectrum analyzer. Front panel switches allow selection of either 240 kHz or 600 kHz bandwidth in the spectrum analyzer mode. A vector display function is also available for stereo phase adjustments and continuous monitoring of the off-air signal. Bessel null calibration of the monitor is easily accomplished with the built-in calibration oscillator and low-frequency oscilloscope.

Circle (373) on Action Card

QSI SYSTEMS—At the heart of the QSI Demod 400, exhibited at NAB, is a QSI-designed sync generator with switch-selectable original or replacement sync, burst, and blanking. The user has full control of burst gain and phase, sync level, and set level in process mode. Vertical blanking ends at line 10 for preservation of any test signals or data transmitted with original programming. The price of the Demod 400 is \$1895.

Circle (374) on Action Card

R-COLUMBIA PRODUCTS—New from R-Columbia Products was a wireless

base station that interfaces existing hard-wired intercom systems to FM wireless intercom headphones. The new System 50 base station provides full duplex intercommunication between a producer, director, etc. (wearing a R-Columbia FM wireless intercom headphone) and camera, lighting, and/or sound equipment operators who communicate via existing hard-wired intercom systems like Clear-Com, RTS, etc. Within its range (150 yards), the System 50 provides crystal-clear two-way voice communication between studio, stage, and/or set management personnel, and technical operators without using wires.

Circle (375) on Action Card

RANK PRECISION—Scotty Campbell of Rank Precision was very pleased with booth traffic this year and with the response to two new options for their popular Mk III flying spot film scanner: an X-Y Zoom and a Varispeed control.

The X-Y Zoom extends production versatility by allowing the user to alter the position and size of the picture being shown. Zoom range is 4:1 in and out. Anamorphic and non-anamorphic controls are provided with preset format ratios for 1.85:1, 1.66:1 and variable. A joystick adjusts position, and automatic blanking to the image position is provided. The TOPSY automation system can program X-Y Zoom functions automatically.

Varispeed gives scanner users the ability to precisely alter film running times. It provides speed control in 64 discrete steps from 16 fps to 30 fps with fixed speeds of 18 fps and 24 fps in the 525/60 version. Interface to audio pitch correctors is provided.

Circle (376) on Action Card

SAKI MAGNETICS—Saki supplies ferrite heads for Ampex, Scully, Studer, and most professional recorders.

Circle (377) on Action Card

SCIENTIFIC-ATLANTA—This booth was about what you'd expect, but S-A was pushing digital audio this year, and they did it with a 3-meter earth station. This earth station is designed for reception of media information broadcast via satellite using digital data techniques. It's been designed to receive high-speed TDM digital data at about 9 mb/s, demodulate, and then multiplex the data into the desired audio and data channels. That's new.

Circle (378) on Action Card

SCRIBE RECORDERS—Last fall Frank Beaman surveyed RTNDA Conference delegates asking what radio newsmen

Continued on page 204

needed in a rugged, reasonably-priced cassette recorder. Beaman brought his prototype to the NAB and asked newsmen to tear it apart. He went home with a notebook full of suggestions and a healthy collection of orders. The Scribe is a tough, no-frills cassette recorder, which drops into a sturdy lined canvas case which has big side pockets for accessories. The Scribe will weigh less than 3½ pounds and features single-button recording and talk-over-tape. The connections are sturdy XLRs for input and output. Production was scheduled to begin just as soon as the post-NAB modifications were worked out.

Circle (379) on Action Card

SHINTRON—New from Shintron was the model 515 FonTex Graph-Titler, a software-base, microprocessor-controlled graphic titler. The model 515 features microprocessor-based multiple fonts with 20 nanosecond resolution, color graphics, color background, color characters, automatic page and line centering, expandable floppy disc memory, character over input video, and self-contained enclosure with an edit monitor and disc memory. According to the company, deliveries will begin this month.

Circle (380) on Action Card

SKOTEL—Time code readers and generators were on display, including portable models. Interesting in their new line was the VITC (vertical interval time code) approach. According to Skotel, the content is compatible to longitudinal time control and control format. It includes even/odd field identification, and it mounts internal to and is powered by your time code reader or generator.

Circle (381) on Action Card

SOUND TECHNOLOGY—The newest product to be added to the Sound Technology line is the model 1501A Balancing System. This is a dual-channel device that interfaces any single-ended signal generator and measuring system to a balanced and/or floating device under test. It is specifically designed for use with the 1500A tape recorder/audio test system.

Circle (382) on Action Card

SPHERE ELECTRONICS—The 1604 Satellite Mixer is available from Sphere, featuring 16 inputs, 4 outputs, and 7 inches of rack space, in addition to mike or line input selection, and channel on/off LED. Options include stereo modules to allow panning between any two selected buses, and VU meter panel

for the 4-bus outputs.

Circle (383) on Action Card

STATION BUSINESS SYSTEMS—Station Business System featured the BAT 1700 business, accounting, and traffic system for radio and television stations. The BAT 1700 System is an in-house, minicomputer-based system which integrates order entry and availabilities, scheduling, invoicing, and accounts receivable functions along with producing on demand a broad range of management reports and analyses designed to increase station productivity and profitability.

Circle (384) on Action Card

STOREEL—Storell displayed a wide assortment of storage racks and cabinets.

Circle (385) on Action Card

STRAND CENTURY—Strand Century introduced an addition to the Matrix/CD80 Pack portable dimming family: the CD80 6KW Pack has 6-6000-watt dimmers for high-wattage loads and is available with optional Cam-lok connectors for portable applications or may be wall-mounted for permanent installations.

Circle (386) on Action Card

SYLVANIA/GTE—New from Sylvania was the Big Beam™ 1200 PAR 64 5600°K Studio Lamp. Designed for use as a daylight fill-light for film, television and theatre, the medium arc length light source has an initial color temperature of 5600°K. Fewer lamps are needed to provide desired illumination levels, and the cooler-operating properties of the Brite Beam result in significantly less heat output in the light beam and the fixture.

Circle (387) on Action Card

TDK ELECTRONICS—TDK showed a full line of audio and video cassette products for industrial and broadcast applications, including professional-use VHS videocassettes, and test and calibration audio cassettes.

Circle (388) on Action Card

TELEVISION EQUIPMENT—Elcon Tape Cleaner/Profiler is a new machine dedicated to the evaluation of 1-inch videotape. This machine retains the popular cleaning and evaluating features of Elcon's 2-inch/1-inch model, and incorporates a modified display and printout which were developed for the ¾-inch cassette unit.

Circle (389) on Action Card

TELEVISION TECHNOLOGY—Traffic was good at the booth where translators

and amplifiers were in the spotlight. Highlighted was the TTC model T-99 solar-powered translator series. The translator comes in a 1-watt FM version, and a 1 or 5-watt VHF TV version. Included is a solar panel, storage battery, and an optional system regulator. CTC translators are available in FM, UHF, and VHF models. Their highest powered rig is the XL 1000 UHF translator.

Circle (390) on Action Card

TENDEL—Tentelometer® Tape Tension gages measure dynamic tape tension to diagnose problems in videotape recorders. Models are available for 2-inch quad; 1-inch Type C and B; and ¾-inch U-matic, Beta, and VHS. Prices range from \$279 to \$740. Delivery is normally 2 to 3 weeks ARO.

Circle (391) on Action Card

THERMODYNE—This company manufactures equipment shipping and field cases, and their latest emphasis is on what they call the Rack Pack. You can install your field equipment in it, and at the site of a remote or EFP assignment, you pop off the covers and the protected equipment is already in the rack and ready to go.

Circle (392) on Action Card

TIFFEN—The Universal Matte Box from Tiffen consists of five parts: the rotating body assembly, two filter frames for holding 3x3 inch filters, the front mount with the rubber lens shade, and a Series 9 insert ring.

Circle (393) on Action Card

TRUE TIME INSTRUMENTS—From the True Time Instruments division of Kinermetrics came a display of WWV time receivers, satellite synchronized clocks, remote time displays, WWVB time phrase comparator, WWV antennas, HF time and frequency receivers, and even WWV antenna kits.

Circle (394) on Action Card

URSA MAJOR—New enhancements on the 8X32 digital reverberator were unveiled by Ursa-Major. These enhancements include an optional remote, and capability for computer-automated mixdown interface. Also, early reflections, initial reverberation, decay time, and low and high frequency decay are pushbutton adjustable within each of four basic programs. The system will synthesize reverberation over a wide range of natural and unnatural spaces, including decay times up to 20 seconds.

Circle (395) on Action Card

VIDEOMAGNETICS—Videomagnetics,

which specializes in head refurbishing services, introduced a warranty extension on VMI strong-back ferrite heads to 36 months retroactive to June 30, 1981. VMI also announced that they will be refurbishing and repairing 1-inch and ¾-inch heads by mid-year.

Circle (396) on Action Card

WILKINSON ELECTRONICS—A long-time builder of AM and FM transmitters, including low-power solid-state rigs, Wilkinson showed a lineup of transmitters with the new, modern look. Known for their reliability, the transmitters on display included 10- to 250-watt rigs in the low-power FM solid-state class, and four rigs in the 500- to 2500-watt FM group (using solid-state exciters and power supplies). In the FM high-power FM line, Wilkinson rigs range from 5,000 to 30,000 watts. The AM solid-state rigs hit 125 and 250 watts, while the higher power models handle 1, 3, 5, and 10 kW.

Circle (397) on Action Card

WOLD COMMUNICATIONS—Wold was promoting its Wolcom transportable uplinks. Wold has acquired 4 transponders on Westar IV to expand its newsfeed and syndication services. The satellite company was also promoting the Wold Satellite TV Network, which distributes programming for syndicators.

Circle (398) on Action Card

WOLF COACH—This company custom builds mobile units for the broadcast, production, and cables industries. Wolf Coach can handle anything from basic vans for single-camera local access programming, to 42-foot trailers for complete multi-camera production.

Circle (399) on Action Card

ZENITH RADIO—On display in the Zenith booth were multi-channel STV and tiered teletext decoders.

Circle (400) on Action Card

The following companies also exhibited at NAB '82. For more information on these companies, circle the appropriate number on the Action Card in this issue.

ADC PRODUCTS—Enclosed video jackfield. (Circle 228)

ADVANCED DESIGNS—Weather presentation system. (Circle 160)

ADVANCED MUSIC SYSTEMS—Digital reverberation system. (Circle 161)

PETER ALBRECHT—TV studio machinery control. (Circle 162)

ANVIL CASES—Full line of heavy-duty rack-mount cases. (Circle 229)

APHEX SYSTEMS—Aural exciter that restores presence, clarity, naturalness,

and definition to sound. (Circle 164)

ARBEN DESIGN—Set design. (Circle 163)

TOBY ARNOLD & ASSOCIATES—Music formats.

AUDICO—Videocassette tape loader/reloader designed for loading tape directly in U-matic, VHS, and Betamax cassettes. (Circle 246)

AUDIO KINETICS—Synchronizer for controlling up to three video/audio tape transports. (Circle 165)

AUDIO TECHNICA—Phantom power shotgun microphone. (Circle 230)

BIW SYSTEMS—Complete line of optical fiber cables. (Circle 166)

BILL BLACK & ASSOCIATES—Turnkey newsgathering vehicle, the Mobile-Cam One. (Circle 167)

BROADCAST CARTRIDGE—Audio cartridge reconditioning. (Circle 231)

BRYSTON MANUFACTURING—Power amplifiers. (Circle 227)

CBS RADIO—New network for 18-34 market. (Circle 169)

CAMBRIDGE PRODUCTS—Fast-fit connector. (Circle 232)

CANFORD AUDIO—Conductive thermo-plastic shielded microphone cables. (Circle 170)

CELESTIAL MECHANIX—Radio promotion services. (Circle 233)

CENTURY 21—Automation equipment and music formats. (Circle 171)

CLYDE ELECTRONICS—Full line of broadcast equipment, including Alpha modular mixer. (Circle 172)

COLUMBINE SYSTEMS—Computer packages to handle all business functions, plus music inventory and rotation, sales analysis, media inventory, and more. (Circle 247)

COMPUCON—Engineering services. (Circle 173)

COMPUTER OPERATIONS—Real-time animation system. (Circle 174)

CONCEPT PRODUCTIONS—Program formats designed for use on automated stations. (Circle 175)

CONTINENTAL RECORDINGS—Jingle packages for radio. (Circle 176)

COOL LIGHT—Mini-Cool 250-watt light. (Circle 177)

PETER DAHL COMPANY—High-efficiency modulation transformers and reactors for 1 kW and 5 kW AM transmitters. (Circle 234)

DATA COMMUNICATIONS CORP.—Business computer system. (Circle 235)

DATUM—Model 9400-630 VBI data encoder and associated reader. (Circle 178)

DE WOLFE MUSIC LIBRARY—Library of sound effects for production uses. (Circle 236)

DRAKE-CHENAULT—Radio formats. (Circle 179)

DYNAMIC TECHNOLOGY—Datalite lighting control equipment, remote

control and data transmission equipment, and distribution equipment. (Circle 180)

E-N-G CORPORATION—ENG Suburban truck and ENG/EFP van. (Circle 237)

ECHOLAB—SE-3 production switcher. (Circle 238)

EIGEN VIDEO—Videograph, an artist-oriented illustration and animation system for video and slide production. (Circle 248)

ELECTRO CONTROLS—A new patching system using custom keyboard and CRT terminal to assign and display control-dimmer cross connections. (Circle 249)

EMCOR PRODUCTS—The 10 Series of cabinets. (Circle 181)

ENVIRONMENTAL CONTAINER SYSTEMS—The ECS transportable electronics enclosure. (Circle 182)

EXCALIBAR INDUSTRIES—VTR case. (Circle 183)

FIBERBILT—Carrying and shipping system for photographic equipment. (Circle 250)

FIRSTCOM—Production and commercial library. (Circle 184)

FITZCO SOUND—Professional mixing console for large-scale reinforcement and remote applications. (Circle 251)

FORT WORTH TOWER—Guyed and self-supporting towers, and factory-fabricated communications buildings. (Circle 252)

FOSTEX—Recorder/reproducer featuring 8 tracks on ¾-inch tape. (Circle 253)

GENERIC COMPUTERS—Poly Morphic System 8810. (Circle 185)

GOLDEN IMAGE—Syndicated TV commercials for radio stations. (Circle 254)

GRUMMAN AEROSPACE—Combination synchronizing generator/processing amplifier for a subcarrier/horizontal sync-timed broadcast facility. (Circle 186)

HARDIGG INDUSTRIES—Package cushioning products. (Circle 187)

IMMAD BROADCAST SERVICES—Turnkey broadcast systems. (Circle 255)

INNOVATIVE TV EQUIPMENT—Fluid heads featuring adjustable counter-balance. (Circle 188)

INTERACTIVE MARKET SYSTEMS—Computer time-sharing services. (Circle 189)

INTERACTIVE SYSTEMS—Super Edit, a complete editing system operating program. (Circle 190)

INTERAND/TELESTRATOR—Telestrator 440, a new product designed for real-time television programming plus quick pre- or post-production anima-

Continued on page 206

tion and graphics effects. (Circle 191)

INTERFACE DATA SYSTEMS—Model 2000 station automation system and new machine control unit. (Circle 192)

INTERFACE ELECTRONICS—Battery-operated portable professional 8-in/2-out stereo mixer. (Circle 193)

JENEL CONSULTANTS—Video Frame Storer which permits inexpensive storing of color video signals on removable discs. (Circle 239)

JENSEN TOOLS—JTK-85 installer's tool kit. (Circle 194)

KLARK-TEKNIK—Stereo profanity delay unit. (Circle 195)

KOBOLD LICHT—DLF 200 S Unit featuring lockable pivoting bracket which permits inclination within 270°. (Circle 196)

LEADER INSTRUMENTS—NTSC vectorscope. (Circle 258)

LEMO—Connectors for broadcast and recording applications. (Circle 256)

LIBRA PROGRAMMING—Computer broadcast system for traffic, sales, general ledger, and payroll. (Circle 197)

LIGHTNING ELIMINATION ASSOCIATES—Protective device that guards your sensitive equipment against all types of powerline irregularities. (Circle 259)

LIPSNER-SMITH—CF-100 ultrasonic film-cleaning machine. (Circle 240)

LIVE SOUND—Syndicated radio formats. (Circle 198)

LOGICA—Teletext system based on the BBC Ceefax system and Flair videographics system. (Circle 260)

MAGNASYNC/MOVIOLA—Film-to-tape unit. (Circle 261)

MAGNUM TOWERS—Fabrication of radio and TV towers, and related hardware. (Circle 241)

THE MANAGEMENT—Computer software programs for radio station traffic and billing. (Circle 242)

MINOLTA—Luminance and chroma meters. (Circle 199)

KEITH MONKS AUDIO—Record cleaning machines. (Circle 262)

MOTOROLA—Microprocessor-controlled, portable base/repeater featuring 35 watts in repeat mode. (Circle 263)

MUSIC DIRECTOR PROGRAMMING SERVICE—Complete line of Joel Whitburn's Record Research Books. (Circle 200)

NOVA—Tape cleaner that fits all formats and all videotape recorders. (Circle 264)

NTI AMERICA—Animation system which converts analog signals into digital and stores the code on a disc. (Circle 257)

NAUTEL MAINE—Modular 5 kW AMPFET 5 AM broadcast transmitter. (Circle 201)

NETWORK PRODUCTIONS—Whisper Disc, a new form of record with brighter, clearer, and quieter sound. (Circle 202)

NEUTRIK—Professional connectors for broadcasters.

NYTONE ELECTRONICS—Flying Spot Scanner System. (Circle 203)

OLESEN—The Wizard computerized lighting control console. (Circle 204)

PACE—Micro portable desoldering/soldering system. (Circle 205)

PARSONS—Cases with recessed wheels and handles. (Circle 243)

PETERS PRODUCTIONS—Music formats. (Circle 206)

THE PHOEBUS CORPORATION—Ultra Quartz lamp. (Circle 207)

PORTA-PATTERN—Test charts and chart systems for studio, EFP, and ENG applications. (Circle 265)

POWER OPTICS—Synchronized background equipment for chroma key. (Circle 266)

PROCART—Audio cartridge that exceeds type AA cartridge standards. (Circle 267)

PUBLISON AUDIO—Stereo audio computer. (Circle 208)

Q/TV/TELESYNC—Cueing equipment, console transport, and conveyor

transport for studio and on-location prompting. (Circle 268)

QUAD-EIGHT—Consoles designed for TV post-production audio enhancement. (Circle 269)

RADIOCOM—Computer system for handling all business functions. (Circle 209)

ROSCO LABS—Fog/Smoke Machine for theater and television applications. (Circle 270)

HOWARD W. SAMS—New catalog, *Silent Salesman*, that allows you to present your total product line. (Circle 271)

SOUNDCRAFT—Stereo mixer. (Circle 272)

SPECTRUM—Analysis and design of high-quality communications systems. (Circle 210)

STANTRON—Rack cabinets, console cabinets, turret cabinets, bench cabinets, and accessories. (Circle 244)

STEPHENS ELECTRONICS—Professional recorder/reproducers. (Circle 222)

SYMETRIX—Hybrid telephone interface. (Circle 211)

SYSTEM ASSOCIATES—Brokers for used broadcast equipment. (Circle 212)

TAMRON—Lens for 2/3-inch color separation prism-type cameras. (Circle 213)

WILLIAM B. TANNER CO.—Music IDs and background music. (Circle 214)

TECHTRAN INTERNATIONAL—This company featured a portable video unit for sales and training presentations. (Circle 215)

TELESCRIPT—Terminal-prompter combination which can be applied to newsroom word processing. (Circle 216)

TELFAX—Miniature telephone remote unit. (Circle 217)

TENNAPLEX SYSTEMS—UHF combiner package for satellite receive/terrestrial rebroadcasting. (Circle 218)

THEATRE SERVICE—Cyclorama curtains. (Circle 219)

THEATRE VISION—Turnkey studio installations. (Circle 220)

TRIDENT USA AUDIO—Expandable audio consoles. (Circle 221)

TWEED AUDIO—Custom consoles for radio and television. (Circle 168)

UNI-SET—Studio and news set designs. (Circle 223)

UNITED RESEARCH—Solid-state erase/play/record amplifier. (Circle 224)

UTILITY TOWER—Tower sections. (Circle 225)

VLAHOS-GOTTSCHALK—Video matting. (Circle 226)

WEATHER STATION—Complete television weather program with high-quality color animation. (Circle 245)

Product Specialist Cartridge Machines

Career opportunity for a technically trained individual with strong interest in cartridge machine performance and application. Must have practical up-to-date experience with cart machines and good communication skills to interface with design engineers and with customers. BS Degree preferred. This important new position reports to company Vice President.

Excellent company benefits including Profit Sharing Plan.

Please send resume, in strict confidence to Personnel Department.



BROADCAST ELECTRONICS INC.
4100 NORTH 24TH STREET, P.O. BOX 3606
QUINCY, IL 62305. PHONE (217) 224-9600

An Equal Opportunity Employer

Circle (149) on Action Card

SBE MONTHLY LOG

ARIZONA:

PHOENIX (Chapter 9)—Dalis Electronics sponsored their Ninth Annual Pizza & Beer Party for the chapter members. New officers are Bill Beckner, chairman; Bill Strube, vice-chairman; and Pat Porter, sec/treas.

CALIFORNIA:

EUREKA (Chapter 71)—James Thibodeaux of Videomedia/SED demonstrated and discussed the Hitachi VKC-1000 CCD color camera.

FRESNO (Chapter 66)—Mac Mehafey of RCA demonstrated and discussed the TK-86 and TK-710 ENG cameras.

LOS ANGELES (Chapter 47)—John Sullivan of Econco Tube Rebuilders led a discussion on the techniques of lowering the cost of staying on the air (using rebuilt tubes, of course). Also, members discussed the highlights of the NAB convention in Dallas.

NORTH VALLEY (Chapter 83)—Jim Wilson of Alamo Communications in Anderson gave an overview of the communications equipment and theory in use today by many services, and explained proper installation and service on the equipment.

ORANGE COUNTY (Chapter 77)—Ed Gordon, national SBE board member, provided a detailed update on SBE's national doings and presented the new promotional videotape that will be available to all chapters from the national office.

SACRAMENTO (Chapter 43)—Dave Ericksen, of the FCC field office in San Francisco, talked about some of the effects that deregulation will have upon broadcasters—not the least of which is the need for local frequency coordination. New officers are Dave Porte (KX-TV), chairman; Ken Blue (Sacramento State University), vice-chairman; and Kent Randles (KXOA), sec/treas.

SAN FRANCISCO (Chapter 40)—A review of the 1982 NAB convention technical sessions and equipment exhibits was conducted.

COLORADO:

DENVER (Chapter 48)—Bill Harris discussed the SBE Certification Program plus the entry-level "Broadcast Technologist" and explained that details on this level have been mailed to all SBE chapters. New officers for Chapter 48 are Chuck Waltman (KIMN-KYGO), chairman; Paul Montoya (KBPI), vice chairman; and Gary Nakashima (KFTM-KBRU), secretary-treasurer.

CONNECTICUT:

CONNECTICUT VALLEY (Chapter 14)—Bill Bansavage and his staff conducted a tour of their plant in Manchester. Multi-Circuits produces circuit boards of all types and is the fourth largest producer of boards in the country.

FLORIDA:

JACKSONVILLE (Chapter 7)—There was a presentation by US JVC (southeastern division), made possible by Southeast Electronics and Gray Communications. Several ENG-type cameras were demonstrated, as well as a new model of a VHS recorder with stereo audio.

ILLINOIS:

CHICAGO (Chapter 26)—Bill Carpenter of Ampex presented a program on "How Cost Effective Technical Changes Allowed the Introduction of a Lower Cost 1-Inch Type C Recorder, the Ampex VPR-80." This recorder is designed to be a more economically priced machine than the VPR-2 series, but more useful than the 3/4-inch machines.

QUAD CITIES (Chapter 65)—Bob Henson of Lenco gave a presentation on subcarrier to H-phasing of RS-170A and the Lenco PVS-430 Videoscope.

INDIANA:

INDIANAPOLIS (Chapter 25)—Bob Griffiths of Telemet discussed "Fiber Optics Applications for Broadcasters" with a demonstration over 300 feet of line. New officers are Steve Brant (Midwest Corp.), chairman; Doug Garlinger (WHMB-TV), vice-chairman; Norm Birnbaum (WTHR-TV), sec/treas; and Otis Robinson, Jr. (WRTV), re-elected treasurer.

KANSAS:

KANSAS (Chapter 3)—Gene Beaver of the Sedgwick County office of Civil Preparedness conducted a tour of the police and sheriff radio dispatch area and described the operation of the 911 emergency phone number.

MARYLAND:

BALTIMORE (Chapter 46)—Leonard Kahn, president, Kahn Communication, gave a presentation on AM stereo and summarized the various marketplace systems offered. He also discussed the technical developments of AM stereo receivers both on and off the drawing board.

MICHIGAN:

SOUTHEASTERN MICHIGAN (Chapter 82)—Ed Portman of Detroit Edison described how they are set up and the types of transmission systems used. He also discussed procedures during power outages and how to interface with Detroit Edison lines. This was a joint meeting with AES.

MINNESOTA:

MINNEAPOLIS/ST. PAUL (Chapter 17)—A joint meeting with the local chapter of the Audio Engineering Society featured a Nortronics presentation of the manufacture of tape recording heads, along with discussion of the pros and cons of various head types. Bruce Larsen of Nortronics conducted a tour of their manufacturing facility.

MISSOURI:

KANSAS CITY (Chapter 59)—Phil DeSantis of Lexicon gave a presentation on "Audio Time Compression & Expansion." He demonstrated the operation of the Lexicon model 1200 audio time compressor working in conjunction with a 1-inch Type C video recorder.

ST. LOUIS (Chapter 55)—Chris Kreger & Joe DeAngelo of Harris Broadcast Products discussed their new line of AM transmitters. The transmitters include a fully automatic control and diagnostic system that is operated by two microprocessors.

NEW YORK:

CENTRAL NY (Chapter 22)—David Schnirman, audio technician working for Syracuse State (Theatre Group), discussed and demonstrated the use of Pressure Zone Microphones (PZM) manufactured by Crown International.

NEW YORK CITY (Chapter 15)—Review of the NAB convention was conducted. New officers are Herb Squire (WHN Radio), chairman; Richard Silvera, vice chairman; and David Bain, treasurer.

NORTHEAST NY (Chapter 58)—Tom Oliviero and Bert Hilaire of Chyron discussed the operation of the latest Chyron character generation equipment.

OHIO:

CENTRAL OHIO (Chapter 52)—William L. Ammons of Broadcast Electronics, gave a slide presentation and talk on FM exciters; he also discussed practical RFI elimination techniques for the broadcast engineer. New officers

Continued on page 208

are John Battison, chairman; John Cooper, vice-chairman; and Rick Farquhar, sec./treas.

NORTHEAST OHIO (Chapter 70)—The program was presented by the Midwest Teleproductions. They are a complete television production house, with a mobile truck which was on display. Midwest handles all television feeds from the coliseum for all cable broadcasts of any sporting event from the coliseum to ESPN and the USA Cable nets.

SOUTHWESTERN OHIO (Chapter 33)—Bill Brock of Pacific Recorders & Engineering Corp. gave an interesting talk on recorders and audio systems.

OKLAHOMA:

TULSA (Chapter 56)—Jennifer Lloyd, assistant safety director for the American Red Cross of Tulsa, presented a program on CPR.

PENNSYLVANIA:

PHILADELPHIA (Chapter 18)—Phil Gant, Larry Will, and Glenn Romsos discussed the ideas and equipment presented at the NAB.

PITTSBURGH (Chapter 20)—Ted Washburn of Fujinon Inc. presented a

program entitled "Zoom Lenses, The Quiet Front End of Camera Technology": a detailed presentation of the structure and uses of zoom lenses for ENG, studio, and other applications.

TENNESSEE:

MEMPHIS (Chapter 61)—A tour of the satellite dish at WLVS was conducted.

TEXAS:

CENTRAL TEXAS (Chapter 79)—Sandra Morris of the Dallas office of the FCC discussed the role of the FCC. The major topic was the FCC is no longer the "bad guy"; instead, they want to work with the broadcaster in any way they can to resolve problems, questions, etc.

NORTH TEXAS (Chapter 67)—Leo MacWilliams, stage manager, Dallas Communications Complex, conducted a tour of this rental, television, and film sound stage complex. New officers are Gerry Dalton, chairman; Clyde Miller, vice-chairman; and Josh Socolof was re-elected sec./treas.

SOUTH TEXAS (Chapter 69)—Joe DeAngelo and Jack Ducart of Harris Broadcast Products Division presented a program on AM stereo.

VIRGINIA:

RICHMOND (Chapter 60)—A field tour of WWBT-TV was conducted.

TIDEWATER AREA (Chapter 54)—Art Constantine of Fidelipac presented a program on cartridge tape alignment techniques and characteristics of the new "Master Cart II" tape cartridge.

WASHINGTON:

SPOKANE (Chapter 21)—T. O. Jorgenson, chapter member, gave a report on tube rebuilding techniques and recommended procedures in the use of rebuilt tubes.

TRI-CITIES (Chapter 51)—Don Eckis of Cascade Broadcasting discussed their new ¼-inch videotape machine. The videocassette is not much larger than an audio cassette box.

WISCONSIN:

FOX VALLEY (Chapter 80)—Peter Thorpe of Robert Jones Consulting Engineers gave a talk on Alaskan radio stations and demonstrated the use of minicomputers in designing directional antenna arrays. Bob Gorjance of the Harris Corp. updated the group on AM stereo progress. **BC**

*Register Now
for the*

1982 RTNDA CONVENTION

September 30 - October 2
Las Vegas

Emphasis:

- Day 1. "Improving the News Product"**
- Day 2. "Utilizing the New Technology"**
- Day 3. "Sharpening Management Skills"**

See us at
NAB BOOTH 3205A



or phone
202/737-8657

If you're in the market for a newsroom computer . . .

. . . this could be the smartest \$10 investment you've ever made.

Sooner or later, your newsroom will be revolutionized by the innovative marvels of computer technology. But before you spend thousands of dollars—or tens of thousands—on a newsroom computer system, invest \$10 in the industry's first authoritative guide to newsroom computers. THE COMPLETE GUIDE TO NEWSROOM COMPUTERS contains factual, applications-oriented information on every aspect of newsroom computers . . . from understanding computer basics and making the initial purchase, to utilizing the computer to full potential in daily radio and TV news operations. And featuring a detailed description of systems currently on the market. Chapters include:

- ★ Understanding how a computer works
- ★ Developing a buyer's checklist
- ★ Financial aspects of a

computer purchase

- ★ Selling management on the benefits of a computer
- ★ Training people to use computers
- ★ Radio and TV applications
- ★ Future applications of computer technology
- ★ Descriptions of systems now available
- ★ And more

Edited by Phillip Keirstead and published by BROADCAST COMMUNICATIONS magazine, THE COMPLETE GUIDE TO NEWSROOM COMPUTERS is the only single source of information about newsroom computers . . . available anywhere.

LIMITED PRESS RUN. SEND YOUR ORDER TODAY!

Newsroom Computer Guide
BROADCAST COMMUNICATIONS
4121 West 83rd Street; Suite 132
Prairie Village, KS 66208

Please send _____ copies of **The Complete Guide to Newsroom Computers** at \$9.50 plus .50 handling per copy. My check or money order is enclosed.

NAME _____

COMPANY/STATION _____

ADDRESS _____

CITY _____

STATE _____

ZIP _____

Make checks payable to BROADCAST COMMUNICATIONS. Kansas residents, please add sales tax.

The Complete Guide to Newsroom Computers

Phillip O. Keirstead, editor

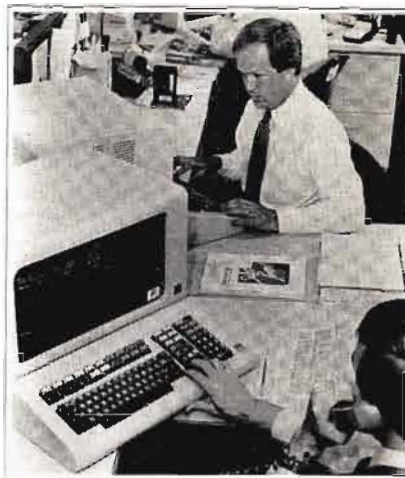

ADVERTISERS INDEX

<p>ADM Technology IFC ATI-Audio Technologies Inc. 142 Circle (88) on Action Card AVL Digital Ltd. 125 Circle (69) on Action Card Adda Corp. 1 Circle (1) on Action Card Alexander Manufacturing ... 124 Circle (68) on Action Card Allen Avionics 169 Circle (140) on Action Card Allen Osborne 12 Circle (8) on Action Card Ampex AVSD 13 Circle (9) on Action Card Ampex MTD 27 Circle (21) on Action Card Anders, Inc. 139 Circle (85) on Action Card Angenioux, Inc. 101 Circle (58) on Action Card Aristocart 116 Circle (60) on Action Card Asaca 32, 121 Circle (83), (85) on Action Card Audio Accessories, Inc. 88 Circle (51) on Action Card Audiomedia Associates 167 Circle (112) on Action Card Autogram 150 Circle (95) on Action Card BSM 176 Circle (126) on Action Card Bal, William Corp. 170 Circle (116) on Action Card Belar Electronics Labs 152 Circle (99) on Action Card Broadcast Electronics 206 Circle (149) on Action Card Broadcast Systems 88, 170 Circle (50), (115) on Action Card Broadcast Technology, Inc. . 193 Circle (135) on Action Card CEI (Commercial Elec. Inc.) . 87 Circle (49) on Action Card CMX Systems/Orox 3 Circle (3) on Action Card C.S.P., Inc. 196 Circle (138) on Action Card Calvert Electronics 65 Circle (38) on Action Card Camera Mart 28-29 Circle (22) on Action Card Canon U.S.A. 59 Circle (35) on Action Card Capitol Magnetic Products . 143 Circle (89) on Action Card CeCo Communications 81 Circle (46) on Action Card Central Dynamics 31 Circle (24) on Action Card Cine 60 45 Circle (154) on Action Card Comad Comm. 164, 166 Circle (103), (104) on Action Card Comex Systems 197 Circle (143) on Action Card Comrex 26 Circle (20) on Action Card Continental Electronics 17 Circle (13) on Action Card Cosmin Electronics 139 Circle (88) on Action Card Crosspoint Latch Corp. 91 Circle (53) on Action Card Datatron 73 Circle (42) on Action Card</p>	<p>Delcom 164 Circle (110) on Action Card Delta Electronics 71 Circle (41) on Action Card Deltamod Corp. 135 Circle (91) on Action Card Di-tech 57 Circle (34) on Action Card Victor Duncan 172 Circle (118) on Action Card H.M. Dyer 199 Circle (148) on Action Card Dyma Engineering 191 Circle (133) on Action Card Dynacom Electronics 172 Circle (119) on Action Card Dynair Electronics . 127, 129, 131 Circle (72), (73), (76) (77), (80) on Action Card EEV, Inc. 67 Circle (39) on Action Card EMCEE Broadcast Products . 53 Circle (32) on Action Card E.S.E. 24-25 Circle (152) on Action Card Elector 2 Circle (2) on Action Card Electronic Devices 137 Circle (84) on Action Card Electro-Voice 14 Circle (10) on Action Card Elektropex 149 Circle (94) on Action Card Fernseh 33 Circle (100) on Action Card Fidelipac 175 Circle (124) on Action Card Finntek Ltd. 132 Circle (81) on Action Card Fluxcom Systems 137 Circle (155) on Action Card For-A Corp. 118 Circle (62) on Action Card Fujinon, Inc. 69 Circle (40) on Action Card Full Compass Systems 166 Circle (107) on Action Card GE VDEO 61 Circle (36) on Action Card Geleco 202 Circle (157) on Action Card Giesler Broadcasting Suppy 166 Circle (109) on Action Card Gorman Redlich Mfg. Co. ... 183 Circle (131), (132) on Action Card Graham-Patten Systems ... 176 Circle (125) on Action Card Grass Valley Group 5 Circle (4) on Action Card David Green Broadcast Consultants 133-134 HEDCO 120 Circle (64) on Action Card Harris Video Systems 79 Circle (45) on Action Card Hitachi 55 Circle (33) on Action Card Howe Audio 145 Circle (90) on Action Card Ikegami Electronics Inc. 63 Circle (37) on Action Card Image Magnification 201 Circle (146) on Action Card Image Video 173 Circle (158) on Action Card Industrial Sciences (ISI) ... 177 Circle (127) on Action Card</p>	<p>Inovonics 126 Circle (71) on Action Card Integrated Sound Systems ... 45 Circle (153) on Action Card Integrated Technology 30 Circle (23) on Action Card K & H Products 201 Circle (147) on Action Card LPB, Inc. 153 Laird Telemedia 123 Circle (67) on Action Card Linrose 167 Circle (111) on Action Card Listec TV Equipment 119 Circle (63) on Action Card Logitek 200 Circle (144) on Action Card 3M 18-19 Circle (14) on Action Card MCI, Inc. 83 Circle (48) on Action Card MCI/Quantel 36 Circle (101) on Action Card Magna-Tech 75 Circle (43) on Action Card Marcom 167 Circle (113) on Action Card Marconi Electronics 49 Circle (30) on Action Card Marti Electronics 174 Circle (122) on Action Card Merlin Engineering Works ... 194 Circle (136) on Action Card Micron 163 Circle (102) on Action Card Midwest Corp. 9 Circle (8) on Action Card Moseley Associates 117 Circle (81) on Action Card Motorola 89 Circle (52) on Action Card Multidyne Electronics 178 Circle (128) on Action Card Northeast Broadcast Labs . 164 Circle (105) on Action Card North Hills Electronics ... 200 Circle (145) on Action Card Orban Associates (Pro-Audio) 16 Circle (12) on Action Card Orban Associates (OPTIMOD) 21 Circle (16), (17), (18) on Card Pacific Recorders & Engr. ... 47 Circle (29) on Action Card Perrott Engineering 93 Circle (54) on Action Card Philips Test & Measuring ... 11 Circle (7) on Action Card Potomac Instruments 130 Circle (79) on Action Card Processing Plus 162, 164 Circle (120), (106) on Action Card QEI 171 Circle (117) on Action Card Quantum Audio Labs 192 Circle (134) on Action Card Racal-Decca Canada Inc.- Insulators Division 130 Circle (78) on Action Card R. E. Instruments 195 Circle (137) on Action Card RTS Systems 126, 128 Circle (70), (74) on Action Card Real World Technologies ... 122 Circle (66) on Action Card Rees Associates 174 Circle (123) on Action Card</p>	<p>Recortec 179 Circle (130) on Action Card Rohde & Schwarz(foreign) ... 25 Circle (19) on Action Card Sachtler 181 Circle (151) on Action Card Saki Magnetics 132 Circle (82) on Action Card Satt Electronics 95 Circle (55) on Action Card Schneider TV Lenses 141 Circle (87) on Action Card Sescom 147 Circle (92) on Action Card Shane Media Services 164 Circle (26) on Action Card Sharp Electronics 34-35 Circle (27) on Action Card Siemens (Austria) 97 Circle (56) on Action Card Siemens (Germany) (foreign) . 31 Circle (25) on Action Card Sigma Electronics 178 Circle (129) on Action Card Sony 6-7, 22-23 Circle (5), (28) on Action Card Spectra Computer Systems . 115 Circle (59) on Action Card Spencer Broadcast 168 Circle (114) on Action Card Stainless 198 Circle (141) on Action Card Studer ReVox 128 Circle (75) on Action Card Surcom Associates 147 Circle (93) on Action Card Swiderski 151 Circle (97) on Action Card TFT Inc. 77 Circle (44) on Action Card Tech Laboratories 151 Circle (98) on Action Card Telemet 85 Circle (47) on Action Card Tentel 197 Circle (142) on Action Card Todd Communications 165 Circle (108) on Action Card True Time Instruments 173 Circle (121) on Action Card UMC Electronics 196 Circle (139) on Action Card U.S. JVC Corporation 51 Circle (31) on Action Card Vacuum Tube Industries ... 150 Circle (96) on Action Card Varian 99 Circle (57) on Action Card Videomedia IBC Circle (150) on Action Card Videotek 15 Circle (11) on Action Card Ward-Beck BC</p>
--	--	---	---

WHERE TO FIND IT

GENERAL INDEX,
Pages 38-45

WHO MAKES IT

PRODUCT DIRECTORY,
Pages 46-113

WHERE TO BUY IT

MANUFACTURERS,
Pages 114-162
DEALERS/DISTRIBUTORS,
Pages 168-189