

5-8

AUG 1934

BROADCAST NEWS

PAT. CFF. REG. U. S.



IN THIS ISSUE



A NEW HIGH-FIDELITY 5-KILOWATT TRANSMITTER

By Loren F. Jones

THE NEW LAPEL VELOCITY MICROPHONE

By J. P. Taylor

100-WATT BROADCAST TRANSMITTER

By L. W. Olander

THE INDUCTOR MICROPHONE

By L. J. Anderson

"TERRA-WAVE" GETS ITS MEN

RCA Victor Company, Inc., Camden, N.J.

NUMBER 12

PRICE 25 CENTS

AUGUST, 1934



RCA Victor Company, Inc.

A Radio Corporation of America Subsidiary

Camden, N. J.

"RADIO HEADQUARTERS"

DAVID SARNOFF, Chairman

E. T. CUNNINGHAM, President

W. R. G. BAKER, Vice-President
and General Manager

G. K. THROCKMORTON,
Executive Vice-President

P. G. McCOLLUM, Comptroller

J. D. COOK, Treasurer

J. T. CLEMENT, Vice President
in charge of Sales to U. S. Govt.

G. HAROLD PORTER, Vice-President
In Charge of Pacific Coast Activities

F. S. KANE, Secretary

L. B. MORRIS, General Counsel

F. R. DEAKINS, Manager

ENGINEERING PRODUCTS DIVISION

TRANSMITTER SALES SECTION

(OF ENGINEERING PRODUCTS DIVISION)

I. R. BAKER, Manager

S. W. GOULDEN, Commercial Engineer

T. A. SMITH, C. B. S. Contact

J. P. TAYLOR, Sales Engineer

C. L. BEACH, N. B. C. Contact

P. A. ANDERSON, Police Radio Sales

T. W. ENIS, Power Radiotron Sales

PIERRE BOUCHERON, Advertising Manager

1 EASTERN DISTRICT—T. A. Smith, Manager, 153 E. 24th St., New York City; R. P. May, Assistant

MAINE
VERMONT
NEW HAMPSHIRE
MASSACHUSETTS

RHODE ISLAND
CONNECTICUT
NEW YORK
PUERTO RICO

NEW JERSEY
PENNSYLVANIA
MARYLAND
NORTH CAROLINA (Broadcast)

WEST VIRGINIA
DELAWARE
VIRGINIA

2 CENTRAL DISTRICT—H. C. Vance, Manager, 111 North Canal St., Chicago, Ill.; D. A. Reesor, Assistant

NORTH DAKOTA
SOUTH DAKOTA
NEBRASKA
WISCONSIN

MISSOURI
IOWA
MINNESOTA

ILLINOIS
INDIANA
KENTUCKY

OHIO
MICHIGAN
KANSAS CITY (KANSAS)

3 WESTERN DISTRICT—W. H. Beltz, Manager, 235 Montgomery St., San Francisco, Calif.;

Edmund Frost, Assistant

WASHINGTON
OREGON
CALIFORNIA

IDAHO
NEVADA
HAWAII (Police)

UTAH
ARIZONA
ALASKA (Police)

MONTANA
WYOMING

4 SOUTHWESTERN DISTRICT—W. M. Witty, Manager, Santa Fe Bldg., Dallas, Texas.

TEXAS
OKLAHOMA

ARKANSAS
LOUISIANA (Except New Orleans)

KANSAS (Except Kansas City)
COLORADO

NEW MEXICO

5 SOUTHEASTERN DISTRICT—B. Adler, Manager, 144 Walton St., N. W., Atlanta, Ga.

TENNESSEE
NORTH CAROLINA (Police)

SOUTH CAROLINA
GEORGIA

ALABAMA
MISSISSIPPI

FLORIDA
NEW ORLEANS (LA.)

BROADCAST TRANSMITTERS

POWER RADIOTRONS

POLICE TRANSMITTERS

POLICE RECEIVERS

SPECIAL COMMUNICATION EQUIPMENT

STANDARD BROADCAST

AMPLIFIED

BROADCAST NEWS

Edited by
E. JAY QUINBY

NUMBER 12

AUGUST, 1934

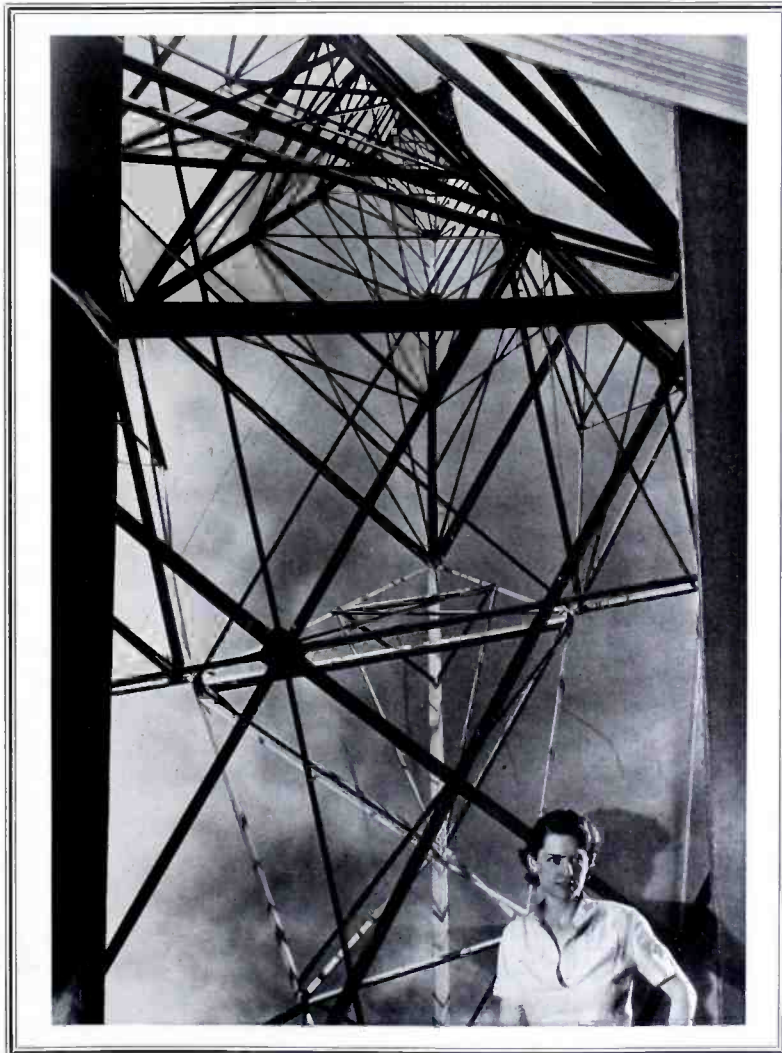

PHOTO OF A PHOTO
MURAL IN THE RADIO CITY STUDIOS OF NBC.

ONE OF WJZ'S TOWERS AT BOUND BROOK, NEW JERSEY, PROVIDES THE SUBJECT, BEFORE WHICH STANDS THE CLEVER AND ATTRACTIVE YOUNG PROPONENT OF THIS NEW ART . . . MARGARET BOURKE-WHITE. (SOME OF HER OTHER PHOTO-MURALS APPEAR ON PAGES 21, 22 AND 23)

Published Occasionally and
Copyrighted 1934 by
RCA VICTOR COMPANY, INC.
CAMDEN, N. J., U. S. A.

A New High-Fidelity 5-KW Transmitter

By LOREN F. JONES, Transmitter Engineer, RCA Victor

THE RCA Victor Company, Inc., herewith announces the new Type 5-C KW broadcast transmitter. This transmitter has been designed to complement in appearance and performance the recently developed Type 1-D 1KW transmitter which has been causing so much favorable comment. Both transmitters have the same exterior treatment and are similar in appearance. John Vassos, RCA Victor's internationally famous artist, is responsible for the pleasing appearance. The high standard of performance obtained in the 1-D transmitter has been equalled with the 5-C transmitter.

Design

The 5-C transmitter consists of the same exciter as used for the 1-D transmitter, a 5 KW class B radio frequency amplifier, a rectifier, a line terminating and antenna tuning unit, and a standard audio cabinet rack mounting a cathode ray modulation indicator and a hum compensator.

The three main units, shown in the accompanying sketch, are each completely shielded. The left unit is the exciter, the center one is the power amplifier and the right one is the rectifier. The hum compensator and cathode ray modulation indicator will generally be installed in the control room. The rectifier plate transformer, the water cooling unit and the copper water tank may be installed in the basement.

In the design of this equipment a number of new features have been incorporated. For instance, there are no bias or filament machines, the transmitter being completely AC operated. No wood insulation is used anywhere. Porcelain hose reels are used in place of the usual rubber type, thereby eliminating contamination of the water supply and simplifying maintenance. No fuses are used in the filament and power supply circuits of the 5 KW amplifier. Instead there is a combination breaker



L. F. JONES, RCA VICTOR

and overload breaker, which can be immediately reset by hand after opening but cannot be held closed under overload conditions. Thus no time is lost in finding and replacing lost fuses, because there are none.

The control system is arranged so that starting may be entirely automatic, partly automatic, or entirely manual. For automatic operation, a sequence relay is provided which brings the transmitter back on the air twice after an overload, and in the event of a third failure removes plate voltage from all stages. After any failure the sequencing relay can be restored to its normal position by pressing a reset button. This system insures a minimum of lost time due to casual trouble, yet provides complete protection for the equipment. Protective devices guard against excessive plate currents and inadequate flow or excessive temperature of cooling water. The reliability of the apparatus is insured by simplicity and by ample rating of all component parts, while sufficient meters in the radio and power circuits make it possible to observe operating conditions at all times.

The 5 KW class B amplifier employs two UV-863 tubes. In the design of this amplifier great care

was taken to suppress the radiation of harmonic frequency energy from all parts of the circuit. A balanced output circuit, together with a static shield placed between the power amplifier tank inductance and the antenna coupling coil, reduces to a minimum the harmonic energy transferred to the transmission line. To further reduce the harmonic radiation, a tuned circuit is used to terminate the transmission line. The audio amplifier consists of one stage using RCA-843 tubes in push-pull, transformer coupled to the grids of the RCA-845 modulator tubes. The modulator tubes operate class A push-pull and are transformer coupled to the plate circuit of the output stage of the exciter. The transmission line terminating equipment is supplied as a unit mounted in a metal house. This metal container is entirely weather-proof and is intended for installation on wooden posts or a steel cradle directly below the antenna. A monitoring rectifier in the antenna tuning unit provides sufficient energy to operate the loudspeaker in the exciter unit. This rectifier was very carefully designed to faithfully reproduce the modulation envelope.

Self Cooled

The main rectifier supplying plate voltage for the 5 KW amplifier utilizes twelve UV-872A mercury vapor tubes connected in a three-phase full-wave circuit. Taps are connected to the transformer switch so that 25, 50, 75 or 100% of normal operating voltage may be used. The normal operating voltage of the rectifier is 14,000 volts DC. The UV-872A Radiotron is a highly efficient type of rectifying tube having low internal losses and low replacement cost. No cooling is required other than a free circulation of air. An automatic induction regulator is mounted in the rectifier unit. It regulates the line voltage to a constant value for the entire trans-

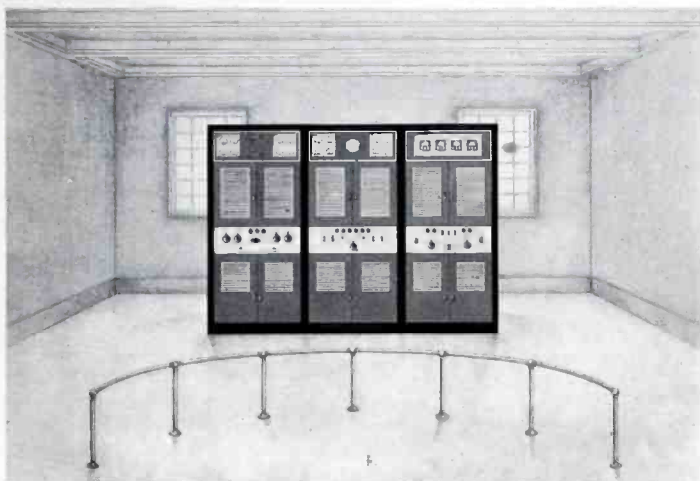

THE NEW RCA VICTOR TYPE 5-C TRANSMITTER

mitter, thus eliminating all difficulty with fluctuating line voltages and fluctuating output. The regulator has a range of 10% buck or boost.

Performance

Recent trends in broadcasting indicate that high fidelity transmission and reception are likely to be the most important development within the next several years. Improvements in receiver performance will force transmitter designers to work to new standards. In anticipation of this, the performance limits set for the 5-C equipment are well ahead of present-day demands. The audio frequency characteristic is substantially flat between the frequencies of 30 and 10,000 cycles. More specifically, the response is uniform within plus or minus 0.5 db. between 100 and 5,000 cycles and within plus or minus 1.5 db. between 30 and 10,000 cycles.

Wide volume range is made possible by the reduction of carrier noise to an unusually low value. The low noise level is secured primarily by AC filament operation. Hum generation in the audio stages is reduced by using indirectly heated cathodes in the low level stage, and push-pull operation throughout. In the 5 KW class B RF stage the hum produced by the "axiotron" effect in the tubes is reduced by connecting the filaments 90 degrees out of phase using the

Scott transformer connection. In addition to the steps described above, a hum compensator is provided

which, by introducing into the audio system voltages of the correct amplitude and phase, actually balances out the residual hum components. A measuring system is provided with the hum compensator so that each appreciable harmonic of the power frequency may be segregated and conveniently balanced out.

High Fidelity Insured

Although the 5-C transmitter may be operated at the customary 33% plate efficiency with reasonably good results, it was realized that the highest fidelity could be obtained only at a lower plate efficiency. Therefore, sufficient power is available from the rectifier to operate the power amplifier at an efficiency of only 23%, with the result that at 100% modulation the total RMS value of the audio harmonics is well below 4%.



CHARMING HARRIET HILLIARD, WHO IS POPULAR AMONGST THE VAST NBC AUDIENCES

NBC PHOTO



New Lapel Velocity Microphone



By J. P. TAYLOR, Transmitter Sales Engineer, RCA Victor

THE Type 30-A Lapel Microphone will fill a long-felt need in soundwork. For broadcasting as well as other sound pickup applications, it has several advantages which will be readily recognized. Most important of these is the added flexibility—the release of the speaker from the fixed limits imposed by a stationary microphone. There are numerous occasions where the greater freedom of movement allowed the artist is of appreciable convenience. There are many instances where the conventional type of studio microphone would be ineffectual or useless.

Every broadcast engineer will recognize the particular type of events for which the lapel microphone is best adapted. There is probably no active engineer who cannot recall several times when he has been confronted by a setup which caused him to wish for a really practical microphone of this new type. Banquets and political gatherings are common examples, for at such gatherings the speakers usually demand considerable freedom of movement. Moreover—the broadcast sometimes being considered incidental—they pay but scant attention to the location of the microphone.

No Obstruction to View

There is often objection to the obstruction of view caused by a relatively large fixed microphone in front of the speaker. The lapel microphone helps to overcome this. It allows the speaker to move about and gesture with the greatest freedom. Monitoring is thus made easier, even when the speaker completely forgets he is "on the air." This diminutive microphone is almost unseen by the audience. Thus, for lectures, receptions, and various other outside pickup events, it is often invaluable.

In the studio, the use of this new microphone has decided advantages for certain types of programs, such as morning exercises and cooking demonstrations, where the speaker requires considerable latitude of move-



J. P. TAYLOR, RCA VICTOR

ment. Under such circumstances, the necessity of using several microphones, which involves difficult monitoring, is dispensed with. Finally, there is that bane of all pickup engineers, the ex-vaudeville artist whom even the chalked circle on the floor fails to curb. For him, for the cookery demonstrator, for the gesticulating orator, and for many other performers, this new microphone possesses a decided advantage over the fixed type.

Marked Superiority Over Earlier Models

The idea of a small, light microphone which would move about with the artist is not new, and in recent years several attempts have been made to produce microphones for this purpose. However, for such use there are several critical design requirements. The first requirement is sensitivity and frequency characteristics substantially independent of the movement of the speaker's head—second, a frequency characteristic properly compensated for the effect of the diffraction of sound waves about the head—third, sufficient sensitivity—and fourth, small size and weight.

Previous designs of lapel microphones have only partially met these requirements. Usually of the carbon type, they offered a good ratio of sensitivity to size and weight—but little more. The frequency charac-

teristic of those types of microphone was nearly fixed and could not be easily altered to effect the necessary compensation. Moreover, it varied widely with the angle between sound source and microphone normal, with the result that the quality of the voice reproduction was changed when the speaker turned his head. Finally the directional characteristic was broad so that an undesirable amount of surrounding noises, such as those of the audience, was picked up. Because of such handicaps, the early designs were disappointing and they came to be generally regarded more as a novelty than as a practical device.

Frequency Response Independent of Angle

The perfection of the *Velocity* (pressure-gradient) type of microphone for studio use opened up a new field, and engineers immediately foresaw the advantages of a similar type of microphone for lapel use. The frequency characteristic was just as desired, i. e., independent of angle. The microphone could be readily placed so that



THE NEW LAPEL VELOCITY MICROPHONE PRODUCED BY RCA VICTOR HAS MANY OBVIOUS ADVANTAGES FOR THE ACTIVE SPEAKER, SUCH AS THE LEADER OF "MORNING EXERCISES"



IN ANY POSITION—IT GETS THE VOICE. NO MORE WORRY ABOUT BEING "WITHIN RANGE," FOR THE NEW RCA VICTOR LAPEL VELOCITY MICROPHONE FOLLOWS THE SPEAKER ABOUT THE STUDIO

the head movement would approximately follow an equi-sensitivity curve. The inherently flat frequency characteristic could be easily compensated. And finally, the very favorable directional characteristic would do much to suppress undesirable noises. With this in mind, development of a lapel microphone having these advantages was begun. The result is the Type 30-A Lapel Velocity Microphone—one which is not a toy, not a novelty, but a finished and practical instrument, considerably superior to anything previously available, and ideal for professional performance.

Uniform Frequency Response

The widespread acceptance of the Velocity Microphone is essentially due to its superior frequency characteristic—a superiority which is evident not only in the inherent flatness of the characteristic but also in its remarkable independence of source-

to-normal angles. The latter is unequaled in any other type of microphone and is likewise the feature responsible for the success of the Type 30-A Microphone. In the past, it has been practically impossible to confine the movement of the speaker's head to the "microphone normal." Hence, with other types of microphones, the quality of the voice must

change with head movement. With the Velocity type, the voice quality remains constant. As mentioned before, it is necessary to compensate for the diffraction of the sound waves about the head—also for the "velocity effect"—that is, the increase of particle velocity close to the source. This has been accomplished by properly proportioning the other constants of the circuit to give the desired response, as arrived at by calculation and by measurement (with an artificial mouth) under actual conditions. As a result the overall response of the Type 30-A Microphone in use is substantially flat (± 2.5 db. over the range of 80 to 7000 cycles with a 7.5 db. rise at 5000 cycles) and is practically independent of head movement.

Constant Sensitivity

It is, of course, possible by constant monitoring to roughly compensate for the fluctuation in output level caused by the ordinary movements of the speaker's head. But with the average speaker, who turns his head often and rapidly from side to side, this would be both tiring to the monitoring operator, and largely ineffective. It is therefore desirable that the microphone pickup be as nearly independent of head position as it can be made. It is impossible to maintain the mouth-to-microphone distance constant, but with the velocity type microphone the same effect can be obtained by placing the microphone so that the normal movement of the head from side to side moves the speaker's mouth approximately along an equi-sensitivity curve. The diagram (Figure 1) is intended to show how this is accomplished. In practice the conformity is better

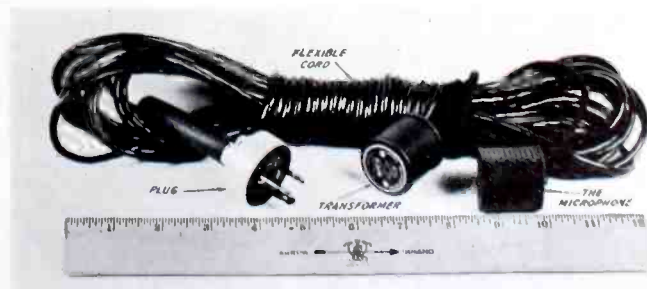

THE RCA VICTOR TYPE 30-A LAPEL VELOCITY MICROPHONE
A PRACTICAL INSTRUMENT CAREFULLY DESIGNED FOR RUGGED COMMERCIAL SERVICE
FURNISHED COMPLETE WITH COUPLING TRANSFORMER, 95 FEET FLEXIBLE RUBBER CORD
AND PLUG



"THE MAN IN THE STREET"

FEATURE BROADCAST REGULARLY BY WCAU, DURING WHICH PASSERSBY ARE INTERVIEWED ON POPULAR CURRENT TOPICS. FOR THIS TYPE OF SERVICE, THE NEW RCA VICTOR LAPEL VELOCITY MICROPHONE IS INVALUABLE

than is shown in this sketch, as in the first position the mouth actually projects somewhat forward of the normal plane, thereby more nearly equalizing the pickup at that point. As a consequence of this favorable arrangement the speaker may turn his head as much as 45 degrees in either direction without noticeable change (1.5 db.) in the output.

Standard Output Level

The lapel microphone is primarily an auxiliary. As such it is desirable that its output be nearly the same as that of the more regularly used microphones. And "sufficient sensitivity" is that sensitivity which will insure an output that may be mixed directly with the output of a standard studio microphone. The experience of RCA Victor engineers in perfecting the

the same time, by taking advantage of the special directional properties of the velocity microphone they have achieved a very favorable signal-to-background ratio. The output of the Type 30-A Microphone as normally used is the same as that of the standard Velocity microphone placed 4 feet from the sound source, and the pickup of background noise is much less than that of previous designs of lapel type microphones.

Small Size and Weight

Finally, but no less important, a requirement of a lapel microphone is to be as small and light as possible. Through the use of cobalt-steel magnets and special mechanical and electrical design, RCA Victor Engineers have made this new microphone so small that the audience can barely detect it, and so light that the speaker will hardly notice it. The Type 30-A Microphone measures $1\frac{3}{8}'' \times 1\frac{5}{16}'' \times \frac{1}{16}''$ and weighs $3\frac{1}{4}$ ozs., while the associated transformer (which is usually placed in the coat pocket) is $1\frac{1}{4}'' \times 1\frac{3}{8}''$ in diameter and weighs $3\frac{1}{4}$ ozs.

Acknowledgment is made to Dr. H. F. Olson, L. J. Anderson, and R. W. Carlisle of the Engineering Department of the RCA Victor Co.,

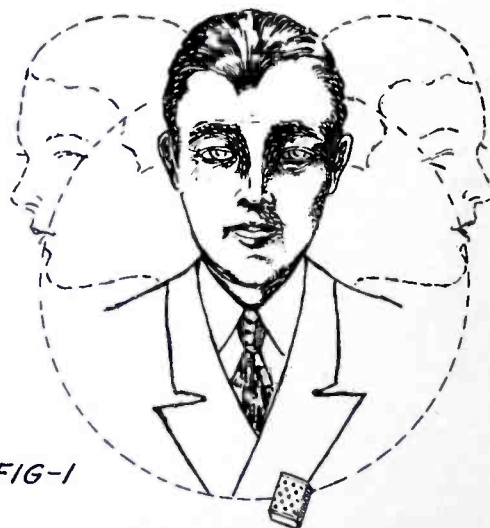

FIG-1

velocity type of microphone has enabled them to obtain this same sensitivity in a relatively small unit. At

who were responsible for the development of the Lapel Velocity Microphone.

Tube Consideration in Class B Amplification

By LOY E. BARTON, Transmitter Engineer, RCA Victor

THE selection of tubes for a class B audio amplifier depends upon several factors, such as output power desired, available space, cost of tubes, permissible cost for driver amplifier, and the available plate supply. The purpose of the following discussion is to present some of the more important considerations in selecting the proper tubes for a given power output and the precautions necessary to get good performance.

The class B audio amplifier, if designed properly, permits a much higher output from a given size tube than can be obtained from any other present type of audio amplifier, and with greater plate efficiency. However, it must be recognized that in an audio amplifier, the instantaneous grid voltage causes a corresponding voltage in the plate circuit, which, in turn, is transferred to the output system. This fact merely means that in an audio amplifier the voltage applied to the grid must not be distorted if the output is to be undistorted. In the case of an amplifier that does not draw grid current, it is not difficult to supply an undistorted wave to the grids of the output tubes. However, in the case of class B audio amplifiers it is usually necessary to drive the grid into the positive region to obtain the maximum power output. Therefore, after the proper tube is selected for a given power output, the next most important consideration is the proper driver system.

Low Power Class B Amplifiers

In general, the power output requirements determine, to a large extent, the type of tube necessary to use, although in some power ranges more than one type of tube may be used and other considerations determine the selection of the particular type to be used. An example of this condition is the 25- to 30-watt output



LOY E. BARTON, RCA VICTOR

class for which two of either the 46's, 210's, 841's, or 59's may be used. This power range is, of course, high power for receivers. For amateur service, where the tube ratings are usually exceeded and cost is a primary consideration, the 46's or 59's are used to a large extent, in spite of the fact that 20 watts output is the normal maximum output of these tubes. The higher output is obtained by using a higher plate voltage than is recommended with a corresponding shorter life, but the tubes are inexpensive to replace and the bias problem is solved by supplying zero bias to the 46's or 59's. Of the two tubes, the 46 is the more popular among the amateurs because its output is somewhat higher and it is somewhat easier to drive.

The driver for either of the tubes as class B amplifiers, to obtain full power output, should be two 45's as class A push-pull amplifier coupled to the grids of the class B tubes through a 5 or 6 to 1 stepdown transformer from the plates of the 45's to one side of the secondary. This gives approximately 140 ohms as the effective resistance in series with the grids of the class B amplifier.

The minimum instantaneous grid resistance of the 46 may be as low as 300 to 500 ohms at the peak grid swings. It is desirable to make the series input impedance to the grids of the class B amplifier as low as possible, but certain peak voltages must be had on the grid to obtain full power output and, since there is a definite limit for the plate voltage swing, it is obvious that there is a limit to the stepdown ratio of the driver transformer for any driver amplifier selected.

A somewhat detailed calculation of the driver in the above case will illustrate the procedure in such calculations and should form a basis upon which to make similar calculations for the driver of other types of tubes as class B audio amplifiers. The published characteristics of the 46 indicate that full output can be obtained with a peak grid swing of about 60 volts and that the peak plate swing of the 45 is about 150 volts when the tubes are operated at about 250 volts on the plate and somewhat lower than rated plate current. Since two 245's are used in push-pull, the peak voltage from plate to plate is double the peak plate swing, or 300 volts, and about 60 volts peak output is needed to each grid.

Therefore:

$300 \div 60 = 5$ ratio of transformer plate to plate to each grid.

$5^2 = 25$ impedance ratio to each grid from plates of drivers.

The plate resistance of the 45 is about 1750 ohms and for two tubes in push-pull, the resistance is:

$1750 + 1750 = 3500$ ohms plate to plate.

$3500 \div 25 = 140$ ohms in series with each grid.

If higher resistance driver tubes are used, or if only one tube is used, it is preferable to choose a driver transformer of such ratio that the im-

pedance to the grid is kept below 200 ohms if low distortion is expected. However, in such cases, the peak grid swing is limited because of the limited swing of the driver tube and the output is lower than if full grid swing is provided. The 46 and 59 tubes are the only tubes especially constructed for zero bias operation, as class B audio amplifiers and all other available tubes require bias, which complicates the class B operation of other tubes when such are required for higher power outputs.

Further details of the class B audio amplifier may be had by referring to articles by the writer in the *Institute of Radio Engineers Proceedings* and *QST*, and articles by other individuals.

The 210 and 841 may be used for approximately 25 to 30 watts output, which is about normal maximum output of these tubes. For this power output, a plate voltage of about 500 volts is required, as well as a separate and low impedance bias source to keep the bias constant when grid current flows. Since the 210 requires a higher bias than the 841, the grid swing for the 841 will be less than for the 210, which in general means less driver power requirements for the 841 and a low impedance, low bias source for the 841 is easier to obtain than a higher bias for the 210.

The load resistance for the above tubes, as well as other tubes, is somewhat critical if the maximum power output is expected with normal plate dissipation. Power outputs lower than maximum are usually obtained by lower input grid voltage and higher load resistance. This means of getting lower outputs reduces the plate loss and increases the efficiency of the class B amplifier, and is the procedure for getting lower outputs for receivers in the 10- to 15-watt class.

Medium Power Class B Amplifiers

The problem of supplying instantaneous grid voltages to the various tubes is beyond the scope of this discussion, except that certain characteristics are given for the UV-203A and the UV-849 as class B audio amplifiers in order that certain specific difficulties may be discussed. Two UV-203A's may be used for outputs

of 200 to 250 watts and the grid and plate characteristics for the tube are given in Figure 1. The plate characteristic probably will not vary appreciably for individual tubes, but the grid current characteristic is not easily controlled in the tube manufacture, so that appreciable variation may be expected. The grid current slope in the range of +30 volts on the grid represents a resistance of about plus 3000 ohms and the resistance at about plus 85 volts is about minus 2500 ohms for the 1250 ohm load. If maximum power is expected for the 1250 ohm load, a peak grid voltage swing to about plus 115 volts is required and the slope of the curve at this point is about plus 500 ohms. It will be seen that the driver requirements to supply such a variable load resistance are rather strenuous if full output is

expected without appreciable distortion because the peak grid swing is about 150 volts from a bias of about minus 35 volts. However, if only about 150 watts are required, the driver requirements are reduced materially. The tubes may also be operated at 1250 volts on the plate, which also reduces the driver requirements for a given power output, or permits a higher power output if full grid swing is used.

Similar curves for the UV-849's are given in Figure 2, which indicate the difficulties in driving the grids of the UV-849's. The curves for the UV-849 grids are more difficult to drive because of the low negative resistance characteristic in certain positive grid ranges, and because of the relatively high grid swing of approximately 235 volts for full output. The power output from two

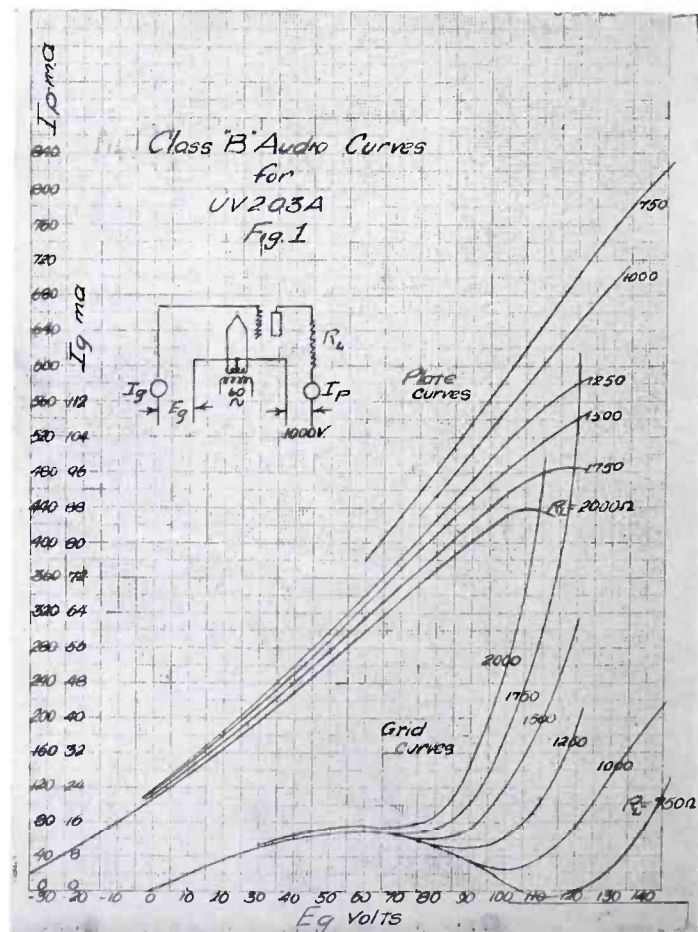

FIGURE 1

UV-849's as class B audio amplifiers is about 1000 to 1100 watts, if the proper driver is used.

In general, the input impedance to the grids of the UV-203A's and the UV-849's should be only 10 to 20 percent of the minimum instantaneous resistance of the grids if the distortion is to be kept to a low value. This is especially necessary in the case of negative grid resistance because if the input resistance is higher than the negative grid resistance, a condition for oscillation is present and the signal will not only be badly distorted but the output transformer will be subjected to high parasitic voltages, which may cause insulation breakdown of the transformer.

Little choice of tubes is possible for a given power output above 100 watts so that, in general, it is neces-

sary to use the size of tube that will give the desired output, and means must be provided to properly load and excite the tube. Recent measurements of distortion in the new RCA Victor 1-D 1000-watt transmitter of audio input, to detected output, gave an arithmetic sum of all harmonics of less than 4 percent for any percent modulation and the highest individual harmonic was 1.65 percent at any percent modulation to 100 percent. The transmitter is modulated by two UV-849's operating as class B audio amplifiers and the audio output required for modulation is about 900 watts. The above measurements were made at 200 cycles, but measurements at other frequencies gave distortion of the same order of magnitude. The above values of distortion indicate how well the input requirements to the UV-849's can be met. It is well

to keep in mind that the input impedance to the grids of a class B amplifier includes leakage reactance of the driver transformer so that the input impedance to the UV-849's cannot be kept low if the leakage reactance of driver transformer is high. This point is very important and applies in particular to grid characteristics such as shown for the UV-849's, which represent positive and negative resistance as low as 500 ohms. Leakage reactance in the output transformer is also important and must be kept at a low value.

High Power Class B Amplifiers

Higher audio powers in the order of 15 to 25 kilowatts may be obtained from two UV-863's, as class B audio amplifiers and powers of the order of 75 to 100 kilowatts may be obtained from two UV-862's as class B audio amplifiers. The modulator for the new WLW 500-kilowatt transmitter, at Cincinnati, consists of eight UV-862's as class B audio amplifiers, the output of which is about 320 kilowatts of audio power.

As yet, higher audio powers have not been required, but it is probable that no particular difficulty would be experienced in operating larger tubes than the UV-862 in a class B audio amplifier for still higher outputs.

Although some audio amplifiers, up to 1000 watts, are used for sound systems or other uses, the principal use, at present, for the medium and high power audio amplifiers is for plate modulating the highly efficient class C amplifier for broadcast and other telephony radio transmitters.

WTAR GOES NBC

When station WTAR joined the NBC networks, the door panels and elevator boys' uniforms were already adorned with the NBC monogram, the studios being located in the National Bank of Commerce building in Norfolk. Just suppose the National Biscuit Company started a station and joined the chain!

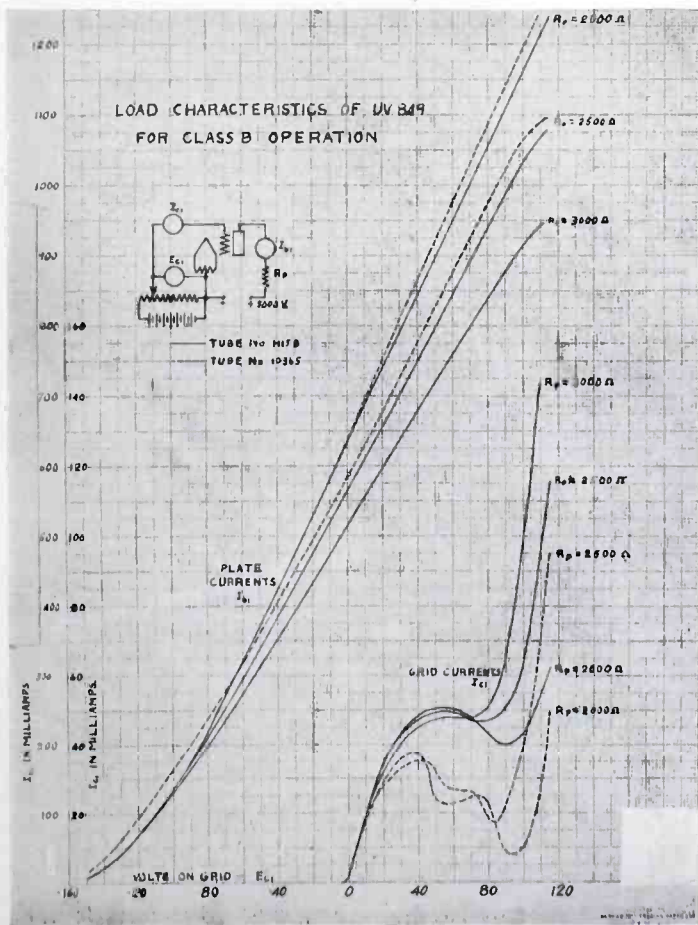

FIGURE 2

LET'S GET ACQUAINTED



THEODORE A. SMITH, EASTERN DISTRICT SALES MANAGER FOR THE RCA VICTOR TRANSMITTER SECTION, WITH HEADQUARTERS LOCATED AT 153 E. 24TH ST., NEW YORK CITY.



RCA VICTOR'S BEST BACK-SEAT FLYER! FRED MULLER OF THE COMMERCIAL APPARATUS SECTION, INTERNATIONAL DIVISION, IS LEAVING CAMDEN SOON TO TAKE UP HIS NEW DUTIES AS SALES ENGINEER IN THE LONDON OFFICE

TA. SMITH, born in New York City in 1905, began at the tender age of three to take alarm clocks apart, so his parents sent him shortly thereafter to Stevens Tech, where he was graduated with the degree of Mechanical Engineer.

In 1925 he joined the RCA organization, entering the Technical and Test Laboratories at Van Cortlandt Park, New York City, where he did considerable pioneer work on radio-fading recording, later turning his attention to standards of receiver measurement, and subsequently building field intensity measuring equipment, with which he did extensive survey and measurement work in the fields of WJZ and WEAJ. Before leaving the Van Cortlandt Park establishment, he was in charge of the Television Development Section.

In 1930, Ted Smith was transferred to the Sales Department of the RCA Victor Company, Inc., and since 1931 he has been Eastern District Sales Manager for the Engineering Products Division.



Ted's hobbies are tennis and radio (*no golf*, he informs us); he has an amateur radio station, call W2QR, and when we pressed him for further personal items, all we could get out of him was that his favorite color is blue (more popular than red these days in *any* department) and that he is fond of chocolate ice cream. Then he closed up tight and refused to divulge any further details. Maybe that's because Ted is still a bachelor.

FRED MULLER, better known to his friends as "Fritz," is leaving "Radio Headquarters" in Camden, N. J., to take over Commercial Apparatus Sales work in the London office of the RCA Victor Company, Inc. He is particularly well fitted for this important post, because of his linguistic ability and his extensive experience in this work.

When Mr. Muller arrives in London, it will really be the completion of a step-by-step trip around the world. A Swiss by birth, he was educated in England, started his business career with an import and export house in Ceylon, subsequently conducted a business venture of his own in Japan, and later came to America across the Pacific Ocean. He has been with the RCA organization for the past five years, having graduated from a course in the RCA Institutes.

"Fritz" is ever popular among his associates for his hobby of photography, and the results of his informal and often unexpected snapshots have provided us with many pleasant surprises. The interior of his bachelor apartment in Camden resembles an electrical and chemical laboratory more than a dwelling, and many of us are going to miss the convenience and service which he provided in his unusual workshop.

Fred has promised to act as English correspondent for *Broadcast News*, and we anticipate not only much interesting news but some of

BROADCASTING PERSONALITIES

his characteristic pictorial expressions from across the sea, as soon as he has had an opportunity to get into action at his new address.

NOTES FROM WSOC

Two real veterans are on the transmitter staff of WSOC! Like true veterans they hold their age well. No long white beards on this pair of old-timers—they're still spry and trim looking, after their long battle with the waves!

No, they're not old sea captains—just a pair of Radiotrons UV-203A, still doing duty in WSOC's transmitter after five and a half years of service. Purchased in October, 1928, they have been operating since then, day after day. Incomplete records from their early days do not permit an accurate statement of their active life, but it is estimated conservatively that they have at least been on the air 25,000 hours.

Recently it was thought advisable to replace them with new tubes, but they measured up right alongside their newer mates—so they are still in service.

NOTES ON WTIC By Clate Randall

Beginning May 8, WTIC was granted experimental authorization enabling the station to operate on full time. This was made possible by co-ordinating carrier transmission with KRLD of Dallas, Texas. Needless to say, many additions are being made at the big New England station to cope with the full-time project.

The following new members have been added to the technical staff: Clarence E. Carpenter of Whitehall, New York, transmitter engineer; Dick Blackburn of RPI; Fred Edwards of Manchester, Conn.; Carlton Noyes of Waterville, Maine; and Charles Wiley and Robert S. Miner of Hartford, studio control engineers.

A truckload of new equipment was received from RCA a few days ago. This shipment consisted of new line amplifiers, monitor amplifiers, loudspeakers, velocity microphones



TAILORS NOW BELIEVE IN MIRACLES!
IN HIS LATEST FOX FILM, "YOUNG AS YOU FEEL," WILL ROGERS WEARS A WARDROBE OF SMART CLOTHES THAT EVEN A BROADWAY PLAYBOY WOULD FIND SATISFYING. AT THE RACE TRACK, IN NIGHT CLUBS, ON THE STREET, IN THE AIR—THE USUALLY SHAGGY MR. ROGERS IS A DEBONAIR FELLOW—SEEING LIFE FROM THE CONFINES OF CLOTHES THAT WILL MAKE EVERY TAILOR THAT SEES HIS PICTURE GASP WITH DELIGHT

and other pieces of equipment with which to make up the new high-fidelity studio control and audio system now being installed.

The station is adding two studios, one of 11,000 cubic feet and the other 19,000 cubic feet, to its present complement. Two additional transcription rooms are being provided, an additional observation room in conjunction with the two new studios and an entirely new executive office location.

A new push-button relay system is being installed to replace the one originally incorporated in the station.

While this work has been going on for the past six weeks, it is anticipated an additional six weeks of time will elapse before completion. The new studio group of WTIC will then occupy the entire sixth floor of the Travelers Insurance Company's building, which incidentally is a block long and a block wide, and will be the most spacious of all New England stations.

All new equipment installed in audio system is of RCA manufacture. The entire project, including building of the studios, with their mammoth

soundproof walls, retractable acoustical panels, lighting fixtures, audio and switching systems, furnishings and decorations, is being cradled under the personal wings of Clayt Randall and Herm Taylor. Wilbur F. Clancy, studio engineer, better known as "Push-Button Pat," has been dislocated from program obligation to assist Clayt and Herm on installation of the studio equipment.

Bill Coleman, operating engineer, is sporting a new Plymouth. Milt Mix, chief operator, moved to Avon, Conn., and R. M. Luckingham, transmitter engineer, moved to Bloomfield, Conn. It must be the boys at the transmitter are awakening to the possibilities of the wide open spaces.

New acquisitions: Clayt Randall recently side-tracked the Auburn cabriolet often mentioned in these columns, and is now driving a Packard, and a new secretary graces his office to keep a watchful eye on him as well as Herm. If you want to forget all about a business trip to WTIC, just ask for Clayt and you will be promptly ushered into the presence of the new secretary. (Smiles from the secretary will have to be by reservation only. Kindly specify with or without dimples.) If you don't believe us, ask Ted Smith.

SBC NOTES

Commercial managership of SBC includes jurisdiction over stations actively engaged in nightly program exchange: KTSA, San Antonio; KOMA, Oklahoma City, Okla.; KOWO, Waco, Texas; KNOW, Austin, Texas, and KTAT, Fort Worth, Texas. Other SBC associated stations include KRLD and WRR, Dallas; KLRA, Little Rock, Ark.; KFDM, Beaumont, Texas; KGKO, Wichita Falls, Texas; KTRH and KXYZ, both of Houston, Texas.

KTAT NEWS

Mr. Lee Armer, President of the Southwest Broadcasting Company, with key station KTAT, Fort Worth, Texas, announces the recent appointment of Sam Bennett, former KTAT

Manager, to position of Commercial Manager of the Southwest Network. Ray Lang of KTAT's announcing staff, succeeds Mr. Bennett as Manager of KTAT.

Mr. A. E. Cullom, Jr., of Dallas, Texas, recently joined the staff of the Southwest Network as Technical Supervisor. Mr. Cullom makes his headquarters at KTAT, Fort Worth.

WFAA NOTES

Mr. Raymond Collins, Chief Engineer, and Mr. William Ellis, Production Manager, WFAA, Dallas, recently returned from a successful and enjoyable fishing trip in Old Mexico.

NEWS FROM WOAI

Mr. Hugh A. L. Halff, Manager of WOAI, San Antonio, Texas, and Mrs. Halff recently returned from a very enjoyable vacation trip to Mexico City. They were accompanied by Mr. E. E. Voynow, of Edward Petry & Company, and Mrs. Voynow.

KYA NEWS

Completing an exacting job of a general "check-over" and "tuning up" of the KYA transmitter, located in the Whitcomb Hotel in San Francisco, F. W. Eilers, Chief Engineer, remarks that the finished product was greatly benefited and the process much simplified by the use of an RCA Victor cathode-ray modulation indicator and an RCA Victor beat frequency oscillator. Coverage reports have been very favorable and KYA is rapidly increasing its listening audience at distant rural points.

PHOTO AT WAPI

James L. Middlebrook, Chief Engineer of Station WAPI, located in Birmingham, Ala., was recently visited by Ben Adler, and donated the photo (herewith) of Beatrice Tate Wright, their versatile production manager, at the console of the studio organ.

WSYR AIR CONDITIONED

T. A. Smith, transmitter sales engineer of the New York District, tells us that WSYR in Syracuse has just completed the installation of air-



BEATRICE TATE WRIGHT, VERSATILE PRODUCTION MANAGER AND ORGANIST AT WAPI

conditioning equipment in two of their studios. General Electric equipment was installed for blowing cooled air at the rate of 1400 cubic feet per minute. With the average number of people in each studio, a person is assured of a supply of 47 cubic feet of fresh air each minute, which ought to be enough even for the hot weather we have been having lately.

RCAV COMPLIMENTED

W. M. Witty, Manager of the RCA Victor Southwestern District Office at Dallas, Texas, recently received a letter from M. H. Clack, Engineer in charge of Radio Station KGRS at Amarillo, Texas, from which we quote certain high lights as follows:

"I want to compliment you on the service received through your office and the RCA Victor Company at Camden, N. J.

"One Friday afternoon at 4.45 we had a tank condenser blowout, which put the station off the air. After some makeshift arrangements, we were back on in twelve minutes. . . . I then called your office in Dallas to try to secure a UC-2303 Faradon condenser. . . . Saturday morning I received a wire from your office in Dallas stating that the condenser would be in on the 2.15 plane. Much to my surprise, it arrived, and was installed and working by 3 p. m.

"In less than 22 hours the transmitter was operating normally, and the replaced part had to be shipped from Camden, N. J. That is what I call service. . . . I want to thank you and compliment you."

IRA NOTICE

The International Radio Association will stage their Fifth Annual Radio Party at St. Petersburg, Fla., in the month of November. It is expected that representatives from every leading radio station in all America will be present, and if past performances can be taken as a guide, it means that there will be a good time for all.

KGER MOVING

KGER, Long Beach, California, was recently granted permission by the Federal Radio Commission to move their transmitter locally to a more ideal spot. The site will be towards North Long Beach, some three miles from the present location.

Along with the move comes the installation of the first Blaw Knox vertical radiator for broadcast use on the Pacific coast. Naturally, such an installation is being watched with interest in southern California. . . . Jay Tapp, chief engineer for the station, is working out an elaborate ground system to be used in con-

junction with the new radiator and is anticipating a substantial increase in signal strength and service area. . . . Work has started and some fifty tons of concrete has been poured for the base of the tower (extra strength for earthquakes). . . . Jay promises that as soon as the new building and radiator are completed he will send some photos of the new layout.

KGER uses an RCA Victor one-kilowatt type one-B transmitter, which will be moved from its present location, atop the Doby's Footwear Building. . . . Just to show how tough these RCA transmitters are, KGER's job went through the famous Long Beach earthquake in 1933 with nary a scratch and the only loss of time off the air was when the power from the local supply company failed (even that was for only about six minutes, after which transmissions were resumed as though nothing had happened). . . . Quite a record and boost for the one-B.

WTAG NOTES

Mr. John J. Storey, Managing Director of WTAG, in Worcester, Mass., sailed for Europe on the S.S. *Britannic* from Boston, July 29th. He will be gone for about six weeks. (See photo on page 33.)

ABS GETS WIP

Mr. Frederick H. Weber, formerly of the Station Relations Department, NBC, has become Vice President, in Charge of Operations and Station Relations for the American Broadcasting System. The ABS has recently taken over WIP in Philadelphia as its network station.

5½ DAYS TO FRISCO

Mr. Henry Grossman and Mr. Robert Trago, of CBS, made a flying trip from N. Y. by car to the west coast and back as a vacation this year. Outside of running out of gas in the middle of the desert, the trip is reported as uneventful.

BA VISITS RH

Ben Adler, of the Southern District, arrived at Radio Headquarters for a brief visit during the early part of July, having called at Station

WFBC, Greenville, S. C.; Station WAPI in Birmingham, Ala., and Station WMAZ in Macon, on the way north.

WMAZ BOOSTS

E. K. Cargill, Manager of WMAZ, was in New York where, accompanied by Ben Adler, he visited Radio City and the NBC studios, on the Fourth of July. Mr. Cargill made this trip to New York to complete arrangements for increasing the power of WMAZ from 500 watts to 1 kw.



CARNERA AT WMAZ

Station WMAZ, in Macon, has just completed the new studios located in Macon, which are connected to the transmitter in the suburbs by wire. There are two studios and modern reception room, finished in modern artistic style. (See picture herewith, showing Carnera at the Velocity Mike.)

FIRE AT WFBC

On Friday, August 3rd, WFBC, the broadcasting station of the Greenville News-Piedmont Company at Greenville, South Carolina, had the misfortune to be completely destroyed by fire. After some hasty communication with "Radio Head-

quarters" at Camden, N. J., one of the new RCA Victor Type 1-D, one kilowatt transmitters was shipped by express, arriving on the scene within three days after the catastrophe, and Robert Lingle, Jr., the Chief Engineer of the station, immediately set to work with his crew to get back on the air again.

The three Peace brothers—B. H., Charles and Roger—are the owners of the station and we trust their peace of mind was greatly improved by the prompt action of the Transmitter Sales Department—although Roger Peace is enjoying a sojourn in Europe and probably is not worrying much.

NEMO SPEAKING

(Courtesy of L. & N. R. R. Employees' Magazine)

Hard to Lay Off Old Employees

"See here," said the Indian inspector, "it is a violation of the law now to have more than one wife, and the law must be obeyed. When you get back home you tell all of your wives, except one, that they can no longer look upon you as their husband."

"You tellum," suggested the Indian after a moment's reflection.

Back-Seat Drivers All

Judge: "Who was driving when you collided with that car?"

Drunk (triumphantly): "None of us; we were all in the back seat."

Customer Mortality

Jaywalker: "So many people are struck by autos while alighting from street cars."

Street Car Official: "Well, yes, but those people have paid their fares. It's this running over people who are waiting to get on that makes me mad."

Powerful Impetus

Three minutes after receiving a warning letter, a darky appeared at the ticket window of the railroad station. The following conversation ensued:

"Cap'n, suh, when de fastest train leab dis town?"

"Sorry, uncle, but the fastest train left five minutes ago."

"Dat's all right, boss; I'se in a hurry; jus' you sell me a ticket and tell me which track she lef' on."

100-Watt Broadcast Transmitter

Type ET-4230

By L. W. OLANDER, Transmitter Engineer, RCA Victor

THE average low-power local broadcast station is confronted with certain inherent problems which are not considered by the higher power stations. As the field intensity produced by a 100-watt transmitter is low, it is advantageous to locate the transmitter so as to include the largest possible number of listeners in the service area. The blanket area is of very small extent, so the location may be in a commercial district where space is at a premium and rents are high. This selection is justified, however, when the additional expense of a field survey for a favorable site outside the limits of the service area, the purchase of the site, erection of the transmitter building and renting of telephone lines are considered.

Due to the limited space usually available and for reasons of operating economy, it is desirable to combine the studio control room with the transmitter room. The low power station should, therefore, be equipped with a transmitter which is not prohibitively expensive and combines maximum operating efficiency, low maintenance cost and small size with high quality broadcasting. With this in mind, the RCA Victor Company, Inc., has developed the Type ET-4230, 100-watt broadcast transmitter in which are incorporated the essential high quality features that are found in their high-power broadcast transmitters.

Simplification which results in economy, reliability and efficiency of operation is one of the outstanding features of this transmitter. The elimination of all rotating equipment and the housing of all equipment in a single unit, completely self-contained, make it inexpensive to install and operate.

Another feature is the tube complement which has been reduced to a minimum and consists of the popular inexpensive type of transmitting tubes resulting in a reduced main-



L. W. OLANDER, RCA VICTOR

tenance cost, investment in spare tubes, and input power.

The crystal oscillator stage utilizes a single RCA-10 tube and crystals, heater boxes and heater circuits supplied in duplicate. The heater circuits are independent, one crystal unit may be conveniently removed for inspection while operation continues with the other. Either crystal may be connected in the oscillator circuit by means of the crystal selector switch and is capable of controlling the carrier frequency well within the limits of plus or minus 50 cycles. A vernier tuning control, adjustable from the front, in the grid panel circuit of the oscillator permits the transmitter frequency to be varied through a range of approximately 50 cycles. Thus it is possible to compensate for differences in oscillator tubes and adjustments in thermostats.

A buffer amplifier, employing an RCA-10 tube, is used in order to reduce to a minimum frequency variations due to load reaction. The first radio frequency amplifier stage employs an RCA-10 tube and the second stage a UV-211 tube. The third or power amplifier stage employs two UV-211 tubes, connected in parallel.

All the radio frequency amplifiers are operated Class C, which makes it possible to secure high efficiency. In Class C operation, the bias is several times greater than the value required to cut off the plate current. Each stage is neutralized by utilizing the tank circuit of the preceding stage. Great precautions have been taken to prevent undesirable couplings and parasitic oscillations. The tank circuit of each radio frequency stage is tuned by a variable condenser. Care was taken in the design of the power amplifier tank circuit to secure the proper KVA/KW ratio in order to reduce the radio frequency harmonics to a minimum.

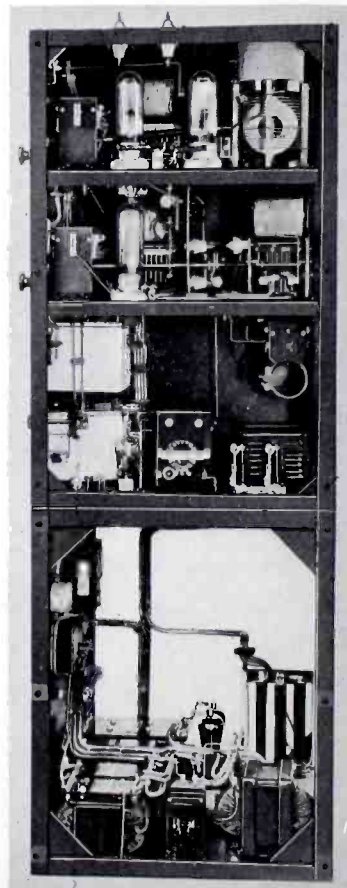

FIGURE 2—RIGHT SIDE OPEN, SHOWING ACCESSIBILITY OF ALL EQUIPMENT

The transmitter is designed to feed directly to the antenna, which is inductively coupled to the power amplifier stage. The antenna is tuned by means of a variable inductance, the tuning control of which is located on the front panel. A transmission line may be employed by making minor circuit changes.

The modulator capacity of the transmitter is sufficient to modulate the carrier output 100% without distortion. Modulation takes place in the power amplifier stage, a system commonly designated as high level modulation. The modulator consists of two UV-845 tubes in push-pull, operating Class A-B. The modulator is excited by two RCA-10 tubes in push-pull operating Class A.

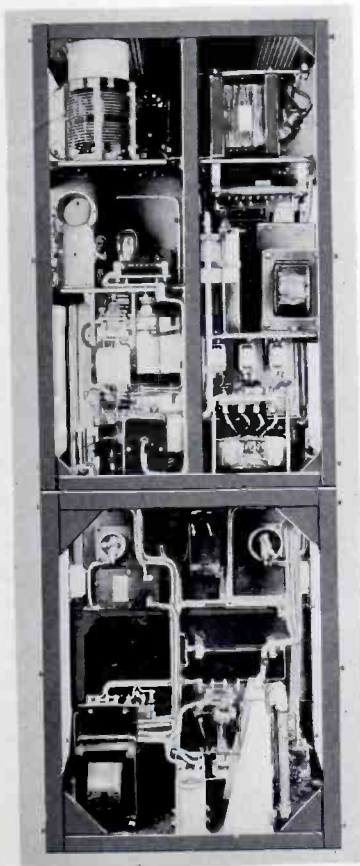

FIGURE 3—BACK VIEW. THE UPPER PART OF THE TRANSMITTER IS DIVIDED INTO TWO COMPLETELY SHIELDED COMPARTMENTS. ON THE LEFT IS LOCATED ALL THE RADIO FREQUENCY EQUIPMENT AND ON THE RIGHT THE AUDIO AND RECTIFIER EQUIPMENT

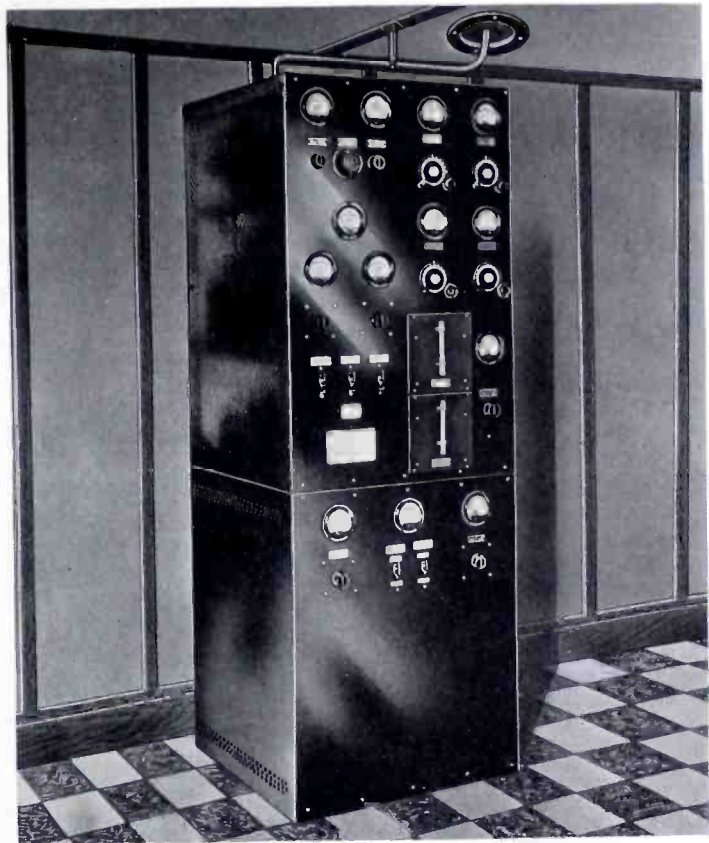

FIGURE 1—FRONT VIEW OF ET-4230 TRANSMITTER. NOTE MULTIPLICITY OF METERS

In Class A operation, the bias of the tube is adjusted to permit the grid voltage to swing the plate current over the linear portion of the tube characteristic. Since the plate current swings the same amount in each direction, the average current as indicated by the plate current meter remains constant and the average plate current remains the same whether a signal voltage is applied to the grids or not.

In Class B operation, the tube is biased nearly to plate current cut-off and as the signal voltage is applied to the grids, the average plate current increases to a value depending upon the amplitude of the signal. Because of the fact that the tubes operate over a much greater portion of the characteristic, the audio power obtainable and efficiency are much greater than those obtained from a Class A amplifier.

As more power is obtained from two UV-845 tubes operating Class

B than necessary to modulate the transmitter 100%, the UV-845 modulator tubes are operated Class A-B. Under these conditions the bias is adjusted between the values required for Classes A and B and a definite value of plate current flows when no signal is applied to the grid. For small values of signal voltage, the plate current is essentially constant. However, if the signal voltage is increased sufficiently, the plate swings over a larger portion of the characteristic, and the average plate current increases.

Due to the use of Class B modulators and high level modulation, the total input power required to operate this equipment under normal program conditions is only 1600 watts.

Two rectifiers, each utilizing two UX-866 tubes, in a single phase full-wave circuit are incorporated in the transmitter. One furnishes plate and bias voltages for the oscillator and radio frequency amplifiers, and

bias voltage for the audio stages, while the other supplies plate voltage for the first audio amplifier and modulators. The filament power of all the tubes is supplied by transformers.

The overall frequency characteristic is substantially flat within 1 db. between 30 and 10,000 cycles. Measurements taken indicate that the combined audio frequency harmonics are below 3% at 100% modulation. The carrier hum is approximately 50 db. below the level of 100% modulation. This is equivalent to a modulation of approximately 0.3%.

A total of 13 meters is provided to indicate readily the operating condition of the filament and plate circuits of all the radio and audio frequency stages and rectifier equipment.

Controls of practically all the circuits are accessible from the front panel. On the lower panel are located rheostats for controlling the audio amplifier and audio amplifier plate rectifier filament voltage and main line and plate voltage switches. On the left of the upper panel are rheostats which control the filaments of the radio frequency amplifier tubes and radio frequency amplifier plate rectifier tubes and rectifier and amplifier filament switches and crystal heater switches. At the top left are potentiometers for individually controlling the bias voltages on

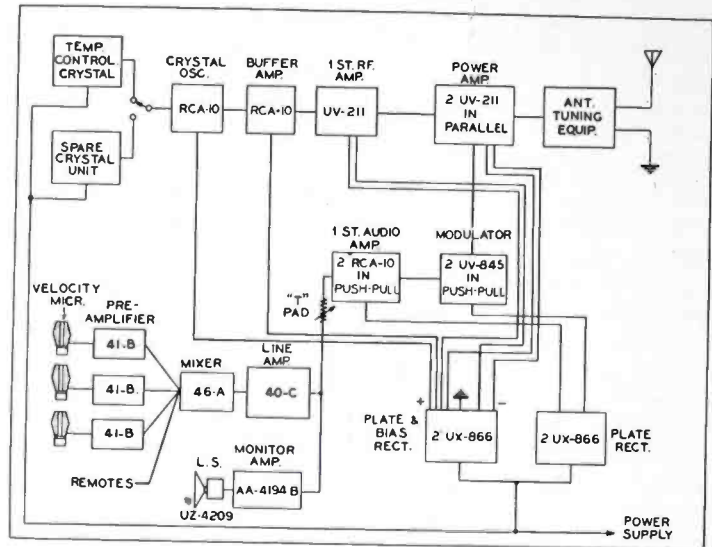

FIGURE 5—BLOCK DIAGRAM OF TRANSMITTER TUBE COMPLEMENT, SPEECH INPUT AND MONITORING AMPLIFIER EQUIPMENT

the two modulators and the level of input voltage to the audio amplifier. On the right of the upper panel are the vernier tuning controls of the radio frequency amplifiers and antenna circuit, crystal selector switch and vernier frequency control.

In the design of the transmitter, consideration was given to the protection of the operating personnel and all removable screens are provided with interlock switches which remove the high voltage.

The upper part of the unit contains the radio and audio stages and the

rectifier which supplies the bias voltage and plate voltage for the radio frequency amplifiers. The rectifier which furnishes plate voltage for the audio amplifier and modulator is located in the lower compartment. Unusual accessibility has been provided by the careful arrangement of all equipment.

A block diagram in Figure 5 includes the transmitter tube complement and the RCA Victor AC operated, high quality speech amplifier and monitoring equipment. The speech amplifier equipment consists of the 41-B microphone pre-amplifier, 46-A mixer and 40-C line amplifier and has an overall frequency response that is substantially within 1½ db. between 30 and 10,000 cycles. The undistorted output level of the 40-C amplifier is plus 16 db., while the Type ET-4230 transmitter may be fully modulated with an audio input level of plus 6 db., or zero level if the audio input volume control in the transmitter is shorted. The AA-4194B monitoring amplifier and UZ-4209 double voice coil loudspeaker have an overall response (loudspeaker sound pressure) that is practically flat over the 60 to 8,000 cycle range. The entire equipment may be mounted in a Type 9A1X cabinet rack and with the Type ET-

(Continued on Page 29)

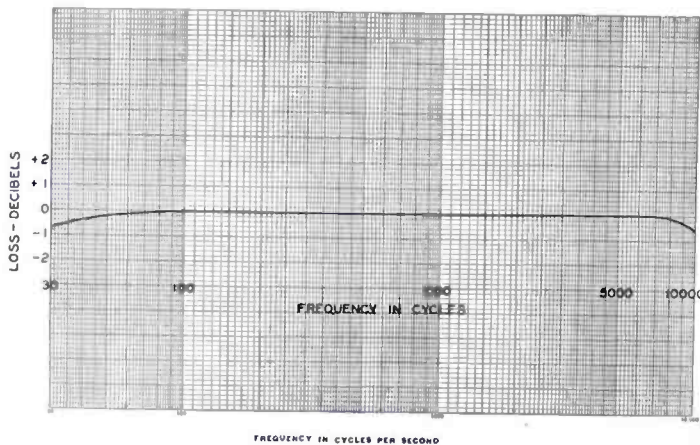

FIGURE 4—THE AUDIO FREQUENCY RESPONSE CURVE WAS MADE ON ONE OF THE PRODUCTION MODELS OF THE TYPE ET-4230 TRANSMITTERS. IT INDICATES THE VARIATION IN GAIN FOR DIFFERENT AUDIO FREQUENCIES AND WAS MEASURED FROM AUDIO INPUT TO RECTIFIED ANTENNA CURRENT FOR 80% MODULATION

Cathode-Ray Notes

By E. B. PATTERSON, RCA Victor Engineer

AS WE are passing through a cycle of new deals, the new deal of high-vacuum cathode-ray tubes by RCA Radiotron merits comment. Accordingly, a brief review of the history of the tubes may be of interest, as we can better appreciate these tools for test and measurement purposes now at hand.

The cathode-ray tube is an instrument which has as its moving part a stream of electrons. The stream may be considered as a flexible wire in which current is flowing. In the oscillograph, the ray is deflected by electric or magnetic fields and its travel is observed on the fluorescent screen at the end of the tube. This instrument is of great value in all types of research and engineering work.

The cathode-ray tube has slowly evolved from a critical device of dubious life to a commercial high-vacuum type, paralleling advances in present-day transmitting and receiving tubes.

The cathode-ray tube has been known for many years and Professor F. Braun is credited with first applying the tube for measurement purposes.¹

At the start, the tube was used in much the same manner as a galvanometer and the beam's travel was examined by a rotating mirror.² Later, of course, arrangements were provided which dispensed with the necessity for the mirror.

In the same year of Braun's early experiment, Sir J. J. Thomson, in following the work of J. Perrin, proved that cathode rays consisted of negatively charged particles.³ Prior to this, a controversy was raging among the physicists regarding the nature of cathode rays and Thomson's experiments served to end the arguments as he showed the rays were deflected by electrostatic and electromagnetic fields and, further, the direction of deflection proved the particles in the rays were negatively charged.⁴

It was found possible to measure the velocity of the particles and also to determine the ratio of the mass to



E. B. PATTERSON, RCA VICTOR

the charge as the velocity of the particle was a function of the potential across the tube.

Thus the cathode-ray tube was applied for measurement purposes at the same time as definite information was obtained regarding the electrons which constituted the cathode-ray stream. Other experiments were conducted, utilizing other means, to determine the charge on the electrons. C. T. R. Wilson utilized clouds confined in a chamber and arrived at essentially the same figures as Thomson's.⁵

Other discoveries also took place about the same time. For example, J. A. Fleming was examining the Edison effect and several years later J. J. Thomson showed that negative electricity was given off from the hot filament in the form of electrons.

This explained how the current was observed passing between the filament and a metallic plate. Edison had noticed in 1883 that if a metallic plate was inserted inside an incandescent lamp and connected to the positive end of the filament, a current was established.⁶ This same period was also an important one, as Marconi had brought the Hertzian waves out of the laboratory and was actively engaged in interesting the British with his system of wireless telegraphy.²

Hence, the latter part of the nineteenth century saw the birth of commercial wireless, the determination of the value of the electron charge, and the birth of the Cathode-Ray Tube and its cousin, the Fleming valve.

The electron charge may be considered as having a charge of ⁴

$$4.77 \times 10^{-10} \text{ Electrostatic Units}$$

or

$$1.59 \times 10^{-20} \text{ Electromagnetic Units}$$

with a mass of

$$9 \times 10^{-28} \text{ Grams}$$

From the foregoing it can be seen that the mass of an electron is of a very low order when compared to the moving parts of a Dudell galvanometer with its mirror and strips, or a fibre of the Einthoven instrument. Consequently, the Cathode-Ray Oscillograph, having practically no inertia, can be applied to the higher frequencies where former oscillographs are useless as the mass of the electron is electrical and is due to the charge which it carries.

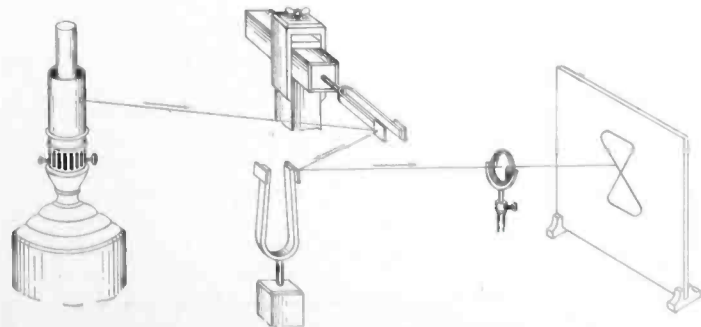

FIGURE 3—EQUIPMENT UTILIZED BY LISSAJOUS IN HIS CLASSICAL EXPERIMENT

TYPICAL OSCILLOGRAPH CIRCUIT

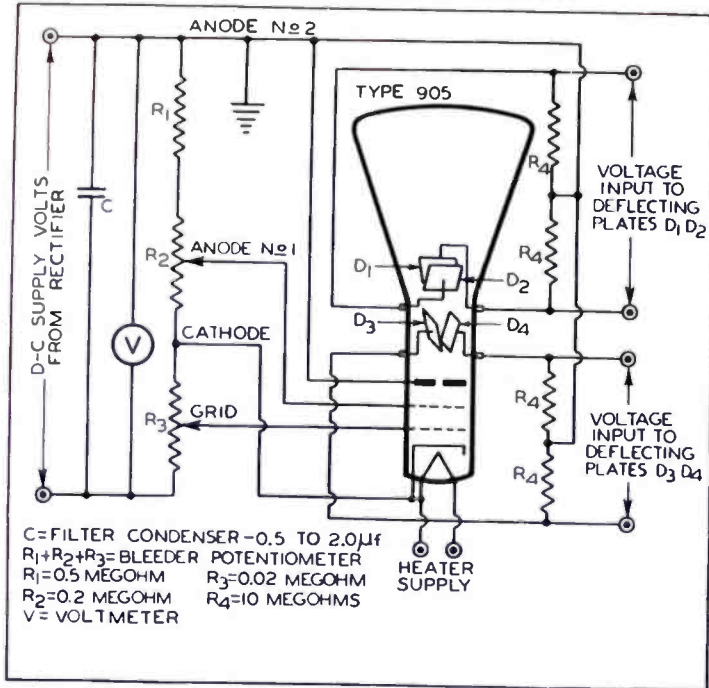

FIGURE 1—DIAGRAM FOR A MODERN TUBE

In dealing with new Cathode-Ray tubes with brilliant spots there are certain precautions to be observed. One is the beam should not be allowed to remain idle or it may cause deterioration of the screen. A better idea of this can be obtained by examining the formula

$$Ve = \frac{mv^2}{2}$$

showing the change in kinetic energy is equal to the change in potential energy where

V = Potential difference between two points

e = Electron charge

m = The mass

v = The velocity

which gives

$$v = \sqrt{\frac{2Ve}{m}}$$

The velocity⁷ acquired by the electron with 1000 volts is about

$$18.8 \times 10^8 \text{ cms/second}$$

or 42,000 000 miles/hr.

In view of the tremendous speed attained, it is at once evident that care should be exercised in keeping the spot moving.

As mentioned before, the evolution of the Cathode-Ray tube has required

a number of years to bring it to its present commercial state. The original Cathode-Ray tubes employed a cold cathode and the circular anode having a small hole in its center. It was necessary to exhaust the tube to about 0.006 millimeters of mercury and accelerating voltages from 10,000 to 20,000 volts were employed. The rays were produced by bombardment. A few gas molecules, positive ions, and free electrons are always found in the tube. Consequently, the application of a strong field causes the positive ions to be attracted toward the cathode. These ions, however, collide with neutral gas molecules and electrons are knocked out. The positive ions which strike the cathode in turn liberate electrons which constitute the cathode beam toward the anode.⁸

The high voltages required for bombardment result in a high-speed electron stream of more than 58×10^8 cms/second. Comparing this speed with that for 1000 volts given above, it is evident that the electron beam requires a stronger deflecting field than the lower voltage tube.

A. Wehnelt in 1905⁹ employed a hot cathode-ray tube which was a distinct advance over the earlier type. It consisted of a line-spot source and contributed to the fineness and intensity of the stream by limiting the initial diameter of the stream and causing the effective part of the accelerating field to be parallel. Since a hot cathode created a copious supply of electrons, it was possible to use a lower potential on the tube, which greatly increased its sensitivity as the speed of the ray was reduced.

Various forms of tubes and methods of focusing have been described by MacGregor-Morris and Mines.¹⁰ Some unusual types have been developed such as the one by Dufour,¹¹ who devised a Cathode-Ray tube for recording rapid transient phenomena and utilized a rotating drum placed inside the exhausted tube. A door was provided at the end of the tube for access to the drum or plate magazine.

Other arrangements to obtain high-speed photography have employed a Lenard¹² window which permits the rays to pass outside of the tube and affect a photographic film. This window is of very thin metal and is located at the screen end.

A typical diagram of a modern tube is shown in Figure 1. This tube employs electrostatic deflection plates and each set of plates is separated from the other—there being no internal connection to ground between the horizontal and the vertical plates, as found in some of the earlier as well as present types. This permits greater freedom in the use of the tube for measurement purposes. Typical Radiotron tubes are shown in Figure 2.

The Cathode-Ray tube is extremely useful in frequency determination and phase relations and it is interesting to note that a discovery in the field of sound many years before the Cathode-Ray tube is of considerable application in this type of work.

Jules Antoine Lissajous¹³ showed that an exact relation could be obtained between the vibratory motions of two sounding bodies. The equipment utilized by Lissajous in his classical experiment is shown in Figure 3 and consisted of two cur-



FIGURE 6—RCA VICTOR MODULATION METER TYPE 49-A

ing forks, a beam of light and a screen.¹⁴ The two forks are so placed that one vibrates in a vertical and the other in a horizontal plane. The beam of light received on one mirror, attached to a fork, is refracted to the other mirror, on the other fork, and then brought to a point on the screen. When the first fork vibrates alone, the point on the screen is lengthened out to a vertical line. The second fork lengthens the point to a horizontal line. When both forks vibrate the point describes a curve.

In essentially the same manner Lissajous figures are obtained with the Cathode-Ray tube, although the electron beam replaces the light source and is deflected by electrostatic or electromagnetic fields instead of the actual mechanical motion as in the case of the tuning forks.

The RCA Radiotron Co. has published a pamphlet with many Lissajous figures, some of which are shown in the accompanying diagrams.¹⁵

Figure 4 shows the relation of sine-wave voltages applied to each set of deflecting plates of a tube. For example, as in Figure 1. The various phase relations are illustrated, as well as the results obtained with multiples of frequency.

In Figure 5 are shown additional Lissajous figures. The frequency ratio is equal to the number of peaks on the circumference divided by the term, one plus the number of

horizontal lines of intersection. The horizontal intersections have been indicated at the side of the diagrams.

A convenient method when observing cyclic phenomena employs a sweep circuit which can be adjusted easily in frequency. Beddel and Reich¹⁶ have described a linear time axis, or sweep circuit, and it has since been improved with several variations.

The applications¹⁷ of the Cathode-Ray tube are numerous and a partial list follows:

1. Oscillograph and power supply but without amplifier or sweep circuit.
 - a. Modulation Meter trapezoidal pattern.

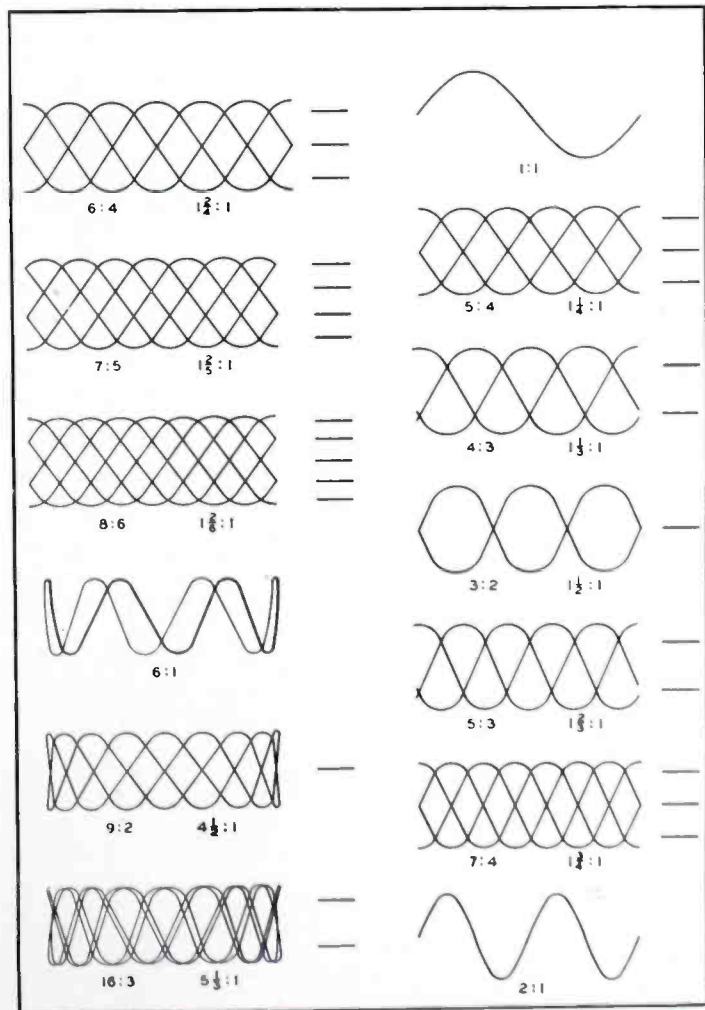

FIGURE 4—LISSAJOUS FIGURES

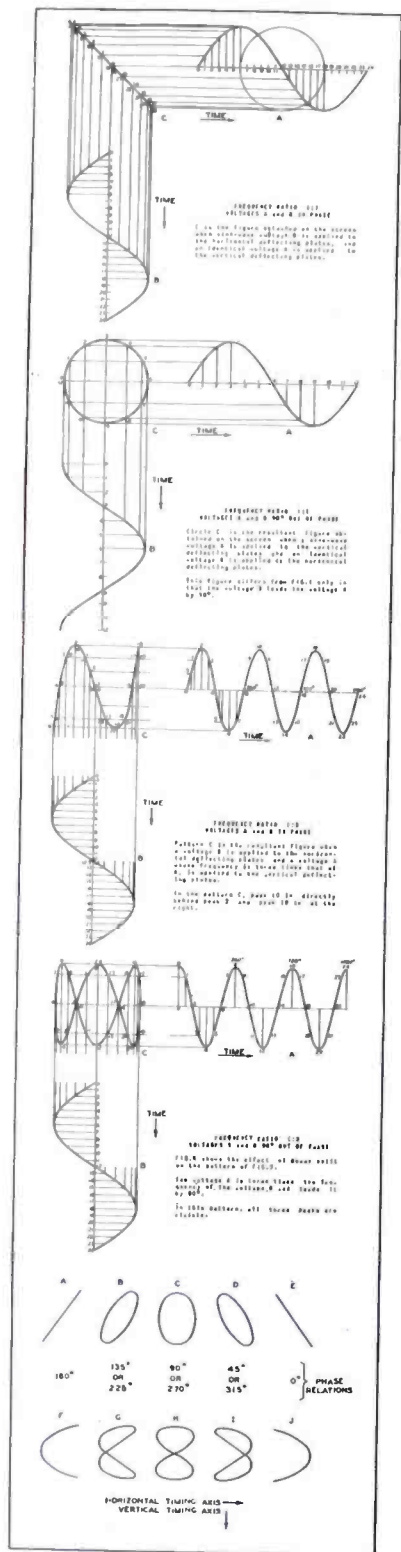

FIGURE 5—LISSAJOUS FIGURES

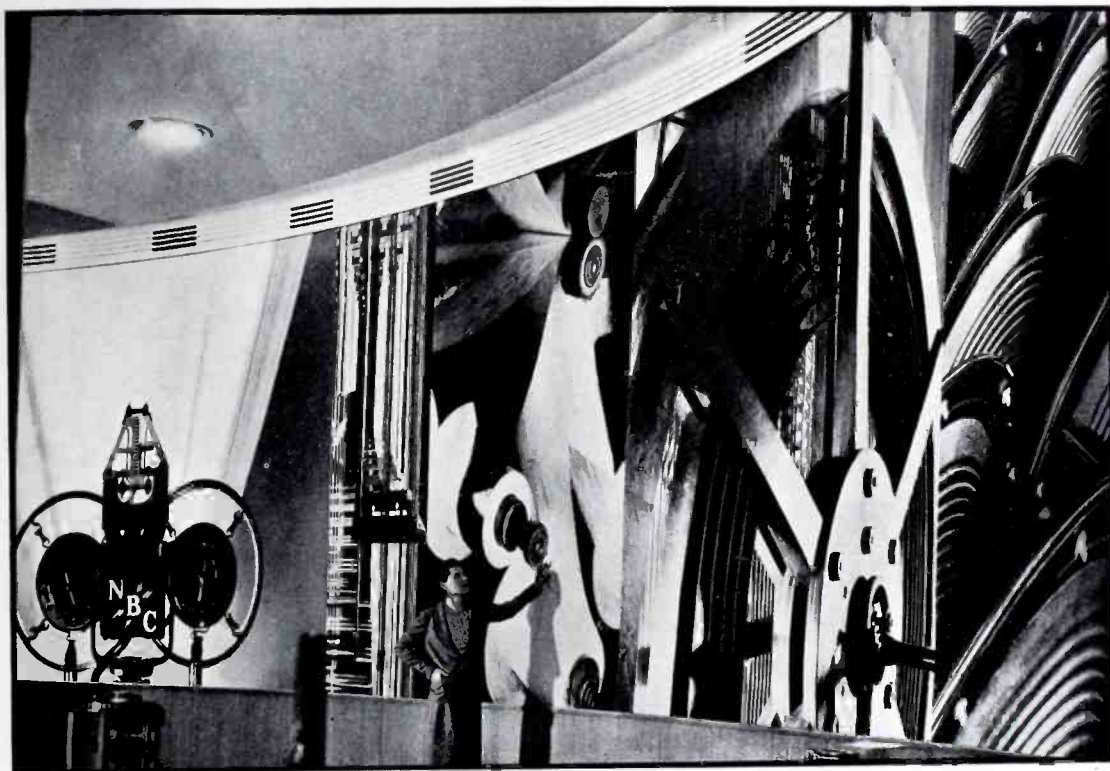

FIGURE 2—RCA 904, 905 AND 906 CATHODE-RAY TUBES

- b. Polarity and Amplitude in D-C circuits.
 - c. Frequency Comparison Meter.
 - d. Phase Indicator and Amplitude in A-C circuits.
 - e. High-Voltage Peak Voltmeter for low and high frequencies.
 - f. Bridge Balance Indicator for phase and amplitude.
 - g. Speaker Impedance Characteristic Measurement.
 - h. Synchronization of Alternators phase and amplitude.
2. *Oscillograph* and power supply with amplifier but without sweep circuit.
 - a. Peak Voltmeter and Ammeter amplifier with as wide a frequency range as practical.
 3. *Oscillograph* and power supply with amplifier and linear sweep circuit.
 - a. Waveform and distortion studies.
 - b. Receiver Test Equipment indicating stage gain output and distortion.
 - c. Detector Performance Tests.
 - d. Study of Static and Stray Electric Noise.
 - e. Monitoring in a Radio Station.
 - f. Study Voice and Music Waveforms in conjunction with a microphone.
 4. *Oscillograph* and power supply with linear sweep circuit but no amplifier.
 - a. Check on Code Signals.
 - b. Waveform studies on Alternators, Transformers, Generators, and Rectifiers.
 - c. Study of dynamic characteristics of circuit breakers and fuses.
 5. *Special Equipment* in conjunction with oscillograph assemblies outlined above.
 - a. Resonance Curve Tracer—use case (1) with extra equipment.
 - b. Audio Frequency Response Tracer or Sound Prism—use case (1) with extra equipment.
 - c. Frequency Comparison Meter with standard frequency source enclosed—use case (1) with standard frequency oscillator.
 - d. Electrocardiograph—use case (1) with extra equipment.

(Continued on Page 43)

A Tribute



MARGARET BOURKE-WHITE PAUSES BEFORE HER PHOTO-MURALS AT THE NBC STUDIOS IN RADIO CITY. HERE MAY BE SEEN HOW SOME OF THE VIEWS ON THE NEXT TWO PAGES HAVE BEEN VERY EFFECTIVELY UTILIZED IN THIS NEW ART

HIGH above Fifth Avenue, New York, with a view of the harbor, the Hudson River, Long Island Sound, Westchester County, and suburban New Jersey, Margaret Bourke-White rules the skyscraper pent house, where her enchanting photographs are produced. Perhaps the original plates are exposed out on location, as is often required; but here above the clouds they are carefully developed, enlarged, printed and artistically rendered in their final form—which may or may not include all of each original plate, at the discretion and direction of Miss Bourke-White. Here, amid strikingly artistic and modern surroundings, designed by John Vassos, one finds the Bourke-White staff busily engaged in the specialty which has grown in importance and popularity throughout the industrial and artistic world with amazing swiftness.

Here one sees artists at work over their layout boards,—besmoked photo-chemical specialists emerging

from and disappearing into mysterious dark passages called "light-traps," where all light is excluded save the confined rays of the ruby lamp. And here we were greeted cordially by the charmingly secretarial Miss Fratkin.

"Yes," we were informed. "Miss Bourke-White is expected momentarily. She has been out photographing locomotives at the Harmon roundhouse."

"How exciting!" we observed.

"Miss Bourke-White's work is often more exciting," we are told—"climbing up over the steel spider-web of unfinished bridges, hanging over the edge of lofty water-power dams, or getting closeups of huge industrial machinery."

Then entered the Bourke-White herself, effervescing with instructions to a half dozen assistants—and we couldn't wait to ask for a choice presentation of a locomotive to hang in our office. Locomotives are interesting to us from any angle, but we can't wait to see some of them from a

Margaret Bourke-White angle. But that isn't the object of our visit. . . . We want some of the Radio City pictures for *Broadcast News*.

"Of course," says Miss Bourke-White. "Radio is a subject full of possibilities—its ramifications are boundless. With a little consideration one finds some most unusual opportunities to present photographic portraits of its many mechanical and electrical personalities."

Certainly. Look at the picture of the inductance. We've looked at those things and their ancestors for more than twenty years, but we never noticed anything artistic about them—until Miss Bourke-White comes along and takes their portraits. Then they suddenly become artistically interesting.

The Soviet Government has had Miss Bourke-White over in the U. S. S. R. three different times now, taking industrial views. Wish we could make pictures like *that*. Would we go places!

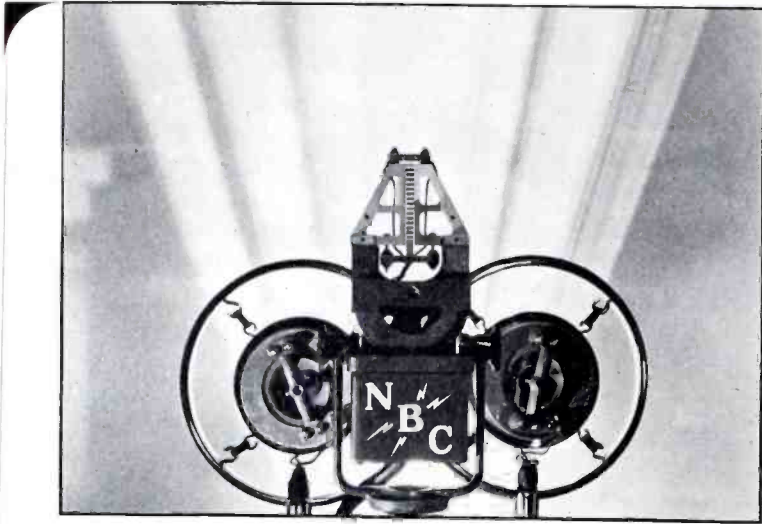

"MIKES"—A NAKED VELOCITY MICROPHONE AND TWO OF THE CARBON TYPE

THE SPIRIT
OF RADIO
—A SERIES OF EXOTIC
PHOTO-MURALS
IN THE
N.B.C. STUDIOS
AT RADIO CITY. —

By

Margaret
Bourke-
White

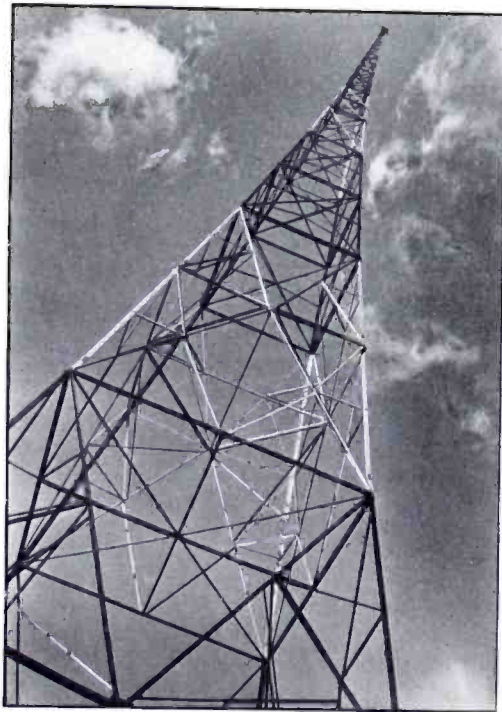

ONE OF THE WJZ TOWERS AT BOUND BROOK, N. J., WHERE THE PROGRAM IS HURLED FORTH INTO SPACE

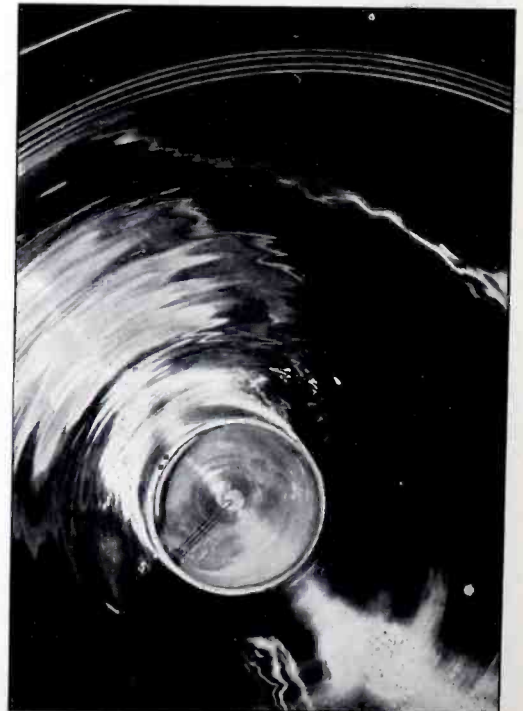

—AND LOOKING A TELEVISOR STRAIGHT IN THE ELECTRIC EYE

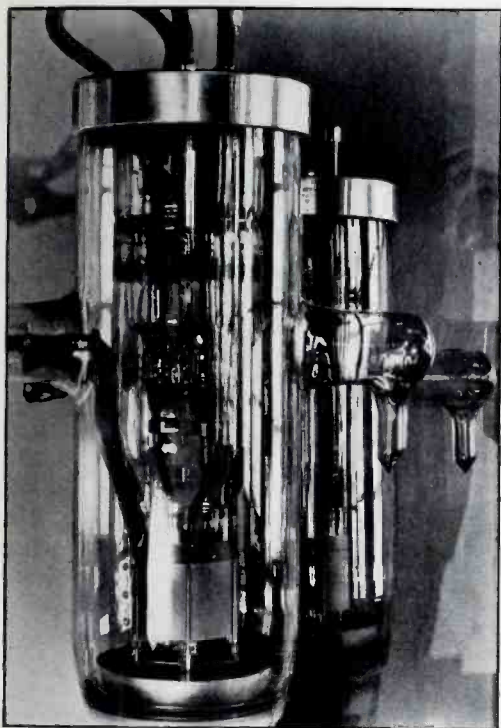

TRANSMITTING RADIOTRONS—DRAMATICALLY
SILENT RADIO GIANTS

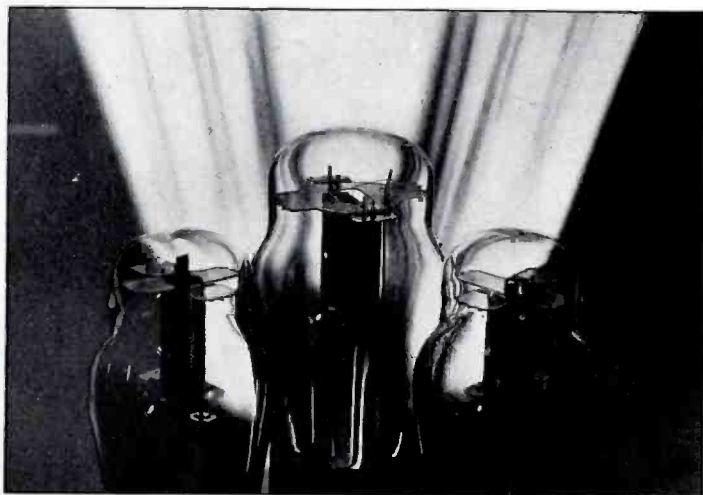

GROUP OF RCA TUBES—THE MOST IMPORTANT PART OF ANY
RECEIVER



FARADON CONDENSERS IN THE MAKING, AT
"RADIO HEADQUARTERS," CAMDEN, N. J.



INTIMATE VIEW OF TRANSMITTER INDUCTANCE
—TOO INTIMATE WHEN THE POWER IS ON!



Did You Know?



By W. S. FITZPATRICK, RCA Institutes

THAT although Marconi's development of radio communication resulted in the saving of thousands of lives and paved the way to the present uses of radio, his latest demonstration, termed radio lighthouse, is said by him to be his greatest invention?

That towels, shirts, megaphones, red lights and steam whistles are still being used for communication with, and between, New York City's fleet of fireboats, and that the ten boats comprising the fleet are still called the best equipped fire boats in the world?

That Roger Wolfe Kahn, famed millionaire band master, has three radio receivers in his home, one in each of his three airplanes, one in each of his two cars and still another in his speed boat? (*Radio Mirror.*)

That eighteen radio stations are maintained by the Radiomarine Corporation of America for the sole purpose of serving ships at sea? Radiograms in many different languages pass through these stations daily and some of the stations regularly handle traffic with ships half way around the world.

That a small microphone, employing the velocity principle, weighing only three ounces and designed to be worn on a coat lapel, is a new development of RCA Victor engineers? (*Radio Industries—See page 4.*)

Just in Case

That O. H. Caldwell tells of a man who, fearful of being buried alive, has arranged that a microphone be installed in his coffin and connected with loudspeakers in the caretaker's home? The circuit is to be kept energized for a year, after which it is to be assumed that the man is dead.

That in Radio City there are 325 clocks synchronized with a master clock controlled by the meteorological office? (*Radio Index.*)



W. S. FITZPATRICK, THE "RADIO RIPLEY"

That the tiny 8-watt transmitter, which so well served its purpose in keeping the world informed of the progress of the recent stratosphere flight and which was recovered from the gondola after its crash in a Nebraska cornfield, is being displayed among other historic exhibits in the NBC museum at Radio City? The battered little instrument has a place of honor beside the other stratosphere transmitter, which was carried aloft to a world's record of 62,000 feet last year by Commander Settle.

That a radio dealer won a prize by sending in to RCA Radiotron this stanza:

Distorted music arouses his ire,
RCA advertising creates desire;
Identification sign makes him inquire,
That's why Radiotrons sell like fire.

Probably his prize may have been greater had he ended the third line with "yell."

That in referring to Radio City, O. O. McIntyre says: "No city in the world has such a splendid throb in its very business heart as this new section pulsates. Magazines of Europe and South America are featuring illustrated articles about it?"

That the 50-kw. broadcasting station KOA at Denver has a single 470-foot-high tower which is used as an aerial, replacing the conventional antenna supported between two towers? It is the highest self-supporting tower used as an aerial and is expected to increase signal strength and reduce fading.

That professional as well as amateur radio operators are finding thrills in listening to the dramatizations of real-fact stories of outstanding exploits of amateur operators as broadcast from an NBC network on Tuesday evenings?

35 Years of Progress

That on the thirty-fifth anniversary of Marconi's first demonstration of radio in America, when he reported the international yacht races from a radio-equipped boat, the Radiomarine Corporation will perform a similar service at this year's races? But what a far cry from the equipment of thirty-five years ago when the high power then used emitted slow signals barely discernible ashore! Radiomarine will have two channels of automatic transmission, from each of which 200 words per minute may be sent with 150-watt power.

That an extensive promotion program is under way on RCA parts and accessories for radio sets, with a view toward developing that business into a real volume producer?

That five of the instructors at the New York school of RCA Institutes have college degrees?

That an important item being merchandised by the RCA Parts Division is the new RCA noise-reducing All-wave Antenna Kit? Development of this antenna is an outcome of experience of engineers of R.C.A. Communications in picking up foreign programs for re-broadcast and is popular among users of all-wave sets, which require a special antenna for satisfactory results.

That 1,500 former soldiers who served under General Harbord in France were present with their families in the Auditorium Studio of the National Broadcasting Company in Radio City on June 8th, when they listened to a broadcast of a dramatization of stirring events in which they played an important part in winning the war?

That *Electronics* listed thirteen clever tricks of magic through the use of photo-cells?

That Mayor T. S. Walmsley of New Orleans sent the first message upon the joining of that city to the RCA inter-city radio telegraph system on July 5? The mayor pointed out that, in addition to the advantages of being a link in the domestic chain, the new circuit made available to New Orleans the vast RCA international radio service.

That *Radio News* points out a new market for radio receivers, and possibly transmitters, in the one million pleasure craft, including yachts, motor sportsters and launches, now that the problem has been solved in automobile radio installations?

That Radiomarine Corporation has instituted a new service through which passengers on ships at sea may send radiograms to be mailed from the Radiomarine station ashore? A greater number of words may be sent at a lower cost than applying to the regular fast radiograms.

Ahead of Schedule

That Radio City has already reached the point in relation to office and shop rentals and general popularity that was predicted would not come about for five years?

That the Federal Radio Monitoring Station, located at Grand Island, Neb., close to the geographical center of the United States, with the well-known old-time radioman, Benjamin Wolfe, in charge, monitors all wave lengths, short, broadcast and commercial long waves from all points of the compass, according to C. S. Anderson, of RCA Institutes, who made a motor trip to that point this summer and who says the station is a highly interesting one to visit?

That a new type of radio program is being sponsored by RCA Radiotron Company over NBC on Saturday nights?

That being questioned about any of the items which have appeared here—particularly the one about a wrench not falling to the bottom of a deep pit—places us about in the position of the NBC sound-effects man who was called upon to imitate a dinosaur, which he did to the satisfaction of the radio audience?

Exit FRC, Enter FCC

That applicants preparing to take examinations for government radio licenses should note that their study of the radio law should now be in terms of the Communications Act of 1934, rather than the radio act of 1927, and in terms of Federal Communications Commission, rather than Federal Radio Commission, and that the applying international treaty is now the Madrid Convention of 1932, rather than the Washington Convention of 1927? (QST.)

That A. J. Costigan, traffic superintendent of the Radiomarine Corporation, with supervision over the personnel and maintenance of all that company's shore stations, and an internationally-known radio personage, is a son of a former New York police captain who became nationally known as "Honest Dan Costigan"?

That cigar-box radio stations with curtain rods for aerials is a diversion of the engineers at the NBC associate station, WHAM in Rochester, N. Y., and that it is a common occurrence to see them walking through the studios and offices adjusting their ten-cent curtain-rod antennas while carrying on a conversation with other fans a few partitions away?

That in order to more fully cover new developments, the RCA Institutes resident school course in Radio Servicing has been increased 66% in class and laboratory time with only 37% increase in tuition?

That a prominent school of aeronautics is now located in the RCA Building in New York?

That if all the persons on earth were to get together and shout at the same time the voice produced would be but one-thirtieth as strong as a voice from a broadcasting station?

That new Mazda electric light bulbs, one inch in diameter and 18 inches long, developed at Nela Park, are designed to be placed end to end to form a continuous line of light? (Bartlett in *GE Review*.)

That 114-volt dry batteries, with caps every six volts and weighing six pounds, may now be obtained in ribbon form, which may be rolled in cylinder shape, folded, laid out flat, hung on a wall or carried about wrapped around a person?

That R.C.A. Communications has twelve traffic officers in New York City?

That the recent death of H. H. Westinghouse recalled to several writers the ridicule which met his greatest invention because of the idea that railroad trains could be stopped with air?

Records Up

That according to current trade publications the demand for Victor phonograph records has increased two-hundred per cent?

That messages to ships at sea may be sent via the RCA inter-city radio telegraph system through RCA coastal stations.

That Western Union call boxes, messengers, printers, private wires, telephones and offices may be utilized in sending inter-city radio messages "via RCA" and "via RCA" traffic to foreign countries? Even Western Union blanks may be used if marked "via RCA."

That, although the commercial application of the photo-electric cell, the "tireless electric eye which far outdoes the human," is quite recent, its principle has been known for forty years?

That "electric eyes" are divided into four classes: the photo-electric tube, the selenium cell, photovoltaic cells and dry oxide plates which produce comparatively large, low-voltage currents when illuminated?

(Continued on Page 29)

Combined Radio Pickup and Public Address Installations

By KENNETH W. STOWMAN, Publicity Department, WCAU

ENGINEERS of WCAU, under the supervision of John G. Leitch, installed one of the largest sound reinforcing systems ever attempted in Lewisohn Stadium, early this spring, for the regular summer concerts by the New York Philharmonic Orchestra.

This installation, the second of its kind to be made in the United States, has been acclaimed by newspaper and magazine critics as one of the outstanding features of the concerts. The first installation, made by WCAU engineers, made last season in Robin

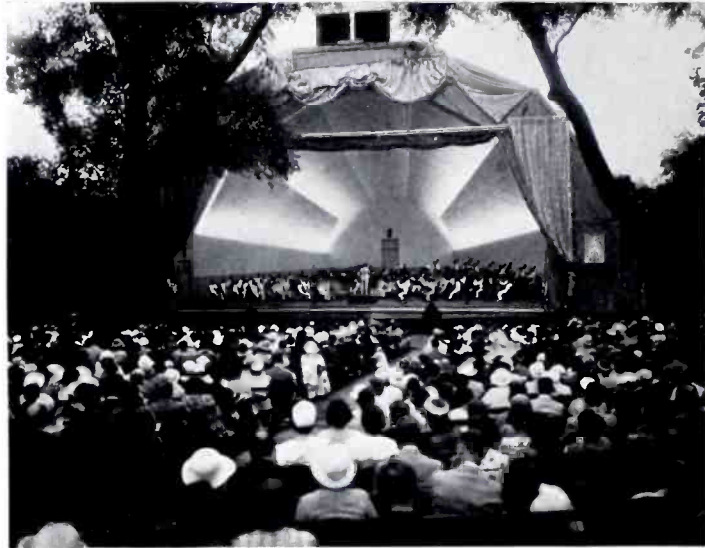

A CONCERT IN PROGRESS AT ROBIN HOOD DELL, PHILADELPHIA. THE TWO DIRECTIVE BAFFLE RCA VICTOR LOUDSPEAKERS ATOP THE SHELL SERVE THE REAR PORTIONS OF THE AUDIENCE, AND ARE ACTUATED BY THE SAME VELOCITY MICROPHONES WHICH PICK UP THE RADIO BROADCAST



LEROY ANSPATH, WCAU ENGINEER, AT THE CONTROLS IN THE RADIO-PUBLIC ADDRESS ROOM AT THE LEWISOHN STADIUM, CITY COLLEGE, NEW YORK CITY. NOTE THAT HE FOLLOWS COPY OF SCORE

Hood Dell, Philadelphia, is a feature again this year.

Some of the following quotations from New York papers and magazines are noteworthy: From the *Literary Digest*, July 7th issue, article by Charles Roland, "A special amplifying system carried pianissimo measures, limpid and clear, to the farthest reaches of the stone tiers." From the *New York Times*, the following is quoted: "This latter music, heard in the uppermost seats of the stadium, demonstrated the usefulness of the loudspeakers which have been installed this season. At this distance the sound is heard to its subtlest nuance." The *New York Sun* states: "Three huge loudspeakers were mounted at the top and front of the stage to carry music to the farthest parts of the stadium, and persons in distant seats said they seemed to be entirely satisfactory, with none of the harsh and objectionable features of such systems."

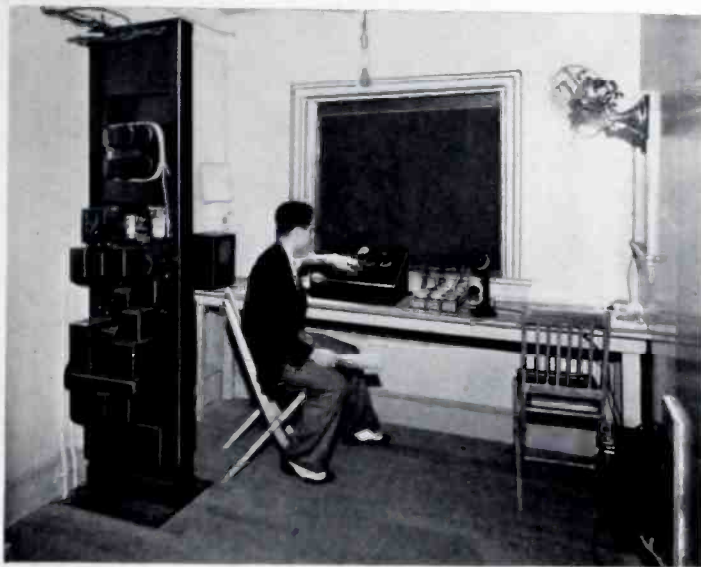

ARTHUR COHEN, OF THE WCAU STAFF, AT THE CONTROLS IN THE NEWLY CONSTRUCTED RADIO AND PUBLIC ADDRESS BOOTH AT ROBIN HOOD DELL, PHILADELPHIA

in a small room in one of the wings of the stage, which gives the radio engineer a full vision of the conductor and orchestra. However, this year at Robin Hood Dell, a special radio booth was constructed and placed to the right of the audience in the Dell. This was found advisable due to the construction of the stage at Robin Hood Dell, which did not afford the engineers and announcers a full view of the stage. This booth, designed by John G. Leitch, is sound proof and is built on the principles of the control rooms in the main studios of WCAU.

On the evenings when operatic performances are given, velocity microphones are placed on the stage and regardless of where the artist may be singing, the sound is properly picked up. In order to accomplish this, sound-absorbing baffles have been fitted to

Samuel Chotzinoff, writing for the *New York Post*, states: "What is more, one heard them last night to a greater degree than ever before . . . the instruments took on a power that reduced the vast field to the dimensions of a back yard."

At Robin Hood Dell, which has a seating capacity of 7,000, two large ten-foot directional baffle-type loudspeakers have been placed on top of the shell in such a manner that an even distribution of sound is accomplished throughout the audience. In Lewisohn Stadium the seating capacity is 17,000 and three of these large speakers were installed on top of the stage.

In Lewisohn, the main portion of the amplifying equipment was placed

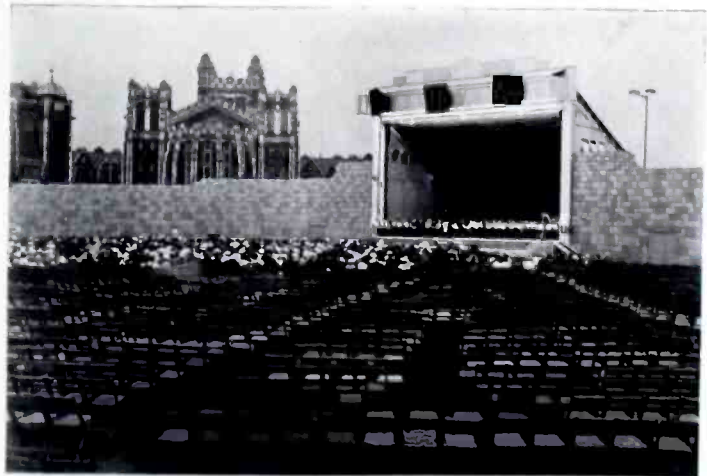

A REHEARSAL OF THE NEW YORK PHILHARMONIC ORCHESTRA AT LEWISOHN STADIUM. THE THREE DIRECTIVE BAFFLE RCA VICTOR LOUDSPEAKERS OVER THE STAGE "PROJECT" THE PROGRAM TO THE REMOTE CORNERS OF THE AUDIENCE. THE RADIO CONTROL OPERATOR DOES THE WHOLE "SOUND JOB"

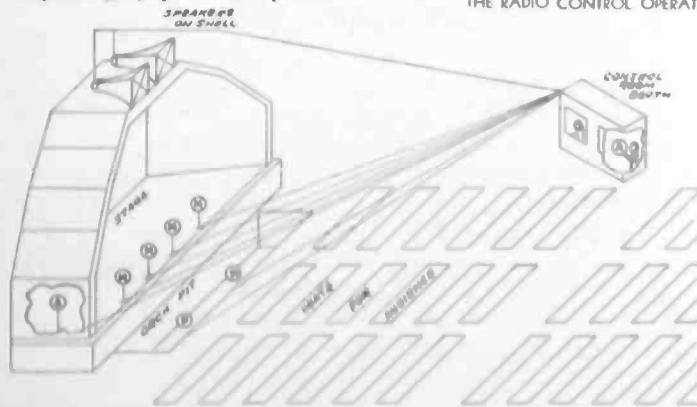

- ① OPERA MICROPHONES
- ② ORCHESTRA MICROPHONES
- ③ ANNOUNCERS MICROPHONES

RCA VICTOR SOUND INSTALLATION FOR STATION WCAU AT ROBIN HOOD DELL

the microphones, which make them to some extent directional. This also prevents the unwanted volume of the orchestra from reaching the microphones used for the operatic stars. Other velocity mikes are placed in the orchestra for the pickup when they are playing in the pit for the operas.

The fidelity of reproduction from these two systems is largely due to the microphones, which faithfully reproduce frequencies ranging from the lowest audible tones to those beyond the highest range of the orchestra. The speech input equipment has practically a flat frequency response from

(Continued on Page 29)

"Who's Who" at Radio Headquarters



"JACK" E. YOUNG, RCA VICTOR TRANSMITTER ENGINEER, WHO IS ACTIVE IN THE DESIGN OF ALL SORTS OF EQUIPMENTS FROM THE 50 KW CLASS DOWN TO HIS OWN AMATEUR RIG



LOREN F. JONES, TRANSMITTER ENGINEER OF RCA VICTOR, WHOSE INTERVIEW WITH MUSSOLINI WAS ONE OF THE IMPRESSIVE INCIDENTS OF HIS RECENT BUSINESS TRIP THROUGH EUROPE

J E. YOUNG was born in West Chester, Pennsylvania, in 1906. He received his early schooling in Chicago and West Chester and in 1928 he graduated from Drexel Institute with a B. S. in Electrical Engineering.

Immediately after graduating from Drexel, he joined the Radio Engineering Department of the General Electric Company, and having a very definite idea of what he wanted to do, jumped at the chance to work on the then super-power 50 KW broadcast transmitter under development at South Schenectady. He retained his enthusiasm for high power transmitters in spite of an initiation including some weeks during which he spent the nights in a tuning house in a South Schenectady field, alternately telephoning antenna current readings to the station and watching the thermometer struggle to get up to zero; and the days puzzling on how to put the test clips, taken off during the night's experiments, back into the transmitter so that it could

be used for that evening's super-power broadcast. It might be recorded in passing that the test clips did not always get back in precisely the right circuits, but the situations resulting therefrom are too numerous to chronicle in this brief history.

Mr. Young spent the early months of 1932 in an investigation; the causes and remedies of adjacent channel interference, an unexpected form of interference caused by high power broadcast transmitters.

On June 1, 1932, he transferred to the Engineering Department of RCA Victor Company, Inc. Since then, he has been engaged in designing transmitters for broadcast and government services. A proponent of the theory that beauty can be combined with utility, his ideas have been reflected in his transmitter designs.

His hobbies include driving, bridge, and, like the proverbial postman, amateur radio. He has been building

a transmitter and receiver of his own for the past three years, and estimates that it will be actually completed any year now.

The development work which led to the design of the Type 5B and 50B transmitters completed, Jack turned his attention to high power, short wave broadcast transmitters, developing a linear amplifier for 2XAF of 160 kilowatts peak capacity. This was the highest power short wave broadcast transmitter in use at that time. It is of interest also because it represented the first application of multi-phase AC to filament heating in high power broadcast equipments.

The following year was devoted to the installation of Type 5B and 50B transmitting equipments. The installation of a 5B transmitter at Mexico City deserves more than passing mention, since it was here he met the young lady responsible for his graduation from the state of single blessedness.

LOREN F. JONES was born in 1904, in St. Louis, Missouri. After receiving a B. S. degree from Washington University in 1926 he joined the Radio Engineering Department of General Electric Company where he soon specialized in the development of high power broadcast transmitters. In 1928 he received a leave of absence to attend the Graduate School of Business Administration at Stanford University. While in California, he worked in his spare moments on the development of short wave channels for facsimile and radio telephony. Upon returning to the East in 1929, he proceeded to Hartford to complete the installation of WTIC's new 50 KW transmitter. Next, the 50 KW installations at WENR, Chicago; WFAA, Dallas; and WOAI, San Antonio provided him with plenty of work.

On August 1, 1930, he transferred from General Electric to RCA Victor and on the same day sailed for Rome to complete adjustments on the 50 KW transmitter there. What was supposed to be a several weeks trip to Italy turned out to be a seven months visit to many European countries. During the stay in Italy he and Joe Biondo of the International Division spoke with Premier Mussolini. The Premier accepted an invitation to address America by radio and, on January 1, 1934, the first international broadcast from Italy to America was successfully made. Considerable time was spent in demonstrating the 50 KW RCA transmitter to visiting engineers from many European countries, and various miscellaneous and interesting duties were performed, including the preparation and presentation (by mail) of a very special receiving set to Hali Saleja, King of Ethiopia.

Upon leaving Italy, "Lorry" proceeded to the R.C.A. office in Paris, thence to Berlin to observe engineering developments of the Telefunken Company, thence to Warsaw to visit Polskie Radio, and thence to Moscow and Leningrad to represent the RCA in connection with a mutual transfer of engineering information between the Radio Corporation and the "Weak Current Trust" of the U. S.

S. R. After conferences, visits to laboratories, visits to radio stations, inexpressibly bad food, worse hotels, still worse trains, bitterly cold weather tempered by small doses of fiery vodka—he left Russia early in 1931 and returned to Camden shortly thereafter.

Craving variety, he coordinated and installed the ultra-high frequency television transmitters in the Empire State Building and supervised some television demonstrations in New York. Since then he has been kept busy with the design of new 1, 5, and 50 KW broadcast transmitters, not to mention the 500 KW installation at WLW.

Being an ardent pilot, he surprises distant friends by "dropping in" for visits, and occasionally employs the plane on business trips to save time.

100-WATT TRANSMITTER

(Continued from Page 16)

4230 transmitter forms a high quality economical combination.

It is important to emphasize that the Type ET-4230 transmitter was designed for the small local station with regard to simplicity of operation, installation and cost and to conform in every respect with the high performance of the best transmitting equipment available.

COMBINED RADIO PICKUP AND PUBLIC ADDRESS

(Continued from Page 27)

30 to 10,000 cycles, which guarantees faithful reproduction of both the high and low frequencies. The equipment in both installations is operated on alternating current.

George Lewis, Assistant Technical Supervisor of WCAU, is in charge of both installations, and the results are most gratifying. It is felt that the effort and expense represented in these installations are more than justified by the satisfaction and appreciation expressed by the music-loving public.

DID YOU KNOW?

(Continued from Page 25)

That the exact figure recently determined on the speed of sound in air is 1087.13 feet per second? Previously accepted figures ranged from 1085 to 1089.

Plant Life Stimulus?

That when the new WOR 50-kilowatt transmitter is completed at Carteret, N. J., J. R. Popple, chief engineer of that station, will have the soil of many adjacent acres planted and keep scientific data on the results of high-frequency bombardment as an experiment in cooperation with the New Jersey College of Agriculture?

That for the first time since the formation of RCA Radiotron Company on January 1, 1930, all field representatives, numbering about 60, recently met together at the home office for a general sales conference?

That after passing through thirty-four stories of steel and concrete, and then penetrating armor-plate steel of a vault forty feet below ground, cosmic-ray electrons were found to have reduced in count from 60 rays per minute, under the open sky, to 27 per minute? (*Electronics*.)

RCA Tours

That RCA Radiotron Company has received requests for its Radio Tours maps from all over the world, including the League of Nations; that 16,000 were sold at ten cents each direct by mail to consumers and over 700,000 to dealers and distributors, and that the maps have been widely reproduced in newspapers and radio magazines throughout the country? The Radio Tours maps were brought out last Fall. The third edition is now off the press.

That less than two pounds of radium are available for use in the world today? (*Popular Mechanics*.)

That R.C.A. Communications has twelve traffic offices in New York City?

That radio has entered the dentistry field, where experiments have shown diseased teeth may be treated with a simple short-wave broadcasting set; germs are killed and teeth saved with no resulting pain?

Roselle, N.J., "Terra-Wave" Gets Its Men

Four Bandits Fleeing from Scene of Unsuccessful \$4000 Payroll Holdup Apprehended
by Alert Police with Modern Radio Equipment

THE capture of four New York gunmen by the Roselle, N. J., police in less than half an hour after they had staged an unsuccessful holdup on August 3rd was made possible by the new RCA Victor Terra-Wave Police Radio Equipment, recently installed.

Lieutenant J. J. Petersen single-handedly captured Eugene Uricola, 24 years old, of 196 Hester Street, New York City, and Michael Randazzo, 23 years old, of 2258 East Fifteenth Street, Brooklyn, N. Y.; James Odde, 25 years old, of 9294 Elizabeth Street, New York City, and Charles Marine, 20 years old, of 15 Monroe Street, New York City, were captured in the neighboring city of Elizabeth, N. J., by crews of two police radio cars. Chief of Police Burt M. Avery announced that all four men have been identified in police line-ups as connected with the holdup gang.

Radio Spreads Alarm

The bandits, driving a Chevrolet sedan, which had recently been stolen in New York City and bearing New York registration tags, 1K 75-54, also stolen from another car, had been in the neighborhood when the armored payroll car delivered \$4000 to the premises of the Godoff factory, located in the Drittell Building. Shortly after the payroll was delivered, the four armed bandits got out of their car and went into the first-floor office, where they forced the treasurer, Nathan Goldberg, to open the office safe, despite his protests that the money had been removed to another safe upstairs. In the meanwhile, the bandits covered with their guns the two girls in the office and the fifty girls employed in the cutting room on the first floor. Other employees upstairs in the building were unaware that a holdup was in progress.

After failing to find the money in the safe, and suspecting that Goldberg's contention that the money was located upstairs involved a trap, the

bandits left the premises and fled in their car. Immediately the Roselle police were informed by telephone of the attempted robbery and were given a sketchy description of the men and the direction in which they had fled. Although detailed information was

two motorcycle officers, Petersen and Ball. In the meantime, County Park Patrolman Joseph Tierney found the abandoned car which had been used by the bandits in Warinanco Park, Roselle, and a Linden truck driver advised him that he had just seen

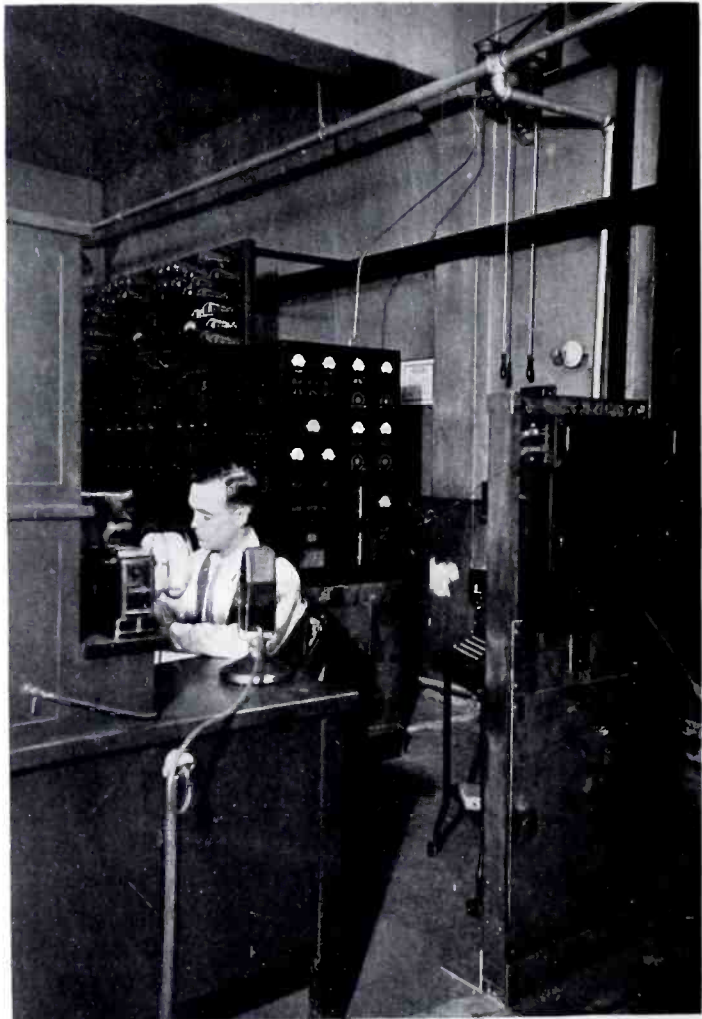

RCA VICTOR MODEL ET-3670 POLICE TRANSMITTER AT THE CITY OF SOUTH BEND, IND. HIGH FIDELITY SPEECH INPUT EQUIPMENT AND VELOCITY MICROPHONE IN THE FOREGROUND

not available in the excitement, the alarm was immediately broadcast to all police radio cars in the vicinity.

In addition to the police cars, Captain Fenton Keenan had dispatched

several men jump out of the car and run through the woods in the park, separating in several directions.

Subsequently, Lieutenant Petersen, cruising on his motorcycle near Sheri-

dan and Third Avenues, saw three men running and gave chase, threatening to shoot. He captured Uricola and Randazzo. The third man escaped in the direction of Elizabeth.

Bandits Fail to Escape Police Radio Net

Mayor Francis V. Lowden and Captain Keenan, aiding in the search, arrived on the scene at this time and took the two captured bandits in charge. At 4.35 P. M., Patrolmen Walter Hildenbrand and Frederick Norsk, in an Elizabeth radio car, arrested Oddo on suspicion, the radio alarm having been received in Elizabeth police headquarters at 3.58 P. M. Patrolmen Knakal and William Young, cruising in radio car No. 3, received the same alarm while in the vicinity of Warinanco Park, and meeting Motorcycle Patrolman Ball, they held a brief consultation, which resulted in their picking up Marino at 4.30 P. M.

A search, in the vicinity of the abandoned car, resulted in the discovery of two .45-caliber automatics, two .45-caliber revolvers and a shotgun, which had been thrown in the underbrush. In the back of the car was a large box of ammunition. The car had been stolen in New York City and reported by police the previous Tuesday, while the license plates on the stolen car were also reported as stolen on Wednesday.

Employees Make Immediate Identification

Treasurer Goldberg, of the Godoff Dress Company, and two of the girls employed by the company had no trouble in picking out Uricola, Randazzo, Oddo and Marino from the lineup at police headquarters. The whole incident was considered one of the swiftest and most successful jobs of apprehending and identifying criminals in the history of the vicinity, and the police force, deservedly praised for their accomplishment, give much credit to their new radio system for its part in expediting the action.

In Roselle, N. J., the RCA Victor "Terra-Wave" Police Radio equipment consists of an ET-5004 transmitter and four police receivers in automobiles.



HARRY C. ENAULT, CAPTAIN OF POLICE AT WINNETKA, ILL., WITH THE RCA VICTOR TERRA-WAVE POLICE TRANSMITTER

SINCE the last issue of *Broadcast News* was published, RCA Victor "Terra-Wave" Police Radio systems have been installed in McKeesport, Pennsylvania; in Lima, Ohio; in Greensboro, North Carolina; in Stockton, California, and one in Springfield, Missouri. See the pictures herewith of the antenna installation at this last location.



TRANSMISSION LINE FROM RCA VICTOR "TERRA-WAVE" POLICE RADIO TRANSMITTER TO THE ANTENNA AT SPRINGFIELD, MO.



POLICE RADIO TRANSMITTER ANTENNA AT SPRINGFIELD, MO.

As we go to press we are also in receipt of pictures taken by D. A. Reesor, from the Central District, showing Police Captain Harry C. Enault of Winnetka, Illinois, with the RCA Victor "Terra-Wave" installation, (call letters are W9XM), and a view of the RCA Victor installation at South Bend, Indiana.

2000 KVA High-Pressure Capacitor

By V. E. TROUANT, Transmitter Engineer, RCA Victor

IN designing the largest and most efficient capacitor ever utilized for broadcast purposes, the following general requirements were kept in mind:

1. There should be a high ratio of breakdown voltage to operating voltage. Repeated breakdowns should not make the unit inoperative.

2. The unit should have very low loss. To meet this requirement, the dielectric and insulating materials should be the best obtainable and should not be injured by repeated applications of very excessive voltage. Precautions should be taken to reduce eddy current losses to a minimum.

3. The unit should occupy small space. The space required is important for two reasons. One is that a small capacitor decreases the size and cost of the transmitter frame. The other is that a small capacitor permits the radio frequency circuits to be so confined that losses are reduced and coupling to other parts of the circuit is minimized.

4. The capacity should be adjustable in small steps over a wide range of values.

5. The condenser should be a fully enclosed unit. Open units are subject to the accumulation of dust or other foreign material and to arc overs caused by flying insects.

6. Approximately no maintenance should be required.

7. The cost should be low.

Several preliminary designs using "pie plates" of widely different construction were discarded because of the space required and because of their failure to meet other of the above requirements. The simple solution of enclosing the pie plate design in a cylinder and increasing the pressure to obtain the necessary voltage rating was resorted to.

Figures 1 and 2 are photographs of an experimental model. The capacitor stack consists of four Mycalex end pieces supporting four



V. E. TROUANT, RCA VICTOR

rods on which the plates and spacers are assembled. The plates are 0.25 inch commercial aluminum sheet spaced, in the case of the photograph, 0.28 inch. This ratio of plate thickness to dielectric thickness results in a very high breakdown voltage for a given space. The tank in which the stack is assembled is made of solid copper and is about 4 feet long. Solid copper is used to reduce eddy current losses to the vanishing point.

The insulators are mounted on cast copper bosses welded to the cylinder. The desired pressure may be maintained by either a small air compressor with an automatic regulator or by a cylinder of compressed gas, using an ordinary reducing valve as the regulator.

The unit shown has a capacity of 0.0015 mfd. on each side and has room for a capacity of 0.002 mfd. per side. The condenser is capable of handling maximum currents of about 200 amperes. The unit shown was tested to determine the 60 cycle flash-over voltage for various pressures with the result shown in Figure 3. The data was taken with carbon dioxide as the dielectric, although the values for air are about the same. Available data indicated that nitrogen is slightly superior to carbon dioxide for pressures below 100 pounds but only about 80% as good for pressures of 200 pounds. The radio frequency flash-over voltage is approximately 70% of the 60 cycle value.

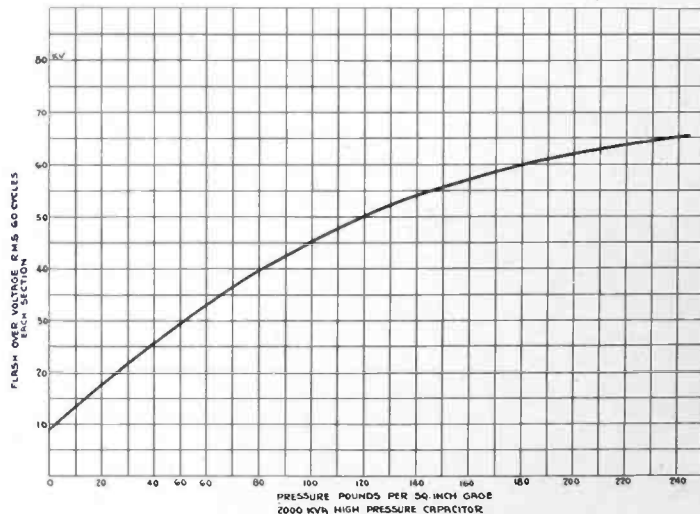

FIGURE 3—2000 KVA CAPACITOR, 60 CYCLE FLASHOVER VOLTAGE FOR VARIOUS PRESSURES

An attempt was made to measure the losses with ordinary laboratory equipment, but the losses were so small that they could not be measured. It is not necessary to control the pressure between close limits, as the dielectric constant changes only 1% with pressures from atmospheric conditions to 300 pounds per square inch.

To insure safety, the insulators and tank are designed for a mechanical safety factor of at least 5 and are tested at 400 pounds per square inch. Furthermore, a safety valve is included to release at 300 pounds. This condenser is suitable for use in high power telegraph transmitters and for use in the power amplifier

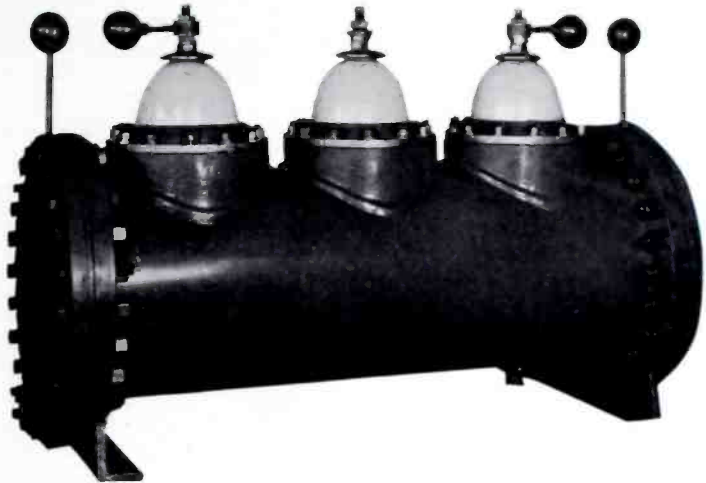

FIGURE 1—RCA VICTOR'S NEW 2000 KVA HIGH-PRESSURE CAPACITOR DEVELOPED FOR USE IN 50 KW TO 200 KW TRANSMITTER

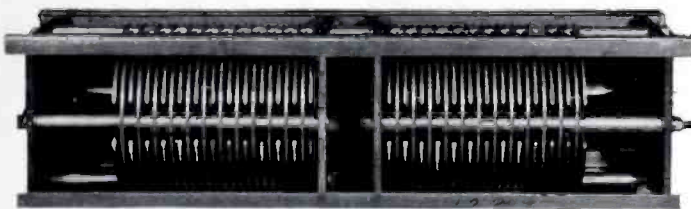
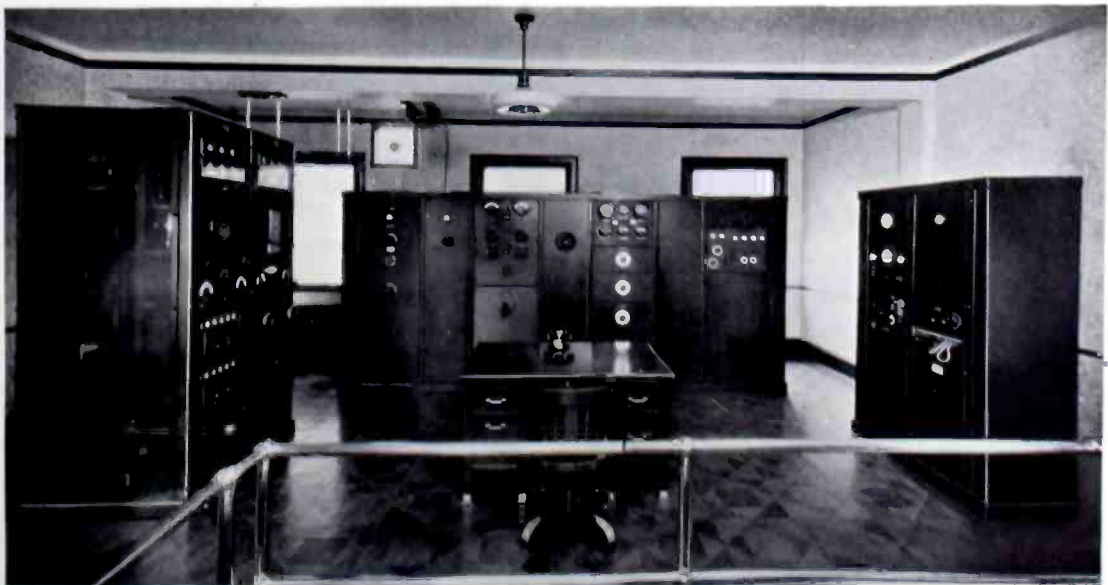

FIGURE 2—CAPACITOR STACK USED IN 2000 KVA CAPACITOR, SHOWING THE EXTREMELY SIMPLE AND RUGGED CONSTRUCTION

tank circuits of broadcast transmitters up to 200 KW power. By employing it in the new RCA Victor 50 KW broadcast transmitter and by designing the remainder of the tank circuit with corresponding conservatism, the power amplifier of this new transmitter is made suitable for operation at various powers between 50 KW and 170 KW.

WTAG Installation at New Location



THE 1.8 RCA VICTOR TRANSMITTER RECENTLY INSTALLED ATOP THE WORCESIER TELEGRAM AND EVENING GAZETTE BUILDING IN WORCESIER, MASS. THE LOFTY ANTENNA IS SUSPENDED BETWEEN STEEL MASTS LOCATED ON THE ADJACENT ROOFS OF THE PARK BUILDING AND THE BANCROFT HOTEL. THE STATION OPERATES ON 500 WATTS AND IS EQUIPPED WITH A CATHODE-RAY MODULATION INDICATOR

Type 50-A Inductor Microphone

By L. J. ANDERSON, Sound Engineer, RCA Victor Company, Inc.

THE primary object in the development and design of the Type 50-A Inductor Microphone was to secure a microphone which would adequately meet the needs of the outside pick up field. The requirements of this particular type of service were carefully considered and may be listed somewhat as follows:

- (a) Minimum size.
- (b) Minimum weight.
- (c) Sensitivity sufficient to allow low level mixing.
- (d) Adequate frequency response.
- (e) Insensitivity to wind.
- (f) Insensitivity to mechanical shock.
- (g) Mechanical ruggedness.
- (h) Good directional characteristics.
- (i) Applicability to close talking uses.
- (j) Suitable impedance.

Obviously, a number of the above requirements conflict and as a result no one requirement can be set apart, but each must be considered in its relation to the others. As an example, it is at once obvious that increased sensitivity secured at the expense of increased size and weight must soon reach limitations. Rather, we must start with what may be taken as a maximum in size and weight and secure the necessary sensitivity through the efficient use of space and materials. The Type 50-A Inductor Microphone represents what we consider to be as good a balance of the above features as is obtainable.

After a careful consideration of the possibilities of various types of microphones, it appeared that a moving conductor or inductor type of microphone was the most promising.

In order to obtain a curve of uniform output against frequency with this type of microphone, it is necessary that the conductor move with a constant velocity for all frequencies. In the case of the velocity type of microphone, this is obtained by having the



L. J. ANDERSON, RCA VICTOR

system mass controlled and having the driving force proportional to the frequency.

Such a system necessitates a very low resonant frequency for the moving system in order that it satisfy the condition of being mass controlled over the useful range. The result of this is a very compliant moving

system which does require a certain amount of cushioning against vibration, and screening from wind.

A second type of moving conductor microphone which lends itself more readily to the requirements is a microphone in which the driving force is constant over the frequency range and the moving system resistance controlled over a large portion.

The force available for driving the mechanical system is:

$$F = p A$$

p = pressure in the sound wave

A = Area of the diaphragm

Further, the moving system is so designed that

$$Z_t = K_1$$

The velocity V of the moving system will be

$$V = \frac{F}{Z_t}$$

and the generated voltage

$$E = B l V = K_2$$

B = Flux Density

l = Length of Conductor

Values of F , V and E are R.M.S. A microphone of this type may have

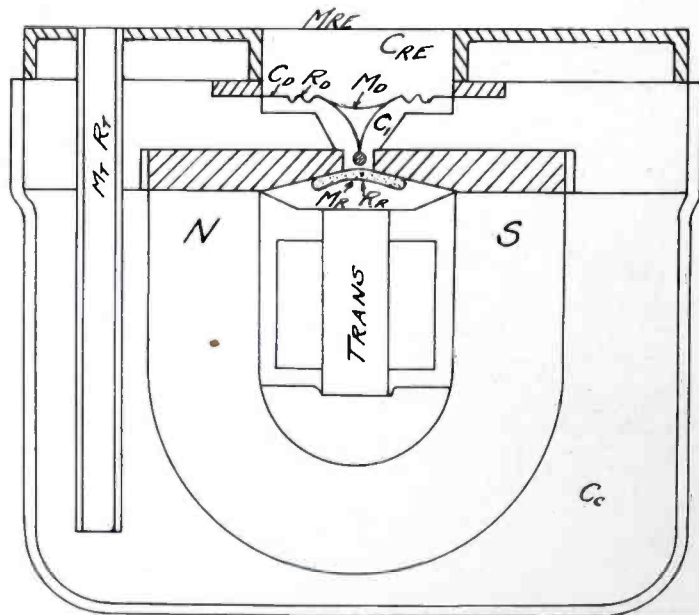

FIGURE 5—THE NEW RCA VICTOR TYPE 50-A INDUCTOR MICROPHONE, ARRANGED FOR OVERHEAD SUSPENSION

a moving system which is relatively stiff, and is, as a result, quite rugged.

Equivalent Circuit

A schematic cross section of a microphone of this type is shown in Figure 1, and the electrical equivalent of the mechanical system in Figure 2. In Figures 1 and 2 the parts may be identified as follows:



FIGURE 6—THE RCA VICTOR 50-A INDUCTOR MICROPHONE MOUNTED ON FLOOR STAND

M_D —Mass of the moving system consisting of the diaphragm and associated conductor.

C_D and R_D —The compliance and resistance of the diaphragm edge, respectively.

C_1 —The compliance of the enclosed space immediately behind the diaphragm.

M_R and R_R —The effective mass and resistance of the damping means.



FIGURE 5—THE NEW RCA VICTOR TYPE 50-A INDUCTOR MICROPHONE, ARRANGED FOR OVERHEAD SUSPENSION

C_C —The compliance of the volume of the case.

M_T and R_T —The effective mass and resistance of the tube connecting the case volume to the atmosphere.

M_{RE} and C_{RE} —The effective mass and compliance of the cavity in front of the diaphragm.

The mass of the moving system (M_D) and the compliance (C_D) of the edge of the diaphragm are so chosen that the resonant frequency is about 400 cycles. This results in a system sufficiently stiff to be relatively unaffected by shock. The com-

pliance of the case is sufficiently large as compared with the compliance of the diaphragm as to be negligible.

In order to flatten out the frequency response, the acoustic resistance R_R is inserted into the circuit. Along with it come C_1 , the compliance of the cavity formed behind the diaphragm, and M_R , the effective mass of the acoustic resistor. The value of R_R is made sufficiently large to secure resistance control over the desired range. At approximately 2500 cycles the reactance of M_R becomes sufficiently large so that another resonance occurs. By properly selecting the values of M_D and R_R , it is possible to make the amplitude only about + 4 to 6 DB. The dropping off in response above this point is not particularly rapid and the region at 8000 cycles is given an additional boost by the short tubular resonator diagrammed by M_{RE} and C_{RE} .

Below the fundamental resonant frequency of 400 cycles the system gradually becomes stiffness controlled, with a resulting dropping off in response. This effect is offset by the

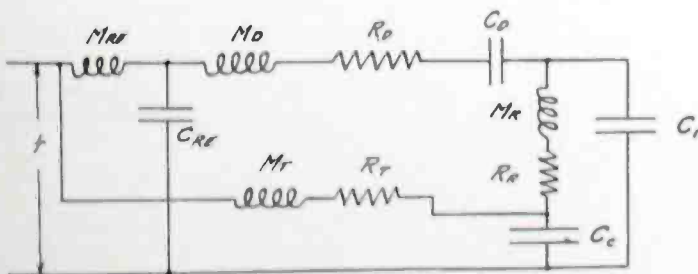

FIGURE 9—EQUIVALENT ELECTRICAL CIRCUIT OF THE MECHANICAL SYSTEM

introduction of the tube M_T , R_T which in combination with the compliance of the case C_C serves in effect to reduce this stiffness. At frequencies lower than the resonant frequency of M_T and C_C the response is practically zero because the pressure on the front and back of the diaphragm will be equal and practically in phase. The whole objective of these complex coupled circuits is to secure one in which the impedance is such that the constant driving force will drive the diaphragm with as uniform velocity throughout the frequency range as is possible.

Mechanical Design

The external appearance of the microphone is shown in Figures 5 and 6 and something of the general inside layout may be gathered from the schematic cross section, Figure 1.

The essential parts of the microphone assembly are: the diaphragm and conductor, the magnetic circuit, the acoustic damping assembly and the transformer.

The conductor in which the voltage is generated is approximately 2 inches long and 10 mils in diameter. It is coupled rigidly to the diaphragm by means of a V-shaped glassine paper structure. The diaphragm proper is made of thin aluminum and is approximately $\frac{1}{4}$ " wide and 2" long. It is slightly concave for the purpose of added rigidity. The supporting edge of the diaphragm is corrugated in order to secure the proper value of compliance.

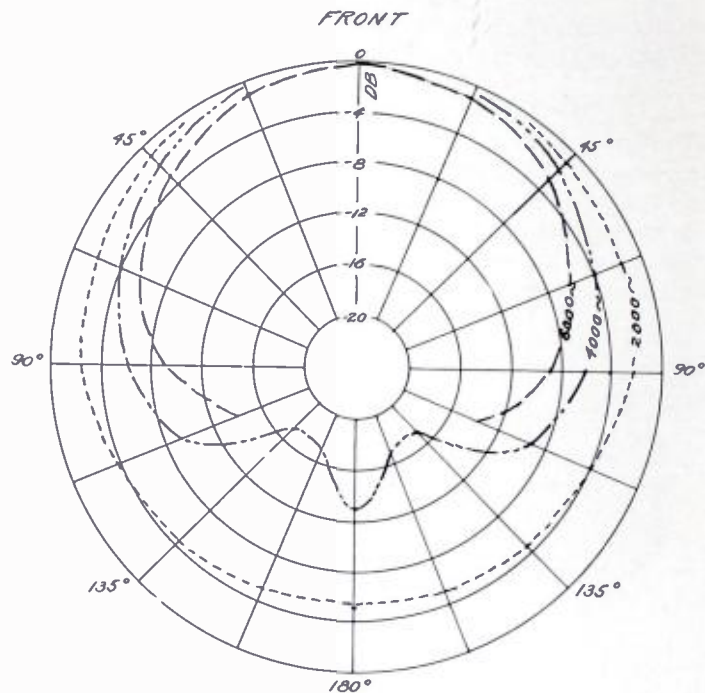

FIGURE 3—DIRECTIONAL CHARACTERISTICS OF THE NEW INDUCTOR MICROPHONE

The use of the straight conductor makes possible the design of an extremely efficient magnetic circuit. The leakage flux in this design is very low, resulting in an air-gap flux density of about 12,000 gauss with a relatively small amount of 35 per cent cobalt steel. This is one of the prime factors in securing a microphone light in weight and high in sensitivity.

Acoustic resistance may be effected in various ways, one form consisting of fine slits, and another a semi-infinite tube. In the case of the

former, the dimensions of a slit and the tolerances to be held in order to secure and maintain the proper value of resistance lead to manufacturing difficulties.

On the other hand, the semi-infinite tube requires an excessive amount of space. As a result a new type of acoustic resistance was developed. It is easy to manufacture and has a large ratio of resistance to mass reactance. It is extremely simple and consists of several turns of silk wound around an aluminum form. The resistance is due to the losses incurred in forcing the air through the small openings in the cloth. The resistance is inversely proportional to the cube of the diameter of the holes in the silk. The total resistance is approximately proportional to the number of layers of silk and inversely so to the area exposed.

The electrical resistance of the moving conductor is of the order of 0.07 ohm and as a result, a transformer must be provided to match this to a 250- or 25-ohm line. After some experimentation it was found possible to place the transformer within the open portion of the horse-shoe magnets. It is securely held in

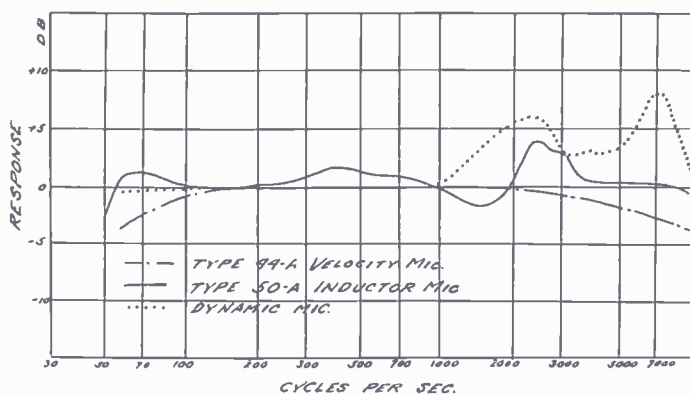

FIGURE 4—FREQUENCY RESPONSE CHARACTERISTICS FOR THREE DIFFERENT TYPES OF MICROPHONES (THE DYNAMIC MICROPHONE INDICATED BY THE DOTTED LINE IS NOT MANUFACTURED BY RCA VICTOR)



TWO NEW DEVICES DEMONSTRATED BY THE TWO HOPKINS

GEORGE P. HOPKINS DELIVERS AN ADDRESS BEFORE THE NEW RCA VICTOR 50-A INDUCTOR MICROPHONE, WHILE A. R. HOPKINS OPERATES THE NEW OP-4 REMOTE PICKUP EQUIPMENT

place with a sponge rubber wedge.

The entire assembly is contained in a spun-brass case and held in place by means of a threaded ring on the front. Provision for connection is made on the rear of the case with a Cannon Type 0-3-42 D plug.

The entire assembly is carefully sealed. Disassembly for internal inspection is not advisable inasmuch as subsequent air leakage may seriously affect the low-frequency response of the microphone.

Performance

Frequency response curves* for various types of microphones are shown in Figure 4. In the case of the velocity type of microphone, special attention must be called to the smoothness of response which readily allows compensation in the following amplifiers if desirable.

The frequency response of the Type 50-A Microphone compares very favorably with that of the dynamic type of microphone, except that the useful range of the inductor microphone is purposely limited at 60 cycles. Below this frequency, pressure equalization exists between the front and back of the diaphragm. This feature will assist greatly in the elimination of noise due to wind and allow

the microphone to be used out-of-doors under adverse conditions.

The directional characteristics of the Type 50-A Inductor Microphone are shown in Figure 3, and are practically spherical for frequencies below 1000 cycles, varying, as shown, for frequencies of 2000 cycles and above. This phenomenon is due to the diffraction of sound around an object placed in a sound field. As a result, these curves would be approximately the same for any microphone of this type and of similar size.

Good coverage will be obtained at angles of approximately 45 degrees on either side of the zero axis under normal operating conditions.

The sensitivity of the Type 50-A Inductor Microphone is approximately 6 to 8 DB higher than that of the Type 44-A Velocity Microphone and will operate satisfactorily in properly designed low-level mixing equipment.

*Curves for Type 44-A Velocity Microphone and Dynamic Microphone taken from I. R. E. Proc., May, 1934, "High Quality Radio Broadcasting," by Stuart Ballantine, pp. 580-582.

†The writer wishes to credit Dr. H. F. Olson with the research work on this device and to express his appreciation to Mr. R. H. Heacock for his suggestions on mechanical phases of the development.

Father, Son Hear Each Other on Byrd Program

AN interesting feature on the "Admiral Byrd" program on Wednesday night, August 1st, included reciprocal broadcasts between Dr. James Sterrett, Sr., a resident of Beaver Falls, Penna., and Dr. James Sterrett, Jr., a member of Admiral Byrd's party in Little America. A special setup was made at the Granada Theatre in Beaver Falls under the supervision of Engineer Charles Smith of WCAU, who had been sent to Beaver Falls to make the



CHARLES SMITH, WCAU ENGINEER WHO MADE THE SPECIAL PICKUP ARRANGEMENTS WITH THE NEW RCA VICTOR OP-4 EQUIPMENT AT BEAVER FALLS, PA.

necessary arrangements for the Columbia Broadcasting System.

The program originating at Beaver Falls included a number of selections by the local American Legion Band, which were acknowledged by Admiral Byrd's party at the South Pole. Return reception was made via RCA at Buenos Aires, and RCA at Riverhead, Long Island, and was put out by the Columbia network including WJAS, Pittsburgh, whence Beaver Falls obtained their reception. RCA Victor loudspeakers and amplifiers, together with the new OP-4 program equipment was installed at the Granada Theatre for the occasion by the WCAU organization of Philadelphia.



The Show Must Go On

By LOUISE LANDIS, Feature Editor, NBC



"GENERAL strike!" The words even now cast a chill over the hearts of San Franciscans, still filled with memories of those tense days between July 16 and July 19, when there were no street cars and no gasoline; no fresh vegetables and fruits, no theaters, few open restaurants and—no musicians.

To the National Broadcasting Company that latter item was regarded as the strike's most serious aspect, until the strike was actually on. Once the emergency actually arrived, it was a different matter, however. The audience mail department is still answering the hundreds of letters from listeners commending the National Broadcasting Company for the manner in which it continued to render service, and for the high quality of programs which were presented throughout the strike.

Despite the fact that every orchestra man on the staff was out on strike there was plenty of entertainment, dramatic and musical as well, for the western radio audience. Not an instant of silence on the air resulted from the general strike, and not a sponsor, even though his program was a musical one, lost time on the NBC facilities.

Faced by the first crisis of the kind ever encountered in its history, the spirit of program executives, producers and artists rose courageously to meet it. By Saturday evening Lew Frost, NBC Program Manager, knew that on Monday morning not a member of the musicians' staff would report for work. There was the *Woman's Magazine of the Air* to be considered first of all; orchestra and soloists play an important part in the makeup of this daily microphone magazine for women. There were programs like the *Alpine Milk Company's* one-man show, in which Will Aubrey, singing guitar-player, is the star. He was a union man; who would fill his place? There was the *Standard Oil Company*—not a San Francisco

symphony man would be on the job—and there were dramatic programs, like *Memory Lane*, *One Man's Family* and similar serials in which the organ theme is an important part. What about them?

Frost called the program and production departments and there was a late conference Saturday night. Early the next morning the staff was assembled for actual work, and work it was, too, rebuilding almost every program on the schedule for the next week.

Swiftly, practically, they went to work on the next day's schedule and worked all night on it. Musicians might not be available, but singers were, and every singer on the staff

was called and asked to stand by. They did, and with the spirit characteristic of entertainers the world over they sang when the time came. They sang without accompaniment in most cases, and sang so well that the telephone girls were kept busy answering calls from listeners who wanted to express their appreciation of the manner in which service was continued.

Programs were rebuilt day-by-day, some of them not even twenty-four hours in advance, during the strike, but they seemed to gain instead of lose showmanship thereby. Bobb Nichols, producer of the *Woman's Magazine of the Air*, had a real problem on his hands—without or-



SOPRANO ON A SKATE—IT'S THE SAN FRANCISCO STRIKE!
WHO GOES THERE? RITA LANE, NBC SOPRANO, PLEASE, SIR, ON THE WAY TO THE STUDIO. NO STREET CARS, NO TAXICABS. PRIVATE ROBERT NELSON IS TRYING TO DECIDE WHETHER TO LET HER PASS OR MAKE HER STAY



RADIO CANTEEN IN NBC STUDIOS

ARTISTS AND STAFF EMPLOYEES DIDN'T GO HUNGRY WHEN SAN FRANCISCO'S GENERAL STRIKE CLOSED THE RESTAURANTS. THAT'S WANDA WOODWARD POURING TEA, AND THAT'S BOBB NICHOLS WIELDING THE COFFEE POT

chestra, without even Bennie Walker, editor and master of ceremonies of the magazine. Bennie wasn't on strike, but he was out of town on vacation, and Bobb had been scheduled to take his place. Pinch-hitting for Bennie was a big enough job, but pinch-hitting for an orchestra was another thing. There were the Clef Dwellers, men's trio, the Coquettes, a girls' trio, however, and there were John and Ned, good all-around entertainers, the Southern Harmony Four, magnificent negro quartet, whose voices are pure music, with or without accompaniment. Bobb called on them all, and during the next few days let the various ensembles act as background for the regular soloists on the Magazine. He and Helen Webster, Ann Holden and other speakers on the Magazine ad-libbed everything between the musical numbers except the recipes—and put on a grand show.

The Clef Dwellers, Coquettes, Southern Harmony Four and NBC's two famous male quartets, Doric and Knockerbocker, were on duty from early morning to late at night throughout the strike. So were the individual soloists who sang altogether, alone or with a vocal trio or quartet accompanying them. John with his guitar and Ned with his patter appeared on all kinds of programs—and listeners are them up!

Theme songs generally played by orchestras or organists were heard just the same, but they were sung or

hummed, without accompaniment, as in the case of Memory Lane, where Eileen Piggott, Ted Maxwell and Bennie Walker sang the serial theme, "On the Banks of the Wabash," then returned to their rôles. Pianists who are members of trios, such as Marjorie Primley, mezzo-soprano and accompanist of the Coquettes, and Gene Close, coach of the Clef Dwellers, continued to play with their own groups, but the National Broadcasting Company did not call upon them to accompany other singers.

Literally by the hundreds, would-be substitutes for the union musicians and conductors telephoned the NBC headquarters every day. During the entire time, however, no outside musicians were employed; the San Francisco NBC carried on without the aid from anybody except its own devoted and loyal staff.

It wasn't just a matter of coming down to the studios and singing, or playing, or talking, or building programs, or making out schedules. Not the least among the problems the strike involved was that of transportation. Taxi and street car men were on strike, and San Francisco is a big town, with many residential districts as far as ten miles from the business section. Even if one had a car, gasoline was a serious problem, for all gas stations in town were closed, and those selling gasoline on the outskirts of the city had block-long lines of prospective customers. If you ran out of gasoline before you got up to the tanks it was just too bad. So many of the staff members and artists walked to work. They didn't like it, but they managed to smile, and the show went on.

When the Key System Ferries employes went out on strike it strand-

(Continued on Page 43)



RECORDS CAN'T STRIKE

RECORDINGS AND THE RCA VICTOR TRANSCRIPTION EQUIPMENT IN NBC'S SAN FRANCISCO STUDIOS HELPED TO VARY THE ENTERTAINMENT FARE FOR KPO LISTENERS DURING THE GENERAL STRIKE OF JULY 16-19. HERE DOROTHY BROWN, SECRETARY TO THE PRODUCTION MANAGER, AND GUY CASSIDY OF THE NBC ENGINEERING DEPARTMENT ARE PICKING OUT A FEW GOOD ONES FOR THE NEXT BROADCAST

New Broadcast Organ at WBEN



Novel Installation Insures Successful Reproduction by Permitting Organist to Hear Only Monitor Loudspeaker

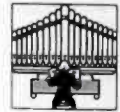

By OSCAR McCLELLAN

BUFFALO can boast that WBEN houses one of the few pipe organs in existence constructed solely for radio broadcasting. It has just been erected in a special organ studio on the eighteenth floor of Hotel Statler.

It was our fortune to accompany Ralph Kingsley, chief of WBEN's technical staff, on an inspection of the new studio. Making our way to his office, we reflected that the station had grown considerably since its inception in 1930. We passed the offices of Sally Work and George Sutherland, passed the commercial department, directors' quarters and reception room. Then swinging into another corridor, we marched by studio A, studio B, the audition and control rooms, announcers' office, and met Mr. Kingsley at room 1859, headquarters of the chief engineer.

"Now," he said, "let us proceed next door." Here we halted before a frosted glass-paneled passageway bearing this sign:

1861
WBEN
Studio "C"
ORGAN

As our guide opened the door, we entered a narrow hall. Two rooms led off from here. "Straight ahead is the organist's room," said Mr. Kingsley. "The console and control equipment are located there." We turned our attention to a large high-ceilinged room on our right, which is the studio proper. It provides facilities for dramatic and musical broadcasts." Beyond the studio, we learned, is the organ chamber, which contains the several hundred pipes. It is provided with swell-shades which face the studio, and which the organist may open or close to any desired degree by means of a rocking pedal at the console.



ORGANIST'S ROOM AT WBEN, WHERE ONLY THE REPRODUCED PROGRAM MAY BE HEARD THROUGH THE LOUDSPEAKER

Not wishing to be phased by the awe-inspiring atmosphere of this new WBEN unit, we volunteered the belief that conventional pipe organ music rarely, if ever, has been broadcast in an absolutely satisfactory manner. Mr. Kingsley immediately became the cool, calculating engineer that he is, and explained that this was the result of difficulties in sound distribution. He agreed that in the past, the "pickup" by microphone always seemed inefficient.

"But with the installation of this organ, we have a specially designed organ studio, and we have accom-

plished an outstanding achievement in the development of studio acoustics for broadcasting," he continued.

In modeling this studio after the score or more recently built by the National Broadcasting Company in Radio City, R. M. Morris, NBC staff engineer, was called to Buffalo by WBEN to aid in construction work. Because of his experience in developing scientific and acoustically-perfected studios, he is considered an authority in his field, having been in charge of studio construction at Radio City.



THE NEW ORGAN STUDIO AT **WBEN**, BUFFALO, N. Y. VELOCITY MICROPHONE SHOWN IN FOREGROUND, AND ORGAN SWELL-SHADES IN BACKGROUND

Turning our attention to the console in the organist's room, Mr. Kingsley pointed out that it is patterned much after the one in the AEolian-Skinner organ headquarters in New York City, which, via remote control, is used frequently by NBC.

Separating the organist's room from the studio proper, we noticed a large, specially constructed triple-plate glass sound-proof window. On the opposite end of the studio, the organ grille occupies an opening in the center of the wall.

Mr. Kingsley explained that the organist creates the first process of music by manipulating the keys and pedals of the console. This action is transferred by cables to the organ chest, fifty feet away. The music, upon issuing from the pipes, is reflected by the hard surface of plaster on the walls of the organ chamber. It then flows into the studio through the large swell-shades, which the organist can open and close at will, for the purpose of decreasing or increasing volume.

The music, flowing into the studio, may be employed as an organ solo, or here it may be properly "blended" with vocal soloists or with orchestral instruments. Here the velocity microphone is located, and here the resultant "mixture" is picked up and fed through the monitoring equipment, which is located in the organist's room.

Stepping into the studio, Mr.

Kingsley followed our glance as it swept in the modern design, and the Gothic windows that shed a pale golden light. "Beautiful as this room is," he said, "far more important than its harmonious perfection of form is its construction.

"When first I entered the radio field, I remember plainly that the walls and ceilings of studios were blanketed with heavy curtains and drapes," mused our guide. "More recently they have been constructed of a soft, porous composition designed to 'mellow' sound waves."

"Then why," we ask, "is it that the walls of this most modern of all

studios have alternate vertical strips of hard plaster and soft material that looks like cork to me?"

Mr. Kingsley replied that engineers have learned that too much soft material results in too much "deadening." More brilliant and life-like reproduction is assured if music and speech can be transmitted accompanied by a natural percentage of reverberating echo. In order for this to take place, there must be hard as well as soft surfaces in the broadcasting studio where the sound is picked up by the microphone.

The combination of alternate panels of hard plaster and acoustically-treated porous material helps to give the hard and soft surfaces necessary for preparing sound prior to actual broadcasting.

We noticed that the cork-like strips of wall were perfectly flat, whereas each plaster strip was beveled to a noticeably concave shape, more or less like the narrow point of a "V" biting into the wall. Intrigued by this peculiar construction, we asked Mr. Kingsley for an explanation.

His answer bore out the fact that a clear reverberation or echo is produced easily from one hard flat surface. By changing the shape of the surface of these plaster panels, any sound wave hitting the curved part of the panel is deflected to a point on the opposite wall, where

(Continued on Page 44)



THROUGH THE TRIPLE-PLATE GLASS SOUND-PROOF WINDOW IS THE ORGANIST'S ROOM, WHERE THE PROGRAM MAY BE HEARD ONLY THROUGH A MONITOR LOUDSPEAKER. THERE THE MONITOR OPERATOR (WITH HIS CONTROL EQUIPMENT) IS ALSO LOCATED, CLOSE TO THE ORGAN CONSOLE

More RCA Transmitters in the Foreign Field



By FRED. MULLER, Transmitter Sales Engineer, RCA Victor

THE International Division Transmitter Group of RCA Victor reports the sale of another 50-KW Broadcast Transmitter to the influential Argentine newspaper, *El Mundo*. This sale was handled by our office in Buenos Aires, in cooperation with Mr. C. G. Roberts and shipment of the transmitter will be made late in 1934 or early in 1935. This will give Argentina the most powerful and most up-to-date broadcast transmitter in the entire South American Continent.

While in Argentina, Mr. Roberts also sold a 20-40-KW Short-Wave Telegraph Transmitter to Transradio Internacional—the Argentine Radio Communications Company.

Another 20-40-KW Short-Wave Transmitter was sold to the Chinese Government Radio Administration by the Shanghai, China, office of RCA Victor.

Among the distinguished foreign visitors to "Radio Headquarters" during the last two months were: Messrs. A. A. Nude, Chairman of the Commission for Radio Industries in Russia; S. S. Arschinoff, J. V. Pulisar, G. F. Friedman, who accompanied Mr. Nude as consulting engineer and Mr. A. W. Renke who acted as interpreter, Mr. L. E. Sillerman, Chief Engineer of the Russian Radio Laboratories, and Mr. Noboru Marumo, Division Engineer of the Broadcasting Corporation of Japan and Professor K. Takayanagi of the Hamamatsu College.

The RCA Victor Ultra High Frequency Transceiver, Type ET-5000, has been of great interest to many foreign clients. Recently the newspaper *l'Intransigeant* made some tests with two of these units for reporting an important French automobile race—the Grand Prix de l'Automobile Club de France—



B. F. MOORE, Jr., RCA VICTOR

and obtained excellent communication at a distance of $3\frac{1}{2}$ km., although one of the Transceivers was partly screened in the woods. We are giving below a translation of an article which appeared in *l'Intransigeant*, three or four weeks ago. This is one of the most important Paris evening papers, and we are highly pleased that their initial tests with this equipment were so successful:

"M. Gautier-Chaumat, located at the Chateau d'Eau, was connected by short waves with a set installed at the Turn of the Biscornes.

"It is this innovation that we would like particularly to emphasize today; the radio reporting service of the *l'Intransigeant* used last Sunday for the first time a new short-wave transmitting receiving set, the RCA Victor Transceiver, still almost unknown in France, although it is already in current use in the United States.

"This set—the exact designation of which is 'Telephonic Intercommunication set on ultra short waves'—operates on wavelengths from 8 to 11 metres.

"Supplied with current from batteries which run for from two to eight hours, or by a dynamotor, the Transceiver—which was introduced to the *l'Intransigeant* by Lieutenant Martelliere—is of extremely small size. It only weighs with its four tubes 3.7 kgs., so that the total weight with batteries, microphone and two headphones does not exceed 11 kgs.

"We need not dwell upon the immense interest presented by an apparatus of this kind for radio reporting, an interest all the greater because (1) industrial or atmospheric disturbances have practically no influence at all on very short waves, (2) the modulation of the Transceiver is excellent, (3) it insures day and night reception with the same degree of sensitiveness and is always free from fading.

"The radio reporting department of the *l'Intransigeant* considers it their duty to acquaint the French public with this new development which it has been the first to test in Europe and which opens up an altogether new field for radio reporting."

A GRADUATE of the Moore School of Electrical Engineering, University of Pennsylvania, B. F. Moore, Jr., whose picture appears herewith, spent some time in the test departments of the General Electric Company and the Baldwin Locomotive Works before joining RCA Victor in 1930. He started out in the Order Service Department of the Foreign Sales Division and has become familiar with all phases of the Company's foreign commercial apparatus business. He will take over the work at "Radio Headquarters," formerly handled by Fred Muller, in the Export Transmitter Section, when Mr. Muller leaves for his new post with RCA Victor at London, England.

CATHODE RAY NOTES

(Continued from Page 20)

- e. Vibration and Noise Apparatus—use case (3) with extra equipment.
- f. Pressure Measuring Apparatus with Piezo Crystal—use case (4) with extra equipment.
- g. Ignition Test Indicator—use case (4) and extra equipment.
- h. Power Factor of Dielectrics—use case (1) with extra apparatus.
- i. Magnetic Hysteresis Indicator—use case (1) with extra equipment.
- j. Trace Vacuum Tube Characteristics—use case (1) with extra equipment.
- k. Check Tube Noise — use case (1) with extra equipment.
- l. Chemical Analysis by Dielectric or Resistance Properties—use case (1) with extra equipment.
- m. Circuits for locating ore deposits, locating concealed weapons on persons, etc.—use case (2) as balance indicator on extra bridge circuit equipment.
- n. Radio Beam Direction Indicating as used in navigation or airplane landing—use case (2) with extra equipment.

In Figure 6 is shown the Modulation Meter Type 49A, which serves to illustrate one of the many uses.

The Cathode-Ray Oscillograph is a powerful tool, superior to other forms of oscillographs since it utilizes an electron stream which acts on and obeys the same laws as a flexible conductor with the current flowing toward the cathode. It is reasonable to suppose that this new tube, now produced at very low cost, will be on the same common plane as ordinary meters. The Cathode-Ray tube will no longer be confined to

the innermost portion of the laboratory and regarded with a degree of awe.

BIBLIOGRAPHY

1. Prof. F. Braun, "Wied Ann der Physik"—1897, vol. 60, p. 552.
2. J. A. Fleming, "The Principles of Electric Wave Telegraphy and Telephony."
3. Sir J. J. Thomson, "Conduction of Electricity Through Gases"—3rd ed.
4. J. A. Crowther, "Ions, Electrons and Ionizing Radiations."
5. C. T. R. Wilson, "Phil Trans A"—1897, p. 265.
6. Van der Bijl, "Thermionic Vacuum Tube."
7. J. M. Stinchfield, "Vacuum Tubes"—Radio Engineering Handbook.
8. August Hund, "High Frequency Measurements."
9. A. Wehnelt, "Physik Z"—1905, vol. 6, p. 732.
10. MacGregor-Morris and Mines, "Jnl. Inst. Elec. Eng."—pp. 1056-1107, 63, 1925.
11. A. B. Wood, "Jnl. Inst. Elec. Eng."—pp. 1046-1055.
12. M. Knoll, "Jnl. Am. Inst. Elec. Eng."—pp. 49, 463, 1930.
13. Encyclopedia Britannica, Article under "Sound."
14. "Ganot's Physics"—276-277.
15. RCA Radiotron, "Application Note No. 36."

Also see:

- F. J. Rasmussen, "A. I. E. E. Transactions"—Nov., 1926, vol. XLV, pp. 1256-1265.
- "Ganot's Physics"—pp. 276-277.
- August Hund, "High Frequency Measurements"—pp. 72-74.
- Glazebrook, "Dictionary of Applied Physics"—article on "Sound."
- Lord Rayleigh, "Theory of Sound."

16. Bedell and Reich, "The Oscilloscope"—Jnl. Am. Inst. El. Eng., pp. 563-567, 46, 1927.
17. Communicated by R. T. Orth and J. M. Stinchfield—RCA Radiotron.

Also see:

- R. A. Watson Watt, "The Applications of the Cathode-Ray Oscillograph in Radio Research."
- August Hund, "High Frequency Measurements."
- Brown, "Radio Frequency Measurements."
- Olson and Massa, "Applied Acoustics."

THE SHOW MUST GO ON

(Continued from Page 39)

ed many commuters in town. NBC obtained hotel rooms in San Francisco for them, and the work went on.

Only a few restaurants were open during the strike, and these, under "permit" from the unions, were so crowded that a lunch-hour wasn't long enough to get food. Roy Frothingham, promotion manager, met that bridge even before he came to it, however; Monday morning, July 16th, he appeared with boxes filled with sandwiches, an enormous coffee pot and cans of coffee. His assistant, David McKay, and Wanda Woodward, head of the audience mail department, opened a canteen in an unused office and here throughout the strike every NBC artist or staff worker was fed. Perhaps they got tired of sandwiches, but they didn't go hungry while they worked.

Recordings helped to keep entertainment going for the NBC audience. New York service was available much of the time for Station KGO, but in order to vary the fare on station KPO, the RCA Victor transcription equipment was called into serious and frequent use. A number of music lovers naturally were found in the program and production departments and they generously loaned their private Victor record libraries. This opened the whole world of music to the audience: the Elman String Quartet, John Charles Thomas, Richard Crooks, Paul Robeson, Paul Whiteman, the Chicago Symphony, the Hall Johnson Choir, Rudy Vallée, Dennis King, Conrad Thibault, Ray Noble, Arthur Pryor's Band—name your favorites. They all played and sang, via records, for the NBC audiences. Donald Cope, NBC Production Manager, took charge of the transcription programs, and Lew Frost, Program Manager, says that the bright spot of the strike, so far as he is concerned, is the picture he has of Cope's tall body bending over some five hundred recordings of all varieties. Being a musician himself in private life, Don couldn't resist singing over each record that he liked, to himself, before he chose it.

NEW BROADCAST ORGAN AT WBEN

(Continued from Page 41)

there is a soft, porous material. "In this way," the chief engineer added, "too much echo is eliminated, but the right amount is retained."

By going to the farther end of the studio and peering through the swell-shades into the organ chamber, we saw hundreds of pipes, giant ones and tiny ones. The temperature of this room must remain within certain limits in order to avoid unequal expansion and contraction of the large and small pipes, which would cause an "out-of-tune" result.

Passing from the studio into the observer's corridor ahead of Mr. Kingsley, we were surprised at the weight and thickness of the door as we swung it open. "All doors in the new studio are sound-proof," advised our guide. "Their weight is considerable, being constructed of several layers of sound-absorbent materials and plywood."

We reminded Mr. Kingsley that his imaginary broadcast of organ music had started in the organist's room, traveled (technically) to the organ chamber, come out through the swell-shades into the studio, where it was blended and picked up by the velocity microphone. "Now, since the organist is in a sound-proof room adjoining the studio, how does he hear what he is playing?" we asked.

"Well," said Mr. Kingsley, "the answer to that one is easy."

"The organist's room is provided with high-fidelity loudspeaker facilities, so that the organist, himself, may hear exactly how his program sounds over the air. In other words, upon manipulating the keys and pedals at the console, he does not hear the resultant sounds until they have been released from the pipe room into the studio, picked up by microphones and carried through the main control room. A wire from the control room then feeds the broadcast back through a loudspeaker on a specially constructed four-foot baffle board to the organist."

We observed a monitor's control booth in the organist's room. Mr.

Kingsley made plain that it was supplementary to the main control room.

A powerful motor-driven organ blower and an action-current generator are located on the floor below the studio. To avoid blower noises being transmitted into the broadcast studio, this equipment is located more than fifty feet away on the floor below, and is carefully mounted on vibration absorbing cushions.

All of the equipment incorporated

in this new studio was subjected to rigid tests before final acceptance.

Radio listeners heard the new AEolian-Skinner organ for the first time when it was formally dedicated in a special program. The Liberty Bank production of "Nocturne," under the direction of James E. Corbett, head of WBEN's dramatic department, is produced in the new studio at the "Nine o'Clock Show" Sunday evenings.



GEORGIA BACKUS, CAPTIVATING NBC VOCAL ARTIST, PAUSES DURING REHEARSAL. AND . . . CLICK!—WE HAVE THE PICTURE

Efficiency — Improvement — Progress

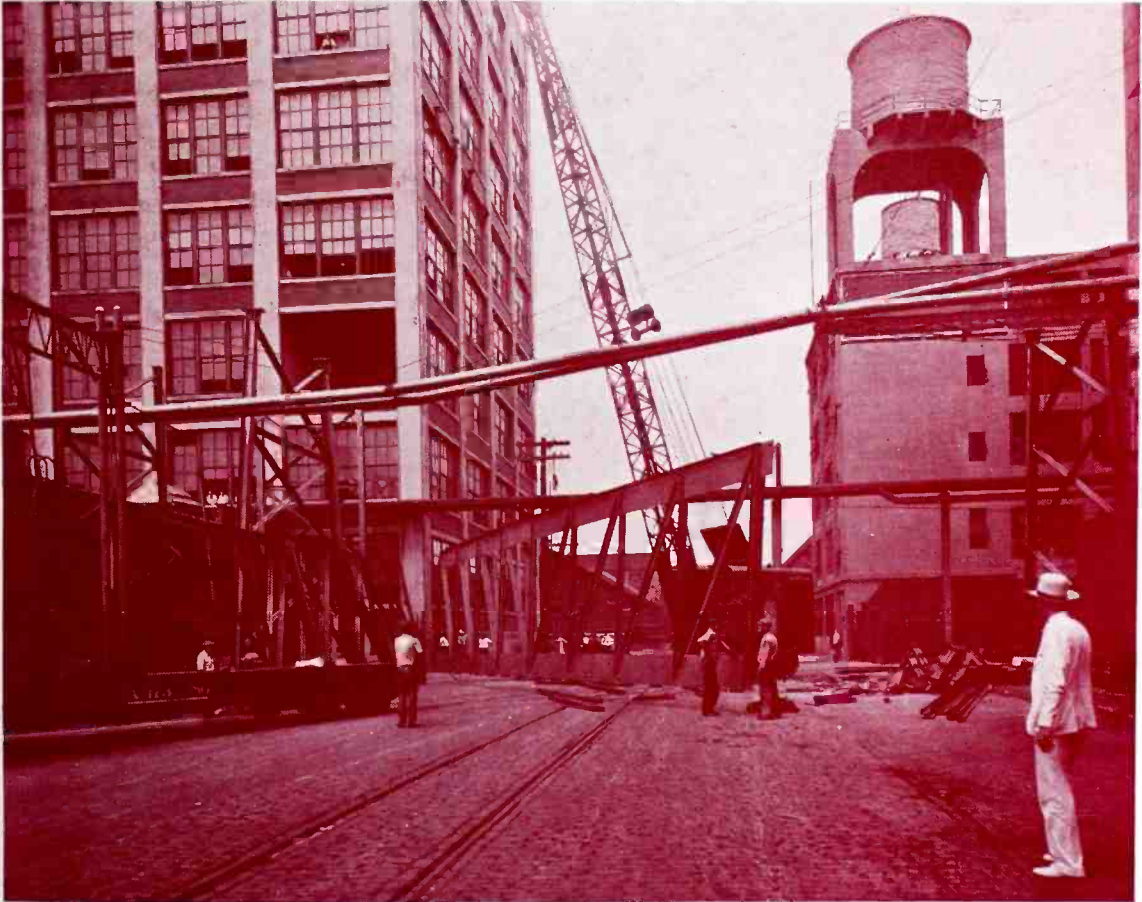

PHOTO BY HARRY ATTMORE

"RADIO HEADQUARTERS" BUILDS A NEW BRIDGE

CONNECTING THE THIRD STORIES OF BUILDINGS 10 AT LEFT AND 17 AT RIGHT OF THE RCA VICTOR FACTORY, THIS NEW STRUCTURE ACROSS DELAWARE AVENUE IN CAMDEN WILL EXPEDITE INTRA-PLANT COMMUNICATION WITHOUT INTERFERING WITH STREET TRAFFIC. THE OPEN BAY IN THE THIRD FLOOR SHOWS WHERE THE BRIDGE WILL CONNECT WITH BUILDING 10.

NEW BULLETINS ISSUED

Just off the press—and available to those interested, upon request to the Transmitter Sales Section, RCA Victor Company, Inc., Camden, N. J.

Bulletin 44—Lapel Velocity Microphone
Type 30-A

Bulletin 45—Equipment for Remote Pickups
Type OP-4

Bulletin 46—Inductor Microphone
Type 50-A



SEND FOR YOUR COPIES