

BROADCAST NEWS

PAT. OFF. REG. U. S.



IN THIS ISSUE

A BRIEF SURVEY OF THE CHARACTERISTICS OF BROADCAST ANTENNAS

By H. E. Gihring and Dr. G. H. Brown

OP-4 PORTABLE BROADCAST SPEECH INPUT EQUIPMENT

By A. N. Curtiss

DETROIT ORCHESTRA HALL

By Howard Allan Chinn

BROADCASTING CARACAS

An Interview with Edgar J. Anzola

WTAR GOES HIGH FIDELITY

By J. L. Grether

—and Many Other Features of Timely Interest

RCA Victor Company, Inc., Camden, N.J.

NUMBER 13

PRICE 25 CENTS

DECEMBER, 1934



RCA Victor Company, Inc.

A Radio Corporation of America Subsidiary

Camden, N. J.

"RADIO HEADQUARTERS"

DAVID SARNOFF, Chairman

E. T. CUNNINGHAM, President

W. R. G. BAKER, Vice-President
and General Manager

G. K. THROCKMORTON,
Executive Vice-President

J. T. CLEMENT, Vice-President
In charge of Sales to U. S. Govt.

P. G. McCOLLUM, Comptroller

F. S. KANE, Secretary

J. D. COOK, Treasurer

L. B. MORRIS, General Counsel

F. R. DEAKINS, Manager

ENGINEERING PRODUCTS DIVISION

TRANSMITTER SALES SECTION

(OF ENGINEERING PRODUCTS DIVISION)

I. R. BAKER, Manager

S. W. GOULDEN, Commercial Engineer

T. A. SMITH, C. B. S. Contact

J. P. TAYLOR, Sales Engineer

C. L. BEACH, N. B. C. Contact

P. A. ANDERSON, Police Radio Sales

T. W. ENIS, Power Radiotron Sales

E. JAY QUINBY, Engineering Products Advertising

1 EASTERN DISTRICT—T. A. Smith, Manager, 153 E. 24th St., New York City; R. P. May, Assistant

MAINE
VERMONT
NEW HAMPSHIRE
MASSACHUSETTS

RHODE ISLAND
CONNECTICUT
NEW YORK
PUERTO RICO

NEW JERSEY
PENNSYLVANIA
MARYLAND
NORTH CAROLINA (Broadcast)

WEST VIRGINIA
DELAWARE
VIRGINIA

2 CENTRAL DISTRICT—H. C. Vance, Manager, 111 North Canal St., Chicago, Ill.; D. A. Reesor, Assistant

NORTH DAKOTA
SOUTH DAKOTA
NEBRASKA
WISCONSIN

MISSOURI
IOWA
MINNESOTA

ILLINOIS
INDIANA
KENTUCKY

OHIO
MICHIGAN
KANSAS CITY (KANSAS)

3 WESTERN DISTRICT—W. H. Beltz, Manager, 235 Montgomery St., San Francisco, Calif.;

Edmund Frost, Assistant

WASHINGTON
OREGON
CALIFORNIA

IDAHO
NEVADA
HAWAII (Police)

UTAH
ARIZONA
ALASKA (Police)

MONTANA
WYOMING

4 SOUTHWESTERN DISTRICT—W. M. Witty, Manager, Santa Fe Bldg., Dallas, Texas.

TEXAS
OKLAHOMA

ARKANSAS
LOUISIANA (Except New Orleans)

KANSAS (Except Kansas City)
COLORADO

NEW MEXICO

5 SOUTHEASTERN DISTRICT—B. Adler, Manager, 144 Walton St., N. W., Atlanta, Ga.

TENNESSEE
NORTH CAROLINA (Police)

SOUTH CAROLINA
GEORGIA

ALABAMA
MISSISSIPPI

FLORIDA
NEW ORLEANS (LA.)

BROADCAST TRANSMITTERS

POWER RADIOTRONS

POLICE TRANSMITTERS

POLICE RECEIVERS

SPECIAL COMMUNICATION EQUIPMENT

APR 1941

APR 1941

BROADCAST NEWS

Edited by
E. JAY QUINBY

NUMBER 13

DECEMBER, 1934



PRESIDENT FRANKLIN D. ROOSEVELT, DELIVERING ONE OF HIS POPULAR RADIO REPORTS TO THE AMERICAN PUBLIC ON HIS STEWARDSHIP OF THEIR GOVERNMENT. BOTH THE VELOCITY AND INDUCTOR MICROPHONES WERE USED ON THIS OCCASION.

Published in the interest of the broadcasting industry
and Copyrighted 1934 by
RCA VICTOR COMPANY, INC.
CAMDEN, N. J., U. S. A.

Broadcasting Caracas

As Related to the Editor by EDGAR J. ANZOLA



ALBERTO LOPEZ, CHIEF ENGINEER OF STATIONS YVIRC AND YV2RC IN CARACAS, VENEZUELA. HE IS A MEMBER OF THE ARRL AND THE IRE

NEARLY five years ago the "C. A. Almacen Americano," who are the RCA Victor Distributors in Venezuela, realized that a well-organized commercial broadcasting station was needed to serve the country surrounding Caracas. Consequently, on December 11, 1930, the pioneer broadcasting station for that vicinity—only 100 watts output, but a marvel nevertheless—was inaugurated. Immediately the populace of Caracas and the surrounding territory went radio mad, for the novelty of local programs, strong and clear enough for the people to receive on their modest types of receivers, was really something to be enthusiastic about.

So successful was this venture, with its two-fold income from the sale of receivers and time on the air, that on July 10, 1932, a new 5 KW RCA Victor transmitter was placed in commission, with the call letters YVIRC. The resultant expansion in coverage resulted in increased sales of receivers, and, of course, increased the value of program time.

Shortly after this step, experiments were conducted in the short-wave field with a view toward operating an auxiliary transmitter, using the same programs. Confirmations began to

pour in from all America—from Canada to Brazil. In fact, as the experiments progressed, thousands of acknowledgments were received from all over the world. The result was that a modern 250-watt high-frequency transmitter with the call letters YV2RC was put on the air to operate simultaneously with the long-wave transmitter.

The studios are conveniently located in the city of Caracas, on the second floor of the Almacen Americano Building, while the transmitting equipment is located four and a half miles distant, on top of a mountain. The tops of the two insulated steel towers are over 4,000 feet above the sea level, and being within five and a half miles of the coast line, they present an outstanding landmark to the incoming steamships. As the climate is such that there is never any fear of freezing, the water-cooling system for the transmitting tubes is arranged outside the station in the form of an attractive fountain. In the background, other mountain tops thrust



EDGAR J. ANZOLA, DIRECTOR OF THE "BROADCASTING CARACAS" ORGANIZATION, WHICH OPERATES YVIRC AND YV2RC IN VENEZUELA. HE WAS RECENTLY DECORATED BY THE VENEZUELAN GOVERNMENT WITH THE HONOR MEDAL OF PUBLIC INSTRUCTION

their peaks even higher, often disappearing into passing cloud banks. Altogether, a more picturesque and romantic setting for a modern scientific marvel of this kind is difficult to envision.

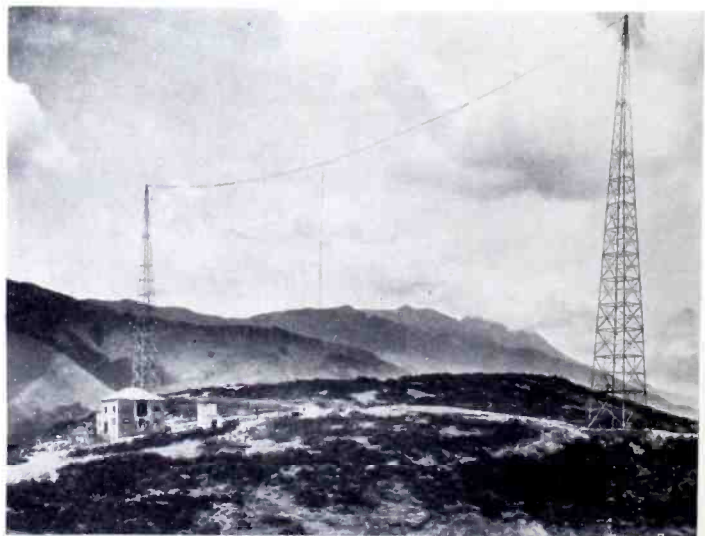

WHEN YOU TUNE IN CARACAS, VENEZUELA, ON YOUR RCA VICTOR WORLD-WIDE RADIO RECEIVER, YOU DON'T HAVE TO SHUT YOUR EYES AND TRY TO IMAGINE WHAT KIND OF A COUNTRY YOU ARE LISTENING TO. HERE IS THE STATION, ON THE BRINK OF A 4,000-FOOT MOUNTAIN, OVERLOOKING THE TURQUOISE WATERS OF THE CARIBBEAN SEA. THE STUDIOS ARE DOWN AT THE FOOT OF THE MOUNTAIN, IN THE CITY OF CARACAS



ALICIA HARDY
"MISS YVIRC"

JOSEFINA CORCANO
"MISS BROADCASTING CARACAS"

GRAZIELLA OSORIO
"MISS YV2RC"

A recent popularity contest conducted by this organization had many unique features, and might well be duplicated by American stations with similar success. First, through the local newspapers, several very attractive artists from the local territory were introduced by numbered photographs. The identity of each young lady was withheld. By means of coupons, the people's first, second, and third choices were established. Immediately following this, the same artists were presented to the listening public over the air, and again the identities were withheld—the artists being identified this time only by letters of the alphabet. Thus it was impossible for the audience to definitely associate the voices that were heard with the photographs they had seen. A second voting contest was then held to ascertain the first, second, and third choices of the listeners. The winners were then determined by a combination of the two ballots, and their pictures appear herewith. Miss Josefina Corcano, having received the greatest number of votes for both her personal appearance and for her microphone artistry, was elected "Miss Broadcasting Caracas." Miss Alicia Hardy came out second best and won the title of "Miss YVIRC," while Miss Graziella Osorio won the title of "Miss YV2RC," through being next in line. Altogether, the contest drew a tremendous amount of popular interest and enthusiasm, with the

result that these three stars are now called upon to deliver regular performances at the studios of "Broadcasting Caracas."

The monthly fan mail received from foreign listeners (outside of Venezuela) averages 1,500 communications, approximately 80 per cent of which comes from North America. This station has been heard in every country throughout the world, and acknowledgments are continually being received from the Antipodes.

YVIRC broadcasts on a frequency of 960 kilocycles (312.3 meters), while YV2RC broadcasts on a frequency of 6112 kilocycles (49.8 meters). The city of Caracas and the radio stations are run on local apparent time, which is 28 minutes ahead of Eastern Standard time. In other words, a program which starts at 9 P.M. in Caracas may be heard at 9.28 P.M. Eastern Standard time.

(Continued on Page 27)

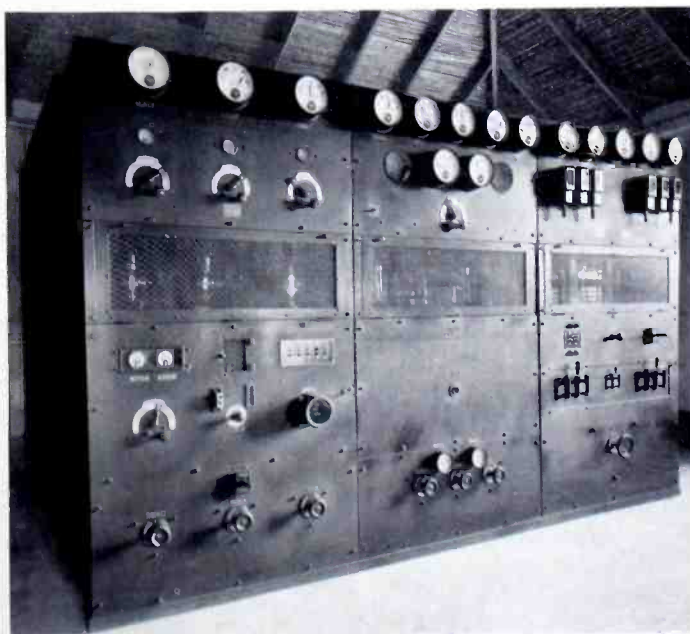

RCA VICTOR 5 KW TRANSMITTER AT CARACAS, VENEZUELA

A Brief Survey of the Characteristics of Broadcast Antennas

By H. E. GIHRING and DR. G. H. BROWN, RCA Victor Eng. Dept.



DR. G. H. BROWN, RCA VICTOR

ALTHOUGH the antenna system of a broadcasting station is apparently a simple device, the theory behind the design of the antenna is probably more complicated than that of any other part of the transmitter. The choice of antenna may do much to determine the effectiveness of coverage. The prime object of an antenna used with a police or broadcast transmitter is to set up the strongest possible field over the greatest possible area with the minimum amount of fading. The proper choice of antenna is so dependent on the particular conditions, such as frequency assignment, assigned power, soil conditions of the surrounding country, and distance to other stations on the same or adjacent channels, that each installation should be considered separately. In this article, we will merely consider a few of the factors which influence the choice of antenna

The Current Distribution on the Antenna

The antenna itself may be either a vertical wire or a T. It is energized by an alternating voltage applied between the base of the antenna and the ground system. The upper extremities

of the antenna are connected to the supporting cables by strain insulators of small enough capacitance so that the end of the antenna is effectively an open circuit. The vertical section is the radiator, while the horizontal section merely provides a place to store energy so that the current at the top of the vertical section need not be zero. When a tower is used as the radiator itself, a cage or framework at the top replaces the flat top of the T antenna. Recently, it has been proposed that the framework at the top of the tower be insulated from the tower and connected to it through a variable inductance. A variation of this inductance has the same effect as varying the length of the flat top in the conventional T antenna.

The assumption that the current remains in phase and varies sinusoidally along the antenna has been made by most of the investigators who have attacked the problem.^{1,2} The assumption is justified by the close agreement of the analysis made on this basis with the experimental facts. R. M. Wilmotte³ has shown that the above assumptions for cur-

¹G. W. Pierce, "Electric Oscillations and Electric Waves," pp. 437-440.

²Stuart Ballantine, Proc. I. R. E., 12, 823, 1924.

³R. M. Wilmotte, "The Distribution of Current in a Transmitting Antenna," Journ. I. E. E., 66, 617, 1928

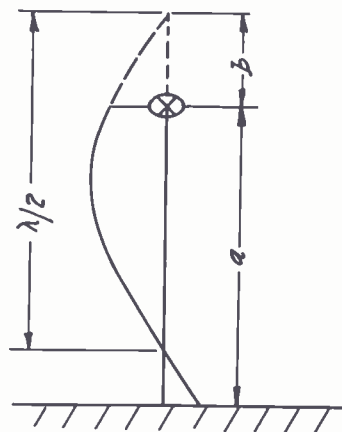

FIGURE 1



H. E. GIHRING, RCA VICTOR

rent distribution are extremely good for antennas shorter than a quarter wave length. He has also shown that sinusoidal distributions prevail in T and inverted L antennas.

To describe the distribution of current on the antenna, we will use the nomenclature of Pierce¹. Suppose that the current distribution on an antenna of height, a , is as shown in Figure 1. Then b is the effective length which is replaced by the flat top or capacity outrigger. Then, if the quantities, a/λ and b/λ were specified, we would immediately have a picture of the current distribution. (λ = wave length measured in the same units as a and b .) It is convenient to define

$$A = 360 \cdot a/\lambda, B = 360 \cdot b/\lambda, \\ G = A + B \quad (\text{degrees}) \quad (1)$$

Another method of describing the current distribution has been to use the term, λ/λ_0 , where λ is the operating wave length and λ_0 is the so-called fundamental wave length. This is the longest wave length at which the antenna comes into resonance. Besides the fact that this value is awkward to use, it does not give true values when a flat top or capacity area is used at the top of the

antenna. Even when the antenna is a simple vertical wire, the value depends on assuming that $\lambda_0 = 4a$, which is not correct.

If the system of electrical degrees is used, the current distribution along

form a right-handed system. Then the instantaneous power flowing across any surface, Σ , is

$$\int_{\Sigma} P_n d\sigma = \int_{\Sigma} \frac{[\mathbf{F}, \mathbf{B}]_n}{\mu} d\sigma \quad (4)$$

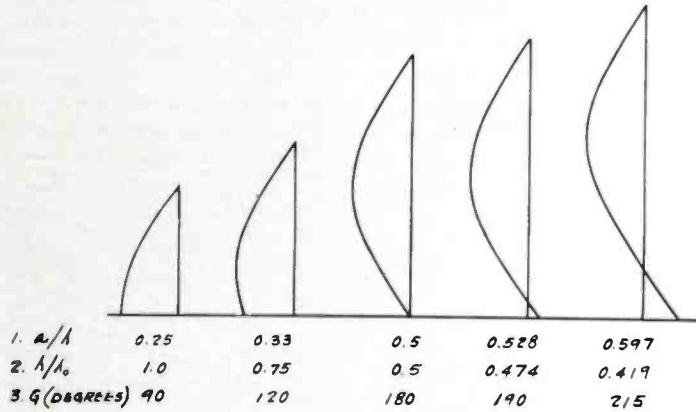

FIGURE 2

the antenna is given by

$$i_y = i_0 \sin(G - 360y/\lambda) \sin(G) \quad (2)$$

where i_y = the current in the antenna a distance y from the ground
 i_0 = the current at the base of the antenna.

Figure 2 shows several typical distributions, when there is no flat top. Then $B = 0$, and $G = A$. The table on this figure shows the three methods of describing the current distribution.

The Radiation Resistance of a Transmitting Antenna

In 1884, Poynting¹ discovered the vector relation that now bears his name. This relation has been investigated and restated many times since then. It may be stated simply as follows. At any point, O , in space, there exists an electric vector, F , and an electromagnetic vector, B . These two vectors are considered to be functions of time and space. At a given instant of time, the two vectors lie in a plane which passes through the point, O . Then Poynting's vector is $P = [F, B]/\mu$ (vector product) (3)

where P is a vector which measures the flow of power per unit area across the plane at the point, O . P points in such a direction that F , B , and P

¹J. H. Poynting, Phil. Trans., 2, 343, 1884.

If the time variations of the intensities are harmonic, the average value of power flow can readily be obtained from (4). If the surface, Σ , is closed, Poynting's vector theorem gives the total power lost by radiation into space.

These ideas may be immediately applied to the case of an antenna located above a perfectly conducting plane. The surface in question is a hemisphere of radius great compared to the wave length and whose center is placed at the base of the antenna. The Poynting vector is computed at all points of the surface, and then integrated over this surface. This yields the total power radiated from the antenna system. If the electric and magnetic vectors are expressed in terms of the current at the base of the antenna, the radiated power has

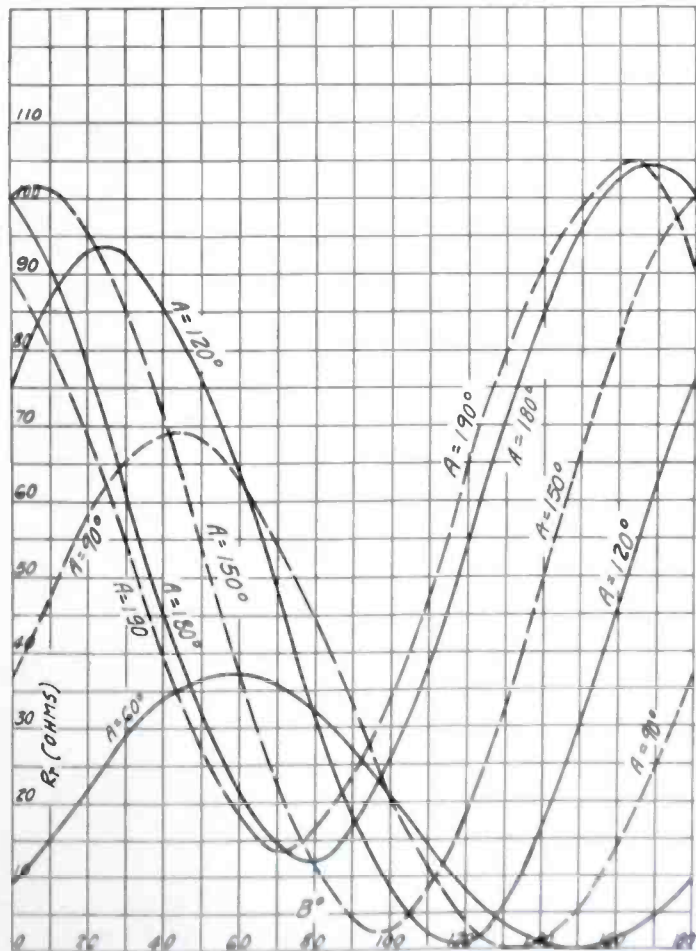

FIGURE 3—RADIATION RESISTANCE OF LOADED ANTENNAS THE VALUES GIVEN BY THE CURVES ARE REFERRED TO THE CURRENT LOOP. TO FIND THE RESISTANCE AT THE BASE, DIVIDE BY $\sin^2(G)$

as a factor the square of this current. If the average radiated power is P_r and the current at the base of the antenna is I_0 , the radiation resistance is defined as

$$R_r = P_r / I_0^2 \quad (5)$$

Such a procedure has been carried out by a number of investigators. This method is often very tedious and leads to complications in the geometry when a T antenna is considered. A much neater method of solution is

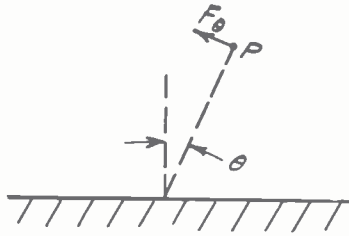

FIGURE 4

that one which moves the surface of integration to the surface of the conductors of the antenna system. This involves a knowledge of the electric and magnetic vectors in the neighborhood of the antenna. Such a procedure has been carried out for a number of antenna arrays.^{5,6} Of course, the results will be the same regardless of the method used. In the latter method, however, the preliminary manipulation is less cumbersome.

Pierce¹ has derived the expressions for the radiation resistance of an L antenna. His results are expressed in terms of an infinite series. The expressions for the resistance of a T antenna are very similar. In fact, the part contributed by the vertical portion is identical. The contribution made to the resistance by the flat top is very small and, in most cases, can be neglected. Fulton Cutting⁷ shows two curves of radiation resistance of an L antenna computed by means of Pierce's analysis. One curve is the total radiation resistance and the other is the radiation resistance found on the assumption that the flat top does not radiate. There is only a slight difference between the two curves. The difference is even less when a T antenna is used.

⁵A. P. Tolpeltors, "The Radiation Resistance of Beam Antenna," Proc. I. R. E., 17, 562, 1929.

⁶P. S. Carter, "Circuit Relations in Radiating System," Proc. I. R. E., 20, 1004, 1932.

⁷Fulton Cutting, "A Simple Method of Calculating Radiation Resistance," Proc. I. R. E., 10, 154, 1922. (Figure 4)

When the radiation from the flat top is neglected, the radiation resistance is⁸

$$R_r = \frac{30}{\sin^2(G)} \left\{ \sin^2(B) \left\{ \frac{\sin(2A)}{2A} - 1 \right\} - \frac{\cos(2G)}{2} \left\{ C + \log(4A) - Ci(4A) \right\} + \left\{ 1 + \cos(2G) \right\} \left\{ C + \log(2A) - Ci(2A) \right\} + \sin(2G) \left\{ \frac{Si(4A)}{2} - Si(2A) \right\} \right\} \quad (6)$$

Here A, B, and G are the quantities defined previously but expressed in radians, $C = 0.57721 +$ is Euler's Constant, and $Ci(x)$ and $Si(x)$ are respectively the Integral-cosine and the Integral-sine as defined on page 19 of the Jahnke-Emde "Funktionentafeln."

When there is no flat top at all, $B = 0$, $G = A$, and

$$R_r = \frac{30}{\sin^2(G)} \left\{ - \frac{\cos(2G)}{2} \left\{ C + \log(4G) - Ci(4G) \right\} + \left\{ 1 + \cos(2G) \right\} \left\{ C + \log(2G) - Ci(2G) \right\} + \sin(2G) \left\{ \frac{Si(4G)}{2} - Si(2G) \right\} \right\} \quad (7)$$

⁸Balth. van der Pol, Jr., Jahrbuch d. drahtl. Telegr., 13, 217, 1918.

When G approaches 180° , the above expressions assume very large values. As an expedient in plotting the values of radiation resistance, we often plot, instead of R_r , the quantity, $R_r \cdot \sin^2(G)$, and call this term the radiation resistance referred to the loop of current. Such a set of curves is shown in Figure 3. It should be remembered that the radiation resistance measured at the base of the antenna is given by dividing the values on Figure 3 by $\sin^2(G)$.

The Vertical Radiation Characteristic

Since the purpose of a broadcast antenna is to transmit a strong ground wave, the ideal antenna would be one which confined the radiation of energy to a region within say 20° of the earth's surface. This could not be done without a very elaborate antenna structure. Where the antenna is a single vertical wire with a sinusoidal distribution of current, quite a bit of the energy is radiated at the higher angles. The relative amount radiated at any particular angle depends on the constants, A, B, and G.

Let us refer to Figure 4. Suppose that P is a point in space remote from the antenna. The angle between the vertical direction and a line joining P with the base of the antenna is called θ . Then at P the electric intensity, F_0 , is normal to the line joining P to the base of the antenna.

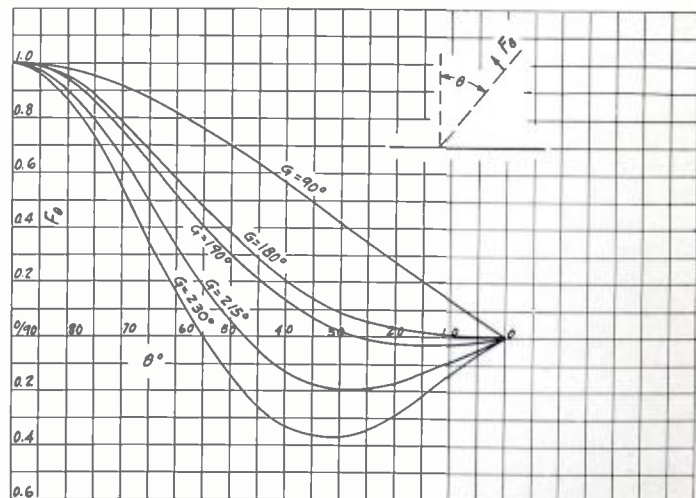

FIGURE 5—VERTICAL RADIATION CHARACTERISTICS OF VERTICAL ANTENNAS

F_0 varies with θ . A plot of F_0 as a function of θ is called the vertical radiation characteristic. Figure 5 shows the vertical radiation characteristics for a number of vertical antennas without a flat top. It is to be noted that the radiation at the angles close to the vertical gradually decreases as the antenna length is increased above 90° . For antennas less than 90° in length the radiation pattern is essentially the same as for a 90° length. As the antenna length becomes greater than 180° , a secondary lobe appears which becomes larger as the electrical length is increased. It can be seen that the antenna giving minimum radiation at the higher angles is 190° long. In Figure 5, all the curves are plotted with F_0 equal to unity at θ equal to 90° . This is done so that a direct comparison can be made of the relative amounts of radiation at various angles.

The Ground Wave

A method of gauging the efficiency of an antenna is to measure the field intensity at the surface of the earth one mile from the antenna and compare with the theoretical value. The distance of one mile is arbitrary. In this country, it has become standardized through common usage. The field strength does not tell us anything unless the power input to the antenna is known. Accordingly a new term has appeared. This is "millivolts per meter at one mile for one watt input into the antenna." Then to find the field strength for any other power, we merely multiply this value by the square root of the new power measured in watts.

Even the above measurement does not tell the true story. If the measurements are made at one mile, another variable is introduced, namely, attenuation in the first mile. This may be negligible for soil of high conductivity and for the longer wave lengths in the broadcast band, but for poor soil and shorter wave lengths, it may be appreciable. The usual procedure is to take measurements at a mile and correct for attenuation. This involves assumptions as to the conductivity. A more accurate method is to measure the field intensity at one to two wave lengths and correct to one mile by an

inverse distance relation. At any rate, it is unfair to penalize the antenna itself for poor soil conditions in the first mile.

The field strength at one mile for

Figure 6 shows (8) as a function of antenna length when $B=0$ and the efficiency is 1.0. The corresponding radiation resistance referred to the loop is shown on the same figure. We

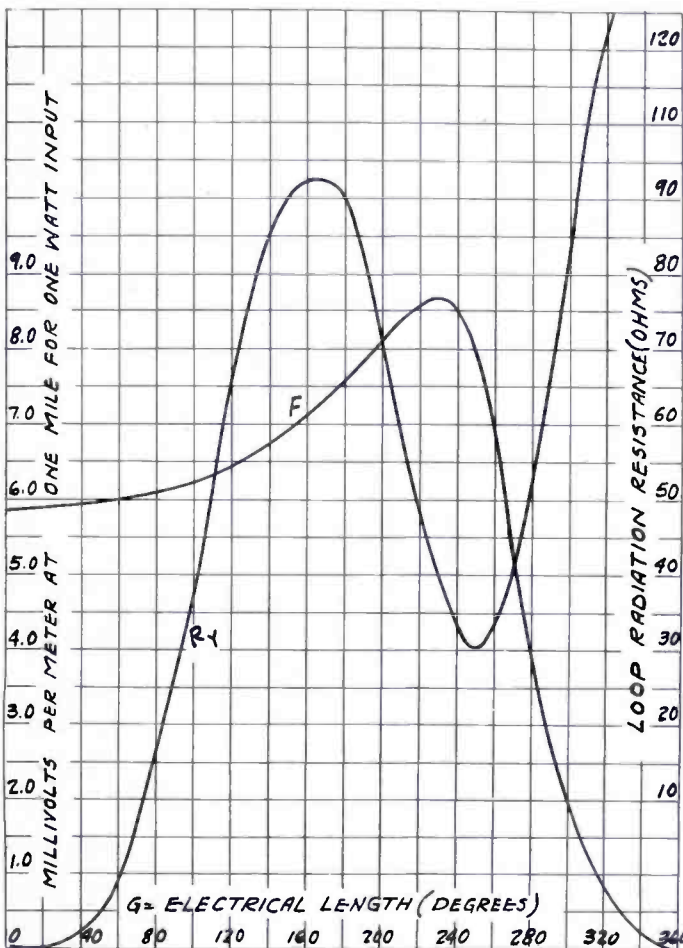

FIGURE 6—RADIATION RESISTANCE AND FIELD STRENGTH AS A FUNCTION OF ANTENNA LENGTH. INPUT POWER EQUALS 1 WATT. (1) TO OBTAIN FIELD STRENGTH FOR ANY OTHER POWER THAN 1 WATT, MULTIPLY VALUE ON CURVE BY THE SQUARE ROOT OF THE POWER IN WATTS. (2) TO OBTAIN THE RADIATION RESISTANCE REFERRED TO THE BASE, DIVIDE VALUE GIVEN ON CURVE BY $\sin^2(G)$

one watt input is given by

$$F \text{ (millivolts/meter)} = \frac{37.25}{\sqrt{R_r + R_L}}$$

$$\frac{[\cos(B) - \cos(G)]}{\sin(G)} = \frac{37.25}{\sqrt{R_r}}$$

$$\sqrt{\text{eff.}} \frac{[\cos(B) - \cos(G)]}{\sin(G)} \tag{8}$$

where R_L = the loss resistance of the antenna,

Eff. = the efficiency of the antenna
 $= R_r / (R_r + R_L)$

see that a maximum of field intensity occurs when the antenna length is 230° . At this point, the field strength exceeds that from a 90° antenna by 41.0 per cent. A study of Figure 5 shows that it is not desirable to operate at the peak of the field intensity curve, because of the large lobe of high angle radiation. It is this radiation at high angles that limits the primary service radius at night because of fading. Since the average height of the Heaviside layer is 100 kilometers, it is desirable to keep the radiation at a

minimum for values of θ lying between 0° and 30° . It is obvious from Figure 5 that a 190° antenna does this best. It will be noted that the field strength along the horizon is only 27.0 per cent greater than that obtained with a 90° antenna. Hence the primary reason for using such an antenna is not to increase the signal strength along the ground but to increase the distance to the fading zone.

It is of interest to examine the field strength at one mile as given by (8) when a flat top or capacity area is used. This case also covers the

the peaks are higher than the value obtained with a straight vertical 230° antenna. It would appear at first glance that it is always desirable to load an antenna at the top. Actually there are only a few antennas which yield better results by thus loading. For instance, a study of the vertical radiation characteristics shows without exception that a large secondary sky lobe is present when the antennas are operated with such a value of B that the field intensity is maximum. The radiation characteristic is similar to the one on Figure 5 labelled " $G =$

height antenna, with the loading adjusted at the top to give a vertical radiation characteristic which reduces the sky wave at the high angles as well as does a simple 190° antenna, the field strength at one mile for one watt input is very nearly 7.75 millivolts per meter. Another factor to be considered is radiation resistance. If the radiation resistance is extremely low, the efficiency of the antenna may be ruined by the loss in the loading coil alone. For instance, if the antenna is 90° high, the best suppression of sky wave occurs when $B = 125^\circ$. Figure 3 shows that the corresponding radiation resistance is about 1.5 ohms at the loop or about 4.5 ohms at the base of the antenna. At this point, 2.0 ohms in the loading coil will reduce the efficiency to less than 70.0 per cent. It is also seen that a straight 190° antenna can be replaced satisfactorily by an antenna 150° high with about 50° loading at the top.

The Ground System

Since the ground system plays an important part in the performance of an antenna, some general recommendations will be made here. The ground system should consist of buried radial wires. Where the antenna is of the order of one half wave length long, the maximum earth loss occurs at about 0.35 wave lengths from the antenna. It is important to have the ground system extend well beyond this point. If only a few radial wires are used, the current returning to the base of the antenna through the ground will flow in the earth itself, instead of in the buried wires provided to carry it. An efficient antenna system should have at least 100 radial wires. With ordinary methods of laying these buried wires, that is, digging trenches 1.5 to 2 feet deep and refilling after the wire is rolled out, the cost of such a system would become prohibitive. However, it is not necessary to bury the wires more than 6 to 12 inches below the surface. For depths of this order, the wire can be laid using a special wire laying plow consisting essentially of a straight blade with a pipe welded on the back. The blade is pulled

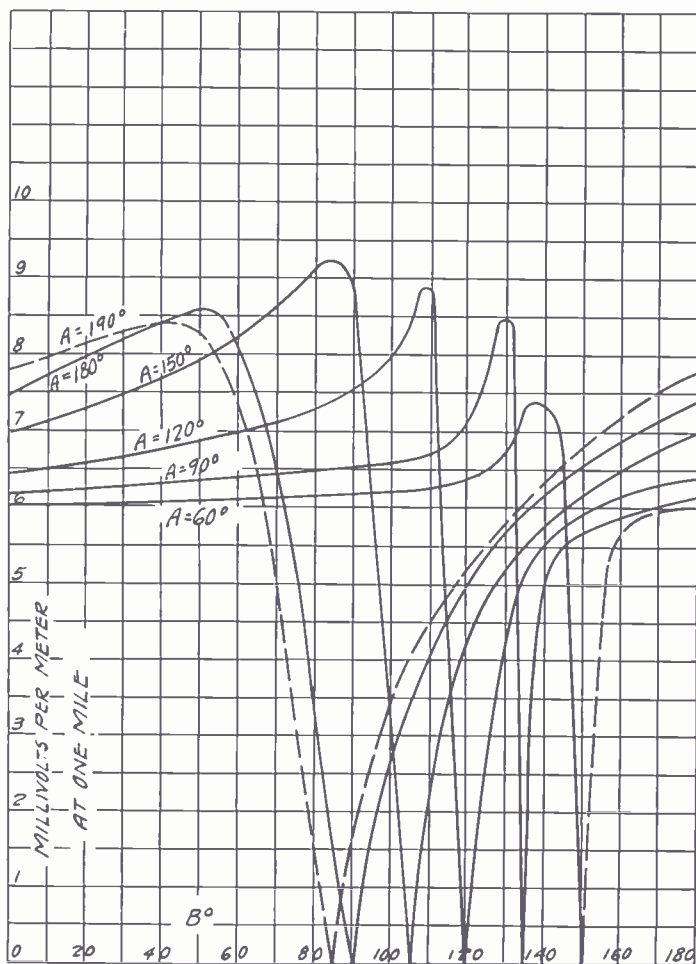

FIGURE 7 FIELD INTENSITY AT ONE MILE FOR 1-WATT INPUT TO A LOADED ANTENNA

tuned capacity area. Figure 7 shows the field strength at one mile for one watt input as a function of the loading at the top of the antenna for a number of antenna heights. We see that loading at the top increases the field strength in every case. Some of

230° ." Of course, if we are interested in getting the largest ground wave and not interested in controlling the sky wave, it might be desirable to use an antenna 120° high with 100° of loading. It should be pointed out that, for any

through the ground and the wire is fed from a reel through the pipe. If the soil is not especially hard or rocky, the complete ground system can be laid in a few days.

Departures from the Simple Theory

The above considerations have all been made on the assumption that the current is sinusoidally distributed. We have made extensive tests on towers used as antennas and have found that the current distribution departs seriously from the sinusoidal, due to the fact that the cross-section of the tower varies along the tower. It is rather a formidable task to measure this current distribution on an actual tower. We have, however, measured the distribution on small models operated at high frequencies. The results of these tests, as well as extensive measurements on actual towers, will be given at a later date. One of these tests was made on a tower 0.597 wave lengths high. Instead of having a current distribution as shown by the curve on the extreme right of Figure 2, it was found that the current along the antenna showed no tendency to cross through zero to negative values. The measured distribution was as shown in Figure 8. These departures from the sinusoidal make it extremely difficult for the antenna designer to control the radiation from the antenna. It has been found that it is most desirable to use a tower which has a constant cross section electrically over its entire length.

General Recommendations

The type of antenna system to erect will depend a great deal on the type of service and class of channel. For a cleared channel station with a power of 50 kilowatts or more, fading will be the most serious limitation on the service area. In this case, it is desirable to use an antenna giving minimum sky wave at the angles most likely to produce fading. For this situation, the best antenna is the 190° antenna or its equivalent. For stations on regional channels, this same antenna may be used if no interference from another station on the same channel is encountered in the zone which will be freed from fading by the use of this antenna.

Radio Rides the "Zephyr"



AT LAST! RADIO BROADCAST RECEIVER BUILT INTO THE MODERN TRAIN

The Burlington "Zephyr," built by the Edward G. Budd Manufacturing Company of Philadelphia, has every possible comfort and luxury to make the traveller contented, including radio broadcast reception in each of the passenger compartments.

This is the first railroad train in

which such equipment has been originally designed and not added as an after-thought. Other features include table meal service right at the passengers' seats, diffused lighting, reclining seats, complete air conditioning, rubber-insulated trucks and general sound-proofing.

The fading distance can be increased from 40 to 70 per cent by the use of a 190° antenna, depending on the terrain over which the ground wave

is a rather costly gain. The increase is only 27 per cent. It can be shown that, due to attenuation of the ground wave, the service radius of the station is not proportional to the field intensity at one mile but is proportional to the square root of this quantity. Therefore the use of a 190° antenna extends the service radius only 13 per cent over that obtained when a 90° antenna is used. Thus, if a 90° antenna gives a signal of 1.0 millivolts per meter at 100 miles, a 190° antenna will give 1.0 millivolts per meter at 113 miles. Hence, for a regional or local channel where interference is encountered, the most logical antenna would be about 0.25 wave lengths high, although somewhat shorter lengths can be used to good advantage.

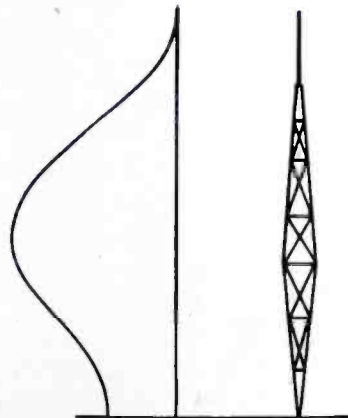

FIGURE 8—MEASURED CURRENT DISTRIBUTION ON A TOWER ANTENNA WHOSE HEIGHT IS 0.597 WAVE LENGTH

travels. If interference of this nature is encountered in the zone freed from fading, there is obviously little object in using the 190° antenna since the interference limits the service area. The use of a 190° antenna merely for its increased signal strength over a 90° antenna

It is hoped that the information given in this article may be of some assistance to the radio station contemplating a new antenna system. More detailed information may be obtained by writing to any of the district offices of the RCA Victor Company, Inc.

The RCA Radio Tube That Fell Out of the Stratosphere

—AND STILL WORKS!

A FRAGILE glass tube, which was picked up unscathed from a mass of unrecognizable wreckage of the stratosphere balloon, perpetuates the memory of one of the most dramatic broadcasts in radio history.

It was one of the seven Radiotrons in the tiny 8-watt, short-wave transmitter that enabled the world, sitting breathlessly by its radio, to listen to the voices of three men ten miles in the air fighting for their lives as their stratosphere balloon Explorer shot earthward as "fast as a man would fall if he jumped off a roof."

The tube, dropped with the equipment, survived the shock of the crash in a Nebraska cornfield, and remains in perfect working order, although the plate structure is slightly bent. This simple glass relic, reposing in the "radio museum" of the National Broadcasting Company in Radio City, represents not only a landmark in aeronautic history but in the history of broadcasting.

It will recall to posterity the thrilling two-way conversation which a

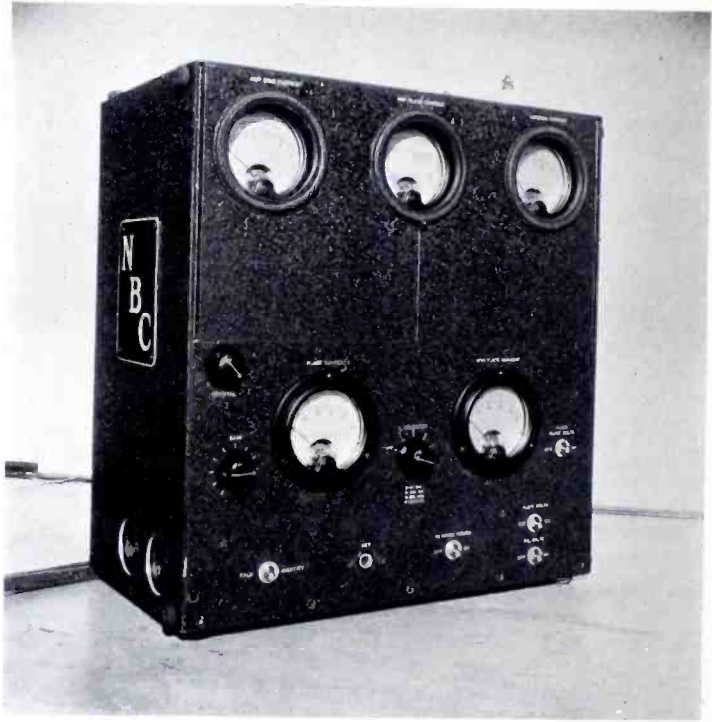

BEFORE THE ASCENT
THE COMPACT LITTLE 8-WATT TRANSMITTER THAT MADE HISTORY

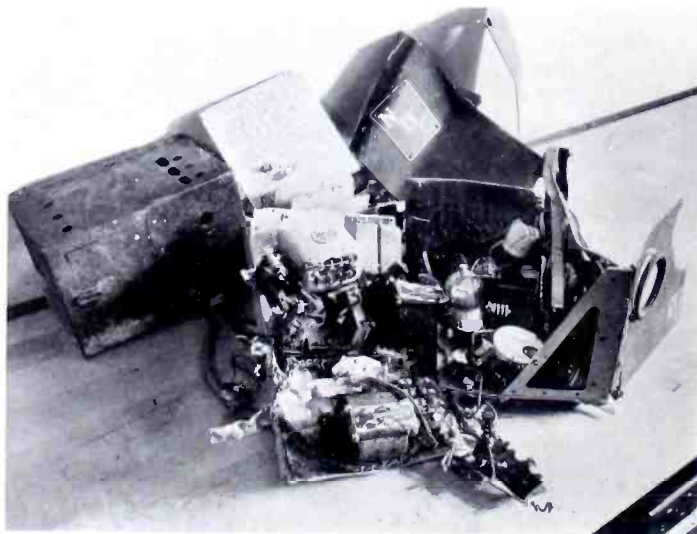

AFTER THE CRASH
FALLING OUT OF THE SKIES LIKE A METEOR, THIS MASS OF TWISTED WRECKAGE LANDED IN A NEBRASKA CORNFIELD. NOTE THE RCA RADIO TUBE STILL INTACT—AND, AFTER TESTS, PROVEN STILL IN PERFECT OPERATING CONDITION

nation-wide radio audience heard from the time the great balloon took off near Rapid City, South Dakota, ripped open at an altitude of more than 60,000 feet, and continued until the last of three balloonists parachuted to safety, more than seven hours later.

When a 50-foot gash suddenly halted the balloon's ascent at an altitude of 37,000 feet, Major William E. Kepner, commander, was heard to say:

"I don't know how long it will hold together, but there's nothing that we can do about it."

Then Captain Albert W. Stevens, observer, and Captain Orvil A. Anderson, two of the other occupants of the gondola, were heard discussing the grim details of the accident. "There's a big hole in the bottom . . . she's going back down again . . . we're coming down 400 feet a minute. . . ."

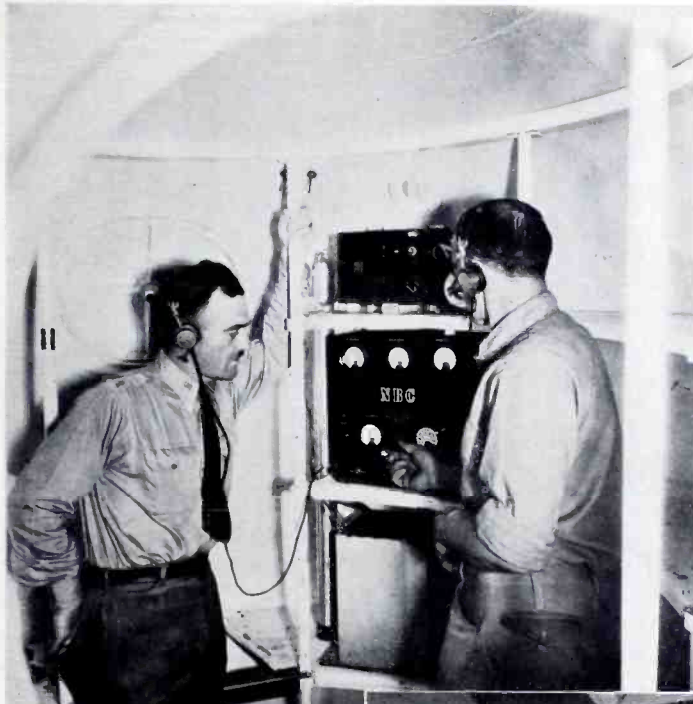

PREPARING FOR ASCENT

MAJOR W. E. KEPNER (LEFT) AND CAPTAIN A. W. STEVENS, SHOWN INSIDE THEIR STRATOSPHERE GONDOLA, TRYING OUT THE SPECIAL NBC TRANSMITTER AND RECEIVER WHICH KEPT THEM IN CONSTANT TWO-WAY COMMUNICATION WITH THE GROUND DURING THEIR TRIP TO THE STRATOSPHERE

The world listened breathlessly as one of the three airmen asked another: "What's the highest you ever jumped without oxygen?"

"About 24,000 feet," came the answer.

Even after the balloonists leaped one by one out of the falling gondola and parachuted safely to earth, the carrier wave of the radio transmitter remained on the air until the balloon itself crashed.

The twisted and battered radio equipment, which now occupies a prominent place in the "radio museum," enabled not only the listeners to get their information on the ascent first-hand from the three airmen themselves, but also made it possible for the intrepid trio to get the advice and encouragement of General Lejeune,

General Westover and others on the ground. From the War Department Building in Washington, the voices of these officials and others were flashed over NBC networks to short-wave transmitters, which in turn shot them out into the air to be picked up in the stratosphere, where they penetrated the air-tight metal ball in which the fliers were sealed.

Even if all the equipment on the balloon had been demolished and the fliers had perished, posterity, none the less, would have a complete record of their ascent and descent, thanks to the little transmitter.

It was the second time in the history of wireless that the National Broadcasting Company had brought to world radio listeners exclusive broadcasts from the stratosphere. The first time was in November, 1933, when Settle and Fordney made an ascent of 61,237 feet from Akron, Ohio.

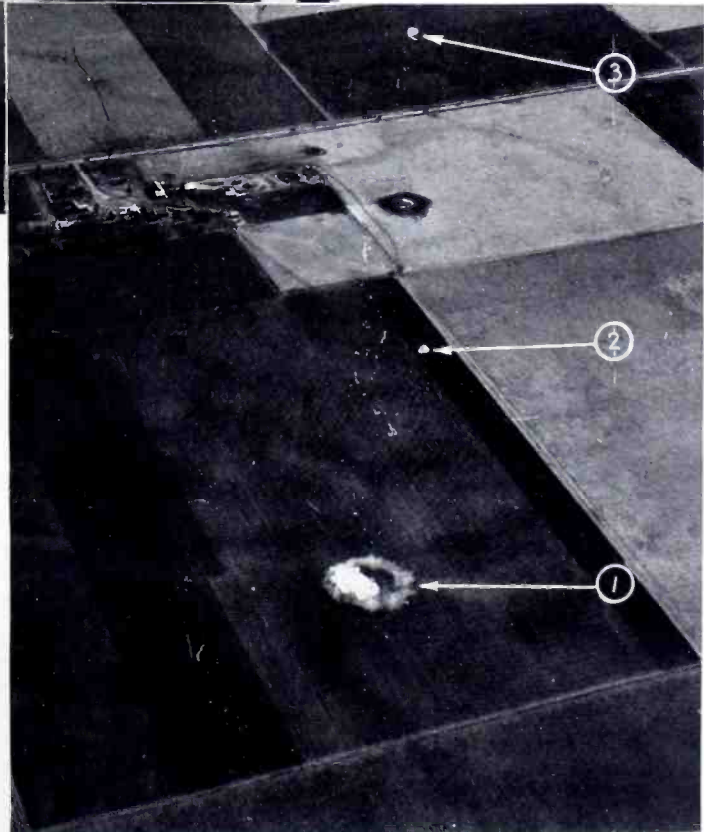

THE MOMENT THE GONDOLA HIT

1 IS THE STRATOSPHERE BALLOON AS IT CRASHED TO EARTH; 2 AND 3 ARE THE PARACHUTES OF TWO OF THE STRATOSPHERE EXPLORERS (THE THIRD FLIER'S PARACHUTE IS BEYOND RANGE OF THE CAMERA). NOTE THE SHREDS OF THE DISINTEGRATED BALLOON FLOATING IN MID-AIR DIRECTLY ABOVE THE CRASHED GONDOLA

The Type OP-4 Portable Broadcast Speech Input Equipment

By A. N. CURTISS, Radio Engineer, RCA Victor

IF YOU were building a portable broadcast amplifier, what features would you incorporate in its general design? How much gain should it have? Should it be adaptable to AC operation by the addition of the proper power supply? These questions and many others have been asked of competent operators who have had considerable experience in remote pick-up programs.

The result of this general questionnaire and the general advance in tubes and circuit design have been combined in a new RCA Victor Portable Broadcast Amplifier, to be known as the OP-4.

The general purpose of the amplifier is for remote pick-up of outside programs such as football games, outdoor concerts, political and social meetings and all the other important affairs that may happen outside the studio. It may also be used as a semi-permanent installation from locations such as hotel ball rooms where dance



A. N. CURTISS, RCA VICTOR

programs are picked up regularly several times a week.

Because we are entering a period of high-quality pick-up and transmission, it is rather important that this amplifier be within this class. Telephone lines are being improved; studio equipment and transmitters are already in the high-quality field, so it is

necessary that an amplifier for remote pick-up be of the same high quality type as the rest of the station equipment. The OP-4 amplifier has a useful frequency range from 40 to 12,000 cycles and is essentially flat from 60 to 8,000 cycles. Its volume range is such that it will handle a Velocity Microphone, or the new Type 50-A Inductor Microphone which has been developed particularly for use with the OP-4 for outside pick-up work.

General Specifications

Two carrying cases enclose the complete amplifier. The amplifier carrying case has a detachable cover, which may be removed by opening the catches, two on each side. Figure 2 shows the front of the amplifier after the cover has been removed. The amplifier case has a copper shield, which encloses the amplifier in a complete electrostatic shield. The battery supply is carried in a separate battery box and contains an "A" battery of the lightweight aircraft type and four "45"-volt "B" batteries. Space is also arranged in the battery box for three Inductor Type Microphones (50-A), a set of spare tubes, three microphone cables (30 feet each) and one power cable (10 feet long). There is also sufficient space to carry a small amount of tools and a pair of headphones if so desired. The battery box and the carrying case for the amplifier are cases similar in size and approximately 20½ inches long, 15 inches high and 8½ inches deep.

These cases, when complete with equipment, weigh approximately 50 pounds each.

One radical departure has been made in the design of this amplifier. The conventional heavy wooden case has been discarded, and a lighter

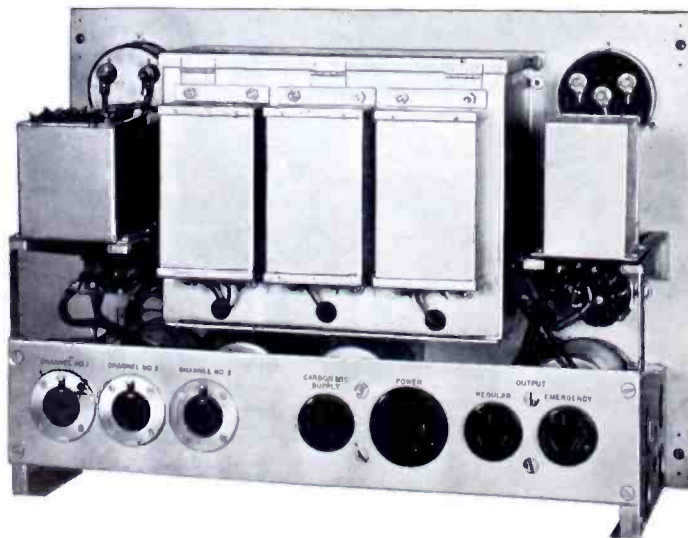

FIGURE 1—CHASSIS OF THE AMPLIFIER-CONTROL UNIT (REAR VIEW)



FIGURE 2—THE AMPLIFIER-CONTROL UNIT (FRONT VIEW)

wooden case lined inside and out with a heavy gray fiber is used. The change to this type of case was partially necessitated by the increased weight in the amplifier. Because of a much higher gain, and low level mixing, it was necessary to shield and double shield vital parts of the circuit. The fiber construction was suggested and designed by a trunk company that has been building fiber trunks for department stores for years. Based on their experience in the rough handling of these trunks, it is felt that this new construction will easily prove itself in the field.

Another change is the departure from the conventional black color for all panels. The cases are a battleship gray and the front panel of the amplifier is finished with a new durable wrinkled gray finish. All the parts behind the panel are finished in silver-gray opalescent.

Reducing weight of the amplifier presented a considerable problem in this high-gain amplifier. The tube boxes are fabricated from sheet steel for shielding, but all the other parts are made out of aluminum or duralumin.

Electrical Specifications

The amplifier has an overall gain from input to output, including mixers, of 92 db. The undistorted output level is plus 6 db. or 50 milliwatts.

The input is provided with three channels, using 250-ohm balanced

"H" pads for mixers in each channel. The output matches into a 500-ohm line.

The OP-4 amplifier utilizes the latest types of Radiotrons to give better performance in gain and frequency response. The first stage uses an RCA-77 as a tetrode and is resistance coupled to the second stage, another RCA-77 used as a tetrode. This second stage is also resistance coupled to the output stage which uses an RCA-41 as a triode. The master gain control is used in the grid circuit of the second stage. The output transformer feeds into a 500-ohm line output plug through two key switches. There are two output plugs provided, regular and emergency. A key switch controls each output and a four db. pad may be

inserted in the line through this same key switch. A phone jack amply protected against shorting the output lines is provided for monitoring.

A volume indicator meter is tied directly across the output and with its attenuator will handle levels from minus 10 db. to plus 8 db. The switch itself varies in 2 db. steps from minus 8 to plus 6 db. The individual mixers as well as the master gain control will attenuate 38 db. in 2 db. steps. The mixers and the master volume control are mounted on a separate sub-panel which is held to the main panel by three thumb screws. By removing these screws the mixers and master control may be easily removed, the cover taken off, and the units serviced without any difficulty.

Other mechanical features which should be mentioned are the double rubber suspension used on the input stages so that all shock noises are eliminated. As may be seen from Figure 3, the amplifier and plug panel on the rear of the amplifier are one assembly. Referring back to the second figure, it may be seen that the main panel is held in the carrying case by four thumb screws, one in each corner. A handle on the front of the amplifier facilitates removal. When the four thumb screws are loosened, the amplifier and plug panel slides out on its feet. The tubes are then readily accessible as well as the rest of the amplifier. All parts are easily serviceable, which is an impor-

(Continued on Page 29)

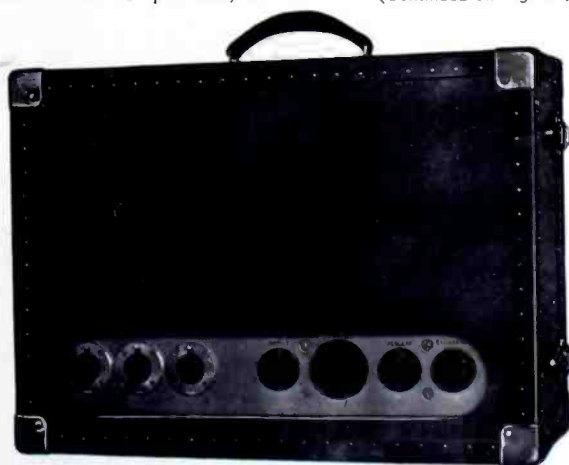

FIGURE 3—REAR VIEW OF THE AMPLIFIER-CONTROL UNIT, SHOWING CONVENIENT FLUSH OUTLET RECEPTACLES

Detroit Orchestra Hall

HOWARD ALLAN CHINN, CBS Engineer

THE Columbia Broadcasting System recently installed complete speech input equipment in Orchestra Hall, Detroit, in order to provide pick-up facilities for the Ford Sunday Evening Hour. This program features The Ford Symphony Orchestra conducted by Victor Kolar and is broadcast each week over a coast-to-coast network. The equipment has also been designed to provide the auditorium with a public-address system for talks, speeches and lectures whenever desired.

A control room having a double-glass observation window was constructed on the orchestra floor of the auditorium. This was done in as unobtrusive a manner as possible and, as evidenced by the accompanying photograph, the addition of a radio control room has not altered the appearance of the hall to any appreciable extent. In fact, when the control room is not lighted from within, its presence is hardly noticeable. The control room is entirely outside of the auditorium proper.

Thirteen microphone receptacles were distributed throughout the auditorium, on the stage, backstage, and



MARIA JERITZA, REHEARSING WITH THE FORD SYMPHONY ORCHESTRA, VICTOR KOLAR, CONDUCTOR, AT THE DETROIT ORCHESTRA HALL

in the wings. Twisted, two-conductor wire, shielded in copper braid, runs in conduit from each microphone receptacle to a "low-level" terminal box in the control room.

Microphone pre-amplifiers were not provided as part of the permanent installation, inasmuch as only one pro-

gram per week is being broadcast from this point at the present time. The office effecting the pick-up provides portable pre-amplifiers for each program. These are connected by means of flexible cables fitted with plugs and connector bodies to the termination of the microphone leads and to the mixer console.

A six-position, microphone mixer console, containing mixer and master gain controls, a volume indicator, a program switch and a talk-back switch has been installed. In addition, each mixer control is provided with an on-off switch and an appropriate load resistor. The input impedance to each mixer is 50 ohms, and the six mixers have been connected in series and fed into a 250-ohm master gain control. The output of this variable pad passes through a "talk-back" switch, a program switch and finally into an RCA-Victor type 40-C program amplifier.

The volume indicator meter, originally a part of the 40-C amplifier, was removed and mounted on the mixer console. Extension leads connect this meter into the circuit at the proper point.

The output of the 40-C amplifier passes through a 6 db. fixed pad, a line

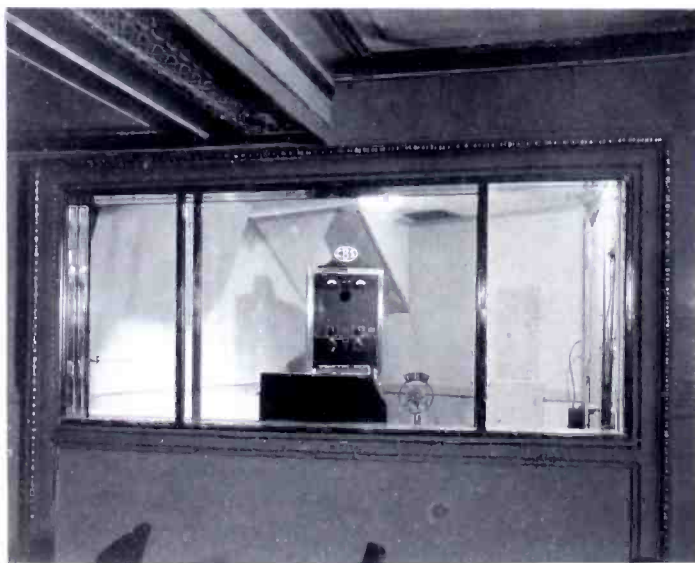

THE CONTROL BOOTH OF THE NEW COLUMBIA INSTALLATION AT DETROIT ORCHESTRA HALL. DOUBLE PLATE-GLASS WINDOWS SEPARATE THE CONTROL OPERATORS FROM THE AUDIENCE

SPEECH INPUT EQUIPMENT ORCHESTRA HALL - DETROIT

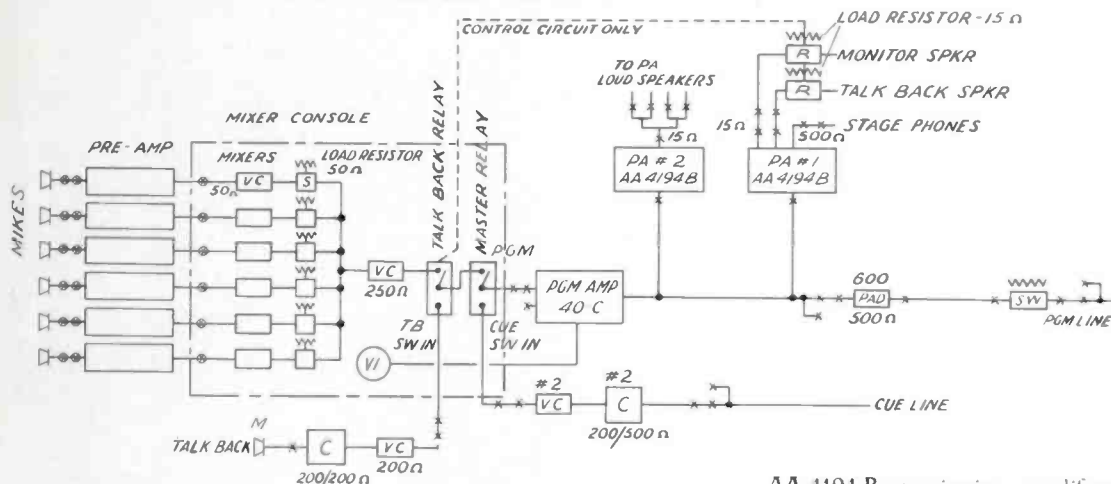

switch, and then to the line connecting Orchestra Hall with the CBS network.

In addition to providing programs to the radio line, the 40-C amplifier supplies two RCA-Victor type

- VC - VOLUME CONTROL
- C - COIL
- E - EQUALIZER
- SW - SWITCH
- R - RELAY
- * - JACK
- ⊕ - TWIST LOCK

AA-4194-B monitoring amplifiers. One of these units is used to energize two RCA-Victor type UZ-4209 loudspeakers, one of which is placed in the control room for monitoring purposes and the other mounted backstage for use in connection with the talk-back circuit. The output of this monitor amplifier also connects to a circuit leading to the stage, where it may be used to feed a pair of headphones for an auditor at this point.

The second monitor amplifier energizes four RCA Photophone loudspeakers, having type MI-1425 speaker units, connected to type MI-477 horns. These loudspeakers, which are mounted behind valances in the upper boxes on each side of the stage, serve as a public-address system when it is desired to use the speech input equipment as such.

Provisions were made for the installation of public-address loudspeakers in any one or all of three locations in the auditorium. High-level audio and loudspeaker field supply outlets are provided in the upper boxes to the right and the left of the stage and over and back of the proscenium arch. The wiring from these outlets is brought in conduit to a "high-level" terminal box in the control room.

The "talk-back" equipment consists of a two-button carbon microphone in the control room, a suitable input transformer and a volume control. This equipment is wired through a switch and an associated relay so that the occupants of the control room

(Continued on Page 32)



INTERIOR OF COLUMBIA'S NEW CONTROL ROOM AT DETROIT ORCHESTRA HALL—
RCA VICTOR EQUIPPED

LET'S GET ACQUAINTED



RCA VICTOR TRANSCRIPTIONS IN THE MAKING

A RECORDING SESSION IN THE WORLD-FAMOUS "CHURCH STUDIO" AT CAMDEN, N. J. THE CHARACTERS, LEFT TO RIGHT, ARE MATHILDE HARDING, PIANIST, FRANK CHASE, OF NBC PRODUCTION DEPARTMENT, OSCAR J. CLAIR, PIPE ORGAN TECHNICIAN, CHARLES SOOY, RECORDING ENGINEER FOR RCA VICTOR, AND IRENE HARDING, ORGANIST. THE UNUSUAL ORGAN-PIANO DUOS PRODUCED BY THE HARDING SISTERS HAVE GAINED WIDESPREAD POPULARITY AMONG THE LISTENING PUBLIC. THE VELOCITY MICROPHONE IS USED TO MAKE THESE HIGH FIDELITY RECORDINGS

KOA, NBC

ROBERT H. OWEN, engineer in charge of station KOA at Denver, Colo., visited the NBC studios at "Radio City," New York, during the week of October 14th, and was escorted on a tour through the "works" by Ray Guy, NBC Radio Facilities Engineer. Probably Ray Guy was trying to reciprocate for the ride over the mountain tops surrounding Denver during his visit out there in June and July.

NBC

William Duttera, NBC Radio Engineer, is very busy on the directional antenna at Raleigh, S. C.

William Fitch, NBC Radio Engineer, has spent the last few months covering the middle West in one of the NBC engineering cars, giving the RCA Victor 75-B Measuring Set a good workout.

Lester Looney, NBC Radio Engineer, has been dividing his time between Washington, D. C., and Cleve-

land, Ohio, during the past few months, making high fidelity adjustments on NBC transmitters.

WTIC

J. C. Randall, Plant Manager of WTIC, Hartford, Conn., having completed an extensive program of studio facilities expansion which was started early in June, is off on a hard earned vacation in the Adirondack Mountains to do a little deer hunting. Let's hope the boys at WTIC will enjoy the venison.

WBEN, WHEC, WGR

Other broadcast engineers seem to have taken advantage of the hunting season for their vacations. Among these are R. J. Kingsley of WBEN, M. H. Clarke of WHEC, and Karl B. Hoffman of WGR.

WLVA

Station WLVA of Lynchburg, Virginia, suffered a major catastrophe on November 8th, when fire destroyed their Main Street studios.

Due to the quick wit and ingenuity of A. E. Heiser, Station Engineer, programs were fed to the transmitter from remote points, thus avoiding loss of time on the air.

WHBF

Station WHBF, Rock Island, Illinois, has purchased a new RCA Victor 250-W transmitter for operation at 100 watts.

WCFL

Station WCFL of the Chicago Federation of Labor, which for several years has been operating at 1500 watts with an RCA Type 1-B transmitter and speech input equipment, is replacing this installation with one of the new RCA Victor Type 5-C all AC operated 5 KW sets, at their new site near Downers Grove, Illinois. Construction work on their new building is progressing rapidly and the new station will probably be on the air shortly after January 1, 1935. This new installation boasts a 530-foot half-wave vertical radiator.

BROADCASTING PERSONALITIES

WDOD

Joe Eiselein, chief engineer of WDOD in Chattanooga which is owned by Earl Winger and Norman Thomas, claims that his new half wave vertical radiator has practically doubled his signal at one mile. This improvement was accomplished merely by changing from their old antenna system to the new. Doubling the signal intensity at one mile is equivalent to quadrupling the power of the transmitter.

WMAZ

E. K. Cargill and George Rankin, manager and engineer respectively of WMAZ in Macon, Ga., are devoting most of their time at present to the installation of their new 1000-watt transmitter and 3/8 wave vertical radiator. It is expected that the station will be in operation shortly after the first of the year.

WDAE

L. S. Mitchell, manager of WDAE in Tampa, is quite technical minded and is probably one of the few radio station managers in the country who is willing to stay up nights helping his engineer making adjustments and changes in the transmitter. William Pharr Moore, engineer of that station, is responsible for all the technical operations.

WIOD

Radio Station WIOD has already started construction of their new studios in the News Tower on Biscayne Boulevard in Miami. The studios will be housed in a new section being added to the roof of the fourth floor of the building directly behind the tower. RCA Victor studio equipment including the new Inductor Microphone will be used in the studios. The owners have spared no expense in working out what is considered to be the last word in studio design.

Jesse H. Jay, manager of Station WIOD, is busily engaged in working out details for the opening of their new studios in the News Building. It is expected that the studios will be

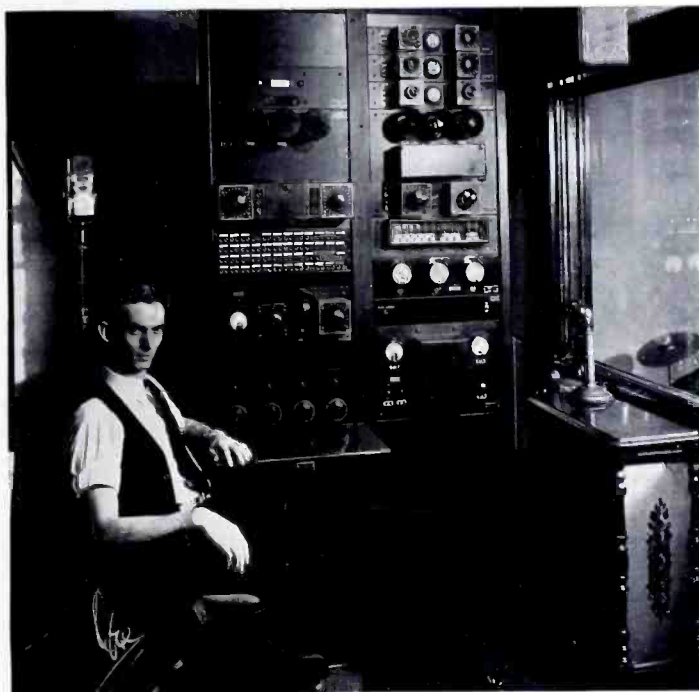

J. E. ADAMS, CHIEF CONTROL OPERATOR AT WFBC, IN THE CONTROL ROOM WHICH NOW INCLUDES AN RCA VICTOR 41-B PREAMPLIFIER, A NEW 4-CHANNEL MIXER, AND A VELOCITY MICROPHONE

dedicated during the early part of January when a nation-wide hook-up of the NBC will be fed from Miami.

Milton C. Scott, chief engineer of Station WIOD, is using a new RCA Victor type OP-4 outside pickup amplifier for temporary studio equipment while his present studio equipment is being combined with new equipment and moved to this station's new studios.

The International Radio Club will hold its annual meeting in Miami on January 7, 8, and 9. Headquarters will be at the Miami Biltmore Hotel. Elaborate plans have been made and it is expected that the party will be the greatest affair that has ever been known to radio broadcasting. The dedication of WIOD's new studios will constitute part of the program.

WMBR

Frank King, manager of WMBR in Jacksonville, Florida, has done an excellent job in building up the popularity of that station since it was moved from Tampa. Mr. King is

planning big things for his new station, but won't tell us all about them just yet.

WDBO

Colonel George Johnson, owner of WDBO in Orlando, Florida, is quite proud of his composite radio station which has just been increased to one kilowatt. The entire station including studios and transmitter is very well appointed, having been entirely designed and constructed by his chief engineer, Mr. J. E. Yarbrough.

KWCR

Station KWCR at Cedar Rapids, Iowa, has installed one of the new RCA Victor Type 1-D transmitters, putting this station in a class by itself west of the Mississippi River, with "High Fidelity" performance.

WOC

A new RCA Victor ET-4250 transmitter (250 watts) and speech input equipment have been purchased for the new WOC station at Davenport, Iowa.

WTAR Goes High Fidelity

By J. L. GREYER, Technical Director and Chief Engineer, WTAR



JULIUS L. GREYER, TECHNICAL DIRECTOR AND CHIEF ENGINEER, WTAR. ORDINARILY PRETTY EASY TO GET ALONG WITH, BUT THEY CALLED HIM OUT OF BED TO TAKE THIS PICTURE, JUST AFTER A 36-HOUR STRETCH INSTALLING NEW EQUIPMENT

STARTING out early in 1923 as amateur station 3GY, with an outfit built up by some of the radio-inclined members of the staff of the Reliance Electric Company, then the largest and most thriving electrical contractors and dealers in

the Virginia Tidewater, there gradually came into being Virginia's pioneer broadcasting station WTAR. The first regular program was put on the air on September 21, 1923, using a composite 15-watt transmitter, equipped with the almost-forgotten UV-202 power Radiotrons, and single-button carbon microphones. The station achieved immediate popularity, however, and in less than two months was forced to increase its power to 100 watts, by insistent public demand for stronger signals. Another composite transmitter consisting of two UV-203-A oscillator tubes, modulated by two more UV-203-A's, and fed by the well-known 7-A amplifier, was placed in operation early in December of 1923. Since the owners of the station were the leading battery dealers for Norfolk, this transmitter was empowered by storage batteries, both for filament and plate. The 1000-volt bank of "B" batteries was the main item of interest in the transmitter power room, and the bane of existence to the operators, who had to keep them serviced!

Under the leadership of Jack Light, station manager, WTAR rapidly progressed in spite of the vicissitudes



JOHN C. PEPPER, ASSISTANT CHIEF ENGINEER, WTAR—A 6-FOOT HUSKY, IN A SERIOUS MOOD

of early-day broadcasting, and in 1926 installed its first master-oscillator power-amplifier transmitter, using 500 watts, with two UV-204-A amplifiers and two UV-204-A modulators. When the demand for higher percentages of modulation began to be felt in the early days of the Federal Radio Commission, the modulator was modified to use two UV-851's, and a 50-watt speech amplifier was added to drive the grids. This permitted about 55 per cent modulation and materially increased the range of the station. This transmitter remained in use, with minor changes and improvements, until the necessity arose for maintaining the carrier frequency within plus or minus 50 cycles, whereupon plans were begun for an entire new station.

New Site

The new transmitter site was chosen in the fall of 1930, some five miles out in the country from the thickly populated city area, and work began immediately on the construction of a suitable building and the two 150-foot steel towers. A crystal-control transmitter, using low-level modulation and a water-cooled linear



STUDIO A (80 BY 36 FEET), LOOKING TOWARD CONTROL ROOM. RADIO STATION WTAR, NORFOLK, VA.

"Class B" R. F. amplifier, with capacity coupling to the antenna for harmonic reduction, was installed. New speech input equipment was built by the engineering staff and was all completed before the arrival of the transmitter. During one of the coldest and nastiest spells of the winter of 1930-'31 a six-wire cage antenna with six-wire cage lead-in was built, and it was while this part of the job was going on that the entire staff learned all about polar exploring. It was necessary to keep two blow torches going all the time to solder the joints, one inside the building and one outside. When the torch in use got too cold to vaporize the gas, it was exchanged for the hot torch inside, and the work went on.

The first crystal-controlled transmitter was officially dedicated on May 30, 1931, operating with 500

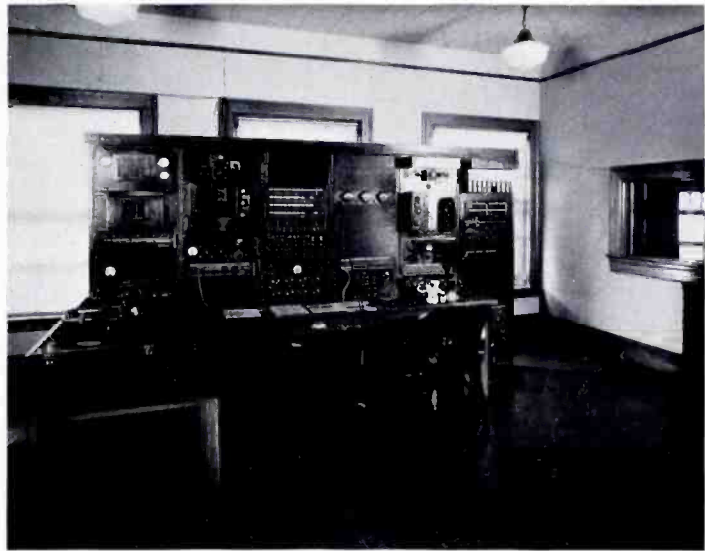

WTAR, NORFOLK, VA.—AMPLIFIER AND CONTROL BOARD, STUDIO MASTER CONTROL ROOM, SHOWING RCA VICTOR 33½ AND 78 R. P. M. TRANSCRIPTION EQUIPMENT

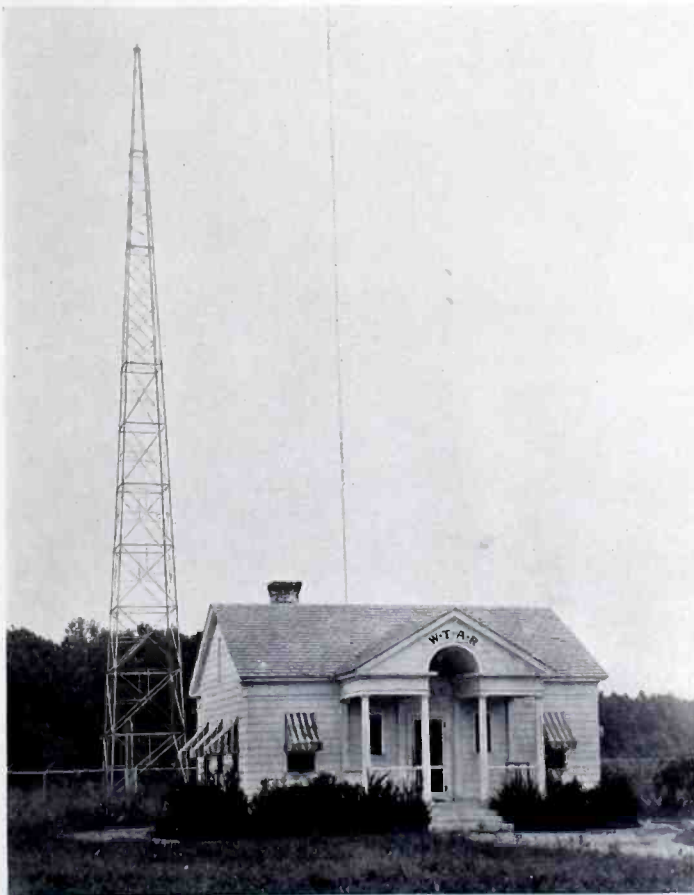

VIEW OF WTAR TRANSMITTER BUILDING, LOCATED ON VIRGINIA BEACH BOULEVARD, 1.7 MILES FROM NORFOLK CITY LIMITS AND 5 MILES FROM STUDIOS. ONE OF THE ANTENNA MASTS IN REAR. ANTENNA IS A 6-WIRE CAGE, 8-INCH DIAMETER, 140 FEET LONG, T TYPE, WITH 132-FOOT, 2-INCH, 6-WIRE CAGE LEAD-IN (VISIBLE JUST BEHIND BUILDING)

watts on 780 kilocycles and with better than 75 per cent modulation. During the course of its three years' service, it was found necessary to make several changes in circuit design in this transmitter, each change bringing about an improvement in the service rendered by the station.

New Transmitter

The concluding phase of the long history of the development and improvement of equipment at WTAR was reached just a few weeks ago when a new RCA Victor 1-D broadcast transmitter was installed. Set up in front of the old transmitter, which will now become a standby unit, the 1-D was connected up and placed into operation in record time, and has passed all tests with flying colors. Installed by the staff engineers, and tuned and checked by L. W. Olander, of RCA Victor's engineering division, the new transmitter has now been in continuous operation on program tests for some time, and has materially increased the listening audience of WTAR and very favorably impressed both the public and the personnel with its smooth high-fidelity performance.

Repeated frequency runs and careful examination of the wave-form by means of the cathode ray oscilloscope have proven beyond doubt that the 1-D has the lowest distortion and the widest audio frequency range of any transmitter, or any other broadcast

equipment previously available to the industry. In a territory which is rapidly becoming "high-fidelity conscious" due to the sales campaigns of several leading radio receiver dealers, the real high-fidelity of the 1-D has proven a huge asset, and has caused highly favorable comment everywhere that conversation has turned to radio.

A.F. Characteristic

Figure 1 shows the audio-frequency characteristic of the 1-D, showing the audio input level necessary to maintain 100 per cent modulation at frequencies from 30 to 17,000 cycles. This characteristic was taken by running the input up to the point where the negative peaks of modulation were just beginning to flatten out, and the positive peaks were just twice the width of the carrier, as indicated by the cathode-ray tube in the transmitter. After having been previously adjusted to 100 per cent modulation at 1,000 cycles, the modulation meter incorporated in the transmitter was also observed at each frequency as an additional check on the cathode-ray modulation indicator, and as a final check, both instruments were compared with the readings obtained with a well-known make of modulation meter, coupled externally to the antenna lead. All readings agreed within 2 per cent and completely substantiated all claims which had been made for the 1-D transmitter.

Old Defects Eliminated

Careful observations made on a number of radio receivers of many makes, and with both high-fidelity and "ordinary" characteristics, indicate that the hum level of the carrier is so far below the 100 per cent modulation level that it is completely inaudible, a fact which speaks well for the special filters and tuned traps incorporated in the rectifiers in the 1-D. As a matter of fact, it was found that slight noises caused by a bad resistor in one of the studio amplifiers, and a slight 60-cycle hum which was picking up in a short unshielded lead less than six inches long, which was in circuit with the input of one of the studio amplifiers, caused serious interference with the program through the 1-D transmitter, whereas it had been entirely unnoticed in the old transmitter. Steps were taken to remedy

this trouble, and since this was accomplished, we have been unable to detect any sound in the carrier other than the intentional modulation.

Other New Equipment

In addition to the 1-D transmitter, and the auxiliary transmitter, with its motor-generators and high voltage rectifier, the WTAR plant includes a composite speech input panel, consisting of a line amplifier, a volume indicator, a monitoring amplifier, and the necessary jacks, switching facilities and a local announcing microphone control panel. Power is supplied the amplifiers by two banks of 12-volt storage batteries and a 350-volt rectifier, using 866-A tubes. Since the 1-D transmitter incorporates its own high-fidelity monitoring speaker, the monitoring amplifier is no longer used except in connection with the old transmitter and for testing the equipment before going on the air.

A new line amplifier having even better characteristics and providing special circuits for equalizing the incoming line from the studio is under construction. The new amplifier will be completely self-contained.

New Range

Prior to the installation of the 1-D transmitter the program lines from the studio to the transmitter were equalized only to 5,000 cycles, but special equalizers have now been designed by our transmitter staff to make the lines flat to 10,000 cycles, within plus or minus 1.5 decibels. With the installation of the new amplifier, it is hoped that this characteristic may be still improved.

In conclusion, a word is appropriate regarding the engineering staff and the management of Virginia's Pioneer Broadcaster, without whom the present state of high quality equipment



WTAR, NORFOLK, VA.—POWER SUPPLY RECTIFIERS AND FILTERS. STUDIO MASTER CONTROL ROOM, SHOWING TWO 12-VOLT, 10-AMPERE FILAMENT RECTIFIERS AND TWO 350-VOLT PLATE RECTIFIERS, USING 866-A TUBES. NOTE—THE PAIR OF 866 TUBES IN THE TOP OF THE 350-VOLT UNIT LASTED 8,000 HOURS AND WERE STILL GOOD WHEN REMOVED. (WE WERE BEGINNING TO FEEL APPREHENSIVE!)

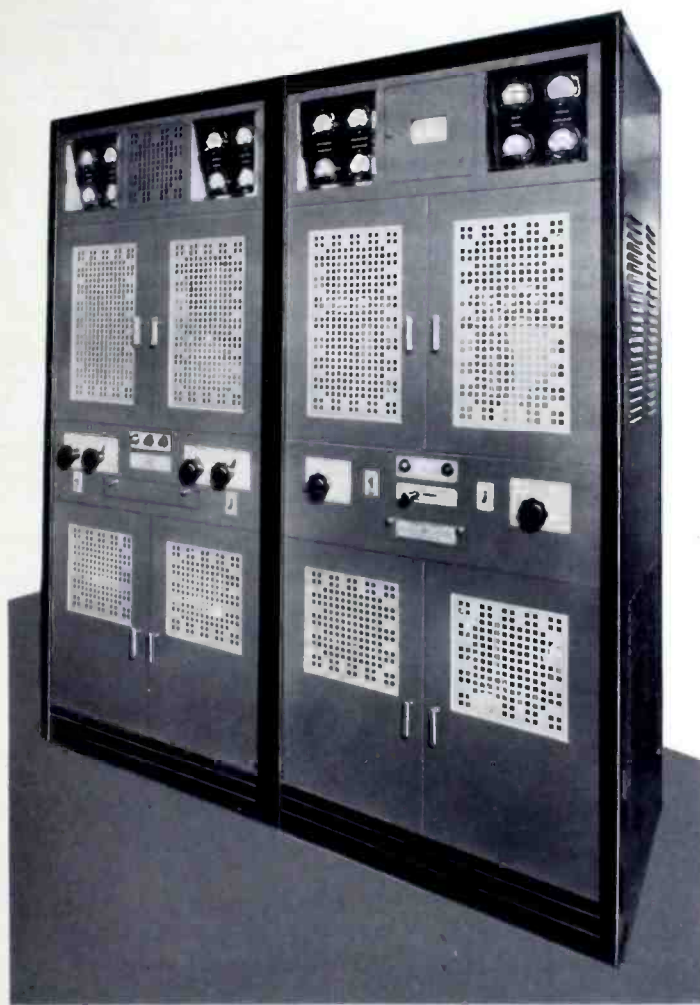

THE NEW RCA VICTOR TYPE 1-D TRANSMITTER WHICH PUTS WTAR IN THE "HIGH FIDELITY" CLASS

would never have been possible. The station is owned by Norfolk Newspapers, Inc., the directors of which appointed Campbell Arnoux, former manager of KTHS, in Hot Springs National Park, as general manager of the station early in 1934. He succeeded Jack Light, who had carried the station through its early career to become a leading 500-watt broadcaster, and who then became assistant manager, in charge of studio operations. Himself a pioneer in the broadcasting field, having brought two high-power stations out of the woods to become leaders in their territory, Mr. Arnoux proved himself a friend indeed to the engineering department, demanding better performance and setting higher standards of operation. Not only were the standards set, but the equipment to achieve them was

made available. This has been of the greatest value in providing an incentive to the entire engineering staff to make every improvement possible, and, once made, to keep all equipment operating at the peak of perfection.

Much credit is due those members of the engineering staff whose tireless efforts have made the achievement of these plans possible and without whose assistance the writer would have been severely handicapped in the completion of the many items of special equipment. Headed by John C. Peffer, assistant chief engineer, the staff is composed of Robert L. Kennedy, and William L. Davis, senior and junior plant engineers, respectively, and Myrle M. Harrison, control operator in charge of studio production; Trafton Robertson, announcer and control operator, and Gordon R. Kerr, announcer in charge of commercial continuity department.

In addition to the above, the commercial department boasts a large staff of salesmen, continuity writers, program arrangers and stenographers.

New Standards

With the incentive which the excellent frequency characteristics of the 1-D transmitter are bound to give the engineering department of any station, the broadcasting art as a whole will greatly benefit, for audio equipment must be brought up to the standard set by the 1-D, and when this has been done and every station has become "high-fidelity" throughout, the manufacturers of all receivers will be forced to come through with real wide-range equipment, capable of ten-thousand-cycle reproduction. Then true and natural transmission, reception and reproduction of high-grade programs will be a reality to the vast listening public. The rapid strides which radio broadcasting has made in the past will then be as nothing compared to the pace possible in its new seven-league boots.

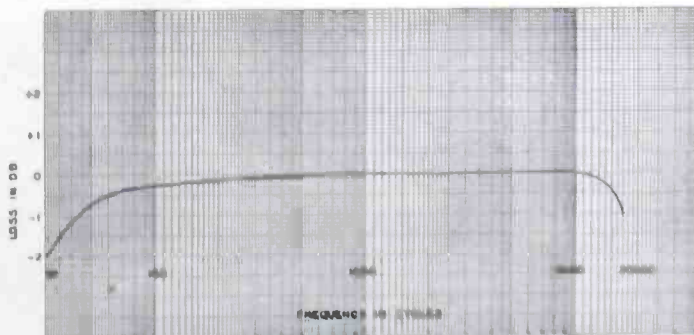

FIGURE 1—AUDIO FREQUENCY CHARACTERISTICS OF RCA VICTOR TYPE 1-D TRANSMITTER AT WTAR, NORFOLK, VIRGINIA, OCTOBER 15th, 1934



Did You Know?



By W. S. FITZPATRICK, RCA Institutes

THAT all the power plants in the world have not yet produced the equivalent of one-millionth of a gallon of electricity? A million kilowatt hours, used at 110 volts, represents less than 1-15,000 of a grain. (*Everyday Science and Mechanics*)

That the RCA Victor Company has just produced an A. C. operated Amateur Communication Receiver, Model ACR-136—a 7-tube Superheterodyne, with 460 K. C. intermediate frequency and a range of 540 to 18,000 K. C., continuous in three bands? The bands are changed by a switch on the front panel, and a full electro dynamic loudspeaker is a built in feature, although 'phones may be plugged in.

Dinner in the Clouds

That on the sixty-fourth floor of the 70 story RCA Building in Radio City, New York, there is a restaurant where 25 waiters and 25 cooks and helpers serve about 700 persons daily?

That there is an unsolved mystery in the transmission of sound made by meteors? The fact that it is heard the instant the meteor is seen forces the conclusion that the sound is transmitted in some way other than air waves, for ordinary sound waves would take several minutes to travel the distance (*Popular Science*)

That with the addition of Chicago there are now six large cities in the RCA domestic radio-telegraph service with three more soon to be added? The cities are New York, Chicago, San Francisco, Boston, New Orleans and Washington. Those next to be added are Los Angeles, Detroit and Seattle.

That RCA Radio Tubes respond to a million impulses a second, whereas a stopwatch, generally thought to be the ultimate in precision and accuracy, functions only on tenth-of-a-second intervals?



W. S. FITZPATRICK, THE "RADIO RIPLEY"

That a short story containing every known sound in the English language was read by a New Yorker, a Californian, a Bostonian, a Texan, a Georgian, an Englishman and a Frenchman, in a unique NBC-WEAF network broadcast?

Modern Magic

That the accomplishment of RCA Victor in producing a new Victor record of Caruso, re-recording the voice of that famous singer with the modern "fidelity" method and eliminating the "tinny" accompaniment of the original recording, caused a reader to ask *Science and Mechanics* how it was done? In giving the procedure the editor's reply stated that it was as much a musical feat as an electrical one.

That, excluding the photo-electric cell, there are some 300 uses for the three or more element vacuum tube for other than communication purposes, according to J. Kenneth Whitteker, Chief Instructor at the New York school of RCA Institutes, who is preparing a book on the subject? Recognizing radio reception and transmission as "communication," and further eliminating the 250 or so applications of the photo cell, Mr. Whitteker's 300 other uses are being looked forward to with interest.

That an NBC release dated October 31 gave thumb-nail sketches of 28 announcers of the New York NBC studios? It is noted that two of the recent additions attained their places without prior experience, one is a former NBC page, three studied law, three theology and two medicine. Three are former newspaper writers. Two are actors, six are singers and six are musicians. Three are listed as bachelors. (A condition or just another profession?) Ed.

Pictures by Radio

That messages, maps and pictures transmitted by radio are reproduced on paper at the rate of a full letter-sized sheet every eight minutes, by an improved fac-simile receiver perfected by RCA Victor engineers?

That the Kennelly-Heaviside layer, as the electrified region has been called for years, is now more often referred to as the Ionosphere? (*Radio World*.)

That an important recent development is the RCA emergency marine transmitter which operates from a 12-volt battery, obviating the necessity of the elaborate 60-cell storage battery equipment, with great saving in space and less maintenance attention?

That a new Department of Commerce book gives an official list detailing frequencies, power and call letters of all short-wave stations throughout the world?

That a radio receiver has been developed that picks up enough energy to turn a small motor at high speed?

That the biggest stars in radio are heard on the sparkling new NBC program, "Radio City Party," Saturday night, 9 to 9.30 E. S. T.? Crossley statistics give this program a rating of 14.2, which means that it ranks among the first twenty leaders on the air—most of which are old-established programs.

That because of the tall RCA structure, it and other buildings, as well as persons, in Radio City and the surrounding area in New York City, are protected from lightning? Its high steel frame and plumbing system make the building the best possible safeguard against lightning because the energy of the bolt is divided and subdivided by it.

That NBC radio pack transmitters have become standard equipment at the annual National Horse Show? This year's show at New York in November is the second at which spectators learn official results immediately through a transmitter carried by an NBC observer in the arena. Heretofore announcements were not made until long after the contestants left the ring.

Small But Efficient

That the RCA Victor Lapel Velocity Microphone has a frequency range extending from 80 to 7000 cycles with an output level the same as a standard Velocity microphone at four feet?

That 3,000,000 old radio tubes per year were sold as *new* until RCA developed the non-refillable sealed carton to put the racketeer "on the spot"?

That the new RCA Victor 16 mm. Sound Movie Camera is only as big as a derby hat, can be used for "news reel" type of shots, where the cameraman describes the action directly into the built-in "mike," or with an extension microphone for "on-stage" sound? Portable RCA Victor Sound Movie 16 mm. projectors are also available so that you can show these films or "rental" subjects right in your own home.

That United States has 43 per cent of the world's radio sets? Statistics just compiled by the Department of Commerce gives the radio census of the United States as 18,500,000 sets as compared to a world total of 42,540,239. Europe has 18,594,605. (*Scientific American.*)

That the seven means of transmitting signals at sea are: radio,

flags, semaphore, lights, rockets, whistles and bells?

World-Wide Wireless

That a new map of the world showing the R.C.A. Communications network of radio-telegraph and radio telephone systems, just compiled for distribution, is of scientific interest in noting how the circuits spread from New York and San Francisco to all parts of the world?

That government experts find the distance between Washington and California has increased by forty feet since 1926, when the last check was made?

Short Waves in Surgery

That Marconi in an article about the use of short radio waves in surgical operations states three great advantages in that the loss of blood is reduced, which leaves the surgeon a clear field, and the method reduces the shock to the patient's nervous system, greatly enhancing the prospects of rapid recovery unattended by the dangers of relapse?

That portable radio telephone sending and receiving sets, weighing 16 pounds, complete with batteries and antenna, are used in fighting fires by the U. S. Forest Service? Radio has proved extremely valuable for rapid communication during outbreaks of fire. (*Radio World.*)

That photo-electric cells play an important part in the operation of the world's largest underwater vehicle tunnel in England? The tunnel, incidentally, is a half mile longer than New York's Holland Tunnel. (*Modern Mechanix.*)

World-Wide Program

That radio broadcasting scored another point when, with the use of a self-constructed radio receiving set, run by an old auto dynamo driven with a wooden wheel propelled by human power, 300 miles from the nearest habitation, a man in Mpweto, Belgian Congo, Africa, listened to an NBC broadcast and gave to officials of that isolated place the news of their King's death, ten days before it reached there officially?

That the use of cellophane for coin wrappers enables the money to be counted without unwrapping the rolls?

That an Australian radio amateur named Pollock has established 2-way voice communication with other amateurs in each of the six continents of the world, using a power of less than ten watts? (*Radio World.*)

That a contract for installation of short-wave radio-telegraph equipment on thirteen Standard Fruit and Steamship Company vessels has been received by the Radiomarine Corporation of America? This will provide direct and constant communication between the ships and their home-office ports, even over distances of several thousand miles.

That, according to *Popular Science*, the language most intelligible over the telephone is Italian and the one conveying the most ideas in the shortest time is French?

Even the Orchestra

That for each act in the performance at the Radio City Music Hall in New York, members of the orchestra change into uniforms fitting the setting or spirit of the act?

That at the Brooklyn Navy Yard there is a switching engine run by stored steam? The engine is charged with a 200-pound pressure of steam from a stationary plant. It operates without loss of pulling power until the pressure falls below 50 pounds, which does not occur for several hours.

That the average span of life has increased from 20 years, in Queen Elizabeth's time, to the present 58 years for men and 61 for women?

That to make an artificial lake the size of Lake Erie all the power of Niagara Falls would be needed for years and all the pumps now in the United States would work for a lifetime on the project? (*Science and Mechanics.*)

That nearing completion in one of the big NBC studios in Radio City, is an unusual pipe organ with three keyboards of 61 notes each, 20 pedals magnetically operating 1034 pipes, and 400 wires to hook up the stops in scores of combinations, which will produce an almost unlimited variety of effects and which will be heard over the air at an early date?

Recent Police Radio Installations

By C. T. ANSON, RCA Victor Engineer

THE transmitter of the new Police Radio installation at Norfolk, Va., is located in the penthouse on top of the National Bank of Commerce building. The control point is the First Precinct Headquarters building at Cove and Court Streets. The control room has been specially prepared for dispatching, in being isolated with Cellatex on the walls and ceiling, and rubber tile on the floor. The radio dispatcher's desk and files are kept in this room, and the room has direct telephone connection with the police PBX board.

The transmitter is an RCA Victor type ET-5004. Ten AR-5006-A car receivers were installed, one in the car



POLICE CHIEF H. W. CHURN, OF SUFFOLK, VA.

of Col. Charles B. Borland (Chief), three in cruisers at large, and six in scout cars assigned to the six districts

into which the city is divided. In addition to the car receivers, six station-house receivers, AR-5024, have been installed—one at each of the sergeants' desks in the first, second, third, fourth and sixth precincts, and one in fire-alarm headquarters.

The total coverage required at Norfolk was thirty-seven square miles, in an oblong shape, with the transmitter located at one end. The transmitting antenna is 220 feet above the street and, in several tests, coverage in excess of fifteen miles has been obtained. In addition to the three time-test calls per hour put out, the calls per day average between 60 and 100—the higher figure being reached during week-ends.

Fifteen officers of the force successfully passed their examinations for third-class radio telephone operators' licenses. Of these fifteen, three have been definitely assigned to dispatching duty. In addition to the officers, there are four men of the Bureau of Electrical Affairs, of which William Walsh is the Superintendent, who passed their examinations for licenses, and these four men are charged with the maintenance of the equipment.

The transmitter operates on 33.1 megacycles. The equipment went into operation officially September 16th, at 7 A. M., and in addition to the 72 time calls, 75 calls were handled by the cars in the first twenty-four hours of operation. It is understood that the radio-equipped cars are now handling better than 75 per cent of the work previously handled by the patrol wagons, and, of course, doing it much faster.

Police Installation at Suffolk, Va.

The antenna is suspended from a cypress pole mounted on the rear of the City Hall building, and guyed near the top. The whole structure is 117 feet above ground. With this antenna, commercially usable signals are obtained in an eight-mile radius. The RCA Victor type ET-5004 transmitter is located near the sergeant's



CAPTAIN F. KEENAN, OF THE ROSELLE, N. J., POLICE DEPARTMENT AT THE MICROPHONE OF THE RCA VICTOR POLICE RADIO TRANSMITTER

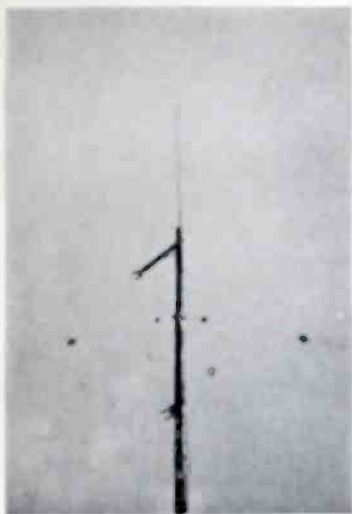

"TERRA-WAVE" ANTENNA MAST INSTALLED AT SUFFOLK, VA.

desk, with an operator's control box on the same table. As at Norfolk, the room in which the transmitter and control box are located was specially prepared for dispatching purposes—in other words, sound-proofed.

The transmitter operates on 37.1 megacycles. Two type AR-5006-A car receivers were installed—one in

the Buick car of Chief H. W. Churn, and the other in a Ford touring car.

Suffolk is a city of 17,000 people. The radius of the city is approximately one and three-quarters miles.

Five men, including the chief, successfully took the examination for third-class radio telephone operators' licenses.

"Terra-Wave" Successful in Danville, Virginia

Since early in 1934 the Police Radio Station W3XZ, located in Danville, Virginia, has been rendering an excellent account of itself. This RCA Victor installation is operated on a frequency of 33,100 KC and it has the distinction of being the first police radio installation in the state of Virginia.

During the brief period it has already been in operation, this installation has performed many useful tasks, including saving life, preventing crime, and apprehending criminals and fugitives from justice. Members of the Police Department in Danville praise the equipment very highly and feel that it has already proven indispensable.

Roselle, New Jersey, Police Praise RCA Victor Equipment

Chief of Police B. M. Avery, of Roselle, N. J., states that while his officers and men deserve just praise for the excellent results they have been achieving lately in suppressing crime and bringing criminals to justice, he is highly appreciative of the RCA equipment, the installation of which marked a new chapter in the police routine in Roselle.

The police radio equipment at Roselle consists of an RCA Victor "Terra-Wave" transmitter, Type ET-5004, and four police receivers in automobiles. Captain F. Keenan is in charge of the transmitting station at police headquarters.

Other New Installations

Other recent installations of RCA Victor "Terra-Wave" equipment include New City, New York, for the Rockland County Police, Scarsdale, New York and Clairton, Pennsylvania.

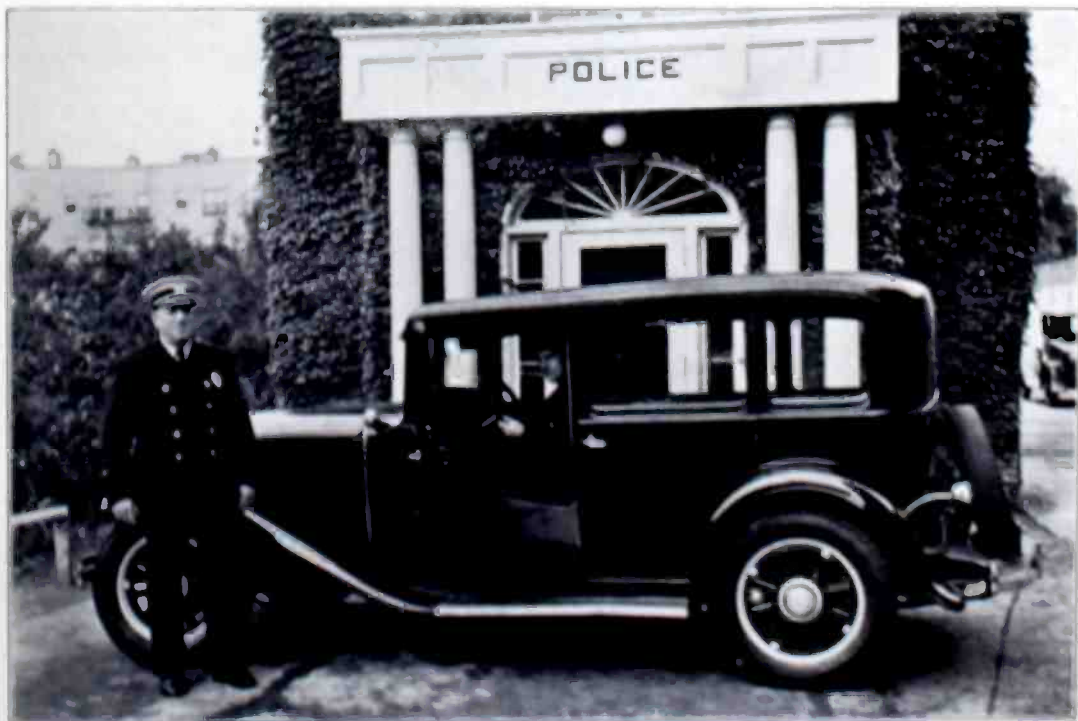

CHIEF OF POLICE B. M. AVERY, OF ROSSELLE, N. J. (STANDING) AND OFFICER WILLIAM WOODRUFF SEATED IN AN RCA VICTOR RADIO-EQUIPPED POLICE CAR

How Echoes are Produced

NBC Engineers Perfect Artificial Sound Reflection

OPENING off a narrow passageway, hidden behind the world's largest broadcasting studio in Radio City, are three rooms of varying size. The rooms themselves are "brilliant," that is, their ceilings, walls and floors are tile and concrete, so that every sound made in them "bounces back."

These are the NBC echo chambers, used in dramatic programs to give voices the effect of being heard in a large, empty, echoing room or building.

If a person speaks in an auditorium or other large hall, his voice has a "hollow" sound, due to the length of time it takes for its reverberations to die away. Conversely, if he speaks in a completely sound-deadened room, there will be no echo and the voice will sound as if it were out-of-doors.

It was to give variations of these effects, to control the amount of reverberation so that the voice from the ordinary-sized studio could be made to appear to be coming from the smallest or the largest-sized room, that the National Broadcasting Company developed and inaugurated the use of the famous "echo chamber" which adds greatly to the scenic verisimilitude of many programs heard over NBC networks.

Each of the three echo chambers is merely a small room, 6 by 11 by 10 feet, with a cement floor and hard-plaster walls and ceiling. Fifteen feet away from the room is an enclosed loudspeaker from which a long six-inch tube leads to an ordinary horn within the echo chamber, in the center of which stands a microphone.

A program is broadcast from one of the NBC studios which has a reverberation time of only about 75/100ths of a second. The sound waves travel from the studio microphone to the adjacent room, but before they are amplified and put on the air, a portion of the flow is diverted to the echo chamber. This is again

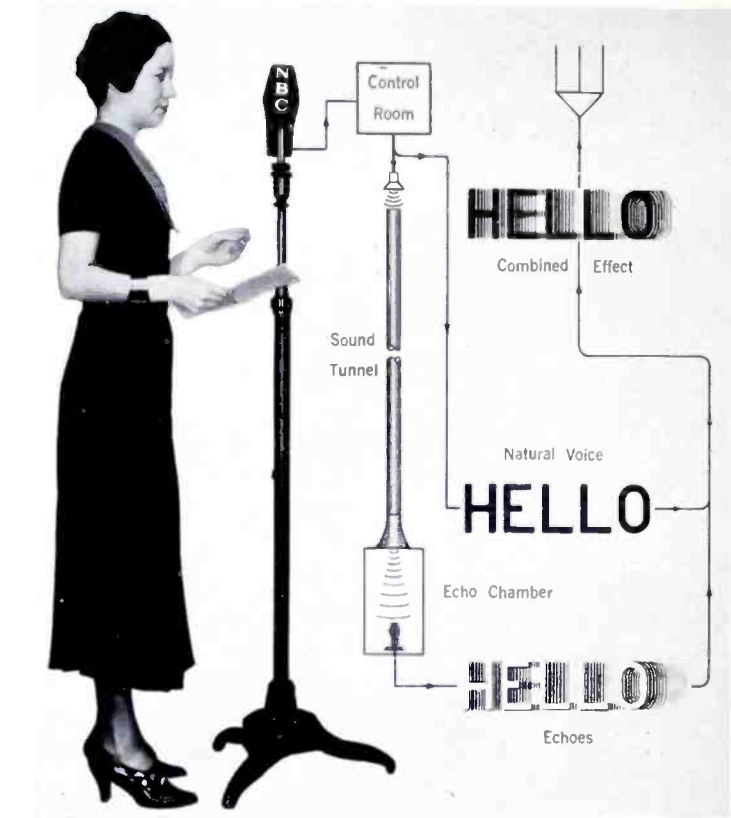

THE NBC "ECHO" SYSTEM

transformed into sound waves at the loudspeaker, which traverse the tube and reverberate against the hard surfaces of the echo chamber. The augmented sound waves are then picked up by the microphone in the echo chamber and are taken back to the "main line," where they are again mixed with the undiverted flow from the studio, amplified, and put on the air. The entire operation, of course, takes place almost instantaneously, the only delay in going through the echo chamber being a lag of about 1/75th of a second while the sound waves pass through the hollow tube into the chamber.

The effect of this process is to greatly increase the scenic illusion of a program broadcast from an ordinary studio. The scene of a drama, for instance, may be laid in a large church;

the bride and her attendants are talking in an anteroom before the wedding ceremony and their voices naturally produce only a slight reverberation. But from the church comes the singing of the choir, and the sound waves would, if actually reflected from the hard walls and vaulted roof of such an auditorium, create reverberations of perhaps one or two seconds' duration. However, both of these effects—the small and the large room—can be produced at the same time in the same studio by adding reverberations to the choir music in the echo chamber and mixing this with the echoless voices of the women who are supposed to be in the anteroom. In this way the listener actually gets the impression of being in a small room adjacent to a large auditorium.

In a recent Eno Crime Clues broadcast over an NBC-WEAF network, the characters mounted the stairs from the lower floor of a barn to a large, bare upper room. As they opened the door, the sound waves were diverted through the echo chamber and an effect of space and bareness was obtained which could only have been produced physically by the actual progress of the characters from the semi-sound proofed studio into one of large size with hard-surfaced walls and ceiling.

Little more than a year ago the first echo chamber was put into use in the NBC studios, then located on Fifth Avenue, New York. The engineering department, under its chief, O. B. Hanson, continued to conduct experiments, and when the new Radio City studios were built many improvements and refinements were incorporated in the echo chambers as a result of these daily scientific researches.

BROADCASTING CARACAS

(Continued from Page 3)

The C. A. Almacen Americano, which operates the "Broadcasting Caracas" organization, as well as being local distributors for the RCA Victor Company, Inc., runs regular RCA Victor programs twice a week, designed to assist their dealers throughout the surrounding territory; in fact, each program is directed to one of these dealers. These special programs are on the air Tuesdays from 9 to 9.30 P.M., Caracas time (9.28 to 9.58 Eastern Standard time), and on Saturdays from 8.30 to 9 P.M., Caracas time (8.58 to 9.28 Eastern Standard time). In addition to this, the signature every half-hour throughout the operating day includes the phrase, "RCA Victor Distributors."

Mr. Albert Lopez, the young chief engineer of "Broadcasting Caracas," began his career in the Lee DeForest laboratories in the United States, and in 1924, when the sound-movie industry was first awakening, he was active in the development of sound equipment. He is a member of the Institute of Radio Engineers, and was recently appointed president of the Venezuelan Radio Club.

The entire organization of "Broadcasting Caracas" is proud of owning

"Acorn" Tube for Radio Experimenters

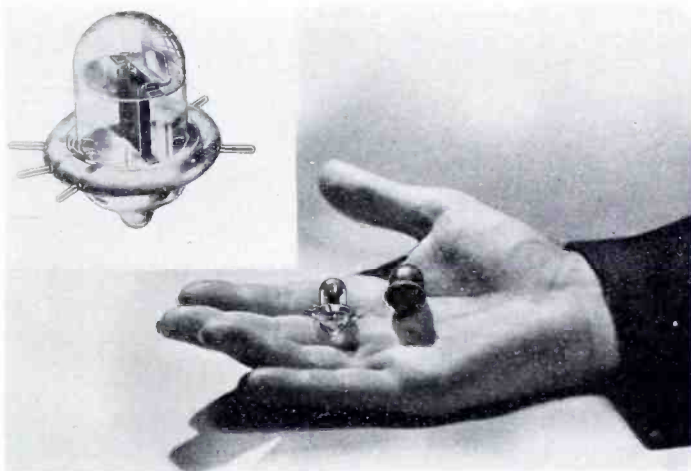

A RADICALLY new type of radio tube, resembling an acorn in size and shape, for use by amateurs and experimenters in ultra-high frequency, or micro-wave reception and transmission, has been announced by the Amateur Radio Division of the RCA Radiotron Company.

Amateur radio experimenters, who have been credited with being the first to open up the practicable possibilities of short waves, are now exploring the possibilities of the extremely short, micro-waves which are similar in some ways to light rays because they seem to reach out only as far as the eye can see. Comparatively little is yet known about the micro-waves, and they offer an attractive field for research and experimentation which the new acorn type tube should advance.

their RCA Victor transmitter equipment, and feel that regardless of price, it is the best investment that they could have made.

A very complete and interesting illustrated booklet entitled, "Interesting Facts About Venezuela and Broadcasting Caracas," may be had upon written request to these stations. Probably every question that the broadcast listener might ask concerning YVIRC and YV2RC has been answered within its covers, and this booklet might well serve as a guide to the management of other stations contemplating the production of a similar booklet.

In announcing the new device, the RCA Radiotron Company emphasizes that it has been developed for amateur and experimental use, and is in no way to be considered as a substitute for use in conventional types of receivers. The tube, which has been designated by the number RCA-955, is a heater-cathode triode which may be used as an amplifier, detector, or oscillator at frequencies up to 600 megacycles, or about half a meter in wave-length. The new tube is the only triode capable of operating at ultra-high frequencies and it is therefore indispensable for use in the 2½-meter and lower wave-length bands.

Although the "955" is not especially designed to be a transmitting tube, it may be used as such just as other receiving tubes are used in transmitters by amateurs. When used for this purpose, sufficient power output is usually obtainable to cover the line-of-sight transmission distances which are generally reached by micro-wave transmissions. Because of its extremely small size, the acorn-type tube is especially suited for use in portable radio equipment where conservation of space and weight is important.

The essential characteristics of the 955 acorn-type tube are:

Heater Voltage	6.3 volts
Heater Current	0.16 amp.
Maximum Plate Voltage	180 volts
Grid Voltage	5 volts
Maximum Plate Current	4.5 milliamps.
Mutual Conductance	2,000 micromhos
Amplification Factor	25
Plate Resistance	12,500 ohms

WFBC Gets a New 1-D Transmitter

By BEN ADLER, RCA Victor Sales Engineer

SHORTLY after the first of August, one of the most important parts of the Piedmont Section in South Carolina was threatened with the possibility of having to get along without daytime radio reception. This was brought about when the transmitter of WFBC which serves Greenville and its environs was demolished by fire. The tense situation was relieved by the quick and decisive action of the owners which placed Mr. Charlie Peace's signature on a contract covering the purchase of a shiny new one-kilowatt transmitter from the RCA Victor Company, Inc.

Started by Phone Call

A telephone call to Radio Headquarters started the grinding of quartz crystals for WFBC's frequency and at the same time gathered the many intricate components of the 1-D transmitter into a single express shipment which was on its way to Greenville almost before the ink had dried on the contract. The complicated details of preparing the equipment for shipment were carried out with such precision and rapidity that one would consider the operation analogous to a huge machine in Camden remotely controlled from Mr. Peace's desk in Greenville.

Immediate Preparations

While the equipment was en route, all preparations were being made at the transmitter building in Greenville to expedite placement of the equipment on the air and the resumption of service. R. H. Lingle, Jr., engineer of WFBC, supervised the construction work. With the aid of blue prints and instructions sent from Radio Headquarters by air mail, he was able to have everything in complete readiness for the transmitter when it arrived.

The design of the type 1-D transmitter is such that a minimum of external connections is required. A. C. power supply, audio input and antenna and ground connections are the only ones necessary. A reduction in the number of connections has

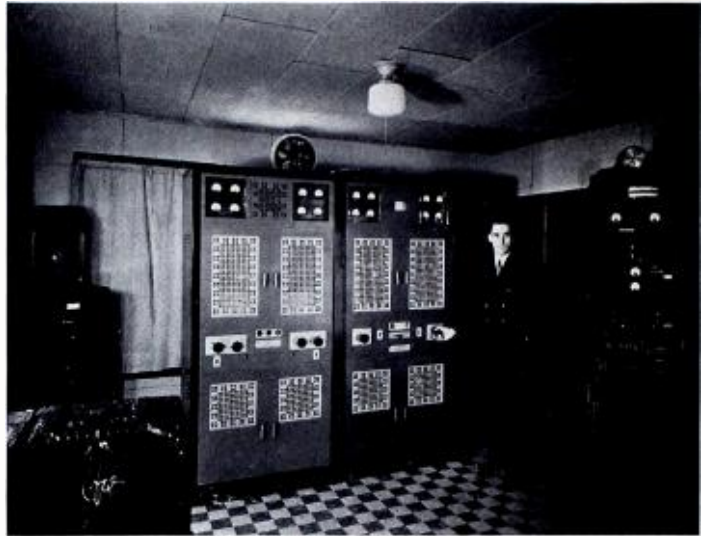

R. H. LINGLE, JR., CHIEF ENGINEER OF WFBC, AT THE CONTROLS OF THE NEW RCA VICTOR TYPE 1-D TRANSMITTER, RECENTLY INSTALLED AT GREENVILLE, S. C.

been brought about by improved design which eliminates water connection, monitoring loudspeaker connection, external power supply from rotating machinery and others. The new transmitter at WFBC utilizes air-cooled tubes throughout, has no rotating machinery, has self-contained high fidelity monitoring loudspeaker and cathode-ray modulation indicator.

Because of this simplicity of design it was possible to place the transmitter into actual operation within a very few hours after the equipment arrived on the scene. Actual program service was resumed before the crystal ovens had time to reach their exact operating temperature.

Power Increase Granted

Just before the fire at Greenville the Federal Communications Commission granted WFBC an increase in power to 1000 watts day and 250 watts night, together with a change in frequency to 1300 K. C. The new equipment was installed to operate under the new conditions granted by the Commission. A tremendous improvement in coverage has been brought about by the changes.

More widespread coverage together with improved performance

from the new equipment has greatly enhanced the value of this station to the public, making it one of the outstanding broadcasting mediums in the Carolinas. Higher fidelity, including better frequency response and lower audio harmonic content, has rendered the transmitter capable of doing justice to the very fine studios WFBC has always been able to boast of.

Special Lines

The lines connecting the studios in the Imperial Hotel to the transmitter building located in the suburbs of Greenville have been carefully equalized. They feed into an RCA Victor type 40-C amplifier at the transmitter. The output of this amplifier is connected to the audio input leads of the transmitter which connect in successive stages to the highly efficient class "B" modulator capable of delivering approximately 1000 watts of audio power to modulate the last radio stage of the transmitter.

The operation of the new WFBC is under the direction of B. H. Peace, Jr., Manager, and Beverly Whitmire, Assistant Manager. Mr. Peace is closely associated with the Greenville News Piedmont Company, owners.

From Microphone to Loudspeaker



"THE ABC OF BROADCASTING"

THIS DRAMATIC DISPLAY DEMONSTRATES THE PROGRESS, STEP BY STEP, OF VOICE OR MUSIC FROM THE MICROPHONE AT THE BROADCAST STATION TO THE LOUDSPEAKER IN THE HOME. THE CATHODE-RAY OSCILLOGRAPH IS EMPLOYED TO GRAPHICALLY ILLUSTRATE THE APPEARANCE OF SOUND WAVES WHICH HAVE BEEN TRANSFORMED INTO ELECTRIC WAVES. TWO OF THESE EXHIBITS HAVE BEEN BUILT, ONE OF WHICH IS A PERMANENTLY LOCATED DISPLAY AT THE NBC STUDIOS, RADIO CITY, NEW YORK, AND THE OTHER FORMS PART OF A ROAD SHOW WHICH IS TOURING THE UNITED STATES AT THE PRESENT TIME. UNDER THE DIRECTION OF H. P. KASNER.

THE CAPTION IN THE UPPER LEFT-HAND CORNER SETS FORTH THE FACT THAT "RCA VICTOR IS THE ONLY RADIO MANUFACTURER THAT BUILDS ALL THE RADIO EQUIPMENT FROM THE MICROPHONE IN THE STUDIO TO THE RADIO SET IN THE HOME." ONLY THROUGH PERFECT CO-ORDINATION AND PROPER ATTENTION TO EVERY LINK IN THIS CHAIN CAN GENUINE "HIGH FIDELITY" PROGRAMS BE DELIVERED AT THEIR DESTINATION

THE OP-4 EQUIPMENT

(Continued from Page 13)

tant criterion in a portable amplifier.

A volt-milliammeter is provided on the left-hand side of the panel, Figure 2, together with its switch which permits the checking of plate current in each of the stages and the filament voltage of all the tubes.

A lamp and lamp shield are provided on the Volume Indicator Meter.

The power switch, also located on the left-hand side of the panel, is a four-pole single-throw switch which breaks all power leads to the amplifier. The filament supply to the tubes has been carried separately throughout so that AC operation may be used without any changes in amplifier wiring.

Each transformer and capacitor has a circuit diagram, part number and electrical constants printed thereon. All of the wiring is neatly cabled wherever possible and is arranged for the best service.

The drain on the "A" battery is one ampere at 6 volts. The battery to be used with this equipment has a thirty-eight-ampere hour rating. A separate plug and wiring has been provided in the battery box to facilitate charging without removing the batteries from the box. The "B" battery drain is approximately .015 ampere at 180 volts and the batteries intended have a life of 40 hours.

An AC supply for the OP-4 may be supplied which will fit into the space in the battery box assigned for the batteries. This supply works from

105 to 125 volts, 50 to 60 cycles AC, and will deliver to the amplifier 1 ampere at 6.3 volts for the filaments and .015 ampere at 180 volts for the plate supply.

This completes the new RCA Victor OP-4 Portable Broadcast Amplifier as designed after considering the answers from the operators to the questionnaires. It is a unit admirably suited for portable use, with all the advantages of the high-quality system now predominant in studio amplifiers. This equipment is a complete studio rack in itself and yet is portable in every respect. Because of the modernistic finish, it will fit well into any location and not be an odd black box with queer gadgets to incite the mysterious elements.

A Plea for Better Station Maintenance

By J. E. YOUNG, RCA Victor Transmitter Engineer

A VERY great effort has been made by equipment manufacturers during the past several years to design apparatus in such a manner as to facilitate its maintenance and servicing. Wherever possible, components are made up into readily removable sub-assemblies and many major changes have even been made in fundamental mechanical designs to the end that component units will be more accessible. The complete equipments are carefully checked mechanically and electrically before their sale and again when they reach the ultimate customer. As a result they go into operation in perfect condition.

To maintain the equipment constantly in that same perfect condition becomes the job of the station engineer, and an exacting job it is. Too often careful maintenance is overlooked so long as the apparatus continues to function properly. Then, when a failure of sufficient proportions to attract attention does occur, it is found that the steady deterioration constantly going on in poorly maintained equipment had become so serious as to necessitate costly repairs or even complete replacement.

Proper maintenance requires the correct maintenance equipment, not



J. E. YOUNG, RCA VICTOR

only to keep the station in perfect mechanical condition but also to monitor and check-test its operation. The simplified diagram below shows a common broadcast station set-up and the equipment required to check its operation. It will be noted that this equipment includes at the studio a high-fidelity monitoring amplifier and loudspeaker, and an audio-frequency oscillator of reasonably constant output and low harmonic content over its frequency range. At the transmitter, the monitor equipment

includes a high-fidelity amplifier with a volume indicator and a calibrated attenuator arranged for connection to the circuit at any point between the incoming audio line and the monitor rectifier. The output of the high-fidelity amplifier may be connected to a loudspeaker except when used to operate the distortion factor meter, or except when it is used for frequency characteristic or hum measurements. Low pass filters should be provided at the studio and transmitter to insure that from any desired point in the system only a single frequency will be transmitted, free of all its harmonics. A cathode-ray oscilloscope coupled to the transmitter output provides an accurate check on percentage modulation and a visual check on wave form. A radio-frequency resistance and impedance measuring set insures that the characteristics and adjustments of the transmission line and antenna will always be known.

The intelligent periodic use of this equipment will keep the operating engineer completely informed on the condition of his station equipment. The maintenance of high standards will pay dividends in the shape of longer equipment life, less time off the air and more commendable service.

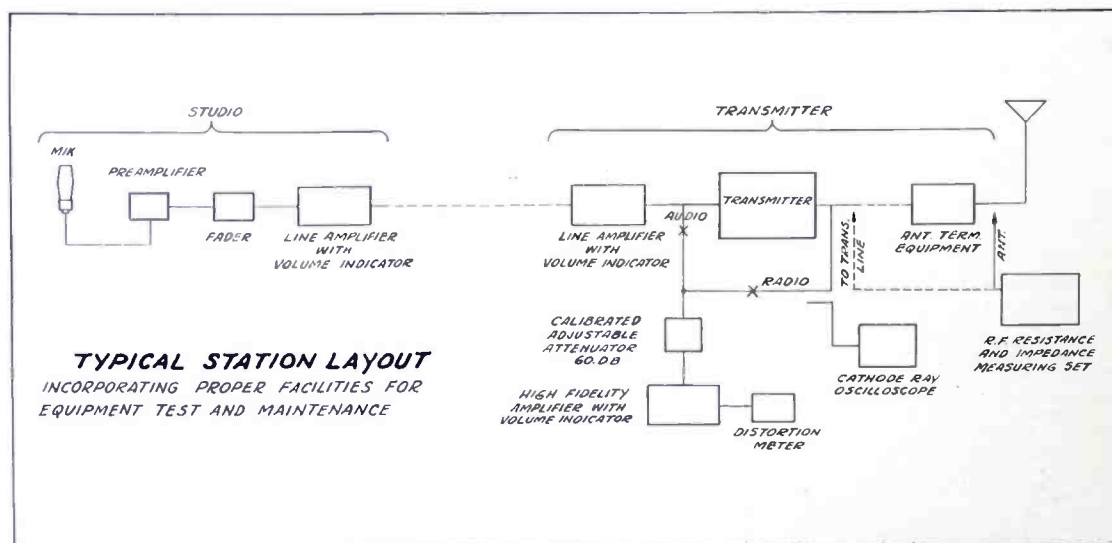

British Television Commission Visits Camden, N. J.



BRITISH TELEVISION COMMISSION HEADED BY LORD SELSDON

LEFT TO RIGHT: MR. LITTLE, BRITISH GENERAL POST OFFICE, E. T. CUNNINGHAM, PRESIDENT RCA VICTOR COMPANY, F. W. PHILLIPS, UNDER SECRETARY, GENERAL POST OFFICE, DAVID SARNOFF, PRESIDENT RADIO CORPORATION OF AMERICA, LORD SELSDON, COLONEL A. S. ANGWIN, CHIEF ENGINEER, GENERAL POST OFFICE, NOEL ASHBRIDGE, ASSISTANT CHIEF ENGINEER, BRITISH BROADCASTING SYSTEM

DISTINGUISHED VISITORS ENJOY TOUR THROUGH "RADIO HEADQUARTERS"

A DISTINGUISHED group of British engineers headed by Lord Selsdon visited the Camden laboratories of the RCA Victor Company today accompanied by Mr. David Sarnoff, President of the Radio Corporation of America, and Mr. E. T. Cunningham, President of the RCA Victor Company. The Commission, which was appointed by the British General Post Office, under whose jurisdiction are all communications services, is here to make a study of television progress in this country.

The visitors included, besides Lord Selsdon, the Chairman, F. W. Phil-

SEE
IMPORTANT NOTICE
ON
PAGE 32

—DON'T FAIL TO FILL OUT
AND MAIL THE COUPON

lips, Under Secretary, British General Post Office; Colonel A. S. Angwin, Chief Engineer, General Post Office; Noel Ashbridge, Assistant Chief Engineer of the British Broadcasting System. While here, the group viewed the experimental television laboratories of the RCA Victor Company under the guidance of W. R. G. Baker, Vice President and General Manager, and Dr. V. K. Zworykin. Later they inspected the new radio facsimile picture transmission apparatus and some of the "Magic Brain" radio factories.

DETROIT ORCHESTRA HALL

(Continued from Page 15)

can, during rehearsals, cut the program coming from the stage, energize the talk-back microphone, and converse with the performers by means of the loudspeaker located backstage. When the switch operating the talk-back circuit is thrown to the talk-back position, relays simultaneously disconnect the monitor speaker in the control booth, connect the talk-back speaker located backstage, disconnect the stage microphone and connect the talk-back microphone to the program amplifier. This sequence of events prevents any

possibility of an audio frequency feedback between loudspeakers and microphones.

The function of the program switch previously mentioned is to connect the input of the program amplifier, and hence the monitor amplifiers and their attendant loudspeakers, either to the output of the stage microphones or to a cue circuit, from which the "air" program preceding or succeeding the auditorium presentation may be heard. The incoming line, upon which the cue is received, is provided with a suitable matching coil and a variable pad, as indicated in the block diagram.

The various component circuit elements which go toward making up the completed circuit connect to each other through jacks which, when normally closed, complete the circuit in the desired manner. This is clearly shown in the accompanying block diagram of the equipment layout. This arrangement provides a jack strip free from patchcords during all normal operations. However, in the event of the failure of any circuit element, it may be jumped out of the circuit by a patchcord, or a similar element may be "patched" into the circuit. The liberal use of "normal through" jacks provides for maximum flexibility, minimum of program interruptions, and for ease in locating defective equipment.

The control room contains a single rack of equipment, a mixer console, a talk-back microphone and regular telephone facilities. The monitor speaker, an RCA UZ-4209, is mounted at one end of the room behind a large baffle. The talk-back loudspeaker, previously mentioned, is mounted backstage in the wings in a similar manner.

As is seen in the photograph, the equipment mounted on the rack consists of a meter panel at the top, an RCA Victor 40-C program amplifier immediately underneath, then a panel carrying the volume controls and matching coils, next a "low-level" jack strip, followed by a "high-level" jack strip, below which are mounted the two RCA Victor AA-4194-B monitor amplifiers. At the very bottom of the rack is mounted a panel which carries the terminal block strips, to which all wiring cables are brought.

A detail of construction, which is commonly employed in the assembly of such speech input equipment racks, is the use of terminal blocks at the base of the rack.

In order to facilitate wiring from the mixer console to the rack and to the various wall boxes, a trench was provided under the floor of the control room for the various wires and cables. The entire equipment was assembled, wired and tested in New York City, crated and shipped to Detroit, and placed in operation in a little more than an hour's time after arrival.

IMPORTANT NOTICE to Our Readers

Due to the increased circulation of BROADCAST NEWS, we wish to announce our new distribution policy. Hereafter, one copy only of BROADCAST NEWS will be mailed direct from "Radio Headquarters" to every Broadcast Station in the United States.

Members of the personnel of each station may obtain individual copies throughout 1935 upon written request to the local RCA Victor District Office, as listed herewith. Changes of address should be included.

We trust that our present readers will understand the necessity for this new system of distribution and will cooperate by communicating directly with our District Offices, as we do not wish any interested persons to miss an issue.

Paid subscriptions will of course continue to be honored.

- 1—EASTERN DISTRICT—T. A. Smith, Manager, 153 E. 24th St., New York City

Maine	Connecticut	Maryland
Vermont	New York	North Carolina (Broadcast)
New Hampshire	Puerto Rico	West Virginia
Massachusetts	New Jersey	Delaware
Rhode Island	Pennsylvania	Virginia
- 2—CENTRAL DISTRICT—H. C. Vance, Manager, 111 North Canal St., Chicago, Ill.

North Dakota	Iowa	Kentucky
South Dakota	Minnesota	Ohio
Nebraska	Illinois	Michigan
Wisconsin	Indiana	Kansas City (Kansas)
Missouri		
- 3—WESTERN DISTRICT—W. H. Beltz, Manager, 235 Montgomery St., San Francisco, Calif.

Washington	Nevada	Alaska (Police)
Oregon	Hawaii (Police)	Montana
California	Utah	Wyoming
Idaho	Arizona	
- 4—SOUTHWESTERN DISTRICT—W. M. Witty, Mgr., Santa Fe Bldg., Dallas, Texas

Texas	Louisiana	Kansas
Oklahoma	(Except New Orleans)	(Except Kansas City)
Arkansas	Colorado	New Mexico
- 5—SOUTHEASTERN DISTRICT—B. Adler, Mgr., 144 Walton St., N. W., Atlanta, Ga.

Tennessee	South Carolina	Mississippi
North Carolina (Police)	Georgia	Florida
	Alabama	New Orleans (La.)

BROADCAST NEWS COUPON Date _____
RCA VICTOR Co., Inc.
(Address to your local District Office)

I wish to be placed on your mailing list to regularly receive BROADCAST NEWS as issued during 1935, without charge.

I am connected with Station _____, located at _____
in the capacity of _____

(Signature) _____

□

THE LATEST ADDITION TO UNCLE SAM'S NAVY

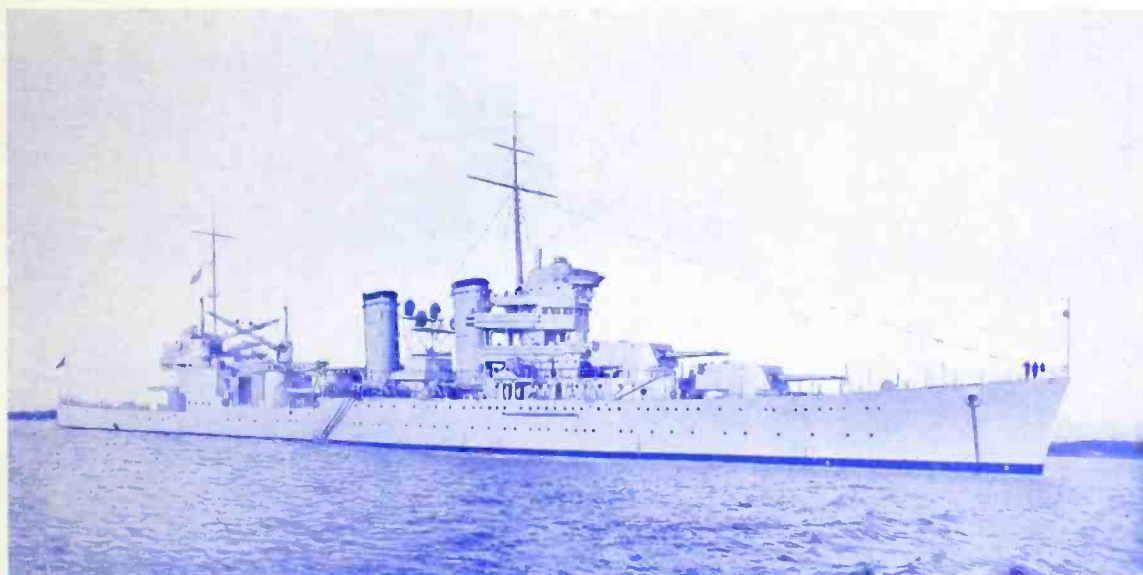

U. S. S. "TUSCALOOSA"—A PRODUCT OF CAMDEN, NEW JERSEY

IN ADDITION TO THE RADIO COMMUNICATION EQUIPMENT, THE RCA VICTOR COMPANY, INC., SUPPLIED THE U. S. S. "TUSCALOOSA" WITH SPECIALLY DESIGNED SOUND MOTION PICTURE EQUIPMENT, AND THE ANTENAPLEX SYSTEM (FOR MULTIPLE BROADCAST RECEIVERS). CHIEF RADIOMAN ALLAN SINCLAIR, U. S. N. R., OF THE RCA VICTOR TEST DEPARTMENT, WENT OUT IN THE TUSCALOOSA AS OPERATOR ON HER TRIAL TRIP TO ROCKLAND, MAINE

□

A CHRISTMAS PRESENT FOR YOU
ONE WHICH WILL LAST THROUGHOUT 1935



SEE



IMPORTANT NOTICE

ON PAGE 32

— FILL OUT AND

MAIL THE COUPON

NOW