

MAY 7 1935

BROADCAST NEWS

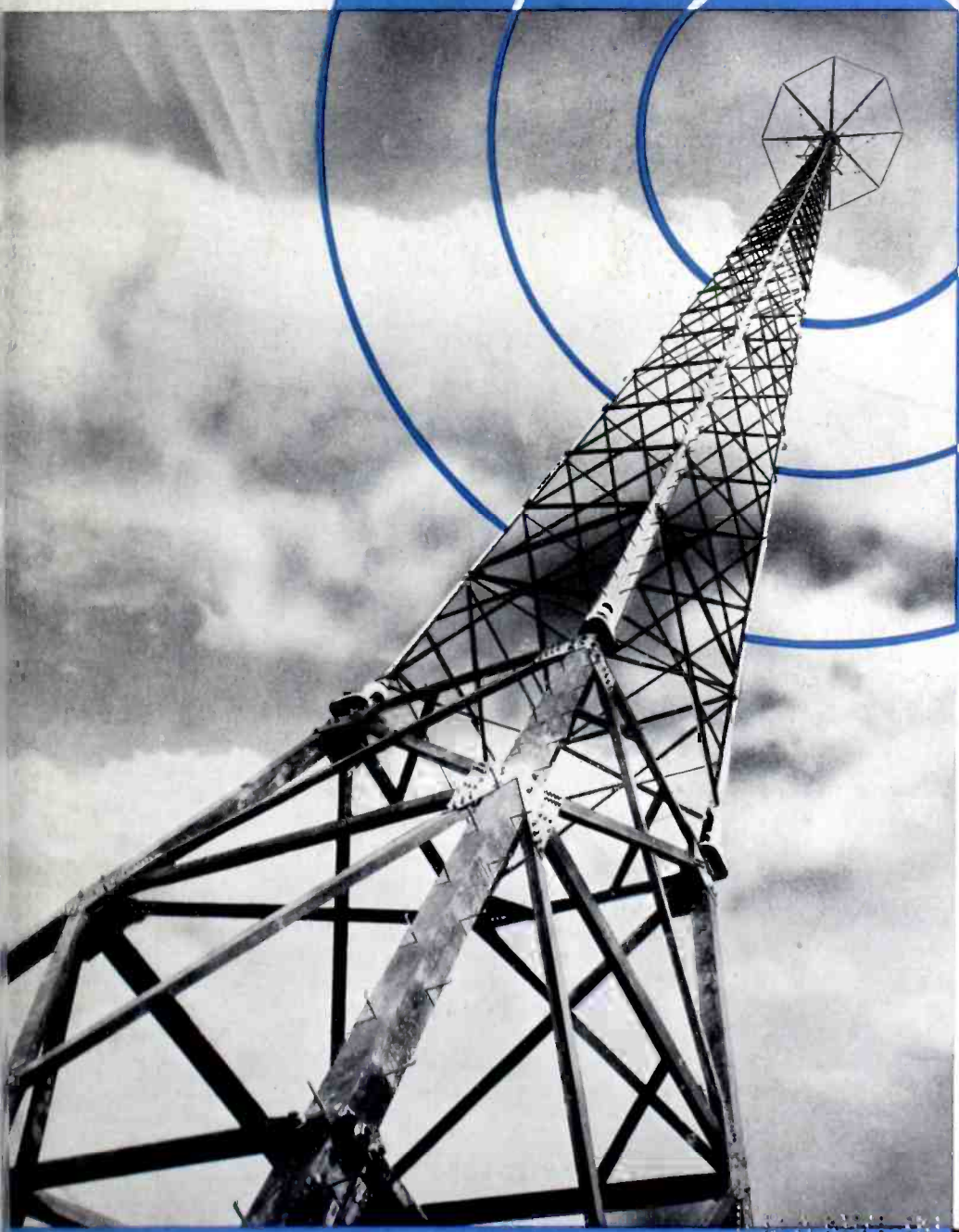

In this issue

BROADCAST TOWER ANTENNAS

By Dr. G. H. Brown and H. E. Gihring

RCA Manufacturing Company, Incorporated, Camden, N. J.
NUMBER 15 PRICE 25 CENTS APRIL 1935



RCA Manufacturing Company, Inc.
A Radio Corporation of America Subsidiary
Camden, N. J.

"RADIO HEADQUARTERS"

DAVID SARNOFF, Chairman of the Board
 E. T. CUNNINGHAM, President G. K. THROCKMORTON, Executive Vice-President

L. B. MORRIS, Vice-President and General Counsel	J. M. SMITH, Vice-President in Charge of Manufacturing, RCA Radiotron Div.	P. G. McCOLLUM, Comptroller
W. R. G. BAKER, Vice-President and General Manager, RCA Victor Division	J. T. CLEMENT, Vice-President in Charge of Washington, D. C., Office	E. J. SCHNEIDER, Assistant Comptroller
J. C. WARNER, Vice-President and General Manager, RCA Radiotron Div.	J. D. COOK, Treasurer	F. H. CORREGAN, Secretary
J. W. BURNISON, Vice-President in Charge of Mfg., RCA Victor Division	E. F. HAINES, Assistant Treasurer	DAVID MACKAY, Assistant Secretary
	F. H. TROUP, Assistant Treasurer	C. B. MYERS, Assistant Secretary
		H. TROUP, Assistant Secretary

F. R. DEAKINS, Manager
 ENGINEERING PRODUCTS DIVISION

TRANSMITTER SALES SECTION
 (OF ENGINEERING PRODUCTS DIVISION)

I. R. BAKER, Manager

S. W. GOULDEN, Commercial Engineer	T. A. SMITH, C. B. S. Contact
J. P. TAYLOR, Sales Engineer	C. L. BEACH, N. B. C. Contact
BEN ADLER, Power Tube Sales	T. W. ENIS, Power Tube Sales
P. A. ANDERSON, Police Radio Sales	

E. JAY QUINBY, Engineering Products Advertising

- EASTERN DISTRICT**—T. A. Smith, Manager, 1270 Sixth Ave., New York City; R. P. May, Assistant

MAINE	RHODE ISLAND	NEW JERSEY	WEST VIRGINIA
VERMONT	CONNECTICUT	PENNSYLVANIA	DELAWARE
NEW HAMPSHIRE	NEW YORK	MARYLAND	VIRGINIA
MASSACHUSETTS	PUERTO RICO	NORTH CAROLINA (Broadcast)	
- CENTRAL DISTRICT**—H. C. Vance, Manager, 111 North Canal St., Chicago, Ill.; B. A. Wilson, Assistant

NORTH DAKOTA	MISSOURI	ILLINOIS	OHIO
SOUTH DAKOTA	IOWA	INDIANA	MICHIGAN
NEBRASKA	MINNESOTA	KENTUCKY	KANSAS CITY (KANSAS)
WISCONSIN			
- WESTERN DISTRICT**—W. H. Beltz, Manager, 235 Montgomery St., San Francisco, Calif.; Edmund Frost, Assistant

WASHINGTON	IDAHO	UTAH	MONTANA
OREGON	NEVADA	ARIZONA	WYOMING
CALIFORNIA	HAWAII (Police)	ALASKA (Police)	
- SOUTHWESTERN DISTRICT**—W. M. Witty, Manager, Santa Fe Bldg., Dallas, Texas.

TEXAS	ARKANSAS	KANSAS (Except Kansas City)	NEW MEXICO
OKLAHOMA	LOUISIANA (Except New Orleans)	COLORADO	
- SOUTHEASTERN DISTRICT**—D. A. Reesor, Manager, 144 Walton St., N. W., Atlanta, Ga.

TENNESSEE	SOUTH CAROLINA	ALABAMA	FLORIDA
NORTH CAROLINA (Police)	GEORGIA	MISSISSIPPI	NEW ORLEANS (L.A.)

BROADCAST TRANSMITTERS POWER RADIOTRONS
 POLICE TRANSMITTERS POLICE RECEIVERS

SPECIAL COMMUNICATION EQUIPMENT

AMPLIFIER

BROADCAST NEWS

PAT. OFF. REG. U. S.

Edited by
E. JAY QUINBY

NUMBER 15

APRIL, 1935

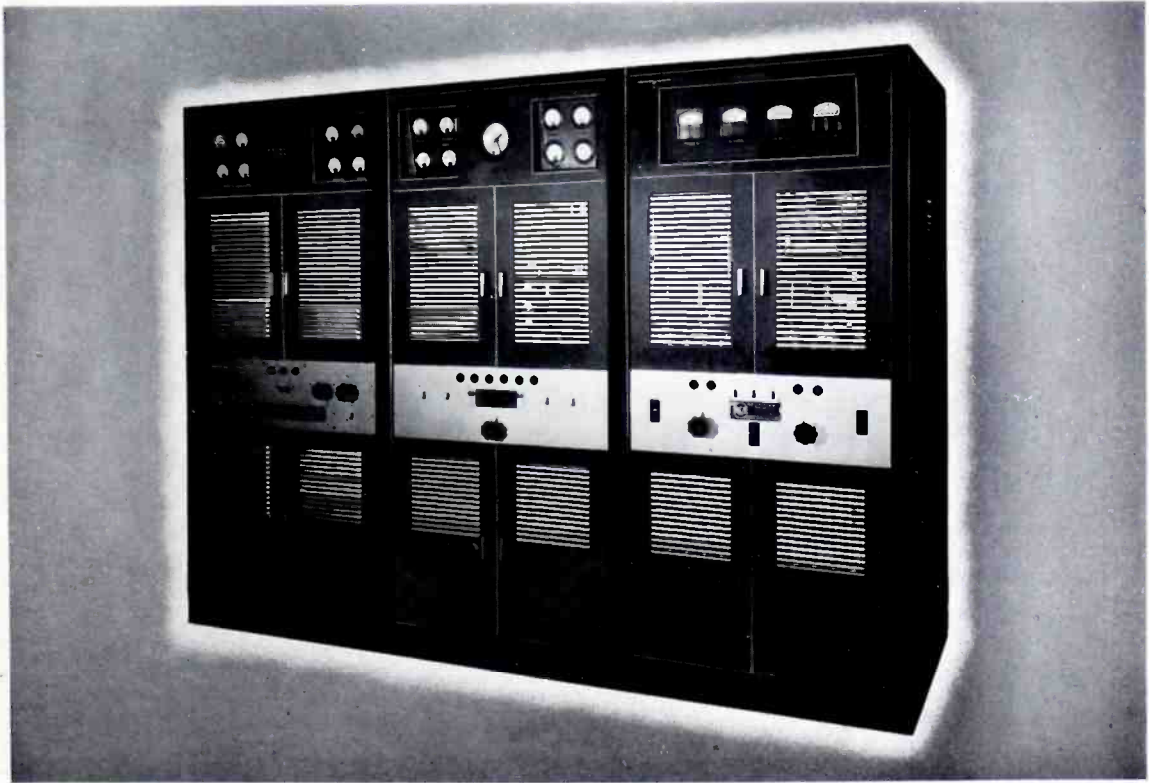

"HIGH FIDELITY"

THE NEW RCA TYPE 5-C BROADCAST TRANSMITTER
FOR 1/2.5, 1/5 AND 5 K.W. STATIONS



Published Bi-Monthly in the Interest of the Radio Broadcasting Industry
and Copyrighted, 1935, by the
RCA MANUFACTURING COMPANY, INC.
CAMDEN, NEW JERSEY, U. S. A.

Direct Reading and Averaging of Signal Intensities

By JOHN P. TAYLOR, Radio Engineer, RCA Manufacturing Company

LIKE all portable field intensity measuring equipment, the RCA Type TMV-75-B Field Intensity Meter is intended primarily for survey work in the field. In its design the requirements for such use have been given first consideration. The method of making readings and computing results has been made as convenient as the requirements of accuracy permit. Field strengths in microvolts per meter are given by the relatively

simple formula $F = \frac{R \times A \times C}{f}$ where A

is the attenuator ratio used, R the output meter reading, C the constant for the loop used, and f the measured frequency in kilocycles. In surveying the coverage of a particular station, C and f are, of course, fixed and even A will be changed infrequently. The computation of results is thus very simple. Moreover, since these measurements are for the most part



FIGURE 1—THE AUTHOR, WORKING UNDER TEMPORARY DIFFICULTIES, DEMONSTRATES THE CONVENIENCE OF THE ARRANGEMENT DESCRIBED IN THIS ARTICLE

confined to near-by areas, it is usually only the ground wave which is measured. The signal under such conditions is steady and a single reading is all that is required for complete accuracy.

Measuring Many Stations

The writer has, however, had occasion recently to use a TMV-75-B Equipment under quite different conditions—conditions which make even the simple computations involved seem overly tedious. This situation arose when it was desired to use this equipment, not just for making a survey of a single station, but rather for measuring the signal strength, fading, etc., of a large number of stations at a semi-fixed point, and to estimate the variation in signal quality of these stations over various periods of time. For example, it was in one instance desired to measure the variation of signal strength throughout a full day of some half dozen stations. This involved measuring each in turn at frequent intervals. In

that case, the necessity of making successive measurements at different frequencies would at once double the amount of slipstick pushing involved. Moreover, these stations were all several hundred miles distant so that their signals constantly fluctuated in a manner which could only be properly taken into account (in the absence of complicated recording equipment) by averaging a number of readings. To compute the signal strength for each such reading would have involved a tremendous amount of labor. To average the readings and then compute the signal strength would have been somewhat less work, but would have the disadvantage that such items as the maximum and minimum field strength would not be immediately available when wanted. It seemed obvious, therefore, that some means of reading field intensities directly would have to be contrived—and, if possible, some way of easily averaging them as well. After some experimenting an arrangement was arrived at which

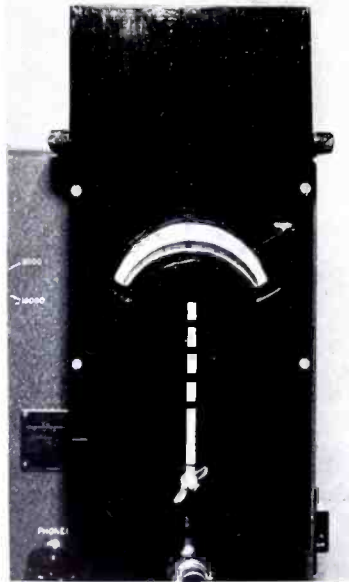

FIGURE 6—VIEW OF THE MOVABLE APERTURE PLATE WHICH CONVENIENTLY PROVIDES THE METER WITH THE VARIOUS SCALES REQUIRED

WLW Jan. 24 '35		
8:30 PM	1	5.5 0
		9.5 0
	1	1.5 0
	1	7.2 0
	1	3.5 0
	1	4.5 0
		8.5 0
	1	2.5 0
	1	1.5 0
		7.0 0
	1 2	1.2 0 *
		#
8:45 PM	2	1.5 0
	2	0.5 0
	2	3.0 0
	1	7.5 0
	1	5.5 0
	1	8.5 0
	1	7.0 0
	1	9.5 0
	2	1.5 0
	2	0.5 0
	1 9	5.0 0 *
		#
9:00 PM	2	1.0 0
	2	3.5 0
	2	0.5 0
	2	2.0 0
	1	8.0 0
	1	9.5 0
	1	6.5 0
	1	5.5 0
	1	3.0 0
	1	0.5 0
	1 8	0.0 0 *
		#
9:15 PM	2	1.5 0
	2	2.0 0
	2	3.0 0
	2	8.5 0
	2	9.5 0
	3	1.0 0
	2	9.0 0
	2	6.5 0
	2	2.0 0
	2	3.0 0
	2 5	6.0 0 *
		#

FIGURE 7—A SAMPLE RECORD, SHOWING THE FIELD INTENSITIES OF STATION WLW, FROM 8.30 P. M. TO 9.15 P. M. (M. S. T.), JANUARY 24, 1935

would accomplish this in quite simple fashion.

It necessitates an hour or two of preparatory work—in making the direct-reading scale—but it saves that a hundred times over whenever a large number of measurements have to be made. The saving in tedious labor will particularly appeal to those who, like the writer, are constitutionally opposed to unnecessary slip-stick pushing—for, if the scale given here is made use of, all slide-ruling is eliminated. While there is nothing particularly ingenious about it, nor anything, perhaps, which could not be done better some other way, this arrangement does have the advantage of having been tried and found satisfactory. Armchair engineers should find it handy as—using the information given here—they can have the scale made up in the nearest shop, and thus avoid the headache of devising and constructing one of their own design.

A Direct Reading Scale

As noted above, field intensity as read on the TMV-75-B Meter, is equal to the product of the loop constant, attenuation ratio and meter reading, divided by the frequency. Short-time variations in the field strength of a single station are thus observed on the output meter—the other three quantities remaining constant for such small variations. This output meter is simply a d-c microammeter with a scale slightly altered to correct for the small departure from linearity which occurs in the diode rectifier circuit of which it is a part. The output voltage and hence the signal intensity is, of course, directly proportional to the reading of this meter—but the scale divisions are, of necessity, arbitrarily chosen. Despite this arbitrary marking it soon becomes apparent when using the instrument that, for certain frequencies, there is a very simple relation between the scale markings and the measured signal. For instance, at 700 kc. this relation is always a whole number. Thus at

this frequency, if the attenuation ratio is—for example—20, then multiplying the meter reading by four gives the field intensity in microvolts per meter. This coincidence immediately suggests consideration of the possibility of devising a direct-reading scale for all frequencies. Obviously, it is quite easy to make up a scale for any one particular frequency. But if such a scale is considered for each frequency that it might be desired to measure, it is apparent that the number of these required would be out of all reason—one hundred being necessary for the broadcast band alone. On the other hand, if a single scale is used for the whole broadcast band the possible error (assuming use of the scale figured for 1000 kc. will be plus or minus 50 percent. Fortunately, a reasonable and useful compromise is possible. In the arrangement adopted by the writer such a compromise is accomplished by the use of eight scales. The frequencies to which these scales correspond are: 450, 520, 600, 700, 850, 1040, 1250 and 1500 kilocycles, respectively. These frequencies have been chosen so that the maximum error which will accrue due to using the nearest of them in measuring an in-between frequency will be less than 10 per cent. In this type of measure-

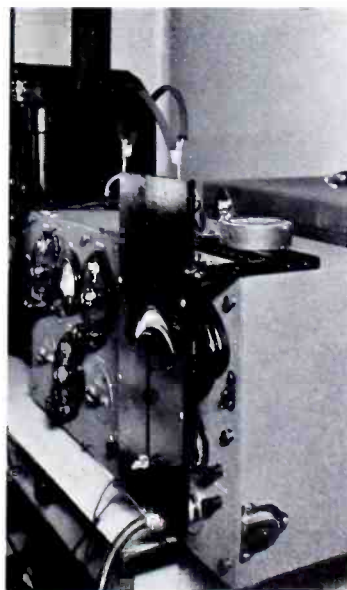

FIGURE 5—THIS VIEW SHOWS HOW THE ADJUSTABLE SCALE DEVICE IS APPLIED TO THE RCA TMV-75-B FIELD-INTENSITY METER

ment this is not an appreciable error.

The frequencies above cover, of course, only the broadcast band. It seemed desirable to use the same scale for the high-frequency bands as well—and fortunately this was found, after some figuring, to be feasible. It was accomplished by making use of the fact that these different scales are proportional, not just to frequency alone but rather to the ratio of C (the loop constant) to the frequency. As C changes with the change of bands approximately as the band limits, this works out quite well. For bands B and C the meter reads directly—for band D the scale reading needs simply to be multiplied by two. The frequencies in the higher bands which correspond to those listed above are:

Band A	Band B	Band C	Band D
450	1660	5250	11830
520	1920	6070	13700
600	2210	7000	15850
700	2580	8170	18450
850	3130	9930	
1040	3840		
1250	4600		
1500			

Thus any frequency in the range of the TMV-75-B Meter (550 to 20,000 kc. can be measured with these eight scales with an error due to scale no greater than 10 percent. Moreover, these eight frequencies have been chosen so that there is a high-fre-

quency scale to correspond closely with each of the special bands marked on an all-wave receiver. In order these are:

1660 KC for the lower police band
 1920 KC for the 160m. amateur band
 2580 KC for the higher police band
 3840 KC for the 80m. amateur band
 6070 KC for the 49m. broadcast band
 7000 KC for the 40m. amateur band
 9930 KC for the 31m. broadcast band
 11830 KC for the 25m. broadcast band
 13700 KC for the 20m. amateur band
 15850 KC for the 19m. broadcast band
 18450 KC for the 16m. broadcast band

Thus as a direct result of this particular choice of scale frequencies, eleven of the sixteen higher frequencies which correspond fall almost precisely on the bands of the high-frequency spectrum in which a majority of measurements will ordinarily be made. This means that for the most part the error introduced by the scale will be far less than the probable error in reading.

The eight scales chosen are carefully drawn one above another on a 5-by-7-inch paper, as shown in Figure 2. Half-moon slots are cut in the paper as shown, so that the meter needle may be correctly observed with relation to any one of the scales.

Three ranges of field intensity are marked on each scale. These correspond to the 5, 20 and 100 settings of

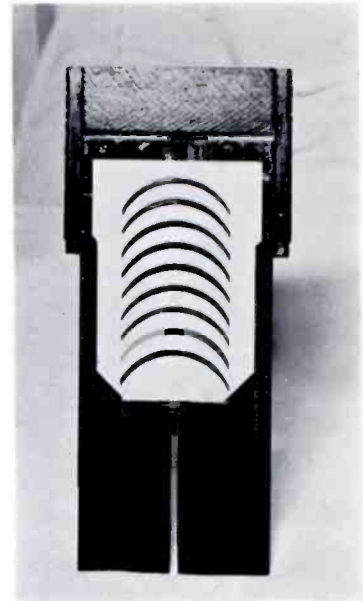

FIGURE 4—THE ADJUSTABLE SCALE ARRANGEMENT DEvised BY THE AUTHOR

the attenuator. Readings for these ratios are, therefore, direct—the range so covered—from average noise level to several millivolts—covers the entire range ordinarily used in this type of observation. Readings at other ratios are almost as easily made simply by setting the decimal point left or right on one of the three marked

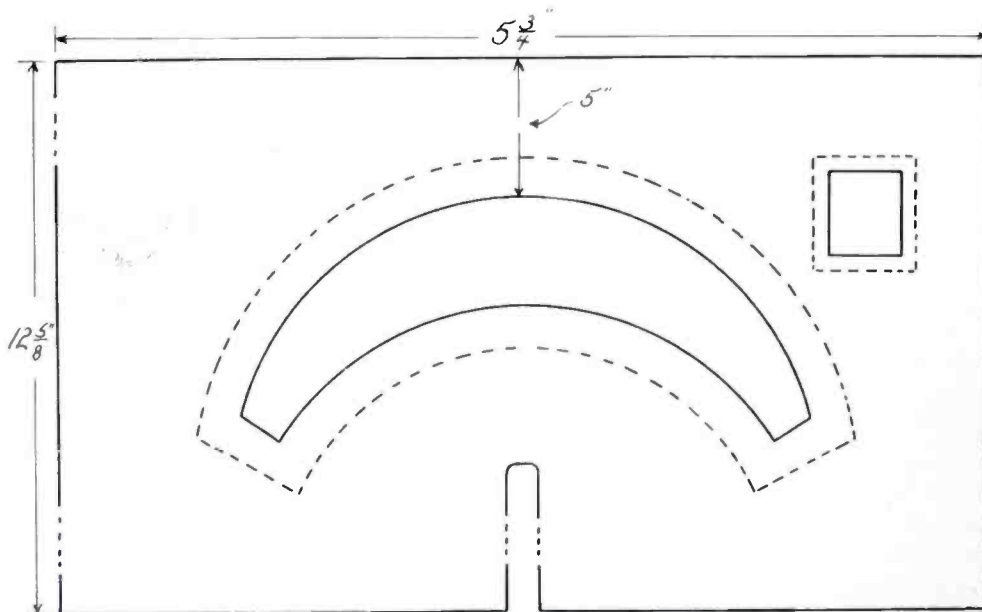
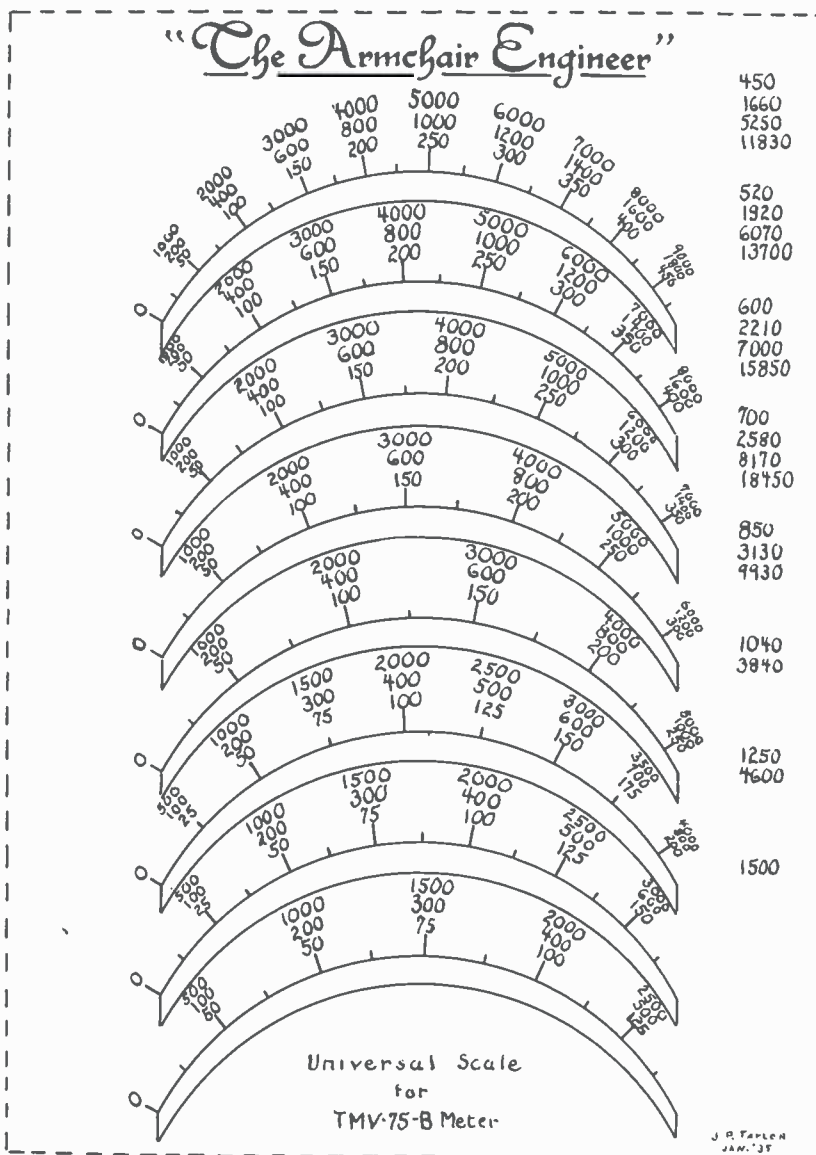

FIGURE 3—THE FIXED APERTURE PLATE, WHICH SERVES TO DISCLOSE ONLY THE DESIRED SCALE AT ONE TIME, AND CONCEAL THE OTHERS

scales. Thus it is possible to read directly from these scales any intensity from 20 microvolts to 5 volts at any frequency from 550 KC to 20,000 KC—i. e., the complete range of the instrument.

After the scales have been marked and the slots cut out (it is best to do this with a sharp blade, as scissors tend to stretch the paper), the paper is glued to a 1/16-inch glass of the same dimensions. (To be obtained from 5 by 7-inch photo holder mentioned below.) As the paper must be held tightly and must lie flat, this is no cinch—but with a little care, it can be accomplished. The writer put the paper on the top of the glass—however, a very clear, thin varnish might be used to attach the paper to the back instead, thus somewhat reducing the parallax in reading.

The scale having been finished, means are required for holding it in place over the output meter. The mounting contrived to do this is fairly well illustrated in the several accompanying views (Figures 4, 5, 6). (The photographs accompanying this writing are of the first model of the scale which was made for the broadcast band only. The final model differs in that the opening for the frequency designation is larger and, of course, the scale is different.) It was made from a boxboard and the parts of a photo holder from the dime store. (These holders are sold with pictures of popular radio idols—be sure to select one of your pet animadversions, as the pleasure to be derived from tearing the same into very small pieces should not be missed.) The board is cut as shown in Figure 3, so that when the scale glass is slid up and down behind it only one scale, with its accompanying slot, comes into view at a time. The small square hole simultaneously brings into view the frequencies for which the scale in view is calibrated. The two sides of the picture frame are fastened to the rear of the panel (see Figure 5) to form the retainers for the glass slide. Incidentally it is well to glue thin strips of cardboard at either side of the glass to bear the brunt of the wear. A sliding catch consisting of a small block of wood, a bolt and a



THIS FULL SIZE SCALE MAY BE CUT OUT AND USED AS IS

wing-nut provides a means of raising and lowering the scale-glass from the front, and of holding it at the wanted position. A bracket for holding the board and scale is made from the two uprights and the base of the holder. These are rearranged as shown in Figure 5 so that they form an arm which can be rested on the top of the meter case—being held there by placing a weight or a book on top. This may be slack engineering, but it does have the advantage that it can be removed easily—and it is really just as effective as a permanent mounting.

Moreover, the arm may be folded flat (see Figure 6) and the whole thing placed conveniently in the battery box.

The scale, as actually made by the writer, has been described here in detail, as this information will allow its being duplicated by a carpenter or machinist without further planning. While each TMV 75 B Meter is hand calibrated, the differences between scales of different instruments are very small, so that the template for the scale which is printed here can

(Continued on Page 36)

RCA Cathode Ray Oscillograph

By J. P. ALLEN, Service Engineer, RCA Manufacturing Co.

THE Cathode Ray Tube is an electronic device which perhaps will be as important to the radio industry in the future as the vacuum tube has been in the past. While its present stage of development concerns mostly its application in test equipment, its extreme versatility enables one to visualize innumerable uses for the future.

Possibly the most important use today of the cathode ray tube has been in the development of test equipment such as the RCA Cathode Ray Oscillograph. In this field its applications have consisted of visual presentation of innumerable alternating current electrical phenomena. For such purposes, it is ideal, as not only visual voltage variations are noted, but phase shifts, wave shapes, distortion, percentage modulation and many other characteristics are visually presented.

To properly utilize the cathode ray tube for many of these uses, certain auxiliary equipment is necessary. This equipment consists of power supplies, timing oscillators, vertical and horizontal amplifiers and proper controls to facilitate circuit connections. The combination of this various equipment into one compact unit, small enough for portability, is an engineering feat of first magnitude. That it has been successfully done is a tribute to the RCA Victor engineering organization.

For the benefit of those engineers not entirely familiar with the operation of the cathode ray tube, a brief elementary explanation of the manner in which it functions may be of interest. Actually, its operation is extremely simple, it being merely a voltmeter that also records time.

Cathode Ray Tube

The cathode ray tube has often been called the "electron gun," as this in effect describes its functions. Figure 1 shows an elementary diagram of the tube.



J. P. ALLEN, RCA MFG. CO.

For the purpose of understanding the action of the "electron gun," one may consider the cathode as emitting electrons which are accelerated by the high-voltage anodes and which strike the fluorescent screen at the end of the tube, thereby creating light. The course of the electrons is controlled by the two sets of deflecting plates, one for horizontal deflection and one for vertical deflection. The amount of deflection, which controls the location of the light-spot on the screen, is a direct function of the voltage at any particular instant on the deflecting plates.

From the foregoing it is seen that a pattern of light may be traced on the screen by the simultaneous appli-



RCA CATHODE RAY OSCILLOGRAPH TYPE TMV-122

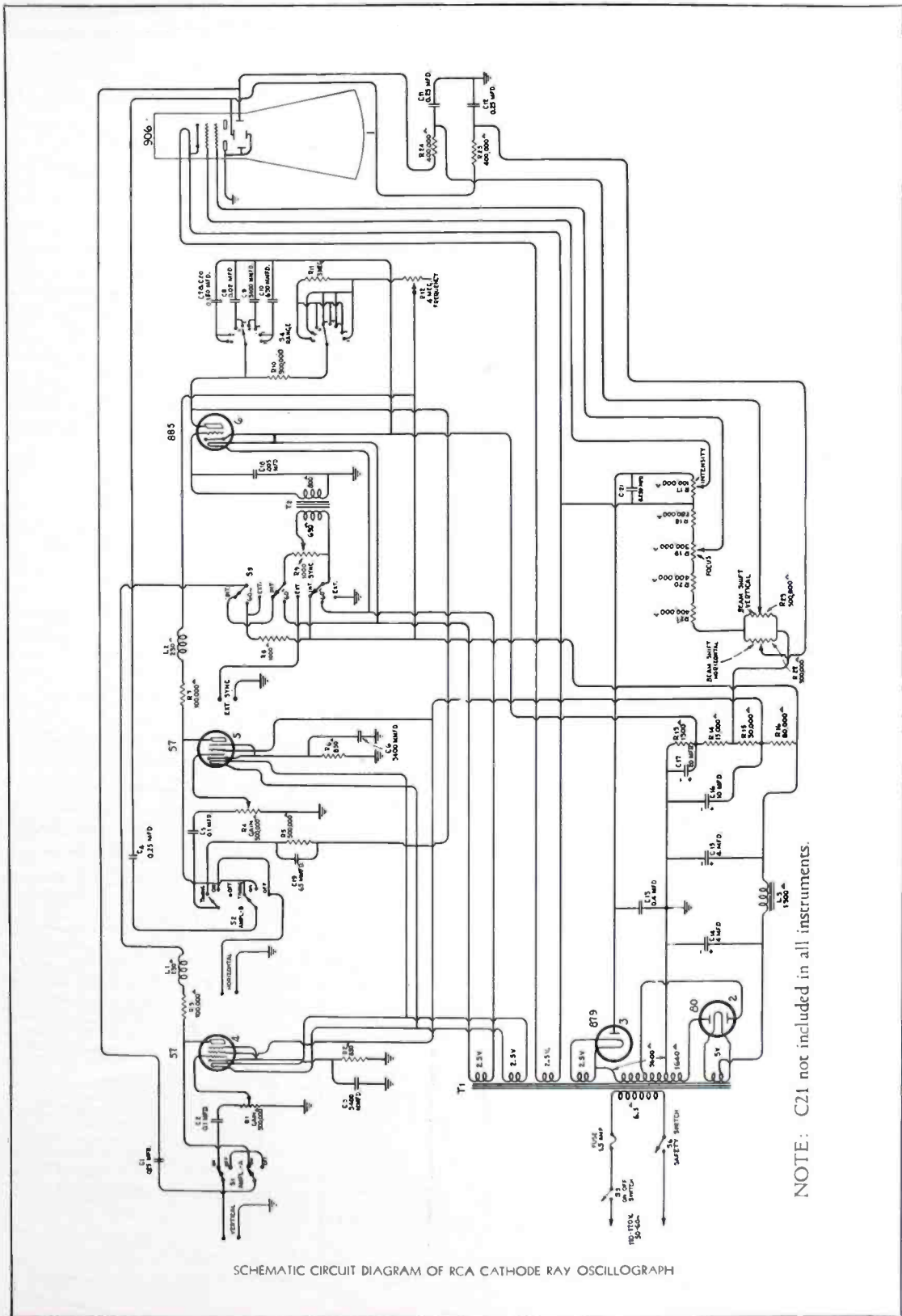

SCHEMATIC CIRCUIT DIAGRAM OF RCA CATHODE RAY OSCILLOGRAPH

NOTE: C21 not included in all instruments.

cation of voltages to the horizontal and vertical deflecting plates. If this action is repeated twenty or more times per second, the persistence of the eye is such that the tracing will not be discernible and the entire pattern will be seen.

Focusing of the light beam on the fluorescent screen is accomplished by adjusting the ratio of the two anode voltages. The intensity of light is controlled by the negative voltage applied to the grid.

Linear Horizontal Oscillator

The external voltage under test is always connected to the vertical deflecting plates. However, unless a means is provided for moving the beam simultaneously in a horizontal direction, a beam rising and falling

across the screen. See Figure 2. The frequency of the oscillator must have a definite relationship to the frequency of the voltage under test. For example, to examine one cycle, the saw-

tooth oscillator must be the exact frequency of the voltage under test. If the saw-tooth oscillator is one-half of the frequency of the voltage under test, then two cycles will be shown on the screen at one time.

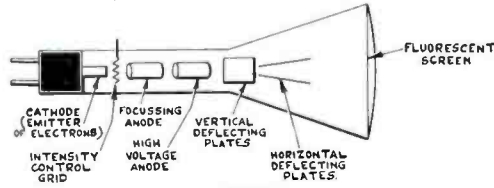

FIGURE 1

With the saw-tooth oscillator pro-

drop in voltage, will be positive and in phase with the voltage under test. The ripple voltage is of course a portion of the voltage under test.

Amplifiers

The sensitivity of the cathode ray

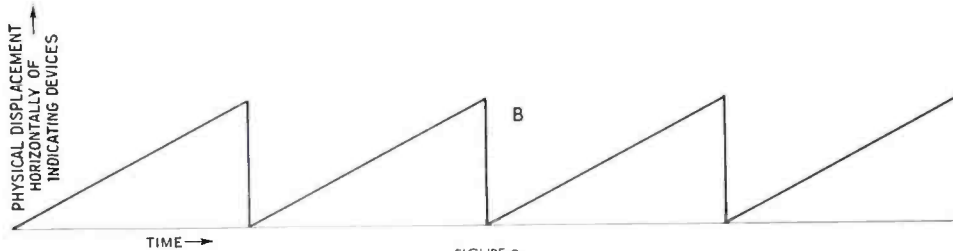

FIGURE 2

vertically will be obtained. As this would merely give an indication of the maximum voltage available, a means must be provided for simultaneously deflecting the beam horizontally. For this, the so-called variable frequency "saw-tooth" oscillator is necessary. The "saw-tooth" refers to the wave shape of the oscillator and is required because of the necessity for having the horizontal deflection increase in a linear manner and then abruptly return to zero and again shift

vided in the TMV-122B, the minimum number of cycles for the highest frequency is six, being obtained when a 90,000-cycle voltage is observed with the saw-tooth oscillator at 15,000 cycles. Higher frequencies may be examined by connecting directly to the vertical plates and using an external timing oscillator.

To prevent the image from drifting across the screen, it is necessary to synchronize the saw-tooth oscillator with the voltage under test. Syn-

chronizing is accomplished by introducing a certain amount of ripple voltage on the saw-tooth oscillator so that the breakdown of the RCA-885 oscillator tube, which causes the rapid drop in voltage, will be positive and in phase with the voltage under test. The ripple voltage is of course a portion of the voltage under test.

Designing an amplifier circuit of such wide frequency range is a difficult engineering problem. Its solution greatly increases the flexibility of the equipment.

Power Supply

The high voltage anode of the cathode ray tube requires 1200 volts DC for proper operation. Also DC voltages are required for the amplifier. The RCA-879 rectifier is used in a half-wave rectifying circuit for providing the necessary anode voltage for the RCA-906. The RCA-80, connected in a full-wave rectifying circuit, provides plate and grid voltages for the two RCA-57 amplifiers. While a single transformer is used for both

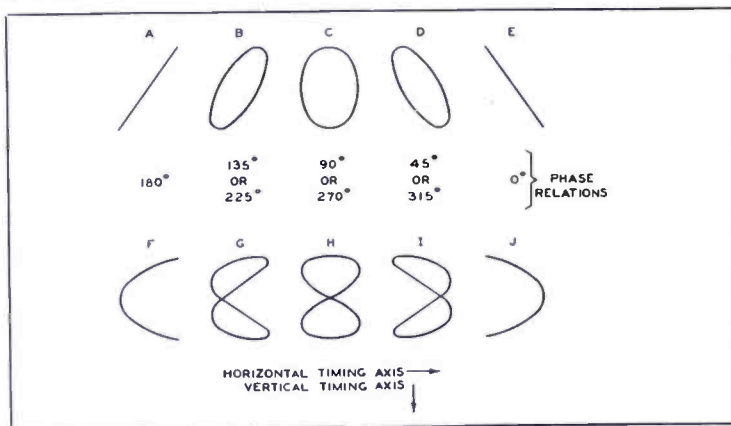

FIGURE 3

A	B	C	D	E	PHASE RELATIONS
180°	135° OR 225°	90° OR 270°	45° OR 315°	0°	
F	G	H	I	J	

rectifiers, individual filter circuits are provided. The transformer is oversized to prevent stray magnetic leakage that would otherwise affect the operation of the cathode ray tube.

General Applications

The most universal method of employing a cathode ray tube is to impress the voltage to be observed on the vertical deflecting plates and to impress a voltage varying linearly with time on the horizontal axis. The latter voltage is usually obtained from an oscillator having a "saw-tooth" characteristic, as in Figure 2. The true wave form of the signal on the vertical axis can then be observed without distortion, since none is introduced by the horizontal signal source. The conventional procedure

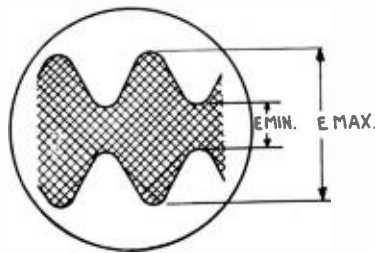

R. F. Modulated at 1000 Cycles
 Timing Axis Supply: 500-Cycle Saw-Tooth
 Percent Modulation = $\frac{E_{MAX.} - E_{MIN.}}{E_{MAX.} + E_{MIN.}} \times 100$

FIGURE 4

value, it is usually desirable to synchronize the timing axis oscillator. For the observation of transient phenomena the timing axis supply frequency is, of course, not critical and

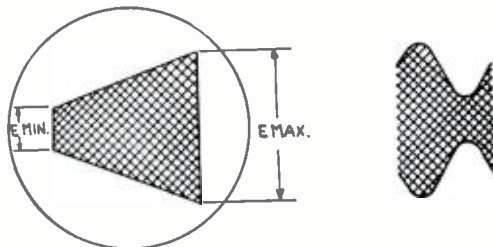

Timing Axis Supply—The Modulating Signal
 Percent Modulation = $\frac{E_{MAX.} - E_{MIN.}}{E_{MAX.} + E_{MIN.}} \times 100$

FIGURE 6

when observing recurrent phenomena is to operate the timing axis supply at a sub-multiple of the observed frequency, so that several complete cycles will appear on the screen. Since the image will drift across the screen unless the ratio of the two frequencies remains constant and of a certain

synchronizing is often useless. In some cases, however, it is desirable to synchronize the start of the phenomenon with a timing axis impulse.

Although use of a linear timing axis is fairly general, there are quite a few applications of the tube which do not employ one. If a sine-wave source of known frequency is impressed on one axis, a variable frequency source can be impressed on the other axis and calibrated at a number of points other than the known frequency. The phase shift in an electrical device can be observed by impressing the input on one axis and the output on the other axis. If there is 0 or 180-degree phase displacement in the unit, a sloping straight-line image will appear. Refer to Figure 3, (A to E). If the above electrical device happened to be a frequency doubler, Figures 3F and 3J would apply.

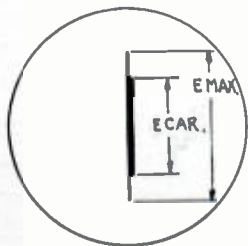

Timing Axis Supply None
 Percent Modulation = $\frac{E_{MAX.} - E_{CAR.}}{E_{CAR.}} \times 100$

FIGURE 5

Either set of deflecting plates can be used as a peak voltmeter. The impedance can be made very high, and the input capacitance very low, so that the voltmeter will show no discrimination between D-C and reasonably high radio frequencies. Transients can be observed almost as effectively with a sine-wave timing axis supply as with a linear one, as in this case the supply functions purely as a "spreader."

Measuring Percentage Modulation

In order to illustrate the flexibility of such apparatus, a desired measurement will be assumed and several methods of obtaining the unknown quantity outlined. An R-F oscillator is being modulated an unknown

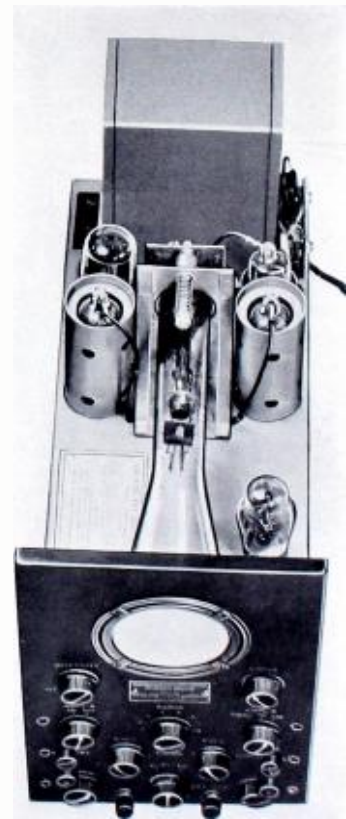

INTERIOR VIEW OF TMV-122 B OSCILLOGRAPH

amount with a 1000 cycle tone, and it is desired to determine the percentage modulation. One method is to observe the modulated R F envelope by impressing either a sine wave or linear supply on the horizontal axis

(Continued on Page 36)

Complete Field Intensity Survey of All NBC Network

By **RAYMOND F. GUY**, Radio Facilities Engineer, NBC

THE National Broadcasting Company recently completed the most comprehensive and complete field intensity survey ever undertaken. Eighteen measuring cars were driven 232,218 miles, throughout 1,250,000 square miles (40% of the area of the United States), to make 21,360 separate field-intensity measurements on ninety stations in only four months' consecutive elapsed time.

The study of the methods of evaluation of coverage, or the "airea" (a new word coined for this purpose), satisfactorily served by a broadcast transmitter, has been in progress for many years. Several factors enter into such a study and each must be given proper weight in arriving at a just and equitable determination. The objective sought and successfully accomplished was a method of commercially evaluating the service rendered, the listeners consistently reached, much as newspapers express their effectiveness in the word "circulation."

Exhaustive Mail Survey

It was obvious that a single factor such as the mapping of the field intensity would probably not in itself be adequate, at present at least, but it was also obvious that the field-intensity survey was a very important factor and could be the starting point.

To give the proper weight to other factors, exclusive of field intensity, the most exhaustive mail survey in the history of radio was made. Audience mail was counted over a period sufficiently long to insure that the figures were not the reflection of a temporary or abnormal condition, but that they constituted proof of a regular, listening audience. Due to the magnitude of the job no one had ever previously attempted to analyze listener mail, county by county for each



RAYMOND F. GUY, NBC

of a large number of stations, except over brief periods. NBC has done so over many months, nearly five million letters having been counted and tabulated in NBC's efficient machine system. One and a half million letters, not especially solicited, were used in this study. These letters were

tabulated, first by station, then by individual counties for each of the ninety stations! If five million letters were stacked vertically they would reach 9,000 feet high. End to end they would reach 400 miles.

It was found that differences between the field intensity and audience mail studies were easily traceable to clearly understandable and identifiable influences. Thus for the first time, radio-station signal strength measurements have been successfully combined with the results of audience mail analyses, perhaps the most important feature of this dual study.

F. R. C. Yardstick

The Federal Radio Commission has established certain "yardsticks" for normal reception, and published data as to the minimum signal strength required in rural areas, in suburban sections and in densely built-up cities. It may be accepted with little question that, except under unusual circumstances, signals as strong as, or stronger than, the minimum set by



ONE OF THE NBC RADIO ENGINEERING CARS IN WHICH THE RCA TYPE 75-B MEASURING SET, RECORDERS, ETC., HAVE BEEN INSTALLED. NBC USES FIVE OF THESE CARS, SIMILARLY EQUIPPED



VIEW INSIDE ONE OF THE NBC RADIO ENGINEERING CARS, SHOWING ONE OF THE FIELD SURVEY MEN OPERATING THE RCA TYPE 75-B MEASURING SET. THE GRAPHIC RECORDER MAY BE SEEN AT THE CENTER OF THE PICTURE, AND OVERHEAD IS THE WHEEL CONTROLLING THE LOOP ANTENNA

the commission supply at least the first requisite for consistent year-round service.

The Commission considers a signal strength of one-tenth of a millivolt per meter adequate for satisfactory reception under favorable conditions. It has been common practice for many years for radio-set manufacturers to market receivers designed to produce satisfactory tone and volume on a signal of one-hundredth of a millivolt (10 microvolts).

NBC set up a standard well above the Commission's minimum figure, only counties receiving 500 microvolts being accepted for primary field strength classification. These county field-strength ratings were then compared with audience mail ratings.

When Equals are Unequals

A station located at a point giving good coverage in all directions, but having competition to the east and not to the west, would show what appears to be improper coverage to the east and exaggerated coverage to the west, although the field intensities in both cases are the same. It is particularly inadvisable to judge the coverage of stations upon a power basis alone since there is large difference in efficiencies due to antenna systems and the positions of the stations in the frequency spectrum. It is quite possible for a one-kilowatt station, engineered to give the best performance with a good frequency, to have as good or better coverage than a five-

kilowatt transmitter making poor use of its possibilities. So far as the listener and the advertiser are concerned, the small station may be doing the better job and worthy of a higher rate of

compensation than the larger station. For the first time radio station signal strength measurements have been successfully combined with audience mail analyses to give proper weight to such factors. The data and conclusions are interesting and valuable in many ways.

Mail Analysis

From an advertising standpoint, primary coverage is of most importance and this may be defined as that area which is adequately served during all hours of the day or evening. Secondary coverage, which may be defined as that obtained only during the evening and night hours, is desirable and important, but is difficult of evaluation and may be considered "bonus" coverage. It became evident early in the NBC study that a fair determination of coverage was going to require field-intensity measurements combined with an audience

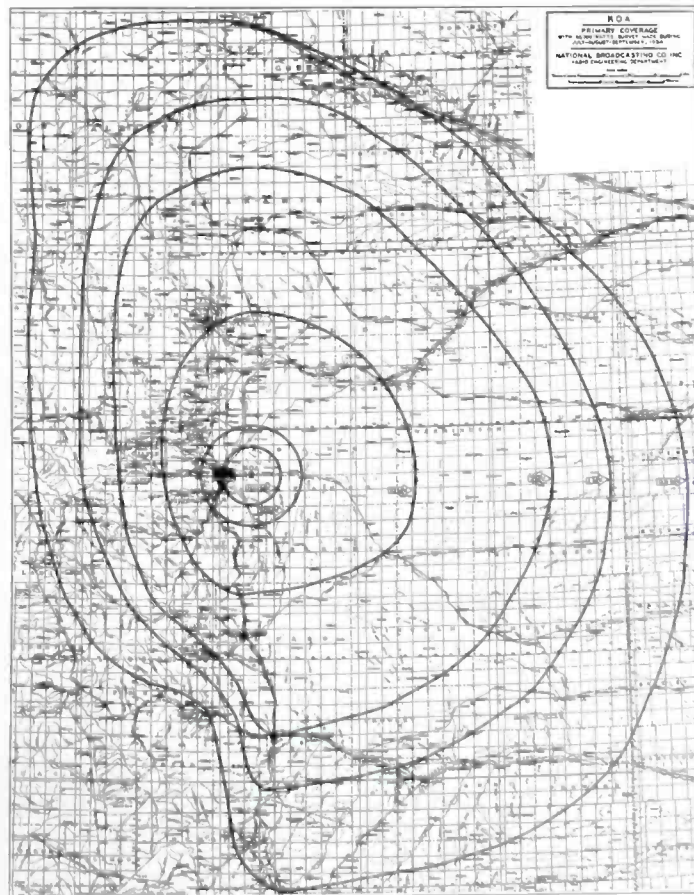

THE PRIMARY COVERAGE OF STATION KOA, DENVER, COLO., USING 50,000 WATTS. THIS SURVEY WAS MADE DURING JULY, AUGUST AND SEPTEMBER, 1934



(ABOVE) NBC MAIL SORTING MACHINE. IN THIS MACHINE MAIL IS SORTED BY PROGRAMS.

(BELOW) THE COMPLETE "LOWDOWN" ON THE PRIMARY AREAS OF THE NBC NETWORKS. 100 SURVEYS, COVERING 1,230,000 SQUARE MILES, OR 40% OF THE UNITED STATES.



(LEFT) AUDIENCE MAIL CODING MACHINE. ALL DESIRED INFORMATION IS EXTRACTED FROM MAIL AND RECORDED BY PUNCHINGS IN CARDS

(ABOVE) ANALYSES SORTING MACHINE. AUTOMATICALLY RECORDS INFORMATION DESIRED FROM CARDS.



(ABOVE) MEASURING THE COVERAGE AREA OF A RADIO STATION BY THE USE OF A PLANIMETER



(ABOVE) AUDIENCE MAIL STAMPING MACHINE

THE BUSINESS OF COMPILING SURVEY STATISTICS

mail analysis for each of the stations involved, to properly determine the coverage of the NBC networks. The decision was made to immediately survey all of the stations operated by or associated with the National Broadcasting Company.

The job undertaken by the NBC Engineering Department was the field-intensity coverage survey of every one of approximately 90 stations out to the 1/2-millivolt contour and the job had to be complete, written up and ready for statistical analysis within four months. It was not believed that there would be many satisfactory coverage surveys available from the stations involved and this turned out to be the case. In order to insure a high standard of accuracy of measurement for every station, any surveys which were in doubt were either checked carefully for accuracy or scrapped altogether and made over by NBC.

Since there were seventeen 50-kilowatt stations, thirty-three of 5 kilowatts or more, ten 2 1/2-kilowatt stations and a considerable number of smaller ones, covering the entire United States and parts of Canada and Mexico, it looked like a whopping big job and so it was.

A better idea of the work involved may be had from the following statistics covering the completed job:

Total number of automobile miles.....	232,218
Total number of recorded observations (not including check measurements or repeats).....	21,360
Number of measuring crews in the field.....	18
Number of square miles covered (40% of the entire United States).....	1,230,000

Procedure

It was estimated that it would take NBC's two staff crews 135 weeks to survey the 90 stations alone. Even had NBC desired to expand its Radio Engineering Staff to a "four-months'-basis" to do the work, the measuring apparatus could not have been procured in time, two months being required for the manufacture of the instruments. Rapidly approaching winter weather conditions along the Canadian border would have prevented any such procedure, and there was the added question of what to do with fifteen extra measuring equipments and automobiles after the one and a half months period.

For several reasons it was decided

to "farm out" the overflow work to the experienced consulting engineering firms known to have the necessary trained personnel and satisfactory equipment ready for immediate action. Their knowledge and expert skill were thus made available immediately for this work.

A map showing all of the network stations was studied and a number of tentative measuring routes were laid out. Since winter weather was approaching it was of great importance that the stations near the Canadian border be surveyed at once with the crews from that point working southward and finishing up at the Gulf of Mexico during the cold weather. A list was prepared of the consulting

engineering crews which inquiry showed to be available. Based on NBC experience with many years of such measurements, a standard form of contract was prepared which specified for stations of various powers a minimum number of measurements, the accuracy of the measurements, the contours to be shown, details covering the maps to be submitted and the reports to accompany them, the price, special arrangements for stations of overlapping service areas, the usual legal points to protect both parties to the contract, plus other miscellaneous specifications.

The stations in Canada and along the Canadian border were a particular cause of concern because snow was already in evidence, so a Chicago firm was assigned immediately along the route parallel to the border to beat

(Continued on Page 35)

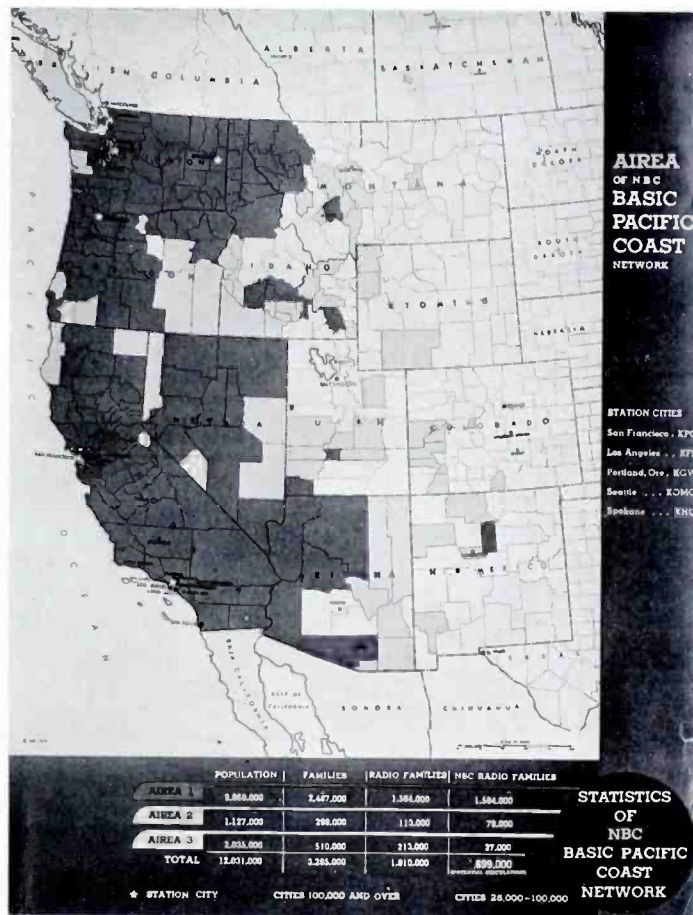

A TYPICAL "AREA" CHART FOR THE WEST COAST DISTRICT, AS PUBLISHED BY NBC. OTHER SIMILAR CHARTS FOR THE OTHER SECTIONS OF THE UNITED STATES ARE INCLUDED IN THE COMPREHENSIVE SURVEY BOOK COMPILED BY THIS ORGANIZATION



R. A. WILSON, WHO RECENTLY JOINED THE TRANSMITTER SALES DEPARTMENT OF THE RCA MANUFACTURING COMPANY, INC., WITH HEADQUARTERS IN THE CHICAGO DISTRICT OFFICE AS ASSISTANT TO HAROLD VANCE, WAS BORN IN BOSTON IN 1905 AND IS A GRADUATE OF THE MASSACHUSETTS INSTITUTE OF TECHNOLOGY. HIS EXPERIENCE INCLUDES ELECTRIC LIGHT AND POWER ENGINEERING AND TRANSMITTER DEVELOPMENT WITH THE WESTINGHOUSE COMPANY. IN RECENT YEARS HE HAS BEEN ACTIVE IN THE FIELD, INSTALLING RCA BROADCAST TRANSMITTERS AND HAS ALSO SPENT CONSIDERABLE TIME DEVELOPING THE NEW RCA LINE OF POLICE, AIRPORT AND BROADCAST TRANSMITTERS.

LET'S GET ACQUAINTED



FRED S. HART, OF RCA BROADCAST TRANSMITTER SALES DEPARTMENT, IS ASSISTANT TO S. W. GOULDEN. BORN IN LONG ISLAND IN 1905, HE RECEIVED HIS TRAINING AT THE UNIVERSITY OF PENNSYLVANIA. HIS ASSOCIATION WITH THE RCA ORGANIZATION DATES BACK TO 1927 WHEN HE JOINED THE ADVERTISING DEPARTMENT. HE WAS TRANSFERRED TO THE ENGINEERING PRODUCTS DIVISION IN 1933.

Broadcasting Personalities

WBT

Because of the great number of visitors that have been storming the studios of Radio Station WBT, Charlotte, N. C., daily and nightly for the past several weeks, this broadcaster has decided to bar all visitors from sustaining programs for the time being.

The limited number that can be accommodated and the detail work that was involved with issuing passes, together with the always-present possibility of disappointing some, led the station to bar all visitors until suitable arrangements can be made for properly caring for them.

On commercial programs visitors are permitted only when the client sanctions it.

A recent happening motivating Manager W. A. Schude into issuing this blanket order, was the visit to a studio by a fat woman, who sat on a turntable for playing transcriptions, and bent it hopelessly out of shape.

J. J. Beloungy, former chief engineer for WPG, Atlantic City, and a veteran radio technician, has joined WBT, 50,000-watt Charlotte, N. C., station as chief engineer.

He replaced Paul Rosekrans, who resigned.

Before serving WPG for a year as chief engineer, Mr. Beloungy was with the Amalgamated network during its lifetime, had engaged in consulting work, and was with NBC at WEAf for eight years. Before entering the commercial radio world, he

was attached to the government ice patrol as a radio man.

This is another story of moving the mountain.

When a client found it impossible to come to the studios of WBT, Charlotte, N. C., to listen to an audition, the commercial department of the broadcaster merely took the audition to the client—nearly a hundred miles distant.

Engineer, announcer, talent and plenty of equipment was loaded in an automobile and upon arriving at the client's office, one room was used for a studio and loudspeakers set up in the adjoining one.

Client liked the audition and signed on the dotted line.



BEN ADLER, WHO NOW BECOMES MANAGER OF POWER TUBE SALES WITH HEADQUARTERS AT CAMDEN. HE WAS RECENTLY MANAGER OF THE ATLANTA DISTRICT OFFICE, IN CHARGE OF BROADCAST TRANSMITTER SALES

KPRC

Mr. Kern Tips has been appointed new Manager of Station KPRC, Houston, Texas, following the resignation of Mr. I. S. Roberts. Mr. Tips comes to KPRC with a background of several years' experience in newspaper work and broadcasting.

WMAZ

At Macon, Ga., Station WMAZ has gone to 1,000 watts. E. K. Cargill is the proprietor.

KTBS

Mr. and Mrs. C. E. Maddox of Shreveport, La., are the proud parents of a young son born March 29th. Mr. Maddox is Chief Engineer of KTBS.

WRVA

An eight-pound daughter joined the family of Bob Eubank, Plant Chief of WRVA, Sunday, February 17, 1935 at 7 P. M.

WIP

Station WIP, Philadelphia, opened its new RCA equipped studios in March and a complete description will be given in our next issue.

FAMILIAR FIGURES
IN NEW SPHERES



D. A. REESOR, THE NEW MANAGER OF THE ATLANTA DISTRICT OFFICE, IN CHARGE OF RCA BROADCAST TRANSMITTER SALES. HE COMES FROM THE CHICAGO DISTRICT OFFICE

New York Transmitter Office Moves

Effective April 29th, the Eastern District Office of the Transmitter Sales Section, managed by T. A. Smith, will be located in the RKO Building, 1270 Sixth Avenue, New York—which is in "Radio City."

WFIL

Several changes in the Engineering staff of Station WFIL, Philadelphia, are reported. Frank Becker, formerly of NBC, is now Chief Engineer and Messrs. Pamphilon and Nygren, also formerly of NBC, are on the Engineering staff.

This station is rebuilding its studios and has been using OP-4 amplifying equipment temporarily.

Don Withycomb, formerly of NBC, N. Y., is the new manager.

WWNC

George T. Mayer, formerly control engineer NBC and WMCA, is now production staff member of WWNC, Asheville, North Caro-

lina, as is Bob Bingham of WKBC, WCAU and Columbia, N. Y. Don S. Elias has been appointed President Citizen Broadcasting Company, in full charge of operations.

New RCA Audition Amplifier and Reproducing units have been purchased by WWNC for audition purposes. Extensive plans are being made to broadcast Easter Sunrise Services from Beaver Lake.

WLVA

Al Heiser, WLVA, Lynchburg, Va., reports that they have just completed the studio's first frequency run, proving that the entire setup of RCA equipment is within 1db. from 35 to 1250 CPS.

Announcer Pat Taylor woke up one morning to answer a call from the hospital—a boy (BOB). Congratulations!

Just found out that there are 8500 receiving sets in Lynchburg. Plans are being made for new shack and new antenna system. Men on staff at transmitter are J. T. Orth, F. L. Jesse, R. L. Williams and Al Heiser.



DID YOU KNOW?



By W. S. FITZPATRICK, RCA Institutes

THAT "electric eye" once meant the detector or "coherer" of a radio receiver? "Modern radio fans know the 'electric eye' as the photoelectric cell which opens doors, operates photo-radio transmitters and with numberless other uses. Back in the 1900's the term meant far another thing. It was first used by Lord Kelvin and designated the detector of those days, the coherer. Some one suggested the use of 'spectacles' for the electric eye, which was a prophetic anticipation of the modern amplifier. Some day there will be something new under the sun." (George Clark.)

That a new house organ for employees of the various RCA organizations called "Within the RCA Family Circle," made its initial appearance in March with Montgomery Wright, of the RCA Department of Information, as editor? Mr. Wright was editor of the former *RCA News*.

That Bertha Brainard, NBC Program Manager, and Helen Guy, an NBC secretary, were regular announcers at station WJZ several years ago; Miss Brainard identifying herself as ABN—as was the custom then instead of names—meaning "Announcer Brainard, WJZ" (The "N" for WJZ being retained from the time the station was in Newark and where Miss Brainard started as an announcer), and Miss Guy as AGN? Milton J. Cross was then identified only as AJN, and Raymond F. Guy, now NBC Radio Facilities Engineer, was known on the air as OGN, the "O" in his case meaning "operator" rather than regular announcer.

That the ordinary automatic time stamps, which record hours and minutes, were discarded by R.C.A. Communications' central offices several years ago and a stamp was developed that records the seconds as well?

That when the first broadcasting station was opened in San Francisco, Mayor Rolph, who officiated, was so sceptical of the proceeding that he



W. S. FITZPATRICK, THE "RADIO RIPLEY"

asked everyone who heard him to send a collect telegram, the resulting messages costing him four thousand dollars for his doubts about radio? Likewise sceptical was Eddie Cantor the first time on the air at RCA's pioneer broadcasting station, WDY, at Roselle Park, N. J., in 1922, when he asked that dimes be sent in for his pet charity. When the sack of dimes was later delivered to him, his only comment was: "It works"!

Magic Brain at Radio Central

That Lee Galvin, of the RCA Department of Information, in conducting a tour for foreign engineers to the R.C.A. Communications' transmitting and receiving plants at Rocky Point and Riverhead, Long Island, noted in each place RCA Victor "Magic Brain" receivers, which the station engineers said were of valuable assistance to them because of the sensitivity and selectivity of the "Magic Brain"?

That in the construction of the 8-mile San Francisco Bay bridge workmen are using radio to keep in touch with one another?

That sixty per cent of the students in a present class at RCA Institutes hold college degrees?

That the net profit for 1934 of the Radio Corporation of America was more than four million dollars?

That the telegraphic letter "S," consisting of three dots, was used three times in important events in the history of communication without wires? Mahlon Loomis used it in his tests with kites; Marconi used it in his experiments on his father's estate in Italy, and finally it was the famous signal which first spanned the Atlantic. (George Clark.)

That photoelectric cells are employed in the making of postage stamps? The cells activate a compensating mechanism to keep the perforators at a correct distance between the stamps. Last year 12 billion stamps were made, along the borders of which 370 trillion holes were punched, making 35 tons of paper dots.

It's in the Air

That a book author, after a visit to Camden, hit the nail, or something, on the head when he wrote: "Artisans, apparently joyous in their jobs, hum music over their benches. There is visible and audible happiness rampant in the Camden staff that strikes all visitors to the plant as being in peculiar harmony with the daily task to which it is devoting itself—the mass production of instruments of melody"?

That the Radiomarine Corporation is extending its service through facsimile reception of weather maps, photographs, printed and other visual material on ships at sea? New facsimile receiving racks have been ordered from the RCA Manufacturing Company.

That the transmitting building of the new WOR station has no ordinary heating plant, but is heated by the energy dissipated from the power vacuum tubes?

That a greater number of photos was projected through the air by R.C.A. Communications during the

week-end following the Morro Castle catastrophe than ever before in a like period of time in the history of photo-radio?

That Marconi was only 22 years old when he arrived with his wireless invention in London from Italy in 1896?

Radio on Tap

That the famous Walt Whitman Hotel in Camden has arranged with RCA Victor for the installation of an elaborate centralized sound distribution system which will bring a choice of three programs into all its guest rooms and public spaces?

That 32 applications of the cathode-ray oscilloscope were listed in a recent issue of *Radio-Craft*?

That the Radiomarine Corporation's diorama display, which attracted much attention during two years at the Chicago Century of Progress exposition, has been shipped to Brussels for exhibition at an International Exposition opening in April?

Under Cover Transit

That, unknown to many of its citizens, Chicago has a 62-mile subway system, 40 feet below the loop business district? About 3300 cars and 150 electric locomotives make up the 300 trains of 10 to 15 cars in daily use. No passengers are carried.

That radio receivers now outnumber telephones in the United States?

That the term "talking machine" came from a description of the original invention which appeared in a Buffalo, N. Y., newspaper in 1877, but that it was at the time, and still is in most foreign countries, known as "Gramophone"? The recording equipment was called "Phonautograph," and the records "Phonautograms."

That the year 1934 attained the all-time high record in the sale of radio sets? Total sales in this country last year reached 5,350,000 as compared to the previous peak of 4,438,000 in 1929.

That the Radiomarine Corporation maintains temporary offices on steamship piers for the convenience of passengers' friends who wish to send *Bon Voyage* and other radiograms to departing ships?

That the uses of electron tubes have increased to 338, under sixteen classifications, as shown by the list in the January issue of *Electronics*?

That eighteen engineering crews recently traveled 230,000 miles throughout the country, recording the signal strength of all NBC stations?

That a motion picture or radio mystery play is referred to as a "Who-dun-it"?

That a giant model of an RCA Victor radio receiver, built on a scale of 20-to-1, with tubes five feet high, so large that thousands of persons walk through it daily, is in operation in the National Broadcasting Company studios in Radio City for the purpose of acquainting the layman of the mysteries of how a radio signal is converted into sound?

That in the near future R.C.A. Communications expects to have in operation a micro-wave domestic facsimile circuit?

That *Popular Science* says a fly climbing one inch up a vertical wall uses the same amount of power that would be picked up in 35 years by a New York station with a one-foot antenna receiving signals from the largest transmitter in California?

That the book of rules and regulations for the guidance of marine radio operators has just been revised and reprinted by the Radiomarine Corporation of America?

That the RCA Radiotron Pacific Coast district sales offices, service station and warehouse are now housed in their large new building at 170 Ninth Street, San Francisco?

500,000 Visitors

That more than half a million persons have taken the conducted tour through the NBC Radio City studios since they were opened in November, 1933?

That the RCA facsimile system delivers a full page of typed matter or a photograph in exact reproduction, requiring no developing? It is especially desirable in transmitting weather maps and for police, who can send finger prints, identifying photographs and useful information. The service is available to several foreign countries.

That broadcasting companies forbid the writing of cries of alarm in scripts, with particular stress on the elimination of such shrieks as "Fire!", "Help!" and "Police!"?

That 47 radio stations affiliated with the NBC network, daily from 12:30 to 1:30, bring the Farm and Home Hour into thousands of rural homes? (*Carolina Co-operator.*)

That in the register at the Radio City studios of the National Broadcasting Company may be seen signatures of many world-famed personalities?

That a new NBC feature is the Sunday evening Amateur Hour over the NBC-WEAF network?

That in measuring the depth of water with the Fathometer, twenty soundings may be made each second? A vessel traveling ten miles an hour can obtain soundings every ten inches in water ranging from a depth of six to 120 feet. (*Scientific American.*)

That the air conditioning plant for NBC's Radio City studios supplies 20,000,000 cubic feet of air every hour? The air ducts are fastened to the inner walls by canvas hose to prevent transfer of vibrations.

And Finger Printed?

That in 26 states of U. S.—New York is one—radio engineers must be licensed? It is illegal in those states to engage in responsible engineering practice, either as a consultant or an employed "engineer" without first registering and obtaining an "engineer's license." The laws are definite in limiting the application of the word "engineer" to persons who have qualified and registered. (*Electronics.*)

That all windows looking into NBC studios at Radio City, from control rooms, observation or clients' booths, are made of three-ply plate glass, hermetically sealed, with special valve adjustments for barometric pressure to protect the glass from being broken?

That recorded on a copper disc, chromium-plated, and sealed in a bronze casket cemented into the corner-stone of a new building in New York, noises of street traffic and city life of 1935, have been preserved for posterity? (*Electronics.*)

Elaborate Ceremonies Mark Inauguration of WHIO

Modern Station Established in Dayton, Ohio, by the Miami Valley Broadcasting Corporation



JAMES M. COX, JR., PRESIDENT OF THE MIAMI VALLEY BROADCASTING CORPORATION, WHICH OPERATES STATION WHIO

ACCORDING to schedule, Station WHIO began regular service on February 9th, 1935, with a gathering of broadcast stars and leaders of the industry seldom congregated for any occasion. However, this new station is unusual in many respects. Modern in every sense of the word, it has been 100% outfitted by RCA, with the latest

High Fidelity equipment, from microphone to antenna.

Former Governor James M. Cox, proprietor of the *Dayton Daily News*, which sponsors this station, was present for the opening ceremonies, and an excerpt from his address on that occasion conveys a clear picture of the ideals upon which is founded this new and important member of the NBC network:—

"May I express this christening sentiment—that the voice of this Miami Valley empire will always be an instrument of dignity, culture and practical service; that it will carry the light of joy to places that are dark; that it will build a love for goodness and beauty; that it will plant in the hearts of men a philosophy that will help them to see divinity in sunshine and shadow; that it will sense its obligations to the more than a million people who are by common interest to be our immediate radio fireside. In brief, may WHIO in its long watches of the night and in its endless days be conscious ever of its duty to God and humanity."

Included in the list of prominent stars who furnished the opening programs, some of whom were present



FORMER GOVERNOR OF OHIO, JAMES M. COX, PROPRIETOR OF THE *DAYTON DAILY NEWS* WHICH SPONSORS THE NEW BROADCAST STATION WHIO

and some who contributed their services from remote points located throughout the nation from coast to coast, are the names of Marjorie Squires, nationally known contralto; John Alda Lewis, dramatic tenor; Jesse Crawford, nationally famous poet of the organ; the comedy team of Gene and Glenn; Amos and Andy; the Pickens Sisters; Tim and Irene, comedy team, and Will Rogers.

In addition, many nationally famous figures in the broadcasting industry were present for the opening, including Richard C. Patterson, Jr., Executive Vice President of the National Broadcasting Company; John F. Royal, Vice President of the National Broadcasting Company; Frank Mason, Vice President in charge of Operations and Public Relations of the National Broadcasting Company; Charles W. Horn, NBC Research Engineer; and E. C. Wooley, of the NBC Station Relations Department. Graham McNamee, Dean of Network Announcers, acted in the capacity of guest announcer for the occasion.



THE ATTRACTIVE AND UP-TO-DATE TWO-STORY RECEPTION ROOM OF WHIO, LOCATED ON THE FIRST FLOOR

James M. Cox, Jr., son of Ex-Governor Cox, is the President of this new organization, and E. K. Steiner is the General Manager. R. H. Lingle, Jr., the Chief Engineer, who was formerly with WFBC,

artistic and scientific design. The illustrations which are shown herewith will serve to indicate that no trouble or expense has been spared to make WHIO foremost among modern radio stations.



VIEW FROM MAIN CONTROL ROOM, THROUGH SOUND-PROOF WINDOW, INTO THE SALON STUDIO. RCA SPEECH INPUT EQUIPMENT IS SHOWN AT THE LEFT AND IN THE CENTER FOREGROUND, AND THE TELETYPE EQUIPMENT IS LOCATED AT THE RIGHT



E. K. STEINER, GENERAL MANAGER OF WHIO

modern towers, each 293 feet high. One of these towers is featured in our cover design this month.

In Studio C is located a specially designed three-manual Wurlitzer organ, and in Studio B is located the

Greenville, S. C., is justly proud of the modern and complete equipment of this new station which makes it an outstanding example in the field of broadcasting.



ROBERT H. LINGLE, JR., CHIEF ENGINEER OF THE ULTRA-MODERN STATION WHIO

Not alone is the radio equipment of this station the latest thing in advanced design, but the studios, control rooms, reception rooms and other quarters which house this new enterprise represent the latest advances in



THE WHIO ORGAN STUDIO "C", LOCATED ON THE FOURTH FLOOR. THE FAMOUS JESSE CRAWFORD PLAYED THE DEDICATING PROGRAM ON THIS UNUSUAL INSTRUMENT OPENING NIGHT

The up-to-date RCA Type 1-D Transmitter is located in a building out in the suburbs many miles from the studios, and puts a High Fidelity 1 KW signal on the air at a frequency of 1260 KC. High Fidelity performance is insured by the carefully designed equipment, from the Velocity Microphones in the studios right through the Speech Input Equipment to the Antenna itself, which is supported on two ultra-

Transcription Equipment. All together, there are four studios and in addition there is an audition room, where sponsors may hear rehearsals of programs or where additional studio activities may be carried on if desired. An artists' lounge is provided on the mezzanine floor, where artists and musicians may comfortably await their cues. A two-story

(Continued on Page 29)

Radio Centre, Philadelphia, Goes Fluorescent

Startling and Beautiful Color Effects in Auditorium

Devised by Frank Hartman



CLARENCE TAUBEL, PROGRESSIVE PROPRIETOR OF PHILADELPHIA'S RADIO CENTRE. HIS NOVEL IDEAS IN BROADCASTING HAVE MADE STATIONS WPEN AND WRAX EXTREMELY POPULAR

IF IT WERE possible to pour the various colored lights out of the glowing glass tubes of a modern electric sign and apply them with a brush to create artistic mural decorations in the darkened interior of an auditorium, you would still fall short of the impressive and fascinating results that Frank Hartman and his staff of artists, directed by Stanley Read, have achieved at Radio Centre, Philadelphia. Here, at last, is something really new in decorative art. The novice, viewing this exotic spectacle for the first time, blinks his eyes and wonders for the moment if he is still on earth—or if he has been transported through space into some remote corner of the heavens where things are indescribably beautiful—but not real!

Unusual Setting

To begin with, the building occupied by Radio Centre is a thing of architectural beauty and grandeur itself. Formerly the palatial residence of Ambassador Childs, it now houses the various studios, control rooms and executive offices of the William Penn Broadcasting Company, which operates Stations WPEN and WRAX. Clarence Taubel, the proprietor and moving spirit behind this venture, is

a man of vision and progressive courage. Unafraid to try an idea if it looks good, no matter how radical, his efforts have been crowned with more than the usual percentage of success.

The grand ballroom in this majestic edifice once was the scene of formal receptions, where nationally and internationally famous statesmen and diplomats, with their ladies, were entertained. Two stories high, it is as large as a modest-sized moving picture theatre, and its walls and ceiling are exquisitely garnished with plastic murals of cupids, doves, cornucopiae, fruits, flowers, and all the things one finds in such formal interiors. And it is these figures that have been enlivened to fluorescence by the magic of Frank Hartman's touch. Not alone these mural figures, however. The performers in the visual broadcasts witnessed by visiting audiences as well as heard over the air, have been treated by Hartman's new art. Their costumes are illuminated with glowing colors, as are the settings in which they work.

"All Girl Revue"

Outstanding among the visual broadcast features at Radio Centre is the new "girl show." This is a creation of Paul Alger, versatile program manager of the organization. (His confreres have recently nicknamed him Paul "Carroll.") For this feature, he has collected from near and far a bevy of young girls who possess the rare combination of beauty and talent. Some sing, some play, some do monologue or dialogue stunts, and many of them are both vocally and instrumentally accomplished. It is as interesting to drop in and watch this show rehearse "new business" as it is to witness an actual broadcast. Christine Breese, who has become famous in theatrical and radio circles for her fast and fascinating work at both piano and organ, is the Musical Director of the show, and Adele



PAUL ALGER, WHO MANAGES THE PROGRAMS AT RADIO CENTRE. HIS NEW "ALL GIRL REVUE" IS TYPICAL OF HIS POWER TO ANALYZE THE DESIRES OF HIS AUDIENCES

Firth, though new to radio, performs admirably as Mistress of Ceremonies. The twelve girls in this cast are the final group selected out of more than a thousand candidates, and their inexhaustible store of new material is heard on their nightly hour starting at 9.10 P. M., (except Sundays). Attractive as these girls are in their personal appearance, the beauty of their presentation is greatly enhanced by the wizard Hartman, for he has created for them fluorescent costumes in glowing colors. Their gowns, their hats, their shoes—all specially treated so that their colors are brilliantly radiated in the semi-darkness of the auditorium. Truly, here is an effect that baffles description by the spoken word or the printed page. Even the pianos and the organ console under this treatment become living, glowing objects of rare and colorful beauty.

Fluorescent Art

How is it done? Let Frank Hartman himself explain: "The fluorescent art process can be applied wherever decorative color is desired, and where it is possible to at least partially exclude other light. The colors themselves have been derived from Nature's minerals, after ex-

haustive research and experimental work. Certain mineral substances possess the rare property of absorbing ultra-violet rays and re-emitting them in shorter wave lengths. One such mineral substance will reradiate this light in a certain shade of red, another will produce a certain blue effect, and so on throughout the entire band of visible color frequencies. It is only necessary to select the proper minerals, properly combine them, and use them as pigment in this specially developed paint, to create any desired color effect.

Violet Rays

"In ordinary light, such as daylight or incandescent electric light, these paints appear just as ordinary pale tints. But when other light is at least partially excluded, and violet rays are employed as a light source, any surfaces treated with these colors immediately become fluorescent, and are brilliantly radiated in the form of colored light. However, there is absolutely no radio-activity involved,

In the auditorium studio at Radio Centre, Philadelphia, when this new fluorescent effect is employed, it is customary to turn out all other lights and exclude daylight, allowing the violet-ray tubes distributed about the hall to furnish the only actual light source. However, these tubes are emplaced in "indirect" fixtures and coves so that they are concealed from the view of the audience, but so that their rays are focused upon the fluorescent art work.

Popular From Start

The new "girl show" at Radio Centre lends itself particularly well to this novel treatment, and its popularity on the air brings great numbers of radio fans in to witness the broadcast in the auditorium. Those who attend this unusually colorful and artistic presentation carry away with them an enthusiastic feeling of appreciation, mingled with a sense of mystification, which they invariably attempt to describe to their friends. The result is that hosts



THE CHARMING ADELE FIRTH, MISTRESS OF CEREMONIES AT THE "FLUORESCENT FROLICS," THE CAST OF WHICH INCLUDES TWELVE OF PHILADELPHIA'S MOST ENTERTAINING YOUNG BEAUTIES. THEIR RADIO PERFORMANCE IS VISITED NIGHTLY BY A LARGE STUDIO AUDIENCE

lively, merry nature, with plenty of good vocal and instrumental music of the kind which carries popular appeal. Sprinkled into this mixture is a running banter of good humor and fun. Essentially, it is the kind of a show which would interest mostly the men-folk, but there are also many women in the auditorium audiences. Perhaps this is because some of the women-folk feel that it is better not to trust their men alone to witness such a galaxy of feminine pulchritude. Perhaps it is because some of the less talented ladies wish to make a profitable study of how these girls achieve such popularity. Whatever the cause, the all-important result is capacity audiences and a tremendous following of radio listeners, whose number at this writing baffles attempts at estimation.

Guaranteed Matrimony-Proof?

"And," Paul Alger tells us, "we hope to keep the show intact for at least a year, as we have required the girls to sign an agreement not to get married for twelve months from the date of their first broadcast."

Radio Centre's 1000-watt transmitter, the velocity microphones and various other studio equipment are RCA built, and H. S. Frazier, the Chief Engineer of Radio Centre, tells us that the new equipment soon to be added will also be "RCA built."



A TALENTED LITTLE GIRL WITH A BIG JOB—THE LOVELY CHRISTINE BREESE, MUSICAL DIRECTOR OF THIS NEW "ALL GIRL RADIO REVUE." SHE IS SHOWN AT THE CONSOLE OF THE MAMMOTH ORGAN IN THE METROPOLITAN OPERA HOUSE, PHILADELPHIA

and the paints, the process of illumination, and the whole scheme are entirely harmless to human tissue.

"The violet-ray light sources are purposely concealed from the view of the observer so as not to interfere with the color effects of the art work itself."

of others who have not as yet been initiated also attend the studios to witness the presentation, and it can safely be said that they are not disappointed. Rather, it should be said that the experience of attending the show totally exceeds the anticipation.

The material broadcast is of a



Broadcasting Grand Opera

Special Facilities Arranged by NBC



BROADCASTING Grand Opera from the scene of its performance presents many unusual technical problems which are not encountered in the course of an ordinary broadcast. The NBC engineering staff has found it necessary to devise and install new equipment so that the broadcast from the stage of the Metropolitan Opera House, a regular weekly feature that has delighted Saturday afternoon audiences of the NBC networks for the past few years, was able, during the season that has just ended, to take its place with other accomplished and noteworthy performances of the air.

An important event that helped to overcome the forces that were retarding the appearance of more finished performances for the air waves was the reconditioning of the power and light supply system of the Opera House. All cables and connections were rerouted in rigid iron conduits whereas prior to this, it had been necessary to run the wires along the walls. The current was changed from direct to alternating so that the rerouting of the cables in the iron conduits not only serves to protect them, but minimizes the hum pick-up from the alternating current, as well.

In modern studio broadcasting, proper conditions for the program are carefully determined in advance. The studios are sound-proofed and treated to provide satisfactory acoustics and the artists and musicians are placed in the positions which will allow the microphone to pick up the sounds with the best results. Moreover, there are always sufficient rehearsals so that the proper effects will be obtained.

In Grand Opera, on the other hand, broadcasting is obviously of secondary importance from the producer's point of view. The artists are performing before an audience that is present in body as well as in spirit so that their gesticulations sometimes



INTERIOR OF THE METROPOLITAN OPERA HOUSE IN NEW YORK CITY, TAKEN DURING ONE OF THE PERFORMANCES

have meaning which will be lost over the air. Furthermore, the actors are constantly moving about and their voices are sometimes addressed to the audience and sometimes to the sides or rear. In order to compensate for this and catch the slightest sound so that possible loss of continuity from action on the stage will be made up for, many microphones are required. They are situated at various points of vantage, some being concealed in the footlights, others in the wings and backstage, and more are suspended from the proscenium arch (the direct function of these being to pick up the orchestra).

Rehearsals Important

Proper control of this extensive microphone equipment requires that the engineer in charge has had much experience with this type of pick-up and also necessitates that he be familiar with the scores of the operas that are being broadcast. A new opera requires the engineer's attendance during many rehearsals so that he can be familiar with the score and action. Seated at the controls with an

experienced coach next to him, he must watch the pick-up of the numerous microphones, fading from one to the other as the action moves about the stage, and carefully blending this pick-up with that of the orchestra. Before him are the amplifiers and the very essential mixer panel which is covered with various controls and tally lights each marked to indicate the microphone that it represents.

Carefully Cued

The successful opera broadcast, therefore, actually requires the close cooperation of two men, the engineer and the production man or coach. The latter has before him the score carefully marked and cued to indicate exactly when each change in the controls should be made. Most of this information is passed on to the engineer at the controls through a system of prearranged touch signals. While the production man is following the score and signalling the engineer, the latter must concentrate his attention upon the action on the stage and keep an eye on his meters and controls.

Charles Gray, NBC engineer, and George Meador, production man, are both operatic experts who are thoroughly familiar with the action of the entire Metropolitan repertoire. They attend many performances and rehearsals in addition to those which they broadcast.

In the early days of opera broadcasting when microphones were, in addition to other faults, less sensitive than they are now, it was not possible to transmit a true picture of the performance. Today, however, the NBC staff points with justifiable pride to the achievements that have been made in broadcasting technique, for the methods used in connection with the NBC broadcasts from the stage of the Metropolitan Opera House provide a sound picture that is worthy of the performance.

The new broadcasting equipment that has been installed is abreast of the latest developments in high-fidelity transmission and pick up facilities and includes the new velocity type microphones. In addition, a broadcasting booth was installed for the use of Miss Geraldine Farrar, the famous star of grand opera, who returned to the scene of her triumphs during the past season as raconteuse.

Prize Location

All technical equipment is installed in a Grand Tier Box, situated near the center of the Horseshoe, thus providing a comprehensive view of the stage. The apparatus is semi-portable so that the box can be cleared for use at times when the performance is not being broadcast. In the rear of the box is a booth with a glass observation panel for the use of the announcers. The engineer and the production man sit at the control table which is located in the front of the box.

The microphones are located at numerous points on and near the stage. There are four in the footlight trough, three are suspended from the proscenium arch, and there is one each on the prompt and O. P. sides of the stage. In addition, a spare position is provided in the arch. These microphones terminate in a ten-position mixer on which are mounted the faders controlling the announcer's and communicator's microphones. Vol-

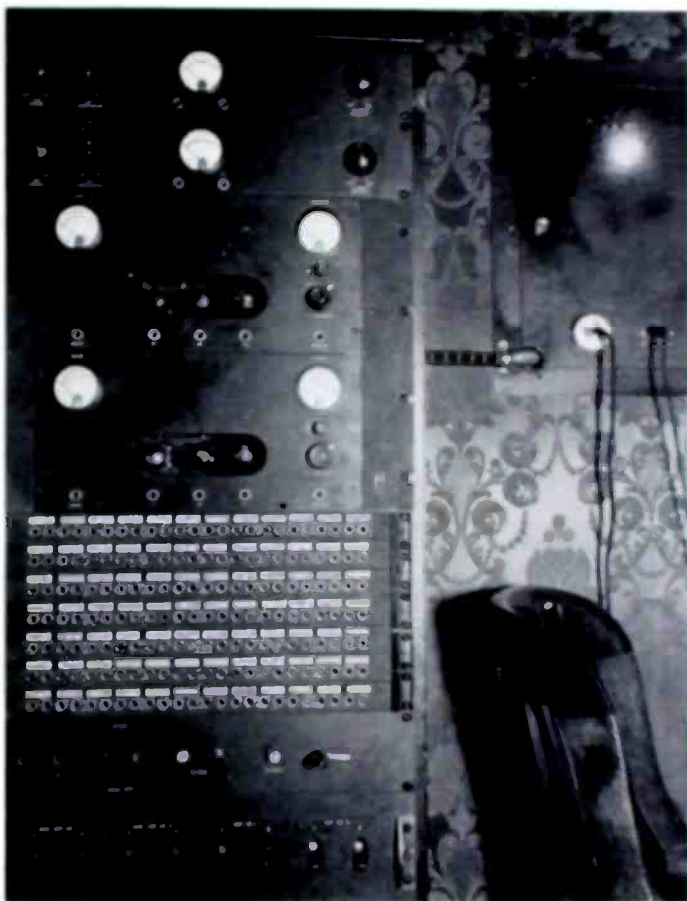

VIEW INSIDE THE GRAND TIER BOX WHICH IS USED AS A CONTROL BOOTH DURING GRAND OPERA BROADCASTS

ume indicator meters, tally lights and switching controls also are mounted on the same panel.

Special Faders

The arrangement of the fader controls is unique, as they must be operated in the dark, because no light is permitted other than a miniature lamp which illuminates the volume indicator. The faders are, therefore, grouped in two pyramids, one on each side of the panel, the bottom row representing the footlights and backstage positions and the upper rows the arch, thus approximating the positions of the microphones about the stage.

The mixer output is connected to two amplifiers operating simultaneously and continuously feeding two circuits to the Radio City studio. These amplifiers and the associated monitoring amplifiers (which are

compensated to afford high quality head phone monitoring for the announcer and engineer) and the battery supply unit have been especially designed and constructed to occupy a very small space. This has been necessary so that the opera box in which the equipment is located can be utilized by spectators when the performance is not being broadcast. At such times, the mixer table is removed and stored near by. The equipment rack on which the amplifiers, battery supply equipment, jack strips, private line telephones, and other apparatus are mounted, is located in the rear of the box and is concealed by a plush drape when not in use.

The main power supply used for the microphone equipment, both velocity and condenser, is located in a special steel cabinet mounted under the stage.

Broadcast Station Maintenance

This installment of the Series is Written by A. R. HOPKINS,
Transmitter Engineer, RCA Manufacturing Co.

THE increasing interest in "High Fidelity" as applied to both transmitters and receivers, along with improvements in quality of reproduction of receiving sets, has emphasized the importance of maintaining station equipment in the very best operating condition. In some cases it may be necessary to replace some of the older equipment in order to obtain satisfactory performance, but in all cases it is important to make sure that the present equipment is operating efficiently.

It cannot be assumed that even the best of equipment will continue to operate for month after month with the same degree of fidelity and efficiency as when it was installed. The only assurance of continued high quality performance is constant supervision and regular checks. And these regular checks should include actual measurements of the most important performance characteristics, such as frequency response, noise level and distortion.

Response and Noise

From the maintenance standpoint the measurement of frequency response and noise level are most important since they are more likely to change without warning of some kind. The noise-level check should be a measurement of the over-all background noise with all equipment in operation, including the microphones in their normal locations and with mixers and gain controls set at average operating levels. To measure the noise use an amplifier, such as the type 40-C, a portable amplifier, such as the type OP-4 or any amplifier with a volume indicator, a calibrated gain control and a gain of 60 db. or more. Simply determine the gain required to amplify the over-all background noise to the normal operating program level at that point. The gain



A. R. HOPKINS, RCA MFG. CO.

required in db. is the measure of noise below normal program level or the signal-to-noise ratio. The settings of the mixers and gain controls should be recorded and all succeeding checks should be made with the same settings for comparison. This check should be repeated for each studio and each channel of studio equipment, and the entire procedure should be

interested in the over-all noise existing on the carrier when the transmitter, remote studio equipment, telephone line, studio amplifiers and probably microphones are all in operation and adjusted to their normal gains. In this case the carrier noise should be measured by means of a monitoring rectifier coupled to the antenna output, an amplifier such as mentioned above, an audio oscillator and a calibrated attenuator pad. Figure 1 shows the set-up for this over-all noise measurement.

Filter Designs

The filters shown are not essential for a general check, but for "high fidelity" broadcasting it may be necessary to obtain a lower noise level in the range between 150 and 5000 cycles than below 150 cycles and above 5000 cycles. This is reasonable since the sensitivity of the ear is decreased at very low and very high frequencies.

To make the measurement with the set-up as shown in Figure 1, all

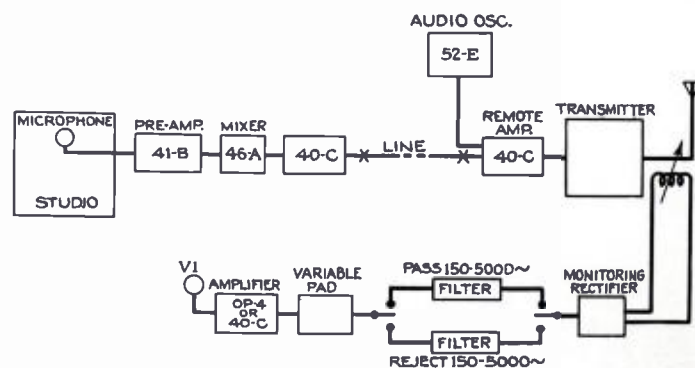

FIGURE 1

included in the program of routine checks to be repeated at least once a week.

The Federal Communications Commission in connection with the proposed high fidelity requirements has indicated that it would be

mixer and gain controls should be set at normal operating levels. The constant tone from the audio oscillator is applied to the transmitter and adjusted to 100% modulation, with the frequency of the audio oscillator set within the frequency range of the

filter used. Adjust the variable attenuator pad and the gain of the 40-C amplifier at least 60 db. below maximum gain setting and note the volume indicator reading. Then remove the modulation tone and record the increase in gain required to bring up the noise to the same level.

Separate Checks

For routine or weekly noise-level checks, it is more practical to divide the responsibility and check the studio equipment and the transmitter separately. The limits for each test should first be determined from an over-all measurement as outlined above and from a measure of the two components separately under the same conditions. The line from the studios to the transmitter may be taken into account by having it connected to either the transmitter or studio equipment when the separate measurements are made. The line must always be properly terminated.

It is much better to try to avoid the origination of the noise than to detect the noise by measurement after it has developed. For this reason it is highly important to include in the maintenance program a routine inspection and cleaning of all parts such as volume control and mixer contacts, plugs, jacks and terminal connections. For cleaning use either crocus cloth or carbon tetrachloride. The latter is preferable on sliding contacts as on attenuators. Tubes should also be removed from their sockets and the contacts cleaned with crocus cloth. Good ground connections, especially to shields on low level circuits, are important from the noise standpoint.

Frequency Characteristic

As in the case of noise level the over-all frequency response from microphone to antenna shows the true picture. This measurement should be made periodically and at the same time the frequency characteristic of the studio should be determined so that each studio may be checked separately.

For an over-all frequency characteristic measurement from microphone output to antenna, only the monitoring rectifier and volume indi-

cator meter are required at the transmitter.

At the studio the set-up should be as shown in Figure 2.

The variable attenuator pad between the oscillator and the low level microphone circuit is necessary in order to operate the oscillator at a sufficiently high level for measurement. The values of the resistors X should match the variable pad and oscillator output circuit and the value of R should be very low, in the order of 5 to 10 ohms for a 250-ohm microphone or less if the impedance of the microphone is less.

The voltage induced across the small resistor R may be any conven-

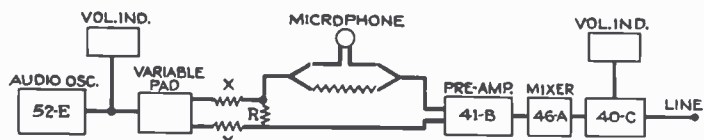

FIGURE 2

ient amount so long as it does not overload the amplifiers. Preferably the mixer and gain controls should be set at normal levels and with the oscillator output set at a convenient level the variable attenuator should be adjusted for normal output on the program line to the transmitter.

To determine the over-all frequency characteristic, including the microphone (which of course will vary with distance of sound source from the microphone) the microphone characteristic should be obtained from the manufacturer. Some microphone characteristics are taken on open circuit, while others are loaded. In order to properly combine or add the characteristic of the microphone to the over-all of the studio equipment and transmitter, the measuring method used on the microphone should be taken into account as shown in Figure 2. If the microphone was measured open circuit, should be connected in series with the input circuit to the pre-amplifier to take into account the characteristics of the microphone transformer. If the microphone was loaded with the proper resistor, a resistor of the same value should be

connected in series with the input circuit to substitute for the microphone.

To be sure that there is no regeneration due to unbalanced circuits when making frequency runs, set the oscillator frequency at 10,000 cycles, disconnect each side from the amplifier input at R and see that the output meter drops to zero.

Once the necessary equipment is available routine frequency response check can be made in a surprisingly short time and it is the only assurance of continued efficient performance.

The microphones should not be forgotten in making these routine checks but they present a more difficult problem. Without more elaborate

equipment, about the only thing that can be done is to make a direct comparison one with another by listening tests and checks for sensitivity. By comparison on speech and on piano a surprisingly small difference in frequency response can be detected.

Harmonic Distortion

If proper voltages are maintained on the tubes and the tubes are checked there is no reason why the audio harmonics should change appreciably. However, if the equipment is available it is worth while making this measurement, although possibly not as often as the other measurements mentioned.

The power supply voltages and plate currents of each tube should be checked before each broadcast.

To make harmonic measurements it is necessary to have a low pass filter in the oscillator output circuit, otherwise the set-up is the same as shown in Figure 2. The filter is to attenuate the harmonics of the oscillator. In connection with high fidelity broadcasting, it is desirable

(Continued on Page 36)

General Considerations of Tower Antennas for Broadcast Use

By Dr. G. H. BROWN and H. E. GIHRING, RCA Engineers

This is the first installment of the paper prepared for and copyrighted by "Proceeding of the Institute of Radio Engineers." It is being published herein by permission as a serial.



DR. G. H. BROWN, RCA MFG. CO.

The ground system and earth currents are considered from both a theoretical and experimental viewpoint. A simple method of measuring the earth currents is described and it is pointed out that such measurements indicate whether the antenna current is sinusoidal or not.

Appendix A gives a method of computing the radiation characteristics and the radiation resistance when the current distribution is known but is not expressed analytically. Appendix B contains the theory behind the ground current measurements. Appendix C shows the influence of the base insulator capacitance on the operating characteristics.



H. E. GIHRING, RCA MFG. CO.

SUMMARY—The factors influencing the action of towers when used as radiators are considered. It is shown that the results predicted from the simple theory of sinusoidal distribution of current on the tower differ to a major extent from the actual results. A series of measurements using small models of actual antenna structures resulted in data correlating closely with the performance of the full-sized structures. These measurements showed that departures from the simple theory are due to non-sinusoidal current distribution.

Several types of recently installed antenna towers are shown to be less effective than the simple theory prediction, particularly with regard to reduction of sky wave and fading. Means for correcting the current distribution and thereby improving the performance are pointed out.

The statement that low base capacity is essential to high antenna efficiency is shown to be a fallacy providing simple precautions are taken to reduce conduction losses.

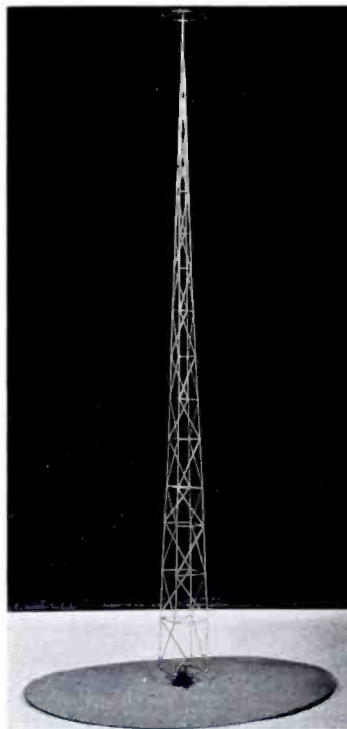

FIGURE 1B—TYPE B ANTENNA

I. Introduction

THE antenna system of a broadcast transmitter is an important factor in determining the effectiveness of the coverage. This is especially true in the case of high-powered transmitters where the service area is limited by the signal fading due to reflections from the Heaviside layer. The ideal antenna would send most of the radiated energy out close to the earth and very little at angles above say twenty degrees. Several years ago, Ballantine¹ attacked the problem of a straight vertical antenna over a perfect earth, with a sinusoidal distribution of current existing on this antenna. He showed that, for a given radiated power, the field strength at the horizon was greatest when the antenna height was 0.64 of one wavelength. An antenna of this height would then yield a field intensity at the horizon which would be approximately forty per cent greater than that given by a

¹S. Ballantine: "On the optimum transmitting wave length for a vertical antenna over perfect earth," Proc. I. R. E., vol. 12, p. 833; December (1924).

quarter-wavelength long antenna which was radiating the same power. Recently Ballantine² has discussed the problem still further, showing that while an antenna 0.64 wavelength long gives the greatest intensity along the horizon, the smallest ratio of reflected sky wave to ground wave is obtained from an antenna whose length lies between 0.5 and 0.64 wavelength, depending upon the amount of attenuation suffered by the ground wave.

In the attempt to attain these optimum conditions, it has been necessary to depart from the conventional antenna construction, consisting of a wire antenna supported between two towers. The idea of using a single tower as the radiator itself was soon proposed and has been widely adopted. The guyed cantilever tower soon appeared. (Fig. 1a.) This consisted essentially of two conventional towers placed base to base.

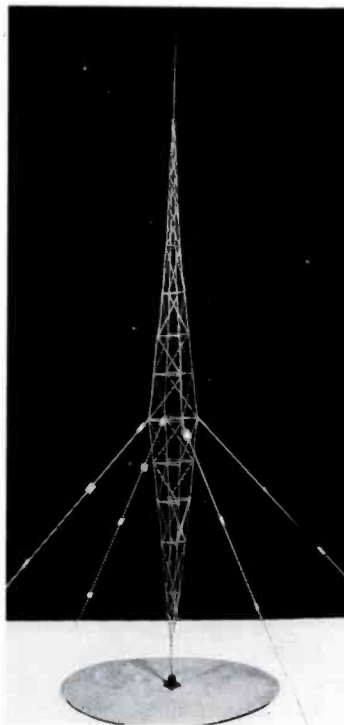

FIGURE 1A—TYPE A ANTENNA



FIGURE 2

The lower end of the antenna rested upon a base insulator and the antenna was held in place by from four to eight guy wires. These guy wires, which were broken up at several points by strain insulators, were fastened at the largest cross section of the antenna. Additional height was

obtained by a rod at the top of the tower. The conventional tower was also used for an antenna. The tower was mounted on four base insulators, and required no guy wires. (Fig. 1b.) A capacity crown was often placed at the top.

It has been found that these self-supporting antennas gave results not consistent with the theory, in regard

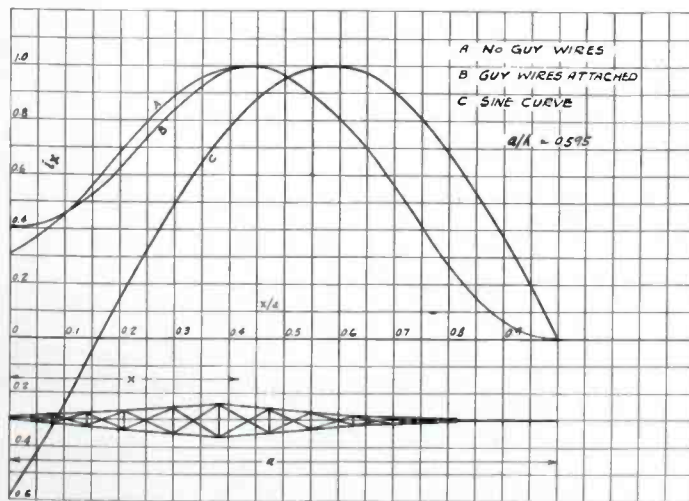

FIGURE 4—CURRENT DISTRIBUTION ON TYPE A ANTENNA SHOWING THE EFFECT OF GUY WIRES

to several points. The ground wave was not as large as would be predicted. The resistance versus frequency curve did not check the theoretical curve. Another important effect was also found. The vertical radiation pattern of an antenna whose length is somewhat greater than 0.5 wavelength and whose current distribution is sinusoidal consists of two lobes, one large one along the ground and a smaller one at high angles with a distinct minimum in the neighborhood of fifty-five degrees (curve A, Fig. 2). Airplane measurements of the vertical radiation pattern of actually installed antennas showed a

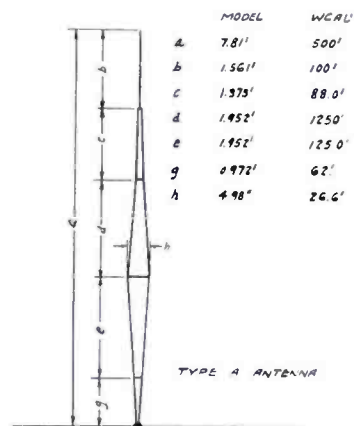

FIGURE 3—DIMENSIONS OF TYPE A MODEL ANTENNA

complete absence of the high angle lobe and the minimum (curve B, Fig. 2). Ballantine² has published airplane measurements on WABC, Wayne, New Jersey, that also show this absence. He gives as possible reasons, (1) the antenna current distribution is not sinusoidal, (2) the guy wires have sufficient current flowing in them to cause this skyward radiation, and (3) the ground system is inadequate.

Probably the most important factor is the nonsinusoidal distribution of current. In the type A (Fig. 1a) especially, the distributed inductance and capacitance per unit length vary rapidly along the antenna. An examination of the fundamental equations of a long transmission line shows that the current distribution is sinusoidal only if the inductance, L , and capacitance, C , per unit length are

²S. Ballantine: "High quality radio broadcast transmission and reception," Proc. I. R. E., vol. 22, pp. 616-629; May (1934).

constant along the line. In general L and C vary in such a fashion that the product LC is a constant, while L/C is not. Thus the velocity on any section of line is a constant value close to the velocity of propagation of light, while the surge impedance (approximately $\sqrt{L/C}$) changes. Thus the surge impedance is small where the cross section of the antenna is large, and vice versa. It is evident that the frequency at which the antenna reactance becomes zero depends on the tower dimensions in a very complicated fashion. It is most certainly erroneous to use this resonant frequency to describe the mode of operation of the antenna. The ratio of operating wavelength to fundamental wavelength (λ/λ_0) is often used. This ratio is only significant when the current distribution is sinusoidal. Even when this is true, it is much better to describe the antenna in terms of its height, a , measured in wavelengths as a/λ . This fraction immediately gives a picture of what portion of a sine wave of current exists on the antenna. A still further simplicity is gained by defining a quantity $G = 2\pi a/\lambda$ radians = $360a/\lambda$ degrees. For example

- $a/\lambda = 0.125 \quad G = 45^\circ \cdot \lambda/\lambda_0 = 2$
(for sinusoidal current distribution)
- $a/\lambda = 0.25 \quad G = 90^\circ \cdot \lambda/\lambda_0 = 1$
- $a/\lambda = 0.50 \quad G = 180^\circ \cdot \lambda/\lambda_0 = 0.5$
- $a/\lambda = 0.5975 \quad G = 215^\circ \cdot \lambda/\lambda_0 = 0.418$
- $a/\lambda = 1.0 \quad G = 360^\circ \cdot \lambda/\lambda_0 = 0.25$

When the current distribution is not

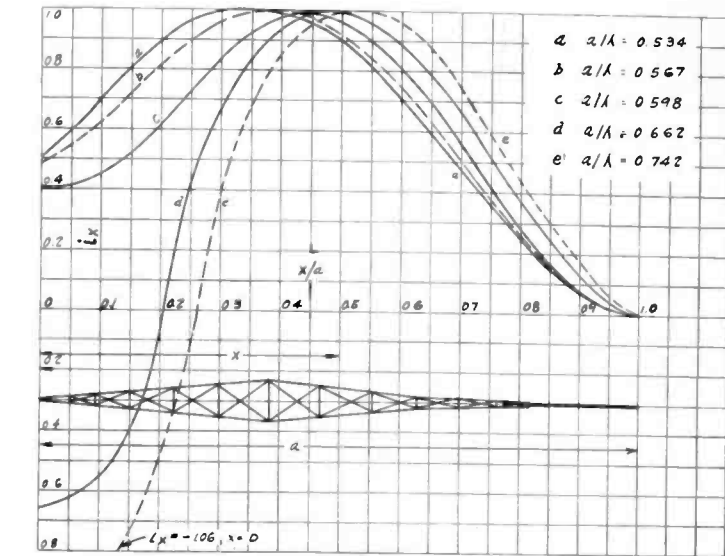

FIGURE 5—CURRENT DISTRIBUTION ON TYPE A ANTENNA AS A FUNCTION OF FREQUENCY

sinusoidal, the length may still be expressed in electrical degrees. While it does not tell the current distribution, it does tell the ratio of antenna length to operating wavelength. Even if the current distribution were sinusoidal on the tower antennas, the value λ_0 obtained experimentally would be erroneous due to the capacity currents which flow to earth through the base insulator.

II. Measurement of the Current Distribution

(a) *The use of models to determine the distribution*

There has been much speculation as to just what the current distribu-

tion is. As far as is known, no one has attempted to measure the current distribution on one of these large antennas. The authors soon abandoned the idea of measuring the current distribution on an actual antenna in favor of the use of models operating at short wavelengths. Two model antennas were built, one of each type. A metal plate of fifteen-inch radius was placed on the ground. A small porcelain insulator supported the antenna. The type A tower was provided with guy wires. The antennas were excited through approximately fifty feet of transmission line from the driving oscillator. A small wavemeter circuit was constructed. This consisted of a small coil (two turns), a small variable condenser, and a thermal milliammeter. This wavemeter was placed on a support which enabled it to be moved parallel to the axis of the antenna. The wavemeter was kept at a large enough distance from the antenna axis so that wavemeter readings remained constant as the antenna was rotated about its vertical axis. This constancy of wavemeter reading indicated that the flux density was constant at all points on the circumference of a circle whose radius was equal to the distance from the center of the wavemeter coil to the antenna axis. The plane of this circle is perpendicular to the vertical axis of the antenna and the vertical axis passes

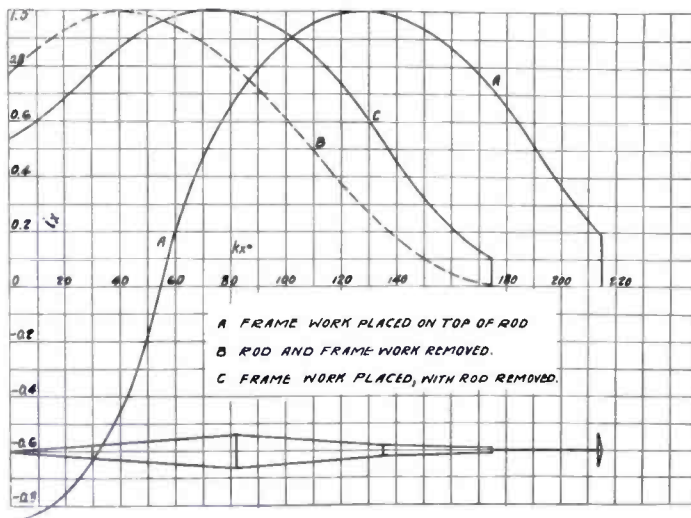

FIGURE 6—THE EFFECT OF SOME CHANGES ON THE TYPE A ANTENNA

thru the center of the circle. Then the antenna current at the height of the wavemeter is proportional to the wavemeter reading. It is not necessary to calibrate the apparatus, since relative measurements give the desired quantity, namely, the current distribution.

(b) *The current distribution on type A antennas*

Since it was possible to obtain other pertinent information relating to the antenna in use at WCAU, Philadelphia, Pa., the type A model was a small scale replica of this antenna. Fig. 3 shows the antenna with the important dimensions. The WCAU tower proper is 400 feet high with an additional shaft extending 100 feet higher, making a total height of 500 feet, (152.5 meters). The operating wavelength is 256 meters. Thus $a/\lambda = 0.595$. The model was to operate at four meters when simulating the WCAU operating conditions, so that the over-all height of the model was $a_m = 0.595 \times 4 = 2.38$ meters = 7.8 feet. Guy wires were provided, in this case being No. 18 wire, while the actual guys are about three inches in diameter.

The first test was to determine the effect of the guy wires on the current distribution. Measurements were made with the guy wires attached to the antenna, and also with the guy wires replaced by string. The results of this test are shown in Fig. 4. A theoretical sine curve is plotted on this same diagram to show the great departure of the current distribution from the theoretical distribution. Other points to be noted are:

- (1) The guy wires affect the current distribution only slightly.
- (2) The guy wires seem to have no effect on the current distribution above their point of attachment.
- (3) The maximum value of current occurs at a much lower point on the antenna than the simple theory predicts.
- (4) At no place on the antenna (except at the top end) does the current become zero or even approach zero.
- (5) The rod which makes up the top twenty per cent of the antenna carries very little current.

The fourth remark requires amplification. On a long line with uniformly distributed constants, where the end remote from the voltage source is open circuited, the current on the line may be regarded as being made up of two components, one of which travels down the line from the generator to the open end, and the other of which travels in the reverse direction. If these two components have the same amplitude at all points along the line, which condition can occur only when the losses in the line are zero and when no radiation takes place, the result will be a standing wave of current, sinusoidally distributed along the line. Thus at points separated by a half wavelength, the current will go to zero, and the current in the half-wave interval on one side of a zero point will be opposite in phase to the current in the half-wave interval on the opposite side of this zero point. When losses occur in the line, the phase reversal will take place by means of a phase rotation rather than by means of the amplitude going through zero. When the losses are low, the current distribution remains very nearly sinusoidal at all points except in the region of the theoretical zero points. Here the current will be very small except when the losses are very large. On a nonuniform line no such simple picture can be made. It is very likely, however, that phase reversals take place, but not at nicely spaced intervals. In our measurements on these models, it was not possible to measure the phase of the current along the antenna, but only its amplitude. Thus our results can only be reported in terms of magnitudes, although we will plot results as negative values where we find that the current reaches small values and then gets larger. In later tests, it was found that when apparent phase reversals occurred, the current went to very small values. Because of these facts, Fig. 4 may be regarded as showing that no phase reversal occurs.

With the guy wires in place another series of measurements was made, with frequency as the parameter. These results are shown in Fig. 5. The frequency was varied so that measurements of current distribution are given for values of a/λ from

0.534 to 0.742. It is apparent that the current distribution is far from the simple sinusoid. These curves will be examined again when the radiation patterns are discussed.

A framework was constructed which could be placed at the top of the antenna to give added capacitance. This framework was square and of the same dimensions as the largest cross section of the antenna. The frequency was returned to seventy-five megacycles so that $a/\lambda = 0.595$, and the framework was placed on the top of the antenna. A measurement of current distribution was made. Curve A, Fig. 6, shows this effect. This has the same effect on the current distribution as lengthening the antenna. We see that the current passes through a minimum and apparently undergoes a phase reversal. The rod which formed the top twenty per cent of the antenna and the framework were next removed. Then the value of a/λ was 0.476. The resulting current distribution is shown by curve B, Fig. 6. When the framework was again placed on top of this antenna, curve C, Fig. 6, was obtained. Because the antenna length was changed, the abscissa of Fig. 6 is distance from the ground plane measured in electrical degrees.

(To be continued in our next issue)

ELABORATE CEREMONIES FOR WHIO

(Continued from Page 19)

reception room greets visitors upon arrival at the studios which are located at 39 South Ludlow Street, in Dayton.

The studios are not only completely soundproof, but are also air conditioned so that it is not necessary for the artists and staff to suffer in silence from heat, humidity, and clouds of tobacco smoke, due to the efforts of the engineer to shut out extraneous noises as in days gone by. In these modern studios, the weather is always maintained at an ideal state—frequently superior to the weather out of doors, for within these walls the atmosphere is always controlled as to temperature, humidity, and chemical content.

Mobile Police Radio Equipment

By P. A. ANDERSON and W. L. LYNDON, RCA Manufacturing Co.



P. A. ANDERSON, RCA MFG. CO.

REPORTS and statements issued by various cities and municipalities employing a two-way police radio system indicate without a doubt the importance of such a system in waging war against crime. The rapid expanse of good highways and the development of high-speed transportation facilities have made it possible for those who have committed a crime to be far from the scene, within a few hours, thus adding to the difficulty of their apprehension.

Radio has given to the law-enforcement groups an instrument whereby information may be dispatched instantaneously to innumerable points, either fixed or movable, and there are numerous cases on record of where the culprits were actually apprehended in the act of completing the crime.

Radio has also in many cases improved the efficiency of the existing police system. With receivers located at fixed points and in patrolling automobiles, the chief dispatcher is in position to transmit information instantaneously to the officer or officers for which it was intended. In the case where pull-boxes are employed where a call is put out by means of a signal light or other devices, a considerable time may elapse before dispatcher is in communication with the desired party.

The utilization of ultra high frequencies for police service has made possible the application of two-way radio communication, which means that a call can be dispatched by the chief dispatcher and the interested patrol car can immediately call back to headquarters by using a transmitter located in the mobile unit.

A police system utilizing two-way communication provides the utmost efficiency for the system and the mobile unit can be constantly in communication while in motion with headquarters if so desired, and it does not necessitate standing by at a phone outlet.

Over a year ago, the RCA Manufacturing Co. began the development of a mobile transmitter unit that would be suitable for a two-way police communication service. There were many factors which had to be considered, such as power supply available, transmitting power to be used, range to cover and special-design features which had to be incorporated in equipment for this service.

Numerous tests were made to arrive at what power would be best suited to meet average conditions to be encountered. As a result of tests made, a transmitting power of 25



W. L. LYNDON, RCA MFG. CO.

watts was arrived at as that being satisfactory to provide commercial signal range with a minimum number of isolated pick-up receiving points.

Tests were conducted to determine the most suitable type of power supply for use with such transmitting equipment. The most obvious source of supply is to utilize the automobile storage battery. However, there is a limitation as to the amount of current that can be obtained from the car battery and still not impair its opera-

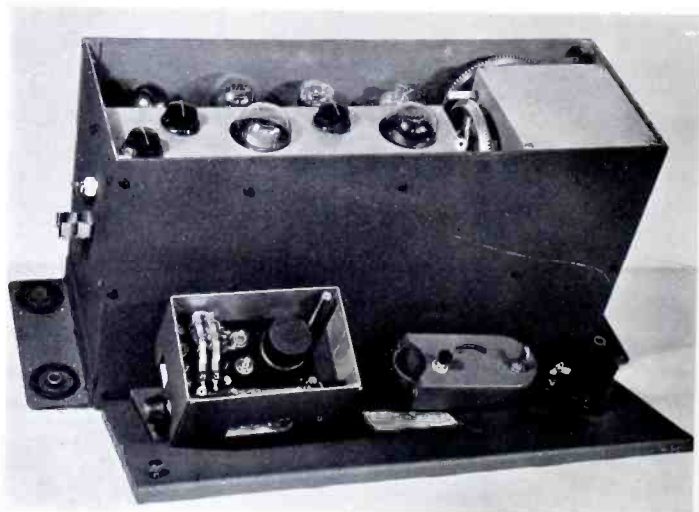

VIEW OF THE ET-5022 MOBILE TRANSMITTER (WITH COVER REMOVED) AND ITS ASSOCIATED CONTROLS

tion. During the winter months, a considerable demand is made on the battery circuit due to the extra drain required for starting the car and, therefore, unless exceptionally good care is taken of the battery system, difficulties and poor radio performance are liable to result. Also in cases of long duration of operations of the transmitter the battery supply becomes too low for satisfactory performance. It was, therefore, decided to obtain the power supply for the transmitter from other sources, and as a result of tests made on various machines, a unit was selected which could be mounted on the motor and the power supply obtained for operating the transmitter from the fan belt. This generator is a ruggedly-designed unit, having incorporated in it a feature which provides substantially constant output voltage for various changes of speed of the automobile motor and thus eliminates excessive drains being taken from the car battery.

ET 5022-25-Watt Mobile Transmitter

This transmitter has been designed expressly to be used as a part of a police communicating system and employs three Radiotrons in the radio frequency circuit and four Radiotrons in the speech amplifier and modulator circuit. Every precaution has been taken to insure good frequency stability and provide good intelligible quality. The oscillator unit consists of the component parts mounted in an aluminum housing. There are two large calibrated dials mounted on this housing used for changing the frequency. The circuit employed is a stabilized master oscillator type, and the coils and condensers are rigidly

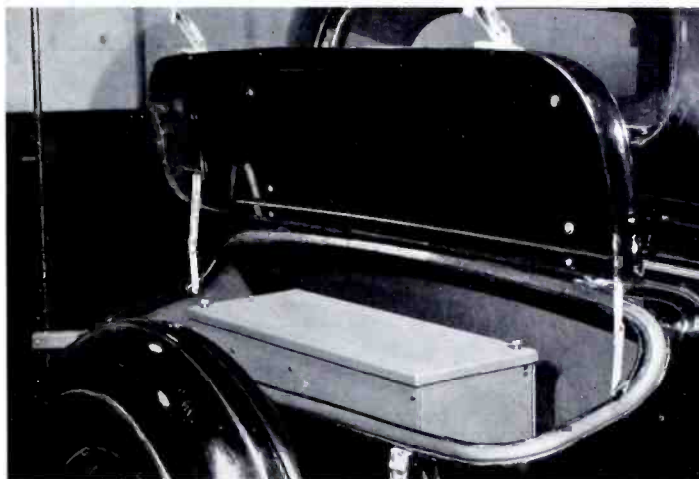

HOW THE ET-5022 MOBILE TRANSMITTER MAY BE CONVENIENTLY INSTALLED IN THE REAR OF A COUPE

built and are mounted in this case in such a manner that mechanical vibrations do not affect the frequency stability of the equipment. This oscillator compartment is provided with a cover and the equipment is so wired that when the automobile receiver is placed in the operating position, the filament of the transmitter oscillator tube is also turned on. The heat generated by the filament in this compartment is utilized as one of the means of providing good frequency stability. The oscillator tube is of the multi-element type and, in order to eliminate the possibility of frequency modulation, the oscillator circuit is operating at a lower frequency than that of the output of the transmitter. The output of this oscillator provides radio frequency excitation for an RCA-801 operating as an intermediate and buffer amplifier and this in turn provides excitation for a power-amplifier tube which is also an RCA-801. The output of the power ampli-

fier is inductively coupled to a flexible concentric transmission line which terminates at the base of the antenna. Tuning and neutralizing adjustments are accessible from the top of the transmitter when the outside lid is removed. The transmitter covers the range of 30.1 to 40.1 megacycles.

The microphone used with this equipment is a magnetic type requiring no excitation or polarizing voltages and obviously gets away from packing, a condition which is encountered with the use of carbon microphones. This microphone is a ruggedly-constructed unit and provides good intelligible speech quality. The microphone is transformer-coupled to an RCA-32, which in turn is coupled to an RCA-71A. This acts as a driving tube for two RCA-841's operating as Class B modulators and which plate modulate the RCA-801 power amplifier. Jacks are located on the chassis of the transmitter, which make it possible to check the various plate currents from time to time and also can be used to facilitate the tuning up of the equipment.

The DC power supply is obtained from a double-winding fan-belt-driven generator. The low-voltage winding is used to supply the filament and the bias voltages and the high-voltage armature is used to provide the plate voltage. Plate and filament filtering is incorporated in the transmitter in order to keep the ripple on the carrier to a minimum.

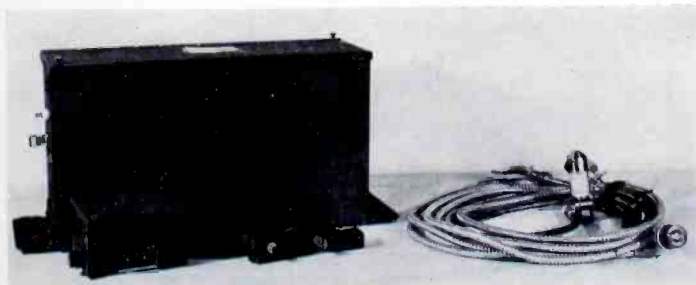

FLEXIBLE ARMORED CABLES ARE EMPLOYED SO THAT THE INTERCONNECTIONS WILL BE PROPERLY PROTECTED

The overall frequency characteristic is substantially flat between the limit of 250 and 7000 cycles, making possible the equipment's use for purposes other than police.

The overall dimensions of the transmitter proper is 22 inches long, 8 inches wide and 12 inches high. Four shock mounting units are provided so as to prevent excessive vibrations being transmitted to the equipment. Four bolts are furnished for securing the shock mounts to the car. All power and control circuits on the transmitter are terminated on plugs, so that the equipment can be readily removed for examination or servicing. In the output circuit of the equipment there is located a low-capacity relay which makes it possible to use the equipment for simplex service, and the transmitting antenna can be used for receiving purposes.

There are two accessory units provided with this equipment, namely, a junction box and a control box. The junction box, which is designed to mount against the fire-wall of the automobile by a single bolt mounting, houses the generator field relay, various plugs for the termination of control cables and a tone generator.

Convenient Controls

The control box is designed to mount on the steering column and has the key switch type of volume control which is used to turn on the receiver and filament supply for the transmitter oscillator circuit as well as acting as a volume control for the receiver. There is incorporated in this box a meter which indicates to the operator the performance of the transmitter and also indicates whether the equipment is being properly modulated. A push button is also located on this box which is used as a means of controlling the calling tone. This unit is designed to clamp on the steering column where the receiver control is normally clamped. When a talk-back transmitter is employed, the receiver control unit is not required.

Magnetic Microphone

The magnetic microphone provided has incorporated with it a push button which is used for controlling the field supply of the generator. The microphone cord is terminated in a plug. Its jack is located in the junction box. When the plug is removed from the circuit, it is not possible to

operate the transmitter. A bracket is provided for holding the microphone which may be mounted to the dashboard or any other convenient location.

Special Cables

All the connecting cables for the transmitter, which are provided, are the BX type and, in addition to acting as shielding, provide against mechanical injury to the cable. For temporary or emergency service, a 12-volt dynamotor is available which will allow the equipment to operate independent of the automobile.

Antenna

Numerous tests have been made to determine the most effective type of antenna that can be used. As a result of this investigation, it has been determined that a vertical antenna which projects about 2 to 3 feet above the top of the car, is the most suitable type. Any form of concealed antenna greatly reduces the efficiency of the radiator and ultimately cuts down the effective range of the transmitter. A dural rod is provided with a stand-off insulator which may be cut to length at the time of installation. It is desirable to allow the antenna

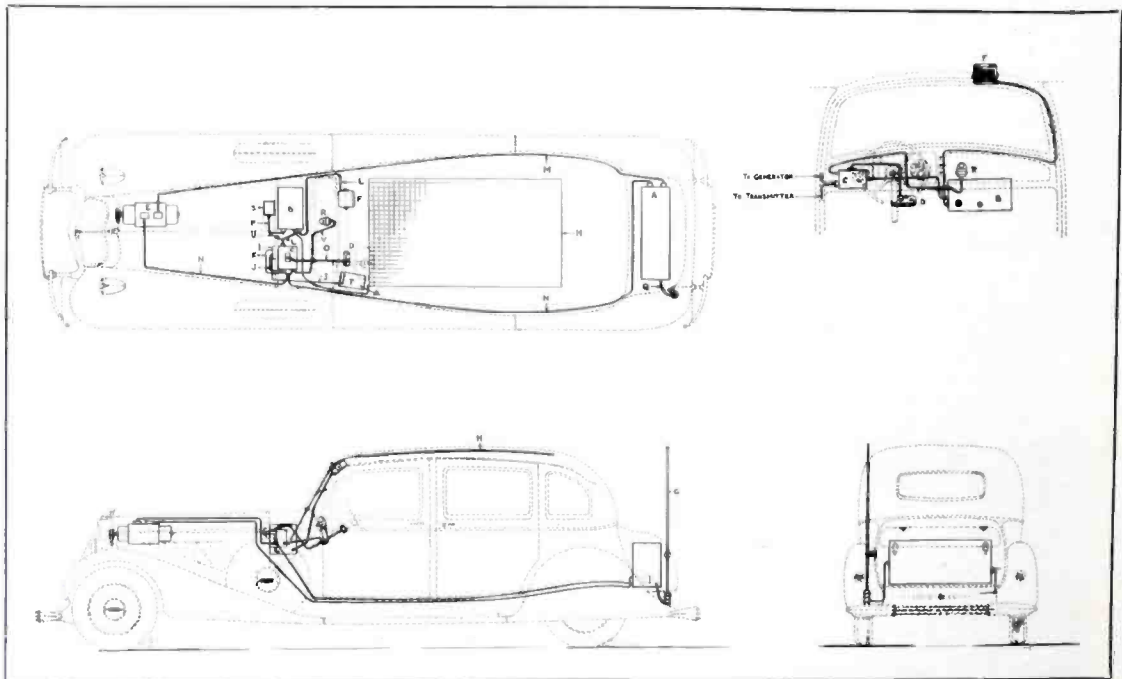

DIAGRAM SHOWING THE LOCATION OF THE VARIOUS PARTS AND INTERCONNECTIONS FOR A TYPICAL AUTOMOBILE INSTALLATION, EMPLOYING THE NEW 25-WATT MOBILE TRANSMITTER

height to project above the car in order to obtain the best results.

U. F. H. Automobile Receiver

The RCA Manufacturing Company has designed a receiver designated as type AR-5019 to operate in conjunction with this mobile equipment. It was developed especially for police service and is of the super-heterodyne type. It employs a total of 9 RCA Radiotrons and has one stage of R-F amplification, first detector, three stages of intermediate amplification, second detector acting also as automatic volume control and part of the squelch circuit, a squelch circuit tube and two stages of audio amplification. The receiver is mounted in a case 12 inches long, 8 inches deep and 7 inches high and weighs 16 pounds. The case is designed to mount against the fire-wall and is so constructed that it can be readily



STATION HOUSE RECEIVER, EMPLOYED TO PICK UP SIGNALS FROM THE MOBILE TRANSMITTER

opened up for servicing or changing tubes. The squelch circuit has proven to be a very desirable feature which permits the main transmitter to be operated with the carrier off between dispatches, and the squelch circuit can be so adjusted from the front of the receiver to any degree of squelch which is required. It is also possible to switch the squelch out of the circuit, if so desired. The squelch tube which operates in conjunction with the second detector tube allows the output of the receiver to be dead when

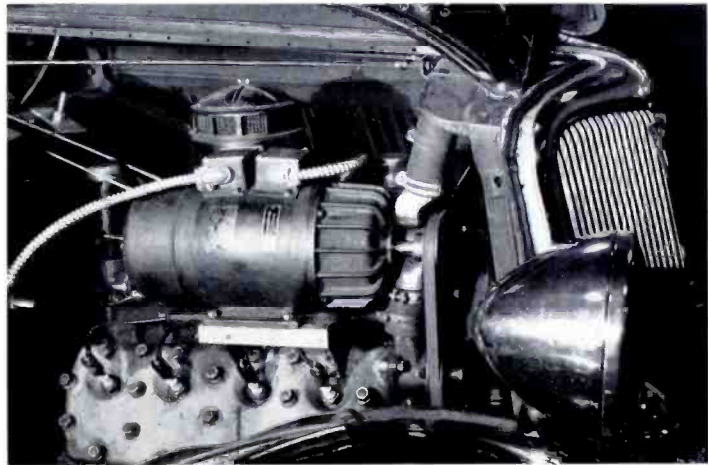

THE DYNAMOTOR IS CONVENIENTLY LOCATED UNDER THE ENGINE HOOD IN SUCH A MANNER THAT IT IS DRIVEN BY THE SAME BELT WHICH OPERATES THE RADIATOR FAN

the carrier is removed. This makes it possible for the operator to have the volume control turned up and yet not have to contend with the extraneous noises which are encountered in ordinary types of receivers, unless the carrier of the main transmitter is left on continuously. The loudspeaker is a separate unit, whose dimensions are $5\frac{1}{2}$ by $5\frac{1}{2}$ by $2\frac{1}{2}$ inches deep and is provided with a bracket so that it can be mounted over the windshield or in any desirable location, depending on the type of car in which the equipment is located. The plate power supply is obtained from an efficient type of dynamotor and the whole equipment draws 7 amperes at 6.6 volts from the car battery.

Fixed Tuning

The receiver is of the fixed tuned type and is designed to cover the band of 30 to 41 megacycles. A jack is provided on the receiver chassis as a means of facilitating the proper tuning of the receiver, and the three tuning condensers are accessible when the case of the receiver is opened up.

With this receiver is provided an external cable and control unit designed to clamp to the steering column. On this control unit is located one knob which acts as a receiver volume control and the "on-off" power switch. When the receiver is installed in the car with the ET-5022 mobile transmitter, this control is not required. On the front of the receiver

case is located a red "on" indicating light and a squelch circuit control.

The dynamotor is mounted in a case in which is included the necessary filtering and is designed to mount on the engine side of the fire-wall with a single bolt mounting.

Station House Receiver

There has also been developed as part of this equipment the AR-5014 station-house receiver which employs the same electrical radio circuit as the AR-5019 automobile receiver, except that an additional power supply is provided so that the equipment can be operated from a supply of 105/125 volts, 50/60 cycles. The equipment is mounted in a two-tone gray wooden cabinet and is $13\frac{1}{2}$ inches wide, 10 inches deep and 22 inches high. An 8-inch dynamic type of loudspeaker is employed as part of this equipment and on the front of the cabinet, in addition to the loudspeaker grille, there are located the pilot light, the "on-off" power switch and volume control and the squelch circuit. A transformer is available so that the output of the receiver may be coupled to a 500-ohm line if necessary.

The above three equipments have been designed expressly for police communication service, utilizing the latest circuit developments and refinements and the design has been carried through with the idea in mind of providing the utmost in reliability and performance.

Terra-Wave Crashes Through in Danville, Illinois

Chief of Police Richard H. Johnson Enthusiastic About Efficient Service Rendered
by New RCA Police Radio Installation

THE newly installed RCA Terra-Wave equipment at Danville, Illinois, proved a big factor early on the morning of January 29th in the capture of four men who, police say, confessed to a holdup at a local gasoline service station.

While the finishing touches were being put on the new RCA Terra-Wave installation for the police department and final tests were being carried out, an emergency call came in to the effect that a daring holdup had just been staged at the Ingram Oil Station. A description of the bandits and the car was flashed over the new radio to all the squad cars with which tests were being carried on. The result was that the first of the alleged bandits was captured within thirty minutes after the alarm was broadcast, and the others were rounded up within the hour.

All Four Apprehended

According to the Danville *Commercial-News*, warrants charging all four with robbery while armed were issued. They were arraigned in police court, waived preliminary hearing and were bound over to grand jury. In default of \$2,000 each, all went to jail. All made confessions in which they admitted, police said, that they came to Danville for the purpose of "sticking up" the Ingram Oil Station. One of the bandits, Roy Blackford, who confessed that he "put the gat" on the attendant, said he was released from Pontiac Reformatory, where he served a term for robbery.

Otto Allison, attendant of the oil station, has been held up five times within the last few years, and was on duty when the bandits' automobile stopped in the driveway. Three of the bandits entered the station, held



CHIEF OF POLICE RICHARD H. JOHNSON,
DANVILLE, ILLINOIS

him up, and rifled the cash drawer. The fourth bandit, said to have been Clarence Duffy, remained in the automobile.

Traffic Officer J. W. Stricklin, responding to the alarm, saw the bandits' car approaching at Main and Crawford Streets, where he attempted to force it to the curb. Swerving around the officer's car, the bandits continued their flight to Alexander Street, where two of the occupants jumped out and fled on foot.

Attempted Escape

Officer Stricklin, firing at the car as he pursued it, continued the chase through Seminary and Collett Streets, where he was successful in forcing it to the curb. Here the two other occupants jumped out and attempted to escape on foot. Officer Stricklin, however, captured Benton Stewart and took him to police headquarters, where he is said to have confessed participation in the holdup and to have named his accomplices.

While all available officers were searching for Stewart's companions, Duffy entered the police station and reported that he had been forced by the three other men to drive them to the Ingram Station. After continued questioning by the officers he confessed, they said, that his participation in the robbery was voluntary and he was placed under arrest.

Fast Work

While Police Officers Stricklin and Blakney were subsequently cruising on North Vermilion Street, they came upon two men in front of the post office. When the police car's searchlight was thrown upon them, the men separated and fled. One of them was overhauled at the Texaco Service Station near by, and gave his name as Roy Blackford. Officers said that he had a revolver in his hand when captured. Blackford is said to have told the officers that the fourth man implicated in the hold-up was James Holmes and that his "hangout" in Danville was at 24½ North Jackson Street. Detectives W. C. Smith and Jesse Cowan, Traffic Officer C. V. Hart and Patrolman C. Howk went to that address and arrested Holmes.

According to the reported confessions obtained by the police, the four men met in a confectionery store at Champaign, Ill., where they planned the robbery before coming to Danville.

Chief Richard H. Johnson of the Danville, Ill., Police Department praises the work of his organization in rounding up these four men so speedily, and has paid a high compliment to the RCA Terra-Wave equipment, without which, he says, such efficient and rapid work could not have been accomplished.

FIELD INTENSITY SURVEY

(Continued from Page 13)

the cold weather. Similarly, another firm was immediately engaged and assigned to the Northwest to survey certain other stations which the first crew could not reach in time. Arrangements were also made with a West Coast concern to go to the Pacific Northwest and start down the Pacific Coast to wind up in the San Francisco area. Another firm was engaged and its three crews assigned to the New England and Chicago areas, and another was engaged also to get five crews in the field to work from north to south at intermediate points. In this way the entire northern part of the United States was covered by survey crews which began to function almost simultaneously.

A Canadian firm was engaged to measure the Canadian stations plus the Canadian coverage of the American stations. Likewise American engineers were assigned to the American areas of the Canadian stations.

The routes for the various crews were laid out for the utmost efficiency and the minimum traveling time. The object was to have all of the crews finish their work along the Gulf by Christmas. Also wherever possible (and in nearly every case it was possible), the consulting engineers were assigned stations which were or had been their clients previously. Special pains were taken to do this since it was felt that it would be preferable to both the client and the consulting engineers involved.

Office routine arrangements were set-up in the Radio Engineering Department of NBC to go over all incoming reports, follow-up the crews on their schedules, arrange for payment for station surveys as each was completed, collaborate with the Statistical Department in the preparation of maps, keep files, covering each station, the dates of the survey, the firm involved, the date of payment, the number of days required, number of miles traveled, area covered in square miles, etc., etc.

As each report and its accompanying maps came in they were gone over carefully and where necessary supple-

mentary or checking observations were requested. After the final checking and the measurement of the areas (by Planimeter) these maps were turned over to the statisticians. Due to unforeseen difficulties in one or two cases only, it was necessary to reroute a crew in order to obtain the most economical routing. The work was scheduled so closely that in about a half-dozen cases the final completed reports were not received until noon of December 31st, the final deadline given each contractor.

There were many indirect benefits from the network survey which are still in evidence. There is a general quickened interest among station executives and engineers throughout the country to improve the efficiency of their stations and there is a growing consciousness of the importance of the most effective use of the radio facilities they are using. As might be expected, many unusual experiences fell to the lot of the survey engineers. One crew was unable to buy a good steak in the heart of the Texas cattle

lands, although the surrounding country was heavily populated by cows and bulls. They drove away amid the roaring guffaws of the said C's and B's. The story was brought back of the Houstonite who didn't like to go north to Dallas because he didn't like those "damned Yankees." One car hung over a cliff with its front wheels before stopping, another was shot at by bootleggers in the Everglades, and another crew in California, experienced two inches of snowfall in fifteen minutes. All of the crews are at home in cemeteries, having visited hundreds of them throughout the country during the survey. It is the one place where no interfering power and telephone lines are found. One driver is supposed to have suggested that the cemetery he was in was a "dead spot." One man in the northwest was almost exterminated by an enterprising rattlesnake which took a liking to that corpulent engineer. The snake now serves his country by holding up the corpulent engineer's trousers on Sundays.



DIRECT READING AND AVERAGING SIGNALS

(Continued from Page 5)

be used for any of these instruments without introducing an error of more than a few per cent. In the construction of the mounting the writer had to work under unique handicaps, so the appearance of the sample produced should not be too harshly judged. With a little care it should be possible to achieve a finished laboratory appearance. If it is desired to go to the extra bother, it would be possible to greatly improve the dynamic symmetry by slightly changing the overall dimensions. Use of a bakelite panel would also considerably enhance the general appearance.

To realize the full possibilities of this direct-reading scale it is almost necessary to observe it in use. However, anyone who has had occasion to make several hundred measurements a day at a number of different frequencies will appreciate it—and those confronted with such a requirement for the first time will do well to take a tip from old hands and make up one of these scales before beginning. But in addition to the saving in labor it effects where a large number of measurements are required, it is also extremely convenient at various other times. A typical instance of this is occasioned whenever it is desired to make a quick check of intensity in connection with some other type of observation. For example, the writer has found it very valuable when making observations of the distortion accompanying reception of a distant station—as the fluctuations of signal intensity may be followed directly on the meter while the distortion is observed on a standard receiver, thus providing a quick means of differentiating distortion due to volume fading from that due to other causes such as phase slipping.

Automatic Averaging of Readings

As was pointed out at the beginning of this write-up, it is very desirable when making groups of readings to have some easy method of averaging these. The writer's system, which is simply to note them directly on an adding machine, can hardly be considered as any remarkable innova-

tion—still, as the advantages of so doing may not have occurred to everyone, they will be briefly pointed out. In the first place it is far easier to operate such a machine while keeping one's eye on a meter than it is to write down the successive readings. And in the second place, totalizing requires but a flick of the thumb. If readings are made in groups of ten or a hundred (and using the direct-reading scale groups of a hundred are quite easy), the average for the run is instantly available just by totalizing and setting over the decimal point. Similarly subtotals may be utilized to break down a run into shorter units of time. The number of readings to be made, as well as the time interval between, will depend on the requirements of the work under way and also on the fading period of the signals to be observed. Where the period is fairly short—say a minute or less—a group of ten readings at fifteen-second intervals will usually prove sufficient. Where the period is longer—and regular periods as long as twenty minutes have been occasionally observed by the writer—the readings should be further spaced and extended over a much longer time interval. For the extremely rapid fading sometimes encountered on short waves it is usually necessary to devise some special method, such as reading peaks and valleys only.

The complete set-up for making observations in the manner described above is shown in Figure 1. The limitations under which the writer has to work are striking evidence of the convenience of the arrangement. A sample of the record which is made is shown in Figure 7. It has been found possible to record fifteen to twenty groups (of ten readings each at fifteen-second intervals) such as that shown, in the space of an hour. And the record made is complete and finished—there is no computation. Interesting records made in this way will be published at a later date.

RCA CATHODE RAY

(Continued from Page 9)

and impressing the modulated R-F signal on the vertical axis. Figure 4 shows this method graphically. In-

centally, if a linear timing axis is used, as shown, the true wave-shape of the envelope will appear, and an appreciable lack of symmetry or other irregularities will be immediately apparent, indicating distortion. If no timing axis voltage is used, the percentage can be determined as shown in Figure 5. This obviously necessitates removal of modulation. A third method is shown at Figure 6. The 1000-cycle audio voltage which is modulating the R-F signal is impressed on the horizontal axis (modulated R-F remains on vertical). A trapezoid results which allows ready measurement of the peak deflections. Symmetry of modulation can be checked with methods of Figures 4 and 6 by removing modulation from the R-F oscillator and noting whether the carrier height is midway between the positive and negative audio heights.

The foregoing gives a general outline of some of the possibilities of the RCA Cathode Ray Oscilloscope. Innumerable other uses will suggest themselves in practically every phase of the radio art.

STATION MAINTENANCE

(Continued from Page 25)

to make harmonic measurements at several frequencies and in that case a filter would be required for each frequency. It is important when measuring distortion to use an input signal corresponding to the maximum signal normally encountered in the studio, and the controls should be adjusted to give a normal output level to the transmitter. For routine checks, the modulation on the transmitter should be adjusted to an average operating level.

A distortion factor meter or a harmonic analyzer should be used to analyze the output signal from the monitoring rectifier at the transmitter. From experience we know that the operation of even the best of broadcasting equipment may be seriously impaired because of slight misadjustments, failing vacuum tubes, or other faulty circuit elements, or by disturbances entirely external to the equipment itself, and no broadcaster can afford to permit such conditions to exist.



NEW YORK OFFICE MOVES

Effective April 29, 1935, the Eastern District Office of the RCA Transmitter Sales Division will be located at 1270 Sixth Avenue, New York City, under the management of T. A. Smith. This new office is conveniently located in the RKO Building, Rockefeller Plaza.



RCA Makes Another Great Contribution to Crime Control



No severe drain on car battery. Special generator is furnished, driven by engine, supplying 250 watts to transmitter. Only one tube is connected with the battery and it draws less current than a headlight. Tubes are easily replaced and are standard types obtainable anywhere.

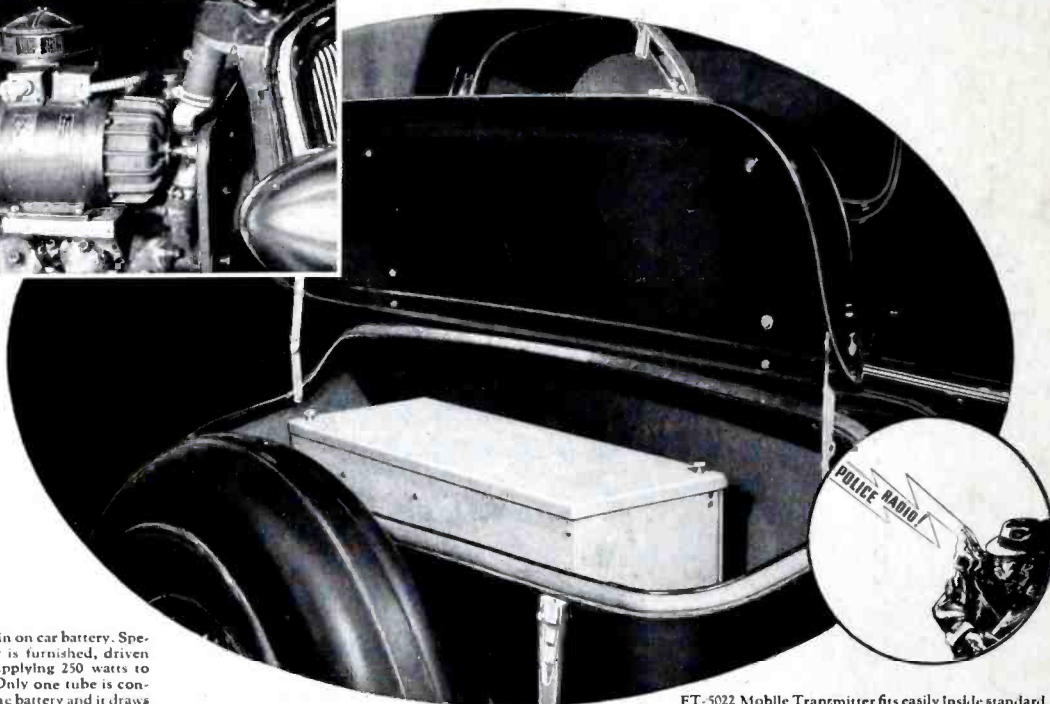

ET-5022 Mobile Transmitter fits easily inside standard rear trunks. May also be located within car if desired. Self-contained in strong but light aluminum case, mounted on shock absorbers. Total weight about 60 lbs.

Adds 2-way communication to Terra-Wave Police Radio System

Here is the biggest news since the introduction of the famous RCA Terra-Wave Police Radio! Now your patrol cars can be equipped for 2-way radio communication, easily doubling the effectiveness of the system. Cars using the new RCA Terra-Wave Mobile Transmitter can call headquarters by radio to transmit important information, acknowledge orders, answer questions, ask for help, advise when returning to service. Within 3 seconds after pressing a switch, every word spoken by the driver is heard by the dispatcher. There is no interruption of work on the immediate emergency.

Several years of intensive research went into this remarkable development. It had to be 100% right before it was worthy to bear the RCA Terra-Wave

name. Power is 25 watts actually put on the air, the highest ever offered for such use. Our tests prove conclusively that this much power must be used if complete reliability is to be had—and nothing less than absolute reliability is good enough for police use.

The transmitter is compact, simple to operate and so sturdy that only a major collision can injure it. No changes are required in your present RCA Terra-Wave equipment. The 2-way feature is obtained merely by installing the new transmitter in each of your cars. Write for complete details and specifications of this second great RCA contribution to the speed and efficiency with which your department controls crime.

Sales and Service Representatives in Principal Cities



TERRA-WAVE POLICE RADIO SYSTEM

RCA MANUFACTURING COMPANY, INC., CAMDEN, NEW JERSEY

(A Radio Corporation of America Subsidiary)