

# BROADCAST NEWS

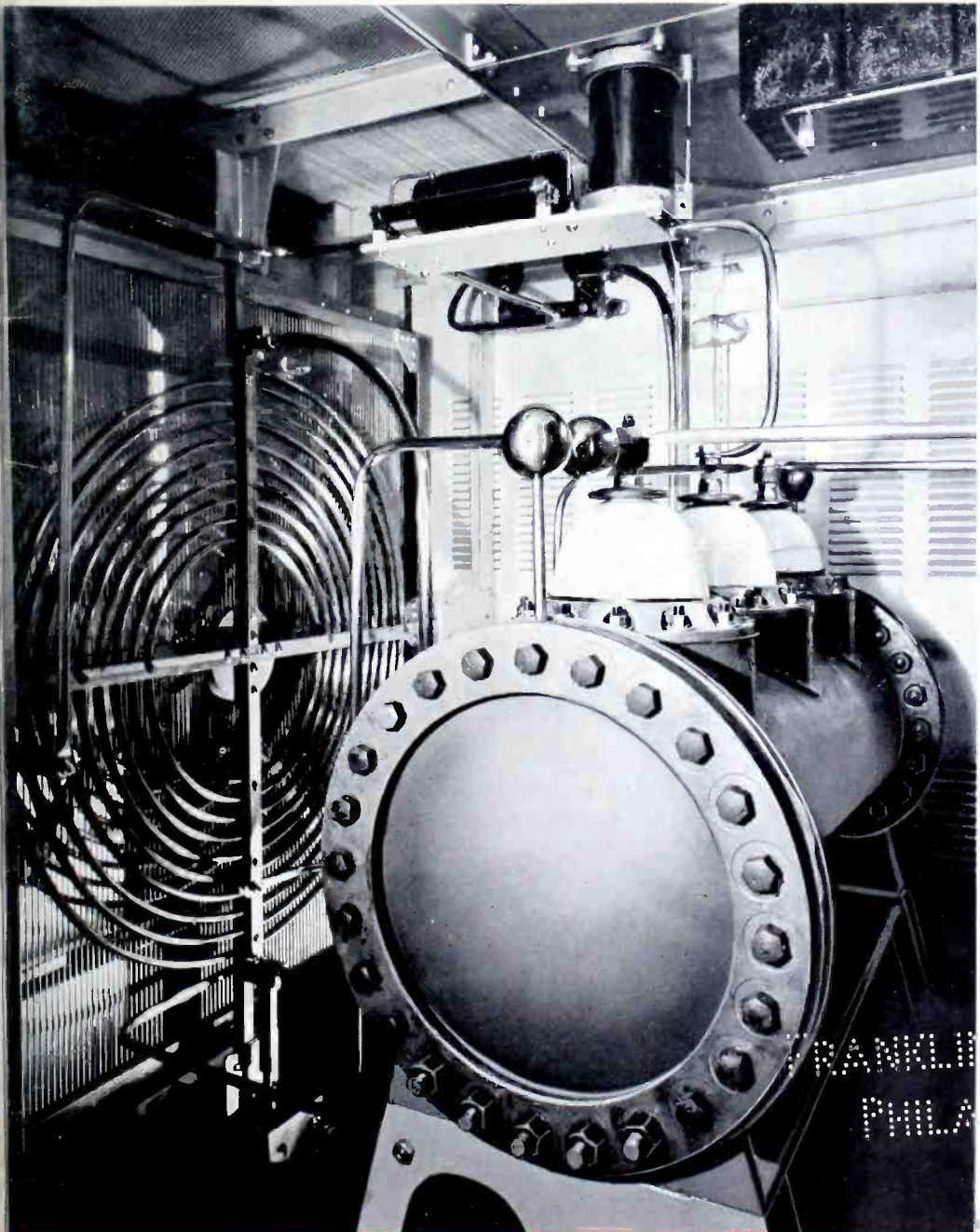

## *In This Issue*

**MODULATION SYSTEMS  
FOR  
BROADCAST  
TRANSMITTERS**  
BY LOY E. BARTON

**NEW STUDIOS  
FOR WIP**  
BY EDWARD R. JOHNSTON

**FAST TELETYPE  
NEWS SERVICE  
FEATURED ON  
WFIL PROGRAMS**

» «  
← AN INTERESTING CORNER INSIDE THE  
NEW RCA 50 KW HIGH FIDELITY  
TRANSMITTER

**PUBLISHED BY  
RCA MANUFACTURING COMPANY, INCORPORATED  
CAMDEN, NEW JERSEY**

NUMBER 16      PRICE 25 CENTS      JUNE 1935



# RCA Manufacturing Company, Inc.

A Radio Corporation of America Subsidiary  
Camden, N. J.

## "RADIO HEADQUARTERS"

DAVID SARNOFF, Chairman of the Board

E. T. CUNNINGHAM, President	G. K. THROCKMORTON, Executive Vice-President
L. B. MORRIS, Vice President and General Counsel	J. C. WARNER, Vice-President and General Mgr., RCA Radiotron Div.
W. R. G. BAKER, Vice-President and General Manager, RCA Victor Div.	J. M. SMITH, Vice-President in Charge of Mfg., RCA Radiotron Div.
LEWIS M. CLEMENT, Vice-President in Charge of Research and Engineering, RCA Victor Div.	J. T. CLEMENT, Vice-President in Charge of Washington, D.C., Office
J. W. BURNISON, Vice-President in Charge of Mfg., RCA Victor Div.	J. D. COOK, Treasurer
	E. F. HAINES, Assistant Treasurer
	P. G. McCOLLUM, Comptroller
	E. J. SCHNEIDER, Assistant Comptroller
	F. H. CORREGAN, Vice-President and Secretary
	DAVID MACKAY, Assistant Secretary
	C. B. MYERS, Assistant Secretary
	F. H. TROUP, Assistant Treasurer and Assistant Secretary

F. R. DEAKINS, Manager  
ENGINEERING PRODUCTS DIVISION  
AND INTERNATIONAL DIVISION

### TRANSMITTER SALES SECTION (OF ENGINEERING PRODUCTS DIVISION)

I. R. BAKER, Manager

S. W. GOULDEN, Commercial Engineer	T. A. SMITH, C. B. S. Contact
J. P. TAYLOR, Sales Engineer	C. L. BEACH, N. B. C. Contact
A. R. HOPKINS, Sales Engineer	P. A. ANDERSON, Police Radio Sales
BEN ADLER, Power Tube Sales	T. W. ENIS, Power Tube Sales

E. JAY QUINBY, Engineering Products Advertising

- 1 EASTERN DISTRICT—T. A. Smith, Manager, 1270 Sixth Ave., New York City; R. P. May, Assistant
 

MAINE	RHODE ISLAND	NEW JERSEY	WEST VIRGINIA
VERMONT	CONNECTICUT	PENNSYLVANIA	DELAWARE
NEW HAMPSHIRE	NEW YORK	MARYLAND	VIRGINIA
MASSACHUSETTS	PUERTO RICO	NORTH CAROLINA (Broadcast)	
- 2 CENTRAL DISTRICT—H. C. Vance, Manager, 111 North Canal St., Chicago, Ill.; B. A. Wilson, Assistant
 

NORTH DAKOTA	MISSOURI	ILLINOIS	OHIO
SOUTH DAKOTA	IOWA	INDIANA	MICHIGAN
NEBRASKA	MINNESOTA	KENTUCKY	KANSAS CITY (KANSAS)
WISCONSIN			
- 3 WESTERN DISTRICT—W. H. Beltz, Manager, 170 Ninth St., San Francisco, Calif.; Edmund Frost, Assistant
 

WASHINGTON	IDAHO	UTAH	MONTANA
OREGON	NEVADA	ARIZONA	WYOMING
CALIFORNIA	HAWAII (Police)	ALASKA (Police)	
- 4 SOUTHWESTERN DISTRICT—W. M. Witty, Manager, Santa Fe Bldg., Dallas, Texas.
 

TEXAS	ARKANSAS	KANSAS (Except Kansat City)	NEW MEXICO
OKLAHOMA	LOUISIANA (Except New Orleans)	COLORADO	
- 5 SOUTHEASTERN DISTRICT—D. A. Reesor, Manager, 144 Walton St., N. W., Atlanta, Ga.
 

TENNESSEE	SOUTH CAROLINA	ALABAMA	FLORIDA
NORTH CAROLINA (Police)	GEORGIA	MISSISSIPPI	NEW ORLEANS (LA.)

BROADCAST TRANSMITTERS	POWER RADIOTRONS
POLICE TRANSMITTERS	POLICE RECEIVERS
SPECIAL COMMUNICATION EQUIPMENT	

# BROADCAST NEWS

REG. U. S. PAT. OFF.

Edited by  
E. JAY QUINBY

NUMBER 16

JUNE, 1935

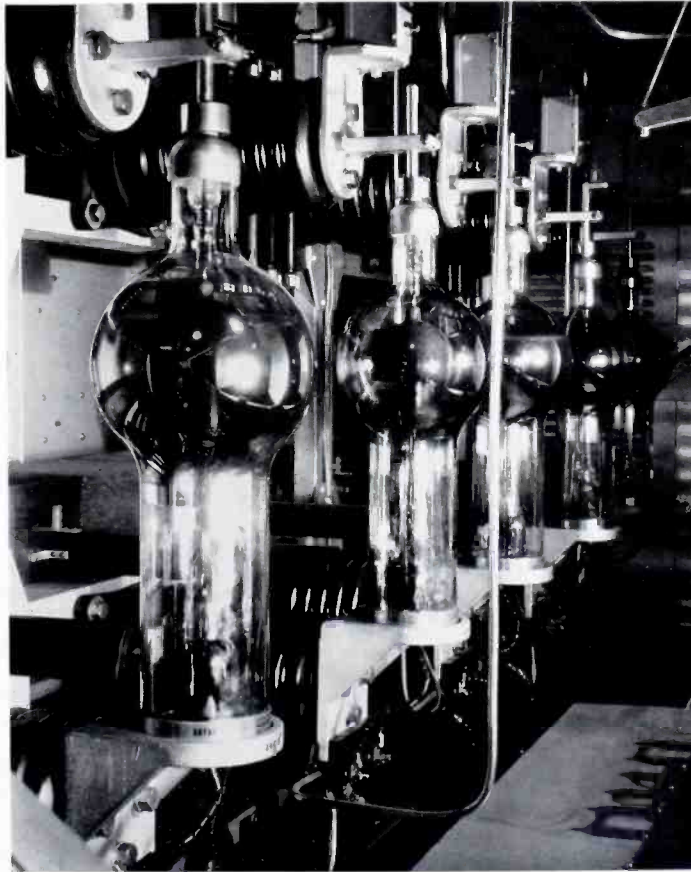

## THE POWER BEHIND THE BROADCAST

This regiment of Radiotrons inside the new RCA 50 KW High Fidelity Transmitter presents an imposing spectacle to the layman and engineer alike. These sturdy soldiers have been trained in the school of reliability and efficiency.

Published Bi-Monthly in the Interest of the Radio Broadcasting Industry  
and Copyrighted, 1935, by the  
RCA MANUFACTURING COMPANY, INC.  
CAMDEN, NEW JERSEY, U. S. A.

# New Studios For WIP

By EDWARD R. JOHNSTON, Technical Supervisor, WIP

THE NEW \$100,000.00 studios of "Philadelphia's Pioneer Voice," Station WIP, were put into service on March 16, 1935, on the thirteenth anniversary of the station's founding. The occasion was marked with a five-hour inaugural program which included all of the WIP staff artists, as well as many nationally known figures in the entertainment world. The "Star Spangled Banner" was sung by Thelma Melrose Davies, the first person ever to sing over a Philadelphia radio station; and the dedicatory address was made by Mayor J. Hampton Moore of Philadelphia who opened the original WIP on March 16, 1922.

The present modern studios on the twelfth floor of the Gimbel Building, 35 South Ninth Street, in Philadelphia, are a far cry from the original tiny plant which consisted of a small room which had formerly been used for playing phonograph records, separated by a flimsy partition from a similar room which contained all the control and transmitter equipment. The present studios are the result of three years of study of many modern stations throughout the



BENEDICT GIMBEL, JR., THE YOUNG AND PROGRESSIVE PRESIDENT OF THE PENNSYLVANIA BROADCASTING COMPANY, WHICH OPERATES WIP AT GIMBEL'S STORE IN PHILADELPHIA

country and the combined experience of architects, radio, ventilating and acoustical engineers incorporated to produce ideal broadcasting conditions.

The architects chosen to develop the station were Silverman and Levy of Philadelphia and Charles S. Leopold was called in as consulting engineer for air conditioning. The actual construction of the studios was done by S. H. Levin and Son.

The station has been constructed in modified style of modern architecture which was adopted as being attractive, cheerful, and consistent with the comparatively modern development of the radio industry. Accommodations are provided for the comfort and convenience of visitors and performers; including a spacious reception room, musicians' lounge, artists' lounge, and the various workshops and other facilities attendant on radio broadcasts.

## Studios

Four studios have been provided varying in size from the small key-operated stand-by studio to one forty by thirty feet for more elaborate programs.

Expansive vision windows are provided between each of the studios and the public space adjoining while the three sides of the central control room are glass enclosed to provide maximum vision for the operator.

All sound communication between any of the studios, control, and audition rooms, has been eliminated by "floating" the walls on supports which are lined with felt and by placing sheet cork both top and bottom for isolation from ceiling to floor. The doors to the studios weigh 350 pounds apiece and have rubber gaskets, special locks and automatic closures at the bottom to protect all door openings from outside noises. The vision windows are similarly protected with two thicknesses of glass, padded in felt, and a dead air space between, the outer glass being a different thickness in order to eliminate any tendency toward sympathetic vibration. Parallel windows have been constructed at an angle to obviate the creation of a standing wave.

## Audition Room

Every effort was made to secure the finest available facilities for the station's audition room. A spacious sound insulated chamber has been constructed, with every comfort for the client, with the



THE COMPLETELY RCA EQUIPPED MASTER CONTROL ROOM AT THE NEW STUDIOS OF WIP



THE ATTRACTIVE LOBBY AND RECEPTION ROOM AT THE NEW STUDIOS OF STATION WIP. AT THE CENTER MAY BE SEEN THE ENTRANCE TO STUDIO NUMBER 1 AND THE STUDIO ITSELF MAY BE SEEN THROUGH THE DOUBLE PLATE GLASS WINDOWS AT THE RIGHT, BEYOND WHICH IS THE MASTER CONTROL ROOM

modern motif carried out in the furnishings and decorations. A high fidelity RCA speaker has been provided and, from this room, any one of four programs can be monitored. Two telephones are installed with relay control light signals instead of bells for calling those in the audition room. A signal system has been arranged between the audition room and control room so that auditions may be run off smoothly and without interruption. The audition room contains signal lights and microphone outlets and can be pressed into service as a studio in case of emergency.

#### Microphones

The studios are completely equipped with the new RCA Victor microphones, which were selected by the WIP engineers after careful study of almost every

microphone on the market today. RCA microphones are also used on all of the WIP's eighteen remote control pick-ups.

#### Studio Transmitter Lines

The studios on the twelfth floor are connected with six high quality telephone lines to the transmitter house which is located on the roof of the Gimbel Building two floors above the station, a distance of about 250 feet. Three of these are program lines, a regular line, and two for emergency; the other three lines are for control, monitoring, and the inter-communicating service.

#### Inter-Communicating System

All inter-office communication is carried on by a self-operated private telephone system which eliminates much of the traffic through the PBX switchboard.

The private telephone line connects all offices and the control room, and has selective ringing and talking circuits to all points.

An RCA paging system has been installed with a microphone before the PBX operator and loud speakers throughout the building so that persons may be paged throughout the plant when needed.

Three studio channels are fed from the master control room to each office, the corridors and the reception room and each is provided with a volume control and switch for selective channels.

#### Time System

Twelve inch electric clocks are provided throughout all the offices, studios and control room. All the clocks are controlled by a master regulating system located in the master control room. Checks are secured three times daily from Arlington and all clocks are re-set three times per day.

#### Wiring

All wiring throughout WIP is in conduit, and, in addition, all radio wiring is in lead shielding. All high, intermediate and low-level circuits and equipment are isolated from each other as well as from the AC wiring. Over 30,000 feet of wire was used in making the installation and about 30,000 feet of wire was used in two twisted conductors in lead shielding. Grounding is completed by tying in to the steel framework of the building. Every effort has been expended to make the equipment and wiring readily accessible in order to facilitate maintenance.

#### Master Control Room

The studios are operated from a central control room which is at once studio and master control room. The room is raised four feet above the level of the studio floors; the operator can observe all parts of each studio. The latest type RCA high fidelity equipment has been used throughout. All amplifiers are completely AC operated and are self-contained units. No DC is used in the control room except for telephone and signal lights.

Four cabinet type racks have



THE CASCADE PLATFORM IN STUDIO NUMBER 3 IS DESIGNED FOR ORCHESTRAL SET-UPS AT STATION WIP. RCA INDUCTOR MICROPHONES ARE EMPLOYED IN THIS STUDIO

been installed for equipment mounting and termination facilities. Rack No. 1 contains seven RCA type 41-B pre-amplifiers for use with the studio microphones. Rack No. 2 contains four RCA type 40-C program amplifiers and AC power supply switches. Rack No. 3 contains equalizers, spare volume indicators and channels, line and multiple jack facilities. Rack No. 4 contains four RCA type AA-4194-B monitoring amplifiers and a public address amplifier. All racks have two or more jack strips to provide input and output jacking for every piece of equipment used either in the rack or at the control desk.

Normal connections have been so arranged that patch cords are necessary only for remotes. Two fifty-pair telephone cables are wired into the jacks to care for WIP'S many remote controls and special news events broadcasts. The four monitoring amplifiers each developing twenty-six watts output are a real innovation being equipped with remote control volume controls and switches for AC operated push buttons at the desk. One button operates a motor connected to the volume control and increases the volume, another reverses the direction of the motor and decreases the volume. The third and fourth burrons control relays which apply or remove AC from the input. Stress has been

placed on the location of all equipment for convenience and operation as well as accessibility.

#### Master Control Console

The master control console has been arranged so that it can be operated from four positions with a panel facing each studio for use in connection with that studio. On each panel are four volume controls, a master fader, and four input keys connected to the four faders. These provide the choice of eight different inputs including microphones, and four channel

keys for selecting the proper destination of the program. The volume indicator externally connected to the RCA type 40-C program amplifier completes the panel assembly. Any one of these panels may normally utilize two microphones, two remotes, two transcriptions (78 RPM and 33-1/3 RPM), a local feed from another channel, and a network program, without any patch cords becoming necessary. The output or channel keys also provide the proper signals for studio and master control as well as taking care of the monitoring for both. To the left of the center panel is the private inter-communicating telephone system and the private PBX board for remote control telephone communicating. Also, over the center panel is a unit containing four special rotary switches connected to the input of the four monitor amplifiers with provision for seven different inputs. The normal connection of these switches is the output of the three studios and the four channels. The 78 RPM transcription machines are recessed in the ends of the desk with a hinged lid so that they are covered when not in use.

#### Air Conditioning

The new WIP studios are completely air conditioned with the machinery which is the latest development of Frigidaire, and forced draft ventilation is used in



STUDIO NUMBER 2, DESIGNED FOR "SMALL GROUPS" AT STATION WIP

the corridors and offices. The air is washed, humidified and cooler heated so that an even temperature is maintained at all times, regardless of whether the studio is occupied by one performer or by a large audience. The cooling tower and compressors for summer cooling are located two floors above the studios, with feed and control lines terminating in the machinery room within the studio plant. In order to eliminate any sound of the moving air, and to eliminate the possibility of having sound carry from one studio to another through the air ducts, silencers have been installed at both the feed and exhaust outlets.

Benedict Gimbel, Jr., is the President of the Pennsylvania Broadcasting Company which owns and operates Station WIP, and Albert A. Cormier is the Vice President and General Manager. George A. Lough is the Treasurer. Ellis A. Gimbel is the Chairman of the Board of Directors, which includes Arthur Kaufmann, Charles Edwin Fox, Richard Gimbel, Kenneth Collins, and Albert A. Cormier, Secretary.

Edward R. Johnston is the Technical Supervisor of the Engineering Staff, and Clifford Harris is the Chief Engineer. Edward Turner and Edgar Penny are Transmitter Engineers.

## David Sarnoff's Statement On Television Creates Stir In Broadcasting Industry



DAVID SARNOFF, PRESIDENT, RCA

AT THE annual meeting of the RCA Stockholders in New York City on May 7th, 1935, David Sarnoff, President of the Radio Corporation of America, issued a statement which proved to be of unusual interest

not only to the stockholders, but also to the entire broadcasting industry.

Instantly becoming front page news in the daily papers of the nation's leading cities and subsequently widely quoted by the radio periodicals, Mr. Sarnoff's statement has quite apparently been accepted as a criterion in the American field of Television activities. As our contemporary publications have already published Mr. Sarnoff's statement, during the interval between our last issue and this one, we are quoting below only a few of the important highlights:—

### The Plan

"1. Establish the first modern television transmitting station in the United States, incorporating the highest standards of the art. This station will be located in a suitable center of population, with due thought to its proximity to RCA's research laboratories, manufacturing facilities, and its broadcasting center in Radio City.

"2. Manufacture of a limited number of television receiving sets. These will be placed at strategic points of observation in order that the RCA television system may be tested, modified and improved under actual service conditions.

"3. Develop an experimental program service with the necessary studio technique to determine the most acceptable form of television programs.

"Through this three point plan of field demonstration we shall seek to determine from the practical experience thus obtained, the technical and program requirements of a regular television service for the home.

"It will take from twelve to fifteen months to build and erect the experimental television transmitter, to manufacture the observation receivers and to commence the transmission of test programs.



AN UNUSUAL FEATURE OF STATION WIP IS THE SPACIOUS AUDITORIUM WHICH IS SHOWN HERE, WITH A MEETING OF THE HOME MAKERS' CLUB IN PROGRESS. AS THE STATION IS LOCATED ATOP THE GREAT GIMBEL STORE IN PHILADELPHIA, THE VALUE OF ANY FEATURE WHICH ATTRACTS SUCH LARGE NUMBERS OF WOMEN TO VISIT THE ESTABLISHMENT IS OBVIOUS.



# NBC Broadcasts From the Normandie

Maiden Voyage of World's Largest Liner an Outstanding Radio Event



ALFRED H. MORTON, MANAGER OF THE NBC PROGRAM DEPARTMENT, WHO WENT TO FRANCE WEEKS IN ADVANCE AND SAILED FROM HAVRE ON THE NORMANDIE TO SUPERVISE THE BROADCASTS

THE MOST pretentious welcome ever to herald arrival of a ship was accomplished by radio recently when, in pronounced contrast to the silence of the sea that veiled the ships of old, the gigantic French liner Normandie on her maiden voyage was transformed virtually into a sailing broadcasting studio.

To the layman the broadcasts incident to the first trip of the world's largest steamship were extremely interesting. To the technicians, engineers and announcers of the National Broadcasting Company they represented the meticulous fulfillment of intricate broadcasts which required weeks of preparation.

From the time the giant craft "shoved off" from Havre on May 29 until she was serenaded in New York harbor on June 3, novel programs were carried shoreward by short wave and broadcast daily over NBC networks.

These programs, of themselves, entailed the sending of special NBC representatives to France and the installation of NBC microphones, amplifiers and other equipment aboard the Normandie. The climax in this series of ship to shore broadcasts, however, came when the Normandie steamed up

New York harbor on the morning of June 3. A talking beam of light from the torch held high by the Statue of Liberty, France's gift to the United States a half century ago, carried the voice of a government official in Washington as a greeting to the vessel.

This was accomplished through the cooperation of the National Broadcasting Company and General Electric. This transmission differed from short-wave broadcasting in that the words were confined solely to the light beam, and received aboard the Normandie by a special apparatus. The words of greeting were carried from Washington to the statue by land wire and transposed there into pulsations of light, thence directed to the ship by means of a powerful reflector. This reflector is sufficiently powerful to transmit a light beam a distance of from five to six miles.

## Talking on Light Beam

The receiver on the bridge of the Normandie consisted of a large concave mirror which, after picking up the light rays, converged them upon a photo tube or electric eye. This tube transposed the waves of light back into electric pulsations the same as those which originate from a radio broadcasting station. The original voice in the talking beam of light was reproduced by an ordinary radio receiver and fed through the public address system of the ship for the benefit of the passengers. It was sent by short wave to Radio City where it was directed to the network. It was also sent by the short wave station, W2XAF, in Schenectady, to France. In all, the broadcast involved five distinct relays before it was heard abroad.

## Special Broadcast Set

Anticipating that the Normandie's own transmitter for use in ship to shore telephone service would be unavailable for broadcast purposes this side of Quarantine because of the tremendous number of telephone greetings that

were received, NBC installed its own 50 watt transmitter before the ship sailed from Havre. To arrange for the broadcasts from the ship A. H. Morton, manager of the NBC program department, Announcer George Hicks, and Engineer Alfred E. Jackson, went to France weeks in advance and sailed on the Normandie. Special NBC microphones and amplifiers were also installed aboard because, although the ship's telephone circuit could have been used, the



GEORGE HICKS, NBC ANNOUNCER, WHO MADE THE MAIDEN VOYAGE ON THE NORMANDIE TO HANDLE THE SPECIAL PROGRAMS BROADCAST FROM THE SHIP

quality of transmission on such a circuit is not on a par with that required for broadcasting.

The reception ceremony in New York harbor offered an excellent example of the ability of broadcasters to blend an interestingly precise and graphic description of an unusual public event from many widely separated vantage points. One of NBC's mobile units was at the Battery and followed the huge ship on West Street, along the shore of the North River. Another vantage point was on a tug where a 15 watt transmitter was installed.

The Normandie, itself, of course, was another broadcasting point and in addition to the regular broadcasts over the 50 watt

(Continued on Page 11)



# George Clark Views Normandie's Arrival

—And Describes the Proceedings from His Perch Atop the RCA Building

By GEORGE H. CLARK, Information Dept., RCA



**B**E IT known to my children, and to my children's children, and to my children's grandchildren, that I, George H. Clark, saw the Normandie dock at Forty-eighth Street, New York City, on her first visit to her Creditor Nation.

### So What?

So what? So this!! . . . That in this country where the superlative rules (or used to), the Largest ship, the Blackest smoke, and the Finest Wine, and the Slowest motion toward docks, has just come to rest at the Forty-eighth street pier. (No pass is needed. Admission fee 50c.)

My observa<sup>n</sup> post was in tier 53 of the RCA Building, where I found a chance to observe the arrival of leviathan after throwing out of the window seven NBC men who had established squatters' rights. There I could look down the river; up at the



GEORGE CLARK, RCA

could I note the brilliant neon light, red as France's finest wine, which signalled by General Electric to the watchful electric eye on the vessel. Nor could I, even with the finest binoculars, pick out

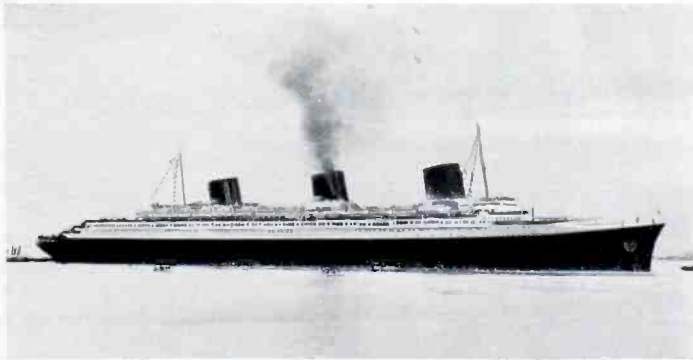

THE TURBO-ELECTRIC LINER **NORMANDIE**, FRANCE'S LATEST PRIDE, AS SHE APPEARED ON HER TRIAL TRIP. IT IS RUMORED THAT SHE HAS PROVEN SO SUCCESSFUL THAT THE FRENCH LINE PLANS TO CUT THE **S.S. ILE DE FRANCE** IN HALF AND INSERT AN ADDITIONAL MID-SHIP SECTION TO INCREASE HER LENGTH BY 100 METERS.

escorting planes and the dirigible; and *straight* down at the bald heads and bobbed tresses of four hundred and seventy-three other non-workers of the same building. It was almost as much fun as going to a movie.

Thanks to a beneficent mist, I could not see the Statue of Liberty bow in humility as France's latest Gift swept past her; nor

Monsieur Pietri, of the Compagnie Generale de Telegraphic sans Fils, who was sent over by the government with the joint task of doing something about wireless and also paying the French war debt to us. (Hence the size of the ship.) All I could see was fog . . . Later it proved that it wasn't fog at all; it was smoke from the French fuel

which, with their usual patriotism, the owners had insisted on using.

And when I say smoke I mean **SMOKE**. Fume. Real, black, exuberant essence of floating carbon. As the ship emerged from her self-made obscurity, one could see the middle funnel shooting up a plume of black like a Grande Bertha aimed at Mars. Someone in the Embassy must have sent the French Line the rules and regulations of New York, for how else could they have known that such emission of black fumes was compulsory within our city limits!

Perhaps, too, it was this compliance with our civic regulations which led to the presence of our finest fire-boats, two of which followed the monster at a respectful distance, shooting up huge sprays which fell, alas, only too soon to the river which spawned them. Whether this was done to prevent the Normandie from setting the river on fire, or in an attempt to raise the tide level and hence prevent premature grounding, has not been learned up to this moment, even by the NBC engineers in charge of broadcasting. And *they* would know if any one would!

Below me, on the thirtieth floor (plus or minus), a window washer hung out from his windows, turning an unheeding back to the sight that all the rest of New York was trying to witness. Industriously he washed, never turning. Was he merely angry because the Normandie's smoke was making his task all the harder, or did he still harbor feelings of anger due to the War Debt?

### Boats, Planes and Blimps

Just as all big fleas have little fleas, so did the Normandie have her attendant hoppers. Three of the Hudson River day line boats hovered beside her all the way up the river, at so much a hover. Above, Mr. Goodyear himself rode in his private rubber throne, which looked like a toy balloon let loose

(Continued on Page 11)

# DeLuxe Transcription Turntable Equipment

Designed to Meet the High Standard of Reproduction Fidelity Required in Modern Broadcast Stations,  
And to Maintain This Standard Under Constant Hard Use

THE RCA Victor Type 70-A Transcription Equipment is assembled complete in a console-type cabinet—a change from the table mounting cabinet previously used having been made in order to provide space for a flexible coupling and mechanical filter between the motor and the turntable. The console, 31" high and approximately 20" square, is recessed in front to provide leg clearance. It is ruggedly finished in durable black Duco with silver striping. Three point support—two front legs and a third support in the center rear—is utilized to eliminate rocking when the floor is uneven.

## Cast Aluminum Turntable

A cast aluminum turntable 16" in diameter is provided. This is felt-covered on top and finished around the exposed edge in gray wrinkle matching the finish of the tone arms. Since many of the transcriptions currently used are of very thin material, with a consequent tendency to warp, a special weight is provided to make them lie flat. This weight—which has a soft rubber face next to the record—engages the hexagonal record-spindle and thus assures a positive drive between the turntable and the record. Set in a slot in the top of the disc is a small positive-acting sliding button, by means of which the change in speed from 33-1/3 revolutions to 78 revolutions per minute is effected.

## Ball-Bearing Speed Reduction Mechanism

Change of speed in this equipment is accomplished by means of an ingenious ball-bearing reduction mechanism exclusive in RCA Victor reproducing equipment. This device has been in use for several years and has proven very satisfactory and distinctly super-



THE NEW RCA VICTOR "DE LUXE" TRANSCRIPTION TURNTABLE EQUIPMENT IS COMPACT AND IS DESIGNED WITH A VIEW TOWARD OPERATING CONVENIENCE. WITH TWO OF THESE UNITS, AN UNINTERRUPTED PROGRAM MAY BE RUN FROM ELECTRICAL TRANSCRIPTIONS EITHER AT 33-1/3 R.P.M. OR 78 R.P.M. SPEEDS, AND WITH EITHER VERTICAL OR LATERAL TYPE RECORDINGS

ior to any other type of reduction mechanism.

The main turntable spindle revolves constantly at 78 R.P.M. For 78 R.P.M. reproduction a shifting member—which is operated from the button on the top of the disc—engages a pawl ring and this engagement couples the driving mechanism from the motor direct to the turntable. When the speed-shift button is set at the 33-1/3 R.P.M. position the shifting member on the turntable is disengaged from the pawl ring and engaged in a slot in the bearing housing. In this clutch position the ball-bearing reduction intercepts the direct drive from the motor to the turntable and thus reduces the speed of the turntable.

The ball-bearing reduction mechanism used in this equipment is of special dimensions appropri-

ate to the heavy duty to be expected in broadcast use. As an additional precaution, and in order to eliminate shock to the mechanism when changing speed, the speed-shift control has been located on the turntable proper as mentioned above. This allows the control to be operated when the turntable is revolving at 33-1/3 R.P.M.—but it cannot be operated when the turntable is revolving at 78 R.P.M. Thus the operator is forced to lower the speed of the revolving mass either by using his hand as a brake on the turntable, or by turning off the motor, before he can shift the clutch lever to the lower speed position.

## Cushioned Bearing Housing

A rugged iron housing set in the top of the cabinet supports the clutch mechanism and the main turntable spindle with its large

balanced fly wheel, which is fixed to the spindle just below the housing. The whole housing is felt-insulated from the cabinet top in order to prevent the torque vibration of the motor from being conducted from the turntable through this housing to the pickup arm. The main turntable spindle is well-journalled in a heavy-duty combination radial-and-thrust-load ball bearing at the top of the housing and in a bronze radial bearing at the bottom of the housing. The turntable thrust is taken on a single ball bearing, thus eliminating friction. The radial bearings are wide spread, are made of bronze, and are journal-finished to assure long life and a true turntable face when revolving. An oil-hole located in the top of the record spindle on the turntable provides for lubrication of all bearing surfaces. The care taken in the design of this bearing insures a smooth-running and absolutely

true turntable over a long period of use.

### High Torque Synchronous Motor

In any reproducing equipment speed-constancy is an essential requirement. Unless the regulation of the driving motor is such that variations of the load imparted by the pickup and suspension arm do not appreciably affect the motor speed, there is tendency to produce "wows" on sustained notes of low frequency. This is a type of distortion which is particularly noticeable in broadcast transmission and it is therefore, absolutely necessary that a transcription equipment for broadcast use be supplied with a driving motor having extremely good regulation. In the Type 70-A Equipment considerable attention has been given the problem of obtaining the very best possible regulation. Driving power is furnished by a self-starting synchronous motor of sufficient size that the

torque developed is large compared to the load variations and the effect of the latter is, therefore, small. A fan mounted on the motor armature shaft dissipates the heat in the cabinet generated by the motor, and affords some damping on the high speed shaft of the motor. As an additional refinement an oiled-felt filtering mechanism has been incorporated in the motor driving spindle. The effect of this is to allow the inertia of the main turntable and the fly wheel to be used to the best advantage in damping the slight irregularities which occur in the motor. As a result of these design features the maximum deviation of the turntable is not more than four-tenths of one percent at 78 R.P.M. and not more than six-tenths of one percent at 33-1/3 R.P.M. Such regulation insures complete freedom from mechanical load distortion.

### Flexible Motor Coupling

The driving motor is mounted on the bottom shelf of the cabinet, and is entirely independent of the turntable mechanism. It is set in a heavy cast-iron block which is fixed to a layer of felt and the felt in turn clamped to the shelf of the cabinet. This prevents motor noise and vibration from being conducted through the cabinet but at the same time insures correct motor line-up.

In order to still further insulate the motor from the reproducing units the connection between it and the driving mechanism has been made quite flexible. In addition to the filtering mechanism—which is on the spindle just above the motor—a specially designed flexible coupling is placed between the filter and the turntable driving shaft. This consists of two semi-flexible joints together with a secondary spring-coupling which disengages the turntable shaft from the motor shaft whenever the turntable and fly wheel are revolving at a greater speed than the motor. This occurs when the current is turned "off" or when the table is advanced by hand.

### Balanced Suspension Systems

The two reproducing systems of this equipment are entirely independent. The lateral pickup

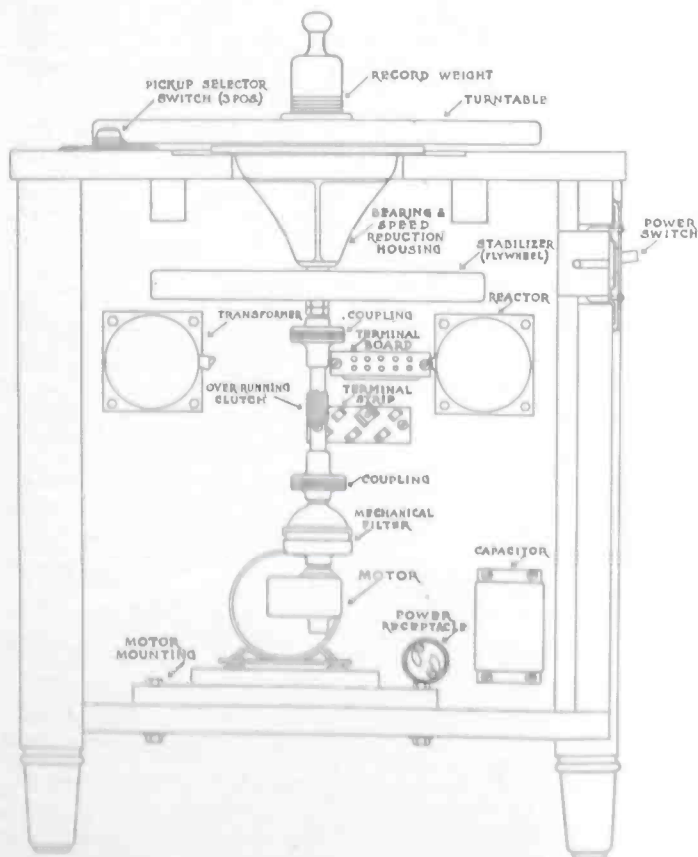

THIS OUTLINE DRAWING DISCLOSES THE RUGGED AND SIMPLE MECHANISM MOUNTED IN THE CONSOLE OF THE TYPE 70-A TRANSCRIPTION EQUIPMENT

and suspension arm are mounted on the right side of the console; the vertical pickup and suspension arm at the rear. The mountings, which are similar, consist of cast metal brackets rigidly fixed to the cabinet. These brackets have two arms: one is formed into a swivel-cup in which the suspension arm support is cushion-mounted; the other forms a rest for the pickup end of the arm when not in use. Long suspension arms are provided and mounted to obtain good tracking for both the largest and the smallest records. These arms are of the inertia type and are correctly balanced to insure correct needle pressure for each type of pickup. The lateral arm has additional weighting to eliminate resonance. The brackets, suspension arms and pickups are finished in gray wrinkle.

#### Improved Lateral Pickup

The lateral pickup used in this equipment is of a design specially developed for transcription and other high-quality pickup. This magnetic-type pickup has now been improved and standardized for such use. The fidelity of re-

ent-day recording characteristics. This compensation results in an overall recording-reproduction characteristic almost uniform throughout the whole useful range—viz. about 30 to 7000 cycles.

#### Improved Vertical Pickup

The Vertical Tonearm Attachment Kit Type 71-A, for use with the Type 70-A Transcription

thus provided better reproduction. As in the case of the lateral pickup, the actual characteristic of the vertical pickup is sloped downward to correctly match the upward-sloping recording characteristic. This characteristic, extending as it does to 10,000 cycles, insures reproduction fidelity at least equal to that of any pickup of this type yet developed.

The output impedance of the two reproducing circuits and the output levels developed across these impedances are very nearly the same, so that they may be used interchangeably without change of connections or gain in the succeeding speech input equipment. These circuits are designed to match a 200-to-250 ohm line. Reproducing quality will not, however, be noticeably affected when the output is fed into 500 ohms. Using test records XL-81 and XL-113 (for lateral and vertical, respectively) the output voltage developed is approximately 0.01 volt r.m.s. at 1000 cycles. Output connections as well as the input power connections are located at the back of the cabinet.

The switch controlling the power to the motor is located on the right hand side of the cabinet at the top and toward the front. This is a mercury switch of the tumbler type, noiseless in operation. The pickup selector switch, located at the left on the top of the cabinet, is a three-position switch with a detent for positive contact.

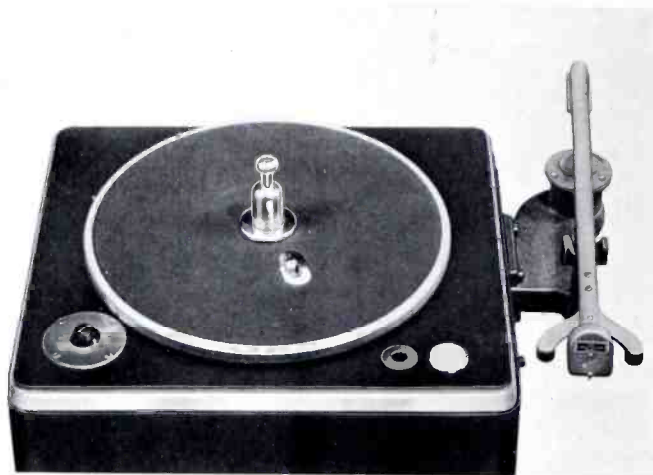

TOP VIEW OF THE NEW RCA VICTOR TYPE 70-A CONSOLE, SHOWING THE TURNTABLE, SUSPENSION ARM, PICKUP, AND SELECTOR SWITCHES. THE SPEED SHIFT BUTTON IS LOCATED ON THE TURNTABLE DISC ITSELF. THE VERTICAL PICKUP TYPE 71-A IS NOT SHOWN

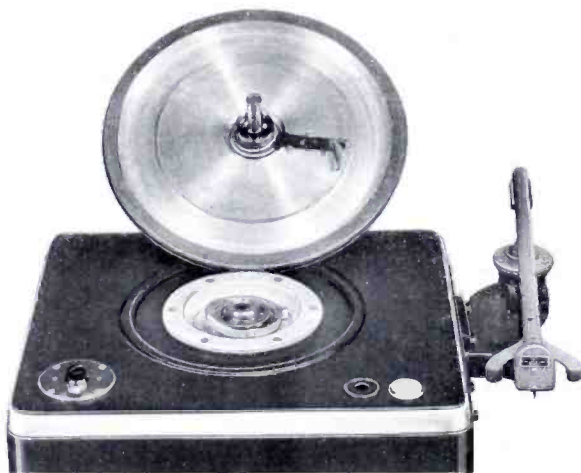

THIS VIEW SHOWS THE TURNTABLE DISC TURNED OVER TO DISCLOSE THE INGENUOUS BALL-BEARING SPEED REDUCTION MECHANISM. THE PAWL ON THE BOTTOM OF THE DISC ENGAGES THE SLOT IN THE CLUTCH RING WHEN 33- $\frac{1}{3}$  R.P.M. OPERATION IS DESIRED

production which it provides is as nearly perfect as the present state of the art permits. The actual frequency-response characteristic of this pickup is sloped downward to an amount closely equivalent to the upward slope of pres-

Equipment, is of the moving-coil type and is supplied with a diamond-point needle. In general it is similar to preceding models, but small changes in design have been incorporated which have improved the high-frequency response and

# Victor Book of the Symphony

Latest Work by Charles O'Connell Held Outstanding in Musical Circles

WITH THE increasing amount of fine symphonic music being broadcast regularly through independent and network stations, radio broadcasters everywhere have found the new "Victor Book of the Symphony" increasingly useful in the preparation of radio scripts and announcements. The book, which is now in its second edition, was written by Charles O'Connell of RCA Victor's Record Department, and is published by Simon & Schuster of New York.

Written in non-technical language, the "Victor Book of the Symphony" contains more than 600 pages covering the entire standard musical repertoire of the greatest symphony orchestras. It includes an absorbingly interesting chapter which describes the various instruments of the modern orchestra; and a large number



CHARLES O'CONNELL, MANAGER OF THE ARTISTS AND REPERTOIRE SECTION OF RCA VICTOR'S RECORD DEPARTMENT. HE PERFORMS ADMIRABLY AT THE PIANO AND THE ORGAN CONSOLE

of its pages are given over to biographical sketches of famous com-

posers. Not the least important feature of the volume is an enthusiastic foreword by Dr. Leopold Stokowski, famed conductor of the Philadelphia Orchestra.

Hundreds of enthusiastic reviews have been written about the new volume by book editors in every part of the country. Music editors, radio editors, and newspaper columnists have joined in hailing the work as the first of its kind really to make good orchestral music more intelligible to the average person who has had no special musical training.

The author, who now heads up the Artist and Repertoire Section of the RCA Victor Division, was once music critic of the Springfield (Mass.) Republican, is an able pianist and organist, and has conducted the Minneapolis Symphony Orchestra.

## NORMANDIE BROADCAST

(Continued from Page 6)

transmitter, an announcer with a pack set roamed the decks as passengers, gushing with excitement, rushed here and there.

The French line pier offered another point from where a description of the event was broadcast, while surveying the majesty of this entire scene. William Lundell, director of Special Events for NBC, was stationed atop the RCA building, the control spot for the broadcast.

Equipped with high power field glasses he was able to sight the Normandie almost before she reached Quarantine. In contact through the "cue channel" with the ship, the mobile unit, the tug and the announcer with the pack set, and by telephone with the pier, he was in a particularly appropriate position to direct the broadcast.

The average speed of the Normandie from Bishop's Rock, England to Ambrose Light, outside of New York harbor, was 29.98 knots, and her last day's

run averaged 31.55 knots, hanging up a new world's record for the crossing.

## GEORGE CLARK VIEWS THE NORMANDIE

(Continued from Page 7)

by some rollicking Frenchman on A deck. And above all these swirled and swooped the planes, dozens of them, autogyro and plain plane, most of them silent except one. And this one, old High Fidelity himself, made up for the others, as it skimmed the top of the RCA Building and bade everyone "visit the Normandie." Until this happened, I had fully intended to.

(And outside of one of the Patent Office rooms, one story below me, some one had stuck out ten feet of fishing pole (five and ten cent store variety) with a few feet of wire dangling from its end. Fishing for signals from the ship! How appropriate!)

Every whistle in New York blew a welcome to the maritime Mademoiselle from Armentieres, and she, in return, gave three deep blasts in a key nine octaves below

Middle C. No wonder so many of those old French peasant women have beards! Such a noise had not been heard in our city since the Armistice—if France remembers that. (And we won't come back till it's over, over there.)

On the dock stood the French Ambassador, fully aware of the momentous character of the occasion . . . . At two fifty-five p.m. by Enna Jettick's clock, the bow of La Normandie slid by the dock's end . . . . At four p.m. it had progressed seven inches farther . . . . By midnight, the ship was docked. . . . Hastily uttering his speech, which consisted of the phrase "Normandie, you are here," he hurriedly ran back to La Maison Francaise, and seven bottles of the finest product of France's vineyards bit the dust. (And if you don't think it is a dusty business, this running through New York's streets, just try it yourself once.)

And so arrived La Normandie—And I saw it!

And so, if you still insist, what?



# DID YOU KNOW?



By W. S. FITZPATRICK, R.C.A. Institutes

THAT the addition of New Mexico makes the 28th state in which it is illegal for any one to call himself an "engineer" without passing a state examination, and that A. F. Van Dyck, engineer of the RCA licensing division, is heading an I.R.E. committee to ascertain the licensing effect upon radio men? (*Electronics.*)

That with the change in time from Standard to Daylight Saving the advancing of the 291 synchronized electric clocks in NBC'S Radio City studios and offices was uniquely solved through doubling the frequency on the master circuit, causing the clocks to gain an hour in exactly one hour's time?

That there is a soldier in the Italian army who can hear the dropping of a pin at a distance of 350 feet and whispered words over the same distance, and that, with such sensitive hearing, he detects the approach of airplanes before the automatic monitoring apparatus responds?

## Classmates

That Arthur A. Isbell, Manager, Commercial Department, R.C.A. Communications, was a classmate of Dr. Lee de Forest when at the age of 17, he attended the preparatory school at which Dr. de Forest studied for entrance to Yale University?

That radio programs may soon be heard from Iceland with the completion of a 100 k.w. broadcasting station being installed near Reykjavik, and that another station with a short wave transmitter of 12 k.w. power will be completed this summer?

That over 10,000 copies of the Victor Book of the Symphony have been sold through book stores and Victor record and radio dealers; that the book has been listed as a "best seller" in many cities, and that its companion volume, the Victor Book of the Opera, is now in its eighth edition with more than a half million copies sold?



W. S. FITZPATRICK, THE "RADIO RIPLEY"

That the metal radio tube dissipates heat rapidly; it is smaller and more sturdy than glass; the metal shell provides its own shielding and is an efficient heat conductor and radiator; it is particularly useful in the shortwave field; the short leads permit great amplification at higher frequencies, and the efficient shielding insures stability? (*Popular Mechanics.*)

## RCA Going Up Again

That both the transmitter and receiver being used in this year's National Geographic Society-U.S. Army Air Corps stratosphere flight, are products of RCA Manufacturing Company? The receiver is an RCA Victor single control superheterodyne weighing only 15 pounds and ten times more sensitive than the former dual control sets. The RCA transmitter, but little larger than a miniature home receiving set, weighs 40 pounds. The ground transmitter is a 200 watt Radiomarine Corporation model.

That radio ranks next to the flatiron as an essential household appliance, according to a survey by McCall's Magazine? The housewives voting on "essentials", ranked them in this order: Irons, radio, vacuum cleaners, refrigerators, washing machines.

That the RCA Marine Gift Service, through which passengers on ships may "send" gifts of flowers, cigars, books and numerous other articles, to friends ashore, has been extended to include the S.S. Normandie?

That the first quarter of 1935 is the sixth consecutive quarter in which the Radio Corporation of America has earned a profit?

That the entire NBC Radio City plant was operated from storage batteries for three minutes on May 13, when failure of the electric power supply created an emergency, and that the emergency battery installation is sufficient to keep the broadcast channels open for 48 hours?

## Melting Pot

That sixteen countries in Europe, Asia and South America are represented by 52 students at the New York school of R.C.A. Institutes? There are six students from India and three from China.

That the term "Tickler" was devised by George Clark in 1914, while he was radio expert for the Navy, to designate what we now call "feedback"? The word was used to conceal the experimental use of the feedback system and it was so called because it "tickled" the set and "made it oscillate".

That another instance of an air rescue at sea was recorded when, on March 24, in response to radio calls from the Bull Line freighter Cornelia, a Coast Guard amphibian flew 96 miles out to sea, landed alongside the Cornelia, took off an injured sailor, and flew him to a hospital at Cape May, N. J.?

That the first vacuum tube detector was Marconi's original coherer of 1895, consisting of a sealed glass tube with the air removed and containing fine metal filings?

That in 200 years our present-day coins will be rare and much sought after? (Chance for editor to add wisecrack about the present.)

That this year has seen unusual number of women students at both the New York and Chicago schools of R.C.A. Institutes?

That the price of a new calendar may be saved by preserving this year's for use in 1946?

That twelve United States cities are now included in the RCA inter-city and international radio telegraph service?

That with the outfitting of two Standard Fruit Company passenger ships with high frequency apparatus, Radio Marine Corporation's installations for this line now include all its 26 vessels?

#### Nearly Blew Fuses

That when Senator Huey Long spoke over an NBC network at midnight on March 7, the Edison Electric Illuminating Company of Boston reported the load for the period increased 7,000 k.w., or 7 percent above the normal output for that night and hour, and that as a result of his broadcast the Senator received 160,950 letters?

That the qualifications of a developmental engineer were in-structively outlined in a recent address by M. A. Whiting before a joint meeting of the Schenectady sections of A.I.E.E., A.S.M.E. and A.S.C.E.? Mr. Whiting classed under intellectual qualifications: general intelligence, power of observation, engineering aptitude, ability to analyze and synthesize, intellectual sensitivity and originality. Under temperamental traits: good judgment, a balance between optimism and pessimism, skepticism, conservative intuition, a balance between patience and impatience, persistence and freedom from the worrying habit. Under emotional traits and general qualifications Mr. Whiting spoke of resourcefulness, ability to cooperate, breadth of interests, education, training and experience.

That not a ship has been lost through collision with ice since the U. S. Navy organized patrol of the North Atlantic ice-field following the Titanic disaster 23 years ago?

That the American Radio Relay League has started a radio museum at its headquarters in Hartford?

That the opening of the ZLT transmitting station in New Zealand recalls a sale to the government of that country of its first wireless station by Mr. Arthur A. Isbell, now Manager, Commercial Department, R.C.A. Communications, and the erection of it by him at Wellington in January, 1901?

That in Belgium if a local electric company changes the supply from AC to DC, it must pay indemnity corresponding to the amount required for buying a new radio set, according to a recent court decision?



LUCILLE MANNERS, FASCINATING BLUE-EYED VOCALIST OF NBC RADIO CITY STUDIOS, WE HEARD HER SING "SOME ONE WILL MAKE YOU SMILE" DURING A REHEARSAL FOR THE CITIES SERVICE PROGRAM,—AND SMILED OUR APPRECIATION THROUGH TWO THICKNESSES OF PLATE GLASS.

#### Radiotron in Dictionary

That in Webster's dictionary "Radiotron" is listed as a new word meaning "an electric tube bearing the trade-mark 'Radiotron'?"

That the world's long distance record for spark transmission is held by Harry R. Chetham who, on December 21, 1912, communicated 8000 miles, from the Boston Marconi station to the Pacific Mail steamer Mongolia at Nagasaki, Japan?

That a requirement for admission to R.C.A. Institutes, then known under a different name, during the first six years of its existence, was ability to copy code?

That the S. S. *Normandie*, which cost \$40,000,000, is insured for \$10,000,000, with a premium rate of 2-1/3 percent gross for 12 months, but the underwriters are liable for claims only in excess of \$125,000? (Approximate equivalent figures of French money.)

That the locality of Radio City is fast replacing lower Broadway as New York's steamship and travel center?

That to construct the new 1,100 feet long piers in New York to accommodate the big transatlantic ships, *Normandie* and *Queen Mary*, it was necessary to move the shore of Hudson River 360 feet inland over a stretch of six blocks? The piers, incidentally, are but six blocks from the RCA Building in Radio City.

#### Victor Record Mystifies

That the accomplishment of modernizing the Victor record made years ago by the famed Caruso, is still a subject of wonderment, as evidenced by inquiries as to how it was done? A query to the New York Sun was answered by two correspondents, one of whom was Julius Haber, who clearly explained the intricate process which "brought the voice of Caruso back to life" with the accompaniment of a modern orchestra.

That 372 women hold pilots' licenses in the United States, and of the 109 glider pilots, three are women?

That the ringing of chimes on the NBC network is omitted only during addresses by the President, the Chief Justice of the Supreme Court, or while the National Anthem is on the air?

That it is not uncommon for a radiogram to be received in London or Paris in less than one minute after being filed at the New York office of R.C.A. Communications?

That the first broadcasting in Europe was from a Belgian station, using an arc transmitter, in 1913?

That school of R.C.A. Institutes was in existence seven years before evening classes were started?

# LET'S GET ACQUAINTED



E.K. CARGILL, PROPRIETOR OF STATION WMAZ, MACON, GA., WHICH HAS RECENTLY INCREASED ITS POWER TO 1,000 WATTS AND MOVED INTO MODERN QUARTERS

## Broadcasting Personalities



ATTRACTIVE MODERN TRANSMITTER BUILDING, RECENTLY COMPLETED FOR STATION WMAZ AT MACON, GA.



GEORGE RANKIN, JR., CHIEF ENGINEER OF STATION WMAZ, MACON, GA., WHO IS RESPONSIBLE FOR THE MODERNIZATION OF THIS POPULAR STATION



### WRVA

At Richmond, Va., WRVA has just completed the installation of a unique wood tower with vertical loading of the antenna. Work has been under the direction of Paul Godley.

### CBS-CCIR

On May 18th, E. K. Cohan, Technical Supervisor of CBS, sailed on the Ile de France for a trip of several months. He will attend the CCIR meeting in Spain.

### WBEN

Preparations are being made at WBEN, Buffalo, for the installation of a new RCA 100 watt ultra high frequency transmitter for W8XH.

### CBS

Bill Lodge of CBS still denies the rumor that he caught an eight pound salmon while measuring field strength.

### BEA-RCA

L. F. Jones of RCA Manufacturing Company engineering staff addressed a meeting of the Broadcast Executives Association in Buffalo on May 16th.

### WSYR

At Syracuse, N. Y., WSYR has just installed a new 200 foot vertical radiator.

### KVSO

The first High Fidelity transmitter in the state of Oklahoma goes to Radio Station KVSO (The Voice of Southern Oklahoma) in Ardmore, Oklahoma. Besides the new RCA Type ET-4250 100 watt transmitter, this station now boasts of complete RCA Speech Input equipment. KVSO is owned and operated by the Daily Ardmoreite, of which John F. Easley is the President, Ernest Riesen the Treasurer, and Albert Riesen the Secretary.

### WTAR

Among broadcasters who visited New York during the news paper convention was "Cam" Arnoux of WTAR who was unfortunate enough to be an innocent participant in an automobile accident on the way back to Norfolk.

### KIUN

Barney Hubbs and Jack Hawkins, proprietors of Radio Station KIUN in Pecos, Texas, have installed new RCA Speech Input Equipment and Type 100-E 100 watt Transmitter.

### KXYZ

Radio Station KXYZ in Houston has recently increased its power from 500 to 1,000 watts. The studios have been moved to the Gulf Refining Company Building, where the very latest in RCA High Fidelity Speech Input equipment has been installed. The





SCENE ON MAIN STREET, GARDEN CITY, JUST AS THE DUST STORM APPROACHED

transmitter is also located in this building. Something unusual in vertical radiators is the 140-foot metal flag pole on top of the building, which has been insulated and guyed for the purpose. This tower, located on the roof of the Gulf Building, is fed through a concentric transmission line. The formal opening and dedication of the new studios was held June 1st. T. F. Smith is the General Manager of the Station, which is owned and operated by the Harris County Broadcasting Company.

**KIUL**

Frank D. Conard, professional photographer in Garden City, Kansas, and Homer A. Ellison, formerly of the RCA Photophone Sales Department (who, incidentally, is the owner of the two motion picture theatres in Garden City) have formed a partnership and are now the proprietors of Station KIUL. The new RCA ET-4230 100 watt transmitter, which operates on 1210 KC, is located in a new building of modern architecture in the suburbs of Garden City. Other equipment includes new RCA High Fidelity Speech Input equipment, and there are two 100-foot towers. The entire installation represents the first 100 watt High Fidelity installation in the state of Kansas, and is the only station within a radius of 50 miles. The station went on the air May 23rd, on an unlimited schedule.

W. M. Witty, RCA Southwestern District representative, visited the "Editorial Offices" and was quite enthusiastic about the studios and reception rooms of Station KIUL, which are centrally located in Garden City. He has promised to send us a complete set of photographs and a story to go with them, for publication in

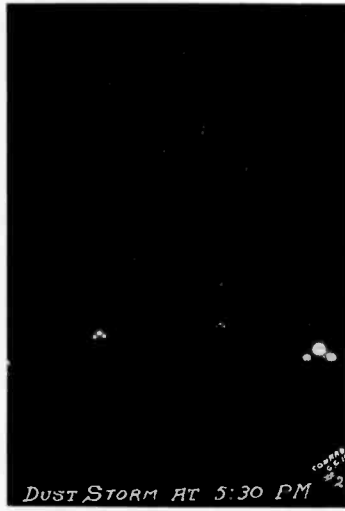

SCENE TAKEN FIFTEEN MINUTES LATER, WHILE THE DUST STORM WAS AT THE HEIGHT OF ITS FURY



HOLD EVERYTHING,—HERE SHE COMES! ITS JUST THE TOPSOIL OF ONE STATE MOVING OVER INTO ANOTHER STATE

a future issue. According to his account, however, hell, highwater, or sandstorms can't stop these boys, and to prove his point he submitted the pictures appearing on this page, which we understand he chiseled from Mr. Conard. We believe everything he told us except the one about the size of the jack-rabbits.

**Frohman Predicted Her Success**



AFTER DANIEL FROHMAN, VETERAN BROADWAY PRODUCER, SAW ARLENE FRANCIS PERFORM IN A CHILDREN'S PLAY NOT SO MANY YEARS AGO HE WROTE HER NAME DOWN IN HIS LITTLE RED BOOK WHICH HE DEVOTES TO PEOPLE LIKELY TO SUCCEED. ARLENE NOW PLAYS SUPPORTING ROLES IN DRAMATIZATIONS ON BEATRICE LILLIE'S PROGRAM HEARD EACH FRIDAY AT 9:00 P.M., E. D. S. T., OVER AN NBC-WJZ NETWORK

**WBT-WPTF**

R. E. Penny, Sales Manager of WPTF, Raleigh, N. C., recently spent the day in Charlotte and visited at WBT, Southern Columbia Key. He was the guest of Manager William Schudt and staff.

J. J. Beloungy, WBT Charlotte, Chief Engineer, is back on the job after a week's attack of flu.

# "Thesaurus"—A Treasure House of Recorded Programs

New NBC Service Built on Best Suggestions of Station Program Managers Throughout the Country



**XAVIER CUGAT.** THE CHOICE OF SOPHISTICATED DANCE LOVERS FROM COAST TO COAST, SPECIALIZES IN RHYTHMIC TANGOS AND RHUMBAS, THE TYPE OF MUSIC WHICH LENDS COLOR AND DISTINCTION TO A DANCE OR VARIETY PROGRAM. HIS BROADCASTS FROM THE WALDORF-ASTORIA IN NEW YORK CITY OVER AN NBC NET-WORK HAVE MADE HIS ORCHESTRA ONE OF THE MOST POPULAR ON THE AIR.

THE NBC Thesaurus is a Treasure House of programs designed for use by program builders just as a Thesaurus of words and phrases is used by writers and editors. It gives the builder of sustaining or commercial programs a service prepared in accordance with the expressed desires of many station operators whose program needs have been analyzed. NBC Thesaurus is not just another Transcription Service. It is a complete program service. Behind it are the experience, the resources, the programming facilities of the National Broadcasting Company. It is without equal for quality of talent and entertainment, flexibility, adaptability, merchandising possibilities and economy.

### The Purpose of NBC Thesaurus

The purpose of NBC Thesaurus is to provide program builders with a wide choice of excellent program material made easily

adaptable and convenient to their own specific program needs—and those of national and local spot advertisers. This service is complete in every detail. Experience has built it—the programming and merchandising experience of the National Broadcasting Company and the experience of the individual stations themselves. It provides three basic elements essential to effective programming:

1. Program Material. Recordings of the finest entertainment by leading artists, produced under the direction of NBC.

2. Continuity. A comprehensive continuity service designed to develop, from the wealth of musical material, programs suitable for all occasions and types of products.

3. Planning and Operating Unit. A complete file, storage, and cataloging service—a unit that helps build programs with speed and efficiency.

### Stations Built This Service

NBC Thesaurus is the result of months of research and contact with stations all over the country. It includes the best suggestions of individual station program managers with whom NBC consulted. This service, as offered, meets the present day need of stations for a recorded program.

### The Program Material

The program material supplied by NBC Thesaurus has been planned with care and precision for programming purposes. Consideration has been given to the amount—and the variety—of material needed by stations to operate the service on a paying basis. The recorded material will consist of over a thousand selections of popular, classical and semi-classical music, 40 percent of which are ready for immediate use. In addition to the current tunes, the popular music includes the standard so necessary to program



**NATHANIEL SHILKRET** THIS CELEBRATED COMPOSER AND CONDUCTOR NEEDS NO INTRODUCTION TO RADIO LISTENERS—OR TO PROGRAM BUILDERS. HIS MANY RADIO TRIUMPHS WITH HIS ORCHESTRA HAVE PUT HIM IN THE FOREFRONT OF LEADING ARTISTS. THE PRESTIGE OF THIS RENOWNED MUSICIAN IS AN ASSET TO ANY PROGRAM. NBC THESAURUS MAKES HIS BRILLIANT MUSIC AVAILABLE FOR YOUR PROGRAM NEEDS.

builders. The balance of the selections will be made available month to month.

The material will also include novelty numbers and useful incidental musical effects such as fanfares, scene-setting music, bugle calls and "signatures." Every effort will be made, however, to include in the service as it progresses, those things that stations request.

### Artists

NBC Thesaurus artists are leaders in their respective fields, known to millions of radio listeners. The already imposing list will continue to grow, and already includes: Nathaniel Shilkret and Orchestra, Harry Reser Orchestra, Ray Heatherton, Rosario Bourdon and Symphony Orchestra, Xavier Cugat and Orchestra, Westminster Choir, George Hall and Orchestra, Master Singers, Rhythm Makers, Richard Leibert at the Organ, Green Bros. Orchestra, The Dreamers,

Robert Hood Bowers, The Honey-mooners, Jack, June & Jimmy, and Gus & Church.

**Recorded Material Meets All Needs**

The flexibility and adaptability of material provided in NBC Thesaurus enables the production of many types and unlimited numbers of entertaining programs. There is a varied selection of music to choose from including dance, symphonic, choral, bands, organ and vocal—useful in many different ways for sustaining and commercial programming purposes. From this wealth of musical material programs can be designed for any time of the day or evening, and for periods ranging from five minutes to an hour—dance programs, fine concerts, variety shows, "musical clocks," in fact all types of musical programs. Whatever the program need the answer can be found quickly and with good results—in NBC Thesaurus.

**Complete Continuity Service an Aid to Effective Program Building**

NBC Thesaurus includes comprehensive continuity service designed to get the maximum use from the recorded program material. There are three types of service provided: 1. Daily. A daily continuity service for musical clocks or announcement periods recommending selections to be played, and all necessary "copy" excepting your local announcements or commercials. 2. Special. Special continuity will be regularly provided for programs with appeal to various audiences, adaptable to different types of sponsors. 3. Occasional. Continuities will be provided for special programs for important holidays and events.

**Builds Better Programs**

The building of a good program may be reduced to a mathematical formula: Fine artists—plus intelligent, imaginative, pleasing continuity—equals a program that wins and holds audiences. NBC Thesaurus offers outstanding radio performers and comprehensive continuity service—a combination that assures entertaining programs of individuality and real audience appeal.

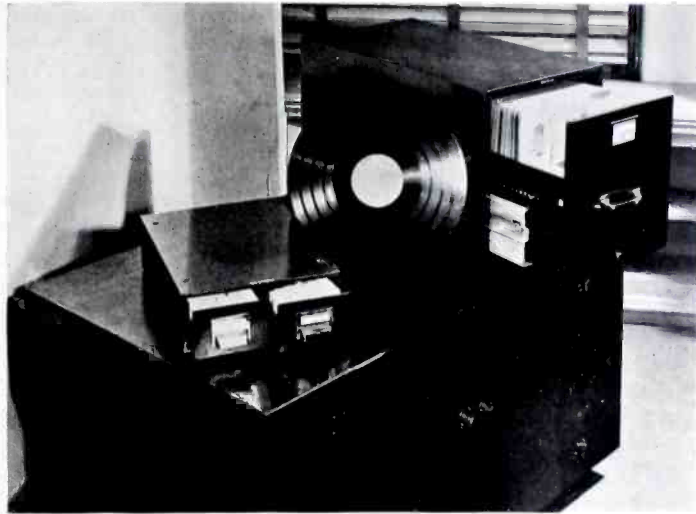

THE PHYSICAL UNITS COMPRISING THE NBC THESAURUS. THE STORAGE CABINET HAS AN INGENUOUS AUTOMATIC ARRANGEMENT FOR KEEPING THE DISCS IN PERFECT CONDITION. THE CROSS INDEX REFERENCE FILE CABINET CONTAINS CARDS GIVING ALL PERTINENT INFORMATION RELATIVE TO THE SELECTIONS, THE ARTISTS, CLASSIFICATION, ETC.

**RCA Victor Recordings**

A noteworthy feature of NBC Thesaurus is the ease with which its working units are operated. The filing and storage cabinet for the records requires a minimum of floor space, but nevertheless gives quick and easy access to the records. An efficient card index reference system assures quick assembling of programs, selections are filed under title, artist, composer and classification. Each card includes information pertinent to the use of the selection—timing, composer, publisher and annotations suitable for inclusion in continuity. Space is also provided for station notation of the uses made of each selection.

The records have been made by a new RCA Victor Higher Fidelity System used for the first time

in this service resulting in a clear, brilliant, noiseless reproduction.

**A Vehicle for Selling Station Facilities**

The station using NBC Thesaurus will have the advantage of:—1. A wealth and wide variety of recorded entertainment by outstanding artists. 2. Ready-made yet flexible program material adaptable to any sponsor's need. 3. Priceless programs at a cost low enough to eliminate sales resistance.

This Electrical Transcription Service is offered to stations by the National Broadcasting Company, 30 Rockefeller Plaza, N. Y. City.

**Fine Feathers Don't Make Fine Birds**

(Quoted from L. & N. Employees Magazine by permission)

Jack Tar had just arrived at the old home cottage after voyaging about for a number of years. "Well, mother," he said heartily, "how did you like the parrot I sent you?"

"Well," said his old mother dubiously, "it was nice and plump, Jack, but, my! it was tough."

**Practically Simultaneous**

The shortest perceptible unit of time is the difference between the moment the traffic light changes and the boob behind you honks for you to go.

**NOTE**

..

The Transmitter Sales Section of RCA Manufacturing Co., in San Francisco, is now located at 170 Ninth Street.

# FAST TELETYPE NEWS SERVICE

"Don" Withycomb of NBC Fame,  
Becomes New Manager of WFIL  
—"Morty" Gosch Enters

**H**EADLINES have turned studios into miniature newspapers, as the listening nation at last begins to reap a harvest of worldwide information resulting from the recent withdrawal of William Randolph Hearst from the long existing press-radio agreement. With him went the International News Service syndicate, closely followed by the United Press. News became a commodity, a distinct gold-filled commodity for broadcast resale.

### I.N.S. Pioneers

WFIL was the first station in the United States to sign the INS agreement. Little wonder then, that studio officials should look to this Philadelphia NBC blue network outlet as the hub of radio news activity, to study minutely its method of headline dissemination and accept it as one of the most notable advances in news production.

What is the reason WFIL has been so successful with this new addition to broadcasting? How have they been able to meet and



"DON" WITHYCOMB, VERSATILE STATION MANAGER WON BY WFIL FROM NBC

overcome news competition? Why does its news audience number hundreds of thousands?

The answer is complex in its simplicity. One word tells the story—*staging!*



WFIL has made a business of news. The station views the headline from the showmanship standpoint. Nor just any news will do; it must be the best news . . . the *first* news! Therein lies the initial piece of staging, a slogan. So, today, when a Philadelphia listener hears: "WFIL IS FIRST ON THE AIR WITH THE NEWS"—he believes, he trusts and he respects this slogan.

Albeit the news is WFIL's current program pet, it does not follow that these radio headlines receive all of the station's broadcast pampering. On the contrary, the studio has moved into the charmed circle of quality outlets solely through the well managed presentation of the daily program schedule.

### Two Stations Combine

There is an interesting story behind the call letters, WFIL, which is worth telling here. WFIL is the result of combining stations WFI and WLIT early this year. The two studios, owned by competing department stores in Philadelphia, were housed separately and divided the 560 kilocycle frequency. Both were pioneer broadcasters, having seen the light of day in the halcyon era of the ticklish "cat's whisker" detector. Both became affiliates of the National Broadcasting Company in the experimental age of a decade ago. And both operated as secondary advertising media for two commercial enterprises.

Then, toward the end of 1934, a network rearrangement at NBC forced an unexpected move. A merger and a switch from the red (WEAF) to the blue (WJZ) web became imperative.

The emporium entrepreneurs figuratively looked across the street at each other, floundered for a moment—and then reached a

# FEATURED ON OF P

. . . and . . . *'WFIL is first*



momentous decision in local broadcasting. If a merger of broadcast interests was necessary, then so be it. But not half-heartedly; it was to be all or not at all. No more department store subsidiary association, said they; no more kowtowing. If this be destiny, then, they said, we'll build a *real* radio station.

### New Station Born

And so the vast fortunes and incalculable amount of good will of two great and nationally known stores were placed solidly behind a new endeavor. January, 1935, saw the birth of station WFIL—a young, hardy offspring of pioneer parents. Fitting smoothly into a niche just cut, WFIL strode ahead with the cocksureness of a vet-

eran, and in a few months to cite a notable picture. been the Gra —where not in —then WF with having spark.

It brought covation and local industr

A goodly success has manager. Dia As former re Relations Broadcasting Wthycomb familiar with mistakes, tri of local stud. a fund of exper few men in



# N PROGRAMS PHILADELPHIA STATION

*on the air with the news!*

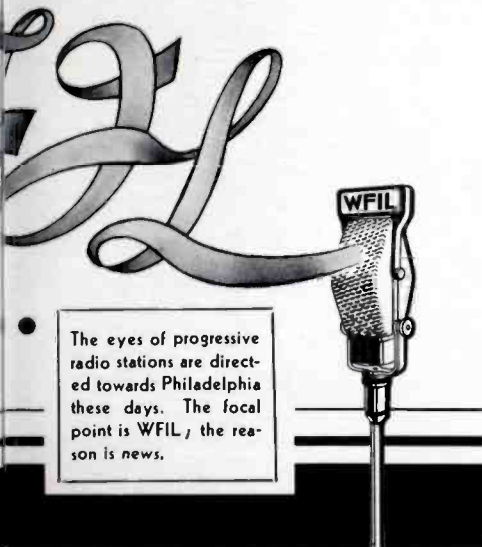

The eyes of progressive radio stations are directed towards Philadelphia these days. The focal point is WFIL, the reason is news.

space of a short much to resus-ly poor broad-Philadelphia had Hotel of radio g ever happened can be credited hted a dormant

sow, nurture and reap the benefits of radio. Little could happen at WFIL, in its infancy, that he had not met and conquered before. It was only natural that, when the station's joint ownership sought a captain for the vessel, their choice was Mr. Withycomb.

### Important Territory

And their selection was well founded. Because today WFIL has long since outstripped its adolescence and become a dominating force in the nation's third largest market.

But a wise captain needs a stalwart crew to man the ship. Mr. Withycomb knew that, also, with the result that the WFIL personnel numbers in its ranks some outstanding names in radio. Keith McLeod, the first

program director of WEA, is now with WFIL in that same capacity; Jack Stewart, former manager of several large stations, is sales chief; Roger Clipp of the NBC Station Relations Department is assistant studio manager; and so on down the production, program and announcing list. Edward Becker, renowned technician of NBC, heads an efficient engineering staff which watches over the latest and best in RCA equip-

ment. An expert staff finally ensconced and working smoothly, WFIL settled down to viewing the Philadelphia situation. The Quakertown was found to be subject to a mass of radio precedents. It was: "This can't be done," or, "this has never been done." So deeply imbedded was the city in prejudice against even mild forms of reformation, that Mr. Withycomb discovered he was slowly but surely being shackled by convention. There was only one thing to do, and he did it. Ripping off the ties that bound, with one fell swoop he commenced to branch off from the local straight and narrow path.

### Policies Sound

From then on, WFIL began a series of 'firsts.' One of the most notable smashes of precedent concerned local talent. It had been either underpaid or not paid. Don Withycomb took the initiative in bringing about this much needed change. His decision to pay each and every sustaining artist or act on WFIL will go down in Philadelphia radio history.

It was a move that sent the budget skyrocketing. But it has been doubly repaid by the good will of the trade which accrued from it.

This gives a brief look at the inner workings of WFIL. It is a

new station built upon a Gibraltar-like foundation. No cut rates mar the serenity of WFIL; no questionable trade practices are there to cause raised eyebrows. It has no right or left bank—it shoots straight ahead, hard, fast, but fair.



MARTIN GOSCH, "NEWS OF THE AIR" EDITOR AT WFIL. THE RADIO COLUMNS MISS HIM

So, when Mr. Hearst and his colleagues opened a new field for radio, WFIL was ready to meet the emergency. While others deliberated, Don Withycomb's signature was already affixed to the I.N.S. contract.

### Three Teletype Machines Installed

The celerity with which WFIL began its news programs and the manner of presentation brought the station an immediate and tremendous increase in popularity, with an expanded audience.

In a rush of activity, while three teletype machines were being hastily installed, the studio scoured the town for its own news editor. Martin Gosch, former radio columnist of the Philadelphia Record and New York Post, was handed the berth. Possessing years of experience with newspapers and broadcast script and production, the job fitted like a glove. It was the first position of its kind ever created in a radio station—a "managing editor for the air."

### Air Editing

And editing is necessary. WFIL does not subscribe to Mr. Hearst's editorial twists, although it subscribes to his service. Further, fifteen minute programs do not allow for lengthy details of stories.

Yarns must be chopped, rewritten, and still retain the meat. This must be done quickly—and accurately.

But good news needs some thing in the way of spice to catch the radio ear. WFIL found it in headlines.

Two announcers are assigned to each news show. One introduces the session with the usual fanfare, the other delivers the news. The added simple, but attractive, punch comes in headlines. The change of voice between stories, the additional bit of preview on the yarn, made a direct

where the bulletins are concerned. Out to make its listening audience news conscious, the studio rams it home several times each day. Much of I.N.S. material is exclusive, sometimes a news bear. The mere fact that this station secures news by wire almost always assures WFIL a scoop willy-nilly.

And this is a distinct advantage. Monitoring all competing news broadcasters throughout the day and night, WFIL logs all beats on stories, makes a comprehensive recapitulation weekly and uses the data for sales promotion.

should augur well for broadcasting. He doesn't believe that radio news is newspaper competition; rather, he ventures the opinion that, were he a publisher, he would welcome the innovation as a distinct circulation builder.

He explained, "Radio has neither the time nor the facilities to devote to news. Stories cannot be told in complete detail in the rush of the control room clock. And, in the final analysis, there's nothing like the printed word. Certainly we'll make money out of our news service; and meanwhile, by merely tagging along, the newspapers undoubtedly will benefit also."



THE "NEWS EDITOR OF THE AIR," MARTIN GOSCH OF WFIL, SCANS THE ENDLESS PRODUCT OF THE THREE I. N. S. TELETYPE MACHINES SHOWN AT THE RIGHT. HOT "FLASHES" MAY POP OUT AT ANY MOMENT, AND THE EDITOR MUST BE CONTINUALLY ON THE "OUI VIVE"

hit with listeners. Letters by the score reach WFIL daily from dial-twisters, and each tells the same thing. They like that staging; they feel that the pomp and circumstance which surrounds the news in headline parade form puts WFIL across the line a winner.

True, headlines are newspaper standbys. But, since radio has so closely allied itself with the black and white sheet in news offerings, what better procedure could be used than the one newspapers have found the most successful?

#### News Flashes

The news material is taken directly from the teletypes, and rarely rests on Mr. Gosch's desk more than fifteen minutes for the regular four broadcast periods. During the day, of course, WFIL airs flash events. No program, either sustaining or commercial, is sacred

Each news story is punctuated by an audio-oscillated overseas sounder, transmitting a clear 500 cycle note. Its code spells "WFIL NEWS"—and thousands of amateurs prick up their ears to decipher it.

No credit is given to I. N. S.; rather, the term 'WFIL News Bureau' is used and lends a ring of personality. The station's tag, "WFIL Is First On The Air With The News" is the last touch, the final filip. In itself, the slogan is a winner, and although other adjectives, "the newest," "quickest," "fastest," "most accurate," may be heard through the air with the greatest of ease, none seems to compel the ear quite so well.

The future of news in radio is difficult to prophesy. Don Withycomb suspects that it presages a definite link with newspapers that

#### RCA ISSUES PARTS REFERENCE BOOK

A COMPREHENSIVE 92-page parts catalogue, crammed with a wealth of technical information for the radio serviceman and dealer has just been issued by the RCA Manufacturing Company for selective distribution through wholesale RCA radio and parts distributors.

In it are listed all of the numerous radio replacement parts and specialty apparatus with their electrical and mechanical characteristics and specifications so that the serviceman can get all the information he needs on a part or piece of apparatus at a glance. There are also profuse illustrations, schematic diagrams and technical information on the functions of the various parts in their circuits. Prominent space is devoted to an assortment of recently developed RCA test and measuring apparatus, such as the cathode-ray oscillograph and beat frequency oscillators. Sections of the book deal with such subjects as short-wave and noise reducing antenna systems, public address and sound reinforcement, phonograph modernization, and many others.

A particularly useful feature is the inclusion of an exhaustively cross-indexed chart of all the important replacement parts for the RCA Victor radio receivers and the corresponding models of the General Electric, Graybar and Westinghouse Companies, with stock numbers and prices.

# THE WCAU PHOTONA

By JOHN G. LEITCH, Technical Supervisor, WCAU

EXPERIMENTAL work has been carried on for the past two years in the laboratories of the WCAU Broadcasting Company upon a new instrument for producing electrical tones. This work was instituted and authorized by WCAU, believing that an instrument of this type was a necessary adjunct to modern broadcasting.

Development work and tests were conducted with several types of sound production — moving film, rotating discs, and a number of others—and it was finally determined that the present instrument was the most suitable type for the purpose intended and for relatively rapid completion.

The Photona has been constructed under patents held by Mr. Ivan Eremeeff. The actual work was done under his direction and in conjunction with the engineering staff of this station.

The tones are produced by means of rotating discs inserted between a light source and a photo-electric cell. The output of the cells employed is fed to a system of amplification which is capable of high-fidelity response and loudspeakers which are capable of both high-fidelity reproduction and of handling a wide dynamic range. The entire rotating mech-



LEONARD McCLAIN. AT THE CONSOLE OF THE WCAU PHOTONA

anism is driven by a single synchronous motor and the speed of

the discs is governed by the size of the driving pulleys. The Photona is entirely AC operated and the average load from the AC mains is 350 watts. This load, of course, will vary with the number of light sources used.

There are twelve of the rotating disc shutters, similar to the one shown in Fig. 1, which may be seen in accompanying photograph. The sections cut from the periphery of the disc vary in depth and are arranged to admit light from the proper light sources. The diameter of each disc pulley is determined mathematically by the number of sections cut from it and by the speed of rotation.

The light sources, of which there are 900, are standard 6-volt automobile lamps. The manner in which these are placed is shown clearly in rear view of interior.

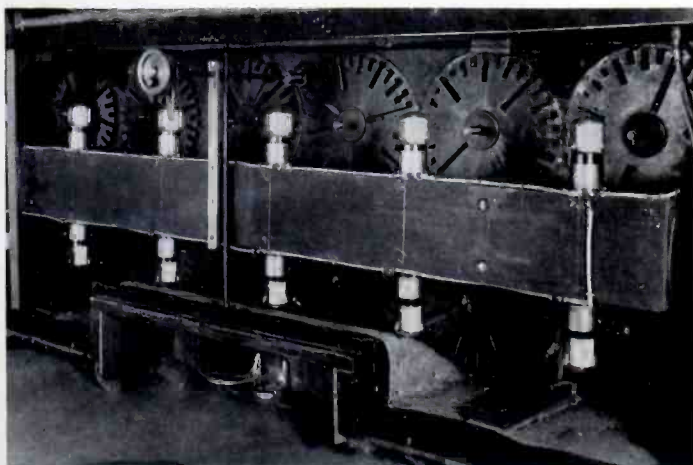

CLOSE-UP OF THE REVOLVING TONE-SHUTTER DISCS WHICH INTERRUPT THE LIGHT BEAMS FOCUSED UPON THE PHOTO-ELECTRIC CELLS SO AS TO PRODUCE MUSICAL FREQUENCIES

The filaments are lighted from AC through a stepdown transformer.

There are two manuals, each comprising six octaves. The keys in these two manuals are used as switches to light the filaments of the lamps desired. There are two banks of stops, one of which is used to insert harmonics or sub-harmonics in any predetermined ratio to the fundamental, and the other is used for striking chords from a single key.

The tremolo, which may be seen in the diagram, may be either foot or hand operated and varies the speed of the driving belt. This is done by working the belt back and forth across a cone-shaped pulley at some predetermined rate. The vibrato thus accomplished is a variation in pitch and not in intensity. The volume control is

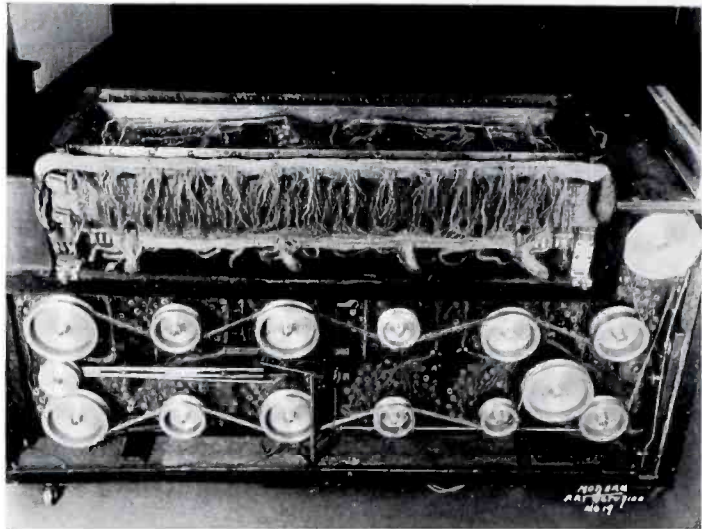

ONE CONTINUOUS BELT, DRIVING ALL THE ROTATING DISCS, INSURES THE PROPER SYNCHRONOUS SPEEDS. NOTE THE MAZE OF ELECTRICAL WIRING REQUIRED FOR THIS DEVICE

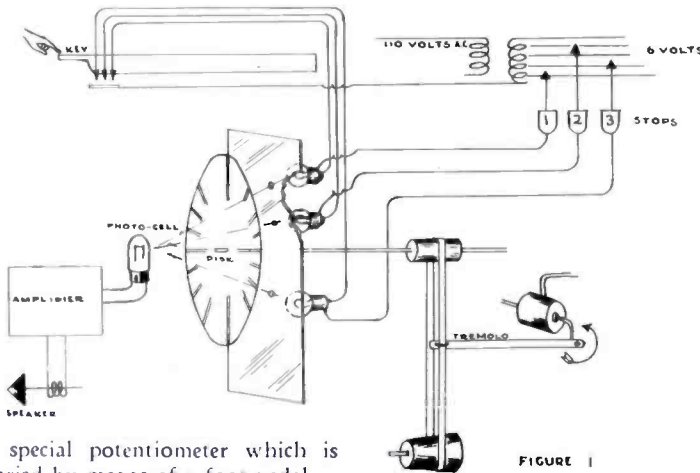
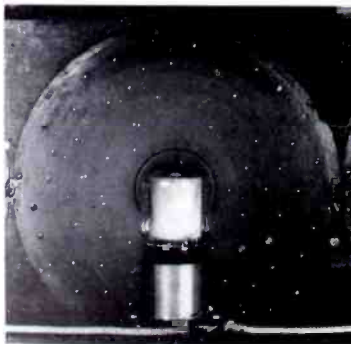

FIGURE 1

a special potentiometer which is varied by means of a foot pedal.

The output of the photo-electric cells is transformer-coupled to the input of a pre-amplifier and thence through a voltage and



VIEW INSIDE THE PHOTONA, SHOWING THE PHOTO-ELECTRIC CELL. LIGHT BEAMS MAY BE SEEN THROUGH THE HOLES IN THE REVOLVING DISCS BEHIND THE CELL

power amplifier to the loudspeaker assembly. It may also, if desired, be fed directly through the microphone receptacle into the standard speech input equipment.

It is evident that the tuning of the Photona is dependent entirely upon the speed of rotation of the discs. When it is once properly tuned, it will, therefore, remain in tune indefinitely and is also subject to no temperature variation.

It may be seen from the accompanying photograph of the completed instrument that it is sufficiently small to pass through an ordinary studio door. It may, therefore, be wheeled from one studio to another and be made ready for operation by plugging into the AC mains and by connecting the output to the amplifier-

speaker unit. Because of its compactness, it may also be moved to points outside of the studio, if an occasion should arise, with the same facility as an ordinary piano could be moved.

When this work was first started, it was not intended primarily that the new instrument replace or imitate the pipe-organ. Rather, it was our intention to develop a musical instrument which could be used to good advantage in broadcasts from our studios either for solo parts or in conjunction with an orchestra. It has been found, however, that effects can be produced which are very similar to that of the pipe or reed organ and, in addition, innumerable new effects can be accomplished and the timbre and color of the tones may be varied at will by changing the ratio of fundamentals to harmonics.

Considerable knowledge has been gained during the construction of this instrument which will improve future models to a considerable extent. Various changes and additions are now under way at the moment, one of the most important of which is the adding of a set of specially constructed foot pedals by means of which the base notes may be played.

Final testing is practically complete and it has been announced that the Photona was first heard on the air from WCAU and other stations of the Columbia network on April 6, 1935.



# Broadcast Station Maintenance

## Adjusting the Class B Linear R. F. Stage

By S. GUBIN, Transmitter Engineer, RCA Mfg. Co.

**A**LTHOUGH the theory and design of the Class B linear amplifier may be clear to the station engineer, he may experience considerable difficulty in tuning his transmitter for optimum conditions. The difficulties arise from the fact the linear amplifier is a non-saturated stage and as such exhibits a high internal resistance compared with the relatively low resistance of a Class C stage. This directly leads to instability of tank voltage and makes the point of exact coupling difficult to recognize. For proper operation the linear amplifier requires not only correct antenna adjustments and amplifier coupling but in addition is quite critical with regards to both grid bias and grid excitation. This forms the basis of prejudice against the Class B R.F. amplifier, although when properly adjusted it is capable of high fidelity and offers advantages in the form of flexibility, tube economy and low initial cost.

### Direct Method

The two methods of adjustment, using the direct and the indirect method of power measurement are essentially the same. In the former, the output is that granted by the F.C.C. and requires antenna resistance measurement. This means a definite current to the antenna. The input power to the output stage then is a function of efficiency and waveform requirements. Once either a particular efficiency or particular harmonic content is fixed the other quantity must be accepted and depending upon the amplifier characteristics.

### Indirect Method

In the indirect method, the efficiency is fixed by the commission so that the adjustments are based upon obtaining the required output consistent with waveform for a definite input. This method of power measurement fixes the har-



S. GUBIN, RCA MFG. CO.

monic output of the transmitter and requires very careful adjustment.

The "half-voltage method" is the simplest method of tuning as it definitely separates the grid and plate circuit adjustments. In principle it is fairly simple, being based upon a linear relationship between grid excitation and efficiency. For a given d-c plate voltage, the efficiency will vary linearly from 0 to a theoretical limit of 78.6 per cent and a practical limit of between 50 and 70 percent depending upon the characteristic of the tubes in use and the source of grid voltage. In normal operation, to amplify a completely modulated wave, the efficiency is adjusted to one-half the maximum value, allowing the output voltage to vary from 0 to twice the carrier value. When so adjusted, the d-c plate voltage may be changed over fairly wide limits without changing either the output or the plate current. When the plate voltage is reduced to half value with the bias likewise reduced to half voltage so as to maintain sinusoidal half waves of plate current during the r-f cycle, the efficiency will be found to be double that of the normal oper-

ating efficiency with the same output. Thus at half voltage we have the required output and d-c plate current meter readings.

### Tuning the Output

The advantage of tuning the output circuit at this point is that the amplifier is now nearly saturated, and may be tuned and loaded like a Class C stage. From this a practical tuning procedure may be followed.

(1) The plate voltage is reduced to half.

(2) The bias is adjusted to half. The normal operating bias may be taken from the manufacturer's recommendations and should later be changed a few percent either way if maximum efficiency with minimum distortion is sought.

(3) The grid excitation is adjusted for maximum. This procedure is not quite in agreement with the theory as outlined above but is desirable to facilitate loading of the plate circuit. The result of this deviation is that the efficiency obtained is too high requiring a minor readjustment later. In order to saturate the grids it may be necessary to remove grid loading resistors if present and to couple closely to the modulated stage. Adequacy of excitation may be judged by detuning the plate circuit and observing a plate current in excess of its normal operating value.

(4) The output circuits may now be tuned in the usual way with precautions taken to leave the plate tuned for minimum plate current. When the coupling is not variable continuously, it may be found that a particular turn gives insufficient loading and the next turn excessive loading. Under this condition the higher turn may be used with the antenna circuit slightly detuned to bring the plate current to its proper value. If a transmission line is used, this procedure may lead to reflections and

(Continued on Page 26)

# Modulation Systems For Transmitters

Proper Broadcast Methods Explained

By LOY E. BARTON, Transmitter Engineer, RCA Mfg. Co.

THE purpose of modulation in any radio frequency transmitter is to so control the output signal that intelligence may be transmitted. When code is used, various simple means are used to send dots and dashes. The systems used to key a transmitter are essentially a single or limited frequency device. However, if the transmitter is to transmit speech or music it is necessary to use a modulation system that does not appreciably discriminate between frequencies in the audio frequency band. This requirement for radiophone transmitters necessitates the use of vacuum tubes for the modulation system with the associated losses. Certain types of modulation systems are inherently more efficient than others and the overall efficiency of the output system of a transmitter is a function of the type of circuit used.

It is the purpose of this short discussion to give some of the essential characteristics of each of the common systems and the associated type of output devices. The three general types of modulation are frequency modulation, phase modulation and amplitude modulation. Phase and frequency modulation require special receivers and for this reason will not be discussed further except to say that for special services these two systems may become very useful.

The average broadcast receiver will not receive satisfactorily any signal except one that is amplitude modulated, that is, the carrier amplitude is caused to vary up and down, according to an audio modulating signal. There are several methods to obtain amplitude modulation of a carrier but fundamentally the carrier must be caused to go down to zero and up to double the value of the normal carrier level as a limit of normal operation. This variation occurs over an audio cycle so that the peak power is four times the normal carrier power. The above is

*It is significant that Loy E. Barton is the originator of Class B Modulation, having started his development of this system while he was instructor in the University of Arkansas. He has contributed greatly to the present Class B Modulation system employed by RCA, and is considered the outstanding authority on the subject of Class B and other types of Modulation.—Ed.*

a condition for 100 percent modulation and if the modulating signal is a sine-wave the antenna power will increase 50 percent or the antenna current will increase approximately 22 percent.

The theory of modulation can be obtained from many hand books on radio but the fundamental requirement of the output system is that the power handling capabilities must be present to permit peak outputs required for complete or 100 percent modulation of the carrier output. Another fundamental characteristic of a vacuum tube amplifier is that its efficiency is a function of the variation of the plate voltage as related to the d-c plate voltage. If the plate voltage swings 100 percent, that is, if the peak plate tank voltage is equal to the d-c plate voltage the efficiency for an ideal system is 78.6 percent, for one-half this plate voltage swing or one-half of the above tank voltage the efficiency would be one-half the above value or 39.3 percent, and so on for any other plate voltage swing. It is obvious that ideal amplifiers are not possible so that in general the maximum efficiency of a Class C amplifier is about 70 percent.

If a Class C output amplifier is

used for the output system and the instantaneous plate voltage is raised to double the value of a normal carrier level the efficiency remains at 70 percent so that the output power is four times the carrier power and at instances of zero plate voltage the carrier power is zero which is a condition for 100 percent modulation. This type of modulation and output system is commonly known as high level modulation and if a Class B audio amplifier is used to vary or modulate the plate supply to the Class C amplifier, the transmitter is known as a Class B modulated transmitter.

Low level modulation as the name implies is a system of modulation in which the modulating signal is applied to a low power stage and this low power modulated radio frequency amplifier is followed by a Class B radio frequency output amplifier which if operated properly will not introduce appreciable distortion. However, it must be remembered that the plate voltage of this output amplifier is constant because no audio power is available to modulate the plate voltage. Therefore, in order to transmit a modulated carrier through the output amplifier the plate voltage swing or tank voltage must be reduced to a value such that double the tank voltage will not cause any undue non-linearity in the output amplifier. Since the amplifier is not linear to a plate voltage swing equal to the Class C amplifier plate swing the peak plate efficiency of the Class B radio amplifier is not more than about 60 percent and because of heavy grid currents at peak plate swings corresponding to 100 percent modulation it is usually necessary to reduce the peak efficiency to 50 or 55 percent to prevent undue distortion. Therefore, if 100 percent modulation is to be possible the efficiency of the output amplifier is only one-half of the above or 25 to 30 percent. This

low efficiency is necessary for any output system in which the modulation is not applied to the plate supply of the output amplifier unless special means are used to vary the efficiency of the output amplifier as explained below.

There is only one type of high level modulated output amplifier which is the Class C amplifier and it is driven in such a manner that the output or antenna current is proportional to plate voltage. The audio power to modulate the plate voltage of a Class C output amplifier may be a Class A amplifier for constant current modulation or for transformer modulation or the modulator tubes may be operated as Class B audio amplifiers for transformer modulation.

There are several low level modulation systems as follows:

- (1) A low power plate modulated amplifier followed by a Class B radio output amplifier. This system of low level modulation requires tubes with average three-element vacuum tube characteristics for low distortion outputs and at least the modulated Class C amplifier is not critical to adjust.
- (2) A grid modulated r-f amplifier may be followed by a Class B amplifier. This system requires critical adjustment of all amplifiers including the modulated stage and the modulated amplifier requires tubes of a more or less special design to prevent distortion. The audio signal in this system is applied in series with the grid of the modulated tubes and a low impedance output is required of the audio system to prevent distortion at peak upward modulation. The low impedance audio system is especially necessary if the output tube is grid modulated.
- (3) Suppressed grid modulation is being used in small transmitters but the difficulty in constructing pen-

tode tubes of high output capacity limits its use. The audio signal is applied in series with the suppressor grid for this type of modulation.

- (4) A carrier controlled radio frequency output system also known as super-modulating and floating carrier, has been considered for several years as a means of reducing input plate power. This system provides means for reducing the carrier output to a value just sufficient to permit approximately 100 percent modulation, by the particular audio signal level. At zero audio signal level the carrier output may be any low value but should be at least 10 to 20 percent of full output level in order that the signal may be kept tuned. This system of control may be accomplished by one of several methods and may become quite useful for certain types of services where minimum power is available. It is obvious that the output efficiency of this system is low because the output power is reduced at the same time the input power is reduced and that the average broadcast receiver with automatic volume control will not satisfactorily receive a signal from this type of transmitter.
- (5) Controlled plate efficiency of the output amplifier for low level modulated systems has been considered as a means of increasing the plate efficiency of the low level modulated transmitters. Briefly any one of the above systems of low level modulation systems may be used to which is added a system for changing the operating conditions of the output tube during periods of low percentage modulation in such a manner that the

efficiency of the output amplifier is increased for a constant antenna current. At these periods the modulation capability of the output amplifier will be reduced. Therefore, a high audio signal must work through the plate efficiency control system to reduce the efficiency of the output system thus permitting high modulation capabilities for the high signal. Such a control may be obtained in a Class B r-f output amplifier by changing the plate voltage and excitation and/or bias in such a manner as to maintain a constant carrier. The efficiency of the output amplifier may be increased to 40 or 60 percent during silent or low modulation periods. The average efficiency of such an output system would probably be 35 to 50 percent. However, it is obvious that the plate efficiency controlling device which would be actuated by the amplitude of the audio signal would of necessity be a relatively complicated device and its adjustment would be critical along with the other critical adjustments of a low level modulated system. It is also obvious that such a system may be the source of considerable distortion during normal variations of the audio signal.

A low level modulated system given as Item 1 above has certain advantages over the other low level modulation systems as indicated and for certain power ranges may have an advantage over a Class B modulated system if no convenient tube arrangement is available for a Class B modulator and a Class C amplifier. However, a convenient tube arrangement is available for a one kilowatt Class B modulated transmitter, such as the RCA 1-D broadcast transmitter.

The table herewith summarizing the various types of broad-

cast output systems indicates the desirable features of a Class B modulated one kilowatt transmitter as compared to a one kilowatt transmitter using other types of output systems. The following table is devised to apply primarily to a one KW transmitter but the relative values may apply to any size transmitter. The values given in the table are approximate values which may be verified theoretically or experi-

mentally for transmitters capable of full 100 percent upward modulation with low distortion.

The performance of the systems as indicated in the table below shows a power saving of \$130 per year for the Class B modulated transmitter, which would justify an additional expenditure of approximately \$1000 for this type of transmitter on a basis of 10 percent depreciation and 6 percent interest charge.

Lower tube costs for the Class B modulator is also a very important item.

Additional advantages of the Class B modulated RCA 1-D broadcast transmitter are increased reliability, lower distortion, and lower maintenance costs which are difficult to evaluate in dollars but field experience with this transmitter indicates that the above additional advantages are quite valuable to a station owner.

APPROXIMATE SUMMARY OF 1 KW BROADCAST TRANSMITTER OPERATION

Type of modulation	Power input to lower power stages plus titis. of output ampl. & modulator, watts	Adj. of modulated amplifier	Adj. of low power amplifier	Adj. of output amplifier	Average input to modulator, watts	Input to output amplifier, watts	Power input for monitor system, controls, bias & other normal power loss, watts	Total power input, KW	Cost of power per yr. for 15 hrs. daily operation at 3c per KW Hr.
1. Low level modulated system.....	1,500	not critical	critical	critical	.....	3,500	1,000	6.5	\$1,065.00
2. Low level modulated system.....	1,500	critical	critical	critical	.....	3,500	1,000	6.5	1,065.00
3. Low level suppressor grid modulated system.....	1,500	critical	critical	critical	.....	3,500	1,000	6.5	1,065.00
4. Low level modulated system with controlled plate efficiency.....	1,800	critical	critical	critical	.....	2,500	1,200	5.5	902.00
5. High level Class A modulated.....	1,500	not critical	not critical	not critical	2400	1,600	1,000	6.5	1,065.00
6. High level Class B modulated.....	1,500	not critical	not critical	not critical	700	1,600	1,900	5.7	935.00

NOTE: Item 2 and 6 performance is based upon actual commercial transmitter performance. Also that the power input to monitor system, etc., is high for item 6 because of the power taken by elaborate built-in accessories.

## BROADCAST STATION MAINTENANCE

(Continued from Page 23)

should be checked. The plate tank circuit must, of course, be tuned for minimum plate current.

(5) The plate and bias voltages may now be restored to their normal values. The grid excitation should also be reduced and left where either the proper plate or antenna current is obtained, depending on the method of power measurement. The transmitter is now roughly in adjustment.

(6) The transmitter should now be completely modulated. Needless to say, the audio input, the modulator and the modulated

stage should be free from serious distortion. At 100 percent downward modulation where the envelopes of the carrier meet the zero axis, as observed on a cathode ray oscilloscope, the increase in antenna current should be  $22\frac{1}{2}$  percent. It will be possible to meet this requirement and still have serious distortion if the bias is too high. Therefore a harmonic analyzer is essential.

(7) In the direct method of measurement, excessive audio distortion is indicative of over efficiency which may be corrected by a slight increase in coupling with a corresponding readjustment of excitation to restore the antenna current to the proper value. This

small change in efficiency may sometimes be conveniently obtained by detuning the antenna if directly coupled to the amplifier as outlined in paragraph 4. When a transmission line is used more coupling will be required.

Using the indirect method, the goal is maximum output for the allowed input consistent with the maximum distortion which may be tolerated.

(8) The correct value of bias should be sought as a slight change will result in low efficiency or bad wave form depending upon the direction of change. Also, at half-plate voltage, the bias should be accurately adjusted to one-half value so as to maintain linearity.

# Versatile Engineers Rig Police Radio Antenna

**Problem of Getting Antenna Atop Tall Chimney Solved With Balloons**

**S**OMETIMES the most baffling problem is solved by the simplest means,—if only time is taken to sit down and think a bit.

The new RCA Terra-Wave Police Radio Transmitter, which was being installed for the city of Chicago Heights, Ill., presented an antenna problem. There was a swell smokestack located on city property near the site chosen for the transmitter, but no facilities were at hand for climbing the stack, either inside or out. How to get a line up to the top of that stack? The cost of building a scaffold about this brick chimney would have been prohibitive. Professional steeplejacks were not available at the time, and none of the personnel present felt inclined to attempt to scale this structure

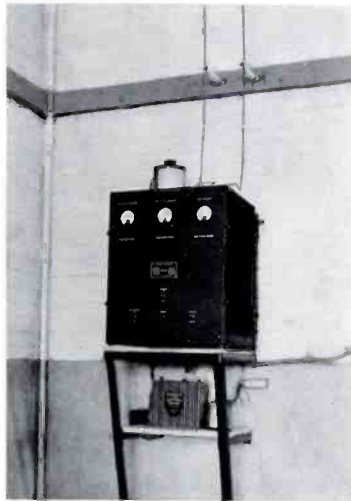

RCA TERRA-WAVE TRANSMITTER, INSTALLED AT THE POLICE DEPARTMENT, CITY OF CHICAGO HEIGHTS

carried by the wind, the balloons were well out southward over the city. A police officer was then called upon to shoot the balloons down, which he did with a fine display of his marksmanship.

When the line settled to earth heavier rope was pulled out through the top of the stack and finally a stranded copper wire rope of suitable size was drawn into place to serve as a permanent anchor for the Police Radio antenna.

### No Shadow Effect

Subsequently, the RCA Police Transmitter was set up in the City Hall, connected to the antenna by a transmission line, and tests were conducted with excellent results. It was interesting to note that no shadowing effect was produced by the antenna which paralleled the stack at an average of only five feet. The signal laid down was equally strong in the direction toward the stack, as in all other directions, and coverage was obtained well in excess of the requirements.

Station W9XGD of the Chicago Heights Police Department, operates on a frequency of 30,100 KC's and is now in continuous service.



NO ONE WANTED TO TRY CLIMBING THIS STACK,—

to the dizzy limits of its 175 ft. height above the ground.

### An Inspiration

After giving the matter some thought, one of the engineers on hand conceived the idea of flying captive balloons up through the center of the stack. After some deliberation and no little experi-

menting, it was determined that five balloons, each 16 in. in diameter and filled with hydrogen, would raise an ordinary chalk line about 175 feet in the air. Accordingly, the fires were drawn from under the boilers which this stack served and the five balloons were started up through the flue, trailed by the light cord. The balloons rose only to a height of 140 feet, indicating that the preliminary experiments and calculations were misleading. This was explained as being due to the cool draught inside the stack contracting the gas in the balloons. Therefore, it was decided to give them a little heat. This was accomplished by burning a few oil-soaked rags at the bottom of the stack.

### Success

Immediately the balloons rose farther up through the chimney, and, as soon as they passed out through the top of the stack, the force of the wind caught them and the line began to run out with additional speed. Heavier line was spliced on to the cord and allowed to run out through the top of the stack. Eventually,

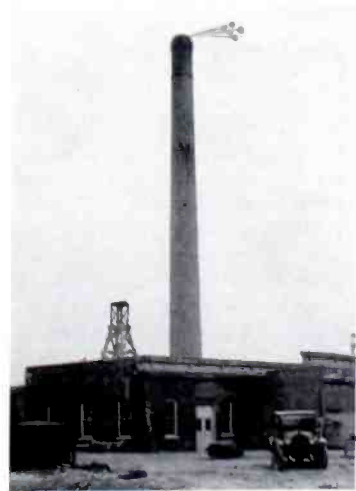

—SO HYDROGEN BALLOONS CARRIED A LINE OUT THROUGH THE TOP!

# General Considerations of Tower Antennas for Broadcast Use

By Dr. G. H. BROWN and H. E. GIHRING, RCA Engineers

This is the second installment of the paper prepared for and copyrighted by "Proceeding of the Institute of Radio Engineers." It is being published by permission as a serial.



DR. G. H. BROWN, RCA MFG. CO.

## (c) The current distribution type B antennas

The type B antenna is a conventional tower. Its dimensions are shown in Fig. 7. This antenna was a model of the antenna in use at KOA, Denver. The capacity area at the top is circular, having a full scale diameter of thirty feet. For our tests, another ring was prepared which was the equivalent to a diameter of fifty feet. The tests were made in exactly the same manner as before. The first test was made with no capacity area at the top. These results are shown in Fig. 8. The same remarks that were made regarding the distribution on the type A antenna hold true here. Type B tower used no guy wires.

Next, the small ring was placed on the top of the antenna. The results are shown in Fig. 9. Fig. 10 portrays the current distribution when the large ring is placed at the top.

These tests show that type B antenna yields current distributions more nearly sinusoidal than does the type A antenna. This is no doubt due to the fact that the type B antenna changes cross sec-

tion less abruptly. A study of these diagrams shows the effect of capacity areas at the top of the antenna.

## (d) The current distribution on a vertical wire antenna

In the above, we have attributed the departure from the sinusoidal distribution to the changing cross section of the antenna. It has been assumed that an antenna of uniform cross section would yield a current distribution very nearly sinusoidal. To prove this point, the tower antenna was replaced by a single No. 14 copper wire. The wire was taped to a vertical wooden pole and the lower end of the wire was fastened to the top of the base insulator which formerly supported the tower antennas. The frequency was held constant at seventy-five megacycles (four meters) and three separate lengths of wire were used. These

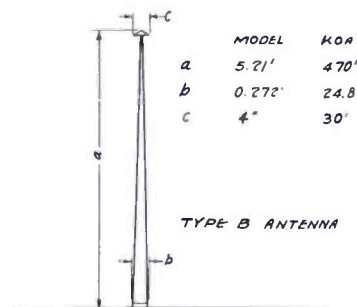

FIGURE 7—DIMENSIONS OF TYPE B MODEL ANTENNA

lengths were related to the wavelength as follows:

$$a/\lambda = 0.2265, G = 81.5 \text{ degrees}$$

$$a/\lambda = 0.555, G = 199.5 \text{ degrees}$$

$$a/\lambda = 0.6475, G = 233.0 \text{ degrees}$$

Fig. 11 shows portions of sine waves  $G$  degrees long. The crosses, circles, and squares indicate experimental values. It is seen that there is a substantial agreement between the theoretical and experimental values.



H. E. GIHRING, RCA MFG. CO.

## III. The Vertical Radiation Patterns

When the current distribution is known, the vertical radiation pattern can be calculated. For our purposes, the earth may be considered to be a perfect conductor, since this assumption changes the high angle radiation only a little. Using the current distributions shown in Fig. 5, we have computed the vertical radiation pattern of the type A antenna for three values of  $a/\lambda$ . These are shown in Fig. 12. Airplane measurements of the vertical radiation from WCAU were taken and the results are shown by the circles on Fig. 12. As stated before, the ratio,  $a/\lambda$ , equaled 0.595 for the WCAU antenna, so that the agreement between the results of the model experiments and the actual airplane measurements would indicate that the effect is due almost entirely to the fact that the current distribution is nonsinusoidal. Fig. 13 shows the same sort of curves for the type B antenna with the small capacity ring. As a means for comparison, we have included Fig. 14 to show the patterns that might be expected if the current distribution were sinu-

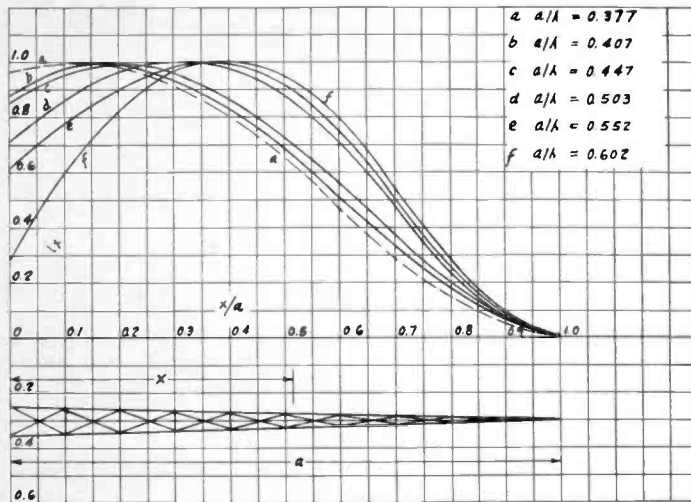

FIGURE 8—CURRENT DISTRIBUTION ON TYPE B ANTENNA

soidal. These diagrams show that the best height of antenna to use to reduce the sky wave to a minimum depends on whether it is a type A antenna, type B antenna, or an antenna with sinusoidal distribution.

IV. Information on Existing Antennas

It is desirable to compare the action of these tower antennas to the theoretical results one might expect if the distribution were sinusoidal. Resistance measurements of the WCAU antenna were made at a number of frequencies over the broadcast band. The results of these measurements are shown by Fig. 15. Curve A shows the resistance of the WCAU antenna. For this measurement, the tower stood entirely alone with no lighting equipment or static drain coils on the antenna. Later, an insulated generator and other equipment were attached to the tower, increasing the base capacity a large amount. This capacity changed the effective series resistance of the antenna system. The resistance values under these operating conditions are shown by curve B. Curve C is the corresponding theoretical curve of radiation resistance for a sinusoidal distribution of current. It is seen that there is very little agreement between the two in the region,  $a/\lambda > 0.5$ . It is interesting to note that the maximum value of resistance is only of the order of 400 ohms. This is due to two causes.

The first is that the current at the resonant point reverses phase by a rotation rather than by passing through zero. The other is that the true antenna impedance is shunted by the capacitance of the base insulator. This shunting effect has been found to be even greater in other installations. It should be pointed out that the size of this base capacitance plays no part in determining the efficiency of the antenna, if there is no leakage resistance to ground. Since it is likely that these capacitance currents will flow through some earth before getting back to the antenna coupling coil, it is important that a conducting path be provided for these currents. This is best done by placing a screen on

top of the earth around the base insulator and bonding this screen directly to the ground system.

Another test made on the WCAU antenna was the measurement of the field strength at one mile as the frequency was varied and the power was held constant. The results are given as curve A, Fig. 16. Curve C of this same figure is the theoretical curve obtained if the earth is a perfect conductor, and the antenna current is assumed to be sinusoidally distributed. The input power was a constant value, 50,000 watts. There is seen to be a great departure from the theoretical value. The crosses indicate values computed from the distribution obtained on the model antenna, assuming a perfectly conducting earth.\* These values are in very good agreement with the actual situation and show that the departure from the simple theory is due to current distribution. Curve B of Fig. 16 is a similar curve obtained on KOA, Denver.† This is a type B antenna. The circles are values computed from the current distributions shown in Fig. 9. We see that neither type of antenna approaches the theoretical curve

\*When  $a/\lambda$  is large enough that the antenna current undergoes a phase rotation, one is not justified in computing the polar diagram and field intensity without knowing the phase of the current at all points. Our model measurements gave only amplitude.

†The authors are indebted to Mr. Raymond F. Guy of the National Broadcasting Company for the data shown by curve B.

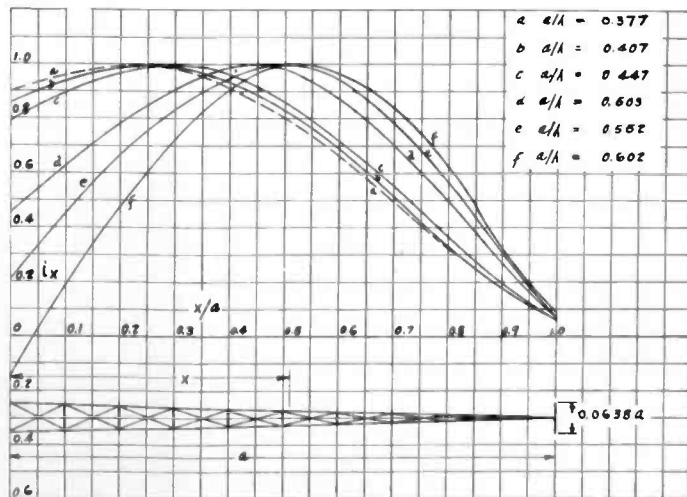

FIGURE 9—CURRENT DISTRIBUTION ON TYPE B ANTENNA WITH A SMALL CAPACITY

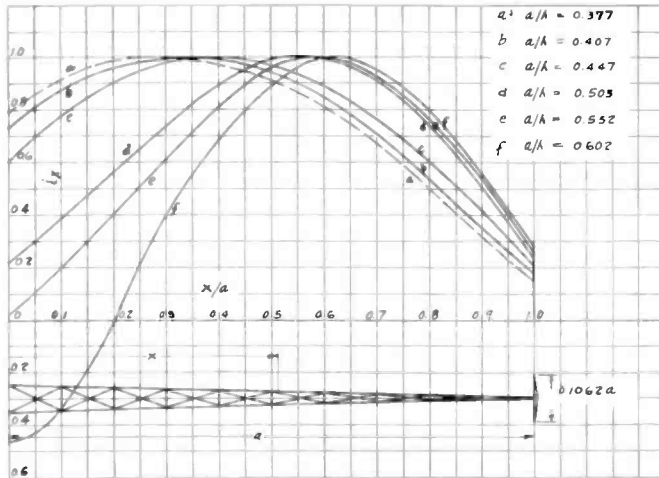

FIGURE 10—CURRENT DISTRIBUTION ON TYPE B ANTENNA WITH A LARGE CAPACITY AREA

through the whole range. If we refer to the vertical radiation patterns at the same time, we see that the type A antenna gives a large high angle radiation by the time it has reached the maximum value of field strength. If the antenna is shortened to reduce the high angle radiation, there is a very appreciable loss in field strength. Besides this it seems doubtful whether shortening really decreases the high angle radiation in this case. It is seen that there is room for a great deal of improvement on the type A antenna. The type B antenna

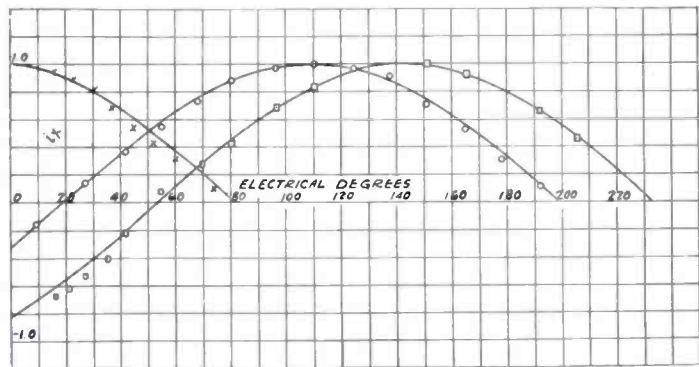

FIGURE 11—CURRENT DISTRIBUTION ON VERTICAL WIRE ANTENNA

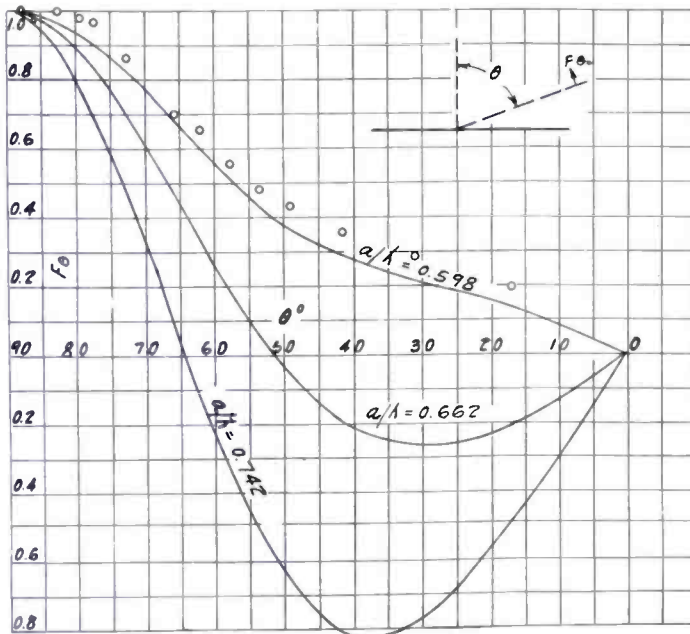

FIGURE 12—VERTICAL RADIATION CHARACTERISTICS ON TYPE A ANTENNA. (THE CIRCLES ARE EXPERIMENTAL VALUES OBTAINED BY AIRPLANE MEASUREMENTS AT WCAU)

gives values much closer to the theoretical and seems to suppress the sky wave for values of  $a/\lambda$  up to 0.55. Beyond this point, the intensity curve drops off rapidly. The maximum value of intensity obtained is far short of the theoretical maximum. It is evident that there is much to be gained by using an antenna which will have a sinusoidal distribution of current. Such a result might be had if the tower were of uniform cross section for its entire length. This of course involves some difficulties in the design of the taller towers. A method of obtaining a sinusoidal distribution of antenna current will be discussed below.

### V. A Method of Attaining a Sinusoidal Distribution of Current on the Type A and B Antennas

As it has just been pointed out, it is desirable to make the cross section of the antenna be constant. This was accomplished in a very simple fashion. The tests were made on the models as before. The square framework was placed on top of the type A model. From each corner of the framework, a wire was dropped vertically downward to the corners of the largest cross section of the tower, and from there to the corners of a square frame placed at the base of the antenna. The arrangement is shown by the sketch on Fig 17. The current distribution was measured and found to approximate the sinusoidal much better than when the wires were not used. (Fig. 17.) The departure from the sinusoidal would no



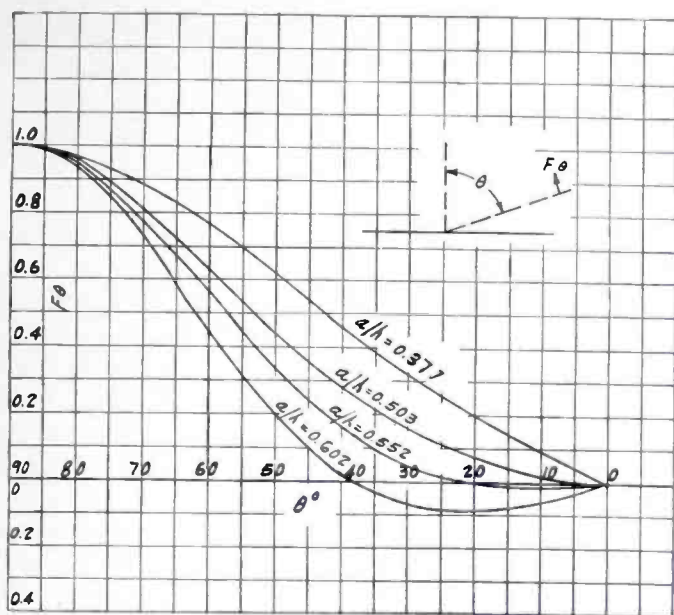

FIGURE 13—VERTICAL RADIATION CHARACTERISTICS OF TYPE B ANTENNA

doubt be made less by the use of more wires. The minimum of four wires was used to show the great correction that was obtained with the minimum number of wires.

The same procedure was followed with the model of the type B antenna. The small circular ring was placed at the top and four wires were dropped from the diameter of this ring to join the tower a short distance above the base insulators. The current distribution was measured for  $a/\lambda = 0.602$ . This distribution is shown in Fig. 18. This curve agrees well with the expected sinusoidal distribution. The frequency was shifted so that  $a/\lambda = 0.407$ , and a series of measurements made. These results are shown by Fig. 19. This curve was so close to a true sine wave that it was not possible to plot a sine wave on Fig. 19 and have it show as a separate curve.

Other arrangements of the wires were tried without correcting the current distribution. For instance, on the type A antenna, wires were placed only from the top framework down to the bulge of the tower. This gave a distribution far from the sinusoidal. Another test was made with wires strung from the bulge to a point

near the ground. This was also found to be unsatisfactory.

A test was made on the type B tower to determine the effect of changing the taper. Current distributions were measured for a number of tapers, varying from the case where the tower came to a point at the top to the case where the tower was of uniform cross section. The tower model was of such dimensions that it

corresponds to an actual tower 518 feet high, 30 feet square at the base, operated at a wave length of 300 meters. The tower is thus 190 degrees tall. Fig. 20 shows the measured current distribution for this arrangement. We see that the current distribution is vastly different when the tower is only one foot across the top than it is when the tower is of uniform cross section.

It is a little difficult from inspection of this figure to determine the relative merits of the different current distributions. We will illustrate these relative qualities by a simple calculation. From the measured current distributions of Fig. 21 we will first compute the vertical radiation characteristics. We will next assume that the Heaviside layer height is 100 kilometers (62.5 miles), and that the layer has an efficiency of reflection of 33.3 per cent. We can then compute the magnitude of the reflected ray at any point on the surface of the earth. We will designate this intensity by  $F_2$ . The value of the direct or ground ray, designated by  $F_1$ , is next computed, for an earth conductivity of  $50 \times 10^{-15}$  e.m.u. and a wave length of 300 meters. The ratio of  $F_2/F_1$  is plotted as a function of the distance from the antenna along the ground, with width of the top of the tower as

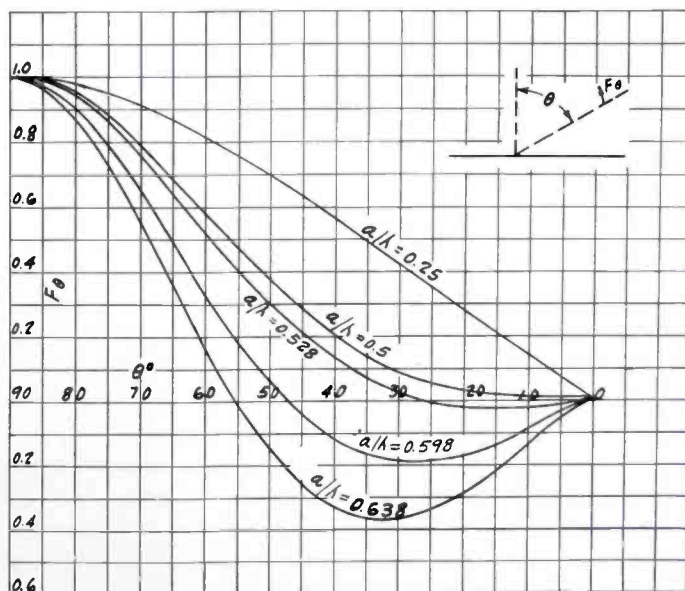
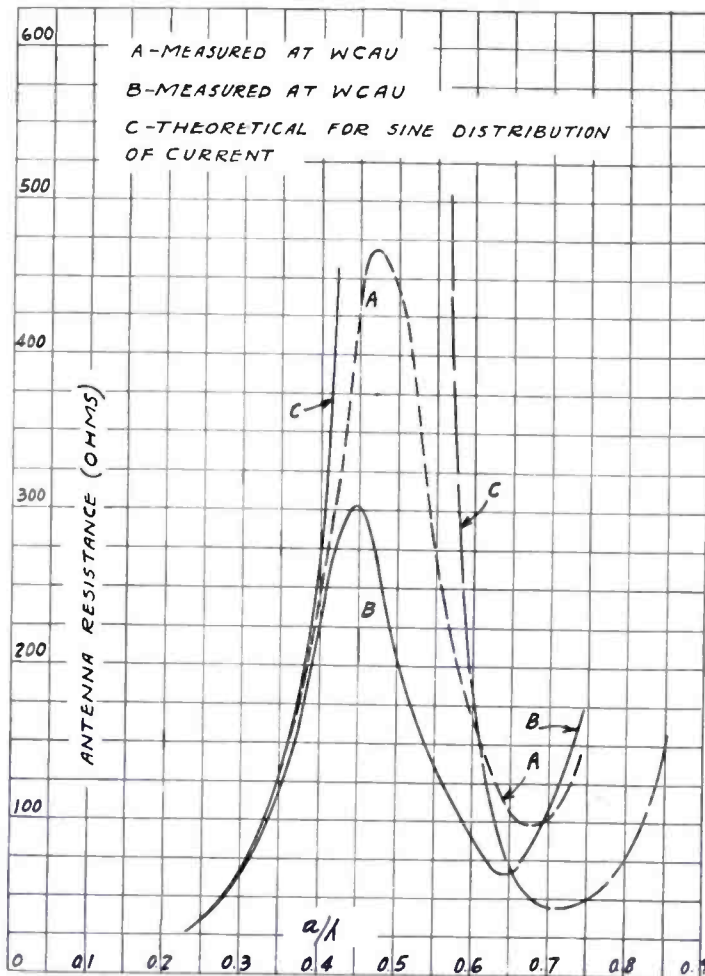

FIGURE 14—VERTICAL RADIATION CHARACTERISTICS OF STRAIGHT VERTICAL WIRE

FIGURE 15—RADIATION RESISTANCE VS.  $a/\lambda$ .

a parameter. These results are shown in Fig. 21. It is interesting to see that when the tower is one foot across the top, the ratio of reflected to direct wave is unity at 73 miles, while the ratio becomes unity at 102 miles when the tower is uniform. Thus we see that the night service radius is extended about 30 miles, thus doubling the night primary service area.

While it may be argued that there may be other distributions of current than the sinusoidal which will give equal or better results, it seems more desirable to use the sinusoidal distribution. For every particular distribution proposed, it would be necessary to go through a great deal of tedious computation to examine the theoretical results that we might expect. So much of the

theory for a sinusoidal distribution has already been worked out that the antenna designer's prob-

lem is very much simplified if he can assure himself that the current distribution is sinusoidal.

## VI. Earth Currents Near the Antennas

It has been pointed out by other writers that ground systems beneath antennas play a dual role. One function of the ground system (usually buried radial wires, with the base of the antenna as the common point) is to provide a good conducting path for the earth currents, so that these currents will not flow through a poorly conducting earth. This is necessary close to the antenna where the earth current densities become high. The other function is to act as a good reflector for waves coming from various points on the antenna, so that the vertical radiation pattern will be close to that obtained if the earth under the antenna were perfectly conducting. Actually these two functions are synonymous. If the ground system is complete and extensive enough to eliminate all power expenditures in the earth, the reflection of each little incident wave will be perfect. We will concern ourselves only with an examination of the earth currents. We will discuss ground systems which consist of buried wires running radially in all directions from the base of the antenna.

To form a picture of what is happening in the earth beneath an antenna, let us examine Fig. 22.

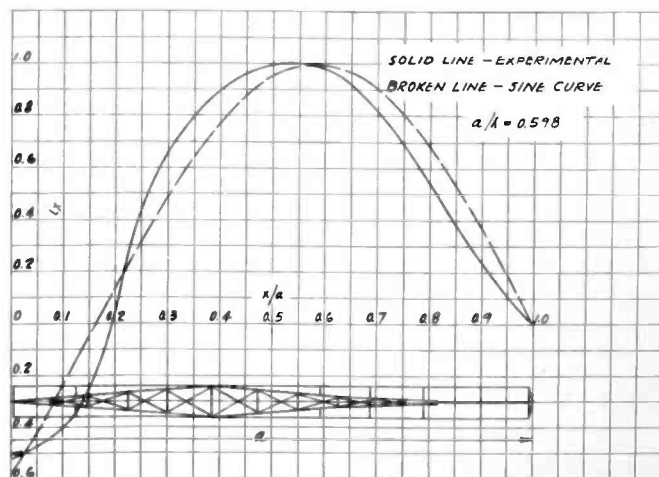

FIGURE 17—CURRENT DISTRIBUTION ON TYPE A ANTENNA EQUIPPED WITH OUTRIGGER AND VERTICAL WIRES.

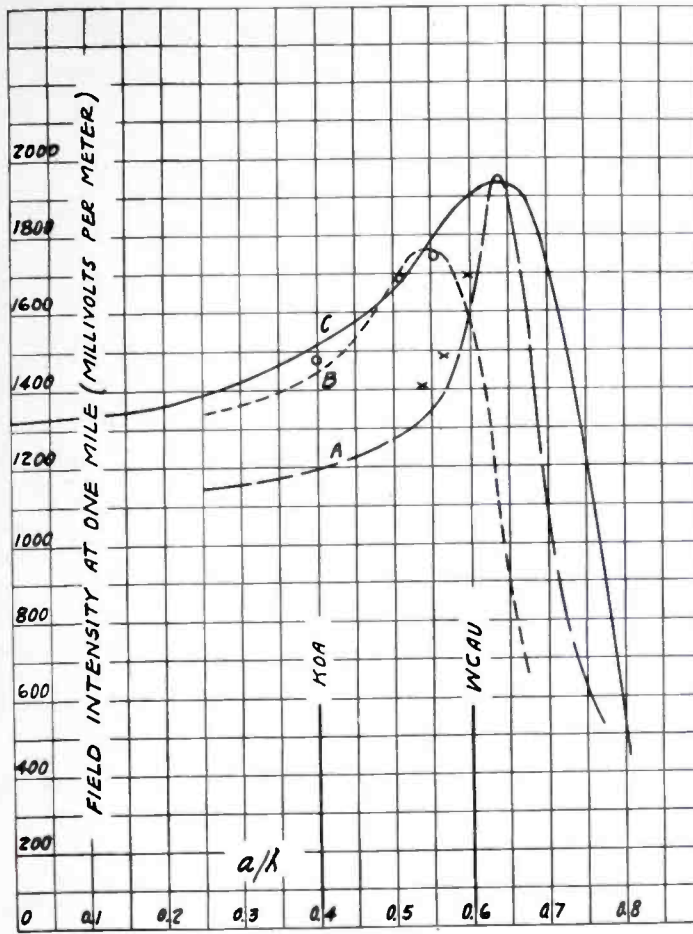

FIGURE 16—FIELD INTENSITY AT ONE MILE VS.  $a/\lambda$ . (INPUT POWER—50,000 WATTS)

Displacement currents leave the antenna, flow through space, and finally flow into the earth where they become conduction currents. If the earth is homogenous, the skin effect phenomena keep the current concentrated near the surface of the earth as it flows back to the antenna. Where there are ground wires present, the earth current consists of two components, part of which flows in the earth itself and the remainder of which flows in buried wires. As the current flows in toward the antenna, it is continually added to by more displacement currents flowing into the earth. It is not necessarily true that the earth currents will increase because of this additional displacement current, since all these various components differ in phase. In Fig. 22, let C

be a cylindrical surface of radius,  $x$ , where the vertical antenna and the cylindrical axis are coaxial.

Then we will denote the total earth current flowing radially inward across the surface of C as  $I_e$ . If buried wires are present,  $I_e = I_w + I_o$ , where  $I_w$  is the component flowing in the wires and  $I_o$  is the part which actually flows in the earth. It is interesting to examine the factors which determine the proportions of these two components. An approximate relation is\*

$$I_e/I_w = \gamma_c \left[ \pi(c^2 - r^2) R_{ac} (1 + j) + j4\pi \cdot 10^{-9} f \left\{ \pi c^2 \log \frac{c}{r} - \frac{\pi}{2} (c^2 - r^2) \right\} \right] \quad (1)$$

where,

$\gamma_c$  = earth conductivity (mhos per centimeter cube)

$R_{ac}$  = radio-frequency resistance per centimeter length of wire used in the ground system

$r$  = radius of the wire in the ground system (centimeters)

$f$  = frequency (cycles per second)

$x$  = distance from the antenna (centimeters)

$n$  = number of equally spaced radial wires

$$c = \pi x/n$$

\* G. H. Brown, "A Theoretical and experimental investigation of the resistances of radio transmitting antennas," Chapter V. This is an unpublished thesis filed in the University of Wisconsin Library.

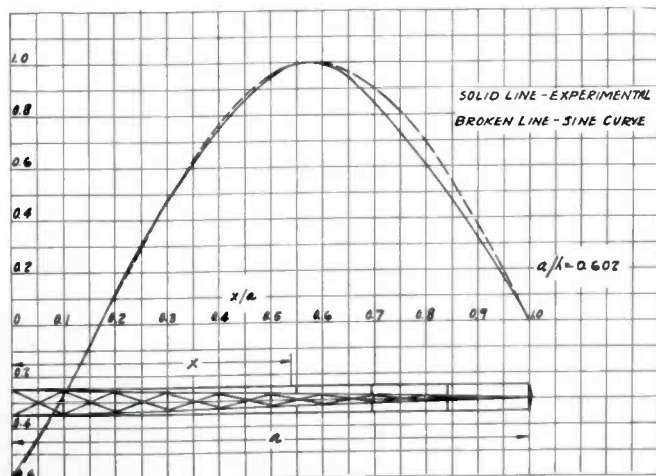

FIGURE 18—CURRENT DISTRIBUTION ON TYPE B ANTENNA EQUIPPED WITH OUTRIGGER AND VERTICAL WIRES ( $a/\lambda = 0.602$ ).

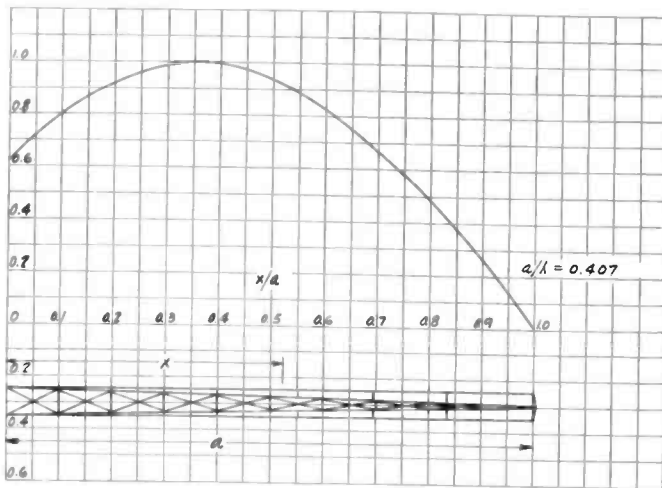

FIGURE 19—CURRENT DISTRIBUTION ON TYPE B ANTENNA EQUIPPED WITH OUTRIGGER AND VERTICAL WIRES ( $a/\lambda = 0.407$ )

- $\gamma_e = 0.2 \times 10^{-4}$  mhos per cm cube  
 $= 20.0 \times 10^{-15}$  e.m.u.
- $\gamma_e = 0.5 \times 10^{-4}$  mhos per cm cube  
 $= 50.0 \times 10^{-15}$  e.m.u.
- $\gamma_e = 1.0 \times 10^{-4}$  mhos per cm cube  
 $= 100.0 \times 10^{-15}$  e.m.u.

The results are expressed graphically in Figs. 23, 24, and 25. It is seen that as the conductivity of the earth increases, a greater part of the total current flows in the earth and less in the buried wires. The number of buried wires is also an important factor. These curves show merely the ratio of the current in the wires to the total earth current. We will now examine the way in which the total earth current varies.

The assumptions are that the earth is homogenous, the wires are buried between six and twelve inches deep, and the ends of the wires are well connected to the earth, possibly through deep rods or large plates. Because of the relative size of the quantities involved, (1) is quite accurately given as

$$\frac{\bar{I}_e}{\bar{I}_w} = j\gamma_e \cdot 4\pi^2 \cdot 10^{-9} f c^2 \left\{ \log \frac{c}{r} - 0.5 \right\} \quad (2)$$

Then the current in the wires is expressed in terms of the total earth current as

$$\left| \frac{\bar{I}_w}{\bar{I}_e} \right| = \left| \frac{1}{1 + \bar{I}_e/\bar{I}_w} \right| \quad (3)$$

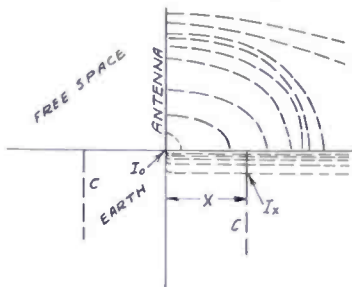

FIGURE 22

Using (2) and (3), we have computed the ratio of the current in the radial wires to the total earth current for 30, 60, and 120 radial wires, (No. 8 annealed copper) and a frequency of 1000 kilocycles per second. Three different earth conductivities were chosen. These were:

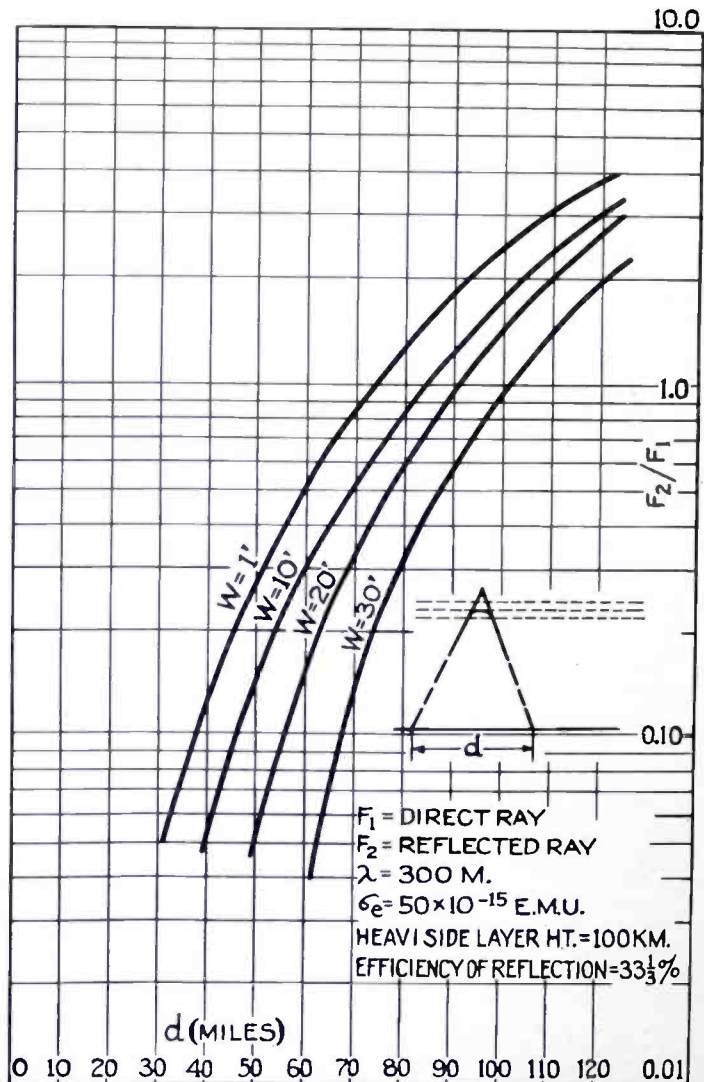

FIGURE 21

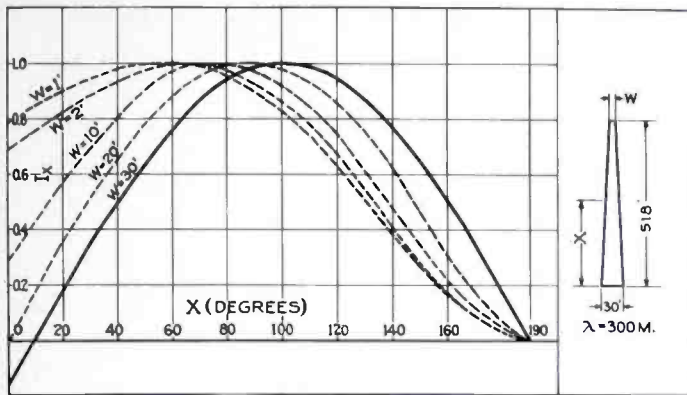

FIGURE 20

If it is assumed that the earth below the antenna is a perfect conductor, it is a simple matter to calculate the earth current flowing across any cylinder of radius,  $x$ . This current is a function of the distance from the base of the antenna, the wavelength, and the dimensions of the antenna. When the antenna is a straight vertical wire of height,  $a$ , with the current distributed sinusoidally on the antenna, the total earth current is given by

$$\bar{I}_x = j \frac{\bar{I}_0}{\sin G} [\epsilon^{-jkx} - \cos G \epsilon^{-jk(r_2 - x)}] \quad (4)$$

where,

$\bar{I}_0$  = current at the base of the antenna

$r_2 = \sqrt{a^2 + x^2}$

$\lambda$  = wavelength

$k = 2\pi/\lambda$

$G = ka$ .

The absolute value of this earth current is

$$|I_x| = \frac{I_0}{\sin G} \sqrt{1 + \cos^2 G - 2 \cos G \cos k(r_2 - x)} \quad (5)$$

This equation has been used to compute the earth currents for several different antennas, namely,

$G = 60$  degrees,  $G = 90$  degrees,  $G = 120$  degrees,  $G = 180$  degrees,  $G = 215$  degrees,  $G = 230$  degrees, and  $G = 270$  degrees. The mag-

of the antenna when the antenna is longer than a quarter wavelength. These values were computed on the assumption of a perfect earth, but it is highly probable that the same general law is followed when the earth becomes conducting, at least in the range of frequency used for broadcasting. It has previously been shown that the maximum losses in the earth beneath a half-wave antenna occur in the region about 0.35 of one wavelength from the base of the antenna. A similar treatment of the curves of Fig. 26 shows that this same value, 0.35 of one wavelength, is true for the other antennas whose height is greater than a half wavelength. Thus, an examination of Figs. 23 to

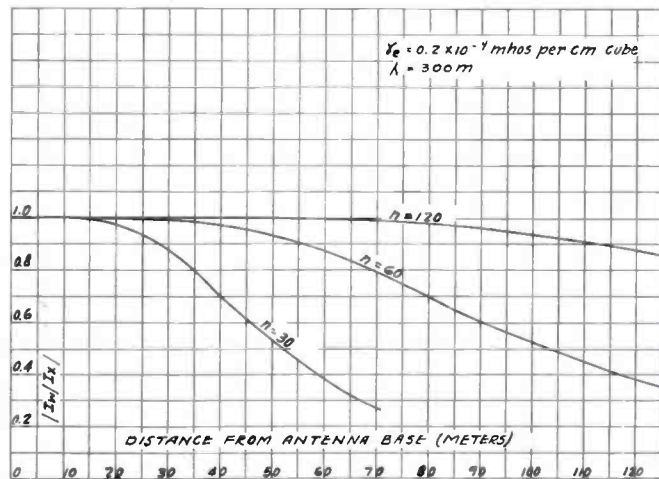

FIGURE 23

nitudes of the earth currents are plotted in Fig. 26. It was assumed that 50,000 watts was radiated in each case. It is seen that the earth currents are larger at remote points than the current at the base

26 shows the importance of using many wired radial ground systems and extending them much farther than is the present practice. We thus see that with a wavelength of 300 meters, it is important to use at least 120 radial wires, whose lengths are at least 130 meters. It is also evident that if only a small number of radial wires is used, there is little point in running them out to great distances, since they will carry little current.

Returning to Fig. 26, we see that in the case of the group of antennas longer than one-half wavelength the earth current drops off very rapidly for a short distance from the antenna and then builds up. It is possible to

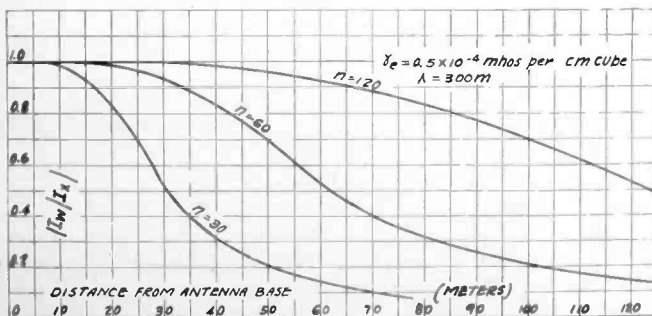

FIGURE 24

make use of this peculiar characteristic to determine whether there is a reversal of phase on the antenna. Let us first examine these earth currents in more detail. In Fig. 26 we have shown the magnitude of the earth currents for a number of antennas whose current distribution is sinusoidal. Equation (4) gives not only the magnitude but the phase position of the earth current with respect to the current at the base of the antenna. These alternating-current vectors have been computed from (4) for a 215-degree antenna with a sinusoidal distribution of current on the antenna.

(To Be Concluded In Our Next Issue)

### SALTY TALES FOR NBC Cameron King in Unusual Broadcast

TO BRING a picture of one of the Atlantic Coast's principal industries to radio listeners last week in broadcasts from the modern steam trawler Heckla out at the fishing grounds on George Banks, special equipment of the National Broadcasting Company was installed aboard ship.

#### Right Aboard Vessel

The broadcasts over an NBC-WJZ network visualized for listeners life aboard the fishing vessel, enabled listeners to "sit in" at Sunday dinner on the Heckla, and brought them a description and the actual sounds of trawling and hauling, the dumping of fish on the deck, and later the packing of the catch in ice. The ship's departure from the largest fish pier in the world in Boston was also heard on the air in another program.

During these broadcasts communication with the mainland and NBC's Radio City studios was maintained through the use of the Heckla's marine telephone, which was equipped for the sailing with a special microphone attachment enabling the fishermen to broadcast from all parts of the craft.

#### Broadcast from Banks

Descriptions of the interesting work of fishing were given by Magnus L. Magnusson, captain

of the Heckla, and one of the most famous of Atlantic Coast fishermen; Cameron King, NBC's nautical reporter, Edward H. Cooley, veteran fisherman and manager of the Massachusetts Fisheries Association, and Alan Kent, NBC announcer.

The major units of the special marine radio equipment used for the broadcasts were the transmitter, receiver, control unit, telephone set and power equipment. The Heckla supplied power from 110 D.C. motors to operate a generator which furnished the power for radio equipment.

The transmitter used was crystal controlled, capable of delivering sufficient power to assume fifty watts at any time and on any of its assigned frequencies. The Heckla transmitter operated on 2110 kilocycles. As a protection feature, a safety switch broke the high voltage whenever the top of

the transmitter was removed.

A six tube super-heterodyne radio receiver, with crystal controlled oscillator, was used. The set was built to work on either of two pre-tuned frequencies within a band of 2102 to 3300 kilocycles, and operated on 2506 kilocycles.

The control unit included the start and stop switching facilities, telephone hand set mounting, volume control and output meter with bell and lamps which indicated when the transmitter and receiver were operating.

Two way conversations were carried on by means of the telephone hand set. Pressing the button of the hand set released the radio receiver from the antenna circuit and placed the transmitter carrier on the air. When the button was released, the receiver was restored to its operative condition.

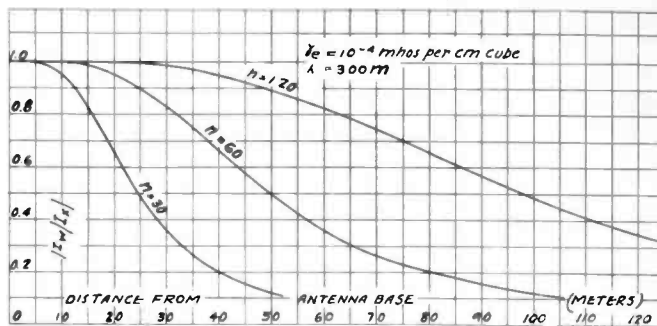

FIGURE 25

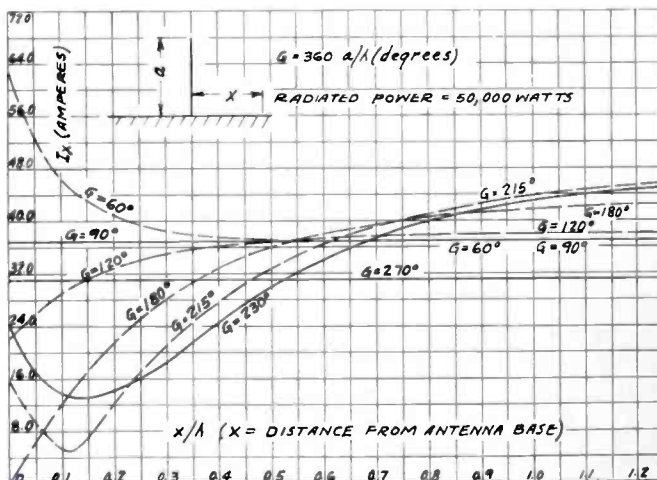
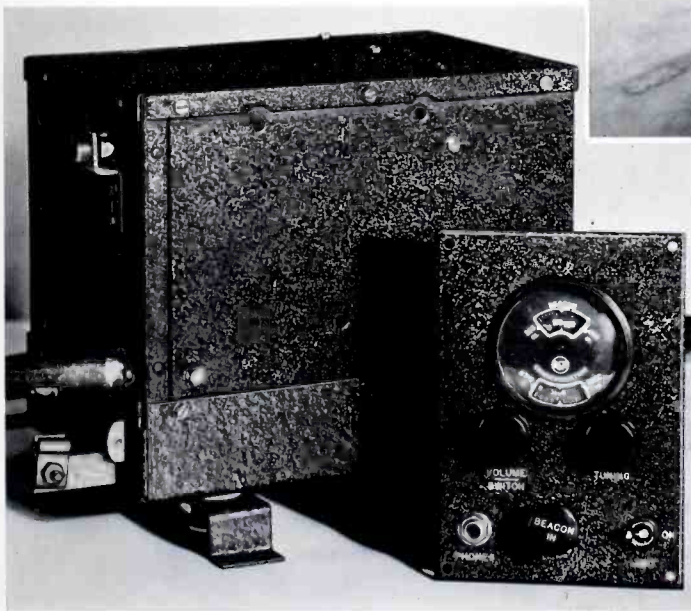

FIGURE 26—EARTH CURRENTS IN THE NEIGHBORHOOD OF TRANSMITTING ANTENNAS

# Latest in Aviation Radio Equipment

Displayed by  
RCA MANUFACTURING CO., Inc.

(Right) Compact and Light Airplane Transmitter Type AVT-3A. Power output 20 watts, weight only 38 pounds. During flight it offers pilot the choice of three types of high quality emission: 1. Telephone, 2. Continuous wave telegraph, and 3. Tone modulated continuous wave telegraph.



(Left) The new RCA Aircraft Receiving Equipment specially designed for aviation service, covering the beacon and communication bands. Also made to include entertainment bands.

Spacious hangar accommodations, radio installation and servicing facilities, office and resting spaces, as well as a working demonstration of all the newest types of aviation radio apparatus are placed at the disposal of itinerant pilots by the **RCA Manufacturing Company**, at its newly established aviation radio headquarters, located at Camden's Central Airport. All of the above facilities and equipment are housed in a modern hangar building 120 feet long by 80 feet wide. The airport radio station is shown at the right.



**NEW!**  
**RCA VICTOR**  
**70-A**  
**TRANSCRIPTION**  
**TURNTABLE**



## *Economical Equipment for High Fidelity*

The new RCA Victor Type 70-A Transcription Equipment offers true high fidelity performance on all records, at a reasonable price. It will play lateral-cut records with a full usable range of 30 to 7,000 cycles, and vertical-cut records with a range of 30 to 10,000 cycles. Record speeds of 78 and 33 $\frac{1}{3}$  r.p.m. are available at will, and standard

and long-playing records may be used interchangeably. Thus this unit serves all record-playing needs. Only two units are needed to make it possible to switch instantaneously from one record to another, regardless of type, without loss of time on the air, in accordance with the best control-room technique. Write for complete technical bulletin.

### **RCA VICTOR—THE ORIGINAL SOURCE**

It always pays to do business with those who know their business best. When considering transcription equipment, remember that RCA Victor possesses the greatest experience in the world in the recording and reproduction of phonograph records.



# **TRANSMITTER SECTION**

**RCA MANUFACTURING COMPANY, Inc.**

**CAMDEN, NEW JERSEY**

### **SEE THESE ALL-INCLUSIVE FEATURES:**

**High Fidelity Reproduction** — 30 to 7,000 cycles from lateral-cut records. 30 to 10,000 cycles from vertical-cut records. Constant-speed motor and felt filter eliminate "wows" even on long sustained notes.

**Two Speeds.** 78 or 33 $\frac{1}{3}$  r.p.m. Speeds are shifted easily and quickly.

**Compact Design.** Cabinet 31" high, 21 $\frac{1}{2}$ " wide, 19" deep.

**Easily Installed.** No special foundation or base required. Plug in and operate.

**Quiet Operation.** Microphone may be used nearby. To prevent transfer of motor vibrations to pick-up motor is sound insulated from both cabinet and turntable, and pick-up arm is insulated from cabinet.

**Matched Frequency Response.** Frequency characteristics of both pick-ups have been designed to match recording characteristics, resulting in substantially flat over-all characteristics.

**High Output Level.** Output circuits of the pick-up match a 200- to 250-ohm line. At 1,000 cycles either reproducer delivers approximately 0.01 volts r.m.s. to such a line which is about -48 db compared with a zero level of 12.5 milliwatts.

**Priced Right.** The low price for this complete equipment, plus the fact no additional equipment is necessary for the second speed, reduces the expense to the station. The units are sold outright and can be carried on your books as assets.