

BROADCAST NEWS



JAN 5 1937

Dec. 1936

In This Issue

- FOURTH ESTATE VIEWS TELEVISION
- GRAPHIC RECORDING OF FIELD INTENSITIES
- 'HOOSIERS LISTEN IN ON NEW WSBT

FRANKLIN INSTITUTE
PHILADELPHIA



RCA Manufacturing Company, Inc.

A Service of Radio Corporation of America

Camden, N. J.

"RADIO HEADQUARTERS"

DAVID SARNOFF, Chairman of the Board

E. T. CUNNINGHAM, President

G. K. THROCKMORTON, Executive Vice-President

L. B. MORRIS, Vice-President
and General Counsel

R. SHANNON, Vice-President in
Charge of Mfg., RCA Victor Div.

J. T. CLEMENT, Vice-President
in Charge of Washington,
D. C., Office

J. M. SMITH, Vice President in
Charge of Mfg., RCA Radiotron Div.

I. C. WARNER, Vice-President and
General Mgr., RCA Radiotron Div.

F. H. CORREGAN, Vice-President
and Secretary

LEWIS M. CLEMENT, Vice-President
in Charge of Research and
Engineering, RCA Victor Div.

F. R. DEAKINS, Manager Special Products

J. L. SCHWANK, Manager
ENGINEERING PRODUCTS DIVISION
AND INTERNATIONAL DIVISION

TRANSMITTER SALES SECTION

(OF ENGINEERING PRODUCTS DIVISION)

I. R. BAKER, Manager

S. W. GOULDEN, Commercial Engineer

F. S. HART, Sales Contact

J. P. TAYLOR, Sales Engineer

T. A. SMITH, C. B. S. Contact

A. R. HOPKINS, Sales Engineer

C. L. BEACH, Affiliated Co. Contact

J. C. CALVERT, Sales Engineer

T. W. ENIS, Ass't Affiliated Co. Contact

BEN ADLER, Power Tube Sales

P. A. ANDERSON, Police Radio Sales

E. C. HUGHES, Jr., Amateur Radio

A. H. CASTOR, Factory Contact

C. M. LEWIS, Sales Engineer

D. J. FINN, Engineering Products Advertising

1 **EASTERN DISTRICT**—T. A. Smith, Manager, 1270 Sixth Ave., New York City; R. P. May, Assistant

MAINE

VERMONT

NEW HAMPSHIRE

MASSACHUSETTS

RHODE ISLAND

CONNECTICUT

NEW YORK

NEW JERSEY

PENNSYLVANIA

MARYLAND

NORTH CAROLINA (Broadcast)

WEST VIRGINIA

DELAWARE

VIRGINIA

2 **CENTRAL DISTRICT**—H. C. Vance, Manager, 589 E. Illinois St., Chicago, Ill.; R. A. Wilson, Assistant; A. Josephsen, Assistant.

NORTH DAKOTA

SOUTH DAKOTA

NEBRASKA

WISCONSIN

MISSOURI

IOWA

MINNESOTA

ILLINOIS

INDIANA

KENTUCKY

OHIO

MICHIGAN

KANSAS CITY (KANSAS)

3 **WESTERN DISTRICT**—W. H. Beltz, Manager, 170 Ninth St., San Francisco, Calif.; Edmund Frost, Assistant

WASHINGTON

OREGON

CALIFORNIA

IDAHO

NEVADA

HAWAII (Police)

UTAH

ARIZONA

ALASKA (Police)

MONTANA

WYOMING

4 **SOUTHWESTERN DISTRICT**—W. M. Witty, Manager, 2211 Commerce St., Dallas, Texas

TEXAS

OKLAHOMA

ARKANSAS

LOUISIANA (Except New Orleans)

KANSAS (Except Kansas City)

COLORADO

NEW MEXICO

5 **SOUTHEASTERN DISTRICT**—D. A. Reesor, Manager, 490 Peachtree St., N. E., Atlanta, Ga.

TENNESSEE

NORTH CAROLINA (Police)

SOUTH CAROLINA

GEORGIA

ALABAMA

MISSISSIPPI

FLORIDA

NEW ORLEANS (LA.)

LONDON, ENGLAND—B. Gardner, European Manager, Radio Corporation of America, Electra House, Victoria Embankment.

POWER RADIOTRONS

BROADCAST TRANSMITTERS

POLICE TRANSMITTERS

POLICE RECEIVERS

AVIATION RADIO EQUIPMENT

SPECIAL COMMUNICATION EQUIPMENT

BROADCAST NEWS

REG. U. S. PAT. OFF.

E. T. JONES
Editor

PAUL V. LUTZ
Associate Editor

NUMBER 23

DECEMBER, 1936

CONTENTS

	Page
Fourth Estate Views Television	2
David Sarnoff	
WHBL Improves Facilities	4
RCA Presents Television to Broadcasters	5
Graphic Recording of Field Intensities	6
John P. Taylor	
Power Goes Up at WDBJ	10
A Treatise on Piezo-Electric Quartz Crystals	12
Rapid Growth for WHIO	16
Palmer A. Greer and Charles E. Gay	
Hoosiers Listen in on New WSBT	18
A Turnstile Antenna for Use at High Frequencies	20
Dr. G. H. Brown	
Probable Percentage Modulation at Various Audio Frequencies	26
WTRC Increases Coverage	29
WRGA Installs New Antenna	31
A Review of Broadcast Engineering	34
John P. Taylor	

Published in the Interest of the Radio Broadcasting Industry
and Copyrighted, 1936, by the

RCA MANUFACTURING COMPANY, INC.
CAMDEN, NEW JERSEY, U. S. A.

FOURTH ESTATE VIEWS TELEVISION

An Address to Newspapermen Who Attended Demonstration in New York

By DAVID SARNOFF, President,
Radio Corporation of America

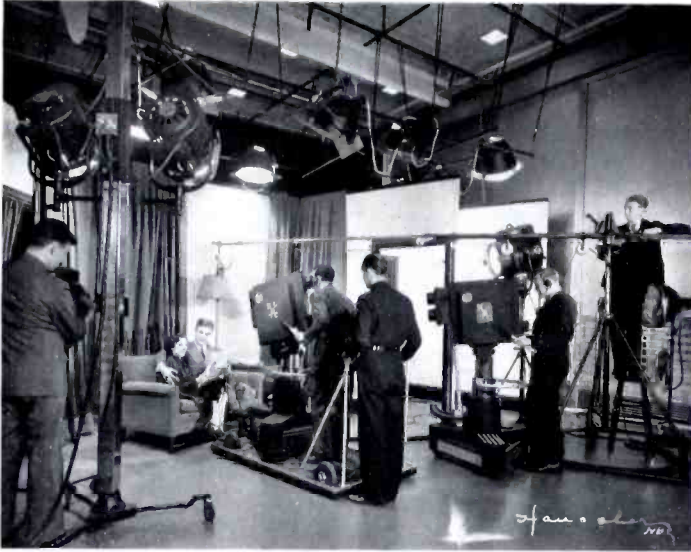

Lights, Iconoscope, Action. A new art goes on the air.

IN view of the public interest in the promise of sight as well as of sound through the air, we have invited you here to witness an experimental television test so that the progress in this new and promising art may be reflected to the public factually rather than through the haze of conjecture or speculation.

Field Tests

You will recall that our field tests in television began only on June 29 of this year. That date marked the beginning in this country of organized television experiments between a regular transmitting station and a number of homes. Since then we have advanced and are continuing to advance simultaneously along the three broad fronts of television development—research which must point the road to effective transmission and reception; technical progress which must translate into practical sets for the home the achievements of our laboratories; and field tests to determine the needs and possibilities of a public service that will ultimately enable us to see as well as to hear programs through

the air. On all these fronts our work has made definite progress and has brought us nearer the desired goal.

Progress

First and as of immediate interest, let me tell you the progress of our field tests. As you know, we

have been transmitting from our television station on top of the Empire State Building in New York City which is controlled from the NBC television studios in the RCA Building. We have observed and measured these transmissions through a number of experimental receivers located in the metropolitan area and adjacent suburbs. The results thus far have been encouraging, and instructive. As we anticipated, many needs that must be met by a commercial service have been made clear by these tests.

Distance Attained

We have successfully transmitted through the air, motion pictures as well as talent before the televisor. The distance over which these television programs have been received has exceeded our immediate expectations. In one favorable location due to the extreme height of our transmitter, we have consistently received transmissions as far as 45 miles from the Empire State Building.

The tests have been very instructive in that we have learned

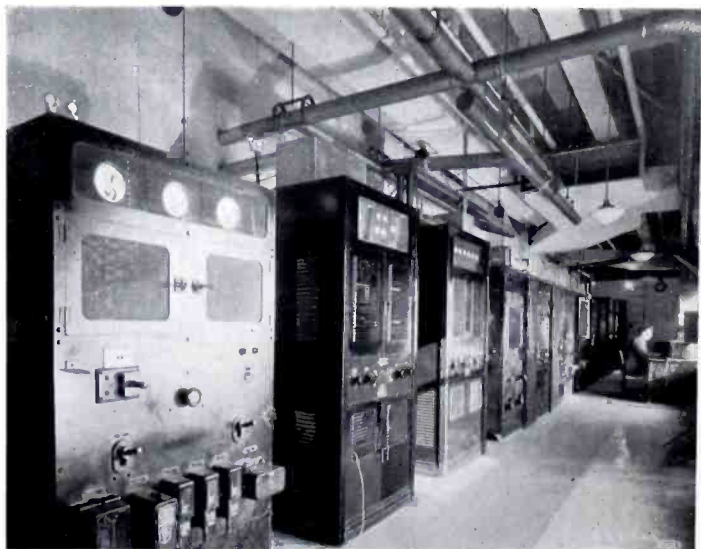

Audio and Video Transmitters in the Empire State Building.



Shooting a close-up—or, changing a visual image into electrical impulses.

a great deal more about the behavior of ultra short waves and how to handle them. We know more about interferences, most of which are man made and susceptible of elimination. We have surmounted the difficulties of making apparatus function outside of the laboratory. We have confirmed the soundness of the technical fundamentals of our system, and the experience gained through these tests enable us to chart the needs of a practical television service.

We shall now proceed to expand our field tests in a number of ways. First, we shall increase the number of observation points in the service area. Next we will raise the standards of transmission.

New Line Definition

In our present field tests we are using 343 line definition. Radio Corporation of America and the radio industry have, through the Radio Manufacturers Association, recommended to the Federal Communications Commission the adoption of 441 line definition as a standard for commercial operation. Our New York transmitter will be rearranged to conform to the recommended standards. That also means building synchronized receivers to conform to the new standards of the transmitter. Synchronization of transmitting and receiving equipment is a requirement of television that imposes responsibilities upon those who

would furnish a satisfactory product and render a useful service to the public. On the one hand, standards cannot be frozen prematurely or progress would be prevented, while on the other hand, frequently changing standards means rapid obsolescence of television equipment.

Vast Potentialities

Basic research is a continuing process in our laboratories not only that the problems of television may be solved but also to develop other uses of the ultra short and micro waves which pos-

sess such vast potentialities in this new domain of the ether.

While we have thus proceeded on the technical front of television, the construction and operation of television studios have enabled us to coordinate our technical advance with the program technique that a service to the home will ultimately require. Today, you are the guests of RCA's broadcasting unit—the National Broadcasting Company. Under the direction of its president, Mr. Lenox Lohr, the NBC has instituted a series of television program tests in which we have sought to ascertain initial requirements.

Ten years ago the National Broadcasting Company began a national service of sound broadcasting. Now it enters upon its second decade of service by contributing its facilities and experience to the new art of television.

Major Problem

One of the major problems in television is that of network syndication. Our present facilities for distribution of sound broadcasting cover the vast area of the United States and serve its 128,000,000 people. Similar coverage for television programs, in the present state of the television art, would require a multiplicity of transmitters and network interconnection by wire or radio facilities still to be developed.

(Continued on Page 24)



Make-up for the air. Panchromatic make-up in shades of pale orange, red and brown supplant the ordinary stage technique.

WHBL IMPROVES FACILITIES

Audience Growth Brings Necessity for Wider Coverage



The attractive home for the Wisconsin station's new equipment.

ONE of the outstanding stations of the lake region which recently modernized its plant is WHBL of Sheboygan. Situated in one of the richest market regions of the country and serving a highly critical audience, the station recognized the necessity for an installation which would guarantee perfect transmission.

The site selected for the new WHBL station and tower consists of a 28-acre tract located two and one-half miles south of Sheboygan, on Highway 141, just north of the Milwaukee Northern right-of-way. It was chosen after exhaustive tests by expert radio engineers who say that it is the most suitable for transmitting in this territory.

New Transmitter Building

The new transmitter building for WHBL is a one-story structure approximately 22 x 35 feet, housing the transmitter room, a garage, a dinette and a lavatory. One large room in the basement under a portion of the building will contain the heating plant and provide sufficient additional space for repair work and storage.

The exterior walls are to be of masonry finished with white stuc-

co set off with horizontal bands of red brick between the window openings to obtain the modern design. The entrance will be deeply recessed with offsets of the same color brick. Over the entrance the call letters of the station will be inscribed in neon lights.

A room 13 x 20 feet will contain the transmitting apparatus. Access from this room may be had to the garage on one side and to the dinette on the other. From the dinette a stairway leads to the basement, and the lavatory also opens off this room. In a recess in the dinette will be incorporated a complete kitchenette unit comprising an electric range, refrigerator and sink, over which cabinet storage is provided for dishes, utensils and supplies. When not in use, the unit is entirely concealed by folding steel doors. A closet also provides space for a rollaway bed, making it possible for the operator to remain over night at the building if necessary.

A system of forced warm air heating, operated by an oil burner, will be installed. This system will make possible the re-circulation of air to cool the rooms during warm weather.

Early Development

Sheboygan knew its first radio station through the efforts of The Sheboygan Press in April, 1926, when the portable station WIBJ was set up in the Van Der Vaart theatre and Eagle auditorium for one week's duration. At the close of the week it was taken to various spots in the east, but through that first visit of radio the city was given its original tempting taste of broadcasting, and its lasting effect was felt a year later, when on November 7, 1927, WHBM was dedicated by C. E. Broughton of The Sheboygan Press.

As time went on, interest increased, improvements in reception were effected, and finally on February 23, 1928, the call letters

(Continued on Page 24)

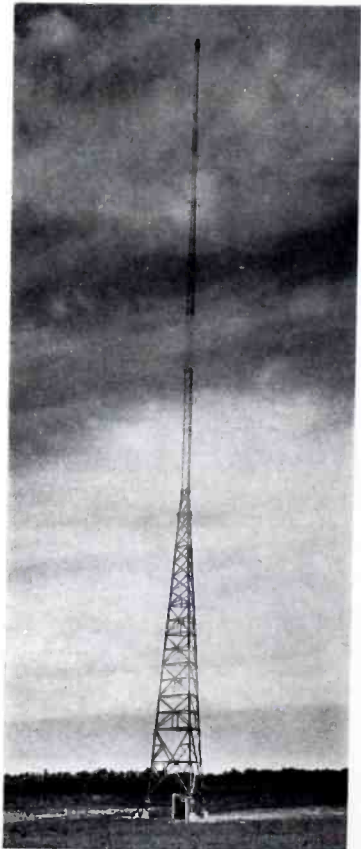

The antenna located just outside of Sheboygan.

RCA PRESENTS TELEVISION TO BROADCASTERS

Representatives from Every Section of the Country Attend



ABOVE: The line-up of receivers which reproduced the program.

RIGHT: High frequency tubes used in the equipment.

BROADCASTERS from all over the country gathered in New York on November 12th in response to an invitation from RCA Manufacturing Company to attend a demonstration of the RCA television system. Nearly 300 station executives assembled in the RCA Building where a number of television receivers had been set up to reproduce programs originating in a studio 59 stories below them. The pictures seen were actually transmitted by radio from the Empire State Building transmitter about one mile distant, so that the images viewed in the receivers had travelled from the NBC Studios to the Empire State Building via concentric cable and thence back to the RCA Building by radio.

The guests were welcomed by Mr. E. T. Cunningham, president of the RCA Manufacturing Company, who spoke from the studio and who appeared to the audience by means of television. Following this, a program of entertainment was broadcast, consisting of two acts in the studios and

several film transmissions. At the conclusion of the demonstration, brief talks on the details of the system were given by Messrs. J. C. Warner, and L. M. Clement, Vice Presidents of RCA Manufacturing Company, E. W. Engstrom in charge of research, Dr. V. Zworykin, and F. R. Deakins, in charge of the Engineering Products Division. Mr. I. R. Baker introduced the speakers and explained the arrangements.

Afterwards luncheon was served in the Cafe Francais, Rockefeller Center. A number of the visitors went on tours through the NBC Studios during the afternoon and at 5:30 a trip was made to the television studio to inspect the cameras and the lighting arrangements.

This demonstration was arranged to acquaint those in the industry with the results achieved after several months of field tests of the RCA television system. Experimental work is being continued and further operational tests are being carried out.

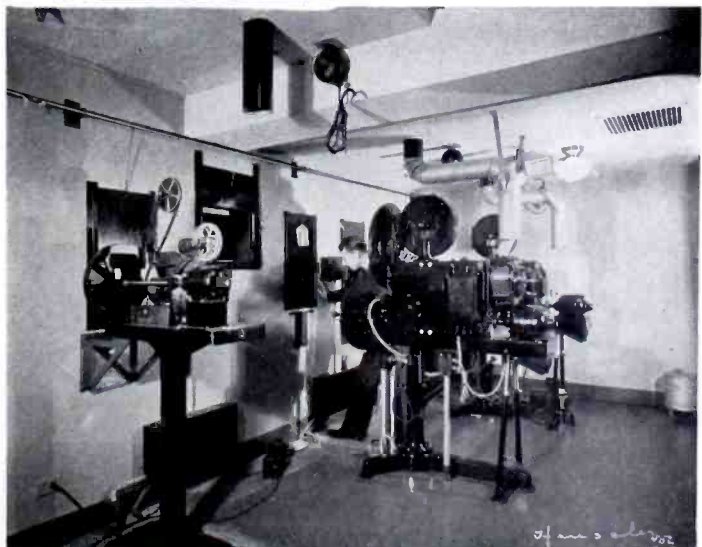
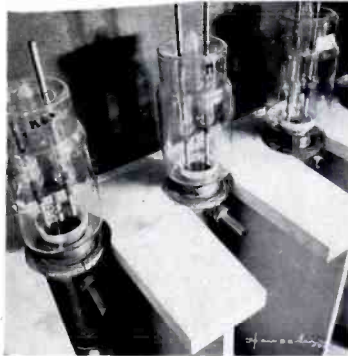

Demonstrating the transmission of film through television.

GRAPHIC RECORDING OF FIELD INTENSITIES

An Introductory Discussion of the Subject With Some Suggestions as to Choice and Arrangement of Equipment

By JOHN P. TAYLOR



FIG. 1. The new model of the TMV-75-B Field Intensity Meter. Improvements include provision for operating a 5 mil recorder direct.

RECENTLY a station engineer asked the writer to "measure the signal strength" of his station in a town some 65 miles distant from the transmitter. This engineer was fully cognizant of the fading accompanying reception of his station at the point in question—but he thought that "the average of four or five measurements" would serve as a measure of the service provided. As a matter of fact the quality of services rendered in such cases is more dependent on other factors—such as the extent of the fading swing and the ratio of the minimum points to the existing noise level—than it is on the average value of the signal. For this reason, this type of service can be evaluated only by measuring the signal strength continuously over a fairly extended period. The only method of doing this is to make a graphic record of the received signal.

As the desirability of making service surveys in more detailed form becomes better appreciated, it is certain that graphic recording of field strengths will become a far more common practice. It is

probably not too optimistic to prophesy that many stations will keep at least one recording equipment in operation almost continuously. Such equipment could be made practically automatic in operation, and thus could be left

to operate by itself for several days at a time. By moving it, at intervals, from point to point in the service area, a very detailed analysis of the service rendered would be made available. This procedure would also furnish a check on the well-known, but usually overlooked, fact that station service often changes without any indication of such change at the transmitter.

An Important Subject

The imminence of developments along this line make the subject of graphic recording of interest not only to consulting engineers—who are constantly working along these lines—but to every station engineer. It is a subject the complexion of which is both over, and under, estimated. Over-estimated because many engineers—with cumbersome and unstable home-made equipments in mind—are not familiar with the convenience and foolproofness of equipment of standard manufacture. Under-estimated be-

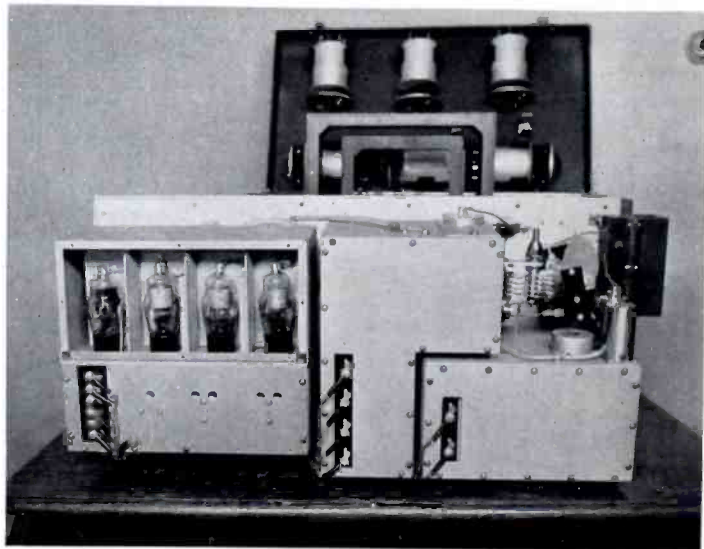

FIG. 2. Rear view of the interior of the TMV-75-B Meter. Precision design, particularly complete shielding and construction to withstand the hardest use are outstanding features.

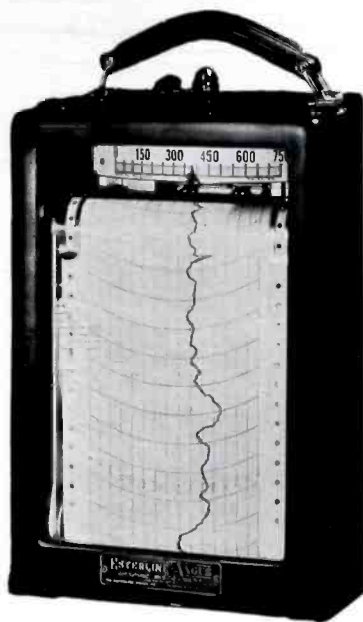

FIG. 3. A graphic recording instrument particularly suited for recording of field intensities. Current of 5 mills is required for full scale deflection.

cause engineers who have seen such equipment operate have a tendency to overlook the fact that coverage surveys must be made systematically. Reduced to essentials, the facts are, that with the equipment now available any station engineer can make his own graphic recordings—but that, in doing so, he must exercise the same care and intelligence that are given to this work by consulting engineers of long experience.

Procedure

Generally speaking, the first step, when undertaking the use of field intensity recording equipment, is to study the equipment carefully, with a view to understanding the way in which it operates, the possibilities which it offers and the limitations which must be observed. The second step is to experiment with the equipment enough to become confident in its use. Several trial runs under various conditions will be more than repaid in time saved later. All of this is an old story to the engineer who has had experience with this equipment. However, for those who are just considering the undertaking of such work, a brief sketch of the equipment and procedure may be of some help.

The Field Intensity Meter

Fortunately, the chief item of the necessary equipment, that is, the field intensity meter, no longer presents any problem. The TMV-75-B Meter—the new model of which is shown in Fig. 1—has proved its reliability and convenience. A large number of the original models have now been in use for nearly two years, and have become the accepted standard—as is evidenced by the large number of consultants, networks and stations that have, and that are, using it. In fact, so well has the design of this instrument proved out that the changes made for the new model are—with the exception of the added provision for driving a recorder—of minor nature.

The TMV-75-B has been described in detail before¹—and the details of its design can be referred to there. However, it is probably of point to add here, that neither the mathematics entering into the design of this equipment, nor the at-first-imposing array of knobs and dials should cause any engineer to have doubts. On the contrary, once the arrangement is understood, the actual making of measurements with this equipment is a simpler procedure than many of the operations carried out regularly by most station engineers.

Essentially, the equipment consists of a receiver, an indicating meter and a calibrating oscillator. Referring to Fig. 1, the two large dials at the upper left are the receiver tuning controls. Using these—and with the phones plugged into the jack—the signal to be measured is tuned in. This done, the meter placed in the circuit of the diode-detector gives a reading proportional to the signal strength. The attenuator, located conveniently just to the left of the meter, allows measurements to be made over a wide range (20 microvolts to 6 volts per meter). These elements form the measuring circuit proper. However, as the sensitivity of such a circuit varies with frequency and, over an extended period, with battery voltage, it is necessary to provide a means of checking the calibration. A built-

in oscillator of special design accomplishes this conveniently. This oscillator is tuned by the large dial at the lower left. Its output is controlled by the small knob just to the left of this dial, and read on the thermocouple meter just above. With this output adjusted to a set value, the output meter of the receiver is adjusted to read a predetermined value (by adjusting the control marked "gain"). This operation—accomplished in a matter of seconds—automatically adjusts the receiver-measuring circuits to the sensitivity corresponding to the scale marked on the output meter. Thus set, the reading of the output meter, times the attenuator-setting, times the constant, gives the field strength directly in microvolts per meter.

The Recorder

In addition to the field intensity meter, which does the actual measuring of the received signal, it is, of course, necessary to have a means of graphically recording these readings. Several types of recording instruments suitable for this use are available. The graphic recording milliammeter illustrated in Fig. 3, is probably the most widely-employed, and its operation is typical of such equipments. Essentially it is a 0.5 milliampere movement which carries an inking pen at the end of the

(Continued on Page 8)

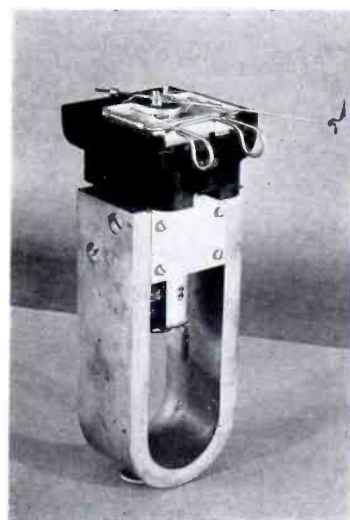

FIG. 4. The movement of the instrument shown in Fig. 3. Oversized construction and a simple, but unusually trouble-free, pen design insure a smooth working action.

¹Broadcast News, February, 1934.

pointer, thus producing a continuous record on a ruled paper which is carried tautly beneath the pointer by a clock-motor. In practice this is more easily said than done—but the smoothness and reliability with which the newer-type recorders operate, make their use a real pleasure. Two things are outstanding in accomplishing this. First of these is the special design of the movement. Referring to Fig. 4—which is the movement of the instrument shown in Fig. 3—the relatively large size of the magnets and field coils employed will be noted. Also the simple, but particularly effective, design of the pen, which consists of a hollow tube bent so that it siphons ink from the well through an arc-shaped slit.

The pen itself is a glass tube drawn to a fine point. The light, smooth contact of this pen, plus the high torque provided by the large magnets and coils, results in an action which is rapid and accurate, and which when prop-

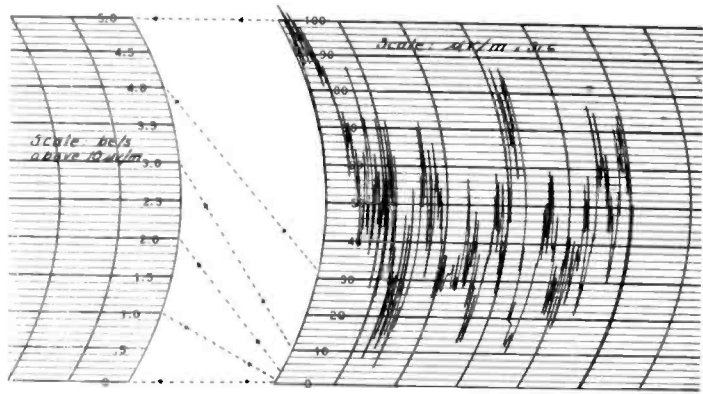

FIG. 7. A section of a typical recording of skywave reception. At the left is shown a logarithmic scale for comparison with the linear scale to which this record was made.

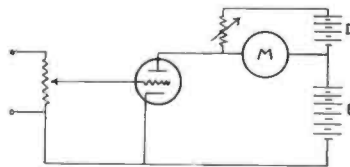

FIG. 6. The essential circuit of a triode used as a direct-current amplifier.

erly serviced never blots or dries. The second important feature is the paper driving mechanism. An oversized clock motor, cogged driving rolls and an efficient take-up mechanism, insure foolproof operation of this part of the instrument. Standard paper with ruled spacings is available in a large assortment of scale notations, as well as in various time markings which match the several speeds obtainable by interchanging the several sets of gears provided.

The Amplifier

The diode detector of the TMV-75-B forms an almost ideal arrangement in so far as driving the indicating meter is concerned. However, the rectified current which it provides (300 microamperes at full scale) is, of course, not sufficient to drive the recorder. In providing for operation of the latter it is, therefore, necessary to employ what amounts to a direct-current amplifier. This may be built-into the field intensity meter or it may be a separate unit.

The new models of the TMV-75-B have been arranged so that connections may be made such that the output tube will function as an amplifier, and thus make it possible to drive a 5-mil recorder direct. The older models do not have this provision, but a simplified method of converting them has been worked out by the engineers who designed these equipments. The necessary changes are indicated in the diagram shown in Fig. 5. The changes are simpler than would at first appear, and can be made without diffi-

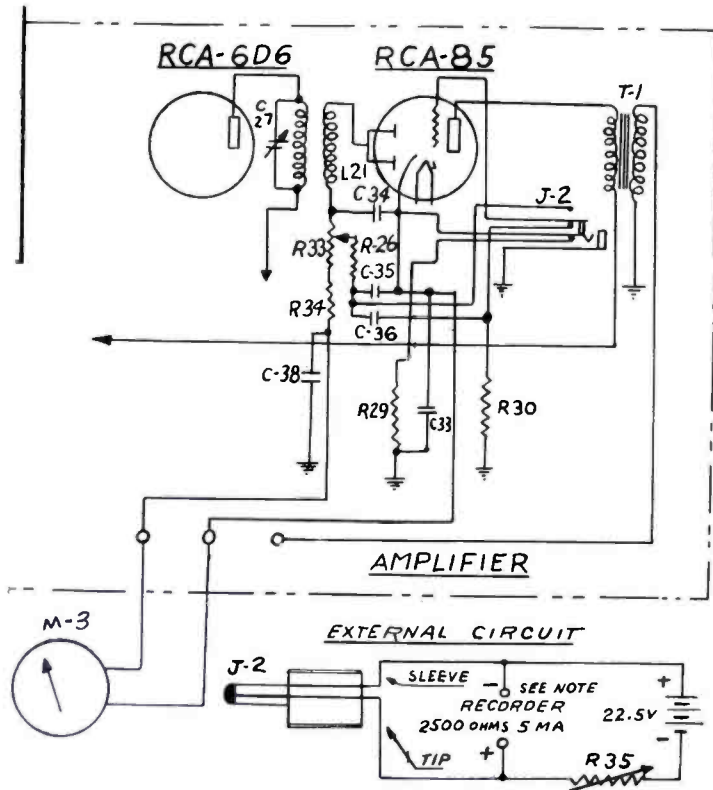

FIG. 5. The circuit of the old model TMV-75-B modified for driving a recorder without the use of an external amplifier. R-33 is a 30,000-ohm potentiometer with slotted shaft for screwdriver adjustment. R-34 a 27,000-ohm, 1/2 watt, resistor. R-35 a 10,000-ohm wired wound rheostat, and J-2 a Yaxley Number 705 jack. All other items are as before.

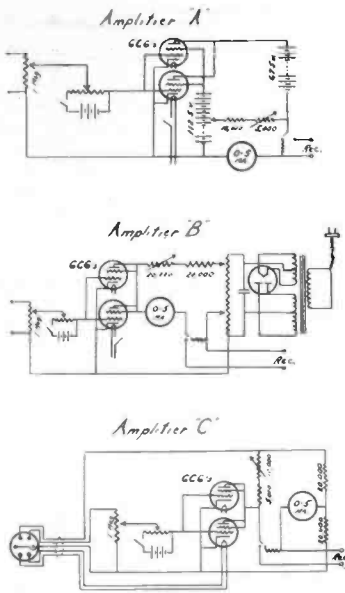

FIG. 8. Circuits of three amplifiers suitable for use as indicated in the set-ups of Fig. 9 and Fig. 10.

culty. The jack, as well as the other added parts, should be mounted within the inside amplifier case. It should also be noted that this circuit is designed for a 2500-ohm recorder. If a recorder of lower resistance is used, the necessary resistance must be added in series.

By thus converting the older models of the TMV-75-B, the original easy portability of these equipments is retained. This means that field recordings can be made almost as conveniently as simple measurements. And, so far as relatively short recording periods are concerned, this arrangement is ideal. However, it has one drawback where recordings are to be made over an extended period. This is the fact that the calibration has a tendency to drift with battery voltage. The reason for this will be evident from a study of Fig. 6, which is the essential circuit of a triode used as a direct-current amplifier. It will be seen that the current in the recorder is a function of the battery voltages D and B—particularly of the latter. Since the triode is used at a point where the curvature of the plate characteristic is relatively steep, the recorder current will fall off rapidly as the voltage of B decreases with

use. For the circuit of Fig. 5, the change will be approximately 0.1 mils per volt. This means that changes of a few volts in the battery supply (which would have only small effect on the calibration of the meter itself) will cause a relatively large error in the amplifier calibration. This error is particularly serious near the lower part of the scale—since in this range it may amount to a large percentage error. This is a distinct disadvantage, since for sky wave observations (which, of course, are those usually involved where recordings are concerned) the minimum points, and the decibel range of the fading swing, are the important factors—and a large error at the bottom of the scale will cause serious error in both.

Compensation

Since this drift in the amplifier is much greater than that in the field intensity meter itself, it will be desirable, where any large amount of work is involved, to make provision for compensating for it. One way would be to increase the balancing voltage so that the drop in it would compensate for the drop in plate voltage. However, as this would require making battery D larger than battery B, it is not very practical. A more effective course would be to use small size batteries for D, so that the voltage would fall off more rapidly than that of B. An extended test would, however, be necessary to establish the correct ratio. For the older model of the TMV's, probably the best arrangement is to use an external amplifier.

Amplifier Circuits

Three practical amplifier circuits, which have been tested by the writer and found to provide satisfactory compensation, are shown in Fig. 8. Amplifier "A" is for battery operation. Compensation for drift is obtained by taking the balancing voltage off of a separate battery which supplies the screen grid voltage. A falling-off in balancing voltage will also cause a decrease in screen grid voltage—and by adjusting the tap the consequent changes in recorder current can be made to just

balance. Since pentodes are employed, variations in plate voltage have negligible effect on plate current. Thus, only voltage changes in that part of the battery above the tap can cause drift—and, since the drain from this part of the battery is very low, this drift will be very small, and will be partially balanced by the change in C battery voltage. Amplifier "B" is for a.c. operation.

Compensation is provided by adjusting the balancing voltage to a value which will compensate for changes in plate current caused by varying supply voltage. The plate current can be made completely independent of a.c. supply voltage at any one point on the scale, and, if this point is located near the lower end of the scale, the percentage error at any scale point will be small. It should be noted that the balancing voltage required for this is high, and the rectifier should, therefore, supply about 450 volts across the bleeder. Amplifier "C" is the simplest of all, since it requires no external power supply. It is designed to work with a Type ACR-175 Receiver (see below), and all of the terminals are brought out to a six-prong plug. This is simply plugged into the socket of the receiver

(Continued on Page 28)

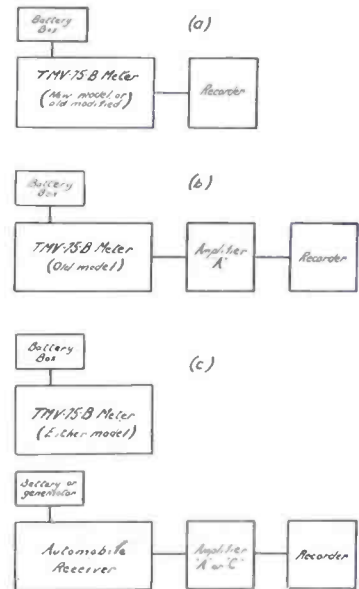

FIG. 9. Alternative arrangements suggested for making recordings in the field. The several advantages are discussed in the text.

POWER GOES UP AT WDBJ

Roanoke Station Joins 5 KW Group

THE boost in WDBJ's daytime broadcasting power and the operation of the new transmission equipment will mark, one step in the steady progress the station has made since it was started 12 years ago.

Licensed May 5, 1924, it was the second broadcasting station in Virginia. It was originally assigned to transmit on a frequency of 1310 kilocycles with 20 watts power. Later this assignment was changed to 930 kilocycles, the frequency on which it operates at present.

Frequent Power Increases

Several months afterward, its power was raised to 50 watts, then to 250 watts. On October 27, 1933, the Federal Radio Commission granted the station authority to increase its power to 500 watts before sunset. In April 1934 it was granted the authority to increase this power to 500 watts day and night; and on June 15,

1934, a construction permit was granted, allowing the station to build equipment necessary to broadcast on 1,000 watts day and night. This was begun September 2 of that year.

Today the power is increased to 5,000 watts for daytime broadcasting.

Joins Columbia

On October 8, 1929, WDBJ became a part of the Columbia Broadcasting System, an affiliation which has enabled the station to broadcast some of the world's outstanding programs.

WDBJ is on the air 17 hours daily and 16 on Sunday. The operating hours on week-days are from 7 A. M. to midnight. Its offices are in the Times-World building and its studios on the fourth floor of the American Theatre building.

There are several remote control broadcasting points: the American Theatre organ, Hotel Patrick

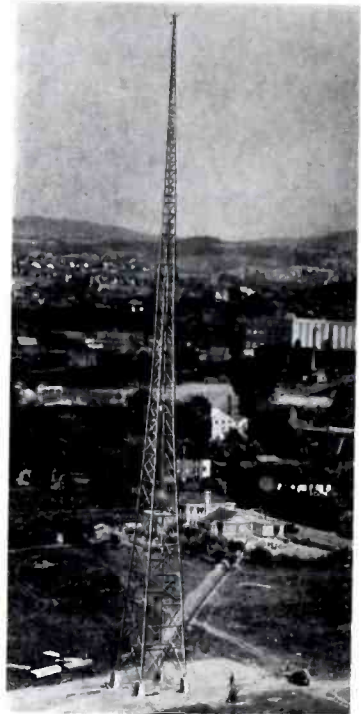

Looking over the city from the antenna site.

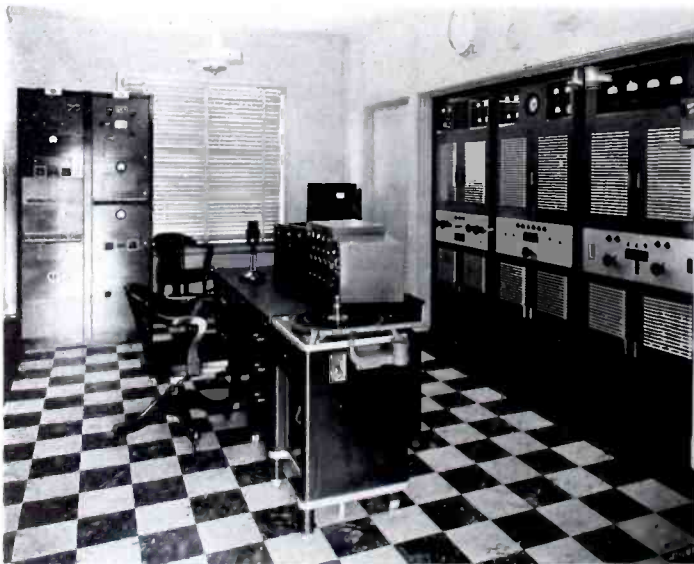

Showing the compact arrangement of transmitter, speech input and transcription equipment.

Henry, Hotel Roanoke, Elks Club, First Presbyterian church, First Baptist church (colored), and the Roanoke auditorium.

The station was purchased from the Richardson-Wayland Electrical Corporation in May, 1931, by the Times-World Corporation, by whom it is now owned and operated.

WDBJ's new transmission equipment, including a 5,000-watt transmitter housed in a thoroughly modern building, and a 312-foot antenna tower standing nearby, give the station one of the most complete and up-to-date broadcasting set-ups in the South.

The new transmitter, the latest type RCA "high fidelity," makes it possible to broadcast a wider range of musical frequencies. Without blurring or fading, it will



R. D. AVERY
Chief Engineer

carry the highest note of a flute and the lowest note reached by a bass horn.

Jumps Signal Strength

The new antenna will increase the signal strength of the station within the 50-mile radius without increasing interference.

From the base of the tower radiate 120 strands of bare copper wire, forming the ground system. The longest of these radials is 650 feet and the shortest 350 feet. Underneath the tower, the radials are pointed to a copper ring, while at the far ends the radials are soldered to another wire which forms the outer circle. The entire network is buried several feet underground.

The 20,000-pound tower has a base 23 feet, nine inches square while at the top the sides are only nine feet. Its sections are painted alternately orange and white, a combination of colors most easily discernible to airplane pilots, who at night will be warned by red lights installed at varying heights on the tower. The lights are turned on and off at dusk and dawn by an automatic clock which compensates for the change in the length of the day throughout the year.

Situated on the top of the hill a few hundred yards from the junction of Brandon road and the road leading to the city farm, the transmitter building in Colonial Heights is of somewhat "different" design, and thoroughly modern.

Studio for Emergencies

Besides the actual transmission equipment situated in the operator's control room, the building also contains a workroom for every type of repair, designing, and construction work connected

with the operation of the plant.

A completely equipped studio is provided for emergencies. All equipment is installed in a specially constructed housing and is shielded, even to the windows, to such an extent that not even the local station itself can be picked up inside the house.

Connecting the transmitter and the tower is the concentric transmission line, consisting of a seven-eighths inch copper tube containing a one-quarter inch copper tube, the whole being filled with nitrogen gas. It is buried about two-feet deep below the frost level.

A small apartment, consisting of a bedroom, kitchen and shower is located on the first floor of the building.

On the second floor is a modern six-room apartment in which Chief Engineer Bob Avery makes his home. It consists of a living room, two bed rooms and connecting bath; a den, a dining alcove and a kitchen.

To the rear of the building is a two-car garage the top of which is used as a porch for the second-floor apartment.

The whole building of brick and steel is air conditioned throughout.



J. W. ROBERTSON
Staff Engineer

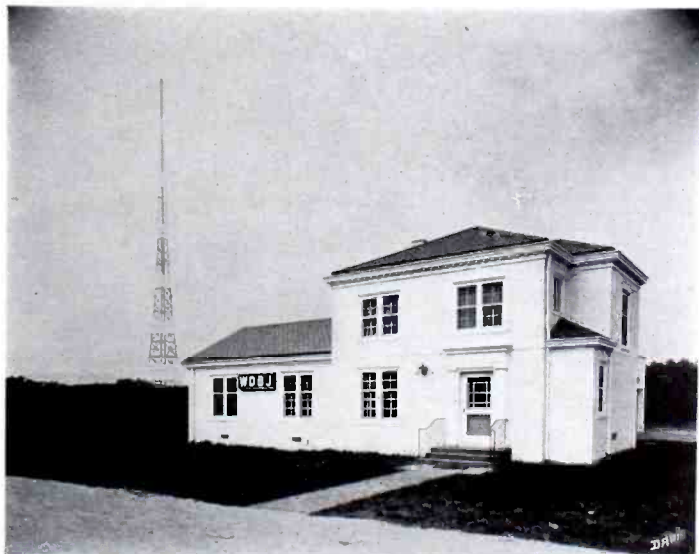

The up-to-date plant of WDBJ in the Blue Ridge section of Virginia.

A TREATISE ON PIEZO-ELECTRIC QUARTZ CRYSTALS

A Study of Their Application in Broadcasting

Continued From the October Issue

By W. F. DIEHL

NATURAL crystals may be either right hand (Fig. 1) or left hand (Fig. 2) and are often a combination of both, in which case they are said to be "twinned." In most crystals, however, the C and/or D faces are missing, the average formation resembling Fig. 3 and illustrated by Fig. 5.

Referring to Figs. 1, 2, 3, and 5 the major apex face, or cap face, of which there are three, is designated A. The three A faces join each other at the Apex. The minor apex face B, of which there are three, terminates in an A face. The faces C and D are rare but when a crystal is found which has either or both of these faces it may be classed as right or left hand by observation as follows:

When the C and/or D face is to the lower right of an A face the crystal is right hand quartz. When either or both of these faces are to the lower left of an A face, the crystal is left hand quartz.

The major face of the hexagon which joins an A face is designated E, while the minor face of the hexagon which joins a B face is designated F. These designations apply only when the apex is up, as the lower end of an E face is an F, and vice versa. We

have found that the faces of the hexagon taper so that, if the caps are knocked off, we can determine the position of the A face if not present, by observing the direction of taper. The sides of the hexagon always taper towards a major apex or A face.

The optic or Z axis joins each apex, bisects the cap face angles and is exactly $38^{\circ} 14'$ to the A face (Fig. 4).

The electric or X axes, of which there are three, are parallel to the sides of the hexagon, and do not join diagonal corners except

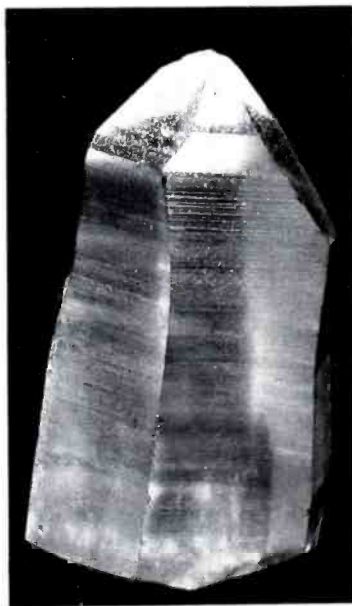
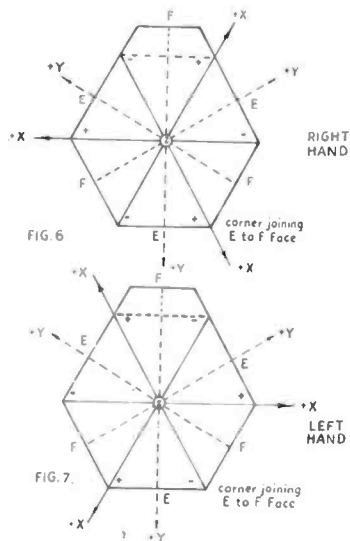
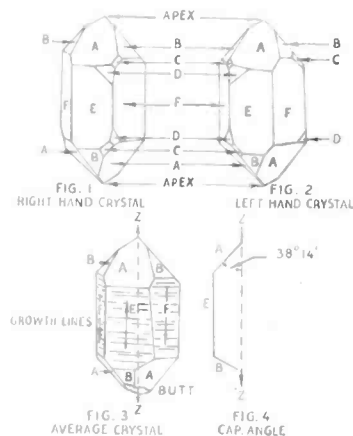

FIG. 5



Figs. 8 and 9, and for internal defects.

Crystals which are not symmetrical, or are too small to be economical, or have any internal defects, are rejected. Only the best optically clear crystals are shipped to our Crystal Laboratory at Camden.

It has been found that quartz which has been located in river bottoms and known as "river quartz," is generally free from twinning as the surface has been knocked off. By resorting to optical and electrical methods, the axes can be determined in these crystals.

Re-Inspection at Camden Laboratory

when the crystal is symmetrical. The mechanical or Y axes, of which there are three, are perpendicular to the sides of the hexagon (see Figs. 6 and 7).

Preliminary Inspection at the Office of the Importers

The natural crystals, Figs. 1, 2, 3, and 5, are examined visually for size and symmetry as per

The natural crystals are re-inspected under more favorable conditions and with more complete equipment in our Crystal Laboratory. Crystals are examined very carefully in a dark room, with elaborate optical equipment, and here the crystals are coated with cedar oil, which brings out the defects more clear-

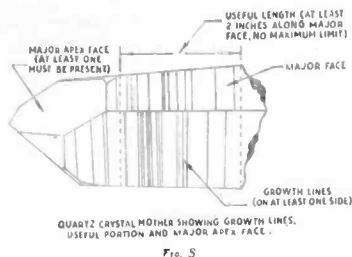

FIG. 5

ly. In certain cases a microscope, which discloses defects, is resorted to.

The crystal is next viewed through a polarizer¹³ for twinning.

Transparent Quartz,¹⁴ besides its use for piezo-electric crystals, has other applications. One of the importers has classified it as follows:

Flawless Fusing Grade—Entirely clear with no clouds, feathers, or bubbles, chips or fragments. Entire surface broken and glassy; weight 5 grams to 150 grams. (1 oz. equals 28.35 grams.)

Flawed Fusing Grade—Mixed sizes—60 grams up to several thousand grams. Pulverizing or granulating of this grade for other trades is done to order in the importer's mills.

For Jewelry—Water-White. Irregular pieces or crystals without flaws, phantoms, cracks, feathers, cloudiness, bubbles or other imperfections visible to the naked eye, except rarely near surface or ends. Sizes are grouped by weights into the following classes: 30 to 60 grams, 60 to 125 grams, 125 to 250 grams, 250 to 500 grams, 500 to 1000 grams, 1000 to 2000 grams, 2000 to 4000 grams, 4000 to 8000 grams.

For Optical Cutting—Water-white. Crystals showing at least one crystal face, indicating optic axis. Without faintest optical imperfections discernible with approved optical apparatus in the importer's laboratories. These imperfections include smokiness, phantoms, flaws, cracks, cloudiness, feathers, cloudy needles, bubbles or flakes, except rarely near surface or ends. A round

disc, ¼ inch (0.6 cm.) thick may be cut of the stated diameter and normal to the optic axis. Size A—Minimum 1 to 1½ in. (2½ to 4 cm.); Size B—Minimum 1½ to 2 in. (4 to 5 cm.); Size C—Minimum 2 to 3 in. (5 to 7½ cm.); Size D—Minimum 3 to 4 in. (7½ to 10 cm.).

For Piezo-Electrical Use—Crystals showing at least two crystal faces, indicating the optic axis. Without flaws, cracks, feathers, cloudiness, bubbles or other imperfections visible to the naked eye, except rarely near surface ends. Diameters given below per-

mit cutting, parallel to the optic axis, a square column of this minimum diameter and over four inches (ten cm.) long. Size A—Minimum 1 to 1½ in. (2½ to 4 cm.); Size B—Minimum 1½ to 2 in. (4 to 5 cm.); Size C—Minimum 2 to 3 in. (5 to 7½ cm.); Size D—Minimum 3 to 4 in. (7½ to 10 cm.); Size E—Minimum 4 to 5 in. (10 to 12½ cm.).

It is interesting to note that in the above classification of 1930, the specification for Optical Quartz was more rigid than for Piezo-Electric Quartz, and that in examining the former, optical equipment was used. At the present time the most desirable piezo material would be that which is selected from the best optical material and then given a double inspection as outlined previously. It is because of the other uses of Quartz that it is impossible to obtain large quantities of excellent material at one time. For example, we might select on first examina-

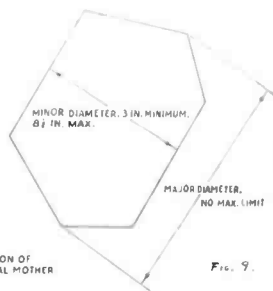

CROSS SECTION OF QUARTZ CRYSTAL MOTHER

FIG. 9.

(Continued on Page 14)

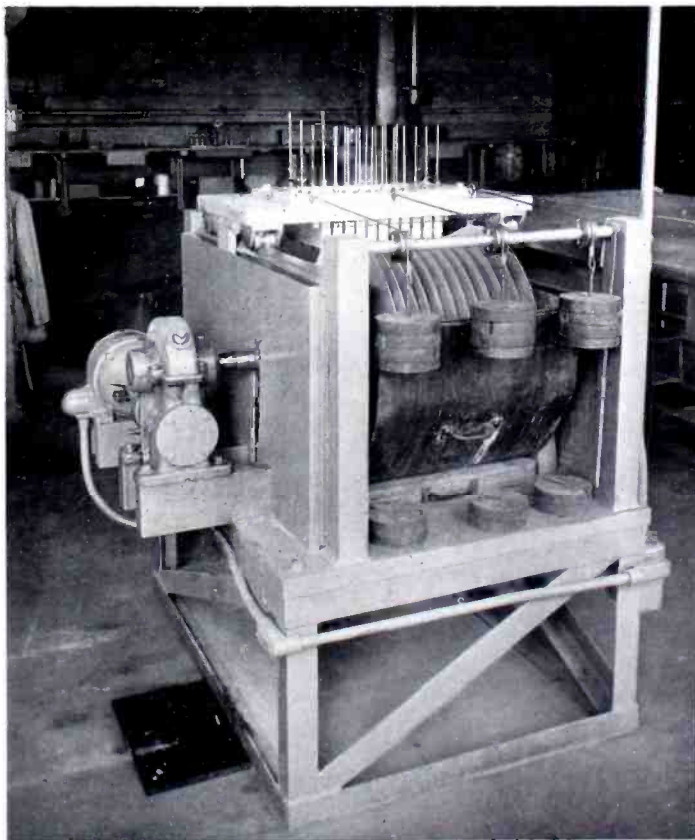

FIG. 10

¹³ "Examining Quartz for Oscillator Use" by L. H. Dawson, QST Sept. 1926, page 23.

"Looking at Quartz" by A. W. Eshelby, QST Nov. 1926, page 52.

P. Vigoureux, "Quartz Resonators and Oscillators," p.p. 7 to 12, p.p. 23 to 25.

¹⁴ Foote-Prints, Vol. No. 1, 1930, page 59.



FIG. 11

tion 500 lbs. and obtain only 200. On re-examination in our laboratories this would dwindle down to a possible 125 pounds. This 125 pounds in turn will net only from 15 lbs. to 45 lbs. of finished Piezo-Electric elements after cutting and rejecting twinned material which can only be determined accurately after a section is cut.

Cutting the Section¹⁵

Regardless of the shape, size or type of finished element, it is the general practice to first cut a section from the mother crystal. The thickness of this section will be the length in mils (approximately 1150) along the optic or "Z" axis.

The natural crystal is mounted in a fixture which is then mounted on a horizontal bed plate of a gang saw, see Fig. 10. The natural crystal is held to the fixture by means of clamps and a compound which permits the optic axis to be aligned parallel with the driving shaft of the saw. This alignment may be accomplished by arranging the natural crystal so that the growth lines, which are approximately perpendicular to the "Z" axis, Fig. 3, are parallel to the saw blades.

The crystal may also be lined up by using the major apex or A face, which is exactly 38 degrees and 14 minutes to the optic axis, Fig. 4, and, therefore, is parallel to a plane flat surface which is 38 degrees and 14 minutes to the flat surface of the mounting fixture of

the gang saw. Several natural crystals may be mounted in the saw at the same time as the saw will accommodate a crystal which is approximately 13 inches long or one or more crystals, the sum total length of which does not exceed 13 inches. The full capacity of the saw is eleven sections which may be cut at one time.

A section as it comes from the saw is shown in Fig. 11. The sides of such a section are approximately parallel to the optic or "Z" axis, the flat surface being approximately normal to the optic or "Z" axis and in the XY plane.

The section is next sent to our optical laboratory where it is analyzed for twinning, Fig. 12 (two figures), and other defects and where one surface is corrected so

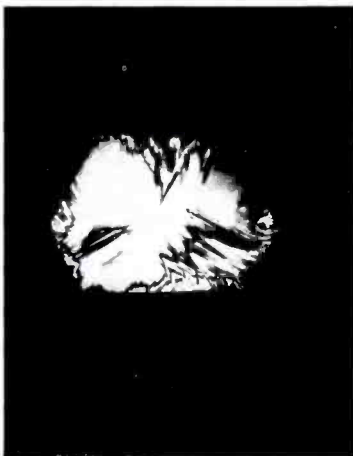

FIG. 12

as to be normal to the optic axis. Optical polariscope polarizers, microscopes and chemical treatment equipment are used for this purpose. After these analyses the defective areas of the section are marked out so as to be avoided in subsequent cutting.

The section is next cut into bars which in turn are cut into blanks and inspection and further analyses, similar to those of the sections is resorted to after each operation. Special double angle saws are used in order to obtain the correct orientation of the bar and blank with respect to crystallographic axes.

The blanks or elements are then mounted in special fixtures and delivered to the X-ray room where they are oriented accurately on

an X-Ray Spectrometer. From here they go to the lapping room where several lapping operations are performed until the blank is the correct dimensions. It is then checked on optical flats and delivered to test.

The elements are first tested on a cathode ray analyzer for frequency response and frequency spectrum. Blanks which show only single response are accepted and are then mounted in holder and placed in an automatic recorder. This recorder automatically makes curves of output, frequency and temperature over any desired frequency range and any temperature range between -50 degrees C and +70 degrees C.

The finished crystal mounted in holder is then subjected to stability test in particular circuit for which it is made and the thermostat cycle is recorded on an automatic recorder.

Terminology

For convenient future reference the principal crystal terminology is defined below:

Mother: The natural crystal as received from the mine or the importer, Figs. 1, 2, 3 and 5.

Apex: The pointed end of the Mother crystal, Figs. 1 and 2.

Apex Face Major: (Cap face) There are three such faces (The A faces) which terminate at the Apex (Figs. 1 and 2).

Apex Face Minor: There are three such faces (the B faces) which terminate in two major Apex faces (Figs. 1 and 2).



FIG. 12

¹⁵ R. C. Hitchcock, Use of Oscillating Piezo-Electric Quartz Plates, Foote-Prints, Vol. No. 1, pages 3 to 18.

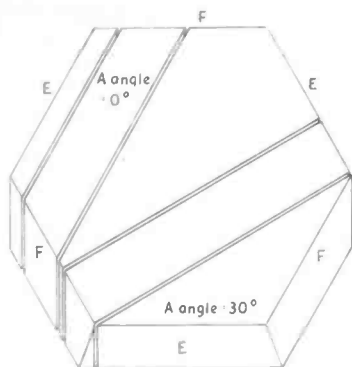

FIG. 13

Major Face: The side of the Mother which terminates in a Major Apex Face when the Apex is up. There are three such faces (designated E, Figs. 1, 2 and 3).

Minor Face: The side of the Mother which terminates in a Minor Apex Face when the Apex is up. There are three such faces (designated F, Figs. 1, 2 and 3).

Butt: The end of the crystal opposite the Apex—generally broken off in the mining operation.

Growth Lines: These appear on the sides of the Hexagon and are approximately normal to the optic axis, (Fig. 3).

Section: The hexagon which is first cut from the Mother. Fig. 11.

Major Surface (of a section): The large surface lying in the XY plane normal to the Z axis.

Reference Face (of a section): The E face, (Figs. 1 and 2).

Corrected Surface (of a section): The surface that has been corrected to be normal to the Z axis.

Bar: The crystal which is first cut from a section, the length axis being an orientation about Z, Fig. 13.

Optic Axis: Symbol Z. Runs lengthwise through the Mother, joins the two apices, and makes an angle of 38 degrees 14 minutes with each major apex face. Fig. 4.

Electric Axes: Symbol X. There are three such axes each being parallel to the sides of the hexagon, (Figs. 6 and 7).

Mechanical Axes: Symbol Y. There are three such axes, which are normal to the sides of the hexagon, (Figs. 6 and 7).

Plate or Blank (The finished element): This may be either circular, square, or rectangular in shape.

Major Surface (of element): The large surface normal to the applied electric field.

A Angle: The angle between an X and an X' axis (Figs. 10 and 15).

B Angle: The angle between a Z and a Z' axis, (Figs. 16 and 17).

Symbols: x, y and z represent crystal dimensions in mils in the direction of X, Y, and Z.

x', y' and z' represent crystal dimensions in mils in the direction of X', Y' and Z'.

K is a frequency constant (cycles per second multiplied by mils).

F represents the frequency in cycles per second.

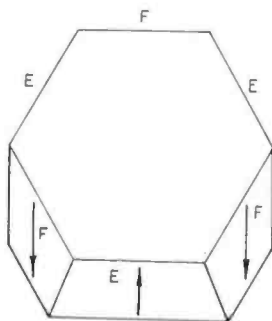

FIG. 14

T represents temperature in degrees centigrade.

E represents the applied electric field.

TC represents the temperature coefficient of frequency, cycles per megacycle per degree centigrade difference in temperature.

Crystal Cuts¹⁶

Piezo-electric elements are cut and ground into various shapes, such as long rods or bars, shallow cylinders, flat discs, and thin plates. The characteristics of the finished elements will depend on:

- (a) Quality of mother crystal
- (b) Shape of element
- (c) Dimensions of element
- (d) Orientation of element with respect to crystallographic axes of natural crystal.
- (e) Precision of cutting and finishing
- (f) Type of holder or mounting
- (g) Oscillator circuit constants
- (h) Operating temperature range.

¹⁶ Ponder Mellwain Handbook, Electric Communications and Electronics, Volume 2:63 to 2:71.

Two types of vibration are generally used for practically all crystal applications. These are the thickness vibration and the contour vibration. When the thickness of the crystal is small compared to the area, the frequency of the thickness vibration is solely a function of the thickness dimension and is not appreciably influenced by the contour (length and width) dimensions. On the other hand the frequency of a contour crystal is a function of the contour dimensions and the ratio length/width and is not affected appreciably by the thickness dimension.

For frequencies between 10 kc. and 50 kc. the longitudinal vibration in long bars is utilized. Between 50 kc. and 500 kc., contour vibrations in square plates are utilized by RCA Manufacturing Company, Inc., although some manufacturers utilize thickness vibrations. Between 500 kc. and 20,000 kc. thickness vibrations in square plates are utilized.

X-Cut

This cut, also called Curie, zero-angle, perpendicular, and normal, is an orientation about the optic or "X" axis. In this cut the "A" angle is zero, the "B" angle is zero and the major surfaces are normal to an "X" axis parallel to a "Y" axis and parallel to the "Z" axis. When x, y and z are properly related a piezo oscillator, controlled by this type crystal, will oscillate at only one fundamental high frequency and one fundamental low frequency. In the frequency range 400 kc. to 20,000 kc. TC is approximately minus 22 and K is 113×10^6 and $F = K/x$. For frequencies between 50 kc. and 500 kc. $TC = -22$, $F =$

(Continued on Page 25)

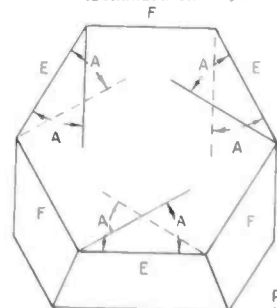

FIG. 15

POSITIVE A ANGLES

RAPID GROWTH FOR WHIO

Miami Valley Station Makes Big Advance With New 5-C-1

By PALMER A. GREER and CHARLES E. GAY

WHIO is just twenty-two months old—but it's already a Miami Valley institution. Affiliated with the Dayton Daily News, and the Springfield News and Sun, it is as important to radio listeners as their newspaper.

In the early spring of 1934, former Governor James M. Cox, with the vision of the need for adequate broadcasting facilities in a town that had heretofore been deprived of radio entertainment, started looking for a suitable studio and transmitter location, and wave length, which could be brought to this area.

Negotiations were started with WLBW, in Erie Pennsylvania, and the station's wave length was bought in the early fall of the same year. After permission was obtained from the Federal Communications Commission to erect a plant in Dayton, all new equipment from towers to tubes, most of which was RCA, was ordered and on December 1st, 1934, ground was broken on the Brandt Pike for the transmitter house, and the building adjoining the Daily News office was completely renovated, and three major studios installed, each with individual control room.

Opening of WHIO

At 4 p. m. on February 9th, 1935, practically every set in this area was turned to 1260 kilocycles for the formal opening. The first bit of broadcasting after the station identification was a prayer by Rev. Herman Page, the first time this procedure had ever been used to open a new station.

WHIO immediately started a program of showmanship in a series of "First" broadcasts in this vicinity. They were the first station to broadcast the proceedings in a traffic court, which program is still on the air; the county, sectional and state basket-ball tournaments; the Dayton Ducks' ball games; the circuses which ap-



Hon. James M. Cox

peared here (both sponsored and with pack transmitter, interviewed side-show attractions); the first to describe major holiday and convention parades; the Soap Box Derby, which originated in Dayton; the Cincinnati Reds Baseball games, which were relayed to WPAY; The Dayton Speedway dirt track races; and other important civic events.

To boost the opening of the Tarzan of the Apes series on the station, they gave a Tarzan movie preview which attracted 15,000 children—and two squads of police to keep order.

The WHIO transmitter building is located three and one half miles northeast of the city of Dayton, and lies in the center of an eleven acre plot of ground. A short distance from the house the towers are located, one to the north, and one to the south. They are fed by means of a concentric tube transmission line.

New Equipment Necessary

Prior to the time that WHIO was granted a construction permit for a power increase, an RCA 1-D transmitter was operating as a full 1000 watt station. Soon after the construction permit was granted, an order was placed with RCA, for an amplifier and rectifier and all associate equipment to increase the power to 5000 watts. As soon as the order was placed, work was started on the building, making the necessary changes in the building's interior, and adding a room to the rear of the present building to house the water cooling and power equipment. By the time the building was complete, the equipment was delivered, the transmitter moved in, and work on the wiring and changes in the 1-D transmitter was started immediately. The installation was carried on to the completion without interruption.

During installation of new equipment, the 1-D transmitter was

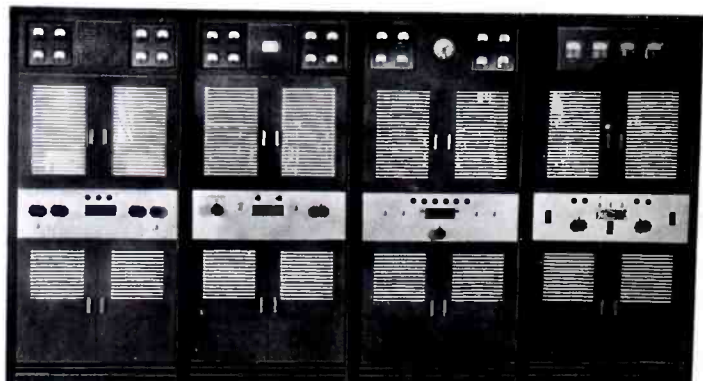

The 5-C-1 Transmitter installed at WHIO.

moved to another position in order that trenches could be cut in the floor to accommodate additional wiring necessary for the new transmitter. These trenches were made amply large to facilitate work with the wiring. All of the transmitter wiring runs in the trench between the various units. One trench runs the entire length of the transmitter, then curves at a right angle to the speech input equipment rack, to facilitate proper connection. Another runs underneath the transmitter to the room in which was installed the power equipment and water cooler. This trench carries all wiring to the power transformer, voltage regulator, water cooler and pump relays, and is then routed to the proper units through conduits which open directly into the trenches.

Old Equipment Used With New

After the trenches were completed the transmitter was moved into position along with the 5 kilo-watt amplifier and rectifier. All of the units are built with the same cabinet design and color scheme, so when placed side by side they harmonize perfectly in their modernistic design, even though the I-D transmitter was a year and a half older than the new units.

All wiring changes were made during the hours the station was off the air (between 1 and 6 a.m.) These changes included the installation of relays to provide a means of switching back to the I-D transmitter from the 5 kilo-watt with about one second interruption. To do this, relays were installed to take care of power circuits, switching excitation, modulators and antenna change over. In this transmitter installation there is a total of 40 relays used, which represent an installation that is as near automatic as possible. This system of switching back to the I-D transmitter from the 5 kilo-watt has proven very successful, and in addition to the manual switch to reduce power to 1 kilo-watt for night operation there is an automatic system that takes care of the switch-back in case of failure in the 5 kilo-watt transmitter. Should the 5 kilo-watt

transmitter be overloaded, it trips a relay that turns on one of the indicator lights on the panel at the same time energizing the filaments in the I-D transmitter. The third overload in succession removes the plate voltage from the 5 kilo-watt unit, at the same time applying voltage to the tube-plates in the I-D unit, during the fraction of a second break between the time the plate is removed from the 5 kilo-watt ampli-



James M. Cox, Jr.

fier and applied to the I-D unit, relays switch excitation, modulators and the antenna, back to the 1 kilo-watt position. As the exciter unit used for these two amplifiers is practically trouble free, the automatic switch-back amounts to an auxiliary transmitter.

Placement of Equipment

The line-up of the panels from left to right is: the regular exciter unit, the 1 kilo-watt amplifier (used for 1 kilo-watt operation); the 5 kilo-watt amplifier, and the rectifier.

This 5-C-1 transmitter is the exponent of the present day desire for high fidelity transmission. The frequency response of the entire transmitter from 100 to 10,000 cycles is within plus or minus 1 DB and from 30 to 17,000 cycles is within plus or minus 2.5 DB. The total harmonic distortion for any percentage of modulation from 0 to 100 is less than 4%. The noise level of this transmitter is very

low, being measured as low as 68 DB below the zero level required for 100 percent modulation.

Only One Motor Needed

Another feature of this transmitter is its departure from the older type of transmitters, as the only piece of rotating equipment is the water pump and the air blower, both of these are run by the same motor. Therefore only one motor is needed in the station.

This transmitter is fed from a normal 220 volt, three phase power line. Two lines reach the station from opposite directions. One is used regularly and the other as an emergency. In the event the regular line fails, the feed is automatically switched to the emergency line by a relay mounted at the point the line goes underground to enter the station. All of the circuits are brought underground for several hundred feet before entering the transmitter house.

The personnel of approximately 42, is headed by J. L. Reinsch, manager, with Ernest L. Adams as chief engineer. The staff is perhaps the youngest in years of any station on the air, but all are rich in radio experience with a broadcasting background which dates from the beginning of the crystal stage.

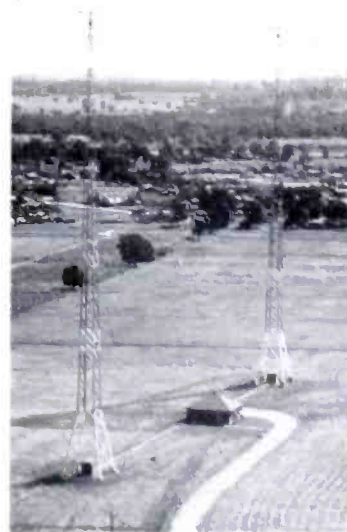

View across the valley from the antenna.

HOOSIERS LISTEN

South Bend Station Goes All

WITH the installation of new RCA High-Fidelity transmitter and speech equipment and new acoustically treated studios, WSBT-WFAM launches a new era of service for the discriminating radio listener.

Growth of Station

WSBT, owned and operated by the South Bend Tribune, first went on the air in June, 1922, and was authorized to broadcast under the called letters WGAZ. Since that day the station has always endeavored to serve the public with the best entertainment. In order to provide more adequate service WFAM was purchased in 1931. The schedule of these two stations has been arranged so that when one station signs off, the other one signs on. Local popularity of these stations is attestable by the fact that in November a telephone survey showed 78.3 of the listening audience in South Bend was tuned in on WSBT-WFAM.

To better serve this audience, a year ago the Tribune decided to buy the most modern equipment. First, new studios were construct-

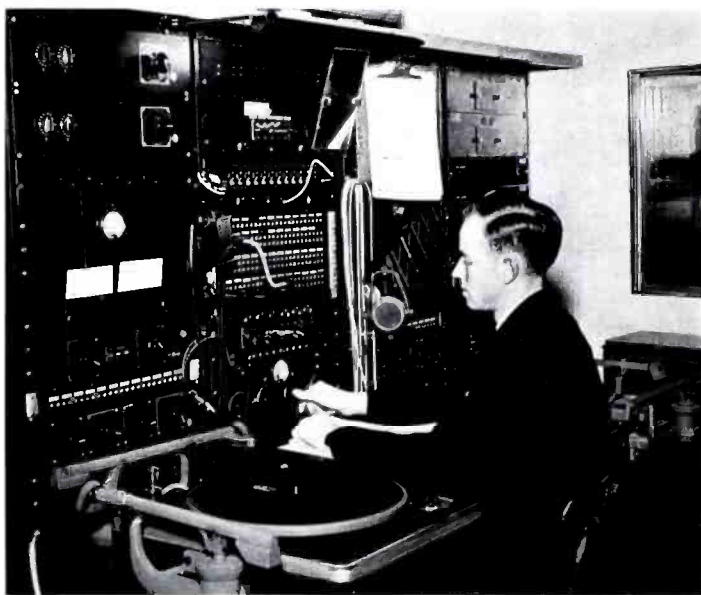

New racks of Speech Input Equipment.

ed utilizing the latest in design and accepted acoustical knowledge. The finished result is, studios modernistic in design air conditioned and attractively furnished. RCA velocity microphones are used in all studios and High-

Fidelity RCA monitor speakers are used for talk back circuits, cueing and guest entertainment purposes and indirect flush lighting systems are employed in all studios and all doors, windows and ventilator ducts are sound proofed against outside noises.

Special Press Problem

The greatest problem was presented by the presses which transmit vibration through the columns of the building. The new presses which were installed in the Tribune this summer were mounted on springs. Tests show that these springs have eliminated 90% of vibration. The Tribune is the third newspaper in the United States to mount its presses on springs. Another problem though less serious was presented by the Intertype type-setting machines. Vibration from these machines can be eliminated by mounting them on rubber pads. Experiments are still being made to determine the best type of pad for this purpose.

Complete new speech input equipment in the form of twin

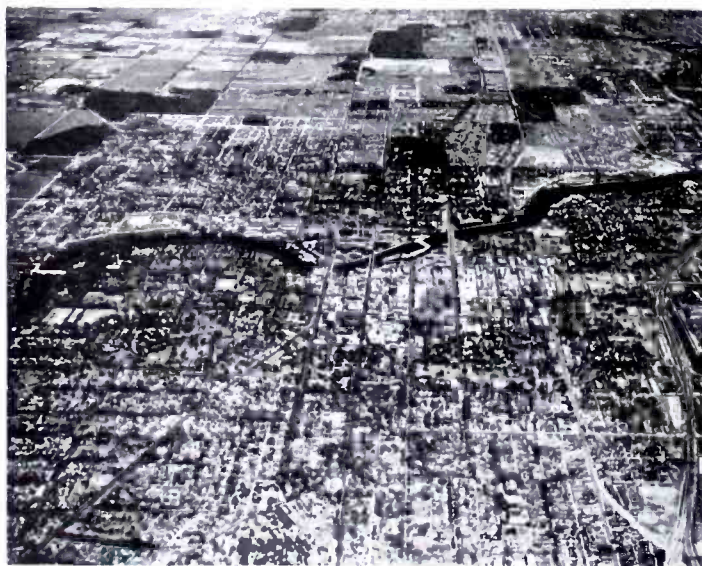

Aerial view of South Bend.

IN ON NEW WSBT

Way With RCA in Modernizing

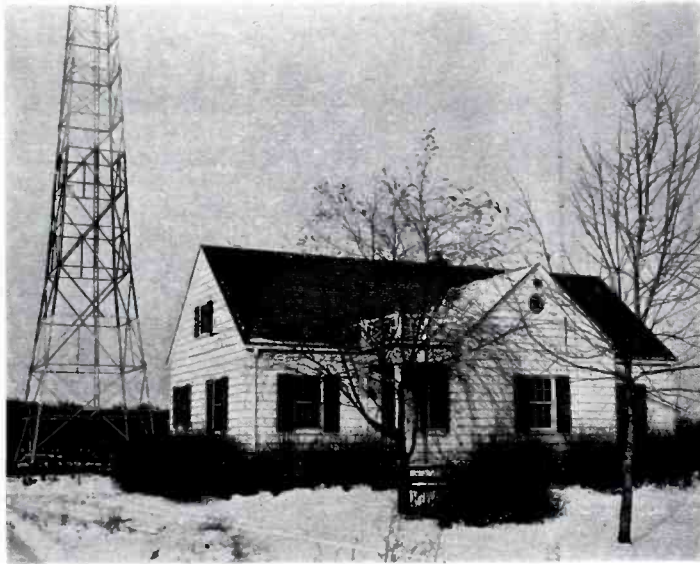

The Colonial bungalow which houses the transmitter.

racks controlled by a central master control has been installed. It is now possible for the operator to preset any or all of the four input channels by rack for audition or program purposes. The flip of a single key places either rack in operation on the broadcasting line to the transmitter. All apparatus by this method is duplicated in its entirety and insures against partial or complete failure. Uninterrupted service is thus insured to the listeners of WSBT-WFAM.

Monitoring Speakers

Visitors to the studios are entertained by the many monitor speakers which are located in the executive offices and in the reception rooms. Executives have speakers equipped with selectors making it possible to listen either to auditions or programs. Talk backs are so arranged as to permit direction of skits and programs from remote points in the offices on direction from the master control. RCA transcription equipment is used throughout and can handle both vertical and lateral transcriptions.

Notre Dame University lies just outside the city limits of South Bend and from the WSBT-WFAM studios on the campus come many interesting programs. The officials of the University have graciously constructed a studio in the engineering building and the

Tribune has installed complete RCA High-Fidelity speech input equipment.

Bungalow Type Transmitter House

The distance from Notre Dame to the transmitters is about six miles by air and visitors to this site, see as they approach two steel towers 200 feet in height located some 100 yards apart with a heavy steel cable suspended between them bearing the weight of a vertical cage antenna. The lower end of the antenna is terminated in a white, colonial type bungalow which serves to house the new High-Fidelity RCA transmitters. WSBT, the higher powered of the two, is rated at 500 watts and is of the 1-D type. WFAM, a 100 watt job, is a No. ET4240 type. Both transmitters utilize the same antenna for a radiating system and since neither is operated simultaneously a switch is used for connecting from one transmitter to the other. This change can be made in a matter of seconds and both transmitters are utilized twice during the 17 hours daily sched-

(Continued on Page 32)

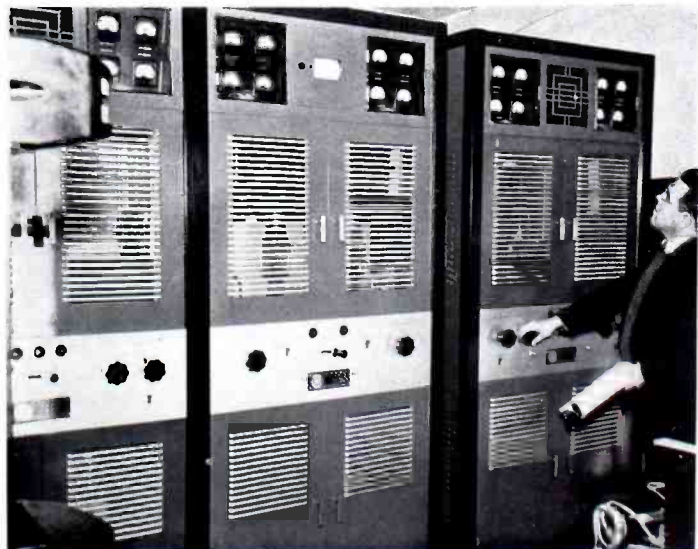

The new 5-C 5 KW Transmitter at WSBT.

A TURNSTILE ANTENNA FOR USE AT ULTRA-HIGH FREQUENCIES

By DR. G. H. BROWN

Reprinted through courtesy of "Electronics"

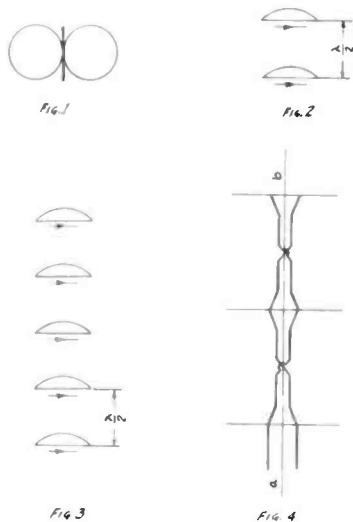

ANTENNAS operated at short wave lengths can have dimensions of the order of several wave lengths without becoming unwieldy in actual physical size. A great many arrangements can be used which direct the radiated energy in some one particular direction. This concentration thus yields a greater field strength than does, for example, a single half-wave antenna operated at the same power. If the signal strength in the remaining directions is of no consequence, the arrangement of a few wires in a directional array has accomplished the same result as building a more powerful transmitter. Now that the ultra-high frequencies are being used for broadcast purposes, the directional arrays are not always desirable. If the antenna is located in the heart of a city, it is desirable to radiate equal signals in all directions in a horizontal plane. It is still possible to rob energy from the high angles and concentrate it near the horizon. An investigation was undertaken to develop an antenna for ultra-high frequency use which embodied the following features.

1. The antenna should give a circularly symmetrical radiation pattern.
2. The antenna should concentrate the energy in the vertical plane so that the signal strength toward the horizon for a given power input will be considerably greater than that obtained from a single half-wave vertical antenna with the same input power.
3. The antenna must be structurally possible where high winds occur and should preferably be a rather simple structure not liable to damage easily.
4. If possible, the antenna should be supported by a single mast.

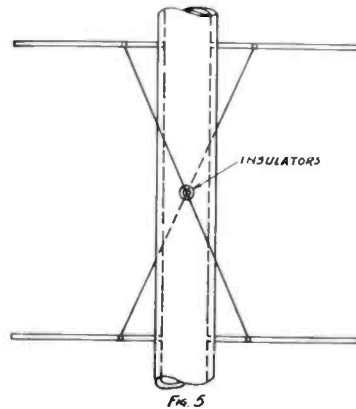

One system which immediately suggests itself is the "Franklin" antenna which consists of half-wave elements placed vertically, one above the other, and connected with phase shifting devices so that the currents in all the elements are in phase. This antenna fulfills the first two conditions, but it seems very difficult to meet the last two conditions.

Arrangements which use horizontal elements usually do not fulfill the first condition stated, since each horizontal element yields a "Figure 8" as the horizontal pattern.

The antenna which was finally developed uses horizontal elements and fulfills the four conditions outlined.

Theoretical Development

Let us first examine the action of a horizontal half-wave antenna in free space. In the horizontal plane which passes through the antenna, the field strength is horizontally polarized. The horizontal pattern has the shape of a "Figure 8" with the maximum intensity occurring in a direction normal to the axis of the antenna (Fig. 1).

Suppose that another half-wave antenna is placed parallel to the first, and one-half wave length above the first antenna (Fig. 2). The antennas are both excited so that the currents in each antenna are equal and in phase. This arrangement still yields a "Figure 8" pattern in the horizontal plane, but the magnitude of the horizontal pattern has increased since energy has been robbed from high angles and sent out horizontally.

If still more elements are placed in the array, Fig. 3, each one-half

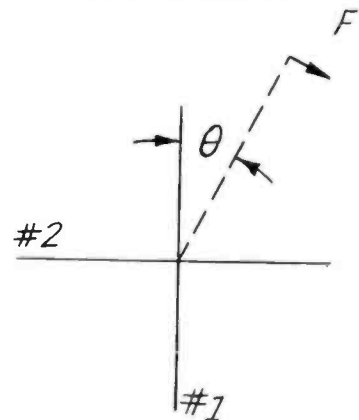

FIG. 6

wave from its neighbor and excited all in phase, the horizontal signal is still further increased, but the horizontal pattern still remains "Figure 8" in shape. For the time being, we will ignore this latter fact and consider means of constructing the arrangement of Fig. 3.

Suppose that the elements are supported in space in some fashion. Then the elements can be excited in the proper phase and current magnitude by means of a single two-wire transmission line transposed once between each pair of elements. The half-wave length of transmission line gives a phase reversal of voltage along the line so that the single transposition returns the voltages on adjacent elements to the in-phase condition.

In Fig. 4, the line a-b lies in a neutral plane with respect to the antenna elements and the transmission line. Thus if this line were a wire or piece of metal, there would be no voltage induced in it due to the radiating system. This fact makes it possible to replace the line a-b by a metal shaft or flag pole, thus affording a supporting structure for the system. Each half-wave antenna, instead of running through the pole, can consist of two quarter-wave rods screwed into opposite sides of the pole. The transmission lines, instead of having an abrupt transposition, twist continuously around the pole. It is possible to do this if supporting insulators are placed on the pole midway between the elements (Fig. 5). This arrangement now fulfills all the conditions imposed except that of the circularly symmetrical horizontal pattern.

On our flag pole, let us put a second system of radiators and transmission line identical with the first, but so placed that the two sets of radiators are at right angles and corresponding elements are at the same level on the pole. Thus with two sets of identical elements on the pole, we have two separate transmission lines coming down the pole to the transmitter. These two transmission lines are so fed, with equal power into each, line, so that the currents in one set of radiators are in time quadrature with the

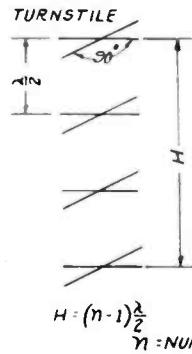

$$H = (n-1) \frac{\lambda}{2}$$

n : NUMBER OF ELEMENTS

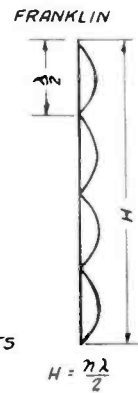

$$H = \frac{n\lambda}{2}$$

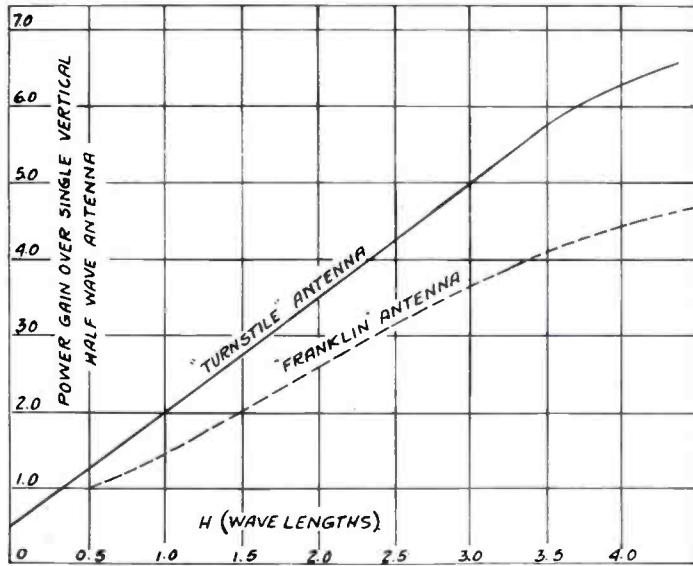

FIG. 7

currents in the other set which is at right angles in space with the first set. Figure 6 shows a view of the antenna looking down from the top. Then the field in the horizontal plane due to Set No. 1 is

$$F_1 = I \sin(\omega t) \sin \theta \quad (1)$$

where θ is the angle indicated on Fig. 6

The field due to Set No. 2 is

$$F_2 = I \cos(\omega t) \cos \theta \quad (2)$$

The sum of (1) and (2) gives the total resultant field.

$$F_t = F_1 + F_2 = I \cos(\omega t - \theta) \quad (3)$$

Thus the total field is constant in magnitude and changes in phase as θ changes, giving us a circularly symmetrical horizontal pattern.

As mentioned previously, the signal strength toward the hori-

zon increases with the number of antenna elements. The ordinates of Fig. 7 show the ratio of the power into the single vertical half wave antenna to the power into the array in question to achieve the same field strength.

Experience with mechanical design of these antennas has shown that it is convenient to use six antenna elements in each set. Then the distance from the bottom radiator to the top radiator is 2.5 wave lengths.

The vertical radiation characteristic of this antenna is made up of a horizontally polarized component and a vertically polarized component. The vertically polarized component becomes zero in the horizontal plane. Figure 8 shows these two components as a function of the angle measured

(Continued on Page 22)

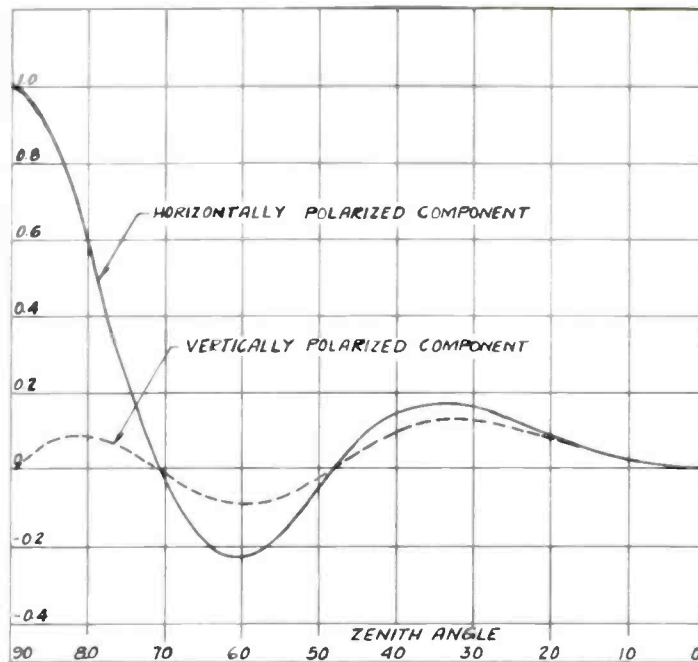

FIG 8

from the zenith, when the antenna consists of six elements per set.

Experimental

While this antenna layout looked very good on paper, it was necessary to verify the results experimentally. The experimental method was also used to determine certain optimum dimensions. Accordingly, a model was built to operate on a wave length of 3.0 meters. The flag pole used was 42 feet long and 3 inches in diameter. The six-element antenna was chosen. The radiators were one-quarter inch brass rods, each one-quarter wave length long. These rods were threaded and screwed into the steel flag pole. The insulators for supporting the transmission lines were porcelain standoff insulators, fastened to the pole by means of stud bolts in their bases. The experimental antenna is shown by Fig. 9.

The quadrature phase relation between sets of radiators was accomplished by means of transmission lines of the proper lengths.

After all critical adjustments were made, a check was made of the horizontal pattern to determine how circular it was. A horizon-

tal half-wave antenna was mounted on the end of a bamboo pole. This pole was 26 feet long. A transmission line connected this antenna with a detector placed at the base of the pole. Readings were taken on the circumference of a circle

whose radius was 175 ft. with the axis of the flag pole as the origin of the circle. The circles on Fig. 10 show the results of this test.

Next, the elements pointing east and west were disconnected to determine the expected "Figure 8" pattern. The crosses on Fig. 10 show the measured results. This test indicates the necessity of using two sets of elements if it is desired to send equal signals in all directions.

A measure of the field strength was made at a fixed point. Then the flag pole was replaced by a single vertical half-wave antenna excited with the same power. The field strength from this arrangement was slightly less than one-half that obtained with the array, indicating a power gain for the

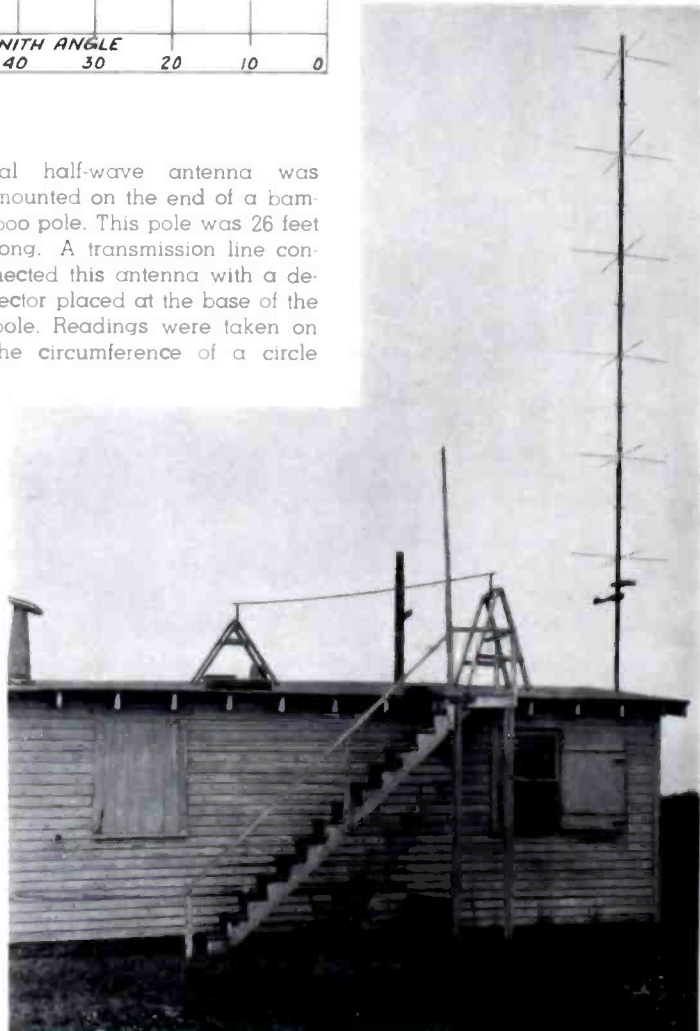

Fig. 9. The experimental model of the turnstile antenna.

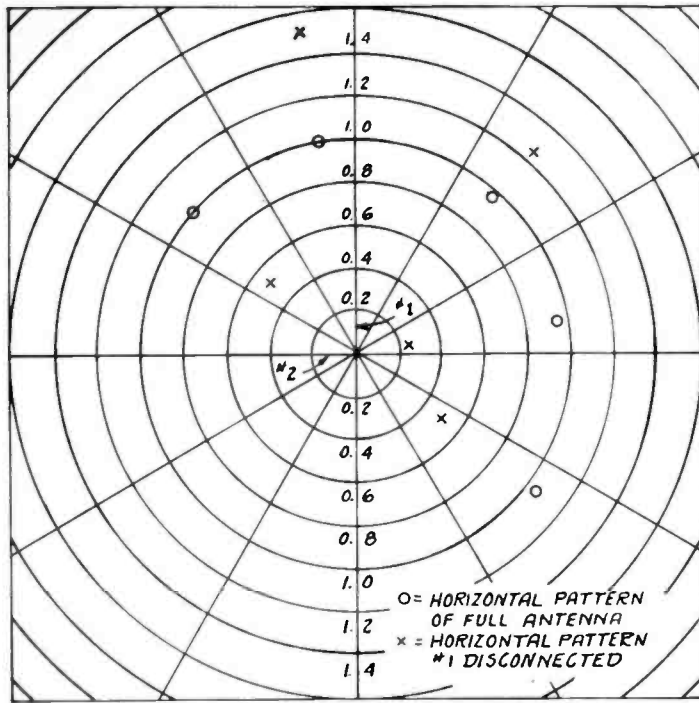

FIG. 10

array of approximately four to one. From Fig. 7, we find the theoretical figure to be 4.27 to 1.

Constructional Details

The first full scale antenna was constructed for operation at 45 megacycles, Fig. 10. The supporting pole extended 70 feet above the roof. The radiators were nickel-steel tubes, copper plated. These tubes were made with sufficient wall thickness to allow a slight taper. This taper is supposed to avoid possible fracture due to vibration of the tubes. The stand-off insulators are 8 inches in length. The transmission lines are made up of No. 8 hard drawn wire. The antenna elements are placed slightly less than one-half wave length apart so that the transmission line length between the elements is exactly one-half wave.

To achieve the proper phase shifts, the antenna is fed by an arrangement of transmission lines as shown in Fig. 12. If the lines have a characteristic impedance of 500 ohms, the following dimensions will hold approximately.

1. The distance from c or d to the lowest antenna element is

0.355 wave lengths (plus any integral number of half-wave lengths desired).

2. The length of c (or d) from line connection to shorting bar is 0.085 wave lengths.

3. e is any convenient length.

4. f equals e plus one-quarter wave length.

5. The distance from T-T to point of connection of g is 0.4 wave lengths.

6. The length of g is 0.15 wave lengths.

Four strain insulators are placed at the top of the pole to neutralize the pull on the top elements due to the transmission lines.

The transmission lines are connected to the antenna elements by means of clamps placed 0.06 wave lengths from the surface of the supporting pole.

Small metal pads are fabricated to the pole to insure firm horizontal mounting for the insulators and radiating rods.

In designing a particular antenna, consideration should be given the highest recorded wind velocity, the possibility of the formation of sleet on the antenna, and the possibility of excessive corrosion due to proximity to salt water.

Factors Affecting Horizontal Radiation Pattern

The design of the turnstile antenna has been based on the premise that it is most desirable to

(Continued on Page 30)

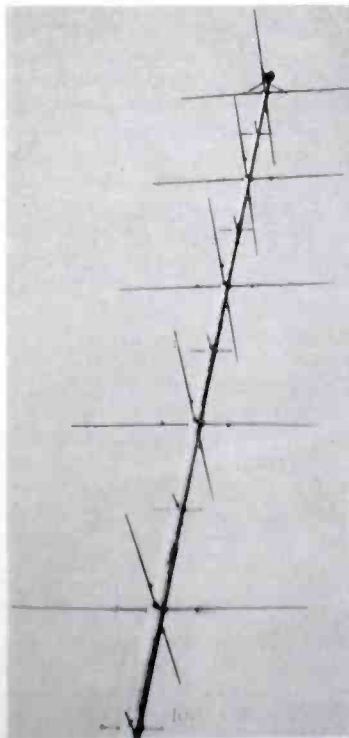

Fig. 11. The 45 megacycle turnstile antenna.

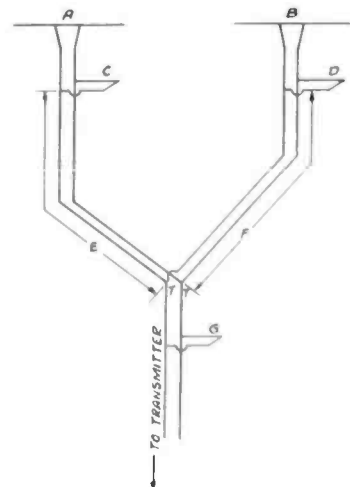

FIG. 12

WHBL IMPROVES FACILITIES

(Continued from Page 4)

were changed from WHBM to WHBL, as they have remained since then.

The station was improved with new speech input equipment in 1931, and the radio division of the department of commerce cited the station in May of that year for the accuracy of its transmitter in maintaining the assigned frequency of 1410 kilocycles.

In May, 1934, the station was granted the authority to operate its new transmitter, constructed in January to insure greater perfection of reception over a wide service area. Along with the changes of the transmitter, new equipment was added in the studios and the speech input. New high fidelity amplifiers were installed, which further increased the tone range. New type ribbon microphones were used, and two new RCA Victor high fidelity turn-tables for reproducing electrical transcriptions were added.

Constant Improvement

All these changes, that have continued as improvements in the technical end and were found advisable and effective, and at no time was expense spared, for it

was known that WHBL must build for the future. This trend in constant improvement continued, and on May 11, 1934, an all-day special feature broadcast was arranged dedicating the final new transmitter with its ultimate changes.

Time went on, and after many months of endeavor, WHBL was finally rewarded with a favorable decision from the federal communications commission to the effect that WHBL was granted full-time operation on a frequency of 1300 kilocycles, effective as soon as necessary technical changes could be made. This decision was granted on November 26 of last year.

Now the time has come when finally these dreams of a new station—so perfectly assembled and so entirely modern as to compete with the largest stations in the country for perfection in reproduction—is a reality. No expense has been spared to give the finest of service, both from program and reception standpoints.

The best transcription service, a production department, special continuity writer, publicity and business departments, are all ready to serve WHBL's listening area to the best of their ability.



Hildegarde, who starred in the Press Television Demonstration.

FOURTH ESTATE VIEWS TELEVISION

(Continued from Page 3)

Our program is three fold; first we must develop suitable commercial equipment for television and reception; second, we must develop a program service suitable for network syndication; third, we must also develop a sound economic base to support a television service.

From the standpoint of research, laboratory development, and technical demonstration, television progress in the United States continues to give us an unquestioned position of leadership in the development of the art.

We are now engaged in the development of studio and program techniques that will touch upon every possibility within the growing progress of the art. The distinction between television in this country and abroad is the distinction between experimental public services undertaken under government subsidy in countries of vastly smaller extent, and the progressive stages of commercial development undertaken by the free initiative, enterprise and capital of those who have pioneered the art in the United States.

While the problems of television are formidable, I firmly believe they will be solved. With the establishment of a television service to the public which will supplement and not supplant the present service of broadcasting, a new industry and new opportunities will have been created.



Ready to go on the air at WHBL.

QUARTZ CRYSTALS

(Continued from Page 15)

K/y and $K = 107 \times 10^6$. When Z/y is less than 0.2, $TC = -7$ and as Z/y becomes greater than unity, TC may reach -50 and $K = 123 \times 10^6$. With certain Z/y ratios TC becomes low, between ± 2 to 5.

Y-Cut

In this cut, sometimes called 30° or parallel cut, the "A" angle is 30° and the "B" angle is zero. The major surfaces of a "Y" cut crystal are normal to a "Y" axis, parallel to an "X" axis, and parallel to the "Z" axis. On account of coupling between over-tones of the contour frequencies and the thickness frequencies, these discontinuities appear in the frequency temperature curves of the thickness vibration. In general, however, $K = 78 \times 10^6$, $F = K/y$ and TC varies from -20 to $+100$. If the contour vibration is used in the "Y" cut crystal $K = 113 \times 10^6$, $F = K/x$, $TC = -10$ to -35 .

AT-Cut

This is a trade designation for a low temperature coefficient crystal manufactured by the Bell Telephone Laboratories, Inc. The "A" angle is 30°, the "B" angle is -35° , $K = 67 \times 10^6$, $F = K/y'$ and $TC = \pm 2$.

BT-Cut

This is also a trade designation for a low temperature coefficient crystal manufactured by the Bell Telephone Laboratories, Inc. The

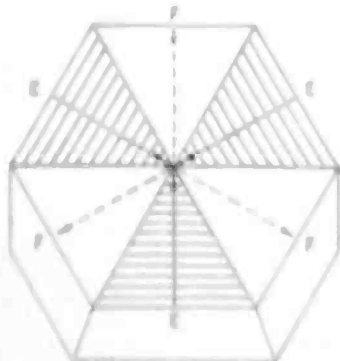

Positive direction of B angle for all cases except A angle = 0. For A angle = 0 characteristics are same when direction of B angle is positive or negative

FIG. 16

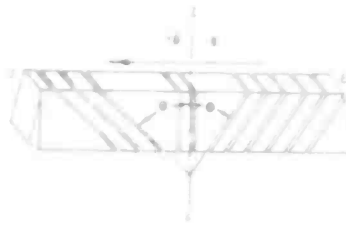

Direction of positive and negative B angles for all cases except A angle = 0. 60, 120, 180, 240 and 300

FIG. 17

"A" angle is 30°, "B" angle is $+49^\circ$, $K = 100 \times 10^6$, $F = K/y'$ and $TC = \pm 2$. Since "K" is much higher in the BT cut than in the AT cut this latter type is preferable for high frequency use in the frequency range of 4,000 kc. to 10,000 kc., although frequencies up to 20,000 kc. are possible.

AC-Cut

This is a trade designation for a crystal manufactured by the Bell Telephone Laboratories, Inc. The "A" angle is 30°, the "B" angle is -31° , $K = 66 \times 10^6$, $F = K/y'$, $TC = +20$.

BC-Cut

This is also a trade designation for a crystal manufactured by the Bell Telephone Laboratories, Inc. The "A" angle is 30°, the "B" angle is $+60^\circ$, $K = 102 \times 10^6$, $F = K/y'$ and $TC = -20$.

V-Cut

This is a trade designation for crystals manufactured by the RCA Manufacturing Company, Inc. Unlike other low temperature coefficient crystals the major surfaces of "V" cuts are not parallel to any "X", "Y", "Z" axis. The temperature coefficient TC of "V" cut crystals in the frequency range of 50 kc. to 550 kc. lies between 0.1 and 2.0. Broadcast crystals are manufactured to have a temperature coefficient of less than 1.5 and in range 1600 to 20,000 kc. TC is less than 2.0.

The author wishes to make grateful acknowledgment to the following: Mr. L. M. Clement, Vice President of the RCA Manufacturing Company, Inc., for his personal report on this subject, and for numerous valuable suggestions in connection with both development and manufacturing; Dr.

W. D. Phelps of the Research Division, for mathematical work; Mr. S. A. Boikovoy and members of the Crystal Development and Applications Sections for development and design work; and Mr. Groeber and members of the Crystal Manufacturing Group for work and suggestions.

NEW HEAD FOR ENGINEERING PRODUCTS ADVERTISING

During the past month Mr. D. J. Finn has been placed in charge of Engineering Products and Phonograph Advertising.

Born in Natick, Mass., Mr. Finn was educated at Little Rock College, Arkansas, and at Texas A. and M. College. In 1921 he went with Stone & Webster in the statistical department. He began his career with the Edison Lamp Works in Harrison, N. J., in the Lighting Service Department in 1923. Subsequently he was transferred to Atlanta.

Mr. Finn, after a number of years with the Edison Lamp Works, joined the Radiation Company in 1930 as sales promotion chief of District No. 5.

The advertising of the following sections, in addition to Phonograph, will be handled by the department: Aviation, Police Amateur, Broadcast Tubes and Parts.

F. R. DEAKINS DIRECTS SALES OF ALL SPECIAL PRODUCTS

Mr. F. R. Deakins, formerly heading the Engineering Products and International Divisions, now assumes charge of sales for special products of RCA. These include all products with the exception of receiving sets, records and tubes.

Mr. Deakins began his career with G. E. in the Testing Department, and prior to joining RCA he was Manager of Radio Sales.

In 1930, he came with RCA to head the two divisions with which he has been connected, except for an interval of two years when he was Executive Vice President of the Victor Talking Machine Company of Canada.

PROBABLE PERCENTAGE MODULATION AT VARIOUS AUDIO FREQUENCIES

ROBERT SERRELL

A MORE exact knowledge of the distribution of sound energy over the usual audio spectrum has often been desired. In connection with the design of radio transmitters, the questions have often come up: "How much sound energy can be found in an average program at any particular audio frequency? How much modulation are we likely to get?" Today, with the advent of super-power transmitters, this question has become of even greater interest. Harmonics of the modulating audio frequencies are always present in the output of any transmitter. A certain amount of harmonic distortion is inevitable.

Ordinarily Not Harmful

In the usual broadcast transmitter of moderate power, the audio harmonics do not modulate enough carrier power to be very harmful. In a 500 kilowatt transmitter, however, conditions are very different. The same percentage of harmonics will, in this case, modulate considerably more energy, enough, perhaps, to cause prohibitive side-band interference between transmitters operating in adjacent chan-

nels. With the present 10 kc. separation of broadcast carriers, audio harmonics will cause side-band interference at any modulating frequency above 2500 cycles. It is, therefore, particularly important that the energy content of average programs around this frequency be accurately known, and it is precisely to help us determine just what percentage of

audio harmonics is permissible in high power transmitters, that the question has recently been studied anew.

Fortunately, enough data are available in the present literature on the subject to help us obtain a definite answer. Most of the "raw material" which has been used in this work originated in two articles from Bell Laboratory sources. One is entitled "Speech Power and its Measurement" by L. J. Sivian, and was published in the Bell System Technical Journal for October, 1929. The other article, by L. J. Sivian, H. K. Dunn and S. D. White, was published in the Journal of the Acoustical Society of America for January, 1931. It is entitled: "Absolute Amplitudes and Spectra of Certain Musical Instruments and Orchestras."

Average Sound Pressures

These two articles give curves showing the average sound pressures obtained at various frequencies for 18 different musical instruments or orchestras, as well as for speech. For measurement purposes, the audio spectrum was divided into thirteen bands by means of filters as follows:

FIG. 2 RELATIVE SOUND PRESSURE

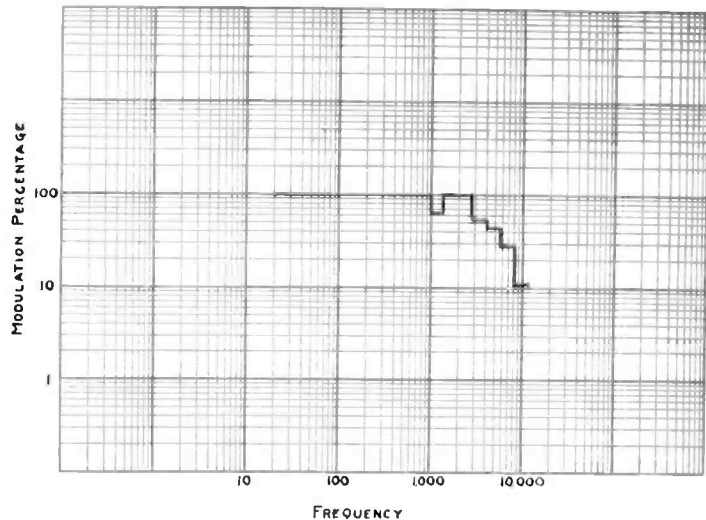
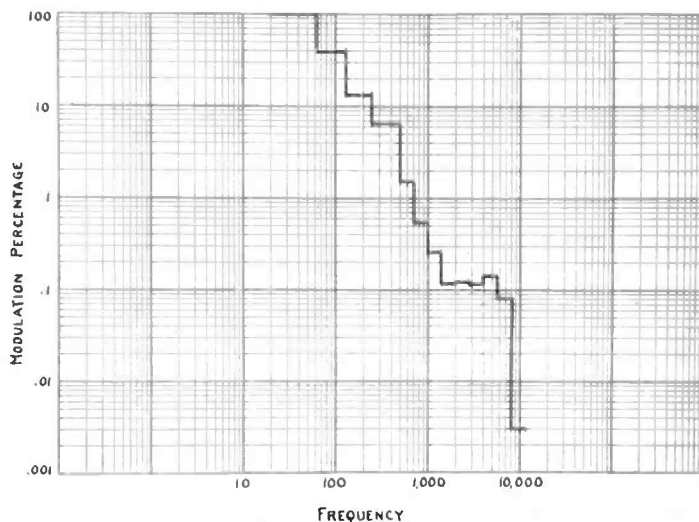

FIG. 1 ABSOLUTE SOUND PRESSURE



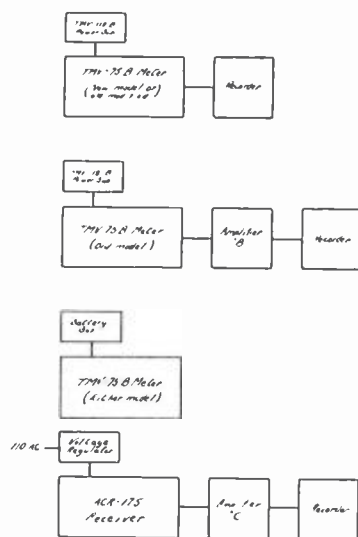

FIG. 10. Three alternative arrangements suitable for making recordings at more or less fixed points where a 110 volt a.c. supply is available.

FIELD INTENSITIES

(Continued from Page 9)

which is intended for the 6E5 "magic eye" tube. Thus the amplifier takes its filament and plate voltage from the receiver, and provides a very convenient arrangement. No compensation is provided, since for this arrangement (Fig. 10f), a voltage regulator must be used.

Recording in the Field

With the several equipments described above well in mind, the best arrangement for the work at hand should next be considered. Several possible layouts are feasible, and the choice will depend on the conditions of the particular job. Fig. 9 shows the three best setups for use at points in the field. That of (a) is the simplest, and most convenient where portability is the chief criterion. It, of course, assumes use of the new model, or of the old model modified as per Fig. 5. That of (b) is generally similar, but utilizes amplifier "A" in order to escape the necessity of converting the old model field intensity meter. The arrangement of (c) is probably the best where a considerable amount of work is involved, since it provides a large degree of flexibility and may be arranged to obtain a greater degree of stability (and hence more automatic operation) than that of the pre-

ceding arrangements. A set-up of this type is illustrated in Fig. 11. As can be seen, this leaves the field intensity meter entirely free from encumbrance, so that it may easily be removed for making measurements away from the car.

Recording at Fixed Points

In Fig. 10 are shown three suggested arrangements for making recordings at a more or less fixed point. In such cases—and particularly if an extended period of recordings is contemplated—it is desirable to consider a set-up which will be all, or nearly all, a.c. operated. This not only saves the expense of replacing batteries, but also greatly reduces the frequency with which the calibration of the equipment must be checked. The arrangement of (d) is the simplest, and consists merely of



FIG. 11. Interior of one of NBC's five TMV-75-B equipped cars. The arrangement of the equipment, which is as in Fig. 9a, is particularly convenient where a large number of observations are to be made at widely separated points. Note the steering-wheel which controls the loop mounter above the car roof. This type of loop mounting is strongly recommended for field use.

providing an a.c. power supply for the field intensity meter, which drives the recorder direct. A Type TMV-118-B Regulated Power Supply should be satisfactory for furnishing plate voltages. Filament voltage may come from an A-power supply, or from a pair of storage batteries which are alternately in use and on charge. This arrangement, of course, presupposes the use of the new model of the TMV-75-B or of the old model modified. The arrangement of (e) is similar, except that Amplifier "B" (the compensated type) is used in order to obviate necessity of making the conversions in the old model. Arrangement (f) is in many respects the most con-

venient of all. In this the recording arrangement comprises a Type ACR-175 Receiver (or similar), which drives an amplifier "C" (see Fig. 8 above), which in turn drives the recorder. All power is obtained from a 110-volt a.c. supply, through a voltage regulator. The field intensity meter is used only for calibrating the set-up (by the direct comparison method). Thus it is instantly available for other uses whenever required, and without in any way impairing the operation of the recording equipment. Moreover, no fuss with batteries or power supplies is required, and the equipment is automatic in the fullest sense of the word. It is quite easily calibrated, and will operate with minimum attention.

Special Recording Methods

The discussion above has covered the elements involved in making the usual straightforward linear recording. At the present time a large proportion of all recording work falls in this category. There are, however, a number of special types of recordings which can be accomplished with the addition of certain other equipment units. While these complicate the procedure, they have advantages for many types of surveys—indicating that they will in the future be more-widely used. Foremost in this classification is the logarithmic recording. Referring to Fig. 7, which shows a typical linear recording with a corresponding logarithmic scale for comparison, it will be seen that sev-

(Continued on Page 33)



FIG. 12. The TMV-75-B-equipped station wagon of Edwards and Martin. Consultants. The equipment is arranged as in Fig. 9c—that is, the recorder is driven from a receiver-amplifier combination, the field intensity meter being used for calibrating purposes only. This provides flexibility and allows the meter to be used for measurements outside of the car.

WTRC INCREASES COVERAGE

Elkhart Station Installs New 250 W Transmitter

FROM the day WTRC was launched, nearly five years ago, it has been the constant endeavor of the management to operate the station in such a manner that its listeners will consider it as much a part of their daily lives as the local newspapers. The success of this psychology is apparent by WTRC's recent increase in power to 250 watts, and the purchase of new equipment, which includes an RCA Transmitter, Control Board, Turntables, Studio Equipment, and Modulation Monitor. A new brick transmitter house, located on an eight acre site just outside of city limits, and a new Trucson antenna of the

latest design, complete the improvements.

Serves Rich Territory

Located in Elkhart, Ind., the center of a rich farming area celebrated for its dairying, fruit and poultry, many of WTRC's programs are directed to the rural residents of Northern Indiana and Southern Michigan, and have met with such success that they will of necessity continue over WTRC's increased area. This popular service is made possible through the supervision of Mr. Ira Martin, Farm Editor of the Elkhart Daily Truth (owners and operators of WTRC), and the cooperation of the

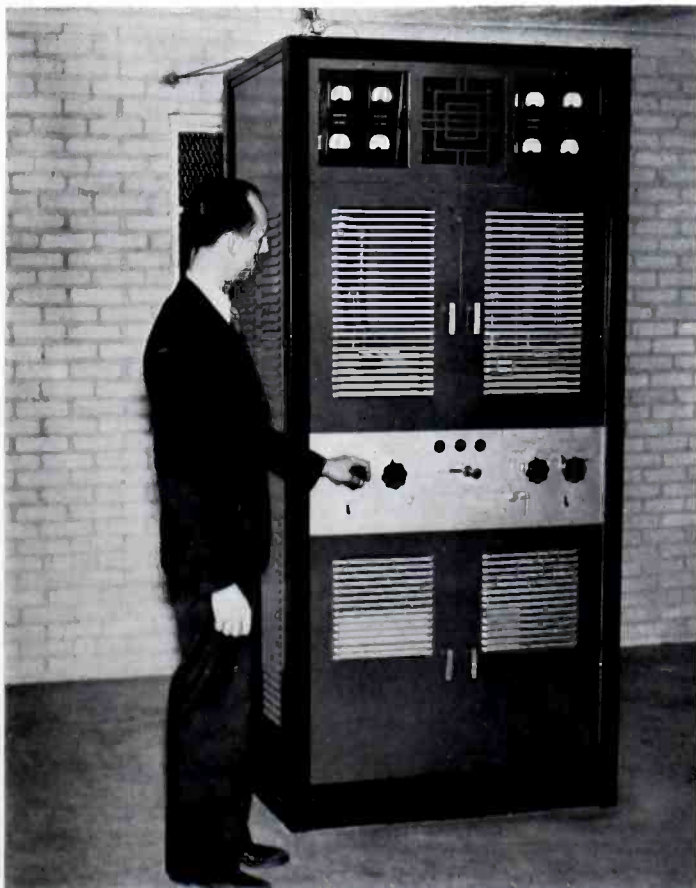

The new ET-4250 at WTRC ready for operation.

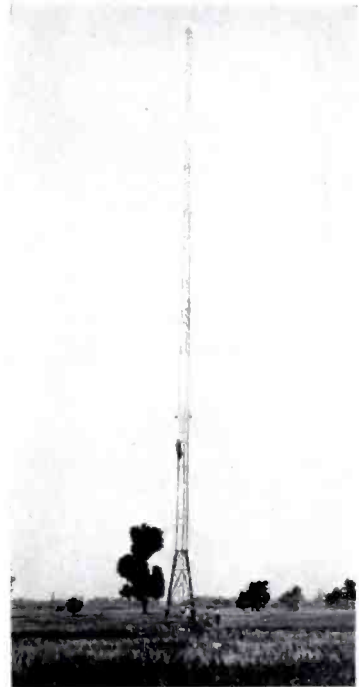

View of WTRC antenna.

Farm Agents of eight Indiana and Michigan Counties, as well as such esteemed institutions as Purdue University, Michigan State Agricultural College, and the U. S. Department of Agriculture.

Interesting Programs

WTRC's ambition has been further realized through the use of 11 religious programs, all sponsored on yearly contracts, a rotation of 26 communities in their own half-hour weekly "free-for-alls"—which, incidentally, has resulted in some of WTRC's best talent—and several Elkhart, Mishawaka and South Bend musical combinations. In addition, WTRC is a member of the ABC network.

Installation of the new RCA equipment has doubled WTRC's coverage to the entire satisfaction of its former potential audience, which had been clamoring insistently for this service long before its inauguration.

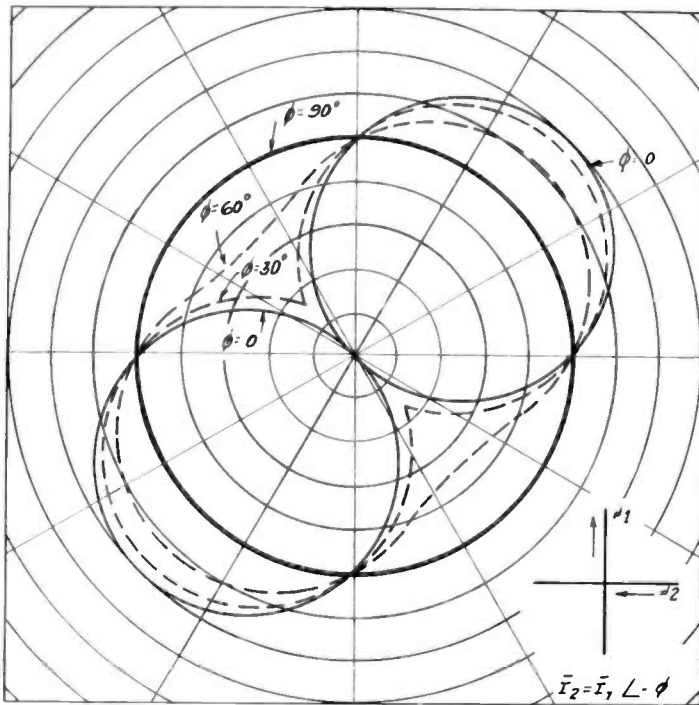

Fig. 13

TURNSTILE ANTENNA

(Continued from Page 23)

have a circularly symmetrical horizontal radiation pattern. It is, however, conceivable that such an antenna might be located in the heart of a city which is oblong in shape. In this event, it would be desirable to have a horizontal pattern which is elongated. This may be accomplished by controlling the phase relation between currents in the two perpendicular sets of radiators or by controlling the ratio of the currents in these two sets.

Figure 12 shows what happens to the horizontal radiation pattern when the currents in the two sets of elements are held equal in magnitude but the phase relation is shifted. We see that the pattern can be elongated along a line which bisects the angle formed by the two sets of radiators.

Figure 14 shows similar results when the current ratio is varied but the currents are held in quadrature. Here the elongation points along the axis of one of the antenna elements.

By choosing the proper phase and current ratios, it is possible to make the elongation occur at any angle in the horizontal plane.

Field Intensity Measurements

As stated previously, the first full scale antenna was constructed for operation at 45 megacycles. This antenna was located on the

roof of a building in an urban district. The top of the turnstile antenna is 470 feet above sea level and 310 feet above grade. Before the antenna was placed in operation, the probable field strength as a function of distance was estimated from the formula

$$E = \frac{88 h \alpha \sqrt{WK}}{3 \lambda r^2}$$

where

E = field intensity in volts per meter

λ = wave length (meters)

r = horizontal distance (meters)

h = height of transmitting antenna (meters)

α = height of horizontal receiving antenna above ground (meters). It was known that this dimension would be 8 meters for the measuring equipment.

W = power into the antenna (watts)

K = power gain factor from Fig. 7.

(Continued on Page 33)

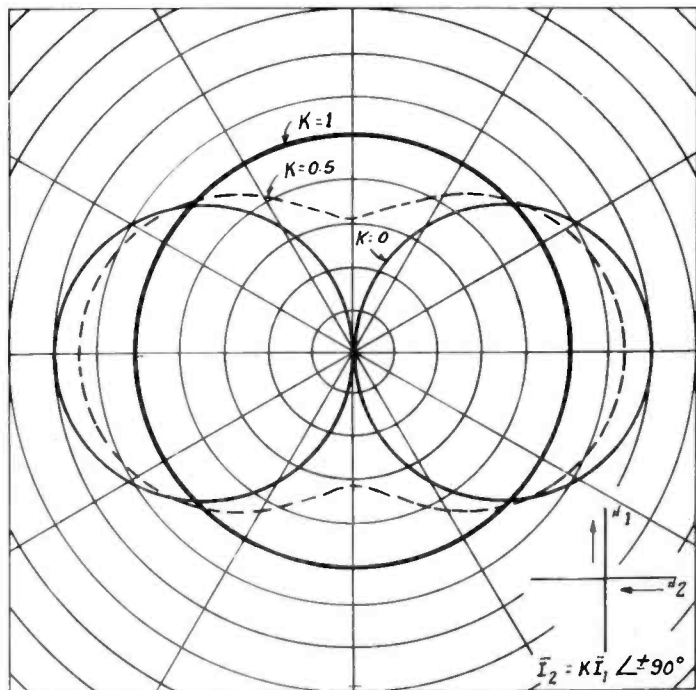

Fig. 14.

**J. L. SCHWANK NEW
HEAD OF ENGINEERING
PRODUCTS DIVISION**

The appointment of Mr. J. L. Schwank as head of the Engineering Products and International Divisions, has recently been announced.

Mr. Schwank began his career with the Philadelphia Electric Company, and remained there fourteen years, seven of which were spent as Chief Test Officer in the laboratory, and an additional seven in the operating engineering department.

Later, Mr. Schwank joined the Atwater Kent organization, with whom he remained for twenty years in various phases of administrative work.

In addition to being an engineer, Mr. Schwank studied law and was admitted to the Patent Bar.

**E. T. JONES NOW IN CHARGE
OF INSTRUMENT ADVERTISING**

Mr. T. F. Joyce, Manager, Advertising and Sales Promotion department announces the appointment of E. T. Jones as Manager of Instrument Promotion, which includes Home, Farm, Auto and Radio Phonograph instruments.

Mr. Jones is one of the most widely known members of the radio industry and is exceptionally well qualified for the new position having had ten years wholesale radio experience.

He has been interested in radio for many years—in fact, his career began in 1909 when he began working with amateur radio.

During the whole period of his association with the electrical and radio industry, Mr. Jones has invented many devices which have aided in very definite advances in the art. He has also written a number of articles which have appeared in technical publications, and has been a member of the I. R. E. for many years.

NEW HOME FOR WSYR



A modern structure for a modern station.

WRGA INSTALLS NEW ANTENNA

RADIO Station WRGA has materially increased its service area with the addition of a new vertical antenna, erected in June. This Duralumin pipe-mast antenna is 165 feet high and is installed on the roof of the National City Bank Building which is fifty feet high. The mast is $6\frac{3}{4}$ inches in diameter tapering in the top section to two inches at the tip. It is made up of five telescoping sections mounted on a large pivot type insulator to allow for variations in wind pressure. The antenna is designed to withstand an actual wind velocity of ninety M. P. H. Erection was under the supervision of W. J. Holey of Atlanta. The weight of this type mast, being only 750 pounds for this height, makes it ideal for erection on roofs of buildings where weight is an important factor. Jimmy Burke, Chief Engineer of the station, claims an average field strength at one mile of twice that of the old antenna with no increase in power. The antenna is fed with a concentric transmission line from the transmitter some 120 feet distant.



The new antenna at WRGA, Rome. An ideal type where it is necessary to place the antenna on the roof of a building.

PROBABLE PERCENTAGE MODULATION

(Continued from Page 27)

ator) in such a way as to obtain 100% modulation constantly, at every instant during operation. In the first case the gain control should naturally be set so as to obtain exactly 100% modulation with the loudest sound ever to be broadcast, and in the second case, there should naturally be sufficient gain available in the microphone amplifiers to give 100% modulation with the weakest sounds encountered.

It is easy to show that these two cases provide actual limits to the modulating energy occurring at the various frequencies. The percentage of modulation existing under the first assumption represents a lower limit to that which is likely to be found. The transmitter is then adjusted to be modulated 100% by only one source of sound, i.e., the most intense one. This maximum intensity occurs at only one frequency, so that, at all other frequencies, the percentage of modulation is necessarily smaller. Under the second assumption, the modulating energy obtained represents an upper limit, since the transmitter, in this case, can be modulated 100% at many more than one frequency.

Computing Modulating Energy

For our purpose then, it is sufficient to compute the modulating

HOOSIERS LISTEN IN ON NEW WSBT

(Continued from Page 19)

ule. From 1360 kc., WSBT, to 1200 kc., WFAM, is quite a jump on the dial but experience has shown us at WSBT-WFAM, that good programming and the ability to give the people real radio service

energy obtained at various audio frequencies under these two assumptions. In the first case, the highest sound pressure observed in each one of the 13 bands is taken, without any consideration as to which instrument produces it. The greatest of these energy values is then chosen as giving 100% modulation in the transmitter, and the twelve other figures are converted accordingly to obtain the corresponding percentage of modulation in each band. This is shown graphically in Fig. 1. It is convenient to speak of the modulation percentages thus obtained as resulting from absolute sound pressures, since these pressures are arranged according to their absolute magnitude.

Under the second assumption, the highest sound pressure in each band is also taken, but in this case the relative value of this pressure is considered rather than its absolute magnitude. The modulation percentage obtained in any one of the thirteen bands is

has taught them that it is wise to change when stations change.

The transmitter house is modern in every respect and the grounds around the bungalow have been landscaped and gardened.

WSBT-WFAM invite visitors to South Bend to call and inspect the station and equipment.

equal to 100% whenever an instrument (or combination of them) develops sound energy reaching a maximum within that band. When there is no maximum within a particular band, the modulation percentage corresponds to the sound pressure of that instrument (or group of them) which is closest to its maximum. The results can be represented as shown in Fig. 2. The dip of the curve to 63% modulation between 1000 and 1400 cycles simply means that no source of (musical) sound could be found which developed more than 63% of its maximum energy within that band. The curve shows, however, that instruments were found which developed their maximum energy at every other frequency up to 2800 cycles. Beyond this point, no instrument or orchestra has any maximum. Modulation percentages shown on Fig. 2 correspond to relative sound pressures, since these pressures are chosen according to their value with respect to an arbitrary maximum.

FIG. 5

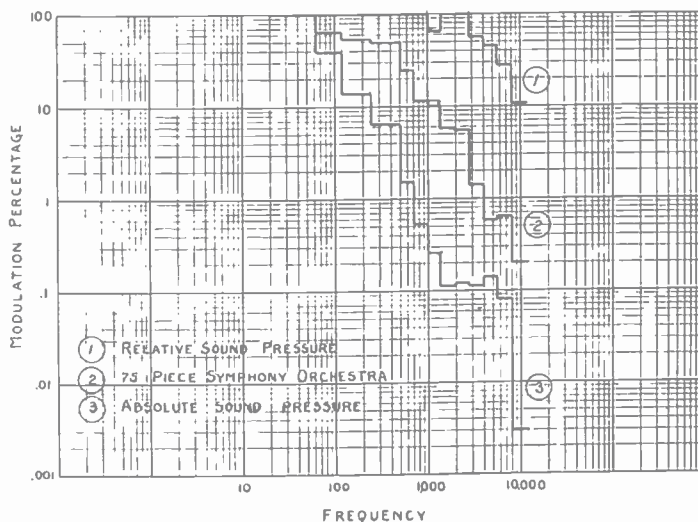

Comparison

For purposes of comparison, the modulation percentages from a 75 piece orchestra, and for normal speech, are shown in Figs. 3 and 4. The values given also correspond to relative sound pressures. That is to say, 100% modulation corresponds in each case with the maximum sound pressure of the particular source considered.

Fig. 5 shows both the modulation from absolute and from relative sound pressures (Figs. 1 and 2,) together with the modulation from a symphony orchestra. It is interesting to note that the modulation percentages given for the orchestra fall in each frequency band between the limits assigned by the values of Figs. 1 and 2.

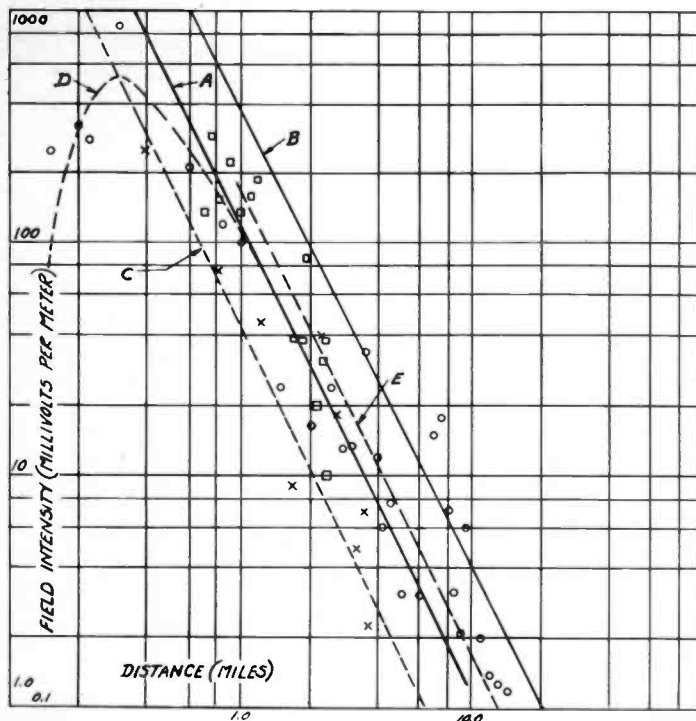

Fig. 15

TURNSTILE ANTENNA

(Continued from Page 30)

Curve A, Fig. 15, shows the curve calculated from this formula, on the basis of 1,000 watts and a power gain of 4. Curves B and C are reference lines placed 10 db above and below A. Curve D is computed from a more exact formula. The points shown on Fig. 15 are the measured points on the basis of 1,000 watts, when the horizontal receiving antenna was 8 meters from the surface of the earth. The points are naturally scattered since the measurements were made through the city.

The theoretical curves show that the field intensity drops off as the inverse square power of the distance, and thus is a straight line with a slope of -2.0 when plotted on log paper. By means of the theory of least squares, an analysis was made of the experimental points for all measurements made at one mile or more. The best straight line on log paper was found to have the equation

$$E = 170/r^{1.98}$$

where E is the field strength in millivolts per meter and r is the distance in miles. Curve E, Fig. 15, shows this equation.

When the 45 megacycle anten-

na was placed in operation, another striking effect was noticed. Observers reported that, in districts where signals from a single half-wave antenna had fluctuated as much as ten to one due to changes in field distribution due to moving automobiles and possibly elevator cables, the signal from the turnstile only shifted between limits whose ratio was two to one. This effect is probably due to the fact that the transmitting antenna is spread through a space two and one-half wave lengths long, thus giving "diversity" effect.

GRAPHIC RECORDING OF FIELD INTENSITIES

(Continued from Page 28)

eral advantages are provided by the logarithmic scale. In the first place, the extent of the average fading swings can be read almost directly in decibels—certainly more easily so than on a linear scale. In the second place, the minimum points—which in the case of skywaves are all important—are read more accurately, and far more easily, due to the fact that the lower part of the scale is greatly enlarged. And finally, of course, there is the fact that the

decibel variation in signal strength reflects more closely the actual performance than does the linear scale.

Although the output of the TMV-75-B is linear, it can be used to make logarithmic recordings by employing a separate logarithmic direct-current amplifier. The output of the field intensity meter is approximately linear over only 15

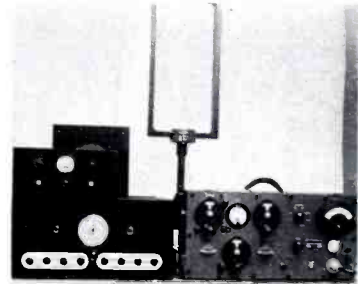

FIG. 13. An arrangement of equipment, similar to Fig. 10f, for making records at a fixed point. The recorder (not shown) is driven by the receiver-amplifier combination, the meter being reserved for calibration. The amplifier operates from the AVC circuit of the receiver, and also takes its power supply from the latter.

to 20 db. However, by properly compensating the amplifier used, and allowing the output meter to run a little off scale, it is possible to obtain a good logarithmic recording up to nearly 50 db. A special amplifier designed to accomplish this (as well as similar applications) is shown in Fig. 14. For those who are interested, this amplifier has been described in detail elsewhere.

In addition to linear and logarithmic recordings, other special types of recordings, as, for instance, of the interference on shared channels, are not only possible, but also quite practical.



FIG. 14. A setup for making logarithmic recordings. The special linear-logarithmic amplifier shown at the left may be operated either from the receiver or from the recorder direct. It is arranged for either battery or a.c. supply.

A REVIEW OF BROADCAST ENGINEERING

Articles in Leading Publications, July-September, 1936

Reviewed by
J. P. TAYLOR

ADVANCED DEVELOPMENT

Prof. Armstrong's System—What it Means, by Paul F. Godley, *Broadcasting*, July 1, 1936, Pg. 72.

A well known consultant explains briefly some of the possibilities of frequency modulation in the future development of broadcasting—possibilities which, to date, have perhaps not been fully appreciated.

Ultra-High-Frequency Transmission Between the RCA Building and the Empire State Building in New York City, by P. S. Carter and G. S. Wickizer, *IRE Proc.*, Aug. 1936, Pg. 1082.

Some notes on an experimental 117 mc. channel designed for the broad band transmission requisite for high-definition television.

ALLOCATION

FCC in Half Year Grants 22 Stations, *Broadcasting*, July 1, 1936, Pg. 87.

FCC Authorizes 10 New Stations Prior to Recess, *Broadcasting*, July 15, 1936, Pg. 24.

New stations authorized by FCC during 1936.

NAB Allocation Report, excerpts from testimony by Dr. Charles B. Aiken, *Comm. and Broadcast Eng.*, July 1936, Pg. 5.

NAB Seeks Long Waves, from testimony of Dr. Charles B. Aiken, *Broadcasting*, July 1, 1936, Pg. 41.

Two resumes of Dr. Aiken's testimony at the June hearings, in which he advocated, and presented data in favor of, broadcast authorizations at frequencies in the neighborhood of 200 kilocycles.

ANTENNAS

The Grounded Vertical Radiator, *Bell Labs. Record*, Aug. 1936, Pg. 387, by J. F. Morrison.

First authoritative writeup of the grounded (Shunt-excited) vertical radiator which has been successfully employed at several stations. Such antennas should simplify erection and lighting arrangements—and are less subject to the effects of lightning. This article is purely introductory and no details of design or adjustment are given.

Directive Antenna Solves Coverage Problem, by J. F. Morrison, *Bell Labs. Record*, Sept. 1936, Pg. 17.

Directional arrangement employed at WJAR to reduce interference.

FIELD INTENSITY

Field Strength Measurements, by H. M. Smith, *Electronics*, Aug. 1936, Pg. 20.

Brief note on the importance of field intensity measurements. The field intensity measuring equipment used by the Canadian Radio Broadcasting Commission is illustrated, but no description is given.

Sommerfeld's Formula, by W. A. Fitch, *Electronics*, Sept. 1936, Pg. 23.

A short but outstanding note on the use of Sommerfeld's Formula in calculating (from a minimum amount of accurate data)

the expectable fields of broadcast stations. Simplifications of the complete formula are introduced by using an average value of dielectric constant in all cases, and by adopting a standard of conductivity to which all other conductivities are referred. Curves based on these assumptions are presented. These are arranged in the most usable manner conceived to date, and—since they have been correlated with a large amount of measured data—probably represent the most dependable information available.

MEASUREMENT

Convenience in Noise Measurement, *General Radio Exp.*, Sept.-Oct. 1936, Pg. 1.

Brief description of a new sound-level meter which is completely self-contained and unusually convenient where a portable equipment is required.

A Direct-Reading Frequency Meter with Built-in Calibrator, *General Radio Exp.*, Sept.-Oct. 1936, Pg. 9.

A short description of a new direct-reading frequency meter designed especially for use at frequencies above 10 megacycles.

A General Purpose V. T. Voltmeter With Ray-Tube Indicator, by F. T. Griffin, *QST*, Aug. 1936, Pg. 19.

A simple form of wide-range vacuum tube voltmeter in which a 6E5 tube is used as an indicator.

Putting the Oscilloscope to Work, *Service*, July 1936, Pg. 299.

Some ideas on the use of the cathode-ray oscilloscope in various fields of radio engineering. Points out the fact that many radio men have failed to appreciate or make use of the many possibilities of this instrument.

MICROPHONES

A Static Velocity Microphone, *Electronics*, Sept. 1936, Pg. 21.

A short description of a new type of microphone which while not claimed to possess broadcast-quality response is, nevertheless, interesting as still another development in this field.

MODULATION

Broadcast Station Modulation Monitors, by J. P. Taylor, *Comm. and Broadcast Eng.*, July 1936, Pg. 18.

Some comments on the design and operation of the modulation monitors approved by the FCC for broadcast station use.

Modulation Measurement, *Electronics*, Aug. 1936, Pg. 23.

A discussion of various possible means of measuring modulation, with some comparisons of the resulting readings under various conditions.

OPERATION

WOR'S Queen Mary Broadcast, *Comm. and Broadcast Eng.*, July 1936, Pg. 10.

A schematic diagram of the complex ar-

angement utilized to obtain complete coverage of the initial arrival of the Queen Mary.

Micro-Waves in NBC Remote Pickups, by R. M. Morris, *RCA Review*, July 1936, Pg. 41.

A description of the micro-wave (Acorn tube) transmitter developed by NBC for remote pickups—with some interesting comparisons with earlier type transmitters.

POLICE

The Illinois State Police-Radio System, *Comm. and Broadcast Eng.*, Sept. 1936, Pg. 9.

A description of the unusually complete police radio system recently installed by the State of Illinois.

Mobile Receiving Equipment, by C. A. Brokaw, *Comm. & Broadcast Eng.*, Sept. 1936, Pg. 5.

Detailed description of the automobile and motorcycle receivers utilized with the above systems.

A Modern Two-Way Radio System, by S. Becker and L. M. Leeds, *IRE Proc.*, Sept. 1936, Pg. 1183.

A rather complete description of the problems encountered in designing two-way police systems, with a description of several types of equipment designed especially for such case.

SPEECH INPUT

Loud Speaker Measurements, by F. Massa, *M. Sc., Electronics*, July 1936, Pg. 18.

The second article in this very timely series. Particularly outstanding for the emphasis given to the practical aspect of a subject too often discussed in terms of theory beyond the grasp of the average reader.

Theory of the Loudspeaker and of Mechanical Oscillatory Systems. Part I, by H. Roder, *Radio Eng.*, July 1936, Pg. 10.

Theory of the Loudspeaker and of Mechanical Oscillatory Systems. Part II, by H. Roder, *Radio Eng.*, Aug. 1936, Pg. 21.

Theory of the Loudspeaker and of Mechanical Oscillatory Systems. Part III, by H. Roder, *Radio Eng.*, Sept. 1936, Pg. 24.

First three parts of a very complete mathematical development.

Resistance-Coupling Design Charts, by G. Koehler, *Electronics*, Aug. 1936, Pg. 25.

A chart—with detailed instructions—for determining gain in terms of tube and circuit constants by conveniently rapid method.

Stabilized Feedback—New Control Principle Produces High Stability and Fidelity and Eliminates Distortion in Amplifier, by H. S. Black, *Pickups*, July 1936, Pg. 12.

An interesting discussion of the use of stabilized negative feedback (degeneration) to improve the overall performance in various types of audio frequency and modulated radio-frequency circuits. Curves showing the improvement in response and distortion as a function of feedback are presented.

Feedback Amplifiers. Electronics, July 1936, Pg. 30.

A short resume of the preceding paper.

Inverse-Feedback Circuits for A-F Amplifiers. Radio Eng., Sept. 1936, Pg. 11.

Another general discussion of inverse feedback, with particular attention to the application to beam power tubes. Some typical circuits and expectable results are given.

An Effective Oscillator. by F. J. Burriss. Radio News, July 1936, Pg. 18.

B. F. Oscillator. by J. H. Potts, Radio News, Sept. 1936, Pg. 154.

Two "How-To-Make-It" articles on simplified types of audio oscillators.

Beat Frequency Oscillators. by A. W. Barber, Radio Eng., July 1936, Pg. 13.

Some notes on the design of beat frequency oscillators, with some suggested methods for reduction of harmonic content and improvement of stability.

A New Variable-Antenuation Equalizer. by S. F. Stewart, Radio-Craft, Aug. 1936, Pg. 80.

Description of a new equalizer unit of simple design which provides for choice of starting attenuation point by means of a six position selector switch.

Balanced Amplifiers. Part III. by A. Preisman, Comm. & Broadcast Eng., Sept. 1936, Pg. 13.

Continuation of a series of articles reviewed previously.

Fundamentals in the Application of Matrices to Electrical Networks. Part II. by J. D. Pernice, Comm. & Broadcast Eng., July 1936, Pg. 12.

Fundamentals in the Application of Matrices to Electrical Networks. Part III. by J. R. Pernice, Comm. & Broadcast Eng., Aug. 1936, Pg. 11.

Conclusion of a series of articles reviewed previously.

Decibel Level of Harmonics. Radio Eng., Aug. 1936, Pg. 18.

Chart for determining harmonic level in decibels when power or voltage ratio is given.

Reflection Loss Due to Mismatch. Radio Eng., Aug. 1936, Pg. 28.

Chart for determining loss in decibels when the ratio of impedances is given.

TELEVISION

The Farnsworth Television Receiver. Radio Eng., Sept. 1936, Pg. 14.

The Farnsworth Receiver. Comm. & Broadcast Eng., Sept., 1936, Pg. 10.

A brief description, illustrations and diagrams of the Farnsworth television receiver.

RCA Television Field Tests. RCA Review, by L. M. Clement and E. W. Engstrom, July 1936, Pg. 32.

A brief note on the actual operating tests which are being conducted in order to determine more definitely the necessary standards for satisfactory service, and the degree to which present equipment approximates these standards.

Iconoscopes and Kinescopes in Television. RCA Review, by V. K. Zworykin, July 1936, Pg. 60.

The inventor of the iconoscope and kinescope presents a review of the essential

part played by these devices in making possible the present advanced position of television development.

New Developments in Television. by R. D. Washburne, Radio-Craft, Aug., 1936, Pg. 74.

Some notes on the publicity attendant on recent releases referring to RCA television plans.

Television on the West Coast. by Don Lee, Radio-Craft, Aug., 1936, Pg. 76.

A description of the television transmission being carried on by W6XAO of the Don Lee network.

The Importance of Interlaced Scanning. by U. A. Sanabria, Radio-Craft, Aug. 1936, Pg. 79.

An explanation of the reasons for using interlaced scanning. Clears up some of the misconceptions associated with this subject.

Television Progress in Italy. Radio-Craft, Aug. 1936, Pg. 86.

A description of the most recent equipment developed by Arturo Castellani.

Note: The August issue of Radio-Craft, which is designated as a "Special Television Number" also contains other short articles on various aspects of television development.

TRANSMITTER DESIGNS

Design and Equipment of a Fifty-Kilowatt Broadcast Station for WOR. by J. R. Pople, F. W. Cunningham and A. W. Kishpaugh, IRE Proc., Aug., 1936, Pg. 1063.

Description of the equipment and antenna system installed at WOR. Includes schematics of speech input, transmitter and antenna coupling equipment, together with over-all measured characteristics.

A New High Efficiency Power Amplifier for Modulated Waves. by W. H. Doherty, IRE Proc., Sept. 1936, Pg. 1163.

The paper, originally presented by Mr. Doherty at the Cleveland Convention, in which is described a linear amplifier arrangement capable of providing efficiencies considerably greater than the conventional arrangement.

The Doherty Circuit. by W. H. Doherty, Pickups, July 1936, Pg. 4.

The Doherty Circuit. by F. Siemens, Radio News, Aug. 1936, Pg. 88.

Two short resumes of the above paper.

Dynamic Shift, Grid Bias Modulation. by F. E. Terman and F. A. Everest, Radio, July 1936, Pg. 22.

Another presentation of the dynamic-shift amplifier (in which improved non-modulated plate efficiencies are obtained by reduction of modulated capacity at the zero modulation point).

Recent Developments of the Class B Audio—And Radio—Frequency Amplifiers. by L. E. Barton, IRE Proc., July 1936, Pg. 985.

Some further notes on Class B amplifiers by the well-known engineer who first developed the use of high-efficiency Class B modulating systems. The requirements for low distortion are taken up, and the fallacy of the widely-prevalent idea that the driver system should be heavily loaded pointed out.

General Theory and Application of Dynamic Coupling in Power Tube Design. by C. F. Stromeyer, IRE Proc., Pg. 1007.

Discussion of method (called "Dynamic Coupling") of driving an audio power-output tube.

Reactors in D-C Service. by R. Lee, Electronics, Sept. 1936, Pg. 18.

Methods for designing and rating iron-core audio reactors in terms of the steady direct current they must carry.

Superstability for Radio Carriers. by O. M. Hovgaard, Pickups, July 1936, Pg. 8.

Description of, and data on, the new Type 702A Crystal Oscillator Unit (using AT-cut crystal) which provides an improved degree of frequency stability.

New 100-250 Watt Transmitter Uses Small Tubes, Less Current. by R. E. Coram, Pickups, July, 1936, Pg. 6.

Short description—with illustrations and diagram—of the new Type 23A (100-250 watt) broadcast transmitter.

Transmitter Adjustments. by J. G. Sperling, Electronics, July 1936, Pg. 15.

Some pertinent ideas on a subject on which too little information has been made available. Includes several useful and convenient charts.

TUBES

The 300A Vacuum Tube. by J. O. McNally, Bell Labs. Record, July 1936, Pg. 365.

Description, and characteristics, of the new Type 300A Tube for audio output circuits.

Working at One Meter and Below. by R. A. Hull, OST, Sept. 1936, Pg. 22.

Description of the new Type 316A Tube designed for use at ultra-high frequencies. Includes some suggestions on appropriate circuits.

Master of Megacycles. by C. E. Fay, Pickups, July 1936, Pg. 10.

Description, with characteristics, of the new Type 304B Tube designed for operation in the range from 30 to 300 megacycles.

What You Want to Know About Tubes. by The Staff, Radio News, July 1936, Pg. 10.

An up-to-date chart, or series of charts, giving operating data and socket connections of all modern receiving tubes. Arranged in logical manner for easy comparison.

WIRED RADIO

High Fidelity Wired Sound. by N. J. Lessem, Radio-Craft, Aug. 1936, Pg. 81.

A brief description of the service provided by the Muzak Corporation (subsidiary of Wired Radio, Inc.). Interesting because of relation to present broadcast services.

Rediffusion in Great Britain, Part II. by P. Adorian, Comm. & Broadcast Eng., Aug. 1936, Pg. 8.

Some technical details of this very interesting English practice.

MISCELLANEOUS

Cosmic Cycles and Radio Transmission. by H. T. Stetson, Ph. D., Proc. Radio Club of America, July 1936, Pg. 11.

Authoritative and interesting discussion of the relation of such factors as sunspot activity and earth magnetism to radio transmission.

Remote Receiver Tuning at KDYL. by J. M. Baldwin, Electronics, Aug., 1936, Pg. 19.

Discussion of the method one station has employed to solve the press reception problem.



TO THE BROADCASTERS

... of this and the many other lands with whom we have enjoyed such pleasant relations during the past year, we wish once again to put into words that are old, a sentiment which must remain forever new—

A Merry Christmas!

A Happy and Prosperous New Year!

J. R. Baker



Frequency Measuring Service



To Our Radio Friends:

While playing Truant Officer on the ether lanes for numerous Broadcasting, Police, Aviation and Commercial Stations throughout the U. S. A., Canada, Mexico and the West Indies, our operators picked up old Santa Claus conducting tests on his ultra short wave transmitter.

This prompts us to put in print those pleasant thoughts that have been uppermost in our minds during the year 1936. That is, we want to express our most genuine heartfelt thanks to the numerous subscribers to the RCA Frequency Measuring Service, as well as the entire Radio Industry.

1936 has been an excellent year in all branches of the Industry, and here's wishing you and yours an even more prosperous 1937.

Sincerely yours,

Arthur A. D. Bell

... Broadcast Equipment ...



High Fidelity Broadcast Transmitters, 100 watts to 500 KW

Ultra High Frequency Transmitters

Mobile transmitters and receivers

Microphones for Every Purpose

Microphone Stands

Mixers

Monitoring Amplifiers

General Purpose Amplifiers

Pre-Amplifiers

Program Amplifiers

Line Amplifiers

Portable Broadcast Amplifiers

Frequency Monitors

High Quality Station Monitoring Equipment

Complete Studio Installations

Modulation Indicators

Portable Remote Pickup Equipment

Transcription Turntables

Instantaneous Recording Equipment

Sound Effects Equipment

Field Intensity Measuring Equipment

Beat Frequency Oscillators

Cathode Ray Oscillographs

Transmitting Power Tubes for Every Purpose

