

BROADCAST NEWS



In this Issue

• FROM THE TOP OF THE WORLD

• NORTH OF THE BORDER

• CALCULATION OF T. I. F. FOR TRANSMITTER LOADS

PHILADELPHIA INSTITUTE
PHILADELPHIA



RCA Manufacturing Company, Inc.

A Service of Radio Corporation of America

Camden, N. J.

"RADIO HEADQUARTERS"

J. L. SCHWANK, Manager

ENGINEERING PRODUCTS DIVISION

TRANSMITTER SALES SECTION

(OF ENGINEERING PRODUCTS DIVISION)

I. R. BAKER, Manager

L. BEACH, Affiliate Company Contact	H. C. VANCE, Facsimile and Communications Equipment
C. M. LEWIS, Speech Input Equipment	EDWARD BRADDOCK, Amateur Equipment
W. L. LYNDON, Speech Input Equipment	J. A. FRIED, Faradon Condensers
T. A. SMITH, Television Equipment	T. W. ENIS, Affiliated Companies
H. E. RHEA, Television Equipment	S. W. GOULDEN, Commercial Engineer

1 **EASTERN DISTRICT** I. R. Baker, Manager and CBS Contact, 120 Sixth Ave., New York City; R. P. May, Assistant, W. S. High, Assistant

MAINE	RHODE ISLAND	VIRGINIA	WEST VIRGINIA
NEW HAMPSHIRE	CONNECTICUT	DELAWARE	NORTH CAROLINA
VERMONT	NEW YORK	MARYLAND	(Broadcast)
MASSACHUSETTS	NEW JERSEY	PENNSYLVANIA	

2 **CENTRAL DISTRICT** W. H. Jones, Manager, 289 E. Illinois Street, Chicago, Illinois; A. Josephsen, Assistant, I. M. Pratt, Assistant

ILLINOIS	NEBRASKA	MISSOURI	OHIO
SOUTH DAKOTA	WISCONSIN	IOWA	MICHIGAN
MINNESOTA	ILLINOIS	KENTUCKY	INDIANA
			KANSAS CITY (KANSAS)

3 **WESTERN DISTRICT** W. H. Belt, Manager, 1016 N. Sycamore Street, Hollywood, California; Edmund Frost, Assistant, 170 Ninth Street, San Francisco, California

WASHINGTON	IDAHO	UTAH	MONTANA
OREGON	NEVADA	ARIZONA	WYOMING
	CALIFORNIA	HAWAII (Police)	ALASKA (Police)

4 **SOUTHWESTERN DISTRICT** W. M. Witty, Manager, Santa Fe Building, Dallas, Texas; J. P. Taylor, Assistant

TEXAS	ARKANSAS	NEW MEXICO	KANSAS (Except Kansas City)
OKLAHOMA	COLORADO		LOUISIANA (Except New Orleans)

5 **SOUTHEASTERN DISTRICT** D. A. Reesor, Manager, 530 Citizens and Southern Bank Bldg., Atlanta, Ga.

TENNESSEE	GEORGIA	ALABAMA	NORTH CAROLINA (Police)
MISSISSIPPI	FLORIDA	NEW ORLEANS (LA.)	SOUTH CAROLINA

POWER TUBES	BROADCAST TRANSMITTERS
POLICE TRANSMITTERS	POLICE RECEIVERS
TEST EQUIPMENT	AVIATION RADIO EQUIPMENT
SPECIAL COMMUNICATION EQUIPMENT	FACSIMILE EQUIPMENT
TELEVISION EQUIPMENT	

STUTSON WILMARTH
ANNOUNCING

BROADCAST NEWS

REG. U. S. PAT. OFF.

PAUL V. LUTZ, Editor

BOARD OF ADVISORY EDITORS

J. B. Coleman	Transmitters	M. C. Batsef	Test Apparatus and Studio Equipmt.
V. E. Trouant	Transmitter Development	F. X. Rettenmeyer	Receivers
E. W. Engstrom	Television	Dr. Irving Wolff	Microwaves
Dr. V. K. Zworykin	Electronic Research	Dr. H. F. Olsen	Acoustics
	DR. G. H. BROWN		Special Research

NUMBER 32

MARCH, 1940

TABLE OF CONTENTS

Cover Design—A Glimpse of the Midnight Sun Through the KFAR Antenna.	
WCKY—Fifty Grand in Watts	2
C. H. Topmiller	
From the Top of the World	3
(Photos—Pages 4-5) Photos by Hylan Photo Shop	
Stanton D. Bennett	
New Equipment to Measure Intensity of Radio Noise	6
Charles M. Burrill	
The New Standard Volume Indicator and Reference Level	8
R. M. Morris	
North of the Border	11
(Photos—Pages 12-13)	
Edmund A. Laport	
Flexible and Compact	14
L. J. Flodman	
New Communications Receiver	16
Edward Braddock	
It's Modern—It's WFMJ	17
(Photos—Pages 18-19)	
F. A. Dieringer	
Parallel Mixer Circuit Calculations	22
C. W. Slaybaugh	
Calculation of T.I.F. for Transmitter Loads	24
J. C. Walter	
WHBC Among the Leaders	28
Doing a Man-Sized Job in Mansfield	32
From the Arctic to the Tropics	36

Published in the Interest of the Radio Broadcasting Industry
and Copyrighted, 1940, by the

RCA MANUFACTURING COMPANY, INC.

CAMDEN, NEW JERSEY, U. S. A

WCKY—FIFTY GRAND IN WATTS

Plus New Speech Input Layout for Hotel Gibson Studios

By C. H. TOPMILLER

IN October of 1939 WCKY moved its main studio location from Covington, Ky., to the Hotel Gibson in Cincinnati, where three modern studios were constructed.

In order to take full advantage of the high fidelity characteristic of our new RCA 50-D, 50 KW transmitter which was put on the air in July of 1939, it was decided to install new speech input in these studios which would have frequency response, distortion, and noise level characteristics equal to or better than the transmitter. RCA speech input was chosen for the job.

Custom Built

While the speech input system was assembled from standard RCA speech input components it was "custom built" to suit our needs. A conference between the writer, Mr. Curtiss, Mr. Colvin and Mr. Wilson of RCA in Indianapolis, was held at which time the speech input system was planned which embodied all the features we desired.

Briefly the system consists of a master control assembled on four racks and two racks of studio equipment. The master control has three outgoing channels and provision for five studios. Four of



Fig. 2. The control console for Studio A.



L. B. Wilson, President and General Manager of WCKY, at the dedication of the new studios.

these studio positions are already in use. Three are assigned to the regular studios and the fourth to the Hotel Gibson Ballroom where audience shows are held. The three outgoing channels are assigned; one for feeding WCKY transmitter, one for feeding CBS, and the third for feeding the recording equipment. Master Control also has provision for terminating 24 incoming remote program lines and 24 remote order lines, as well as four tie trunks to each studio. The incoming CBS program line is fed through an 84-A line amplifier and then into an isolating pad which provides 50 DB isolation between the five branches that feed the separate studios.

Monitoring Facilities

Monitoring facilities on Master Control provide for monitoring the five studios, the three outgoing lines and the incoming CBS line. Ten office monitoring busses are also fed from master control and, by means of a selector switch at each office monitor speaker, any of the following busses may be selected in each office. These are the three outgoing lines, any one of the five local stations, the incoming CBS line and an audition buss on which special auditions are fed to

(Continued on Page 21)

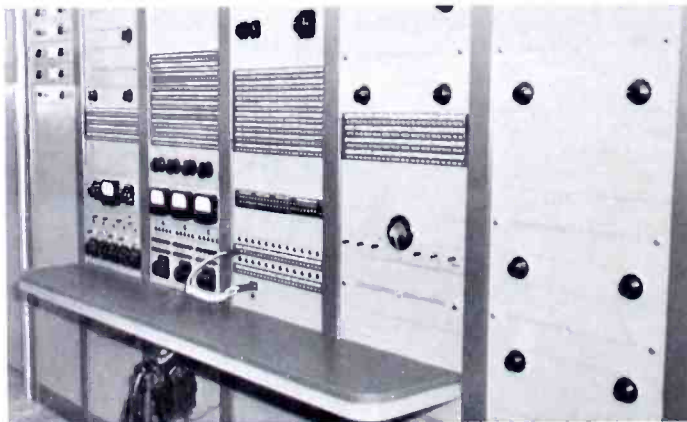

Fig. 1. A portion of the six speech input racks.

FROM THE TOP OF THE WORLD

Far North Installation Goes RCA All the Way

By STANTON D. BENNETT
Chief Engineer, KFAR

AT no spot on earth does radio play a more important role than it does in Alaska. Wire facilities in this extensive territory nearly one-fifth as large as the United States are practically non-existent. The trapper "mushing" his way from cache to trap line returns to his cabin with nothing but a portable battery set for entertainment and news of the outside world. Mining camps isolated except for an occasional airplane dropping food supplies and mail again rely on radio to shorten their long winter evenings.

A Memorial to Alaska

And until October 1st of this year the people of interior Alaska were without broadcast radio reception nearly 10 months of the year. "Outside" stations, the closest nearly 1500 miles away, were received only under favorable conditions. Programs from shortwave international broadcasts are subject to fading and are unreliable, to say the least. It remained for Captain A. E. Lathrop, a generous "sourdough" who has made and spent his money in Alaska for the past 40 years, to bring to the people of interior Alaska their first real broadcast reception.

The station was constructed as a memorial to the people of Alaska, and no expense was spared in making it modern to the last word of engineering.

KFAR's Transmitter Igloo

Just 15 minutes drive west of Fairbanks and 1½ miles north of the University of Alaska is a one-story white all-concrete structure the control room of which houses the RCA 1000-watt type 1G standard broadcast transmitter and associated controls. To the right is a modern five-room completely furnished apartment offering living quarters for the station engineers. To the left is the boiler

room, automatic coal stoker, and hot water heating system designed for the severest Alaskan winter. A double garage adequately heated to cope with winter driving conditions occupies the remaining portion of the left wing.

Ice at 40 Feet Below

Construction of the station was begun in early June of 1939, and with the aiding light of the midnight sun (daylight nearly 22 of the 24 hours) two and three shifts were worked the early part of the summer to complete construction during the relatively short building season. The first problem encountered occurred when well drillers were forced to go 256 feet before striking water. Much of the drilling was through layers of frozen soil and ice 15 to 20 feet thick, as there is little opportunity for thawing 3 or 4 feet below the surface.

Building construction in the north country necessarily takes into consideration the fact that temperatures of 50 and 60 degrees below zero are not the least uncommon during winter months. Precautions are made to take care of frost formations on the inside of 8 inch concrete walls which are further insulated by dead air spaces, celotex, roofing paper, ply board, plaster board, and 1-inch cork.

It might be mentioned that concrete buildings in this section of the country are about as scarce as the mythical "Alaskan ice-worm." The freight charges alone are somewhat over three times the original price of cement.

Twelve thousand nine hundred and eighty three pounds (4 miles) of 6-pair lead cable was suspended beneath a private 2300-volt power line to carry programs and telephone service between studios and transmitter. Again ice and frozen ground were encountered in putting in 5-foot post holes

where it required several weeks of labor to install and guy poles across swampy areas.

300-Foot Shunt-Fed Vertical Is the Final Word

The choice of a grounded tower was necessitated by the rather severe ice formations which would have rendered an insulated radiator less efficient or inoperative without heating devices. A 300-foot Lehigh vertical was the final choice, erected immediately behind the transmitter building and shunt-fed directly from the transmitter at 50 percent of the tower height.

Approximately 11½ miles of No. 12 copper radials were then plowed 12 to 18 inches underground every three degrees from the base of the antenna. The radials ranged in length from ¼ to ⅓ wave.

Dual Diversity Reception

News of the first importance to the average Alaskan, some of whom see a daily newspaper less than once a month in the many remote sections! and news has turned out to be one of KFAR's primary services with 5 news periods scheduled throughout the day. A problem not occurring to the average station in the states with telephone, telegraph, and teletypewriters hourly rolling off volumes of news, is the obtaining of sufficient material for such broadcasts.

Reception of short-wave press schedules from New York and San Francisco has proved to be the only satisfactory solution. To cope with the unusual and somewhat erratic receiving conditions, two directional rhombic beam antennas were installed to be used with dual diversity receiving methods. Special efforts were made during building construction to bond all metal objects, shield the control room with cop-

(Continued on Page 30)

KFAR STAKES CLAIM TO CENTRAL

"Top-of-the-World" Station



▲
 "Cap" A. E. Lathrop looks over plans for the latest and most ambitious enterprise of his career—America's farthest north broadcasting station.



▲
 A portion of KFAR's transmitter control. Chief Engr. Stan Bennett at the console. Door to the right gives quick accessibility to RCA 1-G transmitter.



Hylon Photo Shop

▲
 KFAR Studio control room layout. Studio "A" front and center and studio "B" to the right.



▲
 Somewhere In Alaska groups like this are becoming radio conscious.

ALASKA RADIO LISTENERS

Tops in Equipment

Chief Engr. Stan Bennett takes the ice off the KFAR lead-in during some 35 degrees below zero weather.

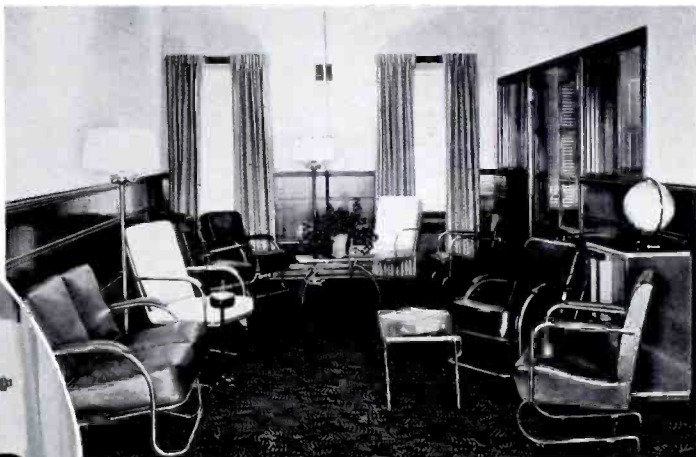
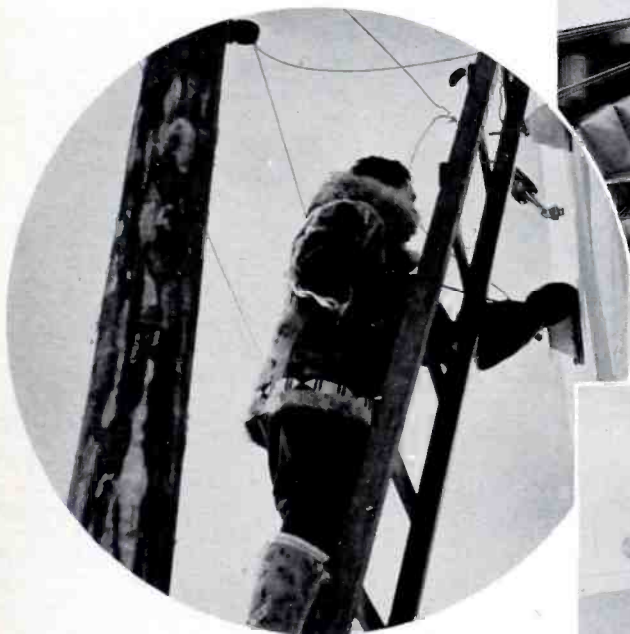

▲ The KFAR Reception Room.

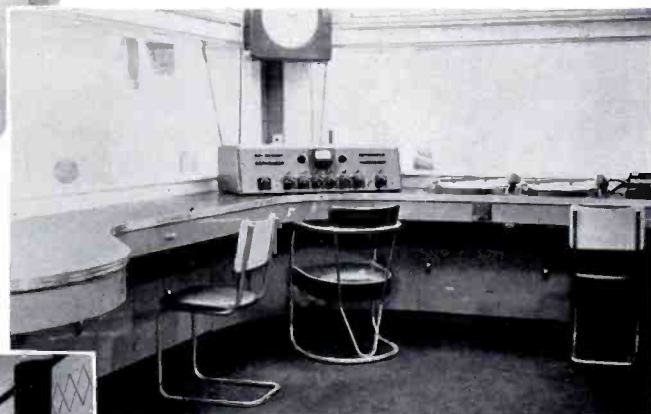

▲ Corner of the control room showing RCA 76-B Consolette.



Hylan Photo Shop

▲ The RCA 77C Mikes in Studio "A"—KFAR, Fairbanks Alaska.

▶ KFAR transmitter house. Location — 6 miles northeast of Fairbanks and 1½ miles north of the University of Alaska.

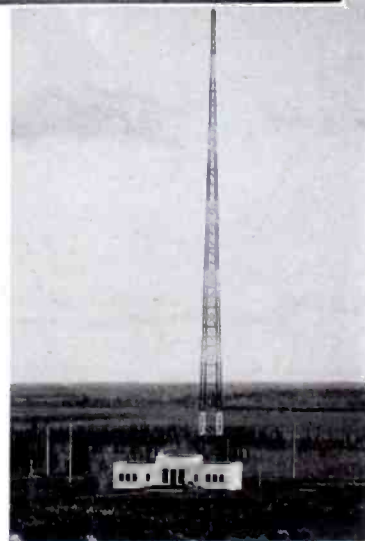

NEW EQUIPMENT TO MEASURE INTENSITY OF RADIO NOISE

RCA 312-A Noise Meter Designed to Aid in Securing Better Reception in the Future

By CHARLES M. BURRILL

IN the battle between field intensity and radio noise, which determines broadcast service, field intensity gets most of the attention. This is partly because field intensity is a simple fellow, easy to measure by straightforward methods, whereas radio noise is an elusive and subversive rascal, most difficult to catch and measure. However, the result of the battle, or signal-to-noise ratio, is the important thing, and this is often improved far easier by reducing noise than by increasing signal. Hence the measurement of radio noise is important as the best preliminary to noise reduction.

To those who have never made radio noise measurements the problem usually appears extremely simple. The specialist in noise



Front view of the RCA 312-A Noise Meter.

measurements is frequently "on the spot" to explain why all the bother about method. But the extensive literature* on the subject demonstrates that the matter is not simple. The experienced agree that method is very important, and that it is much easier to obtain readings than to make noise measurements that are really significant. One reason for this is that the ultimate judge of broadcast service is the listener's ear. Thus the seriousness of noise is in the realm of sensation, of psychology, and not merely a cold physical quantity.

Method

Until recently there has been little agreement as to the proper method to use in measuring radio noise. In particular, the methods used by many radio engineers were different from those generally used by electrical engineers working to prevent the generation of radio noise by electrical equipment. This situation has now been remedied by agreement, in the Joint Coordination Committee on Radio Reception of the Edison Electric Institute, the National Electrical Manufacturers Association, and the Radio Manufactur-

ers Association, on a specification for a new standard radio noise meter.

The RCA Type 312 Radio Noise Meter has been designed in accordance with this specification of the Joint Coordination Committee.* Since this specification embodies the best thought of specialists in the electrical manufacturing, power, and radio industries, developed through several years of cooperative effort, this new instrument should find wide acceptance among all who are concerned with radio noise measurement.

The new Radio Noise Meter is essentially a portable, battery operated, all-wave, superheterodyne radio receiver in which a quasi-peak indicator is substituted for the conventional detector and audio amplifier. The quasi-peak method of indication, which is also used in the RCA Type 302 Audio Noise Meter, has been found to give the best approximation to the annoyance factor of noises of varied wave forms.

In the present instrument, a diode rectifier, driven from the output of the intermediate frequency amplifier, charges a condenser

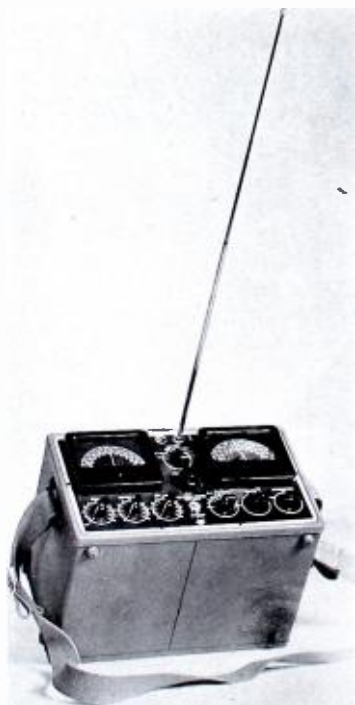

Showing the method of inserting the antenna.

* See for example the Bibliography by L. F. Roehmann in *Electronics*, Vol. 11, No. 10, p. 32, Oct., 1938.

* *Methods of Measuring Radio Noise*, E.E.I. Publication No. G-9, N.E.M.A. Publication No. 106, R.M.A. Engineering Bulletin No. 32, Feb. 1940.

through a circuit such that the charging time-constant for increasing noise is 10 milliseconds and the discharging time-constant for decreasing noise is 600 milliseconds. The D. C. voltage across the condenser, after one stage of amplification, is read on a rugged indicating instrument. A recording instrument may be connected externally, if desired. A logarithmic scale is provided by feeding back the diode condenser voltage to control the gain of the radio frequency and intermediate amplifiers.

This arrangement measures the peak value of the separate noise pulses, unless the pulses are repeated at too slow a rate, in which case the indication tends to be proportional to the repetition rate. Hence the designation "quasi-peak." This is approximately the way the ear behaves.*

Selectivity

The selectivity or effective band width of any noise meter is one of its most important characteristics. In fact, the measured magnitude of a hiss-like noise is proportional to the square root of the effective band width of the measuring circuit, while for a noise composed of separate pulses, such as most ignition noises, the measured magnitude is directly proportional to the effective band width.** The selectivity of the Type 312 Radio Noise Meter is in accordance with the specifications of the Joint Coordination Committee, but for the sake of completeness a more explicit statement will be given here. The effective band width of the intermediate frequency is 9 KC within the tolerance established by the Joint Coordination Committee. Thus readings with the Type 312 instrument are comparable with measurements made at audio frequency with other instruments, for example the Type 302 Audio Noise Meter, using an audio band width of 4.5 KC.

The three logarithmic scales each cover a range of 100 to 1, with generous overlap between

ranges. This is of great advantage in measuring rapidly fluctuating noises. The slow discharge rate of the quasi-peak indicator results in a "floating" meter needle which is easy to read and permits the use of a robust standard speed movement.

The input impedance of the instrument is over 5000 ohms for all frequencies up to 1500 KC so that noise voltages on power lines and at the terminals of noise producing appliances may be measured using the 600 ohm networks which have been standardized for these purposes of the Joint Coordination Committee. At frequencies above 1500 KC the input impedance is less, but this is no disadvantage, since the impedance of lines and noise sources are also less at these frequencies.

Antenna

A vertical rod antenna of one meter effective height is provided for use in measuring radio noise fields. This is collapsed and stored within the instrument case when not in use.

The full frequency range is from 150 KC to 18 MC, omitting only the band from 350 to 540 KC encompassing the 455 KC intermediate frequency employed. This is covered in four bands, the usual X, A, B, and C bands.

The limitations imposed by battery operation, light weight, and all-wave operation have been

overcome as far as possible in making the sensitivity at least 10 microvolts or 10 microvolts per meter on all frequency bands. The sensitivity has been made substantially uniform throughout the X and A bands, and as uniform as practicable on the other bands, in order to minimize the need for calibration adjustments or frequency corrections.

Calibration

Calibration is made easy, however, through a circuit arrangement which uses the shot noise from a saturated diode as a standard voltage. This is possible because the noise generated by such a tube is proportional to its average or D.C. space current, which is easily read by the D. C. indicating meter and adjusted by means of a filament rheostat. Calibration with a standard noise is preferable to calibration with a sine wave because in this way the effect of variations in selectivity are compensated for. By means of this calibrating process and through the use of an antenna trimmer to insure accurate resonance in the input circuit at all frequencies, an overall accuracy of $\pm 15\%$ is maintained throughout the A band (540-1600 KC) and an accuracy of $\pm 25\%$ for all other bands.

For making signal field intensity measurements or for listening to or identifying a noise or signal to be measured, a switch is

(Continued on Page 31)

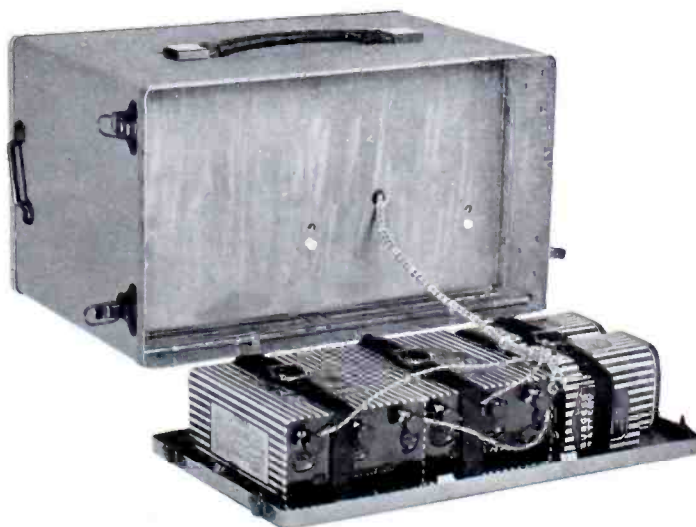

The batteries are conveniently mounted for easy accessibility.

* U. Stendel, *Hochfrequenztechnik und Elektroakustik* Vol. 41, 1933, p. 15.

** V. D. Landon, *A Study of the Characteristics of Noise*, Proc. IRE, Vol. 24, No. 11, p. 1514, Nov., 1936.

THE NEW STANDARD VOLUME INDICATOR AND REFERENCE LEVEL

By R. M. MORRIS

National Broadcasting Company, Inc.

THE volume indicators in use, until recently, differed widely as to type and characteristics; method of calibration and use; and the values of the reference level on which the calibration was effected. The type and characteristics of instruments used included: rms or quasi-peak; "slow, medium or high speed"; half or full wave rectification and critically or under-damped meter movement. The reference levels on which calibration was effected included: 10⁻³, 1, 6, 10, 12.5 and 50 milliwatts in 500 or 600 ohms. The possibility of confusion and misunderstanding which resulted when two different groups attempted to correlate measurements on the same circuit is obvious in view of the many variables.

Uses of Volume Indicator

Radio broadcast service, involving the inter-connection of many radio stations by means of telephone circuits, necessitates the almost continual use of volume indicators, not only for controlling volume but in a supervisory manner to insure the transmission of the proper program level and to isolate circuit irregularities. Volume indicators used in this manner may be located at points in the circuit separated by dis-

tances ranging from a mile or less to two or three thousand miles. The usual procedure to determine any circuit irregularity is to check "peaks" between the various points in the circuit. Under normal circumstances the indications of identical full wave rms instruments located at different points, properly adjusted as to sensitivity, should all produce the same "simultaneous" indications throughout the circuit. Until the present time the instruments in the majority of broadcast stations usually differed widely from those in the various associated telephone companies as to characteristics, calibration and interpretation of the indications. As the instruments differed, exact correlation was not possible; consequently arguments and misunderstandings resulted when attempts were made to adjust level discrepancies or to determine what level should be transmitted to or received from telephone circuits.

The Bell Telephone Laboratories, the Columbia Broadcasting System and the National Broadcasting Company have participated in a cooperative investigation to determine the type and characteristics of a volume indicator which would meet the vari-

ous theoretical, practical and economic requirements and the value of a reference level and a standard of impedance to use as a basis for the calibration of the instrument. An agreement was announced Dec. 16, 1938, involving a volume indicator exemplified by the Weston Type 30 instrument and a calibration at the maximum marking point for program peaks based on 1 milliwatt in 600 ohms.

The characteristics of the new instrument are briefly as follows.*

1. The meter responds to the rms value (approximately) of the impressed voltage and contains a full wave copper oxide rectifier within its case.
2. The total resistance of the instrument and the external resistor (of 3600 ohms) is 7500 ohms.
3. The sensitivity of the instrument is such that a deflection to the 100 division mark is obtained when connected across a sinusoidal voltage of 1.228.
4. The pointer movement is almost critically damped with an "overshoot" of between 1½ and 3%; the pointer is deflected from the "at rest" position to 99% of the steady value, 0.3 seconds (±10%) after the sudden application of 1.228 volts.
5. The distortion introduced by the connection of the instrument and its series resistor across a 600 ohm circuit is less than that equivalent to 0.3% (arithmetic sum of harmonics).
6. The instrument sensitivity is uniform within 0.2 db of the 1000 cycle value over the frequency range from 35 to 10,000 cycles and within 0.5 db over



Showing the use of the vu meter in the RCA 76-B1 Consolelette.

*A more complete description will be found in "Electronics," February, 1939; "A New Standard Volume Indicator and Reference Level," H. A. Afel; H. A. Chinn and R. M. Morris and in the Proceedings of the I R E, January, 1940; "The New Standard Volume Indicator and Reference Level," D. K. Gannet; H. A. Chinn, and R. M. Morris.

the frequency range from 25 to 15,000 cycles.

7. The instrument scale is approximately linear with voltage and the markings are on a cream yellow scale card to reduce eye strain and fatigue. The "voltage" markings are from 0 to 100 in black numerals above the pointer arc. The corresponding *vu* markings, with the 0 *vu* mark at the 100 division mark (70% full scale), are in red numerals below the pointer arc. The arc above the 100 division mark is a broad red band providing an upper margin of 3 db above the reference point.

From a study of the fundamental considerations involved, it may appear that an instrument responding to the peak or crest value of the program wave—that portion which causes distortion—would be more satisfactory than an *rms* instrument. However, the results of a series of cooperative and individual tests, that began in 1935 and were in progress until December 1938 show that, on the average, within a range of about 1 db, neither the quasi-peak nor the *rms* type of instrument of the design finally determined upon, exhibited any marked superiority as regards indicating aural distortion.

Phase Distortion

It was found, furthermore, that the phase distortion on program circuits, some of which are only a few miles in length, may be such that considerable discrepancies are obtained from the use of quasi-peak-indicating instruments even when the distortion is not aurally detectable. Since telephone circuits are almost always involved, even though they are only from a remote point to the studio or from the studios to the transmitter site, errors of this type would be inevitable in practice if a peak instrument were used. A full-wave *rms* type is not, of course, subject to these errors.

Still another consideration was the fact that the instrument must be suitable for use at both fixed and field locations if complete standardization is to be accomplished. The use of a quasi-peak

reading instrument which, at present, involves a number of tubes and an associated power supply was not considered feasible in portable equipment, particularly in view of the fact that no great benefit was to be derived from its adoption.

Under these circumstances and also since it is essential that the instrument be relatively inexpensive in order that its general adoption is not hampered by economic considerations, an *rms* type of instrument of the type described, has been determined upon.

New *V I* Scale

Both *vu*^{*} and percent voltage markings are incorporated on the new instrument scale. The need for the former in wire line transmission is obvious, but the philosophy which led to the inclusion of the latter requires explanation. It is evident, assuming a linear system, that the voltage scale is directly proportional to percentage modulation. If the system is adjusted for complete modulation for a deflection to the 100% mark, then subsequent indications will on the average show the degree of modulation under actual operating conditions. In the interest of best operation, it may be desirable, of course, to adjust the system for somewhat less than complete modulation when the 100% indication is reached. The use of the new instrument will in no way reduce the desirability of a limiter amplifier at the transmitter, as the indications of the new instrument will, in any event, show the "percentage utilization of the channel."

Standard Reference Level

The adoption of the new volume indicator will not permit full-realization of all the advantages of proper correlation unless the manner of use and calibration of the instrument by each user are identical. The first step in this direction was an agreement upon a standard reference level to replace the numerous "zero" or reference levels now in use. As already mentioned, this problem was given a great deal of consid-

eration and agreement was finally reached on a one milliwatt standard.

A standard reference level based on one milliwatt has much to commend itself, as compared with former reference levels, some of which seem to have just "happened" into being. The value of one milliwatt was chosen because it is: (a) a unit quantity and readily applicable to a decimal system, (b) a "preferred" number, (c) related to the "watt" by the "preferred" factor* of 10^{-3} , (d) it results in positive values for the majority of transmission levels encountered in practice at the present time and (e) it was found to be the one value to which general and perhaps international agreement is possible.

Although the reference level is a unit of power, the devices employed for measurement are in general some form of volt-meter, consequently a standardized value of impedance is desirable. The extent to which existing plants were standardized, the values of impedance in use and future trends as to impedance values for various circuits were all regarded as important considerations in this problem. The usual broadcast plant employs several different impedances, consequently, the value of "standard impedance" selected is in a sense nominal and largely for the purpose of specifying a voltage sensitivity in the calibration of the instrument. The telephone company has standardized on a value of 600 ohms and expended their plants to such an extent that the selection of any other value is impractical in view of the extensive changes in plant equipment which would be involved. Consequently, a value of 600 ohms was adopted as the standard impedance.

Calibration

Theoretically, the new instrument is calibrated in such manner that a deflection to the 100 division mark (or 0 *vu* mark) is produced when the instrument is connected across a 600 ohm resistor in which one milliwatt or "sinusoidal" power is being dissipated.

(Continued on Page 10)

**vu*—numerically equal to the number of db above (or below) the new reference level based on 1 mw.

*A. Van Dyck, "Preferred Numbers," Proc. I R E, Vol. 24, pp. 159-179 (1936)

VOLUME INDICATOR

(Continued from Page 9)

pated. This value corresponds to a voltage across the resistor of a 0.775 volts, r m s. The standard instruments are not sufficiently sensitive to indicate this value directly.* Measurements and calibration at the 100 mark (or 0 vu mark) must be effected, in practice, as a volume level of +4 vu or higher. (See Figure 1).

It will be noted that the philosophy employed in the majority of broadcasting studios in the calibration of volume indicators has been retained, viz.: the power required (or the voltage across the standardized impedance) to cause a deflection to the reference or "marking point" has also been used to designate the volume of program material.

An important advantage in the use of the new instrument is that, since they are all exactly similar, the various instruments on a circuit may be lined up with a 1000 c p s sinusoidal voltage with the assurance that they will then read alike on program waves.

A precaution to be observed in connection with the use of the new instrument is the fact that as available at present, it should not be mounted on a steel panel (except when specifically designed for this use). The deliberate, highly-damped characteristic of the instrument has been obtained by the use of a greater magnetic flux than is required in a normal instrument. Any loss of magnetic flux such as would occur through the shunting effect of a steel

*Instruments with a sensitivity of "0" vu are available from two manufacturers for use where the effect of temperature changes are not of great concern.

panel, prevents the development of the required characteristics. It is best, therefore, that magnetic materials be kept at least 2 inches away from the center of pointer rotation. It is further desirable that other instruments be located a similar distance to prevent interaction of the magnetic fields of the instruments.

Terminology

The primary purpose of the instrument is to measure volume levels, although it is suitable for steady-state measurements. In the use of the new instrument, it is proposed to use a new term "vu" which is "numerically equal to the number of decibels above (or below) a one milliwatt reference level." This procedure will make it possible to avoid confusion with several existing standards for volume measurements.

It is emphasized that the designation of volume level in vu implies measurement with the new standard instrument. Previous types of volume indicators, even though recalibrated to a 1 milliwatt basis, in most instances will not give indications of program material corresponding to those of the new instrument.

The use of the new term will clarify the terminology used for expressing the performance of a piece of equipment or of an entire system. For example, in the past, it has been the practice to specify the performance of equipment by stating its (a) input level, (b) output level, (c) gain and (d) signal-to-noise ratio—all in decibels. In the case of (a) and (b) "decibels above a reference level of X milliwatts" is implied while in (c) and (d) pure ratios are involved. The use of the new term "vu"

obviates this inconsistency since the term immediately implies measurements with the new standard instrument referred to a 1 milliwatt reference level.

Thus it should be borne in mind that the term "vu" implies an absolute volume level and where ratios are involved, the term decibels is to be used as in the past. For instance, the gain or loss of a system, a program line or a piece of apparatus is expressed in "db" as is a signal-to-noise ratio or a response-frequency characteristic. Volume levels, on the other hand, are expressed in "vu" since absolute quantities based on the use of the new instrument are involved.

(To Be Continued)

WEST COAST FACSIMILE DEMONSTRATION

A recent demonstration of Facsimile was given at Sherman Clay & Co., in San Francisco, jointly sponsored by NBC and the Leo J. Meyberg Co.

One of the large windows in the Sherman Clay store was used for the scanner and the display type Facsimile receivers while the home receiver was placed in an adjoining window. Large groups were attracted to the display which was in operation from 10:30 to 5:00 P. M. daily.

A wide variety of material was used to show the flexibility of the Facsimile equipment. Publicity shots of NBC stars were used and news flashes were sent from the NBC news room every hour.

Lectures were delivered on RCA Facsimile, its operation, its uses and future possibilities.

A NEW TREATMENT FOR DEAFNESS

Dr. Christian Volf, Danish physicist, has developed a synthetic sound treatment for many types of chronic deafness. Synthetic sounds whose frequencies are scientifically controlled have been placed on records and effectively exercise the tiny muscles of the inner ear.

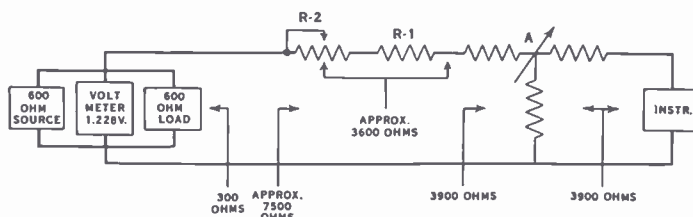

Fig. 1. Schematic showing method of calibration of the Standard Volume indicator.

R_2 is about 800 ohms and is adjustable to compensate for variations in deflection of the instrument.

R_1 is usually a portion of the adjustable attenuator A .

A is an adjustable 3900-3900 ohm attenuator for adjustment of sensitivity.

NORTH OF THE BORDER

Two RCA 50 KW's for Canadian Broadcasting Corporation

By EDMUND A. LAPORT
RCA Victor Company, Limited, Montreal

THE year 1939 saw the completion of stations CBA, in Sackville, New Brunswick and CBK, in Watrous, Saskatchewan. These two new 50 KW stations make a total of four high power stations owned and operated by the Canadian Broadcasting Corporation in the building up of its national network. CBA is located near the head of the Bay of Fundy, where it ensures the most effective coverage of the Canadian Maritime Provinces. The region is one of rather poor soil conductivity so that the attenuation to radio waves over land is high; however, due to the manner in which the various arms of the sea encircle these Provinces, the location takes advantage of the better propagation conditions presented by the salt water to obtain the most effective coverage in northern and southern Nova Scotia, Prince Edward Island, eastern New Brunswick and the lower part of the Gaspé Peninsula of Quebec. As a result the coverage of the Maritime Provinces from this station is very effective. CBA operates on 1050 kc.

CBK's Area

CBK is located in the middle of Saskatchewan and is intended to serve the Prairie Provinces of Manitoba, Saskatchewan and Alberta. In contrast to the propagation conditions of the Maritime Provinces, these Prairie Provinces are a region having the highest soil conductivity on the North American continent. This, together with the fact that CBK operates on 540 kilocycles, gives a primary coverage area of unusual extent. Due to the excellent propagation conditions in all directions, CBK's 0.5 millivolt per meter field intensity contour is practically a circle with a radius of approximately 400 miles. This is possibly the largest primary coverage area of any station on the continent.

Both stations were conceived and constructed with the utmost thoroughness in both architectural and engineering details, under the supervision of the staff of the Canadian Broadcasting Corporation located in Montreal. The architectural work was under the supervision of Mr. D. G. McKinstry. Photographs of the CBA and CBK station buildings are shown herewith. Internally these buildings provide every modern convenience for the welfare and comfort of the operating staffs, convenient arrangements for the reception and instruction of the many visitors, spacious operating rooms which house the transmitting equipment, small studios for the origination of local announcements and transcription programs, work shops, material and tube storage vaults, power vaults, etc.

Appearance, as well as serviceability, was considered in the execution of the thousands of details which comprise projects of this magnitude. This is evidenced in the internal photographs of the stations. The beauty of both these stations has been apparent to the thousands of people who visited them during 1939. Sackville, N. B. and Watrous, Sask. have become very proud of their stations. CBK has already wielded a great influence on the sundried but progressive town of Watrous. In addition to the station, the CBC has found it necessary to design and provide living quarters for their staff and a row of ultra modern houses is under construction on a new street in the town. These will serve as models for the future civic developments already being considered.

The technical facilities for these stations were planned and supervised by the engineering staff of the CBC under the able direction of Mr. H. M. Smith, Chief Construction Engineer. Backed by fifteen years of active experience in high power broadcast station

construction, Mr. Smith's influence is to be noticed throughout in the thoroughness of the planning and excellence of the execution of the electrical plant from telephone lines and power lines to the antennas. These stations are not duplicates, as one will notice from the various photographs reproduced to illustrate this article.

The transmitting equipment used at CBA and CBK is the RCA Type 50-D, 50 KW. Broadcast Transmitter using the straight line enclosure. The styling of this transmitter has been effectively worked into the internal architecture of the building at CBA where the lines of the transmitter are carried around the operating room to give an impressive, unified style motive.

Field engineering work for these stations was carried out by Mr. John W. Sanborn, formerly of the High Power Transmitter Design group at Camden. Mr. Sanborn was transferred to RCA Victor, Montreal, in June, 1938 to superintend the manufacture and installation of these transmitters.

Transmission Line

For these stations the CBC adopted the RCA open 4-wire transmission line described in BROADCAST NEWS of January, 1939. These lines have a length of 500 ft. and feed radio frequency energy to the vertical radiator. The same design and height of vertical radiator is used at both CBA and CBK. This radiator is 460 ft. above grade level and is uniform in cross section. It is supported by a special method of doubling guying. The CBA antenna has an electrical height of 190°, the optimum height for anti-fading characteristics. At CBK, on 540 kc., this radiator is slightly more than 90° in height but on this frequency, together with the high conductivity of the region, anti-fading characteristics are of

(Continued on Page 27)

FROM SASKATCHEWAN

CBK Covers the Prairies

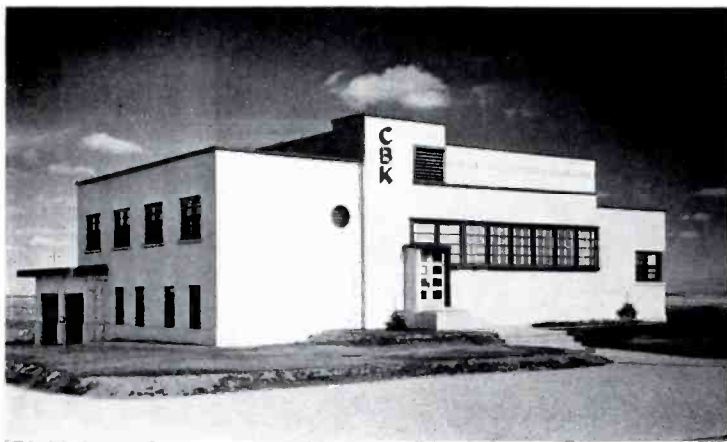

Radio Station CBK at Watrous, in the midst of the Saskatchewan wheat fields. This CBC station is in charge of Roy D. Cahoon, Prairie Regional Engineer.



Above: 460 ft. Vertical Radiator and Transmission Line at CBK.



Antenna Coupling house at the base of the CBK Radiator.



Above: RCA 50-D transmitter at CBK. The transmitter enclosure is finished in maroon.



Below: The visitors' entrance and observation lounge at CBK is here shown, together with the transmitter supervisory and monitoring consoles.

TO THE BAY OF FUNDY

CBA Speaks to the Maritime Provinces

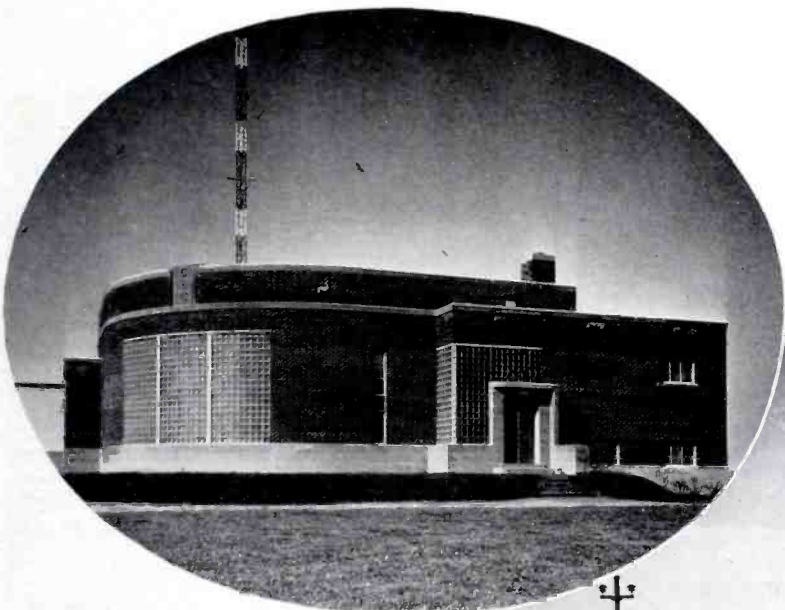

Radio Station CBA at Sackville, New Brunswick, at the head of the Bay of Fundy. This CBC station is in charge of James Carlisle, Maritime Regional Engineer.



The CBA antenna coupling house and the base of the 460 ft. radiator.

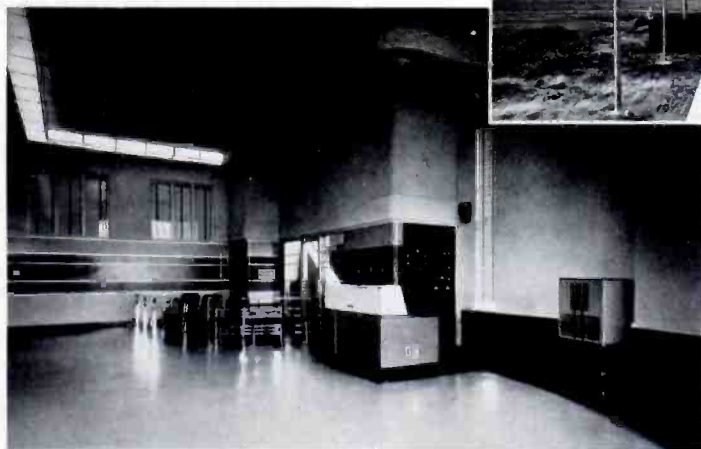

This view of the CBA operating room shows how the transmitter styling was carried around the room past the visitors' observation lounge to the speech input and monitoring racks.



RCA 50 D Transmitter at CBA, as seen from the visitors' entrance. The supervisory console is at the left.

FLEXIBLE AND COMPACT

The 76-B1 Console Fills an Important Place in Many Stations

By L. J. FLODMAN

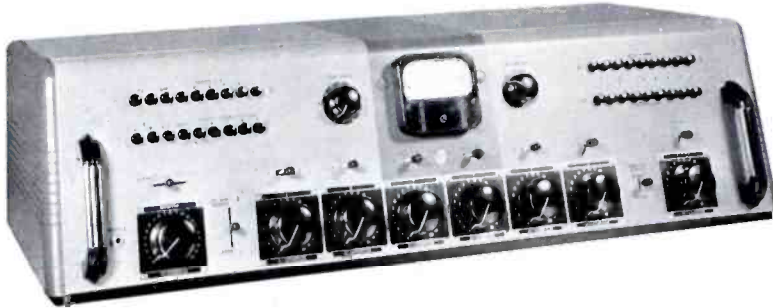

Neat, compact design emphasized in the RCA 76 B1 Consolelette.

THE consolette type of speech input equipment has, in the past few years, enjoyed a tremendous growth in popularity. While rack and console equipment is still preferred by many studio engineers as offering the utmost in desirable qualities, the consolette has been gaining favor where space is at a premium or cost is a major factor. In the Type 76-B1 Consolette, RCA is providing the broadcasting industry with complete high fidelity studio audio facilities at a minimum cost.

In order that as many of the advantages of the rack mounted type of speech input assemblies could be incorporated, the design of the 76-B1 required the careful consideration of several factors. First among these is performance. No sacrifice in gain or power could be made since these are primary requirements in any studio installation. Consequently, the 76-B1 uses amplifier circuits that are time proved in their workability. Likewise a conventional parallel mixing circuit is employed for combining the outputs of the various microphone pre-amplifiers, transcription and line inputs.

Since the use of jacks and associated plugs and cords, always found with rack mounted equipment, does not lend itself very well for mounting on a console, it becomes an absolute necessity to provide sufficient switches to

provide the flexibility desired in speech input equipment. Not only during normal operation of studio equipment are various combinations of circuits necessary, but also, each station has its particular requirement that must be satisfied. Thus any consolette equipment must provide a maximum of switching and circuit combinations. A glance at the block diagram of the 76-B1 (Fig. 1) will show the circuit combinations available. It will be noted that the use of interlocked push but-

ton switches has materially increased the circuit combinations possible, with a given set of amplifier circuits, yet their use has simplified the switching operations.

Simultaneous Auditioning and Broadcasting

Two complete audio channels are provided for in the 76-B1. One channel is used for program while the other is used for auditioning but also performs several other functions. Thus the 76-B1 is primarily designed for two studio operation, that is, while one studio, remote line or transcription is on the air, the other studio (or remote line or transcription) can be auditioned. The transcription equipment and associated announce microphones can very well be located in a separate studio or booth, so that three studios in all can be handled by the 76-B1. The consolette can be readily adapted for single studio operation as well.

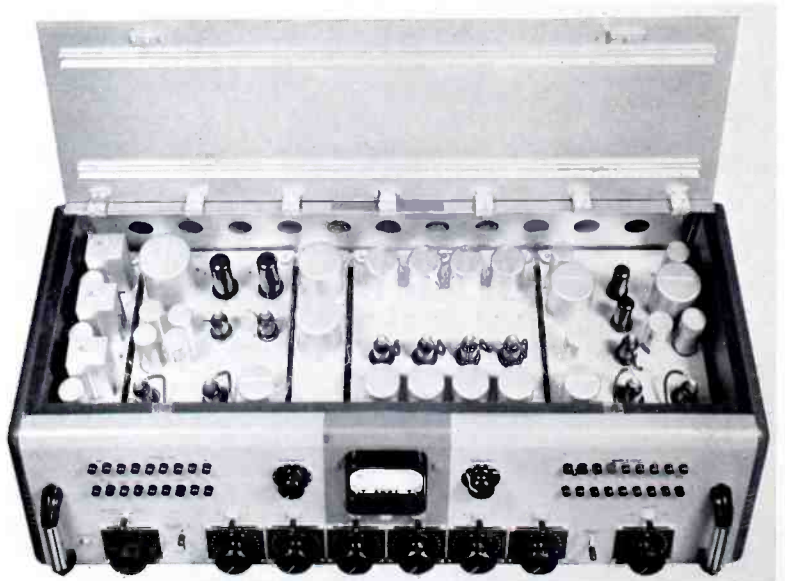

Easy accessibility—one of the features of the 76-B1.

Hinged Chassis for Easy Servicing

All controls, switches, amplifiers, etc. of the 76-B1 are contained in a single console cabinet while the power supply required to furnish filament and plate power to the amplifiers, DC current for relays, and field power for speakers, is mounted in a wall box. Both console and power supply are mechanically designed so that access to all wiring and component parts can quickly and easily be made by means of hinged chassis construction.

The controls mounted on the front panel of the 76-B1 console are so located that each control is in its proper place—both from an operational and electrical standpoint. The control panel has a slight slope—15 degrees from the vertical—for ease of control and maximum visibility.

Six Mixer Positions

A total of six mixer controls are used in the 76-B1. These are conveniently grouped together and located along the lower edge and center of the control panel. Four microphone pre-amplifiers are connected to the inputs of the first four mixer controls. The first two being normally connected to

microphones in one studio (Studio A) and the other two to microphones in another studio (Studio B). The input of the fourth pre-amplifier has a three-way lever key which permits the selection of two additional microphones. These can be announce microphones; one located in the control booth (Studio C) and the other at a remote point such as a transcription booth. The announce key is located just to the right of the mixer controls on the 76-B1 control panel.

Push Button Flexibility

The fifth and sixth mixers have at each of their inputs, a set of interlocked push buttons. These push buttons, located in the upper right hand corner of the control panel, each have a total of nine positions, mechanically interlocked so that only one button of a set may be depressed at a time. Two of the nine buttons in each set are for connections to transcription turntables such as the RCA Type 70-C's. Six buttons connect through resistor attenuating networks and line isolating transformers to incoming remote lines. The ninth button is used as an "off" button which places a loading resistor across the input of the corresponding mixer con-

trol. The two sets of push buttons are electrically interlocked so that any one of the remote lines or transcription outputs can not be connected to both mixers. Mixer No. 5 and associated push buttons has priority over No. 6 mixer and push buttons.

The outputs of the six mixers feed into six three-way locking type lever keys. These switches are located directly above their corresponding mixer on the 76-B1 control panel. When the lever keys are in their center or normal position the output of the corresponding mixer is open while loading resistors are placed across both the program and audition input circuits. Throwing a switch to the right, or "program" position, connects the mixer to the program channel. Throwing switch to the left, or "audition" position, connection is made to the audition channel.

All mixers are high quality step-by-step type which have proved to be the most satisfactory for low level circuits.

High Fidelity Program Channel

When a signal is being fed to the program channel it passes through a four stage program amplifier. This amplifier has first a

(Continued on Page 20)

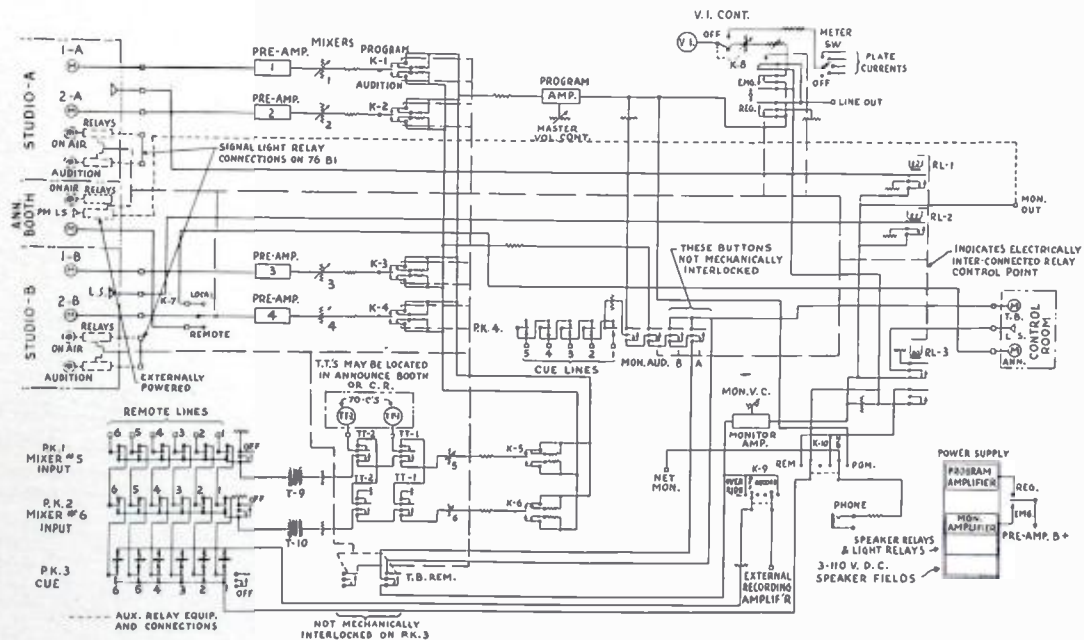

Simplified schematic of the 76-B1.

NEW COMMUNICATIONS RECEIVER

RCA AR-77 Has "Stay-Put" Tuning

By EDWARD BRADDOCK



The RCA AR-77 Table Model Communications Receiver.

Features with performance is the keynote of design in the RCA General Purpose Communication Receiver Model AR-77. All worthwhile features have been incorporated to provide the highest degree of successful reception for communication purposes. Emphasis has been placed on all the fundamentals of design in order to provide a truly high degree of owner satisfaction. These basic requirements are: (a) signal-getting ability of the electrical circuits and accessory aids to acquire the desired signal (b) stability of tuning adjustments to hold the signal and for accurate re-setability (c) convenience of controls (d) size, shape and color (e) economy of ownership.

Signal-Getting Ability

The average sensitivity throughout the tuning range is about two microvolts for 2-to-1 signal-to-noise ratio. An optimum balance between maximum sensitivity and minimum circuit noise has been chosen to render the greatest usable sensitivity for weak signals.

Greater approach to constant sensitivity throughout each tuning range is achieved by dual alignment of each r-f circuit with air-dielectric trimmers for the high-frequency end and inductance adjustment of the coils for the low end. This keeps the tracking of r-f, first detector and first

crystal filter circuit. A glance at the average K.C. bandwidth values, at two times down from the response at peak resonance, shows the degree of sharpness available for each step: (crystal out) 6 K.C., No. 2—3 K.C., No. 3—2 K.C., No. 4—500 cycles, No. 5—175 cycles, No. 6—80 cycles. Steps 2 to 4 inclusive, are of great aid in receiving 'phone signals through interference from other stations. Steps No. 5 and No. 6 provide that "razor-blade" sharpness for single-signal c.w. telegraph reception.

Image rejection has been greatly improved by the accumulative benefits of excellent "front-end" (r-i) selectivity through having high Q circuits, optimum L/C ratio and proper shielding. Image ratio of approximately 40-1 at 30 m.c. is obtainable with proper input load.

The improved noise limiter circuit will be found most helpful for making signals intelligible through local interference caused by automobile ignition and other electrical impulses of high amplitude and short duration. With the variable adjustment of the limiter

(Continued on Page 35)

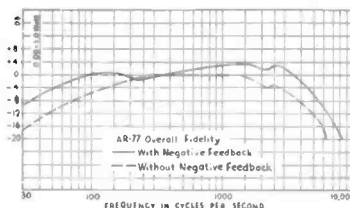

Performance Curve plotted on the AR 77.

heterodyne oscillator circuits uniform for best sensitivity and r-f selectivity.

Selectivity is variable in six steps employing an efficient i-f

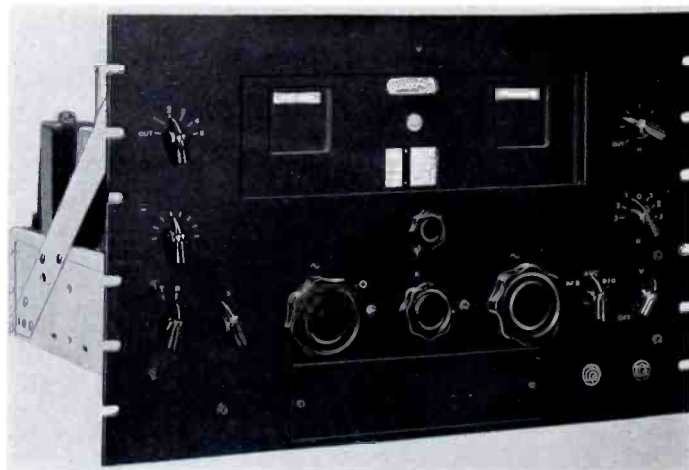

Rack mounted type AR-77 receiver.

IT'S MODERN—IT'S WFMJ

Ohio Station Has Outstanding Installation

By F. A. DIERINGER

YOUNGSTOWN, Ohio's newest radio station WFMJ, owned and managed by William F. Maag, Jr., publisher of the Youngstown Vindicator, began operation on Sept. 7th, 1939.

This station is a 250 watt plant operating full time on 1420 kilocycles and occupies the entire top floor of a three story building of modern design, especially constructed for the purpose in downtown Youngstown. Designed and equipped in the manner of a 50 kilowatt station, it is believed to be one of the few local stations in the country so well provided with such unusual facilities. Unsolicited comments from well known radio personalities such as Paul Whiteman, Lowell Thomas, Dick Powell, Glen Gray, Horace Heidt, and many others who have broadcast in person from WFMJ, have been alike in praising this station for its beauty of design and quality of facilities.

The Studios

RCA equipment has been used throughout from the microphones in its three well designed studios to the transmitter in the master control room. Studio No. 1 is 47 feet long, 27 feet wide with a ceiling height of 16½ feet, and is used for large set-ups and for audience participation programs. It is of the live-end dead-end type, incorporating floating construction throughout all walls as well as ceiling and floor. In order to secure a very satisfactory reverberation-response curve a new type of absorption element was built into the acoustical construction, the efficiency of which, is much greater in the low frequency region than former acoustical materials. The principle involved is not that of direct absorption but is better described as diaphragmatic action. Studio No. 2 is of medium size and possesses all of the features of studio No. 1 except that it is not a live-end dead-end type. Studio No. 3 is a smaller one of

similar construction, used for speech only, and contains two RCA 70-B turntables complete with lateral and vertical tone arms. One machine is equipped with the RCA type 72-B recording attachment. A record storage room is provided adjacent to Studio No. 3 and is equipped with specially designed storage cabinets for transcriptions and the Victor records of which there are several thousand. These cabinets built by a large manufacturer of office equipment located in Youngstown, provide rapid and convenient record filing in much the same manner as filing a letter. Compression devices prevent warping but are so arranged that the record label is made plainly visible without removing the disc from the cabinet. This entire assembly is compact and occupies a minimum amount of floor space.

Control Rooms

Control room No. 1 serves studio No. 1 only, and is equipped with an RCA type 76-B console modified for one studio operation so as to handle four microphones at one time. Five microphone outlets are provided and the microphones used in this studio are the RCA 77-B and 44-BX types. The master control room serves both studios No. 1 and No. 3 and is provided with an RCA 80-AX control desk. This control room also contains two racks of RCA speech equipment and measuring apparatus in addition to a type 250-D transmitter. The rack equipment consists of a 96-A volume limiter, a 94-D amplifier for supplying general cue to the various office loud-speakers, a 68-A audio oscillator, 66-A modulation monitor, 681-A frequency deviation meter, 69-A distortion and noise measuring unit, an attenuator panel and an R-F monitor rectifier used for monitoring the overall transmission by picking up a portion of the station's output on a small receiving antenna.

The transmitting antenna is a steel tower 150 feet high erected on top of the WFMJ building. A ground screen covers the roof and is connected to all of the metallic members of the building which are welded or brazed throughout. All metal lath, ducts and pipes have been brazed or welded together and to supporting steel members at very frequent intervals making a solid metallic mass. The work and expense of bonding all metallic building objects has resulted in a high efficiency radiating system indicated by a very complete field strength survey which was made recently.

Executive Offices

Six spacious private offices are provided for the department heads and, a clients' audition room is included in the office area. In addition, a large general office area equipped with eight desks and filing facilities, forms the center of the office group. Most of the ceiling areas are treated acoustically to reduce noise. Several RCA type 64-A loud speakers and type 82-B amplifiers are installed in the offices and studios. The manager's office is equipped with a special 64-A loud speaker in a bleached mahogany cabinet to match the Swedish modern style furniture. All other offices are equipped with steel and aluminum furniture finished in a special gray to blend with the interior color scheme.

A large roof penthouse contains elevator equipment and two complete air conditioning systems. One system supplies the studios and control rooms and, the other is connected with the offices and reception room. A precipitron, or air-cleaning device, is being installed to take all impurities out of the air before it enters the station.

Regarding the interior decorations we quote a portion of an article by Dorothy M. Carew which appeared in the Youngstown Vindicator. "The station interior is

(Continued on Page 34)

WFMJ—LOCAL IN POWER



Left: RCA 80-AX control desk located in master control room.

Right: Exterior view of WFMJ Building located at the corner of Phelps and Boardman Streets, Youngstown, Ohio.



Right: South end of reception room.



Below: A view in the main reception room at WFMJ.

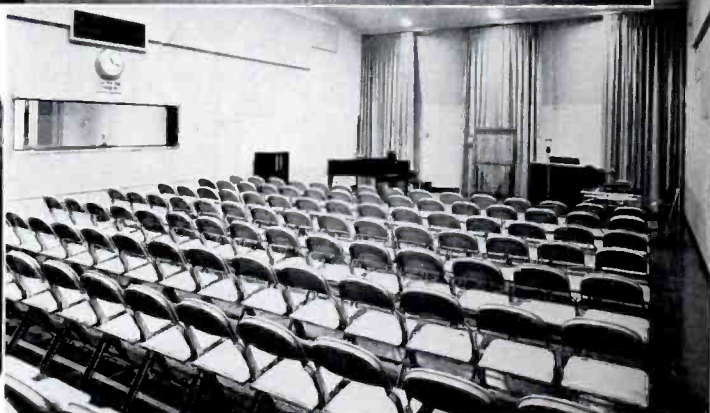

Above: Studio No. 1 which accommodates visitors to live talent shows.

TOPS IN DESIGN

Left: Control Room No. 1 showing RCA 76-B Consolette.



Above: R C A 70-B Turntables located in Studio No. 3.

Right: Studio No. 2 showing 64-B speaker on the left and 44-BX microphone on the stand.



Above: A view of the south end of the reception room.

Right: RCA 250-D Transmitter, measuring equipment and speech input racks.

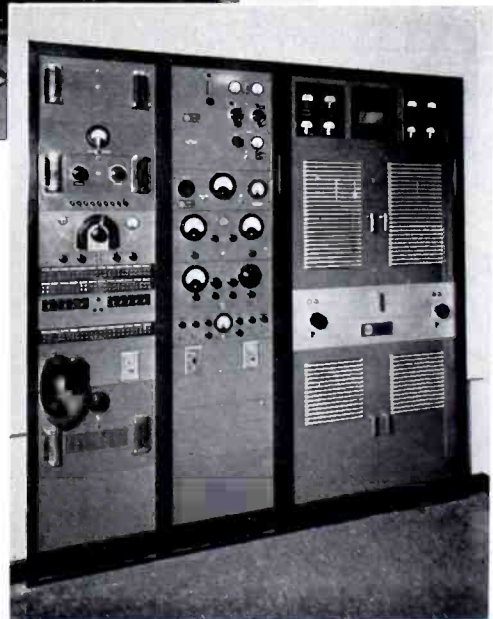

FLEXIBLE AND COMPACT

(Continued from Page 15)

"booster" stage, master volume control, and then three additional stages. The output stage is capable of delivering up to +28 vu* of audio power. The output connects to a "line-out" switch. This switch in addition to its normal (or off) position has a Regular and an Emergency position. When in the normal position, a load is placed across the output of the program amplifier. Across this circuit is the volume indicator meter. This meter which is the large, illuminated, VI meter recently developed is calibrated to indicate vu's and is centrally located on the control panel of the 76-B1. A VI control switch which allows adjusting the output to four different output levels is located just to the right of the VI meter.

When the line out switch is thrown to the Regular position, the output of the program is fed into the outgoing line, with load removed and the volume indicator still across the circuit. The function of the line out switch when in the emergency position will be described later.

The master volume control is located to the right of the six mixer controls while the line out switch is directly above this control.

High Power Audition and Monitor Channel

When a signal is being fed to the audition channel of the 76-B1 it passes first through one of the buttons on another set of nine interlocked push buttons. This set of push buttons is placed at the input of the monitor amplifier. Like the program amplifier the monitor amplifier has four stages of amplification, the first being used as a "booster" amplifier stage, following is the monitor volume control, and then three additional stages. The output stage is capable of delivering up to 8 watts of undistorted (4%) power. The power is fed through three relays, the operation of which will be described later, to three loudspeaker terminals.

* 0 vu = 0.001 watt.

The set of push buttons at the input of the monitoring amplifier allows the following operations to be made:

1. Monitoring—One button connects the input of the monitoring amplifier, through proper bridging resistors, across the output of the program amplifier. A program on the air may thus be monitored by means of the control room loudspeaker.

2. Auditioning—One button as mentioned above feeds the output of the mixer controls (when the corresponding program—audition switch is in audition position) into the input of the monitor amplifier. This allows carrying on of an audition in one studio while the other is on the air.

3. Cueing—Five of the buttons are used for the selection of any one of five monitoring or cue lines. These five buttons and the monitor and audition buttons are mechanically interlocked so that only one is on at a time. Pressing any one button releases the button previously actuated. This circuit may be used to monitor the output of an adjacent transmitter or for cueing from an incoming network.

4. Talk-back—Two buttons, associated with the seven buttons above but not mechanically interlocked with same are used for talk-back, one for talk-back into Studio A and the other for Studio B. Pressing either button connects the talk-back microphone to the input of the monitor amplifier. When button is released, the connection previously made is restored.

This set of push buttons on the input of the monitoring amplifier is located in the upper left hand corner of the 76-B1 Control Panel. The monitor volume control is located just below these buttons to the left and in line with the mixer and master controls.

Unique Remote Line Cueing and Talk-back

A fourth set of push buttons is used in the 76-B1 which provide a function usually not found in console type speech input equipments. These buttons perform the following.

1. Cue—Six buttons of this set

of push buttons connect to the six incoming remote lines. One side of the buttons are normally connected through switch K-10 to the output of the monitoring amplifier. Pressing any one of the six buttons will feed the signal from the output of the monitoring amplifier into the corresponding remote line, provided that the corresponding button of the push buttons on the input of mixers No. 5 and No. 6 is not in use. Another button interlocked with the above six buttons is used as an "off" position.

2. Headphones—A phone jack is connected to switch K-10 which when thrown to the "Remote" position removes the monitor output signal and allows headphone monitoring of any one of the six remote lines.

3. Override—Each of the six line cueing push keys has a bridging pad connected across its normal terminals. The outputs of the six pads are connected in parallel and may be bridged across the input of the monitoring amplifier by throwing switch K-9 to the "Override" position. This arrangement enables the control room operator to listen to all six lines simultaneously on his monitoring loudspeaker. Thus he can immediately hear the remote operator call in from a new setup.

4. Talk-back—Talking to the remote lines can be done by pressing either one of two push buttons associated with the six remote cue buttons but not mechanically interlocked with same. When these two buttons are pressed, the talk-back microphone is connected to the input of the monitoring amplifier and the output of the monitoring amplifier reconnected to the output of the remote cue buttons. Thus, a conversation can be carried on with any of the six remote lines by plugging in phones, and holding down the remote line talk-back buttons.

This fourth set of push buttons is located on the left hand side of the 76-B1 control panel just above the monitoring input selector push buttons. The remote monitor phone jack is situated in the lower left hand corner of the panel.

(Continued on Page 31)

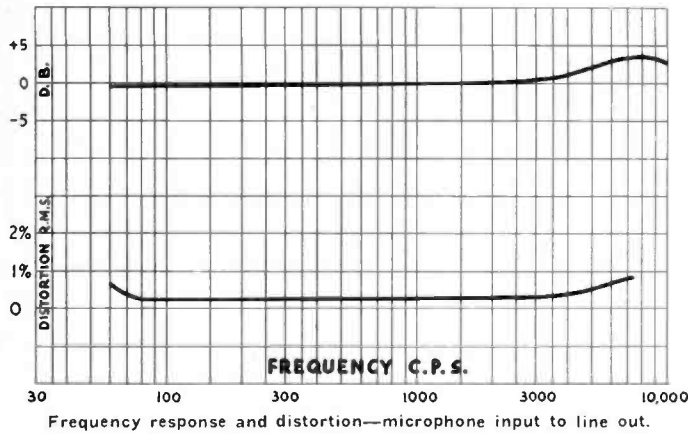
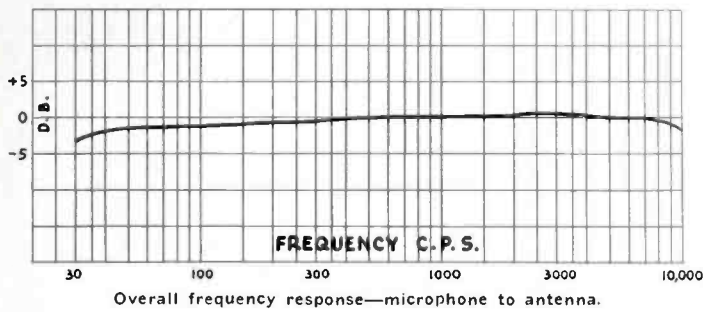

WCKY

(Continued from Page 2)

the office speakers. This audition buss works as follows: the output of each studio channel terminates in a key which may be switched either to master control or to this audition buss. Thus if an audition is being fed from a studio, the key is thrown to the audition buss and the program does not go through master control which simplifies switching somewhat. For regular operation, of course, the key is thrown to the "line" position which feeds the program to master control where it is switched to an outgoing channel. This key is interlocked with the output switching so there is no chance of feeding a program to the audition buss that should go on the air.

Studio B where station breaks and remote programs are handled is operated from master control. This studio is provided with two separate program channels with provision for switching the faders from the regular to the "audition" channel. The 82-B monitoring amplifier is switched to this position for use as a program amplifier.

Provision is made for setting the gain of this amplifier equal to that of the program amplifier and a VU meter is connected across the output, thus making it possible to set up one program on this studio while another program is on the air from the same studio. This

allows consecutive programs to be run from this studio, and simplifies operation.

Fig. 1 shows a photograph of the six racks in master control. Rack 1 on the left carries the five receivers for "off the air" monitoring of the five local stations. At the bottom of this rack is the power supply for the receivers and an 82-B amplifier which drives one of the speakers in master control. Rack 2 carries the equipment for Studio B. As mentioned previously, this studio is operated from master control and the control panel can be seen just above the writing shelf. Rack 3 has the out-put switching as well as jack termination for the master control equipment. Rack 4 has the jack termination for the 48 incoming remote lines, the ring-downs, line equalizers and tie trunks to the studios. Rack 5 carries the equipment for studio A, and Rack 6 has the line amplifiers, the CBS amplifier and a monitoring amplifier. In addition, an oscillator and attenuator panel are provided for checking the performance of the system and for equalizing remote lines.

Figure 2 is a photograph of the control console for studio A. The other studio equipment which is in an individual control room is similar to studio A, with the ex-

(Continued on Page 34)



J. A. Chambers, consultant, and C. H. Topmiller, chief engineer, WCKY, conferring during the installation.

PARALLEL MIXER CIRCUIT CALCULATIONS

A Few Suggestions on this Important Subject for Station Engineers

By C. W. SLAYBAUGH

WITH the advent of the recent FCC "Standards of Good Engineering Practice," mixer circuits have achieved a new and greater importance. These "Standards" include limits on frequency characteristic, hum level and distortion from microphone input to transmitter output. One of the important links in the chain is the mixing circuit. A poor design in this link may create sufficient loss so that the design and adjustments of other portions of the circuit must be far better than would ordinarily be required. Wheeler* has shown the proper calculations for parallel mixing circuits when they are worked into a known load. However, the engineer frequently runs into circuits where the load impedance is unknown, or where the number of attenuators and their impedance can determine the load for minimum loss. A majority of the normal conditions into which the design engineer may run are shown below.

For purposes of simplicity, all calculations are made with unbalanced circuits. Where balanced attenuators or circuits are used, it is only necessary to halve the calculated resistor values and place one resistor in each leg. It should be noted that the losses are for the mixing circuit only and do not include the insertion loss of the attenuators used. The normal insertion loss of a true or bridge "T" attnr. is 0 db., of a 1/2 ladder attnr. 3 db. and a 1/1 ladder attnr. 6 db.

Likewise, no consideration is given to the proper method of grounding. Let it suffice to say that for absolute minimum of hum the lowest level point only should be grounded, i.e. the low side of the booster or line amplifier, or the low side of the master gain control. For absolute maximum cutoff, the low side of the

mixers should be only points grounded.

Loads

There are four general types of loads or circuits into which mixing circuits are worked. The first is a master gain control. This has a definite input impedance, generally 50, 250, 500 or 600 ohms. The second is an amplifier with transformer input mixing a properly loaded secondary so that the input impedance is resistive and is the value specified. These are generally 250, 500 or 600 ohms. The third type of load is one which has a number of input impedances so that the mixing circuit can be worked into a particular impedance which is optimum for the number of input circuits used. This type of load is generally found where a mixing transformer is used working into a load of types one or two. The fourth type of load circuit that is in common use, is the amplifier using an input transformer with an unloaded secondary. Practically all microphone pre-amplifiers and booster amplifiers fall into this class. It must be remembered however, that even though the input impedances in this case

are not as specified on the terminal board (but considerably higher), the amplifiers, in order to maintain their guaranteed frequency response, must work from the specified source, i.e.: 50, 250, 500 ohms, etc. These four types of loads will be discussed below as CASES 1, 2, 3, and 4, respectively.

In the consideration of the various types of parallel mixing circuits, the symbols used will be defined as follows:

- Z_1 = Output impedance of mixers or circuits to be mixed,
- Z_2 = Source impedance of the device into which the mixing circuit works,
- R_1 = Resistance in series with the mixers or circuit to be mixed,
- R_2 = Resistance in series with the input of the device into which the mixing circuit works,
- N = Total number of mixers or circuits to be mixed.

CASE 1

One of the most common mixing circuits that the engineer comes across is that in which he has a given number of circuits to be mixed of definite impedance,

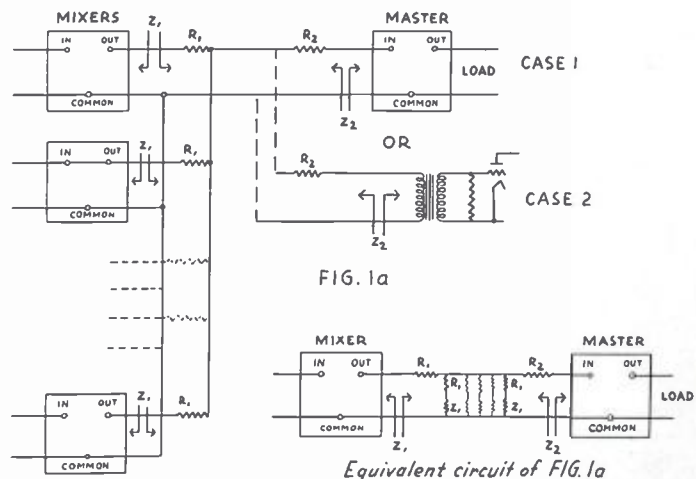
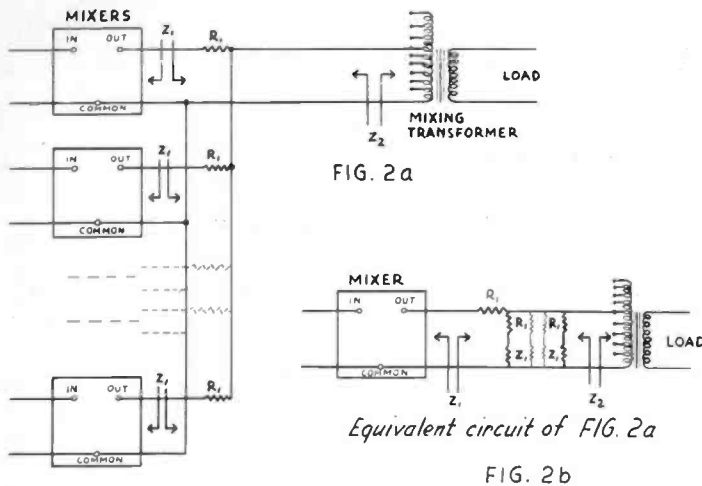

FIG. 1b

* Multiple Circuit Pads; Fred Wheeler, Electronics, Mar., 1937.



working into a master gain control, (see Fig. 1). It can be seen from figure 1b that for the mixer and master gain control to be properly matched the following formulae must hold:

$$Z_1 = R_1 + \frac{\left(\frac{R_1 + Z_1}{N - 1}\right)(R_2 + Z_2)}{\left(\frac{R_1 + Z_1}{N - 1}\right) + (R_2 + Z_2)}$$

$$Z_2 = R_2 + \frac{R_1 + Z_1}{N}$$

Instead of laboriously solving these two simultaneous equations for R_1 and R_2 , a simpler solution has been found by Wheeler as follows:

Let

$$C = \frac{K(N - 4)(N - 2) + 1}{K(N - 2)^2 - 1}$$

$$E = \frac{C + 1}{N - 2}$$

where $K = \frac{Z_2}{Z_1}$

Then $R_1 = Z_1 C$

and $R_2 = Z_1(K - E)$

The mixing loss is then equal to

$$\text{Db. loss} = 20 \log \frac{(2K - E)}{\sqrt{K(1 - C)}}$$

If $Z_2 = Z_1$

$$\text{Db. loss} = 20 \log \frac{1 + C}{1 - C}$$

CASE 2

Where the mixing circuit works into an amplifier with an input that looks like 250 ohms, the same method of calculating R_1 , R_2 , and the loss may be used. If the transformer has several taps it is sometimes worth while to check the loss in the circuit will vary depending upon the actual load into which it is matched.

CASE 3

Where a mixing transformer is used in a circuit, generally a substantial improvement in the overall loss can be accomplished. From Figure 2b it can be seen that if the number of mixing circuits and their impedance is given, then for proper match:

$$Z_2 = \frac{R_1 + Z_1}{\left(\frac{R_1 + Z_1}{N - 1}\right) Z_2}$$

$$Z_1 = R_1 + \frac{\left(\frac{R_1 + Z_1}{N - 1}\right) + Z_2}{\left(\frac{R_1 + Z_1}{N - 1}\right) + Z_2}$$

Solving these two simultaneous equations:

$$Z_2 = \frac{Z_1(2N - 1)}{N^2}$$

$$R_1 = \frac{Z_1(N - 1)}{N}$$

and the loss is

$$\text{Db. loss} = 10 \log (2N - 1)$$

CASE 4

In consideration of a mixing circuit working into a pre-amplifier or booster amplifier, the input impedance of the amplifier plus R_2 is assumed to be high enough that it will not materially load down the circuit. Such being the case the following formula must hold for proper matching:

$$Z_1 = R_1 + \frac{R_1 + Z_1}{N - 1}$$

Then $R_1 = \frac{Z_1(N - 2)}{N}$

The parallel impedance of the mixing circuit is

$$\frac{R_1 + Z_1}{N}$$

Then Z_2 must equal $R_2 + \frac{R_1 + Z_1}{N}$

from which

$$R_2 = Z_2 - \frac{R_1 + Z_1}{N}$$

and the loss in the circuit is

$$\text{Db loss} = 20 \log N$$

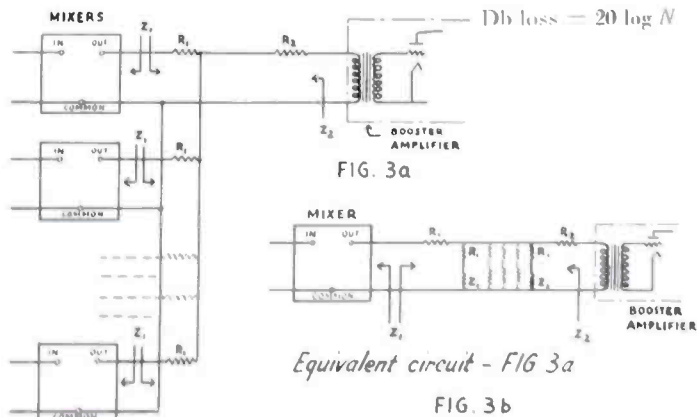

CALCULATION OF T.I.F. FOR TRANSMITTER LOADS

By J. C. WALTER

THIS paper presents an elementary discussion of the factors involved in estimating harmonic currents and voltages in a power system due to rectifier operation.

With a growing tendency toward polyphase ac-filament operation, the problem of voltage wave shape distortion on the supply system becomes of increasing interest and importance.

In applications where the power transmission system is paralleled by telephone circuits, the harmonic voltages induced in the telephone circuits may cause considerable interference. The term "voltage T.I.F." has been adopted as standard nomenclature for this type of interference, and indicates the "Telephone Interference Factor" expressed as the ratio of the weighted RMS total of harmonic voltages to the fundamental voltage of the system. In general, T. I. F. voltage is considered as existing at any point in the transmission system, and may be defined as that harmonic voltage produced by an harmonic current flowing through the system impedance as measured at the point in question, looking away from the rectifier producing the harmonic current.

H. S. Osborne (Trans. A. I. E. E., vol. 38, 1919) has given the following expression for T. I. F.

$$\text{T.I.F.} = \frac{\sqrt{(H_1 W_1)^2 + (H_2 W_2)^2 + \dots + (H_n W_n)^2}}{E_0}$$

Where

H = harmonic voltage

W = T. I. F. weighting factor

E_0 = fundamental voltage

The empirical weighting factors are proportionate to the response of the human ear at various frequencies, and are given in tabular form later in this report.

Where direct measurements on existing installations are possible, T. I. F. values may be obtained at any point in the system by means of direct reading wave analyzers. For example, where polyphase a-c filament operation is being contemplated, analysis of the voltage wave on the 220-volt bus will indicate at once what distortion is present due to the power rectifier, permitting the selection of the correct method for eliminating such harmonics. This paper is, however, primarily concerned with the engineering analysis of proposed sites where it is required to select the most economic combination of transmission systems and corrective apparatus.

Elements of Wave Distortion

The operation of a rectifier gives rise to harmonic currents in the supply circuit and may also distort the voltage wave shape of the supply system. The degree to which this distorted current may react upon the wave shape of the supply voltage depends upon the size of the rectifier and the impedance at harmonic frequencies of the source of supply.

In most radio applications where the KVA rating of the main rectifier is of any considerable magnitude, six-phase rectification is employed, with the plate transformers connected delta-wye or delta-delta. In either case, the line current wave shape is rectangular and contains only odd harmonics. Furthermore, the triple harmonics are short-circuited in the delta primary, leaving only odd non-triple harmonics to be dealt with.

The rectangular current wave produced by a six-phase rectifier consists of a single positive lobe and a single negative lobe for each cycle, current flowing, at a uniform rate during an operating

angle of $\frac{2\pi}{3}$ radians, with an

angle of $\frac{\pi}{3}$ radians separating

the positive and negative lobes.

Expressing this wave in its general form as a series:

$$y = A_0 + A_1 \sin \alpha + A_2 \sin 2\alpha \dots + A_n \sin n\alpha + B_1 \cos \alpha + B_2 \cos 2\alpha \dots + B_n \cos n\alpha$$

From the symmetry of the wave, the d. c. term becomes zero, and the series will contain only cosine terms, so that for any harmonic its amplitude may be evaluated by multiplying the rectangular wave by a unit cosine wave. In general, for the n th cosine term, B_n , we may write

$$B_n = 2 \left[\frac{1}{2\pi} \int_0^{2\pi} y \cos n\alpha d\alpha \right]$$

A point-by-point Fourier analysis can be used to obtain each cosine term, although it involves considerable labor due to the necessity of using a very small integral when dealing with the higher order harmonics. After tabulation, the harmonic amplitudes are obtained from

$$B_n = \frac{2 \sum_0^{\pi} y \cos n\alpha}{K}$$

Where K is the number of points used.

While the foregoing exposition is technically correct, its practical application is extremely cumbersome and requires an exact knowledge of the primary current wave shape.

Empirical methods have been developed which give results well within a reasonable degree of accuracy and have been used by various investigators.

The ensuing section of this report discussing empirical methods of analysis is an embodiment of several committee reports written by members of the Edison Institute during recent years.

Empirical Method of Analysis

For the theoretical case where the rectifier transformer is assumed to have zero reactance and the system impedance is negligible, the rectifier is assumed to produce a harmonic voltage E_n acting on the internal resistance R_0 of the rectifier. The harmonic current I_{n0} in the circuit is given by

$$I_{n0} = \frac{E_n}{R_0} \text{ amperes.}$$

Measurements on a large number of rectifiers by the Edison Institute have indicated that, for a given rectifier load, the so-called internal resistance R_0 may be assumed approximately constant over the frequency range from 300 to 2200 cycles. These measurements also indicate that R_0 is approximately equal to the fundamental frequency phase to neutral voltage $V_{\phi N}$ divided by three times the fundamental frequency line current I_{ϕ} , or

$$R_0 = \frac{V_{\phi N}}{3I_{\phi}} \text{ ohms}$$

and

$$I_{n0} = \frac{I_{\phi}}{n} \text{ amperes}$$

By substitution, we may write

$$E_n = \frac{V_{\phi N}}{3n} \text{ volts}$$

For the practical case where the rectifier is supplied from a system having a definite impedance at harmonic frequencies through a rectifier transformer having appreciable leakage resistance, the equivalent circuit will be

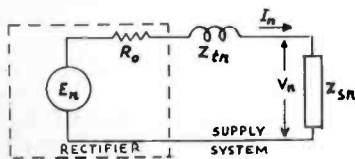

and the harmonic current will be

$$I_n = \frac{E_n}{\sqrt{R_0^2 + Z_n^2}} \text{ amperes.}$$

In this equation Z_n represents the vector sum of the system im-

pedance Z_{sn} and the rectifier transformer leakage reactance Z_{Tn} at each harmonic frequency. Eliminating E_n by combining equations we have

$$I_n = \frac{V_{\phi N}}{3n\sqrt{R_0^2 + Z_n^2}} \text{ amperes}$$

Where

n = order of harmonic
 I_n = magnitude of harmonic current

$V_{\phi N}$ = fundamental phase to neutral voltage

Z_n = total phase to neutral system impedance at n th harmonic (ohms)

R_0 = approximate "internal resistance" of rectifier

$$\left(R_0 = \frac{V_{\phi N}}{3I_{\phi}} \right)$$

The harmonic phase to neutral voltage impressed on the system by the action of the rectifier is the product of the harmonic current I_n and the phase to neutral system impedance at that frequency looking away from the rectifier, or

$$V_n = I_n Z_{sn}$$

Similarly, the harmonic phase to neutral voltage due to the rectifier at any other point on the supply feeder may be obtained by multiplying the harmonic current due to the rectifier at that point by the harmonic phase to neutral impedance of the system at that point looking away from the rectifier.

All impedances and the fundamental current must be referred to the phase to neutral voltage of the circuit at the point where the harmonics are to be computed. Although R_0 is assumed constant over the frequency range for any one value of fundamental current supplied to the rectifier, its magnitude varies with different loads on the rectifier.

The assumption that the harmonic currents produced by a rectifier are caused by a constant harmonic voltage acting on the internal impedance of the rectifier in series with the system impedance is not strictly correct but is convenient and gives approximately correct results.

The calculations for Z_{sn} may be simple or complicated, depending

upon the type of supply system. The impedance of various systems may vary with frequency over a wide range. Since at any one frequency the system may be replaced by an approximate equivalent circuit containing series and parallel combinations of inductive and capacitive reactance, resonance often plays an important part in determining the system impedance at individual frequencies. The system impedance Z_{sn} at any frequency is added vectorially to the inductive reactance of the rectifier transformer Z_{Tn} to obtain the total impedance of the supply circuit to the rectifier Z_n . Where Z_{sn} is capacitive, as often occurs, the value of Z_n may be less than the value of Z_{Tn} . In the formula for Z_{Tn} , the KVA rating of the rectifier transformer is the total for the three phases. If a voltage regulator or an additional transformer bank is connected between the rectifier transformer and the point in the circuit where the voltage wave shape is desired, the impedance of these elements should be included in Z_{Tn} .

If the wave shape for several values of load is required, it will be necessary to determine R_0 and the harmonic currents and voltages for each load, since the quantity $n\sqrt{R_0^2 + Z_n^2}$ which enters into the formula for I_n will change with both load and frequency.

The harmonic voltages and currents resulting from the usual types of three-phase utilization apparatus are essentially balanced in character. The power system impedances through which these harmonics regulate are, therefore, the phase-to-phase or phase-to-neutral impedances. As a matter of convenience, calculations of this character are generally made using a phase-to-neutral equivalent circuit and phase-to-neutral impedances are used exclusively in this paper.

In making an estimate of system impedance it is important to secure accurate data on the characteristics of the lines and equipment associated with the system.

(Continued on Page 26)

CALCULATION OF T. I. F.

(Continued from Page 25)

For purposes of analysis, it has been found convenient to build up a composite equivalent circuit made up of elements representing the impedances of the lines and of the various pieces of connected apparatus. It has been found that overhead transmission lines or cable circuits may be approximately represented by networks of inductive and capacitive reactances, while equipment such as transformers, reactors, regulators and rotating machinery can usually be represented approximately by pure inductances.

At harmonic frequencies the resistance and leakage of the various elements of the power system are ordinarily negligible compared to the inductive and capacitive reactance. However, at frequencies where series or parallel resonance occurs for a combination of elements, the resultant impedance is largely determined by the resistance and leakage. From the practical standpoint, however, the error introduced in impedance calculations in the vicinity of resonant frequencies by the approximations involved in the selection of circuit constants is probably as important as that due to neglecting the resistance and leakage.

The system impedances which are of primary interest in studies of the harmonic currents and voltages produced by various types of utilization apparatus are the phase-to-neutral impedances of the system at harmonic frequencies as seen from the point where the particular apparatus is connected. Generally, the lowest impedance path to harmonics is that toward the main source of supply and the impedance of that path is, therefore, generally the controlling factor in the system impedance. The shunting effect of the admittance-to-neutral of other circuits fed from the main source of supply must be considered.

Before the equivalent impedances of the various circuit elements can be combined into the equivalent network of the supply system, all impedances must be

referred to a common voltage base. After a reference voltage has been selected, the impedances of all elements calculated on other voltages must be referred to the reference voltage by multiplying them by the square of the voltage ratio of the transformers between each element and the reference point.

When the equivalent impedances of the individual elements of the system have been calculated, referred to a common voltage and assembled in their proper physical relationship, the elements are combined to reduce the network to the single impedance of the supply system at each harmonic frequency seen from the point where the source of harmonic voltage is connected. In cases where the network is relatively simple, this may be accomplished by the ordinary formulas for the series and parallel combinations of impedances. In more complicated cases, the operation may be simplified by the use of equivalent T and π transformations.

A summary of formulas is presented herewith for use in obtaining impedances of lines and equipment on a phase-to-neutral basis:

Overhead Circuits:

$$L = 0.741 \log \frac{D}{r} + 0.080$$

$$= \text{MH/mile/conductor}$$

$$C = \frac{0.0388}{\log \frac{D}{r}} = \text{MFD/mile}$$

$$\theta = 6.28f\sqrt{0.1}LC \times 10^{-1} f \text{ radians}$$

$$A_F = +j6.28fL \left[\frac{\sin \theta}{\theta} \right] \times 10^{-3} f$$

ohms

$$B_F = -j \frac{10^6}{3.14fC \left[\frac{\tan \theta/2}{\theta/2} \right] f}$$

ohms

Cable Circuits:

$$C = \frac{0.0776K}{\log \left[\frac{3a^2 (R^2 - a^2)^3}{r^2 (R^6 - a^6)} \right]}$$

MFD/mile belted cable

$$C = \frac{0.0388K}{\log \left(\frac{R}{r} \right)}$$

MFD/mile shielded cable

$$X_{ck} = - \frac{10^6}{(2\pi f)C} \text{ ohms}$$

Transformers:

$$X_{Tn} = + (n) \frac{\%X}{100} \frac{V^2}{1000 \text{ (KVA)}} \frac{1}{\text{ohms } n\text{th harmonic}}$$

Current Limiting Reactors:

$$X_{rn} = + (n) \frac{V_L}{I}$$

ohms at n th harmonic

$$X_{rn} = + (n) \frac{\%X}{100} \frac{V}{3I}$$

$$X_{rn} = + (n) \frac{1000 \text{ (KVA)}}{I^2}$$

Induction Voltage Regulators:

$$X_{regn} = + (n) \frac{\%X}{100} \frac{1000 \text{ (KVA)}}{3I^2}$$

$$= + (n) \frac{\%X}{100} \frac{1000 \text{ (KVA)}_1}{I^2}$$

$$= + (n) \frac{\%X}{100} \frac{V^2}{1000 \text{ (KVA)}}$$

Explanation of symbols:

a = Cable dimensions in inches. See figure.

A_F = Series impedance of equivalent π network.

B_F = Shunt impedance of equivalent π network.

C = Capacitance to neutral per conductor mile.

D = Mean spacing of conductors in inches.

f = Frequency (cycles per second).

K = Specific inductive capacity of cable insulation (Paper 3.7, oil filled paper 3.5, rubber 6.0, varnished cloth 4.5).

(KVA) = Three phase rating.

(KVA)₁ = Single phase rating.

L = Inductance per conductor per mile.

l = Length of line in miles.

n = Order of harmonic.

% X = Reactance expressed in percent.

R = Cable dimensions in inches.

r = Radius of conductors in inches.

$$\frac{\sin \theta}{\theta} = \text{Correction factor}$$

$$\frac{\tan \theta/2}{\theta/2} = \text{Correction factor.}$$

V = Rated phase - to - phase voltage.

V_L = Reactive voltage drop across reactor.

X_{cr} = Shunt capacitive reactances of cable.

X_n = Equivalent inductive reactance of rotating machinery.

X_{reg} = Series inductive reactance of regulator.

X_{ra} = Series inductive reactance of reactor.

X_n = Equivalent series inductive reactance of two winding transformer.

θ = Hyperbolic angle of circuit in radians.

The hyperbolic angle of a line having only inductance and capacitance (neglecting resistance and leakage) is a pure imaginary quantity of the form j° . The correction factors

$$\frac{\sin j^\circ}{j^\circ} \quad \text{and} \quad \frac{\tanh j \frac{\theta}{2}}{j \frac{\theta}{2}}$$

reduce to

$$\frac{\sin \theta}{\theta} \quad \text{and} \quad \frac{\tan \theta/2}{\theta/2}$$

respectively,

since

$$\sinh j\theta = j \sin \theta$$

$$\tanh j\theta/2 = j \tan \theta/2$$

Line Configuration

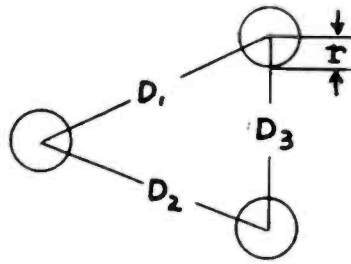

$$D = \sqrt[3]{D_1 D_2 D_3}$$

Cable Configuration

Three conductor belted cable.

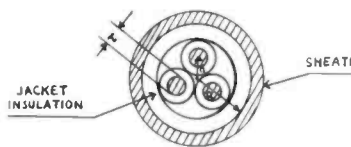

Single conductor or three conductor shielded cable.

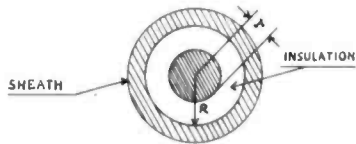

Equivalent T and π Conversions.

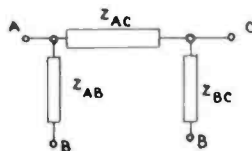

Given π ; to find T

Given Δ ; to find Y

$$\sum Z = Z_{ab} + Z_{bc} + Z_{ac}$$

$$Z_a = \frac{Z_{ab} \cdot Z_{ac}}{\sum Z}$$

$$Z_b = \frac{Z_{ab} \cdot Z_{bc}}{\sum Z}$$

$$Z_c = \frac{Z_{ac} \cdot Z_{bc}}{\sum Z}$$

NORTH OF THE BORDER

(Continued from Page 11)

secondary importance, as evidenced by the actual coverage of the station, mentioned previously. The engineering in connection with the antennas, station locations and field surveys was under the direction of Mr. K. A. McKinnon of the engineering staff of the CBC. The vertical radiators were built and erected by the Canadian Bridge Company.

In the extension of its directly-owned facilities for coast-to-coast service by the Canadian Broadcasting Corporation, the four 50 KW. stations now in operation play a major roll. RCA Victor in Canada is proud to have contributed to this progress by supplying the transmitting equipment for these two latest stations of the CBC.

Continuing its construction program, the CBC has started work on its new 5 KW station for CBM in Montreal. This station is also completely new, and, like CBA and CBK, will be RCA All-the-Way. The 5-DX transmitter for CBM is currently under construction in RCA Victor's plant in Montreal and the project is to be inaugurated on the air about June 1, 1940.

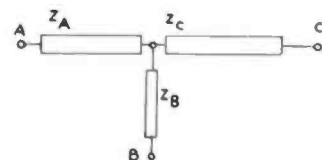

Given T ; to find π

Given Y ; to find Δ

$$Z_{ab} = \frac{Z_b Z_c + Z_a Z_c + Z_a Z_b}{Z_c}$$

$$Z_{bc} = \frac{Z_b Z_c + Z_a Z_c + Z_a Z_b}{Z_a}$$

$$Z_{ac} = \frac{Z_b Z_c + Z_a Z_c + Z_a Z_b}{Z_b}$$

(To Be Continued)

WHBC AMONG THE LEADERS

Canton, Ohio Installation Picked Best Features of Many Stations

Acclaimed by visiting radio engineers as one of the finest and most modern stations in the U. S., WHBC has been provided with the best studios and best equipment obtainable. Nothing was spared in the design of the studio building, the transmission building and tower. Site of the transmitter tower is considered one of the finest in the country.

The new station is the result of careful planning and research and a comprehensive analysis of the needs of the community. Before any work was undertaken an extensive study was made. This included surveys of all the more recent installations of modern broadcasting equipment in the country's leading studios and radio centers. The best features of each were adopted and worked into design and equipment of the new WHBC.

Best Tower Site

Selection of the tower site came after similar exhaustive surveys. Extensive tests were carried on to find the best possible location for the transmitter tower, consideration being given to the type of soil, elevation and freedom from interference.

When all surveys and tests had been completed and the data assembled engineers and architects went to work to design a modern broadcasting plant that would utilize all of the latest developments now used in the field of radio broadcasting. Assisting WHBC's local engineering staff were expert technicians from the Radio Corporation of America's laboratories.

Main Studios

The two main studios are 17 feet wide by 28 feet long. The central or transcription studio in which are located two of the most modern transcription recording machines, is 14 feet wide by 12 feet deep.

Studios A and B, from which the station's major programs will emanate, are of the "floating type," rooms within rooms. Walls and ceilings of the inner room are locked to the outer walls and ceiling by metal brackets separated by felt padding. In no instance does metal touch metal or wood touch wood. The floor of the inner room is separated from the floor of the outer room by the cantilever principle of suspension and here as in the walls and ceilings vibration and noise have been completely eliminated by the use of felt pads between all contact points and by using rock wool filler between the two rooms as a sound-absorbing element.

Three Control Rooms

Adjoining each studio is a control room equipped with a high fidelity monitoring speaker and a custom built control console. From this point the engineer on duty, in addition to viewing the talent in the studio, can also observe the equipment in the main control room. Switches on this control console automatically turn on warning lights and shut off studio loudspeakers when microphones are opened. Each of the microphones in the studio is regulated by separate "gain" controls so that the volume level of one or more microphones can be kept at a proper level as indicated on the meter built into the console. Programs from the outer studios or remote broadcasts can be placed on the air from any one of the control room consoles.

In the main control room directly back of the transcription studio and midway between the two large studios are located five racks of high fidelity speech equipment. This includes amplifiers used to raise the volume level of programs to a point suit-

able for feeding the special equalized telephone lines to the transmitter located on Lakeside Avenue, N. W.

Includes Master Control

Amplifiers for driving the loud speakers located in the observation lounges and offices are mounted in these racks. All remote broadcast telephone lines are terminated here as are amplifiers and outgoing lines for feeding programs to other stations. A complete metering panel for locating any trouble and to show correct operation of all amplifiers is also built into this equipment. The master control console is located in the master control room from which point an engineer may make corrections to program volume levels coming from any of the studio control rooms, remotes or network broadcasts.

A sound effects table for use in any of the studios completes the equipment in the studio part of the broadcasting plant.

NEW RCA 64-B SPEAKER



A complete story and description of this unit will appear in the next issue.

A FEW OF THE HIGH SPOTS AT WHBC



Left: Studio "A" showing the console with K. Sliker operating.



Above: Front view of the speech input racks with K. Sliker, Chief Engineer, doing the checking.

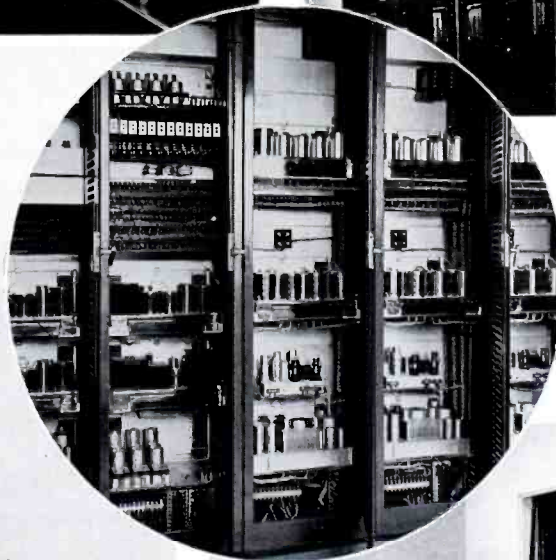

Left: Rear view of the speech input equipment racks indicating neatness of assembly and easy accessibility.

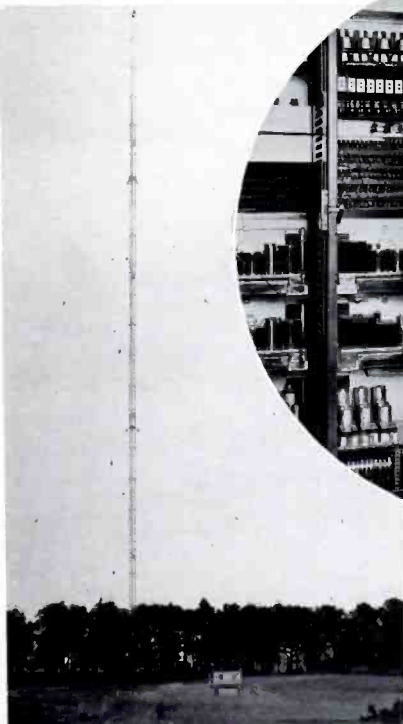

Above: The 492 ft. Truscon Tower that carries the signal of WHBC.



Right: Studio "C" of WHBC showing console turntable and a speaker.

TOP OF THE WORLD

(Continued from Page 3)

per screens, and bring telephone and power lines underground to insure the maximum efficiency in short-wave reception.

Proposed Short-Wave Chain Connection

KFAR's only hope for a network affiliation at present is also by short-wave. Diversity reception arrangements with tuned vertical and directive antenna have been installed in contemplation of rebroadcasting of short-wave network programs (now pending FCC approval).

Studios in Downtown Fairbanks

Captain Lathrop, a pioneer contractor, banker, cameryman, and theatre, newspaper and mine owner in Alaska, has had the vision of a radio station to serve interior Alaska in the back of his mind for several years. Thus in 1937 when the present Lathrop Apartment and Office Building was constructed in downtown Fairbanks, the entire 4th floor was reserved for control room, studios and offices of the proposed station.

This past summer saw the finishing touches of two completely modern "floating" studios, a suite of offices and master control room all of which are finished in Acoustic Cork with Philippine malogany trim. The recently developed RCA type 76B mixer occupies its position on the control desk with six channels and full facilities for auditions, remotes, remote cues and talk back at the finger tips. In fact the statement that the 76B has "everything but the kitchen sink" wasn't far wrong.

The new RCA "Tri-Purpose" type 77C microphone has been found to serve an all-round purpose in studio "A" as a non-directional, bi-directional and uni-directional mike as the occasion arises. The remaining 7 microphones for studio and announcing purposes are the RCA pressure type 88A's.

No Spares at the Corner Store

"Reliable service" was the keyword to construction and design of the installation on every point

economically feasible where the nearest spare part is 2000 to 5000 miles away and a good 2 weeks by express or 5 to 7 days by airmail. Thus, duplicate controls have been installed at both transmitter and studio, the program normally originating at the studio and passing through one of the transmitter console mixing channels into a 96A limiter amplifier which drives the low level stages of the RCA 1G audio section. The arrangement allows full control of the programs from either studio or transmitter and permits use of any of four RCA 70B transcription tables at either location.

As usual the carpenters and building contractors hit the last nail a short ten days before the scheduled station opening. However the equipment tuned up with surprisingly few "bugs" and everything was in order after a week's testing for the grand opening and public debut of KFAR to the people of Alaska on the scheduled date of October 1st, 1939.

Thanks go to Jim Wallace, Seattle consulting engineer (KVI) for assistance with the final tune-ups and much of the preliminary design. Installation was made by Chief Engineer Stan Bennett and ably assisted during the latter days of construction by assistant operator August Hiebert, formerly of KBND.

Programs Built for the North

KFAR's program service during its first 60 days of operation already has proved of inestimable value.

Airplane flight schedules to remote points throughout the territory are broadcast twice daily in many cases bring to a people who fly on the average 17 times as much as "outsiders" their only word of often delayed airmail, transport and supply ships.

Emergency messages to isolated communities without other means of communications are not in the least uncommon. Only recently a message was broadcast to a remote mining camp regarding a medicine prescription which was to be dropped from an airplane the following week. The week previous an effective "blind broadcast" to Nome calling for

an emergency airplane pickup from a mining camp perhaps saved the life of an appendicitis victim. It is in appreciation of these services as well as a full schedule of well rounded entertainment that KFAR has received letters and radiograms from Alaskan villages ranging from Point Barrow to Juneau expressing their gratitude for the programs of America's farthest north broadcasting station.

DANA PRATT WILL JOIN CENTRAL DISTRICT



Dana Pratt was born near Topeka, Kansas, in 1912. His five years of college were divided between Kansas University, where he received his B.S. in E.E., and Washburn College where he received his B.M. in piano, both in 1934. During the last year at Washburn College and until 1935 he was employed on the operating staff at Radio Station WIBW.

From 1935 to 1936 he worked with government and commercial transmitters in the RCA Test Department at Camden. Since 1936 he has been with the Broadcast Transmitter group in the Installation and Service Department. Radio, in addition to being a business, has also been a hobby with Dana and his amateur station calls have been W9BGI, and W3FWM.

During the past month he has joined transmitter sales and, in the near future, will be stationed in the Central District with Mr. A. R. Hopkins.

FLEXIBLE AND COMPACT

(Continued from Page 20)

Emergency Program Channel

As mentioned above, the line out switch is provided with an emergency position. When thrown to the emergency position, the outgoing line is connected to the output of the monitor amplifier, through a bridging resistor network. At the same time the volume indicator meter is connected to the outgoing line. Thus, in case of failure in the program amplifier, the monitoring amplifier can be used as an emergency program amplifier.

Emergency "B" Supply

A switch in the power supply unit permits obtaining "B" supply voltage from the monitoring amplifier power supply circuit instead of the program amplifier power supply circuit. It should be noted that the 76-B1 power supply unit has in reality two separate and complete power supply circuits—one for the program amplifiers (and pre-amplifiers) and one for the monitoring amplifier.

Relay Operation

A system of relay interlocking is used in the 76-B1 which provides the necessary function of controlling the output of the monitoring amplifier into the two studio speakers, and the control booth speaker. Provision has been made for adding an interlocked relay for a speaker in a third studio. Provision has also been made for easily connecting signal light relays which can control signal lights in the studios.

The interlocking is such that at no time is a speaker on in a studio whenever that studio is on the air. Likewise the booth speaker is disconnected whenever the talk-back microphone or an announce microphone in the control booth is connected to the 76-B1.

When signal light relays are used, the interlocking is such that an "on-air" light will be turned on in the studio which has a microphone connected through to the outgoing line. Also an audition light in a studio can be turned on whenever an audition is being carried on with the studio.

All relay power is obtained from the 76-B1 power supply so that no external relay rectifier is required. Extreme care has been taken in the design and production of the relay switching circuits so that the "clicks" resulting from breaking the DC relay current have been reduced to an absolute minimum.

Cutouts have been provided in the 76-B1 for mounting two signal lamps on the control panel which may be used for various purposes. One of these may be to obtain "preset" and "on air" signals from master control room in large studio installations.

An additional control on the 76-B1 control panel is a plate current switch for checking tubes in the 76-B1. This switch, located just to the left of the VI meter, is used in conjunction with the VI meter for measuring the bias voltages of the tubes in the program channel of the 76-B1. While the scale of the meter is not calibrated to give exact voltage measurements an indication of the tube condition or tube voltages can be obtained.

Conclusion

While the 76-B1 provides switching, amplifiers, and control circuits comparable to those found in large rack and console speech input assemblies, the overall size and weight of the console is quite small. Small enough that broadcasting stations should have very little difficulty in fitting this unit into their speech input requirements—both in present studios or in contemplated new studio installations.

312-A NOISE METER

(Continued from Page 7)

provided which connects a conventional detector, average type indicator, and audio amplifier with an output jack for the connection of headphones in place of the quasi-peak indicator. So operated, the instrument is the practical equivalent of the standard field intensity meter, except that great accuracy is not to be expected, since the effective height of the rod antenna provided will vary appreciably depending upon the location of the instrument

with respect to ground and other conductors.

The demands for light weight and long battery life are directly opposed. The Type 312 Radio Noise Meter has been designed to give the longest battery life obtainable with a reasonable weight for a portable instrument. By clever design the sensitivity of the instrument has been made relatively independent of the battery voltage, so that during an average battery life of 50 hours intermittent service four hours per day, the sensitivity changes only about 10%. This change is, of course, taken care of by the convenient calibration check provided. Standard readily procurable batteries are used, yet the weight of the complete instrument, including these batteries contained within the case, is only 32 lbs. The condition of the filament and plate batteries may be checked at any time by means of a switching arrangement which permits the use of the D. C. indicating instrument as a battery voltmeter.

This single D. C. indicating instrument performs so many functions that it may be of interest to enumerate them.

- (1) Filament Voltage
- (2) Plate Voltage
- (3) Plate current or diode used as a standard noise source for calibration.
- (4) Output indicator of the average-reading type, for field intensity measurements.
- (5) Output indicator of the quasi-peak type, for radio noise measurements.

The different functions are selected by a multi-position rotary switch. In this way the accuracy and reliability of the readings of the Type 312 Radio Noise Meter are insured without the necessity for the weight and cost of additional meters.

Great care has been taken to prevent overloading and cross-modulation in the Type 312 Radio Noise Meter. For this reason a radio frequency amplifier stage has been used, and the range change attenuator has been introduced ahead of the tube in this stage. Thus inputs up to 0.1 volt or 0.1 volt per meter may be measured and inputs 100 times

(Continued on Page 34)

DOING A MAN-SIZED JOB IN MANSFIELD

*WMAN, New Ohio Station, Off to a Good Start
with RCA Equipment*

ONLY a few months old, but already a potent force in community life, is the record of Mansfield's new radio station—WMAN.

And not only is WMAN doing a real job of providing entertainment, news, special features and community service to Mansfield itself, but reports reaching the station indicate that listeners throughout the western half of Ohio are fast becoming accustomed to tuning to 1370 kilocycles for their daily radio fare.

Operating daily between the hours of 7:00 A. M. and local sunset, WMAN is specializing in two distinct phases of radio service—complete news coverage and music.

Modern Equipment

WMAN stands out, among the nation's 700-odd broadcasting plants, as one of the best-equipped and most modern stations in the United States today. Equipped, at present, to operate with 250 watts of power, transmission facilities of the station are arranged to make increases in power feasible on the shortest possible notice, and without interruption of program schedules.

Equipment used throughout by the new station was designed and constructed by the RCA Manufacturing Co. and represents the last word in that company's radio transmission equipment.

WMAN's five studios are located at 140 Park Ave. West, in Mansfield—on the second floor of the Ohio Theatre Building. The studios, too, are of the latest design and construction.

A highly experienced staff has been assembled to administer the affairs of and operate WMAN.

The station's General Manager is Marie Vandegrift, whose experience in radio dates back to 1926. Originally a newspaperwoman, Miss Vandegrift entered radio as manager of station WAIU which, in those days, was operated in Columbus, O., by the American Insurance Union. After nearly six years in this post, she took over the management of station WPAY, in Portsmouth, O., which connection she retained until coming to Mansfield three weeks before WMAN's opening, on December 3, 1939.

In charge of WMAN programs is Gwen Fields, whose tenure and career in radio parallels that of Miss Vandegrift's both as to years in the industry, and stations served.

Engineering is in charge of John Weimer, a native of Mansfield, and former owner of WMAN's predecessor in the city.

As Chief Engineer, Weimer is credited with the installation of the station's equipment, now operating so efficiently. He is also Secretary and Treasurer of Richland Inc., the company which owns and operates the station.

In addition the general operations staff consists of three announcers, three engineers (Howard Jonard, Perry Wilson and Wendell Garmon), and a news department embracing three persons.

Announcers

The announcers are Carl Raymond, Earl Black, Gene La Valle and Orville "Sky" Fields. Black was a member of the staff of WJW, when that station was located in Mansfield, and was absent from radio during recent

years, having been interested and active in Mansfield musical circles during the interim. Black will serve on the WMAN staff as Musical Director, as well as announcer.

La Valle came to WMAN from Akron, where he had been serving on the staff of WJW. Previous to that, he will be remembered for the various roles he portrayed on programs over stations KGAR, WJAY, WCLE and WHK, in Cleveland, and on programs of the Mutual Broadcasting System.

Fields cut his radio teeth with one of the country's first broadcasting stations, WHBD, which for many years was operated in Mt. Orab, O., later going to WJAY, in Cleveland, and still more recently serving on the staff of WPAY, in Portsmouth, O.

Publicity

The News and Publicity Department is directed by Arthur Cook, whose connection with the newspaper and radio fields dates back to 1923, when he assumed the post of Radio Editor of the Cleveland Press and radio feature writer for the Scripps-Howard league of newspapers. His past radio connections include service with WHK, Cleveland, WXYZ, Detroit, and WSPD, Toledo, as well as with both the Columbia and Mutual Networks. WMAN's local news beat is being covered by Harvey Bogen.

Aside from numerous live-talent programs, WMAN is featuring programs of the NBC Transcribed Service, which provides listeners with entertainment featuring many of the really "greats" in the radio field.

That's WMAN, the newest voice in Radioland!

LOOKING IN ON WMAN, MANSFIELD, OHIO

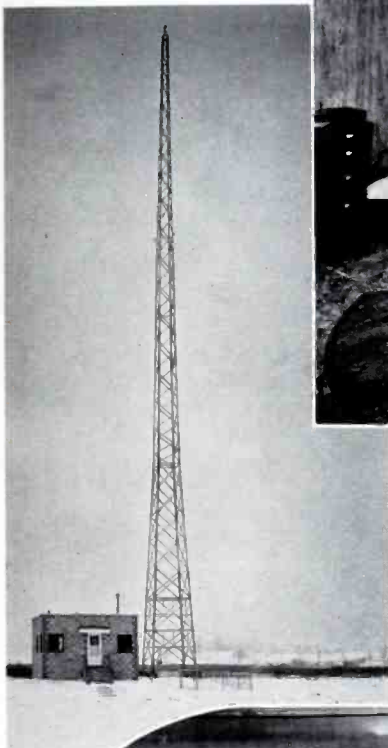

Reception Room—WMAN.

Left: Transmitter House and Tower.



Above: Studio control room, showing control console and transcription turntables. Small studio visible through glass panel.



Interior transmitter house. John Weimer, Chief Engineer, Secretary and Treasurer of Richland Inc., operators of WMAN, at left; Howard Jonard, Asst. Chief Engineer, center; Perry Wilson, Operating Engineer, seated.



Right: Large Studio, WMAN. Studio control visible through glass panel.

H. E. RHEA IN TELEVISION EQUIPMENT SALES



H. E. Rhea, who has recently joined the Television Equipment Sales Section, was born in 1913 at Clinton, Ill.

After completing high school he entered the University of Illinois where he was graduated in 1935 with a B.S. in Engineering Physics.

For a time after leaving school he was connected with an automotive accessory business.

In the latter part of 1935 he joined the Advanced Development and Design Section of RCA specializing in Television Equipment.

His interest in sales work led to his transfer to the Sales Department early this year.

NOISE METER 312-A

(Continued from Page 31)

greater will not cause overloading. Thorough shielding has also been provided, to prevent any disturbing stray pickup.

The accuracy and convenience of this new radio noise meter and its reasonable price should greatly encourage the quantitative study of radio noise, in all its aspects, by broadcaster, radio service engineer, electrical contractor, appliance manufacturer, radio manufacturer, and by technical schools, colleges, and industrial laboratories. This should do much to end the neglect of noise reduction in the battle for better broadcast service.

CLEVELAND INSTALLATION

The City of Cleveland has recently completed the largest 2-way Police Radio System in the world. All of the equipment included was designed and installed by RCA.

The value of the equipment to the city is reflected in the fact that major crime in Cleveland has dropped almost 18% since the system has been in use.

ITS MODERN — ITS WFMJ

(Continued from Page 17)

decorated in tones of dove gray and apricot, accented with black and contrasting colors. Reproductions of antique Persian tiles decorate the wall opposite the elevator where the visitor enters the station. The luxurious reception room, paneled in walnut, sets the color theme for the station. It has dove gray and apricot walls, an apricot-hued rug and harmonizing furniture. A blue davenport blends with upholstery of two lounge chairs in imported print damask, a fabric used also for the drapes. The dove gray theme is carried out in offices of WFMJ executives. Carpeting in the office section is of deep apricot tone in a rectangular design. The entire station is planned for effective use of indirect lighting. Some of the offices have drop lights while others have recessed illumination in the ceilings. The office of the general manager, William F. Maag, Jr., is paneled in gray English hore wood, set off by a pale apricot-toned acoustical ceiling with recessed lighting. Scenes of the 'Roofs of Paris' in tones of pastel blue and beige, provide novel wallpaper for the audition room. Swedish modern furniture in bleached mahogany is upholstered in harmonizing blue and golden brown. The ladies' lounge is Parisian in tone with modern 'Directoire' wallpaper and furnishings in bleached wood with periwinkle blue and Georgian green upholstery. The broadcasting studios continue the basic color theme of the station. Doors throughout combine the apricot hue with metal paneling. The smallest studio is in dove gray and blue; a lime-yellow is used for walls of studio No. 2. The

large studio is furnished in tones of green with a bittersweet chenille drape at one end."

A remote studio located in the Youngstown Vindicator Building is equipped with RCA type 62-A portable equipment and from this point a number of the hourly news broadcasts originate.

WFMJ is under the personal direction of William F. Maag, Jr. The department heads are Leonard Nasman, Sales Manager; Frank Dieringer, Chief Engineer; Ed. J. Lord, Program Manager.

WCKY

(Continued from Page 21)

ception that 40-C and 41-D amplifiers are used.

The floor of the control room was raised 12 inches and channel irons were placed under this floor which carried the racks. Beneath the racks a metal race-way was placed which carried all the cross connections, and into which fed the conduits from the other studios. The wiring in this race-way was segregated into four groups, low level, medium level, high level, and signal. With this precaution, no cross talk at all was experienced. The hotel in which the studios are located has its own power supply and arrangements were made to use this as an emergency supply. The regular supply from the Cincinnati Gas and Electric Company feeds through an automatic change over switch, so in the event of failure the entire studio load including the lights and air conditioning are automatically switched to this emergency supply. We were fortunate in having an emergency supply available that would carry the entire load.

The great number of favorable comments from listeners after the installations of the new RCA 50 KW transmitter and speech input equipment on the quality of WCKY's signal has convinced us that listeners are beginning to appreciate high fidelity broadcasting.

AR-77

(Continued from Page 16)

it is possible for the operator to attain a setting to gain maximum reduction of the interference.

Uni-view dials on the AR-77 enable the operator to tell at a glance what part of the radio spectrum the receiver is tuned to since only the calibration of the range in use is visible. An aperture in the slide-shutters moves up or down with the setting of the range switch. Ease of dial reading is of prime importance in a communication receiver when consideration is given to the sustained periods of tuning by the operator. Transparent lighting of the dials facilitates easy viewing and freedom from parallax.

Calibrated Bandsread for the 10, 20, 40 and 80-meter amateur bands has been provided and each calibration scale extends to nearly the full rotation of the dial, thereby spreading out the calibration for "split-kilocycle" readings. Electrical bandsread is accomplished by a special three-gang, triple-section condenser connected in parallel with the three-gang, double-section main tuning condenser. Calibrated bandsread provides an easier way to locate signals in the amateur bands and to serve also as a check on the transmitter frequency.

Since the electrical band spread functions throughout the tuning range above 3.3 MC. the arbitrary scale, 0-200 divisions, may be employed to plot a calibration—spread curve for the commercial or short-wave broadcast channels.

Carrier Level

The carrier level meter serves two very useful functions: first, for peak tuning of desired signal, and second, to measure signal strength in terms of the popular "S" scale. The "S" units are calibrated 6 db apart up to "S9". Calibration is extended above this point to 40 db. In practice, much attention is given to this meter as an aid in seeking a desired signal while tuning through a band.

Negative feedback, a new feature for improved communication and rebroadcast service, is incorporated in the AR-77. Negative feedback, or degeneration, is applied to the audio output stage. The effect acquired with this circuit is to smooth out the natural peaks and valleys of the audio response curve, including the fall-off at the upper and lower limits.

The audio fidelity curve, voice coil voltage, (Fig. 1) shows the response to average ± 4 db from 50 to 4500 cycles which is unusually good for a receiver of this type.

The selectivity requirements of a communication receiver are necessarily such that the higher side-band frequencies of voice or entertainment-modulated signals are attenuated considerably. By increasing the response of the audio circuit through use of negative feedback, these higher audio frequencies are boosted so the overall response is appreciably flattened out. Having a communication receiver with improved fidelity enables the station to pass better relayed programs. A switch is provided to apply negative feedback at will.

Diversity reception of commercial frequencies employing two or more AR-77's has been facilitated by providing terminals to connect together the A. V. C. bias of the receivers and to parallel the audio output. This arrangement in conjunction with antennas properly designed and spaced will allow reception of modulated signals with considerable reduction of fading.

An eight-inch permanent magnet dynamic loudspeaker MI-8303 housed in a metal cabinet to harmonize with the receiver is recommended for use with the AR-77 in communication service. In monitoring modulated signals a 12" P. M. speaker such as the RCA Stock No. 9713 mounted on a suitable baffle is desirable. The strongly magnetized core and careful design of moving parts gives an unusually high degree of sensitivity and faithfulness of reproduction.

IMPROVED INSTANTANEOUS RECORDING ATTACHMENT



A NEW and improved instantaneous recording attachment has just been designed for use with RCA's 70-C Transcription Turntable. The new recorder is known as the RCA Type 72-C and offers many outstanding features. When used with a 70-C turntable, it provides a reasonably priced recording equipment with which fine recording can be made. The 72-C can be easily and quickly mounted on a 70-C turntable. No modifications are required, because the 70-C is furnished with the proper mounting holes already drilled. The 72-C may be used with RCA 70-A and 70-B turntables by modifying the platter.

FROM THE ARCTIC TO THE TROPICS

It's RCA—All The Way

In the second article appearing in this issue of Broadcast News we have told you the story of the installation at KFAR, Fairbanks, Alaska. To secure the maximum results from the transmitter, RCA speech input equipment was used throughout. The I-G transmitter and associated equipment chosen for this station were selected because engineers knew they would function perfectly in the frigid temperatures to which they would be subjected.



Above: Front view of the Transmitter Building located at Catia, Caracas, Venezuela.

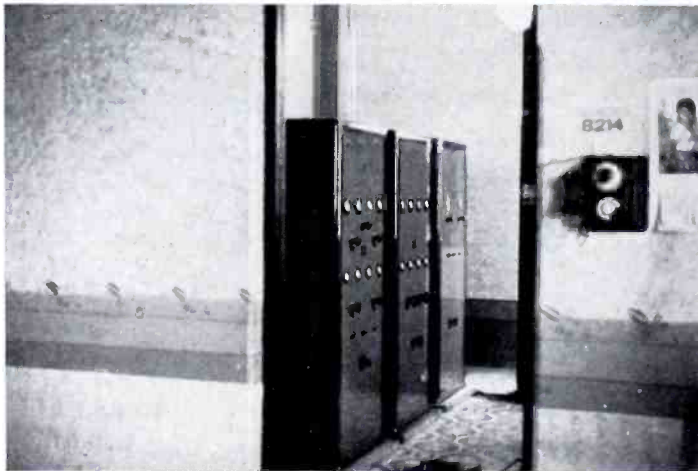

Left: Radio Contинente Installation. View of the RCA I-G.

Below: The AZ 4293 Antenna Coupling Unit and 4-wire Transmission Line.

Now we show you the same transmitter, the I-G, operating in Caracas, Venezuela, a tropical region, where it must function equally well in a torrid climate. Here, too RCA speech input equipment complements the transmitter.

No finer tribute can be paid to RCA equipment than this choice by stations presenting such widely divergent requirements.



RCA EQUIPMENT FOR HIGH FIDELITY

Recording and Reproduction of Transcribed Programs

OVER 1400 RCA 70 SERIES transcription turntables are now in use. Surely this is impressive evidence of the high regard broadcasters have for the performance of this equipment. Designed to meet every requirement of all types of transcribed programs, RCA equipment gives maximum dollar for dollar service.



● **RCA 70-C Turntable With Lateral Pickup!** Long wear Diamond Point Stylus. Frequency response 30 to over 9,000 cycles. Low distortion. High quality Lateral Reproducer, adjustable filters for properly reproducing all recordings. Accurate timing. Low noise level in reproduction, operates quietly. 33½ and 78 RPM—speed change mechanism in rim where it can be seen at all times and can be changed quickly. Quiet starting synchronous motor with gear speed reducer provides accurate timing. Large fly-wheel which always revolves at 78 RPM. Large front door provides complete accessibility. Finished rear of cabinet improves appearance.



● **Vertical Pickup Attachment Type 71-C.** Proper frequency response in reproducing present day vertically cut recordings is assured by a new compensator. The tone arm is similar in appearance and construction to the lateral tone arm of the 70-C. Pickup head of the moving-coil type with a diamond point stylus.



● **Instantaneous Recorder Attachment Type 72-C.** Complete with fittings to adapt it for use on 70-C turntable. RCA "float stabilizer" prevents "flutter." High quality 6,000-cycle cutting head. Three pin drive prevents slippage and eliminates knocks. Spiraling handwheel permits separating selections without breaking continuity of groove. New lowering mechanism prevents damage to stylus. Accurate and convenient adjustments for stylus pressure and angle.

Use RCA Radio Tubes in your station for reliable performance



Broadcast Equipment

RCA Manufacturing Co., Inc., Camden, N. J. • A Service of the Radio Corporation of America

FOR FINER PERFORMANCE...
GO **RCA** ALL THE WAY

Microphones
Speech Input Systems
Associated Equipment
Transmitters



They let their **CONFIDENCE** be their Guide

Sight Unseen . . . Sound Unheard . . . Broadcasters buy entire factory order of New RCA 250 watt transmitter

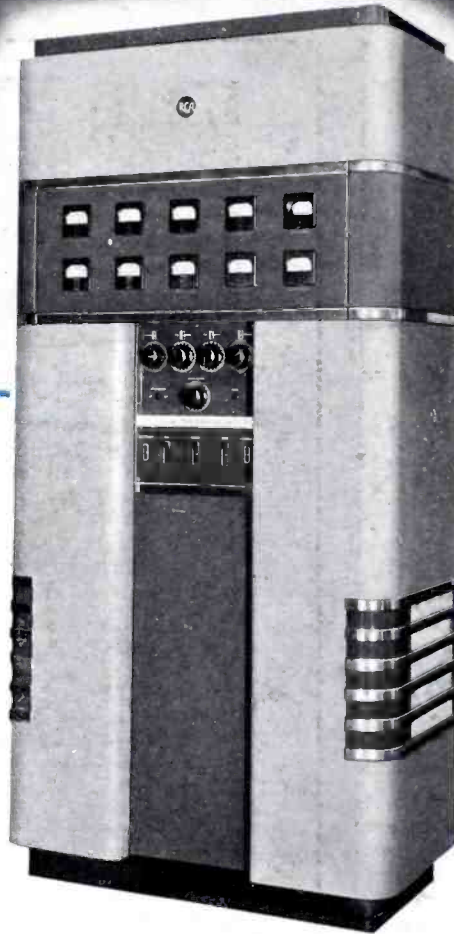

IN THIS TROUBLED world where treaties are scraps of paper...where discord, distrust, and discontent are everyday headlines... we believe you will find this report of good-will and confidence as refreshing as we did.

No broadcaster ever saw an RCA 250-K Transmitter. No broadcaster ever heard an RCA 250-K. Nevertheless, broadcasters had such confidence in RCA engineering that they purchased the entire factory order of this new 250 watt transmitter...sight unseen, sound unheard.

RCA tries to merit confidence of this nature through the application of sound fundamentals of good engineering practice. Ours is a constant and studied effort to design and build the best possible equipment at the right price... We would welcome an

opportunity to be of service to your station. We are confident that the engineering resources of RCA will find the correct solution to any problem you may have.

Use RCA Tubes in Your Station For Reliable Performance

Specifications of the RCA 250-K

Frequency Response: Flat within ± 1.5 DB from 30 to 10,000 cycles at any percentage of modulation from 0 to 95.

Operation: Three power outputs, 100, 250, 100/250 Watts.

Frequency Range: 550-1600 KC.

Fidelity: Stabilized feedback reduces distortion to less than 3% RMS between 50-7500 cycles up to and including 95% modulation.

Carrier Noise Level: At least 60 DB below the level for 100% modulation—unweighted.

Utilizes power change switch and equipment where required.

High level class B modulation.

Uses RCA "V"-Cut Crystals.

All meters at eye level for convenience in reading.

Low Maintenance: Uses minimum number of inexpensive tubes.



Broadcast Equipment

RCA Manufacturing Co., Inc., Camden, N. J. • A Service of the Radio Corporation of America