

BROADCAST NEWS

REG. U. S. PAT. OFF.



IN THIS ISSUE

WBT EXPANDS TO 25,000 WATTS

By Earle J. Gluck

THE VELOCITY MICROPHONE

By Dr. H. F. Olson

**INSULATION FOR VERTICAL
RADIATORS**

By Ralph L. Jenner

THE LINE TO THE ANTENNA

By Edmund A. Laport

POLICE RADIO

By H. C. Vance





RCA Victor Company, Inc.
A Radio Corporation of America Subsidiary
Camden, N. J.

"RADIO HEADQUARTERS"

DAVID SARNOFF, Chairman

J. R. McDONOUGH, President

I. E. LAMBERT,
 Vice-President and General Counsel

P. G. McCOLLUM, Comptroller

E. A. NICHOLAS, Vice-President
 in Charge of Sales

W. R. G. BAKER, Vice-President in Charge
 of Manufacturing and Engineering

J. D. COOK, Treasurer

F. S. KANE, Secretary

H. SADENWATER, Manager

J. M. SAWYER, Assistant Manager

ENGINEERING PRODUCTS DIVISION

TRANSMITTER SALES SECTION
 (OF ENGINEERING PRODUCTS DIVISION)

I. R. BAKER, Manager

S. W. GOULDEN, Commercial Engineer

J. P. TAYLOR, Sales Engineer

A. H. CASTOR, Power Radiotron Sales

T. W. ENIS, Assistant

T. A. SMITH, C. B. S. Contact

C. L. BEACH, N. B. C. Contact

PIERRE BOUCHERON, Advertising Manager

1 EASTERN DISTRICT—T. A. Smith, 153 E. 24th St., New York City. W. H. Beltz, Assistant

MAINE
 VERMONT
 NEW HAMPSHIRE
 MASSACHUSETTS

RHODE ISLAND
 CONNECTICUT
 NEW YORK
 NEW JERSEY

PENNSYLVANIA
 MARYLAND
 WEST VIRGINIA
 DELAWARE

VIRGINIA
 NORTH CAROLINA
 SOUTH CAROLINA

2 CENTRAL DISTRICT—H. C. Vance, 111 North Canal St., Chicago, Ill. D. A. Reesor, Assistant

NORTH DAKOTA
 SOUTH DAKOTA
 NEBRASKA
 WISCONSIN

MISSOURI
 IOWA
 MINNESOTA

ILLINOIS
 INDIANA
 KENTUCKY

OHIO
 MICHIGAN
 KANSAS

3 WESTERN DISTRICT—C. F. Coombs, 235 Montgomery St., San Francisco, Calif.

WASHINGTON
 OREGON
 CALIFORNIA

IDAHO
 NEVADA
 UTAH

ARIZONA
 NEW MEXICO
 COLORADO

MONTANA
 WYOMING

4 SOUTHERN DISTRICT—B. Adler, Sante Fe Bldg., Dallas, Texas. W. M. Witty, Assistant

TEXAS
 OKLAHOMA
 TENNESSEE

ARKANSAS
 LOUISIANA

MISSISSIPPI
 ALABAMA

GEORGIA
 FLORIDA

BROADCAST TRANSMITTERS

POLICE TRANSMITTERS

SPECIAL COMMUNICATION EQUIPMENT

POWER RADIOTRONS

POLICE RECEIVERS

BROADCAST NEWS

Edited by
E. JAY QUINBY

NUMBER 5

OCTOBER 1932

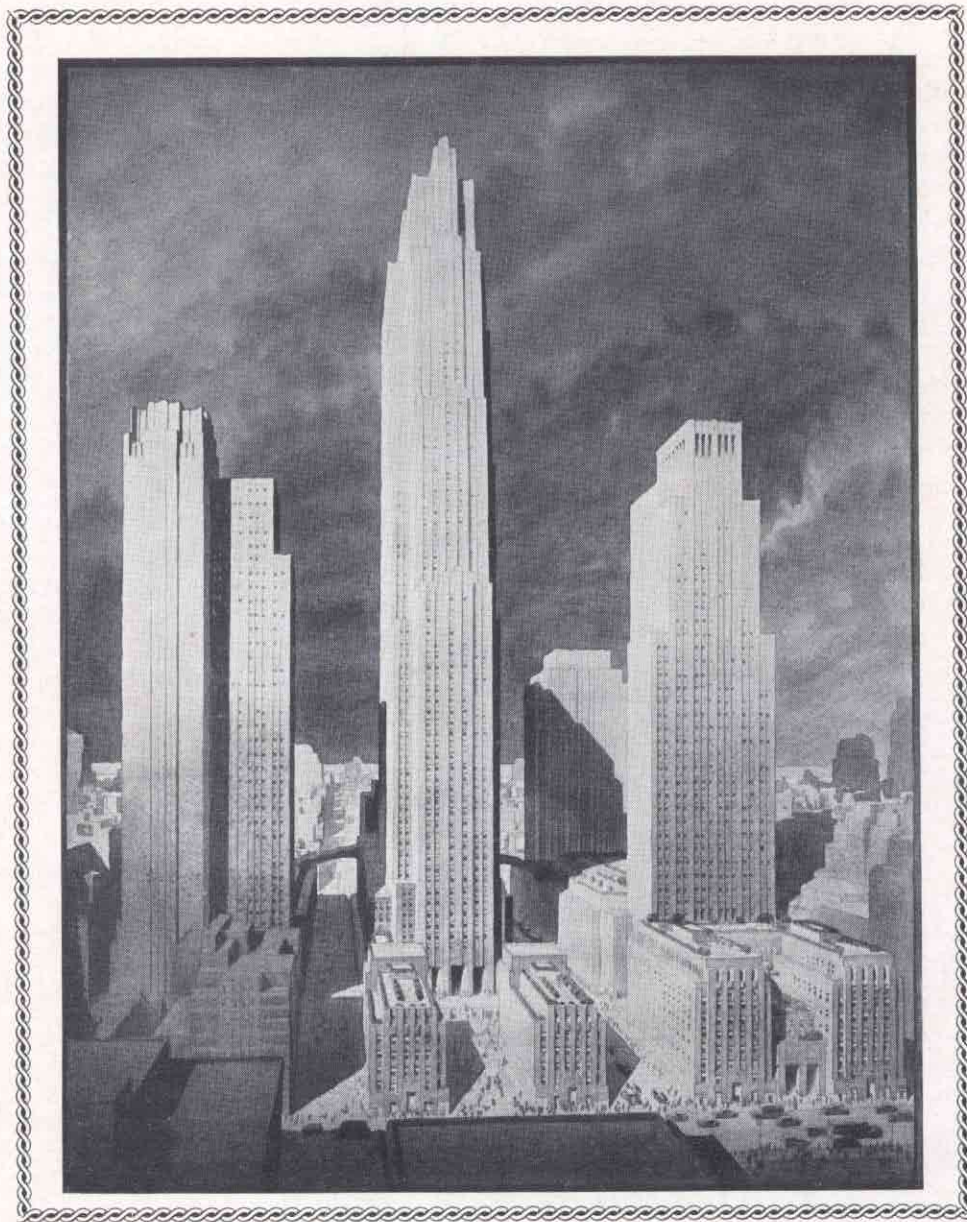

ROCKEFELLER CENTER, NEW YORK

A NEW VIEW OF ROCKEFELLER CENTER FROM FIFTH AVENUE SHOWING FOR THE FIRST TIME A REDESIGNING OF THE NORTH BLOCK. MUCH OF THE EQUIPMENT FOR THIS MAMMOTH PROJECT HAS ALREADY BEEN SHIPPED FROM "RADIO HEADQUARTERS" AT CAMDEN, N. J., AND IS NOW BEING INSTALLED UNDER THE SUPERVISION OF RCA VICTOR RESIDENT ENGINEERS WHO HAVE BEEN APPOINTED FOR THIS PURPOSE.

Published Occasionally and
Copyrighted 1932 by
RCA VICTOR COMPANY, INC.
CAMDEN, N. J., U. S. A.

WBT Expands to 25,000 Watts

By EARLE J. GLUCK, General Manager, Station WBT, Incorporated

THE new 25,000 watt equipment of WBT went into operation with colors flying on Aug. 12th with a gala dedication program participated in by North Carolina, South Carolina and Charlotte city officials and civic leaders, and some of the system's outstanding musical artists.

Radio fans over the south and middle west were able to pick up the dedicatory program, broadcast from the steps of the new transmitter building on Nation's Ford road after the switch had been thrown in and the power was expanded from the 5,000 watt local station power to the 25,000 watt national broadcast power.

Ronald Jenkins, announcer, explained to the invisible audience that the station was still operating on its low-power basis and had the orchestra, headed by Michael Wise, play a



EARLE J. GLUCK
GENERAL MANAGER WBT.

fore the federal radio commission and aided in getting the new power

Kuester Speaks

The first speaker was Clarence O. Kuester, Chamber of Commerce executive, who declared the new station marks an important step in the advancement of the two Carolinas. Mayor Charles E. Lambeth pointed out that radio links the country together, has wonderful educational possibilities, and aids in instilling in the people a better understanding of their government. Mayor Lambeth expressed the hope that the station will soon be allowed by the government to use its full capacity of 50,000 watts.

Lauds System

Representing Governor Gardner, Col. J. W. Harrelson, director of the North Carolina department of conservation and development, praised Gardner's safe and sane administration, praised the Columbia Broadcasting System for its progressive move in improving the Charlotte station and described the state's resources for the benefit of listeners outside the state.

The group taking part in the program, members of the WBT staff including the manager, Earle J. Gluck; V. Paul Rousseau of the Charlotte Merchants Association, H. Elliott Stuckel of the New York office of the Columbia Broadcasting Company, artists of the system, and newspaper men attended a dinner at the Chamber of Commerce, and went to the transmitter plant in a long motorcade, led by state highway patrolmen and rural policemen.

41-Hour Broadcast

WBT was on the air for forty-one hours of continuous broadcasting. After the dedication at the transmitter station, there was a special broadcast from the studios in the Wilder Building, featuring songs by Barbara Maurel, famous Philadelphia opera contralto who has been starred by the Columbia system for several seasons. The program featured by



ENTRANCE TO TRANSMITTER BUILDING OF WBT

number. The switch was pulled and the number was repeated under the new power with five times the strength and volume.

Lieutenant Governor James O. Sheppard of South Carolina pointed out that people of that state testified for station WBT in the hearings be-

advancement, even in the face of objections from Spartanburg and Columbia stations.

He asserted the station will serve as a link to further join the sister states. The address was closed with a description of South Carolina's resorts and resources.

the Modernists, artists taking part being Alfred Garr, Bill Elliott, the Dixonians' quartet, Ephraim Lee, Slufoot Lochman, Clair Shadwell and Peter Martin. Lee Everett was master of ceremonies. Billy Hamilton's orchestra played during this program.

This special dedicatory program of music was broadcast over the stations

Eight miles south of Charlotte stands this new monument to the faith of man in the progress of the South. Located on an old Southern plantation, it occupies thirteen acres, many of which are underlaid with a network of buried wires constituting the elaborate ground system.

The approach to the building brings one facing architecture mod-

letters of ever bright monel metal carry the WBT identification.

The Entrance

Directly over the entrance doorway is the universally accepted insignia of radio, a large relief sculpture of a carbon microphone, carved in white limestone. Modernistic light brackets of chromium on either side of the entrance are in pyramidal design; white stone steps flanked by wrought iron rails complete an attractive, hospitable doorway.

Entering, one finds a pleasant reception room, with the chief operator's room to the right, and ahead the main control room, acoustically treated so that the operating engineer, listening to programs from a high quality speaker, can judge their quality without room-echo or other disturbing sound.

The control desk faces the center of three large plate glass windows which provide a complete view of the transmitting switchboards, and the tubes in the adjoining transmitter room. The desk is fitted with push button controls for starting or stopping the entire plant at will, or for controlling individual units of the transmitting apparatus.

Here also are the regular telephone, private line telephone and telegraph instruments for communication with the control room at the studios in the Wilder Building. The oscillograph,

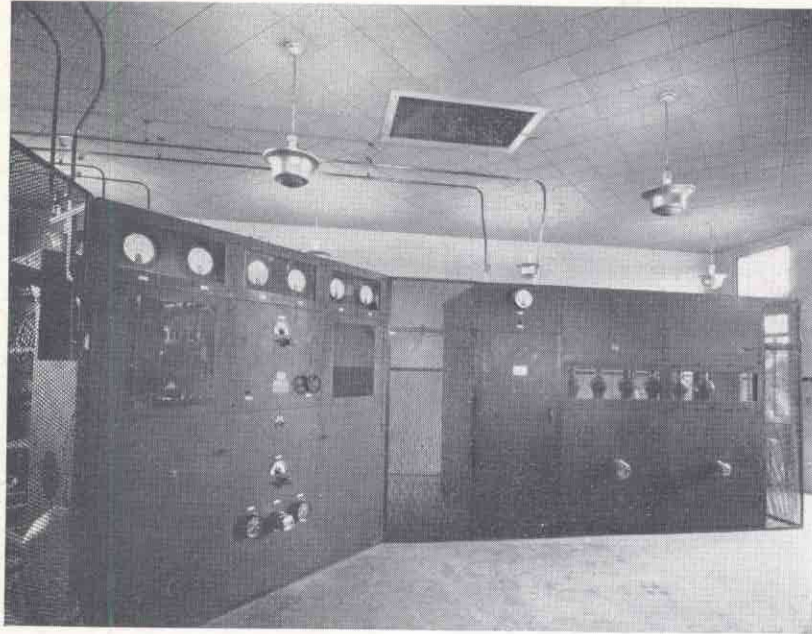

VIEW INSIDE TRANSMITTER BUILDING AT WBT

of the Dixie network and the Columbia Broadcasting System.

Quietly business like in appearance yet in no sense lacking the refining touch of artistry, nestling in a panorama of rolling hills and forest, stands the newly completed transmitter building of WBT, the only high power radio station authorized to the two Carolinas.

No throbbing scene of activity here. Almost as silently as the electric range in the modern home fulfills its duties, so the array of transmitter equipment functions; giant transformers, intricate control boards, monster radio tubes that dwarf a child in size. Trained and created to do the will of man, bank after bank of apparatus grasps the feeble electrical signals filtering through from the broadcast studios in the Wilder Building, adds new strength to them, finally to hurl them amplified millions and millions of times, to every nook and corner of the Carolinas, to the far reaches of the nation and frequently to the opposite end of the globe.

ernistic in design, a touch in harmony with the rapid advance of the broadcasting industry. The mottled red of the face brick is relieved by trimming of white limestone, while large

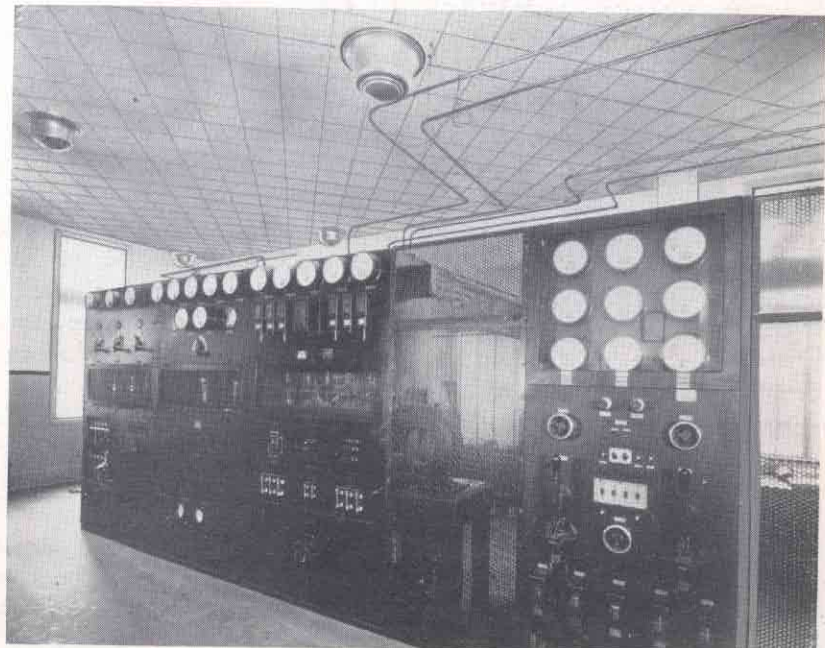

ANOTHER VIEW OF WBT'S TRANSMITTER BUILDING

too, finds its place on the control desk; a unique instrument this, showing a constantly changing picture of the radio waves themselves,—as they leave the transmitting aerial.

To the rear of the control room are three large panels or switchboards containing line-terminating equipment, facilities for changing the regu-

nal strength would be sufficient to actuate some twenty average receiver sets speakers at more than usual room volume.

Careful shielding of the control room from the powerful waves constantly being generated in the transmitter and radiated from the aerial is desirable to prevent pickup in delicate

heat generated in the latter is overcome by a continuous stream of distilled cold water. Each of the power tubes is rated electrically at 100 kilowatts, or four times the 25,000 watts power on which WBT will operate. They are capable of delivery of more than 130 horsepower of high frequency electrical energy, and two of them are used continuously in the familiar (push-pull) arrangement.

Radiotrons

A story of electrical romance and development could well be devoted to tubes of this type, the largest available. The twin pair in operation require over 13,000 watts of electrical energy to light the filaments alone, sufficient to light a dozen large homes to full brilliancy.

The masts and antennae of WBT are a familiar sight to many Carolinians, but only the initiated know of the "dummy antennae" located in the transmitter building. The dummy duplicates electrically every detail of the regular antennae, but it sends forth no signal.

One might wonder at its purpose and would readily understand the explanation of its use while testing the transmitting equipment under actual operating conditions during the wee small hours of the morning, or for warming-up purposes before going on the air in the morning, when it is desirable that no signal be broadcast.

A bank of six tubes partially screened by a metal grill, each glowing with dancing purple lights catch the eye. It is explained that these are rectifiers, changing high voltage alternating current to direct current to be applied to the plates of the 100,000 watt power tubes. The voltmeter above shows a reading of 18,000 volts direct current, or ample to operate ten electric chairs according to some morbidly inclined statistician.

Adjoining is the precision crystal control units, remarkable combination of vacuum tubes and a thin slab of quartz, which holds the broadcast wave in its proper place. Two such units are used, each with its elaborate electric oven and sensitive thermostats, maintaining a constant temperature.

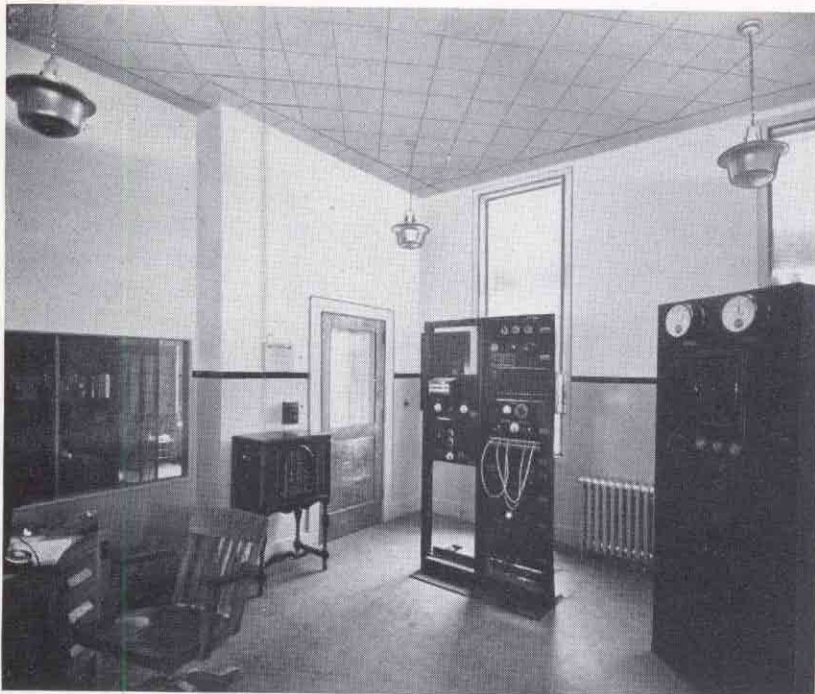

CONTROL ROOM AT WBT

lar wires bring the broadcast in the Charlotte studios, to emergency lines always kept in readiness should the regular wires fail. Meters at this point check the weak incoming signals, while others measure the strength of the outgoing music or voice.

To one side is the frequency monitor, a precision measuring device constantly indicating just exactly how close to 1080 kilocycles clear channel wave length the sign of WBT, that the transmitter is being maintained. Since WBT's wave does not vary more than ten parts in one million, and since each part of the ten is directly indicated on the meter, the precision of modern broadcasting equipment is easily realized.

Amplifiers

The next panel to come to the visitor's attention is the high power audio amplifier which builds up the weak incoming currents to a degree suitable for delivery to the transmitter proper. At this point the sig-

measuring instruments and amplifying equipment. At the WBT transmitter building this is accomplished by totally enclosing the room in two layers of copper screening, each insulated from the other, and laid in floors, walls and ceiling—literally a "room within a room, within a room".

The room housing the main transmitting equipment adjoins the control room, with the apparatus erected in the form of a large L before the control room observation windows. Acoustical treatment of the ceiling reduces and absorbs the slight hum of the generator located in the basement directly below.

The transmitter proper consists of seven units, each eight feet high, varying in width from three to eight feet and in depth from ten to twelve feet. In these units are the array of vacuum tubes ranging from those which, in size, compare with tubes used in radio receivers, to the giant power tubes some five feet high. The

Modulation Panel

Next to greet the visitor's eye is the modulation panel where the continuously varying voice or music currents are impressed on the radio wave to be amplified to higher power and relayed to the transmitting aerial, to be broadcast as radio waves into the ether. Large fans carry away the heat generated by the multitude of glowing tubes and keep the air fresh and comfortable.

The remaining space on the main floor is occupied by a tube storage, and spare parts room; shop and laboratory; washroom, and a completely equipped kitchen with electric stove, electric refrigerator and other necessary appliances. As the station is isolated from stores and restaurants, it is necessary that cooking facilities be provided for engineers' use while on duty. A long corridor separates the transmitter room from the utility rooms, providing individual entrance to each.

Power Room

A concrete basement extends under the entire area of the building, and here are found the power transformers and generators. Here also is the outlet of the 210-foot deep artesian well, drilled through 150 feet of solid granite to provide adequate water supply for the use of operators and engineers, for watering shrubbery and for cleaning purposes.

Auxiliaries

A separate room is allotted to the pumps, one regular and one reserve, constructed to force distilled water to and around the huge water cooled tubes in the transmitting room, then back again to the storage tanks and cooling radiator. To the cooling radiator is assigned another room; a giant of metal standing 15 feet high, it encases a high-power blower forcing air around a system of copper coils through which flows the incoming water carrying the heat from the tubes, to be quickly cooled and returned to gather more heat.

An elaborate system of switches permits disconnecting any part of the equipment from operation for repairs, and in many cases allows the throwing into service of other reserve units

so that service to the listener may go on without interruption.

The main power switch board in the basement distributes the incoming power from the power company to the various circuits of the transmitter, and also shows the amount of power being consumed by each unit. Large high-voltage switches, immersed in oil with only the operating levers projecting to the front of the switch board, enable the engineers to control the power without risk to themselves.

The entire building is heated by steam, with a modern automatic oil-fired boiler. Immediately to the rear of the building an automobile shelter affords parking space for cars of staff members; at some distance to the rear stands the big outdoor sub-station erected by the power company to supply the tremendous flow of power required to operate WBT's super-power station.

Spare transformers which may be thrown into service by switches at the sub-station provide for the pos-

sub-station by the power company can be drawn from two different sources and the equipment is installed to automatically shift to the other, should the power fail on the line in use.

Thus every possible precaution is taken to guard against interruption of broadcast service to the listening audience.

From the north side of the transmitter building extends a feed line composed of two heavy copper wires supported on wooden poles, leading to a small brick structure directly under the center of the antennae. It is known as a radio frequency transmission line, and serves to carry radio energy from the transmitter to the aerial.

Arriving at the "tuning house", the energy travels through a group of massive coils and condensers and then to the aerial, which also has entrance to this building. In appearance the tuning house is almost a replica of the transmitter building. Though much smaller in size, it is



POWER ROOM WBT

sibility of failure of those in use. From the sub-station the 2300 volts is fed to the transmitter plant through underground cables, which too, are in duplicate and equipped with switching devices at each end, for use in the event of failure of the main cable supplying power.

Even the power supplied to the

further dwarfed by the towering masts supporting the antennas overhead.

The antennae and masts erected three years ago for WBT's 5,000 watt station, and designed at that time for possible use on 50,000 watts power, will continue in use without

(Continued on Page 22)

The Velocity Microphone

By DR. H. F. OLSON, Research Division, RCA Victor Co., Inc.

WITH the advent of broadcasting and sound motion pictures, a need arises for a highly efficient microphone having uniform response over an extremely wide frequency range, together with directional characteristics which will reduce the detrimental effects of reverberation and other undesirable sounds without frequency discrimination. In addition to these fundamental important characteristics, the microphone should be small and light and possess electrical characteristics which will make it possible to separate the microphone and amplifier. Development work was undertaken to build a microphone which would possess these characteristics. As a result of this work, a high-quality microphone having uniform response over a wide frequency range and possessing directional characteristics which are independent of frequency is now available. It is entirely different in principle and construction from other microphones now in use. Instead of a diaphragm, in the commonly accepted sense of the word, the Velocity Microphone contains a thin metallic ribbon suspended between the poles of a magnet with its length perpendicular to, and its width in the plane of the magnetic lines of force.

The vibration of the ribbon due to an impressed sound wave leads to the induction of an e.m.f. corresponding to the undulations of the incident sound wave. The ribbon is moved from its position of equilibrium by the difference in pressure existing between the two sides. In general, the ribbon is made light so that its motion corresponds to the motion of air particles even at very high frequencies. This microphone can therefore very appropriately be termed a velocity microphone. One of the important advantages of this type of microphone as compared with a pressure-operated microphone, such as those of the condenser, electrodynamic and carbon types in current



DR. H. F. OLSON

BORN DECEMBER 28, 1902 AT MT. PLEASANT, IOWA. UNIVERSITY OF IOWA, B. E. 1924; M. S. 1925; E. E. 1932; Ph.D. 1928. ILL. BELL TELEPHONE CO., 1924. RESEARCH ASSISTANT UNIVERSITY OF IOWA 1925 TO 1928. RESEARCH DEPARTMENT RADIO CORP. OF AMERICA, 1928 TO 1930. RESEARCH DIVISION, ENGINEERING DEPARTMENT, RCA PHOTOPHONE, 1930 TO 1932. RESEARCH DIVISION, RCA VICTOR COMPANY 1932.

use, is that it possesses marked directional characteristics, whereas the pressure-operated microphone possesses non-directional response. This has decided advantages in sound pick-up work, as will be pointed out later.

As will be seen from Fig. 1, the configuration of the baffle surrounding the ribbon is of rectangular shape. The important parameter that designates the differential pressure between the two sides of the ribbon is the shortest air distance between the front and back of this portion of the ribbon. It can be shown that the difference in pressure between the two sides of the ribbon is the same as that in a sound field between two points in space separated by this distance. It is this difference in pressure, due to the difference in phase between the front and back that actuates the ribbon in the ribbon microphone.

This difference in pressure acts upon the ribbon mass and the air which the ribbon carries along. Due

to the nature of the ribbon and air load, the acoustic impedance of this system is proportional to the frequency. The difference in pressure between the two sides of the ribbon is proportional to the frequency. The velocity in a mechanical system is the ratio of the pressure to the acoustic impedance. Since the pressure and acoustic impedance are both proportional to the frequency, the velocity of the ribbon, which is the ratio of these two quantities, is independent of the frequency. The e.m.f. generated by the ribbon is given by the expression

$$E = B l \dot{X}$$

where B = the flux density

l = the length of the ribbon

X = the velocity of the ribbon.

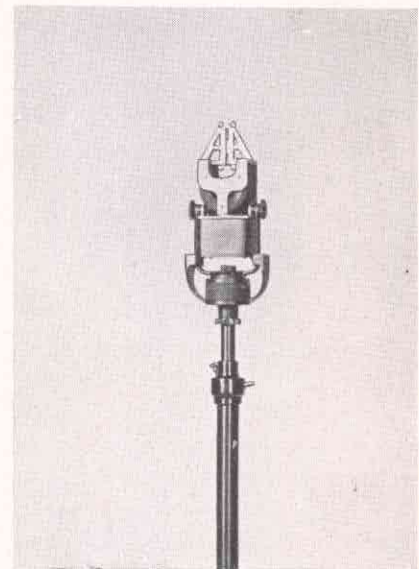

FIG. 1. THE VELOCITY MICROPHONE (CASE REMOVED)

As we previously stated, the velocity \dot{X} is independent of the frequency, therefore the e.m.f. which the ribbon generates is independent of the frequency. In other words, the response of the Velocity Microphone should be uniform over the working range for which the microphone was designed. This was tested by calibrating a microphone of the type shown

in Fig. 1 by means of a Rayleigh disc. The variation in response at the grid of the first vacuum tube as a function of the frequency is shown in Fig. 2. It will be seen that the output is practically independent of the frequency. This agrees with the generalized discussion of the operation outlined above.

The uniform output over a wide frequency range indicates that this microphone is free from resonant systems. The natural period of the ribbon is below the audible frequency range. In the condenser microphone, at least two resonances occur within the audible range that influence the output; viz., the cavity resonance and the diaphragm resonance. In pressure-operated electro-dynamic microphones, the response at the higher frequencies is accentuated due to the pressure doubling which occurs when the wavelength becomes comparable to the size of the microphone. This means that when the normal to the face of the microphone passes through the source of sound, the high frequencies are accentuated. However, if the microphone is turned away from the source of sound, a loss in the high-frequency region occurs. In other words, pressure-operated microphones of dimensions which are comparable to the wavelength in the working range, in general, possess very sharp directional characteristics at the higher frequencies in addition to peculiarities in

response at these frequencies. As we will show in the next paragraph, the directional characteristics of the ribbon microphone are independent of the frequency.

When the normal to the face of the microphone is inclined by the angle θ to the line of propagation, the air distance from front to back is multiplied by the factor $\cos \theta$. When θ is 90° , the pressure difference between the front and back is zero for all frequencies and the ribbon remains stationary. The observed directional characteristics of this microphone are shown in Fig. 3. It will be seen that the experimental results are in close agreement with the predicted performance. These results indicate that the directional characteristics of this microphone are practically independent of the frequency. For this reason, this microphone does not produce frequency distortion due to its directional characteristics.

The effective reverberation as perceived in a sound pickup system is the ratio of generally reflected to direct sound. The direct sound travels from the source to the microphone without being reflected from any surface. The generally reflected or reverberant sound may encounter one or more reflections by walls, ceilings and floor before it reaches the microphone. The direct sound pressure varies inversely as the distance between the sound and microphone. The generally reflected sound as picked up by the microphone is in general independent of the relative positions of the source and microphone. To reduce the reverberation,

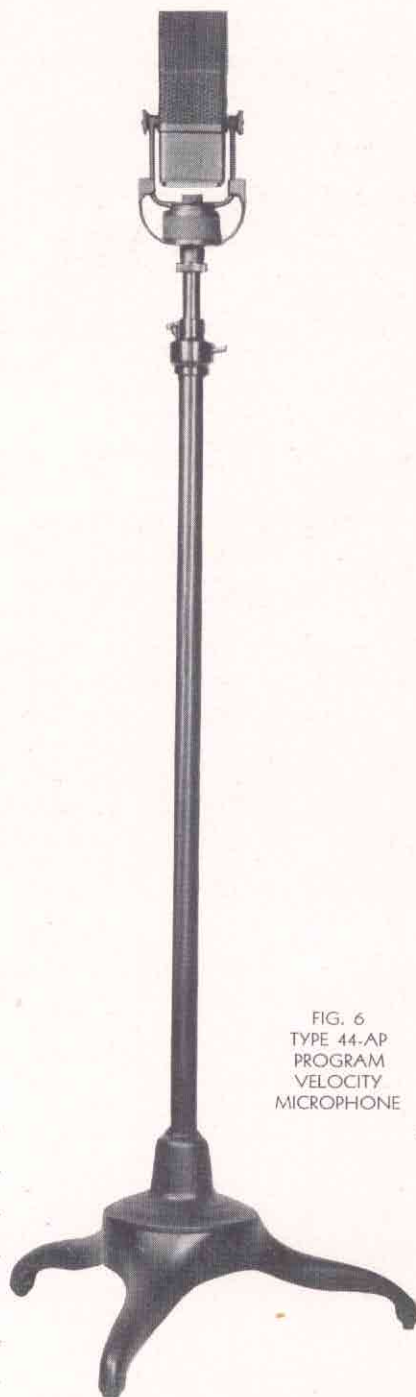
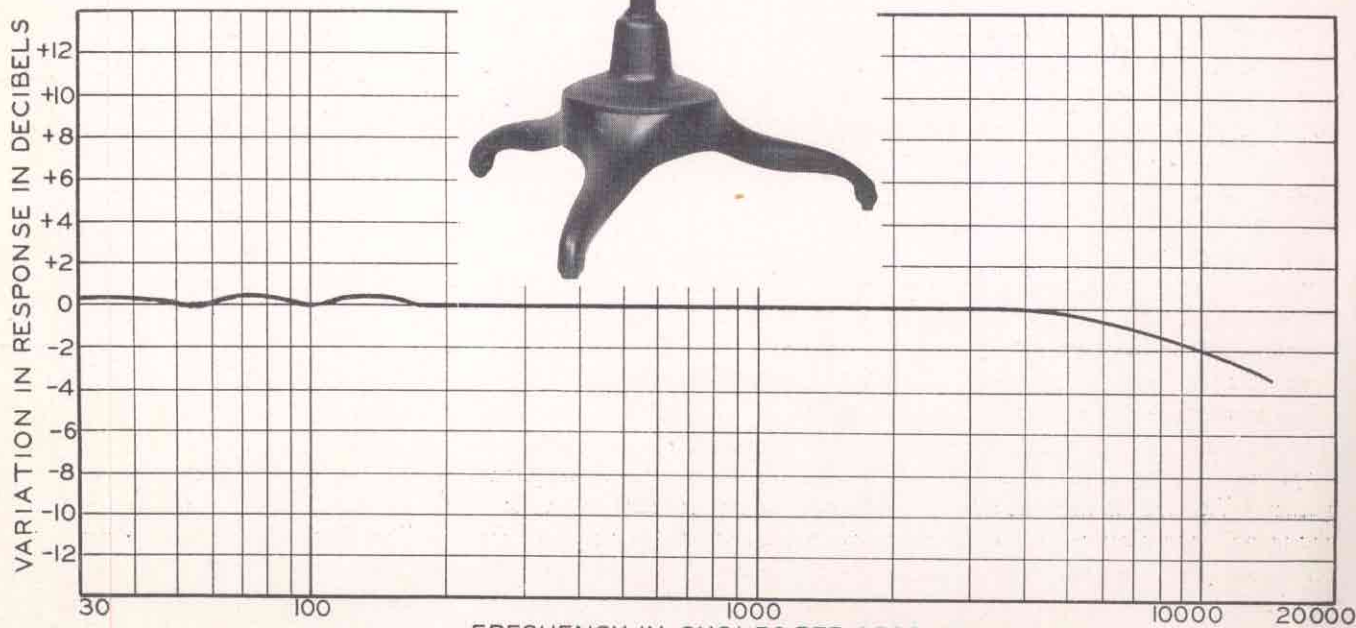

FIG. 6
TYPE 44-AP
PROGRAM
VELOCITY
MICROPHONE



THE VELOCITY MICROPHONE

(Continued from Preceding Page)

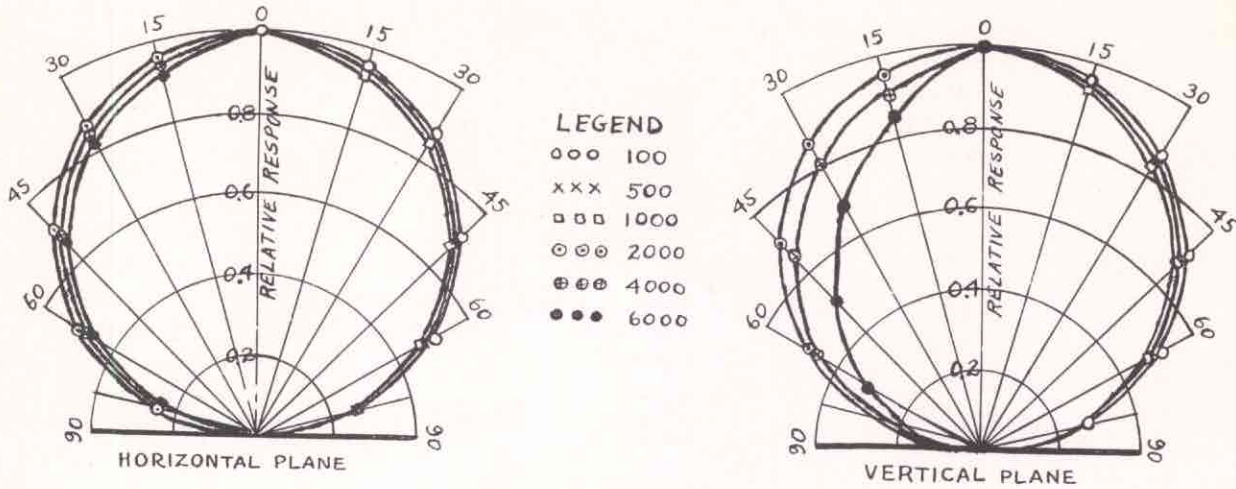

FIG. 3—POLAR DIAGRAMS SHOWING THE DIRECTIONAL CHARACTERISTICS

that is, the ratio of generally reflected to direct sound, we must either decrease the generally reflected sound by increasing the absorption of the reflecting surfaces or decrease the distance between the sound and microphone. This, of course, places a limitation upon the sound pickup system.

Minimum Response to Reflected Sound

It can be shown that due to the directional characteristics of the Velocity Microphone, the energy response to generally reflected sound is one-third that of a non-directional microphone such as the condenser, the diaphragm type of electro-dynamic microphone or the carbon microphone. This, of course, means that this microphone can be used in a studio with less damping or absorbing material on the walls and ceiling and still obtain better results than with a non-directional microphone. Or, in the same studio, it can be used at 1.7 times the distance of a non-directional microphone and still retain the same reverberation characteristics.

In this connection, attention is called to the fact that the directional characteristics of the Velocity Microphone are independent of the frequency. This means that the microphone will not discriminate against certain frequencies either in the case of direct or reflected sound. We have stated that the condenser electro-

dynamic and other diaphragm microphones are non-directional. This is true for the lower frequencies up to 2,000 cycles. Above this frequency, the dimension of the microphone is comparable to the wavelength and the microphone becomes quite directional. This is a very undesirable characteristic. As a matter of fact, this characteristic is more undesirable than a pure non-directional char-

acteristic throughout the entire frequency range. In general, excess reverberation occurs at the lower frequencies due to the fact that the absorption characteristics of most materials used in reducing reverberation are less efficient at the lower frequencies. Using a microphone which is non-directional at the lower frequencies and directional at the higher frequencies means that the excess low-frequency reverberation will be further accentuated. Further-

more, due to the sharp beam of the pressure-operated microphones at the higher frequencies, the microphone must be directed at the action or the direct sound received by the microphone will be practically zero. It might be mentioned in passing that the use of a directional antenna in discriminating against static and other undesirable sounds is well known. The same reasoning can

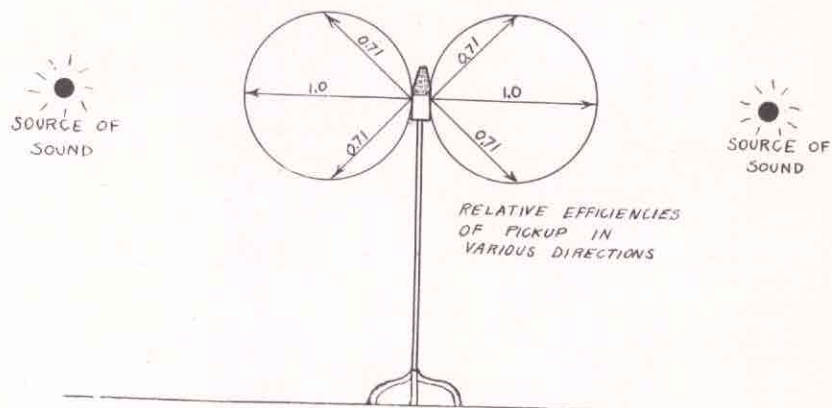

FIG. 4

be applied to sound pickup systems. The directional characteristic of the ribbon microphone, as we stated previously, is given by the expression

$$R = R_0 \cos \theta$$

where R = the response at the angle θ

R_0 = the response for $\theta = 0$.

The Velocity Microphone has two reception zones. Fig. 4 shows how these two zones can be used to advantage in picking up certain dramatic

action. The microphone receives sound with the same efficiency in both directions, and therefore the action can be placed on both sides of the microphone.

Another example is shown in Fig. 5. Here are several sources of sound arranged around the microphone. In the case of the non-directional microphone to balance the various sources of sound, such as an orchestra, the distance from the microphone is adjusted for the various instruments. As will be seen in Fig. 5, S_1 is the same distance as S_3 from the microphone, yet the response of S_1 as perceived by the microphone is one-half that of S_3 . Furthermore, as the source of sound recedes from $\theta = 0$, that from the position of maximum reception the reverberation increases. Suppose we have an undesirable sound such as S_3 . To practically eliminate this sound, we place it in the plane of zero reception. Of course, we will receive the reflected sound from this source but, in general, this will be small. This feature has been used in sound motion pictures in eliminating camera noise by placing the camera in the zero reception zone.

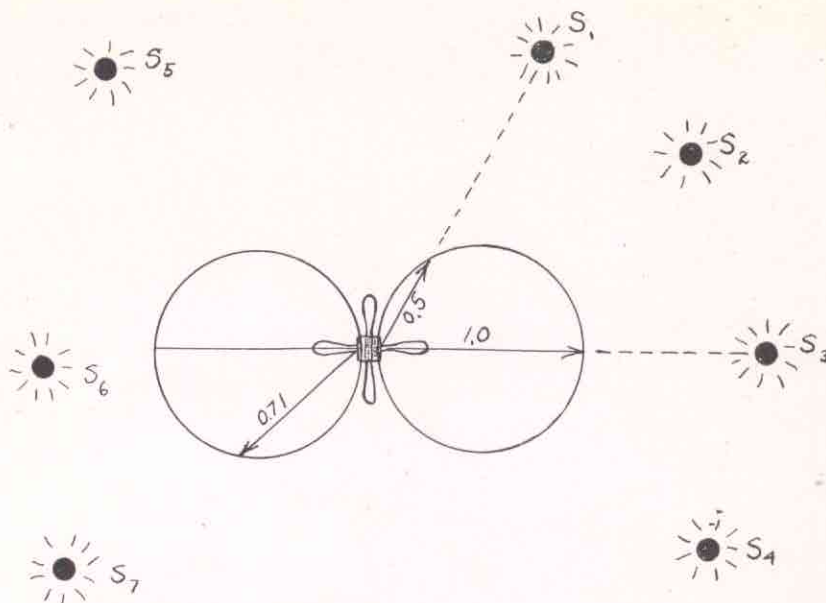

FIG. 5—PLAN VIEW OF MICROPHONE IN A STUDIO SHOWING HOW THE DIRECTIONAL CHARACTERISTICS MAY BE USED TO "BALANCE" THE VARIOUS SOURCES OF SOUND.

shows some of the apparatus supplied.

As indicated above, the impedance of the ribbon is low so that the amplifier can be located at great distance from the amplifier. The output of the ribbon is fed to a transformer which raises the impedance to a level suitable for transmission over large distances. This trans-

plier is practically independent of frequency over an extremely wide frequency range.

KDYL 10 YEARS OLD

Maintaining its position in the ranks of pioneer broadcasting stations, KDYL this year celebrates its tenth anniversary. This Salt Lake City, Utah, station received its first license from the Department of Commerce on May 8, 1922, and began broadcasting immediately. It has been on the air continuously since, and for the past four years has maintained a consistent eighteen-hours-a-day schedule.

The entire month of May this year will see many special features broadcast over the station in celebration of its tenth birthday.

According to Philip G. Lasky, the station's director, an old amateur and likewise a pioneer in broadcasting, this station was one of the very earliest to be licensed; the first equipment was built by Ira J. Kaar, then a Salt Lake amateur, now chief of the General Electric Company's radio transmitter design division. Part of the original 50 watt is now preserved as a historical exhibit.

KDYL, a member of the Columbia network, is one of the major stations of the west, serving the people of the great Intermountain territory.



FIG. 7—FREQUENCY IN CYCLES PER SECOND. CURVE SHOWING OUTPUT AT THE 250 OHM LINE OF THE AMPLIFIER FOR CONSTANT SOUND PRESSURE IN FREE SPACE.

It is beyond the scope of this article to enumerate all the uses to which this instrument can be placed. Of course the user will undoubtedly find further applications for the characteristics which this microphone possesses, to obtain results which are far superior to that obtainable with existing microphones.

For broadcast use it is ordinarily required that stands for either floor or table mounting be supplied. The accompanying photograph (Fig. 6)

former is located in the microphone case. Another transformer is provided at the amplifier which raises the impedance used for transmission over a line to that suitable for the input of the vacuum tube used. The output of the amplifier is a 250 ohm line. The response characteristic giving the voltage in this 250 ohm output for constant pressure in free space is shown in Fig. 7. This characteristic shows that the output of the microphone and associated am-

RCA Broadcast Transmitters in South America

By FRED MULLER, Export Sales Engineer, RCA Victor Co., Inc.

JUST two years ago the RCA Victor Co., Inc., sold the first Broadcast Transmitter in Venezuela. Previous to this a number of RCA Radio Telegraph transmitters had been installed in that country and the excellence of their performance no doubt had a bearing upon the choice of our equipment for a broadcasting service.

While a number of broadcast transmitters were in operation in Venezuela, they were mostly of low power, assembled locally. Their quality of reproduction and their percentage of modulation on the whole were far below the standards as set by RCA Victor equipment.

Radio receiving sets were being imported in fair quantities, but the RCA Victor distributor in Caracas, C. A. Almacen Americano, con-

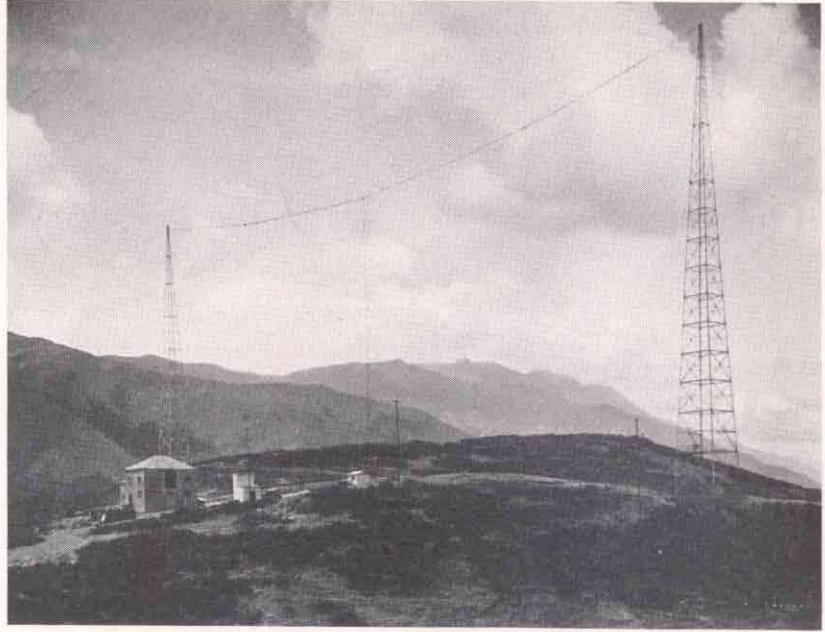

WHAT A SETTING FOR A BROADCAST STATION!
YV-1-BC IN VENEZUELA



EXTERIOR OF THE STATION BUILDING, DURING A TOUR OF INSPECTION
BY REPRESENTATIVES OF THE PRESS.

vinced himself that a first class broadcast transmitter would greatly benefit his sales. His choice—after a thorough investigation—rested upon a standard RCA model 100W transmitter, rated at 100 watts of unmodulated carrier power.

This set was installed by his own staff. Although none of his engineers had had previous experience with

high grade broadcasting equipments, the very thorough and detailed drawings and instructions furnished by the RCA Victor Company made the installation easy for them.

The results obtained with this low power transmitter were quite remarkable. The town of Caracas was well covered and good reception was consistently reported from a large part of

the country. The set was heard in the West Indian Islands and in Central America. The owner of the station relied upon local talent and the excellence of his broadcasts as well as the greatly improved quality of speech and music received wide and favorable comment. The sales of receiving sets were greatly stimulated and convinced our distributor that he would do even better with a transmitter of higher power.

Early this year he purchased an RCA transmitter of 5000 watts output. Again the installation was made by his own engineers. Their experience with the 100 watt set had given them an excellent training for the larger equipment. The final tests and adjustments, of course, were made by one of the factory trained engineers, who reported that the local staff had made an excellent job of the installation. Messrs. Lopez and Rivero, the engineers in charge, are to be congratulated upon their very fine work.

A standard RCA double studio and control room installation is located in the customer's store in the center of Caracas. Condenser microphones are used throughout.

The transmitter itself is located some three miles West of the city in very hilly country, somewhat higher than the city itself. The transmitter is about 3500 feet above sea level and the building housing it closely follows typical RCA layout plans. Living quarters for the operating engineers are provided in one wing of the building.

The antenna is supported by two 200-foot insulated towers and a 125-foot transmission line provides connection to the transmitter.

Power to the transmitter is supplied by a 5000 volt, 3 phase, 3 wire, 50 cycle line, stepped down to 220 volts. An induction voltage regulator takes care of line frequency variations between 48 and 50 cycles.

This new 5 kilowatt set has been on the air for some time now. Good



A VENEZUELAN ORCHESTRA IN THE STUDIO OF YV-1-BC

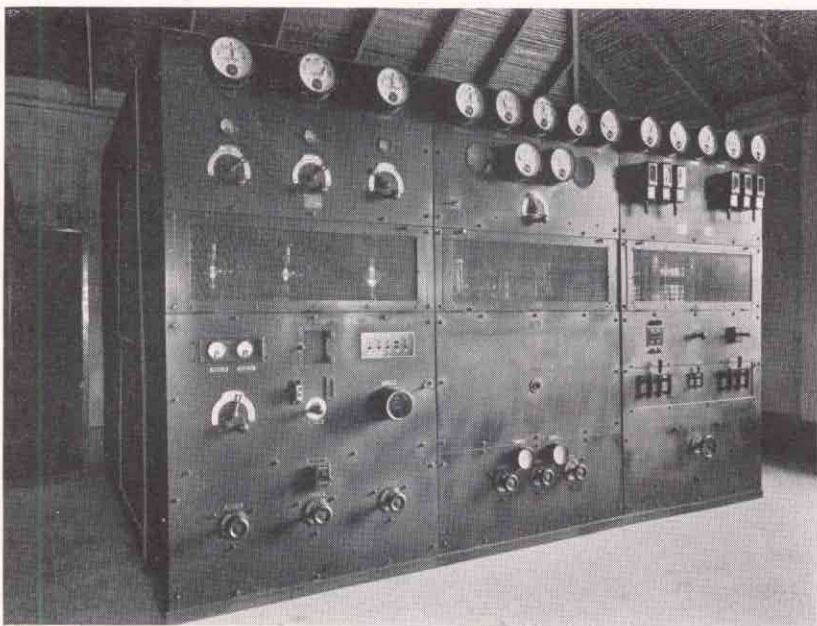

THE RCA TRANSMITTER—5 K.W.—AND THE FIRST IN VENEZUELA

reception is being reported from all over Central and South America and the RCA Victor Company has been receiving inquiries from DX fans in the United States, who had heard the station, but to whom the rather weird call letters—YV-1-BC—were a puzzle!

The transmitter operates on 960-KC and in this region it heterodynes badly with Canadian stations on the same frequency.

The photographs herewith show a general view of the transmitter building, an inside view, and one of the studios with a Venezuelan orchestra.

The customer's two chief aims, continuity of service and good coverage of Venezuela, have been successfully realized and results obtained from this new equipment have far exceeded his expectations. He is greatly pleased with the operation and reliability of his new 5 kilowatt Broadcast Transmitter.

"Broadcast News" is not on sale. If you wish to be placed on our mailing list, please notify the editor, at the RCA Victor Co., Inc., Camden, N. J.

STUDIO NOTES

Television is a fearful and wonderful thing in the minds of some radio listeners, judging by the telephoned and written inquiries that come to NBC's San Francisco studios. Not long ago a department store made an experimental television broadcast using NBC facilities and the next day a little old lady whose voice was trembling with indignation, called up to announce:

"I read in the paper yesterday that there would be a television program broadcast. I sat up beside my radio till ten o'clock last night—and I never saw a thing!"

Seth Parker has fans in all sorts of places. Here's a letter one of them wrote to the NBC studios:

"We live in the mountains fifty miles from civilization. We have an old dish pan we hammer on to give the Seth Parker call, and some of the hill billies walk three and four miles up the canyon to hear Seth Parker."

The record attendance at the NBC Times Square studio was shattered Tuesday, August 23, when 850 persons were admitted to the Ed Wynn Texaco program.

Happy Jack Turner, NBC's solo pianist, wrote a song and then left on a trip. The royalty check followed him the entire distance and did not catch up until three days after his return to the studios.

Insulation for Vertical Radiators

By RALPH L. JENNER, Electric Engineer, Lapp Insulator Co., Inc.

SO much information and misinformation concerning the insulators used on WABC, WCAU and other similar half or fractional-wave Vertical Radiators has appeared in print that the writer feels that engineers interested in broadcasting stations would be pleased to have some of the real facts concerning these insulators and also know some of the problems that confronted the designer.

In the past ten years radio engineers have given considerable thought to the improvement of their antenna and its method of support. Base insulated and sectionalized towers resulted from this effort and gave confidence in porcelain as an insulating material capable of standing great mechanical load without failure under severe conditions. Porcelain used for the support of the antenna itself gave proof of its suitability to stand radio frequency electrical stress. With this ground work complete it was then possible to consider the feasibility of insulating a vertical half-wave antenna for broadcast use. On short-wave length construction the problem is an easy one due to the small physical dimensions of the structure involved. This has been solved by the use of piping fastened to a wooden pole or the support of a cable between cross arms. The half-wave antenna for broadcast use involves a much greater problem.

To cover the broadcast range of 550 KC to 1500 KC, structures 350 to 900 feet in height are required. The use of a large number of guys as would be general on such a mast is not feasible due to the inherent loss and the difficulty of satisfactory structural design. After considerable thought and study the most practical structure appeared to be a mast guyed at one elevation; with this basic consideration settled the loads can be computed and the insulator requirements specified.

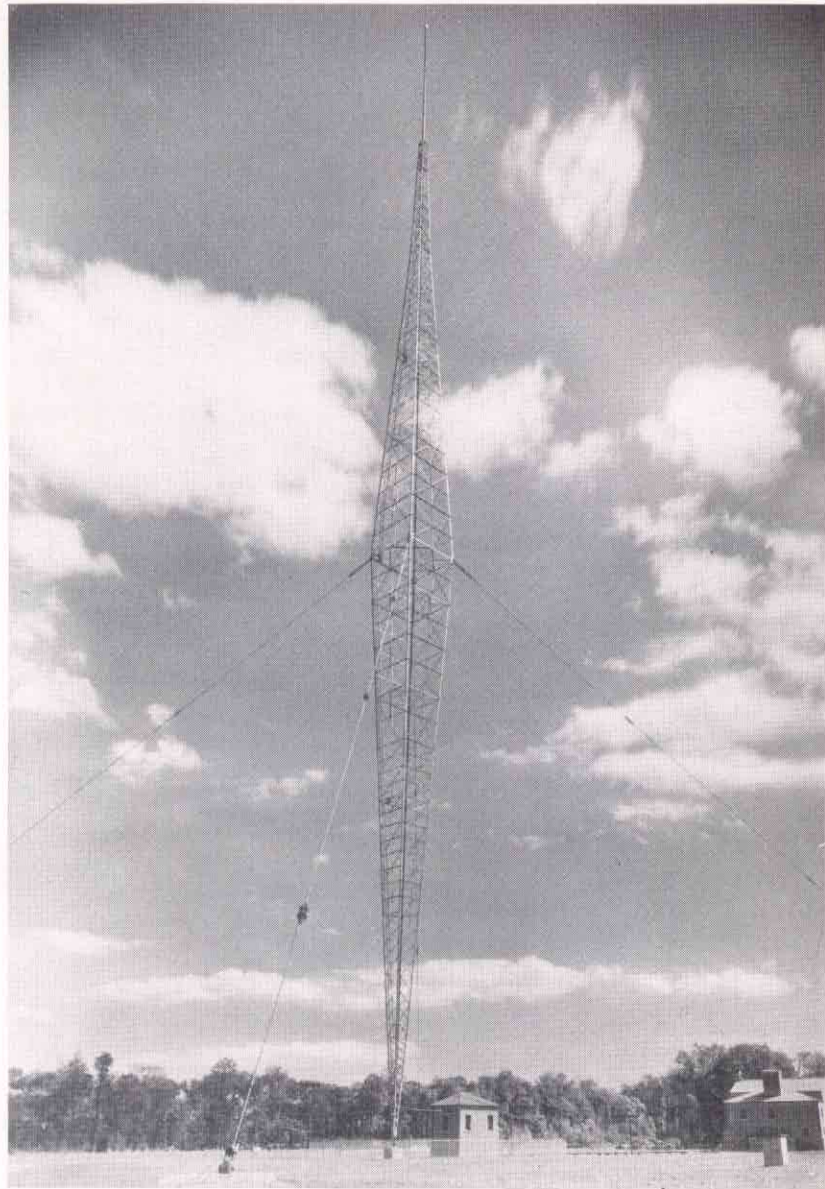

VERTICAL RADIATOR WABC. HEIGHT 665 FEET, WEIGHT 62½ TONS. DESIGNED BY BLAW KNOX COMPANY, PITTSBURGH, PA.

Taking WABC as an example of this type of construction the following are the specifications for the insulators:

<i>Mechanical</i>	<i>Base Insulator</i>	<i>Electrical</i>	<i>Guy Insulator</i>
Ultimate Strength		Capacitance.....	For main group
Compression.....	900,000 lbs.		50 m.m.f.
Normal Comp. Load..	360,000 lbs.	Operating Voltage	18,500 V at
Max. Comp. Shear			860 KC
Ratio.....	10-1	<i>Mechanical</i>	<i>Guy Insulator</i>
Max. Calculated Load	450,000 lbs.	Ultimate Strength	
		Compression.....	375,000 lbs.
<i>Electrical</i>	<i>Base Insulator</i>	Normal Comp. Load..	60,000 lbs.
Capacitance.....	50 m.m.f.	Max. Comp. Shear	
Operating Voltage....	18,500 V at	Ratio.....	
	860 KC	Max. Calculated Load	110,000 lbs

Ten years of designing, testing and developing of insulators for radio use covering antennae, tower footing, sectionalizing and guy insulators were of immense benefit in working out the new designs.

The Mechanical Problem

Porcelain is a weak material in tension and particularly liable to fracture if given a shock load while under tension. In compression it is approximately twenty times as strong and is not so subject to this shock fracture. The strength figures may be taken as 4,000 lbs. per square inch in tension and 80,000 lbs. per square inch in compression. The most successful method of obtaining uniform loading is to use portland cement between the porcelain and metal parts. This is practically a universal method in modern insulator assembly. Experience has shown that cement is both strong and little subject to change over a period of years.

From the above consideration porcelain in compression is obviously the choice for both base and guy insulators. The shape of this porcelain is the next detail of importance. The hollow truncated cone has everything to recommend it and was consequently chosen. A hollow cone has the following characteristics: (1) Inherent stability. (2) Can be made in large sizes. (3) Ease of equalizing the load. (4) Minimum amount of porcelain to carry the load.

The Base Insulator

The base insulator for WABC was specified to have an ultimate strength of 900,000 lbs., requiring a new design, and, of course, tests were essential. In our laboratory we have a hydraulic test machine that can be used up to 1,250,000 lbs. and this was employed in checking the designs.

Inherent stability is an important feature of design, by this we mean that no tension shall be produced in the porcelain. Referring to Fig. 1 we have the vertical load W equal to 900,000 lbs., the shear S equal to 90,000 lbs. This produces a reaction R having a slope of one in ten. It can be shown that to prevent tension in a thin walled cone the reaction should fall within the centre half

i.e., AF equal to $\frac{r}{2}$; and in a solid cone AF equal to $\frac{r}{4}$. As a practical condition for the cones used in these base insulators we can take the average of these values, i.e., to prevent tension in the porcelain the reaction should fall within the "middle third", making AF equal to or less than $\frac{r}{3}$. Figure (1) shows the test specimen originally built. Under compression this gave a strength of 980,000 lbs. which exceeded the requirements.

One interesting feature of the base design is the use of two similar cones; one attached to the concrete foundation, the other is inverted and bolted to the structure. As explained before to prevent tension the load reaction must pass through the mid-

dle third of any section. It will easily be seen that if we want to double the insulation, with a single cone, i.e., double the flash distance, the slope of the cone will have to remain the same and we would have a tremendous insulator approximately four times the weight and considerably more than four times as difficult to make but with no more strength. However by inverting the upper cone and placing a free moving point in the center, we can use two small similar cones and get a more efficient and economical design. The connection at the center is merely a dowel in a socket allowing the tower to swing without placing a cramping load on the insulators.

Electrical Tests

A similar unit to that used for mechanical test was subjected to

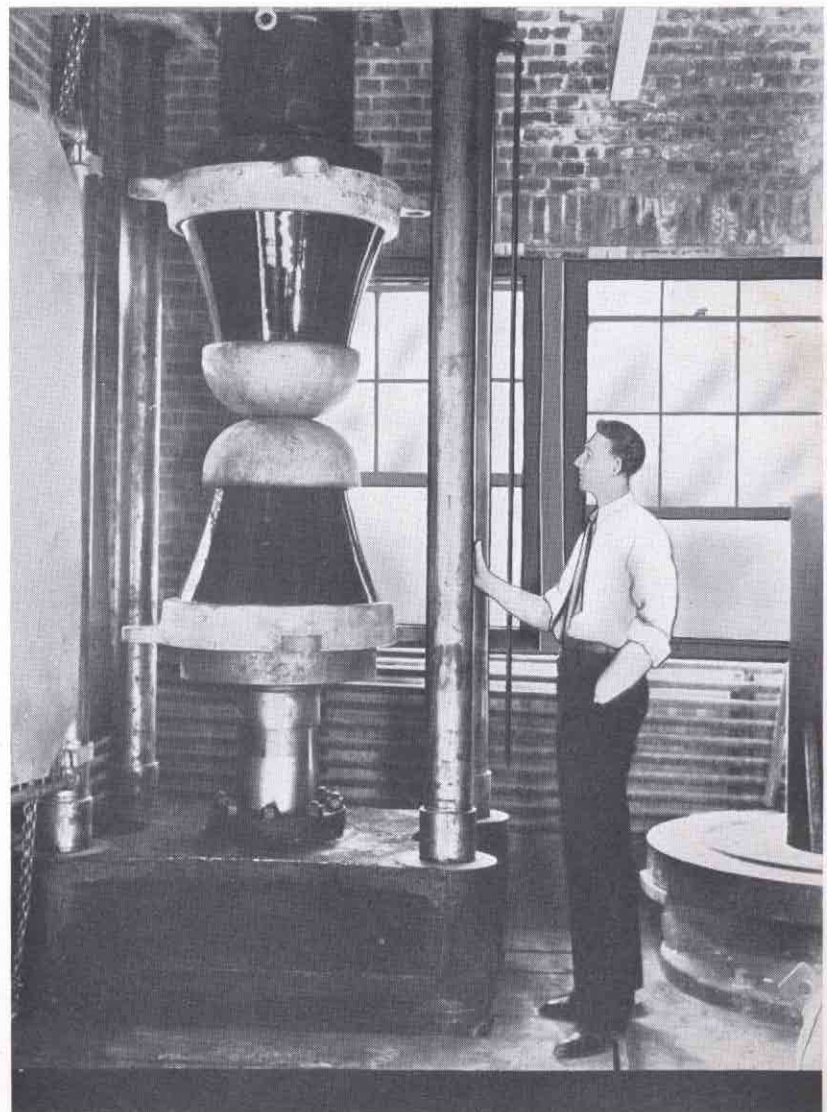

RALPH L. JENNER

SUPERVISING THE TESTING OF THE BASE INSULATOR FOR A RADIO TOWER

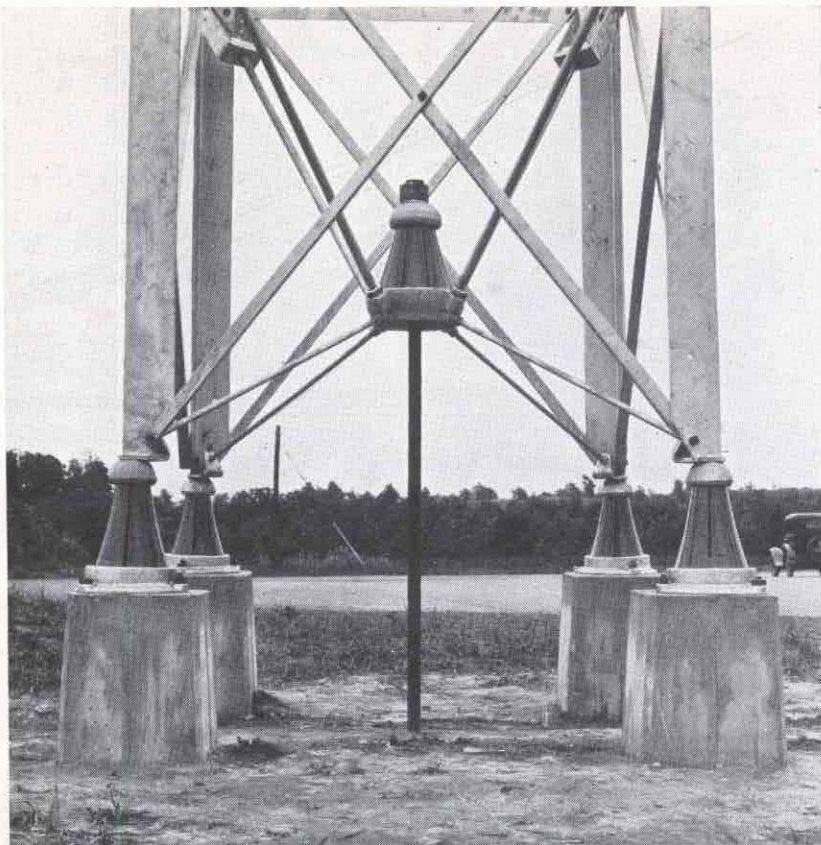

SHOWING INSULATION OF VERTICAL ANTENNA FOR THE AIRWAYS DIVISION, DEPARTMENT OF COMMERCE. THESE ANTENNAE ARE USED IN THE LATEST DESIGN OF RADIO RANGE BEACONS.

different voltages at 1500 KC and temperature curves taken. At 25 KV in three hours the temperature rose to 115° C. and was still rising; at 20 KV, the temperature reached 110° C. in $7\frac{1}{2}$ hours; at 15 KV, 65° C. in 7 hours. The ambient temperature was approximately 27° C. Operating temperatures of 65 to 70° C. were considered satisfactory.

The test unit shown in Fig. 1 had eleven inches clearance between metal caps. After the test it was decided to increase this to 15". The final design is shown in Fig. 3. Heating tests on the complete unit showed that at 18,500 volts the normal operating voltage, but at 1500 KC the temperature rise was negligible. At 25,600 volts the temperature rise was 39° C. This gives a perfectly satisfactory operating temperature. The capacity of the base insulator is 30.5 m.m.f.

The Guy Insulator

The same procedure of building a test unit was followed in the design of the guy unit and a strength of 395,000 lbs. was developed. Fig. 2 shows a section through the final

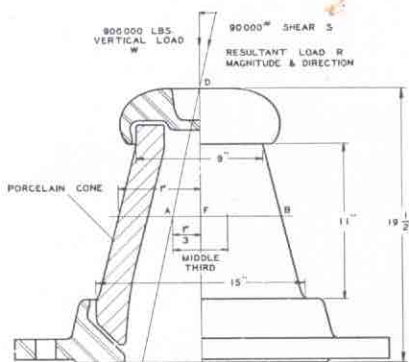

FIG. 1
SHOWING BASE UNIT DESIGNED FOR PRELIMINARY MECHANICAL AND ELECTRICAL TESTS.

design which varies but slightly from the original, the porcelain being increased in height from 4" to 6". It will be observed that the cap will not pass through the base casting, giving an interlocking feature. To assemble the unit, the forged steel bolt A passes through the steel cap B and is held in place by the split ring C. This gives a very efficient unit. Clevis and eye connections are made interchangeable with standard rope sockets.

Electrical Test

A heat run was made on a double unit, i.e., two porcelain cones in series at 15 KV and 1500 KC. The maxi-

mum temperature reached was 62.5° C. The redesigned unit was changed to a single cone type and the porcelain height increased to 6" from the original 4". It was decided to use four units in series to form the main insulator group. Three other units of the same design were used as break-up insulators to prevent absorption and reradiation. The capacitance of a single unit is approximately 40 m.m.f.

Factory Tests

All units used on Vertical Radiators are tested to approximately two-thirds of their guaranteed ultimate strength. The base insulator used on WABC was proof tested to 680,000 lbs. and the guy insulator to 250,000 lbs. In addition to the proof test one unit of both base and guy designs was tested to destruction. In test for WABC the base unit showed initial failure at 980,000 lbs., complete failure at 1,100,000 lbs. The guy insulator failed at 395,000 lbs. by pulling off the head of the eyebolt the porcelain breaking on the rebound.

It is interesting to note that initial cracking does not instantaneously produce complete failure, it is rather of the nature of a relief crack, producing better stress distribution. We have found that after a crack has been produced we can reload the unit to the same value many times without



GUY INSULATORS USED TWO IN SERIES ON DIRECTIONAL BROADCAST ANTENNAE WFLA-WFSB IN BREAKING STRENGTH 90,000 LBS.

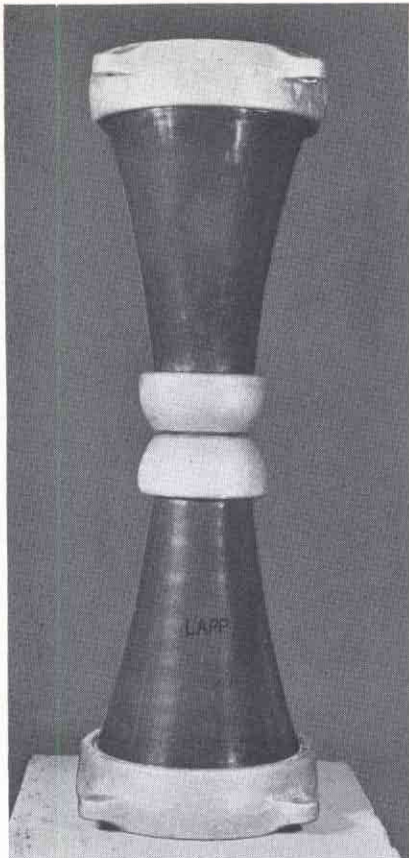

BASE INSULATOR USED ON DIRECTIONAL BROADCAST TOWERS WFLA-WSUN, CLEARWATER, FLORIDA. BREAKING STRENGTH 680,000 LBS.

further failure. Considerably greater loads are necessary to cause complete failure.

The above description has covered more in particular the insulators for WABC which are typical of those for WFLA-WSUN, WCAU, WAAB-WNAC, WFEA, WSM.

Lightning Gap

High steel masts such as these Vertical Radiators make excellent lightning rods. To prevent any damage due to flashover an adjustable ball lightning gap is provided as shown in Fig. 3. The guy insulators are self protecting, having a direct gap of $2\frac{1}{2}$ inches between metal parts with a 6" flashover path along the surface of the porcelain.

Latest Improvements

Careful studies of the load distribution and the cause of failure under test have been made and new designs developed on the basis of the information gained. The improvements in design resulting from these studies have increased the average stress

developed on the porcelain from 20,000 to approximately 80,000 lbs. per square inch. This has not been done by any gross change in design but greater refinement of detail and minor changes in the shape of the porcelain. The latest design of insulator is that for the radio beacon system of the Airways Division of

The guy insulators also have been somewhat modified particularly in the method of assembly and in the use of an integral steel casting in place of two castings with connecting bolts. An up-to-date design that was used on WCAU, has a clevis connection at the top and the bolt is constructed so as to be directly socketed to a $1\frac{3}{4}$ " cable. Two other types are made, one with the same body but with an eyebolt, the other one used as a "break-up" unit is made with a socket at the top into which a cable with pre-cast zinc cone is held by means of a split cone. These three types eliminate the use of a large

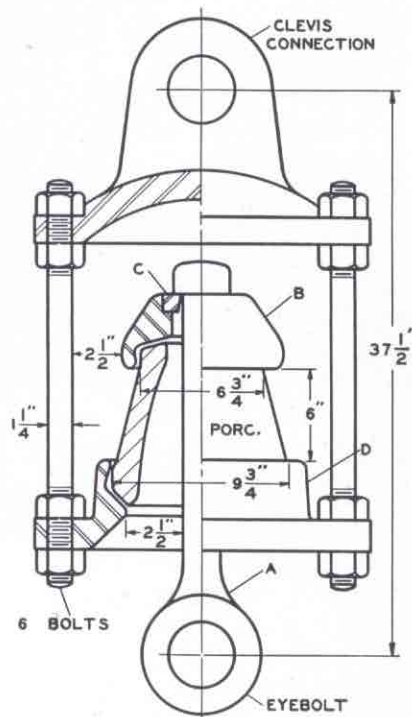

FIG. 2—SHOWING GUY UNIT DESIGNED FOR PRELIMINARY TEST. NOTE INTERLOCKING FEATURE. CAP B CANNOT PASS THROUGH RING D.

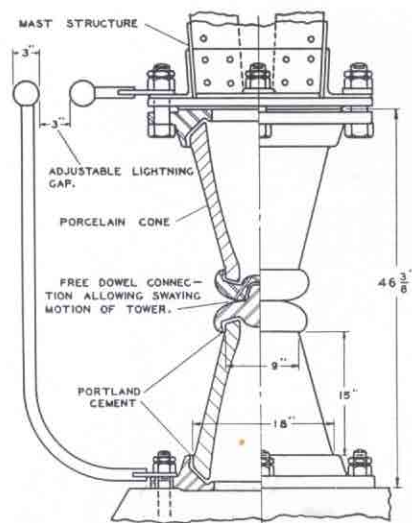
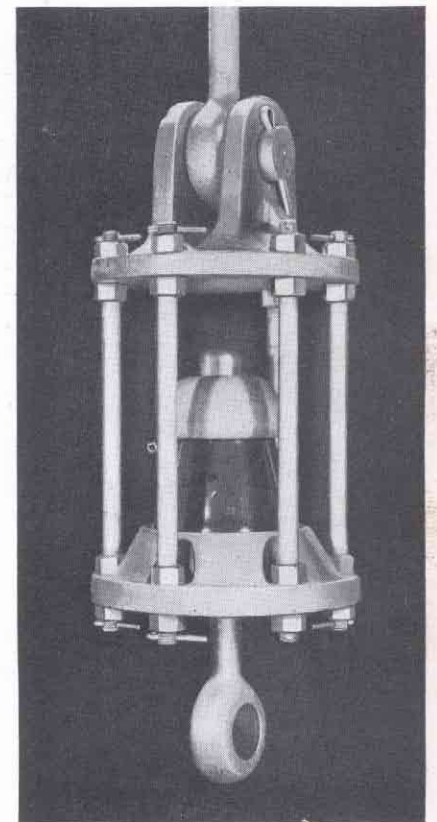

FIG. 3—BASE INSULATOR OF WABC. BREAKING STRENGTH APPROXIMATELY 1,000,000 LBS.



GUY INSULATOR USED ON WABC. BREAKING STRENGTH 395,000 POUNDS. FOUR OF THESE IN SERIES FORM MAIN INSULATOR. THREE ADDITIONAL UNITS USED AS "BREAKUP" INSULATORS IN EACH GUY. SEE FIGURE 2.

number of expensive rope fittings and therefore are more economical.

Base insulator designs have been developed to carry safe loads of 200,000 to 1,200,000 lbs. and guy insulators capable of breaking up $\frac{7}{8}$ " to $2\frac{1}{4}$ " cable.

Design testing plays an important part in these developments and proof testing is essential in order to render assurance that everything is right before it goes into service.

the Department of Commerce. These insulators support a tower 125 feet in height which is used as a self-supporting vertical antennae. The insulator has only $10\frac{1}{2}$ square inches of section and has carried loads up to 800,000 lbs. without failure.

A New High-Frequency Broadcast Transmitter

By J. P. TAYLOR, Sales Engineer, RCA Victor Co., Inc.

SOCIOLOGISTS have an intensive interest in international broadcasting because of the effect such wide intercourse will have in bringing together the diverse races of the earth. Students of economics, history, and language are similarly intrigued by its possibilities. But their interests are purely academic—concern only distant and indirect results. Broadcasters have a more immediate and tangible interest—the commercial application of international broadcasting. True, the presently available channels are restricted to experimental use—but this may not always be the case. Many manufacturers are building thousands of short-wave adapters as well as combination sets. The army of short-wave listeners being formed may soon start demanding more and better programs—something that can only be furnished by a service which is self-sustaining. The networks and several of the larger independent stations are preparing for this by operating short-wave relay stations on regular schedules. Unfortunately, the operation of a short-wave auxiliary is, for most stations, not yet economically justifiable. Nevertheless all broadcast stations are anxiously interested in the future of short-wave broadcasting and hence most readers of BROADCAST NEWS will be much interested in the new transmitter which engineers of the RCA Victor Company, Inc. have designed for W2XE, Columbia Short-wave Relay Station.

Design

In the past, most short-wave broadcast transmitters have been "hay-wire" in design and "composite" in construction. Two reasons for this are obvious. First, the work was mostly experimental and frequent changes in equipment were made. Second, the programs carried were non-commercial and reliability was thus less important. But developments of the last few years have altered this situation. Engineers of

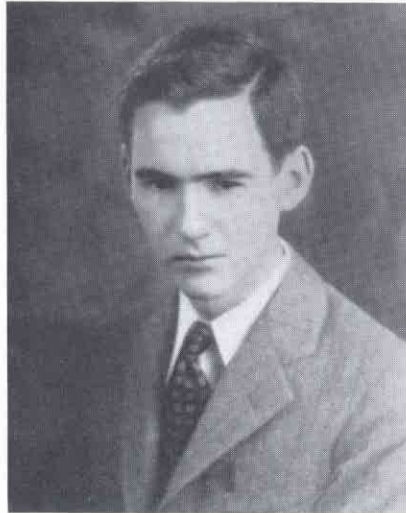

J. P. TAYLOR

the Columbia Broadcasting System in planning the new W2XE installation decided that the equipment, at least, of a short-wave transmitting station was no longer "experimental" and that therefore a permanent installation was justified. Moreover, since this service might some time

be commercialized, reliability and quality equal to that of standard broadcast transmitters was necessary.

Rigid Specifications

As a matter of fact the specifications of this transmitter were even stiffer than those of a broadcast transmitter, since operation was required at different frequencies according to the time of day. Experience has led to the use of the 15-30 meter band during daylight hours and the 30-50 meter band at night. By designing this transmitter for operation in the band of 15-50 meters continuous 24-hour operation was made possible. Space is provided in the heater box for six crystals—a switch on the front of the panel allowing selection of the one to be used. All tuning controls are furnished with micro-vernier dials so that they may be quickly and accurately set at previously determined points. A flexible antenna coupling arrangement makes possible use of the same an-

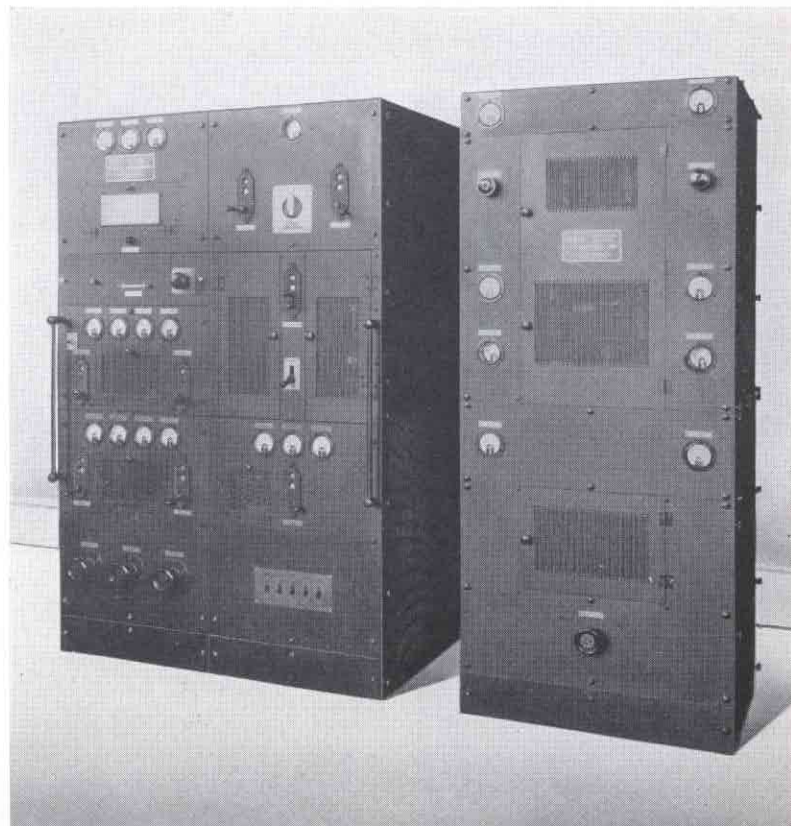

tenna at all frequencies. As a result of these features this transmitter may be used at six different frequencies during the day, and the shift from one frequency to another made with almost no loss of time.

Radio Frequency Circuits

The radio frequency circuits of this transmitter are best understood by reference to the schematic circuit diagram. The six crystals mentioned above are placed in the grid circuit

plifier stage consists of two UV-861's in parallel. This stage (as well as the preceding amplifier stages) operates as a "Class C" amplifier. Modulation of the last stage is made economically advantageous by the use of a push-pull modulating system in which the modulators operate as "Class B" audio amplifiers.

Simplicity

The simplicity of the radio-frequency amplifier circuits of this

either "voltage-fed" or "current-fed" for an antenna reactance which is either inductive or capacitive. Also it may, if desired, be fed through a transmission line.

Audio Frequency Circuits

The transmitter is designed to accomplish 100% modulation of the carrier when the audio signal voltage is fed to it at a -6 db. level. Two speech amplifier stages precede the modulator stage. The first of

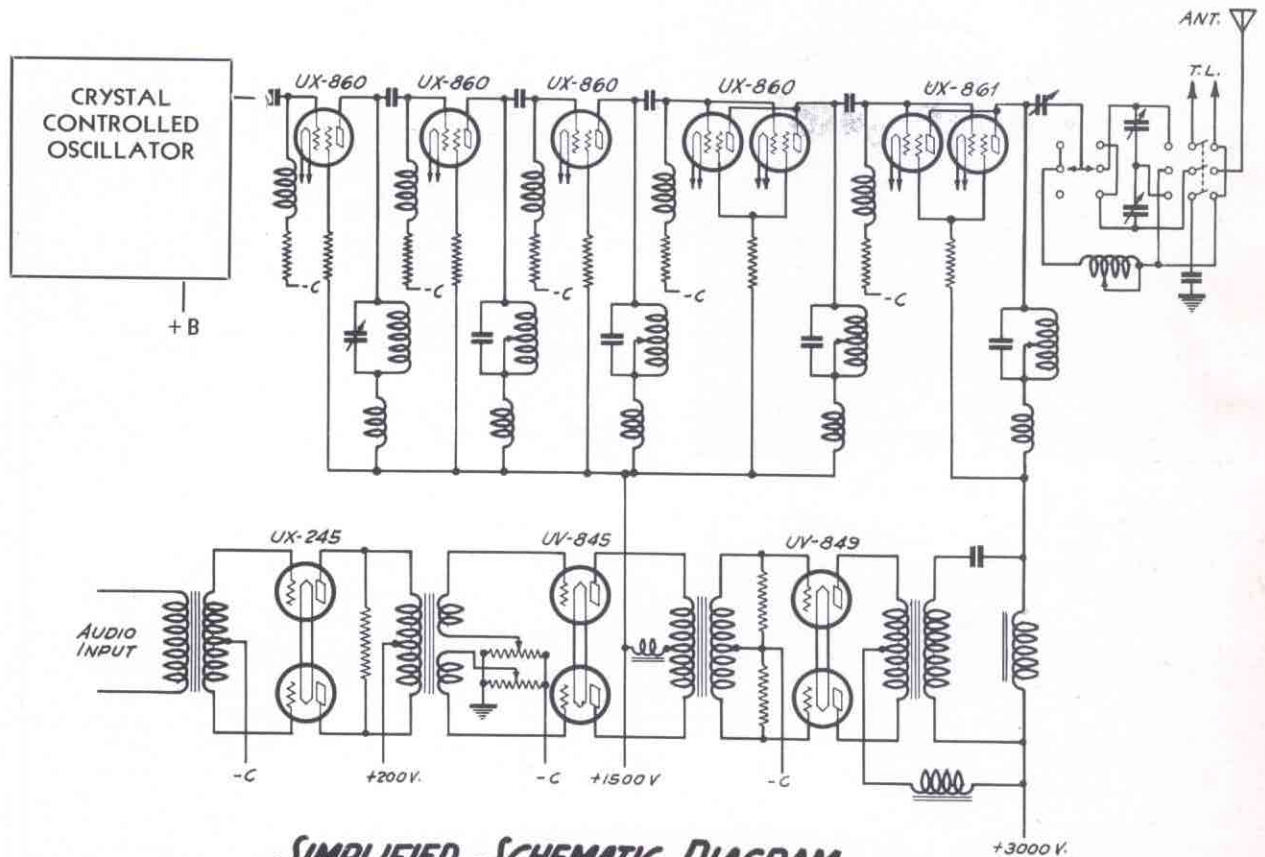

SIMPLIFIED SCHEMATIC DIAGRAM

(POWER AND CONTROL CIRCUITS AS WELL AS BY-PASS CAPACITORS, etc, HAVE BEEN OMITTED)

of a UX-210 oscillator. Low plate voltage on this tube limits the radio frequency current through the crystal. The oscillator stage is followed by a UX-860 buffer stage. The use of this buffer stage allows the oscillator to be very lightly loaded, thus improving its regulation. Moreover, by thus isolating the oscillator stage, reaction from the following stages is practically eliminated. The buffer stage is followed by two UX-860 doubler stages. The fourth amplifier stage utilizes two UX-860's in parallel. This stage, which also acts as a doubler at higher frequencies, operates as a straight amplifier in the

transmitter is particularly noteworthy. The tubes used in these circuits (type UX-860 and type UV-861 Radiotrons) were developed specifically for use in transmitters designed to operate in the medium high-frequency range. Since they are all of the screen-grid type the plate to grid feedback coupling is negligible and no neutralization is required. This elimination of critical neutralizing adjustments makes quick frequency change feasible.

The power amplifier tank circuit is capacity coupled to an antenna tuning system which permits of great flexibility. By means of two change-

these utilizes two UX-245's in a push-pull circuit, the second, two UV-845's in a similar circuit. The second speech amplifier stage drives the modulator stage which consists of two UV-849's operating as "Class B" audio amplifiers in a push-pull modulating stage. This modulator stage, operating through a modulation transformer, modulates the plate and screen-grid voltages of the power amplifier. The overall audio characteristic of the transmitter varies less than 2-db. from 30 to 10,000 cycles—thus making it the equivalent of standard broadcast transmitters.

LET'S GET ACQUAINTED



HARRY SADENWATER

PIONEER IN RADIO ON LAND, AT SEA, AND IN THE AIR. HE IS WELL KNOWN IN THE RADIO INDUSTRY FOR HIS ACTIVITIES IN RADIO RESEARCH AND DEVELOPMENT WORK BOTH WITH THE GENERAL ELECTRIC COMPANY IN SCHENECTADY AND LATER WITH THE RCA VICTOR COMPANY IN CAMDEN.

HIS RECENT APPOINTMENT AS SALES MANAGER OF THE ENGINEERING PRODUCTS DIVISION BRINGS HIM GREATER OPPORTUNITY TO UTILIZE HIS EXPERIENCE AND RESOURCEFULNESS IN THE RADIO FIELD.

A MORE COMPLETE OUTLINE OF HIS CAREER IS SET FORTH IN THE COLUMNS BELOW.



C. L. BEACH

OF THE RCA VICTOR TRANSMITTER SALES SECTION, WHO MAINTAINS CONTACT WITH THE NATIONAL BROADCASTING COMPANY, RCA COMMUNICATIONS, INC., AND RADIOMARINE.

THE RADIO EXPERIENCE OF C. L. BEACH HAS INCLUDED NOT ONLY PIONEER OPERATING WITH AMERICAN MORSE AND CONTINENTAL MORSE IN THE UNITED WIRELESS COMPANY, BUT HE WAS ALSO RADIO INSPECTOR FOR THE MARCONI WIRELESS TELEGRAPH COMPANY OF AMERICA, IN THE EARLY DAYS OF THE RADIO INDUSTRY.

HE WAS RADIO INSPECTOR-SUPERVISOR IN THE SECOND NAVAL DISTRICT DURING THE WORLD WAR, AND LATER DID RESEARCH WORK IN THE RCA LABORATORY AT VAN CORTLANDT PARK UNDER DR. A. N. GOLDSMITH.

IT IS A CURIOUS COINCIDENCE THAT JUST TWENTY YEARS AGO, HARRY SADENWATER, AND C. L. BEACH SAILED OUT OF NEW YORK, BOUND FOR PORTO RICO, AS RADIO OPERATORS ON RIVAL SHIPS, AND SUBSEQUENTLY TIED UP ON OPPOSITE SIDES OF THE SAME PIER IN PONCE, PORTO RICO.

AND NOW, AFTER WIDELY SEPARATED CAREERS THROUGH THE YEARS WHICH HAVE INTERVENED, THESE TWO PIONEERS FIND THEMSELVES ASSOCIATED IN THE SAME DEPARTMENT AT "RADIO HEADQUARTERS", CAMDEN, N. J.

Broadcasting Personalities

THE March of Progress continues. With this issue of BROADCAST NEWS we welcome Harry Sadenwater to the post of Sales Manager of the Engineering Products Division, replacing F. R. Deakins, who has taken a new post in Montreal, with the Victor Talking Machine Company of Canada, Ltd., as Executive Vice-President. While we regret losing Mr. Deakins

and wish him success in his new undertaking.

Few of us who are now active in the radio industry can boast of the diversified and colorful career which we find making up the background of Harry Sadenwater. In 1909 he was operating an amateur radio station in New York City. In 1911 he was a radio operator at sea. In 1912 he was instructing radio theory and

C. A. Radio School in New York, and from 1913 to 1917, he was with the Department of Commerce, inspecting ship radio installations and supervising radio license examinations.

During the World War, from 1917 to 1919, Harry Sadenwater was Radio Officer in the U. S. Naval Reserve Force, first in charge of radio censorship in the Third Naval Dis-

Aircraft Laboratory at Hampton Roads Air Station, being later transferred to the Bureau of Steam Engineering at Washington, D. C.

He conducted the first long distance two-way aircraft radio telephone conversation from a plane, out over Chesapeake Bay to the Secretary of the Navy in Washington, D. C. He not only supervised the installation of the radio equipment on the famous NC planes, but he also actually made the first transatlantic flight, as communication officer, in the NC-1, in May, 1919, which goes down in history as one of the outstanding pioneer achievements of the U. S. Navy.

From 1920 to 1929 we find him with the General Electric Company, supervising installations and tests of government radio transmitters, and



HARRY STONE, WSM

also supervising the installation of Stations KGO and KOA, continuing in charge of the technical operation of these two stations, and Station WGY at Schenectady.

In 1930, Mr. Sadenwater joined the RCA Victor Company as Division Engineer in charge of field engineering, maintaining contact with broadcast receiver design and development work, and subsequently taking over this work on centralized radio, special receivers, custom auditorium equipment, electric carillons and ultra-high frequency apparatus.

And now his appointment as Sales Manager of the Engineering Products



MARTIN B. CAMPBELL
GEN. MGR. WFAA, DALLAS, TEXAS

couragement to all of us who are associated with this work.

Happenings at WTIC, Hartford, for the summer months have been investigated and found to be:

Ted Smith of the RCA Transmitter Section paid us a visit on August 17th and complained of the usual polished floors.

"Clayte" Randall, Plant Manager, didn't tell us a word about the new Dual Ratio Auburn he purchased in June. Perhaps he has been too busy with his golf to get down to the mill for a report. Perhaps the fishing has been too good. At any rate, by the time this gets to press he will be digging into his stock of red flannels and 30/30s for his annual deer hunt.

Herm Taylor, Plant Engineer, just returned from his two weeks' vacation at Old Orchard, Maine. Herm still has the DeVaux which lies in wait on the mountain side for asthmatic Fords, Model T preferred.

Other members of the transmitter plant: Coleman, Operating Engineer; Luckingham and Sanders among the "has beens" on vacations, with Coe, Clancy, Kingsley, Buell and Jackson of the studio control group in a like class.

Carl Scott and Ed Sanders of the transmitting plant division secured courage enough during the summer to be married.

a new RCA Victor frequency monitor unit which is giving very satisfactory service.

Oh Yes,—the boys of the Plant Division played baseball this summer, and HOW—! They played the musicians of the studio group; Wire Cutters vs. Muddy Hub Caps (Merry Mad Caps). The score (who brought that up?) 18 to 6 in favor of the Hub Caps. They were brutes for punishment, and they took on a few announcers, run boys and the like. Results,—another beating to the tune of 13 to 9. They are now open for engagements with any fair playing nine of stenographers or girl scouts. (Watson—bring on the dominoes.)

All for this time and we'll see you again from the mountain top where the wind blows, IF we don't get snowed in.

E. D. Aber transferred WMBH of Joplin, Missouri, to W. M. Robertson, Chevrolet Dealer, the middle of August. New owner is making considerable repairs, such as new ground system, new antenna system, etc. The station is covering the territory

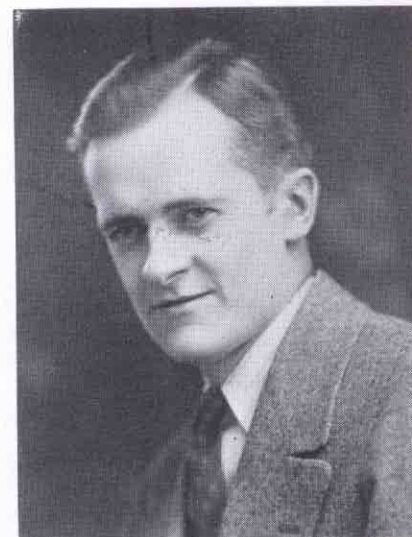

GEORGE HAY, WSM

in a much more satisfactory manner and the new owner says he has only begun. WMBH now has an agreement with the local Joplin newspaper (*The Globe and News Herald*) where once daily the radio audience can hear the latest news flashes of the day. A remote station has been installed in the newspaper offices. D. J. Poyner, formerly with the local

A New Network for New England

By GEORGE MALCOM-SMITH, of WTIC

A NEW network has taken its place on the ether waves. "The New England Network," as it is named, links five of New England's foremost transmitters in a chain that extends from the far reaches of Way Down East to that section known as Forty-five Minutes from Broadway.

The member transmitters are WTIC of Hartford (50,000 watts), WEEI of Boston (1,000 watts), WJAR of Providence (250 and 500 watts), WTAG of Worcester (250 and 500 watts) and WCSH of Portland, Maine (2,500 and 1,000 watts). Each of the quintet is also affiliated with the WEAf wing of the National Broadcasting Company.

The new chain gives sponsors an intensive coverage of a very fertile field, a section which boasts that



PAUL W. MORENCY, MANAGER OF STATION WTIC OF HARTFORD AND ONE OF THE ORGANIZERS OF THE NEW ENGLAND NETWORK, COMPRISED OF STATIONS WTIC, WEEI OF BOSTON, WTAG OF WORCESTER, WJAR OF PROVIDENCE AND WCSH OF PORTLAND, MAINE.

although it comprises only two per cent of the nation's total area, it contains nearly seven per cent of the nation's population and controls eight per cent of its wealth.

New England has long been regarded by advertisers as an ideal radio "testing ground." Its population of eight million owns nearly a million receiving sets, rendering radio a most effective medium in this neck of the nation. The new network serves as an excellent means of cultivating this rich market.

The programs transmitted over the hookup emanate from each of the five member stations, with the majority coming from the studios of the two larger units, WTIC of Hartford and WEEI of Boston. The Hartford member is especially well equipped as a key station, possessing as it does one of the largest permanent studio staffs maintained by any individual station in the country. Its staff orchestra, comprised of 45 musicians, is a particularly valuable asset to the new network. This ensemble, by the way, is one of the featured attractions of the National Broadcasting Company and is heard each week over the NBC coast-to-coast "red" chain.

The 50,000-watt plant of WTIC is one of the outstanding achievements of the RCA organization in the field of broadcast transmission. It has attained what is probably a record for long-distance broadcasting without benefit of short wave. Its signals are heard frequently as far west as Australia, New Zealand and Alaska and as far east as the British Isles, France, Germany and even South Africa.

The WTIC transmission equipment, installed in 1929 by RCA and known by RCA engineers as "Number One" of its type, is the first high-power commercial transmitter to use 100-kilowatt tubes, the first to use mercury-vapor type rectifiers throughout, and the first capable of 100 per cent modulation of its full rated 50-

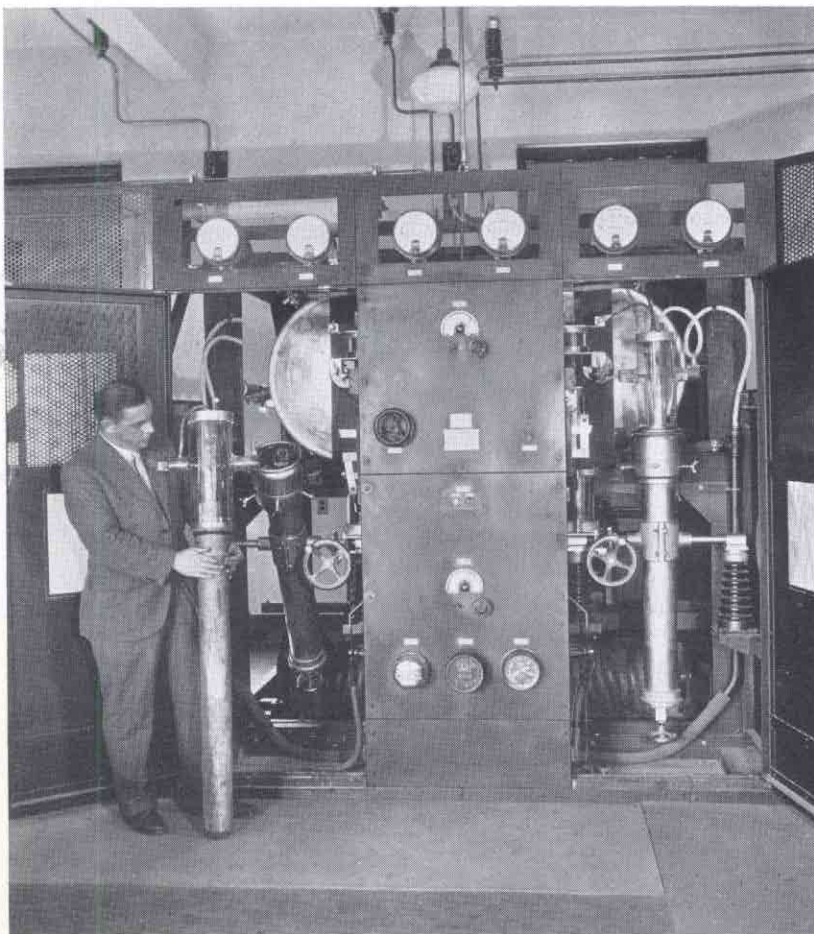

A PEEK INTO THE INTERIOR OF THE 50,000-WATT TRANSMISSION PANEL OF STATION WTIC, ONE OF THE KEY STATIONS OF THE NEW ENGLAND NETWORK. THE TUBE HELD BY THE OPERATOR WAS THE FIRST 100,000-WATT TUBE EVER USED COMMERCIALY IN A BROADCAST

this apparatus served as the model after which RCA engineers patterned the new national radio station of the Italian government in Rome, perhaps the best known station in the Old World.

The station managers instrumental in organizing the new hookup are Charles W. Burton, WEEL; Paul W. Morency, WTIC; John J. Storey, WTAG; Henry P. Rines, WCSH; and Joseph S. Gettler, WJAR.

The New England Network should prove a source of pleasure to the New England audience and of profit to its advertisers.



THE "MERRY MADCAPS" OF STATION WTIC, ONE OF THE STELLAR FEATURES OF THE RECENTLY ORGANIZED NEW ENGLAND NETWORK, AND PROMINENT BROADCASTERS OVER THE NATIONAL BROADCASTING COMPANY'S "RED" CHAIN.

WCAU Uses Dead End and Live End Studios

THE Studios of the new home of WCAU, 1622 Chestnut Street, have been designed to feature certain acoustical characteristics. This is the first attempt made in this Country to construct or to broadcast from what is known as a "live" and "dead end" studio. From one-half to two-thirds of each room, depending on the size of the studio, is lined with sound absorbing material to form a "dead end" where the microphones are properly placed to receive every note and part of the program which is in progress at the opposite, or "live end" of the room. The "live end" walls are constructed with a hard material that reflects the sound waves to the receiving, or "dead end".

Another innovation that has never been used in this Country are the zig-zagging walls of the two larger studios. These studios are constructed with "V" shaped walls which break up the sound as it strikes the sides and deflects them at various angles and prevents the reverberations of the notes from striking the opposite walls.

In order to minimize the transmission of extraneous sounds, special walls, floors and ceilings are employed. The walls have no direct connection with any of the outer walls for support or suspension ex-

which serve to break all sound connections. The floors which are known as "floating floors" are also free from contact with other surfaces. The studios are virtually rooms within rooms. The ceilings are suspended in the same manner.

Each studio is entered through a vestibule which also decreases the possibility of any sound entering the studio during a broadcast. Special heavy duty soundproof doors are used throughout.

The acoustical treatment in all the studios includes a one and one-half inch rock wool blanket placed against the soundproof wall and another blanket of the same size and style placed in front of it with a two inch air pocket between the two blankets. The outer blanket is covered with perforated metal. Tests have shown that this method produces an ideal broadcasting studio.

Each studio and control room window is composed of a triple sash, and three panels of glass measuring $\frac{1}{4}$ ", $\frac{5}{8}$ " and $\frac{3}{8}$ " respectively. Each section of the sash and glass is insulated inside and outside to stop sounds that might be carried through the framing. The heaviest glass, $\frac{5}{8}$ " thick, is placed between the lighter layers as an added guard against sound waves caused by any vibration

RADIOTRON LONGEVITY AGAIN

The following missive from the Chief Engineer of Station WDAY, Fargo, North Dakota, is printed for its face value:—

WDAY, Inc.
Fargo, North Dakota
September 15, 1932

H. C. Vance
RCA Victor Company, Inc.
111 North Canal Street
Chicago, Illinois

Dear Sir:

Just thought you would be interested in hearing about a UV-211 tube which was recently taken out of service when we dismantled our old transmitter.

This tube was purchased about three years ago and was in operation in our broadcast transmitter continuously for over two and one-half years or a total of over 14,000 hours. When this tube was taken out of service it was working perfectly and had the same identical characteristics as when it was new.

We are now sending it over to KGFK, Moorehead, Minnesota and expect that it will run many more thousand hours over there.

Yours truly,
WDAY, Inc.
(Signed) Julius Heland
Chief Engineer

OF POPULAR INTEREST



DOLLO SARGENT, NBC

FROM GOLD NUGGETS TO IVORY KEYS

DOLLO Sargent, pretty auburn-haired organist of NBC's San Francisco staff, was born on a farm near Madison, Wisconsin, but

grew up in the heart of the Rocky Mountains. Her father was a mining engineer who taught her about gold mining as soon as she was old enough to play marbles with nuggets, and took her on long prospecting trips with him. Between times she learned to play the piano and developed so rapidly in technique that she passed the entrance examination of the Boston Conservatory of Music when she was just thirteen—the youngest westerner ever to do so. She played the organ in the Publix theaters in Los Angeles and in Sid Grauman's Million Dollar Theater, as well as in the Hal Roach studios.

Dollo Sargent has a music library which contains more than 3000 compositions for organ and 2000 orchestra selections. She can play for five months, she says, without duplicating a number.

Thomas C. J. Prior, Chief Engineer of WJAR, Providence is arranging to use Velocity Microphone equipment in his studios.



A GLIMPSE INTO THE RECORDING STUDIOS OF THE RCA VICTOR COMPANY WHICH ARE UNDER THE DIRECTION OF R. R. SOOY AT "RADIO HEADQUARTERS". ONE OF THE VOCAL ARTISTS WHO RECENTLY VISITED CAMDEN IS SEEN PERFORMING BEFORE THE NEW VELOCITY MICROPHONE, WHICH IS IN A LARGE WAY RESPONSIBLE FOR THE PERFECT QUALITY TO BE FOUND IN THE NEW RCA VICTOR RECORDINGS NOW BEING RELEASED FOR BOTH 78 R.P.M. AND 33 1/3



MARY MILLER, WNOX

NO WONDER WNOX IS SO POPULAR

AMONG the recent visitors at the NBC Studios in New York, Mary Miller breezed in from Knoxville, Tennessee, and Mary seemed to be almost as much fascinated by what she saw at 711 Fifth Avenue as we were by her charming personality and captivating Southern accent.

In private life, the little lady's real name is Edna Jennys.

Down at WNOX, Mary puts on many of the regular vocal features besides being the radio voice of Miller Brothers and producing their theatrical fashion revue.

During her brief sojourn, we eventually prevailed upon Miss Miller to put on a little number for us, accompanied by the studio pipe organ, and there being no microphones in evidence around the place, Mary was—just herself, and that is something to hear and to behold.

Which, together with the fact that the new Velocity Microphone was carefully concealed behind the grille, made the recording most natural and pleasing.

Thanks, Mary, and we hope you all again soon!

BROADCASTING PERSONALITIES

(Continued from Page 19)

papers, is the new manager of WMBH.

Edgar Bill of WMBD, Peoria, Illinois, says that his business has been increasing slowly but surely during the past days. This can likely be blamed to "old man hard work".

"Radio Headquarters" welcomes two old-timers back into the fold this month,—E. J. "Uncle Joe" Hendrickson as Merchandise Manager in E. H. Vogel's department, and Gerald Nelson as Assistant to E. A. Nicholas. Happy Days are coming back again,—sure enough!

Bob Compton, WCAZ, Carthage, Illinois, reports more signed contracts and better business than ever heretofore throughout their eleven years of broadcasting. He admits only hard work did it.

In a recent popularity contest polled by the *Radio Digest* in the State of Missouri, KMOX of St. Louis was awarded first place, WDAF of Kansas City, second and WIL of St. Louis, third.

Mr. L. A. Benson, President WIL, St. Louis, reports business 25% better during the months of April, May, June and July than it was during the same months of last year. And business for September has started off with a bang. WIL maintains a staff of thirty-two employees.

WIBW, Topeka, Kansas, fed Columbia chain from Roosevelt speech in Topeka, also Curtis' notification ceremonies.

Herbert Hollister, Owner and Manager of WLBF in Kansas City, Kansas is the proud daddy of a big boy born August 19th. Herb reports that business is good.

WMAZ, Springfield, Mass. started operations September first. "Bill" Foss, formerly of WCSH is manager.

Earl Dannals has just completed the installation of new studio equipment for WEVD in the Hotel Claridge, New York.

WJAR, Providence, has just celebrated its tenth anniversary of broadcasting.

Earl J. Gluck, Paul Rosekrans and C. T. Anson of WBT have just taken

installation after completion of the usual tests. A complete story of this installation appears in this issue.

A. R. Rumble, formerly of the radio department, General Electric Company, is now Chief Engineer of WAAM, Newark, N. J.

Harold Thomas, formerly engineer of WEAN, Providence, R. I., is now attached to WSAR, Fall River, Mass.

Jack Kiefer, manager of KMPC, Beverly Hills, California, recently made a flying trip to New York, and returned by plane also. Just what the occasion for the hurry was hasn't yet been determined.

Mr. C. O. Chatterton, plenipotentiary of the Oregonian and KGW, both of Portland, will long remember his last trip to San Francisco, and the RCA Victor office. His recollection may or may not be of the fog.

Mel LeMon, chief engineer of KMPC, Beverly Hills, who does a little extemporaneous announcing on the side, should stick to his engineering activities, according to Clyde F. Coombs. At a recent remote broadcast he told the listening world of Mr. Coombs' retiring and unassuming disposition, by dedicating a selection to him. The number was "Keeping Out of Mischief Now".

Mr. J. W. Baker, assistant to A. H. Saxton, Pacific Divisional engineer for NBC, profited by Mr. Saxton's experience when he paid a visit to Portland, Oregon recently. He refused, very graciously, to accept any farewell gifts from the employees of KEX . . . and in fact shunned the National Broadcasting Company representatives at the train. It appears that Mr. Saxton, when departing from Portland, was presented with a box by Mr. John Cope, engineer for NBC in the Northwest Triangle. Greatly touched by Mr. Cope's thoughtfulness, Mr. Saxton could hardly wait until he reached his berth (it was an evening train) before opening the gift. The gift, upon being released, jumped an estimated twelve feet, with Mr. Saxton in hot pursuit. Not that Mr. Saxton

to catch it. (The gift was a giant bull frog, with a "wing spread" of three feet.)

"All police cars stand by" was the alarming call that went out in the district where Harry Singleton was making a field survey for KGW. It appears that the rural residents surrounding Portland became suspicious of the nice, compact RCA box which contained the necessary equipment, and believed Mr. Singleton might be trying to pull a Mooney.

Clyde F. Coombs, Pacific Divisional Representative for RCA Victor, recently transported two Transceivers for demonstration to the California State Forest Fire Patrol. Astride his fiery Arabian Steed, he plunged fearlessly through the dense smoke, carrying the Transceivers. Upon their arrival, Mr. Coombs and the horse pitched camp on the ground for the night. The tests were made the following morning, much to the Rangers' glee. Mr. Coombs, however, returned alone and on foot,—since the unappreciative fire patrol felt that the horse was more valuable to their cause than Mr. Coombs. After all, it *was* an emergency.

WBT EXPANDS

(Continued from Page 5)

change. Elaborate tests and varied experiments on super-power will be made to determine just what type will be most effective in serving the Charlotte station's listening audience, and a change may be instituted in the near future.

The new super-power transmitting plant of WBT represents the highest development of radio engineering and research. The tone and quality of the music sent out from this station is considerably higher than even the most modern radio receiver is capable of reproducing. In keeping abreast of the engineering advances in radio transmission of sound as WBT's doing, listeners possessing the new receivers now being introduced will find every delicate tone shading and the full roundness and richness they are capable of reproducing.

WBEN—The Buffalo Evening News Station Installs New Transmitter

By T. A. SMITH, Sales Engineer, RCA Victor Co., Inc.

ON August 1st, WBEN officially went on the air with its new RCA 1 KW transmitter and since that date many have been the reports received of better reception of that station in the Western New York district.

The new equipment is housed in the same building which contained the old equipment and its installation necessitated the removal of the old and the installation of the new apparatus without loss of time on the air. This was accomplished by the removal of the old equipment and connecting it up in a temporary fashion for use during the three months' period required for the new installation. The installation work was done under the supervision of the WBEN engineering staff while

Two antenna systems are available for use at WBEN. One system uses 200 feet steel masts and is located directly over the transmitter building. The other system is located at some distance from the transmitter and is fed over a seven hundred and thirty foot transmission line. This system is of the inverted "L" type and due to this fact is slightly directional towards Buffalo and the south. To further emphasize this directional effect, a reflector system is used which is located one-quarter wave behind the main antenna and is tuned to the transmitter frequency of 900 kilocycles. By the use of this antenna system the bulk of the signal is to the south and not over Lake Ontario which is located only twenty miles to the north.

for days at a time. Due to its sleet melting equipment, WBEN has so far escaped damage from this source. A closed loop comprises the antenna proper and into this is fed either 110 volts 85 amperes at 25 cycle or if the

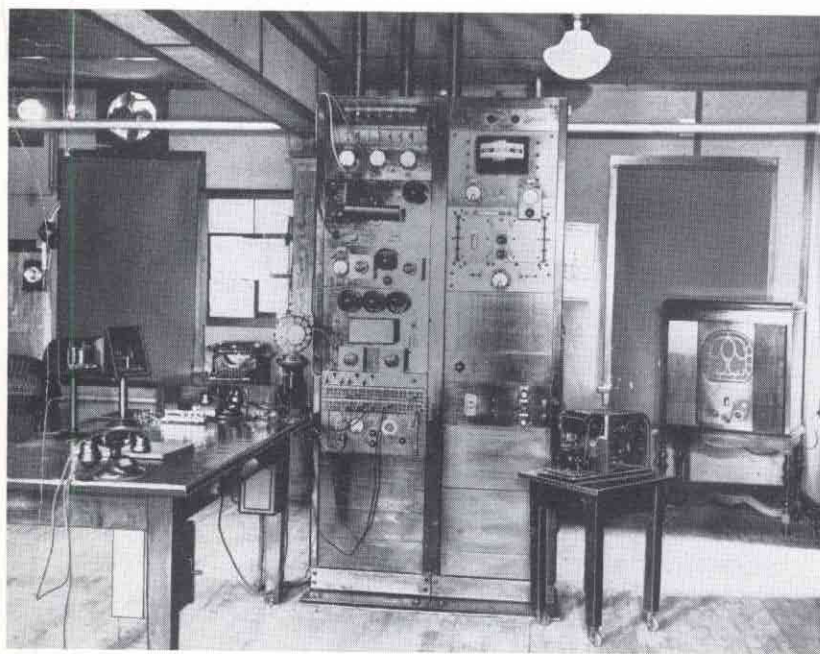

THE REMOTE SPEECH INPUT RACK AT WBEN. THE EX-4180 FREQUENCY MONITOR IS IN THE UPPER RIGHT PORTION OF THE PANEL. IT IS READING ZERO DEVIATION FROM WBEN'S ASSIGNED FREQUENCY.

Mr. R. Wilson of the Westinghouse Engineering Staff did the final adjusting of the transmitter. A field survey to be taken soon will show just how much more effective the new transmitter equipment is over the old.

In connection with this antenna system, an ingenious system is used for the melting of ice from the antenna proper in the winter time. It is a frequent occurrence for sleet storms in the Lake region to demolish the antenna system.



THE NEW RCA 1-C TRANSMITTER AT WBEN.

occasion warrants its use, 220 volts 125 amperes at 25 cycle. The heating current is fed into the antenna system through a system of tuned chokes which prevents the loss of R. F. current but allows the heating current to pass through. It is possible to heat the antenna at the same time that a program is on the air without affecting the quality of transmission or introducing objectionable hum.

The possibility of main transmitter failure at WBEN has been largely offset by the use of a duplicate and emergency transmitter located at the studio control room in Buffalo. An automatic starting feature in connection with this transmitter has proved itself to be remarkably effective. If for any reason the main transmitter goes off the air, the Emergency unit goes into operation with only a ten-second break in the program which is necessary for the generators to come up to speed. This is

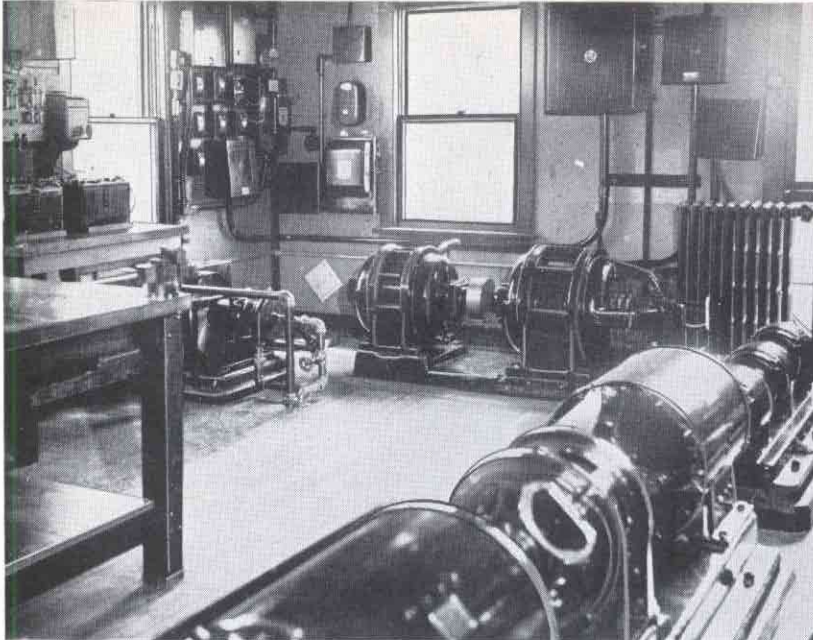

POWER ROOM OF WBEN. THE STATION OPERATES FROM A 25 CYCLE SUPPLY AND THE 60 CYCLE CONVERTER IS SHOWN IN THE CENTER BACKGROUND. THE POWER EQUIPMENT FOR THE OLD TRANSMITTER IS STILL IN PLACE.

posite telephone circuit used in connection with the order wire between the control room and main transmitter and by means of relays and this composite circuit, the automatic starting is accomplished. A signal

light in the control room indicates that the emergency unit is going into operation.

Mr. R. J. Kingsley, Chief Engineer of WBEN, is responsible for many of the unusual features of this station which were worked out in conjunction with Messrs. Horle and Godley. With the double antenna system, the sleet melting device, and the automatic auxiliary transmitter, WBEN has achieved a record for uninterrupted service.

WHAT IS IT, OLDTIMER??

CURIO NO. 2—CAN YOU IDENTIFY IT?
LOOK FOR ANSWER IN THE NEXT ISSUE OF "BROADCAST NEWS"

The names of those who communicate with the Editor, furnishing the correct identification of the above antique will be published here next issue.

The Voice of The Red Oak
Radio Corporation

"The Station With A Kick"
Telephone 1100

RADIO STATION

KICK

RED OAK, IOWA

Mr. E. Jay Quinby
R. C. A. Victor Co.
Camden, N. J.

August 21, 1932.

Dear Mr. Quinby:

In February of 1931, we purchased from the RCA Victor Company, four 866 Radiotrons for use in the new transmitter of Radio Station KICK, which was under construction at that time. We have had such exceptional service from these No. 866 tubes that I felt it expedient to inform you of what we believe to be a record of tube life.

Despite adverse advice from a number of engineers to the effect that these tubes would not withstand our operating conditions, we selected No. 866 for our transmitter. One of the 866 tubes was placed in the transmitter when we opened the station on March 24th, 1931. This tube is operating today, and from all appearances and operating conditions, it will continue to remain efficient for some time to come. To date this tube has operated 8,303 hours, and the other three approximately 2,862 hours.

As one of the construction engineers and Chief engineer of Radio Station KICK, I feel in a position to compliment you on the RCA Victor transmitting equipment, and although we have a composite job in our operating room (including a new RCA Victor Frequency Monitor), should occasion arise we will certainly recommend RCA Victor equipment. We think your specifications are mighty good.

Sincerely yours,

Radio Station K I C K,
M. E. Jones
Manager & Chief Engineer.

LK*MEJ

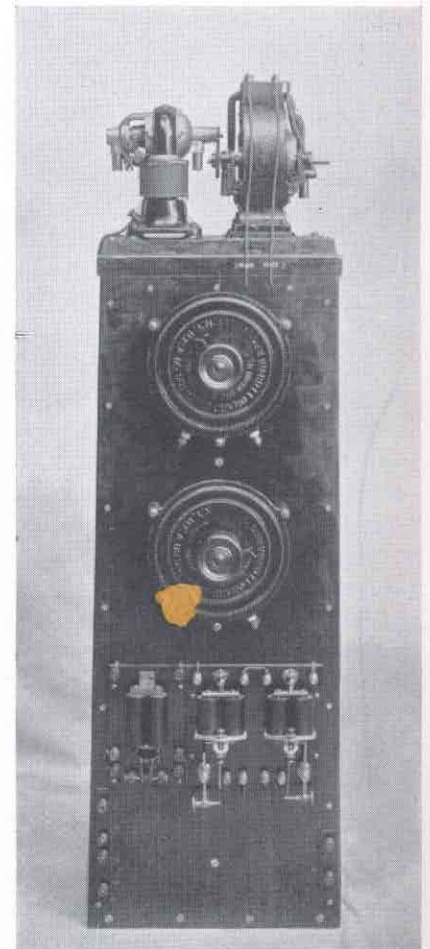

**ANSWER TO CURIO NO. 1
IN THE JULY ISSUE:**

The picture shown was that of a "Loose Coupler," manufactured by the Shoemaker Co. between 1905 and 1906. Approximately 30 of these instruments were turned out and placed in service in commercial stations and naval stations, both afloat and ashore. The process of tuning in the desired station, especially when the wavelength was unknown (as was frequently the case in the early days) involved much plugging in and plugging out. Apparently none of our readers remembered

The Line to the Antenna

By EDMUND A. LAPORT
Radio Engineering Department
Westinghouse Elec. & Mfg. Company

AS one looks down the transmission line from the station to the antenna and observes the familiar appearance of two parallel wires, one may not readily appreciate the physical complexities of such a system. If we had the ability to see in reality the passage of the transmitted wave down the line to the antenna, and perhaps also waves traveling back and forth due to reflections, we could more easily comprehend the importance and magnificence of the problem. In the absence of this quasi-aetherial vision, we must construct the picture of the conditions in our imagination, using observed instrument readings and measurements as guides to understanding, together with a theory of traveling waves.

The transmission line is simple in its ideal aspects. This simplicity is what we seek in applying it to radio uses. When correctly terminated it is a convenient and flexible means of coupling a transmitter to a remote load circuit. Transmission line coupling permits the location of the antenna at a position well removed from the station building, thus contributing toward the ideal of an antenna in free space.

Much has been written about transmission lines, but unfortunately, the subject has been essentially mathematical, thus being beyond the reach of the average man who is not skilled in higher mathematics. Comparatively little practical information is available. The following notes, though necessarily brief, may be useful to those who have not made a special study of this type of coupling.

A transmission line has a natural impedance called the "surge" or "characteristic impedance". If we had a uniformly constructed line of infinite length, and connected this line across a generator, transformer, or other source of alternating current, a certain current would flow into the line for a given voltage. Since there

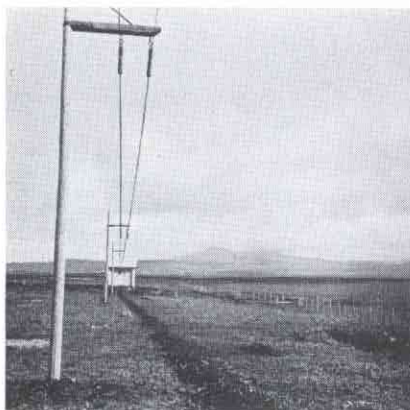

FIG. 1—ANTENNA TRANSMISSION LINE FOR ROME 50 KW BROADCAST TRANSMITTER.

would be no energy reflected back to the generator on an infinite line, the energy from the generator would continue to flow down the line and never return. The characteristic impedance of this line would then be the ratio of the voltage across the line input to the current flowing into the line (by Ohms' law). At radio frequencies, with the usual line construction, the characteristic impedance is equivalent to a pure resistance, the value of which has been found to be, for a perfect line in free space,

$$Z_0 = 276 \log_{10} \frac{2D}{d} \text{ (in ohms) } *$$

Here D is the number of inches between the centers of the wires and d is the diameter of the wire in inches. For the usual 600 ohm transmission line the spacing between wires is 75 times the wire diameter.

In a practical radio frequency line of usual lengths it is necessary to "terminate" the line in a "resistance" equal to its characteristic impedance in order that all the energy delivered to the line by the transmitter will be dissipated in the antenna. If this condition is not met some energy will surge up and down the line in the form of reflections. Reflections are not harmful if they are of moderately low magnitude, although one usually aims to obtain an exact match of impedances if possible. The usual

test for a correct termination is to measure the current in each wire at both the transmitter and antenna ends, the correct adjustment being when the currents are the same or essentially so.

Due to the frequent use of tank circuits for terminating transmission lines, with the antenna circuit magnetically coupled to the tank inductance, a sample calculation of a correct line termination with this type of circuit will be given. This example is a typical one which was worked out for a Type 1-C transmitter operating on 830 kilocycles. The transmission line impedance figured out to be 575 ohms. The antenna resistance measured 104 ohms at 830 kilocycles. The tank condenser across the line was chosen at .003 microfarad which has a reactance of 63 ohms. Using an oscillator, the tank circuit inductance was adjusted until resonance was obtained, this being done with the line disconnected and the antenna circuit open. The required useful number of turns of the tank coil were thus determined. Taking the mechanical measurements of the useful portion of the tank coil and the coupling coil, and substituting them in formula 193 of the Bureau of Standards Circular 74, the mutual inductance between tank and coupling coils for various coupling turns was calculated and plotted (see figure 2).

From well known formulas given in numerous texts it can be shown that at resonance of the antenna and tank circuits, the following equation can be used with satisfactory results (though approximate)—

$$R_0 = \frac{X_c^2 R}{X_m^2}$$

where R_0 is the impedance across the tank at resonance.

X_c is the reactance of the tank condenser.

R is the antenna resistance.

X_m is the reactance of the mutual inductance

*See Electric Journal, January 1928 — "Some Transmission"

In practice we want R_o to equal Z_o as nearly as possible. There are two good ways of proceeding to get this result. One is to solve the preceding equation for the mutual reactance, and then the mutual inductance, from which the coupling turns can be read from the curve of mutual inductance. Solving for mutual reactance—

$$X_m = \frac{X_c^2 R}{R_o}$$

Substituting the values found at 830 KC, for example, we get—

$$X_m = \frac{63^2 \times 104}{575} = 26.8 \text{ ohms}$$

The mutual inductance which has this reactance at 830 kilocycles is 5.14 microhenries which corresponds to approximately 3.4 turns of coupling.

By the second method, the tank impedance resonance (unity power-factor) is plotted against turns of coupling, as in figure 2, using the same formula. The correct adjustment is where $R_o = Z_o$.

After making careful calculations in the preceding manner the only remaining work is to tune the circuits to resonance. This is accomplished very conveniently in the following procedure:—

- (1) Open the tank circuit and the transmission line connections.
- (2) Using the calculated number of coupling turns, tune the antenna to exact resonance using an oscillator and suitable meter for indicating this condition.
- (3) Then replace the tank circuit connection to their previously found positions and retune the tank circuit to resonance by adjusting for minimum current in the antenna circuit. (The oscillator and indicating meter is left in circuit after tuning the antenna.)
- (4) Then connect the transmission line across the tank circuit without altering the antenna or tank adjustments. The circuit is then adjusted for an essentially correct termination.

This procedure, if faithfully followed, enables anyone to readily make a satisfactory transmission line termination adjustment with the type of circuit discussed

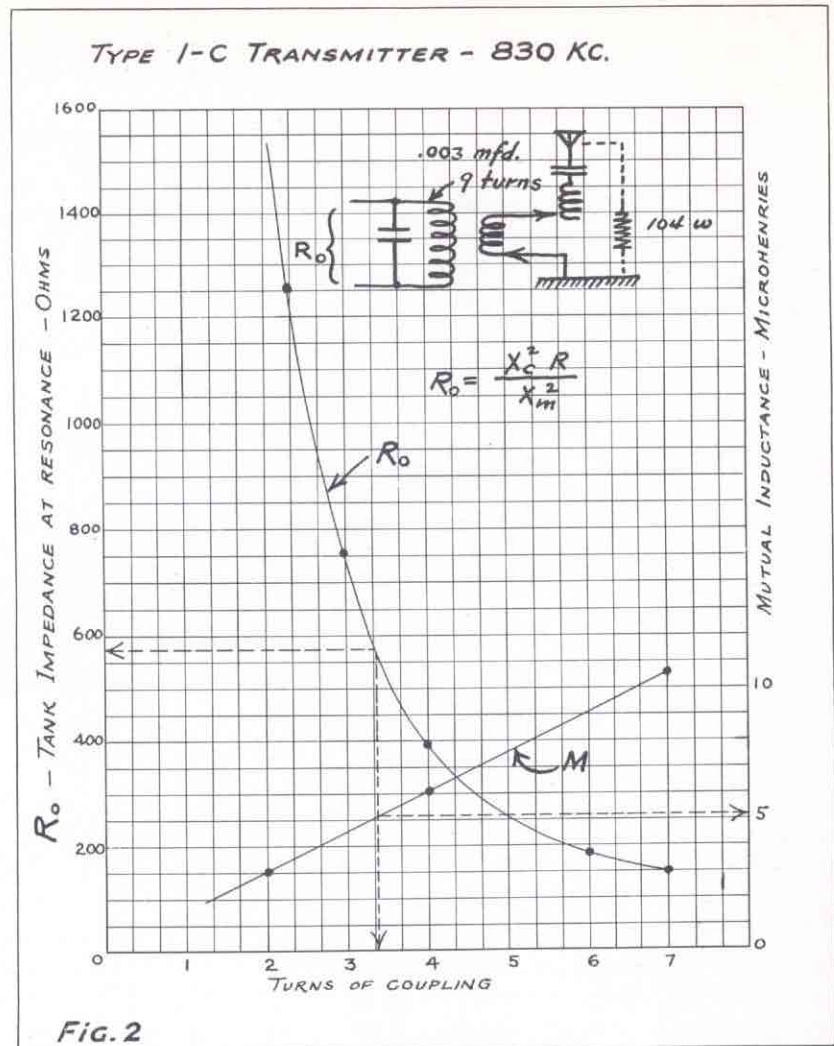

Fig. 2

If the coupling to the antenna is too tight the terminal impedance will be less than Z_o and the voltage at the end of the line will be low, while the potential will increase rapidly going toward the transmitter end. If the line is greater than a quarter wavelength long the voltage beyond a quarter wave from the end will decrease again going toward the transmitter. If the termination impedance is high, the voltage on the terminal end will be high, and will decrease going in the direction of the transmitter, becoming a minimum at a quarter wave from the terminal end and increasing again beyond that point up to a half-wave. If the termination is not in unity-power-factor resonance, the distribution of voltage will differ from that started.

It should be mentioned that the termination, when once correctly adjusted, should not be changed. The input end of the transmission line should then be thought of as a resistance of value Z_o and the line and its

termination forgotten entirely. The power dissipated in this Z_o resistance is proportional to the square of the voltage across it. The power fed into the line is adjusted by varying the coupling to, and adjustment of the power amplifier, thus changing the voltage across Z_o until the correct power input to the antenna is obtained.

NBC GOSSIP

Charles Range, a junior production man working on sound effects, is answering to the name of "Tiger" these days. He was running a machine which imitates the growl of a tiger on the First Nighter Show—the string broke—and Charley came through with an extemporaneous vocal imitation of the beast which was little short of perfect.

Harvey Hayes is persistent. He spent fourteen hours fishing in Crystal Lake without getting a bite—but he is going back to try again.

Police Alarm Broadcast News

POLICE RADIO IS APPROVED

Property Saved in One Month Valued at \$386,953

ADD to the neighborhood loudspeaker nuisance, cause of that malady called "radio insomnia", a new complication—the police radio nuisance. Not that any citizens are complaining against the use of radio by police in their eternal vigilance against criminals, but some good people are decidedly irked at having police squad cars stop in front of their homes or under their apartment windows in the wee hours of the morning while their radios are blaring forth their loud masculine monotones.

At least one bitter complaint on that score has been lodged with the Federal Radio Commission. But the commission's experts say that nothing can be done about it except locally. As in the case of squawking neighborhood radios, it is a matter solely within the local jurisdiction. Against the ordinary loud speaker nuisance, many cities have passed ordinances. Police radios, it is suggested, can be silenced or toned down upon appeals to the police themselves.

Used in Sixty Cities

On the whole, the system of police radio, now established in about sixty large and small cities of the United States, is working out excellently. A Radio Commission questionnaire circulated among them recently, asking for reports and comments on a typical month, April, 1932, elicited some interesting responses.

Replies from fifty cities using radio-equipped police cars showed that 155,656 calls were answered during that month, resulting in 12,676 arrests. The amount of property recovered was reported valued at \$386,953.

Speeded Up Calls

It took the police cars, getting radio reports from headquarters, an



POLICE CHIEF WILLIAM J. QUINN
OF SAN FRANCISCO, CALIFORNIA

TALKS ON CRIME

Police Chief William J. Quinn of San Francisco is heard twice a week now by NBC listeners. So popular are his talks on crime, which are broadcast Thursday evenings, over the NBC-KPO network, that the National Broadcasting Company asked permission to interview him over the air Friday nights, and "Chinatown Squad", thrilling series of true stories of Chinatown in the old days is the result.

Chief Quinn was a member of the Chinatown Squad more than twenty years ago and many of the stories, although drawn from the San Francisco police records, are part of his own personal recollections. The Chief and Carlton E. Morse, NBC writer who has dramatized the stories for radio, chat together at the microphone at the opening of each episode, and the sound of wind-bells, Chinese music and perhaps a revolver shot, are heard in the background as the Chief's tale fades into a dramatic presentation of the action.

Starting July 21, Chief Quinn's Thursday night talks began at 6:30 o'clock, instead of 6:45. The Friday night broadcasts are released at 8:30

The following story is quoted verbatim from the New York Herald Tribune of Sept. 10th.

POLICE EXPERTS SEE ELECTRICITY BEAT THEM TO IT

Mock Jimmie Valentine Is Caught, Confesses Twice 17 Minutes After "Crime"

A modern Jimmie Valentine was caught, identified, forced to confess, and, when he tried to repudiate the confession later, was forced to confess again, all within seventeen minutes of the time he attempted to rob a safe last night in the grand ballroom of the New Yorker. The episode was part of a demonstration of scientific crime detection at the dinner of the National Identification Association, which brought to a close its seventh annual convention.

The lights of the ballroom were darkened and the members of the association saw Jimmie, masked and gloved, steal toward the safe and start to work. He didn't work long, for almost instantly a bulb flashlight exploded and a buzzer started to ring. The cracksman fled without knowing that he had intercepted an invisible beam focused on the front of the safe, which had actuated a photo-electric cell and relay to set off the flashlight and operate the buzzer. The flashlight had enabled a camera, concealed in the wall, to take his picture. Jimmie dashed out of the building, jumped into his car and sped away. But some one had noted the number of the car, had telephoned it to Police Headquarters, and a radio patrol car soon picked up Jimmie and his confederate and brought them in.

No Way Out But Confession

Jimmie's protestations of innocence turned to admissions of guilt when he was shown the picture he had taken of himself. The picture had been developed while the radio car was chasing him. He talked freely in the excitement of the moment, but later, when his case came to trial and he had had time to frame a defense, he

Police Radio

By H. C. VANCE, Sales Engineer RCA Victor Co., Inc.

THE procedure incident to obtaining a license, choosing a site, financing, choosing equipment and operating a police radio system is frequently looked upon as somewhat of a mystery by city officials because it is relatively new and not much information has been printed, aside from stories on the use of radio by some of the cities already so equipped. It is the purpose of this article to outline these various steps, so as to serve as a guide for city officials and public spirited citizens who wish to investigate the possibilities of equipping their police departments with this new weapon for combating crime.

The futility of sending police officers equipped with night sticks and revolvers against criminals equipped with the latest machine guns and other modern weapons has been demonstrated in the past. Statistics also show that the sooner the officers arrive at the scene of a crime the higher the percentage of arrests and convictions. This approaches 100% if the officers are able to arrive while the crime is actually occurring. It is astonishing how many times police radio enables them to do this.

The use of cruising automobiles by the police enables the police force of a town to cover their territory faster and more frequently than a patrolman on foot possibly could. However, the officers ordinarily do not report in to their headquarters oftener than every fifteen or thirty minutes and if an emergency call comes in shortly after they have reported it is necessary to send out the emergency car from headquarters. Frequently this car must travel several miles or more to the scene of the call, thus losing valuable time and giving the criminal time to escape, altho the patrol car for that district may be only a few blocks away, but unaware of the emergency.

Instant communication is a vital need in these situations and police radio is the answer to the problem.

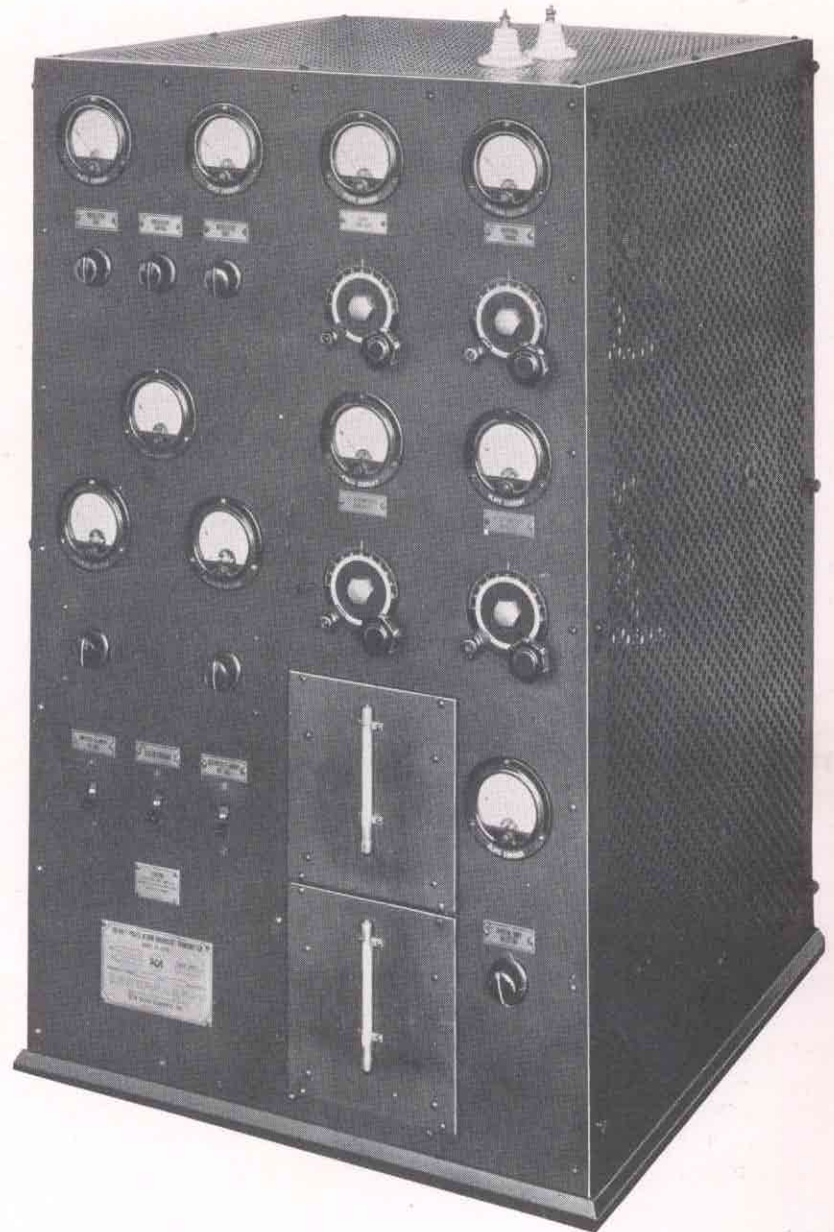

MODEL ET-3670, POLICE ALARM BROADCAST TRANSMITTER 100 WATTS
(RCA VICTOR CO., INC.)

The citizens of a town feel much more secure when they know that thru the efficiency of their police radio system a patrol car can be at their door almost before they have finished phoning the police department.

Along this line, it is important to educate the people of the town to phone the police department instantly when anything happens, giving the location first, a brief statement of what happened and then as much of a description of the criminals as possible. Chief H. A. Alber of Des

Moines, Iowa, found that a series of demonstrations before the various civic organizations of the town was of great value in this respect.

The remainder of this article will be divided into two general parts; the first part will deal with general information on the procedure to follow in obtaining permission from the Federal Radio Commission to establish a police radio station while the second part will go into detail regarding apparatus developed for such a station.

General Information

One of the first questions of interest is, how much power will the Radio Commission allow your city to use. The population of the area to be served determines the maximum amount of power that can be used. The Radio Commission has established the following ratios of power to population:

Population	Watts
100,000 or less.....	50
100,000 to 200,000.....	100
200,000 to 300,000.....	150
300,000 to 400,000.....	200
400,000 to 500,000.....	250
500,000 to 600,000.....	300
600,000 to 700,000.....	400
700,000 and over.....	500

The distance to be covered does not make any difference in the amount of power that will be allowed. If the maximum rated power for a given population does not give sufficient field strength for reliable signals in part of the area involved the Radio Commission has in several cases approved of the installation of several transmitters, each rated at the maximum allowable power or less and so located that their good service areas overlap and a fairly uniform signal is obtained throughout the territory.

These transmitters are generally controlled from a central dispatching point and only one put on the air at a time, the message being repeated over each transmitter on general alarms or where the location of the desired squad car is not known. It is expected that eventually such transmitters will be synchronized and operated simultaneously, producing a more constant signal strength over the entire area involved. Special synchronizing equipment for this service has already been developed by the RCA Victor Company.

The financing of the police radio system is generally handled by the city or other governing unit thru the medium of an appropriation made in the usual manner, but it is interesting to know that in several instances where the city finances would not allow of this expenditure, groups of public minded citizens have organized and purchased all the necessary equipment. In some cases they have

made an outright gift of the equipment to the city and in others they have leased it to the city at a rate which would allow the city to pay for the equipment over a period of years, or the citizens have carried the investment for periods of a few months to a year until the necessary legislation could be enacted which would enable the governing body to make the necessary appropriation for its purchase.

The U. S. Government requires that a licensed operator be in charge of the transmitter whenever it is being used. If the radio system is to be used twenty-four hours a day this

When it has been decided to install a police radio transmitter the city should write to the nearest Office of the U. S. Supervisor of Radio and request that they forward blanks for Application for Construction Permit. These offices are located in New York City, Boston, Baltimore, Atlanta, New Orleans, San Francisco, Seattle, Chicago and Detroit.

In filling in these applications a technical description of the transmitter to be installed is required. This technical data should be obtained from the manufacturer of the transmitter.

The frequency or wavelength on



2 STAGE A.C. OPERATED MICROPHONE AND LINE AMPLIFIER
(RCA VICTOR CO., INC.)

generally means that three operators will be necessary. Some of the smaller cities find that it is possible to operate only during the hours of darkness, when crime is the most frequent. This of course allows them to employ fewer operators.

It is frequently found that some of the officers on the force are radio amateurs and have the necessary operator's license or can obtain one.

Choosing the proper site for the transmitter, designing the proper antenna and ground system and similar problems should be handled by radio engineers who are experienced in police radio requirements. The Transmitter Sales Engineers of the RCA Victor Company will be glad to furnish this service without charge. Making use of their experience will save costly experiments.

which your station will operate will be assigned by the Federal Radio Commission. The following eight frequencies have been assigned for the use of municipal police radio stations: 1712, 2414, 2422, 2430, 2442, 2450, 2458 and 2470 kilocycles. Three frequencies, 257, 1574 and 2506 kilocycles, have been assigned for the use of state police stations. Special call letters can be requested by the applicant or, if none are requested, the Commission will specify them.

When the Application for Construction Permit has been filled out and replies made to all of the questions, it should be properly signed and returned to the U. S. Supervisor for your zone. The Supervisor makes certain records and recommendations

Washington, D. C. where it is acted upon by the Federal Radio Commission.

Transmitter Equipment

Inasmuch as comparatively few cities in the United States have large enough populations to enable them to obtain licenses for more than 100 watts, the RCA Victor Company has developed a transmitter of that power as their basic unit for police work. A 500 watt amplifier has recently been made available for use in conjunction with the 100 watt set by state police or cities having more than 200,000 population. This amplifier can be added to an existing 100 watt station if it is desired to increase power after the original installation has been completed.

The 100 watt set can be operated at either 50 or 100 watts. The amplifier, in conjunction with the 100 watt set, can be operated at any power between 100 and 500 watts, making a very flexible combination.

The 100 watt set is illustrated in Fig. 1. It is entirely A.C. operated from 220 volts, 60 cycles, single phase and is complete as shown. Its installation is nearly as simple as that of a modern A.C. broadcast receiver; the transmitter can be set on one corner of a desk, as its width and depth are only about 25 inches each and its height 41 inches.

It is crystal controlled, two precision quartz crystals of the type used in broadcast transmitters being furnished. One crystal is used at a time, the other being a spare. A quick selector switch allows either to be connected in the circuit instantly.

The crystal oscillator stage uses a UX-210 tube. The first buffer stage uses a UX-210, while the intermediate amplifier stage employs a UV-211.

The output stage, a single UV-211 tube in a special, high efficiency circuit, is plate modulated thru a modulation transformer by two UV-845 modulators operating in a semi-Class B circuit and excited by a UY-227 speech amplifier. This unusual tube complement delivers over 100 watts of power to the antenna, 100% modulated.

Two UX-866 mercury vapor rectifier tubes in a single phase, full wave

rectifier circuit furnish plate and grid bias voltages for all of the tubes in the set except the UY-227 grid bias which is supplied from a small C battery. The filaments of all tubes are operated on A.C., eliminating the necessity for any rotating machine.

The speech amplifier audio input transformer has two separate input windings so that either a local microphone circuit of about 200 ohms impedance or a remote line circuit of about 500 ohms impedance can be used to feed the speech amplifier.

An A.C. operated microphone and line amplifier is shown in Fig. 2. This is used when it is desired to modulate the equipment from a remote point over a telephone line, or if a low level microphone such as the condenser or double button carbon type is used. Input impedances of 200 and 500 ohms and output impedances of 500 and 4,000 ohms are available in this amplifier.

The amplifier has an overall gain of about 54 D.B. and includes two stages of resistance coupled, push-pull amplification. The first stage uses two UY-224 and the second stage two UX-245 tubes. A UX-280 rectifier furnishes plate and bias voltages. The tube filaments are lighted from A.C. as they are of the indirect heater type.

The volume indicator meter is operated from a dry-plate rectifier. Two variable T pads, one in the line input and one in the local microphone input, allow the audio input to be held at the desired level. These are shown on the front of the amplifier panel.

The 500 watt amplifier will be described in a later issue of BROADCAST NEWS.

Station WEVD had the official opening of their new studios in the Hotel Claridge, N. Y., on September 28th.

Andrew Massey, Chief Engineer of WPTF, Raleigh, N. C., used a 5-meter portable transmitter to relay the events of the North Carolina State Fair. The hook-up was very successful.

Frank Marx, Chief Engineer of WMCA, has moved into his new quarters at Flushing, N. Y.

POLICE EXPERTS SEE ELECTRICITY BEAT THEM TO IT

(Continued from Page 28)

repudiated the confession, saying it had been extorted from him by third-degree methods. The District Attorney placed on the stand a police technician, who swore that not only had the confession been taken down in shorthand, but it had been electrically transcribed on a record. The playback of the record gave the entire conversation, with the recognized inflections of voice of the accused, who thereupon entered a plea of guilty.

Another device which was demonstrated for the benefit of association members earlier in the day was a short-wave radio machine which can send and receive between New York and Scotland Yard, London, the picture of a criminal, his fingerprints and signature, all on one plate. A number of such radio telephotos were sent and received at the Radio Corporation of America station at Broad and Beaver.

POLICE RADIO IS APPROVED

(Continued from Page 28)

average of 1 minute and 2 seconds to answer each call, according to the survey. Some of the replies disclosed that, in order to avoid listening-in by criminals on the short waves used by police, code was used, but in most cases it was discarded. A suggestion was made that the cruising cars be equipped with light transmitters to afford two-way communication so that the policemen might talk back and forth with headquarters.

Recently, the City of Lexington, Kentucky, went on the air with an RCA ET-3670 100 Watt Police Transmitter, with call letters WPET. This station is already known for its excellent coverage and quality. The standard RCA recommendations were followed in the installation, using a 200-foot transmission line and a Type 1-C antenna tuner unit.

Mr. Lee Russell Penn is directing the activities of the station.

R.C.A.C. Diversity Telephone Equipment As Used In Its Addressed Program Service

By S. H. SIMPSON, Jr., Program Service Supervisor, RCA Communications, Inc.

THE rapid advance of broadcasting not only brought on a natural desire to hear programs originating in foreign countries but the American Public almost demanded the right to hear first hand, the great operas, orchestras, speakers and news events of foreign countries.

Back in 1923-24 tests were made with the old well known British 5XX on 1600 meters. In fact, several programs were rebroadcast over the old WJZ of Aeolian Hall days, but only the novelty of the deed sustained the poor quality obtained.

Then short waves were discovered. A few kilowatts of power reaching around the world—very little static so characteristic on long waves, but afflicted with the serious problem of fading. This may be classified under

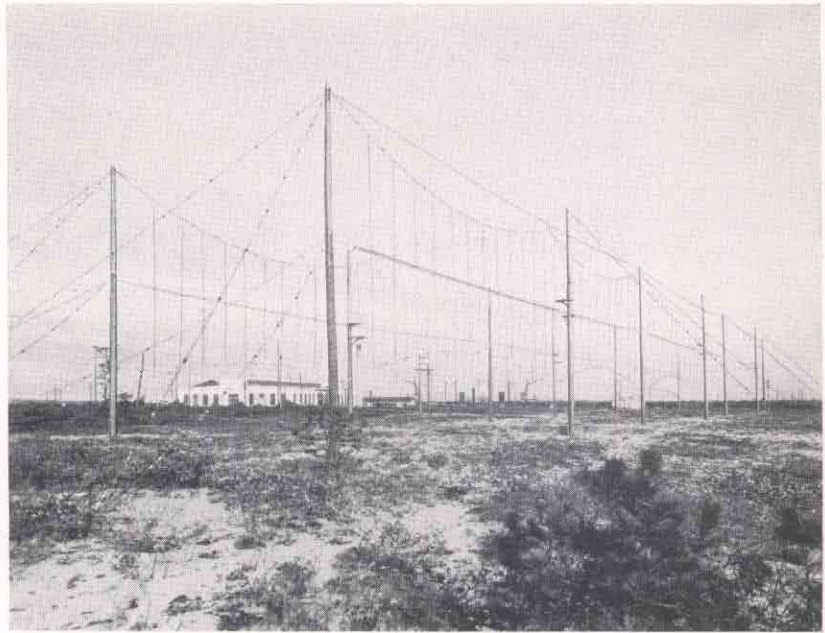

SPECIAL ANTENNA SYSTEM DEVELOPED FOR THIS SERVICE AT ROCKY POINT, L. I.

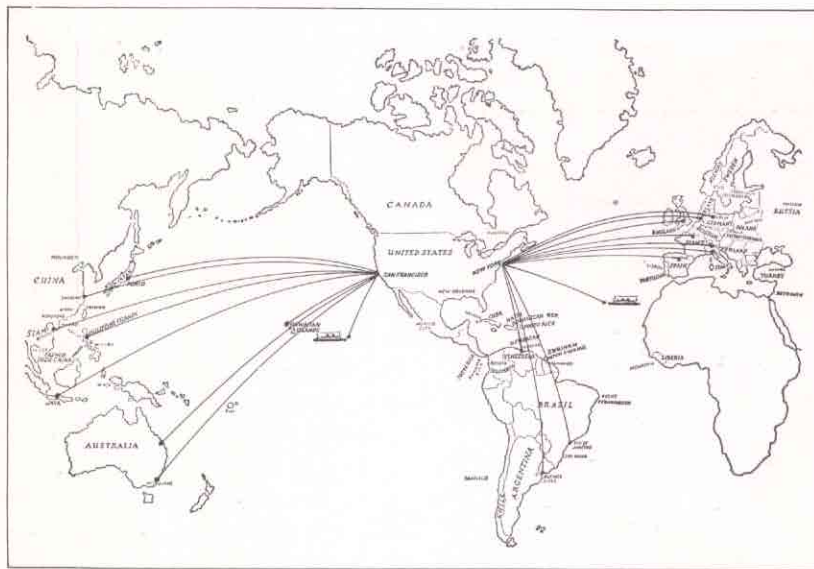

THE DIRECTED PROGRAM CIRCUITS OF THE RCA COMMUNICATIONS, INC. A RADIO CORPORATION OF AMERICA SUBSIDIARY

its periodicity and also under its depth. We have slow fading of from a few seconds to a few minutes duration or rapid fading of such speed as to modulate or superimpose the frequency of fading on the program being transmitted. This very rapid fading is called flutter or audio fading on account of the fluttering effect it produces in the signal.

Another troublesome form of fading is that known as selective fading in which one frequency out of the transmitted group fades out leaving the rest intact. If the frequencies which fade out are the so-called sideband frequencies no appreciable damage is done to the signal, but if the carrier frequency fades out leaving the sidebands intact the signal is

badly distorted, the effect being the same as extreme overmodulation of the transmitter.

The first procedure was the application of an automatic volume control to the short wave receivers. This is normally accomplished by rectifying the amplified radio signal—or intermediate frequency signal in the case of a superheterodyne receiver—and passing the D.C. current so obtained through a suitable resistor. The resulting voltage drop across this resistor is used as grid bias voltage for the radio frequency amplifier. When the radio signal strength rises this bias voltage becomes more negative, reducing the R.F. amplifier gain, and vice versa, with the result that the audio frequency output of the receiver varies only slightly though the radio signal varies greatly. Such an arrangement, however, cannot provide additional carrier when the carrier fades. Neither can it improve the signal to noise ratio at times of weak signal. Noise level remains fairly constant over a given period but a weak signal produces only a weak bias for the R.F. ampli-

fiers and the receiver gain is increased. In amplifying the signal to normal level the noise is also amplified in proportion.

Experiments by the engineers of RCA Communications, Inc., showed that fading does not occur simultaneously on several antennas spaced some distance apart and that the antenna delivering the strongest signal normally produces the best quality at its receiver output. The next step was to apply this knowledge but the range of frequencies to be handled, and the quality expected, made the addition of two or more signals a real engineering problem due to phase distortion or cancellation.

The system developed and now generally used by RCA Communications, Inc., at Riverhead, N. Y., Point Reyes, California, and Koko Head, Hawaii, is very practical and efficient. A very serviceable and efficient superheterodyne receiver has been developed for this use. The signal from each antenna is fed through its receiver to bias type second detectors. The detector plates are all supplied from one common

By means of this connection, all receivers are kept at substantially equal gain. A strong signal output from one of the three receivers will reduce the gain of all receivers and thus lower the noise contributed by the other two. Obviously this is a very desirable condition.

may not allow response to the more frequent rates of fading. Also, it is preferable to make the constant sufficiently small so as not to follow the faster rates of fading. For example in the latter case: the auto control may lag behind a deep, rapid fade to the extent of maintaining a

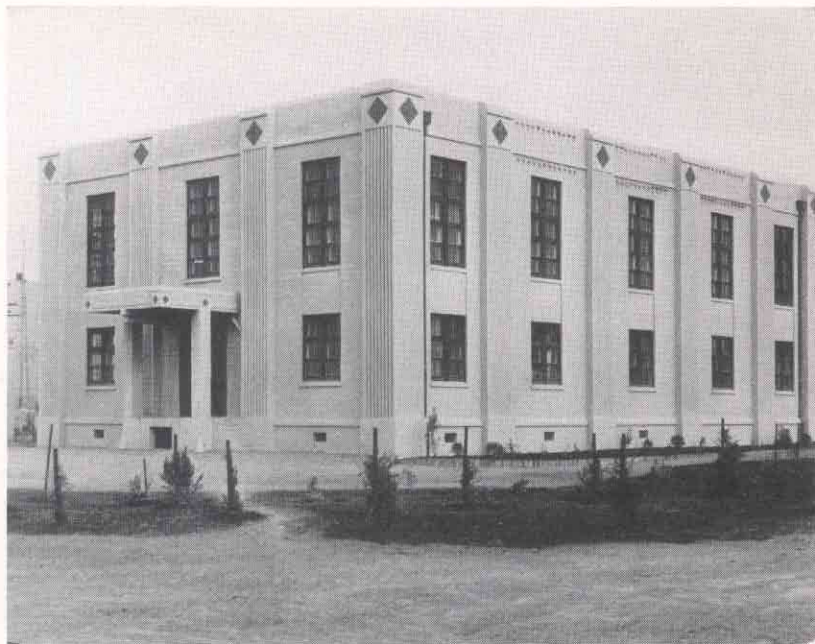

RCA SHORT WAVE TRANSMITTER HOUSE, BOLINAS, CALIF.



GERMAN RADIO CENTER—BERLIN (COURTESY REICHS RUNDFUNK AND NBC)

plate battery through a load resistance, the resistance being connected between the negative terminal of the battery and filament. The audio frequency output is taken from this load resistor and the D.C. voltage drop across the resistor is fed back to all R.F. amplifier grids as automatic volume control bias voltage.

The choice of the volume control time constant, i.e., the time required for the control to change from maximum to minimum and vice versa, is more or less a compromise. A time constant so small as to affect the amplitude of low frequency modulation is obviously unsuitable; and on the other hand too large a constant

high gain level after the signal returns to normal and a sudden "burst" of strength results in the output.

The well known flexibility and selectivity of the superheterodyne receiver accounts for the adoption of this type of receiver in the telephone diversity system developed by RCA Communications, Inc.

Fundamentally, the receiver consists of three parts, viz.: R.F. Amplifier, Heterodyne Tuner Unit, and I.F. Amplifier Detector Unit. The apparatus is capable of operating satisfactorily from approximately 42,800 KC (7 meters) up through the broadcast band, but the usual standard equipment for commercial use calls for operation only of from 20,000 KC (15 meters) to 5000 KC (60 meters). The load resistance and auto bias circuit, including the time constant circuit, are all included in the Audio Amplifier Unit which controls the audio output levels fed to speakers or lines for distribution.

A very unique unit, namely, the I.F. Monitor Unit, is included in each diversity receiver installation to

facilitate quick and exact tuning. This piece of apparatus utilizes a constant frequency oscillator, tuned exactly to the middle of the I.F. band, the output of this oscillator being fed into a special balanced detector. This balanced detector also receives a small amount of the I.F. signal through a "bleeder" tube in the I.F. Unit. Now by tuning the main heterodyne oscillator until zero beat with the monitor unit oscillator is obtained, the receiver operator knows that the signal is exactly in the middle of the I.F. band pass filter and the receiver is precisely in tune.

This diversity equipment which has been described is in use at the Hawaiian end of the San Francisco-Honolulu telephone circuit.

The foregoing refers particularly to the reception of programs from abroad to be broadcast in this country for the entertainment of American listeners, but RCA Communications, Inc., has gone still further and has provided facilities, in conjunction with its world wide radio telegraph installations, for transmitting American programs to broadcasting organizations in many foreign countries.

Directive transmission is used throughout in conjunction with high quality high power transmitters, ensuring a high degree of reliability in service. These transmissions are received by the foreign receiving stations cooperating with RCA Communications, Inc. in program service and delivered over suitable wire lines to the addressee for broadcasting.

The transmitters consist of three main units, a crystal controlled frequency doubler type of exciter unit with an output of 1 KW, a power amplifier using either 4 UV-207 or 2 UV-858 watercooled tubes in a push-pull circuit, with a maximum output of from 20 KW at 14 metres to 40 KW at 45 metres, and a 3 phase full wave rectifier for plate supply to the power amplifier. A.C. filament supply is used throughout.

These transmitters are normally engaged in telegraph service but can be readjusted for program transmission

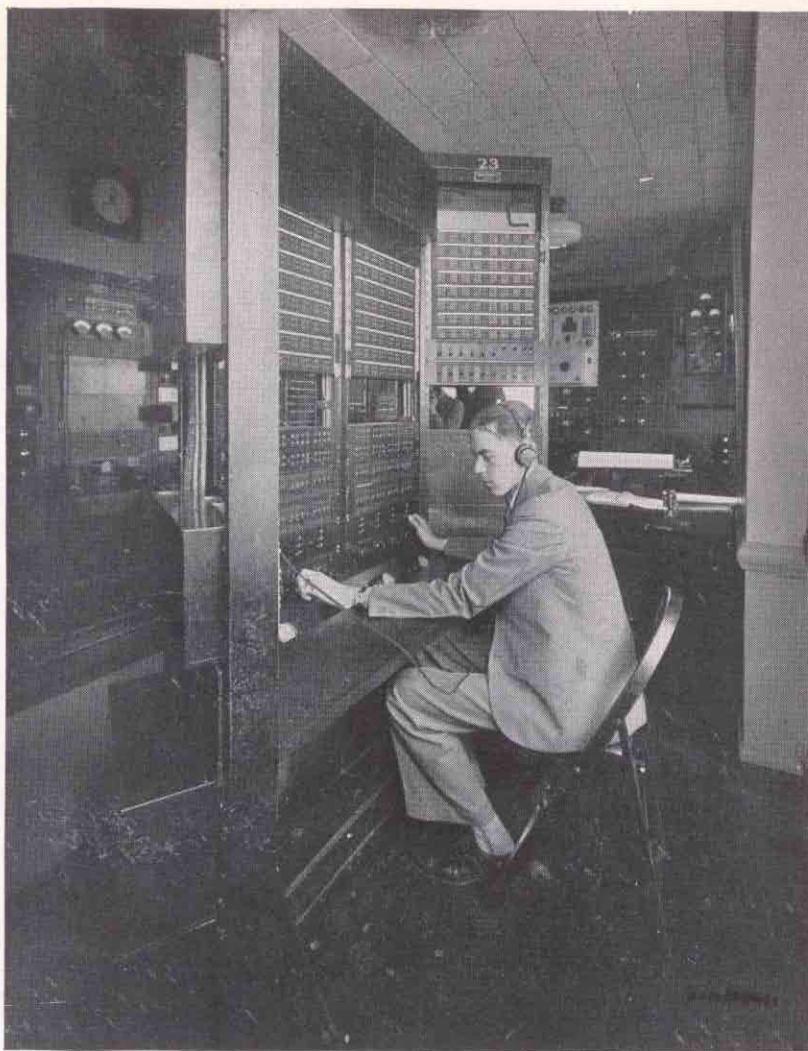

MASTER CONTROL BAY THROUGH WHICH ALL PROGRAMS ARE ROUTED TO NETWORK

change being the application of Husing type modulation to the output of the exciter unit. The modulators are small compact units mounted on wheels so they may be moved around from one transmitter to another as required. They incorporate one resistance coupled stage of amplification driving 4 to 6 UV-849 modulator tubes and are entirely self-contained, with one flexible two conductor cord and plug for making connection to the line amplifier output and another cord and 5 terminal plug for A.C. supply for the filaments, 3000 volt plate supply for the modulator, modulated plate supply to the exciter output stage and a ground connection.

The transmitter output is carried

over a transmission line consisting of two bare copper wires approximately one-quarter inch in diameter about one foot apart. Many of these transmission lines are more than a half mile long as even the most compact types of highly directive antenna occupy quite a large area of land and must not be placed so closely together as to interfere with each other. The large transmitter buildings at Rocky Point and Bolinas, with their combined total of 44 short wave transmitters, and their surrounding networks of transmission lines and antennas occupying a total of several square miles of land are most impressive sights, that must be seen for realization of the extent to which international radio communication

Broadcasting Station WWSW Pittsburgh 100 Watts. 1500 Kc. 199.9 Meters

By M. J. SARTORY, Manager, WWSW.

THIS morning we dedicate the new broadcasting station WWSW. This station is under the direction of the Walker and Downing Radio Corporation with studio at the Schenley Hotel. The first service to be put on the air is our Church service this morning. Through the courtesy of station WWSW First Church will broadcast morning and evening each Sunday for a year. We are deeply indebted to the Sponsor of the Sacred Song Concerts for the installation of the microphones and wires which connect us with station WWSW, and which are our own property through her generosity. We wish as ministers and officers of the Church to publicly express to the Sponsor and the Walker and Downing Radio Corporation our gratitude for making possible this enlarged sphere of our Church activity."

These words, delivered from his pulpit by the Rev. Dr. C. Wallace Petty, pastor of the First Baptist Church, Bellefield Ave. and Bayard St., in the fashionable Schenley Farms District of Pittsburgh at 10:45 on Sunday morning, May 31st, 1931, marked the formal opening of station WWSW, the first commercial station in the United States that, to our knowledge, was formally opened with a church service from a remote control point.

In spite of this auspicious opening, those guiding the destinies of the infant station had a tough row to hoe. To begin with the Radio Editors of Pittsburgh, the cradle of the Radio industry, considered a 100 Watt station far beneath their notice, and only through friendship was it possible to have their schedule included and listed on the same page with the four other Pittsburgh stations, the newest of which was at that time about 8 years old. "Stunt" broadcasts were tried, which on the chains would have attracted Nation-

tion prevailed upon some of their friends that broadcasting would help their business, and within a few weeks after the opening no fewer than six commercial programs were on the air. The Summer months however, were not very productive, and with the opening of the schools and colleges, new interests had to be created in the station. Sporting events seemed the logical outlet, as no other Pittsburgh station was broadcasting local sporting activities. The big colleges would not listen to the plea for permission to broadcast their regular football games, fearing, as they stated "It might hurt attendance". Basketball, however, was considered in the light of a minor activity, and permission was easily obtained to broadcast the games from the Carnegie Institute of Technology. "Tech" had a team that was "going good" and contrary to the prediction of the wisecracks, the crowds did not dwindle, but, as a writer for one of the opponent colleges put it, after an unsuccessful attempt on his part to get through a crowd of over one thousand basketball enthusiasts who, for lack of space were turned away from the Tech Gym, "I hied me home and listened to the game from WWSW." WWSW broadcast every one of Carnegie Tech's "Home" games, and received a letter of thanks from the Athletic authorities of the Institute for their valuable assistance in making basket-ball popular and the unprecedented increase in patronage.

Meanwhile, the "Yellow Jackets" Pittsburgh's representatives in the International Hockey League, were putting up an indifferent display of their abilities with the crooked stick, and seemed to be going nowhere in particular. Hockey games however, could be made interesting if properly described. The game is fast, and a word-picture of such an event would be a constant flow of language. Why

the air? A little persuasion convinced the owners of the "Yellow Jackets" that broadcasting the games would not hurt, and might help the attendance. The result was that when the Yellow Jackets returned from the northwest about Christmas time, Ed. Sprague was sitting on the sidelines with a pair of "Mikes" ready to tell the world what our noble representatives in the game of pushing the puck were doing on the ice at Duquesne Garden. The broadcasts proved to be a magnet. From a sparsely filled auditorium, the games at Duquesne Garden turned into the converging point of interest for sports enthusiasts from every section of the county. The "S.R.O." sign made its first appearance at the entrance gate, and stayed there throughout the balance of the season. Plans are now under way to enlarge the seating capacity of the Garden and WWSW has been invited to broadcast all home games from that location, in addition to the boxing bouts which it is hoped will be staged there during the coming fall and winter.

By this time, WWSW had attracted the notice of not only sport fans but also sports editors and the sports editors of the two evening newspapers accepted with alacrity an invitation from the Station to participate in the broadcasts of sports events. Boxing bouts were being staged in three different clubs in the city, but the promoters were rather stand-off-ish when approached regarding the privilege of broadcasting, and not until the station was taken over by Pittsburgh's only morning newspaper, the Pittsburgh Post-Gazette and some pressure brought to bear was it possible to get the necessary permission to "Air" the boxing bouts. Here again, patronage and attendance was increased after the first few broadcasts.

Meanwhile, however, the musical portion of the programs had not been

Pittsburgh's outstanding supper and dance club, was featuring "Name" orchestras. Some of the best of the M. C. A. bands were appearing for weeks at a stretch. WWSW invaded the "downtown" section of the city, the studios of the two largest stations in the city being only one block apart. The Nixon Restaurant lies halfway between them, and both had their eyes open for the opportunity to broadcast the features offered on a sustaining program basis. Both had made overtures to run lines in but the proprietors "took a chance" and

hooked up with the infant, and WWSW broadcast nightly from that point beginning November 10th, until the close of the season on May 17th, 1932. These broadcasts proved so satisfactory to the proprietors of the Nixon, who are also the proprietors of the "Willows" at Oakmont, about 14 miles from Pittsburgh proper, that when they opened the Willows for the summer season, WWSW just naturally went along, and are broadcasting nightly such orchestras as Lloyd Huntley and his Isle O'Blues Orchestra, Ted Weems,

Sleepy Hall and his Melody Boys, and orchestras of that rating from that point.

Dr. Charles Heinroth, director of Music at Carnegie Institute of Technology and organist at Carnegie Music Hall was giving free organ recitals Saturday evening and Sunday afternoons. A conference with the Trustees of the Carnegie Foundation resulted in WWSW broadcasting his recitals every Sunday afternoon, giving Pittsburghers quality in music such as few had the opportunity to hear prior to these broadcasts. Dr. Heinroth is now in New York and his place at the console will be taken by Dr. Marshall Bidwell, of Cedar Rapids, Iowa. WWSW will continue the broadcasts. Each afternoon at three o'clock WWSW broadcasts a half hour recital from the Pittsburgh Musical Institute, which is really the School of Music of the University of Pittsburgh and the second largest recognized musical school in the state of Pennsylvania.

News is broadcast three times daily from the Pittsburgh Post-Gazette studios of the station, and each afternoon at one o'clock a program of luncheon music by an outstanding trio is broadcast from the restaurant at McCreery's, one of Pittsburgh's largest better class department stores. WWSW numbers among its clientele Kaufmann's, Pittsburgh's largest department store, who present a shopping period under the title of "Babbette" from 10:45 until 11 o'clock each morning except Sunday; the Wood Street Ass'n., an organization of business men from the "Quality Thoroughfare" of Pittsburgh, in a half hour of high-class music and narration of historical events each week; manufacturers of Ginger Ale, Food Products, etc., that go to make up the best class of advertisers in Western Pennsylvania.

Among the features most prominent, and which have attracted probably the most listeners as well as the most comment are:—"Behind the Kitchen Door", the adventures of a young married couple with all the trials and tribulations that go to make up life in a flat. The program first took the air the day following

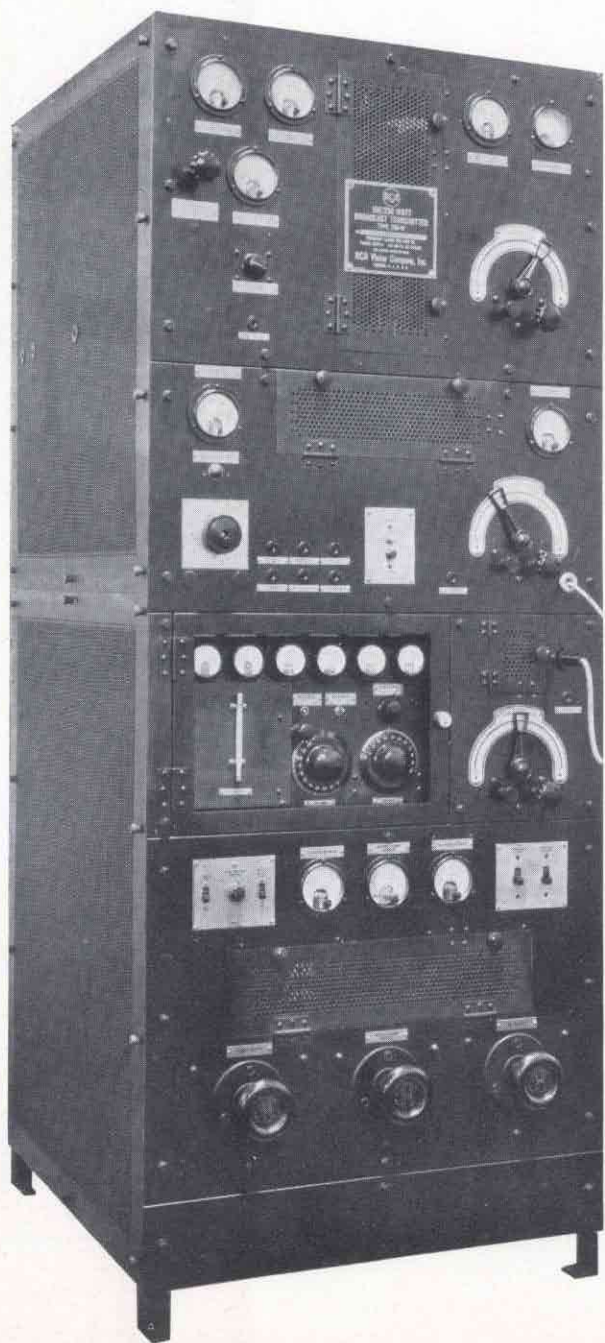

1st, and was presented intermittently, alternating between morning and evening until September 1st, at which time the period 7:30 until 7:45 P. M. was selected. Haven Haas, regular announcer on the station and Margaret Leyda, a contralto, reader and mimic were selected for the characters and have never missed a program in 13 full months of broadcasting. The feature went commercial on December 4th, 1931, being sold for a twenty-six weeks' period to the Bauer Baking Company, who exercised their option of renewal before the contract had run three months, for an additional twenty-six weeks' period. Helen's Hi-Lights, a style and economy feature was added to the regular program schedule about the middle of June, under the supervision of Miss Helen Solomon. This feature has never failed to pay its way, and, for a time during the winter and spring months it was necessary to put on an extra period daily to take care of conflicting advertisers. These extra periods have been cut to three times weekly during the Summer months. Francis Owen was added to the staff as Program Director about February 1st, 1932, and brought with him that famous presentation which has been copied under one name or another in every part of the United States: "The Waste-basket", bits of poetry and prose with comments, original with Mr. Owen, the whole presented with a musical background which may be heard each Sunday afternoon at 1 o'clock. Many other features, each and every one worthwhile, are constantly being prepared and presented, and the station has the reputation of being "Up and Coming".

In the past WWSW got along with a composite set of 100 Watts power. Recently, however, an RCA Victor 100-250 Watt transmitter was purchased, and is now in operation. Frank R. Smith, Jr., is General Manager, M. J. (Joe) Sartory, Promotion Manager, and A. A. Lewis, Chief Engineer.

Negotiations are at present under way to broadcast open-air boxing bouts and perhaps semi-pro baseball from Greenlee Field, a new open-air baseball field and boxing arena re-

cently completed, and it is hoped that by the time this goes to print, WWSW will be bringing its fans this extra service during the open-air season. Negotiations are also just about completed to broadcast Pittsburgh's season of Grand Opera presentations from the Pitt Theatre, beginning about the middle of October and continuing on throughout the winter season, as well as Football, Basketball and Hockey, with a possibility of Polo as a diet for sports fans. An increase in power would, of course, make WWSW even more valuable to Pittsburgh and Allegheny County than it has already proven itself, and it is to be hoped that the Commission will see its way clear to grant this at an early date.

THE SUNNY SIDE OF THE MICROPHONE

SOME SPEED

Ed Wynn, NBC comedian, has his own ideas on speed. The other night he was discussing the subject with Graham McNamee and said: "The fastest thing I ever saw go was Mahatma Gandhi in a strip poker game."

RUNS IN THE FAMILY

Ted Weems' real name is Wilfred Theodore Weymes. The NBC orchestra leader is a descendant of the Angus Weymes, who invented the Scottish bagpipes. Weems, too, is an inventor having both the goofus horn and the mellohorn to his credit.

TOE BAD

Richard Gordon, NBC actor, was talking to his favorite boot-black recently and Tony started to tell him all about "his operation."

"I was carry a bigga rock," said Tony. "I drop him on my foot and when I taka off my shoe I find my big toe she's got a black eye."

PARKED PROSPERITY

Mr. E. K. Cohan, Technical Director of CBS, is sporting a new Chrysler. He calls it "Prosperity" because it's always parked just around the corner.

A NEW HIGH FREQUENCY BROADCAST TRANSMITTER

(Continued from Page 17)

"Class B" Modulators

This transmitter offers a particularly good example of the advantages of "Class B" modulators. If we suppose, for the instant, that the same general arrangement were to be used but the modulators were to operate (as formerly) as "Class A" amplifiers, we would find it necessary to use ten UV-849's as modulators in order to obtain 100% modulation. Similarly, if we were to consider an alternative low-level modulation system, the two UV-849's (as "Class A" amplifiers) would modulate the two UX-860's in the I.P.A., but we would then have to operate the power amplifier "Class B" and would require eight (instead of two) UV-861's. If, as a third alternative, we were to consider grid modulation we could eliminate the two UV-849 modulators but the power amplifier would still be essentially a "Class B" amplifier and would still require eight UV-861's—thus greatly overbalancing the saving effected by eliminating the modulators.

Power Supply

Plate voltages for this transmitter (except those for the first speech amplifier, which are furnished by a separate rectifier) are obtained from a single motor-generator set. Bias voltages for the r.f. stages are also obtained from this unit. Bias voltages for the audio tubes are furnished by a rectifier employing two UX-866's. All filaments are operated on A.C.—most of them from separate transformers.

Construction

High-frequency circuits particularly require finely developed mechanical construction. The new W2XE transmitter was designed on the basis of the experience gained by the RCA Victor Company, Inc. and its associated companies in building and operating many transmitters of similar type for marine communication services. It consists of two compact units housing, respectively, the radio

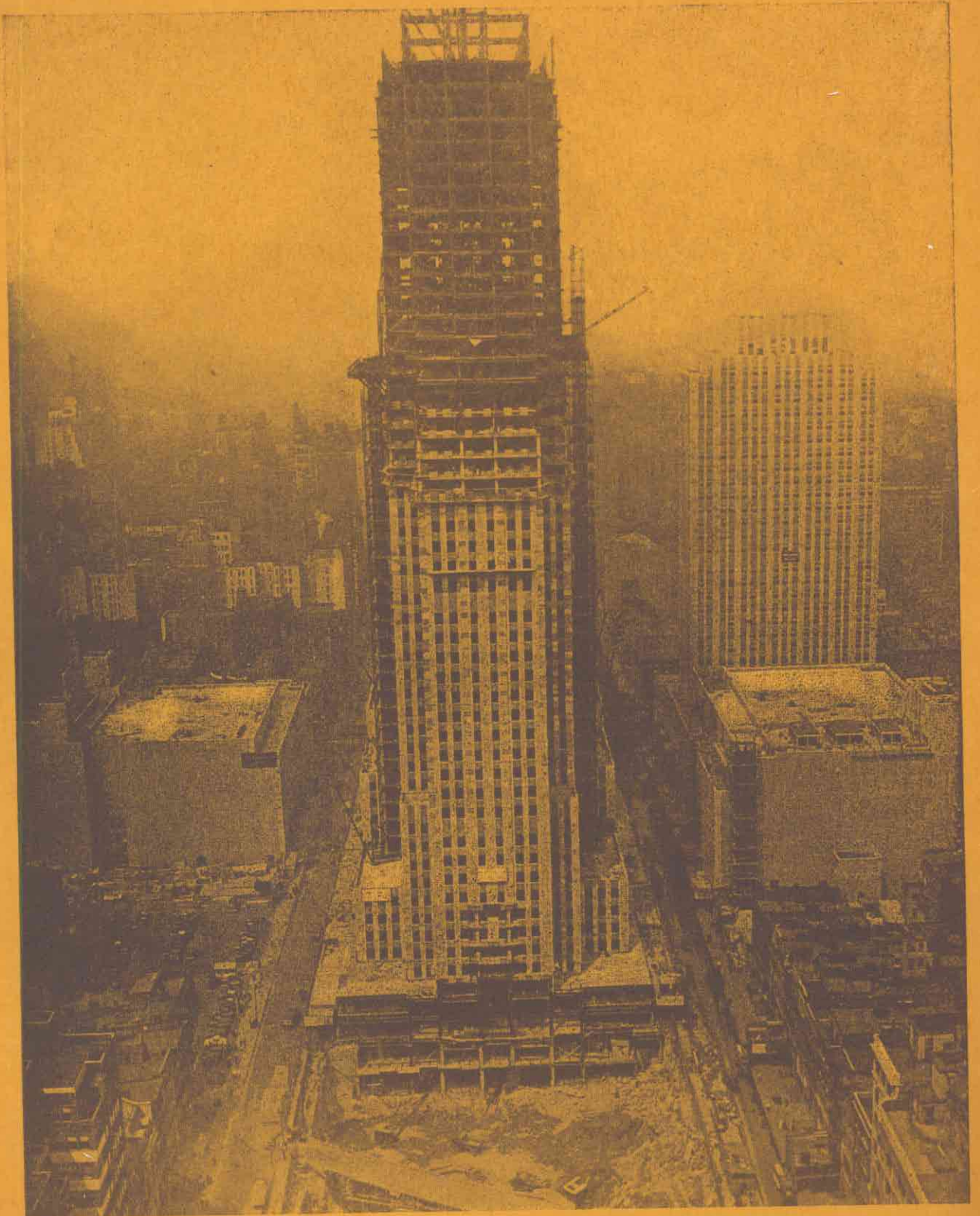

OUT OF THE DUST RISES A CITY WITHIN A CITY

ROCKEFELLER CENTER PROGRESSES BY LEAPS AND BOUNDS, AND KEEPS THE RCA VICTOR ENGINEERS BUSY NIGHT AND DAY.

NEW BULLETINS ISSUED

Just off the press,—and available to those interested upon request to the Transmitter Sales Section, RCA Victor Company, Inc., Camden, New Jersey—

Bulletin No. 24—VELOCITY MICROPHONE

Program Type 44-AP

Announcer Type 44-AA

Suspension Type 44-AS

Bulletin No. 25—MICROPHONE AMPLIFIER

Type 41-A

SEND FOR YOUR COPIES