

BROADCAST NEWS



Vol. No. 114
AUGUST 1962



The Voice of the Land

It's a big land . . . a proud land . . . that sweeps from sea to sea. Only a strong voice can fill it . . . reach it . . . move it to its very heart.

Listen to this voice. It talks to motorists as they crowd the busy roads. It gives a warning to farmers that frost is ahead. It sings a sweet song to lovers. It carries the news to businessmen. It wakes millions every morning and sends them off to work . . . informed . . . entertained . . . often inspired. For this is a practical voice, a spiritual voice, the very voice of America. *It is the voice of AM Radio.*

RCA has played an essential part in the steady progress

of AM. You will find the RCA nameplate proudly affixed to transmitters whose owners never toy with quality . . . never compromise with dependability. You will find the RCA nameplate your highest assurance of superior performance no matter what your broadcast requirements may be. Why not call in your RCA Broadcast Representative today. He speaks your language.



The Most Trusted Name in Radio

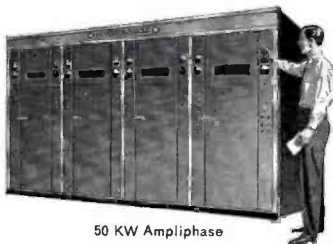

50 KW Ampliphase



5/10 KW Type BTA-5U/10U



5 KW Type BTA-5T



250/500/1000 W Type BTA-1R1

BROADCAST NEWS*published by***RADIO CORPORATION OF AMERICA**
BROADCAST & COMMUNICATIONS PRODUCTS DIVISION, CAMDEN, N. J.*issued quarterly***PRICE** *in U.S.A. - - - - - \$4.00 for 4 issues*
*outside U.S.A. - - - \$5.00 for 4 issues***C O N T E N T S**

	Page
KCRA, KOVR, KXTV ERECT WORLD'S TALLEST CANDELABRA ANTENNA	8
WKZO MODERNIZATION PROGRAM	16
VIDEO ALIGNMENT TAPE	26
RECORD 2000 HOURS OF COLOR TV ON NBC FOR 1962-63	30
NEW 5-KW AND 10-KW AM TRANSMITTERS	31
100-KW SHORTWAVE TRANSMITTER FOR INTERNATIONAL BROADCASTING	36
U.S. ARMY SIGNAL CORPS USES CC-TV FOR TRAINING	42

*As We Were
Saying*

MOST OF THE BEST use mostly RCA equipment—but the WKZO stations go us one better, they use all RCA equipment. The WKZO story (Pg. 16) continues our series on new installations of outstanding stations. And this is one we are especially proud of. It includes RCA transmitters for AM, FM, TV, STL, mobile and complete RCA studio equipment with TK-12 4½-inch I.O. Cameras and RCA color film equipment. The FM transmitter, incidentally, is the first RCA 50 KW FM transmitter to be installed anywhere.

AUDIO ENGINEERING SOCIETY CONVENTION at the Barbizon-Plaza Hotel, New York City, October 15-19, will include several sessions of interest to broadcast engineers. One on BROADCAST AUDIO is being arranged by A. H. (Tony) Lind, manager of our Studio Engineering section. Another, on FM STEREO BROADCASTING will be directed by Warren L. Braun, Assistant General Manager of WSVA, who is well known to broadcasters from his years with the FCC. A third, on SOUND REINFORCEMENT AND ACOUSTICS

Copyright 1962

All Rights Reserved Trademark(s) ®Registered. Marca(s) Registrada(s) Radio Corporation of America, Broadcast & Communications Products Division, Camden, N. J.

PRINTED
IN
U.S.A.

*As We Were
Saying*

while not particularly broadcast-oriented should be of interest. It will be arranged by John Volkmann of RCA Laboratories who is widely recognized as an authority in this field.

This is all very interesting to us. At the time the AES was formed, and during its early years, the main interest of its members was in professional-type audio gear. However, with the subsequent tremendous growth of the consumer hi-fi market the Society inevitably gravitated in that direction. Now we think we see a trend back toward the more professional field. In his announcement of convention plans, H. E. (Ed) Roys, this year's Convention Chairman, pointed out a broadening of the Society's interest and called attention to the fact that there would be specially planned sessions on telephony and broadcasting. We think this is all to the good. And we know Ed Roys, who is Chief Engineer of the RCA Victor Record Division (and who has written numerous articles for BROADCAST NEWS), will have an outstanding program.

TW NEARS SRO, meaning the Traveling Wave antenna is such a smash success that we may soon have to hang out the SRO sign. With some 33 on the air, several being installed and others in fabrication, the TW is now far and away the most popular antenna for high-band TV stations. Reasons are pretty obvious. Most intriguing is that because of high gain (with complete null fill-in) the TW makes possible an ERP of 316 KW with a 25 KW transmitter. Also important are very low VSWR, no vertical polarization, completely enclosed feed system, no protruding elements and practically no maintenance problems.

"THE MYSTERY ABOUT FM STEREO" is who said there was any mystery. As we said at the time the FCC announced stereo standards (April 24, 1961), and showed at the NAB Convention at Washington in May 1961, if you have an RCA FM Transmitter (any post-war model), all you need to do is add the relatively simple RCA BTS-1A Stereo Generator and you're in. No need to buy a new exciter—the RCA BTE-10B Exciter incorporated in all RCA FM Transmitters since 1959 provides for SCA, too. (Those with earlier type exciters need change to the 10B only if they want SCA.)

And, as for "Direct FM," we had it in the first FM transmitters we ever built (1940)—and we've had it in all the FM transmitters (some 500) we have built since then. But we don't mind company—we're glad others are finding out how good it is.

ED (POP) FRASE will not be at next year's NAB meeting—and it's a saddening thought. He passed away on June 15, just two months after returning to Memphis from this year's convention where, as for many years past, his friendly coun-

tenance was in the very center of the technical meetings, the sidebar discussions and the congenial gatherings of the industry's top engineers.

To chronicle the inevitable is not our wont. But for Ed it seems different. He was just about our "most favorite" customer, a personal friend, a top-drawer engineer, and above all a gentleman. One of the industry's true pioneers he built his first ham set in 1916 (when he was 13 years old). He joined WMC in 1934, became Chief Engineer in 1944. The plant that he built for WMC, WMC-FM and WMCT was widely acclaimed by those most critical of critics, his fellow engineers. His opinion of equipment, of installation methods, and of operating techniques was highly regarded and much sought after. He was, as they say, an engineer's engineer. Even so he probably will be more remembered for his gentlemanly mien, his disarming simplicity, his discerning humor, his engaging and very human personality. It is given to few men to be at once so highly respected and so greatly loved by his compatriots—both associates and competitors alike.

H. W. (Hank) Slavick, Vice President and General Manager of the WMC stations, has announced that Robert A. (Buddy) Frase, previously WMCT Studio Supervisor, will move up to his father's old spot and Landon Covington will become Chief Plant Engineer. No doubt as time goes on Buddy and Landon will expand and improve on the plant that the old master built—he would expect it. And they will take his place in the busy NAB whirl—he'd want that, too. We wish them every success—but we old-timers are going to miss you, Pop.

OUR "MARK-OF" ADS (opposite page) have elicited complimentary letters from critics, customers and even our own field salesmen (imagine that). This pleases us no end—for these are ads over which we have labored mightily (and feared, no doubt, the proverbial result).

It all started with a feeling that our regular product ads (what the Mad Av boys call "nuts and bolts" ads) are not enough; that quoting our specs against someone else's specs is a puerile pastime; that our pretty product pictures are no prettier than someone else's; that somehow we haven't been getting the **whole** RCA story across.

So, we asked ourselves—what is different about RCA cameras, transmitters, etc.? How are they distinguished from the look-alikes? There were many answers, of course—but finally some joker in the back row, said, "They are the only ones with the meatball."¹ This was followed by a moment of shocked silence—but when the sky didn't fall, Alice said, "Truer words were never spoken in jest."

That did it! It sends me said the Red Queen three letters as familiar as station calls who's



*As We Were
Saying*

familiar said the White Queen and anyway I don't like meatballs what does it mean who's mean said Alice now you're getting me confused it must mean something when most of the best² use mostly³ and have since I was a very little girl.

Yes, Alice, it does mean something—that little red meatball. Our legalites call it our "trademark"—and they are very prissy about how we use it. To them it's a mark of responsibility. And we've no quarrel with that—but we think it goes much

further—that the monogram really is a mark of many things—of leadership, of quality, of matched design, of protection, etc. Yes, Alice, you recognize that, and lots of people do—don't you wish everybody used . . .³ We do—and that's why the "mark of" ads.

¹ Camdenese for **the** monogram

² Stations

³ You know whose equipment

MICROWAVE JOINS THE WEATHER WATCH

Uncommon communications jobs are continually being handed to RCA's broadcast microwave equipment. One such assignment calls for a TVM-1B microwave system to relay weather radar pictures from the Weather Bureau station in midtown New York to closed circuit TV installations at the city's three airports. This will provide airline pilots preparing for flights from Idlewild, LaGuardia and Newark airports with a first-hand view of current weather patterns within a 280-mile radius of the city.

When the system begins operations, microwave beams from the RCA Building at 30 Rockefeller Plaza, where the Weather Bureau is located, will replace the traditional methods of communicating weather information to airport briefing rooms. This is now handled by a staff meteorologist who studies the Bureau's radar scope and reduces the weather factors observed to a numerical code which is teletyped to airports, decoded and drawn on a weather map.

Three two-foot microwave antennas will be used to relay the signal from the RCA Building to the airports. At the receiving end, an unusual feature is the use at Idlewild of two pickup points spaced more than a half-mile apart.

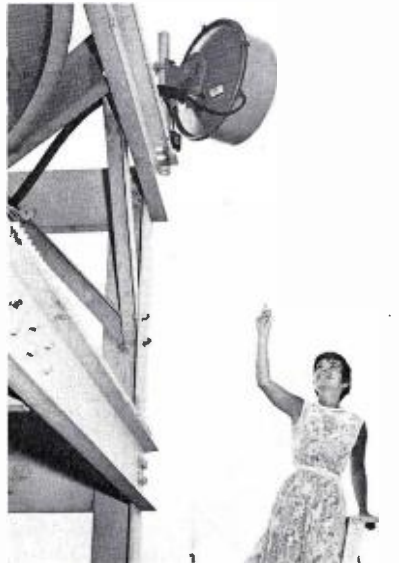

High above New York skyline, Anne Young indicates antenna that will beam weather radar pictures.

In spite of the lateral distance, RCA engineering tests have produced a satisfactory signal at the airport's Arrivals Building, where pilot briefings are held, and at Hangar 11, where the weather pictures are viewed by FCC route controllers.



CRADLED IN A HUGE TURNTABLE at RCA's test site near Camden, N. J., this 114-foot UHF antenna, first of its type, is capable of radiating the maximum 5 megawatts of ERP. The new antenna weighs 13 1/2

tons, contains 232 oblong slots to shape the TV signal into the pattern prescribed for the coverage area. Designated TFU-46K, it will be put in service by WSBT-TV, South Bend, Ind.

UNDERWATER TV HELPS FUEL A NUCLEAR PLANT

Seven RCA television cameras, operating in 25 feet of water, provided technicians at the new Indian Point nuclear power plant in Westchester County, N. Y. with close-up views of every step in the loading of fuel elements into the reactor's core.

The \$121 million electric generating station was built by Consolidated Edison Company of New York and went critical—sustained a nuclear reaction—early in August. When in full operation, it will be capable of producing 275,000 kilowatts, enough for the residential needs of 1,000,000 New Yorkers.

The underwater "eyes" that watched the remotely-controlled loading operation were encased in water-proof aluminum housings with viewing windows of non-browning glass to minimize any possible radiation effects. RCA engineers said only slight modifications were required in the cameras to adapt them to the assignment.



Pictures from underwater cameras guide technician in remote control of fuel loading at nuclear plant.

The cameras were trained on an underwater conveyor system used to move large baskets, each containing four fuel elements, from the plant's fuel storage building to the reactor. Each camera relayed its pictures to a control unit where, by observing a TV monitor screen, technicians were able to make adjustments to the remote handling equipment which guides the baskets.

The loading operation involved placing 120 fuel elements into the core where they will remain for a period of about two years. With the loading completed, the television system was removed from the reactor area and placed in storage. At the end of the reactor's operating cycle it will be repositioned to observe the unloading and refueling of the core.

SMILE! THEY MAY PUT YOUR NEXT X-RAY EXAM ON TELEVISION TAPE

Two of the nation's most distinguished hospitals are pioneering a new technique for medical diagnosis in which the moving images of X-ray examinations are recorded on television tape.

Now under test at Johns Hopkins Hospital in Baltimore and at Childrens' Hospital in Pittsburgh, the new method makes use of RCA's standard TV tape recorder (TRT-1B) and an RCA closed circuit system in which the television camera is coupled with an X-ray image intensifier.

Because of the tape recorder's immediate playback capability, the diagnostician or a group of consulting physicians is able to view and evaluate the patient's examination within seconds. Watching these motion studies of the inner man, the physician can pinpoint the location of a functional disorder or single out a trouble spot for closer study, using conventional X-ray photographs.

In the examining room, the television camera is mounted on an image intensifier which produces a bright picture from a relatively low level of X-rays. As the examination proceeds, television pictures are relayed to the tape recorder in a nearby room. At the same time, the pictures appear on a monitor in the examining room where they may be viewed by the physician and, in some cases, by the patient undergoing the examination.

The Johns Hopkins' system was developed by Dr. Russell H. Morgan, director of the hospital's Department of Radiology. It now is being used to record pictures coming from one examining room and shortly it will be extended to four others. In addition, a special viewing room,



THE DOTTED LINE ROUTINE, which Frank Marx, ABC-TV Network Vice President In Charge of Engineering is performing here, completes arrangements for the network's purchase of two of RCA's new TR-22 transistorized TV tape recorders. Witnessing the contract

signing is O. E. Wagner, Manager of RCA's Broadcast Equipment Sales Office in New York. The recording equipment is slated for use in ABC-TV's new Washington, D.C. news facilities, now nearing completion on capitol's Connecticut Avenue.

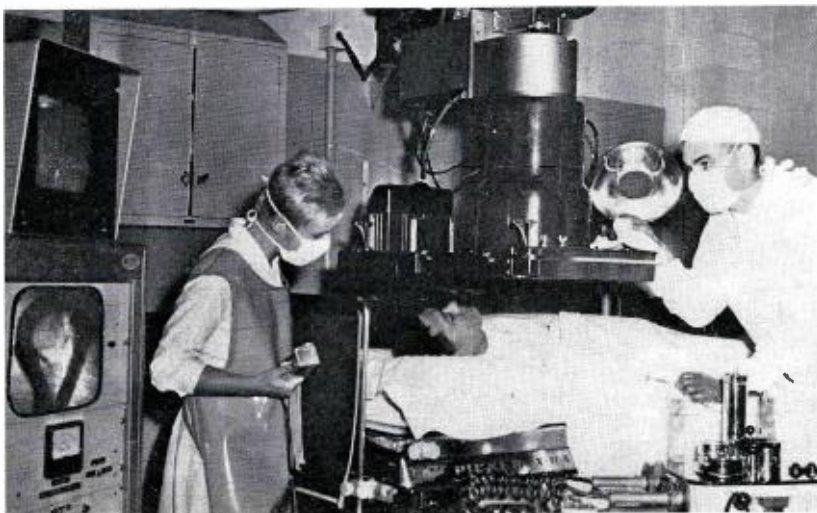

Tape recording an X-ray examination at Johns Hopkins Hospital, physician can check results immediately on monitor screen. Taped record of moving images can be viewed later by group of doctors in consultation.

equipped with a TV monitor, is planned for group consultations.

Physicians familiar with the new technique point out that television is particularly useful in diagnostic or research studies

where motion is important to a determination of organic malfunction. In analyses of the heart function, televised pictures have been used to observe the flow sequence through the heart chambers of a dye intro-

(Continued on next page)

(Continued from page 5)

duced into the organ. Similarly, they enable the doctor to follow the progress of a barium "cocktail" immediately after it is swallowed by the patient.

When tapes of several examinations are spliced together, the patient's complete case history can be reviewed by any number of physicians at a time convenient to the group. Also, tapes of patients with similar conditions can be joined for use in medical research.

The immediate playback virtue of television pictures on tape makes possible a check of the examination's results while the patient remains in the examining room. Further X-ray examination may then be made, if required, obviating the need for a return hospital visit by the patient, as sometimes occurs when conventional X-ray photographs are made.

RCA CAMERAS ABOARD RANGER SPACECRAFT

Beginning next year, four of the nation's lunar-probing Ranger spacecraft will carry RCA six-camera television systems to provide close-range pictures of the moon's surface in preparation for the eventful day when man will land on that remote planet.

The 350-pound television package will be loaded aboard four spacecraft, Rangers 6 through 9. Its slow scan, high resolution cameras are expected to produce detailed pictures of the lunar surface not discernible in photographs from earth.

Four spacecraft in the Ranger series for lunar exploration already have been launched, and Ranger 5 is scheduled for a shot this fall with the objective of rough landing an instrumented package on the moon's surface.

The television payload for Rangers 6 through 9 was designed and manufactured by RCA's Astro-Electronics Division. It will consist of the two wide-angle cameras, four narrow-angle cameras, a control programmer, camera sequencer, telemetry system, two-channel transmitting system and power supply. The wide-angle and narrow-angle cameras are designed as two separate systems and will transmit over different frequencies. One of the wide-angle cameras will provide a color image.

The pictures will be transmitted to the

NEW RECORDER FOR RADAR DATA USES 5-MILE TAPE, HITS 60 MPH SPEEDS

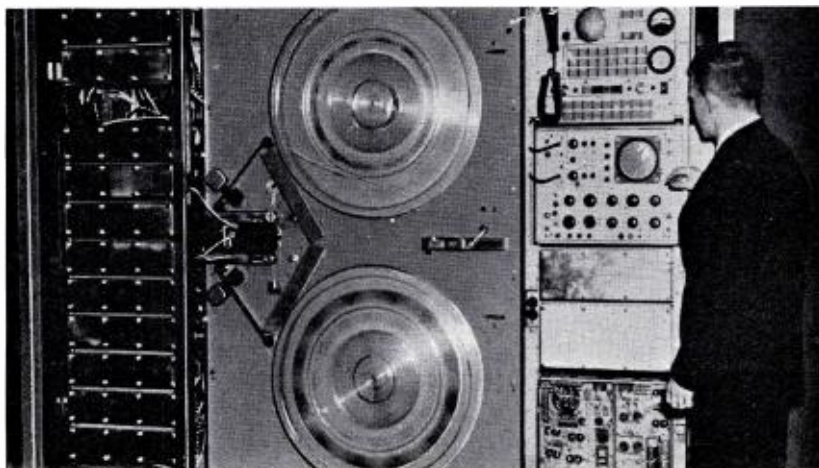

Thirty-inch reels of new recorder uses one mile of tape to reach top speed, another mile to brake down.

A new video tape recorder which races along at the turnpike speed of nearly 60 miles per hour has been developed by RCA Defense Electronic Products for recording operational analog data from a missile-tracking radar.

Recording 14 channels of information at this high speed, the "mile-a-minute" machine far outstrips broadcast-type recorders which loaf along at less than one m.p.h. Tape is guided by compressed air to allow the seven miles of tape stored in the machine's 30-inch reels to travel at such a high rate of speed without undue mechanical wear. An air turbine capstan drive, using both radial and thrust air bearings, is among the design features which make the high speed possible.

The recorder uses a mile of tape to get up to operating speed and a mile to brake down and stop. The extreme accuracy of its running speed—within two parts in 100,000 over the five miles of tape—is accomplished by using one of the 15 channels for stability control. This provides five miles of usable tape and 14 data channels, each with an 8 mc bandwidth. The recorder has a signal-to-noise ratio of 40 db.

Each of the tape reels, which achieve peripheral speeds up to 120 miles per hour, has its own servo motor, providing constant tape tension throughout the run. Faithful recording of radar data is further

enhanced by low tape distortion—20 millionths of an inch or less across the full one-inch wide tape—and uniformity of output between channels of 1 db.

The recorder's air bearings eliminate bearing run-out or wobble. High frequency jitter, caused by unsupported lengths of tape at the recording head, also has been virtually eliminated by the use of a grooved capstan. Another unique feature made possible by the air guides is a built-in, 1000-inch loop of tape which can be quickly threaded into the recorder for quick test purposes without loading the reels.

Because of the very high operating speed, the recorder incorporates some unique devices to protect it in the event of accidental loss of power, tape breakage, or improper operation. For instance "emergency brakes" are automatically applied the moment trouble is sensed. If the trouble is loss of primary power, an auxiliary compressed air system is cut in to keep the air bearings and guides operating until the recorder can stop itself. These and other safety functions are accomplished by the use of air and electrical interlocks, tension sensors, and other protective devices.

BEST HEADWHEEL LIFE GUESS WINS COLOR TV

Chief Engineer of WAVY, Andrew M. Jackson, Jr., is the winner of a new RCA Color TV console. His estimate of the total life of an experimental RCA long-life headwheel panel earned him top prize over other entrants in a contest held at the recent NAB Convention.

The headwheel was placed into operation in the RCA booth at the convention and visitors were asked to estimate total life hours. At that time, the headwheel had already accumulated about 850 hours in engineering tests in Camden. It was demonstrated on one of the convention recorders and then returned to engineering for conclusion of the life test. Tests ended four months later with the headwheel racking up 1565.6 hours.

The life test was conducted under standard operating conditions; that is, in accordance with the new RCA alignment tape which complies with SMPTE recommendations. The end-of-life point was determined as the time when the headwheel could no longer record a tape which could satisfactorily be played back on other recorders.

The experimental panel utilizes a new video head material. The heads are fabricated employing a new construction technique.

The headwheel was shown at NAB to demonstrate the progress RCA is making to extend the effective life of magnetic head materials and to improve bandwidth, signal-to-noise ratio and general performance of RCA tv tape recorders.



The Winnah: Andrew M. Jackson, Jr.

TV SYSTEM TAPE RECORDS PILOT LANDINGS ON THE FLATTOPS

In a unique application of television to military training, three of the U.S. Navy's big aircraft carriers are using RCA closed circuit TV systems to tape-record pilot landings. Known as PLAT (for Pilot/LSO Landing Aid Television), the systems have been installed aboard the U.S.S. Coral Sea, the U.S.S. Franklin D. Roosevelt and the U.S.S. Kitty Hawk.

Because of TV tape's immediate playback capability, the pilot can view the televised record of his landing as soon as he has left his plane and descended to the ship's debriefing room. In addition, the tape can be promptly reviewed by Navy officers ashore to check on training progress.

RCA TK-202 cameras are recessed at the centerline of the carrier's flight deck and aimed skyward along the plane's landing path. This gives the TV system a vantage point that no human observer

could occupy during landings. Pictures of descending planes are fed to a standard broadcast tape recorder (TRT-1B) below deck. At the same time they are relayed to a monitor on the ship's LSO platform, permitting the LSO (landing signal officer) to check the plane's attitude and lineup with respect to the flight deck's centerline.

Below deck on a control room, another TK-202 camera is trained on three meter dials reporting the date, time of day, the plane's landing speed and the wind intensity. The dial pictures are superimposed on those made by the other cameras so that the composite picture, as recorded, shows both the plane and information pertinent to its landing.

A TK-11 camera is mounted at a manned position on the ship's "island" above the flight deck. From this high point, the cameraman picks up the scene as the plane

touches down and follows it until the landing is completed. A "zoom" lens provides for closeups of plane numbers and other details.

The television tape includes two voice channels: one to record the two-way radio conversations between the pilot and the landing signal officer, the other for dubbing in comments either during the landing or later when the tape is played back for a training critique.

Deck cameras use a high-sensitivity image orthicon and a light control device, making them capable of either daytime or after-dark operation. The pickup tube is mounted separately from the camera assembly and scans the flight path by means of a lens mirror arrangement. The lens mirror is connected to the ship's stabilizer which allows the camera to maintain its assigned view up the flight path even in rough seas.

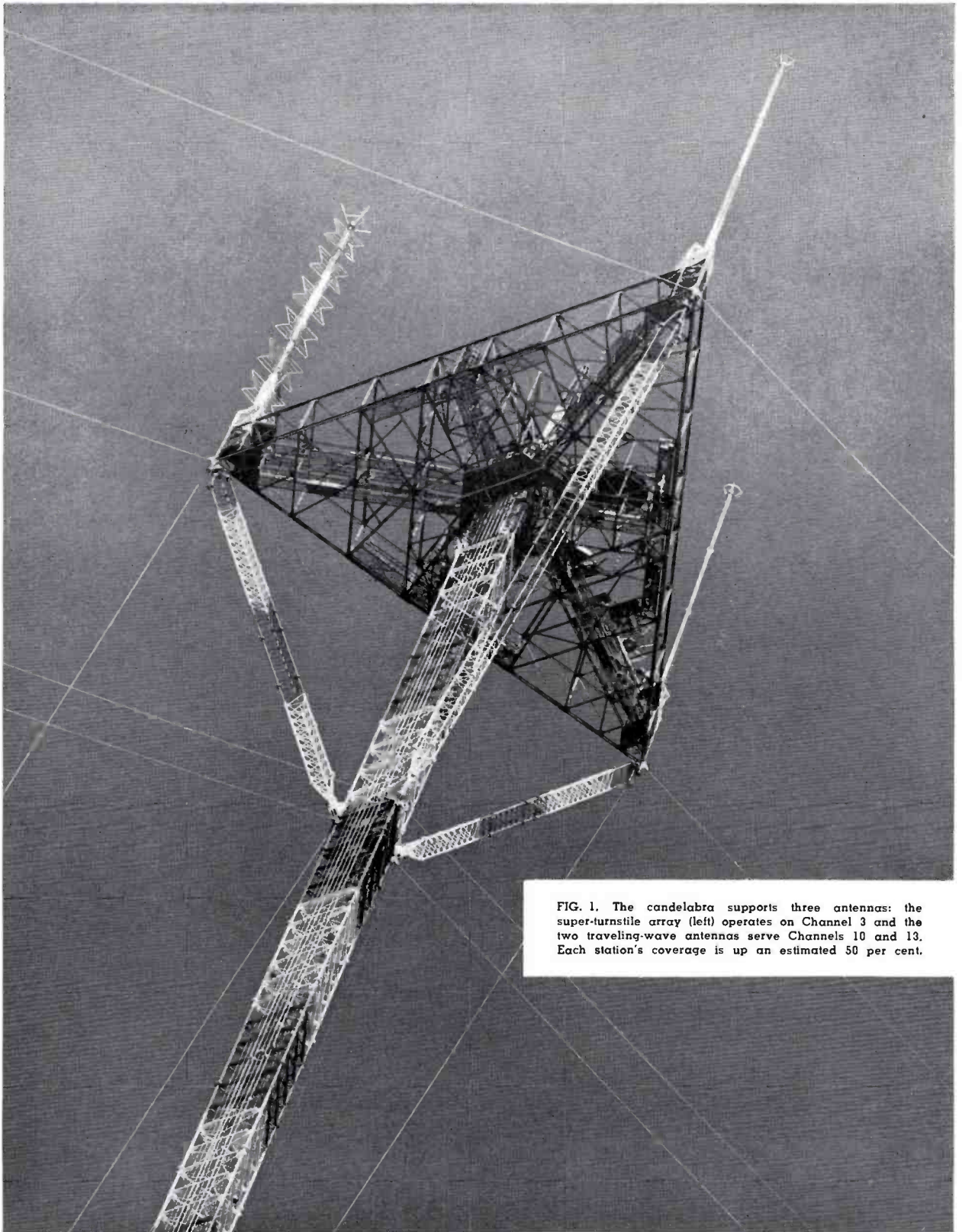

FIG. 1. The candelabra supports three antennas: the super-turnstile array (left) operates on Channel 3 and the two traveling-wave antennas serve Channels 10 and 13. Each station's coverage is up an estimated 50 per cent.

KCRA, KOVR AND KXTV ERECT THE WORLD'S TALLEST CANDELABRA ANTENNA SYSTEM

1500-Foot Guyed Tower Supports Traveling-Wave
and Super-Turnstile Antennas Affording
Substantially Increased Coverage

During mid-January, 1962, the three stations of the Stockton-Sacramento area started transmission from the world's tallest 3-antenna candelabra tower . . . 1548 feet of steel, copper, glass and plastic rising above the banks of the Sacramento River (see cover photo). The site lies approximately midway between Sacramento and Stockton in a little town called Walnut Grove. The new installation has increased each station's coverage an estimated 50 per cent. In addition, the TV homes that were within the "old" coverage now receive pictures of improved quality with all three signals arriving from the same direction.

Before the completion of the new installation, KCRA transmitted its Channel 3 programming from a site in downtown Sacramento. This location placed Stockton—the next largest population center in the area—in the stations Grade "B" coverage area.

KOVR transmitted from a location three miles southeast of Jackson (California), a town approximately 40 miles east of the new location. KOVR used a 400-foot tower which placed the Channel 13 antenna 1180 feet above average terrain and 2700 feet above sea level.

KXTV, operating on Channel 10, transmitted from a site near El Dorado (California) using a 500-foot tower to place the antenna 1100 feet above average terrain and 2500 feet above sea level. The coverage pattern placed Stockton at the edge of the Grade "A" contour.

Tower Serves 30 Counties

The tower is located at the geometric center of population in California's vast inland valley and serves all or portions of 30 counties. Before the tower was completed, the three stations were separated by 20 to 30 miles and signals arrived at home-receiver antennas from three different directions. This, of course, resulted in



FIG. 2. Stations KCRA, KOVR and KXTV occupy essentially identical sections of the 3-section transmitter building. The base of the tower rests nearby to minimize horizontal transmission-line runs. The transmitter facilities of KOVR are in the section at left, KCRA in the center, KXTV in the right.

any number of reception problems in relative signal strength, antenna orientation and so on.

Another contribution to this reception problem was the presence of submarginal signals in the valley. Further, it was the practice of TV-service organizations to promote the installation of lucrative receiving-antenna arrays oriented to these submarginal transmissions which, in most cases, deteriorated the receiver's ability to receive the Sacramento-Stockton stations.

KXTV and KOVR (the two high-band stations) had, in the past and prior to the new candelabra, reoriented thousands of receiving arrays—at no cost to the homeowner—to effect the best compromise in antenna response to the Sacramento-Stockton stations. The location of the tower midway between Sacramento and Stockton provides better-than-city-grade coverage in

both cities and has eliminated nearly 100 per cent of the reception problems.

Beginnings of Project

KCRA personnel spent years in continuous attempts to find an ideal location for an antenna site in the area which would satisfy air-traffic requirements. Sacramento-Stockton straddles a portion of one of the nation's most densely used air spaces. The Regional Airspace Panel indicated that they would look favorably upon a common site, a parcel of land suitable for an antenna farm serving all stations in the area, before granting airspace for any one station. Agreement was reached by KCRA-TV and KOVR to file jointly for the location proposed by KCRA-TV, with identical antenna heights. During this period (late 1958), the Corinthian interests were awaiting approval of their application to acquire ownership of KBET-TV (now KXTV).

Immediately after FCC approval of the acquisition, the Corinthian people began active participation in the antenna project and pledged their support to bring about the success of the common site for all three stations. With a common cause presented by all three broadcasters, airspace approval was given on July 28, 1959.

Most Economical Design

Engineering representatives of the three stations met in Washington, D. C., during September 1959, for a full-scale planning session. Several days later, they met with RCA in Camden. In this meeting, interest was shown in a single tower to support the three antennas, candelabra fashion. Although separate towers were feasible, the immense land requirements of a 3-tower installation pointed to the use of a single structure to serve all three stations.

Each participant indicated the requirements for his own antenna system: transmission-line provisions, emergency antennas, conduit runs, etc. At this stage, the specs were subject to later revision, but there was enough information presented so that RCA could offer proposals to support the stations' applications before the FCC.

Pilings Solve Foundation Problems

The unique location of the proposed structure, in the midst of the rich Sacramento-San Joaquin delta waterways and islands provided engineering problems to be solved through foundation studies and soil tests.

Previously gathered information was elicited from oil companies that had drilled in the area. The information placed some doubt as to whether the structure could be erected on the selected site. Porter, Urquhart, McCreary and O'Brien made complete foundation studies and some 10 test holes were bored to depths of 100 feet into the earth at the proposed locations of the footings. The soil samples were laboratory tested. The resulting report was one of the most extensive ever submitted in that it indicated maximum permissible bearing-loads, recommended foundation types and included expected contingencies for the various foundation designs.

Since the site rests at sea level (some parts of the tract are below sea level), one can drill a well with a post-hole digger and get water at only two feet beneath the surface. This condition resulted in a final foundation design which consisted of concrete pilings with massive, monolithic concrete blocks resting on top. More of this later.

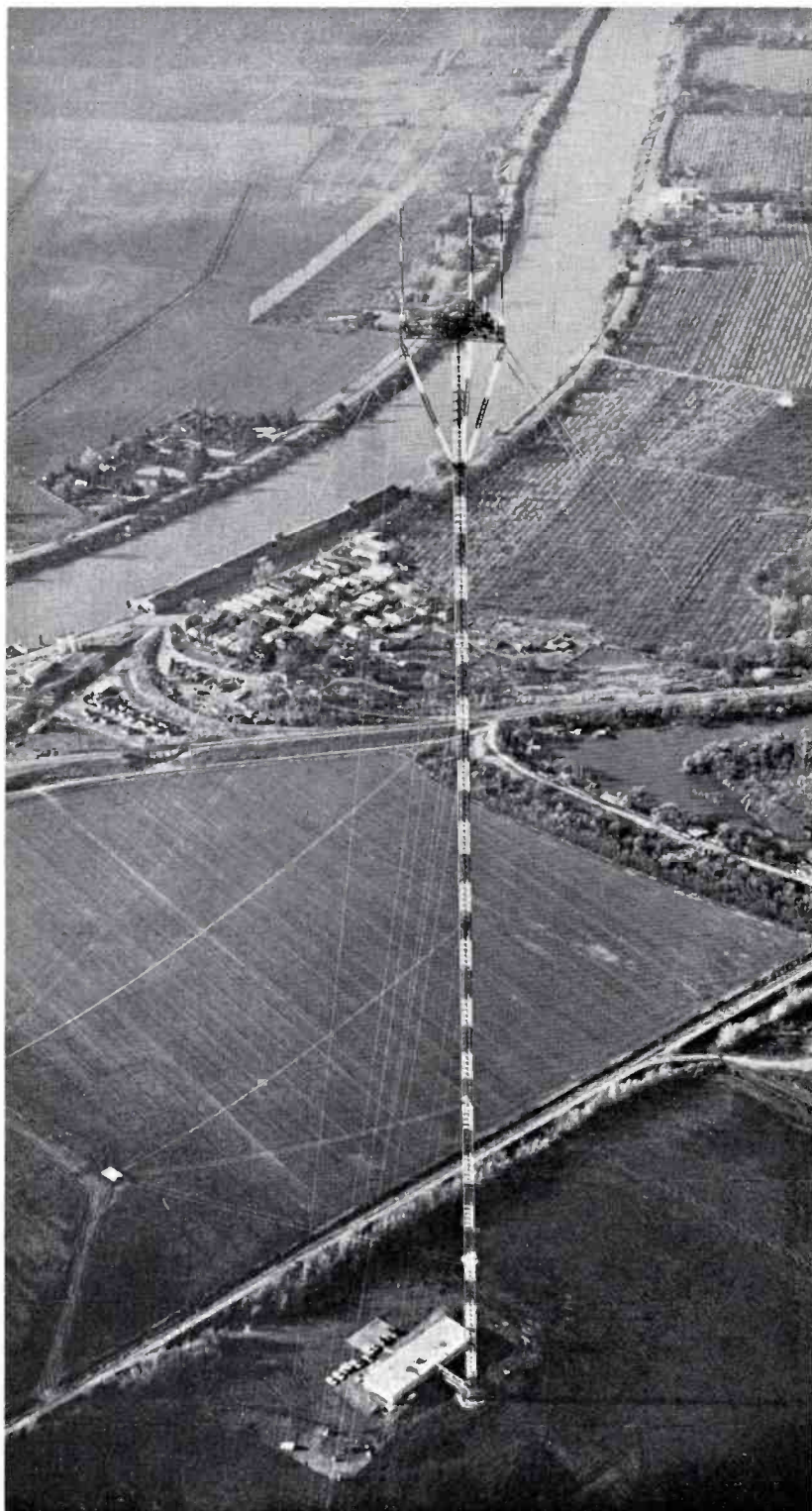

FIG. 3. This view, taken from a helicopter, looks toward the northwest. The candelabra design reduces land requirements well below those of three separate towers . . . even when located in close proximity of one another. The economies afforded through a single tower, as opposed to three separate structures, are obvious.

Tripartite Administration Committee

During the early part of 1960, the applicants awaited FCC approval of their individual requests for permission to move to the new site. Since there was no formal organization for project administration, all activity was performed on a cooperative basis by representatives of each of the three broadcasting organizations. In anticipation of the organization of a company to take title to the tower, KCRA-TV made formal agreement with the land owners for lease of the tract and later transferred the lease to the tower company.

During this period in time, KOVR was purchased by the Metropolitan Broadcasting group from the Gannett interests and the new owners pledged to continue the tower venture started by their predecessors. The effects on the project of this transition in KOVR ownership were hardly apparent to the other participants and work continued in the investigation of utilities availability, estimating necessary road construction, water and sanitation considerations, tentative building plans and so on.

CP's Come Through

Once the construction permits were issued, RCA was again contacted for an updated timetable. The three managements issued a joint memorandum to indicate their intent to complete the project in lieu of the final formation of the tower management company among the principals of the three stations. This memo authorized RCA to schedule antenna production and begin the engineering design of the tower through Dresser-Ideco as soon as agreement could be reached on the structural requirements of the tower. The immediate goal, at the time, was to permit the start of foundations before the arrival of winter and the weather conditions that come with it.

This led to two areas of discussion: (1) the decisions involved with structural design, (2) the decisions concerned in electrical specifications, cost and policy and the coordination of the choices for individual systems.

In line with these objectives, the foundations were started during the following November (1960) and Ideco started fabrication of the steelwork in their plants. At approximately this time, RCA started the design and fabrication work on the two traveling-wave antennas: Channel 10 and 13. The start of the Channel 3 super-turnstile antenna fabrication followed shortly thereafter.

Tower Steel Arrives

It was during the following June that the steelwork arrived at the railhead in Walnut Grove loaded in eleven gondola

freight cars. Possibly this was the largest single shipment ever to arrive in the river town. Cranes quickly transferred the steel to trucks for the trip to the site.

The three-station transmitter building construction commenced and the station representatives continued the day-by-day administration of the project through the tripartite engineering committee.

The delivery of all three antennas and transmission line was closely coordinated with tower erection to prevent arrival too soon, and thus cause storage problems, or too late and thereby delay the project. As prime contractor, this was RCA's responsibility.

Previous Candelabra Experience Saves Time

A great deal of painstaking work was avoided through the experience gained by RCA in the design and layout of previous candelabra systems, especially the 3-antenna candelabra in Baltimore.¹

The Baltimore system is almost identical to the California installation as to channel spectrum spacing, antenna types employed, platform layout, emergency-antenna provisions, microwave equipment space, and

¹"WBAL, WJZ and WMAR Build the World's First Three-Antenna Candelabra" *Broadcast News*, Vol. 106, December, 1959, pp. 30-35.

FIG. 4. Simplified drawing of tower elevation. A total of 36 bridge-strand guy cables, totaling 44,000 feet in length, support the structure. The candelabra is designed to withstand wind velocities to 109 mph. The tower-base pier rests on 61 forty-foot concrete piles driven into the 1-foot-above-mean-sea-level terrain.

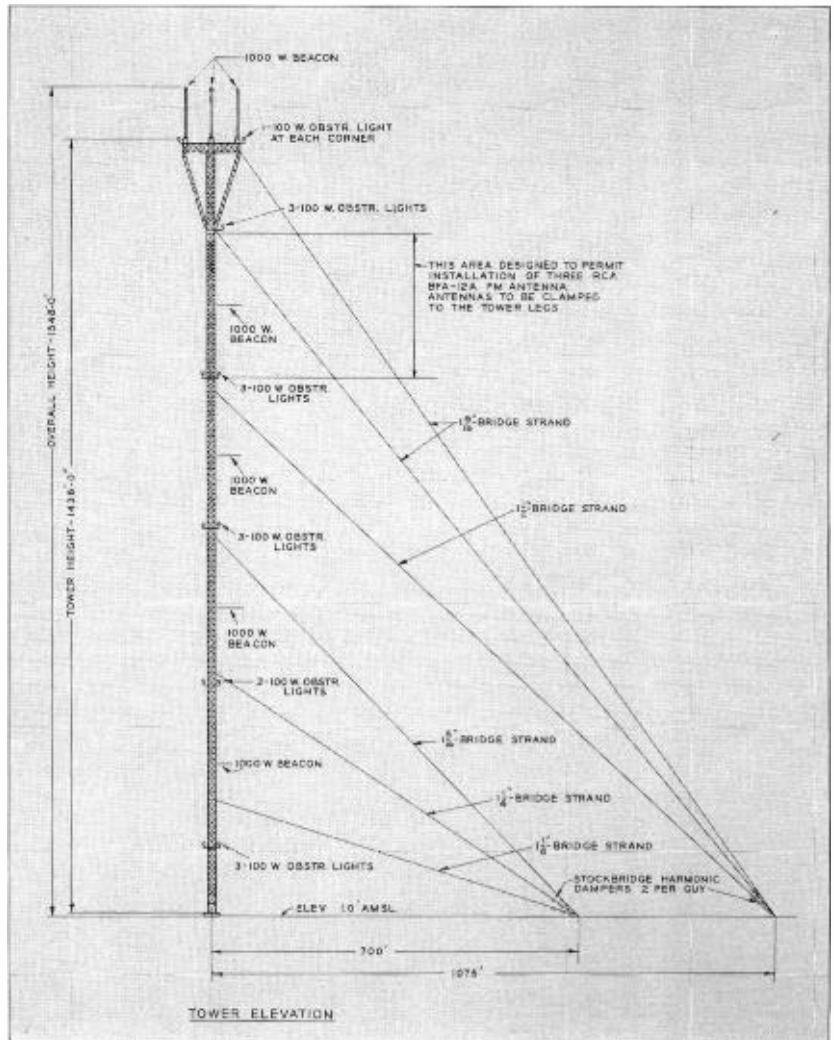

shelter design. The only important difference between the two is structure height (the Baltimore tower stands 729 feet; the California tower, 1548 feet). There is no doubt that, due to the excellent cooperation of the Baltimore stations, the California project was spared a great deal of effort. The California people were afforded the opportunity of visiting and examining the Baltimore structure firsthand on many occasions.

First Use of R-F Pulse Technique

Perhaps the most unique difference between the Walnut Grove and other antenna installations is the final set of system specifications agreed upon by the stations and RCA. The principal feature was the new method of r-f pulse measurement technique² for determination of system compliance. Standards were proposed and agreed upon which used this technique as the sole specification for entire system performance. The component parts of the system, in addition, were to meet conventional VSWR requirements.

Numerical Values of P-T Measurements

Although it was agreed that Peterson's proposal to substitute pulse techniques for the more conventional VSWR methods was desirable, no one had, at the time, proposed a system to attach numerical values to the results sought. There is no simple way to correlate the reflected pulses (seen on the CRO face) with the numerical significance of the VSWR measurement.

In an effort to relate the pulse measurements to numerical values, various inquiries were made. These inquiries generally revealed that it was desirable to keep reflected signals to a level at least 26db below the driving signal. Reflected signals above this value become objectionable in the reproduced picture.

Since antenna reflections on a long-line system result in correlated echoes of the primary image, it was agreed to use a "yardstick" of -26 db as the minimum acceptable figure of reflected pulse voltage for the super-turnstile (Channel 3) antenna. This is equivalent to a 5 per cent reflection from a finite discontinuity.

It was also felt that a 0.25 microsecond sine-squared shaped pulse would also approximate the energy content of a typical TV picture transmission. This pulse would provide the desired frequency weighting curve which most nearly represents the

effect on actual picture transmission. The measured values were -38 db and -35 db for the two lines terminated in the antenna . . . well below the barely objectionable value of -26 db.

For the two traveling-wave antennas, the known capabilities of these newer and simpler antennas led to acceptance of the even lower reflection figure of 3 per cent or, 30.5 db below the peak level of the launched reference pulse. In the Channel 10 system, the figure achieved was 0.7 per cent or -43 db; the Channel 13 system measured 0.6 per cent or -44.4 db.

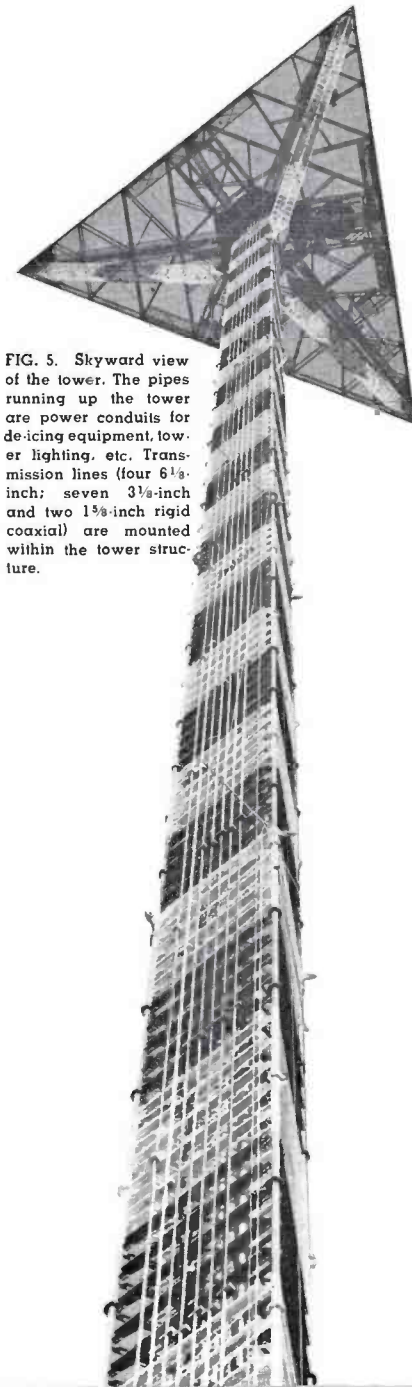

FIG. 5. Skyward view of the tower. The pipes running up the tower are power conduits for de-icing equipment, tower lighting, etc. Transmission lines (four 6 $\frac{1}{8}$ -inch; seven 3 $\frac{1}{2}$ -inch and two 1 $\frac{3}{8}$ -inch rigid coaxial) are mounted within the tower structure.

George Jacobs of KXTV reports that, now that the system is in full operation, transmission-line and antenna reflections cannot be seen in the picture even during the transmission of a high-contrast test pattern. As KXTV's transmission line is 1600 feet in length, a mismatch in the antenna would produce a ghost that would be displaced about 7 per cent of picture width. The important point is that KXTV's personnel have been unable to see an antenna-reflection ghost or, for that matter, any degree of "smudging" from accumulative transmission-line irregularities . . . surely, the true measure of performance.

Cross-Coupling and Reradiation Measurements

In addition to the individual-system measurements, cross-coupling measurements were required to prevent, as much as possible, problems with cross modulation and reradiation of signals from one antenna system to the other. The specification here placed heavy reliance on the Baltimore performance record. It was agreed that the spec should be at least 35 db "separation" between any two antennas. The measured values greatly exceeded this specification in that the usual value obtained was in the order of 50 db and, even the most unfavorable combination exhibited a 12.9 db margin above the 35 db requirement ($35 + 12.9 = 47.9$ db).

Transmission Lines "Pulsed" During Erection

Owing to the length of the transmission lines up the tower, there were quality-control checks at frequent intervals during erection. This proved the quality of the line as it went up, rather than risking the delay and extra expense of replacing damaged sections after the installation was complete. Space doesn't permit a detailed explanation of some of the other more obscure precautions taken in this 3-antenna system.

Interesting Construction Facts

The "California Candelabra" required some 900 cubic yards of concrete, 1 million pounds of steel and more than 117,000 individual parts. At 150 pounds per cubic foot, 900 cubic yards represents more than 1800 tons of concrete.

Before any of the footings could be poured, the contractor set almost 200 prestressed and pretensioned concrete pilings. The tower pier rests upon 61 pilings which penetrate the earth to a level of 40 feet. These, from a bird's-eye view, form a checkerboard pattern with 3.5 feet (center to center) between the 16-inch diameter

² Peterson, Donald W., "Proposed Impedance Requirements for Television Antenna Systems," *Broadcast News*, Vol. 104, June, 1959, pp. 40-43.

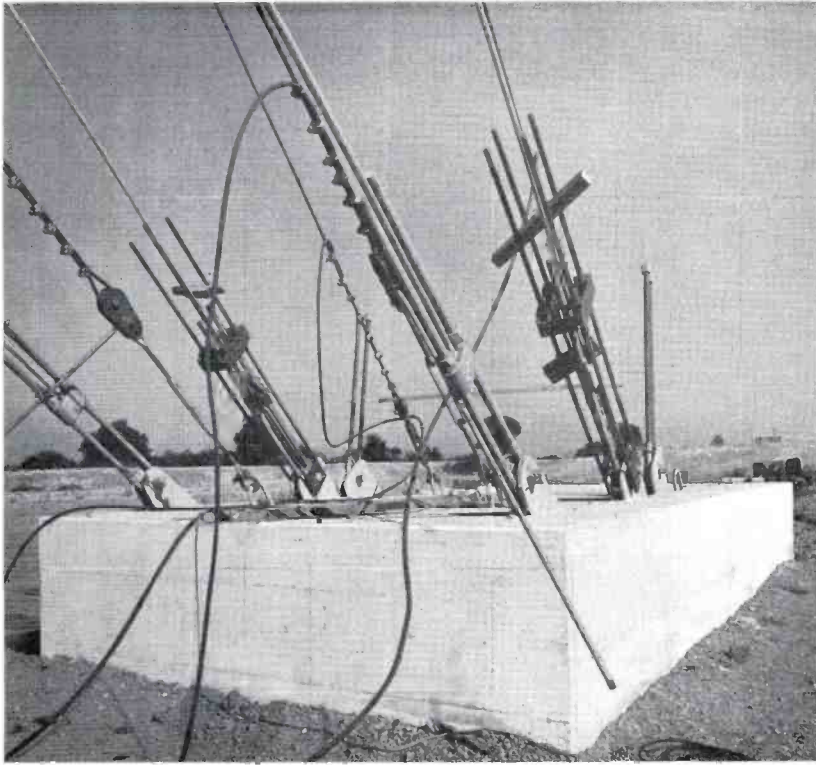

▲ FIG. 6. One of the guy anchors during construction. The "haywire" guys are temporary and were removed after tower completion. The permanent guys are identified by their considerably thicker cross-section.

piles. The three outer guy anchors each use 32 piles driven at approximately 60 degrees from the vertical; the inner anchors each have 20 piles driven at an angle. The guy-anchor piles, to reach the 40-foot specified depth, are 44 feet long.

Hexagonal in shape, the tower pier measures 18 feet on a face, 31 feet in diameter (flat to flat) and six feet thick. Eleven inches of the piles penetrate the pier and reinforcing steel bars pass between each pair of piles. The top surface, meeting an elevation tolerance of 0.01 foot, contains 18 imbedded bolts which fasten the three base plates and the tower to the concrete pier.

48-Section Tower

The tower, a triangular cross-section structure, employs solid-steel legs of a special alloy that permits the 7-inch diameter rods to provide the strength of 12-inch-diameter components. The 7-inch diameter decreases, in 10 increments, to 3 inches in the top section. There are forty-three 30-foot sections, plus 3 shorter lengths, between base section and the platform-center section. Bracing of each section is a combination of solid-rod and double-angle girts with gusset plates of $\frac{3}{8}$ - $\frac{1}{2}$, and $\frac{3}{8}$ -inch thickness.

At the levels between 978 and 1269 feet, the legs of the tower are designed with additional strength to support three RCA 12-bay FM antennas, one attached to each leg, to be installed at a future date.

A total of eleven 1000-watt beacons and eighteen 100-watt obstruction lights mark the tower for air navigation at night. Each antenna supports a 1-kw beacon with the remaining eight distributed evenly down the tower in four clusters of two. The 100-watt obstruction lights are arranged in six 3-light groups mounted at the six guy-wire levels.

Owing to the tremendous height of the tower, a two-man elevator is installed between the 20-foot level and the shelter house at the top. The trip from bottom to top requires approximately 14 minutes. A ladder immediately outside of the elevator prevents isolation in the remote possibility of elevator failure.

A total of 36 bridge-strand guys reinforce the tower: Six levels of six guys. The diameter of the bridge strand ranges from $1\frac{1}{8}$ inches at the lowest level to $1\frac{3}{16}$ at the platform corners. The guy

FIG. 7. Simplified drawing, guy-anchor pier elevation. Owing to the sea-level altitude of the site, piles—61 under the lower pier and a total of 136 under the guy-anchor piers—provide the firm base required. The ultimate settling of the structure, fully loaded, is determined to be less than one-tenth inch! ▼

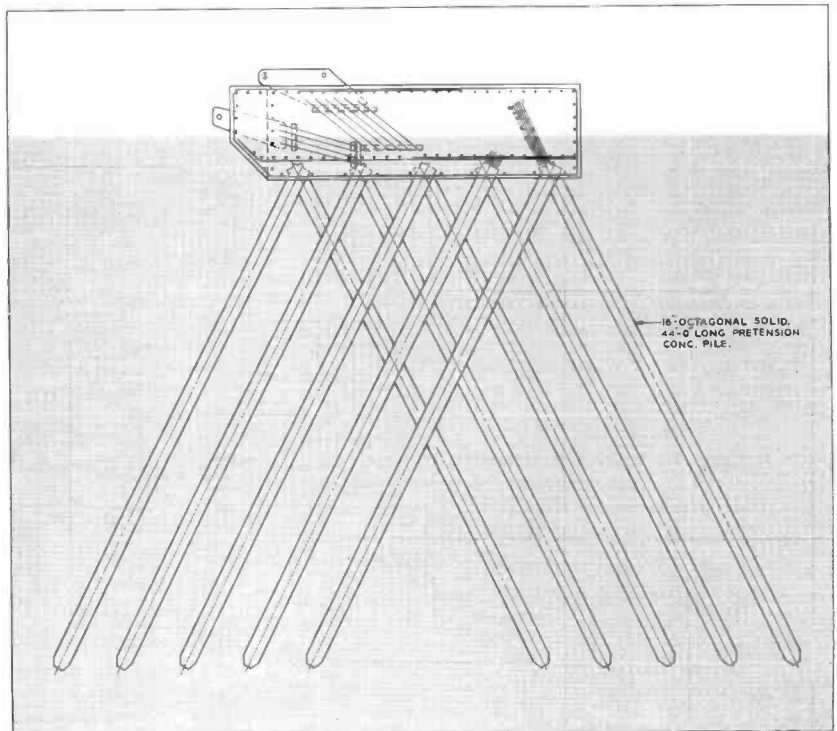

strand initial tension ranges from 31,000 pounds, at the lower levels, to 36,000 pounds at the upper.

Antenna Platform

The platform atop the tower measures 105 feet, 3 inches on each of its three faces. At the center (in effect, the top of the tower) is a shelter house for the elevator pulley mechanism and the branching out of the various transmission lines, decider power conduits, etc.

The platform, on its lower level, contains six radial catwalks and three which parallel the platform faces. These walks are fabricated of expanded metal for maximum surefootedness in combination with the angle-iron rails which are 39 inches above the "skywalk."

In addition to the two traveling-wave antennas and the one super-turnstile, there are provisions for three emergency antennas: each mounted in the center of a platform face adjacent to the primary antenna

for the channel. The one exception to this is the Channel 13 emergency antenna: it occupies the platform face opposite the location of the primary antenna.

The platform is 16 feet "high" from bottom to top. Six ladders allow access to the antenna bases from the skywalk.

Radio-Controlled Elevator

The control link between elevator car and mechanism uses low-frequency radio signals as opposed to the usual "dangling" wiring harness. The reason for this is the fact that the elevator shaft is 1500 feet high and wiring strong enough to support itself in a 750-foot, one-end-up position lacks the required flexibility, not to mention the effects of weathering on its dependability.

The radio-control device puts the transmitter in the elevator car with the receiver located near the elevator-driving mechanism. The air coupling between the two units is never more than just a few inches because the receiving antenna is a pair

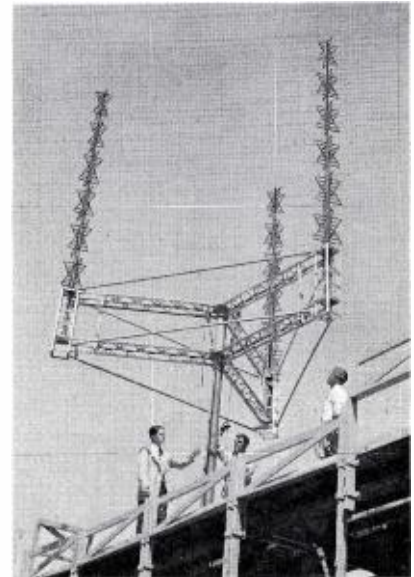
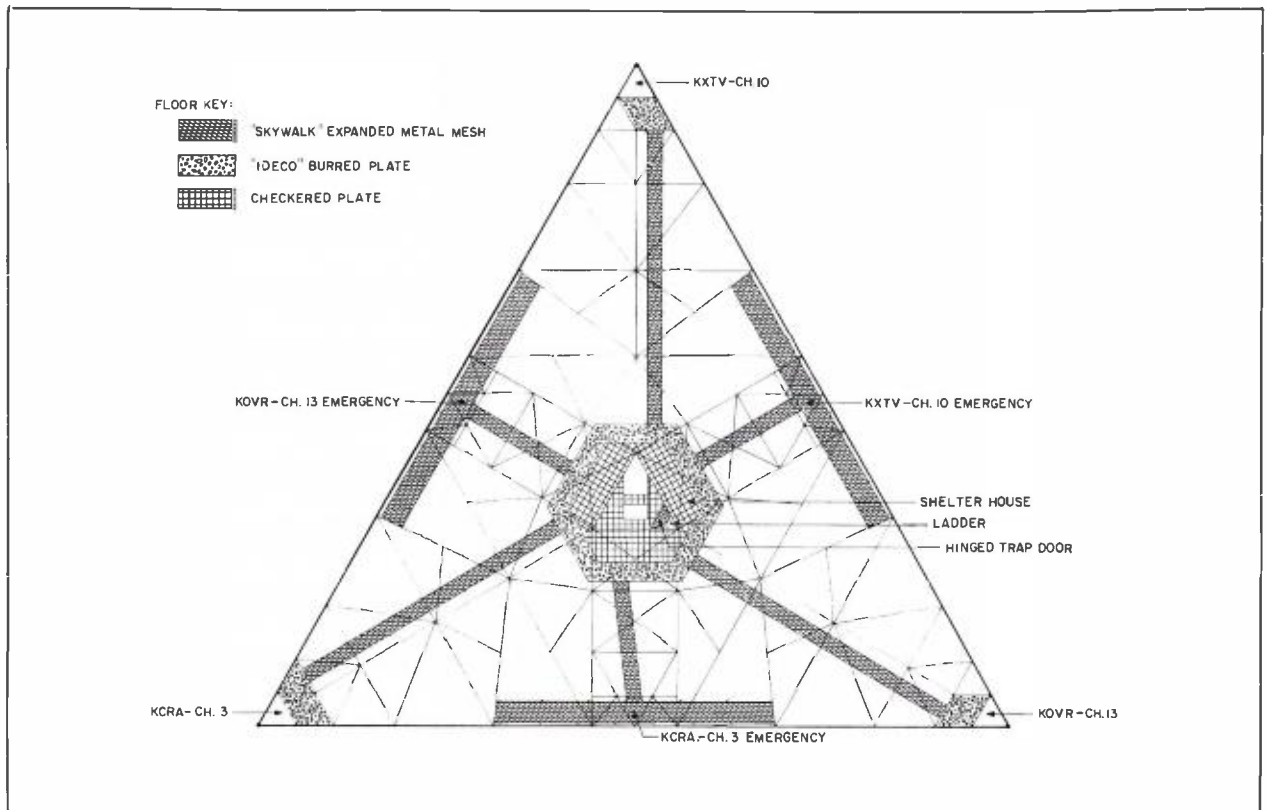

FIG. 8. This scale model, constructed for the Baltimore Candelabra project established engineering parameters in candelabra design and thus spared the California group considerable engineering effort.

FIG. 9. Simplified drawing of lower plane of antenna platform. Expanded-metal "skywalk" provides maximum surefootedness in combination with 39-inch-high railings of angle iron. The 105-foot length of each face allows a 100-foot (center-to-center) distance between the three main antennas.



of heavy-gauge, well insulated wires which are supported vertically along the side of the elevator shaft. The transmitting "antenna" is a small inductor mounted on the car in such a way as to keep it in close proximity with the pair of wires serving as the receiving antenna.

Since the receiving-antenna wires are fastened to the elevator shaft, no flexibility is required thus resulting in the utmost dependability.

The close coupling between transmitting and receiving antennas prevents extraneous radio signals from actuating the elevator mechanism. As a further precaution against this possibility, the transmitter carrier is "programmed" in a certain manner and the receiver "sees" only the properly programmed transmission.

STL Facilities Operate on 950, 2000 and 7000 Megacycles

Each of the three stations have installed their own STL microwave equipment. KCRA uses both 2 and 7 Kmc bands plus a 970 mc aural link and KXTV uses two 2-Kmc links with an audio link operating on 950 mc.

KCRA uses two dishes mounted on the platform face: a 10-foot one for the 2-Kmc link and a 6-foot for 7 Kmc. The microwave receivers are rack mounted in the 1400-foot shelter and the video travels via two 1 $\frac{7}{8}$ -inch rigid co-ax lines to the building below. These lines are sending end terminated in addition to matched loading at the lower end.

For 7 Kmc back-up, a 4-foot dish and receiver is located at the 225-foot level. Another 6-foot parafflector receiving dish, at the 1400-foot level, is used for the 927 mc aural link. Twenty-six megacycle voice-communications gear is used between studio and transmitter sites.

The KOVR installation places the receiving "dishes" on the platform with passive reflectors located at the 225-foot and 460-foot levels. The KXTV installation uses ten-foot dishes: one at the top platform level and the other at 460 feet. A coaxial line connects the dish at the 460-foot level to a receiver located in the transmitter room while the receiver for the 10-foot dish on top is located within the shelter house, on top.

The KXTV 950-mc audio link uses a top-located antenna and receiver and sends the audio signal down a balanced pair housed in a 2-inch conduit installed for the purpose.

Performance Exceeds Predictions

Although engineering coverage surveys have not, as yet, been completed, audience surveys indicate that the coverage of all three stations is up considerably over that achieved with their former antenna facilities. There is also substantial improvement in picture quality in practically all regions of the service area. And, by employing a single tower, the stations enjoy these benefits at a considerable reduction in cost.

Acknowledgment: The material contained in this article was obtained through the very kind cooperation of Richard Anderson (Chief Engineer, KOVR); C. Daniell Byrd (Assistant to the President, Dresser-Ideco Company); Roger M. Courtney (Promotion Manager, KCRA); Glover Delaney (General Manager, KOVR); Don Ferguson (Chief Engineer, KXTV); W. Herbert Hartman (Director of Engineering, KCRA); and George Jacobs (Director of Engineering, Corinthian Broadcasting Corp.) The editors express their deepest appreciation for the unstinting effort these gentlemen displayed in supplying the background material for the story.

INTERESTING FACTS CONCERNING THE CALIFORNIA CANDELABRA

Prime Contractor: Radio Corporation of America

Tower Design and Fabrication: Dresser-Ideco, Columbus, Ohio

Tower Erection: Macco Construction Company

Tower Management: Transtower, Inc., Sacramento, California

Tower Height: 1548 feet; 1549 feet above mean-sea-level

Platform Height: 16 feet (plus 9-foot extension for Type TF6AL Super-Turnstile, Channel 3 antenna and 7-foot, 6 $\frac{1}{2}$ -inch extensions for the Channel 10 and 13 Traveling-Wave Antennas, Type TW-15A10-P and TW-15A13-P).

Platform Face: 105 feet, 3 inches

Tower Face: 12 feet

Center-to-Center Antenna Spacing: 100 feet

Knee-Brace Length: 143 feet, 7 $\frac{3}{8}$ inches

Guy Levels: 6 (6 guys at each level)

Wind Loading: 50 pounds per square foot on flat surfaces

Wind Velocity Limit: 109 miles per hour (actual)

Weight of Steel Used: 1,026,299 pounds

Amount of Concrete Used: 942 cubic yards (1900 tons)

Length of Guy Wires (total): 44,000 feet

Amount of Paint Used: 150 gallons of International White, 200 gallons of International Orange

Number of Bolts in Structure: 50,487

Total Number of Parts: 67,171

FIG. 10. The 1500-foot height of the candelabra often rises above a fog bank in the valley as shown in this dramatic photograph. The single structure, in spite of its height, is less of an air-traffic hazard than would be three separate towers.



WKZO, WKZO-TV MODERNIZATION PROGRAM

Fetzer Flagship Stations Complete
A Program of New Construction and
Updating of Technical Equipment

by ARTHUR E. COVELL
Chief Engineer, WKZO, WKZO-TV

A three-part modernization plan of the Fetzer Broadcasting Company facilities in Western Michigan has been completed. The plan included (1) construction of "Broadcast House" with its new office and studio facilities for WKZO-TV and WKZO Radio; (2) customizing of the WKZO directional antenna and phasing system; and (3), relocation of the WKZO-TV transmitting facilities to better serve Western Michigan viewers.

Latest design tv equipments have been installed in newly constructed facilities, de-

signed for today's most modern technical operations. The contemporary building with its tastefully landscaped grounds give evidence of the technical innovations to be found inside.

WKZO and WKZO-TV, Kalamazoo, Michigan, are owned and operated by the Fetzer Broadcasting Company—John E. Fetzer, president and Carl E Lee, executive vice-president and general manager. They are the flagship stations of the Fetzer group. Other radio and tv properties include WJEF and WJEF-FM, Grand



FIG. 1. John E. Fetzer, president.

Rapids, WWTW and WWTW-FM, Cadillac, WWUP-TV, Sault Ste. Marie, Michigan; and KOLN-TV, Lincoln, and KGIN-TV, Grand Island, Nebraska.

"Broadcast House"

New studios and offices for both radio and tv stations are located in "Broadcast House", a 40,000 square ft., tri-level building of contemporary design—see Fig. 2. The exterior is faced with buff brick and set off with sandstone trim. A 77-foot microwave tower, covered with green por-

FIG. 2. Broadcast House. The 77-foot tower, at front, houses STL microwave and weather equipment. The building is of a tri-level contemporary design.





FIG. 3. Carl E. Lee, vice pres. and gen. mgr.



FIG. 4. Arthur E. Covell, chief engineer.

access from the parking lot. The film editing department is located at the rear entrance for easy delivery and shipping facilities. General offices and an area for future expansion are located in the east wing.

Personnel in the office wings are able to keep in touch with operating activities through a complete audio and TV monitoring system. Special audio monitors can select any one of eight different audio lines. An RCA tv monitran system offers a choice of four different pictures and associated sound.

The building also houses the Fetzer Music Company which holds the Muzak franchise for Western Michigan. Operation of a multiplex channel on WJEF-FM, the Fetzer Broadcasting Company's 50-KW FM station, is an integral part of the Fetzer Music Company in its job of distributing background music in the Western Michigan area.

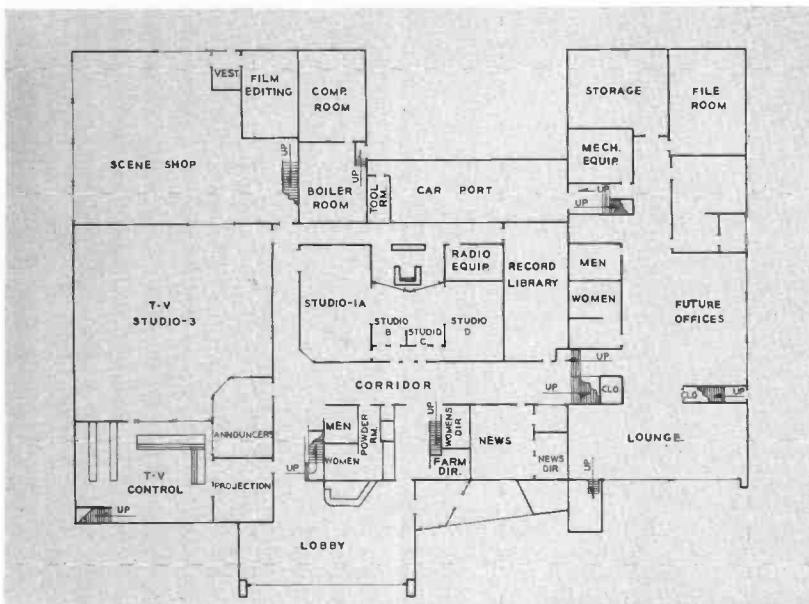

FIG. 5. Ground floor plan, radio and tv studios. The layout is planned for completely integrated radio and television operations.

FIG. 6. Second floor plan, studios and offices. Area for future expansion is also accommodated.

celain enamel on steel proudly displays the station call letters. This makes the building an outstanding landmark in Kalamazoo.

Convenient access to the parking lot and beautifully landscaped grounds makes possible frequent production of outdoor telecasts. The variety and natural beauty of the surrounding hills makes it easy to select a suitable backdrop for such programs. The building and grounds were recently given the Michigan Award by the Federated Garden Clubs of Michigan.

The general layout of "Broadcast House" provides easy access for visitors to both radio and television operations—see floor plans, Figs. 5 and 6. Both the scene shop and TV "studio 3" have drive-in

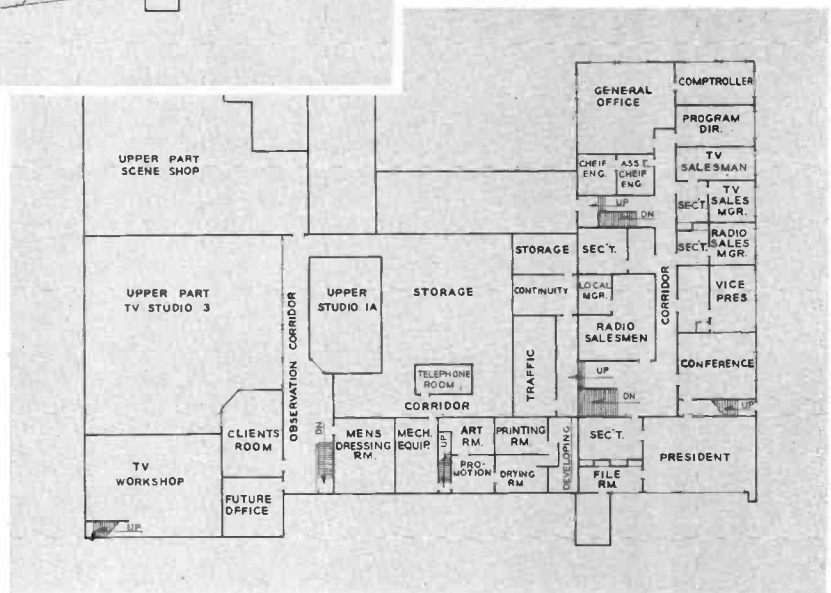

WKZO TELEVISION

"Studio 3"

The heart of WKZO-TV live operations is "studio 3", shown in Fig. 7. This is headquarters for the station's two new TK-12 4½-inch image orthicon cameras. The studio is 50 ft. by 60 ft. and is constructed of cement block. Sound treatment is accomplished through the use of attractive drapes on three sides of the studio and acoustosorber pyramidal type units suspended from the ceiling. A conventional lighting grid is combined with a conduit network for providing 40 overhead power circuits. A bank of magnetic amplifier dimmers provide variable control over part of these power outlets. Adequate power capacity for possible future live color operations has been provided.

Twenty microphone outlets have been installed in the studio walls. Facilities for two different types of rear screen projection help provide production flexibility. Complete sets can be wheeled in from the scene shop through a large overhead door designed expressly for this purpose. This door is electrically operated and has proved to be an excellent production convenience.

Studio clocks are driven by an IBM system synchronized by a radio receiver tuned to WWV. In addition to conventional wall clocks, two synchronized clocks are mounted on the large studio rolling monitors and a large clock is mounted on a swivel in the center of the studio, making it difficult for studio personnel not to know what time it is. Remote reading Bendix Friez electronic weather instruments are installed in the studio for direct reading "on-air" during weather programs.

Air Conditioning System

A 100-ton air-conditioning facility provides the necessary cooling for the studios and for the rest of the building. A carefully designed individualized zone control over heating and cooling has resulted in optimum working conditions in every part of the building. The part of the system that serves the TV and radio studios has been carefully sectionalized to prevent undesirable sound transference through the ducts.

TV Control

The location of TV control affords the operators an excellent view of "studio 3",

announce booth and film projection room—see Fig. 8. The heart of the control room equipment is a TS-21A remote control switching system with which two 12-input control panels are operative. By providing two switching panels greater flexibility is obtained in all kinds of programming requirements. One control panel is located at the left end of the main row of control consoles, Fig. 9. The other is located near the right end, adjacent to the audio console, Fig. 10. Delegate relays make it easy for either control panel to take over the job of feeding picture to the transmitter. The control panel, not being used on the air, is therefore available for rehearsal or other audition purposes.

The control room layout at Broadcast House, designed by Chief Engineer Arthur Covell, has proved its worth under actual operating conditions. The arrangement of equipment and controls is such that two men can perform the whole technical operations job during film-network periods. On more complicated shows, such as color film with live, the flexibility is such that more technicians are added without overlapping their duties.

FIG. 7. "Studio 3" in use on Feminine Fancies women's show. Studio equipment includes two new TK-12 4½-inch image orthicon cameras.





FIG. 8. WKZO-TV control room provides operators full view of "Studio 3", announce booth and film projection room.

FIG. 9. Close up of tv control console showing both switching panels, light control, one of two projector controls and live camera controls. Engineer Elton Hiscock is seated at the console.



FIG. 10. Tv control showing a close up of the second TS-21 switching panel which is adjacent to the BC-6 audio console.

Control over studio lighting is effected by means of a bank of 49 numbered, toggle switches conveniently located at the left of the video operator. The d-c potentiometers, which control the magnetic amplifier dimmers, are also located on this panel. Actual switching of lighting power is done by power relays located in a cabinet at the lighting distribution center.

Ten 21-inch monitors are located above the control room windows, giving control room personnel a full view of all tv operations. The sign which designates a particular monitor's function is lighted with white letters when the piece of equipment associated with the monitor is on standby. When this piece of equipment is being used by the audition switcher, its designating sign lights up with green letters. Correspondingly these letters light up red when the source is punched-up on the "on-air" switcher.

Film Room Equipment

Other equipments which have proved their value under actual operating conditions are the TP-15 multiplexer with associated projectors and film cameras in the



film projection room—see Fig. 11. Two TP-6C film projectors and a TP-7 slide projector supply the source material for TK-21 monochrome film camera and a TK-26A color film camera chain. A TM-21A color monitor is used for color film monitoring. An example of the use of the color equipment is the filming and telecasting in color of the annual Benton Harbor Blossom Festival. This is an annual color special which has been telecast by WKZO-TV for the last four years.

The film projection room also contains a second equipment setup, complete with TK-21 film camera chain, TP-7 slide projector, TP-16 film projector and multiplexer. See Fig. 12. This provides a standby for the regular projection equipment and is used for news films that may come in too late to be set up on the regular projectors.

WKZO-TV has complete photographic news facilities so that it can take the pictures, process them, and get them on the air quickly. A 1200-ft capacity sound-on-film camera enables the program department to shoot entire programs of area events in color or black and white. A complete photographic laboratory is equipped to process both color and black and white films.

STL Microwave System

The 77-ft. porcelain-clad tower at the entrance of "Broadcast House" serves the



FIG. 11. WKZO-TV projection room showing TK-26 color film chain, TK-21 monochrome film chain, TP-15 multiplexer and TP-6 projectors. The station produces many of its own color film specials.

multiple purpose of displaying station call letters and supporting the STL parabolic reflectors mounted within an enclosure at the top.

FIG. 12. Looking into the tv projection from the control room. Two projection equipment groups are included; one for standby use.

A TVM microwave system links the studio with the transmitter. Transmitting facilities are located in the base of the tower. Waveguide carries the microwave signal to the parabolic reflector at the top. A passive reflector on the TV transmitting tower routes the signal to the receiving parabolic antenna, mounted on the roof of the transmitter building.

This facility makes two video and four audio circuits regularly available to the transmitter. By using ferrite circulators at the transmitting and receiving ends, normal operation allows one video/audio circuit to be used while the other is on standby.

Also located in the base of the tower is a 900 MC microwave transmitter whose output feeds a second parabolic reflector at the top of the tower. This provides the feed to WJEF-FM from Kalamazoo studios.

The tower also supports a wind direction wind velocity unit which is part of a six instrument display used in the TV studios. For the convenience of radio and TV personnel, as well as the visiting public, the weather instruments are duplicated on the wall of the wire and photo fax room.



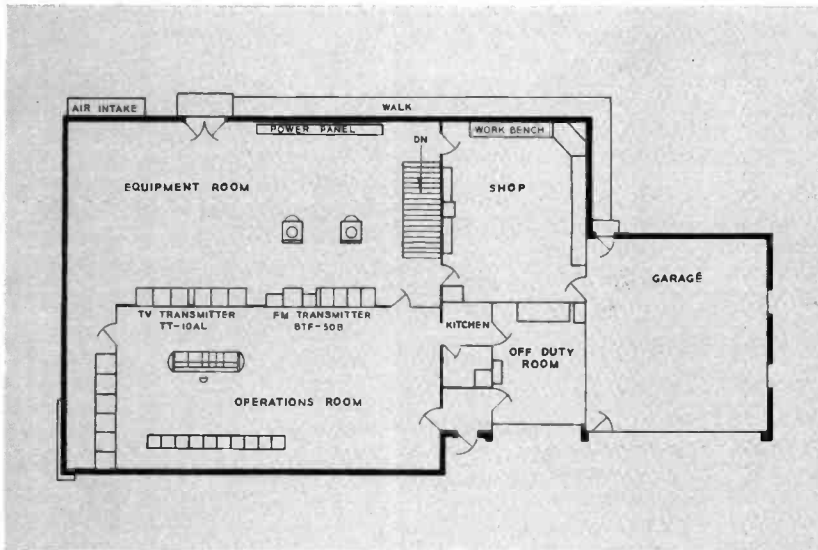

▲ FIG. 13. Floor plan of transmitter building, first floor. These spacious quarters house the TT-10AL television transmitter and BTF-50B FM transmitter. Ample shop space, an off-duty area and garage are included.

FIG. 14. Transmitter building at Gun Lake. This serves as headquarters for both WKZO-TV and WJEF-FM. Relocation of the transmitting facilities marked the completion of step 3 of the modernization plan.

TV Transmitter Site

WKZO-TV came on-air in 1950 with 8-KW ERP from a 300-ft. tower located 15 miles north of Kalamazoo. Increases in power to 100 KW and tower height to 1000 feet increased its coverage to make it a Western Michigan station.

In 1960 the decision was made to move the transmitting plant to a point half way between Kalamazoo and Grand Rapids to better serve the total viewing area. A new facility was constructed near Gun Lake in the Yankee Springs Recreation area, see Figs. 13 and 14.

In July, 1961 telecasting began from the new Gun Lake plant. The new WJEF-FM transmitter, increased in power to 500,000 watts, began broadcasting from the same site at this time. Both tv and fm transmitters are housed in a large, attractive building, constructed of prestressed concrete and clad with aluminum. The design of the building roof and its location south of the tower protects the building from damage due to falling ice. A new TT-10AL television transmitter was purchased for this installation—see Fig. 15.

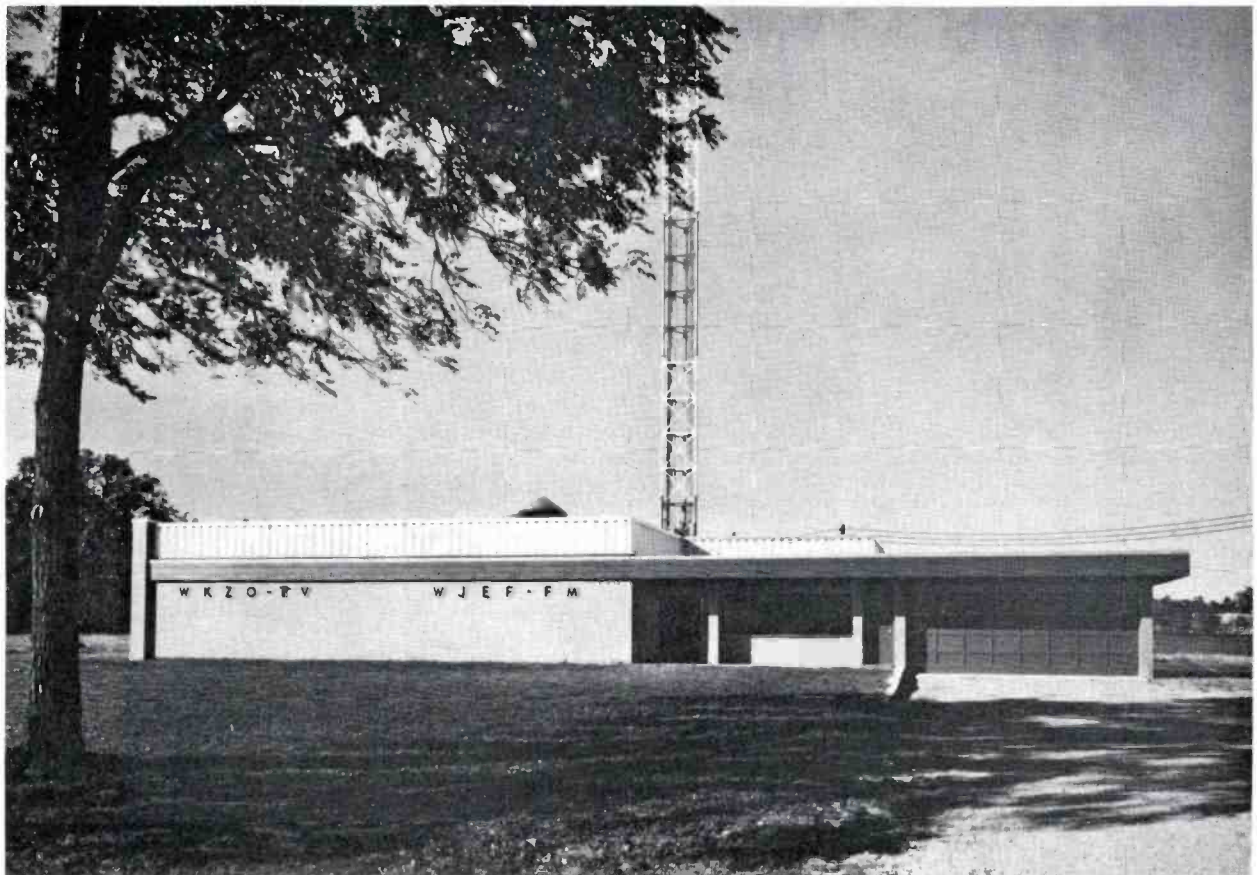

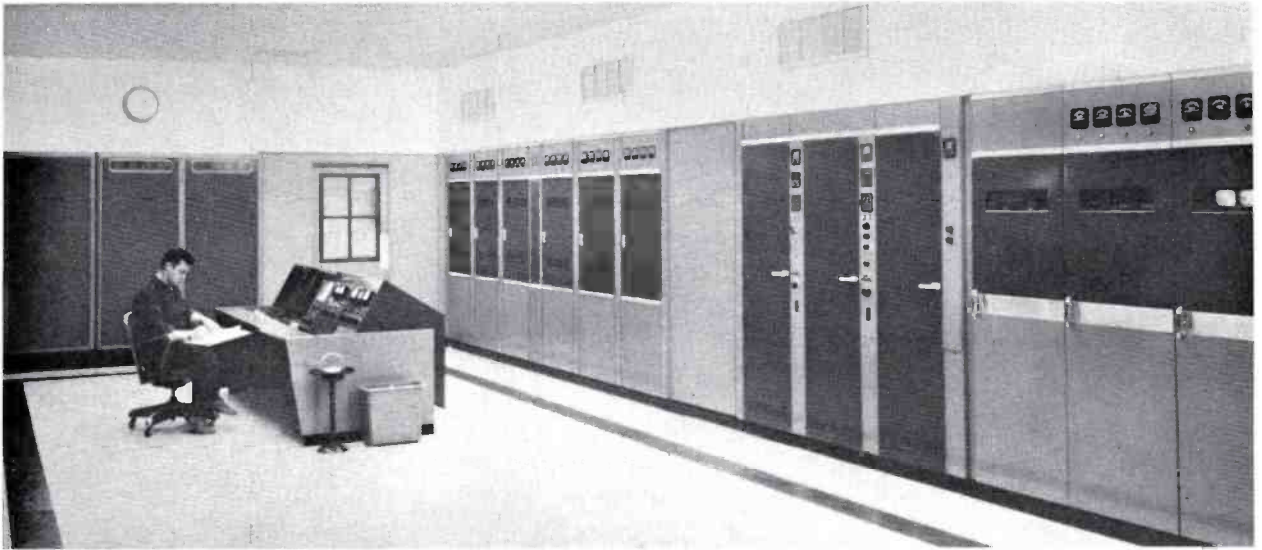

FIG. 15. View of the transmitting equipment room. Television transmitter, TT-10AL, is at left and FM transmitter, BTF-50B, is at right.



FIG. 16. Tower before erection of big antenna. A 2-bay standby antenna and microwave screens are already in place.

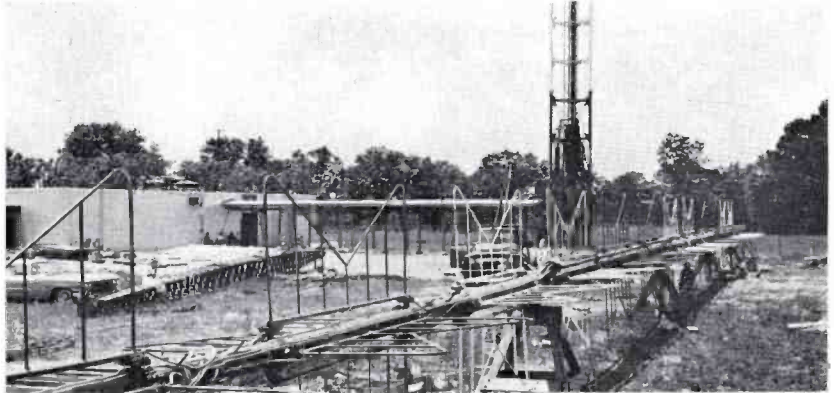

FIG. 17. Raising the top section of WKZO-TV's TF-12AL antenna.

FIG. 18. TF-12AL antenna on horse is being dressed prior to raising.



Moving the Antenna

One of the problems connected with the move (very intriguing to our viewers) was the removal of the 39-ton TF-12AL superturnstile antenna from the old tower and its installation atop a new tower at the new location. See Figs. 16, 17 and 18. This job was ably handled by the Seago Construction Company. In the interim, operations were carried on from the old 300-ft. tower.

Some features of this modern transmitting plant are electric heat, air-conditioning and electrostatic air filtering. All transmitter blowers and large transformers are mounted in the basement for reduced vibration and better accessibility.

The 1100-ft. Ideco tower and antenna is equipped with a two-man elevator to facilitate antenna service. The TF-12AL TV antenna is backed up by a two-bay side-mounted superturnstile standby antenna, fed by separate transmission lines.

WKZO RADIO

Radio Studios

"Broadcast House" is also headquarters for WKZO Radio. While the left wing of the building is devoted to tv, the radio control room and studios are located in the center section, across the hall from tv "studio 3".

Both studio groups were designed to make "simulcasting" practical. The technical facilities of both control rooms are integrated to permit television operations from one of the radio studios. Similarly television's space and equipment can be used to further radio's plans.

Studio 1A, the largest of four radio studios, is also equipped with camera outlets and lighting grid for tv operations. TV shows have originated in this studio. It is of cement block construction and uses the acoustosorber pyramidal units for sound treatment.

The other three studios, used exclusively for radio, are treated with acoustic tile. The acoustic qualities are excellent. Double walls and suspended ceilings provide sound isolation. A sound lock entrance to these studios completes the sound isolation.

Radio Control

The WKZO control room is laid out with tape and record-playing facilities—a prime consideration. It contains the control equipment for remote operation of the WKZO transmitter. Taping phone interviews is an important part of the station's fast moving news coverage, and an extra tape recorder is kept on standby expressly for this purpose.

The need for extra microphone inputs in a certain studio is a common problem around a radio station. In this control room, relay switching can make available extra microphone inputs associated with studio D, for instance, for use with microphones plugged in at studio A. Here, as elsewhere, relays do many jobs, and so a particular type of three-pole double-throw plug-in-relay is used for almost all relay jobs in both TV and radio. A defective unit can quickly be replaced. However, this particular type of relay has worked so well, that no replacements have been necessary to date.

Radio Transmitter

WKZO radio is a fulltime, 5-KW station, directional at night. The station has just

completed modernization of its 4 tower-directional antenna ground and phasing system which was installed in 1942. In the intervening years the transmitter plant built up an enviable record for dependability and stability. Remote control, unattended daytime operation was carried out very successfully for several years. However, it was determined that installation of all possible improvements would guarantee even better service in future years, and would facilitate extending remote control to nighttime directional operations.

The transmitter plant is located about five miles north of Kalamazoo on low land near the Kalamazoo River, see Fig. 19. The good propagation qualities of the site have been amply demonstrated. The transmitter is a BTA-5H, see Fig. 20.

As part of the modernization, the ground system was carefully inspected and reinforced. New steatite transmission line was installed. This is mounted, along with control wire conduits, on hardwood rollers fastened to heavy steel posts. Hairpin shaped expansion loops are provided in the lines in the central tower house. In this manner, expansion of the line due to tem-

FIG. 19. Aerial view of WKZO Radio transmitting site shows the transmitter building and the 4-tower directional array.

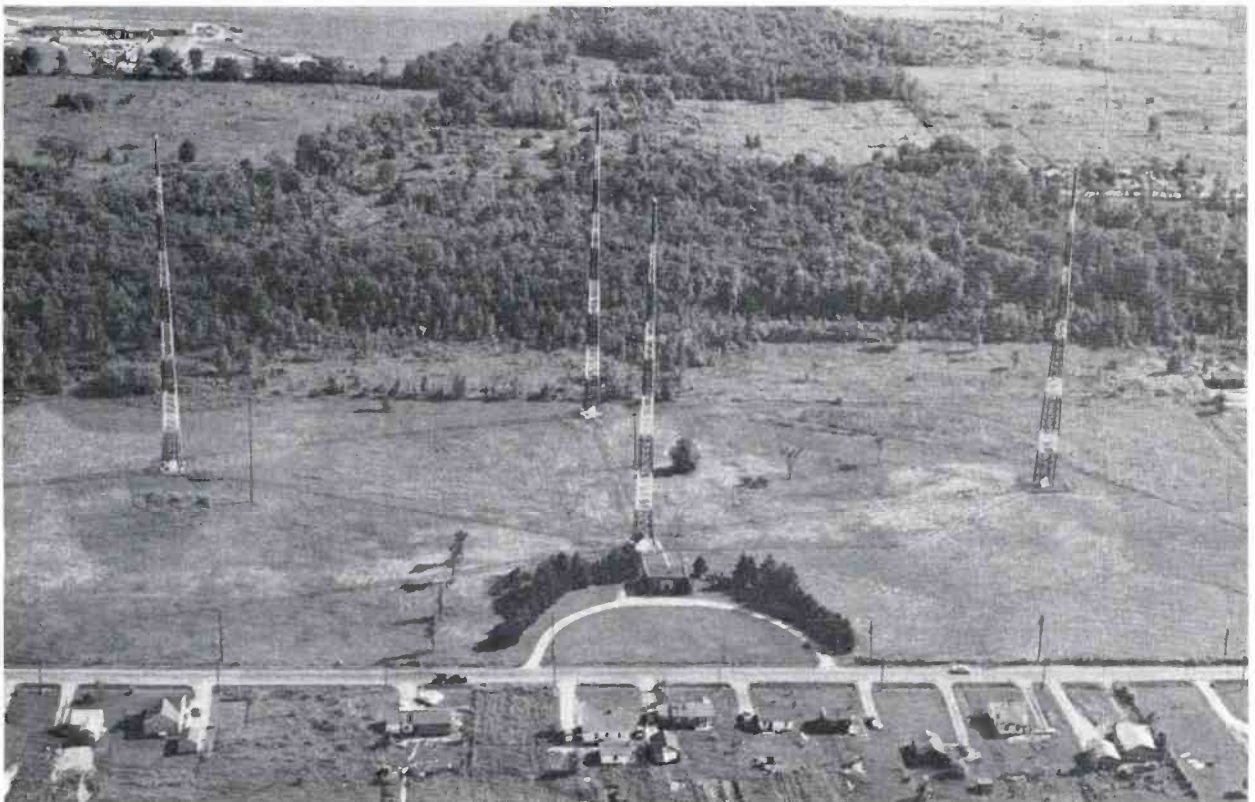

perature change on the long horizontal runs can be compensated.

Installation of Austin lighting transformers simplified the tower lighting. Type 173-10 phase sampling loops are mounted about 40 feet up on each tower, and equal length coaxial lines, insulated from the tower, are run back to the transmitter house. During tuneup and in operation of the new phasing equipment, this phase sampling system has proved to be very reliable.

Installation of a new RCA custom phasing unit, Fig. 21, completed the modernization job. The phasing unit gives ease of control over antenna currents and phases. This was lacking in the former equipment. The end result of the modernization is a transmitting plant that is tops for stability and efficiency.

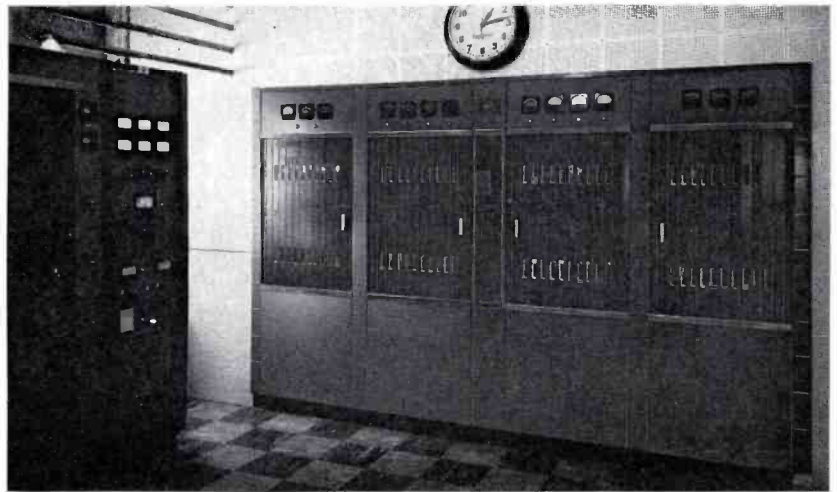

FIG. 20. AM transmitter BTA-5H, showing part of directional equipment.

Mobile Radio Equipment

Another facility to help WKZO give the public a more complete broadcasting service is Satellite 590, a mobile studio fully equipped for broadcasting from remote points, see Fig. 22. It is completely equipped with air-conditioning, telephone, turntables and transistorized console. The desk-console-turntable unit can be removed for use at remote locations.

Other mobile units are used by the News Department. One of their important tools is an RCA 166-mc mobile transmitter installed in "WKZO Explorer" a 1962 Corvair. It is a great help in the quick delivery of news and special events to our listeners and viewers.

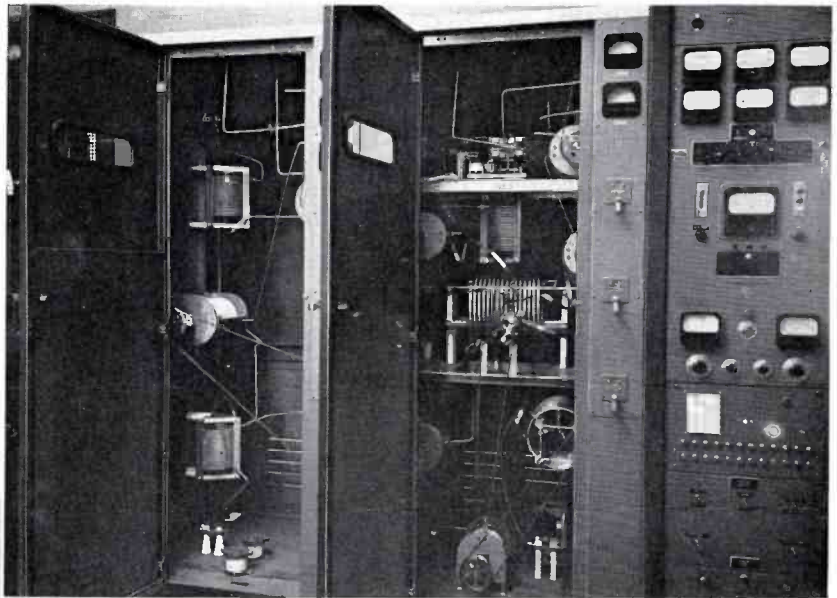

FIG. 21. Phasing and equipment racks at the AM transmitter building. The phasing unit provides extremely easy control of antenna currents and phases.



Up-To-Date Radio and Television Facilities

With the completion of the Gun Lake transmitting plant, the Fetzer Broadcasting Company has gone through a complete cycle of construction and modernization of its facilities in Western Michigan. But no one who is familiar with the company's thirty year history expects it to be satisfied with the status quo for very long.

FIG. 22. WKZO "Satellite 590" is a fully equipped mobile radio studio.

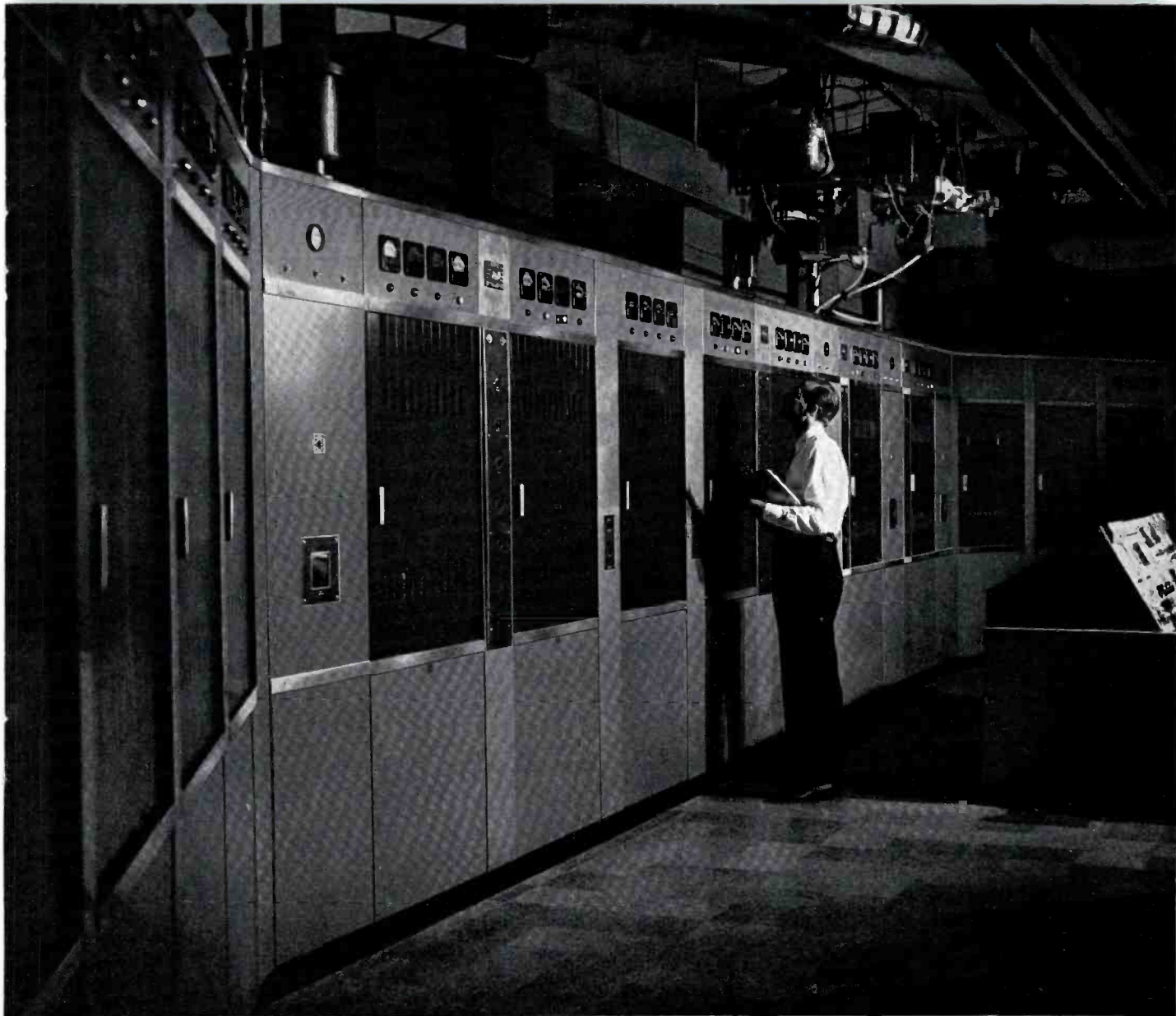

RCA 50-KW IN NEW YORK CITY UHF-TV TESTS

For its UHF tests in New York City the FCC is using a high-power transmitter designed and built by RCA. The most powerful of its kind, this 50-KW UHF transmitter consists of two TTU-25's in parallel. It operates on channel 31 and is installed on the 80th floor of the Empire State Building, where seven other channels serving the metropolitan area are located.

The work was performed under a contract awarded RCA by the FCC on March 1, 1961. The award was made based on considerations of power consumption, tube replacement and experience in equipment

installation, as well as general performance and cost.

RCA also supplied the studio equipment to WNYC (the New York City-owned station) which will handle programming for the FCC outlet. This includes four TK-12 4½ inch I.O. Cameras, a film system with TK-21 Film Camera, TP-11 Multiplexer, TP-6 Film Projectors, TP-7 Slide Projector, and a TRT-1B Television Tape Recorder.

This same RCA experience and equipment are available to all those who seek for leadership in the field of television broadcasting.



RCA BROADCAST AND TELEVISION EQUIPMENT
CAMDEN, N.J.



The Most Trusted Name in Television

RCA VIDEO ALIGNMENT TAPE

Helps Extend Headwheel Life, Achieve High Degree of Performance and Tape Interchangeability

The first video alignment tape recorded in strict adherence to recommended SMPTE practices is now available to broadcasters for evaluating the performance of all quadruplex television tape recorders. Use of this universal test tape, recorded with signals specified by SMPTE recommended practice RP-10, enables operators of tv tape recorders to determine accurate quadrature and vacuum guide alignment.

A number of other tests can also be performed—all designed to help them achieve finest tape pictures, maximum headwheel life, and the highest degree of tape interchangeability.

Headwheel assemblies can now be set up in a manner to assure the ability to play *all* recordings for the full wear life of the heads. Furthermore, by standardizing operating parameters, intersplicing of tapes can be accomplished with ease.

Twelve Test Conditions

The composite signal contained on the alignment tape consists of (a) stair-step, (b) multi-burst, (c) window, and (d) sine-squared pulses. The sine-squared pulses form a vertical stripe pattern of narrow lines, convenient for skewing, scalloping and quadrature error observation. Use of the standard alignment tape when placing a new headwheel assembly into operation, plus periodic use throughout the life of a headwheel assembly, enables operators to readily check the following conditions:

1. Head quadrature
2. Vacuum guide position
3. Video levels
4. Video amplitude vs. frequency response
5. Video transient response
6. Low frequency tilt
7. Video amplitude linearity
8. Video head playback sensitivity
9. Relative noise banding

10. Carrier deviation frequencies
11. Program and cue audio level
12. Control track level and phase

Using the Alignment Tape

The tape is made with precision quadrature (exact 90 degree angle between the video heads). When a headwheel with errors in quadrature is used to play the precise tape, horizontal displacements directly proportional to the errors in quadrature will be visible on the test monitor. These horizontal displacements can be corrected until straight vertical lines result. The amount of adjustment required is a direct measure of dynamic angular position of the video heads in the headwheel. If the proper timing correction is applied to each channel or to each angle between video heads, the video headwheel will record with proper quadrature. A recording made in this manner can then be reproduced by any television tape recorder properly adjusted for quadrature.

The position of the vacuum guide can be adjusted until the vertical bars of the alignment tape are reproduced as straight vertical lines with minimum horizontal displacements. The perpendicular position is adjusted to remove "scallops" or "bows"; and the parallel position to eliminate "skewing" or "jogs".

The performance of the remaining characteristics or adjustments accommodated by the alignment tape can be checked by following the accepted methods and techniques associated with the inspection and evaluation of video and audio signals. The signal characteristics covering the recorded information are set forth in the SMPTE recommended practice RP-10.

Custom Recorded

Each alignment tape is individually made under precise laboratory conditions and closely checked against the RCA master. A polaroid photograph of the input signal taken at the time the recording was being made is included with the alignment tape for user reference (see Fig.). The tape is wound on an 8-inch diameter reel and is housed in a special plastic case. Playing time of each alignment tape is approximately 5 minutes.

Monitor photograph of input signal taken while recording a new RCA alignment tape.

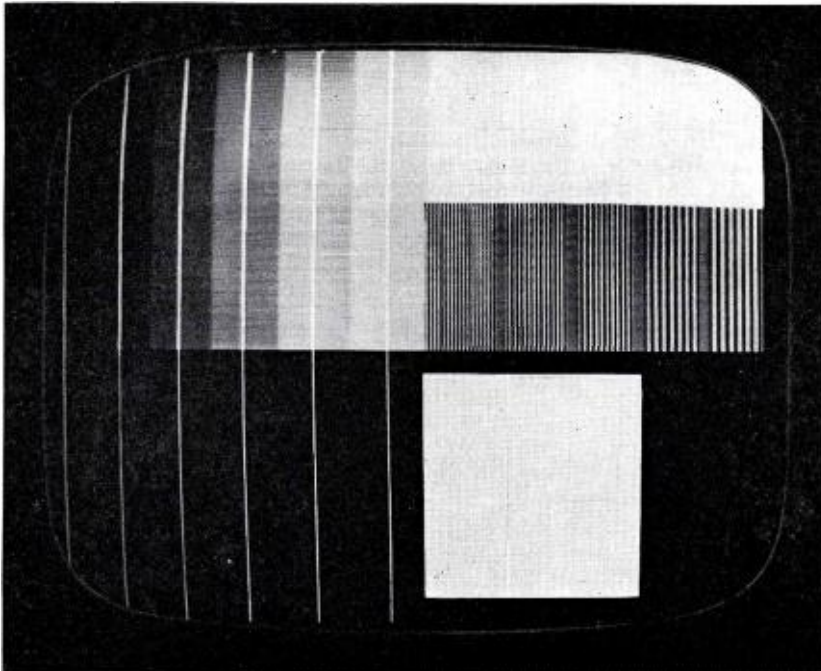

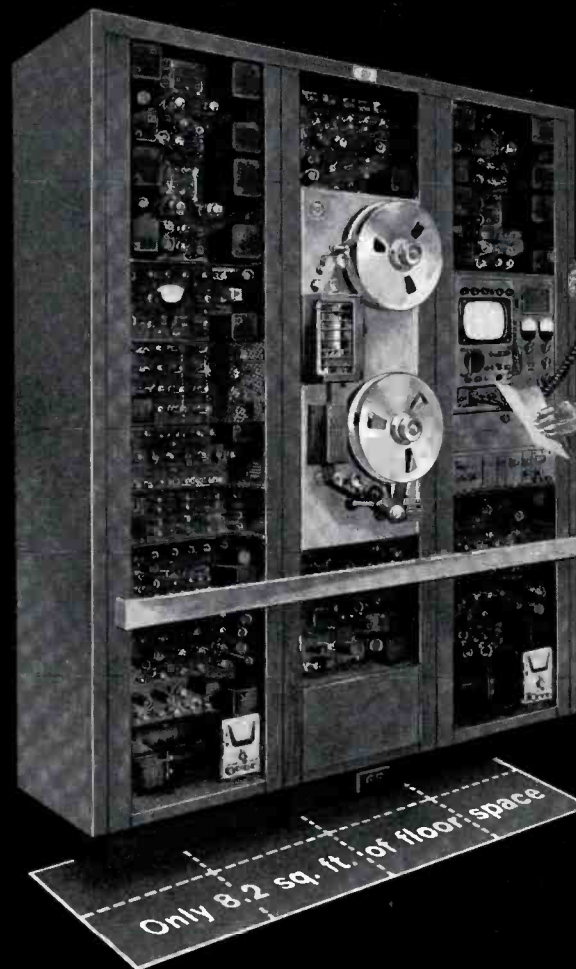

THE RCA
"COMPACT" TV TAPE RECORDER TYPE TR-11

**Compatible...easy to operate...simple to install...
 and it meets all Professional TV tape standards**

This compact, compatible TV tape recorder assures the excellence of performance users expect from RCA quadruplex equipment. Although it occupies only 8.2 square feet of floor area—saving space and costs—it makes no sacrifice in quality. Its reduced size makes it ideal for mobile applications.

EASY TO OPERATE. Simplified set-up and control procedures make operation easy. All monitoring and other features are conveniently grouped. Tape deck is located for easy threading and loading.

LOWEST OPERATING COSTS. Power requirement is only 2750 watts. This means less heat, less air conditioning. And headwheel exchange cost is the lowest in the industry.

SINGLE-UNIT CONSTRUCTION. TR-11 is a self-contained unit, pre-wired and pre-tested at factory, with no external racks to interconnect. Simple to install—there's only one 30 amp twist-lock power connection. Just plug in and operate.

OPTIONAL TWO-SPEED OPERATION. Permits tape speed to be switchable from conventional 15 inches per second to half speed of 7½ ips. Effects 50 percent saving in tape costs and storage space.

See your Broadcast Representative for all the facts. Or write RCA, Broadcast and Television Equipment, Building 15-5, Camden 2, N. J.

ENGINEER'S CHECK LIST*

- Air-lubricated tape guides.
- Simultaneous playback of audio and control track.
- Built-in deviation measurement for accurate adjustment of recording signals.
- Quadrature delay lines adjust for both record and playback.
- Transistorized signal processor provides finger-tip control of video pedestal and sync.
- Variable de-emphasis control for optimum playback of tapes recorded to non-standard pre-emphasis characteristics.

*Also a Complete Line of Accessories including SwitchLock, PixLock, Automatic Timing Corrector, Master Erase, Picture and Waveform Monitors and Remote Control.



The Most Trusted Name in Television



RCA MATCHED

...with Many

YOU SELECT A COMPLETE COLOR PACKAGE...DESIGNED TO FINEST SYSTEM SPECIFICATIONS

RCA COLOR STUDIO CAMERA—Fifth generation model of the first practical color camera—now featuring stabilized circuits for simplified operation . . . precision yokes for pin-point registration . . . prism optics for sharp, clear pictures.

RCA TV SWITCHING SYSTEM—The brains of the color system . . . key to program flexibility . . . and protector of system specifications—there's an RCA switching system to ideally match every program need.

RCA COLOR MONITOR—The professional color monitor for quality control of color performance—with new circuitry and improved capacity for evaluating color pictures.

RCA COLOR TV TAPE RECORDER—Designed from the

beginning for color operation . . . new solid-state recorder is the ultimate choice for the finest color systems.

RCA 3-VIDICON COLOR FILM SYSTEM—The practical solution to color film programming—now featuring the same optical and stabilization features found in studio cameras.

RCA TRANSMITTER-ANTENNA COMBINATIONS—Built-in color capability . . . at all powers . . . at all frequencies—produce highly reliable, full-fidelity color transmissions—tailored to individual requirements.

RCA COLOR MOBILE UNITS—Custom designed to put the matched color system "on-the-road"—provide color studio performance on-location.



COLOR TV LINE

New Features

Your Only Source for a Matched System

RCA is the only manufacturer that builds a complete line of matched color TV equipment. Proved in color operations for the past nine years, RCA color equipment is matched—electrically, mechanically and operationally—to work as a smoothly functioning TV system with finest color performance. The equipment shown above includes new features and technical refinements. Many use transistors and other solid state devices to gain compactness, long term reliability, and low maintenance cost. All are designed with the RCA brand of operating ease, convenient access to components, and real ruggedness. Set an RCA matched system as your goal, and you will be assured of achieving the easiest, most flexible, most reliable color operation.

See your RCA Broadcast Representative for the complete story. Or write RCA, Broadcast and Television Equipment, Dept. KE-372, Building 15-5, Camden, N. J.



The Most Trusted Name in Television

RECORD 2000 HOURS OF COLOR TV

Will Be Presented
By NBC In 1962-63 Season

Color TV programming by the National Broadcasting Company continues to increase.

A record 2000 hours of color television programming will be presented. This is more than the total of all American color motion pictures produced in the past eight years!

There will be some 22 hours of regularly scheduled evening color programming each week. In addition, there will be a series of five daytime color programs daily. Also, the network children's color shows on Saturday morning will continue in color.

Daytime Color

The daytime color schedule starts out in early morning with "Continental Classroom." It's followed by a series of excellent color shows, Monday through Friday, each headed by a top personality:

PLAY YOUR HUNCH

10:30-11:00 a.m.

PRICE IS RIGHT

11:00-11:30 a.m. with Bill Cullen

YOUR FIRST IMPRESSION

12:00-12:30 p.m. with Bill Leyden

THE MERV GRIFFIN SHOW

2:00-2:55 p.m.

Children's Color Shows

On Saturday morning three additional programs are being presented in color:

RUFF 'N REDDY

9:30-10:00 a.m.

SHARI LEWIS

10:00-10:30 a.m.

KING LEONARDO

10:30-11:00 a.m.

Night-time Color

In the current 1962-63 television season more than two-thirds (68 per cent) of the total night-time schedule will be in color. This compares to 57 per cent for the previous season, and 41 per cent for the year before that. More than 22 hours of night-time color will be programmed each week.

There are several new color shows making their bows this season. Brief descriptions of new formats and principal cast

members follow. Programs are listed according to premiere dates. Times are EDT.

Sept. 15—"THE JOEY BISHOP SHOW"—new format (Saturday 8:30-9:00 p.m.) in color.

Sept. 19—"THE VIRGINIAN" (Wednesdays, 7:30-9:00 p.m. in color).

Sept. 21—"THE JACK PAAR SHOW" (Fridays, 10-11 p.m., in color). Jack Paar stars in a weekly series of programs featuring conversation, music, and prominent guest stars.

Sept. 25—"EMPIRE" (Tuesdays, 8:30-9:30 p.m.) in color. The first drama series set in the real West of today.

Sept. 27—"THE ANDY WILLIAMS SHOW" (Thursdays, 10-11 p.m.) in color. Full-hour weekly musical program with top name guests.

Oct. 1—"THE TONIGHT SHOW" starring Johnny Carson (Mondays through Fridays, 11:15 p.m.-1 a.m.). New faces in the entertainment world—as well as established performers—will sing, dance, perform comedy and chat with host.

New Color Studio

There is great current demand for added color programs on the part of advertisers, the public, and dealers all across the country. For this reason, it has been decided to colorize the largest studio in the RCA

Building headquarters in New York—Studio 8-H. This will increase existing color facilities in the RCA Building, making possible elaborate color productions direct from the NBC main headquarters in New York.

Advertisers Go for Color

There has been growing enthusiasm among advertisers for color programs. NBC-TV has more business for 1962-63 with the three automobile companies than ever before. Color was also the deciding factor in the decision of the National Automobile Manufacturers Association to award coverage of the National Auto Show from Detroit to NBC this Fall.

In the case of the new "Merv Griffin Show" (color) which begins Oct. 1, from 2 to 2:55 p.m. daily, advertisers—at the rate of more than one per day—have ordered sponsorship. On July 2 the new color show was announced. During the following 16 days, 19 advertisers ordered sponsorship in the new program.

Sports and Operas

In the world of sports the following are announced color specials: "World Series," two "All-Star Baseball Games," championship tennis from Forest Hills, "All-Star Golf" and "Wonderful World of Golf" series, plus many end-of-season football classics.

The world premiere of a new opera by Gian Carlo Menotti and the first complete presentation on television of Bach's "St. Matthew Passion" will be the highlights of the NBC Opera Company scheduled for the 1962-63 season. In addition, two outstanding productions of past seasons will be repeated. These are "Boris Godunov" by Moussorgsky, and "The Love of Three Kings" by Monte-mezzi. All of these presentations will be in color.

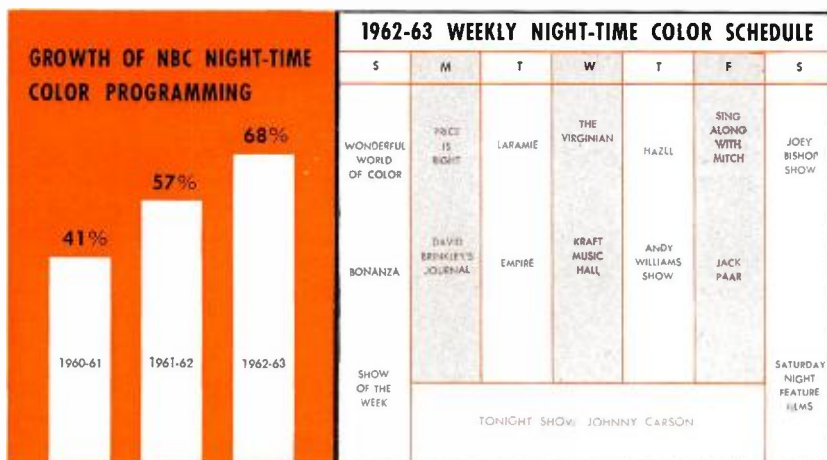

5-KW AND 10-KW TRANSMITTERS For High-Fidelity AM Programming

Types BTA-5U and BTA-10U Permit Significant Increase in
Average-Modulation Level Without Distortion Increase

by NORMAN E. KATZ
Broadcast Transmitter Marketing

AM broadcasters today demand the kind of transmitters that offer the opportunity to cash in on the "BIG-sound" audience . . . the shirt-pocket transistor portable. . . the inexpensive AC/DC table radio . . . while, at the same time, delivering the quality sound listeners seek on their car radios and home consoles. The new BTA-

5U and 10U (5- and 10-kw) transmitters offer this kind of sound—plus many other features: silicon rectifiers in the power supplies, temperature-controlled crystals in the exciter, high-efficiency power amplifiers, extra-capacity Class AB₁ modulator, built-in readiness for remote control, and 5-kw transmitter expandable to 10 kw in the field.

Five- or 10-kw broadcasters considering the replacement of out-dated facilities will

do well to consider these outstanding designs to gain the advantage of BIG sound, an increase in reliability and signal quality and a decrease in operating expense over that of their old transmitter.

Silicon Rectifier Dependability

Since the majority of AM stations now on the air operate via remotely-controlled transmitters, continuity of transmitter operation is more important than ever

FIG. 1. The 3-cabinet BTA-5U or BTA-10U. The 5-kw transmitter houses all components within these cabinets.



before. The BTA-5U and BTA-10U employ silicon rectifiers in all three of the power supplies needed for operation. Silicon rectifiers offer the advantages of almost-limitless life with only the smallest of maintenance requirements . . . an occasional measurement of reverse resistance with an ordinary ohmmeter.

Scotchman-Like Operating Economy

There are several reasons for the outstanding operating economy the BTA-5U and BTA-10U transmitters offer their users. These transmitters require—for most localities—no building-heating system as the direct result of the silicon rectifiers and the temperature-controlled crystals. For other reasons the minimum ambient temperature (at start-up) will be greater than -4 degrees F which is the lower operating-temperature limit of the crystal ovens. (This guarantees ± 5 cps carrier-frequency accuracy.) Thus, in most locations, the transmitter room that houses a BTA-5U or a BTA-10U requires no heating system

and thus eliminates the costs associated with building heating.

The BTA-5U and BTA-10U are thrifty users of kilowatt-hours. The silicon rectifiers operate without filament power, the high-efficiency power amplifier requires fewer KWH and the elimination of the extended warm-up period prevents wasted power. All of these minimize the total number of KWH per month and, consequently, reduce power bills.

The BTA-5U and BTA-10U keep spare-parts inventories (and investment) at minimum. They use only eight tube types with operating parameters selected for maximum life at top performance. Only one type of silicon-rectifier is used, reducing investment in spare parts. Moreover, the conservative rating of all components assures long, trouble-free life.

All of the eight tube-types used in these transmitters have a proven reputation for long life. This reduces the costs of tube operation to just pennies per hour. Complete accessibility to all sections of the

transmitters speeds service, cutting maintenance costs to minimum.

Highly Accessible Mechanical Design

Three aluminized-steel cabinets house the entire BTA-5U transmitter (the BTA-10U employs an externally-mounted plate transformer). This design precludes the possibility of hidden or otherwise-inaccessible components and an average-sized man can reach—and repair or replace—any component within the cabinets. The larger transformers, chokes, capacitors, etc. are neatly arranged on the cabinet floor. All other parts are easily accessible from either the front or rear of the transmitter cabinets (removable panels at the rear; hinged, full-length doors at front).

Forced-air cooling, through a plenum-chamber distribution system, supplies cooling air to the bases of the driver tubes, the radiators of the modulator, and power-amplifier tubes. An air stream is also forced to the seals of the modulator and power-amplifier tubes via pre-formed, plastic hoses.

FIG. 2. BTA-10U with doors open. At left, the control exciter, IPA and driver plus the audio amplifiers. The single, central blower pushes filtered air through a plenum chamber and hoses to the end cabinets and to the modulator tubes at the top of the center cabinet. The right-hand cabinet houses the modulation transformer (and reactor) as well as the PA stage.

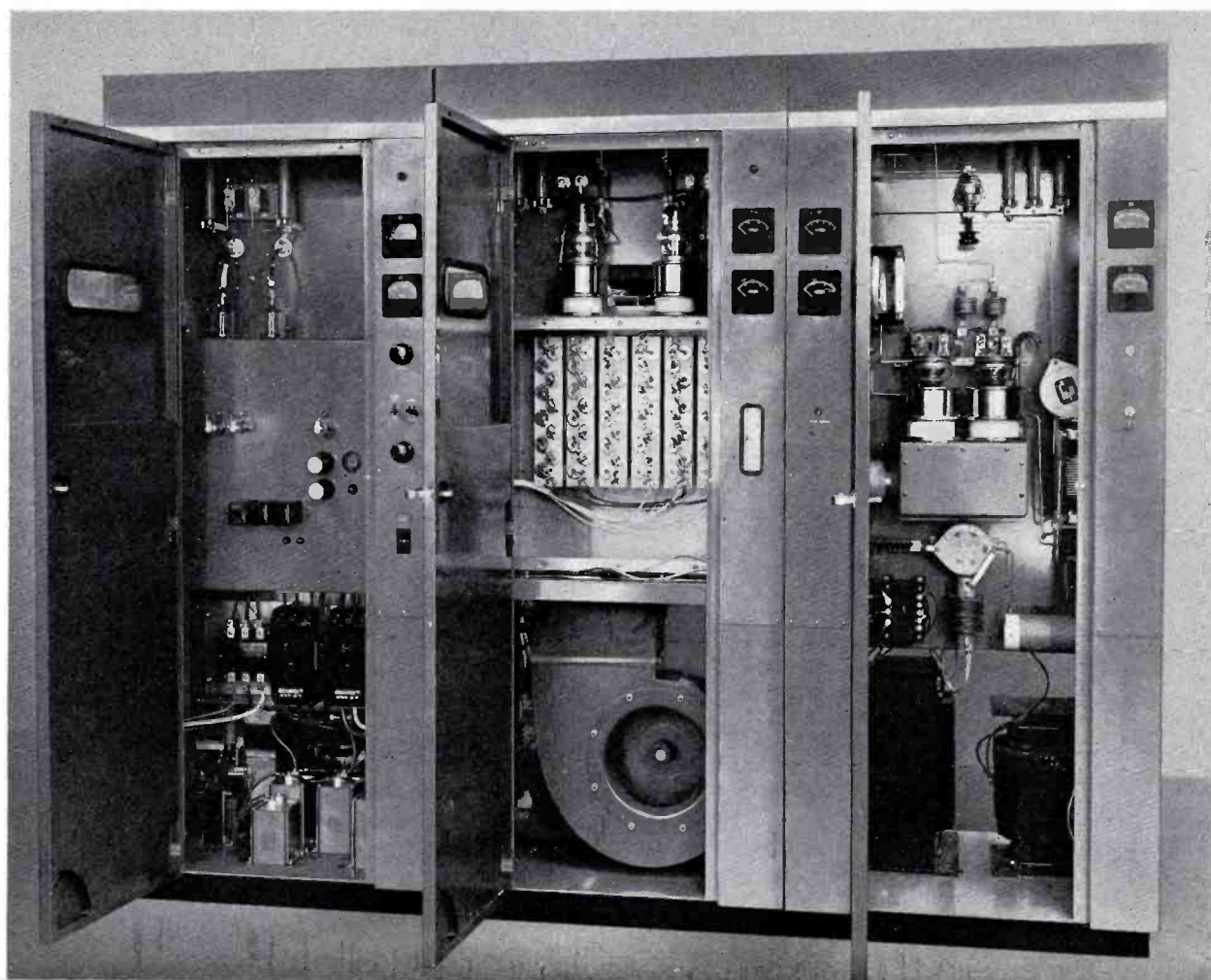

Temperature-Controlled Crystals

The oscillator section, including the buffer amplifier, is a removable, etched-wiring, dip-soldered panel that provides for three temperature-controlled crystals of the plug-in type: (1) operating; (2) one standby and (3) one Conelrad. A relay-switching arrangement allows instantaneous crystal change in the event of crystal failure or a Conelrad alert. The actuation of the relay is through a front-panel toggle or through remote control equipment (such as the RCA Type BTR-11B or BTR-20B).

The temperature-controlled crystals are completely unaffected by ambient temperatures because they are maintained at a

high temperature by individual 14-watt thermostatically-controlled heaters. This makes them the ideal choice for silicon-rectifier-equipped transmitters in that the combination of the two permits transmitter operation in unheated, indoor surroundings in temperatures down to -4 F.

The oscillator uses a Type 6AK5 pentode operating at very low cathode current to assure long, dependable life. The buffer amplifier uses a Type 5763 pentode and is resistance coupled to the intermediate power amplifier (IPA) Type 6146 beam tetrode. The IPA plate load is a broadly-tuned inductance adjustable for any frequency within the broadcast band.

Stable, Screen-Grid Driver Amplifier

The driver uses a Type 4-400A filamentary tetrode operating as a Class "C" impedance-coupled amplifier. The tuning at this power level is accomplished through a slug-tuned coil that operates at d-c ground potential. The Type 4-400A operates with 2300 volts on the plate with 170-volt grid bias and 250 volts on the screen grid.

High-Efficiency Power Amplifier

The BTA-5U and BTA-10U use a unique Class "C" amplifier design that allows plate efficiencies of 86 to 92 per

FIG. 3. Close-up of the top of the center cabinet. Safety cover panel removed from rectifier compartment to show inside. Note the preformed plastic hoses that direct cooling air at the seals of the 3X3000F1 tubes.

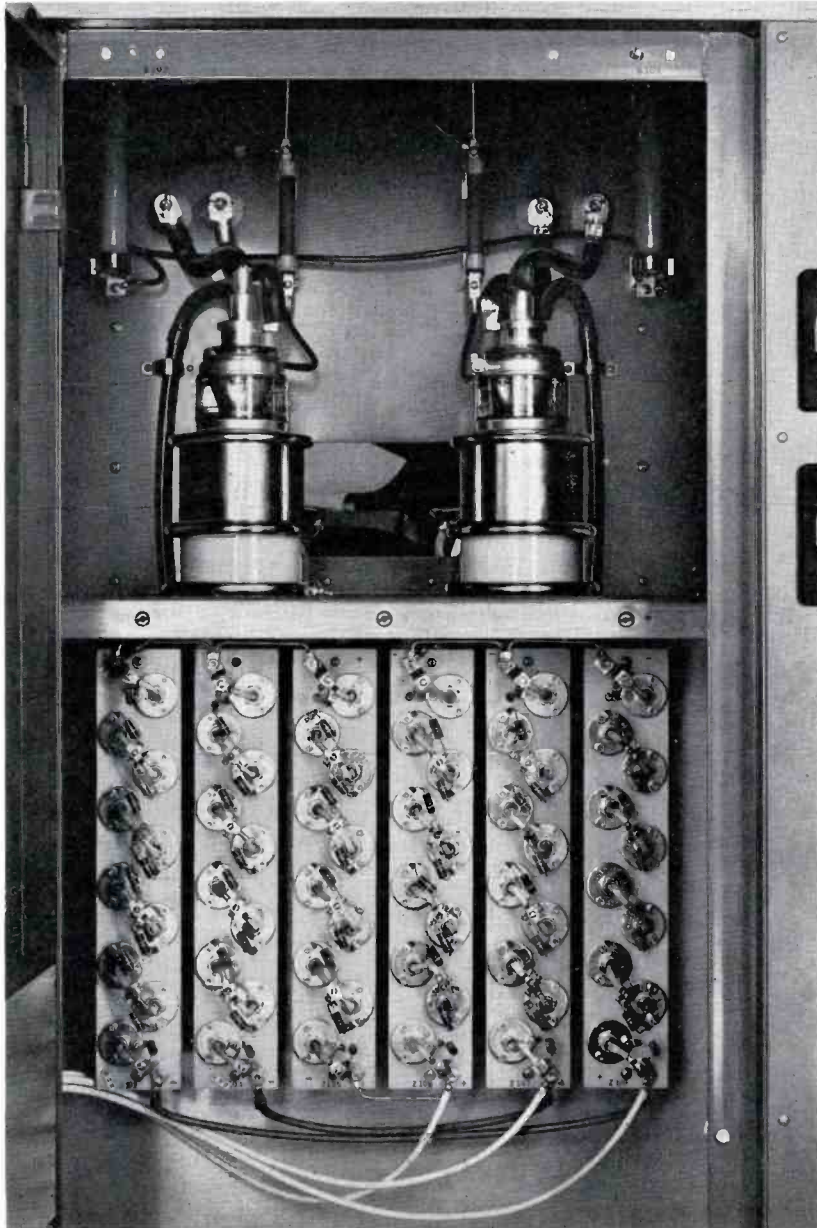
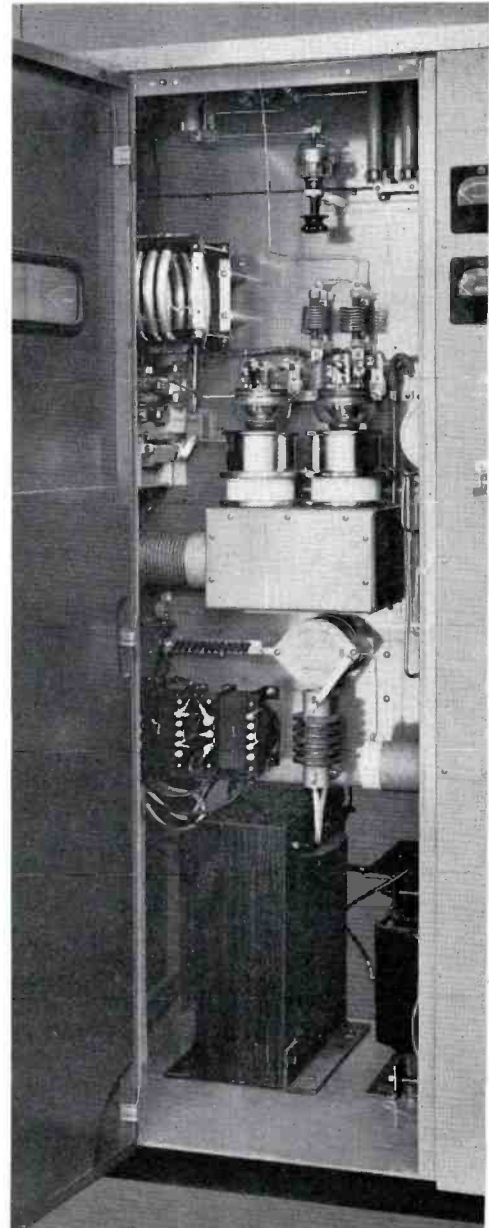

FIG. 4. BTA-10U power-amplifier cabinet. The coil and vacuum capacitor at the center right make up the plate resonator. The cathode resonator is located in the rear half of the cabinet.



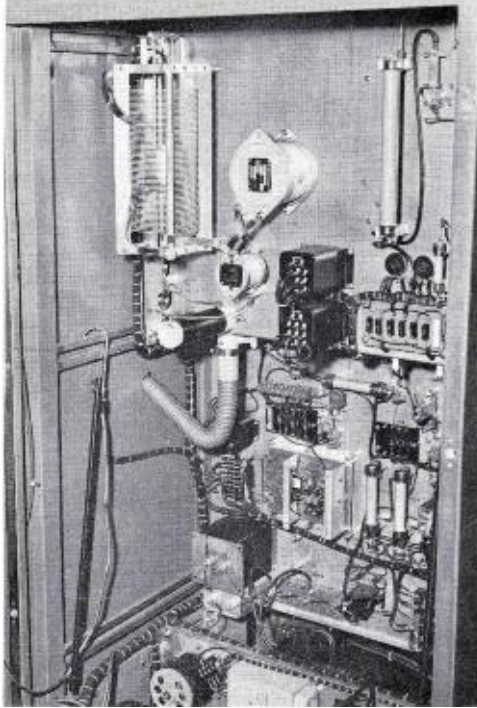

FIG. 5. The rear of the exciter/driver cabinet. The large coil in the upper left is the broadbanded tank for the 4-400A tetrode driver. Note the "potted" transformers, snap-in power resistors, etched-wiring oscillator circuit and the laced-harness wiring.

cent.* This is 15 to 20 per cent greater efficiency than conventional Class "C" amplifiers offer, when operating at top efficiency.

The circuit uses a Type 5762 triode for the BTA-5U (5 kw) and two paralleled 5762 triodes in the BTA-10U (10 kw). This high-efficiency operation reflects significant reductions in power requirements—it has been estimated that the BTA-5U saves more than 15,000 kilowatt-hours of primary power per year if operated on a round-the-clock schedule.

The power amplifier offers capability in excess of rated power to offset the losses of transmission lines, phasing equipment, etc. and still deliver full power to the antenna. Quantitatively, the BTA-5U delivers 5500 watts of unmodulated r-f power and the BTA-10U delivers 10,600 watts of unmodulated power. The 110 per cent modulation capability pushes this power to 44 kw on positive modulation peaks.

Extra-Capacity, Class AB₁ Modulator

The first audio amplifier uses a pair of Type 2E26 pentodes, resistance coupled to a pair of Type 6155/4-125A tetrodes. These, in turn, are resistance coupled to the Type 3X3000F1 triodes operating as a Class "AB₁" modulator. Minimum distortion and

* "New High-Efficiency 5-Kw AM Transmitter," by I. R. Skarbek, *Broadcast News*, Vol. 107, March, 1960.

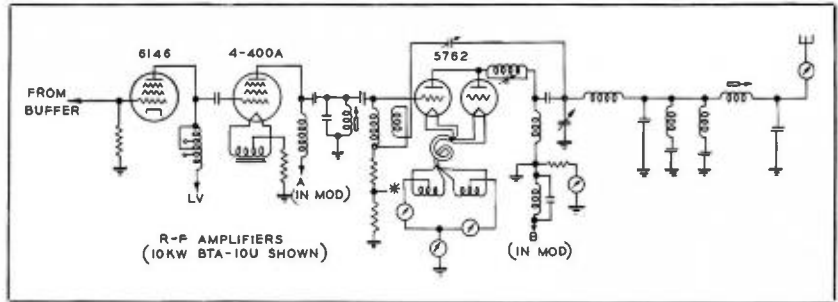

FIG. 6. Simplified schematic, r-f chain. Note the L/C circuits in the plate and cathode legs of the power amplifier. These are the high-efficiency resonators which boost plate efficiency to approximately 90 per cent.

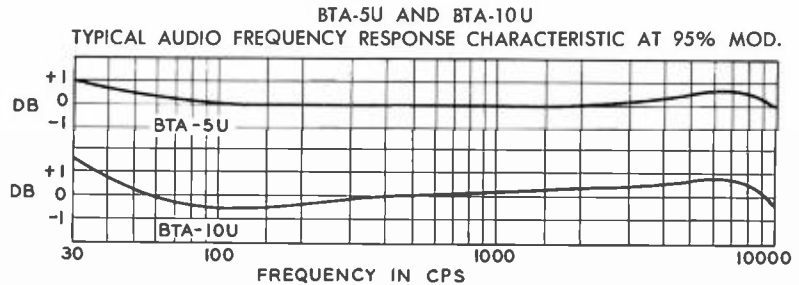

FIG. 7. Typical response characteristic, BTA-5U or BTA-10U. Note the smooth roll-off of response at the high end to prevent adjacent-channel interference and yet not distort the audio "highs".

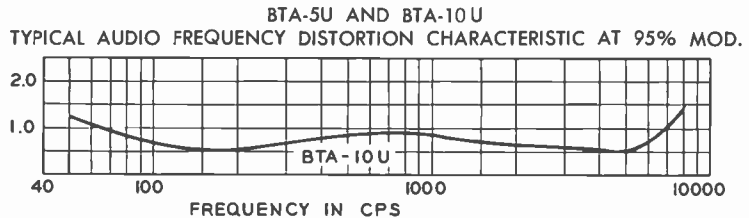

FIG. 8. Typical distortion curve, BTA-5U or BTA-10U. Note that distortion, at its highest point, is substantially less than both the industry standard and RCA's stricter specification. You'll hear the difference on a good receiver.

extra power-handling ability are the keynotes of the audio design. The Type 2E26 pentodes are famous for their low-distortion characteristics; the Type 6155/4-125A tetrodes use filamentary cathodes for excellent thermal efficiency. The 3X3000F1 triodes employ external-anode type of construction with high-efficiency, finned-radiator, forced-air cooling.

Full, three-stage feedback controls audio system distortion to within tight tolerances and adds great stability to amplifier operation... another reason for the high-fidelity sound of the BTA-5U and BTA-10U.

The BIG-sound capability of these transmitters is mainly the result of the extra-

capacity modulator. Strict avoidance of "corner-cutting" in transformer iron and copper gives the modulator the extra "beef" that many comparable-power transmitters lack. This, combined with bi-level modulation, gives the BTA-5U and BTA-10U transmitters the extra measure of modulation capability—at low distortion—that results in the much sought-after BIG sound.

Silicon Rectifier Power Supplies

Three separate d-c power supplies serve the transmitter's power needs. These supplies use silicon rectifiers with their advantages of proven long-life and trouble-free operation. The same diode type serves in all three supplies thereby requiring only

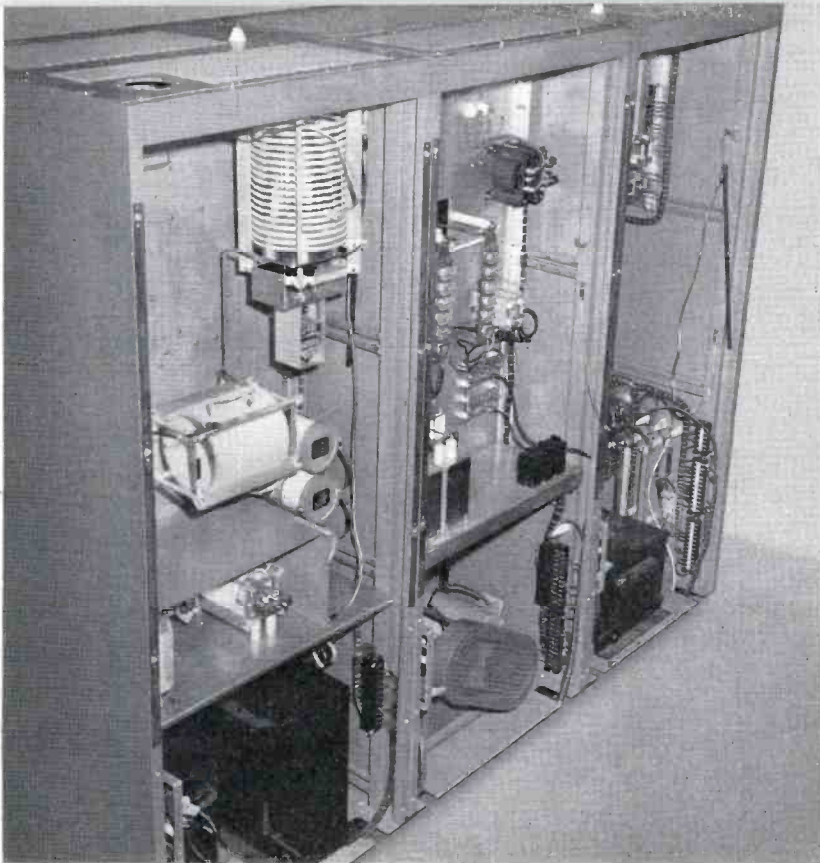

FIG. 9. Oblique rear view of the BTA-10U (external plate transformer not shown). Note the freedom of access when rear panels are removed. The cabinet in the foreground houses the power amplifier; the center, the modulator, the rectifiers and the cooling blower while the exciter and driver are in the far cabinet.

one type in spare-parts inventories. This, of course, reduces idle capital investment in spare parts.

In the high-voltage supply, a series-parallel, 3-phase arrangement—with “bleeder” resistors—maintains peak-inverse voltage (PIV) and forward current on each rectifier well within rated values. These bleeder resistors prevent build-up of PIV across any one rectifier owing to change (through aging) of reverse resistance of any remaining diodes in the leg. The paralleling arrangement assures ample current capabilities during starting transients or power-line surges. The overall results is a current-reserve factor in excess of 200 per cent and a PIV-derating factor of greater than 50 per cent on each of the diodes in the power supplies.

Many Protection Devices

High-speed, adjustable-threshold overload relays protect the transmitter’s tubes and components from damage in the event of a load-increasing fault. These relays automatically disconnect the low- and high-voltage power supplies from the transmitter to prevent damage to themselves or their loads.

Filament and main-line circuit breakers constantly monitor currents in their respective circuits and act quickly if the current exceeds a pre-determined value for more than a few seconds. A separate, time-delay circuit breaker controls the cooling-motor power and automatically continues blower operation after transmitter shutdown to carry off the last remnants of tube heat and thereby increase tube life several fold.

Built-In Readiness for Remote Control

The BTA-5U and BTA-10U, like all RCA radio transmitters, are completely ready for full remote control. The only additional equipment necessary is the external remote control unit and an ordinary telephone “pair” strung between (studio and transmitter) locations. The RCA BTR-11B and BTR-20B Remote Control Units are the ideal choice for use with these transmitters (however, any equivalent remote-control equipment performs the same task).

Suitable for Day/Night Power Cutback

The 5-kilowatt BTA-5U, at the purchaser’s option, may be equipped for instantaneous power cutback to either 1000- or 500-watt operation. Similarly, the BTA-10U may be equipped for cutback

from the 10-kw to 5- or 1-kilowatt night-time operation. Once installed, power cutback is the mere flip of a switch.

5-kw Transmitter Field-Expandable to 10-kw

The design of the 5-kw BTA-5U is engineered for relatively inexpensive upgrading *in the field* to 10 kilowatts output. This upgrading requires only a larger plate-power transformer (which is mounted externally to the cabinets), an additional Type 5762 power tube and socket plus some smaller components. The cost of the power increase components averages some 3500 dollars. Thus, a 5-kilowatt using a BTA-5U can easily and inexpensively go to 10 kw at some time in the future at nominal expense and without unnecessary equipment obsolescence.

Improves Station Performance

Summarizing, the Types BTA-5U and BTA-10U transmitters are excellent choices for any 5- or 10-kw station . . . whether the station be a long-established outlet seeking to upgrade the “sound” of the facility or, the new “spot-on-the-dial” where, until billings reach planned levels, every penny of operating costs count against profitable operation. The BTA-5U and BTA-10U are, truly, the finest high-quality 5- and 10-kw transmitters ever manufactured.

FIG. 10. Full-length photo of PA cabinet. Note the accessibility to all components.



The growth of international broadcasting in the past 15 years reflects both the rapid emergence of new nations and the technical advances made in receiving and transmitting equipment. During this period, RCA has supplied more than twenty-five 50 kw shortwave broadcast transmitters to eight different countries. Now, RCA is installing seven 100 kw shortwave complexes in three more countries for 3.6 to 26.1 mc operation. This 100 kw BHF-100A equipment utilizes "ampliphase" modulation and a number of design innovations.

100 KW SHORTWAVE TRANSMITTER for International Broadcasting

by W. S. DAY and J. Q. LAWSON
Broadcast Transmitter Engineering

In addition to the normal requirements for a good broadcast transmitter such as high fidelity, low operating cost, and easy maintenance, the good shortwave transmitter must possess certain other requisites. Most important among these is that frequency of operation be changed as many as six times a day with a minimum of *off-air* time. The transmitter must also operate into an antenna, or antenna system, having standing-wave ratios as high as 1.5:1 and impedances from 300 to 600 ohms.

Other requirements, such as high overall efficiency, simple and reliable cooling methods, a minimum of different types of electronic components, lightweight materials, and easy-to-service mechanical components are all dictated by the remote areas where most of these transmitters will be located.

The BHF-100A shortwave transmitter (Fig. 1) utilizes the RCA-developed outphasing system of modulation, *ampliphase*,¹ to achieve excellent performance and meet the stringent requirements imposed on shortwave transmitters. The basic ampliphase system is well-accepted in medium-wave standard broadcast transmitters—over 40 of these, from 10 to 250 kw, are now operating in the field.

As Fig. 2 illustrates, the 100 kw BHF-100A occupies significantly *less* floor space than older 50-kw shortwave transmitters—a compactness achieved by the ampliphase system.

The heart of the BHF-100A is the exciter-modulator, drive-regulator unit (Fig.

2). On each side of this central area, the two RF power-amplifier chains extend toward the rear of the transmitter and are fixed to the "combining-point" balun where the AM, balanced output is produced. The over-all arrangement forms an approximately square transmitter area with complete accessibility to all components in a minimum amount of space.

Ampliphase Modulation

Ampliphase, or outphasing, modulation (originally proposed by H. Chiriex²) produces an AM signal by synthesis of two RF signals, each containing linear phase modulation of the intelligence to be transmitted.

¹ C. J. Starnier, J. Q. Lawson, and C. D. Mulford, "The RCA Ampliphase Fifty," *Broadcast Notes*, Vol. 84, Aug. 1955, p. 54.

² H. Chiriex, "High-Power Outphasing Modulation," *Proc. of the IRE*, Vol. 23, Nov. 1935, p. 1370.

FIG. 1. Front view Type BHF-100A 100-kw Shortwave Transmitter.

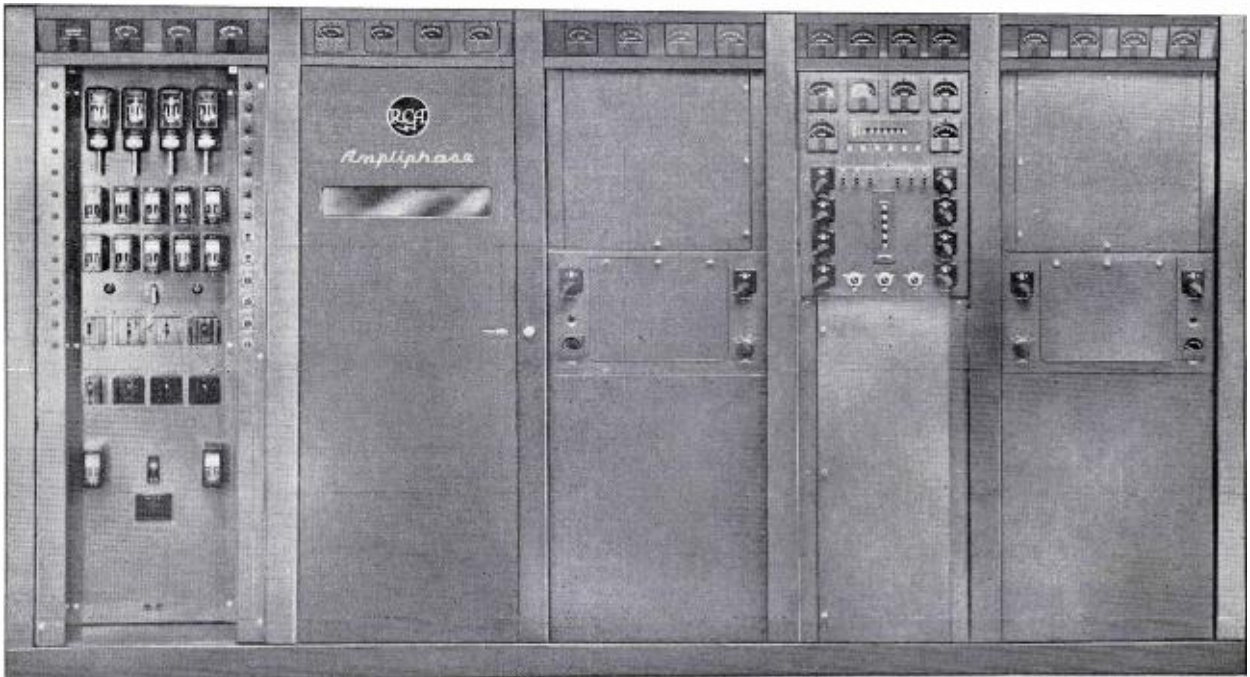

Basically, AM is obtained in the transmitter as follows: A single low-level RF source is split into two separate channels having a fixed angle of separation less than 180 degrees. These two sources are then phase-modulated by antiphase audio signals containing the information to be transmitted, amplified in separate channels to the output power level required of the transmitter, and then combined in a common impedance to produce the AM signal.

With two constant and equal current generators of phase difference θ feeding a common resistive load R , the real power P_R will be:

$$P_R = \left(2I \cos \frac{\theta}{2} \right)^2 R$$

The load impedances, Z_1 and Z_2 , that the two generators see are:

$$Z_1 = 2R \cos^2 \frac{\theta}{2} + jR \sin \theta$$

$$Z_2 = 2R \cos^2 \frac{\theta}{2} - jR \sin \theta$$

This, in effect, means that unless compensation of the circuit is made, the generators will be feeding complex loads. Since the generators in question are high-power vacuum tubes in the BHF-100A transmitter, there must be compensation of the circuitry in order to procure maximum efficiency of tube operation.

The practical circuit to get AM from two differentially phase-modulated, high-power sources is shown in Fig. 3. The plate tank circuit of tube V_1 consists of a 90 degree network C_1 , L_1 , and $\frac{1}{2} C_3$. The plate tank circuit of tube V_2 consists of a 90 degree network C_2 , L_2 , and $\frac{1}{2} C_3$. The 90 degree networks provide:

1. correct impedance transformation between load and each tube;
2. a high-Q tank circuit for proper operation of a Class C high-efficiency amplifier; and
3. a constant-current output source when a constant voltage is supplied to the input.

Capacitors C_1 and C_2 are also used to compensate for the reactive component of the load seen by each tube. An increase in capacitance on one side and a decrease on the other allows each tube to look at a unity power-factor load and achieve maximum efficiency at one particular phase angle between the two signals. In this particular transmitter, the compensation offset is done at a phase angle θ of 135 degrees, the angle at which carrier level is achieved. Deviations from 135 degrees to

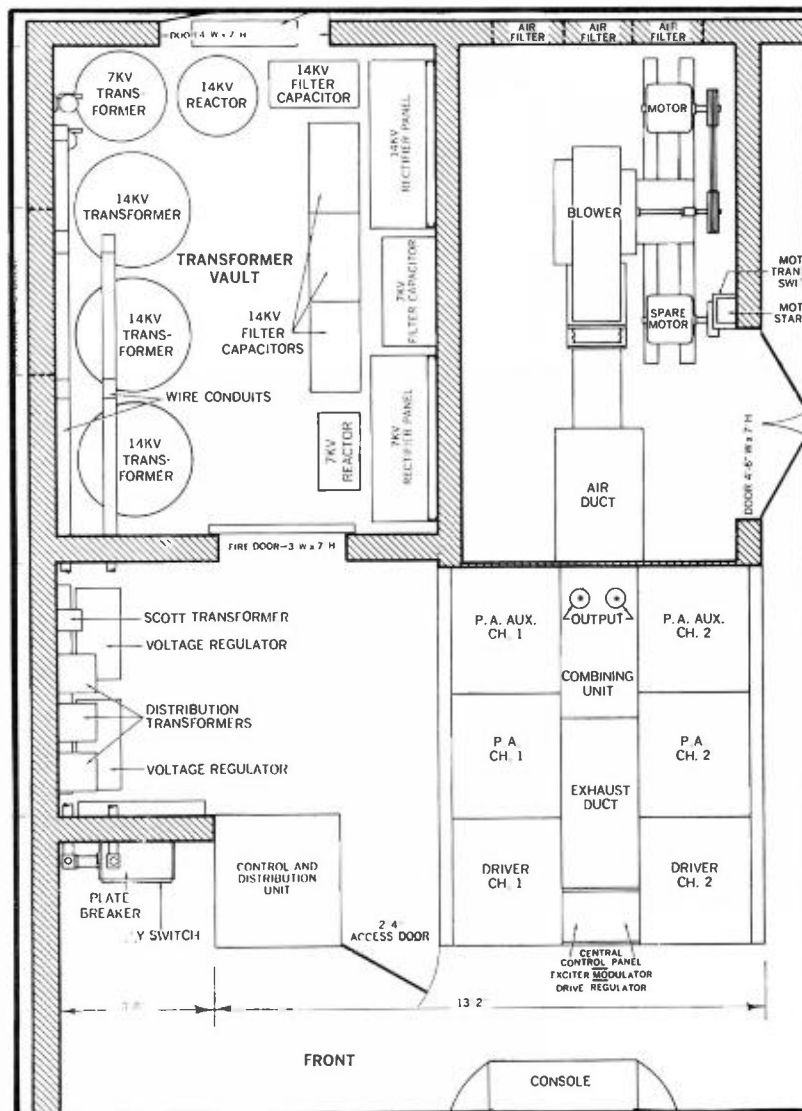

FIG. 2. Typical floor plan for BHF-100A ("old" 50-kw had a floor area—shown by heavy lines—approximately 25 per cent greater than the "new").

produce modulation detunes each tank circuit slightly; however, the power factor does not vary too widely even at 100 per cent modulation, as evidenced by a minor loss in power amplifier efficiency (80 per cent at carrier and 77 per cent at 100 per cent modulation).

Ampliphase Features

Ampliphase modulation is particularly suitable for high-power transmitters. Lower fabrication cost and economy in operation and in utilization of tubes and components are the principal advantages. In the BHF-100A power-amplifier stage, two air-cooled tubes are used in each channel to supply

an equal amount of power to the load. Each tube has the same dissipation requirement and the same RF plate swing, never exceeding the swing at carrier level.

In addition to balanced tube operation, there is a balance in plate-circuit configuration. All like elements of the final tank circuit are of equal value, except for the input capacitor to the network. The same equality of the two RF amplifiers is carried through the transmitter to the input stage where the original unmodulated signal is divided.

From the users' standpoint, identical channels mean fewer different spare parts

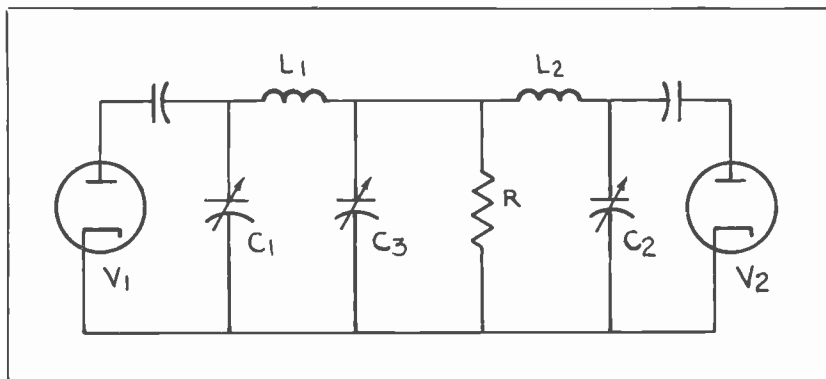

FIG. 3. Simplified PA output circuit.

and tubes to be carried in inventory, and the convenient checking of suspect components by side-by-side interchange between channels. Other features are the compact size (no large modulation transformers and reactors are required), the ease with which a complete new modulator can be installed or switched in, and high over-all transmitter efficiency.

Another important feature of the BHF-100A is its capability for fast frequency change . . . a basic requirement for all short-wave broadcast transmitters. The BHF-100A includes a built-in reflectometer and two built-in oscilloscopes for use in frequency change.

The reflectometer accurately measures antenna load, and one of the two CRO's aids in final amplifier tuning (using power factor instead of resonance). The second CRO indicates proper carrier phase-angle.

Furthermore, the BHF-100A changes frequency without use of plug-in coils. This, of course, reduces frequency-change-over time significantly . . . often measured in seconds instead of minutes.

Circuit Description

Figure 4 indicates that a circuit description of one phase-modulated channel readily applies to the other. This should be so visualized in discussing the circuitry. The RF excitation of approximately 5 watts at any frequency between 1.0 and 9.0 mc is supplied to a broadband transformer at the input to the transmitter. Output of this transformer is push-pull, with a grounded center providing two RF voltages of 180 degrees phase relationship for the two transmitter channels. These 180 degree voltages are then fed to two 600-ohm variable delay lines ganged to one control; rotation of this control delays one signal and advances the other until 135 degree phase separation is achieved.

Output of the delay line is fed to a modified Belaskis Phase Modulator having the triode section of a 6EA8 as the modulator and the pentode section as a tripler to achieve sufficient linear phase modulation in one tube. The Belaskis phase modulator does not require tuning and is most compatible with short-wave requirements in that respect. It is however, difficult to cascade this type of modulator—thus, the 6EA8 tripler requirement.

The output of the tripler, a phase-modulated signal at the transmitter operating frequency, is fed to a high-gain RF amplifier. A 12BV7 tube is used as a limiter to remove incidental AM and 1/3-carrier-frequency modulation from the signal. The output of the 12BV7 is then fed

to the final amplifier of the exciter modulator, a Class C power amplifier having approximately a 7-watt output at 75-ohm impedance.

It is interesting that the full range of 3 to 27 mc is covered in four bands. A frequency change can be made by moving one band selector switch to the proper position and adjusting only one control, which drives six inductor tuning slugs to a calibrated point. This rapid phase-modulator tuning is of sufficient accuracy to permit the transmitter to be set up and operated without utilizing the fine trimmers of each circuit. The fine-tuning controls provided can, however, be adjusted while programming to optimize performance.

The exciter-modulator output is fed through a 75-ohm cable to a broadband transformer driving the intermediate power amplifier—a straightforward Class C amplifier utilizing a parallel pair of 7094 tetrodes to provide approximately 100 watts to the driver stage. Although the input circuitry to this stage is very broad, it is necessary to compensate the circuit by switching four shunt indicators to cover the band.

The intermediate power amplifier output is tuned by a variable coil in parallel with a capacity divider formed by blocking condensers and the input capacitance of the driver tubes. The two driver tubes are grid-modulated amplifiers, providing proper drive for the final stage under all modu-

FIG. 4. Block diagram of 100-kw transmitter.

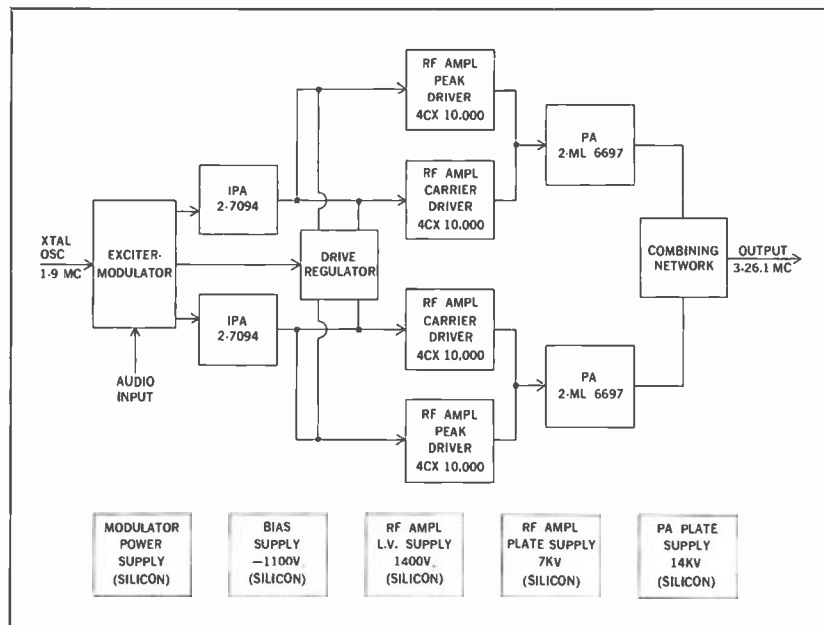

lation conditions. Because of the widely varying drive requirements and load impedances, the two tubes of this stage are biased at different levels. Thus, at carrier and below, one tube is supplying power; above carrier level, both tubes are supplying power to drive the final stage. To match the low input impedance of the grounded-grid power amplifier to the relatively high impedance of the driver stage, a 180 degree network plate-tank circuit is used. This network meets the special requirements of feeding a load of a varying nature. Load impedance at the peak of modulation is low and at the trough of modulation is high. The network accomplishes the correct transformation ratios and precludes incidental phase modulation (usually resulting from variable loads). There are other satisfactory methods, such as transformer coupling; however, in the BHF-100A the 180 degree network provides greater tuning simplicity.

Each final power amplifier utilizes two ML-6697 air-cooled triodes in a grounded-grid configuration to produce 50 kw of carrier power and 200 kw of peak modulation power. The input of this stage consists of the output portion of the special 180 degree network with its output capacitance located directly between the two tubes. In addition to this capacitance, a shunt inductance is required at the high-frequency end of the spectrum to compensate for the high input capacitance of the tubes. This shunt inductance is also one arm of a neutralizing bridge which prevents incidental phase modulation.

A 90 degree network transforms the final output circuit from a constant-voltage source to a constant-current source, it is then combined in the common load with current from the other channel amplifier to produce AM. The combined output is fed through a section of the line containing a reflectometer to the balun for transformation from a single-ended 15-ohm output to a balanced output of 300 ohms. Electrically, the balun consists of a series-tuned resonant-primary circuit inductively coupled to a balanced parallel-resonant secondary circuit. In addition to serving as an impedance matching device, the balun also provides RF harmonic attenuation.

The remaining components of the transmitter such as power supplies, control circuits, protective devices and metering circuits are conventional and compatible with the high design criteria used throughout.

Special Electrical-Mechanical Component Design

Because of the wide frequency range of the transmitter and the high power level involved, many of the electrical components had to be designed and fabricated rather than purchased. Close cooperation between electrical and mechanical design engineers resulted in the use of new materials and ideas that have given good electrical performance and minimum product cost.

A major problem area in high-power transmitter design is to provide an economical trouble-free variable inductor. The approach used in the power amplifier and the balun of the BHF-100A has proven highly successful under actual operation. Basically, the line inductor consists of two sets of parallel 1½-inch-diameter hard copper tubing (Fig. 5), ranging in separation from 10 to 12 inches; the adjustable (sliding) shorting bar is made from 1½-inch-square hard-brass tubing of 0.060-inch wall thickness. By notching and slotting the contact area of the square tubing, fingers are shaped to provide good line contact along the entire path of travel. These fingers tend to have a leaf-spring action, creating a direct positive pressure on the copper line and reducing the possibility of joint-heating and resultant failure. With this configuration, five mechanical joints of the rotary-type inductor are reduced to two. Contacts are mounted in pairs on a melamine crossbar which is driven by a pair of chain-connected lead screws.

In addition to these contacts, a series-parallel switching arrangement in the lines allows a greater range of inductance. With this, the operator may change the set of four 1½-inch lines arranged on the corners of a 10- by 12-inch rectangle from series to parallel configuration. The mechanism is operated by a motor drive interlocked by limit switches and an overriding slip clutch.

The balun is situated between the two RF cabinets in an area 22 by 40 inches (Fig. 2). This system consists of three lines. The center one serves as a primary coil, and the two outer lines, either in series or parallel, serve as the secondary coil. Since the primary coil is completely surrounded by an electrostatic shield and shunt capacitance to ground is high, it is necessary to "trombone" this line (Fig. 5). By linking drives of the three movable shorts to a pair of lead screws inside the

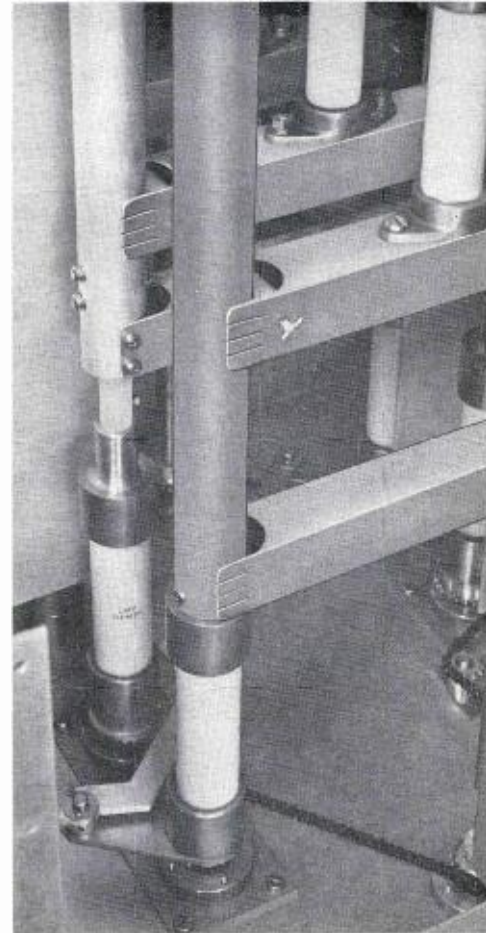

FIG. 5. Partial side view of balun, with electrostatic shield removed to show slide contacts in "trombone" section.

primary lines, the bottom of the primary line is allowed to slide over its upper portion. Thus, at the high-frequency end of the band, the volume of the coil is half that of the low end.

Since the only way to drive this collapsing line and derive maximum capacitance reduction is by having lead screws operating directly on the line, an insulating material with the correct properties had to be found. The lead-screw material chosen was polypropylene, which has electrical properties very similar to teflon, mechanical properties similar to nylon, and a cost about a third that of teflon.

Several other mechanical features were incorporated into the RF units. In mounting the power-amplifier tubes (ML-6697) in each channel, a Rexolite shelf was used

FIG. 6. Central control panel.

as the tube support. The mechanical strength of Rexolite (a cross-linked styrene co-polymer) is sufficient to support the 82-pound weight of the tubes. Rexolite has many other advantages in this application including its low dielectric-constant, low loss-factor and relatively high impedance to tracking.

As is usual in most transmitters, the cooling problem in the BHF-100A proved to be the power-amplifier tube anode glass-metal seal. The solution was to notch the plenum portion of the MI-6697 air distributor at its point of contact with the cooling fins of the tube. Thus, sufficient cooling air is channeled over the seal surface. The area between the two RF channels and the front of the combining network forms an air exhaust duct for the driver and power-amplifier tubes and houses the various tuning drives which terminate at the central control panel.

Central Control Panel

From the standpoint of the transmitter operator, the most important area of the transmitter is the central control panel (Fig. 6). The upper portion of the panel is devoted to the final-tube current meters and the read out indicators of the motor-driven inductors. Directly above the indicators is a roll chart containing tuning data for six precalibrated frequencies. Directly below the indicators are the motor operating switches for the inductor driving motors. Along either side of this panel are all the variable-capacitor tuning controls with their roll chart located directly in the center.

On either side of the vertical roll chart is a plate-to-cathode monitoring oscilloscope which indicates unity power factor or maximum efficiency of the final-amplifier tubes, and also the phase and loading status of the double- π network driving the final amplifiers. These oscilloscopes are direct-reading and so designed and constructed that from 3.0 to 26.0 mc there is less than 3 degrees differential between the vertical and horizontal deflection circuits.

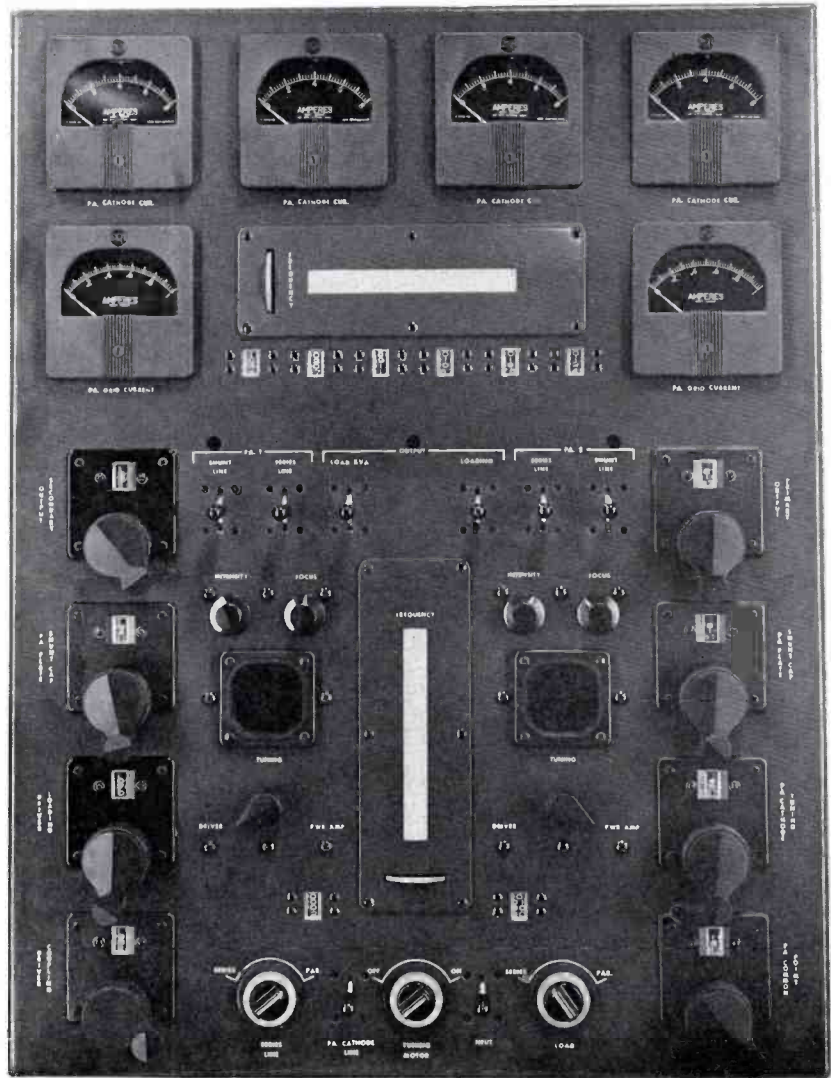

The deflection circuits also contain low-pass filter networks so that the straight-line fundamental indication on the scope will not be misread because of harmonic distortion.

Transmitter Performance

Seven of the type BHF-100A transmitters have been shipped to the international market and an eighth is presently set up

in Camden for further testing and demonstration. A typical set of data taken at 3.6 mc is given in Table at left, indicating the excellence of performance.

The application of the ampliphase concept to short-wave transmitters permits short-wave broadcasters the advantages that medium-wave broadcasters, using ampliphase transmitters, enjoy. Among these are: reduced floor-space requirements, greater efficiency, lower operating costs. Also, elimination of costly and bulky iron-core modulation transformers, superb audio at high modulation levels, and (often an important consideration) power increase without equipment obsolescence. As a matter of fact, equipment is now in manufacture for the diplexing of two 100-kw Ampliphase transmitters to provide 200 kw of power from a single r-f frequency source.

Transmitter Harmonic Distortion at 3.6 Mc
Hum & noise, 56 db; modulation capability, 100%

% of Full Modulation	% Harmonic Distortion at Test Frequencies						Carrier Shift, % @ 400 cps
	50 cps	100 cps	400 cps	1 kc	5 kc	7.5 kc	
25	1.4	1.2	1.2	1.3	1.5	1.7	0
50	1.4	1.1	1.2	1.4	1.8	1.9	0
85	3.0	2.2	2.3	2.4	3.2	3.4	0
95	2.0	2.0	2.0	2.0	2.5	3.1	0



RCA CARTRIDGE TAPE SYSTEM

Automatically Triggers Playback Units, Tape Recorders, Turntables, and Other Devices

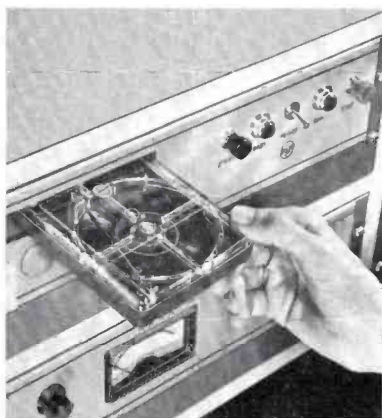

Here's a unique built-in feature! The Recording Amplifier of the RT-7B Cartridge Tape System generates two kinds of cue signals. One is used to automatically cue up each tape, at the beginning of a program, the same as in ordinary units. The other signal, a special Trip-Cue, can be placed anywhere on the tape. This will cause the playback unit to trip and start other station equipments.

You can preset two, or a dozen or more RCA tape units, to play sequentially. You can play back a series of spots or musical selections, activate tape recorders, turntables, or other devices

capable of being remotely started. (In TV use Trip-Cue is ideal for slide commercials. Tape announcements can be cued to advance the slide projector.)

You'll like the RT-7B's automatic, silent operation, its compactness, high styling, perfect reproduction. Cartridge is selected, placed in playback unit, forgotten until "air" time, then instantly played. Cueing and threading are eliminated. Cue fluffs are a thing of the past!

Transistor circuitry, good regulation for precise timing, low power consumption, are among other valuable features.

See your RCA Broadcast Representative for the complete story. Or write RCA Broadcast and Television Equipment Building 15-5, Camden 2, N. J.



THE MOST TRUSTED NAME IN ELECTRONICS

U.S. ARMY SIGNAL CORPS USES CLOSED-CIRCUIT TV FOR TRAINING

Signal School at Ft. Monmouth Employs 7-Channel System, With Modern TV Studios, Film, and Tape Facilities, to Bring Instruction, Information, and Briefings to 500 Class-Conference Rooms and to 10,000 Students Per Year

The year 1961 commemorated two enviable periods in U.S. Army Signal Corps history: A century of personnel training and instruction; and a decade of experience in the use of closed-circuit TV as an educational medium.

Pioneer in Educational TV

The U.S. Army Signal Center and School at Ft. Monmouth, N. J.—center of training for the Signal Corps—first acquired in 1951 a single-channel TV system to train technical personnel in camera operation and maintenance, and to train instructors in TV presentation techniques. Equipment consisted of an RCA field-type image orthicon camera wired to a single 16-inch receiver.

Within weeks, facilities were added and experimental instruction by TV began. Six

pairs of classes, one pair at a time, were taught radio electronics. Approximately 100 hours of the 230-hour course were presented over the closed-circuit TV channel. Classes averaged 20 students each and were taught by civilian instructors.

In May, 1952 additional TV facilities were acquired and TV as a teaching tool was applied to courses in radio, radar, photography, wire and fundamentals.

A research study of the project made by the Special Devices Center, Port Washington, L. I., under the supervision of Dr. Martin F. Fritz of Iowa State College, determined that TV could be advantageously integrated into the Army training program, and recommended that the Army make use of this new medium of communications.

TV No Longer An Experiment

As early as in 1953 the Signal School TV system had proved that it could do an important job in training military personnel. In fact, so satisfactorily so, that there followed a rapid growth of the TV facility, and in 1956 a permanent Educational Television Division was established within the Signal School to produce instructional and informational television programs.

TV's stature in training and instruction was further documented at Ft. Monmouth during dedication of the TV facility, WFM-TV, in 1959. "Television is no longer an experiment at the Signal School," said Major General A. F. Cassevant, then Commandant of the Signal School. "This new closed-circuit system makes it possible to put programs over the closed-circuit

FIG. 1. Typical TV studio scene at Fort Monmouth.

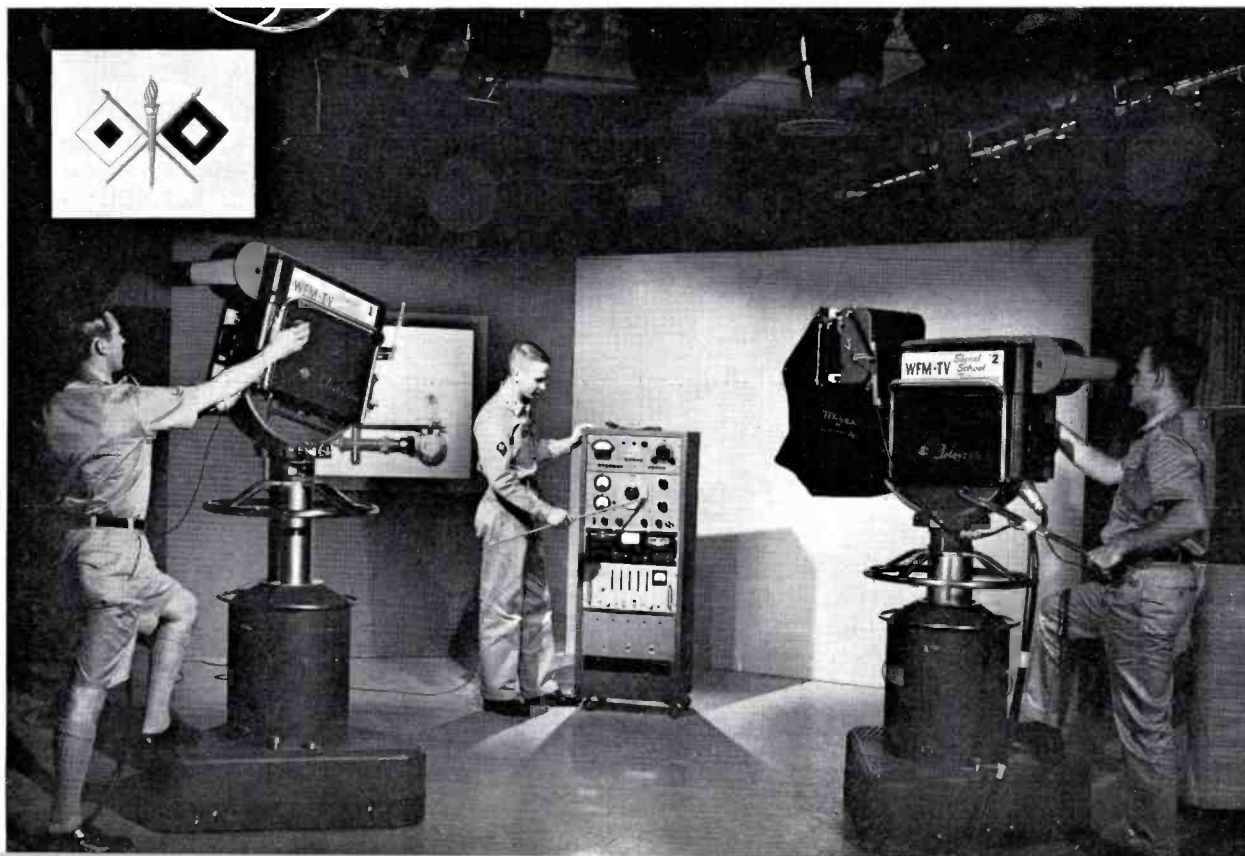

network for practically all of the Signal School's 65 communications courses."

Today, the School operates one of the Army's largest and most active educational television systems. A 7-channel TV facility extends from modern, well-equipped studios to almost 500 classroom and conference room receivers—and to five Post auditoriums where theatre-size TV projectors are used. An audience of 10,000 personnel. Virtually the entire Post can be reached at any one time by television for briefings or special programs, or in the event of mass mobilization.

Every year some 10,000 students receive training through the Signal School television system. These students consist of 8000 enlisted men and 2000 commissioned officers of the United States and allied countries. The Signal School produces 370 live programs and transmits 6000 film programs annually. Television is estimated to have saved the school 75,000 man-hours in 1960 alone.

The USASCS television facility functions much like a large television station. By Army regulations, however, its output is restricted to closed-circuit transmission or to exchange with other military installations via TV tape. There are presently ten other military TV centers utilizing TV as an instructional tool.

Extensive Instruction by TV

Presently, approximately 50 of the Signal School's resident courses, ranging in length from 10 to 52 weeks, utilize an average of 2½ hours of TV tape, film or kinescope recordings daily. Subjects cover a wide field of study, from equipment maintenance and fundamentals of electricity for enlisted students, for example, to "Career Courses" in Administrative Leadership, or "Specialist Courses" in Automatic Data Processing Systems or NATO Countermeasures (52 weeks each) for officer students. Classes of 20 to 25 students each have an instructor, and are held five days a week in combined lab and classroom facilities.

TV is used in three basic ways for instruction, depending upon the subject matter and nature of the course. It is used to supplement combined classroom and laboratory instruction by bringing into the classroom complex, time-consuming demonstrations, field applications of equipment, "follow-me" trouble shooting and adjustment techniques, "how it works" animations, and similar topics which cannot be taught effectively or efficiently within the conventional classroom.



FIG. 2. Typical TV classroom scene at Fort Monmouth.

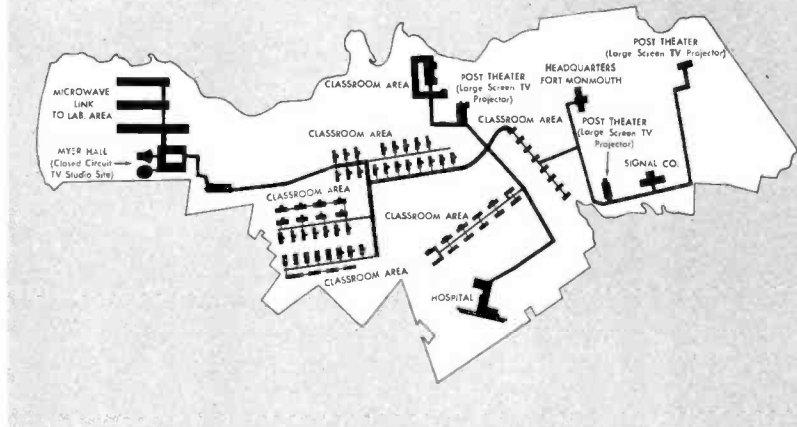

FIG. 3. Closed-Circuit Educational Television System at Fort Monmouth.

Several short courses specially designed by the School are taught *entirely* by TV. Such subjects include letter writing and counter-insurgency. A substantial part of a course in automatic data processing is taught by TV. Future plans call for the presentation and evaluation of complete TV instruction in radar and other subjects.

"Programmed" Courses

In another particularly effective method of teaching, TV is "programmed" with self-tutoring textbooks (prepared by the School). Students are introduced to each lesson by TV, as well as critiqued by TV during a self-test at the end of the lesson.

Programmed instruction lends itself to teaching basic electronics and other subjects where there is no change in material from time to time. Eight months' experience in teaching A.C. and D.C. fundamentals by this method has proved the value of TV not only as an instructional tool, but also as a means for shortening instruction time.

Instructor Training

Another major use of closed-circuit TV is in the Instructor Training Division of the Signal School. Here instructors learn to use TV effectively, as well as benefit from recordings of their own performance.

FIG. 4. Maj. Gen. Wm. D. Hamlin, Commanding General, Fort Monmouth, and Brig. Gen. Chas. M. Baer, Commandant, USASCS view new RCA TV system equipment. (L-R) Brig. Gen. Baer, Paul Bergquist, Mgr. CCTV Sales, RCA; Neil Vander Dussen, Sales Engineer, RCA, and Maj. Gen. Hamlin.





Each new military or civilian instructor trained to teach in the School can observe an immediate playback of his presentation by television tape. Selected "practice lessons" of 5, 10 or 30 minutes duration are picked up by RCA vidicon cameras, fed by cable to the WFM-TV recording room and taped on RCA TRT-1A TV tape machines. Following a classroom session, the tape is then replayed so that the instructor-trainee can observe and improve his teaching techniques.

Special TV presentations demonstrating instructional techniques are produced and recorded on tape or film by the Television Division for extensive use in training instructors.

"It is an enlightening experience for these men," said Mr. Entin, full-time civilian instructor for the Instructor Training Division, "to see and hear themselves on TV for the first time. Good teaching requires, among other things, a touch of showmanship. This they easily acquire with proper direction."

Instructor training courses run 8 hours per day, 5 days per week—for a total of 10 days or 80 hours. Included in the cur-

ricula is a course in Effective Speaking tailored to engineering people.

Training Films Viewed on TV

Most of the Signal School's training films, whether produced by the TV Division or obtained from other sources, are viewed in the classrooms via TV. As Walter E. Whitaker, former Television Coordinator, points out: "A television receiver costs less than an optical film projector. TV is easier to operate and permits students to view films, as well as live programs. Furthermore, students are in *lighted* classrooms where they can take notes." The TV system has also proved convenient in enabling instructors and supervisors to preview new training films as soon as they are received.

Information, Educational Programs by TV

Character guidance presentations by the Post chaplains, periodical programs by the safety officer, medical and health staff and similar groups are seen by students, staff and faculty via TV. Orientations of new students and visitors are frequently given by television. New policies, educational developments, short courses, command

FIG. 5. Closed-circuit television is also used for presenting command addresses, new policies, and daily newscasts to the widely dispersed staff and faculty of the Signal School and Command Post.

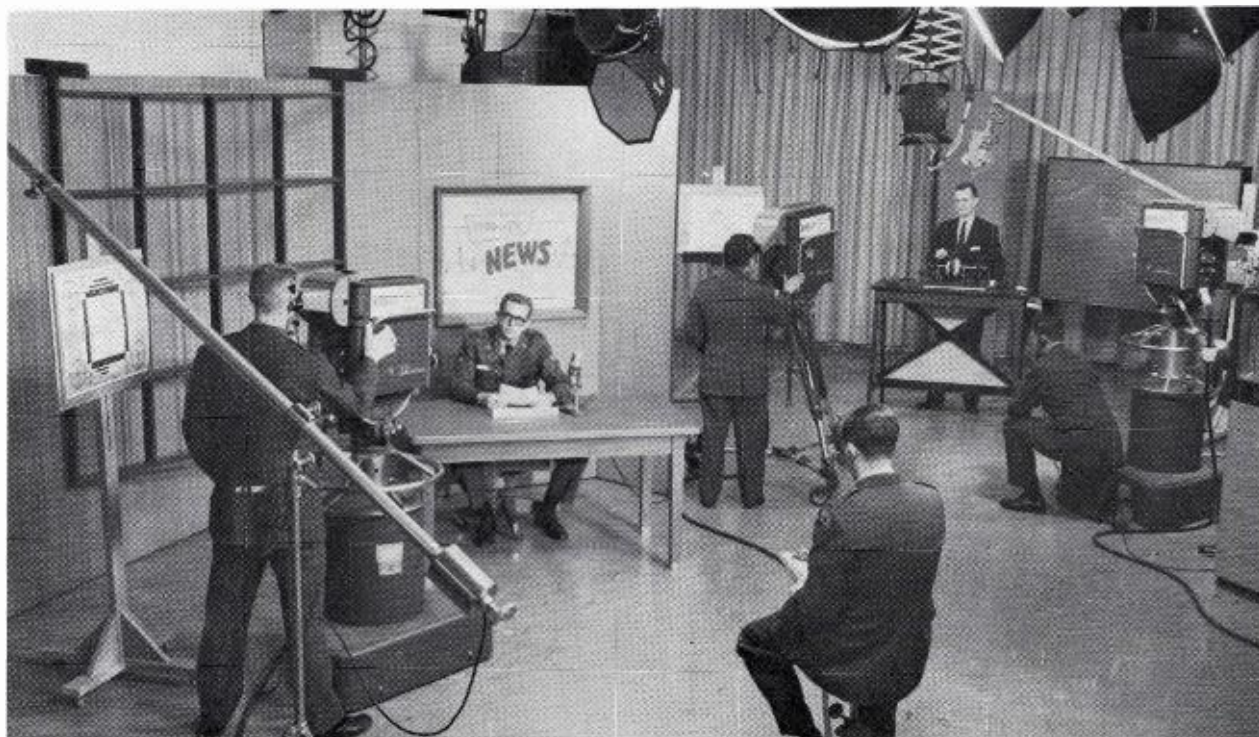

addresses and daily newscasts are delivered to the widely dispersed staff and faculty of the School through the closed-circuit system.

Taped addresses by high-ranking local and visiting military personnel are frequently prepared for viewing throughout the Post and for distribution to other educational TV centers. Briefings containing the findings of a team of leading Signal Corps research scientists have been prepared by integrating slide, chart, and background projection material into one taped program. This is reviewed and perfected, for presentation by one member of the group over a remote TV facility, thus saving valuable time and personnel.

Through off-air pickup facilities, special TV programs are either taped or "piped" live to selected viewing areas. Each of the "Continental Classroom" educational TV series, produced by the National Broadcasting Company, has been shown on the Fort Monmouth TV system for viewing by personnel in off-duty hours.

The trend at the School is toward more extensive use of TV during off-duty hours. Plans call for equipping troop housing areas for presenting courses in mathematics, physics, the languages, and special military activities. Also refresher courses for instructors, and even credit courses for schools and colleges.



FIG. 6. Six TV film chains are used to distribute training films to classrooms.

TV Repair and Maintenance Courses

TV is used to teach TV in the Communications-Electronics Division of the Department of Specialist Training. The Signal School conducts a 25-week course for television repair and maintenance technicians. The training, which has also been

given to Air Force and Navy personnel, proceeds from the simplest industrial vidicon TV system through receiver repair, image-orthicon monochrome cameras, film chains and microwave relay systems to an RCA image-orthicon color camera system and color receivers.

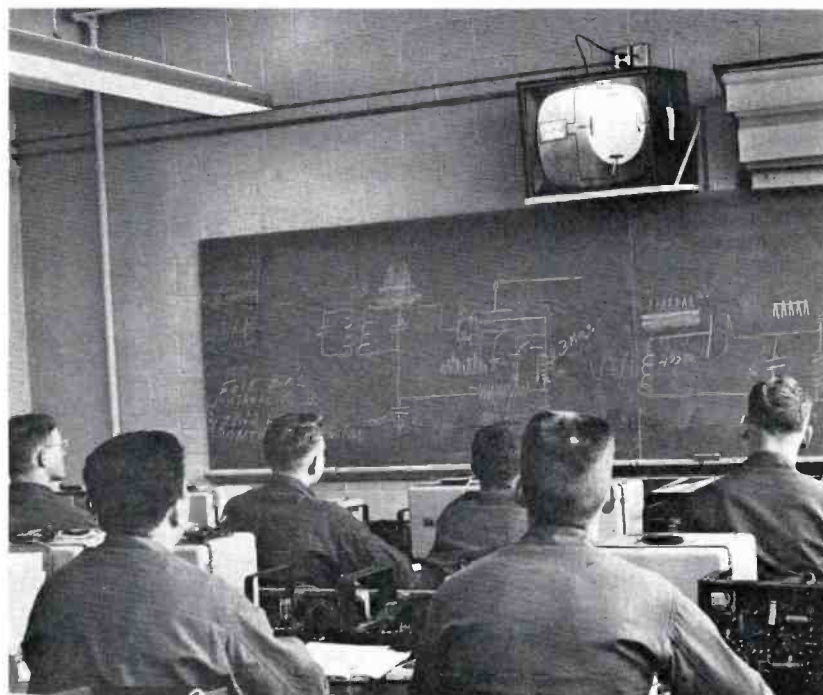

FIG. 7. Students can view training films via TV in LIGHTED classrooms, and without delay caused by setting up of projectors.

How Closed-Circuit Television Is Used

U.S. ARMY SIGNAL SCHOOL
FORT MONMOUTH, N. J.

- Supplementary Instruction
- Complete Instruction
- Programmed Instruction
- Orientations
- Information
- Staff and Faculty Hour
- Briefings
- Instructor Training
- Training Films
- Film Previews
- General Education

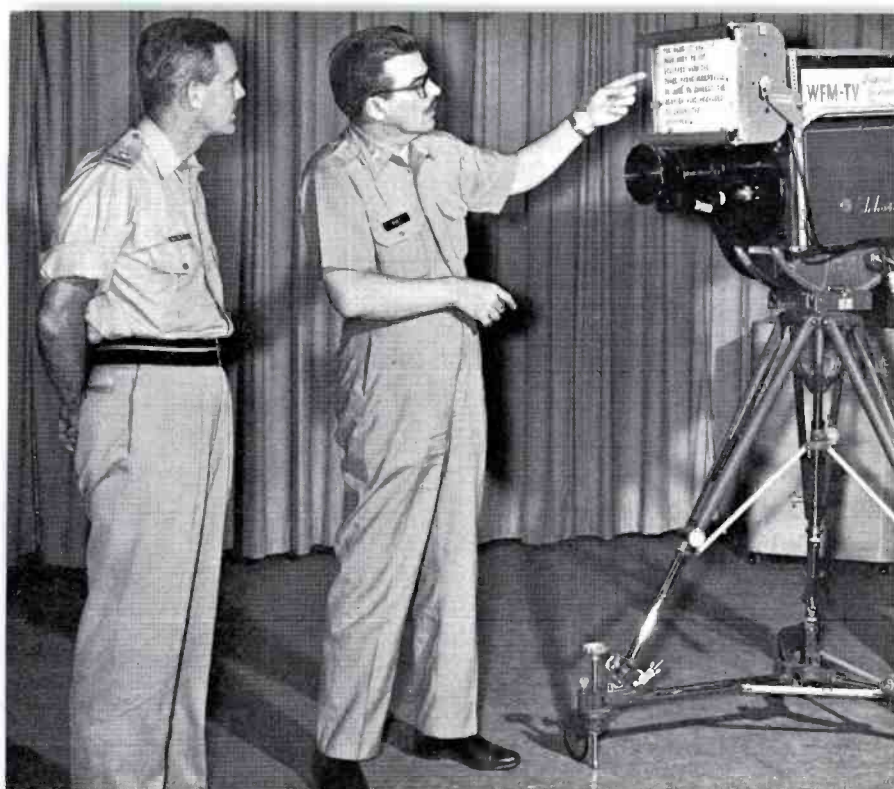

FIG. 8. Major Andrew G. Burt, Jr., (right), Chief of the TV Division, Office of Plans and Operations, explains WFM-TV's use of the Teleprompter to visiting Major Robert Maunsell, Royal Signals, School of Signals, Catterick Camp, Yorkshire, England.



FIG. 9. Walter E. Whitaker (left), Signal School Television Coordinator, discussing a new program with WFM-TV's Producer-Director, James Cast.

Students must qualify in maintenance and repair of every item of equipment used in Armed Forces TV facilities throughout the world. So thorough and effective is the course that many upon graduation have qualified for First Class Radiotelephone licenses. Graduates may be assigned to Army training, surveillance, briefing, or overseas troop information and troop morale stations.

WFM-TV Services and Staff

The WFM-TV closed-circuit TV system was established to provide educational television facilities and services to meet instructional needs of the various academic divisions and other official organizations of the Signal School and Fort Monmouth.

The Television Coordinator, Office of Plans and Operations, assists the academic departments in planning their television

requirements and advises the television staff on effective instruction by TV. He also is School television liaison with higher headquarters and with civilian agencies. Each academic division determines its television requirements, assigns instructors and technical advisers to write and present TV material.

WFM-TV is manned by the Television Division, Office of Plans and Operations, which also provides production "know how" to assist academic personnel in planning, staging and presenting their lessons through the video medium.

The Division encompasses administration, engineering and production branches and is staffed by a nucleus of civilian TV specialists and a majority of military personnel, many with previous experience in commercial television. Others are trained in the Signal School technical courses or on-the-job in the TV Division. Considering its size and complexity, WFM-TV operates with a minimum staff.

The Chief, TV Division is in charge of all divisional personnel and activities. He reviews all new programs for matters of policy, and assigns personnel and facility resources necessary for each program.

The Program Director is Chief of Programming. He works with agencies and other divisions in planning their programs, and in obtaining special training aids or other resources for their programs. He also

FIG. 10. Class in television camera operation and maintenance conducted by Ft. Monmouth Signal School.





FIG. 11. In TV repair studio, Greg Lentzakis (right), Chief Instructor, TV Repair Course, discusses aspects of course with Instructor, Sergeant Charles Peckham.



FIG. 12. J. J. Flanagan, Instructor, displays TV microwave equipment which is part of course in equipment operation, repair and maintenance.

supervises the scheduling of studio facilities and programs for viewing in the School or elsewhere on Post.

The Broadcast Supervisor assists the Program Director in scheduling programs for transmission to classrooms.

Engineering Branch

Under the direction of the Chief Engineer, the Engineering Branch of the TV Division staffs 20 persons and is responsible for the design, installation, operation and maintenance of the entire closed-circuit TV system, and for the procurement and training of technical directors, cameramen, film projectionists, video control operators, and other technical operating personnel.

Duties and responsibilities of Engineering Branch personnel are as follows:

The Chief Engineer is Chief of the Engineering Branch. He assigns and supervises all technical personnel associated with the operation and maintenance of WFM-TV equipment facilities. Distribution and receiving equipment is maintained by the Post Signal Officer.

The Technical Director, working closely with the Producer-Director, operates the video switching and fading facilities in the studio control room. He sets up visual effects and switches scenes on cues from the director. He also supervises technical quality of pictures in control room by video camera control operation.

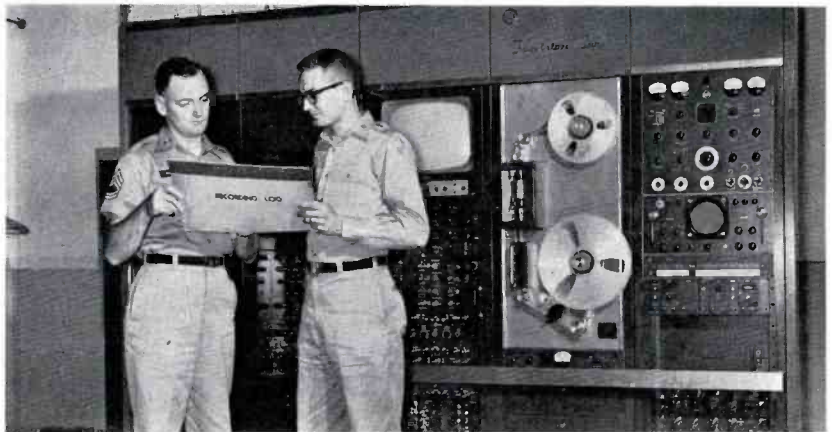

FIG. 13. Sergeant Charles E. Daniels, Chief of TV Tape Recording, checks the tape log with Lieutenant William B. Poe, Programming Officer of the TV Division.



FIG. 14. Chief Warrant Officer Darwin A. Koppie, Chief Engineer of TV Division, and Sergeant Richard Makowski, TV Specialist, observe video waveform in master control.



FIG. 15. At audio control console, Audio Engineer, Ralph Behringer "rides gain" during program rehearsal.

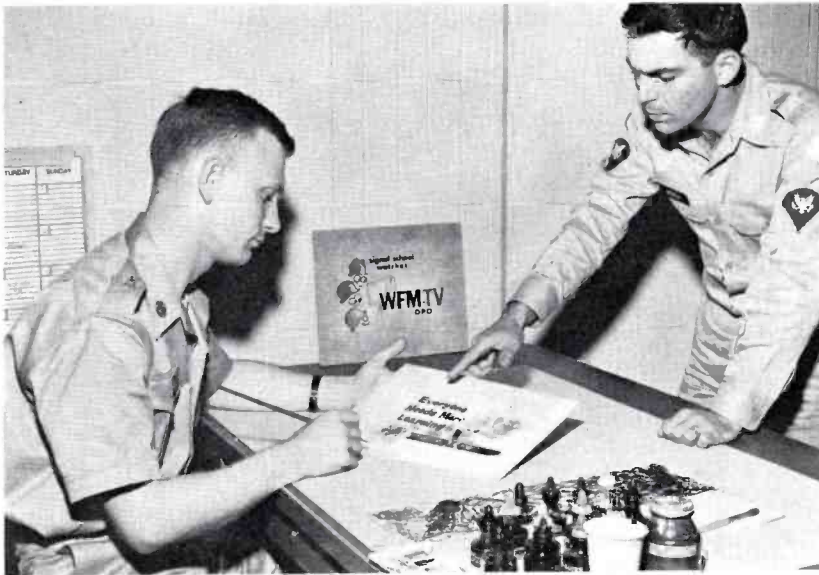

FIG. 16. WFM-TV has its own Graphic Art Department to prepare TV teaching aids. Illustrators Ed Cerullo and Lawrence Janiak prepare an opaque for TV transmission.



FIG. 17. Lt. William Hartnett, Production Officer, discusses a new production sequence with TV Director, Wm. Moody and Asst. Director, David Hopfensperger.

The Video Engineer controls the quality of the pictures transmitted by all TV equipment, aligns cameras, and assists in lighting prior to the program.

The Audio Engineer controls the quality of all sound on the program, sets up microphones, maintains correct volume levels, operates turntables, the audio console, tape machines and film sound controls.

Production Branch

The Production Branch, led by a Production Officer, staffs 22 people and trains program directors, script writers, studio floormen, narrators, artists, illustrators and others necessary to the production of TV programs. The duties and responsibilities are as follows:

The Production Officer is Chief of the Production Branch. He assigns and supervises all production personnel and facilities. He assigns studio equipment, props and other devices that the program requires, and reviews all production details of the program.

The Producer-Director advises in planning and preparing scripts, visual aids and materials. He stages the program, conducts rehearsals and advises on techniques of good production. He is in charge of the program and all TV personnel assigned to it.

The Floor Manager is the director's assistant in charge of the studio. He is responsible for having all scenery, props and

equipment in place. He gives cues for movement during the program.

The Cameramen maneuver cameras into position for good picture composition; they focus, change lenses, take cues from the director.

Professional TV Productions

Through a closed-circuit system, which means that programs are not broadcast for the public, WFM-TV creates and produces programs in much the same way as any large commercial TV station.

"We have the most modern facilities and a professionally trained staff, and we demand a high standard of quality in our TV productions," said Major Andrew G. Burt, Jr., Chief of the TV Division. Major Burt, who was cameraman for an Oscar-winning Signal Corps motion picture, is a veteran 35-year motion-picture cameraman with six years' experience in TV production.

Commenting on the type and availability of personnel, Major Burt said, "we have to find the people and train them. An advertising agency copywriter who joined us is now a director, narrator and actor, as well as a good writer. Similar examples could be cited for those on our technical staff. It's a golden opportunity for these people. No other place in the world can a student get across-the-board training for commercial TV."

Normal attrition of military personnel alone creates a problem in keeping WFM-



FIG. 18. View from main studio showing control room personnel in action during rehearsal, on elevated director's platform, and at the video control console.



FIG. 19. At the video console, Video Engineer, Malcolm Carr corrects camera shading while Technical Director, Owen Stofel observes the outgoing picture. Overhead monitors are for three TV cameras, Line and Preview.

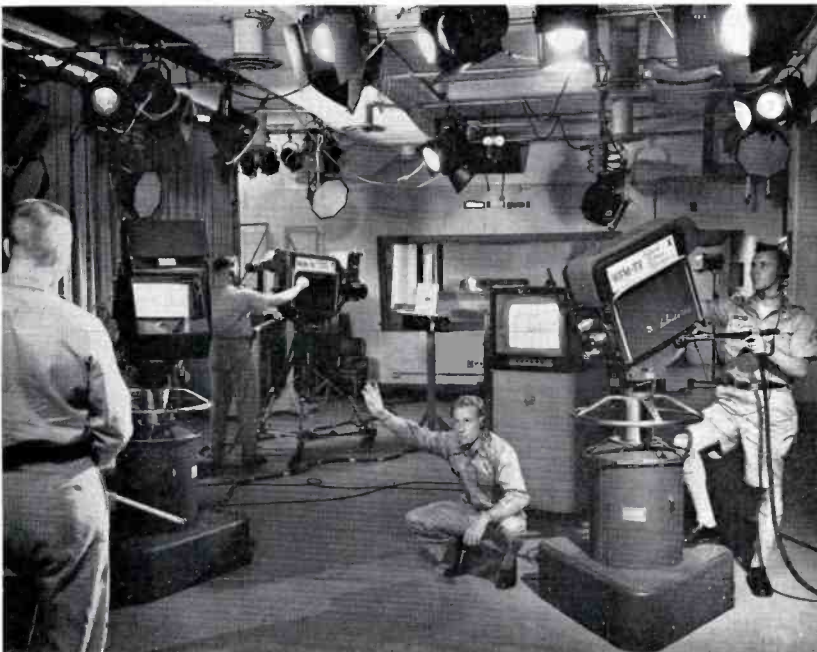

FIG. 20. View of studio as seen by instructor. Hand cue-signal is given by Floorman Gene Weiss while Cameraman James Dab (right) pans down to pick up view of subject. Cameraman Wm. Elenbaas (center) focusses on upcoming I.D. insert.

TV staffed. "We have a continuing need for people in all phases of TV production, particularly capable script writers," said First Lieutenant William B. Poe, formerly in TV production at KEFA-TV, Fort Smith Arkansas, and now Programming Officer of the TV Division. "Productive training hours for the School have increased tremendously in the last few years of TV operation. In fiscal 1962 alone we expect to complete 1400 hours of production time at WFM-TV."

WFM-TV Facilities

Studio, control and programming facilities of WFM-TV are located on one floor in a wing of Myer Hall, which also houses headquarters and administration offices.

There are two studios, each with a control room, a film-projection room, tape and kinescope recording room, master control, art and production departments, film-viewing area, and storage areas for scenery and props.

In an adjacent wing of the Hall are two classrooms which are used for training instructors in TV presentation techniques. These classrooms are equipped with vidicon TV cameras and are served by a centrally located control room.

TV material originating in WFM-TV can be transmitted simultaneously to a total of 485 TV receivers located in remote classroom areas and to 5 large-screen TV projectors in theatres and auditoriums throughout the Post.

7-Channel System

Transmission to receivers and large-screen projectors is over a 7-channel RF distribution system utilizing approximately 15 miles of coaxial cable, one of the largest such closed-circuit systems in use by any ETV facility.

At the sending end, program video and audio information from the TV switching system in master control modulates 7 separate RF transmitters which feed a 72-ohm, double-shielded coaxial cable with approximately one-volt of RF on each of TV channels 2, 4, 5, 6, 8, 10 and 12. At the receivers, the cable is wired to the RF front ends (modified for 72-ohm input), permitting selection of the desired RF channel for viewing. Broad-band, distributed type amplifiers are inserted at intervals in the distribution cables to maintain signal strength.

One additional RF channel is provided as a "house monitor" channel and is wired to selected administrative offices. Also available is a microwave system linking the Signal Corps Research and Development Laboratory, three miles away.

TV Equipment for Every Medium

Major TV units of WFM-TV comprise seven live camera chains, nine 16mm TV film projectors, a slide projector, two TV tape recorders, kinescope recorder, monoscope camera, step generator and off-air TV receiver. These facilities provide a total of 18 video program sources.

"WFM-TV, as it is today, is an outgrowth of our informational and instructional program requirements," said Chief Warrant Officer Darwin A. Koppie, Chief Engineer of the TV division and designer of the WFM-TV system. These School programs now utilize every medium known to commercial TV, including live pickup, tape, kine, films and slides. Then we have the additional requirement of a 7-channel distribution system to make the maximum number of our program sources available to classroom needs."

Studios and Control Rooms

The main studio is 22 by 50 feet equipped with three TK-11B studio cameras, rear screen projection equipment, and extensive lighting facilities. It is used for live pickup of presentations by Post personnel and instructors. Flip charts, animations or other devices may be used in whole or in part for informational and instructional programs.

Teleprompter units for the cameras aid personnel in making their presentations from prepared scripts. TelePro 6000 and Cellomatic rear screen equipments project transparencies, film strips, opaques and similar materials on a 9 by 12 foot screen for camera pickup and integration into the program. This equipment also permits optical animations and wipes. "Limbo" (separation) shots are made on a black section of the acoustic curtains in the studio.

The Studio A control room contains the camera controls, a TS-11A video switcher,

FIG. 21. Floor plan Ft. Monmouth Educational Television System.

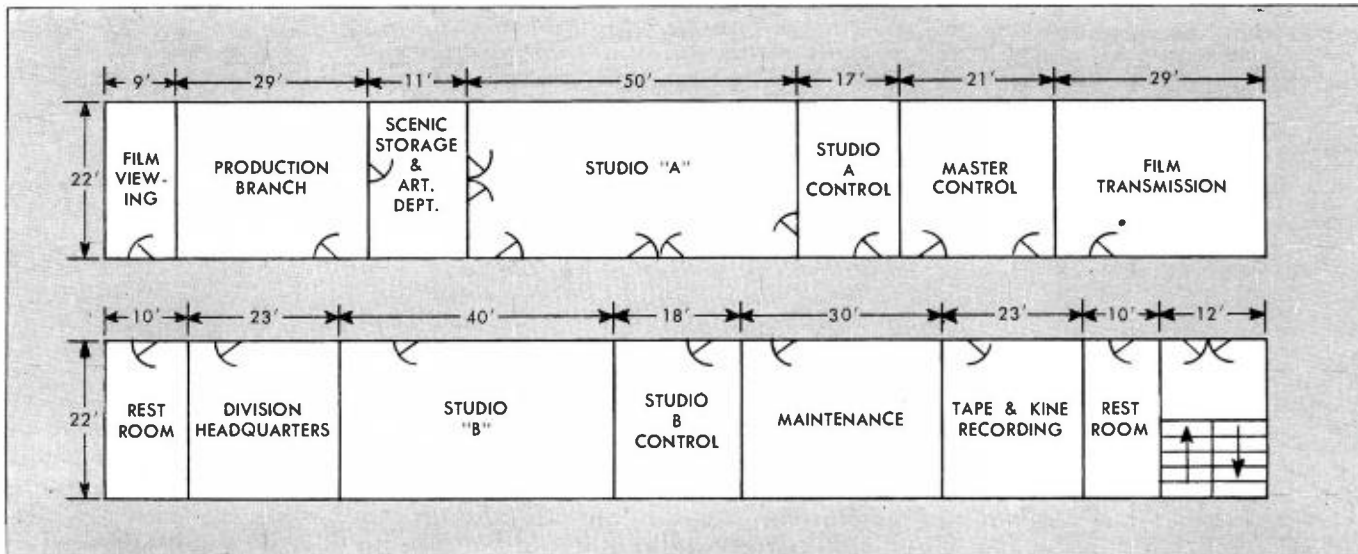

Equipment Employed in Ft. Monmouth CC-TV System

Except for the color TV studio facility and the monochrome TV instruction classrooms, which are used to train students in the operation and maintenance of color and monochrome equipment, the television equipment listed below is directly associated with WFM-TV activities:

STUDIO A

- 3—TK-11 Studio I.O. Cameras
- 1—Taylor-Hobson Studio Varatol II
- 3—Teleprompter Systems
- 2—21" TV Monitors
- 1—TelePro 6000 Rear Screen Projector
- 1—Cellomatic Rear Screen Projector
- Eastern and Century Lighting
- Century Dimmer Consoles

STUDIO A CONTROL ROOM

- 3—TK-11B Camera Controls
- 1—TS-11A Video Switcher
- 4—WP-15B P.S.
- 4—TM-6C Master Monitor
- 5—TM-7AC Preview and Line Monitors
- 1—76B Audio Console
- 2—Audio Turntables
- 2—Audio Tape Recorders
- 1—Multiplexer Remote Control Panel

STUDIO B AND CONTROL ROOM

- 2—Image-Orthicon Field Type Cameras
- 2—Field Camera Controls
- 1—Field Type Switcher & Sync Gen.
- 1—BC-5B Audio Console

FILM PROJECTION ROOM

- 8—TK-21C Vidicon Film Cameras
- 2—TP-6DC 16mm TV Projectors
- 1—TP-7A Slide Projector
- 1—TP-15 Universal Multiplexer
- 7—TP-16F 16mm TV Projectors
- 8—TM-7BC Film Line Monitors
- 8—TM-6C Master Monitor
- 1—Multiplexer Remote Control Panel
- 4—WP-15B P.S.
- 2—WP-16B P.S.

MASTER CONTROL ROOM

- 1—Video/Audio M. C. Switcher
- 2—TS-2A Video Switchers
- 1—TM-6C Master Monitor
- 7—24" TV Receivers (RF Line Monitor)
- 1—Off-Air Pickup TV Receiver
- 2—BI-5A VU Meter Panel
- 1—Audio Tape Recorder
- 7—Modulator/RF Transmitters
- 2—TG-2A Sync Generator
- 6—TA-4A Pulse D.A.
- 6—TA-3B Video D.A.
- 7—TA-3C Video D.A.
- 1—TK-1C Monoscope Camera
- 1—Step Generator
- 8—WP-15B P.S.
- 1—Microwave-Link

RECORDING STUDIO

- 2—TRT-1A TV Tape Recorders with Pixlock and Air-Bearing Headwheels
- 1—Kinescope Recorder, 16mm

CLASSROOM AND AUDITORIUM RECEIVERS

- 485—21" and 24" Classroom TV Receivers (modified for 72-ohm input)
- 5—PT-100 Theatre-Size TV Projectors

INSTRUCTOR TRAINING STUDIO

- 2—TK-202 Vidicon TV Cameras (with Remote Pan & Tilt)
- 1—TG-21A Studio Sync Generator
- 2—TM-35 Master Monitors (Rack-mounted)
- 2—BN-6B Transistor Portable Remote Amplifier
- 2—Audio Tape Recorders

COLOR TV INSTRUCTION STUDIO AND CONTROL ROOM

- 1—TK-41 Color TV Camera
- 1—TM-21B Color TV Monitors
- 1—TK-41 Camera Control Console
- 1—Audio Console
- 1—Audio Turntable
- 6—21" Color Receivers

TV INSTRUCTION CLASSROOMS

- 2—TK-30 Field-Type Camera
- 4—TK-31 Field-Type Camera
- 2—TS-30 Field Switcher
- 2—TG-10 Field Sync Generator
- 1—TM-5 Master Monitor
- 1—TM-6C Master Monitor
- 1—TVM-1A Microwave System
- 2—BC-3C Audio Console
- 6—ITV-6 Vidicon Camera Chain

FIG. 22. Block diagram showing the inputs to, and outputs from, master control.

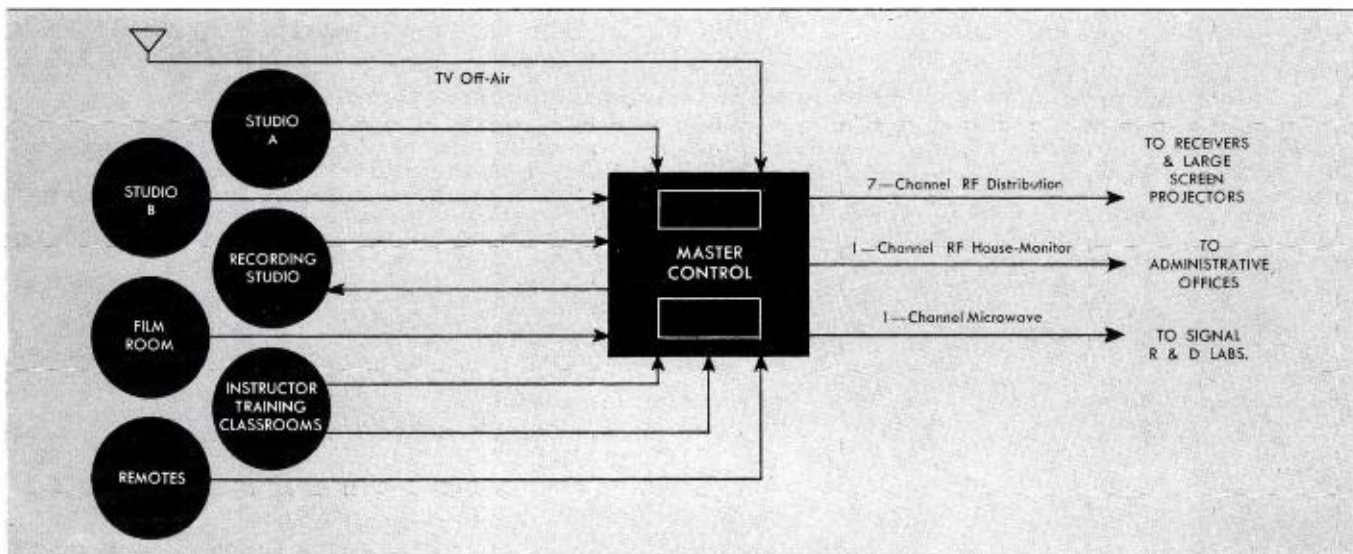

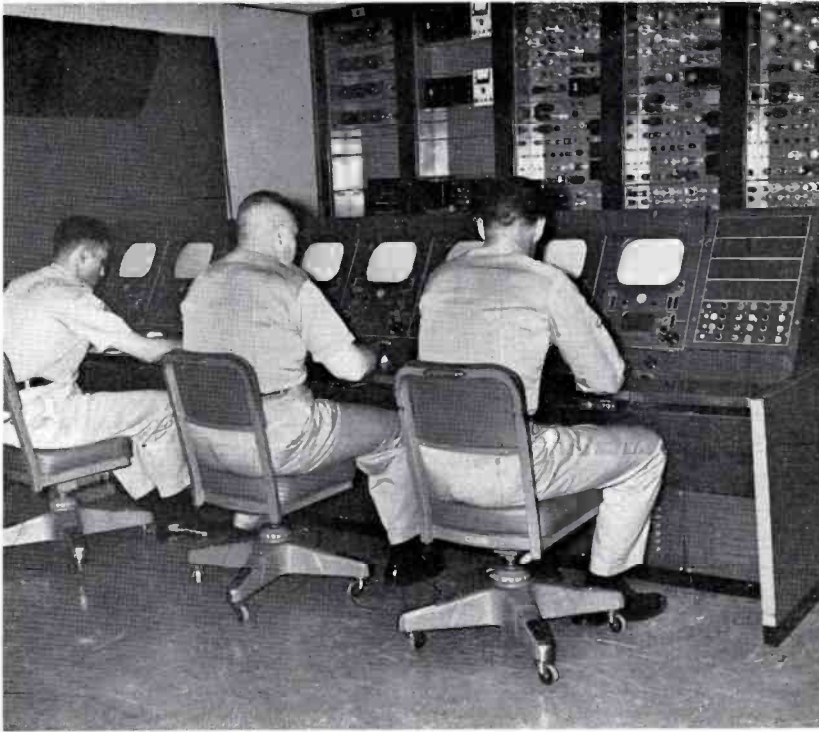

FIG. 23. Control console for comprehensive 7-channel film system.



FIG. 24. CWO Darwin A. Koppie, Chief Engineer of TV Division re-loads the TP-7A slide projector.

TV monitors, a 76-B audio console, turntables, and two audio tape recorders. The switcher permits instantaneous selection of camera, fading or dissolving between pictures and superimpositions.

Studio B is 22 by 40 feet and also has a separate control room looking into the studio. This studio contains two field-type cameras as well as lighting and audio facilities. It is used primarily for rehearsals and special programs when Studio A is in use. The control room contains field-type camera controls, a field switcher, sync generator and a BC-5 audio consolette.

Instructor Studio/Classrooms

The two instructor classrooms, where student instructors observe and practice TV teaching techniques, are located at opposite ends of a control room which looks into both classrooms. Students are present when student-instructors deliver their lectures.

Microphones mounted to pick up the instructor's voice and special lighting are the only equipment facilities in the practice classroom. The control room contains two TK-202 vidicon cameras, each equipped for remote pan and tilt, two rack-mounted TV master monitors and two audio tape recorders. Duplication of control room equipment permits both classrooms to operate simultaneously. Video output of these classrooms is fed to TV Tape Recording studio (via Master Control).

TV Film Projection Room

TV film projection facilities are installed in a room 22 by 29 feet and comprise seven unplexed 16mm TV film chains, two professional 16mm TV projectors multiplexed with a 2 by 2 slide projector, and associated camera controls and TV monitors.

The seven individual 16 mm film chains provide TV material (through master control) for each of the seven distribution channels of WFM-TV. This leaves the multiplexed slide projector and two 16mm Professional projectors free to support the live studios with continuous film and slide material for integration into programs.

Master Control

Master control facilities are located in a room 21 by 22 feet and consist of seven 24-inch TV receivers used as RF line monitors, an off-air pickup TV receiver, TK-1C Monoscope camera for test pattern I.D., a step (gray scale) generator, two TS-2A video switchers, seven modulator/transmitters to produce the seven RF channels, an audio tape recorder, and a microwave link.

Master control is the center of all program selection and switching to desired distribution channels. Guided by a "master schedule," the operator selects from a total of 18 incoming video programs, and routes them at designated times to the proper RF channels or to the recording studio. Switching is accomplished by a custom-built relay system which provides simultaneous switching of video and audio.

Recording Studio

The recording studio contains two TRT-1A TV tape recorders, a 16mm kinescope film recorder, a dark room, and storage areas for processed tapes and films.

Most of the TV material produced by WFM-TV is recorded on TV tape, either for storage or immediate playback. Film recording is used in conjunction with tape recording when extra copies are needed either for exchange with other Post facilities or for playback on TV projection equipment. Tape and film recordings are made simultaneously to provide first-generation copies. One of the two TRT-1A TV tape recorders is equipped with a Pix-lock device, which permits integrating fades, dissolves, wipes, superimpositions and other effects into the master tape.

Color TV Instruction Studio

The Signal School maintains a professionally-equipped and operating color TV studio and control room which is used exclusively for training students in the operation and maintenance of color TV receivers and studio equipment.

Equipment for this purpose consists of a TK-41 color TV camera, TM-21B color TV monitor, TK-41 camera control console, six 21-inch color TV receivers, audio console and audio turntable.

Students, many of whom have been trained by the facility for operation and maintenance of military color TV systems throughout the country, are taught the fundamentals of color TV theory, set-up and adjustment of color TV camera systems, studio lighting for color productions, and equipment repair and maintenance.

WFM-TV "Planning Guide" for ETV Programs

Supplementing the assistance given by the Television Division Staff, a "Television Planning Guide" has been prepared by Office of Plans and Operations of the Signal School for use by Post agencies and divisions wishing to utilize WFM-TV facilities for preparation of informational and instructional programs.



FIG. 25. Master control console, where pictures are selected for transmission on each of WFM-TV's seven channels.

Subjects covered by the booklet include what has been learned about "TV as a Medium of Training," the "Advantages and Limitations of TV," what to consider in "Planning Educational TV Programs," "Writing an Educational TV Script," "Selecting Good Illustrations," suggestions in "Presenting ETV Programs," and many others, plus a detailed description of WFM-TV facilities and capabilities.

Selecting TV Program Participants

Sponsoring organizations are expected to provide technical advisers and/or television instructors (participants) for all TV programs which the organization wishes to present. In instructional programs, the technical adviser assists in the planning

and preparation of program content; the same individual or another in the organization presents the program on TV. Programs to be used in several courses or for several divisions require joint planning by technical advisers from each of the academic areas.

Certain factors are considered in selecting participants: How well he knows his subject; classroom teaching experience; TV personality requirements such as reasonably good speaking voice, warmth, good grammar and good diction; and whether he will have time to participate in the planning and preparation. TV techniques can be learned by most experienced classroom instructors in relatively short time.

FIG. 26. Two TV Tape recorders are used for recording and playback of training programs. Video Specialist, R. C. Gustafson operates recorder.

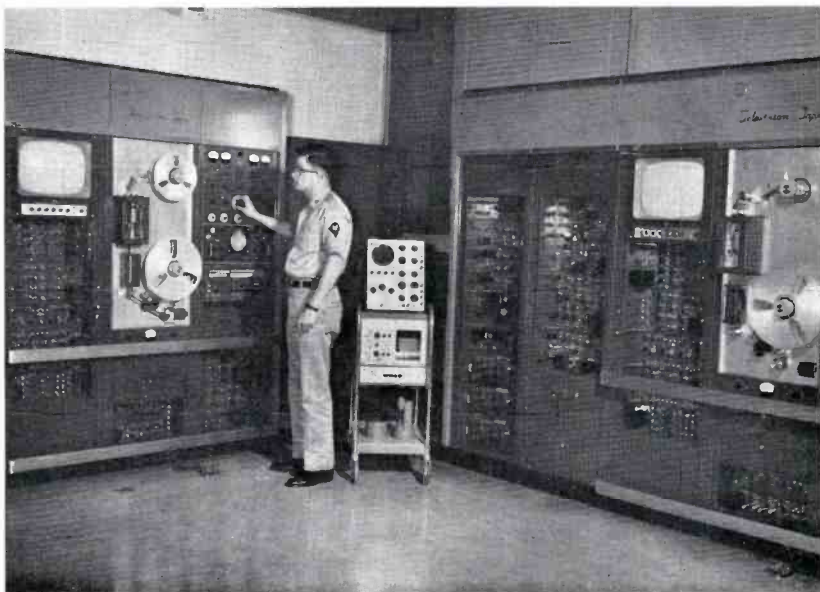

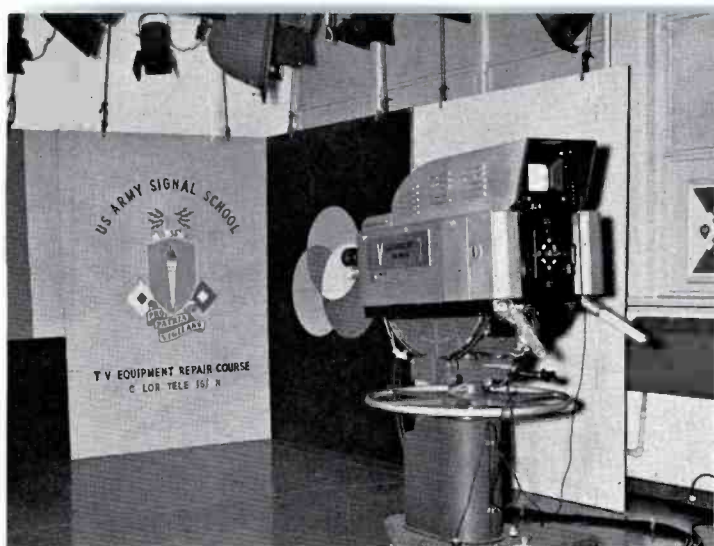

FIG. 27. Color TV studio utilizes TK-41 color TV camera chain, color backdrop and overhead lighting for instruction in the fundamentals of color TV setup and operation.



FIG. 28. Camera control console and 24-inch color monitor in control room of color TV instruction studio.

How WFM-TV Produces an ETV Program

When the academic division has completed general plans for its TV program and has selected technical advisers and instructors, or participants to work with TV Division personnel, detailed preparation of the ETV program begins.

1. The sponsoring division prepares, with the help of a TV staff writer, a written script so that the TV director and crew members can follow the presentation. For instructional pro-

grams, the script is normally a good outline, with instructions regarding demonstrations, use of visuals, planned movement and important cue lines.

2. The script is then discussed with the producer-director to be sure all the information he requires is included.
3. The script is then "blocked," or marked by the TV director for cameras, lenses, cues, etc.

4. Necessary graphics and visual materials are then prepared by a TV Division illustrator. Complex materials are prepared by the Training Aids Division.

5. Program is rehearsed and taped.

The program is then scheduled for transmission and documented in a regularly published "TV Program Schedule" which gives the MOS (Military Occupational Specialty), the time at which the subject matter will be shown, and the channel on which it can be seen.

FIG. 29. Students in the 2-week color phase of a 25-week course for TV equipment repair. These students must be prepared to rectify any malfunctions.

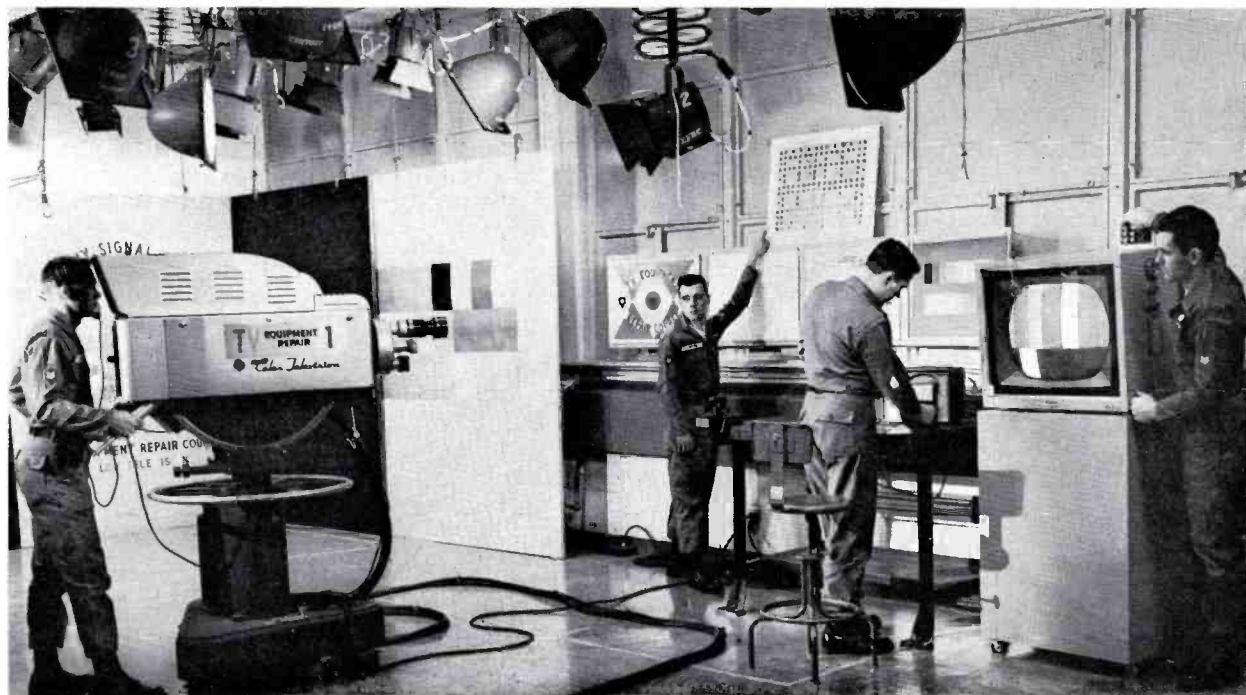

Advantages of TV in Instruction

TV provides the following technical advantages not readily available in normal classrooms:

Gives close-up magnification of small objects so that each student has a "front-row" seat.

Changes perspective instantly from wide angle to close-up.

Allows comparison of two or more illustrations at the same time.

Eliminates distraction; directs student's attention to essential detail.

Allows use of actual pieces of small equipment for illustration rather than large and costly "mock-ups."

Brings "live" or recorded views of equipment and demonstrations from remote locations into lighted classrooms.

Allows integration of films, slides, graphics, special training aids into TV presentations.

Saves time and effort of moving personnel to theatres to view films, or to remote locations for demonstrations. Saves time of setting up film projection equipment.

TV provides enrichment of training:

Increases use of visual and training aids.

Increases interest and understanding of students.

Provides a common grounding of all students in certain fundamental subject areas.

Gives classroom instructors an opportunity to observe presentation techniques of other instructors, and to observe students while they are watching a TV presentation.

Allows the instructor more time to teach applications of complex subject matter initially presented by TV.

Future Plans

WFM-TV plans are for the eventual expansion of production facilities and personnel. Modernization and expansion of the smaller TV studio is presently under way.

The most recent equipment addition was the installation of Pixlock on one of the two TV tape recorders. "This has proved to be an invaluable tool in the integration of pre-recorded segments of taped information into live productions," said Warrant Officer Koppie. "We now have the right kind of equipment, but we could use more of it."

By the end of fiscal 1962, WFM-TV expects to complete 4500 hours of tape and film transmission for classroom use.

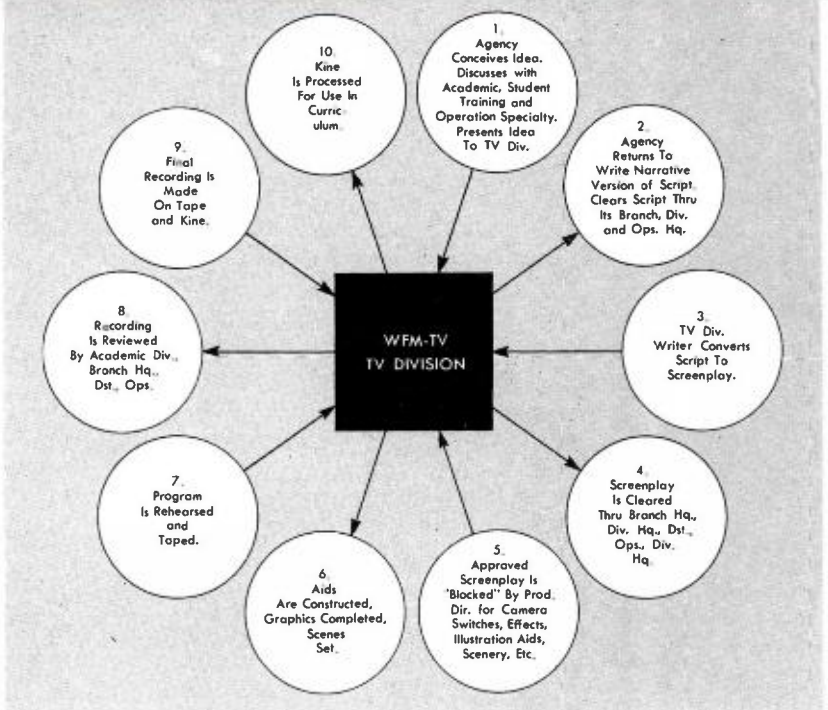

FIG. 30. Steps in the evolution of a typical educational television program.



FIG. 31. An instructor points out small parts of electrical equipment as camera sends it out over closed-circuit TV. Monitor at left shows the result. Thus, students in classroom get excellent view of subject.

HISTORY OF TV AT USASCS

- 1951 U.S. Army Signal School acquired a field-type, image-orthicon TV camera for experimental training by TV. TV classroom instruction in radio electronics was begun on 27 September.
- 1952 The School acquired a second TV camera, and added TV courses in radio, radar, photography, wire and fundamentals.
- 1953 The School instituted a program of expansion to include new facilities in Myer Hall, a 3-channel closed-circuit distribution system, two new image-orthicon cameras, two 16mm film projection systems and a 16mm kinescope film recorder.
- 1956 Educational Television Division was established to produce instructional and informational TV programs.
- 1958 TV system further expanded with addition of three image-orthicon cameras, four 16mm vidicon film projection chains, new audio system, directors console, studio accessories and 7-channel RF distribution system.
- 1959 Dedication on 6 February of Signal School Closed-Circuit Television System, WFM-TV. Staff and functions of TV Division increased.
- 1960 Addition of two TV Tape recorders, and air-conditioning of studios and control rooms.
- 1961 Addition of two 16mm vidicon film projection chains and multiplexer system with two professional film projectors.



TOMORROW?

From RCA Research on the Highway of the Future Comes Today's Vehicle Detector...the RCA VE-DET!

Engineers at RCA's Princeton Laboratories have for some time been operating an experimental "electronic highway," an integral component of which is the "VE-DET" detector. Proved under the most rigorous conditions, this compact transistorized sensing device, with its own power supply, is designed to operate in conjunction with a loop of wire buried in the road's surface.

The "VE-DET" system produces a signal when any moving vehicle passes over the imbedded wire

Distributed nationally through the Data Reduction Division, Fischer-Porter Company, Warminster, Pa. For literature write to RCA Industrial and Automation Products, Dept. H-442, 12605 Arnold Avenue, Detroit, Michigan.

loop. This system is now in use, providing automatic vehicle detection for traffic signal actuation, vehicle counting, parking and other applications.

The "VE-DET" system operates equally well in all types of weather. It is extremely accurate, easy to install, and inexpensive to maintain. Since the loop is imbedded in the road, it is not subject to damage by plows, or cars, or resurfacing. One power supply will handle up to four detectors.



**THE MOST TRUSTED NAME
IN ELECTRONICS**

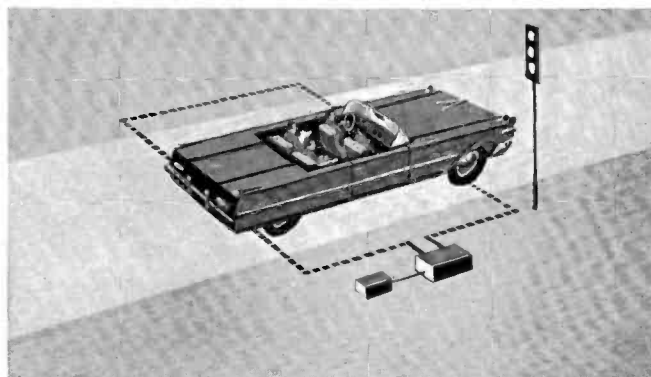



The Mark of **COLOR** Leadership

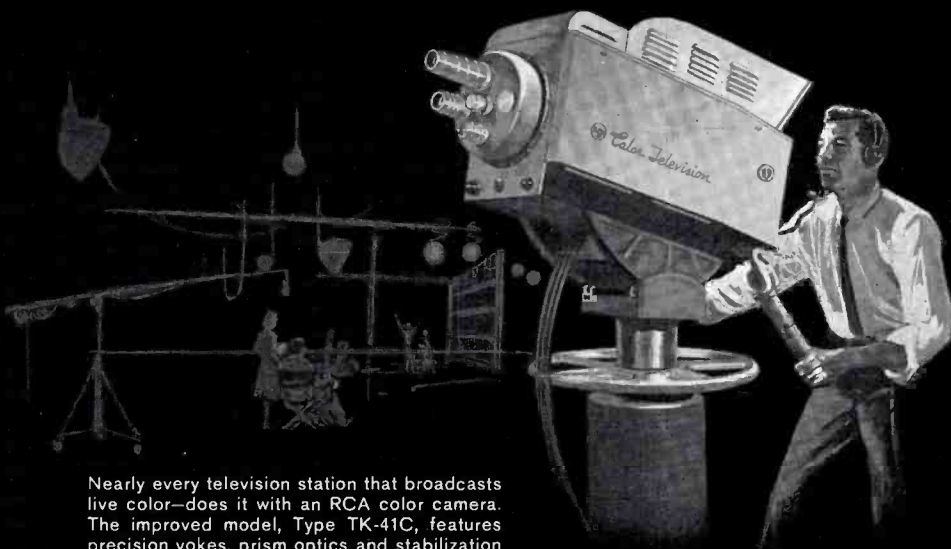

Nearly every television station that broadcasts live color—does it with an RCA color camera. The improved model, Type TK-41C, features precision yokes, prism optics and stabilization of all critical control circuits. These features assure precise registration of colors and unmatched resolving power. The result is living color performance.



The Most Trusted Name in Television



See All-Star and World Series Baseball, All-Star Golf, and other top events in color!

Almost like being there! New RCA VICTOR **COLOR TV** is so lifelike you have to see it to believe it!



THE COVENTRY, \$950.00. See Walt Disney's "Wonderful World of Color" Sundays, NBC-TV Network. ©1961 Walt Disney Productions



Only RCA Victor makes the Color TV that's been *performance-proved* for 7 years in American homes from coast to coast. Result: reliability and quality you can count on, plus color so lifelike *you have to see it to believe it!*

Only RCA makes the amazing new Color TV picture tube, adopted as the standard by the entire industry. And, RCA Security Sealed Circuits are *precision-crafted* circuit boards . . . replacing many old-fashioned all-hand-wired circuits in every set! The super-powerful New Vista Tuner pulls in clearer pictures from

many hard-to-get stations. "Wireless Wizard" full-function remote control, available on many models, controls color, tint, and turns the set *completely* off!

Choose from many fine furniture styles, from \$495.00 (The Bromley, not shown). See your RCA Victor Dealer now!

Nationally advertised prices shown, optional with dealer. Slightly higher West, South. UHF OPTIONAL, EXTRA. Prices, specifications subject to change.

Tmk(s)®



The Most Trusted Name in Television