

# BROADCAST NEWS

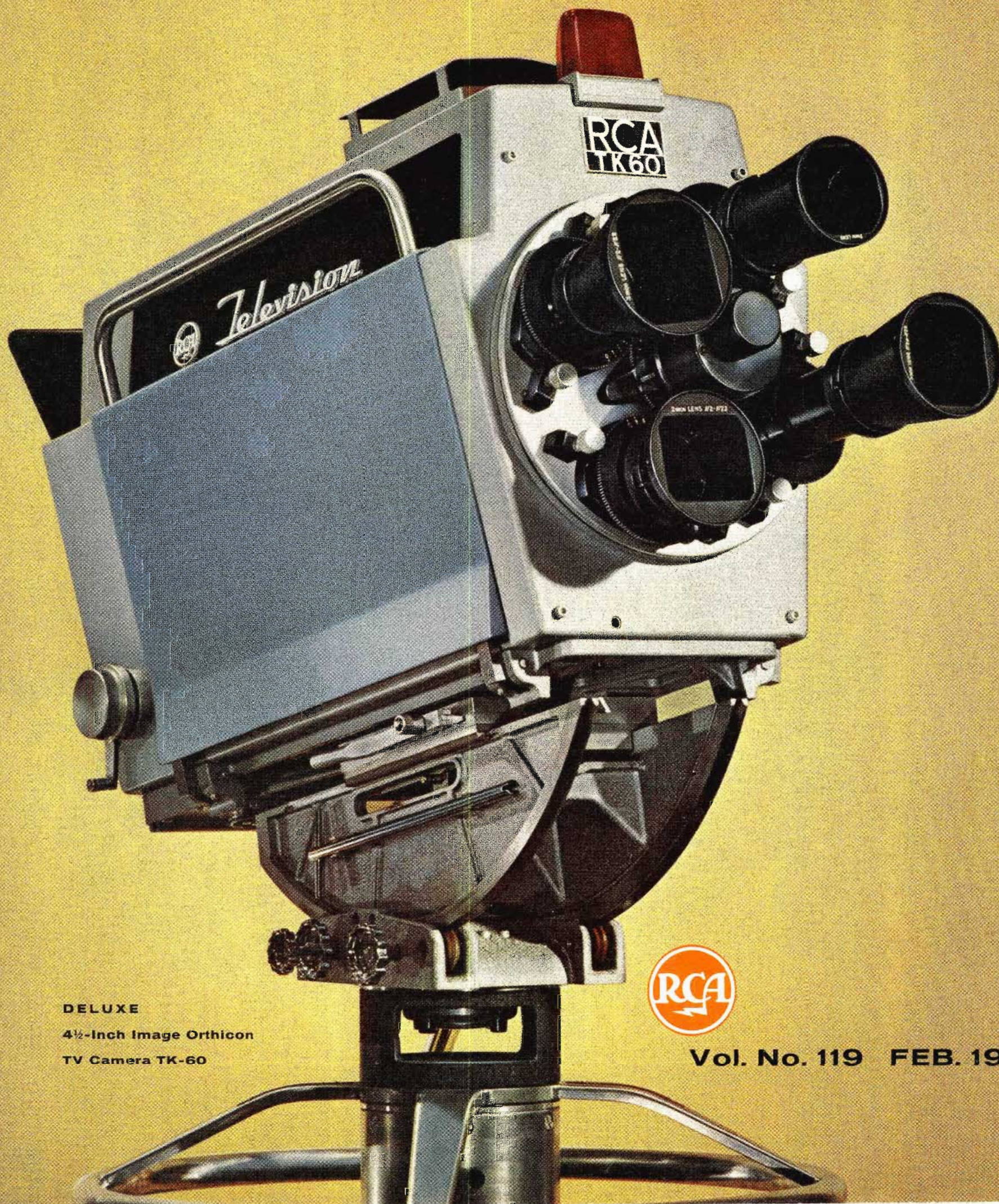

**DELUXE**  
4½-Inch Image Orthicon  
TV Camera TK-60



**Vol. No. 119 FEB. 1964**



quadruplex  
new TV Tape Recorder

Compact... completely transistorized...  
compatible recorder at a budget price!



NEW TR-4

You can change your sights on low-cost TV taping equipment—it doesn't *have* to be incompatible! For the first time you can have budget equipment that's completely compatible with all standard quadruplex recorders. Fully transistorized for compactness and dependability, the TR-4 provides professional broadcast quality. This is a complete quadruplex machine for both record and playback. It's standardized and modularized for ease of installation and simplicity of operation. Uses standard modules (like those used in RCA's deluxe TR-22 Recorder). Has space for color modules. A compatible recorder at a compact price! Completely contained in one 33" x 22" x 66" unit.

*See the TR-4 before you buy something less!*

RCA Broadcast and TV Equipment  
Building 15-5, Camden, N.J.



THE MOST TRUSTED NAME IN TELEVISION

# BROADCAST NEWS

published by

**RADIO CORPORATION OF AMERICA**

BROADCAST & COMMUNICATIONS PRODUCTS DIVISION, CAMDEN, N. J.

issued quarterly

PRICE *in U.S.A. - - - - - \$4.00 for 4 issues*  
*outside U.S.A. - - - \$5.00 for 4 issues*

## CONTENTS

	Page
MANAGEMENT TV AT AIR FORCE SYSTEMS COMMAND . . . . .	10
AMPLIPHASE . . . FOR SUPER-POWER AM TRANSMITTERS . . . . .	24
EFFECTS OF SIDE-MOUNTED FM ANTENNAS . . . . .	30
TECHNICAL FACILITIES FOR EFFECTIVE PROGRAMMING AT WBAL-TV . . . . .	34
COLOR SEMINAR PAPERS:	
PART III, HANDLING THE COLOR TV SIGNAL . . . . .	48
PART IV, MICROWAVE RELAYING OF THE COLOR TV SIGNAL . . . . .	58
PART V, GETTING THE COLOR SIGNAL ON THE AIR . . . . .	69

### *As We Were Saying*

**COLOR SEMINAR PAPERS** are continued in this issue. These are the papers from the Color TV Transmission Seminar conducted by a group of our engineers in several cities last year. Previously (Vol. No. 118, Oct. 1963) we had printed the papers on "Introduction to Color TV Transmission" and "Network Color Transmission." In this issue we conclude the series with the papers on "Handling the Color TV Signal," "Microwave Relaying of Color TV Signals" and "Getting the Color TV Signal on the Air."

All five of these Color TV papers will be reprinted in a bulletin which will be available about the time you read this. Single copies of this bul-

letin will be sent free to all requesting them. Quantities will be furnished at ten cents each.

Incidentally, we also have available a limited number of copies of the cartoon "It's all right leaving here" which appeared in the June 1963 issue. These are suitable-for-framing size. If you'd like to have one, write us—or ask your broadcast representative.

**COLOR TV ORIGINATION SEMINAR**, which we promised would follow the **transmission** seminar, has been several times postponed. But it will be held—and before very long. One reason we have waited is that we want to be able to talk about

JOHN WILNER, Director of Engineering, The Hearst Corporation, holds a copy of BROADCAST NEWS for December 1947 in which a block diagram of WBAL's facilities (Circa 1947) is shown on the right-hand page. It makes an interesting comparison with the 20 ft. by 6 ft. diagram of WBAL's present facilities which is mounted on the wall behind. Mr. Wilner, with a team of WBAL engineers, planned and installed the WBAL, AM, FM, and TV facilities referred to below and described in the article beginning on Page 34. One of the industry's best known and highly respected engineers, Mr. Wilner was the recipient (in 1959) of the NAB's first Engineering Achievement Award—given to him in recognition of his work on methods of extending the life of image orthicon camera tubes.

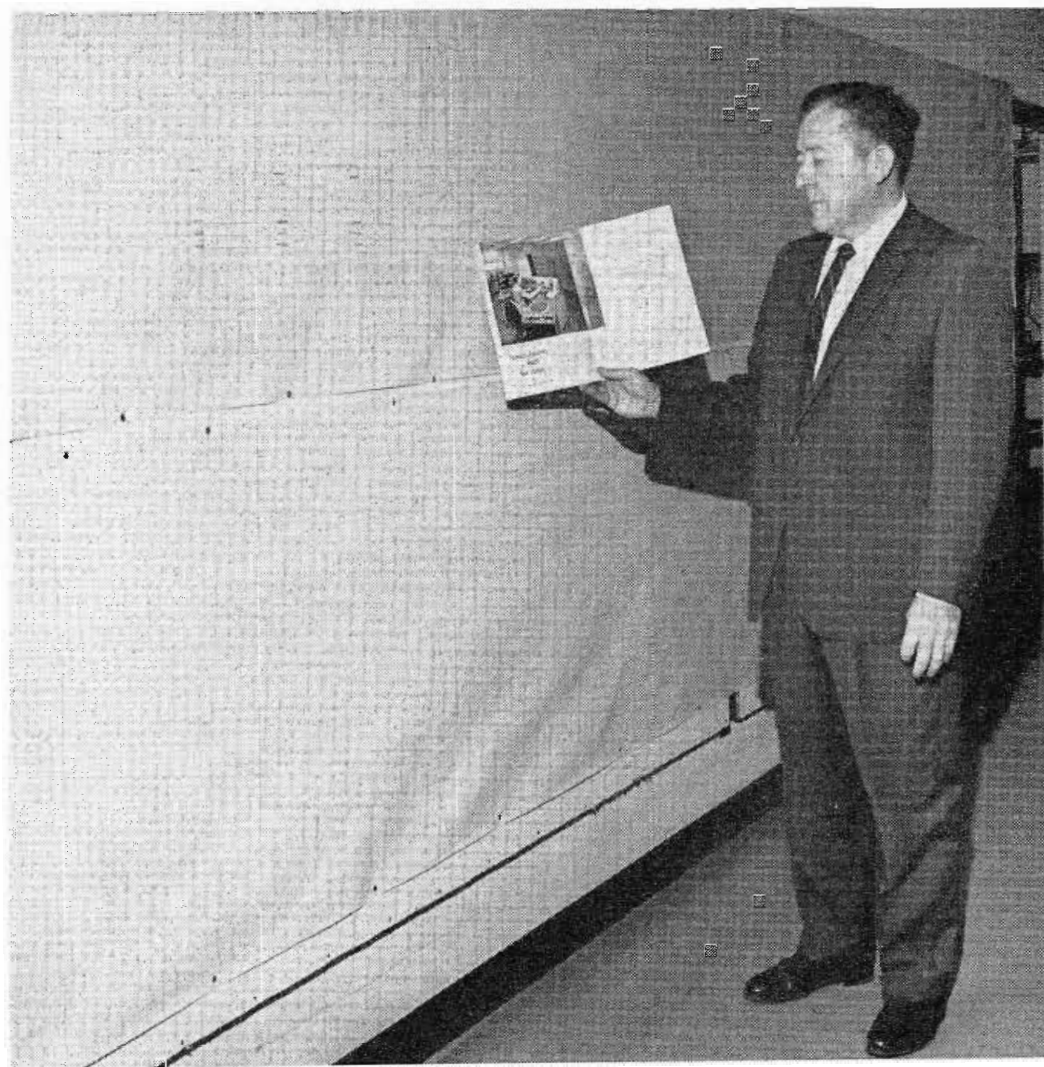

—and show—some of the new things just coming out of the labs. That won't be long now. In fact we hope to announce the date in our next issue. Meantime, if you are interested in attending, let your RCA representative (polite for salesman) know. It helps in our planning to have an idea how many will attend.

*As We Were  
Saying*

**OLD FRIEND, WBAL**, makes it the most in this issue. Story starting on Pg. 34 is, we think, very unusual. Rather than using up a lot of space glamorizing its operations—and showing a lot of pretty studio pictures—we have devoted almost the whole article to describing the arrangement of facilities, especially the switching system. When you read the article, you will understand why.

John Wilner and his "planning team" (see Pg. 36) put a lot of study and thought into the development of "a functional arrangement of utmost utility." The switching system they developed provides just about the ultimate in flexibility. No mortal engineer will ever devise a system that does everything the program people can think up—but this one comes close.

WBAL-TV engineers designed the overall system, and had the control consoles custom-built. They did a beautiful job, as the pictures indicate. Happily, they used our TS-40 switchers as the basic elements—so we're proud with them.

**WE'RE PROUD**, in fact, of the whole WBAL installation. The article does not contain a single RCA mention (a new high—or low—in something or

other). But eagle-eyed readers will have no trouble in recognizing that all major items of WBAL's equipment—cameras, switchers, audio consoles, transmitters, antennas are RCA. And it's been that way for a long time.

BROADCAST NEWS for December, 1947 described WBAL's "New-World-of-Tomorrow" AM Studios—all RCA. BROADCAST NEWS for September 1949 described the then-new WBAL-TV installation—all RCA. There have been several notes since then: WBAL-TV's installation in 1959 of our Serial No. 2 and 4 Tape Recorders; also in 1959 the first three-station Candelabra Antenna, which WBAL shares with WMAR and WJZ (also good RCA friends and customers).

The engineering staff of the Hearst stations (of which WBAL is one) is one of the best—and most experienced—in the business. The fact that they have consistently chosen mostly RCA equipment is a great satisfaction to us.

**NOSTALGIA** of the sort we're often guilty of creeps into the WBAL story at one point. In the section on AM, the writer—after describing the "three functionally designed studios"—adds, longingly, "should the occasion arise when Radio might require the equivalent of the studio space once needed for 'live' broadcasts, 'TV Studio One' is equipped to feed radio master control." Ah me, what old-timer wouldn't like to turn off the idiot-box, lean back, close his eyes and listen again to the big bands—live!



LETTER-OF-THE-MONTH comes from our old friends at KGNC, Amarillo, Texas (see below).

KGNC

RADIO	—	10,000 WATTS	—	710 KC
F M	—	14,500 WATTS	—	93.1 MC
T V	—	100,000 WATTS	—	CHANNEL 4



GLOBE NEWS PUBLISHING CO. AFFILIATE

PHONE EVergreen 3-3321 • P.O. BOX 751 • 2000 N. POLK • AMARILLO, TEXAS 79105

January 24, 1964

Mr. C. H. Colledge  
Division Vice President  
Radio Corporation of America  
Camden 2, New Jersey

Dear Mr. Colledge:

Our respect and admiration for, and belief in, RCA is even higher after our experience with the TK-12, now the TK-60 camera.

It is comforting to know when you do business with the biggest and best company in their field that they stand behind their products.

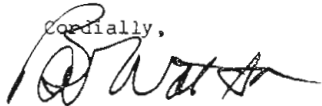
Cordially,  
  
Bob Watson  
General Manager

*As We Were  
Saying*

**THANK YOU BOB** Watson, of KGNC, Amarillo, for one of the nicest letters (see above) we have received in a long while. You play it fast, and you play it sweet. And, albeit, you shame us a little. For this column has been trying for years and, in the process, has used up thousands of words—trying to say what you have said better in “fifty words, or less.”

We do, indeed, stand behind our products. In the case of the TK-60 (nee TK-12) it cost us over a million dollars. Letters like yours make it worthwhile.

**WE MADE THE JOURNAL**—the Wall Street Journal, that is—last month with the biggest splash in the history of our division. We did it with a two-page center spread advertisement in which we announced that the RCA Broadcast & Communications Division would introduce 27 new major products during 1964. Some three-fourths of these new products are for broadcast and CC-TV applications; the others are for the mobile, marine and microwave communications markets. The ad itself is reprinted on Pg. 4 and 5. Of course, the reproduction is only about one-fourth the size of the WSJ insertion, so it does not have quite the impact it did in the JOURNAL.

**IT'S IMPORTANT.** This is not only the biggest, but also the most important, ad our division has ever run. It announces, in effect, a major intensification of our new-product development program. But it's

really more than that—it represents a new dedication—almost a rebirth—of our broadcast and communications business.

**HOW CAN THAT BE?** Well, to understand it you must have an appreciation of how we have conducted our business over the years. Especially the fact that for more than three decades we have prided ourselves not only on making the best equipment, but on being first with the newest developments in technology. To do this we have always spent a large amount of our income on engineering. Percentagewise it has averaged about four times that normally expended on consumer electronics. Moreover, over the years, this policy of putting a large part of our available dollars into engineering has become a way of life. Of our some 2000 catalog items we have regularly re-engineered from 10 per cent to 20 per cent each year (not counting updating jobs). Broadcasting is a fairly stable business—and equipment life is normally seven to ten years. So you would have thought that our replacement program would insure continued leadership. So did we! And, in fact, it has—until now.

But the technological developments of the last few years have accelerated obsolescence. Suddenly, almost everything more than two or three years old is obsolete. Transistors (“solid-state devices” if you want to be hifalutin) are the

*(Continued on Page 76)*



# PRESENTING... 27 MAJ

## to make broadcasting and com

Pictured here is the largest number of major, new electronic products ever presented at one time by RCA. □ A pioneer in broadcast and communications, as well as all other phases of electronics, RCA is the world's most broadly based electronics company. Its achievements range from tiny transistors through color television sets and data processing systems to the giant BMEWS (Ballistic Missile Early Warning System), guarding our nation from surprise attack. □ The multi-million dollar invest-

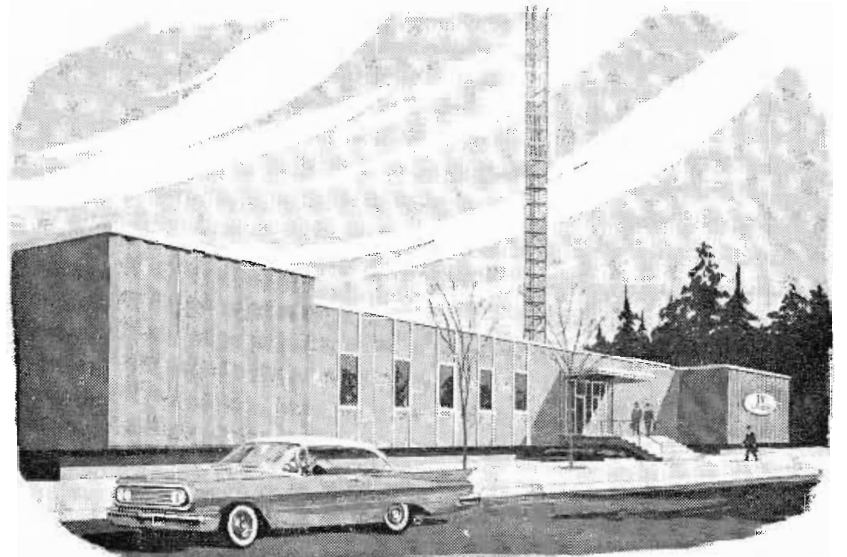

**NEW** RCA TV cameras and film equipment:

Compact and dependable as only RCA transistorization can make it... for finest commercial and program pictures.

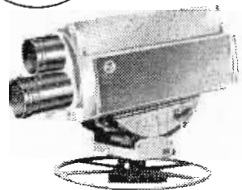

Live Color TV Camera

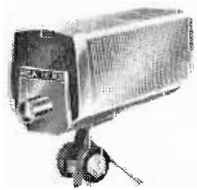

Closed Circuit Camera



Ultra-Portable TV Camera-Transmitter



Color Film Camera



Film Projector



New Black and White Film Camera

**NEW** RCA TV tape equipment:

High-performance quadruplex models with RCA quality at budget prices... compact, fully transistorized, standard modules.



Compatible TV Tape Playback Unit

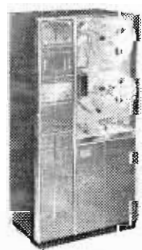

Compatible Compact TV Tape Recorder



Mobile Compatible TV Tape Recorder

**NEW** RCA TV transmission equipment:

Transmitters and antenna designed to beam a bright, clean signal that covers a wide viewing area.



2 KW UHF Television Transmitter

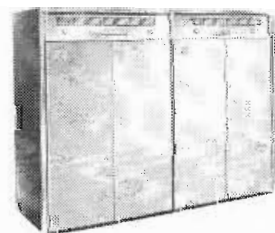

10 KW UHF Television Transmitter

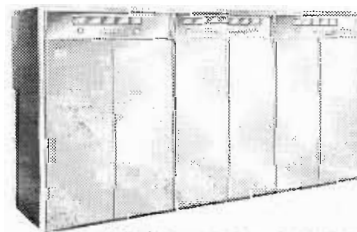

30 KW UHF Television Transmitter

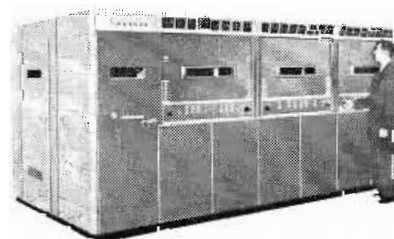

25 KW Low Band VHF Television Transmitter



Tower-type VHF Antenna



The Most



# OR NEW RCA PRODUCTS

## munications better than ever!

ment required to market simultaneously 27 new products exemplifies RCA's non-stop efforts to produce the most modern design and engineering concepts. These new products are transistorized for dependability and compactness . . . standardized for simplicity of installation . . . modularized for ease of operation and expansion. □ If you are thinking of buying electronic equipment, investigate the practical advantages of these and other RCA products—serving science, government, home and industry.



**NEW**

**RCA FM stereo equipment:** FM stereo sound hits new peaks of brilliance with this RCA FM transmission, recording and control equipment on duty.

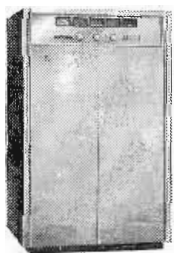

5 KW Transmitter

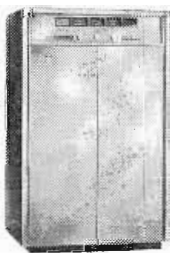

10 KW Transmitter

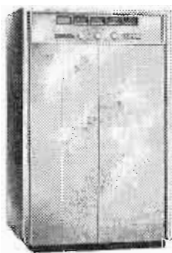

20 KW Transmitter

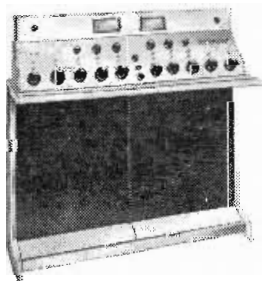

FM Stereo Control Console



FM Stereo Tape Recorder



**NEW**

**RCA communication equipment:** RCA perfects transistorization of this equipment to answer dependably all advanced control and contact needs.



Super-Carfone Mobile Telephone

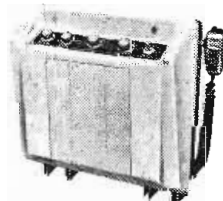

Ship-to-Shore Cruisephone 25-55 Watter



Ship-to-Shore Cruisephone 110-150 Watter

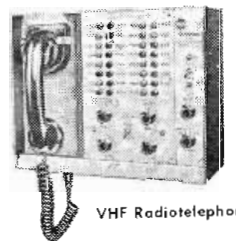

VHF Radiotelephone

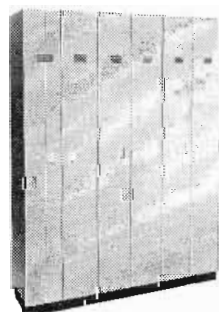

1200-Channel Microwave Relay System



CW-60 Total Solid State Microwave

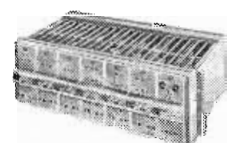

CT-42 Tone Multiplex



Light Route Radio Relay Equipment

**Trusted Name in Electronics**



## WHOPPER OF SPEAKER FOR WORLD'S FAIR

A World's Fair wouldn't be a World's Fair without superlatives to describe its attractions. The 1964-65 extravaganza opening soon in New York will be no exception. It is likely to be incomparable, unmatched, unrivaled, inimitable, the best and probably the most.

It was almost inevitable that the Fair would have "the most powerful loudspeaker ever built," a 7,000-pound superlative of sound reproduction designed at RCA Laboratories. The 16-foot-diameter giant has been installed in the Fair's "Fountain of the Planets" and each night will pour forth music in high fidelity as part of a synchronized display of water patterns, color, sound and fireworks.

The \$30,000 speaker appears as two huge metal saucers joined, bottom to bottom, by a cellular cylindrical structure. This center unit is made up of three tiers, each containing 16 cast aluminum horn sections for a total of 48 sections. A separate speaker driver mechanism, used with each radial horn section, is capable of producing the full spectrum of sound (50 to 15,000 cycles).

The radial horn sections are designed to "fold back" the sound, virtually concentrating the total energy at a central source position that radiates from the cylindrical speaker system into a sharper vertical pattern than otherwise would be achieved.

The result, according to RCA sound engineers, is that the sound energy drops off at only half the normal rate as it travels a given distance from the speaker, and a person 600 feet away hears nearly as well as one only 300 feet away. At the Fair the closest approach to the huge speaker will be 300 feet which is the radius of the fountain.

Music for the nightly spectacles has been especially recorded on tape by a 60-piece philharmonic orchestra and will be reproduced by RCA's professional RT-21A audio tape equipment like that used by many of the nation's broadcasting stations.

Musical notes will occupy only half the tape's width; the remainder will carry tone pulses that will cue a computer-type network in controlling the thousands of operations, such as turning the fountain's more than 500 pumps on and off several times, in a 30-minute show.

## SPRING STEALS IN ON ITS PRETTY WINGS

You can have your robins. We've got our own harbingers of spring. Like Susan Carson, up there on the flying bridge of a 38-footer. She's using a radiotelephone to message you winter-locked sailors that Boating Time 1964 will soon be here. For those of you who insist on more information about the radio equipment—there's at least one in every crowd—it's a remote control unit for a 150-watt Cruisephone. It boasts 11 channels and you can get it at your RCA Radiomarine dealer's. So to the marinas, men! Let the early spring air be filled with sandpaper dust and paint fumes. With an early start, we should have the old scow in the water by August.

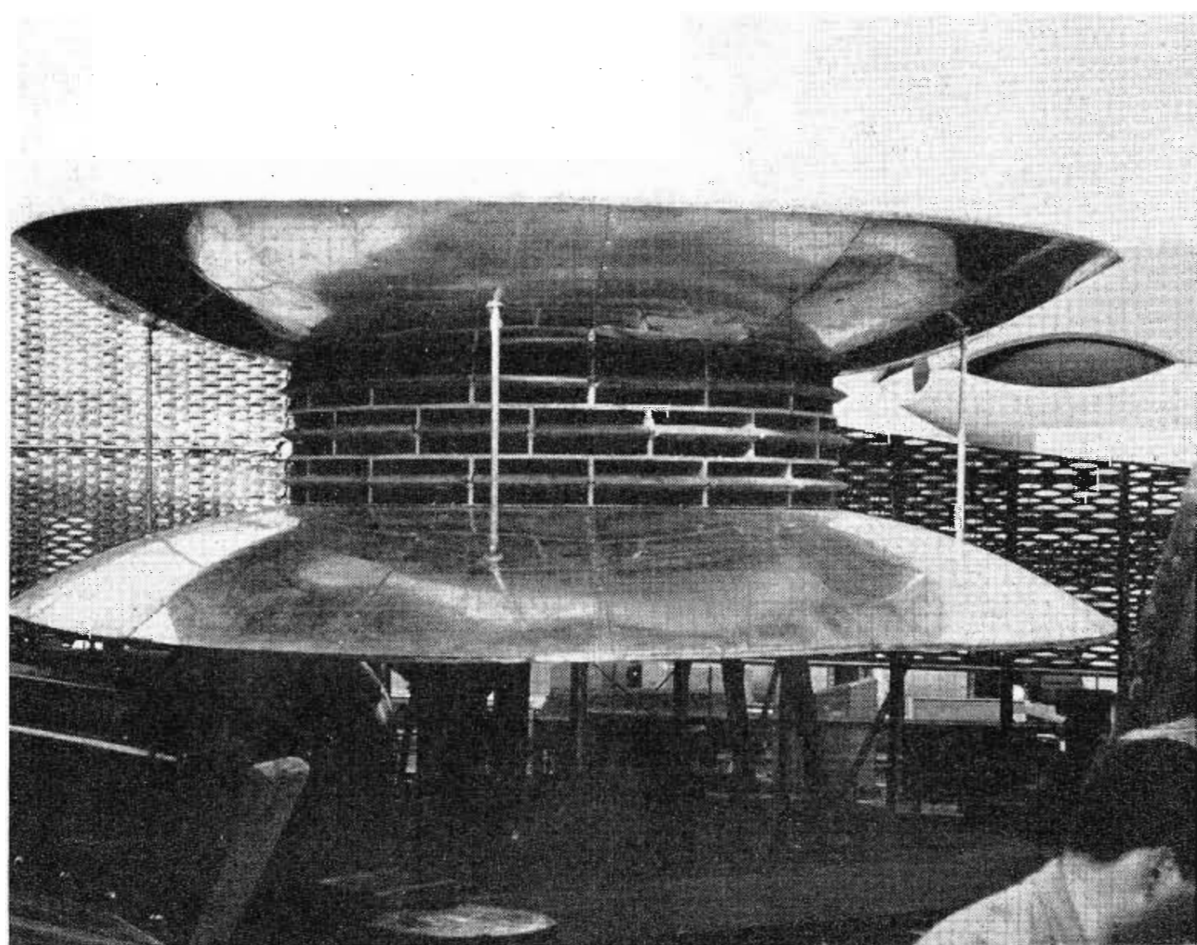

Behemoth of sound has maximum output equal to 1,000 console phonographs operating at full power.

Thus the water forms are changed to match the mood of the music. The fountain's elaborate lighting effects and its fireworks, which are shot from some 600 mortars, likewise are synchronized into a brilliant display.

Additionally RCA, through Commercial Radio-Sound, Inc., its distributor of sound products in the New York metropolitan area, is supplying equipment for complete sound coverage over the Fair grounds.

Multiple speaker installations have been incorporated in overhead "luminaires," or modular lighting fixtures, which are located some 60 feet apart.

Since the speakers distribute sound uniformly in a pattern that extends 30 feet in all directions from the fixture's base, Fair visitors will in effect be "surrounded by sound." They will hear music and announcements over the system without being aware of a directional source.



**NEW GENERATION TP-66  
TV FILM PROJECTOR  
IN PRODUCTION**

Cynosure of all eyes, the handsome show-piece in the center is production model No. 1 of RCA's new television film projector—the TP-66—shown as it was rolled off the assembly line at the company's Plymouth, Michigan plant. The proud quartet, standing by with a fatherly air, includes (from left) Arnold Jackson, Bruno Melchionni, Norman Amberg and Walter Varnum, all of RCA.

The first TP-66, and a second one, were shipped to WMAR, Baltimore, and since the picture was taken the Plymouth facility has begun cranking out the new projector on a volume basis. Four units from the first production run are slated for the RCA exhibit at the New York World's Fair.

As the photograph makes clear, the TP-66 uses a modular design in which modules and panels are assembled in a rack-type mount typical of studio equipment. In styling, the projector presents a clean-lined, uncluttered look typical of the new RCA products for the broadcaster.

Functionally, the TP-66 provides a high degree of automatic operation for surer control and greater reliability in film broad-

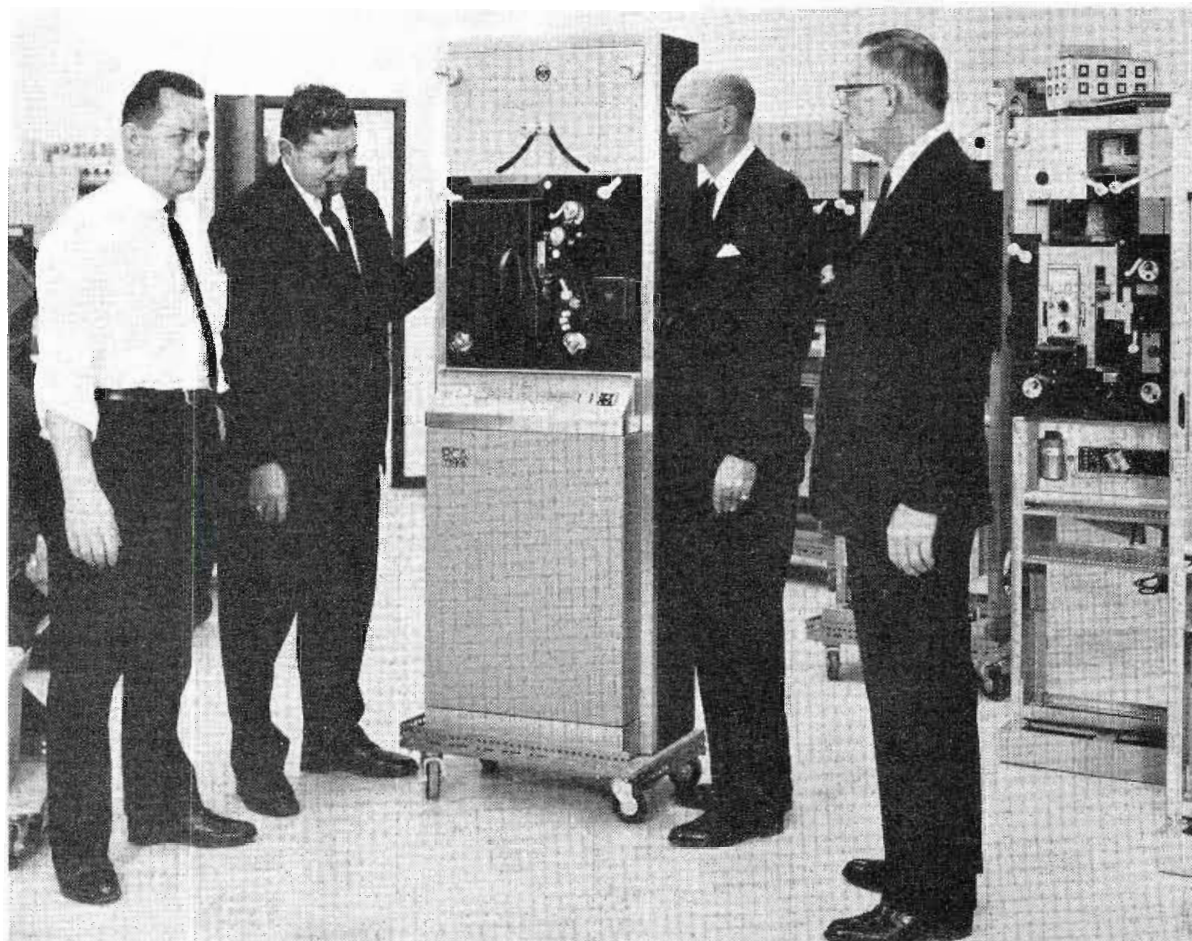

casts. Its many advanced features include provision for automatic change of both projection and sound system lamps, virtually instantaneous start (three-tenths of a second), automatic cueing, reverse operation and automatic restoration of film loops. Since the projector is capable of showing

a single frame at full light level for an extended period, the program director has available a quick means of identifying an upcoming film. Reverse operation makes the TP-66 particularly useful in "live" show rehearsals or video tape sessions where film inserts must be re-run or re-cued.

**KSTP USING NEW AUDIO  
TAPE CUSTOM UNITS**

First two units of a new custom-designed RCA system for recording, editing or re-recording audio tape in broadcast station studios have been installed by KSTP, Minneapolis. The system is capable of accepting program information from a variety of inputs—network, live, disc or tape—and mixing it into a pre-recorded, broadcast-ready show, ranging from a brief spot announcement to a complete program.

As an independent recording and playback facility apart from the studio control center, the system permits station personnel to prepare or edit either reel or cartridge tapes without interfering with on-the-air programming. Other suggested uses include the sequential recording of spot announcements on tape for playback in radio automation systems.



John Kalbrenner, Assistant Production Manager-Radio at KSTP, loads tape cartridge into new custom system.



# RCA announces...a whole new

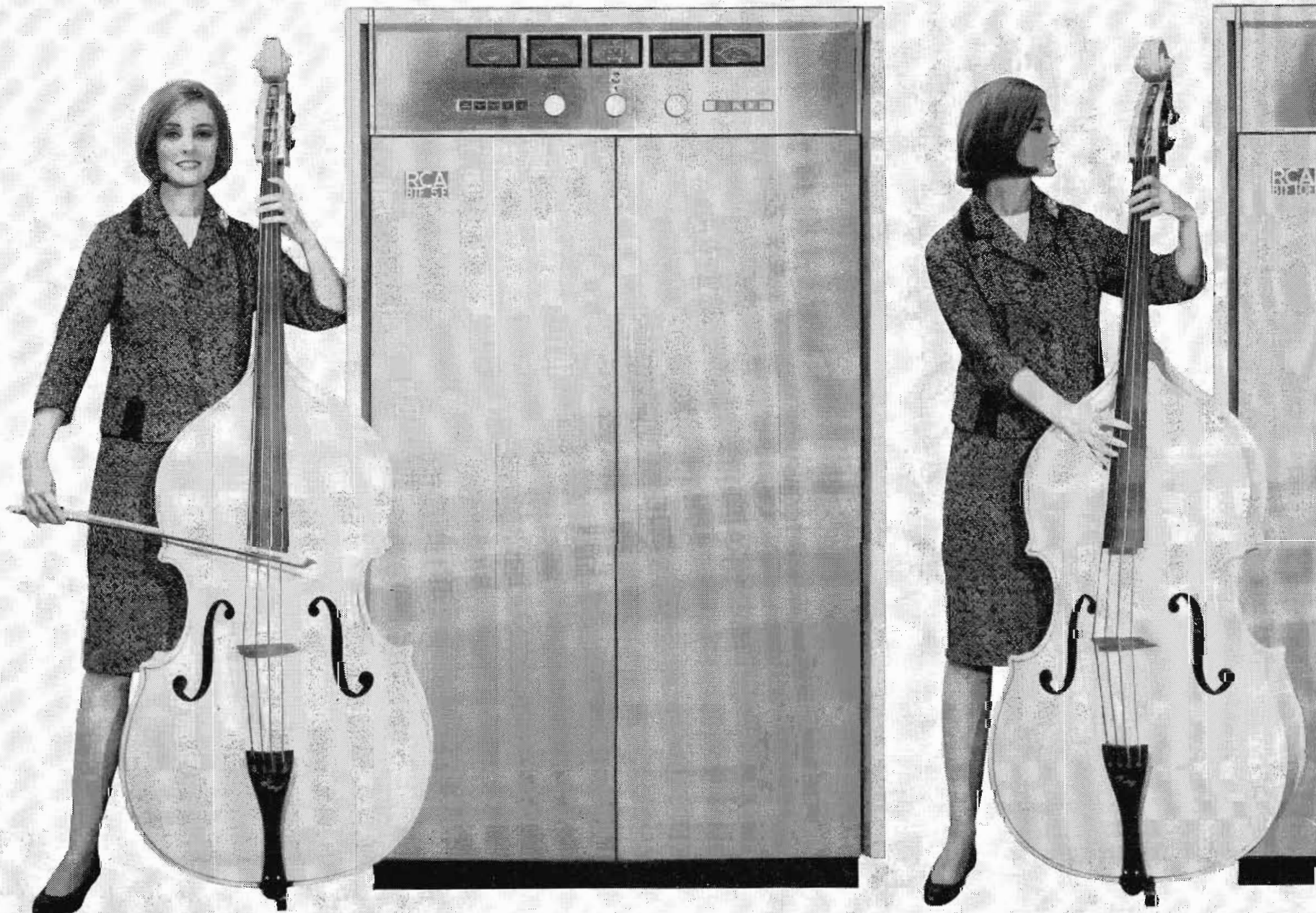

NEW BT-5E 5KW

Here's a line that's completely new and different! New in styling, new in color and size, new in operation, it's an entirely advanced concept of transmitters, in all desirable powers, employing the famous RCA direct-FM principle. RCA had "Direct FM" in its first FM transmitter, built in 1941—and in all the FM transmitters built since then, including this new line.

NEW STYLING, new steel/blue color and convenient new "eye-level" height make these transmitters most attractive to look at and much easier to use.

RCA Broadcast and TV Equipment, Building 15-5, Camden, N. J.



# Line of FM transmitters!



NEW BTF 10E 10KW

NEW BTF 20E 20KW

NEW CIRCUITRY means improved stability and a new kind of stereo and multiplex performance.

NEW EXCITER assures simpler, more straight-forward operation and maintenance, greater dependability.

Attuned to the quality needs of FM for today and tomorrow with finest sound and fidelity, these are the transmitters to put your station "out front." Find out what it's like to own the finest in FM transmitters.



**The Most Trusted Name in Radio**



# MANAGEMENT TV AT AIR FORCE SYSTEMS COMMAND

Closed Circuit Color Television Network Provides Instant  
Information For Critical Management Decisions

Closed circuit television is the nucleus of a comprehensive management plan conceived by the Air Force Systems Command, and personally endorsed by General B. A. Schriever, to establish a "real time" communications link between AFSC Headquarters at Andrews Air Force Base, Washington, D.C., and the Command's 13 divisions and centers throughout the country. The purpose of the link is to expedite the decision making process by presenting

current information with modern television techniques and equipment.

### "Real Time" Communications

Totally new in concept, the management communications plan is based on the exchange of information in *real time*, that is, the instantaneous presentation of events, audibly and visually, as they actually occur. It is virtually "conference television" but much more, since it not only combines

two-way, live television with all the known visual display and storage techniques, but incorporates means to make the channels jam-proof and intercept-proof and thus "secure."

Such real-time communication will provide critical information—the moment it is needed—for instant management decisions required by the Air Force Systems Command in carrying out its responsibilities for the research, development, production,

FIG. 1. Air Force Systems Command headquarters building at Andrews Air Force Base.

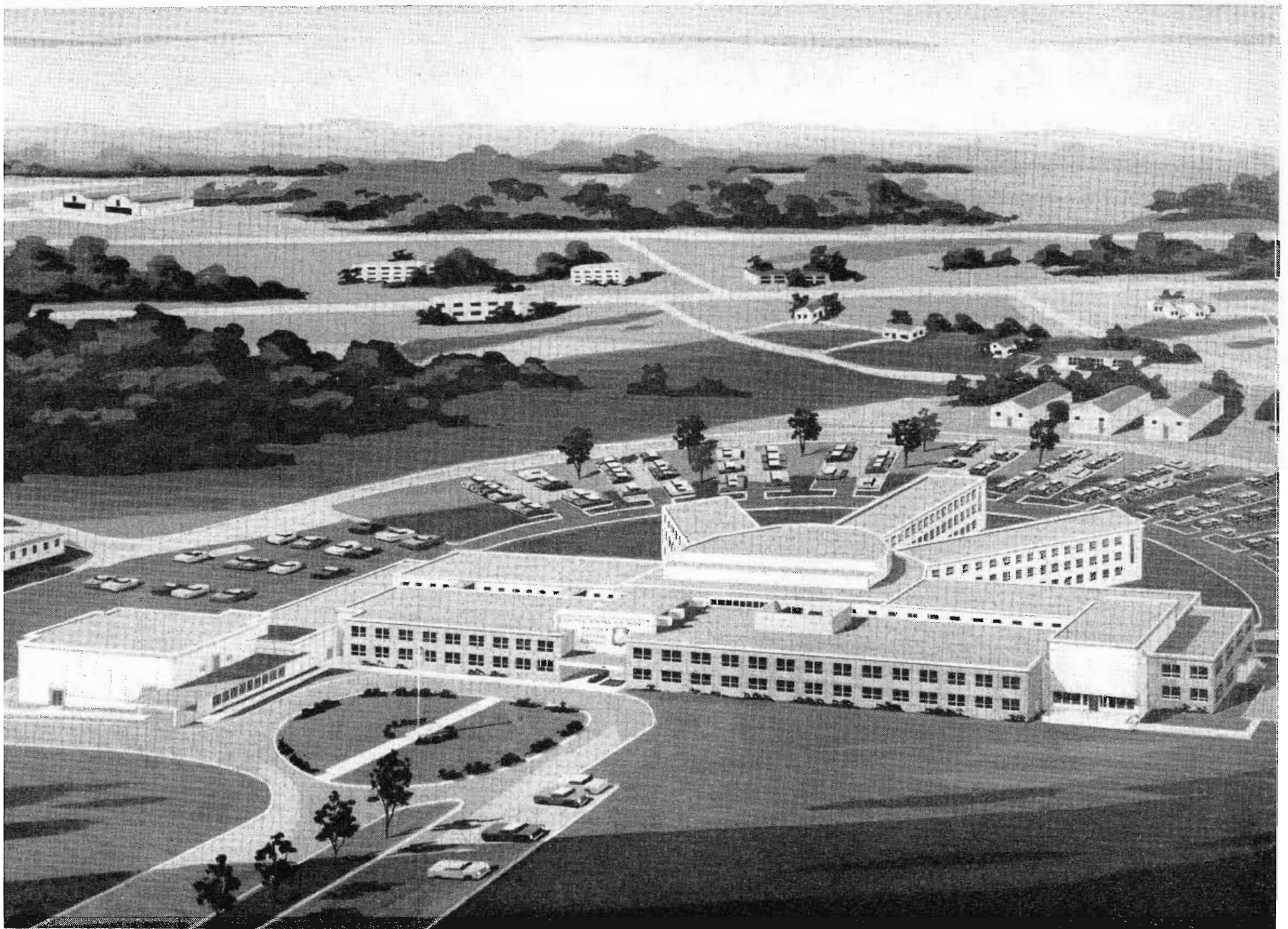





procurement and check-out of complex aerospace systems among its geographically dispersed divisions, test centers and possibly principal contractors.

Information sought from such a network may be the kind needed to make timely and accurate technical judgments. Today, the future work course of a dozen of the Command's far flung offices may hang in the balance while awaiting a decision. Real-time communications is looked upon as the only solution.

**Example of how real-time communications is applied:**

1. An unforeseen problem at Space Division in California halts evaluation of a new spacecraft re-entry technique.
2. Project commanders and officers quickly prepare charts and other visuals for briefing distant headquarters at Andrews Air Force Base via TV.
3. Headquarters personnel prepare for briefing. General Schriever assembles staff members to participate. Cameras are moved into TV conference room.
4. California is "on the air." The securely transmitted briefing is viewed by the General and his staff, is simultaneously videotaped for future use. Discussions ensue between East Coast and West Coast personnel by "live" TV. Each can see the other. Points are clarified by charts and diagrams. A decision is made.
5. A second TV conference is called. All cognizant Command divisions and centers are similarly briefed on the West Coast re-entry problem and its solution.

In only a few minutes notice, real-time communications by TV has bridged the distance gap by resolving an urgent difficulty and advising all concerned of the outcome.



FIG. 2. At Headquarters AFSC, Gen. Schriever is alerted to stand by for a briefing on the President's budget.

**ADVANTAGES OF USAF TELEVISION NETWORK**

**Accelerated decision-making is just one advantage of the plan. Large savings are anticipated in travel and in the time people spend away from their jobs. Far reaching returns are summed up in the following comments by General Schriever:**

"This real time system will provide us with much better management control throughout the command. And I think it will produce one other thing as far as the individuals in the Command are concerned, and that is a sense of participation in what goes on in our wide-spread organization. I think we will go a long way toward cementing the Command as an entity rather than a group of separate empires."



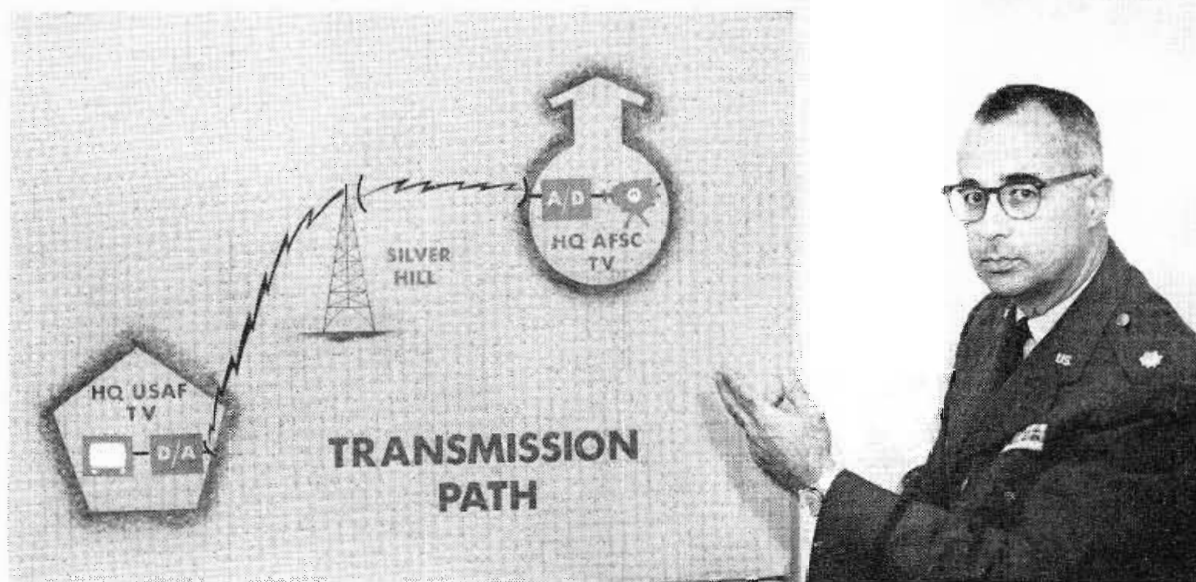

FIG. 3. Major J. F. Sublette, Telepresentations Branch, displays proposed secure microwave link to interconnect AFSC headquarters and the Pentagon.

in research and development, information on foreign technology, latest systems project data and noteworthy Department of Defense, national or world news events are displayed on viewing monitors in conference rooms and key management offices in each of the CCTV equipped divisions and centers. Key briefings are taped and forwarded to headquarters for playback on secure distribution outlets. Recordings received from other commands or contractors may be viewed, integrated with existing tapes, or recorded on tape or film for future use.

CCTV facilities are also providing System Command personnel, and when the workload permits, Office of Information personnel with production guidance and

### Secure Nationwide Network

The AFSC system as visualized could ultimately provide the Air Force and other military and government agencies, including the White House, with a nationwide, secure closed circuit color TV network integrated by microwave and coaxial cable links and combining both live and video tape transmission and reception capabilities.

Tests have demonstrated the practicality of encoding and decoding video signals for security in transmission. As to the required transmission channels, it is possible they may be made available through implementation of already planned facilities such as the Defense Communication Service Automatic Digital Network (AUTO-DIN) or use of a communications satellite system.

### Present Use of CCTV

Facilities of AFSC and its development divisions and test centers are in various stages of operation, acquisition or planning. Headquarters, at Andrews AFB, as well as the Space Systems Division in California and the AF Missile Test Center at Patrick AFB, are all operational with color cameras and TV tape recorders. At Brooks AFB, the Aerospace Medical Division, which has cognizance of R & D programs in "bioastronautics," the study of life sciences and biological payloads, operates with monochrome TV but presently is being converted to color. TV systems are planned for the Ballistic Systems Division, Aeronautical Systems Division, Foreign Technology Division, Electronic Systems Division, AF Flight Test Center and the Air Proving Ground Center.

Live or taped briefings or special presentations covering up-to-the-minute advances

## MANAGEMENT TV NETWORK OF AIR FORCE SYSTEMS COMMAND

FIG. 4. AFSC "Instant Communications" Network showing systems in operation, and those planned for the future.

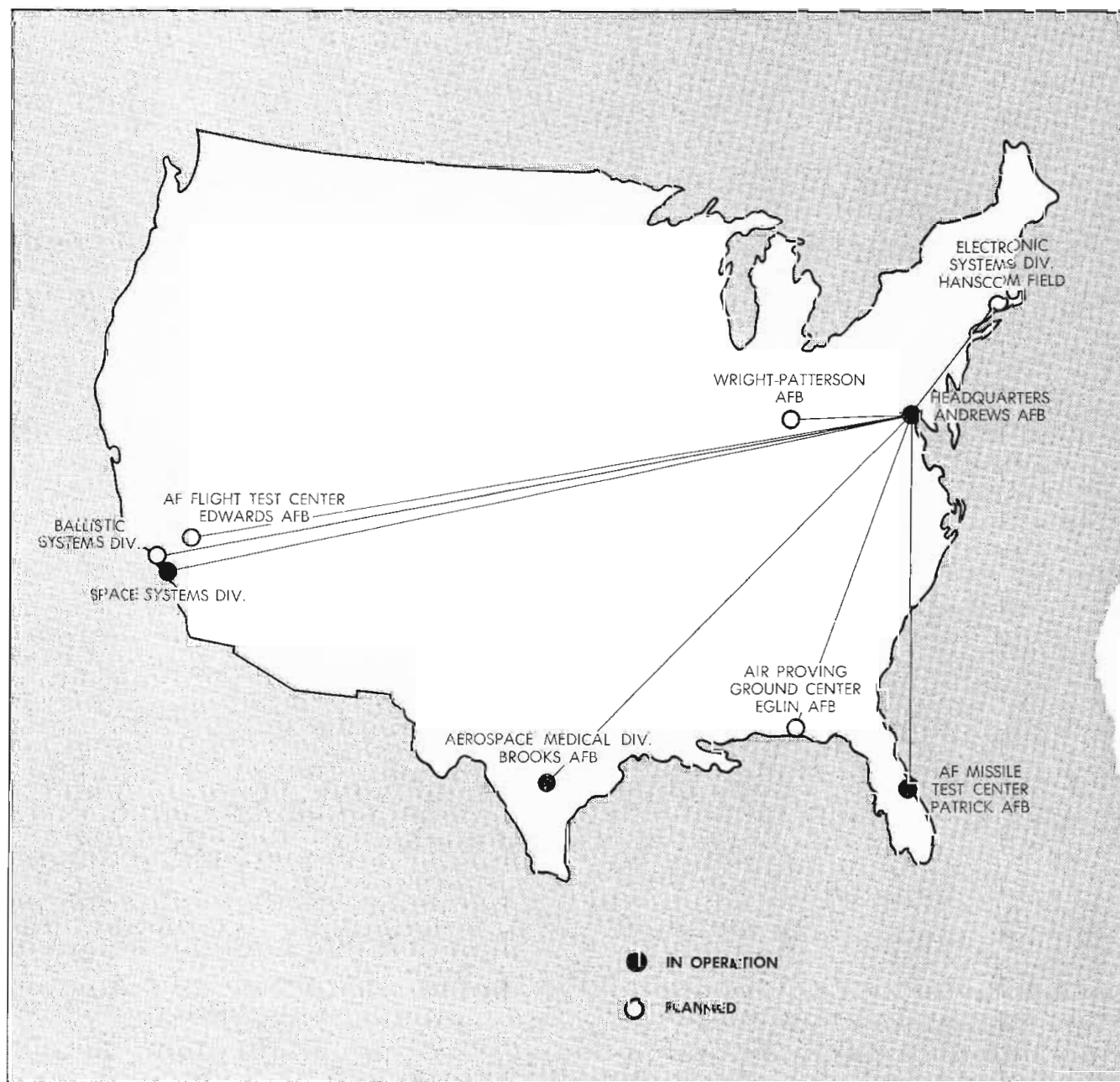



valuable experience in the direction, recording, storage and playback of briefings.

In recent Project Forecast, which was a study of future Air Force weapons systems requirements utilizing top echelon experts in almost every field, some 50 tapes were made and disseminated to various military commands and agencies.

Distribution of tapes between the commands, divisions and centers of AFSC is made via the "pouch" system which is capable of overnight coast to coast delivery.

### The Command Management Center

A report on AFSC's plans to establish at headquarters a Real Time Control facility, of which closed circuit TV is an integral part, was the subject of a TV presentation made by Lt. Col. Maynard Y. Binge, Chief of the Command Management Support Division of the AF Systems Command. In essence, the report is briefly summarized as follows:

A construction program was begun in 1961 to modernize and centralize head-

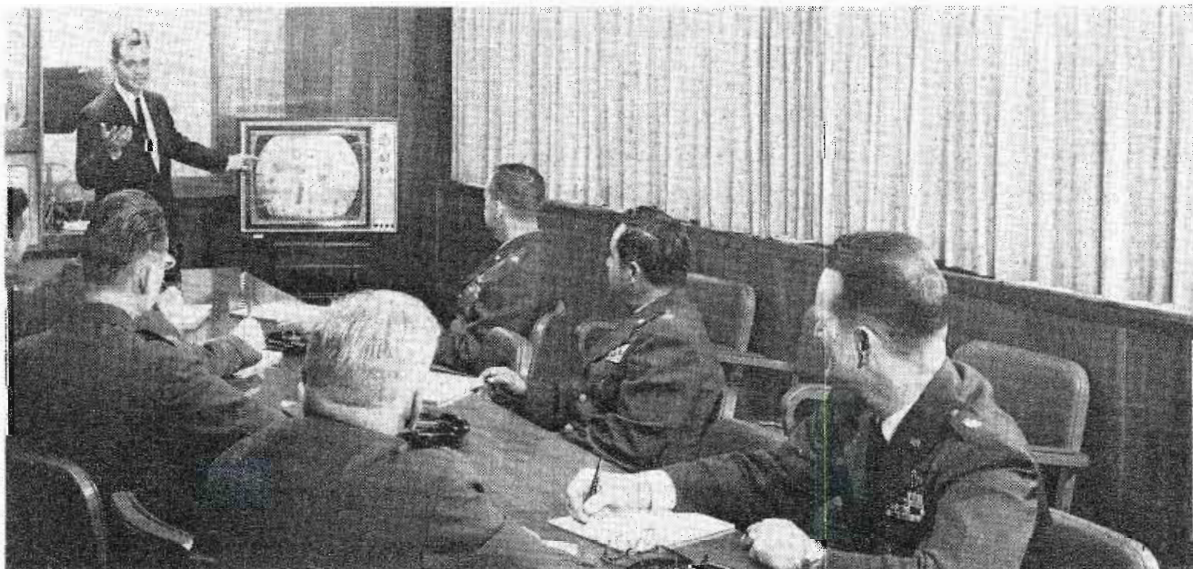

FIG. 5. Color opaque materials, color slides and 16mm film can be integrated into live presentations.



FIG. 6. Lt. Col. Binge presents a briefing in main conference room at AFSC HQ, using charts, TV tape and film inserts, and rear screen projections.

FIG. 7. Air Force staff group in briefing room views televised report on a command project from distant base.



quarters' communication facilities. New switchboards were installed with long line interconnections to all divisions and centers. Improvements were made in data presentation and reporting capability by setting up a Real Time Control Room as the center for all teletype and telephone communications, and incorporating an Instant Management Data System to be integrated with the CCTV facility and, eventually with the Command automatic data processing system. A TV studio was constructed, conference rooms were equipped for TV viewing and for camera pickups, and the CCTV system was installed. The result was the creation of a "Command Management Center," a facility that will be ultimately geared to command-wide, real-time management communications.

### Headquarters AFSC TV Facilities

The TV equipment originally installed at Headquarters early in 1962 was operated primarily as a monochrome system, although the equipment included a color film system and the first RCA TV tape recorder to be used for color. Major items consisted of two TK-15 studio camera chains, TK-26 color film and slide system with opaque pickup, TRT-1 TV tape recorder, TS-11 video switcher and a BC-6 dual-channel audio control console.

When, in October of 1962, results of tests had shown that color was a requirement for the system, the two monochrome cameras



and the switcher were replaced by two TK-41 color camera chains and a TS-40 video switcher with special effects. At the same time, a transistorized TR-22 color TV tape recorder was added to complement the original tape recorder. In addition, two vidicon TV cameras were set up to read from two teletype printers in the communications center and to feed data into the CCTV system.

Program lines emanating from the TV equipment rooms can simultaneously feed three different TV programs to a total of four conference viewing rooms and five offices, plus the communication room and normal TV equipment monitoring areas. Camera cables are permanently installed between the control room and two of the four conference rooms, permitting TV cameras to be rolled into conference rooms for live pickups during briefings. The main conference room is equipped with two 21-inch color TV monitors, two rear screen optical projection systems and a large screen monochrome TV projector.

In the TV control room, both video and audio input and output lines are on jack panels permitting any desired patching between signal sources and viewing rooms and offices. Other features of the system

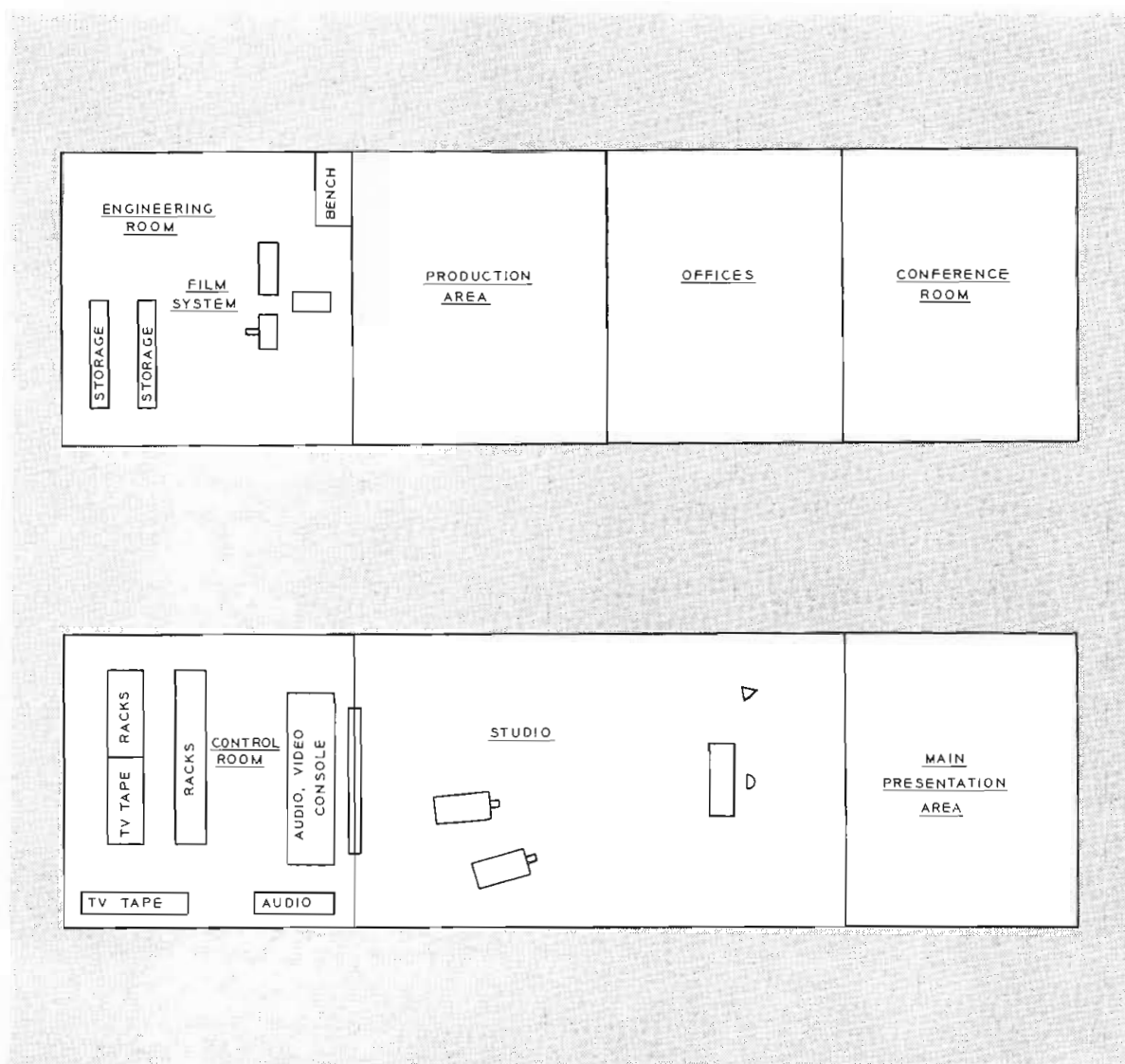
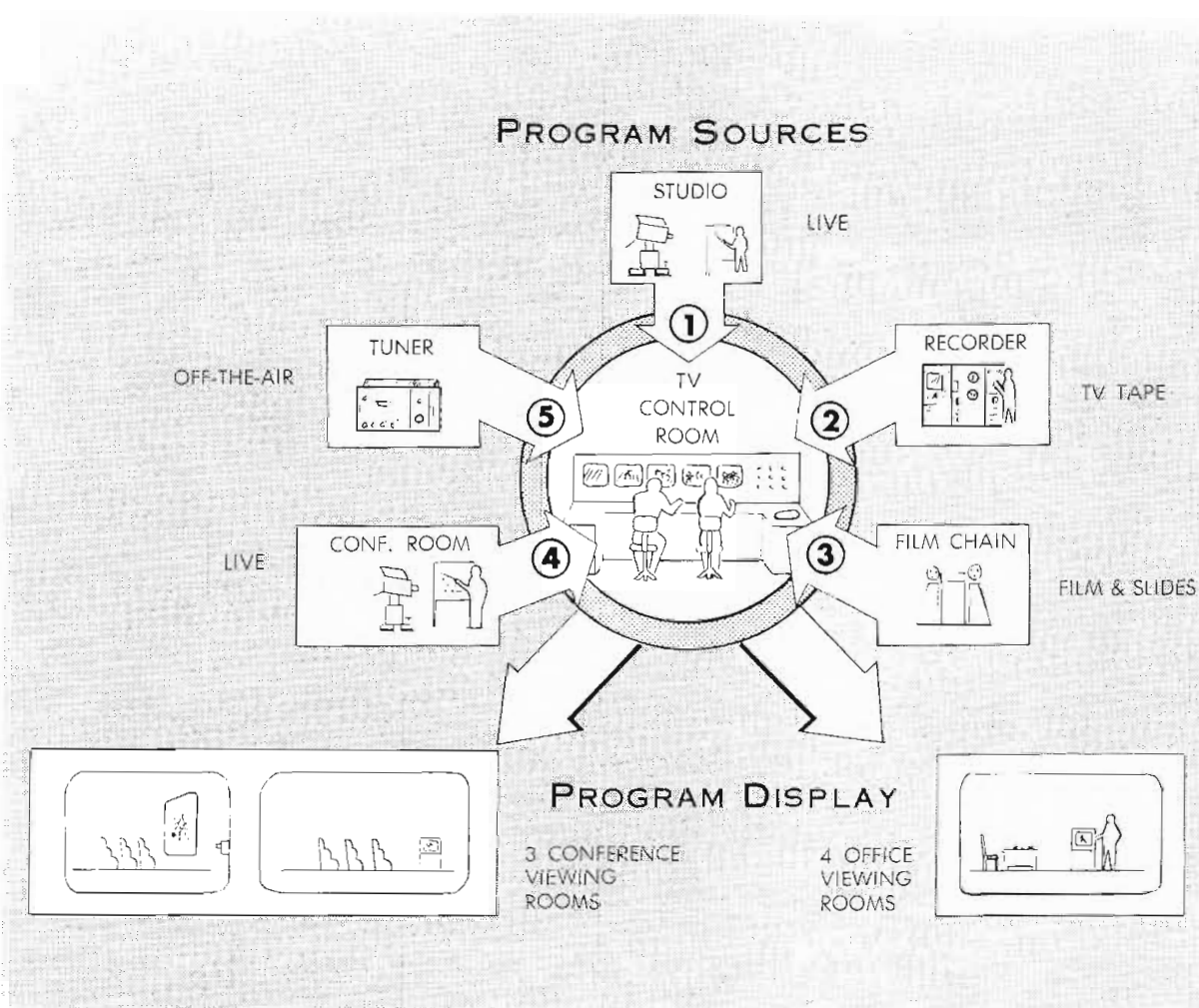

FIG. 8. Floor plan of TV system at Andrews AFB.

FIG. 9. HQ AFSC programming capabilities.



include two independent audio channels and talk-back facilities for question and answer liaison between the briefer and each viewing area. An off-air pickup tuner permits integration of commercial TV broadcasts into CCTV programs.

#### Production of TV Briefings

TV briefings and other special presentations are initiated and produced by CCTV-equipped divisions and centers with the help and guidance of the Telepresentations Branch at headquarters which draws additional support from the Graphics Branch of the Office of Information.

A TV production planning guide issued by Headquarters describes TV capabilities, lists available sets and properties, tells how to prepare the script and how to plan presentations, discusses the selection of visuals and the preparation of artwork and graphic materials, and lists tips to guide the performer in well-executed presentations.

Generally, there are four steps to the production of a briefing, from conception to final presentation, each of which is treated at length in the planning guide:



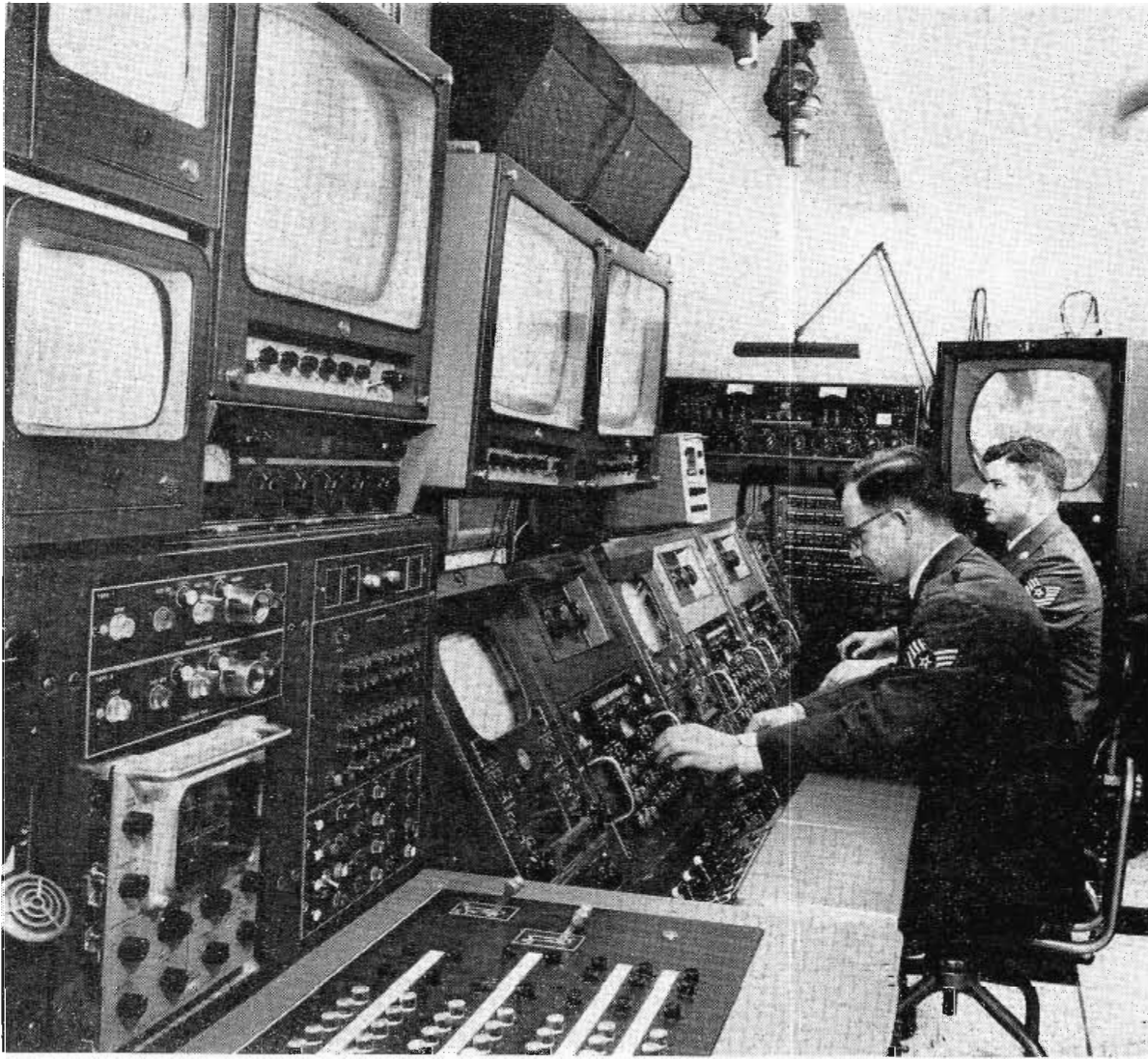

FIG. 10. Control room at Andrews for switching and control of color film and color studio cameras, and audio.

1. *Initial Script and Production Conference.* At this meeting the "briefer" presents the TV staff with an academic "action outline" containing in sequence the material he plans to cover, including statements of purpose and audience description. This meeting provides an opportunity to agree upon treatment, settings and format, scheduling of rehearsals and presentation.
2. *Visual Aids Conference.* This is set up by the production director and attended by an artist from the presentation or graphics section. The briefer presents sample charts, graphs and photos for visualization of the content material. With the action outline as a guide, the entire production is discussed, visuals are sketched and located in the outline as desired. Methods of presentation, whether on film, slides, flip cards, blackboards or special devices, are decided. This "talk through" is a major step in the creative process of production, helping the briefer to organize his commentary, and the artist to understand what his visuals should describe. The artist then begins to prepare the TV artwork.
3. *Script Conference.* With the revised action outline and a list of the visual

FIG. 11. TV switching system Type TS-40 selects program source requested in any of the conference rooms or offices. System permits special effects to be inserted.



FIG. 12. Control room equipment includes dual channel audio console Type BC-7, permitting simultaneous use of two sound channels.





### EXAMPLE OF PART OF A TELEVISION PRODUCTION SCRIPT

TITLE: \_\_\_\_\_



CLASSIFICATION: (Unclassified)

DATE: \_\_\_\_\_

VIDEO	AUDIO
CU pan flannel board	These, then...the visual aids conference, the script conference, and the rehearsal are the three general areas in production planning for your telecast. Remember, no electronic device can eliminate the factor of effort from a good presentation.
MS talent walks to chalkboard	(TALENT DRIFTS BACK TO CHALKBOARD)
CUs of each chart	In the race for space there is a pressing need for up-to-the-moment management information. Television, used as a tool of management communication, holds great promise as one way of helping to meet this need. The information output of television is only as good as the input. It is a tool...as such, it is neutral; its use by you determines its value. It presents certain unique advantages (POINT TO #1 CHART) and, with them, certain inherent limitations. (CHART 2) These we have sketched for you and, in addition, outlined some of the procedures (CHART 3) you may encounter when briefing by TV.

### TELEVISION SAFETY FIELD FOR 8"x10" OPAQUE

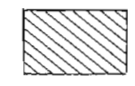
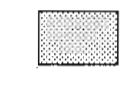
These ratios closely apply to all other material for Television projection

-  8" x 10" - The overall outside dimension
-  6 3/8" x 8 1/2" - The inside border or opaque mask opening - the extent of the prepared artwork
-  6" x 8" - The area scanned by the film chain TV camera
-  4 1/2" x 6 1/2" - Safety field for ultimate receiver

materials selected, the production director and the briefer meet and discuss preparation of the complete script. The actual commentary for the script, which is prepared according to standard TV format, is written by the briefer with the help of the production director who may suggest changes in wording to enhance the presentation. Depending on the experience of the briefer and the nature of the material, an outline script rather than a full script may be prepared. In this, the narrative of the full script is replaced with key words, topics and reminder phrases.

4. *Rehearsal.* In this final area of production planning, all elements of production are brought together. Visuals are ready for camera. The script is complete and cleanly typed for the briefer. Camera action is plotted; lights, microphones

and properties are arranged. The first rehearsal may be a "walk through." Slight revisions of organization may be made, and "rough" areas may receive added rehearsal. If time permits, a dress rehearsal may be desirable. The briefer is then ready to go "on the air."

The TV production planning guide places heavy emphasis on the importance of good visuals to an effective TV presentation, detailing specifications as to correct proportion, size and content. "Getting the right kind of visual materials, especially from inexperienced briefers, is sometimes a problem," said William R. Smith, civilian producer-director for the headquarters CCTV facility. "To be effective they should be bold, simple and direct; not finished and polished work, just clean, simple and bold. But we still receive what we call 'laundry list' copy. Our eventual goal is to have all

offices prepare their own visuals to our tried and accepted standards."

He further pointed out that if briefers follow the steps in the planning guide, professional quality productions will result. However, in order to provide quick reaction, the television facility has, and practices, the capability of adapting whatever visuals the briefer may have, and doing the production on an immediate basis without benefit of rehearsals. While the quality may suffer slightly, the state-of-the-art and briefer acceptance advances with each usage.

### TV As A Management Tool

The first official TV production milestone was accomplished by AFSC early this year when, by color television tape, the Commander of the Space Systems Division in



FIG. 13. William Smith, civilian producer, coaches officers in making presentations.

Inglewood, California, briefed the Commander of AFSC at a management conference in Washington, D.C.

The audience in Washington included General Schriever and members of his staff. Simultaneously in California, Major General Funk and his staff were viewing another copy of the secret tape. After the tapes were presented, questions were answered over the inter-headquarters secure telephone. The success of this first test of the CCTV management system has resulted in a steady increase in the number of high priority briefings. In the short, few months of AFSC CCTV operation, some 200 briefings and presentations have been made.

Air Force officials agree that the present system, although not truly "real time" in the national sense, is a direct means of governmental management communications and a significant step toward the goal of providing current information of the kind necessary for accurate decisions in literally a world of exploding technology. Experts



who have made studies of the complex Air Force management problem consider it to be the most comprehensive of all the known audio-visual techniques and one that may reduce the immense quantities of staff time and energy, as well as expense, that are consumed in technical, management and background V.I.P. briefings.

Major J. F. Sublette, Chief of the Telepresentations Branch of AFSC is one who foresees TV management surpassing all other uses of CCTV. In his words, "It is the only means we've got of reacting immediately to demands from those with one foot in the airplane. This condition will be alleviated by bringing the real-time approach to all our divisions and centers."

### The Economics of Management TV

Major Sublette, whose extensive research and findings in the application of CCTV are contained in a thesis he prepared for Indiana University, is presently studying the economics of TV as used by the Systems Command. Some aspects of the difficult undertaking are presented in his comments:

"Where TV is used in education and training, economies brought about by mass communications alone are real, even measurable. We are looking for some such 'yardstick' for TV as a management tool.



FIG. 14. Slides, charts and other visuals are prepared in the graphics department.

FIG. 15. Col. Binge rehearsing a briefing in TV Studio at Andrews. Included are two Color TV Cameras, Type TK-41, for preparing tapes for television presentations.

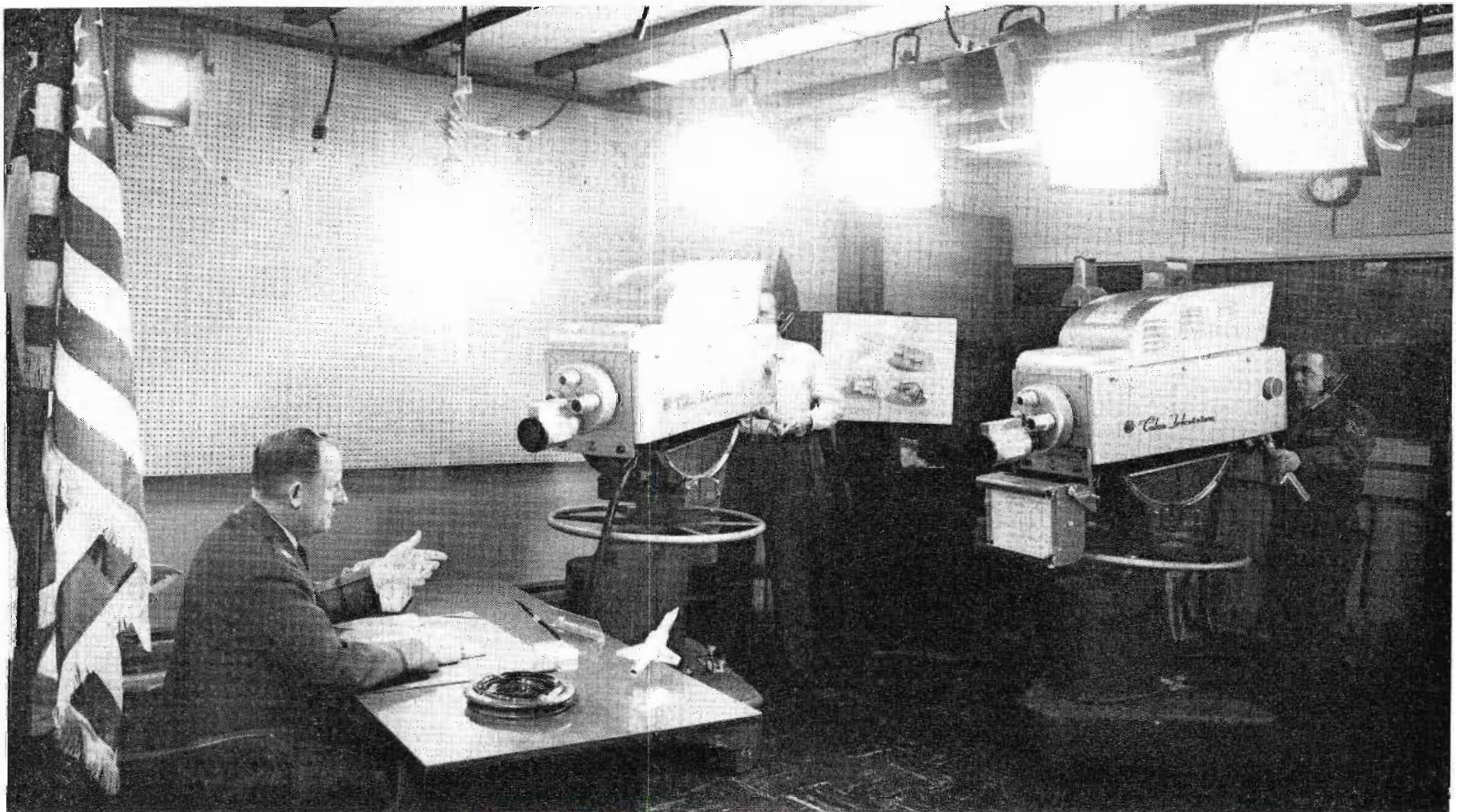



“Undoubtedly, TV achieves savings in personnel time, in travel, in the number of trips, and in the costs of repeated briefings. This does not take into account the value of closer communication or of greater speed and accuracy in the decision making processes, or the increased effectiveness of presentations. But exactly how are these things measured?”

“We do know that the ultimate result is better efficiency in communications, and in overall participation and decision making. The Air Force is growing, becoming more complex and dealing with more sophisticated systems. We must improve communications in order to keep ahead.”

### The Value of Color TV

Color was found to contribute significantly to preception and understanding, particularly in complex presentations. Charts and graphs, which play an important part in the visualization of problems, are more easily seen, understood and remembered when in color, and color is frequently used as a “key” to indicate important instructions and zoning. The color TV system also permits integration of available maps, slides and other materials that may be unusable or totally ineffective if presented in monochrome.

### Future Plans

CCTV space limitations at AFSC headquarters are becoming a problem as more of the associated offices call upon them for service. Plans are being made to enlarge the studio and other facilities.

AFSC’s long range plans are to equip all the Command’s divisions and centers with similar CCTV facilities to permit the production and viewing of TV briefings.

The most immediate goal, however, is to establish a completely secure microwave leg to the Pentagon. This system would permit AFSC to tie into the existing Air Force TV system at the Pentagon, and into a similar proposed system at the White House. This could be the first step in a nationwide, two-way TV network that would eventually link USAF headquarters and all AFSC divisions and centers.

Also envisioned is an Instant Management Data System at Systems Command headquarters. In this concept, all divisions and centers would enter current information in their respective computer or storage equipment. This data could then be forwarded electronically, upon request, to headquarters or to any receiving point having need for the information.

## HOW CCTV IS USED BY AFSC

1. To serve as a management aid in presenting current information and data to the decision making staff level.
2. To serve as part of a video tape network between major air commands and Headquarters, USAF.
3. To serve as a production source and library for current and past briefings on TV tape.
4. To serve as an aid to administrative and training activities.
5. To serve as a means of enhancing briefings.
6. To serve as a method of extending the audience.
7. To serve as a centralized briefing facility using live and taped presentations.

FIG. 16. Equipment complement at Andrews includes transistorized TV Tape Recorder, Type TR-22, for producing color briefings.





## Function of Patrick Air Force Base in Management TV

The functions of Air Force television at Patrick are, in part, unique, since the mission of the entire Air Force Missile Test Center is itself singular in the country. Several organizations are part of the Cape Kennedy team, and all of them have occasion to be aware of the value that television brings to modern communication.

The Air Force is the host at this gigantic rangehead and at the several downrange

stations. Pan American is the prime contractor, charged with running and maintaining the range, and the Radio Corporation of America provides AMR instrumentation. Many other organizations contribute, obviously to the total effort, which is to serve the many range users who bring projects, missiles, tests and a myriad of other programs to the Missile Range for military and scientific research. The prob-

lems of management communication among these several types of organizations are accentuated on the AMR, and in meeting these problems, the Management Information Office (MIO) with its fixed and mobile television capabilities—has its prime mission.

Intra-mural briefings are continually being made, as management in the Air Force, PanAm, RCA, or a range user



FIG. 17. Mobile van makes it possible for Air Force to extend services of Management Information TV studio to scenes of actual launches.



FIG. 18. Mr. Gordon Fountain, Production Director makes a final check inside the van before a remote pickup.



agency goes about its business of handling, sorting, and analyzing technical or human data. Where a message is important to many people, a briefer can easily put his presentation on TV tape, after taking advantage of the consulting and graphics services within MIO. Once a tape is made, it can be shown at several locations, and it can be shown repeatedly. Thus, the briefer gives his message but once, and his audience, from that moment until the message is outdated, continues to grow.

Technical briefings, however, make up but a part of the television fare at Cape Kennedy. Documentaries are produced quite often, requiring the skills and talents of writers, producers, artists and the television crews. The prepared and rehearsed TV tapes are used within the Air Force across the country, in bringing to other Commands, other agencies within the Systems Command, and even the Air Staff itself, the ever changing story of the country's space effort and the details within it.

The Public Information Office has taken advantage of the television center at Patrick, and arrangements have been made for cooperation with network news departments so that signals recorded by the MIO

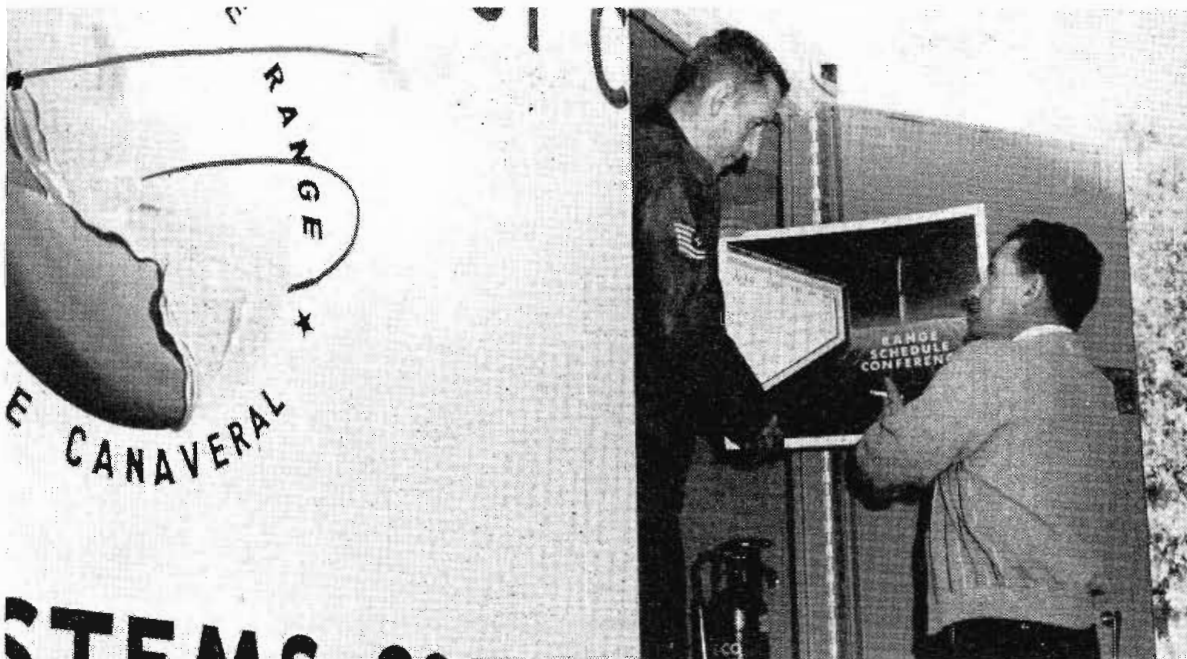

FIG. 20. Dr. Frederick Breitenfeld, Jr. Director of Missile Test Center's Management Information Office. He supervises the TV operation and acts as consultant on matters pertaining to presentations.

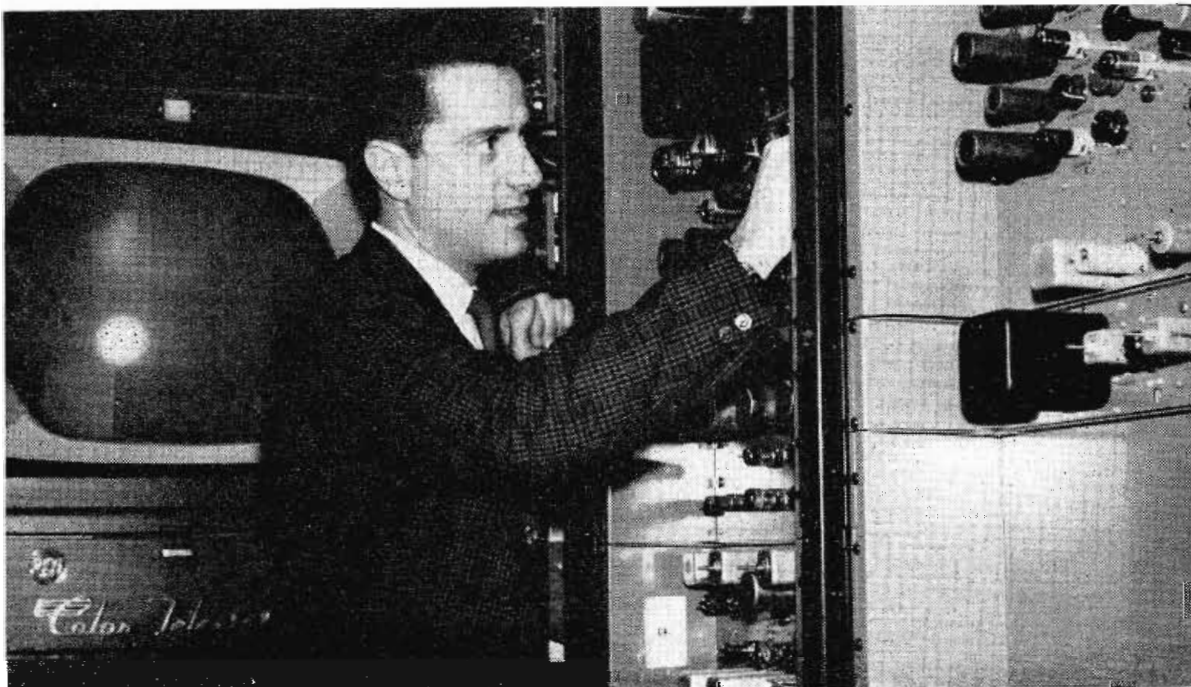

FIG. 19. A vital part of each production is preparation of visual material. T.S. G. R. Zambs checks flip card with staff illustrator, R. M. Rubin, before live pickup.

can be shipped—or even fed electronically—to news media, with striking speed. The Cape Kennedy story, then, is carried to the people, through a magnificent combination of efforts and talents. Tapes are made of all important launchings, both for public release and for use in solving the problems of launch operations.

The Management Information Office makes continual use of televisual communication in management, public relations and handling of technical data.





▲ FIG. 21. Studio Control Room at Patrick. Cameras are switched here and films are integrated in TV Tape presentations. Note, at far right, window looking into TV studio.

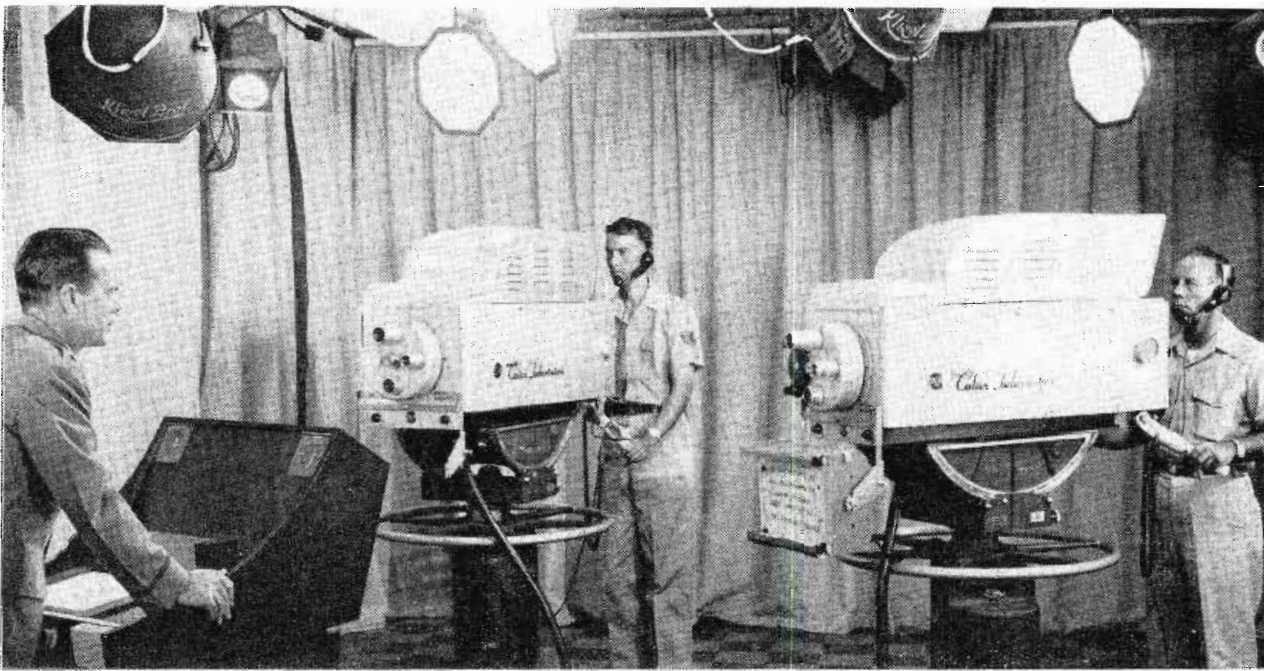

◀ FIG. 22. Color TV Studio at Patrick Air Force Base, Florida.

▼ FIG. 23. Television tape and film systems installation at Patrick.

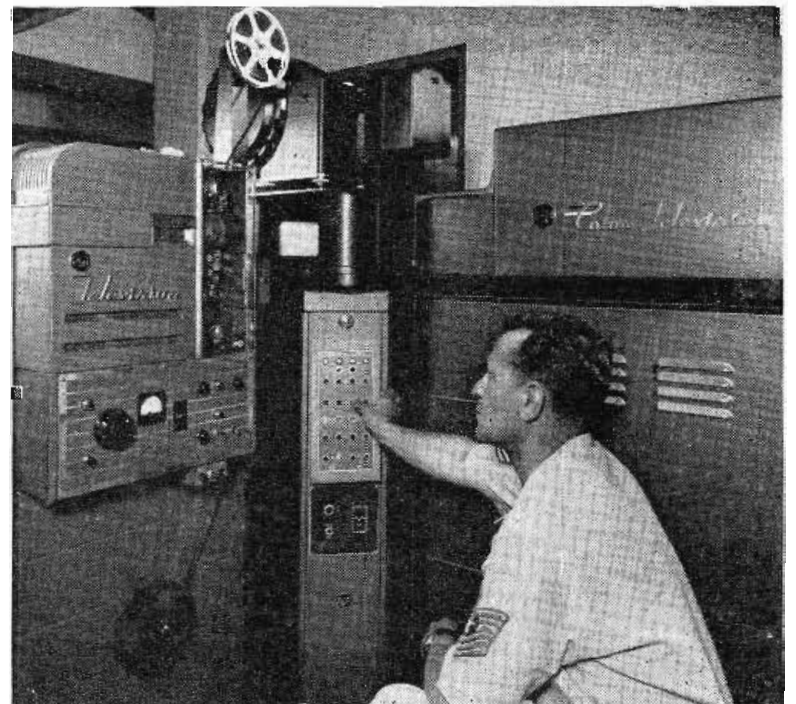
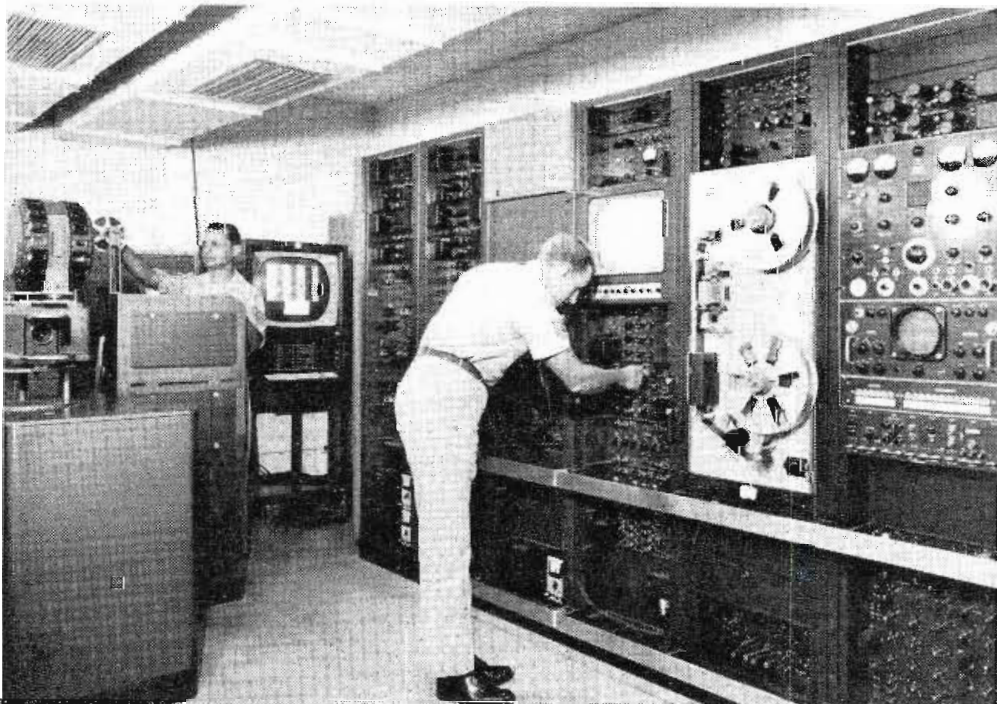

▼ FIG. 24. Film System may be controlled locally (as shown here) or remotely from the studio control.



# Closed Circuit Color TV is a Management Tool

## At Space Systems Division

Recently an SSD officer had to be in two places at once. His schedule called for delivering an important briefing at the same time that urgent orders came for him to catch a plane to Washington.

The solution to his problem was the SSD closed circuit color TV system—latest management communications tool set up to facilitate exchange of information about the Division's space projects.

"Because of his priority we juggled the schedule and had him on camera in 15 minutes," Ken Whitman, Prod/Tech manager of the CC-TV system, said. "This

officer knew his subject and we used his visual aids just as they existed.

"It usually takes about 10 minutes to explain the simple techniques we use. After that the briefer gives his report in his own manner."

### Conferences Taped

Tapes of important AFSC conferences have been assembled into a library available for instant showing. They can be replayed at any time, updated when necessary, or erased when not needed.

TV tapes are time savers. A briefing officer can be certain that the same infor-

mation is presented in the same manner each time. If any question arises as to what was said and in what context, the video tape gives the answer.

These tapes can be shown locally in secure playback areas accommodating 5 to 50 people. Copies can be sent by pouch to AFSC or to other areas. The briefing officer can accompany the tape or handle questions by telephone.

"If an officer comes prepared to speak and has his visual aids in order, we can work in 'real time', doing all our taping as he goes through his regular briefing. By speaking once, he is free to do other work



FIG. 25. Col. Richard E. Sims checks in with receptionist as the first step in making a closed circuit color TV briefing tape.

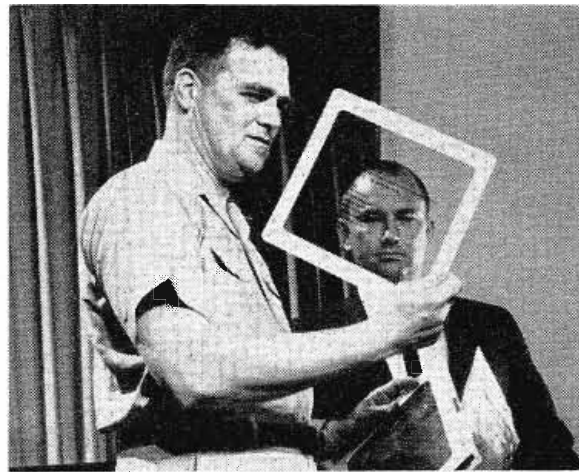

FIG. 26. Next step is to check visual aids. These aids will be integrated in the TV tape presentation.



FIG. 27. TV cameras are adjusted before shooting the briefing.

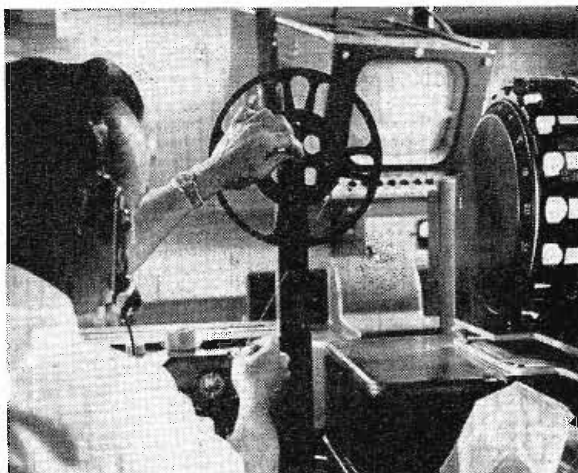

FIG. 28. Projectors are readied for inserting film clips and slides into the TV briefing.

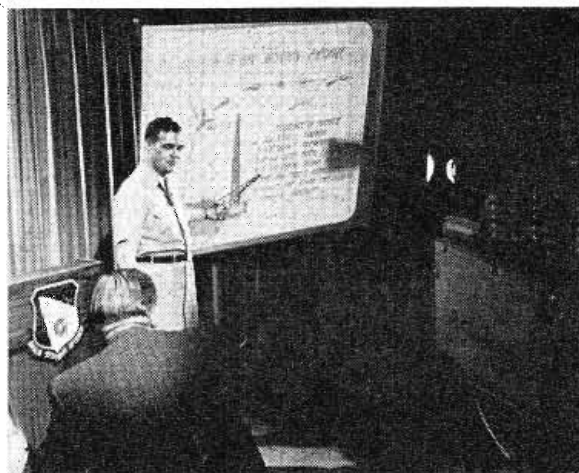

FIG. 29. Shooting begins . . . this single briefing on TV tape can be repeated numerous times—frequently accomplishing the job better.



FIG. 30. Views from the three cameras show on the monitor screens as the briefing goes on tape for future showings.



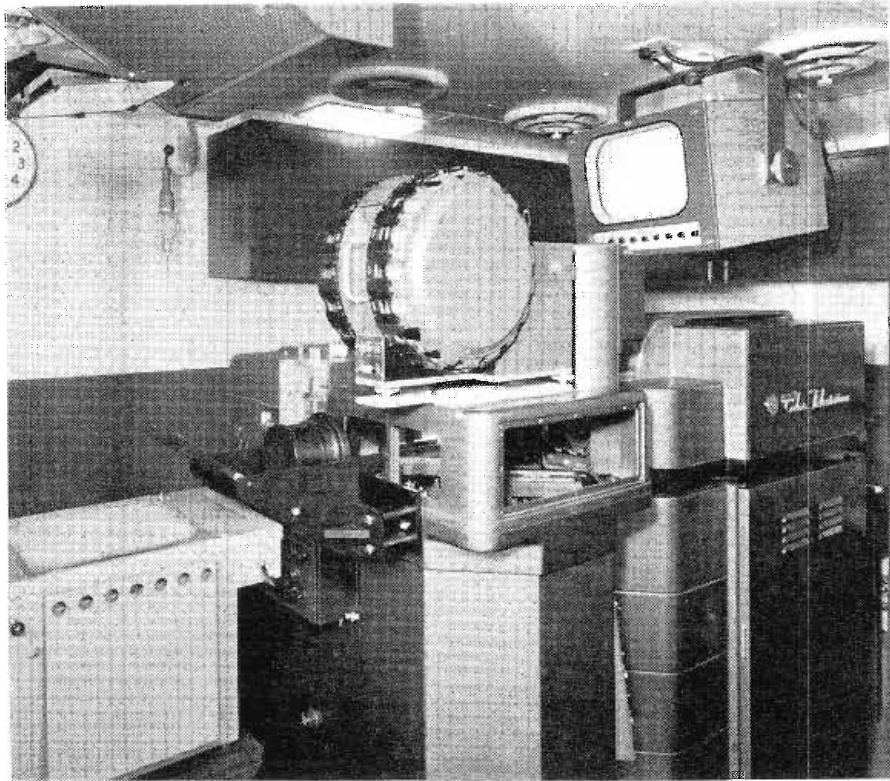

FIG. 31. Tele-Cine area of S.S.D. mobile van includes color film chain with slide, film, and overhead transparency projectors.



FIG. 32. TV tape area in S.S.D. color mobile van.

while his color image and voice work for him at hundreds of other showings," Whitman said.

#### Experienced Craftsmen

Briefings are done by acquainting the officer with simple television presentation procedures and by employing professional TV cameramen who are experienced in following the action.

On a low priority basis tapes will be made for speakers who simply want to study their own delivery.

In addition to technical briefings, other types of material are taped to aid directores. Recently, a briefing was made for the transportation office to free personnel from repetitive explanations about household goods shipments to transferees.

The television section is a highly professional group. Many of the personnel are veterans in the communications business and in the television industry. Some are recognized authorities in their specialties.

Value of the TV tape is shown by the remark of an industry representative who said that he walked out on a live briefing. "I couldn't see the charts from the ninth row, but when I saw it replayed on TV it was just like I was an audience of one."

It was explained that this is because the TV camera can zoom down to show chart detail.

Results of the use of television for management decisions and for briefings have been gratifying. Time and money have been saved and people have been welded closer together.

FIG. 33. Operations area of mobile van, showing relationship of camera controls and monitors to the control desk.

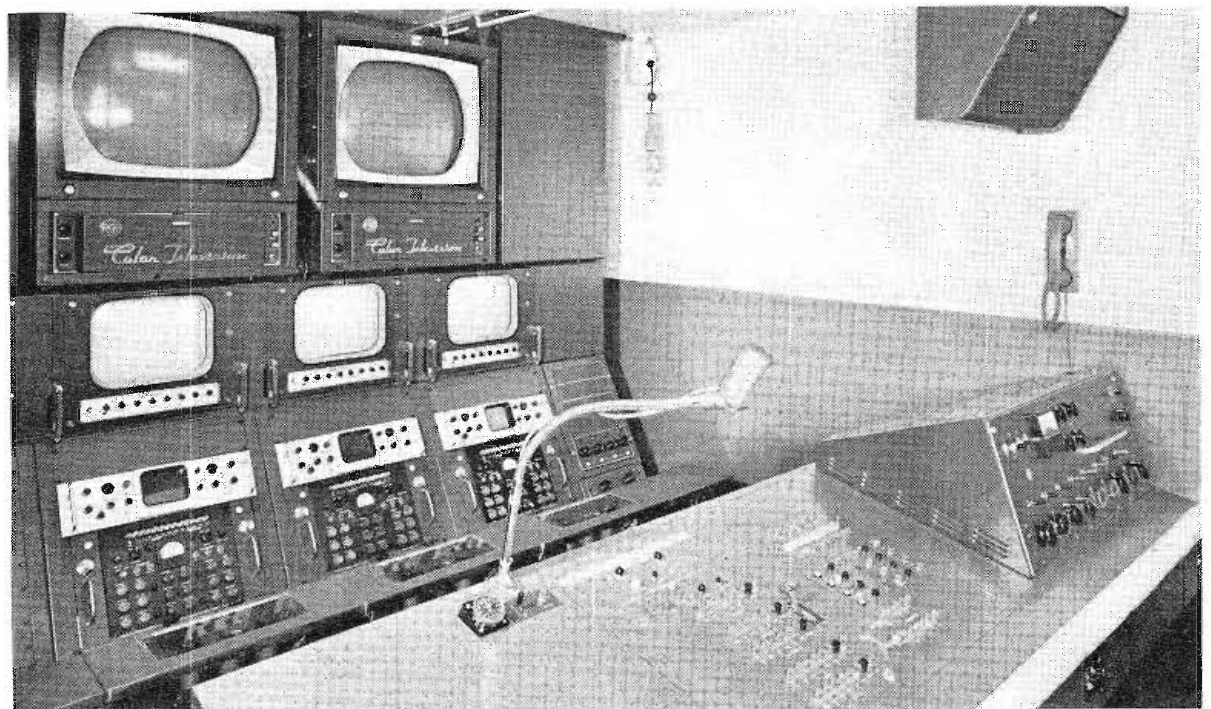
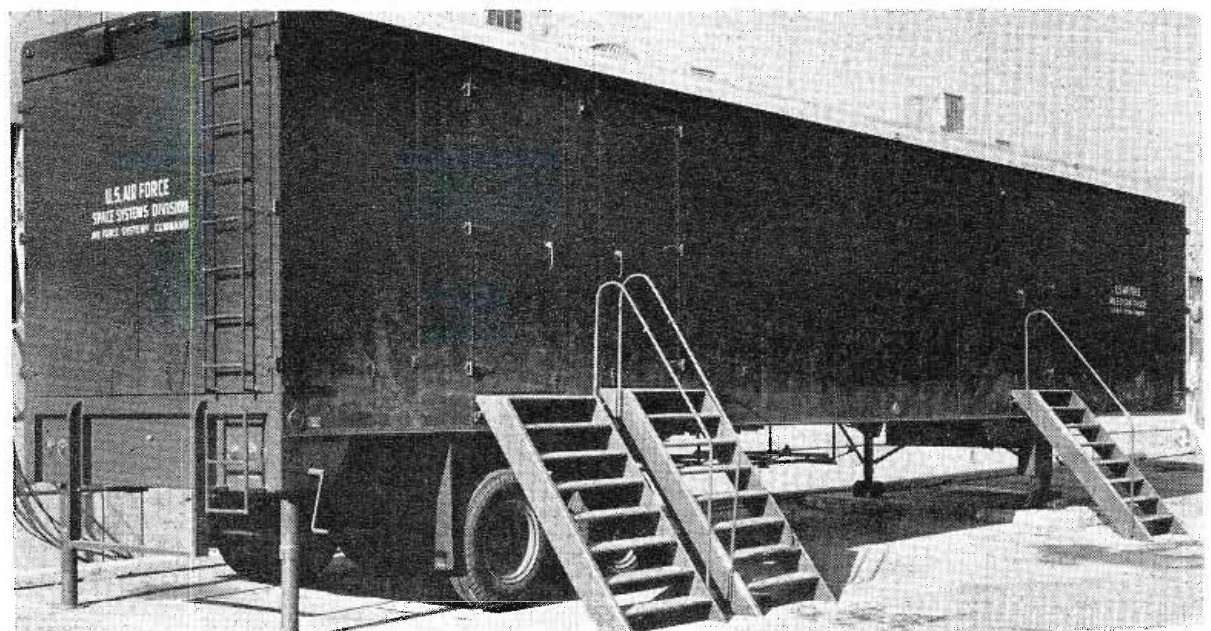

FIG. 34. External view of S.S.D. color mobile van. It is 50 ft. long by 10 ft. wide and contains all facilities for making Color TV Tapes in the field.





# AMPLIPHASE . . . FOR ECONOMICAL SUPER-POWER AM TRANSMITTERS

by D. R. MUSSON

*Broadcast Transmitter Engineering*

The development history of high-power, amplitude-modulated transmitters is most interesting. As the power-output requirements on AM transmitters increased, the difficulties encountered in obtaining performance and efficient operation became more complex. In order to keep the power capabilities of modulation circuits low, the linear-amplification system was used. This system, however, is inefficient and wasteful of primary power. This fact, in itself, made the linear-amplification system undesirable for high-power installation for, the higher the power, the more prohibitive the costs of the power lost in such a system. As a consequence, more efficient systems of high-power-AM systems became necessary and were developed.

A variation of a linear-power amplifier was devised by W. H. Doherty. This more efficient system, in its early days, also had limitations, mostly because of the difficulty encountered in attaining good system linearity.

The high-level, plate-modulated transmitter system became most popular in AM Broadcasting. This system, too, has deficiencies, particularly in high-power systems (50-kw and greater).

A third system, to which this article is devoted, has been developed and is in use in an increasing number of high-power-transmitter installations.

**Ampliphase** is a variation of—what is termed—“outphasing modulation” and, in general, improves on both of the preceding systems, particularly in high-power applications. It is the purpose of this article to describe the system, explain its operation and to discuss its application in high-power-AM transmitters.

“Ampliphase” is a word coined to describe phase-to-amplitude modulation and avoid the cumbersome group of words it replaces. RCA *Ampliphase* is a system technique whereby the amplitude modulation is formed across a single capacitive element, which is coupled directly to the transmitting antenna system. Several equipments using outphasing modulation have been

<sup>1</sup> “High-Power Outphasing Modulation,” by H. Chireix, *Proceedings of the I.R.E.*, Vol. 23, Nov. 1935, pp. 1370-1392.

developed by others with varying degrees of success. The French pioneer in this system, H. Chireix<sup>1</sup> created considerable interest on the European Continent and a number of equipments, mostly high-power types, were completed. On the North American Continent only one equipment was in commercial operation before RCA undertook its *Ampliphase* development program.

RCA's *Ampliphase* is a system in which a portion of the transmitter, outside of the active components, converts phase modulation into amplitude modulation. In order to fully appreciate the advantages of this system, a review of the fundamentals of amplitude modulation and the popular means of achieving high-power AM is presented here.

Take, for example, the properties contained in an amplitude-modulated r-f signal of a 50-kw radio transmitter. (See Fig. 1). With no modulation applied, r-f energy

at one level (50 kilowatts) is produced. That same transmitter, heavily modulated with an audio signal, produces various r-f levels throughout the modulation cycle. At the negative modulation peak the r-f level is very low and the power produced is, likewise, very low. Conversely, at the positive peaks of modulation the r-f level is very high. At 100 per cent modulation, the r-f level is such that, at the positive-modulation peak (assuming no carrier shift with modulation) the peak power produced at this instant is four times the zero-modulation power or 200 kw from the 50 kw transmitter. All power levels between this peak and zero are produced over the range of the modulation envelope. With this in mind, let us examine the mechanics of achieving this variation of rf-output level in the three high-power-transmitter systems.

## The Linear Power Amplifier

First, in a linear system, the final-power amplifier reproduces, at its output, essentially the same signal present at its input. The reproduction faithfulness depends upon the tube, load and the proper adjustment of a number of critical parameters. Each stage of linear amplification distorts the signal to some extent as it raises the power level. The amplifier produces the value of *peak* power most efficiently. By nature, however, when the amplifier operates at carrier level, or any level below peak modulation value, the unused power (the power input to the stage is constant) is lost in the amplifier tube in the form of heat. This lost power is the greatest objection in the high-power, linear-amplifier system.

## The Doherty System

A more efficient, linear system is the Class “BC” or “Doherty” system. In this “modified-linear” system, two amplifier tubes are employed. The main, or, “carrier” tube is operated with its most efficient operation point at carrier level. Power above carrier level is supplied by the carrier

FIG. 1. Oscillogram of the output waveform of an AM transmitter with and without modulation.

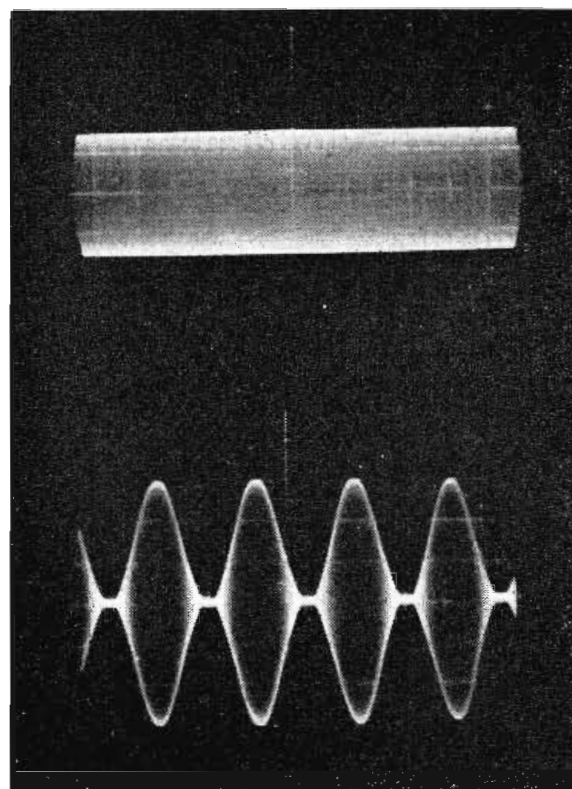



and a second, "peak" tube. Here, again, the reproduction faithfulness of the output signal depends not only on tube characteristics but also the proper adjustment of a large number of circuit parameters.

It was noted that, in the more efficient "Doherty" version of the linear system, the efficient output was achieved by utilizing the carrier tube at its full capability with a minimum of unused power. This leads us to the second method of producing modulated r-f energy: high-level modulation, a system in which the rf-amplifier tube always operates at maximum efficiency.

### High-Level Modulation

In this modulation method, the plate voltage on the final amplifier is raised and lowered as dictated by the modulating intelligence which is supplied by high-power-audio amplifiers. At carrier level, the plate voltage is at a given value; at high-modulation peaks, the plate voltage is nearly double that given value and at negative-modulation peaks, nearly zero. The plate voltage is constantly changing, in step with the modulating intelligence, thus producing the differing rf-output levels.

Faithful reproduction of the input signal in the system is heavily dependent upon the tube-linearity characteristics of the high-power-audio stages. A certain amount of feedback is incorporated in the system to correct for deficiencies in the linearity. Performance of this system is limited at low modulating frequencies by the iron content of the modulation transformer (which controls the varying power-amplifier plate voltage). Other limitations lie in the losses encountered in other modulation components. In very high power systems, care must be exercised to avoid lengthy periods of maximum modulation to prevent the power dissipated within the modulation transformer from permanently damaging the transformer.

### The Ampliphase System

In the third method of producing high-power, amplitude modulation, the final-

FIG. 2. Block Diagram of the "Ampliphase" System.

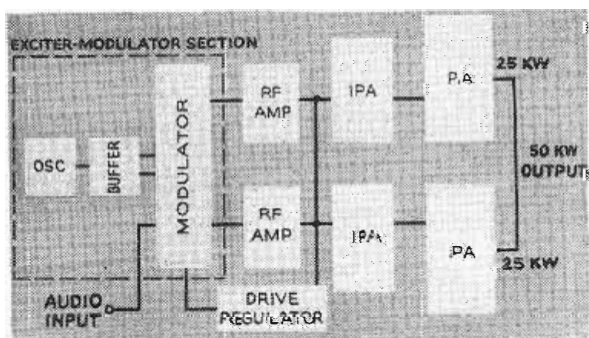

$$Z_T = 2R \cos^2 \frac{\theta}{2} \pm jR \sin \theta$$

Where

- $Z_T$  = Impedance at tube
- $\theta$  = Angle between r-f voltages of the two channels
- $R$  = The effective combining point load

FIG. 3. Equation for Calculating Power Amplifier Plate Impedance.

amplifier plate voltage remains constant while the current delivered to the load varies in accordance with the modulating waveform. In addition, the amplifier operates at full r-f voltage output from carrier level up through full peak-power output. This results in high efficiency at these various levels. This is the *Ampliphase* system.

### Ampliphase Theory

The *Ampliphase* system is, basically, two paralleled, continuous-wave transmitters, using conventional Class "C" amplifiers—with their attendant high efficiency—as the final-power amplifiers. (See Fig. 2) Tube-plate voltages are constant throughout the modulation cycle and radio-frequency energy is amplified by conventional means. It is at the output ends of the two high-power amplification channels where the key to the *Ampliphase* system lies.

The modulation information is imposed at the low-power end of the transmitter and the modulation is realized at the high-power end. During amplification the information is in the form of phase modulation and depends only slightly on r-f amplifier-tube characteristics for faithful reproduction.

FIG. 4. Simplified Schematic, "Ampliphase" Combining Network.

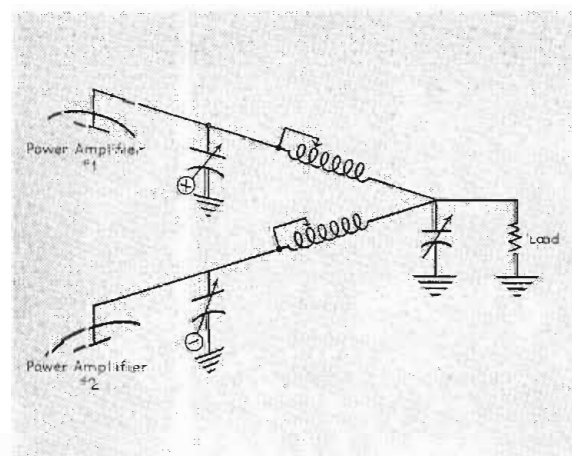

This, then, leaves two areas in which to concentrate our attention. Since the output circuit is where the modulation is actually formed, we shall direct our attention there first.

### Output or Combining Network

The heart of the *Ampliphase* system is the network across which the modulation is formed. Surprisingly enough, this is a very basic circuit. Several papers have been written on the mathematics of the conversion of phase modulation to amplitude modulation in an outphasing system. (See Fig. 3.) The development of the theory is not required in gaining an understanding of the *Ampliphase* system, only the general impedance equation of Fig. 3 need be cited.

### Ampliphase Modulation

In arriving at a suitable transmitter design, solutions of several points throughout the modulation cycle are computed. In the *Ampliphase* system, the points from carrier level upwards to the positive peak of output power are of prime interest. The secondary importance of those points *below* carrier level are revealed later in the discussion of drive requirements for the power-amplifier tubes.

The combining network is made up of two 90-degree  $\pi$  networks: one network couples each power amplifier to the common load. (See Fig. 4.) If the r-f energy from the two power amplifiers is fed in phase, the network acts as a simple paralleling device to couple the two amplifiers to the single load.

Feeding the two signals to the network in an out-of-phase condition produces less voltage at the output than in the "in-phase" condition. Further, since the impedance at

FIG. 5. Vector representation of the phase difference between the two r-f chains in an "Ampliphase" transmitter at zero modulation.

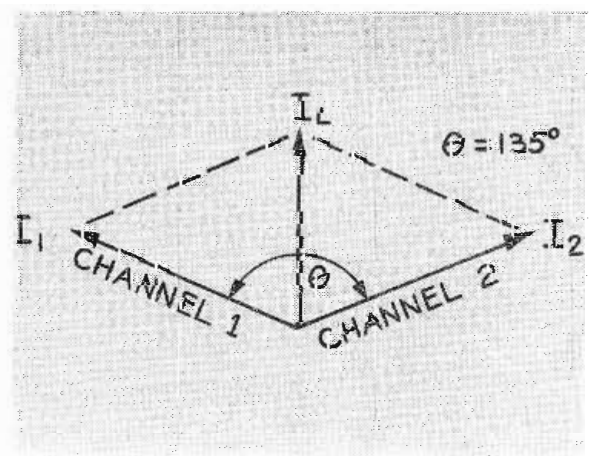



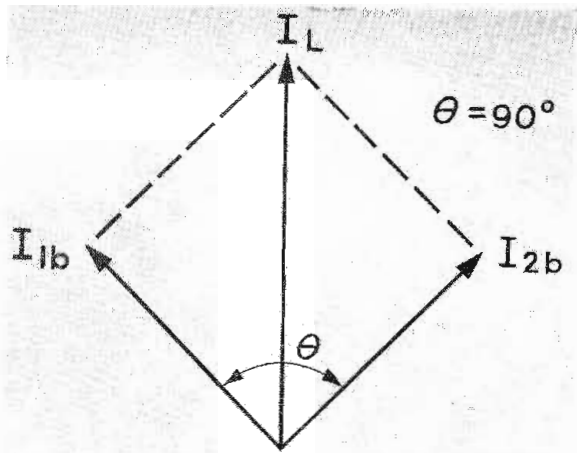

FIG. 6. Vector representation of the phase difference between the two r-f chains in an "Ampliphase" transmitter at the peak of a 100-percent modulation envelope.

the output of the combining network changes in the "out-of-phase" case (indicated by the lower voltage level), the network no longer appears as a tuned load to the power amplifiers. The amount of reactance present under this condition is contained in the last part of the impedance equation. (Fig. 3.) Note that equal amounts of reactance, differing only in sign, appear at each power amplifier. To provide resistive loads for the power tubes, the input element of each of the 90-degree networks is adjusted accordingly. The  $\pi$  input capacitor on the power amplifier, experiencing inductive reactance, is increased to draw more capacitive current from the amplifier, thereby compensating for and providing the "real" load required for efficient amplifier operation. Likewise, in the power amplifier experiencing capacitive reactance, the input element is adjusted an equal amount in the opposite direction to provide amplifier its purely-resistive load at carrier level. (See Fig. 5.)

The modulation equation is of use over a fairly wide range of phase angles, but not over the entire modulating range. (See Fig. 6.) The loads deviate slightly from a unity-power factor toward the positive, in-phase, condition and especially in the negative, out-of-phase, condition. (See Fig. 7.)

The quite-definite departure from unity power-factor in the negative modulation region is of minimum importance because the drive-regulator system in the transmitter apportions drive to the amplifier tube as the depth of the negative-modulation peak dictates. The total result is that, when the load to the PA's is least "real" and, hence, provides for the least-efficient operation, the available drive is small. As a result, the inefficiencies of the system are minimized. Even more important, the

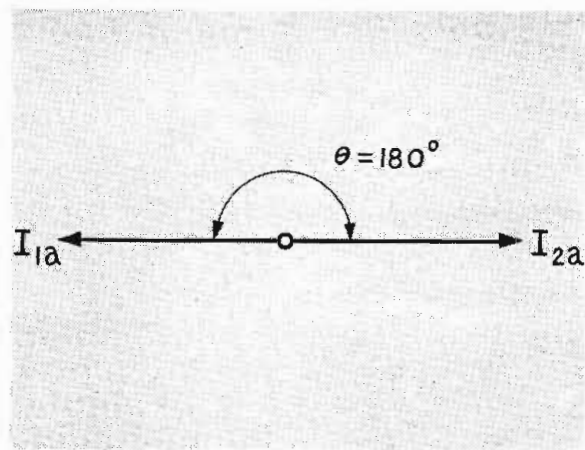

FIG. 7. Vector representation of the phase difference between the two r-f chains in an "Ampliphase" transmitter in the trough of a 100-percent modulation envelope.

linearity of the modulation system is improved, and both efficiency and faithful reproduction are gained. Drive regulation further provides the high value of drive necessary when the PA tubes are required to develop the high-power levels of the positive modulation peaks.

The combination of the regulated drive and the outphasing modulation leads to a highly-efficient and highly-linear system with a minimum of major components.

The characteristics of this combining network offer some very definite operating advantages over other transmitter systems. A particular advantage is that a change in load reactance does not detune the amplifier stages to any great extent, but serves only to adjust the proportion of the power contributed by each stage. The power delivered to the load and the efficiency of the system changes very little over a fairly wide range of reactance values.

This advantage is of great importance when the antenna load has highly reactive side-band impedances, for modulation linearity and efficiency are not greatly affected and the output capability is not limited by this condition.

#### Imparting the Modulation Information

After the consideration given the modulation and how it is formed at the output, let us now look briefly at the means of applying the phase modulation on two r-f channels of the RCA *Ampliphase* transmitter. Two types of simple phase modulators are in use presently on commercial *Ampliphase* transmitters. Both are highly acceptable and each is used to best satisfy the design requirements of the particular equipment. The modulator used on the medium-frequency AM line is a very stable device, highly linear in phase modulation. (See Fig. 8). This stage is a simple, tuned-

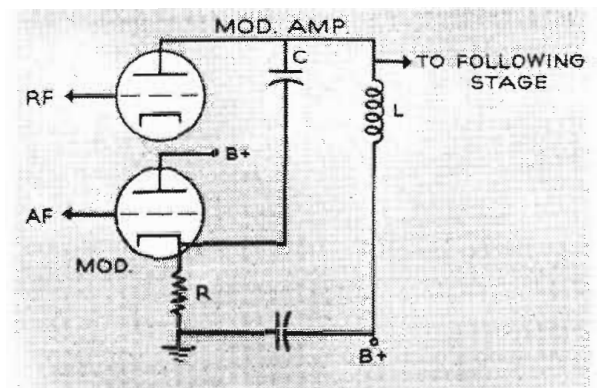

FIG. 8. Basic circuit: "Ampliphase" phase modulator.

rf amplifier with the tuned load formed by a parallel-resonant circuit in which a variable resistance ( $R$ ) is placed in series with the capacitive element ( $C$ ). The inductive element ( $L$ ) is tuned so that its reactance is equal to twice the reactance of the capacitive element. At this point, varying the resistance changes only phase angle and not the magnitude of the impedance seen by its driving tube. The resistance variation in the audio phase-modulator is the cathode impedance of an audio cathode-follower stage. This is the circuit in which phase modulation at an audio rate is attained. The phase-modulation characteristic, complemented by a given transconductance characteristic of the cathode follower, produces linear phase modulation over a given range. The magnitude of phase modulation required for full amplitude modulation at the output of the transmitter is then attained by cascading the required number of stages. In practice, the amount of amplitude variation of the r-f output from this stage is very slight, when the modulator is properly tuned. This amplitude variation serves as a simple indicator to tune the stage and, in fact, the entire modulator. The capacitive element is a fixed value and the inductive element, a slug-tuned coil, is tuned for minimum audio "ripple" at the phase-modulator output.

The second type of modulator is a modified "Beleskas Phase Modulator"<sup>2</sup> circuit where the grid voltage of the phase-modulator stage is changed at an audio rate to thus control the amount of r-f through the tube. This adds, vectorially, with a fixed amount of energy feed, in quadrature, directly to the plate circuit. This stage produces some incidental amplitude modulation which must be removed in a subsequent limiter stage but it has the advantage of requiring no tuning. The *Beleskas*

<sup>2</sup> "Phase Modulation Circuit," by S. M. Beleskas, *Proceedings of the National Electronics Conference*, Vol. 3, 1947, p. 654.



modulator lends itself to application in transmitters which change operating frequency quickly, with a minimum of re-tuning, such as short-wave transmitters operating in the high-frequency band between 3 and 30 mc. This modulator, however, is not readily cascaded.

It is appropriate to note here the role the modulator plays in the system. Since the modulator imparts the modulation intelligence at the low-level part of the system, and the linearity of the modulated information is not effected by r-f amplification, there is no practical limit to the extent to which this information can be amplified. The same modulator can be responsible for producing modulation on a 10-kw, 100-kw, or 1000-kw transmitter using the *Ampliphase* system. Hence, great futures exist for the *Ampliphase* system in very-high-power transmitter units where the inefficiencies and linearity difficulties of the linear amplification systems and the expense of high-power, plate-modulated systems make them undesirable for super-power transmitters.

#### Intermediate Stages of Amplification

As indicated at the outset, the r-f power amplification system is conventional. The number of stages and power gain of each is of minimum importance to system performance. Drive regulation is applied at an intermediate-amplifier stage. In general, the ideal point to inject the drive regulation is on the grid of the driver amplifier. This is because of the low amount of modulating power required to produce the regulated drive.

To provide maximum phase stability and performance with feedback applied, the individual amplifiers have broadband loads. This eliminates the necessity of periodical re-adjustment of the amplifier tuning. In general, a check of amplifier resonance need be accomplished only when replacing tubes, and seldom then.

#### Ampliphase System Theory

Before we examine actual applications of the system, let us review the theory of the *Ampliphase* system (see Fig. 2).

The modulated-rf energy to the transmitter load is produced by two Class "C" power amplifiers working into a single load. The impedance of this load is changed by varying the phase angle of the rf into the power amplifiers in step with the audio intelligence. The simple output network is adjusted to produce a resistive impedance to the PA tubes at the carrier output level. Drive to the final amplifiers is regulated

in accordance with their drive needs which, in turn, depend upon the power they are required to supply to the load at any given instant in the modulation cycle.

Unusually good linearity is attained in the system hence the transmitter operates with only small amounts of feedback, contributing to excellent stability. Inherent linearity is displayed by the fact that the standard 50-kw equipment meets all FCC station-performance requirements *without* system feedback whatsoever. A moderate amount of overall audio feedback is generally applied at the secondary of the audio input transformer to further improve low-frequency performance and reduce noise level.

An analysis of the *Ampliphase* system is not complete without discussing the operational aspects, for the proof of its performance capabilities lies in operation.

#### Tuning

To demonstrate operational tuning, take the example of the RCA 50-kw medium-frequency, *Ampliphase* transmitter, BTA-50H. These procedures apply, as well, to the 100-kw BTH-100B and the 250-kw BHF-250A transmitters because of the similarity of these transmitters to the 50-kw equipment. The general modulator alignment was covered earlier in this article.

The two *pi* networks in the output and combining network tune very simply. As a

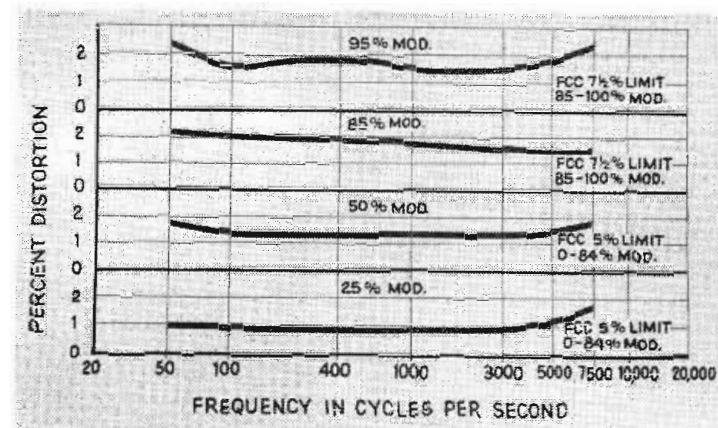
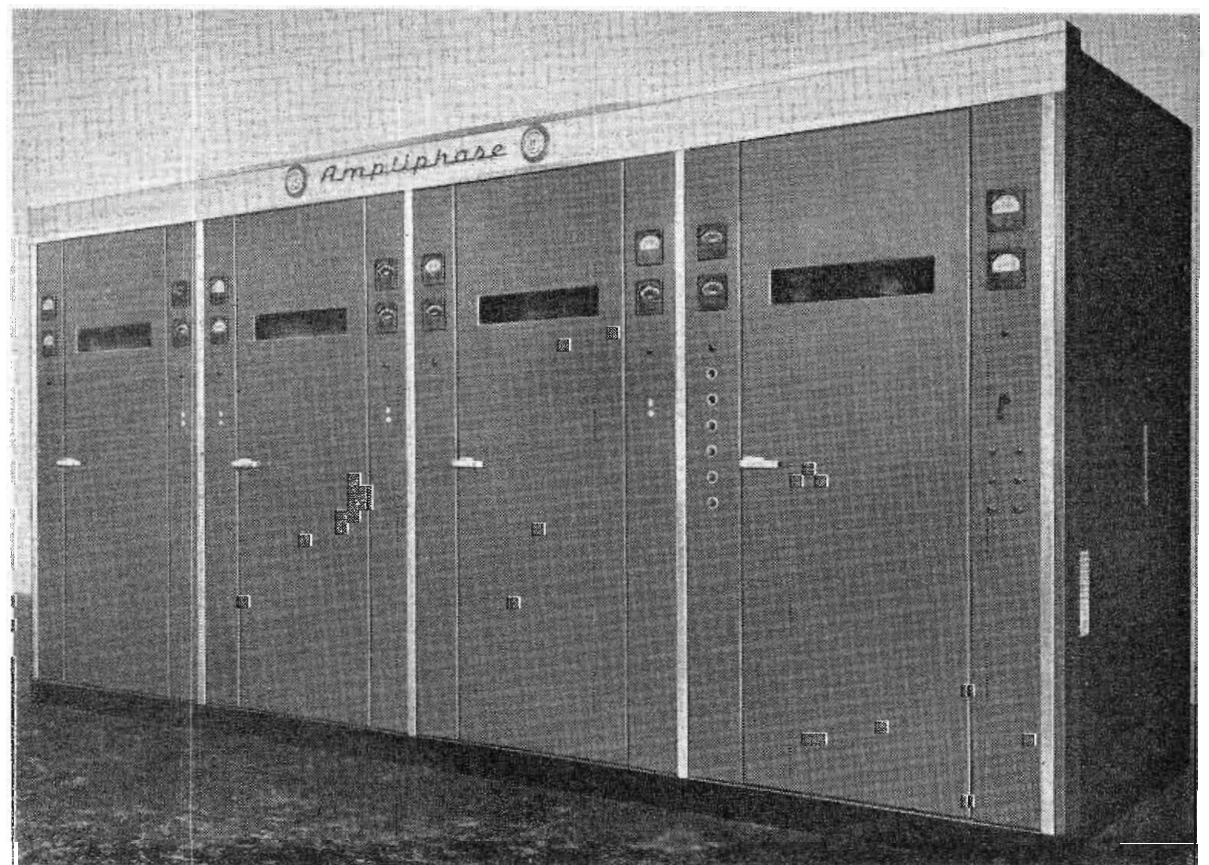

FIG. 9. Audio Distortion at various modulation levels, Type BTA-50H "Ampliphase" Transmitter.

matter of fact, most of the tuning is done as part of neutralizing the power amplifiers. These circuits, as all others in the high power stages, are set up initially and need not be disturbed unless replacement of a component is required. The input-capacitive element is resonated with the series inductance of the *pi* network by grounding (short-circuiting) the combining point and operating the two r-f channels without plate voltage on the final PA's. Feed-through energy from the PA grid is used to tune the unloaded PA-plate-tank circuits to resonance. An oscilloscope or rf-detecting voltmeter may be used to indicate the build-up of energy in this circuit using the plate-voltage-sampling divider provided in the transmitter. The PA-neutralizing capacitor is then tuned for minimum feed-

FIG. 10. The RCA Ampliphase Transmitter serves more than 30 broadcast stations in daily operation.





through energy, thus neutralizing the amplifier. The other channel is neutralized in an identical manner.

The short circuit at the combining point is removed and the input-shunt elements of the two power-amplifier output networks are offset from resonance by an equal amount which is pre-determined by that required to produce normal efficient operation when plate voltage is applied. A chart provided in the transmitter instruction book indicates the proper offset at any given operating frequency.

The zero-modulation phase-difference between the two channels is adjusted to give proper power output at carrier level. Modulation is then applied and the drive-regulator gain adjusted to give sufficient drive for positive-modulation peaks and normal carrier-shift under modulation. A nominal amount of feedback is then applied and the transmitter is ready for duty.

### Operation and Maintenance

Operation consists of observing the usual amplifier-meter readings. Unbalance in the final-amplifier-plate currents indicates a change in load reactance. Considerable change in this reactance can be readily compensated for by readjustment of the capacitance at the combining point, thus returning the PA-plate-current balance.

Modulator performance is readily checked by observation of the usual tube currents, through the convenient metering provided in the transmitter and by monitoring the amount of incidental-amplitude modulation produced by the modulated stages during normal modulation percentages. This modulator check may be accomplished without disturbing normal transmitter operation.

Any operational deficiencies in the intermediate-amplifier stages are indicated by

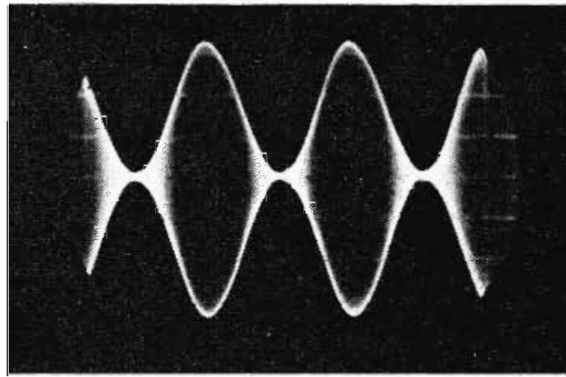

FIG. 11. Output waveform BTA-50H: 30 cps @ 100% modulation. (Distortion 2.3%)

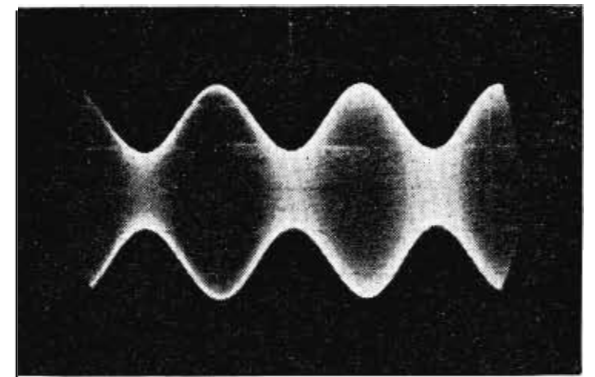

FIG. 12. BTA-50H: 30 cps @ 50% modulation. (Distortion 1.3%)

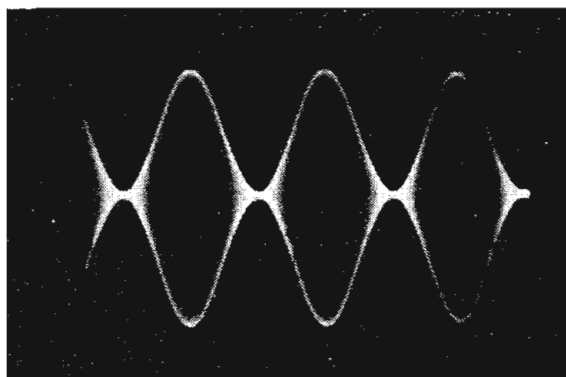

FIG. 13. BTA-50H: 1000 cps @ 100% modulation. (Distortion 0.85%)

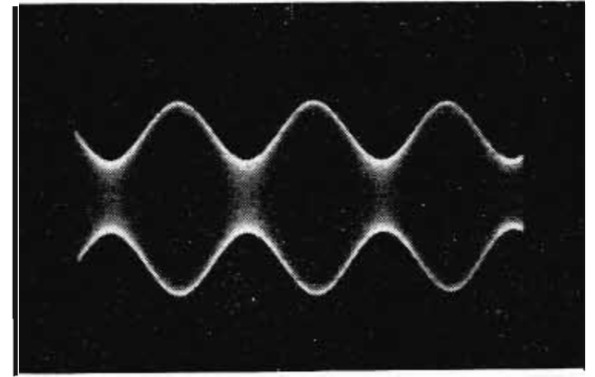

FIG. 14. BTA-50H: 1000 cps @ 50% modulation. (Distortion 0.55%)

the metering of conventional parameters in each amplifier stage. If trouble occurs in either channel, the transmitter can quickly be reduced to two parallel CW channels by removing the final-plate voltage. This allows comparison of the like amplifiers of the two channels which readily indicates the defective circuit. Having identical components in the two channels aids in correcting difficulty. Direct substitution or the "trading" of suspect components leads to rapid location of the difficulty, in the event it ever arises. Thus, the nature of the system of identical and parallel channels is a great aid in rapid servicing of the transmitter system.

As pointed out earlier, changes in power tubes have little effect on modulation performance until reduced emission results in insufficient r-f level to drive the power amplifiers properly. This, too, is readily indicated by the meter readings. It is well to note that the power amplifier tubes, which represent the greatest investment inside the transmitter, operate equally in each channel, providing equal power upon demand by the modulation level. At carrier level on the 50-kw transmitter the power-amplifier tubes dissipate only 7 kilowatts in each PA. Under average modulation percentages, each tube dissipates approximately 13 kw. Ordinarily, a tube capable of plate dissipation between 30 to 35 kw is used in this service. Under constant plate-

voltage and only sufficient emission reserve for positive modulation peaks, this design leads to extended tube life.

### Typical Ampliphase Transmitter Performance

Having discussed operation and maintenance of the system, the remaining item of the system application is the typical performance.

To evaluate the system, let us examine the typical performance of the latest *Ampliphase* design. The performance data found in Fig. 9 were taken on the first unit of the newest 50-kw, medium-frequency transmitter, the BTA-50H broadcast transmitter. (See Fig. 10.) It should be noted

FIG. 15. Typical audio-frequency response of the BTA-50H Transmitter at 95 percent modulation. You can hear the difference on a good receiver.

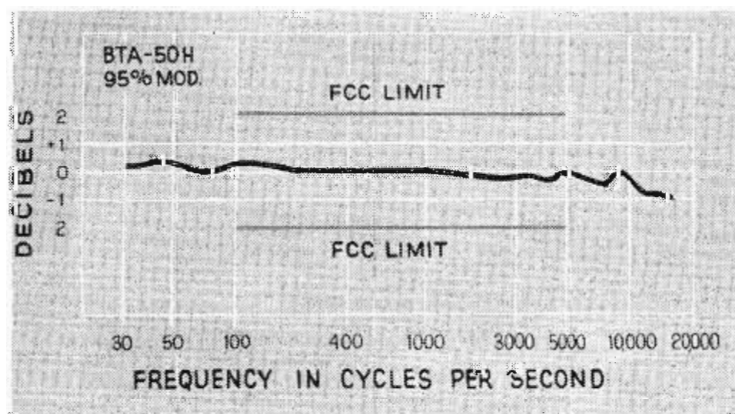

FIG. 16. Typical IM distortion, Type BTA-50H transmitter, at 95 percent modulation. Rarely published for AM transmitters, this characteristic proves the quality of "Ampliphase" transmitters.

### TYPICAL IM DISTORTION—TYPE BTA-50H

Low Frequency (CPS)	High Frequency (CPS)		
	2000	7000	10,000
40	2.0%	2.6%	2.7%
60	2.2%	2.6%	2.7%
100	2.3%	3.0%	3.0%

Intermodulation Signal Ratio 1 : 1  
Carrier Frequency: 1090 kc, 54 kw output  
Modulation Percentage: 95%



that in the *Ampliphase* system, the absence of high values of system feedback permits good high-audio-frequency performance. By the same token, low-frequency performance is not limited by the amount or quality of the iron in modulation components. (See Figs. 11, 12, 13 and 14.) The audio frequency response of the system is excellent as demonstrated by Fig. 15.

This performance is typical and demonstrates the superior system performance of the BTA-50H. Further demonstration of this performance is illustrated in the chart of intermodulation distortion performance obtained from this same transmitter. (See Fig. 16.

The *Ampliphase* modulation system is inherently stable in many respects. As shown earlier in this article, reasonable changes in load impedance have little effect on system performance. To demonstrate the range of sideband-impedance variation into which the *Ampliphase* modulation combining point may normally work, a 50-kw transmitter was set up to work into a dummy load which offers a flat characteristic at all modulating frequencies. The transmitter output was fed through a high-impedance, series-resonant circuit that produces a 38-ohm reactance at 10,000 cycles above and below carrier frequency. Under these conditions, the performance remained quite typical as indicated in the upper right-hand corner of Fig. 17 and the series of distortion curves in Fig. 18.

### Summary

The *Ampliphase* system provides a new high in transmitter efficiency, performance and stability in high-power, AM transmission. The high efficiency of the amplifying and modulating system employs only a minimum of unused primary power. Modulating components do not represent large investments in iron and copper as they do in high-level modulation systems. Inherent system linearity means minimum feedback, and this means ease in attaining and maintaining performance.

Changes in high-power-tube characteristics do not, radically, affect the system linearity. By its very nature, the system is insensitive to unusual load-impedance characteristics. Audio fidelity of the system is exceptional in the high- and low-modulating frequencies assuring high-fidelity performance in very-high-power transmission systems. The combination of these features both in the theory and the demonstrated performance make the *Ampliphase* system most desirable for use in high-power-AM and super-power-AM applications.

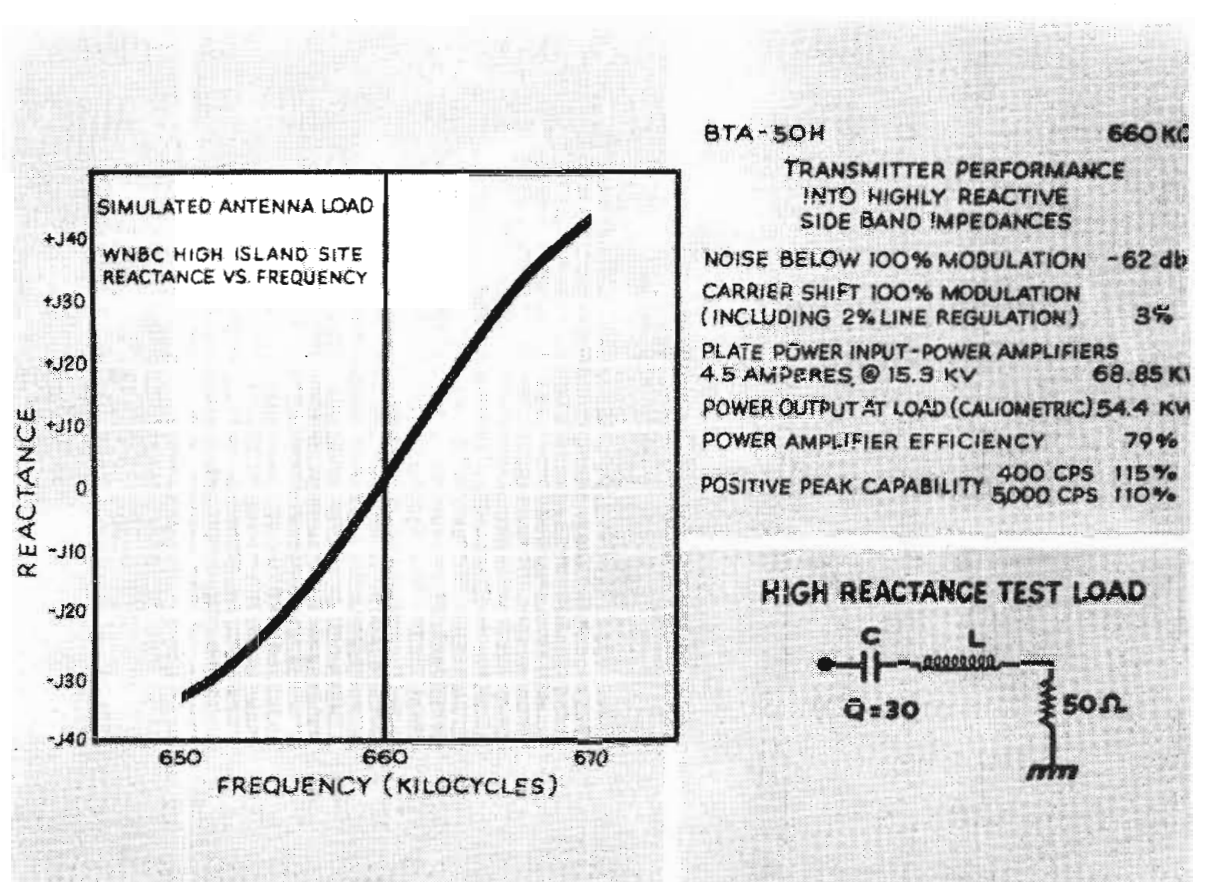

FIG. 17. Typical BTA-50H performance when working into a load with highly reactive sideband impedances.

## PERFORMANCE INTO HIGHLY REACTIVE SIDEBAND IMPEDANCES

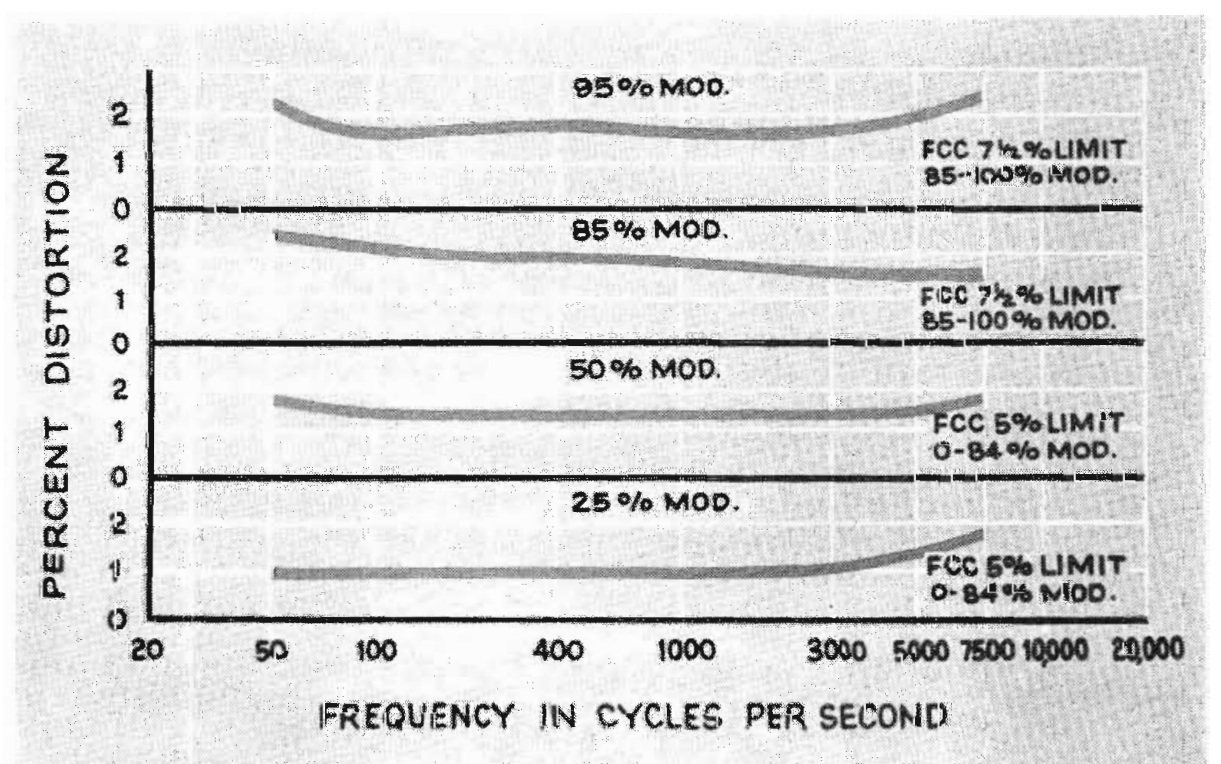

FIG. 18. Typical audio-frequency distortion characteristics of a Type BTA-50H Ampliphase transmitter when operating into a load with highly-reactive sideband impedances.



# SOME EFFECTS ON HORIZONTAL RADIATION PATTERNS OF SIDEMOUNTED FM ANTENNAS

by M. R. JOHNS, *Broadcast Antenna Section*

It is commonly recognized that the proximity of supporting towers affects both the impedance and pattern of television and FM broadcast antennas sidemounted on them. There is, however, little general knowledge and practically no specific knowledge of the magnitude and character of these effects.

To provide more quantitative information in this area which is of great importance to the broadcaster planning the installation of such an antenna, RCA presents the results of pattern measurements made with a standard RCA FM antenna of the BFA type having a horizontal pattern circularity in free space of better than  $\pm 1.0$  db. The antenna was mounted successively on three commonly used sizes of tower sections. This study is not intended to be exhaustive or rigorous due to the number of parameters affecting the results, the possible combinations are myriad, but it is offered as a base from which, at least,

broad assumptions may be drawn in the case of towers of approximately the same dimensions. Nothing which is set forth here should be construed as a guarantee of pattern shape or coverage in an actual installation.

## The Important Variables

Among the many variables which influence the radiation pattern, the following are probably the most important:

- Frequency.
- Cross-sectional size and shape of tower.
- Location of radiators vertically (whether opposite or between tower cross members.)
- Location of radiators around periphery or inside tower.
- Azimuthal angle between center line of radiator and adjacent tower faces.
- Spacing of radiator from adjacent tower members.

In addition, there are influences of a second order nature whose effect is recog-

nized but the results of which were not considered in this study. Some of these are:

- Character and orientation of cross-bracing in tower structure.
- Nature and proximity of transmission lines, ladders, power conduits, and other such conducting material passing into or through the region of the aperture.
- Presence of other antennas in this region.
- Radiation pattern of the antenna itself in free space.

For the first three items of this second group, the size, length, orientation, and position relative to the radiators of the antenna concerned are the characteristics which influence the pattern, since the energy which they obstruct, absorb, or re-radiate in a given direction determines the effect on the pattern of the antenna in that direction.

## The Towers Involved in the Test

The pattern measurements which form the basis for this study were made using tower sections of triangular cross section

**TABLE I: HORIZONTAL FIELD STRENGTH PATTERNS, BFA RADIATORS ON A 4-FT. TRIANGULAR TOWER**

ANTENNA MOUNTED ON CORNER  
Transmission Line Spacing: 8" From Tower

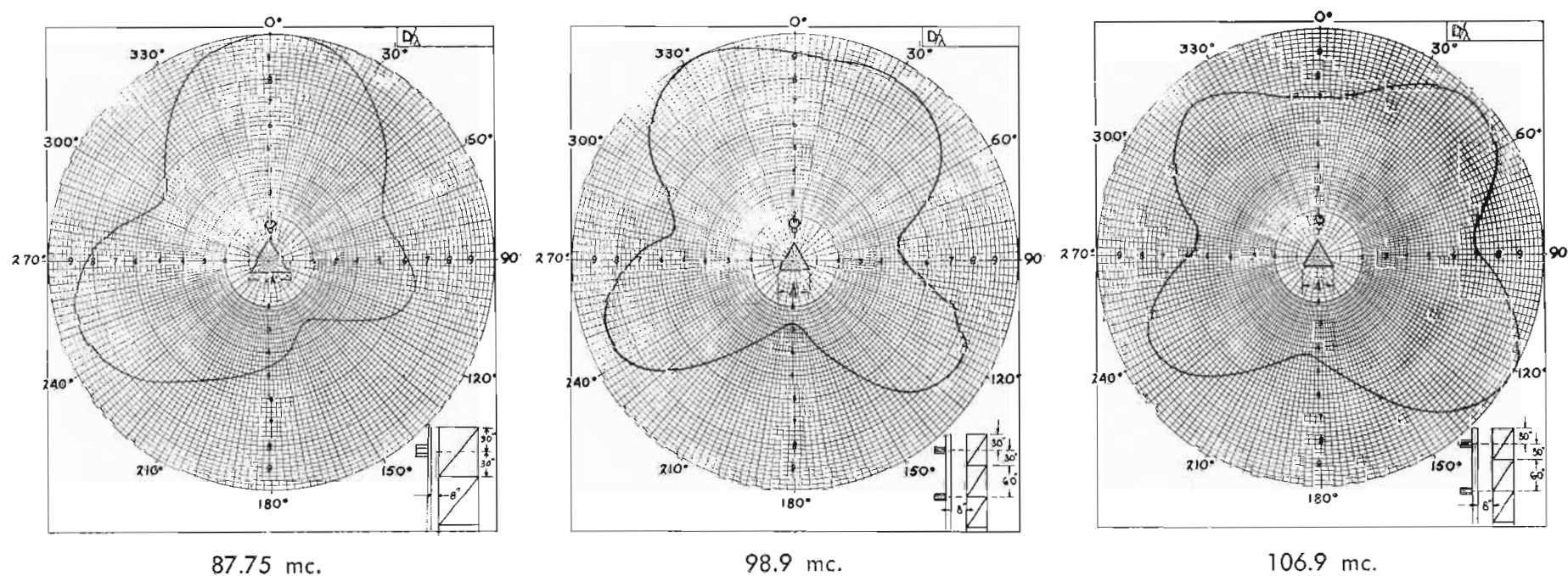



having 15-inch, 24-inch, and 48-inch dimensions between centers of the corner legs. The chief dimensions of these towers are shown in the appropriate tables on the following pages.

**Section Spacing and the Patterns**

The spacing between individual radiators in an array is fixed both mechanically and electrically to obtain a given desired vertical pattern, with the spacing varying, if at all, in accord with frequency. The application of such an array to a standard tower which already exists or is manufactured with a construction set by design stresses and mass-production requirements mitigates against the placement of each individual radiator at an optimum point. These tests were therefore made using two radiators radiating in phase, one at a level (usually opposite a cross member) resulting in the worst horizontal pattern and one at a level (usually halfway between cross members) giving the best horizontal pattern. The resultant pattern therefore approaches the average pattern of an array having, of necessity, a random spacing relative to the tower structure. In each test, the radiators were, of course, kept in line vertically.

Table I shows patterns taken on the 48-inch tower with the radiators mounted on the corner. The effect of spacing the back of the transmission line feeding the radiators 8 inches from the nearest portion of the tower are shown in each case. Conditions for a frequency at the lower end, middle, and upper end of the FM band are shown.

Table II shows patterns taken on the 24-inch tower with the radiator mounted as in Table I.

Table III shows the result using a 15-inch tower.

TOWER CHARACTERISTICS	
<b>LEGS</b>	
Center-to-Center .....	48 in.
Diameter .....	2½ in.
Shape .....	Round
<b>HORIZONTAL MEMBERS</b>	
Vertical Spacing .....	5 ft.
Diameter .....	1½ in.
Shape .....	Round
<b>DIAGONALS</b>	
Number Between Horizontals .....	1
Direction.....	Upper right to lower left (each section)
Shape .....	Round
Size .....	1½ in.

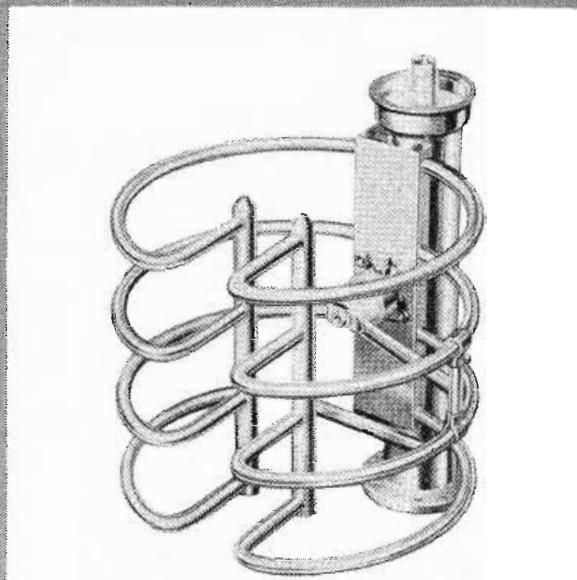
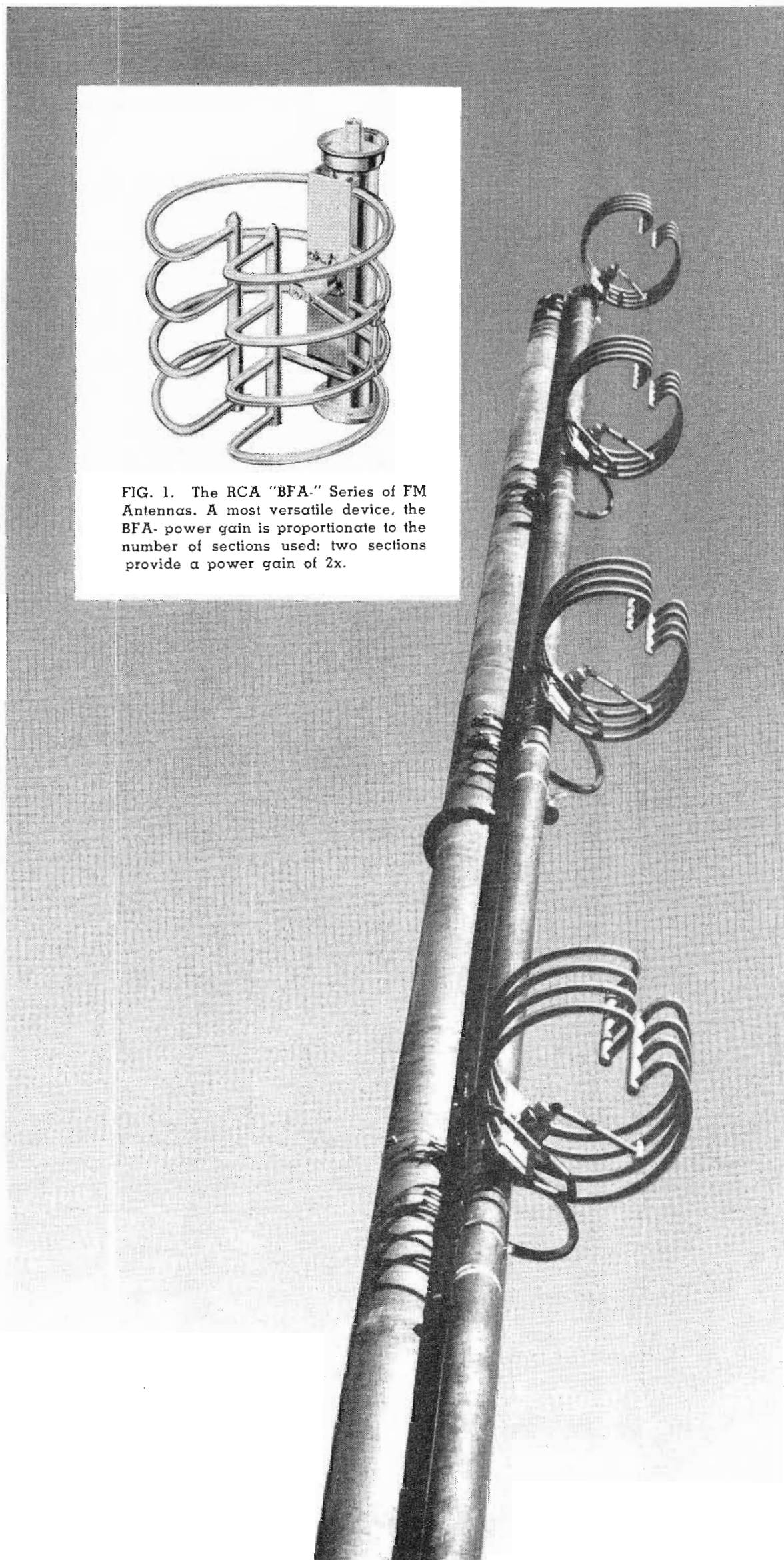

FIG. 1. The RCA "BFA." Series of FM Antennas. A most versatile device, the BFA- power gain is proportionate to the number of sections used: two sections provide a power gain of 2x.





**TABLE II: HORIZONTAL FIELD STRENGTH PATTERNS, BFA RADIATORS ON A 2-FT. TRIANGULAR TOWER**

**MOUNTED ON CORNER**  
Transmission Line Spacing:  
8" From Tower

**MOUNTED ON FACE**  
Transmission Line Spacing:  
8" From Tower

**Conclusions**

An examination of the results of this study will demonstrate the wide variety of patterns resulting from the proximity of supporting structures. Careful consideration must be given to the difficulty of predicting patterns, under conditions such as this, when specific coverage is of prime importance.

Normally, mounting the radiators on a reasonable size pole (10 inches or less, average diameter) on the top of a tower produces the most circular horizontal radiation pattern. No demonstration of patterns obtained in this way is given here but for gains up to 10, the circularity is probably better than  $\pm 2.0$  db. If sidemounting is necessary, a small cross-section tower appears highly desirable.

No attempt has been made to evaluate effects on the vertical patterns, although it is anticipated that these will be less serious than in the horizontal patterns.

To obtain an accurate prediction of both vertical and horizontal patterns, measurements (either on scale models or in full size) on a tower section of the type to be used must be made.

**Reprint Available**

This article is a condensation of a larger article which is available in reprint form. The larger article provides 44 separate horizontal-pattern curves and additional data on antenna mounting and tower characteristics.

The reprint is available, at no charge, to anyone concerned with broadcasting. Simply request "TA-361030" on your company letterhead and address your letter to: RCA Customer Relations, Building 15-5, Camden, N. J. 08100.

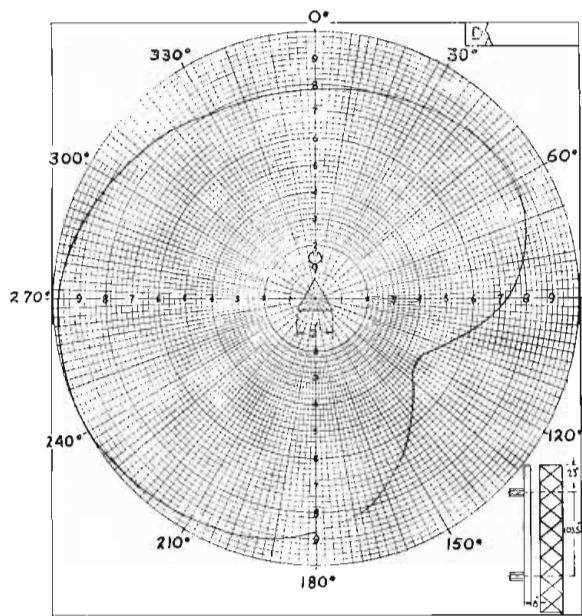

87.75 mc.

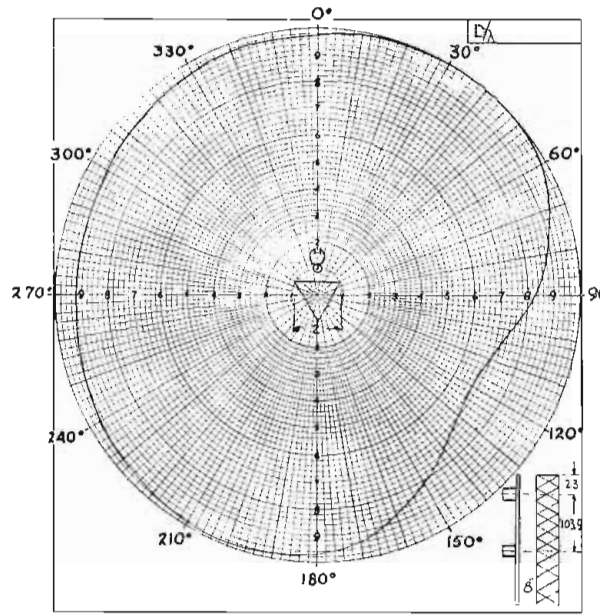

87.75 mc.

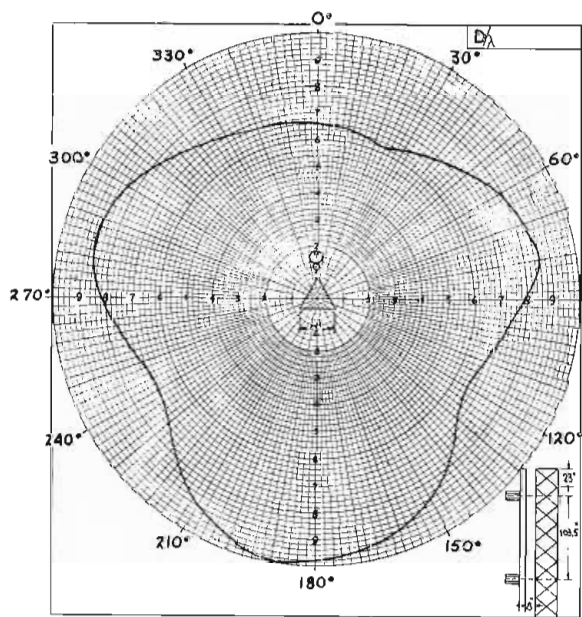

98.9 mc.

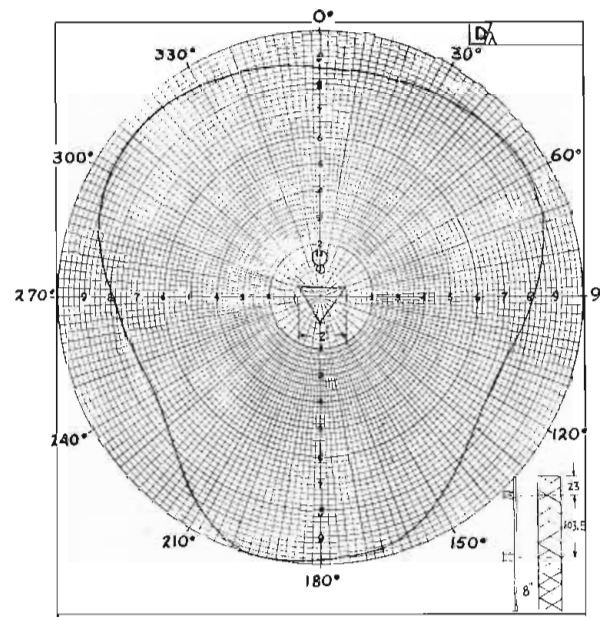

98.9 mc.

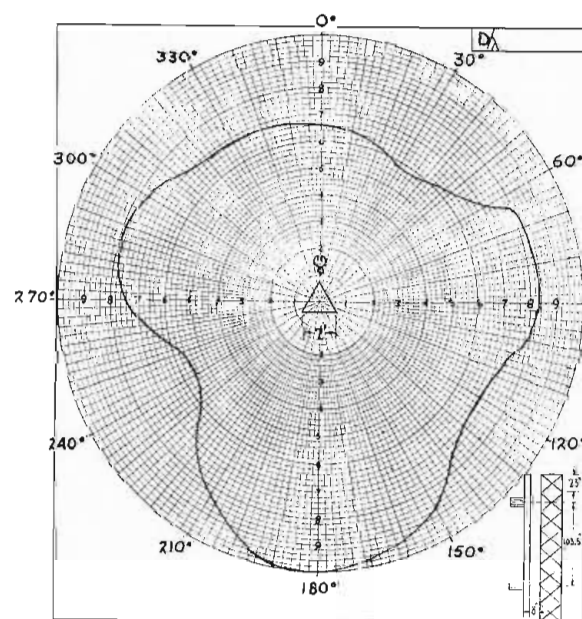

106.9 mc.

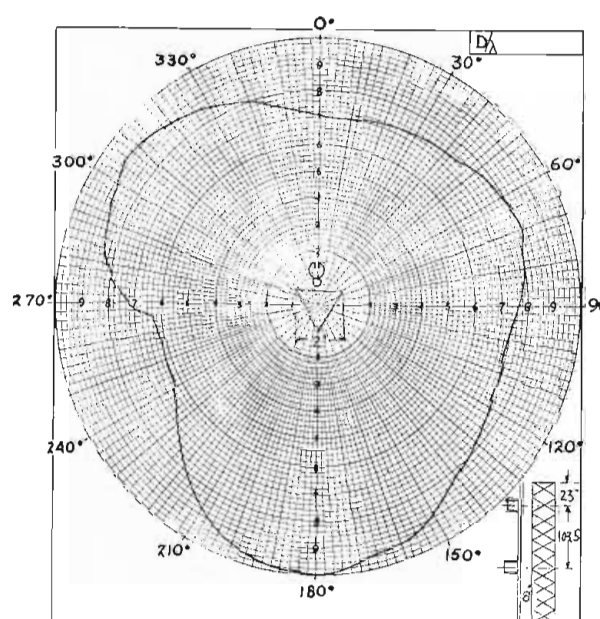

106.9 mc.

<b>TOWER CHARACTERISTICS</b>	
<b>LEGS</b>	
Center-to-Center .....	24 in.
Diameter .....	1 1/2 in.
Shape .....	Round
<b>HORIZONTAL MEMBERS</b> .....	
None	
<b>DIAGONALS</b>	
Number Between Horizontals .....	2
Direction.....	Crossing (Leg connection every 23 in.)
Shape .....	Round
Size .....	1/2 in.



**TABLE III: HORIZONTAL FIELD STRENGTH PATTERNS, BFA RADIATORS ON A 15-INCH TRIANGULAR TOWER**

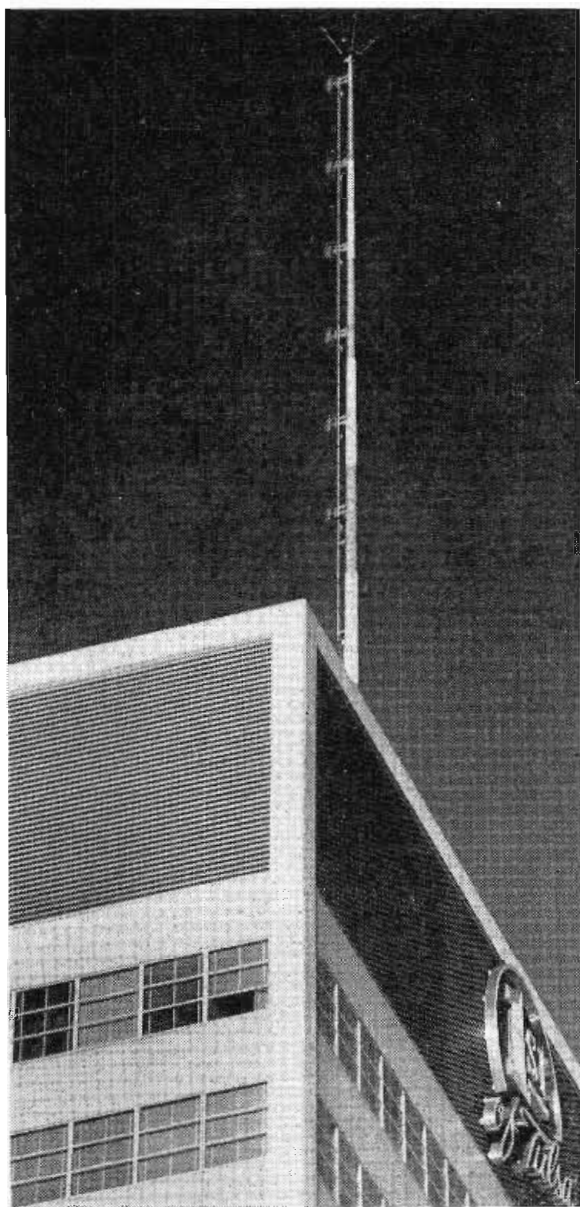
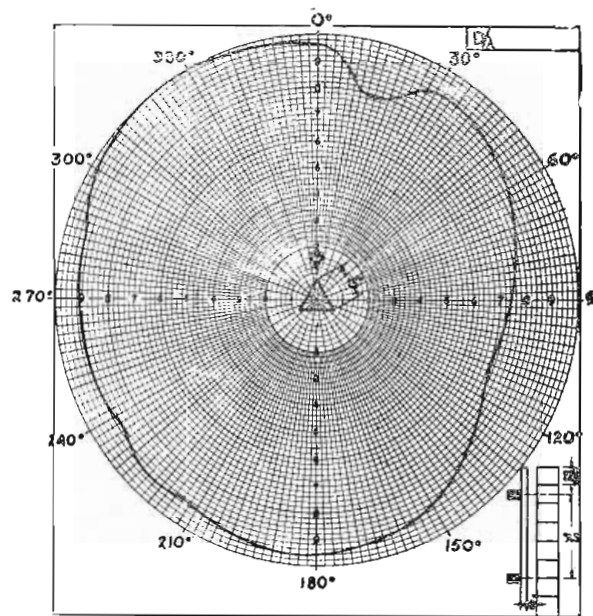

FIG. 2. This six-section BFA-6A serves KRAV in Tulsa, Oklahoma. Pole-mounting of the BFA-antenna provides excellent circularity.

MOUNTED ON CORNER  
Transmission Line Spacing:  
8" From Tower



87.75 mc.

MOUNTED ON FACE  
Transmission Line Spacing:  
8" From Tower

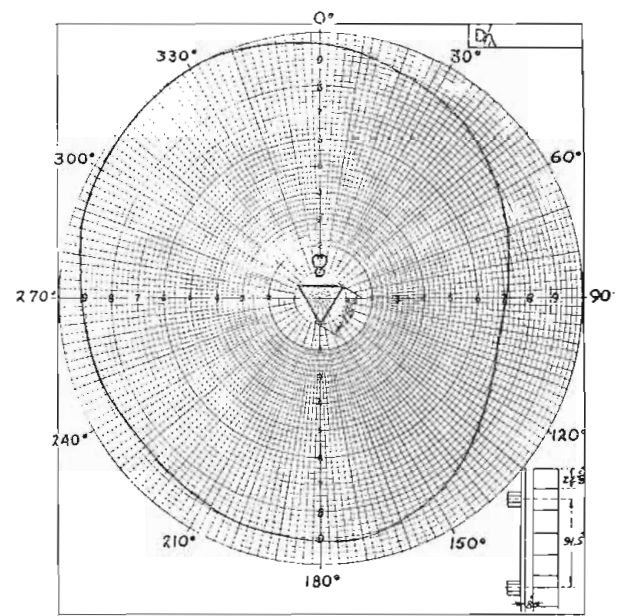

87.75 mc.

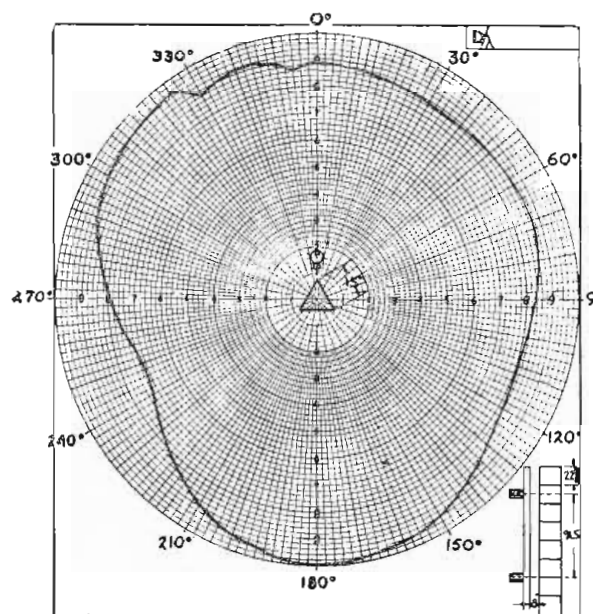

98.9 mc.

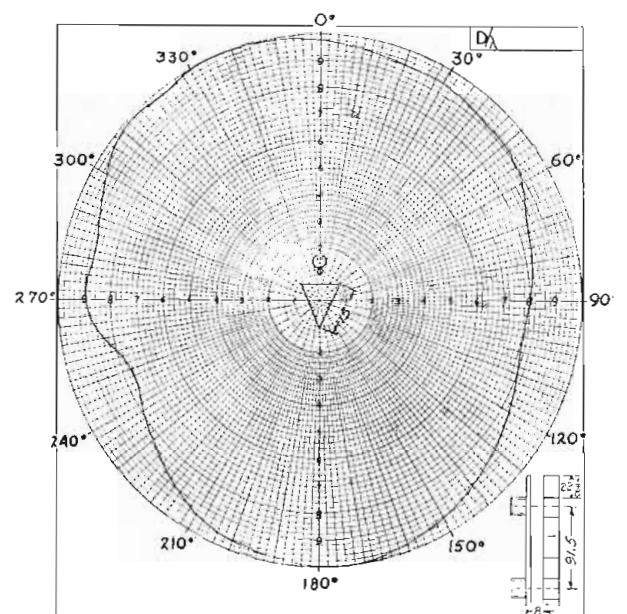

98.9 mc.

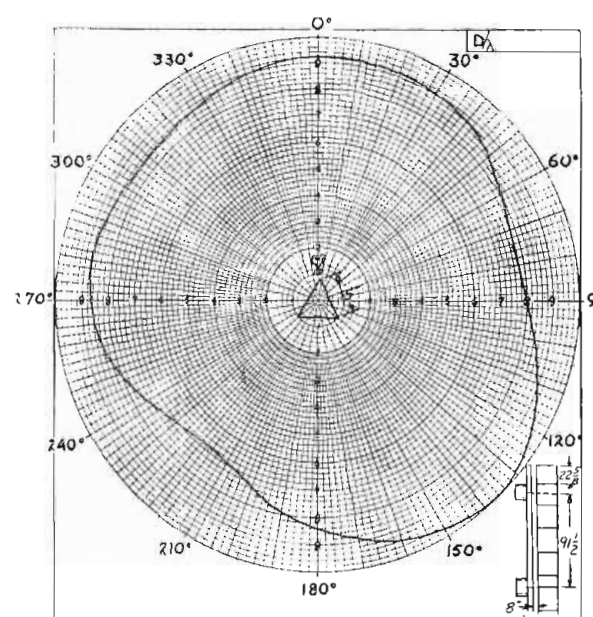

106.9 mc.

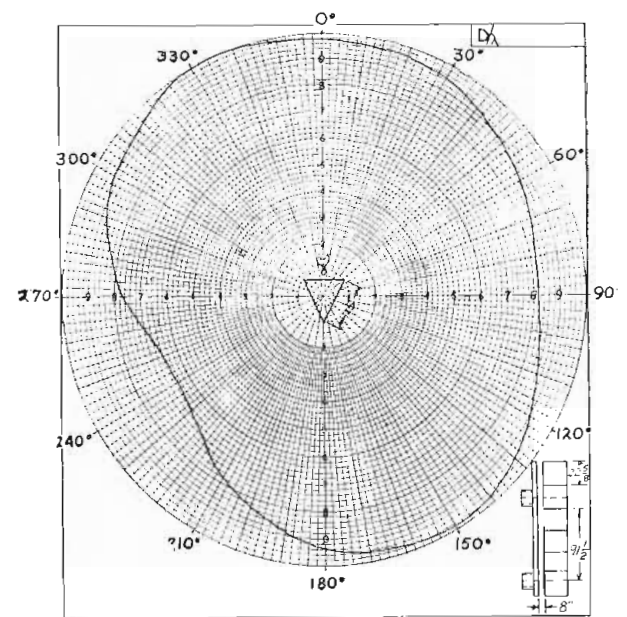

106.9 mc.

**TOWER CHARACTERISTICS**

**LEGS**

Center-to-Center .....15 in.  
Diameter .....1½ in.  
Shape ..... Round

**HORIZONTAL MEMBERS**

Vertical Spacing .....22½ in.  
Dimensions .....¼ x 2 in.  
Shape ..... Flat

**DIAGONALS** ..... None



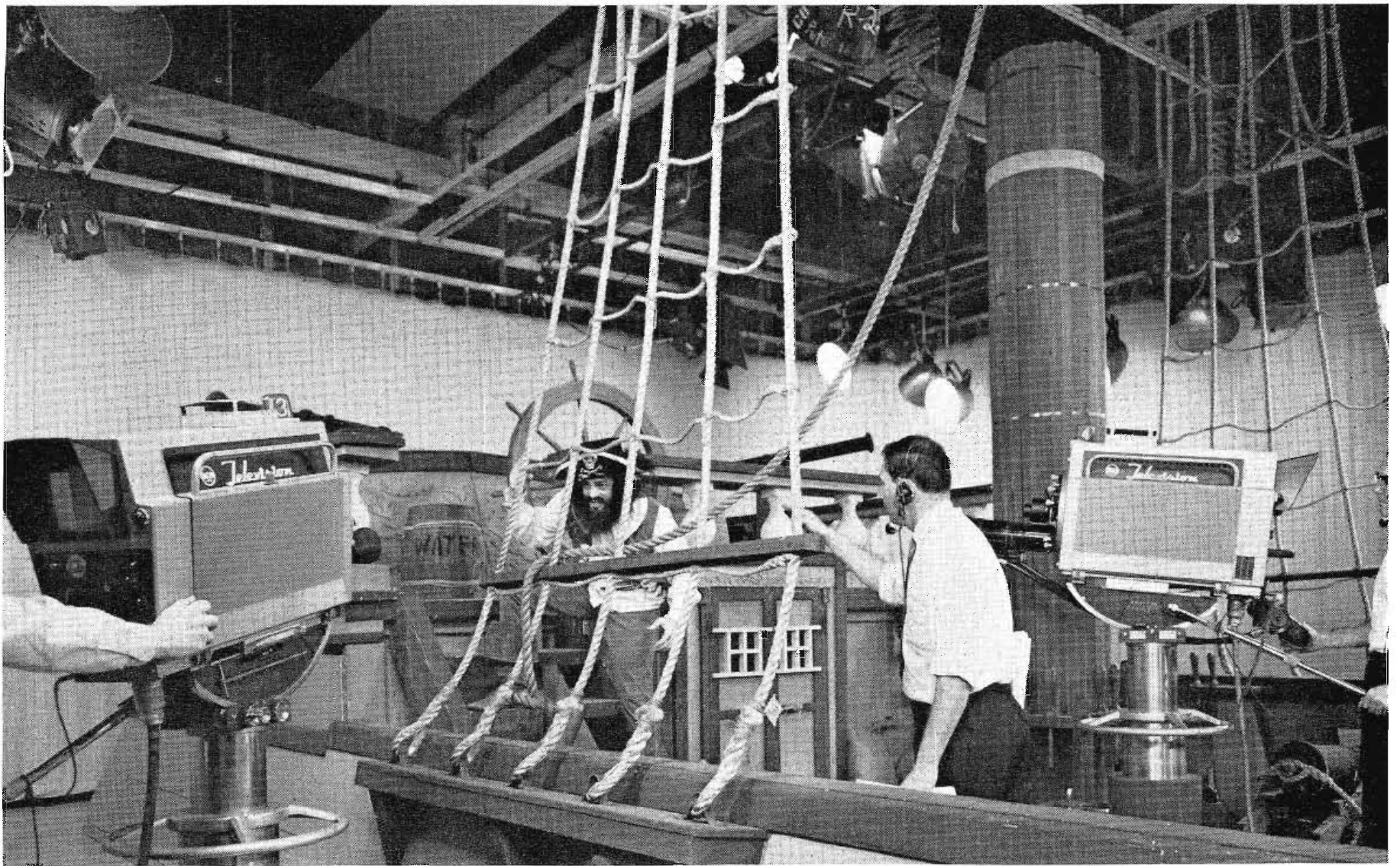

FIG. 1. Live production of "Pete the Pirate" is regularly scheduled for the after-school audience.

## TECHNICAL FACILITIES ARE A TOOL FOR EFFECTIVE PROGRAMMING AT WBAL-TV

by BRENT O. GUNTS, *Vice President and General Manager*

WBAL-TV's diverse programming, aimed at satisfying needs and desires of the Maryland community, places a heavy demand on the technical facilities of Maryland's Broadcast Center. Recognizing in advance the programming needs of an aggressive and progressive television station, construction of Maryland's Broadcast Center proved a challenge to the many engineers and technicians responsible for planning and designing its technical facilities.

From sign-on until sign-off, WBAL-TV is a nerve center of activity—providing our viewers dozens of live and video-taped locally-originated programs each week—running the gamut from eleven daily news

and sports shows to live symphony orchestra programs to seven weekly bowling shows. This requires the highest degree of flexibility and efficiency of design. Award-winning programs such as the "To Promote Good Will" panel show and the nationally recognized "The Dark Corner" are products of Maryland's Broadcast Center's technical proficiency. This kind of programming is a tribute to a plant designed for maximum operational effectiveness.

Technical facilities of WBAL-TV provide highly effective tools for programming. In talented hands these tools shape the programs which are the very life of Maryland's Broadcast Center.



FIG. 2. First programs from new studios are signalled by Brent O. Gunts, at master control.





FIG. 3. Another regularly scheduled live children's offering is "Rhea and Sunshine".



FIG. 4. Live presentation of local news plays an important part in the WBAL-TV program schedule.



FIG. 5. A local commercial, part of the "One O'Clock Show" is produced live.

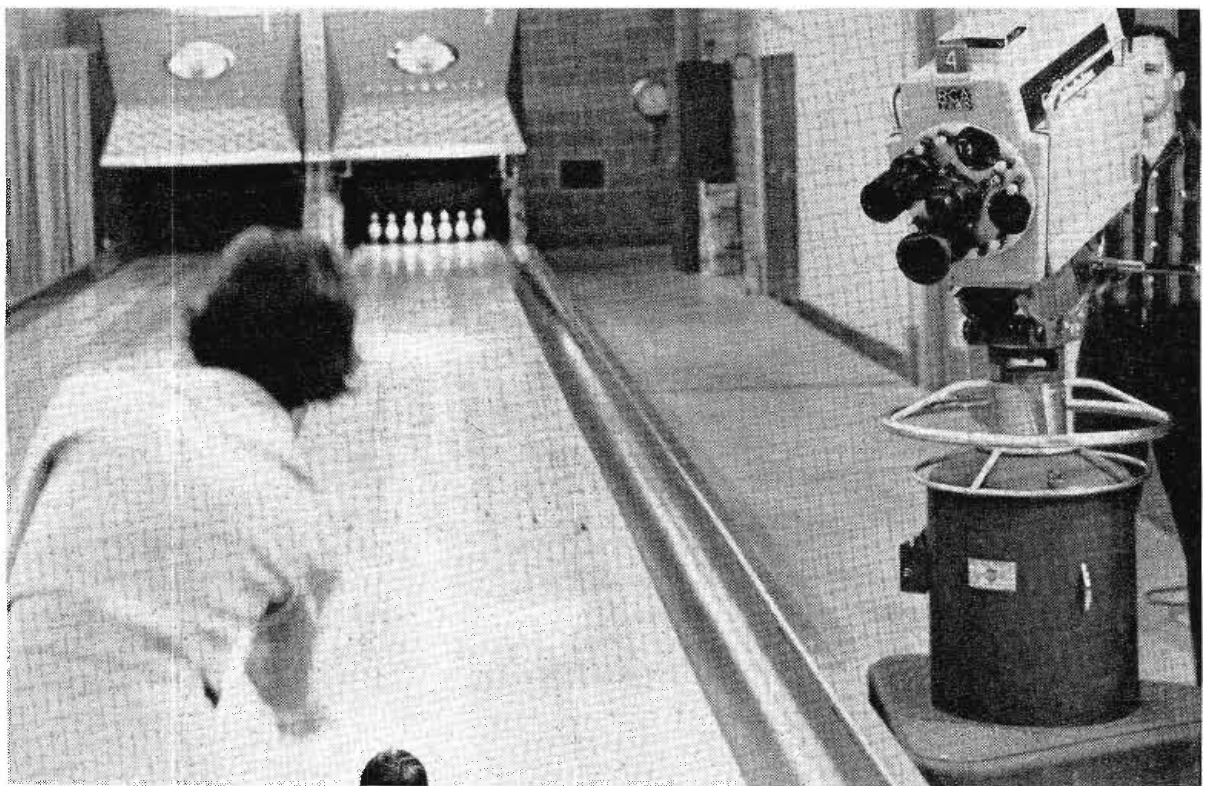

FIG. 6. Daily "Sparetime Bowling" program originates from WBAL-TV's own bowling alleys installed in specially-equipped studio.



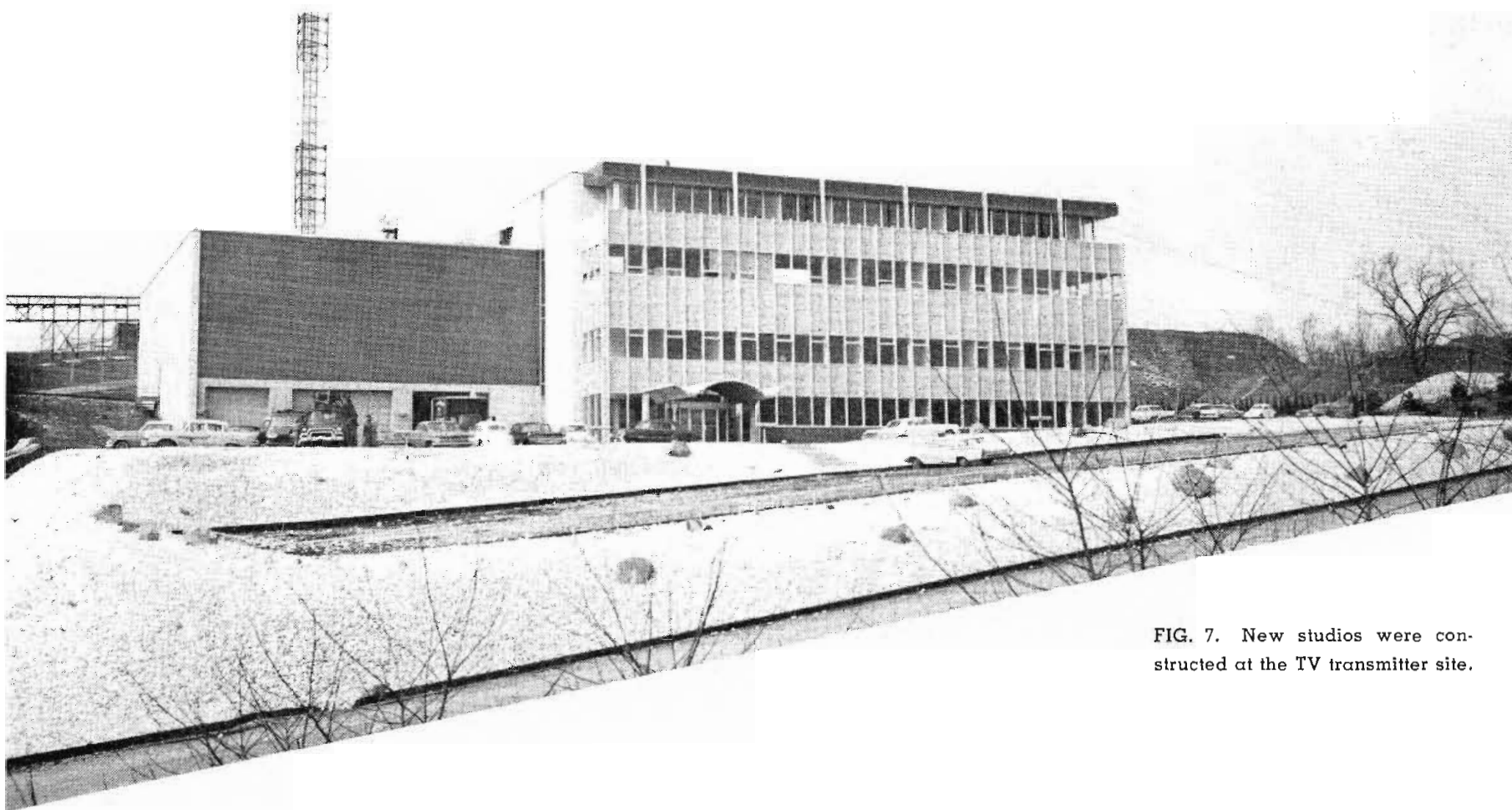

FIG. 7. New studios were constructed at the TV transmitter site.

## Some Advanced Technical Features of The New WBAL-TV Plant

by JOHN T. WILNER, *Director of Engineering, The Hearst Corporation*  
and RALPH MLASKA, *Chief Engineer, WBAL-TV*

The basic objective in the new WBAL-TV plant was to provide complete flexibility of technical equipment in a functional arrangement for utmost utility. It was desired to supply all the tools required to produce creative programming, tailored to client preferences.

This basic flexibility is achieved throughout the plant. For example, the studio lighting system was arranged to provide enough lights to eliminate continual relocation and adjustment. Groups of lights are earmarked for specific shows. Also any of three control rooms can be used with any of three studios. Complicated patch panels are eliminated since cameras, film machines, etc., are relay operated. Audio consoles have the ability to control any groups of microphones in any of the studios.

The master control switcher is designed to allow its operator to handle all of the live and film cameras in addition to his regular duties. The use of highly-stabilized TK-60 4½-inch I.O. cameras along with automatic sensitivity control of the TK-21 film cameras has made this possible.

Other specific improvements were achieved in these areas described in detail on the following pages: (1) a centralized master and camera control system, (2) transistorized control room switchers, (3) remote-control sync generator system, (4) delegate tv tape and film control systems, (5) a custom transmitter control center, and (6) studio lighting, maintenance, audio and house monitoring systems.



FIG. 8. Engineering planning team includes (L to R) John Wilner, Harrison Brooks, Bill Bareham, and Ralph Mlaska.



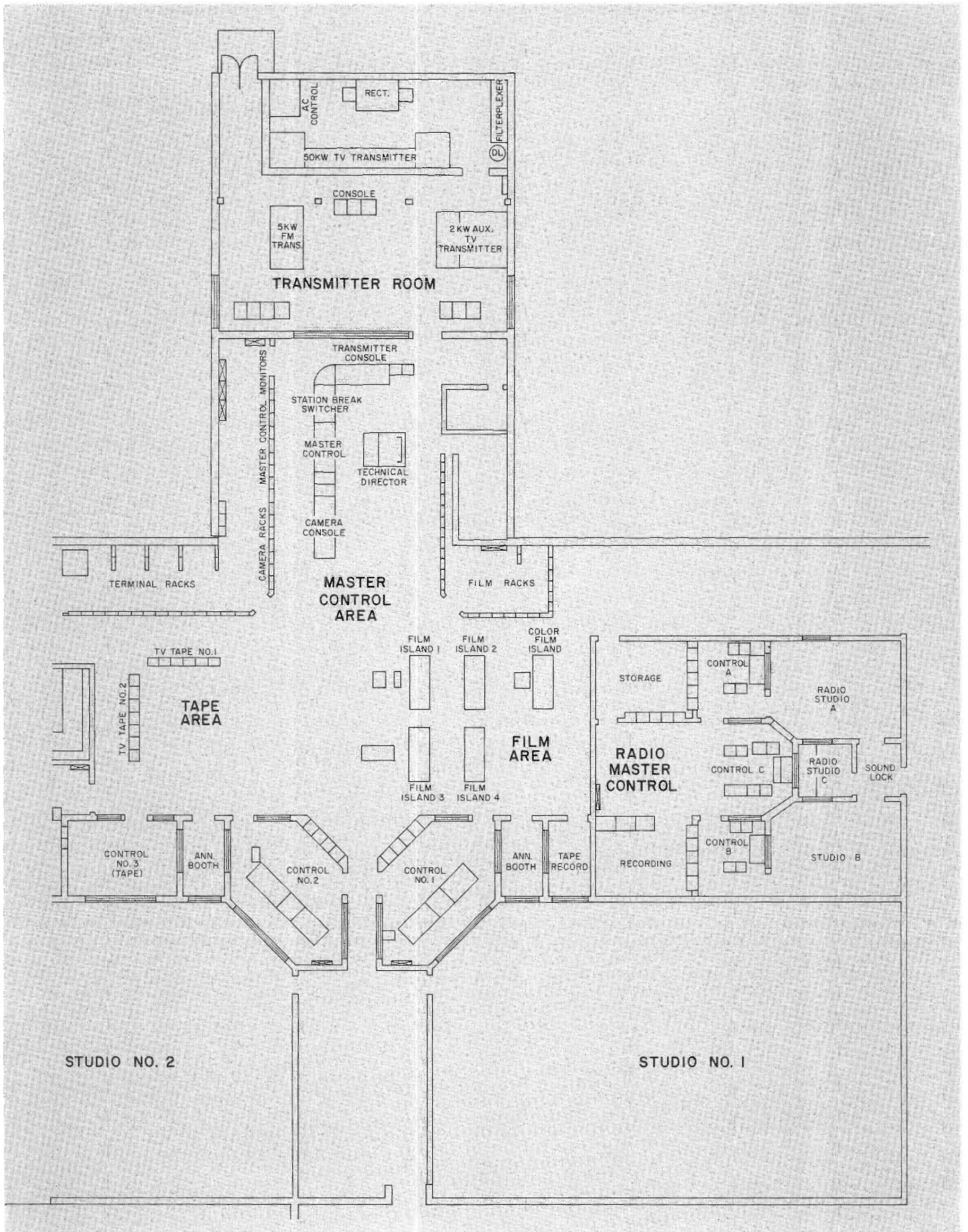

FIG. 9. Partial floor plan showing technical facilities of WBAL-TV.





FIG. 10. Master control with camera control monitor (left), master control board (center), and technical director's position (right).

## Centralized Master and Camera Control System

The master control position is designed so that a single video operator can handle control of live and film cameras in addition to his routine master control duties. This is made possible through the use of highly stabilized live and film cameras—TK-60 4½-inch image orthicon studio cameras and TK-21 vidicon film cameras. Results demonstrate that the TK-60 is so stable that, once aligned, “remote iris” becomes the one and only operating control. Use of automatic sensitivity control with the TK-21 film camera permits remote operation from a small panel having only pedestal and gain controls. Therefore we were able to make live and film camera control an integral part of our master control switcher.

Figure 10 pictures the master control. Camera master monitors and the master control panel are at the left. The elevated platform at the right of the photo is a technical directors position.

### Master Control Board

A closeup of the master control board is shown in Fig. 11. In the very center, along

the horizontal desk position, is the control panel for the TS-40 transistorized switcher. (There are six identical switchers throughout the plant). The lower part of the panel is conventional with special effects, lap dissolve banks, and engineering preview. At the right of the center panel are two vertical rows of buttons for the composite signals. The engineering preview buttons can serve as an emergency switcher or a direct take by pressing the lowest button at the right-hand row. Immediately above the composite buttons is the master control delegation system which can control any one of four lines.

At the left upper part of the panel is a feature we consider an innovation. In order to keep the physical size of the switcher to a convenient operating dimension, an additional switcher is assigned. This switcher allows selection of (1) any five test signals into the first vertical row, (2) any two of six live cameras into the second and third rows, (3) any two of six film islands into the fourth and fifth rows, (4) any two of four video tape machines

into the sixth and seventh rows, and (5) either network or remote into the eighth row.

On the extreme left—occupying a space of only 12½ inches wide by 19 inches high—is the camera control position with provision for handling as many as six live cameras and six film cameras. On the extreme right side of the panel is remote control for starting and stopping and controlling all of the film projectors, slide projectors and tape machines.

At left of the vertical sloping panel is an intercom system which allows any of the cameras to be switched into five different intercom circuits. To the right and top are the controls for audio cartridge tape units. Below is a monitor indicating panel. By means of this panel the operator can control the video signal that appears on the floor monitors in the studios and also his line monitor in the racks. To the right of this panel is a film delegation system with which the operator can select any two film islands. Indications from the other control rooms of film islands in use are also



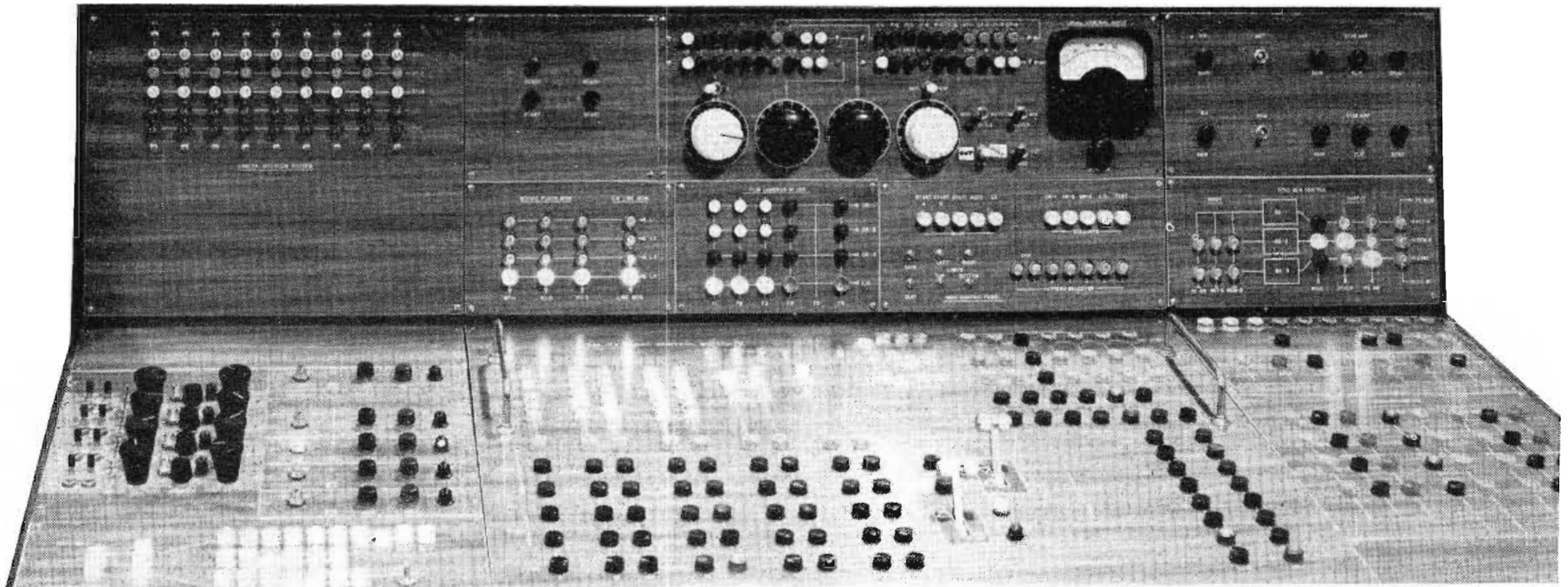
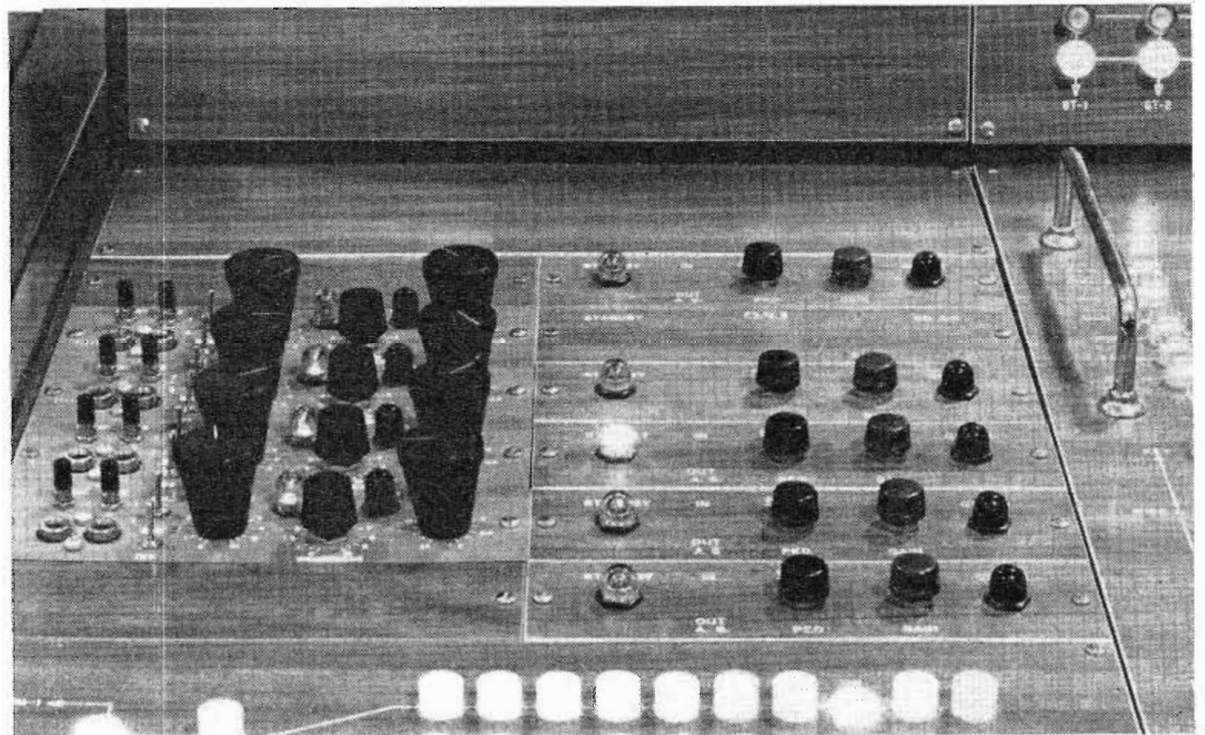

FIG. 11. Closeup of master control board.

included here. A special effects control panel is installed in the next right position. Next right is the sync generator indicator panel. Here the operator can select any one of three sync generators and genlock any two. Immediately above this panel is the stabilizing amplifier and remote gain control for network and remote. The remaining panel in the center of sloping section is another innovation—an audio control panel, which gives the operator the facility of either selecting a manual or completely automatic operation.

#### Live and Film Camera Control

Figure 12 shows a closeup of live and film camera remote control panels. Figure 13 shows their arrangement in functional diagram form. Four TK-60 camera controls—iris, pedestal and contrast—are mounted at left in the photo. Any one of the four live cameras can be switched to either of the two monitors for critical viewing. Automatic sensitivity control permits video film chains to be treated in essentially the same manner. Only gain and pedestal controls are brought out for each film chain. Each of the film chains can also be critically monitored. Also available to the same monitors are the outputs of all studios, local control, network, remote and demodulation of the transmitter. The entire camera control unit at the master control position occupies a very small space, approximately 12½ inches wide and 19 inches deep.



▲ FIG. 12. Live and film camera controls as installed at the master control position.

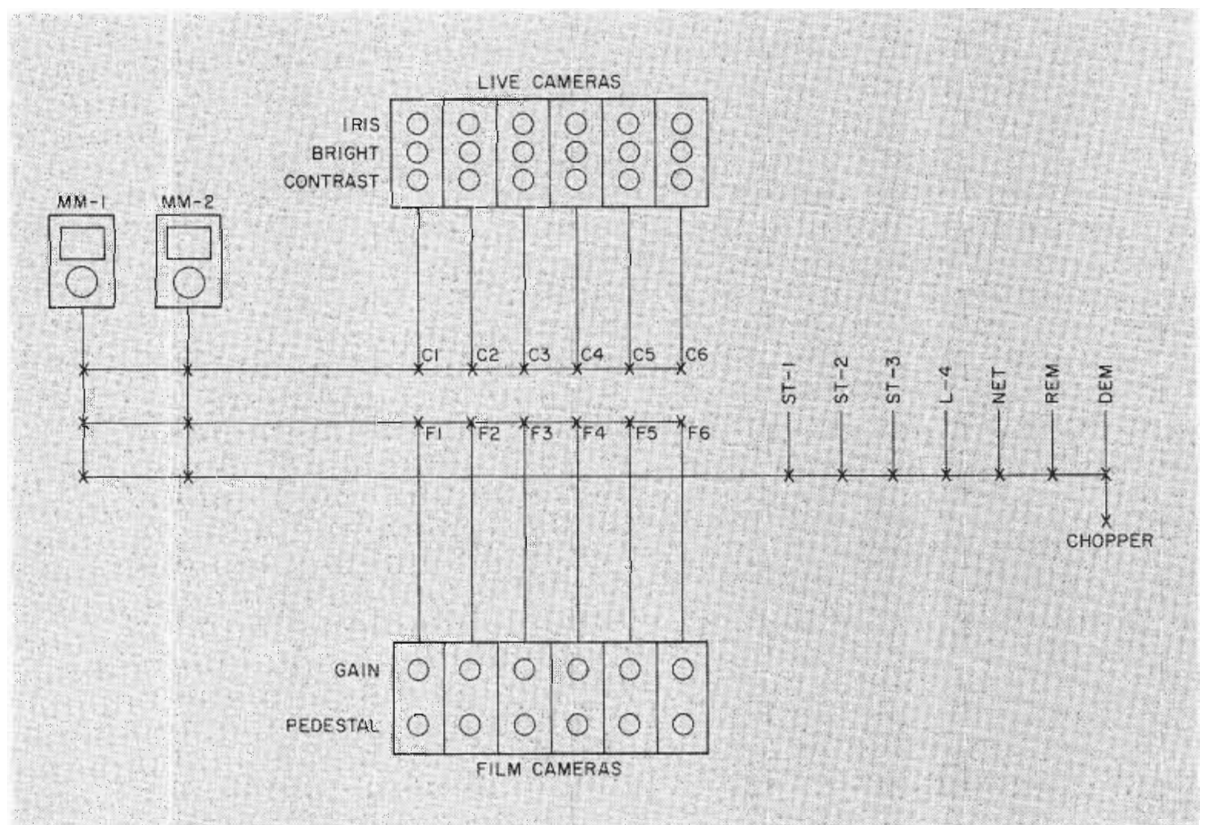
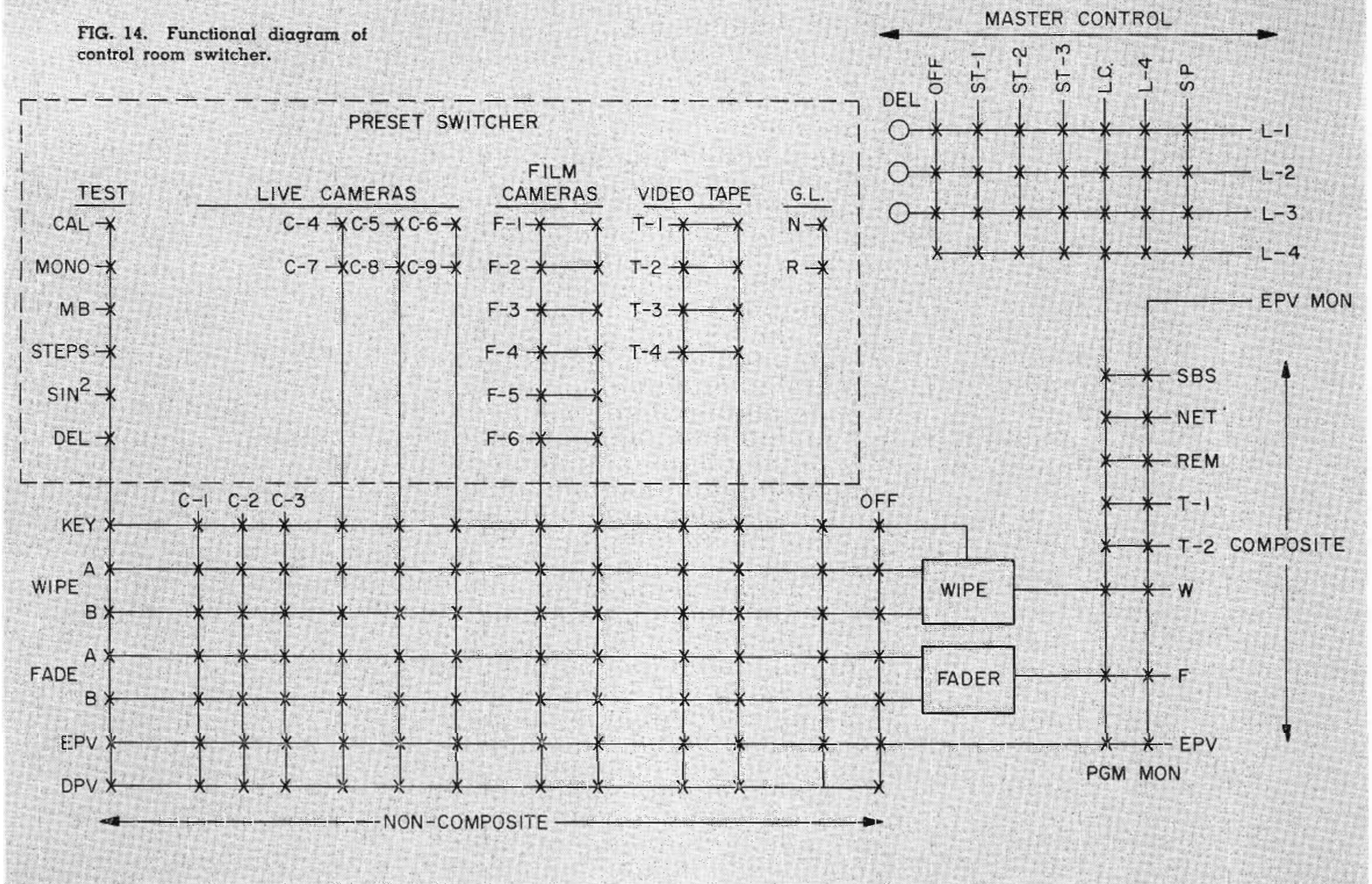

FIG. 13. Functional diagram of remote control for live and film cameras. ▶



FIG. 14. Functional diagram of control room switcher.



## Transistorized Control Room Switchers



FIG. 15. Control room for Studio One. The control for Studio Two is identical in every respect.

The heart of the switching system is TS-40 transistorized equipment. The very first system was installed at WTAE in Pittsburgh, one of the Hearst group of stations. Because of the excellent results obtained with this switching system, it was also incorporated in the WBAL-TV plant. However, several important rearrangements were made. The switching system was divided into completely separate switchers, so that a failure in one switcher would not affect any of the others. Switchers for Control Room 1 and 2 are identical, Control Room 3 and Master Control Switchers have only two live camera inputs. Otherwise all the switchers are the same.

There is a separate switcher for master control, each of the control rooms, and special effects. In order to keep the size of the control switchers to a reasonable length, preset sub-switchers are installed. These allow the operator to select in advance which of the live cameras, the film cameras, and tape machines will be used for any given program. Thus, one control room can



operate any of three studios, or the three studios can be used for one program with complete integration. A test input to the switcher is also provided. These permanent test signals make possible a complete video check of the entire system.

Four output lines are available so that a rehearsal, a taping session, a network feed, and a local feed to the transmitter can take place simultaneously. Number 4 output line is always delegated to the local transmitter, whereas the other three lines are delegated from the master control position for use by any of the three studios.

In addition to the video switching, all of the controls for the film chains and video tape recorders are also located at this control position. See the functional diagram, Fig. 14. Other functions that can be initiated from the control panels are selection of studio floor and control room line monitors, delegation of film island to any of the four operating consoles, operation of any of the slide projectors, rear screen projectors or telop, and remote control of the studio lighting dimming panel.

## Sync Distribution System

Complete flexibility in sync distribution is achieved by installing two sync generators in a custom designed system. Input to the sync generators is remotely controlled. Inputs include stripped sync from both the network and remote as well as 60-cycle reference. The output drives from each sync generator feed into a sync generator switcher which in turn has three outputs. One output is the test position. This allows either of the sync generators to be displayed on both a waveform monitor and a pulse cross monitor in any combination of drives. See Fig. 16. Here we can also display stripped network video and the stripped remote video. Thus, for genlocking we can punch up, let us say, the stripped network video along with the sync of the sync generator we are trying to genlock. If the picture holds solid on the pulse cross monitor, we know that the system has been genlocked. The waveform monitor allows us to critically examine each drive, both in width and in amplitude.

The other two outputs of the sync generator switcher feed two separate and complete sync distribution channels. As shown in the functional diagram, Fig. 17, one sync distribution channel feeds a series of distribution amplifiers with undelayed drives as well as a second series of distribution amplifiers with a set of delayed drives. Each of the individual drives feed into a single 2 by 1 switcher DA. This enables switching the four drives from Sync Generator No. 1 to Sync Generator No. 2 for every live camera in the station—or film chain, control room, special effects, and others. In case of failure in the system, any equipment can be operated on either sync generator at the touch of a switch.

FIG. 16. Sync generator selector panel with associated picture and waveform monitor. ▶

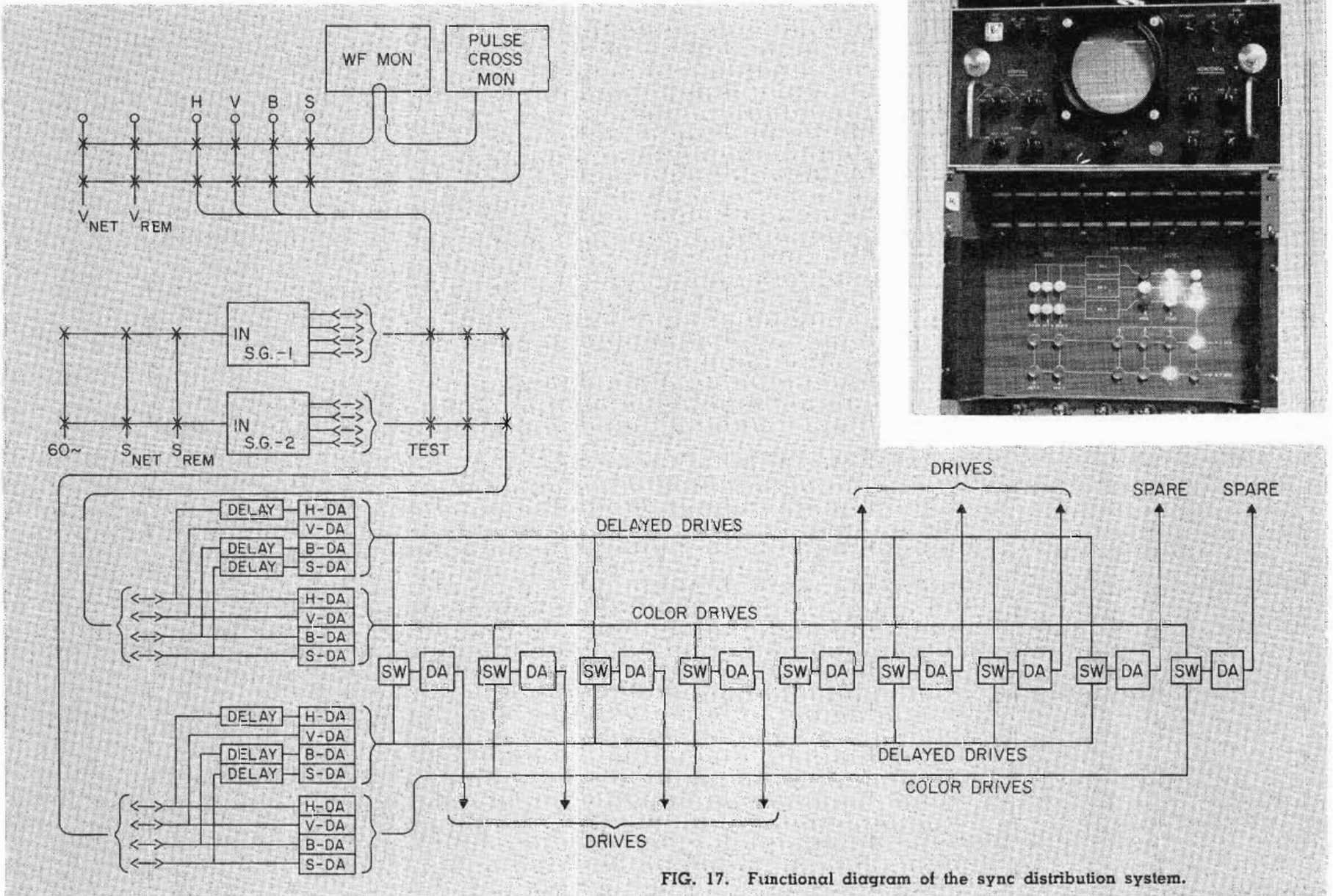
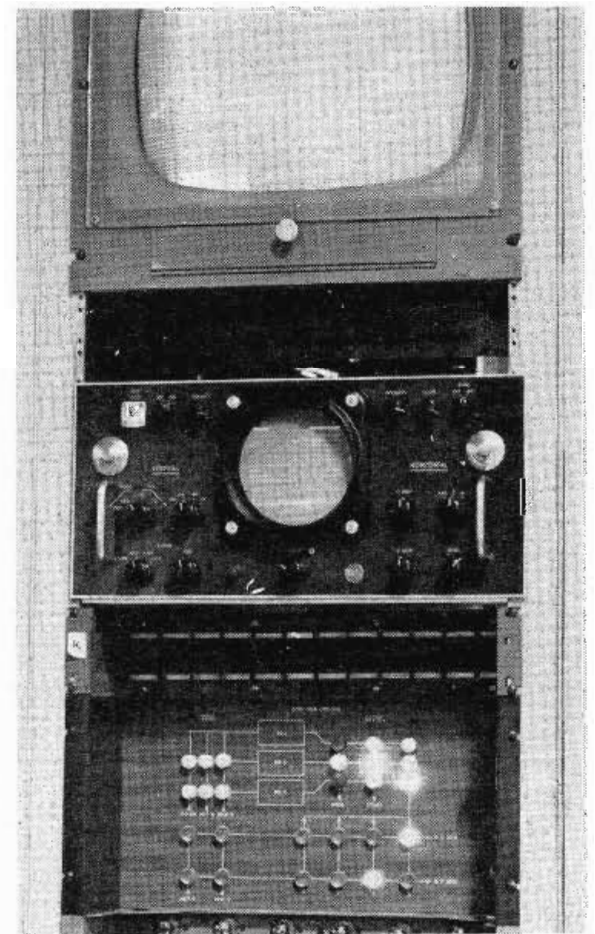

FIG. 17. Functional diagram of the sync distribution system.



# Delegate TV Tape and Film Control Systems



## Tape System

WBAL-TV had formerly installed serial Nos. 2 and 4 of the original TRT-1A tv tape equipment. These machines have been upgraded with a number of modifications—including Pix-lock, half-speed recording, and air bearing headwheels. It is planned to eventually convert them to handle color. Since the tape machines were installed in the old building as an afterthought, each time a tape recording session was held the entire system was thrown into confusion. In the new plant, a video tape switcher and control center was installed in a rack adjacent to the tape machines. From this center it is possible to record and dub without tying up any of the control rooms. However, it is also possible to control the tape machines from each of the four control locations.

Figure 20 is a functional diagram of the video tape system. The present system is comprised of two tape recorders, but it has been designed to handle an ultimate capacity of four. Inputs to the crossbar switcher include a Test Switcher, Studio 1, 2 and 3 inputs, Local Control, Network, Remote and Dubbing. Playback outputs include the dubbing output of each recorder, Control Rooms, Local Control, Clients' Room and House Monitoring System. Note that we have two outputs in the tape machines. One is a composite output and the other is a non-composite output. This permits the tapes to be used as a non-composite input.

▲  
FIG. 18. TV tape area includes two fully-modified TRT series TV Tape Recorders.

FIG. 19. Local control panel for TV tape system is designed to accommodate two more recorders. ▶

FIG. 20. Functional diagram of the TV tape system. ▼

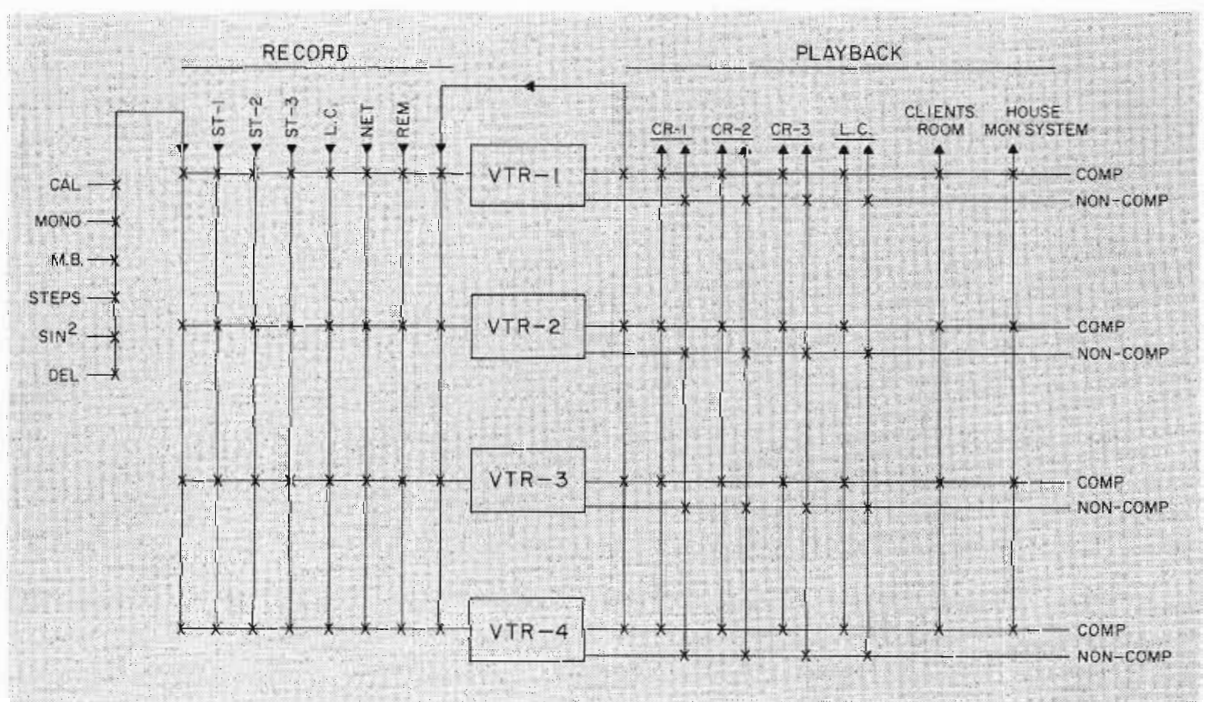
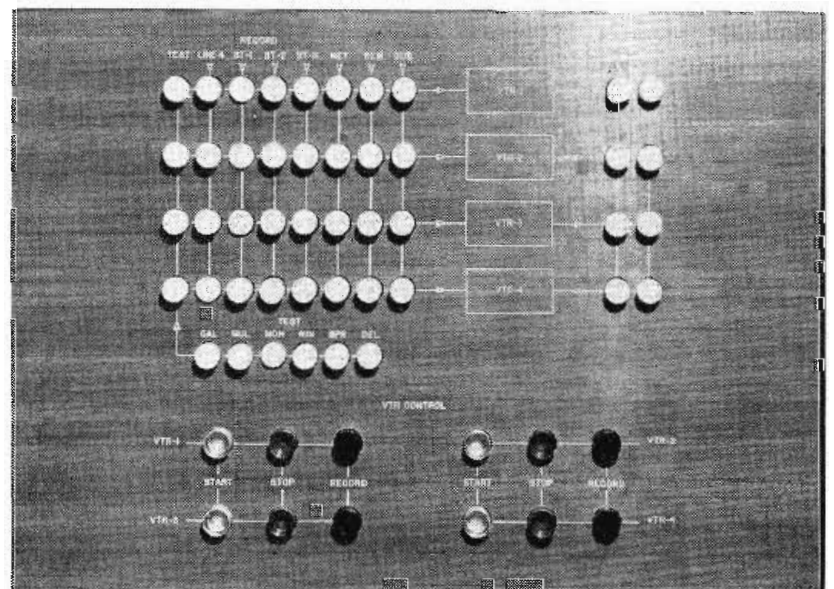



## Film System

Present film facilities include three film islands for monochrome and one island for color. However, provision has been made to install and handle two additional film islands (monochrome or color).

The functional diagram, Fig. 21 shows the control system which will ultimately incorporate as many as six film chains along with their associated multiplexers, and film and slide projectors. At left in the diagram is the "film-in-use" panel located in each of the control rooms, at Local Control, and in the Film Area racks. Similarly a remote control panel, see Fig. 22, is also located in each of these areas.

A series of "film brains" funnel the proper information from the control panels to the film islands where the proper film projectors can be started, stopped, and showed; the proper slides changed; proper power turned on; and proper audio selected. All control circuits are of momentary-contact, normally-open type, so that any number of control panels can be paralleled (including a future station-break switcher).

FIG. 21. Functional diagram of the film control system.

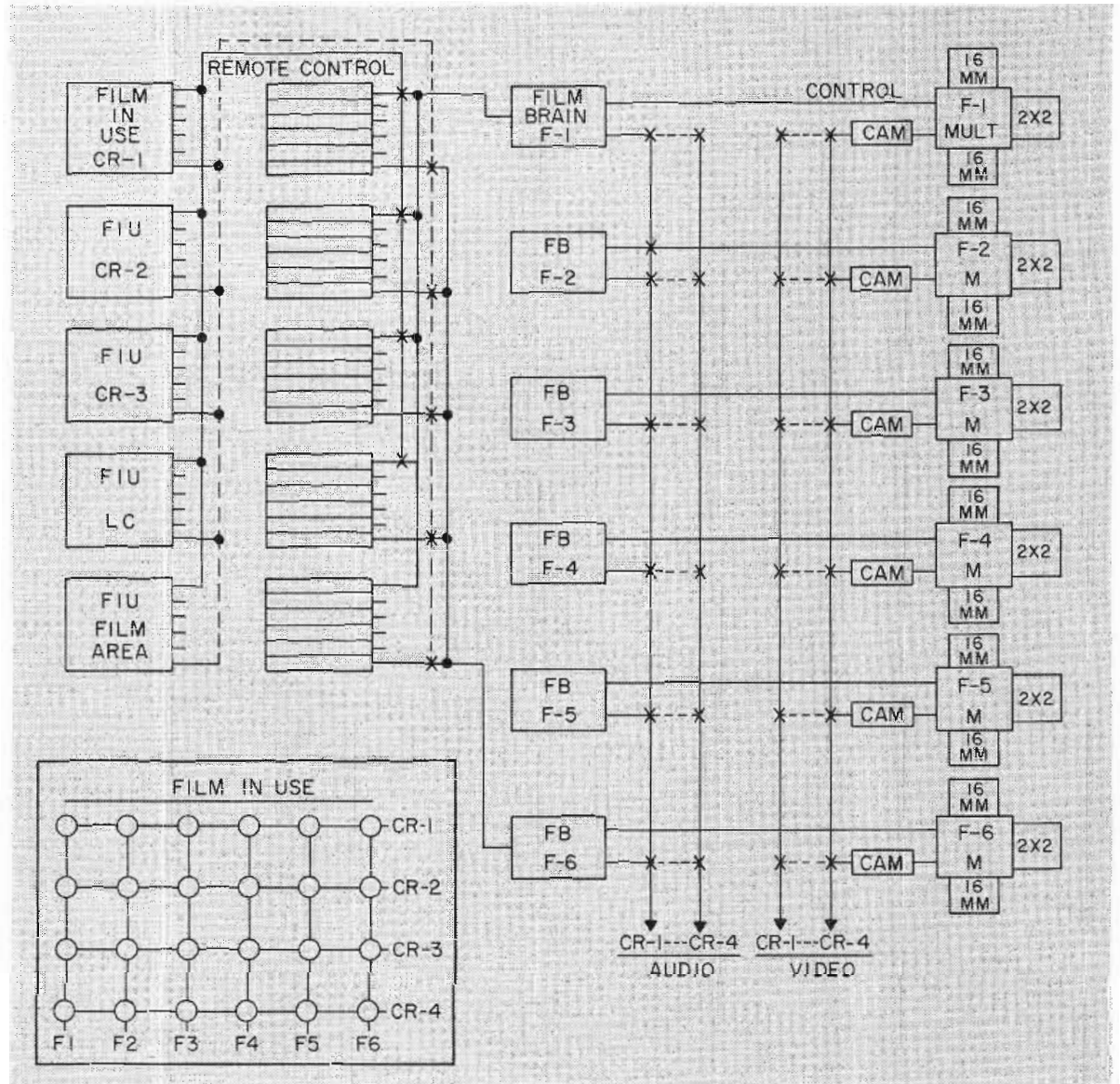

FIG. 22. Local control panel for the film system including remote control and film in-use indicators.

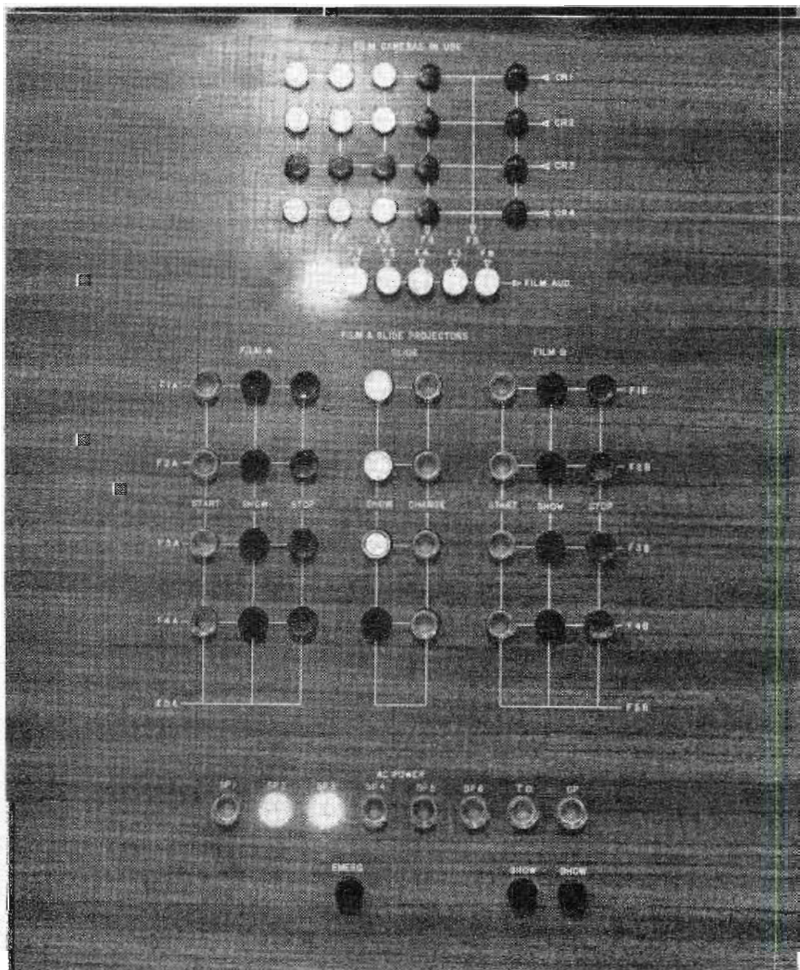
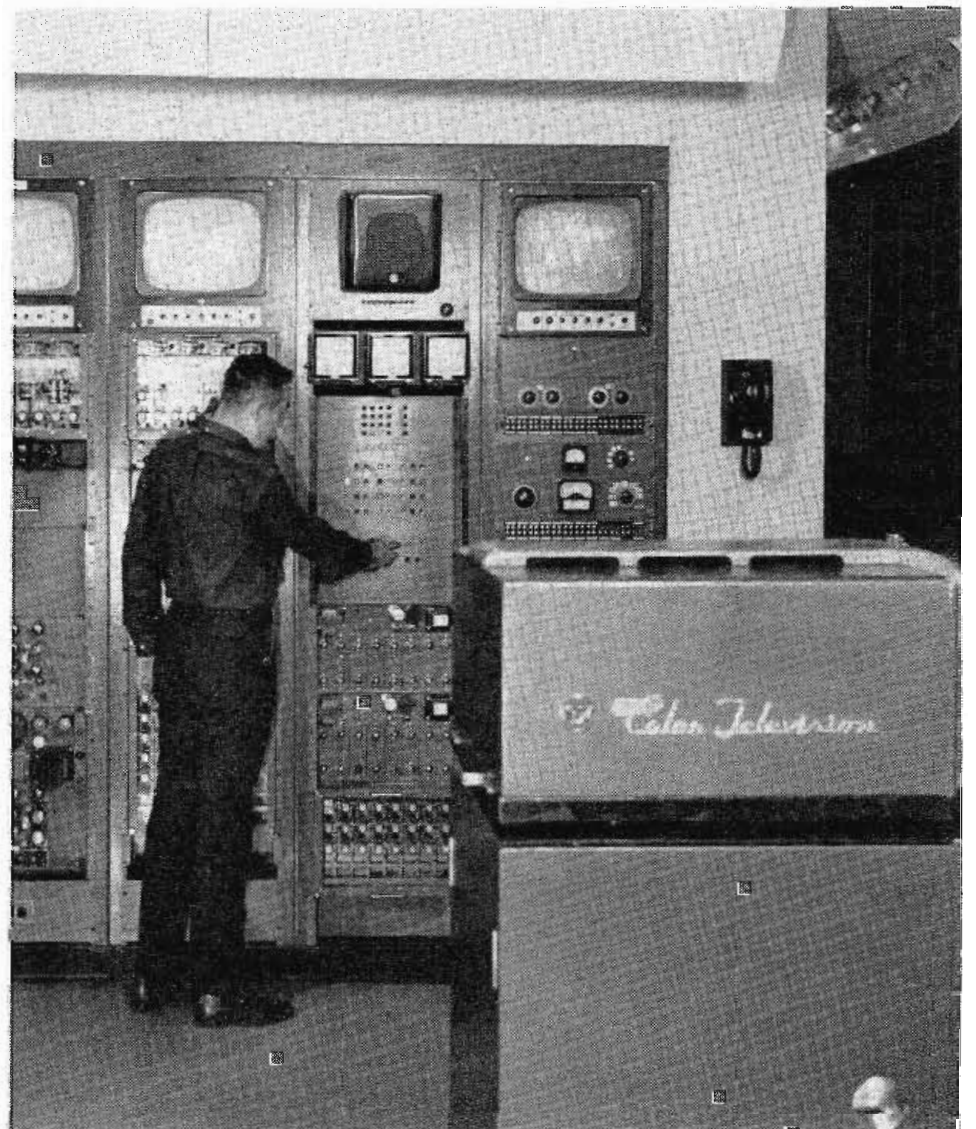

FIG. 23. Local control in the film area. Note color film camera in the foreground.





# Custom Transmitter Control System

FIG. 24. Custom transmitter control panel.

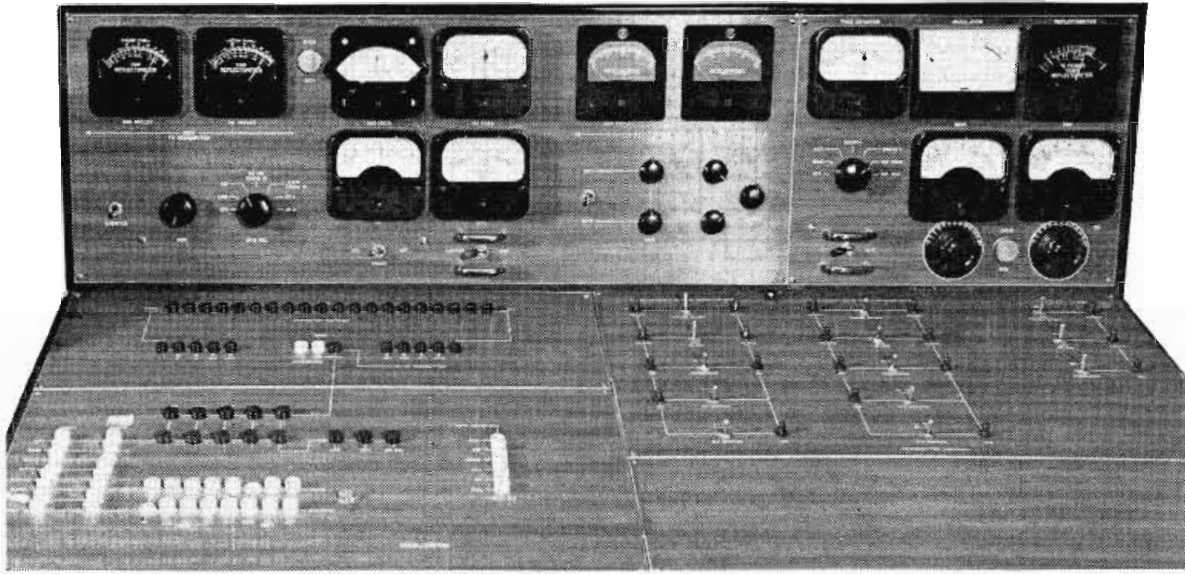

One of the reasons for locating new studios at the transmitter site was to take advantage of combining some of the functions of master and transmitter control. It was desired that the transmitter operator become part of a team with the master control man. To this end a custom transmitter control center was designed. The unit is located just outside the transmitter room in the quiet atmosphere of master control. The transmitter operator can monitor audio most efficiently, and still fulfill requirements for meter reading at proper intervals by making short trips into the transmitter room.

## Control Console

Figures 24 and 25 show details of the control console layout. The top panels enclose the various meters required to indicate reflectometers of both the sound and the picture on both the main and the auxiliary transmitter, as well as the various frequency and modulation readings. Gain controls for two stab amps and a switch to by-pass all of the terminal equipment is also incorporated here along with an

FIG. 25. Functional diagram of the transmitter control center.

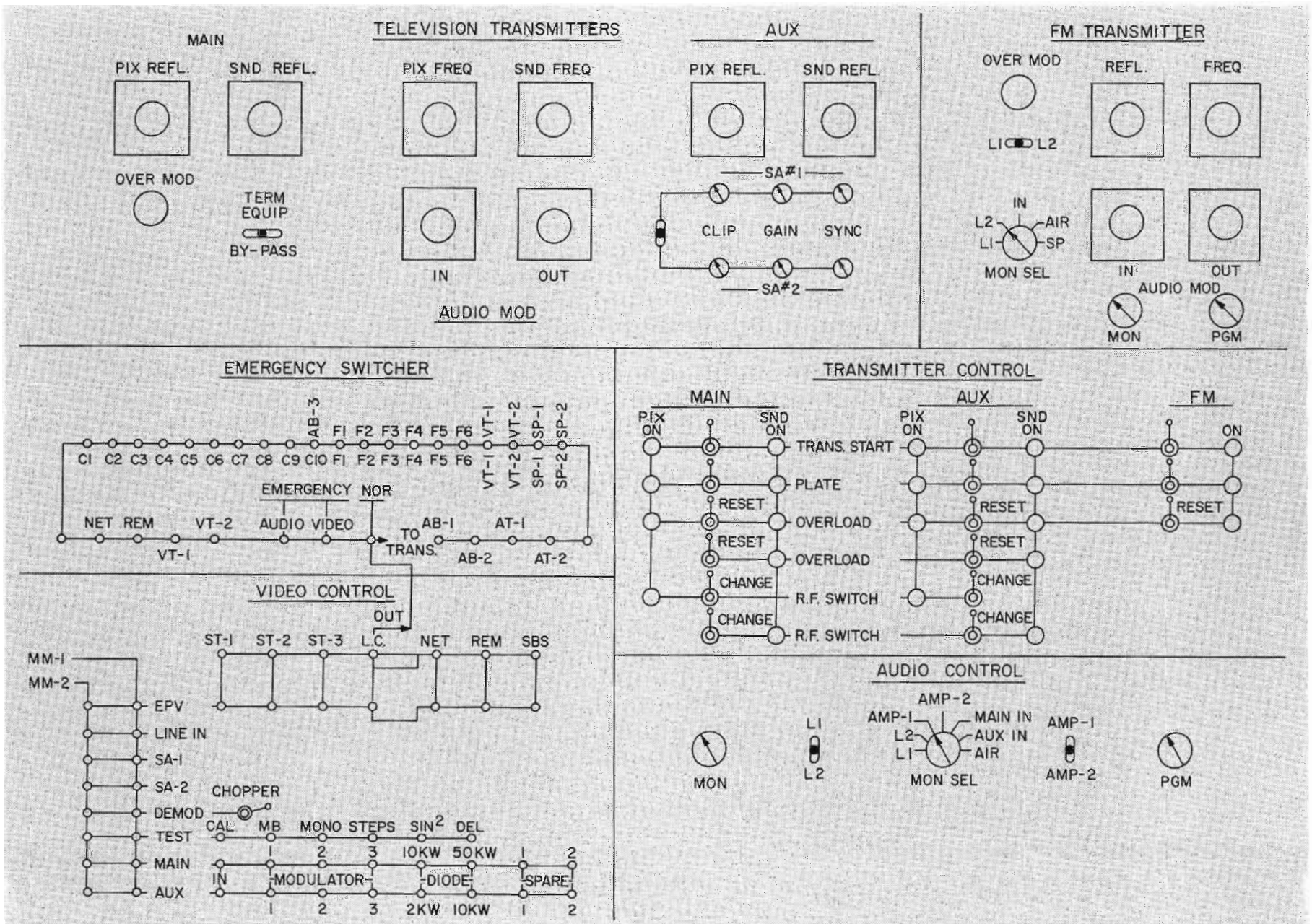



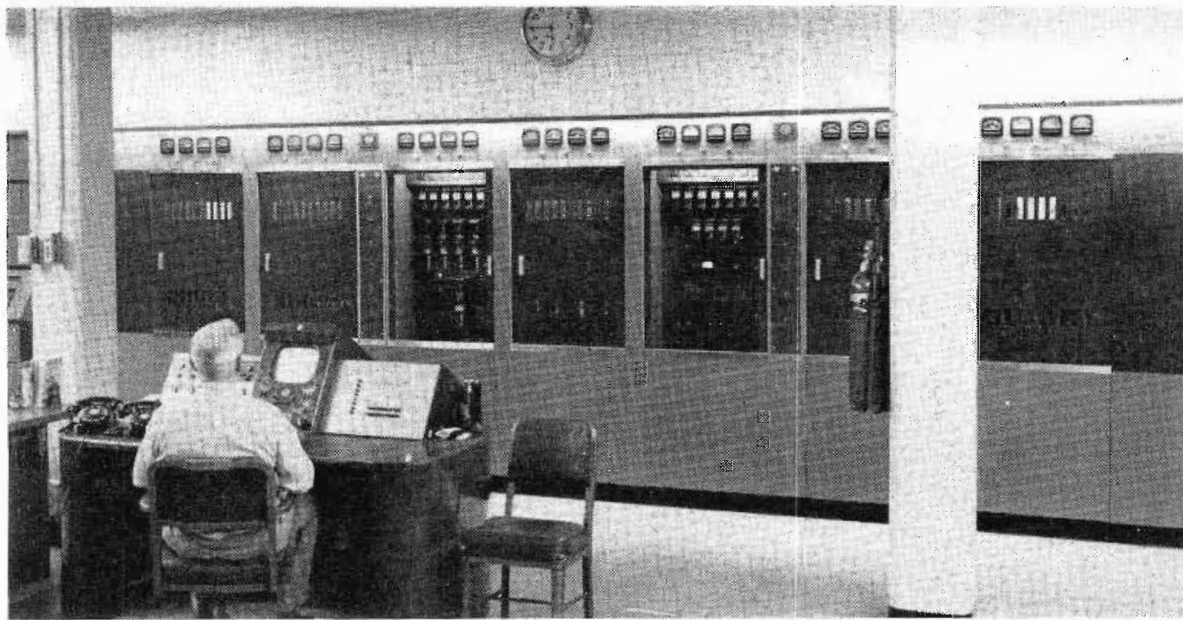

FIG. 26. Transmitter room at WBAL-TV.

over-modulation indicator. On the extreme right side is a meter panel for the FM transmitter. Immediately below the FM transmitter panel is the transmitter control panels for all five transmitters. The operator can start and stop, reset his overload, and change main and auxiliary tv transmitters as well as the FM transmitter from this point. Below is a small audio control panel for transmitter monitoring and for program level control.

To the left of the transmitter control panel is an emergency switcher. In the center of this switcher are three buttons. Normally the button on the right is depressed. This means that the emergency switcher is by-passed completely and everything is

operating normally. If we have an audio failure, the button on the left is punched first. By this action audio from any of the sources, with an audio counterpart, is placed directly on-air by punching up the proper source button. In the event there is only a video failure, the video button is punched up. Thereafter, any time a source button is punched up, this video counterpart of the signal is put directly on the air.

Finally, below the emergency switcher is a video control panel. Here various portions of both transmitters are monitored. The panel also provides control over each of the four operating centers. Thus, much of the master control panel can be operated from this position should the need arise.

## Audio, Maintenance, Lighting and House Monitoring System

### Audio System

The audio system is designed around the BC-7 transistorized dual-channel console. Six of these have been installed. The main advantage of this equipment is the consistent quality of its technical performance. In the control rooms the audio is interlocked to corresponding video buttons on the video switcher. However, the audio man can individually control any audio source he desires. Each of the announce booth microphones has an automatic gain control amplifier (always operated with about 15 db compression). This practically eliminates the need to ride audio level on the announce microphone. At the master control consoles, the announce booth microphones are connected so that the master control operator has the choice of having the announcer override the preceding audio or talk in place of the preceding audio. The audio at master control can be operated in a completely automatic mode if desired.

### Maintenance Aids

In a plant as complicated as WBAL-TV, every effort is made so that the equipment could be maintained properly and proof of performances made with the least expenditure of time and effort. A large, well-equipped maintenance shop is outfitted; equipment can be brought from the studio floors into the maintenance shop by means of an elevator, and enough test signals are incorporated into the switching system to make the proofs as painless as possible. The following test signals were made available at each switching control. Calibration pulse, multiburst, sine<sup>2</sup>, window, and stair-step. By simply pressing the appropriate button, these signals can be made to pass through the entire system, and results recorded by means of a polaroid camera.

### Studio Lighting

The studio lighting is divided into six separate sections for each studio. Each section consists of three 12-foot assemblies,

mounted on transverse rails, so that each assembly can be moved about ten feet in either direction. Each assembly holds three lamps. One assembly in each area is motor driven so that the groups of three lamps can be raised or lowered remotely. The other two assemblies in the group have their light individually adjusted by means of a Chinese finger-grip assembly. These nine lights constitute the "drop" lights.

In addition there are two pantographs assigned to each of six areas. Each accommodates a 2-kw support light for modeling use. These modeling lights also are mounted on tracks for ease of adjustment. Finally, there are a group of rear lights which can be moved as far as 6 feet away from the wall. These also operate on overhead tracks.

A dimming system, not yet in operation, will allow any 25 percent of the lights to be dimmed. Every lamp outlet has two 25 amp relays. A toggle switch selects whether that light will be turned on or off or delegated to the dimmer bus. The dimmers, themselves, consist of three 12-kw magnetic units, each of which is controlled with only 5 ma of control current.

### House Monitoring System

From the outset, a highly flexible house monitoring system was planned. We converted thirty monochrome television receivers by installing a completely new video amplifier (flat to 10 mc) in each of the cabinets. A combination audio and video switcher with a capacity of 24 outputs and 8 inputs is centrally installed. In addition, each of the monitors can be muted for viewing the picture only.

### Operational Results

What have we accomplished in this new plant? To sum up, we have a plant which has been specifically designed for future expansion and to take care of future developments with the least strain. We have plenty of space to install more film and tape machines if needed, or other new developments as they come along. We have used many of our old tube type power supplies. It is our intention to gradually replace these power supplies over the years with the new solid-state power supplies. The system has been designed for full color operation. Any of the control rooms can operate any of the cameras and film chains or tape machines. Any of the tape machines and film chains can be delegated to any portion of the operation. We have a test system so that daily checks of the entire system can be made by merely pushing the proper buttons. We have overcome many of the problems in our previous plant and have made operations more flexible, as well as more efficient and economical.



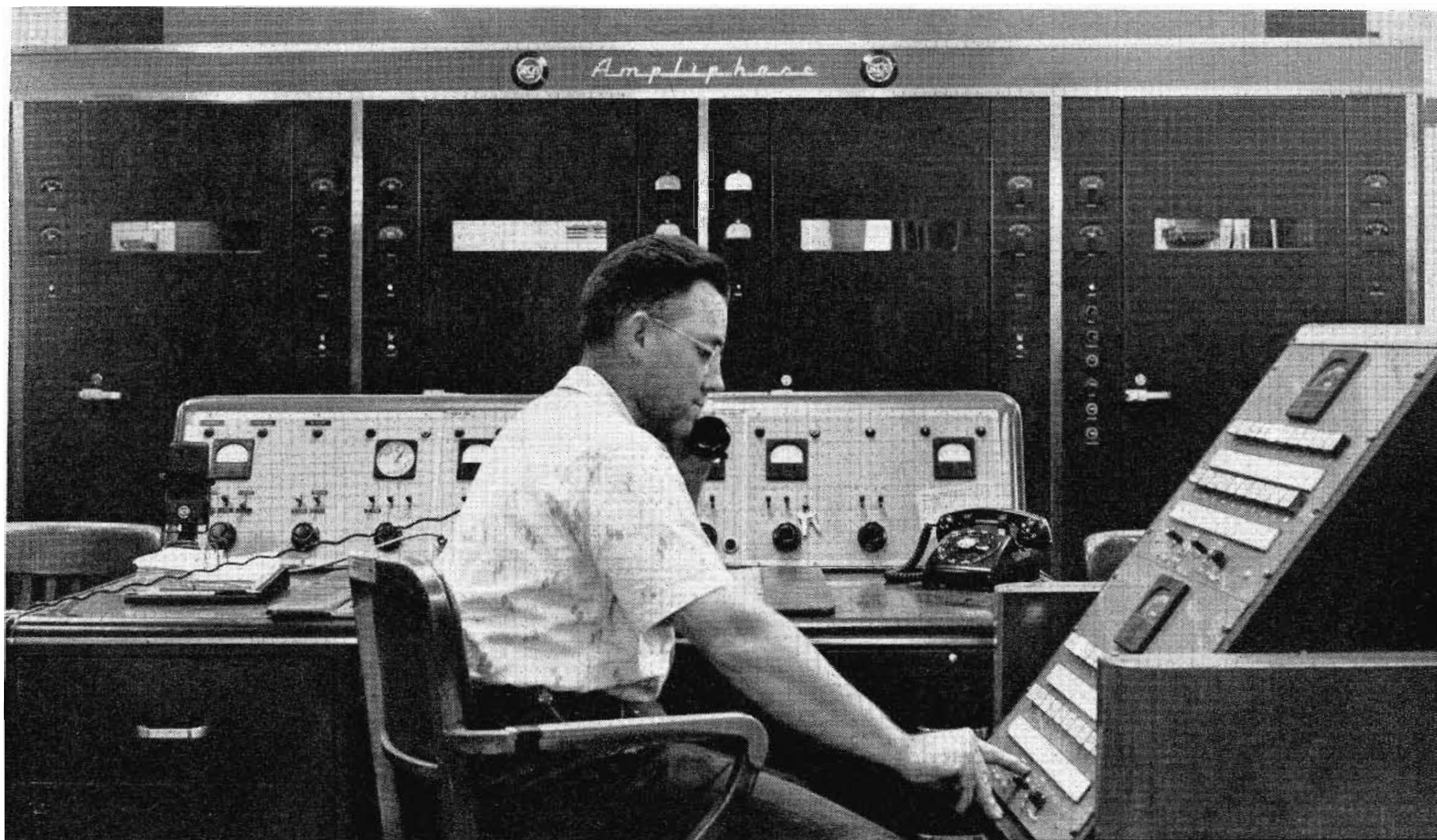

FIG. 27. A 50-kw Ampliphase transmitter provides a sparkling new voice for WBAL radio.

## Streamlined New Facilities For Powerful Voices of WBAL AM & FM

by THOMAS S. CARR, *Vice President and General Manager*  
and HARRISON BROOKS, *Chief Engineer, WBAL Radio*

Of the 70,000 square feet comprising Maryland's Broadcast Center—approximately 7,000 square feet is assigned to Radio—AM and FM. This total area is best described as a square, within a square. The outer square houses management and related departments and the inner square, the "heart" of the operation, houses studios and master control for both AM and FM. WBAL Radio has three functionally designed studios, all operable from master control. Also should the occasion arise when Radio might require the equivalent of the studio space once needed for "live" broadcasts, "TV Studio One" is equipped to feed radio master control.

All three studios use the latest in deluxe stereo consoles; audio tape recorders, and numerous cartridge tape playbacks. Studio and master control facilities are completely interchangeable. This permits following regular programming, while simultaneously

and automatically recording NBC network feeds; news flashes from the station's four radio-equipped news vehicles or mobile studio trailer, and even telephone interviews. In this manner technical facilities complement the fast-paced requirements of today's radio programming.

Special attention is paid to the design layout of the outer square—from the office of the Station Manager, the offices flow in a well defined pattern—Sales, Traffic, Engineering, Program, Music and lastly, the News Department with 16 newsmen providing a "round-the-clock" coverage. Management is never farther than 20 seconds away from the "heart" of the operation.

### Technical Facilities

Two moderately sized studios, each 15 by 20 feet, and one news-type studio, 10 feet square, fulfill AM and FM radio requirements. Control rooms for these studios

FIG. 28. Thomas S. Carr at one of Radio's three BC-7 dual-channel consolettes.





are arranged that the central control room (master control) can handle all of the microphone outlets in any of the three studios. However, to insure flexibility, one of the control rooms is set aside exclusively for FM. This control room is equipped with a BC-7 stereo, dual-channel console. Normally, FM is run from sign-on at 8:00 A.M. to 6:00 P.M. by an automatic tape program service. From 6:00 P.M. to sign-off, FM programming is handled through the BC-7 console. The third control room can also handle the second large radio studio, but it has been set up to be used primarily for audio tape recording. Therefore, three separate programs can be run simultaneously, if desired.

In master control all of the equipment is used either at the console desk position or in custom-made floor-to-ceiling racks. Tape machines of various types are conveniently controlled from one control panel adjacent to the console. Three of the tape machines are available for instant recording and assigned to the NBC hot line, to the output of radio telephone receivers in news vehicles, and to the beeper telephone. During the normal program day one man in master control can conveniently operate the radio technical facilities.

The WBAL radio transmitter site is located about 15 miles northwest of Baltimore City. This plant was originally constructed in 1940 and technological improvements since then have made it desirable to completely rebuild this plant—specifically to eliminate a severe harmonic problem and also to take advantage of remote control. A new Ampliphase 50-kw transmitter was installed along with a new 10-kw



FIG. 29. Radio master control looking into Studio C.

standby transmitter, new phasing equipment, transmission line and terminal equipment. This installation has resulted in a sparkling new voice for WBAL. The stability of the transmitter is such that the technical specifications are met week after week with very few adjustments. Other advantages resulting from the installation of the Ampliphase transmitter are consider-

able savings in power and space and a reduced inventory of tubes. It is largely responsible for the quality of WBAL Radio's new voice.

WBAL Radio today, in its new setting, represents almost four decades of continuous effort to serve the community with pride and professional "know-how" combined with taste and talent.

FIG. 30. Radio equipped news vehicles for WBAL-AM/FM/TV.





# RCA COLOR SEMINAR

## Part III: Handling the Color TV Signal Checking and Monitoring Terminal and Distribution Equipment

by JOHN W. WENTWORTH

*Manager, Educational Electronics*

*RCA Broadcast and Communications Products Division*

In this paper, we shall consider the problems of handling color signals through the "master control" facilities normally found in a television station.

Part II, by Mr. Gronberg, reviewed the steps taken by the networks and the telephone companies to assure delivery to your station of the highest possible technical quality in color television signals and offered comments on some of your own responsibilities in this area. Parts IV and V by Messrs. Bullock, Marye and Small discuss the specialized problems involved in handling color signals through microwave relays and broadcast transmitters. Let me remind you that the main objective of this entire series of seminar papers is to provide information that will help you, as a local station chief engineer, supervisor, or operator, to deliver better color pictures to your broadcast audience.

We shall be concerned here with three basic categories of equipment: stabilizing amplifiers, switchers, and general-purpose distribution amplifiers. I shall also comment on the test equipment we recommend for use in the studio plant, and we'll discuss a number of practical test and alignment techniques as we proceed.

There may be some question as to whether it is really appropriate to consider stabilizing amplifiers in a paper devoted to "master control" equipment. While some stations still make it a standard practice to pass an incoming network signal through a stabilizing amplifier before injecting it into the master control switching and distribution system, more and more stations are finding that it is desirable to abandon this practice, and to use only a single stabilizing amplifier at the transmitter location as recommended in Mr. Gronberg's paper. This writer strongly endorses Mr. Gronberg's suggestion that you avoid the use of stabilizing amplifiers wherever possible—use one at the master control point only if there is a clear reason for doing so. Inclusion of the stabilizing amplifier in this particular paper was planned only to make sure that we cover some of the important problems related to his equipment; the information is not repeated in the Part V paper on transmitters, even though the stabilizing amplifier is perhaps more likely to be used at the transmitter than at the master control point.

### Recommended Test Equipment

A brief list of test equipment that we recommend for use around the studio plant is presented in Table I. (A few additional items are required for specialized measurement problems at the transmitter, as pointed out in Part V.) In order to keep these seminar papers on a non-commercial level, we have avoided the

use of specific type numbers or MI numbers, but your local RCA field representative would be happy to advise you concerning the specific items in each category which would best serve your needs.

I should like to comment in fair detail on color monitors and television oscilloscopes, but I believe we might first discuss very briefly the other items listed. The "Multi-Test Signal Generator" is a device which generates the specific test waveforms reviewed in my introductory paper (Part I) and used by Mr. Gronberg to illustrate Part II. While you can gain a great deal of useful information by viewing the signals which the network line brings into your plant, chances are these signals are somewhat distorted or degraded before you even receive them. You may also experience difficulty in routing the network signal through the specific pieces of equipment you want to check at the times when network test signals are available. Thus, we strongly recommend that you acquire your own multi-test signal generator so you will have a convenient source of good clean test signals of all basic types to check your local plant equipment.

A necessary accessory to the multi-test generator for differential phase measurements is a Color Signal Analyzer or its equivalent. The item designated by this name in the RCA test equipment

Table I

### RECOMMENDED TEST EQUIPMENT FOR STUDIO USE

COLOR MONITOR  
TELEVISION OSCILLOSCOPE  
MULTI-TEST SIGNAL GENERATOR  
VECTORSCOPE OR COLOR SIGNAL ANALYZER  
VIDEO SWEEP GENERATOR  
OSCILLOSCOPE CAMERA



product line has now been discontinued, but the function it performed is now available in the Vectorscope manufactured by Tektronix, Incorporated and available through your RCA field representative. In principle, the Color Signal Analyzer is nothing more than a phase detector with a calibrated phase shifter. We shall comment in greater detail on differential gain and phase measurement techniques a little later in this paper.

In view of the current popularity of the multi-burst test signal for frequency response measurements, you may be a little surprised to see that a video sweep generator remains in our list of recommended test equipment. While we heartily endorse the multi-burst test signal for routine checking purposes, we still feel there is great virtue in the traditional sweep signal for actual maintenance work, such as the alignment of peaking coils. The multi-burst signal checks the response at only a few specific frequencies, while the sweep shows the entire characteristic above a few hundred kc. A sweep generator with good detector circuits and a dual-trace oscilloscope offers the most sensitive test facility for critical alignment tasks where you must be concerned with accuracy of the order of 1 per cent or so.

The oscilloscope camera deserves recognition both as a test instrument and as a communications tool. Mr. Gronberg has pointed out the great value of waveform photographs as a means of describing to outside persons, such as telephone company or network representatives, any difficulty you may be having. You will also find that periodic photographs of test signals made at the major check-points throughout your system can be a valuable addition to your maintenance records. If you have a case of ringing, for example, that looks a little more severe than you remember from previous tests, you'll find that its very handy to be able to pick up a photo made several weeks earlier to help you decide whether or not something has changed.

You will note that the color bar generator is not included on this list of basic test equipment, because such a bar generator is of relatively limited value in testing the "master control" equipment which is our primary concern in this paper. A color bar generator is quite essential, however, if you operate any color origination equipment (either live or film), or if you operate a color tape recorder. A color bar signal is also extremely useful in setting up color monitors, so if you operate a number of color monitors and have any serious plans about eventually acquiring color origination equipment, you can probably justify an investment in the equipment involved in generating the standard color bar signal. (In addition to the color bar generator itself, you will probably need a Colorplexer and color accessories for your studio sync generator.)

### The Importance of Color Monitors

Incredible as it may seem, we find that some stations are attempting to broadcast network color signals without owning or operating a single color monitor! In my judgment, this practice violates common sense. While you can learn a great deal about the quality of a color signal by viewing on a black-and-white monitor and by inspection of the signal waveform, there is still no substitute for actually viewing the color picture. I believe it is wise to keep reminding ourselves that the entire television industry is in the business of making illusions — our viewers *actually* see nothing more than patterns of light, shade, and color on fluorescent screens, but we want them to *think* they are seeing studio or outdoor scenes with as much realism as possible. Soon after I began my television engineering career, a "senior scientist" in the television industry impressed upon me the concept that



FIG. 1

a television system doesn't necessarily have to work—it just has to *look* like it works! In other words, *the picture is the thing*, and if you're trying to transmit color pictures it is very important that you have reasonable facilities for inspecting the product you are delivering.

Because there is only one color monitor designed as a "quality control" instrument available on the American market, I believe that we can, without violating the non-commercial theme of this seminar, make a rather direct recommendation that you install and use at least one RCA TM-21 Color Monitor (Fig. 1) at your master control position. In addition to its ability to display a high-quality color picture, this monitor can also serve as a useful test instrument in its own right. A color receiver modified to accept a video feed offers a lower-cost approach to the problem of displaying a color picture, and such an arrangement is quite satisfactory in many locations where the viewing requirements are not particularly critical. Color receivers have been improved steadily over the past ten years or so, and now require no apology whatsoever as consumer products for use in the home. For use as station monitoring equipment, however, even the best color receiver may leave something to be desired in the sense of absolute stability. When you see something wrong in a color picture at your master control location, you would like to have more than a guess as to whether the problem is in the signal itself or in the device displaying the signal. The TM-21 Color Monitor is sufficiently well stabilized that you can, in fact, be quite sure that it is indicating the true quality of the *signal* itself. You will probably find that the somewhat lower-cost, utility-type color monitors now becoming available are intermediate (between color receivers and the TM-21) with respect to both basic picture quality and long-term stability.

Although part of the stability of the TM-21 Color Monitor results from the use of thoroughly regulated power supplies and very conservative design techniques in the deflection circuits, the



major differences between this monitor and the typical mass-produced receiver are to be found in the decoder, which is shown in block diagram form in Fig. 2. This decoder employs a variety of techniques, such as feedback stabilization and a gated form of d-c restoration, which are clearly too expensive to be practical in home instruments. It is also significant that the monitor has separate filters for the I and Q channels which make full use of the information contained in the color signal. (Most receivers are compromised in this respect, and fail to make full use of the 1.5 mc nominal bandwidth of the I signal component.) The TM-21 can also display a monochrome picture of higher quality than most receivers, since the "color killer" circuits in this monitor not only disable the chrominance channels but also increase the bandwidth of the monochrome channel when the incoming signal has no color synchronizing burst.

### Waveform Monitors and Oscilloscopes

The oscilloscope is certainly one of the most basic test instruments for use in a television studio plant. You probably have two relatively distinct needs for oscilloscopes, in addition to those included in the master monitors associated with your camera chains. You need at least one good waveform monitor "built in" at your master control point, where it is always available for quick inspection of any of the signals passing through your plant. You also need at least one good maintenance instrument, preferably mounted on a "tea wagon" or dolly which can be moved around the racks and utilized wherever it is needed.

The role of the waveform monitor in the "quality control" of television signals is so well known that little time need be spent here in extolling its virtues. If you have not yet had much ex-

perience in color, however, you may not be aware how much you can learn about a color signal by careful inspection of the waveform *on a monitor of known characteristics*. The standard color bar signal shown in Fig. 3 is particularly suitable for waveform analysis.

For those of you who are not already familiar with this waveform, I might point out that you are seeing a superimposition of two signals, corresponding to both portions of what is, in effect, a vertical "split screen" display. In the upper half of the picture produced by the standard color bar signal, each line is divided into seven nominally equal intervals, corresponding to "pure" colors in the following sequence: White, yellow, cyan, green, purple, red, and blue. This entire sequence of colors is transmitted at 75 per cent of the maximum possible level in order to produce a signal which does not exceed the reference white level; hence the "white" bar in this basic sequence extends only 75 per cent of the way between black level and reference white level. In the lower half of the picture, there are only four basic intervals, used to transmit samples of I sub-carrier, reference white, Q sub-carrier and black; the black interval covers nominally half of the entire line. (The samples of I and Q sub-carrier are superimposed on black level, and are transmitted at peak-to-peak levels of 40 IRE units.)

The standard color bar signal has a number of "check points" which enable you to determine readily whether or not the Colorplexer which produced the signal is properly adjusted, and whether serious degradation has occurred in the transmission equipment or recording equipment through which the signal may have passed before inspection. For example, the state of "carrier balance"

FIG. 2

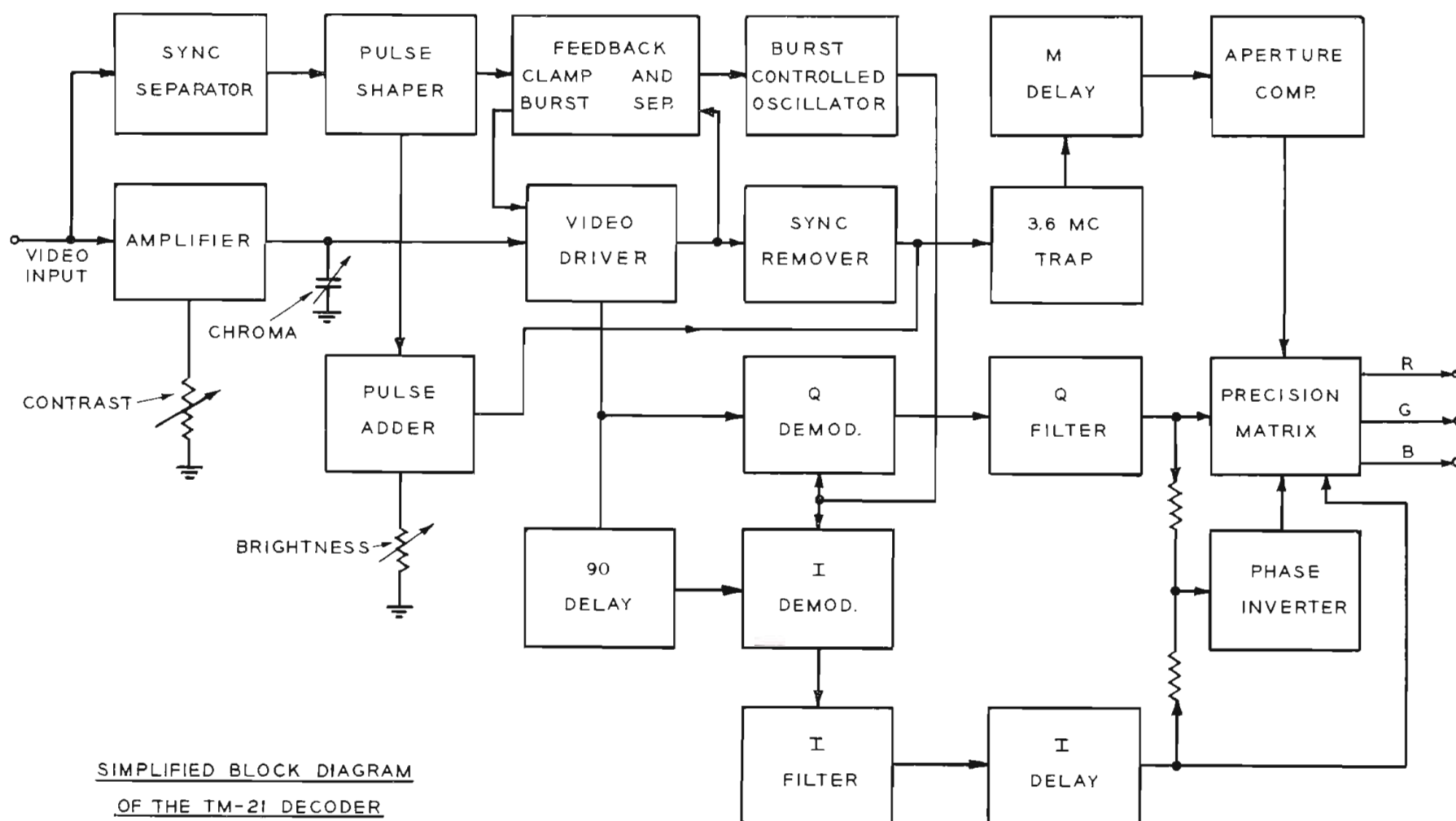



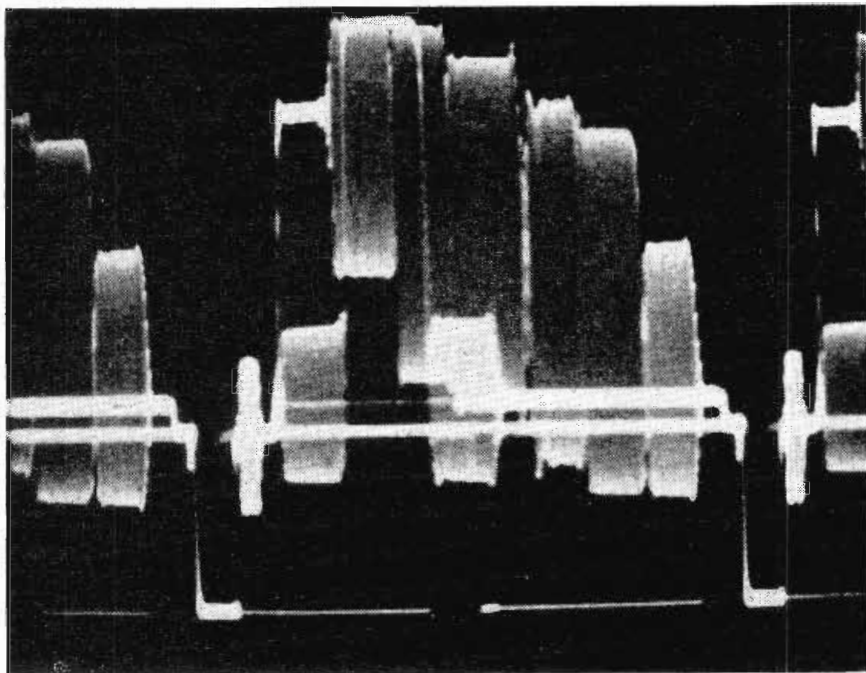

FIG. 3

adjustments is clearly indicated by the residual sub-carrier at the blanking level, and proper "white balance" is indicated by the absence of sub-carrier in the reference white and 75 per cent white pulses. When "chroma gain" is set correctly, the lower excursion of the sub-carrier for the green bar should just touch the black level, and the upper excursion for the purple bar should line up with the 75 per cent white level. If the chroma gain is correct and the I and Q signals are in proper phase quadrature, the "undershoots" for the red and blue bars should line up evenly, and the "overshoots" for the yellow and cyan bars should line up with each other and with the reference white pulse. Burst gain is correct if the signal as a whole shows proper chroma level and the burst has a peak-to-peak amplitude of 40 IRE units (the same as the sync pulse).

It is not possible, of course, to learn nearly as much from the inspection of normal color *program* signals as in the case of the color bar signal, but you can often get a pretty good indication as to what is happening to the chrominance part of the signal by careful inspection of the color synchronizing burst. If your waveform monitor is essentially flat to 4.0 mc, you should expect the burst amplitude to remain constant at 40 IRE units—if it fluctuates appreciably, chances are there is a corresponding variation in the chrominance part of the picture signal, unless you see other evidence to indicate that burst distortion is taking place because of faulty clamping somewhere in the system. The *envelope* of the burst also contains useful clues. Most colorplexers deliver a burst with a good rectangular envelope, and if you detect "football" shaping or other distortion in the burst envelope, you have good reason to suspect that the entire color signal has been subject to some type of high-frequency amplitude or phase distortion, the seriousness of which can best be judged on a good color monitor.

Incidentally, it is recommended that a waveform monitor with the IRE roll-off characteristic be used for routine level-riding purposes, so that judgment as to where "white level" should be set is not unduly influenced by either sub-carrier overshoots or narrow "spikes" in the luminance signal. When the IRE roll-off filter is in use, you must expect to see the color synchronizing burst severely attenuated, as shown in Fig. 4.

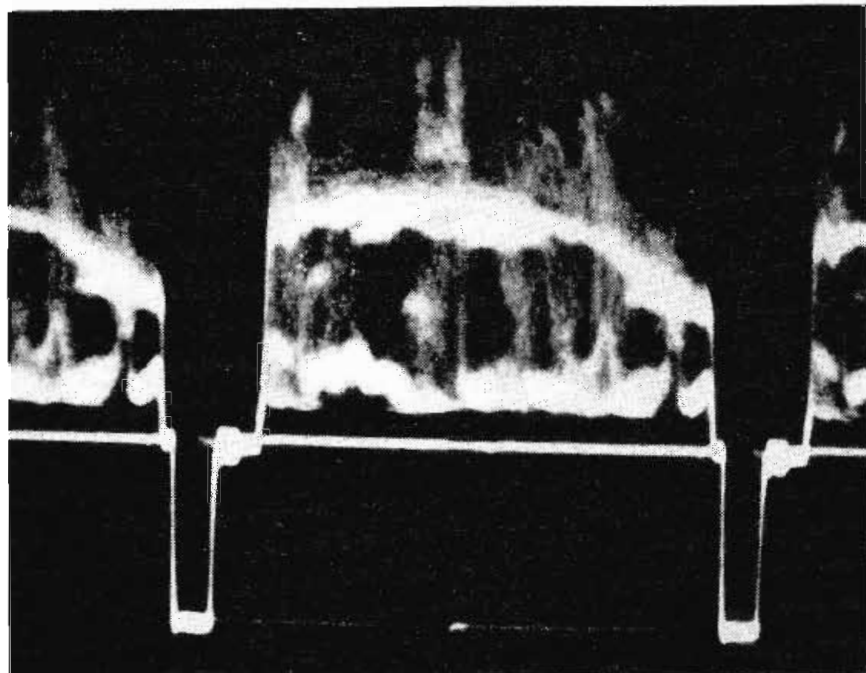

FIG. 4

In addition to its use in inspecting actual color signals, a good waveform monitor is essential for proper interpretation of any of the test signals we have been discussing throughout this seminar. If your waveform monitor shows some consistent defect, such as smearing or ringing, you should be certain that the instrument itself is beyond reproach in these respects before you proceed to trouble-shoot your entire system.

For general maintenance work, many stations find that the 524 series of Tektronix oscilloscopes still satisfy all their needs, but more and more broadcasters are beginning to recognize that an oscilloscope with dual-trace capability expedites a great many trouble-shooting and maintenance procedures, especially where television tape equipment is involved. If you are contemplating the purchase of a general-purpose oscilloscope in the near future, I strongly recommend that you consider one of the dual-trace type. Our field representatives would be happy to discuss with you the characteristics of the several types available.

### Switching Systems

Individual stations differ widely in their requirements for switching equipment, so you may be concerned with passing color signals only through very simple, "direct" switchers comparable to the RCA TS-11, or you may have a very elaborate system with remote controls and a great many features, such as those provided in the RCA TS-40. In no case should you anticipate any particular difficulty in passing color signals *through the switching elements themselves*. If the switching elements are of the metallic-contact variety (coupled either to pushbuttons or relay armatures), there is obviously little opportunity for signal distortion, assuming that the contacts are kept clean so that they close reliably. Even in the newer solid-state switching systems, where the actual switching elements may be transistors or diodes, you have a right to expect from any reputable manufacturer a reasonable choice of signal levels and bias voltages or currents that assures distortion-free handling of color signals through the actual switching circuits. The major problems in handling color signals through switching systems are normally external to the actual switching elements. Capacitance loading effects, variable timing



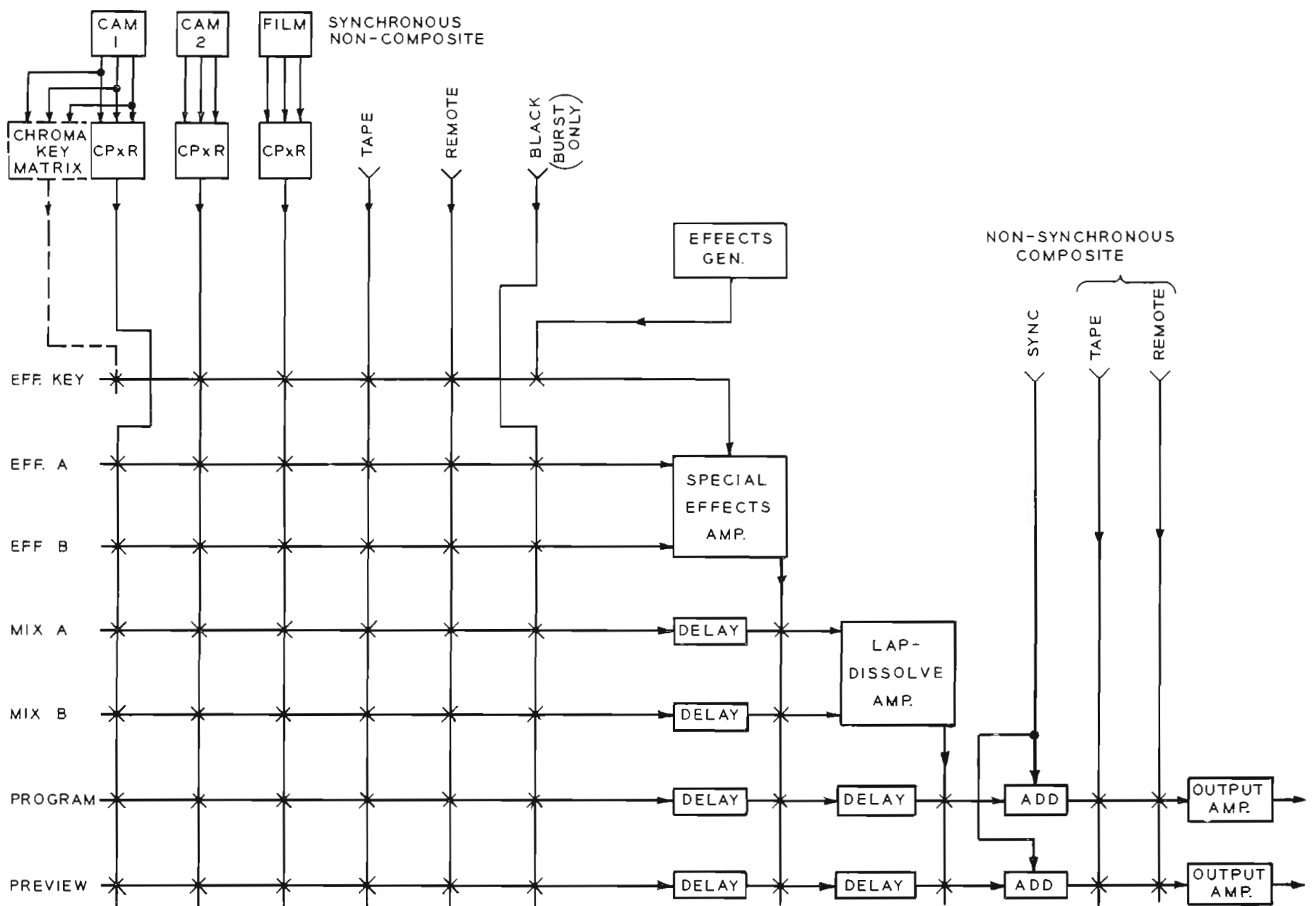

SIMPLIFIED BLOCK DIAGRAM OF A COLOR STUDIO SWITCHING SYSTEM

FIG. 5

problems, and the distortion introduced by isolation amplifiers or output amplifiers are more likely sources of difficulty.

The block diagram shown in Fig. 5 represents a color television studio switching system providing facilities comparable to those used in relatively large local stations. You will note that the system provides both special effects and lap dissolves, and has both program and preview output buses. The diagram is greatly simplified in that it does not show the full number of camera inputs that would normally be required, nor all of the isolation amplifiers and other items that may be required in "transporting" signals from point to point throughout the system, but it does serve to illustrate some of the basic problems involved in color switching systems.

In designing and maintaining color television switching systems, you must, of course, be concerned about uniformity of frequency response through all possible paths; tolerance limits in this area are much tighter than for monochrome switching systems because of the presence of the vital chrominance information in the upper part of the video band. Thus, the variable capacitance load that may be found across a given "cross-point" or switching element must be held within close limits for a color system, while the

same characteristic may be quite unimportant for a monochrome system. Even the distributed inductance of switching buses can be troublesome; you will find that in many color switchers the buses consist of relatively heavy copper straps of rectangular cross-section instead of the traditional round wires. It is also necessary to match path delays in color switching systems so that the color synchronizing bursts are not subjected to rapid changes in phase as various signal sources or effects are "punched up". A basic approach to the delay problem is shown in Fig. 5. Note that delay networks matching the delay characteristics of special-effects amplifiers and lap-dissolve amplifiers are provided so that a signal takes the same amount of time to arrive at the output of the system no matter what route it follows.

#### Color Genlock Facilities

Detailed discussion of design details in color switching systems is beyond the scope of this paper, which is concerned primarily with the *handling* of color signals through facilities which we must assume were properly designed and installed. Actually, in many stations concerned only with *network* color signals, color performance requirements must be met only in the relatively nominal "master control" facilities shown in the lower right-hand



corner of Fig. 5 (where the network signal is treated as a non-synchronous, composite REMOTE input). Some stations, however, may encounter a need for color genlock facilities so that network or other remote signals can be passed through special effects or lap dissolve amplifiers along with local signals. (A TA-9 stabilizing amplifier can be used to remove synchronizing pulses from color signals to obtain the noncomposite signals required for most effects amplifiers.)

One possible approach to such genlock facilities, patterned after the arrangement actually used by NBC in the New York City area, is shown in Fig. 6. This particular approach is based on the use of a two-way video feed between the main plant and a remote location. The outgoing signal from the main plant may have only sync pulses and color synchronizing bursts, but the same line might also be used for a video cueing signal, a film chain output, or some other signal needed at the remote location. The actual color genlock facilities at the remote location consists of a standard monochrome sync generator with built-in genlock for the conventional deflection sync pulses, plus a burst flag generator and a burst-controlled oscillator. (The burst-controlled oscillator may have a "sync stripper" suitable for supply pulses to the genlock input of the monochrome sync generator; alternatively, a stabiliz-

ing amplifier could be used for this function.) Note that a Color Frequency Standard is not required at the remote location. Even though the sub-carrier and the pulse signals may be "locked in" to the master control signal through two nominally independent AFC loops (one in the burst-controlled oscillator, the other in the monochrome genlock), they retain the harmonic relationship specified in the FCC standards. In a situation where you cannot afford a two-way video circuit between master control and a remote location, you can still operate in a "genlocked" mode by making your main plant a "slave" to the remote signal during the period when synchronous operation is required.

### The Importance of Complete System Tests

In studio switching and distribution systems of normal complexity, it is not too unusual to find as many as ten isolation amplifiers or distribution amplifiers in cascade in typical signal paths. Thus, while each such amplifier may not be a significant source of degradation in handling a color signal (ignoring the temporary problems resulting from obvious tube or component failures), the accumulated distortion resulting from a number of such units in tandem can become quite serious. If you attempt to analyze or align individual units with such precision that you can be sure of satisfactory performance in the complete system,

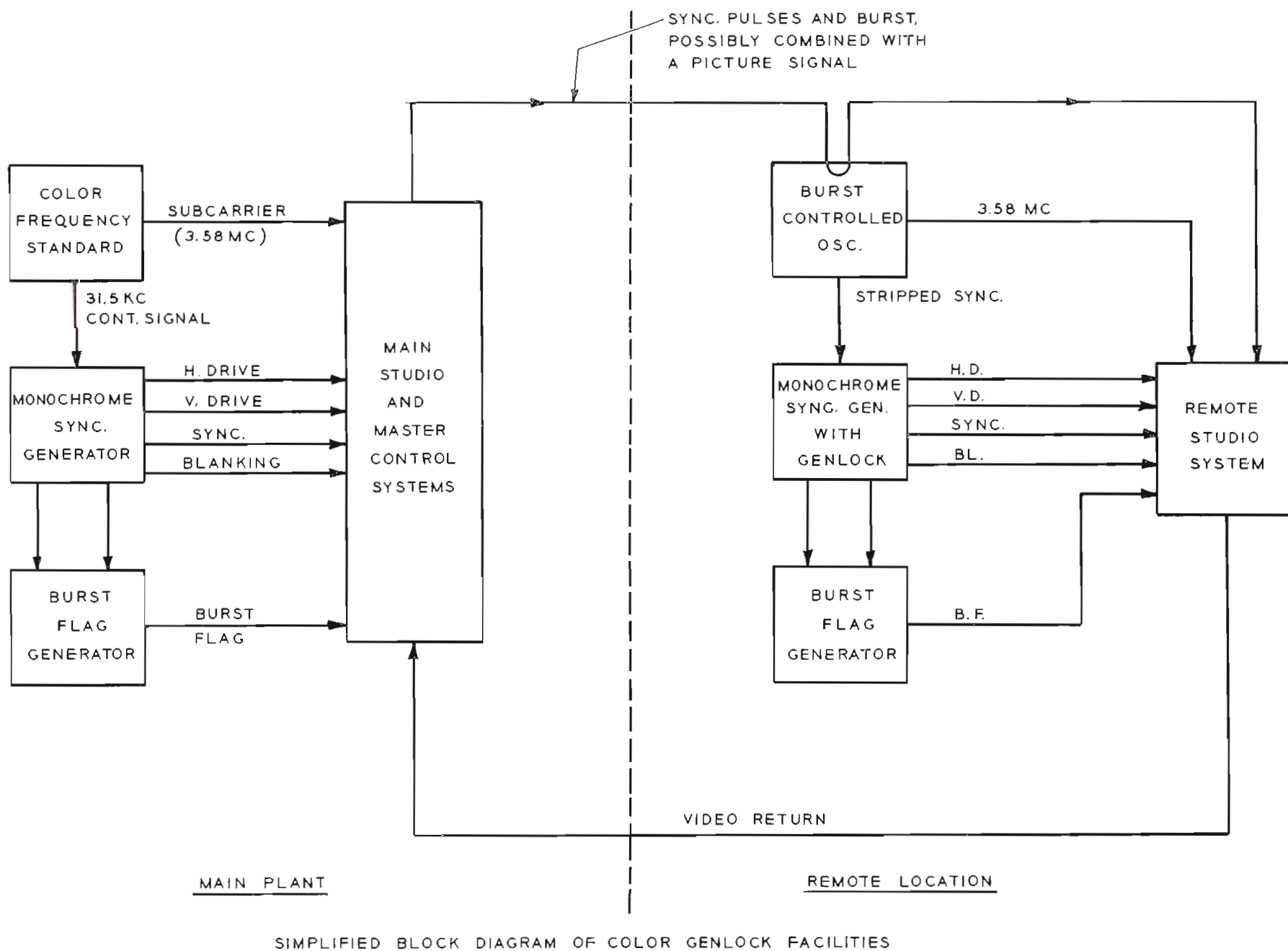

FIG. 6



chances are you will exceed the "resolution limits" of your test instruments. It is more practical, therefore, to align most distribution amplifiers *within the context of the system*. You should, for example, inject test signals at your network input point, and examine the signals as they leave your studio system, preferably with all possible signal paths "punched up" in succession so that you check out all possible signal routes and detect differences between them. Of course, when you discover problems through this approach, you must "track down" the major source of the problem in order to take reasonable corrective measures.

When you "sweep out" isolation amplifiers to adjust their frequency-response characteristics, we strongly recommend that you make it a point to have each amplifier terminated in the actual load which it drives in the system. Stated differently, we suggest that in sweeping out a complex switching and distribution system you start at the output and work back toward the input. If you start at the input, you usually find it necessary to place "dummy loads" on the output of each unit you encounter, if you start with the last amplifier in the chain, however, the output line itself can serve as the load across which you connect your monitoring instruments. Then, as you work back through the chain to the input, each amplifier is called upon to drive the load it actually handles in service. This approach is desirable because the loads to which isolation amplifiers are connected in actual service are seldom simple resistors; the reactances associated with switching buses and amplifier input capacitances can have a significant effect on the overall frequency response characteristics.

#### Transient Response Measurements

Most television engineers and technicians are quite familiar with basic frequency response measurements, using either the multiburst test signal for rapid routine checks or a video sweep signal for more detailed alignment procedures. The value of *transient response tests*, based on the window and sine-squared pulse signal shown in Fig. 7 may not be as widely understood.

As pointed out in my introductory paper in this series, the "window" portion of this test signal may be interpreted as a

specialized square-wave test signal specifically designed to check the low-frequency response characteristics of television systems, and Mr. Gronberg has given you several good examples of the type of distortion you can detect with this signal.

The sine-squared pulse, which appears as the narrow "spike" in Fig. 7 and in enlarged form in Fig. 8, is a specialized transient-type test signal for detecting problems in both amplitude and

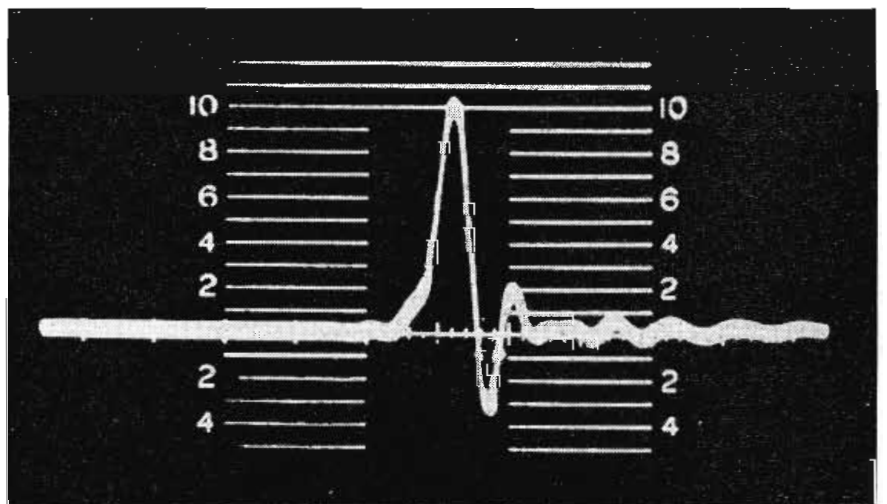
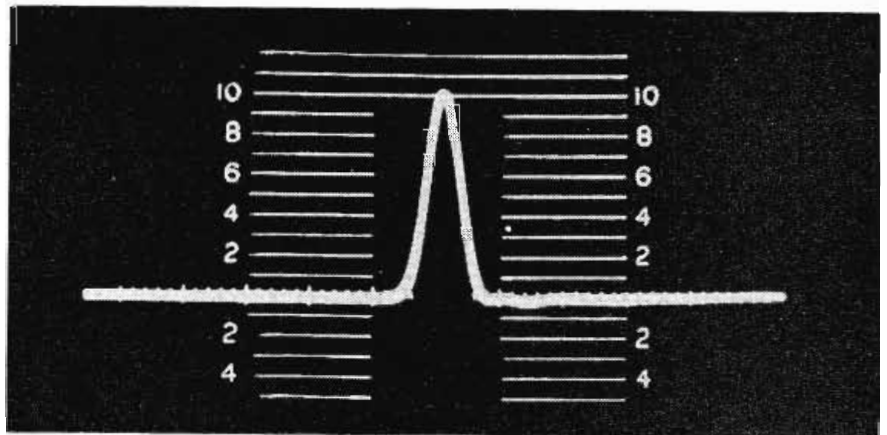

FIG. 8

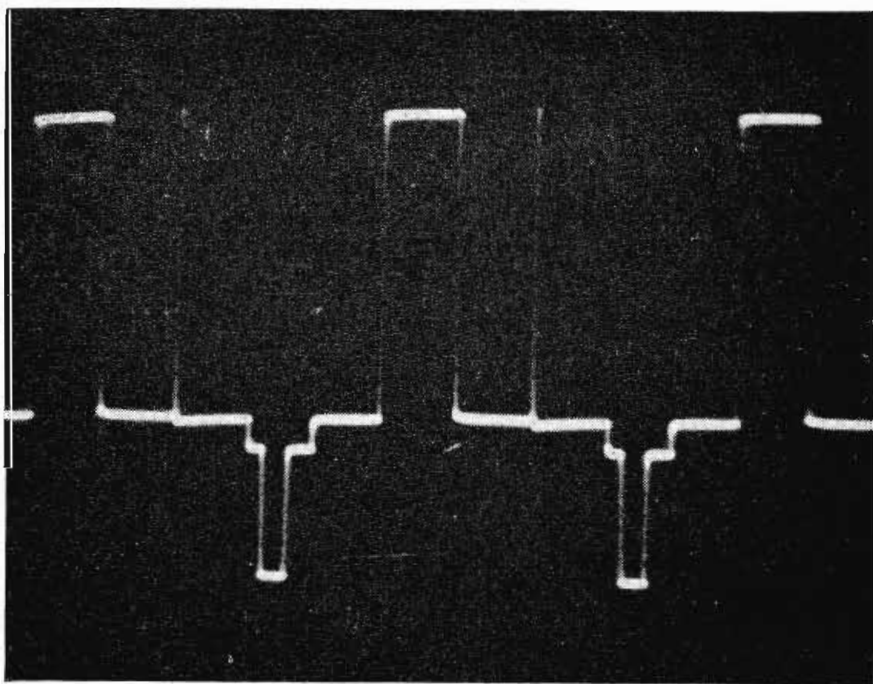

FIG. 7

phase response in the upper portion of the video band. This signal actually represents one of the most practical approaches known for the detection of phase response problems, which manifest themselves through asymmetry in the pulse waveform. The "ringing" distortion in the lower trace in Fig. 8 represents phase distortion far in excess of anything you should expect in a normal studio plant. As a matter of fact, you should expect a 0.125-microsecond sine-squared pulse to pass through your entire studio system with *no* visible distortion.

An important advantage of the sine-squared pulse as a test signal is its predetermined energy spectrum. It is standard practice among television engineers to measure the width of sine-squared pulses at the 50 per cent level, as indicated in Fig. 9. A pulse 0.125 microsecond wide at the 50 per cent point is known to have an energy distribution curve which is 50 per cent down at 4.0 mc and effectively zero at 8.0 mc, as indicated by the lower sketch in Fig. 9. (For those who are mathematically inclined, it may be significant to point out this energy distribution is *Gaussian*;



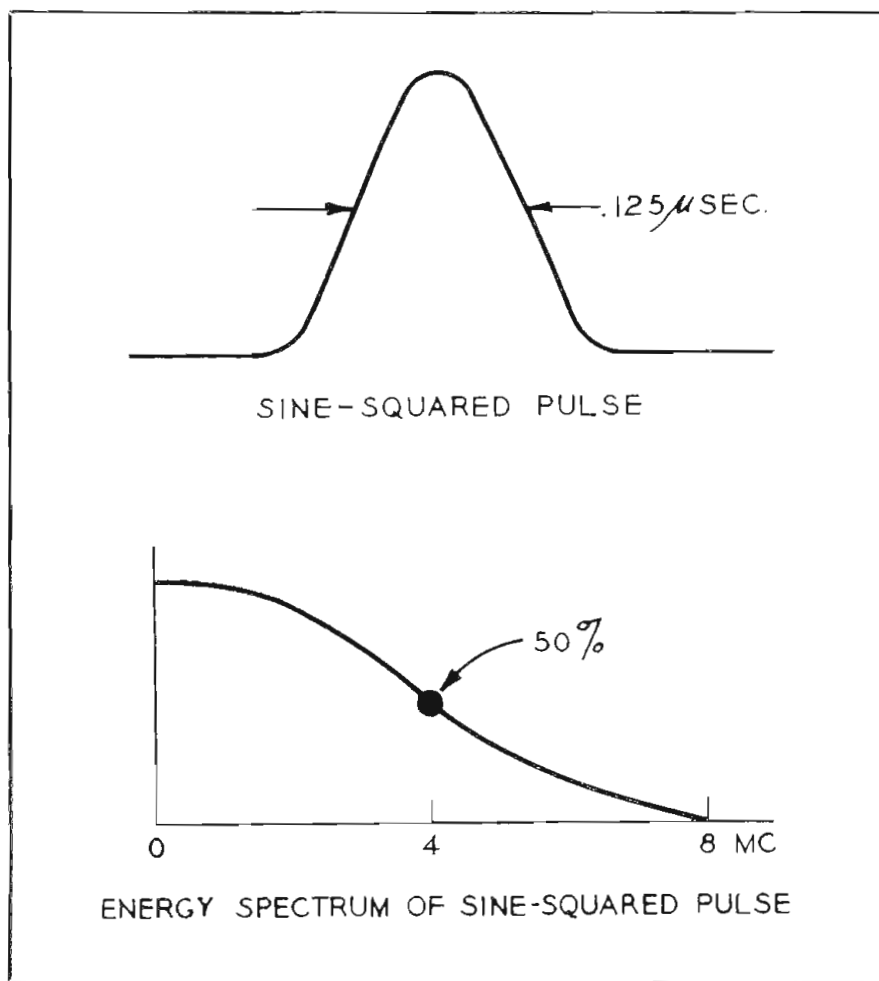

FIG. 9

combined with a mirror image of itself around the zero-frequency axis, the curve should form a probability function.) This energy distribution corresponds rather closely to that in an ordinary television signal, so the visible distortion in the sine-squared pulse gives a rather good indication of the fidelity with which program signals can be transmitted.

The energy distribution curve of the sine-squared pulse differs significantly from that of a square wave with very fast rise

time—another type of transient test signal that is useful in some applications. A fast-rise-time square wave has an energy distribution which is essentially uniform well out into the frequency band, usually well beyond the pass-band of the system to be tested. For tests of a limited bandwidth device, such as a broadcast transmitter, where it is *desired* to see the “ringing” or overshoot effects associated with the cut-off characteristic, a fast-rise-time square wave is a very appropriate test signal. In the case of a studio plant, however, the cut-off region for individual distribution amplifiers is normally located well beyond the band of interest, and the high-frequency transients associated with this cut-off are of only academic interest because no normal video signal would have energy in that part of the spectrum. Hence the sine-squared pulse is most appropriate for checking studio facilities. While Mr. Gronberg has indicated that you must expect some degradation of the 0.125 microsecond sine-squared pulse when received through “long lines” facilities (because the bandwidth of such circuits is usually less than 8.0 mc, and the cut-off characteristic of many “links” in tandem can become quite steep), you have reason to become concerned if you see *any* degradation of the same pulse in your studio facilities. Chances are that a distribution amplifier which fails to pass a sine-squared pulse satisfactorily has poor frequency-response alignment, a defective component, or a tube that has “slumped” enough to prevent a feedback loop from maintaining good phase and frequency response.

#### Differential Gain and Phase Measurements

As we tried to emphasize in the introductory paper in this series, good frequency and phase response alone is not enough to assure distortion-free handling of color signals—it is also necessary to keep differential gain and phase within relatively tight limits. A basic arrangement of test facilities for differential gain and phase measurements is shown in Fig. 10. The test signal generator would normally deliver a signal consisting of a stair-step with a sub-carrier superimposed upon it; this signal is passed through the circuit under test, and the sub-carrier component is recovered through a suitable band-pass filter. For differential gain measurements, direct inspection of the envelope of the sub-carrier signal on a CRO is usually satisfactory. Mr. Gronberg’s paper

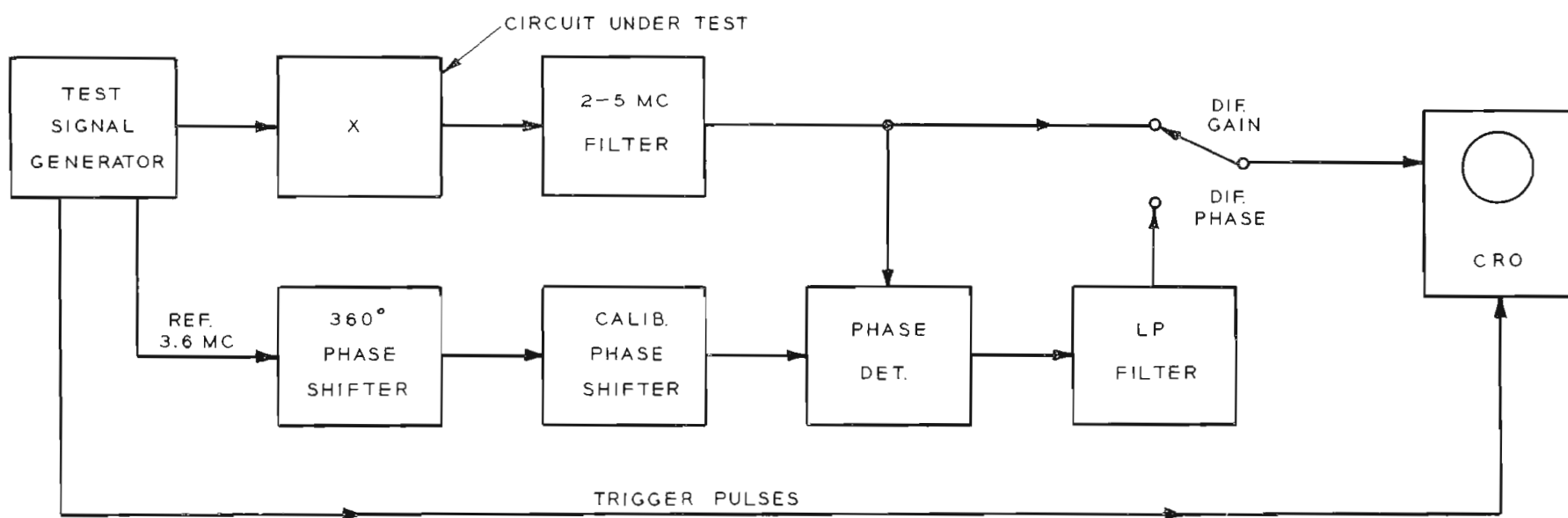

TYPICAL SETUP FOR MEASURING DIFFERENTIAL GAIN AND PHASE

FIG. 10



provides typical examples of “clean” and distorted differential gain test signals. For differential phase measurements, it is necessary to use some type of synchronous detector to compare the phase of each interval in the test signal with a reference sub-carrier signal. In some cases, this reference sub-carrier might be derived directly from the test signal generator (which may be a section of a multi-test signal generator), but if you wish to test a microwave link or some other extended system where it is not possible to gain access to the input and output ends simultaneously, you may need a burst controlled oscillator to provide the reference sub-carrier. In either case, a calibrated phase shifter of some type is normally used to vary the phase of the reference signal to permit measurements of phase displacements between the various intervals in the test signal.

Differential phase measurements represent one of the best ways to “log” the performance of feedback-stabilized amplifiers where the feedback itself tends to maintain reasonably uniform frequency response and gain stability until the tubes are near the end of their useful life span. Differential phase is usually one of the first characteristics to begin changing significantly as tube aging becomes serious.

### Stabilizing Amplifiers

We noted earlier in this paper that stabilizing amplifiers should be avoided in a color television system unless there is clearly some type of signal degradation or some system objective that requires their use. It must be recognized that stabilizing amplifiers have always been relatively troublesome devices, not because the equipment is not well designed but because it is called upon to perform in a “substandard” environment and to perform a variety of complex and “delicate” operations on the television signal. (The very use of a stabilizing amplifier normally implies that you have some kind of trouble with your signal.) One of the first steps you can take to minimize stab amp trouble is to acquire the very best unit available. In the RCA product line, the best unit available is the TA-9, so the following discussion will be based on this unit. Since we have not manufactured any of the older types of units for many years, I believe we can, in good conscience, suggest that you consider a modern replacement for any older type that may be giving you problems in handling color signals.

I’d like to offer two basic pieces of advice for avoiding problems with the TA-9: (1) keep in mind that the equipment by necessity is unusually complex, and that it needs and deserves considerably more attention than most other types of equipment; and (2) take the instruction book seriously. The instruction book we provide for the TA-9 is quite comprehensive, and contains virtually all the information you need for operation and maintenance. It is appropriate, however, that we conclude this paper with a few more specific comments concerning the TA-9.

The waveform sketches in Fig. 11 illustrate several of the reasons why a *color* stabilizing amplifier must be considerably more complex than a *monochrome* unit.

One of the features normally required in a stab amp is the ability to re-generate or reshape the synchronizing and blanking pulses. In some cases, it is even required that composite signals be converted to non-composite signals through the complete removal of synchronizing pulses. In a monochrome amplifier, removal of original sync pulses and “clean-up” of the blanking interval is accomplished by a simple clipping operation, which simply

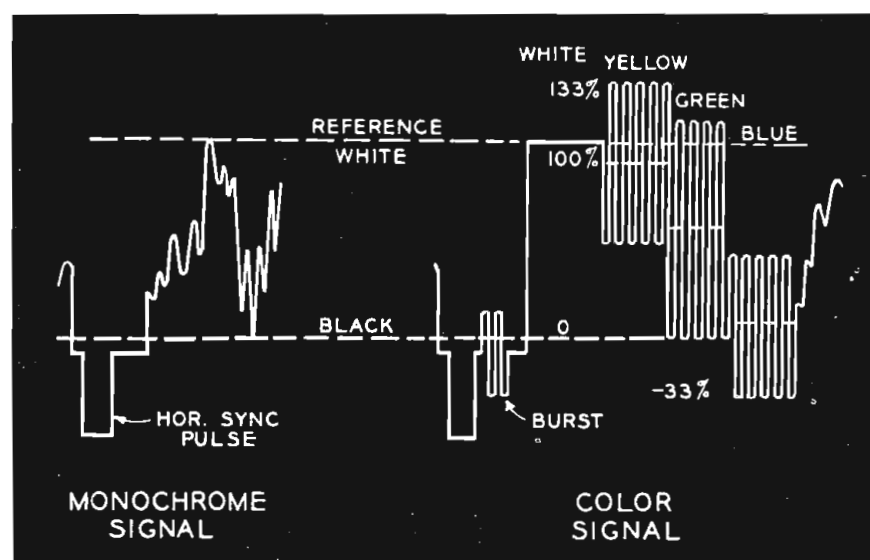

FIG. 11

“wipes off” everything extending below the blanking level. (Of course, a little bit of “set-up” or pedestal is lost in each such clipping operation.) In a color stab amp, such a simple clipping circuit cannot be used because of the presence of the color synchronizing burst and the “blacker-than-black” excursions of the sub-carrier signal during the transmission of red and blue colors: clipping of these burst and sub-carrier signals would obviously represent intolerable distortion of essential information. Thus, it is necessary in a color unit to employ a “crossover network”, or a filter arrangement which separates the chrominance information (centered around 3.6 mc) from the lower-frequency luminance information. The luminance signal alone is then subjected to the clipping operation, while the chrominance information (and the color synchronizing bursts) are handled in a separate but parallel channel.

A simplified block diagram for the TA-9 is shown in Fig. 12. Note that the clipper in this unit is a *double* clipper, indicating that it has the ability to clip the signal at the reference white level (or slightly above) as well as at black level. The white-clipping feature is desirable in cases where signals are marred by impulse noise or excessive highlight “glints”, but the same feature can be a source of serious distortion for color signals if inadequate attention is given to proper setting of the WHITE CLIP control. Note that the d-c restoration for the clipping operation is accomplished with a feedback-stabilized clamp; while the unit may have its share of problems, drift in clipping levels is not likely to be one of them. The “white stretcher” which follows the clipper is another potential source of trouble. This feature is essential when the stab amp is used to drive some types of television transmitters, but some operators tend to forget that the white stretch circuit is designed to alter both the differential gain and differential phase characteristics to compensate for distortions in other types of equipment. If the white stretch adjustments are not made carefully with the aid of differential gain and phase test signals, the final result may be worse than no compensation at all.

The fact that the chrominance information is handled in a separate amplifier which bypasses the clipper, represents both an opportunity and a hazard. The *opportunity* is that of adjusting the gain separately in the chrominance channel to compensate for obvious problems in the chrominance level of the incoming signal. The *problem* (and we know from experience that this is a chronic



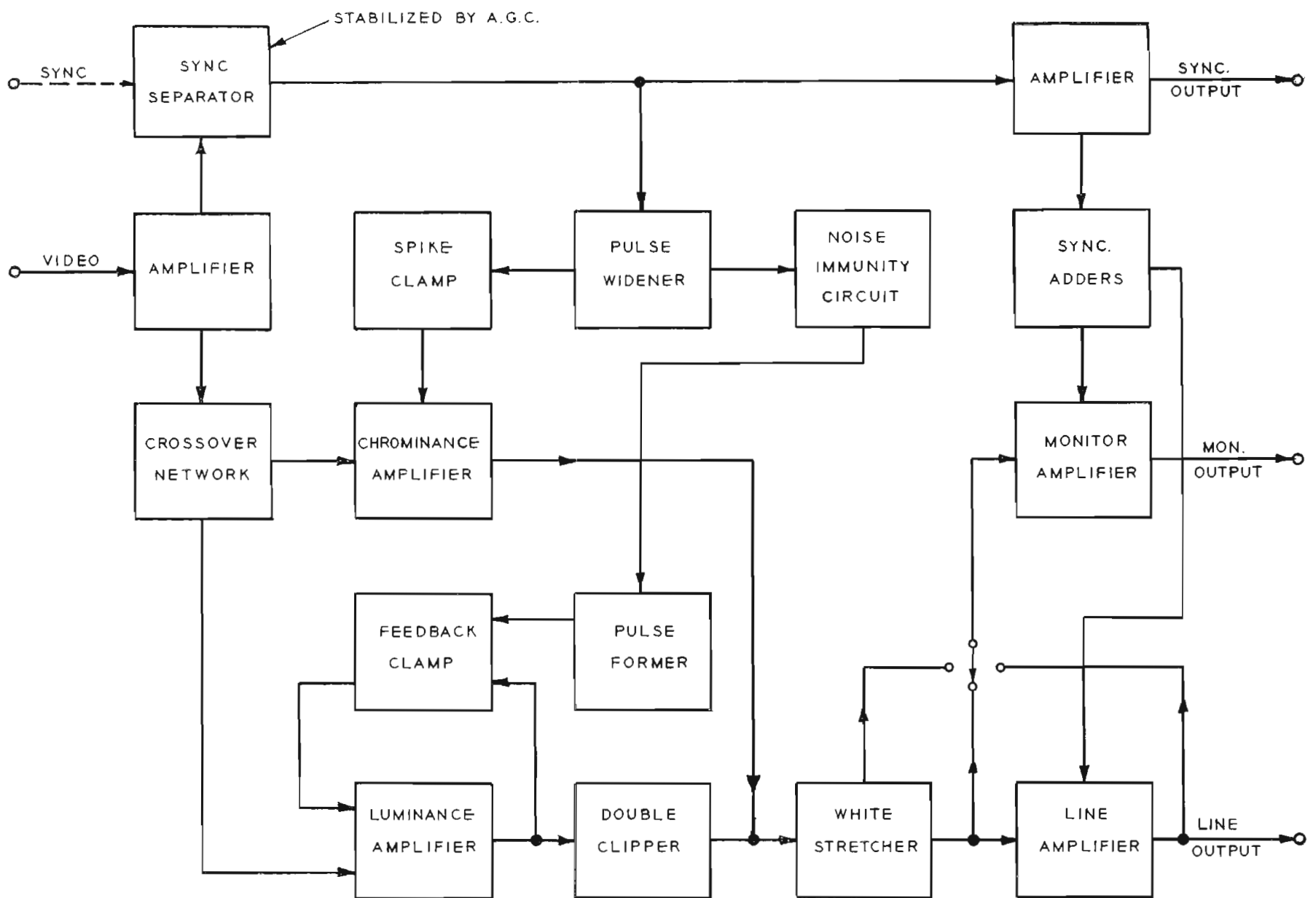

SIMPLIFIED BLOCK DIAGRAM OF TA-9 STABILIZING AMPLIFIER

FIG. 12

problem) is that operators tend to forget when they have deliberately increased the chroma gain to compensate for a substandard signal, and fail to restore the gain to normal when the abnormal signal condition no longer exists. Our home office people tell me that they have had many telephone calls from customers complaining about excessive noise or "spiking" in the TA-9, and in the great majority of cases the problem turns out to be nothing more than excessive gain in the chrominance channel.

The "spike clamp" associated with the chrominance amplifier is necessary to remove the high-frequency "spikes" associated with the leading and trailing edges of the original sync pulses. These spikes pass through the high-pass section of the cross-over filter, but must not be added back to the signal because the reshaped sync pulses provided by the sync channel (shown across the top of the block diagram) already have a full share of high-frequency information in their edges. The spike clamp circuit should not be particularly troublesome, although it is conceivable that it could introduce some burst distortion if badly out of ad-

justment. The instruction book has complete information on the function and adjustment of this circuit.

We occasionally hear complaints about low-frequency instability, or a tendency toward "bounce", in the TA-9. In the majority of cases, we find that this problem results from the use of an improper voltage tap on the power transformer, which delivers a-c power both to the heaters and to the built-in bias supply used for the output amplifier stages. If the tap is improperly chosen, the voltage regulator tube in this bias supply may not "fire" reliably, and the resulting instability in the bias voltage becomes evident in the output signal.

#### Conclusion

We realize that in a brief paper it is not possible to cover all possible sources of difficulty in handling color signals through "master control" facilities, but we hope that these comments prove helpful in your efforts to deliver better color pictures to your broadcast audience.



# RCA COLOR SEMINAR

## Part IV: Microwave Relaying of Color TV Signals

### How to Adjust and Maintain Modern S-T-L Equipment

by JOHN B. BULLOCK

*RCA Microwave Engineering*

A modern TV studio-transmitter link, properly adjusted, should be a very minor contributor to the total distortion in the color picture. The better equipments on the market today are capable of differential gain of less than 5 per cent, differential phase of less than 1 degree, a video frequency response that is flat well out through the required  $4\frac{1}{2}$  megacycles, and a vertical rate square wave tilt of well under 1 per cent.

Most of the studio transmitter link equipments employ klystrons. The source of the r-f signal at the transmitter is a klystron which is directly frequency modulated; the receiver is a superheterodyne, usually without any r-f pre-selection, whose local oscillator is also a klystron. The major requirement in maintaining the stability of STL equipment, is in preserving proper adjustment on both these klystrons. The transmitter klystron must be set to oscillate at its assigned frequency, and that frequency must be attained by mechanical and electrical adjustment which will permit the klystron to be modulated linearly. In the receiver, AFC assists in preserving klystron adjustment.

This paper will briefly review a typical STL equipment, pointing out where certain distortions might arise, then follow with a relatively simple procedure for adjusting such an equipment for optimum performance.

A typical STL microwave transmitter is block diagrammed in Fig. 1. Video input is through a modulation level control, gen-

erally an attenuator. If sound is to be transmitted, the sound sub-carrier is picked up next and the "combined" video signal is then fed through the pre-emphasis network and on to the transmitter modulator.

It is almost the universal custom to transport sound over the link by frequency modulating the audio on a sub-carrier somewhere in the 6 to 7 megacycle region, and that frequency modulated sub-carrier is then simply added to the video. The addition is made after a 6 mc notch filter. The filter serves both to prevent video inputs at the sub-carrier frequency from going on to the microwave transmitter and to prevent the sound modulator r-f output from going back into the camera equipment. This filter will cause some ringing to the  $.125 \mu\text{s}$  sine-squared pulse, however, the  $.250 \mu\text{s}$  sine-squared pulse is passed with virtually no distortion.

In RCA's TVM-1 equipment pre-emphasis is an option, however, we urge its use for color transmission. Pre-emphasis (or pre-distortion) is accomplished by a high-pass filter which attenuates the low frequency content of the picture signal by some 8 to 12 db. Unfortunately there is no standardization. At the other end of the microwave link there will be a restorer network, a low-pass filter, which attenuates high frequencies so that, overall, the link is restored to flat video frequency response.

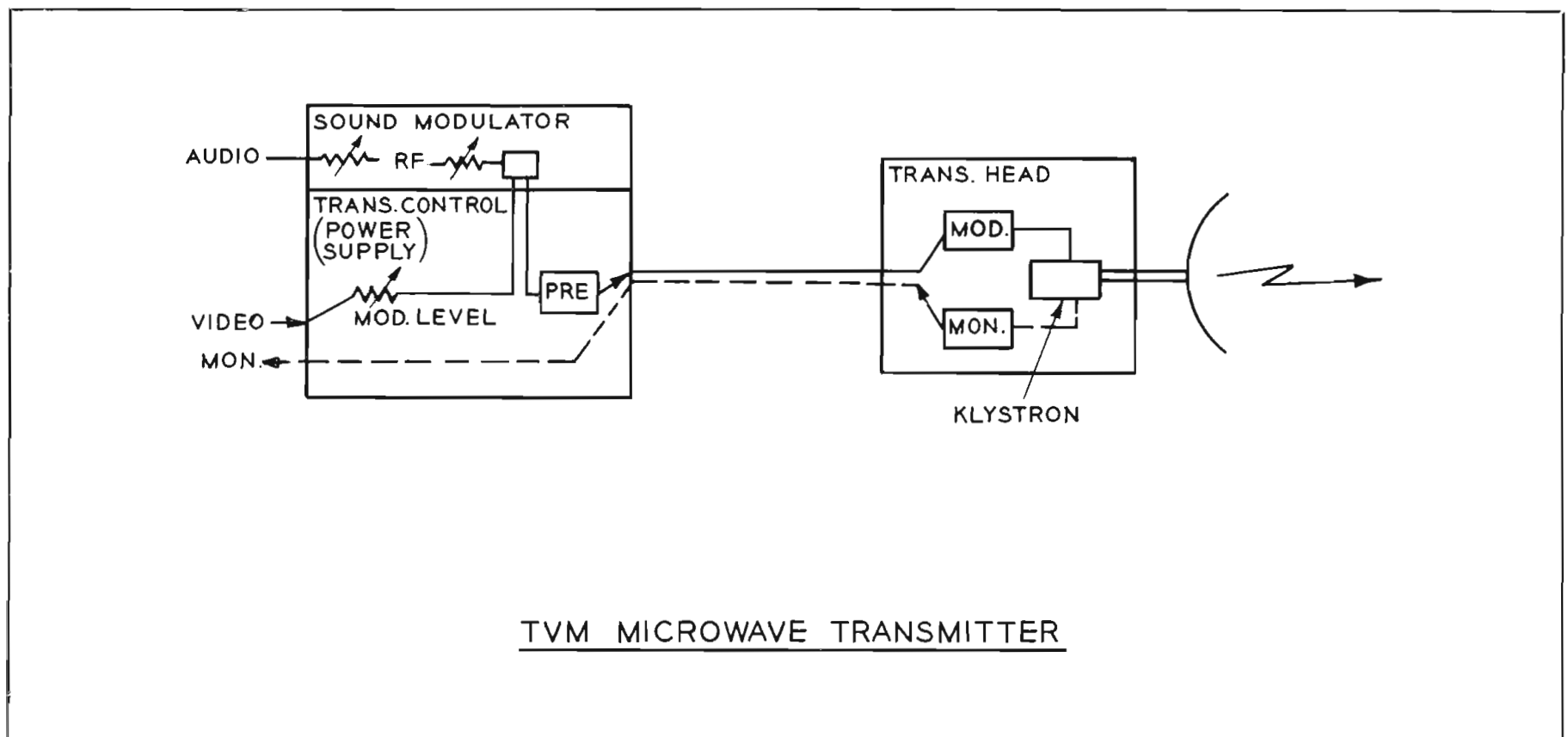

FIG. 1



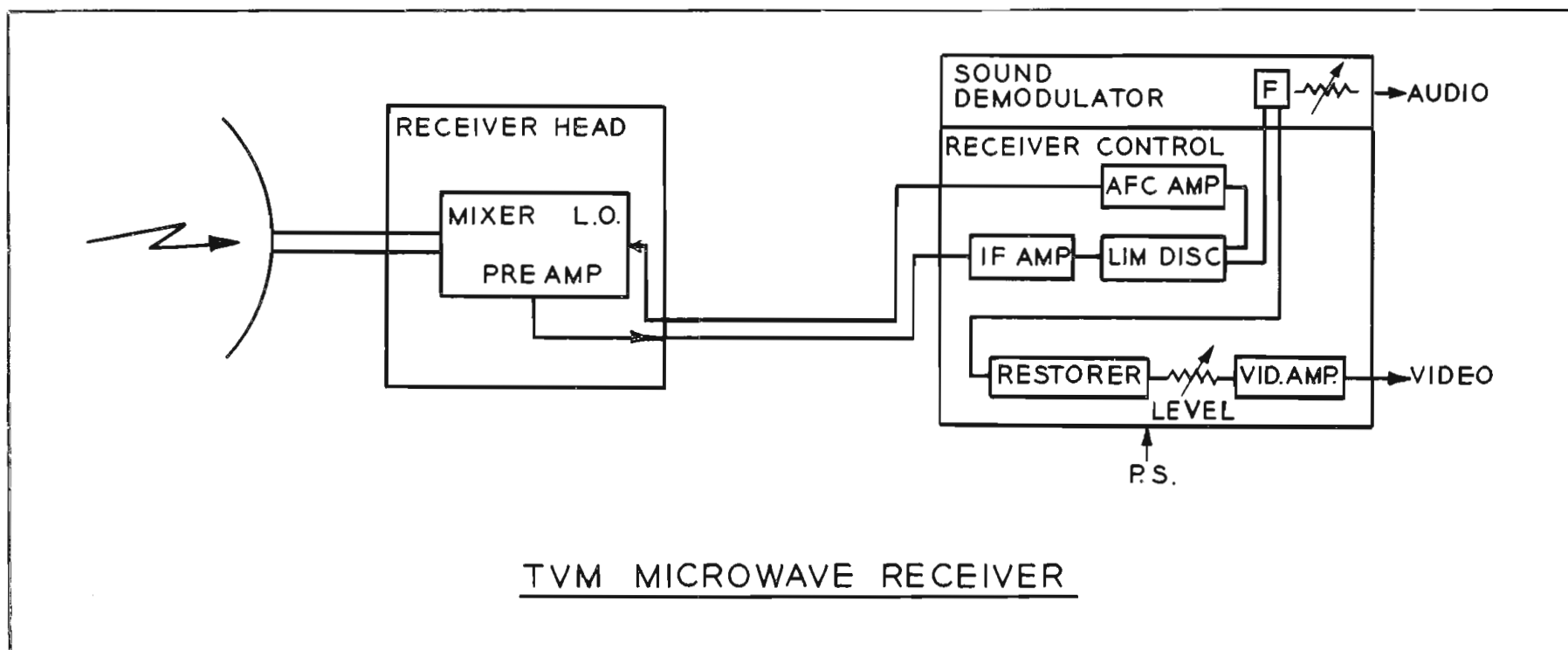

FIG. 2

After pre-emphasis, the video signal goes to the active part of the equipment, the transmitter head. There a video amplifier, called the transmitter modulator, will amplify the signal to a sufficient level to directly frequency modulate the klystron. The transmitter head will be discussed in more detail later in this paper.

In the RCA TVM-1 equipment there is also an optional monitoring feature which detects video from the outgoing signal by means of a tunable discriminator. The detected video is then amplified and fed back to the control unit for observation.

At the other end of the link is the receiver. A typical receiver is diagrammed in Fig. 2. In the RCA TVM-1, the receiver head contains mixer, local oscillator, and four stages of IF preamplification. After the preamp, the IF signal is further amplified in the main i-f amplifier, then fed to limiter and discriminator. Following the discriminator, the signal is again video, and if a sound sub-carrier is used, it is picked off at this point. Next is a sub-carrier notch filter, similar to but not necessarily identical to the one in the sound modulator. Its function is to exclude sound sub-carrier from the video channel outputs.

Following the sound sub-carrier pick-off the video passes through the restorer network then on to video level control and video output amplifier. The restorer is a low-pass filter, and for this reason the sound sub-carrier is picked off prior to this network.

### Pre-emphasis of the Video Signal

Figures 3 through 6 deal with the subject of pre-emphasis. Figure 3 shows what happens to the stair-step signal when it goes through the 8 db pre-emphasis network used in the RCA TVM-1 equipment. Notice that the net effect of the network is to "squash" the signal; to reduce its peak-to-peak amplitude. If one thinks in terms of the excursion of plate currents in video amplifiers, obviously there will be less distortion to a signal which is reduced in amplitude compared to one which is not. The purpose of pre-emphasis is to reduce differential phase and differential gain, and it does this by reducing the excursions of plate currents in video amplifiers and the frequency deviation in r-f and i-f areas.

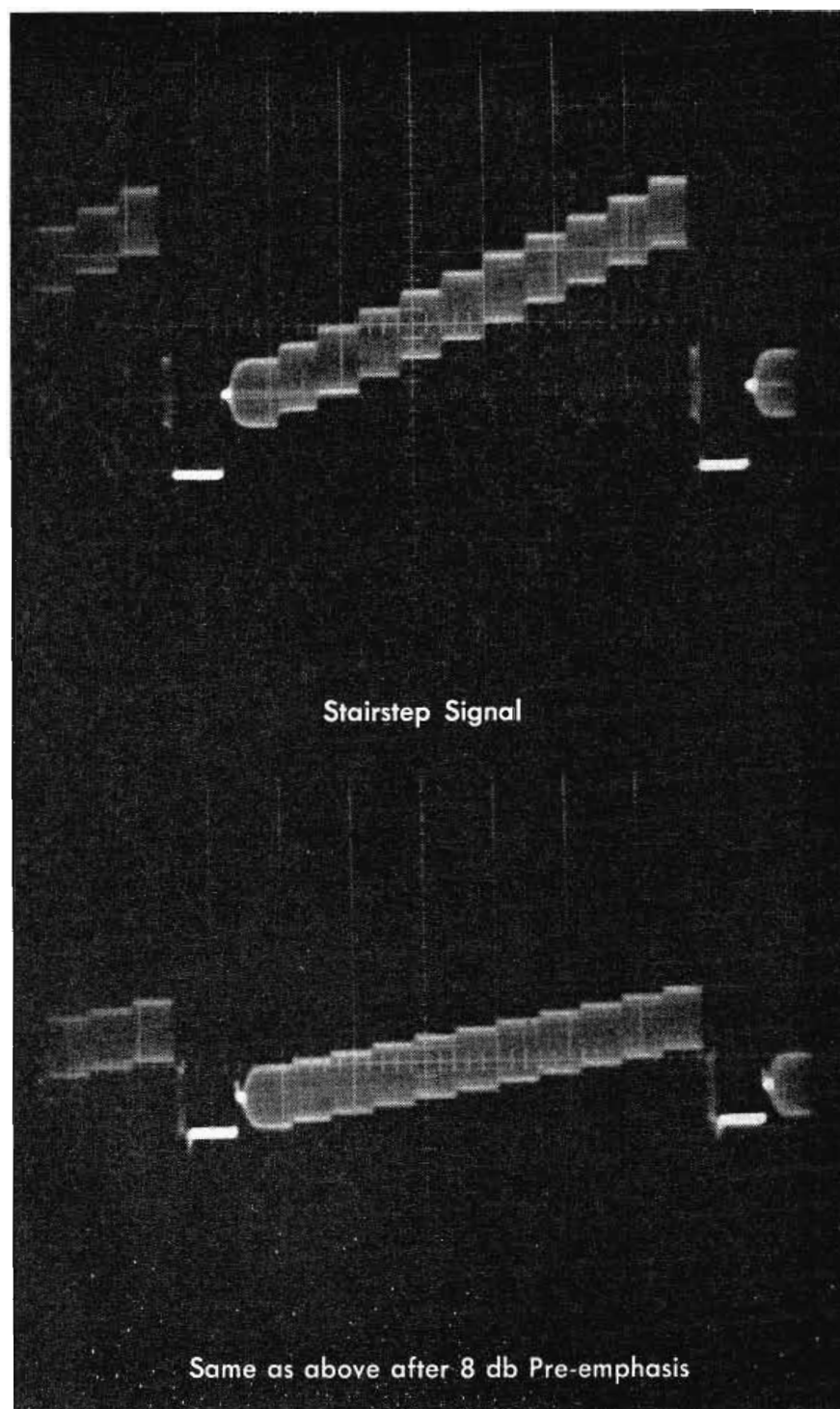

FIG. 3



One might ask why differential phase and gain reduction could not be accomplished by simply reducing the deviation of the transmitter rather than using fancy networks. The answer is that by dropping the deviation via the pre-emphasis network, nothing is sacrificed in signal-to-noise ratio. In an FM system, the noise output of the receiver rises with frequency, hence the restorer network, being a low-pass filter, attenuates noise more than it does signal. This compensates for the fact that deviation was reduced and results in an improvement in differential phase and gain without any sacrifice in signal-to-noise ratio.

Figure 4 shows the multi-burst signal plus sound sub-carrier before and after pre-emphasis. Recalling that the pre-emphasis network is a high-pass filter we note in this photograph that the "squashing down" of the signal is not near so apparent. The highest frequency (4.2 mc) burst here comes through very nearly with no attenuation, as does the sound sub-carrier (6.8 mc).

If one were to scale the portions of any of these signals that are basically the 15 kc rate information, like the shift from

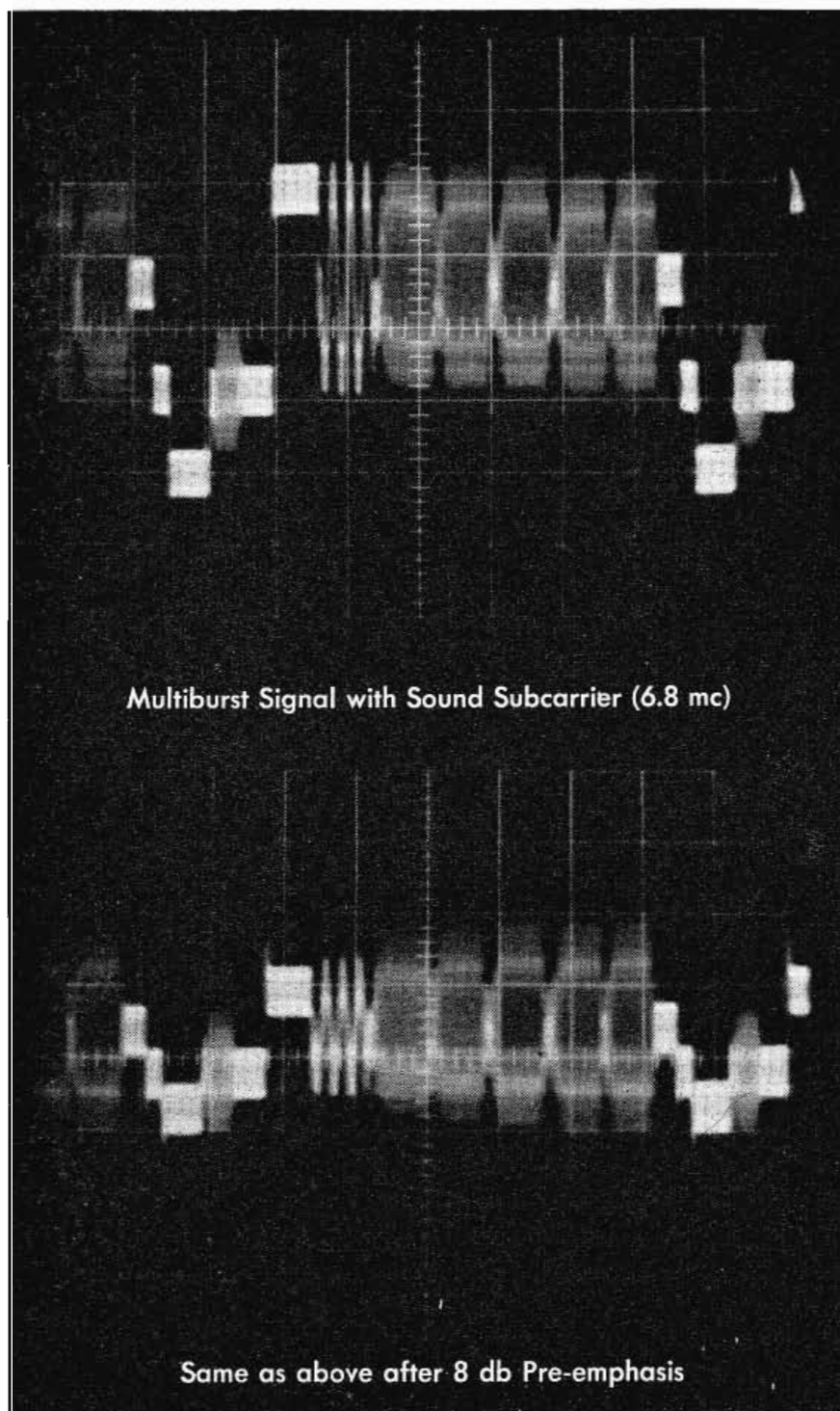

FIG. 4

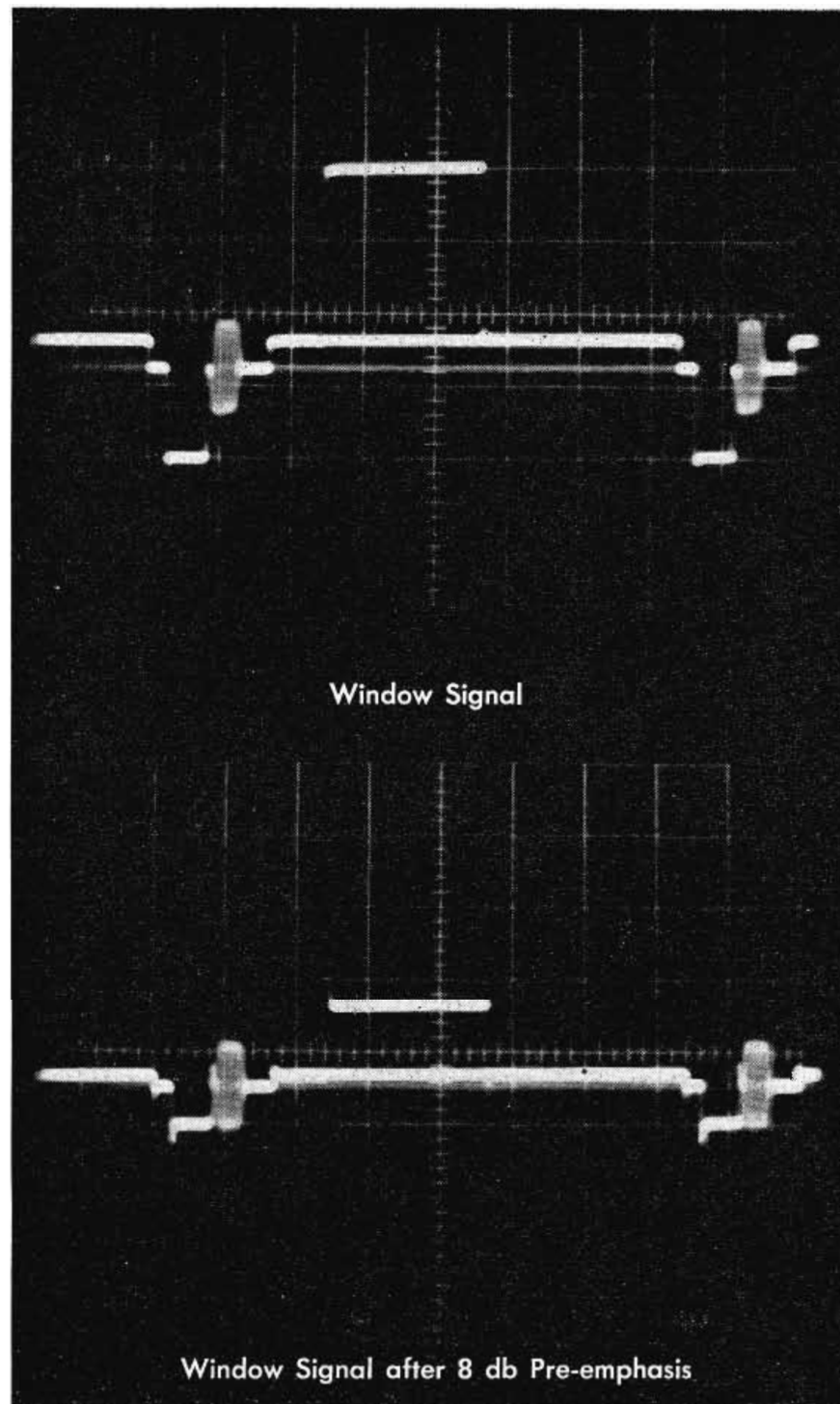

FIG. 5

blanking to white level, one would find this amplitude reduced almost exactly 8 db, the amount of the pre-emphasis. The sync excursion would be another example of this.

Figure 5 shows a window signal. The window signal in the absence of any sine-squared pulse contains very little in frequency above say 20 times the basic 15 kc rate, and so is reduced in amplitude almost exactly  $2\frac{1}{2}$  to 1, or 8 db. As seen, the color burst is hardly attenuated at all.

Finally, Fig. 6 shows the staircase signal in the presence of a sound sub-carrier. The sound sub-carrier in the TVM-1 equipment is at 6.8 megacycles. It is generally operated at about 10 or 15 per cent of the overall picture amplitude. The sound sub-carrier amplitude can be measured in the sync interval in Fig. 6. During the picture interval both color and sound sub-carriers are present and their addition makes up the "fuzzy" line pattern. Any non-linearity in the microwave equipment will result in inter-modulation products between these two sub-carriers and a



visible "beat" between them. However, if the microwave is linear both in phase and amplitude, that is if differential phase and gain are held within the required limit, then there will be no inter-modulation between these two sub-carriers.

### Transmitter Considerations

The transmitter head, the really active part of the transmitter is diagrammed in Fig. 7. The heart of this unit is the klystron, which generates the r-f signal. The klystron is directly modulated by the video signal from the modulator amplifier.

The input video signal, after amplification, is fed directly to the klystron repeller electrode. There, added to the d-c tuning voltage, it causes the klystron frequency to be deviated the required amount and in accordance with video waveform. In the TVM-1 the peak-to-peak deviation used is 6 mc (with pre-emphasis this is reduced). The typical VA-222 klystron is devi-

ated 6 mc peak-to-peak by 15 volts of peak-to-peak video on its repeller electrode. The amplitude of video required to deviate the klystron 6 mc depends on the modulation sensitivity of the klystron, and this modulation sensitivity can vary as much as 2 to 1. The actual range of modulation sensitivity for the VA-222 is 225 kc/volt to 525 kc/volt. This means that to produce 6 mc deviation may require as little as 11.4 volts or as much as 21.8 volts. An important point to be noted here is that whenever the klystron is changed, the transmitter deviation should be checked and reset.

Regulated voltages are supplied to the klystron. Klystron stability can be no better than the stability of these regulators, so a periodic check is recommended. At least one point of maintenance is worth noting. Regulation may be accomplished by two or more regulator tubes in parallel. These tubes should at all times share the load current equally, say within  $\pm 20$  per cent. If one tube should fail, the other will assume the full load and the

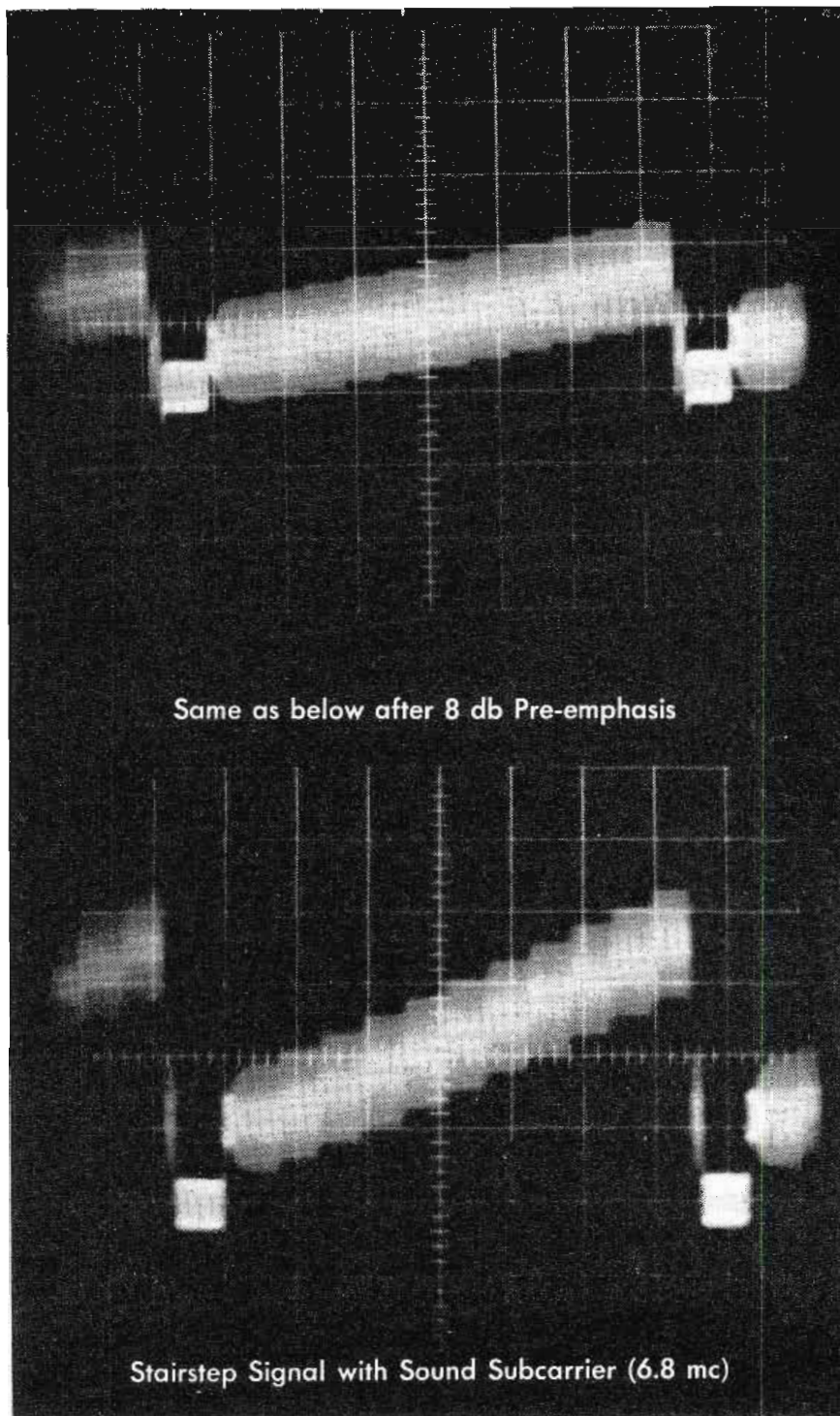

FIG. 6

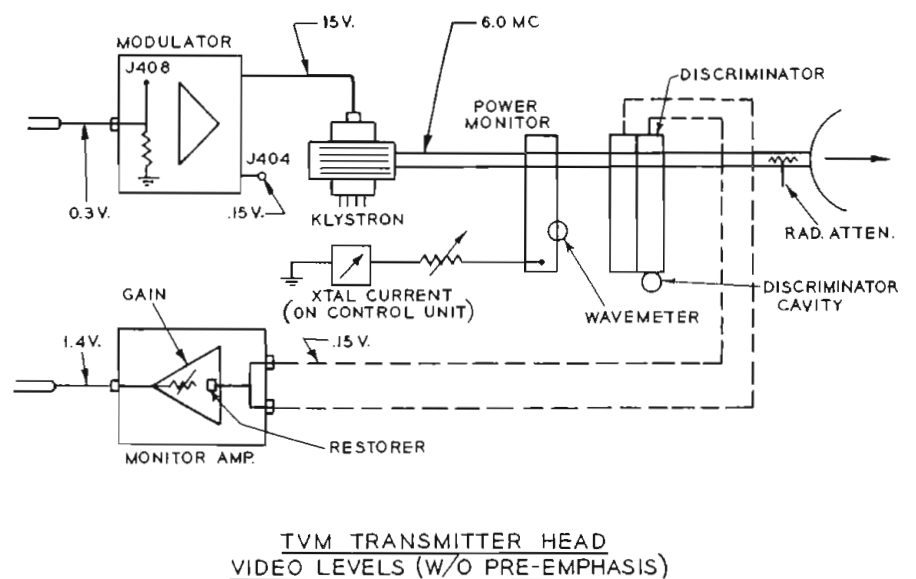

FIG. 7

regulated voltage may not change but the life of the remaining tube will be seriously shortened. Sharing of current is easily checked by noting the drops across the regulator cathode resistors.

In the r-f plumbing of any of the STL equipments is a power monitor. The power monitor is a directional coupler which samples some of the outgoing r-f energy, and brings it past a wavemeter to a crystal detector. The d-c output of the detector is displayed on the control unit on the panel meter. The first rough adjustment when a new klystron is installed is to adjust its d-c repeller voltage for maximum power output from the klystron. The crystal current meter reading is a display of power output.

The dotted lines in Fig. 7 show the video monitoring accessory that is available for the TVM-1. Video is detected by a tunable discriminator which must of course be tuned to the outgoing r-f signal. The detected video is amplified and fed back to the transmitter control unit for observation.



The basic modulator amplifier schematic of the TVM-1 is shown in Fig. 8. In any of the STL equipments one would find an equivalent. The low level video comes in at J401 and feeds a conventional video amplifier whose output is then added to the d-c repeller voltage supplied to the klystron. Two "touch-up" adjustments are provided in this unit. Similar adjustments will be found in the video amplifier at the receiver. These are high frequency peaking and low frequency TILT controls. The former are adjusted using a multi-burst or video sweep for test signal, the latter using the window signal. In practice the TILT control can be adjusted using any signal that contains vertical sync by observing at vertical rate and removing any apparent tilt in the sync interval.

When tracing a video signal through an amplifier such as this two precautions should be heeded: 1. Do not load the test point with too much cable capacity, thus low impedance points are best; 2. Observe *outside* of any feedback loop. Two excellent monitoring points are provided in the schematic of Fig. 8, J408 and J404.

In Fig. 9, the modulation process is described. The two characteristic curves show klystron frequency and klystron power output as a function of repeller voltage. Sine wave modulation is shown. The sine wave at (c) in Fig. 9 would be about 15 volts peak-to-peak and this is added to an approximate 300 volt negative repeller voltage. As a result the repeller voltage is swung plus/minus  $7\frac{1}{2}$  volts and this swings the klystron frequency plus/minus 3 megacycles if the repeller voltage has been adjusted so that the deviation is in the linear center region of the frequency characteristic. It is important in adjusting the klystron to set the repeller voltage so that deviation is in the linear region

of this modulation characteristic. The region is quite broad in the VA-222 series.

In the center of the linear modulation region, the slope of the modulation characteristic is minimum, i.e., a given modulating voltage will produce the *least* frequency deviation. This will be the method of locating this linear modulation region. By design of the klystron, this region very nearly centers at the repeller voltage which produces maximum r-f power output from the klystron.

Waveforms (d) and (e), projected off the power characteristic show the variation of power fed to the power monitor crystal with and without the wavemeter tuned to center frequency. It can be seen that as the frequency goes through one cycle of deviation, the power will go through two cycles, thus giving the "120 cycle" pattern shown in (d). If the wavemeter is present, energy is absorbed each time the frequency swings through the wavemeter resonance, and the absorption of some of the r-f energy produces the pips shown in (e).

The modulation process is further illustrated in Fig. 10. This shows with a video signal what happens if the repeller voltage is not set for operation on the linear part of the modulation characteristic. In this case equal modulating voltage above and below the d-c repeller voltages produces unequal frequency deviation above and below center frequency. The result as indicated is a "stretching" of the deviation in the white direction compared to that in the black direction. Thus with a klystron off center as shown in Fig. 10, video from the receiver would have whites stretched. If the klystron was off center in the other direction, sync would be stretched by the modulation process. The repeller voltage adjustment here is quite broad between stretched sync on one extreme and stretched white on the other.

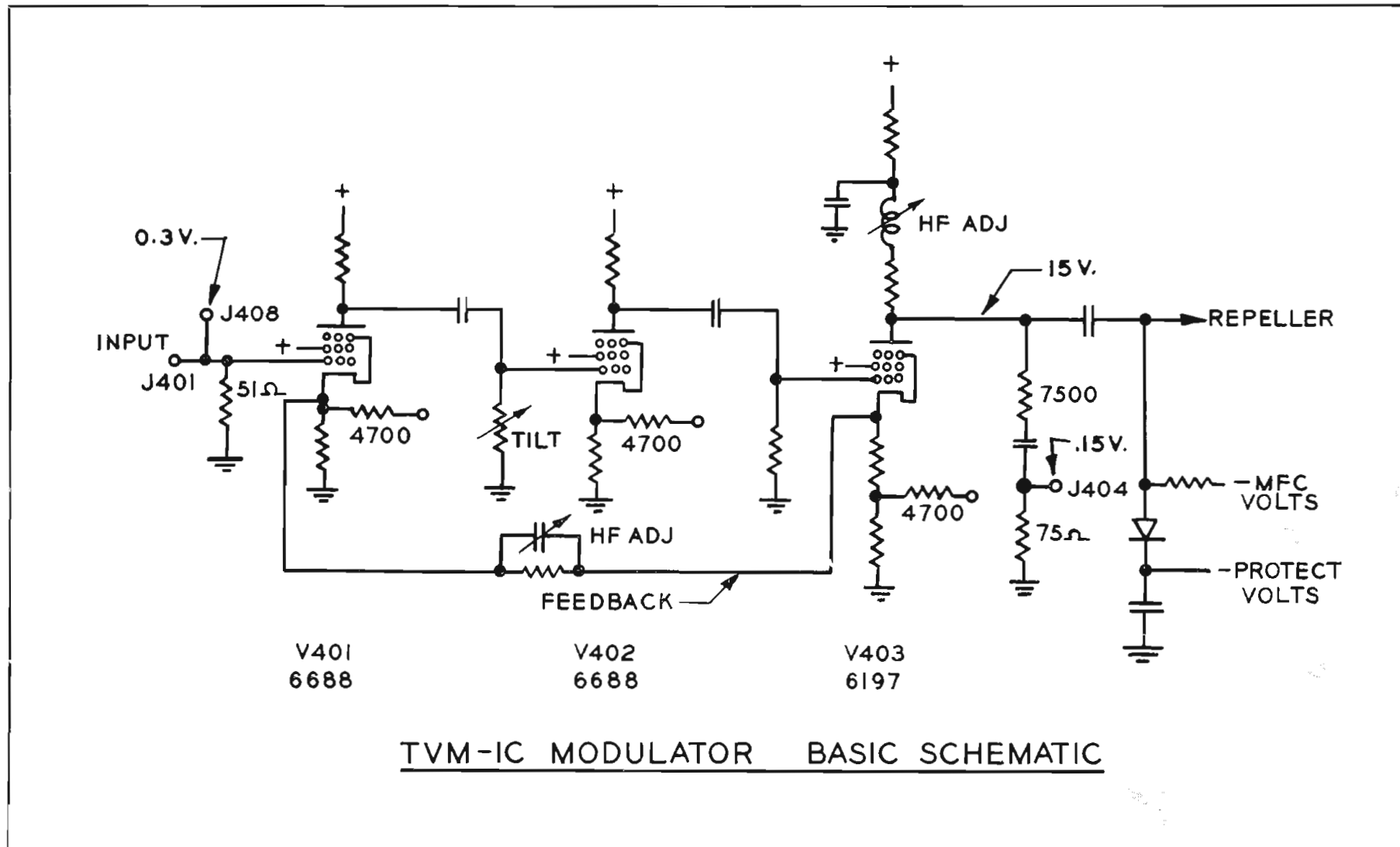

FIG. 8



# TVM-1 MODULATION PROCESS

(Correct Adjustment)

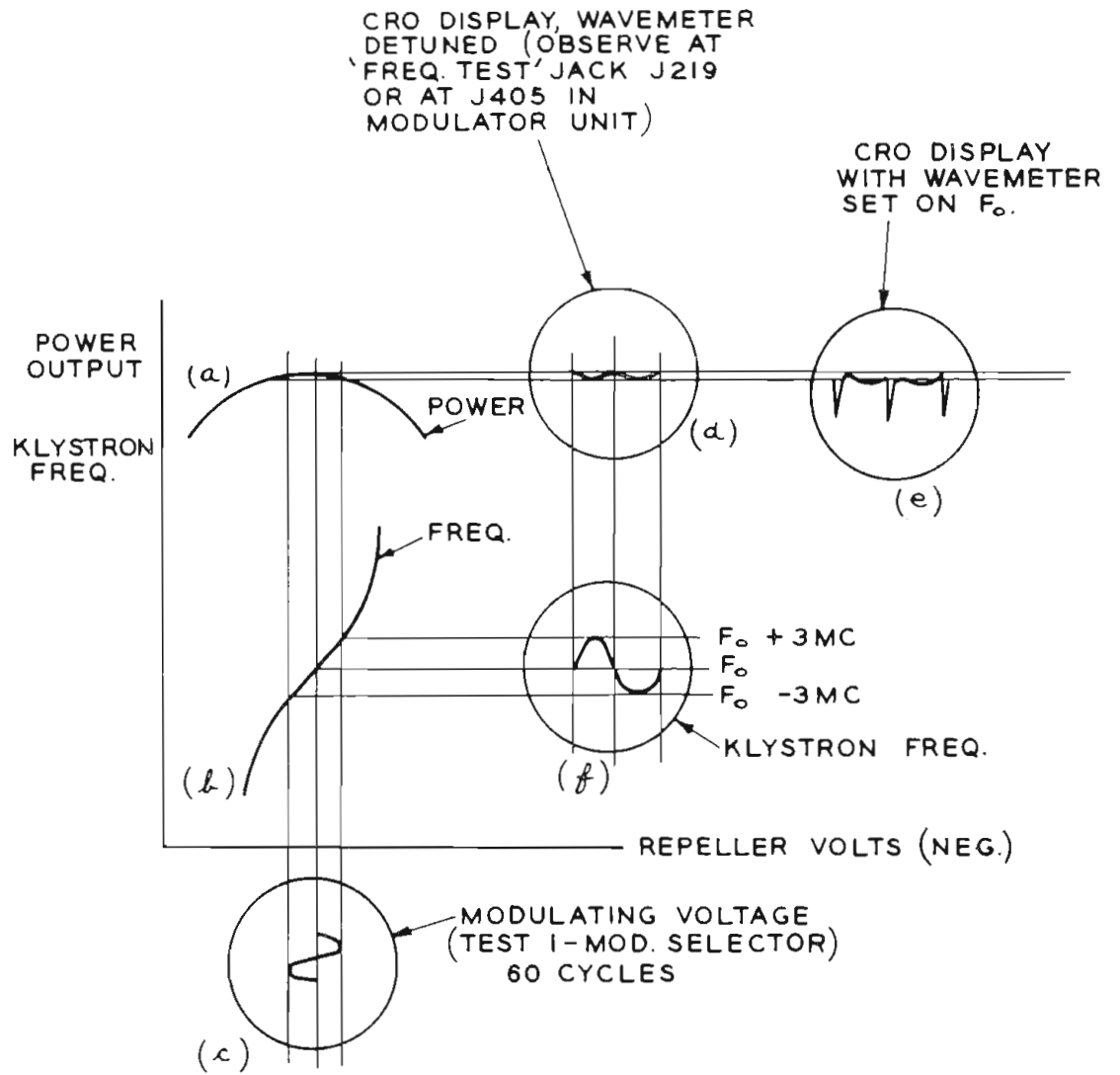

FIG. 9

# TVM-1 MODULATION PROCESS

(Incorrect Adjustment)

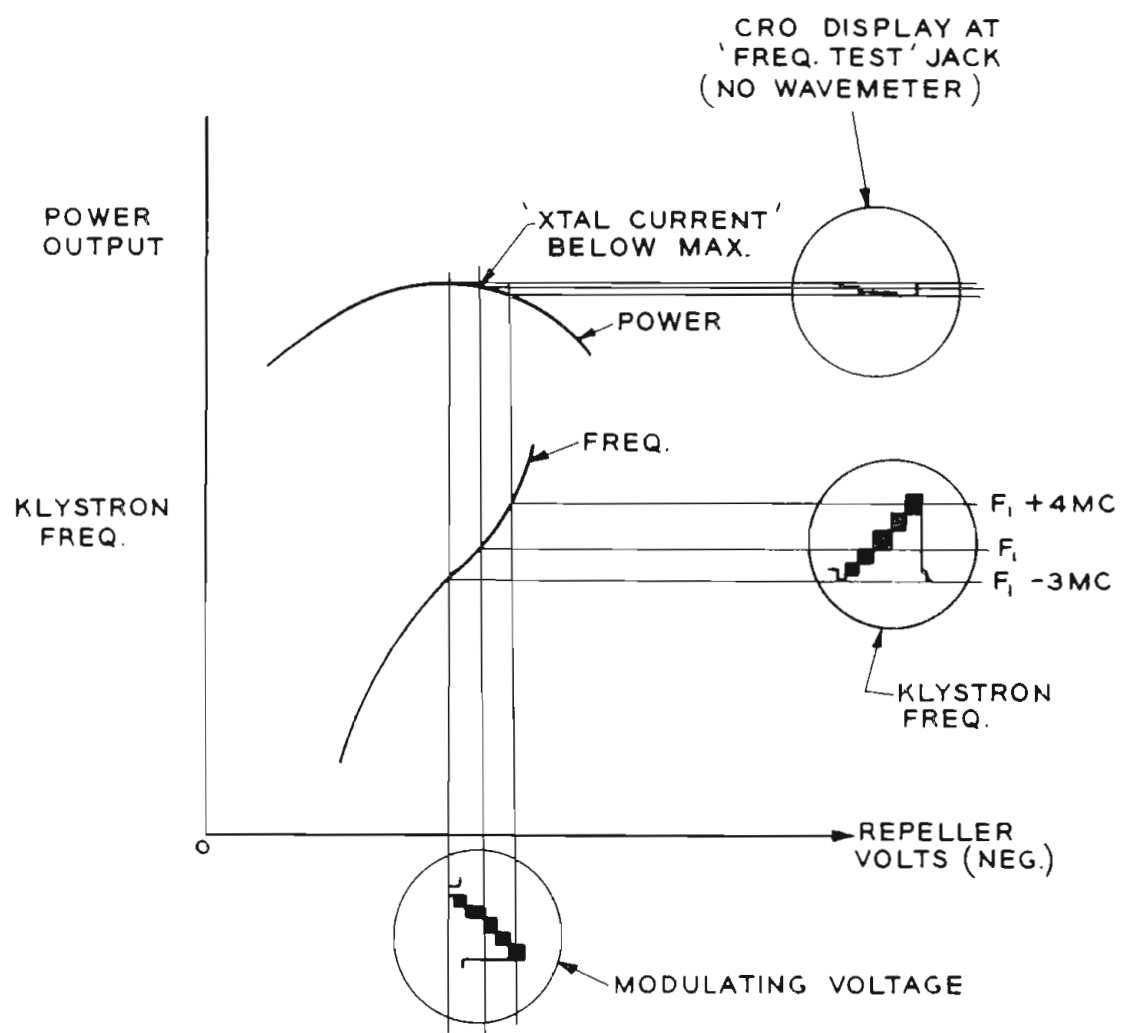

FIG. 10



### R-f Feed Line Considerations

Figure 11 illustrates a typical STL path, and serves to bring several points to mind. One is that to be linearly modulated the klystron must work into a constant fixed load as its frequency is deviated. The characteristics depicted in Figs. 9 and 10 assume this. If the waveguide run to the antenna exceeds 10 to 15 feet, then reflections from bends and joints in the waveguide, and from the terminating antenna feed make it difficult to maintain this load within the required limits. In such cases a ferrite isolator should be installed at the transmitter output.

The r-f signal proceeds to the receiver by way of a passive reflector. We will assume that adequate path clearance is provided, and that antenna orientation is correct as determined by the calculated amount of r-f signal being delivered to the receiver, or by the measured video S/N ratio at the receiver output. Path problems are somewhat outside the scope of this paper.

Figure 11 shows a waveguide filter ahead of the microwave receiver. Such a filter is often employed where there is danger of adjacent channel interference, image interference, or where two or more r-f signals are on the same antenna. If any sort of r-f filter is employed ahead of the receiver, then it is doubly important that the transmitter be kept on its assigned frequency and thus in the middle of the passband of the waveguide filter.



TYPICAL STL MICROWAVE PATH

FIG. 11

Serious differential phase distortion can result if the received signal is off center of the r-f passband.

### Receiver Considerations

Figure 12 is a diagram of the receiver. The signal from the antenna which in the general case might be 2000, 6000 or 13,000 megacycles, but with 6 megacycles of peak-to-peak deviation, beats against the local oscillator in the mixer to generate the IF. This, still carrying the 6 megacycles peak-to-peak deviation, is

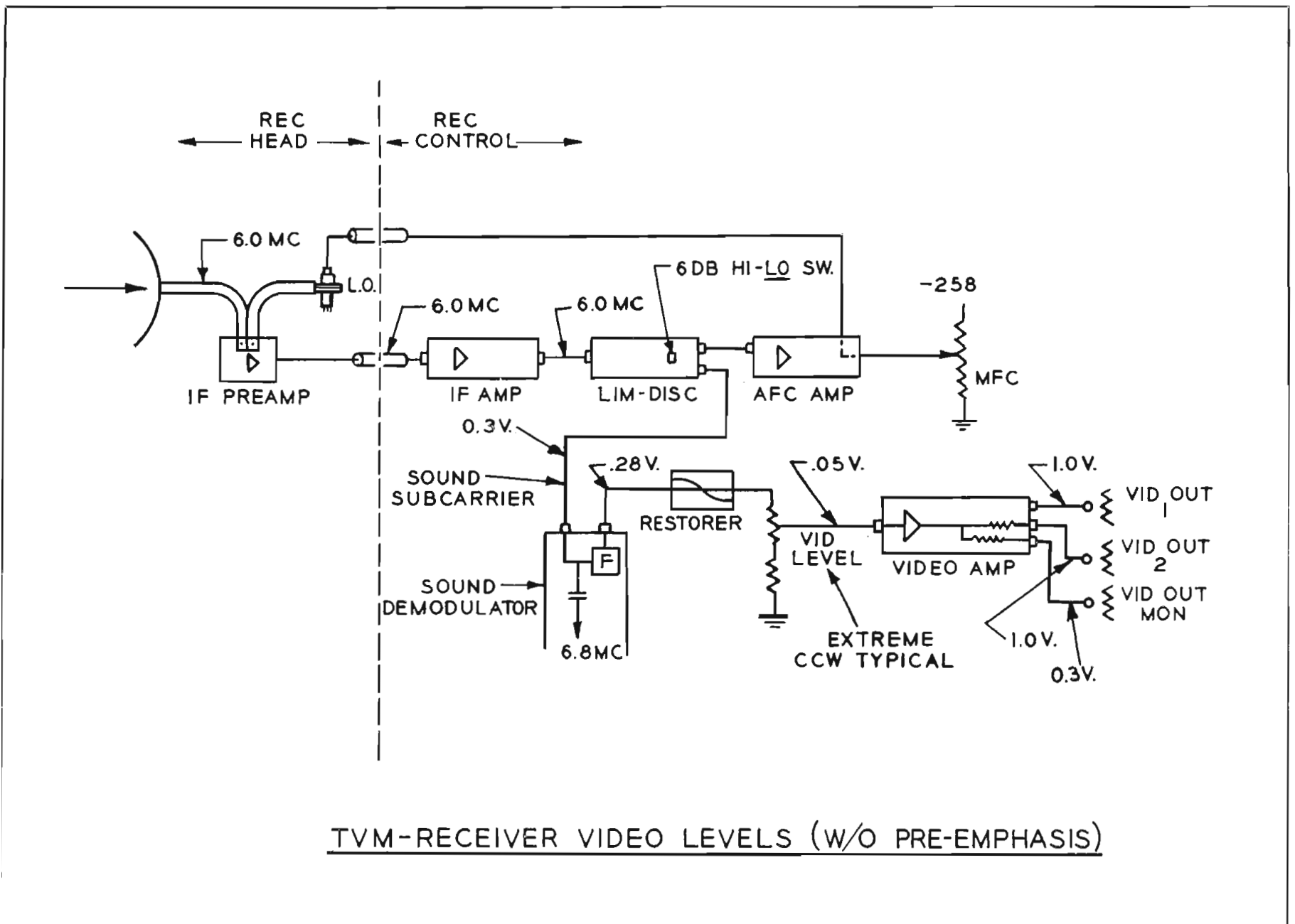

TVM-RECEIVER VIDEO LEVELS (W/O PRE-EMPHASIS)

FIG. 12



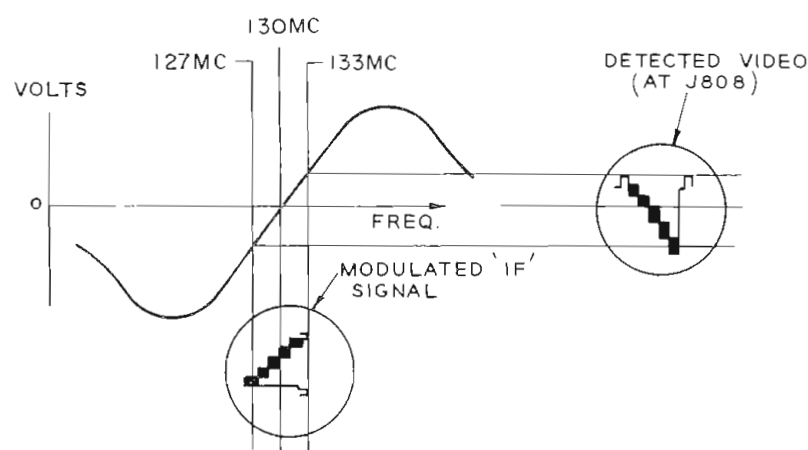

TVM-I RECEIVER PROPERLY TUNED

FIG. 13

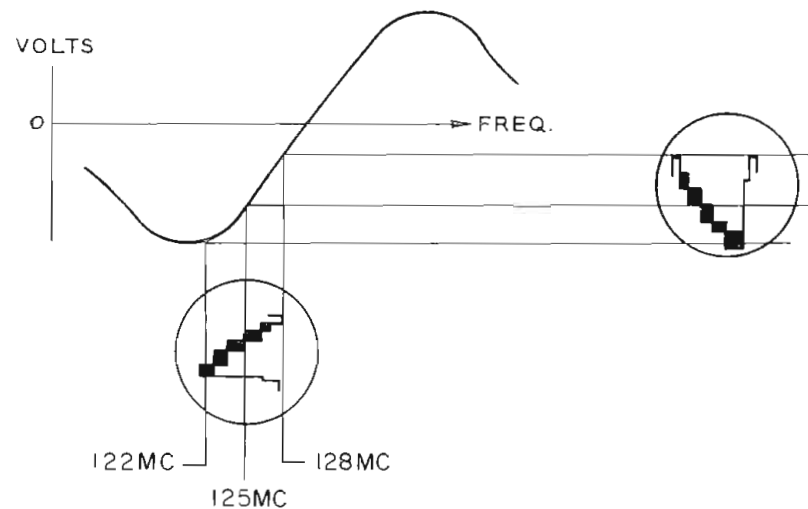

TVM-I RECEIVER IMPROPERLY TUNED

FIG. 14

amplified in the i-f preamp and main i-f amplifier to a level high enough to drive the limiter, and then to drive the discriminator. From the discriminator, there are two useful outputs. One is the video signal, and the other is a d-c signal to be used for AFC. It is very important that AFC hold the tuning of the receiver so that the local oscillator *always* differs from the incoming signal center frequency by exactly the i-f frequency. It will be shown later that the sharpest indicator of receiver tuning is minimum differential phase. AFC will then be set to hold that tuning.

The video output from the discriminator goes first to a filter where the sound sub-carrier is picked off and then the "clean" video signal is fed to the restorer network. This network attenuates high frequencies and thus restores the overall relay system to flatness. As mentioned earlier, it thus also attenuates a great part of the noise and permits the achievement of good signal-to-noise performance along with improved differential phase and gain.

After the restorer the signal passes through a level control, the video amplifier and on to one or more video outputs.

The receiver klystron, like the one in the transmitter, is tuned mechanically by an adjusting screw in a cavity on the tube and electrically by the d-c voltage fed to its repeller. The repeller voltage is derived from a pot across a regulated negative voltage supply. After initial set up is completed this repeller voltage is used to "tune" the klystron, manually by means of the pot, and automatically by means of the output of the AFC amplifier, which is added to the pot voltage as indicated in the diagram.

Any shift in the incoming signal frequency *or* in the local oscillator frequency results in a shift in the IF, and any shift in the IF away from the center of the i-f discriminator characteristic results in a d-c error voltage from the discriminator. This voltage represents an error in tuning. It means that the signal has moved away from the center of the i-f passband. The error voltage is amplified, added to the manual tuning voltage, and fed back to correct the local oscillator frequency to make up for the shift. The action is the same, whether the drift occurred in the transmitter or in the local oscillator, and the result is that the difference frequency or IF comes back to the *center* of the i-f passband.

At this point a few words should be said about i-f responses. We urge that, in the RCA equipment, and probably in other equipment too, the setting of the i-f coils and trimmers *not* be disturbed so long as it is possible to get good overall differential

phase, differential gain, and video response through the system. The swept i-f response is an internal inspection of the receiver which is not necessary unless end to end video performance cannot be met. The reason for this attitude is that it is difficult to perform a precise i-f alignment without factory test equipment, and it is also difficult to state how much an i-f response can degrade from the ideal before it will prevent good video performance. Often the excess of tilt or valley or other departure from ideal i-f response in a field test will be as much due to the test setup and test equipment as to the i-f circuitry. For these reasons we emphasize that so long as normal tuning procedures result in good system video performance—leave the IF alone.

When good video performance cannot be obtained, and video areas of the equipment are known to be good, then an i-f sweep may show up i-f troubles and these will generally indicate a *drastic* departure from the ideal passband, rather than simply excess tilt or valley.

When the receiver is "*tuned*," what we really tune is the local oscillator. We simply adjust the frequency of the local oscillator so that it beats with the incoming signal to produce the correct IF, and if it does produce the correct IF, it will produce a group of signals that is in center of the i-f passband, and in the center of the receiver's discriminator curve. This is illustrated in Fig. 13. When the receiver tuning is varied the group of signals centered in the 127 to 133 mc region is moved up or down in frequency. If the receiver is tuned one way in frequency the group of signals to the discriminator will increase in frequency; if tuning is moved the other way the group will move downward. Too much detuning in either direction results in compression—of sync if detuning moved the i-f signal up in frequency, or of whites if detuning moved the IF lower. The latter case is illustrated by Fig. 14. Proper receiver tuning is obviously in the center of the discriminator characteristic, where neither sync nor white compression results. This linear region will be quite broad as the receiver output is viewed on a CRO.

#### Differential Phase as A Tuning Indicator

A very *sharp* indicator of the exact center of tuning is available, however, and this is differential phase. When the receiver is tuned "dead center," differential phase will null to a minimum.

Once the receiver has been tuned to the point of minimum differential phase, the discriminator balance control, which shifts the discriminator curve (Fig. 13 or 14) up or down, should be

set so that the d-c output from the discriminator at this point of tuning is zero. The AFC system may then be set to hold the discriminator output at 0 d-c.

Video output from the discriminator is pictured as inverted in Figs. 13 and 14, and such is the case in the TVM-1. The video amplifier that follows will invert this video so that the receiver output has proper polarity.

One more point on the receiver tuning: An examination of the noise in the audio channel, the sound sub-carrier channel passing through the microwave *in the presence of video*, will show that a small crosstalk component is present, particularly at the vertical rate. At the point of best tuning, minimum differential phase, this crosstalk or sync buzz, will very nearly null out.

#### Touch-Up Procedure Restores Optimum Performance

Figure 15 describes a "touch up" procedure which should be applicable to any klystron type equipment. If the steps described are applied in sequence to an already properly installed and operating system, they should provide a method by which optimum performance may be restored at any time. If some fault should exist, these procedures will readily show the area in which it lies.

We suggest that with the TVM-1 equipment, a two months interval is about the right period between inspections. If one waits longer than two months, the distortions that take place due to ageing, AFC drift, trimmers which need readjustment, etc., may become a bit excessive for good color performance.

The tests outlined can be performed with pre-emphasis network in or out. (If the pre-emphasis is in, the restoration net-

work must also be in). If the tests are performed with the networks in, better differential phase and gain can be expected than if they are performed with the networks out.

The tests performed with the networks out are sometimes of value because the networks themselves, due to a fault, can interfere with the flat video frequency response. It is suggested that performance of the equipment be checked once with the networks out, then with the networks in. If tests are performed with the networks out, then when the networks are inserted it will be necessary to raise the receiver (and transmitter monitor) video gains by the amount of the pre-emphasis to recover normal output levels. The differential phase in the TVM-1 equipment should be within 1 degree with the networks in, within 3 degrees with the networks out.

The tests must be performed in the sequence indicated. In the event that a fault is discovered and repaired it would generally be advisable to start again with step 1.

#### Transmitter Tuning and Adjustment

The first step in the adjustment procedure is given in Fig. 16. The object of this step is to center the transmitter klystron in the linear region of its modulation characteristic and to place it on the assigned frequency. This is accomplished by using the receiver as a deviation indicator to tell when transmitter deviation is minimum for a given video input, and using the transmitter's wavemeter to check transmitter output frequency. The procedure outlined, plus a working knowledge of the equipment should be sufficient for completing this first step.

<b>FIVE-STEP TOUCH-UP PROCEDURE</b>	
<b>TVM-1 Equipment Installed and Operating at Normal Levels</b>	
<b>ADJUSTMENT</b>	<b>PURPOSE</b>
1. Transmitter Tuning	For linear modulation
2. Receiver Tuning	For min. differential phase
3. High Freq. Response	For flat multiburst
4. Low Freq. Response	For zero tilt
5. S/N Test	To check fade margin

**Notes**

Perform steps with Pre-emphasis and Restoration either **in** or **out** (See text).

Perform in sequence.

On multi-hop circuits, each receiver serves as signal source for following hop.

Suggested checking interval: two months.

FIG. 15

<b>1. TRANSMITTER TUNING</b>	
<b>TRANSMITTER</b>	<b>RECEIVER</b>
Input signal: optional; staircase recommended, full level.	<b>(NO ADJUSTMENTS)</b> Operating normally, with signal.
Full deviation.	AFC on.
Transmitter AFC off.	
(a) Adjust MFC controls for min. p/p video from receiver.	<b>TRANSMITTER MONITOR (IF USED)</b>
(b) Check transmitter freq.—if required, adjust klystron mech. tuning, and repeat (a).	(c) Adjust monitor cavity for most linear output from monitor (J218).
	(d) Adjust transmitter AFC to hold this tuning.

FIG. 16

When the klystron is found to be within two or three megacycles of the assigned frequency further adjustment should not be made, as this should be adequate both from the licensing standpoint and from the standpoint of any waveguide filters that are used. The MFC adjustment required in this step will be quite broad and will not normally move the transmitter but a few megacycles from the point of maximum power output.

The last two adjustments (under transmitter monitor) apply only to an equipment which has the transmitter monitor. The discriminator in the transmitter must be tuned manually to the klystron frequency. It is tuned via its cavity for most linear output from the monitoring amplifier. Then, if there is any trans-



mitter AFC, it must be adjusted by the routine procedures to hold transmitter tuning with whatever the discriminator d-c output may be at this setting. This d-c should be very near zero, possibly  $\pm 0.1v.$  max.

### Receiver Tuning and Adjustment

Figure 17 outlines the second step in the touch-up procedure, receiver tuning. AFC is turned off and the receiver is tuned for minimum differential phase. Then the discriminator balance control is adjusted to give zero d-c volts output from the receiver discriminator at this point of tuning. AFC is then turned on and should hold this tuning. If it does not hold, an AFC adjustment is required. This, in the TVM-1, is the balance adjustment on the AFC amplifier. It is called the modulator balance control and it should be adjusted so that AFC holds this minimum differential phase, zero d-c point of tuning. Next, the differential gain in the receiver output should be checked. If it's excessive, something is wrong and trouble is indicated. Tuning a receiver for best differential phase should inherently produce best differential gain.

Figure 18 shows the stair-step signal and the resulting differential phase display at the output of a TVM-1 receiver obtained using a Telechrome 1004B Test Receiver. The Test Receiver translates the difference in phase shift to the color sub-carrier at the various brightness levels of the staircase into an amplitude. Thus the lower waveform in Fig. 18 indicates difference in phase shift to the color sub-carrier at black and at gray level. At white level the phase shift is again the same as it was at black level. That difference in phase shift, differential phase, can be meas-

display shown here; however, it may appear inverted. The polarity of the display is a function of test equipment adjustment—either a “right-side” up saucer or an “upside down” one indicates proper tuning—if accompanied by good differential gain.

Figure 19 continues with receiver adjustment. Receiver tuning has been completed but the high frequency trimmers in the video amplifier which follows the discriminator may require touch-up. If there is excessive roll-off in the high frequency response, more than 1 db at 6 mc, then it may be that the similar trimmer in the transmitter's modulator amplifier needs adjustment. If there is a monitoring unit on the transmitter, then the high frequency trimmers in it should be adjusted at this time. These adjustments are performed using the multi-burst or preferably, the video sweep generator.

Figure 20 shows the same procedure as applied to TILT controls. Here again only a slight touch up is expected to be required, and it is most easily done in the receiver. If tilt is excessive then the modulator TILT must be investigated. And, if there is a monitor, it should be adjusted for zero tilt at this point.

2. RECEIVER TUNING	
RECEIVER	TRANSMITTER (NO ADJUSTMENTS)
Operating normally, with signal.	Input signal: staircase, full level.
AFC off.	Full deviation.
(a) Adjust MFC for <b>minimum differential phase</b> .	
(b) Adjust DISCRIM BAL to give <b>0.0 volt</b> d-c on cable to AFC amp (J901).	
(c) Adjust MOD BAL on AFC amp to hold <b>min. differential phase</b> and <b>0.0 volt</b> d-c.	
(d) Check differential gain. If excessive, repeat transmitter tuning. Check discriminator circuit.	

FIG. 17

ured by means of a calibrated knob on the Telechrome unit which varies the location of the marker visible during the sync interval. The marker may be moved up or down on the display. Differential phase can be measured by setting the marker abreast of the lowest point in the display, then jumping it up in one-degree steps until it coincides with the highest point in the display. The differential phase thus measured should barely exceed one degree.

As the microwave receiver is tuned, first CW, then CCW from the correct point, this differential phase display should rock back and forth tilting one way for CW detuning, the other way for CCW. The proper point of receiver tuning is the cusp shaped

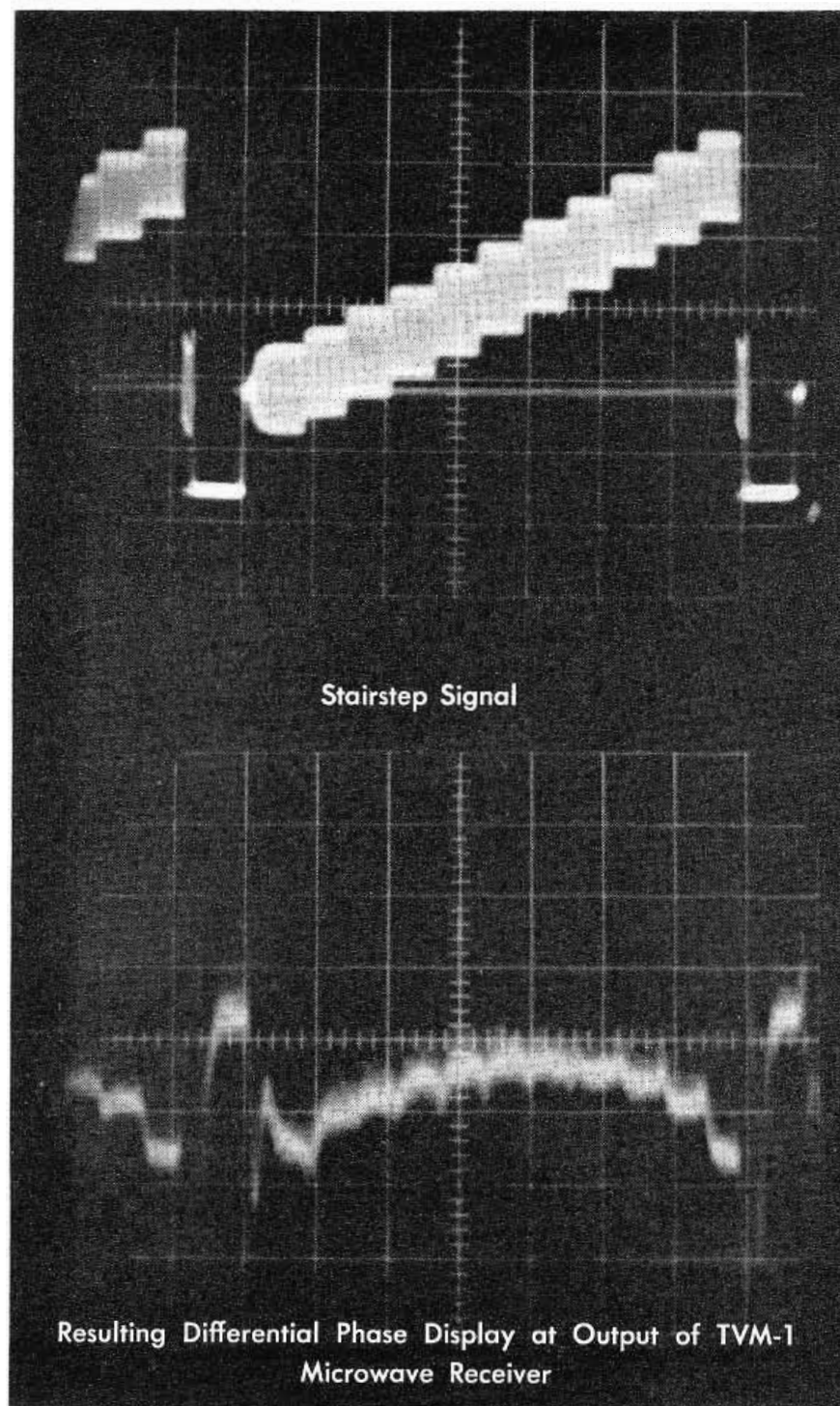

FIG. 18

Lastly, we suggest a periodic check of signal-to-noise ratio at the output of the microwave link. This has to be done last because the noise that is measured depends on the bandwidth of the receiver, and this is not determined until Step 3 in this procedure is completed.

The measurement of S/N (see Fig. 21) simply consists of operating the transmitter with full deviation and assuring that the peak-to-peak output of the receiver is set at some known level, usually 1 volt. Then the transmitter video input is removed, the sound diplex equipment is turned off, (the sub-carrier is up in the noise region) and the noise is measured. Hum must be ex-

The importance of this S/N measurement lies in the fact that most STL links have a fade margin of 20 or 30 db, adequate to go through the fading season without any interruption of service. During the season when there is no fading, the fade margin can disappear due to antenna misalignment, fall-off in power output of the transmitter, degradation of the noise figure of the receiver, etc. These degradations may not be noticed because the resulting noise will be too low to be apparent in the picture. The first warning of lost fade margin will come with the fading season. Then, what was before merely a slight noisy interval may be an outage. A periodic measurement of signal-to-noise ratio will assure that the fade margin has not deteriorated.

### 3. HIGH FREQ. RESPONSE

#### RECEIVER

Operating normally, with signal.

AFC on.

(a) Adjust C514 to eliminate roll-off at VID OUTPUT #2 (or #3).

(b) Adjust C522 to eliminate roll-off at VID OUTPUT #1.

#### TRANSMITTER

Input signal: multiburst

No adjustments unless need is indicated.

#### TRANSMITTER MONITOR (IF USED)

(c) Adjust monitor C611, C605 to eliminate roll-off at MON OUTPUT.

FIG. 19

cluded from the measurement and the bandwidth of the measurement must be known. The S/N ratio may be calculated from these two measurements.

To evaluate this measurement it is necessary to calculate from the transmitter power, waveguide losses, antenna gains, receiver noise figure, etc., what the signal-to-noise ratio *should be* for a particular path. Information on how to do this is given in RCA's TVM-1 instruction book. The measured S/N ratio may be expected to come within 2 db of that calculated via the path information.

### 4. LOW FREQ. RESPONSE (TILT)

#### RECEIVER

Operating normally, with signal.

AFC on.

(a) Adjust R506 TILT control for zero tilt.

#### TRANSMITTER

Input signal: Window

No adjustments unless need is indicated.

#### TRANSMITTER MONITOR (IF USED)

(b) Adjust R605 TILT control for zero tilt.

FIG. 20

### 5. S/N MEASUREMENT

#### RECEIVER

Operating normally, with signal.

AFC on.

(a) Set p/p video output signal at 1.0 volt.

(c) Measure noise. Exclude hum. Note bandwidth of measurement.

(d) Calculate S/N:  $S/N = 20 \log \frac{1.0}{\text{rms noise volts}}$

#### TRANSMITTER

Input signal: optional; full level.

Full deviation.

(b) Terminate transmitter input.

Turn sound diplex modulator off.

FIG. 21

### Multi-Hop Systems

Now, one last word for those few STL's which are multi-hop. We suggest that the *first* link be checked first, using the procedure indicated. Then the receiver test equipment may be taken to the next receiver location and the output of the number one link used for the signal source for checking the number two link. This may be repeated for the third and fourth links, and so on.

A reverse procedure, i.e., checking the last link first, then moving the transmitter test equipment to the next station as each link is ok'd might be used. Such a method would in effect use the checked links as a long "cable" to the receiver test equipment. However, this method results in having to make adjustments to a receiver remote from its test equipment and coordination becomes difficult. Most adjustments in these tests are made at the receiver and it is advantageous to have the receiver test equipment at that same location.

Proceeding down the system as recommended takes advantage of such cancelling distortions as may occur, and allows test equipment error to accumulate only once. In "n" identical equipment there will be little "cancelling" of distortions, and it is suggested that any deliberate off-setting of one equipment to make up for troubles in another *be avoided*. It is much better to know that each transmitter and receiver is *dead on center* and thus providing the maximum in range for "drift" and "ageing" which of course does take place in even the best of equipments.



# RCA COLOR SEMINAR

## Part V: Getting the Color Signal On-the-Air

### Adjusting the TV Transmitter for Good Color Signals

by R. B. MARYE, *Manager*

and H. E. SMALL, *Project Engineer*

*RCA Transmitter Engineering*



FIG. 1

Preceding papers have discussed how to deliver and maintain a high-quality video signal to the transmitter input. Now, the objective is to modulate an r-f carrier with this signal of approximately one volt, peak-to-peak. In most TV transmitters, it is necessary to amplify the video signal to a peak-to-peak value between 200 and 400 volts, and reinsert the d-c component in order to produce a high-power, modulated, r-f signal.

The problems encountered in this process would be relatively simple and straightforward if a double-sideband system were employed. However, in order to conserve space in the frequency spectrum, the FCC adopted the vestigial-sideband system in which approximately three-quarters of the lower sideband is suppressed. Thus, video frequencies below 1.25 mc are transmitted at twice the amplitude of the frequencies above 1.25 mc but the receiver has a complementary amplitude response. Hence, the amplitude response of the overall system is essentially flat.

All of the available bandwidth allocated for a TV channel must be utilized for the transmission of a color-TV signal or a high-quality monochrome signal. In order to maintain the necessary bandwidth, while at the same time meeting FCC specifications on out-of-band radiation, it is necessary to use sharp cut-off filters to attenuate frequencies which fall outside the channel. The lower sideband is attenuated by a vestigial sideband filter while a video low-pass filter is used to prevent modulation by fre-

quencies above 4.2 mc. The problems encountered as a result of this sideband shaping will be discussed later.

#### The Four Transmitter Parameters

There are four basic parameters of a TV transmitter which require careful attention to insure the transmission of a good-quality color signal. These are:

1. Bandwidth (or amplitude response)
2. Differential Gain (or linearity)
3. Differential Phase
4. Envelope Delay (or delay distortion)

#### Bandwidth

To assure proper hue and saturation values, the amplitude response should be maintained as flat as possible out to 4.18 mc, since the color information is contained in the frequency spectrum between 2.1 and 4.18 mc. Variations in amplitude response with changes in brightness level should also be observed to ascertain that there are no drastic changes which would give false saturation values at different degrees of luminance.

When adjusting the transmitter for proper bandwidth, it is recommended that the Type BW-5 Sideband Response Analyzer, shown in Fig. 1, be used. The BW-5 greatly facilitates the ad-

justment by separating the sidebands and providing an oscilloscope presentation of the overall bandwidth as shown in Fig. 2.

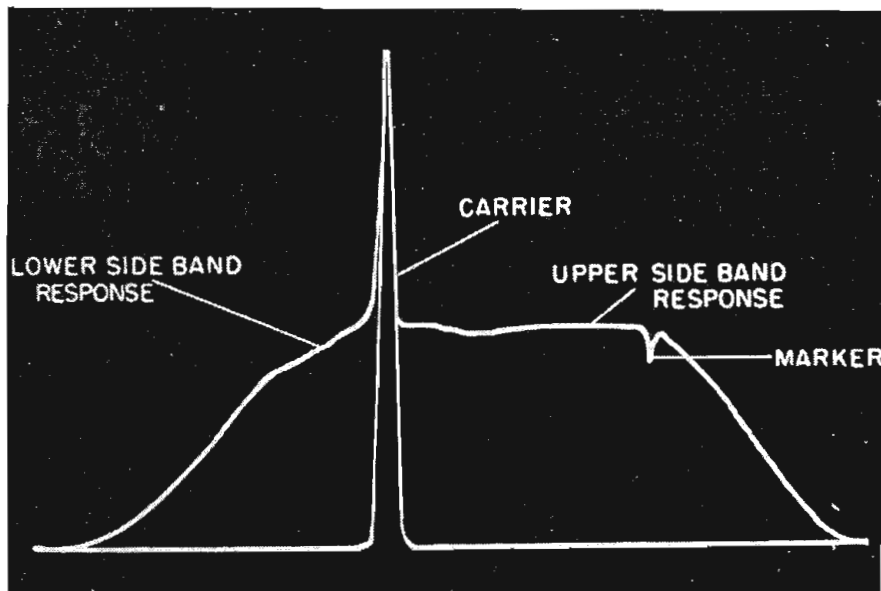

FIG. 2

The multiburst signal, illustrated in Fig. 3, provides a convenient method for making daily checks on the transmitter's bandwidth; however, as explained later, it should not be used for the purpose of making adjustments to the transmitter.

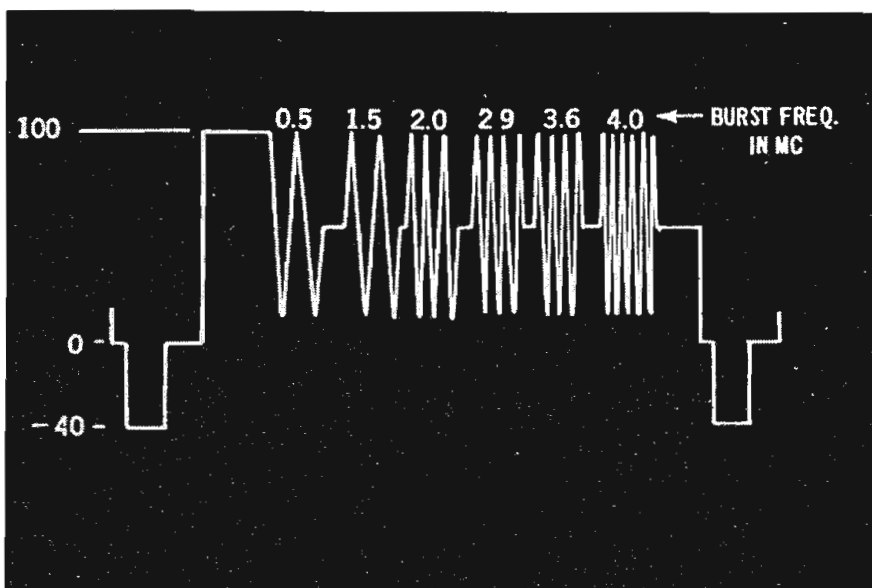

FIG. 3

### Bandwidth Adjustment

During initial tune-up, the transmitter should be terminated in a suitable dummy load, with the vestigial sideband filter out of the circuit. The video-sweep from the BW-5 should be fed directly into the modulator, by-passing all input equipment ahead of the modulator.

Typical BW-5 presentations under these conditions are shown in Figs. 4a and 4b. The marker is at 4.2 mc. Figure 4a is typical

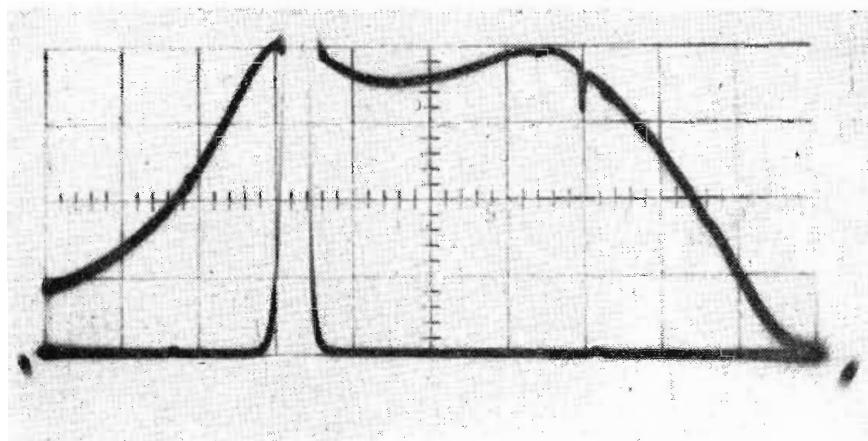

FIG. 4a

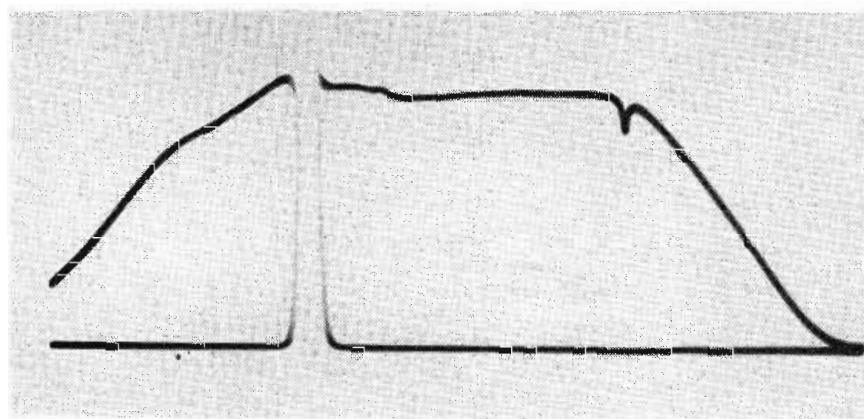

FIG. 4b

of the older transmitters; while better upper sideband response as shown in Fig. 4b is characteristic of new transmitters.

If the transmitter contains more than one broadbanded stage, each stage must be tuned for a flat response into the dummy load. Peaking one stage to compensate for a deficiency in another—commonly known as “stagger” tuning—is one of the main causes of excessive variation in response with changes in brightness. Another common cause is poor impedance-match between stages; the input of each linear amplifier should be adjusted for the best possible match.

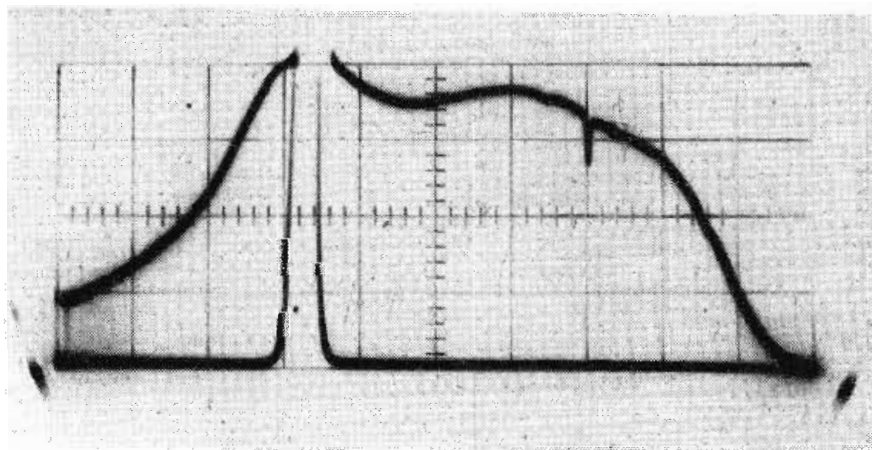

FIG. 5



After the transmitter has been tuned directly into the dummy load, the response of the vestigial-sideband filter can be checked by feeding the output of the transmitter into the filter with the filter terminated in the dummy load. Figure 5 shows the response at the input to the sideband filter. Note that there is only a slight drop-off of the high frequencies as compared to Fig. 4 which indicates that the sideband filter presents a reasonably good termination across the pass-band. The response characteristic at a

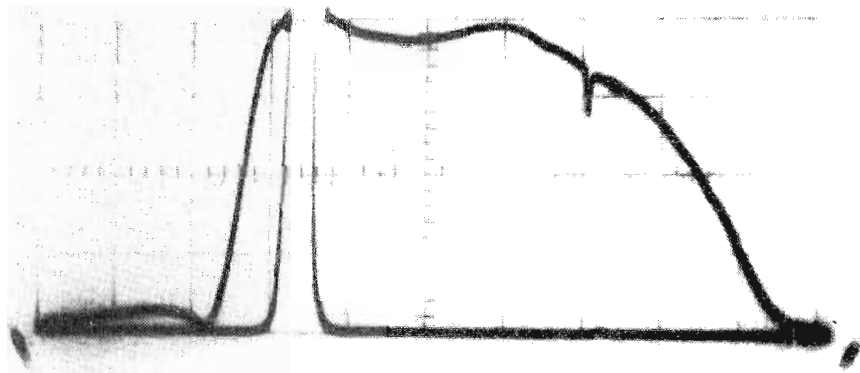

FIG. 6

point following the sideband filter is shown in Fig. 6. Note the sharp cutoff of the lower sideband with no appreciable change in the upper sideband response.

By inserting the low-pass filter in the input-video line, the overall bandwidth of the transmitter, as shaped to meet FCC specifications, can be observed. Figure 7 displays the usual waveform.

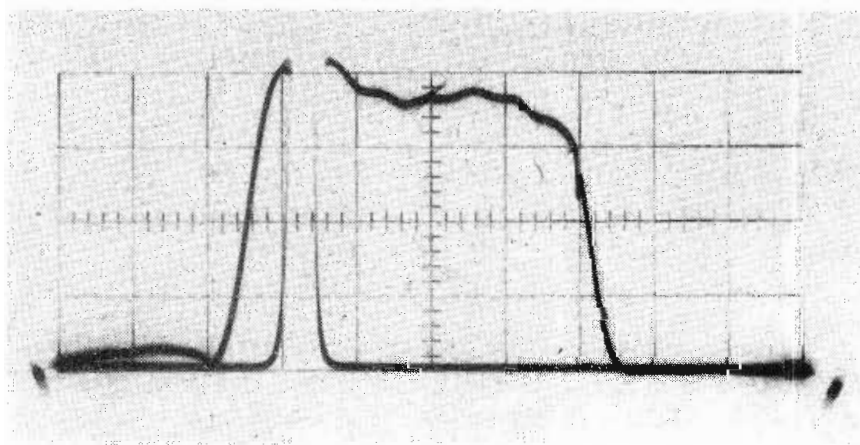

FIG. 7

### Differential Gain

Variation of transmitter gain with change of brightness is known as differential gain, or non-linearity of the transfer characteristic of the transmitter. Non-uniform differential gain is a characteristic of grid modulation and grid modulation is used extensively in TV transmitters. The effect of this characteristic is demonstrated graphically in Fig. 8. In color transmission, differential gain produces errors in luminance and saturation in the bright areas of a color picture. Because it is objectionable to the home viewer, this condition must be corrected.

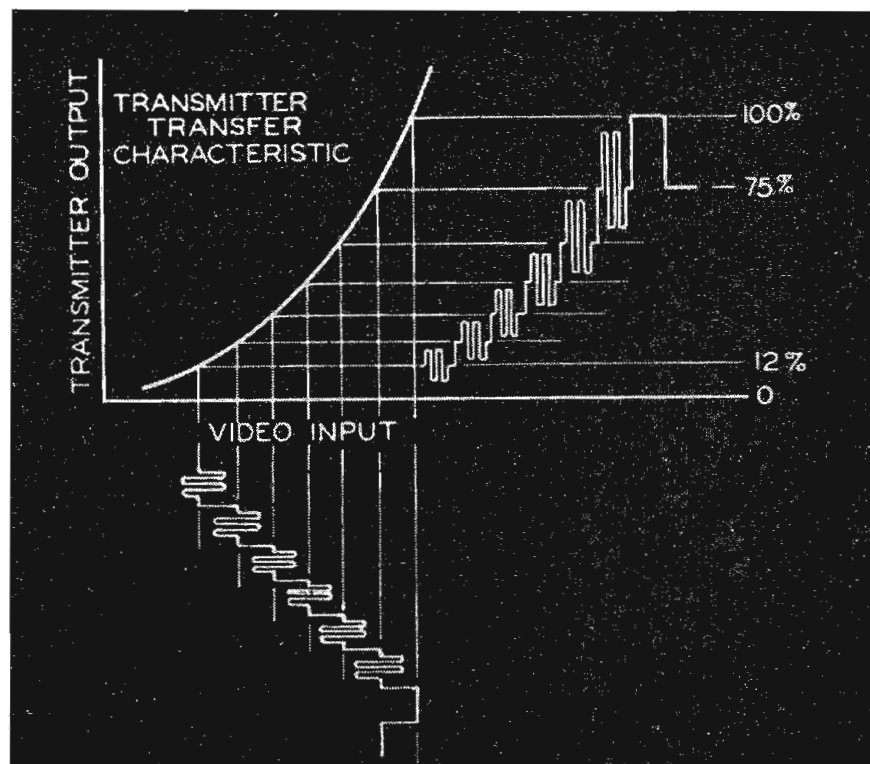

FIG. 8

Correction is accomplished by predistorting the video signal before modulation of the r-f carrier. Most TV transmitters designed within the past seven years have linearity correction circuits included as part of the modulator. For transmitters of earlier design, a stabilizing amplifier containing linearity correction must be used between the video line and the video input to the transmitter.

### Differential Gain Adjustment

The most convenient method of measuring and adjusting differential gain is to modulate the transmitter with a stair-step signal that includes a 3.58-mc signal superimposed on each step. The demodulated output of the transmitter is observed on a scope, and the depth of modulation is adjusted (using a chopper to obtain the zero reference) as shown in Fig. 9.

The low-frequency, step-component of the stair-step signal is then removed with a high-pass filter, and the linearity corrector

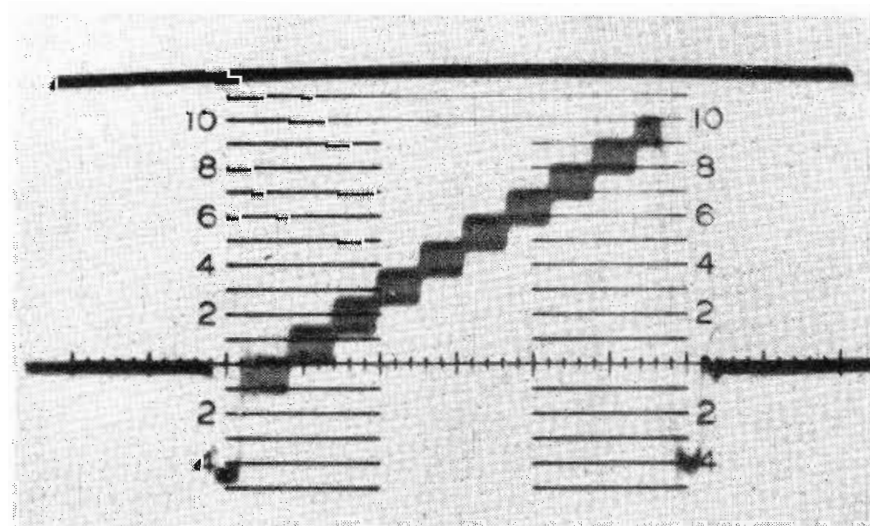

FIG. 9

control adjusted to make each high-frequency component the same amplitude as its neighbor or as close to that value as possible. Figure 10 shows the typical, corrected linearity of a TV transmitter through the high-pass filter. It should be noted that, when linearity adjustments are made, the overall video gain is altered. As a result, it is wise to recheck the depth of modulation frequently while making linearity corrections. After adjustments are completed, all further control of video level should be made ahead of the linearity-correction circuit.

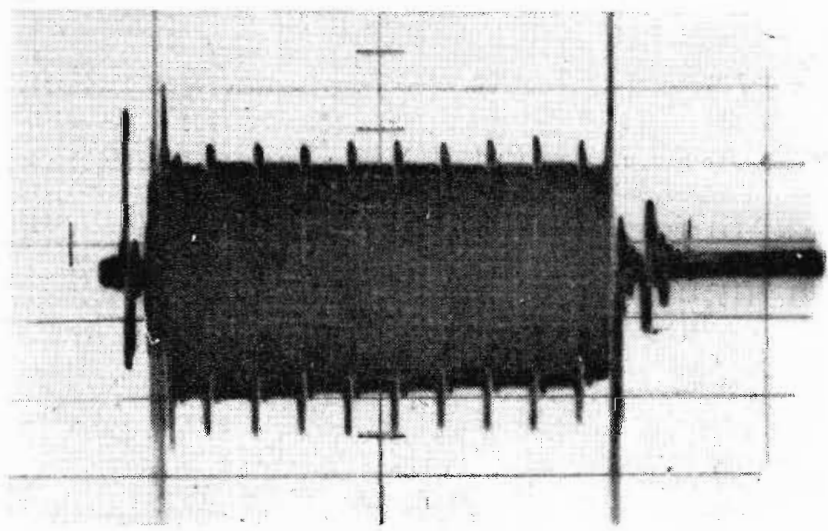

FIG. 10

#### Differential Phase

Differential phase shift is a term used to describe a change in phase of the color sub-carrier with a change in picture brightness. This type of distortion changes the hue of an object with the intensity of lighting. The most common source of this problem is a change in the plate impedance of an amplifier circuit because of a shift in the operating point of the tube in the amplifier. Two other causes of differential phase shift are: feedback due to improper neutralization and variations of the load into which an amplifier works.

The inherent differential phase shift in most TV transmitters is kept at a point below six degrees by careful selection of tube types used and a circuit design which minimizes the effect. Amplifiers should be checked for proper neutralization in accordance with the transmitter instruction book in order to obtain minimum differential phase shift.

#### Measuring Differential Phase

Differential phase measurements are made with the same stair-step signal as used for differential gain measurements. A color-signal analyzer or Vectorscope must be used in conjunction with this test signal. The signal should be obtained from a demodulator connected at the output of the sideband filter. It is important that the harmonic filter be ahead of the monitoring point, since the presence of harmonics can give a false reading.

Although the vestigial sideband filter will not introduce differential phase shift, since it is a passive network, it is possible to obtain different measurements before and after the filter. Such a condition indicates the presence of incidental phase modulation in the video signal. The presence of both sidebands would ordi-

narily result in cancellation of incidental phase modulation; however, with one sideband suppressed the resultant appears as differential phase shift. Unwanted feedback in a video amplifier is often the main cause of incidental phase modulation.

#### Envelope Delay

The term envelope delay refers to the relative time required for different frequencies within the passband of a transmission system to pass through the system. Unequal delay, or delay distortion, throughout the frequency spectrum results in smearing, ringing, and loss of detail in both monochrome and color pictures. In color pictures it can also result in lack of registration between color and luminance parts of the signal as well as distortion of hue and saturation around color edges.

Delay distortion is the result of the sideband shaping mentioned previously. In order to meet the FCC specifications with regard to envelope delay, it is necessary to use envelope-delay equalizers. These equalizers are passive networks that pre-distort the phase characteristics of the video signal before it arrives at the transmitter video input. A low-frequency phase equalizer compensates for the phase distortion introduced by the vestigial sideband filter; while a high-frequency phase equalizer compensates for several factors including phase distortion introduced by the high-frequency cutoff characteristic of the home receiver, the notch diplexer or the filterplexer (if used), and irregularities in the transmitter's high-frequency characteristics. The low-pass filter is ordinarily phase compensated within itself.

Under the standards, each color receiver is required to have its own low-frequency phase compensation; however, the receiver depends on the transmitter for high-frequency phase equalization and therefore correction must be included in the transmitter. Consequently, the transmitter is required to have a pre-distorted phase characteristic in accordance with FCC regulations to complement an assumed typical-receiver-envelope-delay curve.

#### Measuring Envelope Delay

To accurately measure and adjust the envelope delay of a transmitter, it is necessary to use an Envelope Delay Measuring Set such as the RCA Type BW-8A shown in Fig. 11. When measuring the envelope delay of the system, the stabilizing amplifier

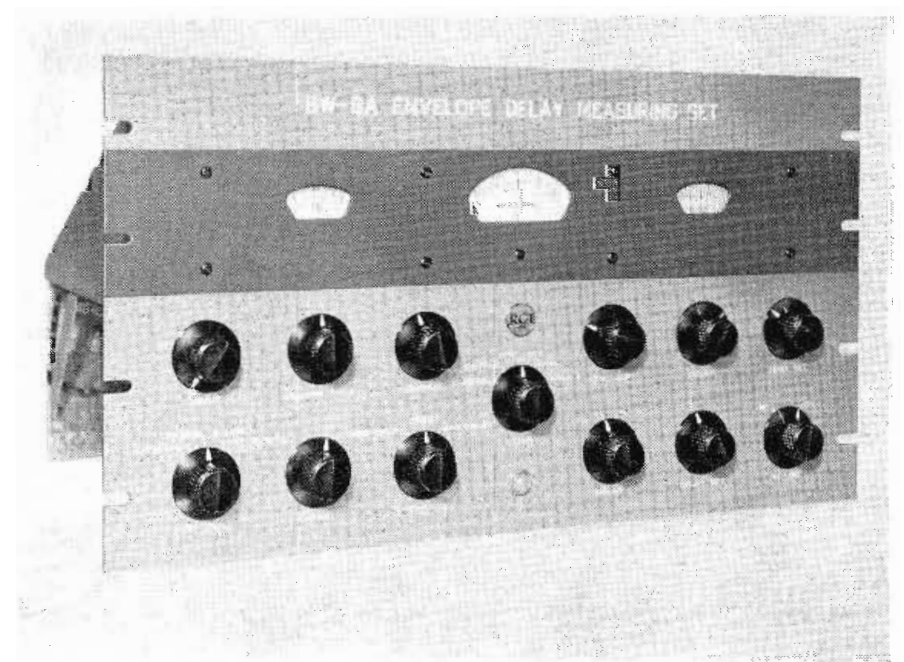

FIG. 11



should *not* be included in the tested system. Due to the nature of the circuitry of a stabilizing amplifier whereby the sync is separated, reshaped and reinserted, it is not possible to measure its envelope delay characteristic with the BW-8A. However, because of its wide bandwidth and flat frequency response, the envelope delay of a stabilizing amplifier is normally very uniform and thus contributes negligible error.

The envelope delay characteristic of the demodulator must be taken into consideration when using the BW-8A to measure the transmitter characteristic. A properly adjusted RCA Type BW-4B Vestigial Sideband Demodulator coupled to the output of the sideband filter will yield fairly reliable measurements. Figure 12 shows

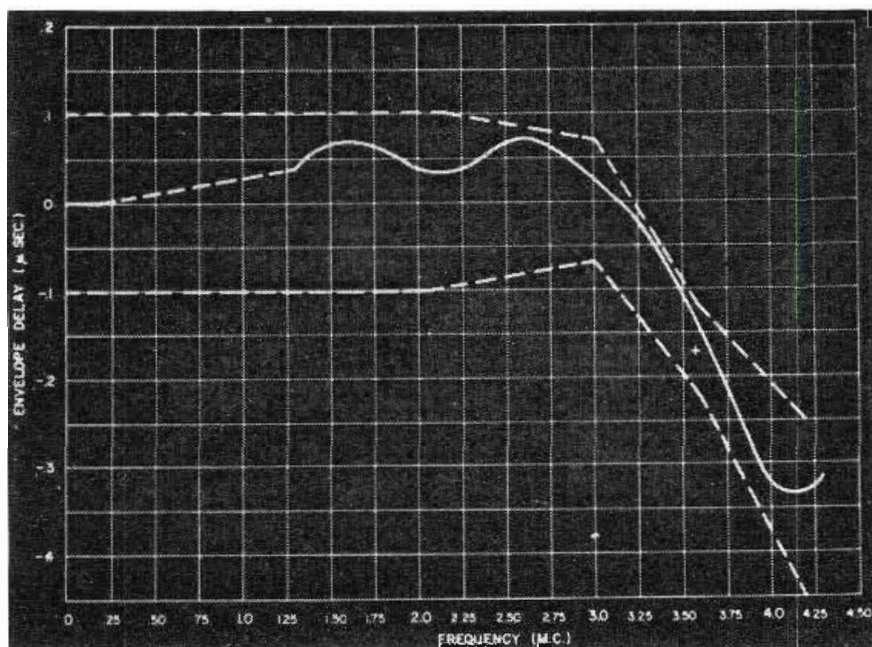

FIG. 12

an envelope delay curve plotted from data obtained using a BW-8A Envelope Delay Measuring Set and BW-4B Demodulator with the sound notch switched out. The dotted lines represent the FCC limits for positive and negative delay.

A diode demodulator can be used to measure the frequency range above 1.4 mc if a correction factor of  $-0.008$  microseconds is applied to all readings obtained in this range. The diode can be used as a check on the BW-4B with the sound notch switched out. Figure 13 shows two curves obtained using a diode demodulator. Curve 1 was taken with no phase equalizers in the circuit, while Curve 2 was taken using the same equalization as used for the curve shown in Fig. 12. (The downward swing at 1.3 mc is due to phase-shifted energy from the lower sideband of the transmitter and should be disregarded.)

#### Another Method for Measuring Envelope Delay

A 100-kc square wave can be used as a test signal to check the transmitter's envelope delay characteristic. The square wave should first be observed at the output of the square-wave generator with a 75-ohm termination resistor across the oscilloscope input. This ascertains that the square-wave signal is as it should be under that load. The square wave should then be checked at the transmitter input after passing through all of the video-input equipment, but with all the phase equalizers switched out.

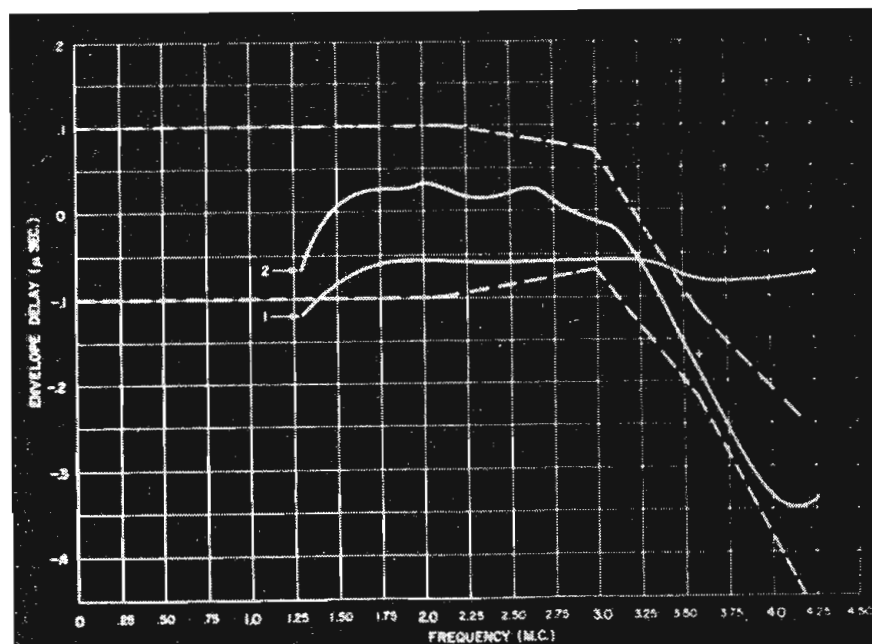

FIG. 13

If the square wave is observed ahead of the low-pass filter or with the filter switched out, a spike-type overshoot appears, as shown in Fig. 14. This spike is caused by a 10-mc (parallel) resonance in the amplitude equalizer. It is removed when the bandwidth is restricted by the low-pass filter as can be seen in Fig. 15. This is the square-wave signal as it appears at the transmitter input.

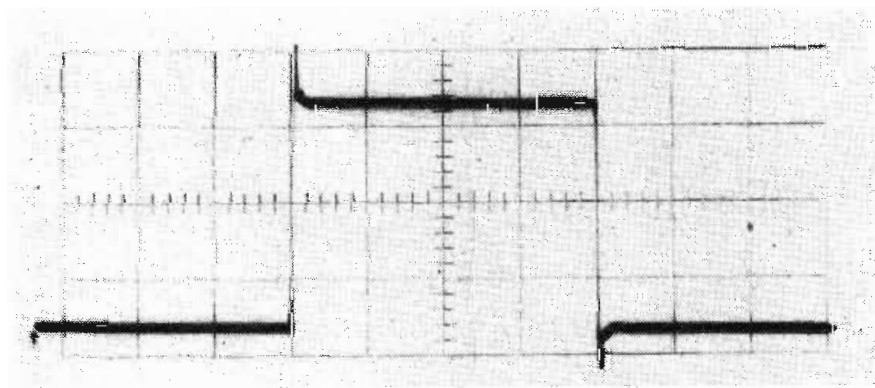

FIG. 14

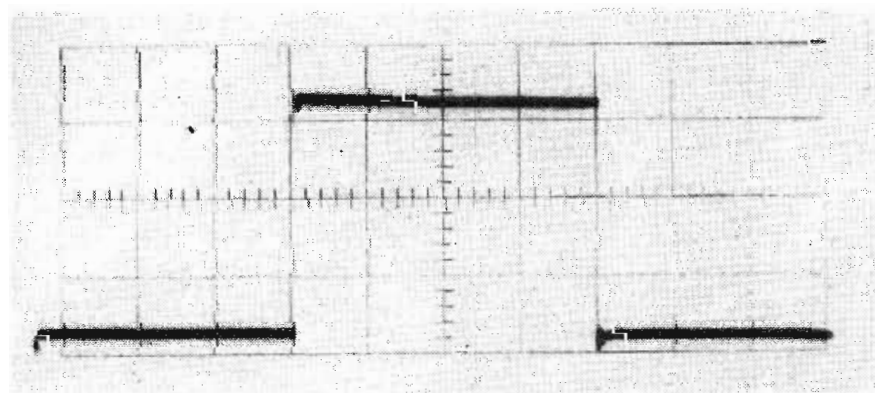

FIG. 15

Figure 16 shows the demodulated square wave as it should appear at a monitoring point following the sideband filter (using a BW-4B Demodulator with the sound notch switched in and with no equalizers connected in the circuit). When the equalizers are inserted and properly adjusted, the ringing will be symmetrical about the vertical transition as exhibited in Fig. 17. The ringing cannot be completely eliminated due to the limited bandwidth of the transmitter and inherent quadrature distortion in the demodulator.

The shape of the square wave will also be affected by the frequency response and linearity of the system, and the phase equalizers will not correct for deficiencies in these areas. Therefore, it is important that all other adjustments be properly made before envelope delay adjustments are even attempted.

When checking the square-wave response at various points in the system, consideration must be given to the equalization inserted ahead of that point, and to which components requiring phase equalization enter into the observation. When using the BW-4B to check the overall system, the sound notch should be switched out, and under these conditions the receiver equalizer should also be switched out. During normal operation both the sound notch and the receiver equalizer should be switched in. Figure 18 shows the effect of the receiver equalization when the demodulator sound notch is out. The anticipatory ringing is the effect of the pre-distortion inserted to compensate for the receiver's sound notch.

Figure 19 shows the 100-kc square wave at the transmitter video input with full equalization applied. The ringing would

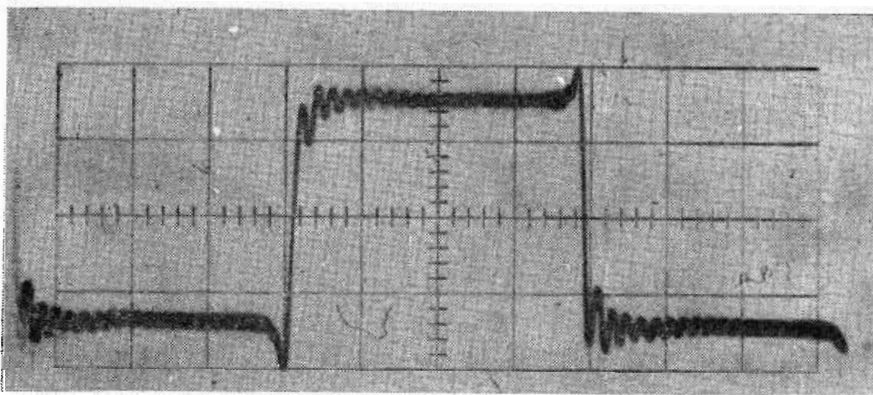

FIG. 16

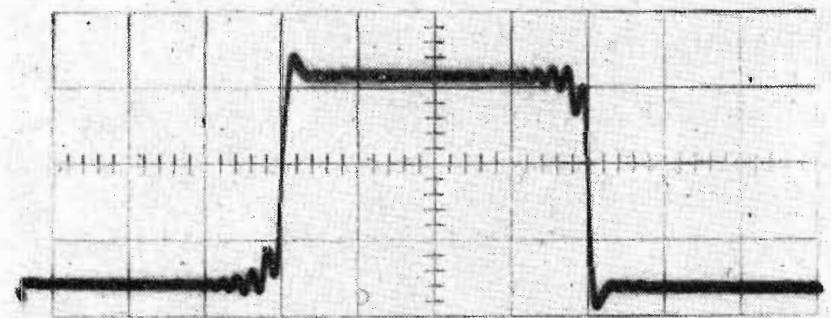

FIG. 19

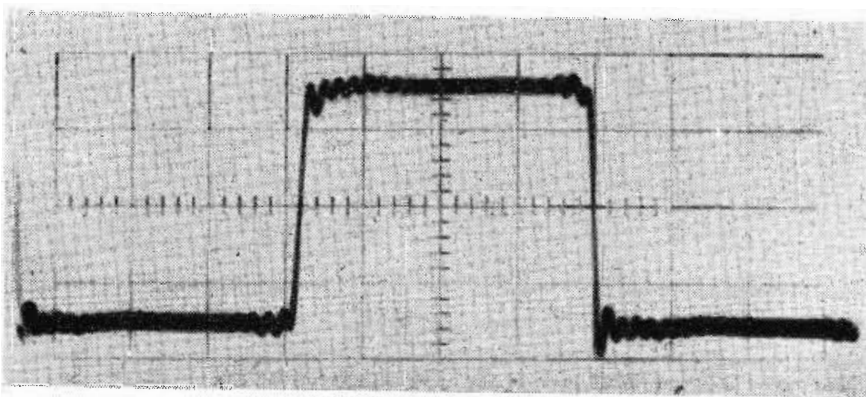

FIG. 17

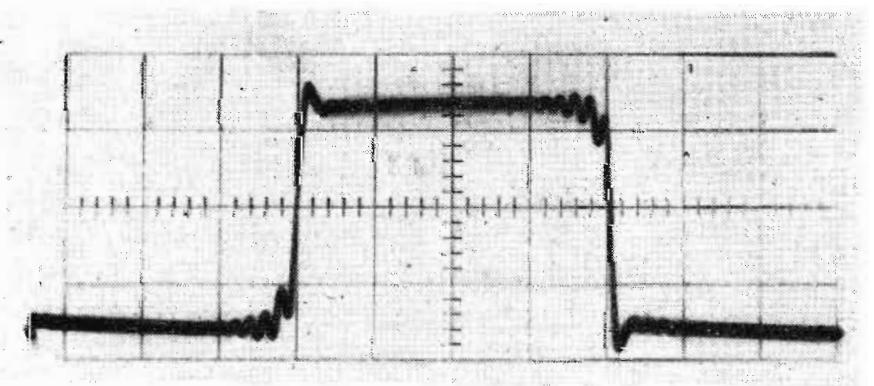

FIG. 20

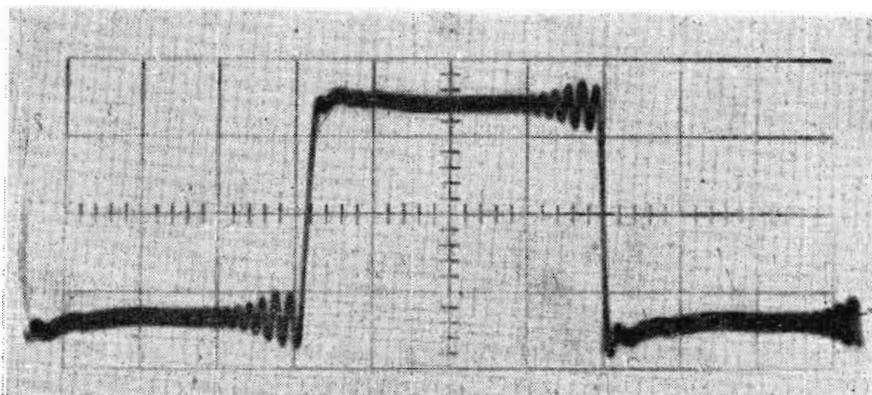

FIG. 18

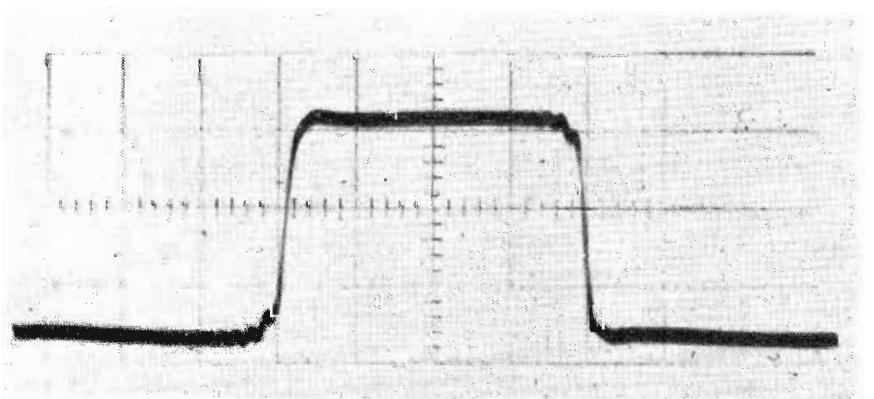

FIG. 21



necessarily be more pronounced if the transmitter feeds a filter-plexer or notch diplexer as part of the system, since the notch equalizer would then be in the circuit. Figure 20 shows the same square wave at the output of the modulator, indicating that the modulator needs little or no equalization.

The square wave as presented by a diode demodulator connected ahead of the vestigial sideband filter is shown in Fig. 21. Visible rounding of the corners is due to the 2-to-1 ratio of low-to-high frequencies encountered when using a diode demodulator.

#### Using Network Test Signals

The TV-test signals commonly employed by the networks can be used to advantage in making periodic checks on transmitter operation. Regular use of these test signals can often help in locating trouble in the system before it becomes serious enough to cause degradation of the transmitted signal.

The multiburst signal is very convenient for checking the amplitude response, since it can be fed through the entire system without disabling the clamp circuits or changing the operating point of the modulated amplifier. However, as mentioned earlier, the multiburst signal should *not* be used for making adjustments to the transmitter, since it only spot checks a few frequencies and gives no indication of excessive bandwidth or irregularities between these frequencies.

The stair-step signal serves to indicate changes in differential gain which, in turn, indicates a change in linearity-corrector gain or that of one of the following stages. Use of a Vectorscope allows monitoring of differential phase with the stair-step signal.

The white window test signal places a critical test on the transmitter and readily shows up smearing and ringing due to phase errors, in addition to faulty clamping and antenna reflections.

#### Cautions

When observing any test signal at any point in the transmitter system from the stabilizing amplifier to the antenna, evaluation is complicated by the need-to-know whether pre-distortion of the "video" is used and how it effects the signal under observation. If the observed signal is demodulated, the characteristics of the demodulator and its location in the system must be considered.

It is recommended that a diode demodulator be used with the BW-8A for quantitative measurements such as differential gain, differential phase shift, and envelope delay. The BW-4B vestigial sideband demodulator replaces the diode for qualitative observations of test signals such as multiburst, white window, and square-wave analysis of envelope delay. The BW-4B is ideal for air-signal picture monitoring of both monochrome and color transmissions when connected to the appropriate picture monitor.

#### Summary

The requirements of a TV transmitter for transmission of a good color-TV signal are not much different from those required for a high-quality monochrome signal. However, slight maladjustments can result in serious degradation of color-picture quality while the monochrome-picture quality will still be acceptable. So, when operating with color, transmitter adjustments must be carefully made and maintained or picture quality suffers noticeably.

Adequate test equipment should be on hand for proper adjustment of the parameters just discussed, and the personnel who use the test equipment should be thoroughly versed in its proper operation. It is most important that this test equipment be given good care and be well maintained. A regular maintenance schedule on all equipment, including test and monitoring equipment, should be set up and rigidly followed.

Most TV transmitters presently in operation are capable of transmitting a good color signal if they have been well maintained. All RCA transmitters have been type accepted for color by the FCC, and kits for any modifications required to meet color specifications have been supplied. Older transmitters require a color-stabilizing amplifier for linearity correction, and all transmitters require phase equalizers in order to meet color specifications.

Once the transmitter has been properly adjusted for color operation, it is not at all difficult to keep it that way as long as adjustments are not attempted by personnel who do not thoroughly understand what they are doing. A well-planned maintenance program with adequate test equipment and training of personnel enables any TV station to keep a good color signal on the air.

(Continued from Page 3)

main reason. Corollary reasons are modularization, stabilization and standardization. If you don't know what we mean by this gobbledy-gook, relax—we'll explain it all, at length, in the next issue of BROADCAST NEWS. At the moment it's sufficient to say that the four add up to a revolution in equipment design.

### *As We Were Saying*

**YOU MIGHT SAY**, at this point, that transistors are more than ten years old (as a product)—why the sudden sweat. Answer—for the first eight of the ten years transistors did not look very attractive for broadcast gear. Reason—high price, lack of standardization and, even more important, the fact that there were no suitable types for many circuit requirements. Some hybrid equipments (part tubes, part transistors) were built. But using even a few tubes negates most of the advantages of transistors—i.e., getting away from heat, high plate voltage, conventional panel construction, etc. So, all in all, we saw no reason for rushing into a wholesale changeover.

**BUT THIS TOO** has changed. Starting about two years ago we began to realize that the day when we could produce all transistorized equipment of very high performance was within sight. (And, we weren't thinking of individual units, such as DA's, but of completely transistorized control rooms.) So we began to plan for it—and then the enormity of the task came to us. Instead of re-doing our line over a period of five to ten years (our immemorial practice)—we would have to redesign the whole line, from scratch, in a matter of two to three years. Obviously it would entail spending a lot more money for engineering. There was no way to get it except to ask management to let us take it out of profit. To make a long story short, we did; they did; and we're now well along the way to a whole new line. The WALL STREET JOURNAL ad (which is where this discourse began) was the opening announcement of **the results** of our greatly accelerated engineering program.

**WHY THE WALL STREET JOURNAL** for this ad, you might ask. Well, the reasons are several. For one, many of the owners or backers of today's stations are not old-line broadcasters, but financial people who have come into the field in recent years. The WSJ is their bible. For another, it is important to us that our stockholders, our business friends and the financial "community" know what we are doing—we need their backing. Still a third reason—and one that we think has great importance to you—is that we want agencies, reps and sponsors to know about new and advanced equipment that is coming into use. It's part of our campaign to convince advertisers that you can judge a station by the equipment it keeps. We think it will help you—as well as us.

**THE NEW-LOOK PRODUCTS** that will result from our stepped-up engineering program (or, anyway, some of them) have been announced not only in the WSJ ad but also in a number of trade ads which we have run in the past two months. (See FM ad, Pg. 8 and UHF ad, Pg. 78.) Such ads, of course, do not tell very much about the equipments. They can't (in the space available)—and they are not supposed to. More detailed information is available on preliminary catalog sheets which you can get from your RCA representative (if you've not already received them in the mail). Beyond this we are planning a special "NAB Issue" of BROADCAST NEWS in which we will picture and describe all of them—together with some ideas on their importance in future station planning.

**AT NAB**, we will show all of these equipments—in operation—in setups where you cannot only examine them detail by detail but also twiddle knobs to your heart's content. This will be our biggest NAB show, our best (we think)—and it will include by all odds the most truly new equipment we've shown in many years.

**TWICE BEFORE** we have had NAB shows where the new equipment we showed truly leapfrogged the field. Once was at Atlantic City in 1947. That was the year we first showed our post-war commercial TV gear. We were the only exhibitor with operating TV equipment! That was also the convention at which General Sarnoff made his famous speech urging the NBC affiliates, and by inference all broadcasters, to get into TV. (Remember the scoffers!!).

The second "milestone" show was at Chicago in 1954. That was the year we first showed operating color equipment. Again we were the only exhibitor to do so! As in 1947, the leadership of our engineering was strikingly evident. And the equipment we showed became the pattern for the industry for a whole decade.

As we approach this year's NAB, there is a widespread feeling—among our engineers, our product people, our salesmen, our management—that this is to be another "milestone" show. A show at which we will set a new pattern—for a new decade. This is a show which we are looking forward to with pride and pleasure. Come prepared to share our pleasure.

**THE TAPE PLAYER (TR-3)** is, to us, the most intriguing of the three new video tape machines we recently announced. This "playback only" machine is more than just an outstanding technical development. It's an important breakthrough in the area of TV tape handling. Why so? Well, from the beginning, one of the arguments against tape (vis-a-vis film) has been the fact that you can't just stick it in any handy projector and take a look at it. Agencies and reps like to preview



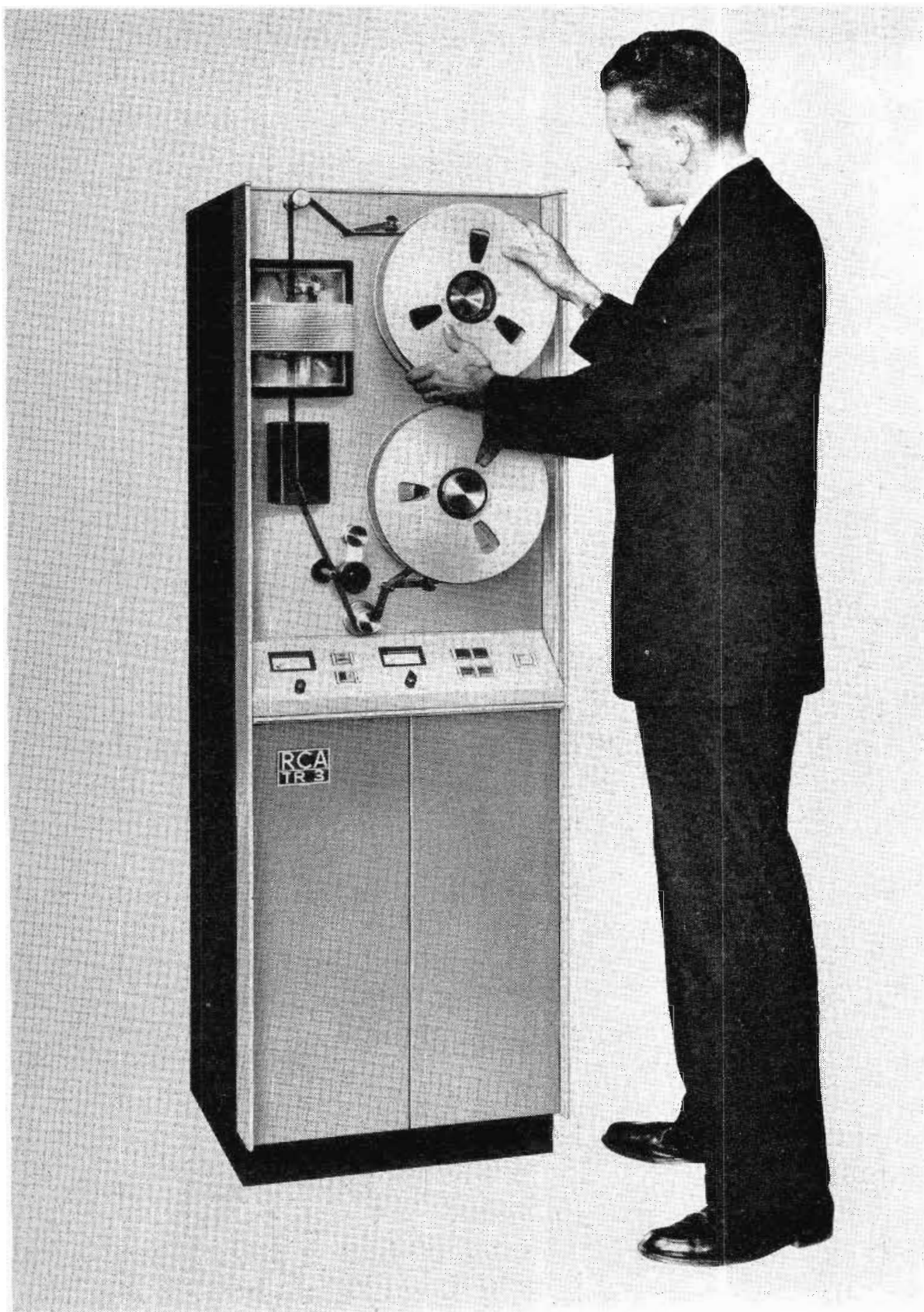

New RCA Type TR-3 Television Tape Player for playback of standard quadruplex recordings.

*As We Were  
Saying*

commercials, pilots (and even programs) in the inner sanctum. Sponsors' ad managers like to show their commercials to their management—at the latter's convenience. Until now they couldn't do so unless they bought a full-sized recorder (slant machines won't do it because they are not compatible). We only know of two agencies and one rep who have had the nerve to install a standard recorder.

The TR-3 is small, simple to operate, and reasonably priced. We look for agencies, reps—and

even sponsors—to buy them. Eventually almost everyone handling tapes will have them. It will put a new face on the business.

We also suspect that stations and producers who already have the big recorders will want one or more of these little dandies. Some rough, but probably representative, figures we've heard indicate that the average tape recorder is used three-fourths of the time in the "reproduce" mode. The requirements of checking, editing and previewing make this necessary.

Assuming this ratio is right, look what happens when one of these tape players is added to the equipment layout. The user increases his equipment investment by about one-third (the TR-3 sells for about one-third the cost of our TR-22 Recorder.) But by so doing he **doubles** his overall tape-handling capability. Dollarwise it might come out even better—because his big recorder is not tied up at important moments by some editing, previewing or checking chore that could just as well be done by the little dandy. This is such a good deal we don't see how anyone who uses his recorder very much (and who does not) can afford to pass it by.

Here's another thought. Engineers who are tired of having the program people hanging around the record area can get some relief by putting a "playback only" upstairs in the program department. And while you're at it, give your sales department one, too.

**COMPACTS ARE IN** the new line, too. The TR-4 (see ad on inside front cover) is a complete record-playback machine, fully transistorized, same quality as our deluxe TR-22 Recorder—but without some of the convenience and automatic features. Uses mostly the same modules as the TR-22, has space for ATC and color modules (available extra). If you want quality, but can live without some of the conveniences, the TR-4 will do your job for about half the cost of the deluxe machines.

**TRANSPORTABLES**, too, are here—and we mean in quadruplex. The TR-5 is the record part of the TR-4 compact—mounted in a "tea wagon" which is 32 inches wide, 22 inches deep and 32 inches high (including castors). It includes a very simplified playback facility which is good enough for checking the recorded picture (but not on-air quality). It's not small enough that "one man can carry it." But you can put it in one of the larger station wagons and take it anywhere you please. You get a top-quality picture, a quadruplex compatible picture that you can edit—that you can put on the air from your standard machines—without converting. That's worth a few extra pounds—and dollars— isn't it. We think so!

See you April 5,  
The Armchair Engineer

# RCA announces...an all new

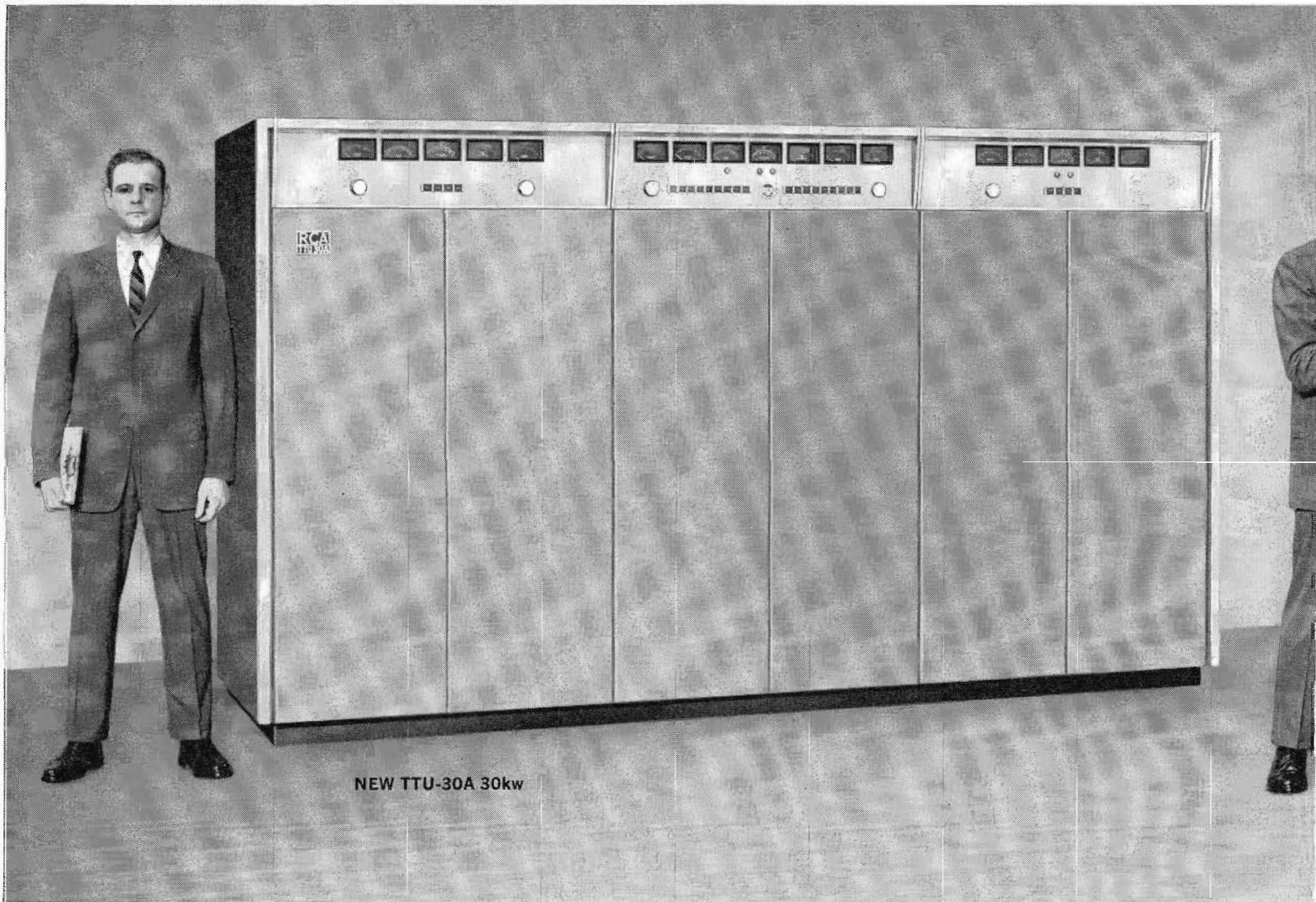

Here's the most exciting news in UHF since the first Ultra High Frequency TV station went on the air over a decade ago! These new transmitters, with important design innovations, are keyed to the accelerating market. You'll like their new size with eye-level, easy-to-read meters, their new steel/blue color, their new ease of operation and economy. All are designed for remote control, all use Direct FM aural modulation for the finest sound.

**THE TTU-30A** is the only UHF transmitter with vapor-cooled, long-life Integral-Cavity Klystrons. The Klystrons are pretuned and can be replaced in a matter of minutes. They are guaranteed for up to 8,000 hours. Available on lease if preferred. Silicon rectifier power supply with plug-in modules also is a feature of this transmitter. Vapor cooling assures the highest cooling efficiency. Altogether, the TTU-30A is the finest UHF transmitter of its class ever offered.

**UHF stations in the U.S. use more RCA transmitters than all other makes combined.**



# line of UHF transmitters!

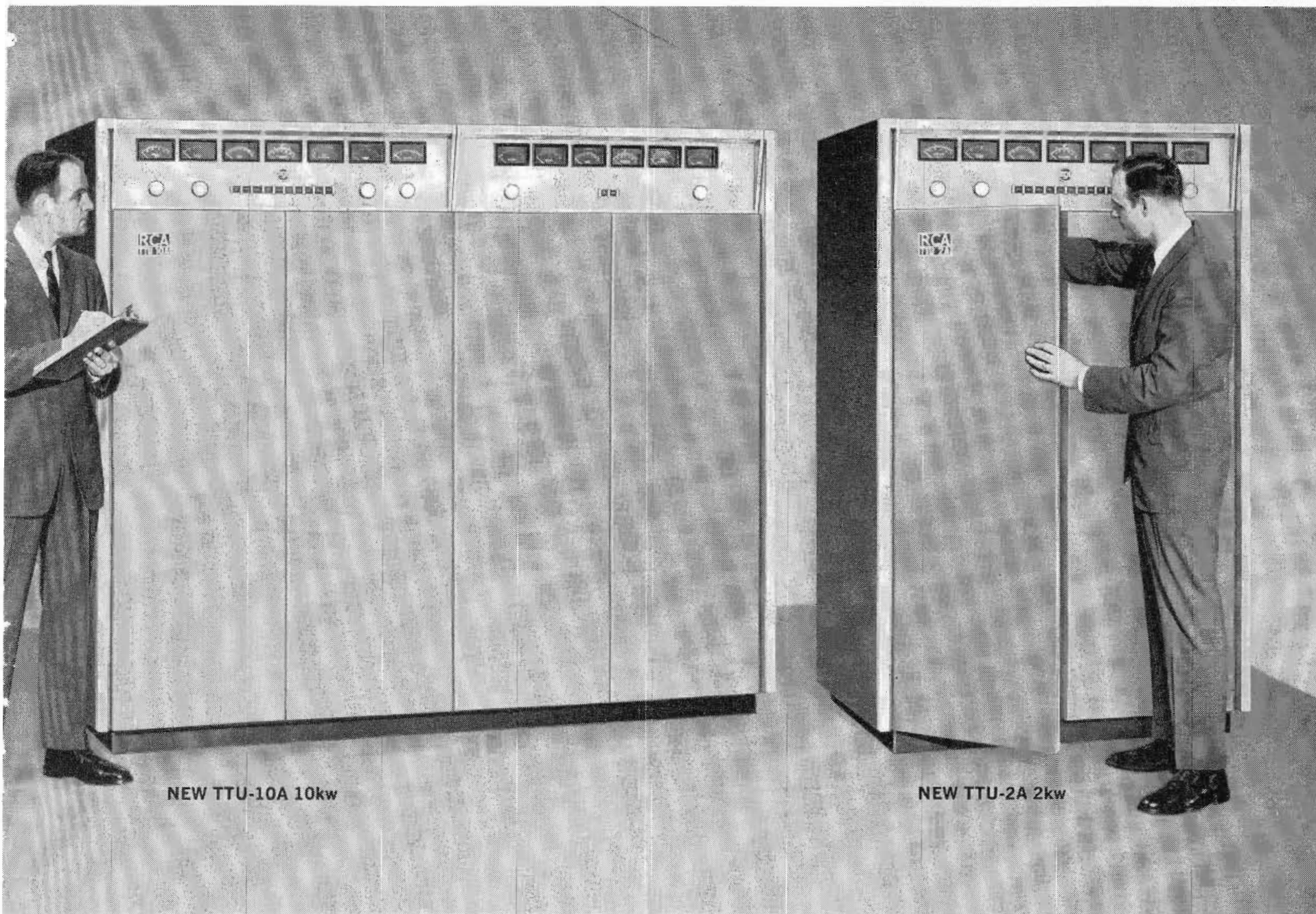

**THE TTU-10A** is the first 10 kw UHF that is completely air cooled. It needs less than half the space of its 12 kw water-cooled predecessor and has the lowest operating cost of any 10 kw. The TTU-10A uses less input power than the previous 12 kw and is lower priced than any transmitter of similar power.

**THE TTU-2A** is a real honey! Much smaller than the 1 kw that it replaces, this 2 kw, with plug-in silicon rectifiers, offers twice the power in  $\frac{2}{3}$  the space! It has the lowest operating tube cost and

lowest input power requirements of any transmitter on the market today. And it can be easily expanded into a 10 kw at modest expense.

**RCA UHF** transmitters are the best performing UHF transmitters now in operation, and this new line, with its design innovations, promises even more! Find out all about these distinctive new UHF transmitters from your Broadcast Representative. RCA Broadcast and Television Equipment, Building 15-5, Camden, N. J.



**The Most Trusted Name in Television**

# RCA SERVICE

keeps all your  
AM, FM, TV  
equipment  
in top  
condition!



*Antenna System Measurements*

## TAKE ADVANTAGE OF THE FOLLOWING SERVICES OFFERED BY RCA:

- Video Tape Recorder Service • TV Camera Overhaul • TV Transmitter Overhaul**  
**• Installation Supervision • Microphone and Pick-Up Repairs • Transmitter Performance**  
**Measurements • Antenna Inspection Measurements • Console Repairs • Microwave Service**  
**• TV Projector Service • Custom Fabrication • Teletypewriter Maintenance**

Your audience demands a superior signal which requires top performance from all your station equipment. RCA Broadcast Service is planned to assure you of meeting this objective. More than 30 years in the broadcast industry have provided a background of solid service experience. This is the type of protection broadcasters have relied on for years, the kind of protection you can count on . . . contract or per-call . . .

from the experts in the service business, RCA Service Company. To guard performance of all your equipment . . . simply telephone one of the following field offices: Atlanta (phone 355-6110), Chicago (WE 9-6117), Camden (GL 6-7984), Hollywood (OL 4-0880). Or contact Technical Products Service, RCA Service Company, A Division of Radio Corporation of America, Bldg. 203-1, Camden 8, N.J.



**The Most Trusted Name in Electronics**



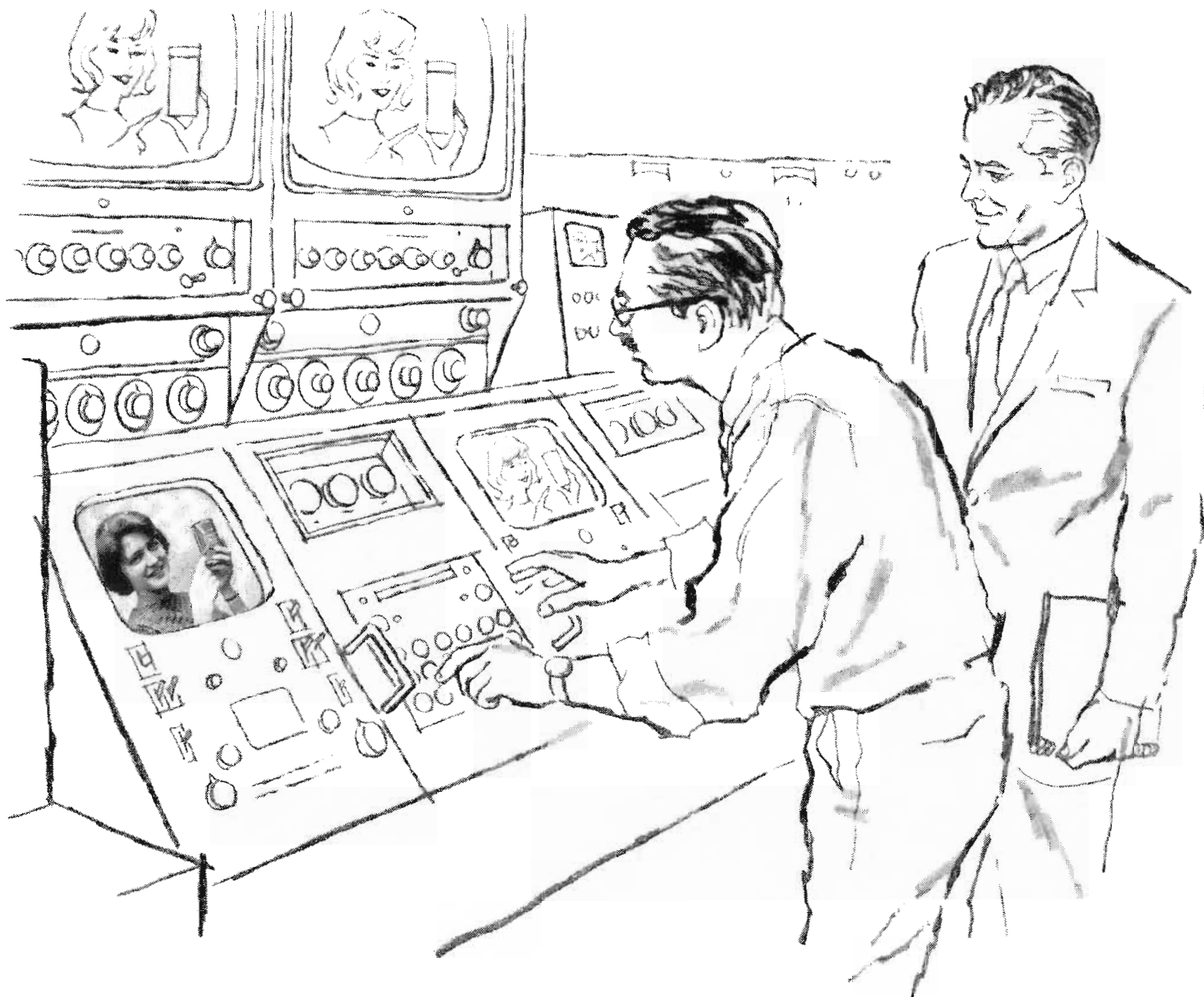

## For Picture Quality Sponsors Want

### Use the New RCA-7295B and 7389B Image Orthicons

You'll air the sharpest product shots ever with these two new 4½" field-mesh image orthicons, each a substantial improvement over its predecessor types.

**Improvement in 7389B over 7389A...** New improved and tighter limits in: signal output current—operating sensitivity—background uniformity—signal uniformity • Increased amplitude response • Highest signal-to-noise ratio of any commercial image orthicon (95:1 at 4.5 Mc) • Decreased microphonics • Improved detail response with best gray scale obtainable FOR LIVE B&W STUDIO PICKUP AND MAGNETIC TAPE RECORDING OPERATIONS.

**Improvements in 7295B over 7295A...** Improved background uniformity • Higher signal-to-noise ratio (75:1 at 4.5 Mc) • Improved signal uniformity • Higher signal output levels • Lower microphonics • More stable sensitivity characteristics. FOR B&W VIDEOTAPING.

#### INCORPORATING NEW "MICRODAMP" CONSTRUCTION

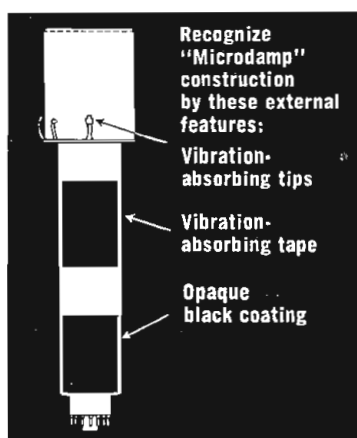

"Microdamp" construction in these new image orthicons reduces microphonic noise in the output signal by isolating the target-to-mesh assembly from the effects of external acoustical noise and camera vibration, and by damping out internally induced vibration of the target.

An opaque black coating is applied to lower part of tube which eliminates possibility of "washed-out" pictures due to extraneous light entering tubes.

RCA ELECTRONIC COMPONENTS AND DEVICES, HARRISON, N. J.



The Most Trusted Name in Electronics

#### AVAILABLE THROUGH YOUR AUTHORIZED RCA BROADCAST TUBE DISTRIBUTOR

FOR NAME AND ADDRESS OF YOUR LOCAL DISTRIBUTOR WRITE OR CALL YOUR NEAREST RCA DISTRIBUTOR PRODUCTS SALES OFFICE— NEW YORK: 36 W. 49th St., MU 9-7200; NEEDHAM HEIGHTS 94, MASS.: 80 "A" St., HI 4-8480; WASHINGTON 6, D. C.: 1725 "K" St., N. W., FE 7-8500; ATLANTA, GA.: 134 Peachtree St., N.W., JA 4-7703; CLEVELAND, OHIO: 1621 Euclid Ave., CH 1-3450; CHICAGO ILL.: Merchandise Mart, 467-5900; DALLAS 7, TEXAS: 7901 Carpenter Freeway, MELrose 1-3050; KANSAS CITY 14, MO.: 7711 State Line, EMerson 1-6462; LOS ANGELES 22, CALIFORNIA: 6801 East Washington Blvd., RAYmond 3-8361.





## The Mark of the Finest in TV Tape Recorders

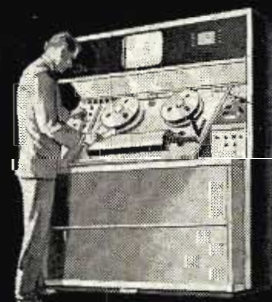

The TR-22, with its excellence of design and brilliance of performance, attracts attention wherever it's in operation. Fully transistorized, it does away with problems of power, heat and space, reduces maintenance. It provides highest standards of quality and reliability. Any studio can benefit from this symbol of the finest in TV Tape.



The Most Trusted Name  
in Television

