

# BROADCAST NEWS



RCA "NEW LOOK" FM TRANSMITTER

Vol. No. 121 JUNE 1964



## TV TAPE DISTINCTION AT WOC-TV

*Deluxe TR-22's in dual set-up assure convenience and versatility in taping of programs and commercials*

For TV taping of distinction—it's the RCA TR-22 deluxe TV tape recorder. Two of them mean twice the production versatility! At WOC-TV in Davenport, their new two-recorder Tape Production Center provides for immediate review of taped programs and commercials. They can be perfected for broadcasting ... ready for on-air presentation in a matter of minutes. Also, using two recorders, WOC can record on one while the other is on air, for greater convenience and speed.

In the words of Vern Gielow, Production Director,

WOC, "Our new building is not merely a large and elegant physical plant—it's an efficient production facility. That's why we proudly bring clients in, show them our equipment and demonstrate our TR-22 TV tape recorders and TK-60 cameras. Their striking design and brilliant performance never fail to impress our clients."

If all this has made an impression on you, we suggest you let RCA be of service. Call your Broadcast Representative. Or write RCA Broadcast and Television Equipment, Building 15-5, Camden, N.J.



**The Most Trusted Name in Television**

# BROADCAST NEWS

*published by***RADIO CORPORATION OF AMERICA**  
BROADCAST & COMMUNICATIONS PRODUCTS DIVISION, CAMDEN, N. J.*issued quarterly*PRICE *in U.S.A. - - - - - \$4.00 for 4 issues*  
*outside U.S.A. - - - \$5.00 for 4 issues*

## C O N T E N T S

	Page
Behind the "NEW LOOK" FM Transmitters . . . . .	10
Monitoring FM Stereo . . . . .	18
Combined V and H Polarization Improves FM Coverage . . . . .	21
New FM Antennas . . . . .	24
This Is The Show That Was . . . . .	26
How a New TV Station Can Achieve Success . . . . .	34

**FM RESURGENCE** has been noted everywhere. And there are lots of reasons. There's stereo, and multiplex, and SCA, and FM car radios. There's thawing at the FCC—and vertical polarization—and, above all, a new look at the future of radio broadcasting.

This is FM's third boom. The first—the original one before the war—was born and nurtured in an engineer's dream of perfection. The second—right after the war—was carried along by a mass hysteria which overlooked the obvious fact that broadcasting is built on the advertiser's dollar (and that advertising goes where the customers are—listening).

This third boom is different—at least to a degree. It has a better start (20 million FM sets in use). It has more reason for being (the new and different services it offers). And it has a more solid base—a general realization that it takes time to build an audience, and that meantime advertising

revenue will be slim. Thus, despite all of the earlier difficulties and disillusion there is a general feeling in the industry that this time FM will go.

**OUR CONFIDENCE IN FM** has been demonstrated by our work in the development of FM broadcast equipment. In the 25-year period since 1939, we have been the leading developer of FM equipment—and our equipment designs have, in general, been the most successful. For example, we have used "direct FM" in all of our FM transmitters from the very first. This is not to infer that others have not made notable contributions—they have. Nor is it to say that we have always been first—we have not. But those who made the biggest to-do about FM in the early days have dropped out. And some of those in it now, weren't then. But we offered our first FM transmitters in 1939—and we have been manufacturing and selling them continuously ever since. No other manufacturer . . . !

*As We Were  
Saying*

Copyright 1964

All Rights Reserved. Trademark(s) Registered. Marca(s) Registrada(s) Radio Corporation of America

PRINTED  
IN  
U.S.A.

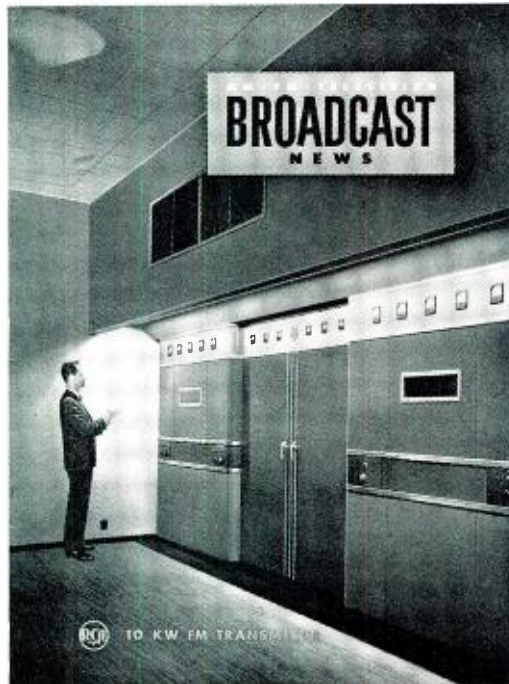

"A" SERIES of RCA FM Transmitters was introduced before the war, including the FM-1-A in 1939, the FM-3-A in 1940 and FM-10-A (10 KW) in 1941. Latter is shown above on the cover of our January 1944 issue. This transmitter was 18 feet wide, 84 inches high, required 54 square feet of floor space. The 10-E Transmitter, shown on the cover of this issue is 4 feet wide, 78 inches high, requires 13 square feet of floor space (less power supply).

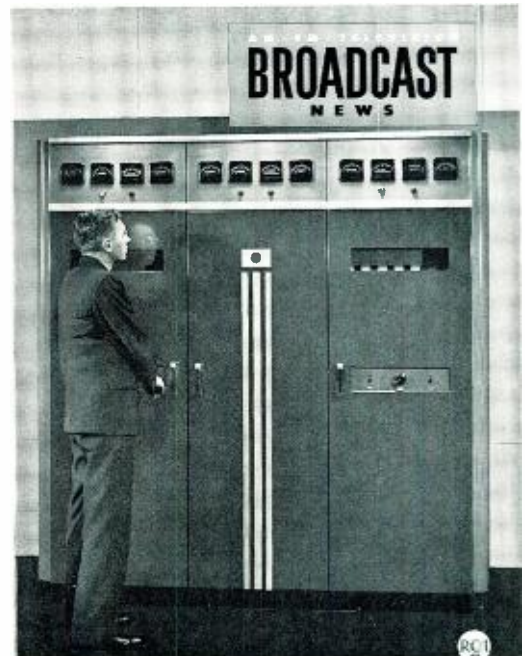

"B" SERIES of RCA FM Transmitters was introduced soon after the war. The RCA BIF-3B Transmitter is shown above on the cover of our January 1946 issue. These were the first transmitters of the new unit-design type. In the mid-fifties RCA introduced its C Series of FM Transmitters, and a few years later the D Series. The newly announced E Series is completely new inside and out but bears heavily on RCA's 25 years of experience in FM Transmitter design.

### *As We Were Saying*

**NEWEST FM EQUIPMENT** is described in this issue. In fact, it's more than new; it's New Look. Our FM transmitters were the first transmitters to be designed in our new look program. As you can see from the cover of this issue (and the old covers above), these new transmitters are smaller, trimmer, and by all odds better looking than preceding designs (although their heritage is plainly evident). They are also all new inside—as the article starting on Pg. 10 will prove. And they provide a degree of performance, reliability and stability not attained before.

**NAB REPRISÉ** starts on Page 26. For those who were not there we have tried to give an idea of how our exhibit looked. But it's not really possible to do this in the small-space, two-dimension and black-and-white of our pages. It seems a little surprising to describe a trade show exhibit as beautiful—but that is the word that best describes it—as most who were there will surely agree.

In a memory that goes back through hundreds of equipment shows this is the first time that we really felt sorry about giving the word, when the convention was over, to start tearing it down.

Usually, by the time the show closes, we are sick and tired of that tenth-acre of carpet. But not this time—this time we hated to see it come down. Others felt the same. Even our Division Vice President, Mr. Colledge, must have felt it—for he spent several hours in the exhibit after it closed. As he said, he was so busy during show hours that he really hadn't had a chance to look at it.

We've received many compliments on our show—and we won't pretend we don't feel good about it. However, in honesty we have to admit that with so many strikingly new equipments it's really not very hard to have a good show. And we certainly had them—everything new from one end of the show to the other. Not since we first showed operating color equipment (1953) have we had so much of interest.

Most of the nice things that were said to us (about the show) were immediately followed by—so what are you going to do next year. We're not too worried. The New Look, as we never tire of pointing out, is a program—and we've just launched it. There's much more to come—and of that more later.



**What is Suzy Parker doing on the cover of FORTUNE?**

The answer is change—radical change. Not necessarily change in FORTUNE—though it is true that the first pretty girl cover after 34 years is something of an innovation—but change in everything: change in science and technology, change in business, change in America.

"Science and industry will advance more in the next 30 years than in all the millions 'race man's' century," says RCA's General David Sarrett in the May FORTUNE.

The lead article of the same issue is titled "The Era of Radical Change." It probes in depth the enormous significance, dangers, and opportunities of rapid change for those whom it will "concern most—American business leaders."

Specifically, the Suzy Parker cover originates from an article on precisely how one great American company, the nation's No. 1 retailer, Sears Roebuck, dealt with the era of change and rose to new heights of business success. The article reveals the inside view of how Sears Roebuck transformed itself from a 19th Century mail order house to one of the mid-20th Century's largest sellers of merchandise. It

required a glamorous girl to make the point properly, about a glamorous and corporate image, and hence Suzy Parker made the cover of FORTUNE.

What does this mean to FORTUNE's 150 advertisers in May? It means that FORTUNE's content attracts the kind of management men who mean business. Who are these men? They can be found throughout management, but always at decision-making levels. They share in common a questing for the tools and techniques, for the information, for the knowledge that will enable them to do their jobs even better. And they share with FORTUNE a constant concern with the future—not just what happened yesterday, but what's going to happen tomorrow.

For they know that they and all of us live in an era of radical change. They know that no product is safe in a changing world. No corporation, however big, is safe. In the era of radical change we all live dangerously and try to our best abilities to communicate and to listen for the potentialities of the marketplace. They know that FORTUNE is their very special associate as the interpreter of change.

**FORTUNE** Time & Life Building, Rockefeller Center, New York, N.Y.  
The Magazine of Business Leadership

This FORTUNE "house ad," explaining the cover of their May issue, appeared in ADVERTISING AGE

**WHAT IS PATRICIA COYLE DOING ON THE COVER OF BROADCAST NEWS?**

We can think of no better answer than that given by FORTUNE in their house ad (above) explaining the cover of their May issue. For those of you who need bifocals FORTUNE'S ad reads, in part:

"The answer is change—radical change. Not necessarily change in FORTUNE—though it is true that the first pretty girl cover after 34 years is something of an innovation—but change in everything: change in science and technology, change in business, change in America."

*As We Were Saying*

Well, thank you, FORTUNE. That's just about what we have been trying to say—and we'd like to borrow the words—"radical change." It's what we think our New Look line truly represents. Not just change in appearance, or change in

engineering, or even change in equipment, per se. But rather "radical change" in our way of thinking about broadcast technical operation—in all of its phases: planning, specifications, installation, operations.

You might think, at this point, that we copied FORTUNE'S cover. (We wouldn't be above it.) But we didn't. Our cover shot was made back in February—and we had not the least idea what FORTUNE was doing. Miles Moon, our associate editor, was given the assignment of getting a cover shot which would symbolize not only the "radical change" of the New Look, but also the resurgence of FM and the boom in stereo. Patricia and her bull fiddle was his answer. We are very happy with it. So FORTUNE had somewhat the same idea—well, that's a good book, too!

**WE SAT** with Sol Taishoff at the NAB luncheon where Chairman Henry was the featured speaker. Sol hardly got to eat for making millions of notes on his advance copy of the speech. No doubt these have, or will, lead to erudite and knowing editorials in BROADCASTING. It's not our field. We're not experts on government relations, or programming, or ratings—or even the "public interest." And normally we carefully avoid these areas. So we didn't make any notes. But one thing the Chairman said keeps coming back to us. It was one of those corny, poignant, slightly exaggerated, somewhat affected, emotional catch-alls that public speakers love. He said:

"For millions of Americans with low incomes, the glow of the TV set is one of life's few lights."

The sophisticated will smirk. And those who know us well may think we're going soft—but, we like what the Chairman said. It seems to us that this single statement explains both the success and the failure of our industry. And perhaps, too, it contains the clue to many of our problems.

**WHO'S ON FIRST?** Just who you would expect. But what you wouldn't expect is all the to-do about it. Someone should tell these boys that singles (or walks) don't win ball games—and it's mighty hard to score from first. According to Earnshaw Cook, writing in the March issue of SPORTS ILLUSTRATED, the chances of a runner who gets on first eventually scoring are 43 per cent if there are no outs, 29 per cent if there is one out, and 14 per cent if there are two outs.

We're up next—with our New Look lineup. And we don't play for singles—we play to score. Run for the hills, boys—the sluggers are coming.

**BRASSBOARD** is a new word in the engineering lexicon—well, anyway, it's new to us. We grew up in the days when lab models were called "breadboards" (and some of them would have

(Continued on Page 44)

**TWO WORLD'S FAIRS ARE SCENES OF TV HISTORY IN THE MAKING**

History in the making was recorded in the top photograph, taken April 20, 1939, when David Sarnoff, then RCA President and now Chairman of the Board, stood before TV cameras and dedicated RCA's pavilion at the 1939 New York World's Fair. The dedication marked the first time a news event was ever covered by television. On that occasion General Sarnoff delivered a speech, entitled "Birth of an Industry," in which he predicted that television one day would become an important entertainment and information medium.

A quarter of a century later history repeats. It is April 2, 1964 and General Sarnoff again stands before the cameras (bottom photograph) at the 1964-65 New York World's Fair. On this occasion the RCA Chairman dedicated the RCA Official



Color Television Communications Center at the Fair with the promise that soon television will be a global service to which all nations can contribute and from which all nations can benefit.

"We have added sight to sound, color to sight, and now space to color." General Sarnoff said at the 1964 event. "There is neither end nor limit to the capacities of this service that began a quarter century ago here in Flushing Meadows."

He noted that "through communications satellites, such as Telstar and Relay, international television signals are moving at the speed of light through outer space. The technical means now exist to give television a new programming dimension that is distinctively global in character."

**NOW IT'S COLOR TV VIA DIGITAL ROUTE**

RCA's Defense Electronic Products activity has developed a color television system which transmits digital signals similar to those used in computers in place of the normal analog signals. The effect is to provide "secure" color television transmission desired by the armed forces and others.

The system converts the analog color TV signals to binary digital signals, which are easy to code or "scramble." The signal is then transmitted, reconverted back to analog at the receiving end, and appears on the television screen in the normal manner.

Another advantage of the system, besides the primary one of security, is the fact that there is no amplitude or phase distortion along the transmission path, which often causes degradation of television pictures.

The system uses a "bandwidth compressor," necessary because in the conversion to digital signals the normal four-million-cycle television signal is increased to 20 million cycles.

Since this is too wide for existing microwave links to handle, the two-level binary signal is converted to a four-level signal

to get the bandwidth down to 10 million cycles.

RCA is studying eight- and 16-level transmission which would provide 3-to-1 and 4-to-1 bandwidth reductions, respectively, but high signal-to-noise ratios are required for these conversions.

The present RCA system does not use a scrambling or coding device. It consists of the Analog-to-Digital Converter and Bandwidth Compressor at the transmission end, and a Bandwidth Decompressor and Digital-to-Analog Converter at the receiving end. The system is therefore fully compatible with NTSC standards.

## TALL TEXAS TALE TELLS US OF SIX ON A TOWER

A candelabra broadcasting tower rising 1521 feet into the Dallas-Fort Worth area sky soon will radiate programs from three TV and three FM stations, a record number for structures of this type.

The sky platform, now used by two TV and two FM stations, additionally will become the site for broadcast antennas of WBAP-TV and WBAP-FM of Fort Worth under contracts signed with the RCA Broadcast and Communications Products Division.

First of the candelabra type, the tower was erected in 1955 near Cedar Hill, Texas, a community about equidistant from Dallas and Fort Worth. It originally supported the antennas of WFAA-TV and KRLD-TV, both of Dallas, which were installed 75 feet apart at two of the structure's three corners.

The pioneer candelabra was an RCA project from its inception, with RCA's antenna design group running exhaustive tests, in advance of installation, to make sure the two TV antennas would not interfere with each other. The original antennas, as well as all subsequent installations, were supplied by RCA.

In 1961, the platform's third corner was occupied by antennas of FM stations, operated by the two Dallas broadcasters, WFAA-FM and KRLD-FM. The two antennas were mounted on the same pole, a "first" in FM broadcasting. The WBAP-FM antenna will be mounted on the tower, below the triangular platform.

WBAP's transmitting facilities now are located at its studio, 3900 Barnett Street, Fort Worth. Moving them to the tower site will improve the station's coverage in Dallas and environs, according to WBAP officials.

Because the available tower space for TV antennas is fully occupied, WBAP-TV will share with KRLD-TV a common diplexed antenna capable of radiating the signals of two TV stations simultaneously. The common antenna system was introduced in this country by RCA and currently is used by two Rochester, N. Y., broadcasters, WROC-TV and WHEC-TV.

The system's key element is a broad-band diplexer which combines the stations'

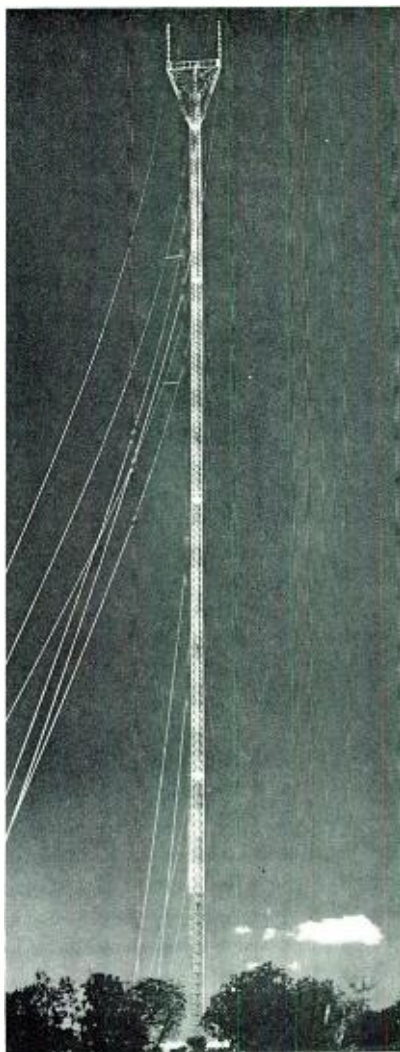

Majestic Hill tower wears candelabra like a crown.

four signals (two video, two audio) and transmits them at the assigned frequencies.

Other candelabra-type towers, each shared by three television stations, are located near Baltimore and at Walnut Grove, Calif., covering the Sacramento-Stockton viewing area. The design offers broadcasters who agree to use the same antenna location the advantages of equal height, the economies of a common tower and single-site erection and construction costs.

An open-air elevator inside the tower's metal framework lifts maintenance men to the 1500-foot-high perch where they can step out on the platform and walk to the base of each antenna.

## CBS-TV ORDERS 9 TR-22s, MAKING TOTAL BUY 21 QUALITY RECORDERS

The Columbia Broadcasting System has ordered nine more TR-22 TV tape recorders, bringing its total purchases to 21 machines. The initial order included ten of the RCA deluxe recorders for the new CBS Broadcast Center in West 57th Street, New York, and two others for the network's Washington, D.C. news program facility at 2020 M Street.

CBS officials said the nine additional recorders would be installed in the CBS Broadcast Center which will gather under one roof the network's numerous broadcasting operations scattered throughout New York City.

The TR-22, which also is used by the NBC and ABC television networks, is the first TV tape recorder to be fully transistorized. Since deliveries began late in 1962, more than 250 units have been shipped to broadcasters and other TV tape users in this country and abroad.

## KIII CALLS ON COPPER CLAD FEED LINES TO CLOBBER CORROSION

KIII, a new Channel 3 station in Corpus Christi, Texas, will become the nation's first broadcaster to use copper-jacketed Styroflex feed lines in its transmitting facility. About 900 feet of the newly-designed lines will be required for its RCA Superturnstile antenna which is mounted on an 810-foot tower.

Use of a copper covering for feed lines is expected to improve TV antenna operating reliability, particularly in areas like the Gulf Coast with heavy concentrations of salt and other corrosion-causing elements in the atmosphere.

Protection of feed lines in this manner means that Superturnstile antennas can now be supplied entirely with corrosion-resistant materials. Broadcasters in other seacoast areas also have expressed interest in the new development.

KIII's custom-built antenna was fabricated at the RCA Broadcast and Communication Products Division's facilities in Camden, N. J. It also was tested there and partially disassembled for shipment to the Texas station.

**'BIG RED' MR. K (FOR KLYSTRON) GETS PLAY FOR TV TRANSMITTER**

An attention-getter at the recent N.A.B. convention was RCA's new 30-kw UHF television transmitter, the TTU-30A. One reason for the clamor was the unit's big, red-painted klystrons. They're the vapor-cooled type that contribute to the transmitter's efficiency and lower its operating cost. In fact, demonstrators at the RCA exhibit were quick to point out that the TTU-30A is the first broadcast transmitter to use vapor-cooled klystrons as power amplifiers.

Another eye-catcher at the transmitter display was the nifty revolving carriage for a quick change of klystron tubes. The carriage was developed by RCA transmitter engineers who, on dull afternoons, ran through time trials with all the zeal of submarine crew firing off a Polaris missile.

The tilt-down klystron change system is not just faster than the old ungainly overhead crane method. There's no need for



First TTU-30A to WIHS-TV, Boston. Shown with it at 1964 NAB are (left) Msgr. Walter L. Flaherty, Director, Boston Catholic Television Center; Austin Harrison, Center's General Manager, and E. C. Tracy of RCA.

extra-high headroom and the transmitter room remains at normal size.

First to sign for the TTU-30A, as the accompanying photograph shows, was WIHS-TV, the Boston station which will

be operated by the Boston Catholic Television Center, Inc. The Center is getting its transmitting plant in shape to go on the air late this summer and recently took delivery of an RCA directional antenna.



**LEM LANDING ON LUNAR SURFACE WILL CARRY RCA COMMUNICATIONS GEAR CLEAR TO MOON**

RCA has begun work on a \$22 million contract from Grumman Aircraft Engineering Corporation for the communications subsystem of the Lunar Excursion Module (LEM), the spacecraft that will carry two of our astronauts to the moon's surface. This is the second contract awarded RCA by Grumman, prime contractor to the National Aeronautics and Space Administration.

As subcontractor to Grumman, RCA has responsibility for the LEM communications subsystem, the radar subsystem, portions of the stabilization and control subsystem, and ground support equipment.

The communication subsystem will provide communications links between LEM and the earth, between LEM and lunar orbiting Command Module from which LEM will descend to the surface, and, after the landing is achieved, between LEM and the astronaut walking on the moon.

Continuous voice and telemetry data will be sent to earth by the communications subsystem except while the LEM spacecraft is on the far side of the moon.

Voice links between the astronauts in their space suits as well as between LEM and the Command Module also will be provided. Design requirements call for maximum utilization of advanced solid state circuits to obtain extreme light weight and high reliability for the equipment.

Under present plans for Apollo, LEM will be one of three modules of the Apollo spacecraft which, linked together, will be placed in orbit around the moon prior to the landing. The other two modules are known as Command and Service modules. During the moon orbit, two of the three astronauts will pass from the Command Module into the Lunar Excursion Module which will then be detached for the descent to the moon's surface.

After landing and when the mission's engineering and scientific tasks have been completed, LEM will be launched from the moon for rendezvous with its orbiting parent modules. Its two astronauts will re-enter the Command Module for return to earth, and LEM will be left to circle the moon as a permanent satellite.



## NEW 10-13 KMC MICROWAVE SYSTEM FOR TV RELAY ANNOUNCED

A new wide-band FM microwave relay system for high-quality transmission of color or monochrome signals in the 10.5 to 13.25 KMC frequency range has been added to RCA's line of commercial broadcast equipment. Known as type TVM-3B, the system provides exceptional broadband frequency coverage and transmission fidelity and is packaged for either rack-mounting or portable applications.

Transmitter power of 350 milliwatts is

generated by a new type klystron with an inherent frequency stability common to most low-band reflex klystrons. The equipment dependability thus afforded in the 10-13 KMC range is achieved without resort to AFC circuits. The new RCA system meets both CCIR and EIA performance standards for monochrome and color TV transmission. Differential phase of 0.3 degrees and differential gain of 0.1 db per hop are provided.

The 30-megacycle intermediate frequency bandwidth in the receiver allows for tuning error while helping to maintain optimum phase response and system linearity. The system's amplitude frequency response, flat within 0.5 db from 60 CPS to 7 MC, permits simultaneous operation of up to three sound channels in conjunction with the main channel. RCA TV microwave gear also is available for operation in the 2 KMC and 7 KMC bands.

## RETTINGER HEADS NEW ACOUSTICAL CONSULTING SERVICE AT DIVISION FACILITY IN BURBANK

A new acoustical consulting service, under the direction of Michael Rettinger as engineer in charge, has been announced by the Burbank, California, facility of the RCA Broadcast and Communications Products Division. The service, previously available only to users of RCA film recording equipment, is being extended to include architects, builders and others requiring professional counsel in acoustics.

Mr. Rettinger has designed studios for motion picture companies, radio and TV stations, disc recording firms and theaters. He was responsible for the acoustical design of the Cinerama Center Theatre opened last year in Hollywood. He has made acoustic analyses of scoring stages, review rooms and other facilities for Columbia Pictures Corp., Paramount Studios, Republic Studios, Revue Productions,

Twentieth Century Fox and Walt Disney Studios.

A graduate of the University of California at Los Angeles, Mr. Rettinger holds a master's degree in physics. He joined the RCA Engineering Department in Hollywood in 1936 and participated in the development of microphones, loudspeakers, headphones, magnetic heads for sound film recording, and other equipment. He is a member of several professional societies and has written two books and many articles on acoustics.



RCA's color TV mobile unit, photographed here between assignments, ranges over World's Fair grounds to capture the action.

# RCA transistorized audio

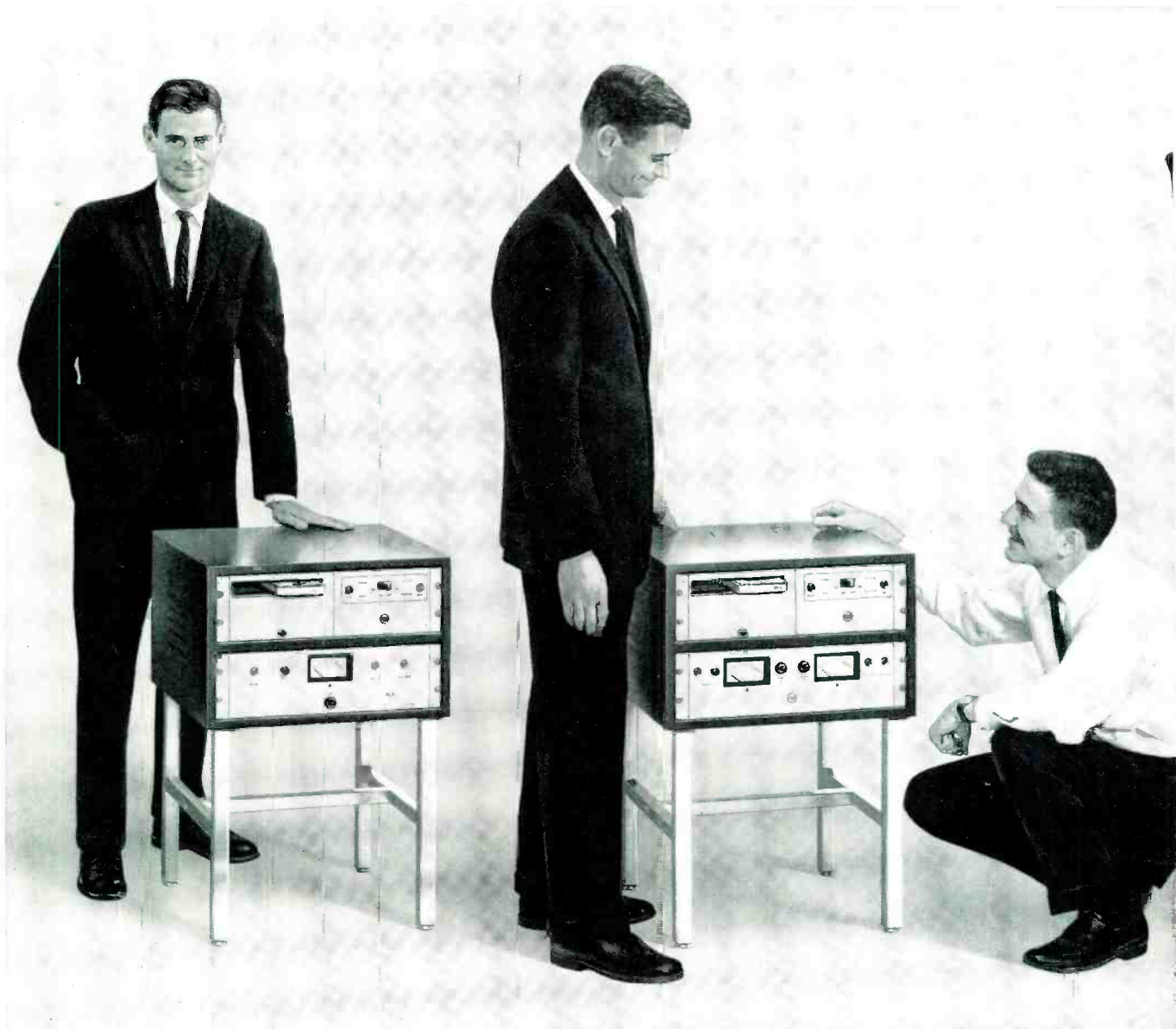

## Monaural Cartridge Tape System . . . RT-17

With silent, automatic operation, compact, distinctive styling and high quality sound reproduction. Three cue tones include a "trip cue" for automatically triggering other equipments capable of being remotely started (in both this and the RT-37 stereo system). Remote control recording and playback.

## Stereo Cartridge Tape System . . . RT-37

Has all the convenient record/playback features of the BT-17. Handles voice and music with unmatched realism. Adds new stereo believability to recorded material. Also provides remote control recording and playback.

**Get all the facts** about the RCA line of transistorized audio tape recorders. Call your RCA Representative. Or write RCA Broadcast and Television Equipment, Building 15-5, Camden, N.J.

# tape recorders

---

## STEREO MONAURAL

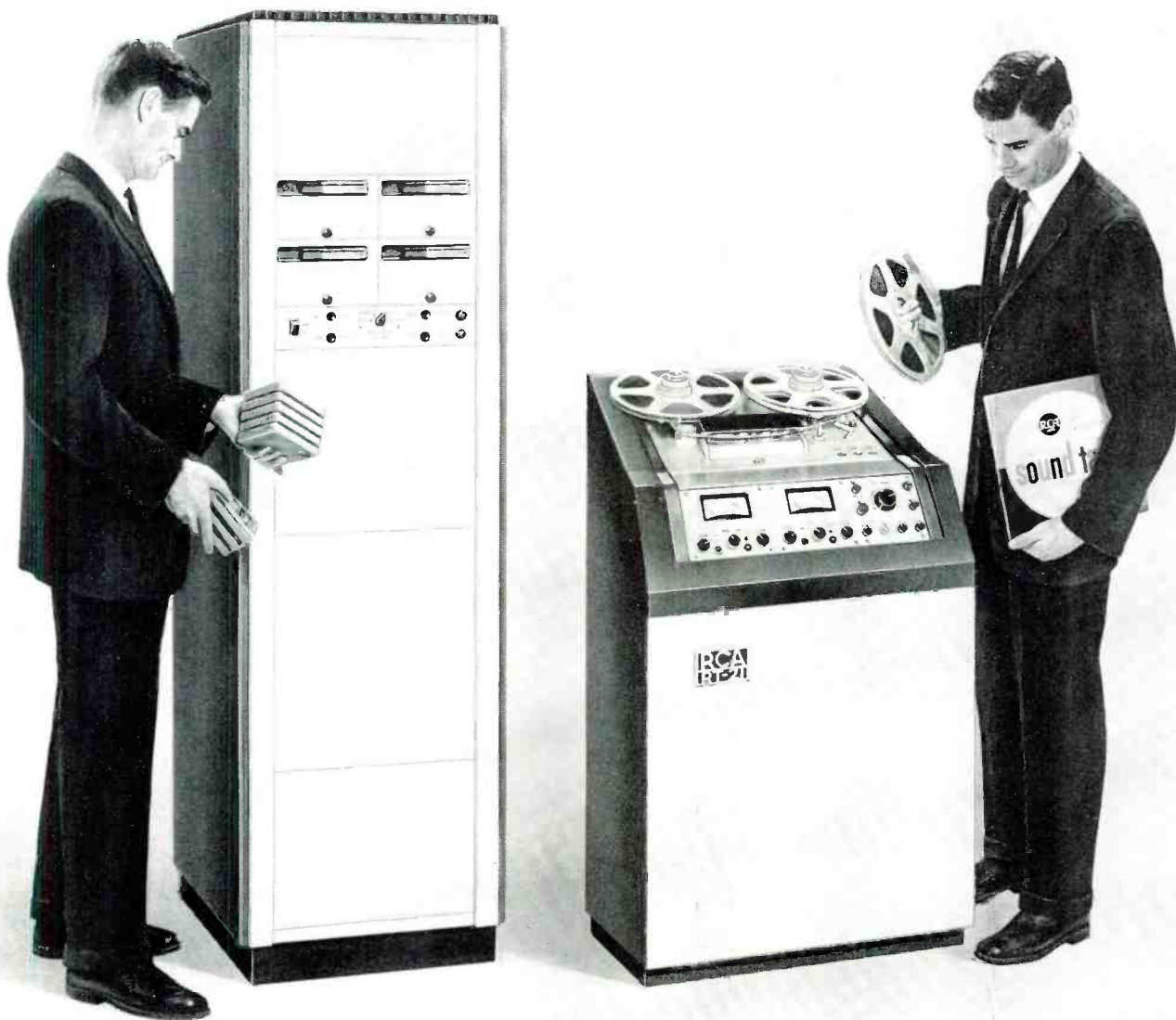

### Multiple Cartridge Playback System . . . RT-8

For handling quantities of tapes. Can be operated manually, sequentially, or by pulses supplied from an automation system. Each unit houses four plug-in cartridge decks which can be stacked in systems of 8-12-16 or more units. A random trip cue feature is optional.

### Professional Audio Recorder . . . RT-21

Quality to meet the most critical requirements. Also simplified operating features. Variable speed control for quick cueing of tapes, an optional fourth head for special playback use, rugged construction for smooth reeling and braking. Console, portable, or rack mounting—stereo or monaural.



**The Most Trusted Name in Radio**



FIG. 1. RCA Full Fidelity BTF-20E 20-KW FM Transmitter.

## BEHIND THE FULL FIDELITY SOUND OF RCA'S "NEW LOOK" FM TRANSMITTERS

Styling Innovations are  
Combined with Unique  
Design Features

by WILEY D. WENGER, *Mgr.*  
*Broadcast Transmitter*  
*Merchandising*

RCA's new 5, 10 and 20 kilowatt FM transmitters bring to the FM broadcaster an equipment that is not only exciting and strikingly new—but also one that supplies an unusual experience in full fidelity sound. Designed since the advent of FM-stereo, these transmitters give excellent perform-

ance in stereo and multiplex as well as monaural FM; they are not conversions, but actually designed for stereo duty.

### Simplified Circuits

One important feature of the new transmitters is the entirely new exciter. This unit retains the successful "direct FM" system used in all RCA FM transmitters from the very first, but accomplishes frequency modulation of the oscillator in a new and more efficient way. There are no series or cascaded modulators to be adjusted.

Intermediate amplifier and power amplifier stages feature new tube lineups. They are also much simpler than previous designs. All circuits—from the exciter through the IPA and PA stages are single tuned. This simplifies operation, and eliminates the possibility of poor frequency response due to improper adjustment of double-tuned circuits.

### Less Components—Better Accessibility

These new transmitters introduce several FM firsts. They use far less (in some cases half as many) tubes, transistors, diodes

FIG. 2. All three transmitters—5, 10 and 20 KW—use same attractive cabinet, employ only two simple r-f stages following exciter. Optional FM stereo generator shown below exciter (at lower left).

and other components than any existing FM transmitter. No FM transmitter of comparable power has fewer parts or better accessibility. The 5 KW can be made to double—even quadruple—output power without changing or adding transmitter cabinets. This last feature can be valuable to those wishing to substantially increase power to feed a vertically polarized antenna system in addition to the usual horizontally polarized system.

**Easier, More Dependable Operation**

The overall effect of these design changes is to make these new transmitters much simpler, far easier to tune and operate, and more certain of providing high fidelity performance even under the most difficult stereo and multiplex conditions.

From experience, the less complicated the transmitter the better its operating dependability. The goal for RCA's new "E-Line" of transmitters was an operational simplicity that consisted of little more than "pushing the ON button in the morning and the OFF button at night."

**Power Expansion**

All three RCA FM transmitters, the 5 KW BTF-5E, 10 KW BTF-10E and 20 KW BTF-20E are housed in identical enclosures—a single, double-door cabinet with a new space blue and horizon blue textured vinyl finish trimmed in satin aluminum. All utilize the same novel and extremely simple exciter.

The basic design of the RCA E-Line is a 20 KW transmitter. Thus, r-f components, vacuum capacitors, tuned circuits, screen supply and other components are furnished for use at 20 KW output power. For this reason, the field modification of a 5 KW or 10 KW unit to a higher powered unit requires changes only in the basic power determining parts such as the final amplifier tube, unitized power supply and necessary metering. The conversion of a BTF-5E to a BTF-10E or to a BTF-20E can be accomplished as a field modification by exchange of the components provided.

**Remote Control**

Remote control requirements are built in, and terminals are provided for metering, power control and overload reset so that connection is easily made to optional remote control units such as the RCA BTR-11B or BTR-20B systems. Optional automatic logging equipment can be connected to the terminals provided for remote metering and controls.

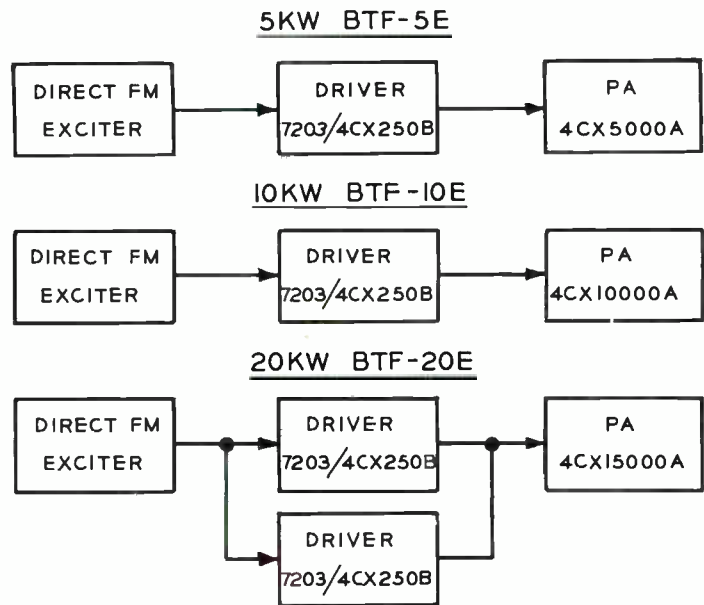

FIG. 3. Block diagrams show simplicity of three RCA FM transmitters.

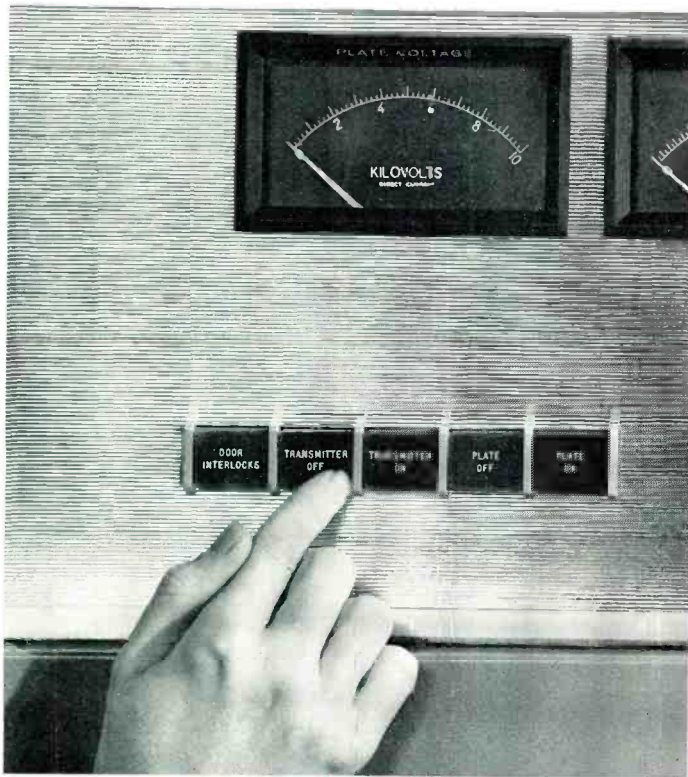

FIG. 4. Illuminated finger tip controls and tallies give instant circuit status.

ture areas of the r-f cabinet, providing cooler operation. Another important consideration is that it permits locating the power supply near the power source so that heavy primary power leads can be kept to minimum length. Power supply filter components are mounted in the transmitter.

#### Advanced BTE-10C Exciter

The BTE-10C FM Exciter is the heart of the new line of FM transmitters. It is the simplest exciter ever offered, with only nine tubes, four of which are r-f tubes, four are in the AFC circuit and one is a voltage regulator. Figure 11 is a block diagram of the new exciter.

An ultra-stable FM oscillator which is temperature compensated and plate-voltage regulated operates at one-half carrier frequency (44 to 54 mc). Therefore, less spurious signals are generated within the system. The oscillator is followed by a buffer, a doubler and a ten watt Class C amplifier utilizing a single-ended, long life tube. All circuits are single-tuned, avoiding the problems in frequency response that arise from double-tuned circuits. Tune-up is straightforward, and is easily accomplished without special test equipment. A built-in multimeter and easily ac-

#### Centralized and Illuminated Controls

Full metering is provided by five easy to read panel meters mounted at convenient eye level together with large, clearly marked multimeter selector knobs. Grouped under the metering panel on both sides of the multimeter knobs are finger tip illuminated controls and tally indicators providing an instant and visible indication of transmitter circuit status. (See Figs. 4, 5 and 6).

#### Unitized High Voltage Power Supply

The high voltage plate transformer together with a plug-in silicon rectifier bank, a line circuit breaker and plate contactor are located in a separate cabinet to permit installation in the basement, closet or other unused area away from the transmitter room as some broadcasters prefer (See Fig. 7.)

Silicon rectifiers are ideally suited for this type of duty because they can't be "frozen" out as can mercury-vapor-tube types. Thus, the place where the transmitter is installed need not be a heated area.

This separate power supply results in a more readily accessible transmitter. It also removes the rectifier from high tempera-

FIG. 5. Multimeter selectors clearly indicate functions being read.

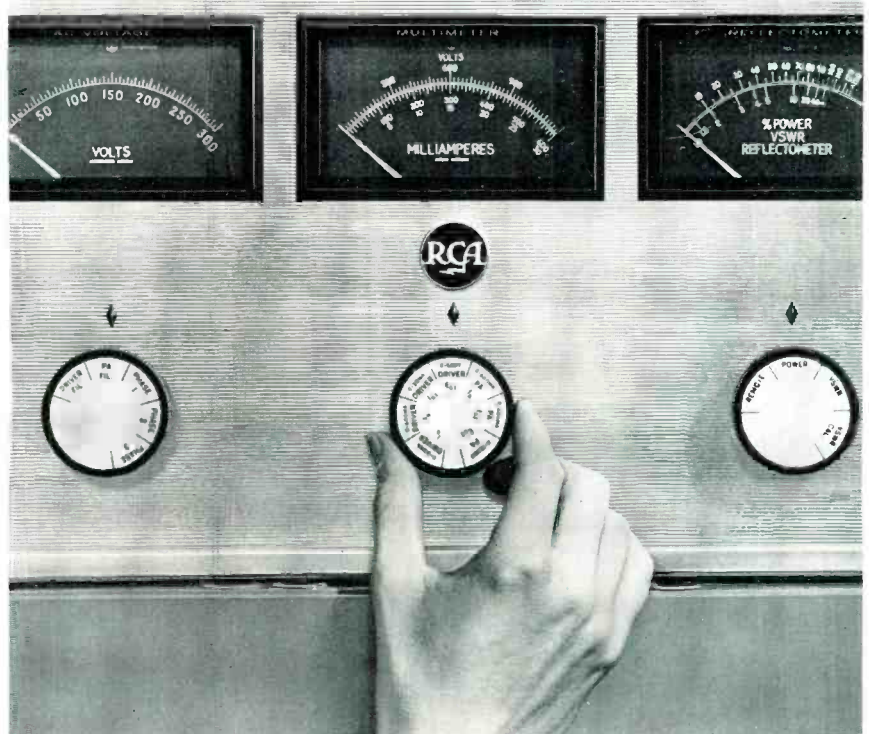



FIG. 7A. Separate unitized power supply contains line breaker, plate contactor and plug-in silicon rectifier.

FIG. 7B. Close up of plug-in silicon rectifier.

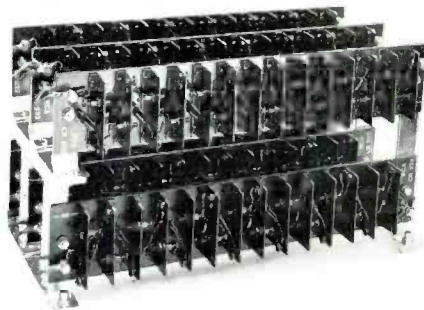

FIG. 6. Illuminated controls and tallies on right side of meter panel include overload indicators, reset and power control.

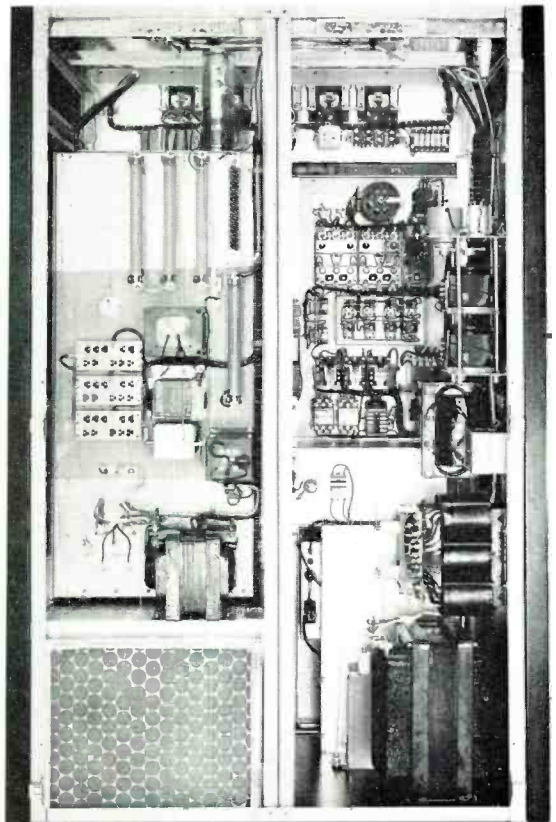
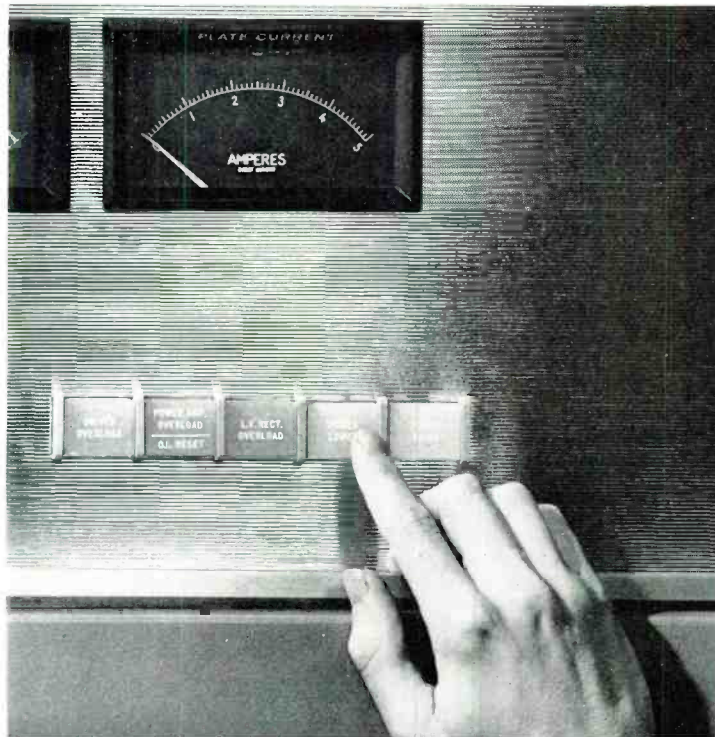
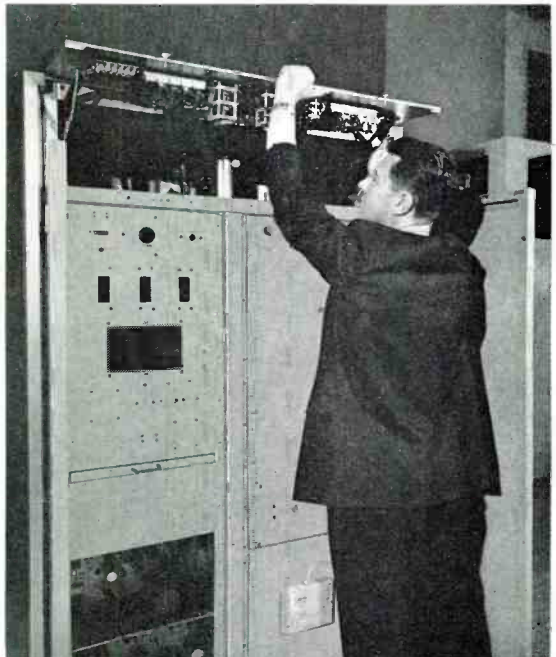

FIG. 8. Doors removed from rear of transmitter showing high voltage filter (lower right), relays and motor-driven power output control above. Low voltage power supply is at left above air filter. At top left is 3 1/2-inch reflectometer and output line.

FIG. 9. Transmitters feature easy access to all areas including rear of meter panel as shown. In addition, exciter chassis (lower left) swings outward by pulling handle, exposing connections to rear of unit.



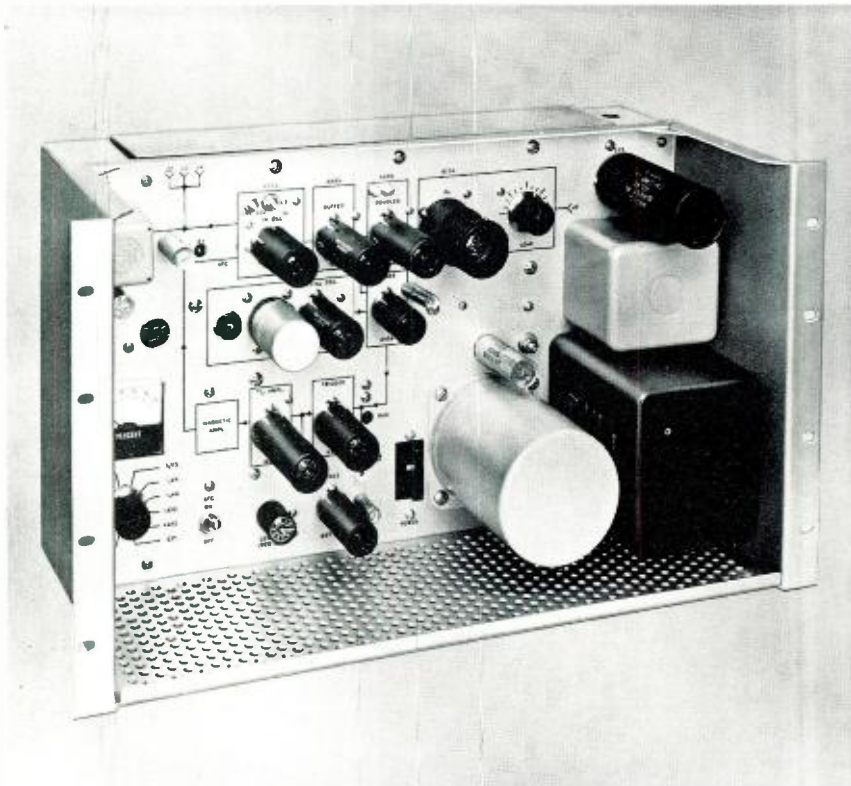

FIG. 10. Besides simplicity, BTE-10C FM Exciter features exceptionally wide temperature operating range. Power supply and test multimeter are built in.

cessible test points allow metering and checking during operation.

A novel circuit in the exciter employs capacitive diodes as modulators, and separate modulators are used for monaural or stereo and the SCA channel. This lessens the possibility of crosstalk between the two. The SCA diode modulator is also used for AFC control of oscillator frequency.

#### Precision AFC Without Tuned Circuits

Frequency of the FM oscillator is precisely controlled by a unique AFC system using no tuned circuits, relays or thyatrons. Shown in the simplified diagram of Fig. 11, this AFC employs only four tubes with a diode counted detector and magnetic d-c amplifier. It is a *go, no go* device, and off-frequency operation is prevented automatically. The crystal is a small plug-in unit that is not extremely sensitive to temperature. Should AFC fail, the exciter will operate for hours on end with easy manual control.

Output from the FM oscillator at half final frequency is fed into a mixer together with a second frequency from the crystal oscillator operating at 130 kc above the

#### REGULATED PLATE VOLTAGE SOURCE FOR STABILITY

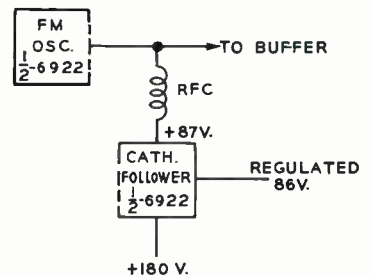

FIG. 12. FM oscillator utilizes one-half of a 6922 dual tube. The other half of the 6922 is effective as a cathode follower voltage regulator to improve oscillator stability.

modulated oscillator frequency. The resultant beat of 130 kc is converted to a square wave in a Schmitt trigger circuit and clipped to make the following counter-detector independent of possible amplitude variations. Since the counter detector has a 130 kc crossover frequency an error signal will be obtained with any frequency departure from the 130 kc square wave. This error voltage is amplified by the mag-

FIG. 11. Block diagram of complete BTE-10C Exciter showing r-f and AFC portions of circuitry.

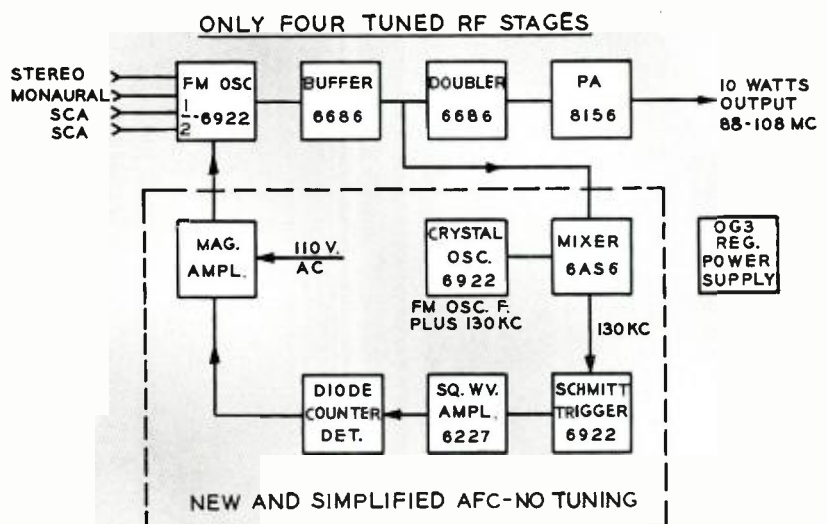
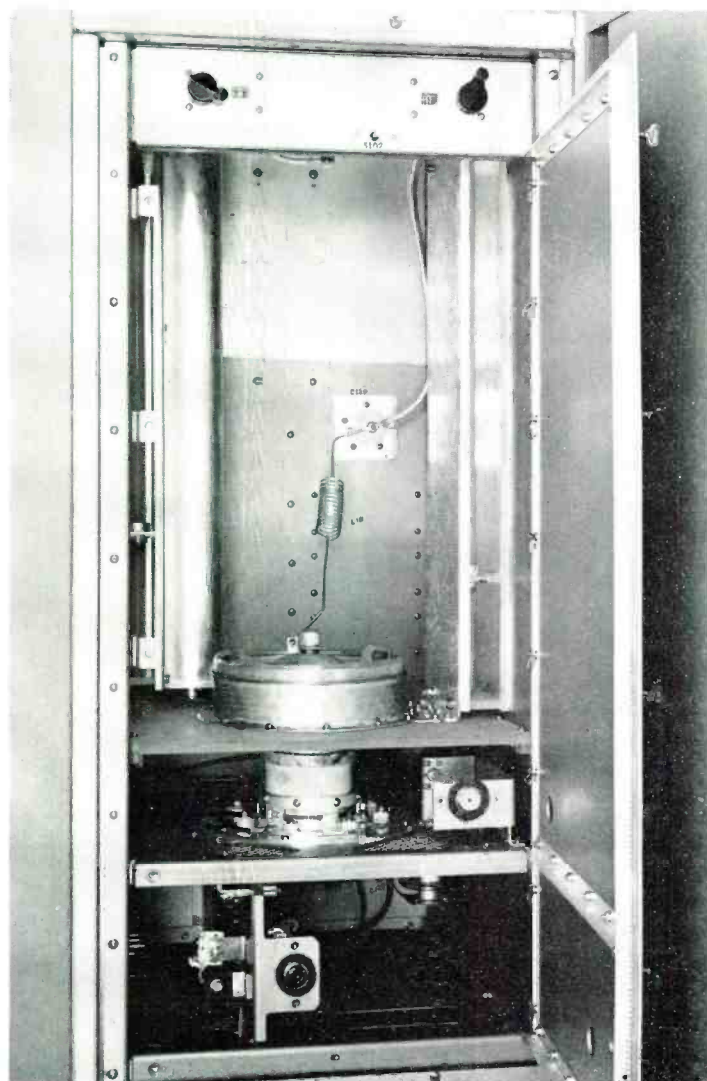



FIG. 13. Type BTR-20C Remote Control unit is normally located in input and monitoring rack, shown below. Other units, top to bottom, are TBM-3000 carrier frequency monitor, BW-73A multiplex modulation percentage monitor, and BW-74 adapter for use with multiplex monitor to check transmitter stereo performance.



FIG. 15. View of r-f box showing PA tetrode (center) and inductive "tuning" and "loading" output lines and counter-indicator controls above at left and right. Interstage pi-network vacuum capacitors are mounted below PA tube.



SEPARATE MODULATORS  
REDUCE POSSIBILITY OF CROSSTALK

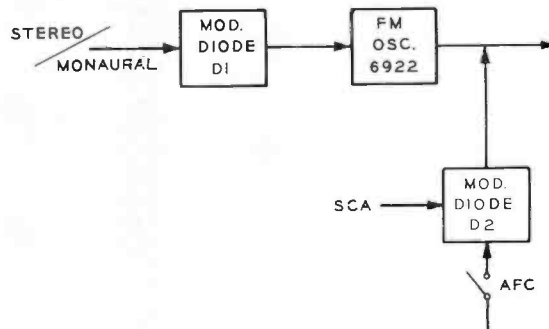
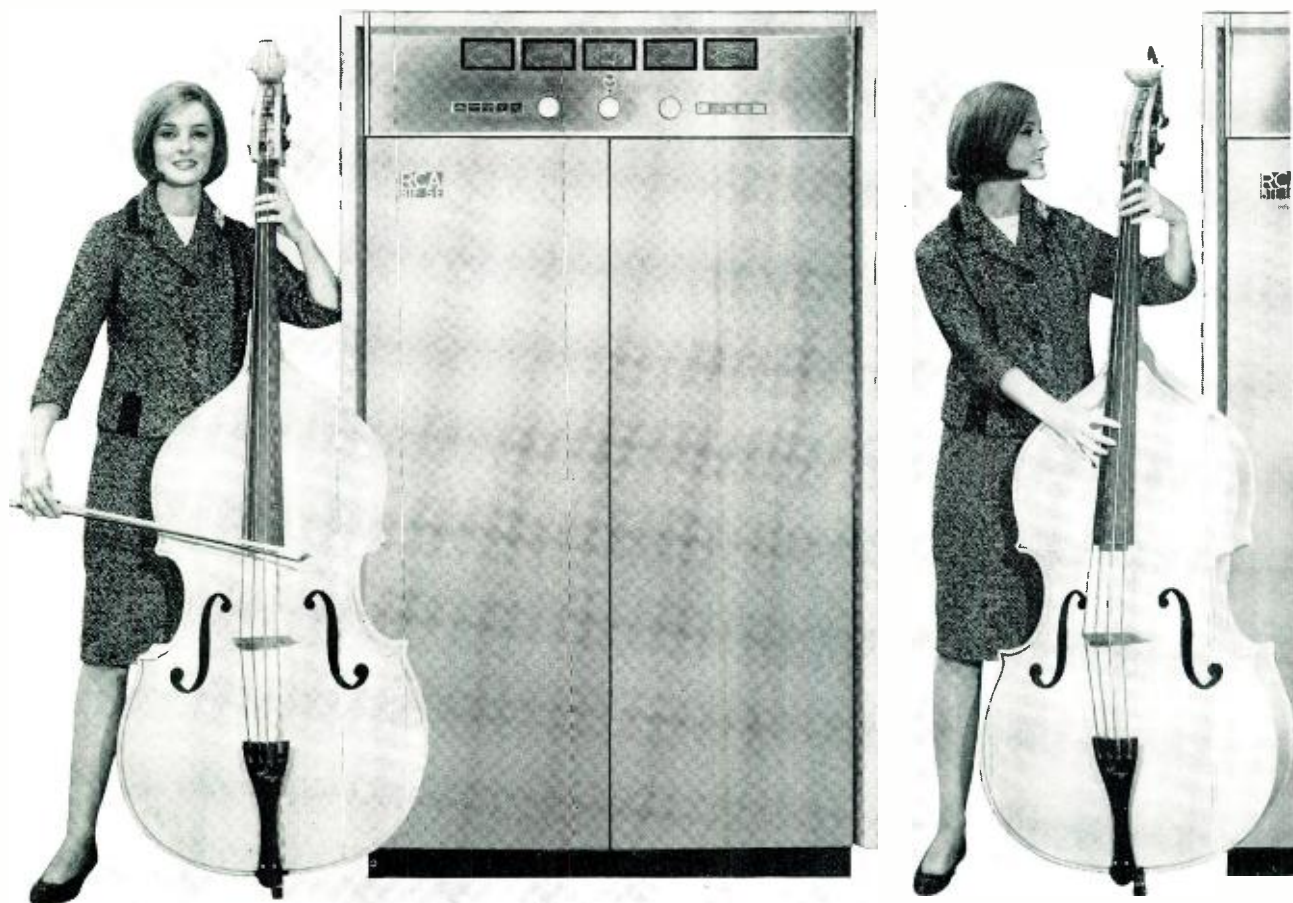

FIG. 14. Stereo/monaural and SCA programming are fed to independent diode modulators to provide utmost isolation between channels.

# THE FINEST FM TRANS



NEW BTF 5E 5KW

netic amplifier and fed to the capacitive diode (see D2 in Fig. 14) which corrects the oscillator frequency. The AFC open loop gain is about 100, and the control range is from +500 kc to -1,000 kc. Operating ambient temperature range of the exciter -20C. to +45C., which permits remote operation with very little or no heat in the transmitter room.

#### Single-Ended Class C Driver and PA

The only two stages following the exciter—the IPA and PA stages—are single-ended. Class C amplifiers. Both these stages utilize pi-network input and output

circuits for maximum harmonic attenuation. The interstage network is tuned by vacuum capacitors, and the power amplifier output is coupled to the harmonic filter through a pi-network utilizing variable line inductances, operating at ground potential for maximum safety. Strict avoidance of critically tuned circuits contributes much to the simplicity and stability of the amplifiers. IPA and PA tubes are both conservatively operated air-cooled ceramic tetrodes.

#### Harmonic Filter Supplied

As standard equipment, each transmitter is furnished with a high grade copper

alloy harmonic filter to keep spurious emission to a minimum. For the BTF-5E and BTF-10E transmitters, a  $3\frac{1}{8}$ -inch type is supplied, and  $6\frac{1}{8}$ -inch for the BTF-20E. Filters consist of an M-derived "half-T" sections, several low pass filter sections and a constant-K, "half-T" section. Additional attenuation provided by the filter is 30 db through the seventh harmonic.

#### Other New Features

Several other features of the new design include a lower transmitter height of only

# MITTERS EVER DESIGNED



NEW BTF 10E 10KW

NEW BTF 20E 20KW

77 inches. Circuits are fully protected against overloads. In addition, a latching relay automatically re-applies power to the transmitter once before locking-out in the event of transient overloads or power interruptions. Cooling for the transmitters is by a single blower which draws air through two filters located below the amplifier stages. A manometer on the transmitter monitors the air flow through the filters and indicates when the air drag is high and the filter should be replaced. Power output is easily controlled by a motor-driven variable transformer which simultaneously

controls the screen voltages of the driver and PA tubes.

#### Conclusion

In summary, the 5E/10E/20E transmitters are the finest FM equipments developed to date: An exciter without peer; outstanding operational simplicity; modern cabinet styling; separate high-voltage power supply; readiness for remote control and automatic logging; self-correcting functions; true frequency modulation; power upgrading of the 5 and 10-kw systems—these are but some of the features of the new line of FM transmitters.

# MONITORING FM STEREO TRANSMISSIONS

by HOWARD J. SHAY, *Broadcast Transmitter Engineering*



FIG. 1. The BW-74 extends the usefulness of any FM modulation monitor and is particularly designed for use with the RCA BW-73A shown on page 20.

The BW-74 FM Stereo Monitor Adaptor has been developed as a companion instrument to the BW-73A FM Multiplex Monitor to assure proper transmission for FM stereo programs. Realizing the complexities of stereo broadcasting and the problems encountered in assuring proper setup, the BW-74 is designed to afford maximum testing and monitoring versatility to the broadcaster. Thus, the adaptor can be driven either directly from the stereo composite generator, or from a high quality main-carrier demodulator, such as the BW-73A.

The functional lineup of the BW-74 is pictured in the block diagram, Fig. 2. A high-impedance isolation amplifier in the input prevents source loading for short cable runs. The output from this stage provides the composite signal at a front panel jack and drive for a second amplifier. This composite signal amplifier drives a balanced phase-splitter and a selective pilot amplifier through a high-Q tuned circuit.

The output from a second stage of pilot amplification is rectified and sensed for

pilot injection measurement, stereo beacon indication, and the automatic oscillator-defeat circuit. Additionally, the output of the first stage of pilot amplification is rectified full-wave. The resultant pulses are used to synchronize a push-pull oscillator to reestablish the stereophonic subcarrier.

The oscillator drives a balanced, synchronous demodulator in which the stereophonic subchannel is demodulated. The demodulator employs the time-division-multiplex concept. The L — R information is matrixed with the main channel to produce the left and right stereophonic channels. From this point separate audio amplifier chains process the signal for meter and aural observation.

The stereo signal is analyzed and the salient characteristics may be observed at various output points. The composite signal is made available from a low-impedance source and can be used as a signal source, for 'scope observation, for pilot-frequency measurement, etc. The left and right stereophonic channel meters are dynamically damped to meet FCC specifications for modulation meters.

During periods of monaural transmission, the time-division-multiplex (TDM) subchannel demodulator is automatically disabled. The meters and audio outputs will, however, exhibit the left and right signals to afford continuous monitoring.

## BW-74 SPECIFICATIONS

### COMPOSITE INPUT

Impedance: 2 megohms  
Sensitivity: 1 to 2.5 volts p-p

### OUTPUTS—LEFT AND RIGHT

#### Audio

Monitoring Circuit:  
Source Impedance: 600 ohms bal.  
Level: 1 volt

Distortion Meter Circuit:  
Source Impedance: 20,000 ohms  
Level: (at 100% modulation) 4 v.  
Frequency Response (30-15,000 cps):  
±0.5 db max.<sup>1</sup>

Distortion (30-15,000 cps):  
1.0% max.  
Noise Level: —65 db max.<sup>2</sup>

#### Composite Output:

Source Impedance: 500 ohms  
Level: 0.75 to 2 volts  
Frequency Response (20-100,000 cps):  
±0.2 db  
Distortion: 0.25% max.

#### Stereo Phones Output:

Source Impedance: 20,000 ohms  
Level: 2.0 volts

### MODULATION INDICATION— LEFT OR RIGHT

Accuracy: 5%  
Frequency Response (30 to 15,000 cps):  
±0.5 db

### PILOT INJECTION

Accuracy: ±1%  
Range: 6 to 10%

### SEPARATION

Left to Right: 40 db 30-15,000 cps  
Right to Left: 40 db 30-15,000 cps  
67 kc (SCA) into Left Channel: 65 db  
67 kc (SCA) into Right Channel: 65 db

### POWER REQUIREMENTS

105-125 volts AC, 50/60 cps, single  
phase, 85 watts

### FUSE

1 amp, Slo-Blo

### AMBIENT TEMPERATURE RANGE

0 to 45° C.

### OVER-ALL DIMENSIONS

Height: 8¾"  
Width: 19"  
Depth: 11"

### MOUNTING

Standard 19-inch rack

### WEIGHT

40 Pounds

<sup>1</sup> Audio frequency response referred to 75 microsecond de-emphasis curve.  
<sup>2</sup> Referred to 90% modulation, at 400 cps.

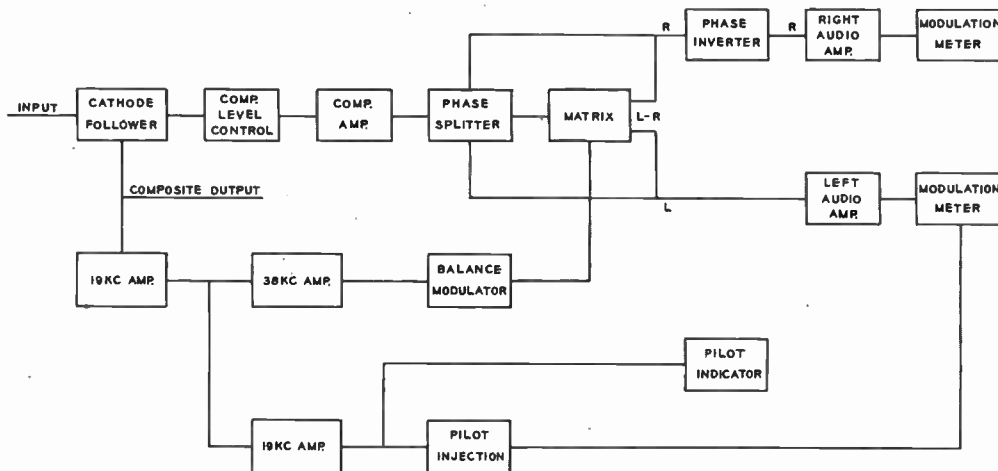

FIG. 2. BW-74 functional diagram. Receiving a demodulated signal, the monitor separates the left-and-right audio plus the pilot. See text.

The stereo beacon light allows immediate observation of the modulation mode. Since the light is energized only upon the presence of pilot subcarrier, it will remind the broadcaster to turn off the pilot subcarrier during periods of monaural transmission. In the RCA Type BTS-1A Stereo Subcarrier Generator, this can be accomplished by remote control.

The pilot injection level may be observed by meter presentation. The measuring accuracy is  $\pm 1$  per cent. It is important to the broadcaster that the pilot-subcarrier modulation level be maintained constant since some of the receiver adaptors are critical to injection level. Additionally, separate left-and-right-stereophonic channel outputs are made available for stereo headphone monitoring, studio line connections, and distortion-meter connection.

### Proof-of-Performance Measurements

Compliance of the transmission in accordance with FCC standards may be checked as follows: (Paragraph lettering is that used in the FCC Ruling on FM Stereo Broadcasting, and reference is made to the measuring setup shown in block diagram in Fig. 3.)

#### Section 3.322 Stereophonic Transmission Standards

(b) Pilot injection is metered directly in the BW-74. The FCC limits are 8 to 10 per cent.

Pilot frequency may be measured externally from the composite signal source using a frequency counter. The pilot subcarrier must be 19 kc  $\pm 2$  cycles.

(c) Correct polarity of the stereophonic subcarrier will be obtained when the

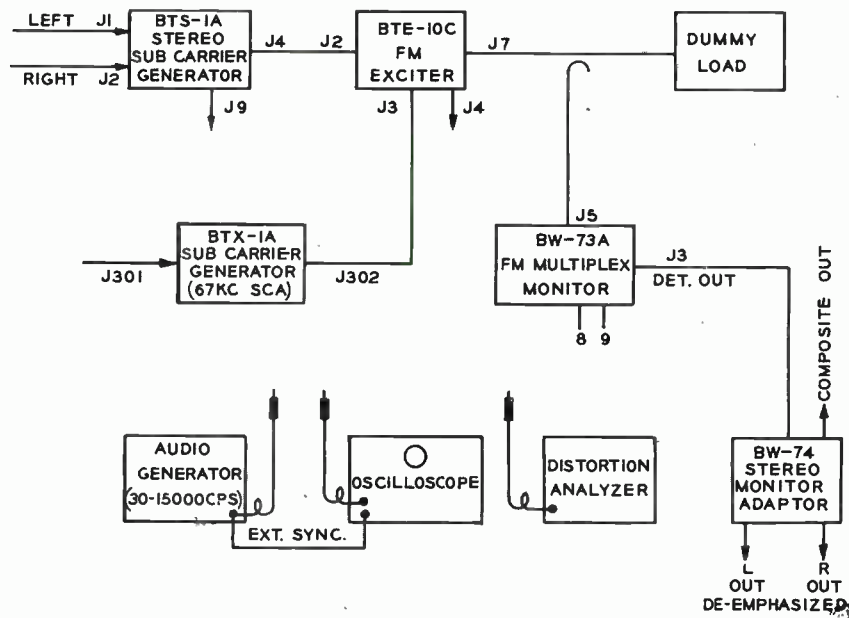

FIG. 3. Functional diagram of the test set-up discussed in this article. See text for step-by-step proof-of-performance tests.

left (or right) stereophonic channel meter indication in the BW-74 is in agreement with the left (or right) audio input signal meter indication to the exciter. All other errors in phasing will result in a degradation of separation.

(e) Stereophonic subcarrier suppression may be measured at the composite output by modulating the main carrier at 100 per cent as observed on the BW-73A and setting the distortion

analyzer to 100 per cent reference. Then, remove the audio and pilot-subcarrier signals and read the 38-kc level in per cent. The maximum allowable level is one per cent or 40 db below 100 per cent modulation.

(i) Peak deviation of the main carrier may be checked by inserting the same audio signal in the left and right inputs to the stereo generator and adjusting the gain to obtain the desired modulation level as read in the BW-



FIG. 4. The BW-73A is both a quantitative and qualitative modulation monitor for demodulating and separating main-channel and SCA audio.

73A. The peak deviation of the stereophonic subcarrier may be checked by simply reversing the phase of the audio signal at the left (or right) input. When properly balanced, these readings are equal. If the composite signal is observed on an oscilloscope with a left (or right) signal only, proper balance may be obtained by adjusting for a straight base-line and sharp crossover.

- (j) Total modulation of the main carrier is read directly in the BW-73A. It is well to remember in this service that a semi-peak reading meter properly damped for FCC ballistics, will not produce a meter reading which is the arithmetical sum of the individual peaks of a complex wave such as is utilized for stereo broadcasting but rather something less. The actual value depends on the magnitudes of the components of the wave but will be approximately 90 to 95 per cent for normal injection levels.
- (k) If the positive terminal of a 1.5 volt battery is connected through a 600-ohm resistor to the polarized jack, J1 or J2, pin 1 and the negative to pin 2 (of the BTS-1A Stereo Subcarrier Generator), modulation polarity may be checked at the BW-73A by observing the meter and modulation polarity switch position or by observing the meter deflection on the station's frequency monitor. The battery should

cause an instantaneous upward deviation of the main-carrier frequency. When this requirement is fulfilled, the receiver will yield correct and consistent phasing of the stereophonic channels as it is tuned across the band.

- (1) (m) The BW-74 is inherently capable of at least 40 db separation in the frequency range 30 to 15,000 cps. Set the distortion analyzer 0-db reference with a left (or right) signal only, modulated at 90 per cent, exclusive of SCA. The signal on the right (or left) is observed as the stereophonic separation ratio in db. When the ratio is 29.7 db or more for modulating frequencies between 50 and 15,000 cps and all levels, the requirements of peak deviation and phase balance have been satisfied.

- (p) (q) Routine measurements of frequency response, noise, and distortion may be made in the standard manner at the de-emphasized channel outputs of the BW-74.

#### Section 3.319 Subsidiary Communications Multiplex

- (e) SCA cross-talk measurements may be made by presetting the 0-db reference on the distortion analyzer at 100 per cent modulation level, applying the multiplex channel with its attendant modulation and observing the cross-talk in db down. However, since the BW-73A provides a broadband output, a 50-to-53,000 cps bandpass filter is needed between the BW-73A and the distortion analyzer to attenuate the SCA band itself. If such a filter is not available, a qualitative evaluation can be made by scope observation at the de-emphasized output of the BW-73A. At this point, noise and spurious components should be no more than 1/3 the amplitude of the SCA subcarrier corresponding to 60 db below 100 per cent modulation. Also, as a practical approach, it would be meaningful to check the cross-talk into the left and right stereophonic channels from the SCA at the BW-74 de-emphasized output in the manner described above.

#### Conclusion

The BW-74 is an instrument utilizing unique circuitry with emphasis on performance and stability in the interest of preserving the maximum capabilities of the stereo system.

The circuit design makes possible monitoring of stereo while simultaneously transmitting an SCA multiplex signal.

The BW-74, in combination with the BW-73A, comprises a complete multiplex monitoring facility.

#### NOTE

It should be pointed out that the FCC has not yet established the requirements for type approval of any stereo or SCA multiplex monitor.

Industry comments have been solicited and rule making will await receipt of these and a determination by the FCC as to the design of future devices.

Meanwhile, the BW-74 provides an excellent means for the continuous monitoring of high quality stereo programming and assures the broadcaster of proper operation of his transmitting equipment.

# COMBINED "V" and "H" POLARIZATION ANTENNA IMPROVES COVERAGE

FM Stations May Now Radiate Both Horizontal and Vertical Polarization

by DAVID A. JOHNSON  
*AM/FM Antenna Product Analyst*

A significant part of the industry expansion in FM broadcasting has been brought about by the economy-type home receiver (with its "line-cord" antenna) and the large numbers of auto-radio and transistor-portable FM sets equipped with "whip" antennas. Since all commercial-FM stations radiate a horizontally-polarized signal, there is some transmission inefficiency when the receiver uses a whip or line-cord antenna because of the essentially-vertical nature of these receiving antennas.

As a result, many stations have applied to the FCC for a construction permit to install a vertically-polarized antenna in addition to the usual horizontally-polarized antenna system. The Commission has issued more than 40 CP's, some of which have been licensed for operation of a vertically-polarized antenna system in addition to the usual horizontally-polarized system.

## Commission Permits Maximum Legal ERP in Both Systems

It should be noted that an FM station that operates both types of antenna systems does *not* reduce its horizontally-polarized ERP when it installs vertically-polarized antenna equipment. The Commission, upon application and approval, issues a construction permit for a vertical system with an ERP up to the maximum allowable ERP for that class of station.<sup>1</sup>

To illustrate, let us assume that we have an existing Class-B FM station that operates with a 10-kw transmitter and an antenna gain of 4. The station transmits a horizontally-polarized ERP of approximately 30 kilowatts. If this station were to install a "V" (vertically-polarized)

system, it could radiate an additional 30 kw of ERP in the vertical mode. Note that the "V" ERP cannot exceed the value of the "H" (horizontally-polarized) energy. Similarly, if the station is operating at the maximum ERP for its classification—in this case 50 kw at 500 feet—it could radiate a full 50-kw ERP in the vertical mode as well.

## Some Cautions

At first glance, one could assume that the addition of a vertically-polarized antenna system to an already-existing "H" system is the answer to increased station coverage. However, this isn't always true. Vertically-polarized antennas cannot necessarily put a signal in an area that is a "dead spot" for an "H" array for a number of reasons. For example, a dead spot might be the result of the "shadowing" effect of large buildings, hills, etc. The same shadowing effect occurs with vertically-polarized energy as well. However, the combined horizontal-and-vertical system does reduce—to an extent—the multipath phenomenon experienced in the "H" system. Indications are that the addition of a vertically-polarized antenna system to an existing horizontal system does improve reception in areas plagued with multipath problems.

It should also be noted that the addition of a "V" system usually doesn't increase the available signal on a horizontally-polarized receiving antenna *unless* there are multipath considerations. It should, however, improve the signal intensity on receivers that use the line-cord or whip-type antenna.

## RCA Vertically-Polarized Antenna

The RCA "BFA-" antenna (see Fig. 1) has earned an excellent reputation among FM broadcasters since its introduction during the late-middle 'fifties because of

several factors. Hundreds of these antennas were manufactured, sold and installed and, most of them are still in daily operation.

RCA has now added to its FM-antenna product line the Type 300- V Vertically-Polarized Antenna. It is, basically, a folded dipole fabricated of transmission-line copper (3<sup>1</sup>/<sub>4</sub>-inch) in the familiar "T" configuration (see Fig. 3). This "T" is the basic antenna section and, like the BFA-antenna, these sections can be "stacked" for increased antenna gain.

Moreover, the Type 300- V antenna is well-suited to installation as the vertically-polarized counterpart of the BFA- antenna thus, stations presently using a BFA- antenna need not obsolete their present antenna in order to incorporate a vertically-polarized system.

## Three Mounting Configurations

There are three basic arrangements for combined vertical-and-horizontal antenna systems.

FIG. 1. The horizontally-polarized "BFA" antenna. An article on page 24 describes the improvements made recently to this design.

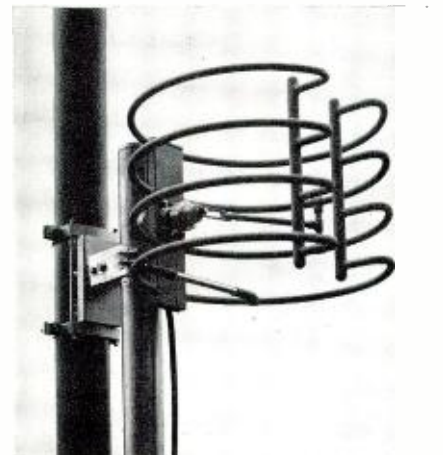

<sup>1</sup> Note—In cases where stations are operating at ERP's protected under a "grandfather" clause, they are allowed only to operate at an ERP authorized under present standards.



FIG. 2. The stacked "H" and "V" antennas of WSMJ (Greenfield, Ind.). Because of tower-loading considerations, the two antennas were stacked.

The "best" arrangement is one called "interlacing" which mounts the "V" antenna in essentially the same plane as the BFA- antenna with the "V" antenna sections between the sections of the BFA- antenna as shown in Fig. 6.

The second form of antenna mount arranges the "V" antenna to the rear or side of an existing BFA- antenna at the same height (see drawing in Fig. 6) above ground. It is essentially a "back-to-back" mounting idea.

The third arrangement places the "V" antenna in the same axis as the "H" antenna but not interlaced. Thus, the "V" antenna would be installed at a lower level than the "H".

### Selecting the Arrangement

Of the three, the interlaced arrangement generally improves signal density in the coverage area established with the "H" antenna. Properly installed, the energy from the "V" system combines with that of the "H" system to result in the closest approximation to "circular" polarization that feeds all of the various home-antenna types.

In the interlaced arrangement, the pole-mounted system is superior in pattern circularity as compared to the tower-leg or tower-side mounting arrangement because the tower has some effect on the distribution patterns of the antennas.<sup>2</sup>

The back-to-back pole- or tower-mounting arrangement balances the load on the

<sup>2</sup> "Some Effects on Horizontal Radiation Patterns of Sidemounted FM Antennas," M. R. Johns, *Broadcast News*, Vol. 119, February 1964.

FIG. 3. The Type 300-V Vertically-Polarized FM antenna. It is designed for installation with existing and new horizontally-polarized systems.



pole or tower. Because the two antennas face opposite directions, the horizontal distribution of their respective signals may not coincide resulting in "V" coverage where there is no "H" and vice-versa.

The "stacked" arrangement places one antenna above the other. This difference in height usually affects the line-of-sight distance to the horizon. However, the addition of the "V" in this arrangement does generally improve signal density to the receivers using line-cord and whip antennas and reduces multipath reception problems in horizontally-polarized receiving antennas.

### Single Line Feeds Both Antennas

Since the usual practice is to feed both antennas from a single transmitter and transmission line, the transmitter power must be split between the two antennas in certain proportions through a device called a "combining network." This network is made up of sections of transmission line which are mounted on the tower near the antennas. (The combining net can be seen in Fig. 2 near the center of

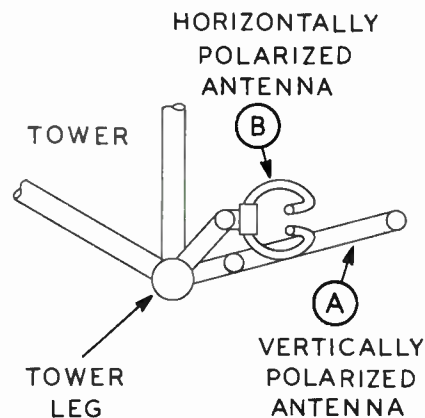

FIG. 4. Top view of the "best" arrangement recommended for a "H" and "V" array mounted on a tower leg. The presence of a guywire (not shown) requires the offset arrangement indicated here.

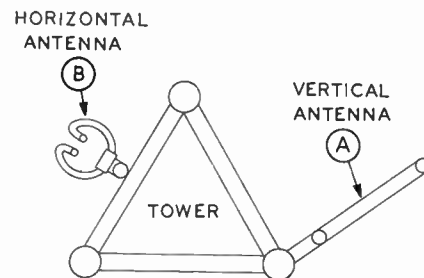

FIG. 5. A typical back-to-back arrangement when the existing "H" antenna is face-mounted on the tower. The rotation of the "V" antenna as shown here minimizes interference with the guy-wire system (not shown) of the tower.



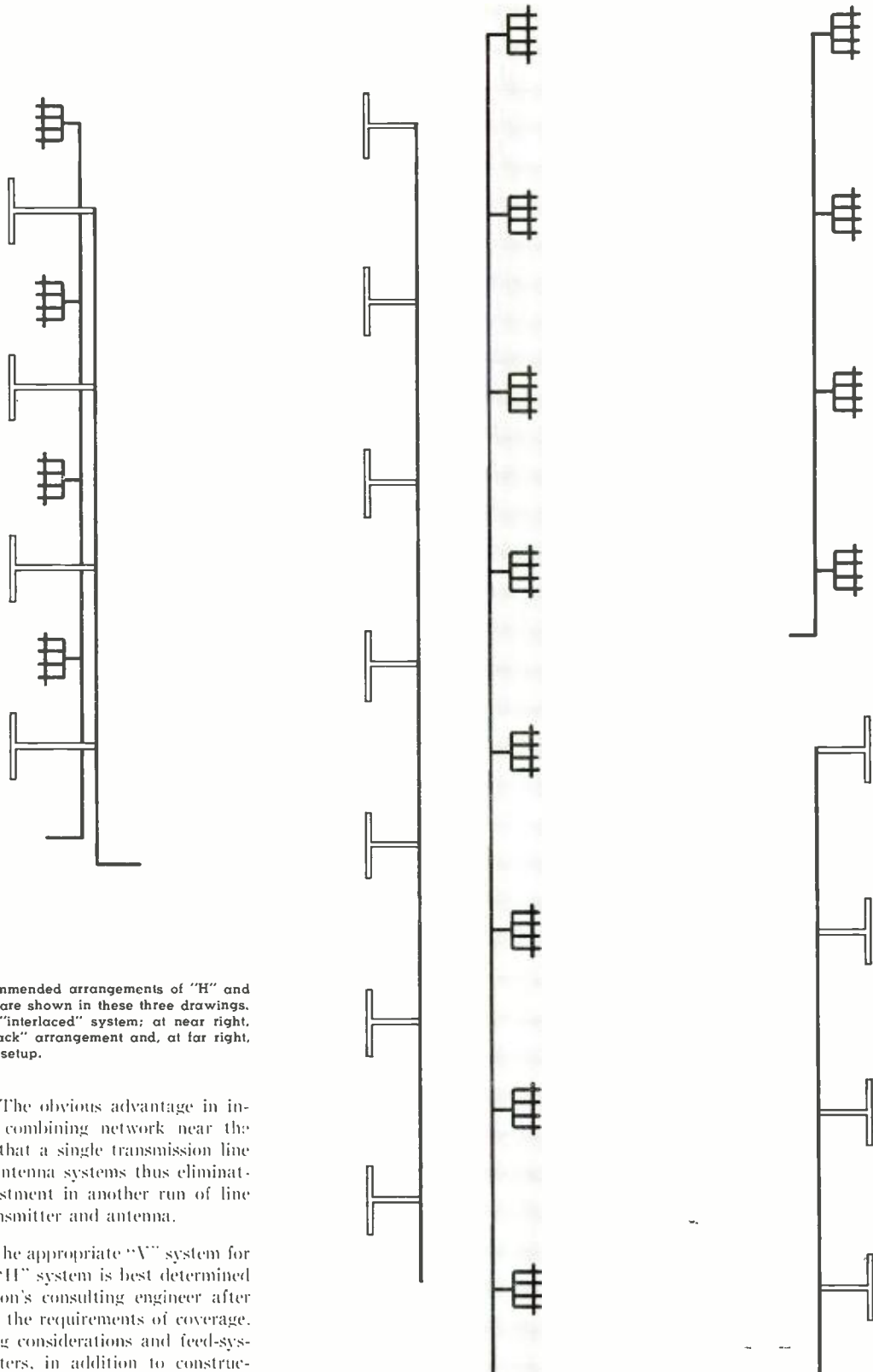

FIG. 6. Recommended arrangements of "H" and "V" antennas are shown in these three drawings. Above is the "interlaced" system; at near right, the "back-to-back" arrangement and, at far right, the "stacked" setup.

the array.) The obvious advantage in installing the combining network near the antennas is that a single transmission line feeds both antenna systems thus eliminating the investment in another run of line between transmitter and antenna.

Selecting the appropriate "V" system for an existing "H" system is best determined by the station's consulting engineer after he evaluates the requirements of coverage, tower-loading considerations and feed-system parameters, in addition to construction-permit information.

# NEW RCA FM ANTENNAS INCORPORATE IMPORTANT IMPROVEMENTS

New "B" Series Offers Increased Power-Handling  
Capability and Broader Bandwidth

The RCA BFA- A antenna, first introduced some six years ago, now serves hundreds of FM stations in the United States and overseas. Its excellent circularity and reliability have made it an industry standard.

However, RCA engineers are never content to stand still and they have been working behind the scenes on a development program to further improve the BFA-series of antennas. Now that the program is complete, the improvements in the antenna have been incorporated in the production models.

So significant are these improvements that the new antennas have been given a new type number: the "BFA- A" antenna will be henceforth the "BFA- B" antenna.

The first of the improvements is an increase in the size of the antenna rings. The "B" series antenna uses an 18-inch diameter ring for operating frequencies in the lower half of the FM band (88 to 98 mc.) and a 16-inch diameter for frequencies in the upper half. This compares to the 13½-inch diameter the "A" series used for all channels in the FM band. The increase in diameter improves the bandwidth of each section and increases its power-

handling capability . . . 5 kilowatts as opposed to the 3-kw rating of the "A" series antenna section. The "B" series retains the 12-inch height of each section.

## Stainless-Steel Radiators

Stainless steel is still the undisputed material for antenna radiators and, like the earlier antenna, the "B" series antenna is fabricated of stainless steel. While the earlier antenna wore a smooth finish, the new antenna is sandblasted to give the metal a "sandpapery" finish. In addition to improving the corrosion resistance of the stainless steel, the finish helps it shed water droplets — rain or condensate — to retard the formation of ice when the temperature drops.

## Re-Engineered Mounting Brackets

Part of the re-engineering program was spent in redesigning the mounting brackets used to support the antenna on a tower. As a result the bracketing is now simpler and more versatile than ever. In the earlier antenna, the brackets were usually not supplied with the antenna because of the many possible configurations of tower, etc. However, these new brackets are so versatile that they are now included as standard equipment at no extra cost. For the un-



FIG. 1. The new BFA- B FM Antenna. This antenna uses a larger-diameter ring than its predecessor and features a water-shedding "sandpapery" finish. Increased power-handling capability, too.



FIG. 2. A four-section BFA- B antenna as it appears when pole-mounted. Pole-mounting provides excellent horizontal-pattern circularity.

usual installation, optional bracket parts extend the versatility even further.

## Available in Power Gains to Sixteen

Each section of the BFA- B antenna delivers a power gain of approximately 0.9. Thus, a two-section antenna provides a power gain of 1.9. However, as more sections are stacked, the per-section gain increases slightly so that a 16-section antenna offers a power gain of 16.5. Thus, it is conceivable that a 10-kilowatt transmitter could deliver the legal-maximum ERP of 100 kw while operating at less than full-power output (6 kw plus transmission-line losses).

## Beam-Tilt and Null-Fill

The BFA- B antenna is normally supplied without beam-tilt or null-fill. However, as the power gain of an array increases, the vertical beam narrows and beam-tilt and/or null-fill may be required in high-gain antennas (12 or higher) to assure the desired coverage. These two factors may be included in the antenna during fabrication. Beam-tilting and null-filling cannot be included after fabrication.

**RCA**  
**BC-7**

*Closest to Custom in a Production Consolette!*



## RCA Transistorized Consolette

for Dual-Channel AM/TV and FM Stereo

Take a good look at this smart new model. Here's that "custom" appearance to satisfy the proudest management; "custom" quality and flexibility to please the most discriminating engineers...all in a production-model!

**CUSTOM STYLING**—Striking new lines in blue and silver bring a color accent to control rooms. Color-coded operating controls are engineered to avoid errors. Only 39" long, it is compact and self-contained...to satisfy new or existing arrangements.

**CUSTOM QUALITY**—The BC-7A is fully transistorized for long-term reliability. All amplifiers have input and output transformers. . . precise impedance matching for both program and monitoring circuits. You get quality stereo monitoring (10 watts out-

put), quality gain controls, quality leaf-type key switches on all program circuits.

**CUSTOM FLEXIBILITY**—You have interchangeable plug-in modules...preamplifiers, isolation/balancing units, program amplifiers, monitoring amplifiers, cue amplifier and power supply—all in one self-contained unit. You get three-mode operation...selector switch to instantaneously convert from dual channel, parallel or stereo operation.

We can't name them all here, but we believe you will agree that this is the kind of customized styling, quality, and flexibility you want. Let your Broadcast Representative show you all the features that make this consolette your best buy. Or write RCA, Broadcast and Television Equipment, Bldg. 15-5, Camden, N. J.



Plug-in flexibility... preamplifiers for low-level sources... isolation/balancing units for high level sources.

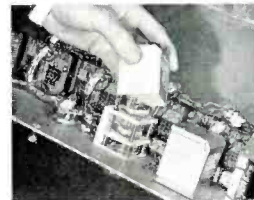

High quality mixers...ganged step-type attenuators when in stereo... individual step-type when in dual channel use.



**THE MOST TRUSTED NAME IN ELECTRONICS**

# THIS IS THE SHOW THAT WAS!

RCA Exhibit at NAB Convention  
Introduces "NEW LOOK" Line of Broadcast Equipment

Shining steel and blue . . . a New Look for the most modern broadcast center . . . accented the RCA exhibit.



Visitors to the RCA exhibit at the 1964 NAB Convention were greeted by a facade of functional simplicity—shining steel and sapphire blue—symbolic of the architectural form of the most modern broadcast centers.

These clean and cool portals set the stage for the introduction of a whole new line of broadcast equipment—a “New Look” line representing a fresh, inventive approach to modern broadcast operations.

New equipments featured in the “first

wave” of New-Look designs are pictured, as they were displayed, on the following pages. They include new cameras, live and film for color and black-and-white; new control room equipment; and complete new lines of tv tape recorders, FM transmitters and UHF television transmitters.

Photos on these pages show the main entrance to the exhibit which featured the most modern of television studios for both color and monochrome operations. Adjoining the studio was an area depicting the

beginning of a revolution in the control room. It displayed a new, modular console housing designed especially for New-Look equipments. Note the compactness of the control position, the absence of rack-mounted equipment, and the custom-built look.

This modern entrance established the theme of exhibit—introduction of a new line of broadcast equipments with a “New Look” for new convenience and new profits in station operation.

Visitors' eye-view down the length of the RCA exhibit at NAB.



Functional new console . . . beginning of control room revolution.



Living color and sparkling black-and-white pictures originated here . . . in modern new studio and control area.



## Space-Age Theme With Moon Studio, Sets Stage for Modern New Equipments

Taking a cue from the current Dick Tracy cartoon strip, the RCA color studio set a space age theme with live "moonmaids" gracing a paper moon. These surroundings were keyed to space-age developments built into the "New Look" equipment — transistorization, modularization, stabilization and standardization.

Transistorization results in equipment that is more compact and more completely self-contained—introducing new and more efficient equipment arrangements. Use of standard interchangeable modules intro-

A moon unoccupied . . . visitors came later . . . see adjoining page.

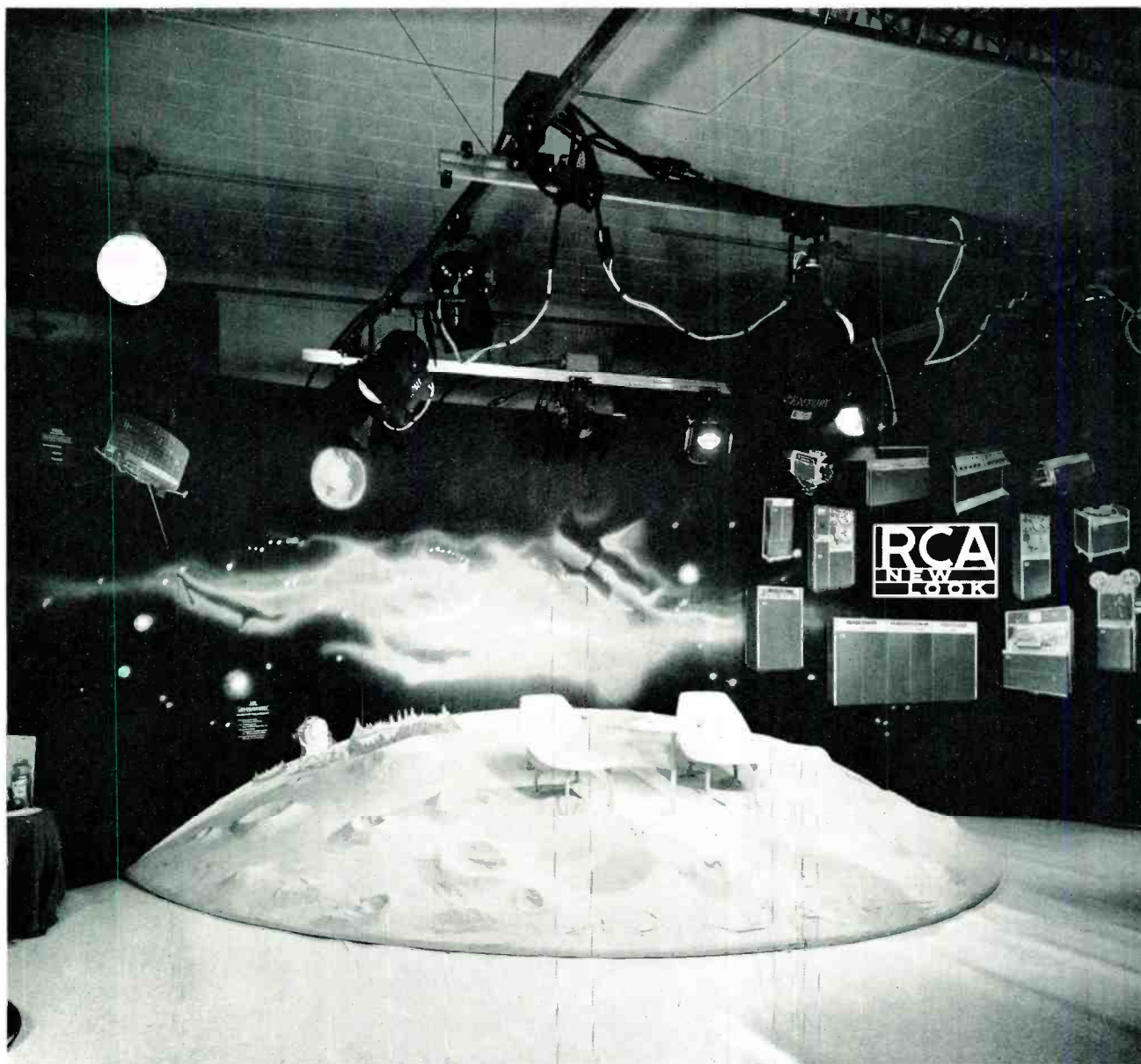

duces new concepts of maintenance—permitting a system of quick replacement of modules to meet most emergencies. Stabilization techniques—self-adjusting circuits which maintain a uniform level of performance—present new opportunities for more efficient operations. Finally, standardization ties the complete line of equipment together—making possible the greatest savings in installation and operating cost.

In the photo below, Chester Gould, Dick Tracy's creator, sketches a "Moon-Maid" from life as the RCA color tv camera looks

on. At right a moon-maid checks out controls of spaceman's self-contained ultra portable tv camera system. Below, a lovelier looking subject than cameraman sights down the viewfinder of the new 4-channel, color studio camera, TK-42. This new camera is fully transistorized, uses a 4½-inch image orthicon in its monochrome channel and vidicons in its color channels for richer-toned color pictures and noticeably sharper black-and-whites. Bottom left, a TK-60 4½-inch I.O. camera focuses on space gals as they tea-party on the moon.

Chester Gould sketches "original Moon Maid" for the color tv camera.

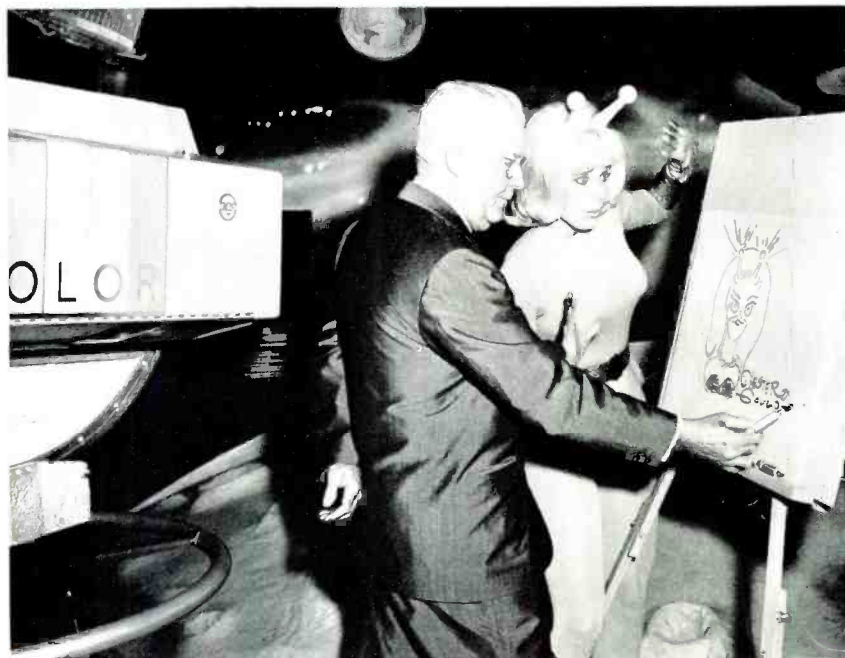

Cameraman's eye-view, as he directs his TK-60 4½-inch image orthicon camera toward some of the beauty spots on the moon.



Just the ticket for moon explorers, this ultra portable camera system includes camera, monitor and battery pack transmitter.

Space age performer, this new color tv camera is transistorized, stabilized, modularized.

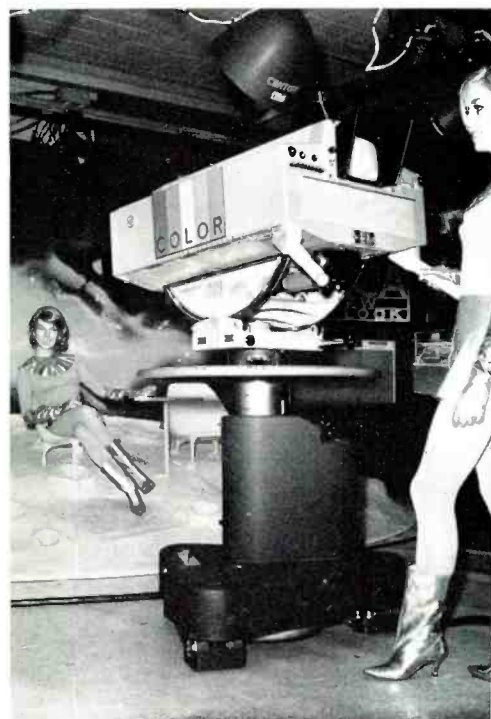



Interior of the RCA display . . . featured functional arrangements of new film, tape, transmitting and audio equipments.

## RCA Exhibit Without the Crowds . . . Reveals Operating Displays of New Studio Equipments



Complete 4-Vidicon Color Film Camera is contained in the stylish cabinet at right.

Take away the hundreds of broadcasters who examined the new equipment first hand, and you get the above view of the interior of the RCA display. Note the spaciousness and functional simplicity of the operating arrangements—the compactness of these new equipments which offer more operational facility than ever before.

Typical of the new studio equipments that do more in less space is the TK-27 4-Vidicon Color Film Camera, shown in the photo at left. This most compact of color film cameras is completely transistorized and uses plug-in modules which are common to those used in RCA's new live color camera, TK-42, and black-and-white film camera, TK-22.

Film pictures that are richer in color and more detailed on black-and-white receivers result from using the same 4-channel techniques as pioneered by RCA in its 4-channel live color camera, TK-42.

In the TK-27, three one-inch vidicon tubes are used in the color channels, while a new 1½-inch vidicon is used in the luminance or monochrome channel. All vidicons in the camera feature electro-static focus and magnetic deflection, and are especially designed for use with highly stabilized transistor circuits.



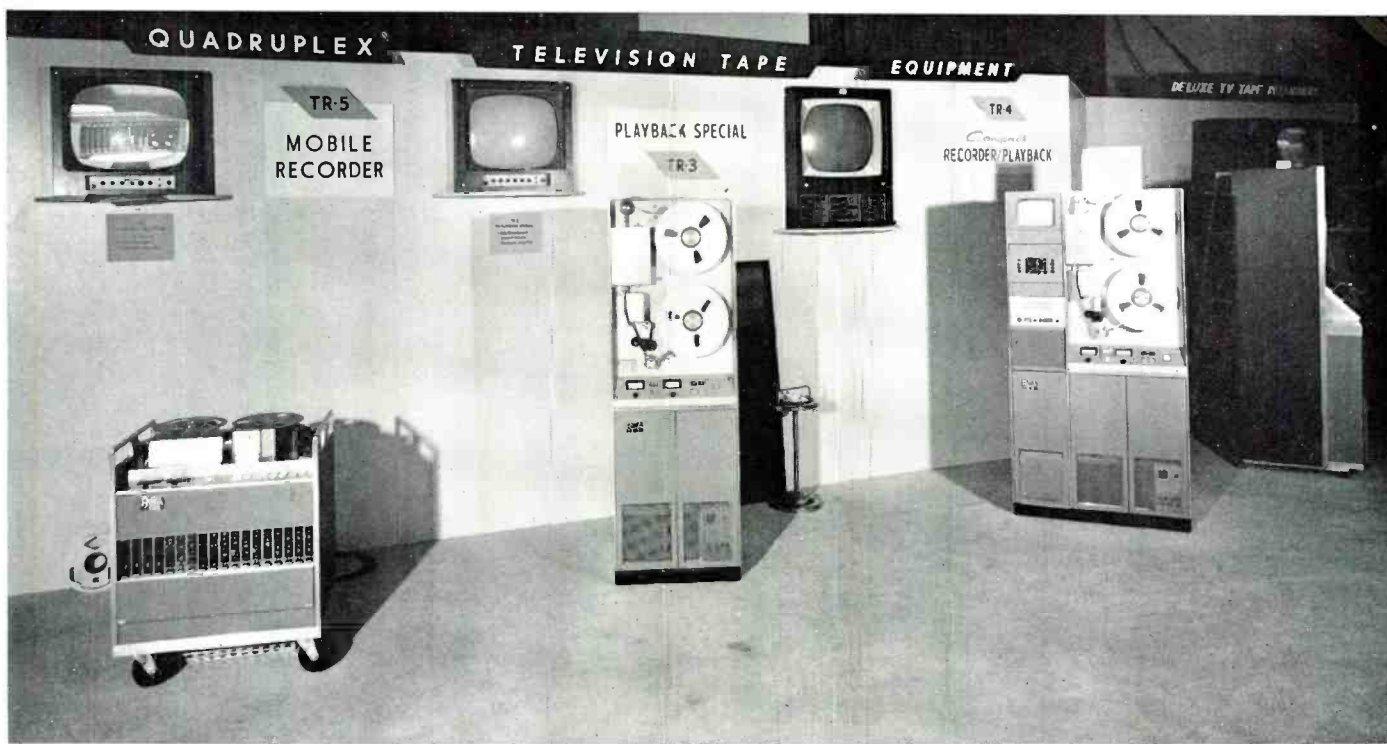

Three compact tv tape equipments . . . a TR-5 mobile recorder . . . a TR-3 playback machine . . . and a TR-4 economy recorder.

## Five Quadruplex TV Tape Recorders . . . Featured in Operating Displays

The New Look in television tape is highlighted by the new tv tape equipments (shown on this page). Each is transistorized, each features interchangeable plug-in modules, each has color capability, and each employs the standard quadruplex principle of recording and playback.

The Mobile Recorder, TR-5, is a transportable unit for quality taping on location. It includes limited playback facilities for preview of tapes to assure a satisfactory recording has been made.

The TV Tape Player, TR-3 is designed to "screen" tapes in much the same manner broadcasters now "screen" film. A playback-only machine, the TR-3 is invaluable for previewing, and "on-air" playback of taped programs and commercials.

The Compact TV Tape Recorder, TR-4, provides a complete recording and playback package—budget priced for installations where economy and picture quality are both important considerations.

Pattern for them all is the Deluxe TV Tape Recorder, TR-22, see photo at right. New additions to this superior tape recording facility include a new highband FM system (23 of which have already been delivered) and an electronic splicer for easy tape editing.



New features for deluxe TR-22's . . . electronic editing (left) . . . high band FM system (right).

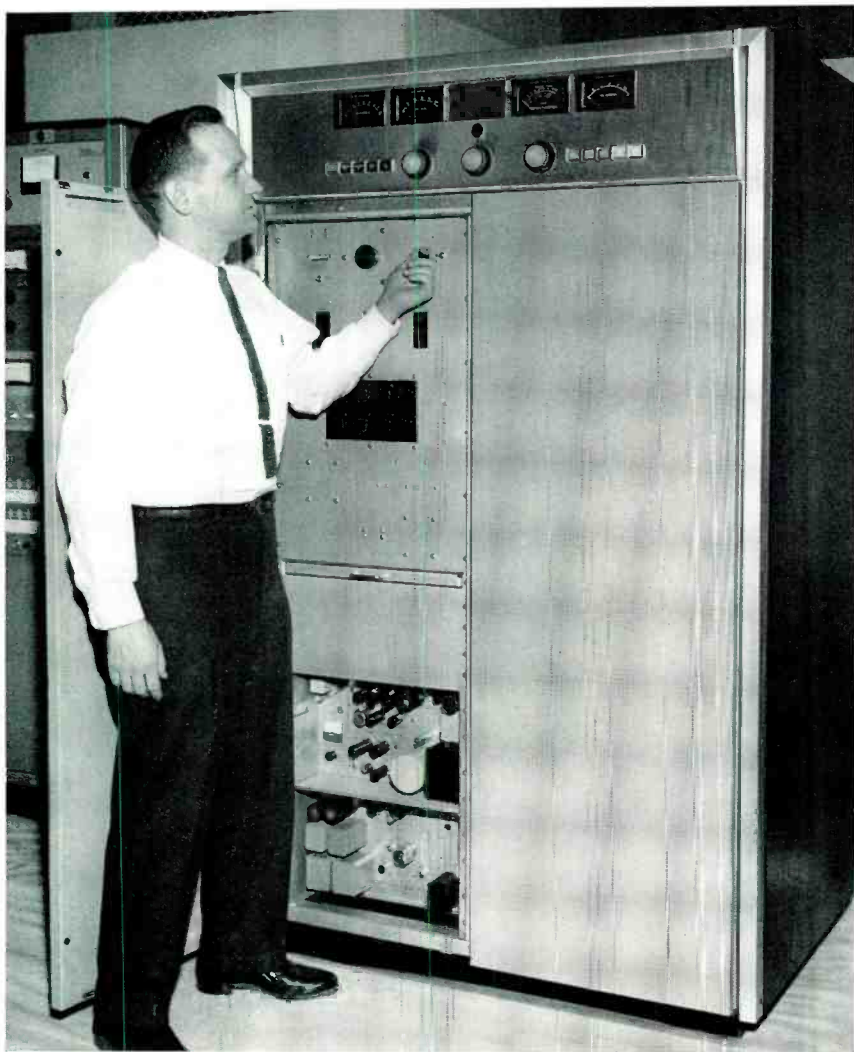

◀ 10 KW representative of a complete line of FM transmitters . . . designed for stereo.

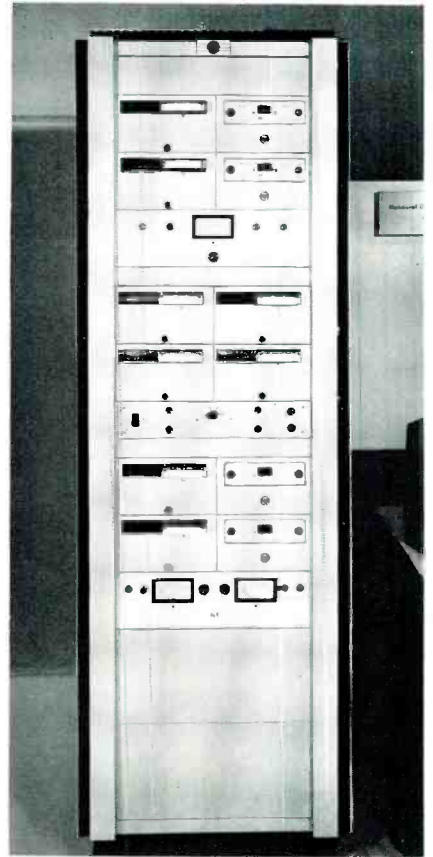

## Complete FM Stereo Center with New FM Transmitter . . . New Audio Equipments

The 10 KW FM Transmitter shown above represents RCA's complete line of 5, 10, and 20 KW offerings. A stylish low profile and a compact single cabinet design accents the all-new features to be found inside. Using a new and more simple exciter (in which the oscillator is directly modulated by capacitive diodes), the new transmitters are more stable, far easier to tune and more capable of performing to the high level of fidelity desired in stereo.

New audio equipments, forming a stereo operations center (bottom, right), include a Professional Audio Tape Recorder, RT-21, a Dual-Channel Consolette, BC-7, and a Transcription Turntable, BQ-51 (equipped for stereo).

Also on display, see photo above, right, where a Stereo Cartridge Tape System, RT-37 and a Multi-Cartridge Playback System, RT-8. All are transistorized, all are designed for the highest level of stereo performance.

Cartridge tape systems for stereo and monaural use include system for playback of 4 to 16 cartridges.

Stereo operation center featured professional audio tape recorder and transcription turntable operating through stereo consolette.





Open for inspection . . . visitors took opportunity to look over latest UHF Transmitter.

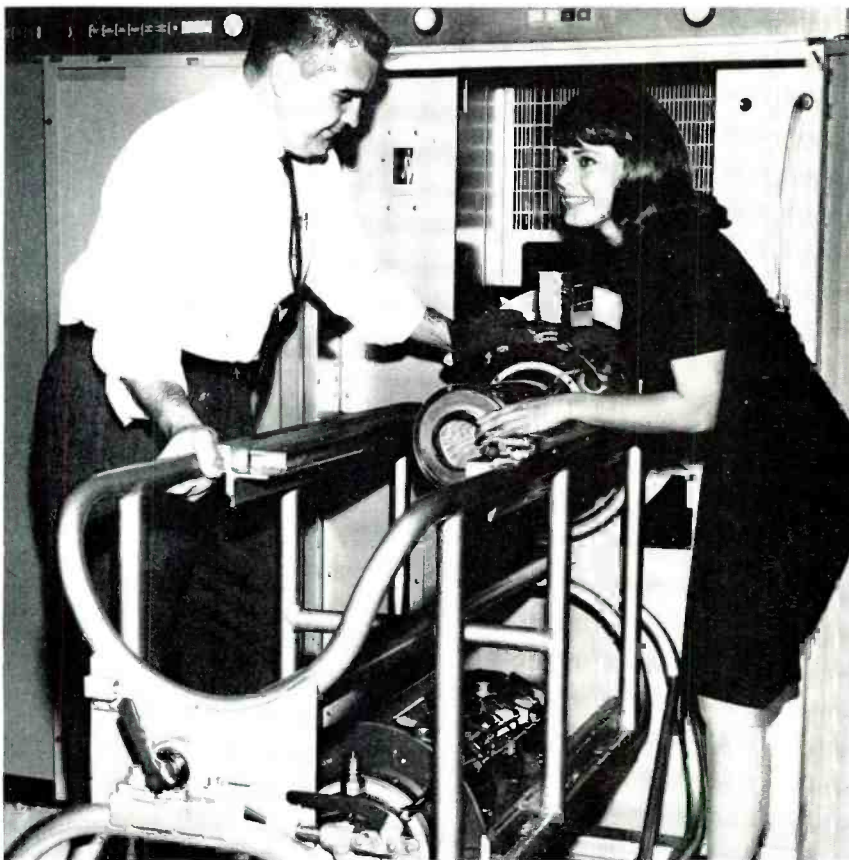

### Visitors Get An Inside Look at UHF Transmitters...Demonstration of Quick-Change Klystron Tube

New designs featuring a vapor-cooled integral cavity Klystron in 30-KW and air-cooled tetrodes in 2 and 10 KW UHF transmitters, lead to low operating cost and maximum efficiency. All three are represented in the exhibit; the 30-KW, as shown in the top photo and 2 and 10 KW types, not pictured.

Simplicity of design in these new transmitters make them easiest of all to install and operate—provide a high level of reliability and a readiness for remote control. These factors add up to maximum savings in operation.

Quick tube replacement is object of this demonstration. The tube slides out onto a tube-carriage which revolves to put a fresh tube into position in a matter of minutes.

# HOW A NEW TELEVISION STATION CAN ACHIEVE SUCCESS

WQAD-TV Demonstrates How to Get On Air Fast  
and Achieve Acceptance Through the Fact of Newness

FIG. 1. WQAD-TV studio building, home of Moline Television Corp., Moline, Ill. On tower are Telco and station microwave reflectors. Programs are beamed to TV transmitter at Orion, Ill., 14 miles distant.

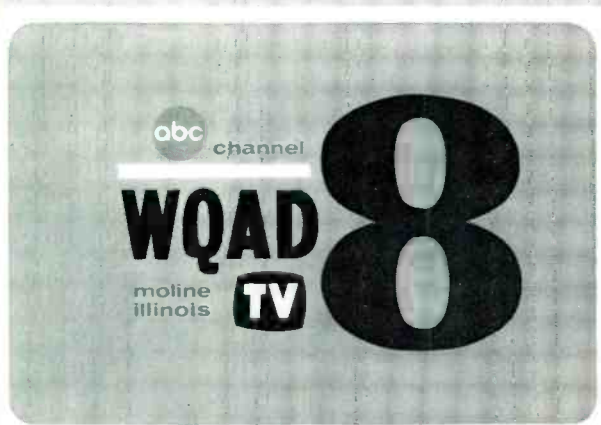

WQAD-TV, Moline's new television station established several records in starting operations on the air.

To begin with, awarding of Channel 8 came after a struggle of almost six years. In the mid-fifties, Channel 8 (originally assigned to Peoria) was transferred to the Quad City area and allocated to Moline, inasmuch as there were two stations already in the area. WOC-TV in Davenport and WHBF-TV in Rock Island.

A syndicate of local civic leaders formed the Moline Television Corp. and made application for the facility. Frank P. Schreiber, a 25-year veteran of radio and television, was elected president and directed the corporation's efforts to secure the license.

In December, 1962, the FCC issued the construction permit, and final court actions were resolved in February, 1963.

The task was a monumental one. In order to comply with the construction permit, a new building had to be built, equipment installed, and the station in operation within the period of a few months.

The construction problems included erection of studio building and microwave antenna located at 3003 Park Sixteenth Street in Moline, as well as transmitter building and tower, which were erected in nearby Orion, Illinois.

In less than five months time from the ground-breaking ceremony, WQAD-TV went on the air—August 1, 1963.

**Emphasis on the New**

From the beginning, the decision was made to capitalize on the newness of the station. Not only was this to be the spring-board of all promotions, it was to become the basic concept of all operations.

People, programs, buildings, equipment—all were new. There were new personalities who brought a new view to the area. Programs were scheduled that had not been available before. But, more than this, new local live programs adapted to the needs of the community were created.

All buildings and equipment were new. The best and most modern were chosen. Construction lent itself to today's needs in television showmanship and selling.



FIG. 2. Successful philosophy of WQAD-TV is based on promoting newness of station. Prime part of the philosophy are new faces and emphasis on news.



FIG. 3. New area programs figure prominently in WQAD promotion. Here is "Romper Room," one of the most popular daytime programs.

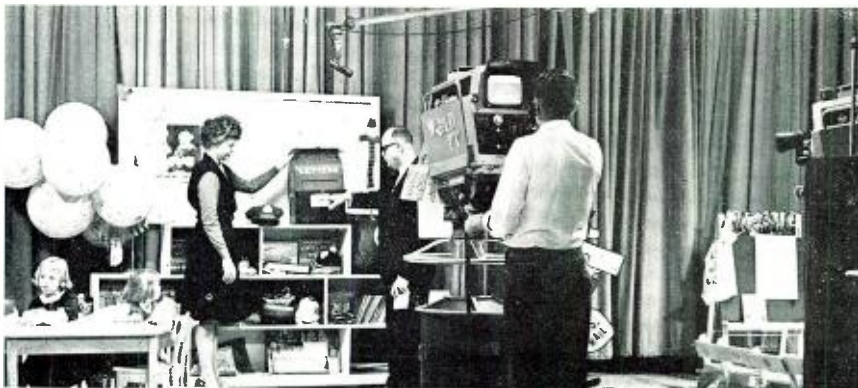

FIG. 4. Construction of new building started March 11, 1963 . . . by April 30 shell was erected and bricks laid . . . May 15 precast cement slabs arrived . . . During June and July equipment was installed . . . August 1 the station went on air!



FIG. 5. Three TK-60 Cameras are used in daily production of "Channel 8 Farm Report" in Studio A.

## Finest Facilities

by FRANK P. SCHREIBER, *Pres. and Gen. Mgr.*  
*Moline Television Corp., Moline, Ill.*

"It has been by experience in previous broadcast operations that purchase of cheap equipment is a poor investment. Accordingly, our facilities at WQAD-TV are the finest that money can buy."

### Modern Equipment Pays Off

"Within our big new physical plant in Moline, we offer the very latest RCA equipment. The two studios alone cover more than 3500 square feet . . . and each is equipped with 4½-inch TK-60 Cameras. We also have RCA television tape recorders and film equipment to back up our local productions.

"We can carry all scheduled ABC network color programs and offer local color in the form of slides and films.

"Combined with the new RCA 25,000 watt transmitter and 1058-foot tower at Orion, Ill., WQAD-TV offers the most up-to-date television facility (tallest tower, maximum power) in the Quad-City area."

### Unique Quality

"We do a professional news job. We believe in getting qualified reporters, photographers and newscasters. Then we equip them with plenty of good equipment and encourage them to expose a lot of film. In this way, we lay the groundwork for dra-

matic and comprehensive video coverage of the local news. My previous experience as a newspaper man and broadcaster probably has something to do with these beliefs.

"Since we are the newest station, our emphasis is on the NEW. In programming, we offer that which no one else has provided, for example, a daily farm and home show.

"A staff of new faces in news, sports, and weather focuses upon local interest subjects.

"*Romper Room*, with pre-school children in early morning, and *Jungle Jay* adventure series for older children at 4-5 p.m. are hosted by fresh, new talent.

"Specials include such programs as: *College Close-up*, on which local universities and colleges present educational programs; *Project Eight*, devoted to local public interest and service programs, and frequently from time to time on special schedules other local programs of public interest, education and sports. More than 13 per cent of WQAD-TV's broadcast schedule is devoted to local live programming.

"We also participated in the Junior Achievement movement with our own J. A. Company. Further, we offer a number of local religious programs."

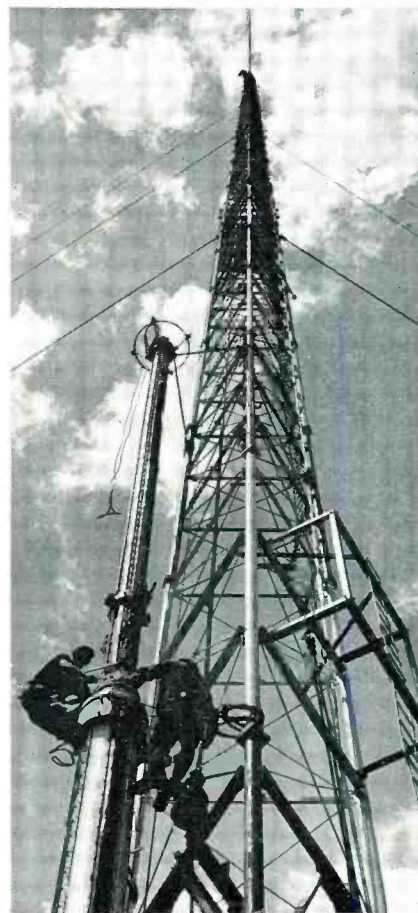

FIG. 6. The RCA Traveling Wave Antenna shown being hauled to top of tower.

**New TK-60 Cameras**

"Our new TK-60 4½-inch "big picture" cameras are terrific. We're putting them to use doing many local commercials.

"The production men like the professional effects they get with these cameras. They're the newest RCA cameras and they're great.

"Together with TV tape, we have fantastic facilities, giving us opportunity of really doing commercials in the manner which we have never been able to do before. These facilities enable us to get the professional feel into local commercials, making them in a way that really pleases the customer.

"We are getting new accounts, department stores and super markets, with these facilities—and our ability to make color film commercials."

FIG. 7. Dick Richmond, news director, is typical of new faces in area—has 18 years experience in newspaper, radio and TV news reporting.



FIG. 8. Ray Ruester, host for morning show—"Top O' The Morning."



FIG. 10. Jim King, sports director.



FIG. 9. John Fuller, Saturday Night News Show.

FIG. 11. Production Mgr., Jack Wilson, with John Benson and Teddy Webster at weather board.



FIG. 12. Ed Kiely and Nancy Strutz, co-emcees for "Hi-Time," the Junior Achievement television show.



FIG. 13. Squad of station cars supports intensive efforts of WQAD for dramatic and comprehensive video coverage of local news.



## Programming Concept

by R. DOUGLAS McLARTY, *Station Manager*

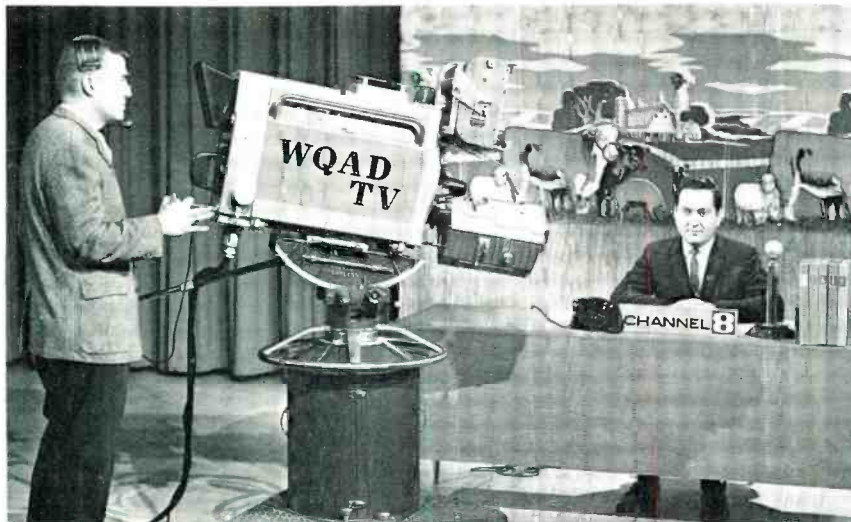
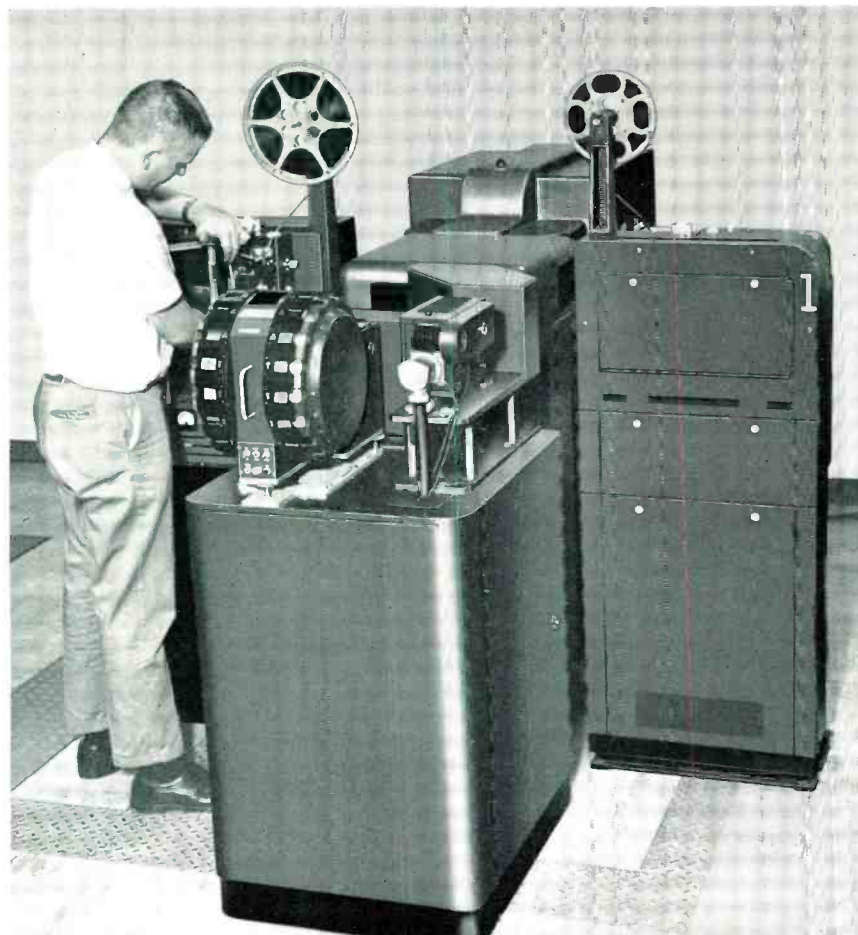

FIG. 14. Originality in programming is captured by TK-60 Camera trained on Roy Harnish, Farm Service Director.

FIG. 15. Feature film programs, hosted by prominent live talent, lead to strong promotional possibilities, and use of RCA Film system assures finest picture quality from films.



As the new third station in the Quad-City market, we believed that our programming would require a new look in order to garner a competitive position.

First, we selected professional air personnel, new to the area, and backed them with a strong promotional campaign.

Second, we developed seven feature film programs with live talent hosting each program. We believe that a talent character gives the station identity and leads to strong promotional opportunities. The feature films selected were thematic and new to the area. *The Jungle Jay Show*, Monday thru Friday afternoons, features jungle films, Tarzan, Bomba and Jungle Jim. *Chiller Theatre*, Saturday night, is a double feature program, utilizing horror-type and science fiction films.

Finally, with TV tape and color projection facilities available, we immediately used both in local commercial production and programming. In public service programming, we purposely selected nationally produced TV tape shows or color films with an eye to giving WQAD-TV that live or color "new" look.

FIG. 16. Gene Edwards, host for "Jungle Jay Show," daily popular film series, that features Tarzan, Bomba, and Jungle Jim.





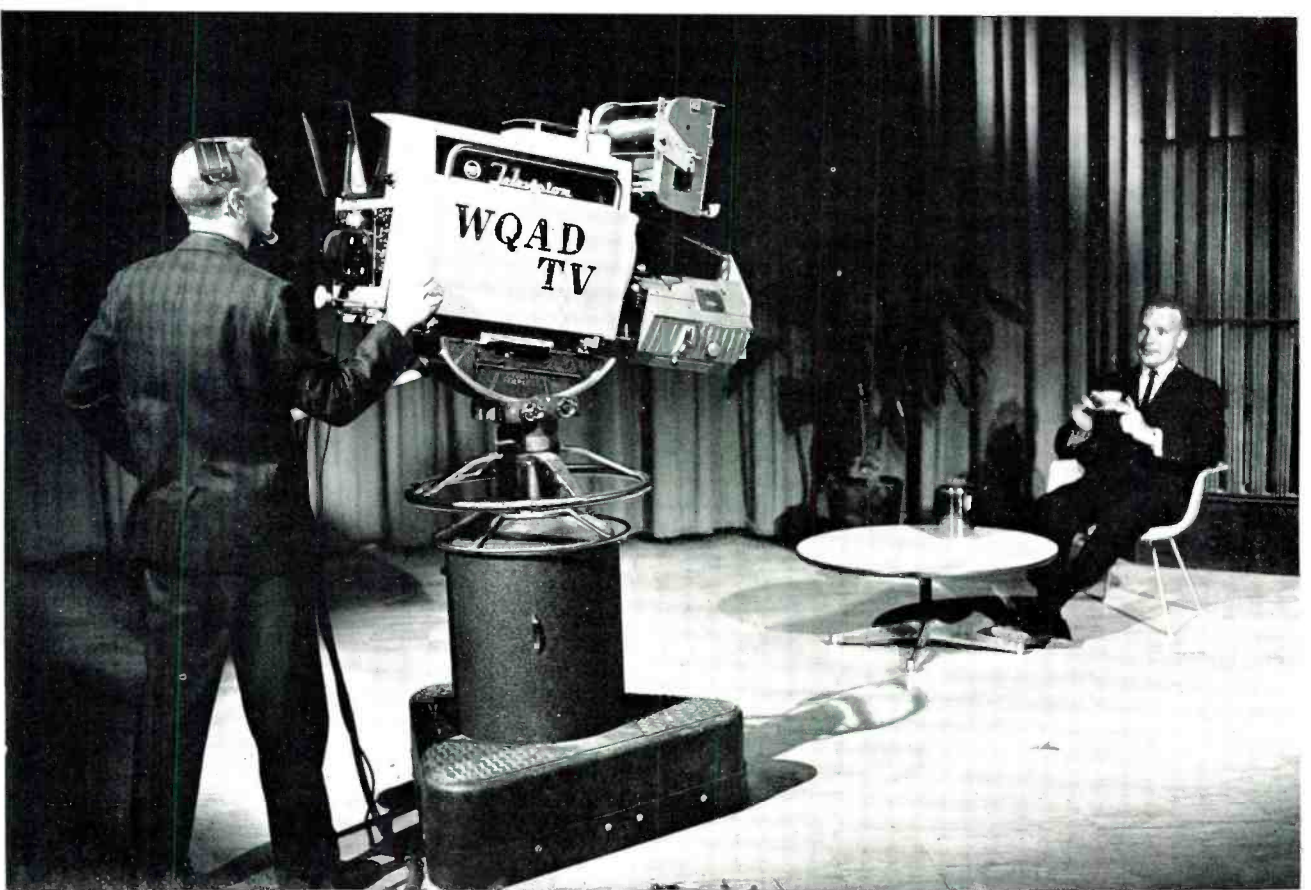

FIG. 17. Putting punch in client's commercials requires professional equipment and production people. Here commercial announcer John Drilling and production cameraman Ray Keller use new RCA 4 1/2-inch Image Orthicon Camera to capture aroma of Maxwell House coffee.

## TV Tape Equipment Aids Sales

by WILLIAM SNYDER, *Sales Manager*

When WQAD-TV went on the air, we entered into an unusual local sales situation. The Quad-City television stations only numbered two, and as a result had ample national business. So, they did not aggressively approach the local advertisers. The national average of local to national spot was 24 per cent. The Quad-City percentage was 7 per cent.

As the third station, WQAD-TV could not depend entirely on national business, as the dollars then being spent would have to be split by three stations rather than two. Therefore, the only alternative was to go after the local merchant. Within a matter of weeks WQAD-TV had, through highly aggressive selling and the back up of two TV tape machines, changed the local advertising percentage from 7 per cent to about 61 percent.

There were approximately five local accounts previously. Suddenly WQAD-TV was faced with a problem of airing daily commercials from 15 to 20 advertisers. Each of these advertisers had a number of commercials. The TV tape machines saved the situation by allowing us to do the well-nigh impossible with fantastic speed. It is difficult now to imagine

what would have happened had we attempted to do all these commercials live. Even though this case is somewhat unusual, the need for tape in any television station's operation is an absolute necessity.

Most recently another piece of RCA

equipment was put into operation. These color slide and color film chains are now being used with greater frequency. Each day a greater number of local as well as national advertisers are requesting color reproductions for their commercials.

FIG. 18. TV Tape facilities portrayed here enable WQAD to get more local accounts, changing local advertising percentage from 7 to 61 percent.

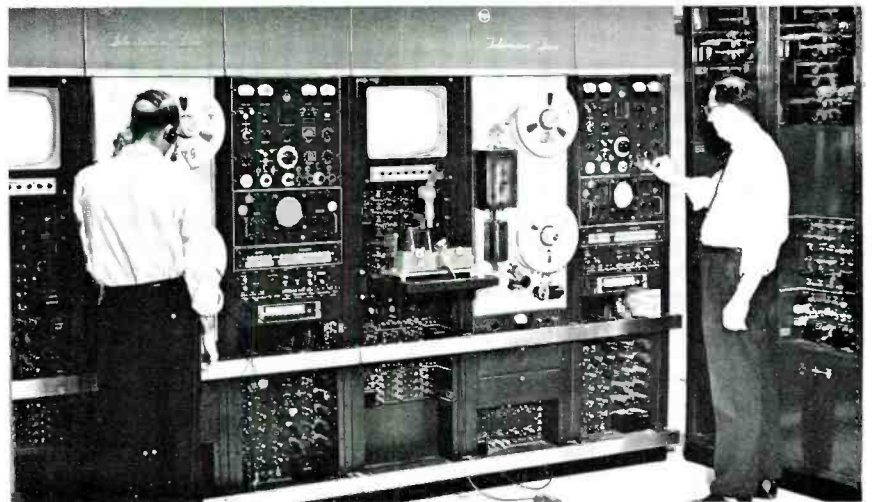

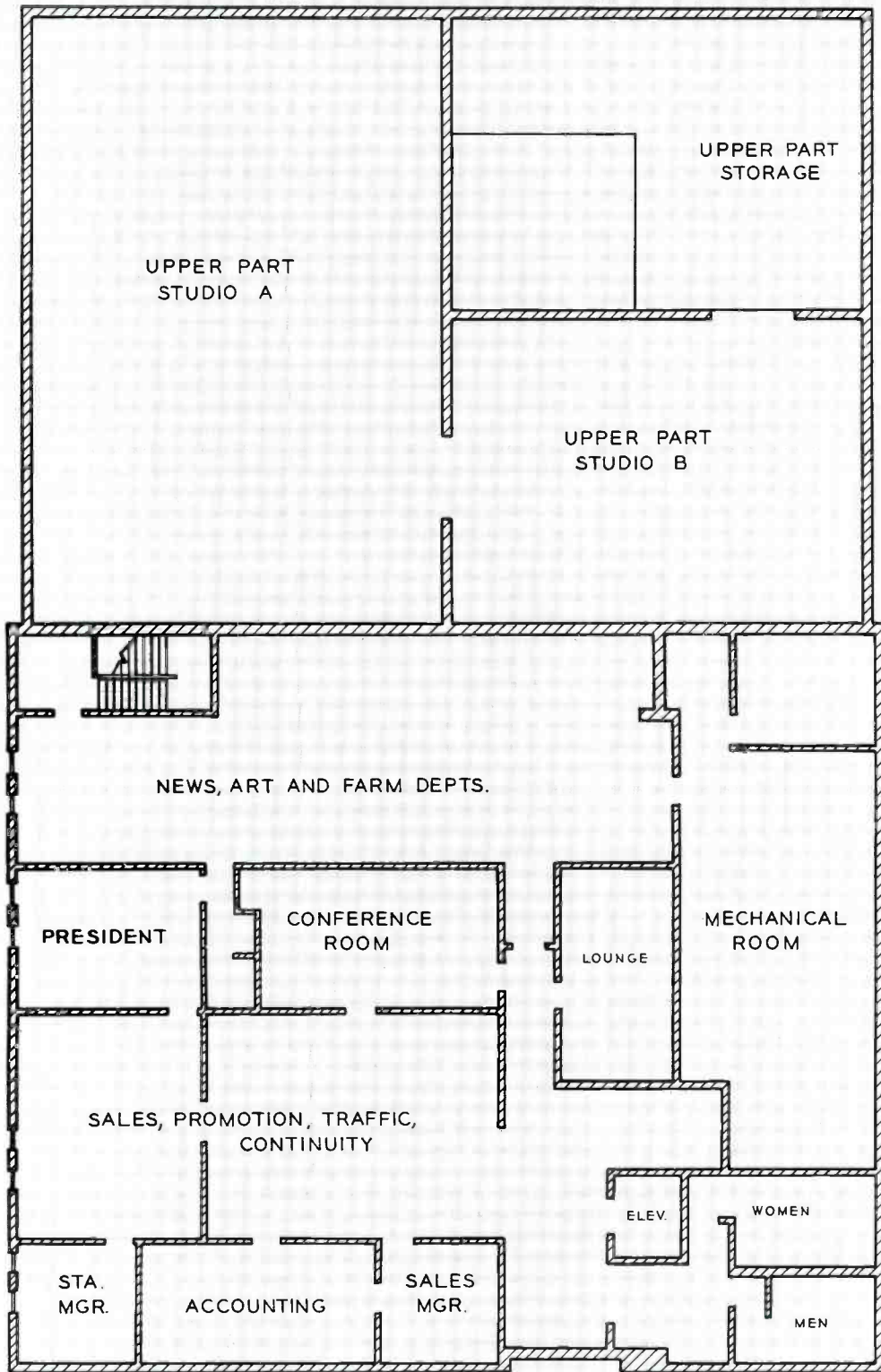

FIG. 19. Layout of second floor of WQAD-TV studio building.

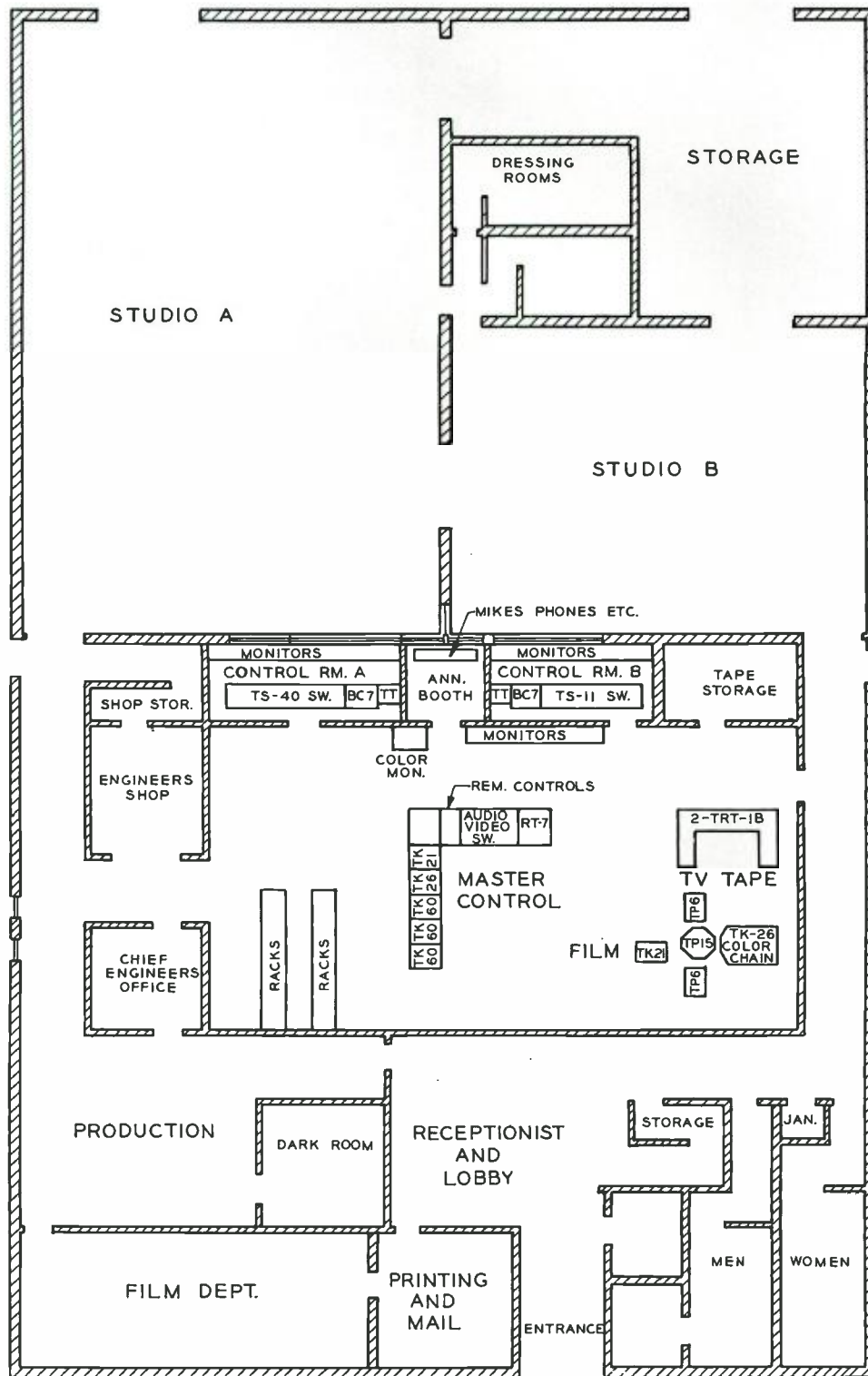

FIG. 20. Layout of first floor showing complete technical facilities for efficient production.

## Technical Facilities

by RAY KRUEGER  
WQAD-TV Chief Engineer

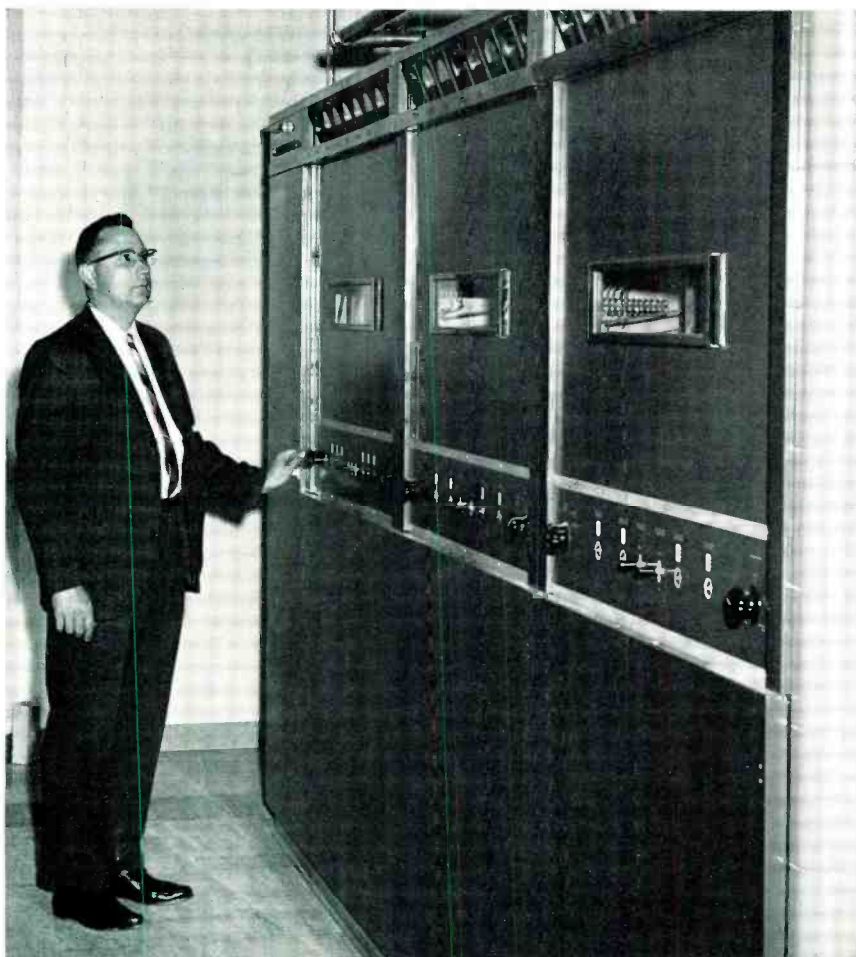

FIG. 21. Chief engineer, Ray Krueger at RCA TT-25DH 25-KW TV Transmitter. This unit is designed for color television and gives high quality monochrome performance.

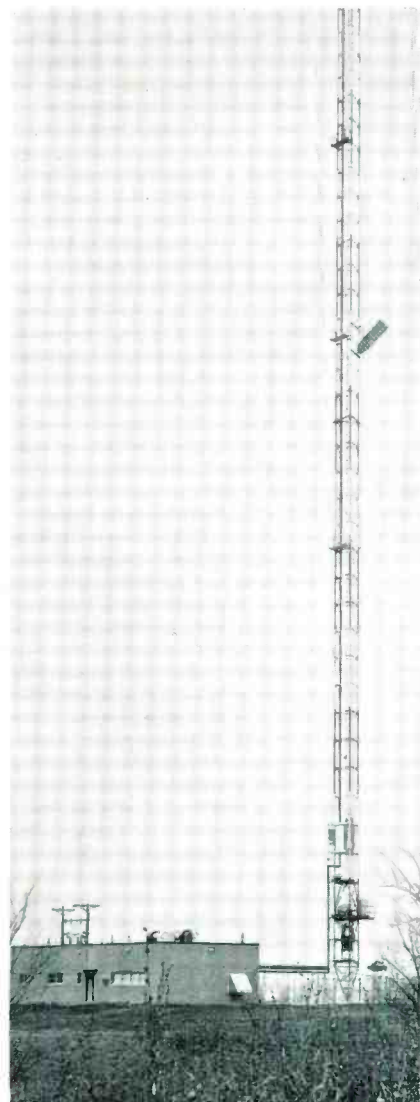

FIG. 22. Transmitter building and tower at Orion, 14 miles from studio. Type TW-15A Traveling Wave antenna covers the signal area.

The layout of the WQAD-TV studios and control rooms is designed to assure an efficient and economical operation.

Each of the two studios has its own control room. Either control room can be visually observed from the announce booth which is placed in the center of the two control rooms.

The control rooms are each equipped with a RCA-7A Dual Channel Audio Console, BQ-2C Turntable and RT-7 Cartridge Tape Playback units. Number One control has an RCA TS-40 Switcher. Number Two control room is equipped with a TS-11 Switcher. Each control room has

twelve monitors, one for each of the video sources.

Master Control with its custom built audio video switcher controls audio and video simultaneously. Remote TV Tape, TK-26, TK-21, TP-15 and the TK-60A Camera Control units with their respective TM-9N Picture Monitor and TO-2 Waveform Monitors are also located at the master control position.

The film and video tape recorder area is also located in the master control room. Concentrated here are TK-26 3-V Color Film Camera, TK-21 Monochrome Film Camera, two TP-6FC 16mm Film Projectors,

TP-15 Multiplexer and two TRT-1B RCA TV Tape Recorders.

The equipment area with its 14 BR-84D racks of associated equipment is also located in the master control room.

WQAD-TV has two RCA type TVT-1B 1-Watt Microwave systems between studio and transmitter which is located near Orion, Illinois.

An RCA type TT-25DH 25-KW Transmitter with a type TW-15A Traveling Wave Antenna is used to radiate 316,000 watts from a 1058-foot tower.

An Onan power generator which cuts in automatically in the event of a power failure is installed at the transmitter.



FIG. 23. Studio A sub-control, TS-40 switcher and BC-7 audio control. There is a turntable to right of audio operator and two RT tape machines (available with one recorder). Intercom switches are located immediately to the left of the switcher. The 17-inch monitors are used for studio monitoring. Audio operator is A. T. Hartman; technical director, Teddy Webster.



FIG. 24. Master Control with Bill Benjamin. Shown is an RCA TS-40 switcher which is an audio follow pre-set type switcher, custom built for this installation. There are remote panels for both TV tape machines. The Master Control operator has the ability to do all station breaks from this position.



FIG. 25. On top of building is a 75-foot tower mounting reflectors for the microwave relays of the telephone company which bring network and other outside programs into WQAD-TV master control and the STL over which programs are transmitted from the studio to the transmitter.

## Color Commercials & Programs

Equipped with color-designed TV transmitter and color film equipment, the station has been carrying network and originating local color film programs.

All ABC network color film series have been carried for benefit of Quad-Cities viewers. The station has purchased Seven Arts films series Group VII, for local programming, and approximately half

are color films.

The station has facilities for producing commercials using color films and color slides and has done so for many local advertisers.

Studio lighting is set up for color, all wiring is in, only fixtures are needed. This makes it a simple matter to add live color TV cameras for local studio originations.



FIG. 26. Transmitter supervisor Bob Larson at transmitter control point, which also handles selection of diplexed microwave receivers.

**DAYTON DAILY NEWS**

# Radio Magazine

DAYTON, OHIO, SUNDAY, OCTOBER 26, 1924.

---

**STIVERS HIGH SCHOOL BOASTS OWN BROADCASTING STATION**  
CLUB FORMED OF RADIO FANS WILL CONDUCT WIRELESS EXPERIMENTS

**THIS** is station WEBT, Stivers High school, Dayton, O.

Dayton fans will be treated with this situation when the next few weeks should they turn the dial on their receiving sets to 210 meters.

Stivers high school is taking the initiative in the radio field in Ohio. It will be one of the three schools in the state with radio broadcasting equipment, a real station.

Last year the Stivers group conducted an amateur broadcasting station with almost the same transmitting set. Who was to stop toward establishing radio places and clubs in high schools throughout the state and to bring out talent that would be dormant without the assistance of the club.

Experiments that would suggest interest in radio may come as a result of starting the work in subjects. It is the opinion of many interested in the program.

Charles Richardson, newly appointed principal of the school, will help out new ideas from students interested in the department.

The fact that Stivers is among the schools in the country to install a station, is regarded by many as just grounds for furthering the work among other high schools in the state.

Members of the Stivers club will take their knowledge of radio broadcasting through watching the work of the licensed operators and experimenters. The club is planning radio and broadcasting have a room where experiments may be conducted and where students will have charge of the transmitting and receiving equipment since they are in this way they may determine whether it is practical.

The transmission of heat lamps with amateur licenses after Wiley Wenger, Burton, Clinton, Warren, Robert Zimmerman, William Penn Sharp and the others at the office had William Nott.

A hand, receiving, amplifier and receiver instruments.

According to preliminary plans which will be used in the preliminary stages of broadcasting during the winter together will be divided upon and which should be able to handle the talent in Dayton will be used.

Members of the club when it plans of the cooperative and the school outside football 2:30 o'clock Thursday night. At times may be broadcast during the time anyone desiring to see the club. Later in the winter they will broadcast the results of received through by use of the bulletin board through the members. Foreign parts will be obtained to any operator the club.

Wiley Wenger and Burton station.

**STIVERS BROADCASTING STATION**

**IRVIN ENDBERG      WILEY WENGER**

The station is equipped with the station will have a broadcasting radius of more than 2000 miles.

Wiley Wenger and Burton station.

## As We Were Saying

(Continued from Page 3)

benefited by the real thing!) But nowadays, with three and four optical channels that must be rigidly aligned, the boys assemble their lab models on a brass plate—hence, brassboards!

**WILEY WENGER'S FORTY YEARS** in broadcasting are bracketed by the illustration above and the article starting on Pg. 10. In the early twenties many high school radio clubs had ham transmitters. But not Stiver's High in Dayton, Ohio. Stiver's had a commercial broadcasting license—and call letters WEBT, duly granted by the Department of Commerce. Wiley Wenger, already holding his first commercial ticket, was the chief operator. He can be seen sitting at the WE transmitter in the photo below. The writeup says "the station will have a broadcasting radius of 2000 miles" (sic). Wiley thinks this may have been the first educational broadcasting station. (This should get us some letters—Ed.)

In the forty years from the picture above 'til today, Wiley has seldom had his fingers off a transmitter control for very long. As a station engineer, RCA field representative, and in recent years as a part of our transmitter merchandising group in Camden, he has devoted a lifetime to what started out as a hobby. As manager of FM Transmitter Merchandising he was responsible for the planning of our new line of FM transmitters. Who better to write about them?

ABOVE, Dayton DAILY NEWS for October 26, 1924, featured story on Stiver's High Broadcasting Station. Wiley Wenger is described as chief operator.



RIGHT, A closer view of Wiley at the controls of the WE transmitter. At right are receiver, audio amplifier and Magnavox speaker.

RIGHT—The towers of WJAR and WJAR-TV—  
a last salute to old friend Tom Pryor.

**TOM PRYOR**, longtime friend, offtime critic, one of the industry's beloved characters, has gone to that place above the tallest towers. In his honor we show at right the towers of WJAR-TV and WJAR-AM-FM. Tom taught these towers to talk. And he taught two generations of young ops the things they couldn't learn from books.

Tom, himself, was largely self-taught—and was fond of saying: "I just grew up with it." But nature had a little help. Following high school Tom took a course at the Marconi School of Wireless Telegraphy, then joined the Navy as a first class radioman. At the end of the war (WW1) he went with RCA Radiomarine as a ship's radio officer.

Tom loved the sea but he came ashore to raise a family. In 1923, he joined WJAR—which had been on the air just eight months—as fourth assistant engineer(!). In 1931, he became chief engineer and remained so for thirty years, retiring in 1961.

### *As We Were Saying*

An iconoclast of sorts, and a skeptic of the slide-rule boys, Tom, nevertheless, was always one of the first to adopt new developments. In 1944, he took a short leave of absence to work with Major Armstrong at Alpine—returned to install FM at WJAR in 1946. In 1949, he put WJAR-TV on the air.

Tom was one of a group of old-time engineers who for years were in the thick of it at every seminar, IRE meeting and NAB Convention. Their ranks are growing thinner.

**RAY BRUNNER**, longtime WBAL engineer is another old-timer who closed his key this year. John Wilner has pointed out to us that Ray should have been given credit for much of the planning that went into the new WBAL (BROADCAST NEWS Volume 119, February 1964). Ray had been with WBAL since its inception thirty-eight years ago. He started as technician, later became assistant chief engineer and then chief engineer of WBAL. During the last three years he had spent all of his time in helping design the WBAL plant. It was a fitting last chapter to a long career.

**WE GET LETTERS**, maybe not as many as you know who, but harder to answer—albeit interesting. One writer asked for a circuit diagram of the Radiola III (our Receiver people found it for him). Another asked for the music to the RCA jingle (will somebody please get it for him). Still another wrote to say he knew the whereabouts of the first broadcast transmitter RCA sold (more



about this later). Several, spurred by the 1923 ad we ran several issues back, have sent in old RCA ads—back to 1917—and we'll show a few of these when we have space. And, of course, any number want us to do stories on their prized installations "the finest in this part of Deaf Smith County" (don't laugh, there is a Deaf Smith County). We wish we could, but we've only so many pages.

We like to get these letters—even though many are a pain to answer (and we've got a stack right now that are unanswered—but will be). They are always interesting, often intriguing, sometimes informative. Keep them coming!

**IF YOU KEEP A FILE** of BROADCAST NEWS, you may find that you are lacking Volume No. 120. This was a "special" convention issue distributed at the NAB Convention. It was designed to introduce our New Look line of equipment—to explain how the New Look was developed, the thinking behind it, its implications for broadcasters—and to describe briefly the key items of the new line. If you did not get a copy, please drop us a line. We will be most happy to send you one, two, three—autographed if you like.

—The Armchair Engineer

# Interchangeable modules in

...assure high quality, easy maintenance



**Modular layout of the deluxe TR-22. Many of these same modules are used in the TR-5, TR-4 and TR-3.**



**Modules of the TR-5 Mobile Recorder are basically the "record" type. Facility for high quality closed circuit playback is provided.**

All four RCA TV tape recorders pictured here have something in common: *They can all use each other's modules!* Even modules of the deluxe TR-22 can be used in the lower priced models. Making modules the common denominator of all these units has important implications. It means the quality is the same in all. It means maintenance is simplified. And it means accessories are modular for easy addition. • Standardizing modules saves time and reduces spare parts requirements where two or more RCA TV tape recorders are

**See the entire RCA line before you buy any TV Tape Recorder.**

*RCA Broadcast and Television Equipment,  
Building 15-5, Camden, New Jersey*



# all these RCA TV tape recorders

and simplicity in adding accessories!

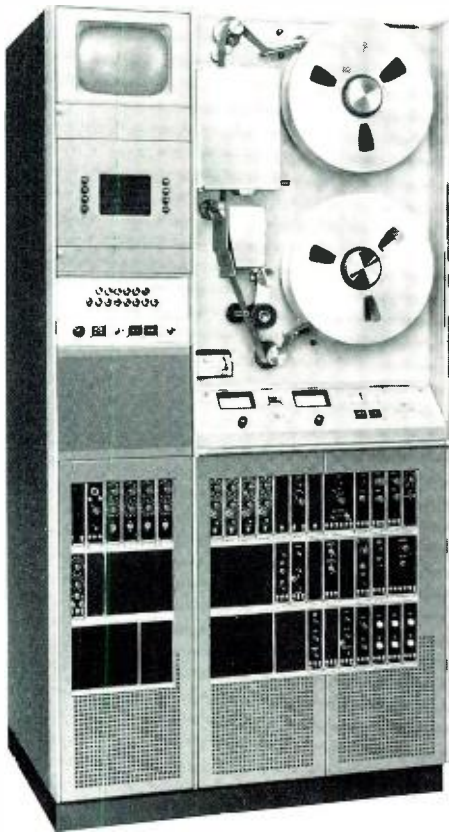

Modular layout of the TR-4 showing "record" group at left and "play" group at right.



"Play" group of modules in the TR-3 Playback Special are the same as those shown in the TR-4.

installed. Standardization also makes quick replacement easy, and operating a group of recorders is a lot simpler. • Accessories, such as color and electronic editing, can be added to any model largely by plugging in necessary modules. • Tapes made on any of these quadruplex units can be played on any other—as well as on all standard broadcast quadruplex recorders. They are all fully transistorized—all capable of producing the highest standards of professional broadcast-quality tapes.



The Most Trusted Name in Television

**RCA  
SERVICE**  
keeps all your  
**AM, FM, TV**  
equipment  
in top  
condition!

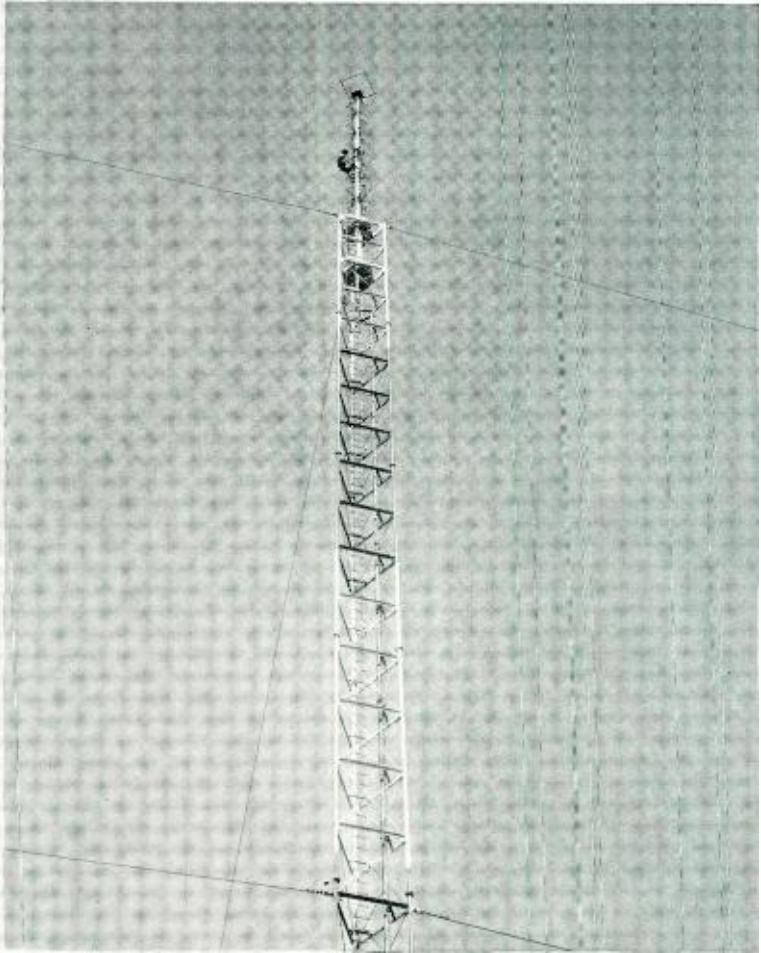

*Antenna System Measurements*

**TAKE ADVANTAGE OF THE FOLLOWING SERVICES OFFERED BY RCA:**

- Video Tape Recorder Service • TV Camera Overhaul • TV Transmitter Overhaul**  
**• Installation Supervision • Microphone and Pick-Up Repairs • Transmitter Performance**  
**Measurements • Antenna Inspection Measurements • Console Repairs • Microwave Service**  
**• TV Projector Service • Custom Fabrication • Teletypewriter Maintenance**

Your audience demands a superior signal which requires top performance from all your station equipment. RCA Broadcast Service is planned to assure you of meeting this objective. More than 30 years in the broadcast industry have provided a background of solid service experience. This is the type of protection broadcasters have relied on for years, the kind of protection you can count on . . . contract or per-call . . .

from the experts in the service business, RCA Service Company. To guard performance of all your equipment . . . simply telephone one of the following field offices: Atlanta (phone 555-6110), Chicago (WE 9-6117), Camden (GL 6-7984), Hollywood (OL 4-0880). Or contact Technical Products Service, RCA Service Company, A Division of Radio Corporation of America, Bldg. 203-1, Camden 8, N.J.



**The Most Trusted Name in Electronics**

*Created by the hand of experience*

## RCA-4415 AND 4416 IMAGE ORTHICONS

### Living color with only black-and-white studio lighting

With this 3-tube set in the TV camera, the studio lighting you now use for B&W pickup is all you need to transmit superior color pictures. At the same time, you air high resolution pictures having normal tone rendition for B&W receivers. You avoid many of the lighting costs normally associated with high-quality studio color pickup...as well as the high scene-lighting temperatures and need for extra air-conditioning.

Precision construction, field mesh, and closely matched tube characteristics assure excellent registration and color uniformity over the entire scanned area.

RCA ELECTRONIC COMPONENTS AND DEVICES, HARRISON, N.J.



The Most Trusted Name in Electronics

High signal-to-noise ratio and signal output, and excellent life expectancy are additional features of the RCA-4415 and -4416.

This factory-matched set consists of two RCA-4415's and one RCA-4416 with a high blue sensitivity which increases over-all camera sensitivity by as much as a factor of two. For quick identification, each image orthicon is marked for its particular color channel.

Write or call your local distributor of RCA broadcast tubes for information on these orthicons that enable you to air living color with only B&W studio lighting.

#### AVAILABLE THROUGH YOUR LOCAL RCA BROADCAST TUBE DISTRIBUTOR

FOR NAME AND ADDRESS OF YOUR LOCAL DISTRIBUTOR WRITE OR CALL YOUR NEAREST RCA DISTRIBUTOR PRODUCTS SALES OFFICE—NEW YORK, NEW YORK: 36 W. 49th St., [212] MU 9-7200; NEEDHAM HEIGHTS 94, MASSACHUSETTS: 80 "A" St., [617] HL 4-8480; WASHINGTON 6, D. C.: 1725 "K" St., N.W., [202] FE 7-8500; ATLANTA, GA.: 134 Peachtree St., N.W., [404] JA 4-7703; CLEVELAND, OHIO: 1621 Euclid Ave., [216] CH 1-3450; CHICAGO, ILL.: Merchandise Mart, [312] 467-5900; DALLAS 7, TEXAS: 7901 Carpenter Freeway, [214] ME 1-3050; KANSAS CITY 14, MO.: 7711 State Line, [816] EM 1-6462; HOLLYWOOD, CALIFORNIA: 6363 Sunset Boulevard, [213] 461-9171; SAN FRANCISCO 2, CALIFORNIA: 420 Taylor St., [415] PR 5-5135-5-7.