

# BROADCAST NEWS

COLOR TELEVISION GROWS  
IN JACKSONVILLE, FLORIDA



Vol. No. 123 OCT. 1964



# FM Transmitters



## A whole new line of the finest in FM transmitters 5-kw...10-kw...20-kw...designed for Stereo

RCA gives you the FM Transmitter you want... with everything that is new and exciting... new-improved stability, simplified operation, space-age styling, full-fidelity sound. Designed for the exacting requirements of FM stereo. Provides excellent performance in monaural and multiplex as well. Ready for remote control and automatic logging.

**IMPROVED STABILITY.** New circuitry means a new kind of stereo and multiplex performance, with stability never before possible.

**SIMPLER OPERATION.** New simplified exciter eases operation and maintenance, resulting in greater dependability.

**NEW STYLING.** Convenient new height, with eye-level metering and space-age colors, combines operating convenience with modern decor.

**POWER EXPANSION.** All three transmitters are housed in identical enclosures. Field modification of a 5-kw or 10-kw to higher power requires changes only in the basic power-determining parts.

**FULL FIDELITY DIRECT FM.** The famous RCA direct FM principle, first used in FM transmitters built in 1941, is your assurance of full-fidelity sound.

These are the exciting new transmitters to put your station ahead in FM. Be the first in your market to own one! RCA Broadcast and Television Equipment, Bldg. 15-5, Camden, N.J.



THE MOST TRUSTED NAME IN RADIO

**BROADCAST NEWS***published by***RADIO CORPORATION OF AMERICA**  
BROADCAST & COMMUNICATIONS PRODUCTS DIVISION, CAMDEN, N. J.*issued quarterly*PRICE *in U.S.A. - - - - - \$4.00 for 4 issues*  
*outside U.S.A. - - - \$5.00 for 4 issues***C O N T E N T S**

	Page
KOOL's New Radio Studios . . . . .	5
Remote Control for Radio Transmitters . . . . .	8
Diplexed TV Antenna Radiates WHEC and WROC Signals . . . . .	14
Color Television Grows in Florida, at WFGA-TV . . . . .	22
NPC Employs Tape-Film Conversion to Step-up Production of Motion Picture Films . . . . .	34

*As We Were  
Saying*

**NON-B/C TV** is getting bigger every day. It's hard for us broadcast-oriented people to realize—and harder yet to admit—that already the number of TV cameras used for non-broadcast purposes far exceeds those in all our TV studios. And the ratio is going up. The TV camera is becoming so omnipresent that before long that "big brother is watching" line will have to be changed to "big orthicon (or little vidicon) is watching." Most of the cameras, and all of the know-how were borrowed (or adapted) from broadcast TV. So we might say that we started it. We might—if anyone cared.

**THE NPC STORY** (Page 34) is a good illustration of the best of non-B/C TV. And maybe there are some lessons in it for broadcasters, too. The use

of TV for educational purposes has been heralded long and loud. But progress in applying TV to school systems has been painfully slow. Only a relatively few school districts have installed TV systems—and most of these use TV in a rather fragmentary way. In contrast, the military services have been quick to adopt TV as a basic training tool. And they have used it not only as a training tool—but also as a technique for producing other training tools—i.e., tapes and films. In the August 1962 issue of BROADCAST NEWS we described the Army's use of TV at Fort Monmouth. In the article starting on Page 34 of this issue the Navy Photographic Center's use of TV is depicted. The interesting thing here is not only the advanced type equipment in use at NPC—but

*(Continued on Pg. 46)*

Copyright 1964

All Rights Reserved. Trademark(s) Registered. Marca(s) Registrada(s) Radio Corporation of America

PRINTED  
IN  
U.S.A.

# ELMER TROUANT RETIRES

## Early Pioneer Our "Chief Broadcast Engineer" For 27 Years

Time marches on. And sometimes we wish it wouldn't—for inexorably it changes our ways, and changes our lives. As we grow older, the change we notice most is the thinning ranks of our old associates. Virgil Elmer Trouant has been one of these. For twenty-seven years he has been our "chief broadcast engineer." On the first of this month Elmer Trouant retired. We'd almost sooner not talk about it. But report it we must—for his old friends and acquaintances in the industry will want



to know that Elmer has departed 15 Building and is now to be found among his clocks, his grandchildren and the State of Maine. (His home address: 429 Westminster Avenue, Haddonfield, New Jersey 08033.)

For some of us Elmer's leaving marks the end of an era. It's not a sharply defined era—either as to beginning or end. It's more a feeling. To understand it fully you have to be old enough to remember the thrill of hearing those first broadcasts from KDKA—especially election night 1920! And to remember how, as a boy in knee pants you worshiped the genius of the men who made this miraculous thing possible. Later you were to meet some of them—and find out that they were just ordinary mortals—although set apart by a fierce devotion to the thing they had created. Some were well known—Marconi, DeForest, Alexanderson, Conrad—but there were many others, the "little men" who get the work done. Elmer Trouant was one of these.

Elmer arrived at Westinghouse Pittsburgh in June 1921—with a still wet diploma from the University of Maine. He had a number of early assignments, but in 1924, he became a permanent member of the Radio Department. From that day

till now he has been continuously connected with transmitter development and design. In 1933, with many other Westinghouse and GE engineers he moved to RCA in Camden. In 1937, he was made supervisor of our broadcast transmitter engineering group. Later other things—studio equipment, microwave, electron microscopes, etc.—were added to his responsibilities. But broadcast remained his first love—and for forty years it has never been out of his mind.

It is strange, then, that for many of our readers, Elmer Trouant's name will not ring a bell. And his leaving will be less noted than would that of some of the men who work in his department. For, with Elmer Trouant, modesty and self-effacement have been a way of life. In the over thirty years he has been with the Broadcast Division his name has appeared only three times in BROADCAST NEWS—although there were literally hundreds of articles authored by his people. He delivered no papers to learned societies, received no medals (although his men were the recipients of many). In a business where we know most of our customers personally he was known to only a few. And even in other Divisions of RCA, he was seldom recognized.

But think what his engineering group did. In the mid-thirties they designed the first all-modern line of broadcast transmitters—using features such as Class B modulation, vertical-chassis construction, air cooling and stylized design which were then entirely new. In the late thirties they designed a complete line of FM transmitters, numerous shortwave transmitters—and the first commercial-model TV transmitter, the RCA Type TT-1A. During the war they worked on all kinds of projects—not just transmitters, but such things as R.F. Heating. Coming out of the war his engineers developed and designed a line of TV equipment (including the first Image Orthicon camera) which became, and still is, the world's standard. Then came a new line of FM transmitters, the first UHF transmitter (for Bridgeport)—and following that a complete line of UHF transmitters. In the early fifties a complete line of color gear, later a new generation of television tape recorders. And just recently our wholly new line of New Look equipment. Over the years many engineers contributed their talents and energy to these developments. And no one man can claim credit for any large part of the total. But all of these things took place during the time that Virgil Elmer Trouant directed our broadcast engineering activities. Our 1000-page catalog of broadcast equipment is a tribute to this quiet and modest man.

On the occasion of his 65th birthday we threw a big party for Mr. Trouant. As usual, he himself had little to say—but what he said triggered a thought. Referring to the things above he said: "It's been fun—I wish I could be around for the next forty." And, listening, we thought—maybe that's it—the men who did it—in the beginning—did it for the "fun" of it.

To follow in Elmer Trouant's steps we have many bright, young engineers. They will not let the business falter—and in time they will outdo the old master. But it is sad to think that we have lost our last personal contact with the early days of broadcasting. For some of us it is indeed the end of an era.

—JPT

**'HAMLET' ON BROADWAY STAGE FILMED WITH TV SYSTEM USING ONLY AVAILABLE LIGHT**

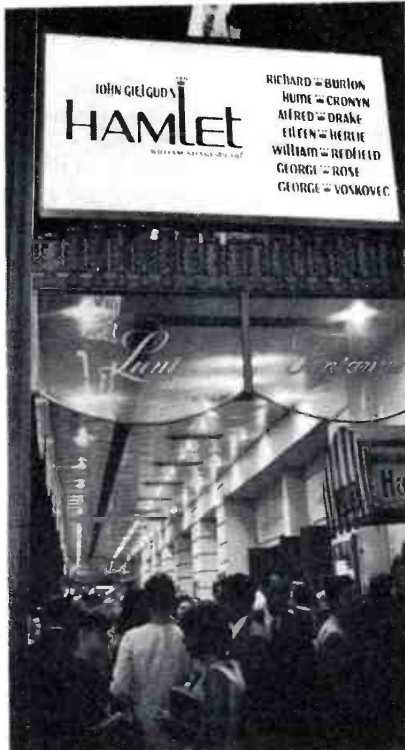

Audiences attended the recording sessions, giving filmed show the sounds of a Broadway performance.

Audiences at three on-stage performances of "Hamlet" at Broadway's Lunt-Fontanne Theater last July had some unusual seatmates: five TK-60 television cameras occupying seats in the auditorium or locations on the stage. The cameras were there as part of a unique system developed by Electronovision, Inc., in conjunction with RCA, to record the stage play on film.

The recording was made directly on 35mm film exposed to the electronic pictures, with RCA's new TFR-1 television film recorder serving as the intermediary. Two recorders, modified to handle the larger-size film, were set up in the theater basement. There the producer and his staff monitored output of the five cameras and selected the pictures to be recorded.

After this initial editing by television methods, the producer had available separate films of each of the individual performances. From them he drew the preferred sequences to be incorporated in the final version. The finished picture, starring Richard Burton, was exhibited at more than 1,000 theaters across the nation on September 23 and 24.

Noting that the picture was shot with ordinary stage lighting, representatives of both Electronovision and RCA pointed out



"Alas poor Yorick," intones Richard Burton.

that the project demonstrated that high-quality TV film recordings can be produced with illumination at this level. They agreed also that the recordings compared favorably with motion pictures when exhibited on a large screen where any technical flaws inevitably are enlarged.

The Electronovision process was used to film another live talent stage show in late October, with other productions planned for next year.

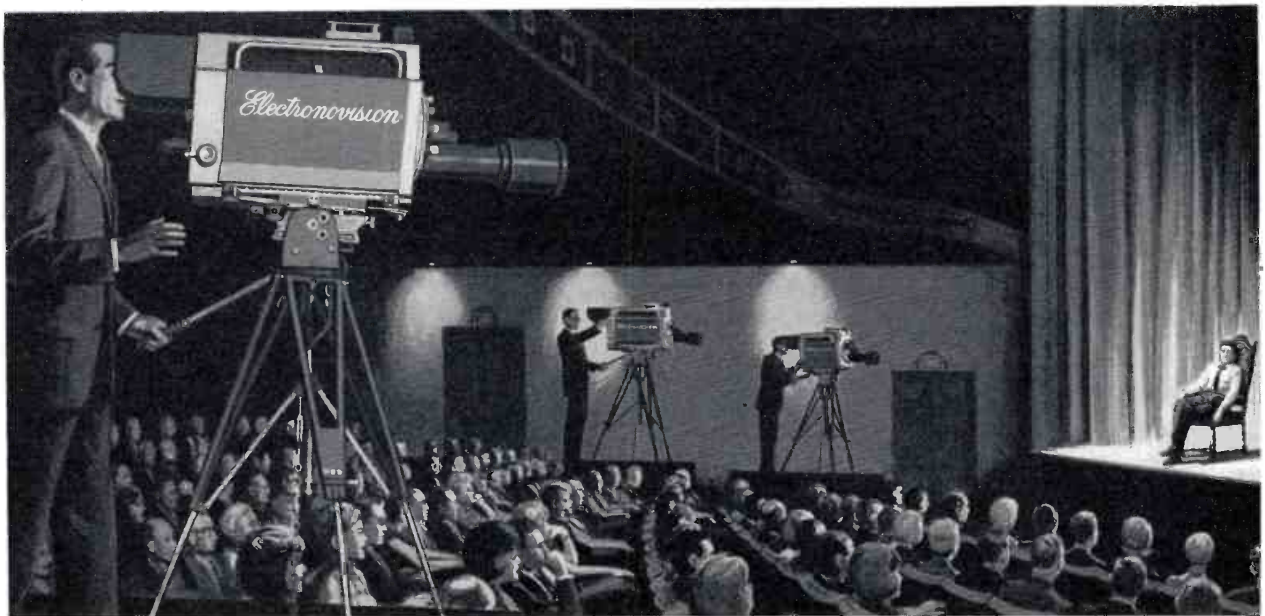

Artist's sketch depicts the scene as TV cameras shared theater auditorium to record Shakespeare's classic on film.

**KETV FILLS TV TAPE NEEDS THREE WAYS**



Tape, tape, tape was on the minds of this quartet as they gathered at KETV's offices in Omaha to formalize the station's purchase of three new RCA television tape machines. Eugene S. Thomas, the Channel 7 station's Vice President and General Manager, signs the papers while Rupert F. Goodspeed, RCA broadcast equipment sales representative, sits next to him. Standing are, from left, Jack Petrik, Program Director, and Larry Sibilia, Chief Engineer.

The order provides a three-way approach to the station's tape needs: a TR-22 for

all-around work in the deluxe category; a TR-3 tape player for previewing and broadcasting, and a TR-5 transportable unit for remote location assignments.

In announcing the tape facility expansion to KETV viewers, Mr. Thomas said the station had stepped up its locally-produced shows during recent months so that they now average 24 programs a week. With more tape equipment in the house the station will be in a better position to conceive and produce documentaries and special report programs as well as local-flavor commercials.

**WTVO TELLS VIEWERS: NEW RCA FILM UNITS A BOON TO QUALITY**

Tele-Log, a pictorial publication for viewers of WTVO, Channel 39 in Rockford, Illinois, tells readers of its September issue that the station scored "A Television First" by becoming the first mid-west broadcaster to install two of RCA's new TP-66 TV film projectors.

Then Chief Engineer Al Petzke takes pen in hand and produces these kind words:

"In addition to providing a sharper, clearer picture with no 'jitter' or 'sound wow,' the RCA TP-66 virtually guarantees continuous performance. For example, a loop lost through torn sprocket holes or otherwise damaged film is instantly recovered by the automatic loop restorer built into the projector. The audio amplifiers in the RCA TP-66 are completely transistorized to give the highest audio quality. There is no doubt that the purchase of these units by WTVO Television will improve picture quality immeasurably."

Well said, Al. The fact is, reports like yours are beginning to come in from all parts of the country as more and more TP-66s go into service. With the TP-66 there's more fidelity in film.

**THIS NEW TRANSMITTER KEEPS PLAYING 'BACK HOME IN INDIANA'**

Students returning to Indiana University for the fall term found their campus FM station, WFIU, was back on the air in a bigger and better way. The reason: a brand new RCA BTF-10E transmitter had been installed during the summer months and was putting out the big sound.

WFIU's voice had been weak for months for the station operated at reduced power after a fire destroyed part of the old transmitter. The new one, first of the BTF-10 series to come off RCA's production line, helps WFIU attain 75,000 watts ERP.

The new FM transmitter was introduced to the broadcasting world as part of RCA's exhibit at last spring's NAB convention in Chicago. Designed to bring even greater economy and reliability to the FM transmitter world, it features single cabinet styling, simplified circuitry and a new exciter that uses RCA's "direct FM" system.



WFIU'S Supervisor William H. Krool (left) and Chief Engineer James Rolfe with new transmitter.

# KOOL'S NEW RADIO STUDIOS

by ALBIN R. HILSTROM

*Director of Engineering  
KOOL Radio-Television, Inc.*

When KOOL decided to build all new studio facilities, the foremost thought was how to build an attractive, dignified, modern, and practical station. We wanted a facility here in Phoenix (Ariz.) that was as simple as possible, that would serve modern-day, network-affiliated radio, with superb production capabilities.

KOOL Radio went on the air in 1947 and operates at 960 kc with 5000 watts. KOOL-FM went on the air in 1960 with 100 kw at 94.5 mc. Both are CBS affiliates owned by KOOL Radio-Television, Inc.

We used RCA transistorized studio equipment throughout for its modern and attractive design and low heat dissipation. Any equipment that was retained from our old facility was fully transistorized by our engineering staff.

## Floor Plan and Building Features

The floor plan layout is simple, yet serves very well. Master Control, from which the daily operation originates, is a room 10 by 16 feet. Custom building of the console desk and equipment housing left ample space for record storage and work space. Production Control is separated by a hallway from Master Control and is the same size.

One studio serves the entire operation. It is located next to Production Control, since 99 per cent of its use is associated with production and taping, however, full visibility is afforded from Master Control since all walls are built of double pane 1/4-inch glass. Each area has visual contact with other areas and the open office area. The News Room is adjacent to Master Control, thus providing quick access and close visual and physical communication. All walls are pre-finished rustic walnut paneling or glass. The entire area is carpeted in red, including the studio and control rooms, which effects an excellent balance for softening the acoustical liveliness developed by all the glass walls.

## Master Control Equipment

Master Control is equipped with an RCA BC-7A Control Console, one RT-21A Reel-to-Reel Tape Deck, two RT-7A Cartridge Playback units, and three BQ-2A

Turntables. The equipment layout was designed for ease of operation, hence the "U"-shaped console. One of the reasons we selected the BC-7A is that it lends itself to customizing and we utilized this feature. All equipment starts when the key on the console is turned "on", therefore, the operator has only one function to do when he puts anything on the air. This feature facilitates a very tight operation.

While, at present, we do a lot of simulcasting for AM and FM, the output from the master-control console is split so that the AM and FM feeds may be separated by key selection.

## Production Control Equipment

Production Control is also equipped with an RCA BC-7A Console, two RT-21 Tape Decks, one RT-7A (with a BA-7A Record Amplifier), three turntables and one disc-cutter. The equipment layout and features are the same as those for Master Control. The RT-21 Tape Deck speeds are arranged with one operating at 3 3/4 and

7 1/2 inches with the other operating at 7 1/2 and 15 inches. With this configuration, even 1 7/8-inch-speed tapes can easily be handled (via a "fast-copy" system). All equipment inputs and outputs are routed through patch panels which give practically unlimited flexibility in the system.

The production control console feeds Master Control, therefore, if needed, all the facilities of the production control room are available directly for air programming.

## News Room Set-up

The News Room is open to the office area and the newsman airs his news directly from there. Two tape recorders, a beep phone and full monitoring of any program feed provide extra program flexibility. In addition, the newsman has control over a cartridge-tape and reel-to-reel tape deck located in Master Control. Therefore, he can tightly program his own news show. The News Room has an intercom between it and both control rooms,

FIG. 1. KOOL's street-front building is finished in bronze ceramic-veneer tile with red lettering. The metal framing of the portico is gold-anodized to harmonize with the bronze-colored tile.



while both control rooms have intercom with each other.

### Studio Facility

The studio size is 10 by 17 feet . . . large enough to serve modern-day requirements. Both control rooms and the studio are sunken two feet below the office area, therefore, anyone in the office area gets a bird's-eye-view of the operation. Microphone outlets are provided in the studio that connect directly to production and master-control rooms. Also, microphone outlets are installed in the office area, in the event anything comes up that requires additional studio space. A microphone outlet is installed on the outside of the building for "on-the-street" type interview programming.

### No Equipment Racks

When you walk into the new control rooms, you will notice the absence of equipment racks. There is no equipment room either. There isn't a single rack in the entire studio plant.

By using 100 per cent transistorized equipment, we were able to eliminate all racks. All operating equipment is mounted within the custom-built control cabinets. Each cabinet offers ample space for future expansion.

### Record Storage

Record storage for on-the-air and production work is provided in Master Con-

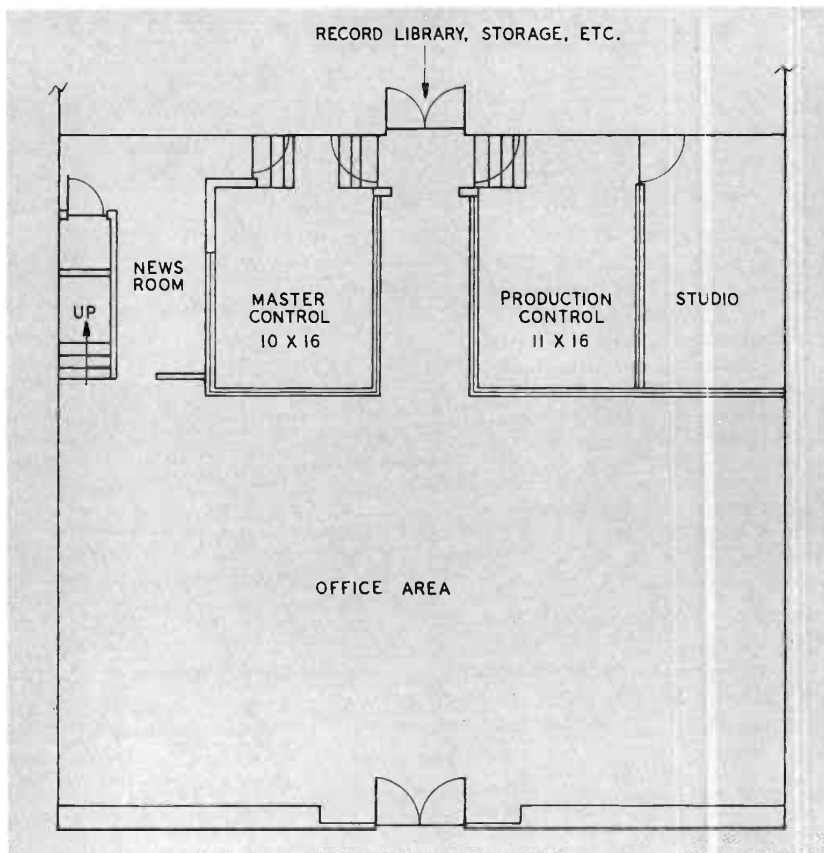

FIG. 2. KOOL's building floor plan. The large office area is immediately inside of the street entrance while the Newsroom, Master Control, Production Control and the "live" studio line up along the rear wall. Further rearward is the record library, storage, etc.

FIG. 3. Panoramic view of the office area showing Production Control at the far right. The decor is walnut paneling, walnut furniture and red carpet.







FIG. 4. Master Control is equipped with three turntables, a reel-to-reel tape deck, two cartridge-tape machines and, of course, the control console. Note cartridge-storage bins above cartridge-tape machines.

control and Production Control beneath the turntables. Tape storage is provided near the tape machine for the operator's convenience. Additional record and tape storage is provided in the studio for Production Control. The record library is located immediately behind the two control rooms in the storage area (see floor plan).

#### Facility Has Proven Itself

Until this modernization, we operated with the same equipment since 1947 when KOOL went on the air. Over the years modifications were added to update the old control rooms. With the advent of TV, radio was treated as sort of an outcast

and shoved into one small room. The new facilities put this behind us.

When the new facilities were built, everything was all new, including office furniture. When we made the changeover, the staff merely got up from their old desks and walked across the block and set up operation in a completely new environment. The two facilities are as different as day and night. (The new facility has seven times more space.)

After operating in the new control rooms for a number of months, no problems of any consequence have arisen. The operators are exceptionally happy with the

simplicity and ease of the operation. Due to the identical design of Master Control and Production Control, the operators are able to step from one control room to the other without changing operating habits. Also, in addition, should anything go wrong in Master Control, all the operator needs to do is step across the hallway, throw a key and program from Production Control.

We are very pleased with the low maintenance and reliability of the new facilities. While it is a rather bold departure from standard radio station design, the operation has proven itself functionally and we would do the same thing over again.

FIG. 5. Production Control is arranged very much like Master Control except that there are two reel-to-reel tape machines (RT-21) and one tape-cartridge system equipped with recording facilities.



# REMOTE CONTROL FOR RADIO TRANSMITTERS

Versatile RCA Equipment Permits Wide Flexibility in System  
Designed for Control of WBAL AM Transmitters

by DONALD L. WRIGHT  
*Transmitter Equipment Product Analyst*

In recent years, strides in broadcast-transmitter design have improved transmitter reliability so much that unattended remote control of the transmitter is now practical, both technically and economically.

Of the many advantages transmitter remote control affords, these three are probably the most important:

1. Reduction in the cost of operation in the transmitter plant through elimination of the "environmental" requirements of humans.
2. Reduction in the space requirements of the building which houses the transmitter.

3. Relocation of the transmitter supervisor(s) to the studio, where other duties can be assigned such as equipment maintenance, etc.

### Transmitter Requirements

Operating a transmitter via remote control requires that the transmitter incorporate certain relays, wiring, motor-driven controls, meter shunts, meter multipliers, etc. All RCA transmitters produced in recent years have those provisions built-in. Older transmitters, in many instances, can be modified to include the necessary equipment at moderate cost.

### Basic Remote Control

Generally, a basic remote-control system should be capable of nine control-and-

metering functions; of which four are control functions: *filament power on/off; plate power on/off; power output raise/lower and overload reset*. The five metering functions are: *plate current; plate voltage; antenna current; frequency deviation and modulation monitor*. These basic requirements exceed the specifications of FCC rules pertaining to remote control.

RCA offers two remote-control systems: the BTR-11B and the BTR-20C. The former provides for 11 on/off (or raise/lower) control functions and 11 metering functions while the latter performs 20 control and 20 metering functions. (See Fig. 1.) Both systems include a "homing" function for the control portion and a "calibrate" for the metering portion.

For the basic system, the smaller of the two is adequate but provides little "room" for expansion. The BTR-20C, because of its larger "capacity" and semi-automatic operation, is the better choice.

### How It Works

Figure 2 is a simplified schematic diagram of the smaller of the two systems: the BTR-11B. The system consists of two units: a *master* and a *slave*. The master unit, located at the studio, gives orders to the slave (at the transmitter site) via a pair of telephone lines. The telemetry (metering) information is transmitted back to the master via a second telephone pair.

Communication between the two units is in the form of four d-c voltages and a 60-cycle tone. These signals traverse the "control" pair while the answer signals occupy the "telemetry" pair.

The 60-cycle tone is part of the fail-safe feature of the system that constantly monitors the condition of the "control"

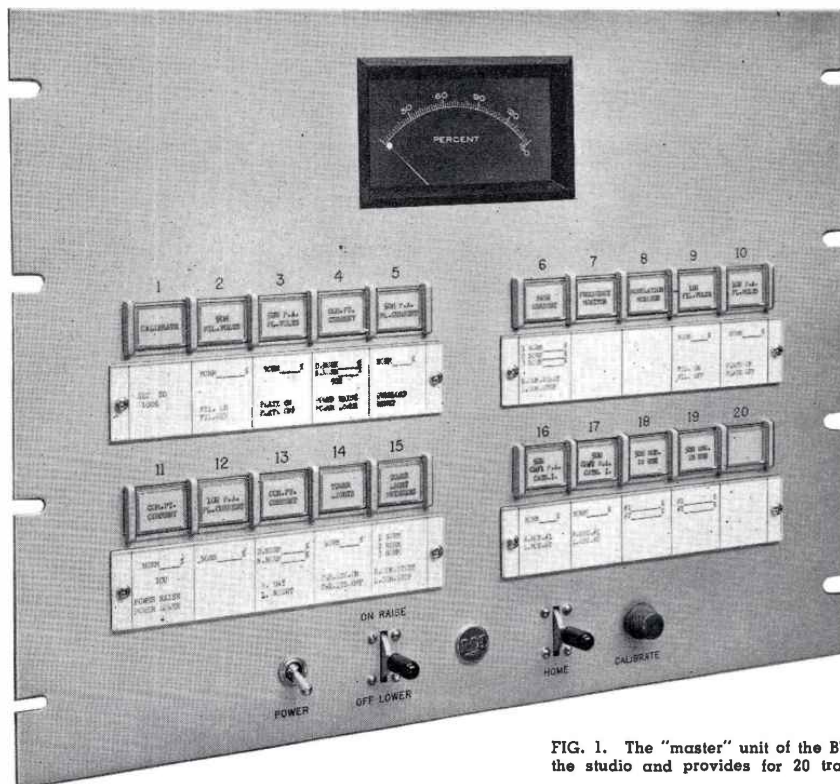

FIG. 1. The "master" unit of the BTR-20C Remote Control System. This unit is located at the studio and provides for 20 transmitter-control functions and 20 metering functions.

pair (an FCC requirement). In the event the "control" pair becomes unfit for adequate control, the fail-safe feature immediately removes the transmitter from the air by removing plate power. Further, since this 60-cycle tone is derived from the powerline at the studio site, a power failure at that site automatically shuts down the transmitter.

Of the four d-c "signals" used for control, there are: (1) a high-level positive; (2) a high-level negative; (3) a low-level positive and (4) a low-level negative. The high-level signal is three times as large as the low-level to prevent any confusion between the two.

The two high-level signals actuate a stepping relay in the master unit through its sequence and back to "home". This relay switches the various metering functions and connects them to the meter in the master unit via the "telemetry" pair. The low-level signals perform the *on* and *off* functions of the system (positive *on*; negative *off*).

At the transmitter end of the system, two polarized relays respond to the posi-

tive or negative voltages and, by virtue of predetermined sensitivities, to the two levels of signal strength. An interlock system (not shown in Fig. 2) prevents actuation of the low-level relay while the high-level relay is energized.

As pointed out earlier, the metering information travels over a second telephone pair which is calibrated for 5000 ohms loop resistance. A 1-volt potential across this pair deflects the meter full-scale.

The BTR-20C system, the studio unit of which is pictured in Fig. 1, offers greater capability than the BTR-11B in combination with a push-button system of sequential switching.

The smaller system requires that the operator manipulate the lever switches to sequence the system; the BTR-20C design includes an internal system that automatically advances the stepping switch to the position corresponding to the activated push button. When the switch arrives at this position, the label above the push button lights and thereby indicates the function in use. Because of the rapid response of the system, the time required for arrival at that function is less than three

seconds—in the extreme condition. This is a highly desired feature in many stations.

### Larger Systems

As mentioned earlier, the BTR-20C affords 19 control and 19 metering functions plus "home" and "calibrate". A number of AM/FM installations require a greater number of functions. In this case, the 20/20 system is expandable to 40/40 using an "extension" unit, Type BTRX-40A, which attaches to the slave unit at the transmitter site and is controlled by the BTR-20C master unit at the studio.

In all, the extension unit provides for 39 control functions and 39 metering functions plus the usual "home" and "calibrate" steps without increasing the requirement for telephone pairs . . . the same two pairs serve the doubled capacity.

In addition to the increased control and metering capabilities, other accessories may be added to perform virtually any operation. For example, a diesel-powered emergency power plant can be switched-in via the remote-control system; remote pickup units measure antenna or base currents, etc. in large antenna-tower complexes; tower-light metering and switching can be

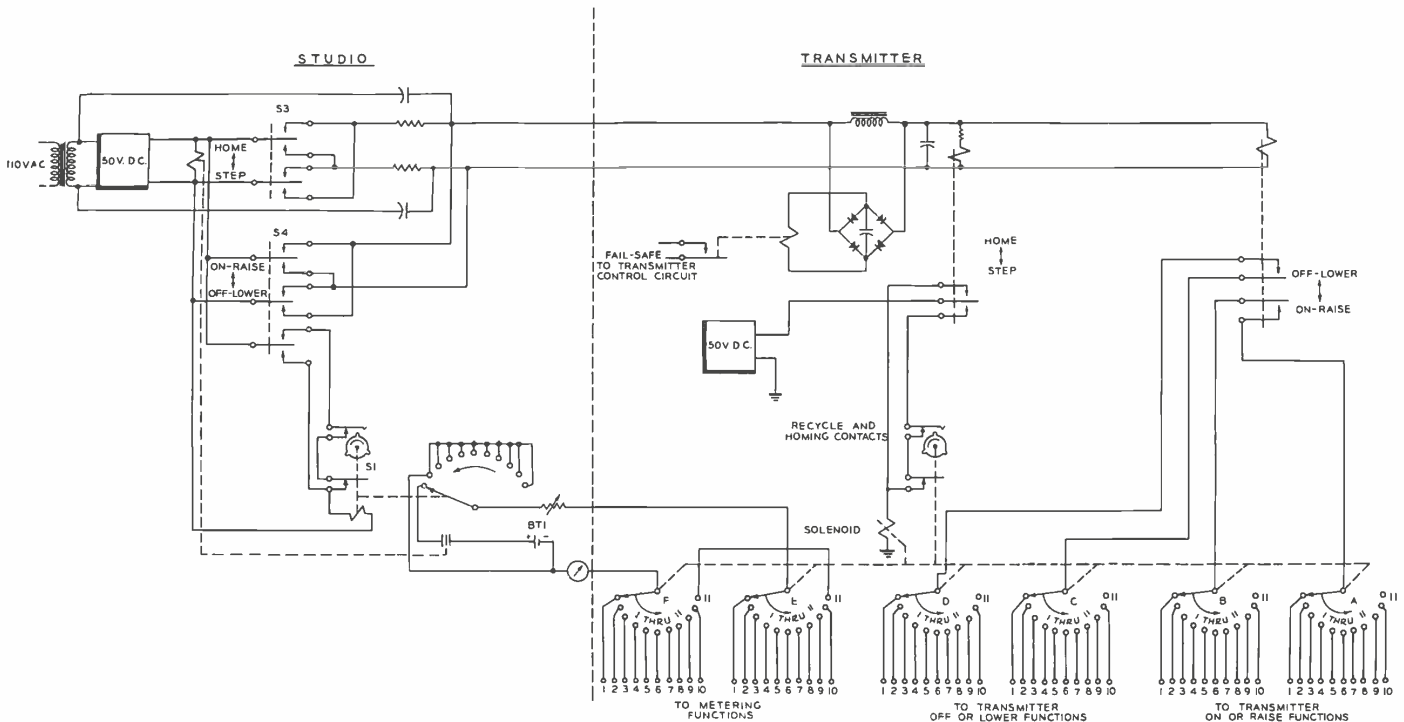

FIG. 2. Simplified schematic diagram of the RCA remote-control system. All control functions operate over one d-c telephone pair while all metering functions use a second d-c telephone pair.

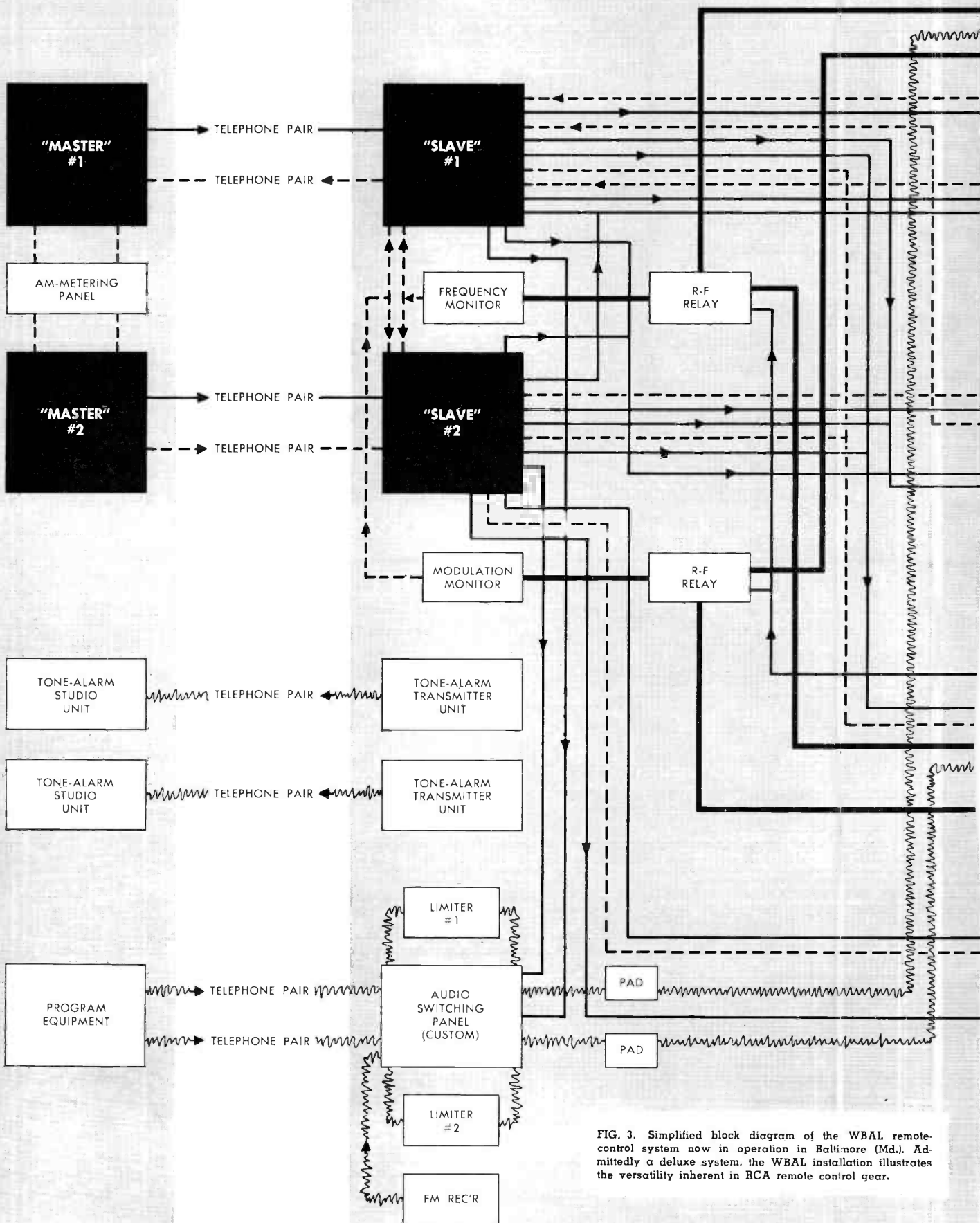
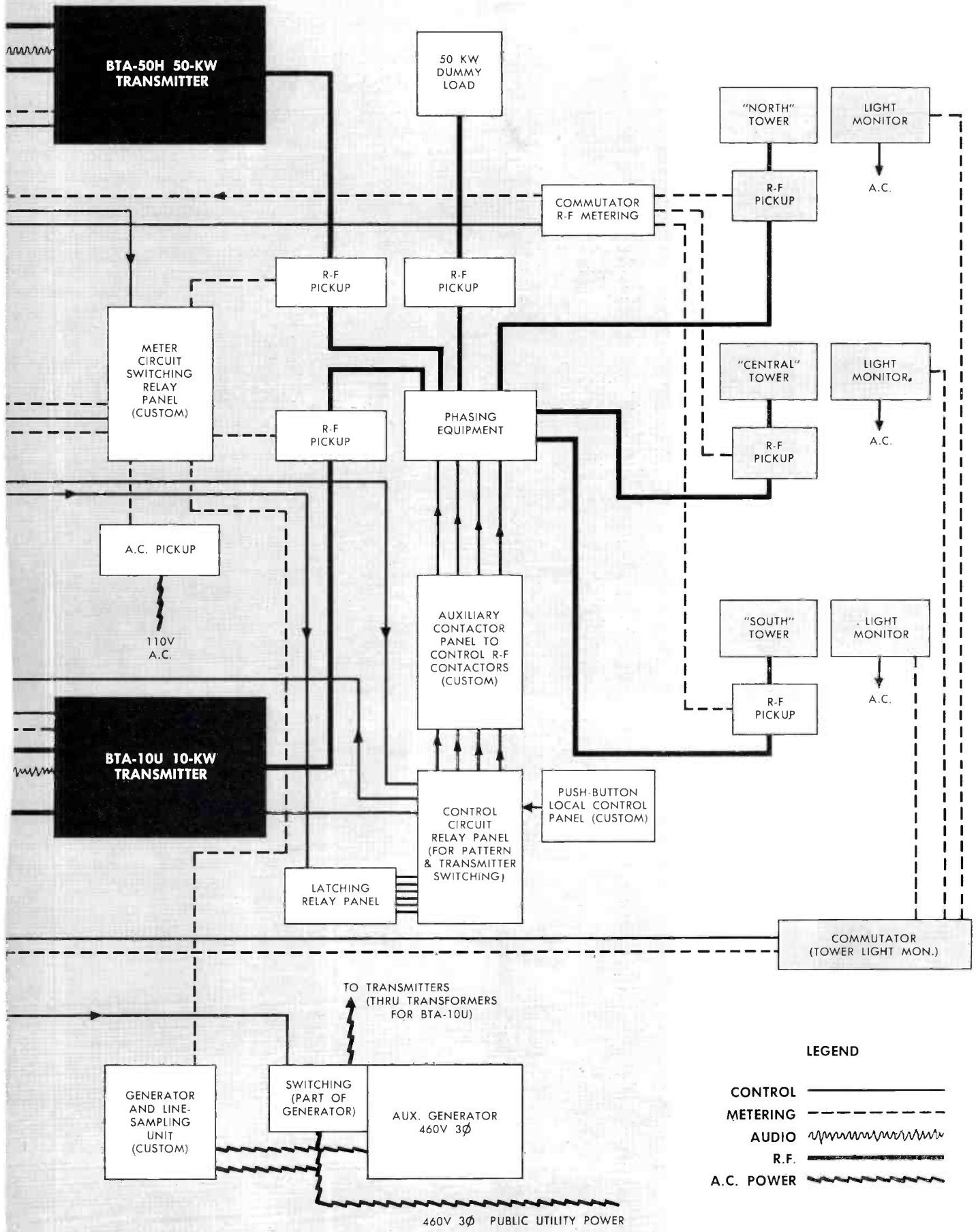

FIG. 3. Simplified block diagram of the WBAL remote-control system now in operation in Baltimore (Md.). Admittedly a deluxe system, the WBAL installation illustrates the versatility inherent in RCA remote control gear.

ANTENNA SYSTEM



LEGEND

- CONTROL —————
- METERING - - - - -
- AUDIO ~~~~~
- R.F. ————
- A.C. POWER ⚡



FIG. 4. The studio portion of the BTRA-5A Tone-Alarm System. This unit, in combination with the one shown below, constantly monitors five separate parameters at the transmitter site.



FIG. 5. The transmitter unit of the BTRA-5A Tone-Alarm System. This unit utilizes one of the remote-control telephone pairs to communicate with its studio counterpart.

added with appropriate accessories . . . the list is almost limitless.

Another accessory, called a "meter commutator" can extend the metering information even further by allowing as many as 12 separate meterings to share just one

of the 40 metering functions of the remote-control system. Other accessories permit main-to-standby transmitter switching, daytime-to-nighttime pattern switching, measurement of powerline voltage, filament-bus voltage, standby generator status, indoor or outdoor temperature measurements, etc.

#### Automatic Alarm Systems

A further extension of the remote-control system is an alarm device that constantly monitors as many as five separate parameters such as burglar detection, transmitter power output, plate current, building over-temperature, smoke detection, etc. As a matter of fact, any situation that can be electrically sensed is suitable for automatic alarm. Should any of the five parameters under scrutiny deviate beyond a pre-determined limit, the alarm system indicates which parameter is beyond tolerance so that the operator can take the appropriate action.

This alarm device is the BTRA-5A Tone-Alarm equipment which uses transistorized tone generators and resonant-reed relays to perform its function. The design allows it to operate via the telemetry telephone-pair thus avoiding the necessity for an additional telephone pair between studio and transmitter.

The equipment consists of two units: a "studio" and a "transmitter" unit. Figures 4 and 5 show these two.

The BTRA-5A design is such that all five alarm functions could operate simultaneously without interference between them. Each function offers its own indicating device on the "studio" panel.

It should be pointed out that the tone-alarm system does not require a telephone pair of its "own" . . . the design lets it ride "piggy-back" on either of the pairs used for remote control.

Some larger transmitter installations require more than five alarm functions. In this case, another tone-alarm system—of five alarm functions—may be added to the second of the remote-control telephone pairs to result in a 10-alarm system.

#### Great Versatility

The usefulness of the equipments described here is limited only by the imagination because the combinations that can result are myriad. To illustrate this great versatility, let us examine the extensive remote-control system now in operation at WBAL in Baltimore.

#### Remote Control at WBAL

WBAL's AM-transmitter plant is located some 15 miles out-of-town and separate from the FM-transmitter plant. Op-

FIG. 6. A corner of the WBAL transmitter plant. At far right is the 10-kw BTA-10U standby transmitter. Just left of center are the racks containing the "slave" units of the remote-control system, as well as the transmitter units of the tone-alarm system.

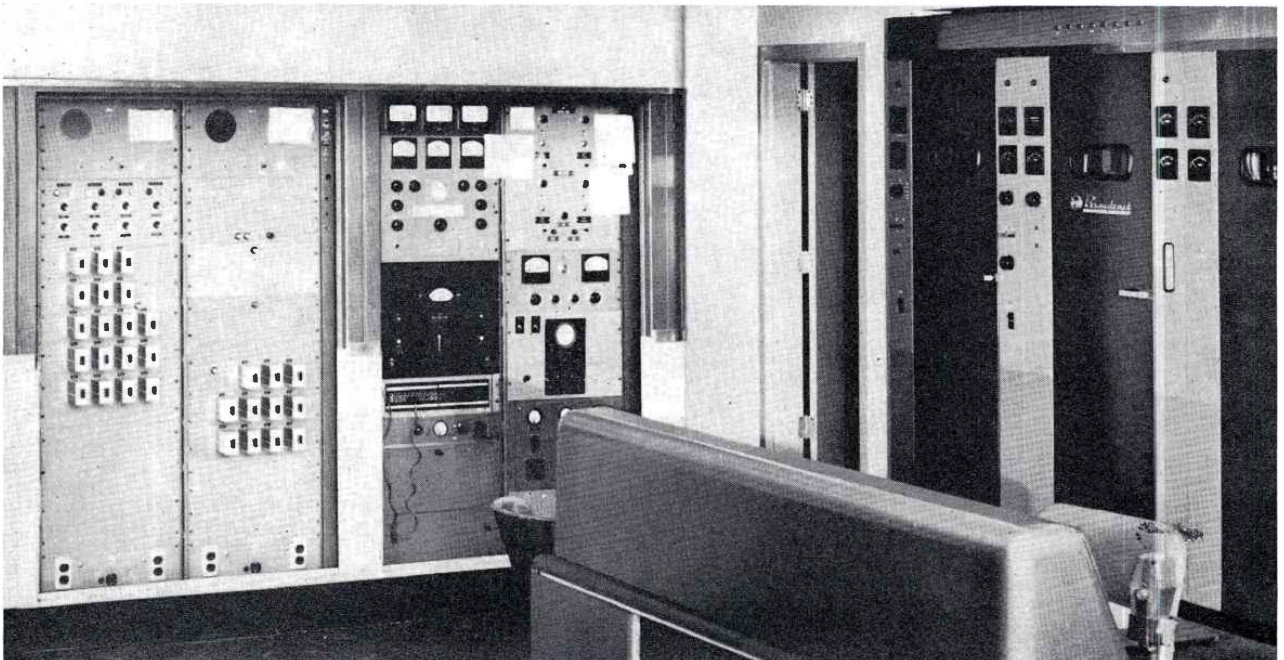

erating as a Class 1-B station on 1090 kc., WBAL uses a 50-kw transmitter—an RCA BTA-50H Ampliphase—as its main transmitter with a 10-kw BTA-10U as the standby transmitter.

WBAL's license requires that it operate a directional antenna at night and, as a result, the station uses a three-tower antenna array with appropriate phasing gear.

In addition to this, the AM plant is equipped with a diesel-powered emergency generator capable of supplying the main or standby transmitters for long periods of time.

Figure 3 is a simplified diagram of the remote-control system at WBAL-AM.

Starting at the upper left-hand corner, we have the first of two BTR-20C remote-control studio units. (WBAL chose to install two separate remote-control systems as opposed to extending a single system to the 40/40 functions mentioned earlier).

### Studio-Transmitter Interconnections

Each remote-control system (No. 1 and No. 2) operates through two pairs of d-c telephone pairs to its respective "slaves" at the transmitter site. Although the two tone-alarm systems could operate through any two of these four pairs, WBAL chose to provide each with a separate a-c telephone pair as indicated in the block diagram.

At the lower left, the two program lines are shown. At the studio end, manual switching is employed while program-line

FIG. 8. Close-up of the remote-control racks shown in FIG. 6. At top are the two BTR-20C "slave" units. The remaining equipment in these two racks is custom-built gear for the WBAL remote operation.

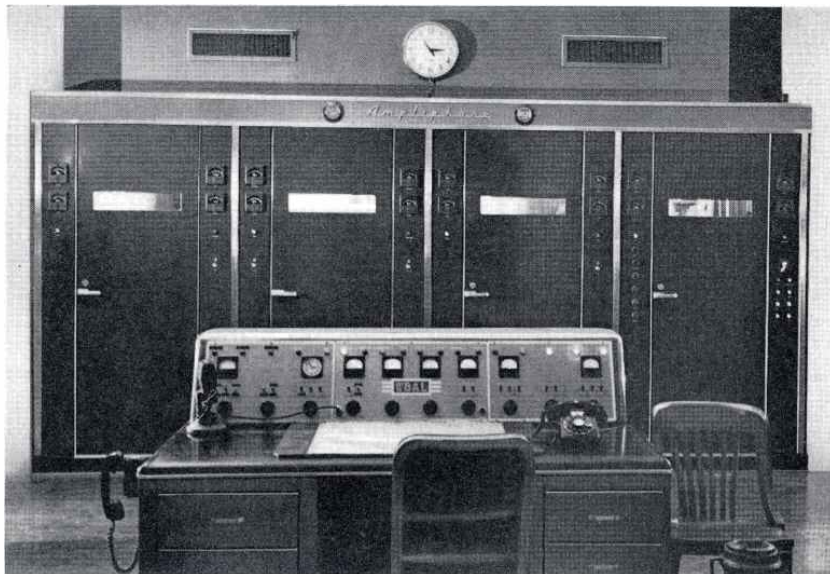
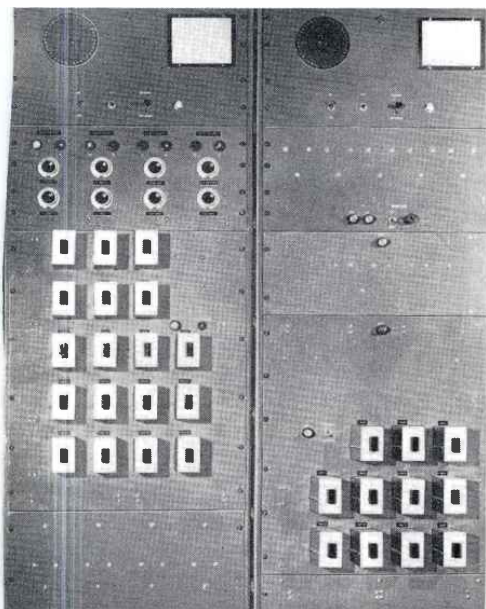

FIG. 7. WBAL's now-unused transmitter console stands in the foreground of the 50-kw BTA-50H main transmitter. This Ampliphase transmitter feeds a three-antenna array during nighttime operations.

switching at the transmitter site is performed through the remote-control system.

### Transmitter-Site Gear

At the transmitter end of the remote-control system, the two "slave" units are interconnected as shown so that each is the back-up for the other. Several pieces of custom-built equipment (such as the meter-switching relay panel, the night-phasing switching system, the main- and standby-transmitter switching equipment, latching relay and push buttons) complete the equipment rundown. (See Figs. 6, 7 and 8.)

### Thirty-three Control Functions

In all, the WBAL system permits control of 33 functions ranging from transmitter on/off, transmitter switchover, antenna switchover, frequency and modulation monitor switching, oscillator switchover, program-amplifier switching, day/night antenna switchover, overload resets, blower on/off, main/spare powerline switching, modulation generator switching, etc. The list is too long for publication here.

### Forty-one Telemetry Functions

The WBAL remote metering system encompasses a total of 41 separate meter readings including filament voltage, plate voltage, plate current, frequency monitor, modulation monitor, primary powerline voltage, cathode currents, indication of main or standby equipment-in-use, dummy-load current, antenna current, common-point antenna current, etc. Bear in mind that WBAL operates two transmitters via

remote control thus some measurements in the listing above mean two separate voltage measurements.

The 40-metering-function capability of the two BTR-20C's employed at WBAL is extended to 41 by the use of a three-step commutator in one of the functions. This allows the one metering function to serve the tower currents of the three towers thus providing a means to keep tabs on the operation of tower lighting.

### Conclusion

The foregoing shows that remote control can be applied to virtually any AM or FM transmitter plant, even the largest. The WBAL system is, admittedly, a "deluxe" system but it does point up the fact that there is no real limit to the application of remote control except, possibly, for the limits of imagination. Modern technology has provided the "hardware" . . . only men's minds can assign duty.

### Acknowledgements

The preparation of this article would have been an impossible task were it not for the generous aid provided by Mr. Lester Lappin of RCA's Transmitter Systems Engineering Department and the kindness of Mr. John Wilner and Mr. Harrison Brooks,<sup>1</sup> of WBAL Radio.

<sup>1</sup>"Some Advanced Technical Features of the New WBAL-TV Plant" by John T. Wilner and Ralph Mlaska. *Broadcast News*, Vol. 119, February, 1964.

"Streamlined New Facilities for Powerful Voices of WBAL AM & FM" by Harrison Brooks and Thomas S. Carr. *Broadcast News*, Vol. 119, February, 1964.

# DIPLEXED SUPERTURNSTILE SIMULTANEOUSLY RADIATES CHANNELS 8 AND 10

Single 12-Section Superturnstile,  
In Operation Since August, '62 . . . Handles Two  
Maximum-ERP Television Signals

by B. K. KELLOM  
*VHF Antenna Product Analyst*

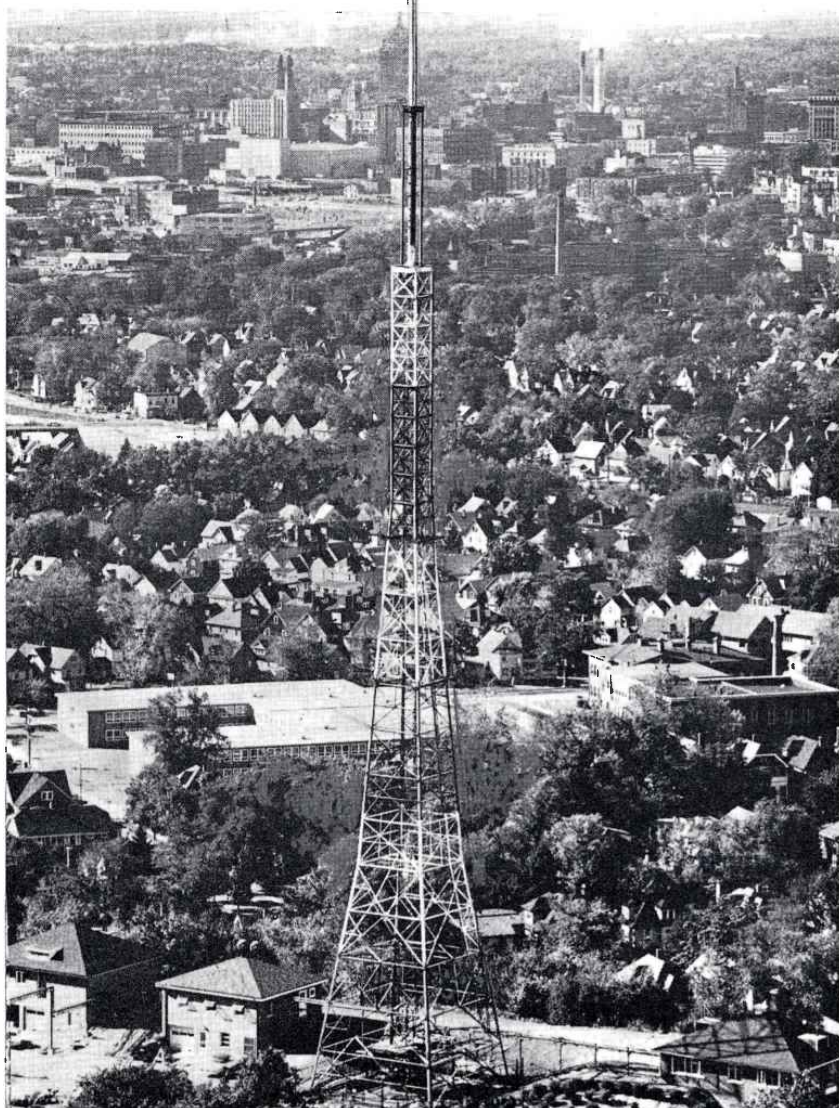

FIG. 1. The WHEC-TV/WROC-TV Diplexed-Antenna and tower as it appeared shortly after completion of the installation. The superturnstile antenna is arranged so that either the top six or the lower six sections can be operated separately.

During August, 1962, a television "first" was recorded in Rochester (New York) in that two maximum-power TV stations—WHEC-TV and WROC-TV—started regular transmission via a *single* antenna system, a specially-modified RCA Type TF-12BH Superturnstile. This single antenna serves two separate TV stations through an adaptation of the principle called *diplexing*.

### No Sacrifice in Performance

As the foregoing indicates, each of the two stations obtains full antenna-system performance — pattern circularity, picture quality, power gain, antenna height, etc.— as if each were using an individual tower. However, the diplexed antenna significantly reduced each station's capital outlay by utilizing an existing tower, not to mention the significant reduction in maintenance expense compared to that of two separate towers supporting two separate antennas. Neither station sacrificed any of the antenna performance they need and yet, both stations reap the economic benefits of the single-tower, single-antenna system.

### Investment Economy

To illustrate the investment economy a diplexed-antenna system affords, let us examine a situation in a hypothetical three-station, VHF market.

Presently, all three stations—two high-band plus one mid-band—operate with stacked antennas atop a tall building in the downtown section of the city. All three stations want to abandon this arrangement for a tall-tower (1500-foot) system outside of the city.

If each station were to invest in its own tall tower, the cost would approximate 425,000 dollars for each station. If all three stations were to pool their resources and build a 1500-foot candelabra tower, the per-station cost drops to approximately 300,000 dollars.

If, however, the three stations were to occupy a single tower with the mid-band antenna supporting the diplexed high-band antenna, the cost per station drops to approximately 225,000 dollars . . . thus, a diplexed-antenna arrangement reduces the per-station investment some 75,000 dollars



less than the candelabra system and a resounding 225,000 dollars less than the investment required for three, separate, 1500-foot towers.

### The Diplexing Technique

Almost since the beginnings of electrical communications media, there has been a concerted effort to increase the "payload" of these communications facilities, particularly commercial facilities.

Possibly, the first use of diplexing was the time when more than two telegraph stations used the same overland line. The carrier-current systems that came later increased the payload of communications lines by allowing several "conversations" to occupy the same circuit.

### Diplexing and Broadcasting

Over the years, there have been several instances where two AM stations share the same antenna system through a diplexing arrangement; several European FM stations diplex their signals and radiate them from a single antenna. More recently, organizations operating both TV and FM stations have installed diplexing equipment that permits a single RCA Superturnstile Antenna to radiate the TV signal as well as the FM signal. Obviously, this reduced overall investment by eliminating the expense for an FM antenna.

In television broadcasting, the technique of diplexing is most common in that it is the usual practice to combine the outputs of the aural and visual transmitters before transmission to the antenna.

### Other Forms of Antenna Diplexing

Antenna "stacking" is a form of antenna diplexing. It is, more accurately, tower diplexing because one antenna supports the other and the composite TV signals are kept separate. Probably the most famous stacked-antenna system is atop the Empire State Building in New York City.<sup>1</sup>

Columbus (Ga.) boasts one of the tallest stacked-antenna towers. Here, the antennas of WRBL-TV and WTVM share a 1749-foot guyed tower with the Channel-3 superturnstile on top and the Channel-9 super-gain side-mounted on the tower faces immediately below.<sup>2</sup> There are several other stack-antenna arrangements in daily operation throughout the United States.

A second form of "tower diplexing" is the so-called "candelabra" tower. As of this writing, three candelabra towers have been built: the first in Dallas (Tex.), the second

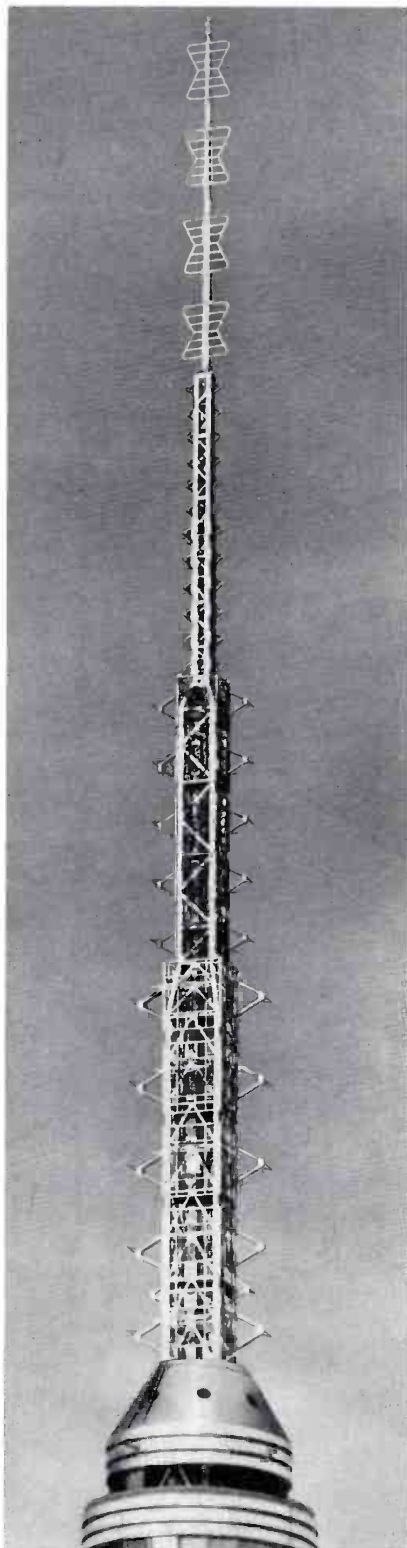

FIG. 2. Probably the most famous of all the stacked-antenna projects, the Empire State Antenna Tower now supports seven VHF, one UHF and several FM antennas. This photograph shows the system as it appeared shortly after completion.

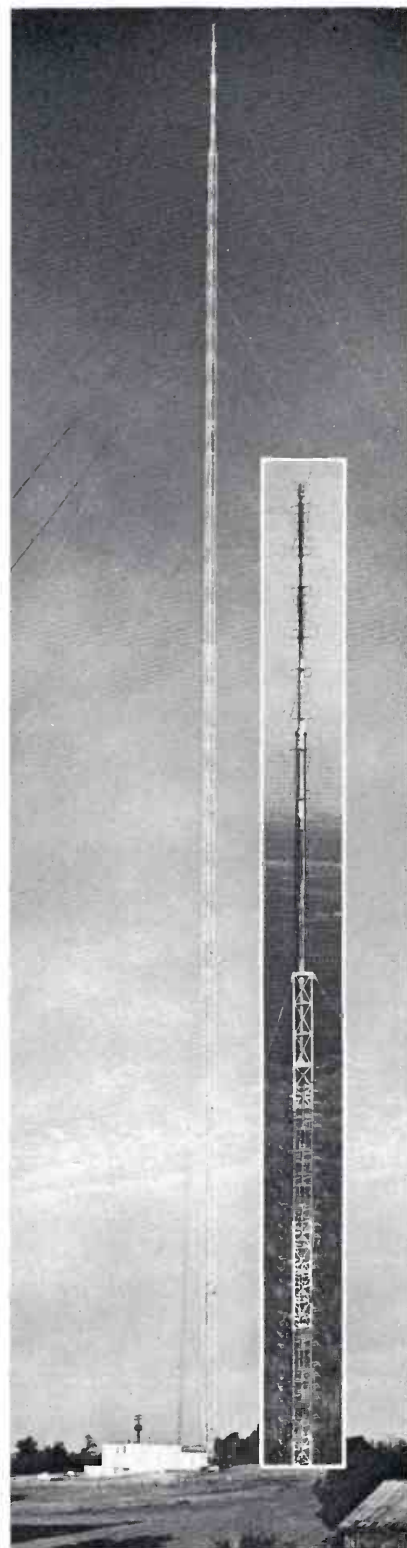

FIG. 3. This 1749-foot tower, serving WRBL-TV and WTVM in Columbus (Ga.) illustrates the two-antenna stack. The inset shows the stacking arrangement that utilizes two RCA antennas: a Super-Gain Mark II and a Superturnstile.

<sup>1</sup>"The Empire State Television Antenna System", H. E. Gilhring, *Broadcast News*, Vol. 70, pp. 25-33.

<sup>2</sup>"Television Tower In Georgia Is World's Tallest Structure", *Broadcast News*, Vol. 117, June, 1963. pp. 55-59.

in Baltimore (Md.)<sup>3</sup> and the latest installation serves the Sacramento / Stockton area of California<sup>4</sup>.

### Rochester TV History

Before describing the diplexed antenna system now in use at Rochester, let us take a few moments to introduce a brief history of television as it concerns the Rochester area. This history should help the reader realize some of the circumstances surrounding the project.

Originally, Rochester had only one TV station, WHAM-TV, operating Channel 6. As a result of an allocations change, WHAM-TV was required to move to Channel 5. At about this time, two organizations were planning to operate the other Rochester Channel, 10, on a share-time basis. For the sake of economy and other reasons, the antennas of Ch. 5 and Ch. 10 occupied the same 226-foot, self-supporting tower

in a "stacked" arrangement with the Ch. 5 superturnstile atop the Ch. 10 antenna.

The 1957 allocations plan again changed the assignment so that Ch. 5 became Ch. 8 and a third channel was assigned: Ch. 13. Rochester now has Ch. 8, 10 and 13.

The "beginnings" of the diplexed-antenna project started with the intended move of Ch. 5 to Ch. 8.

### The Rochester System

Over a period of several months, the people involved in the project examined and rejected several plans that would have accomplished the job were it not for strong restrictions, some set down by various agencies. A few of these restrictions were:

Separate towers for each of the stations were out of the question as far as the local authorities were concerned. Although not formally rejected, it was apparent that the same fate awaited a proposal for a candelabra tower. On top of these was the FAA restriction of antenna height above average terrain of 505 feet.

These restrictions left only two solutions: antenna stacking or close, side-by-side mounting of the antennas on the existing 226-foot tower.

The stacking arrangement, because of the tower height, prevents the lower antenna from taking full advantage of its allowed antenna height while the side-by-side arrangement placed structural demands on the existing tower that made it economically impossible to attain the separation requirement for any two commercially-made antennas.

The stacking arrangement, because of the tower height, prevents the lower antenna from taking full advantage of its allowed antenna height while the side-by-side arrangement placed structural demands on the existing tower that made it economically impossible to attain the separation requirement for any two commercially-made antennas.

<sup>3</sup> "WBAL, WJZ and WMAR Build the World's First Three-Antenna Candelabra", *Broadcast News*, Vol. 106, pp. 30-35.

<sup>4</sup> "KCRA, KOVR and KXTV Erect the World's Tallest Candelabra Antenna System", *Broadcast News*, Vol. 114, pp. 9-15.

FIG. 4. The "candelabra" antenna tower extends tower usefulness by placing all antennas at the same level. This tower, the "Dallas Candelabra," was the first of the "birthday-cake" towers. The tower now supports two TV antennas as shown here plus two "interlaced" FM antennas.

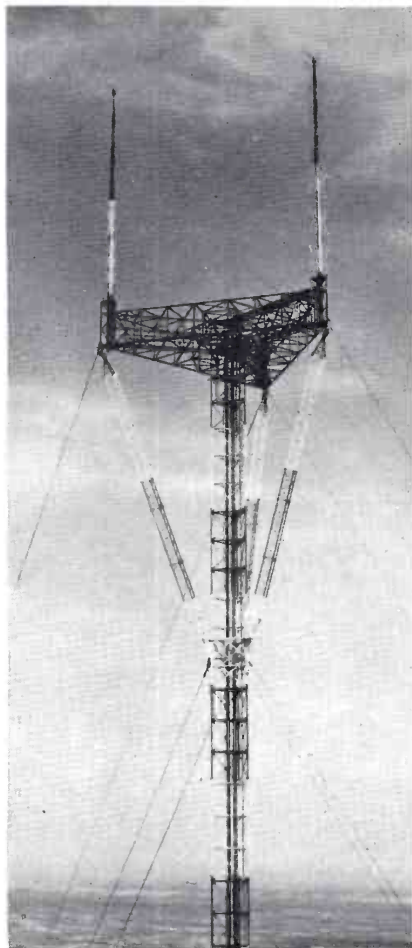

FIG. 5. The "Baltimore" candelabra was the second such tower. 725 feet tall, the tower "sees" virtually every part of the Baltimore metropolitan area. Supporting two RCA Traveling-Wave Antennas and an RCA Superturnstile, the tower is now being extended to 1000 feet.

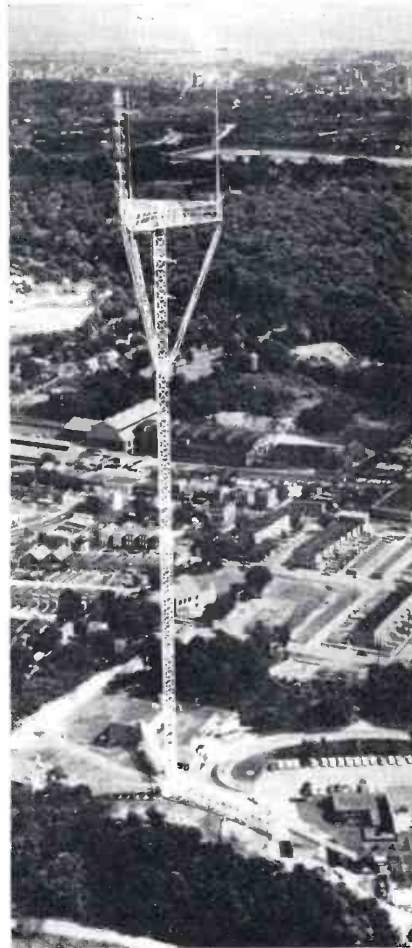
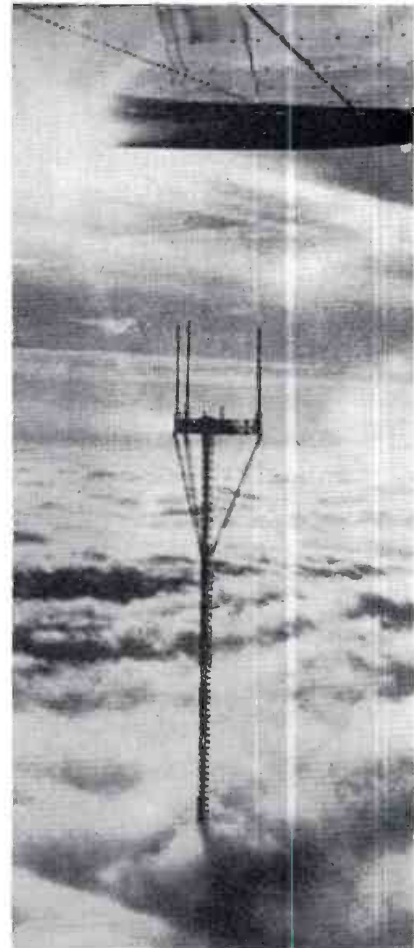

Fig. 6. The latest of the candelabras . . . the "California" candelabra. Situated along the banks of the Sacramento River at Walnut Grove, this 1500-foot giant often has its head in the clouds as this dramatic photograph shows. It is the world's tallest candelabra tower.



Input Frequency	Isolation Between Inputs in DB
180 mc	35
183 mc	35
186 mc	30
192 mc	38
195 mc	38
198 mc	25

With these thoughts in mind, the ideal solution appeared to be an antenna system that could radiate the Ch. 8 and Ch. 10 TV signals simultaneously . . . diplexing the diplexed outputs of two television transmitters and feeding this new "composite" of the four signals (two aural; two visual) to a single antenna atop the tower.

#### RCA Superturnstile Antenna

Of the several antenna-type "candidates" considered, only the RCA superturnstile appeared likely for diplexed operation. In addition, the superturnstile antenna design permits separate excitation of the "upper" and "lower" six sections with little additional wiring. This arrangement, if included in the design, could—if the need arose—provide a six-section "working" spare antenna system. For these reasons and others, no other antenna type received further consideration and the decision was made, the RCA Superturnstile Antenna would be used.

#### Antenna Modifications

The antenna is a conventional TF-12BH Superturnstile with two important modifications: one to increase the power-handling capability of the antenna and, the other, to prevent induced currents in the de-icer wiring as a result of the additional r-f power.

The 50-kw power-handling capability of the TF-12BH was increased to 80-kw by substituting  $\frac{7}{8}$ -inch Styroflex line for the  $\frac{3}{4}$ -inch line ordinarily used and, to preclude the possibility of induced currents in the de-icer system, the wiring was enclosed in copper tubing.

These were the only modifications performed on the antenna. However, WHEC and WROC requested that the antenna be

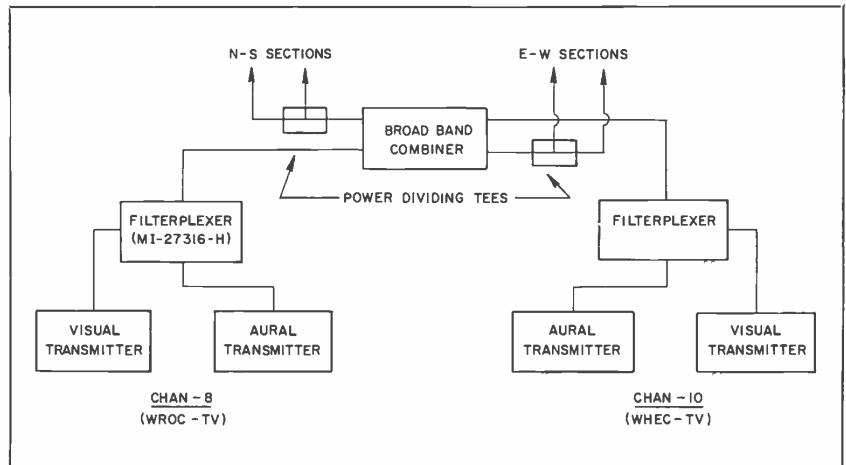

FIG. 7. Block diagram of the Rochester Diplexed System showing basic connections. The manual power-transfer panels, etc. are not shown in this drawing.

wired so that the top six sections and the lower six sections could be operated individually to provide a "working-spare" antenna system with a power gain of approximately 6.

#### The Broadband Combiner

The unique part of the system is the broadband combiner . . . a device that combines the diplexed outputs of the Ch. 8 transmitter with the diplexed outputs of the Ch. 10 transmitter. Fig. 8 is an oversimplified drawing of the device.

#### Power Split

The combiner operates on the principle of a directional coupler. Referring to Fig. 8, the energy from the Ch. 8 transmitter (aural and visual already diplexed and filtered) enters port 1 and flows to port 2. During the pass through the combiner, approximately half of the energy is coupled to the "second" circuit and appears at port 4. Thus, one-half of the energy appears at port 2 and the other half at port 4.

The energy from the Ch. 10 transmitter

FIG. 8. Simplified drawing of the broadband combiner. Essentially two directional couplers back-to-back, the combiner divides the diplexed output of each transmitter between Port 1 and Port 2. This illustration, used with the text, helps in the understanding of combiner operation.

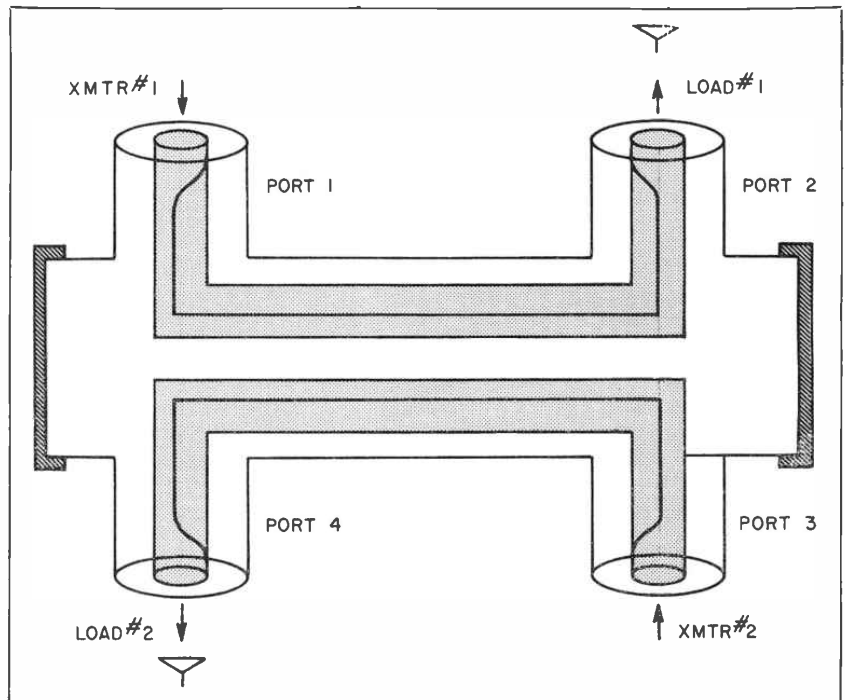

enters the combiner at port 3, divides its power between the two circuits and emerges from the combiner at port 4 and port 2, mixed with the energy from the Ch. 8 transmitter. Thus ports 2 and 4 deliver combined energy from both transmitters ready for transmission to the N/S & E/W sections of the antenna.

Since the broadband combiner uses the principles of the directional coupler, it inherently isolates the two transmitters from one another thus, virtually no Ch. 8 energy appears at the Ch. 10 input and vice versa. Table I lists the measured isolation. (See opposite page.)

#### Negligible Insertion Loss

The broadband coupler, through careful design and fabrication, offers the advantage of virtually no insertion loss. The measured power loss across the combiner is less than 0.004 db . . . truly negligible.

#### Testing the System

Because this was the first diplexed television-antenna system ever engineered, extensive tests were performed to indicate, with reasonable accuracy, the performance of the system under actual operating conditions.

The tests performed were divided into two groups: those measurements to be made after antenna fabrication but before shipment and, the second group, those tests required after system installation at the site.

To illustrate the completeness of the tests, each antenna section was measured for VSWR after assembly on the antenna pole. Upon completion of all of the as-

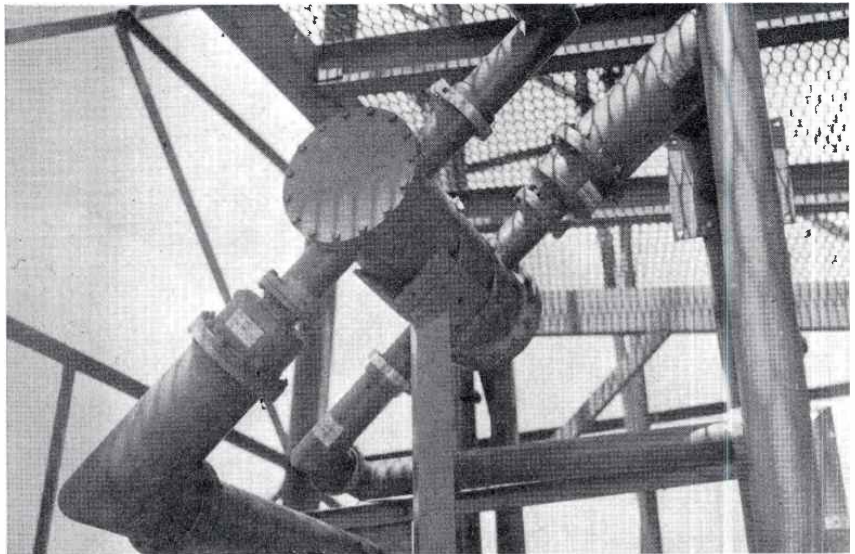

FIG. 9. Candid photograph of the combiner in its mount at the base of the tower. The two 6-inch lines deliver the diplexed power from the transmitters and the 3-inch lines connect to the power-dividing tees shown in the block diagram of Fig. 7.

sembly and tests, the antenna was transported to RCA's 40-acre antenna-test site at Gibbsboro (N.J.), a rural community several miles from the Philadelphia/Camden metropolitan area.

At Gibbsboro, the completed antenna was mounted in a horizontal position on a "turntable" which sits upon a knoll with the antenna 23 feet above ground. (See Fig. 10).

#### Antenna Receives Signals

For utmost accuracy, the antenna's patterns are tested with the antenna serving

as a receiving device. Test signals are beamed at the turntable-mounted antenna from a target transmitter some 2.5 miles from the knoll on which the turntable sits.

The antenna is rotated in two planes, axially and radially, and is moved in precision increments while engineers measure the received energy on appropriate equipment. Fig. 11 displays typical vertical patterns of the Rochester antenna.

#### Antenna Tested Vertically

At the completion of the tests performed on the horizontal turntable, the antenna

FIG. 10. The horizontal turntable at RCA's 40-acre antenna-test site in Gibbsboro (N.J.). This wooden, trestle-like device allows radial and axial rotation of the antenna under test so that measurement of the vertical radiation patterns can be made in any antenna plane. The antenna shown here is an RCA-Pylon device for UHF television transmission.

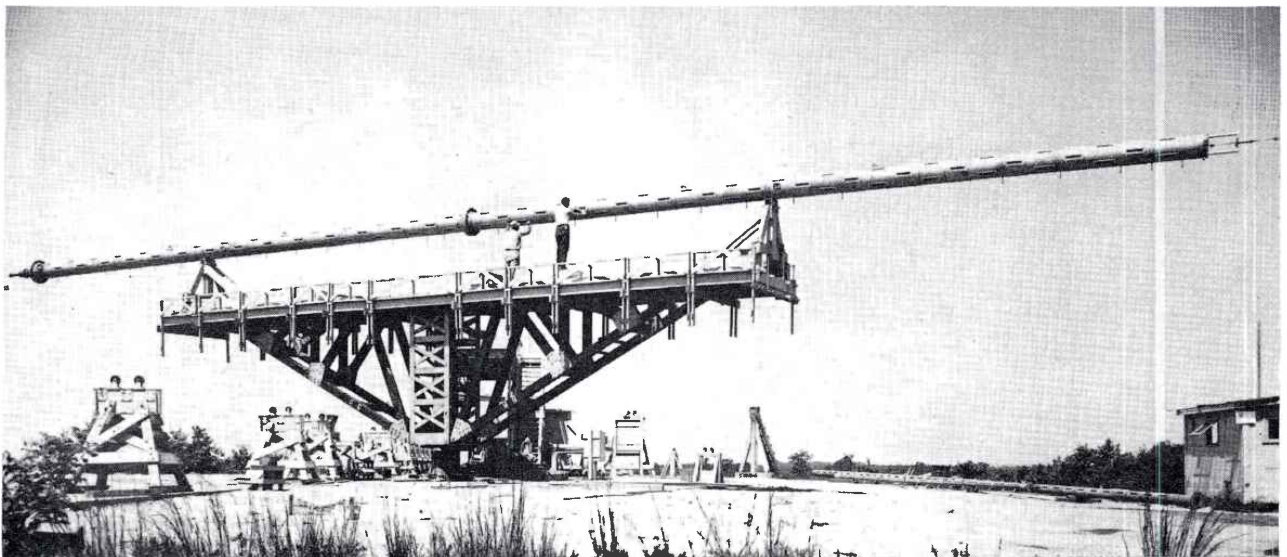

was moved to the "vertical" turntable for measurement of the input VSWR in free space and horizontal signal distribution. Mounted on the turntable, the lowest antenna radiator is 27 feet above ground on a knoll that is the highest point in an area of dozens of square miles.

The impedance of each of the four sections of the antenna (upper E/W, lower E/W, upper N/S, lower N/S) was measured using the slotted-line method. Figs. 13, 14, 15 and 16 reproduce the "smith" charts recorded at that time. Notice that the VSWR for each section measured less than 1.1/1.0 at both channels.

Next came the horizontal pattern measurements at the picture-carrier frequencies of the two appropriate channels, Ch. 8 and Ch. 10. Figs. 17 and 18 are reproductions of the pattern measurements. The measured circularity was  $\pm 1.38\text{db}$  and  $\pm 1.60\text{db}$ , respectively. So that these patterns would be a true representation of the expected patterns after installation, the tests were performed with all four circuits of the antenna wired to the combining networks which, in turn, were wired to the

broadband combiner or "diplexer". Thus, the entire system was connected essentially as it would be in Rochester save for the long runs of transmission lines (up the tower) from the broadband combiner (see Fig. 8).

After completion of the pattern tests, the assembled system was measured for impedance match and transmitter isolation through the broadband combiner. Fig. 19 is a reproduction of the typical impedance match of the combiner. Table I lists the value of input isolation within the broadband coupler at six frequencies between the lower edge of Ch. 8 and the upper edge of Ch. 10. Notice that the average isolation exceeded 33 db.

At the completion of these and other tests, the antenna was ready for shipment to Rochester.

#### Installation in Rochester

In anticipation of the arrival of the new antenna, the stations had temporary antennas installed on outriggers that were fastened to the tower at the 100-foot level.

In addition to these arrangements, the stations had some 50 feet of 8-foot-square tower sections installed *around* the Ch. 10 antenna. This tower extension was a purely temporary measure to speed the removal of the "old" Ch. 5 superturnstile and thus make way for the installation of the new antenna.

The new antenna was hoisted to the tower top and placed in position. Because of the stations' requirement for separate operation of the upper and lower halves of the antenna, four runs of  $3\frac{1}{8}$ -inch *Universal* transmission line were installed in the tower.

Once connected, the antenna and its feed system were readied for the application of power. Ch. 8 was the first to deliver and Ch. 10 followed shortly thereafter. This all occurred in August of 1962 . . . two full years ago. In all honesty, there was one minor correction to be made . . . a tiny gas leak in the broadband combiner that was repaired with an epoxy-resin cement. Since initially going on-the-air during September, reliability has been 100 percent for this unique antenna system.

FIG. 11. Two of the many vertical patterns taken on the Rochester antenna. These two show the minor differences in pattern when the same antenna is operated at two frequencies that are 12 megacycles apart.

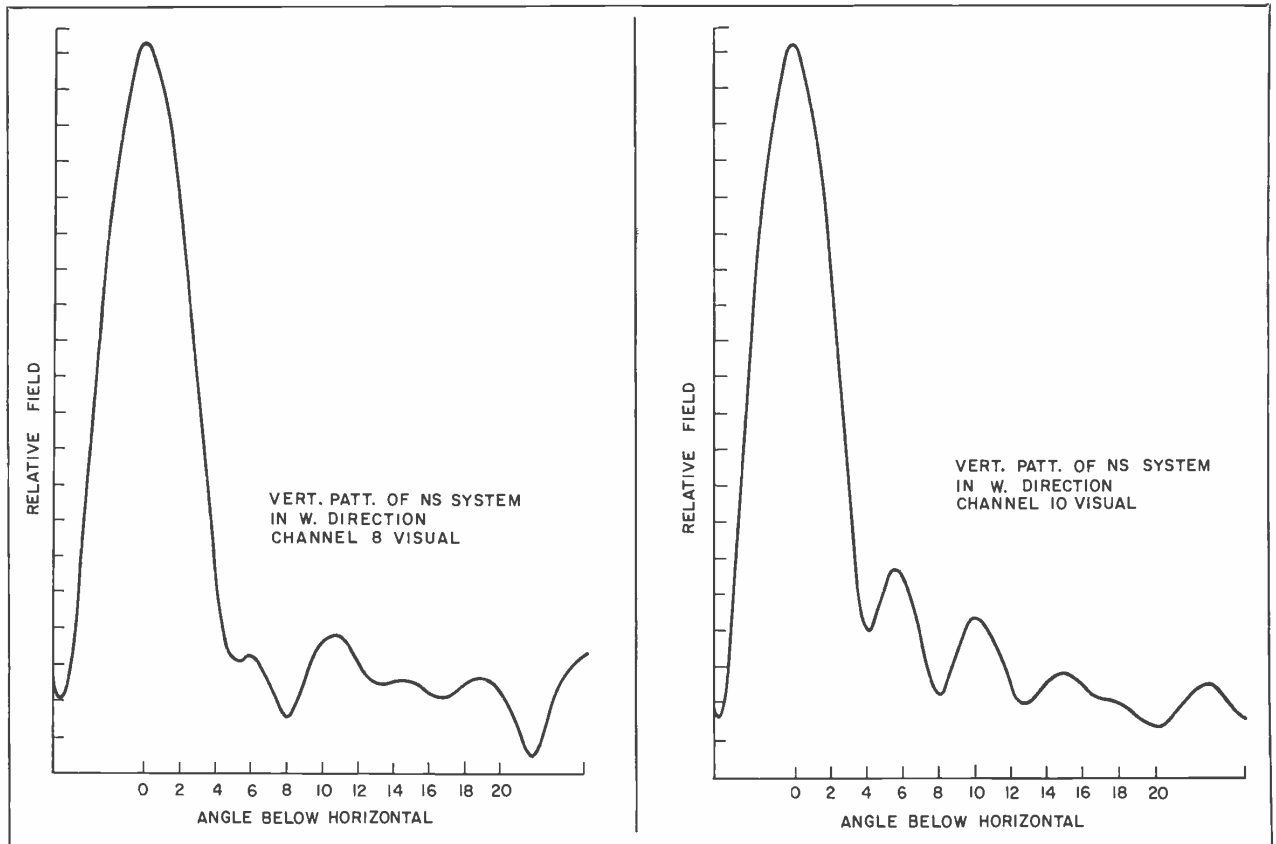

FIG. 12. The Rochester antenna as it appeared while installed on the vertical turntable at the RCA's Gibbsboro test site. Note the relative size of the men standing in the structure at the base.

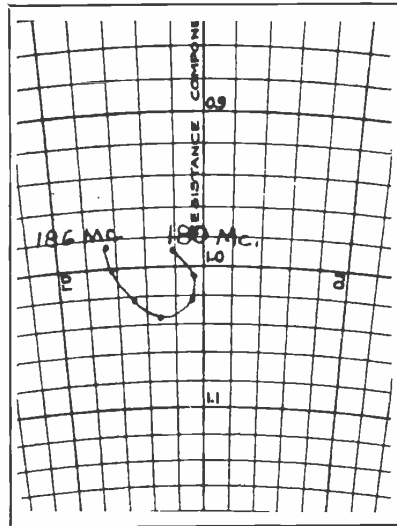
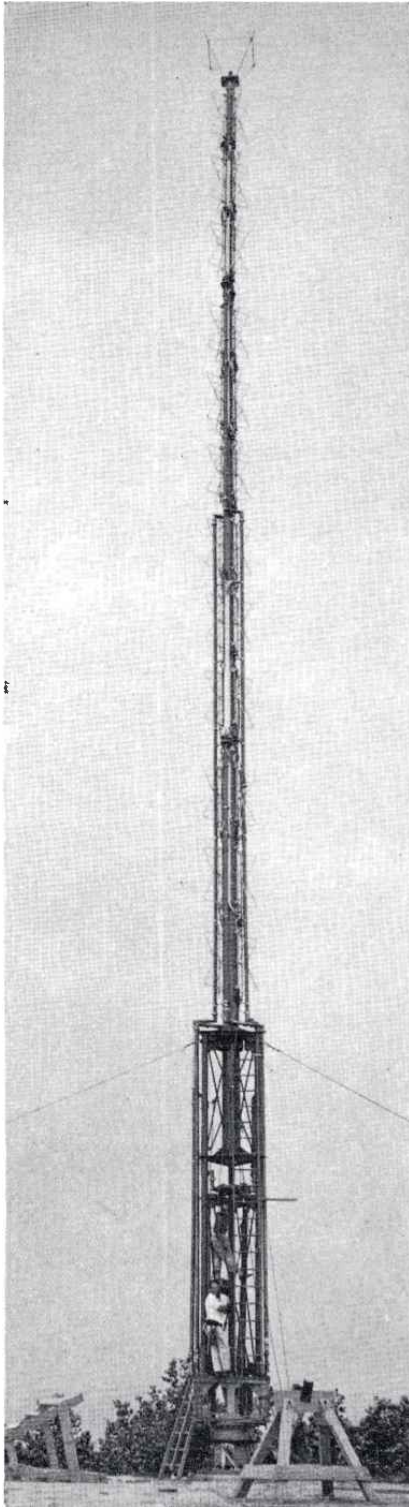

FIG. 13. Graphic presentation of the input-impedance characteristic of the (lower) east/west system at the frequency of Ch. 8.

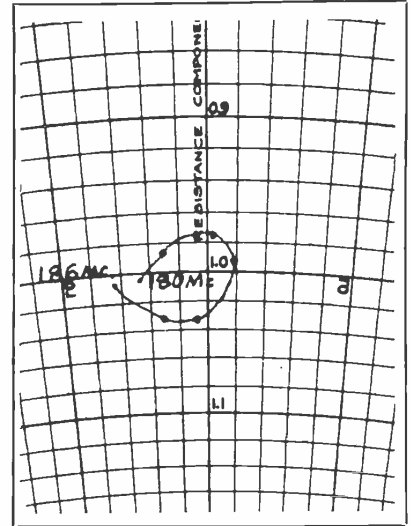

FIG. 14. Graphic presentation of the input-impedance characteristic of the (upper) east/west system at the frequency of Ch. 8.

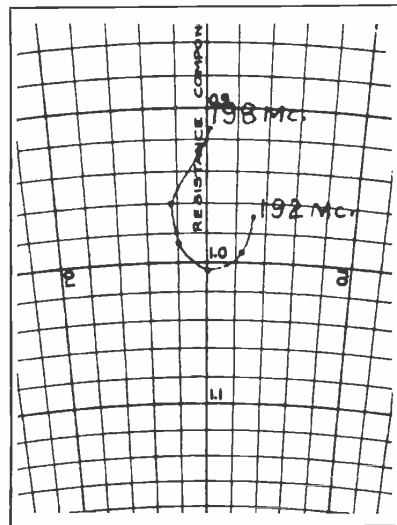

FIG. 15. Chan. 10 counterpart of curve in Fig. 14.

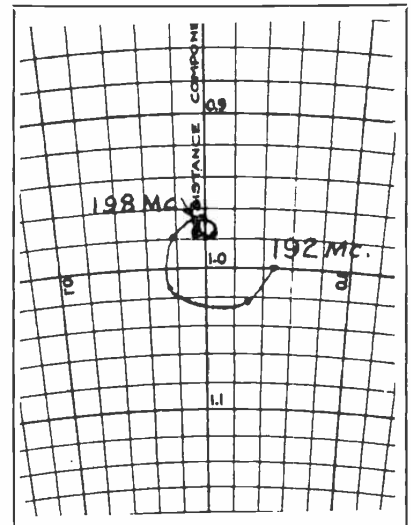

FIG. 16. Chan. 10 counterpart of curve in Fig. 13.

#### Channels "Eligible" for Antenna Diplexing

In the high-band portion of the VHF spectrum, any two channels assigned to the same market area are "candidates" for a diplexed-antenna system. For example, a Ch. 7 station can share an antenna with a Ch. 9, 10, 11, 12 or 13 station; a Ch. 8 with Ch. 10, 11, 12 or 13 and so on. There are 15 possible combinations.

In the mid-band spectrum, there are only two possible combinations: Ch. 4 and Ch.

5 or Ch. 4 and Ch. 6. The adjacent-channel combination is possible because of the 4-megacycle separation between Chs. 4 and 5.

Diplexed antennas for the low-band portion of the spectrum are uncalled for because of the fact that Chs. 2 and 3 are never assigned to the same market.

Potentially, the diplexed-antenna system could be used in a good many of the nation's 128 multi-station markets. Diplexed-antenna systems cannot be used in the markets where there is only one station op-

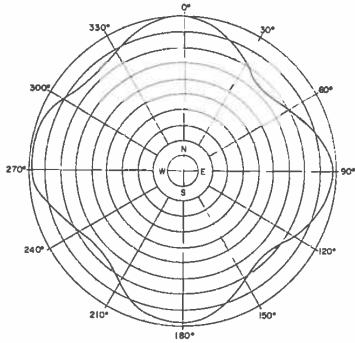

FIG. 17. Plot of the Ch. 8 horizontal-pattern circularity of the completed antenna. Non-circularity measured less than  $\pm 1.38$  db. (Plotted from data gathered while the antenna was on the vertical turntable at Gibbsboro.)

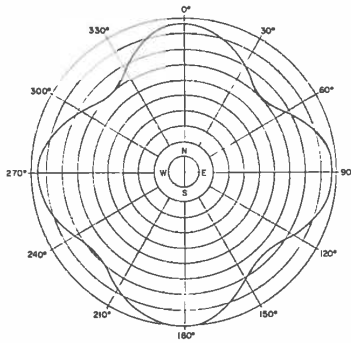

FIG. 18. Plot of the Ch. 10 horizontal-pattern circularity of the completed antenna. Non-circularity measured less than 1.6 db. Were this pattern superimposed on the one in Fig. 17, the difference between the two would be barely discernible.

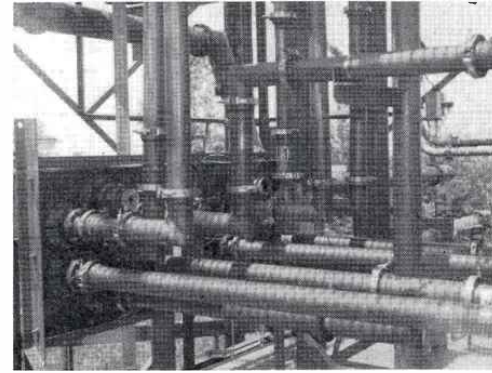

FIG. 19. Snapshot photograph of the manual power-switching complex at the tower base. Shown at left are the switch panels with the (Universal) transmission-line connections.

erating in either the mid-or-high-band portion of the spectrum. It takes two stations within the same portion of the spectrum.

#### Diplexed Antennas Come of Age

In the months since that first on-air day in August, 1962, diplexed antennas have

come of age. In the 24 months since that day and this writing, WHEC-TV and WROC-TV have experienced *not one* outage as a result of the antenna system including the interconnecting *Universal* transmission line.

In summary, the diplexed antenna af-

fords both stations identical signal-distribution patterns, excellent picture quality, the utmost in reliability, reduced capital investment, reduced maintenance costs and low operating costs. Yet, with all of these advantages, both stations operate at full power at maximum height.

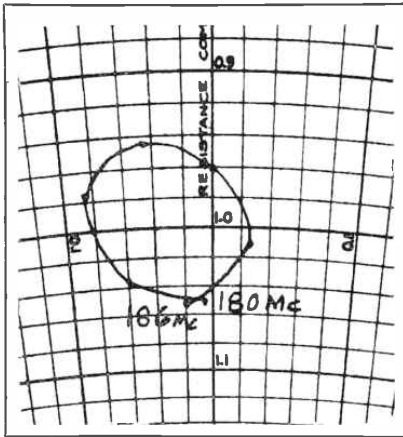

FIG. 20. The input impedance characteristic at Ch. 8 of the broadband combiner with the entire antenna system connected to the combiner's output ports. This curve essentially duplicates the one taken at the Ch. 10 spectrum at the Ch. 10 input port. Thus, the two inputs "looked" alike from the transmitter point-of-view.

FIG. 21. Close-up of the modified TF-12BH Superturnstile. Notice the four transmission-line connections instead of the usual two? The two extra runs are a result of the stations' desire to operate the upper and lower sections separately or together and thus provide a "working spare" antenna with a gain of approximately 6x.

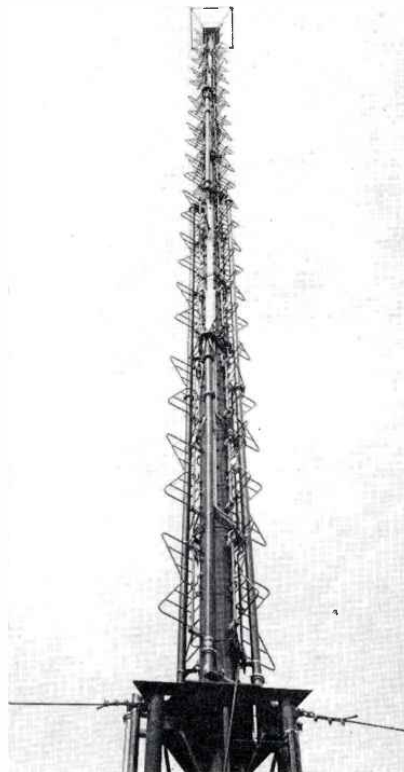
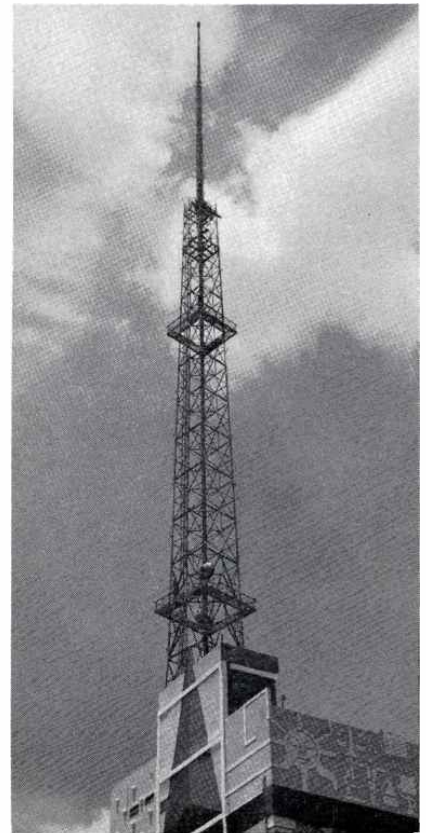

FIG. 22. As this article was being written, Mexico City installed a diplexed superturnstile for Chs. 4 & 5. It's a four-section S-T on top of a four section Ch. 2 superturnstile. This photo shows the self-supporting tower as a background for one of the buildings of Telesistema Mexicana, Mexico City.



**COLOR  
TELEVISION  
GROWS IN  
FLORIDA**



**More Than 1300 Hours of Local Color in  
1964-65 Season for Viewers in North Florida and  
South Georgia via Live, Film, and Tape Programs**

by **JESSE CRIPE**  
*Vice-President and Gen. Mgr.*  
*Florida-Georgia Television Co., Inc.*

Back in 1956, a decision was made. WFGA-TV was not to be simply another station. This plant was to be designed from the ground up for full-color operation. And, when telecasting began on Channel 12, in September 1957, WFGA-TV went on-air with maximum power—316 kw, erp.

The new building housed all facilities—studios, offices, transmitter. A 1000-foot tower behind the building supported microwave and transmitting antennas. Latest RCA program-originating equipment and broadcast advances were installed. There was a 50-kw transmitter designed for color-casting, two color studio cameras, and two color film systems. Later, as they became available, TV tape recorders were added—WFGA became one of the first to install TR-22 “New Look” tape machines with transistorized color modules.

Since the station originated many of the pick-ups from Cape Kennedy for the networks and pools, a considerable investment was made in special mobile equipment with unique camera mounts and lenses designed for visual tracking.

For reasons that will appear later, WFGA-TV does things somewhat differently. A single studio is used, rather than several; equipment placement is divided into isolated rooms, according to function; and, more than one master control is employed.

The station was the first in the area to originate live and film colorcasts. At the time, WFGA-TV was one of the first television stations in the nation to be initially planned and conceived for color. Today ('64-'65 season) over 3000 hours of color (local and NBC) programs are being presented, and over 90 per cent of local commercials are being done in color.

**Mushrooming Market**

With all of Jacksonville, WFGA-TV has shared the new dimension taken on in recent years. Not only Jacksonville, but the entire North Florida and South Georgia area. This composite market served by the station has shared a growth only slightly short of fabulous. The mushrooming of military installations and the influx of people have helped spur economic, indus-

trial and social expansion. To this the station has contributed by wholesome, imaginative programming; by assisting the marketing of area products; by being a significant contributor to educational television; and by fostering the advent of color telecasting.

**FIG. 1. Mr. Jesse Cripe, vice-president and general manager, Florida-Georgia Television Co., Inc. WFGA-TV is an affiliate of WOMETCO Enterprises.**





**Color Stature in Jacksonville**

When the decision was made not to be another monochrome-only station—back in 1956—we were looking to the future but had no particular desire to be a pioneer. It was for practical business reasons that we made our decision.

Today, we are reaping many benefits from our decision to go into full color. Our facilities will not need replacing and our crews will not need retraining—which is what many stations are now facing. Furthermore, we are enjoying some economic benefits as well.

Our station is in a position of leadership. The advertiser who has a product that he wants to present in its natural appearance, comes to WFGA-TV. Viewers who wish to see color programs on their color sets will always tune us in.

Besides all this, we have reaped another plus as a result of having color TV facilities in that we have been put on some cable systems because of the benefits we bring them.

We have been both pleased and somewhat amazed at the stature color has given to our station.

**Programming Over 60 Hours of Color Weekly**

For more than seven years, WFGA-TV has been beaming the beauty of color television into homes of Northeast Florida and Southeast Georgia viewers. During that time the number of programs have grown consistently. From the beginning most studio originations have been in color as well as many of the film programs.

Daily, the following local live morning programs have been done in color:



FIG. 4. How WFGA-TV cameras track moon shot at Cape Kennedy.

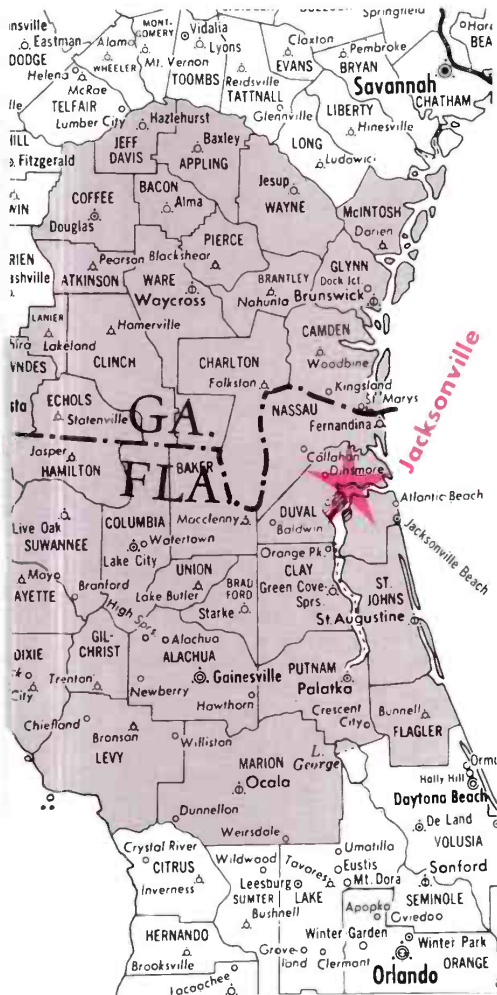

FIG. 2. WFGA-TV Jacksonville television market coverage in North Florida and South Georgia.



FIG. 3. Skipper Ed and Bozo the Clown are two favorites of the small fry in the WFGA-TV color loving audience.

“Living Words”  
 “Hi Neighbor”  
 “Romper Room”  
 “News and Weather”  
 “Cameras Please”

Again at 4 p.m. the station puts on a daily ½ hour children’s show in color entitled “Popeye’s Pals.” More than half of the show is live color origination; the remainder color cartoons. (On Saturday, Bozo the clown joins Popeye for a full hour of color.) These have been interspersed with the NBC color shows in both morning and afternoon.

In the evening local news, weather, and sports are done daily in color, beginning at 6 p.m. Then follows the network programs of color entertainment in prime time. At 11 p.m. local news, weather, and sports in color again takes over, to be followed by the Tonight Show (color).

In addition to night-time network color offerings, WFGA-TV programs its own



FIG. 5. News, weather, and sports are done daily in color.

Monday Night Movie—7 to 9 p.m., usually in color.

Saturdays and Sundays offer their own local programs in color in addition to the

network schedule. For example, “Together We Worship” is a regular Sunday color program. It’s done on Thursdays in the studio on tape. Different churches are invited to bring pastor and choir with a representative congregation.

Occasionally, there is a local color special such as: “Christmas Symphony”, or a historical documentary on the area, for example, “And Then There Were None”, or “Babes in Toyland” or “Pensacola Naval Air Station Choir.”

All of this adds up to make the majority of the offerings of WFGA a feast of living color, for viewers in the Jacksonville area.

**Color Promotion**

Station WFGA-TV cooperates with television receiver distributors and dealers in the area; also engages in station promotions in order to push set sales in the area. As a result, the number of color set owners has grown consistently over the years.

The NBC closed circuit TV presentation of upcoming programs for press preview was put on tape by WFGA in color for a special private presentation to distributors and large department stores.

The station prepares a program schedule that highlights the color presentation. This is used in promotion efforts with set distributors, educators, agencies and our reps. It is mailed to set owners, and bulk quantities are given to distributors and CATV systems for their mailing programs.

Calls are made on dealers to secure cooperation in promoting color programs. Display cards promoting color TV programs are prepared for dealers’ use. Color television displays are prepared and set



FIG. 6. Audience of 30-50 attends daily “Popeye’s Pals” color show.

FIG. 7. Select group of kindergarten age provides daily talent for “Romper Room.”



up in department stores and wherever color sets are sold.

In addition, there is the station effort via ID's and TV promotion on upcoming color programs. These are all staff written and produced. Further, a deluxe station promotion brochure has been created that features color TV capabilities.

Yearly, a World Series party is given for all advertisers. The opening game is presented in color at the local hotel in a setting complete with hot dogs, beer, peanuts and a copy of the regular official souvenir program. Invitations are mailed in advance and a facsimile world series ticket is printed. Over 98 per cent of the invited guests participated in the 1963 series.

### Color Production

All sets and backgrounds are made in color. It's just as easy to do and gives a better atmosphere. Pastels are difficult to handle because they all appear much the same on a black and white receiver. However, we have found that the Munsell charts—which show the various shades of gray resulting from different colors—have helped.

Incidentally, our scenery construction is unconventional. No 4 by 8 foot flats are constructed. We make them in the actual size required; for example, a certain background should be 8 by 12—we make it that size. In this way, we avoid the line that frequently appears when two flats are butted together. Also, we can construct to exact sizes, for example, 8 by 13½.

In addition, we make frequent use of curved sections of background, which we call arcs. The curved construction tends to give stability and makes a more pleasing background. These are covered with corrugated color paper and are mounted on casters. They can be rapidly moved about and give us the mobility needed in the single studio set-up. The flat used for a particular program may be positioned in front of the arc, and then simply moved away leaving the arc background for the next event.

### Over 90 Per Cent of Commercials are Done in Color

We make it a practice to do all commercials in color—unless otherwise requested by the client. There is no extra charge for this service of making and telecasting the commercial in color.

All artwork is done in color—whether for monochrome or color commercials. All material put on slides is shot on color film.

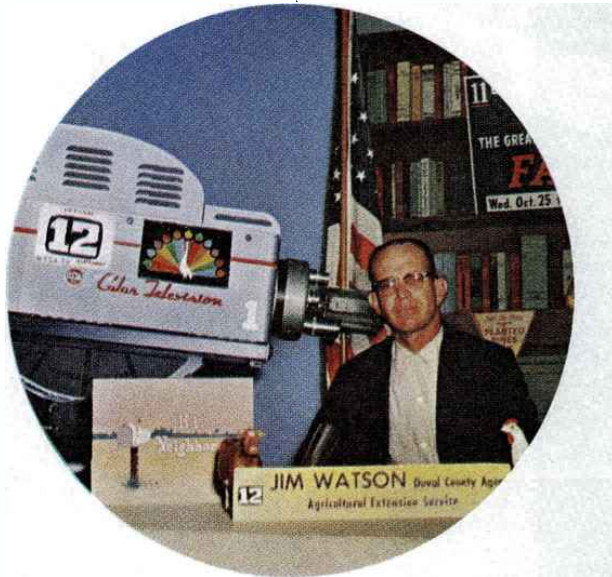

FIG. 8. Jim Watson sparks the daily farm show "Hi Neighbor"—a color offering.

FIG. 9. Studio set of "Cameras Please" daily conversation and interview program in color.

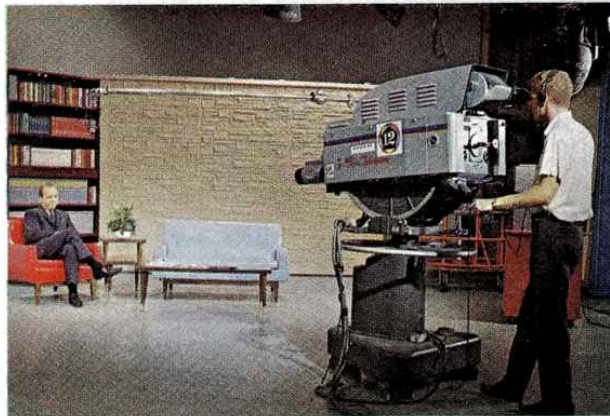

FIG. 10. Typical color program special, "Christmas Symphony" was created and produced by WFGA-TV for local group.



Since we have arranged for six hour processing of color film, we can give extremely fast service. If an advertiser, for example, asks for a commercial (or for a revise) in the morning, we can put it on-air in color by 5 p.m. the same day.

The majority of our color commercials are done on tape. Most local advertisers prefer tape so that they can preview and change if desirable. It's more convenient for us also. We only do commercials live when there is commentary from the announcer or for last minute matters.

Color film commercials are used occasionally, but only for outdoor remote or moving shots.

### Color Creates New Business

Advertiser interest in color has been on the increase during the last few years. Advertisers are beginning to realize the extra emphasis that comes from color. They are surrounded by examples in magazine and newspaper color advertising, as well as the publicity by makers of color television sets.

From the beginning, we would automatically do a commercial in color. However, if the client were to insist upon monochrome, we would reply that we do not charge extra for black and white.

Some of our advertisers have surprised us by insisting on our preparing their com-

mercials in color. Some of the results, too, have been no less surprising. There was, for example, a small bookshop proprietor who wished to display some of his colorful Christmas cards on TV spots. Well, after this tint exposure he did nothing but sell, sell, sell . . .

Other local color advertisers include:

1. Local Dairy
2. Vogue Shop
3. Crown Carpet Co.
4. Facto-Bake (an Auto Paint Shop)
5. Robert Meyer Hotel
6. Barnett National Bank (likes prestige of color)



FIG. 11. WFAQ-TV studio produced Local Color Commercial for space heater.



FIG. 13. Local Color Commercial for car.

FIG. 12. Local Color Commercial for boat.



FIG. 14. Color Commercial put on tape for local Sears store.



7. Georgia Pacific Plywood Panelling
8. Tresca the Florist
9. Florida Theatres
10. Brooks Motors

Sears Roebuck local store is likewise an excellent color customer.

Prior to Easter we created a half hour TV tape color program feature "Spring Styles for Children, 6 Months to 6 Years" for Sears. They were delighted with the beauty of our staff-produced color program. It was all done in our studio in five separate tape sessions then spliced together.

There's no doubt that advertiser interest in color has brought us extra dollars in business. We have the facilities and the staff to do the job.

### Single Studio Concept

At the outset, WFGA-TV faced the problem of whether to construct one large studio or two smaller ones. Although this was to be a new building, there was only a limited amount of ground available. Space for studios was limited.

The final decision was largely based on economics and ease of operation. While two studios would provide more versatility, they would often require two operating crews. Further, dividing the available space would restrict the capacity for any given program. Since it was desirable to be able to drive cars into the studio for making local commercials, and also desirable to have a large area for production of occasional local spectacles—the single studio concept won out. This studio will accommodate as many as five of the largest prestige cars. It is 60 by 80 ft.

We have found that the single studio does not hamper operations. A local show may be going out of the studio while a network feed of a remote is also in progress. Or, a local show on tape or film may be on air, while the production of a commercial on tape is being conducted in the studio. (Use of multiple tape machines gives this versatility.) Moreover, it has been demonstrated that two live shows back-to-back can be readily accommodated by planning in advance and positioning both sets so that movement from one to the other is smoothly done during the station break.

### BROADCASTING EQUIPMENT

#### Color Facilities

From the ground up for color—that's the way WFGA-TV was built at the start—back in 1957 when the station first be-

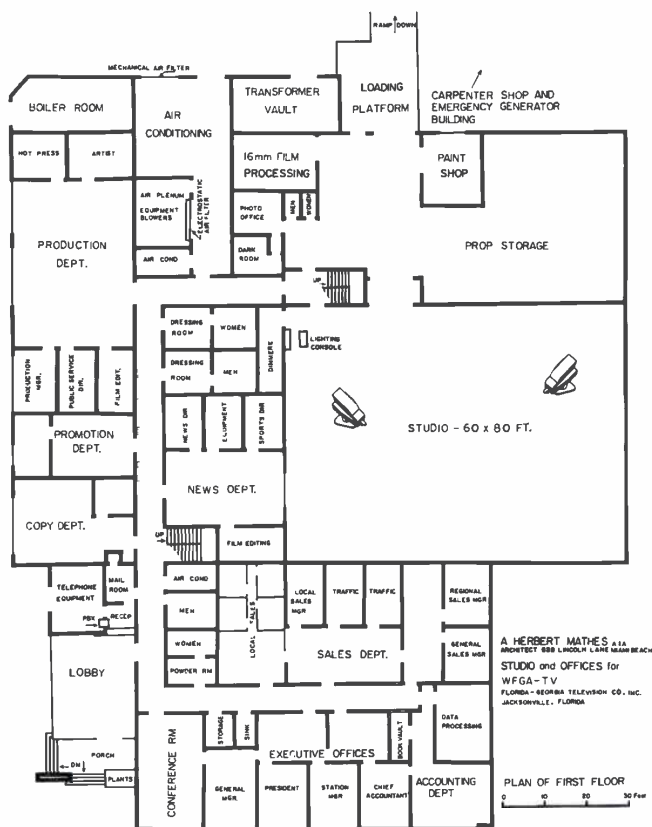
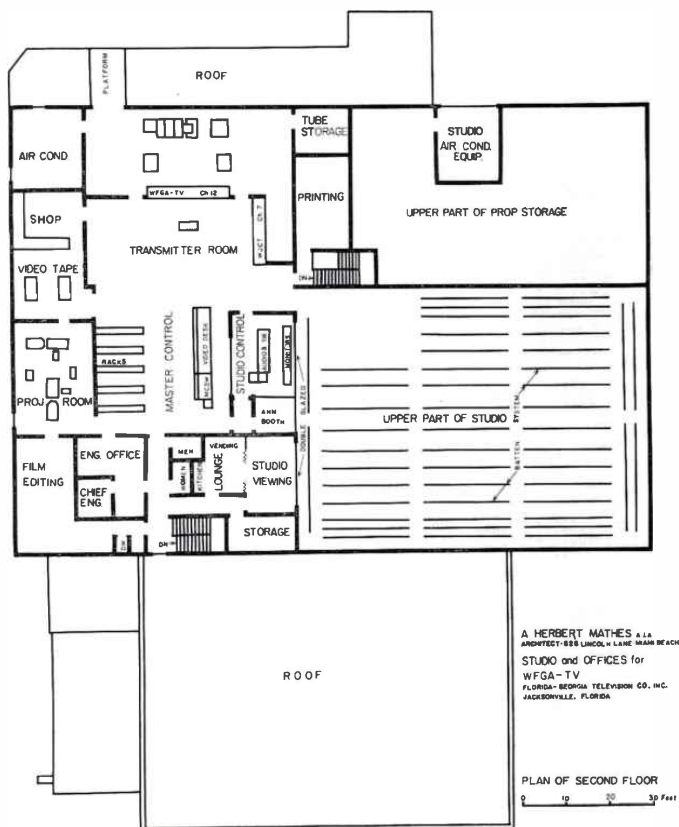

FIG. 15. WFGA-TV layout, first floor.

FIG. 16. Second floor layout.



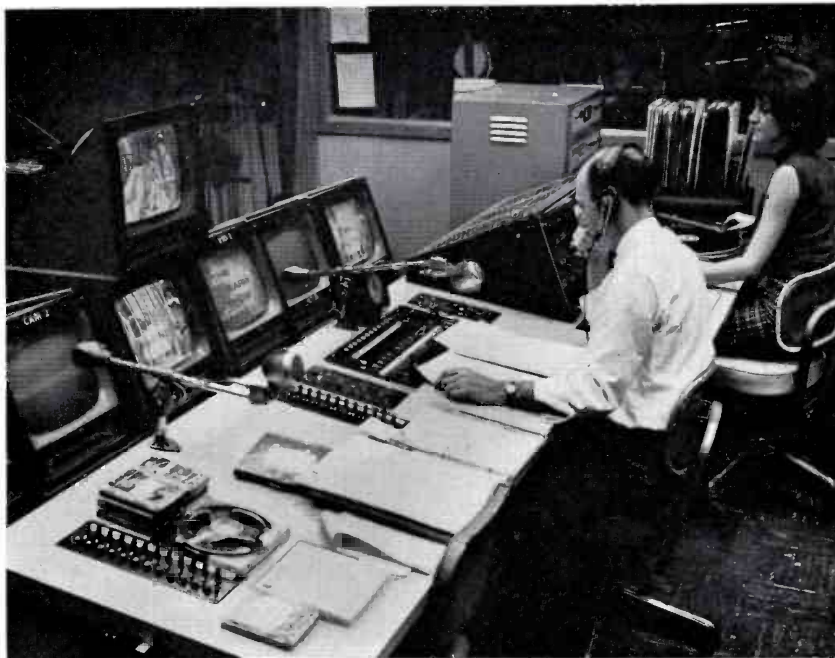

FIG. 17. Control Room "A" where all live productions are directed. Positions (L. to R.): producer, director, audio. In upper right is announce booth. Key switches on left of video switcher for inter-com to all production positions. RCA custom switcher panel is part of a TS-40 system.

FIG. 18. TV Tape Room is located next to Projection and Master Control. Contains two RCA TR-22 TV tape recorders, with transistorized color modules. (A third TR-22 is installed in WFGA-TV mobile unit.) Recorders have remote start in Control "A", Projection, and Master Control.



gan operating. Of course, the decision was made before that time and, ever since, the same progressive outlook has been the pervading spirit. As a result, WFGA-TV has been adding to its facilities and equipment.

Latest acquisitions include three of the new transistorized RCA TV Tape Recorders, Type TR-22. These deluxe top-of-the-line equipments were acquired as a result of the confidence the station has in these latest advances. Two of the new tape machines are housed in the studio building. These are equipped for color operation. The third is housed in a mobile unit. Demands for tape production are so extensive that a fourth TR-22 (in a mobile unit) is frequently leased for some of the remote pick-ups.

#### Isolation Advantages

The equipment placement is divided into several areas or rooms, according to function. The operation is split into tape, film, and master control areas. There are several reasons for this at WFGA-TV.

Unique perhaps to this station are the many network feeds done simultaneously with local shows. Quite often the studio will be taping while a film or the network is on air. Thus it is quite desirable to separate the two operations, so the tape operator can work without disturbance.

Further, there are frequent cutaways, since two networks are served. All these requirements mean close concentration on, as well as separation of, the various activities. Isolating tape and film permits concentration on the precise switching that is necessary—without interference from another operation.

The station acts as a sectional feed point for NBC southbound, sometimes changing the commercial inserts, in order to advertise a product more applicable to the south (for example, when snow tires are being advertised up north). Isolating the area doing this is a definite advantage.

#### Master Film Control

In the film room there are located two complete color TV systems. Each consists of: TK-26 Color Film Camera, TP-15 Multiplexer, TP-6 16mm Film Projector, and TP-7 Slide Projector.

Distinctive to the station is a special program control unit designed by WFGA-TV engineers and custom built by RCA for the film room. This is actually a master control unit designed for use by the film operator.



FIG. 19. Film Projection Room. Equipments are operated by the projectionist-switcher at an RCA custom-built control pedestal. They may also be remotely controlled from Control "A" or Master Control. One monitor is for "off the air" viewing, the other is switched from the control pedestal for previewing.

Physically, it's a stand-up unit, approximately 40 inches high with a horizontal panel 10 by 20 inches. At either end of the panel are delegate switches for each film chain. Remote control may be delegated to Master Control or to Studio Control. Thus, the director may do his own rolls, slide changes (or rolling of tape)—from his remote position. Delegating does not, however, mean loss of local control.

In the center of the panel are buttons for program switching, since station breaks are often handled here (in the film room) like regular master control switching. The audio system is interlocked. Thus, the projectionist can punch up any program source: Remote, net, studio, film or tape.

#### Master Control

In the master control area are located all the rack equipments and the transmitter, as well as the regular video and audio controls, together with master switching.

There are controls for two TK-11 studio cameras, two TK-41 color TV cameras, the two color film systems and master

FIG. 20. This is the Projectionist's Master Control Switcher. It controls two TR-22 TV tape recorders, two 3-V color chains, network, remotes and two slide projectors. This overrides every control position except Master Control. It is also tied in with the interlock system of video and audio sources.





FIG. 21. In background is Control Room "A". Foreground (L. to R.): TK-11 controls; TK-41 color camera controls; TK-26 film color controls; master switchable monitor; master video switching panel; master audio switching panel; cartridge audio tape and RCA turntable.

FIG. 22. Master Control Switching. Left panel contains video switching, stab amp controls, and remote start and stop switching for tape and projection equipment. Next panel contains audio program and monitoring equipment. Audio switching is normally interlocked with video, but an interlock defeat switch can lock any program source either in or out. Master Control can handle the air operation while other facilities are being used for TV taping or studio rehearsals.



monitoring switching to any circuit in the plant.

Rack equipments are fed air through the floor and exhausted out through vents in the roof. All air is filtered through an electronic precipitron.

For air conditioning, two separate chilled-water systems are employed. One serves the office and equipment areas. The other is used to condition the studio.

Cartridge tape is employed liberally both in master and in studio control. It's ideal for commercials repeating frequently, for ID's, and for sign-ons. Program themes and other things that do not vary a great deal lend themselves to this treatment.

All conduits for TV signals are in floor trenches. Power for racks is overhead in order to isolate ground problems. All equipments are bonded with 6-inch copper strip to one master ground system.

#### Transmitter at the Studio

It's a great advantage to have the entire operation located physically in one area of the building. In this way, one man can handle both master video and the transmitter. It makes the crew more versatile and the whole operation more efficient.

A TT-50AH 50-KW TV Transmitter is employed. The amplifiers and filterplexer are laid out per the standard plan in a room adjacent to master control. The transmitter proper faces into the master control area.

A TT-5 console houses monitor and usual controls. An adjacent custom-built panel contains controls for an emergency power supply. This is a diesel-powered 250 KVA generator. It has seen service during storms that cut off the commercial supply of power, for periods as long as 3 hours. Viewers have expressed appreciation for this round-the-clock service given by the station during storm emergencies.

#### ETV Contributor

Station WFGA-TV provides space for the 5-KW TV Transmitter of the local ETV station: WJCT, Channel 7 in Jacksonville. Room is provided for the control console monitor and an operator. Also, the ETV antenna is sidemounted on WFGA's tower. All this is done gratis as a public service to the community.

#### Antenna and Tower

The tower is located directly behind the station pushing the antenna 1000 ft. up into the atmosphere. A TF-12BH Super Turnstile with gain of 9.8 is employed.



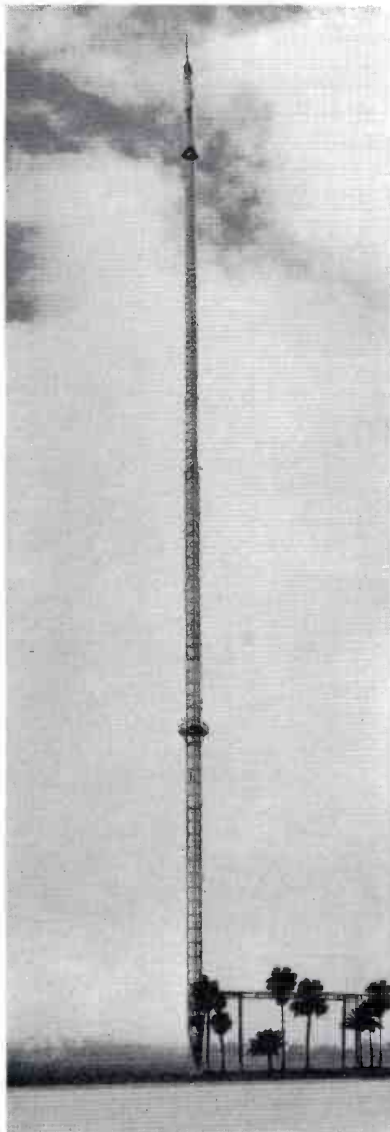

FIG. 24. Type TT-50AH 50-KW TV Transmitter is located in master control room, along with the video control desk and master control switching. It feeds a TF-12BH antenna located behind the studio building on a 922-foot Ideco Tower. The overall height is 996 feet above ground.



FIG. 23. All WFGA-TV telecasting facilities are housed here at Television Center in downtown Jacksonville, Fla., 1070 E. Adams St.

Since the terrain is quite flat (only rise being 150-200 feet over 30 mile distance) signal reception is uniformly good.

At the 150 ft. level a passive reflector is mounted for reception of the ETV studio signal. At the 400 ft. level another microwave reflector is mounted for Florida State ETV Network System. Platforms at 175 and 750 ft. levels are used for mounting microwave equipment for station remotes.

#### Massive Mobile

Station WFGA boasts of possessing one of the nation's most extraordinary remote mobile units. It's 10 foot wide by 56 foot

long—a regular house trailer that has been built to station specs and outfitted by station engineers. Specifically built for use in broadcasts from the "Cape", it is divided into four compartments:

1. Planning and Briefing
2. Tape and Transmission.
3. Film Chain, and
4. News Office.

In the planning and briefing room, there are the usual furnishings—plus chairs and tables. Wiring is in the walls. Coffee pot and refrigerator are included here for use of personnel.

In the tape and transmission area are the TR-22 TV tape recorder, incoming and outgoing audio and video, with power panels. The telephone company has provided facilities for feeding five lines to phones scattered throughout the unit. Video patch, sync and distribution amplifiers, off-air receiver are all in this area. Included is a 2-way radio system for communication with a cameraman that may be remote from the unit and also for communication with six newsmen and the base station at Jacksonville.

In the film area, there is installed a uniplexed chain that may be used either with

a 35mm slide projector or a 16mm film projector. This is used for inserts, either when taping or feeding the network.

At the rear, in the news office, are tables, typewriters, desks, phones, and lounge. Teletypewriters are installed here by the wire services when the unit is in use at the Cape. There is also a direct teletype service to NBC in New York.

Complementing these facilities are a camera platform on the roof and portable 30-foot tower for off-air pick-ups—used at fairs and other places where this unit is also employed. Six tons of air-conditioning are supplied by two 3-ton units mounted on a 2-wheel trailer. This giant mobile unit can handle six cameras, switching, and

audio control, affording WFGA many opportunities for pick-ups of historic national significance.

**Van Mobile**

One additional mobile unit—a smaller van type—is used. It's complete with three camera chains and associated equipment. This is used mainly for local area pick-ups as well as supplementary pick-ups on major telecasts. For example, at Daytona a single camera chain operated via microwave from the smaller unit to the main mobile unit, gives a great deal of flexibility.

**Live from Cape Kennedy**

It was named Cape Canaveral when WFGA-TV personnel and equipment origi-

nated the first live telecast there. From that historic moment, this station has participated in the great majority of network and pool programs. Whether it was the Ranger Lunar Probe, the Mercury Program, or the Saturn test flight, it was WFGA-TV that helped to do it . . . with the latest and finest of TV equipment and facilities.

WFGA handled close to half of the originations for the networks and pools, handled all manned flights and all of the Saturn flights. The record is as follows:

- Lunar Probe . . . . . Aug. 1958
- Lunar Probe II . . . . . Oct. 1958
- Lunar Probe III . . . . . Dec. 1958
- Saturn . . . . . Oct. 1961
- MA-5 . . . . . Nov. 1961
- MA-6 . . . . . Feb. 1962
- Centaur . . . . . May 1962
- MA-7 . . . . . May 1962
- MA-8 . . . . . Oct. 1962
- Telstar Int'l . . . . . July 1962
- MA-9 . . . . . May 1963

**For the Future**

Coverage of the proposed manned flights to the moon, as well as the test flights of the equipments, are undoubtedly in the offering for WFGA-TV.

Increased color programming, both network and local, will continue to make this station one of the top colorcasters in the nation.

Progress in planning and installation of RCA "New Look" equipments, together with a dedicated staff, will keep WFGA in position to offer the finest in production of color television programs and commercials.



FIG. 25. TV Tape and transmission area in main mobile unit. Video patch, sync, and distribution amplifiers are located here.

FIG. 26. Large mobile unit is converted house trailer 56-ft. long. It's especially designed for use at the Cape. It incorporates six cameras, tape and film systems, briefing room and news office.





FIG. 27. TK-31 Camera assembled on machine gun mount for tracking to vertical position at the Cape.

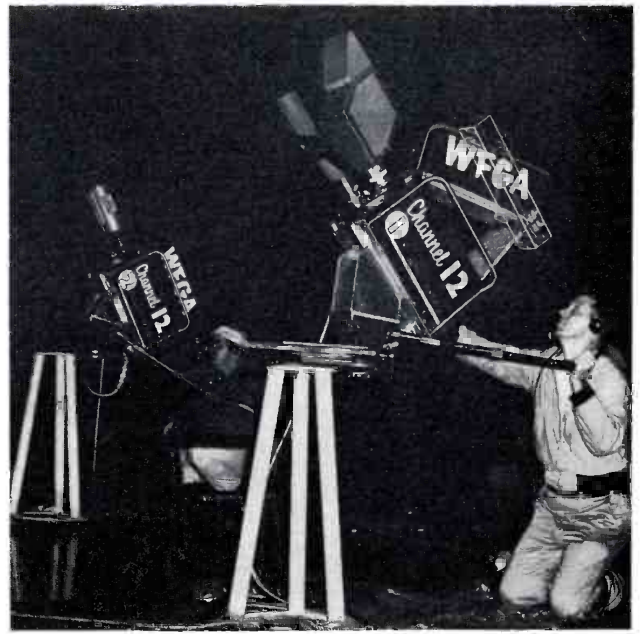

FIG. 29. Tracking moon shot that went up some 79,000 miles. Note position of viewfinder on Camera 1. Also note lucite box attached to camera for use as auxiliary viewfinder. Box has a pin-hole in one end and small flashlight for edge lighting. Camera 1 has 125-inch lens, which is a sighting scope used for shooting. Large top lens is a specially built 40-inch lens.

FIG. 28. Rear view of Fig. 27. Note space for 16mm camera at left.

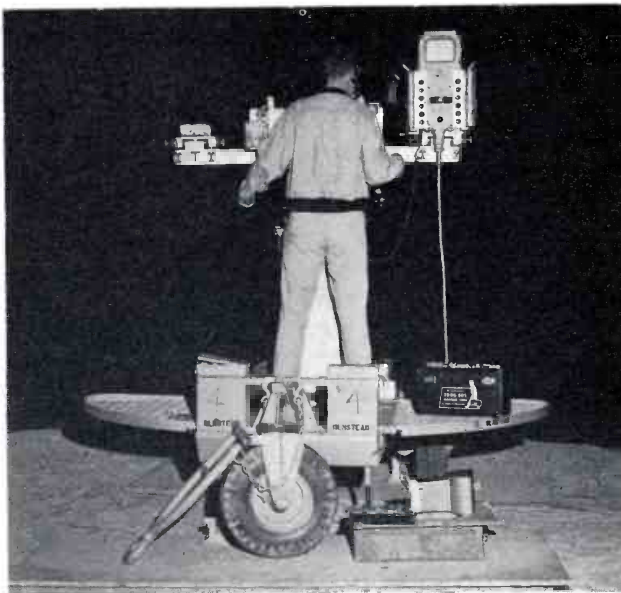
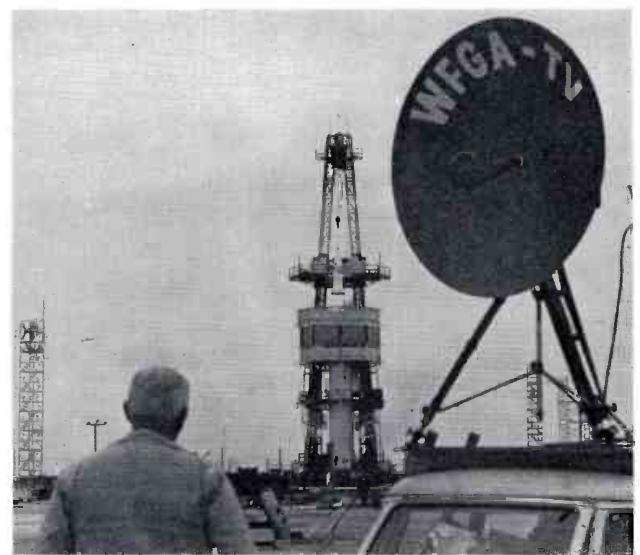

FIG. 30. WFGA-TV remote camera unit at Cape Kennedy. Microwave transmits signal back to main mobile unit.



(Photo credits Herb Gold and Bob Huntley)

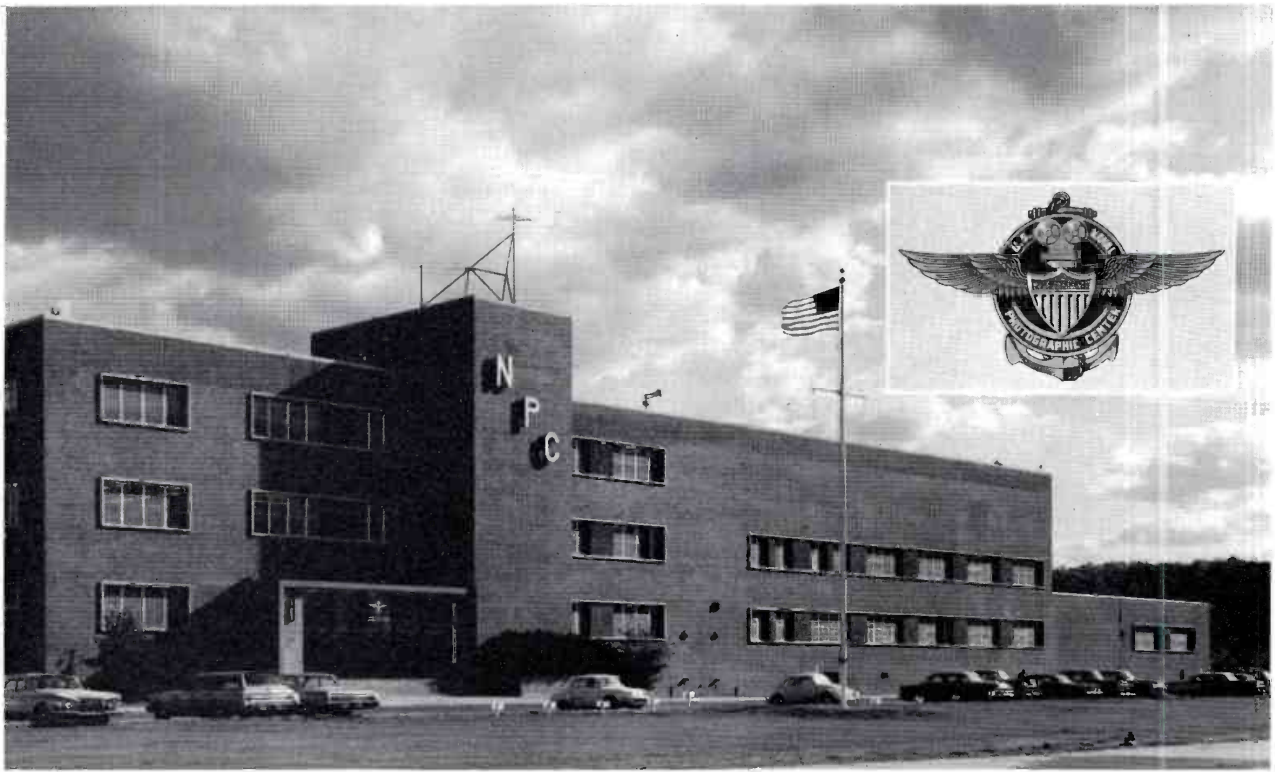

FIG. 1. U.S. Naval Photographic Center, Washington, D.C.

## NAVAL PHOTOGRAPHIC CENTER EMPLOYS TAPE-FILM CONVERSION TO STEP-UP PRODUCTION OF MOTION PICTURE FILMS

Live Television Production Techniques Used For Subjects  
Difficult to Cover by Standard Film Techniques

Out of a background rich in experience, the Naval Photographic Center has developed a unique method for making motion pictures by employing the immediacy of television. The heart of the new system is a combination of two devices, the TV Tape Recorder and the TV Film Recorder. This combination of equipments speeds production of films by capturing studio subjects on tape as the action occurs and then transferring the electronic picture to film within a matter of minutes. By this means, subjects of fleeting existence (that cannot be re-photographed the next day) are captured on film for widespread distribution. Information can be gotten to personnel as fast as it happens. Subjects not otherwise available can be given widespread distribution via films. All this assists tremendously in the program of making training and indoctrination films, revealing new devices, providing leadership guidance, and expediting decision making.

"Closed circuit television was the giant step that speeded up high quality film production by NPC. It makes use of a newly developed TV Film Recorder that eliminates shutter-bar and produces excellent results on film conversions. It also added immediacy to our recorded communications and provided the flexibility needed for rapid and effective integration of all our photographic media." So stated William G. Wilson, Head, TV Branch of the Naval Photographic Center, Washington, D.C.

### Description of TV System

The closed circuit TV system consists of studios, control room with switching equipment, a TV film chain, 2 TV tape recorders, and a TV film recorder. The production may be an audio-visual instructional presentation, a rehearsed program with talent, an interview, a lecture or a briefing. The program is produced in a

regulation studio, equipped with three television cameras, monitors and microphones, necessary lighting and staging equipment, and TV production personnel.

The control room contains video and audio controls to get proper picture and sound quality. There is also switching and effects equipment to put the pictures in proper sequence with visual smoothness of execution.

The TV film chain is used for inserting film clips and slides into the production. The television tape recorders are used to make original recordings, and for a check on quality of the production before disassembly of the set and disbanding of the talent. The TV Film Recorder is employed to convert the television tape production into a film (either negative for printing or positive print complete with sound track).

### ADVANTAGES OF TV FACILITY

*"If the NPC television facility had an insignia, I think it would be the face of a clock superimposed upon a page of a calendar, seen on the face of a cathode ray tube.*

*"TV production techniques buy that most elusive of commodities—time. The quickly produced kinescope communicates information that can be handled within studio confines, and does it well. By so doing, it not only provides the Navy with an additional source of audio-visual material, but also frees the Navy's motion picture program for projects of increasingly ambitious effort."*

CAPT. M. P. MACNAIR,  
Commanding Officer,  
Naval Photographic Center



FIG. 2. Capt. MacNair, Commanding Officer of NPC, and W. G. Wilson, Head, TV Branch, compare TV monitor display of video tape with rear-screen projection of same subject two minutes after conversion to film.

FIG. 3. NPC-TV cameramen pick up a typical interview for recording on TV tape—then to be transferred to film for editing and for distribution to the fleet.



FIG. 4. Television tape machine used for recording TV studio pickups. Also used for playback of TV tape recordings to feed the Kine-Recorder.

FIG. 5. RCA TV Film Recorder which transfers TV signals (from the TV Tape machine) to 16mm film stock (positive or negative.)



### TV Beginnings

Early in 1958, the Navy set out to discover the contribution TV could make to the operation at Anacostia. Two TK-31 field cameras that had been used for research and evaluation at the Naval Training Devices Center, Sands Point, L.I., and an early model kinescope recorder were installed. A closed circuit TV pickup and recording system was set up to study TV techniques. NPC found the system extremely useful for inserting live pickups, such as interviews and briefings, into the films.

### Advantages of Film Conversions

By 1963, both the training film and other film services had undergone drastic changes in techniques and methods resulting in more efficient camera work and



FIG. 6. Typical interview in studio while making TV tape of the program "Leadership Speaks."

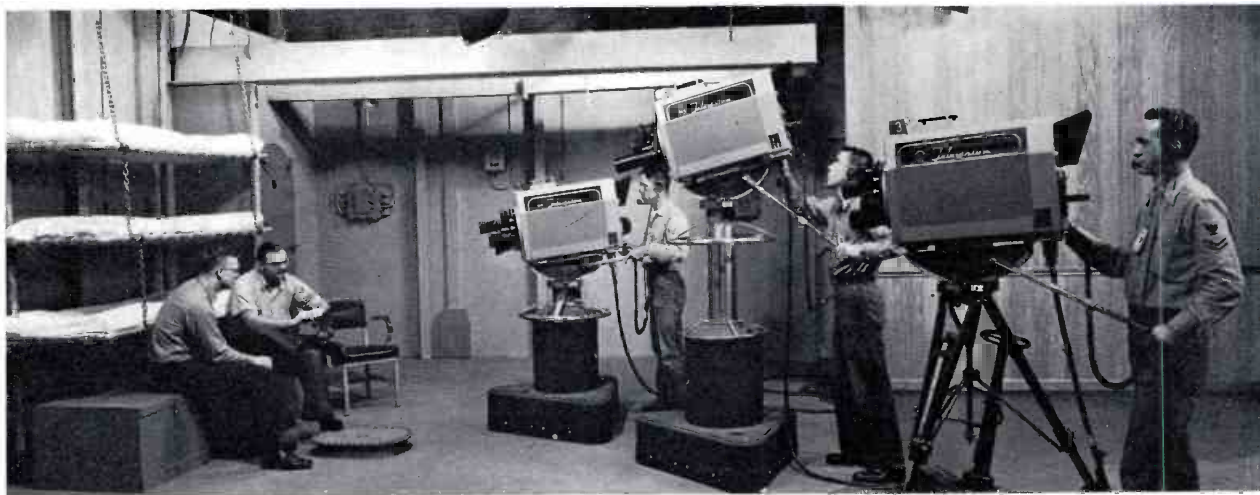

FIG. 7. RCA TK-60 4 1/2-inch cameras are employed in order to procure improved picture quality.



processing. Art and animation were widely used.

But more important was the fact that motion pictures produced only a year ago on film were now being recorded first on magnetic tape. NPC-TV had acquired a TR-22 TV Tape Recorder and the new TFR-1 TV Film Recorder, a combination that revolutionized operations at NPC. Television permitted the recording of images with less illumination than needed for film, and since tape provides immediate playback, it was possible to project it

FIG. 8. Set used in TV film produced by NPC for Federal Bureau of Internal Revenue.

for acceptance and editing. Then, by means of the new TV Film Recorder, it was put on film with little delay. An Eastman Viscomat Processor delivered the finished film in less than 90 seconds after starting the film recorder.

"Recording first on tape, then playing the tape for acceptance and finally transferring the edited tape to film saves time and film," explained Mr. Wilson. "It eliminates the time-consuming steps necessary with ordinary film production: Expose, process, edit, print and screen."

"With our TV system, clients may come in with tape—wait ten minutes—and walk out with finished film.

"Another advantage of tape is that it is less expensive. Using film and non-professional talent, we may make several studio pickups before we get something we can use. But with tape, we can make any number of pickups, then edit and record on film what we need and return the tape to service again. The tape can also be used for making more than one film print—all of equal quality.

"Our end product is nearly always 16mm film, because it is the most universally used medium among the branches and organizations that we serve."

#### Types of Programs

The facilities of the TV Branch are used by many Bureaus of the Navy as well as other governmental services. Programs have been produced in the television studios for the Bureau of Medicine, Bureau of Personnel and the Internal Revenue Service. Normally, an officer or civilian instructor will assist in production of the program, or an officer will make a briefing presentation. A leadership series features interviews of admirals by well known personalities or messages from the Secretary of the Navy to the fleet.

Some programs are put on film from tapes that have been made by others. NPC gets tapes from such sources as: Great Lake Training Center, Guided Missiles School, Interservice (e.g., Andrews AFB) and NBC (when a prominent naval figure is involved).

Tapes are frequently received for Kinescope conversion from aircraft carriers equipped with closed circuit television to record plane landings by the Pilot Landing Aid Television (PLAT) System. Conversion to film permits study of procedures and analysis of accidents. Slow motion and still frame inspection of film reveals much more information.



FIG. 9. Video control desk contains switcher for selecting cameras, film chain and tape, and remote controls for film and tape.

FIG. 10. Close-up of program switching position showing video switcher and remote control and switching panel at right.





FIG. 11. Use of two television tape recorders permits simultaneous rehearsals and programming, and provides backup in recording.

#### TV Tape Assures Studio Quality Films

Although originally acquired for film "back-up", the television tape equipment has, in most applications, become the primary means for pickup, replacing film. The reason for this lies in the use of much non-professional talent. As many as 16 "takes" have been required to insure an acceptable film pickup. This has been avoided with the TV Tape machines. Immediate playback permits correction of miscues in short order. The job is finished while the talent is present. And, if urgent, a positive film complete with sound can be produced in minutes by means of the TV film recorder.

#### TR-22 Perfects Tapes

Many of the television tapes that are converted to film have been made outside the NPC, evidently under less-than-adequate conditions. Imperfections appear that would show up in the finished film unless corrected. Automatic timing correction in playback permits elimination of many of the errors in the original tape.

#### Future TV Tape Facilities

As the use of television pickup increases, there appears need for use of some portable type of equipment, especially for use in the field or anywhere that studio tape equipment cannot be employed.



FIG. 12. Serial No. 1 RCA TR-22 TV Tape Recorder being inspected upon arrival at NPC by Lt. Cmdr. Myatt, then Head of Motion Picture Department of NPC.



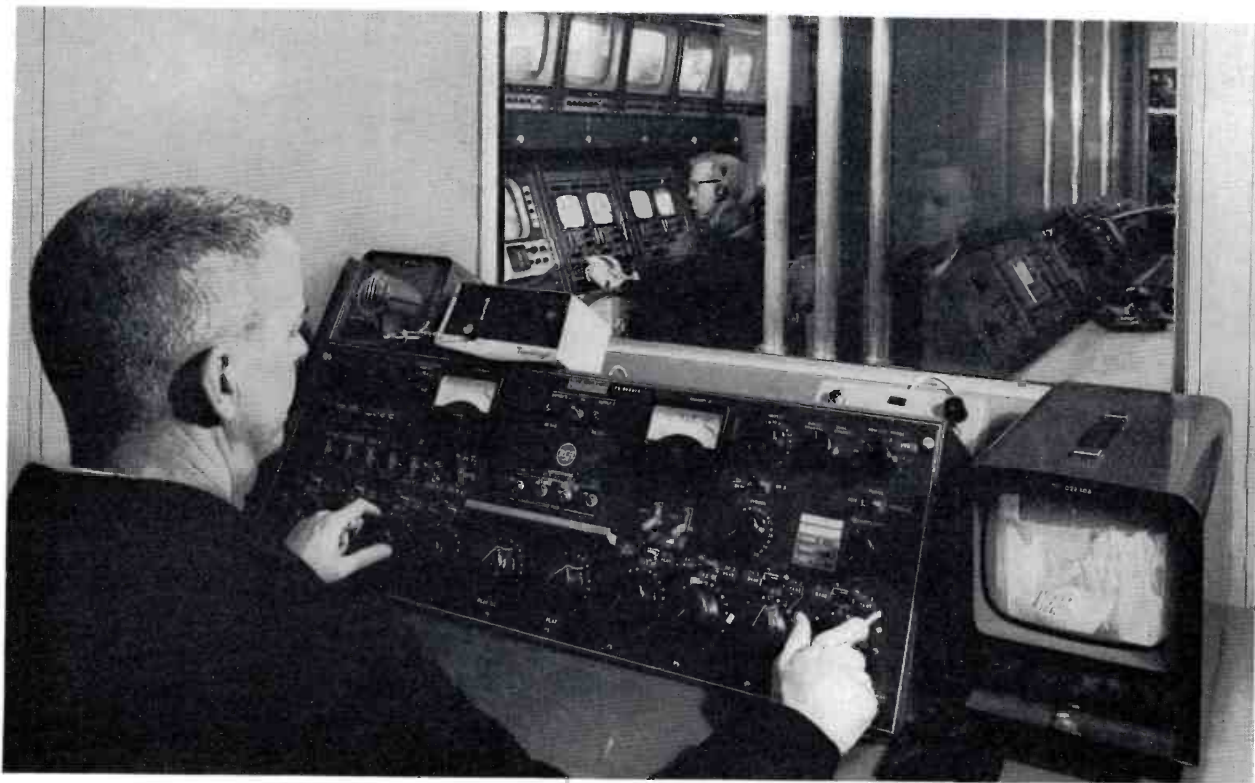

FIG. 13. Audio booth, showing BC-6 Dual Channel Console and TM-9 picture monitor. (Note that audio operator can see into control room.)

Also, there appears need for tape projection facilities on a more widespread scale. Just as the various ships and departments have film projection equipment, so it is likely in the future many may have television tape projection equipment. The new "playback only" machines should serve this function.

#### TV Tape Facilities

Two of the deluxe TR-22 RCA Television Tape Recorders are employed. These are the new fully transistorized machines with interchangeable modules. Serial No. 1 was acquired by NPC. These recorders are equipped with Pix Lock and Automatic Timing Correction. This permits inserts and effects to be achieved without "rollover" or discontinuities. A dropout compensator has been added in order to help correct deficiencies in tapes received from outside sources. Tape machines are equipped for both 7½ and 15-inch operation. Electronic editing is being added.

Two TV Tape machines are installed to give more versatility and to speed production. In this way, two operations can be going on at the same time. One machine can be used for rehearsing and recording a program being produced in the studio. The other machine can be used for transferring a previously recorded program to

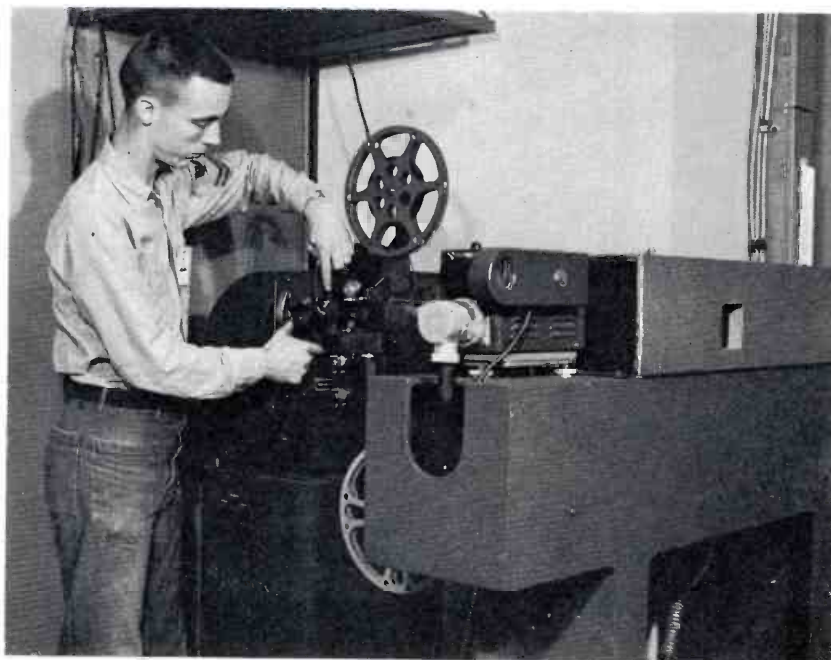

FIG. 14. Television film system, complete with 16mm TV film projector and 35mm slide projector is used for inserts in completed productions of tapes and films.

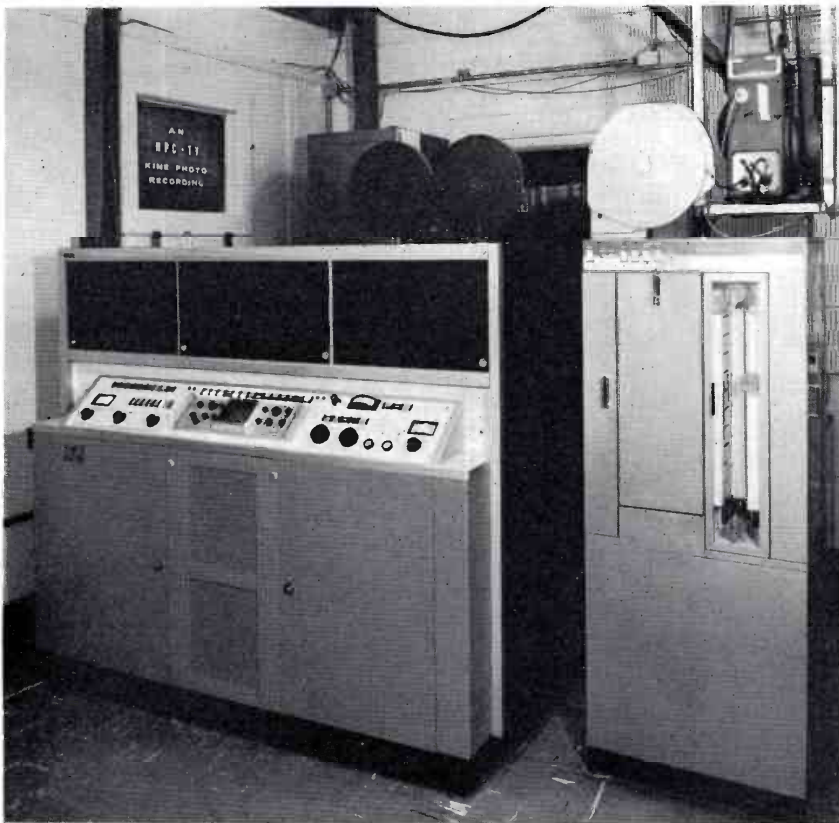

FIG. 15. TFR-1 TV Film Recorder (Kine Recorder) installed with Viscomat Processor (Eastman) produces finished films in minutes. Images from recorded film are projected in reverse on screen (above, at left) for viewing in adjacent conference room.

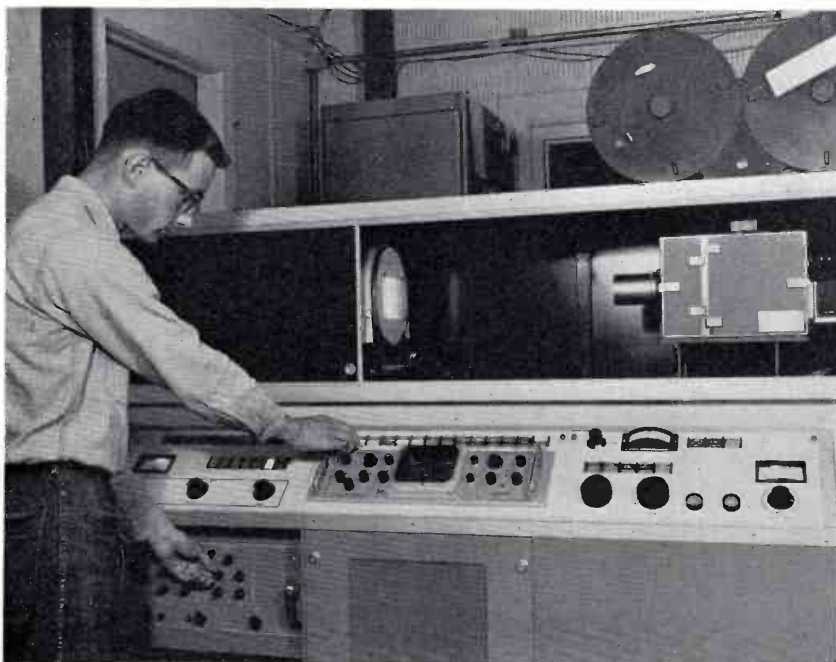

FIG. 16. Controls of Film Recorder are preset to desired standards. Automatic circuits maintain these standards throughout film recording.

film. In this way, all equipments and people can be used at top efficiency and full production achieved.

Furthermore, with two machines, it is possible to obtain two originals of a program. After all rehearsals are finished, both machines can be switched to record the program. This not only gives two original tapes, but also provides for a back-up in the event of error or failure.

#### Heart of the System

The TFR-1 TV Film Recorder is the most vital piece of gear used in film reproduction, its big feature being automatic calibration. Once the exposure is determined—that is, which neutral density filter is to be used—the “CAL” button is pushed and the predetermined setting is maintained throughout. This is accomplished by a reference pulse which appears automatically on the scope to match the video level to the CAL pulse. It’s a good guide to quality uniformity, especially if the video source is not of the best quality. The copy can be preset, and the blacks can be stretched—with both exponential and gamma correction—which is what is needed for direct positives.

Another feature is the selectable aperture correction for either tape or live material. Of course, ease of operation is an advantage, too. Personnel are stationed here for only a year or two, so there is little time for training. However, men can be trained for operation of the TFR-1 in a matter of only a few weeks.

#### TK-60 TV Cameras

NPC’s reasons for choice of the TK-60 4½-inch image orthicon cameras were

FIG. 17. Camera of TV Film Recorder features ease of loading and threading.

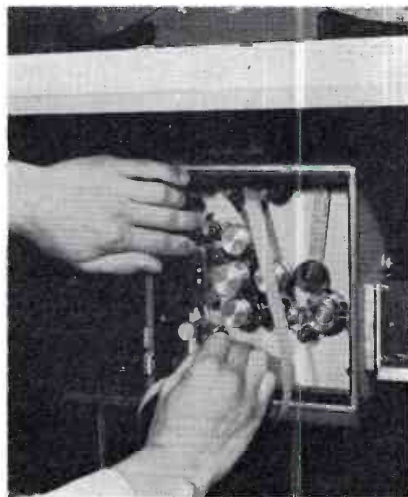

partly based on their extensive background experience with the early TK-31 cameras. These cameras used a "clamp-on-black" method and results were not as good for kine recording as with the TK-60's, which are "clamp-on-white" cameras. While the lighting for the new camera is slightly more critical the quality of picture, particularly gray scale, is much improved, and NPC is primarily interested in quality of picture. Also, the controls are simpler, there being really only one operating control for the TK-60, the iris.

#### Operating Personnel

NPC-TV uses eight enlisted personnel and four civilians in its operation. These are cameramen, floormen, lighting man, director, TV tape/film operator, kine recorder operator, switching operator, audio and video operators. Technical personnel, when not operating the equipment, double as maintenance personnel.

#### TV Film Production

The Center's TV film production, which daily averages from 3000 to 4000 feet, is all in black and white. The use of color is anticipated in the future. Both negatives and direct positives are made. Usually multiple copy prints are obtained from outside suppliers.

The TV Branch's principal contribution is the recording of live studio material on film by way of TV tape, but some work consists of recording customers' taped material on film. Recordings are made of special off-air TV pickups such as the Army-Navy football game. NPC-TV averages about two live studio productions a



FIG. 18. RCA optical sound recorder used at NPC to record sound on film by using the double system.



FIG. 19. NPC TV Branch has complete facilities for editing of TV produced films.

week. Normally, an officer-instructor will help produce the program which is usually an interview by a well-known personality or the presentation of a briefing by a high ranking officer. Sometimes these productions are made to be integrated with already recorded material to make up a composite film or tape.

Productions vary in length and cover a wide range of subjects. One of these productions—a course on psychology—employs nearly 40 hours of film. Others are mostly on evaluations of new equipment, descriptions, instructions and briefings. NPC also produced a series of medical films. NPC's integral film processing facility is a big asset in obtaining high quality films.

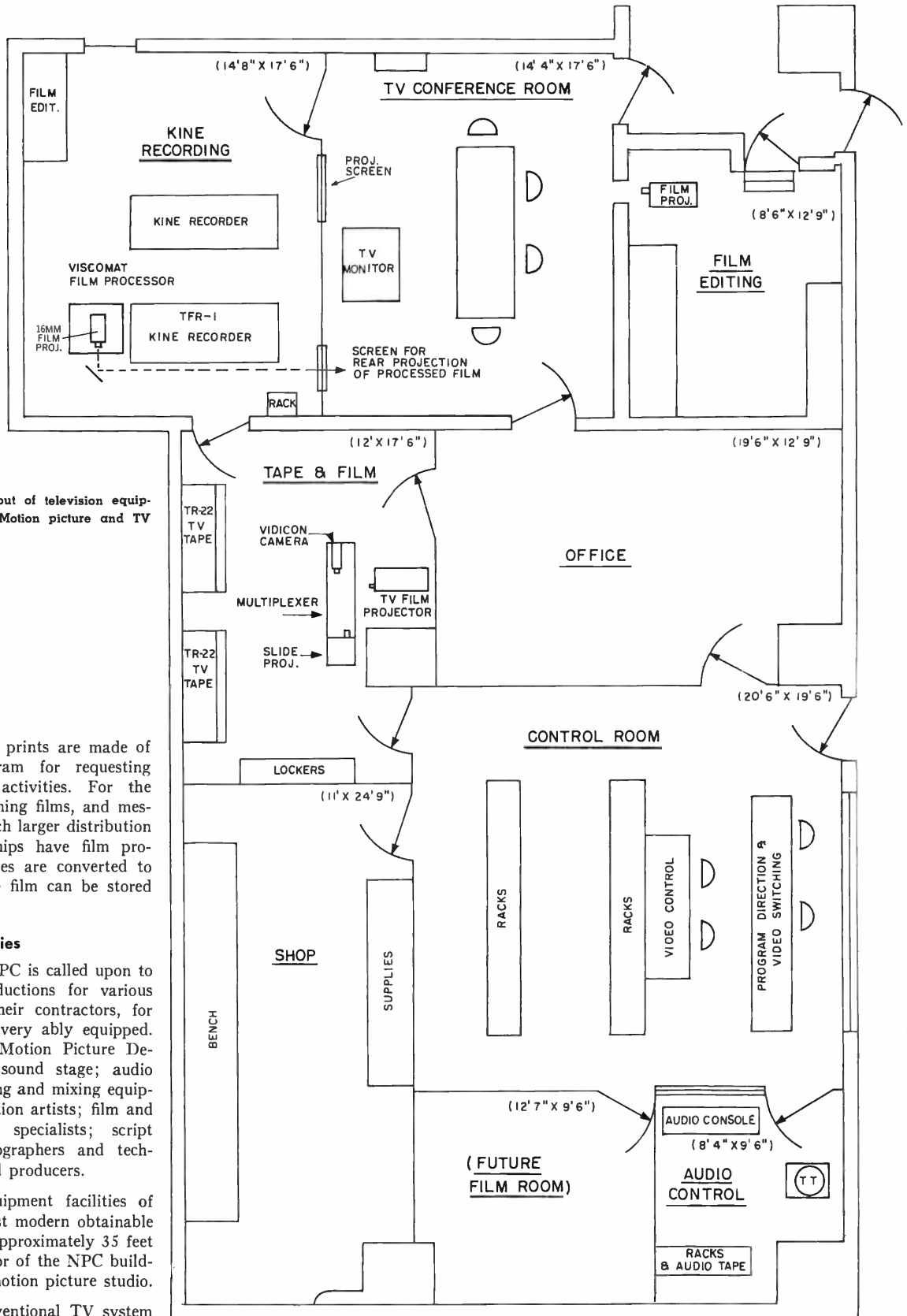

FIG. 20. Floor plan layout of television equipment facilities at NPC. (Motion picture and TV studios are not shown.)

**Distribution Via Film**

Normally, five film prints are made of each technical program for requesting bureaus and other activities. For the leadership series, training films, and messages to the fleet, much larger distribution is made since all ships have film projection facilities. Tapes are converted to film for storage since film can be stored more easily.

**TV Equipment Facilities**

Quite frequently NPC is called upon to make full scale productions for various Navy branches or their contractors, for which the Center is very ably equipped. Facilities of NPC's Motion Picture Department include a sound stage; audio film and tape recording and mixing equipment; art and animation artists; film and sound editors; TV specialists; script writers; Navy photographers and technicians; directors and producers.

The television equipment facilities of NPC-TV are the most modern obtainable and occupy an area approximately 35 feet by 60 feet on one floor of the NPC building adjacent to the motion picture studio.

The layout is conventional TV system

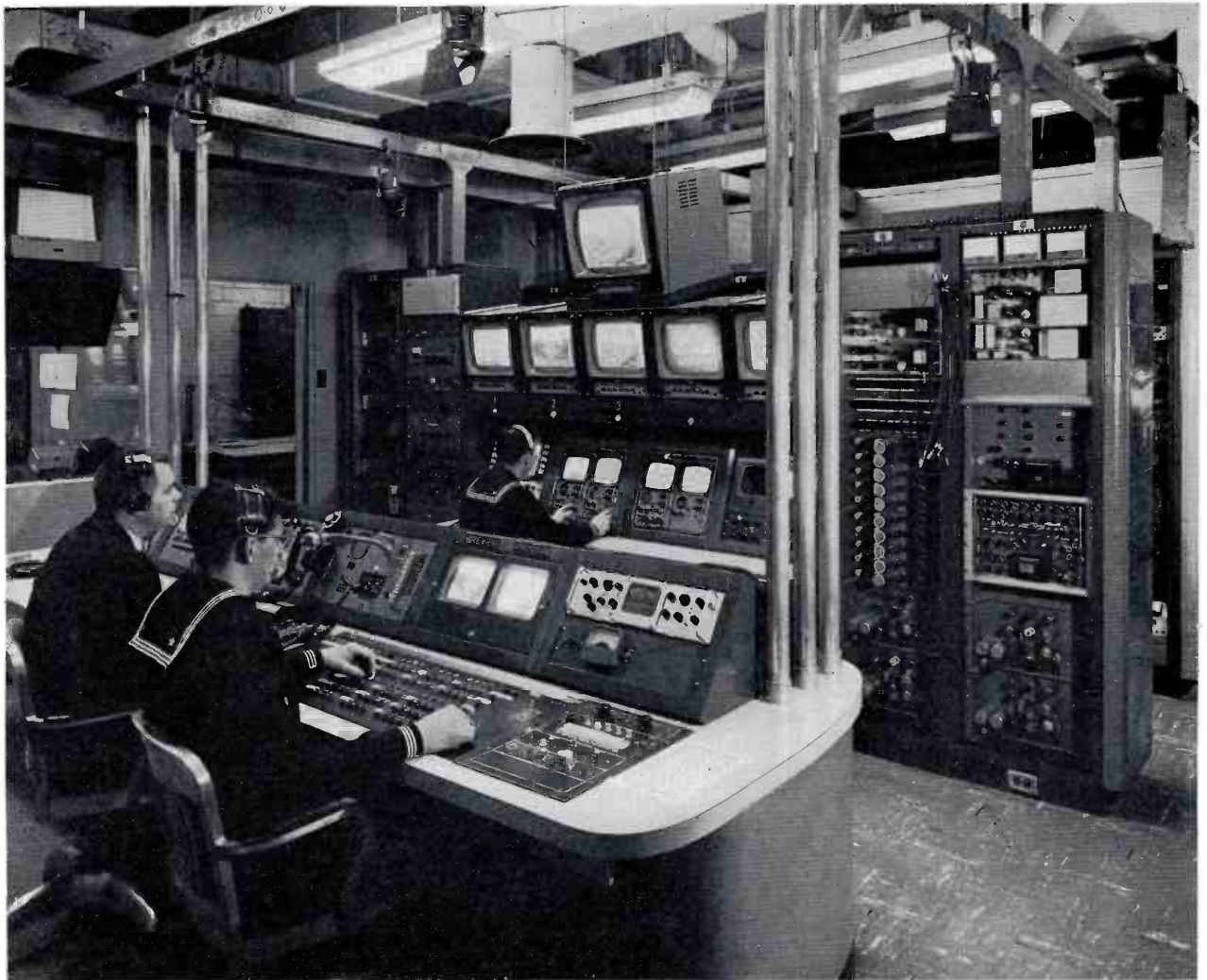

FIG. 21. TV control room at NPC. In foreground is switching and effects position, in rear, video control position (camera controls). Overhead monitors preview picture sources for program director and display on-air signal.

design: three-camera studio, tape and film room, kine recording and TV conference room. A "blind" control room is preferred over the "window-looking-into-the-studio" design, because it allows more flexibility in equipment layout with no sacrifice in operating efficiency.

Two custom desk consoles provide two separate control positions—video control, and program direction and video switching. The video control desk contains a switcher for selecting any of the three cameras, plus the film chain and two TV tape machines. There is also a panel for remote control of both tape machines. At this position the cameras are perfectly matched for one-light (uniform) negative.

A TS-40 switcher with special effects equipment is located at the video switching position, plus a remote control for the film chain and a custom built slide projector switch for selecting up to 50 slides either sequentially or individually. Rows of lights at the control positions indicate the status of programming and equipment, i.e., program being recorded; rehearsal; playback, etc.

Audio equipment, which consists of a BC-6 Dual Console, tape recorder and one turntable, is located in a small sound studio looking into the control room. As in the motion picture industry, the double system of recording sound on negative film is used.

A special feature of NPC-TV is the TV conference room, which contains a TV monitor and a rear projection screen. This enables clients to see and compare the images from the TV tape with those projected from the film being produced by the kine recorder.

Presently, NPC is using a TK-21 film chain with a slide projector and one 16mm projector. A TK-22 film camera chain will be added to allow special effects between the two chains. The TV output is fed into a house monitoring system that distributes the picture to selected points. A master antenna provides for feeding off-air TV pickups into the NPC system.



FIG. 22. The U.S. Naval Photographic Center has a proud record over the past 25 years, often working under dangerous conditions to produce the still and motion picture footage needed by the U.S. Navy.



#### History of N.P.C.

Established in 1943 as the U.S. Naval Photographic Science Laboratory, NPC began by first meeting the overwhelming demand for photo services during World War II. Highly skilled motion picture and still photographic personnel were recruited. Under the supervision of industry experts, a new building (housing a sound stage) and filming studios was constructed. A laboratory was designed, built and equipped with the latest photographic and sound equipment.

In short order, the new facility was an efficient, swift moving team consisting of a Research and Development Department, Motion Picture Department and Still Picture Department. These departments plus a full scale film processing facility filled the demand for Naval photography of every kind. The R & D Department came up with new developments and modifications of photo equipment, cameras and chemistry. They expanded production and improved quality. The Motion Picture Department made films to train men for the thousands of highly specialized jobs covering just about every subject from battlefield surgery to operation of five-

inch/38 guns. They used the concept of motion pictures and audio slide films, a new and radical but effective approach that was to be the forerunner of NPC's well-known Filmgraph technique.

Assisted by industry and the Hollywood U.S. Naval Photographic Services Depot, which provided the Navy's liaison with Hollywood Studios, NPC produced several award winning documentary films. NPC provided the footage and cooperated in the production of NBC's "Victory at Sea."

The Still Picture Department struggled to keep up with the processing and printing requests from Government and civilian agencies. But the importance of the operation was signified when a portion of the building was sealed off to become one of the most closely guarded top secret areas in Washington. Navy personnel worked night and day to produce photo mosaics of the Normandy Beaches.

With the end of the war, most of the laboratory staff returned to industry. For NPC, however, the post-war breathing spell was temporary. Its importance had increased as photography has become a critical tool in Navy planning and doctrine and training. As new ships, submarines and

missiles became operational, there was a need for film services for training personnel and to provide photo information for intelligence uses, and to the public and the press. NPC was caught up in these sweeping demands. Improved cameras, films, and papers required special techniques in handling but produced photography of higher quality and in greater volume than ever before.

NPC's success in this endeavor is documented by a series of invaluable technical developments in photography, by the excellence of its tutorial films and by the millions of feet of stock footage film. While instructional films are produced primarily for the Navy's use, their demand by private industry and educational institutions is heavy. An average of about 200 motion pictures a year are completed. These are primarily for training, research and development, technical photographic reporting, recruiting, indoctrination, instruction in new devices and historical purposes. The Processing Division of NPC is capable of developing and printing negative film, releasing prints in 35mm or 16mm, black and white or color. The Division processes and prints over 15 million feet of film yearly.



FIG. 23. Today the NPC's ability to produce films via television, speeds the flow of information about latest developments to Navy personnel, making a substantial contribution to Navy training and Fleet readiness.



## INCREASING IMPORTANCE OF TELEVISION-TO-FILM CONVERSIONS

*(An interview with Mr. Walter Evans, Asst. Head, Motion Picture Dept., NPC)*

### Major Equipments Used by TV Branch at NPC

- TK-60 Cameras (3)
- TS-40 Switcher
- TK-21 Film Chain
- TK-22 Film Chain (on order)
- TR-22 TV Tape Recorders (2)
- TFR-1 TV Film Recorder
- TG-2 Sync Generator
- TG-10 Sync Generator (2)
- BC-6 Dual Audio Console
- Custom Slide Selector
- Audio Tape Recorder

### Conclusion

The system has need for more in the way of playback facilities, in order to be more productive. By installing the proposed new film projection equipment in a separate room, there will be more space in the present tape room. There is no question about the contribution TV has made to the mission of the Center. As to color, it will eventually be necessary, although not required at the present time.

"Television film recordings are growing in their usefulness and significance to the Navy mainly because of the immense growth in material to be communicated to naval personnel and the speed with which kine recordings can be made.

"Speed is of utmost import to the military. In some cases, we just do not have the time to go through the regular procedures for making a film. The television-to-film procedure provides an essential short cut that saves valuable time in addition ends up with an acceptable print—either positive or negative as the requirement dictates.

"New developments such as the PLAT system ends up with a television taped recording of the take-off and landing excursion of carrier-based aircraft. These tapes require conversion to film for training of future pilots and perfecting of present pilots. There again the television film recorder serves a vital need.

"Important new developments in areas such as medicine and surgery come in via television. These can be converted and used for instruction purposes by the

Bureau of Medicine and Surgery. This department is one of the main clients using TV conversion for teaching and examining clinical practices.

"Occasionally, a lecture or a college course could not be picked other than by the immediacy of the television camera. Taping these pickups produces an acceptable source for the TV Film Recorder. Then we can make master negatives for printing and processing in the normal manner to produce as many copy prints as needed.

"Overall, the ability to immediately establish communication by means of TV conversion plus film introduces a whole new concept. New devices and new equipments such as computers can be rapidly introduced to navy personnel by an expert before the TV camera. Immediate playback on TV tape and 2-minute conversion to film gives the new development wide distribution and rapid utilization without the long time delay of the regular motion picture production. All of these new techniques improve this Center's primary contribution to Navy training and to Fleet readiness."

3

Please send me a PGW Colonel in living color.

NAME \_\_\_\_\_

COMPANY \_\_\_\_\_

ADDRESS \_\_\_\_\_

CITY \_\_\_\_\_ STATE \_\_\_\_\_

REMARKS \_\_\_\_\_

\_\_\_\_\_

**For free color, fill in coupon.**

Don't be confused by the coupon. It's really very simple. WFGA-TV doesn't charge anything extra to air your commercials in full color, and your Peters, Griffin, Woodward "Colonel" will be happy to give you full details. You see, WFGA-TV airs everything possible in color...news, weather, station breaks, feature programs, even promos. This is a great place to test new color commercials, too—we've had over six years' experience.



**WFGA-TV/JACKSONVILLE**

AN AFFILIATE OF WOMETCO ENTERPRISES, INC.

BROADCASTING, October 18, 1964 15

(Continued from Pg. 1)

also the way live, tape and film are used separately, or in combination, to derive the best possible final result.

**COOL** is the word the younger generation would use to describe the KOOL setup (Page 5). And Webster would back them. According to the Third Edition the word cool—when used in this sense—means "superior, excellent—showing a mastery of the latest in approved technique and style." Who can say it better? KOOL is cool.

**FOR FREE** color, fill in coupon, says the WFGA-TV ad in recent trade journals (see above). As an inveterate ad-watcher this one caught our eye. We don't want to get in the middle of the argument as to whether stations should charge for color. There are pros and cons. But either way it seems like now is a good time for a color-equipped station to push the value of color—especially commercials. And we're impressed with the way WFGA is doing it. More of how and what they do is contained in the story on Page 22.

**AS WE WRITE** we have been watching the Ohio State-Southern Cal football game—in color. Absolutely beautiful! This is where color shines. We turned to black and white for a few minutes just to compare. What a difference! We're truly sorry for those who have to watch it in monochrome. It's not just the beauty of color. It's the

added contrast of the color. The extra information it provides. The greater ease in following the play. We're not among those who think color is everything. But where the conveyance of detailed information is important (as contrasted to a simple story line), the extra intelligence in color is undeniable. And did you see the Gillette commercial in color? Talk about detail. Of course, after all that color, "the big bright Texaco Star"—in shades of gray—was a bit disconcerting. But, so what—we came to play.

**HAPTIC** is our word-of-the-month. We didn't invent it. Jack Williams, who is vice president in charge of advertising and promotion for the RCA Sales Corporation is (natch) a great booster for color. In a recent talk to the New York Advertising Club he quoted DuPont's Color Council as saying, "Mostly, color permits television advertising to more strongly influence the viewer's optical, symbolical and haptic sensations." Yes, that's what the man said—h-a-p-t-i-c. We-l-l-l, we thought it was just that color tells more. But we love these crazy words—so off we went to our trusty Third Edition. Sure enough, there really is such a word as haptic. It means "related to the sense of touch." Touch? We knew television had sight and sound, and sometimes taste, and occasionally smell. But touch? Wait till the Code Board hears about that.

*As We Were  
Saying*



**NEW HEIGHTS OF POWER ON KIRO-TV...**

**DELIVERS A CLEARER STRONGER PICTURE!**

**REACHING MORE HOMES... BETTER WITH TOP-RATED CBS PROGRAMMING!**

This newest technical improvement is another step in the planned progress of a great STATION-ON-THE-GO in the growing Puget Sound Market. Tested and proved by some sixty of the nation's leading stations, the traveling wave antenna delivers a clearer, clearer and higher-powered signal.

Your PGW "Colonel" will give you the full story on the many other STATION-ON-THE-GO plans and accomplishments of the new KIRO-TV—the station-to-buy because it's the station-to-watch in the nation's SIXTENTH market!

**KIRO TV 7**  
CBS FOR THE GREAT NORTHWEST

Affiliated with: WFOU, RADIO NEW YORK WORLDWIDE KSL-AM/FM/TV KID-AM/FM/TV KROQ-AM/FM/TV

just in time for the new Fall Season  
**WAPI-TV IS NOW ON THE AIR WITH A NEW TRAVELING WAVE ANTENNA!!**

**INCREASING PICTURE POWER IN EVERY DIRECTION**  
Especially designed WAPI-TV's new Traveling Wave Antenna assures excellent circularity of signal pattern increasing picture power in every direction. This means much greater signal strength in the major metro areas of Anniston, Gadsden, and Tuscaloosa with a total of 71,000 TV homes.

**SUPERIOR METRO COVERAGE**  
A special feature of the Traveling Wave Antenna is null-free vertical radiation patterns for superior clear-air reception.

**WAPI-TV**  
**13**  
**BIRMINGHAM**

**WAPI-TV BIRMINGHAM** CBS  
Member Station for Birmingham, Florida, and Panama, Inc.

August 24, 1964

*As We Were  
Saying*

Come to think of it, though, maybe he's got something. There have been color commercials—like those for Kraft foods—that make you feel like reaching out for them. There will be more—when advertisers realize the appeal of simple things elegantly done—in color. Think of the cake mix adds in the shelter magazines, the bulb ads in the flower magazines—and (if we dared) those cool, frosty drinks. In color TV—they'd be haptic. No doubt about it, haptic is a good word for color.

**THEY SWITCHED**—and are they glad they didn't fight. So glad, in fact, that they have taken ads to tell about it. Both WAPI and KIRO switched recently from helical-type to traveling-wave-type antennas. And you can read for yourself what they say about it (above). These ads appeared without our foreknowledge—but they didn't surprise us. WAPI and KIRO have just found out what sixty odd users of RCA Traveling Wave antennas already know.

**NEW LOOK SYMBOL** now appears in all of our ads (see covers of this issue). It's similar to the markings on all of our New Look equipments. Whyso this insignia? Well, partly because we're proud of this new line and want to call attention to it. But more so, perhaps, because we want to give identity to the new equipment which you will be installing—and of which we think you'll

be equally proud. We want your sponsors to notice it when they come into your studio.

**NEW LOOK ACCEPTANCE** has been fabulous. It had to be or we wouldn't be here. After the way we shot the works, a lukewarm reception would have put this column on early retirement. But rejoice, brothers, all is copacetic. An hour after the NAB Convention opened, we knew that you liked the new line. Only question left was did you like it the green way. Now we know the answer to that, too. Our sales people report their orders in the months since the Convention are running 35 per cent above a year ago. In a business not given to hysterical buying that's pretty good. We take it as a big vote of confidence.

Perhaps even more indicative of the acceptance of the New Look are the plans of some of the largest stations. A number are planning to junk their present equipment and install all-new all-blue. They figure that the savings in space, operating costs and maintenance will pay for the new equipment in a relatively short time. How are they going about it? In our first issue of the new year and following issues we will describe the plans and progress of some of these stations. But don't wait. We will give you custom help if you want to start now.

—The Armchair Engineer

# RCA SERVICE

keeps all your  
AM, FM, TV  
equipment  
in top  
condition !



*Amplifier Overhaul*

## TAKE ADVANTAGE OF THE FOLLOWING SERVICES OFFERED BY RCA:

- Video Tape Recorder Service • TV Camera Overhaul • TV Transmitter Overhaul
- Installation Supervision • Microphone and Pick-Up Repairs • Transmitter Performance Measurements • Antenna Inspection Measurements • Console Repairs • Microwave Service
- TV Projector Service • Custom Fabrication • Teletypewriter Maintenance

Your audience demands a superior signal which requires top performance from all your station equipment. RCA Broadcast Service is planned to assure you of meeting this objective. More than 30 years in the broadcast industry have provided a background of solid service experience. This is the type of protection broadcasters have relied on for years, the kind of protection you can count on . . . contract or per-call . . .

from the experts in the service business, RCA Service Company. To guard performance of all your equipment . . . simply telephone one of the following field offices: Atlanta (phone 355-6110), Chicago (WE9-6117), Philadelphia (HO7-3300), Hollywood (OL 4-0880). Or contact Technical Products Service, RCA Service Company, A Division of Radio Corporation of America, Bldg. 203-1, Camden, N.J. 08101.



**The Most Trusted Name in Electronics**



# TV Film Projector

A deluxe model  
with every feature  
your program people  
could ask for

This new equipment does what you would expect from the world's most advanced television film projector. It has deluxe features, like instant start, reversible operation and automatic cue. These assure the finest quality and versatility. Completely transistorized and automated, the TP-66 is specially designed for TV film programming's faster pace.

**INSTANTANEOUS START**—Start and show buttons can be pushed at the same time, since projector sound is stabilized within 0.3 second. A pre-roll period, prior to switching projector "on air," is not necessary. Start is instantaneous, allowing preview of upcoming film when desired.

**STILL-FRAME PROJECTION**—Single frames can be shown at full light level for extended periods, permitting preview of first frame at start, or for special effects. Film is always completely protected by a filter that automatically moves into light path during still-frame use.

**FILM REVERSING**—Film motion can be reversed—a time-saving feature when rehearsing live or tape shows with film inserts . . . or as an imaginative production device.

**AUTOMATIC CUEING**—For full or partial automation, films can be stopped and cued up automatically. This eliminates the need for manually threading and cueing individual films, eliminating human error.

**AUTOMATIC LAMP CHANGE**—Both projection and exciter lamps are automatically switched in place, when burnout occurs. These time-saving features assure continuous operation and avoid costly delays.

**AUTOMATIC LOOP RESTORER**—Unique fail-proof feature eliminates need for human intervention, makes unattended operation practical.

**TRANSISTORIZED SOUND**—The TP-66 can be equipped for both magnetic and optical sound systems. Fully transistorized for finest quality and reliability.

## NOW BEING DELIVERED

For full particulars, write RCA Broadcast and Television Equipment, Building 15-5, Camden, N.J. Or see your RCA Broadcast Representative.



New 16mm Television Film Projector, Type TP-66



The Most Trusted Name  
in Television



# 30 kw UHF transmitter



Type TTU-30A

**... with long-life, integral-cavity klystrons  
has lowest operating cost of any 30-kw UHF transmitter**

Here's a brand-new 30-kw transmitter in a compact size, combining top performance with lowest operating cost. It features eye-level, easy-to-read meters, new space-age electronics, new vapor-cooled klystrons. (Vapor cooling uses smaller, more economical heat transfer equipment—reducing operating costs.) . . . Designed for remote control . . . Direct FM aural modulation for finest sound . . . to 1,000,000 watts ERP . . . Also in this new line are a completely air-cooled 10-kw, and a 2-kw that easily can be expanded to a 10-kw.



Klystron change is accomplished in only a few minutes with this unique carriage.

RCA Broadcast and Television Equipment,  
Building 15-5, Camden, N.J.



**THE MOST TRUSTED NAME IN TELEVISION**