

# BROADCAST NEWS

Deluxe New Studios  
at WJAC-TV



Vol. No. 124 DEC. 1964



**For assistance in planning  
and equipment... see your  
RCA Broadcast Representative**

---

Atlanta 3, Ga. 134 Peachtree St., N.W. <b>P. G. Walters</b>	524-7703	Indianapolis, Ind. 501 N. LaSalle St. <b>C. Raasch</b>	636-5321
Austin 3, Texas 4605 Laurel Canyon Drive <b>J. N. Barclay</b>	GL 3-8233	Kansas City 14, Mo. 7711 State Line Rd. <b>V. S. Mattison</b>	EM 3-6770
Burbank, Calif. 2700 W. Olive Ave. <b>E. Frost • M. Ellison</b>	849-6741	Memphis 12, Tenn. 2110 Airways Blvd. <b>B. Fincher</b>	324-4434
Camden 2, N.J. Front & Cooper Sts. <b>J. A. Gimbel</b>	WO 3-8000 Ext. PC 3592	Minneapolis 16, Minn. 5805 Excelsior Blvd., Suite A <b>W. G. Eberhart</b>	929-3033
Charlotte 4, N.C. 504 Charlottetown Mall <b>R. Williams</b>	333-3996	New York 20, N.Y. 36 W. 49th St. <b>O. E. Wagner • J. L. Nickels R. Varda</b>	MU 9-7200
Chicago 54, Ill. Room 2000, Merchandise Mart <b>A. Jester • A. Power</b>	467-5900	San Francisco 2, Cal. 420 Taylor St. <b>R. J. Newman</b>	OR 3-8027
Cleveland 15, Ohio 1600 Keith Bldg. <b>W. C. Wiseman • W. I. McCord</b>	CH 1-3450	Seattle 4, Wash. 2246 First Ave., S. <b>R. E. Harding</b>	MA 2-8350
Dallas 35, Texas 7901 Carpenter Freeway <b>E. H. Hoff • D. Crawford</b>	631-3050	Southfield 76, Mich. Rm. A3-300, Southfield Office Pl. <b>J. P. Shipley</b>	357-0080
Dedham, Mass. 886 Washington St. <b>E. Herlihy</b>	DA 6-8850	Washington 6, D.C. 1725 "K" St., N.W. <b>O. J. McReynolds</b>	FE 7-8500
Denver 11, Colo. Continental Terrace, Room 223 2785 N. Speer <b>R. F. Goodspeed</b>	477-6832	West Palm Beach, Fla. 645 S. Military Trail <b>R. E. Giles</b>	683-2219

---

**RCA BROADCAST AND TELEVISION EQUIPMENT  
BUILDING 15-5, CAMDEN, NEW JERSEY**



**The Most Trusted Name in Electronics**

# BROADCAST NEWS

published by

**RADIO CORPORATION OF AMERICA**  
BROADCAST & COMMUNICATIONS PRODUCTS DIVISION, CAMDEN, N. J.

issued quarterly

PRICE *in U.S.A. - - - - - \$4.00 for 4 issues*  
*outside U.S.A. - - - \$5.00 for 4 issues*

## CONTENTS

	Page
Parallel Operation of TV Transmitters at WNAC-TV . . . . .	8
New Look Transistorized Sync Generator . . . . .	16
Broadcast House that WJAC Built . . . . .	21
Planning Data and Equipment for 12,000 mc Microwave Relay Service . . . . .	30
New Cartridge Tape Equipment . . . . .	40

**MOSTLY** the stations we describe in this journal are big-city stations. It's not that we are biased in that direction. Rather it's because these stations generally have larger operations, bigger plants, more equipment—and hence more of technical interest. From an engineer's viewpoint it shouldn't be, but usually is, true that equipment layouts tend to be proportional to rate cards. However, there are heartening exceptions. One of these is WJAC-TV in Johnstown, Penna. Their plant would be the envy of a good many big-city stations.

### *As We Were Saying*

The house that WJAC built is a thing of beauty. "Independence Hall on a Pennsylvania hilltop" you might call it. And what's inside, to the connoisseur, is equally beautiful. Live and film color cameras, four TK-60's, two TR-22 tape recorders—and everything that goes with them of the best. Two studios—one tremendous. A big control room angled between studios—and so on. But don't take our word, read the story on Page 21.

**ADVERTISING AGENCIES** have been complaining loudly about the poor quality of their radio commercials as aired by some stations. They

blame it on the practice, now almost universal of transferring these commercials from disc to tape cartridge for convenience in airing. Obviously this procedure in itself should not noticeably degrade the quality. Therefore, it must be either the equipment or the technique. An NAB engineering committee studied the problem for a year—decided the best answer was a set of detailed specifications for cartridge tape equipment. In the article starting on Page 40 Chuck Meyer, who is an authority in this area, discusses the reasoning behind these specifications—and, not incidentally, tells how our equipment has been designed to meet these specs.

**GIGACYCLES** is a word we gag on. In our soldering-iron days 30 megacycles was the top of everything. And we didn't call it 30 megacycles—we called it "ten meters." In fact, not till the action got down below one meter did we give in to the language of the frequencies. Nowadays megacycles sit easy with us—but gigacycles, ugh.

All of which is by way of explaining why we used 12,000 MC rather than 12 GC in the title

*As We Were  
Saying*

of John Bullock's article (Page 30). But either way you call it, John's material is some of the most useful we've carried in a long time. Pre-planning of microwave systems is important in any frequency range—at 12 GC it's a must. The high path losses that can occur during rain precipitation must be considered and suitable allowance made in calculating system performance. John's article shows how to figure it. Also indicated are some of the other pros and cons of 12 GC.

No one is likely to use 12 GC in preference to 2 GC or 6 GC. But when the latter are not available, it is certainly possible to use the higher frequency range. But do it with your eyes open—read what the man says.

Incidentally we have available brochures which provide similar planning information for the 2 GC and 6 GC microwave bands. You can get them from the nearest RCA Broadcast Representative (see inside front cover for name and address).

**OF ALL** the equipments we have ever built it is likely that our sync generators have been the most popular. Possibly this is because this unit is so critical to station operation. It's the one unit without which a station can't possibly run. And, it's the one unit that you can't patch around or substitute for. Thus stations who would take a chance on an off-brand camera, or d.a., or monitor (easily substituted-for items) haven't dared to take a chance on their sync generator—and so have bought ours.

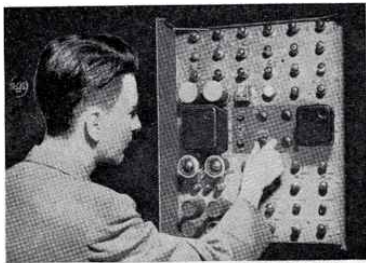

**Smallest, finest Studio Sync Generator ever built!**  
**RCA Type TG-2A**

COMPACTNESS, NEW TECHNOLOGY LEAD TO...  
 • 21 inches of rack space  
 • 100% reliability  
 • 100% automatic operation  
 • 100% manual operation  
 • 100% automatic switching  
 • 100% manual switching  
 • 100% automatic reset  
 • 100% manual reset  
 • 100% automatic lockout  
 • 100% manual lockout  
 • 100% automatic test  
 • 100% manual test  
 • 100% automatic repair  
 • 100% manual repair  
 • 100% automatic maintenance  
 • 100% manual maintenance

**RCA RADIO CORPORATION OF AMERICA**  
 MANUFACTURING DIVISION

think will be the new standard of the industry. You can read all about it in Ray Smith's article (Page 16).

**NEW LOOK "COMMERCIAL"** for this issue might well use the TG-3 as an example. Back in 1954, when we introduced the TG-2A, we made quite a thing of the small size (for those days). The TG-1 had occupied a whole 84-inch rack. The copy in the introductory TG-2A ad (see above) said "It takes only 21 inches of rack space . . . is so compact you can easily install two TG-2A's

and a changeover switch in a single rack." Sic semper something-or-other. The new TG-3 goes in a 5¼-inch rack space. If anyone is interested, you can get ten or a dozen in a single rack. In fact the monochrome set of modules, which do everything the TG-2A did, require only half a 5¼-inch space. Moral: when all of our New Look units are ready, you can put your whole equipment room in two or three short racks.

**REDUNDANCY** is a word more often encountered in defense electronics than in such prosaic fields as broadcasting. Engineers designing space vehicles, tracking systems and sophisticated weaponry put great store in the use of redundant circuits, or components, to insure ultra reliability. Their aim, of course, is to provide equipment which will have no breakdowns during the life of the mission—be it a few minutes, a few months, or even years.

Broadcast design engineers have never aimed quite so high. Generally they have felt that "up-time" of the order of 99.9 per cent was good enough. (Or, at least all the economics of station operation would justify.) Translated, that 99.9 per cent meant a loss of five to ten hours of air-time a year. Of course, that was average. Some stations, by careful preventive maintenance (and some luck) have held their off-air time to an hour or so per year. Others have run above the average.

In the early days of broadcasting, the loss of a few hours a year was inconsequential. But as station rates soared, the loss began to represent thousands of dollars in air-time. The first answer to the problem was to install an "emergency" transmitter—and today nearly all larger stations have one. However, it takes time to "fire-up" an emergency transmitter—and this time in itself may represent an important time loss. If the change is made manually this, too, takes time. If it is by automatic switching this device, also, has failure probabilities.

Many engineers are coming to the view that "parallel" operation of one kind or another is the best answer. Some transmitters parallel tubes in the output stage—which gives some protection. Others provide parallel output amplifier stages—which provides more. But, obviously, the most breakdown-free arrangement is two completely independent transmitters in parallel. In the past the cost, and the problems of combining outputs, have weighed against such a setup. However, the arrangement which RCA and WNAC engineers have worked out (See Page 8) overcomes these objections. And, interestingly, the parallel operation actually provides a distinct improvement in performance. The whole system works so well that WNAC engineers will push a button and take one of the transmitters off the air just to demonstrate it to you. As the man said, that's confidence!

## TRACY NAMED DIVISION VICE PRESIDENT IN SALES ACTIVITY

The appointment of Edwin C. Tracy to the new position of Division Vice President, Broadcast, Technical and Scientific Sales Department of the RCA Broadcast and Communications Products Division was announced November 12 by C. H. Colledge, Division Vice President and General Manager.

Mr. Tracy continues to have overall responsibility for Division sales of radio and television broadcast equipment, closed circuit TV systems, the RCA electron microscope and related items. He had been Manager of Sales for this product group for the 14 months preceding his promotion.

He joined the RCA Service Company in 1939 as a television engineer and shortly thereafter was assigned to the RCA TV operations staff at the New York's World's Fair. During World War II, as a service engineer on contract to the U.S. Navy, he traveled extensively in Europe and the Pacific while working on airborne and sea-borne radar installations.

In 1942 Mr. Tracy was one of 10 civilians summoned to the White House to re-



ceive citations from President Roosevelt for their contributions to the war effort. He was honored for developing a method for rapid checking of altimeter accuracy.

With the return of peace, Mr. Tracy became an RCA broadcast equipment sales engineer in Chicago, and four years later was named Field Sales Manager. He continued in this capacity until early 1963

when his responsibilities were broadened to include sales of standard TV products to government agencies, and sales of the electron microscope.

Mr. Tracy was born in Smyrna, Turkey, a country where his father and grandfather served as missionaries, and was brought to the United States when a year old. He grew up in New England where his father held several pastorates and where the younger Tracy, at his uncle's urging, tried his hand at building radio receivers. On one occasion he improved his reception by climbing to the roof of his father's church to string an antenna.

This early interest in radio led Mr. Tracy to become a ham operator, a radio serviceman in Hartford, Conn., and a service manager. Later he resumed his education by attending Pratt Institute School of Science and Technology in Brooklyn, N. Y.

When radio and television equipment became his business career, Mr. Tracy gave his fellow hams one final "73" and turned his spare-time interests to golf, where he enjoys a 12 handicap, and fishing where he angles for fresh-water bass.

## NEW UHF OUTLET OFF ON RIGHT FOOT WITH ORDER FOR COMPLEMENT OF RCA EQUIPMENT

WNJU-TV, the first new commercial television station in Metropolitan New York-New Jersey in 16 years, has signed contracts for more than \$1,000,000 in RCA broadcast equipment and services.

The Channel 47 station is expected to begin transmitting in both color and black-and-white from the Empire State Building next Spring and will radiate a half-million watts of ERP. The New Jersey Television Broadcasting Corp., licensee of the Newark-based UHF station, is headed by Edwin Cooperstein as President.

WNJU-TV will become the first commercial UHF outlet in the nation's largest market as well as its seventh commercial station. The populous New York metropolitan zone has had six commercial broadcasters since 1961 when Channel 13 was converted to an educational station. The City of New York operates a municipal UHF station on Channel 31 with programming described as "instructional television" and "civics plus culture."

The new station's daytime schedule will be devoted exclusively to New Jersey-oriented programming while the evening hours will be set aside for quality ethnic broadcasts, including Spanish-language, Negro and other cultural-background series.

The transmitter, to be installed on the Empire State Building's 84th floor, is RCA's new type TTU-30A for UHF service. The antenna system was custom-designed by RCA for mounting at the Empire State Building level, 1,200 feet above ground, that was originally intended as a mooring mast for dirigibles. The system will consist of separate antenna radiators, each approximately 50 feet high, on the north and south sides of the building. The antenna sections will be joined electrically to provide an overall transmission pattern for the station's broadcast signal.

The station's studio equipment complement includes three TK-60 cameras, two TR-22 TV tape recorders, and a color film chain.



RCA's Charles Colledge (left) and WNJU-TV's Edwin Cooperstein decide where to put TV tape recorder.



## IT'S LIKE CHRISTMAS RUSH FOR TV TAPE

The first commercial shipments of two advanced types of RCA television tape machines, the TR-3 tape player and the TR-4 recorder/reproducer, were made in early November. With volume production under way at RCA's Camden, N. J. plant, at least 70 machines will be delivered before the year's end.

Initial shipments were made to broadcast stations in this country and in Canada, to the U.S. Army and Air Force, and to other domestic users. Future deliveries will fill orders from customers in such foreign countries as Great Britain, Argentina, Uruguay and Finland. The tape machines were introduced at last April's N.A.B. convention and are noteworthy for their modular design, advanced styling and interchangeability of standardized parts and modules. They use quadruplex operation for full broadcast quality, compatibility and standardization.

The new machines are the technological

offspring of the RCA type TR-22, the industry's first TV tape recorder to use all solid-state circuitry. Their design retains the TR-22's basic performance features but eliminates some automatic controls and introduces other cost savings. The result is full broadcast-quality operation at a budget price.

The TR-3, the industry's first "playback-only" machine, reproduces previously-recorded video tapes in the same manner that a projector screens film. It can be used for broadcasts of tape shows or for previewing tapes in the studio, at advertising agencies and elsewhere.

The TR-4 is a complete recording-playback system contained in a small (33 by 22 by 66-inch) cabinet, and is suitable for any assignment in the video tape area. Like the TR-3, it has inherent color capability and will accept such other accessories as ATC and electronic splicing.

The push is on at RCA-Camden as inspectors (top) and shippers (below), using new package, work to fill backlog of orders for TR-3 and TR-4 machines.



## ON BROADWAY WITH TWO LEOS AND A BOOM



TK-60 camera mounted on 22-foot boom gives MGM Telestudios new mobile tape unit wide versatility, while below nine-month-old Leo shows you what a hard day at the viewfinder does for a lion.



Times Square gawkers had themselves an eyeful in early October when MGM Telestudios rolled its big new RCA-built mobile tape unit into the Crossroads of the World and put on a full-dress demonstration for newspaper and trade press writers. Traffic slowed as the unit's 22-foot boom, smoothly controlled by the cameraman himself, moved a TK-60 camera up and over busy Broadway, capturing the passing scene and sending it inside the van to a TR-22 TV tape recorder.

After the cherry-picker had gone through its paces, somebody thoughtfully produced a nine-month-old lion cub. It turned out that the cub's name was Leo which, by an odd coincidence, happened to be the very name the MGM people had chosen for the mobile tape unit. The cub rode the cameraman's chair side-saddle and stared docilely as photographers popped their flash bulbs.

This over, the lion left via station wagon without so much as a parting snarl, and the press group got down to the business of touring Leo the mobile tape unit. They found it to be a marvel of efficiency and convenience, right down to its electric pencil sharpener.

George K. Gould, MGM Telestudios' President and General Manager, told them the unit could be in ready-to-shoot condition only 60 seconds after arriving at a remote location. Cameras are lowered to the ground on hydraulic platforms and cables are stored on powered drums. When the day's work is over, cables are reeled back with no "spaghetti" entanglements.

Leo is completely self-powered by its own motor generator for electronics and stage lighting, and is fully heated and air-conditioned. It contains a mobile telephone and special walkie-talkie system, allowing contact with helicopters, planes and motorboats for running shots.

An exclusive feature is the "director's caddie" which takes the director's center of operations outside the vehicle to wherever the taped action is. On wheels, the caddie contains its own portable communications center for pictures, audio and talkback. It thus is possible for the director to talk with any of the truck's personnel privately by pushing a button on the console.

For George Gould the big rolling tape studio is the fruition of a five-year dream. For ad agencies, broadcasters and other tape users, a new and highly-versatile production tool for putting camera and tape recorder in hard-to-get-at places.

# Interchangeable modules in

...assure high quality, easy maintenance

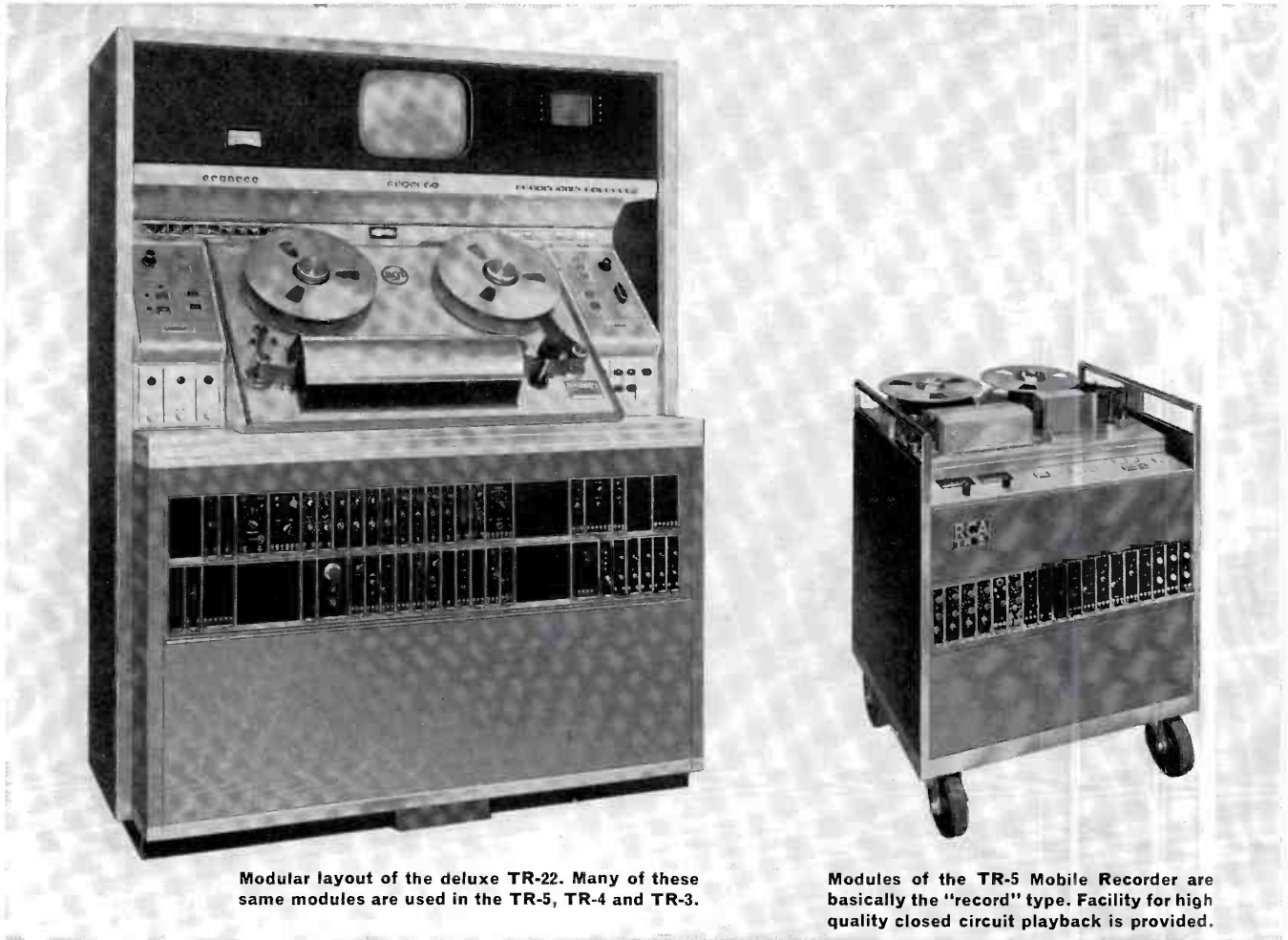

**Modular layout of the deluxe TR-22. Many of these same modules are used in the TR-5, TR-4 and TR-3.**

**Modules of the TR-5 Mobile Recorder are basically the "record" type. Facility for high quality closed circuit playback is provided.**

All four RCA TV tape recorders pictured here have something in common: *They can all use each other's modules!* Even modules of the deluxe TR-22 can be used in the lower priced models. Making modules the common denominator of all these units has important implications. It means the quality is the same in all. It means maintenance is simplified. And it means accessories are modular for easy addition. • Standardizing modules saves time and reduces spare parts requirements where two or more RCA TV tape recorders are

**See the entire RCA line before you buy any TV Tape Recorder.**

*RCA Broadcast and Television Equipment,  
Building 15-5, Camden, New Jersey*



# all these RCA TV tape recorders

and simplicity in adding accessories!

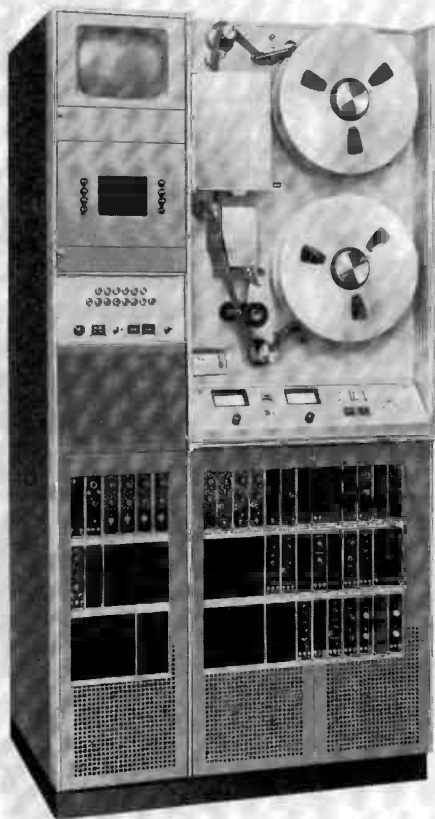

Modular layout of the TR-4 showing "record" group at left and "play" group at right.



"Play" group of modules in the TR-3 Playback Special are the same as those shown in the TR-4.

installed. Standardization also makes quick replacement easy, and operating a group of recorders is a lot simpler. • Accessories, such as color and electronic editing, can be added to any model largely by plugging in necessary modules. • Tapes made on any of these quadruplex units can be played on any other—as well as on all standard broadcast quadruplex recorders. They are all fully transistorized—all capable of producing the highest standards of professional broadcast-quality tapes.



**The Most Trusted Name in Television**

# PARALLEL OPERATION OF TV TRANSMITTERS AT WNAC-TV\*

Two RCA 25-KW Transmitters Employed in a  
System That Increases Reliability,  
Reduces Operating Costs and Improves Performance

Last February, WNAC-TV became the first U.S. station to operate with parallel TV transmitters. The idea, pioneered in this country by RCA represents a relatively new concept in broadcast system design and operation. WNAC-TV's increased reliability and economy over the conventional main and standby transmitter systems has been documented in performance tests over the last few months. The Boston color station's success has led another maximum power station, KCRG-TV, Cedar Rapids, Iowa, to order two new RCA 25-KW transmitters for a similar installation.

## Paralleling Transmitters Increases Reliability

It should be noted that parallel operation of transmitters is more than the paralleling of tubes or amplifiers. The purpose of paralleling amplifiers is to fill the need for higher power equipment than otherwise available. Just recently, RCA paralleled TV amplifiers for KGW and WIIC to obtain 100 KW, and thus became the only supplier of 100 KW TV transmitters.

The object of paralleling completely independent transmitters, however, is to get the increased reliability offered by 100 per cent redundancy. If either transmitter fails, the other transmitter is unaffected. Due to the combining scheme used, a 6 db fall-off in radiated power (half field strength) takes place. As a result, viewers usually notice no change in aural reception due to inherent properties of frequency modulation. Picture quality is

visibly unchanged for close-in audiences; while distant viewers in fringe areas may lose some quality due to less contrast and resolution, depending upon receiver noise and interference levels. If patch panels are employed, as they are at WNAC-TV, to by-pass the combining diplexer, the power loss can be held to 3 db.

In addition to the fact that both transmitters are always in use and there is no uncertainty or lost time by "firing up" the standby transmitter, mathematical studies show that in any redundant system employing identical units the mean time between failures improves 150 per cent.

The WNAC-TV system is a series-parallel combination: The series leg is the audio and video equipment ahead of the parallel transmitters and the filterplexer equipment following them. In the event of failure the input equipment can be bypassed by patch lines and the transmitter driven directly from the studio cable. The filterplexer is a passive network and therefore considered less likely to fail than the transmitter. That is the reasoning behind the absence of redundancy for these equipments.

## Parallel Operation Improves Performance

Data pertinent to FCC type acceptance taken on the WNAC-TV system provided interesting comparisons between single and parallel transmitter performance measurements.

Slight improvements were noted in the amplitude vs. frequency response and in differential gain data as compared to previous identical transmitters operating singly. This suggests that the transfer

characteristic of the parallel transmitters is more linear. The supposition is that irregularities occurring in one transmitter do not occur at the same time in the other; thus, an averaging of the two takes place. A comparison of the system square wave modulated shows that overshoots in the parallel system are reduced from  $\pm 10$  per cent to  $\pm 5$  per cent.

Performance is enhanced by "ghost cancelling" which has for a long time been identified as a feature of the diplexed amplifiers in the TT-25DH transmitter. Reflections from the antenna, occasioned by unusually high VSWR, are equally split at the diplexer, then recombined 180 degrees out of phase, resulting in cancellation of the reflection and elimination of the source of ghost in the transmitted picture. VSWR's of 2:1 caused by antenna icing have been reported without noticeable ghosting on receivers.

## Parallel Operation Costs Less

The operating cost of two parallel transmitters compares favorably with a single high-power transmitter and a low-power standby. The idle standby transmitter can be expensive. It is usually of different design than the main transmitter, requiring higher inventory costs for tubes and spare parts. Maintenance cost is reduced with parallel operation since work can be performed by shutdown of the faulty transmitter during regular hours. And, of course, when one transmitter fails, the operating unit provides a set of correct meter readings and dial settings to speed troubleshooting and repair. As to first cost, a rule-of-thumb estimate is that two parallel transmitters cost approximately 30 per cent more than a single transmitter to achieve the same total power.

\* Major credit for this article goes to Robert E. Winn, Project Engineer, RCA Broadcast Transmitter-Antenna Systems Engineering. Mr. Winn developed the original text entitled "The Parallel Operation of a 50-KW TV Transmitter."

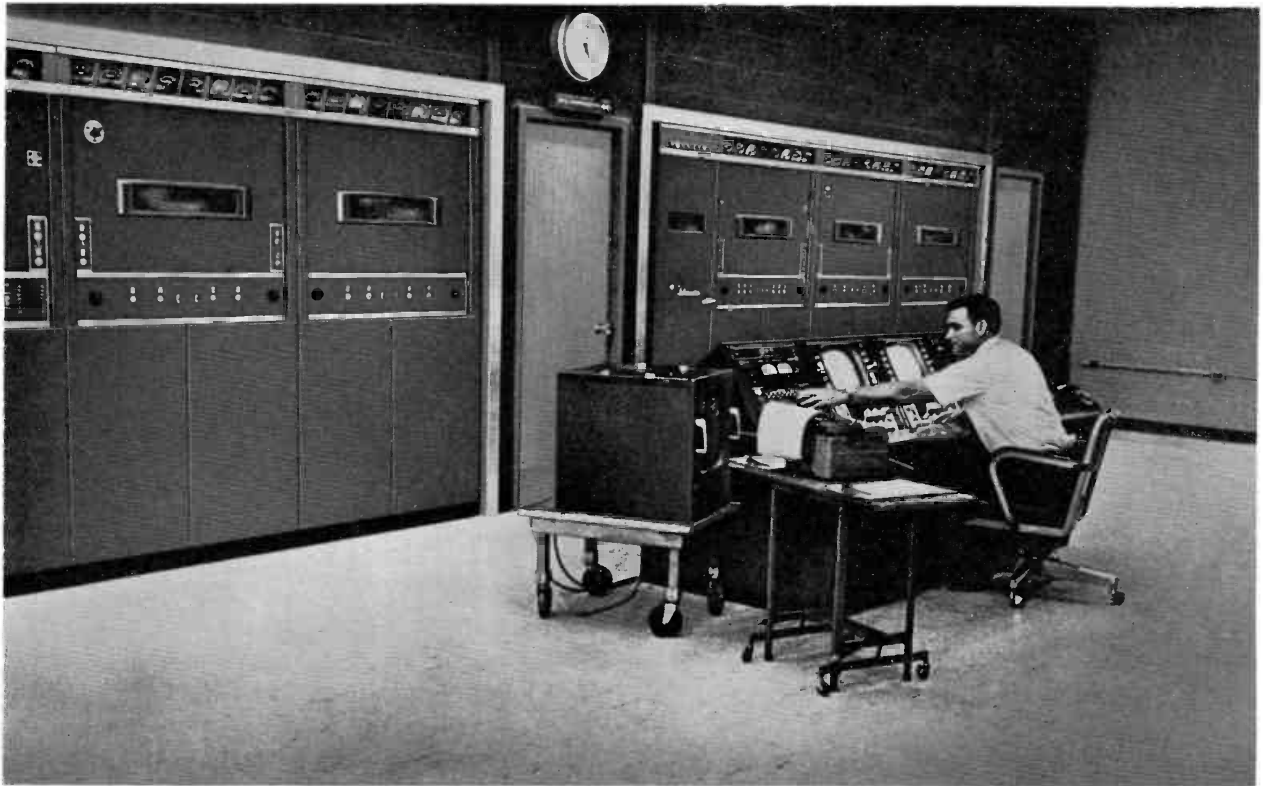

FIG. 1. Parallel transmitter installation at WNAC-TV, Boston.

#### WNAC-TV System Designed for Color

The parallel transmitter system at WNAC-TV differs from others basically in the methods used for detection and correction of video and RF phase errors.

Color transmission is the main consideration in the design and this dictates the improved method of modulator phase detection and correction. Most other systems phase the modulator pair for the best sine-squared pulse combined output at the time of installation and assume that very small phase error will occur in operation. But this method relies on the combined output as seen on the picture monitor, and employs no absolute technique of correction. At WNAC, continuous video phase monitoring and correction means are afforded by using a wideband, differential oscilloscope as a phase detector and monitor, and a variable synthetic line switching section as a corrective device. This method, which has proved very effective, allows video phase to be monitored and corrected if necessary during program time.

RF phase detection and correction circuits use constant impedance aural and visual line-stretchers between exciter and

FIG. 2. RCA TT-25DH 25 KW transmitter of the type used in the WNAC-TV parallel transmitter installation. Two of these transmitters were recently ordered by KCRG for a similar parallel transmitter system in Cedar Rapids, Iowa.

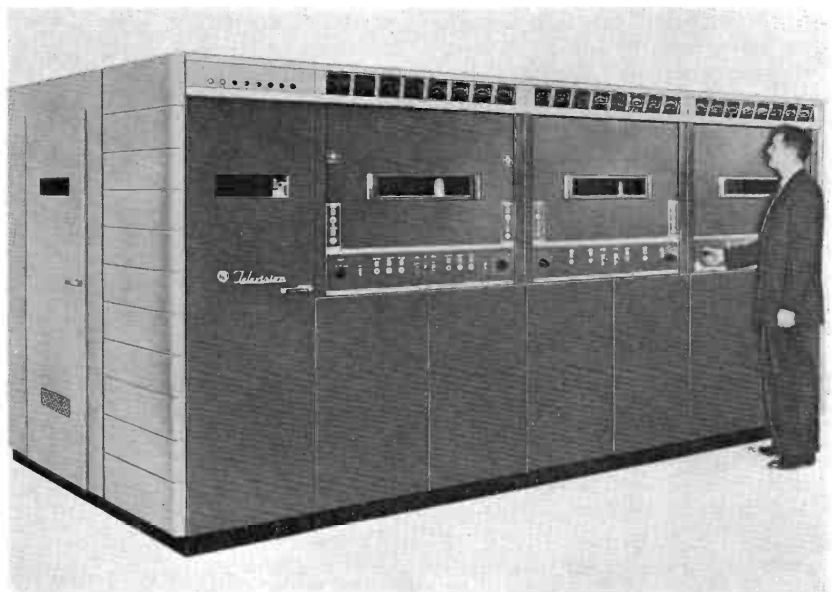

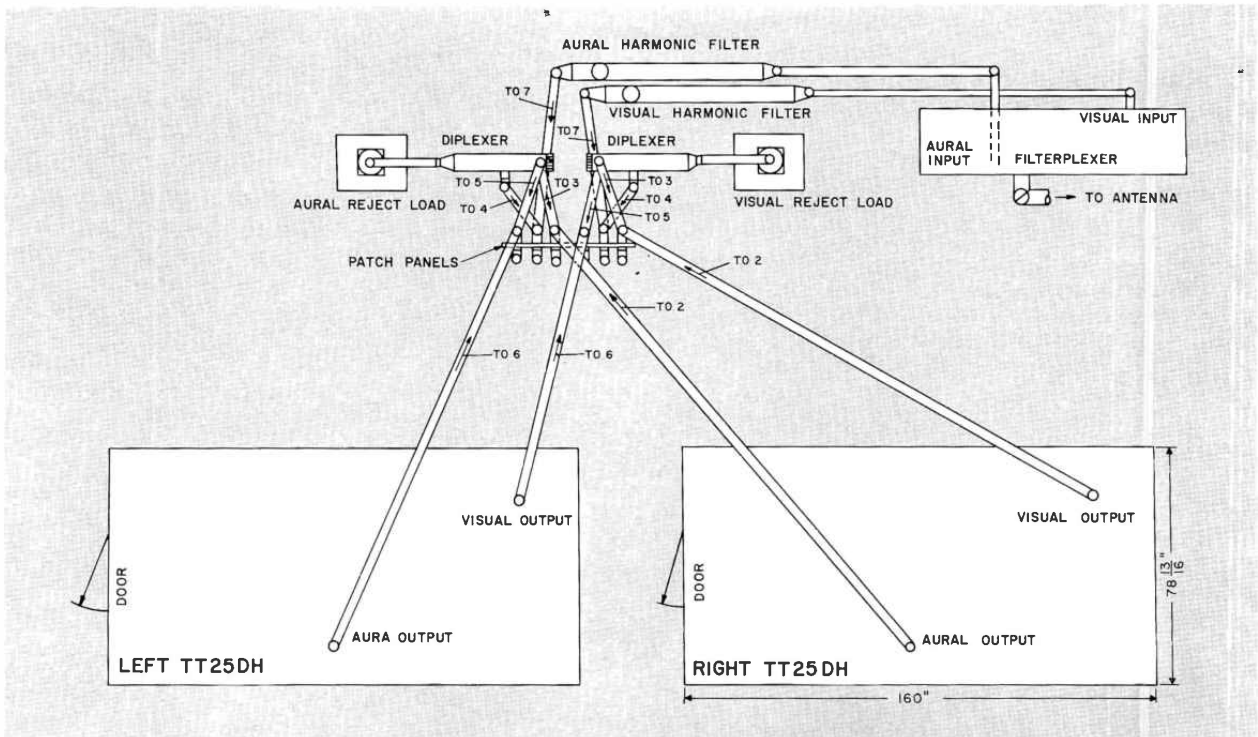

FIG. 3. Floor plan, showing parallel transmitter equipment layout at WNAC-TV.

transmitter in opposite halves of the parallel transmitter chains. By varying the line stretcher length and minimizing diplexer reject load power, correct in-phase operation is achieved. This is an outgrowth of the two most common methods of RF phase control, one of which is the trial-and-error insertion of pre-cut lengths of coaxial cable, and the other is an automatic system employing a servo, motorized line-stretcher and feedback type of control circuit. The expense of the automatic system seems unwarranted in an installation such as described, but would be invaluable for unattended station use.

#### WNAC-TV Equipment and Floor Plan Layout

The parallel transmitter equipment consists of two TT-25DH 25-KW TV Transmitters, patch panels, aural and visual reject loads, diplexers and associated monitoring equipment. Layout of the basic items is shown in the floor plan diagram, Fig. 3.

Transmitter outputs are fed into the manual patch panel section where the signal is normally routed to the combining diplexer, or in the case of failure, patched directly into the harmonic filter or test load. The two diplexers, their reject loads and the filterplexer are all mounted near the rear wall, with the harmonic filters

mounted above the diplexers. About four feet of aisle space is left between the transmitters and the patch panel to allow for test equipment entry and removal. Alternatively, space could be saved by mounting all components except the reject loads on the ceiling above the transmitters—at some sacrifice in system simplicity. At installation, equal line lengths are approximated by “make up” loops located between the patch panels and the lower input arm of the diplexers.

System interconnections are shown in the block diagram, Fig. 4. The left and right transmitters are, of course, identical TT-25DH types. Their circuitry is shown in the simplified block diagram, Fig. 5.

#### Exciter System

By reference to the system diagram, Fig. 4, it can be seen that switching arrangement permits selection of either of the 5-watt exciters, but no provision is made for obtaining visual drive from one exciter

FIG. 4. Simplified block diagram of WNAC-TV parallel transmitter system.

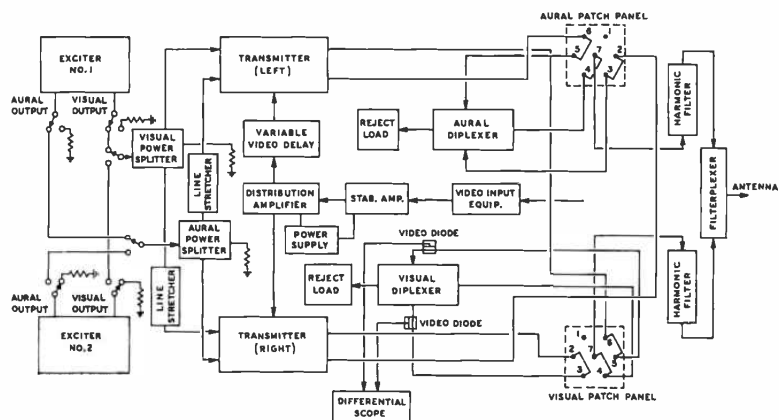

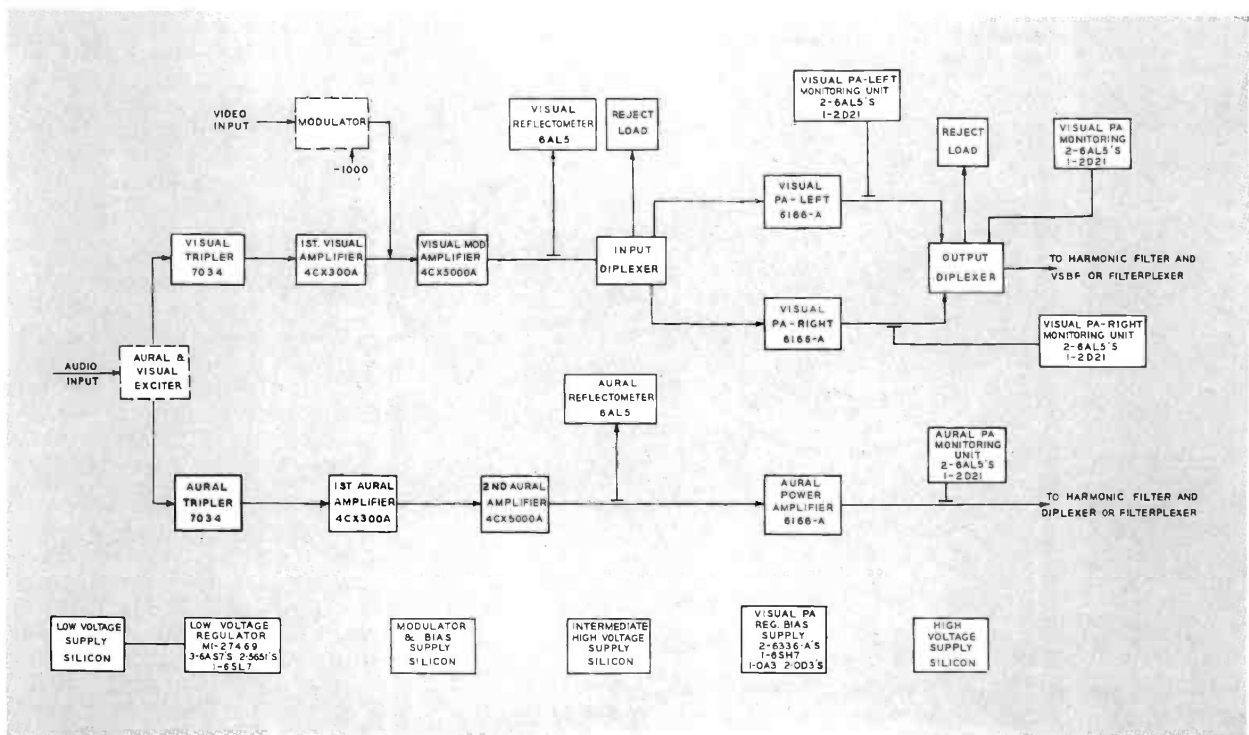

FIG. 5. Simplified block diagram of one TT-25DH 25 KW Transmitter.

FIG. 6. Transmitter aural and visual exciter (left) and modulator are mounted on hinged chassis allowing the units to tilt forward for accessibility.

and aural drive from the other. This is mainly because the aural/visual carrier separation is determined within the exciter. The aural chain is FM modulated within the unit and an automatic frequency control circuit maintains the intercarrier separation of 4.5 mc. Since aural modulation takes place in the exciter, it follows that no audio phasing is necessary with this unit. Aural/visual carrier separation could be maintained externally by additional circuitry, but failures requiring this mode of operation are deemed remote.

#### Aural and Visual Power Splitters

Aural and visual signals are fed from the exciter to the aural and visual power splitters, each of which is a coaxial ring hybrid consisting of some 120 inches of subminiature coaxial cable with an impedance of 75 ohms, or 1.41 times that of the characteristic impedance of the external line.

The power splitter is shown schematically in Fig. 7. Tracing the input signal, it is first split into two paths at Port 1.

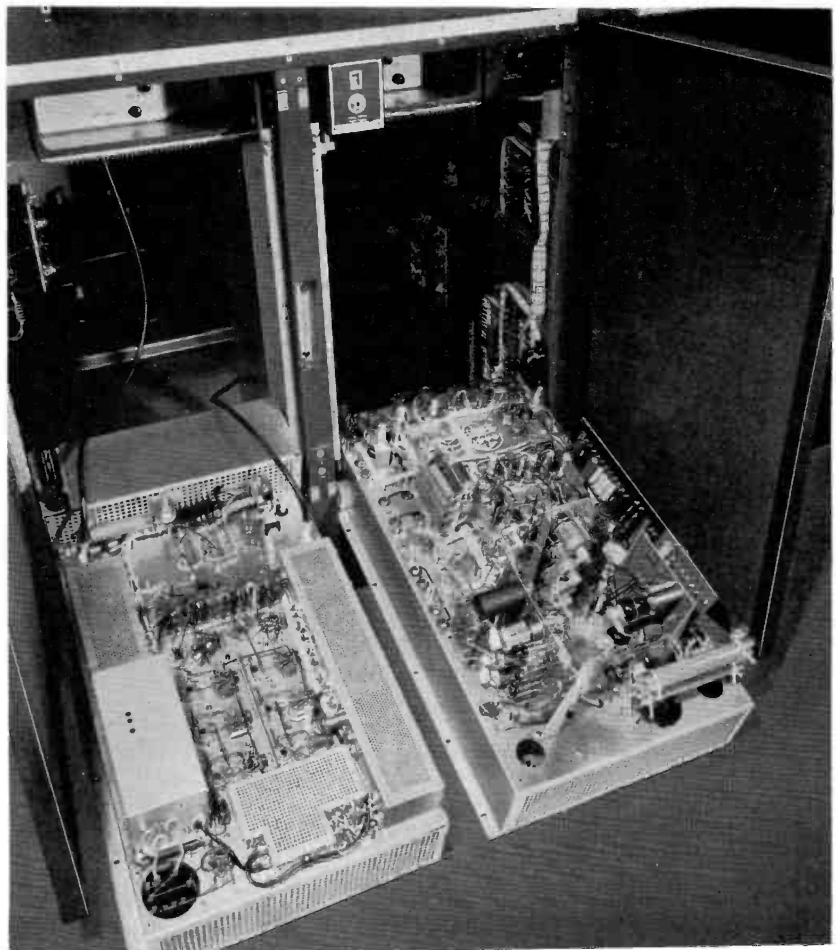

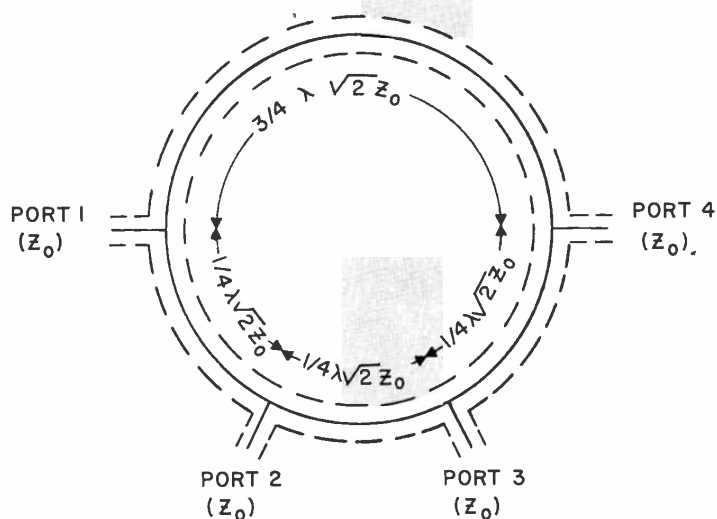

FIG. 7. Schematic diagram of power splitter.

Both signals arrive at Port 4 after traveling  $\frac{3}{4}$  wavelength in each path, therefore adding in phase. The signals arriving at Port 3 are  $\frac{1}{2}$  wavelength apart and, therefore, cancel. At Port 2 the signals are again in phase and adding. Thus, if Port 1 is used for input, Ports 2 and 4 are the outputs—separated by  $\frac{1}{2}$  wavelength—and Port 3, separated from either Port 2 or Port 4 by  $\frac{1}{4}$  wavelength, is the reject port. The reject port can be used to feed into a resistive load energy resulting from phase or amplitude inequalities.

Standing waves existing between the exciter and transmitter usually are of little consequence where broadband circuits are not involved and drive power is not at a premium. It is therefore apparent from Fig. 8 that two ring hybrids could cover the 40 to 90 mc exciter output frequency range—and thus the entire VHF band—with no more than 1.3:1 VSWR.

#### Video Line Stretcher

A variable line stretcher replaces the usual cut-and-try method of obtaining the

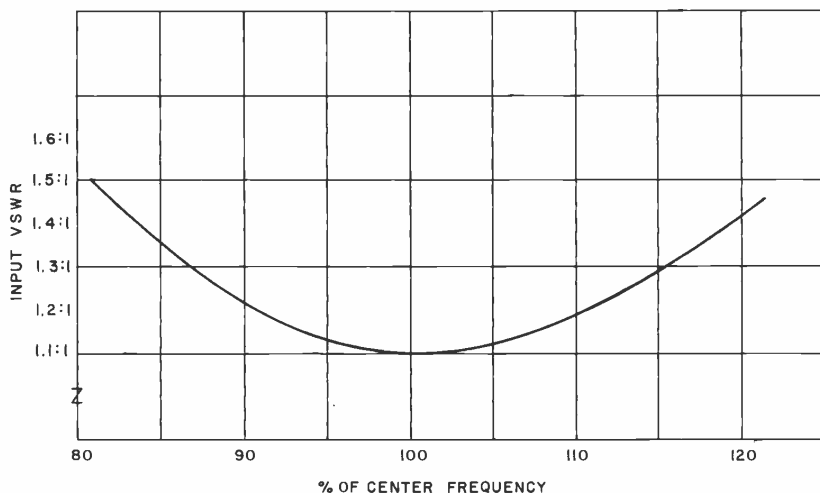

FIG. 8. Typical VSWR values of power splitter over a range of percentages of the operating frequency.

correct video feed line length to the modulators for correcting phase error.

A synthetic lumped constant line designed for a 30 mc cut-off frequency, the unit will produce up to 50 milli-second delay at 3.58 mc in ten milli-microsecond steps. The variable synthetic line offers simplicity in initial adjustment and ease in compensating future video phase drift.

#### Diplexer System

The bridge diplexer has been used for many years to combine the aural and visual signals into a common output such as an antenna, and the techniques are well known. But surprisingly little time has been devoted to the diplexer that combines the outputs of two independent amplifiers.

The equivalent circuit for a diplexer that combines two like signals into a common load is shown in Fig. 9. Generators G1 and G2 correspond to the respective transmitter output signals to be combined. The inductive coupling sections shown are assumed to be ideal networks containing no losses. The reject load corresponds to R1, and the combined signal output appears at R2. Either R1 or R2 can be used as the combined output arm depending upon the phase relationship of the two signals combined.

Two curves showing diplexer efficiency have been plotted. Figure 10 shows efficiency ( $\eta$ ), as a function of input amplitude unbalance ( $a$ ), varying between 100 and 50 per cent over a range ( $a$ ) from zero to infinity, with peak efficiency occurring at  $a = 1$ . Figure 11 shows how efficiency, as a function of phase relationship ( $\phi$ ), varies between 100 and zero per cent for phase ranges from zero to 180 degrees, peak efficiency occurring at in-phase operation.

#### Reject Load Function

The indications produced by the reject loads, which are used at the combining diplexer to absorb the mismatch power, hold the key to the correct operation of a parallel transmitter system. The indication of the reject load is unique in that the load receives zero power only when the two input signals are in phase and equal in amplitude.

In the WNAC-TV installation, the reject power is below 150 watts. The maximum fault power possible at the load, however, will be one-quarter the normal diplexer output power which in this case is 50 kw. Therefore, the visual reject load must be

rated for 12.5 kw peak and 7.45 kw average power. Likewise, the aural reject load must be rated for 7.5 kw for a 60 per cent sound/visual power ratio.

**RF Phasing and Amplitude Balance**

To operate the parallel transmitter system at optimum efficiency and avoid wasting power in the reject loads, it is essential that the RF carriers of both transmitters are combined in-phase and equal in amplitude. To accomplish this, an RF phasing and amplitude control was designed and incorporated into the system. The panel is made up of two constant-impedance line stretchers (one aural and one visual), meters to indicate the amount of reject power and amplitude controls to adjust the power output of both aural and visual chains in each transmitter.

It is interesting to note that the RF phase drift error encountered at two parallel transmitter installations using RCA transmitters—and the manual phasing scheme just described—has in both cases been less than five degrees per month. This represents less than 0.2 per cent fall-off in radiated power.

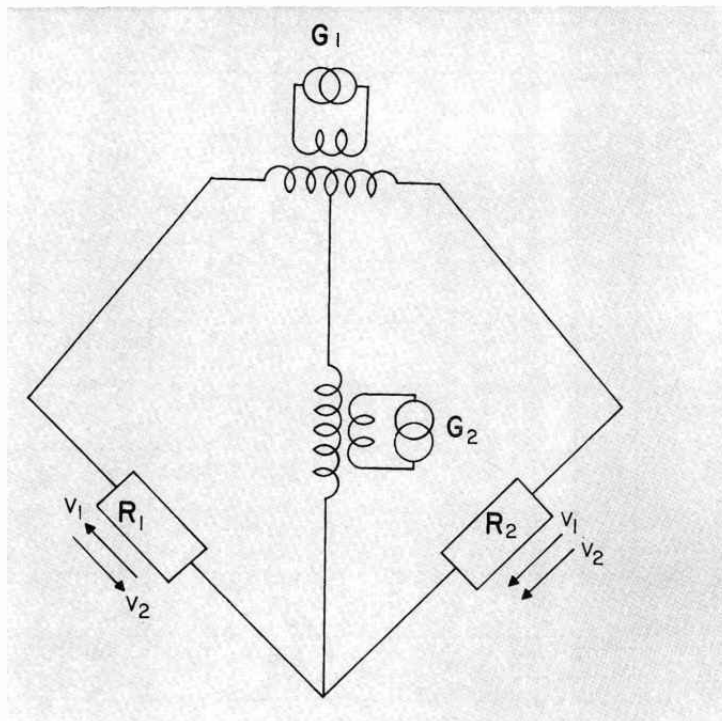
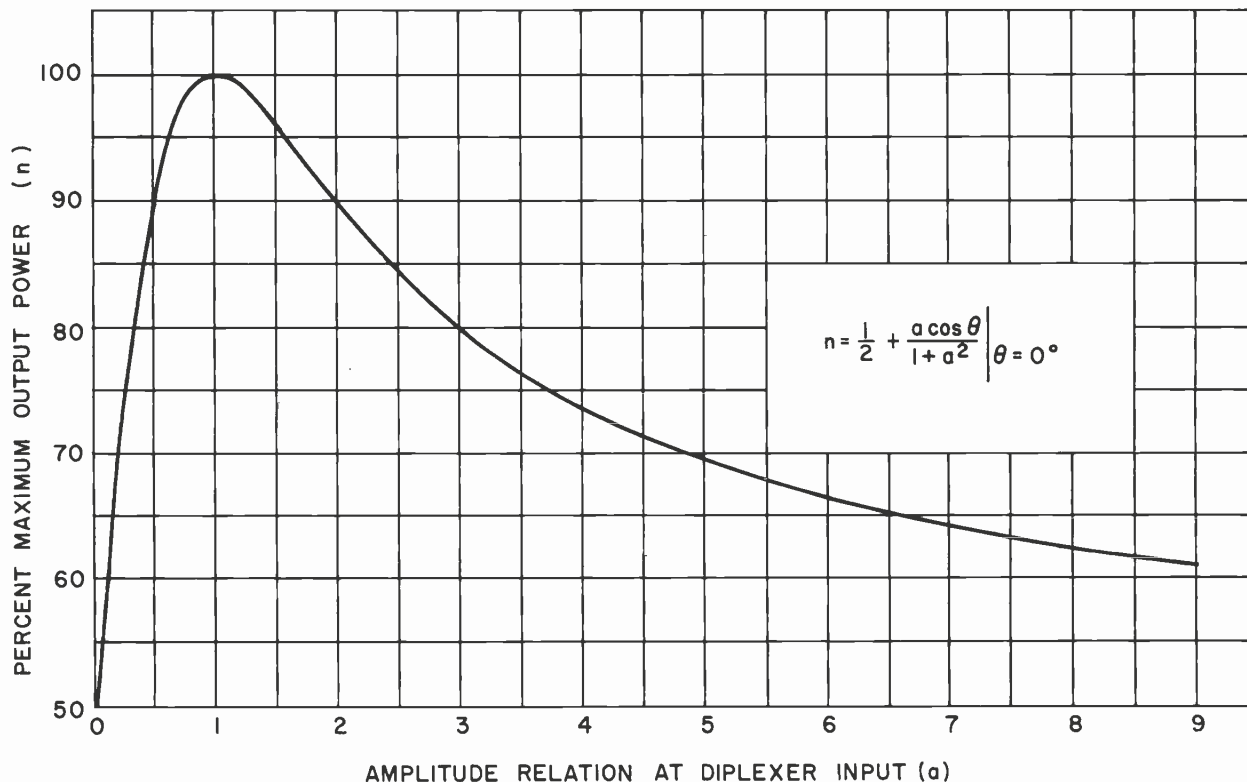

FIG. 9. Simplified schematic diagram of diplexer system.

FIG. 10. Curve showing diplexer output for various ratios in amplitudes of input signals.



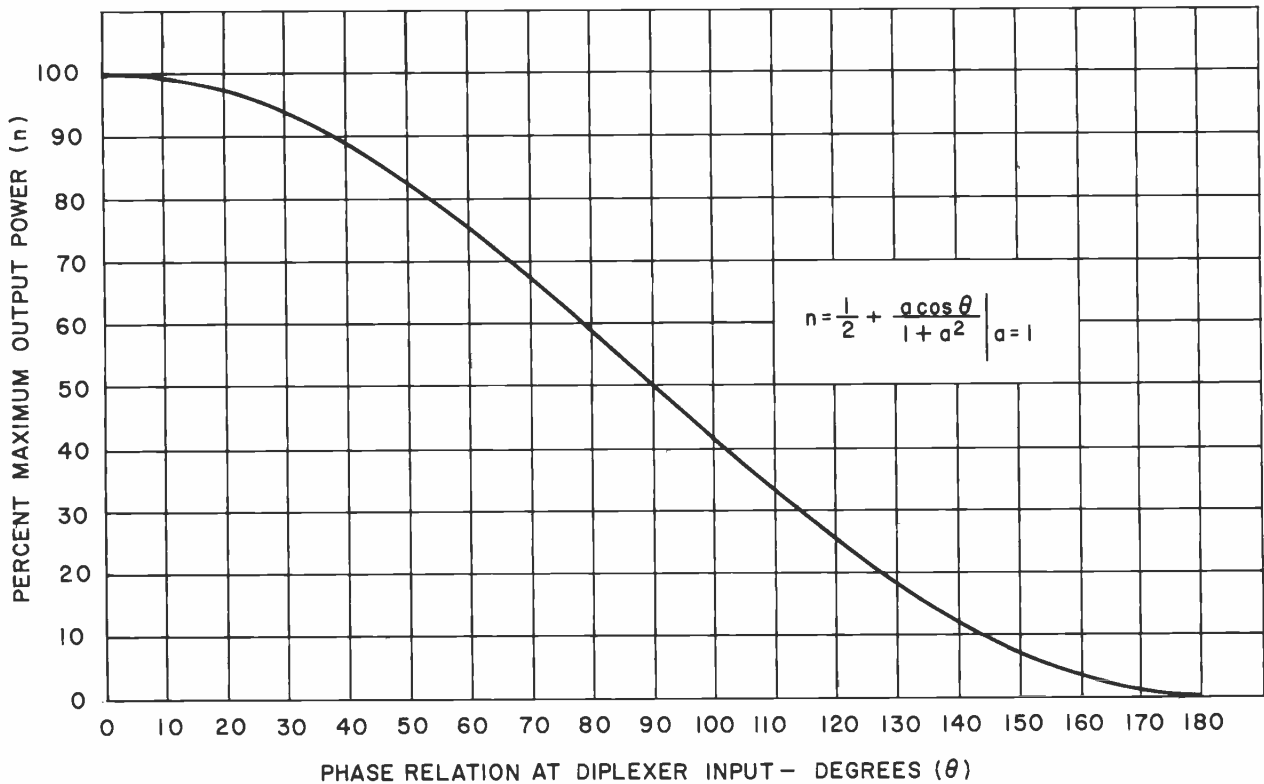
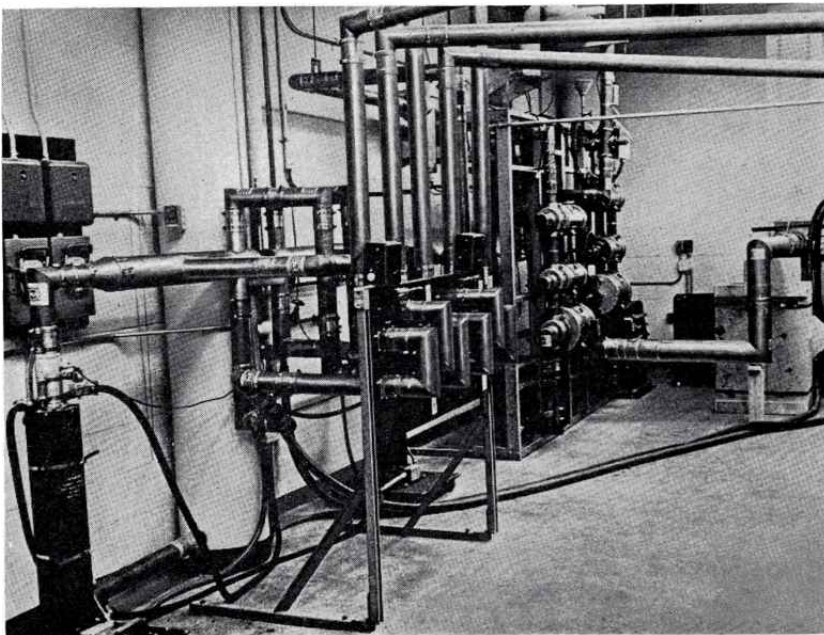

FIG. 11. Curve showing diplexer output for various input signal phase relationships.

FIG. 12. View behind transmitters at WNAC-TV showing patch panels (center) which, in the event of failure of one transmitter, permit connection of operating transmitter directly to antenna. One of two water-cooled reject loads can be seen at extreme left (below diplexer). At right center is the filterplexer, feeding output line at extreme right.



### Video Phase Monitoring

Video phase monitoring equipment consists of two video detectors attached to the output lines to reclaim video from each transmitter, a two-channel differential oscilloscope and two cables of equal delay for feeding the detected video to the oscilloscope.

Correct video phasing is readily detected by feeding a standard video stair-step waveform containing a 3.5 mc burst on each step to the system input, and varying the video delay line switch for minimum vertical deflection as observed on the oscilloscope. Gain control adjustments on the oscilloscope are used to maintain equal inputs from the pickup diodes thus showing a true display of modulator combining phase.

For monochrome broadcasting, modulator phasing is less critical and can be accomplished without phase monitoring equipment such as used here. However, for color, video phase monitoring is advisable. The phase monitoring oscilloscope can always double as a general purpose 'scope for maintenance and repair.



**Console Functions**

The transmitter control console is essentially two TTC-5A Transmitter Consoles modified as shown in Fig. 13.

The master monitor contains a picture monitor and waveform monitor used to view the video signal at various test points in the transmitter system as selected by pushbuttons located on the monitor control panels.

Two master monitors are used so that the combined waveform can be viewed simultaneously with waveforms at other test points.

Two monitor control panels are used, above which are located panels containing transmitter indicator lights and, below, the monitor control panels. An input-audio-level meter, frequency monitor meter and power output meters for one of the transmitters are mounted on the left-hand monitor control panel. The right hand monitor control panel contains, (in addition to the pushbuttons) power output meters for the

HOW PARALLEL OPERATION IMPROVES PERFORMANCE*		
	Single Transmitter	Two Transmitters In Parallel
FREQUENCY RESPONSE	±0.5 db	±0.3 db
SAWTOOTH LINEARITY	4%	2%
OVERSHOOTS	±10%	±5%
AM NOISE	-60 db	-68 db

\*Data from SMPTE, Vol. 72, No. 1, page 5.

second transmitter, and combined aural and visual power output meters.

The TA-9 remote control panel controls the stabilization amplifier and provides a common video gain control for the two modulators. The exciter control panel selects the desired exciter and provides the common aural and visual excitation controls for the two transmitters.

**Conclusions**

No unusual problems were encountered during installation of the Channel 7 parallel transmitter system. Throughout operation, it has functioned well and station personnel are very pleased with its performance. Overall system reliability is believed to be improved by some figure very near to, if not completely 1.5 times.

FIG. 13. Diagram showing WNAC-TV transmitter control console equipment for parallel transmitter operation.

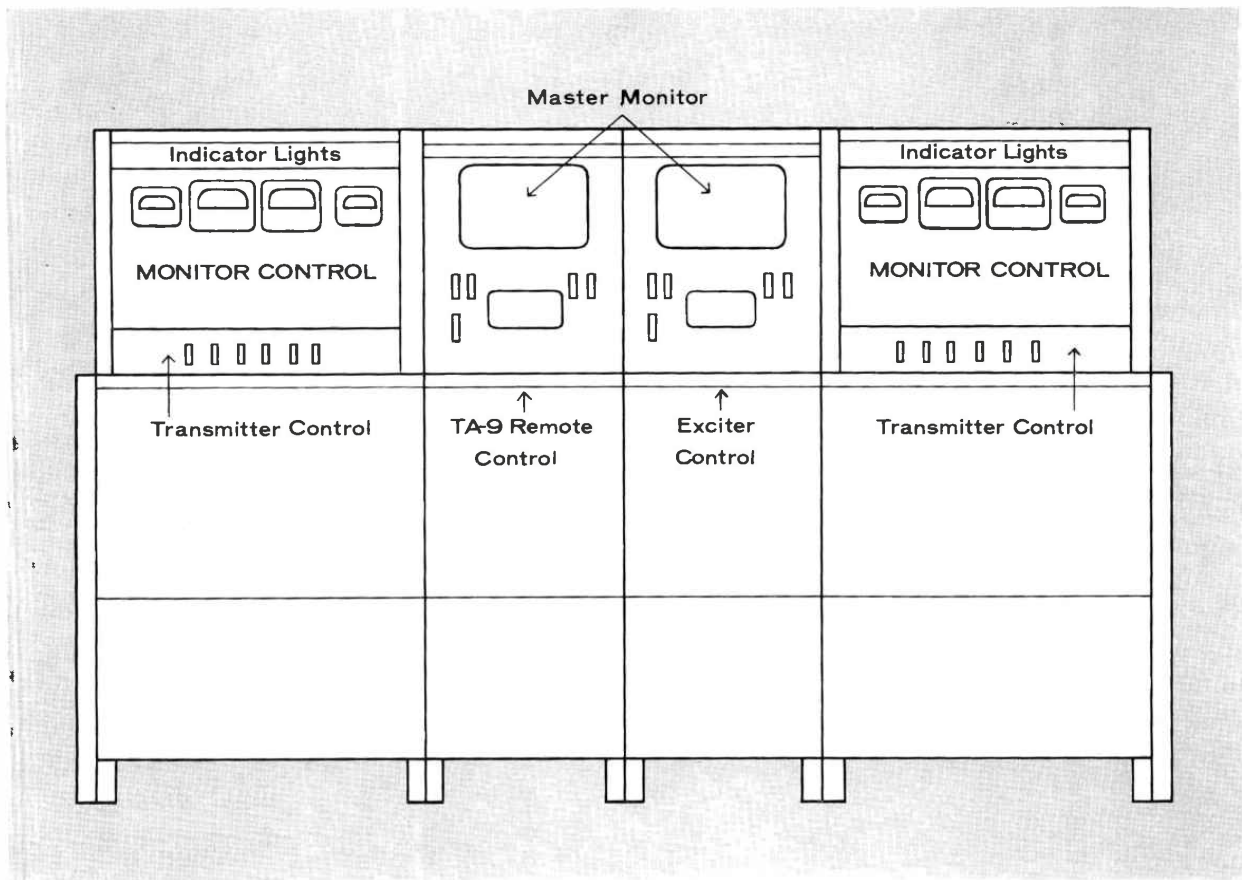

# NEW LOOK TRANSISTORIZED SYNC GENERATOR

by RAYMOND J. SMITH, *Mgr.*  
*TV Terminal Equipment Engineering*

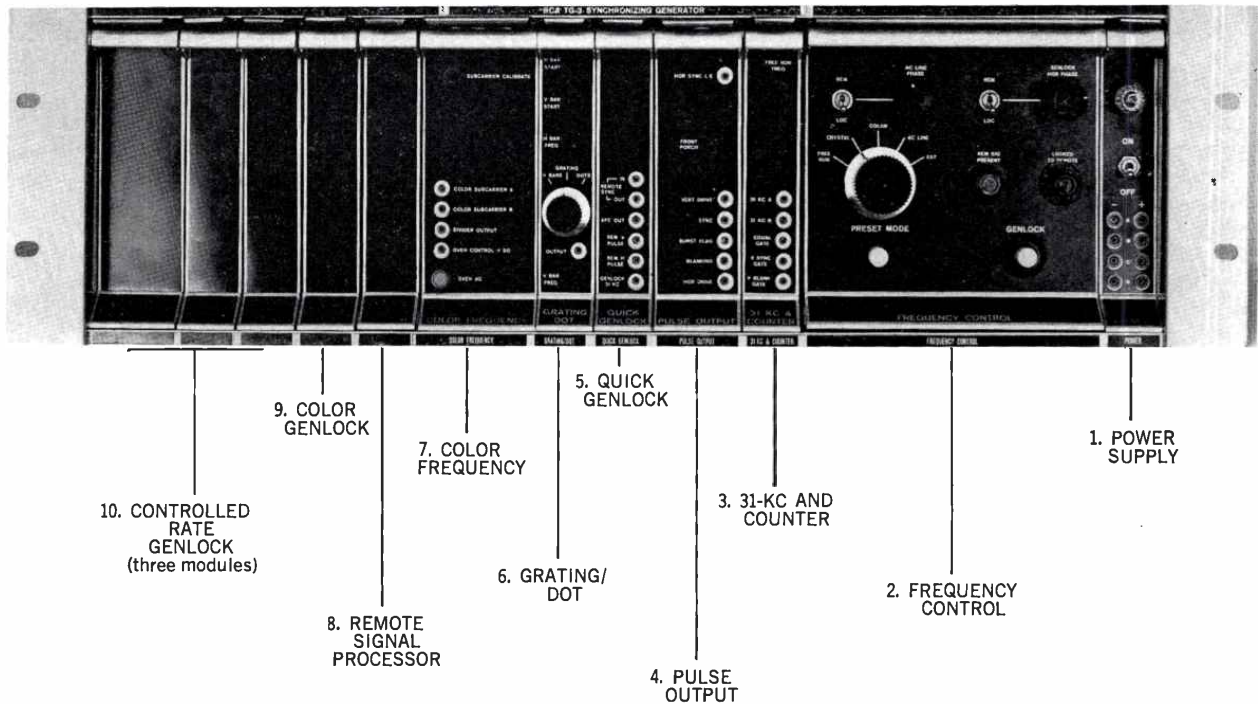

FIG. 1. TG-3 Sync Generator with all modules in place.

- All-New Modular Design
- Features Automatic Controls
- Saves Space and Power
- Provides for Color and Monochrome
- FCC and CCIR Standards

As the television industry has grown over the years the demand for improved and varied programming has kept pace. The needs to satisfy the viewing public have been met, by providing more eyes to observe the scene from many angles, and more complex switching devices to better integrate the information from the various viewpoints into a pleasing presentation. To the casual observer it may not be obvious, but the increased performance demands placed on cameras and switching systems have also found their way to the synchronizing generator located in that out-of-the-way rack in the control room.

In the early days, when the TG-1A generator was the standard of the industry, much of the program material was from film that reached the air through the

Iconoscope camera. This combination, motion picture film and the Iconoscope, required that control of the sync generator master oscillator be obtained from the power line. The facilities in the TG-1A went beyond this basic requirement and were available to utilize the control information from the Genlock unit when it was introduced a few years later to improve the continuity between studio and remote programs. With the start of compatible color television it was necessary to obtain the control for the sync generator master oscillator from the color subcarrier oscillator. After minor modifications, the TG-1A was ready for action in this new field.

The arrival of the TG-2 Sync Generator in the early 1950's established a new standard for the industry, which has been maintained to the present time. Not only are the basic signals for monochrome television systems supplied by the TG-2 generator, but Genlock control is also contained within the unit. The much used grating signal for the adjustment of camera and monitor scanning circuits is also provided by the TG-2, although this signal generation is not normally considered a sync generator function.

#### Transistorized TG-3

A careful review of the knowledge gained from field operating experience with the TG-1 and the TG-2 Generators, a study of present day programming needs and desires, and some "crystal ball gazing" as to the needs of the New Look system of the future all contributed to the design of the Transistorized TG-3 Synchronizing Generator to insure that it will serve as the standard of the industry as did its predecessors.

#### Modular Concept

Although the basic philosophy of the TG-3 generator design gives top priority to the needs of the color television system, it was obvious that a modular concept was necessary to make the TG-3 the top performer in all applications.

The concept was satisfied from the mechanical viewpoint by adopting, as the housing for the generator, the 5¼-inch module frame that had already been standardized for the New Look camera chains and distribution amplifiers (see Fig. 1). From the functional viewpoint, the concept was accomplished by meeting the less demanding requirements of the monochrome system through the omission of unneeded circuits without compromising the performance of either system.

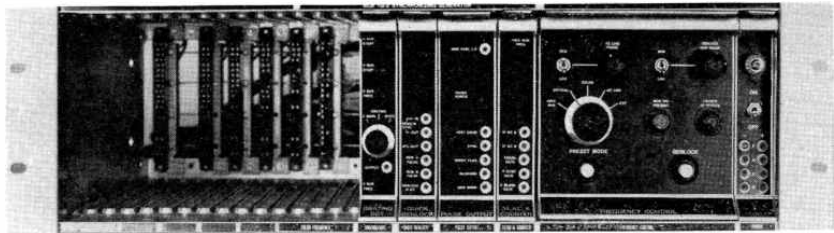

MONOCHROME SYSTEM

FIG. 2. TG-3 Sync Generator with modules 1 thru 6 in place, provides facilities similar to the TG-2.

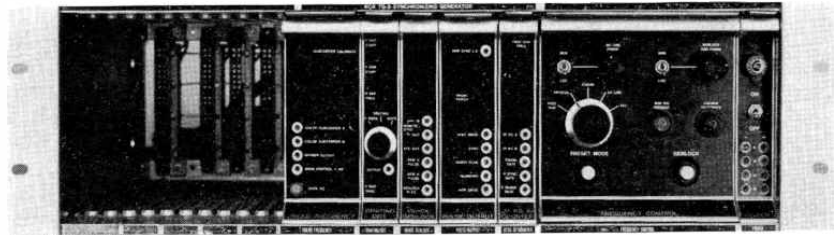

COLOR SYSTEM

FIG. 3. TG-3 Sync Generator with modules 1 thru 7 in place (adding No. 7 Color Frequency module to monochrome system).

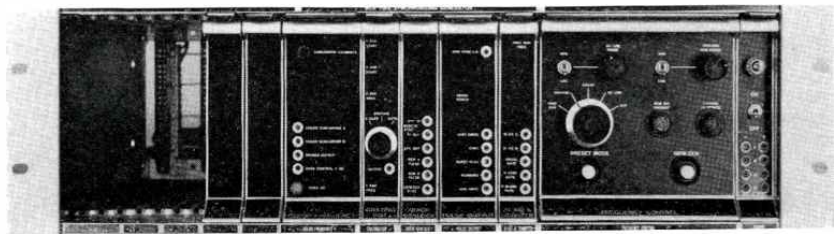

COLOR GENLOCK SYSTEM

FIG. 4. TG-3 Sync Generator with modules 1 thru 9 in place (adds No. 8 Remote Signal Process and No. 9 Color Genlock modules).

The results of the design of the TG-3 generator provide the following modules mounted in a pre-wired frame:

1. Power Supply
2. Frequency Control
3. 31-KC and Counter
4. Pulse Output
5. Quick Genlock
6. Grating/Dot
7. Color Frequency
8. Remote Signal Processor
9. Color Genlock
10. Controlled Rate Genlock (three modules)

#### For Monochrome Systems

It was decided that the basic TG-3 for monochrome systems would use Modules 1 through 6 as shown in Fig. 2 to provide facilities similar to the TG-2 generator. Since the broadcaster had come to depend upon the synchronizing generator for a

source of grating and dot signal, that function is provided. However, the grating-dot module can be omitted without adverse effects on basic signal generation. The Quick Genlock operation in the TG-3 is an improvement over that obtained from the circuits used in the TG-2. Although the frequency of the master oscillator is altered at about the same rate in each generator, the TG-3 control is bidirectional, permitting the shortest path to lock-up to be used. The maximum lock-up time is two seconds in the TG-3—which is one-half that of the TG-2.

#### For Color Systems

All signals required in the color synchronizing system are available from the monochrome TG-3 simply by adding the Color Frequency module (see Fig. 3). The Burst Flag signal is available at all times in the monochrome TG-3 since it is generated in the Pulse Output module. This

choice was made for improved reliability and better space utilization.

### Color Genlock System

A stabilizing amplifier is commonly used to accept the remote composite video signal and provide a sync signal that is used for genlock of horizontal and vertical frequencies. Normally, separated color burst information is not available at a convenient point in the system. Therefore, it was decided that Color Genlock facilities, consisting of the Remote Signal Process and Color Genlock modules (see Fig. 4) would accept a composite color signal at the input. The Remote Signal Processor accepts a composite signal and extracts sync for use in the Quick Genlock module and burst for use in the Color Genlock module.

The Color Genlock module provides frequency control information to the color subcarrier oscillator, while the horizontal and vertical frequencies are controlled in a normal genlock manner through the Quick Genlock circuits. The control information is obtained by comparing the burst signal with the oscillator output. Frequency control of the master oscillator from the color frequency divider is disabled during color genlock operation.

The addition of only the Remote Signal Processor module to a monochrome gen-

erator will permit genlock to be accomplished when a composite signal is applied to the generator input.

### Controlled Rate Genlock

In most genlock systems operating at the present time the rate of change of horizontal scanning frequency is excessive during the locking-up process. The transient resulting from this process may be of some consequence and, in certain cases, is intolerable. This disturbance can have a serious detrimental effect on the resulting picture—should it occur during a tape recording session. FCC regulations may be violated, should this disturbance be transmitted over the air. It is intended that the Quick Genlock system be supplemented by the Controlled Rate Genlock system to provide facilities that permit the sync generator to be placed into or taken out of the genlock mode at any time, without causing a noticeable disturbance in the picture signal. During the lock-up process, the relationship between horizontal and vertical frequencies is maintained to insure that the number of lines in each successive field is the same. Since the time for lock-up is much greater in the Controlled Rate mode compared to Quick Genlock, the selected mode will vary, depending on programming demands.

### FCC and CCIR Standards

Two versions of the TG-3 Generator are being made available. One provides signals for the 525 line-60 field system specified by the FCC, the other provides for the CCIR 625 line-50 field system. The variations between the two models are accommodated in the wiring of the frame. All modules are interchangeable without modification between the two versions for monochrome operation. However, some readjustment of pulse-width controls may be necessary. For color operation it is necessary to use two different Color Frequency modules because of the differences in the color subcarrier oscillator frequency. In the Remote Signal Processor it is necessary to change a jumper for proper functioning of the burst separation circuits.

### Master Oscillator Frequency Control

Television tape recording and color television have both had a strong influence on the functional and operational requirements of the synchronizing generator. Because of the precise relationship between the scanning frequencies and the color subcarrier frequency that is required by FCC regulations, frequency control of the sync generator during color programming must be obtained from the subcarrier oscillator. To achieve top performance from present day television tape recorders, the synchronizing signal that is supplied as the timing reference must possess better frequency stability than that of the power line.

The increased use of tape recordings for programs and commercials is in effect increasing the number of remote programs that must be integrated with local originations. It follows that the expanded use of genlock to accomplish this integration will depend upon the degree to which the selection of frequency control in the sync generator can be made operational. Choice for frequency control should be available as a remote control. In addition, it should be possible to change the Genlock reference signal, by remote control, without causing serious disturbances in the transmitted signal.

The frequency control philosophy used in the TG-3 is noticeably different from that used in the earlier sync generators. Except for the Free Run mode, which is primarily a test position for the oscillator, the frequency of the master oscillator is controlled by the precision Automatic-Phase-Frequency-Control (APFC) system. Since the APFC system was required as a vital part of genlock operation, it was decided to take advantage of its characteris-

FIG. 5. Frequency Control Module Control Panel, showing six modes of control: 1. Free Run, 2. Crystal, 3. Color, 4. AC Line, 5. External, and 6. Genlock.



tics in all operational modes of control to obtain a smooth transition from one to the other.

As may be seen in Fig. 5, the six modes of control provided in the TG-3 Sync Generator are as follows: 1. Free Run; 2. Crystal; 3. Color; 4. AC Line; 5. External, and 6. Genlock. The arrangement of controls permits any of the modes 1 through 5 to be chosen by the Preset Selector while the Genlock mode may override any of the Preset modes. The Preset Selector is a rotary switch located on the left side of the front panel of the Frequency Control Module.

To place the generator in any mode other than Genlock the Preset Selector is set to the desired position. The PRESET MODE pushbutton, a momentary switch located below the Selector, is then depressed. Selection of the Genlock mode is accomplished by operating the GENLOCK pushbutton, also a momentary switch that is located to the right of the PRESET MODE switch. Both pushbutton switches are of the illuminated type to provide visual indication of the status of the switching.

In order to make the generator perform satisfactorily when in the genlock mode, some logic has been included within the Genlock module to insure that a signal is present to provide control. In the event that the remote signal is interrupted while the generator is in Genlock, control of the oscillator is automatically returned to the mode determined by the position of the PRESET MODE selector unless AC Line is preset. In this case, control is switched to Crystal. When the remote signal is restored to normal, the control will return to the genlock mode without the need of further action by the operator. Should the GENLOCK switch be operated at a time when a remote signal is not present, the light in the pushbutton will be illuminated indicating the switch has been activated, but the frequency control will remain in the existing preset mode. An exception is made in the AC line position when control is transferred to the Crystal. At the moment a remote signal is applied, genlocking action will take place.

The Genlock-Preset selection system has a permanent memory. When power is applied to the sync generator, the control mode will return to that which was active when power was removed. The operator is relieved of the task of restoring the frequency control to normal after momentary interruptions of power since the interruptions will not cause the control mode to change.

Additional logic provides the operator with the information that a remote signal is available for genlocking by illuminating the REMOTE SIGNAL PRESENT tally lamp on the panel. The operator is also advised that genlock control has been accomplished by the illumination of the LOCKED TO REMOTE tally light on the panel.

The circuit design of the Preset Mode-Genlock switching allows the use of parallel switching at a point remote from the sync generator. Parallel operation of tally lamps indicating the status of Preset-Genlock switching, Remote Signal Present, and Locked to Remote is also possible at the remote control panel.

Two additional controls are provided on the Frequency Control Panel. The GENLOCK HORIZONTAL PHASE Control is used to align the edges of local and remote blanking. The AC LINE PHASE is used when the control is in the AC Line mode to vary the phase relationship of vertical pulses to the power line. Remote control provision for both phasing adjustments has been included. Control is transferred between the Control Panel in the generator and the remote location by the operation of toggle switches located adjacent to each control.

Except for the External mode of control, all means of frequency control are familiar to members of the television industry and need little explanation. The External position has been provided to accept a 15 KC signal such as that which might be obtained from the Audlok system.\* In this system synchronizing information is transmitted from a master location to a remote generator over telephone lines at audio frequency. Proper phasing of the two signals is accomplished at the master location.

### 31 KC and Counter Module

A voltage controlled 31.5 KC (31.25 KC in 625 line generator) master oscillator that receives controlling information from any of the sources previously described is located in the 31 KC and Counter Module. The edges of all Sync Generator output pulses are derived from this oscillator. The 525 to 1 or 625 to 1 frequency division is accomplished in this module using recently developed circuits in which fewer than half the number of transistors required in a binary divider are used. Several gating sig-

\* Audlok—Synchronization of Television Picture by an Audio Frequency, J. L. Hathaway. Presented at Convention of the National Association of Broadcasters, April 1964.

nals required to assemble the various output signals are generated from the master oscillator output.

### Pulse Output Module

Synchronizing, Blanking, Horizontal Drive, Vertical Drive and Burst Flag signals are all generated in this module using master timing and gating signals from the 31 KC and Counter Module. All five output circuit configurations are identical, however, component values have been chosen to meet the particular signal requirements. Extensive use of modern computer techniques is made in the logic circuits used to develop the required trigger information for the various signals. Since the desired results were attainable in a simpler, more direct manner, no attempt was made to obtain the logic through the use of standardized sub modules.

The trailing edges of all pulses are precisely determined by the master oscillator signal as well as the leading edges. The controls to adjust the width of the various pulses are independent of one another.

In Vertical Blanking both edges are derived from trigger pulses to insure that an exact relationship exists with the edges of Horizontal Blanking. The leading edges of Vertical Blanking coincide with the leading edge of Horizontal Blanking in one field and are displaced exactly one half line in the other field. The trailing edges also coincide in one field and are displaced by a half line in the other. This eliminates the jitter that is frequently observed in the monitor raster at the top and bottom.

The logic used to determine the number of equalizing pulses and vertical sync pulses insures that exact number of each is present, without the need for adjustment. In order to provide a precisely timed edge that might be used to trigger vertical interval test signal equipment, the trailing edge of Vertical Drive is established by triggers that are in phase with the trailing edge of Horizontal Blanking.

### Grating/Dot Module

A selector switch on the front panel of this module determines the type of signal to be generated. Choice may be made among vertical bars, grating (horizontal and vertical bars) and dots. The number of both the vertical and horizontal bars is adjustable. The phasing of both bars with respect to blanking is also adjustable, to insure that compatibility between the signal and the linearity chart is completely achieved. Care has been taken in the circuit design that the signal will be clean

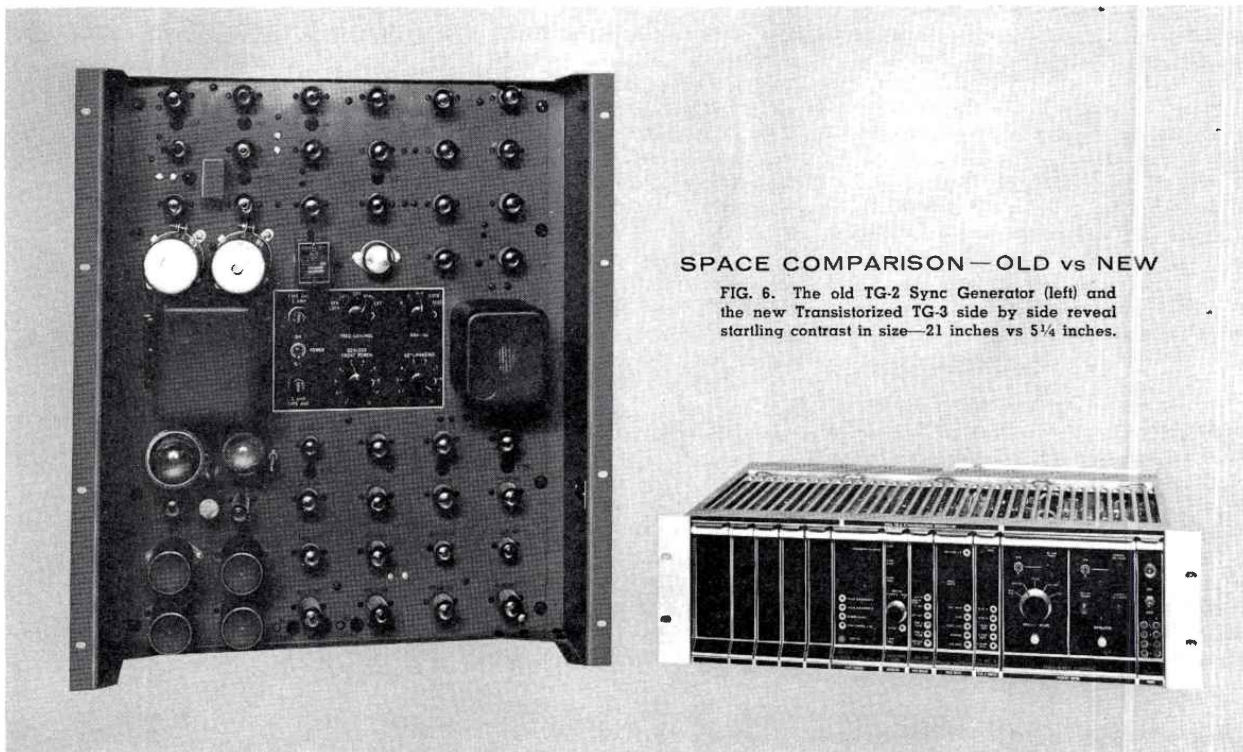

### SPACE COMPARISON—OLD vs NEW

FIG. 6. The old TG-2 Sync Generator (left) and the new Transistorized TG-3 side by side reveal startling contrast in size—21 inches vs 5¼ inches.

and free from ringing when observed on a high-quality, wide-band monitor.

Provision has been made to add sync to the output signal, thus producing a standard one-volt composite signal. Although a fixed amount of set-up is present in the output signal at all times, the sync addition may be disabled by a jumper change on the module.

#### Color Frequency Module

A packaged oscillator operating at the color subcarrier frequency is the heart of this module. The frequency controlling elements of the precision crystal oscillator are temperature-controlled in a proportional-control oven. The use of this oven reduces short-term frequency excursions caused by temperature—compared to an oven in which the temperature is permitted to cycle. Long-term frequency variation caused by crystal-aging is minimized by the use of a pre-aged crystal. The oscillator will remain within the tolerance range without recalibration for a minimum period of six months. The oscillator contains a frequency-controlling element that normally obtains its reference from within the

module but is switched to an external source during genlock operation.

A dc power supply is included in the Color Frequency module to permit the oven to be operated independently of the other circuits in the generator.

Phase lock between the color subcarrier signal and the trigger signal from master oscillator is maintained by the frequency divider system in the Color Frequency module and the APFC system associated with the master oscillator.

The circuits used in these higher-frequency divider stages are similar to those used in the 31 KC and Counter module. The subcarrier frequency and the count-down requirements are sufficiently different in the 525 line-60 field system from the 625 line-50 field system that a different module is needed in each application.

#### Power Supply Module

DC power for the circuits in all modules is obtained from the Power Supply module. The supply is designed for operation on either 117 or 220-volt power lines

at 50 or 60 cycles. The design of the regulators provides satisfactory performance over a wide frequency range, 48-62 cps, and accommodates normal line voltage variations around both voltages. In the interest of standardization, the module is the same as that used in the TK-22 Vidicon Camera Chain.

#### Saves Space and Power

At the same time that the outstanding progress was made in the TG-3 to meet the increased demands for improved synchronizing generator facilities, a substantial gain was made in the conservation of space and power. The TG-3 generator for monochrome requires only 5¼ inches of rack space compared to 21 inches for the TG-2 (see Fig. 6) and 77 inches for the TG-1. Even greater space saving is observed when generators for color systems are compared. The 5¼ inches of rack space required by the TG-3 represents a 9 to 1 reduction over the TG-2 system, and an 8 to 1 reduction of power requirements for a color sync generator system is noted when the 75-watt requirement of the TG-3 is compared to the TG-2 system.

# BROADCAST HOUSE THAT WJAC BUILT

New Look on the Johnstown Horizon Combines  
Traditional Architecture with Modern Concepts  
in AM-FM-TV Operation and Equipment



**MASTER PLAN FOR NEW LOOK** in WJAC operations was drawn up by the management team shown here—Walter W. Krebs, President (center); Alvin D. Schrott, Executive Vice President and General Manager of WJAC-TV (left); and Edward J. Klym, Vice President and AM-FM Manager (right).

**LIGHTING UP THE SKY** with the weather forecast for tomorrow is one of the highlights of the WJAC building in Johnstown, Pa., the exterior of which emulates Independence Hall in Philadelphia. Each evening the cupola is illuminated to signal the weather to residents of the valley below—green for fair, red for rain, yellow for stormy. Constructed of steel frame, wood and translucent plastic the cupola also houses STL microwave reflectors.





## New Broadcast Center Paces AM-FM-TV Progress

One of the newest and most modern AM, FM and TV facilities, the WJAC Building is situated in a suburban area three miles from the center of downtown Johnstown. Cost of the structure was slightly over one million dollars. Architects were Hunter, Campbell and Rea, with offices in Johnstown and Altoona, Pa. The building fronts 160 feet and is 120 feet deep.

WJAC-TV studios and operational offices occupy the entire first floor of the two-story structure. The first floor layout includes two studios, control room, video tape and projection facilities, dressing rooms, news headquarters, film editing, and shipping. The lobby entrance is walnut paneled and features a receptionist area, a lounge and waiting room, and display cases which show the products of WJAC advertisers.

The main television studio is 60 by 80 feet; the second, 30 by 40 feet. Overlooking both studios from a slightly elevated position is the master control room.

The second floor houses the management, program, and sales offices of WJAC-TV in addition to the offices and studios of WJAC-AM and WJAC-FM. Accounting offices and viewing rooms also make up part of the second floor plan.

**COMPLETELY COLORIZED** for network, film and live studio programs, WJAC-TV was the first completely modified station in 1953 to carry network color telecasts. Today regular live color offerings from Studio A include "Romper Room." This lively program format is heightened all the more by the added impact and natural appeal of color. It has become the showcase for much of the station's work with color commercials.

**HEADQUARTERS FOR NEWS, SPORTS, WEATHER** is Studio B. This studio is especially designed for the late evening news, the sports and the weather. Sets are left standing and lighted for these daily programs. Two TK-60 cameras are normally operated from here.





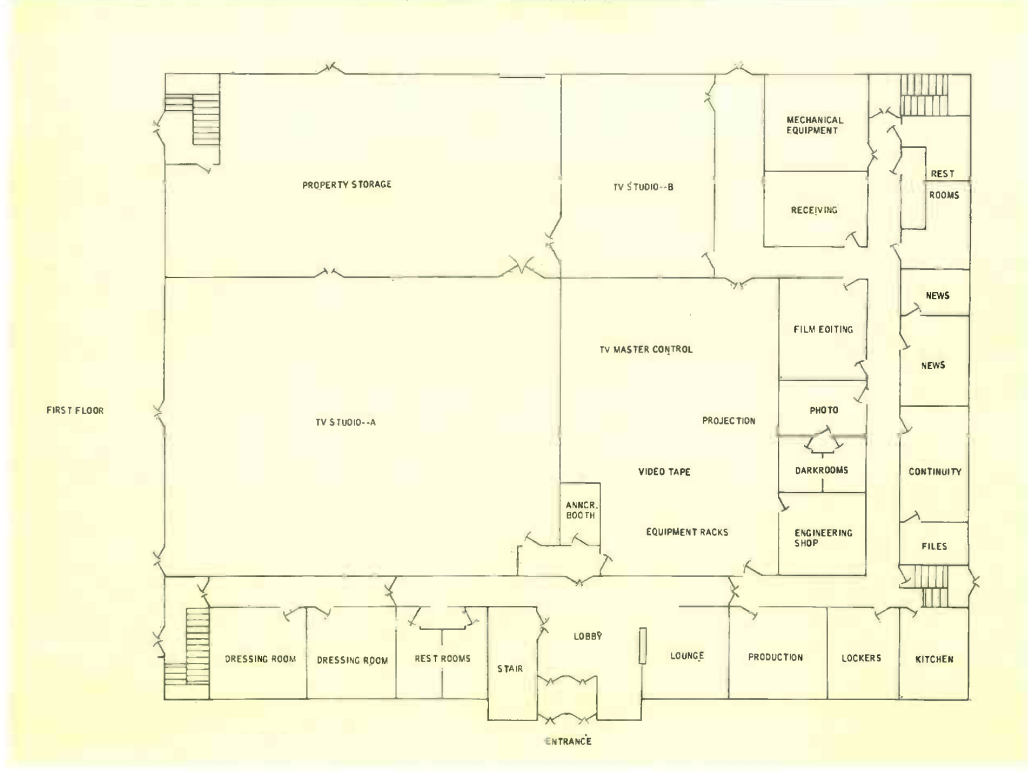

**FUNCTIONAL AM-FM-TV LAYOUT** is demonstrated in these floor plans. All operating equipment is located in one spacious TV master control room which overlooks both TV studios. A fast-moving local news operation is consolidated with dark rooms, film processing, and film editing areas located adjacent to film projection equipment. Sliding panels in the film editing room connect it with the projection area to expedite handling and airing of news clips, movies and film commercials. The second floor features grouping of AM and FM radio operations, client viewing rooms which overlook both studios, and functional arrangement of administrative offices for most effective business communication. Radio control rooms overlook Studio B, so that live radio programs of choral groups, orchestras and the like can be handled.

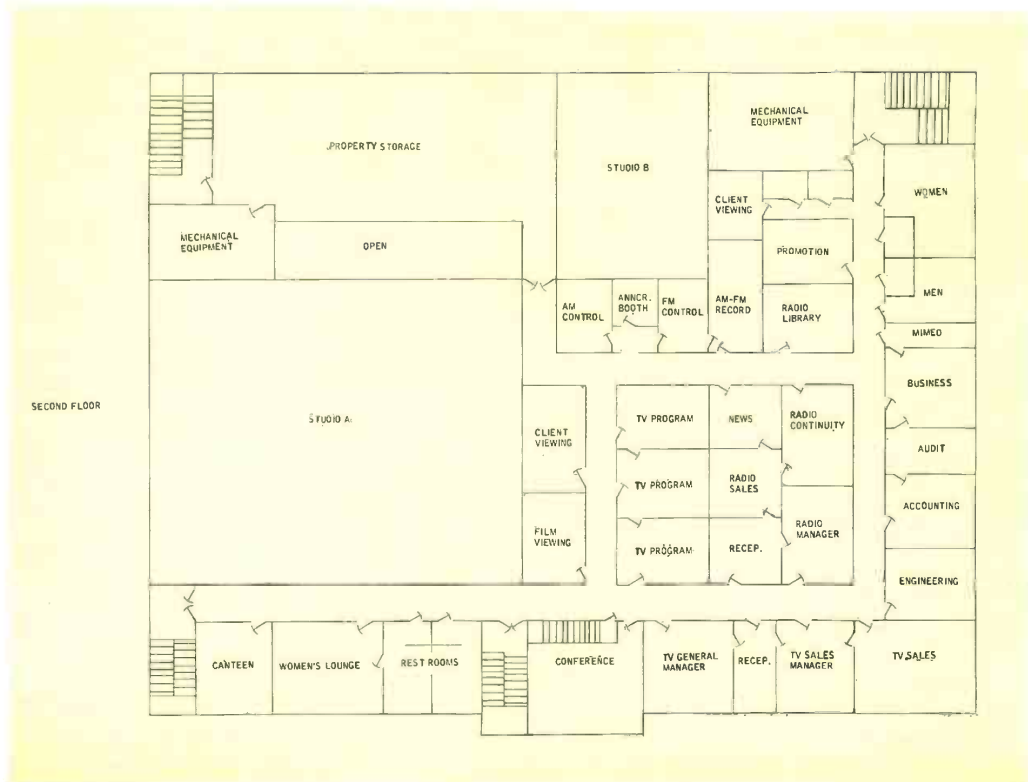

**MERCHANDISING SERVICE** plays an important part in station selling. The front lobby is completely faced with picture-window displays of products of local, regional and national advertisers. Here, a discussion of merchandising aids starts with the product itself.



**FOUR OF THE FINEST** tv studio cameras provide WJAC-TV with top picture quality for top results in creative hands. These TK-60 4½-inch image orthicon cameras have earned the endorsement of production, programming and sales. They reflect the WJAC-TV practice of providing the best.



## Locally Produced Commercials

Service to local advertisers of WJAC-TV is characterized by use of the most advanced facilities the tv art has to offer.

The impact and selling ability of color in tv advertising has been available to clients since 1955, when local color film facilities were first installed. A season later live color cameras (the first in the state of Pennsylvania) were added to complete the color equipment complement. In over nine years of operation an increasing number of station advertisers have gained

an extra measure of effectiveness as well as valuable experience in selling via color tv.

Versatility in producing commercials is exemplified by the station's elaborate switching and special effects system and the installation of two deluxe TR-22 tv tape recorders. Originally only one recorder was earmarked for use in the WJAC-TV master control room. However, the use of tape grew locally to such a great extent that a second recorder was installed. Because many local and regional advertisers

are taking advantage of the tape facilities, frequently it happens that one machine is being used to record a program while the other is simultaneously being used to play back a program or spot on the air.

WJAC-TV engineers have also discovered great use for the second machine in duplicating tapes and dubbing portions of one tape to another.

TK-60 black and white cameras provide added versatility in producing high-quality spots and many live studio originations. This step to the use of the 4½-inch image orthicon tube has resulted in a new standard of excellence in local programs and commercials—tape or live.



**TV COMMERCIALS GET VIP TREATMENT.**

Sound planning, meticulous execution, and production with the finest of equipment give WJAC advertisers first class service in preparing their commercials. For example Glosser Brothers, a local department store chain, is using a variety of WJAC services. In the photo above, Alvin Glosser discusses plans for commercials on "Weather in Motion" show in which he is a participating sponsor. Center photo shows production of color spot in association with "Romper Room." Note merchandising tie-in for in-store promotion. Inspection of the commercial on tape is another phase of the station's VIP service. In this photo the client gets an opportunity to check commercial before airing. Here again the equipment used is the finest—a pair of TR-22 deluxe tv tape recorders.



## High Efficiency Equipment Area



**CENTRAL MASTER CONTROL** area looks into both TV studios. All operating equipment is located in this room. The photo above shows both equipment control and program production consoles. A camera cable patch-panel installed diagonally across a corner of the room (far right in the photo) allows any combination of camera equipment—two TK-41 color cameras and four TK-60 cameras—to be used in either studio.

One of the design innovations being incorporated into more and more of today's most modern broadcast centers is the use of a single, centralized "equipment room." In this "equipment room" is installed the greater share of the station's operating technical equipment (in some cases even the transmitter). By centralizing camera control, video switching, master control, projection and tv taping facilities, stations obtain the benefits of greater programming flexibility, more simplified and economical installation and a generally more straight forward method of operation.

At WJAC several nuances highlight the equipment room. These include: the diagonal arrangement of production and video control consoles to serve two studios, the elevated, modular floor to simplify wiring and provide for easy future expansion, and the studio camera patch panel to implement use of all cameras in either studio.

The photos on these pages illustrate the layout of the equipment room and show some of its construction details. In operation, this layout has proved to be both versatile and efficient in handling each and every programming job.

**PROGRAM PRODUCTION CONSOLE** has complete vista into either Studio A or Studio B. Both master control and studio control functions are executed here.





**MASTER SWITCHER.** This single TS-40 video switching system handles all program switching requirements. It is fully equipped for a multitude of electronic special effects.



**SPACIOUS EQUIPMENT ROOM.** Film, tape, and rack mounted equipments are all located in the master control room. This is a view of master control looking from the equipment control console toward the rear of the room.



**EASY ACCESS TO CABLING** is a construction feature of the equipment room floor. A platform floor is elevated two feet above the floor level of Studios A and B. The photo above shows detail of its construction. A strut-like steel framework is supported at intersections by pipe stanchions (threaded for level adjustment). Over this frame are laid two-foot square blocks. The blocks are fabricated of  $\frac{3}{4}$ -inch plywood and steel sheets, topped with vinyl flooring, and encased in a frame of thin aluminum. Here a suction cup device (such as that used for handling large sections of plate glass) is being used to lift out the blocks for checking wiring between tape and film areas and the control console. These blocks form the entire equipment room floor. Use of this technique substantially expedited the initial installation of equipment. It also holds promise for ease of maintenance and simplified future expansion.

**ENGINEERING TEAM** responsible for the equipment layout and planning: Theodore E. Campbell, Chief Engineer (right) and Arthur L. Vrooman, Assistant Chief Engineer.



## Mountaintop Transmitter Site



**OVERLOOKING SCENE OF JOHNSTOWN FLOOD**, the WJAC-TV antenna gives the station's signal its start 2890 feet above sea level and 1120 feet above average terrain. This area today is center of industrial expansion in steel, mining and public utilities.



**SHORT TOWER ON TALL PERCH**—the peak of Laurelhill Mountain—is line-of-sight to the studio building, six air miles away.

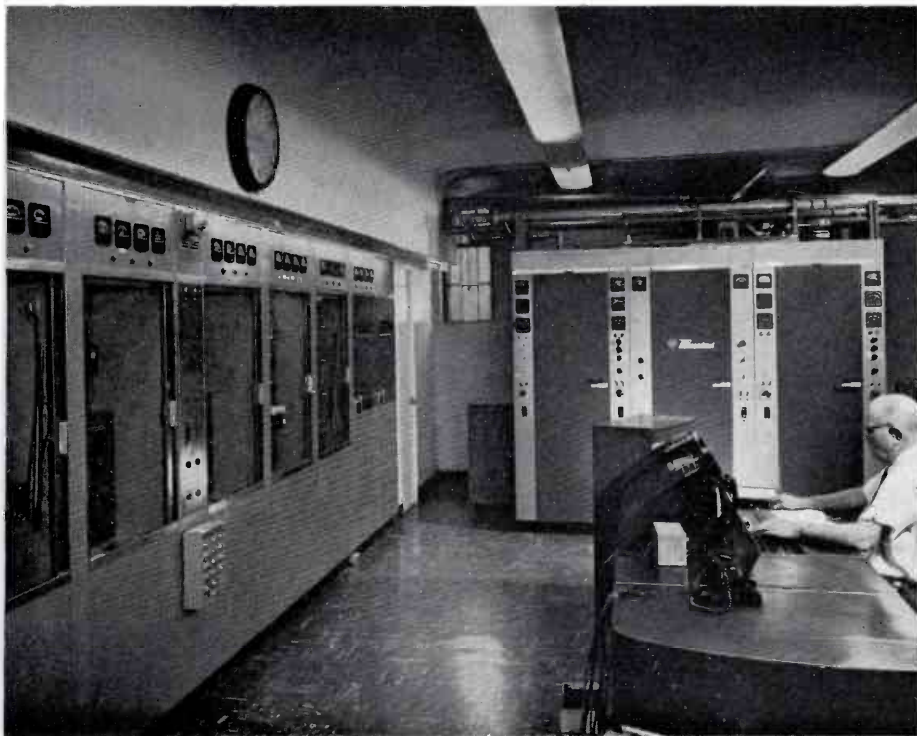

**TV AND FM STEREO TRANSMITTERS** operate from WJAC-TV's original studio location. Advantages of this particular operation include simple tower construction, minimum transmission line lengths, and a relatively short studio-to-transmitter microwave path—while making efficient use of the propagational benefits of the natural terrain.



# PLANNING DATA AND EQUIPMENT FOR 12,000 MC MICROWAVE RELAY SERVICE

by J. B. BULLOCK  
*Microwave Engineering*

New broadcasters, community TV operators, educators and users of microwave relay for private business purposes will find themselves in increasing numbers required to use channels in the 12,000 mc/s (12 gc/s) microwave frequency range. This article discusses systems engineering considerations and new equipment available for operation at these frequencies.

The new equipment is the TVM-3B, a 12 gc/s version of the widely used 6 gc/s TVM-1 series of microwave equipments. See Fig. 1.

## New Factors

Radio relaying at frequencies above 10,000 mc/s requires consideration of several new factors in equipment design and in systems engineering. In equipment design

it has proven difficult to secure r-f transmitter power outputs as great as those now commonplace in the lower frequency bands. Where a klystron is used as the r-f power source, frequency stability has generally been inadequate whenever a reasonable tuning range was provided.

In systems engineering, consideration must be given to the fact that rain precipitation (and to a much lesser extent hail, snow, and even thick fog) along the microwave path can cause significant losses. Waveguide transmission losses are greater, and antenna-passive reflector requirements change, imposing new limits on equipment location.

Fortunately some of these new factors are favorable to the use of the higher fre-

quencies. For example the gain of a given parabolic antenna will be 4 to 6 db greater at 12 gc/s than at 6 gc/s. Thus a pair of antennas will have added gains which will more than overcome an increased path loss between them at the higher frequency.

Also, the parabola-passive reflector "periscope" combination yields higher gain at greater separation than at lower frequencies. The passive reflector face must now be solid however, instead of perforated as at 6 gc/s. Path clearance requirements are generally taken as identical to those at 6 gc/s, but may actually be slightly less on short paths.

## Microwave Path Clearance

Point-to-point microwave transmission is "line of sight," requiring adequate clearance over the earth or other intervening objects. For lossless transmission<sup>1</sup> it is accepted that at least 0.6 of the first fresnel zone surrounding the line of sight must be kept clear. Fresnel zones are defined later in this article in connection with multipath fading.

In traveling through an average atmosphere near ground level, the microwave path follows a slightly downward curved trajectory and thus travels somewhat further than a straight line would indicate. To facilitate planning, this trajectory is generally plotted as a straight line, and the earth assumed to have a radius equal to 4/3 the actual earth's radius. Clearance is then planned over the profile of a 4/3 earth.

Figure 2 shows a path profile plotted on 4/3 earth paper between two points 20 miles apart. It will be noted that the tower heights used provide a clearance of 28 feet at mid path. This clearance is 0.6 of the first fresnel zone at 12 gc/s and is calculated from:

$$H_o = 0.6 \sqrt{\frac{N \lambda d_1 (D - d_1)}{D}} \text{ ft.}$$

Where  $N = 1$  for first fresnel zone

$\lambda =$  wavelength (ft.)

$d_1 =$  distance to point in question (ft.)

$D =$  path length (ft.)

This portion of required tower height is a function of frequency, and for 12 gc/s is only 70 per cent of that required for a 6 gc/s path.

The major portion of tower height provided can be seen to be that required to surmount the bulge of the earth and the

FIG. 1. Frequency coverage as provided by TVM-3B microwave system.

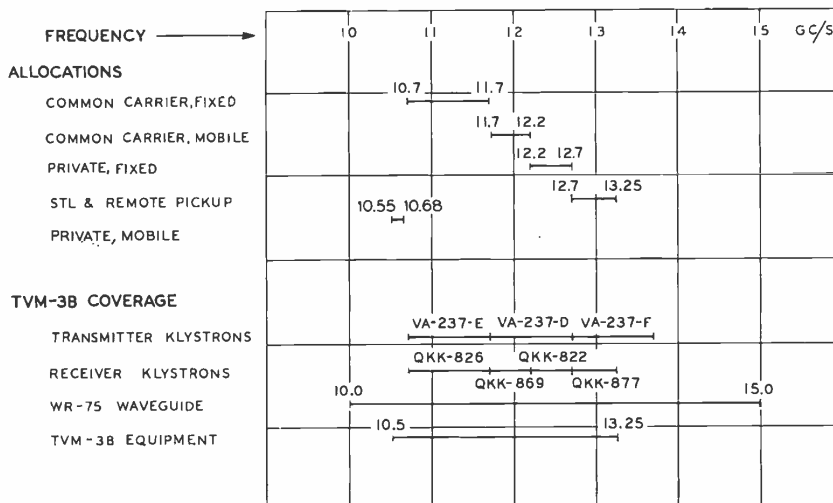



high terrain near mid path. The bulge is calculated from:

$$B = \frac{2}{3} d_1 (D - d_1) / K$$

D and  $d_1$  entered in miles in this expression will give B in ft.

K is the effective earth radius factor.

In the example, Fig. 2, B is 50 ft. ( $K = 4/3$ ) and a remaining 100 feet of tower height is required to clear the high terrain. Thus the total elevation required on the plot at midpath is  $28 + 50 + 100 = 178$  feet. In this example the required elevation is supplied by elevating the antennas at each end of the path 178 feet.

Only in rare instances would the clearance indicated in Fig. 2 actually be adequate. This is because the curvature of the radio path, which leads to the  $4/3$  earth concept, is not constant but varies as temperature, pressure, and moisture combine to vary the refractive index of the atmosphere. At times the curvature may even be upward, a condition described as "inverse bending," so that the only path between transmitting and receiving antennas might be blocked by the earth. When this happens the "effective earth radius" has become smaller than  $4/3$  actual. Clearance *must* be provided over the smallest expected earth radius if transmission is not to be interrupted by inverse bending.

The effective earth radius Kr is given by the following expression.

$$Kr = \left( \frac{1}{1 + r \frac{dn}{dh}} \right) r$$

where  $\frac{dn}{dh}$  = gradient of the refractive index with height  
 $r$  = true earth radius (3960 miles)

It is possible to calculate  $\frac{dn}{dh}$  and therefore K from climatological data<sup>2</sup> and research has indicated this to vary less than 0.5 per cent with frequency up to 30 gc/s.<sup>3</sup> Thus the amount of any "bending" of the microwave beam is virtually identical from 2 gc/s thru well above 13 gc/s. A practical method for determining the required tower heights to meet effective earth radius requirements is given in the available brochure.<sup>4</sup>

An alternate method for determining tower heights is to assume a flat earth with the radio path bowing downward for the various expected earth radii. Such a method is utilized in available work sheets for path planning.<sup>10</sup>

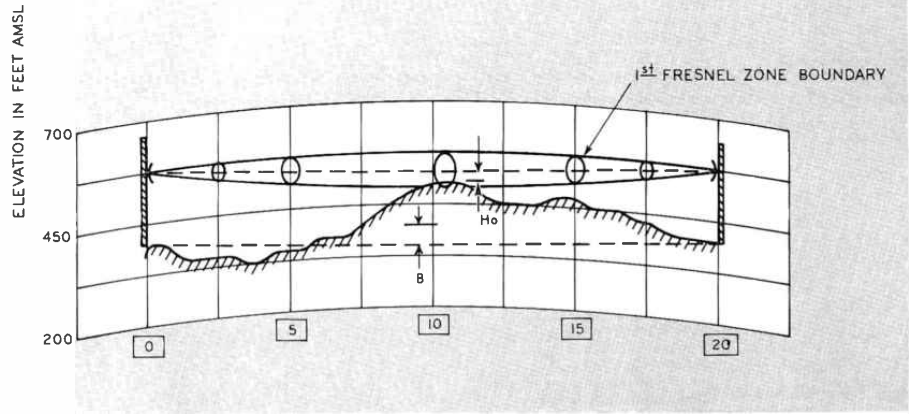
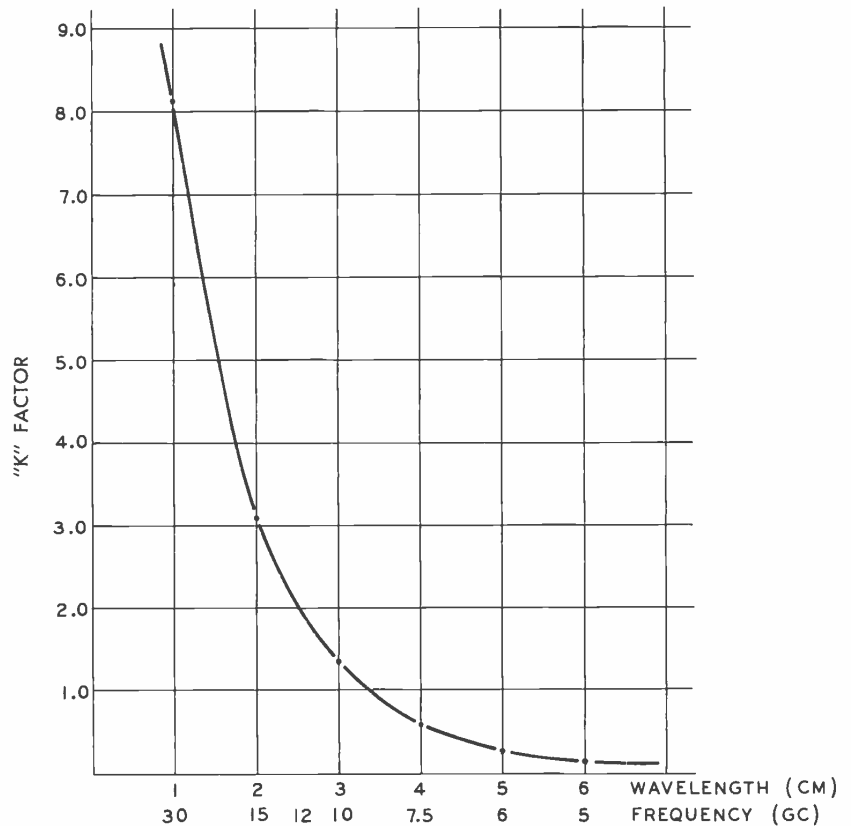

FIG. 2. A typical microwave path profile showing the first fresnel zone at 12 gc/s.

FIG. 3. Values of K factor vs. wavelength for rainfall at 18 degrees C.



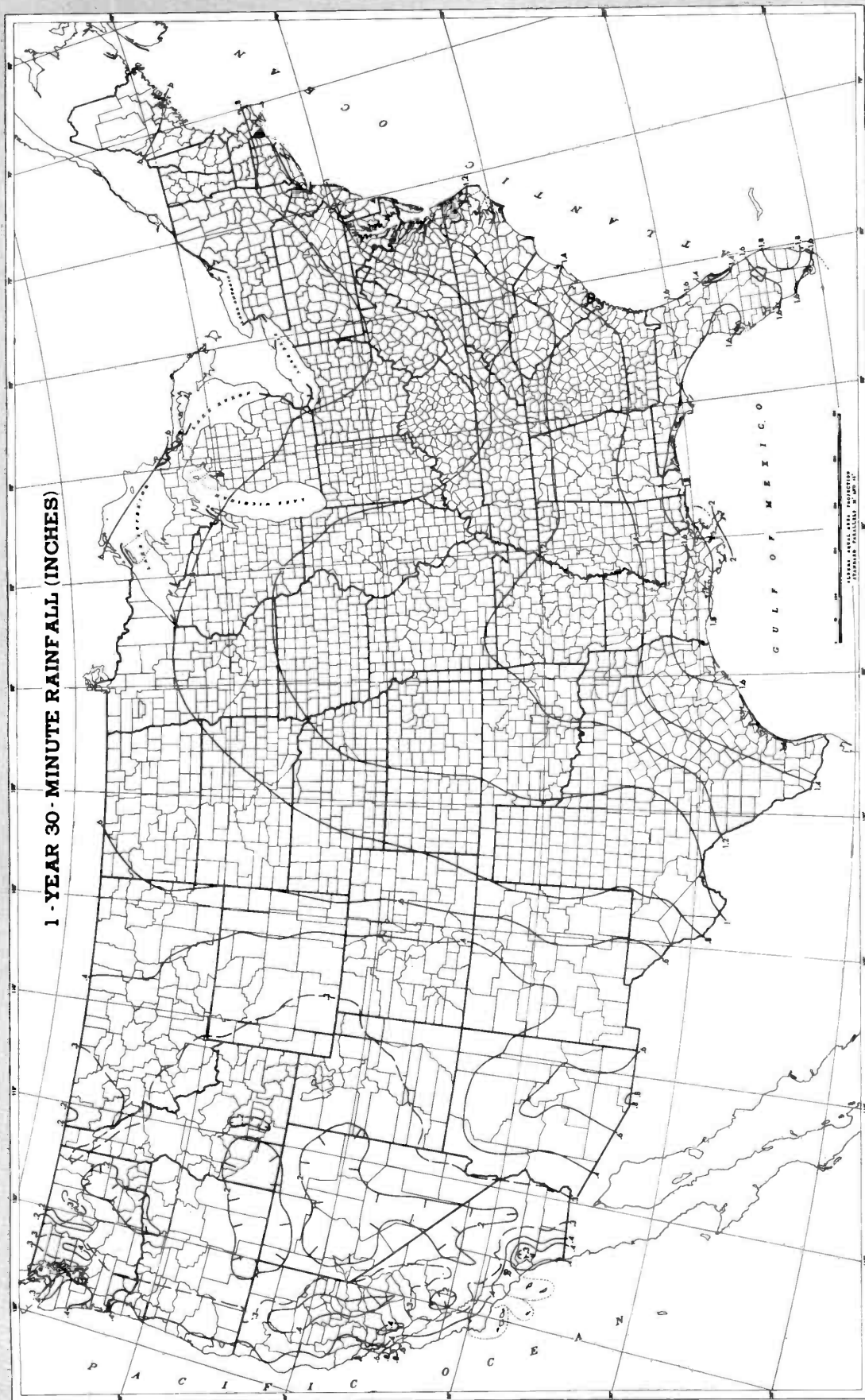

FIG. 4. Map indicating one-year, thirty-minute rainfall averages (in inches).

The importance of adequate clearance at higher frequencies is underscored by the fact that once obstruction of the radio path does exist, the losses suffered by the higher frequency signal are somewhat greater. Thus if equal fade margins are provided, a lower frequency path may be expected to persevere longer during times of "inverse bending" fades. One reason for this may be illustrated by referring again to Fig. 2. If bending were sufficient to increase the earth bulge by 75 feet (an earth radius factor of 0.53) the entire first fresnel zone of the 12 gc/s signal would be blocked. Such an obstruction would block about 85 per cent of the fresnel zone of a 6 gc/s signal. Blocking the entire first fresnel zone could be expected to produce fades from 30 to 60 db deep depending on the nature of the obstruction. If instead 85 per cent of the zone is blocked, the fade depths (while still very severe) will be 3 to 6 db less. The calculation of such obstruction losses is dealt with in some detail in the literature.<sup>1</sup>

An optical illustration of the lesser obstruction losses to lower frequency signals is the glow of longer wavelength red light on the horizon after the sun has set.

#### Attenuation Due to Precipitation

It has long been known that above 10 gc/s, droplets of water in the atmosphere begin to cause both a significant scattering and attenuation with increasing frequency. It is indicated in current literature<sup>8,9</sup> that attenuation due to rainfall can be approximated by

$$\text{db/mi} = "K"p$$

where "K" = a constant depending on wavelength and temperature  
 $p$  = precipitation rate in in./hr.

Values of "K" for wavelengths between 1 and 6 cm are plotted in Fig. 3. (This "K" is not to be confused with that used earlier in this article.)

It is readily seen that at frequencies above 10 gc/s ( $\lambda = 3$  cm) attenuation due to precipitation increases quite rapidly with frequency. One should therefore inquire into what precipitation rates are expected in the area of a proposed path, how frequently these will occur, what their duration is likely to be, and what diameters of storm are usual. A tremendous amount of data on this subject has been compiled by the U.S. Weather Bureau over the years, and some has been reduced to useful forms.

Typical of some of this USWB information is the map,<sup>11</sup> Fig. 4, which shows contours of maximum rainfall in a 30 minute

interval to be expected in any one year in the U.S. One inch of rainfall in 30 minutes, of course, indicates a 2 inch/hr. average rate for that 30 minute period. This is a very heavy rate of rainfall. (The Weather Bureau classifies rainfall rates as follows: less than 0.1 in./hr., light; 0.1 to 0.3 in./hr., moderate; greater than 0.3 in./hr., heavy.)

Combining the data of Figs. 3 and 4, it can be predicted for example that a 12 gc/s microwave path in the vicinity of Washington, D.C. might expect rain attenuation over a 10 mile path to average  $2 \times 2 \times 10$  or 40 db during the 30 minute period of maximum rainfall each year. (This assumes that all 10 miles is subject to the same heavy rainfall.) It compares with only  $.255 \times 2 \times 10$  or 5.1 db at 6 gc/s. How often this would be expected to happen in any one year, and the frequency

of heavy rainfalls of other durations would require extensive studies of additional data. The technical literature<sup>6</sup> shows the results of such a study.

It is interesting to note that the Pacific northwest, an area known for high annual rainfall, gets much lower rates than even a relatively dry area such as Central and Western Texas. It is the *rate* of rainfall, the *frequency* of heavy rate occurrence, and the *diameter* of storm that are important in considering the limitations rainfall imposes on 12 gc/s microwave transmission.

It is fortunate for transmission at these higher microwave frequencies that during heavy rainstorms there is always turbulence. Therefore the inverse bending and multipath type fades, (multi-path is discussed later in this article), which are only possible in still atmospheres, are ex-

FIG. 5. Values of attenuation due to fine droplet clouds and fog vs. wavelength. (Temperature at 20 degrees C.)

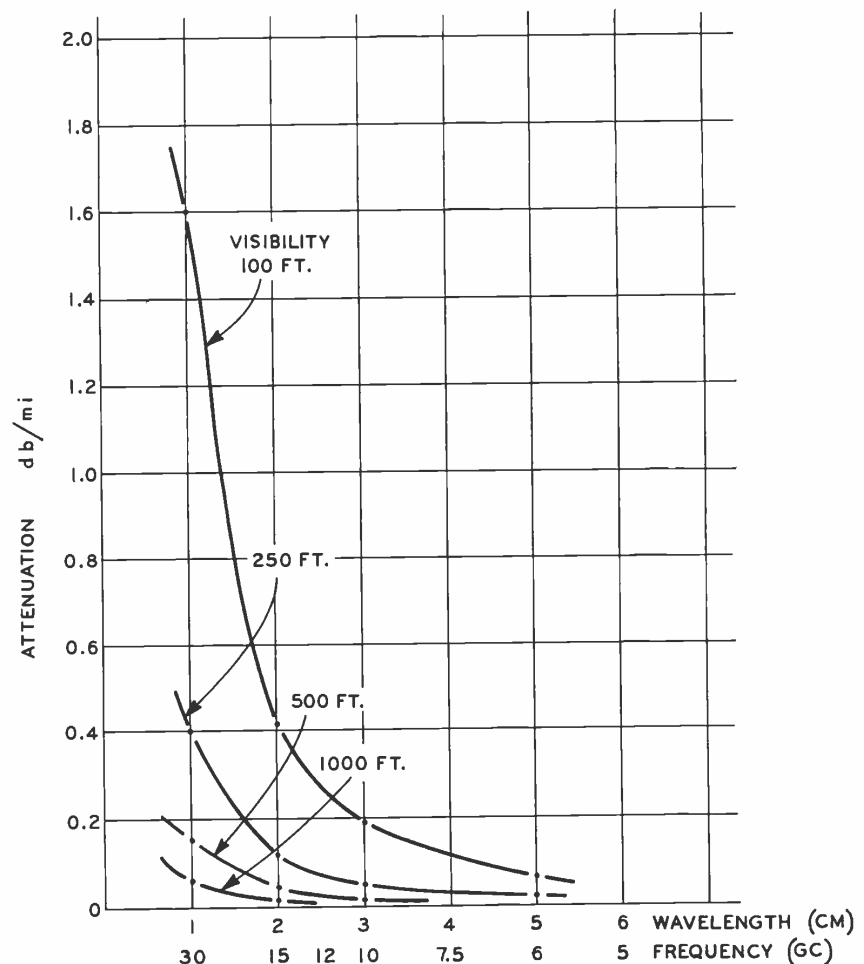

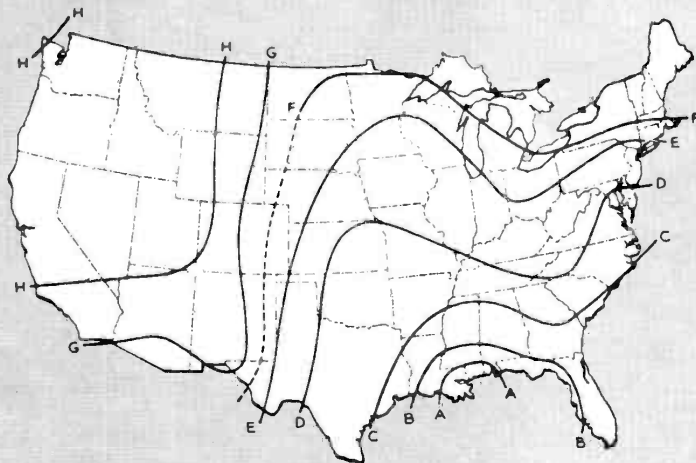

FIG. 6A. Contours of precipitation outage time for given path length 40 db fade margin.

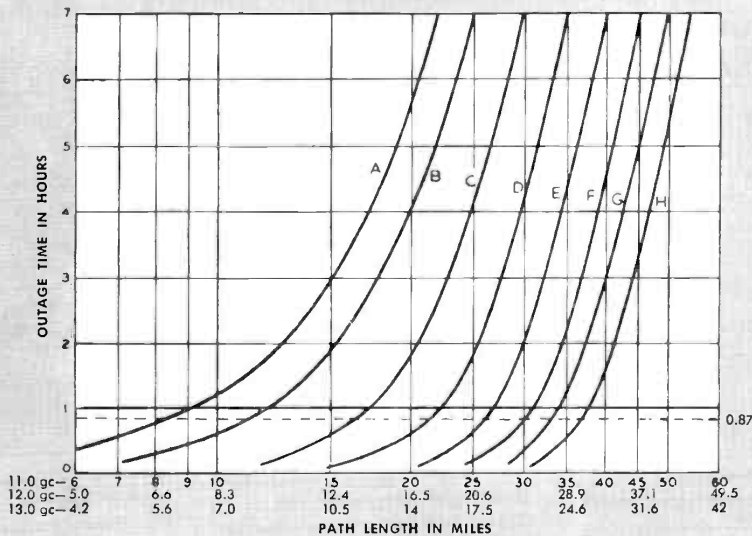

FIG. 6B. Expected precipitation outage time vs path length.

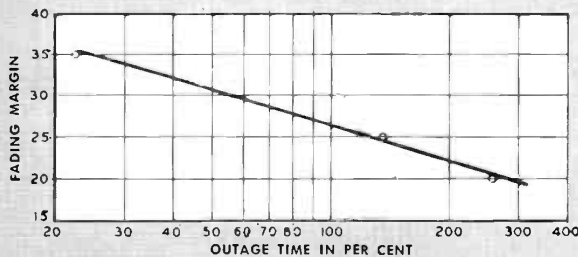

FIG. 6C. Added precipitation outage expected with fade margins less than 40 db.

tremely unlikely to occur coincident with rain attenuation. The fade margin provided in the system design is therefore available in total to help prevent rain outage.

Attenuation due to hail is discussed in the literature,<sup>8</sup> and data shows hail attenuation at 12 gc/s to be only about 5 per cent that of rain at the same rate. Attenuation due to snow also appears insignificant when compared to that of rain at the same rates of fall. Most authors dismiss all but rain attenuation in studies of the effects of precipitation at 12 gc/s.

Thick fog, or fine droplet clouds, produce a surprising attenuation<sup>5,9</sup> although it is small when compared to rain. Fine droplet clouds are defined as those wherein the drop diameter is less than 0.02 cm. For such cases the attenuation is independent of the individual drop diameters and depends instead on the total mass of liquid present per volume of air. Fog attenuation versus frequency is plotted in Fig. 5.

It will be noted from Fig. 5 that if the visual range in fog exceeds 500 feet, attenuation at 12 gc may be ignored. However, if a path is expected to be frequently shrouded in dense fog, (visibility less than 100 feet) good practice would call for an added "fog margin" of about 0.25 db per mile.

Hathaway and Evans,<sup>6</sup> of the Bell Telephone Labs have published a most interesting article, providing basic system engineering data for Telephone Company installations of the TJ and TL 11 gc/s microwave relay equipments. Their work has produced the map and accompanying plots of Fig. 6. These figures can be used to predict the expected outage time due to precipitation on 11 gc/s microwave paths anywhere within the continental United States. Figures 6A and 6B are for paths having a 40 db fade margin, while Fig. 6C provides a correction factor to be applied to paths having less than a 40 db fade margin. The similarity between the maps of Figs. 4 and 6 is readily apparent.

It is noticeable from Fig. 3 that attenuation due to precipitation increases rapidly above 10 gc/s. At 13 gc it is over 40 per cent greater in db than at 11 gc/s. Thus a rainstorm which would produce a 40 db fade at 11 gc/s, may cause a 56 db fade at 13 gc/s. This suggests that different scales should be used for attenuation at 11, 12 and 13 gc/s, shortening the path lengths of Fig. 6 in proportion to the increased attenuation expected. For this reason mileage scales for 12 gc/s and 13 gc/s have been added under the original 11

gc/s scale on Fig. 6A. These figures are derived by simply shortening the paths in proportion to the added rain attenuation expected per mile.

If one allows, as a design objective, no more than .01 per cent outage time in a year due to precipitation (.87 hours) it is apparent from Fig. 6 that paths in the Gulf Coast region (contour B) must generally be limited to less than 12 miles at 11 gc/s. On the other hand, paths in the Rocky Mountain area (contour H) can exceed 35 miles.

As an example of the use of Fig. 6, assume a proposed 25 mile, 13 gc/s path in the vicinity of Boston. The expected rain outage time from Fig. 6 (contour F) would be 2.3 hours per year if a 40 db fade margin were provided. If only a 35 db fade margin is provided 22 per cent more outage time could be expected, or a total outage due to rain of 2.8 hours. Such an outage time is generally considered excessive.

In TV STL service, outage times of less than .01 per cent are mandatory. If this standard is adhered to, path lengths in the Boston area should be limited to about 21 miles on 13 gc/s, with 40 db fade margin. At 11 gc/s, however, the path might be lengthened to 30 miles with the same expected rain outage time.

#### Path Attenuation—Antenna Gains

The free space path loss in db between isotropic antennas is given by

$$d = 37 + 20 \log f + 20 \log D$$

where  $f = r-f$  frequency in mc/s  
 $D =$  path length in miles

This expression shows clearly that the free space loss at 12 gc/s is higher than that for the same path at lower frequencies. This added path loss however is more than offset by the antenna gain available from the generally used parabolic antennas. The gain of a parabolic antenna in db is given by

$$G = 20 \log f + 20 \log (2R) - 52.6$$

where  $R =$  the radius of the parabolic reflector in feet  
 $f = r-f$  frequency in mc/s

From the above it may be seen that on a given path, the added gains of the two antennas and the path loss would yield a *net* theoretical path loss actually 6 db less at 12 gc/s than at 6 gc/s.

Waveguide losses are higher at 12 gc/s than at lower frequencies. Figure 7, reprinted from the catalog of the Andrew Co. gives an interesting view of the spread of waveguide transmission line losses at the various microwave frequencies. Losses in flexible waveguide are generally about triple (in db) those of the rigid waveguide shown in the figure. Obviously long runs and the use of flexible waveguide should be carefully considered before inclusion in 12 gc systems.

The increase in waveguide losses makes favorable equipment location and the use of passive reflectors generally mandatory at 12 gc/s. In these cases the passive reflector is of course located on a tower at the elevation required to provide the path clearance and is then illuminated from the equipment building by a parabolic antenna.

The most effective use of rectangular passive reflectors<sup>7</sup> occurs where

$$h/4a^2 = 0.4 \text{ and where } R/a < 1$$

In these expressions,  $2a$  is the side of the projected square of the passive reflector, and  $h$  is the height of the reflector above its illuminating parabola of radius  $R$  (all units in ft.). In these passive reflector "periscope" antenna systems, as with the parabolas themselves, greater gains are attainable with smaller area reflectors at 12 gc/s than at 6 gc/s. The optimum separation (height) for maximum gain from a given parabola-reflector combination is greater at 12 gc/s. The general trend then, with increasing frequency, is to smaller elements with greater separation. The literature<sup>7</sup> indicates how "periscope" gain may be calculated for any given system.

#### Fading

Clearance requirements were discussed earlier in this article, and it was pointed out that lack of sufficient clearance may lead to fading when inverse bending occurs along the path. This inverse bending leads to prolonged fades, as the signal path is obstructed for the period during which weather conditions, generally slow to change, are conducive to inverse bending. The only protection against such fading at *all* frequencies is adequate clearance.

Another type of fading which is to be expected on any microwave path is that due to multi-path transmission. It is characteristic of this type of fading that, as frequency increases the fades become more

FIG. 7. Waveguide attenuation vs. frequency.

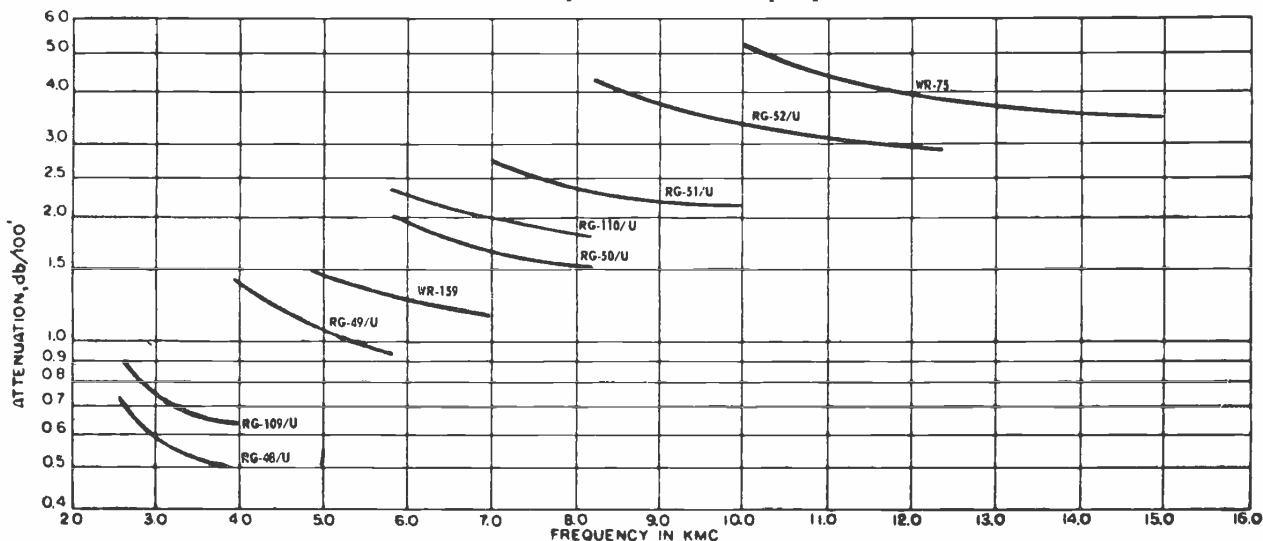

frequent but of shorter duration. This is perhaps explained by the fact that the higher the frequency, the more fresnel zones are included in the width of the antenna beam, thus the more numerous the opportunities for multipath signals to phase in and out, and the more rapidly they can do so as a reflecting layer of air slowly rises or lowers thru the antenna beam.

The fresnel zones, are imaginary curved boundaries by way of which a reflected signal would travel an added 180 degrees in going from transmitter to receiver antenna. A reflection from an air layer at the edge of the first fresnel zone arrives at the receiver as an aiding signal (there is a 180-degree phase change inherent in the reflection process) and one from a layer at the second fresnel zone boundary arrives as a cancelling or fade producing signal.

Figure 8 taken from the literature<sup>6</sup> shows comparative multi-path fading at 4 and 11 gc/s and illustrates the difference in the nature of the fades. Total outage time in the 4 and 11 gc/s cases is roughly equal, so that this type of fading constitutes no more of an outage threat at high microwave frequencies than at low. It is dealt with, in either case, in the same way—by providing adequate fade margin, or by diversity reception, or both.

Both the above fading phenomena are dependent on still air, which can form into layers, or provide uniform bending over a considerable distance. Fortunately nature does not allow such conditions to exist for long. Instead, the atmosphere is inherently unstable, and still conditions soon revert to normal turbulence.

This instability is the product of many forces, but is primarily due to the fact that the warmer air normally found at ground level, seeks always to rise. The sun, warming the ground each day, continually stimulates this effect, and the resulting turbulence provides the average atmosphere, in which radio paths follow the well known 4/3 earth trajectory.

### TVM-3B Equipment

The TVM-3B is a high frequency edition of the 6 gc/s TVM-1C. It operates in the frequency range from 10.5 to 13.25 gc/s. This new coverage is achieved by the use of different plumbing and klystrons for transmitter and for receiver local oscillator. (See Fig. 1.)

The TVM-3B Transmitter, designated TVT-3B, consists of an r-f head unit and a transmitter control unit. The latter is identical to the transmitter control in the TVM-1C system. The TVM-3B receiver, designated TVR-3B, consists of a receiver

r-f head, a receiver control unit and a receiver power supply. Here also, except for the r-f head, these units are identical to and interchangeable with their TVM-1C counterparts. All the various system combinations possible with the TVM-1C are similarly possible with TVM-3B and all the familiar accessories may be used, for example for fault reporting, diversity and standby switching.

The TVM-3B units are rack mountable in the manner of the TVM-1C. The transmitter and receiver r-f heads utilize the same rack mounts as their TVM-1C counterparts, and the total rack space required for a system is identical to that of the TVM-1C.

For portable work, the TVM-1 "suitcases" are used for the control units and power supply, and the TVM-1 r-f head

enclosures with changed plumbing adapters are used for the r-f units.

### Transmitter

The TVM-3B transmitter (see block diagram, Fig. 9), employs a VA-237 klystron oscillator as its r-f power source. Coverage of the 10.5 to 13.7 gc/s region is provided by a family of three klystrons as diagrammed in Fig. 1. The transmitter head, with the VA-237 tube in place is pictured in Fig. 10. The tube is cooled thru its waveguide output flange which mates to an aluminum plate, and this latter draws the heat off to the heat sink at the extreme left of the photo. Nominal r-f power output, using the VA-237 is 0.35 watts. Outstanding features of this klystron are its remarkable stability *without* AFC, its freedom from microphonic effects, and its long life warranty. The klystron's temperature

FIG. 8a. Typical multipath fading at 4 gc/s.

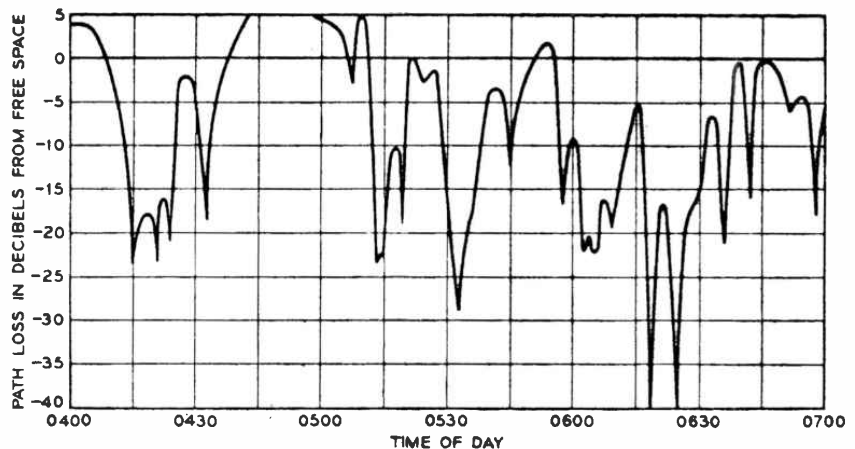
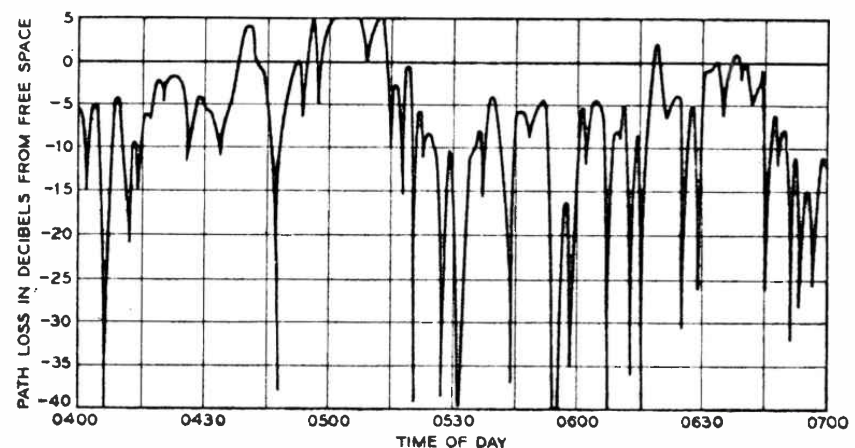

FIG. 8b. Typical multipath fading at 11 gc/s.



coefficient is less than  $\pm 100$  kc per degree C, a number unequalled by any competitive tube. The warranted life is 5000 hours.

*Note: As this article goes to press, Varian Associates has announced a VA-287 Klystron, soon to be available. This tube is to be a direct replacement for the VA-237, and will raise the r-f power output of the TVM-3B transmitter from 0.35 watts to a full one watt.*

The plumbing uses WR-75 waveguide. It includes a directional coupler which feeds the wavemeter and power monitor crystal. The wavemeter is direct reading, with calibration marks every 2 megacycles. It mounts on the waveguide arm just above the power monitor crystal and permits transmitter frequency measurement by dipping the crystal current, or by CRO observation of wavemeter pips when the klystron is modulated. The wavemeter is seen in the photograph of Fig. 10, and its functional location noted in the block diagram of Fig. 9.

Provision is made on the main waveguide for mounting a tunable waveguide discriminator to provide "off-air" monitoring of the outgoing FM signal, or AFC

for the transmitter klystron, or both. The wide spreader on the far side of the main waveguide is removed to permit mounting the discriminator, which, as in the TVM-1C is an option.

When the TVM-3B transmitter is operated with the AFC accessory, its designation changes from TVT-3B to TVT-3B-F. Addition of the transmitter monitor involves no change in type designation.

The transmitter also includes a radiation attenuator in the main waveguide, behind the chassis, Fig. 10. This is actuated from below by a solenoid, and is used to operate the transmitter in hot standby. The attenuator provides 45 db minimum attenuation, which is sufficient to prevent standby interference with an active transmitter on the same frequency when both feed a common receiver over a typical microwave path.

Video is directly frequency modulated on the transmitter klystron via a modulator amplifier identical to the unit in the TVM-1 equipment. Normal deviation is 6 mc, p/p.

#### Receiver

The TVR-3B receiver (see block diagram, Fig. 12), is a super heterodyne em-

ploying a balanced mixer in WR-75 waveguide. The mixer employs low noise MA-490A crystals nearly identical in their i-f characteristics to those used in the TVM-1 receiver. This identity allows direct use of the TVM-1 i-f pre-amplifier on the TVM-3 receiver without readjustment.

The receiver local oscillator is an inexpensive long life plug-in klystron. Four tubes are used to provide complete frequency coverage. These klystrons carry a 7500 hour warranty and increased life expectancy is provided by the heat sink and cooling fins attached to the klystron in service. The klystron, having a co-axial output, is installed on the TM-3B receiver plumbing via a klystron mount which may be seen in place in Fig. 11. The mount contains plug and heat sink connections for the klystron and attaches directly to the local oscillator flange of the receiver plumbing.

Provision is made for mounting the wavemeter on the local oscillator arm of the mixer plumbing to allow direct reading of the local oscillator frequency. This feature, as in the TVM-1, is of immense aid in the field in rapidly restoring service when klystrons are changed, or during antenna alignment. It permits the tuning of the receiver to be verified without the need of the transmitter signal being present. The wavemeter can be seen in place in Fig. 11. The wavemeter is the same removable unit also used in the transmitter.

The output of the i-f pre-amplifier is fed to the main i-f amplifier in the receiver control unit via coax in the multi-conductor cable between the r-f head and control unit. The i-f amplifier and the i-f and video units following it are identical to their TVM-1 counterparts.

#### Multiplexing

RF multiplexing for placing several TVM-3B transmitters or receivers on a common antenna is shown in the diagrams, Fig. 13. For each added channel, one three-port circulator plus a band pass waveguide filter is required. Figure 13 (top) indicates how transmitters are multiplexed on an r-f line to an antenna. In each case the use of an isolator is advisable between the transmitter and the waveguide filter to assure linear modulation of the klystron. The r-f signals in the main line pass clockwise thru the circulator from port 1 to port 2, only to be reflected from the filter on port 2 and passed on to port 3. R-f from the transmitter at the filter frequency enters the circulator at port 2 and is passed on with the other signals to port 3 and the antenna.

FIG. 9. Block diagram. TVM-3B transmitter.

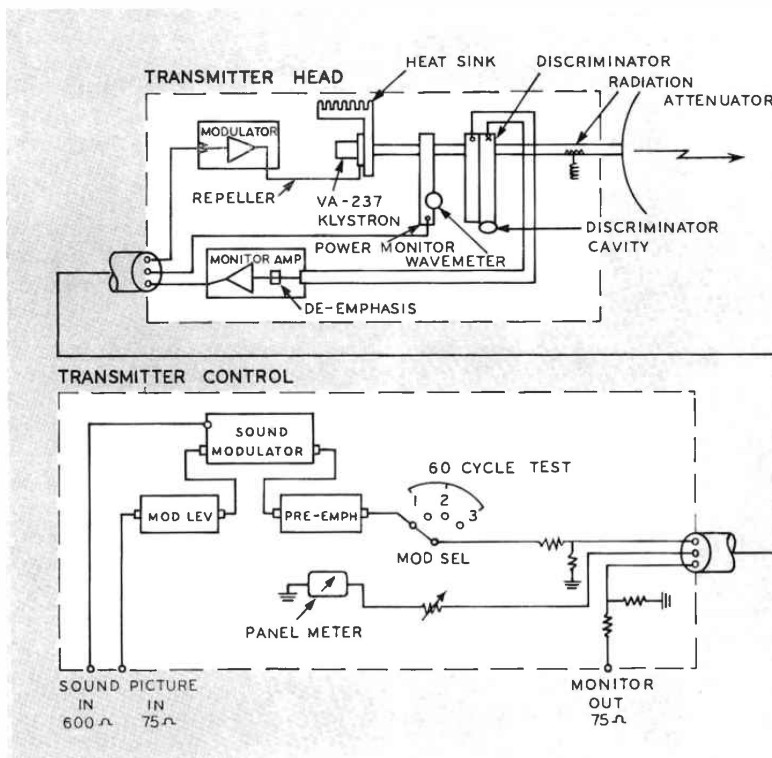

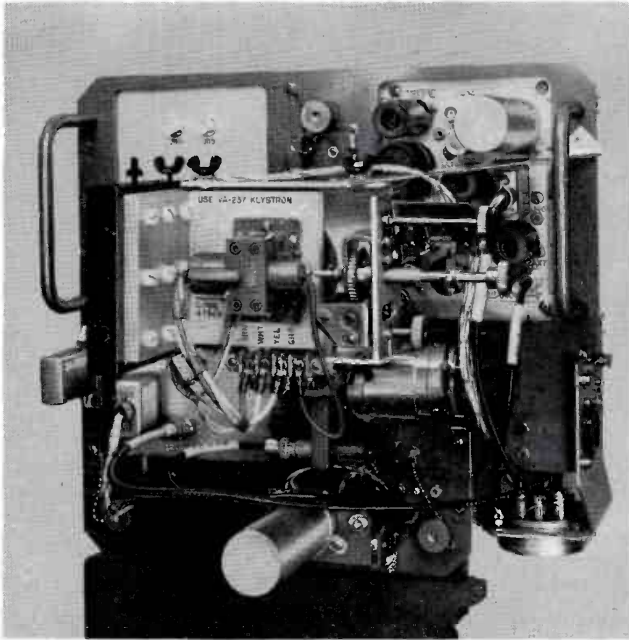

FIG. 10. Closeup view of TVM-3B transmitter.

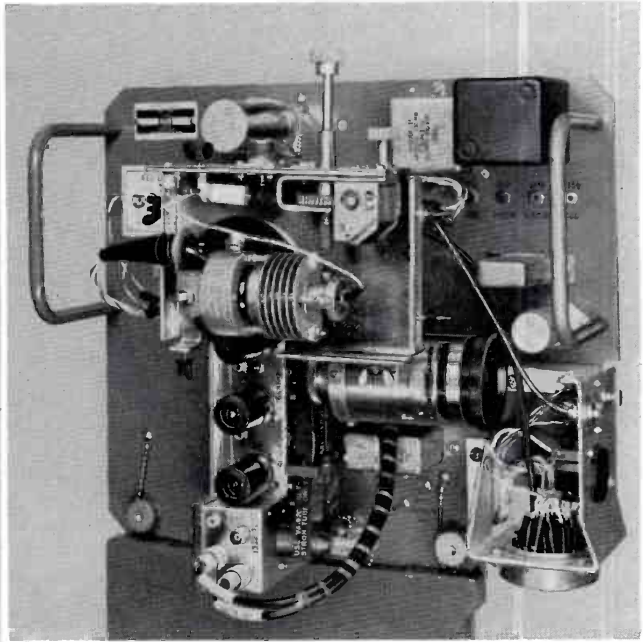

FIG. 11. Closeup view of TVM-3B receiver.

Signal separation at the receiver follows exactly the same principles and is diagrammed in Fig. 13 (center). In some cases it will be desirable to use an isolator between receiver and filter to reduce local

oscillator radiation and improve filter termination.

The case of transmitter and receiver on a common antenna, for two way transmission, is illustrated in Fig. 13 (bottom).

These multiplexing configurations all permit mounting of multiplexed transmitter or receiver heads in adjacent racks or one above another.

#### Standby and Diversity Service

The TVM-3B equipment may also find usage in standby or diversity service with TVM-1C. Current TVM accessories can provide for automatic switching between the two equipments, and dual antenna feeds are available so that a single antenna system may be used for both frequencies.

#### Conclusion

The TVM-3B has been long delayed in its appearance by the lack of truly suitable klystrons. Klystrons have long been available for this frequency range, but they did not possess the long life, stability or power level required for dependable microwave relaying. Only with the appearance of the VA-237 family of transmitter tubes, and the completion of the QKK group of receiver local oscillator tubes has a proper 11-13 kmc equivalent for the TVM-1 equipment become possible.

It is most certainly within the state of the art to provide reliable microwave relaying in the 10.5 to 13.2 gc/s band, simply by recognizing and dealing properly with its limitations. Literature of the Bell system<sup>8</sup> describes successful paths at 11 gc/s up to 48 miles in length (Prescott to Flagstaff, Ariz.), and as much as 22 miles over water (Hampton to Kiptopeke, Va.). Both of these paths and others in the increasing

FIG. 12. Block diagram, TVM-3B receiver.

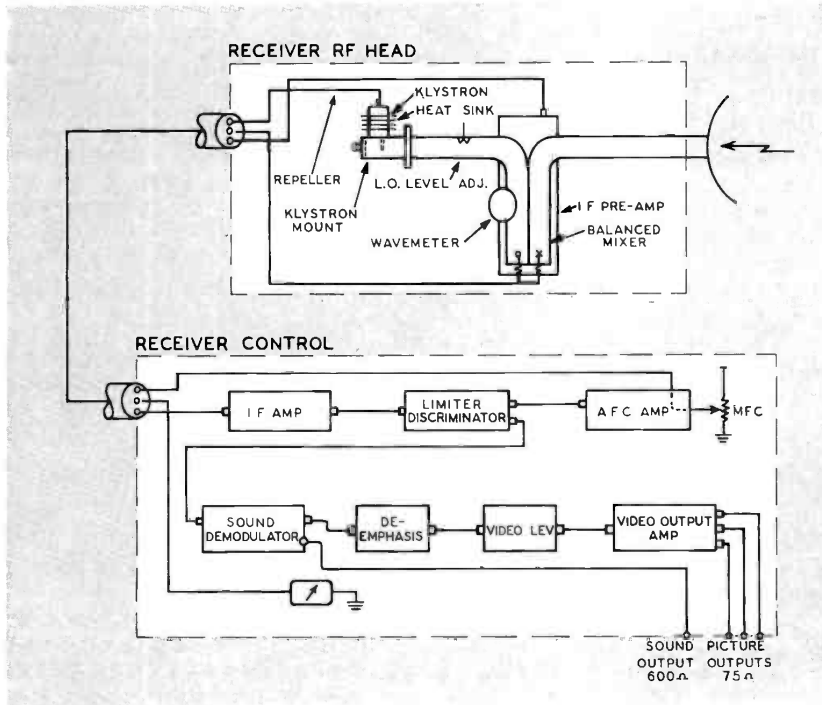



number of Bell TJ and TL systems suggest that there is a considerable amount of conservatism in the literature from which portions of this article were drawn. TVM-3B installations should of course stay within these conservative boundaries until further study and experience show the added liberties which may be taken.

**References**

- <sup>1</sup> K. Bullington, BSTJ, May 1957.
- <sup>2</sup> Bean & Thayer, PIRE, May 1959.
- <sup>3</sup> Bean, PIRE, May 1962.
- <sup>4</sup> How to Calculate Beam Clearance in a Point-to-Point 13 Kmc Microwave System, RCA Pub. 3J4298.
- <sup>5</sup> Ryde, Radio Location Convention, London, March 1946.
- <sup>6</sup> Hathaway & Evans, Communications & Electronics, AIEE, Jan. 1959.
- <sup>7</sup> Medhurst, Electronic & Radio Engineer, Dec. 1959.
- <sup>8</sup> Gammie & Hathaway, Bell System Monograph #3659.
- <sup>9</sup> Rep. 205, CCIR, Geneva 1963.
- <sup>10</sup> Tower Height Work Sheet for Microwave Systems, RCA Form 3J4757.
- <sup>11</sup> Rainfall Frequency Atlas of the U.S. Department of Commerce Tech. Paper #40, May 1961.

FIG. 13. A. (top) Transmitter multiplexing on common antenna. B. (center) Receiver multiplexing on common antenna. C. (bottom) Antenna diplexing for two-way transmission.

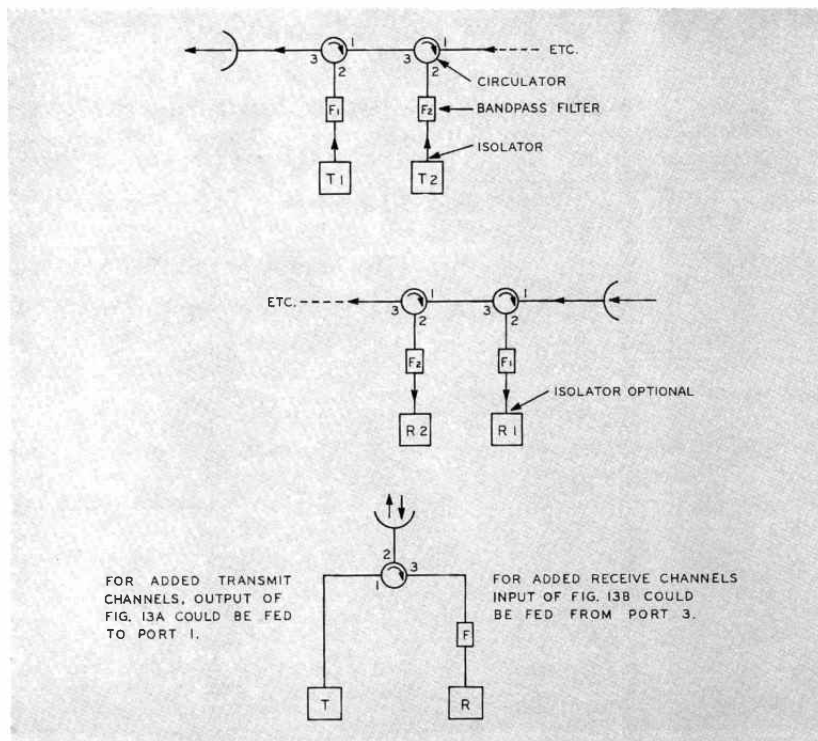

**PERFORMANCE DATA FOR TVM-3B**

The video transmission characteristics of the TVM-3B are identical to those of the TVM-1C, and are as follows for a single hop, using 8 db of low frequency de-emphasis.

**Video Channel**

Differential Gain . . . . .	0.25 db max.
Differential phase @ 3.58 mc . . . . .	1.0° max.
Amp-freq. response . . . . .	±0.25 db, 60 cyc. to 7 mc
Square wave tilt, 60 cycle . . . . .	1% max.
Tx input level, 75 ohms . . . . .	1.0 V P/P ±6 db nominal
Tx monitor output, 75 ohms . . . . .	1.0 V P/P nominal
Rx output level, 75 ohms . . . . .	2 at 1.5 V P/P 1 at 0.5 V P/P

**Audio Channel (up to 3 available)**

Distortion, 50 cyc. to 15 kc/s . . . . .	1% max.
Amp-freq. response . . . . .	0.5 db 50 c/s to 13 Kc -2 db max. @ 15 Kc
S/N—typical path . . . . .	60 to 65 db, incl. hum & crosstalk
Input, 150/600 ohms . . . . .	0 dbm nominal
Output, 150/600 ohms . . . . .	14 dbm max., adjustable

Audio multiplexing equipment is identical to that used in the TVM-1, i.e., utilizes an FM subcarrier in the 6.2, 6.8, 7.5 mc frequency range.

# NEW CARTRIDGE TAPE EQUIPMENTS

Monaural, Stereo, and Multi-Cartridge Systems  
Designed to Meet New NAB  
Recording and Reproducing Standards

by CHARLES B. MEYER  
*Broadcast Equipment Engineering*

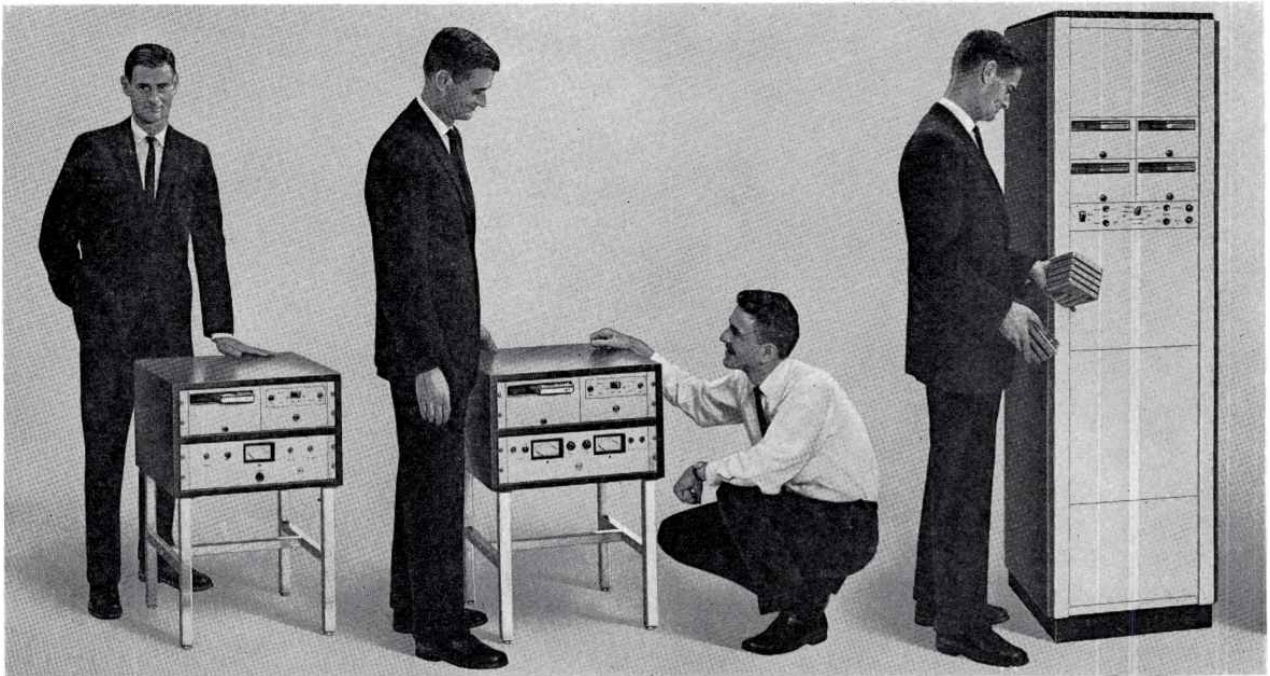

FIG. 1. New Cartridge Tape Equipments include RT-17 monaural system, RT-37 stereo system and RT-8 playback system for both monaural and stereo.

For the past year, engineering committees of NAB have been actively preparing a standard for recording and reproducing cartridge tapes; also during this time RCA engineers have been developing a new line of transistorized cartridge tape equipments designed to meet or exceed these standards. These equipments include a new monaural cartridge tape system, RT-17, and a new stereo system, RT-37—also a new multi-cartridge system for playback of pre-recorded tape cartridges, RT-8. (Descriptions and features of these new systems are presented at the conclusion of this article.)

In building these equipments to meet NAB standards, engineering investigations were made of the following areas: tape speed, flutter, tape tracking, frequency

response and head characteristics. The results of these investigations, which follow, are presented to give the station engineer a better understanding of cartridge tape operation for finest technical performance.

#### Precise Tape Speed

The standard specifies a tape speed of  $7\frac{1}{2}$  inches per second. For programming purposes this means *exactly* that speed; an error of only 1 per cent would amount to 18 seconds in half an hour. Such an error would be a disaster.

At first thought, the perfect solution would seem to be to use a synchronous direct drive motor, whose shaft was ground to a diameter that had a surface speed of exactly  $7\frac{1}{2}$  ips. However, if such a machine were made, the tape would run fast.

The reason for this is demonstrated in Fig. 2. Here a tape is shown wrapped around a capstan. Imagine a number of lines drawn through a cross section of tape, such as a series of butt splices. As these lines move past the capstan, the distance between them at the outer edge of the tape will stretch. The distances at the inner edge will shrink. After the tape leaves the capstan, the distances return to normal. Note that there is one place in the tape where it is not warped. This is called the neutral axis.

Suppose the inner edge of the tape were driven by the capstan at exactly  $7\frac{1}{2}$  ips. As this edge moved past the capstan, the line distances would stretch back to normal, and therefore the tape would run a little fast.

In order to make the tape run at the right speed, that part of it which isn't stretched apart or squeezed together must be driven. Figure 3 shows the same tape, but with the neutral axis added to the drawing. To a first approximation, the neutral axis runs down about the middle of the tape. The effective radius of the cap-

stan is its actual radius plus half the tape thickness. This means that the shaft *diameter* (not radius) must be ground smaller (by the tape thickness) than was originally computed.

At first thought, it may seem like this is a very small effect; too small to consider. However, for the typical shaft diam-

eter found in cartridge machines it amounts to over 10 seconds in half an hour. The standard allows about 7 seconds.

Although a direct drive capstan would seem to be ideal from a tape speed accuracy standpoint, it has a serious potential drawback from a flutter standpoint. Therefore an indirect drive is used in the design of

## SUMMARY OF NAB STANDARDS FOR CARTRIDGE TAPE EQUIPMENT

### A. Mechanical Specifications

1. The tape speed is  $7\frac{1}{2}$  inches per second  $\pm 0.4$  per cent. Speed is measured with a 150 foot tape in a cartridge.
2. The maximum permissible flutter and wow is 0.2 per cent rms. Flutter is measured by a test tape which has negligible flutter.
3. The machine must be capable of pulling tape with a force of  $1\frac{1}{2}$  pounds, minimum.
4. The head closer to the capstan is called the "A" head. It is used for playback of both the program and cue tracks.
5. The other head is the "B" head. It is used for recording the track.
6. For monophonic systems: the top track is the program track and the bottom is the cue track. The track width is  $0.082 \pm 0.002$  inches, with a  $0.156 \pm 0.004$  inches centerline spacing.
7. For stereophonic systems: the top track is the left program track, the center track the right program track, and the bottom track is the cue track. The track width is  $0.043 \pm 0.004$  inches, with a  $0.100 \pm 0.002$  centerline spacing.

### B. Electrical Specifications

1. NAB Standard Level is the level of the 400 cycle tone on the NAB Frequency Response Test Tape. (Note: this level is within about 1 db of a level 8 db below a 400 cycle tone recorded the 3 per cent tape distortion level.) Record VU meters should be calibrated to read 0 VU at this Standard Level.
2. Playback Frequency Response is to be measured with the NAB Frequency Response Test Tape. It should playback flat within the following tolerances: +1 db 50 to 12 KC, -2 db 50 to 100 cycle, -1 db 100 to 10 KC, with a taper to -2 db at 12 KC.
3. Recorded Frequency Response is the difference between overall response and playback response. (The recorded response is standardized rather than the overall. This scheme is better for interchangeability.) This means that the overall response should match the test tape. The tolerance on matching is the same as the playback tolerance, except the -1 db line goes all the way down to 50 cycles.
4. The overall system distortion should not exceed 3 per cent when recording a 400 cycle tone 6 db above Standard Level. (Note: this does not conflict with the 8 db figure given in B1 on Standard Level. The 2 db difference allows for variations in tape, and a small amount of distortion in the record amplifier.)

5. Monophonic Signal-to-Noise Ratio is 45 db, with the signal at NAB Standard Level. (Note: if referenced to the 3 per cent distortion level, the S/N is 8 db better, or 53 db. It is important when discussing S/N ratios to avoid confusion by defining the "signal".)
6. Stereophonic Signal-to-Noise Ratio is 42 db. (Note: the 3 db difference in S/N is due to the narrower track width of a stereophonic system. Again, when referenced to the 3 per cent distortion level, the S/N is 8 db better or 50 db.)

### C. Cue Tone Specifications

1. The primary cue tone (stop cue) is  $1000 \pm 75$  cycles, recorded at about NAB Standard Level ( $\pm 3$  db).
2. The secondary cue tone (end cue) is  $150 \pm 30$  cycles, recorded 6 db above NAB Standard Level ( $\pm 3$  db).
3. The tertiary cue tone (trip cue or random cue) is 8 KC  $\pm 1$  KC, recorded about 10 db below NAB Standard Level ( $\pm 3$  db).
4. The crosstalk from all cue tones into the program channel should be 50 db below NAB Standard Level. An exception is the 1000 cycle cue (stop cue) in a monophonic system; it must be 55 db down.

### D. Test Tapes

Four test tapes are specified. They are:

1. Azimuth Test Tape (15 KC full track)
2. Flutter Test Tape (3 KC, full track, 0.05 per cent max. flutter)
3. Monophonic Frequency Response Test Tape (15 KC to 30 cps)
4. Stereophonic Frequency Response Test Tape (15 KC to 30 cps)

To avoid conflicting measurements, NAB Test Tapes will be available **only** from NAB Headquarters. These tapes will be available at a future date.

### E. Miscellaneous

The playback amplifier equalization is defined in terms of the time constants 3180 and 50 microseconds. This equalization has been used in  $7\frac{1}{2}$  inches per second recorders for many years, and has passed the test of time, although never given formal approval until this Standard. An Annex describes the process of calibrating and properly equalizing a playback system independently of a test tape. This Annex will be of use to manufacturers, the test tape maker, and "do-it-yourselfers". Broadcasters will continue to measure playback response with a test tape, as they always have.

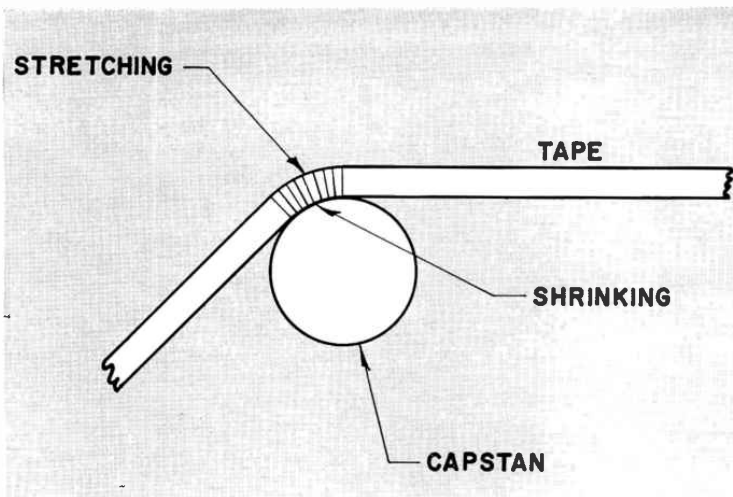

FIG. 2. Tape wrap around capstan showing stretching and shrinking.

all RCA cartridge tape equipment. Field experience with thousands of earlier machines indicates that indirect drive can achieve excellent uniformity of tape speed. Most of the tape speed variances encountered were caused either by using a motor that wasn't synchronous, or involved design errors that ignored the tape thickness effect just described.

#### Minimizing Wow and Flutter

We are all familiar with the effects of wow on piano music and on chimes. Even a very small amount makes most music

sound "sour". Wow usually involves rates up to about 7 cps. Higher rates are usually called flutter; however, the term flutter often includes both meanings. This is rather unfortunate, for flutter rates above 10 cps cause a different effect; flutter usually makes a tone sound harsh or noisy, while wow sounds "sour".

At first thought, one might think that all that is needed to eliminate all wow and flutter from a tape transport is to have perfect machining. This is only half true, although good machining certainly is nec-

cessary. Even with perfect machining, there can be a fair amount of flutter left, and sometimes some wow, too. Here's an example: Experience with direct drive motors used as a capstan shows that they have a tendency to "hunt"; that is, slowly oscillate around their average speed. This produces wow while the motor is "hunting". After a time, the hunting stops—provided that there is no change in load. Thus in a reel-to-reel machine, direct drive is practical, because the tape pays off the supply reel comparatively evenly, and the hunting dies out. But in a cartridge machine the picture is different. Here the tape is literally pulled from the center of the reel, and the back tension becomes rather jerky. This jerkiness, often occurring once each revolution of the platter, would aggravate hunting and wow. So here is a case where precision machining cannot eliminate all wow.

The use of an indirect drive can reduce hunting to practical proportions. In this case the motor is coupled to a massive flywheel by means of a rubber O ring. The capstan is the shaft of the flywheel. It turns out that the springiness of the O ring and the mass of the flywheel are successful in filtering out the motor hunting. Listening tests (which are often more useful than a flutter measurement) verify this conclusion.

One design aid that has been helpful is a "spectrum analysis" of the flutter rates. This involves connecting a wave analyzer to the flutter meter output. If a curve is plotted of the various flutter rates, one can see what each shaft and bearing contributes to the overall flutter. Take for example, an overall flutter measurement. The meter reads 0.2 per cent. What can be done to lower it? The usual procedure is pretty much of a guess and test operation: you try replacing the pressure roller; you clean the heads; you try another cartridge; you lubricate the capstan, motor and flywheel bearings, and so forth. This procedure may or may not be successful. However a spectrum analysis lets you see exactly what each shaft and bearing contributes to the overall measurement.

Figure 4 shows a spectrum analysis. The bottom curve shows the flutter rates of a tape recorded on a reel-to-reel machine (an RT-21B) which has low flutter . . . only 0.03 per cent. This tape was then loaded into a cartridge, and played in the cartridge recorder. Flutter measurements were made at both of the head positions (these are curves A and B). Note that there is a peak around 3.2 cps. This is the pressure roller speed. Note another

FIG. 3. Tape wrap around capstan showing the neutral plane and its effect on tape speed.

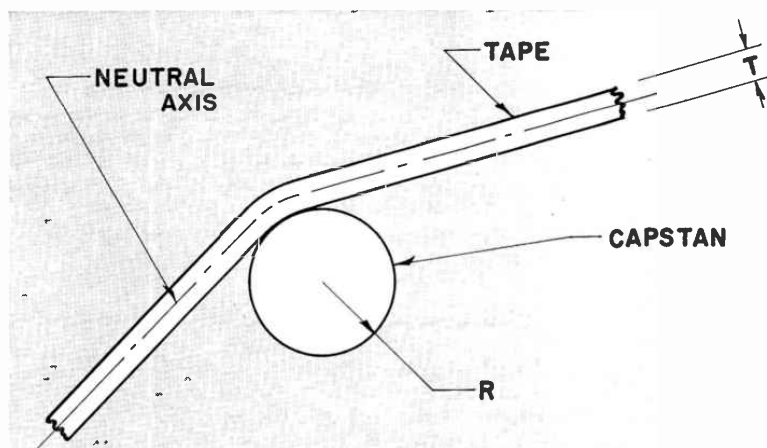

$$\text{EFFECTIVE RADIUS} = R + \frac{1}{2} T$$

$$\text{TAPE SPEED} = \pi N (R + \frac{1}{2} T)$$

peak around 6 cps. This one is the belt rate; it is caused by the once-around speed of the rubber O ring in the drive assembly. Another peak at about 11 cps is caused by the capstan. These three peaks are small, amounting to only a few hundredths of one per cent. But as we go higher in frequency, it becomes more difficult to explain the source of flutter. The large peak at 150 cps occurs at a speed much faster than any shaft rotates including the motor. Preliminary calculations suggest that the 150 cps rate is the result of a resonance involving the tape (it acts like a spring) and the tape and platter in the cartridge (which acts as a mass).

In this case the overall flutter in the A head position is only 0.10 per cent and in the B position 0.12 per cent. The proposed standard allows 0.2 per cent.

Further improvement would be expensive, and rather difficult, for a more precise motor shaft wouldn't help the principal offender (the 150 cps peak) at all. To improve that, changes in the cartridge would be needed.

#### Low Tolerance Tape Tracking

The path the tape takes across the heads is called the track of the tape. It is desirable that the track not vary from one machine to another, or from one cartridge to another. This path is shown in Fig. 5. Note that the tape motion is from left to right. The tape is pulled around the cartridge post, which acts as a guide, across the B head (this is the record head), through a guide mounted on the deck, across the A (or playback) head, and between the capstan and pressure roller. If the tape path is straight for some machines and cartridges, but bent or crooked for others, there will be azimuth errors.

A common source of error that is not well known is caused by the capstan and pressure roller. Normally we assume that they merely pull the tape in the direction we want it to go. However, there are two types of shaft misalignment that tend to push the tape up or down from the deck.

The first type is shown in Fig. 6. As in Fig. 5, the tape moves from left to right. However, here there is a shaft misalignment of angle A. The capstan is trying to move the tape horizontally, but the pressure roller wants to move it down and to the right. How far down it moves depends on the back tension of the tape.

The second type of misalignment is shown in Fig. 7. In this view, the tape is moving away from us. The capstan and

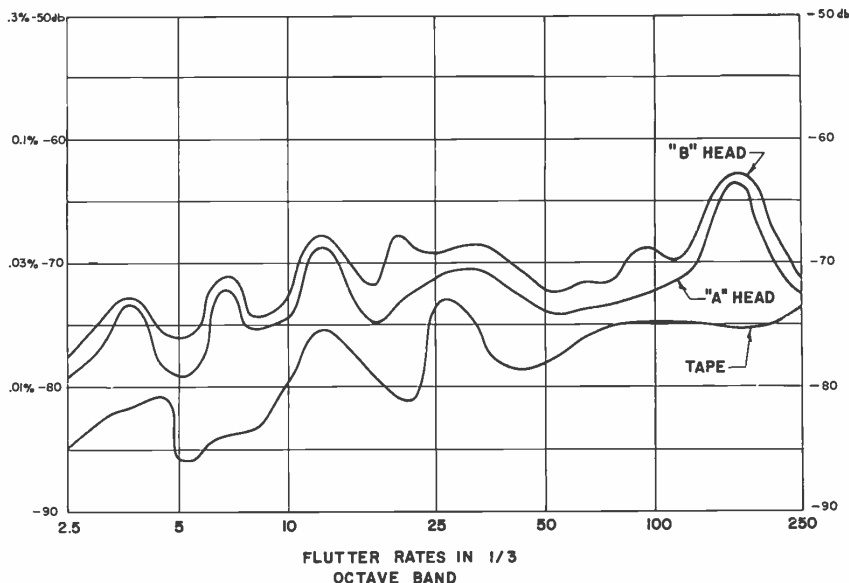

FIG. 4. Flutter content at various flutter rates.

pressure roller surfaces aren't parallel, because their shafts are misaligned.

Although these two alignment errors are rather obvious, what isn't obvious is the precision needed for good tracking. Tests show that these errors must be about 1/4 degree at the most. This is very tight tolerance.

#### Excellent Frequency Response

There are many factors that affect the overall frequency response of a machine—the design of the recording and playback

amplifiers for one. However, in the design of these new cartridge tape machines the factor that affected response the most turned out to be another tracking phenomenon. Back in Fig. 5, it was shown that the cartridge post acted as a tape guide. If different cartridges have guide heights other than 0.562 inches, then these cartridges will have different azimuths at the record head. The azimuth at the play head will tend to remain the same, however. What this means is that different cartridges will have different overall responses,

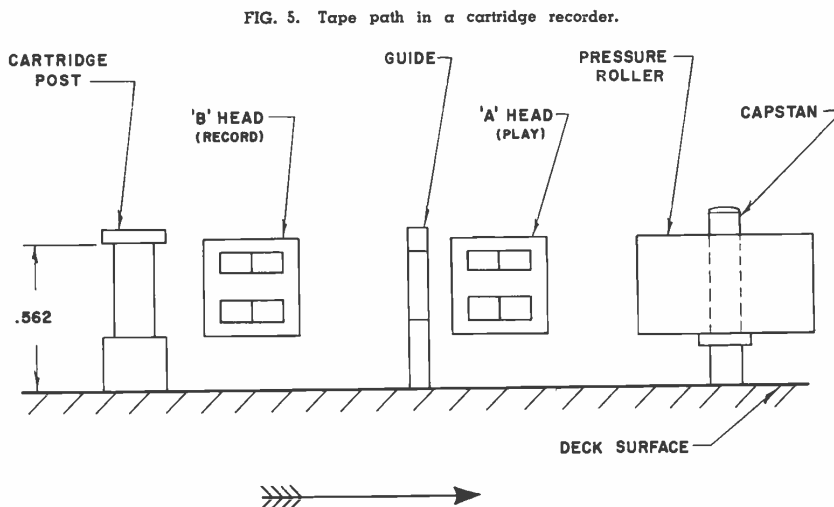

FIG. 5. Tape path in a cartridge recorder.

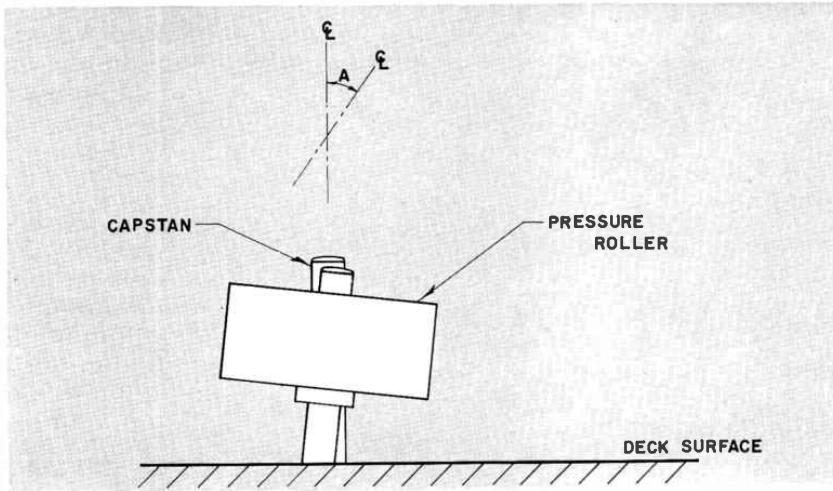

FIG. 6. Shaft misalignment in the tape plane.

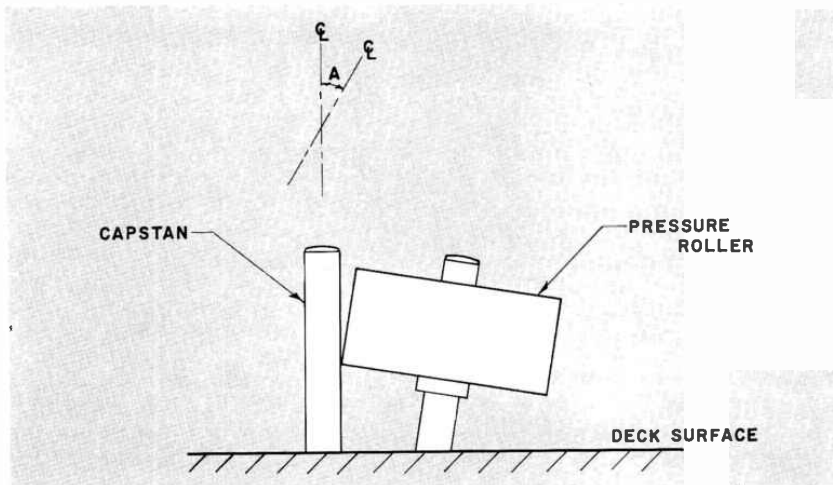

FIG. 7. Shaft misalignment normal to the tape plane.

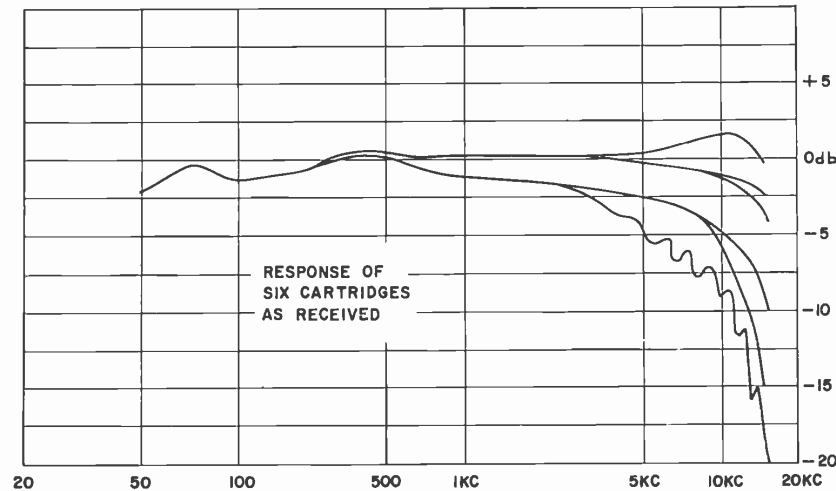

FIG. 8. Frequency response of six cartridges as received.

unless azimuth is adjusted for each cartridge. This, of course, is impractical. An example of post errors is shown in Fig. 8. This shows the response of a machine measured by six different cartridges.

In an effort to improve this response, the post heights of these cartridges, which were off by as much as 10 mils, were hand adjusted to within  $\frac{1}{2}$  mil. Another response run was taken, and is shown in Fig. 9. There are still serious variations. At this point it was noticed that the covers of the cartridge fit very tightly, and could warp the cartridges. After adjusting the covers for proper fit, the results shown in Fig. 10 were obtained. Notice that there is one cartridge still in trouble. This was traced down to too tight a loop in the cartridge (due to improper loading). After the loop was loosened, we obtained an overall response as shown in Fig. 11. The variations between cartridges is only  $\pm 1$  db at 15 kc. (This may have been caused by pressure pad variations.)

Newly redesigned cartridges perform very well indeed; the typical variation at 15 kc is now about  $\pm 1$  db.

While on the subject of pressure pads, it is worthwhile to point out that there is a tendency to blame them for just about everything. (This is probably because they are the only element that is visually wrong.) As a matter of fact, they aren't responsible for as much trouble as they are blamed for. This is demonstrated by Fig. 11. It is suspected that the earlier process of bending the pads into weird shapes to correct response simply put another error into the system that in reality partially corrected for something else (such as post height errors).

### Magnetic Heads

Other factors that affect response are characteristics of the magnetic heads, particularly the playback head. There are many head characteristics, one of which is the gap in playback head. Our friends in the "hi-fi" field often imply that their slow speed (supposedly wide response) tape systems were achieved by using narrow gap heads (such as 50 micro-inches) and that we ought to do the same. Of course, this is only part of the story.

As a matter of fact, there is no great problem these days in making a narrow gap. The gap spacer material can be purchased as a stock item down to about 90 micro-inches. The main consideration is that of head assembly. The gap must be straight-edged, if interchangeability is to be obtained.

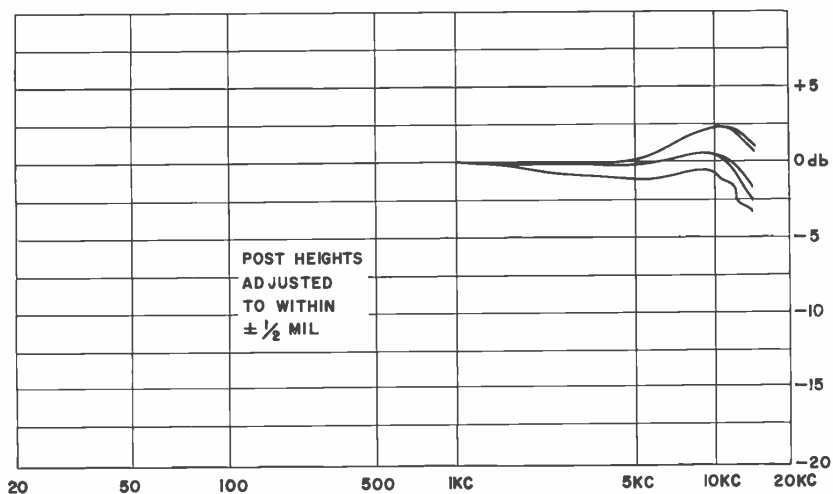

FIG. 9. Frequency response after adjusting post heights.

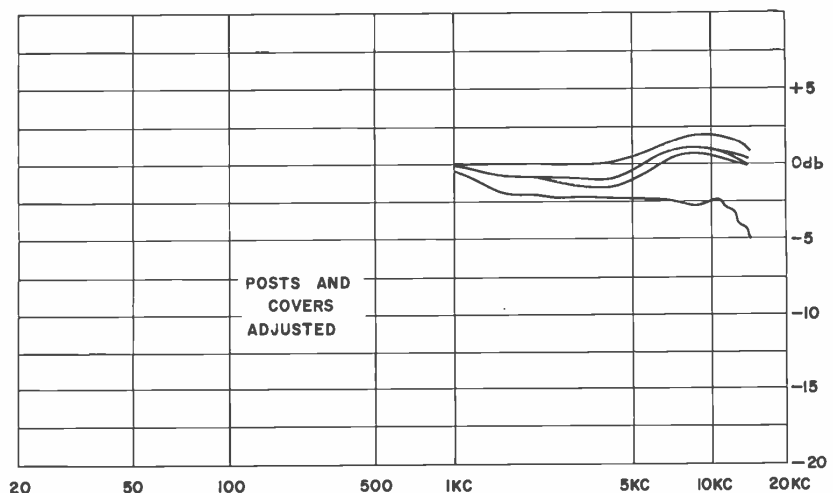

FIG. 10. Frequency response after adjusting posts and covers.

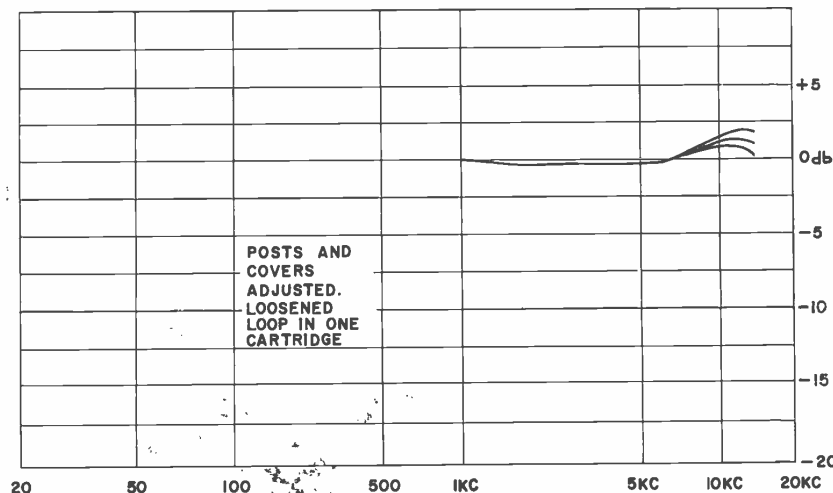

FIG. 11. Frequency response after adjusting posts, covers and loops.

In the process of evaluating magnetic heads, it is our practice at RCA to measure the gap with a toolmaker's microscope. We often take photo-micrographs for our records. Some of these are displayed in Fig. 12. In Fig. 12a, the edges are definitely not straight. (Incidentally, a graticule was photographed each time, and the space between the smallest divisions is 84 micro-inches—about 4 wavelengths of light). Figure 12a is supposed to be a 250 micro-inch gap. Figure 12b shows another type of error; the gap spacer is straight, but the two cores are not pressed tightly together, and the actual gap is about 150 per cent of the spacer! This is supposed to be a 200 microinch gap. In Fig. 12c, the material is smeared across the gap so badly that it is hard to recognize it at all, although this is supposed to be a 170 micro-inch gap. Finally, in Fig. 12d, a 100 micro-inch gap is shown that is very good for an audio recorder as verified by performance tests. The edges are reasonably straight and parallel.

**Miscellaneous Requirements**

The standard specifies that the basic cue tone (at the very beginning of a message) be a 1000 cps tone at about program level. The "end cue" is called out as a 150 cps tone, about 6 db above program level. The "random use cue" (for operating slide projectors, etc.) is an 8 kc tone, about 10 db below program level. All of these are accommodated in the new RCA cartridge tape equipment.

One area of the proposed standard that requires a little explanation is the signal-to-noise requirement. The old standard was actually a distortion (2 per cent)-to-noise requirement. The standard specified noise as 45 db below program level. On the basis of the old standard, this would amount to a little less than 51 db. However, the old standard was intended for full track equipment; cartridge equipment has a narrower track—about 1/3 the width; this represents a theoretical loss of 5 db. With this 5 db track width effect in mind, the two standards are about the same.

The same argument holds true for stereo, except that another 3 db is lost due to its track width, which is only 43 mils.

**Cartridge Tape Systems, RT-17 and RT-37**

These two new transistorized equipments provide ideal facilities for recording programs and commercials—making them available for instant selection and playback. The RT-17 monaural system—with its silent automatic operation, compact modern styling, and high-quality sound reproduction—adds new convenience to

both operation and maintenance. The tape deck is removable from the front for simplified routine maintenance. The stereo version, RT-37, adds still another dimension to the clean sound of this excellent performer.

Use of tape cartridges make cueing and threading of tape unnecessary. The desired cartridge is selected, placed in the playback unit, and instantly switched "on-air" at the touch of the start button. Remote control permits recording or playback from any desired location. By means of a trip-cue tone—which can be placed anywhere on the tape—either of the cartridge

tape systems can automatically trigger slide projectors or other equipment capable of being remotely started. An end-of-message cue can be used to activate additional playback units, reel-type recorders, etc., in a simplified form of automation. A third cue tone (automatically recorded each time the tape is started) re-cues each tape announcement so that it is ready for re-use.

#### Multi-Cartridge Playback System, RT-8

Designed for playback of a number of pre-recorded tape cartridges, the RT-8 system can be operated manually, sequentially or by pulses supplied from an automation system. Each unit houses four plug-in

cartridge decks, however, a number of units may be interconnected to provide 4, 8, 12, 16 or more playback decks in an operating system.

Three RT-8 models are available; one each for use with cartridges recorded on RT-7, RT-17, and RT-37 (stereo) systems. Plug-in cartridge decks, playback amplifiers and power supply modules are identical to those used in RT-17 and RT-37 equipments.

An optional feature of the RT-8 is provision for using a random trip cue to automatically activate slide projectors and other such devices.

FIG. 12a. Gap Photomicrograph (crooked edges).

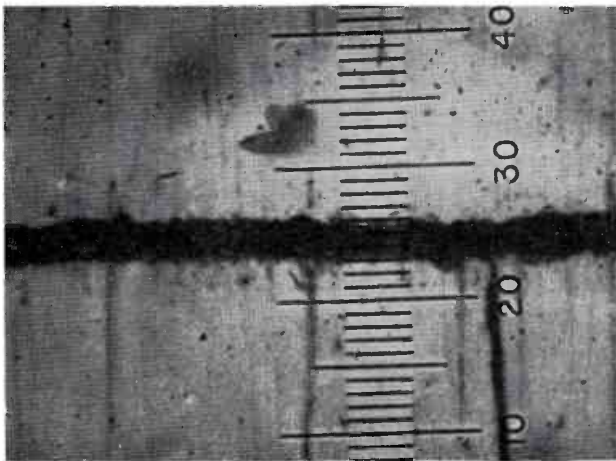

FIG. 12b. Gap Photomicrograph (cores not touching spacer).

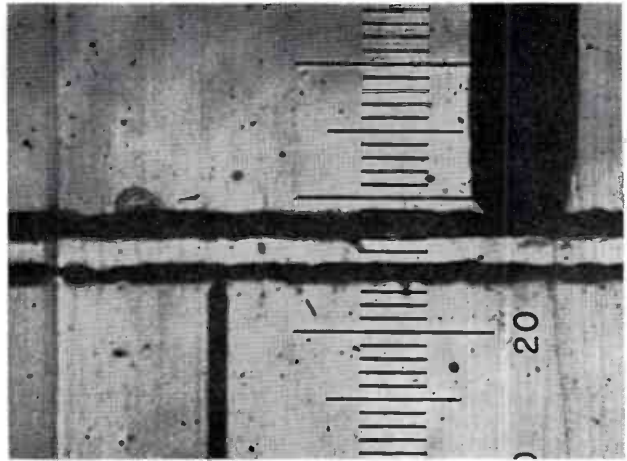

FIG. 12c. Gap Photomicrograph (gap smearing).

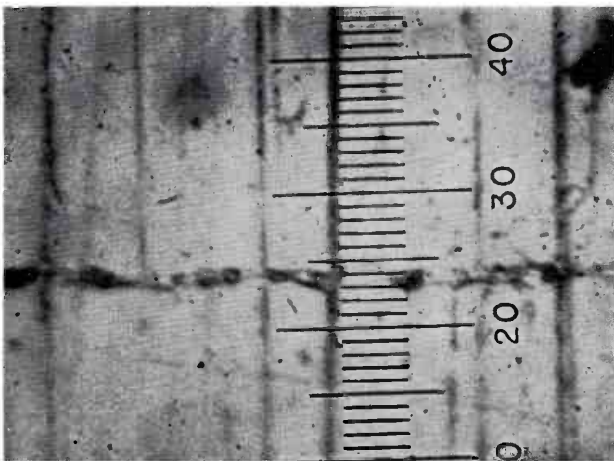
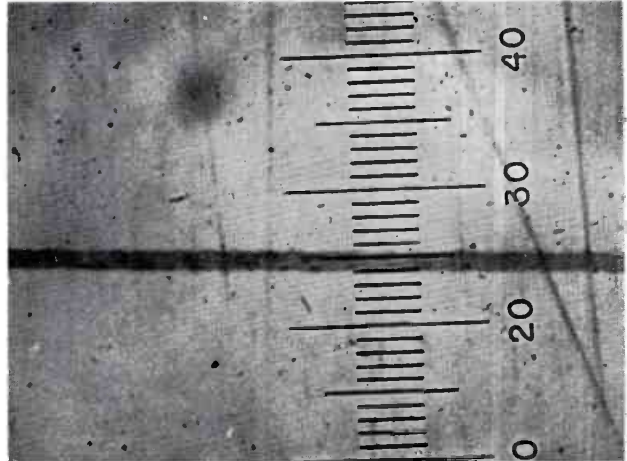

FIG. 12d. Gap Photomicrograph (satisfactory gap).





**RCA**  
**BC-7**

*Closest to Custom in a Production Consolette!*



## RCA Transistorized Consolette

for Dual-Channel AM/TV and FM Stereo

Take a good look at this smart new model. Here's that "custom" appearance to satisfy the proudest management; "custom" quality and flexibility to please the most discriminating engineers...all in a production-model!

**CUSTOM STYLING**—Striking new lines in blue and silver bring a color accent to control rooms. Color-coded operating controls are engineered to avoid errors. Only 39" long, it is compact and self-contained...to satisfy new or existing arrangements.

**CUSTOM QUALITY**—The BC-7A is fully transistorized for long-term reliability. All amplifiers have input and output transformers...precise impedance matching for both program and monitoring circuits. You get quality stereo monitoring (10 watts out-

put), quality gain controls, quality leaf-type key switches on all program circuits.

**CUSTOM FLEXIBILITY**—You have interchangeable plug-in modules...preamplifiers, isolation/balancing units, program amplifiers, monitoring amplifiers, cue amplifier and power supply—all in one self-contained unit. You get three-mode operation...selector switch to instantaneously convert from dual channel, parallel or stereo operation.

We can't name them all here, but we believe you will agree that this is the kind of customized styling, quality, and flexibility you want. Let your Broadcast Representative show you all the features that make this consolette your best buy. Or write RCA, Broadcast and Television Equipment, Bldg. 15-5, Camden, N.J.



Plug-in flexibility... preamplifiers for low-level sources... isolation/balancing units for high level sources.



High quality mixers...ganged step-type attenuators when in stereo... individual step-type when in dual channel use.



**THE MOST TRUSTED NAME IN ELECTRONICS**

# RCA SERVICE

keeps all your  
AM, FM, TV  
equipment  
in top  
condition !



*Amplifier Overhaul*

## TAKE ADVANTAGE OF THE FOLLOWING SERVICES OFFERED BY RCA:

- Video Tape Recorder Service • TV Camera Overhaul • TV Transmitter Overhaul
- Installation Supervision • Microphone and Pick-Up Repairs • Transmitter Performance Measurements • Antenna Inspection Measurements • Console Repairs • Microwave Service
- TV Projector Service • Custom Fabrication • Teletypewriter Maintenance

Your audience demands a superior signal which requires top performance from all your station equipment. RCA Broadcast Service is planned to assure you of meeting this objective. More than 30 years in the broadcast industry have provided a background of solid service experience. This is the type of protection broadcasters have relied on for years, the kind of protection you can count on . . . contract or per-call . . .

from the experts in the service business, RCA Service Company. To guard performance of all your equipment . . . simply telephone one of the following field offices: Atlanta (phone 355-6110), Chicago (WE 9-6117), Philadelphia (HO 7-3300), Hollywood (OL 4-0880). Or contact Technical Products Service, RCA Service Company, A Division of Radio Corporation of America, Bldg. 203-1, Camden, N.J. 08101.



The Most Trusted Name in Electronics

**NEW HEIGHTS OF POWER  
ON KIRO-TV**

**DELIVERS  
A CLEARER  
STRONGER  
PICTURE!**

**REACHING MORE HOMES... BETTER  
WITH TOP-RATED CBS PROGRAMMING!**

This newest technical improvement is another step in the planned progress of a great STATION-ON-THE-GO in the growing Puget Sound Market. Tested and proved by some sixty of the nation's leading stations, the traveling wave antenna delivers a clearer, cleaner and higher-powered signal.

Your PGW "Colonel" will give you the full story on the many other STATION-ON-THE-GO plans and accomplishments of the new KIRO-TV - the station to buy because it's the station-to-watch in the nation's SIXTEENTH market!

**KIRO  
TV 7**

CBS FOR THE GREAT NORTHWEST

KID-AM/FM/TV    KSD-AM/FM/TV

Associated with: WRUL RADIO NEW YORK WORLDWIDE    KSL-AM/FM/TV

just in time for the new Fall Season  
**WAPI-TV IS NOW  
ON THE AIR WITH  
A NEW TRAVELING  
WAVE ANTENNA!!**

**INCREASING PICTURE POWER IN EVERY DIRECTION**

Especially designed WAPI-TV's new "Traveling Wave" Antenna assures excellent circularity of signal pattern increasing picture power in every direction. This means much greater signal strength in the major metro areas of Anniston, Gadsden, and Tuscaloosa with a total of 71,800 TV homes.

**SUPERIOR METRO COVERAGE**

A special feature of the Traveling Wave Antenna is null free vertical radiation patterns for superior close-in reception.

**WAPI-TV BIRMINGHAM**

Represented exclusively by Birmingham, Apalac, and Phoenix, Inc.

**WAPI-TV BIRMINGHAM**

**BIRMINGHAM**

# They switched... and are they glad!

KIRO and WAPI are two of a growing number of TV stations that have switched from another type of antenna to the RCA "Traveling Wave" Antenna. Both of these stations are so pleased with the improvement that they have taken ads (above) to tell about it.

Naturally, we are pleased, too—but we are not surprised. Some sixty stations have

installed RCA "Traveling Wave" Antennas in the past few years.

The "Traveling Wave" Antenna, like other RCA broadcast equipments—cameras, tape recorders, transmitters—is for those who want the best. Your RCA sales representative will be pleased to tell you about it in detail. RCA Broadcast and TV Equipment, Building 15-5, Camden, N.J.



**THE MOST TRUSTED NAME IN TELEVISION**

# RCA TK-60 Mark of Deluxe Television

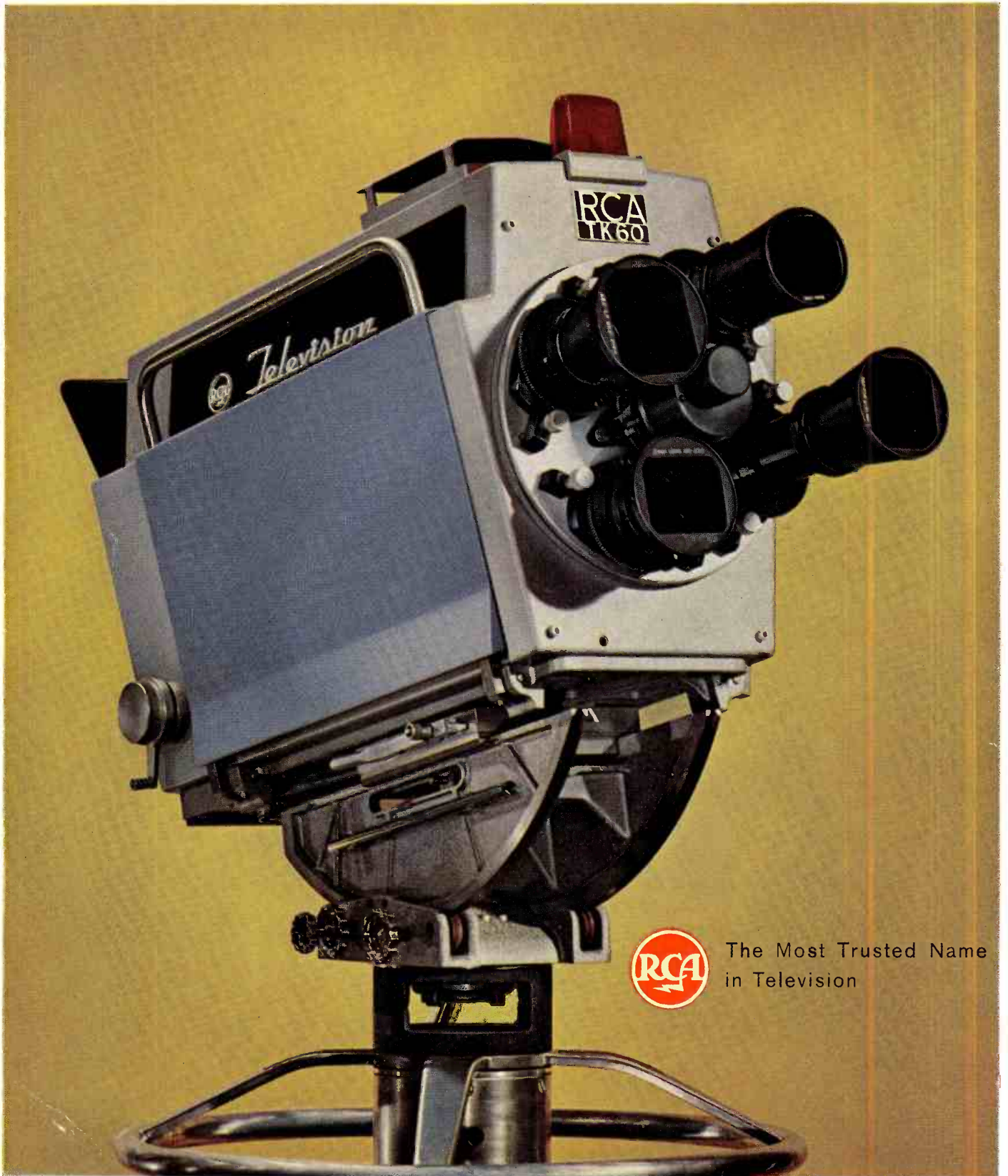

The Most Trusted Name  
in Television