

BROADCAST

NEWS

RCA - THE MATCHED LINE

20 KW FM TRANSMITTER
BTF - 20E
ULTRA-SPECIAL, ENGINEERED FOR BROADCAST COVERAGE

UHF TELEVISION TRANSMITTER
TTU - 110A

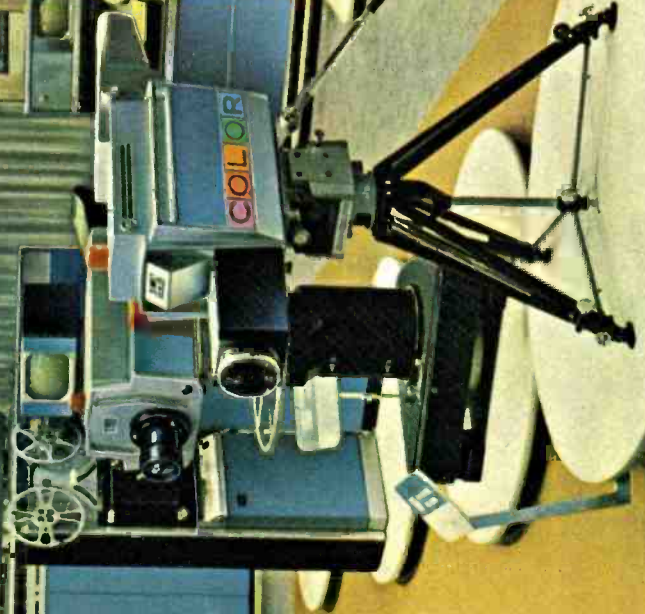

1967 NAB CONVENTION



Vol. No. 134
JUNE 1967

MAKES EVERY PICTURE SPARKLE!

FOR LIVE PICTURES...TK-42—world's most exciting camera! The secret's in the BIG black tube... Combined with three color tubes it means sharpest pictures, purer colors, more exciting contrasts. A "matched" equipment from RCA.



The Most Trusted Name in Electronics

Vol. No. 134

June, 1967

BROADCAST NEWS

published by

RADIO CORPORATION OF AMERICA
BROADCAST & COMMUNICATIONS PRODUCTS DIVISION, CAMDEN, N. J.

issued bi-monthly

PRICE *in U.S.A. - - - - - \$6.00 for 6 issues*
outside U.S.A. - - - \$7.00 for 6 issues

C O N T E N T S

	Page No.
Planning a Radio Station, Part II	6
Dual Polarization FM with Single Antenna	20
Making Color Slides the Easy Way	28
KTAR-TV Colorcasts Rodeo with TK-42 Cameras	38
KHVH-TV Brings Live Color to the 50th State	41
TR-70 International TV Tape Recorder	44
Parallel Operation of VHF TV Transmitters	50
New Vee-Zee and Zee Panel UHF Antennas	61

Copyright 1967 Radio Corporation of America All Rights Reserved Trademark(s) Registered. Marca(s) Registrada(s)

PRINTED
IN
U.S.A.

RCA SHOWS STUDIO SYSTEM OPERATING ON PAL STANDARD AT EUROPEAN TV MEETING

A complete system of U.S. color TV studio equipment, operating on the PAL broadcast standard adopted by most European countries, was demonstrated by RCA in Europe during May. The equipment was shown to officials attending the Fifth International Television Symposium in Montreux, Switzerland.

Major items demonstrated were the TK-42 studio color camera, the TK-27 color film system, the TR-70 color TV high band tape system and the TR-22 color TV tape recorder which had been converted to high band.

The Montreux exhibit represents a further RCA entry into the color television market that is expected to develop rapidly in Europe following the start of scheduled color broadcasting in several countries this year. RCA is a leading producer of color broadcast equipment, picture tubes, and home receivers in the United States. It has already established a subsidiary in England for the manufacture and sale of color picture tubes.

COLOR APPARATUS FIELD SEMINARS ATTRACT 800 TV STATION ENGINEERS

More than 800 television station engineers and other personnel attended color equipment seminars conducted by RCA specialists at 12 cooperating TV stations during the five-month period ended June 1. Additional seminars are slated for the summer months.

The one-day sessions heard technical discussions on how to achieve top performance from RCA color cameras and tape recorders and how to use studio lighting to best effect with the RCA equipment.

The field seminars supplement the technical meetings that RCA holds regularly for network and station representatives in the new training center in Camden.

Stations serving as hosts for the RCA field seminars were WSJS, Winston Salem, N. C.; WHDH, Boston; KGO, San Francisco; KGW, Portland, Ore.; KOGO, San Diego, Calif.; KSD, St. Louis, Mo.; WOOD, Grand Rapids, Mich.; WTMJ, Milwaukee; WMC, Memphis; WLBW, Miami; KWWL, Waterloo, Iowa, and WSB, Atlanta.

"With the development of studio equipment to meet European operating requirements, we believe we can contribute substantially to the advance of color service in many countries," said Charles H. Colledge, Division Vice President and General Manager, RCA Broadcast and Communications Products Division. "We expect at the same time that this will further establish RCA as a significant factor in the extremely promising growth market that color represents in Europe and elsewhere."

The RCA equipment shown operates on the PAL (phase alternation line) standards developed in West Germany and chosen for regular broadcast service by West Germany, Great Britain, the Netherlands, Austria and the Scandinavian countries. The PAL standards differ in their method of signal handling from the NTSC standards used in this country and in Canada, Mexico, Japan and the Philippines.

Great Britain is to begin color broadcasting on the PAL standards within the next few weeks, and the Germans have an-

nounced that they will introduce color programming on these standards in August.

RCA began development of broadcast equipment for PAL standards when it appeared likely that most of the Western European countries would choose these standards for their color television services. The apparatus was designed jointly by Laboratories RCA Ltd., in Zurich, Switzerland, and the RCA Engineering Laboratories in Camden. It is similar to that produced for NTSC broadcasters except for circuit modifications and the replacement of various solid-state circuit modules.

Four RCA TK-42 color cameras already have been delivered to the Italian network, RAI, and the TR-70 high-band color TV tape system is in pre-broadcast use in Germany, Austria and Italy. Other European broadcasters are installing the TK-27 color TV film system.

Following the Montreux demonstration, RCA demonstrated some of its TV studio equipment, including the TK-27 color TV film system, at the Industrial Radio and Television Exhibition held in conjunction with the Inter-American Association of Broadcasters in Buenos Aires.

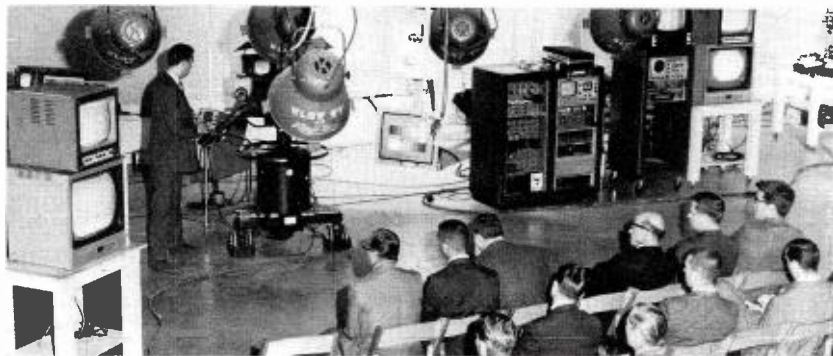

Sessions led by Colin Parkhill, RCA color camera specialist, on the TK-42, at WLBW-TV, Miami (above) and WMC-TV, Memphis, (below) were typical of seminars that attracted large turnout of station personnel.



RCA EXPANDS ANTENNA TEST FACILITIES AS UHF EQUIPMENT DELIVERIES DOUBLE

RCA has begun an expansion of test facilities at its 76-acre antenna engineering and production center near Gibbsboro, N. J., as part of its effort to meet the heavy demand for UHF transmitting systems. Shipments of such systems are currently being made at double the 1966 rate.

The expansion includes construction of a third turntable for testing of gain and vertical pattern coverage of UHF broadcast antennas before shipment. In such tests, the antenna is cradled in a wooden turntable and slowly rotated while radio energy is directed at it.

Energy coming from the test transmitter some three miles away is plotted by automatic recording equipment. The antenna's horizontal pattern is measured in the same way except that the antenna is mounted vertically on a small turntable.

TWO RICHMOND STATIONS SHARE STUDIOS, TOWER

WCWV, Channel 57, Richmond, Va., has begun operations from a studio facility and broadcasting tower it shares with a sister educational TV station, WCVE, Channel 23, in Richmond. The two stations involved in the unique arrangement are owned by the Central Virginia Educational Television Corporation, a non-profit community organization.

B. W. Spiller, its Vice President and General Manager, said the new Channel 57 operation will almost double the corporation's broadcast programs, which are directed to approximately 300,000 pupils in various school classroom audiences in the Central Virginia region.

Production and test areas for UHF transmitters at RCA's Meadow Lands, Pa., plant were expanded last year to handle the increased business.

The antenna facility, located some 18 miles from RCA's plants in Camden, N. J., has fabricated and shipped more than half of the TV broadcast antennas now in use.

Its output includes Superturnstile, Traveling-Wave, UHF Pylon, Supergain, V-Z panel and Z-panel antennas. In addition, the facility designs and produces TV and FM harmonic filters, TV transmitter filterplexers, diplexers, special waveguide components and related equipment.

Accompanying photo shows VHF antenna for KCRG, Cedar Rapids, under test. The complete antenna unit will be twice this height and fully covered by a special Fiberglass protector.

The two stations are using approximately \$1,000,000 in technical equipment supplied by RCA. A recently-acquired color film system will permit origination of educational film programs in color for the first time. Mr. Spiller said color programs are planned for the near future.

The first TV broadcasters to use RCA's Type TTU-30 UHF Transmitter, the corporation purchased a second unit for the new Channel 57 station. The two transmitters are located side-by-side.

A new studio, TK-60 cameras, and tape equipment were added to the plant to meet expanded needs of a two-station facility. Video equipment is linked by a common switching system so that either station may draw on any of the picture sources.



C. H. Colledge, RCA Division VP-General Mgr., breaks ground for antenna test facility expansion as A. F. Inglis, Division VP-Engineering, inspects results.

The second antenna installed on the corporation's 575-foot tower is RCA's "Vee-Zee" type whose reflecting panels cover all three of the tower's sides and extend vertically for 88 feet. The antenna is mounted about 10 feet below the tower top which supports the original Channel 23 antenna, an RCA Pylon type.

Mr. Spiller said the stations would be on the air each school day from 9 a.m. to about 4 p.m., with Channel 23 broadcasting elementary school subjects and Channel 57 high school subjects. Evening broadcasts on Channel 23 include cultural and public affairs programs and college courses for credit. Plans are being made for evening broadcasts on Channel 57. Initially, the station will operate during the day only.

Full engineering staff for Channels 57-23 shown at their on-air posts.



Chief Engineer B. D. Starling checks out new transmitter for WCWV.

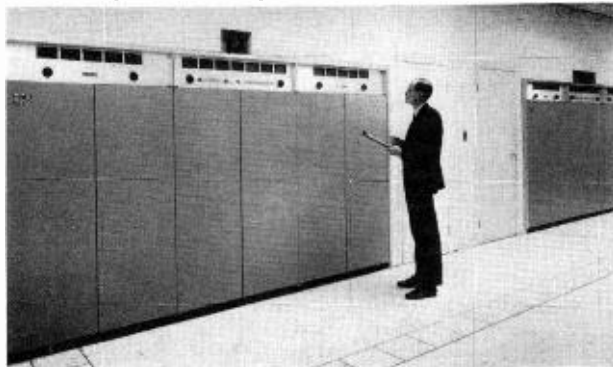



4 TV tape machines

Multiple generation tapes...

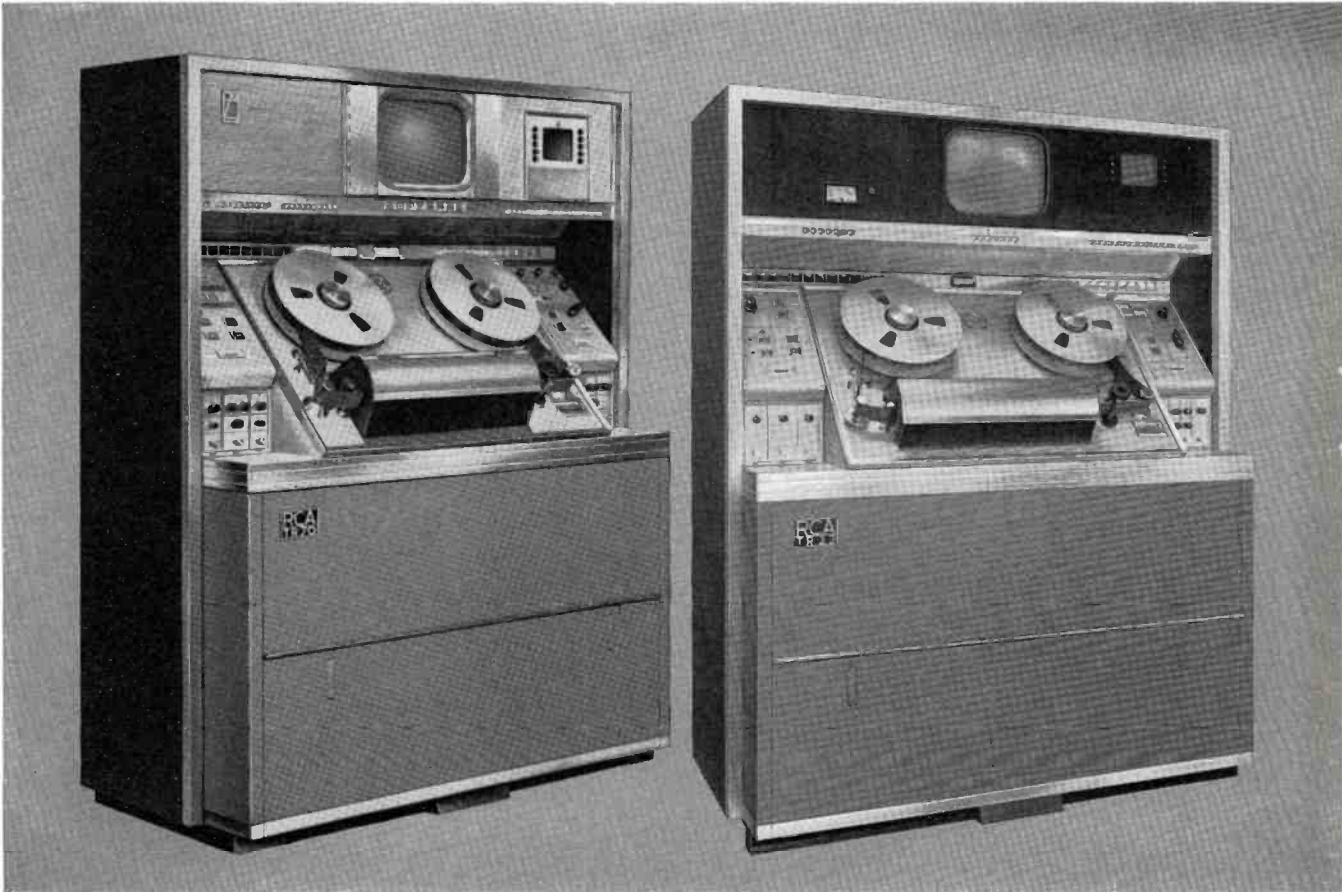

TR-70 SUPER DELUXE

This is the super machine! Designed, built, and tested as a completely integrated unit, for high band color recording and play back. Does everything that the very best recorder could do—with very newest features.

CONVERSION FOR TR-22

This is the unit that set the standards for the industry! Now can be high banded in line with RCA's policy to update existing equipment. Conversion makes it a high-quality high band machine. (High band conversion unit may be installed by the RCA Service Company for a nominal fee.)

Call your RCA Broadcast Representative. Or write RCA Broadcast and Television Equipment, Building 15-5, Camden, N.J. 08102

for High Band Color!

most brilliant color pictures!

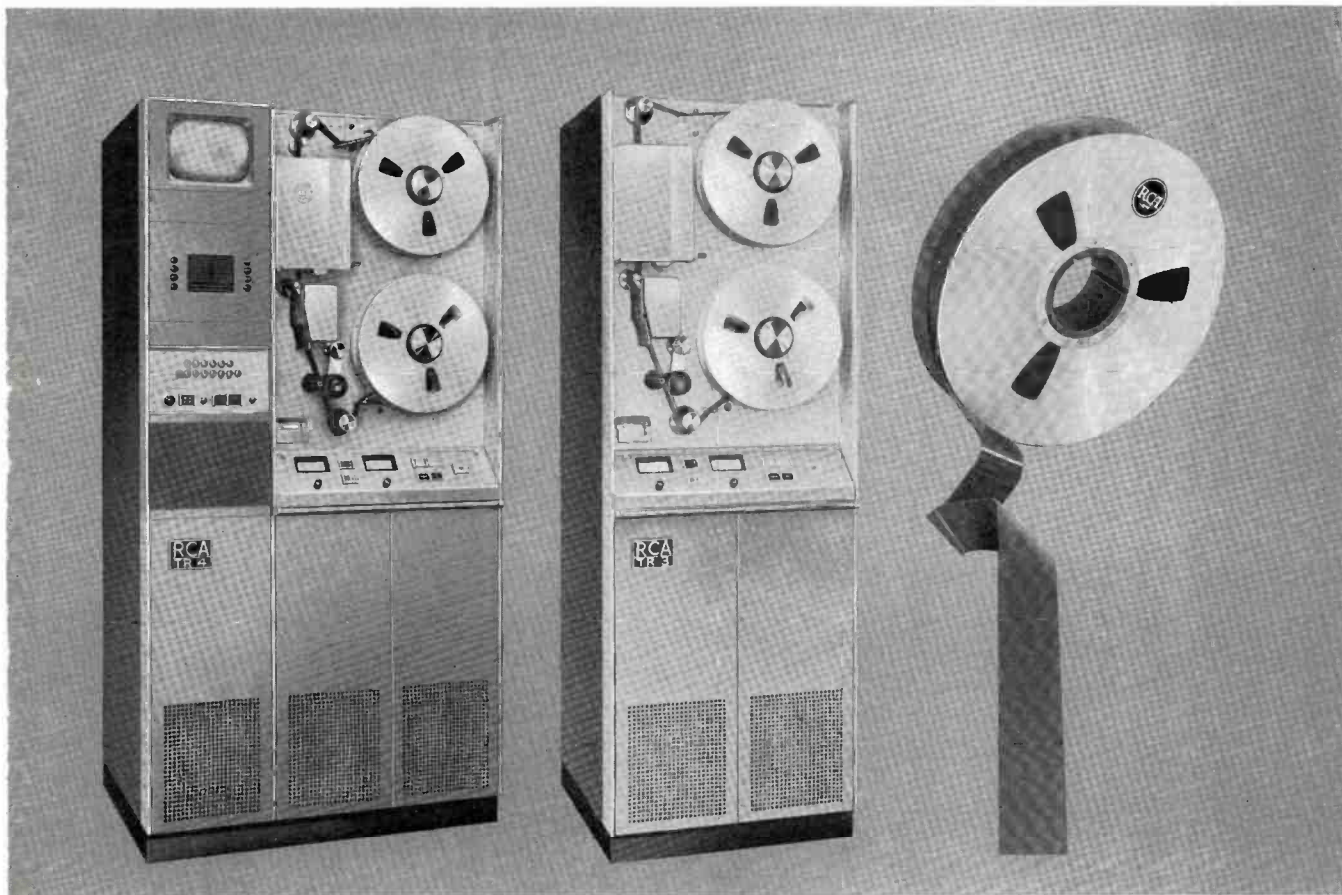

TR-4 HB NEW ECONOMY HIGH BAND

A new recorder, factory-built and tested for high band color. A complete machine, featuring simplified operation, with built-in picture and waveform monitors . . . for high quality pictures. Accepts full complement of high band accessories.

Note: All of these machines have instant low band and high band capability—at the push of a button—together with RCA's famous "human engineered" design for maximum convenience of operation and assurance of quality.

TR-3 PLAYER ONLY

This high band player can be in operation at your station for screening or broadcasting all kinds of tapes. Your present TR-3 player may be converted for high band color (or you may purchase a TR-3 together with high band unit). In either case, conversion unit may be installed on your premises.

NOW...

RCA VIDEO TAPE!

First time available... this is the tape you need to back up all the quality features in RCA tape machines. Series 7000 for standard or high band, with a wide range of reels, providing up to one hour in playing time. Notable for low headwear and signal-to-noise advantages. The finest tape modern technology can provide.



THE MOST TRUSTED NAME IN ELECTRONICS

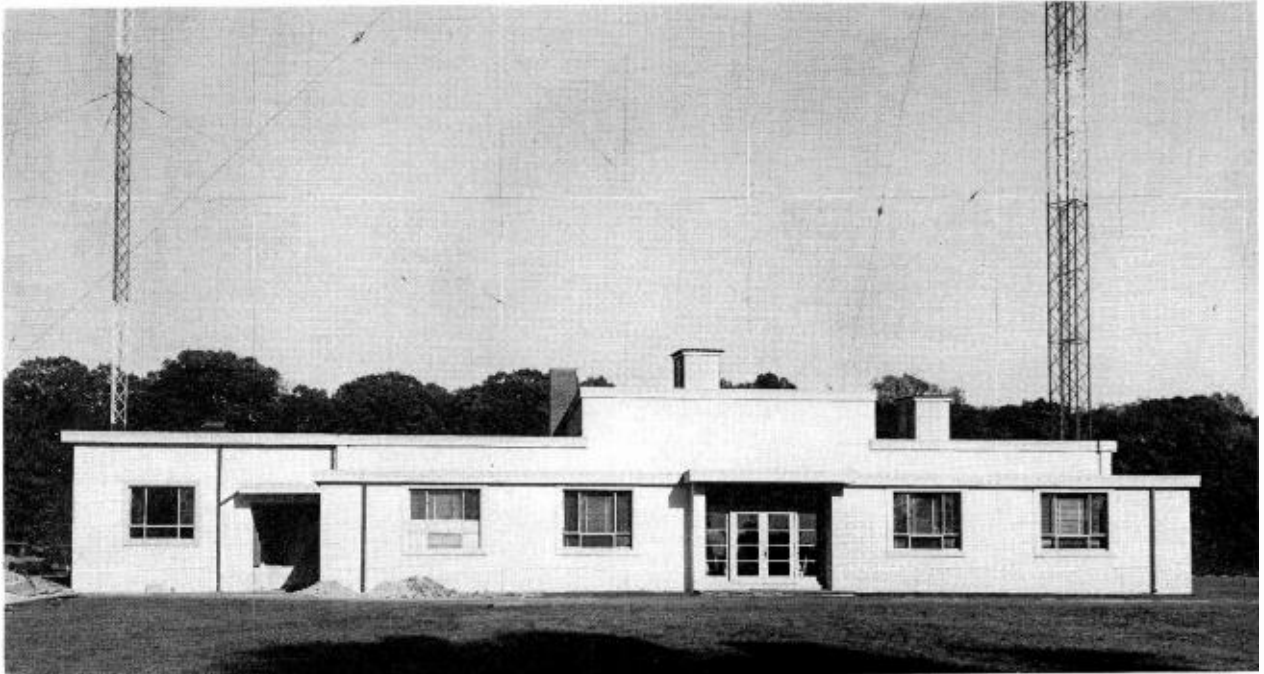

PLANNING AM/FM RADIO STATIONS

PART TWO: THE TRANSMITTING PLANT

(Editor's Note) This portion on radio station planning discusses factors to be considered in the design, layout and construction of the transmitter building, remote control systems, towers, antennas and transmission lines. Part Three, last of the series, will appear in a subsequent issue and will cover the selection, installation and maintenance of AM/FM broadcast equipment.

Transmitter Plant Requirements

Land and building space required for the transmitting equipment increases with station power, although even low power AM installations with directional arrays will require two or more towers as well as additional space in the transmitter building for phasing and branching equipment. FM stations do not need multi-tower arrays or phasing equipment, but provisions must be made in the transmitter building for an external power supply and overhead mounted harmonic filter.

A typical transmitter building layout for a one kilowatt AM directional is shown in Fig. 1. This floor plan, which can also

house up to a 10 kW FM transmitter, includes transmitter, phasing cabinet, equipment rack, work space and lavatory. Heating and air conditioning requirements, of course, vary with location. For higher transmitter power the building is usually expanded both in length and width to accommodate the larger equipments.

Types of Towers

The radiating element of today's AM broadcast stations, of course, is the tower itself, while for FM stations it serves only as the antenna support. Combined AM and FM stations can use the tower both as an AM radiator and an FM antenna support.

Towers are divided into two basic types: self supporting and guyed. Either type may be made in a grounded or insulated version. Towers that will serve as AM radiators are usually insulated and are series fed. Grounded towers may be used as AM radiators if shunt feeding is used. Self supporting towers are used where space is limited. They require no guys and the distance between tower legs is normally about one-eighth the total height of the structure. However, guyed towers are more commonly used, though the guys may extend out as far as 75 percent of the tower length. They are less expensive and generally of a smaller, uniform cross section, making a

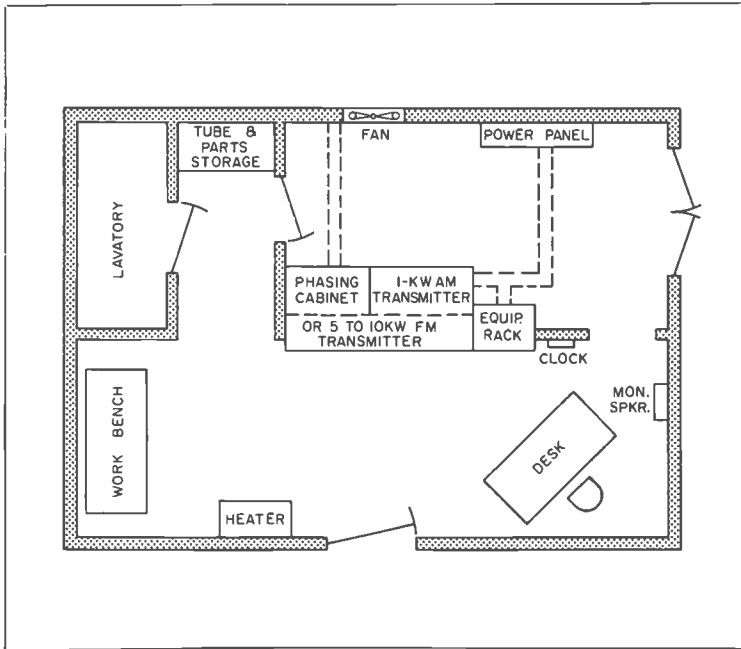

FIG. 1. Typical transmitter building layout for a one-kilowatt AM directional. Floor plan can also accommodate up to a 10-kW RCA FM transmitter.

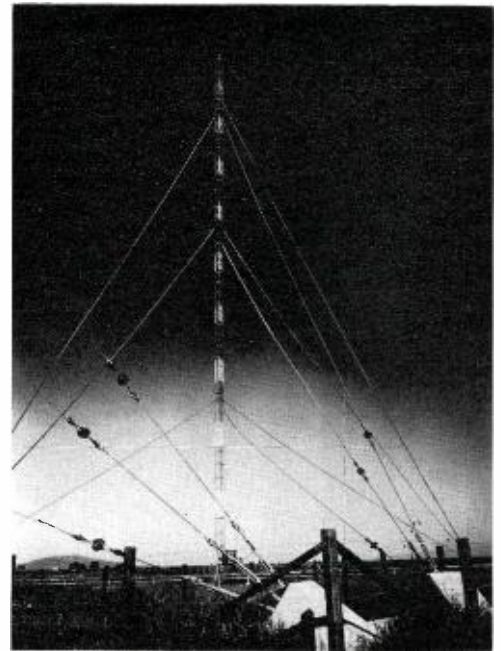

FIG. 2. Insulated guyed tower. Small building at tower base houses antenna tuning unit.

very satisfactory RF radiator for AM installations.

Tower lighting equipment must conform to FCC/FAA requirements as specified on the construction permit. AC lines for tower lighting can either be buried or mounted on the poles supporting the transmission lines. Lighting circuits must be isolated from RF circuits when an insulated tower is used as an AM radiator. This is provided by using either an antenna lighting choke or a lighting transformer. Both devices supply AC to the tower lighting circuits and at the same time prevent appreciable loss of RF energy into the AC power lines.

AM Tower Arrays

An AM station may employ a single tower radiating an omnidirectional signal; but more often, an array employing two or more towers is required to limit radiation in the direction of other stations occupying the same or adjacent frequencies.

Figure 7 illustrates the layout of a typical two-tower directional antenna system. Small buildings have been included at the towers to house the antenna tuning units,

HOW THE ENGINEERING CONSULTANT CAN HELP

At no other phase of station planning are the services of a competent broadcast engineering consultant needed more than in the laying out of the transmitter and antenna installation. Here are some aspects of station design that should be left entirely to him:

- Establish authorized operating frequency and power
- Prepare radiation coverage pattern
- Design antenna system and prepare specifications
- Perform antenna system tuning adjustments and proof of performance tests for FCC

isolation coils, lighting chokes and beacon flashers. Phasing and branching equipment and the phase monitor are located in the transmitter building with the transmitter.

The FCC requires that a radiation pattern of the proposed antenna system be filed by applicant prior to the grant of a c-p. The consulting engineer derives this pattern mathematically to produce radiation in the desired direction and at the same time offer the protection required by other stations.

The station's radiation pattern is determined by the number and location of towers, the phase relationship of the RF signal supplied to each tower and the way in which the power is divided among towers. Power distribution and phasing is achieved by the phasing and branching equipment. This equipment is usually located in the transmitter building in a cabinet matching the transmitter. But depending upon requirements, it can be installed on open panels elsewhere in the transmitter building or in a small weather-proof building near the center of the antenna array.

Specifying AM Phasing Systems

The phasing system is the heart of the AM transmitting plant, being called upon to maintain the station's radiation pattern over long periods of time without failure or need for adjustment. Phasing equipment design and cost varies with its quality and complexity. The simplest "jeep" systems employ a single coil with power takeoffs for the various towers in the array. An "ohms law" phasor employs a separate coil for each tower, and features easier setup since there is less interaction between adjustments.

Frequently, requirements for special design or exceptional quality in phasing equipment add a substantial cost factor to the tower system. For this reason, if the filing data submitted to FCC in the application is to be used for cost estimating purposes, it should be accompanied by design information prepared by the consultant that will alert the supplier to the unusual conditions that must be satisfied in the design. Beside the usual array parameters, the data should state:

1. Recommended type and length of transmission line.
2. Type phasor preferred, with components specified, if necessary.
3. Where remote control or front panel control is required.
4. Particular metering requirements.

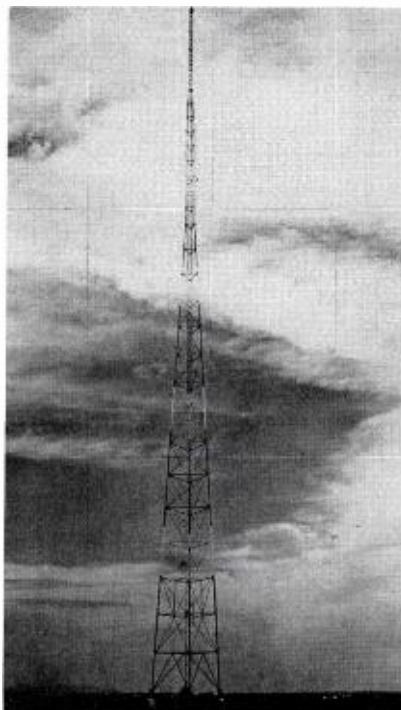

FIG. 3. Self supporting tower. Large base area eliminates need for guys.

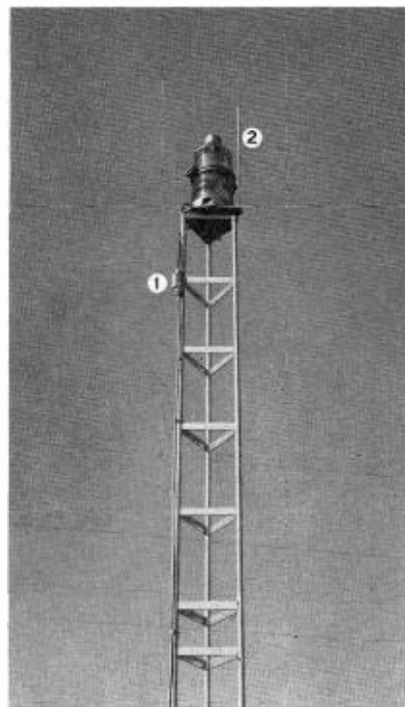

FIG. 4. Tower lighting beacon with junction box (1) and lightning rod (2).

5. Phasor mounting: in cabinet, open construction.
6. Whether tuning units will be in weather proof houses or of open construction.
7. Monitoring requirements.
8. Tower lighting isolation requirements.

A well prepared specification for phasor design assures a system that will not only comply with FCC requirements, but also be stable, easy to adjust, and require only a minimum of maintenance.

Tower Survey Required

The radiation pattern developed by the engineering consultant is based on theoretical computations and ideal conditions. This makes it extremely important to exercise care in the installation of the system so that variations from the ideal are held to a minimum. Spacing and orientation of towers are extremely critical, since an error in tower alignment may make it impossible to achieve the required radiation pattern. To provide an accurate layout of the antenna towers and satisfy the terms of the specifications, the services of a registered civil engineer or surveyor should be obtained.

Ground Systems

A ground system is required at the base of each tower to simulate as closely as possible the perfectly conducting plane earth assumed in computing the pattern. The ground system usually consists of at least 120 radials of No. 10 soft copper wire, as long or longer than the tower is high. The radials are laid in furrows spaced three degrees apart around the entire tower base. Then a ground screen or mat made of expanded copper mesh is laid over the radials and completely around the tower base, covering an area anywhere from approximately 12 to 24 feet square. The entire system is then bonded together by silver soldering, brazing or welding. In some cases, the ground screen or mat can be replaced by short radials about 50 feet long between the full length radials. All radials should be bonded to a copper strap or to a bundle of seven copper wires around the tower base. It is usual to have a copper grounded strap on each face of the tower support pier. These straps criss-cross under the tower insulator. A similar strap or bundle of wire is required to tie tower bases together as shown in Fig. 11. If the towers are spaced such that the radials do not meet, the radials that can intersect should

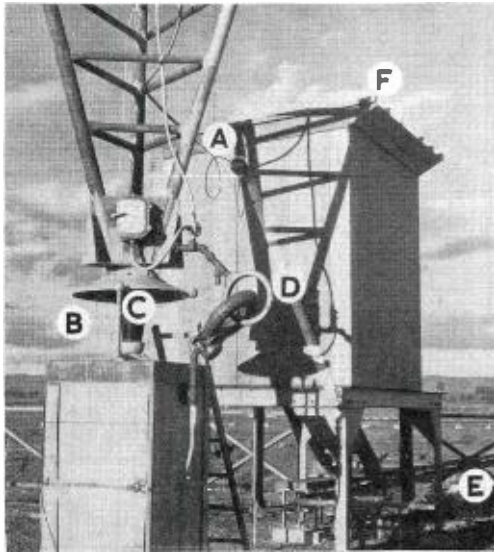

FIG. 5. AM tower showing protective lightning loop (a), tower insulator (b), lightning spark gap (c), lighting transformer (d), transmission line (e) and tuning equipment house (f).

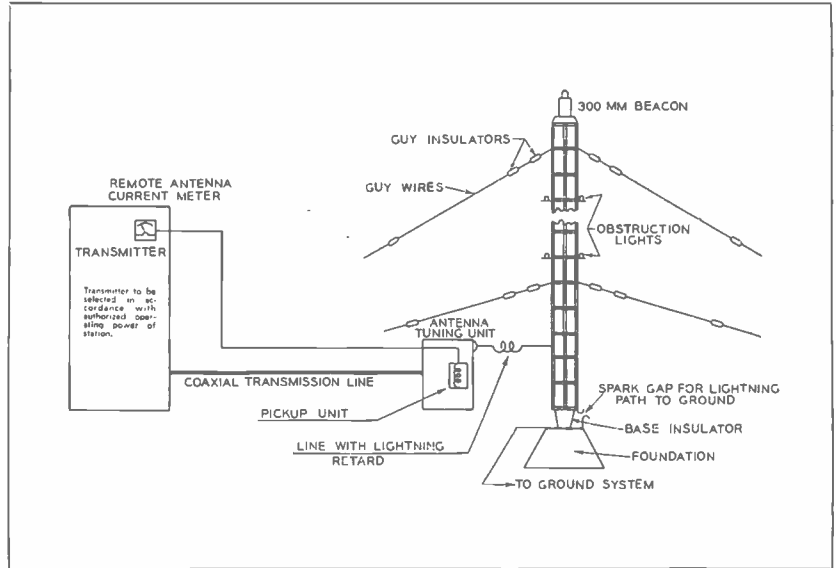

FIG. 6. Typical single tower AM system, showing pickup unit for antenna current measurements, elements of tower installation and position of tower lights.

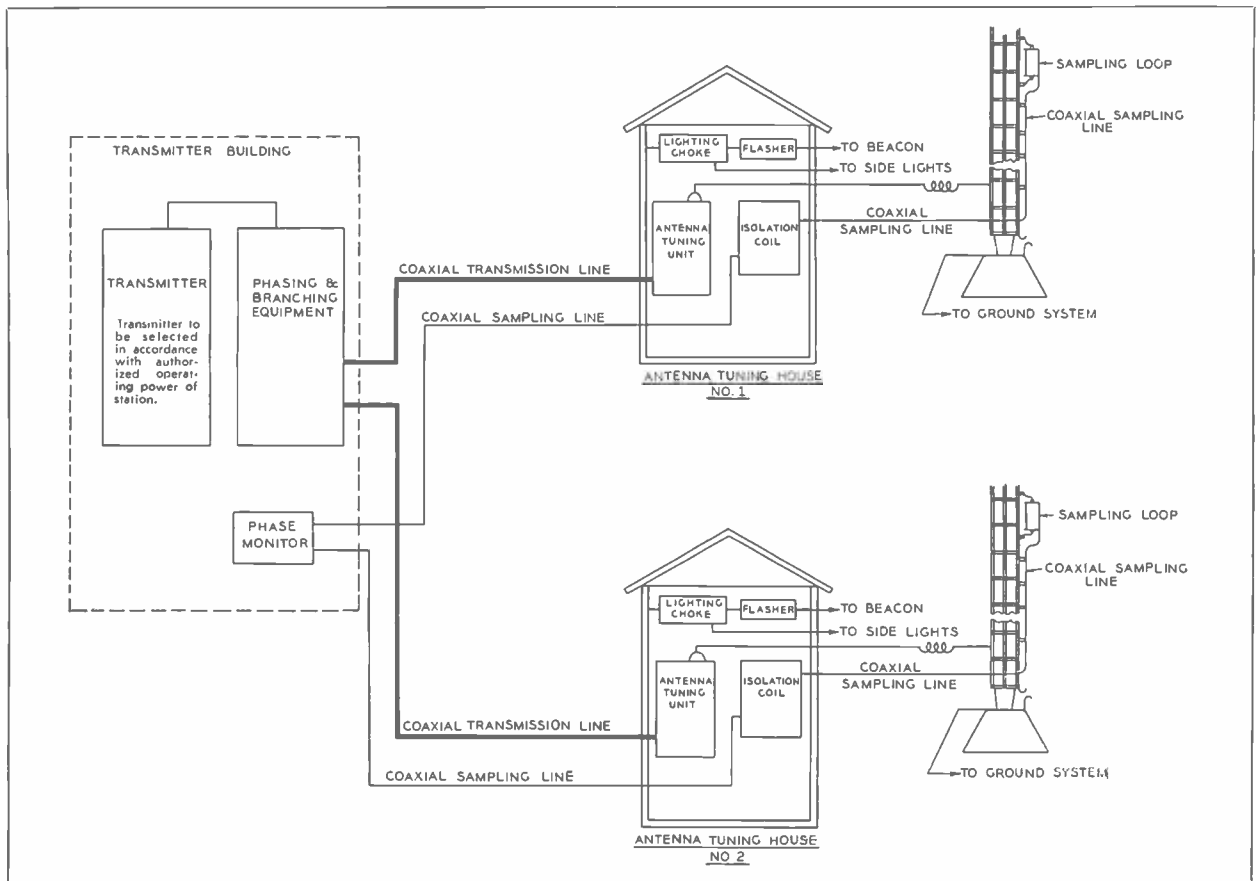

FIG. 7. Typical two-tower directional AM system showing arrangement of phasing and branching equipments.

be extended to a point where they overlap and be bonded in the same way. If the transmitter building is located close to the tower or within the circumference of the ground system, a copper bus or strap should go around the building at the foundation with all radials that approach the building bonded to it. Radials are normally buried just below the surface of the ground, deep enough to protect them from mechanical damage. The actual length and number of radials, the size and shape of the ground system depend upon conditions and should be determined by the engineering consultant.

A chart giving tower height in feet for each 10 kHz increment in the broadcast band is given in Fig. 14.

AM Tower Feed Systems

The two most commonly used methods of feeding tower radiators are the series fed and shunt fed systems diagrammed in Fig. 12. Both systems utilize either 52 or 72 ohm air or solid dielectric coaxial transmission line, and line terminating units (LTU) located in a "dog house" near the base of the tower.

The series fed system requires a tower base insulator, while in the shunt fed system the tower is grounded directly and energy is supplied to the tower via a copper conductor connected to a point well up the tower. The section of tower between the feed point and ground in the shunt fed system serves as an element of sufficient impedance that in combination with the matching network effects a satisfactory transfer of power from the transmission line to the tower.

The transmission line feeding the LTU or ATU (line or antenna tuning unit) can be buried if it is the type of line recommended for that purpose. Alternatively, it can be supported on wood or metal posts and if desired, enclosed in a wood trough for protection against damage from falling ice or other objects. The trough should measure at least four by eight inches, have a removable top and be no more than 36 inches above ground if possible.

Rigid air dielectric coax should always be laid out as straight as possible. Bends, sags or bumps should be avoided, since the flanged seals may have a tendency to leak if there is a bending strain. One end of the line should be anchored and the other left free to move as the line expands and contracts. Portions of the line that run in proximity to the ground system should have the outer conductor bonded to the ground system every 20 feet, preferably to the heavy copper strap running between the towers. In any case, the outer conductor is

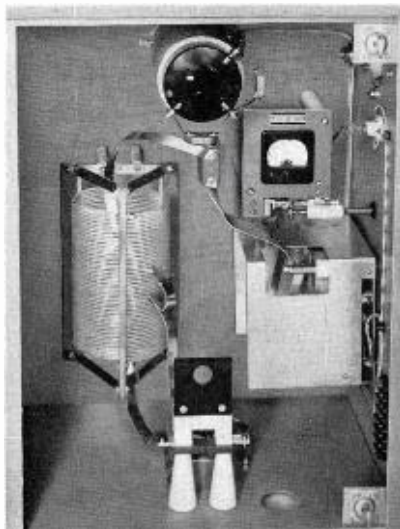

FIG. 8a. Antenna tuning unit. Lightning choke is at top of cabinet.

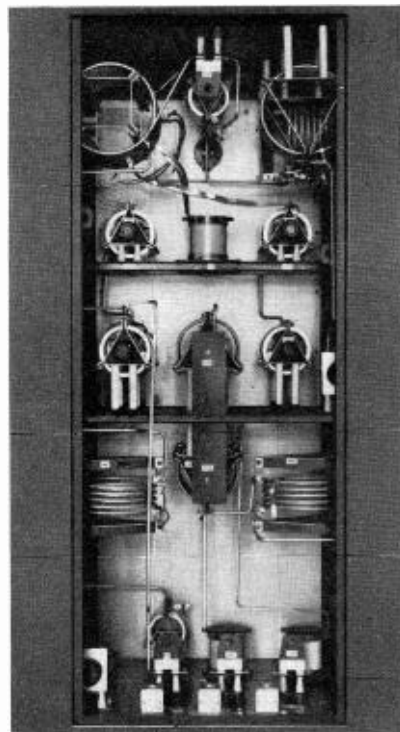

FIG. 9. Phasing equipment for a three-tower system.

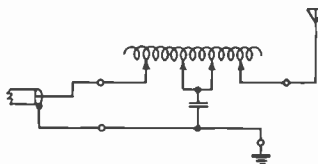

FIG. 8b. Simplified schematic of tuning unit.

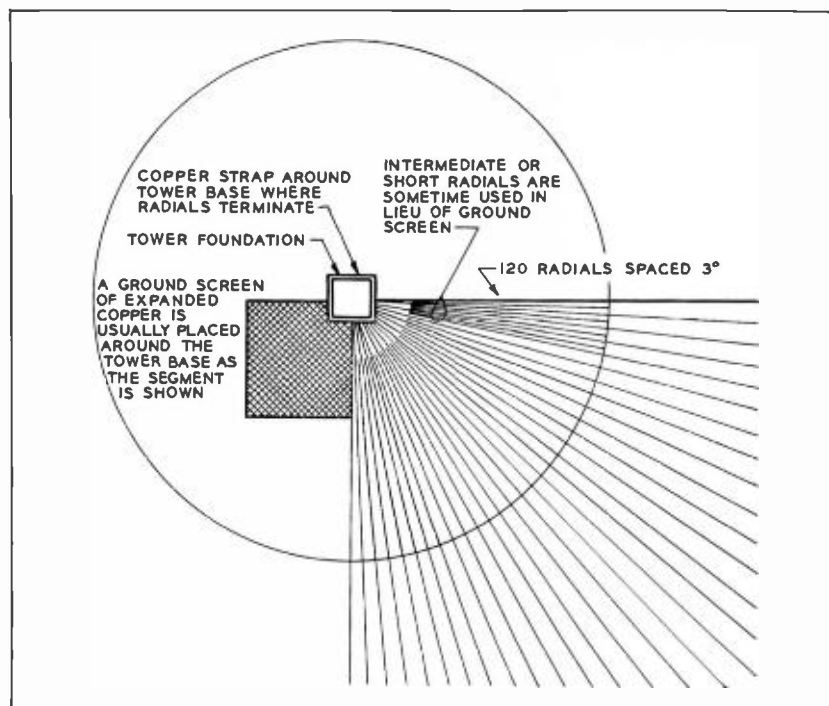

FIG. 10. Typical ground system. Radials and ground screen are positioned all the way around the tower base in each of the four quadrants as shown.

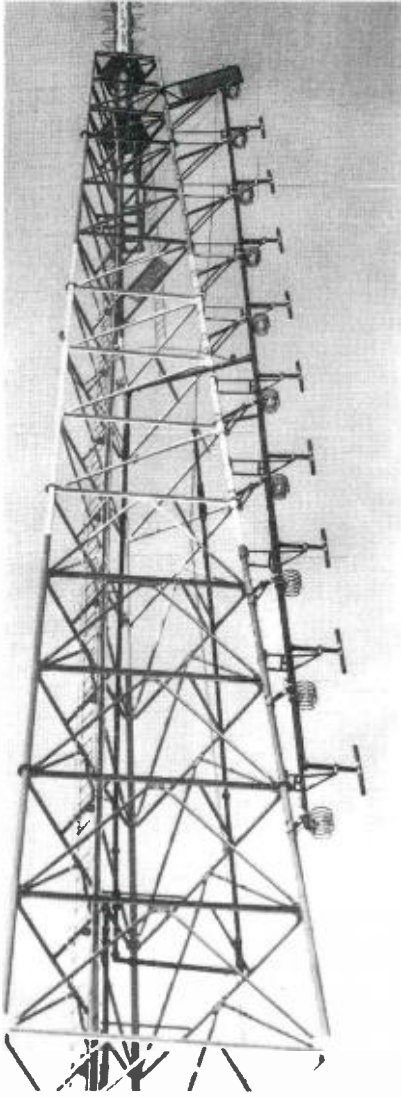

FIG. 15. Interlaced BFA-10 and 300-9V antenna elements side mounted on TV tower.

and horizontally polarized antennas (or by existing stations adding a vertically polarized antenna to their present system) or by installation of a circularly polarized antenna. Each method, of course, requires either additional transmitter power or higher antenna gain to match the original ERP obtained from simply a horizontally polarized radiator.

Achieving V/H Polarization

A signal containing both vertically and horizontally polarized electric vectors can be obtained by: (1) mounting both vertically and horizontally polarized antennas on the tower, and using a power divider either at the base of the antenna or at the transmitter building to split the feed to both antennas; and (2) by using a circularly polarized antenna. For these uses, RCA offers these three antennas: the Type 300-V vertically polarized coaxial antenna rated for power up to 3 kW per section; the Type BFA horizontally polarized antenna for up to 5 kW per section; and the BFC circularly polarized antenna rated at 10 kW per section.

Combined vertically polarized and horizontally polarized antennas are more expensive than the circularly polarized antenna, but they may be of special advantage to broadcasters who already have horizontally polarized antennas and wish to add vertical radiation to their system. The dual antennas for this purpose should have essentially the same gain. They can be mounted in almost any position on the tower, but preferably they should be mounted at the same height and the V and H elements interleaved. Antennas of equal gain mounted this way and fed in quadrature radiate an elliptically or circularly polarized wave. While as yet there is no proof, circular polarization is generally considered superior to that produced by a hap-hazard combination of vertically and horizontally polarized

radiating elements. These dual antennas also have the disadvantages of additional weight and higher wind loading than that of a single antenna such as the BFC.

Circular Polarization

Circularly polarized radiation with low VSWR for optimum stereo and multiplex operation can be obtained from any of the BFC Series of FM antennas. These antennas provide equal vertical and horizontal power gains from 0.46 for a single section, to 8.9 for 16 stacked sections. No external combiner is required since power division is accomplished within the antenna. The BFC antenna has a power capability of up to 10 kW per section.

As in the case of the combined antennas, the circularly polarized antenna will require either twice the transmitter power or twice the antenna gain for a given ERP obtained from the horizontally polarized only antenna. This can be seen by comparing the systems. Transmitter power and antenna gain requirements are computed as follows:

$$ERP = P \times G \times \text{Eff}$$

where:

$$P = \text{Transmitter Output Power}$$

$$G = \text{Antenna Power Gain}$$

$$\text{Eff} = \text{Transmission Line Efficiency}$$

For purposes of simple calculation, it can be assumed that the BFC circularly polarized antenna has a gain of approximately 0.5 per section. For the BFA horizontal radiator as well as the 300-V vertical, the gain is approximately 1.0 per section. Therefore, for either the combined V and H antenna or the circular antenna, the gain should be calculated at $\frac{1}{2}$ per section since power fed to each antenna system is equally divided between the vertically and horizontally polarized modes. This method is useful

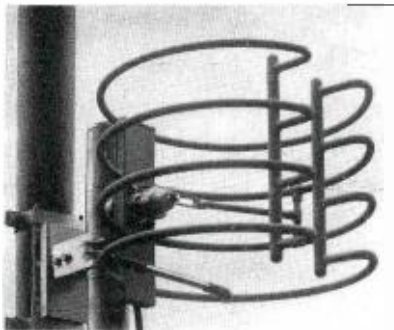

FIG. 16. Radiating element of BFA horizontally polarized FM antenna.

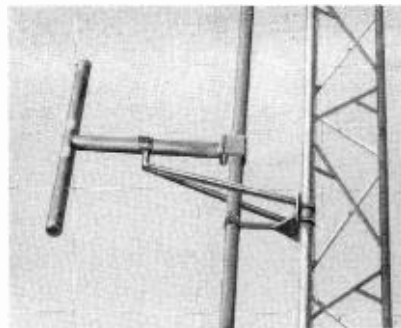

FIG. 17. Radiating element of 300-V vertically polarized FM antenna.

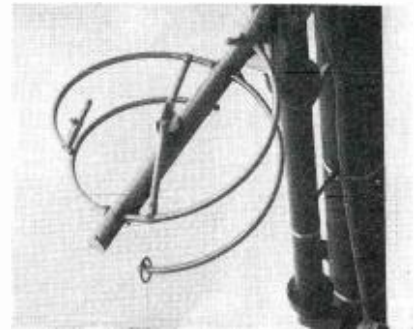

FIG. 18. Radiating element of BFC circularly polarized FM antenna.

TABLE 1. TYPICAL POWER CALCULATIONS

POLARIZATION	TRANSMITTER OUTPUT POWER (X)	TRANSMISSION LINE EFFICIENCY (X)	ANTENNA POWER GAIN (=)	ERP
Circularly Polarized Antenna (BFC-6)				
Horizontal	17.16 kW	0.91	3.2	50 kW
Vertical	17.16 kW	0.91	3.2	50 kW
Note: Total Power Output Requirement is 17.16 kW				
Combined Antennas (BFA-6B and 300-6V)				
Horizontal	8.71	0.91	6.3	50 kW
Vertical	8.60	0.91	6.39	50 kW
Note: Total Power Output Requirement is 8.71 kW plus 8.60 kW or 17.31 kW				

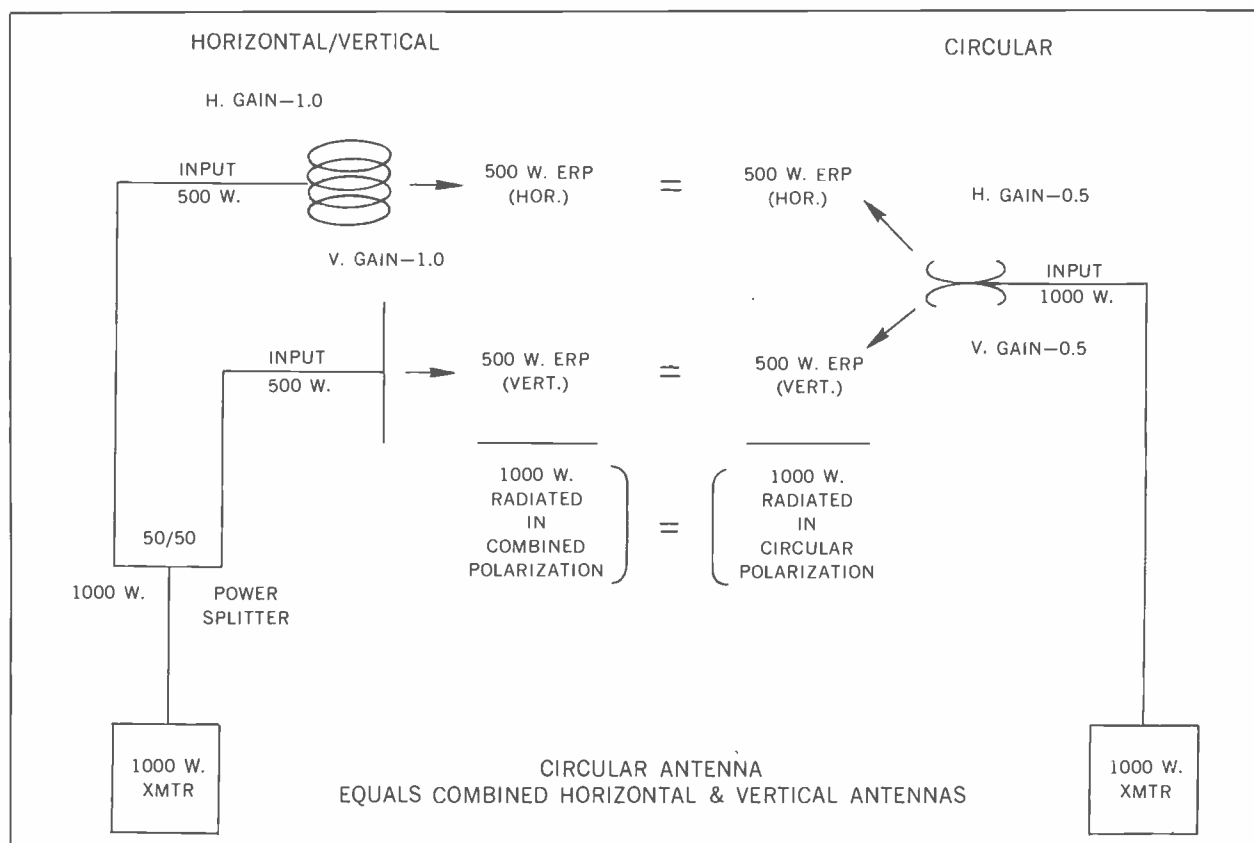

FIG. 19. Chart comparing feed systems and effective radiated power of circularly polarized antenna with combined horizontally and vertically polarized antennas. No power splitter is required for the BFC type antenna.



FIG. 24. RCA Type BTG Automatic Logging Equipment. Six systems are available providing local or remote logging of up to 20 functions.

because a minor fault resulting in a power shutdown may cause considerable loss of air time.

Basic Systems

RCA offers two basic remote control systems, a Type BTR-11B providing 11 control and 11 metering functions, and a BTR-20D that performs 20 control and 20 metering functions. Both include "home" and "calibrate" positions which utilize one control and one metering function in each system. The 20/20 system is expandable to 40/40 by using an RCA BTRX-40A extension unit.

Figure 23 is a simplified diagram of the remote control equipment showing the "master" unit at the studio and the "slave" unit at the transmitter. Control orders are sent to the transmitter via telephone lines. A second telephone pair with a 5,000 ohm loop resistance carries metering information back to the studio.

Equipment is available for conversion of the BTR-20D Remote Control System to tone operation. This permits operation on a single voice-grade telephone line or microwave equipment.

Control and metering signals between the units consist of four DC voltages (positive, negative, high level, low level) and a 60 cycle tone. The tone is a fail-safe feature that removes the transmitter from the air (as required by FCC) should any fault or loss of power develop in the control circuits.

In the tone version, discrete tones are substituted for the DC and 60 cycle signals.

Accessories may be added to perform virtually any operation such as the switching in of an emergency power plant, measurement of antenna base currents in large arrays, tower light metering, standby transmitter switching, antenna pattern switching and many others. In addition, a Type BTRA-5C Tone Alarm system that utilizes the same remote control lines as the BTR units is available to detect as many as five separate conditions such as building over temperature, smoke, burglary, in fact, any condition that can be electrically sensed.

Automatic Logging

RCA automatic logging equipment is designed to record all operating parameters required by FCC regulations as well as other important functions. Equipment supporting 5, 10 and 20 functions is available for local operation, or for remote operation

in conjunction with RCA BTR Remote Control systems.

Easily read, single point strip chart recorders log up to five operating parameters each. Parameters are selected sequentially by a stepping switch. Each function is recorded within a two second period. Chart paper is the inkless pressure sensitive type requiring a minimum of attention.

Various transducers are available to provide the standard one-volt DC required for full scale readings. The system also may be expanded to include the BTRA-5C Tone Alarm.

The control module of the BTG Series Logging systems is a self contained, solid state plug-in device. The operational amplifier, also plug-in, is stabilized by approximately 80 dB of feedback. Only solid state electronic switching is employed.

Construction and Installation Notes

Construction of the station and installation of equipment will vary with the station plan, local conditions and other factors. During this time, the advice of an engineering consultant is a necessity. Plans and equipment requirements should be reviewed with the consultant and with an RCA broadcast sales representative.

A typical work schedule is given in Table 2, and is as follows: tower foundations, tower erection, tower lighting equipment, buildings, ground system, inside technical equipment, antenna resistance measurements, equipment tests, tuneup of phasing equipment, pattern measurements, proof of performance, and program tests. A delivery schedule should be worked out with the supplier to assure arrival of items when they are needed.

Tower Construction

Towers must be designed to withstand the maximum wind velocities that may be encountered. Tower foundation specifications for a given tower and for normal soil conditions having an allowable pressure of 4,000 pounds per square foot, will be supplied by the tower manufacturer. If soil conditions are abnormal, or not known, test borings may be necessary as a worthwhile safety measure. Foundations and guy anchors should be poured at least a week or ten days before any load is applied. The curing time will vary with location and conditions. However, during this period the tower sections can be painted, guy wires fabricated and the tower lighting kit prepared for installation.

Towers for directional arrays should be as nearly identical as possible with respect to guy wires, height, azimuth location, positioning of guy insulators, etc. After erection, all towers should be inspected to be sure bolts are pulled tight to assure a continuous steel radiator. Painting and lighting must be in accordance with FAA requirements. Guy tensions must be uniform and towers plumb.

Until RF is fed to the tower, a temporary ground should be connected to the tower itself to minimize the possibility of damage due to static charges or lightning during the construction period.

TABLE 2. SUGGESTED CONSTRUCTION PROCEDURES

1. Review plans and equipment requirements with RCA broadcast sales representative and consultant. Make sure equipment list is complete.
2. Obtain services of qualified civil engineer or surveyor to lay out antenna tower system.
3. Proceed with tower foundations, tower erection, tower lighting.
4. Construct buildings.
5. Install ground system.
6. Install transmission lines, sampling lines, AC lines and intercommunication line supports.
7. Complete electrical work, transmission line and sampling line runs. Install line terminating units. Make antenna resistance measurements.
8. Arrange with consultant for phasing of array and making proof of performance measurements.



(a)

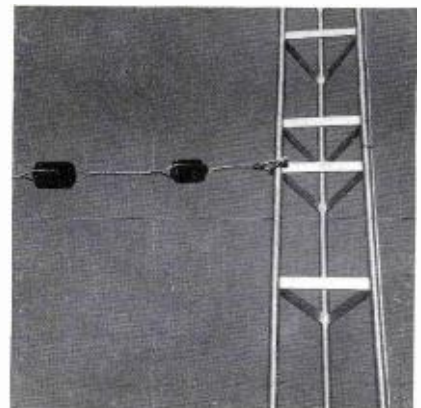

(b)

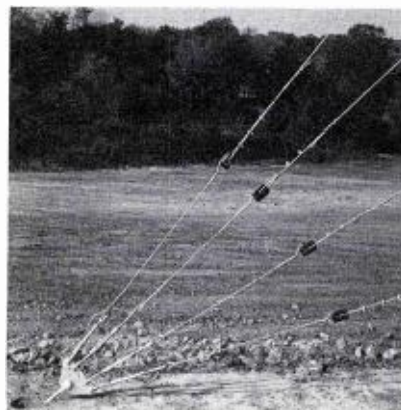

(c)



(d)

FIG. 25. Tightly bolted tower sections to provide good electrical conductivity (a); insulators in typical guy point assembly should be larger at this point to reduce hazard of static discharge from guy wire to tower (b); ground anchor point showing cable looped through turnbuckles to prevent turning (c); lightning spark gap at base of tower and crisscrossed ground straps beneath insulator (d).

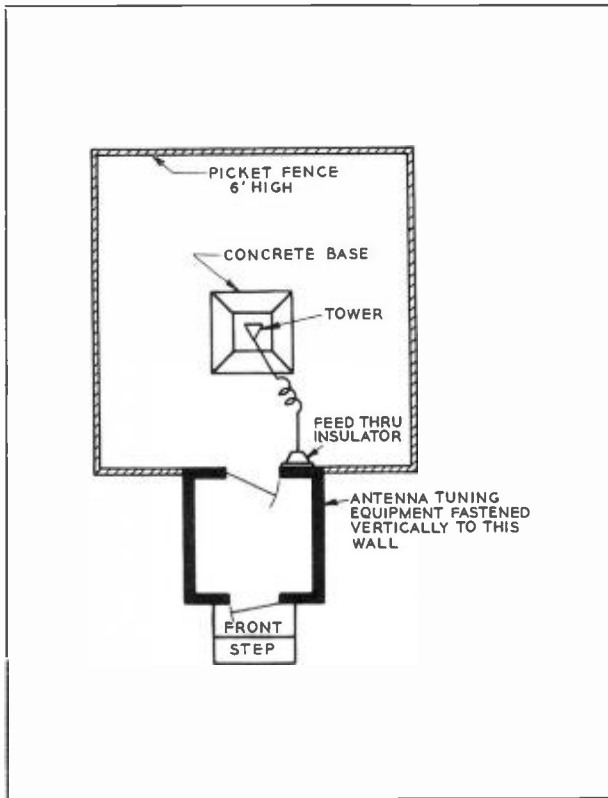

FIG. 26. Plan view of typical antenna tuning house and area at base of tower.

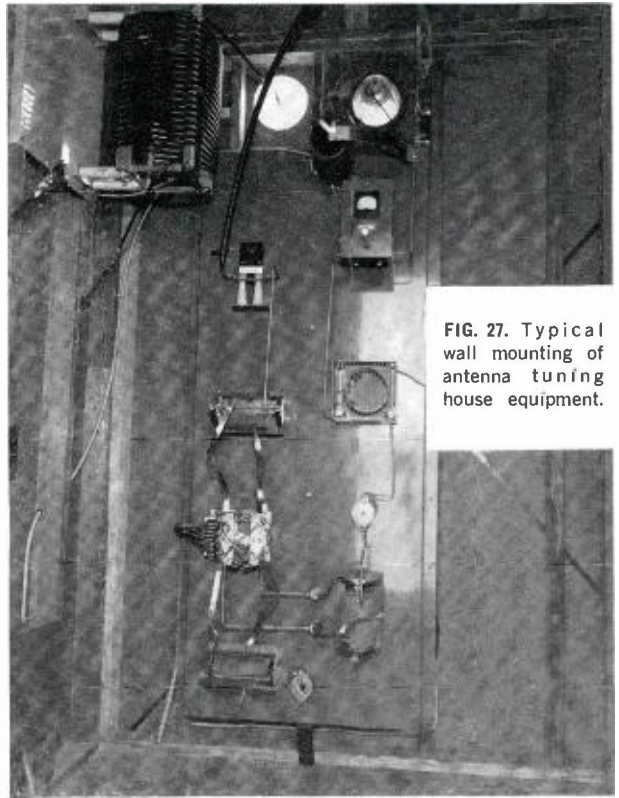

FIG. 27. Typical wall mounting of antenna tuning house equipment.

A fence is usually placed around each tower to prevent unauthorized entry or vandalism. If this structure is metal it should be bonded to the ground system, and its construction completed before any impedance measurements are made on the tower.

Lightning and Static Protection

All insulated AM towers should include a ball gap installed on or across the base insulator. Although a properly adjusted ball gap will often provide all the lightning and static protection needed, it is frequently desirable to add a static drain resistor or static drain choke in each antenna tuning unit to prevent static accumulation on the tower. It may also be desirable to specify a larger than usual number of tower-to-guy-wire insulators in order to reduce the frequency of guy wire to tower static discharges.

In severe cases the addition of static drain resistors across the guy wire insulators may prove helpful in preventing damage to guy wires resulting from continuous arcs

struck from static discharges. Consideration should be given to matters such as larger guy wire insulators or the addition of static drain resistors before the tower is selected and installed, since these measures may require a heavier tower structure than would otherwise be necessary.

The connection from the antenna tuning unit to the tower should consist of heavy copper tubing formed to provide a one or two turn coil approximately 8 to 12 inches in diameter. This small inductance will help retard lightning discharges through the antenna tuning unit. In some cases the tower lightning wires or the phase sampling line can be installed inside this tubing.

Building Construction

Figures 26 and 27 suggest layout plans for a tuning house at the base of the tower. Tuning houses should be as entry proof as possible. They should be provided with light, power and at least two power outlets. Ordinarily they need not be shielded. A heavy ground strap is required to bond the

tuning panel to the ground system. A sound powered telephone between towers and transmitter building will aid in tower construction and future servicing. It is good practice to make sure that all metals utilized anywhere in the station, such as ductwork, conduits, metal window frames, cabinets, etc., are bonded together and securely connected to the station's ground system. Proper ventilation and cooling should be provided for the technical equipment. Areas that are soundproofed, such as the studios, should be well ventilated.

Proof of Performance

Before the station is authorized to go on the air, it will be necessary to submit a proof of performance that the directional antenna as installed meets the requirements of the construction permit and good engineering practice. In addition, the usual proof of transmitter performance measurements are required. These measurements will be made from microphone terminals at the studio to antenna output, thus including the effect of the telephone line.

FIG. 1. BFC-4 Circularly Polarized Antenna of WMMR-FM, Philadelphia.



DUAL POLARIZATION FM BROADCASTING WITH A SINGLE ANTENNA

by MATTI S. SIUKOLA

RCA Antenna Engineering Center

The Type BFC circularly polarized FM broadcast antenna has been developed to provide the dual polarization necessary for improved reception of FM broadcasts by automobile and other FM radios employing vertical whips or other antennas not necessarily best oriented to receive horizontally polarized signals.

Until now, this increasing need has been met wherever practical, by adding a separate vertically polarized transmitting antenna to supplement the horizontally polarized antenna system traditionally em-

ployed. The new BFC FM transmitting antenna, however, results in only half the weight and wind loading of a combination system for the same service, and effects additional economies in installation costs. Moreover, it offers broadcasters the same opportunity to either double the total transmitted power or double the antenna aperture, that is, the total gain, without exceeding the licensed maximums, and thus achieve increased total service.

The antenna uses a radiating element made of two dipoles curved into one-turn

helices, and mounted in interlaced position resembling the threads in a double threaded screw. The dipoles are welded onto a mechanical supporting member, providing a rugged and simple element that radiates circularly polarized signals omnidirectionally. Various gains are obtained by stacking these elements approximately at one wave length spacings.

Benefits of Dual Polarization

The practical and economical whip antenna for car radios and portables does a

very commendable job of pulling in AM stations. It is fundamentally a vertically polarized antenna however, and therefore tends to operate poorly in receiving horizontally polarized waves such as FM broadcasts (See Fig. 3). Obviously, if the transmitted field was purely horizontally polarized and the whip antenna, in the case of the auto, was perfectly vertical and centered on the auto roof (operating on a symmetrical ground plane) no reception would take place. Thus, it may be said that successful FM broadcast reception in automobiles using vertical antennas to a great extent results from "discrepancies" in system performance and is therefore somewhat unreliable. Certainly dual polarization in FM transmission as illustrated in Fig. 4 is desirable.

Achieving Dual Polarization

The method of achieving dual polarization by employing two separate antennas, one for transmitting the horizontally polarized signal and another for the vertically polarized signal is effective but may prove to be complex and expensive. It may also be impractical in some cases where the existing tower structure may be incapable of supporting the additional weight and wind load. There is the need therefore, for a single, compact antenna to radiate a vertically polarized signal in addition to the horizontally polarized signal, and radiate both signals at equal power levels for omnidirectional service.

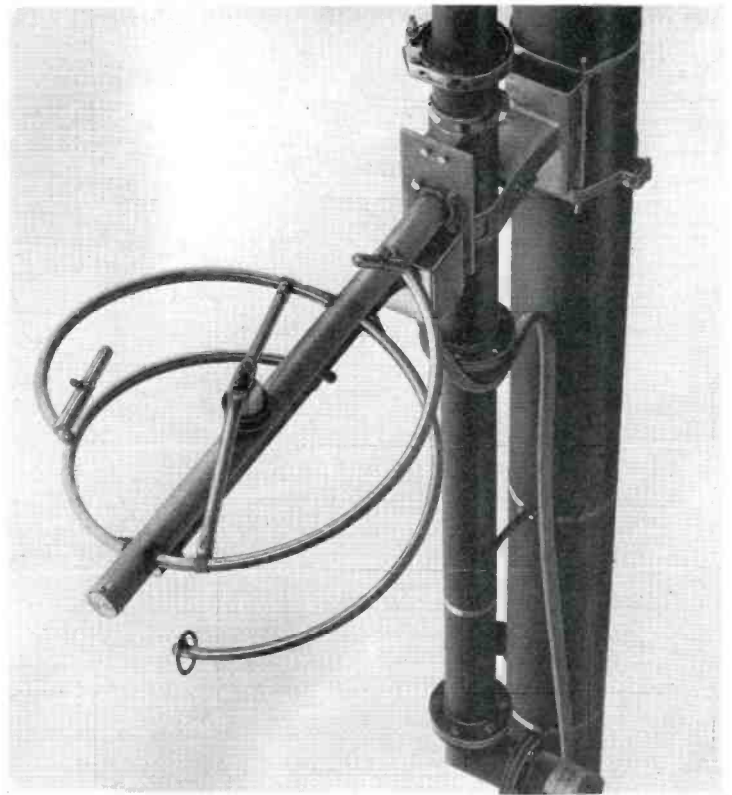

FIG. 2. BFC Circularly Polarized Antenna radiator.

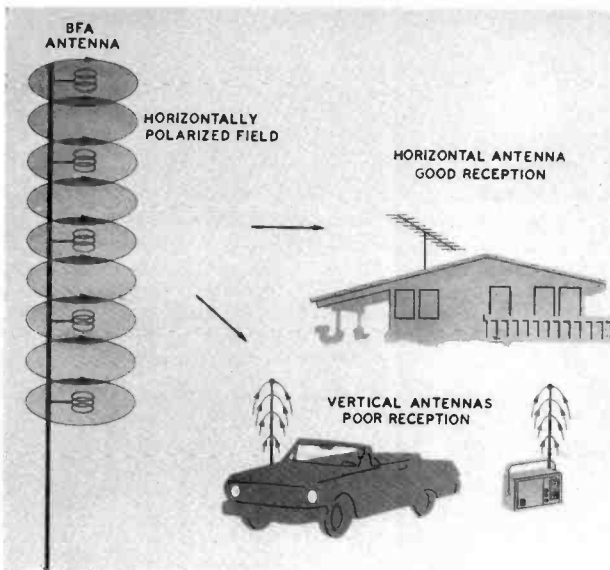

FIG. 3. Horizontally polarized transmission provides good reception for homes but tends to serve autos and portables poorly.

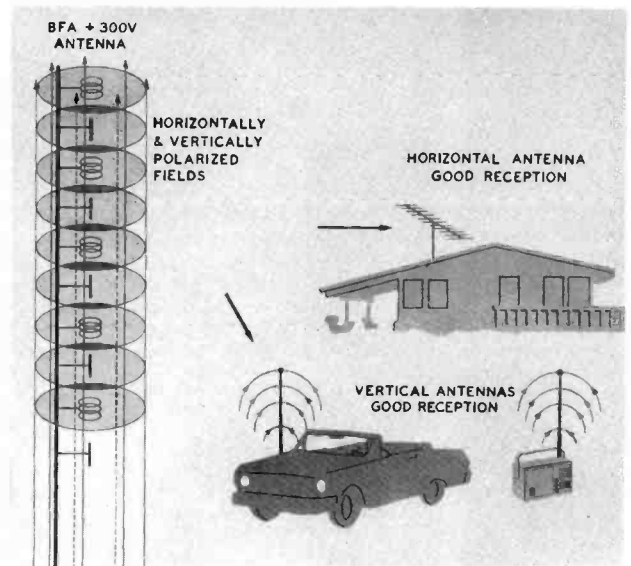

FIG. 4. Dual polarized transmission provides excellent reception for all the various types of receivers.

To meet the requirements for omnidirectional service and to provide broadcasters with a simple, rugged and economical FM broadcast antenna, RCA developed and is now producing the BFC Series of antennas. Using a single radiator, these antennas radiate the signal in two polarizations in the form of a circularly polarized signal to serve home receivers, portables and car radios.

Advantages of Circular Polarization

The principal advantage of circularly polarized transmission is that the rotating field assures reception with any logical orientation of a linear receiving antenna.

In designing a simple antenna to radiate half the power horizontally polarized and half vertically polarized, it was obvious to the author that a predetermined fixed phase between the two radiated signals was desirable. The question arose whether there was a desirable phase relationship.

Of course, if pure vertically and pure horizontally polarized receiving antennas are used and propagation does not depolarize the signals, the phase relationship does not matter, since the receiving antennas are totally "blind" to the other polarization and thus receive only one. However, since receiving antennas such as automobile whips, cord antennas and even built-in antennas vary greatly in polarization and thus receive both signals, phase may become very important.

Performance characteristics of typical dual systems are exemplified in Fig. 5. If polarization is observed in various azimuthal directions, it may be noticed that due to space phase variation a range of phase relationships is obtained. If the spacing between the phase centers is a half wavelength or more, any phase difference between the two polarizations will result. In practice the spacing has generally been kept below a quarter wavelength in order to reduce the overall range of phase variation. However, varying phase differences do exist in present installations.

When the two orthogonally polarized signals with equal power fed into each polarization are examined together (Fig. 6), three categories of signal may be obtained. The most common is the case when the two signals have some oblique phase angle (ϕ) between them and the resultant field vector thus traces an elliptical figure which never touches the origin (Fig. 6a). This is called an elliptically polarized signal. A characteristic of this signal is that a linear receiving antenna approximately

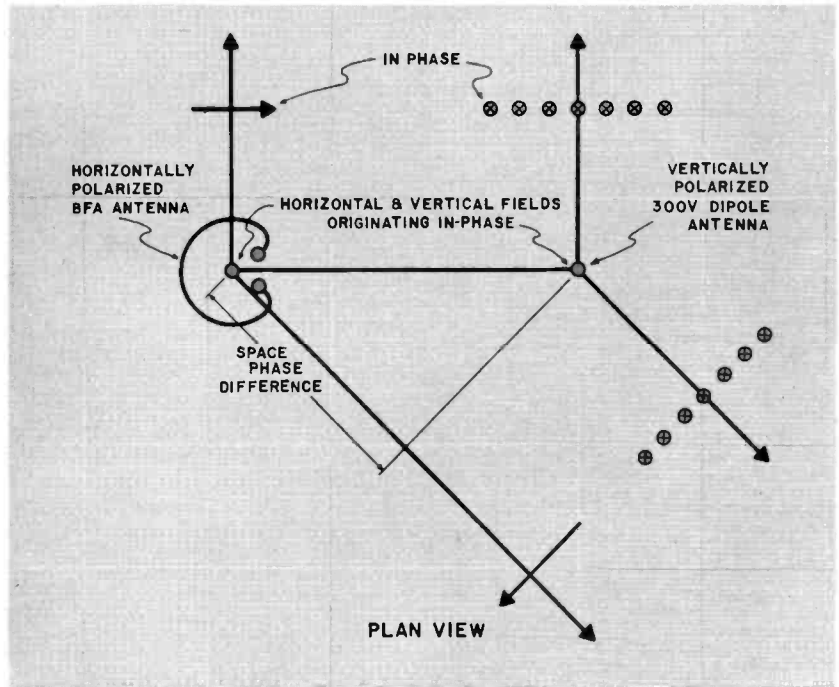

FIG. 5. Phase relationships between signals radiated by separate horizontally and vertically polarized antennas illustrated in two directions.

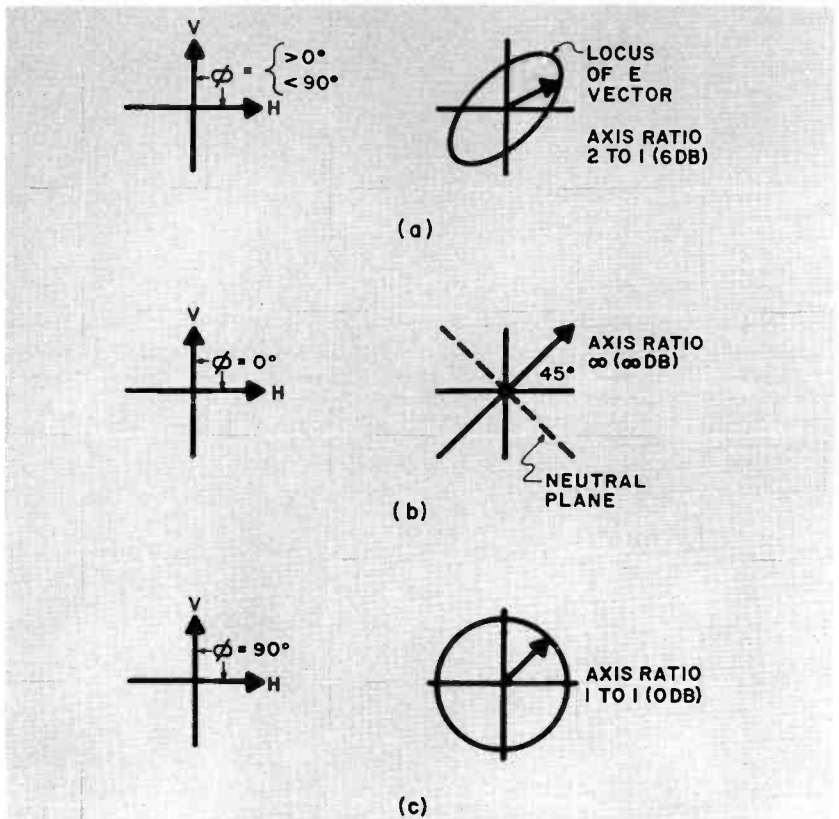

FIG. 6. Total fields produced by two orthogonal signals for elliptical polarization (a), linear polarization (b), and circular polarization (c).

perpendicular to the path of the wave propagation always extracts some energy from the field, regardless of the angular orientation of the antenna. The amount, however, varies, and the ratio of maximum to minimum field is expressed by the polarization axis ratio. This is the ratio of major and minor axes of the polarization ellipse. The ratio is not unity even though the same energy is radiated both in horizontally and vertically polarized components.

A special case is obtained when the two signals are in phase (Fig. 6b). Then the ellipse reduces to a straight line and a 45 degree linearly polarized signal results. The axis ratio becomes infinite (∞ dB). In this case, if the receiving antenna happens to be polarized at the other 45 degree direction, no signal will be received.

A circularly polarized resultant field occurs when the two waves are in phase quadrature (Fig. 6c). The polarization axis ratio then becomes unity (0 dB). In this case a linearly polarized receiving antenna extracts a constant power from the field, whatever the receiving antenna orientation, as long as it is perpendicular to the direction of the wave propagation.

Since 45 degree polarization theoretically provides a chance of no reception, circular polarization was chosen for the RCA design in order to provide a high probability of reception with linear antennas regardless of their orientation. Further, circular polarization is more closely related to elliptical polarization which exhibits no evidence of undesirable characteristics.

Operating Principles

The evolution of the circularly polarized radiating element may be shown with very simple models. As previously described, two orthogonal fields, such as vertically and horizontally polarized fields, when in phase quadrature produce a circularly polarized field. These two fields may be produced by two orthogonal current elements in phase quadrature and in the same plane (Fig. 7). However, phase quadrature may also be produced if two in-phase current elements are separated by a quarter wavelength. This results in a 90 degree phase difference between the two fields as shown in Fig. 8.

If the current elements of this pair are each rotated and shifted in their respective planes as in Fig. 9, circular polarization is still maintained toward the direction perpendicular to both elements. By adding another current element pair as in Fig. 10,

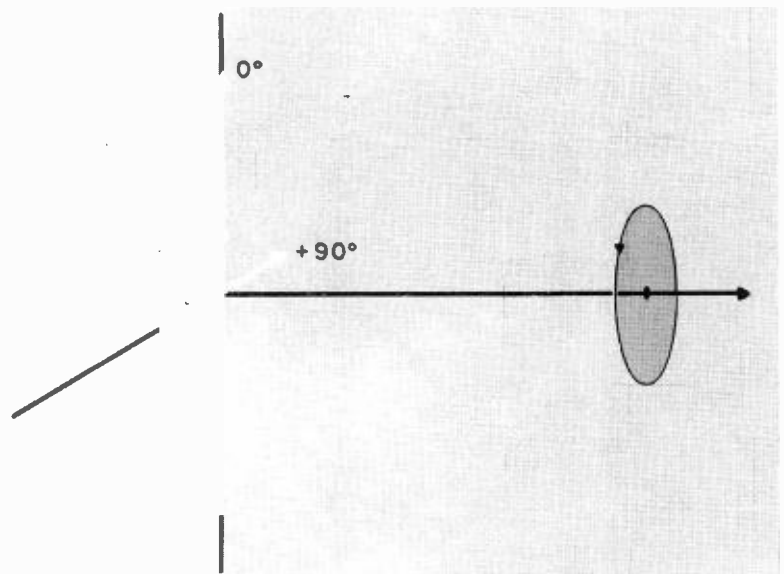

FIG. 7. Two orthogonal current elements in phase quadrature result in circularly polarized radiation in one direction.

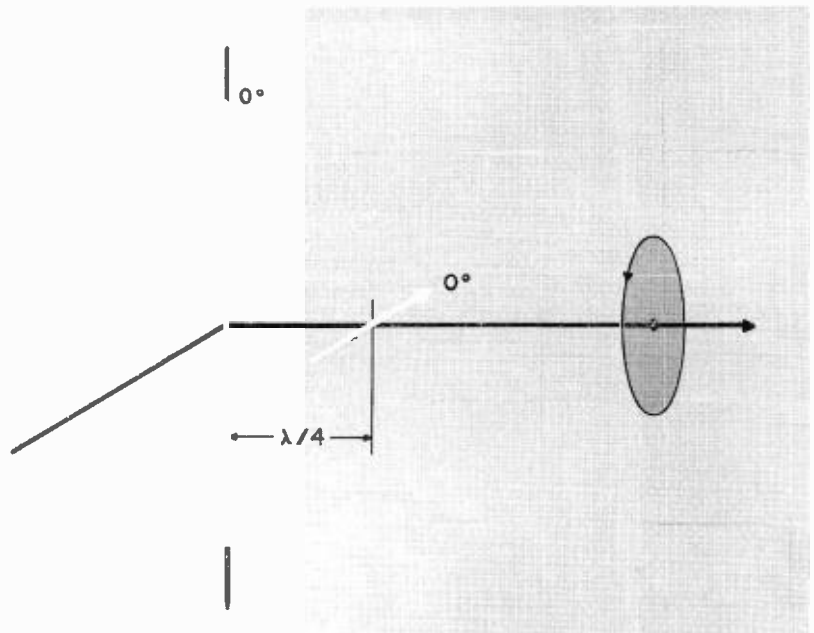

FIG. 8. The phase quadrature is produced by two in-phase current elements separated by a quarter wavelength.

a model of a single-turn helix results. A helix with this construction will then radiate principally broadside and with circular polarization to all azimuthal directions when:

$$C\lambda = \sqrt{2S\lambda}$$

$$\text{and } L\lambda \leq 0.5$$

where:

$C\lambda$ = helix periphery in λ

$S\lambda$ = spacing between turns in λ

$L\lambda$ = turn length in λ

As can be seen this type of helix has a very small diameter in terms of wavelength. The above mode of operation from helices is relatively unknown. The commonly used modes are the end fire and the reflector-induced, side fire modes of large diameter helices.

To employ the principle described, a constant, in-phase current had to be produced. The in-phase current was obtained by employing a resonant half wave dipole. However, the current distribution along the dipole is approximately sinusoidal, and to obtain constant enough current around the periphery to result in an omnidirectional horizontal radiation pattern, the dipole would have to form about a two-turn helix of approximately $\frac{1}{10}$ wavelength or one foot in diameter. Such a small diameter, though mechanically desirable, would have resulted in a quite small volume with relatively narrow bandwidth capabilities. Hence, a larger diameter of about 0.15 wavelengths was chosen and two dipoles employed to obtain a constant current around. The dipoles were each curved into a one-turn helix and interlaced as shown in Fig. 11. The sum of the currents on the two dipoles, in phase, is approximately constant around, and thus, an omnidirectional pattern is obtained.

Ruggedness and Simplicity

The characteristic voltage zero in the middle of a resonant dipole provides an excellent point for good mechanical support. Thus, a $1\frac{5}{8}$ inch diameter "backbone" was designed and the centers of the dipoles were heliarc welded onto this support for mechanically rugged construction as shown in Fig. 12.

The most convenient feed system for the antenna was, of course, a coaxial line. By shunt feeding from a $3\frac{1}{4}$ line, an unbalanced feed point with a single end-seal was obtained. To accommodate the unbalanced feed and to provide flexibility of adjustment; shunt feed in modified delta-match form was employed as illustrated in

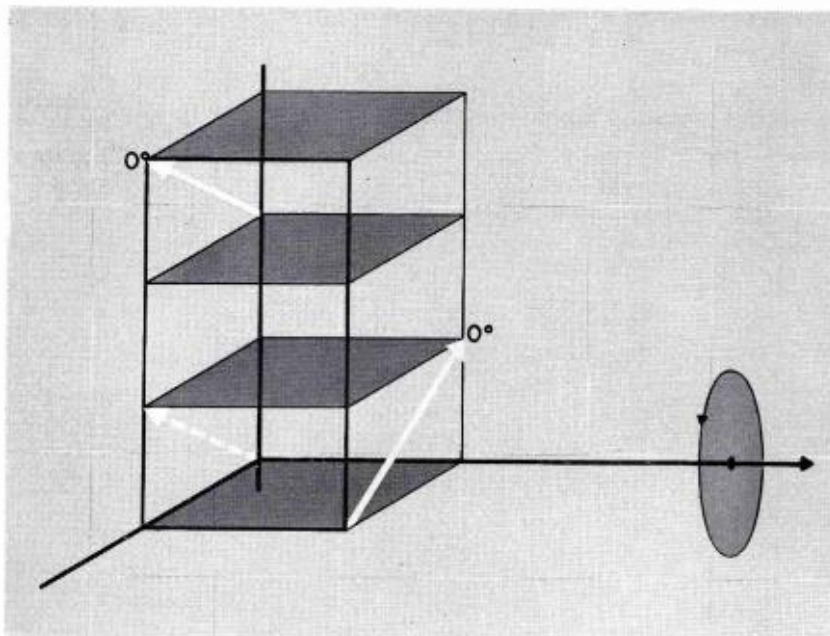

FIG. 9. Current elements of Fig. 8 each rotated and shifted in their respective planes still result in circularly polarized radiation in one direction.

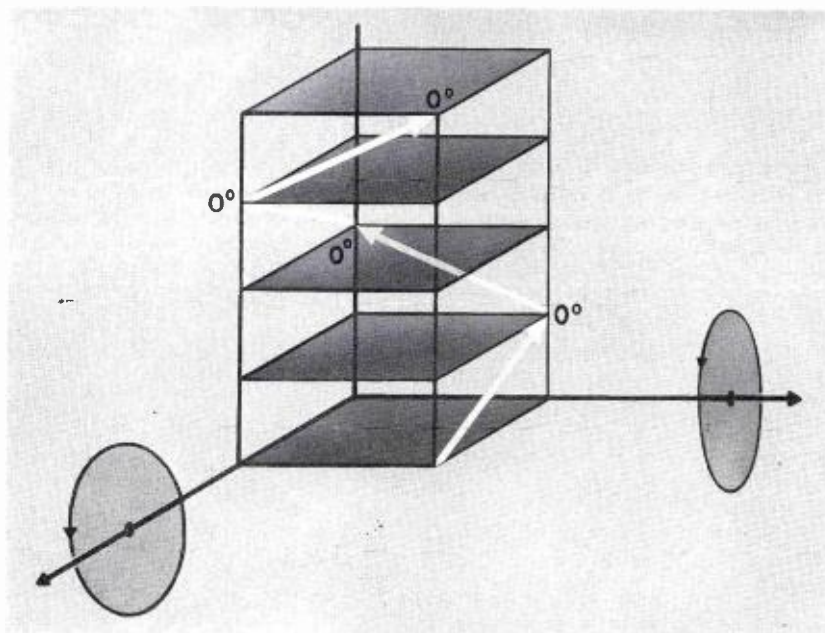

FIG. 10. Two current element pairs are arranged to form a single-turn helix. By adding the second current element pair, in the same phase, a circularly polarized signal in all azimuthal directions is obtained.

Fig. 13, resulting in a very simple and rugged radiating element, an element which is rigidly supported by the heavy-wall $3\frac{1}{8}$ inch transmission line. The only insulator in the radiating element is the end seal.

Electrical Performance Characteristics

Horizontal patterns of the radiating elements in free space are essentially omnidirectional for both polarizations (see Figs. 14 and 15). The best circularity will be obtained with pole mounted antennas installed on top of a tower or building. For a side mounted array, the extent of deviation from a circular pattern is dependent on the type and size of the tower. The shape of the vertical patterns for each polarization is determined by the number layers, magnitude of illuminating currents and their phases, and possible tower effects. Null fill and/or beam tilt can be supplied on special order (Fig. 16).

Although the vertical patterns derive in the conventional manner, principally from the aperture length or number of layers, the gain of the BFC-series antennas is about half a unit per wavelength. This is, of course, due to the fact that the power is equally divided between the horizontally polarized and the vertically polarized components. The antennas are built as Types BFC-1 up to BFC-16, consisting of 1 to 16 stacked layers. Spacing between layers is

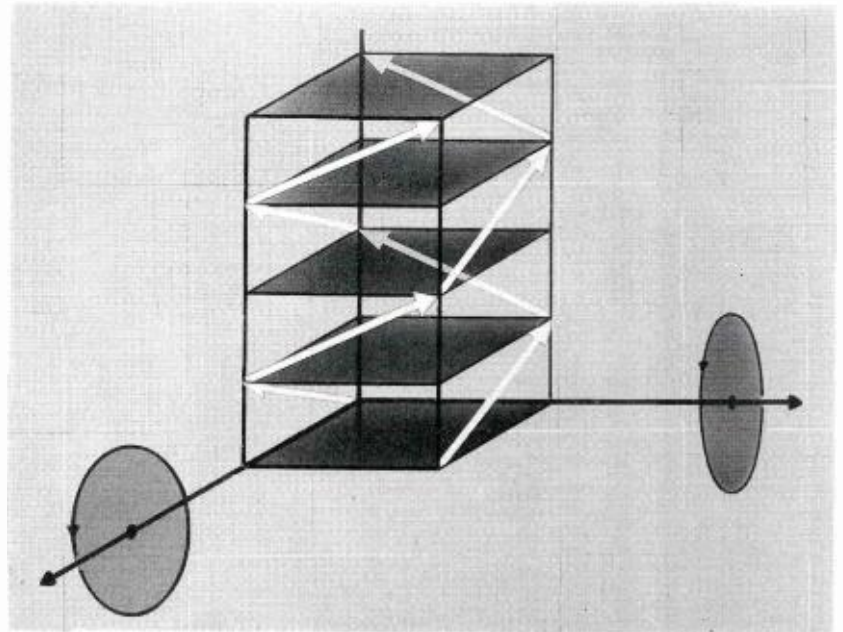

FIG. 11. Two resonant half wave dipoles are curved into one-turn helices each and interlaced to maintain constant current around as required for omnidirectional service. Thus, a practical broadband radiating element is obtained.

approximately one wavelength and the power gains are from 0.46 to 8.9 respectively for both polarizations.

The BFC-series is designed for single channel operation. However, since dipoles

are employed as the basic elements, relatively low circulating currents exist. Thus resulting in a rather broadband element covering some 2 MHz within a VSWR of about 1.3 (see Fig. 17). Each array is

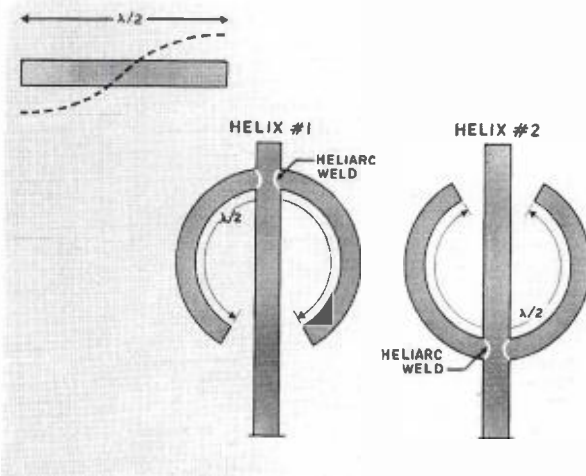

FIG. 12. Heliarc welding to the backbone provides rigid mechanical support.

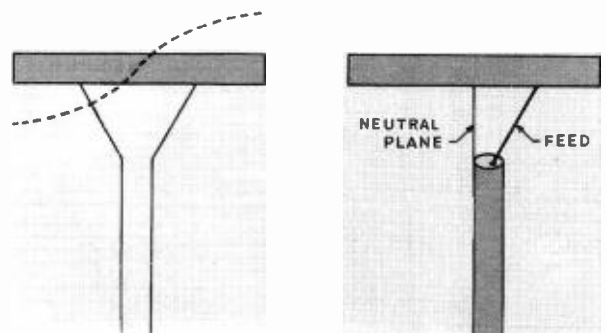

FIG. 13. The simple shunt feed system is based on the common delta-match principle.

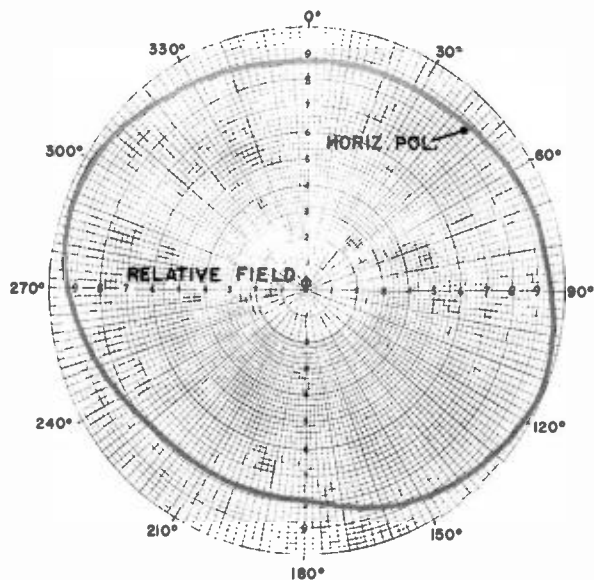

FIG. 14. Horizontal pattern of the horizontally polarized signal component in free space.

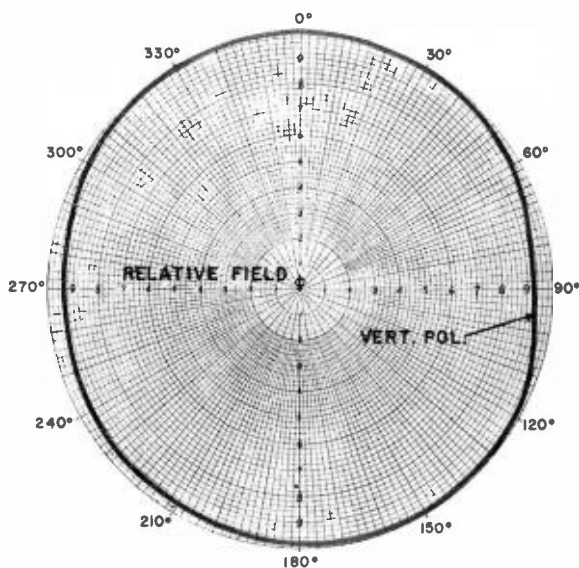

FIG. 15. Horizontal pattern of the vertically polarized signal component in free space.

equipped with a variable transformer at the input, thus facilitating a simple VSWR field adjustment to below 1.1 across the channel in question (Fig. 18). These low VSWR's assure excellent performance and meet the most demanding requirements. The low circulating currents due to dipole principle, also result in low voltage gradients and thus the high power rating of 10 KW per element. When several layers are utilized, the total rating, however, may be limited by the capability of the $3\frac{1}{8}$ inch transmission line to a very adequate 40 KW of input power.

The polarization axis ratio of an element in free space is an average of about 1.5 dB and maximum of about 4 dB around the periphery at the horizontal direction. These values represent a good circularly polarized signal to reduce the chances of "no-signal" with randomly polarized receiving antennas.

Mechanical Characteristics

The BFC design will withstand wind loads of up to 50/33 psf. Both the weight

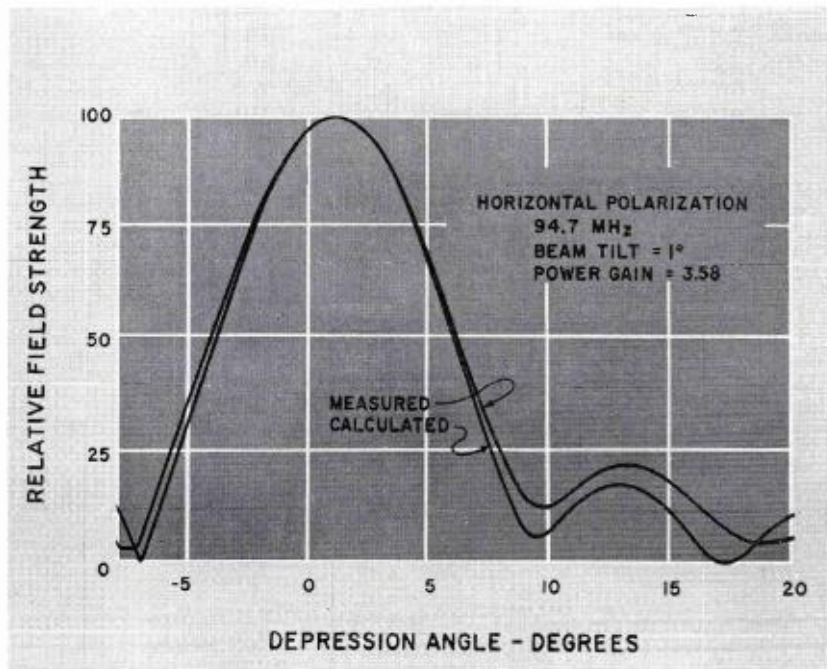

FIG. 16. Vertical radiation pattern of a BFC-7 antenna.

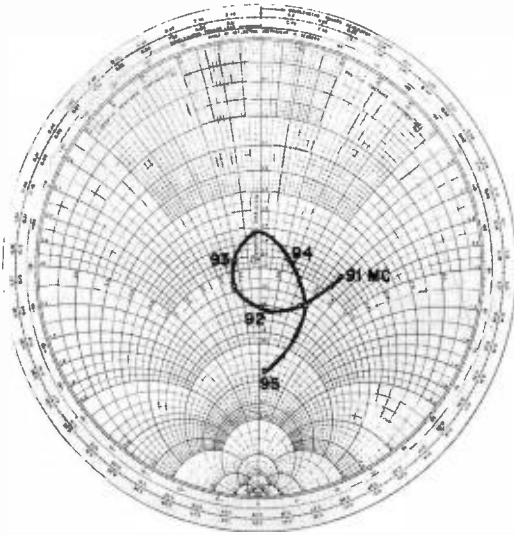

FIG. 17. Typical bandwidth capabilities of BFC antenna.

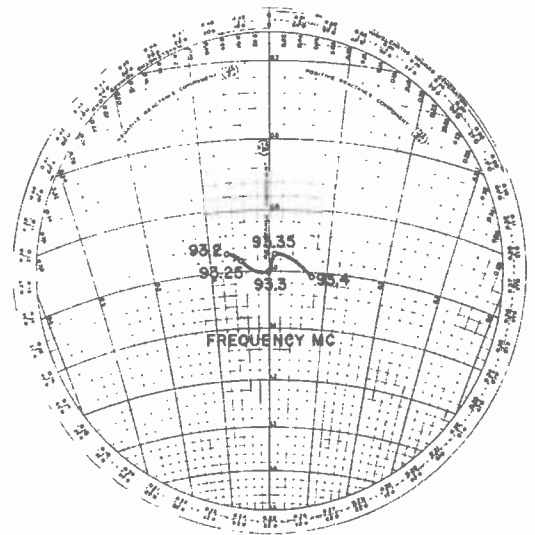

FIG. 18. Typical input impedance plot.

and wind loading of BFC antennas are only about half that of combination antennas for two polarization transmission. Further economies are realized also because of the simpler installation of the BFC.

For environmental protection, good materials are used throughout. The radiator is of stainless steel which assures that no corrosion or electrolysis will take place, for example, where the element joins the copper feed system. The end seal is constructed of ceramic, the hard shiny surface of which tends to stay cleaner than other insulating materials, assuring long, trouble free operation.

The large feed systems which are pressurized all the way to the end seals assure reliable operation. BFC antennas with up to seven layers are end-fed. Antennas employing eight or more layers are fed at the center of the array through a tee (see Fig. 19). Since both horizontally and vertically polarized signals are radiated by one set of radiators, no external power splitters are needed as in the combination antenna systems.

De-icing equipment is needed in areas where icing and sleet conditions are common. Radomes are available for use in areas where severe conditions exist. For less demanding conditions low voltage heating is employed. The heating current is carried from the transformer to the far ends of the dipoles by teflon insulated heavy copper wire. The current return path is along the surface of the elements, heating the stainless steel through ohmic losses and thus providing a highly efficient de-icing system.

Conclusion

The circularly polarized BFC antenna was developed to meet the need for a simple, rugged, and economical FM broadcast transmitting antenna, capable of radiating simultaneously both horizontally and vertically polarized signals. Designed for omnidirectional service, the BFC may be pole mounted on top of a tower or building, or sidemounted on a tower. It combines excellent electrical and mechanical characteristics with low wind loading and weight, and provides exceptional economy of installation.

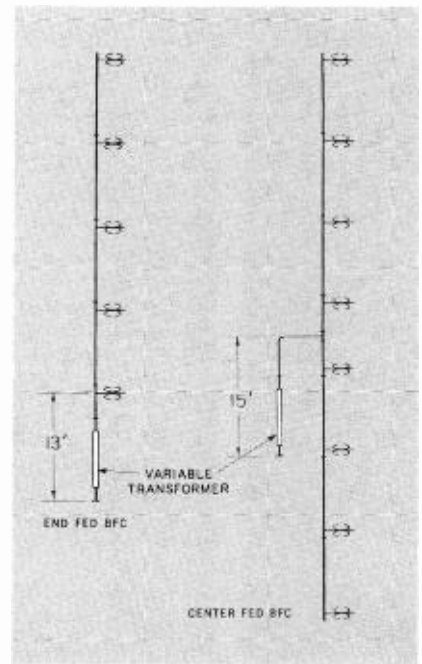

FIG. 19. BFC antenna feed systems.

MAKING COLOR SLIDES THE EASY WAY

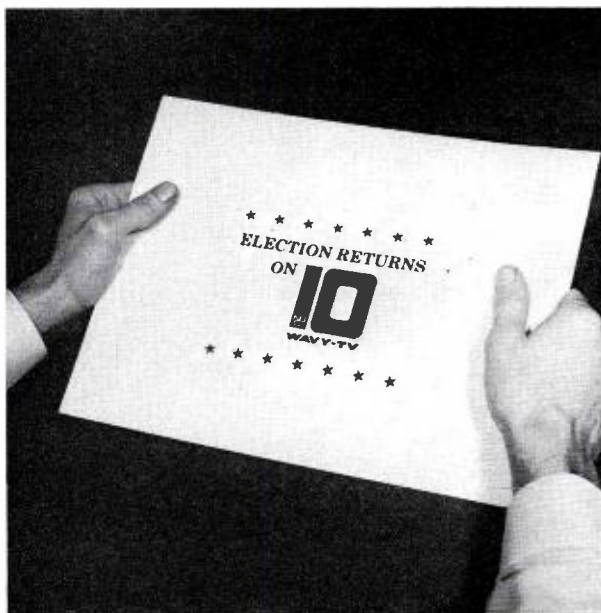

FIG. 1. Basic line copy ready for the camera.

How to Convert Black and White Copy and Art into Color Subjects for Both Live and Film TV Presentations

by DICK PAUL, *Director of Advertising & Promotional Services*
WAVY-TV, Norfolk, Virginia

At a recent Broadcasters Promotion Association Seminar, I happened to mention to a couple of fellow promotion managers that I had come across a method of doing something that was a little bit . . . maybe even a lot . . . easier than the way I previously accomplished the operation—that of making color art for color slides for television. Now maybe this isn't new to you, but it was to me and to the promotion managers, and up until now I haven't found anyone who had volunteered to put it in writing, so I will in the hope that it may prove of value to others.

1. CONVERTING LINE ART INTO COLOR SLIDE

Starting from scratch . . . Fig. 1 shows a paste-up of copy that is to be made into a three color slide. In this example, the copy lines were set on Pro-Type, the stars came from a clip-art service, and the logo is one of WAVY-TV's stock reprints. I'm sure that you are aware that when you copy paste-up art you end up with distinct edge lines around the art paste-ups . . . this will pose no problem in this process since you will be working with the negative and these lines can be opaqued out.

Figure 2 illustrates the negative obtained from copying the original art. From here on it is a simple process. The color combinations available are unlimited and depend only on what colors you decide your final slide should be. In our example we decided on a red, white and blue on a black field. (See Fig. 5.)

Select the negative areas that you wish to be in color and proceed to strip these areas with the colored acetate-like materials available as in Fig. 3.

Any art or lettering that can be copied on line film can be made into a colorful slide with very little effort. After you have arrived at your choice of layout in black and white art, and this can be pasteup copy, logos, title art, etc., you can photograph the copy on line film . . . then you can forget your original layout when you have your negative, unless you wish to use the original as a basic layout and can put it to further use with copy line changes.

At WAVY-TV, we have been using a variety of materials including Amberlith, Rubylith,† Letrafilm and Cinemoid. In addition, we have also found 3M's Color Key and Tecnifax Diazo-chrome, Colo-Proof and Poly-Proof to be most useful. (A source list of materials is given at the end of this article.)

Your own facilities may limit you to the type of materials you can best use. Amberlith, Rubylith, Letrafilm and Cinemoid require no prior preparation and can be used immediately. 3M's Color Key requires an exposure frame and development chemicals. The Tecnifax materials must be used with an Ozalid machine. At WAVY-TV, we are very fortunate and have access to all three materials.

When you have stripped on your colors you are now ready to make your color slide. In Fig. 3, we stripped three layers of red

†Amberlith and Rubylith are trademarks of Ulano.

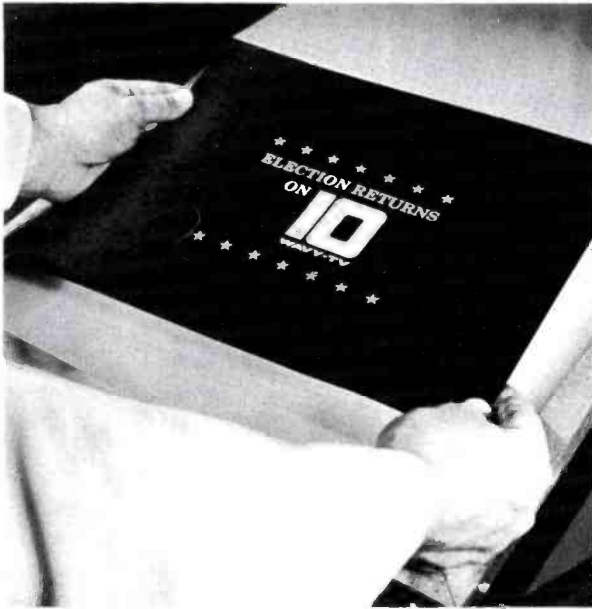

FIG. 2. Line negative now ready for stripping color.



FIG. 3. Example of how color is stripped on the reverse side of the negative.

Letrafilm under the stars, two layers of blue Letrafilm under the logo, and left the lettering clear so that it would come up white.

The stripped negative is placed on a light box, Fig. 4, and the copy is then ready for shooting on 35mm color film. We use the Leitz-Reprovit Ila* copy device that accommodates the Leica* camera. Any illumination box can be used with any good 35mm camera. The light source in the box is fluorescent tube with the equivalent Kelvin color temperature between 2700 and 3200K. Color temperature becomes very important when you combine color transparencies of individuals or products in slide layouts.

* E. Leitz Inc., N. Y., U.S. Distributor.

High-Speed Ektachrome† Type B (ASA-125) film is used in the camera and a light meter reading is taken from the transmitted light to determine the correct exposure. We have found that a shutter setting of $\frac{1}{60}$ at between f.8 to f.16 provides the most pleasing results.

For test purposes, you should make three exposures: one according to the meter reading, one a half stop under, and one a half stop over. When you process your film you can then judge which exposure is correct for your best color transmission. Figure 5 shows the finished slide.

† Ektachrome is a trademark of Eastman Kodak Co.

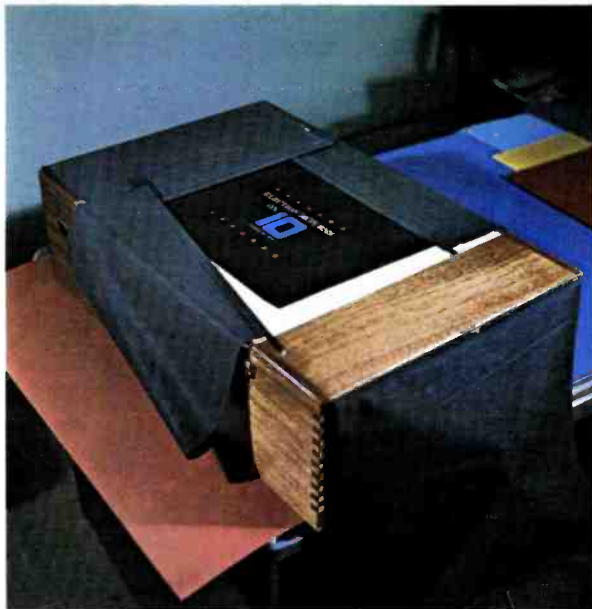

FIG. 4. Color-stripped negative is placed on the light box ready for photographing as slide.

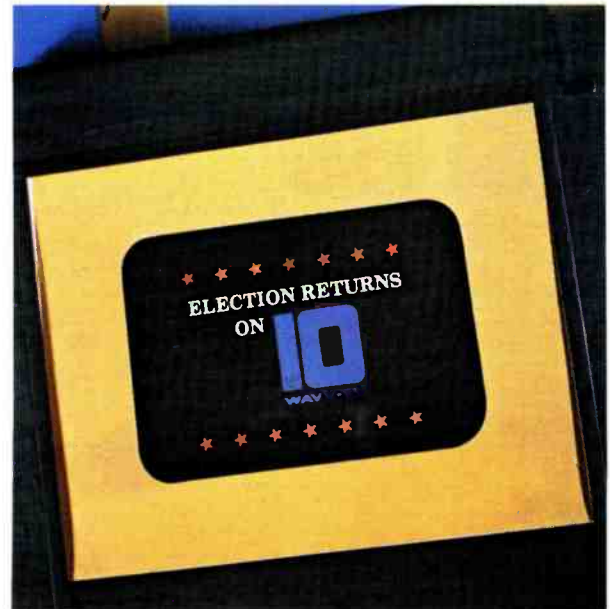

FIG. 5. The finished slide as it will appear on the air.

2. COMBINING LINE ART WITH COLOR TRANSPARENCY

In other instances we have combined copy with color transparencies of our air personalities for show promotion slides. The same procedure is followed as outlined for our Election Returns slide with one slight change when the layout is made. The area in Fig. 6 indicated by the arrow was made solid and was the exact size of the cropped area of a 4 x 5 transparency to be used. When you have the negative (Fig. 7), this solid area will come out clear and provide a perfect masked area in which the transparency is positioned.

In Fig. 8, we selected one layer of red Cinemoid to strip under the show title; two layers of yellow Letrafilm were stripped under the sub-heading; the days and time were left clear to come out white; and the transparency of the personality was stripped into the masked area. Figure 9 shows the finished slide. It is important to remember that when you make a slide using color transparencies that you take your light meter reading from the transparency area to determine the correct exposure. When this is exposed correctly, the other colors in the slide will come out as true colors. Figures 9A-B show other slides made in this manner.



FIG. 6. Basic line art to be used for program promotion.

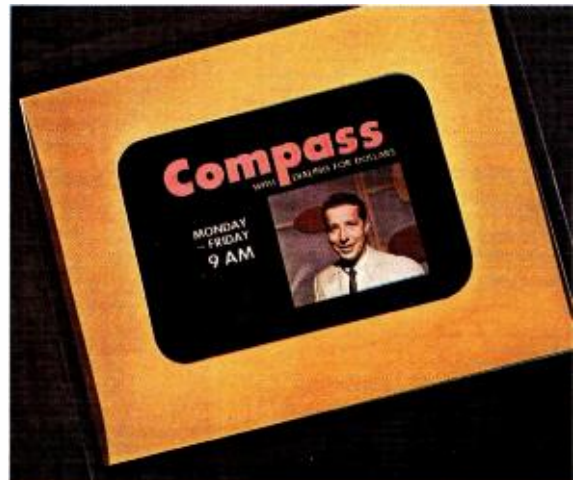

FIG. 9. The finished slide as it will appear on the home receiver.

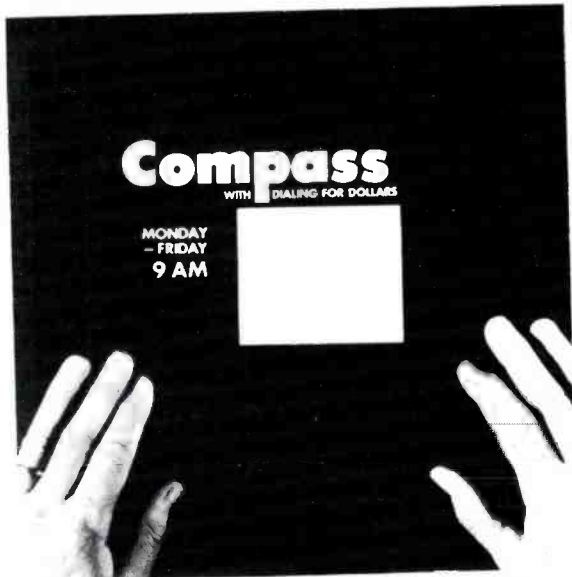

FIG. 7. Resultant line negative ready for color stripping.



FIG. 8. Placing the Cinemoid material on the reverse side of the negative.



FIG. 9A-9B. Other finished color art ready for making the 35mm slides.

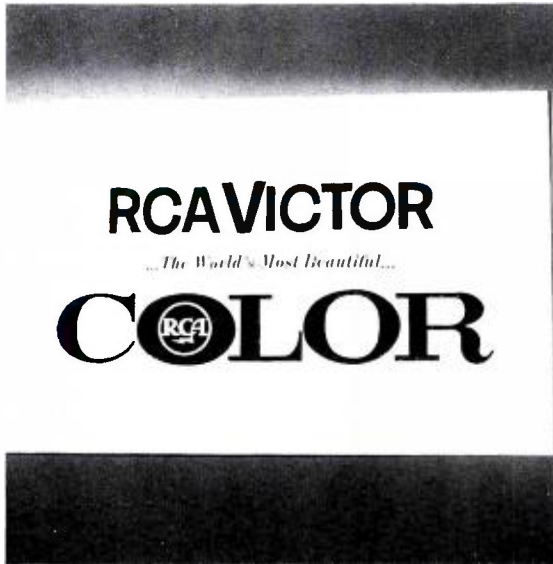

FIG. 10. Paste-up art, camera ready to make the line negative.

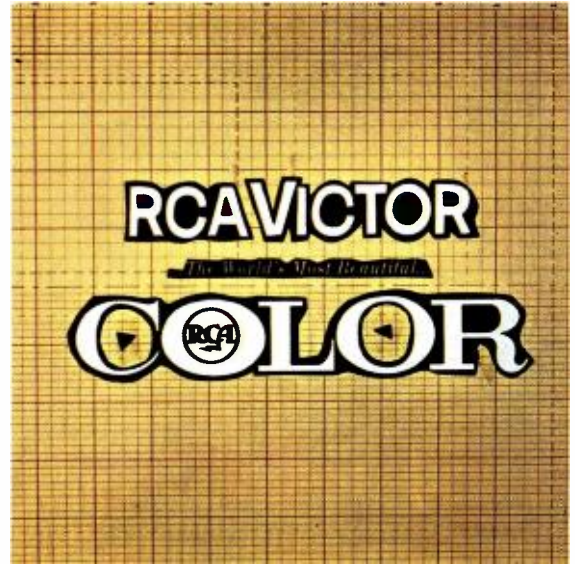

FIG. 11. The negative as it is stripped up on a masking sheet.

3. USING COLOR KEY AND TECNIFAX METHODS FOR COLOR SLIDES OR LIVE CAMERA TITLES

The use of 3M's Color Key and the Tecnifax materials open up other avenues for making color slides with speed and ease. The layout and paste-up process is the same as previously outlined. Figure 10 shows a piece of original art that is photographed on line film. In all cases we use 11 x 14 film. The negative is stripped up on a masking sheet (Fig. 11), cutting out only those areas to be exposed, and then placed over a sheet of Color Key, any color you select for the particular job, and then exposed in a light frame. At WAVY-TV, we use a carbon arc exposure frame and expose it for 2-4 minutes. The Color Key is then removed and processed according to the manufacturer's instructions packed with the product. As soon as it is dry you have your finished color art as shown in Fig. 12.

The Color Key sheet can then be placed over any color background board you choose and the slide made in the conventional reflected light method. Figs. 13 and 14 show the same Color Key positioned over some different back-

grounds. An added advantage of this process is that if you have to meet a rush deadline for airing and can't wait to get your color film processed, the Color Key can be placed on a color board with transparent tape and used as a title card on live camera.

Tecnifax materials are similar to Color Key in that you get your color on acetate base stock. When you have your negative on the masking sheet and ready for exposure, you simply place the Tecnifax color sheet next to the masking sheet and place it in the Ozalid (Fig. 15) and the ammonia process develops your color. This requires no further processing since it comes out of the Ozalid in the color you have selected and is now ready to use as an overlay. Full processing instructions are packed with the Tecnifax materials.

We have also taken the various Tecnifax colors and exposed them without copy to get a colored sheet of acetate that can be used under negatives as shown in Fig. 3.



FIG. 12. A red Color Key sheet on a colored background.



FIG. 13. The same red Color Key placed on a blue background.



FIG. 14. Example of how the red Color Key appears on four different background boards.



FIG. 15. Tecnifax color sheet being run through the Ozalid.

4. COLORING BLACK AND WHITE LINE-COPY SLIDES

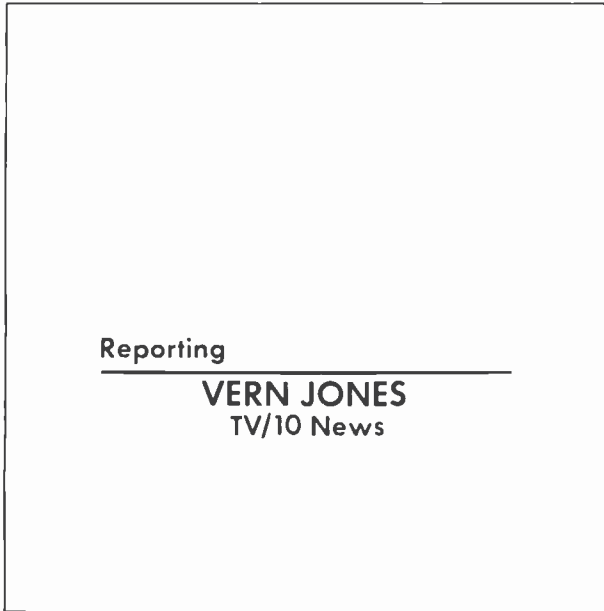

FIG. 16. Pro-Type lettering paste-up art for Color Key slides.

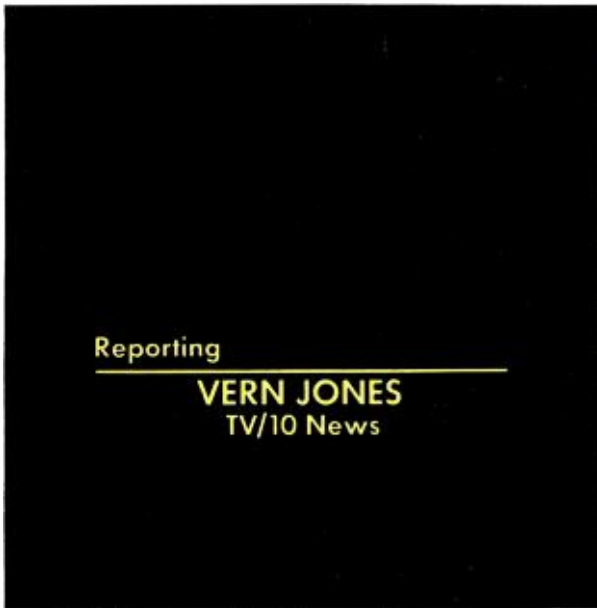

FIG. 18. The finished color slide to key over news film.

Another method of making quick one or even two-color slides is to make a regular 35mm slide on line film. For example, we use Kodak* High Contrast Copy Film and process it in D.19. In Fig. 16, you see copy that was set for keying over our color newsfilm to identify the reporter. When we have our negative we simply place a piece of yellow Color Key or Tecnifax, the same size as the slide, Fig. 17, then bind it in a glass mount and it is ready for airing. Figure 18 shows the finished slide.

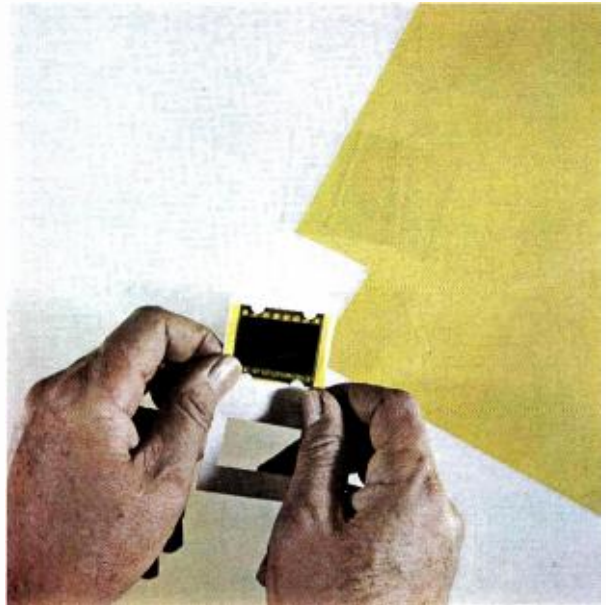

FIG. 17. Cut your color material same size as mask mount.

We have found that each of the foregoing methods outlined save considerable man hours in our Art Department and the need for hand or mechanical color lettering is eliminated. The variety of colors available is almost unlimited yet I believe that you will soon find that certain colors lend themselves better to color transmission and will fill all your art and slide needs.

We continue to find these various methods save us not only time, but money and effort—three important items in broadcasting—or any business. If you find that you need additional information or have a particular problem with either of the methods outlined, I will be glad to offer whatever assistance I can. You can write: Dick Paul, Director of Advertising & Promotional Services, WAVY-TV, P. O. Box 1600, Norfolk, Virginia 23501.

Material Sources

(Contact your local graphic art supplier or write to the manufacturer.)

<i>Amberlith-Rubylith</i> Ulano, 610 Dean Street, Brooklyn, New York 11238.	<i>3M Color Key</i> Contact your nearest 3M Regional Office.
<i>Cinemaoid Color Filters</i> Kliegl Bros., 32-32 48th Street, Long Island City, New York 11101.	<i>Tecnifax — Diazochrome, Cola-Proof, Poly-Proof</i>
<i>Letrafilm</i> Instantype, Inc., North Hollywood, California.	<i>Tecnifax Corp., 195 Appleton Street, Holyoke, Mass. 01040. (Of- fices in principal cities.)</i>

*Kodak is a trademark of Eastman Kodak Co.

"BIG TUBE" COLOR FILM SYSTEM

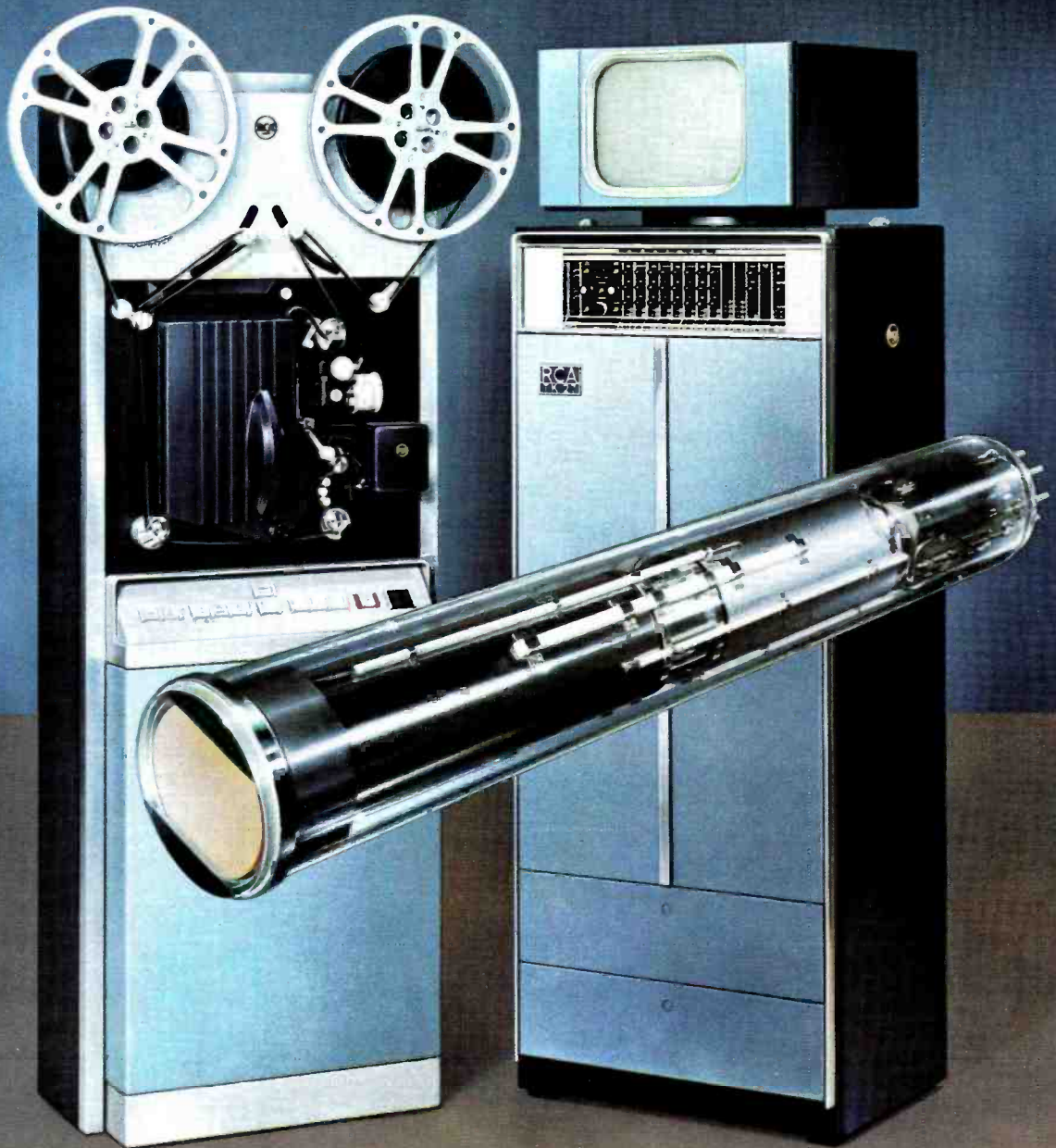

FOR COLOR FILMS...TK-27—BIG tube film system...makes the big difference in your color film pictures...maintains color quality, automatically compensates for film and slide variations. A "matched" equipment from RCA.



The Most Trusted Name in Electronics

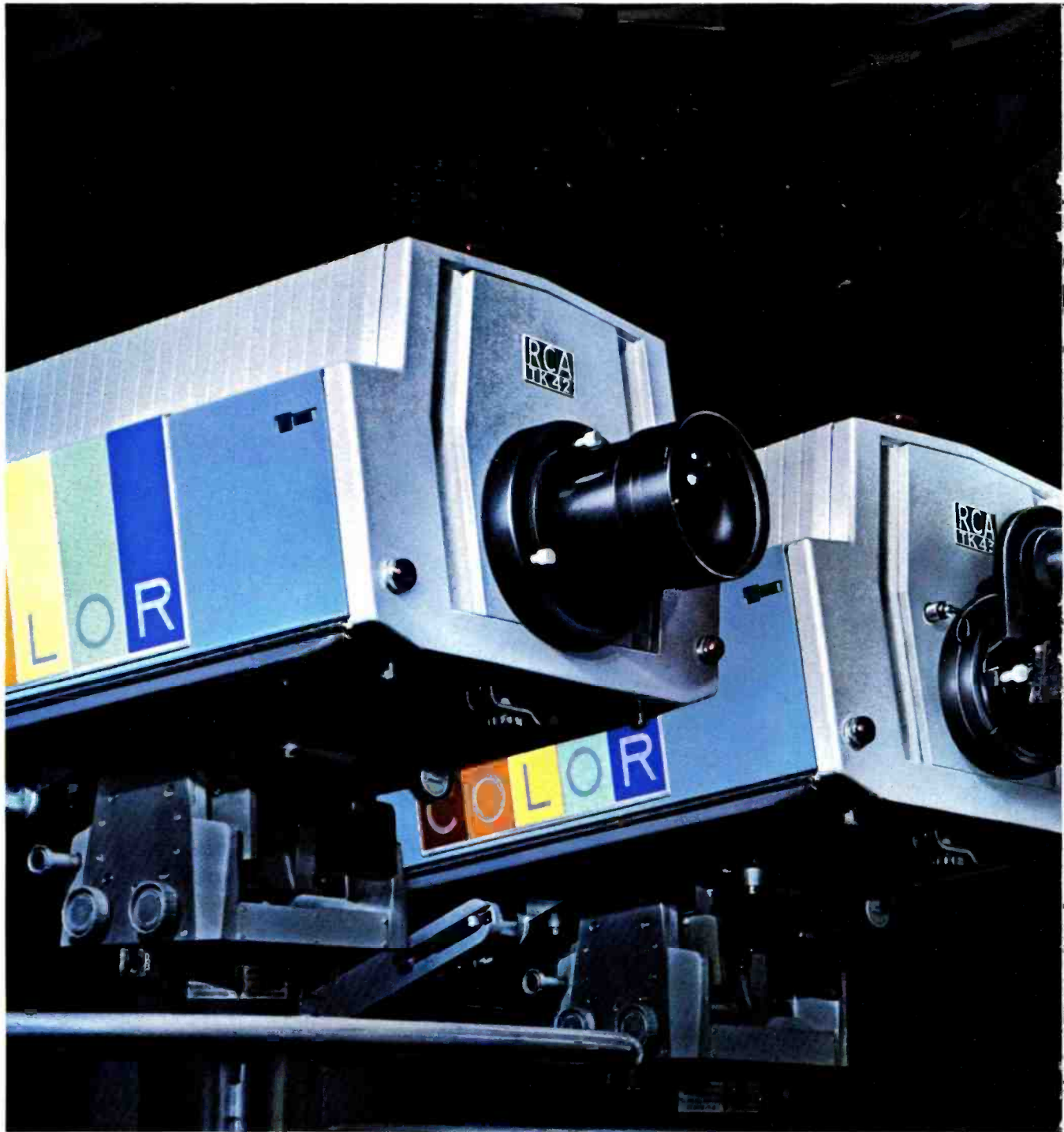

THE TK-42 DELUXE STUDIO CAMERA (with internal zoom) —the finest color camera ever offered—with more built-in operating and convenience features than any other. Big 4½-inch-diameter luminance channel tube (nearly 4 times larger than in other cameras) insures best detail, sharpest pictures. I.O. characteristic (the “knee”) handles wider contrast range—provides most brilliant and most exciting pictures. New Type 4536 Tube gives longer life, eliminates burn-in problems. With new field-effect transistorized preamplifiers and other circuit improvements, provides a dramatic reduction in noise level. Available in 1968—adaptor kits for use of lead-oxide tubes in chrominance channels.

THE TK-43 DELUXE STUDIO CAMERA (with external zoom) offers all the fine features of the TK-42 with the flexibility of a 10-to-1 lens system. Permits the use of range extenders to triple focal length—from 1.6 inches to 4.8 inches, or from 16 inches to 48 inches. Can also be used with standard fixed focal length lens. Makes one of the most versatile color cameras available. The 1967 models of the TK-42 and TK-43 incorporate many new developments providing improved color tracking, reduced noise level and lower operating cost—part of RCA’s continuing product improvement program. Available in 1968—adaptor kits for use of lead-oxide tubes in chrominance channels.

Now...there are 3 RCA "Big Tube" live color cameras



THE NEW TK-44 "ISOCON" CAMERA, an entirely new light-weight color camera for those who want the advantage of "big tube" detail and image orthicon performance in a smaller-size unit. Weighs only 140 pounds (exclusive of detachable viewfinder and lens). Ideal for remote pickups and other field applications as well as studio use. The revolutionary new RCA 3-inch Isocon tube, in the luminance channel combines inherently low-noise characteristic with the recognized advantage of the I.O. characteristic (the "knee") in handling a wide contrast range. Chrominance channels in production models will employ three lead-oxide tubes. The best of both worlds!

Call your RCA Broadcast Representative. Or write RCA Broadcast and Television Equipment, Bldg. 15-5, Camden, N.J. 08102.



THE MOST TRUSTED NAME IN ELECTRONICS

KTAR-TV COLORCASTS RODEO PARADE USING TWO TK-42 COLOR CAMERAS

by PAUL HUGHES

Director Public Affairs

KTAR-TV Broadcasting Co., Phoenix, Ariz.



Photo Credits: Tom Roberson



FIG. 1. Although the day was overcast and the color ranged from one end of the spectrum to the other, nevertheless it was a beautiful show on viewers' screens.

The month of March, any year, sees Phoenix and the entire Valley of the Sun turn out for one of the biggest events of its kind in America, the Rodeo Parade.

Police estimated that 250,000 people lined the streets to see the 1967 version. The rest of the Greater Phoenix population apparently stayed at home to watch the proceedings—for the first time in color—on KTAR Television. It was a great show, either first-hand or via Channel 12.

KTAR, the NBC affiliate for Central Arizona, has three RCA TK-42 color cameras, two of them received in November, 1966, the third in January, 1967. The Parade, highlight of the Phoenix Jaycees Rodeo of Rodeos, was their first use outside the studio. Chief Engineer Cliff Stevens gave them a hearty "well-done" after the outing.

From the first color guard and the appearance of the Parade's grand marshal—former presidential candidate Barry Goldwater—through two hours of pageantry to the final battery of street-sweeping machinery, the event was about as colorful as the rainbow could make it, and the viewers by the hundreds were impressed enough to call or write their favorable sentiments to the station.

From the engineering viewpoint, the show was not a remote. The Parade route passes within half a block of the KTAR studios, right past the station's parking lot, so no relay was necessary. A little extra cable was all it took. A fork lift elevated the two TK-42's used to a raised platform, and the show was on.

Production-wise, it was as remote as you can get. Cameramen Hank Weisheim and Phil Stegwell, and director Jim Fancher, calling shots back in the control room, had to treat it as a game away-from-home. Production manager Woody Hartzog and program director Bob Allingham both declared it was a good game, and Channel 12 won.

Camera Alignment

Cameras are aligned, under standard procedure, just once a week, and it usually



FIG. 2. Station-built master console using TS-40 Transistorized Switcher and "New Look" live and film camera controls.

takes no more than an hour for all three, Stevens says. The TK-42's have proved their stability and dependability, and the problems encountered are already being taken care of by factory modifications.

Color Fidelity

Production people at KTAR are well pleased, Hartzog says. They're getting true colors, consistent quality and the kind of product identification that makes for contented sponsors.

Rodeo Parade day in usually sunny Phoenix was calm, dry, warm, but somewhat overcast. With a minimum of shading back in the control room, the Parade filled the screen with color.

Lighting For Color

For studio use, the station uses mixed lighting, both flat and modeling, with light plots for all daily shows and at least 300 CP. There is no lighting specialist as such, but two members of the floor crew have actually devoted a world of extra time to lighting through the years, and they're satisfied with the color results they've been getting.

TK-42 Makes Color Easy

Everybody at Channel 12 has been happy with the simplicity of the TK-42's, though they were prepared for all kinds of compli-

FIG. 3. Romper Room is a local live color production, five days weekly.





FIG. 4. The Judy No! Show is a locally produced woman's show done back-to-back with Romper Room.

cations. The first month or two, there were a minimum of trials and errors. Emmett Lancaster, art director, nursed the scenery along. There were a lot of experiments with make-up, one or two of them rather bizaare, but the staff has settled down to a minimum of tampering with nature. Some studio announcers get best results from no make-up.

Acid Test For Color Cameras

All of which really didn't prepare anybody for the first "remote." A good many

FIG. 5. Color film system includes: TK-27 "Big Tube" Film Camera, two TP-66 TV Film Projectors, TP-15 Multiplexer and TP-7 Slide Projector.

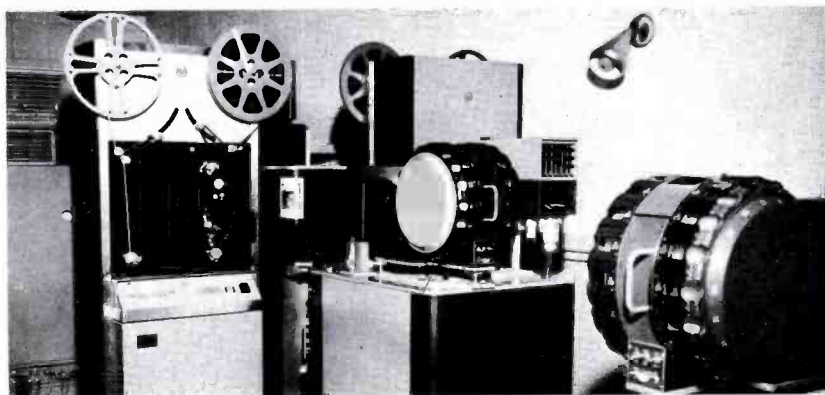

FIG. 6. Because the parade passed close by KTAR studios, it was only necessary to use some 300 foot of cable, a raised 18 ft. platform and a forklift to capture the entire rodeo.



contingencies were conceived and dutifully worried about, but not a one of them happened. The two-hour-long Rodeo Parade was simply a beautiful show; and if there is an acid test for color, this was it. There were horses by the hundreds, in just about every color but green; there were bands by the score, in every color imaginable; there were giant floats that taxed the spectrum and made for some beautiful shots on Channel 12.

Nancy Chappel, KTAR promotion director, gave the show a good advance plug, both in print and on the air. The best plug was the telecast itself; it brought a lot of joy to the viewers as well as spot participants. Bigger and better next year; that's what the Phoenix Jaycees always say.

KHVH-TV BRINGS LIVE COLOR TO THE 50TH STATE

Heavy Emphasis on Remote Pick-Ups and Satellite Transmissions, Using RCA Color Cameras



FIG. 1. The KHVH Air Watch Helicopter with Diamond Head in the background. This is the only news and traffic helicopter in Hawaii and is often called upon to participate in surfing and hiking mishaps on the island of Oahu.

Hawaiian television viewers were treated to the first "live" color telecast in the 50th State November 8 when KHVH-TV, Channel 4, inaugurated the use of its TK-42 color facility with special coverage of the 1966 General Election. Pioneering color in Hawaii with color film in 1957, KHVH-TV originated local live color, with the advent of its number one RCA Color Camera. Effective November 9, all 18 weekly television news broadcasts were originated in "live" color, and with the arrival of a color Jamieson film processor, all local news film is also presented in full color.

First Live Color Via Lani-Bird

An estimated 130 thousand TV sets in

Hawaii were tuned to KHVH-TV November 19 to view the first live television transmission relayed via the Lani-Bird communications satellite from the mainland. The event was the Michigan State-Notre Dame football game. Comsat, ABC, and the Hawaiian Telephone Company joined together to make this historic event possible. Transmission was reversed during halftime, and an estimated 33 million people across the nation had their first opportunity to view live color television from Hawaii. KHVH-TV News Director, Mason Altiery, surrounded by bikini-clad tourists on Waikiki Beach, said that the new satellite means much more than

instant football. "It will, in the future, become a great journalistic link between our country and all the nations of the great Pacific area, of which Hawaii is the focal point."

First Transmission to Japan

On February 19, 1967, the Nippon Educational Television Network (a Japanese commercial network), using the facilities of KHVH-TV in Honolulu, transmitted the first of five live television programs to Japan via Lani-Bird II communications satellite. With this event, NET's Norio Kijima Morning Show became the first commercial telecast between Hawaii and Japan.

FIG. 2. KHVH-TV children's show host, Captain Honolulu, reading the names of the "birthday boys and girls." Captain Honolulu has been the top children's show on Honolulu TV for the past 9 years and still pulls shares in the sixties. Captain Honolulu is now seen 4 hours a day in color using KHVH-TV's RCA TK-42 color cameras.





FIG. 3. A KHVH-TV production crew was on Waikiki beach during half time of the Michigan State—Notre Dame football game to present a 90-second remote, live in color to the mainland—via satellite.



FIG. 4. It was the biggest day in Hawaiian TV history—the first live TV from the mainland. During half time, transmission was reversed and KHVH-TV with TK-42 cameras gave the mainland its first look at Hawaii in live color TV.

NET chose such well-known Hawaiian attractions as Pearl Harbor, Ulu Mau Village, the University of Hawaii's East-West Center, the Ala Moana Shopping Center, and Waikiki Beach as settings for their five programs. KHVH-TV provided complete technical and production facilities and staff for the shows, produced Sunday through Thursday from 1:30 to 2:30 p.m. in Hawaii and received live in Japan from 8:30 to 9:30 the next morning (Monday through Friday).

Live Color Operation

KHVH-TV received its first TK-42 Color Camera in October, and the second in December, 1966. They were placed in service immediately and have 1200 hours on the tubes to April 30, 1967. Cameras are aligned weekly using standard procedure, which takes approximately one hour.

Color quality is consistently good. Operation is extremely stable, there's no drifting—no change of hue or weak colors, either. Colors are true, product identification beautiful. Reports from station management, viewers, and clients are all okay.

A combination of quartz and tungsten lighting is employed. Both flat and modeling effects are employed. Candle power is in the range of 250 to 300. Station engineers handle all lighting requirements quite



FIG. 7. KHVH-TV Chief Engineer Dan Hunter checking over RCA TR-4 color VTR machine.



FIG. 5. KVVH-TV technical director Joe Kim and crew chief Paul Hirata aligning TK-42 cameras before "Conversation," a weekly program feature hosted by KVVH Women's Editor, Betty Smyser.

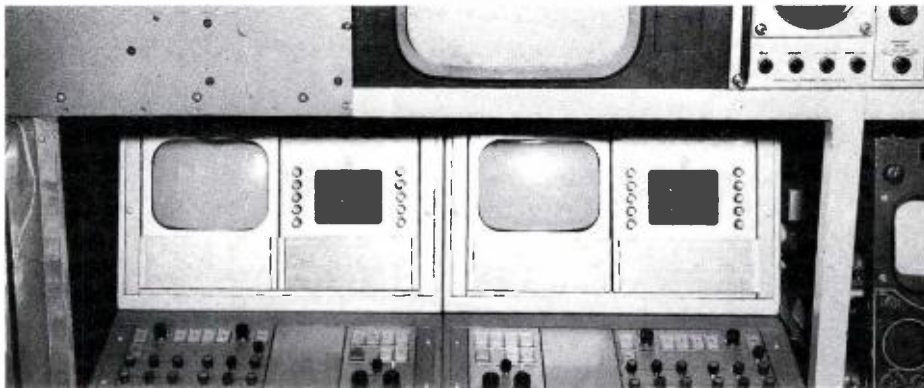

FIG. 6. RCA TK-42 color camera control consoles which are installed in KVVH-TV's mobile videotaping unit. This complete MVTR unit is connected into the KVVH studio control when not in use elsewhere, thus making the TK-42 cameras and their controls available for both remote and studio use.

satisfactorily. Production people handle scenery design, wardrobe and make-up problems.

Special Emphasis on Color Remotes

The TK-42 Cameras are constantly being used for remotes. A special 8-wheel bus-type mobile color-taping unit is employed. Camera controls are permanently installed here rather than in the studio.

KVVH handles network remotes from Hawaii's beaches such as ABC's SHINDIG program in 1966. The large mobile van is fully equipped for 2-camera color pickups either for putting on tape or for live relay. When employed for color studio programs the mobile control is connected in and the color cameras are rolled into the studio.

The mobile color unit is a special adjunct to the station's services for local merchants who want color commercials. It's also a great advantage to be able to offer the Waikiki beaches location to color advertisers on the mainland. The mobile unit with RCA TK-42 Cameras has enabled KVVH-TV to program live TV color to and from the mainland and to participate in some 12 Lani-Bird satellite transmissions.

FIG. 8. KVVH-TV Channel 4's newly acquired Jamieson color film processor which makes it possible, coupled with two RCA TK-42 color cameras, to air 9 hours of news programming in full color weekly.

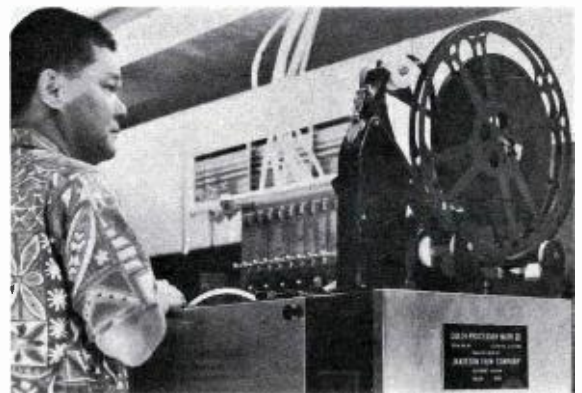

FIG. 9. KVVH-TV MVT unit at one of Hawaii's beaches for ABC's SHINDIG! program in 1966.



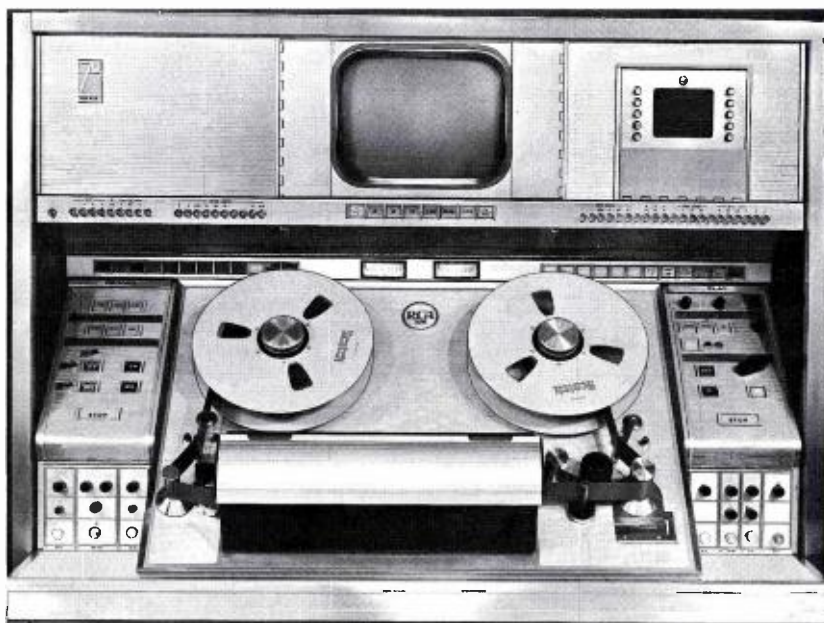

FIG. 1. Closeup view of TR-70 tape deck, with record controls at left and play controls at right.

TR-70 INTERNATIONAL TV TAPE RECORDER DESIGNED FOR PAL COLOR OPERATION

Super Deluxe Quadruplex TV Tape Recorder
Offers Built-In High Band, Operator Engineered Controls,
Switchable Tape Speeds and Line Standards

by PETER A. DARE, *Television Tape Merchandising*

The RCA International model of the Super Deluxe TR-70 high band TV tape recorder was designed by RCA to meet all the requirements of the PAL (Phase Alternation Line) color system developed in West Germany, and in particular, the technical parameters for PAL recording as set down by the European Broadcasting Union.

High band color techniques built into the International TR-70 make possible a new level of performance in producing pictures of increased brilliance and realism. Multiple generation color tapes are almost indistinguishable from originals. To the operator, the precision instrument is the ultimate in human engineering for easy, error proof operation. There is a choice of everything at the finger tips—TV line standards, tape speeds, operating modes—

all conveniently switchable. Complete in a modern, beautifully styled console, the PAL TR-70 is in production in Camden, New Jersey, and equipments are being delivered overseas.

PAL and NTSC Color Systems

The TR-70 TV tape recorder designed for PAL color standards is identical in outward appearance to the TR-70 for NTSC, reflecting the great similarity between the two color systems.

Both PAL and NTSC systems transmit the chrominance signals as phase quadrature components. In PAL, however, color difference signals V (R-M) and U (B-M) replace the I and Q signals of NTSC. These V and U signals are both transmitted on a 4.43361875 MHz subcarrier. In addition, PAL switches the phase of

the burst and V modulator signals during each scanning line. The burst phase is switched ± 45 degrees, and the V modulator phase, ± 180 degrees. Vectorscope PAL and NTSC displays for six colors are shown in the diagrams of Figs. 3 and 4.

Certain immunity to differential phase errors is possible with the PAL system. The degree of effectiveness increases with the complexity of the decoder used in the receiver or monitor. Also, in generating the PAL signal, there exists a wandering or "meandering" burst suppression waveform around the vertical blanking interval. This is diagrammed in Fig. 8. Four fields of the television waveform occur before the waveform repeats itself. It is this condition, together with the switching of the burst, that most closely affects the recording of the PAL signal.

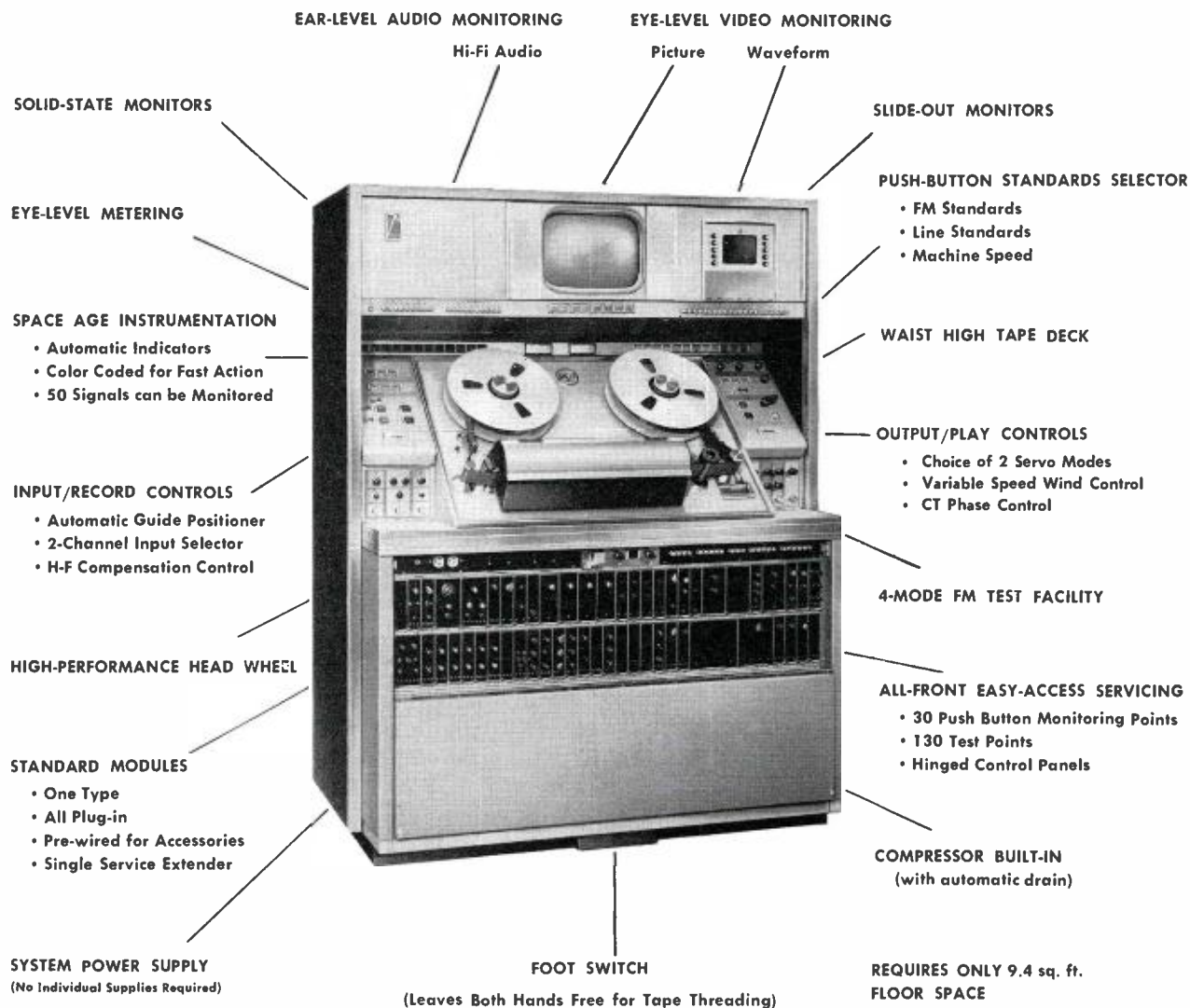

FIG. 2. TR-70 High Band Color TV Tape Recorder showing its many advanced features.

Superior High Band Performance

The International TR-70 utilizes high band frequencies of 7.06 to 10 MHz for 525 line operation, and 7.16 to 9.3 MHz for 625 line operation.

The most advanced high band modulation standards were chosen in the design of the TR-70 in order to minimize the beats or moiré patterns (down 34 dB) that otherwise occur between the tape carrier frequency and the color subcarrier frequency. Furthermore, the greater devi-

ation frequency results in an increased signal to noise ratio over previous recorders, in this case better than 43 dB.

From the basic mechanics to the most complex of the electronic circuitry, the TR-70 represents a complete redesign. Significant improvements in the signal system have eliminated the once troublesome differential parameters most harmful to color signals. Errors are now either absent or so small that multiple generation of color dubs is necessary to make them

visible. TR-70 performance specifications are given in Table 3. From these figures it is apparent that the machine can meet the most critical engineering specification.

Servo Refinements

The fundamental requirement of a tape machine operating on the PAL system is to select one of four fields on which to lock during replay. Since the NTSC system requires one of two fields, certain refinements are necessary in the basic servo system.

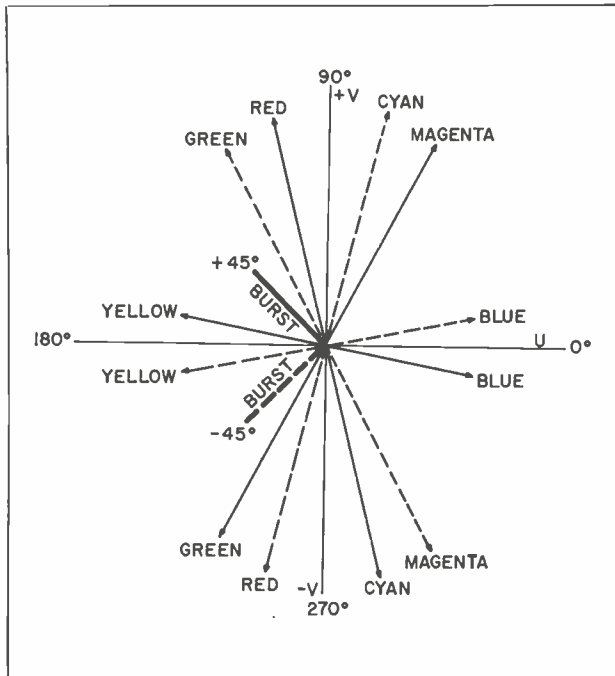

FIG. 3. PAL vector diagram for six colors.

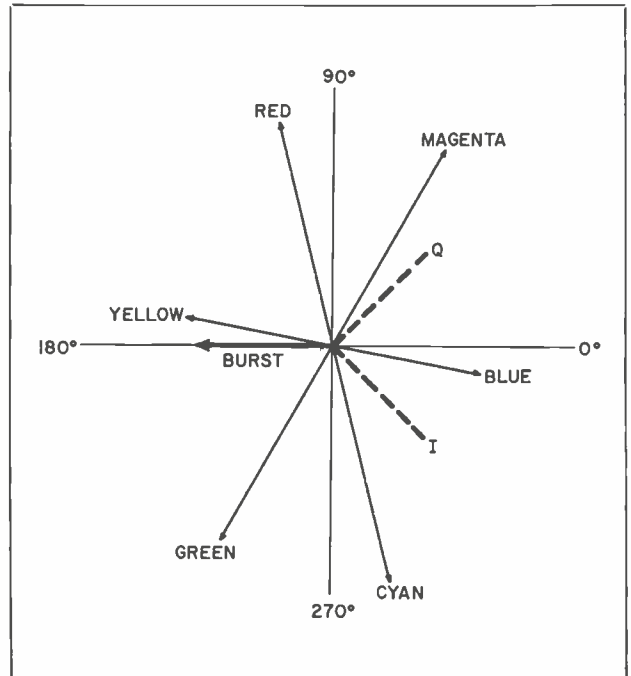

FIG. 4. NTSC vector diagram for six colors.

This critical one-in-four framing process is made relatively easy by recording a 12.5 Hz edit pulse instead of the normal 25 Hz edit pulse. Then, all that is necessary in the replay mode is for the servo to use this slower rate of edit pulse as a reference. Using the edit pulse as a reference, lockup time on the PAL system is maintained at the 5 to 6-second level.

Record Mode

Operationally, the process of recording PAL color signals is no different than monochrome, but there is considerable difference in how the PAL machine achieves it. As soon as color burst appears on the signal it is sensed in the color ATC (Automatic Timing Corrector), and the PAL record circuitry is switched on in order to record the 12.5 Hz edit pulse in the correct position.

To achieve this internal switching, the "E/E" or "back-to-back" electronics diagrammed in Fig. 7 is used. Back-to-back electronics (modulated, demodulated signals) have not been previously used in RCA machines for any more than monitoring. Here, however, use is made of this E/E signal since all the necessary coincidence pulses and waveforms are present in the record mode. Thus the need for a

TABLE 1

BASICS OF PAL COLOR OPERATION

- Burst phase switched ± 45 degrees each line
- V (R-M) signal switched ± 180 degrees each line
- Repetition rate of subcarrier frequency 12.5 Hz
- Immune to small phase errors

TABLE 2

PAL COLOR TAPING REQUIREMENTS (Prescribed by European Broadcasting Union)

- Record on high band standards
- Edit pulse frequency 12.5 Hz
- Edit pulse position to correspond to 4th PAL field

separate complex set of record gating electronics is avoided.

Built In Color ATC

The International TR-70 can be operated in either the NTSC or PAL mode. Therefore, the color ATC circuitry necessarily differs from that of the NTSC-only versions. Provision has been made to switch the burst ± 45 degrees each line in the correct phase with the switched V signal (V is the PAL equivalent to the NTSC I signal). To achieve this, one complete module of the CATC called the "PAL Module" is used. This module (634) also functions in the record mode to insure that the edit pulse is correctly timed.

Replay Mode

Because of the complexities mentioned earlier, the International TR-70 necessarily incorporates a "non standard PAL" warning light to alert the operator when a malfunction has occurred during the framing process. In effect, the indicator says the signal from the tape cannot be "mixed" with studio signals, and that the tape signal should be considered as non-

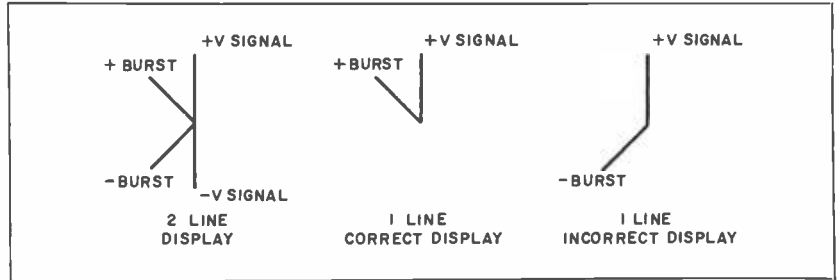

FIG. 5. Diagram showing burst switching requirements.

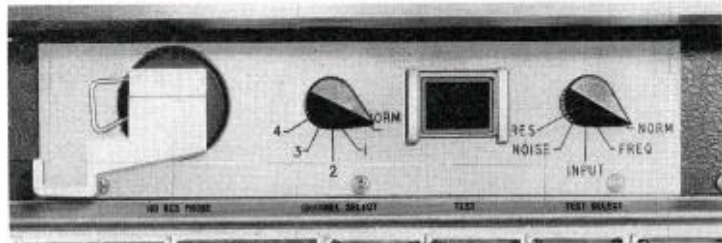
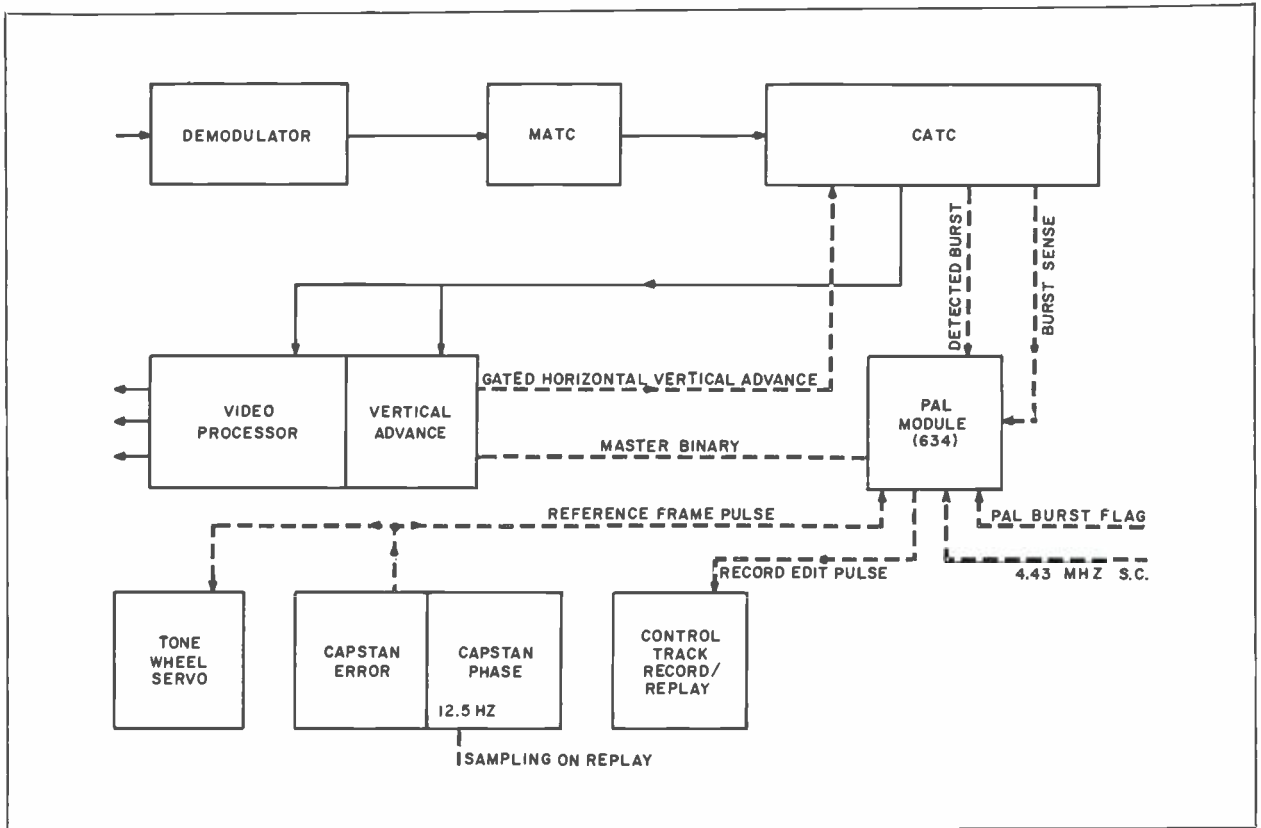

FIG. 6. FM test facility built into TR-70 assists operator in setup measurements and matching of the four video heads.

FIG. 7. Simplified block diagram showing elements of PAL circuitry in dashed lines.



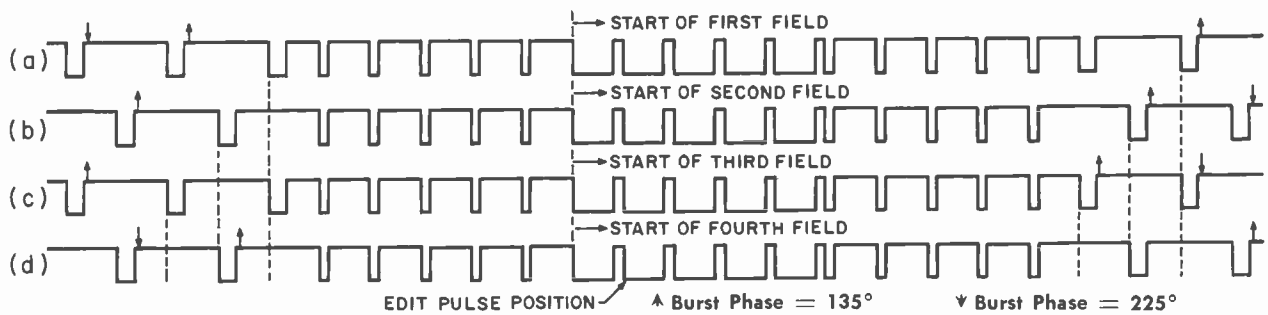

FIG. 8. Diagram showing PAL "meandering" burst repetition.

synchronous. Under normal conditions the non standard PAL indicator will not be illuminated unless the operator is purposely using the line lock mode of operation.

The line lock mode has the ability to recover quickly from sync disturbances or non synchronous switches during the record and replay modes. This fast relock is accomplished by disregarding the phase of the vertical sync during the relock cycle. If the Pixlock mode of operation is selected, the non standard PAL indicator should never be illuminated except for the period of the sync disturbance, after which the machine will return to its original condition of a completely synchronous replay. Tone wheel or switchlock cannot be used for color operation. In order to replay a PAL signal synchronously, 4 Volts of PAL burst flag (Kp) is required in addition to the composite sync (S) and subcarrier (Cs).

Splicing

Either mechanical or electronic splicing can be accomplished on PAL recordings. Mechanical splicing is limited because of the distance between edit pulses (approximately 2.5 cm) and the possibility of poor audio continuity if the splice point is incorrect. Electronic splicing is made possible by using the edit pulse on the control track as the servo reference. In this way, the splice can be made in the same manner as with monochrome.

Chroma Amplitude and Velocity Error Correction

Correction of both chroma amplitude and velocity errors on PAL tapes is desirable and is accomplished by the CAVEC module. The correction of chroma amplitude variation is necessary to the same

degree as in NTSC. Correction of velocity errors in PAL is not as important as in NTSC, however, velocity error correction removes any possibility of difficulty in simple PAL decoder type receivers or the multiplication of errors when dubbing.

Conclusion

The International TR-70 high band TV tape recorder provides the highest standards of performance known to the TV tape industry. It is designed mechanically and electrically to provide the utmost in easy, error proof operation with a minimum of attention and maintenance.

Much of the design and development work on the International model was performed by RCA Laboratories in Zurich, Switzerland. PAL/NTSC TR-70's are presently being delivered to television stations in Austria, Australia, Britain, Germany, Hong Kong, Italy and Norway.

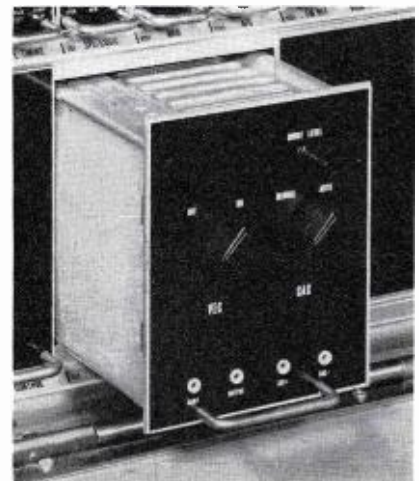

FIG. 9. Solid state plug in CAVEC module for chroma amplitude and velocity error correction.

TABLE 3

TR-70 COLOR PERFORMANCE SPECIFICATIONS

Frequency Response	25 Hz to 5.5 MHz ± 0.5 dB
Signal to Noise	43 dB (measured with RCA Tape Type 7000 or equivalent)
Linearity	1% or better
Square Wave Response80 ns
2T Sine Squared Pulse and Bar	1.5 K or better
Moiré	34 dB or better
Differential Gain	5% or better
Differential Phase5° or better
High Band Frequencies625 line: 7.16-9.3 MHz

Above figures apply to 4.43 MHz color subcarrier, tape speed of 39.7 cm/sec and 625 line high band deviation standards

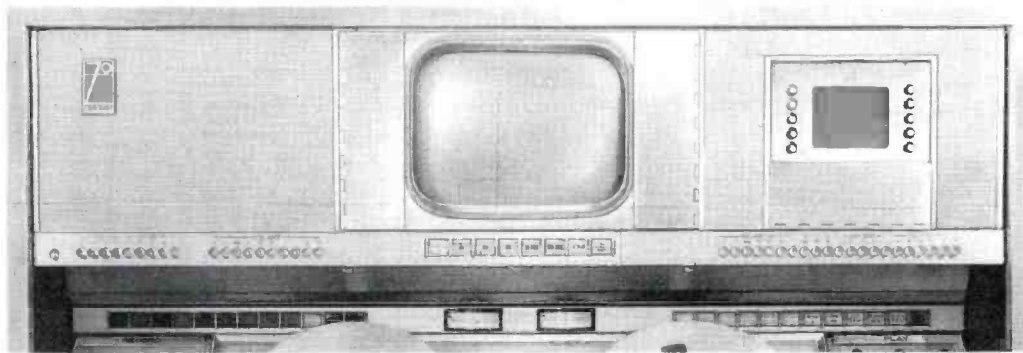

FIG. 10. Full instrumentation for audio and video monitoring.

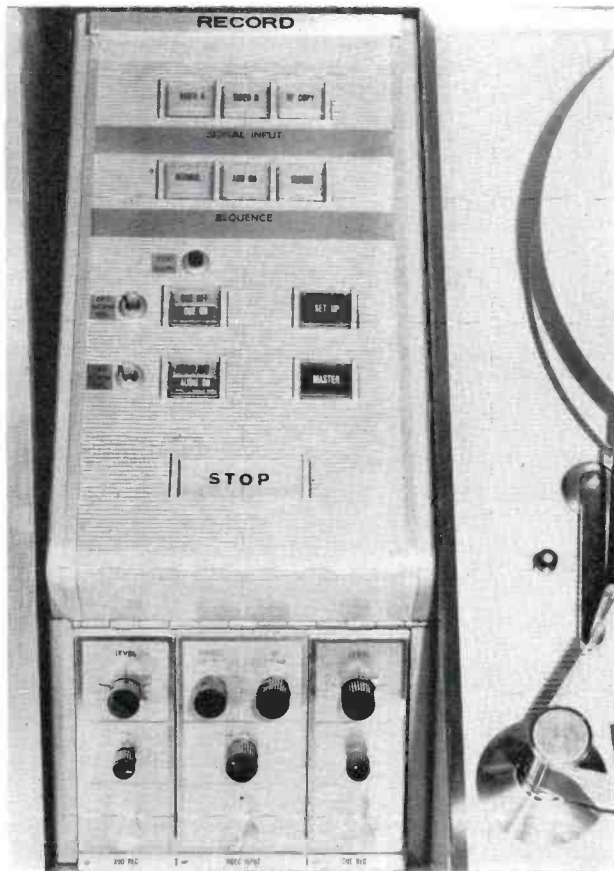

FIG. 11. Record controls.

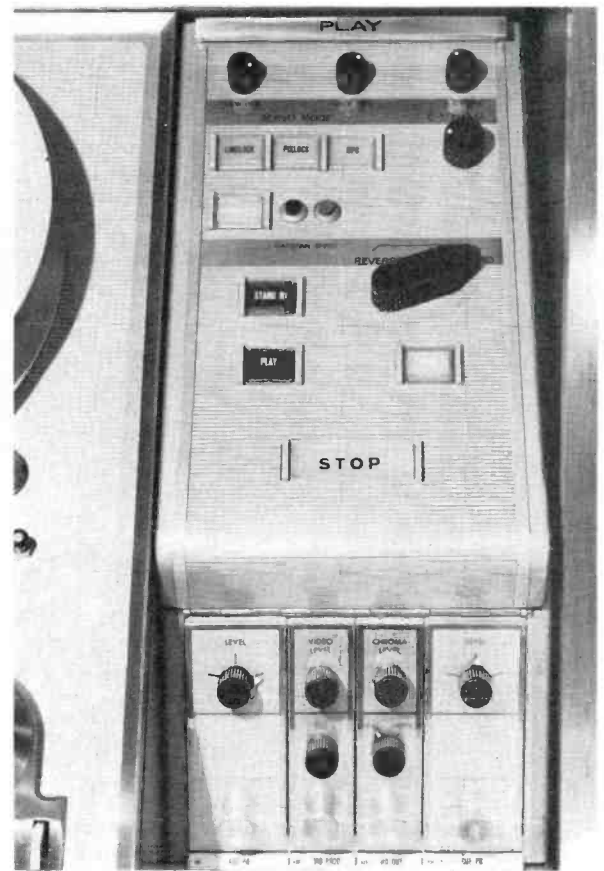
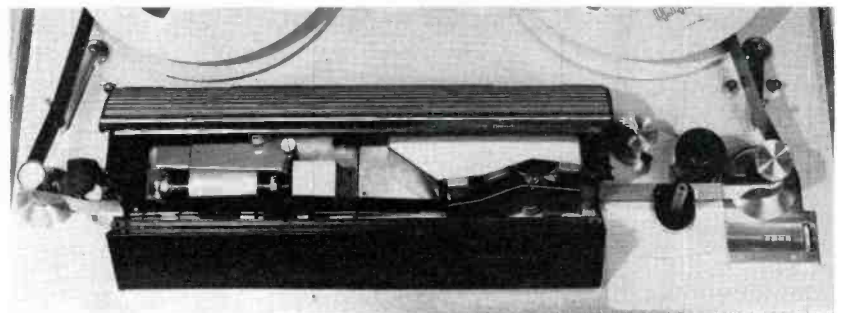

FIG. 12. Play controls.

FIG. 13. High band air bearing headwheel. Simple tape threading.



THE "NEW LOOK" IN PARALLEL OPERATION OF 12.5 KW VHF TV TRANSMITTERS

by D. L. WRIGHT, *Product Analyst,*
VHF Broadcast Transmitter Equipment Merchandising

Parallel operation of TV Transmitters originated in Great Britain and Europe. In the present day television market, outside North America, this concept has become so popular that most of the major TV station installations chose parallel transmitters as the obvious choice of operation over the conventional main and standby system. Realizing the performance and economic advantages of the parallel transmitter operation, RCA adapted this system for television station WNAC-TV located in Boston, Massachusetts. On February 23, 1964, WNAC-TV became the first U.S. station to employ parallel TV transmitters.

Two TT-25DH 25-kW Transmitters are used for this installation to achieve 50 kW output. A similar installation is KCRG-TV Cedar Rapids, Iowa.

Other parallel TV transmitter installations are WCSH and KTLA, employing two TT-12BL 12.5 kW Transmitters to obtain 25 kW; WAPA, using two TT-6AL units to obtain 12 kW; and recently WGAN purchased two TT-12EH 12.5 kW Transmitters to produce 25 kW.

Transmitter Description

The parallel transmitter equipment consists of two TT-12EL 12.5 kW "New

Look" TV Transmitters producing a TT-12/12EL configuration. They operate on VHF Channel 2 through 6 or 47-88 MHz on CCIR Standards, with peak visual power output of 25 kW (22.5 kW CCIR) and designed for 25 per cent aural power.

"New Look" transmitters reflect the newest in styling, performance and operation — with a beautiful matching appearance and matching operating characteristics. These transmitters are designed to provide the ultimate in performance when used with other RCA equipment that is designed to provide the finest performance and most modern appearance for the

FIG. 1. Parallel Transmitter Installation, using two TT-12EL 12.5 kW TV Transmitters.

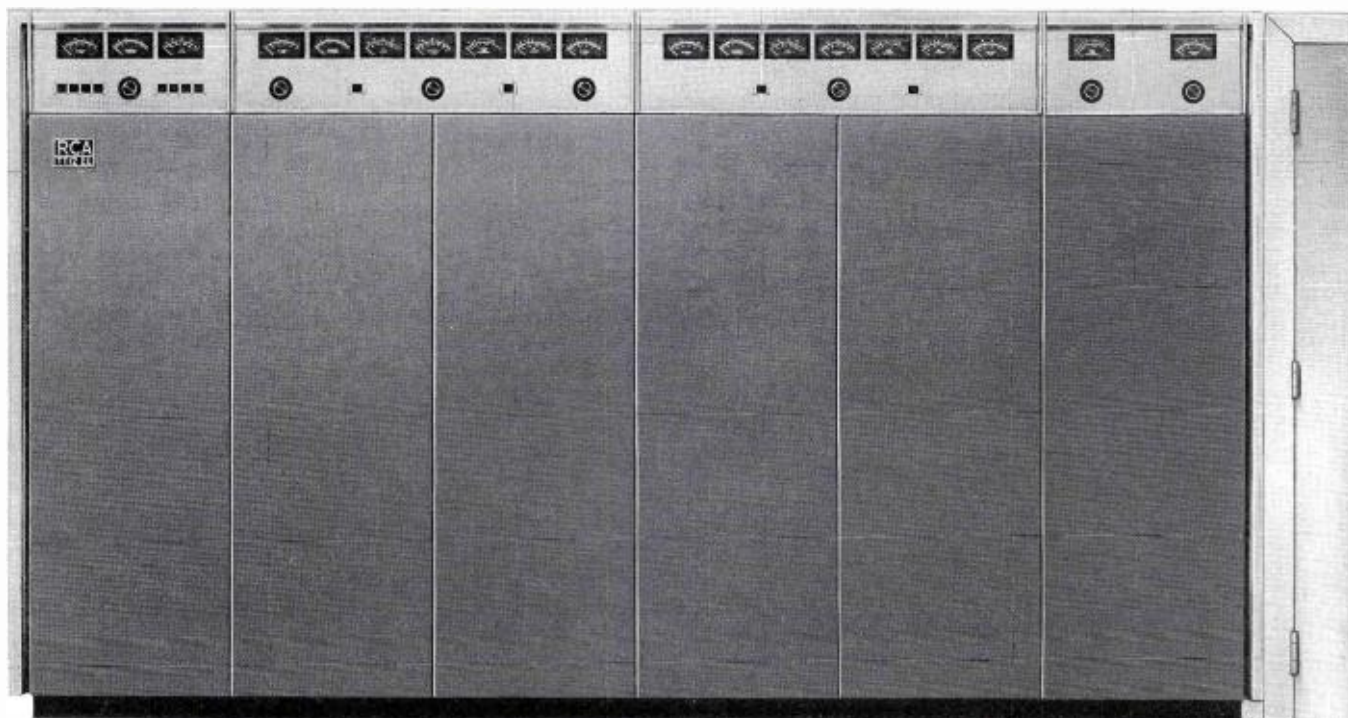
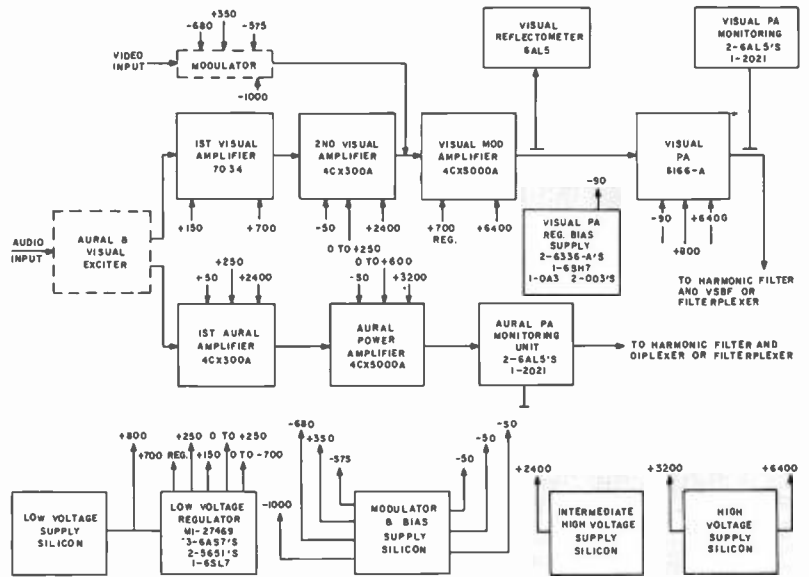

FIG. 2. Simplified Block Diagram of one TT-12EL VHF TV Transmitter.



whole station. The installations are compact, yet easily expandable, offer greater reliability, and provide for easy color operation and maintenance. The TT-12EL Transmitters have three in-line cabinets housing the control circuits, the exciter-driver cabinet, and the final amplifier cabinet. They are finished in two shades of blue, with heavy polished stainless steel trim, and a harmonizing silver-gray finish on the control panels.

"New Look" Way to Maximum Power

Parallel operation of the two TT-12EL VHF TV Transmitters in conjunction with

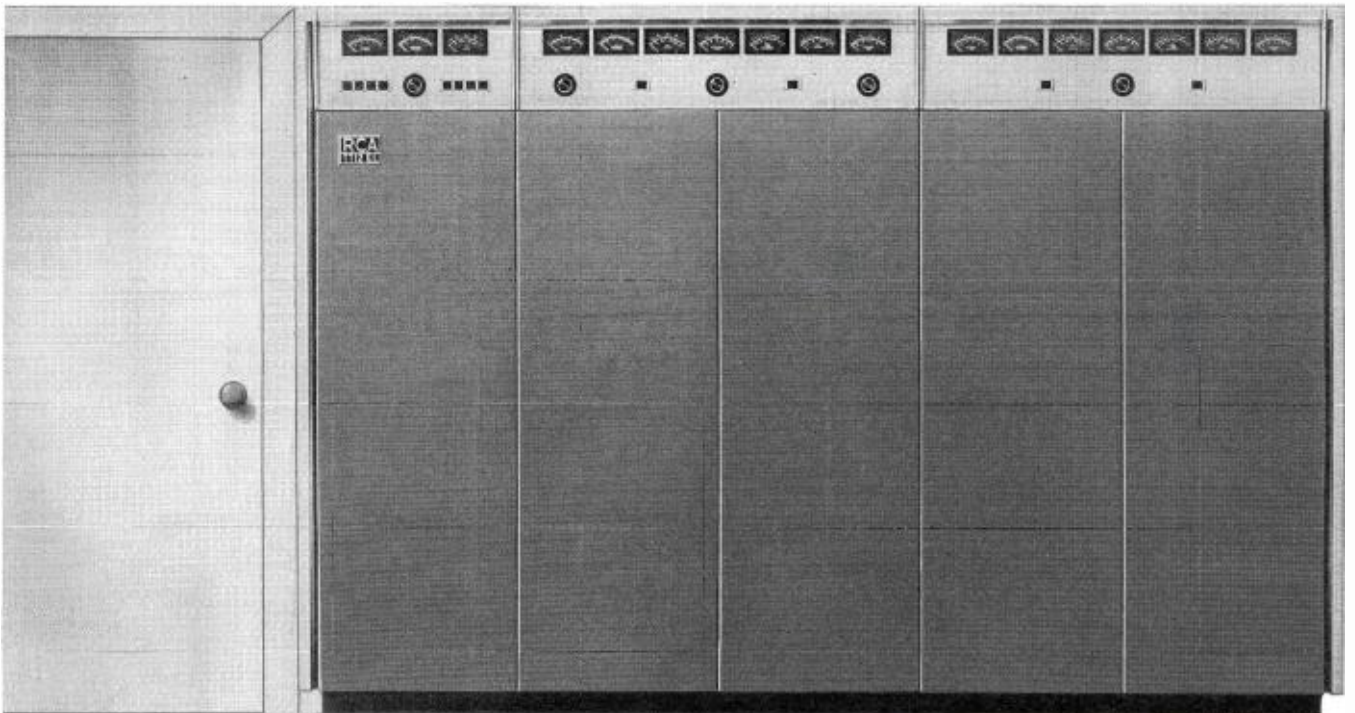

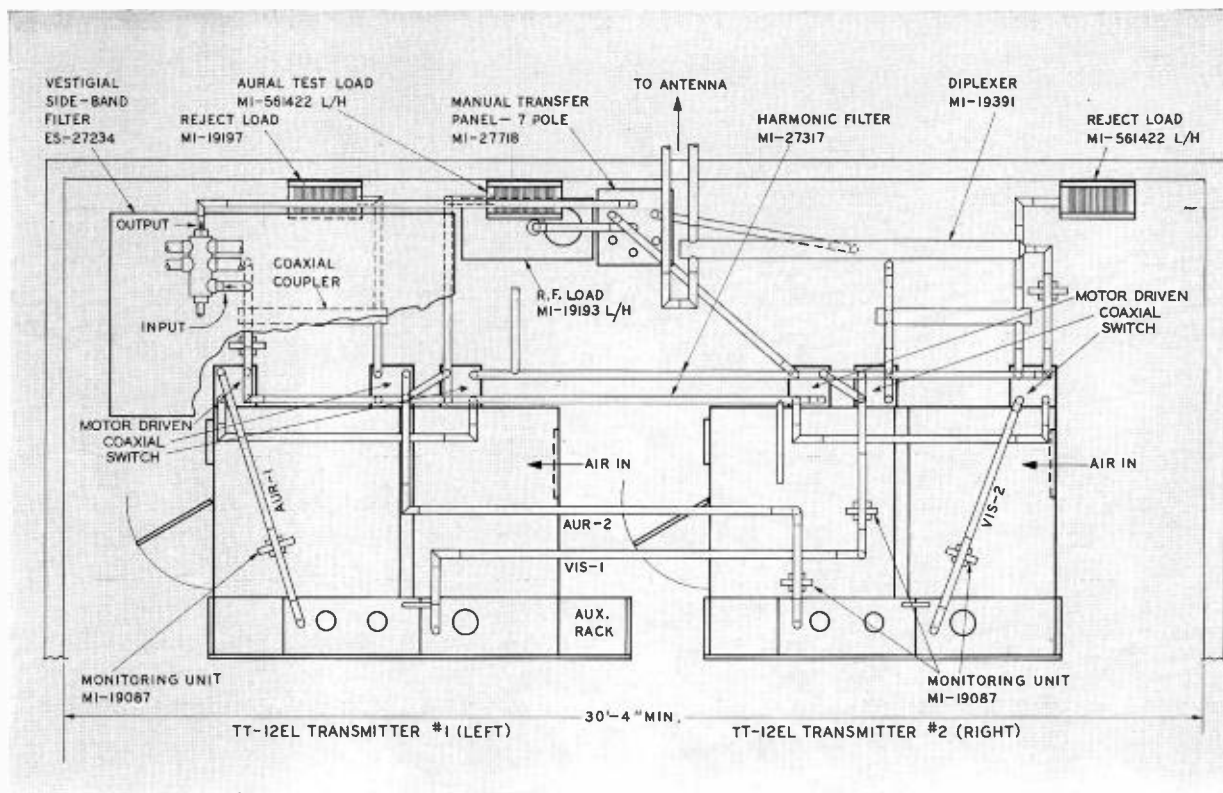

FIG. 3. A typical floor plan showing parallel operation of two TT-12EL Transmitters. The layout shows the coaxial switching system, aural and visual reject loads, diplexers and associated monitoring equipment.

an RCA VHF TV antenna will furnish the TV broadcaster with an economical matched line that can deliver the maximum required ERP. This system will produce a sharp monochrome picture of uniform high quality throughout the service area, and in addition, some extraordinary improvements will be obtained in color transmission.

Advantages of Parallel Operation

There are numerous advantages in utilizing parallel operation of TV transmitters. The greatest advantage is that if one transmitter should fail, the other can still be operated. It is possible to continue operation with one transmitter having a 6dB or one fourth reduction in power. A co-axial switching system can be motor controlled or operated by hand to switch the output of the operating transmitter directly into the harmonic filter. By-passing the hybrid combiner results in a one-half rather than one-fourth the power of the operating transmitter to be fed into the system.

As a result of this flexibility, there is no change in aural reception. Near-by TV

viewers will experience no change in picture quality, while viewers in fringe areas may receive a picture with less contrast and resolution.

There are also secondary advantages such as having both transmitters always in use—it is obvious that there will be no lost time in placing the standby transmitter in operation. By evaluating operational results, it is significant that in any paralleled operation employing identical units, the mean time between equipment failure is improved by 150 per cent.

Provides Top Performance and Economy

Where the very best in performance and reduction in downtime is desired paralleled operation is the obvious choice. Data obtained from accepted systems show the advantages between the single and parallel transmitter performance measurements.

Improved electrical performance results are a significant factor, the improvement in the amplitude vs. frequency response and in differential gain is particularly desirable. A comparison of performance data

is shown in the accompanying table "Parallel Operation Improves Performance."

HOW PARALLEL OPERATION IMPROVES PERFORMANCE

	Single Transmitter	Two Transmitters in Parallel
Frequency Response	±0.5 dB	±0.3 dB
Sawtooth Linearity	4%	2%
Overshoots	±10%	±5%
AM Noise	-60 dB	-68 dB

Parallel transmitter operation will ensure satisfactory transmission of black and white or color signals as observed by the improvement in amplitude linearity, frequency response and differential gain. The improvement in these signal characteristics indicate that the transfer characteristics of parallel operation are essentially more linear.

It is an unlikely assumption that similar imperfections and irregularities will occur

in both transmitters at the same time, usually an averaging of the two takes place. The performance of a paralleled transmitter pair is clearly superior to that of either transmitter alone. This can be particularly noticeable from the data shown in the accompanying table.

A further performance advantage obtained from the parallel arrangement is

that any reflections that come back from the antenna and are reflected back towards the antenna from the output circuits, causing high VSWR, reach the combiner 180 degrees out of phase and are absorbed in the reject load. This results in the cancellation of the reflection and, in addition, the possibility of retransmitting ghosts is greatly reduced—in both monochrome and

color pictures. Reflectometer VSWR readings of 2:1 caused by antenna icing have been reported without noticeable ghosting on receivers.

The economic advantages of two parallel transmitters compare favorably with the main and standby transmitter system, although the supposition is that the cost is approximately 10 per cent more than a

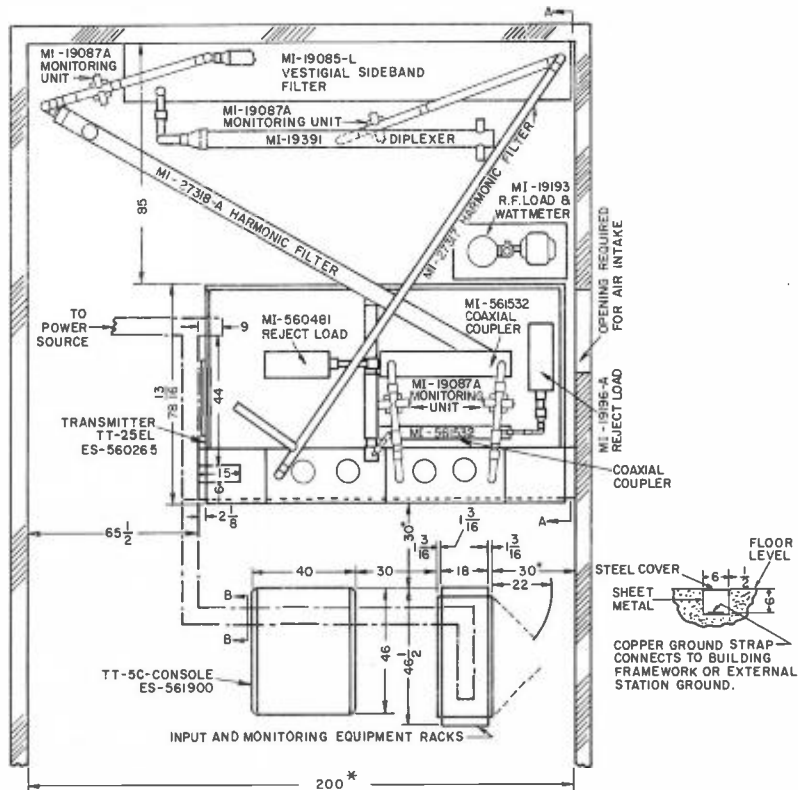

FIG. 4. A typical floor plan for one TT-25EL 25-kW VHF Transmitter.

high power transmitter of equal power. The reliability of paralleled transmitter operation gains in importance as the advantages become more noticeable in uniform high quality performance, smaller spare tubes and parts inventory, less off-air time, and reduced maintenance costs. Fewer problems result as one transmitter can be shut down for servicing and repair during prime time while the other maintains program without affecting the majority of viewers.

Another benefit is the advantage of having an identical transmitter unit available for comparison of meter readings, dial settings, and switch positions; this speeds trouble shooting and repair of any faults.

Parallel Operation Improves Color Transmission

As color programming becomes more popular, improved color transmission is the main consideration for TV broadcasters

to achieve. This dictates the use of the improved method for detection and correction of video and RF phase errors.

For parallel transmitter operation, improved color transmission is accomplished by using the continuous video phase monitoring and correction scheme. A wideband differential oscilloscope performs as a phase detector and monitor, and a variable synthetic line switching section as a corrective device. In this system the video phase is monitored and corrected during program time.

Another application designed for color is the RF phase detection and correction circuits which use constant impedance, aural and visual line stretchers between the exciter and transmitter in opposite halves of the parallel transmitters. Adjusting the line stretcher length and reducing combiner reject load power to a minimum, correct in phase operation is generally achieved.

Parallel Equipment and Floor Plan Layout

A typical floor plan, Fig. 3, shows two TT-12EL 12.5 kW VHF TV Transmitters connected for parallel operation. In comparison to the parallel system, floor plan Fig. 4 details a typical floor plan of a single TT-25EL Transmitter installation.

The outputs from the paralleled transmitters are fed into their respective aural and visual transmission lines to the hybrid combiners in the conventional manner. Manual or automatic switching provisions can be incorporated to route the signal of either one or both transmitters, in case of failure, directly into the harmonic filters or dummy loads for test purposes.

There are numerous configurations that meet practically any broadcaster's requirements. The TV broadcaster should decide on a plan for appearance, simplicity, flexibility, interchangeability, maintainability, and accessibility to all components. The ultimate installation is to provide the

FIG. 5. Simplified block diagram of the TT-12/12EL parallel transmitter system. Switching arrangement permits the selection of either exciter unit and other RF circuits.

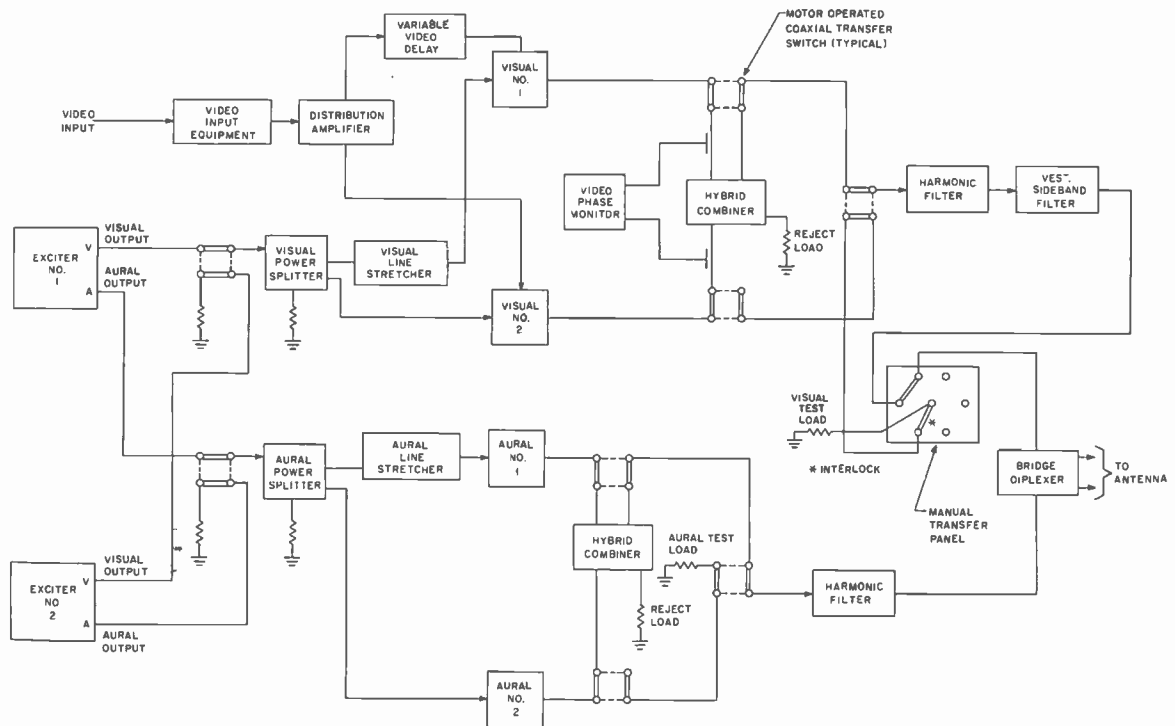

broadcaster with a standard floor plan layout in which the coaxial line lengths, hybrid combiners, reject loads, diplexers, harmonic filters, switching facilities, test loads and other associated equipments are preset and available as a standard packaged installation. Standard station floor plans could be re-designed, if necessary, to meet each customer's unique requirements. Complex installations should be avoided because this tends to make it very difficult to trace the signal path through the system.

During installation of the paralleled system coaxial line lengths are corrected by make-up loops located between the switching panels and the lower input arm of the hybrid combiners to insure in-phasing combining. Adjusting the line stretcher will make up the slight differences in transmitter transfer phase and line cutting errors.

Exciter and Aural Modulator

The parallel TT-12EL Transmitters are driven by a common 5-watt exciter containing both visual and aural chains. Figure 6 is a photograph of the "New Look" exciter unit. A simplified block diagram of the exciter is illustrated in Fig. 7.

Frequency modulation is used to modulate the aural chain, and intercarrier separation is maintained by an automatic frequency control circuit. Since the FM aural modulation takes place in the exciter unit, it is understood that no audio phasing is necessary.

Visual Modulator

The transmitter visual modulator, one for each transmitter, grid modulates the 4CX5000A visual modulated amplifier. (See Fig. 8.) A simplified block diagram is shown in Fig. 9.

Linearity correction is accomplished by the use of four biased diodes connected in the linearity corrector cathode circuit in parallel transmitter operation. The video input signal to each visual modulator is normally fed from the video input equipment through the stabilizing amplifier and distributed to each transmitter visual modulator by the distribution amplifier.

A photograph of the TT-12EL exciter and modulator units is shown in Fig. 10.

Aural and Visual Hybrid Ring Power Splitters

A unique engineering scheme designed for aural and visual power splitting is the

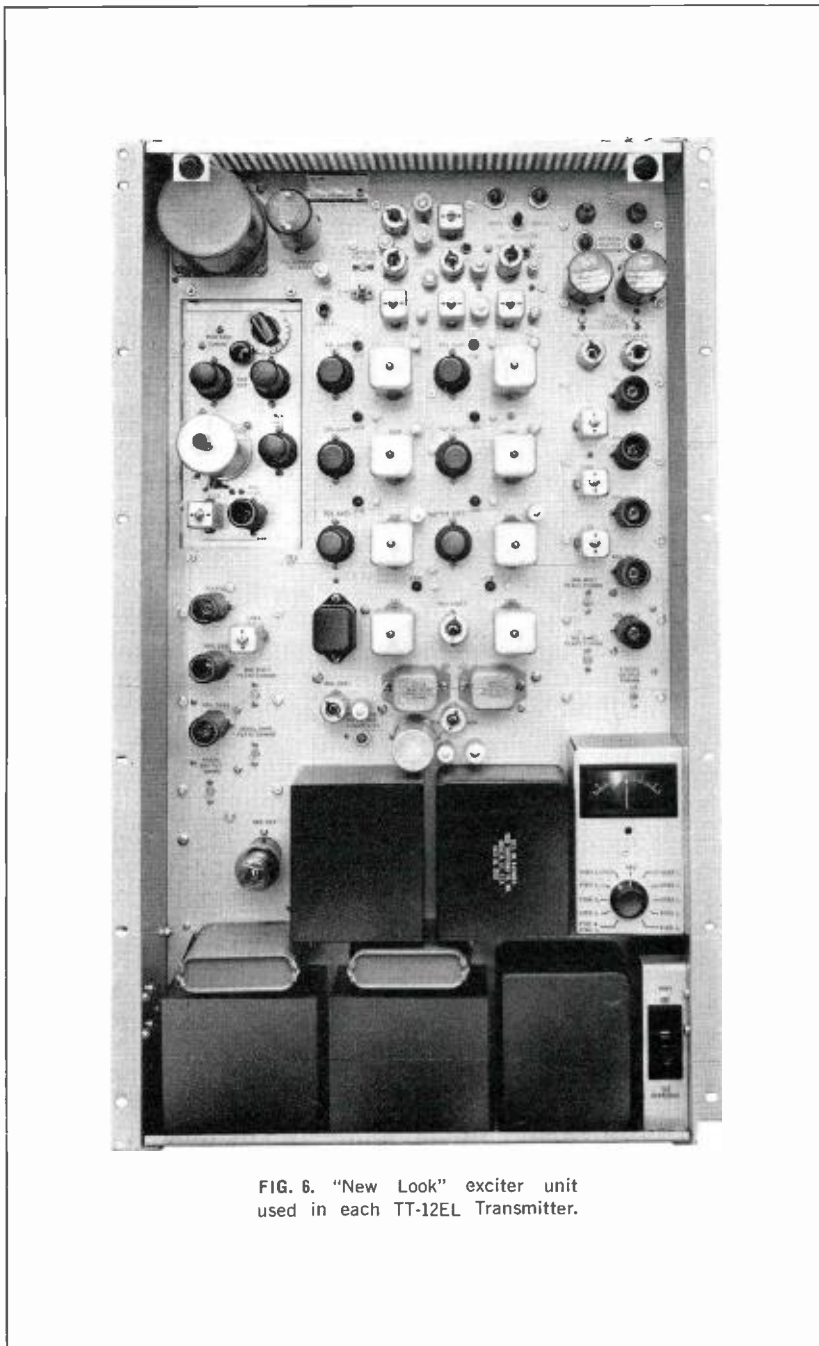

FIG. 6. "New Look" exciter unit used in each TT-12EL Transmitter.

utilization of the coaxial hybrid ring power splitter. The hybrid ring power splitter provides an inherently unbalanced input and output connection for the aural and visual signals produced in the exciter. To prevent input RF mismatches, the coaxial lines making up the hybrid ring have an impedance of 75 ohms or a characteristic impedance equal to the square root of two

times the impedance of one of the arms. The hybrid ring is designed to provide in-phase aural and visual output signals and feed the reject signal into a resistive load resulting from phase or amplitude inequalities.

Two hybrid rings cover the exciter frequency range with no more than 1.3:1 VSWR for the entire VHF band.

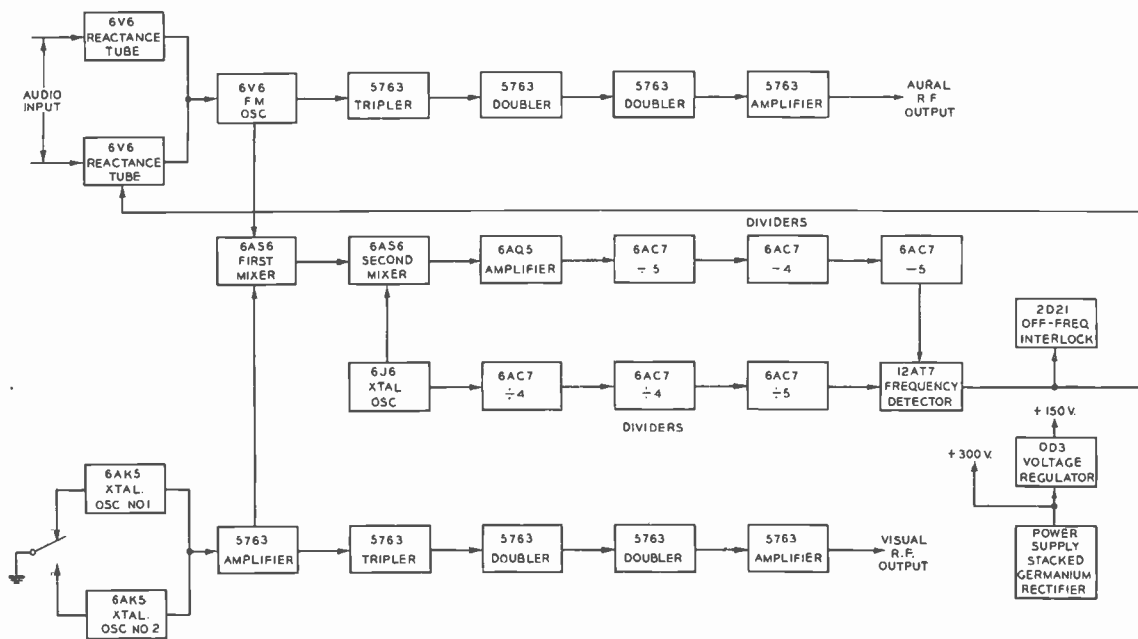

FIG. 7. Simplified block diagram of the TT-12EL aural and visual exciter. Accurate control of the separation of the visual and aural carrier results in the improvement of color TV performance.

Coaxial Line Stretcher

The RCA system of line stretcher replaces the normal cut and try method of obtaining the correct video coaxial feed line length to the modulators for correcting phase errors. A variable line stretcher conveniently used for this purpose is a synthetic lumped constant line designed for the necessary cut-off frequency and delay time period at 3.58 MHz. This device is merely a coaxial line section that is adjustable in length, is simple to operate for initial adjustment, and easy to compensate for future video phase shift.

Bridge Diplexer and Hybrid Combiner

A bridge diplexer is used to accurately control the combined aural and visual signals in phase and amplitude, and feed the two identical signals into a common output, usually a television antenna. The output signals from the parallel transmit-

ters will add and combine, achieving peak efficiency at in-phase condition. Under properly adjusted conditions, the reject load, which is part of the hybrid combiner, does not dissipate any power. Therefore, when the signal from one transmitter is adjusted to be exactly in amplitude and in phase to the signal from the other transmitter, the power dissipated in the reject load will be zero.

To attain the correct operation of a parallel transmitter system, the reject loads, which are used at the hybrid combiner, will absorb and dissipate the mismatch power. The reject load will receive zero power only when the two input signals are in phase and equal in amplitude.

Reject Load Rating

The reject loads are designed to dissipate the maximum possible fault power which

usually is one quarter the normal aural and visual hybrid combiner output power.

RF Phasing and Amplitude Balance Controls

The RF phasing and amplitude controls are placed on a panel which is part of the auxiliary equipment control rack. With the proper operation of the RF phasing and amplitude controls, the RF carriers of both transmitters are combined in phase and equal in amplitude. In this condition the transmitters will perform at maximum efficiency and avoid wasting power in the reject load. The panel contains one aural and one visual constant-impedance line stretcher, meters to indicate the amount of reject power, and amplitude controls to adjust the aural and visual output power of each transmitter.

Data of previous RCA parallel transmitter installations indicate a RF phase

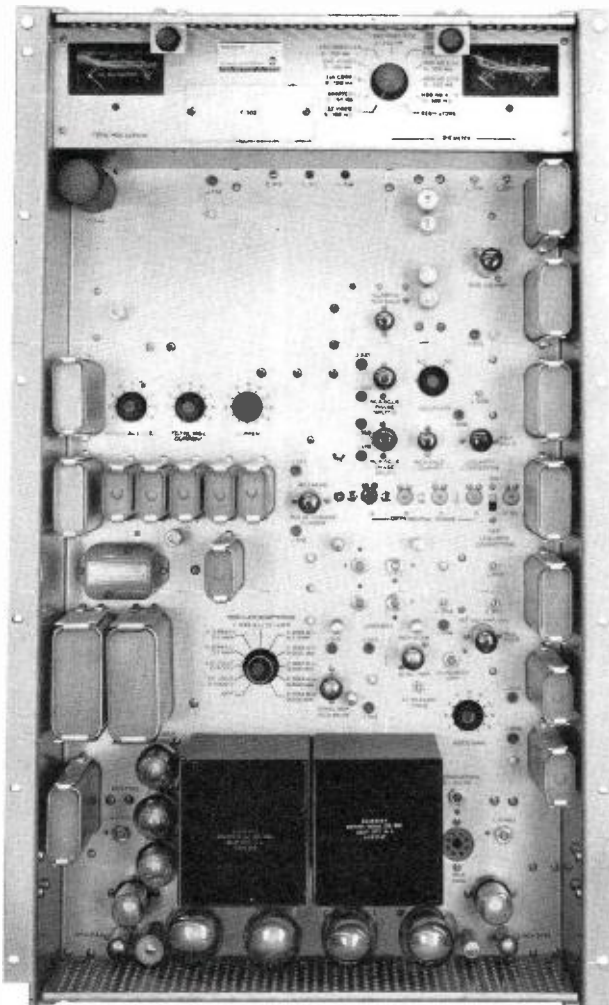

FIG. 8. "New Look" Visual Modulator Unit provides a high quality video signal to modulate the visual modulated amplifier. The modulator has linearity correction circuits for improved color performance.

drift of less than five degrees per month. This portrays less than 0.3 per cent fall-off in radiated power. Figure 13 shows the RF phasing and amplitude control panel located on the auxiliary equipment control rack.

Auxiliary Equipment Control Cabinet

A "New Look" cabinet containing the auxiliary equipment monitoring and control panels is placed to the right of the left

RCA TT-12EL VHF Transmitter as shown in Fig. 1. The control and monitor functions are displayed in Fig. 13.

Many functions provided by the auxiliary equipment control cabinet duplicate some of the control, metering and monitoring functions provided by the transmitter control console. Thus, for economic reasons the auxiliary equipment control cabinet can afford a complete monitoring

and operating center for the TV broadcast transmitters. In addition, it permits the use of a less complex control console providing numerous configurations that meet practically any station requirements.

Flexibility in operation is possible when there are facilities provided for the auxiliary equipment control cabinet to work in conjunction with the transmitter control console to monitor and operate the two parallel transmitters.

Video Phase Monitoring Equipment

For monochrome TV broadcasting, modulator phasing can be performed without the use of phase monitoring equipment. For color TV broadcasting video phase monitoring is desirable. The equipment consists of two video diode detectors attached to the visual output lines of both transmitters feeding to the hybrid combiners. Two cables of equal delay feed the detected video signal to a two-channel differential oscilloscope. Correct video phasing can be conveniently checked by feeding a standard video staircase waveform to the system input, which has the 3.5 MHz burst signal superimposed on each step, and adjust the video delay line switch for minimum reflection on the oscilloscope. A true display of modulator combining phase will be shown when the main controls on the oscilloscope are adjusted to maintain equal input signals from the video diode detectors.

Coaxial Switching for Parallel Transmitter Operation

To operate the parallel transmitters at optimum efficiency for continuous operation and avoid complete transmitter shutdown, an automatic, manual or combination switch arrangement is incorporated in the installation. Figure 5 shows the system interconnection and switching arrangement block diagram of parallel transmitter operation.

Automatic or manual switching enables either of the 5-watt exciters to be connected into the system. The motorized coaxial transfer switches permits either transmitter to bypass the hybrid combiners when either transmitter fails. The one transmitter will be unaffected and the faulty transmitter will be switched to the test load for test and maintenance purposes. Thus, either one or both transmitters can drive the complete antenna through their respective aural harmonic filter, visual harmonic filter, vestigial side band filter and combining bridge diplexer. A 7-pole manual transfer panel places the visual test load across the output of the

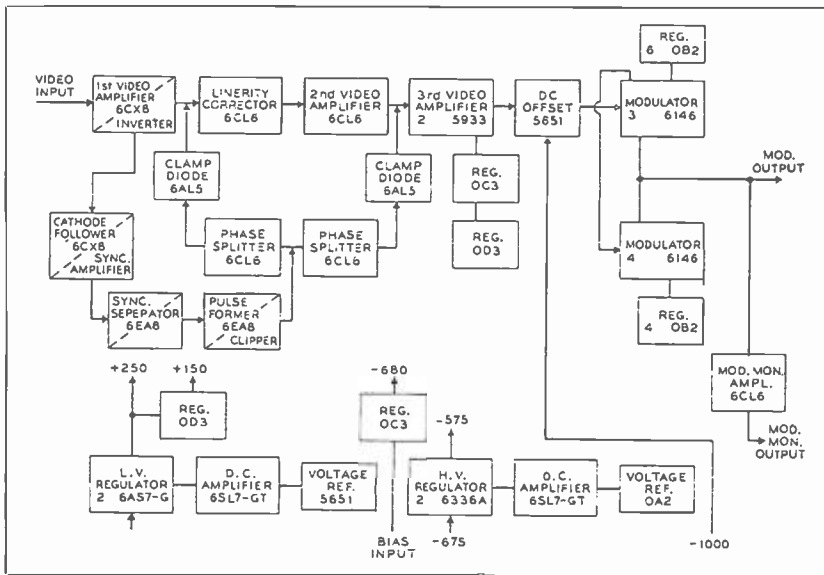

FIG. 9. Simplified block diagram of the visual modulator. Linearity correction circuits can be adjusted to eliminate the grey scale distortion and to improve picture contrast.

On the left-hand monitor control panel there are controls for audio and audio monitor gain, switches for left transmitter turn-on and off, plate voltage on/off and overload reset. Indicator lights show the operating status of various transmitter circuits. Four remote meters provide continuous indication of aural power output, aural transmitter input level, aural percentage modulation level and visual power output.

On the right-hand monitor control panel transmitter and plate on/off and overload

faulty or unused visual transmitter. The transfer switch can also be used to feed the visual output of both transmitters into the visual test load. The unused portion of the switch may be used, at the discretion of the customer, to connect additional circuitry when required during expansion programs.

Transmitter Control Console

The transmitter control console is comprised of two RCA Type TTC-5B Transmitter Consoles modified for parallel transmitter operation as shown in Fig. 14. The custom console is designed specifically for parallel transmitter systems. Each section of the console includes a monitor control panel, a transmitter control and indicator light panel. TO-4 Waveform Monitor and a TM-19 Picture Monitor, arranged as shown in Fig. 14.

Two monitor control panels are used, each panel contains all the necessary switches and indicator lights required for operation and status indication of both transmitters. They may also contain any special controls needed for particular transmitter functions.

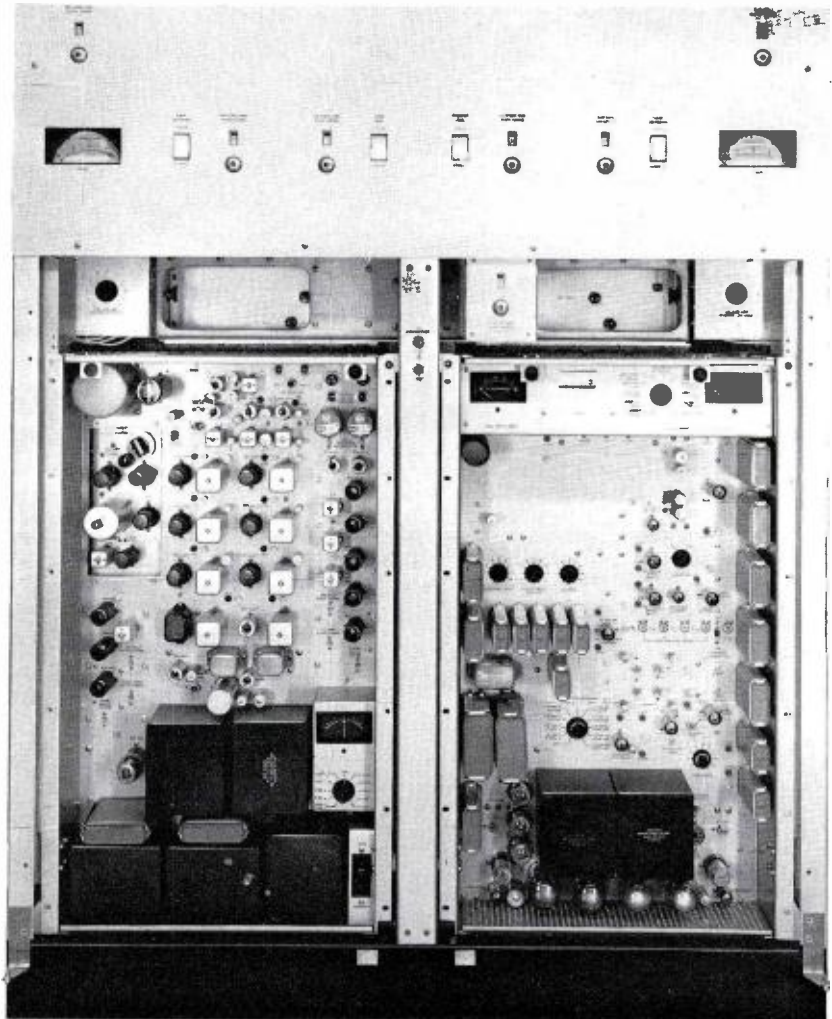

FIG. 10. Transmitter Aural and Visual Exciter (left) and Visual Modulator (right) units are shown mounted in the 6-kW RF unit. The units tilt forward for easy accessibility, for maintenance and servicing.

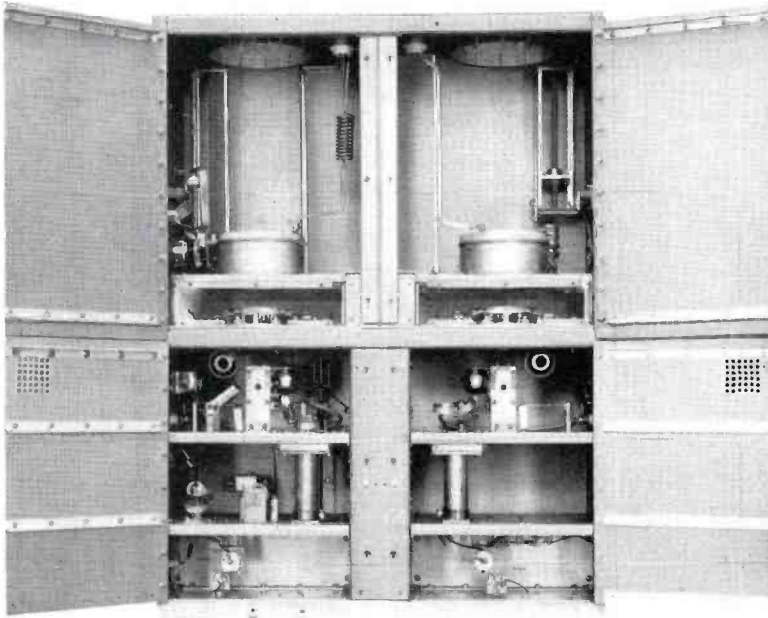

FIG. 11. TT-12EL Visual (left) and Aural (right) RF Driver units. The RF circuitry has the same proven outstanding design features which provided superior performance in prior RCA TV Transmitters.

reset are duplicated for the control of the right-hand transmitter. The panel contains raise and lower controls for aural and visual excitation, video gain and pedestal levels. Four meters provide continuous indication of right transmitter aural power output, combined aural power output, combined visual power output and visual power output.

Two "New Look" transistorized waveform and picture monitors are included for viewing the picture and the video signals at various points throughout the transmitter. In addition, there are provisions for the observation and measurements of the combined video waveforms simultaneously with waveforms at other test points. The exciter control switches select the desired exciter for the two transmitters, and switches are provided for off-frequency interlock bypass.

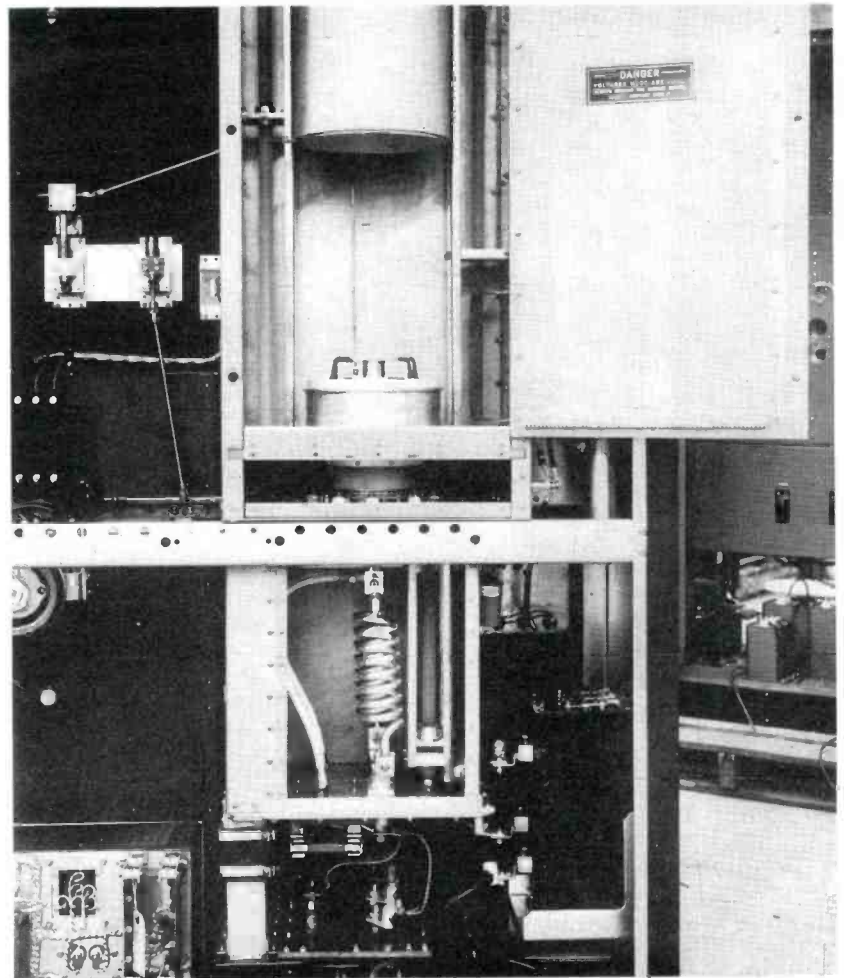

FIG. 12. Visual RF Power Amplifier showing the RF components and 6166A tube socket. Direct current is used for filaments of the 6166A tube to reduce hum modulation to a level well below the usual requirement.

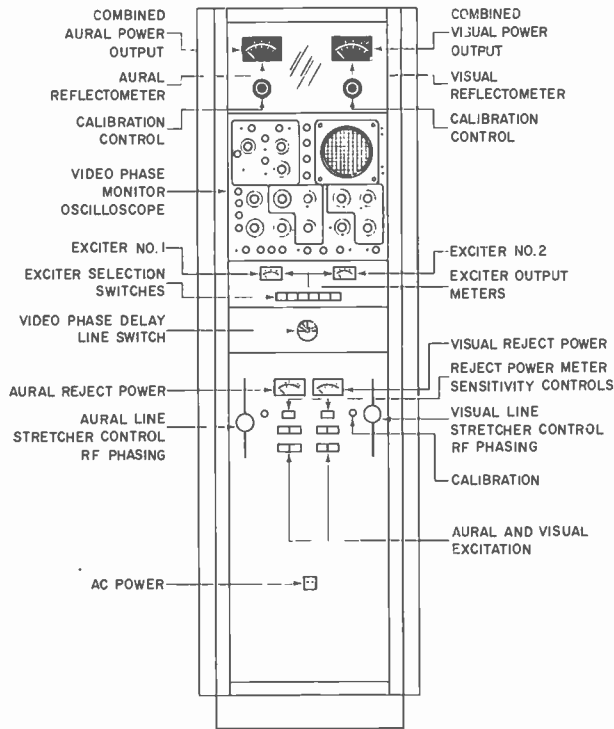

FIG. 13. A view of the auxiliary equipment control rack. In some installations the combined aural and visual power output meters and controls may be omitted. The duplicate function would be provided by the transmitter control console.

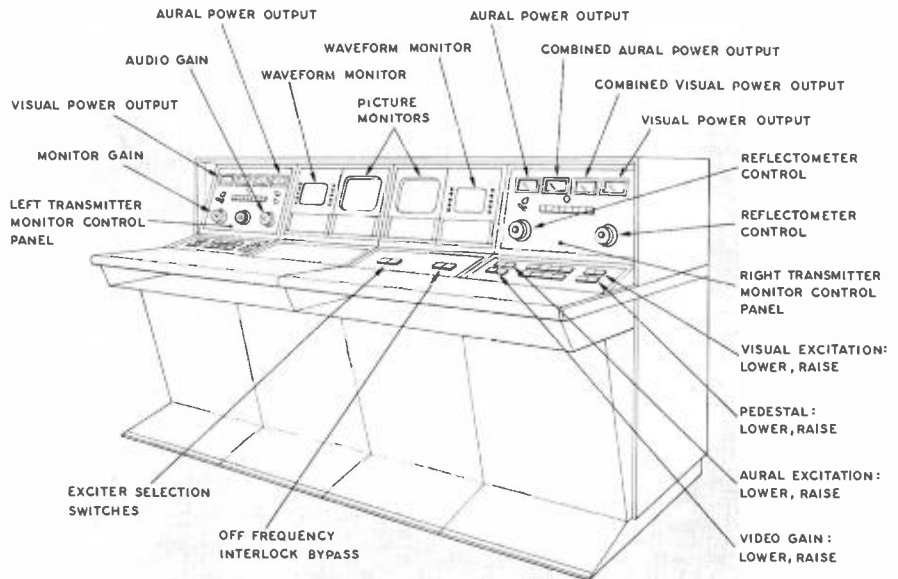

FIG. 14. Diagram showing transmitter control console used for TT-12/12EL parallel transmitter operation.

Conclusion

Reports from previous installations using RCA parallel transmitters indicates that the system functions well and broadcasters are very well pleased by the overall system reliability, performance and operation.

Perhaps the biggest asset of all is realized by the continuous operational factor, smaller spare parts inventory requirement, ease of maintenance, improvement in monochrome and color performance, and adaptability for remote control operation (when FCC rules permit).

Parallel transmitter system installations can be developed and offered as a standard package or they can be tailored for any specific application to meet the most advanced customer requirements. Parallel installations can be provided by RCA for any power level requirement, either low band or high band applications.

The size of the market area served, the possible loss of sponsored program revenue and station prestige that goes with station breakdowns will govern the final choice of the parallel transmitter system of operation.

NEW "VEE-ZEE" AND "ZEE" PANEL TYPE UHF ANTENNAS

by A. J. GALINUS
UHF Antenna Product Analyst

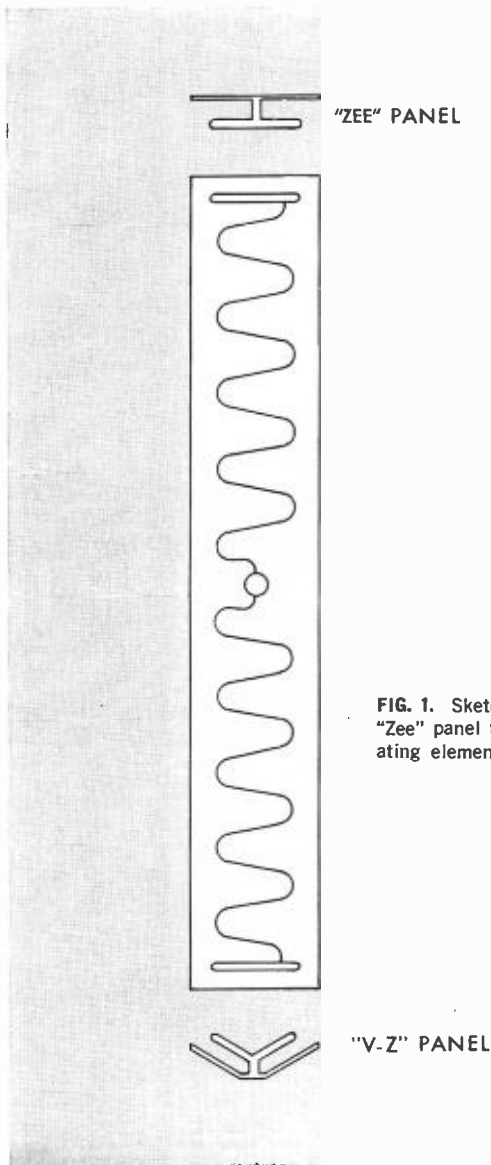

FIG. 1. Sketch of "Vee-Zee" and "Zee" panel type UHF antenna radiating elements.

The RCA "Vee-Zee" and "Zee" Panel Type UHF Antennas are designed especially to meet requirements in the UHF range for either an omnidirectional or directional antenna which can be stacked around a tower, the top of which is used to support antennas for other services. They are also useful as top-mounted ultra gain omnidirectional or directional antennas. Beam tilt and null fill may be designed into the vertical patterns. Both the "Vee-Zee" and "Zee" type antennas, therefore, are useful supplements to the standard RCA Pylons that have proved ideal for both omnidirectional and certain types of directional patterns in top-mounted applications.

History

In the early 1950's, O. M. Woodward, at RCA Laboratories, performed research and development work on the Zig-Zag Panel Antenna Program. The Zig-Zag type of antenna was used in the design of both the transmitting and receiving arrays in connection with the Channel 25 experimental "on-channel" booster installed in the early 1950's at Vicksburg, Mississippi for WJTV, Jackson, Mississippi.¹ Further developmental work has been performed at the RCA Broadcast Antenna Engineering Center on both the "Vee-Zee" and "Zee" Panel Antennas.²

¹"Engineering Aspects of UHF Booster Operation" by J. Epstein, W. C. Morrison and O. M. Woodward, Broadcast News No. 80, July-Aug. 1954.

²The results of some portions of this work were presented in a paper "The V-Z Panel as a Side-Mounted Antenna" by R. N. Clark and A. L. Davidson, showing the performance characteristics of the "Vee-Zee" Panel configuration, published in January, 1967, IEEE TRANSACTIONS ON BROADCASTING, Reprint No. ANT-2967 may be obtained on request from RCA Broadcast and Television Equipment Department, Building 15-5, Camden, New Jersey.

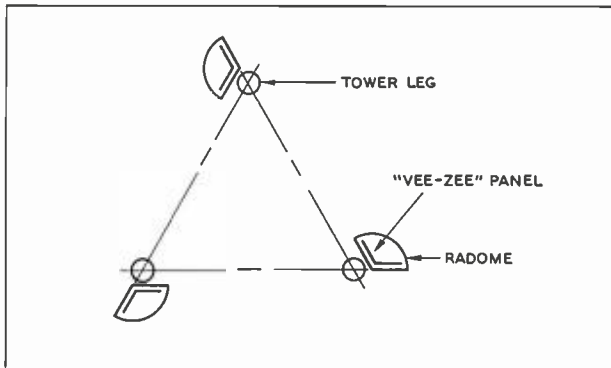

FIG. 2. Sketch of three tangentially-firing "Vee-Zee" panels with individual radomes.

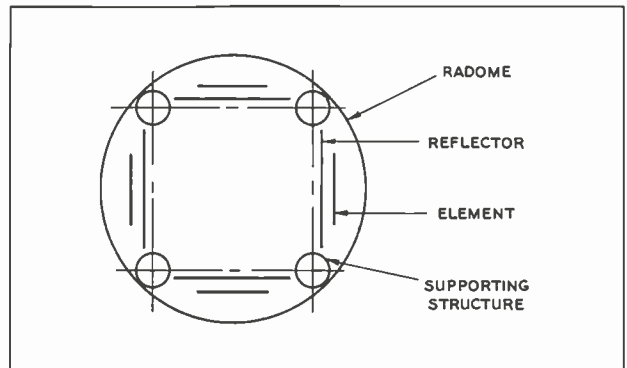

FIG. 3. Sketch of four radially firing top-mounted "Zee" panels enclosed within a common radome.

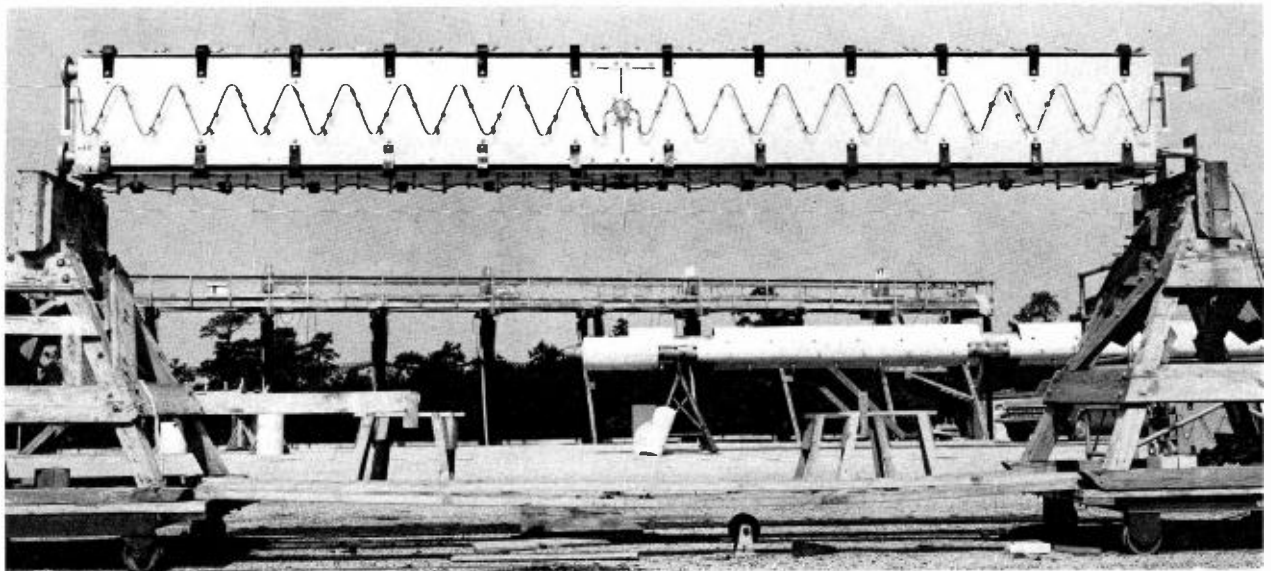

FIG. 4. View of one section of the WAND-TV "Zee" Antenna. The complete antenna consists of four of these sections.

Features of the Two Basic Antennas

With each element complete and electrically independent in itself, a great flexibility in application is achieved through a building block approach. Almost any desired antenna pattern can be achieved by the proper placement of one antenna panel relative to other panels, and by varying the relative power input and phase of signal. The large aperture of each element, fed from a single feedpoint, strikes a balance between the mechanical complexity of many feedpoints and a lack of flexibility in pattern shaping, resulting from too few feedpoints.

Radiating Elements

The new UHF antennas employ two types of radiating elements—the "Zee" Panel and the "Vee-Zee." The "Zee" an-

tenna comprises zig-zag radiating elements branching two ways from a central feedpoint along a flat reflecting plane. The "Vee-Zee" has the same configuration except that both the elements and the reflecting panel are bent along a central longitudinal line to form a forward opening "Vee" (see Fig. 1).

The basic radiator operates on the proven traveling wave principle. To assure that the RCA panel antenna rigorously conforms to this principle, a unique "end loading" design is incorporated, one at each end of the radiating elements. This strict adherence to the traveling wave principle provides inherent VSWR stability.

While both types of radiating elements are similar in electrical concept, their physical shapes affect the basic horizontal

patterns and each offers advantages for particular requirements. Thus, where several services are stacked requiring relatively large size tower structures, excellent circularity for omnidirectional use and flexibility for directional use, may be obtained from the 120 degree pattern of the "Vee-Zee" radiator by mounting three radiators, one on each of the three tower legs, so as to fire tangentially around the tower (Fig. 2).

Where the antenna is to be mounted on top of the tower, either "Vee-Zee" radiators (usually three in number) firing tangentially (Fig. 2), or "Zee" Panels with their 90 degree patterns (normally four in number) firing radially (Fig. 3), can be used, depending on the shape of the pattern desired.

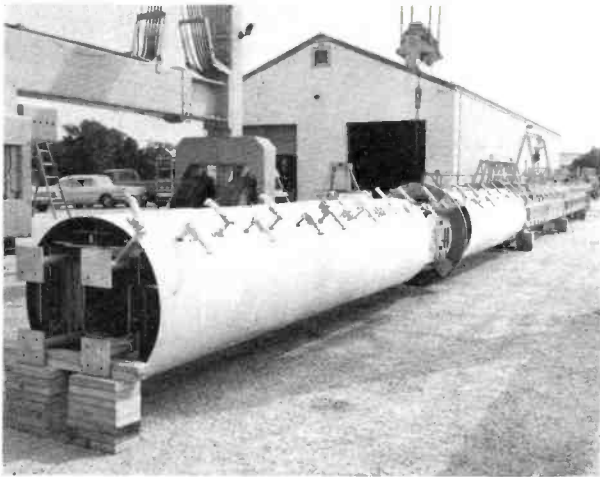
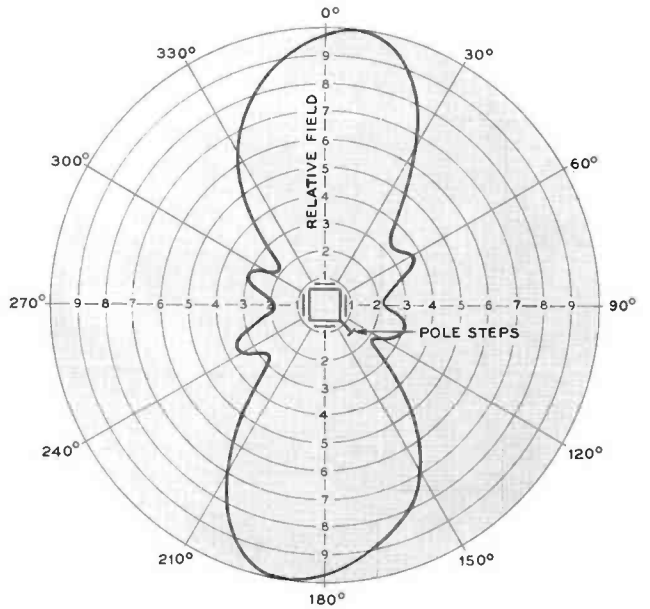

FIG. 5. Overall view of the complete WAND-TV 4-section antenna assembled at the RCA Antenna Engineering Center.

FIG. 6. WAND-TV antenna being pattern tested on turntable. Note antenna feed line assembly (seen at left in photo) located at the base of the antenna.



FIG. 7. Horizontal pattern of WAND-TV. Power division and phasing was used to feed different power levels to each antenna section.



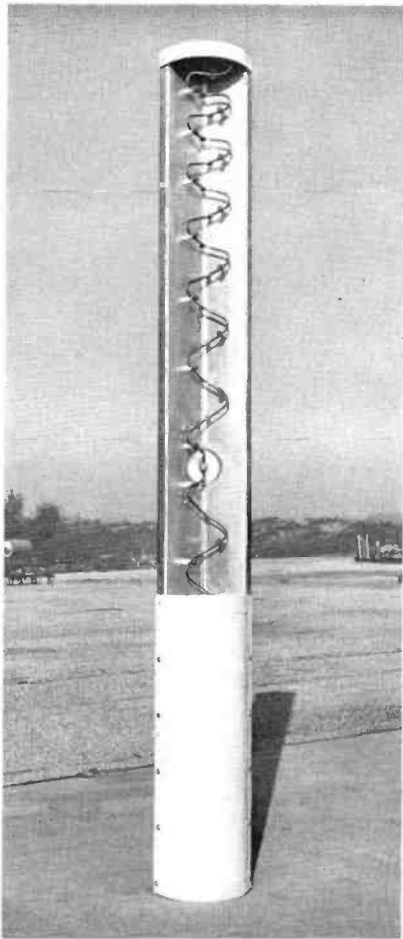

FIG. 8. One actual Channel 57 WCW-TV "Vee-Zee" panel with partial radome installed.

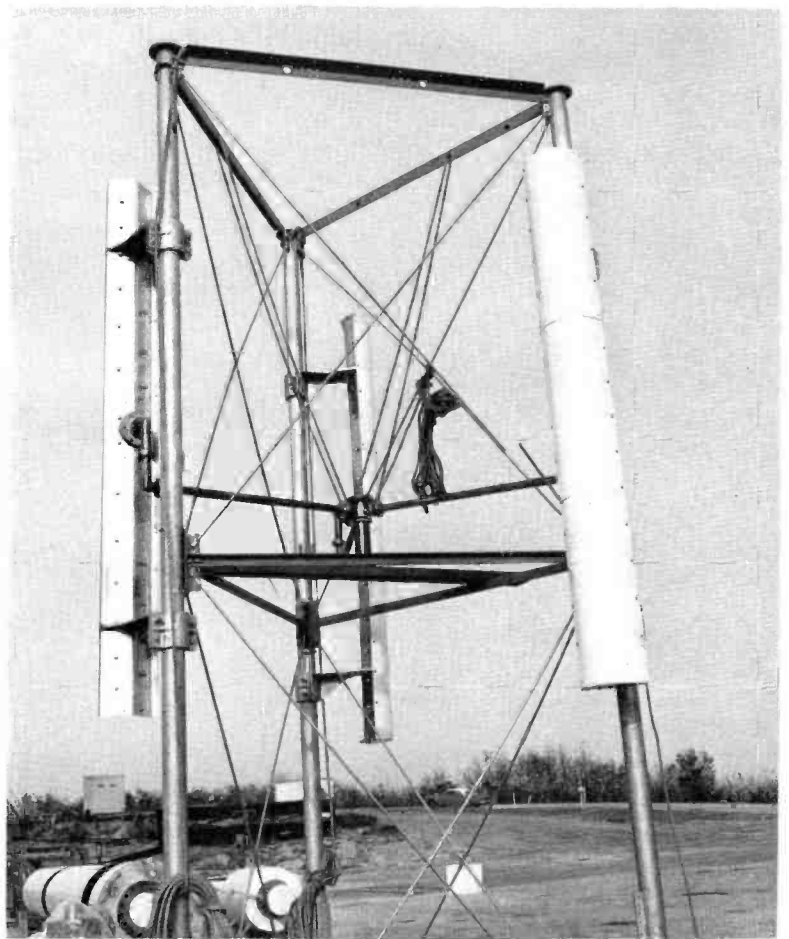
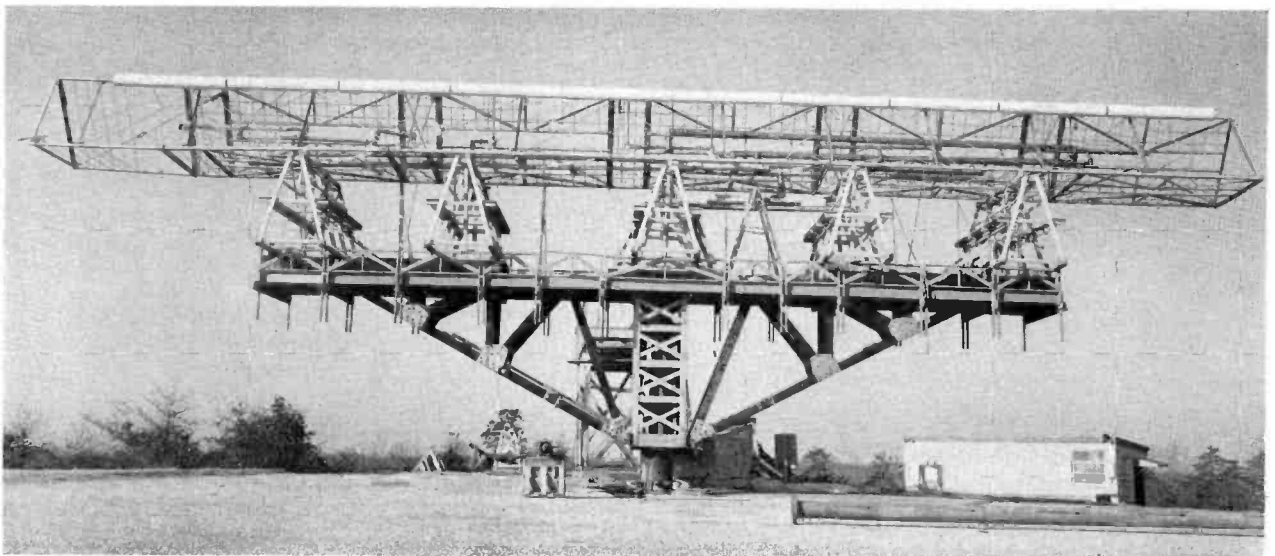

FIG. 9. Three radome enclosed Channel 57 "Vee-Zee" panels mounted on the legs of a simulated tower structure, prior to movement to the turntable for horizontal pattern measurements.

FIG. 10. Ten "Vee-Zee" panels stacked on one leg of simulated lower section, undergoing vertical pattern tests.



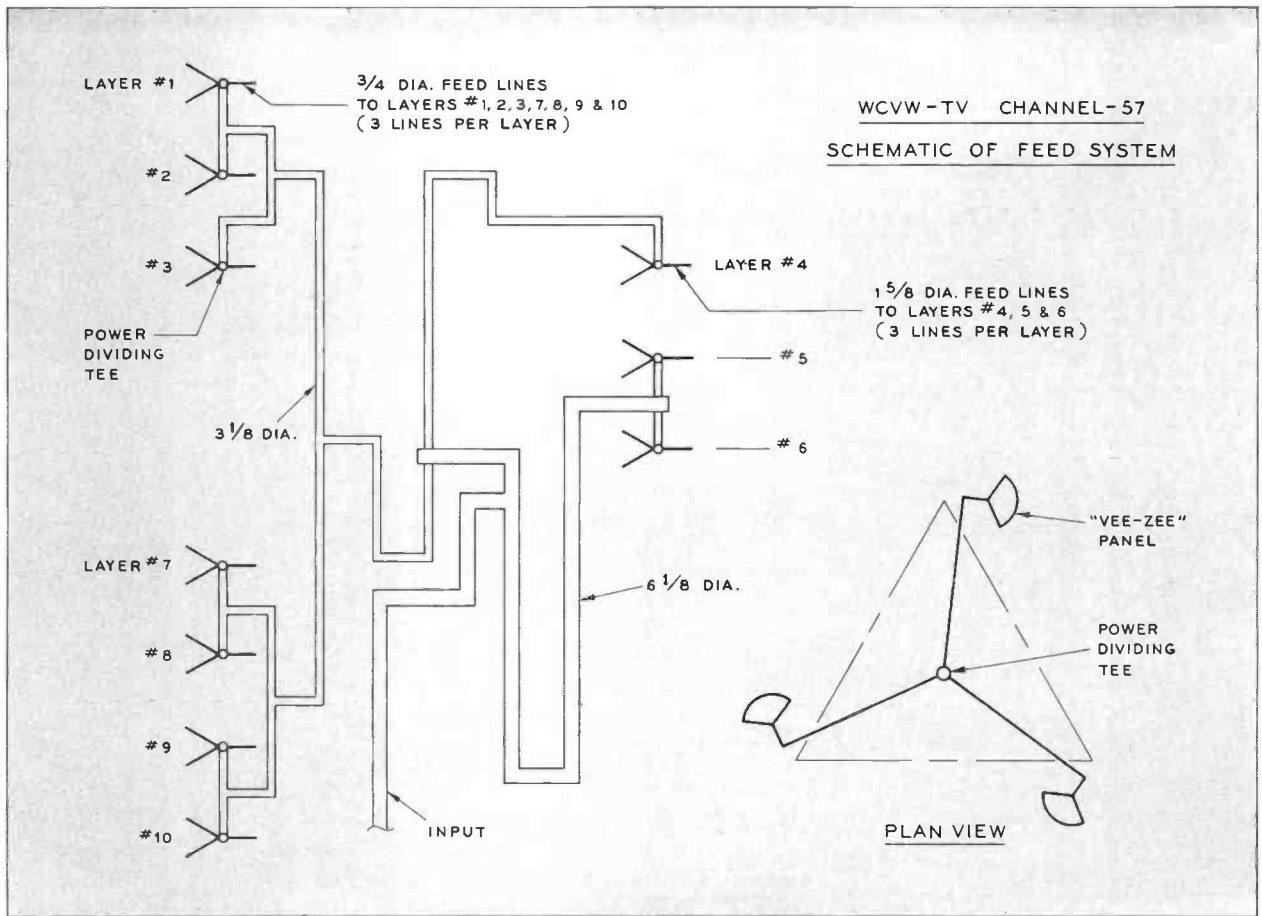

FIG. 11. Channel 57 "Vcc-Zee" Panel Antenna feed system.

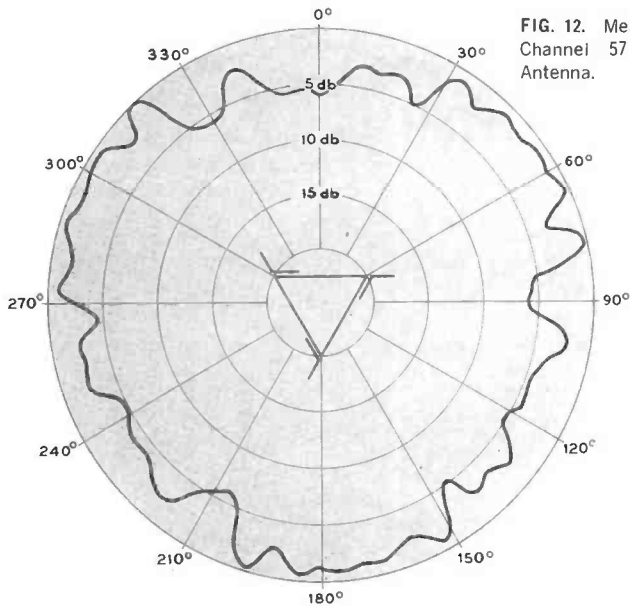

FIG. 12. Measured horizontal pattern of the Channel 57 WCVW-TV "Vee-Zee" Panel Antenna.

Installations

A "Zee" Panel UHF Antenna is in operation at station WAND-TV located in Decatur, Illinois, on Channel 17. This is a directional "Zee" Panel, designed to be top mounted on a supporting triangular tower approximately 1000 feet in height. A TTU-30A Transmitter is used to feed the antenna.

The antenna consists of four individual "Zee" panels assembled around a square supporting frame forming an antenna section. There are four sections fastened together and stacked as a complete antenna assembly, which is enclosed in an easily removable radome, for protection from atmospheric conditions.

FIG. 13. Channel 57 "Vee-Zee" Panel Antenna measured midband vertical pattern. Note the 0.5 degree beam tilt, the main lobe gain of 44, and the gain of 20.1 at the horizontal.

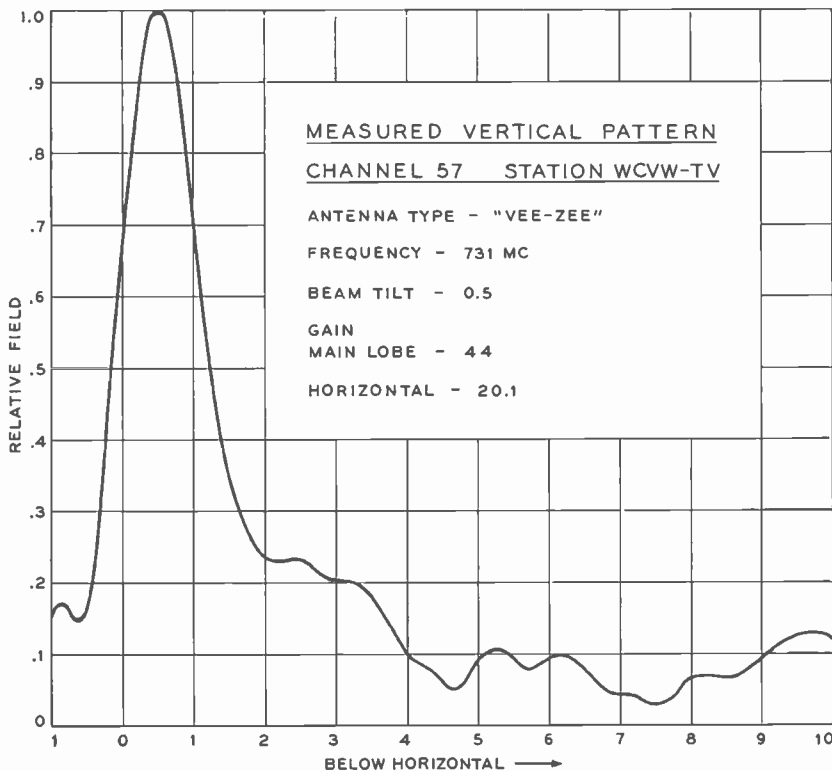

FIG. 14. An aerial view of the WCVE tower showing both the Channel 23, 13.6 ton, 118.3 foot top-mounted TFU-46K Pylon Antenna and the leg-mounted Channel 57 WCVW-TV "Vee-Zee" Panel Antenna just below.

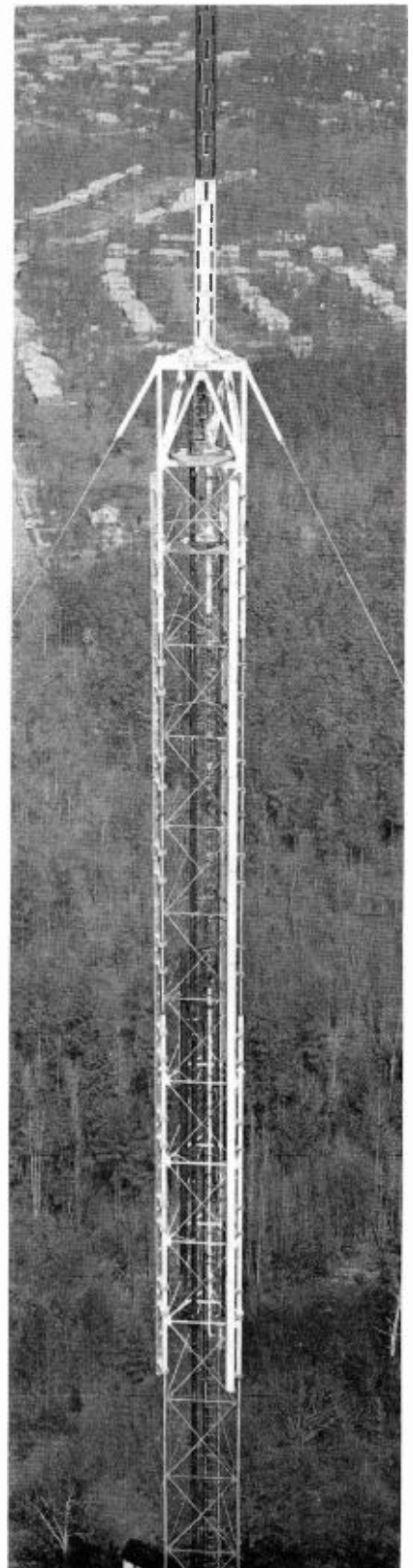

Figure 4 shows one fourth, or one section, of the WAND-TV "Zee" Panel Antenna. The single feedpoint per panel is shown in the center of the photograph. The fiberglass brackets located around the corners are used to mount the radome. Note the zig-zag radiating elements mounted on the reflector panel.

Another panel installation is located at WCVW-TV, Richmond, Virginia. This Channel 57 omnidirectional "Vee-Zee" Panel Antenna is mounted ten panels high on each of the three legs of a 577-foot high, 7-foot face triangular tower used to support a Pylon Antenna. The 30 "Vee-Zee" panels are stacked around the tower beginning approximately 98 feet below the

tower top. A TTU-30A Transmitter feeds the new Channel 57 "Vee-Zee" Panel Antenna. Another TTU-30 Transmitter is used to feed the top mounted Channel 23 TFU-46K Pylon Antenna.

Conclusion

Reports indicate that no unusual problems were encountered because installation is simple and straightforward. Those in operation are giving excellent performance. Results show these antennas are reliable and are well suited for use in high power UHF applications. They provide for complete control of omnidirectional and directional patterns and split feeding. They are especially useful for installations requiring side mounting on the tower.

RCA
BC-7

Closest to Custom in a Production Console!



RCA Transistorized Console

for Dual-Channel AM/TV and FM Stereo

Take a good look at this smart new model. Here's that "custom" appearance to satisfy the proudest management; "custom" quality and flexibility to please the most discriminating engineers...all in a production-model!

CUSTOM STYLING—Striking new lines in blue and silver bring a color accent to control rooms. Color-coded operating controls are engineered to avoid errors. Only 39" long, it is compact and self-contained...to satisfy new or existing arrangements.

CUSTOM QUALITY—The BC-7A is fully transistorized for long-term reliability. All amplifiers have input and output transformers...precise impedance matching for both program and monitoring circuits. You get quality stereo monitoring (10 watts out-

put), quality gain controls, quality leaf-type key switches on all program circuits.

CUSTOM FLEXIBILITY—You have interchangeable plug-in modules...preamplifiers, isolation/balancing units, program amplifiers, monitoring amplifiers, cue amplifier and power supply—all in one self-contained unit. You get three-mode operation...selector switch to instantaneously convert from dual channel, parallel or stereo operation.

We can't name them all here, but we believe you will agree that this is the kind of customized styling, quality, and flexibility you want. Let your Broadcast Representative show you all the features that make this console your best buy. Or write RCA, Broadcast and Television Equipment, Bldg. 15-5, Camden, N.J.



Plug-in flexibility... preamplifiers for low-level sources... isolation/balancing units for high level sources.



High quality mixers... ganged step-type attenuators when in stereo... individual step-type when in dual channel use.



THE MOST TRUSTED NAME IN ELECTRONICS



RCA color TV training center

Another service for RCA customers

To help customers get the very best television pictures, RCA maintains this permanent training center for station engineers. Here users of RCA color studio equipment receive a program of instruction in operation and maintenance. This service is available to all customers, at no charge, to assist in getting the *full capability* of live color cameras, color film equipment, and TV tape recorders.

Instruction is given in seminars devoted to the various equipments. Each course runs from two to five days, depending on

the complexity of the system. Regular classes are devoted to the TK-42 and TK-43 color cameras, the TK-27 color film camera, the TR-70 and TR-3-4 television tape recorders. Groups are small so that each engineer receives as much individual attention as possible. They learn how to obtain peak performance from this sophisticated equipment and how to save money in its operation.

Courses begin with a description of the equipment, circuitry, and nomenclature. This is followed by a detailed study of operation, with practical exercises in line-up, maintenance and trouble-shooting. Courses are conducted by RCA engi-



for station engineers

neers with experience in both practical and theoretical aspects. These seminars give visiting engineers the reasoning behind the complex new designs, their capabilities, and show how broadcasters can best achieve operating efficiency and finest pictures.

The technical and artistic demands of color television have resulted in broadcast equipment far more complicated than a few years ago. This new training center expresses in part RCA's responsibility to help broadcasters produce TV pictures that reflect optimum performance of their equipment. The Center occupies approximately 7000 square feet in RCA's

main office building in Camden, and includes a color TV studio for "live" camera demonstrations, a color TV film area, a color TV tape area, and a master control center.

For further information about this RCA TV Training Center, call your RCA Broadcast Representative. Or write RCA Broadcast and TV Equipment, Building 15-5, Camden, N. J.



The Most Trusted Name In Electronics

110 KW transmitter for

Up to 5 megawatts
ERP tailored to indi-
vidual requirements.

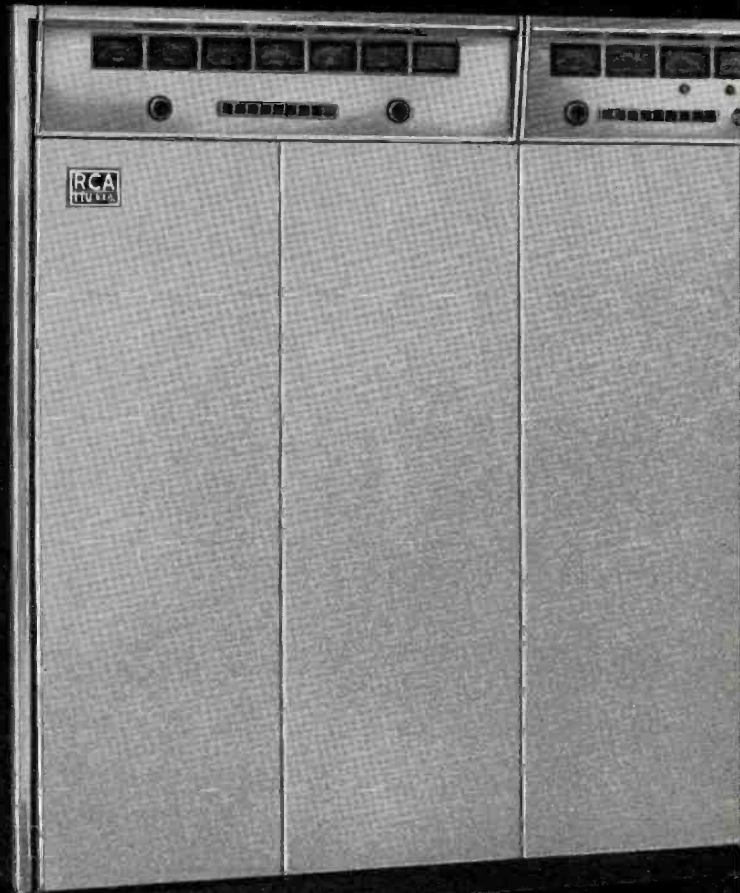

Diplexed Power Amplifiers...

This 110KW transmitter, combined with the right RCA antenna, provides RCA's most powerful transmitter-antenna package, affording up to 5 million watts ERP.

RELIABLE OPERATION The diplexed visual power amplifiers assure the utmost in reliability. One amplifier is always ready to back up the other.

NEW TYPE KLYSTRONS Unique, integral-cavity vapor cooled klystrons are a high power development of those used in the proven RCA TTU-30A and TTU-50C Transmitters. Reliability and long life are major advantages, with faster warm-up time, less weight and pretuning among other points of superiority.

VAPOR COOLING EFFICIENCY Vapor cooling is much more efficient than water cooling. This results in reduced operating expense. Lower input power is required.

maximum power UHF

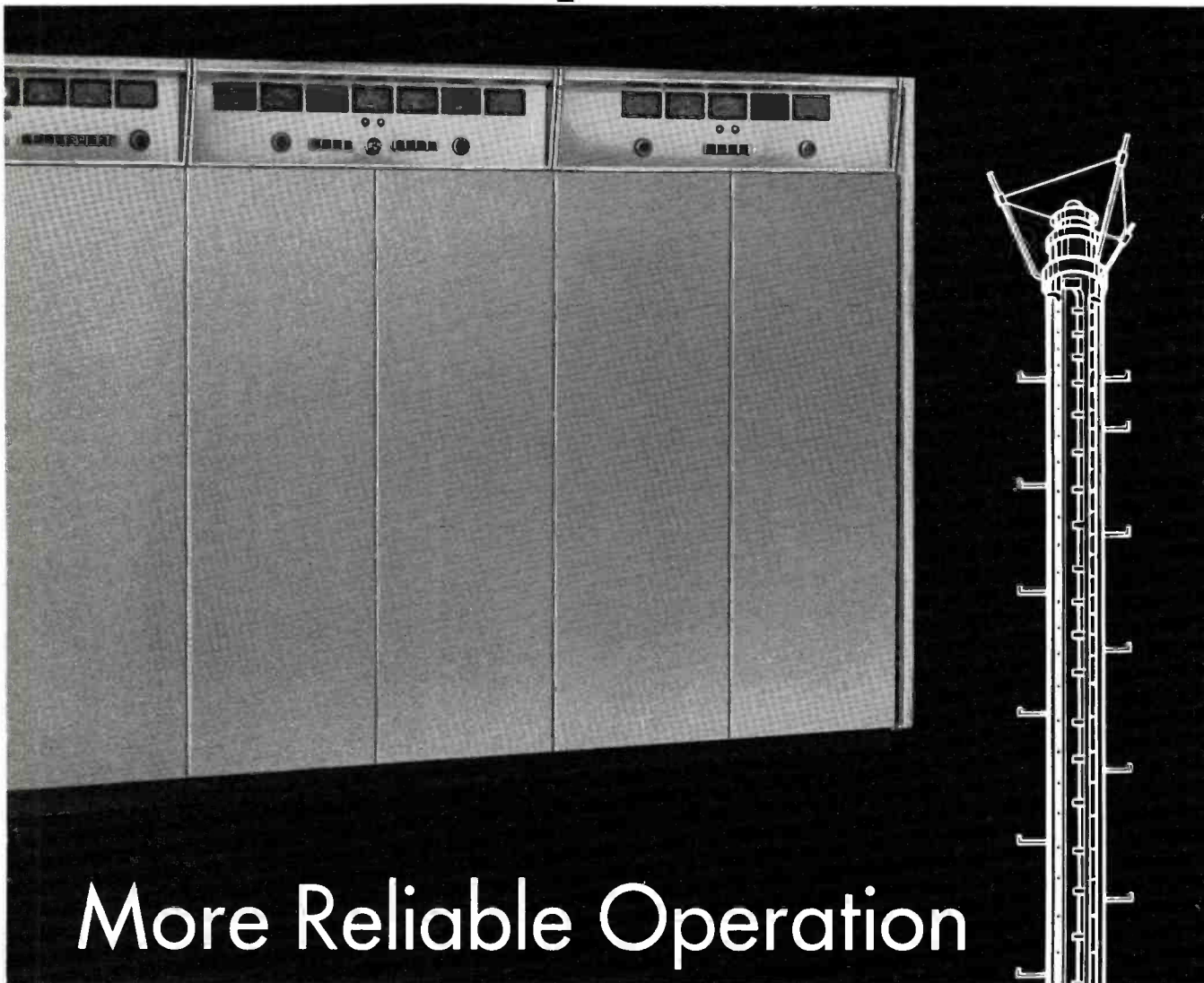

More Reliable Operation

WALK-IN DESIGN New design techniques and walk-in cabinetry result in smaller size and easy maintenance. This means direct savings in installation and operation and will minimize building expense.

ANTENNA CHOICES Only RCA offers a choice of Pylon, Zee-Panel, and Vee-Zee Panel Antennas for use with the new TTU-110A high power UHF Transmitter.

COMPLETE LINE OF UHF TRANSMITTERS Integral-cavity vapor cooled Klystron transmitters 30KW, 55KW and 110KW. Also air cooled 2KW and 10KW transmitters. (The 2KW is easily expanded to a 10KW.)

For more information, call your RCA Broadcast Representative. Or write RCA Broadcast and Television Equipment, Building 15-5, Camden, N. J. 08102.

YOU GET SO MUCH MORE FROM RCA

RCA offers the only full-line of broadcast equipment. RCA's depth and breadth of engineering skills and improved products, ensuring better performance, are your assurance of greater value. From RCA you get matched system design, overall warranty responsibility, single supplier coordination and complete engineering service.



THE MOST TRUSTED NAME IN ELECTRONICS

RCA SERVICE

keeps all your
AM, FM, TV
equipment
in top
condition!

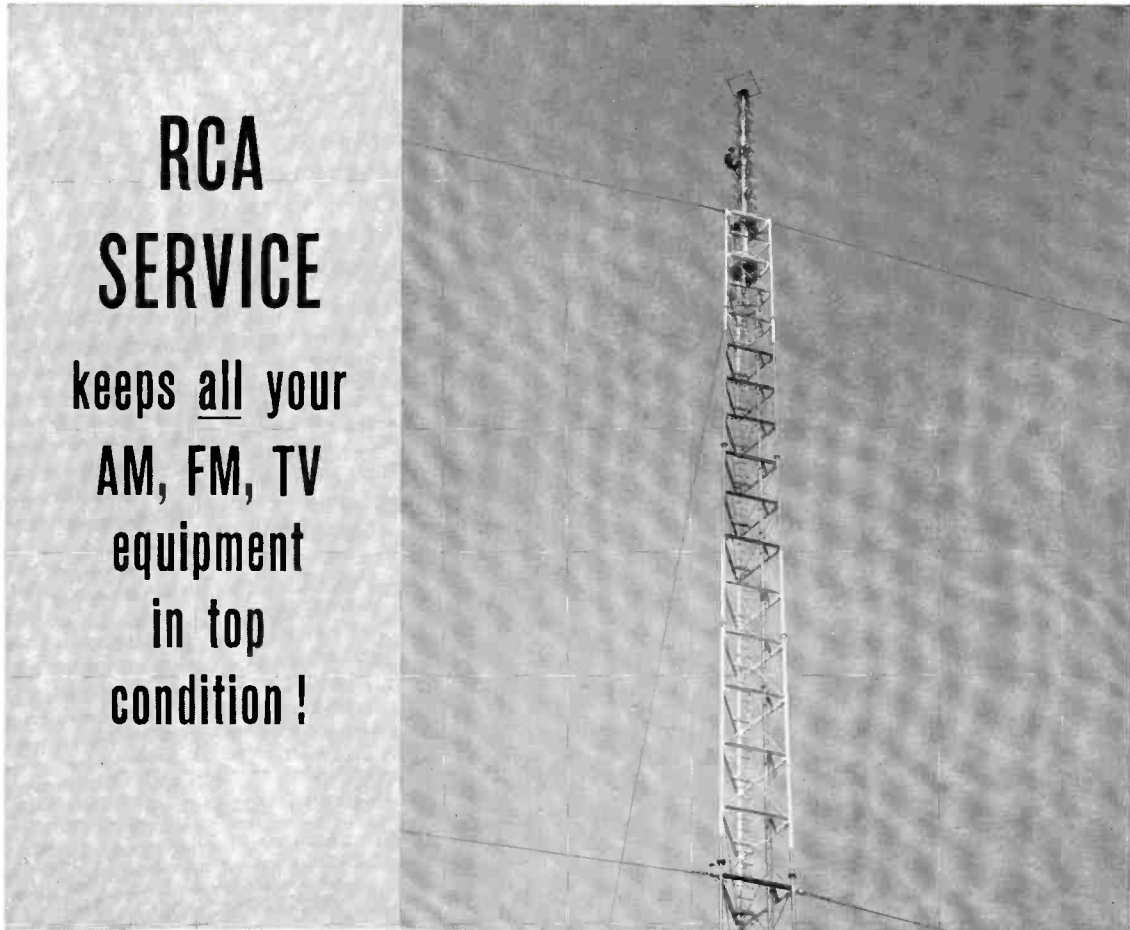

Antenna System Measurements

TAKE ADVANTAGE OF THE FOLLOWING SERVICES OFFERED BY RCA:

- Video Tape Recorder Service • TV Camera Overhaul • TV Transmitter Overhaul
- Installation Supervision • Microphone and Pick-Up Repairs • Transmitter Performance Measurements • Antenna Inspection Measurements • Console Repairs • Microwave Service
- TV Projector Service • Custom Fabrication • Teletypewriter Maintenance

Your audience demands a superior signal which requires top performance from all your station equipment. RCA Broadcast Service is planned to assure you of meeting this objective. More than 30 years in the broadcast industry have provided a background of solid service experience. This is the type of protection broadcasters have relied on for years, the kind of protection you can count on . . . contract or per-call . . .

from the experts in the service business, RCA Service Company. To guard performance of all your equipment . . . simply telephone one of the following field offices: Atlanta (phone 355-6110), Chicago (WE 9-6117), Phila. (HO 7-3300), Hollywood (OL 4-0880). Or contact Technical Products Service, RCA Service Company, A Division of Radio Corporation of America, Bldg. 203-1, Camden, N.J. 08101.



The Most Trusted Name in Electronics

RCA
TR 70

NEWEST AND FINEST



Unexcelled Performance . . . Unequaled Features

NEWEST AND FINEST COLOR TAPE RECORDER...TR-70



The TR-70 Deluxe High Band Color Tape Recorder is the newest entry in a race where each new design "leapfrogs" the last. RCA engineers designing the TR-70 were not satisfied—dared not be satisfied—just to match the already available machines. They had to make the TR-70 better—much better. And they did. Thus, the TR-70 does everything, has everything (good) that the very best previously available recorder could boast of. But that's just the start. In addition it has a whole host of features and advantages not found in other recorders. Read on.

THE TR-70 DOES EVERYTHING

It produces the sharpest, most brilliant, truest color pictures you have seen. Makes superb color dupes through four generations. Offers all the wanted accessories—to electronically edit, compensate for dropouts, dimensional errors, variations in tapes. Operates at four switchable standards. And does it all more easily, more surely and more conveniently than ever before.

THE TR-70 HAS EVERYTHING

Everything you've ever heard of before. The basic machine is High Band color (not monochrome). It's designed, tested, and delivered that way. When you get it, it's ready to go! It's an integrated machine—there's no need to find space for a compressor—everything's built-in. Space is also provided for accessories, and all wiring's in place—no downtime

to install—just plug in modules: Velocity Error Correction, Automatic Chroma Control, Dropout Compensator and Remote Control. (Pixlock, Line Lock, ATC and Color ATC are part of basic machine.)

THE TR-70 HAS MORE

Features not available in other machines, features that make for better, easier, more convenient operation and maintenance. Such as all-front access, eye-level (and ear-level) monitoring, less floor space. Standard modules, all the same type, same extenders—easily removed (you don't need a screwdriver). Test points on front of panels, D-C metering panel, built-in FM test facility. Grouped operating controls, automatic guide positioning, foot-operated brake release. And many more. *To learn the whole story—hear all of the facts—call your RCA Broadcast Representative.*



The Most Trusted Name in Electronics