

Volume No. 143, December 1969



KOMO-TV Covers Seattle Seafair Races with New Mobile Color Unit

**The finest color camera  
ever made for sales managers  
is the finest ever made for  
sponsors, engineers and cameramen.**

## **The New 3-Tube RCA TK-44A.**

The TK-44A can improve your station's color image and help increase sales.

It outperforms any other color camera in the world today. Once you see and try the TK-44A, you'll agree. You'll discover features found in no other camera. Features that mean better color and faster set-up. Features that mean more time for your engineers and camera-men to spend in program production instead of tinkering, to assure less tension and greater efficiency—indoors and out!

The TK-44A. The maximum-performance studio camera that can double as your most dependable remote camera. The camera with the innovations you need today . . . and tomorrow!



# **RCA** Broadcast News

---

Published by BROADCAST SYSTEMS DEPARTMENT  
RCA COMMERCIAL ELECTRONIC SYSTEMS DIVISION

## CONTENTS

---

Four Chicago TV's Begin Broadcasts from Big John . . . . .	5
KOMO-TV Color Regatta . . . . .	12
WDBO-TV Installs First Butterfly Panel Antenna . . . . .	24
WBOC-FM Stereo and SCA . . . . .	26
Fuel for the Imagination: Video Cartridge Tape . . . . .	30
New Concept in Radio Automation . . . . .	36
Color TV at Brooke Army Medical Center . . . . .	42
New Studio Turntable Pickup System . . . . .	49
Products in the News . . . . .	52
Broadcasters Tell it Like it is . . . . .	Special Insert

---

PRICE . . . single copies, \$2.50 each

Copyright 1969 RCA Corporation, All Rights Reserved

## Inglis Appointed Division V.P., Commercial Electronic Systems

Appointment of Andrew F. Inglis as Division Vice President, RCA Commercial Electronics Systems was announced today by Irving K. Kessler, Executive Vice President, Defense and Commercial Systems.

Mr. Inglis succeeds Barton Kreuzer who was recently named Executive Vice President, Consumer Electronics for RCA. Mr. Inglis was previously Division Vice President, Broadcast Systems Department of the RCA Commercial Electronic Systems activity.

Commercial Electronic Systems is concerned with the production and sale of studio and transmitting equipment for the radio and television broadcasting industry. It is also a leading supplier of mobile radio systems to public safety, industrial and other users. It manufactures and markets program originating equipment for cable TV and closed-circuit TV systems, and audio-visual products for educational training and other uses. Other product areas include automated inspection, testing and related systems for industry.

Prior to joining RCA in 1953, Mr. Inglis was associated with a Washington, D. C., consulting firm to the radio and TV broadcast industry. He has held several executive posts, including responsibility for RCA's broadcast product development program and TV systems engineering.

Mr. Inglis also has been manager of RCA's closed circuit TV activities and for three years was operating head of the RCA engineering and manufacturing center for com-



munications, audio visual and broadcast transmitter equipment at Meadow Lands, Pa. He has been a Division Vice President since 1963. In 1968, he was appointed Division Vice President, Broadcast Systems Department of Commercial Electronic Systems.

Mr. Inglis was graduated from Haverford College in 1941 with a Bachelor of Science degree in physics. After a year of graduate study at the University of Chicago, he served as an instructor of electronics there before joining the U. S. Naval Reserve in 1943 as a Lieutenant.

## Color Studio and Transmitting Equipment go to WSMW-TV, UHF in Worcester, Mass.

Color TV studio and transmitting equipment valued at approximately \$1,300,000 will go to WSMW-TV, a new UHF television station in Worcester, Mass.

The purchase was made by the State Mutual Life Assurance Company of America. Plans include erection of a new television studio building for the Channel 27 station on property adjacent to its headquarters in Worcester.

The contract includes a four-camera mobile TV unit for coverage of sports, civic affairs and other remote events. The cameras, which will be used interchangeably in the mobile unit and studio, will be the new three-tube TK-44A. RCA also will supply two TK-27 color film systems and two TR-60 color video tape recorders for use in the new color facility.

In addition to the other equipment items, the contract calls for two TS-51 video switching systems, newly-developed by RCA, associated audio equipment and TVM-6 microwave systems for linking the studio to the transmitting site.

The transmitter ordered is RCA's type TTU-60A which will be connected by eight-inch transmission line to a TFU-25G broadcast antenna. The antenna will be installed atop a 1,350-foot tower which WSMW-TV is purchasing separately from a tower manufacturer. Total height above sea level will be 2,049 feet.

## Colorization at WDCA-TV

WDCA-TV, Washington, D. C., is planning its first "live" program originations in color as the result of its acquisition of approximately \$750,000 in RCA color studio and remote equipment, according to Milton Grant, Vice President and General Manager, who is pictured on the "outer space" set, as Director of Engineering Don Doughty acts as cameraman.

He said the purchase includes four of RCA's new three-tube TK-44A color cameras, three TK-27 color film islands, two TR-70 high-band color TV tape recording systems, a TCR-100 video cartridge system, and other equipment.

Two of the TK-44As will be assigned to the Channel 20 station's mobile unit for remote pickups; the other two will be on studio duty. The new equipment, Mr. Grant said, will enable WDCA-TV to produce color programs, commercials and remote broadcasts of the finest quality.

The equipment installation is part of a capital improvement and colorization program for the station since its purchase by the Superior Tube Company.



## Fire Torn KFBB-TV Gets New RCA Transmitter Via Special Delivery

A devastating fire, destroying just about all but the station's antenna took KFBB-TV, Great Falls, Montana, off the air—but only temporarily. With the help of neighboring stations, the use of a fully equipped mobile unit from Montana State University and a special transmitter shipment from RCA, Meadow Lands, the station returned to business as usual transmitting locally originated programs in only seven days.

The fire was detected early Sunday morning November 2. Before the smoke had cleared that evening, plans had been made to ship a new RCA transmitter. By Thursday morning, KFBB-TV had returned to limited operation, using a VHF translator and amplifier feeding into one of the batwings of their antenna.

Meanwhile the RCA transmitter had already arrived on Wednesday, having been dispatched from Meadow Lands via special van.

A temporary building was in the process of construction, as shown in the photograph below. The transmitter, a TT-6EL, was on the forklift as the roof went on.

Normally all RCA transmitters are factory pre-tuned at the customers' frequency. Since the emergency schedule precluded this final check, RCA sent along the factory-tester, John Kubiear to perform these vital tuning functions as the transmitter was being installed.

The transmitter was set in place Wednesday evening, and by early Sunday morning was on-the-air. Operations had been restored, thanks to an untiring engineering effort.



## First UHF in Savannah WJCL-TV Will Program Live, Tape and Film Color

WJCL-TV, which will become Savannah, Ga.'s first UHF television station, has ordered more than \$1 million in color studio and transmitting equipment in preparation for its initial broadcasts.

The RCA studio system included in the purchase will permit the Channel 22 station to originate color programming "live," or from film or video tape, according to J. C. Lewis, Jr., President of Lewis Broadcasting Corporation, the station's owner.

Mr. Lewis, who also is Mayor of Savannah, said the new station will have studios in an ultra-modern building to be located at 10001 Abercorn St. WJCL-TV, he added, will be a primary affiliate of the ABC-TV network.

The station's 60-kilowatt RCA transmitter will be located some eight miles from the studio, along with a 1,400-foot broadcasting tower. A 13-ton, 113-foot pylon-type antenna, mounted atop the tower, will radiate the Channel 22 signal over a broad viewing area.

## Two New Manufacturing Facilities Announced: Will Serve European Customers of Commercial Electronics and Semiconductors

A new facility on the Isle of Jersey in the English Channel will be used as an improved base for expanding commercial electronic products activities in Europe.

A completely new building will replace an outgrown leased structure occupied since 1966 when RCA Jersey Ltd., a subsidiary company, established a facility for refurbishing television tape headwheel panels. Earlier this year the Jersey Isle operations were expanded to include production of RCA 16mm. sound motion picture projectors for shipment to markets outside the United States.

Completion of the new plant in 1970 would permit the expansion of current activities there and open the way for the manufacture of other products manufactured by Commercial Electronic Systems.

The RCA plant site consists of 2.6 acres in an industrial park in Jersey, an island off the northwest coast of France. The island is about 12 miles long, 7 miles at its greatest width, and has a population of 65,000.

## New Houston Station KVRL-TV Places \$1,800,000 Color Order

RCA will supply the complete \$1,800,000 studio and transmitting system for KVRL-TV, a new all-color UHF television station in Houston, Texas, according to Raymond G. Schindler, Chairman of Crest Broadcasting Company, its owners.

Mr. Schindler and Bruce Kelly, station General Manager, said construction of a multi-story office building, which will house the KVRL-TV studios and offices, will begin shortly on a site on Southwest Freeway, four miles from downtown Houston.

The equipment order, one of the largest received for a new UHF facility, includes five TK-44A color cameras which will be used interchangeably in the studio and in a 30-foot mobile TV unit.

One of the two compact TR-60 high-band color TV tape recorders on order also will be capable of alternate studio-mobile unit use. The station also has ordered RCA's deluxe TR-70B high band color TV tape recording system.

Other major items of studio equipment include two TK-27 color film systems for originating color programs from motion picture film and slides, and two switching systems.

RCA microwave systems will link the studios with the transmitting site in One Shell Plaza, a new 54-story office building under construction in downtown Houston. The station's powerful 60-kilowatt transmitter will be installed on the 50th floor.

Transmission lines will connect the transmitter with KVRL-TV's broadcast antenna, a high-gain "pylon" type, which will be

A new RCA plant at Liege, Belgium will manufacture power semiconductor devices used in TV, autos, computers, industrial and aerospace electronic equipment.

The new plant will be RCA's first electronics manufacturing facility on the European Continent and will be established at \$10.7 million investment.

The 80,000 square-foot plant will provide RCA with an ultra-modern manufacturing facility for supplying customers in the European market with the latest semiconductor components. The rapidly expanding European market for semiconductor devices is expected to approach industry sales of between \$650 million to \$700 million by 1972.

The plant in Liege not only will produce components for the special requirements of European customers but also will include customer service operations such as marketing and applications engineering.

The plant site is located in the Hauts-Sarts Industrial Park, north of Liege.

mounted atop a 200-foot cylinder on the building roof. The antenna, which will stand 1,000 feet above the street, is approximately 107 feet tall and weighs 12½ tons.

The combination of the 60-kilowatt TV transmitter and the high-gain antenna will give KVRL-TV the capability of producing more than 2,500,000 watts of effective radiated power over the Houston viewer area.



## Educational Broadcasters See New Color TV Mobile Unit

A compact color TV mobile unit that brings the same picture quality obtainable in studio program production to broadcasts and video tape assignments in the field was demonstrated to educational broadcasters at the National Association of Educational Broadcasters convention, Washington, D. C.

## N. J. Public Broadcasting Authority Awards \$2 Million Contract For Program Production Center

A \$2 million contract to equip the first color TV studio for New Jersey Public Broadcasting Authority has been awarded to RCA.

The new program production center will rival major commercial TV station facilities in the size and capability of its technical system.

The two-studio/master control complex will become the program originating point for the Authority's future network of four UHF transmitting locations. These will be established in the general areas of Trenton, Atlantic City, New Brunswick and Montclair to cover nearly all of the state's estimated 7½ million population.

The equipment order includes six TK-44A color cameras. In producing taped programs for later broadcast, these cameras will be teamed with four TR-70B color TV tape systems.

Other major equipments include two TK-27 color film systems, program production and master control switching, audio equipment and studio lighting grids. The agreement calls for a complete "turnkey" facility, with RCA to design the technical layout, and supply, install and check out the equipment.

The Authority, which was created by Gov. Richard J. Hughes upon recommendation of a commission of distinguished citizens, will have headquarters in the leased center building at 1573 Parkside Avenue, Trenton.



The new unit offers educational stations a means of covering news, features and other events as they occur. The entire community becomes a laboratory for the educational broadcaster, to be explored by the probing eye of the color camera.

Besides the color camera, the basic mobile unit was fitted out with camera controls, picture monitor, a "high-band" video tape recorder and audio facilities.



FOUR  
CHICAGO  
TV STATIONS  
BEGIN  
BROADCASTS  
FROM  
BIG JOHN

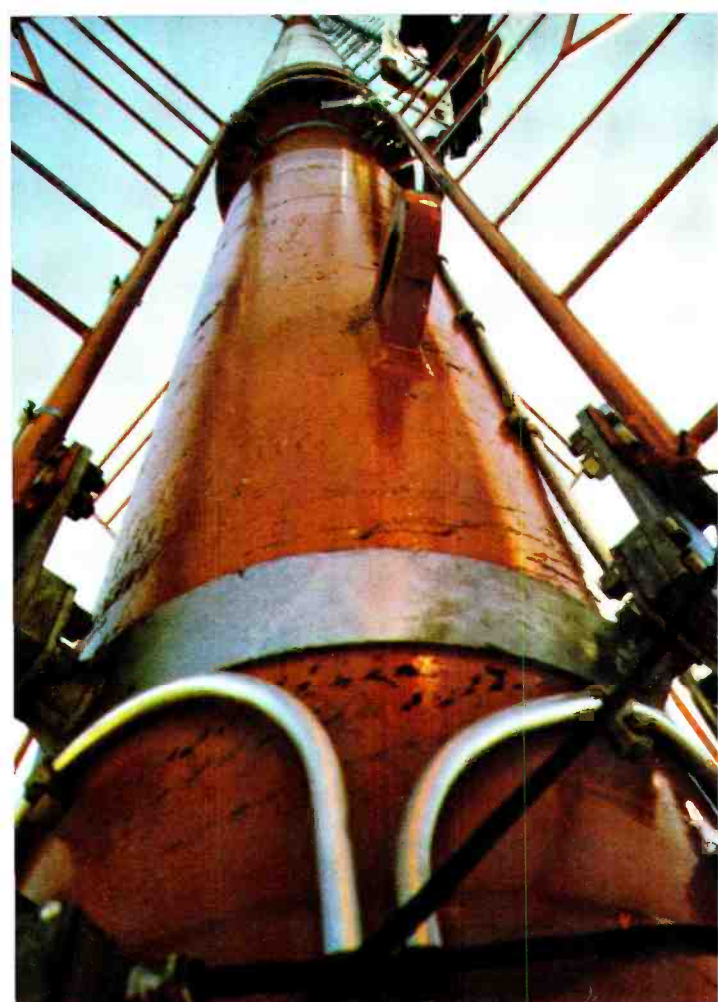

First TV broadcasts October 1 from massive antennas atop the 100-story John Hancock Center in Chicago marked the completion of an engineering feat unparalleled in the broadcast industry.

RCA designed and supplied the six antennas, weighing nearly 150 tons, and supervised their installation on two 100-foot cylinders on the building roof. Four TV stations switched to the new site October 1 while the two others plan to begin broadcasting in 1970.

The \$1,300,000 antenna installation ranks with the multiple system designed by RCA for the Empire State Building and erected 16 years ago. Five TV antennas are mounted on the Empire State in a single stack, while the Hancock project employs twin towers, supporting four and two antennas respectively. In both locations, other antennas are mounted below the stacks.

TV transmitters, four of which were supplied by RCA, are installed inside the Hancock Center, near the roof. Transmission lines connecting them to the antennas run up through the twin towers.

The towers and their bases add 349 feet to the 1,107-foot Hancock Center. The huge building complex contains 705 apartments, more than 800,000 square feet of office space, restaurants, stores, an observatory and indoor parking for 1,400 automobiles.

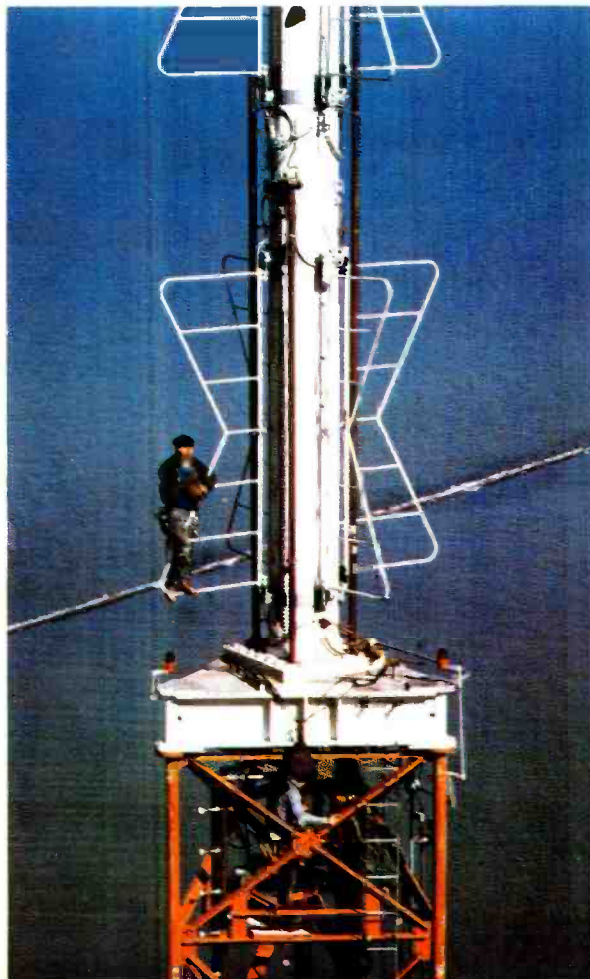







Specifications for the John Hancock TV system evolved during a two year study of the project by RCA and the Chicago Broadcasters Antenna Committee, with Dr. Frank Kear as Consulting Engineer. Members of the Committee, which were selected to represent Broadcasters who are to share the antenna site are:

William Kusack, Committee Chairman and Vice President-Chief Engineer, WFLD-TV; Ralph F. Batt, Vice President, Engineering, WGN-TV; Woodrow Crane, Chief Engineer, WGN-TV; Luther A. Pierce, Director of Technical Operations, WBBM-TV; Tex Brown, Transmitter Supervisor, WBBM-TV; Curt Pierce, Manager, Technical Operations, WMAQ-TV; Walter Lanterman, Transmitter Supervisor, WMAQ-TV; Yale Roe, Manager, WSNS-TV; Charles Buzzard, Chief Engineer, WSNS-TV. WCFL-TV, which joined the group after initial construction started, was represented by Tom Haviland, Manager of the Television Division of WCFL and Lex Young, Director of Television Engineering.

RCA engineers, working with new mathematical model techniques, used computers to design the special radiation patterns that the transmitting antennas emit.

The studies also took Chicago's windy weather into account, and the design proved enough rigidity to keep the sway of the topmost antenna on each tower to less than 0.5 degrees in a 50-mile per-hour wind.

The Chicago project also marked the first use of the new Polygon antenna for UHF stations featuring an improved strength-to-weight ratio. The 10-ton Polygons top each of the 349 foot antenna towers and are used by WFLD-TV, Channel 32, and WSNS-TV, Channel 44.

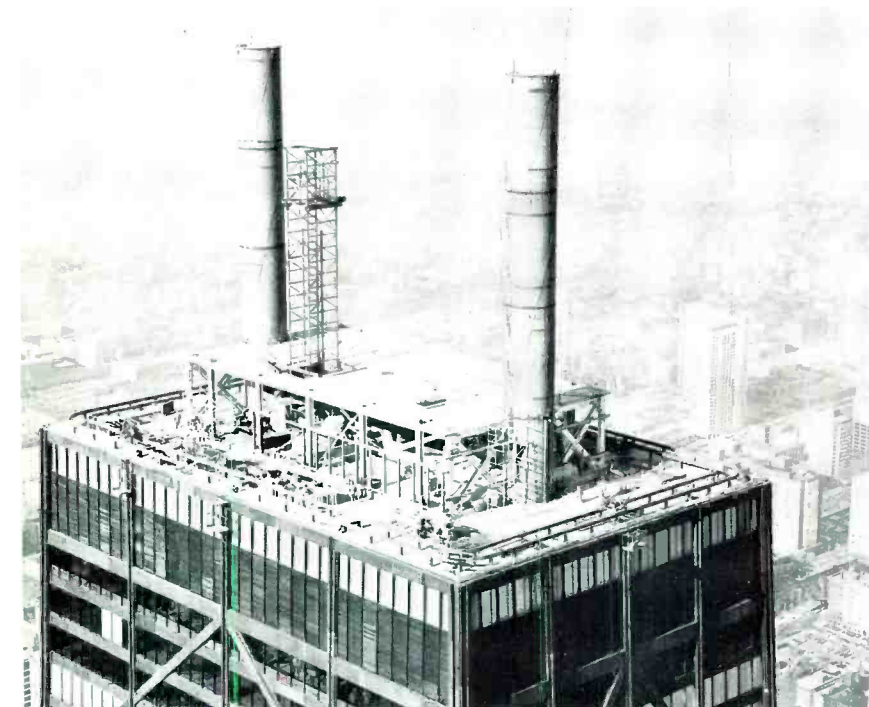

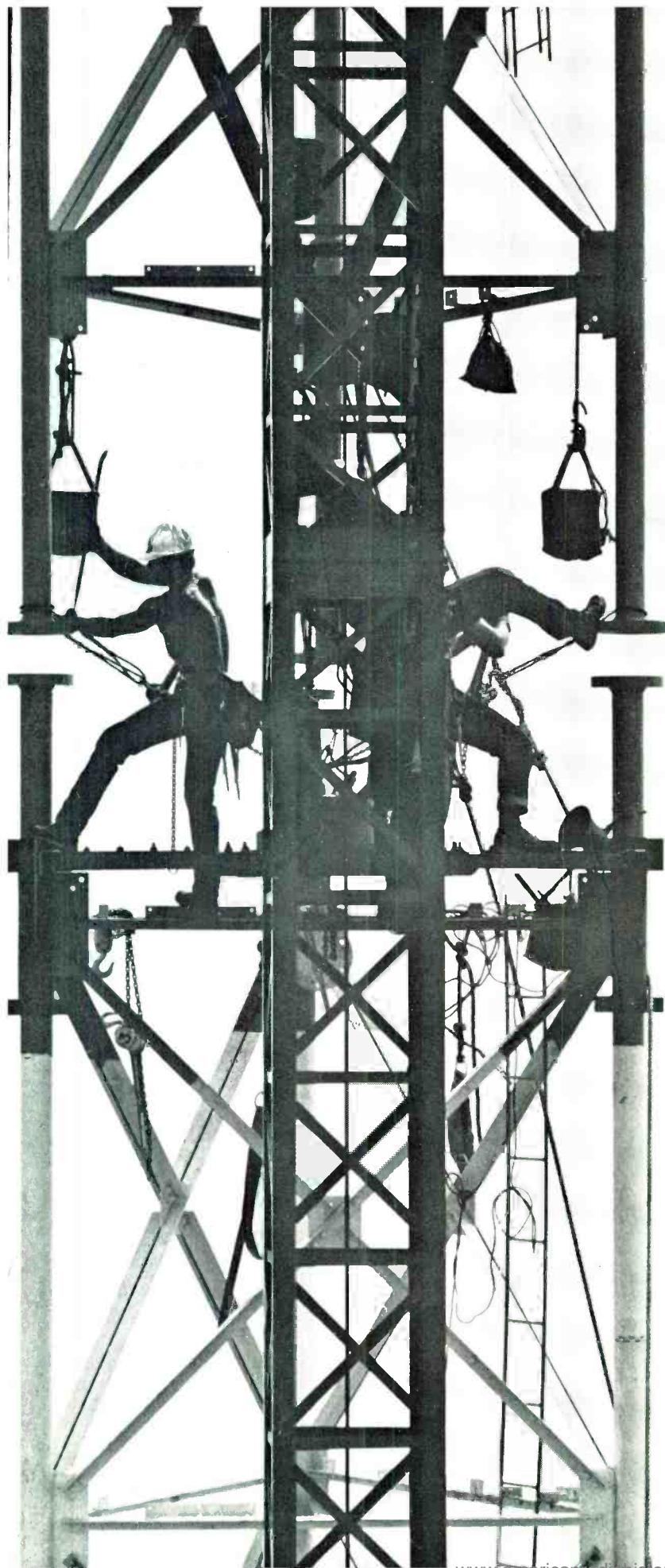

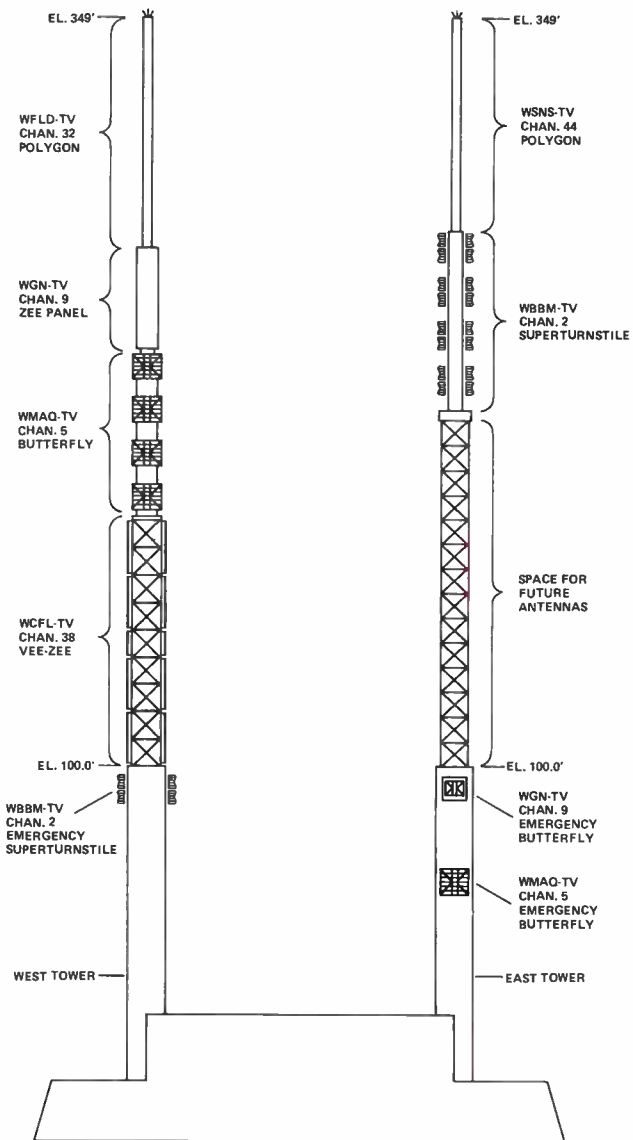

The four stations that signed on October 1 from the Hancock antenna site are WBBM-TV, Channel 2; WMAQ-TV, Channel 5; WGN-TV, Channel 9, and WFLD-TV, Channel 32. The other two are new UHF stations, WCFL-TV, Channel 38, and WSNS-TV, Channel 44, that plan "on air" dates in 1970.

The antennas were designed and fabricated at the RCA Antenna Engineering Center, Gibbsboro, N. J., and trucked to the Hancock site. They were hoisted to the rooftop by a 30-ton crane in an installation project that required approximately 3 months. An RCA project engineer, Robert Marye, supervised the installation. The erection subcontractor was John F. Beasley Construction Company of Dallas.

The on-air date of October 1, 1969 was planned July 1968 when final arrangements were made with the Chicago Broadcast Antenna Committee.



Photographer Jonas Dovydenas had done rock climbs in Colorado during a hitch in the Air Force but walking around on open steelwork high over the city of Chicago produced a different feeling. "I felt like I was balancing myself on a needle . . . The ironworkers tell you that after the first 25 feet it is all the same, but I don't believe them."

Born in Lithuania, but growing up in Scranton, Pennsylvania, Jonas graduated from Brown University, then studied photography at Rhode Island School of Design and at Illinois Institute of Technology.

The work displayed here in this article demonstrates a real creative effort. Mr. Dovydenas is, in all sense of the word, an artist—armed with a camera.



# KOMO-TV COLOR REGATTA

New Mobile Unit  
Baptized at Seattle Seafair

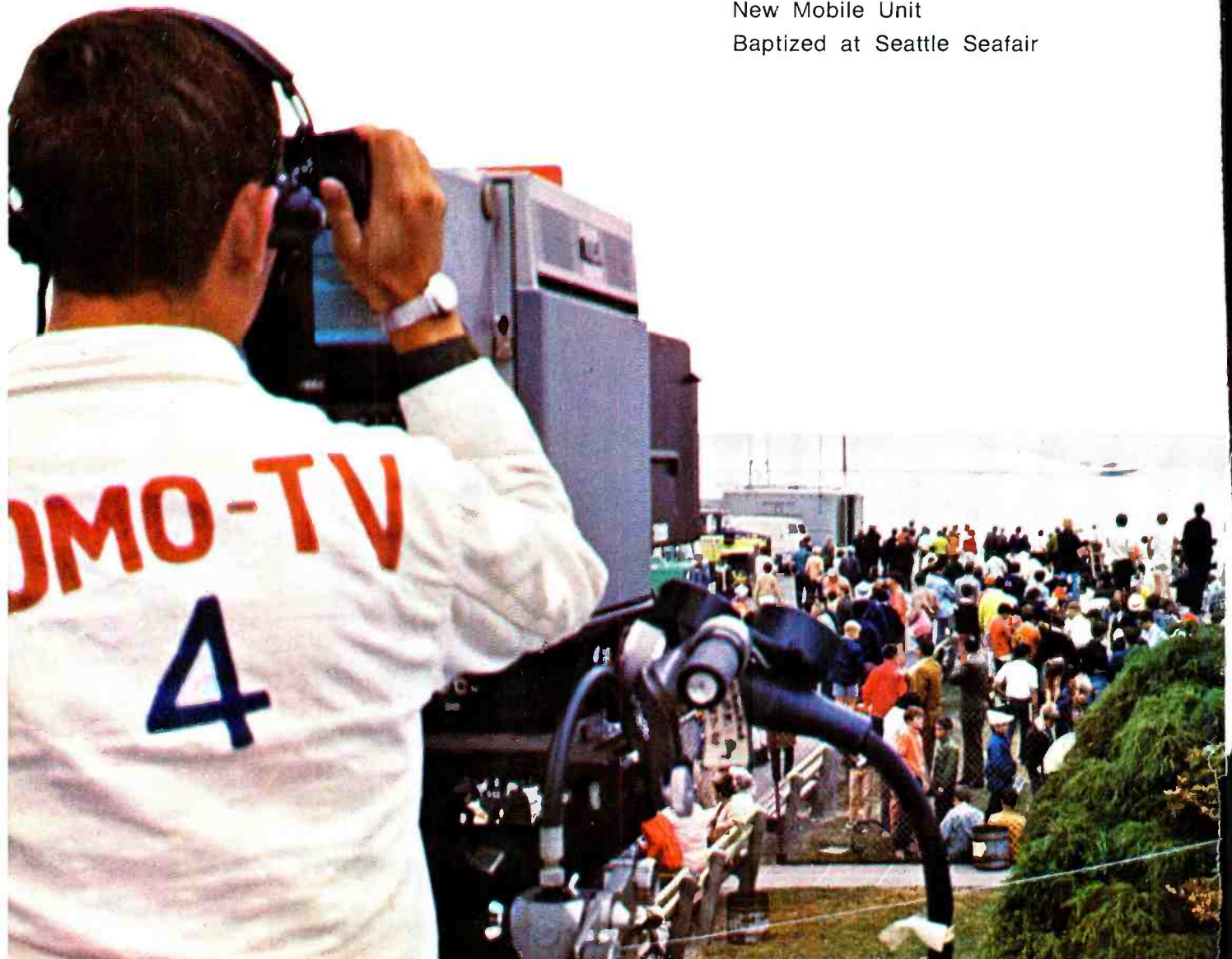

The Seafair Unlimited Hydroplane Regatta is a top attraction in Seattle and, like Christmas, comes once a year. For KOMO-TV, in this year 1969, its big new color mobile unit was an exciting added adventure for this racy color remote. The combo won an enthusiastic audience as a result of creative programming.

The pageantry began with a Seafair Grande Pageant a week in advance of the race. Four days of exciting test runs followed. Finally, the day of the race. It was a great day—for boats, boat-stoppers, and some 200,000 people—who came early, staking claims with blankets, chairs and towels. All day long they lined the shore of Lake Washington watching races, munching lunches, watching races, wading in the water. Amidst this carnival atmosphere the four leading contenders zoomed around a 3 mile oval course in five hydro heats. Miss Budweiser Beer Boat streaked to victory with average speed over 105 mph.

Split-screen special effects were employed for added

interest. An electronic spotlight was used to pinpoint action. Exact heat timing was shown by an electronically inserted starting clock.

While some of the events preceding the day of the race were put on tape prior to prime time viewing, the race itself was colorcast live. All kinds of compliments were received throughout the week. Reception was excellent, color superb. The four local sponsors and their agencies were enthusiastic.

It was all captured by KOMO in a beautiful blend of color, using a barrage of seven cameras, backed up with the newest in mobile television facilities by RCA. From the top deck of the official start-and-finish barge the new TK-44A Cameras surveyed the colorful course, while Sports Director Bruce King called the action. Other cameras covered the pits, close ups of drivers, and human interest candid. Synchronized sound added the final realism bringing viewers the roar of the boats from the direction of the cameras.



## MOBILE COLOR BROADENS STATION HORIZONS

W. W. WARREN, President and  
General Manager, Fisher's Blend Station, Inc.

We felt that a million dollar mobile unit was needed to update existing facilities and to serve as an adjunct to our existing plant. Since it is axiomatic the viewing public should receive more and better service, Fisher's Blend must be prepared for recording and broadcasting remote events as they occur. And since black and white is outmoded today the mobile unit will serve as an extension of our existing color plant.

We believe that network and advertisers will employ the services of the mobile unit, helping to amortize costs and paving the way for profitable enterprise. Certainly our people are very proud of the new facility and as a result of their recent remote experience are sure it will stimulate business prospects.

Local advertisers and agencies have problems in producing commercials comparable in quality to na-

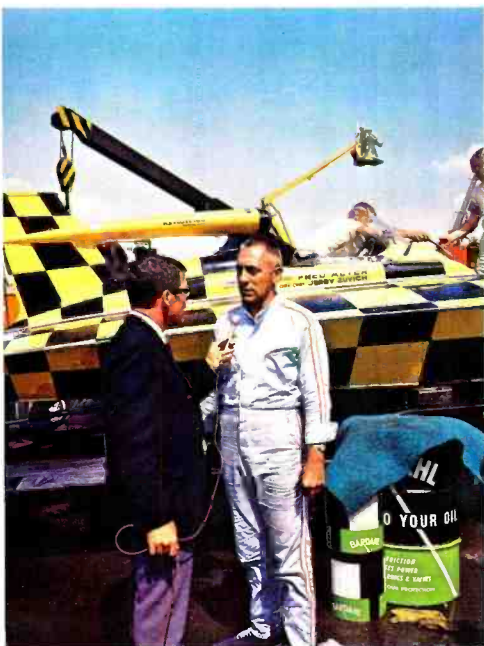



tional and network commercials. With our new facility we can tackle this problem. In fact, the time may well come when local color units will pre-empt local production of film commercials. It is well known that TV tape provides the immediacy of seeing results and of affording opportunity for perfecting the commercial. Further, tape can also provide greater assurance of a high level of quality.

We plan to use the new remote unit to generate more and better quality commercials for local and regional advertisers. Along this line we will use mobile color on a clinical basis with clients. Television production techniques will be demonstrated on the spot to local groups at their meeting places. Seminars will stimulate agencies and sponsors to creatively and more effectively use the television medium.



## CREATIVE USE OF MOBILE COLOR

JACK NORMAN  
Director, KOMO-TV

After completing our first remote from KOMO's new color mobile unit—a six-hour production at Seafair—we have quite a good feeling, a feeling of confidence. I've done quite a few remotes, with different stations, and this is the best!

For one thing the TK-44A Camera gives the director a solid feeling—its the greatest thing with this gear—I can go on working—not worrying about losing a camera. And many people remarked how much better our color pictures looked.

Again, contrasting this with past remotes, there was less chatter on the intercom because there were fewer traumatic situations. Everything was working, and doing all it was supposed to do. We got more of a job done. We handled more last minute changes. We were able to employ varied techniques with the switchers to interest the audience. We were able to do it and not worry. Production was really smooth.



## SEVEN CAMERA LOCATIONS COVER THE COURSE



**1 NORTH TURN** Long shot of the Stan Sayres Pits and the starting control barge as seen by TK-43 at North Turn camera location. The pits and barge are in the middle distance at left center. The race course is just out of the picture to the left of the barge which can be seen setting out in the water.

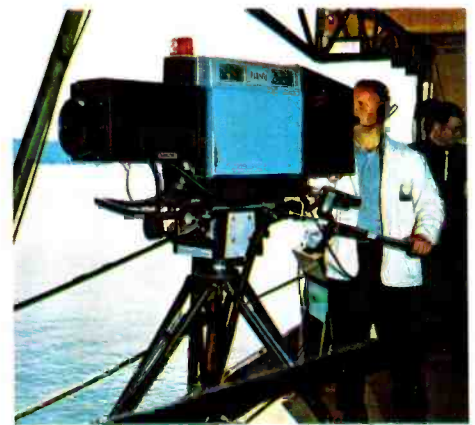

**2 OFFICIAL BARGE** The TK-44A location on the official starting control barge. Course bouy markers and crash attendant boats can be seen in the distance just below the camera lens. The barge and camera are located on the official starting line of the 3 mile elongated oval race course.

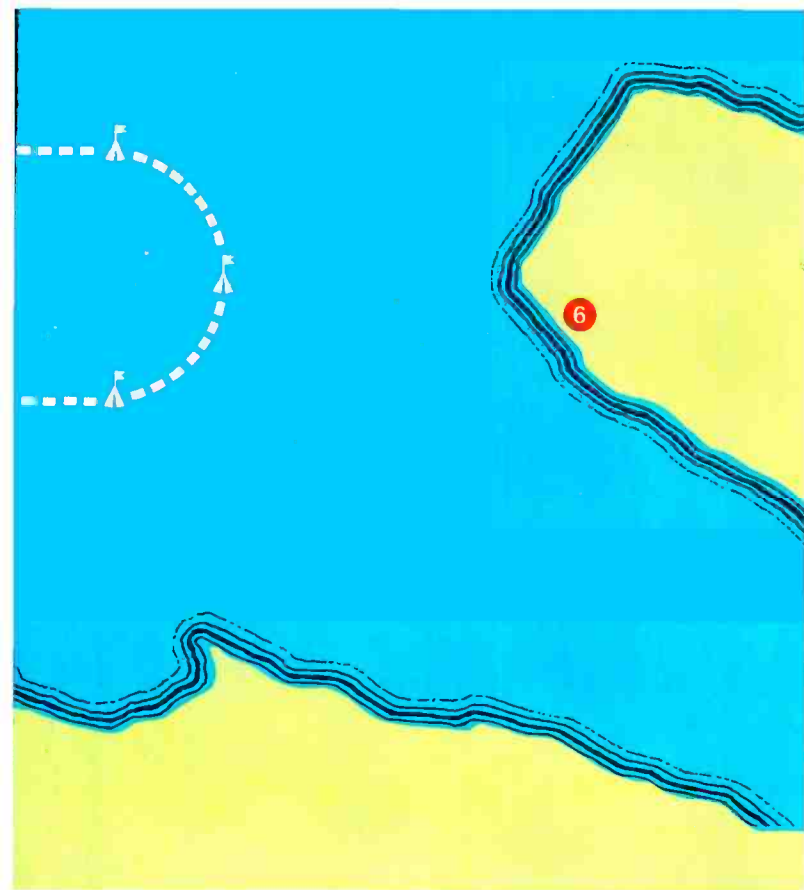

**7 ROVING PORTABLE** A hand-held portable with shoulder pack was used to capture close-ups of the drivers, crews and boats in the pits and surrounding area, and unusual human-interest candid. Interviews at appropriate times were covered. Together with the other two cameras overlooking the pit area, all the excitement generated during the race was captured.



**6 SOUTH TURN** The TK-44A camera at the South Turn location. A fork lift and platform was used here in order to get enough camera height to clear bushes and vegetation along the shoreline. In the left foreground is a parabolic microphone used for picking up hydroplane engine sounds during the running of the races.



**3 MONORAIL OVERLOOKING PITS** The TK-44A monorail camera location showing some of the competing boats and the 50 ton crane used for launching them. In the background at the right just above the tree line is a "scissors-lift" camera. These two cameras were used to cover all of the pit activity, always at feverish intensity with engine changes, emergency repairs, high speed action.



**4 PIT "SCISSORS-LIFT"** The TK-44A camera in the Stan Sayres pits. This was elevated to a height of about 35 feet on a flatbed-mounted "scissors-lift". This location was used for general pit surveillance and for coverage of the pre-race drivers meeting.

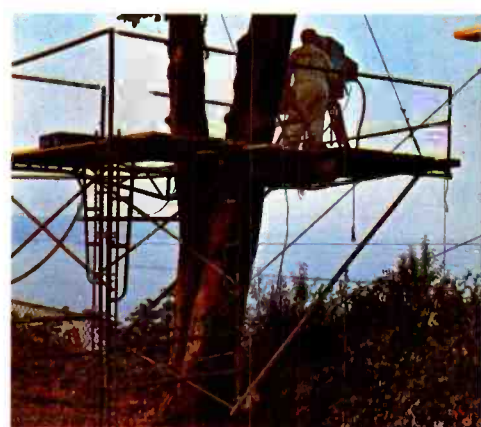

**5 MID-COURSE** The mid-course Hill camera location is another TK-44A. The North Turn of the race course is in the distant background and the pits and starting barge are just out of sight down over the hill a half mile distant. The elevation here is about 300 feet and a panoramic view of the entire course is obtained.

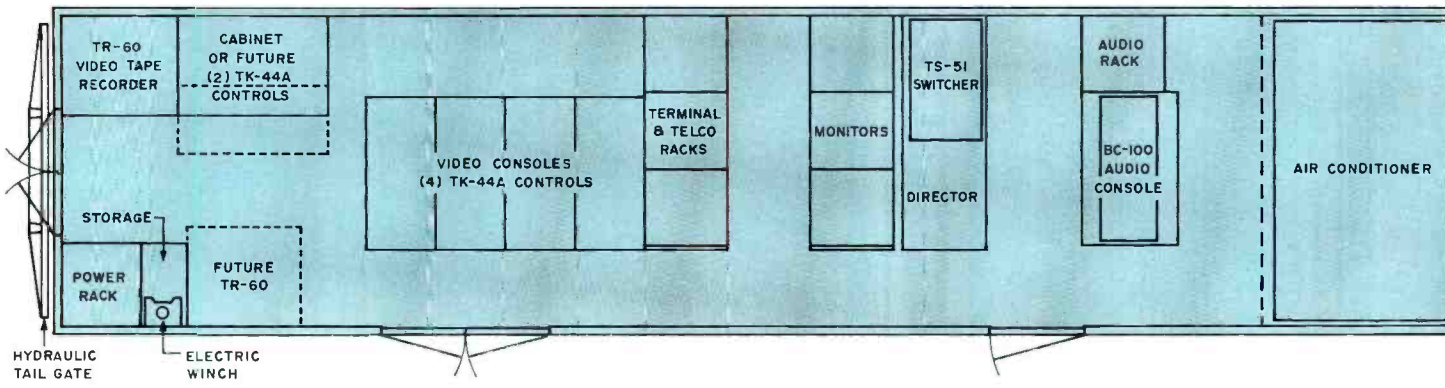

## ADVANTAGE OF UNIFIED REMOTE VEHICLE

RALPH MIFFLIN, Chief Maintenance Engineer, KOMO-TV

VIDEO TAPE



CAMERA CONTROLS

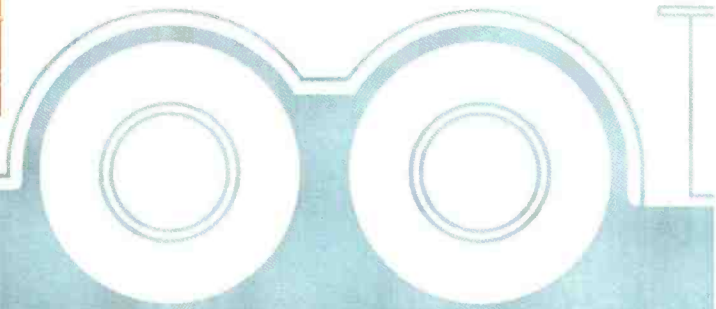

One of the big questions KOMO-TV faced when considering choice of a color mobile unit was whether to buy or to build. Some other stations decided to adapt existing units, whereas Fisher's Blend decided to have an outside supplier build their color unit.

From past experience it was concluded that one can not really adapt an existing vehicle to fit all the requirements of the station. Starting from the bottom KOMO knew it could put into it what past experience indicated was needed. Others would compromise facilities to fit the truck.

In considering supplier it became evident after talking to several that none had the background and experience that was found at RCA. Certainly cost entered into the final decision also.

A big reason for new facilities are remotes we hope to do for the ABC network—football games and sports of all sorts. Our unit is designed for big jobs.

Our new mobile unit has more capability than needed for local remotes. We can handle more than five cameras with ease. In addition, we have TV tape machines so that we can record on the spot. We have a more flexible audio system, with capabilities that eliminate all "haywire".

Formerly at Seafair we used two large units—40 and 35 foot trailers. Now we have been able to combine everything in this one 35 foot unit. And, we like the style of the RCA van—the new ideas in construction and layout, the switchers, and the new audio console. Incidentally, audio is one of the biggest problems on large-scale remotes.

For audio previously, we've had jerry-rigged mixers, sub-mixers, distribution lash-ups, isolated sound, ump-teen channels—a terrible mess of equipment. Now, an audio man merely walks in, pushes the button, plugs in the circuits, and operates. Previously he would spend a week putting a system together.

This was the first time our audio operators used the vertical attenuator console and they were pleasantly surprised with the performance. Now they definitely want to go with vertical attenuators.

Our crew became proficient in the operation of the switching system in short order.

Our experience at the Seafair made this our best overall remote. It has been a great advantage to operate out of one integrated truck. Facilities were highly suitable, the truck was cool even in the hot sun, making it a real pleasure to operate.



DIRECTORS CONSOLE

AUDIO CONSOLE





Left to right, Ralph Mifflin, Chief Maintenance Engineer and overall Engineering coordinator; Bob Koons, Remote Crew Chief; and Fran Miller, Asst. Chief Engineer discussing the setup problems. Truck skirt compartments show, in left-to-right order, the AC power input panel for either single phase or three phase power, the power cable reel, and the video lines and camera cable input/output panel.

Left to right, Ralph Mifflin, Wally Schutter, and John Carlbom carrying one of the RCA TK-44A cameras by means of convenient fold-out handles located on either side. The truck skirt compartment in the background houses two power driven camera cable reels as does the compartment directly forward of the truck rear wheels. A similar compartment on the opposite side contains shock mounts for six TK-44A cameras.



# INTERRUPTED FEEDBACK INTERCOM SYSTEM FOR KOMO MOBILE VAN

WILLIAM VANDERMAY, Chief Engineer  
KATU-TV, Portland, Ore.

One of the greatest challenges in the construction of the KOMO Color Mobile Unit was that of the ideal intercom system. Years of experience and observation had revealed that rarely did intercom systems for complex remote pickups ever meet the necessary specifications for total communications in the field as demanded by modern complicated and sophisticated production requirements. Past experience with stock intercom systems, highly engineered special approaches, and many improvised arrangements had all fallen short of expectations. The advent of this new Mobile Unit clearly called for a total new look and a modern approach to all the detailed requirements.

With the basic objectives in mind and the knowledge of the problems encountered in the past on the many network and local remote originations handled in the Pacific Northwest by the staffs of KOMO-TV, Seattle, and its sister station KATU, Portland, engineers of these two television stations combined their skills and talents on the design and construction of the system. The basic system consists of the following categories of communications channels.

## Headset Intercom System

This provides for 30 possible headset stations for use with six cameras, camera controls, video positions, video tape, audio, Director, AD, TD, Floor Managers, and any other personnel involved in a typical production. Three selectable trunk positions are available to provide isolation between any two or more parties. Director and AD positions feed the system with higher quality dynamic microphones and compression amplifiers for constant level to the system. In case of failure of dynamic microphone or an amplifier, a standard carbon microphone headset can be instantly substituted. Level of the Director or AD talk can be set equal to or above other stations to command the circuit. Special provisions were incorporated for inter-

The actual engineering designs, layouts, and physical construction were accomplished by the KATU Engineering Department—Mr. Robert A. Moore, Assistant Chief Engineer of KATU, and Mr. Donald Wilkinson, KATU Special Projects Engineer. The work was done in the KATU shops and covered a period of nearly six months to complete.

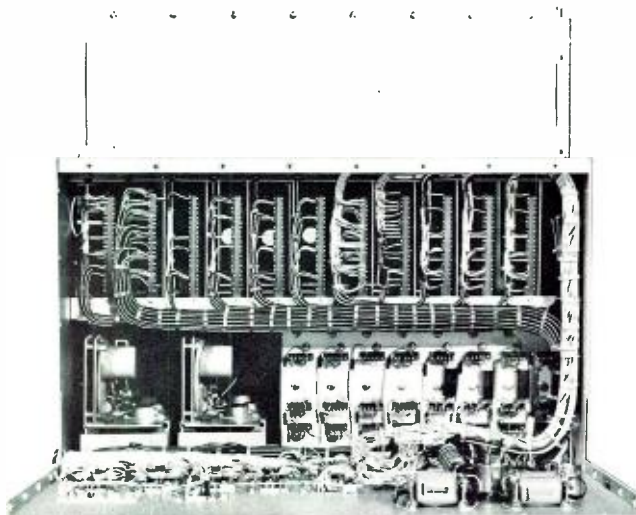

### REMOTE TRUCK I.C. SYSTEM

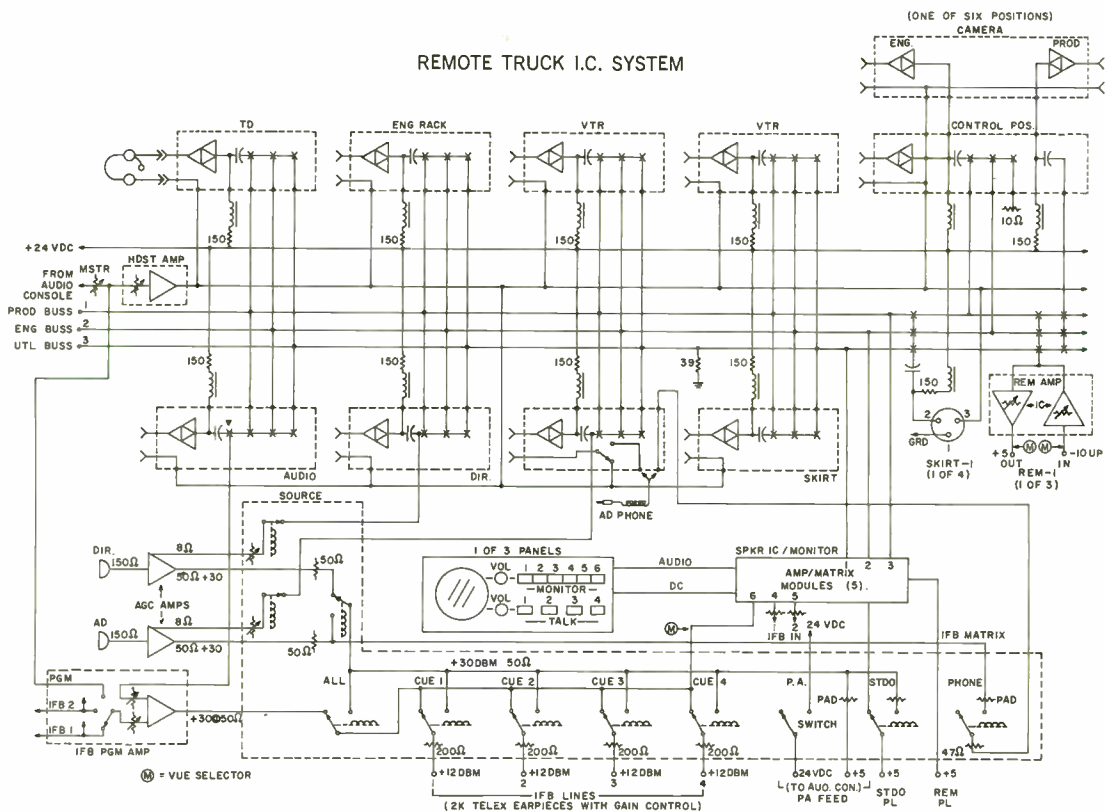

### SPEAKER I.C. SYSTEM

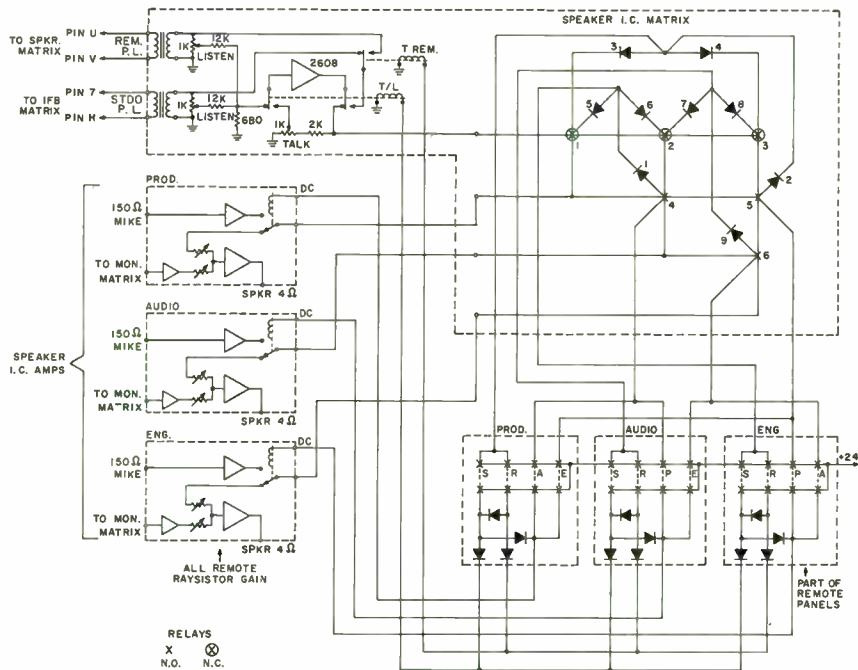



facing the Mobile Unit Headset Intercom systems with 4-wire and 2-wire telephone PL circuits to sub-remote locations, TelCo long lines, etc.

### Speaker Intercom System

This facility consists of three stations within the Mobile Unit that can talk to each other and also to either the Main Studio, or other Remote locations. Listen level controls are provided to adjust Studio and Remote lines to equality with local system. All stations hear the Studio and Remote calls but return answers by a trunk station are not heard by remaining two stations. Studio and Remote locations do not hear intertrunk communications.

### IFB Cue System

This is the system for feeding cueing information directly to talent and announcers. This "interrupted feed back" arrangement has provisions for selective interrupt by the Director or AD of three selectable program sources; Audio Console, IFB-1-IN, and IFB-2-IN, to four output CUE lines. Announcers at their stations can thus be fed normal audio program material which is interruptible by the Director or AD for direct word cues and instructions received on their Telex carsets. The Audioman from his position can also interrupt all four cue lines simultaneously for audio checks and coordination. Relay control is used throughout.

### Speaker Monitoring System

Each of three Speaker Intercom panels in the truck are provided with monitoring selection of six different inputs—Headset Intercom trunks 1, 2, or 3, IFB-1-IN, IFB-2-IN, and the IFB BUS Output. IFB 1 & 2 inputs are also on jacks at the Audio position and can be patched to monitor any source. An 18-relay matrix is used for selection with DC used for controlling.

### Solid-State Construction

The actual construction of the entire system was done in modular form with extensive use of integrated circuitry, solid state devices, diode logic circuits, compression amplifiers, and with a minimum of controls and complicated adjustment procedures. The basic concept of "listen" level controls was followed throughout with transmit levels generally remaining fixed.

### Standard Components

Employment of standard RCA Transistor Interfone Connection Units, MI-11784, at each fixed operating position, and the interfacing with these same equivalent units in the TK-44A cameras greatly facilitated the construction of this system. In addition, camera Transistor Interfone module units were employed in a unique manner by extending from the external communications plug on the camera, or from the Mobile Unit skirt connectors, using standard (reversed) 3-wire microphone extension cable, and using these units mounted in special belt clip housings for roving and extended field use by Floor Managers or other production personnel. The design of the system also

incorporated RCA BA-78B Cue/Intercom Amplifiers, PS-24 Power Supplies, and RCA MI-11737 Retardation Coils. All module connections, intertruck cabling, skirt compartment connections, and all terminal positions are connected by blue-ribbon type connectors and special Cannon connectors, greatly facilitating the installation and any subsequent servicing.

### Conclusion

The initial use of this total intercom system on the remote pickup of the annual Seattle Seafair Unlimited Hydroplane Races on Lake Washington proved its worth and all phases of communications on this job were accomplished with excellent results and the greatest degree of perfection ever achieved in the many years of the coverage of this event.

## COST EFFECTIVENESS OF MOBILE COLOR

C. E. MILLER, Vice-President,  
Engineering, Fisher's Blend Station

Although remotes are not too frequent in our operation, we hope to keep the new mobile unit rolling most of the time. Obviously cost enters in and we cannot cope with each and every local request and cover costs adequately. But we have designed this remote van with the hopeful thought of supplying network and similar large-scale services as well as routine commercials and remote telecasts in our locality.

We believe that we have a saleable product in our new color van to serve Fisher's Blend television stations in all their areas of coverage for both commercial and public interest coverage.

We have proved in our programming of the racing remote at Seafair over a full week that with our new color facilities we can do a better job than ever before. Certainly our splendid audience reaction must be attributed to the new gear as well as to qualified people.



W. W. Warren, President and General Manager, Fisher's Blend Station, Inc.



C. E. Miller, Vice President, Engineering, Fisher's Blend Station, Inc.

# WDBO-TV INSTALLS FIRST BUTTERFLY PANEL ANTENNA

Orlando, Florida, Station Increases  
Grade B Coverage By 24 Percent

BILLY L. PATTON, Director of Engineering  
Broadcast Division of The Outlet Company,  
Providence, R. I.

The Outlet Company, owner and operators of Channel 6, WDBO-TV in Orlando, Florida, has just completed installation of the first RCA Butterfly Panel Antenna atop one of the tallest structures in Florida, to greatly improve coverage of the fast growing Central Florida area. Figures 1 and 2 show the completed 1484-foot guyed tower with the RCA antenna in place.

WDBO-TV began operations in 1954 from an antenna mounted atop their AM tower at a height of 540 feet above average terrain. In 1964 a study was started of ways and means to improve service to central Florida, especially in faster growing areas along the coast near Cape Kennedy. FAA approval was obtained for a site east of Orlando for an antenna farm and The Outlet Company and the owners of WFTV Channel 9 agreed to build a joint tower to support the antennas of both stations. Because of problems in getting FCC approval, Channel 9 was not able to participate. The Outlet Company constructed the tower to provide for later occupancy by Channel 9.

The tower was designed and constructed by Kline Iron and Steel Company to provide for the Channel 6 and Channel 9 antennas to be mounted above the top guy wires. Additional provisions were made for a future UHF Channel, two FM antennas and a number of auxiliary equipments. The design resulted in extremely stringent requirements near the top of the tower resulting in a top set of guys that are 2 $\frac{7}{8}$  inches in diameter and weighing over 15 tons each. This extra heavy cable resulted in a very difficult and most interesting erection problem.

FCC requirements for the agreed antenna farm location made it necessary for WDBO-TV to provide protection to a proposed UHF grant in Melbourne, Florida and to Channel 6 in Miami. RCA was able to produce a pattern to suit these requirements, and was awarded the contract. Figure 3 shows the pattern as measured by RCA at their test site in Gibbsboro, N. J. The approximately 10 dB suppression is in the direction of the proposed UHF station in Melbourne, Florida.

Two other important advantages of the Butterfly panel weighed heavily in The Outlet Company's decision to use this antenna. The directional pattern of the antenna can be easily changed to a non-directional pattern if the FCC requirements should be changed in the future. Not only is conversion simple to make but circularity of resulting non-directional pattern is excellent. The second advantage is that the elevator can pass through the antenna making inspection of the antenna available to non-climbing engineering personnel and greatly simplifying servicing of the antenna and top beacon. Figure 4 and Figure 5 are examples of the details of antenna, feed system, and a junction box as observed from the elevator.

The antenna was assembled in three sections on the ground by Seago Construction and lifted into place with feedlines attached.

The results of the preliminary measurements indicates excellent coverage of the entire central Florida area and especially dramatic increases along the fast growing East Coast area.

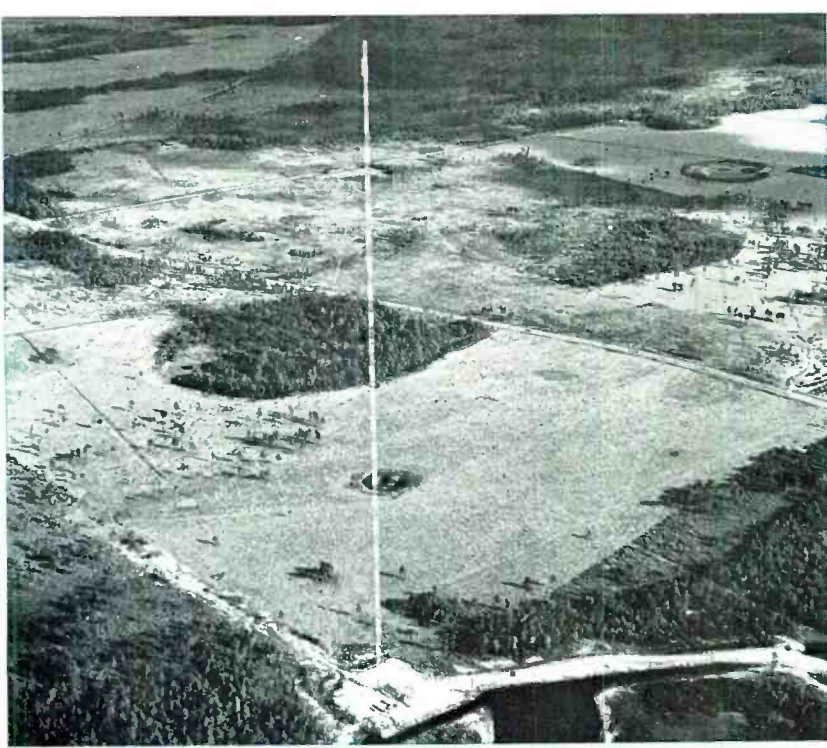

FIG. 1 (above) Aerial view of completed tower and transmitter building.



FIG. 2 (right) Closer view showing Butterfly Antenna mounted on tower.

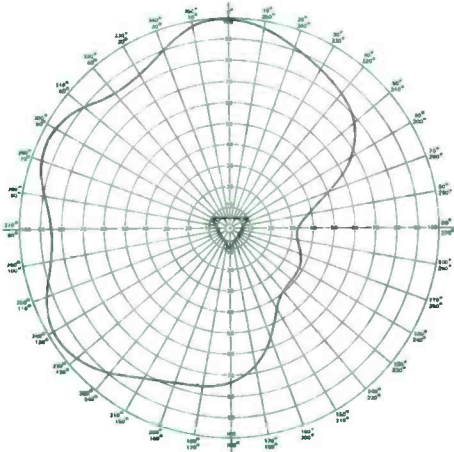
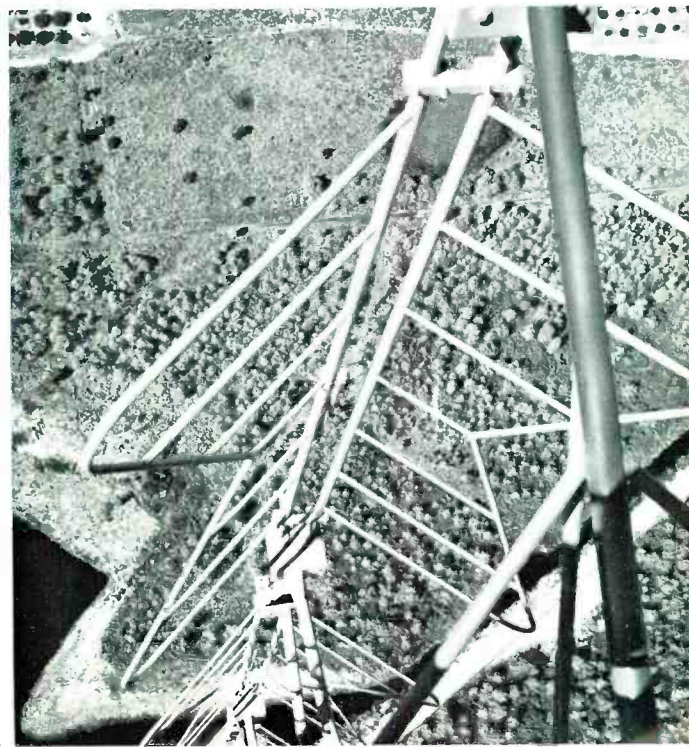

FIG. 3 (left) Measured directional pattern of Channel 6 Butterfly.

FIG. 4 (lower right) Looking at bays of the Butterfly Antenna from the elevator.

FIG. 5 (lower left) Another view from service elevator, inside tower, showing part of antenna feed system and junction box.



# WBOC-FM STEREO AND SCA

Uses Solid-State Exciter,  
Main and Alternate Transmitter, in  
2-Studio Remote Control System



WBOC-FM studio in Radio Park, Salisbury, Md.

When WBOC-FM, Salisbury, Md., first came on the air in July 1965, the ERP was 630 Watts from an antenna located at the Salisbury TV transmitter site. Today, the FM operation has grown to an ERP of 30-kW with STL remote control of transmitting equipment now located at Whaleyville, Md., 16 miles from Salisbury. The changeover in operation began in September 1968 when the station put the first of two Type BTF-10E1 10-kW FM Transmitters into operation. With these new transmitters operating as main and alternate systems, and the BTE-15A Solid-State FM Exciters, WBOC-FM is now able to program for both stereo operation and a single channel of SCA (multiplex) operation.

FM stereo studio at Salisbury with DJ Paul Boylin operating RCA BC-7A Console, BQ-51B Turntables, and a BK-11A Velocity Microphone.



RCA BTE-15A FM Exciter System being checked by maintenance supervisor Vince Donovan.

### Transmitters Suitable for Remote Control

WBOC's two BTF-10E1 FM Broadcast Transmitters are particularly suited for remote operation. Their circuits employ solid-state components with inherent long-life and cool operation that assure extended reliability, while only two conservatively rated vacuum tube stages are required.

In addition to the dependability, long-life and operating economy features of the transmitters, the circuitry for unattended remote control was provided as standard equipment. These transmitters also contain VSWR and under-power disabling circuits.

### All Solid-State FM Exciter

The BTE-15A FM Exciter System, with optional Stereo and SCA generators, provides WBOC with an inexpensive means of broadcasting two or more services simultaneously over the regularly assigned broadcast channel. The wide frequency response and extreme stability of the exciter make it ideally suited for SCA and stereo programming.

### Stereo Programming

A typical day of programming at WBOC-FM comprises 18 hours, of which  $3\frac{1}{2}$  hours are simulcast with the sister AM operation. With the exception of network news and local news programs, alternating on the odd and even hours, the remainder of the programming is devoted to stereo music originating from either the Salisbury FM studio or the newly built Ocean City, Md., FM studio.

### Composite Signal Microwaved to Remote Transmitter

A microwave link operating on 945 MHz at Salisbury transmits a composite stereo signal, SCA subcarrier and control signals subcarrier to the transmitter in Whaleysville. A second microwave link operating on 945.5 MHz at Ocean City transmits only a composite stereo signal to Whaleysville. At both studios a stereo generator provides a composite stereo signal to modulate the microwave transmitter. This type of operation was chosen to minimize the differential amplitude

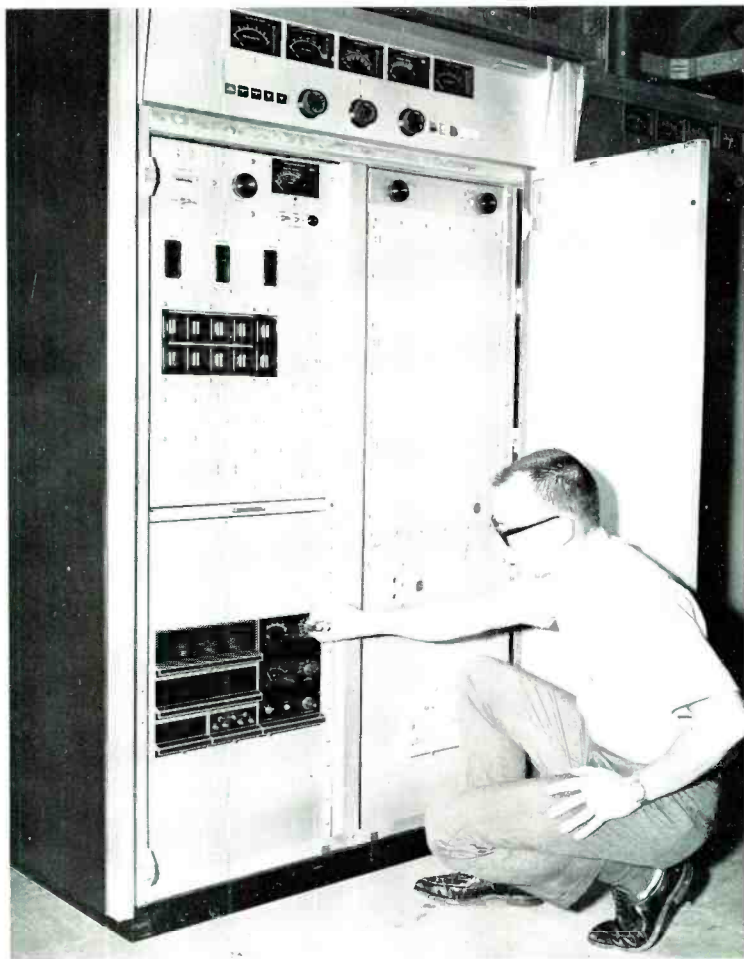

Assistant Chief Engineer Bernie Sparks taking remote meter readings of RCA BTF-10E1 Transmitter located at Whaleysville, Md.

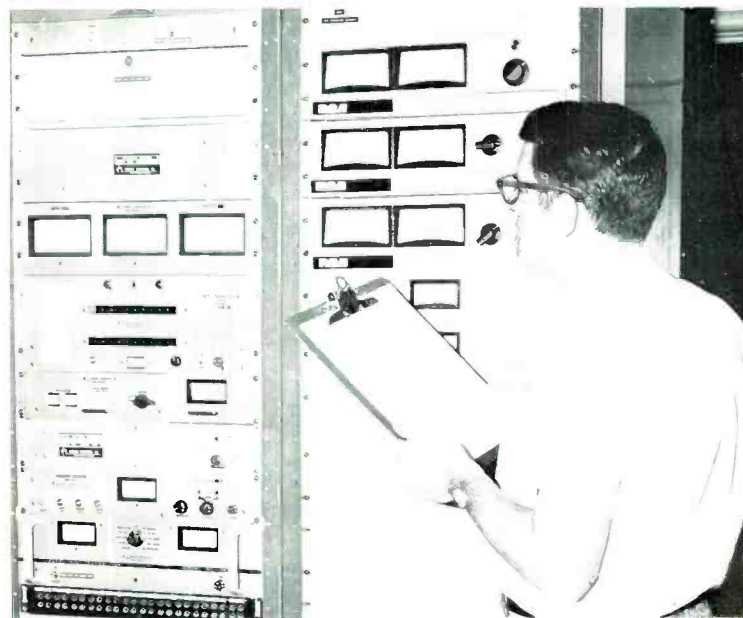

Block diagram of WBOC-FM remote control system and stereo and SCA transmitter operations.

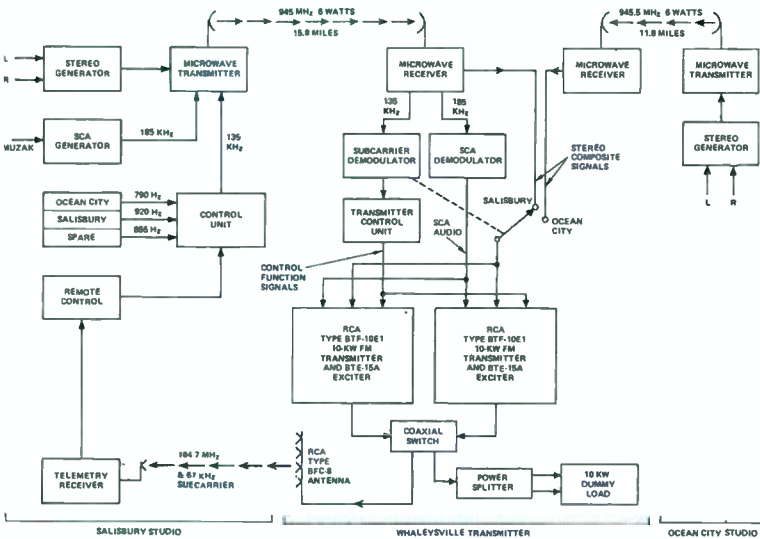

and phase problems that occur when using separate left and right channel transmission. Also, since the stereo generating equipment is located at a studio, it can be easily serviced, simplifying maintenance problems.

In addition, an SCA Generator at Salisbury provides a 185-kHz subcarrier for SCA programming. A second subcarrier at 135 kHz is used to control the selection of the input to the operating transmitter (from either studio), selection of either the main or alternate transmitter for operation, and to provide remote control and monitoring functions.

### Remote Selection of Stereo Signal Source

At the transmitter site, the microwave receivers apply their outputs to a transmitter input switch that is controlled by the 135-kHz subcarrier signal from Salisbury. To select either studio for the transmitter input, the operator at Salisbury presets the selection into the remote control unit and then initiates the change by depressing a switch at an appropriate time.

An alternate method of switching was designed by engineers at WBOC-FM as a backup and also to monitor the transmitter while changing stereo composite signal sources. This method uses the existing 135-kHz subcarrier and tones at 790 and 920 Hz to select either studio. A spare tone at 655 Hz is available for future growth.

### SCA Subcarrier Received and Demodulated

The 185-kHz SCA subcarrier output from the microwave receiver is demodulated to an audio signal and

then applied to the SCA generator within the BTE-15A FM Exciter System. The output from the generator is a 67-kHz subcarrier which is used to directly modulate the FM carrier of 104.7 MHz.

### 45 Remote Control Functions

The 135-kHz subcarrier control signal has 42 control functions from the remote control and 3 added from the backup method. However, only 26 of the total available 45 control functions are used, with the remainder available for future remote control expansion.

### Readout Signal Modulates SCA Subcarrier

All readouts from the circuits and functions that are monitored generate an audio signal of from 22 to 36 Hz. The 22-Hz frequency represents a minimum meter reading while the 36-Hz frequency a maximum reading. The readout signals are frequency modulated onto the 67-kHz SCA subcarrier providing convenient off-air remote monitoring.

### Direct Modulation by Stereo and SCA Signals

Direct modulation of the 104.7-MHz oscillator in the all solid-state BTE-15A Exciter is achieved by applying the composite stereo and SCA signals to a pair of push-pull varicap diodes that are coupled to the oscillator frequency determining resonant circuit. The output from the oscillator is isolated from the following buffer amplifier by a 10-dB resistive attenuator. Thus, the stability and modulation characteristics of the basic direct FM oscillator are not disturbed by the RF power amplifiers that follow. An off-frequency de-

Remote Control Functions of the Salisbury Studio-to-Transmitter Link

Control Position	Function			Readout
1	Plate Volts	On	Off	Main Xmtr Plate Voltage
2	Transmitter	On	Off	Main Xmtr Plate Current
3	Power	Raise	Lower	Main Xmtr Power
4	Overload	Reset	—	(Reset Main Xmtr)
5	Studio Select	Salisbury	Ocean City	—
6	Tower Lights	—	—	Current (Lights)
7	Deicers	On	Off	—
8 to 10	Spare			
11	Transmitter Select	Main	Alternate	—
12	Plate Volts	On	Off	Alternate Xmtr Plate Voltage
13	Transmitter	On	Off	Alternate Xmtr Plate Current
14	Power	Raise	Lower	Alternate Xmtr Power
15	Overload	Reset	—	(Reset Alternate Xmtr)
16 to 21	Spare			

Three Additional Control Channels

1. Select Ocean City Studio
2. Select Salisbury Studio
3. Spare

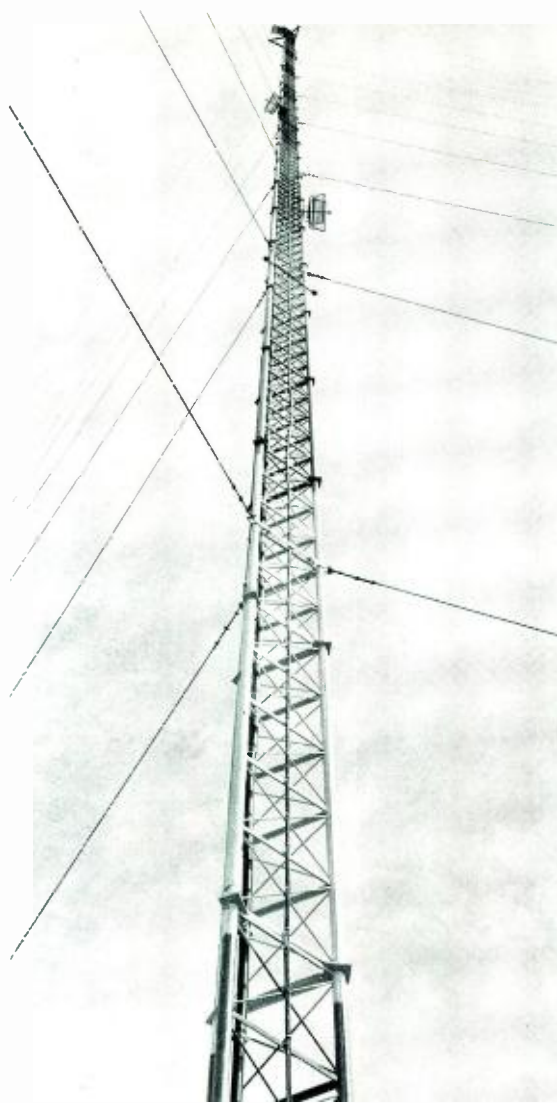

Side mounted on a 647-foot tower, the RCA BFC-8 Circularly Polarized FM Antenna radiates 30-kW of power in both the horizontal and vertical planes. Note the microwave receiving antennas for Salisbury and Ocean City signals.

tor is also provided to turn off the transmitter if the basic oscillator frequency is not phase locked to the reference crystal.

Some of the more interesting performance specifications of the exciter include a guaranteed performance of: maximum harmonic distortion of 0.5% (typically 0.2%), stereo crosstalk of -45 dB, and a maximum FM noise level of -68 dB.

### Coaxial Transmitter Output Switching

The two BTF-10E1 transmitters feed a coaxial switch which routes the output of one transmitter to the antenna while the second output is always terminated into a dummy load. The stereo and SCA inputs to these transmitters are essentially connected in parallel.

### 10-kW Air-Cooled Dummy Load

To eliminate the need for a water-cooled dummy load at the remote transmitter location, and all of the resulting problems of possible freezing in winter—together with maintenance of proper circulation and

water levels, WBOC-FM decided to use air-cooled dummy loads. A power splitter at the output of the coaxial switch feeds one half of the transmitter output power to each dummy load, while maintaining a 50-Ohm output impedance. In effect, the transmitter "sees" two 5000-watt loads connected in parallel for a total capacity of 10,000 Watts. It takes less than three seconds for the coaxial switch to swap transmitters from the dummy load to the antenna system when changing transmitters.

### Side-Mounted BFC-8 Antenna

The antenna system comprises a BFC-8 Circularly Polarized Antenna, side mounted on a 647-foot tower. The antenna provides a power gain of 4.3 in both horizontal and vertical planes, resulting in an ERP of 30 kW. The circular polarization provides improved reception for automobile radios with whip antennas, and for home receivers with built-in or "line-cord" antennas.

### Off-Air Monitoring

At the Salisbury studio, a telemetry receiver is used for off-air monitoring of the 104.7-MHz FM programming and the 67-kHz SCA subcarrier. Outputs from the telemetry receiver are fed into the remote control unit allowing the monitoring of the various transmitter readouts.

### Conclusion

The transmitter and exciter system have proved dependable. The station is installing an automatic changeover 50-kW diesel generator, as an emergency power source, to complete the installation.

Delaware-Maryland-Virginia Peninsula coverage by RCA transmitter and antenna systems located at Whalesville.

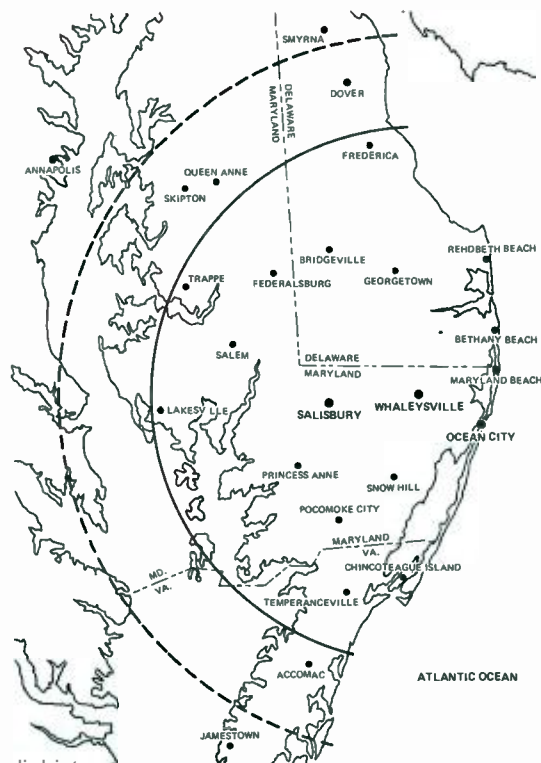
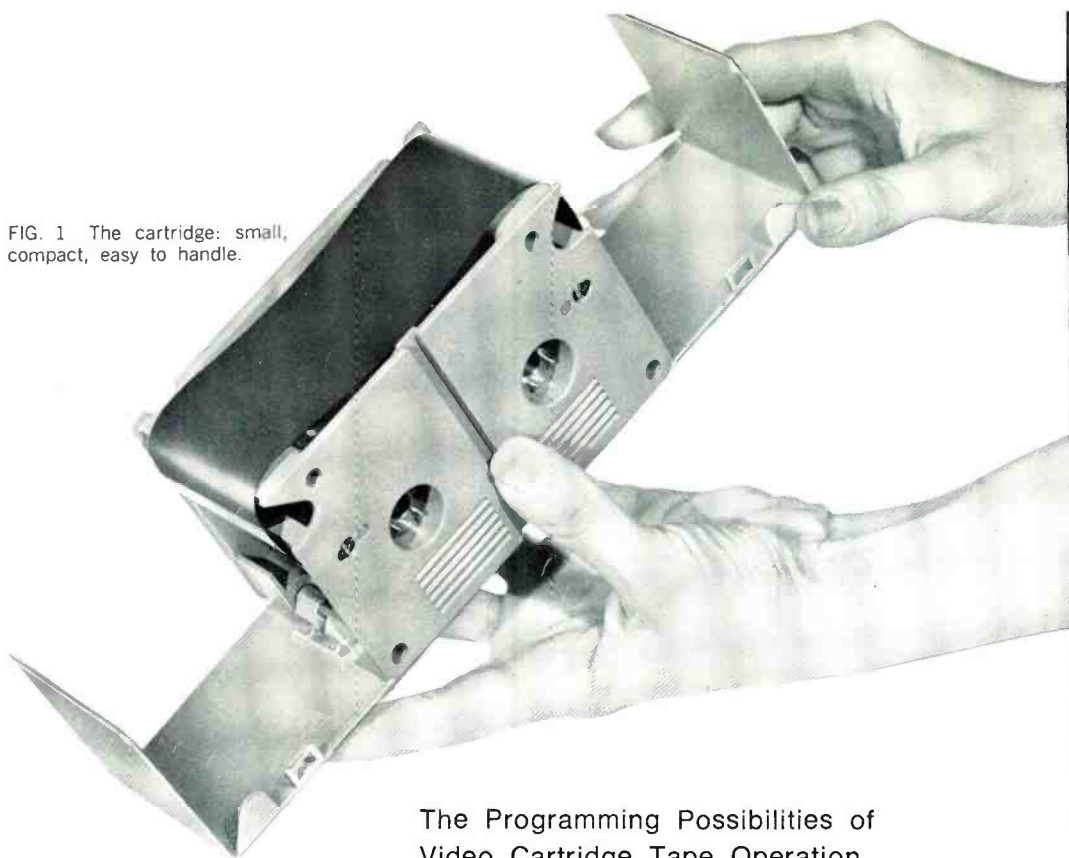

FIG. 1 The cartridge: small, compact, easy to handle.



## FUEL FOR THE IMAGINATION

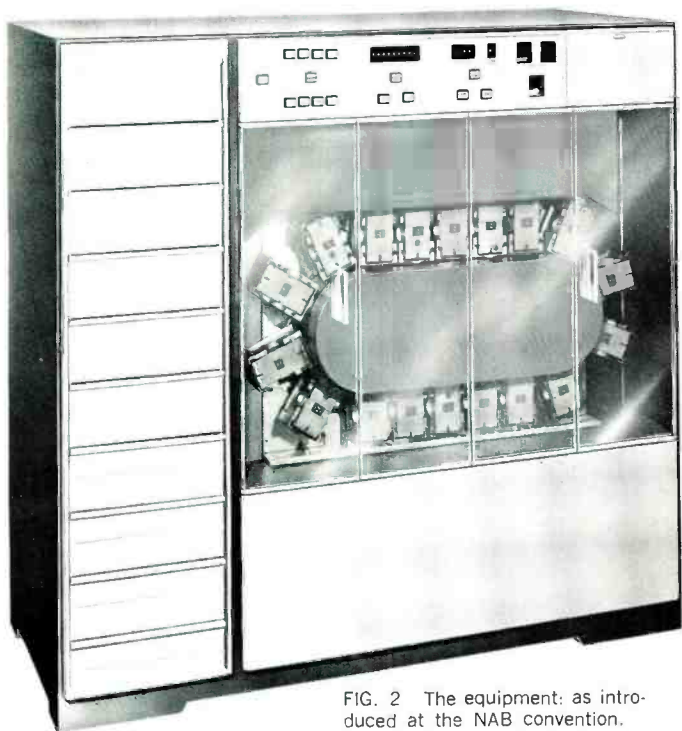

FIG. 2 The equipment: as introduced at the NAB convention.

### The Programming Possibilities of Video Cartridge Tape Operation and How to Determine Them For Yourself

The concept of programming through the use of a number of short pre-recorded video tapes is the subject of much of today's "imagineering". Since the debut of the RCA Video Cartridge Tape Recorder at the 1969 NAB there has been much speculation into the various applications of this equipment. Beyond the obvious station-break activities—in which a single cartridge machine can handle the functions of several conventional reel-to-reel machines—ideas have been generated as to its use in news and other regular program formats.

Presented here are the basics of the RCA video cartridge tape system. Hopefully they will provide fuel for the imagination to help the reader to decide for himself how the video cartridge will best serve his needs.

#### Basic System

The cartridge system utilizes a video tape cartridge as the carrier or package for *each* recorded segment. It has the capability for playing back the cartridges one after another, assembling signals from each into a complete, continuous program. This is accomplished by including two playback stations (tape decks) within the equipment. Also included are appropriate switching and control electronics and a cartridge changer mechanism with a capacity of twenty-two cartridges. The equipment is programmed to play a sequence simply by placing the appropriate cartridges in the changer mechanism in the order in which they are to be played. It is made ready by activating a cue-



up mode, and at the appropriate time, the sequence is initiated by supplying a single start command.

### The Video Tape Cartridge

The cartridge is a molded plastic container approximately  $2\frac{1}{2} \times 3\frac{1}{2} \times 5$  inches. It holds two small spools of two-inch quadruplex video tape. It is low in cost; provides proper tape handling in the equipment, as well as adequate tape protection outside of the equipment. To achieve protection, doors on three sides of the cartridge are normally closed. They open automatically once the cartridge has reached the playing station of the equipment. See Fig. 2. For convenience in handling and storing, there are no protrusions on the cartridge; all requirements are met within the rectangular outline.

Maximum tape capacity is 236 feet of usable tape length plus leader and tail. This gives a program playing time of a little more than 3.0 minutes at 15.0 in/sec for 525-line television systems. One minute cartridges will also be made available. The recorded format on the tape is the same as *highband* quadruplex reel-to-reel tapes. There is only one recording standard and one tape speed (15.0 in/sec). The recorded format also includes several cue marks which are necessary for proper operation of the system. These are placed on the tape automatically when a cartridge is recorded.

### Automatic Cueing

Every cartridge has two permanent mechanical cue marks located near the ends of the tape. See Fig. 3. These are used to prevent the tape from being completely unwound under any condition while in the equipment. Also the start-of-tape marker is used as the bench mark for recording. To make ready for recording, the equipment automatically locates the start-of-tape marker in order to determine where on the tape a recording should begin.

The recorded tape format, see Fig. 4, requires two additional magnetic tone marks on the cue track of the tape to determine exact location and duration of the actual program segment. A start-of-program tone mark is placed exactly two seconds before the start of the active program material. This mark is used to determine the exact point from which the equipment will start when it is commanded to play back. Therefore a two second pre-roll command must be given. The cartridge recorder will start up and provide a fully synchronized color picture in *less than two seconds* so that the signal may be reliably put on-air two seconds after start-up.

An eight-second end-of-tape tone mark is placed ten seconds before the end of the program. This mark is positioned during recording by telling the system the duration of the program, from which the system computes the correct location for the mark. There is also a mode available to re-position this mark to correct an improperly recorded tape. The trailing edge of the eight-second tone mark is used for the start pulse to

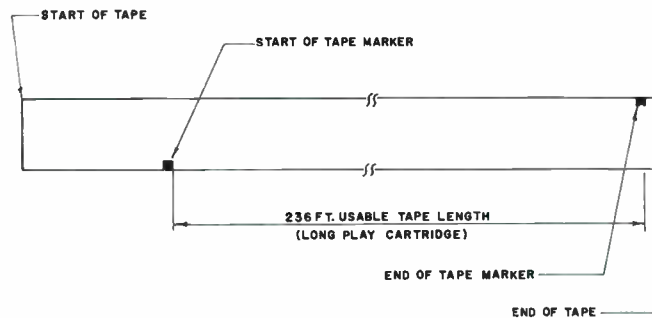

FIG. 3 Locations of mechanical cue markers.

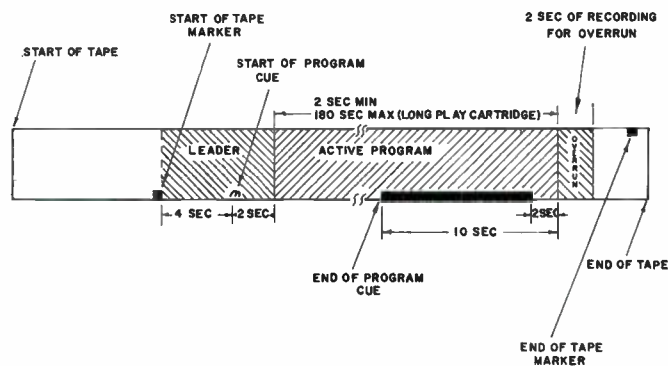

FIG. 4 Format of the recorded cartridge tape.

the next cartridge in a sequence, so that the two second pre-roll is automatically provided. This gives us the concept known as *sequential automation*, which will be discussed later.

### Automatic Threading

Each of the cartridge playback stations in the equipment includes a special tape transport and an automatic threading mechanism. See Fig. 5. The tape transport features rear-side tape handling—no tape guiding elements touch the oxide side of the tape; only the video and audio heads. This makes it virtually impossible to longitudinally scratch the tape.

The video playback uses a standard quadruplex rotating head assembly. In order to thread the tape through the vacuum guide and around the rest of the tape path, a special mechanism extracts a loop of tape from the cartridge and places the tape in the operating path. The threading mechanism then retracts so that it does not interfere with playback, record, or rewind-

FIG. 5 Automatic tape threading path.

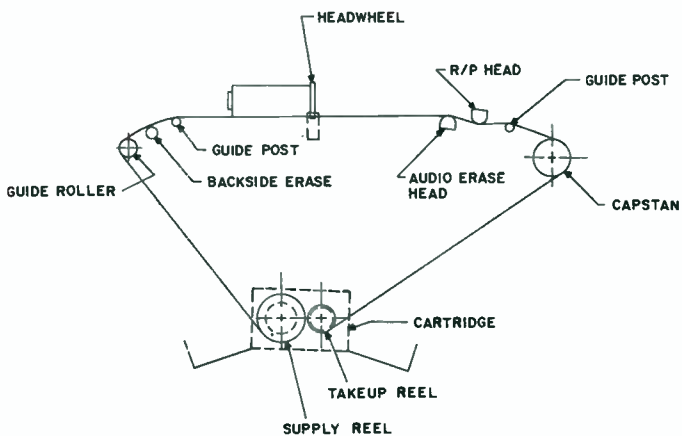

ing of the tape in the normal tape path. At the end of a play or record cycle, the tape is automatically re-wound past the start-of-program mark; then the threading mechanism extends and removes the tape from the tape path and the tape loop is drawn back into the cartridge. The cartridge is now available to be removed from the playing station.

### Cartridge Changer Mechanism

The cartridges are handled in the equipment by a changer mechanism which can carry twenty-two cartridges. See Fig. 6. It consists of a belt with twenty-two bins and two transfer stations located above the entrance to each playing station.

The transfer from the bin to the playing station is accomplished by a pair of arms which rotate downward to engage the cartridge on its recessed plate at the rear. The arms then move horizontally back into the equipment to place the cartridge into playing position.

Upon completion of a play (or record) cycle, the transfer arms again engage the cartridge and move it back into the bin.

### Sequential Operation

The control system in the equipment provides all the facilities for playing cartridges in a continuous sequence. This sequence is determined by the order

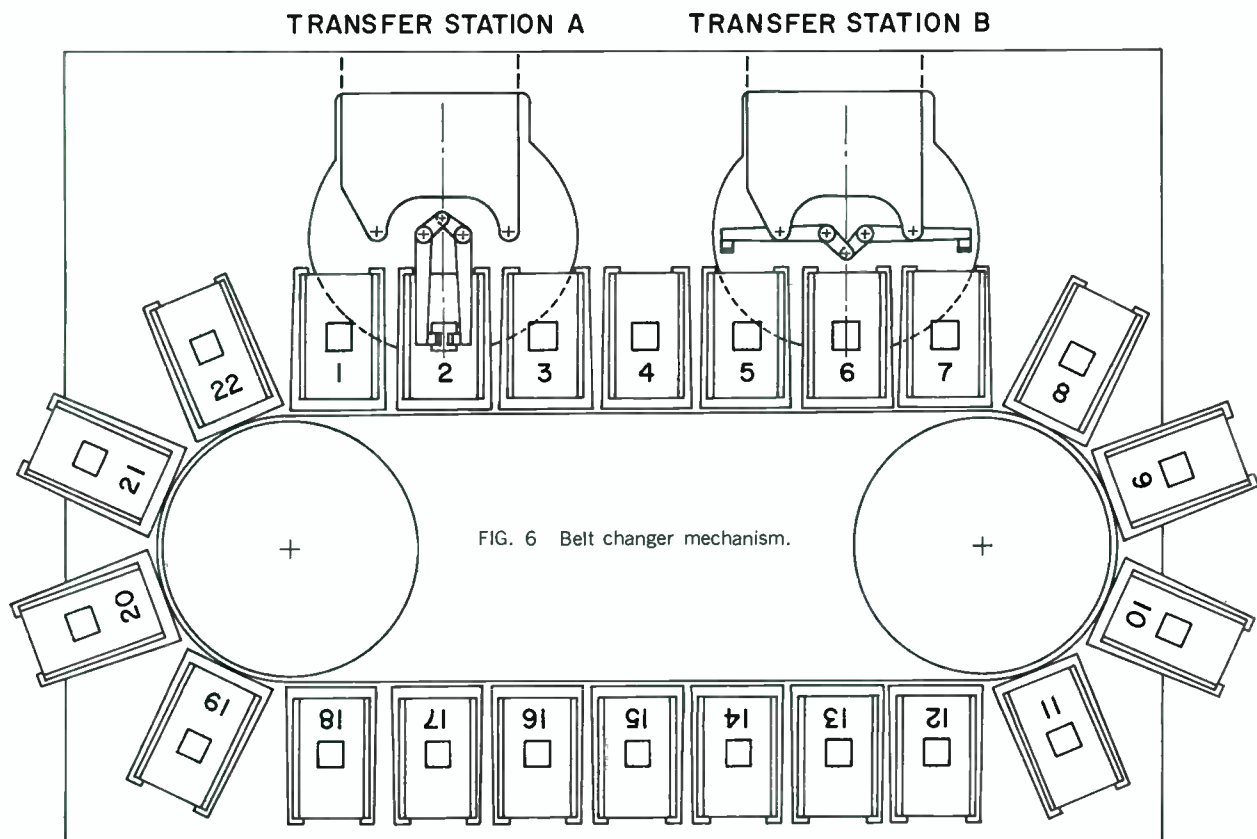

FIG. 6 Belt changer mechanism.

they are loaded into the belt. Figure 6 shows the numbering of the sequential locations (bins) in the belt. It is normal to load the belt starting with bin No. 1. The belt is then positioned for starting by activating the HOME mode, which causes the belt to move so that bin No. 1 is indexed at playing station A, left.

The machine is made ready for playing a sequence by activating the PLAY CUE mode. This initiates a sequence of operations as shown in Fig. 7. This results in both A and B playing stations being loaded, threaded, and cued up. At the completion of the cycle, indicators tell the operator that the PLAY CUE function is completed and the machine is ready to accept a PLAY command.

In more detail, the PLAY CUE command causes Cartridge No. 1 to be loaded in station A (the belt was already positioned for this by the HOME mode). As soon as cartridge No. 1 is loaded, the belt moves three spaces to the right, which positions bin No. 2 at station B. The cartridge from bin No. 2 is then transferred into station B and the belt immediately shifts three spaces back to the left. This puts it in position to receive cartridge No. 1 back in the bin after the cartridge has played.

As soon as each cartridge is in the playing station, the station automatically threads the tape into the tape path and advances the tape in a forward run direction until the start-of-program cue is located. The

tape stops accurately at this point and the playing station is ready to accept a PLAY command.

Upon receipt of a PLAY command, the A station is started in the play mode, see Fig. 8. The servo system provides a fully synchronized color picture in less than two seconds and the active program material commences two seconds after start. The machine then plays through cartridge No. 1 until the end cue is detected (starting ten seconds before the end of the program). The trailing edge of cartridge No. 1 end cue is directed to start the B playing station. (This is two seconds before the end of the program on cartridge 1.) Two seconds after the start of the B station, B will be fully synchronized and the program is automatically switched from the A station to the B station. The program switch takes place during the vertical blanking interval, and gives a transition equivalent to an excellent electronic splice.

As soon as the program switch to the B station has taken place, the A station automatically rewinds cartridge 1 until the start cue is passed. Cartridge No. 1 is then stopped, unthreaded from the tape path, and unloaded back into bin No. 1 in the belt which has been waiting there. The belt then moves two spaces to the left, which brings bin No. 3 into position at the A station. The cartridge from this bin is then transferred into the A station and the thread and cue cycle is again activated. When threading and cueing

FIG. 7 Operations sequence, Play/Cue mode.

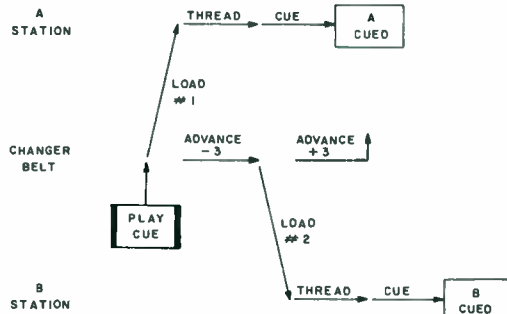
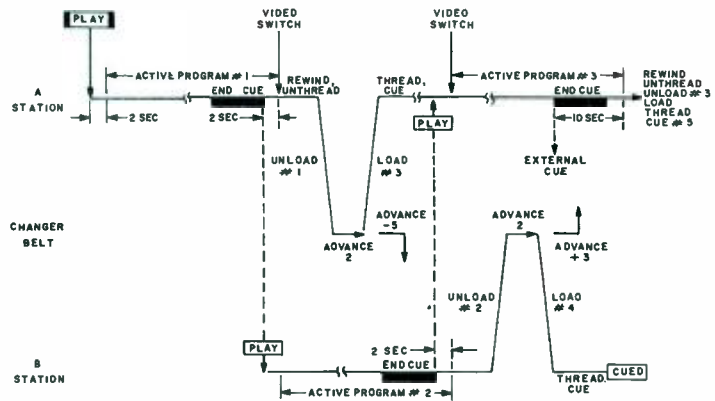

FIG. 8 Three-cartridge operations sequence.



of cartridge No. 3 is completed, it is ready to accept a start trigger. Meanwhile, as soon as cartridge No. 3 has been transferred, the belt moves five spaces to the right, which places bin No. 2 at the B station, ready to receive cartridge No. 2 when its cycle has been completed.

The B station meanwhile is continuing to play cartridge No. 2. When the trailing edge of the end cue from cartridge No. 2 is passed, a start trigger is directed back to the A station. A station, containing cartridge No. 3, begins running and after two seconds the program switches back to A. At this point, the B station goes through the cycle of rewind, unthread, unload, advance belt, load, thread, cue to ready cartridge 4. The cycle of removing one cartridge and readying the next one in the same playing station takes a little less than twenty seconds. This means that the shortest program segment which can be sequenced continuously is twenty seconds. However, either the first or last segment in a sequence can be shorter, since it is not necessary to complete the cartridge change cycle at the other playing station during either the first or last segments of a sequence. In such cases, the cueing system is capable of handling program segment lengths down to two seconds.

### Automatic Sequence Register

The sequential process just described would be endless once started, with one cartridge triggering the next one. This would continue until an empty bin was reached, or the machine was manually stopped. In practice, it is desirable to have a means to program the length of a sequence; this is accomplished by a feature in the machine called an Automatic Sequence Register (ASR). A series of thumbwheels is provided to allow the operator to tell the system how many cartridges to play in sequence for each PLAY command, see Fig. 9.

For example, if we start from HOME position, the system could be programmed to play four cartridges from the first play command by dialing 4 on the first

thumbwheel as shown in the slide. This means that the system will play cartridges No. 1 through No. 4 in continuous sequence and will stop at the end of cartridge No. 4. However, the system will be cued and ready to continue, and on the second play command it will continue with cartridge No. 5 and play the number of cartridges dialed on the second thumbwheel. If this number is 2 as in the Fig. 9, the system will then play cartridges No. 5 and No. 6 and stop. The logic will then advance to the third thumbwheel and on the next play command it will play the number dialed there. A total of nine registers can be so programmed.

The sequence of operations with the ASR is the same as previously explained in Fig. 8, except when the last cartridge of a sequence is being played, the system will automatically detect the leading edge, instead of the trailing edge of the end cue. This will be delivered on an external line as a trigger to continue programming from external equipment. It will be timed ten seconds before the end of the last cartridge. This gives ample time for pre-roll of any type of video equipment. At the end of the last cartridge of the sequence, the system will complete additional cycle steps so that the next two cartridges are in the CUED condition and ready for the next PLAY command.

### Master/Slave Or Self Contained System

The system outlined in the preceding description could basically consist of two independent automated VTR systems coupled together with a common control system and a common cartridge changer belt. However, in such a system, it is not necessary to provide two complete electronic systems for the two VTR's because they are never used simultaneously. More specifically, it is completely possible to time-share the video signal electronics. This is the most expensive portion of the tape recorder electronics, so a major economy can be realized.

The sharing of video signal electronics in playback is accomplished by performing the switching between the two playback stations while the signal is still in the FM format as recorded on the tape, see Fig. 10. Therefore, only one set of electronics including demodulator, monochrome and color time base corrector, velocity and chroma error compensator, dropout compensator and signal processing amplifier is necessary for the two playback stations. However, to allow for one playback station to start up while the other station is still on-air, it is necessary to provide two complete servo systems. It is also necessary to have an FM playback preamplifier, an equalizer amplifier and an FM switcher for each of the two headwheel assemblies. With this equipment arrangement, the system will provide instantaneous signal switching between the two tape playback stations with excellent timing stability of both signals.

Since the video playback signal electronics are identical to those in presently available highband video recorders, the ultimate economy is achieved when the

FIG. 9 Automatic sequence controls.

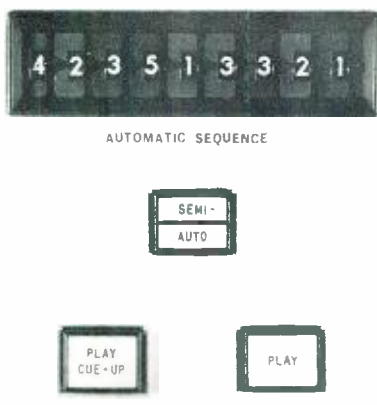

cartridge system “borrows” the signal electronics from an existing reel-to-reel VTR, Fig. 11. In this case, the cartridge system is a “slave” to the reel-to-reel VTR which becomes the “master.” The master/slave arrangement is accomplished by modifying the master machine to provide an FM switch which switches between the normal FM output of the reel-to-reel electronics and the output of the cartridge slave unit. This switch is also arranged to switch during the vertical blanking interval and the servo system of the master machine is modified so that an excellent video switch transition is possible between the master machine and a cartridge. This means that it is possible to insert a sequence of cartridges in a program played on the master reel-to-reel machine with good video switch transitions at all points. It is also possible to go from the master machine to the cartridge playback, change or re-cue the tape on the master while cartridges are playing, and then go back to the master machine at the end of the cartridge sequence—all within the one master/slave equipment complex.

### Recording Of Cartridges

It is clear from the foregoing that the versatility of the cartridge system is dependent on all the elements of a sequence being recorded on cartridges. If it is necessary to include a film or live segment in a sequence, then an external programmer or manual operation will be required to control the external equipment, and the cartridge recorder must operate with two separate sequences. This complication is avoided if all material is recorded on cartridges. It is important, therefore that the cartridge system contain facilities for easily recording any type of material.

The placement of the cue marks on the tape during recording has already been described. This capability is a basic part of the system. In addition, the system includes a feature for pre-roll of external equipment during recording so that a recording can be accurately started. Figure 4 shows that exactly six seconds of signal must be recorded on the cartridge ahead of active program material. If, for example, the program was being copied from a reel-to-reel tape recording, then it would be necessary to cue up the tape recorder enough earlier than minus six seconds to insure that it would be fully stabilized by the time the minus-six-second point is reached, where the cartridge machine should be started in the record mode.

The cartridge system contains a feature to automate this operation also. Suppose an external signal source (VTR) needs a six second stabilization time. This would mean that a twelve second pre-roll is required. The external VTR would be accurately cued twelve seconds prior to the desired start-of-program. It would then be placed under remote control of the cartridge recorder using the control panel. Start-up is accomplished by pressing RECORD on the cartridge recorder. This immediately will deliver a PLAY trigger to the external VTR, which will start up. After six seconds, the cartridge machine will start in the RE-

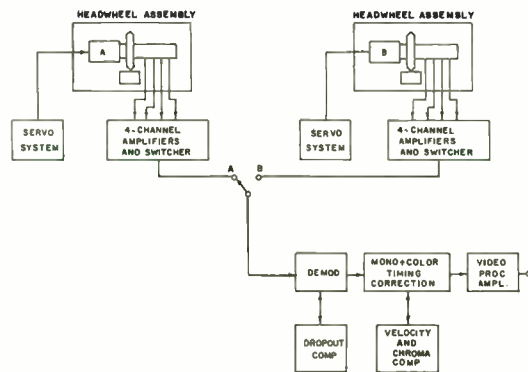

FIG. 10 Electronic system block diagram for cartridge play back.

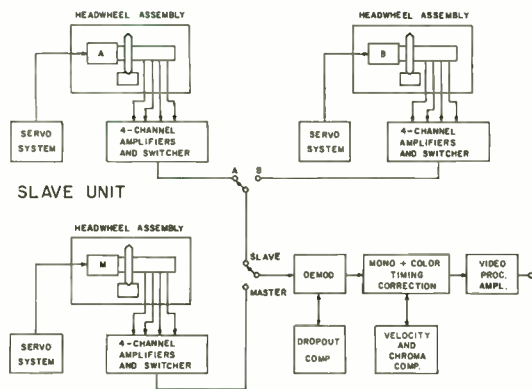

FIG. 11 Block diagram slave/master machine electronics.

CORD mode and begin recording. At two seconds, the start-of-program cue will be recorded, and of course at twelve seconds, the program will begin. Program is then recorded, and ten seconds prior to the end of program (as dialed into the system on the message length thumbwheel) the end-of-program cue begins recording. This continues for eight seconds, taking us up to two seconds before the end of the program. Program recording continues for the remaining two seconds at which time the program is complete. However an additional two seconds of recording will take place to provide protection in event a manual switch to the next program event is made and occurs slightly delayed. The system then automatically rewinds the cartridge and sets it up in the PLAY CUED condition for preview if desired by the operator. The entire tape format was recorded automatically in one pass through the system.

### Conclusion

The video cartridge recorder provides two completely automated video tape recorders, an automatic cartridge changer, and a programmable control system packaged in one compact cabinet which can be attached to a standard highband video recorder or used with an auxiliary signal processing rack. This provides an extremely versatile facility for recording and playing of any type of material in segments up to three minutes in duration. The programming possibilities of such a system are intriguing. They seem only to require imagination to be fully appreciated.

# NEW CONCEPT IN RADIO AUTOMATION

This equipment constitutes a versatile radio automation system. It is one that is practical yet economical. It is suitable for the small station, yet capable of expansion to fulfill the more sophisticated needs of large stations. It is an imaginative approach to automation—with its many advantages over conventional methods.

Most automation systems use some form of memory storage—paper tape, magnetic tape, punched cards, coded log, or other—which is programmed in advance for a certain sequence of events resulting in the automatic control of tape machines, turntables and other program sources. There are advantages to memory storage, but as the complexity of events increases, it often becomes very rigid and difficult to change.

In the simplest concept one program event starts the next. So a memory is not needed. What can be used instead is a method of "routing" events that

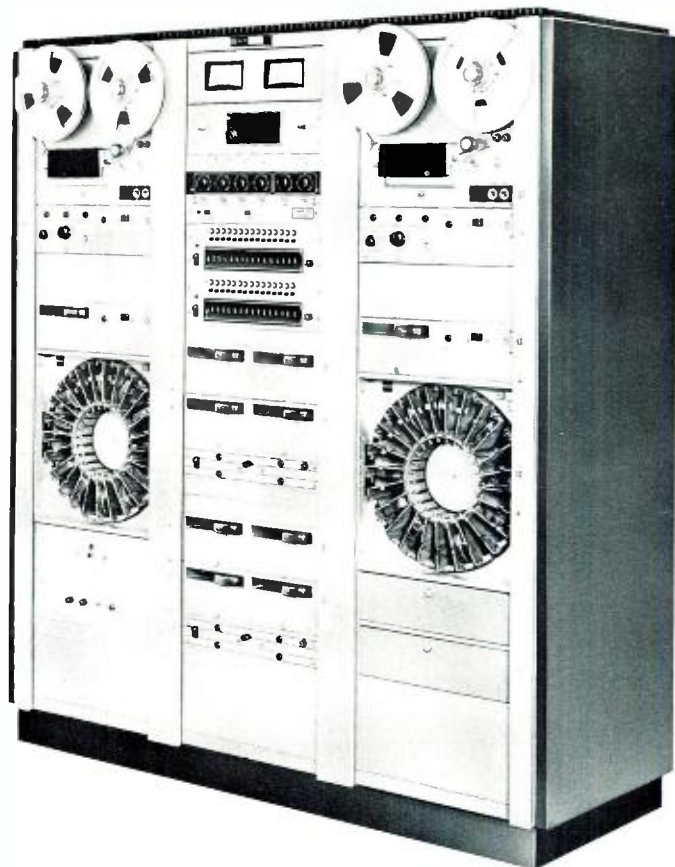

## "Building block" units of RCA Automation systems

Shown in left-hand rack, top to bottom, are the RT-22 Automatic Tape Recorder with Stereo Amplifier and Control Panel, RT-27 Cartridge Playback Unit, RT-25 Cartridge Carousel, Silence Sensor and power supply. Middle rack contains an output VU monitor, BA-8B amplifier, Program Clock, two BCA-15B Programmers and two RT-18 Multi-cartridge Playback units.

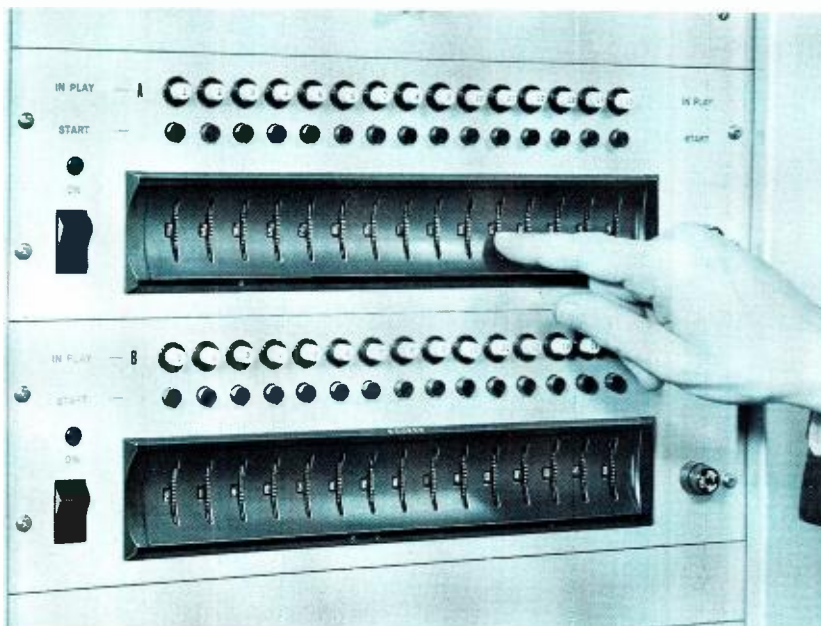

BCA-15B Programmer contains 15 thumbwheel switches which can select any one of 18 program sources to be automatically sequenced as 15 consecutive events.

Use of a second BCA-15B Programmer to sequence additional events and sources into the main sequence.

permits quick and easy change of the program format, event or sequences at any time. Live and automated operations are readily integrated. All of the what-happens-next uncertainty can be eliminated by continuous program status indication to the operator, who may be a non-technical person with very little training. This is the operation of RCA's basic automation system. It borrows solid state computer techniques to permit great flexibility of programming with simple setup requirements. Versatility and speed equip it for applications that may be too fast-moving for rigidly programmed systems, thus providing a "live" sound not ordinarily heard in automated programming.

### Automation Components — Programmer

A major unit of RCA automation, is the BCA-15B Programmer. It is designed to switch between as many as 18 preselected audio sources such as reel and cartridge tape machines, turntables and microphones, and continue to sequence them automatically in any preset pattern of events as long as required.

The sequence of events is programmed by means of thumbwheel switches which select events from any of the up to 18 program sources. Control is given in sequence by circuits in the unit, the end of one event (in the smallest systems) initiating the beginning of the next. The event being played is shown by a tally light above the switch. The capacity is 15 events. Modifications to the program may be made at any time either by: (a) resetting the thumbwheel switches; (b) starting an event using the front panel pushbuttons; or (c) manually starting the audio source itself.

Programmers may be cascaded to provide 30, 45, 60 or more events. Or, a second unit may be used to provide a "subsequence" to the first BCA-15 programmer further expanding the programming capability

Four BCA-15B units cascaded to provide a 60-event system.

A 15-event preset program with Event 1 to play from Source 3, Event 2 from Source 6, etc. Event 9 is "skipped" (S) and Event 15 stops the sequence (O).

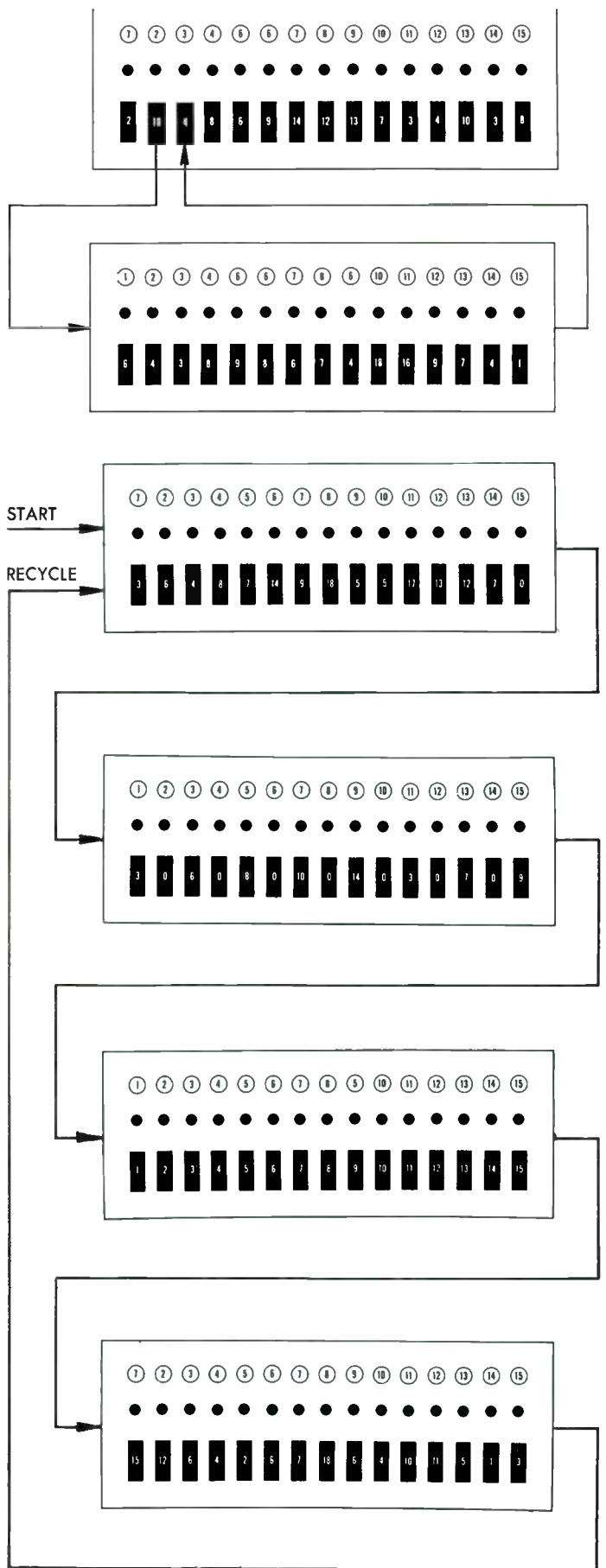
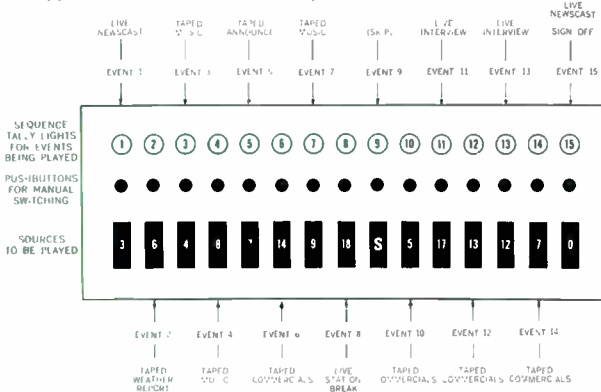

The Type BA-8 Transistor Amplifier is used to cue any audio placed in "PASS" status.

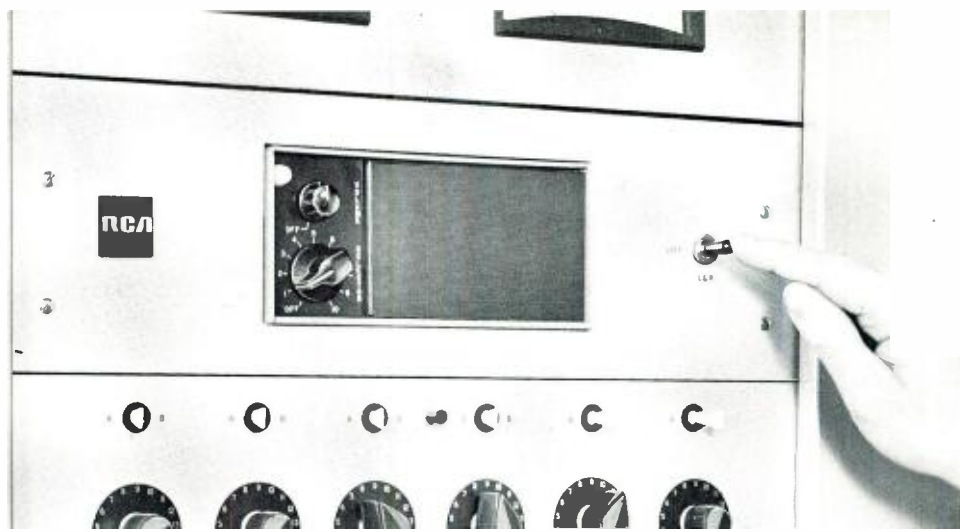

of the combination. The recycling function increases the capability by repeating frequently used program segments. By use of cycling and subsequencing techniques, anywhere from a few hours to a full day's programming may be set up on two BCA-15B Programmers.

### Program Clock

Another major unit of the automation system is the Program Clock. This is actually a timer which synchronizes the program on an average time basis. The timer does not chop or fade program material, rather, for smoothest operation, it adds or deletes events from programmed musical fill at the end of a time segment to guarantee station ID within legal time limits. It then starts a new event after the ID segment is completed. The clock does not work on real time, but rather "pre-arms" the system so that you have a station break in accordance with FCC requirements. There is no fading or chopping of an event.

For stations requiring rigid timing, as when joining and separating from network lines, the station break can be clocked precisely. Here the equipment, activated by network signaling tones, or a digital clock, fades the local programming at the precise time and restarts the automation system at the finish of the network activity.

### Program Status Readout

The event being played and the next to play is continuously read out on the faces of the BCA-15 Programmer, the Clock Timer and the status indicators on each source. Thus the portion of the program in play, and the entire program sequence is always visible to the operator for reference or change.

Even further identification is available in an accessory known as the Source Status Readout system. This is a three-function illuminated display showing the status ("PLAY", "NEXT" and "PASS") of each audio source, and it incorporates a "PASS" switch to remove a source from the system for service, loading, cueing or recording use. The "PLAY" light shows that the

source is operating on-air. When the "PASS" indicator is lighted, the source is not available for use and will be automatically skipped when called up by the programmer. The skip will be achieved with no drop-out or pause of the audio, just as it would before a blown fuse, slack tape or improperly seated cartridge. The "PASS" light will go out when the source is properly loaded and ready to play. If it does not do so, the operator is immediately warned of a malfunction. The "NEXT" indicator shows the next source programmed to play, and if the source is to be automatically skipped, the actual next source to play will be indicated.

### Studio Override — Manual Control

Unique to RCA automation, is the Studio Override and Manual Control System which allows a live microphone or other console controlled source to be inserted into the automation programming sequence with considerable ease. These three insertion modes are provided for maximum flexibility of operation:

(1) The live source can be programmed into the BCA-15 Programmer in the normal manner by dialing up the assigned source number. When this point in programming approaches, the operator will receive a "NEXT" indication to which he must reply with a "READY" signal to indicate his presence in the studio. He then is supplied an "ON AIR" indication to start. At the end of the live segment, the operator presses a "PASS" switch which returns control to the Programmer. If it should happen that the studio is not manned when programmed, an automatic skip will occur and the programmer will select the next event.

(2) The announcer can interrupt the automation sequence and go live at the end of the "ON AIR" event by operating a "NEXT" switch in a control center located at the console or announcer's booth. At the conclusion of a live insert the program will automatically continue from the point of interruption.

(3) The announcer can instantaneously override the "ON AIR" automation program and interrupt the



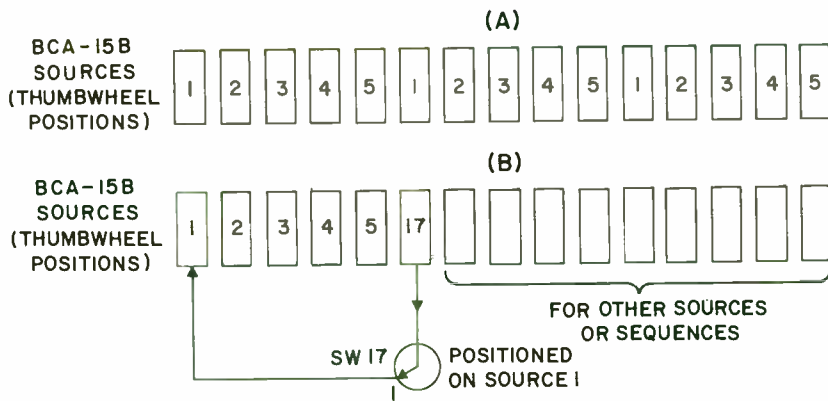

Both A and B continue to repeat a 5-source sequence, but 20-position recycling switch in B uses only six thumbwheel positions.

program sequence for news flashes, etc., by operation of a "PLAY" control. The program will automatically continue from the start of the next programmed event at the end of the interruption.

### Automatic Cue

An additional operator aid is the Automatic Cue accessory. With this, any audio source placed in "PASS" status will automatically feed its audio into an audition bus monitored by a BA-8 cue amplifier-speaker unit. This system allows audio sources to be cued up, or played "offline", while the automation system is on the air. For stereo, a lever switch allows selection of channels A, B or A+B.

### Automatic Silence Sensor

RCA automation equipment is fail safe in that no source malfunction will shut down the entire system and most failures will be skipped without interruption of audio. Failures such as tape breakage during play, or the operator failing to return the system to programmer control at the end of a live segment, will be picked up after a few seconds (adjustable from 2 to 20 seconds) by a silence sensor and the next event will start. Of course, the operator can always override the programmer and play the system by hand. The sensor is equipped with a balanced input and a bridging mixing network to combine stereo inputs while maintaining channel-to-channel isolation. A remote alarm may be triggered by the silence sensor, if desired.

### RT-25 Carousel and Programmer

The RCA RT-25 Carousel is used for bulk spot storage in the RCA automation system. Featuring the latest electrical and mechanical design advances, the RT-25 can be operated manually as well as by automatic sequence, and with random access selectors. Each carousel has space for 24 Series 300 cartridges, which vary in length from 15 seconds to 5.5 minutes.

The RT-25RS Programmer is capable of pre-selecting and starting a total of four random select carousels. Addressed by the BCA-15B as a single

For simplicity, each of Sequences A, B and C are repeated using identical sources. Starting on the hour, Sources 1 to 9 (Sequences A and B) play in consecutive order. After Sequence B finishes, Source 17 returns the program to Source 6, through the program clock timers, and Sequence B plays again. Sequence B will repeat until 15 minutes have elapsed, then the Quarter Hour timer routes the program to Source 11 in Sequence C. By the time Sequence C is finished playing, the Quarter Hour timer will have returned to Source 6. Sequence B will continue to repeat until 30 minutes have elapsed and the Half Hour timer changes position. This routes the program back to Sequence A, and the A-B-C-B cycle that occurred during the first half hour repeats in the second half hour under control of the Three Quarter and One Hour timers.

USE OF CLOCK TIMERS FOR 15-MIN. BREAKS

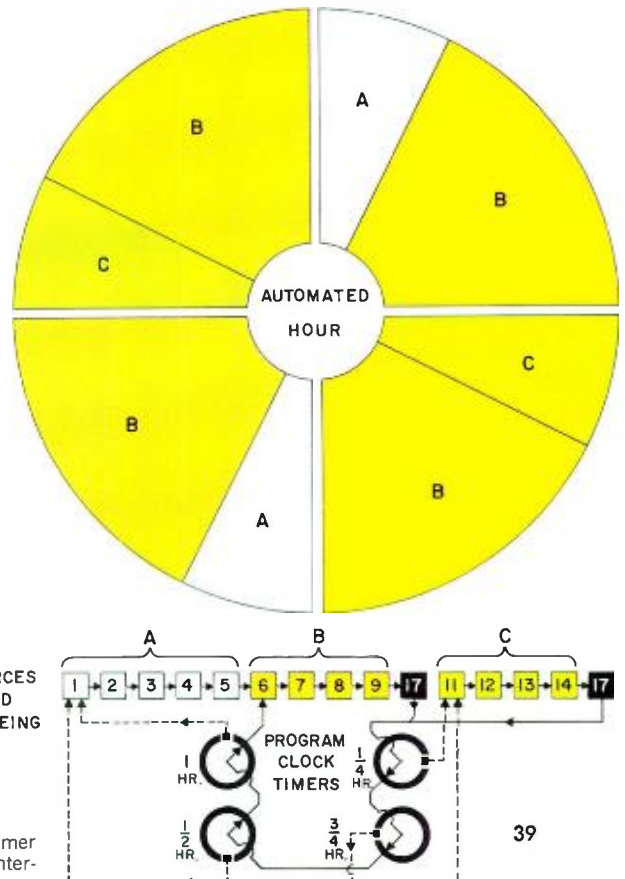

Functional diagram showing how a BCA-15B Programmer and Program Clock make I-D breaks in quarter hour intervals during a single automated hour.

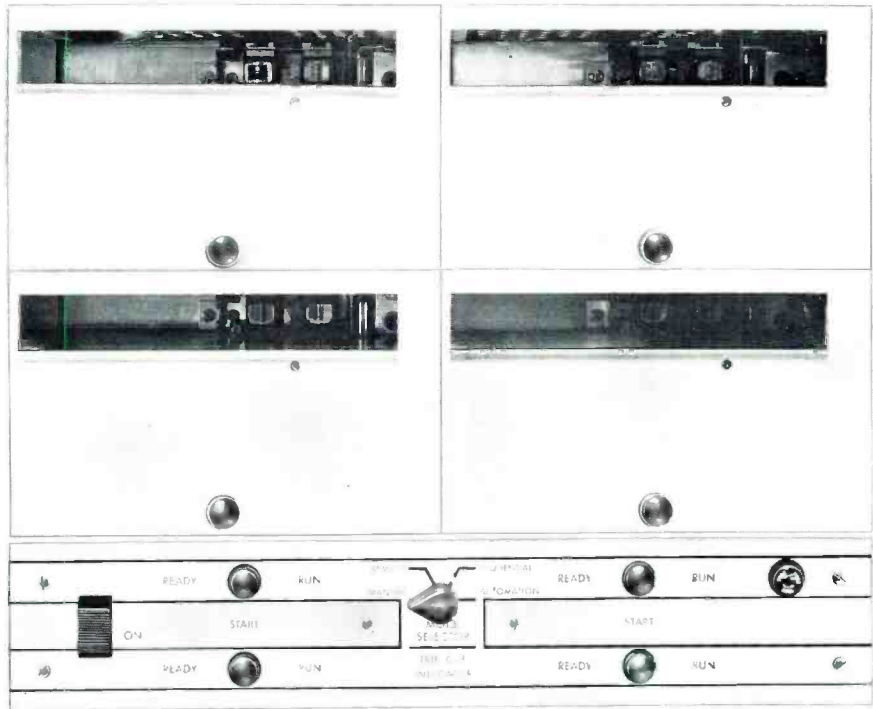

Diagrams showing rack mounted equipment for five basic RCA Automation Systems of different sizes. System I is a suggested starting place for designs which may be expanded upon to provide 24-hour programming.

Multicartridge Tape System allows playback of four pre-recorded tape cartridges, singly or in a pre-selected sequence.

System I

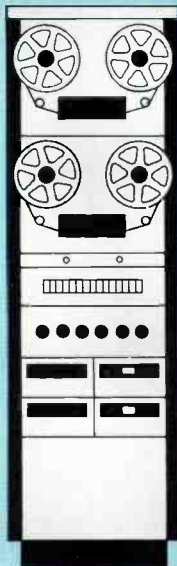

System II

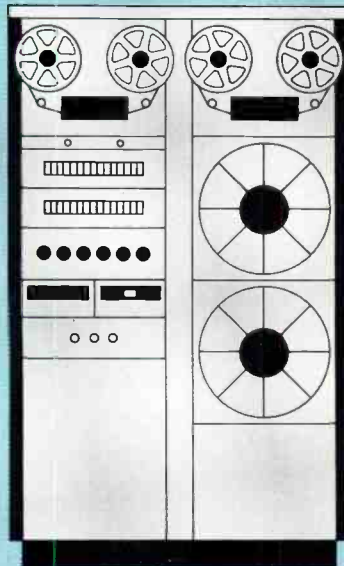

System III

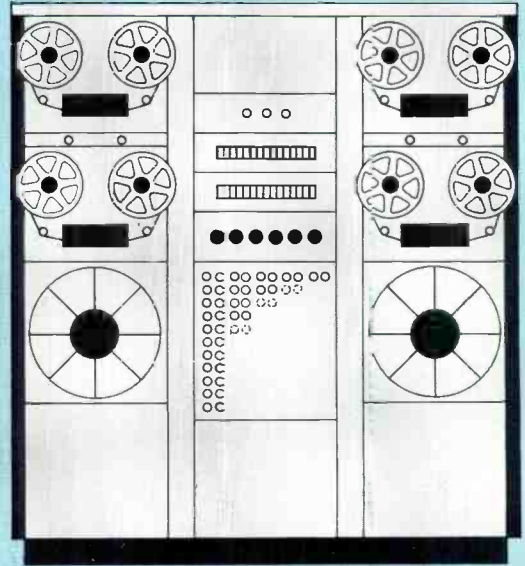

source, the RT-25RS automatically selects and cues the next cartridge to be played. It provides a 50-event sequence with a choice of any one of 96 cartridges at each event.

### RT-20 Reel Playback Units

These units are unequalled for reliable, low cost operation in automated systems, especially when used to free recorders for taping operations. They utilize the most inexpensive one-mil tape and provide more than three hours of stereo at 7.5 ips, while easily meeting the NAB specifications for overall frequency response of 20 to 15,000 Hz. They may be mounted vertically or horizontally. Conservative design and high quality components reduce maintenance to routine checks. All adjustments are readily made from the front.

### RT-27 Cartridge Systems

The basic components of these solid state systems are the RT-27 Playback units and the BA-27 Record units, both of which are available for either monaural or stereo and meet or exceed all NAB specifications and standards for this type equipment. Each deck accommodates from 15 seconds to 31 minutes of program material. End cues and trip cues may be manually recorded at any time without being in the record mode. Monaural playback units may be expanded to stereo with accessory cue facilities and the conversion takes less than one quarter hour.

### RT-18 Multicartridge Systems

The RT-18 provides a solid state playback system that plays four cartridges either singly or in any sequence (depending upon the mode selected). The RT-18 meets

all NAB standards and specifications. Units may be connected in tandem to give systems of 8, 12, 16 or more decks each providing 15 seconds to 31 minutes of instantly accessible program material.

### Basic RCA Automation Systems

RCA automation can be programmed anywhere from one hour to 24 hours, and its flexibility allows a station to select the exact combination of sub-systems to satisfy its present requirements, with the opportunity to expand as needs grow.

For example, a station might buy only enough equipment to do a minimum of programming. Such a basic "System One" consists of two reel playbacks, the programmer, a one-hour timer and the two cartridge units. With a simple program pattern and wise use of the equipment, the operator could program four, five or possibly six hours. Of course, the one-hour timer is a cycling device, so the same sequence of events could be set up to happen as many times as required.

"System Two" utilizes two equipment racks and adds two carousels to the tape equipment configuration of System One, System Three increases to four RT-20 playbacks and the carousel programmer. The programmer provides random access to the carousels allowing you to repeat any cartridge as many times as you like. System Four includes the status lights beside each program source to indicate which of the three conditions, "PLAYING", "NEXT" or "PASS", the source is presently in. System Five adds two more carousels, another programmer and multicartridge playbacks. This system provides 24 hour programming with complex patterns.

System IV

System V

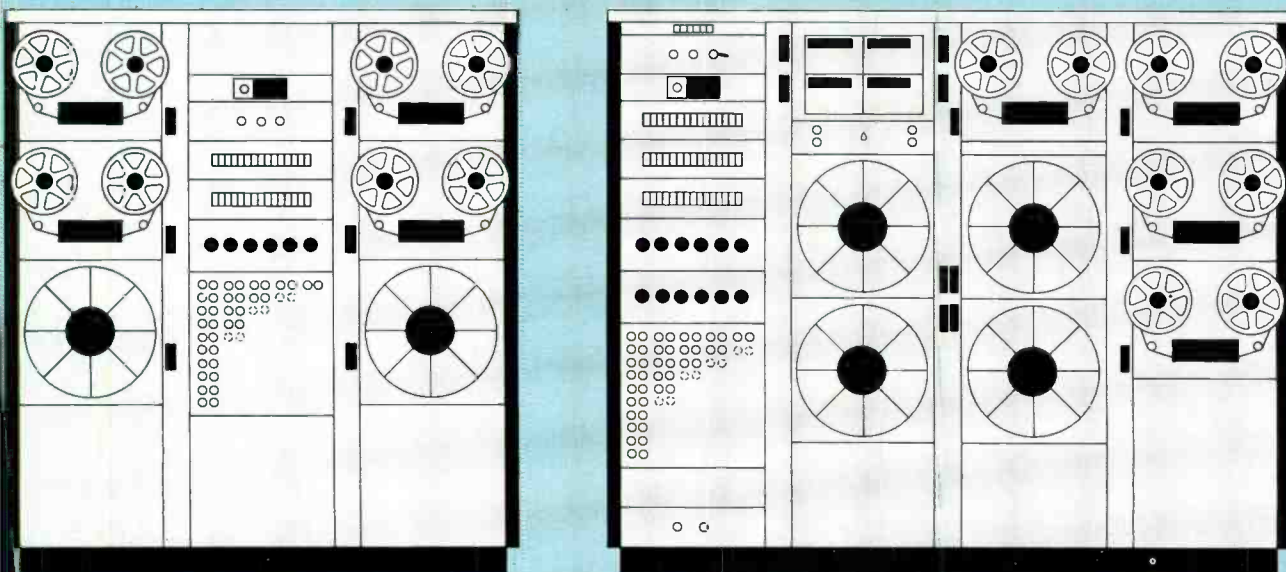

# COLOR TV AT BROOKE ARMY MEDICAL CENTER

LTC. STEPHEN P. DITTMANN, MSC  
Chief, Television Division



COLOR PRESENTATION



FIG. 1 Discussing schedules are (L to R) LTC. Dittman, Brig. Gen. O. Elliott Ursin, Commandant of MFSS, and Maj. Gen. Laurence A. Potter, Commanding Officer, Brooke Army Medical Center.

## Increases Dynamics of Teaching and Student Motivation in Training of 16,000 Yearly



As our medical conferees might say after thoroughly examining the operation of color television at MFSS: "our diagnosis is that the system is in fine health and functions perfectly. The prognosis is for a long and productive life."

They would be referring to the extensive color closed-circuit television system of the U. S. Army Medical Field Service School (MFSS) at Brooke Army Medical Center. MFSS is unique on two scores: it is the only Army medical teaching facility of its kind in the United States, and it has the most extensive color closed-circuit television system ever designed for medical instruction and training.

Based at Fort Sam Houston near the heart of San Antonio, Texas, MFSS-TV telecasts live, tape and film programs daily from 7:30 AM to 4:30 PM to thousands of military medical personnel in 125 classrooms scattered over a square mile area. In 1968 alone, televised instruction was an integral part of the training of more than 16,000 officers and enlisted men destined for assignment to medical and dental units wherever U. S. Army forces were stationed throughout the world.

### The Role of Television

This commitment to use television was a direct outgrowth of earlier Army studies which had shown that instructional television was not only feasible and desirable, but also an educationally significant system for the instruction of military medical students. Among its proven advantages: It provided uniformity of

teaching resulting in a high degree of quality; it permitted large numbers of students in many classes to observe simultaneous demonstrations of surgical, dental, pathological, laboratory and other procedures; it saved instructor manpower hours, expense, and effort in repeating lectures and live demonstrations; videotapes of instruction could be scheduled and rerun as required, could be exchanged with other military and civilian teaching centers throughout the world.

Color television now brings new dimensions to instruction. It increases the impact and dynamics of teaching, thus heightens student motivation to learn. Color is definitely an important factor in medical diagnosis, prognosis, and treatment in surgery, pathology, microscopy, and even pharmacy where medications and capsules often are distinguished by color.

The value of color was expressed rather typically by Captain Sarah D. Lopez of the Brooke General Hospital in her paper, *TV — AN AID TO PHYSICAL THERAPY INSTRUCTION*, when she said: "Color focuses the student's attention on pertinent muscles and anatomical landmarks . . . makes the skin changes associated with nerve injury vivid. Thus, when production facilities are available, color TV is far more effective than either black and white TV or motion picture film."

Color adds greater intelligibility and reality to the instructional process, resulting in increased comprehension and learning. It brings the world as it really is to the student. The fine results achieved here in the classroom have more than justified its use.

FIG. 4 Three color cameras in use during taping program on patient treatment.

### Purpose of TV Division

The Television Division is one of the eleven academic departments and six supporting services and divisions making up the MFSS complex. Its basic purpose is to provide closed-circuit black and white and color television services to the Medical Field Service School, to components of Brooke Army Medical Center, including the Brooke General Hospital and the Institute of Surgical Research, and to the office of the Surgeon General for the purpose of training, education and research. The concept underlying television at the Medical Field Service School is to use it as an aid to classroom lectures rather than as a method of teaching in itself. In addition, the MFSS-TV Division is experimenting with television to determine how it can help the instructor achieve higher learning levels among the students who come from a wide range of socio-economic levels, and have an equally wide range of intelligence and educational achievement.

### Programming

The MFSS-TV Division provides films, live, or videotaped programs required for the support of the edu-

cational mission at Brooke Army Medical Center. Thirty-seven courses are taught ranging in duration from those lasting four weeks, to ten month courses covering a wide scope of basic medical, dental and preventive medicine subjects. On the average, 55 to 65 programs are produced or distributed each week.

At the basic level, courses include: dental technician training, X-ray technician training, pharmacy technician training and surgical technician training. Students from these courses are trained for assignment to medical and dental units located throughout the world.

Not all of the material originating with the MFSS is basic. Videotapes and 8mm cartridge single concept films are being produced both in black and white and in color for the Army's network for continuing medical education. So far, the MFSS has identified over 500 hours of 45-minute lesson plans which will include large segments of videotaped material. MFSS-TV averages about one full-length production per day, has completed over 330 programs.

On the advanced educational level directed to student doctors, dentists and nurses, live television is



FIG. 2 Televising of high level medical conference in MFSS-TV studio.

FIG. 3 One of the larger classrooms where television becomes an important aid to the medical instructor.





FIG. 5 A weekly program of BAMC activities is taped for showing over local commercial TV stations.

FIG. 6 Instructional program on dental techniques is recorded for later use.



being applied to implement problem solving and decision making. A prerecorded tape will visualize certain problems or present a case for diagnosis. The tape will be stopped and the students will be asked to come up with their solutions. The tape will then resume with the "school" solution for the problem. In these cases, television immediately reinforces the proper answer or corrects a faulty answer.

Television has also assumed a major role in many other courses relating to surgery, fluoroscopy, microscopy, endoscopy, psychiatry, preventive medicine, pathology, dentistry, and nursing.

An interesting use of Television in the form of "videotainers" is being used to upgrade instructional methods. Videotainers are small closed-circuit systems consisting of a camera, recorder and a monitor. Recordings of the instructor and students in practice presentations are played back immediately for purposes of self-evaluation. The instructor can then make whatever changes are necessary to improve his method of presentation. The videotainer has also been used

in psychiatric interviewing and counseling at the MFSS. Immediate play-back affords the interviewer an opportunity for self-analysis of his questioning techniques.

### Description of System

When the decision to go color was made, it was specified that broadcast type equipment would be necessary. The programming schedule would be heavy and require equipment designed for professional operation. Life-like color pictures would be needed for live programs and taping. The equipment would have to be stable and reliable, with a minimum of maintenance.

The initial half-million dollar contract included two TK-43 color cameras (a third was added later), two TR-50 high band color TV tape recorders, a TK-27 color film system, studio lighting, and a TS-40 broadcast-type switching system. The combination of these equipments assures MFSS high quality color pictures with the detail and sharpness needed in medical training.

Although most of the programming is now in color, there is still some black and white production via three RCA Professional Television PK-330 vidicon cameras and a broadcast-type TK-22 monochrome film system. Fig. 7 is a simplified schematic of all the production technical facilities.

The distribution system, under the direction of the TV Division, consists of a four-channel coaxial cable network to approximately 125 classrooms in 12 buildings. The system now has 350 color and 25 black and white receivers in use. In addition, two 1000-seat post theatres are used for viewing special programs. Plans are underway for expansion of the four-channel system to an additional twenty lecture halls in six of the hospital buildings.

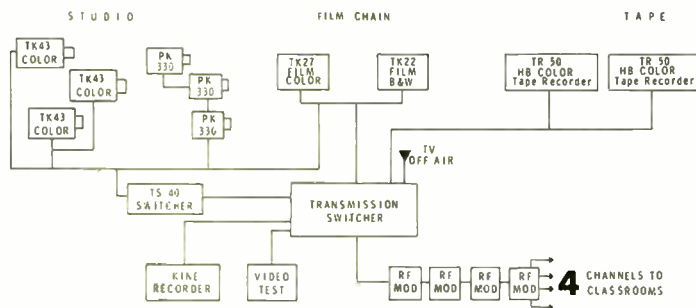

FIG. 7 Simplified schematic of originating, switching, and transmission equipment.

### Future

Color television in the Army Medical Department is here to stay. In the not too distant future it will be as commonplace as the chalk board and slide projector, with the medium in daily use in classrooms, research laboratories, and hospitals throughout the military establishment. Undoubtedly, Army video tape libraries will some day be as large and as diversified as film lending facilities.

The Medical Field Service School is also responsible for an extensive non-resident instruction program. It is conceivable that complete audio visual lessons on video tape cartridges will be furnished to students for play-back on compact, inexpensive units in their home and at Army reserve training units rather than the voluminous packages of printed material now provided.

The importance that television can attain, not only in Army usage but also in any medical educational research institution, will be determined by the frequency of use, quality of program, level of equipment

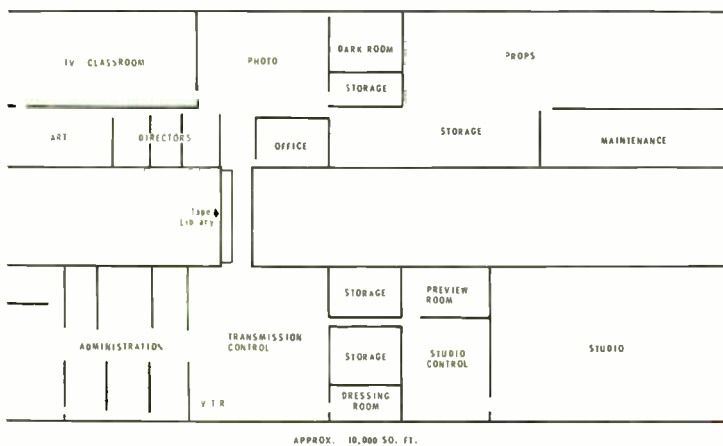

FIG. 8 All major facilities are centrally located for smooth production and distribution.



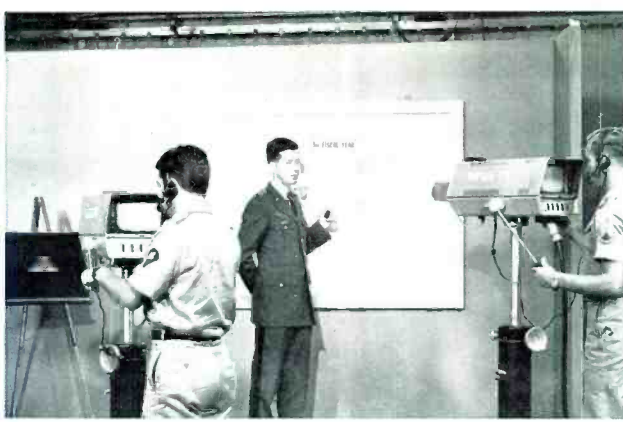

FIG. 9 PK-330 monochrome cameras are used occasionally as in this Medical Administration Procedures program.

FIG. 10 One of a series of programs on the logistics of Medical Supply and Storage.



FIG. 11 Viewing a program in studio control.

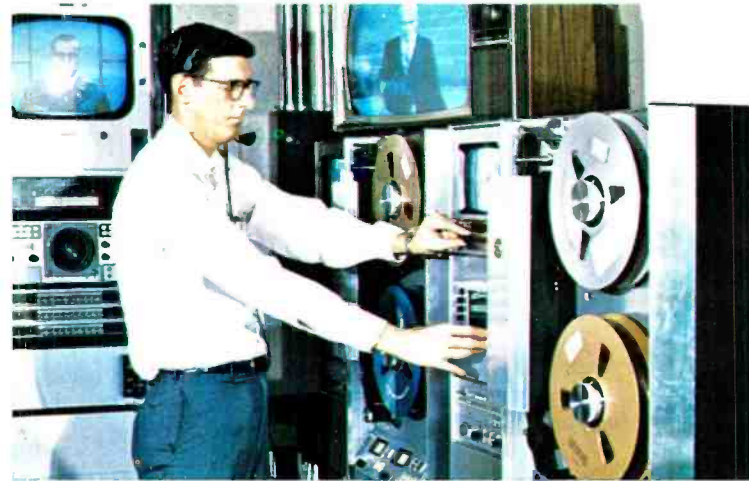
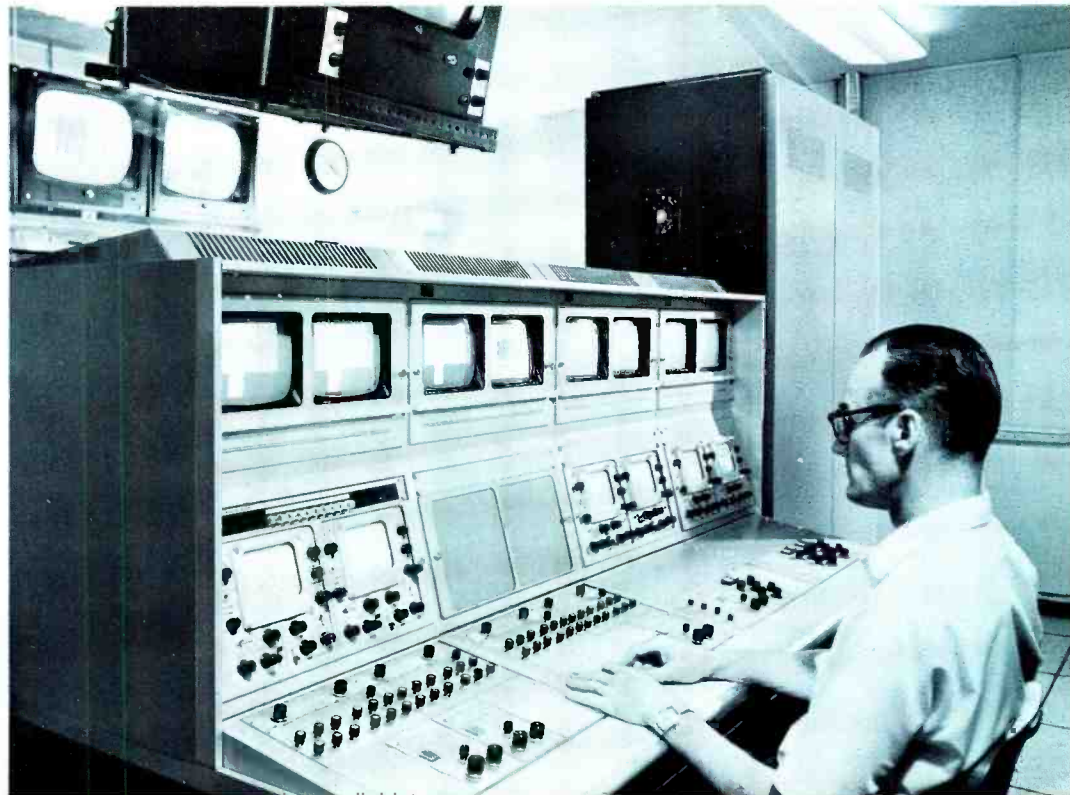

FIG. 12 Engineer checks operation of one of the TR-50 high band tape recorders.

FIG. 13 Video controls for the color and monochrome cameras in the system.



FIG. 14 Brooke facilities includes a TK-27 color and TK-22 monochrome film system, each with a TP-66 film projector.



maintenance, ability of management, and above all, by the improvement it will bring to medical training, research, and patient care.

### TV Division Organization

MFSS was originally established in June, 1920, at Carlisle Barracks, Pennsylvania, as the Medical Department Field School. In the Spring of 1946, the School moved to Fort Sam Houston, Texas, becoming one of the major command elements of Brooke Army Medical Center. On December 31, 1966, the School was redesignated the U. S. Army Medical Field Service School.

The MFSS-TV Division has 36 assigned positions. One-half are staffed by civil service employees, the other half by military personnel—three officers and the remainder technicians. Chart to the right shows the basic organization.

Supervision of all operational and research activities is under the Office of the Chief. He also maintains liaison with other governmental and civilian schools using television as a training medium, and provides consultant services to the Army Surgeon General.

Supporting services for the Division are provided by the Administrative branch. These include personnel, scheduling, funding and procurement of equipment. This activity also maintains a technical resource and a videotape library. It lends videotapes to other government agencies and borrows tapes for use at MFSS.

The Production branch is in charge of all aspects of programming, live or video taping. Its experienced staff includes three Producer/Directors, plus script writers, graphic artists, etc. With this highly compe-

### US ARMY MEDICAL FIELD SERVICE SCHOOL TELEVISION DIVISION

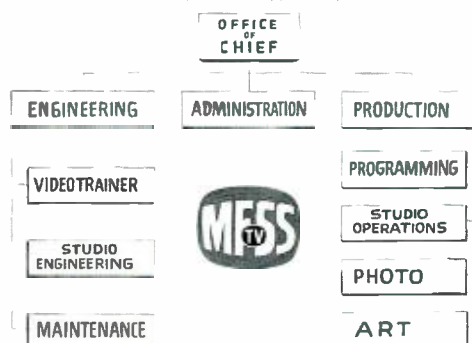

tent staff, at least one major 30-minute program can be produced each day by rehearsing in the morning and shooting in the afternoon. On many occasions they are called upon to produce programs under the adverse and difficult conditions encountered in surgery, the laboratory, or in the field.

The Engineering branch operates much like any similar group in broadcast or closed-circuit television by maintaining all equipment in optimum condition. However, to meet the unusual requirements of military medical training, its standards of acceptable performance are set at an exceedingly high level. Both equipment and methods require considerable adaptation when telecasting microscopic, fluoroscopic, endoscopic, surgical, dental, and other phenomena, usually under less than ideal conditions. The Engineering group has proven itself quite versatile in meeting this challenge of the unusual.



The author of this article, Lt. Colonel Stephen P. Dittmann, is in the Medical Service Corps of the Regular Army of the United States. He has a Bachelor's degree in Zoology and Education from Tulane University, and has only to submit his thesis for a Master's in Television from the University of Maryland.

During his 26 years of active military duty, he has been primarily concerned with the planning and production of training aids and audiovisual media for the Army Medical Service. In 1954, he installed the Army's first color TV (RCA) system for medi-

cal education and research at Walter Reed Army Medical Center.

This is his third year of duty at the Medical Field Service School. He brings to his job as Chief of the TV Division a broad background of education and extensive practical experience and creativity in all phases of photography and television.

Upon his retirement from the Army in the fall of 1969, Colonel Dittman will join the faculty of the Medical College of South Carolina at Charleston as Assistant Professor and Chairman of the Department of Audiovisual Resources.

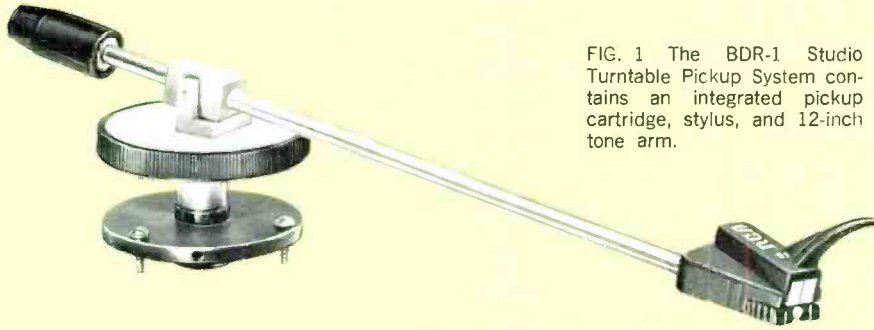

FIG. 1 The BDR-1 Studio Turntable Pickup System contains an integrated pickup cartridge, stylus, and 12-inch tone arm.



FIG. 2 Unique straight-line design and mounting cartridge at an angle eliminates tone arm bend that causes lateral unbalance.

#### TECHNICAL DATA

**TRACKING FORCE**  
Factory adjusted to 1.5 grams  $\pm 0.1$  gram  
(0.2 mil  $\times$  0.7 mil Bi-radial stylus)

**LATERAL TRACKING ERROR**  
Less than 1%

**VERTICAL TRACKING ANGLE**  
15° (Approximately)

**TYPICAL TRACKABILITY (AT 1½ GRAMS)**  
400 Hz — 22 cm/sec or greater  
1000 Hz — 30 cm/sec or greater  
5000 Hz — 30 cm/sec or greater  
10,000 Hz — 22 cm/sec or greater

**FREQUENCY RESPONSE**  
20 to 20,000 Hz

**OUTPUT VOLTAGE**  
3.0 to 4.0 mV per channel at 1000 Hz at  
5 cm/sec peak velocity

**CHANNEL BALANCE**  
Output from each channel within 1½ dB

**CHANNEL SEPARATION**  
Over 25 dB at 1000 Hz; over 17 dB from  
500 to 10,000 Hz

**RECOMMENDED LOAD IMPEDANCE**  
60 K Ohms (per channel) Optimum  
47 K Ohms (per channel) Minimum

**RESONANCE**  
8 Hertz (Approximately)

**BEARINGS**  
Anti-resonant precision ball bearings in  
vertical and horizontal planes

**LATERAL I. M. DISTORTION**  
2% Maximum at 3.7 cm/sec  
6% Maximum at 17.9 cm/sec  
(RCA 12-5-39 Record)

**CARTRIDGE IMPEDANCE AT 1000 Hz**  
3800 Ohms (Per Channel)

**CARTRIDGE**  
Moving magnet type

**STYLUS ASSEMBLY**  
MI-11474 Series Quick change stylus assemblies

**ARM CONSTRUCTION**  
Anodized aluminum, tool-steel and  
brass

**ARM LENGTH (OVERALL)**  
12 Inches

**ARM WEIGHT**  
13 Ounces

**MOUNTING**  
Approximately 8 inches from spindle center

## NEW STUDIO TURNTABLE PICKUP SYSTEM

Recent advances in studio equipment performance standards, particularly in the area of tape playback, have made the broadcaster more aware of the need for improved turntable pickup systems. This is particularly true when stereo and monaural records are used to make second generation tape recordings. To meet these rising standards RCA engineers have developed the BDR-1 Studio Turntable Pickup, an integrated approach using components with matched performance.

### Integrated Pickup Cartridge and Stylus

The BDR-1 is a precision system developed exclusively by RCA for high quality stereo or monaural reproduction. It consists of a 12-inch pickup arm with integrated pickup cartridge and stylus. The system is in-

tended for use with turntables such as the RCA type BQ-50 and BQ-51 series that incorporate either the type BA-26 Monaural or BA-36 Stereophonic Pre-amplifier Equalizer.

### Electrically and Mechanically Matched Components

Most tone arms are designed for use with a wide variety of cartridges and styli. Because of electrical and mechanical mismatches between the various components, this versatility usually results in somewhat less than optimum performance as a combined system. For example, tone arms that are designed to accommodate many types of cartridges must necessarily be made structurally heavy enough to perform with the most massive cartridge types. These "all cartridge"

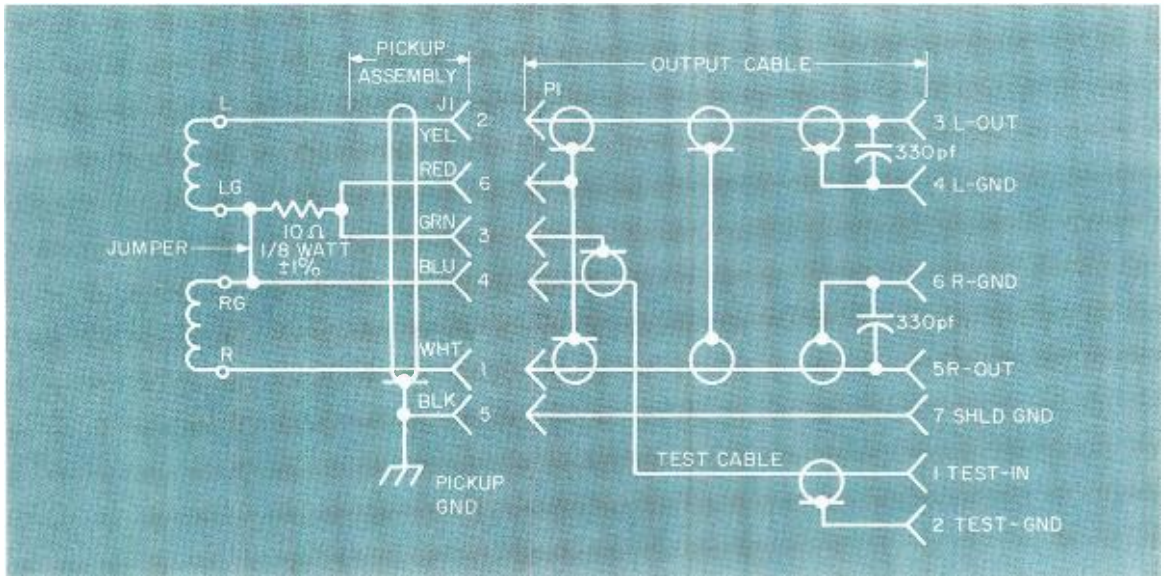

tone arms also require numerous adjustable weights, springs, and lines to optimize performance for the variety of cartridges they must operate with.

The integrated design methods of the BDR-1 minimize these problems by electrically and mechanically matching each component in the pickup system. An extremely lightweight and low-inertia tone arm was designed expressly for the moving magnet type pickup cartridge, with a choice of five different high compliance interchangeable styli to meet a wide variety of purposes. The tone arm parameters have been optimized and factory adjusted to suit the cartridge. There are no balancing adjustments that must be made and therefore none to get out of order. An adjustment in stylus tracking force is made available for broadcasters who may have special requirements.

### Bi-Radial and Spherical Shaped Styli

There are five stylus assemblies of the bi-radial and spherical tip shapes available for use with the BDR-1

Studio Pickup. Tracking forces from 1.5 to 2.5 are obtained from a weight built into the stylus assembly selected for use. Therefore, the stylus force does not require adjustment even when changing between stylus types.

The bi-radial (elliptical) shaped tips provide excellent tracking capabilities, resulting in less tracing distortion and translation loss of high-frequency response than a spherical shaped stylus. The bi-radial stylus therefore traces a more exact replica of the groove cut by the chisel-shaped recording stylus. The various stylus shapes and radius sizes are provided so that the user can select the smallest stylus radius that will withstand the requirements imposed.

### Lower Moving Mass

All of the stylus assemblies have lower moving mass than previous designs, making it quite possible for the 0.7-mil spherical stylus to sound better than the bi-radial stylus of a different manufacturer. BDR-1

List of Stylus Assemblies for BDR-1

Stylus Radius in Mils	MI Number	Color Code	Stylus Force in Grams	Purpose
0.2 x 0.7 (Bi-Radial)	MI-11474-2	Gold	1.5	Highest quality stereo reproduction
0.4 x 0.7 (Bi-Radial)	MI-11474-4	Silver	2.0	High quality stereo reproduction
0.7 (Spherical)	MI-11474-7	Black	1.5	Stereo reproduction
1.0 (Spherical)	MI-11474-10	Red	2.0	Monophonic Micro-groove Records
2.5 (Spherical)	MI-11474-25	Green	2.5	Wide groove records or transcriptions

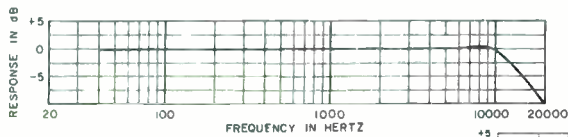
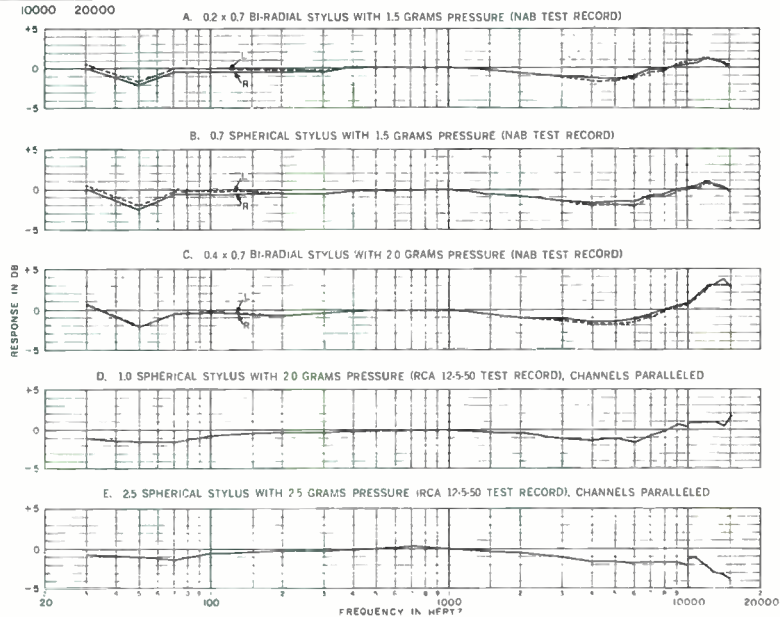

FIG. 4 Typical frequency response from cartridge-test resistor to output of preamplifier (Type BA-36A, or equivalent).

FIG. 5 Typical BDR-1 frequency response curves taken with 60-k Ohm load impedance per channel and NAB equalization, using RCA Type BA-36A Preamplifier Equalizer.



users are urged to take advantage of the 0.2-mil tip, as it may reduce high-frequency distortion on highly modulated records.

The resonance of stylus compliance and tone arm mass are designed to be below the audio-frequency range. However, the extremely low mass of the BDR-1 assures that this resonance does not fall to an undesirably low frequency. The tone arm counterweight is decoupled by a resilient mounting that provides damping at the resonant frequency. This damping prevents the stylus from jumping out of the record groove on warped records, and when excited by a turntable being accidentally bumped.

As in all systems, the stylus will trace an exact replica of the record groove only when it is correctly positioned with respect to the disc. In the horizontal plane, the stylus must be tangent to the groove. An index mark is incorporated on the pickup shell for convenient alignment over the turntable spindle to minimize lateral tracking angle error. In the vertical plane, the stylus has an effective angle of about 15 degrees with the disc to properly track today's records. Vertical angular error is minimized by installing the tone arm parallel to the disc.

### Low Lateral Tracking Error

The unique straight-line design of the BDR-1 eliminates any need for special lateral balance mass adjustment devices. The low lateral tracking error has been achieved by mounting the cartridge at an angle. This eliminates the tone arm bend that causes lateral unbalance. Stylus force is obtained by a small offset in vertical balance. Thus, there is no large force that will

tend to move the pickup laterally when the turntable is in other than a level position.

### Built-In Test Features

A unique feature of the BDR-1 Studio Pickup is the built-in facility for testing the cartridge, input circuits, and equalizer/amplifier without the need of a test record. A test voltage is applied across a resistor that is contained in the cartridge shell. A correct frequency response and gain indication can be obtained only when the cartridge, pickup wire and associated cabling are functioning normally.

The response from the pickup test input to the output of a preamplifier such as the BA-36A should be similar to the curve of Fig. 4. The pickup wiring capacitance plus the external capacitors and preamplifier input impedance load the cartridge output and act as a high-frequency equalizer.

A visual inspection of the stylus assembly is usually sufficient to establish its condition. If an overall system test is desired, an NAB or RCA 12-5-50 test record should be used. Fig. 5 shows the frequency response characteristics that can be expected from the various styli, using an NAB test record for stereo and an RCA 12-5-50 test record for monaural.

### Conclusion

The BDR-1 Studio Turntable Pickup System comprises a lightweight pickup arm integrated with a low mass moving-magnet cartridge with high compliance interchangeable stylus assemblies. It is a system that is sufficiently rugged for broadcast use, while maintaining the highest quality stereo and monaural disc reproduction.

# Products in the News



## Solid State Exciter-Modulator for New Ampliphase Transmitter

A solid state exciter-modulator is one of many features highlighting the new 50 kW Ampliphase AM Transmitter, Type BTA-50J. The solid-state exciter—tube version of which is used in the predecessor BTA-50H Transmitter—has a proven record of producing high power AM transmitters with high fidelity sound, unmatched efficiency and low operating cost. By its use in the BTA-50J, the tube complement of the transmitter has been reduced to only 6 tubes and 3 types.

Stages of the exciter include an integral power supply, multimeter and phase meter. All are modular and plug directly into a standard mounting frame. The transmitter engineer can set up and check transmitter performance by the simple twist of a knob on the front panel of the exciter. The unit is expected to be available for installation in the BTA-50H/H1 in the near future.

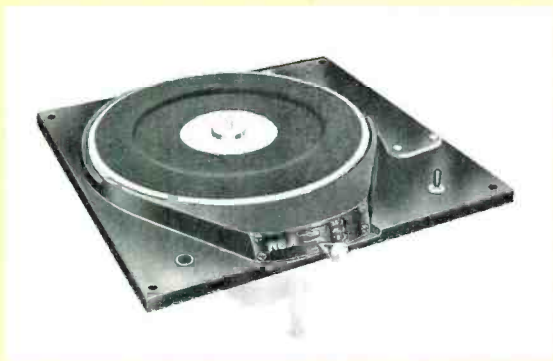

## New Broadcast Turntables

Two new turntables featuring faster acceleration and more compact arrangement are now available for mounting in RCA custom studio furniture or in standard turntable cabinets. Designated the BQ-50 Series, these lightweight units are three-speed, 12-inch turntables with a neoprene idler and other design improvements for longer, maintenance-free service.

The BQ-50 is for 60 Hz operation, and the BQ-50A for 50 Hz. Both turntables will accept any 12-inch tone arm, and the new RCA BDR-1 tone arm will mount on them directly with no modifications.

## Stock Video Production Switcher

Synchronous and non-synchronous switching in the vertical interval, external signal keying, and easy expansion are major features of a new solid state, dual re-entry switcher, Type TS-40/N6. The system is shipped completely assembled, wired and tested, and is available for fast delivery.

The N6 has 18 primary inputs, plus black, and 6 output busses which at any time can be expanded to 10. There are also two additional inputs to the program and preview rows, making a total of 21 inputs. Primary inputs are composite, six of which may be non-synchronous. Non-composite signals may be accommodated by first feeding them through optional sync adders. Switcher frame provisions allow future expansion of the system to include an economical 24 x 4 routing switcher, or a four-bus studio or master control switcher.

The system includes two TA-60B mixing amplifiers, a TE-60B special effects and effects transfer module, and spot positioner control. External signal keying of the special effects unit may be accomplished by pushbutton selection of any of the 18 primary input sources on the preview bus, or the output of an optional chroma key generator. A 14-inch deep by 39-inch wide control panel is "human engineered" for best operating efficiency and ease.

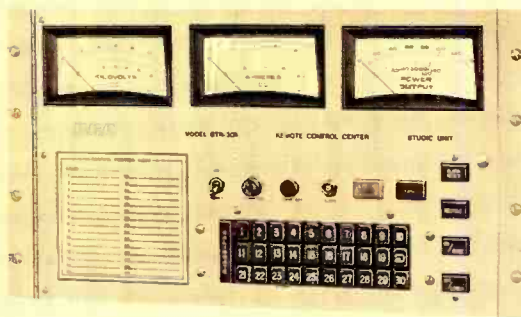

## AM, FM, TV Remote Control

A new, all solid state remote control equipment, BTR-30A, provides wire service over a single voice-grade telephone line, or wireless service over subcarriers of the station STL. The capacity of the system is 30 metering channels and 60 individual control functions, which is sufficient to handle most remote control requirements. Computer-type logic circuitry with its greater reliability and noiseless operation replaces practically all the old mechanical devices. Position of the one stepper relay in the transmitter control unit is indicated on the front panel, a convenience during weekly calibrations. Color coded LOCAL/REMOTE pushbuttons are illuminated for quick indication of system status. Fail-safe provisions meet all FCC requirements.

## High Sensitivity Red Tube for TK-44A Camera

A new Plumbicon with extended red response can now be ordered as an option with TK-44A Color TV Cameras. Used in the red channel, the new tube, Type XQ-1023R, gives improved reproduction of deep reds and magentas, reducing the tendency of these tones to become brownish or muddy as they do with standard tubes. The standard red and extended red tubes are interchangeable in the TK-44A. Present owners of these cameras may install the XQ-1023R without any modifications.



## Production Video Switcher

The Type TS-51 is a new vertical interval, dual re-entry video switcher. It is designed for studio and master control production switching. Major features include handling of composite, non-composite, synchronous or non-synchronous signals, and step signal transient suppression.

The basic switcher is a 16 input by 4 output matrix occupying only 12¼ inches of rack space. Capabilities of the switcher are easily expanded by simply adding basic units. For example, a second 16 x 4 matrix could provide 4 more output busses. One of these might go to the special effects unit so that any one of the 16 inputs could be selected as a keying source. The remaining 3 output rows could then be used for general distribution. Another 16 x 4 matrix could be added to expand the input capability to 32.

Signals fed to the switcher may be composite, non-composite, synchronous or non-synchronous. A selector switch on each input module permits setting up each module ahead of time to accept any one of these types of signals. As an optional extra, an automatic synchronous detector can be employed to "sense" the input signals and communicate to the mixers whether they should mix the signals or go to black before switching. Incorporated in the TS-51 is an APL (average picture level) control circuit to suppress step changes in output when switching between pictures having different duty cycles.

In a typical TS-51 configuration using computer techniques (System 14), a Transition Logic Group added to the basic 16 input by 4-output matrix achieves all the necessary programming functions with just the 4 busses, eliminating the need for a 6-bus switcher with its usual preview and program busses. This TS-51 switcher has 2 of the 4 output rows feeding signals to one of two mixers which, for example, might be assigned to special effects. The other mixer, then, operates

as part of the Transition Logic Group, which is a small supplementary video switcher controlled by logic sorted from program pushbuttons, a cut-bar switch, and the mixer levers. Sources may be preset, then monitored by pressing transition preview pushbuttons, and placed on the air with the cut-bar.

## New Multi-Channel FM Antenna

The Type BFD Panel Antenna is a circularly polarized FM antenna designed for mounting on the sides of square or triangular towers, with face widths from 5 to 10 feet. It has the necessary bandwidth and power capability for multi-channel operation. It is capable of either directional or omnidirectional radiation.

A wide variety of directional patterns can be achieved by varying the number and position of the panels on the tower, and by controlling the power distribution to each. Panels are open wire mesh to reduce wind loading, and each supports two radomed, crossed and inclined dipoles fed with a transmission line network that terminates in a single input line.

Stations WABC and WCBS in New York are being served by a Type BFD Antenna, consisting of two layers of four panels each surrounding the TV mast on the Empire State Building. Other systems are under construction.

## Tips for Longer VTR Headwheel Life

Environmental life tests conducted on video tape and recorder headwheels indicate that high humidity has a pronounced effect in reducing headwheel life. Following are test results and recommendations to VTR owners:

(1) Abrasivity of magnetic tape increases with an increase in humidity. Magnetic tape absorbs moisture readily but is reluctant to relinquish absorbed moisture in a short length of time.

(2) Optimum head wear rates can be achieved by maintaining a relative humidity range of between 20 and 40 percent. Above this range, head wear increases very rapidly and may reach extreme rates at 70 percent.

(3) Head "gunking" can occur on some tapes at between 40 and 50 percent relative humidity. This can result in "burning" the surface of the tape, causing damage which may result in higher wear rates on subsequent plays. Dehumidification of a burned tape will reduce the abrasivity of the tape but is unlikely to restore the original wear characteristics.

(4) A highly humidified tape will wear at an accelerated rate even in a low humidity environment. A dehumidified tape, on the other hand, will wear at normal rates in a high humidity environment but for the first pass only. Subsequent passes will show increased wear rate.

Based on these tests, improved headwheel life can be expected by controlling the atmosphere in machine rooms and tape storage areas to keep the relative humidity between 20 and 40 percent and the temperature between 60 and 80 degrees F.

# How to show the best profit picture in town.



# Get the VHF transmitter with the best specs in the world.



Color is the medium that sells—and pays—and the new Maxim-Air can make the most of it!

The solid-state Maxim-Air TT-30FL is twice as good as the transmitter you're now using. It can help you attract more sponsors by providing you with a promotable difference they can see and appreciate—the best and most stable color signals in town!

What's more, you can forget about having to make rebates or make-up commercials. Maxim-Air not only offers you 100% better specs (and performance) than any other VHF made—but 100% redundancy as well! That's right, there are *two* of them (15-KW each).

You can forget about black-outs seconds before a touchdown, or smack in the middle of a \$10,000 commercial. If anything ever goes wrong with one 15-KW, the other one takes over—instantly, *automatically!* The odds against going off the air with Maxim-Air are virtually infinitesimal!

For a better profit picture, put a better picture on the home-TV. Color it Maxim-Air!

For the complete Maxim-Air story, call your local RCA Broadcast Representative or write: RCA Broadcast Equipment, Building 15-5, Camden, New Jersey 08102.



THE NEW MAXIM-AIR TT-30FL 30-KW

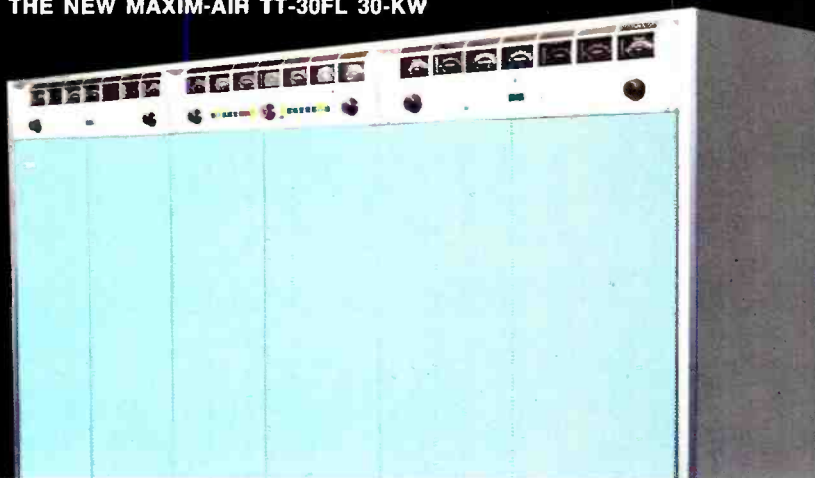

RCA...Totally Responsive

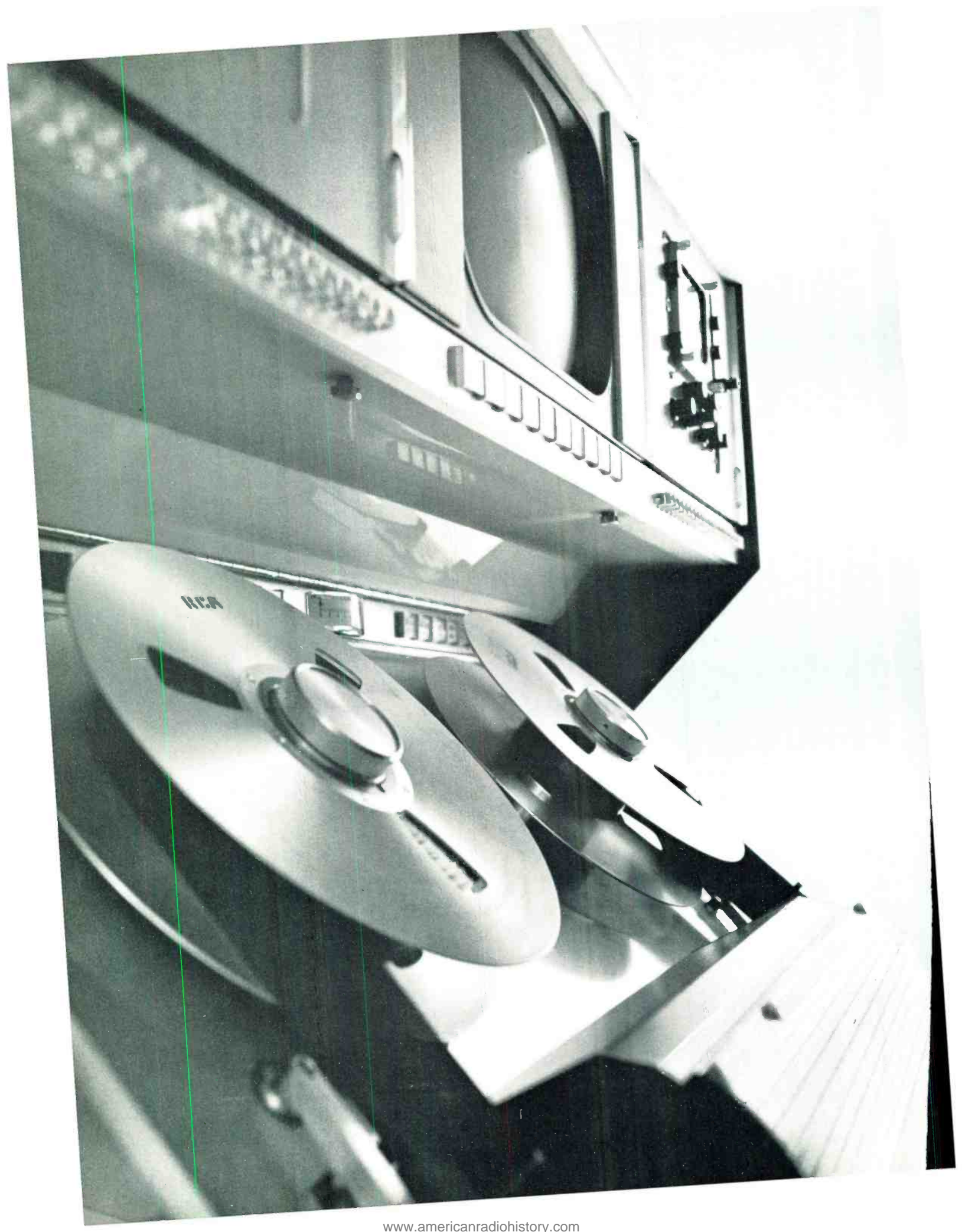

# The NEW RCA 70B is the first VTR to safeguard quality automatically!

In many ways, the 70B can make the VTR operator feel he has more command of tape quality than ever before. Because he can get the highest color fidelity ever achieved—with the most reliable automatic instrumentation ever devised for a VTR.

**Automatically**, the 70B eliminates costly replays. Sensing circuits just won't let you play tape on the wrong FM standard. Instead, the proper playback standard is selected for any tape—highband, lowband monochrome or lowband color—automatically.

**Automatically**, the 70B pinpoints problems through its visual-audible central alarm system and alerts the operator immediately.

**Automatically**, the 70B can save your operator time by eliminating the need for manual cueing. Now he can pre-cue several tapes so they are ready to roll automatically—eliminating tension during the critical station break period.

**Automatically**, the 70B can eliminate saturation and hue errors. Use the RCA exclusive Chroma Amplitude and Velocity Error Corrector (CAVEC), and the 70B will not only correct chroma errors between bands—but between each line of a band as well!

**Automatically**, you get better color. The 70B has broadcasting's highest specs—K factor of 1% with 2T and 20-T pulse; differential phase and gain 3° and 3%; moire down 43 db and S/N of 46 db.

The RCA 70B is the dream VTR come to life. For all the reasons why, call your RCA Broadcast Representative. Or write:  
RCA Broadcast Equipment, Bldg. 15-5, Camden, N.J. 08102.

**IMPORTANT NEWS:**  
The TR-70B can also be used as a master VTR with the world's first automated video cartridge tape recorder/player—the show-stopper of the 1969 NAB! Write for details.

Business radio, police radio—the new Series 700 is a bargain any way you look at it. Because it's *both*. It's an all solid-state 2-way radio that's priced like a tube-designed model. Yet it's equipped with reliability features found only in super-rugged police radios!

Consider these money-saving advantages:

The RCA Series 700 can get your messages through under conditions that would make old-fashioned radios go silent. It has built-in circuitry to protect it from extreme voltage fluctuations, extra high heat levels and antenna shorting. (Some of the common causes of premature failures.)

When time means money, you can go on the air without waiting for it to warm-up. You'll never end up talking to yourself because it won't drift off frequency. Your batteries will last longer, too. The transmit drain is the lowest of any comparably powered 2-way radio. Even so, it's powerful enough to provide loud and clear communications, even in your outlying areas.

The 700 means business, day after day. To find out how it can improve your company's business, write: RCA 2-Way Radio, Dept. , Bldg. 15-5, Camden, N. J. 08102



## The business radio that behaves like a police radio.



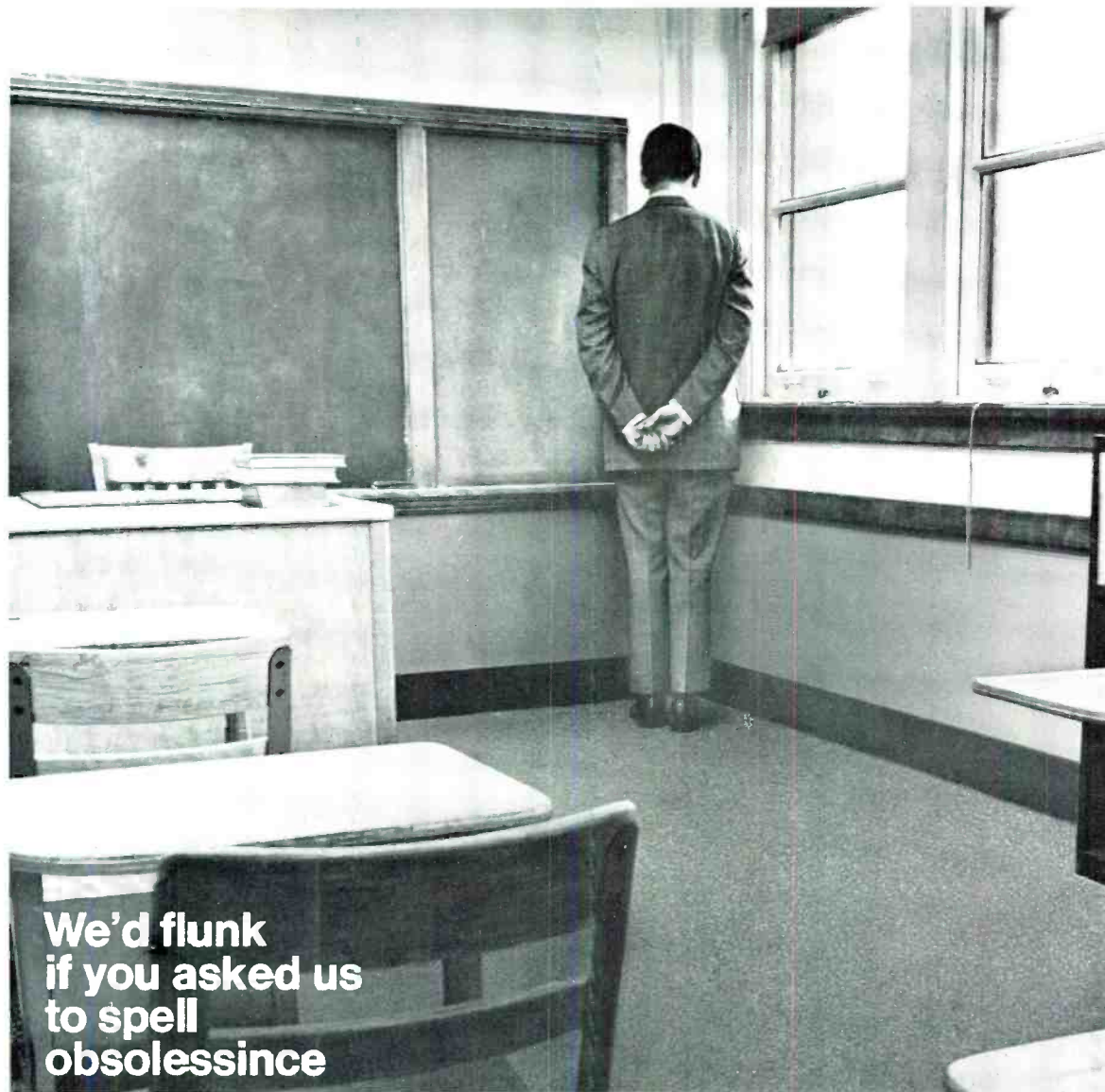

**We'd flunk  
if you asked us  
to spell  
obsolessness**

### **We make TV systems with the future in mind.**

That's why you can avoid "obsolessness"—and save money with our closed circuit television.

First of all, RCA makes every component you'll ever need for TV. Cameras, consoles, video tape recorders, film systems, the works. And we make them better. But that's what you'd expect of the world's foremost manufacturer of television equipment.

RCA components are electronically matched. So you can start big or small, knowing that every new component you add will work perfectly with the rest of the system. You'll be able to expand or update your RCA system whenever you like—not by replacing your original components, but by adding to them!

When you're ready for color, the change is easily made, because many RCA black and white components are even compatible with RCA color equipment. And today—thanks to an RCA engineering breakthrough—you can have a complete color camera system, film or live, at the lowest price ever. Under \$10,000! What's more, your students can run them as easily as monochrome systems!

For all the facts about a TV system for your present and future, write RCA Professional Electronic Systems, Bldg. 15-5, Camden, New Jersey 08102.

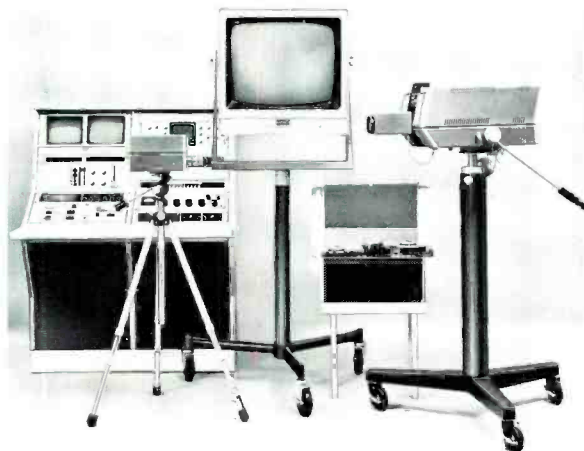

# One-of-a-kind antenna system takes unique skills

You couldn't ask for a more complex TV antenna system than this one-of-a-kind installation—with five RCA antennas on-air from twin masts on John Hancock Center in Chicago next fall. Only the Empire State antenna system by RCA paralleled it in technological involvement.

The John Hancock Center has: Two UHF Polygons. A VHF Zee Panel. A VHF Superturnstile. A VHF Butterfly. Each one is designed to handle maximum authorized ERP. All five can radiate maximum power with minimum inter-reaction. And that's not all: There are provisions in the system for future expansion to a total of 10 antennas!

Did you know that almost all multiple antenna installations in the business were RCA-engineered—planned—tested—built—and installed? And that the basic principles of multiple array antenna operation were first evolved at RCA's Gibbsboro Center—world's best equipped and most advanced Antenna Engineering facility. Or that Gibbsboro maintains the industry's largest and most complete computerized store of reference data. RCA's experience and intelligence are readily adaptable to solutions of every kind of antenna problem.

Your antenna is your bridge to business. Call your RCA Broadcast Representative when you begin to think about that installation. Or write RCA Broadcast and Television Equipment, Building 15-5, Camden, N.J. 08102.

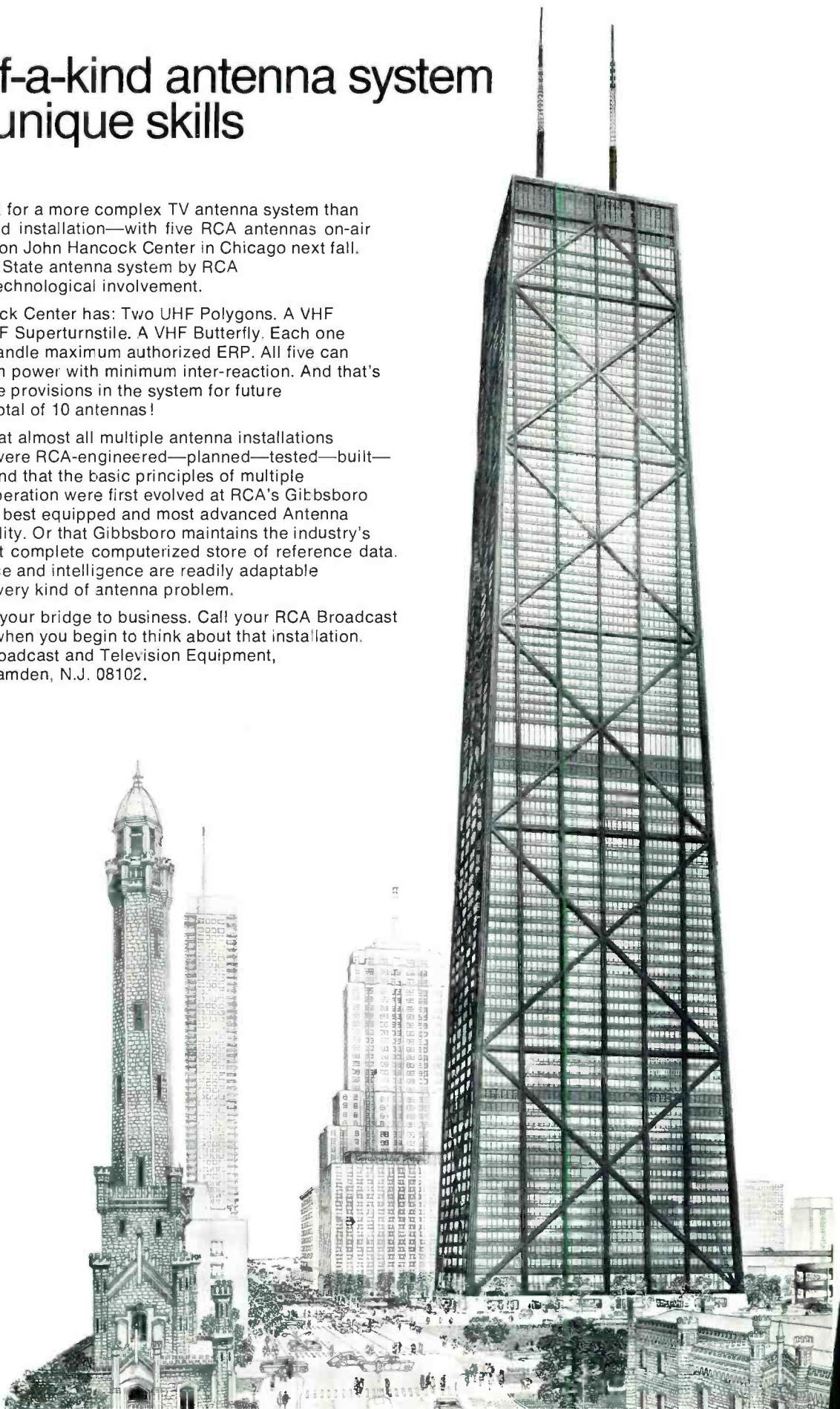

Owner/Developer:  
John Hancock  
Mutual Life  
Insurance Company

# Contour Enhancement . . .

makes your films and slides  
look better



## Matched TK-27 Color Film System . . . now with the "live-like" quality of a TK-44A

The Contour Enhancement accessory for the RCA TK-27 Color Film Camera improves the TV picture by enhancing image edges, increasing overall definition. In addition, a special filter "combs out" the noise—permitting this improved performance without any increase in background disturbance. Thus film and slides will offer a new high level of picture quality. Even those not quite perfectly focused will produce better images on the TV screen. You'll get the same kind of sparkle and snap that you do from live pictures on the TK-44A.

When you use the complete RCA Color Film System your films come alive, they entertain more, educate more, they sparkle as never before. It's all due to a MATCHED system. The TK-27 Camera is the heart of the "matched design" system. Included is the Automatic TP-66 Film Projector, Solid-State TP-77 Slide Projector with preview feature, and new vertical-mirror-wipe TP-55 Multiplexer. All made by RCA, these units work together to produce the finest color TV pictures.

**RCA** Broadcast  
Equipment

