



Broadcast News

Volume No. 148, December 1972



KVRL-TV: 2.6 Megawatts
in the heart of Houston

RCA adds some local color to Old Vienna.

Vienna already has the Opera. Cafes on broad, tree-lined streets. The Danube River. The Vienna Woods. Now it has the best in color television.

Osterreichischer Rundfunk GmbH. (ORF), the Austrian broadcasting agency, is building the most sophisticated color-television broadcasting

center in all of Europe.

And RCA supplied the complete color studio system for the center. It includes everything that goes into total color television production. Live, film and tape equipment.

ORF chose us because we make more kinds of broadcast equipment than

anyone else and because we could provide the knowledge and the manpower to help with planning and implementation. We are on-site for installation and initial operation while we train the ORF personnel who will staff the station.

ORF is one of the first broadcast agencies on the continent to totally integrate its management and color TV production operation under one roof.

RCA color around the world

RCA is helping to make colorful things happen in other parts of the world, too. Taiwan, Hong Kong, Brazil, Mexico. England—RCA is supplying color TV equipment to all of these countries and to many more.

ABS/CBN in The Philippines, the largest and best-equipped broadcasting complex in Southeast Asia, has been broadcasting in color with RCA equipment since 1967.

And Yugoslavia's biggest station, RTB, converted to color programming with RCA equipment.

But we're not only selling television equipment in Europe. We're making it there, too.

Our new plant on the Channel Island of Jersey has already delivered VTR's to Westdeutscher Rundfunk in Germany.

Vienna is just one stop in our tour of the world.



RCA

CONTENTS



Published by
RCA Communications
Systems Division

KVRL-TV, Houston	UHF Pattern for Success	6
Production Managers Report	"Cart" Becomes Part of Station Life Style	16
Kaiser Broadcasting	Bagging Bigger Audiences with Super Power UHF	24
KCET, Hollywood	Coastal Production Center for Public TV	28
CFTO, Toronto	Converts TK-44's for Hand-Held Use	34
ORTF, Paris	Tape Operations in the Shadow of the Eiffel Tower	40
University of Missouri, Kansas City	Color Television Aids Dental Instruction	44
TK-28 Color Camera	A Whole New Telecine Generation	48
TTU-60B Transmitter Option	New Standby Power Package for Once-A-Week Inspection	56
New UHF Pylon	How to Handle Added Power Without A New Tower	58

OUR COVER—Aerial view of dynamic downtown Houston centers on its tallest structure, One Shell Plaza, which is topped by the KVRL-TV (Ch. 26) UHF Pylon Antenna.



IN THE VIEWFINDER

RCA TO MARKET COLOR VIDEO PLAYER FOR CONSUMERS BY LATE 1973

A new magnetic tape color video player/recorder recently announced by RCA will enable home TV viewers to watch pre-recorded tapes and to record and play back regularly broadcast programs and TV home movies over their standard color sets without receiver modification. The player will be available by late 1973.

Two other major U. S. firms, Bell & Howell and Magnavox, also plan to market products based upon the new SelectaVision MagTape System. In addition it is expected that Bell & Howell will manufacture the precision tape transport component of the system for RCA and also will make the component available to others in the industry. Magnavox has also informed RCA that it plans to integrate its low-cost color camera with the SelectaVision MagTape System and make it available to other manufacturers.

The principal features of the SelectaVision MagTape System which will make it attractive to consumers are its design for exceptional performance, reliable operation and low cost. The system has been demonstrated to other manufacturers and their reaction has been enthusiastic. RCA plans to introduce the system to the consumer market at a suggested retail price significantly below that of any other video recorder/player to date. The company has offered to supply other manufacturers with complete systems and to license its inventions to those who wish to manufacture the product themselves.

The SelectaVision MagTape unit was designed and developed by RCA Consumer Electronics. A feature of the unit is the design of headwheel and tape cartridge, which permits "In-Cartridge Scanning".

When the cartridge is inserted into the player-recorder unit, a door is opened in the forward edge of the cartridge allowing the tape to contact the scanner and its four magnetic heads. The tape is never

pulled from the cartridge, and is protected from the external environment when the cartridge is removed from the playback position for storage.

The player-recorder is designed to be used with TV sets currently installed in U. S. homes. Since TV receivers in use today number about 100 million, compatibility is enhanced through an automatic control that eliminates the need for manual adjustment.

In developing the player-recorder, RCA field-tested a sample of the U. S. TV receiver population and concluded that a sizable number of sets are highly susceptible to "flagging"—picture distortion caused by improper timing coordination between the set and video tape player. The automatic control was incorporated in the design to minimize this potential problem and to make the MagTape unit compatible with all TV sets now in use in this country.

Another feature of MagTape is the built-in ability to play stereo sound through optional speakers and a stereo amplifier when such sound has been prerecorded with the TV program.

The reusable magnetic tape cartridge is approximately the size and shape of an average hard cover book. It contains about 900 feet of 3/4-inch magnetic tape and allows a full hour of recording and playback.

3ips!

The MagTape product can play pre-recorded tapes carrying a wide variety of entertainment as well as specialized programming such as educational presentations and golf lessons. It includes a VHF/UHF tuner that allows the viewer to watch a program on one channel and record another program being broadcast on a different channel at the same time. Also included in the unit is a timer and digital clock for unattended recording so programs can be recorded even when the set owner is not home. The system also has an input connector for a TV camera to make possible the recording and instant playback, of TV home movies.

The precision tape transport component of a new magnetic tape home TV player-recorder which RCA plans to market to consumers by late 1973.



RCA's SelectaVision MagTape cartridge television system opens the way for such in-the-home prerecorded programs as golf instruction.

A new record for headwheel life?

KBTV DENVER REPORTS "OVER 5200 HOURS AND STILL GOING STRONG"

On January 13, 1971 when station KBTV, Denver, replaced a headwheel in one of their TR-70 VTR's, it was no big deal—just a routine maintenance requirement.

Nearly two years have elapsed since then, and the same headwheel is still there, alive and performing well. It has now logged over 5200 operating hours and produces superb tapes which show no signs of deterioration according to Herb Schubarth, Director of Engineering.

During that time, the TR-70 with the long-lasting headwheel has been handling the usual variety of tape assignments—production, dubbing, network delay—but its major use has been for recording.

The headwheel now has a pole tip projection of 1 mil, and has been holding there for the past 8 or 9 months, Mr. Schubarth reports.

The KBTV tape room is a bustling, well-trafficked area—far from a "white room" environment. It includes three TR-70's plus two TR-50's, all of which are worked hard and given ordinary attention.

Mr. Schubarth has had the TR-70's for four years now and is quite satisfied with their performance. They produce consistently high quality tapes and have required little maintenance, he notes.



Long-life headwheel at KBTV passes 5200 hours—with no end in sight.

A second headwheel installed on a TR-70 at the same time as the 5200 hour gem also performed yeoman service for more than 18 months. In Mr. Schubarth's words, it was "retired" in September 1972 after logging some 4100 hours. The new replacement has clicked off over 700 hours—barely a "break-in" period according to the performance standards that KBTV has become accustomed to.

4,000 and 5,000 hour headwheel life is unusual, even for our durable Alfecon II headwheels. But the RCA "1,000 Hour Club" now members 165 customers and 325 headwheel panels.

The payoff for long-life headwheels is right where it counts—in more production time, less downtime for your VTR investment. Ask KBTV. They're experts at it.



AUSTRALIAN BROADCASTERS VIEW "TOMORROW SYSTEMS TODAY"

Many of Australia's broadcasters recently saw for the first time RCA's new color TV studio systems. The premier took place at the Institution of Radio and Electronics Engineers conference and exhibit held in Canberra, the island continent's federal capital.

Color broadcast tests have been authorized by the government for early 1975. So visitors to RCA's "Tomorrow Systems Today" exhibit had a timely opportunity to inspect future-compatible equipment available for Australia's plan for color service.

On display were recent developments in live telecasting, tape and telecine equipment—all operable on Australia's PAL standard which is similar to that used in Great Britain.

The equipments—all operating in a typical TV station environment—included the TK-44B Live Color Camera, TK-28 Color Film Camera and TCR-100 Cartridge Tape Recorder, one of which has already been delivered to Austarama TV in Melbourne.

IN THE VIEWFINDER

OKLAHOMA STATE UNIVERSITY CONVERTS TO COLOR

Educational Television Services was established in 1967 at Oklahoma State University to serve a three-fold purpose:

1. To coordinate all closed circuit television programming and distribution on campus.
2. To teach TV production and directing courses in the Radio-TV-Film Dept.
3. To provide continuing liaison with commercial and public television stations.

These lofty objectives were implemented initially by a staff of one and an out-dated industrial type TV system.

A Chief Engineer with commercial broadcasting experience was added, and soon the television system complement was upgraded to broadcast quality studio, control room and terminal equipment. Two TK-60 monochrome cameras were supplemented later by video tape recorders (a TR-22D and TR-5). A new TS-51 switching system completed the facility.

During the "growing" years, ETS assembled a competent full-time staff and pro-

duced a number of innovative instructional and entertainment programs. Program content ranges from History, Engineering and Psychology to Computer Science and Veterinary Medicine and many others. Because of the excellence of its staff and facilities, Educational Television Services was commissioned by the Oklahoma Educational Television Authority to produce programming for the general public. OETA owns and operates Ch. 13 in Oklahoma City and Ch. 11 in Tulsa.

ETS' programming has been widely accepted and applauded locally, regionally and nationally for quality and content. "West By Southwest"—a series of thirty minute programs—illustrated various aspects of Southwestern heritage through the experiences of colorful men, episodes and historical events. This series, and a spin-off entitled "Folklore of the Southwest" received plaudits from broadcasters in neighboring states. Another major production "Lenin and Leninism" produced under a grant from the American Bar Association, brought national recognition.

In spite of the top quality programs developed by ETS, the inability to produce

in color limited the opportunities to obtain broader distribution for its programs.

Fortunately, the excellent results achieved by Educational Television Services in improving the quality of instruction and in extending the visibility and influence of the University through the public television programs it developed, were recognized by the OSU Administration.

Consequently, the University demonstrated its faith in television by approving the conversion of its facilities to color. TK-44 cameras and a TK-610 film system were added. With this new color facility the University will now be able to initiate new and innovative projects in both instruction and research. And the public will benefit through the University's color-enhanced programs of public service and adult education.

Educational Television Services at Oklahoma State University is headed by Marshall E. Allen; the Chief Engineer is Wilbur Brakhage.

Producer/Director handles video control at Educational Television Services, Oklahoma State University.

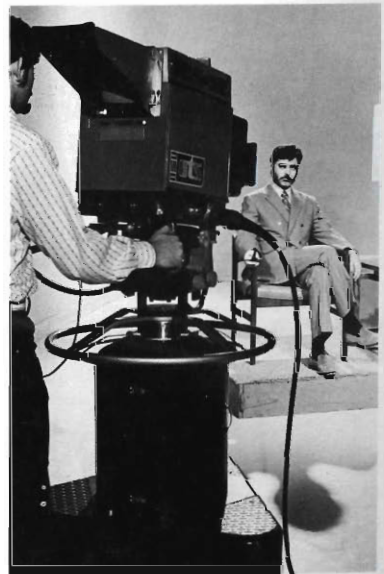

New TK-44 camera on Opus '72 set at OSU's recently colorized studios.

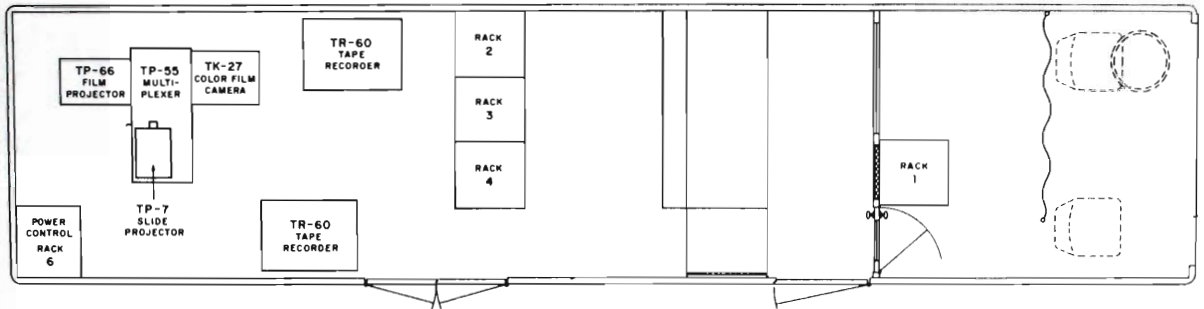

Diagram shows floor layout of color TV equipment items in a 35-foot mobile TV van designed and built by RCA Broadcast Systems for the U. S. Marine Corps.

MARINE CORPS UNVEILS MOBILE TV STUDIO

A complete color TV studio on wheels that can move to virtually any location in the country to produce training and instructional programs on video tape was recently turned over to the U. S. Marine Corps by RCA.

Extremely compact, the vans contain a complete television production facility, including "live" color cameras, video tape recorders, TV film island, video control and switching console, and a full audio system. Two identical vans are being supplied by RCA Broadcast Systems; one will operate from the Marine station at Quantico, Va., and the second from Camp Pendleton, Calif.

The custom-built chassis employs air ride suspension and is powered by a Ford engine with five-speed transmission. Front wheel drive, a unique feature, eliminates the need for differential connections to rear wheels. This provides as much as 70 per cent additional storage space under the van body for carrying cameras and other equipment while under way. A six-ton air conditioning unit, mounted over the cab, provides complete conditioning, i.e., cooling, heating and dehumidifying.

The two "live" color TV cameras aboard each van are TK-44B, which incorporate many automatic features that sharply reduce the number of operator manipulations and, at the same time, result in sharp, detailed color pictures. Among these is "bias light", a system for minimizing scene "lag" when the camera is operating at very low light conditions.

Another is scene contract compression, which enables the camera to produce picture detail usually lost in shadows without overbrightening highlights.

Each van is equipped with a color film system consisting of one TK-27B color

film camera, TP-55 multiplexer, TP-66 film projector, and a TP-7 slide projector. Also included are two TR-60 highband color VTRs and a tape editing programmer. These permit all elements of TV program assembly to be conducted within the van.

CARTRIDGE TAPE SYSTEM PROVIDES READY ACCESS TO UNIVERSITY NEWS

Recognizing the importance of supplying media with fresh news, the University of Minnesota goes a step further by making the news readily available in pre-recorded form which can be accessed by a telephone call. Dialing an assigned number connects the caller with one of three RCA Type RT-27 Cartridge Tape Recorders loaded with taped messages. The

recorders are stacked on a 3-line telephone rotary system that starts with the first ring tone.

John Kalbrener, Broadcast Director of the University News Service, comments on the system: "Virtually everyone who uses the facility here lets us know by phone that the sound quality is everything from fantastic and incredible to no less than great."

The kind words are sincerely appreciated.

OUR APOLOGIES:

Our attention has been drawn to the fact that in our March issue No. 147 on page 4 'IN THE VIEWFINDER' we stated that Manx Radio was acquired by the Isle of Man Government in April 1968 'from a holding Company that had opted on divestiture since it had not been profitable'.

The Richard Meyer Company Limited has pointed out that their late Chairman, Mr. Richard Leveson Meyer, and Pye Limited owned the Isle of Man Broadcasting Com-

pany Limited jointly from its inception and were thus responsible for the promotion and development of Manx Radio in the Isle of Man in cooperation with the Isle of Man Government, and that furthermore the radio was in fact producing profits both before and at the time that it was sold.

We apologise for any embarrassment that we may have inadvertently caused to The Richard Meyer Company Limited and are grateful to them for pointing out the matter to us.

KVRL's omnidirectional antenna atop One Shell Plaza in downtown Houston covers the city with a clear, unobstructed TV signal.



Pattern for Success

KVRL, Houston Shows Profit in First Year of Operation

Bustling, dynamic Houston was already served by five television stations when upstart KVRL, Ch. 26 went on-air in August 1971.

This script is not new, but in Houston the story line is being changed—it has a happy beginning, and an established pattern for future success. KVRL is "making it". This new station with a veteran broadcasting crew has shown a profit in its first year of operation. Unusual, especially for a UHF station—but Channel 26 planned its operation to meet the needs of the burgeoning, diverse Houston market.

Success was no accident. President Raymond Schindler of KVRL already had a solid record of business achievements when he organized a team to plan and build the new station. Consequently, every facet of the operation is geared for efficiency and future growth.

"We wanted a first class technical facility, a strong, but streamlined staff, and programming formula that would attract an audience and advertisers," Mr. Schindler commented.

"We firmly believed that there was a need for a locally oriented, totally independent TV station in Houston," Mr. Schindler added, "and the results have confirmed that judgment."

Programming

Programming at KVRL provides a mix of movies, syndicated shows, and a variety of locally-originated special interest programs. The broadcast day starts at noon and carries through until midnight, but plans are already in the works to extend this schedule.

Among the locally produced shows are "Bobby Brown Sports", hosted by that popular trainer and health club operator, talking with noted sports figures.

The nationally syndicated "Bozo the Clown" show is represented in Houston five days a week with a Ch. 26-produced program that draws a strong following from loyal kids of all ages.

Another sports program "The Rod Paige Show" features the coach of the Texas Southern football team reviewing taped highlights of the previous TSU game with guests.

TV-26 facilities include two fully-equipped studios for handling local productions and commercials.



Local columnist Bill Roberts is presented weekly in a taped program commenting on the happenings and personalities on the Houston scene, and adding his own pithy observations.

Each Sunday a live telecast originates from the First Baptist Church, Houston's largest, using the Ch. 26 remote unit.

In the area of special audience programming, TV 26 has a Sunday night "Cine Latino" show featuring Spanish language movies. The show is hosted by a popular Houston Chicano, Gabriel Jimenez. Preceding "Cine Latino" is a half hour movie "El Gordo y El Flaco"—the ever-appealing Laurel and Hardy duo—with a Spanish sound track.

Syndicated offerings provide a natural counter to the programs scheduled on the network-affiliated stations, and are slotted by TV-26 to accommodate normal audience "flow". Regular shows include "Star Trek", "Hogan's Heroes", "Stand Up and Cheer", "Mancini Generation".

"Houston's Most Powerful TV Station"

KVRL is different. It is the only local TV channel with an antenna in center city Houston. Its pylon antenna stands alone atop downtown Houston's newest, tallest structure, One Shell Plaza. The transmitter is located on the 50th floor, remote controlled via a microwave STL to the studios, some 4.8 miles away on Westheimer Boulevard.

The combination of the TFU-46K Pylon Antenna and the 60 kW TTU-60 Transmitter qualifies KVRL as "Houston's most powerful television station", with an omnidirectional ERP of 2.6 million watts.

The TV 26 antenna is 1049 feet above sea level, 1,000 feet above mean average terrain, just under the FAA maximum limits for the area.

A current TV commercial makes the point that "sometimes *different is better*". That truism can also be applied to the positioning of the KVRL antenna.

When TV-26 was in the planning stage, One Shell Plaza, then under construction, was considered as a potential antenna site. After a careful evaluation, it was decided to locate the antenna there. It proved to be a wise choice.

Located in the center of its coverage area, far above interfering structures which cause multiple path reflections and impaired signal reception, TV-26 is ideally positioned for maximum market coverage.

From its commanding height, the omnidirectional KVRL antenna delivers a superior signal throughout the metropolitan Houston area, and provides good color reception for surrounding communities as well.

To further take advantage of a central location, better coverage, and stronger signal from the antenna on One Shell Plaza, the transmitter was also installed on the 50th floor of the building. This eliminated the need for constructing a separate building to house the transmitter, resulting in a substantial cost saving.

"Efficiency", "economy", and "flexibility" are buzz words at KVRL—a part of the station's operating philosophy. They are repeated frequently by people involved in different activities at TV-26. For example, Dan Bohn, Chief Engineer, uses "flexibility" to describe his total technical facility—as it was planned; as it is now set up, and how it can readily adapt to future requirements.

Deeply involved with TV-26 from its planning stages, Dan Bohn is unabashed in his enthusiasm for the technical aspects of the facility, particularly the Master Control layout which is his "baby". The room is well-equipped, but spacious. There are two TK-27 film islands, with room for at least three more. The tape area occupies one wall of the room and includes three TR-60's, one of which is tied-in with the TCR-100. Space is provided for additional recorders when the need arises.

Even the control console is uncramped and could be duplicated within the present Master Control room. As a further innovation, Mr. Bohn points out that the control room sits on a computer-type flooring, which provides more than enough space for cable runs and air conditioning ducts to cover any projected need. The design also provides easy access to all cabling

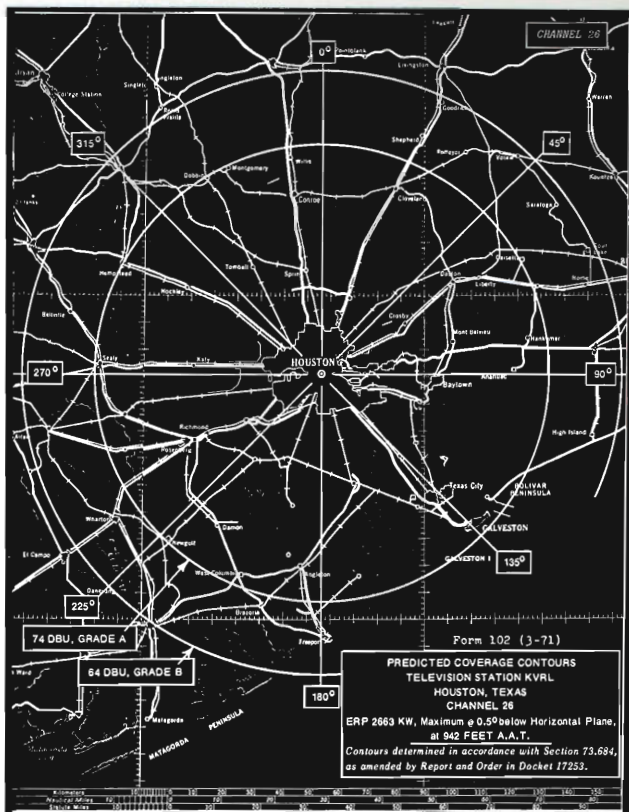

KVRL coverage map.



TTU-60, 60 kW transmitter for TV-26 is centrally located on the 50th floor of One Shell Plaza.

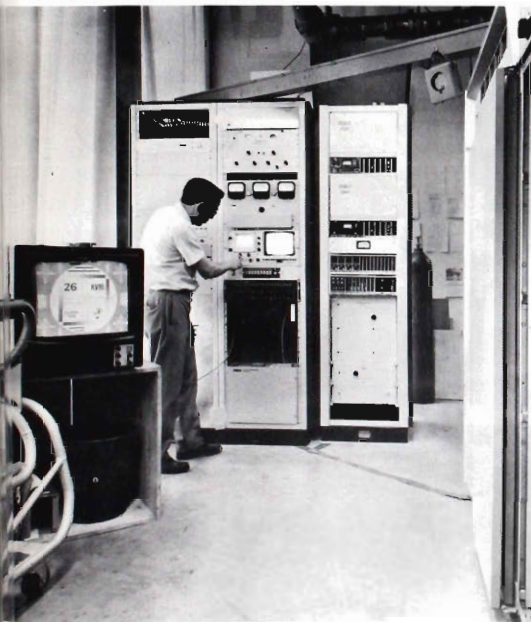
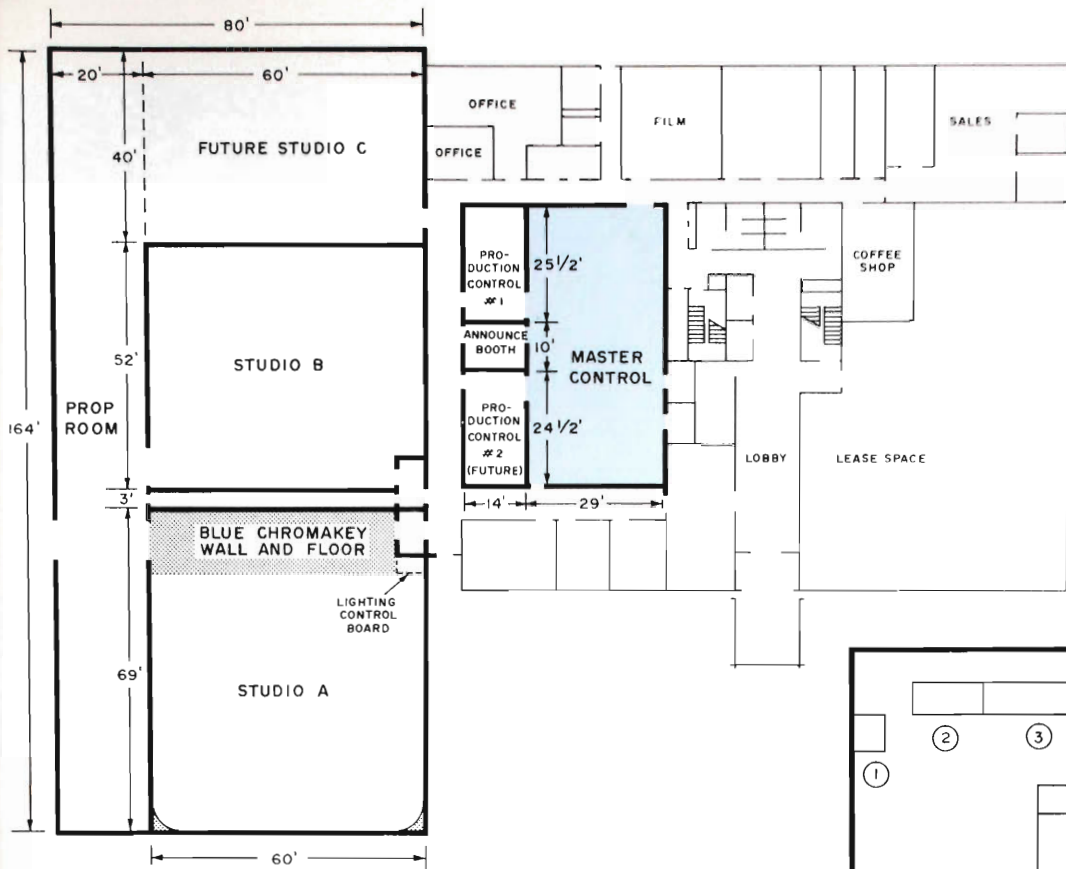

Transmitter is remote controlled from studio via TVM-6 microwave STL system.

- (1) VTR Control; TEP: Vectorscope
- (2) TR-60 VTR's (2)
- (3) TCR-100 with TR-60
- (4) Master Control Console
Including (Top to Bottom)
Audio Console/Cartridge tape
TS-51 On-Air Switching
Film Islands #1 and #2 Controls
CCU, Studio Cameras #1, #2, #3
Space for future CCU's
- (5) System Racks, Including
(Top to Bottom)
Video and Pulse
Video switching for TS-51 and
TS-40 Switchers
Audio
TK-27 rack controls
Transmitter Remote Control
Microwave STL and Remote
microwave controls
Space for 2 future racks
- (6) TK-27 Film Islands (2)

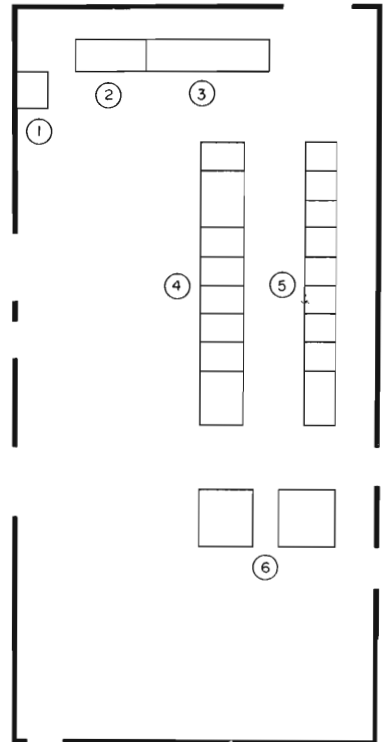

TV-26 Master Control Room Layout

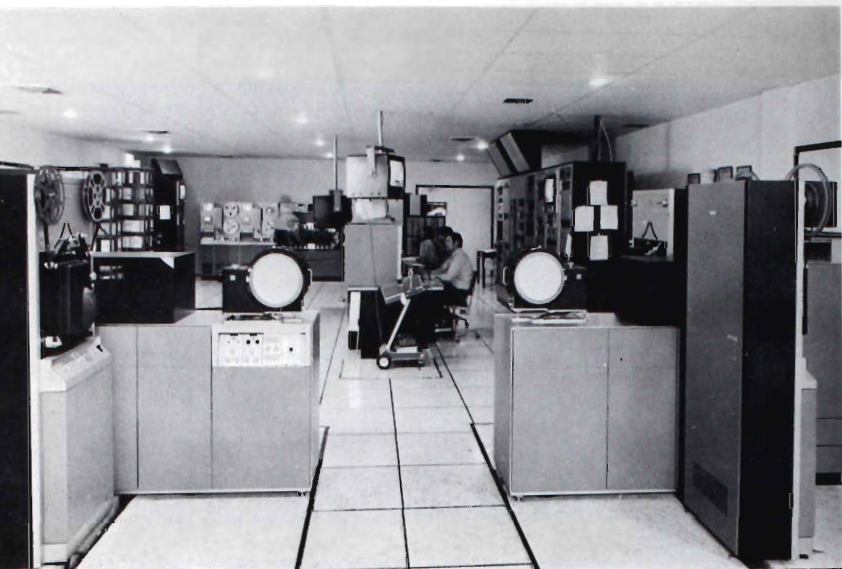

for easier maintenance, installation— plus, of course, full flexibility for making any re-arrangements.

The control room is laid out so that one man can handle the full on-air operations for the station.

The "cart" has been a welcome addition to the TV 26 equipment complement, according to Mr. Bohn, and has made life much easier for his technical staff.

It has freed the TR-60's for production work, and also has relieved pressure on the film islands, since film spots can now be dubbed to tape. The TCR-100 is slaved to share electronics with one of the TR-60's, and can be programmed to switch automatically between the two units for programming and commercials, making for a smoother operation.

TV-26's tape equipment has been durable and efficient. Headwheel life has been excellent and the machines have given trouble-free performance, while requiring a minimum of adjustments.

The efficiency of the engineering operation, Mr. Bohn is quick to point out, is only partly attributable to the layout and equipment. An experienced technical staff with a high degree of professionalism and elan keeps things functioning smoothly. Because there is a minimum of structuring and a maximum of flexibility in handling assignments, a "lean" staff manages to get the job done quite effectively.

One member of the engineering staff, Pat McGowan, works the TV-26 tape area—and finds it to his liking. The TR-60's, he says, are compact, convenient and designed for easier editing. Fewer adjustments are required, so the operator can concentrate on making good spots without having to worry about the machine. The TR-60 takes care of itself.

The TCR-100 has helped tremendously, Mr. McGowan reports. It has freed two tape machines, streamlined the operation. And he adds, the "cart" makes spots look better on the air. Furthermore, building a "cart" library has not been a particular burden, because it is done on a daily basis, dubbing current spots scheduled for airing within the next day or two. The "carts" are stored next to the TCR-100 in a special rolling stand. The stand, which accommodates over 300 "carts", was designed by one of the TV-26 staff.

The Production Control Center is set up to give the director complete command. The compact room includes a BC-7A/BCM-2B audio console, TS-40N1-B production switcher (18 inputs) and a remote dimmer board for controlling studio lighting. Eye-level monitors show outputs from all "live", tape and film sources so the director is aware at all times of equipment status and availability. Since Production Control immediately adjoins the Master Control room, both intercom and direct communications are facilitated. A separate Announce Booth equipped with turntables

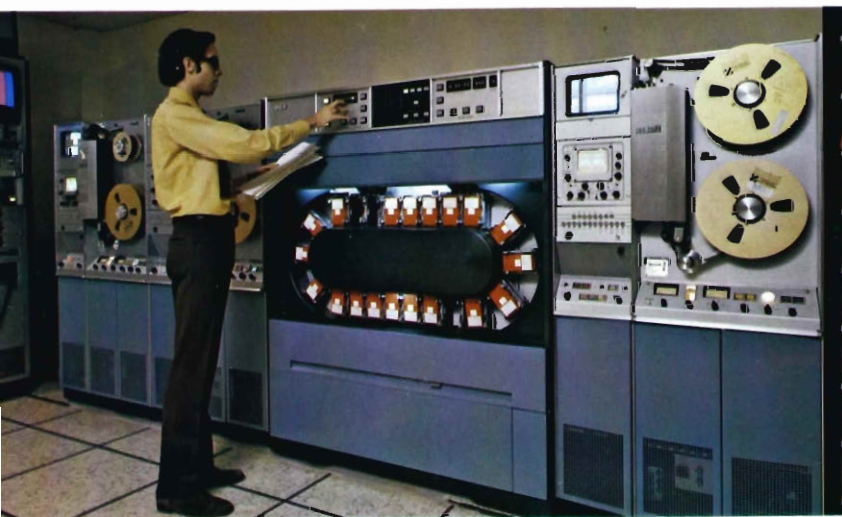

Generous size master control room for TV-26 houses a full complement of equipment, yet provides space and flexibility for expansion.

Recently added TCR-100 "cart" machine has freed two TR-60's for production work and relieved pressure on film islands.



Computer-type flooring under master control room provides easy access to wiring for maintenance.

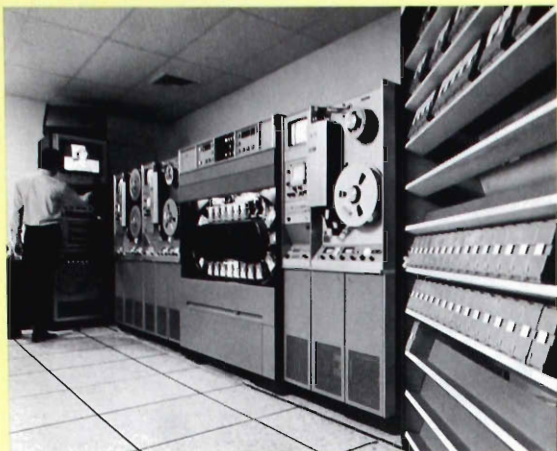

Tape area occupies one wall of master control room and includes 3 TR-60's, TCR-100 and tape editing system.



Instant access to current "cat" commercials is provided by mobile storage rack designed by KVRL.



Efficient console arrangement permits simultaneous handling of on-air assignments as well as studio production.



Straight-line control console is laid out with audio and on-air video switching positions at one end; TK-44 camera control units at opposite end.



Remote controls for transmitter and microwave system are rack-mounted behind camera control position of console.



Two conveniently positioned TK-27 film islands handle TV-26 film requirements. Floor space is available for additional film systems when needed.



Production control room displays outputs from live, tape and film sources for convenience of director. Remote dimmer control board is in foreground.



Compact, wall-carpeted Announce Booth adjoins Production Control room.

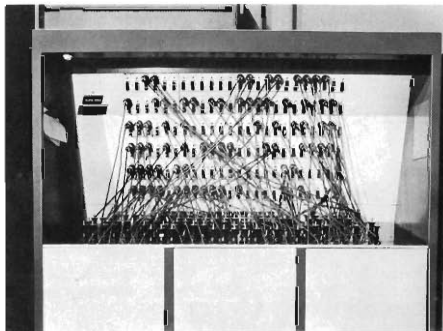

Studio lighting is controlled from this "Safe-Patch" panel.

and cartridge tape decks provides a convenient means of handling small audio production jobs such as music-dubs or voice-overs. On the opposite side of the announce booth, space is reserved for a second Production Control room for future use. For the present, this area serves as a client conference room.

Studio

A look at the studio area confirms TV-26's capability for handling a variety of in-house program productions as well as the versatility for effective commercial work.

Studio "A" is a spacious 50' x 70' with an 18' hard cyc. It is Kleigl lighted, controlled from a "Safe-Patch" panel and equipped with ample lights for achieving just about any color effect. One section of Studio "A" is especially designed for wall and floor Chroma-key work and is large enough to handle automobiles.

Studio "B" is 40' x 60'. A third studio is of similar size and is reserved for future use as a sound studio.

Three TK-44 cameras are permanently used in the studio, and can be augmented by the two cameras in the Remote Unit. A production crane mount is available for lofting the cameraman from ground level up to 10' high.

Production Manager Fred Schultze has seen the workload of his department expand rapidly as studio use increased. Commercial production and the constant addition of house-produced programming resulted in "growing pains" conflicts in equipment utilization. The video tape recorders in particular were required for normal on-air programming, for tape spots, for dubbing—and for commercial production work.

The arrival of the TCR-100 cart machine proved an immediate boon to Mr. Schultze's activity.

"Almost immediately, it opened up the production day. It has doubled our capacity for commercial work by freeing the reel-to-reel tape machines for production use. Previously the effective production day was about three hours, due to conflicts in scheduling around the tape machines which were required for other functions. Now up to three tape machines can be made available for commercial production."

TV-26's confident, spirited production team is looking toward the new challenge of syndicated programming originating from their studio.

Mobile Truck

The TV-26 mobile unit reflects the station's emphasis on efficiency and economy of operation. The unit consists of a special gooseneck trailer which connects to a flat-bed truck. On site, the truck can be unhitched and serve as a roving camera mount. Inside the trailer is a master control console, a TR-60 tape recorder and two TK-44 cameras. Ample room is available for adding more equipment as needed.



Battery of TK-44 studio cameras gives TV-26 superior color capability for commercials and local programming. Normal studio complement is three TK-44's, with two additional units available from the mobile truck.



TV-26 Remote Unit goes where the action is. Gooseneck trailer hitches to flatbed truck which can double as an on-site roving camera mount.



Spacious interior of trailer houses master control, TR-60 and two TK-44's, with ample room for expansion.



Indicative of the flexibility of this unit, the TV-26 Remote Crew planned, set-up four cameras, and telecast a baseball game from the Astrodome. The call came at 2:30 P.M., and the game began at 7:30 that evening—a seemingly impossible task. The results were so good that the customer, Hughes Sports Network, called on TV-26 a week later to handle a Texas Ranger game in Arlington.

Bruce Kelly, Executive Vice President and General Manager came to TV-26 following a 17-year management stint with the NBC affiliate, KPRC. He brought with him a wealth of ideas for building a TV station, and an audience. Mr. Kelly is calm, relaxed and unflappable, except when reference is made to VHF stations versus UHF. "In selling time," he states positively, "we're selling a product that must meet a need or it won't be bought. We're in television, and as such are competing for the total audience on all channels."



Kelly sees a trend developing, as in radio, back to independent stations. The independents, he says, are best equipped to serve the local community with special programming. Without network commitments, complete flexibility is possible.

However, Mr. Kelly warns, unless a new station sets up good program packages, acquires an experienced staff, and goes on the air with latest technical equipment—chances of success are marginal. It takes a substantial financial investment as well as a positive attitude and intestinal fortitude, Mr. Kelly notes.

The new station needs to project an image that instills confidence in prospective advertisers, according to Kelly. An important part of the progressive look at TV-26 is its fully equipped facility—a plant that can handle just about every requirement.

The Astrodome provides the familiar setting for this late-season baseball game covered by the TV-26 Remote Crew.

Community involvement at TV-26 is typified by this special coverage of a charm pageant held in a downtown hotel.

TV-26 studios and offices are located on Westheimer Boulevard, about five miles from the downtown antenna/transmitter site.

Major Equipment at TV-26

Antenna	— TFU-46K Pylon, Omnidirectional
Transmitter	— TTU-60, 60 kW UHF, remote controlled from studio
STL	— TVM-6 Microwave, remote controlled from studio
Color Cameras	— TK-44A (5); 3-studio; 2-remote unit
Film Systems	— TK-27 Film Islands (2) with TP-66 and TP-7 Projectors
Video Tape	— TR-60 (4) TCR-1000
Video Switching	— TS-51, Air; TS-40N1-B, Production
Audio	— BC consoles, cartridge tape, auxiliary equipment
Lighting	— Kleigl



Another key figure responsible for fashioning KVRL's success, Station Manager Richard Albitz, is proud of the remarkable sales record achieved by TV-26. The station's commercial log now includes an impressive list of national advertisers such as Sears, Ideal Toy, Aamco and others to complement the regional and local sponsors. Mr. Albitz is particularly pleased with the TK-44 cameras, which he says give TV-26 "the best live color in Houston".

KVRL, TV-26 is succeeding in its market by following a carefully conceived game plan. Locally originated programming ties the station firmly to the community. The station is run with smooth efficiency by a veteran broadcast staff. Finally, but not least important, TV-26 has a modern technical facility, completely equipped for full service. And, from the top of One Shell Plaza, the KVRL antenna blankets metropolitan Houston and its environs with a crisp, sharp color signal.

TV-26, Houston, has put together that combination of ingredients which add up to the best success pattern—a profitable operation. ■

**WE'RE GETTIN'
IT ON!!** CHANNEL
26
HOUSTON

Visibility and identity for TV-26 is sustained by an aggressive promotion program to viewers and advertisers.



'CART'

Becomes Part of Station Lifestyle

It was just two years ago that BROADCAST NEWS, in a report on what TV producers and advertising planners along Madison Avenue saw ahead for the TCR-100, predicted:

"... as a bonus to both broadcasters and broadcast buyers the TCR-100 will 'liberate' many productive hours of reel-to-reel video tape recorder time, and manpower."

With all the smoothness of a well-run station's spot schedule in the primest of time, what was foreseen a couple of seasons ago is indeed coming to pass at a growing number of stations. Small wonder that the arrival of a "Cart" unit at a station in recent months has been greeted with enthusiasm.

KNTV Finds Local Production Potential

"The 'Cart' is a fantastic advance in the state of the art," says Stewart B. "Stew" Park, Program Director of KNTV, San Jose, whose TCR-100 has been operative for about a year now. "It makes it possible for small stations to engage in much more local production. And the ease of sequencing commercial spots frees us from the trauma of pushing all that tape, reel-to-reel, through the eye of the needle.

"We are currently using our TCR-100 exclusively for the airing of commercial announcements, promotion announcements and PSA's. At this point approximately 99% of our active video tape commercial announcements are run on cartridge tape. Our machine is not used as a production machine, but as our on-air playback machine, which frees our three reel-to-reel recorders for production work. As a consequence, the effect on local production has been to make available to us our full complement of reel-to-reel machines."

There are engineering cost reductions brought about at KNTV by the TCR-100. But, of equal importance is the fact that the RCA cartridge recorder is generating other revenues and opportunities for the San Jose station through its "liberated" reel-to-reel capability.

"We're not likely to represent a really serious threat to the production capability of production centers like Los Angeles," admits Park. "But there is new production business to be had—if you look for it. For example, we have a lot of modern industry in this area, and much of this industry has its own internal communications problems—employee training programs, sales meetings, demonstrations of new products or manufacturing techniques, management seminars, and so forth.

"One direction a station can go in a smaller market, once it has expanded production capability backed by expertise, is therefore into the industrial audio-visual production field of closed-circuit live or taped programs, transfers to non-broadcast video tape or film, etc. Having the 'Cart' unit at KNTV not only gives us a chance to use our full camera and reel-to-reel production capability for programs and commercials but to get into sophisticated 'outside' assignments."

With the extra, freed-up tape capability, KNTV manages to make two studio color cameras behave like three. Reports Stew Park: "We will put a few shots, possibly inserts or special closeups, on one of our reel-to-reel machines on a 'wild' basis, then roll it on cue into the 'work reel' on another machine. Using a reel-to-reel

machine as an extra 'camera source' was just not possible most of the time before we got our 'Cart'."

Station after station reports, often with delight, the "rediscovery" of production capability that has come about through the introduction of "Cart" into the station's operational lifestyle.

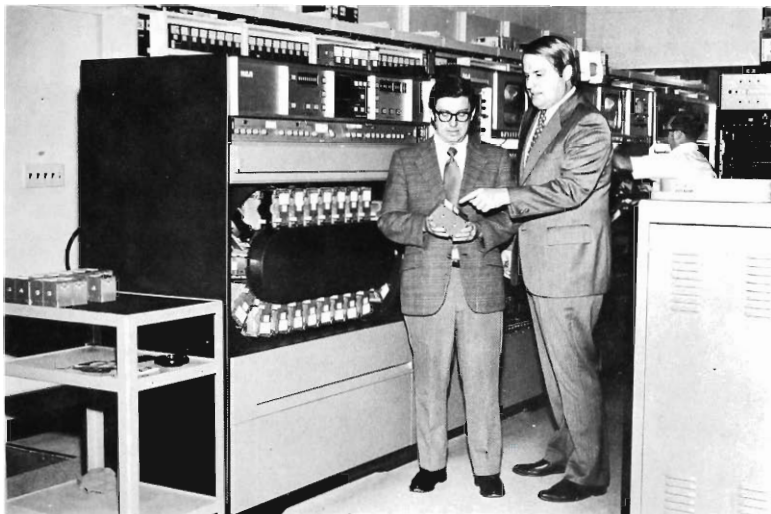

At present about 99% of all KNTV's commercial announcements are run on this TCR-100.

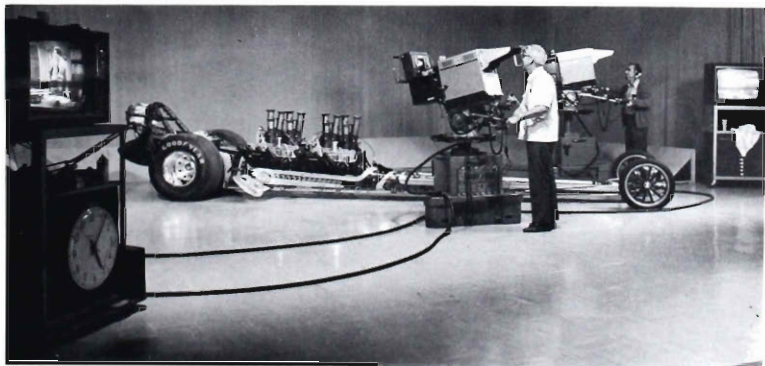

Freed-up reel-to-reel machine acts as third camera in KNTV production of automotive commercial.

WWL-TV Breezes Through Heavy Commercial Schedule

"We take a lot of pride in our major-market news operation," says Francis Jacob, Jr., director of engineering for New Orleans' WWL-TV. "We get strong ratings and have a heavy commercial schedule. In fact, a single commercial—particularly if it's part of a 'saturation' campaign—may run two or three times between 5:00 and 6:30 P.M., during our early-evening news period. A couple of years ago, this would have absorbed our reel-to-reel capability—even with five machines—to a large extent. Today, with one reel-to-reel unit traded in for new gear, we not only have enough capability with four but we can even *record* during news periods! One fast-starting reel-to-reel machine, plus our 'Cart', is enough to handle the news shows."

In the not-so-good-old-days at WWL-TV, from an operational standpoint, before the arrival of its "Cart" unit from RCA, the routine on taped commercials (those produced or distributed on tape, plus some transferred from film) went like this, according to Jacob:

"Before the cart machine, a spot or spots had to be threaded onto the reel-to-reel machine, run through the color bars for proper setup, level and phase, through the billboard for spot verification—because

some reels had more than one spot—and back-timed to six seconds preroll.

"Sometimes, for each spot, this procedure would have to be repeated before all controls could be properly set for optimum results. This adds time to the headwheels on an almost two-for-one basis. With the cart machine, the headwheel time is cut down to the actual time of the spot, or almost one-for-one basis. We have found no variance of chroma level, or out-of-phase tapes from the carts that were recorded recently—or six months ago."



Indicative of WWL-TV's heavy tape load is their library of active "carts". TCR-100, below, handles the commercial load which would have absorbed the capability of as many as five reel-to-reel machines.

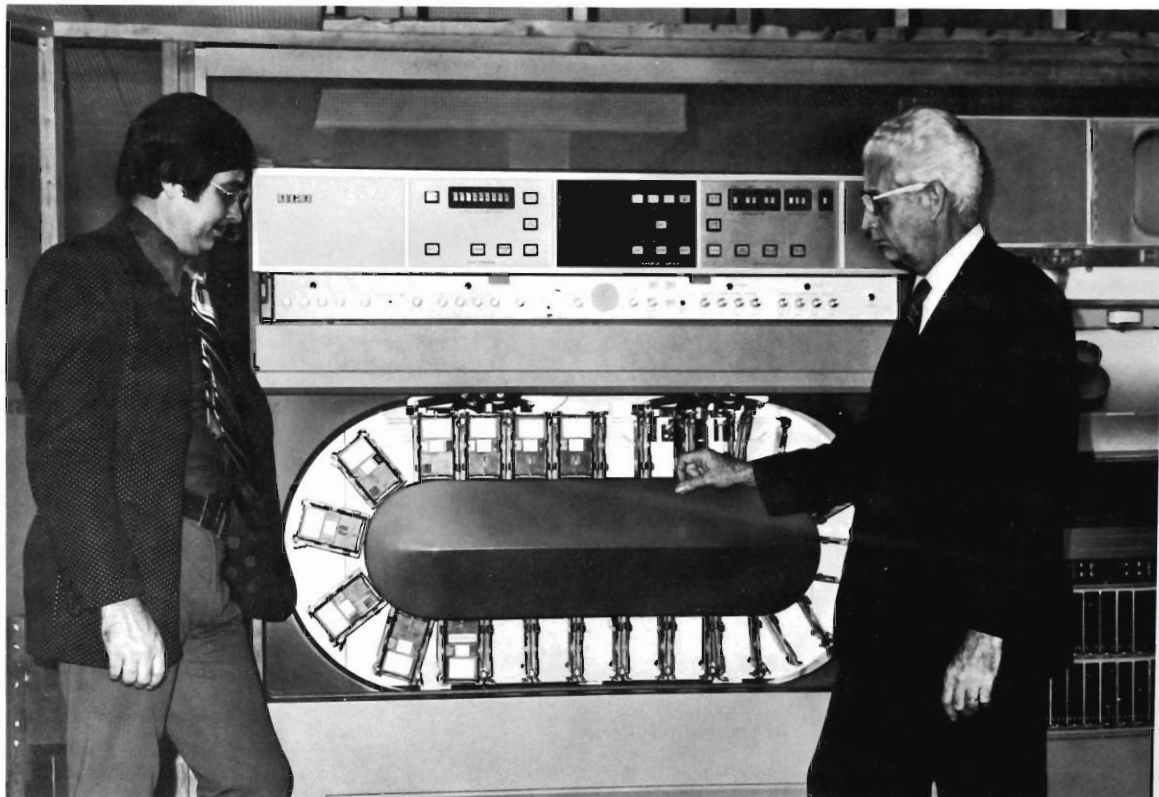

Separate Production Activity for WISN-TV

In major markets, or markets located far from commercial production centers like New York and Hollywood, stations sometimes go "all-out" in the search for new commercial business made possible by the freed-up reel-machine tape capability, or by the dubbing and/or duplicating facilities made possible.

Such a station is WISN-TV, Milwaukee. In fact, the Wisconsin outlet has an entire "sideline" business as a commercial production house, using the station's "Cart"-liberated tape capability as an important revenue source. Business is so good, after a couple of seasons of active production, that the operation now has its own identity: "Studio 12".

Studio 12 has its own studio facilities, its own letterhead and billing systems, its own personnel, its own control room—even its own parking area for visiting agency and client personnel, not to mention visiting performers like Buddy Ebsen (of "Beverly Hillbillies" fame, who did regional Pearl Optical Co. tape commercials at Studio 12) and ace sportscaster Ray Scott.

"Something like 1400 commercials have already been produced at Studio 12," says Ralph Kuehn, the organization's production director. "On a very elaborate spot, we may spend as much as a week's time in the studio, and we make heavy and constant demand on reel-to-reel recording capability and studio equipment freed by the TCR-100. The unit is a real 'support' to our production-house operation. Its engineering is amazing."

Building a sideline like Studio 12 is not something you do overnight, but once its reputation for production skill spreads around rewards are measured in terms of many additional revenue dollars—and 'repeat' business, often from important clients and agencies.

Studio 12's special parking lot is frequented by agency producers, copywriters, art directors and others from the likes of McCann-Erickson (regional commercials for Miller High Life); Needham, Harper & Steers (spots for the new S. C. Johnson product, Edge); Robert Block (network-level spots for A&P Stores); Young & Rubicam's Chicago branch (Milwaukee Chrysler Dealers); and Post-Keays-Gardner (Sentry Foods, Toro Sprinklers).

WISN-TV's cartridge unit plays another role in the Studio 12 operation, apart from handling the bulk of the station's on-air commercial tape plays smoothly and reliably. It is used as part of Studio 12's distribution facilities for completed commercials. These, according to Kuehn, are dubbed to cartridge from reel machines; then, cartridges are arranged in various orders and sequences (according to advertiser/agency schedules for particular markets to which commercials are to be shipped) and dubbed back to reels, which are then boxed and shipped."



Output of Studio 12 commercial production activity at WISN-TV is increasing, thanks to "Cart"-liberated tape capability.



Other production facilities get full-time utilization in completely equipped "Studio 12".



In the WISN-TV tape room, the "Cart" handles the bulk of on-air tape plays, freeing reel-to-reel machines for production.

Experiences at WTAE-TV

From the standpoint of production back-up or capability-creator for stations, the view of virtually all broadcasters contacted for this report was summarized by Ed Young, operations manager for Pittsburgh's WTAE-TV:

"Although we expect to find more and more things to do with it, our use of the TCR-100 is primarily in the commercial spot area. It has lightened the VTR problem greatly. Also, it makes for smoother and more sophisticated 'look' on the air, with transition pieces, program openings and closings and the like. We are not trying to 'force' our use of the machine. It suggests its own uses."

The swing, increasingly, to tape in commercials—as a production or distribution medium, and certainly as the primary medium from which most of a station's commercials (local/regional/national) and local promotion or public service announcements actually go on the air—is another big factor in high acceptance by stations of "Cart" units. To hear stations tell of their "Cart" experience is also to wonder how stations ever got along with only reel-to-reel and film capability as the reproduction media for commercials.

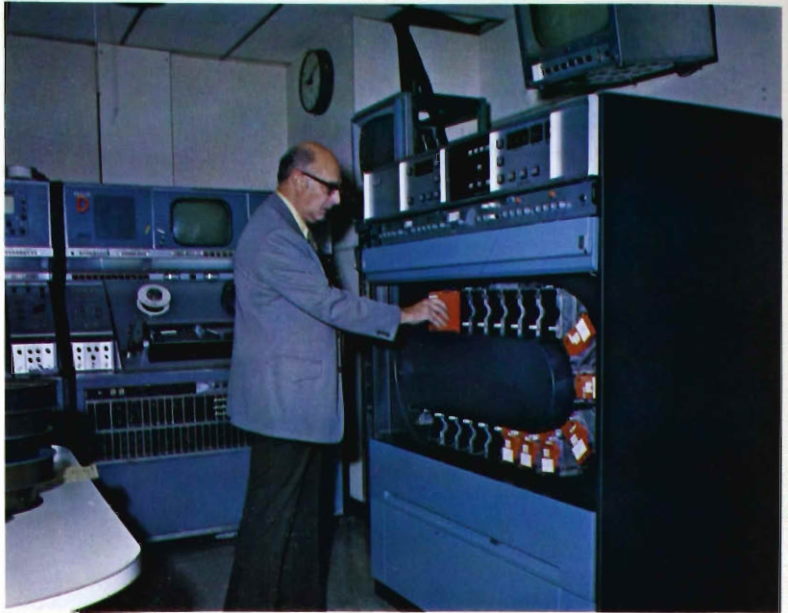

WTAE-TV's "Cart" unit has lightened the VTR problem and produced a smoother, more sophisticated look on-the-air.

Cart Takes Up the Load at WPTV

In West Palm Beach, Florida, Steve McCleaster—operations director for WPTV—told BROADCAST NEWS: "Our 'Cart' has freed our reel-to-reel machines to do what they were designed to do: to be part of local production of programs and commercials, or delayed programming. We now have three reel-to-reel units free during a news block, and we no longer stop recording sessions on reel-to-reel to play something on the air."

WPTV gets strong ratings and audience support for its early-evening news block, "Dateline 90," which consists of an hour of the station's own news reporting that flows smoothly, at 6:30 P.M., into the half-hour NBC-TV network newscast that follows.

Reel-to-reel units at WPTV, ready for quick action because all commercials are on the cartridge unit (plus a few on telecine chain), are even used, on occasion, to take a late network news feed *during the local news show*. This is then worked into the routine of the local news while it's on the air—a juggling act that calls for true professionalism.

"Our 'Cart' really takes the load off the reel-to-reel equipment," says McCleaster. "At other times, 'Cart' enables us to schedule an increased amount of syndicated shows distributed on tape, since we still have reel-to-reel capability for a variety of things ranging from delayed broadcasts to studio commercial production."

WPTV doesn't hesitate to take on commercial assignments with a fair degree of production sophistication.

Reel-to-reel capability enables tape commercial production utilizing the "'A' and 'B' rolls" technique, according to McCleaster, in which segment scenes or

shots of a commercial are laid out on two "parallel" tapes and then combined (with electronic opticals, dissolves, wipes, etc.) on a third recorder through switching and control function. A library of reel masters thus obtained is stored and dubbed to cartridge for actual airplay.



"Cart" machine at WPTV enables station to schedule additional tape syndicated shows while retaining reel-to-reel capability for commercial production.

Stepped Up Commercials and New Activity at KIRO-TV

At Seattle's KIRO-TV, the TCR-100 has become very much a part of the station's operational lifestyle—particularly so in the stepped-up commercial and news-making activity that accompanied the 1972 political year.

Apart from its "Cart", KIRO-TV has five reel machines—and they were enabled to pull their weight significantly in the station's revenues for 1972, thanks to the "cart"-liberated capability.

"At the height of political activity," says Nick Freeman, KIRO-TV production manager, "we found ourselves becoming a real distribution center for political spots. We dubbed an average of two spots for each of nine candidates—including Albert Rosellini, running for governor of Washington state—and shipped them out to 11 stations. To Bellingham, Yakima, Portland, etc. That's something like 200 dubs—and we did it in 10 days. When I say our capability to record on reel tape is freed by "Cart", that's the kind of thing I'm talking about."

Like many stations, KIRO-TV has an early-evening news show ("KIRO-TV Eyewitness News") that flows, in this case,

from Walter Cronkite's network news report. "We come out in a tight cue onto a 'rolling Chroma' teaser for our local newscaster who does a twenty-second synopsis of major stories against a background of headlines. It's pre-taped each day, of course, and dubbed to 'Cart'. Then, we go to a wide studio shot of the five or six news personalities on the team, for about 10 seconds. Then into opening commercials, etc.

"This kind of transition, in which we are going from network to local, and in and out of tape and live, gives our news a smoother, more attractive, more 'professional' look. It provides, as well, a strong teaser 'bridge' to hold the audience from one news segment to the next. And, it's only possible because we have the "Cart" on hand to avoid real switching problems."

More and more commercials are reaching KIRO-TV (and other stations, too) on tape, according to Freeman. "About 30% of 'national' commercials are already on reel tape when they arrive, and about 80% of local/regional commercials are tape. We transfer all of them to cartridge. We are, as a matter of fact, accumulating quite a library—something like 650 at the moment."



KIRO-TV's local news programs get a more attractive professional look by using the "Cart" for teasers and bridges, as well as commercial segments.

Two TCR-100's at WBNS-TV

The swing to taped commercials, and the proliferation of cartridge tape material, raises an obvious question:

If one "Cart" machine enables a station to handle its on-air load of taped commercials smoothly and efficiently, and meanwhile "frees" basic reel-to-reel capacity, wouldn't two "Cart" units be even better?

BROADCAST NEWS raised that question with WBNS-TV, Columbus, O., and with Don King, operations manager, and William T. Orr, vice president, engineering. Reason: WBNS-TV is the first U. S. station to have two "Cart" units installed, as a matched pair, on the premises.

"The units are interchangeable, and each backs up the other, but we use them in different basic modes on a day-to-day basis," says King. "One unit is used, primarily, for recording in a dubbing mode from reel-to-reel units—we have four. The other is used, primarily, for on-air playback."

One problem solved for WBNS-TV by having a double "Cart" capability is the increasing amount of "localizing" that is being called for in commercials arriving on tape or film at the station. Essentially, this is a matter of dubbing dealer names, store addresses, retailer phone numbers, price specials, etc. on the tag end of commercials.

"Our problems are made a lot easier in localizing commercials for accounts like Proctor-Silex, Eastman Kodak, Chanel #5, Mattel Toys, by having two TCR-100 units available," says King.

Are two "Carts" better than one?

The answer, by all indications at WBNS-TV, is "Yes".

Says WBNS-TV's William Orr, head of the station's engineering department:

"On what is virtually an automatic basis, we are transferring all non-program air material to 'Cart' operation—commercials, public service announcements, station promotion announcements. A lot of film spots are played on the air from the cartridge machines, particularly film spots that are scheduled for a heavy play in a short period of time. Film is subject to breakdowns, scratches and other problems. First, we transfer to reel-to-reel, then to cartridge.

"We've had our two 'Cart' units since August, 1972. So far, we have more than 400 spots or material segments on cartridge through transfers and dubbing. We may have as many as 2500 cartridges in our library after the first year of two-machine operation—no small problem when it comes to storage and indexing. We're likely to stay at that 2500 level, however, as commercials and announcements are withdrawn from service and new material comes in."

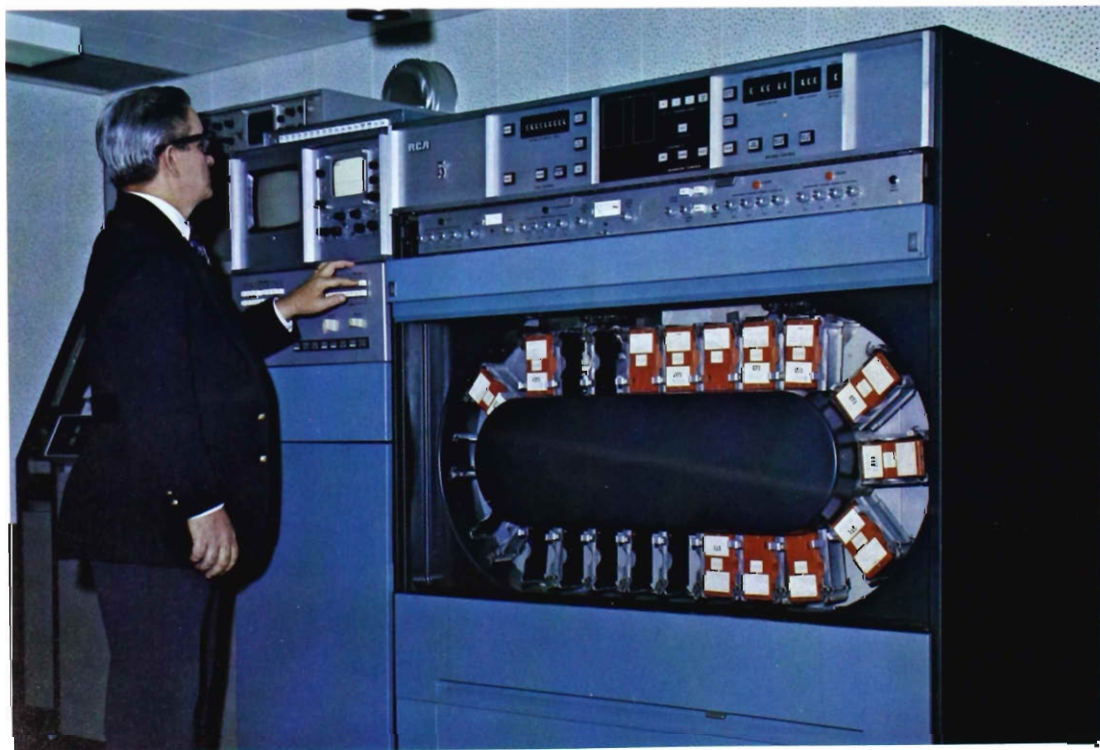

One of two TCR-100's at WBNS-TV. One unit is used primarily for recording in a dubbing mode; the other handles on-air playback.

The Film-to-Tape Question

Stations with "Cart" equipment on-line for some time generally find their own formula for integrating it into the station's day-to-day operations, determining how to handle the film-to-tape question occasioned by the commercials that arrive daily at the average major-market outlet.

WWL-TV's Jacob, who has had a TCR-100 as part of his station's complement of broadcast hardware for nearly two years and who has been keeping tabs on the trends in commercial distribution, puts it this way:

"Like all stations, we still receive film spots and, since we have the capability, generally play them as 'film' on the air. Sometimes, however, we will receive only one print—and a heavy schedule for it. Or, we may have the right number of prints on hand—but the schedule may call for that spot to come up several times in a news or movie period. We had 17 candidates running in a primary election for Governor. Ten had large budgets, and, as a consequence, their requests for time came fast and furiously. The program department had to add a late-late movie to the schedule as a vehicle to accommodate the number of requests for spot time.

"During this time, the average number of spots between 5:00 P.M. and Sign-Off ran between 120 to 138 spots per night—and the majority were on cartridge tape. On only two nights before election did we lose any spots, and the reason we lost these was there were no open spots in the night's log to play a make-good. Had we not had the 'Cart' machine, we would not have been able to play that many spots on the reel machine."

Transfer of film commercials to cartridge is something that stations contacted by BROADCAST NEWS do almost automatically—when there may be a problem with a print due to heavy schedules, or in case of prints with sub-standard color balance.

Generally, stations reported they preferred to avoid "hybrid" situations in on-air commercial playback (a mix of a lot of reel-to-reel spots plus a lot of cartridge spots) by putting everything on the "Cart" as soon as possible. Most predicted that "cartridge" and "tape spot" would eventually be synonymous, with film spots—which are steadily dwindling in sheer number—playing usually (but not always) as "film".

TCR-100 Is Its Own Testimonial

Stations also reported another phenomenon—one with a not-casual resemblance to the "slice-of-life" commercials (in which Mom explains to Daughter how to get those blouses "sparkling white", or Dad is shown by Junior how to wax the family car with a minimum of effort and a maximum of shine, etc.) that so often unreel during commercial breaks.

"Cart"-equipped stations are among the best salesmen for the TCR-100, by all indications. Partly, it's a matter of the "community spirit" among broadcast executives; partly it's the impact of the third-party-endorsement on a station that's "thinking" about joining the cartridge trend.

"Another station in Seattle was considering the purchase of a TCR-100," recalls KIRO-TV's Nick Freeman. "They came to an SMPTE lunch we held at our studios, looked at our unit, watched it operate, and asked a lot of questions. The last I heard, they were buying one." ■

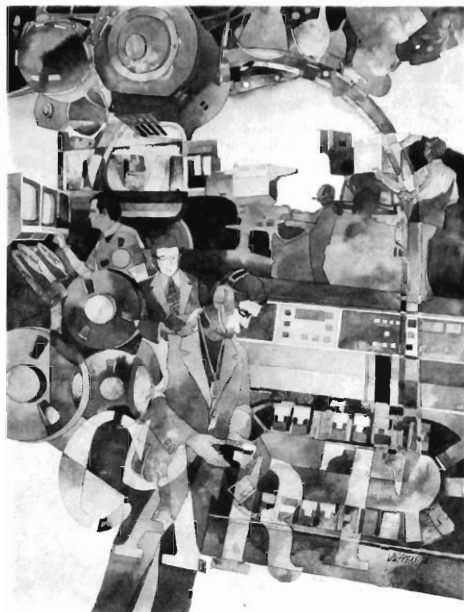

Super Power UHF at Kaiser Broadcasting

By Edward H. Herlihy
Director, Technical Services
Kaiser Broadcasting Corporation

Kaiser Broadcasting moved into television in a big way in 1965, with the construction of UHF facilities in major markets. The first station built was WKBD-TV, Detroit, which was largely equipped by RCA, including its TTU-30A 30 kW transmitter. During 1965, Kaiser's second facility, WKBS-TV in Philadelphia, was constructed also using RCA equipment including a TTU-30 transmitter. Shortly after going on the air, the WKBS transmitter was converted

to 60 kW operation, which was also done at WKBD in Detroit.

In quick succession after Philadelphia came KBSC-TV, Los Angeles; WKBG-TV, Boston; WKBF-TV, Cleveland and KBHK-TV, San Francisco. The last three of these stations also were equipped with RCA TTU-60 Transmitters.

All of the Kaiser stations operated for a period of time with an effective radiated

1. Parallel transmitter installation at WKBG-TV, Boston.

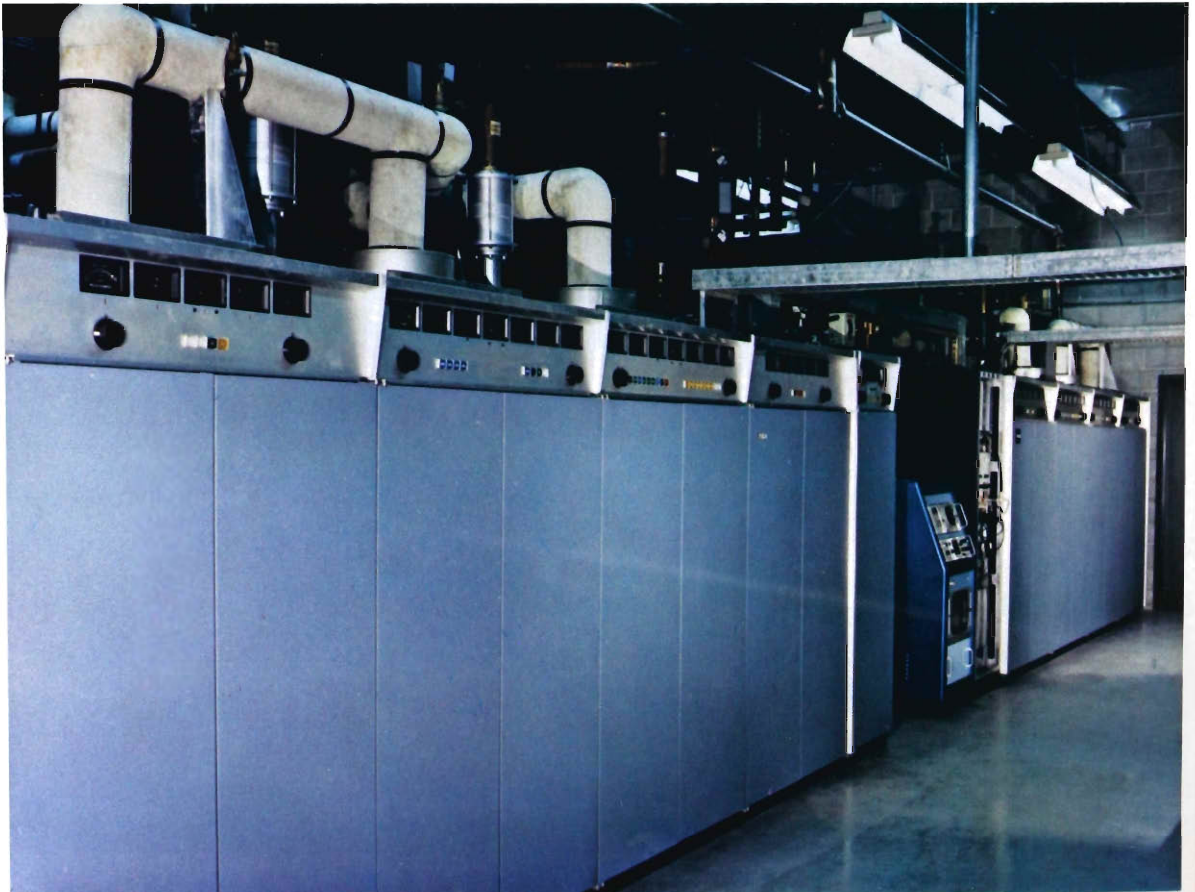

Super-Power TV Bags Bigger Audiences

Doubling the power of the transmitting plants represented a significant engineering accomplishment for Kaiser Broadcasting Corporation—as well as an investment of more than two million dollars.

In each of its four Eastern markets, the Kaiser station now has the most powerful transmitting plant of any station in the market—VHF or UHF. The San Francisco outlet, KBHK-TV, is now operating at

60 kW, but will go to super-power on completion of the Mt. Sutro antenna/transmitter complex.

From a management point of view, the question was: "Did the payout bring desired results—in market coverage, audience response and advertiser acceptance?" For Kaiser, the answer was a clear-cut "Yes".

WKBF-TV, Cleveland, programmed a "blockbuster" evening to celebrate the switch to super-power. An ARB survey gave WKBF a resounding 23 per cent average audience share for the 7-11 P.M. period that evening. And the telephone company reported one of the largest tie-ups in its history as a result of viewers calling in to tell the station about the improved reception.

The same scene was repeated in Boston, when WKBG-TV scheduled "Music Man" as their special super-power inaugural programming. It scored an 18 per cent of prime time audience (ARB coincidental).

In Detroit, WKBD-TV staged a "Super-Sunday" with 15 hours of top-rated programming. And, in Philadelphia, Super-Power Day paid off for WKBS-TV viewers with a \$48,000 (for Ch. 48) "Shower of Powerful Prizes".

"The switch to super power," notes Richard C. Block, Vice President and General Manager, Kaiser Broadcasting, "gives Kaiser stations equivalency with the VHF stations in its markets, and provides a significantly improved Kaiser service for its communities."

power of approximately one million watts. Then, in late 1969, Kaiser management began to explore power increases for all facilities, looking toward better coverage and an increased share of audience.

Various methods were considered, including installation of new 110 kW transmitters, as well as adding transmitters to present facilities to increase power. From both the investment and technical viewpoints, parallel 60 kW transmitters, in combination with new antennas, offered the best solution. Consequently, in July 1970, Kaiser signed an order for five RCA TTU-60 transmitters and five TFU shaped vertical "G" series Pylon Antennas. Installation began in October of 1970 at WKBG-TV, Boston.

In each of the Kaiser stations, the new 60 kW transmitter was installed side by side with the existing transmitter. The color illustration shows the layout of the Boston installation. Fig. 2 shows the entire system line drawing of the parallel transmitters as installed. The combined visual outputs of each transmitter pass through a seven-hole 6 1/8 inch coax patch panel prior to being combined in a waveguide hybrid combiner. Waveguide is used from the output of this combiner to the input of the filterplexer.

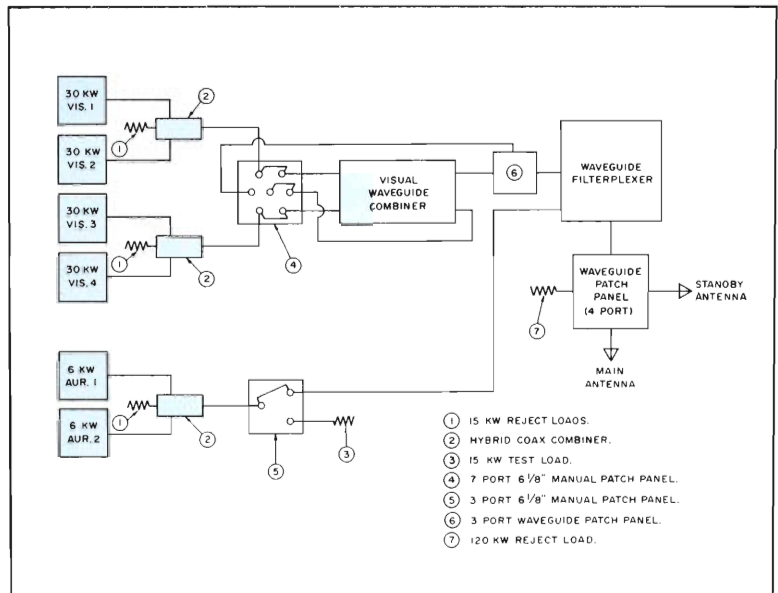

2 Transmitter system
3 Exciter switching.

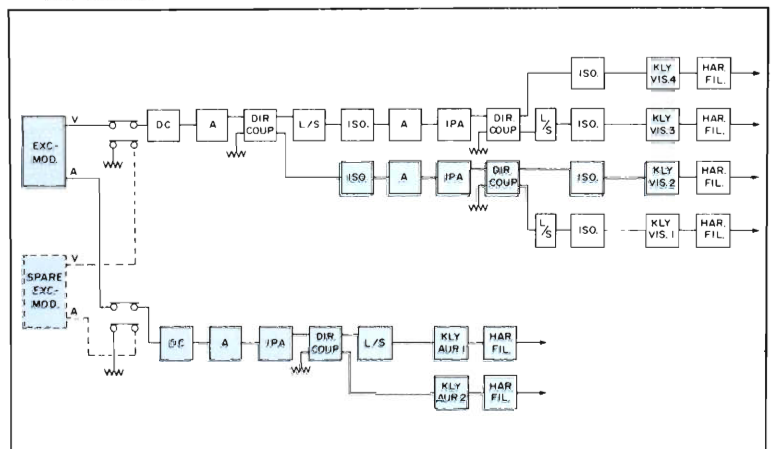

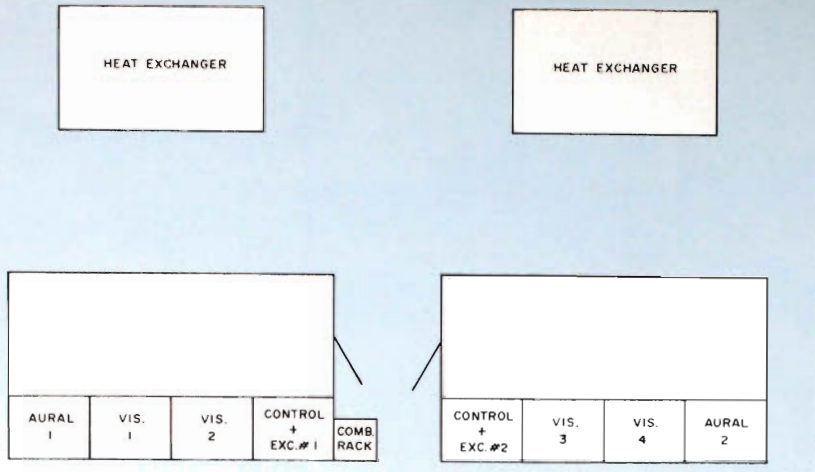

4. Typical floor plan.

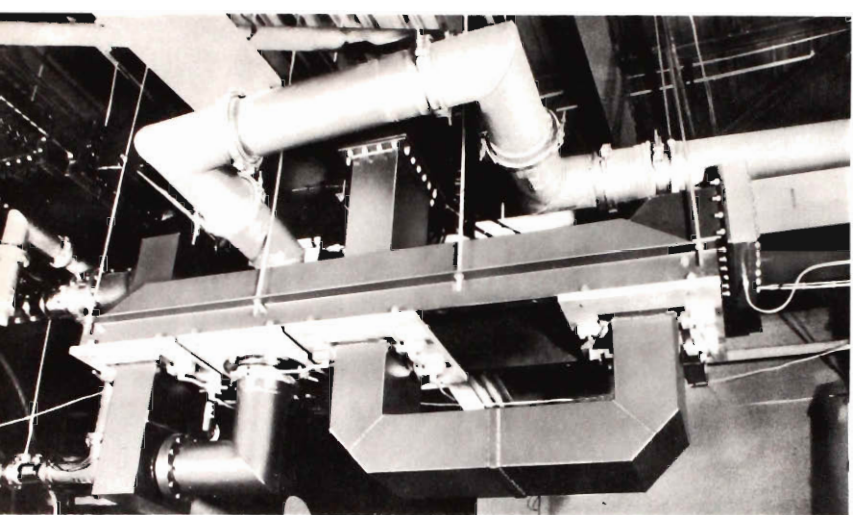

5. Quick-disconnect waveguide patch.

6. WKBF Transmission Line layout.

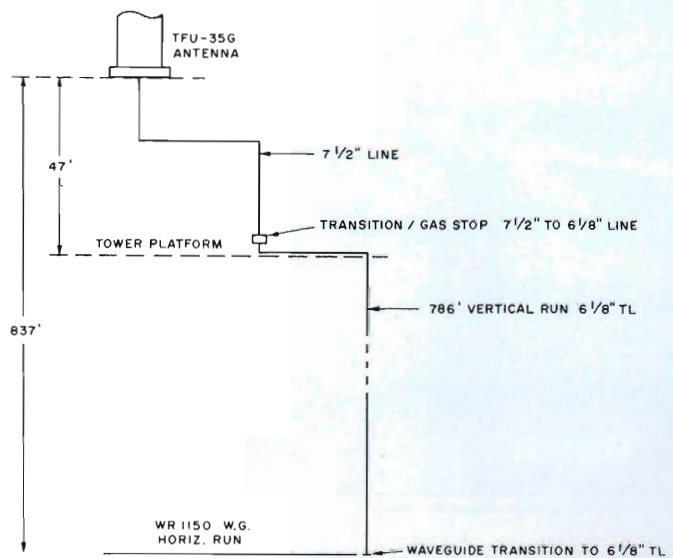

The aural power from each transmitter passes through a three-hole 6 1/8 inch patch panel and into a coax combiner whose output is fed into the aural input of the filterplexer.

RCA designed an input combiner rack which includes automatic exciter switching, reject power monitors, combined aural and visual power meters and line stretchers to balance the two transmitters. Fig. 3 is a line drawing of the combiner rack.

Fig. 4 shows a typical floor plan arrangement of the transmitter installation at WKBG in Boston.

Since Kaiser had installed and maintained five 60 kilowatt transmitters over a period of years, much had been learned about transmitter installation and ways to make these installations more functional.

One of the needs was for fast easy transmission line patching on both the input to the filterplexer for reduced power operation, and the output for power calibration.

To meet this requirement, a quick-disconnect waveguide patch was developed as illustrated in Fig. 5. This patch can be taken down quickly by one man. This particular patch panel has been in operation for eighteen months with no difficulties. A modified version of the waveguide patch is used between the output of the waveguide combiner and the input of the filterplexer so that the combiner may be bypassed and one 60 kilowatt transmitter put on the air at full power.

Special consideration had to be given to WKBF-TV in Cleveland since it operates on Ch. 61. The major problem was transmission line power handling capability. All of the other stations utilized 8 3/8 inch transmission line. This line does not operate above Channel 56 so it was necessary to explore new methods of getting power to the antenna. The use of waveguide was thoroughly reviewed and rejected due to high windloading on the tower, and unknown variances in VSWR with changes in weather conditions. Experiments were conducted in Boston on test pieces of transmission line gassed with Dupont Freon 116, now commonly known as HFE gas. The tests proved that Freon could be utilized in a 6 1/8 inch transmission line and safely carry 132 kW peak power.

It was decided to go with this new type of line and gassing system at the Cleveland facility. Fig. 6 depicts the WKBF trans-

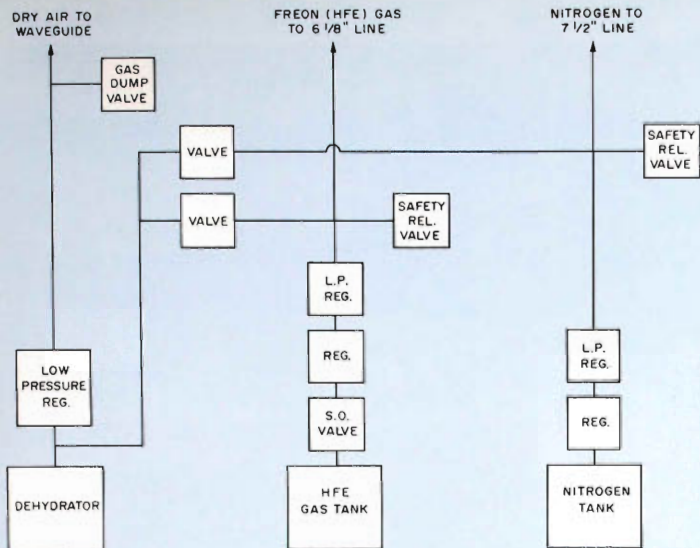

7. Gassing system at WKBF, Cleveland.

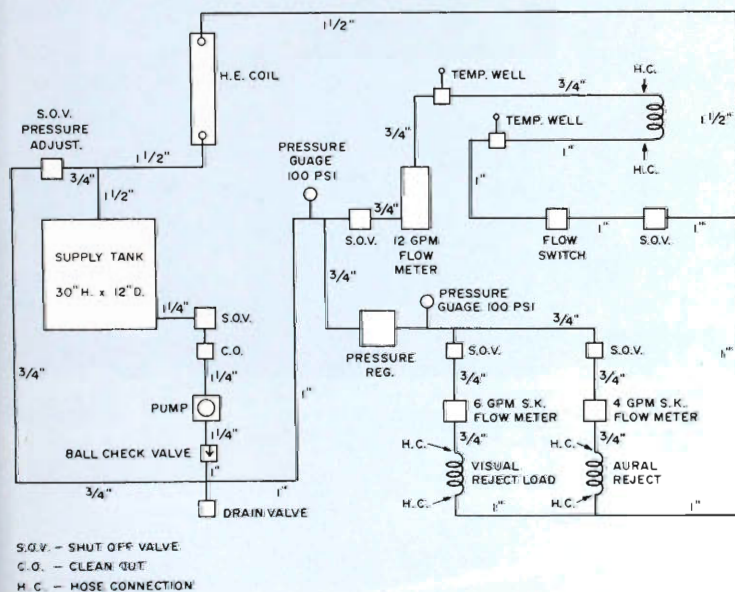

S.O.V. - SHUT OFF VALVE
 C.O. - CLEAN OUT
 H.C. - HOSE CONNECTION

8. Closed circuit water system.

mission line layout, while Fig. 7 shows the gassing system in use there. This entire system has been operating about eighteen months, with complete reliability.

In design considerations for the parallel transmitter installations, it became obvious that water use would be very high in reject loads if city water supplies were to be used. It seemed desirable to go to a closed circuit water system for cooling the combined visual and aural reject loads as well as the high power test load. A fourth coil was added to the new heat exchangers and this was connected to a tank and pump system similar to the one used on the transmitters. Fig. 8 is a line drawing of the entire closed circuit water system, along with flow meters and thermometers for power calibration using the calorimetric method.

All of the stations had originally purchased 60 kilowatt test loads. This item was salvaged by using it as the combined visual reject load. A new 120 kilowatt load was purchased for test purposes. The parallel transmitter concept has proved to be successful in all of these installations. With the parallel transmitter approach, should one transmitter fail, we operate at 25% power. This meets the FCC requirements to allow us a once a week inspection of the transmitter. With the exception of Detroit, all transmitters are remote controlled.

The technical performance of the transmitters has been excellent, with differential phase averaging 1.5 degrees and differential gain between 1 and 2 per cent, on a week to week basis.

All transmitter installations will be converted to RCA's new solid state exciters and drivers, TTUE-4A. This will improve the overall reliability of the entire system. ■



The old Allied Artists and Monogram Pictures studios formerly occupied KCET's new Hollywood location, churning out such forgettable fare as "The Knockout" with Joe Palooka. When grade B movies predominated, Charlie Chan always got his man on this lot.



KCET

Moves into
New Hollywood Home,
becomes Coast Production Center
for Public TV

The address is 4400 Sunset Drive, Hollywood. For 55 years this location saw the movie cameras of such companies as Allied Artists and Monogram Pictures filming everything from murder mysteries to singing cowboy oaters to apocalyptic science fiction thrillers. This is where Charlie Chan always outwitted the villains, where Joe Palooka always won his fights, where Hoot Gibson always (for some reason) chose his horse as a companion in preference to the local school "marm".

The cameras are still rolling now, but

they're television cameras and they record such widely acclaimed prize-winning public TV series as Hollywood Television Theatre. KCET, Channel 28, the community television station of Southern California, moved into its new home in November, 1971, giving it the finest facilities in public television and one of the most modern in the entire industry. It was a major milestone for a station that after just eight years of operation now ranks as the West Coast production center for the Public Broadcasting Service (PBS). As Federal

Communications Commissioner H. Rex Lee observed at dedication ceremonies for the facilities: "Though these studios cranked out a large number of grade B movies, they will now be providing the Los Angeles area and the rest of the country with nothing less than grade A television productions."

A Late Bloomer

In many respects, KCET is a late bloomer. When the station's governing board, non-profit Community Television of Southern



Barry Sullivan stars in "Another Part of the Forest", produced by Hollywood Television Theatre at the new studios of KCET, Los Angeles, for national distribution over the Public Broadcasting Service. The play is one of many that Hollywood Television Theatre will produce for public television during the 1972-73 season.

California, was formed in 1962. Los Angeles was the only major city in the nation without a public (then called "educational") outlet. The first board chairman was Dr. Lee DuBridge, then president of California Institute of Technology and later science advisor to President Nixon. Vice president was James L. Loper, now president and general manager of the station, as well as chairman of the board of PBS.

With money from the Department of Health, Education and Welfare, the Ford Found-

ation, some commercial broadcasters, a few corporations and individual contributors, the station went on the air Sept. 28, 1964. Quarters that were originally designed for radio were leased on Vine Street in Hollywood, with the Channel 28 transmitter located atop 5,700-foot Mount Wilson. Operating budget for the first year was \$854,000.

During its initial years the station was limited by a lack of color capability. This situation was corrected in two steps. First, KCET acquired color video tape recorders

and became the West Coast delay center for national public broadcasting programming in 1968. This meant it picked up programs from the East, recorded them on tape and fed them to stations in western states in appropriate time slots. The second breakthrough came in 1969 when KCET was designated to produce national public television programs such as *The Advocates* and *Hollywood Television Theatre* that required color cameras. A capital gift from NBC helped finance the purchase of four RCA TK-44A cameras, and in 1970 the station bought two more.



James L. Loper, president and general manager of KCET, addresses the audience at dedication ceremonies for the station's new facilities.

Facilities Outgrown

By 1970 the facilities at Vine Street had clearly been outgrown and continued operation there would have required making major improvements in lighting, air conditioning and stage areas. Thus, in July of that year Community Television of Southern California purchased the old movie lot at 4400 Sunset Drive in East Hollywood. Basic purchase cost and some funds for remodeling were made possible by a \$2.5 million loan from the Ford Foundation and a \$500,000 grant from the Michael J. Connell Foundation of Los Angeles. So far

the station has invested \$3.2 million in the new property, including the purchase price of \$800,000 and \$2.4 million in renovation and new construction. The cost of electrical equipment and air conditioning alone was \$1 million.

The new location consists of 3.7 acres. One of the studios on the new site is larger than all three studios combined in the former location. Studio B, which has 120 by 72-feet of usable space, is the largest in public television and is being utilized primarily for drama. Studio A,

95 by 72, has a seating capacity of up to 300 for audience shows. With completion of a rehearsal hall, KCET now has the flexibility to produce a show in one studio, put up or strike a set in the other studio, and hold rehearsals in the third facility.

An 18-foot-high archway connects Studios A and B and houses centralized rooms that contribute to more usable floor area on the stages. The larger studios also allow moving of scenery by forklifts so that sets don't have to be built in the studio in which they are used. A large investment was

Current KCET plant includes two large studios, Stage A, 95 by 72 feet, and Stage B, 120 by 72 feet, with the third stage area used for storage and building sets. Long-range plans call for temporary office buildings to be demolished and a four-story office building constructed on the east side of the location.

KCET's mobile unit can carry up to four TK-44 cameras. Scene here is from a special on how to handle medical emergencies.

Conversion to color was made in 1969, with four TK-44 cameras. Two more were added a year later; major steps in becoming the West Coast production center for public television. One of the cameras (bottom) records a KCET-produced special designed to increase public understanding of the law

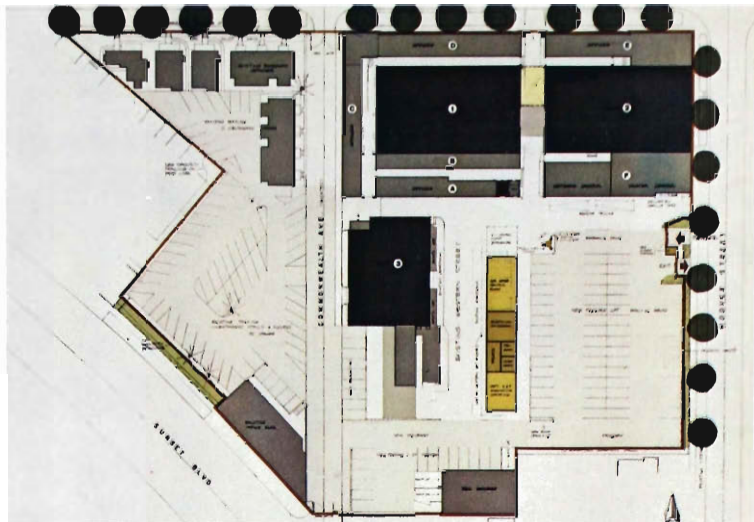

made in providing the most modern lighting control and dimming equipment for color television production.

Revamping of the facilities required installation of 64 miles of AC wiring, 25 miles of audio cable, 15 miles of coaxial video cable, enough air conditioning capacity to cool 135 Southern California homes, and enough electrical power to supply 270 homes. A reflector mounted on a nearby hospital bounces the microwave signal to KCET's transmitter on Mount Wilson, saving construction of a microwave tower on the new lot which is not in the line of sight of the transmitter.

A Dip in Tarzan's Pond

Renovation of the old movie lot, which had become badly deteriorated, was not without its hazards. One day a forklift working in a corner of the stage areas suddenly plunged through the floor into five feet of water—a pond Tarzan had used when he wasn't climbing trees.

On another occasion a construction crew struck water from a hidden outdoor pond, inundating part of the plant. The pond was filled in, but dozens of rats were driven out from some of the older buildings. Resourcefully, the construction company imported some cats to wipe out the rats.

The strangest discovery, however, was of a human skeleton under one of the old buildings. It wasn't determined how it got there or how long it had been there.

More Improvements Planned

KCET has completed phase one of its plans for the new facilities, consisting of the minimum necessary remodeling of the studios, technical areas and offices at a cost of \$3.2 million. This included purchase of the property, electrical, mechanical, general contracting, architectural fees and other move-in expenses. Phase two will involve the construction of a four-story office building of at least 24,000 square feet. Theodore P. Untiedt, vice president for engineering and facilities, anticipates this phase, which includes demolition of temporary bungalow offices, will be completed within two years at a cost of

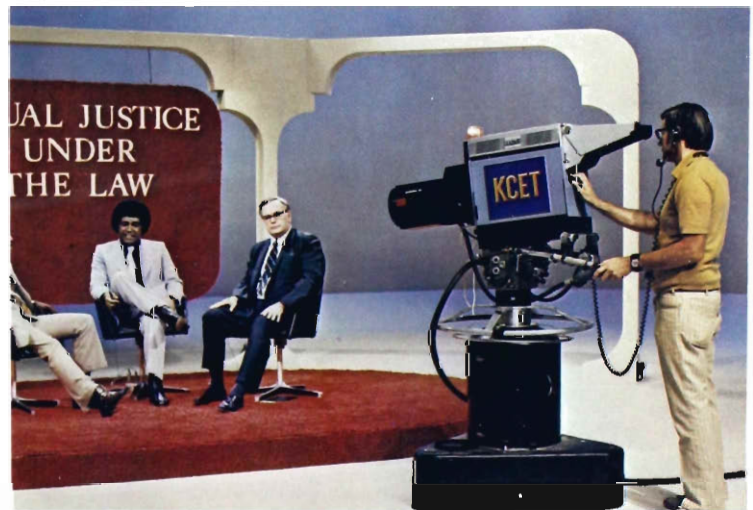

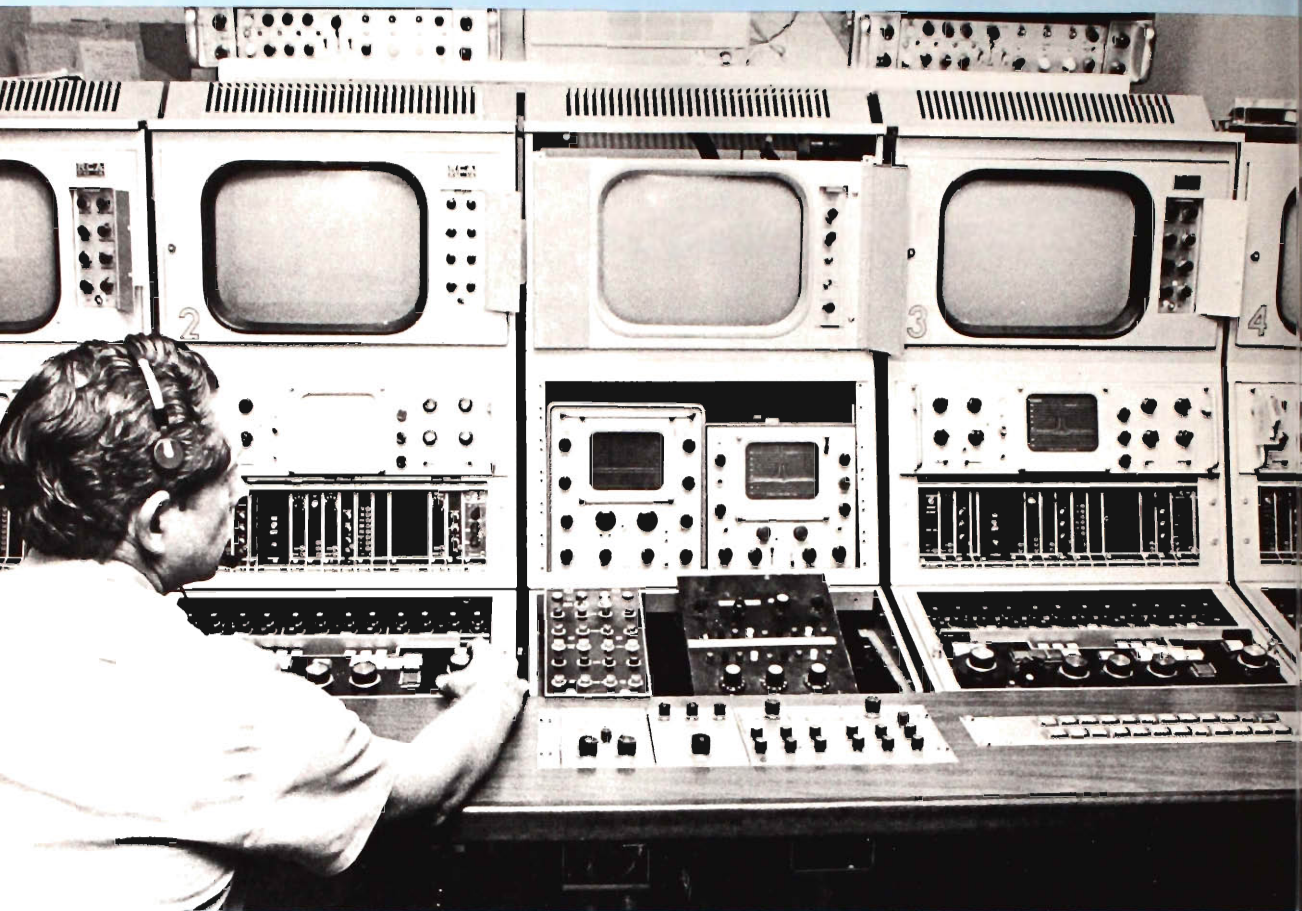

The video control room includes camera controls for four TK-44 cameras, a TK-27 film camera control panel, and remote control for TP-15 multiplexer.

Richard S. Scott, M. D., director of learning resources for KCET, talks with Los Angeles District Attorney Joseph P. Busch, whose office contracted for the production of four films designed to improve understanding between law enforcement agencies and the public.



Academy Award winner Walter Matthau is one of many top stars who have appeared on the KCET-produced Hollywood Television Theatre. The series, produced by Lewis Freedman, gained recognition for last year's most honored show, "The Andersonville Trial". The scene below is from Clifford Odets 1935 hit play, "Awake and Sing", and includes Martin Ritt and Ruth Storey.



\$800,000. Other long-range improvements are planned over the next several years in phase three.

John Yingling, production manager, describes the new facilities as "the most unique plant in public television and one of the most unique in the industry."

"Production units from the East love to come out here to work," Yingling says. "With more than three and a half acres of land, there's a feeling of openness and freedom that's conducive to creative expression."

National programming produced at KCET during its first year in the new facilities included Hollywood Television Theatre, Film Odyssey, The Space Between Words (in cooperation with the BBC), The Advocates, Doin' It, and such specials as "American Conservatives Confront 1972," hosted by William F. Buckley. Local programs during the first year included public affairs programs like Citywatchers and Current Events, plus the first news show by and for teenagers, music shows and specials.

Major Challenges

Two productions at KCET highlighted the first year of operation in the new plant and confirmed the value of the facilities. One was a live production of Hollywood Television Theatre, "Checkov, Live From Hollywood," the first attempt at live drama in years on television. The one-hour program, which would not even have been attempted in the old studios, went off without a hitch.

The other was the live coverage by the National Public Affairs Center for Television (NPACT) through KCET facilities of the 1972 California Presidential Primary. "This has to be the most incredible technical and production feat pulled off by public television," Yingling says. "It required cameras in our own studios, the Los Angeles Times, and four hotels in Los Angeles, plus remote feeds from San Francisco and from the Democratic Governors Conference in Houston. Each location could talk to any of the others.

"Complex productions of this nature can be done with ease here now. With all of these locations involved, the live coverage looked like an edited show. There wasn't a single mistake."

Naturally, with the success it has enjoyed in its new home, KCET is looking for more utilization of its plant. "Now that we've had a great expansion of our facilities, we're looking forward to a great expansion of productions," says Douglas Norberg, senior vice president for business. "We're already making a significant contribution to television production here, but we'd like to make a lot more." ■



"Doin' It," a five-part focus on the black experience in Los Angeles, was produced for local viewing by KCET, then was carried nationally over the Public Broadcasting Service.



Appropriately for a station located in Hollywood, KCET has made available to the nation some of the best motion pictures of all time with its "Film Odyssey" series, a collection of 26 film classics. Shown here are scenes from five of the films: (clockwise from upper left) "M" starring Peter Lorre; Jean Cocteau's "Beauty and the Beast"; "The Blue Angel," starring Marlene Dietrich and Emil Jannings; Jean Renoir's "The Rules of the Game"; and "Jules and Jim," starring Jeanne Moreau and Oskar Werner.

CFTO-TV Converts TK-44's for Dual Use as Hand Carried and Studio Cameras

By R. J. Hutcheon,
CFTO Engineering Dept.

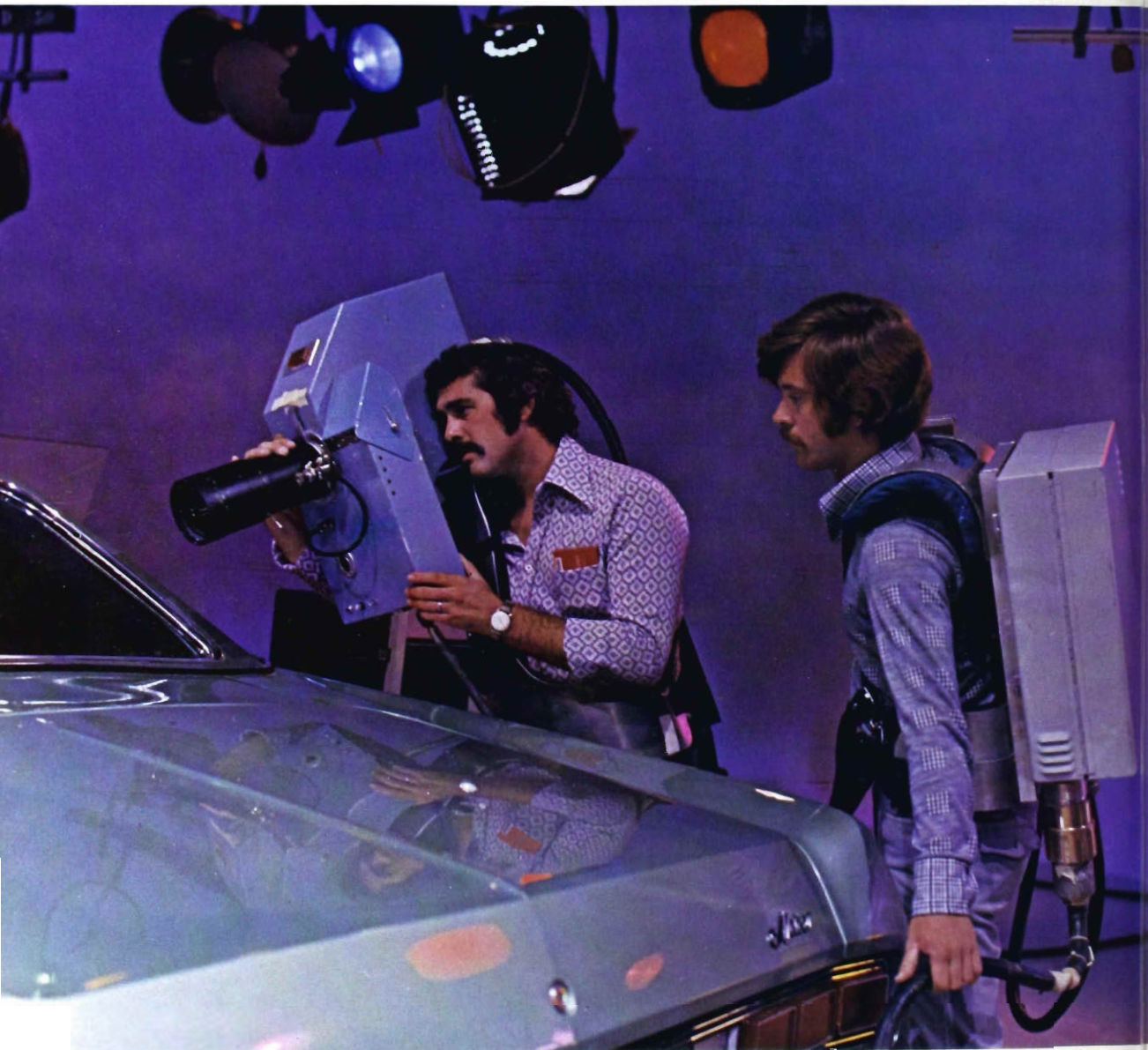

On remotes or in the studio, CFTO's hand-held TK-44 cameras provide an extra measure of flexibility.

Re-packaging of system achieves mobility, flexibility, economy—and top quality color pictures

Three years ago when CFTO-TV, Ch. 9, Toronto purchased seven (7) RCA TK-44A cameras, it was for the usual reasons: performance, stability, colorimetry, easy set-up, etc.

Converting two of the TK-44's for hand-held use started in December of last year, although several of us had kicked the idea around for quite a while before then.

CFTO production work for commercials, shows and remotes was expanding rapidly. There was a need—with increasing frequency—for a hand-held camera to go where our studio cameras could not, and also to provide studio quality color. The alternatives considered were:

1. Rental of portable cameras as needed.
2. Purchase of one or two hand-held cameras.
3. Converting a studio camera for dual use as a portable unit.

Economics dictated the rejection of alternatives #1 and #2. The rental cost of a portable camera, about \$1,000 per day, had to be added to production expense, and the rental period had to include set-up and rehearsal time. Since some of our shows might require a 10-12 day rental, cost was an important factor. Buying a hand-held unit was considered, but the cost of these cameras range from \$80,000 to \$150,000 depending on accessories and options. In addition, we looked at available portable cameras and felt that their performance did not match studio cameras in color quality, resolution, color matching or colorimetry.

The third alternative appealed most to CFTO management and was recommended by engineering. Since the hand-carried camera usually has limited usage, by converting a studio camera for portable applications, we were able to get dual usage from the same camera—and at the same time enjoy the advantages of mobility and flexibility. It's like having your cake and eating it, too.

In our operation, the TK-44's are used mostly with our mobile units for handling remotes.

We decided to convert the TK-44's because we thought they could be most readily adapted, and we also felt that the same color picture quality could be obtained from the TK-44 in the hand-held configuration.

Actually, aside from packaging, the only differences between the studio TK-44 and its two-piece version are a servo iris amplifier, and a smaller viewfinder.

After checking a number of possible arrangements for packaging the TK-44 into two elements, I made a cardboard layout of the camera head. From this model, our carpenters made a wooden box and mounts for the optics.

A similar procedure was followed for the processor modules, but this proved to be somewhat more difficult. A large variety of configurations had to be tried and experimented with before finalizing on what seemed to be the best arrangement. The carpenters came up with a wooden back-pack, and I had a special six foot cable made up to connect the camera head and processor.

The end result was not pretty to look at—but we made a picture and demonstrated the feasibility of our design to CFTO's Vice President of Production, Mr. D. Davis. At this point we got the okay to proceed with converting the first camera into an operational unit. Before this had been

completed, the second hand-held unit was added to the project.

Both cameras were completed with a capital outlay of some \$10,000. This sum includes lenses, viewfinders and other purchased components and materials, but does not include the valuable services and contributions of CFTO's talented staff. Without them, of course, the project could never have been completed.

Before looking at the design and packaging of the TK-44 portable unit, some further elaboration on the advantages it offers might be helpful. Most important, I believe, is the fact that these units are a part of an existing camera complement. Therefore the electronics, circuitry, modules and optics are identical. Servicing is simplified. And, because there is complete interchangeability of modules, there is less likely to be a panic when an emergency occurs. Modules can be substituted from any of the other studio cameras. In addition, there is the saving in time, since technicians are already trained on the TK-44 and familiar with its operation. Also, stocking of spare parts is easier and far more economical.

CFTO operates seven TK-44 cameras for studio and remote use. Two of the cameras are presently convertible for hand-carried applications.

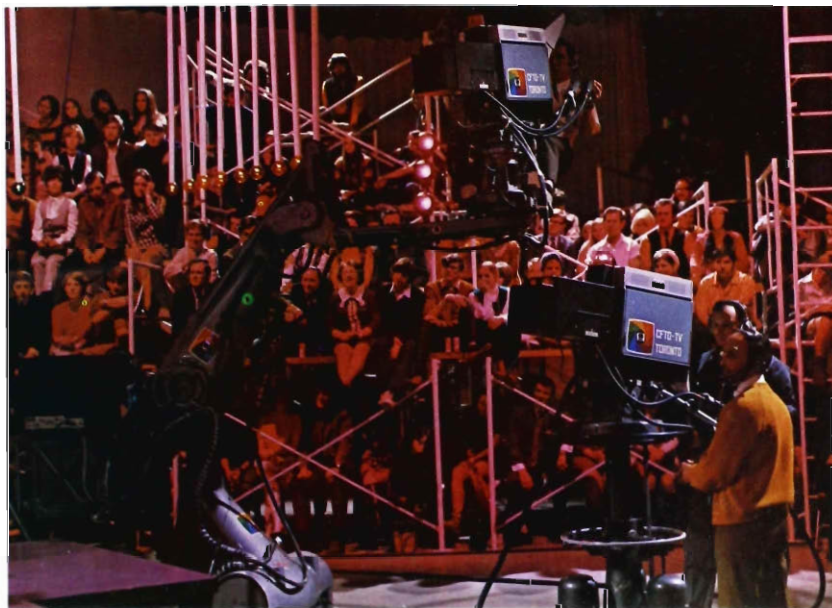

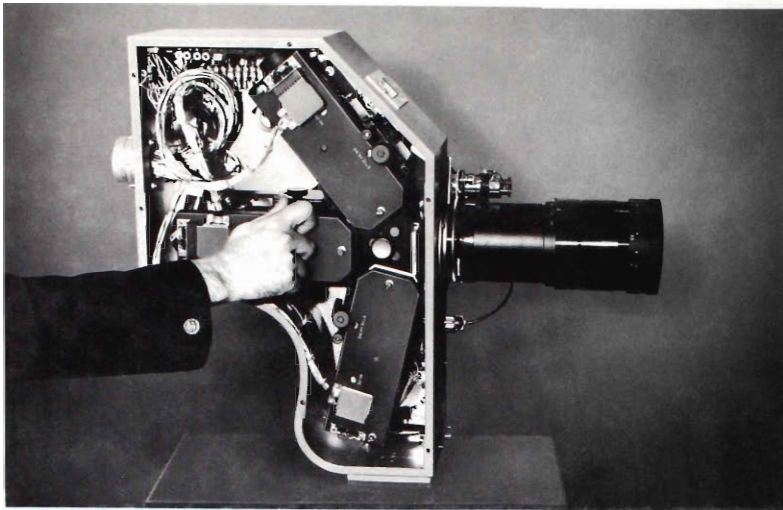

Camera-head design permits optics to be adjusted while camera is being carried.

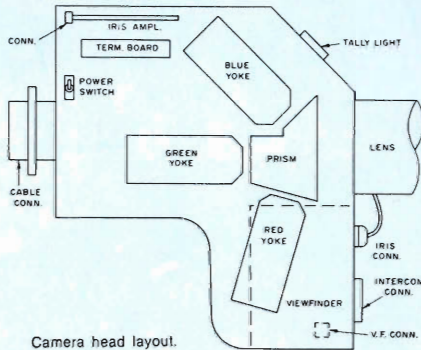

Camera head layout.

Portable Camera Design

The two-part packaging of CFTO's hand-held camera obviously makes this function a two-man operation, with one man handling the camera head, while his partner back-packs the processing circuitry. However, in any case the second man would be required for pulling cable and related tasks. The following parts comprise the camera system and will be discussed separately:

- Camera Head
- Viewfinder
- Interconnecting Cable
- Back-Pack Electronics
- Body Harness Units
- Auxiliary and Camera Control Units

Camera Head

This unit was designed for compactness, proper weight distribution and operational convenience. The camera head and electronic viewfinder are enclosed in a formed sheet metal housing. Yoke-tube subassemblies, beam splitter and pre-amp electronics are removed from a studio TK-44 and installed in this housing. This changeover takes about twenty minutes.

Yokes and optical components are mounted in the camera field pack via index pins to a ¼-inch thick base plate. Accomplishing this was a real challenge, since some of the screw fasteners for the TK-44 optics were eccentric; designed for factory adjustment. With more than a little ingenuity (and considerable patience and perspiration) our machinist was able to make the pins on the portable unit match those on the studio camera. This required extremely accurate measurements and a jig for transferring to the base plate in the hand-held version.

It should be noted here that because of the critical optical positioning, studio cameras used for converting to portables are restricted to the two from which the plate measurements were made. These are our #3 and #5 TK-44's.

Also in packaging the portable camera head we had to invert the optics. This upside-down arrangement permitted us to have a more compact, better balanced camera. In addition, it allowed us to place the optical adjustment controls on the outboard side of the camera, away from the operator. Adjustments can be made while the camera is in operation, without involving the cameraman. By changing the positioning of the pickup tubes, we also had to reverse the scan.

Two lenses have been used with the hand-

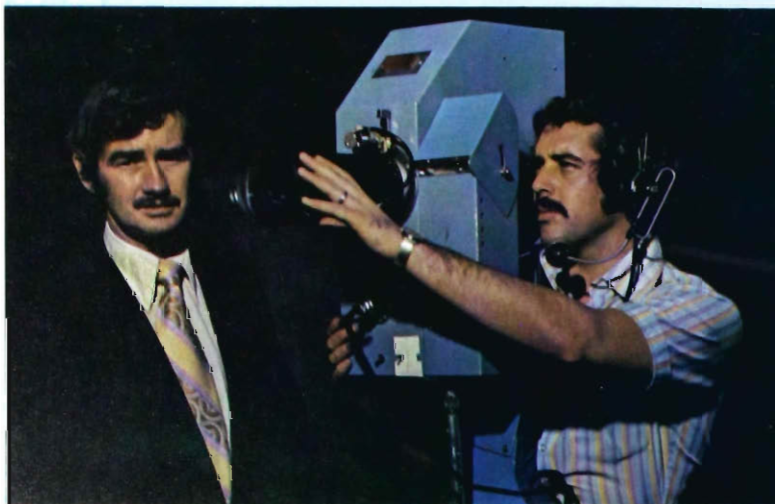

R. J. (Ron) Hutcheon (left) has been associated with CFTO since 1962, in a variety of functions, mostly involving the station's mobile units, and more recently with systems engineering.

held units, and we are considering others which show promise. One lens is a Schneider 10:1 manual zoom (17 mm to 170 mm at f/2). We also use a Canon lens with a 15 mm to 150 mm range and f/2 speed.

A special servo iris amplifier had to be developed for the hand-held cameras, because the servo on the TK-44 studio cameras is a part of the lens package. We are now designing a filter holder for the portable units.

One application for our hand-held cameras is for movie-making. Since films are in the wide-screen format, we had to modify the scan protection circuitry in the camera to accommodate this different ratio. Scan size has been reduced from 30 mm to 1-inch.

Like the studio TK-44, the field system includes a call button for contacting video control; intercom facilities, and a switch for effects display on the viewfinder.

The camera head unit weighs 38 pounds, including lens and harness.

Viewfinder

The electronic viewfinder we selected is a Sony AVR-3200 with a 4-inch diameter

tube. It is mounted in an upright case attached to the side of the portable camera housing. Because of this vertical positioning, a tiltable mirror is used for viewing the camera output, and we reverse scan the viewfinder. Some electrical modification has been made to facilitate interfacing with the camera electronics. Although the viewfinder includes self-contained power (17 watts at 13 V RMS), operating DC power is drawn from the camera electronics. An additional electrical modification to use separate sync has also been made to improve stability.

Interconnecting Cable

The "umbilical" connecting the camera head to the back-pack is a 15 foot multi-coax cable. The length was arbitrary, but was selected as an optimum to avoid potential circuit problems such as cross-talk. In addition, by restricting the length of interconnecting cable, the camera operator and back-pack man are sufficiently close that people would not step between them and get tangled up in the cable. We also tried using a 25 foot cable which worked out satisfactorily. However, we have not found our 15 foot length inconvenient.

As another design wrinkle, both ends of our connecting cable between camera head

and electronics are female, so it is impossible to make an improper connection. The cable was custom-made for us by Boston Wire & Cable, and uses standard 85-conductor connectors.

Back-Pack Electronics

The back-pack represents a complete transplant of the entire complement of circuit boards from the TK-44 (except pre-amps). Modules can be unscrewed, removed from the studio camera, and inserted in the field case in less than ten minutes.

The housing for the back pack is sheet metal and is in two parts which are hinged together to open like a book. The unit is 18 inches square and 6 inches thick in the closed position. Fully loaded, the back pack weighs 20 pounds.

A muffin fan is used to exhaust air and to keep it circulating through the DC converter module. Video switching for the viewfinder is provided, as are cable and control functions for other items such as intercom. RGB video triggering switches for circuit checks are also provided at the back-pack. The support harness for the back pack can be removed, making it smaller and more convenient to ship, particularly by air.

Compact back pack unit contains all circuit modules from TK-44. Transfer can be made in less than 10 minutes.

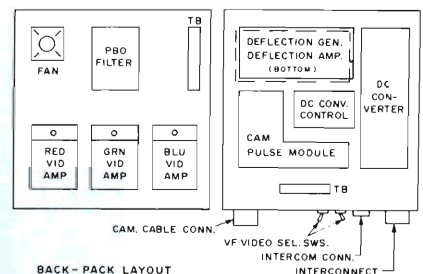



Telescoping camera support rod and hinged shoulder mount make it easy to tilt camera for angle shots.

Body Harness Units

In designing the harness supports for the portable units, we decided that instead of taking the engineering approach, we would talk to our cameramen—both TV and film—who had previous experience with hand-held equipment to assist us in the harness design. Not surprisingly, they had some definite ideas to contribute. As a result, the harnesses do provide ample support, are well padded and reasonably comfortable. The camera head unit has a telescoping rod which supports much of the forward weight. And the camera itself is secured to the shoulder harness by a hinged mount which permits the operator to tilt the camera upward for difficult angle shots, without distorting himself and shifting camera balance.

Attesting to the support capability of the harness, the camera system has been carried by our people intermittently for up to eight hours without ill effects.

In all honesty, it must be said that the initial reaction of cameramen who are first faced with the prospect of carrying our portable camera is usually negative. The package looks awkward, bulky and heavy. However, once they try it and adjust to the harness, most operators become more favorably inclined.

Auxiliary and Camera Control

In its hand-carried configuration, our camera operates from the standard TK-44 CCU via standard camera cable, in a manner identical to that of the normal TK-44A system. The control arrangement is identical also. This provides the definite advantages discussed previously, and also simplifies control panel layout, since there is no need to mix in a "strange" CCU. Mobility and flexibility are, naturally, essential for equipment assigned to handle remotes. For added mobility, we are now mounting the CCU's and related equipment for the TK-44 cameras in rolling racks

which are packaged for moving out by truck or air on moment's notice.

Usage of Hand-Carried Cameras

Our first use of the hand-held cameras was in June of this year at "Explo '72" held in Dallas' Cotton Bowl. Taping this exciting, drama-packed youth religious rally was a fantastic assignment, and the portable cameras worked well—even in the extreme heat which sometimes approached 120 degrees on the field. The cameras were also used in all of the Team Canada-Russia Hockey games played on our ice. Of course they are used regularly as part of our color coverage of the Maple Leaf's home games.

At the Canadian Football League games, particularly the crucial play-offs, we have had the portables in the team dressing room for the post-game interview show.

Last month the finals of the Miss Canada 1973 Pageant were staged at CFTO in our largest studio, and one hand-carried unit was assigned to rove backstage for dramatic coverage. The camera was equipped with a star filter for special effects.

For commercials as well as shows, the hand-carried cameras are becoming popular, especially for the unusual shots—the "cinema verite" artistic effects of tight closeups, angles, tilts which studio cameras can't handle. The changeover from studio to hand-carried version is now made about five times a month, and this frequency is steadily increasing as more people become aware of the availability and advantages of this equipment.

What Next?

The two hand-held cameras which we designed will be improved. We are now considering converting another TK-44 for dual use. A number of suggestions have been given to us, and we have a few of our own. There are many changes worth investigating. For example, we are looking at the feasibility of using 1-inch instead of 30 mm lead oxide tubes. This could reduce the size of the camera head package and trim perhaps 20 pounds from its weight. Another lens is under consideration which would cut the weight and also permit using the full scan of the tube. The next time around, the viewfinder will be a plug-in detachable type, which would make for easier shipping and servicing.

Smaller cable is another possibility as a refinement to the system. The lighter weight



Recent use for hand-carried camera was for back-stage coverage at the Miss Canada 1973 Pageant finals which were staged at the CFTO studios.

might not be a good trade-off, should we end up with crosstalk and less shielding than needed. We are also checking ways of repackaging the camera head circuitry to save space and reduce the size of the unit.

Summary

Converting the TK-44A system for portable use was an interesting, challenging project. For CFTO, it has been a cost-effective approach in that we have not had to invest in special purpose portable cameras which would only be used on a limited basis. Performance of the hand-carried system is essentially equal to top studio quality, so we feel we are getting superior color in the field as well as in the studio.

CFTO

CFTO-TV went on-air in 1961, colorized in 1965, and is affiliated with CTV, Canadian TV Network. It has expanded rapidly, adding studio space and production facilities to extensive remote capabilities. The station now operates seven studios, four mobile units, and is deeply involved in a complete range of production work. Commercials, movies and television shows of all types are currently being done by CFTO.

The station's full complement of equipment and reputation for technical competence have resulted in industry recognition and an ever-growing number of global assignments. They have been dispatched to Israel, Australia, and even handled the pick-up from Anchorage, Alaska of the historic meeting there between President Nixon and Emperor Hirohito.

Some readers will remember that CFTO was featured in BROADCAST NEWS, Vol. #138.

Acknowledgments

As might be expected, designing the CFTO portable camera package was a group effort. George Malcom, Assistant Director of Engineering was most helpful in providing guidance and management support, as well as contributing valuable suggestions. Others who participated prominently in bringing the hand-held camera from an idea to a performing system include: Wally Hobbs; D. Jernigan, and Bob Dally on the mechanical side; Angelo Caldina, Mike Hickey, Ed Edwards and Richard Kupnicki aided with the all-important wiring and packaging of the electronics. ■

This attractive edifice is France's visual culture center, the Office de Radiodiffusion-Télévision Française (O.R.T.F.) in Paris.

O.R.T.F. relies on tape



o make Paris the City of "Enlightenment"

Video tape recording is a dominant factor in programming operations at France's national broadcasting agency, the Office de Radiodiffusion-Télévision Française (O.R.T.F.). Seventeen RCA VTR's, seven TR-22's and ten TR-70C's, are used to copy news, educational and popular-entertainment programs which the state-owned broadcaster then distributes for general viewing throughout the country.

As a working tool serving the mass communications business, the magnetic medium has a lot going for it. Economic distribution of program material is the most obvious benefit. Not to be obscured, however, are: the immediacy of playback and the technical quality of the pictures recovered; plus reliability and ease of maintenance RCA VTR's provide.

Much of the TV fare 50-million Frenchmen watch is produced in Paris, which is the focal point for the entire O.R.T.F. network. Tape preparation involves two separate major facilities. One, in the shadow of the Eiffel Tower, is Cognac Jay where operational headquarters and the original production studios are located. The other is Buttes-Chaumont near Sacre Coeur Church, another famous Parisian landmark.

With the aid of the RCA VTR's, Buttes-Chaumont generates, records and stores the lion's share of the programming material. The complex includes several spacious studios filled with sets and props, and alive with talent and production personnel to maintain the continuous flow of broadcast material the network requires.

To enhance production and technical efficiency, Buttes-Chaumont's facilities also include two RCA Time Code Editors. Making frame-by-frame editing possible (through computer logic), the TCE allows the kind of creativity and flexibility essential to the programming expertise for which the broadcast agency is known.

At present, O.R.T.F. assigns its video-tape capacity to the production of all types of programming, except commercials. Because of government regulations, all advertising messages have been made on 35-mm film; tape equipment has been made available to private production houses only within the past year.

Promotional episodes were prohibited on French TV until 1969. But soon after their debut, the Government decreed that sponsors' announcements were to be confined to the close of a feature, or within certain intervals in the daily schedule.

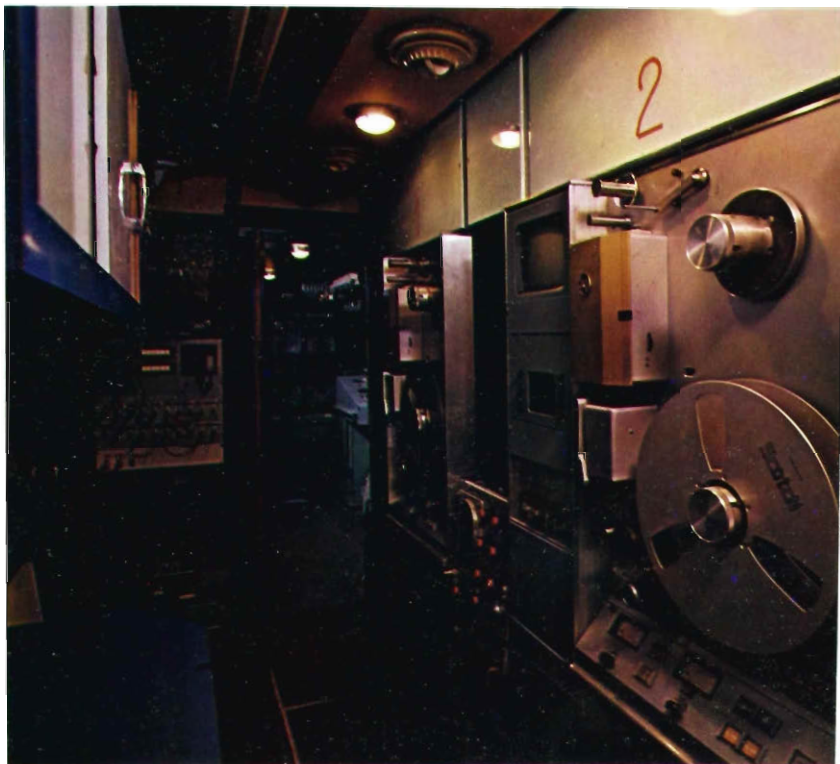

These RCA VTR's are just a few of the 17 installed units that facilitate Buttes-Chaumont's heavy production schedule.

Each time slot is divided into segments and allocated to firms who want to present a commercial message.

Planning the commercial messages, which are produced under O.R.T.F. sanction, is the responsibility of individual sponsors. However, private creative firms, including newly-established teleproduction shops, can be engaged to make the commercials. Now geared to solicit advertisers' business, these creative shops may soon influence the switch to video-taped commercials.

Two other factors should also affect the advent of paid announcements on tape. One is O.R.T.F.'s establishment of a third all-color TV network. Multiplying production needs should call for the use of many more VTR's, and perhaps the introduction of Cartridge Video Systems. The new channel's heavier commercial orientation should provide added impetus. Welcome

will be video tape's economical and physical advantages, plus its ready adaptation to special techniques now so widely used.

Whatever commercial interplay results, O.R.T.F. will still transmit its distinctive service to millions of viewers through a vast far-flung physical network. It consists of transmitters, repeaters, control and switching stations and program bureaus—all fed from the agency's creative center, Paris. Smaller, secondary centers are located in six other large cities. All are interconnected with each other, Paris and the chain of high-and-low-power transmitters, via O.R.T.F. plus the Post and Telegraph's underground cable and microwave links. Any one of the branch offices, or Paris, can supply the main program, which is usually distributed throughout the country.

The location of Cognac Jay, operational headquarters of the O.R.T.F., needs no explanation.

Vital to the mechanics of O.R.T.F.'s mass communications programs are these TR-70's (bottom).



Part of O.R.T.F.'s Paris facilities, this relay tower transmits the agency's programs to all of France's provinces as well as the Eurovision network.



The output of O.R.T.F.'s TV cameras is recorded, stored and then distributed throughout France.

Most of the time Paris telecasts to its metropolitan areas and suburbs from antennas installed atop the Eiffel Tower. Additionally, these signals are sent to the regional stations for broadcast in their areas and for retransmission on to still lower-power units in rural sections. Sometimes, high-power transmitters in the capital are connected directly to the outlying districts for one-hop broadcasts. Most suburban transmitters function on a remote control basis; they receive instructions from either Paris or the larger cities via microwave.

Besides serving national television needs, France's broadcasting agency is a charter member of the European Broadcasting Union (EBU) and its communicating branch "Eurovision". O.R.T.F. participates with other countries via program exchange, since standards differences have been overcome.

Within France, O.R.T.F. broadcasts in black-and-white on 819 lines, 50 fields (CCIR System E); in color, on 625 lines, 50 fields (SECAM III-B).

Incoming color programs from Eurovision (Western Europe and the United Kingdom) are received on PAL standards and transcoded to SECAM at Cognac-Jay. At 1700 hours every day a news input is fed to Eurovision via the technical center in Brussels, Belgium. There it is changed to PAL for transmittal to other EBU countries.

"Intravision", a member of Eurovision, links Eastern European nations and the U.S.S.R., and offers programs to the organization for later distribution to its members.

In an Intravision exchange, O.R.T.F. supplies Brussels, which relays the event to the Intravision Center in Prague, Czechoslovakia. Neither outgoing transmissions nor incoming ones have to be converted, since the Intravision net uses SECAM.

NTSC program pickups fall within the bounds of "Mondovision", a worldwide hookup of satellites and ground stations. They may be received in France, directly from a satellite, at the Pleumeur-Bodou ground station; or they may be relayed there by satellite communications facilities in other European countries—Goonhilly I and II (England), Raisting (West Germany), Buñtrago (Spain) or Fucino (Italy), for example.

O.R.T.F. is continually expanding its services in order to deliver educational, entertainment and cultural programs to



France. Emphasizing the effectiveness of its production format is a recent reorder for five more TR-70C tape machines. They were shipped from RCA's new manufacturing plant on Jersey, the Channel Isles. About 12 miles (20 km) from France, RCA Jersey Ltd. affords distinct freight advantages as well as rapid support service to VTR users within its natural marketing area.

For dedicated enthusiasts of high-quality, expedient programming, like O.R.T.F., the incentives to use the medium of video tape are considerable. ■

Color Television Aids Dental Instruction

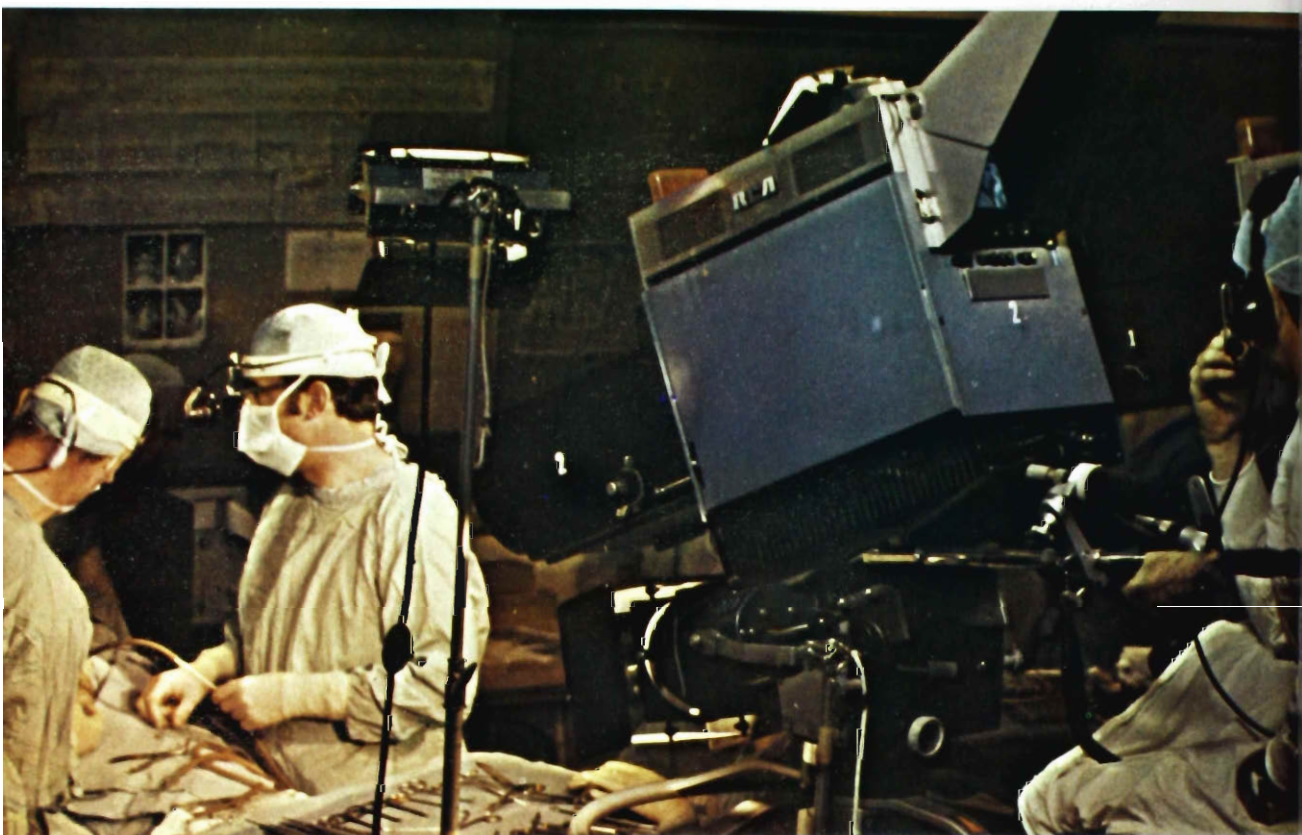

University of Missouri-Kansas City School of Dentistry Makes Extensive Use of Broadcast Quality Facility

Beginning of a Rhinoplasty operation during seminar held at UMKC School of Dentistry. Both TK-44 cameras were in the operating room. At times during the operations, the surgeon would request that all lights be turned out. Then the cameras operated only by the light of the small high intensity lamp the surgeon wore on his head.

The scene is a dim operating room, illuminated only by a high intensity lamp mounted on the surgeon's head. Sharing the room with the medical team are two TK-44 cameras, transmitting dramatic close-up pictures with sharp color detail to TV monitors in adjoining rooms, affording physicians, dentists and dental students an unobstructed view of the proceedings.

Televising operations is just one of many functions assigned to the comprehensive broadcast type color TV facility at the University of Missouri-Kansas City Dental School. The system boasts an equipment complement comparable to many commercial stations; color cameras, video tape recorders, film island and complete switching capabilities.

Dental educators have always recognized the benefit of augmenting instructional presentations with audio-visual materials. This is undoubtedly due to the fact that the principal area of study in dentistry, the oral cavity, almost demands illustration for more effective exhibition by means other than that of direct vision at chairside. Since these presentations are typically made to large numbers of dental students, the need for visual aids is obvious. The most popular visual aid has been 35-mm color slides—a traditional method still widely used by many dental and medical schools. Recently, however, more progressive institutions are finding that television can be effectively utilized as an instructional aid to enhance the teaching/learning process.

UMKC School of Dentistry moved into this attractive new building in 1970

A live demonstration for a class in "Conjoint Dental Morphology and Occlusion" originating in the studio. The demonstration was done live for one section of the class and was taped for rebroadcast to another section later in the week.

First System in 1965

Television was first used as a teaching tool at the UMKC Dental School in 1965, when a basic monochrome closed circuit system was installed. This modest portable system proved its value, and soon plans were made for expanding into a color-capable facility.

Faculty members adapted quickly to the TV medium, recognizing its potential impact on the instructional program. It soon became evident that the existing television system was limited in performance and flexibility and could not handle the increased immediate or anticipated curriculum requirements.

At this time, plans for construction of a new dental building were being formalized, and allowance was made for expanded television facilities.

Television Engineer Hired

During the planning stages, a Chief Television Engineer was hired to develop specifications for a TV system which would meet the projected needs of the Dental School.

Based on his experience in commercial television, the Chief Engineer, Mr. Ike Church, found equipment designed for closed circuit systems lacking in the qualities necessary to handle the desired applications in the Dental School.

The equipment requirements were stringent—fully as demanding as for a commercial television facility. Cameras, for example, had to be sensitive, capable of operating at low light levels. And, most important, they had to provide superior picture quality under less than optimum conditions. Easy set-up and remote operating controls were also factors in camera selection. Video tape equipment also had to measure up to broadcast standards, since multiple copies of certain program material would be required.

After investigating broadcast quality systems, he concluded that RCA offered the best total package of high quality color equipment to satisfy the comprehensive instructional needs of the dental curriculum.

Mr. Church then convinced the Dean of the School, Dr. H. B. G. Robinson, that the superior quality of RCA color equipment was worth the additional outlay of money. Dean Robinson accepted the recommendation and then undertook the task of procuring the additional funds. Ultimately, the money to purchase the RCA color equipment for the School of Dentistry was supplied via a grant from the United States Public Health Service. Included in this equipment purchase were two TK-44 color cameras, a TR-70 video tape recorder, a TK-510 color film chain, a TS-51 switcher,

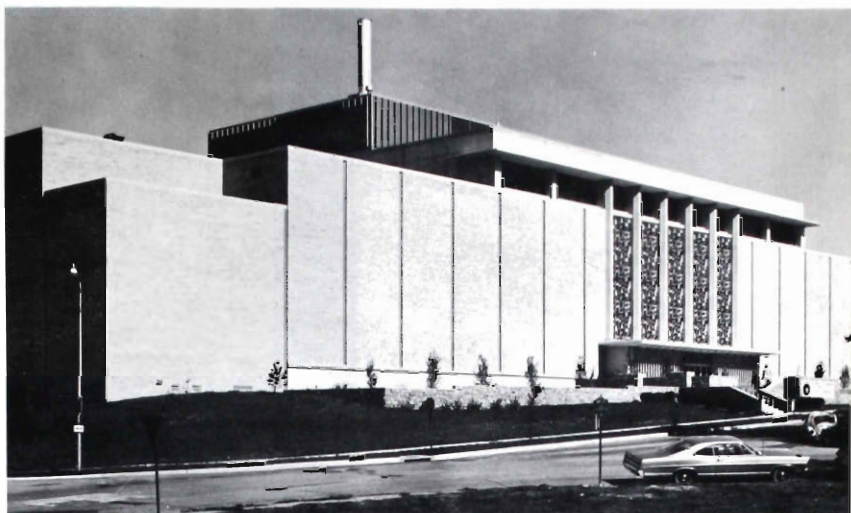

a TE-60 special effects board, plus other ancillary equipment. In February of 1970, the new dental building was completed and occupied by students, faculty and staff.

Diversity of Applications for TV

The color TV facilities have been utilized to demonstrate various dental techniques, both patient-oriented and laboratory-course oriented. For intra-oral demonstrations, a lens extender and, at times, a close-up lens are attached to one of the TK-44's for additional object magnification. Picture quality with these cameras has been excellent as has the quality of color representation of intra-oral tissues, a necessity for the illustration and detection of oral diseases and the discrimination of certain

dental materials in the case of laboratory demonstrations. Some demonstrations of this variety have prompted superlative comments from the faculty and students. This is only to be anticipated, though, since for numerous demonstrative purposes, the "eyes" of the color camera are obviously in a better position to visualize the intricacies of the technique being demonstrated.

Not all applications of the TV facilities involve demonstrations, however. Members of the Biomedical Science faculty utilize television for the production of video tapes on subject-matter incapable of being presented during regularly scheduled course hours but of sufficient importance to be made available to the student. Use

In recording Periodontal Procedures a second TK-44 is used for tight intra-oral closeups.

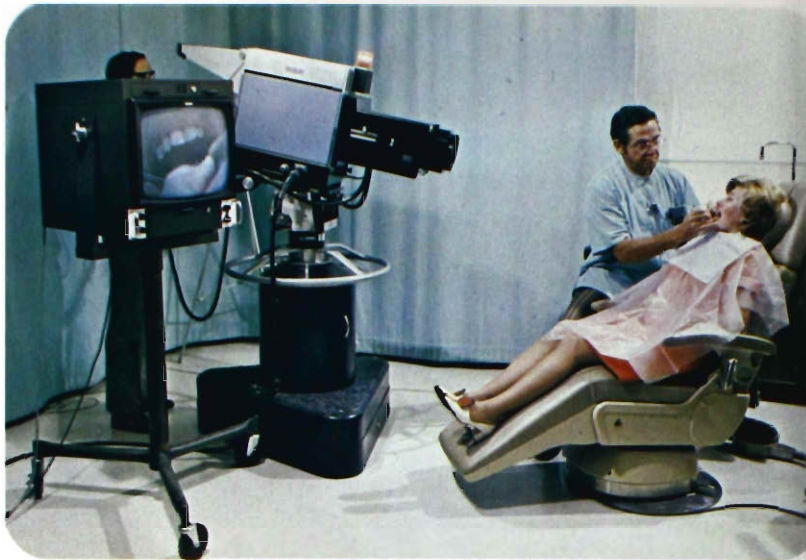

Instructor in Oral Pathology uses TK-44 with special microscope mount to show slide to Dental Hygiene students viewing in one of the school's main lecture rooms. The microscope mount was designed by Chief Engineer Ike Church.



of the TK-610 color film chain has enhanced these presentations by permitting slides or film material to be integrated with the lecture.

Another application of the TV system involved an international seminar sponsored by the American Rhinologic Society. (Rhinology is that medical discipline concerned with the study of the nose.) The seminar was held at the Dental School primarily because of its excellent television facilities. During this seminar ten rhinoplasty operations were performed and video taped from the surgery room, a converted classroom. The close-up capa-

bilities of the TK-44's proved invaluable in recording this highly localized surgery. Both cameras and their control units were on location in the surgery room with all switching and directing done in the control room.

A major project undertaken by the Television Department is in conjunction with the Dental Hygiene Department and involves the promotion of preventive dental care via Public Service Announcements. A number of 30 and 60 second scripts have been written and most are now on tape. After approval by a review board composed of students and faculty of the School, they

will be distributed to local commercial stations for airing. Without the excellent broadcast quality of the School's RCA color equipment, this project would never have been entertained.

The Future: A "Software" Bank for Self-Paced Instruction

Future applications of color television at the UMKC School of Dentistry are virtually unlimited. One concept now under consideration involves developing materials for an independent study program which would permit students to complete requirements for the D.D.S. degree in less than the traditional four years. Since this

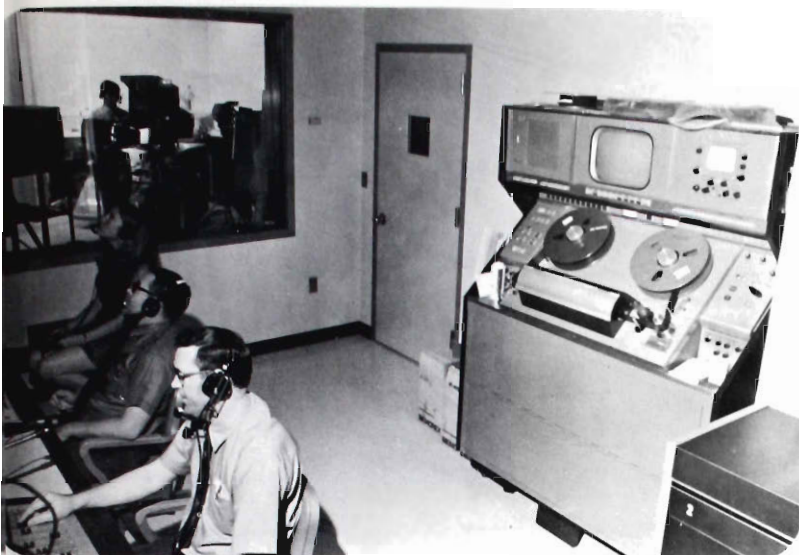

Television control room during taping session. UMKC School of Dentistry facilities are used for production of public service spots on dental care which are made available to commercial stations.

FIRST DENTAL SCHOOL IN KANSAS CITY

The University of Missouri, Kansas City School of Dentistry was established in 1881 as the Kansas City Dental College, a department of the Kansas City Medical College.

In 1889, the Dental College became an autonomous school of dentistry. The next change occurred in 1919 when the Kansas City Dental College merged with the Western Dental College (established in 1890) to become the Kansas City-Western Dental College. In 1926 the Kansas City-Western Dental College became associated with Lincoln and Lee University.

In 1941 the Dental College was consolidated into the University of Kansas

City to be known as The University of Kansas City School of Dentistry. When, in 1963, the University of Kansas City became part of the University of Missouri system, the name of the Dental School was changed to its present title of University of Missouri-Kansas City School of Dentistry.

For the current academic year, the Dental School has an enrollment of 540 students working toward the D.D.S. degree; 74 students in various graduate dental specialty programs, and 92 dental hygiene students. The School supports a faculty of 80 full-time instructors and approximately 100 part-time instructors.

program would be geared to independent study on a self-paced basis, a full range of instructional materials must be made available to the student at times when he needs it, rather than when it could be offered him. Video tape presentations would likely be a major part of the software materials developed for individualized instruction.

Without the University of Missouri-Kansas City School of Dentistry's exceptional RCA color television system, definite limitations would undoubtedly be imposed both on the variety of software to be developed and also, in many instances, on

the instructional effectiveness of such software.

Summary

Utilization is the magic word for instructional television systems. Unless carefully planned, excellent and amply equipped facilities can be expensive "white elephants". UMKC School of Dentistry has an outstanding color television system which is being extensively used in the School's instructional program in a variety of ways:

1. For demonstration of dental techniques to large groups of students.

2. For production of video tapes for repeated playback.
3. For incorporating films and slides into video taped lecture presentations.
4. For specialized seminar presentations.
5. For preparation and distribution of public service video tapes relating to dental care.

With the trend toward developing and making available more materials for self-paced individual instruction, the School of Dentistry television system faces a busy, productive future. ■

There's a whole new "Telecine" generation . . . a package of matched equipments, available today, built specifically to fill tomorrow's needs for high quality, cost-saving, automatic telecine operations.

There's a new, three-tube color camera, the TK-28, that actually does something about improving the reproduction of color films on television. This new camera goes a long way in solving many of the picture quality problems commonly associated with telecine operations—problems involving variations in film density and contrast range; problems with low color saturation, film base errors, scene-to-scene matching and color fidelity. The TK-28 solves these problems . . . automatically.

How? With an innovative new design, which includes instant, automatic level control, pre-selectable Chromacomp and exclusive automatic color balance. And with a three-tube design (either three vidicons or three lead oxide tubes) to achieve the kind of quality performance previously associated only with live cameras such as the TK-44B.

There's a versatile new multiplexer, the TP-55B, that opens new possibilities for space savings and maximum utilization of equipment. It permits several system configurations from a very simple one-projector, one color camera system to an interactive four-projector, two color camera island. Furthermore, solid state logic in the multiplexer control makes it readily adaptable to future automation plans.

A New Generation Color Telecine Camera



1. Complete telecine system including new generation color film camera, TK-28.

The most successful designs in the last generation of color telecine cameras employed four channels and the principle of separate luminance.⁽¹⁾ The same generation of cameras was also among the first broadcast studio products to be designed with solid state devices. Prior to this, in the era of vacuum tubes, color cameras utilizing three RBG receptors were subject to stabilization problems, particularly in the area of registration. Some of these registration errors were the result of mismatches in yoke geometry and others were caused by temperature drifts in the deflection and centering circuits.⁽²⁾

Historically then, the stage was set to make use of the separate luminance principle which is very tolerant to chroma/luminance registration errors.⁽³⁾ These facts, coupled with the unknown circuit problems which had yet to be faced in solid state design, were more than enough at that time to favor the four-channel approach. It should be noted that most solid state devices of that era were of the germanium variety, which did not have the temperature stability of silicon.

The advent of lead oxide tubes and a new generation of live studio cameras introduced precision yokes, silicon solid state devices, integrated circuits and a wealth of design experience in solid state circuitry. These live cameras proved conclusively that with precision yokes, and the use of devices such as operational amplifiers, long-term stability could be realized in an RGB camera.

The camera designers' first consideration is reliability and performance. Cost effectiveness and operational simplicity are two other prime goals. Experience gained with live RGB cameras, such as the TK-44, indicated that these goals could be achieved in a three-channel camera system for telecine use. This is the foundation on which a new telecine camera, the TK-28, was conceived, designed and produced.

Image Conversion

Design of a new camera invariably starts with the selection of pick-up tubes.

Superiority of photoconductive-type tubes (vidicons) for use in telecine cameras has long been established in the United States. There are four basic types of vidicons and the difference, for the most part is related to the photoconductive surfaces. The antimony sulphide (SbS) surface was introduced by RCA in 1950 and has been in widespread use in both telecine and live cameras throughout the world.

A second photoconductive material to be used extensively is lead oxide (PbO). Tubes using this photoconductor were introduced in the early 1960's, and were responsible for marked improvement in the performance of live studio cameras.

The most important parameters of these two tubes are compared in the Table below.

The measurements listed are based on the tubes operating in a camera under typical conditions, where the open gate light level is adjusted to 100 ft. C. and

3200° K. This level of illumination is readily obtained from present day projectors. Electrical gamma is adjusted to make the overall transfer characteristic of the tube and the camera in both cases to be 0.4. Coincidentally, 300 nA's is very close to an optimum signal current for both tubes. At the indicated light level, the blue SbS vidicon signal current is limited to 300 nA, if the dark current is to be kept below 10 nA. The lead oxide vidicon, which is more than one order of magnitude more sensitive than its counterpart, must have the light level padded down in the camera to limit the signal current to the 300 nA level. This is necessary because the beam is only capable of discharging about three times this amount. Film densities can change by a factor of ten times or more, causing highlight transients, and the lead oxide tube being linear will produce a corresponding signal which, if not discharged, will cause blooming or comet tail.

With adequate sensitivity for telecine operation, good aperture response, an inherent gamma which partially complements that of the combined kinescope and film, good spectral response and long life, the SbS vidicon would appear to be a more cost-effective selection. But let's consider also the economics of operating these

⁽¹⁾ "Separate Luminance Colour Television", I. J. P. James, International TV Conference Paper, London, June 1962.

⁽²⁾ "A Brief Review of Color TV Camera Development", K. Sadashige and H. N. Kozanowski, RCA Engineer, August 1964.

⁽³⁾ "Examination of the Problem of Registration with Color TV Cameras Using Three and Four Image Tubes", N. Mayer and G. Moll, Rundfunktechnische Mitteilungen, Vol. 9 (1965) u3 pp 127-134.

TUBE PARAMETERS

	Signal Current	Dark Current	Transfer Characteristic	Resolution ^(a)	S/N ^(b)	Third Field Lag	Typical Operat. Life (Hrs.)
1" SbS ^(c)	300 nA	10 nA	0.65	60%	47 dB	15%	10,000
30mm PbO	300 nA	2 nA	Linear	40%	45 dB	3%	3000-5000

a) Response of 400 TV lines relative to 40 TV lines.

b) Noise measured in a 5.0 MHz band relative to a 300 nA signal.

c) SbS measurements with a 4809-type vidicon.

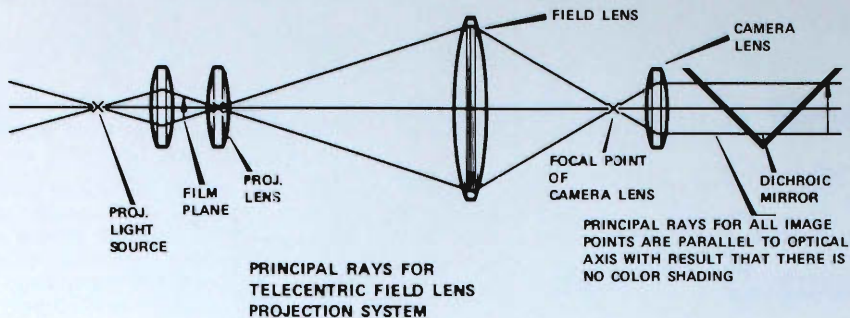

PRINCIPAL RAYS FOR TELECENTRIC FIELD LENS PROJECTION SYSTEM

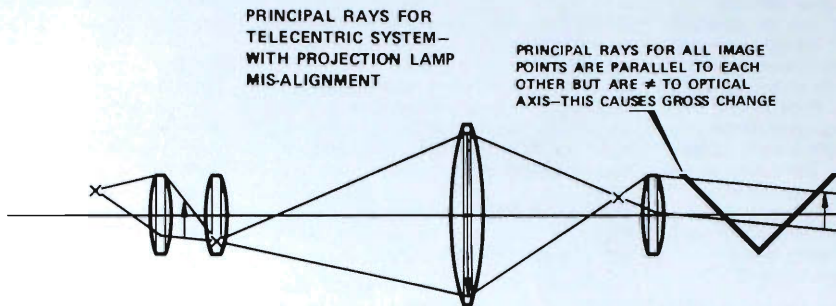

PRINCIPAL RAYS FOR TELECENTRIC SYSTEM—WITH PROJECTION LAMP MIS-ALIGNMENT

PRINCIPAL RAYS FOR ALL IMAGE POINTS ARE PARALLEL TO EACH OTHER BUT ARE ≠ TO OPTICAL AXIS—THIS CAUSES GROSS CHANGE

2. Effects of optical misalignment in TK-28 non-telecentric projection system.

tubes in an RGB camera. The lead oxide costs about \$2000 with an average operating life of 4000 hours, about \$1.50 per hour for the three tubes. SbS vidicons cost approximately \$350 each and last roughly 10,000 hours, about \$.105 per hour for three tubes.

What then, if any, are the advantages of lead oxide vidicons in telecine cameras? Obviously the low dark current, which represents about 0.3% of the signal before gamma, is less prone to cause black balance problems. However, the 4809 SbS vidicon, which normally operates with a dark current of less than 10 nA (3% of peak video), does not require nearly as much gamma stretch at black and performs almost as well. Lag is considerably lower in the PbO tube, but for telecine operation the performance of the SbS vidicon is generally considered adequate.

The SbS vidicon is normally specified with a 0.65 gamma, but this is light-level-dependent and can result in differential gamma and subsequent tracking errors.

It has been found, however, that the absolute gamma of the tube is closely related to dark current and, using this parameter, set-up techniques have been developed which minimize the tracking problem.

Looking ahead, if negative film comes into use, an inverse gamma correction would be necessary and the PbO tube, which would require a lower inverse gamma than the SbS, will have a S/N advantage.

European broadcasters heavily favor the use of lead oxide tubes in telecine chains. These organizations prefer to standardize where possible and PbO tubes, which are a necessity in live cameras, are usually selected for telecine use also. It is for these reasons that the TK-28 has been designed to accommodate either the 1-inch SbS vidicon or the 30mm lead oxide vidicon.

Optical System

A telecine camera is normally operated in a system whereby the input light sources are selected by an optical multiplexing arrangement. The camera represents about 50% or less of the total cost of the system, or "film island" as it is often called. This means that a new camera design should be compatible with existing islands for

both space and economic reasons. This can pose a rather serious problem for the designer. While it is practical to design an ideal optical system for any given light source, where the focal length, speed, cone angle and stability are specified, it becomes a more complicated problem when the camera has to work with a variety of inputs.

The color-splitting coatings consist of thin layers of materials such as zinc sulphide and magnesium fluoride, which are vacuum-deposited on a glass substrate. The efficiency of the reflected colored light from these thin films is highly dependent on the angle of reflection. (Fig. 2). With the dichroic surface reflecting a converging cone of light, the reflected light will be shaded as the angle of reflectance changes across the surface. This shading component can be cancelled by tapering the thickness of the dichroic layer in some cases, or with a neutral density wedge. It is possible to design the optical system so that the light incident to the dichroic mirror is collimated. (Fig. 3). This design, however, is very sensitive to a change in

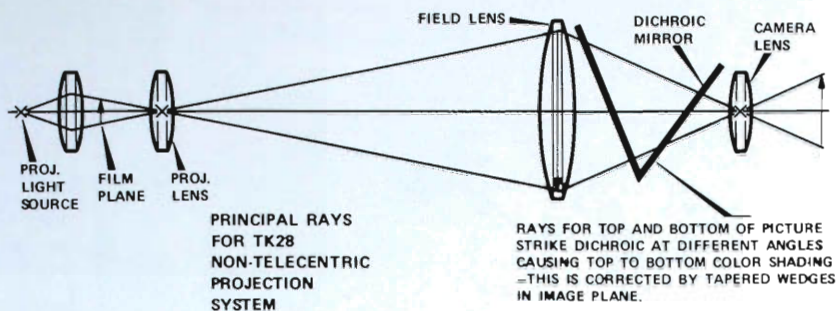

PRINCIPAL RAYS FOR TK28 NON-TELECENTRIC PROJECTION SYSTEM WITH PROJECTION LAMP MISALIGNMENT

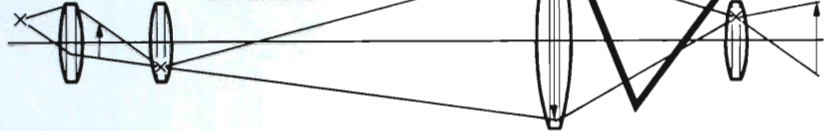

PRINCIPAL RAYS SHIFT SLIGHTLY AS A FUNCTION OF PROJECTION MISALIGNMENT—CAUSING NEGLIGIBLE COLOR BALANCE SHIFT.

3. Effects of optical misalignment in a telecentric projection system.

position of the source of light. In a telecentric system like this, when the position of the source is changed, the light remains collimated, but the angle of incidence of all rays changes which, in turn, changes the reflectance of the dichroic mirror. Consider what happens when, in a multiplexed system, a change is made from one projector to another. If both light sources are not positioned precisely on the same axis, the light reflected from each dichroic will change, resulting in a misbalance at white. Multiplexers and projectors, in general, are not designed to work with a specific camera and many do not have the optical precision required for a camera with a telecentric optical system.

The above discussion outlines some of the reasons why many attempts to adapt live studio camera optics to telecine use have not been very successful.

The TK-28 utilizes a non-telecentric system. Shading, resulting from convergent cone angles, is corrected with tapered neutral density wedges. The camera is, therefore, able to operate efficiently with many types of projectors. Also, the neutral

density and color trim filters are skewed with respect to the axis of the light rays. The optical system layout is shown in Fig. 4. Note that the field lens is split to allow test slides to be inserted in the focal plane. The camera is supplied with framing and alignment slides to facilitate set-up. Also supplied is a holder for the Kodak Inconel Grey Scale slide.

Colorimetry

When color television was introduced in the early 1950's, the TV signal was defined by the National Standards Television Committee (NTSC). Part of the standard described the working primaries

If the color monitor which displays the television signal has phosphors which are identical to the NTSC primaries, then it will reproduce exactly what is on the film, except that the scene will be elevated to the color temperature of the monitor white. Early monitors did, in fact, utilize NTSC phosphors, but the need for brighter pictures resulted in new phosphors being developed with different primaries. Fortunately however, the positive lobes of the NTSC primaries and those of the new phosphors, sometimes referred to as "rare earth", are very similar. The major difference between the two systems lies in

the negative lobes, particularly that of the red. This means that cameras with an optical color-splitting system which transmits the NTSC positive lobes can be electronically matrixed to produce NTSC color or that of "rare earth", which is now known as PAL System 1.¹⁴

In recent years electronic matrixing techniques have been developed¹⁵ which allow the conversion from one system to another to be accomplished quite readily.

In the TK-28 the variable matrixing device is known as Chromacomp. This unit can be set up to reproduce either color system. Chromacomp has the facility to switch between three different matrix combinations. For example, one position can be used for trimming the colorimetry to either NTSC or System 1, and the other two positions could be used to correct the camera for specific film stock dyes.

¹⁴"The Choice of Primary Colours for Colour Television", C. B. B. Wood and W. N. Sprinson, BBC Engineering, January 1971.

¹⁵Color Correction Techniques for Television Cameras", J. F. Monahan and R. A. Dischert, SMPTE Journal, September 1969.

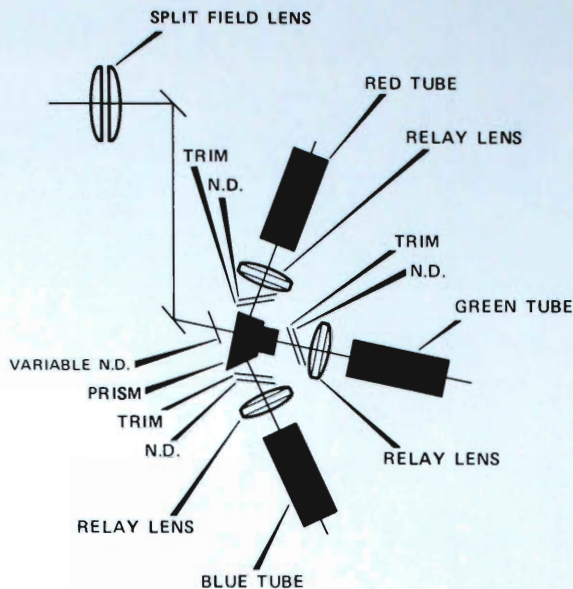

4. Optical layout of TK-28 color film camera.



5. Pair of remote control panels for TK-28.

Aperture Correction

Horizontal and vertical aperture correction in the TK-28 is patterned after the successful combed aperture equalization system used in the TK-44A camera.⁽⁶⁾ The combing and coring techniques effectively reduce noise and are tailored for either the NTSC or PAL standards. Ordinarily, 35mm film and slides and 16mm prints require different amounts of contour correction because of their dissimilarity in frame size. The TK-28 inserts the appropriate degree of contouring in synchronization with movement of the multiplexer mirror associated with each projector. Therefore one value of edge enhancement is introduced when the picture source is a 16mm film, and another when the input is a 35mm film or slide.

Automatic Light Control

A camera which accommodates lead oxide vidicons is restricted to some form of light control to maintain video level. Studies of digital and analog servo control systems indicate that the analog approach will provide a fine degree of control and excellent response times.⁽⁷⁾ The system designed for the TK-28 provides good correlation between the measured results and the theoretical model. In the automatic mode, a 2:1 change in light level is corrected in 80 milliseconds and a 10:1 change in under 200 milliseconds. Control is accomplished with a graded neutral

density disk mounted in front of the prism. The gradient of the disk is compensated with an N.D. wedge mounted in the disk housing. Care has been taken in the design of the disk to minimize color shift throughout the useable range.

The system is normally set up to compensate for a change in highlight density of 10:1. On a fade or cut-to-black the N.D. disk automatically goes to a "preset" condition. This improves the response time and minimizes overshoot when video is restored. The preset level or "black" is normally set to be 2.5% of the maximum light level. At this point, the disk will automatically reset to a position equivalent to 25% of maximum light level. It will remain in this position until the light level received by the camera reaches 10% or more of the maximum highlight level. At that point it will unlatch and go back into normal automatic operation.

Automatic Black Level Control

The use of automatic black level control in telecine operation has long been controversial. It can be argued that automatic black, which pulls the "blackest" signal in any one of the R.B.G. channels to the clipping level, is technically incorrect. This

would be true if all motion picture film and slides had the correct exposure and contrast ratio for television. The fact is that film which runs the gamut of news clips to full-scale motion pictures made for television varies considerably in quality. Therefore most operators prefer the automatic black mode of operation. Recent studies show that automatic black reduces the effects of system flare.⁽⁹⁾ The black level in the TK-28 may be operated in either the manual or automatic mode.

Automatic Black & White Balance

The quality of film can vary widely and much is dependent on the skill and care taken in the many operations involved—starting with the initial exposure through to the final print. Automatic black was an early attempt to correct for some of these deficiencies. Now a special form of automatic black and white balance circuit has been developed for the TK-28.

One of the most common film errors, which usually occurs in the processing cycle, results in color contamination particularly visible in black and white areas of the picture. For example, the problem might manifest itself as a slight blue cast in black and white areas. In the TK-28 all three RGB signals near the black and white levels are sampled. If all are below and above, respectively, a preset threshold, the automatic balance circuit will restore them

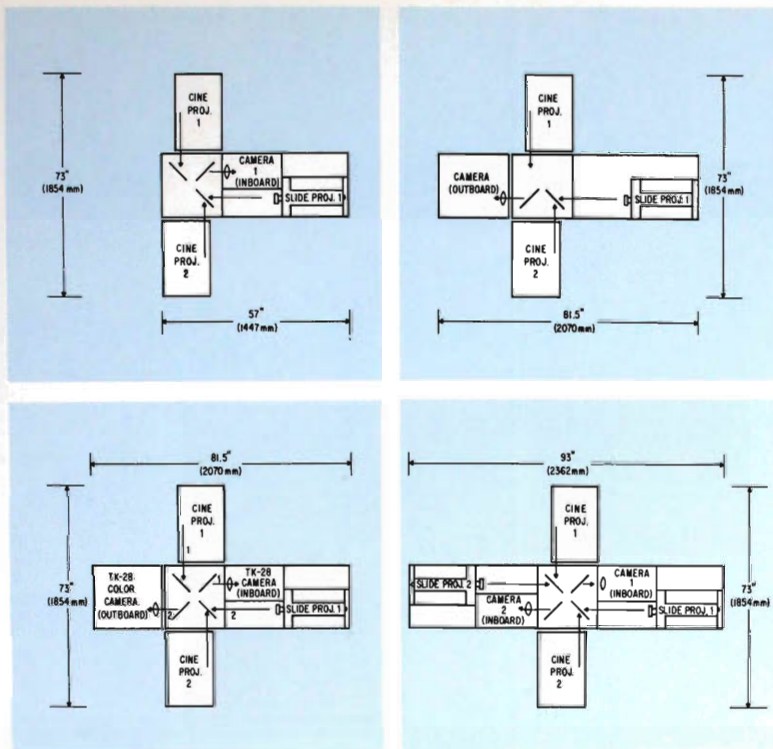

6. Floor plans showing four different systems configurations.

to a predetermined condition. The result is that the whites become white again and the blacks become black again. It has been found experimentally that 10% and 90% of video are satisfactory as the preset threshold points. The fact that all three signals must be above and below these threshold points prevents the circuit from operating on high and low luminance saturated colors. For example the luminance value of a saturated yellow can be 90% and that of a blue 10% or less. The yellow signal is minus blue and the blue signal has no green and red. The absence of these signals prevents the gating on of the automatic balance loop.

The forced black and white conditions which can occur using this technique may introduce minor color errors with particularly poor film. However, the net effect is a marked subjective improvement in the picture. It is of interest to note that the circuit will not effect good film which has a good black and white rendition.

Monitor Switch: When used with a suitable switcher, depressing the joystick control will bring up the camera on the program monitor. The switch is spring-loaded. Thus, by momentarily depressing it, the color match between any camera and the program line can be evaluated.

R.G.B. Black Balance: These controls are detented in approximately 0.1 dB steps to provide a "memory" when "painting" may be required. The total range of the controls is approximately ± 1.0 dB.

R.G.B. White Balance: These are continuous type controls with a range of ± 1.0 dB. Both black and white balance controls are disabled when the camera is operating in the Automatic Balance mode.

Automatic balance will also correct for misbalance problems in the camera due to improper set-up, or for a possible color shift in N.D. filters, etc. The feature can be switched in or out at the set-up position, or at the remote control position.

Remote Control Panel

The joystick method of controlling white and black level is used for the TK-28. From the standpoint of human engineering, this provides compatibility in operation with studio cameras. The remote control panel (Fig. 5) also has the same mechanical format as that of the TK-44. This facilitates intermixing controls at one operating position. Following is a list of controls and their function.

White Level/Black Level: Both functions are controlled by the joystick.

Automatic Black Level/Automatic White Level: These switches select the manual or automatic mode of operation. In the

automatic mode, a 10% override is provided by the joystick for both functions.

Chroma On/Off: In the chroma off position, burst can be added optionally by a jumper arrangement in the Colorplexer.

Waveform: Three waveform displays can be obtained at the remote position; Superposition Sequential (RGB) and the final color output. A special step waveform is generated in the camera for the sequential display.

Chromacomp: Any one of three preset conditions of color "masking" may be selected. Possible uses of this feature were described in the optics section of this paper. It is also possible to switch off Chromacomp and operate in a "standard" matrix condition.

Gamma: With the introduction of standard viewing rooms,⁽⁸⁾ and tendency to preview more and more films, the gamma and Chromacomp selector switches become more meaningful as operational controls. Four gamma laws are available: 0.4, 0.5, 0.6 and 0.7.

⁽⁸⁾Combed Aperture Equalization for Television Cameras", R. R. Brooks and W. J. Cosgrove, SMPTE Journal, January 1971.

⁽⁹⁾"Light Control System for Telecine Cameras", H. G. Seer and L. J. Bazin, I.E.E.E. Broadcast Symposium, September 1972.

⁽¹⁰⁾Performance of Automatic Black Level Systems in Telecine Cameras", L. J. Bazin, SMPTE Conference paper, April 30-May 5, 1972.

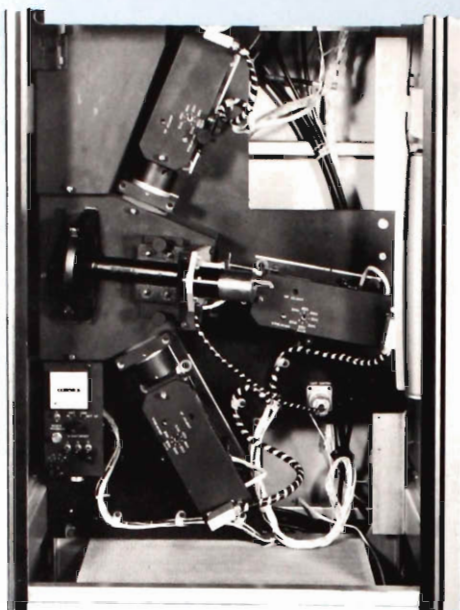

7. Close-up of optical plate assembly.



8. Power supply.

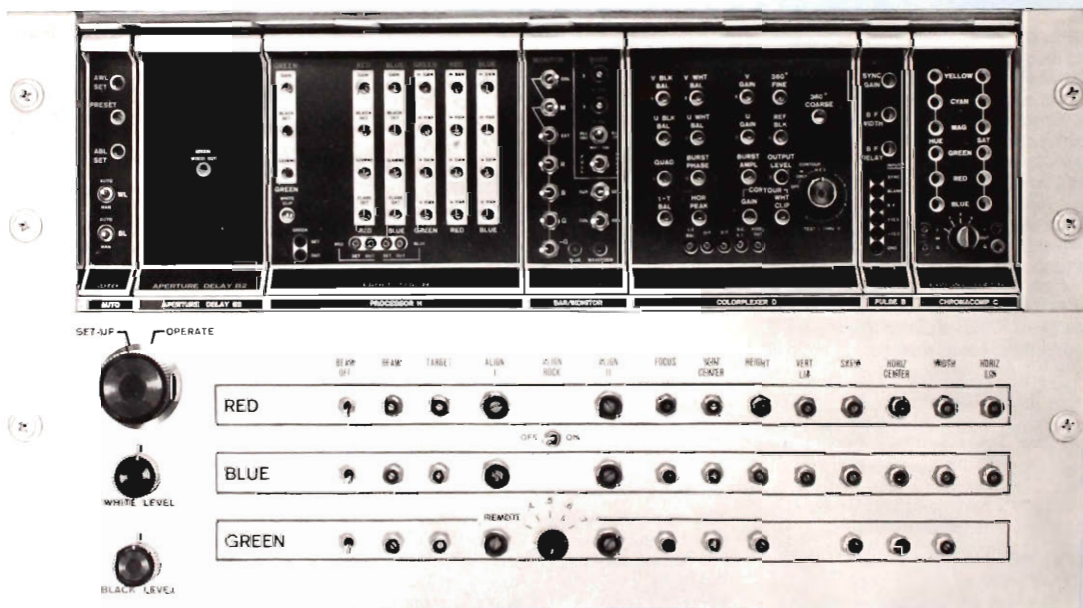

9. Auxiliary set-up panel.



10. Single cabinet color film camera configuration.

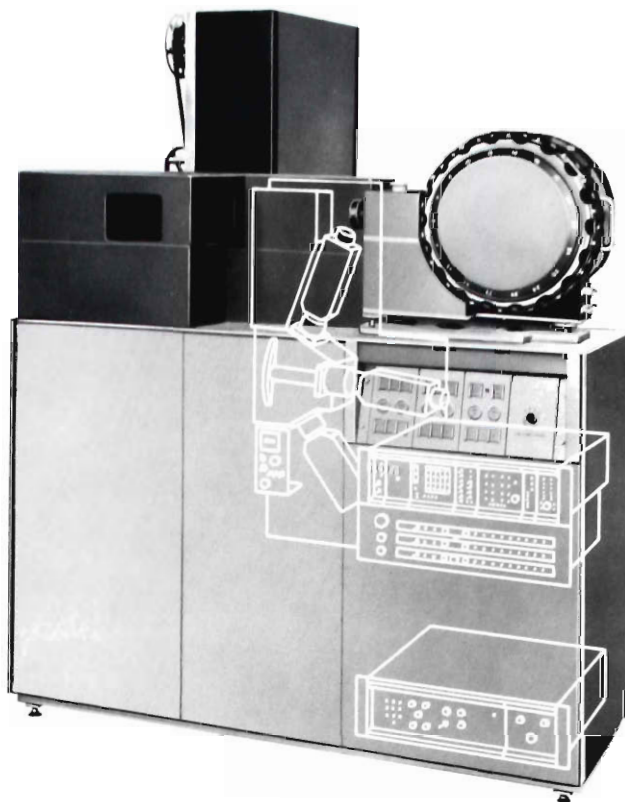

11. Complete TK-28 camera mounted within TP-55 Multiplexer.

Packaging Options

One of the most cost effective features of the TK-28 is the number of packaging options which are available. (Fig. 6).

The camera consists of three basic units, the Optical Plate Assembly (Fig. 7), Power Supply (Fig. 8), and Auxiliary/Set-up Panel (Fig. 9). In addition to the optics, the Plate Assembly contains the yokes, preamplifiers, deflection circuits, and pick-up tube circuitry. With the exception of the Power Supply and drive circuits for the light control servo, the balance of the electronics is contained in the Auxiliary/Set-up Panel Assembly.

In its simplest form, the above three units can be housed in a single cabinet and operated locally or from a remote control panel. (Fig. 10).

In a second configuration, the Auxiliary/Set-up Panel Assembly and Power Supplies can be located up to 200 ft. from the camera head (Optical Plate Assembly). Set-up can then be done at one centralized location. In this format an additional power supply is required at the Set-up position.

A pulse advance system is used, which eliminates the need for any adjustment as the distance between the camera head and Auxiliary is changed. The requirement for horizontal and vertical drive pulses has also been eliminated.

The third configuration, and most unique, is one whereby the complete camera can be integrated in a TP-55 multiplexer (Fig. 11). This allows a three-in and two-out multiplex system which, with the addition of a pedestal, can convert to a four-in and two-out arrangement. This integrated system provides the most efficient use of floor space.

To summarize, the TK-28 can be obtained in either PAL I or NTSC standards, with 30mm lead oxide or 1" SbS tubes and in three mechanical formats, resulting in twelve different versions of the camera. ■

Adapting the TTU-60B Transmitter for Once-a-week Inspection

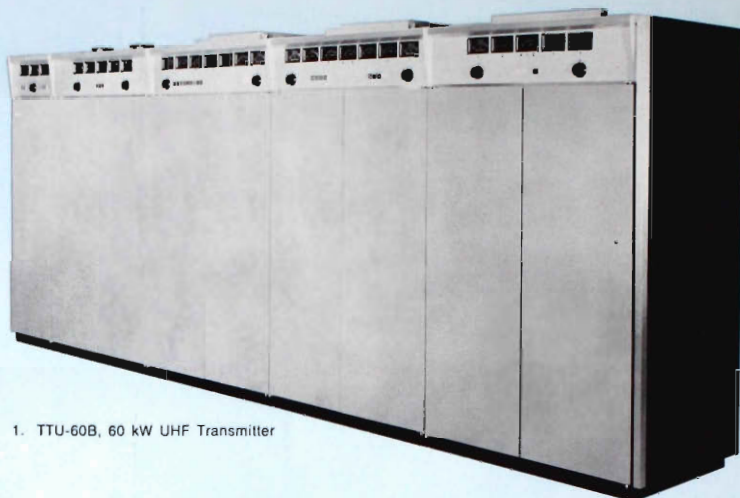

1. TTU-60B, 60 kW UHF Transmitter

New Standby Power Package makes it practical and economical

The RCA TTU-60 series of 60 kilowatt UHF transmitters have been operated successfully by remote control for many thousands of hours. An optional modification is now available to qualify the transmitter for inspection on a once-a-week basis as permitted by FCC remote control regulations under certain conditions.

The FCC regulations covering television transmitter remote control normally require inspection of the transmitter and calibration of the remote metering system once a day, at least five days a week. Inspection and calibration are required only once weekly if provisions are made to maintain at least 20% of normal licensed power in the event of a malfunction of the main transmitter. The facilities required for continued operation in event of a malfunction may be activated either automatically or manually from the remote control point.

In general, the "20% power" requirement may be met in any of several ways depending on the type of transmitter involved. A remote controlled standby transmitter may be employed, provided that the standby transmitter is capable of at least 20% of the normally transmitted power. Another approach is to use a pair of identical transmitters in parallel, each delivering one half of the total transmitted power. In the event of failure of either transmitter, the non-failed transmitter will continue in operation without interruption of service.

In the case of the TTU-60B UHF transmitter, the 20% power requirement can be met by the addition of a spare exciter-modulator and a relatively simple switching facility to provide bypassing or substitution for any failed stage in either the visual or the aural signal path. The necessary

modifications to the standard TTU-60B transmitter are available as an optional equipment group known as the "standby power option" for the TTU-60B transmitter.

A block diagram of the standard TTU-60B transmitter is shown in Figure 2. Following the solid state exciter-modulator, a visual IPA stage drives two 30kW klystron final amplifier tubes in quadrature to produce sixty kilowatts of peak visual power. An identical IPA stage in the aural channel drives a third 30kW klystron tube to produce twelve kilowatts of aural power.

In the event of a failure of either of the two visual klystrons, the non-failed visual klystron may continue to operate independently. Due to an inherent loss of 3dB in the visual combiner when only one input port is being fed, the failure of one visual klystron results in a reduction of total visual power output to 25% of normal level. Thus the transmitter has an inherent, "built-in standby" mode of operation available at all times to permit continued transmission at reduced visual power if one visual klystron should fail.

Standby Power Package

To comply with the requirements for "once-a-week" inspection, however, it is also necessary to provide protection against failure of (a) the exciter-modulator, (b) the aural or visual IPA stage and (c) the aural klystron. This may be accomplished as shown in the next block diagram (Figure 3) showing the details of the "Standby Power Option" for the TTU-60B transmitter.

First, a "standby exciter group" is required. This group consists of a cabinet containing a spare exciter-modulator plus exciter fault sensing circuits and automatic switching to the non-failed exciter. Relays S1 and S2 provide the actual exciter

transfer switching function. Upon failure of an exciter and switchover to the standby exciter, a warning indication is provided at the remote control point by means of the transmitter remote control system.

In the event of failure of the visual IPA, the aural IPA is switched into the visual position by Relays S3, S4, S5 and S6. The aural klystron is then driven directly by the TTUE-4A exciter which has sufficient output to maintain at least 20% of normal aural power.

In the event of failure of the aural IPA, the failed amplifier is simply bypassed by Relays S4 and S6.

In case of failure of the aural klystron, the Visual 2 klystron is switched into aural service. Relay S7 switches the klystron input connection while Relay S9, a motorized 3 inch coaxial relay, simultaneously switches the klystron output connection. This permits operation at normal aural output power and 25% of normal visual output power.

Vacuum relays are provided to permit disconnection of high voltage from any individual klystron in the event of a klystron failure. This serves the purpose of isolating the beam supply from the klystron to safeguard the continued operation of the non-failed klystrons.

Fault detection circuits are included to provide remote identification of the failed IPA stage or klystron, enabling the remote operator to initiate the correct switching action. Logic circuitry is included in the switching control circuits to prevent the operator from switching either an IPA stage or a klystron while power is applied.

Three levels of protection are provided simultaneously inasmuch as the simultaneous failure of one exciter, one IPA and

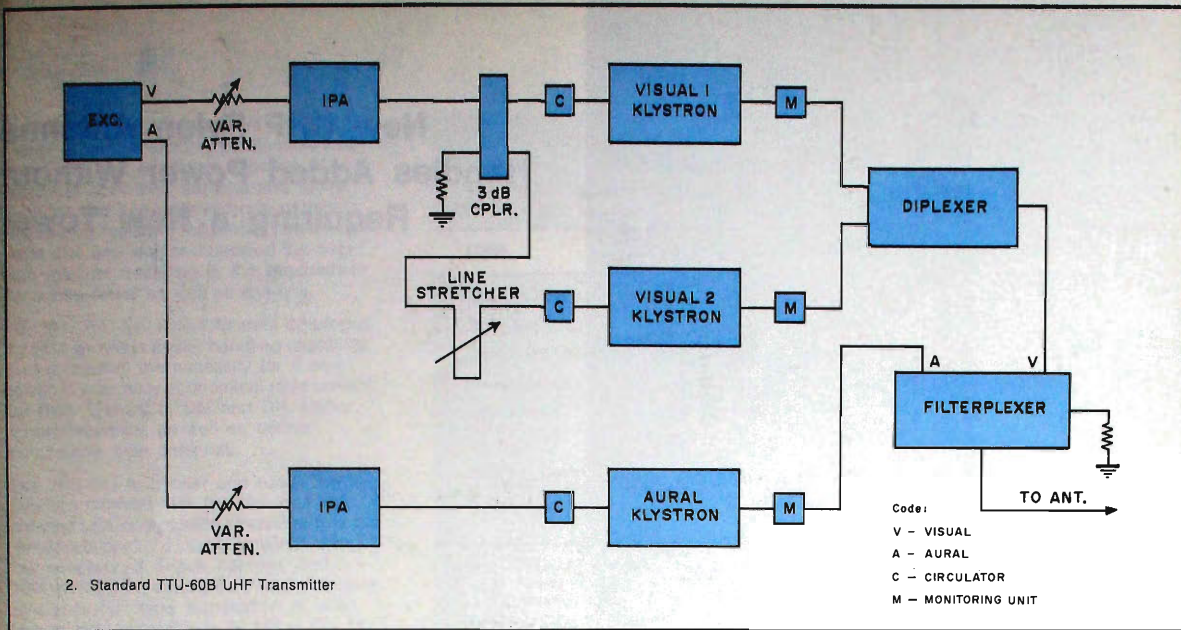

any one of the three klystrons will not preclude operation at a minimum 20% of normal visual and aural transmitter power.

A control panel located in the standby exciter rack provides local switching control of the standby switching system. The switching control functions are also available at the transmitter remote control location by means of the transmitter remote control system. Fault detection circuits are included in the transmitter to provide remote identification of the failed device, enabling the remote operator to determine the proper switching action.

Also shown in the block diagram (Figure 3) although not essential to the protective functions of the switching system are a seven-port 3 1/2 inch and four-port 6 1/2 inch coaxial switch. These switches are recommended to aid in maintenance and testing.

Standby option also available for earlier model transmitters

The "Standby Power Option" is available as an accessory group to the TTU-60B transmitter or to either of its two predecessors, the TTU-60A or TTU-50C UHF transmitter. Any one of these transmitters equipped with the "Standby Power Option"

is an economical alternative to the use of a spare transmitter to qualify for remote control with only a weekly visit to the transmitter site for inspection and calibration. ■

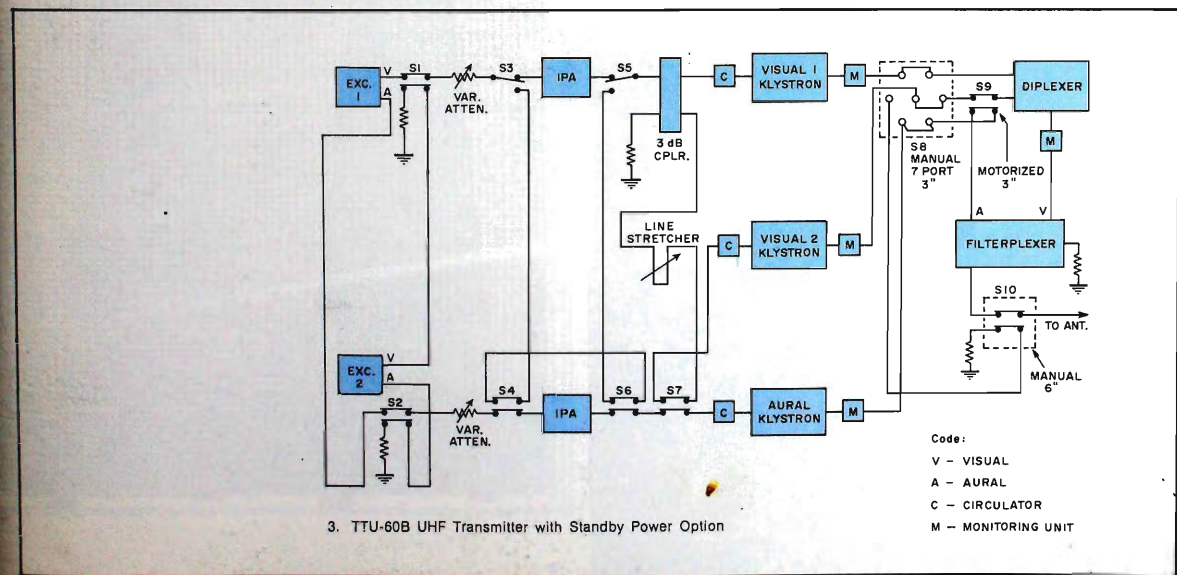

New UHF Pylon Antenna Handles Added Power Without Requiring a New Tower

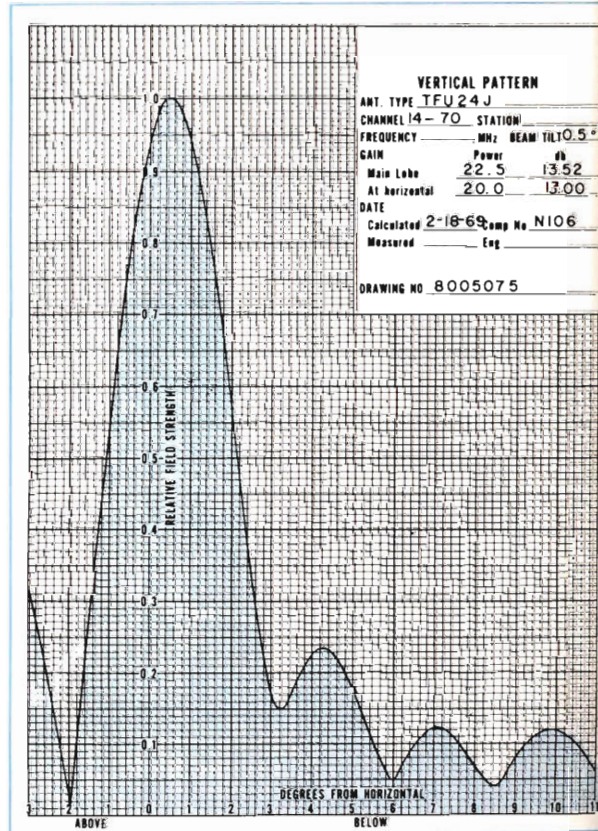
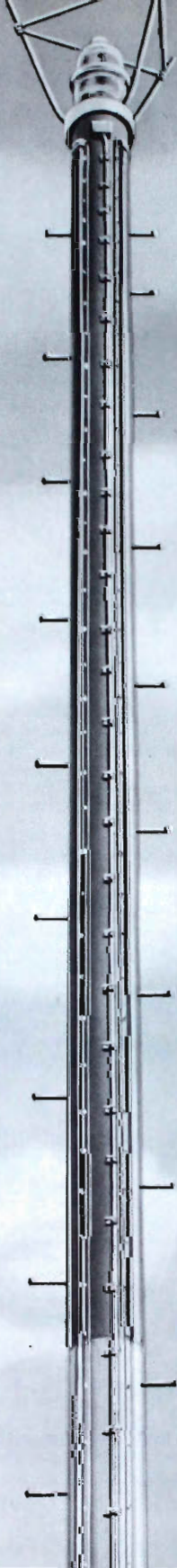

Established UHF broadcasters investing in higher power transmitting plants have been faced with the additional expense of replacing both their antenna and tower. A larger and heavier antenna was usually needed for handling the added power. This extra size and weight increased the overturn moment, resulting in the requirement for a new tower as well as antenna.

The new TFU-24J Pylon Antenna developed by RCA provides power handling capability and eliminates the necessity for a new tower. It is an easy economical replacement for RCA TFU-24DL, DM and DH, earlier model antennas, as well as certain competitive type antennas.

The TFU-24J is shorter and has a lower overturn moment than the previous loop antennas for comparable channels. It is an omnidirectional, "J" type antenna, using bar couplers, a 5-inch harness, and 10 $\frac{3}{4}$ -inch (O.D.) outer pipe. A high aperture efficiency "J" type illumination is used. Power input capability is 60 kW at Ch. 14, decreasing to 38 kW at Ch. 70. ■

COMPARISON TABLE/ANTENNAS

ITEM	24J	21DL	24DL	24DM	27DH	REMARKS
Channel Range	14-70	14-30	14-30	31-50	51-70	
Mounting Flange	10 $\frac{3}{4}$ "	10 $\frac{3}{4}$ "	10 $\frac{3}{4}$ "	8 $\frac{3}{4}$ "	6 $\frac{3}{4}$ "	
Gain @ 0.5° Beam Tilt	22.5	19.8	22.1	22.1	24.0	See Note 1
Power Rating—kW	60 to 38	15.0	15.0	13.5	12.5	See Note 2
H2 @ Ch. 14	46.4'	46.83'	53.08'	—	—	
H2 @ Ch. 31	38.4'	—	—	43.33'	—	
H2 @ Ch. 51	32.1'	—	—	—	40.08'	
OTM Ch. 14 @ 50/30*	39,180	39,800	51,800	—	—	*TFU-24J
OTM Ch. 31 @ 50/30*	26,985	—	—	30,800	—	Derated from
OTM Ch. 51 @ 50/30*	19,514	—	—	—	22,600	50/33 for
						Comparison

- Note 1 TFU-24J gain varies with beam tilt comparably with the TFU "D" series antennas.
 2 Power Input with 20% aural. Higher power (6 $\frac{1}{4}$ %) is available.
 3 Abbreviations: H2 = Height of Antenna less Beacon.
 OTM = Overturn Moment.

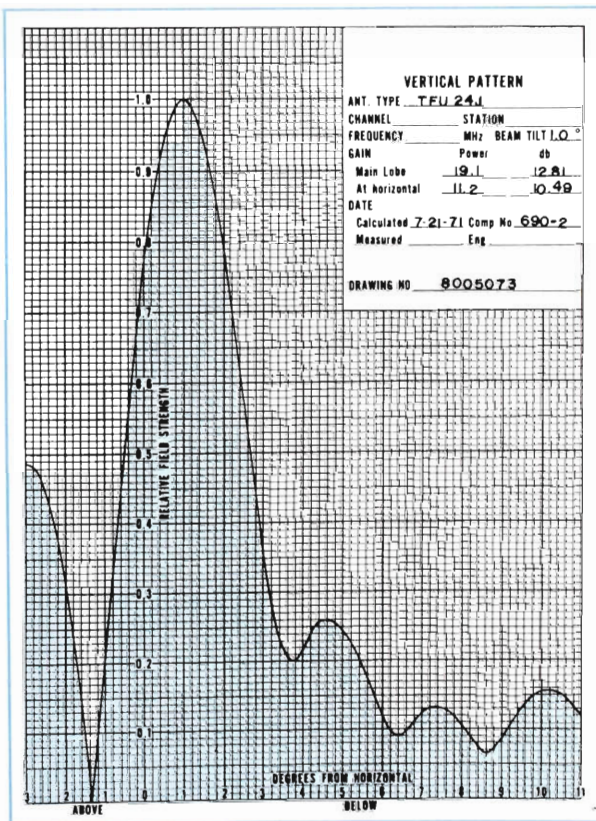
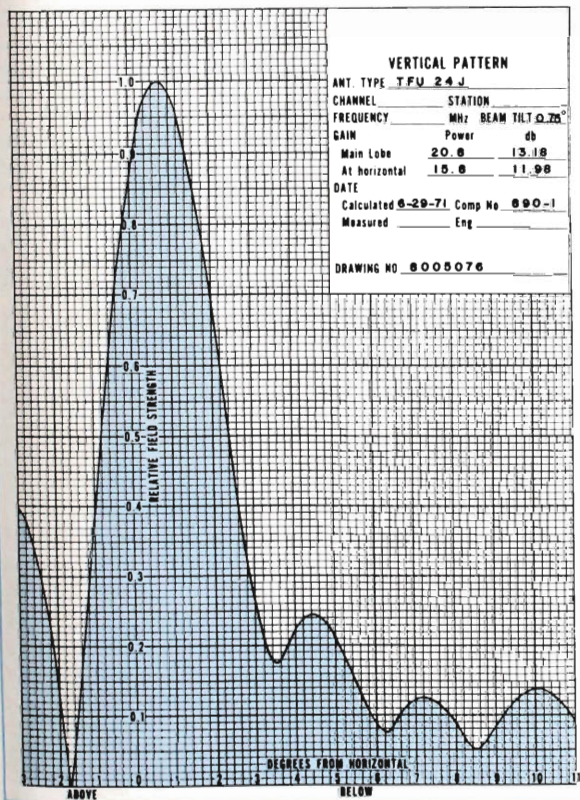

When a low-priced broadcast camera looks like a good buy, keep right on looking.

Take a good look inside. Check out the design and construction features.

Then think about what they mean in terms of reliability, maintenance, and long-term picture quality after the camera has been put to a lot of hard, daily use.

Look at the RCA TK-630 color camera.

The heart of its optical system is a simple one-piece sealed prism rather than the ordinary arrangement of mirrors.

It's simpler to maintain; stays in perfect alignment; eliminates the secondary reflections that even slight contamination of mirror surfaces can cause.

And for stability, the entire optical system is mounted on a sturdy bed-plate for extra rigid support of pickup tubes, lens and prism.

The result? Less shock and vibration. Extra dependability. And pictures that stay sharp and true.

Components are easily accessible so maintenance is fast and simple. The pickup tubes for example, can be replaced in two minutes. Without disturbing the

optical alignment and causing deterioration of picture quality.

Circuit modules are easy to get at, too. And they're totally solid state for compactness and long life.

And the TK-630 is made for portability — with a plug-in detachable viewfinder and carrying handle that make it easy for one man to carry.

There are other quality features which set the TK-630 apart: Calibrated test pulse; built-in encoder with color bar generator; automatic pulse timing; deflection failure protection; electronic lens capping, easy setup. And many more.

The new low price is the first thing that looks good about the TK-630.

But by no means the last.

Ask your RCA Representative, or write for new brochure. RCA Broadcast Systems, Bldg. 2-5, Camden, N. J. 08102.



RCA

New TK-630 color camera.



Look for **versatility** in field or studio use. Plug-in viewfinder quickly detaches for easy portability.



Look for **rugged construction**. An extra measure of design integrity. Sturdy circuit boards take hard knocks. Premium components for extra life.



Look for **optical efficiency**. Sealed dichroic prism and rigid optical bedplate produce brilliant color pictures with quality that lasts and lasts.

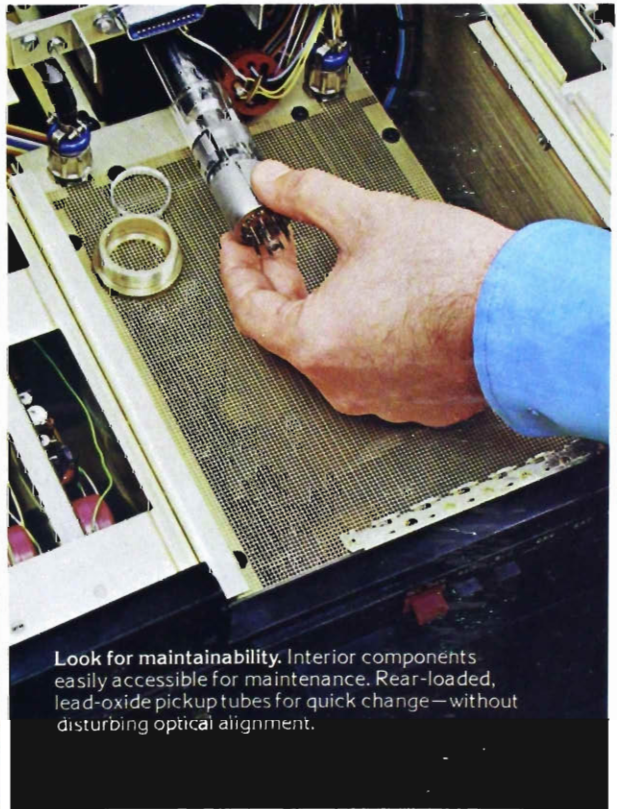

Look for **maintainability**. Interior components easily accessible for maintenance. Rear-loaded, lead-oxide pickup tubes for quick change—without disturbing optical alignment.

