

Journal

RCA Broadcast News

Volume No. 159, October 1976



Night Life in Tacoma . . .
KSTW-TV's New Broadcast and
Production Center

Broadcast equipment designed today for the day after tomorrow.

BEFORE YOU BUY A NEW VTR, LOOK AT A REALLY NEW VTR.

RCA's new technology TR-600 proves medium price and small size can add up to unsurpassed performance. Check the specs — check the price — and you'll discover that the newest offers you the most.

It's about half the size of standard quad VTR's. With built-in automatics that

used to cost you extra and the latest technology incorporated in a design that gives you superb picture performance.

For example, computer designed and tested modules give superior reliability; unique straight line threading; LED diagnostic indicators flash warnings before malfunctions get out of hand.

and its new integrated design cuts active electronic devices by 45%.

Check with your RCA representative. He's got the total value story on the one VTR that's really new.



RCA



Page 8

KSTW-TV, Tacoma Innovates As It Builds (Cover Story)

Programmed as an independent, this Gaylord Broadcasting Company station operates from a new broadcast and production facility that abounds with innovations, including digitally controlled systems for switching, signal distribution and machine control. The newest addition is a TV satellite earth station.



Page 16

TKP-45 Camera Goes Everywhere for KCET-TV

Operating from a compact van, KCET's TKP-45 portable color camera has been a workhorse performer, covering Los Angeles and environs from land, sea and air, with excellent results.



Page 19

TK-76 In Action . . . Around the World

A picture report showing our new camera demonstrating its versatility, performing in a variety of usual and unusual situations.



Page 24

Television at the Montreal Games

The task was an immense challenge successfully met by ORTO's technical facilities and services. RCA equipment played a special part in live coverage and the packaging of unilateral broadcasters' programs for distribution to the world.



Page 30

UHF Success Story

The combination of alternative programming and upgraded technical facilities has been successful for WHMB-TV, Indianapolis.



Page 34

New Transmitters for Transtower Stations

KCRA-TV, KQVR-TV and KXTV serve the Sacramento-Stockton market, transmitting from the Transtower multiple antenna tower. In 1975 each of these stations switched to a new parallel TV transmitter, and the picture quality is better than ever.



Page 37

At Teletronics New Video Center, the Focus Is On Creativity

The new headquarters for Teletronics International in New York City houses an extensive array of sophisticated electronics for TV production. But here the hardware is behind the scenes, so clients can focus on creativity without the distraction of machine operations.

Page 42

Products In The News

Featured new products include: TFS-121 Video Synchronizer; servo-controlled 35mm Projector; AE-600 Editing System for TR-600 Tape Recorder; TT-50FL, parallel 50 kW lowband VHF Transmitter; cardioid UHF Pylon Antenna; audio program automation system, and others.

View Finder



New broadcast facility for KRXX-AM is installed in a mobile home. Temporary studio set-up includes the basics for broadcast operation.



Mr. Ellis mans the mike, announcing KRXX's return to air.

Idaho Flood Disaster Brings Quick Response

The transmitter shack of KRXX-AM, the only radio station in Rexburg, Idaho, all but disappeared in early June as raging flood waters from the breached Teton Dam 15 miles away smashed into it.

That knocked KRXX off the air, leaving the town's 4,700 citizens without radio communications to help locate family members and friends and to broadcast

emergency rescue messages in the stricken area.

Shortly thereafter Idaho Gov. Cecil D. Andrus telephoned RCA to enlist the company's aid in getting the station back on the air. The manufacturing plant in Meadow Lands, Pa., was alerted, and a one-kilowatt AM transmitter was checked out and packed.

On the following day, the 1,200-pound transmitter was put aboard a National Guard aircraft for the flight to Idaho. Meanwhile, RCA transmitter specialists had arrived in Rexburg and were helicoptered to the KRXX site. They found only a concrete floor slab where the transmitter building had been, but the station's antenna tower surprisingly remained standing.

The new BTA-1S transmitter was trucked to the site and the RCA engineers, with the help of National Guardsmen, went to work installing it in a large house trailer that was to be its home. The transmitter was hoisted into place where the trailer's bathtub had been.

The mobile home was also to become KRXX's studio, since its in-town facilities had also fallen victim to the flood waters. Once the transmitter was installed and lines run to the antenna, the RCA men turned to the task of hooking up audio cartridge recorders, a portable audio control console, microphone and record turntable. This equipment also had been rushed to the site by air.

By mid-afternoon, June 15, a little more than four days after the call for help was received, KRXX had resumed broadcasting.

Station owner Don Ellis (below) checks out the RCA BTA-1S transmitter which replaced the bathtub in the mobile home.



Tennessee Educational TV Expands State Network

The State of Tennessee has ordered a complete RCA TV transmitting system, valued at approximately \$642,000, to expand the state's educational television network.

The UHF system includes a TTU-30, 30 kW transmitter; a TFU-30J omnidirectional Pylon Antenna mounted on a 805-foot tower, and associated equipment.

Glen Boatright, Director of Engineering for the network, said the new transmitting facility is being installed near Cookeville, to provide educational and cultural programming to viewers in central Tennessee.

The station will be linked into the network by microwave, joining stations already in operation in Sneadville, Chattanooga and Lexington, Tennessee.

Sundance Productions Adds RCA-Equipped Mobile Unit

Sundance Productions, Inc., Dallas, Tex., has entered the television production field with a mobile TV unit equipped with RCA camera and video tape recording systems.

Rush Beesley, President, said Sundance will concentrate initially on TV commercial production for clients in the Dallas and immediate five-state area. Well known in the audio recording industry, the firm specializes in custom and syndicated music for radio and television.

The mobile TV unit is equipped with RCA's TR-600 quadruplex video tape recorder, and a TKP-45 color camera, a lightweight portable capable of producing pictures that match studio camera quality.

The TKP-45 system includes a minipack battery and camera control unit which allows the camera to go anywhere as a fully self-contained system, and gives the operator more freedom of movement and flexibility on location.

In addition to commercial and industrial production, Sundance is looking ahead to programming for the videodisc market, Mr. Beesley said.

The Outlet Co. Upgrades With \$800,000 Equipment Purchase

In a major upgrading of its station group facilities, The Outlet Co., Providence, R. I., has ordered RCA television broadcast equipment valued at approximately \$800,000. The order includes studio and portable TV cameras, video tape and TV film systems, and associated equipment.

Billy Patton, the group's Director of Engineering, said the new-equipment purchase represents a continuing facilities program to provide the best service to Outlet station viewers.

WDBO-TV, Orlando, Fla., will install two RCA TK-46 studio cameras and two TK-76 portable color cameras.

The studio operations of WCMH-TV, Columbus, Ohio, will be upgraded with two TK-45A cameras and a TK-28 film island. KSAT-TV, San Antonio, Tex., will install two TK-46's; and WJAR-TV, Providence, R. I. will receive a TR-600 video tape recorder and a TK-28 telecine unit.

Two Brazil Stations Purchase TV Studio/Transmitter Systems

A Gazeta do Espirito Santo Radio e TV, Ltda., has ordered RCA color television studio and transmitting equipment valued at approximately \$700,000 for its new TV station. The station serves about 450,000 viewers in Vitoria, capital of Espirito Santo State, and in the nearby cities of Cariacica, Vila Velha and Serra.

Two TR-600 video tape recorders; a TK-28 telecine system and switching, monitoring and test equipment are on the studio order. The new VHF transmitting system includes a TT-15FL, 15 kW transmitter and a Turnstile antenna.

TV Itapoan, Salvador, Brazil, has upgraded its broadcast facilities with the purchase of new color studio and transmitting equipment. The order, in excess of \$580,000, includes a six-kW lowband VHF transmitter and associated dipole antenna. Studio operations are being modernized with the addition of a complete TK-28 telecine system and two TR-600 VTR's.

RCA TK-76: the TV camera with film camera freedom.



NO BACKPACK.

A single-unit TK-76 Color Camera contains all the electronics, yet weighs just 22 pounds. It offers 12v. DC or 6-pound battery pack operation.

Among its many features: automatic iris and white balance; horizontal and vertical aperture correction; exclusive sealed, shock-mounted prism optics; built-in sync generator with gen-lock.

If all this says "new camera", fine. But the TK-76 is great for many live or taped remotes. And for specialized studio assignments, too.

Join the networks and the many knowledgeable broadcasters who are reserving the TK-76 for early delivery. Place your order now for the one TV camera with film camera freedom. For details, write RCA Camera, Building 2-2, Dept. A1, Camden, NJ 08102.

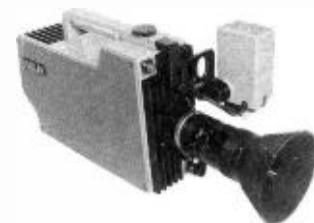

RCA

RCA TK-76: the TV camera with film camera freedom.



TOP VALUE.

You can pay a lot more for a lot less color TV camera.

For instance, you won't find a shock-mounted optical system in any other portable. At any price.

In the TK-76, you will find fast turn-on, prism optics, built-in sync generator with gen-lock, automatic iris, automatic white balance, adjustable viewfinder, and 12v. DC or battery pack operation, all in a shoulder-mounted, 22-pound camera that needs no backpack nor control unit.

The TK-76's film camera freedom lets one or two people do news remotes, sports, special events, documentaries, even profitable local spot commercials.

Never has a camera of this quality been available in this size and at this price. Why not reserve your TK-76 now for the many news-making events ahead? Call your RCA Representative, or write RCA Camera, Building 2-2, Dept. A1, Camden, NJ 08102.

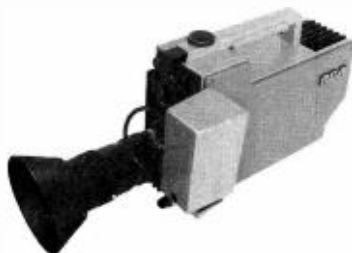

RCA

RCA Receives Post Office Contract To Study Electronic Message Service

A new concept for an Electronic Message Service (EMS) that could revolutionize present mail-handling and dispatching methods and provide nation-wide overnight delivery of letter mail in the country's major population centers, is being studied by RCA.

The system definition and evaluation study is being conducted under a \$2,200,000 contract from the U. S. Postal Service (USPS).

As envisioned by USPS and RCA, the system would draw on many advanced technologies, automated devices and communications capabilities. "The task is to integrate these elements, and others, into a single reliable and economical system," said Dr. James Vollmer, Division Vice President, Government Communications Systems Division, Camden, N. J.

"There are many alternative technologies and system configurations to be investigated," he said. "The results will provide postal management with information required to help determine the proper role for the USPS in the nation's telecommunications future."

Some of the telecommunications systems and technologies being investigated by the study include communications satellites, facsimile devices, computer tape, optical character readers, word processing equipment, store and forward switching systems and paper handling and enveloping equipment.

"The system could be designed to take a letter from its originator and process it through to the destination post office where it will be sorted automatically into its place for the proper mail delivery route," Dr. Vollmer said.

It could serve companies with their own electronic devices and link them directly to one of the proposed EMS centers throughout the country. Electronic mail boxes located in the lobbies of major office buildings or post offices are possible other means to serve USPS customers.

"Most important," Dr. Vollmer said, "is that the final system will be geared to provide one-day service to a much larger portion of the country than is

possible today—and at internal handling costs lower than USPS is experiencing today."

RCA Frame Synchronizer In Bicentennial Debut

The TFS-121 Video Frame Synchronizer introduced at this year's NAB was field tested on the Bicentennial Weekend in a maximum exposure situation.

The Synchronizer was used in producing the "Great American Celebration". This special, hosted by Ed McMahon from Ft. McHenry (Baltimore) was on the air for 12 hours, beginning at 7:00 PM July 3. Production was handled by Mobile Television Services.

Four remote input signals from four different telephone company lines were synchronized by the TFS-121. The remotes originated in San Diego; Wolf Trap (Virginia); King's Island (Ohio) and at the Iwo Jima Monument near Washington.

Early in the show, switching sequences between remote signals were executed, including "hot switches" by telco and TS-51 switches between two incoming telco lines. The TFS-121 did its job of splicing together the incoming non-synchronous information. At several points in the program, the use of the Synchronizer was dramatized by split screens and lap dissolves between remote and local signals.

Throughout, the TFS-121 locked up and performed flawlessly. The system is now in production, with deliveries scheduled to begin early next year. (For additional detail on the TFS-121, see "Products in the News" in this issue).

Antennas And TK-76's For Springfield Television

Springfield Television Broadcasting Corp., Springfield, Mass., has ordered RCA broadcast equipment valued at approximately \$650,000 for two of its TV stations. The order includes two UHF antenna systems; transmission line and associated equipment, and four TK-76 portable color TV cameras.

WWLP-TV, Springfield, Mass., is install-

RCA Broadcast Systems Expands Customer Training

As part of a continuing information program for broadcast and teleproduction engineers, RCA Broadcast Systems is developing a new series of audio-visual instructional programs on products and technical subjects.

The programs will concentrate initially on helping customers understand operation of the TK-76 electronic journalism camera and other advanced RCA equipment, according to John W. Wentworth, Manager, Technical Training.

Later offerings will cover general subjects and will give technical personnel a solid grounding in digital technology, microprocessor applications, image processing and other subjects representative of the leading edge of electronics technology, he added.

"RCA will continue to conduct regular training seminars for customers who purchase our broadcast equipment," Mr. Wentworth said.

"The audio-visual training programs, complete with workbooks and guides, will be offered for sale. They are intended to augment seminars and to help attendees to train others in their organizations. The programs should



Broadcast Systems Technical Training Staff: Charlie Pierce; Jacqueline Joiner; John Wentworth, Manager; Bob Hurst, and Elaine Smith.

prove useful as periodic refresher courses and for orientation of new personnel."

Robert N. Hurst, an RCA engineer with an extensive background in broadcast

equipment design and in digital technology, has joined the RCA Technical Training staff to assist in developing and expanding training programs, with emphasis on the advanced technology used in the equipment.

ing an RCA TFU-28DAS antenna, and WKEF-TV, Dayton, Ohio, is adding a custom TFU-28G. Both are high gain UHF Pylon Antennas. John Fergie, Vice President, Engineering for the group said the new antenna systems will provide improved signal saturation of the stations' coverage areas.

All of the four TK-76 cameras are destined for WWLP-TV to be used in electronic newsgathering.

OB Unit For University Of Jundi Shapur, Iran

As the initial step in establishing television as an educational aid, the University of Jundi Shapur, Ahwaz, Iran, is installing a complete RCA mobile

color TV production and distribution system.

The University is constructing an on-campus Audio/Video Center as part of an expansion program, and the new television equipment will form the backbone of the facility.

The mobile TV unit, designed and equipped by RCA is contained in a tractor-towed trailer. It carries two TK-45 live color TV cameras, and a complete color film originating system, including the TK-28 telecine camera, along with motion picture and slide projectors.

The system, which operates on the PAL color standard, also includes a TR-600 video tape recorder and associated audio and terminal equipment.

The mobile TV production and playback facility will be transported to

locations around the University campus to record instructional programs and to distribute tape and film programs to classrooms.

For classroom viewing, the TV unit contains 20 color picture monitors fed by a distribution system in the mobile trailer. The monitors also are capable of receiving local broadcasts of the National Iranian Radio and Television network.

A special air-conditioning system is installed in the trailer to cope with the high temperatures encountered in the Ahwaz area of Iran in the summer months.

The unit also includes a generator system which can be towed behind the trailer to make the TV system independent of public power supplies either on or off campus.

**RCA TK-76:
the TV camera with
film camera freedom.**



**ONE-MAN
NEWS.**

Even a one-man crew can get news fast with a TK-76 portable color camera. Aim-and-shoot automatic features deliver film camera quality even in low light. Instant warm-up puts you on-air or on tape just seconds after you're on the scene.

There's no cumbersome backpack or control unit to hold your reporter back from the action. The 22-pound, self-contained TK-76 is powered by a 6-pound battery belt or a car's 12v. DC cigarette lighter.

The TK-76 is great for documentaries and profitable local spot commercials, for specialized sports and studio assignments, too.

The list of orders is growing, so place yours now and be way ahead. See your RCA Representative, or write RCA Camera, Building 2-2, Dept. A1, Camden, NJ 08102.

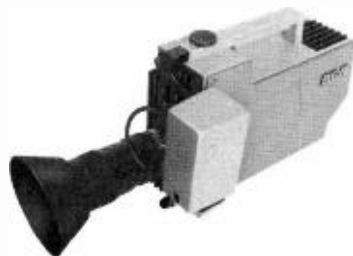

RCA

**Tallahassee's First UHF-TV
Station On-Air With
RCA Broadcast Systems**

WECA-TV, the first UHF television station in Tallahassee, Fla., is installing approximately \$850,000 in RCA broadcast equipment. The order, from Allen Communications, Inc., includes a full complement of transmitting and studio equipment.

The Ch. 27 transmitting system combines an RCA TTU-30, 30 kW UHF transmitter with a high-gain antenna to produce more than 1.3 megawatts of effective radiated power, according to Donald Myers, General Manager. The TFU-36JDA Pylon Antenna provides a directional horizontal pattern and is mounted on a tower with an overall height of 1049 feet.

Two TR-600 video tape recorders and a complete TK-28 telecine system are installed in the studio, along with live color TV cameras, switching monitoring and control equipment.

E. C. Allen, President of the new station, said WECA-TV is Tallahassee's second commercial outlet, giving area viewers an alternate program source.

**Metromedia Expands
Electronic Newsgathering
With TK-76 Cameras**

Metromedia Television is expanding the electronic newsgathering capabilities of its owned and operated television stations with 11 TK-76 color TV cameras.

The Hollywood-based subsidiary of Metromedia, Inc. ordered the new portable camera systems for use by the six stations in the group: WNEW-TV, New York; KTTV-TV, Los Angeles; WTTG-TV, Washington, D. C.; KMBC-TV, Kansas City; WTCN-TV, Minneapolis-St. Paul; and WXIX-TV, Cincinnati, Ohio.

**RCA TK-76:
the TV camera with
film camera freedom.**



**STRONG
CASE.**

Ours seals in shock-mounted optics. Something you won't find in any other portable color camera at any price.

Ours protects a balanced, 22-pound unit that contains all the electronics. With no bothersome backpack, no control unit. And a host of automatic features that let a cameraman aim and shoot, even in low light.

The only item not in the case is a 6-pound battery pack. (Or use a car's 12v. DC cigarette lighter for power.)

The go-anywhere, shoot-anything TK-76 gives film camera freedom to news remotes, documentaries, sports, and profitable local spot commercials.

Ask your RCA Representative about getting on the TK-76 order roster. For details, write RCA Camera, Building 2-2, Dept. A1, Camden, NJ 08102.



RCA

Five Megawatt Signal For Hartford

WHNB-TV, Hartford, Conn., will begin broadcasting a five-million-watt directional signal later this year when it complete installation of a new RCA transmitting system.

The Plains Television Corp. station, Channel 30, has ordered a 60-kilowatt transmitter and custom-built high-gain antenna.

The new TTU-60 UHF transmitter will operate in parallel with the station's existing 60-kW RCA unit to provide up to 120-kW of visual power output.

The RCA panel antenna will be installed on a new tower being erected on Rattlesnake Mountain in Farmington, Conn., the station's present transmission site.

The antenna is a special TZP-404R, Zee Panel with a field convertible horizontal directional pattern.

William Canora, Chief Engineer, said the station currently is broadcasting at 1.2 million watts ERP, in an omnidirectional pattern. "The new higher power transmitter and directional antenna will provide signal saturation of our coverage area, and give our viewers the highest quality pictures possible," he added.

Arkansas State Converts To Color

Arkansas State University students enrolled in broadcast-oriented degree programs will enjoy the benefits of "hands-on" operating experience in the school's own color TV production studio this fall.

The school is replacing monochrome TV facilities at its Jonesboro, Ark. campus with a new RCA color system. The equipment includes two TK-630 color studio cameras, a TK-610 telecine sys-

tem, a TR-600 quadruplex video recorder, and switching and distribution equipment.

The studio systems will be used to train students for professional positions in broadcast stations, commercial and program production facilities and in educational television operations.

Nationwide Communications Installing \$1 Million In RCA Broadcast Equipment

Nationwide Communications Inc. has ordered and installed \$1 million in RCA cameras, tape, and transmitting equipment.

The purchase includes four RCA TK-76 portable color TV cameras, three TCR-100 video tape cartridge systems; a TK-28, and a replacement transmitting system for Nationwide's FM station in Columbus, Ohio.

One of the group stations, WBAY-TV, Green Bay, Wisc., is operating its second TCR-100 "cart" system, averaging more than 300 individual cartridge plays a day.

WATE-TV, Knoxville, Tenn., and WXEX-TV, Petersburg, Va. have also installed second TCR-100 systems.

WBAY-TV also has added a TK-28 telecine system.

A complete new transmitting system will be installed by WNCI-FM, Columbus, including a BTF-40E1, 40 kilowatt transmitter, antenna and remote control equipment.

RCA TK-76: the TV camera with film camera freedom.



NEW FROM ALL ANGLES.

An adjustable viewfinder lets you shoot news, sports or documentary action from shoulder, hip, ground, or overhead.

The TK-76 is new from the convenience angle. It's self-contained and weighs just 22 pounds, plus a 6-pound, waist-worn battery pack. So one person can do the job of a whole crew.

There are more desirable features in the TK-76 than you can find in any comparable camera. They include sync generator with gen-lock, automatic iris and white balance, horizontal and vertical aperture correction, sealed shock-mounted prism optics, 12v. DC operation.

Place your order now for early delivery. Write RCA Camera, Building 2-2A, Dept. A-1, Camden, NJ 08102.

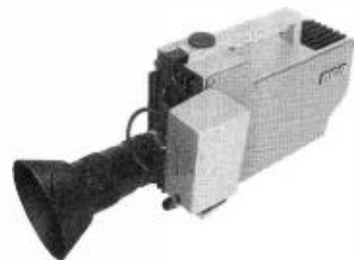

RCA

KSTW-TV

BUILDS A NEW
TELEVISION
CENTER



First Floor

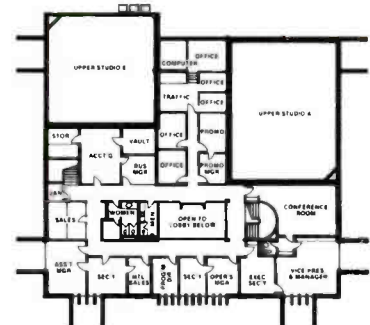

Second Floor

Plan layout for KSTW's new television center shows its efficient flow pattern. The first floor houses technical, production and news operation. Administrative offices and support services are on the second floor.



Production studios at KSTW are fully equipped and professionally staffed for commercial production.

Plan. Decide. Act.

This has proved to be an effective operating style for Gaylord Broadcasting Company in acquiring broadcast properties and in upgrading technical facilities.

KSTW-TV, Tacoma-Seattle, Washington, typifies this successful pattern. Ch. 11 has been broadcasting from an all-new television center since October 13, 1975. What makes this feat remarkable is that it was accomplished in a time span of less than 18 months after transfer of ownership.

KSTW's new home is a solid, 2-story structure of 34,000 square feet, with technical, production and news operations occupying the first floor, and administrative offices and services on the second floor.

Crawford Rice, Executive Vice President and General Manager emphatically notes that "Gaylord Broadcasting's thrust in building the new Ch. 11 plant was to provide the finest facility available in the area—a technical center second to none."

The acquisition of KSTW (formerly KTNT) Mr. Rice adds, fits the planned growth pattern of the Gaylord Broadcasting company to cover major markets in different geographic areas. Other Gaylord properties include WVTM, Milwaukee; KHTV, Houston; KVTM, Ft. Worth/Dallas; WTVT, Tampa/St. Petersburg. All except the last operate as independent stations in their markets. Gaylord also operates radio stations in Oklahoma City and Albuquerque.

A tour of KSTW's technical areas confirms the high quality broadcast and production capability. There are two fully equipped production studios; digitally controlled master and production switchers; four complete film islands, and a video tape room that includes two TCR-100A video cartridge systems, and four other quad VTR's.

Flexible, Redundant Technical Facilities

Paul Crittenden, Chief Engineer for TV-11, is an affable, gregarious individual who is obviously happy with his technical facility, especially since he had the opportunity to participate in its design. Not one to stand pat, Mr. Crittenden is constantly engaged in "fine-tuning" one facet or another of his operation, and the technical staff is encouraged to try new approaches. This explains in part why KSTW-TV's video center includes a number of staff-designed innovations for easier maintenance, improved reliability and simplified operation.

Flexibility is essential, since it is an independent station with a strong emphasis on production. In fact, the words "flexible" and "redundant" are often voiced by Mr. Crittenden to describe various facets of the TV-11 operation.

For example:

- Routing and studio switchers can be used for on-air switching if the Master Control Switcher fails
- Three sync generators permit independent productions in the two studios and also provide Master Control back-up
- Dual air compressors with quick-disconnect hoses provide full redundancy for operating the tape machines.
- For added flexibility, Studio B can be run remotely from Master Control if necessary, since two TK-44B camera controls are remoted to this position.

Master Control

Master control is the core of the TV-11 technical operation—the functional center for the station's digital systems for switching, signal distribution and machine control.

In the center of the room is a large console housing the Sarkes Tarzian Master Control switcher which was

planned as an integral part of the new video system. The MC switcher is interconnected to the pulse distribution system and to the machine control system, as are the two larger production switchers installed in Studios "A" and "B". The Master Control switcher has two busses; 23 inputs; key; chromakey and automatic fade/dissolve for both audio and video.

At KSTW, Master Control is a single-event pre-set operation. The operator selects the next event on a pre-roll, then presses the "Roll" bar three seconds before Air (for tape) or two seconds for film. The switcher automatically makes the transition—cut, fade, dissolve, key—which was called for in the mixer. The Master Control operator can break from the pre-set program and switch manually should this be necessary. The switcher is set up for Audio-Follow-Video operation.

A special remote panel designed by KSTW technicians is located at the Master Control console, tied in with the two "cart" machines. In addition to showing the number of events in a sequence this panel provides a 10-second LED digital countdown on the last event. This makes it easy for the MC operator to start the next event precisely on time.

In addition to the Master Control and studio switchers, there are twelve routing switchers in the station, all of which can be monitored from three master monitor positions—Studio switchers A and B and Master Control. The routing and studio switchers can be used for on-air switching if the Master Control Switcher fails.

Four Film Systems

Positioned in front of the Master Control console are four fully equipped film islands. This layout permits the MC operator to see all film sources and to visually confirm that they are responding to commands. All of the islands are remoted to Master Control and are rolled from there, with a 2-second pre-roll. Each film island includes a monochrome camera which is used for preview and for keying inserts. Color film cameras include two TK-28's; a TK-27B and a GE-240. Paul Crittenden refers to the TK-28 as "the best film camera ever produced".

As an independent, TV-11 is heavy on film for programming, making the four telecine islands necessary for smooth



Master Control operator at TV-11 has direct visual contact with four film islands in front of console, and with the adjoining video tape room.

operation. For example, a studio-originated news and host/interview show aired every weekday morning frequently takes all four film islands for film clips and inserts.

A small announce booth adjoins Master Control and is used for making station break announcements and audio tags for slides.

Video Tape Room

The Video Tape area at KSTW adjoins Master Control, separated only by a glass wall. This arrangement has the advantage of giving the MC operator a direct view of both the tape and telecine operations.

Inside the tape room is an imposing complement of machines, including two TCR-100A "cart" machines; three TR-70C's and a durable highbanded TR-22. The "cart" machines are equipped with EPIS (Electronic Program Identification System), editors, and "Random Home". With this built-in capability, the TCR-100's can serve a dual function—as on-air "cart" commercial playback systems, and as production machines.

Engineering Supervisor Bob Robinson thinks the TCR-100A's are great. "I don't know how we operated without them," he says, "and I know we couldn't get along without them now. I'm glad that we got two 'cart' systems

so we can handle both production and air requirements—and still have backup."

The "cart" machines are workhorses at TV-11, handling an average of 430 plays per day, sometimes running as many as ten "carts" on a single break, according to Mr. Robinson. About 30 new dubs are made daily.

All incoming commercials (film and tape) and PSA's are dubbed to "cart", as are all station-originated promo's, ID's and spots, Paul Crittenden affirms. The TCR-100's are used extensively for "intros" and "extros" for regularly

Four reel-to-reel VTR's at TV-11 include three TR-70's and a TR-22. Every tape machine has access to a routing switcher, eliminating the need for audio and video patching.

scheduled program material. They are used to insert segments into standing program material. For example—in making up dated material, such as promoting the next day's movie—the "cart" machine is used for filling in a "doughnut" commercial. After the intro, an action clip from the film might be inserted, with a part of the sound track, or a voice-over announcement. Using the A to B external dub made on the TCR-100, the intro and extro material is played on the "A" deck through the switcher, where the "fill" material is inserted, with the composite being recorded on the "B" deck.

Later, KSTW plans to dub satellite news material and locally originated news film to "carts". This will provide more flexibility for adding, deleting or changing news sequences.

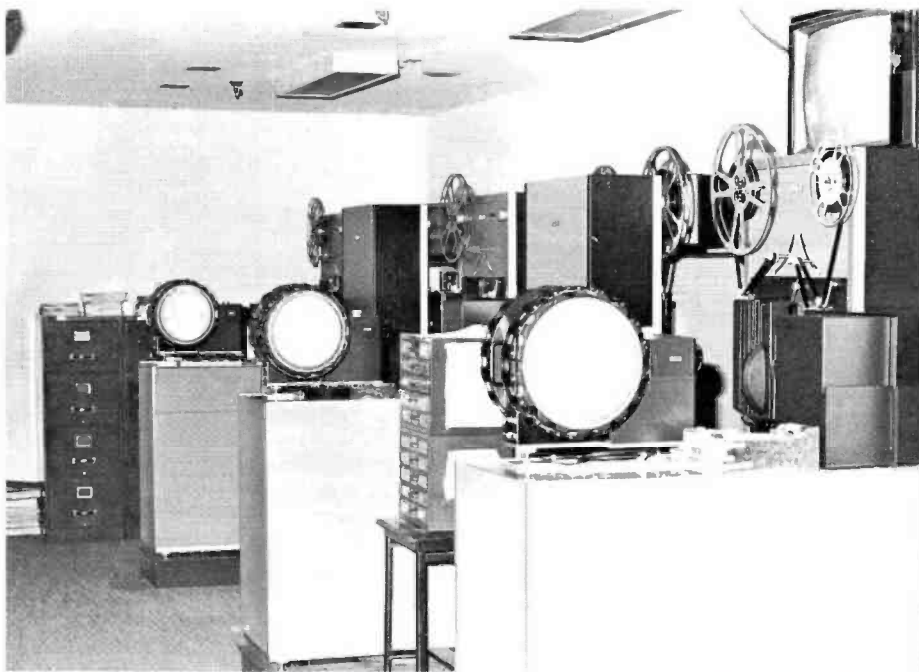

Telecine systems are all removed to Master Control. Heavy film program schedule makes four telecine Islands necessary for smooth operation.



KSTW "cart" machines are averaging 430 plays per day. The machines are fully equipped with EPIS, Random Home and Editing features.

Two TCR-100A cartridge tape machines provide the flexibility needed for production and for on-air playback of "cart" commercials.



Both KSTW studios are geared for production, each with a separate control room and two TK-44B cameras. An enclosed, landscaped courtyard can also be used for outdoor production.

Mr. Crittenden rates the TR-70's as excellent in performance, durability and reliability. Headwheel life is averaging over 700 hours. TV-11 operates their tape machines for 20 hours a day in record and playback. In fact, the TCR-100's are not turned off.

One of the advantages of using all RCA tape machines, Mr. Crittenden remarks, is the interchangeability of the heads. "With three TR-70C's; a TR-22 and two TCR-100's, we operate a total of eight heads, and stock four spares. This gives us more than an adequate back-up."

Each of the four VTR's as well as the two TCR-100's has an editing capability. One pair of TR-70's shares a TEP-1 Tape Editing Programmer. In conjunction with the TEP-1, the KSTW technical staff is developing a system for "group roll" of tape and film machines, which will add even more versatility in production assignments.

Another innovation in the TV-11 tape room is that every tape machine has access to a routing switcher. The input of the VTR is fed by the output of the routing switcher. This makes all of the video facilities of the station available to any tape machines for making recordings, and eliminates the need for audio and video patching, Mr. Crittenden says.

The two new TCR-100A's and three TR-70C's were put on line at the old KSTW facility for "shakedown" operation. When the new building was

constructed, one of the TCR's and one TR-70C were moved in to check out the digital machine control system before moving in the balance of equipment. This advance scheduling paid off, permitting an overnight move into the new location.

Two Production Studios

The two studios operated by TV-11 are geared for production use. Studio "A" is 40' by 50', and smaller Studio "B" is 40' by 40'. Each studio has two TK-44B cameras with 10:1 zoom lenses as normal complement; however, all four cameras could be operated from either studio if needed. Lighting is by Kliegl, with a two-scene pre-set dimmer control panel for each studio. The entire facility is acoustically designed and each studio is completely sound proofed.



Video Control is set up with two Technical Preview positions with Master-Match monitors. This permits the use of both studios for independent, simultaneous productions.

A 40 by 60 foot paved, enclosed courtyard off Studio "A" is used for outdoor production. This unique studio facility is fully landscaped and has full lighting capabilities.

Production switchers in Studios "A" and "B" have access to all available in-house video sources via a machine control panel with a thumbwheel dial. A light by the dial indicates whether a particular source is delegated to that switcher.

On ground level behind the studios are the carpenter shop; set design, set and prop storage area and the engineering mechanical shop facility. A large roll-up door permits driving cars and other large displays or products into the studios for commercial productions.

An audio announce booth next to Stu-



The first commercial TV satellite earth station was installed by KSTW. Viewing the huge dish are Crawford P. Rice, Executive Vice President and General Manager; John Lippman, News Editor; Charles Edwards, Assistant Manager, and Paul Crittenden, Chief Engineer.

dio "B" is used for laying down music beds and voice tracks for production. Often, the audio track is used as the "master" to pace the video action, Mr. Crittenden notes.

Video Control

The video control area, located behind Master Control, is set up so that both studios can be operating simultaneously. There are two separate Technical Preview positions—one for each studio—with separate Master-Match monitors for matching cameras with any source. For situations where it is necessary to operate short-handed, the four TK-44B's and two TK-28's have joystick controls grouped in a single panel so one operator can shade cameras for all film and live sources.

Digital Signal Distribution System

KSTW uses three digital master sync generators in their pulse distribution system. Normally, one sync generator provides sync for Studios "A" and "B" and for Master Control. However, the pulses can be assigned in any combination to either of the studios or to MC. Either studio as well as Master Control can be set up with a separate, independent sync system. An advantage of this scheme is in being able to genlock to a remote or external source without concern about disrupting normal sync operation.

In addition, to simplify system operation, each source—video tape or film—has its own "slave" pulse generator.

There are 17 of these "slave" generators in the system. Slaves are assigned manually for the cameras to the studio. Even if the master sync generator fails, the cameras can still operate on their own slave generator. In the case of the film islands and tape machines, the pulse assignment is married to the machine control.

When a particular machine is delegated to a studio, the pulse is also assigned, so system timing is automatically maintained. The use of slave pulse generators eliminates the need for pulse distribution amplifiers.

A VIR signal is laid down on tape from the output of each studio, and is inserted on the output of each switcher. The switchers have built-in logic to enable smooth transitions to pass on the VIR signal. Also incorporated in the system Mr. Crittenden notes, is a VIR corrector.

The digital machine control system drastically cuts down on wiring for remote machine control. At TV-11, ten sources (six VTR's, including the two TCR-100's, and four film islands) are remote controlled by just six audio pairs.

Encoder/Decoder Operation

For this system, an Encoder/Decoder Panel is located at each tape machine, at each film island, and at the switching locations—Master Control, and Studio "A" and "B" switchers. The system stores commands for the tape and film machines—Stop; Start; Forward; Re-

verse; Change Mirror; switch to magnetic or optical sound, etc.

Digitally encoded commands are sent to each piece of equipment. All sources have a unique address—for example, Film Island #1, #2, #3, #4. And each source on each film island has a separate address. If a TP-66 Projector on a particular film island was desired as a program source, the Encoder/Decoder would send a control signal to that selected Projector, ordering it to start. At the Projector, the signal is decoded, acted on, re-encoded and sent back to the studio or on-air switcher to tell it that the film is rolling as ordered.

The integrated video switching, machine control and pulse distribution system results in smoother, sharper transitions and clean on-air switching. Timing is tightly controlled.

Basement

The attention to detail that was given the new KSTW facility even shows in the basement layout. For example, Mr. Crittenden points out that the building is set on a massive copper grounding system for effective shielding, and extensive use is made of copper strapings for grounding the video tape and film systems. He also notes that during construction, some 40,000 feet of video cable was used.

A crawl space provides access to the wiring cable trays from Master Control and all machines. There is also an underground cable run to the microwave tower outside. This minimizes

interference from "glitch-producing" sources, and results in a better air picture.

The basement also houses intercom and audio power supplies; microwave racks (for a new 100 percent redundant STL); air compressor system (a dual system for handling all tape machines). Additional un-used space is available for expansion of maintenance and mechanical facilities when needed.

Transmitter/Antenna

As a part of the new equipment package, KSTW-TV ordered a 50 kW TT-50FH Transmitter with Opto-Switcher, and a Traveling Wave Antenna. This new transmitting system is still in storage, while TV-11 awaits approval for their new site which will be located on a 1950 foot mountain Southeast of Seattle and Northeast of Tacoma.

Plans call for an underground transmitter building with only one face exposed. This approach combines sound ecological planning and sound construction/operating design. The underground building takes advantage of existing ground contour. The surface will be scraped for construction. Then, after the transmitter building is erected, the excavated dirt will be used as backfill to cover the structure. With only one side exposed, security is simplified, as another "plus".

The new transmitting system, with a higher tower and Traveling Wave Antenna with $\frac{3}{4}^\circ$ beam tilt will increase coverage substantially, as well as provide a stronger color signal for the present market area, according to Mr. Crittenden.

Technical Staff

The Engineering staff of twenty, including supervisors, keeps the KSTW technical facility running smoothly, and also explores new techniques for improving operations. This, too, stems from Paul Crittenden's philosophy. He admits to having an insatiable curiosity and a readiness to check out an untried solution to a problem. As noted previously, this approach has been successful for the station.

Engineering is responsible for maintenance; master video control; camera control, and transmitter operations. The Production Department handles light-

ing; audio; cameras; floor; production switching (done by directors); on-air switching, and projection. Video tape is a split operation, with Engineering making dubs and master recordings, while playback of the reel-to-reel VTR's and the "cart" machines is a Production function.

Programming and Production

Operations Manager Don Lacy is responsible for both programming and production at KSTW-TV. Programming an independent has its advantages, he confirms. One of these is being able to offer syndicated packages with proven track records. Statistics show that only about one-third of the available TV audience has seen all segments of any given series, Mr. Lacy notes, leaving a larger audience for whom the programming is still new. The independent, he adds, can schedule a program for the best time period, and not necessarily head-on with network prime time offerings.

In selecting programs, a continuous check is made of ARB and Nielsen ratings, particularly for series going off network. This permits making early decisions on desirable packages as soon as they are available for re-runs.

TV-11 is now running 18 half-hour syndicated features and 13 one-hour shows. With few exceptions, these are films rather than tape. In addition to the syndicated programs, TV-11 has run more than 700 film features in the past year. More than 300 film titles are stocked, with access to several hundred more through package purchases.

In offering alternative programming, TV-11 is tied in with Western Tele-

communications to receive six incoming video sources, including the three networks. This arrangement gives the station the choice of picking up network programs that are pre-empted by the local affiliates.

The success of TV-11's programming pattern in its overall 12 share of audience rating in the Seattle/Tacoma market. In the afternoon 3 to 6:30 P.M. period, TV-11 is #1 in the market, and maintains a strong position until the prime network programming begins. Nationwide among independents, the station now ranks 10th.

Commercial production capability was a prime consideration in planning the new TV-11 television center, Mr. Lacy says. Consequently, production can be handled on a full-time basis, without affecting on-air programming. In addition to the excellent technical facilities, there is even a creative service group available to assist clients without agencies to develop effective commercials. "We moved into the new plant on a Monday, and started making commercials on the first day," Don Lacy remarks. As expected, the station's production capability has helped to attract local advertisers.

Planning the New TV Center

In developing plans for the new television center, Crawford Rice, Don Lacy and Paul Crittenden were all deeply involved with Architect Dudley Watkins (since deceased). Mr. Rice also gave management in other Gaylord stations an opportunity to contribute ideas. His approach was in the form of two questions: "If there were five things you would discard in building a new

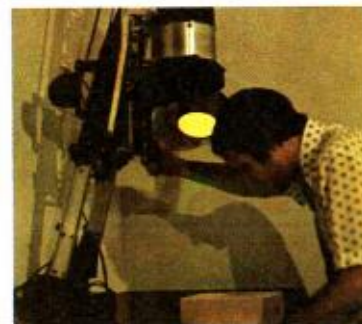
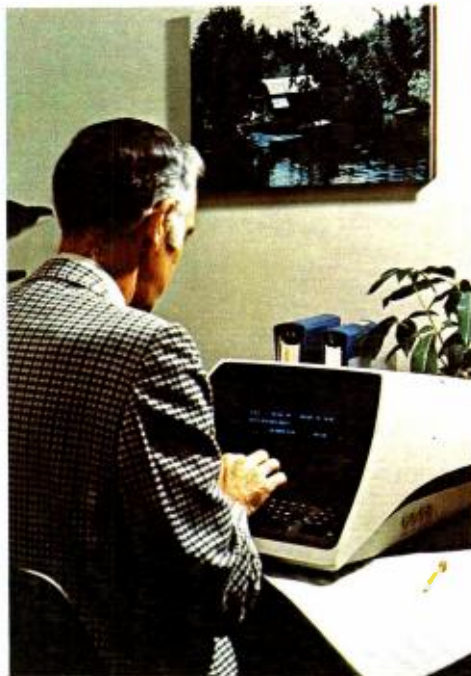

TV facility, what would they be? And, conversely, what five things would you add or change, given the opportunity?" Some useful ideas resulted from this approach, Mr. Rice acknowledges.

As noted previously, design work began even before the final approval on the transfer of ownership was obtained. As a result, the construction contract was let in July 1974, within three months of the approval date.

Making the Move

Early planning, decision-making and action hastened completion of the new plant. And it also facilitated making the move from the old building to the new. Since a substantial amount of new equipment was purchased and delivered before completion of construction, the changeover was not as difficult as it might have been. The major equip-

ment items—cameras, tape and film systems—had already been checked out.

Two of the four TK-44B studio cameras were moved to the new site, along with a TK-28 film island, a TR-70C and a TCR-100A. The wiring had been completed and the TR-70C was rotated into each tape machine position, connected and checked out. This simplified the total move of all equipment to the new location.

The balance of the studio equipment and the business computer were moved on Sunday, ready for Monday morning sign-on. The new microwave STL system was ready, and only had to be turned on. The new path was close enough that it was not even necessary to re-align.

Major dates in the moving cycle were:
September 1975—installed partial

studio equipment complement in new building

October 6, 1975—moved administrative offices.

October 12, 1975—balance of studio equipment moved

October 13, 1975—(Monday) Sign-on from new location

The Right Move at the Right Time

After nearly a year of operation in the new KSTW-TV plant, it is obvious that Gaylord Broadcasting made the right move in investing in a new television center.

The extensive and flexible production capabilities are being well utilized for commercial production as well as for news and public affairs programming. Looking beyond the technical area, the picture's even brighter: share of audience ratings are up, and so are sales.

□

A full range of in-house resources enhance TV-11's program and production efficiency.



LOS ANGELES

TKP-45 sets up quickly and goes anywhere for KCET-TV.

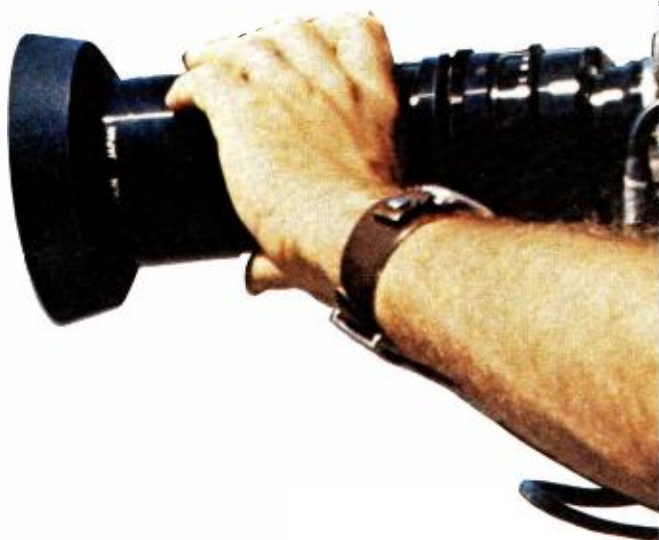

KCET sends its TKP-45 by land, sea and air to cover Los Angeles

WHEN RCA introduced the TKP-45A as the “go anywhere . . . do anything” color camera system, KCET-TV, Hollywood believed—and bought one.

Now, more than a year later, the camera is looking a little beat, but the camera is doing just fine.

Operating from a Dodge Maxi-van, the TKP-45 has covered the Los Angeles area from land, sea and air for Ch. 28, Community Television of Southern California. It has gone aboard helicopters and boats for location shoots.



While most of the assignments have been for news, documentaries and public affairs programs; the TKP-45 is also used in the studio for handling "upstairs" shots for "Hollywood TV Theatre" productions. For the "LA Salutes Arthur Fiedler and the Boston Pops", the TKP-45 was the cover camera on Mr. Fiedler. KCET Engineering Manager Al Hart notes that this situation was perfect for the TKP-45 because it operates without noise or lag, reproducing "pure" blacks, with no flaring.

Most KCET productions from the van involve a three-man crew—a camera-

man; an audio man and a video control VTR operator. The van carries 600 feet of camera cable, and for crowd situations, an additional crew member is needed to clear cable. Audio is plugged into the camera head and sent back to the van on the camera cable.

Two short racks are set up in the control area of the Dodge van. One contains the CCU and monitoring facilities for the TKP-45, the other mounts two $\frac{3}{4}$ " videocassettes which are used for recording. The audio for the recorders was modified by KCET for line level input.

Engineering Manager Loren Kemp likes the TKP-45's performance, noting that the good resolution and low noise of the camera provides excellent tapes. "It gives the 'live' look, even on the $\frac{3}{4}$ inch videocassettes," he adds.

After shooting, the $\frac{3}{4}$ " cassette is transferred, with time code information to 2" quad. At the same time a $\frac{1}{2}$ " reel-to-reel VTR dupe is made, with visible time code. This copy is used by production for "rough cut" editing. All KCET editing rooms are equipped with $\frac{1}{2}$ " tape machines. Usually three 20-minute cassettes are dubbed to the $\frac{1}{2}$ "

Main compartment of the van includes rack-mounted camera controls and VTR's.



Video operator handles TKP-45 camera controls and two cassette video tape recorders.



Closeup of equipment racks. Audio system stores in portable cases.



Rear compartment of van is crammed full, storing the TKP-45 camera head, 600 feet of camera cable and a miscellany of other accessory equipment.

reel recorder for an hour of editing.

KCET has two computer editing systems—CMX-50 and CM-300. With these systems edit and auto assembly operations are much simpler and faster, Mr. Hart says. Editing on the CMX-50 system is done with the cassettes, producing a punched paper tape output that is used for making the master quad recording.

The TKP-45 is doing an outstanding job, Mr. Hart acknowledges. It is stable, maintains registration and produces superb pictures. The pictures from the TKP-45 under just about any conditions, Mr. Hart says, are "super".

The top feature of the TK-45 is its stability, according to Mr. Hart. The camera can be set up, then taken any-

where on location. When it is turned on, the camera is ready to make pictures. This stability, Mr. Hart says, makes it easy to handle the unusual shoots from helicopters or boats.

KCET's TKP-45 is equipped with a 10:1 electric zoom lens. On remotes it is mostly operated as a shoulder mount. However, the van also carries a unipod mount and a O'Connor Hydroped.

Ch. 28 has a TK-76 camera on order and has definite ideas on its use. One application is in the mobile van as a second camera. Loren Kemp also has in mind using it as an ENG camera in an even more basic mobile system. He plans to use it and a 3/4 inch videocassette recorder in a station wagon, going out on assignments.

Al Hart sees the TK-76 as an ideal camera for news and for composite productions—documentaries or public affairs—where several camera crews can cover different segments of the production, with tapes returned for editing and program assembly. This system would save considerable production time, Mr. Hart notes.

Over the years, KCET-TV has garnered many awards for its achievements as the community television station for Southern California, and as the major West Coast production center for Public Broadcasting Service. With its versatility, stability and picture quality, the TKP-45 camera fits comfortably into this environment where demanding performance is a normal requirement. □

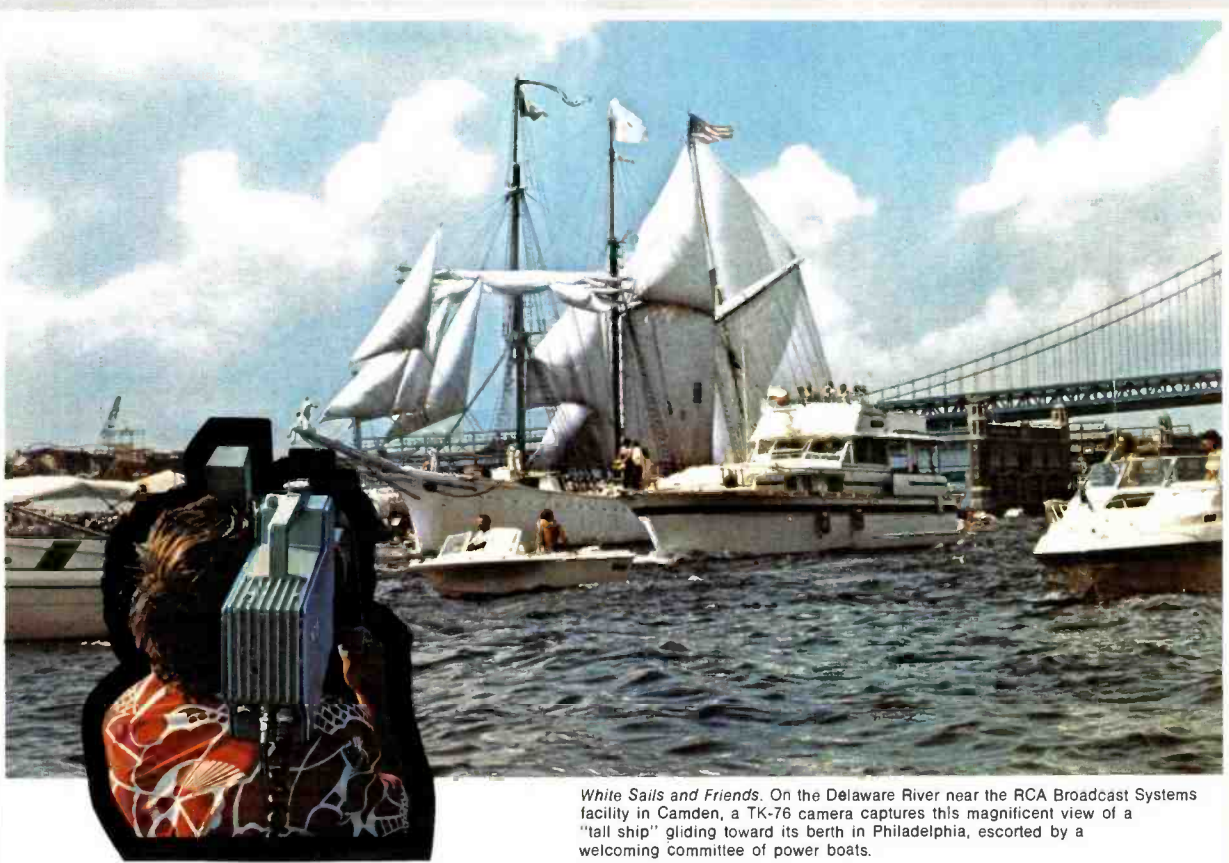

White Sails and Friends. On the Delaware River near the RCA Broadcast Systems facility in Camden, a TK-76 camera captures this magnificent view of a "tall ship" gliding toward its berth in Philadelphia, escorted by a welcoming committee of power boats.

RAGE OF '76

The TK-76 Portable Color Camera has completed its initial cycle of *concept; design; demonstrate, and field test*. Along the way, numerous modifications and improvements were incorporated to meet user needs.

The carefully paced development of the TK-76 and its promising performance features resulted in a large advance order from broadcasters. Now the camera has left the engineering lab and is in full production. At the end of August, nearly 100 cameras had been shipped, and production has been accelerated to shorten delivery dates.

Since the first production unit was shipped late in April, cameras have been delivered to all parts of the globe—and the TK-76's performance has more than matched its promise. Success stories abound, with users reporting that the camera was ready to make pictures as soon as it was removed from its packing case.

This pictorial report identifies some of the early users of the TK-76 and depicts the versatility of the camera in a diversity of locations and applications—from basic EJ to documentaries to production . . . from the Olympic games to the Democratic and Republican political conventions . . . from Hong Kong to Hollywood to Paris.

Getting the TK-76 through design and into production was a carefully planned operation, even with crash schedules—but the rewards of patience are showing in the consistently high quality performance of the cameras in the field. And that's where reputations are made.

TK-76 makes
worldwide
action debut

PARIS • FRANCE



Au service de la télévision française . . . Télévision Française 1, Antenne 2 France and France Régions 3—news and programming divisions of France's huge national TV service—took a closer look at the TK-76's advantages over film. Location assignments included a street in the shadow of the Eiffel Tower, and a news interview at Bois d'Arcy shopping center in nearby Vélizy. The French crews were pleased with the TK-76's near-instant readiness for shooting as well as its excellent picture quality.

MONTREAL • CANADA



Olympic Performer. The little camera handled a big task successfully at the recent Summer Games. ARD, one of West Germany's largest TV networks, supplemented the host broadcaster's standard picture sources with TK-76 material generated indoors and out.

NEW YORK CITY

Two for the Road. Outside Madison Square Garden, an NBC camera crew tapes footage for political convention newscasts. The TK-76 portable camera and a video cassette recorder are a popular EJ combination.



PITTSBURGH • PA.

Quick and Easy. WTAE-TV's ACTION-CAM mobile unit is getting to be a familiar sight wherever the news is happening around Pittsburgh. The TK-76 camera rolls with the Ch. 4 news unit and sends back super pictures—indoors or out, tape or live.



TORONTO • CANADA



Neither rain nor snow.
Weather-resistant characteristics of the TK-76 were proven in the taping of a location segment for CBC's production of "This Land." Snow and rain fell, but the TK-76 never noticed.

WICHITA • KANSAS



First on the Scene.
KARD-TV, Wichita, was the first television station to put the TK-76 into regular service. The camera is keeping a busy schedule, being used for fast-response newsgathering, on-location documentaries and special events coverage as well as for syndicated program production.



HONG KONG

Far-East Pace Setter. Asia's premier field test was by Hong Kong's Television Broadcasts Limited. Maneuvering the TK-76 on busy Nathan Road in Kowloon, the station's location crew made easy work of a remote video-tape production assignment.

NEW YORK CITY



Clear the Aisles. During the Democratic Convention in New York City, the aisles were bustling with camera-toting television reporting teams. A dozen TK-76 cameras were there, performing yeoman service for the networks and for local television broadcasters. Metromedia's WNEW-TV fielded two TK-76's to capture floor action and interviews.

HOLLYWOOD



Mickey Mouse Club Camera. The new Mickey Mouse Club, now being readied for syndication, is a video taped production, using TK-76 cameras for on-location shooting. The first two TK-76's, graphically identified as "Mickey-Cams", have performed so well that two more have been ordered. The cameras were leased to Walt Disney Productions by Image Transforms, Inc. Hollywood.

NEW ORLEANS



Way Down Yonder. In New Orleans, the TK-76 shared in Bicentennial excitement, covering the famed French Quarter, Jackson Square and some of the river scenery for the day-long Fourth of July special presented by CBS. The camera was used with WWL-TV mobile unit, along with several other cameras, and the entire remote was genlocked to the TK-76. The camera performed well, even during periodic rain showers, some of which were heavy.

HOLLYWOOD



Emmy Award Winner. TK-76 pictures went "coast-to-coast" during the televising of the Emmy Award Presentations by ABC-TV, producing excellent pictures from unusual locations and vantage points not available to larger studio type cameras. Extra stability and jitter-free operation were achieved through the use of the CP/76 Steady-Cam system developed by Cinema Products. The camera was linked to a production van by microwave, freeing it from any cable restrictions.

NEW YORK CITY



First On-Air Pictures. Extensive field testing preceded production of the TK-76 and included use of the camera by an NBC-TV news team. The first on-air pictures from the TK-76 were on WNBC-TV, New York, where a taped interview from Sheepshead Bay was broadcast as an evening news segment. Reporter Bob Teague interviewed commercial fishermen and Rep. Stephen J. Solarz, who favor a 200-mile offshore limit to protect U.S. coastal fisheries.

WILKES-BARRE • PA.



One-man News Team. WBRE-TV has a long-standing record of adopting and adapting innovative broadcast products. The Wilkes-Barre station was among the first to install the TCR-100 video cartridge tape recorder and the TCP-1624 cartridge film system. The TK-76 was a natural addition, but TV-28 added a different touch: teaming the TK-76 with a back-packed cassette recorder to permit news coverage by one man if necessary.

ORTO PROVIDES MASSIVE TV FACILITIES

FOR MONTREAL'S GAMES OF THE XXI OLYMPIAD

With a flame ignited electronically via satellite and laser beams from Greece, a torchbearer sprinted into Olympic Stadium on July 17. This heralded the opening of the Games, and thus set into full motion two weeks of the most extensive TV coverage ever handled by a North American broadcaster.

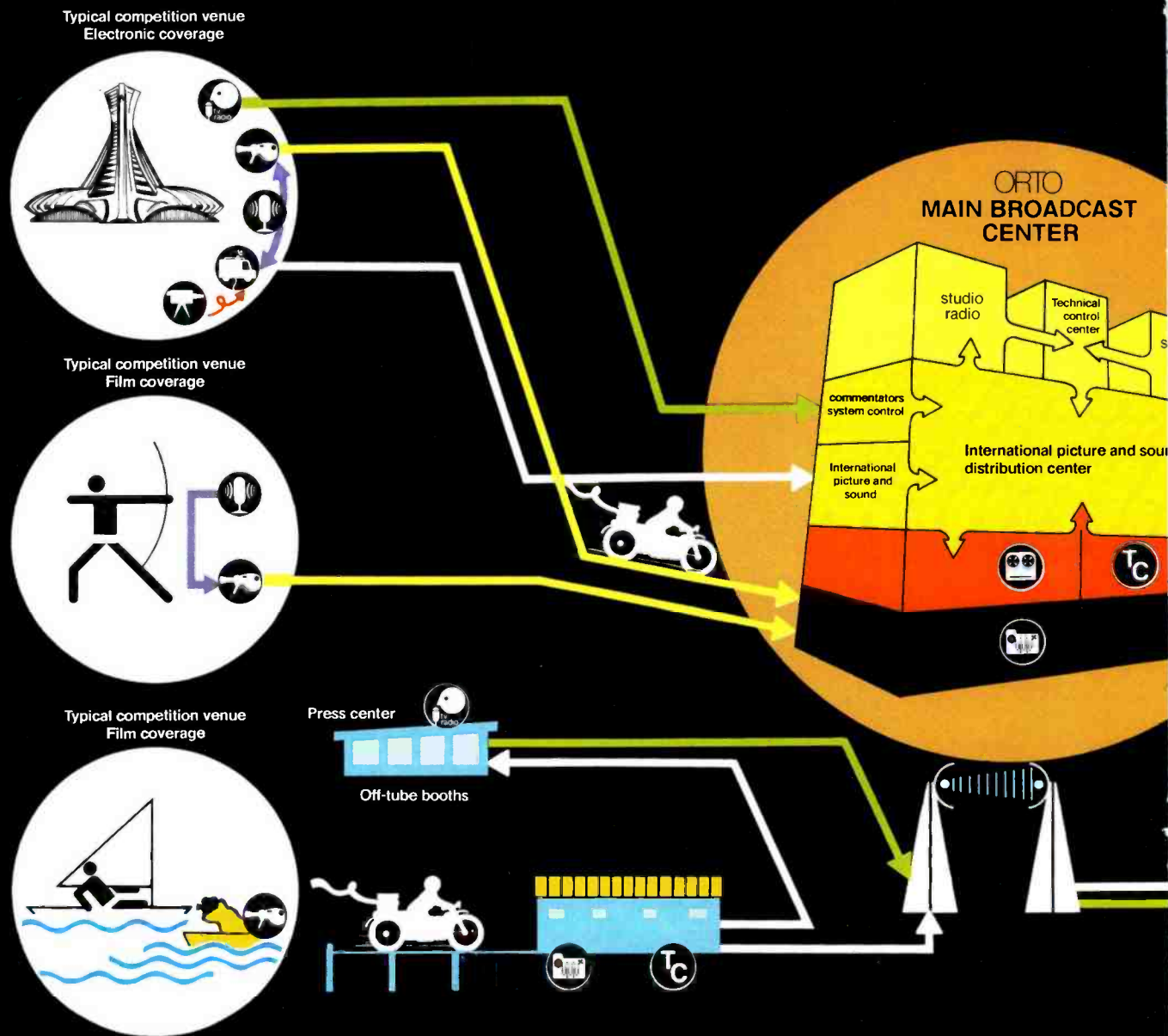

LEGEND

INTERNATIONAL PICTURE AND SOUND ————
 INTERNATIONAL SOUND ————
 BROADCASTERS' PROGRAMS ————

COMMENTARIES ————
 CAMERA CABLE ————

Atlantic
INTELSAT

ANIK 1

Pacific
INTELSAT

Transportable
earth
station
located
in Montreal

Rivière Rouge

Canadian coverage
Time zones other
than eastern

Lake Cowichan

Canadian coverage
eastern time zone

Montreal local coverage

MRC
MAISON
DE RADIO-CANADA

Cité du Havre IBC

UNITED STATES



INTERNATIONAL
SOUND (ambient)



MOBILE
UNIT



COMMENTATOR
POSITION



VIDEO TAPE
RECORDING
CENTER



AUTO CAMERA



MICROWAVE
TOWER



TV-CAMERA



FILM CAMERA



FILM
LABORATORY



TELECINE



FILM
TRANSPORT



TRANSMITTER
TOWER



This gigantic responsibility was undertaken by the Olympics Radio and Television Organization (ORTO), a division of the Canadian Broadcasting Corporation (CBC), which was established three years ago to fulfill the mandate of host broadcaster. To help carry out that role, a significant amount of major RCA broadcast equipment was leased and purchased. Additional units were made available by Canadian broadcasters.

Unlike the German Olympic Center's technical facilities at the Munich Games in 1972, ORTO's were not used to produce a world program. Instead, it provided as many as fifteen simultaneous feeds from which its TV and radio clients—broadcasting groups and entities from 110 countries—sembled their own programs.

Another difference at the 1976 Olympics was the emphasis ORTO's Program and Production Services placed on the human aspects of the competitions. This objective gave TV even more responsibility than had ever been entrusted to it since the advent of Olympic telecasts.

The result of the total TV effort was a glittering picture record of triumph and defeat for a worldwide audience of at least one billion.

Cameras sought out reactions and emotions of happy winners as well as valiant losers, and enthusiastic as well as disappointed spectators. Coverage was diversified further with split screen presentations and superimposing of pictures. Video tape recorded it all, which many broadcasters relied upon in putting together all or part of their own programs.

All of this was accomplished by ORTO's setting up technical facilities for the television services covering 21 sports (plus the opening and closing ceremonies) at the Olympic program's 27 competition sites in Montreal and eight other Canadian cities.

To provide for basic program and production, ORTO devised an integrated system of 20 mobile TV units and more than 700 commentator positions tied into the central production and dis-

tribution facilities at the Main Broadcasting Center (MBC), Located in downtown Montreal, six miles southwest of Olympic Park, MBC was also linked with additional technical facilities at the International Broadcasting Center (IBC) at Cite du Havre, site of Expo '67, and the Maison de Radio-Canada, the distribution point for Canadian coverage.

The IBC building housed master control and studios for ABC (U.S.), NHK (Japan), the Australian Broadcasting Corporation, and broadcasters from New Zealand and Mexico.

The Main Broadcasting Center, however, housed the majority of studios and the technical center. This included ORTO's technical and quality control centers, the main VTR Center and the Production and Technical Area for EBU/OIRT.

EBU (European Broadcasting Union) consists of broadcasting organizations of Western Europe. OIRT is the International Radio and Television Organization made up of broadcasters in seven Eastern European countries plus politically allied countries elsewhere.

The facilities ORTO provided at the MBC and IBC, as well as various venues, included a complex of RCA broadcast equipment.

- 17 TR-600 VTR's
- 5 TK-28 telecine chains
- 38 Color TV Cameras of Various Types

A leasing arrangement, handled by RCA Limited in Ste. Anne-de-Bellevue, Quebec, covered the TR-600's and the telecine chains. Live cameras were provided by CBC and other TV broadcasters throughout Canada.

Olympic VTR's

The TR-600's were customized for use at the Games. The special features, many of which are now standard in current TR-600A production models, are described later in this article.

Twelve of the machines comprised an editing suite at MBC for the EBU/OIRT area. Here, on-site Olympic coverage was received for recording and editing as well as distribution through

its own sub-master control to represented countries.

The machines were divided into pairs interfaced with a rack of electronics for a Tape Editing Programmer with two time-code readers. Each configuration, usually assigned to recording and editing a particular event, was partitioned off. This afforded some degree of isolation from the other machines so VTR operators could better concentrate on the hectic editing schedule.

Four more TR-600's filled additional requirements served by MBC's booking studios, and one was kept in reserve.

Cooperative efforts between RCA and CBC/ORTO led to modification of elements of the machines' circuitry and addition of new features to enhance editing and operational capabilities.

Although time is a significant factor in any editing operation, it is a multi-phase problem in Olympic television. To stay on schedule, time manipulation becomes a way of life. With 21 sports compressed into 15 days, it was necessary to condense events within programs, and meet critical satellite or other transmission schedules to reach the largest number of viewers in home countries at suitable viewing times.

Operating personnel from Eastern and Western Europe seemed very much at ease with the TR-600's. With operations manuals prepared by RCA's Technical Training Department, and just a few hours' practice with the machines, they quickly settled into a smoothly functioning routine.

Editing was very much a "hands-off" operation. It was accomplished as signals from the events were coming in (in real time), or at other times with previously recorded tapes.

For example, personnel from the Russian and Polish broadcast organizations used the RCA equipment early each morning to edit and assemble ORTO library tapes into programs tailored to the interests of their own audiences. These, along with all the other EBU/OIRT program packages, were transmitted through this technical center's sub-master control via a satellite channel.



Unilateral broadcasters had access to 17 customized TR-600's. Pictured in EBU/OIRT's production area is one of six pairs that received on-site coverage of Olympic events for recording and editing.



Five TK-28 film chains were installed at three different studio locations. This one, adjacent to EBU/OIRT's VTR suite, was employed to transmit direct feeds of each day's filmed highlights to millions of viewers in Europe.



One of the six TK-44's assigned to the swimming heats kept pace with competitors' progress by shuttling the length of the pool.

The much-used facilities served numerous EBU/OIRT broadcasters with diverse national interests. So the need to prepare program material quickly within an assigned time period was of paramount importance.

By combining skill and adaptability with the TR-600's new features, the operators were able to meet a variety of production requirements with great efficiency.

Automatic Edit (Tonewheel) Phasing permitted lining up the off-tape signal about to be recorded as soon as the tape reel was rolled prior to making the edit. An edit display or window insert on the video picture monitor indicated proper timing with the coincidence of a moving vertical white line (TR-600 timing) with a fixed white line (signal timing).

Another time saver was Disturbance-Free Video Monitoring. Displaying no picture disturbance at the edit point, it eliminated the need to re-wind the tape for checking.

Variable Capstan Speed Control was still another major advantage. Lip synchronization of two TR-600's was achieved simply by slowing down or speeding up tape motion on either machine until the desired time relationship was reached.

An operating benefit permitting more time for creative control of the editing decision were the Unity/Variable Controls for audio/video input and output levels. This now-standard feature provided a unity position which, once set, required no further adjustment.

A new Pre-Settable LED Tape Timer Display was also useful, as it allowed an arbitrary time reference to be set in either the Record or Edit mode. This saved a step each time a tape was cued up.

Another feature, exclusive with the ORTO machines, was the Audio Matrix Pushbutton. This button, located on the control panel, allowed operators to monitor both audio and cue tracks simultaneously. It was especially advantageous in locating cue tones for editing.

Also contributing to the levels of editing speed necessary at the EBU/OIRT center were the TR-600's straight-line threading procedures, dimensional stability of the tightly held reels and excellent servo stability which helped make very precise edits.

As further indication of the excellent performance of the TR-600's, the sixteen machines in use were "on" for 24 hours daily for almost three weeks. And for the two weeks while the Games were on, recording and editing was virtually a round-the-clock operation, beginning each day at 6:30 am and continuing until 2:30 am the following morning.

Telecine Operations

Five TK-28 multiplexed telecine chains met unilateral requirements for playing out film coverage of the events not covered electronically, in addition to ORTO's daily 20-minute film summary of all events.

Each island was equipped with a TP-7 35mm slide projector, two TP-66 16mm film projectors and a sep-mag unit for foreign-language audio playback.

Two TK-28 islands were located in ORTO's Quality Control Room, where the Director of Program Services supervised electronic coverage of all the venues.

A third unit was assigned to unilateral studios at IBC; another, to Kingston

(site of the yachting competitions covered only on film).

The film footage of the races at the Olympic Regatta Center in Kingston was processed at an on-site lab, edited to produce the best sequences and then transmitted to Montreal each evening via the TK-28 and Post Office lines. Broadcasters were then able to record picture and sound on tape if desired.

The TK-28 system in the EBU/OIRT Technical and Production Area was used every day for direct feeds to Eastern and Western Europe via satellite.

The Olympic record for the performance of the TK-28's is also impressive. Starting a week before the Games opened, they ran continuously—24 hours a day—with no time loss because of camera failure.

Throughout the duration of the Games, these film chains operated unmanned, as built-in correctional controls automatically compensated for any scene-to-scene variations in film densities. In addition to freeing up personnel, this capability enhanced the final product going out.

A Smooth Production Effort

Because the daily Olympic schedule for recording, editing and reproducing film on air was so intense, maintenance and repair were naturally a legitimate concern. An RCA team of tape and telecine specialists assisted in installation and set-up, and then maintained the equipment during the actual period of broadcasting. They saw to it that this important TV effort for EBU/OIRT came off unimpaired.

Capturing the Essence

Another part of the complex array of TV systems used in the worldwide dissemination of program material were thirty-eight RCA color cameras on loan



from Canadian broadcasters, in addition to TK-76's brought to the Games by guest broadcasters.

ARD, one of Germany's largest TV networks, used its new TK-76 to handle different production applications indoors and out (see photo and caption on page 20). The Maison de Radio-Canada, the CBC's French Service Division, utilized its TK-76 for daily news coverage of the Olympics.

The RCA cameras ORTO borrowed, TK-42's, TK-44's and TK-45's, were in the midst of all the activities at five venues and in four studios in the MBC.

Five TK-44's covered basketball, boxing, gymnastics, handball and volleyball at the Forum. The production plan for coverage of basketball exemplifies how ORTO used the cameras to best effect to provide interesting scenarios.

One camera long-lensed the game continuously. Another was stationed closer to the action, and cameras at either end of the court concentrated on free shots and close-ups of action near the baskets from different angles.

By comparison, gymnastics was considered difficult to televise because of the different exercises going on simultaneously. The solution was the assignment of eight cameras (including the five TK-44's), each of which covered a different angle.

Three TK-44's were used for the wrestling matches at the Maisonneuve Sports Center. Six were on hand at the Bromont Equestrian Center. Four at the Olympic Stadium caught the start and finish of the marathon race which traversed city streets.

Diving and swimming events at the Olympic Pool were reported on by six TK-44's as well as two TK-45's. Two

cameras were positioned near the start-finish line, one higher than the other. One allowed long shots of the start and finish of events and the other was used for isolation to show distance between first- and second-place finishers. A third camera moved on tracks alongside the pool to follow competitors during the races. A fourth camera above the stands covered all eight swimmers. A fifth camera caught the swimmers in the turns, while the sixth showed the swimmers from a different angle at the end of the pool. For diving competitions, two TK-44's were moved into the stands.

The TK-44's and TK-45's were chosen to cover wide action and close-ups at these sports sites because they are very stable and adaptable to most lighting conditions which cannot be controlled.

For example, the main stadium, a uniquely designed structure with 60,000 seats covered by a roof and an open area in the center, presented a combination of artificial and natural light in addition to shadows. The adjacent swimming hall, covered by a roof with skylights, provided similar ambient lighting conditions, as well as a humid environment. These structures offered excellent facilities for the Games, but a variety of environmental problems handled well by the RCA cameras.

Despite the differences in light levels, the cameras' excellent sensitivity contributed to pictures with good color rendition and a remarkably high signal-to-noise ratio.

Another consideration—at all sites—was zooming in for close-ups, which was part of emphasizing the human character of the Games. Camera sensitivity again came into play, as it compensated for the light loss brought about when zooming in with the range extenders.

Four studios at MBC, each assigned three TK-42's, produced supplementary discussion and commentary on the various competitions.

The TK-42, introduced in the early Sixties, is regarded as a vintage color camera by many broadcasters. However, compared to the performance of today's advanced cameras, the TK-42 does have its limitations with sensitivity and optics. Nevertheless, it still produces very useable pictures under controlled lighting conditions. Which is why ORTO found them well suited to studio requirements.

3500 Windows

Everything the cameras captured was on constant view throughout the venues and the Olympic Park by means of the 3500 RCA XL-100 Color TV sets RCA Limited furnished on a lend-lease basis. Nine hundred 15-in. receivers were installed in the off-tube TV monitor booths used by radio and TV commentators providing coverage of the Games to some 110 countries. Every commentator was supplied with two receivers, either of which could be switched to any of the ten major events scheduled for the day. The 2600 20-in. sets were placed in press rooms, other media facilities in the Olympic Village, and at locations such as rest areas, hospitality rooms and public lounges.

Et pour maintenant, c'est fini

The Summer Games are over until 1980 in Moscow. However, the dazzling telecast of the Montreal Olympics will be long remembered. RCA was genuinely proud to be among the technical participants, and joins athletes, fans and viewers the world over in saluting the talents and ingenuity of all the Canadian and unilateral broadcasters and technicians who helped make it possible. □



The "Lester Sumrall Presents" program is broadcast live for two hours each evening from this permanent set in the TV-40 studio, using TK-45 cameras.



Three TR-600's handle a heavy video tape load, including recording, editing and dubbing.



Four-input, two-output telecine system uses a minimum of floor space. Both TK-28 cameras are mounted inboard.

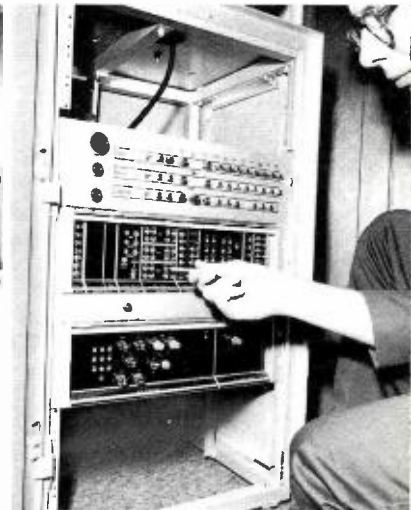

First production Video Processing and Color Correction accessory for the TK-28 camera was installed at WHMB-TV, completing the ASCET system (Automatic System for Correction of Errors in Telecine).

ALTERNATIVE PROGRAMMING AND TECHNICAL EXCELLENCE

build viewers for new
TV-40

BRINGING A "dark" UHF television station back On-Air in a market already covered by three network "V's" calls for unlimited courage and conviction. Dr. Lester Sumrall, President and founder of WHMB-TV, Indianapolis, combines these traits with a complete sense of mission and boundless energy. His broadcast philosophy of Family/Gospel programming is succeeding.

The new TV-40 came back On-Air on November 3, 1972, starting with a viewing audience so small that the station was not even listed in the ARB ratings for Indianapolis. Soon, however, through the inspiration and devoted efforts of Dr. Sumrall, WHMB's alternative religious programming was reaching a growing, responsive audience which provides the support for the broadcasts.

Complete Upgrading of Technical Facilities

Since returning on-air, WHMB-TV has completely upgraded and expanded its technical facilities. Responsible for this extensive and on-going re-building program is Chief Engineer Larry Vehorn. In upgrading, Mr. Vehorn has added technologically advanced equipment which can be expected to provide improved performance for a number of years. With a limited staff, reliability and maintainability were also critical factors in equipment selection.

The technical staff at TV-40 numbers only four, which Larry Vehorn knows only too well is a bare bones crew for handling maintenance and technical operations, including on-air switching, video tape and video control.

In 1974, two TK-45A color cameras and a TK-28 color film islands were purchased. During 1975, the expansion effort continued, with the addition of three TR-600 tape machines. A second, inboard-mounted TK-28 camera was added, providing a 4-input, 2-output island in a very compact configuration. Transmitter performance was also upgraded with the installation of a new TTUE-4A Solid State Exciter and TTS-1A Color Corrector for the TTU-30.

In 1976, the ASCET gamma correction modules have been installed to further enhance the performance of the TK-28's. Still coming is a new production switcher.

Three TR-600's

Larry Vehorn was an early believer in the TR-600, having checked it out at the 1974 NAB in Houston. His first machine was delivered in June 1975, with the others going on-line in September and October.

Between production assignments and programming, the TR-600's are getting ample usage, Mr. Vehorn says. The entire 12-hour Sunday broadcast sched-

ule for TV-40 is on tape, as is about six hours of the daily programs. Production requirements involving tape are running at 20 to 25 hours weekly, and this is growing.

Although the TR-600's are compact and economical, Mr. Vehorn notes that this is achieved without a reduction in performance. "At TV-40, we use these machines extensively for both playback and recording," he says, "and the quality is there—fully equal to the big machines."

The slanted transport deck, waist-high loading and straight-line threading are conveniences that video tape operators at WHMB appreciate. The built-in editor/splicer and tape time display are features that make for better efficiency in tape operations, Mr. Vehorn notes. Headwheel life has also been quite good. After nine months of operation, the original headwheel on the first TR-600 installed in June is still in service. The three TR-600's are installed side-by-side, each with a monitor bridge.

A model 520 Vectorscope and a model 528 waveform monitor are mounted on the monitor bridge of the center TR-600 in the line. A monitor switcher permits looking at the output of any of the TR-600's, thus saving set-up time for the operator. It is not necessary to use the 528's on all the tape machines for calibration, since they are all referenced to the same instrument, according to Mr. Vehorn.

Another bridge houses a TEP-1 Editor-Programmer.

The TEP is used for post-production editing, for making inserts and correcting production "flubs". During teleproduction assignments, the second TR-600 is used for playback, and is started automatically by the TEP. In Larry Vehorn's words, the TEP eliminates "sudden death" edits. The preview feature is excellent, he adds. TEP permits resetting edit points over a plus or minus 3-second range.

"Stability of TK-45A's is Superb"

Whether commercial, public, or religious, every TV station is competitive, Larry Vehorn acknowledges. Along with program preferences, viewers are accustomed to getting off-air pictures.

For locally produced programs, the two TK-45A cameras installed in 1974 have provided this edge for TV-40. Their color sparkles. The quality color and

overall performance of the cameras has been so good that several Indianapolis advertising agencies are using the WHMB facilities for commercial productions. Other organizations are also scheduling the studios for program production. The stability of the TK-45A's is superb, according to Mr. Vehorn. In fourteen months of operation, only two complete set-ups have been performed on the cameras. And, he adds, the stability of the TK-28 is such that only occasional "touch-ups" are required about every six months.

The TK-45A's and TK-28's have joystick controls remoted to Master Control.

Seven-Pole Patch Panel

Another operational improvement was a new 7-pole patch panel for 3-inch transmission line which was added in the fall of 1975 by the TV-40 technical staff. This permits by-passing the filterplexer so the station can stay on-air at reduced power even after losing a klystron. The installation eliminates the need for stocking a spare klystron.

With this patch panel, either klystron can be run into the dummy load, or the output of the filterplexer can be run into the dummy load for off-air testing. The installation provides more operating flexibility as well as saving the cost of a spare klystron.

Production Capitalizes On New Technical Facilities

Pete Sumrall. Production Manager for WHMB-TV, is young, eager, enthusiastic. With a production staff of six, versatility is essential. Three people function as directors, and three perform a variety of specialist functions including cameraman, lighting, audio, set design.

The production staff is responsible for two hours of live programming each evening ("Lester Sumrall Presents"), plus another hour each week night. In addition, the staff is kept busy with commercial production which Mr. Sumrall finds rewarding as a creative stimulus as well as producing revenue for the station. In working with advertising agencies, he says, there is ample opportunity for exploring a variety of solutions to production problems.

According to Mr. Sumrall, the TR-600's have worked out very well. Their fast lock-up permits tighter cues, faster production. The automatic functions built-in have resulted in better perform-



Chief Engineer Larry Vehorn checks TTUE-4A solid state exciter added to upgrade the station's transmission facilities.

ance and more consistent tape quality.

The performance of the tape machines, combined with the color capabilities of the TK-45A cameras have pleased agencies and clients, and have resulted in building repeat production business for the station.

The TK-45A's are convenient, easy to operate and set up quickly, Mr. Sumrall notes. Their automatic features and ability to perform at low light levels has helped TV-40 production. The pictures are sharp, with low noise.

Editing on the TR-600's, Mr. Sumrall notes, is a relative "snap"—just a matter of pushing a button. For tight editing, the reels can be rocked. In fact, Mr. Sumrall adds, the editing capability of the TR-600's has worked out so well that the TEP system is only used for productions requiring split-frame accuracy. The TR-600's can edit manually to within a few frames, he says.

Family Favorites Spur Daytime Viewing

Neil Hale, Vice President and General Manager, came to TV-40 last October

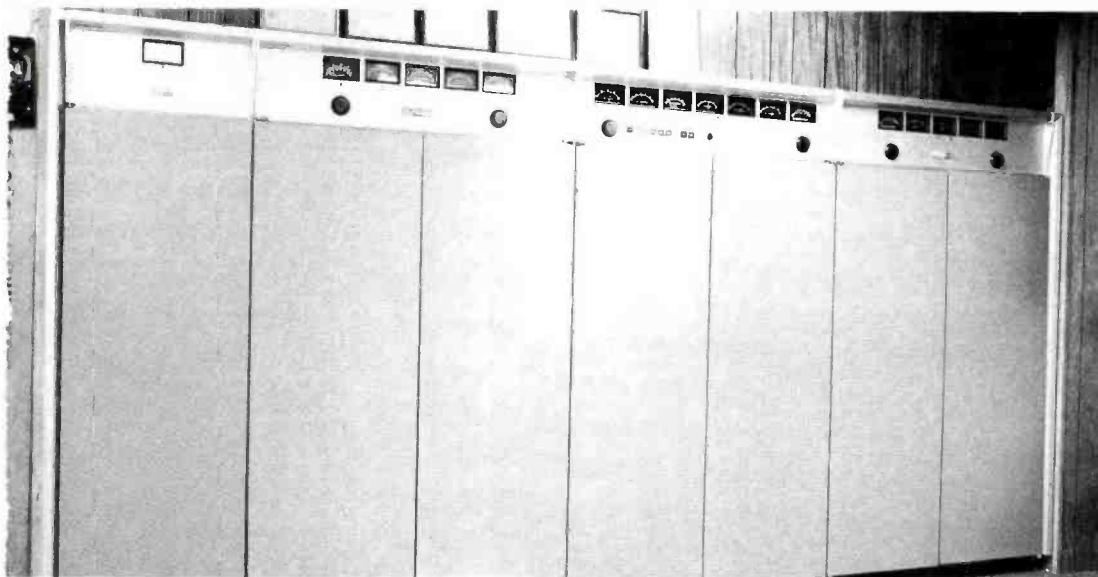

TTU-30, 30 kW transmitter forms one wall of TV-40's Master Control area.

from Christian Broadcasting Network, Portsmouth, Va.

With Mr. Hale's guidance, the broadcast day was extended, and a number of popular programs were added. These family type programs are available to selected commercial sponsors, and include the familiar "Leave It to Beaver", "Father Knows Best", "Our Gang", and cartoons such as the all-time favorite "Popeye".

The daytime programs are appealing, and build an audience for the evening prime time gospel programming, Mr. Hale notes. And, he continues, the plan is succeeding. Starting with no ARB ratings in October 1975, TV-40 now has a 4 rating, with a 12 share of market for some of the afternoon time slots. This result is all the more astounding because it was accomplished with a minimum of advertising and promotional fanfare. The total newspaper schedule came to less than \$500, Mr. Hale says.

Of course the new daytime schedule was heavily promoted on TV-40 with a series of spots. The promotion centered on the theme of "Keep an Eye on TV-40—where the good life begins."

National spots for the daytime pro-

grams are now coming in, including such sponsors as Pepsi-Cola, McDonald's and Coca-Cola.

The prime time period from 7 to 9 P.M. is sold out, with many of the slots taken by local church groups who also use the WHMB studio for live and video tape production. From 9 to 11 the "Lester Sumrall Presents" program is broadcast live, and is also video taped. Tapes are sent to more than 20 states for re-broadcast or showing on cable systems in more than 100 communities.

This is a call-in, interview show with special guests and a bank of manned telephones for handling incoming calls.

Audience response is reflected in the 3,000 letters and 3,000 telephone calls received each month by Dr. Sumrall. He is confident that the Christian programming concept can succeed.

With its viewer base established, TV-40 has expanded its program schedule and is now on-air for more than 15 hours weekdays and 2 hours on Sunday. Daytime programming features wholesome, family shows and cartoons, while religious shows are scheduled for the entire prime time period.

Dr. Sumrall's Church of the Air

In explaining his move into television,

Dr. Sumrall notes that throughout history there has been a dominant medium for reaching mass audiences, and today television is that communications vehicle. For many people, he says, the church of the air is the only church available.

The WHMB call letters are not a random choice. They refer to "World Harvest Mission Broadcasting"—and Dr. Sumrall foresees a network of religious broadcasters. His own organization, LeSea Broadcasting Network has recently added another TV outlet, Ch. 45, in Miami, Fla. An upgrading program has already started for this station with the purchase of two TR-600 tape machines and two TK-28 film islands.

Alternative Programming Plus Technical Excellence

The combination of family/gospel programming is garnering an expanding share of viewers—in Indianapolis and in many other communities via video tape distribution.

With its complement of TK-45A's, TK-28's and TR-600's, WHMB-TV can deliver pictures with a technical quality second to none. Chief Engineer Larry Vehorn intends to keep it that way by setting even higher standards for the future. □

SACRAMENTO

Transtower Stations Upgrade With New

THE THREE commercial television stations serving the Sacramento-Stockton market—KCRA-TV, KOVR-TV and KXTV—made broadcasting news in January 1962 when they started transmitting from what was then the world's tallest multiple antenna tower. The joint ownership antenna system was set up as Transtower, Inc.

While it no longer holds the distinction of being the tallest structure of its type, the tower is still an impressive sight, rising 1548 feet from the banks of the Sacramento River between Stockton and Sacramento, looking down on miles of fertile farms. (BROADCAST NEWS, Vol. #114 detailed this antenna installation.)

In 1975, each of the three Transtower stations switched to new parallel transmitters.

KCRA-TV, Ch. 3, replaced an RCA TT-25BL with a TT-30FL, 30 kW system.

KOVR-TV, Ch. 13, traded its TT-50AH for a TT-35FH 35 kW system. KXTV, Ch. 10, also added a TT-

KCRA-TV—TT-30FL

KCRA-TV, Ch. 3, has a new TT-30FL Transmitter—with ample space provided for adding a second complete transmitting system in the future.

Chief Engineer Bill Karpisek readily acknowledges that the new transmitting system has worked out well for KCRA. Because of the combining characteristics of the parallel transmitter in cancelling reflections, the new dual system delivers a sharp, clear picture. Picture quality is noticeably better on home TV sets, he adds. Ch. 3's antenna is a batwing, Superturndstile TF-6AL, with a two-line feed.

The TT-30FL is only the second transmitter installed by KCRA-TV since going on-air in 1955. This system was the logical choice, Mr. Karpisek says, because of its redundancy, remote control capability and performance record. "It is a good, stable transmitter, and its excellent automatic features simplify remote control operation".

Ch. 3 went on-air with the new system the last week in July of 1975. According to Transmitter Supervisor Tom Hughes, the installation of the TT-30FL system was a little tricky to accomplish. To make room, the aural and the visual sections of the old TT-

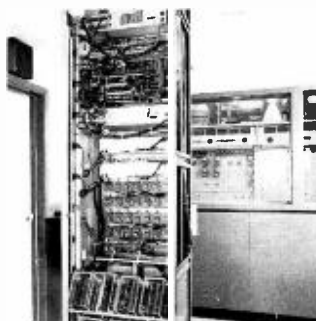
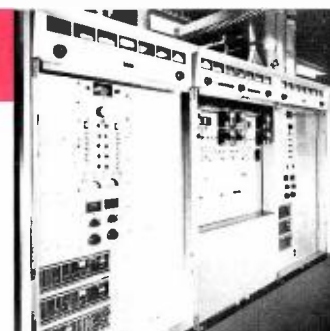

Front and rear view of KCRA's TT-30FL transmitter system. Remote control rack faces transmitter to facilitate making on-site test checks.

25BL were separated. The aural was moved to one side, and the TT-30 slipped into that space. A glassed-in wall separates the transmitter from the control room. The remote control rack is located in the control room, with the wiring overhead in a cable trough running from the top of the transmitter. The remote control rack is positioned in an unusual arrangement—facing the transmitter. This makes it easier to check and compare readings between the transmitter and monitoring facilities, Mr. Hughes says.

Ch. 3's remote control system terminates in plug-in connectors. This took

longer during the original installation, Tom Hughes reports, but makes it easier to handle maintenance. It permits unplugging any panel from the rack and working on it outside the rack—using extender cables. In addition, the rear connectors are brought out to "Christmas trees" for easier access. Plexiglass covers protect the "trees" from dust and damage. Mr. Hughes notes that this arrangement provides flexibility for changing or re-routing wiring if needed.

KCRA-TV's remote control system normally operates on telephone lines, with radio for back-up.

Transmitters

35FH to replace its 50 kW GE transmitter.

Each installation differs, but the basic reasoning for purchasing a new TV transmitter was essentially the same for all stations. The original transmitters were aging, and, advances in technology, particularly in remote control, offered significant operational advantages.

Transtower's multiple TV antennas enjoy a commanding view of the Sacramento Valley.

Stations KCRA, KOVR and KXTV occupy essentially identical sections of the transmitter building at the base of the tower. An addition to the structure (not shown) houses the transmitter for educational station KVIE.

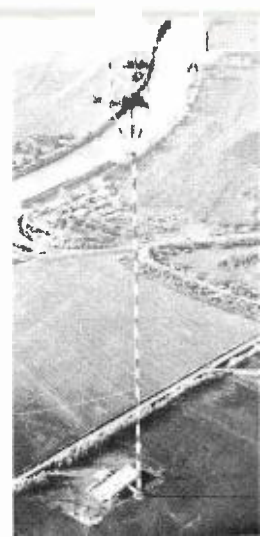
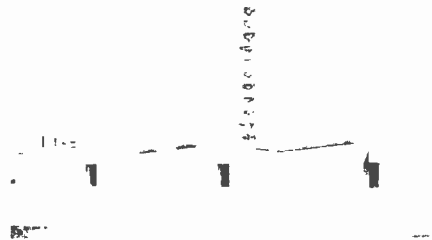

KOVR-TV—TT-35FH

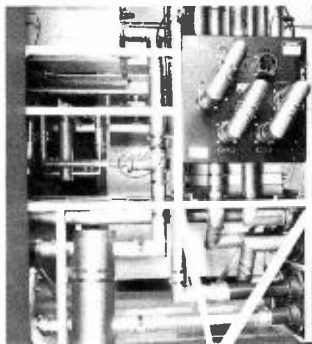

KOVR's TT-35FH transmitter is "easy to tune and maintains broadbanding very well". The system was factory optimized before shipment.

Remote control and telemetry for KOVR is via telephone lines, with microwave for back-up. Switchover is automatic.

factors in selecting this transmitter, Mr. Thompson says. In addition, the TT-50AH had provided excellent service over the years. RCA's continuing technical support in updating equipment and in handling replacement parts were also considered.

The stability and reliability of the new transmitter have been good. Transmitter Supervisor Bill Lawrence notes that the power stability of the visual and the aural are fine. The stages on the TT-35FH are well isolated, Mr. Lawrence says. And, he adds, "the transmitter is easy to tune and maintains broadbanding very well."

A DRS-1AW (Mosely) remote control system is used by Ch. 13. Telco line is used for remote control and telemetry, with microwave for back-up, and provision for automatic switchover in case of telephone line failure. Along with the transmitter installation, KOVR added a new microwave STL between the studio in Stockton and the tower, with heliograph cable from the tower to the transmitter. There is also a microwave link from the Sacramento studio to the tower.

KOVR-TV, a McClatchy Broadcasting station, installed a TT-35FH Transmitter with an Opto-Switcher and new Filterplexer, operating into a TW-15A13 Traveling Wave Antenna.

The RF switching system was factory-optimized for best VSWR before shipment, and went on-air August 11, 1975. There were no unusual problems in effecting the changeover from the TT-50AH, and no lost air time, according to Dick Thompson, Director of Engineering for McClatchy Broadcasting. The redundancy of the TT-35FH and its adaptability to remote control were

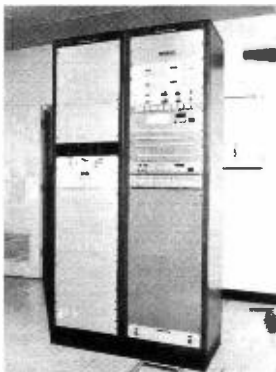

KXTV-TV — TT-35FH

KXTV put its new TT-35FH parallel transmitter on air August 14, 1975, operating into a TW-15A10 Traveling Wave Antenna.

The new system was located in the space previously occupied by a 5kW DuMont back-up transmitter. The replaced 50 kW GE transmitter, purchased in 1955 when the station went on-air, remains in place, beautifully maintained and still in "mint" condition.

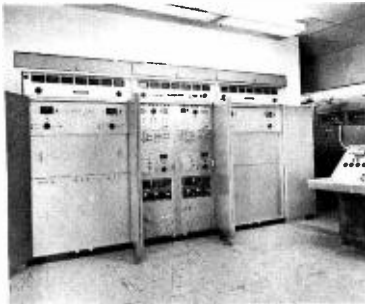

TT-35FH Transmitter for KXTV is built-in, occupying space used for old standby transmitter.

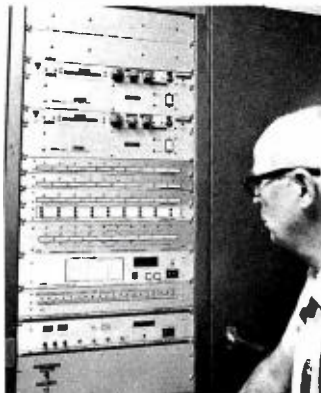

Transmitter Supervisor Bill Barclay checks remote control system.



Chief Engineer Don Ferguson shown with filterplexer for TT-35FH. The Ch. 10 transmitter is manned only part-time for handling routine maintenance.

Don Ferguson, Chief Engineer for KXTV, cited as reasons for the change the desirability of going to remote control and the fact that the tube types employed in the 20-year old system were becoming obsolete and difficult to replace. RCA's technical support was a further consideration.

The TT-35FH system is well within Ch. 10's operating requirements of 27.9 kW for full power.

Transmitter Supervisor Bill Barclay reports that the new transmitter is running well, and the reliability has been quite good, Mr. Ferguson reports. The Ch. 10 transmitter site is only manned on a part-time basis, for handling routine maintenance, he adds.

Tuning the new transmitter is much easier, and it stays in tune. With the solid state design, up to the aural PA and visual IPA stages there is no fall-off from tubes aging. The new system, Mr. Barclay states, has fewer blowers, fewer tube filaments and requires no tuning below the power amplifier tube stages. The TT-35FH also has lower power consumption, an increasingly important consideration.

KXTV also operates a DRS-1AW remote control system, with the redundancy of microwave and telephone lines. Normally the microwave system handles the telemetry and remote control function.

* * * * *

Since television transmission started from the Transtower multiple antenna system, Sacramento-Stockton viewers have enjoyed superior TV reception. Now, with the new transmitting facilities of KCRA-TV, KOVR-TV and KXTV, the picture quality is better than ever. □

THE CASUAL visitor to Teletronics International's new video production center in New York City might leave without ever being exposed to the concentration of electronic equipment that is essential to a teleproduction operation.

This reflects Teletronics' philosophy of separating the creative environment from the machine operations. Behind the scenes, the hardware is there, in a massive array that makes it readily apparent that here is a teleproduction facility capable of responding to virtually any creative requirement. The complement of video tape machines alone is awesome. One large room houses thirteen quad VTR's which by Oct., 1976 will include 10 TR-600's and 3 TR-70's. The telecine room includes a TK-28 color film island with an FR-35A Servo-Controlled 35mm film projector. A second TK-28 chain was being installed at publication time. On the first floor is a large production studio. The most visible "hardware" in Teletronics video center are five CMX computer editing systems, including one with light pen editing.



George Gould, President (right), confers with Will Roth, Vice President of Operations, at Teletronics International's new headquarters in New York City.

**AT
TELETRONICS
NEW VIDEO CENTER
THE FOCUS IS ON
CREATIVITY ... NOT
HARDWARE**

Trend to Tape

Teletronics International, Inc., opened their doors some eight years ago with a distinct advantage. The President and founder, George Gould, knew from the start where the new company was going and how it would get there.

His extensive background as a broadcast production executive convinced Mr. Gould that video tape was the direction to go in teleproduction. He was equally convinced that in the teleproduction arena—where the competitive pricing practices had devastating results—a firm commitment to quality and uncompromised performance standards would provide long term growth opportunities. Mr. Gould was right on both convictions, and Teletronics has moved into the top ranks of the teleproduction industry.

“The swing from film to tape is taking place rapidly, and not just in broadcasting,” he notes. “The non-broadcast market is expanding and its production medium is almost exclusively tape. Video tape is faster and saves both time and money in production.”

Mr. Gould further cites the fact that more television series are being produced on tape now. The escalating costs of film production as well as other costs have resulted in fewer episodes being shot for a yearly series, with more repeats.

Non-broadcast markets that are growing in importance, Mr. Gould notes, include corporate, medical and video cassette production. Not coincidentally, Teletronics is active in all of these areas.

An Advanced Production Center

George Gould matter-of-factly refers to the Teletronics technical facility as the most advanced production center in the U. S. The reference is validated by the extensive concentration of sophisticated electronic equipment and systems in the building.

Since they are basic to Teletronics operating philosophy, the computer-editing facilities have been well publicized. As Executive Vice President Al Markim notes, the most unusual aspect of Teletronics computer-assisted editing systems is in the way they are employed. Editing rooms are far removed from the quad tape rooms, and provide a quiet, comfortable creative environment.

Isolated, but essential, the video tape room at Teletronics maintain a busy

The line-up. Wall-to-wall VTR's fill the Tape Room at Teletronics. With new machines being installed, the tape complement will include thirteen RCA TR-600's and TR-70's.



schedule, operating two shifts normally, and around the clock when necessary to complete urgent assignments. The tape machines are used for editing and production during the day, and for dubbing and assembly operations on the evening shift. Separate facilities are being installed for round the clock dubbing.

Responsible for Teletronics advanced electronics complement is Armand Sarabia, Vice President, Engineering. The electronics may be out of sight but to the energetic, hard-driving Mr. Sarabia, they are ever-present—and accorded tender, loving care.

The video room includes thirteen VTR's both TR-600's and TR-70's. The RCA tape machines are tied in to the CMX computer editing studios which are des-

ignated as "Edit A", "Edit B" and "Edit C".

"The TR-600's with super high band pilot tone will give us master tapes of higher quality than we've ever before seen in the teleproduction business," Mr. Sarabia said. "Their fast shuttling capability also facilitates editing operations. The fast start—less than $\frac{1}{2}$ second—is another feature that is valuable for post-production," he adds, "as is the precise, full-frame advance and lock with no searching. All functions are remotable, and the TR-600 permits easy auto-assemblies of computer-edited tapes."

All VTR's are remoted to a single panel, Mr. Sarabia affirms, for delegation to any designated CMX system. Each VTR has a routing switcher so

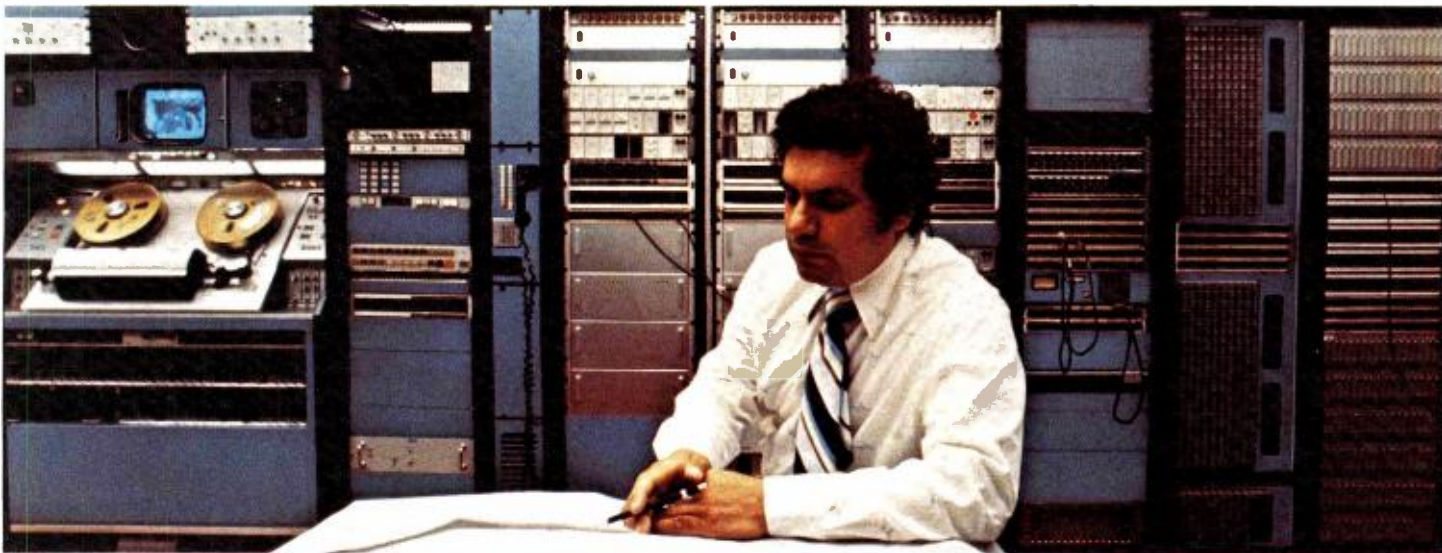

Armand Sarabia, Vice President, Engineering, is responsible for a complex, constantly evolving complement of electronics.

it can be switched to any system, and have access to all available video sources. A two-channel routing system handles audio.

Next to each tape machine is a rack which houses the CMX system controls and computer panel, as well as picture monitor, waveform monitor and vectorscope.

At each tape position is the usual jack and headset for the in-house intercom system. In addition, each location can access outside telephone lines.

A rack at the front of the tape room controls the color frame relationship of sync to subcarrier. All tape machines in the system play on the same color frame in record and playback.

A videocassette recorder on a rolling cart is used in the tape room for transferring material recorded on the $\frac{3}{4}$ " format to the quad machines for editing and mastering. The videocassette machine can be connected to any VTR via a patch panel for audio and video inputs. Audio can be set at zero level input and output.

Computer-programmed "Palette" system designed by Teletronics permits frame-by-frame and scene-by-scene color correction.



Separating the computer editing rooms from the tape machines enhances the creative environment. Both on-line and off-line editing facilities are available.

Telecine Versatility

Telecine is a separate area, close to the Tape Room. Like the other Teletronics technical operations, it abounds in technological innovations. The telecine facility includes two TK-28 cameras, two FR-35A servo-controlled 35mm projectors, "The Palette", and "Optimax". The result is the finest film-to-tape transfers possible.

Film handling capability is increasingly important in teleproduction, since there is a growing trend among film-oriented producers to shoot on film and complete on tape. Will Roth, Vice President, Operations for Teletronics notes that this technique simplifies and expedites editing functions, shortens completion times and permits close step-by-step control of quality.

"What we have done," he says, "is to perfect a method of completing and distributing film spots from 35mm or 16mm dailies that yield commercials with superior picture quality."

The TK-28, Mr. Gould says, "provides incredible quality from 16mm film." This capability has been useful for on-location shoots with 16mm film cameras. The processed film is immediately converted to tape, which, according to

Mr. Gould, actually enhances the quality and colorimetry.

"The TK-28 and the new FR-35A 35mm Film Projector do a terrific job of producing superior film-to-tape transfers," adds Mr. Sarabia. "The fast shuttle, freeze frame and variable speed of the FR-35A are ideally suited for teleproduction work.

"The Palette"* and "Optimax" Systems

"The excellent performance of the TK-28 is further enhanced by using a patented Teletronics system called 'The Palette'. This is computer-programmed and permits frame-by-frame or scene-by-scene color correction. Previously this was done by optical laboratories."

"The Palette" used with the TK-28 is a versatile system which keeps track of footages and frames via electronic edge numbers. The system compares events and color settings to correct for Chroma, color balance, luminance, gamma and pedestal. By comparing luminance matrix the RGB can be varied.

"Optimax" is another patented Teletronics innovation which permits blowing up and repositioning portions of a frame or scene. This system, in con-

junction with the FR-35A, performs many of the effects heretofore only possible through optical labs. The saving in time and the improvement in picture quality are substantial, Mr. Gould notes.

A Complete Facility

In operating a successful teleproduction center in a highly competitive market, Teletronics provides a total capability for production, working with just about any available material—2-inch, 1-inch, or 3/4-inch video tape; 16mm or 35mm film and slides. And, of course, there is a live camera shooting stage; a "working" kitchen and a "living room", both of which serve as sets for TV commercials. From these resources, the tape, film and computer editing systems produce the desired end result: a superior quality video tape.

Commitment to Quality

Abundant in-house production facilities . . . a capacity for quick response . . . innovative technical resources . . . talented creative staff. These elements—plus one other—are basic to Teletronics continuing growth. That "plus" ingredient sums up the operating philosophy of George Gould and of Teletronics: an on-going commitment to quality. □

Sophisticated CMX-600 light pen system is one of the computerized editing systems operated by Teletronics.

Telecine room includes two TK-28 color cameras, two FR-35A servo-controlled 35mm Projectors and a PM-86SL sep-mag sound system. The result is superior film-to-tape transfers, with an unprecedented degree of flexibility.



Electronics for "The Palette" color correction system which provides electronic paint control for secondary colors as well as the primaries.

*Pat. pend. and reg. by Teletronics International, Inc.

Teletronics—Diversity in Video

Teletronics is structured to participate in many segments of the expanding video market. The Teletronics video center in New York is geared to handle production and post-production for commercials, programs, and corporate communications. Among the companies using Teletronics services are Xerox, IBM, Merrill Lynch. A separate program division is set up to handle the total package, from concept to finished tape, including production and post-production.

Another Teletronics company, a joint venture with Sony, provides quantity duplication of video cassettes. This subsidiary also handles the distribution and library cataloging and stocking of some corporate client tapes.

Video City, a wholly owned Teletronics subsidiary in Miami, operates a large production and post-production facility, including a mobile unit. The video center is also equipped with RCA tape and film systems.

Yet another subsidiary, MGS, serves agencies and clients in handling the distribution of television commercials.

Teletronics, George Gould notes, is prepared for the coming home video player market. They are already duplicating program material for the Sony Betamax system. Mr. Gould sees a further market in pay cable television which will generate a demand for more programming and additional marketing opportunities for Teletronics.

Products IN THE News

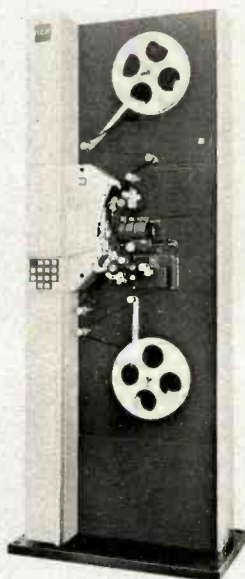

New Servo-Controlled 35mm Film Projector

FR-35A designates a new servo-controlled 35mm film projector developed by RCA. A remarkable film handling system, the FR-35A incorporates numerous features never before available in intermittent projection systems. These include: Instant Stop and Start; Variable Speed Operation (0 to 48 frames per second); Freeze Frame. The projector operates at normal cine speed or high speed (6X cine) in forward and reverse modes. These operational features are particularly useful for film post-production and film-to-tape transfers.

The servo-controlled operation of the FR-35A is the key to its film handling performance, permitting precision registration of the picture at the gate; excellent sound reproduction and high speed operation.

For telecine use, the projector locks to line, TV vertical sync or external drive source. The system meets world-wide standards with no conversion required.

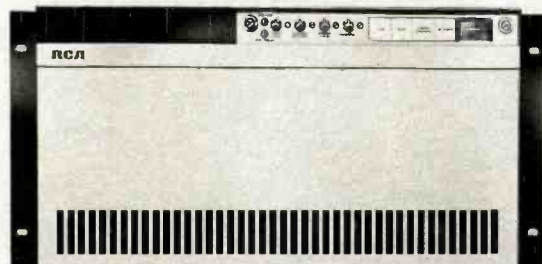
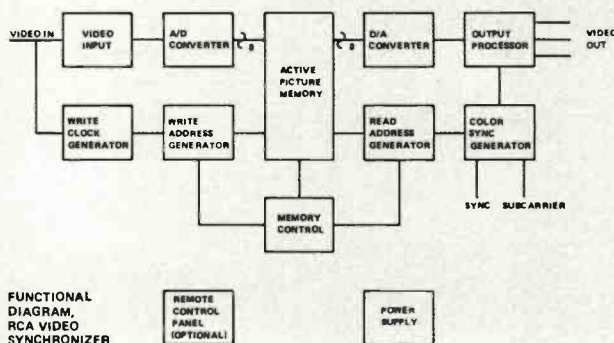

Digital Video Synchronizer, TFS-121

With the new TFS-121 Digital Video Synchronizer, a mix of external video signals can be smoothly integrated into newscasts and live programs without disrupting internal sync, program production or recording. All non-synchronous signals, such as remote pickups or satellite and network feeds are locked automatically to station sync.

In operation, the TFS-121 accepts an incoming non-synchronous video signal, converts it from analog to digital format, and stores it in memory. Two complete television fields are stored, a full frame.

The signal is then converted back to analog and processed through a high quality processing amplifier. Sync, blanking and color burst signals from an internal sync generator are added to the output picture. The picture in-

formation stored in memory is read out at a rate synchronous with the station timing system. The signal can be used for mixing, special effects and chroma key—similar to signals from a live camera, tape machine or other source.

The TFS-121 uses state-of-the-art digital sampling and storage techniques to achieve superior video performance in differential gain, differential phase, a signal-to-noise and frequency response. The higher rate of picture sampling (14.3 MHz) produces an improved picture when converted back to an analog signal. Since only the active picture information (120 IRE units) is coded, amplitude samples are more representative of the original analog signal and quantizing errors are less significant.

Optional features of the TFS-121 Synchronizer include still picture, picture compression and joystick positioning.

New Audio Automation System With Micro-Processor

The PAC-I Program Automation Controller utilizes advanced micro-processing technology to handle up to 15 audio sources and 3,000 events automatically. Modular system design with plug-in interconnects allows system memory and capability to be expanded to 100 audio sources and 10,000 events.

Micro-processing functions of the PAC-I are performed by a high capacity multi-circuit IC cluster which provides for flexible operation with increased reliability. The system adapts to any program format and is easy to program and to operate. Program sources may include reel-to-reel tape players; cartridge tape; network or remote feeds, and local studio programming. An advantage of the PAC-I system is its ability to operate with standard source equipment.

Included in the system is a CRT video display which shows the sequence of "Next to Run" events and verifies the

events and status. The readout allows a search of the entire memory. Program events may be entered, revised or cancelled through a keyboard.

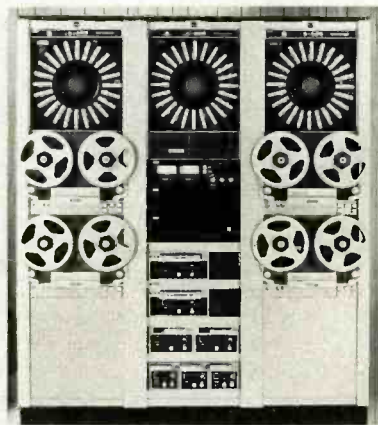

New 50 kW Lowband Transmitter

The TT-50FL, 50 kW VHF Transmitter was developed to meet lowband broadcaster's need for a high power, flexible transmitting system for present and future operational requirements. It is a parallel system comprised of two 25 kW transmitters to provide up to 50 kW peak sync visual power and 11 kW aural power. In an emergency or during scheduled maintenance, either the A or B amplifier may be operated into the antenna, providing half power.

For stations with a total power output requirement of 25 kW or less, the TT-50FL system provides maximum backup protection against lost air time, since the system may be operated in three modes: as a parallel (A+B); as an A only, or B only. For some broadcasters anticipating circularly polarized antenna operation with its increased transmitting power requirements, the TT-50FL permits Main-Alternate operation now, with ample reserve power capability for potential CP operation later.

The TT-50FL system incorporates the time-proven features of the "FL" series transmitters. It is designed with untended operation in mind, with numerous functions controlled automatically, including power and pedestal levels. The system is extensively solid state, with only two tuned tube amplifier stages in each RF chain.

The automatic feedback loops, solid state design and circuit simplicity contribute to the performance stability of the transmitter.

Compactness is another feature of the TT-50FL. The entire front line cabinets require only 136 inches of space—less than 12 feet.

For added operating flexibility, bi-level power switching can be installed in the TT-50FL as an option. It permits changing the power output of either side of the paralleled system by 2 to 1 without readjustment.

The first TT-50FL transmitting system is now being installed at WKYC-TV, Cleveland.

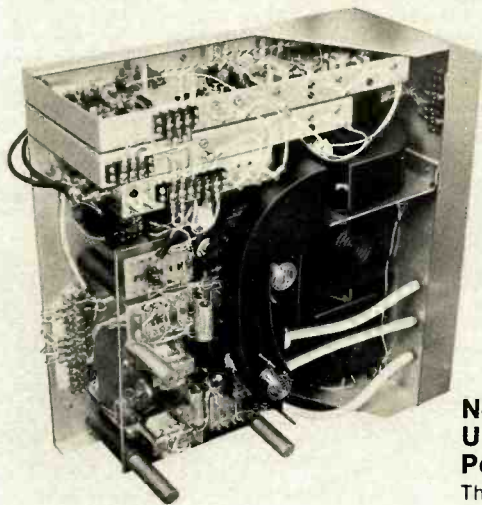
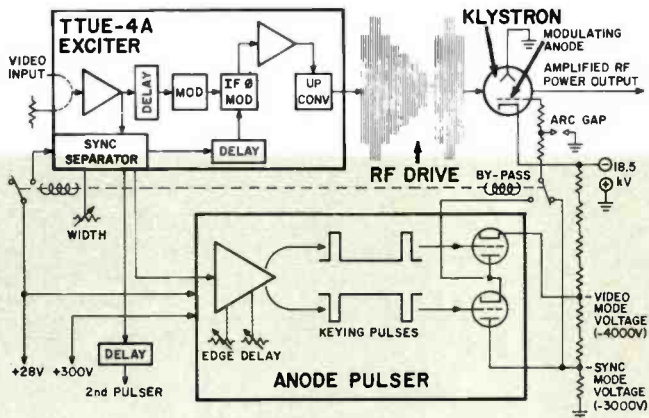

New Technique Reduces UHF TV Transmitter Power Consumption

The Mod Anode Pulsor reduces power consumption of RCA UHF transmitters

through a direct increase in the operating efficiency of the visual klystron amplifier.

The system applies pulses with an amplitude of up to 2 kV to the modulating anode of the visual klystron amplifier tube during the sync portions of the visual signal. Consequently, the klystron operates at reduced beam current during the video portion of the signal and at a higher beam current during the sync interval. Beam power consumption is reduced by approximately 20%, resulting in significant overall power savings.

The Mod Anode Pulsor is designed for use with RCA UHF Transmitters equipped with TTUE-4A solid state exciters and high efficiency klystrons.

One pulser will operate either one or two klystrons and may be used with RCA TTU-30, TTU-55, TTU-60 and TTU-110 Transmitters. Two pulsers are required for TTU-165 and TTU-220 Transmitters.

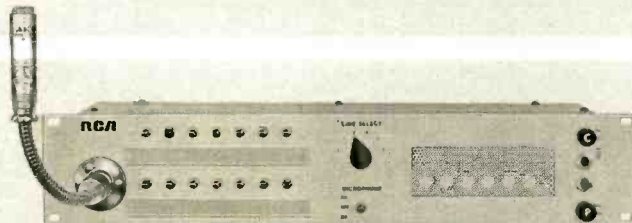

Expandable Intercom System

The BCS-2000 is versatile, economical to operate, and easy to install. It offers the flexibility of an interphone communication system, with the switching capability of more expensive intercom systems. The system is comprised of three active units: a Director's Unit (DU); a Standard Unit (SU), and an Interphone Unit (MI-11784).

The Director's Unit has calling capability and is supplied with seven switches,

with provision for seven more switches for easy expansion. Six input positions are available, three of which are wired into the basic unit, providing for selected private line communications and for future addition of more lines.

All system levels are line level or higher level audio, eliminating the need for special shielding.

The Standard Unit does not include calling switches or built-in amplifier,

but still allows hands-off operation to some degree, using the built-in speaker and microphone. Any calls made through a Director's Unit will over-ride any communications in progress at the Standard Unit being called.

The BCS-2000 interfaces directly with telco and interphone lines and is unique in that it can operate as a normal house interphone system as well as offering the extra capability of an intercom system.

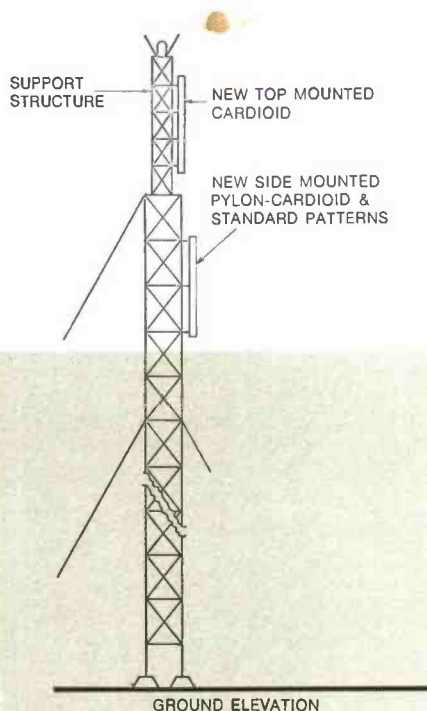

New Lightweight Cardioid UHF Antenna

This new cardioid antenna is a lightweight, medium gain pylon which can be side-mounted from standard towers. It can also be top-mounted, using a separate support structure. The first installation, at WFIE-TV, Evansville, Ind., will be top-mounted. The second installation, KYIN-IBEN-TV, Mason City, Iowa, will be side-mounted from the existing tower. Both of these antennas are Type TFU-36DAS with a vertical main lobe gain of 36.

The antenna is of RCA's basic pylon design, consisting of slotted arrays in a lightweight aluminum tube. Maximum antenna weight is 1.5 tons. The proven radome system of the Traveling Wave Antenna is used for weather protection at a relatively low wind load. The standard input is $6\frac{1}{2}$ "—75 ohms "center feed", with an input rating of 60 kW.

The unique pattern of the cardioid antenna allows close mounting to the tower while minimizing serrations in the horizontal pattern. This well-controlled pattern can be used effectively for protecting one area while offering maximum signal in the other directions, since it is essentially omni-directional for more than 180 degrees of the horizontal pattern.

Other standard pylon horizontal pattern combinations — skull, peanut, trilobe and omni-directional — can be specified with this new antenna. Beam tilt, null fill and horizontal pattern directivity can be obtained to meet most requirements.

TCR-100A: Different And Better

At a glance, the TCR-100A now being delivered looks about the same as the earlier "cart" machines. While the appearance is similar, changes in design and features are both numerous and significant.

Consider these major product differences:

Computer Interface

- TCR-100A accepts a 2 second play command at any time during the last event.
- Allows use of an external programmer, which essentially replaces the automatic sequence register.
- External programmers may operate on real time or use TCR-100A EOM cues.
- Permits full complement of external control inputs, and provides full reporting of machine status to external computer or programmer.

Random Home

- Permits any bin to be "Home Bin".
- Thumbwheel selecting home bin may be operated at TCR-100A or at a remote location.
- Home bin may be selected by an external programmer.
- "Empty" bins may be used for production between on-air breaks, without moving the on-air carts.
- Magazine movement is now bi-directional, reducing access time.

Prewired for Accessories

- Minimizes system down time during installation of future accessories, such as EPIS, Editor, or Timer.
- Allows full factory Quality Control checking of system in final condition.
- Standardizes accessory installation.

Venturi Vacuum Systems

- Reduced maintenance; no carbon vanes to clean or replace.
- Increased reliability; no moving parts.

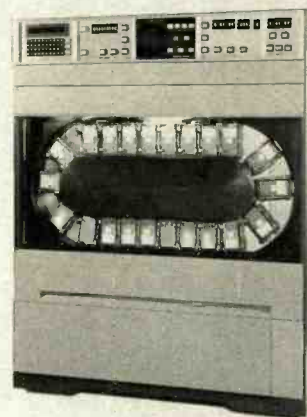

- Lower noise and heat; eliminates two pumps and motors.

Side Cable Access

- Lower frame cutouts allows interconnecting cables between TCR-100A Transport and Signal Processing Unit to be routed under cabinets, even when a cable trench is unavailable.
- Better appearance; No exposed cables.
- Better reliability; Cables better protected from accidental damage.

Discrete Component Capstan PA

- Improved Reliability; higher safety factor.
- Easier Maintenance; Individual parts may be replaced.
- Fewer special parts; individual components more easily available.

LED Motion Sensors

- Higher reliability than incandescent bulbs.
- Better stability; no aging problems.

AE-600 Editing System Extends Capability Of TR-600

The AE-600 is a versatile, state-of-art time code editing system designed for use with TR-600 Tape Recorders. The new system can control one record TR-600, up to eight playback TR-600's and three external sources—up to 12 sources. Complete lock-up, color framing and synchronization of all TR-600's is only four seconds. (NTSC/PAL/SECAM)

For editing flexibility, the system permits split audio-only, video-only, and audio/video edits. In addition, the sys-

tem is capable of editing two audio channels independently, and of making three independent edits in the same pass of the tape.

With this system, editing can be controlled locally from the TR-600 operating panel, or remotely from an editing room. The AE-600 uses latest technology electronics—micro-processors, programmable read-only memories and large scale integrated circuitry (LSI's). These modular assemblies are mounted inside the TR-600.

Other AE-600 features include: six different preview modes; a manual editing mode in addition to the automatic mode; manual and automatic update modes, and a special mode for animation.

Accessories for the basic AE-600 editing system each consist of one or two modules internally mounted in the TR-600 recorder.

A time code generator, besides generating time codes, provides the ability to do add-on time code recording. This eliminates the need to pre-record or post-record each taps with time code before or after each recording session.

A stand-alone time code reader can be used in the TR-600 to display time code on the recorder's own LED tape timer display.

A video character generator can be added to insert the time code information into the picture monitor.

An additional accessory is available to display on an external picture monitor all of the "in and out" edit points for the entire system, up to 12 devices.



PRIME TIME

ANTENNAS AND TRANSMITTERS

WTAF-TV, PHILADELPHIA, BROADCASTS THE WORLD'S MOST POWERFUL OMNIDIRECTIONAL TV SIGNAL.

"When we put our new system on-air in 1974, Ch. 29's 'A' market coverage went up 68% to 9,870 square miles," reports Taft Broadcasting Corporate Vice President Bill Hansher.

"... 'A' market coverage up 68%."

"Viewer reaction was extremely favorable—we were even getting responses from Manhattan, Baltimore and Western Pennsylvania.

"Our 5 megawatt signal makes WTAF-TV the most powerful omnidirectional TV station anywhere—but we achieved our maximum ERP with operating savings of 25%, thanks to RCA planning.

"We selected their TTU-165c transmitter and a 40-gain TFU-40 antenna. Since this 165 kW UHF transmitter needs less primary power, and cost us less than a 220 kW transmitter would have, we realize very welcome economies.

"...operational savings of 25%."

"More than two years later, we're totally pleased with the RCA system's performance."

For more about the WTAF package, see **Broadcast News #155.**

RCA

RCA READY WITH THREE CIRCULARLY POLARIZED ANTENNAS.

When FCC approval is granted, RCA will be able to help stations improve their signals with three circularly polarized TV antennas.

One is a top-mounted Fan-Vee for Channels 2 through 6. It uses individual radiators for horizontal and vertical polarization. They are phased to produce the circularly polarized pattern.

Another circularly polarized antenna, the End Fire Helix, is for Channels 7-13. It uses three small reflecting dishes mounted per layer around the top-mounting pole to

produce an omnidirectional circularly polarized pattern.

A panel antenna for face mounting on the tower (Channels 7-13) may be installed as a horizontally polarized antenna, with the ability to be converted to circular polarization.

Ask your RCA Representative for full antenna information.

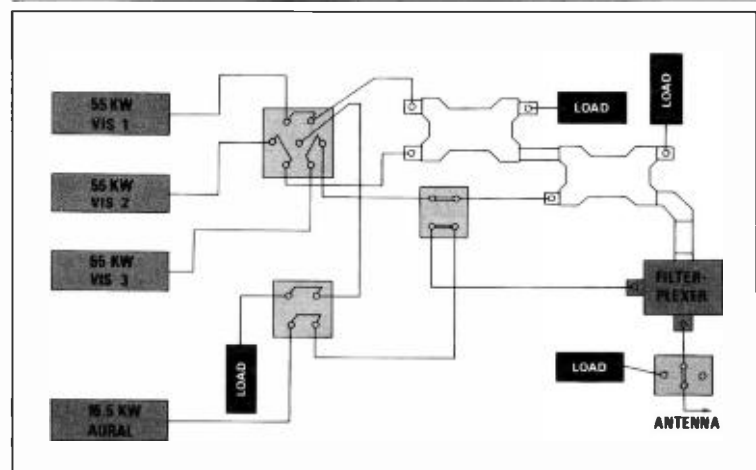
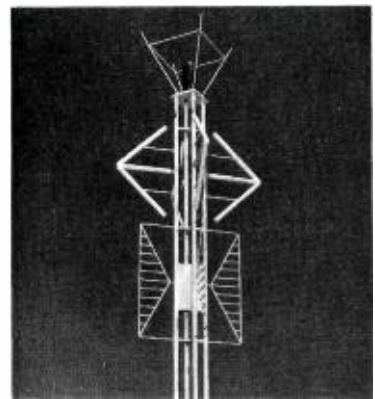
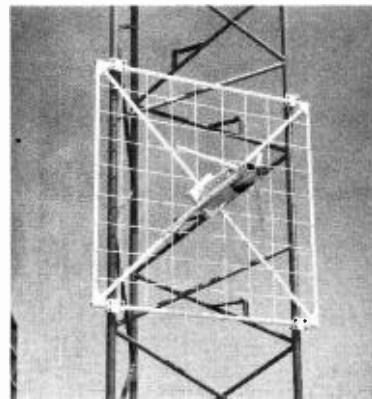

Four 55 kW vapor-cooled klystrons are used in the TTU-165c. A unique triplexing system developed for the WTAF-TV transmitting plant combines the outputs of three of the klystrons. As shown in the diagram, visual amplifiers 1

and 2 are combined through a 3 dB combiner to produce 110 kW peak power. The signal is fed through a 4.77 dB combiner where it is added to the output of visual amplifier 3 for combined visual peak power of 165 kW.

PREMIERE

YOU CAN'T BEAT THE SYSTEM: TKP-45.

The one camera camera system.

The only thing the RCA TKP-45 has in common with other portable TV color cameras is portability. From there on, it's an almost total departure from anything else.

For one thing, the TKP-45 has every studio camera feature. It has been slimmed down to 19.4 pounds, including viewfinder (less lens) by designing new lightweight circuitry, not by eliminating big camera features. So it performs like the finest studio camera, wherever it's needed, inside or out. Imagine the cost-effectiveness of having one camera for every use.



How portable can you get?

As portable as you want to be.

Consider:

With the TKP-45, the cameraman has up to 1500 feet of small-diameter, lightweight cable leading to the CCU. It has just half the weight of other minicable. There's no backpack to add weight, notangles to avoid. Your cameraman can concentrate on picture-getting.

If that isn't enough portability, then pipe the TKP-45 into our "Minipack" CCU. This 35-pound option has a self-contained, rechargeable DC battery unit and AC power adapter. The camera can rove up to 300 feet from a Minipack, or a crewman can easily move this lightweight CCU to the action.

A lightweight junction box is belt-worn, for two-way intercom and audio pickup. And portability imposes no restrictions on lens selection, automatic video control, or any of the TKP-45's studio camera features.





Meanwhile, back at the studio...

Place the TKP-45 on a tripod or pedestal, and—presto!—it's a full-capability studio camera. Indoors or out, you can use fixed optics (teles, wide-angles, fish eyes), or zooms through 34:1 ratio; the choice is yours.

Pick a 3" or 7" viewfinder—no compromise to camera size in the viewing department. Let the TKP-45 perform beside a TK-44 or TK-45, then try to tell the difference. A full range of automatic controls and video performance features says you can't!

For proof, ask MTS.

MTS, Mobile Television Services, is a teleproduction company on the move—to the tune of 20,000 miles in its first four months. This unique firm operates a 40-foot mobile unit that houses more than a million dollars' worth of broadcast television gear. The equipment, equal to many a commercial broadcast station, includes:

- 5—TK-45A color cameras with joystick controls
- 1—TKP-45 portable color camera
- 2—TR-61 video tape recorders
- 2—Slo-Mo video tape recorders



Custom audio and video switching systems

MTS began in mid-1974 as the production company for the World Football League's "Game of the Week". The first season involved 20 games, including WFL action and bowl games, the Miss World Pageant, several "Wide World of Entertainment" segments for ABC, and the new show, "Almost Anything Goes."

TKP-45 gets the action.

Right from the start, the TKP-45 played an integral part in every production. At



TKP-45 UNIVERSAL CAMERA SYSTEM

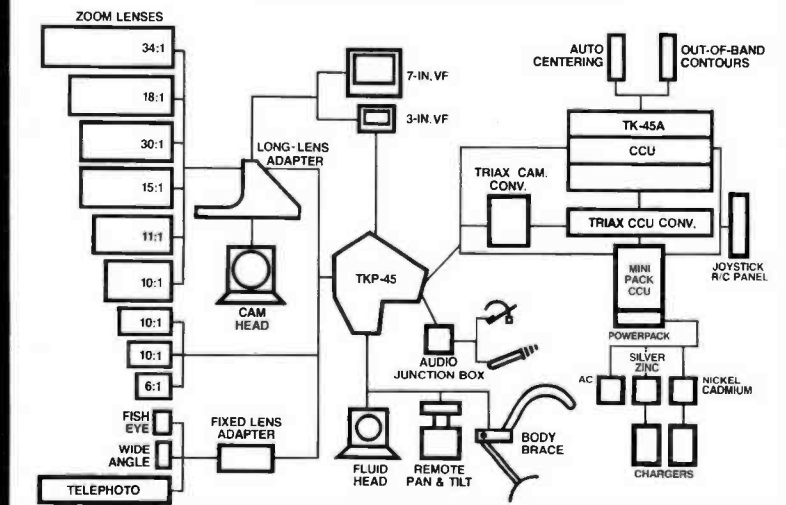

We'd welcome the chance to pit the TKP-45 against any newsgathering or studio cameras to prove that "you can't beat The System" for quality and features at an attractive price.

the sports events, it is used to capture action scenes and impromptu interviews, with all the picture quality of its TK-45 companions. And it adds tremendously to MTS' in-studio productions.

Quality is the MTS cornerstone. "You're only as good as your last job," says MTS Executive Vice President Howard Zuckerman. "Every assignment must be done right, without skimping or corner-cutting."

It's no coincidence that MTS picked the TKP-45 to add the final touch to its RCA camera lineup.



