

BROADCAST NEWS

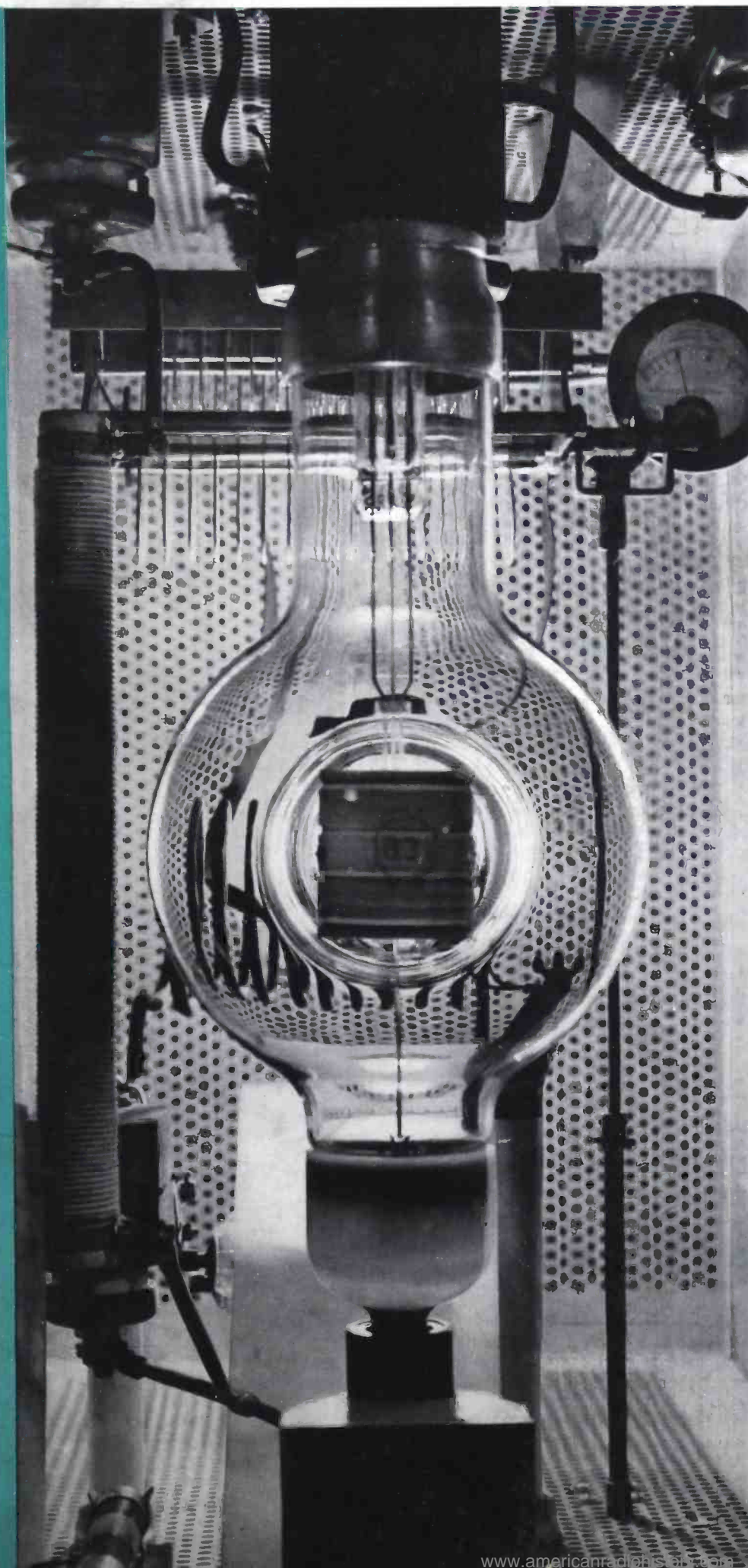

In this Issue

**Hearst Expands Coast
Stations**

Frederick Ragsdale

**Logarithmic Recording of
Field Intensities**

John P. Taylor

**Buildings for Medium
Powered Transmitters**

T. A. Smith

**RCA MANUFACTURING
COMPANY, Incorporated**
Camden, N. J.

NUMBER 24

MAY, 1937



RCA Manufacturing Company, Inc.

A Service of Radio Corporation of America

Camden, N. J.

"RADIO HEADQUARTERS"

DAVID SARNOFF, Chairman of the Board

G. K. THROCKMORTON, Executive Vice-President

L. B. MORRIS, Vice-President
and General Counsel

J. M. SMITH, Vice-President in
Charge of Mfg., RCA Radiotron Div.

R. SHANNON, Vice-President in
Charge of Mfg., RCA Victor Div.

J. C. WARNER, Vice-President and
General Mgr., RCA Radiotron Div.

LEWIS M. CLEMENT, Vice-President
in Charge of Research and
Engineering, RCA Victor Div.

J. T. CLEMENT, Vice-President
in Charge of Washington,
D. C., Office

F. H. CORREGAN, Vice-President
and Secretary

F. R. DEAKINS, Manager Special Products

J. L. SCHWANK, Manager
ENGINEERING PRODUCTS DIVISION
AND INTERNATIONAL DIVISION

TRANSMITTER SALES SECTION

(OF ENGINEERING PRODUCTS DIVISION)

I. R. BAKER, Manager

S. W. GOULDEN, Commercial Engineer

J. P. TAYLOR, Sales Engineer

A. R. HOPKINS, Sales Engineer

J. C. CALVERT, Sales Engineer

E. C. HUGHES, Jr., Amateur Radio

F. S. HART, Sales Contact

T. A. SMITH, Mgr. Broadcasting Transmitter
Sales, C. B. S. Contact.

C. L. BEACH, Affiliated Co. Contact

T. W. ENIS, Ass't Affiliated Co. Contact

P. A. ANDERSON, Police Radio Sales

C. M. LEWIS, Sales Engineer

D. J. FINN, Engineering Products Advertising

1 EASTERN DISTRICT—BEN ADLER, Manager, 1270 Sixth Ave., New York, City; R. P. May, Assistant.

MAINE

VERMONT

NEW HAMPSHIRE

MASSACHUSETTS

RHODE ISLAND

CONNECTICUT

NEW YORK

NEW JERSEY

PENNSYLVANIA

MARYLAND

NORTH CAROLINA (Broadcast)

WEST VIRGINIA

DELAWARE

VIRGINIA

2 CENTRAL DISTRICT—H. C. Vance, Manager, 589 E. Illinois St., Chicago, Ill.; R. A. Wilson, Assistant; A. Josephsen, Assistant.

NORTH DAKOTA

NEBRASKA

WISCONSIN

SOUTH DAKOTA

MISSOURI

IOWA

MINNESOTA

ILLINOIS

INDIANA

KENTUCKY

OHIO

MICHIGAN

KANSAS CITY (KANSAS)

3 WESTERN DISTRICT—W. H. Beltz, Manager, 170 Ninth St., San Francisco, Calif.; Edmund Frost, Assistant

WASHINGTON

OREGON

CALIFORNIA

IDAHO

NEVADA

HAWAII (Police)

UTAH

ARIZONA

ALASKA (Police)

MONTANA

WYOMING

4 SOUTHWESTERN DISTRICT—W. M. Witty, Manager, 2211 Commerce St., Dallas, Texas

TEXAS

OKLAHOMA

ARKANSAS

LOUISIANA (Except New Orleans)

KANSAS (Except Kansas City)

COLORADO

NEW MEXICO

5 SOUTHEASTERN DISTRICT—D. A. Reesor, Manager, 490 Peachtree St., N. E., Atlanta, Ga.

TENNESSEE

NORTH CAROLINA (Police)

SOUTH CAROLINA

GEORGIA

ALABAMA

MISSISSIPPI

FLORIDA

NEW ORLEANS (LA.)

LONDON, ENGLAND—B. Gardner, European Manager, Radio Corporation of America, Electra House, Victoria Embankment.

POWER RADIOTRONS

POLICE TRANSMITTERS

BROADCAST TRANSMITTERS

AVIATION RADIO EQUIPMENT

POLICE RECEIVERS

SPECIAL COMMUNICATION EQUIPMENT

BROADCAST NEWS

REG. U. S. PAT. OFF.

PAUL V. LUTZ, Editor

BOARD OF ADVISORY EDITORS

J. B. Coleman.....	Transmitters	M. C. Batsel... Test Apparatus and Studio Equip.
V. E. Trouant.....	Transmitter Development	F. X. Rettenmeyer..... Receivers
E. W. Engstrom.....	Television	Dr. Irving Wolff..... Microwaves
Dr. V. K. Zworykin.....	Electronic Research	Dr. G. H. Brown..... Antennas
	Dr. H. F. Olson.....	Acoustics

NUMBER 24

MAY, 1937

CONTENTS

	Page
Waves Aren't Always In the Air.....	2
James Galloway	
Hearst Expands Coast Stations.....	4
Frederick Ragsdale	
Logarithmic Recording of Field Intensities.....	6
John P. Taylor	
Model Home for Worcester Station.....	8
New Equipment Solves Problem for Smaller Stations.....	10
W. L. Lyndon	
Directional Antennas.....	12
Dr. G. H. Brown	
Real Drama On the Air.....	15
Floods Make Work for NBC Staff.....	16
Steady Progress for WRAK.....	17
Louis N. Persio	
Twin Buffalo Stations Modernize.....	18
Ralph J. Kingsley and P. E. Fischler	
Features Bring New Transmitter to the Front.....	20
C. M. Lewis	
Electron Paths Made Visible.....	25
Dr. V. K. Zworykin and E. A. Massa	
Unique Features at Seattle.....	26
Francis J. Brott	
Buildings for Medium Powered Transmitters.....	28
T. A. Smith	
Size Isn't Everything.....	31
A Review of Broadcast Engineering.....	34
John P. Taylor	

Published in the Interest of the Radio Broadcasting Industry
and Copyrighted, 1937, by the

RCA MANUFACTURING COMPANY, INC.

CAMDEN, NEW JERSEY, U. S. A.

WAVES AREN'T ALWAYS IN THE AIR

WGRC Became a Submarine Station for Eight Days

By JAMES GALLOWAY



Mount Ararat in miniature. The staff at WGRC knows how Noah felt.

WHEN WGRC returned to the air after their transmitter equipment (which by the way was 100% RCA) had been inundated about two weeks by the flood waters of the Ohio River, the whole staff joined in singing "River Stay Away From My Door."

Charles Lee Harris, President and General Manager, and Robert J. McIntosh, Secretary and Program Manager spent quite a bit of money before the station was built, in research, grading and filling, raising everything above the highest flood level ever known in the Ohio Valley.

The transmitter site is located on 18½ acres of ground lying between New Albany and Jeffersonville, Indiana and immediately across the Ohio from the center of Louisville, Kentucky. It is a part of the original grant from the House of Burgesses as a homestead for George Rogers Clark, "The Washington of the West."

The field is as flat as a pancake and the "1884" high water scarcely covered it, so that the boys thought they had Old Man River beaten to a stand still; "But the rain descended and the floods came," and the floods not only came but they kept on coming and coming and coming and to what extent they came is best

observed by the sad looking little picture of the beautiful transmitter house just as the flood had receded. The floor line of this house, as indicated by the lower band, is 3 inches above the '1884' flood mark. But in the recent flood the entire transmitter house was completely submerged and there the muddy waters of Old Man River stayed for eight days and the worst part was that it came so fast that the equipment could not be gotten out. However, one of the engineers went in, up to his neck and brought out enough parts from the RCA Transmitter so that they could stay on their frequency, and hooked them up to a piece



NORTHSIDE
BROADCASTING CORPORATION
AN INDIANA CORPORATION
THE GEORGE ROGERS CLARK STATION

NEW ALBANY
INDIANA

March 10, 1937

RCA Manufacturing Company
Camden, New Jersey

ATTENTION: Mr. R. A. Wilson

Dear Mr. Wilson:

Have you ever had anything happen in your life that was so good that you could not express it without becoming emotional? Well, the wonderful things that RCA Manufacturing Company have just done for our Station can be put into that category.

First, you came flying to our aid as the flood receded, then thorough cooperation from Camden placed the dynamic Keachle on the job, then our new equipment was shipped by express prepaid within forty eight hours after he arrived. RCA should be proud of Jim Keachle, he completely tore down and reassembled our transmitter and speech input rack in five days time—what an engineer!

Oh well, what's the use of trying to express ourselves except to say that after being wiped out by the Ohio River flood that we are now back on the air with what we believe to be the only transmitter equipment under the sun and we are perking along as normally as ever.

Truly, Mr. Wilson, with the wonderful cooperation that was brought into action by all of your forces no one could receive or even ask for better treatment than we have received in the hands of RCA Manufacturing Company.

We do not have words to thank you and will wind up by saying that we believe that there is not another station in the world, operating on the same wattage, that is putting out a clearer signal and a greater wallop than WGRC and we attribute it all to being 100% RCA equipped.

We are enclosing a resolution that prevailed unanimously at a called meeting of the Stockholders of the Northside Broadcasting Corporation only yesterday, which is self explanatory.

With kindest personal regards, we are,

Yours very truly,
NORTHSIDE BROADCASTING CORPORATION
Charles Lee Harris
Charles Lee Harris, President

CLH:RCM

Thank you, Mr. Harris. We appreciated the opportunity to be of service.

of "ham" equipment. Then the fun began.

After wire permission from the Federal Communications Commission to operate a temporary emergency license on 50 watts, the city power failed. But did that stop them? No! They borrowed a sound truck that was equipped with a gasoline driven motor generator, belonging to a picture show, but were never able to get more than 18 or 20 watts, until those old RCA parts put out an SOS for a larger generator, a distance of thirty miles. Then one of their advertisers, who operates a large hatchery, jerked an 1800 watt, gasoline-driven, A-C generator from his hatchery and brought it in by boat and truck. Old Man River kept coming and flooded the staff out of their temporary location. Then they went to the highest ground in New Albany, a school house, and were able to put lights into the school.

By this time the Police Station was flooded out and they too, went to the only lights in the city at the school. Then the State Police came in, then the Military Authorities, then the Red Cross, and finally the Evacuation Bureau. All of course, went to the lights and WGRC.

The crowding necessitated by the emergency made doubly difficult the work of everyone engaged in the various activities but

could not be avoided. Recognizing the situation for what it really

was — one of the greatest catastrophes in the history of the Ohio Valley — everyone made the best of conditions as they found them.

Early in the game Bob McIntosh conceived the idea of equipping the few motor boats that were available, with battery radio sets and then many automobiles containing radio sets were commandeered by the Military Authorities. Then a train load of cruisers and motor boats was rushed through from Lake Michigan, equipped with battery sets. Well, by this time with everything centered around WGRC the station was certainly doing business — more than it ever expected to do or ever expects to do again.

All other means of communication being entirely cut off for more than a week from both Jeffersonville and New Albany, all rescue boats, land cruisers and ambulances, moving sick from the hos-

(Continued on Page 27)

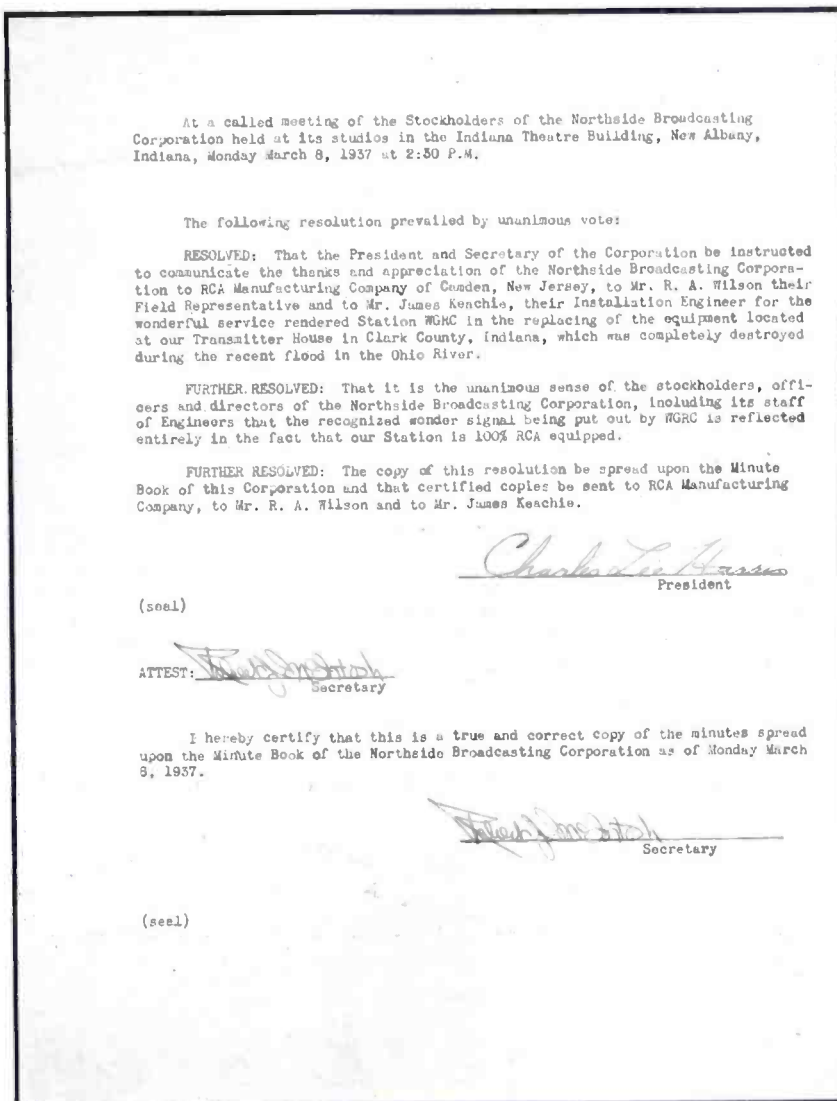

And we greatly appreciate the sentiment expressed in the resolution.

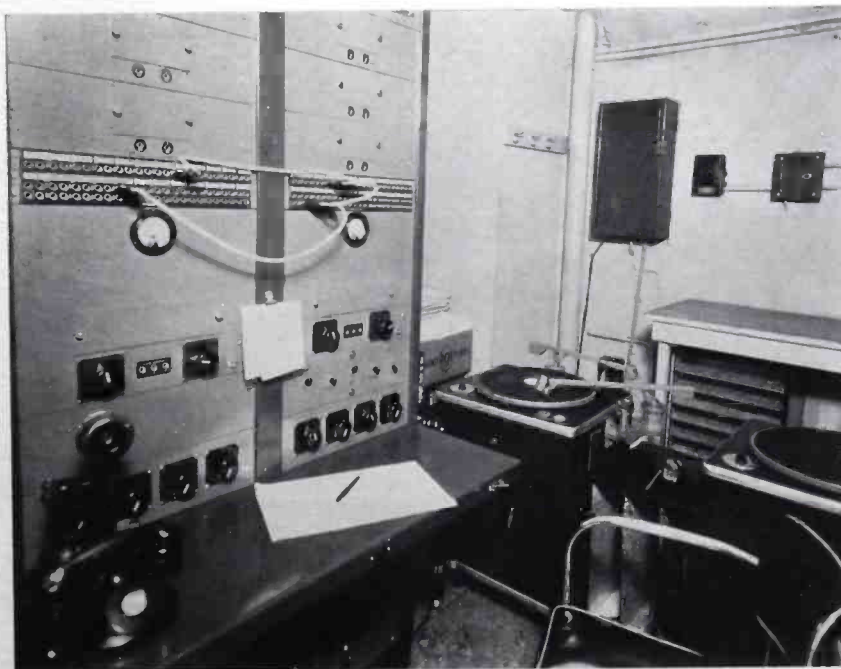

Control room with everything back to normal operating conditions.

HEARST EXPANDS COAST STATIONS

KEHE Steps Out With New Studios and Transmitter House

By FREDERICK RAGSDALE

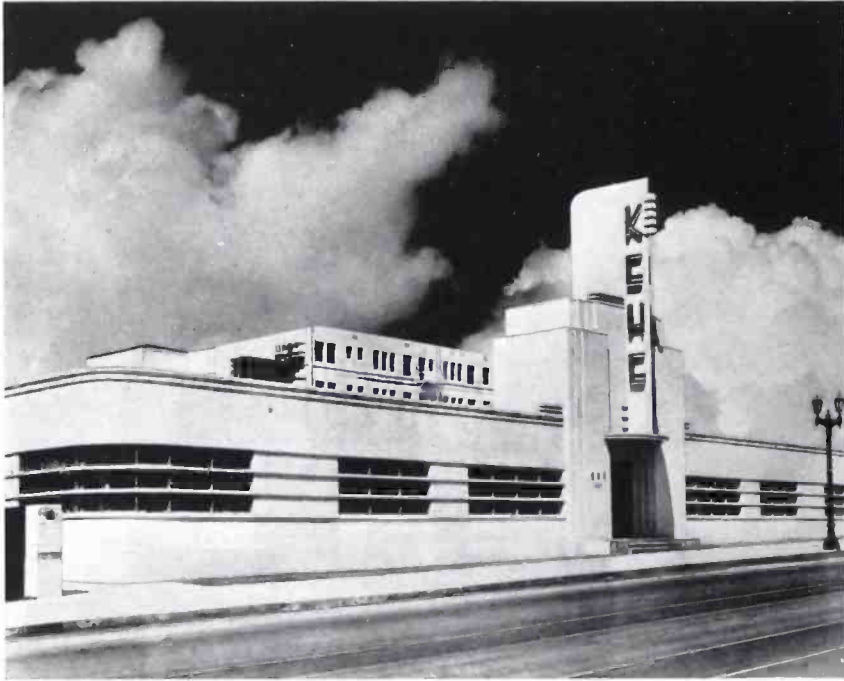

New, modernistic studios of KEHE in Los Angeles.

KEHE, owned and operated by the Evening Herald and Express, and nationally represented by Hearst Radio of New York, together with the California Radio System are entering their new home. As key station of the Columbia Radio System, a McClatchy-Hearst network of six California stations, KEHE's new studios will also house the executive offices of the network.

The large, single-story, California-type structure is located midway between Hollywood and Downtown Los Angeles at 141 North Vermont Avenue—the main crosstown artery in this section of the City. Its modernistically lettered orange neon sign is visible for a half mile in either direction.

The building, with a total of 16,848 square feet of floor space, includes a beautiful radio theatre seating over 300 persons in deluxe loge chairs, a large stage for companies of as many as 100 persons, with an associated monitor booth, artists' lobby, and a secluded sponsor's viewing lounge

on the balcony. Two other large studios for orchestra and ensembles, one of which houses a pipe organ, are also included. There is a connection between the organ studio and the playhouse so that if organ music is required in the theatre, it may be cued in from the other studio. A headphone arrangement for the organist and facilities for putting the organ studio's music on the theatre amplifier system make the arrangement workable.

Master Control Room

Two small studios for solo and small dramatic presentations, together with a large announcer's studio and a rehearsal studio complete the production equipment. The Master Control Room is accessible from any and all of the large studios without passing through long corridors. A separate entrance for the theatre audience has been provided, so that guests of the programs can go directly from the street into the theatre without passing through the offices.

Air Conditioned

The building is completely air conditioned throughout. None of the studios have windows, and the windows in front offices do not open. This affords ideal working conditions for all even on the hottest California summer day. Indirect lighting provides better illumination than daylight.

From the technical standpoint, the station's speech input equipment is the latest designed by RCA, from microphones to monitor speakers. The use of a three-channel system makes it possible to feed three different out-going programs simultaneously. All pre-amplifiers, monitor amplifiers, relays, etc., are installed in rack cabinets in the master control room. In the center of the control room sits the control console desk housing a six-channel mixer, four volume indicators and the key-switches for incoming remote lines. The six channel mixer occupies the center panel, and is used for handling all local announcements, transcriptions, and the pick-up of programs from other studios by means of an extension line bus from each of the other control-booths. In this way the master control operator may, by a key selector, fade in or out of a program locally without disturbing the set-up on the three out-going channels.

Simplicity Emphasized

Likewise, between each control-booth runs a multiple extension bus, permitting any control booth to pick up a program originating in any other control booth simply by throwing a key on that booth's panel. All of the control booth consoles are of duplicate design and incorporate several new features. Along the bottom of the panel is a row of seven faders, six

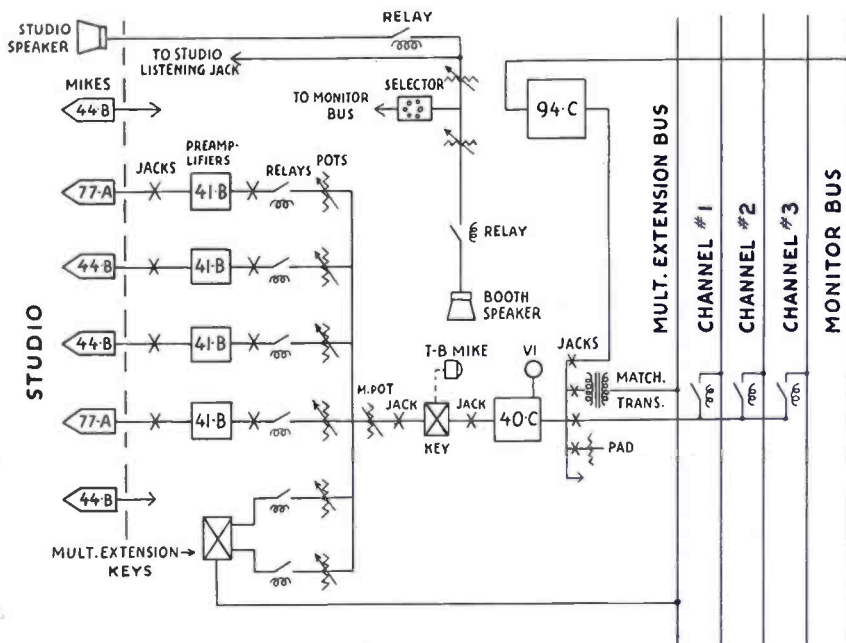

Typical Studio Channel at KEHE.

of which are mixers and the seventh the master gain control.

Above each mixer is an on-and-off push button switch for cutting in or out of the various microphones. Just above the row of faders is a line of fifteen key switches. Fourteen of the keys are used to select from the multiple extension bus. The other key is for the talk-back mike. To the left of the row of key switches is a selector switch for the monitor speaker. With this selector the operator may monitor any other studio channels for program cueing.

On the right of the panel is a group of six signal lights. Three of these lights indicate the channels in use, while the other three work in conjunction with three push-button switches for selecting the outgoing channel. Below the push-button switches are three turn-key switches for controlling the interlocking relays. With this system, an operator in one control booth may, by pressing two of the selector keys, pick up a transcription theme from one of the studios, sound effects from another, and blend both into a dramatic show being put on in the studio before him.

Monitoring System

Another feature is the monitoring system used. Each outgoing channel as well as all program lines from control booths are hooked to monitor amplifiers.

These amplifiers feed a monitoring bus that runs through the building, not only to the studio and control booths but to all the offices as well. In each office is a selector switch box with volume control that controls a speaker mounted in a modernistic console. This arrangement enables persons in any of the offices to listen to any outgoing program or audition by merely turning the selector switch.

Returning to the master control room, all input and output circuits are normaled through jacks, thus providing a flexible arrangement for substituting equipment in case of failures. One of the racks contains a beat-frequency oscillator, a special bridging amplifier for incoming remote programs, a standby power supply and a custom built all-wave receiver of special design that is wired into the monitoring bus. All equipment both in the control booths and the master control room is finished in two-tone gray, giving a very striking appearance.

Future Requirements Anticipated

All wiring between studios and master control room is run through metal ducts with removable covers. There are two of these ducts to each studio control booth in order to segregate the low and high level circuits to avoid interference. Also, anticipating future changes in equipment or circuits, two special conduits were installed from the junction boxes in the control booth to the base of the cabinet-racks in the master control room. The junction box in each control booth is mounted in the wall just below the control console, each box being barred off in three sections, to prevent cross-talk between circuits.

(Continued on Page 33)



The new transmitter house, also modernistic in design.

LOGARITHMIC RECORDING OF FIELD INTENSITIES

An Amplification of the Subject Discussed in the Last Issue

By JOHN P. TAYLOR

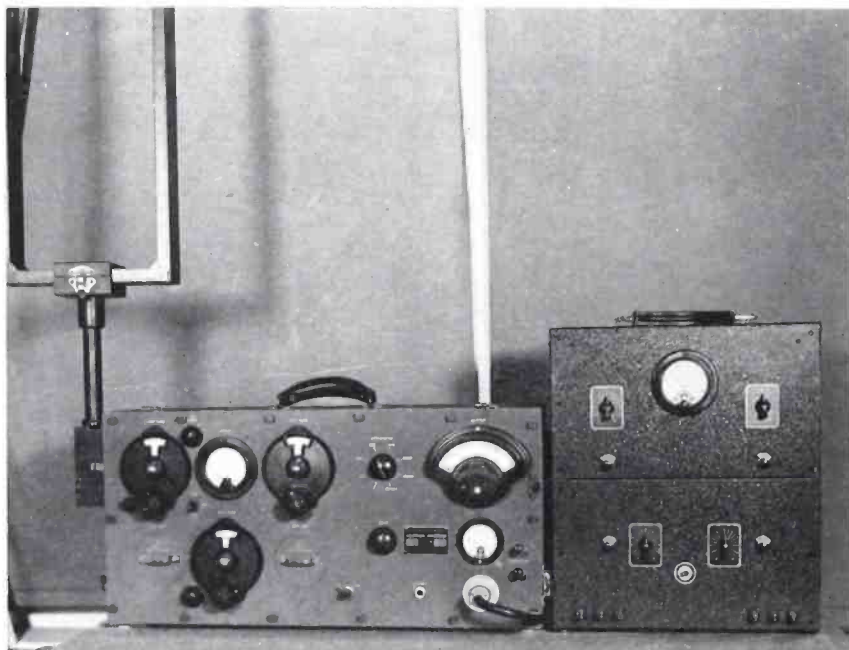

Fig. 1. The TMV-75-B Field Intensity Meter shown with a portable logarithmic amplifier. This combination, operated from batteries, is suitable for use in the field and provides a recording range of 50 db.

IN the preceding part of this article¹ several methods suitable for making graphic recordings of broadcast station field intensities were considered. The equipment setups discussed were those best-adapted for linear recording,—the possibilities of logarithmic recording being but briefly mentioned in the concluding paragraph. In the second part, which follows, an arrangement developed for making recordings directly on a logarithmic scale will be outlined.

Advantages of Logarithmic Recording

Logarithmic recordings have definite advantages in some instances and,—as propagation and coverage phenomena are investigated in more and more detail,—will undoubtedly be made use of more frequently. This is not to say that they will replace linear recordings,—except in special cases. The two types of recordings

have well-delineated applications. For instance, linear recordings will always be requisite where a good degree of accuracy is required, and, probably, in all cases where the range of field intensities to be recorded is comparatively narrow,—within, say, 30 db or thereabouts. This will ordinarily include all observations made to determine coverage of a station within its primary area (that is, where recordings are required for only comparatively brief periods). Also, of course, all measurements

within the vicinity of a station,—as, in determining "effective field intensity at one mile," harmonic radiation, etc. Logarithmic recordings, on the other hand, will be of greatest advantage under those conditions where a wide range of intensities is to be encountered. Such conditions are met with when making observations in the secondary area of a station (skywave reception), or where different powers or different antenna systems are to be compared, or where two stations of quite-different signal strengths are to be recorded alternately. The reasons for the respective advantages under these, and various other, conditions will be obvious from a comparison of the logarithmic and linear scales corresponding to a given range (see Fig. 7, Part I).

Possibilities of Log Amplifier

Field intensity meters can be built to give either linear or logarithmic recordings. The TMV-75-B is of the first type, that is, it is designed to have linear output scale. This is because its most important applications, and those for which it is used most of the time, are in determining primary coverage, effective field strength, harmonic radiation and the like—where a good degree of accuracy is essential. When the possibility of making logarithmic recordings is con-

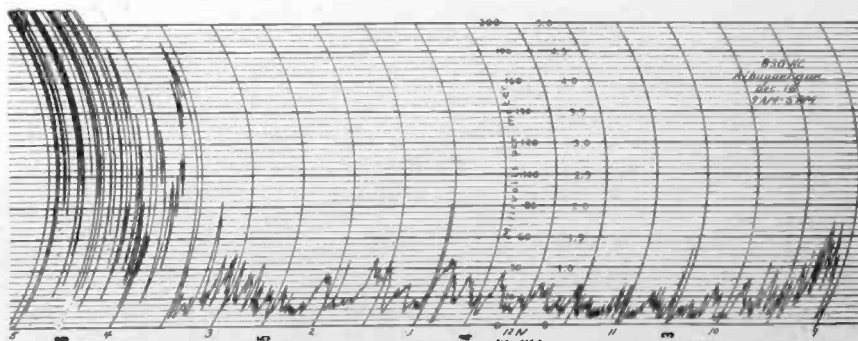

Fig. 2. A typical recording (skywave reception) of a 50 KW station about 400 miles distant. This is about average for winter conditions—summer daytime intensities are considerably lower. The wide range of field intensities from daytime to nighttime conditions illustrates the limitations of a linear scale in recording this type of reception over extended periods.

¹ John P. Taylor "Graphic Recording of Field Intensities." Broadcast News, No. 23, Pg. 9, Dec. 1936.

sidered, the first thought that occurs is to provide, for use with the TMV-75-B, an amplifier, or converter, having a linear input and a logarithmic output. A diode detector such as used in the TMV-75-B is linear over the greater part of its characteristic, but becomes almost parabolic at the low end of the curve. This means that the amplifier characteristic must take this into account—a measure which, fortunately, turns out to be quite easily accomplished. By properly adjusting the compensation a logarithmic curve very good over 40 db and useable up to 50 db can be obtained. A device of this type—illustrated in Fig. 1—has been worked out by the writer and found to operate quite satisfactory.² Such an amplifier has the advantages of being self-contained, thus making it easy to use in the field, and of including a self-calibrating arrangement, so that the whole setup can be placed in operation in a very few moments. Moreover, the unit is available for other laboratory uses where a linear-input-logarithmic-output is of advantage.

Need for Wide Range

Because of its simplicity and portability (speaking relatively, of course) the above arrangement—that is, of a logarithmic amplifier operating directly from the field intensity meter—is the best arrangement for field use. Where observations are to be made over

² John P. Taylor "A Direct-Current Amplifier for Logarithmic Recording" (to be published).

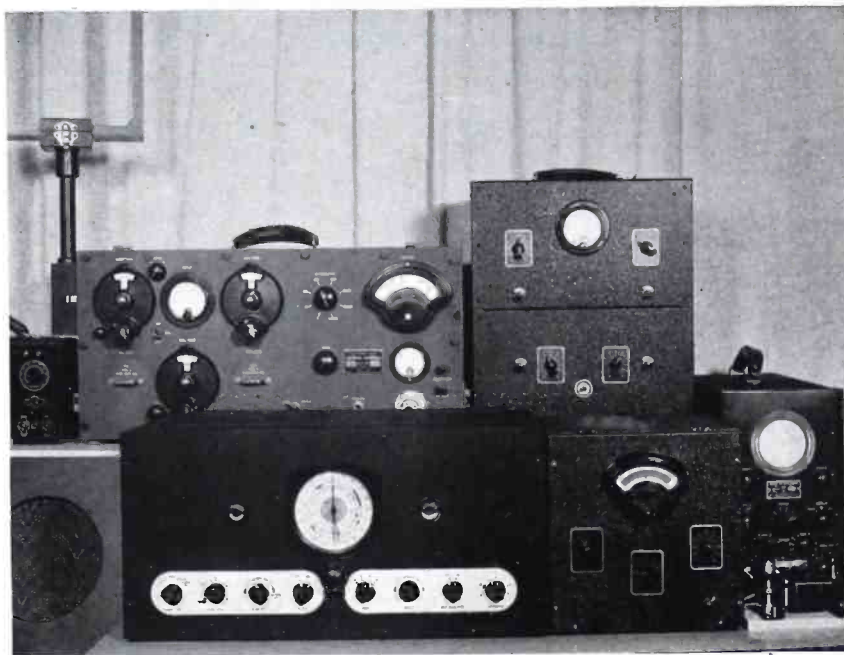

Fig. 3. The ACR-175 Receiver and DC Amplifier (in front). This combination is a-c operated, and hence is particularly suitable for recording at semi-fixed locations. It provides a recording range of 80 db of accuracy satisfactory for this type of recording. The field intensity meter (used to calibrate the setup) and the portable log amplifier are at the rear.

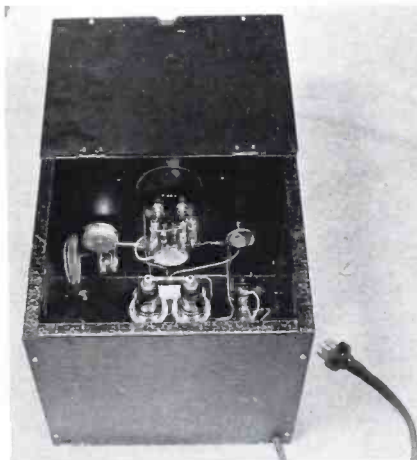

Fig. 4. Interior of the DC Amplifier showing the extreme simplicity. The plug (at the right) is inserted in the 6E5 Magic-eye socket of the receiver. No other connections except those to the recorder are required.

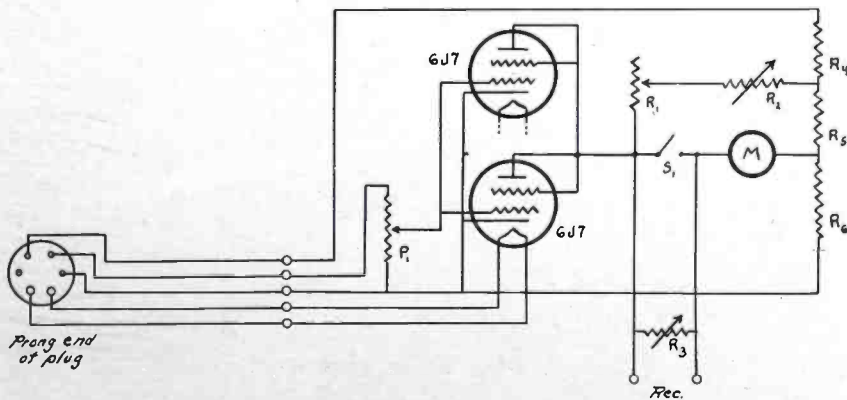

Fig. 5. Schematic diagram of the DC Amplifier (shown in Fig. 3) for use with the ACR-175 Receiver. An additional tube, in parallel, will make it possible to obtain a curve of better correspondence at the high end of the band. Values of components, which are not particularly critical, are as follows:

- | | |
|---------------------------------------|-------------------------------------|
| R ₁ 5,000 ohms, adjustable | R ₅ 1,000 ohms, fixed |
| R ₂ 2,000 ohms, variable | R ₆ 10,000 ohms, fixed |
| R ₃ 20,000 ohms, variable | P ₁ 1 Meg. potentiometer |
| R ₄ 6,000 ohms, fixed | M 0-10 milliammeter |

comparatively short periods—several hours or so—or where an operator stands by to make occasional checks of the calibration, it is quite satisfactory. However, it has two drawbacks which impose limitations that are undesirable, and which lead to the consideration of other methods. First of these is the limited range. Although 50 db provides a widespread curve compared to a linear scale, it will not be sufficient under certain circumstances. (Note: Although an amplifier of this type of range greater than 50 db could be designed, it is hardly practical due to the difficulty in obtaining stability). If, for instance, it is desired to make observations extending from daylight hours into darkness, a very wide range of field intensities will be encountered. This is indicated in Fig. 2, which is an actual record (linear) of the signal of a 5KW station some 400 miles distant. It will be seen that during the daylight hours the intensities are low—ranging from zero to 40 microvolts (this is for winter conditions) and having a mean value of only 7 or 8 microvolts. As darkness approaches the intensities rise very rapidly, as can be seen, and for winter evening conditions will have intensities varying from 0.3 to 7 millivolts, and averaging

(Continued on Page 22)

MODEL HOME FOR WORCESTER STATION

Latest Ideas in Design Incorporated in New Plant

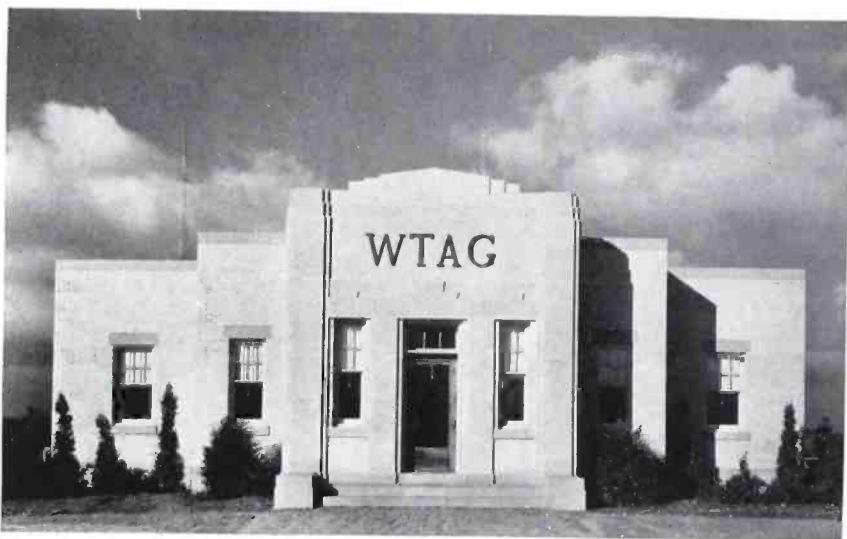

Completed home of important Massachusetts Station.

BROADCASTING operations of WTAG have been transferred to the station's new transmission plant on Shrewsbury street, Holden, accompanied by a rise in power from 500 to 1000 watts, thereby greatly intensifying the service to listeners of this station which is owned and operated by the Worcester Telegram and The Evening Gazette.

Operations will hereafter be conducted at the new Holden plant erected at a cost of one hundred thousand dollars and including in its building program a modern transmitter house and the most modern type antenna system comprised of three giant fabricated steel towers. Offices and studios of WTAG will continue at 18 Franklin street.

Placing in service its new one thousand-watt transmitter of the most modern type, and using the giant, directional, triple towers which form the new antenna system of WTAG, the station brings about a marked increase in the efficiency of coverage for WTAG listeners.

Broadcasts Improved

Broadcasts to the WTAG audience will be markedly improved by virtue of the new transmitter and the antenna system formed

by two fabricated steel towers rising to a height of 360 feet and a third tower 260 feet in height. Broadcasts will continue to comprise complete coverage of entertainment and current events brought to WTAG listeners from all corners of the world through the station's own facilities as well as those of the National Broadcasting Company's coast-to-coast Red Network and the Yankee Network of which WTAG is a mem-

ber station. Installation of the new transmission equipment with attendant improvements in WTAG's capacity for service to the radio public is in line with permission granted by the Federal Communications Commission.

Ideal Site Chosen

Construction of the new transmitting facilities was begun the first of August, following purchase of the large Holden tract selected because of its flat terrain and the good transmitting qualities of its soil which combine to make it an ideal spot for purposes of radio transmission. At that time the site was farm and pasture land. It was necessary to clear the land and remove a farmhouse and other buildings before beginning construction of the WTAG transmitter house, the steel towers and the operator's residence.

Radio programs quite literally will fare forth into the ether from a locale where potatoes and corn flourished a season ago. Programs originating in the Franklin street studios of WTAG, in New York and other studios of NBC



The RCA Type 1-D Transmitter ready to go on the air.

and in the Yankee network studios will be relayed by the new 1000-watt transmitter in a new transmitter house built of yellow face brick and limestone, along modern architectural lines. WTAG's newly-built modern cottage nearby is occupied by the chief transmitter operator.

Land Had to Be Cleared

When WTAG took possession of this site late last summer, the land was partly under cultivation. Brush, trees, and more than a mile of stone walls had to be cleared before construction work could advance far. One of the principal tasks previous to beginning actual tower construction, involved removal of those stone walls, which proved to be of even more sturdy construction than the majority of such walls which dot the New England countryside. Many of them were laid deep underground with a base fifteen to twenty feet wide, only the top to which they tapered being visible above the ground. They yielded to a crane and hand tools used to root them out.

Brush was cleared by hand and burned. The farm buildings were torn down and removed. All of the work, including the construction of all buildings and installation of all equipment, except the actual work of erecting the steel towers, was in the hands of Worcester contractors. Specialists in the latter work swung into place the eighty thousand pounds of the fabricated steel Blaw-Knox towers. Lowell & Whipple were the general contractors for the transmitter house, operator's cottage and other work.

Landscaping of the grounds surrounding the transmitting plant, interrupted in the Fall by cold weather and ground conditions, will be completed in the Spring.

Greater Area Served

The new directional antenna system will bring an increase in the area served by WTAG.

Points previously served by the station in northern Worcester

county will find the quality greatly improved.

Meanwhile, for the average listener in WTAG's territory, installation of the new transmitter and its accompanying increase in power means simply doubling the quality of the programs heard regularly under WTAG's usual policy of presenting the cream of radio entertainment from everywhere.

A glimpse into the technical background of the new transmis-

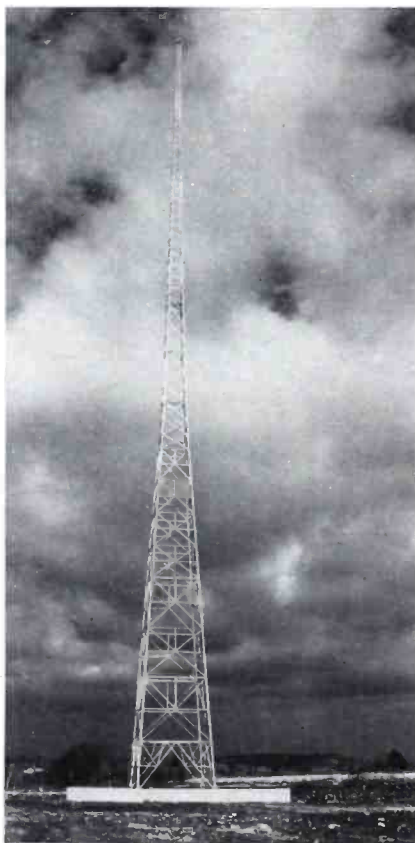

New antenna, new home, new equipment for New England's WTAG.

sion system reveals that 126,720 feet of copper wire were laid to form the ground system of the new set-up. This wire, of about half the diameter of an ordinary lead pencil, was laid six inches underground. Running some 2900 feet between the towers and from the towers to the transmitter house, is the concentric transmission line forming what is perhaps the longest transmission line of any such system in the country.

The towers are set in heavy concrete bases extending eight feet into the earth. Upon these are

comparatively small porcelain insulators which surprisingly bear the eighty thousand-pound load of the towers with complete safety. The towers are built to withstand a wind velocity of 115 miles an hour, which is vastly greater than has ever been recorded in this vicinity.

Completely Equipped Plant

The new antennae and transmitter house were constructed under the supervision of John J. Storey, managing director of station WTAG, and Prof. Hobart H. Newell, consulting engineer of the station. Mr. Storey also supervised building of the operator's cottage. The transmitter house contains the actual transmitter facilities in its 55 x 30 feet quarters, along with reception and observation rooms where visitors are welcomed. In the basement is an emergency electric plant and a modern heating plant. Above are operators' sleeping and lounging quarters and workshop. Equipped with its own emergency electrical plant, WTAG could continue operations even in the event that power from regular sources should fail.

The steel towers are painted in alternate stripes of international aviation orange and white, these colors having been designated by the Airways Division of the Department of Commerce. At night they are lighted by six 100-watt beacons on the sides of the three towers, topped on the East tower, by a 500-watt beacon, and, on the other two, by lights of 100-watt power. These red beacons conform to the specifications of the Department of Commerce and so serve as aviation guides. Under normal conditions their beams are visible many miles. In the day, as well as at night, the towers form a landmark that may be seen from many surrounding highways and railroads—as well as from the highways of the sky.

NEW EQUIPMENT SOLVES PROBLEM FOR SMALLER STATIONS

Two Studio Speech Input Rack Provides Efficient System

By W. L. LYNDON

AMONG the recent developments of great interest to smaller stations is the new RCA 78-A Speech Input Rack. A factory assembled and wired grouping of standard rack-type apparatus, controlled from an operating console and permitting an unusual degree of flexibility, in use this unit solves many of the problems which have confronted the lower powered stations. At the same time the price is sufficiently attractive to place it within the reach of almost every station.

The studio problems in broadcasting stations are often aggravated by the necessity for providing unusual setups, for making rapid changes from one program to another and for holding auditions at the same time that broadcasting is being carried on. It is desirable to be able to do these things without an excessive layout of apparatus, and often such possibilities are not provided when the original installation is made.

Provision for Expansion

It was with these facts in mind that the 78-A equipment was developed. The RCA Standard 78-A Studio Equipment provides the utmost in flexibility for two studio operations, but involves only a minimum amount of equipment. There is available space on the speech input rack which will permit the addition of a pre-amplifier, a meter panel or line equalizer, a 33-A jack panel, and a 55-A line amplifier. Also, space is available on the relay panel for five additional relays and the relay rectifier is conservatively rated which will allow the addition of relays or signal lights. We know from past experience that it is never advisable to design a studio layout without providing means for expansion and changes.



A front view of the 78-A rack.

The equipment is composed of three main items; namely, the booth control console, the rack of amplifier equipment and a wall mounted tube type relay rectifier. All amplifiers are the standard RCA 41-B and 40-C series as used by most leading stations and networks. Facilities are available for three microphone outlets in each studio. These microphones may be the RCA Velocity Type 44-A, 44-B, 74-A, 74-B, 77-A Unidirectional type, or the 50-A inductor microphone. Where it is desirable to have a microphone in the booth to permit station announcements, switching facilities have been included for this feature. This arrangement will permit the use of three microphones in one studio, two in another and one in the control booth.

Separate Control Console

The booth control console should be located so that the operator may have visible access to both studios. This console contains three pre-amplifier input key switches, four mixer input key switches, four mixer output (air-audition) key switches, a two-position line output key switch, a monitor selector key, a talk-back key switch, four mixer controls and an overall master gain control, a volume indicator meter and a monitor amplifier volume control. The black bakelite panel on which these parts are mounted is hinged from the top so that it may be easily opened and the mixers and key switches readily serviced. Twisted pair shielded wire has been used to connect up this console and all out-going circuits are terminated on a connection block located in front of a cutout at the rear panel of the console. The rear of the console is removable to facilitate the connecting of the external wiring. The console

is finished in a medium gray with a silver gray trim.

The mixers employed are of the ladder type and are properly matched by means of loading resistors and a transformer to the master gain control which is of a balanced ladder type.

As shown on the accompanying diagram four normalled thru circuits are provided for remote line or transcription purposes.

The key switches located on the input of the 41-B preamplifiers permit the use of six microphones. The key switches on the input of the mixer controls allow either the output of the pre-amplifier or line to be fed to a mixer. The key switches on the output of the mixers designated "Air-Audition" allow that particular mixer to be switched through to either the regular broadcast channel or to the audition circuit. This feature permits an audition to be conducted during a broadcast by using the monitoring amplifier in the audition channel. During such an audition, the operator may monitor the regular program by plugging a pair of headphones in a jack provided on the side of the console.

There are three inputs on the monitor key switch which will permit switching the monitor amplifier input to either the outgoing program bus, a cue circuit or the audition circuit. The cue circuit may be the rectified output of the



The console — the central unit in the new equipment

transmitter carrier or where the 78A equipment is used in a multi-studio installation involving a master control room, it may be the output of any pre-patched circuit.

Talk-Back Facilities

The monitor circuit is normalled through a non-locking two-position talk-back key. When this key is operated, it transfers the input to the monitoring amplifier to the talk-back microphone circuit and at the same time operates the booth and studio speaker relays. The operation of the booth relay prevents acoustic feed-back. The talk-back microphone may be of the high output magnetic variety or a carbon microphone may be used if a suitable battery, coil and power supply is provided.

An interlocking feature prevents the possibility of talk-back into a studio when that studio has once been set up for broadcast position. However, talk-back facilities are still available in the second studio in which an audition may be picked up.

Standard Speech Equipment Rack

The rack is a standard 9AX cabinet type on which is mounted the loudspeaker relays, three 41-B pre-amplifiers, a 40-C amplifier, a 94-C monitoring amplifier, a 33-A jack strip, and a 57-A master power switch and fuse panel. The rack is wired with twisted pair shielded cable and all power and audio circuits have been carefully separated to prevent coupling.

High-Fidelity Performance

At normal gain settings, the overall hum level of the broadcast channel is -60 db. below zero level output (unweighted). At this output level the overall distortion is .25 of 1% RMS measured at 400 cycles.

The 94-C monitoring amplifier provides 18 watts of audio power which is sufficient to drive a number of office speakers in addition to the studio and booth speakers.

The control room monitor speaker may be the UZ-4209 double voice speaker mechanism which the user may mount in a suitable baffle or the new 64-A loudspeaker which consists of a double voice coil mechanism mounted in an acoustically matched folded horn. The 94-C amplifier will supply field excitation for two of these type speakers.

The equipment is designed to operate from a power supply of 105/125 volts 50/60 cycles and the total power consumption is approximately 450 watts.

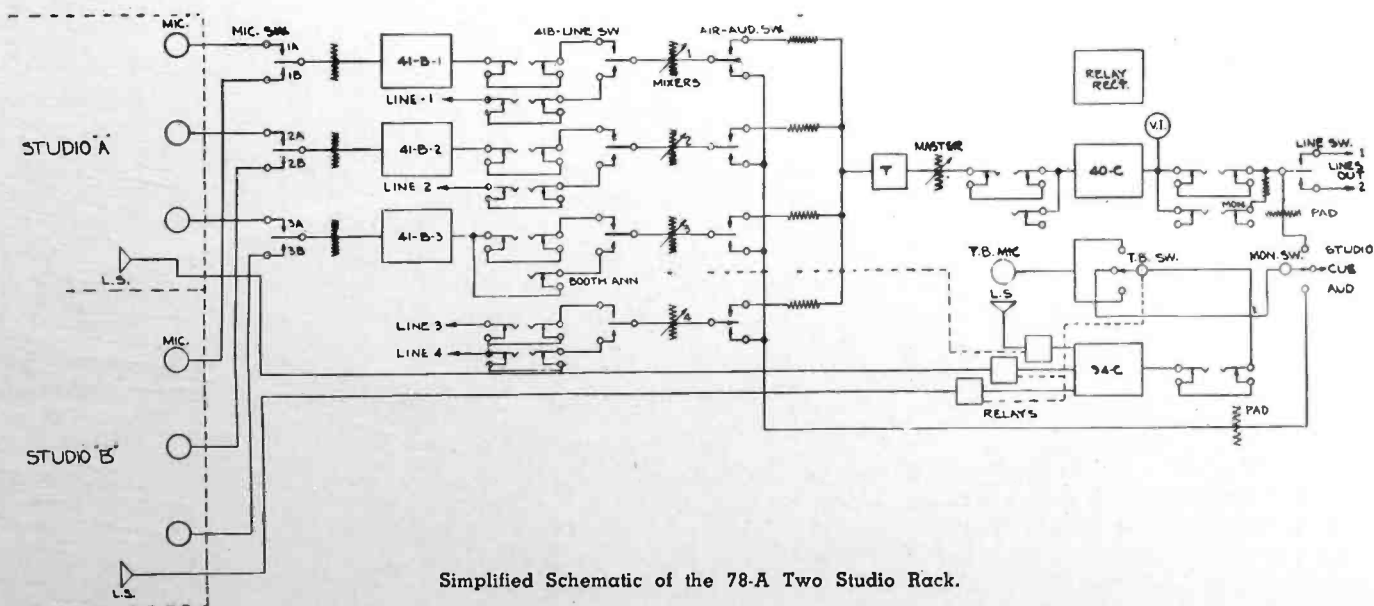

Simplified Schematic of the 78-A Two Studio Rack.

DIRECTIONAL ANTENNAS

A Development of Analytical Methods Applicable to General Problems in Array Design

DR. G. H. BROWN

Reprinted through the courtesy of Proceedings of the I. R. E.

THE multielement or directional antenna is becoming of increasing importance throughout the spectrum of radio frequencies. Various forms of directive arrays have been used for many years for short-wave use. In the past few years, arrays have become important in the so-called "broadcast" band of frequencies. The purpose of the arrays used in this range of frequencies has been twofold. In some cases, the energy is directed into a desirable or densely populated territory at the expense of a decrease in the energy sent out into thinly populated territory, waste land, or large bodies of water. By far the greatest use of the directive array has been to prevent energy from going out in such directions which point toward the service areas of stations on the same or adjacent channels. The use of such arrays allows stations to increase their power without increasing the amount of interference they cause to another station.

Problems in Designing Array

In designing an array, it is desirable to determine several quantities. The shape of the space distribution curve of the electric intensity (or magnetic flux density) at a distance from the array is determined by the relative phase and magnitude of the currents in the elements making up the array. The next step is to place the scale factor on this diagram. This is usually done by integrating the flow of power through the surface of a large sphere whose center lies at the array. For an array consisting of more than two elements, this process is very tedious. By reducing the field relations to a study of self- and mutual impedances, the problem becomes that of analyzing a coupled circuit. This process has the added advantage of yielding relations of importance in designing the feed-

ing and matching circuits. The amount of power contributed by each element is then known, as well as the effective resistance and reactance which each element will offer to its respective transmission line. With a complete knowledge of the phenomena occurring in the system, the adjustment becomes merely a correction of second order effects instead of the usual "cut-and-try" procedure which must be followed when the action of the system is not thoroughly understood.

It is the purpose of this report to develop analytical methods which are readily applicable to the general problems that arise in array design and to provide design curves which may be used without reference to the field theory underlying the problem. The theory will be applied to a number of important cases. It is realized that some of the work closely parallels that of other authors. In fact, a certain amount may seem a duplication of previous work,¹ but this was done for completeness and continuity of treatment. Furthermore, the report has been prepared with the idea of utility predominating over that of presenting entirely new material.

II. The Fields in the Vicinity of a Transmitting Antenna

In order to predict effects occurring at the antenna itself, it is necessary to have available expressions for the electro-magnetic field in the vicinity of a radiating element. In particular, let us examine the top-loaded antenna shown in Fig. 1. This antenna consists of a vertical wire with a nonradiating capacity area at the top so that the current distribution is as shown. Then b is the length of the portion of sine wave suppressed by the

capacity area. We define the quantities.

$$B = 2\pi b/\lambda \text{ radians} \\ = 360b/\lambda \text{ degrees}$$

$$A = 2\pi a/\lambda \text{ radians} \\ = 360a/\lambda \text{ degrees}$$

$$G = A + B.$$

The current on this antenna is then distributed according to the relation

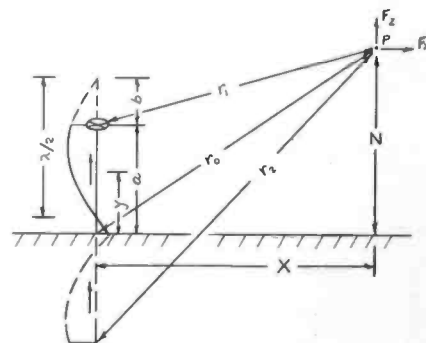

Fig. 1.

$$i_y = \frac{I_0 \sin(G - ky)}{\sin G} \quad (1)$$

where y = the distance from the surface of the earth to the point at which the current, i_y , is being determined.

I_0 = current at the base of the antenna

λ = operating wave length

$k = 2\pi/\lambda$.

The components of electric intensity at point, P , are²

$$F_x = \\ + j \frac{30I_0}{x \sin G} \left[\frac{(z - a)}{r_1} \epsilon^{-jkr_1} \cos B \right. \\ \left. + \frac{(z + a)}{r_2} \epsilon^{-jkr_2} \cos B \right. \\ \left. - \frac{2z}{r_0} \epsilon^{-jkr_0} \cos G - \frac{x^2}{kr_1^3} \epsilon^{-jkr_1} \sin B \right. \\ \left. + \frac{x^2}{kr_2^3} \epsilon^{-jkr_2} \sin B \right]$$

¹ P. S. Carter, "Circuit relations in radiating systems and applications to antenna problems," Proc. I.R.E., Vol. 20, pp. 1004-1041; June, (1932).

² Appendix III.

$$+ j \frac{(z-a)^2}{r_1^2} \epsilon^{-jkr_1} \sin B - j \frac{(z+a)^2}{r_2^2} \epsilon^{-jkr_2} \sin B \quad (2)$$

and,

$$F_z = -j \frac{30I_0}{\sin G} \left[\frac{\epsilon^{-jkr_1}}{r_1} \cos B + \frac{\epsilon^{-jkr_2}}{r_2} \cos B - \frac{2\epsilon^{-jkr_0}}{r_0} \cos G + j \frac{(z-a)}{r_1^2} \epsilon^{-jkr_1} \sin B - j \frac{(z+a)}{r_2^2} \epsilon^{-jkr_2} \sin B + \frac{(z-a)}{kr_1^3} \epsilon^{-jkr_1} \sin B - \frac{(z+a)}{kr_2^3} \epsilon^{-jkr_2} \sin B \right] \quad (3)$$

where,

$$r_0 = \sqrt{x^2 + z^2}$$

$$r_1 = \sqrt{x^2 + (z-a)^2}$$

$$r_2 = \sqrt{x^2 + (z+a)^2}$$

The magnetic flux density lies in horizontal circles, with the center of the circles lying on the vertical axis of the antenna. The magnetic flux density is

$$B_\phi = j \frac{10^{-9}I_0}{x \sin G} \left[\epsilon^{-jkr_1} \cos B + \epsilon^{-jkr_2} \cos B - 2\epsilon^{-jkr_0} \cos G + j \frac{(z-a)}{r_1} \epsilon^{-jkr_1} \sin B - j \frac{(z+a)}{r_2} \epsilon^{-jkr_2} \sin B \right] \quad (4)$$

When there is no loading at the top of the antenna, the field components become

$$F_x = +j \frac{30I_0}{x \sin G} \left[\frac{(z-a)}{r_1} \epsilon^{-jkr_1} + \frac{(z+a)}{r_2} \epsilon^{-jkr_2} - \frac{2z}{r_0} \epsilon^{-jkr_0} \cos G \right] \quad (5)$$

$$F_z = -j \frac{30I_0}{\sin G} \left[\frac{\epsilon^{-jkr_1}}{r_1} + \frac{\epsilon^{-jkr_2}}{r_2} - \frac{2\epsilon^{-jkr_0}}{r_0} \cos G \right] \quad (6)$$

and,

$$B_\phi = j \frac{10^{-9}I_0}{x \sin G} [\epsilon^{-jkr_1} + \epsilon^{-jkr_2} - 2\epsilon^{-jkr_0} \cos G] \quad (7)$$

At times, the sectionalized arrangement (Fig. 2) is used instead of top loading. The coil is placed some distance from the top of the antenna. The total antenna height is d , while a is the distance from the earth to the coil. The length of sine wave which would be above the coil point if the coil and top section of antenna were replaced by a straight wire is b . Then we define

$$D = 2\pi d/\lambda \text{ radians} = 360d/\lambda \text{ degrees}$$

$$A = 2\pi a/\lambda \text{ radians} = 360a/\lambda \text{ degrees}$$

$$B = 2\pi b/\lambda \text{ radians} = 360b/\lambda \text{ degrees}$$

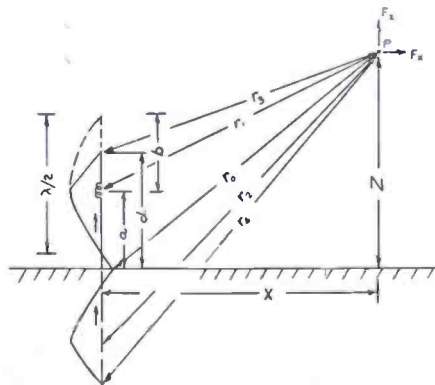

Fig. 2.

The antenna current is given by

$$i = \frac{I_0 \sin(G - ky)}{\sin G} \quad (8)$$

when y is less than a . When y is greater than a , the distribution is

$$i = \frac{I_0 \sin B \cdot \sin(D - ky)}{\sin G \cdot \sin(D - A)} \quad (9)$$

The components of the electromagnetic field become

$$F_x = +j \frac{30I_0}{\sin G} \left[\frac{(z-a)}{r_1} \epsilon^{-jkr_1} \cos B + \frac{(z+a)}{r_2} \epsilon^{-jkr_2} \cos B - \frac{2z}{r_0} \epsilon^{-jkr_0} \cos G + \frac{\sin B}{\sin(D-A)} \left\{ \frac{(z-d)}{r_3} \epsilon^{-jkr_3} + \frac{(z+d)}{r_4} \epsilon^{-jkr_4} - \frac{(z-a)}{r_1} \epsilon^{-jkr_1} \cos(D-A) - \frac{(z+a)}{r_2} \epsilon^{-jkr_2} \cos(D-A) \right\} \right] \quad (10)$$

$$F_z = -j \frac{30I_0}{\sin G} \left[\frac{\epsilon^{-jkr_1}}{r_1} \cos B + \frac{\epsilon^{-jkr_2}}{r_2} \cos B - \frac{2\epsilon^{-jkr_0}}{r_0} \cos G + \frac{\sin B}{\sin(D-A)} \left\{ \frac{\epsilon^{-jkr_3}}{r_3} + \frac{\epsilon^{-jkr_4}}{r_4} - \frac{\epsilon^{-jkr_1}}{r_1} \cos(D-A) - \frac{\epsilon^{-jkr_2}}{r_2} \cos(D-A) \right\} \right] \quad (11)$$

and,

$$B_\phi = \frac{j \cdot 10^{-9}I_0}{x \sin G} \left[\epsilon^{-jkr_1} \cos B + \epsilon^{-jkr_2} \cos B - 2\epsilon^{-jkr_0} \cos G + \frac{\sin B}{\sin(D-A)} \left\{ \epsilon^{-jkr_3} + \epsilon^{-jkr_4} - \epsilon^{-jkr_1} \cos(D-A) - \epsilon^{-jkr_2} \cos(D-A) \right\} \right] \quad (12)$$

where,

$$r_0 = \sqrt{x^2 + z^2}$$

$$r_1 = \sqrt{x^2 + (z-a)^2}$$

$$r_2 = \sqrt{x^2 + (z+a)^2}$$

$$r_3 = \sqrt{x^2 + (z-d)^2}$$

$$r_4 = \sqrt{x^2 + (z+d)^2}$$

(Continued on Page 14)

DIRECTIONAL ANTENNAS

(Continued from Page 13)

All the above fields have been computed on the assumption that the earth beneath the antenna is a perfect conductor.

The above expressions are essential in computing the mutual impedances between antennas. They are also of use in investigating earth currents near transmitting antennas,³ in adjusting top-loaded or sectionalized antennas,⁴ and in estimating the effects of supporting guys.

III. The Mutual Impedance Between Antennas

The classical method of calculating the power radiated from an antenna was to integrate the Poynting vector over the surface of a sphere whose radius was very large compared to the antenna dimensions and to the wave length. This process then gave the radiation resistance of the antenna. Several years ago, Pistolors⁵ moved the surface of the integration so that this surface coincided with the surface of the antenna. This method yields the reactance as well as the resistance of the antenna. This procedure has been elaborated upon by other workers.⁶

The Poynting vector in this case becomes the product of the current flowing in an element of conductor and the component of electric intensity at the surface of the conductor and parallel to the direction of current flow. The component of electric intensity is found by letting the point, *P*, of Fig. 1 approach the surface of the antenna. Then the distance, *z*, assumes the value, *y*, which is the

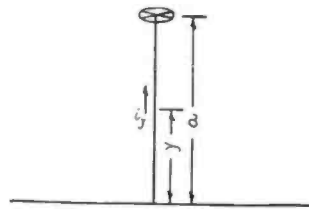

Fig. 3.

elevation of the current element we are examining, and *x* approaches the radius of the conductor. The total power passing outward from the surface of the conductor (Fig. 3) is

$$p \text{ (watts)} = - \int_{y=0}^{y=a} F_y i_y dy. \tag{13}$$

Here *i_y* is the current in the antenna element and *F_y* is the vertical component of electric intensity at the elevation, *y*, where this electric intensity is due to the current (and charge) of the entire antenna. The notation *F_y* has been used instead of *F_z* to agree with the current notation and to indicate that the field is to be taken at the surface of the conductor. This electric intensity is computed from (3), (6), or (11), depending on type of antenna used. Equation (13) consists of a real term and an imaginary term, each of which is proportional to *I₀²*. Thus the real coefficient of *I₀²* is identified as the radiation resistance and the imaginary factor as the reactance of the antenna.

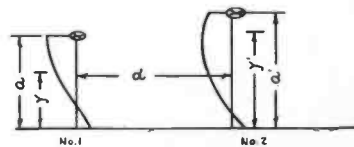

Fig. 4.

Let us now turn to the situation of Fig. 4. Two antennas of heights *a* and *a'* are separated a distance, *d*. The self-resistance and reactance of either antenna may be found by equation (13.) At the same time, antenna No. 2 produces a field at the surface of No. 1 which yields a Poynting term of power. Thus the power flowing out of No. 1 due to the presence of No. 2 is

$$p_m = - \int_{y=0}^{y=a} F_y i_y dy \tag{14}$$

where *i_y* is the current in No. 1 and *F_y* is the electric intensity at the surface of No. 1 due to No. 2 [*x* = *d* in (3), (6), or (11)]. This power term splits into a real and an imaginary part, multiplied by the product, *I₀I₀'*. We have thus arrived at a definition and a means for computing the mutual impedance between two antennas. We shall denote this complex impedance as

$$Z_m = R_m + jX_m = |Z_m| \angle + \theta_m \tag{15}$$

where,

$$|Z_m| = \sqrt{R_m^2 + X_m^2} \tag{16}$$

and,

$$\tan \theta_m = X_m/R_m. \tag{17}$$

Likewise, the power flowing from No. 2 due to No. 1 is

$$p_m' = - \int_{y'=0}^{y'=a'} F_y' i_y' dy' \tag{18}$$

where *i_{y'}* is the current in No. 2 and *F_{y'}* is the electric intensity at the surface of No. 2 due to No. 1.

Because of the reciprocal relation existing between (14) and (18), (*p_m* = *p_m'*), either may be used to evaluate the mutual impedance. When one antenna is top-loaded or sectionalized and the other is a straight vertical wire with no loading, it is generally simpler to integrate along the top-loaded or sectionalized antenna since the expression for the field due to the simple antenna is less cumbersome to handle.

In general, it is desirable to plot the integrand of (14) or (18) and perform a mechanical integration. The actual integration yields very cumbersome formulas⁷ which involve a large amount of arithmetic before a numerical answer is obtained. Experience with both methods has proved that the graphical method is less tedious as well as less time-consuming.

(Continued on Page 32)

³G. H. Brown, "The phase and magnitude of earth currents near radio transmitting antennas," Proc. I.R.E., vol. 23, pp. 168-181; February, (1935).

⁴G. H. Brown, "A simple method of adjusting sectionalized and top-loaded broadcast antennas," Broadcast News, No. 19, p. 14; April, (1936).

⁵A. A. Pistolors, "The radiation resistance of beam antennas," Proc. I.R.E., vol. 17, pp. 562-628; March, (1929).

⁶J. Labus, "Recherische Ermittlung der Impedanz von Antennan," Hochfrequenz. und Elektroakustik, p. 17, January, (1933).

⁷G. H. Brown and Ronold King, "High-frequency models in antenna investigations," Proc. I.R.E., vol. 22, 471, equations (7) and (8); April, (1934).

REAL DRAMA ON THE AIR

WSM Presents Vivid Account of Flood Conditions

By HARRY STONE

"THAT'S all, WSM. Go home and get some sleep. If we need you again we'll call you."

Thus did a tired-voiced WHAS announcer write "finis" to one of the most dramatic chapters of all radio history.

For 79 hours without interruption, WSM had placed its transmitter at the disposal of flood-stricken Louisville. No time to change tubes or make adjustments but 24 hours a day without a moments rest. How many lives were saved by radio is, of course, highly problematical, but it is definitely known that rescue work in Louisville continued to take its directions from a transmitter 175 miles away while WHAS was off the air. That the nation was enabled to listen in on this gripping drama while it was being enacted is evidenced by the fact that more than 200 stations throughout the country were rebroadcasting WSM at intervals during those three days and four nights.

WSM Comes to Aid

Louisville's plight first became known at WSM Saturday night,



Part of the Staff at WSM during the flood crisis.



Aaron Shelton, WSM engineer aboard the "Lockandam," stringing antenna for shortwave transmitter.

January 23rd. Harry Stone immediately offered Lee Coulson of WHAS whatever assistance needed. This was graciously declined. But on Sunday afternoon a teletype message from Coulson to Stone told a startling story. The city flooded, police radio dead, and notice to WHAS that their power was going off at 8 o'clock—would WSM help.

That WSM did help is now a matter of record. Working in two shifts of twelve hours each, WSM announcers and operators kept the station going for the longest period in its history. Police bulletins and emergency calls by the thousands poured forth in a monotonous yet dramatic fashion. Each one meant lives in danger—lives that depended upon a radio transmitter and a makeshift telephone circuit between Louisville and Nashville for their chance to live.

Many times during those agonizing hours this line would crackle and pop, then fail momentarily. But always it would clear up and the calls continue.

All the while Louisville was in trouble there were other localities also in distress. Paducah, Evansville and dozens of smaller communities. These, too, had to have help so as these appeals came in WSM would cut in, read these messages locally.

Boats Equipped

The U. S. Engineer Office with its fleet of river steamers equipped with standard radio receivers, directed the relief activities of this fleet through a pre-arranged schedule on WSM. Two of their boats, the "Lockandam" and the "Jayhawker" were equipped with short wave transmitters and were able to carry on direct communication with WSM wherever they went on the Ohio, Tennessee or Cumberland Rivers. Eddyville, Kentucky, cut off from the world for days, sent out its first word over a twenty watt transmitter on the "Lockandam." Smiths Grove, Kentucky, marooned without food, water or medical supplies, sent the American Legion Commander,

(Continued on Page 24)

FLOODS MAKE WORK FOR NBC STAFF

Wide Area Covered In Keeping Nation Informed



Long shifts fatigue even radio men. NBC group on flood duty.

THE beautiful Ohio River tearing through one of the most fertile and populated sections of the United States gave radio an unforeseen opportunity to demonstrate its capacity for performing extraordinary service, despite adversity.

Encountering the three great scourges, flood, famine, and fire, radio men demonstrated a resourcefulness, energy, and endurance that stirred admiration far and wide. They lived up to the old tradition of a radio man who would never desert a sinking ship or leave a humane act undone.

NBC and associated stations sprang into action as soon as the Ohio reached flood stage. The principal points of departure for the flood zone were Cleveland and Chicago. Portsmouth, Ohio, one of the first cities flooded, was covered by F. D. Whittam and Tom Manning, from WTAM, Cleveland. Their equipment included three transmitters, three receivers, and two portable field amplifiers.

Equipment Rushed

Equipment from Chicago was rushed to Vincennes, Evansville, Cairo, Paducah, and Memphis. In addition to mobile units, there were three portable intermediate

and ultra-high frequency transmitters, three receivers, two portable field amplifiers, and a gas-driven generator for charging batteries.

Eye-Witness Accounts

One of the most spectacular accomplishments by radio men in the flood zone was the eye-witness accounts broadcast from airplane transports—"flying studios"—which covered the flood zone

bearing parties of NBC and local station announcers, and by courtesy of NBC, newspaper reporters.

The transport studio sent out signals from a 50-watt intermediate frequency transmitter, whose wavelength varied between 125-180 meters. Any one of four frequencies were available between the 1600 and 2200 kilocycle band set aside for relay broadcasting.

The FCC ruling which authorized all units to communicate with any class of station, without special license or commission, enabled the portable and mobile units to adopt a broadcasting band and technique which best suited their purposes.

Although they worked in an area where roads were virtually impassable and where regular lines of communication were un dependable, NBC field units managed to get to the "front." They saw and described much of the dramatic action incident to building levee defenses, to feeding refugees, and evacuating homes. NBC's great offensive ranged over an area with a frontage of 1800 miles.

(Continued on Page 33)



Up in the air.

STEADY PROGRESS FOR WRAK

Williamsport Station Installs New Equipment

By LOUIS N. PERSIO, Chief Engineer

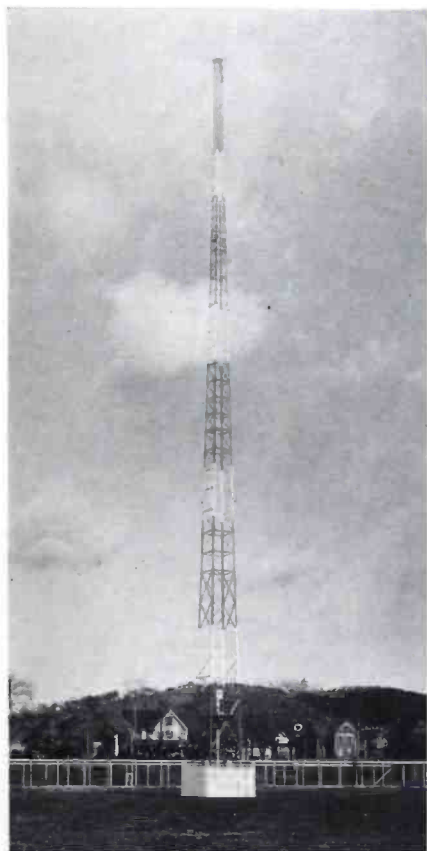

The antenna at WRAK with the substructure to raise it above flood level.

The antenna system and transmitting quarters are located just inside the west city limit, near where the Lycoming Creek joins the Susquehanna River. The transmitting equipment is housed in a newly erected brick veneer building. A new, RCA High Fidelity 100-250 watt transmitter, with associated line equalizers, line amplifier, modulation and frequency monitors make up the transmission installation.

Substructure for Antenna

The antenna is a vertical self supporting quarter wave type. Because it is possible for the area in which the antenna is erected to become inundated as it was dur-

ing the March flood of 1936, the antenna is erected on a twenty foot substructure of the same construction, in order that it may at all times be above high water.

Ground System

A buried radial type of ground system is used. Twenty thousand feet of number eight gauge copper wire went into the construction of this ground system. The radio frequency energy is conveyed to the antenna by a 600 ft. nitrogen filled concentric line, buried two feet underground for protection as well as to minimize temperature change effect. The line terminating and antenna equipment is

(Continued on Page 24)

ON November 5, 1936, Radio Station WRAK, Williamsport, Pa., put into service its new High Fidelity installation. This installation is made up of High Fidelity equipment from microphones to antenna.

The RCA Type 44-B De Luxe velocity and 50-A Inductor microphones are used in the studios. The speech equipment is made up of combinations of RCA High Fidelity pre-amplifiers and program amplifiers.

For High Fidelity reproduction of recorded and transcribed programs, two RCA type 70-A transcription tables with type 71-A vertical tone arm attachments are used.

WRAK's studios are located in the heart of Williamsport's business district.



The new RCA ET-4250 Transmitter which steps up power for WRAK.

TWIN BUFFALO ST

New Equipment all Along

By RALPH J. KINGSLEY, Technical Supervisor, WBEN



Main control room of WBEN between "A" and "B" studios.

A BOOST in daytime power to 5000 watts has resulted in the installation of a new three hundred foot vertical radiator and a new RCA 5-C transmitter at WBEN, located at Buffalo, New York.

The site of the new transmitter plant is on Shawnee Road and is about midway between Niagara Falls and Buffalo. The original building housing the transmitter equipment has been almost completely rebuilt and the grounds surrounding the building have been tastefully landscaped. In order to accommodate the power transformer and water cooling unit, a new wing was added at the rear of the building. A bedroom, kitchen, two-car garage and oil burning heating system keep the operators comfortable during the worst weather conditions.

Auxiliary Transmitter

The original type 1-C transmitter is now used as an auxiliary to the new 5000-watt unit. This transmitter has its separate antenna system supported between two two-hundred foot steel towers as well as its separate power supply. In case of failure of the main transmitter, this auxiliary unit automatically goes on the air.

The new transmitter has now

been on the air about six months and reports from listeners indicate that they thoroughly approve the high fidelity signal. The new vertical radiator has helped materially in extending the service area.

This vertical radiator is 300 feet in height and is of uniform cross-section from top to bottom. The bottom tapers to a point where the base insulator is located. The structure is supported by a single set of four guy wires. The tower is illuminated and painted in accordance with U. S. Airways specifications.

As a part of the new installation is included a four-channel speech rack housing the hum compensat-

ing equipment, duplicate line amplifiers, line testing equipment and modulation and distortion measuring equipment. The rack is completely A.C. operated and in the event of failure of the main power source, the rack automatically swings over to the auxiliary power source.

Ideal Location

The WBEN studios are located on the 18th floor of the Hotel Statler in the heart of downtown Buffalo. This is also the site of the W8XH ultra high frequency broadcast transmitter which is operated in conjunction with WBEN twelve hours daily.



Transmitter house at WBEN, located at Martinsville, N. Y., showing the new 5KW transmitter.

STATIONS MODERNIZE

the Line For WBEN-WEBR

By P. E. FISCHLER, Chief of the Technical Department, WEBR

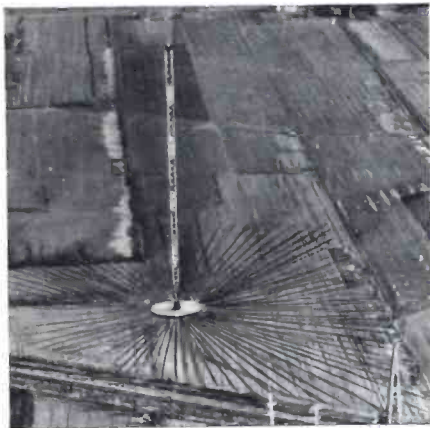

The new vertical radiator at WBEN with ground system converging at the base.

IN July, 1936 WEBR was purchased by The Buffalo Evening News from Howell Broadcasting Company and became a basic outlet for the NBC Blue Network. Almost at once an extensive program of construction was started. This work has but recently been completed and the new WEBR is thoroughly modern, from microphone to 304 foot vertical radiator.

Transmitting Plant

The transmitting plant was given first consideration. The quarters housing the old transmitter on the 10th floor of the Larkin Terminal Building were completely remodeled. An RCA Type E.T. 4250 (100-250 watt) Transmitter and RCA speech-input equipment were installed. Simultaneously, steel workers began the erection of the 304 foot Blaw-Knox vertical radiator on the roof of the Terminal Building. The tower was sectionalized and loaded at the 200 foot level for operation as a half-wave radiator at 1310 K.C., affording low angle radiation which greatly increases signal intensity in the area the station desires to serve. The flashing beacon light atop this structure, 416 feet above street level, is the tallest Buffalo landmark.

Main Studios

For several years the main studios and offices of WEBR have been housed in a three story brick building at 23 North Street. Formerly a private residence, this building has been aptly named "Broadcasting House." It also has been remodeled and redecorated, the most extensive work being done on the 2nd floor where the

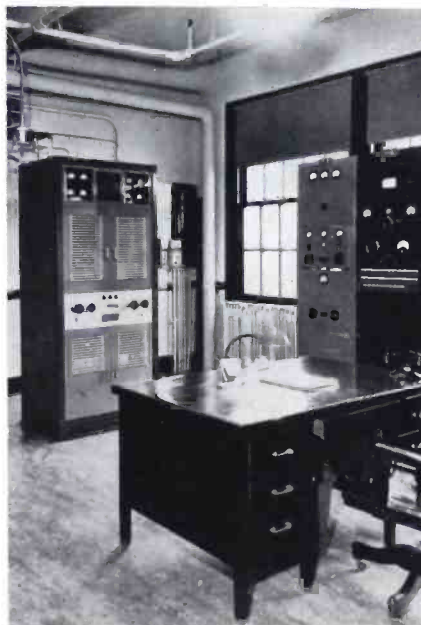

Inside the transmitter house at WEBR showing the main transmitter in the background.

two main studios and master control room are located.

Throughout the studios sound-proof walls, doors and windows have been installed to exclude outside noises and ceilings and side walls treated to assure perfect acoustics.

The master control room has been enlarged to accommodate the new RCA two channel speech-input equipment. All studio and adjacent circuits, mixing and channel switching facilities are

located on a console type desk, so situated as to afford the control operator an unobstructed view into both studios. This method of arrangement has been found highly satisfactory by many stations throughout the country.

Monitoring Systems

A system for monitoring programs and auditions has been installed, with high fidelity speakers located in the studios, client's room, reception room and executive offices. Talk-back facilities are also provided from the client's room, executive offices and master control room into the studios.

The decorative scheme throughout the building has been carried out in black, cream and pastel shades which creates a most pleasant and restful atmosphere for artists and personnel in addition to presenting a beautiful appearance.



A worm's eye view of the vertical radiator.

FEATURES BRING NEW TRANSMITTER TO THE FRONT

Additional Unit Steps Up Power

By C. M. LEWIS

THE Type 100-E Broadcast Transmitter has met with wide acceptance. It has provided a reliable commercial transmitter at a cost which could be economically justified by the lower powered broadcasting stations. Many letters have been received from satisfied users complimenting the manufacturers upon the combined attractive appearance and reliable low-cost operation of the transmitter. Since many of these users were contemplating an increase in power, they requested that the necessary equipment be made available to enable the transmitter to be operated with an output of 250 watts.

After a careful consideration of all the factors involved, the RCA Manufacturing Company decided to place on the market a modification kit with which the RCA Type 100-E Broadcast Transmitter could be converted into a high-quality transmitter capable of operating at either 100 watts or 250 watts. Several important basic factors were involved in the design of such a kit and they are listed as follows:

1. The fidelity of the 100-E transmitter should not be impaired when changed to 250 watts and, if possible, should

be improved by modification.

2. The additional parts should be inexpensive.
3. The installation should be relatively easy—requiring a minimum of time and labor.
4. The modified transmitter must meet all the regulations of the F.C.C. and must be completely reliable during continuous operation at the increased power output.
5. The low-cost maintenance feature of the 100-E should be retained by using properly designed parts and inexpensive tubes.
6. The additional equipment should harmonize in appearance with the 100-E and should require a minimum of space.

Two readily adaptable methods for increasing the power output were available. Either a second linear amplifier could be added to the existing transmitter or the present 100 watt linear amplifier could be converted to a "Class C" r-f amplifier and then plate modulated by means of a suitable modulator. Many advantages of the plate modulation method were readily apparent. First, an inexpensive tube complement was



Front view of the 100/250 E Broadcast Transmitter

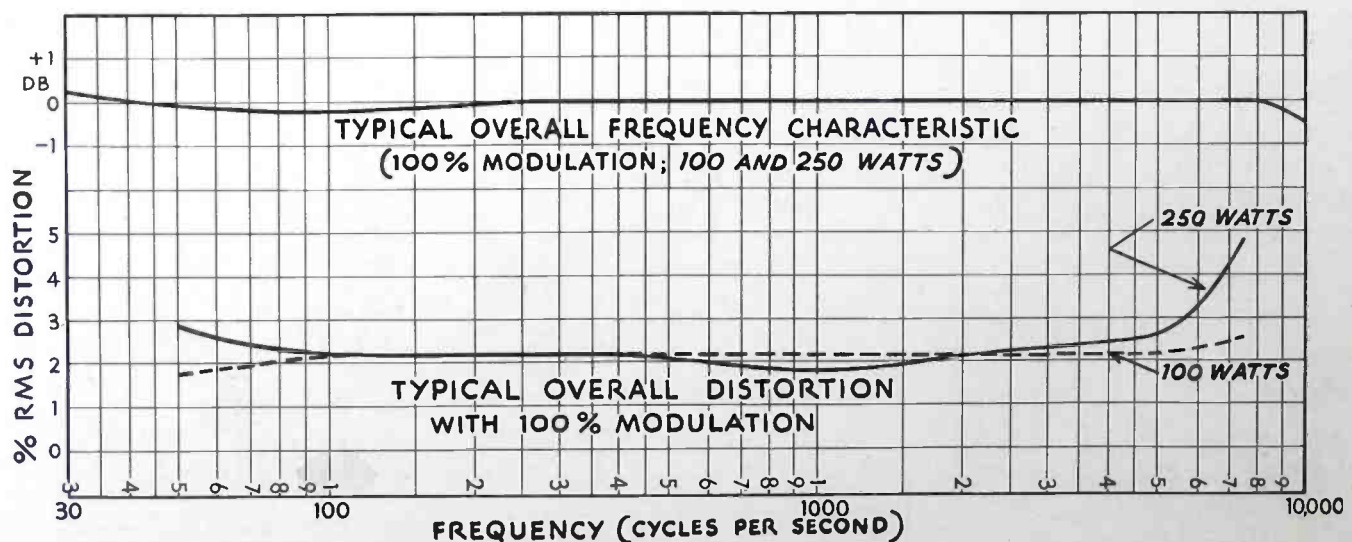

Typical Operating Curves of the RCA Type 250-E Transmitter.

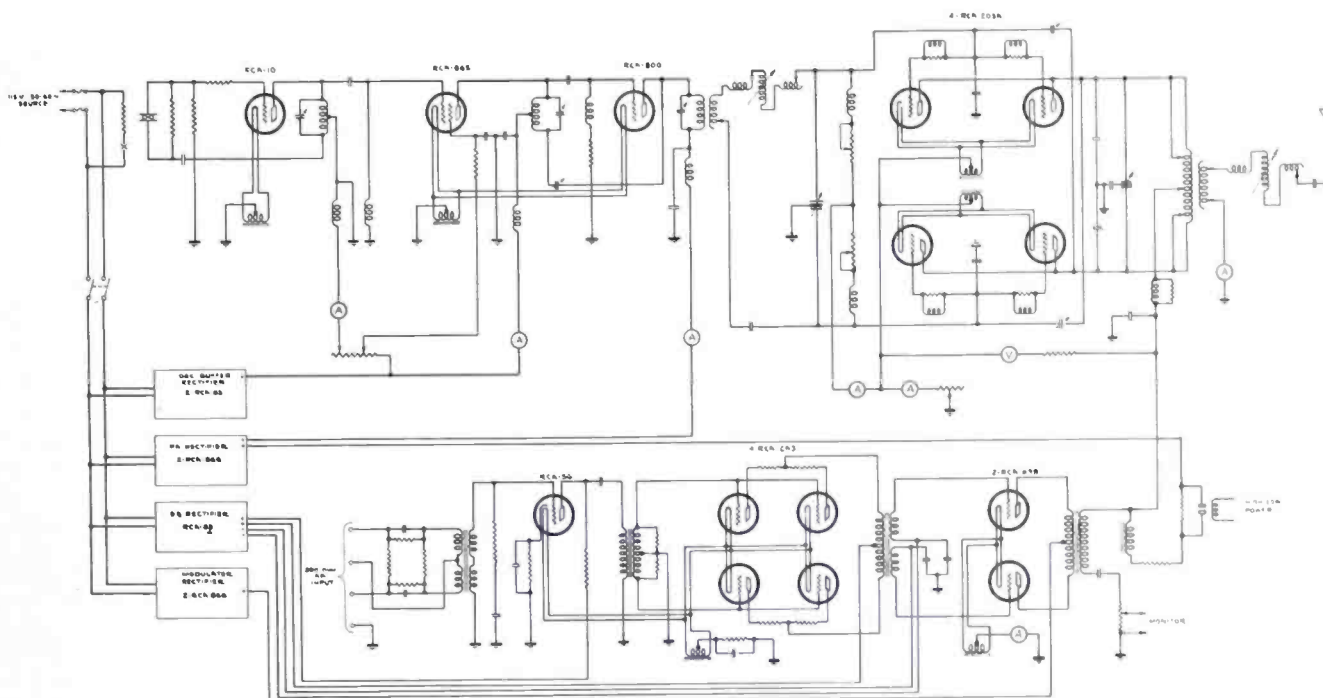

Simplified Schematic of the 250-E

available; second, the increase of power would actually improve the fidelity and ease of tuning; and, third, the modulator would require little space and could be easily installed. Any increase of operating costs would be slight because of the improved amplifier efficiency.

Accordingly, the Type 100-EM Modulator Units were designed and built. When these modulators are added to the 100-E, the completed unit is known as the RCA Type 250-E Broadcast Transmitter. Its circuit and operating characteristics are on file with, and approved by the Federal Communications Commission.

As shown in the accompanying photographs, the 100-EM Modulator unit has been built into a frame assembly similar to that used for each section of the 100-E Transmitter. The unit matches the 100-E in appearance and is mounted on top of the 100-E frame by removing the cover, fastening the modulator frame on the r-f amplifier frame and then replacing the cover on top of the complete as-

sembly. Longer corner moldings are furnished which take the place of those previously used with the 100-E Transmitter. A meter is provided for indicating the combined plate currents of the modulators. Also included on the modulator panel are a rheostat for varying the power output over a limited range and a switch which operates the power change relay providing operation at either 100 watts or 250 watts.

The 100-EM Modulator is furnished with a terminal board and is complete except for the audio input transformer which is furnished separately and is mounted on the lowest shelf of the 100-E transmitter where it replaces the modulation transformer formerly used. The unit uses two RCA-838 modulator tubes and two RCA-866 rectifier tubes. Bias voltage for the modulator tubes is obtained from the rectifier which furnishes power to the audio amplifier on the bottom shelf. Separate potentiometers are provided for adjusting the bias voltages to the two modulator tubes.

Supplied with the modulator unit is a kit of parts which include the necessary wire for making connections between units as well as all the small parts required in modifying the 100-E transmitter for the adaption of the modulator unit and the power increase. Several

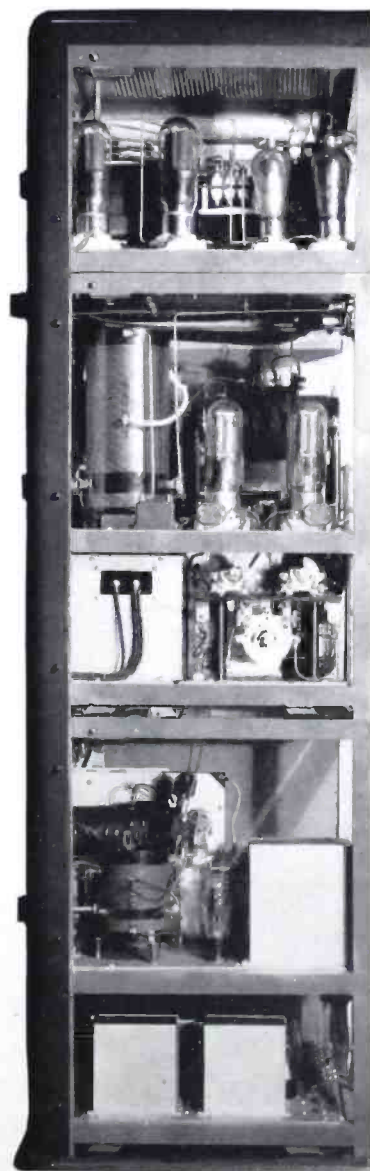

Right hand view of the transmitter showing compact arrangement.



The 100-E Modulator Unit.

(Continued on Page 24)

LOGARITHMIC RECORDINGS

(Continued from Page 7)

around 2 millivolts. That this record represents typical levels to be expected is indicated by comparison with the conclusions of Norton, Kirby and Lester³. Moreover, from data collected by these authors, it can be assumed that in the case of a 500 KW transmitter the maximum nighttime levels will run about three times as high (in fact, skywave intensities as high as 25 millivolts, at 644 kilometers have been observed in the case of WLW), while the daytime minimums will still be of the order of a few microvolts. From a consideration of these levels it is evident that a range approaching 80 db is desirable if extended observations — as for instance over twenty-four hour periods — are contemplated.

Desirability of A.C. Operation

The second marked disadvantage in using the field-intensity-meter-amplifier combination is due to the limitations imposed by battery operation. The field intensity meter itself is very stable, and the amplifier which is illustrated employs a method of compensating

for changes in battery voltage. The combination will operate for several hours without necessity of readjustment, providing the batteries are not too run-down. However, in some cases, it may be desirable to make extended runs. In this event the battery-operated equipment would require an operator to make readjustments every few hours. Obviously it would be desirable to have a completely-automatic equipment which would run without attendance for twenty-four hours at a time. A.C. operation is the only practical answer to this. If all batteries are eliminated, and a voltage regulator used in the A.C. input line, an equipment practically free from drift (once it is fully warmed up) is possible.

Use of AVC Characteristic

In considering means of obtaining an all-a.c.-operated layout, without necessity of building a new field intensity meter, it was decided to try using one of the already available types of receivers. Moreover, since it is more easy to obtain stability in the i-f or r-f stages than in the direct-current amplifier, it was decided to have the output of the detector be as nearly logarithmic as possible. Since the AVC action of a re-

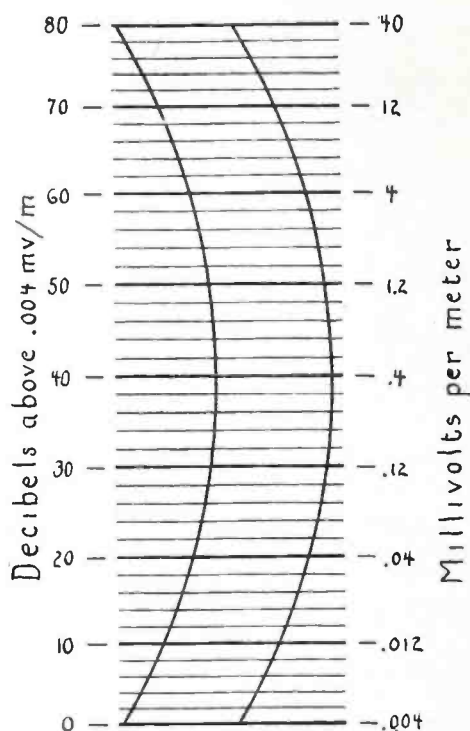

Fig. 7 A section of a record chart suitable for use with the receiver-amplifier combination when an adjustment such as that shown in Fig. 6 is used. Each small division on the chart represents 2 db. The decibel range and the corresponding millivolts-per-meter range are indicated for comparison. As can be seen, this range extends from approximately the smallest measurable intensities to the highest intensities likely to be encountered on skywave reception.

³ K. A. Norton, S. S. Kirby, and G. H. Lester, "An Analysis of Continuous Records of Field Intensity at Broadcast Frequencies," IRE Proc., Pg. 1183, Oct. 1935.

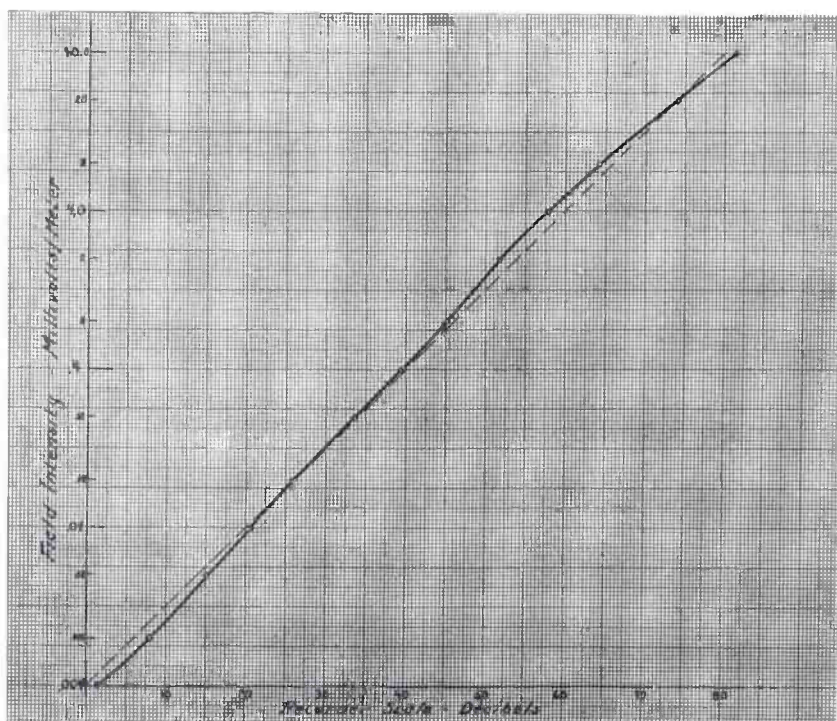

Fig. 6. An actual response curve of the receiver-amplifier combination, made by a direct comparison with readings of the field intensity meter — such a curve should be made for each station to be observed. It can be done quite easily, either by direct observation of station signals or by using a signal generator.

ceiver, as ordinarily employed, operates more or less logarithmically, a start was made from this point. Fortunately, it was found that the Type ACR-175 Receiver possessed an AVC characteristic very nearly exponential over approximately the range desired. Moreover, means were at hand whereby the necessary small adjustments could be made to bring the response within required limits.

General Arrangement

The arrangement, then, is as shown in Fig. 3. The ACR-175 Receiver drives a direct-current amplifier, which in turn drives the recorder, the whole being calibrated by comparison with the field intensity meter. The amplifier is coupled to the receiver by a simple arrangement which consists merely in plugging into the socket of the receiver from which the 6E5 magic-eye tube has been removed. Thus, the part of the avc voltage ordinarily applied to the magic-eye tube is used to drive the grids of the direct-current amplifier. In addition, filament and plate voltages

for the amplifier are obtained from the corresponding socket connections. A five-wire cable carries these leads to the amplifier, thus providing a convenient arrangement, and obviating need of an additional power supply. Since no batteries are required, the operation is entirely from the a.c. line, and, if this is supplied through a voltage regulator, the equipment will be exceedingly stable.

Amplifier Details

The schematic of the amplifier is shown in Fig. 4, along with the values of the various components. The circuit is straightforward and requires only a brief note. The potentiometer P_1 controls the part of the avc voltage applied to the grids of the parallel 6J7's. R_1 , R_5 , R_6 form a voltage divider. Operating plate voltage flows through the meter M and the recorder. In order to balance out the plate current at no input, a small additional positive voltage is tapped off of the bleeder and fed back through resistors R_1 and R_2 to the meter and recorder. Adjustment of R_2 sets the meter and recorder at zero as desired. Switch S_1 provides for shorting the recorder during adjustment and calibration. Resistor R_3 allows the recorder to be shunted down so that only 5 mils will flow through it at maximum. The shape of the characteristics is first adjusted by varying P_1 , the r-f attenuator of the receiver, and, if necessary, the antenna coupling. This done R_2 is used to adjust the zero point on the scale and R_3 to adjust the maximum point.

The construction of the amplifier is exceedingly simple. The front view may be seen in Fig. 3, and an interior view in Fig. 6. Looking at the front panel, the controls from left to right, are the input potentiometer, the balance control and the shunt resistor. Aside from the necessity of shielding and keeping the connecting cable short, details may be changed as desired.

An 80 db Range

This setup will provide a logarithmic output over a range of 80 db. Several minor adjustments are available which allow the shape of the characteristic to be altered slightly, and the range to

be adjusted (and, if desired, reduced to 60 db). These are the input potentiometer P_1 , variation of which changes the range and also the curvature,—by matching the amplifier characteristic to the receiver characteristic. Adjustment of the r-f gain control of the receiver has the same effect, since it changes the shape of the avc characteristic slightly, as well as introducing attenuation. Any type antenna which is non-directional can be used,—but a good height is of advantage in keeping weak signals above the noise level. Some means of varying antenna coupling is handy, although not absolutely necessary. The whole setup must, of course, be calibrated by comparison with the TMV-175-B Meter. Ordinarily this should be done each time the equipment is returned to a different station. A typical calibration is shown in Fig. 6. As will be seen, the correspondence is quite good,—the maximum error being about 2 db. This is generally satisfactory for this type of work. However, should better accuracy be desired this could probably be obtained by adding one or two more tubes in parallel. In this case a Variac can be used to increase the input voltage to take care of the added filament load.

Even for normal operation this use of a Variac is convenient, in that it provides an additional, and particularly convenient, means of further adjusting the characteristic to the desired scale.

Convenient Scale Markings

If the recorder described in the first part of this article is used, the 80 db scale can very handily be made use of. Paper for this recorder can be obtained which has forty small divisions, and is marked from 0 to 80. When this is used the record is direct-recording in decibels above the reference level. Fig. 7 shows a section of such a scale with the corresponding field intensities marked for comparison.

Linear Changeover

It is of interest to note that this same setup may also be used, if desired, in making linear recordings. All that it is necessary to do to make the changeover is to switch the AVC control of the receiver to the "off" position, and to adjust the r-f gain so that the proper scale is obtained (such that the maximum signal to be observed will not cause overloading). A typical calibration for operation in this manner is shown in Fig. 8. As will be seen the correspondence is very good,—max-

(Continued on Page 31)

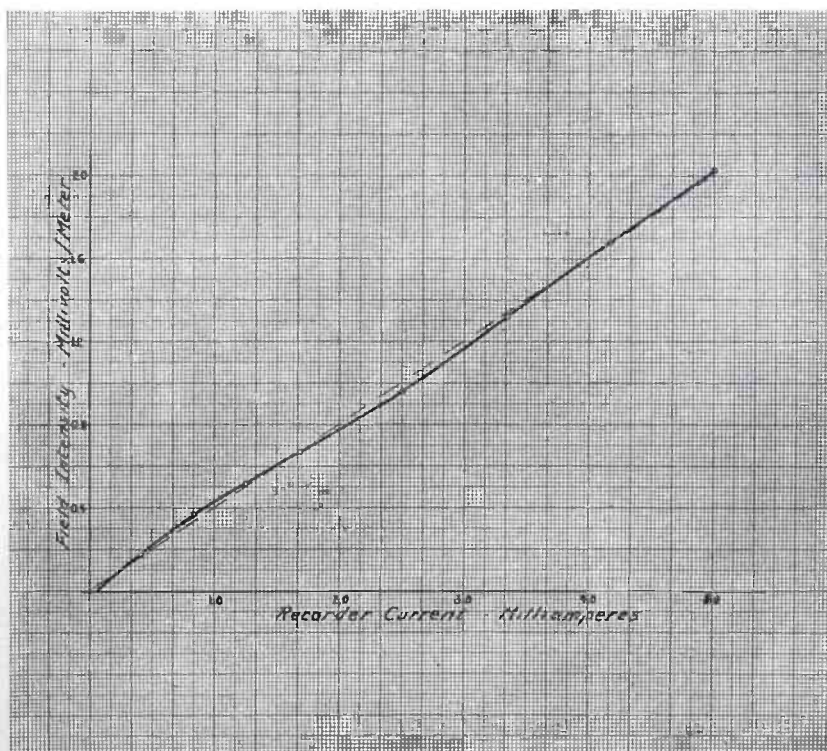

Fig. 8. A typical calibration of the receiver-amplifier combination when used for linear recording. The changeover, from logarithmic to linear recording, is accomplished simply by changing the AVC control from on-to-off position.

STEADY PROGRESS FOR WRAK

(Continued from Page 17)

housed in an all metal tuning house of moisture proof construction, and located on a platform erected at the top of the twenty five foot sub structure, which is also the base of the antenna. Running parallel and buried with the above mentioned concentric line is a one and one quarter inch conduit containing four two wire lead covered lines used for antenna lighting, remote reading antenna meter, direct telephone communication with transmitting quarters and an auxiliary line.

The transmitting site was chosen after the results of an intensity survey showed that it was the ideal location for transmission purposes.

Comments from rural and outside listeners on the increased signal strength and improved quality of the new installation, have justified beyond a doubt, the efforts and cost entailed for an installation of high quality and efficiency.

REAL DRAMA ON THE AIR

(Continued from Page 15)

at midnight, in an outboard motor boat to stop the "Jayhawker" and tell of the plight of their community. This was immediately transmitted to WSM and while he was still on board getting emergency supplies, he could hardly believe his ears when the voice from the radio said help was on the way from Mayfield. Small wonder that a hard boiled World War veteran broke down and cried.

On to Paducah went the "Jayhawker," then to other Ohio River points broadcasting first hand reports from many communities.

WSM overnight became the clearing house for flood relief in the Louisville and Paducah territories. Telegrams, telephone calls, literally thousands of them came in from all parts of the United States offering assistance. Because of limited communication facilities to Louisville, there were directed to WSM. Offers of boats, airplanes, policemen, firemen, serum and supplies all had to be answered over the air. Caravans



Scene on the Booneville Salt Flats near Salt Lake City during an automobile test. The information was relayed to Salt Lake City over KNEF.

of trucks carrying supplies were begging for information on how to get to Louisville over flood covered roads. Airlines, with their transmitters at Bowman Field silenced, were asking instructions for landing their ships near the stricken city. Such was the responsibility placed on the staff of WSM as by water, air, rail and highway, help was being rushed to the flooded area. Radio Amateurs, Automobile Clubs and Railroad employees in remote places, all contributed their bit toward supplying this necessary information.



Watching the portable transmitter on the "Jayhawker"

FEATURES BRING NEW TRANSMITTER TO THE FRONT

(Continued from Page 21)

changes are necessary in the audio shelf to convert it to an audio amplifier and driver unit. The RCA-45 stage is omitted and the RCA 46 stage changed to use four RCA 2-A-3 tubes. The r-f power amplifier is modified to use grid-leak bias and a relay and resistor assembly is provided for correctly adjusting the plate voltage and reducing it for 100 watt operation. A meter is supplied to measure the d.c. grid current of the r-f power amplifier and is mounted on the panel of the exciter unit replacing the "EXCITATION CURRENT" meter. In addition, complete instructions are furnished describing the modifications and wiring changes.

Careful tests and examinations have proved this scheme to be more than adequate to meet the six basic design considerations. Its performance is demonstrated in the accompanying curves and technical specifications. Here is a means which permits the present 100 watt broadcaster to increase his power to 250 watts with a program fidelity of the highest order. The change is made with a minimum of time and expense and the station owner is assured of the operating reliability, service, and patent protection that is built into every RCA product.

(Continued on Page 35)

ELECTRON PATHS MADE VISIBLE

New Method Proves Useful In Laboratory

By DR. V. K. ZWORYKIN and E. A. MASSA

A PHYSICIST who "plays" with electrons in complicated electrostatic and magnetic fields would be aided considerably in solving his problems if he could see the paths taken by the electrons as he causes various forces to act upon them. The paths referred to are not the familiar traces such as those seen on the screens of cathode ray oscillographs, which represent the motions of the ends of a concentrated bundle of electrons, but rather the paths taken by the electrons inside the tube as they pass from the emitting surface through various control fields to their final destination.

One method which has been tried for accomplishing such results makes use of ionization in a small quantity of gas which is placed in the tube for the purpose. This method is not always satisfactory, however, for several reasons; first the gas pressure required is critical; second, the presence of the gas affects the focusing of electrons; and, finally, the thermionic cathodes in the tube are usually ruined after running a while.

Principle of Luminescence

To overcome these disadvantages, a method was developed which makes use of the principle of luminescence. A thin layer of willemite (which is similar to the material usually used on the viewing screens of cathode ray tubes) is deposited on a specially prepared surface which is placed inside the tube along the axis in which the electron path is desired to be observed. The surface introduced in the tube must be an electrical insulator, so that the potential distribution in the tube will not be disturbed and, at the same time, it must be free of the possibility of acquiring a negative charge, otherwise the electrons will be repelled by the charged surface.

A thin sheet of mica coated with

a thin layer of willemite was found successful in making the electron paths visible along the tube in the plane of the sheet, but a negative charge was found to accumulate on the mica, causing distortion of the electron stream. To overcome this difficulty, the mica is first coated with silver "beads," similar to the mosaic of an "Iconoscope." The willemite is then deposited over the silver

sheet of specially prepared mica, such as already described, with its plane at right angles to the planes of the multiplying and accelerating electrodes.

When the tube was placed in operation, the electron paths inside the tube became clearly visible. The variation of the focusing with changes in the magnitudes of the electrical and magnetic fields became clearly observable.

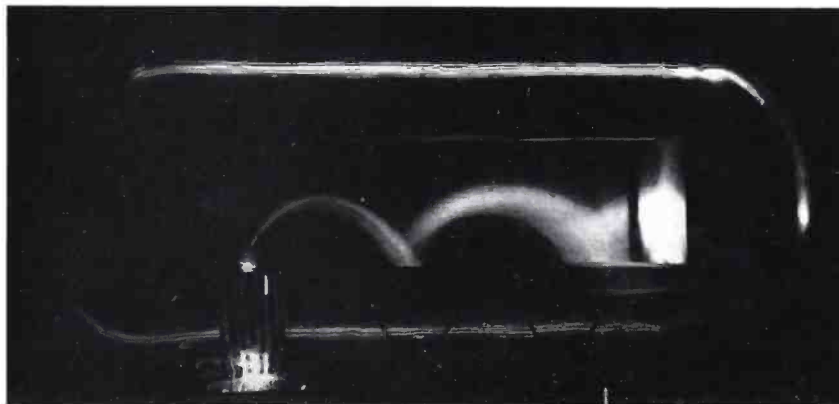

Tube used to show electron paths in operation.

"beads," and the composite sheet is then built into the tube to be studied.

At the proper time during the evacuation and activation of the tube, the silver beads on the mica are oxidized and activated with caesium to make them good secondary emitters. Since the secondary emission ratio of such a surface is greater than unity, the mica tends to go slightly positive if anything, rather than become negatively charged as occurred over the plane sheet of mica coated with only the luminescent material. It has been found that the special composite surface behaves as an insulator inside the tube and, hence, does not affect the potential distribution in space.

To study the shapes of the electron paths inside an electron multiplier, a model of the tube was built having two stages of multiplication and a thermionic source of electrons at one end. Along the axis of the tube was placed a

The paths of the electrons are shown above, which shown the electron multiplier in operation.

Deviation Visible

The development of the described method for making electron paths visible has given us a very useful tool in the electronic laboratory. Various arrangements of electron lens systems in different types of new tubes can now be studied directly by viewing the actual shapes taken by the electron streams inside the tube under various conditions, and it is no longer necessary to rely entirely on the electric meter to determine the performance of a tube. By being able to watch the electron as it moves along its complicated path, it is easy to see at what point along the way it deviates from its desired course. The diagnosis of trouble is thus greatly simplified, and electronic research may be carried on more efficiently.

UNIQUE FEATURES AT SEATTLE

Twin Transmitters on Same Antenna

By FRANCIS J. BROTT, Chief Engineer, KOMO-KJR

TWO five-kilowatt broadcast transmitters operating simultaneously on the same antenna, with carrier frequencies only 50 KC apart! To most visitors, that is the most interesting feature of the new KOMO-KJR transmitting plant in Seattle.

A single 570 foot self-supporting tower is doing double duty at this new installation with full efficiency for both KOMO (920 KC) and KJR (970 KC). An unusually good location on the filled-in tide land of Seattle's Elliott Bay, enables this antenna to deliver an excellent signal throughout the Puget Sound area. In fact, the measured efficiency of this radiator exceeds 95%.

Twin Transmitters

Twin RCA 5-C transmitters housed in a specially designed building, supply the five kilowatts of power needed for each frequency. These units embody the utmost in compactness, neat appearance and performance. In every respect they exceed the ac-



KOMO-KJR Technical Staff

cepted high-fidelity standards of modern broadcast practice.

The modernistic transmitter room contains only the two transmitters and the supervisory equipment. Cooling systems and high-voltage transformers are located directly

underneath them on the lower floor, allowing for great simplicity in installation and using a minimum of floor space.

Terminating the two four-wire transmission lines to the antenna tower is an equipment house, containing the line coupling and filter circuits. The output of each line-terminating unit is passed through an acceptor-rejector network before connecting to the antenna. These networks, supplied by the RCA Mfg. Co., consist of two branches, one of which is series-resonant at the pass frequency. So high a filtering efficiency was achieved that no cross-talk can be measured above the carrier noise level, which is 70 db below program peaks.

Trouble Free

Nothing has been spared in the design of this plant to make it as nearly trouble free as possible. Duplicate high-tension power lines supply the sub-station directly at the rear of the building. Each line feeds a separate transformer bank and automatic relays immediately switch all equipment to the emer-



The antenna and transmitter house of KOMO-KJR in the foreground. Elliott Bay and the business center of Seattle in the distance.

gency bank in case of a power failure on the line being used. This action is rapid enough so that transmission of programs is not interrupted.

Additional 1 KW Transmitter

Another provision against any lengthy delays is the maintenance of a completely separate one kilowatt transmitter on the lower floor of the building. This equipment is ready for immediate use on either frequency, as either KOMO or KJR. Consequently, it would be almost impossible to face a situation in which there would be any need for going off the air due to equipment failures.

A complete apartment occupies the north wing of the building, providing living quarters for the resident engineer, Bob Walker.

The studios of KOMO-KJR occupy nearly an entire floor of the Skinner Building, in the heart of Seattle's metropolitan center. Ample space is available in the five studios and great flexibility of operation is permitted by the unique control system used. A total of one hundred fifty-six relays in a semi-automatic selector system, make the switching of programs and studios smooth and almost mistake-proof. A master control-room centralizes all amplifiers and switching equipment and permits supervision of the entire system.

ATLANTA OFFICE EXPANDS

It isn't often that we have an opportunity to congratulate members of our staff on such important events in the pages of Broadcast News. But on April 5, 1937, there arrived at the home of D. A. "Red" Reesor, twins—Judith Caroline, 6½ lbs., and Thomas William, 5½ lbs.

If the stations in the Southeastern District notice "Red" rushing about these days, they will understand the reason.



Francis J. Brott, Chief Engineer of KOMO-KJR.

WAVES AREN'T ALWAYS IN THE AIR

(Continued from Page 3)

pitals to the temporary quarters on higher ground, all direction in rescue work by boats went out over WGRC. Military messages, Red Cross, the direction of trucks bringing emergency supplies in from the North, South, East and West, in collaboration with the State Police Authorities, all ferrying of supplies coming from the North by boats across the River to Louisville, Ky., were directed by WGRC. In addition to this, these boys established a Bureau of Missing Persons with the aid of the Red Cross, Military Authorities and Evacuation Department, and more than 10,000 messages were handled in bringing families together and locating lost persons. It can be pretty safely stated that the only child ever brought into the world under the direction of radio, occurred in the Silver Street School the second night they were on the air. WGRC stayed on the air 240 hours without a break and some of the boys stayed on the job 72 hours at a stretch.

CBS TO DEDICATE NEW SHORT WAVE STATION

Regular daily program service, especially designed for listeners of Europe and the British Isles, was initiated by the Columbia Broadcasting System on Coronation Day, Wednesday, May 12, when network officials dedicated station W2XE, Columbia's new high-power international short wave broadcast transmitter.

The new station, which has a peak power of 40 kilowatts, was officially opened at 5:00 A. M., EDST (9:00 A. M. Greenwich Mean Time) with short dedicatory addresses by E. K. Cohan, CBS director of engineering, and William Lewis, vice president in charge of programs. The first program of the regular series was transmitted toward Europe and England by means of directional antennas and went on the air at 5:15 A. M., EDST, when W2XE carried the Coronation ceremonies as they were broadcast from London by CBS in collaboration with the British Broadcasting Corporation.



One of the two 5-C Transmitters with studio equipment.

BUILDINGS FOR MEDIUM POWERED TRANSMITTERS

Suggestions Based on Recent Developments

By T. A. SMITH



Rear view of WSYR under construction.

WITH the trend toward locating broadcast transmitters on the edge of built-up areas, more and more stations are faced with the problem of constructing a suitable structure to house their equipment. Such a building must meet the operating needs of the station for convenient service and must offer protection for the equipment against the elements. It must obviously fit the financial requirements of the station.

A Specialized Problem

Many station engineers, to whom falls the lot of solving the problem, are handicapped because of lack of experience in building layouts, which is only natural since the number of buildings designed for broadcasting purposes is not large. Then too, local architects usually have had no experience with such a specialized problem. Architect engineers, dealing with this type of work, can provide satisfactory plans and have the necessary background for designing a radio building. However, the number of such organizations is small and

often the burden lies with the station engineer.

The purpose of this article is not to provide plans which may be used for construction, but to present ideas which have worked out well, and to illustrate good practice by a description of several buildings constructed for 1 KW stations. Two of these contain provi-

sion for a power increase to 5 KW.

Since buildings are designed primarily for the protection of the operators and the equipment, it is of course essential to provide a tight roof and to avoid wall construction which is subject to water seepage. Architects are familiar with precautions to prevent seepage which is apt to occur in certain types of brickwork. Cellars in marshy land must be carefully handled. But, further, building construction should be such as to minimize summer heat and to provide for proper light and ventilation.

The material of the building is an important factor in the design. Insurance rates on non-wood buildings are usually considerably less, and from a standpoint of permanence, brick, stone, or concrete have many advantages to offer over wood. The majority of buildings constructed recently are of the fireproof type.

Cellar Not Essential

Formerly, structures housing transmitters were built with a cellar to contain the radio auxiliaries as well as the heating system. Now that transmitters are smaller



Front view of the structure before completion.

and more compact, and with the use of oil heating systems, buildings are generally of a single floor construction. In some cases, space has been excavated under only part of the building to accommodate the heating plant.

The essential space in a building is that needed for the apparatus, a lavatory for the operators, a small workshop, and room to store spare tubes and other apparatus. Where weather conditions require it, space for a heating plant must be provided also. In addition, a room is often included for an operator to sleep in after late work, or if weather conditions prevent reaching or leaving the building. Many in the northern section of the country consider it advisable to include a bedroom so that a man can remain in the building when snow blocks roads. Often there is an office and in the case of the building at WSYR, this office is provided with a folding bed so that no separate bedroom is need-

ed. A small workshop is practically essential. It should be equipped with a bench, a vise, and other tools.

Many of the station buildings contain one or two garages for the cars belonging to the operating staff. In the case of stations in the north, a garage is quite essential. Buildings often contain a small reception room for visitors and sometimes a small audio control room, although modern practice is to have all apparatus in the same room.

Convenience Necessary

For use with a 1 KW transmitter, a typical building would contain besides the transmitter room, a lavatory, a bedroom, a workshop, heating plant room, and a single garage.

There are, of course, an infinite number of ways to lay out such a building. Convenience dictates a central transmitting room with doors leading off to the other sections. The boiler room and the

lavatory should be adjacent to reduce water piping costs, and if a bedroom is included, it is well to locate it in the rear of the building, to avoid subjecting a sleeping operator to the chance of intrusion from visitors. An inside entrance to the garage is appreciated in wintry weather.

In isolated sections, it is well not to have the entrance to the transmitter room directly behind the operator's back. If visitors enter, the operator should be able to see them at once. WSYR has solved this problem as shown on the drawing.

Often a wide door is placed in the transmitter room opening onto a loading platform in the rear. While this is not normally used, it facilitates handling of heavy equipment during the installation period.

Lighting Important

Lighting and ventilation are deserving of serious consideration. Since a considerable amount of

(Continued on Page 30)

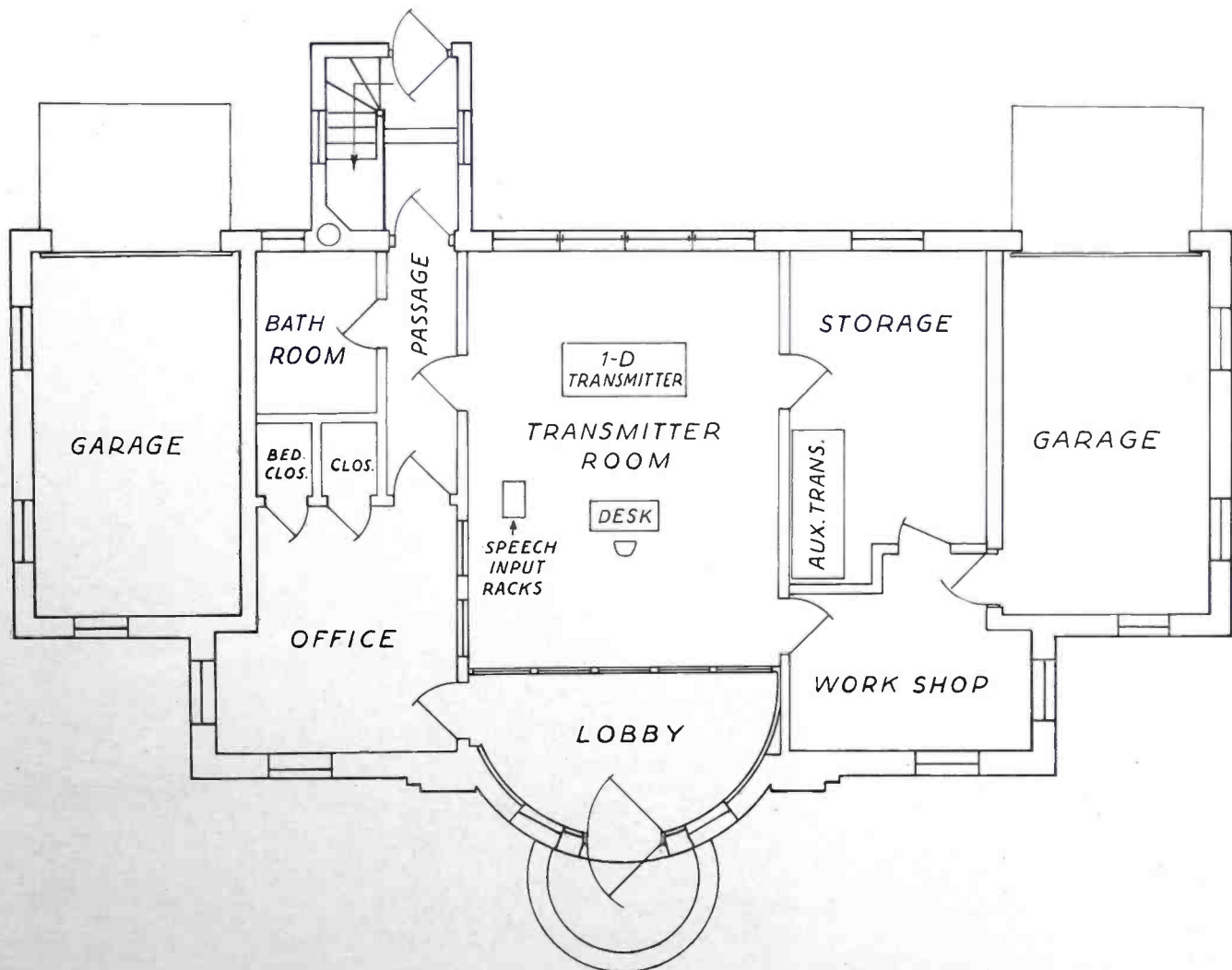

Simplified floor plan indicating location of equipment.

BUILDINGS FOR MEDIUM POWERED TRANSMITTERS

(Continued from Page 29)

heat is developed in a transmitter, provision must be made for carrying it off. The heat developed in a 1 KW transmitter will be in the order of 5 KW which represents the equivalent of a rather good-sized electric heater. RCA transmitters are designed to take advantage of chimney effect—the heat is carried up to the top, where it may be readily exhausted.

Temperature Control

Some stations, such as WFBR in Baltimore, have refrigerating plants at their transmitter building. Others use blowers or fans and some use the chimney effect of the room to carry off heat. In northern climates, heat is not a major factor, because open windows, together with a reasonably high ceiling and a heat insulated roof, will handle the matter. But in the south, careful provision should be made for disposing of this developed heat. It is not merely a matter of comfort for the staff; equipment will last longer and parts failures will be less frequent if room temperature is maintained at a normal value.

If no mechanical means for disposing of the heat are to be used, a skylight above the transmitter with ventilating apertures is often helpful. The monitor roof shown in the accompanying photographs accomplishes this in a more pleasing manner, and also provides better illumination. The natural currents of warm air will provide for circulation and disposal of the heat.

If the room is small or has low ceilings, an exhaust fan above the equipment is a requisite. Of course, wherever possible, ceilings should be high and roofing should be provided with suitable heat insulation which will also save on fuel bills in the winter. There is no more uncomfortable experience than to remain in a room having a low ceiling in the summer with the sun beating down on an uninsulated roof. The temperature in some such buildings may, at times, exceed 130 degrees F. The effect on electrical parts

of such room temperatures is very bad indeed, to say nothing of the discomfort of the operators.

Heating in winter is no serious problem, since ordinary domestic boilers are usually quite suitable. Oil, gas, or electricity are used, depending upon the local rates. If water cooling is employed in the transmitter, a radiator should be located near the transmitter water system radiator, to prevent freezing during the night.

Location of Windows

An important factor in proper building design is correct illumination. Lamps should be placed to avoid shadows and reflections from polished surfaces. It is wise to locate windows away from the operator's line of sight toward the transmitter, since otherwise the glare from daylight will make it impossible to read meters or see other details of the equipment. Windows are preferably located directly behind the equipment or well off to one side.

Having discussed some general points involved in transmitter building design, it may be of interest to examine one in more detail. Photographs and a floor plan layout of WSYR, Syracuse, N. Y., are shown. This building was designed by Lockwood, Greene Engineers, Inc., a firm of engineers and architects who have designed a number of transmitter structures including WBT, WMCA, WNEW, WJSV, KYW, etc. The building was constructed by the J. D. Taylor Construction Corp. of Syracuse. Paul F. Godley was consulting engineer.

Special Design

This building was designed to accommodate an RCA 1-D transmitter and an auxiliary transmitter, and was planned to allow for a possible increase in power if it ever became feasible. The northern climate requires provision for two garages in order to protect the cars of the operating staff, although one of these garages can be used as storage space if it is not required for normal use. The garages are entered from the rear of the building. The heating system is steam with gas fuel. The

boiler room is below the floor level, other cellar space not being excavated.

Rooms consist of: transmitter room, auxiliary equipment room, workshop, office and bedroom, lavatory, boiler room, lobby and two garages. The overall dimensions of the building are 58'-6" by 38'-10" although the main part of the house is only 26'-4" deep. Material is brick and stone, and the finished structure presents a particularly attractive appearance.

Basement May Be Utilized

WTAG, in Worcester, Mass., also has constructed a building to house a 1-D transmitter. In this case, the building consists of a complete basement and first story. Power equipment is located below and it is planned to place an emergency gasoline driven generating system there later. The garage is not included as an integral part of the building, but is located in the rear.

Ventilation is provided by the use of high ceilings and ample window space, although in this location summer heat is not a serious problem. The building is substantial and pleasing. A house nearby for one of the operators makes sleeping quarters unnecessary.

Unique Features

WHEC, Rochester, N. Y., has constructed a transmitter building which was put into service last fall. The general arrangement is somewhat similar to that of WSYR. Several unique features have been incorporated and special attention has been paid to light and ventilation. The transmitter room is large and open, with space for a possible increase in power. Air conditioning is provided. A folding cabinet contains a refrigerator, stove, and food supplies in case the staff is isolated at the building during the winter.

These structures illustrate modern practice in transmitter house design for medium power stations. Considerable time and thought have been expended on the design of these buildings and they have already proved their practicability.

SIZE ISN'T EVERYTHING

Texas Station Covers Wide Area With Low Power

OUTSTANDING among the stations of the great Southwest is the small but powerful KPLT located in Paris, Texas. With a coverage area that belies its size, it has been picked up over four hundred miles distant and covers thoroughly within a radius of fifty miles. This region, one of the many rich trading areas in the state, has not hitherto been served by a local station.

Though not a large structure, the transmitter building of KPLT is strongly constructed and modern throughout. A little less than half of the building houses the transmitter equipment and the remainder of the building was utilized as an efficiency bachelor apartment, to be occupied by the operator. The station will have three licensed operators and the chief plant operator, Herbert Wiley, will live at the transmitter home.

Three coats of stucco and a coat of white paint were used on the exterior of the building. The call letters "KPLT" are done in red tile.

The rock drive-way from Highway 24 to the right-of-way line will be built to connect with the gravel drive-way building from the high-way line to the garage and transmitter home of KPLT.

The building is located on Highway 24, just south of the Paris city



Front view of the new transmitter house for KPLT.

limits. KPLT is equipped with the latest in RCA transmission and studio equipment.

Programs will go on the air through the 165-foot tower, which has been erected and painted according to Department of Commerce, bureau of air navigation specifications. The tower has been grounded with 120 wires, each 165 feet long, buried about six inches beneath the surface of the earth and converging at the center of the tower base. The tower is nine feet square at the base and 16 inches square at the top. Two

days were required to erect the tower, but preparation for the actual erection took many more days.

LOGARITHMIC RECORDINGS

(Continued from Page 23)

imum deviation being about 5%. This curve, moreover, was made offhand,—the linearity could probably be improved somewhat by more careful adjustment.

Conclusion

In closing it is necessary to point out that the setups described above, as well as those considered in the first part of this article, should be properly considered as illustrative rather than as a strict guide. While the details have been given for the benefit of any who wish to follow them, these are for the most part uncritical, and similar arrangements of other components can be used to obtain the same effect. The only reservation necessary is to warn that careful calibration should be made,—preferably under actual operating conditions. An r-f oscillator or signal generator can be used to make the calibration,—providing care is taken to avoid the pitfalls common to such operations. The surest way is to check as many as possible of the calibration points by comparison with actual measurements on the station which is to be observed.



Transcription equipment in control room.

DIRECTIONAL ANTENNAS

(Continued from Page 14)

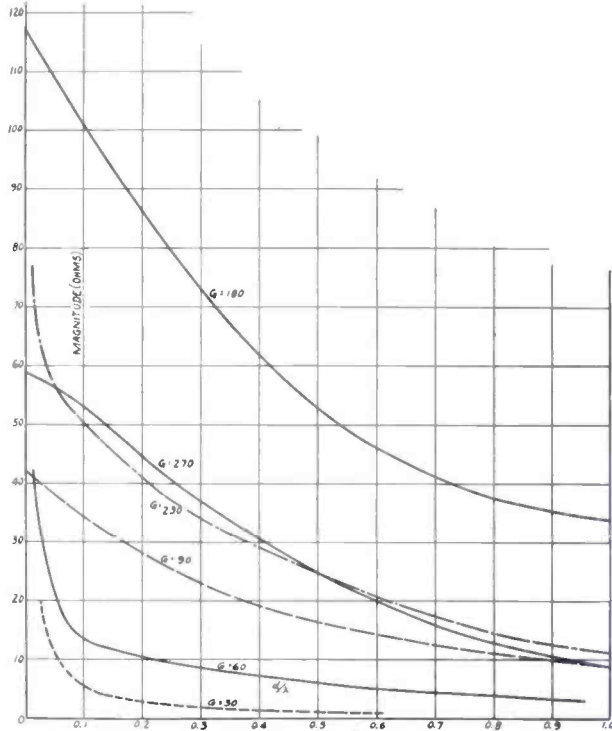

Fig. 5.

The special case where the two antennas are of equal heights is of great importance. Fig 5 shows the value, $|Z_m|$ for height, a , ($G = 2\pi a/\lambda$) and spacing, d , for a number of values of G . The antennas are straight vertical unloaded antennas over a perfect earth. Fig. 6 shows the phase angle, θ_m .

These mutual impedances are referred to the current at the base of the antenna except in the case, $G = 180$ degrees, where the reference is made to the current loop at the center of the antenna.

It is to be noted that, as $d = 0$, the mutual impedance between two identical antennas approaches

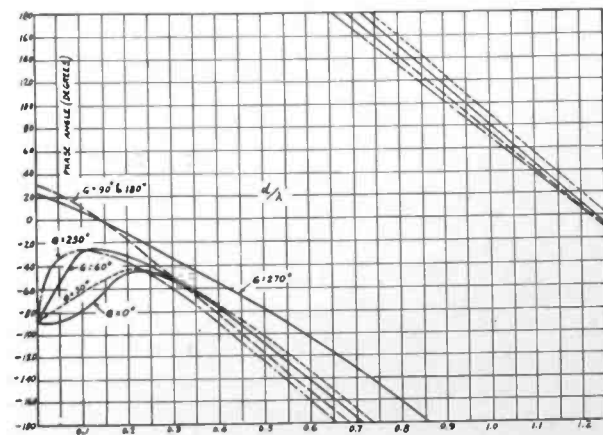

Fig. 6.

the self-impedance of each antenna.

Fig. 7 shows the components, R_m and X_m , as a function of d/λ for $G = 90$ degrees.

Fig. 8 is a similar set of curves when $G = 60$ degrees.

It is seen that for $d > 0.15\lambda$, the curves of mutual reactance are almost identical in shape, differing only in scale. When $d < 0.15\lambda$, the reactances depart greatly in character. The similarity between

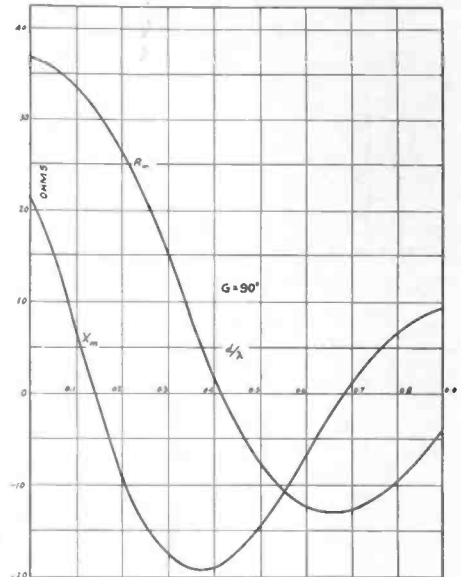

Fig. 7.

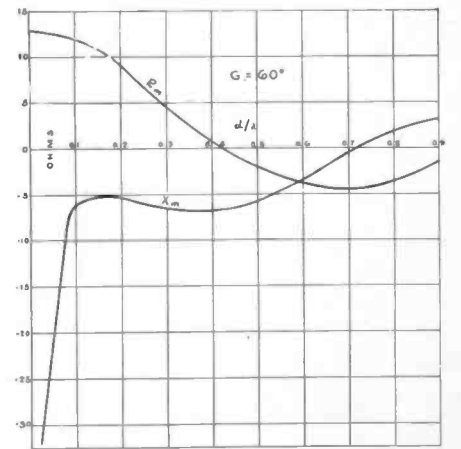

Fig. 8.

the mutual resistance curves holds for all values of d . Table I shows the ratio R_m/R_0 as a function of d/λ for a number of values of G , where R_0 is the value of mutual resistance when $d/\lambda = 0$. R_0 is then the self-resistance of a single antenna. We see that, for a given d/λ , R_m/R_0 is substantially con-

TABLE I.

d/λ G	R_m/R_0			
	0 degrees	90 degrees	180 degrees	230 degrees
0.0	1.0	1.0	1.0	1.0
0.05	0.955	0.967	0.999	0.931
0.10	0.9195	0.918	0.990	0.900
0.15	0.831	0.848	0.936	0.777
0.20	0.710	0.735	0.837	0.640
0.25	0.569	0.582	0.722	0.493
0.30	0.412	0.412	0.598	0.328
0.40	0.1036	0.0532	0.335	-0.0199

stant for all values of G less than 180 degrees. This fact is of importance in the work that follows.

The above values of mutual impedance have been calculated for antennas located directly above a perfectly conducting earth. (Fig. 9(a)).

When the conducting earth is replaced by a wire exactly like the antenna already in use (Fig. 9(b)), the values of mutual impedance given above should be doubled in magnitude.

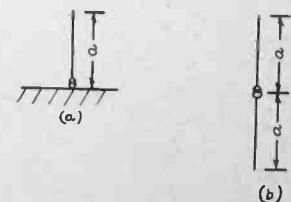
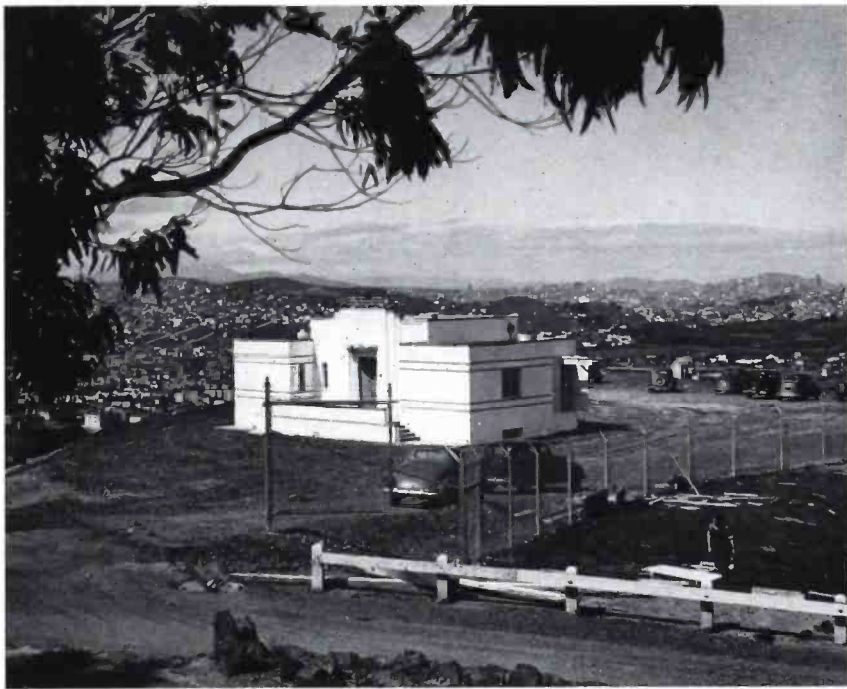

Fig. 9



New transmitter house for KYA, San Francisco.

HEARST EXPANDS COAST STATIONS

(Continued from page 5)

The drawing shown on page 5 will serve to illustrate a typical studio channel set-up. Many novel technical arrangements which should set examples for future similar installations are incorporated in KEHE's magnificent new set-up.

The walls of the three large broadcast studios have been "splayed," or angled, and the space between the flat wall and the splaying is filled with batting to deaden the studios. But the thin facing board is of hard finish, adding to the studio's brilliance, so they're not too dead.

Walls Treated With Acoustical Plaster

The walls of the other studios are being treated with acoustical plaster. The front offices are finished with an acoustical block ceiling, and heavy carpeting. The corridors, however are carpeted in linoleum.

The building measures 156' frontage by 110' deep. It is a one-story structure, with two story rotunda and 35' tower.

HAS IT EVER HAPPENED TO YOU?

Recently we heard of an unusual occurrence in a leading station in the Northwest. A program was on the air, the participants busily engaged in watching their lines and no one bothering to keep an eye on the studio entrance.

Suddenly, without any warning, an additional character was added to the cast—a damsel much the worse from unwise tipping. How, or when she entered, no one seemed to know—but there she was.

Unfortunately for our story, she was escorted from the scene before she got on the air or something that gag men eliminate from their scripts might have been fed into thousands of receivers.

Our point is simply this, that many humorous events must occur during the thousands of programs that go on the air every year and we think Broadcast News readers could get a healthy chuckle out of them. Why not send them in?

Or perhaps it may be a technical problem that had to be solved within a fraction of a second. These items would be interesting and informative for a great number of station employees and we would like to publish them.

WORK FOR NBC STAFF

(Continued from Page 16)

Individual acts of bravery, hardship, and suffering on the part of the microphone crews were many. Five NBC network stations, WCKY, WLW, WSAI, WAVE, and WMC, remained on the air twenty-four hours a day during the emergency. The National Broadcasting Company changed its schedule and broadcast twenty-five network programs and pickups from no less than 150 strategic points.

Among radio's most celebrated flood-fighters are the team of Clyde Baker, Chief engineer of NBC's Memphis outlet, WMC, and Bill Fielding, WMC announcer, credited with having saved 263 people marooned by rising waters. Working a short-wave transmitter, this team directed the rescue efforts of the U. S. Army Engineer boat "Sequoia." Without radio contact, it is doubtful whether such rescues could have been made.

Speedy Action

Within twenty-four hours after flood warnings had gone out, NBC had nine crews in the field. In boats, autos, mobile units, they interviewed refugees, gave eyewitness accounts, and broadcast appeals from relief agencies.

We can judge what working conditions were like from the brief filed in behalf of Announcers Tom Manning and Bromely House and Engineers Alvin McMahon and Frank Whittam. They spent many a day on nothing but chocolate bars and dry sandwiches. This crew didn't mind so much having to sleep cold nights in the mobile unit and their automobile, but going day after day with only a bit of food here and there was wearing on their usual good humor. They not only did their regular job of broadcasting, but joined others in doing the actual rescue and relief work.

A REVIEW OF BROADCAST ENGINEERING

Articles in Leading Publications, October-December, 1936

Reviewed by
J. P. TAYLOR

ACOUSTICS

How Loud Is Sound? by C. H. Tower, *Brush Strokes*, Oct. 1936, Pg. 3.

Timely and useful discussion of the meaning of sound measurements, the units of sound intensity and sound pressure, and their expression in practical terms. Includes a handy table showing the relation of the various units over a wide range of intensities.

How Loud Is Sound? by C. H. Tower, *Comm. & Broadcast Eng.*, Nov. 1936, Pg. 7.

Reprint of the above article.

Acoustical Levels, *Radio Engineering*, Nov. 1936, Pg. 18.

Table only, from the above.

Room Acoustics for Phone Amateurs, by G. C. Omer, Jr., *Radio*, Nov. 1936, Pg. 26.

A simplified but excellent discussion of the use of sound deadening materials in small rooms. Applicable directly to small control rooms.

ALLOCATION

World Congress of Broadcasters Meets in Paris, *Broadcast News*, Oct. 1936, Pg. 24.

Continuation of Dr. Joliffe's report.

FCC Officials Give Outline of Purposes as Allocation Hearings Get Under Way, *Broadcasting*, Oct. 15, 1936, Pg. 10.

Policy Changes, Not Reallocation, Forseen, by S. Taishoff, *Broadcasting*, Oct. 15, 1936, Pg. 9.

Case for Clear Channels and Superpower, *Broadcasting*, Oct. 15, 1936, Pg. 11.

The Case for High Power, *Electronics*, Nov. 1936, Pg. 13.

Regionals Fear Economic Ruin in 500 KW, *Broadcasting*, Oct. 15, 1936.

RMA's Recommendations on Allocation, by L. C. Horle, *Radio Engineering*, Nov. 1936, Pg. 10.

Allocation Hearings: Some Conclusions, *Broadcasting*, Oct. 15, 1936, Pg. 10.

Gradual Increases in Station Power Seen, by S. Taishoff, *Broadcasting*, Nov. 1, 1936, Pg. 26.

Speedy Action Seen on Allocations Policy, by S. Taishoff, *Broadcasting*, Dec. 1, 1936, Pg. 9.

Nine articles covering the so-called "allocation" hearings held in October. Together these present a general resume of the evidence submitted and the reactions of various observers.

Should Broadcasting Occur in the 500-550 KC Band? by C. B. Aiken, *Electronics*, Oct. 1936, Pg. 17.

A careful discussion of this timely proposal by an eminently-qualified authority.

Increased Power Is Proposed by New Chairman in Dominion, by J. Montagnes, *Broadcasting*, Nov. 15, 1936, Pg. 28.

Note on the plans of the CBC indicating general increases of power for Canadian stations.

Permits for 54 New Stations Granted by FCC During Year, *Broadcasting*, Dec. 1, 1936, Pg. 19.

Complete list (with powers and frequencies) of the new stations authorized during 1936.

ANTENNAS

The Shunt-Excited Antenna, by J. F. Morrison, *Pickups*, Nov. 1936, Pg. 8.

Reprint from *Bell Labs Record* for August. See previous review.

A Note on the Placement of the Coil in a Sectionalized Antenna, by Dr. G. H. Brown, *Broadcast News*, Oct. 1936, Pg. 14.

A mathematical analysis of the factors involved, from which are drawn conclusions of definite value in the design of an antenna of this type.

A Turnstile Antenna for Use at Ultra-High Frequencies, by Dr. G. H. Brown, *Broadcast News*, Dec. 1936, Pg. 20.

Reprint from *Electronics* for April. See previous review.

Concerning New Methods of Calculating Radiation Resistance, Either With or Without Ground, by W. W. Hansen and J. G. Beckerley, *IRE Proc.*, Dec. 1936, Pg. 1594.

A new method of computing radiation resistance. Treated in considerable detail.

New Antenna for WJZ, *Broadcast News*, Oct. 1936, Pg. 27.

Publicity on the new WJZ antenna.

MICROPHONES

Microphones and Microphones, *Broadcast News*, Oct. 1936, Pg. 12.

Description and characteristics of three new RCA Velocity Microphones.

Directional Microphone, by J. P. Taylor, *Comm. & Broadcast Eng.*, Oct. 1936, Pg. 8.

Detailed description of the Uni-directional microphone, with emphasis on the relation of this new type to previous types of non-directional, directional, and semi-directional characteristics.

Rebuilding a Commercial-Type Condenser Microphone for Practical Ham Use, by R. S. Coe, *QST*, Dec. 1936, Pg. 35.

Details for the revamping of Type 4A and Type 4A1 condenser microphones.

FIELD INTENSITY

Graphic Recording of Field Intensities, by J. P. Taylor, *Broadcast News*, Dec. 1936, Pg. 6.

Methods and equipment for graphic recording of broadcast station field intensities.

FREQUENCY CONTROL

A New Piezo-Electric Quartz Crystal Holder With Thermal Compensator, by W. F. Diehl, *RCA Review*, Oct. 1936, Pg. 86.

A brief description, with some performance data on the crystal unit used in the new RCA broadcast transmitters.

A Treatise on Piezo-Electric Quartz Crystals, by W. F. Diehl, *Broadcast News*, Oct. 1936, Pg. 2.

A Treatise on Piezo-Electric Quartz Crystals, by W. F. Diehl, *Broadcast News*, Dec. 1936, Pg. 12.

An extended discussion of Quartz Crystals—from mine to transmitter. Good illustrations of various types of circuits, etc.

MEASUREMENT

Making Radio Waves Behave, by E. C. Rundquist, *Broadcast News*, Oct. 1936, Pg. 22.

The frequency measuring service offered by RCA Communications, Inc.

The Measurement of Radio-Frequency Power, by A. H. Taylor, *IRE Proc.*, Oct. 1936, Pg. 1342.

Use of the cathode-ray wattmeter in making measurements of radio frequency power.

An Audio-Frequency Schering Bridge, *General Radio Exp.*, Dec. 1936, Pg. 1.

A new direct-reading capacitance bridge of the Schering Type.

OPERATION

An Engineer Reports, by J. N. Dyer, *Broadcast News*, Oct. 1936, Pg. 6.

A most modest but very interesting resume of the technical aspects of the history-making broadcasts of the 1933-34 Little America Expedition.

NBC Radio in the Clipper Ships, by H. P. See, *RCA Review*, Oct. 1936, Pg. 102.

Short description of the arrangements which made possible periodic broadcasts on the initial flight of the Philippine Clipper.

Probable Percentage Modulation at Various Audio Frequencies, by R. Serrell, *Broadcast News*, Dec. 1936, Pg. 26.

Theoretical investigation of the frequency distribution of modulating power. A start on a subject which has been too long neglected.

A High-Frequency Pack Transmitter. by P. A. Greer, *Comm. & Broadcast Eng.*, Oct. 1936, Pg. 5.

A how-to-make-it article on a type of equipment finding increasing use.

SPEECH INPUT

A Study of the Characteristics of Noise. by V. D. Landon, *IRE Proc.*, Nov. 1936, Pg. 1514.

A valuable note on the "peak value" and "crest factor" of smooth and impulse noise.

Balanced Amplifiers, Part IV. by A. Preisman, *Comm. & Broadcast Eng.*, Oct. 1936, Pg. 16.

Balanced Amplifiers, Part V. by A. Preisman, *Comm. & Broadcast Eng.*, Nov. 1936, Pg. 15.

Balanced Amplifiers, Part VI. by A. Preisman, *Comm. & Broadcast Eng.*, Dec. 1936, Pg. 16.

Continuation. See previous reviews.

Theory of the Loudspeaker and Mechanical Oscillatory system, Part IV. by H. Roder, *Radio Engineering*, Oct. 1936, Pg. 19.

Continuation. See previous review.

Combination Horn and Direct Radiator Loudspeaker. by H. F. Olson and R. A. Hackley, *IRE Proc.*, Dec. 1936, Pg. 1557.

Description and theory of the sensational new reproducing system used in the RCA "magic voice" receivers and the new type 64-A high-fidelity monitoring speaker for broadcast use.

The Magic Voice. by C. O. Caulton, E. T. Dickey and S. V. Perry, *Radio Engineering*, Oct. 1936, Pg. 8.

Another article on the above development—particularly as applied to high-fidelity receivers.

Broadcast Studio Design. by R. M. Morris and G. M. Nixon, *RCA Review*, Oct. 1936, Pg. 64.

A short but valuable and authoritative note on a subject which is receiving increasing attention.

A Studio Control System for Broadcast Stations. by S. Gresham, Jr., *Comm. & Broadcast Eng.*, Nov. 1936, Pg. 5.

Details of a system for the flexible control of a broadcast system of moderate size.

Mixer Circuit Design. by R. F. Smeltzer, *Electronics*, Nov. 1936, Pg. 32.

Some ideas on the proper design of mixer circuits.

Technical Closeup of WGN. by A. R. Hopkins, *Broadcast News*, Act. 1936, Pg. 4.

Description and layout of one of the most outstanding of recent studio installations.

WBT Dedicates New Studios. *Broadcast News*, Oct. 1936, Pg. 16.

Another outstanding high-fidelity studio installation.

A Remote Control Amplifier. by W. H. Wood, *Comm. & Broadcast Eng.*, Dec. 1936, Pg. 22.

How-to-make-it article on an a.c.-d.c. unit.

TELEVISION

Fourth Estate Views Television. by David Sarnoff, *Broadcast News*, Dec. 1936, Pg. 2.

RCA Television Impresses Radio Industry. by M. Codel, *Broadcasting*, Nov. 15, 1936, Pg. 10.

RCA Presents Television to Broadcasters. *Broadcast News*, Dec. 1936, Pg. 5.

RCA Television Put on Exhibition. *Broadcasting*, Nov. 1, 1936, Pg. 30.

Four accounts of the television demonstrations presented during November for the newspapers and broadcasters.

Television at Hand. *Electronics*, Dec. 1936, Pg. 14.

Some illustrations from the above.

The New Philco System of Television. by A. F. Murray, *Radio Craft*, Nov. 1936, Pg. 270.

Television as Good as Home Movies. *Radio News*, Nov. 1936, Pg. 265.

Two articles on Philco's progress in television development as indicated by recent demonstrations.

Television Radio Relay. by B. Trevor, *RCA Review*, Oct. 1936, Pg. 35.

Description of the 177-MC circuit between the RCA building and the Empire State building.

Television for Rural Areas Indicated by Recent Research. *Broadcasting*, Dec. 15, 1936, Pg. 46.

Note on DX reception of ultra-high-frequency stations. Conclusions drawn therefrom are very dubious.

TRANSMITTER DESIGN

A New 5-KW Broadcast Transmitter. by L. G. Young, *Bell Labs. Record*, Nov. 1936, Pg. 72.

Very brief description of WE Type 355D1 Transmitter.

Designing the Tank Circuit. by J. N. A. Hawkins, *Radio*, Dec. 1936, Pg. 60.

Simplified discussion of calculation of optimum L-to-C ratio.

Minimum Plate Current and Efficiency. by "Jayenay," *Radio*, Dec. 1936, Pg. 49.

Some ideas on the meaning of the relation of minimum plate current to efficiency.

Piping RF from Transmitter to Antenna with Concentric Lines. by P. H. Smith, *Pickups*, Nov. 1936, Pg. 3.

Short explanation of practical application of concentric tube transmission line.

Terminating Concentric Lines. by C. G. Dietsch, *Electronics*, Dec. 1936, Pg. 16.

Theory and practice of concentric line terminations. An authoritative article likely to be as widely-referred-to as Mr. Dietsch's earlier article on termination of open-wire lines.

Terminating R-F Lines. by J. L. Potter, *Comm. & Broadcast Eng.*, Dec. 1936, Pg. 5.

Another interesting article along the same line as the above.

Impedance Chart for R-F Lines. *Electronics*, Dec. 1936, Pg. 35.

Impedance versus dimension charts for open-wire lines.

TUBES

Tabulation of Rectifier Tubes. *Electronics*, Oct. 1936, Pg. 35.

A quite complete compilation of the important characteristics of vacuum, gaseous and grid control rectifier tubes for industrial and transmitting purposes.

Molybdenum—A Metal for Vacuum Tubes. by T. G. Troxel, *Radio Engineering*, Dec. 1936, Pg. 8.

A short note on this important material.

MISCELLANEOUS

We Pay Our Respects to Andrew Donald Ring. *Broadcasting*, Oct. 1, 1936, Pg. 43.

Biographical note on the "chief broadcast engineer."

"3700 Sleuths." by F. H. Ham, *Electronics*, Oct. 1936, Pg. 11.

How one "static ridden" town did something about it.

FEATURES BRING NEW TRANSMITTER TO THE FRONT

(Continued from Page 24)

Technical Specifications of the 250-E

Power Output—100/250 watts.

Power Input—

	0 Modulation	100% Modulation
100w	1500 watts	1800 watts
250w	1700 watts	2050 watts

Power Supply—105, 115 and 125 volts. 50-60 cycles single phase. ± 5% variation.

Efficiency of r-f Power Amplifier—Approximately 65%.

Output Circuit—(line or antenna impedance) 70 to 600 ohm line; 45° to 140° antenna.

Type of Modulation—Class "B"—high level—plate modulation.

Audio Input Level—for 100% modulation, -12 db, 500 ohms (12.5 mw reference level).

Audio Frequency Response—±1 db from 30 to 10,000 cycles.

Audio Frequency Distortion—Less than 3% RMS from 0 to 100% modulation between 50 and 5000 cycles.

Hum Level (RMS)——60 db below 100% modulation.

Tube Complement—

- 1 RCA 56 First Audio
- 4 RCA 2A3 Second Audio
- 2 RCA 838 Modulator
- 1 RCA 210 Crystal Oscillator
- 1 RCA 865 Buffer Amplifier
- 1 RCA 800 Amplifier
- 4 203A Power Amplifier
- 3 RCA 83 Low Voltage Rectifiers
- 4 RCA 866 High Voltage Rectifiers

Outline Dimensions—24" wide x 20" deep x 68" high.

Shipping Weight—1100 lbs. (includes 100-EM Modulator which is 317 lbs.)

Notes—(1) By means of switch located on control panel, power output may be quickly changed from 250 to 100 watt (tube complement does not change).

(2) Vernier plate voltage control for power amplifier is provided on the control panel.

Notes About Our Contributors

FRANCIS J. BROTT—Mr. Brott, who tells of the unique set-up at KOMO-KJR, is Chief Engineer of the combined stations.

DR. G. H. BROWN—A biographical note on Dr. Brown appears in Broadcast News, April, 1936.

P. E. FISCHLER—Mr. Fischler, Chief of the Technical Department at WEBR, before coming to his present position was associated with a leading station in Detroit.

JAMES GALLOWAY—Mr. Galloway, who contributes the interesting story on WGRC during the flood period, is the City Editor of the New Albany Ledger.

RALPH J. KINGSLEY—Mr. Kingsley, Technical Supervisor of WBEN, has had wide experience in many phases of radio. He has been at WBEN since it has been owned by the Buffalo Evening News.

C. M. LEWIS—Mr. Lewis started in radio in 1921 when he obtained his first amateur radio license. He attended Baker University and the University of Kansas. For four years he was chief engineer for Station WREN, Lawrence, Kansas. He came to RCA in 1935 where he associated for two years with the Transmitter Engineering Department and is now connected with the Engineering Products Division as Sales Engineer.

W. L. LYNDON—Attended Montana State College, graduated in 1925, B.S. in E.E. Joined General Electric Co. Radio Department on antenna development and speech input equipment. He came to RCA Manufacturing Co. in 1930 with the Transmitter Department. Designed and installed studio equipment at WCAU. In 1935 he transferred to Photophone Department working as project engineer on speech input equipment.

E. A. MASSA—Received his B.S. in physics from Massachusetts Institute of Technology, June, 1934. He came with RCA Manufacturing Co. and from November, 1934, to date has been in the Electronic Research Laboratory.

LOUIS N. PERSIO—Mr. Persio, who again enters our columns to tell of progress at WRAK, is Chief Engineer of that station, located in Williamsport, Pa.

FREDERICK RAGSDALE—Mr. Ragsdale, who enters the list of Broadcast News' contributors in this issue, is Chief Engineer for Station KEHE.

T. A. SMITH—Mr. Smith attended the Stevens Institute of Technology where he received his M.E. degree. Upon leaving school he came to RCA where he was connected with the Technical and Test Department. He devoted his time to work on transmitters and development, including television. In 1930 he joined the Sales Department of RCA and has been in charge of Engineering Products sales for the New York District.

HARRY STONE—Mr. Stone, who tells the story of WSM's contribution to the flood situation in Kentucky, is General Manager of that station.

DR. VLADIMIR ZWORYKIN—Born in Russia. E.E. degree, Petrograd Institute of Technology, where under Professor Boris Rosing, he started his first experiments in television. After graduation entered the laboratory of College de France in Paris, to do X-ray research under Prof. P. Langevin. During the World War he served in the Russian Army as officer in the Radio Corps. In January, 1919, came to the U. S. and from 1920-1929 was member of the Research Laboratory of Westinghouse Electric & Mfg. Co. He received his Ph.D. degree at the University of Pittsburgh, 1926. In 1929, was transferred to Research Laboratory of RCA Mfg. Co., working on television, electron optics, photoelectric cells, etc. Was made director of Electronic Research Laboratory of RCA Mfg. Co., in 1934. On May 29, 1934, received Morris Liebmann Memorial Prize from I.R.E. for contributions to the development of television.



Frequency Measuring Service



PARADOXICALLY SPEAKING . . .

—here's a letter that is worth a hundred pictures.

FREQUENCY ACCURACY
 New York City
 Feb. 19, 1937

R.C.A. Communications, Inc.,
 65 Broad Street,
 New York City.

Attn.: Mr. A. A. Isbell

Gentlemen:
 May we take this opportunity of complimenting the RCA Frequency Measuring Service for the excellent and accurate frequency measurements that you have been making on WOR.

A copy of each of these measurements received by us is forwarded directly to the Federal Communications Commission in Washington in order that they may be accurately informed of the excellent manner in which WOR adheres to its assigned frequency.

Very truly yours,
 (Signed) Edward J. Content,
 Assistant Chief Engineer, WOR

It will please us greatly to be called upon to perform the same accurate service for you

For Routine Service Apply at the Nearer Office

Commercial Department
New York, N. Y.
66 Broad Street
Phone: HAnover 2-1811

Commercial Department
San Francisco, Calif.
28 Geary Street
Phone: Garfield 4200

For Emergency Service Phone or Wire the Nearer Laboratory
(Open Day and Night)

Riverhead, N. Y.
Phone: Riverhead 2290
W. U. Telegraph Only
Riverhead, New York

Point Reyes, Calif.
Phone: Inverness 9-W
W. U. Telegraph Only
Point Reyes Station
Marin Co., Calif.

R.C.A. COMMUNICATIONS, Inc.

A RADIO CORPORATION OF AMERICA SERVICE

. . . Broadcast Equipment . . .



High Fidelity Broadcast Transmitters, 100 watts to 500 KW

Ultra High Frequency Transmitters

Mobile transmitters and receivers

Microphones for Every Purpose

Microphone Stands

Mixers

Monitoring Amplifiers

General Purpose Amplifiers

Pre-Amplifiers

Program Amplifiers

Line Amplifiers

Portable Broadcast Amplifiers

Frequency Monitors

High Quality Station Monitoring Equipment

Complete Studio Installations

Modulation Indicators

Portable Remote Pickup Equipment

Transcription Turntables

Instantaneous Recording Equipment

Sound Effects Equipment

Field Intensity Measuring Equipment

Beat Frequency Oscillators

Cathode Ray Oscillographs

Transmitting Power Tubes for Every Purpose

