

BROADCAST NEWS



In This Issue

★ THE PRINTING PRESS GETS WINGS H. C. Vance

SIMPLIFIED NETWORK SYNTHESIS Edmund A. Laport

★
FRANKLIN INSTITUTE
PHILADELPHIA

RCA MANUFACTURING COMPANY, INC., CAMDEN, N. J.



RCA Manufacturing Company, Inc.

A Service of Radio Corporation of America

Camden, N. J.

"RADIO HEADQUARTERS"

DAVID SARNOFF, Chairman of the Board

G. K. THROCKMORTON, President

L. B. MORRIS, Vice-President
and General Counsel

R. SHANNON, Executive Vice-
President

J. T. CLEMENT, Vice-President
in Charge of Washington
D. C., Office

J. M. SMITH, Vice-President in
Charge of Mfg., RCA Radiotron Div.

LEWIS M. CLEMENT, Vice-President
in Charge of Research and
Engineering, RCA Victor Div.

F. H. CORREGAN, Vice-President
and Secretary

H. C. BONFIG, Commercial Vice-
President

V. C. WOODCOX, Vice-President

F. R. DEAKINS, Vice-President in Charge of Special Products

J. L. SCHWANK, Manager

ENGINEERING PRODUCTS DIVISION

TRANSMITTER SALES SECTION (OF ENGINEERING PRODUCTS DIVISION)

I. R. BAKER, Manager

C. L. BEACH, Affiliated Company Contact
C. M. LEWIS, Speech Input Equipment
T. A. SMITH, Television Equipment
H. C. VANCE, Communications Equip-
ment, State Police

J. C. CALVERT, Sales Engineer
T. W. ENIS, Affiliated Companies
S. W. GOULDEN, Commercial Engineer
F. S. HART, Sales Contact

1 **EASTERN DISTRICT**—Ben Adler, Manager and CBS Contact, 1270 Sixth Ave., New York City; R. P. May, Asst.

MAINE
NEW HAMPSHIRE
VERMONT
MASSACHUSETTS

RHODE ISLAND
CONNECTICUT
NEW YORK
NEW JERSEY

VIRGINIA
DELAWARE
MARYLAND
PENNSYLVANIA

WEST VIRGINIA
NORTH CAROLINA
(Broadcast)

2 **CENTRAL DISTRICT**—A. R. Hopkins, Manager, 589 E. Illinois Street, Chicago, Illinois; A. Josephsen, Assistant

NORTH DAKOTA
SOUTH DAKOTA
MINNESOTA

NEBRASKA
WISCONSIN
ILLINOIS

MISSOURI
IOWA
KENTUCKY

OHIO
MICHIGAN
INDIANA
KANSAS CITY (KANSAS)

3 **WESTERN DISTRICT**—W. H. Beltz, Manager, 1016 N. Sycamore Street, Hollywood, California; Edmund Frost, Assistant, 170 Ninth Street, San Francisco, California.

WASHINGTON
OREGON

IDAHO
NEVADA
CALIFORNIA

UTAH
ARIZONA
HAWAII (Police)

MONTANA
WYOMING
ALASKA (Police)

4 **SOUTHWESTERN DISTRICT**—W. M. Witty, Manager, Santa Fe Building, Dallas, Texas; J. P. Taylor, Assistant
J. P. Taylor, Assistant

TEXAS
OKLAHOMA

ARKANSAS
COLORADO

NEW MEXICO KANSAS (Except Kansas City)
LOUISIANA (Except New Orleans)

5 **SOUTHEASTERN DISTRICT**—D. A. Reesor, Manager, 530 Citizens' and Southern Bank Bldg., Atlanta, Ga.

TENNESSEE
MISSISSIPPI

GEORGIA
FLORIDA

ALABAMA
NEW ORLEANS (LA.)

NORTH CAROLINA (Police)
SOUTH CAROLINA

POWER RADIOTRONS

BROADCAST TRANSMITTERS

POLICE TRANSMITTERS

POLICE RECEIVERS

AVIATION RADIO EQUIPMENT

TEST EQUIPMENT

SPECIAL COMMUNICATION EQUIPMENT

FACSIMILE EQUIPMENT

TELEVISION EQUIPMENT

STUTZMAN ALBRIGHT
APPROX. 1949

BROADCAST NEWS

REG. U. S. PAT. OFF.

PAUL V. LUTZ, Editor

BOARD OF ADVISORY EDITORS

J. B. Coleman.....	Transmitters	M. C. Batsel... Test Apparatus and Studio Equipt.
V. E. Trouant.....	Transmitter Development	F. X. Rettenmeyer..... Receivers
E. W. Engstrom.....	Television	Dr. Irving Wolff..... Microwaves
Dr. V. K. Zworykin.....	Electronic Research	Dr. H. F. Olson..... Acoustics
	DR. G. H. BROWN.....	Special Research

NUMBER 29

JANUARY, 1939

TABLE OF CONTENTS

	Page
The Printing Press Gets Wings	2
H. C. Vance	
Mechanical Design of Open Wire Transmission Lines	4
H. M. Kearney	
New Studios for WOAI	7
Modern Design — Simplicity	8
Lynn Brodton	
“Better than Ratings”— Radio Station KFAM	11
New Studios in Washington	15
Something New in Speech Input Equipment	16
C. M. Lewis	
One of America’s Most Modern Radio Stations	18
James L. Middlebrooks and Royal V. Howard	
Here and There in the Radio World	21
Simplified Network Synthesis	24
Edmund A. Laport	
Directional Antennas	28
Dr. G. H. Brown	
Notes on the Use of Oscillographs	29
B. W. Robins	
WCOU Enlarges Area	32
Leslie R. Hall	

Published in the Interest of the Radio Broadcasting Industry
and Copyrighted, 1939, by the

RCA MANUFACTURING COMPANY, INC.

CAMDEN, NEW JERSEY, U. S. A.

THE PRINTING PRESS GETS WINGS

News and Views Now Broadcast on Wide Scale by RCA Facsimile

By H. C. VANCE

IT is only recently that the general public has heard much about facsimile in the home but RCA has been developing and employing various type of radio facsimile in commercial service for quite a few years.

Photo-Radio, trans-oceanic facsimile service, has been operated commercially by RCA to Europe, South America and the Hawaiian Islands for some years. A great many of the important up-to-the-minute newspaper photographs from Europe and other places are transmitted to the United States every day over RCA Photo-Radio circuits.

An interesting service was developed a few years ago whereby shore stations transmitted weather maps direct to ships at sea by means of the RCA facsimile system.

For some time RCA has had a facsimile circuit between New York and Philadelphia on about 100 megacycles, employing two automatic repeater stations located at New Brunswick and Arney's Mount.

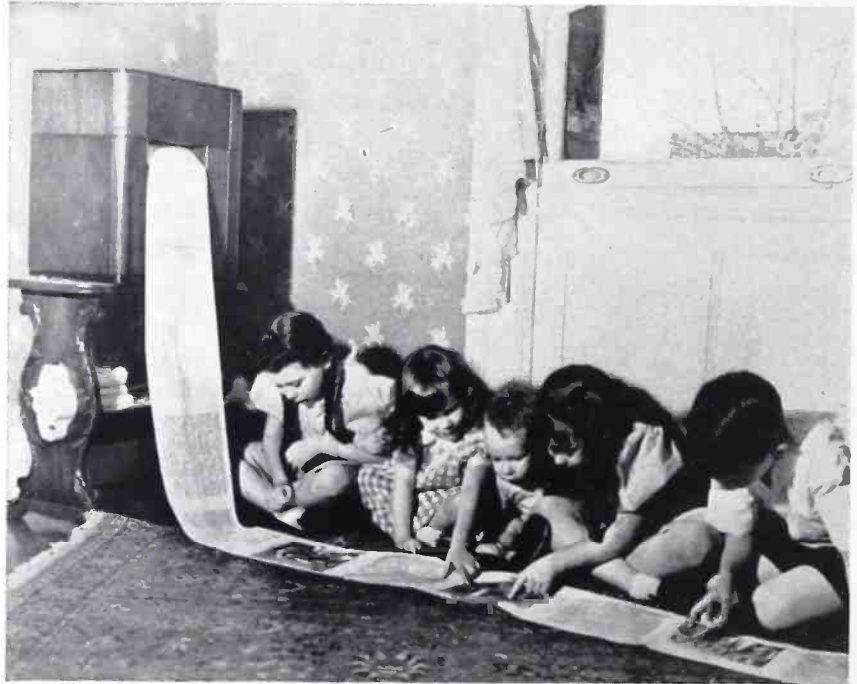

ABOVE: Facsimile and five little fans who show keen interest in world happenings as delivered by their magic newsboy.

BELOW: Adjusting a page from the St. Louis Post-Dispatch in the scanning unit.



A very interesting multiplex transmission was operated experimentally in 1934 between a station located on the Empire State Building in New York and one in Haddonfield, N. J. In this experiment three completely different types of services were broadcast simultaneously over a single ultra high frequency radio circuit including a standard sound or voice channel, a facsimile channel and a telegraph channel.

This combination of years of experimental and commercial experience with various types of radio facsimile places RCA in an enviable position to furnish the best equipment to broadcasters interested in a broadcast facsimile service.

Camden Field Tests

Since the middle of July, the RCA Manufacturing Company, Inc., has been conducting an intensive field test of its new broadcast facsimile system in Camden, broadcasting from six to eleven hours a day on a general experimental frequency of 1614 KC, using the new RCA 5-DX 5000 watt deluxe transmitter.



Greatly reduced halftone reproductions of facsimile reproductions.

these same channels. Ultra high frequency facsimile broadcasting is allowed at any time during the day or night according to present regulations.

It is the opinion of many that eventually early morning facsimile operation on the standard band will be directed primarily towards giving facsimile service to rural listeners located at a greater distance from the station than could be served by present ultra high frequency transmissions, and that stations desirous of serving metropolitan areas will concentrate more on ultra high frequency facsimile broadcasting.

This suggested method of serving both rural and urban listeners appears to have many advantages. The rural listener would receive his facsimile news first thing in the morning giving him a written record of late news flashes and other pictorial matter which he may have missed on his sound radio late at night. These would supplement but not replace his newspaper which generally arrives later in the day.

Listeners in the metropolitan areas served by ultra high frequency facsimile stations would, on the other hand, be able to receive up-to-the-minute news dispatches and other information at any time during the day or night.

(Continued on Page 34)

The transmitting station is located on the outskirts of Camden where high power broadcast and television transmitter development work is conducted. The radiating system consists of a 100 ft. top loaded, insulated base. Lingo guyed pole erected on top of the large one-story building and a radial wire counterpoise supported above the flat roof of the building.

Receivers have been placed in the homes of company executives and engineers located in various suburbs of Philadelphia and Camden up to a maximum distance of about forty miles air line from the transmitter. Special tests have also been made up to about 120 mile from the transmitter.

The broadcast stations which recently commenced experimental facsimile broadcasting operations will investigate not only equipment design and operation but also the most desirable type of program material and, probably most important, the general public reaction to this new type of public service. Judging by the large number of inquiries received from radio dealers and the general public, they are not only ready but anxious for this new service. The RCA tests in Camden are directed primarily at testing equipment design and operation before releasing shipment of the facsimile equipment pur-

chased by various broadcast stations.

Urban and Rural Service

The FCC has granted experimental permits for broadcast facsimile in both the standard broadcast band and the ultra high frequency broadcast band. Facsimile operation on the standard broadcast band is limited to the early morning hours in order to avoid interference with the regular sound broadcast programs on



Something interesting here! A small reader prepared to clip an item that strikes his fancy.

MECHANICAL DESIGN OF OPEN WIRE TRANSMISSION LINES

By H. M. KEARNEY

THE economical design of a transmission line depends on allowable pole spacing, as the cost of line is in direct proportion to the number of poles required. The pole spacing, or span, is limited by the maximum allowable stress in the conductor and the amount of sag to maintain this stress under various mechanical loadings. The maximum sag should be limited to the extent that it will not interfere with clearance to ground or between conductors.

There are certain external factors which produce mechanical stresses in the line conductors and supports, such as temperature range to be expected, the collection of ice and variation in wind pressure.

These, with the weight of the conductor itself, are included in the term "mechanical loading."

In designing open wire transmission lines for the 50-D Broadcast Transmitters, due to the widely scattered localities where these units are to be installed, it was necessary to assume certain mechanical loading zones. The map shown in Fig. 1 is usually taken as a basis for determining the heaviest loading conditions for an open line in a certain locality.

The loadings corresponding to the terms heavy, medium and light are given in table I.



Fig. 1.

TABLE I
Cable or Line Loading

Loading	Radial Thickness of ice ins.	Wind Load lb./sq. ft.	Temperature F.	
			Max.	Min.
Heavy	1/2	8	+120	-40
Medium	1/4	8	+120	0
Light	0	12	+140	+30

Vertical and Transverse Forces on a Suspended Wire

The resultant force acting on one foot of a suspended wire is in general made up of three components, viz.:

c = weight of conductor (including insulation if any) per foot length in pounds.

i = weight of the ice coating per foot length of the conductor in pounds.

h = wind pressure per foot length of the conductor, in pounds.

Let d be the diameter in inches, let t be the thickness of the ice coating in inches; then the weight of the ice coating per foot length of the conductor is

$$i = 1.24t(d + t) \quad (1)$$

Let p be the wind pressure per square foot of projected area; then the wind pressure per foot length of the conductor, i.e., the horizontal component of the resultant force, is

$$h = \frac{p(d + 2t)}{12} \quad (2)$$

The vertical component of the resultant force per foot length of conductor, which is equal to the resultant force for no wind, is

$$v = c + i \quad (3)$$

The resultant force w for any combination of wind and ice loads is readily determined by the formula

$$w = \sqrt{v^2 + h^2} \quad (4)$$

Notation Used in Sag-Tension Formulas

The following notations listed alphabetically will be used throughout the discussion of sag and tension.

A = cross section of the conductor (actual metal cross section) in square inches — circular mils divided by 1,273,000.

a = coefficient of linear expansion of the conductor per degree fahrenheit.

D = deflection in feet of the lowest point of the conductor from the line through supports when suspended from two points of support at the same elevation and at a distance L apart. (D is measured in the direction of the resultant transverse force.)

h = wind pressure in pounds per foot length of the conductor assumed perpendicular to the vertical plane through the two points of support; see equation 2.

L = length of span in feet, i.e., the horizontal distance between the two points of support in feet.

M = modulus of elasticity of the conductor in pound-inch units.

$S = \frac{vD}{w}$ = sag of the lowest point of conductor below the horizontal line through the points of support; for no wind $S = D$.

T_0 = maximum allowable tension in the conductor in pounds; T_0 is usually taken as one-half the ultimate strength of the conductor.

v = vertical force in pounds on a one-foot length of the conductor, including the weight of conductor and the weight of ice, if any, on it, see equation 3.

$w = \sqrt{v^2 + h^2}$ = resultant load in pounds on a one foot length of the conductor.

$Z = \frac{hD}{w}$ = side swing, in feet of

the middle point of the conductor, measured perpendicularly to the vertical plane through the two points of support.

The various symbols with the subscript "0" will be used to designate the values of the various quantities under the conditions of maximum assumed loading.

A typical cross section of the RCA 4-wire transmission line is shown in Fig. 2. The top of pole is 15 ft. above ground. The wire used is hard drawn bare stranded copper A.W.G. No. 8.

A maximum vertical sag (S) of about one foot was the limiting factor in design because of the low clearance to ground and conductor spacing.

Open Wire Transmission Line For Light Load Zone

The calculations for a transmission line in the light load zone shown on map in Fig. 1 follows. Loading taken from Table I.

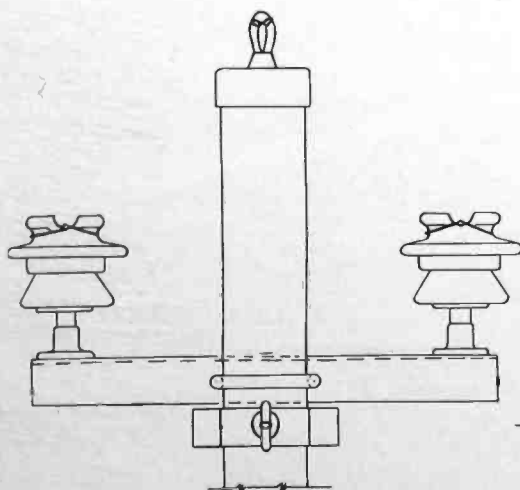

Fig. 2.

No ice, 12 lb. wind, temperature to be expected a minimum of +30° F. and a maximum of +140° F.

Vertical and transverse forces on wire:

Windage from equation (2) is:

$$h = \frac{12(.146)}{12} = .146 \text{ lb. per foot}$$

The vertical force from equation (3) is, in this case, the weight of wire only.

$$v = .051 \text{ lb. per foot.}$$

The resultant force from equation (4) is

$$w = \sqrt{(.051)^2 + (.146)^2}$$

$$w = .155 \text{ lb. per foot}$$

A tension equal to the maximum permissible tension should be assumed and the deflection (D), calculated at minimum temperature, assuming ice and wind loading. The formula is

$$D = \frac{wL^2}{8T_0}$$

The ultimate breaking strength of the wire used is 780 lbs., therefore T_0 becomes 390.

A span of 100 ft. was assumed.

$$D = \frac{.155 \times 100^2}{8 \times 390}$$

$$D = .497 \text{ ft. or } 5.97 \text{ in.}$$

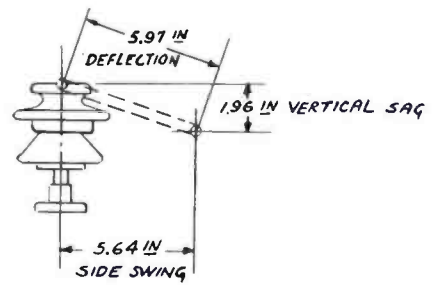

Fig. 3.

Table II gives the wire values at maximum tension and minimum temperature, for the transmission line in the light load zone.

TABLE II

No. 8 Hrd. Drwn. Stranded Copper Wire	Max. Loaded Wire Values With 12 lb. Wind at +30° F. Span = 100 ft.
Deflection	.497 ft. = 5.97 in.
Tension	390 lbs.
Factor of Safety	2.0

As noted above the deflection (D) is measured in the direction of the result and transverse force. The sag (S) therefore, is computed from equation

$$S = \frac{vD}{w}$$

$$S = \frac{(.051)(.497)}{.155}$$

$$= .163 \text{ ft.} = 1.96 \text{ in.}$$

The maximum loaded wire position in the middle of the 100 ft. span is shown below for the values given in table II.

Effect of Changes in Loading and Temperature

When the loading or the temperature changes, then the stress in the conductor and the deflection will change to some new value.

Curves showing the relation between deflection and temperature and between stress and temperature may be plotted. Such curves provide stringing charts and show maximum and minimum sags from which clearance templates may be constructed. Such curves are shown in Fig. 4 for the light load zone shown on map Fig. 1 for maximum values given in Table II.

(Continued on Page 6)

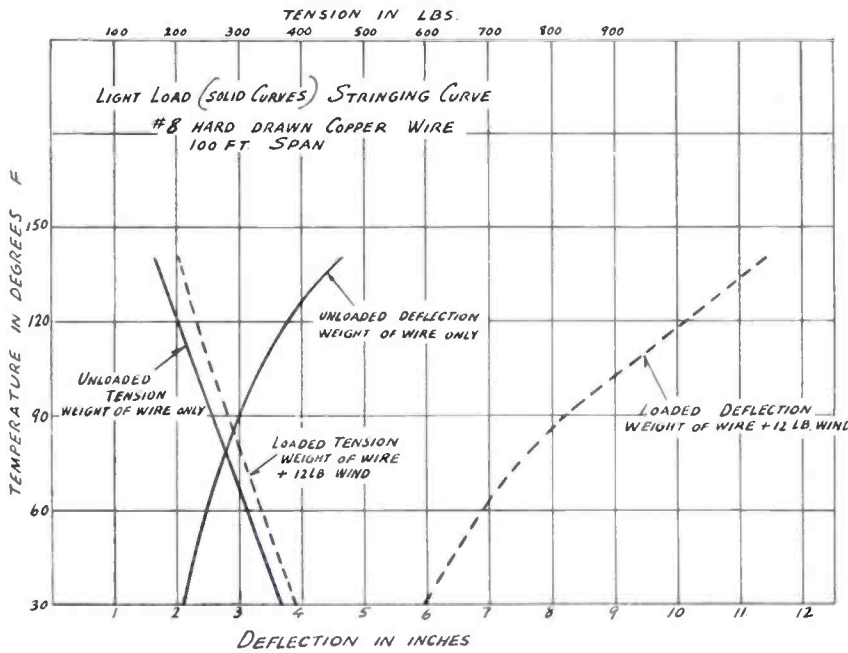

Fig. 4.

(Continued from Page 5)

The solid curves in the above figure give stringing or minimum sags and tensions (weight of wire only) plotted against temperature. The broken line curves give the loaded or maximum sags and tensions (12 lb. wind + weight of wire) plotted against temperature.

For any temperature the corresponding stresses and deflections may be taken from the curve. Conductors strung in accordance with these values will not have the maximum allowable stress or sag exceeded if the maximum loading or temperature selected are not exceeded. It should be remembered however, when using stringing charts, that the temperature of a conductor carrying current and exposed to the sun may rise as much as 30° F. above the ambient air temperature.

Direct Calculation of Change in Deflection and Stress With Loading and Temperature

The formula and procedure is as follows:

$$b_1 = \frac{1000 T_0}{MA}$$

$$b_2 = \left(\frac{w_0 L}{.155 T_0} \right)^2$$

$$b_3 = 1000 a(t - t_0)$$

$$b = \frac{1000 w L}{MA}$$

$B =$ numerical value of

$$[b_1 - (b_2 + b_3)]$$

$$x = \frac{b}{B\sqrt{B}}$$

Take y in terms of x from tables in Electrical Engineers' Handbook by Pender and Del Mar.

Then the deflection is,

$$D = yL\sqrt{B}$$

and the stress is,

$$T = \frac{wL^2}{8D}$$

b_1 is the elongation, in feet per 1000 ft. of a straight wire when subjected to a stress of T_0 pounds.

b_2 is the number of feet per 1000 ft. of wire by which the length of the wire at t_0 degrees and loading w_0 exceeds the horizontal distance between the points of support.

b_3 is the elongation, in feet per 1000 ft. of wire, due solely to a change in temperature from t_0 to t degrees.

b is the elongation, in feet per 1000 ft. of wire, due to a stress equal to wL (= its own weight plus the total ice and wind if any at the temperature t).

Example: To find the sag at which a No. 8 A.W.G. hard drawn stranded wire must be strung at +90 degrees Fahr. on a 100 ft. span so that the wire will have a factor of safety of 2 at +30 degrees Fahr. when loaded with a wind pressure of 12 lb. per 1 sq. foot of projected area.

The breaking strength of the wire is 780 lbs., cross-section 0.013 sq. in., modulus of elasticity 16×10^6 and coefficient of expansion 9.6×10^{-6} .

The data and calculations are then as follows:

$$T_0 = 390$$

$$w = .051$$

$$w_0 = .155$$

$$A = .013$$

$$M = 16 \times 10^6$$

$$L = 100$$

$$t - t_0 = 60$$

$$a = 9.6 \times 10^{-6}$$

$$b_1 = \frac{1000 \times 390}{16 \times 10^6 \times .013} = 1.87$$

$$b_2 = \left(\frac{.155 \times 100}{.155 \times 390} \right)^2 = .0655$$

$$b_3 = 1000 \times 9.6 \times 10^{-6} \times 60 = .576$$

$$b = \frac{1000 \times .051 \times 100}{16 \times 10^6 \times .013} = .0245$$

$$B = 1.87 - (.0655 + .576) = 1.2285$$

$$x = \frac{.0245}{1.2285 \sqrt{1.2285}} = .0179$$

Taking y in terms of x from the table

$$y = .00225$$

$$D = .00225 \times 100 \times \sqrt{1.2285} = .25 \text{ ft.} = 3.0 \text{ in.}$$

$$T = \frac{.051 \times 100^2}{8 \times .25} = 255 \text{ lb.}$$

These are the stringing values of sag and tension shown in Fig. 4 for 90° F.

The values of sag and tension where taken at three other temperatures in exactly the same procedure, vis., +60° F., +120° F. and +140° F., to plot the curve.

(Continued on Page 12)

NEW STUDIOS FOR WOAI

San Antonio Station Installs RCA Speech Input Equipment

THE completion of WOAI's new \$50,000.00 studios and 425-foot vertical radiator was celebrated in an all-day dedicatory program, August 6. Prominent radio and advertising notables were on hand to take part in the proceedings. Throughout the day a number of specially prepared programs went on the air from the new studios, including broadcasts to the National Broadcasting Company and the Texas Quality Network. On the NBC program, Texas' Governor, James V. Allred cited WOAI's contribution to radio progress in the Southwest and Hugh A. L. Halff, President and General Manager of WOAI, spoke in behalf of the station. The Texas Quality Network show included an address by Paul Kilday, Congressman elect. Both network shows featured variety entertainment.

New Studios

Improvements in WOAI facilities include three entirely new studios of the latest architectural design, a new control room utilizing a three-panel console and new speech input equipment, revamp-

ing of the auxiliary 5,000 watt transmitter located in the studio proper, a new rehearsal and audition room and an entirely new private and general office set-up. The first air conditioning plant in the Southwest especially designed for radio station usage has been installed using duct work specially treated to keep extraneous sound at a minimum.



Hoxie Mundine operating the new control console.

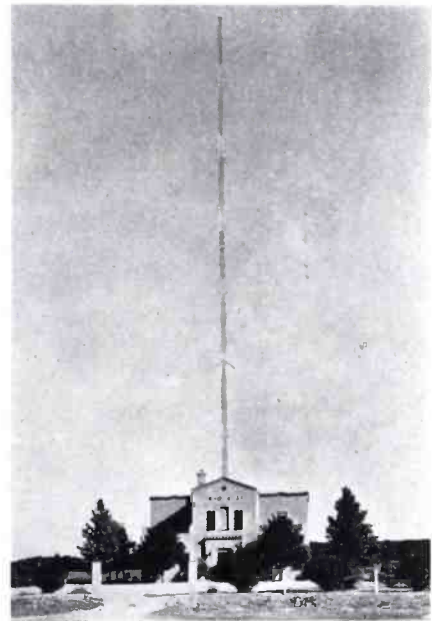

New 425-foot vertical antenna at Selma.

Modern

The new centrally located auditorium accommodates an audience of 200 people and is designed acoustically to be the best-engineered auditorium in the Southwest. It is equipped with all the features necessary to an audience broadcast and the latest type Hammond organ has been placed on the stage. The auditorium (known as studio A), studio B and studio C are grouped around the control room so that the engineers are able to watch activities from one central point.

During the dedication day's activities some 4,000 visitors inspected the new facilities of WOAI and were enthusiastic in their approval of the new studios. San Antonio civic officials made a tour through the studios and also to the site of the new 425-foot radiator north of San Antonio. The radiator, put into service earlier in the year, is of the advanced vertical type and increases WOAI's sphere of influence in Texas considerably. The ground system consists of 160 radial copper wires each 400 feet in length.

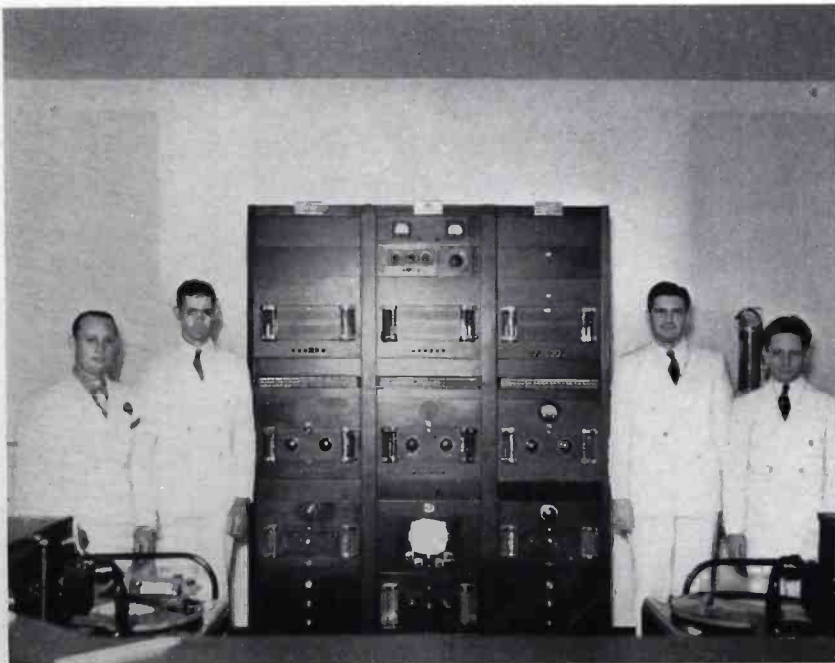

WOAI control engineers grouped about the new RCA Speech Input Equipment. Including, left to right: Thiel Sharpe, Vernon Mallory, Charles Jeffers and Hoxie Mundine.

MODERN DESIGN—SIMPLICITY

New Forms Arise From Industry's Requirements

By LYNN BRODTON

PART II

THE preceding portion of this article (which appeared in last issue) led through general design classification into the field of radio.

The method of designing broadcast equipment and stations was briefly discussed, from the microphone to the transmitter antenna. Next, in the progressive steps involved in bringing a broadcast into a listener's home, is the receiver, which is better known as a "radio."

The Radio-Receiver

From the appearance or styling standpoint, the "radio" or home receiver unit presents manifold problems. It also presents the opportunity for quite a range of development, with the exception of those phases governed by the limitations imposed in quantity production.

To discuss the latter phase first, it will be appreciated that, since receiving sets must necessarily be "package" merchandise, and produced in quantity, it follows that no one style or "line" can be designed as a unit of perfect harmony in any and all surroundings.

Secondly, it is obvious that if a radio were the first unit installed in a room and the remainder of the furniture selected to match it, a different and more pleasing ensemble would result than through the normal manner of adding a radio of any given design after the room has been appointed and arranged.

Further, since radio is essentially a function of sound, which has no known form, it is therefore only possible to accept the known functions, and style the receiver in a manner to best accomplish them.

The RCA Victor sets with the "overseas dials" and push-button tuning (co-designed by John Vassos and the writer) are another example of functional modern design.



Lynn Brodton, author of the articles on Modern Design

Before a single preliminary sketch was made, a list of fallacies or shortcomings of former radio types was made; then a set of specifications of all that was deemed desirable in radio.



An early radio set designed as a housing for mechanical arrangements and circuits.

The first item considered was the dial. It must be more easily read than any other. This led to horizontal reading, the way we read naturally, instead of in various angular or circular forms.

Only the band in use should be illuminated. This meant elimination of the old method, a small spot of light to indicate the particular band in use.

Next the color combination of dial and station listings was selected in such a manner as to provide maximum legibility and clarity in station selection, with a minimum of eye fatigue. Edge illumination, with cream-colored calibration and green station listings, provided the best solution.

Since certain models had as many as seven individually illuminated bands, it was imperative that they be arranged radially, in

order to be viewed readily from a standing or sitting position. Therefore, the latter dictated that the dial with its push-buttons and controls must be located at the upper front corner of the cabinet. This meant the banishment of the old method of personal discomfort in tuning.

The next step in planning was to determine the ultimate in tuning. We could conceive of nothing more simple than pushing a button to bring in a station, and our Receiver Engineering Department came through with a bang to produce electric tuning that exceeded our expectations.

Form Follows Function

As emphasized in the first half of this article form follows function in modern design. It will be appreciated that with the foregoing functions of the radio receiver determined, the cabinet, grille, and general appointments were located and arranged in a manner to best accomplish the functions set forth and as shown in the illustration.

While the radio receiver might seem to be the "terminating unit"



A modern RCA Victor receiver, designed as an integral part of the home and a musical instrument.



One of the first designs for facsimile transmission.

in the radio and sound entertainment field, it is but one unit in the chain so far discussed in broadcasting. As a matter of fact it is only one of thousands of units of all types in everyday production at RCA's Radio Headquarters. Others are the innumerable "custom" designs for special equipment, as well as the studios, buildings, theatres, and the like, which we design to accommodate our various equipment installations.

New Era

Radical changes have taken place in the radio field, as well as in all others in the past decade. In radio for example, the stylist or designer formerly was the last one called upon to see what could be done to "dress up" the product of the engineer. In those days, a large percentage of the purchasers of radios were capable of building their own. Therefore, radio manufacturers had a job on their hands to "beat" the construction and ideas of radio enthusiasts in order to induce them to buy "ready-made" radios.

Consequently, fundamentally sound engineering methods and materials had to be used. Now that leading manufacturers have successfully fabricated and produced higher quality instruments than can be built economically by the individual, the situation is almost reversed. Especially insofar as styling is concerned. Due to competition among reputable manufacturers, the public more or less realizes and accepts, that a unit will perform all that is claimed by its producer. Today, engineering features and longevity

are taken more or less for granted, and since this is the case, the stylist's job become one of attempting to render the unit in a manner to stimulate purchase. In addition to its attractiveness by reason of form and materials, the controls must be at a convenient height, non-fatiguing and pleasing to the touch; its visual units must be readily legible and present no eye-strain; its size must be in harmony with units and surroundings with which it must "associate."

In other words, today the stylist or designer first plans the unit, in all operational and appearance respects. The engineering department then designs the equipment within these limits and to the requirements of sales department the manufacturing department starts production and we have the units of the type illustrated and discussed herein.

As was the case in the preceding portion of this article, the photos of old type apparatus appearing herein, furnishes a basis of comparison with the simpler and more functional styling of today.

Ornate Design Passe

Simplification of castings and general forms means better appearance at less expense to produce, and accounts for ultimately better values to the public at less cost than before.

Simplification of type and arrangement of controls naturally costs less; it looks better; and above all renders easier operation and less study in familiarizing.

It is believed from the foregoing, that the reader has a sufficient idea of how various of our specific units are designed or styled, as to warrant deviation into a more general discussion of modern design and its influence and effect in contrast to earlier modes of design.

"Pioneering"

Admittedly, some so-called "modern" types of units, utilities, furniture and the like, lack a sufficient degree of functionalism to yet warrant complete acceptance by the public in general.

However, as has been the case in every era through which we

passed, the pioneers "pay the price" through the necessity of first proving to the public the merit of the new over the old. This applies to the field of art and design as well as all others. Chipendale was probably considered a "radical" until his work gradually merited wide acceptance.

Today, however, modern functional design has passed the pioneer stage due to its ready adaptability to industry in general, and, in its better presentations, is rapidly becoming the mode in all commodities.

Undoubtedly many readers are devotees of Eighteenth Century, Colonial and various periods of design, or are collectors and fanciers of antiques, and therefore, unless it is specifically pointed out, might fail to realize just how many items used in their every day life are constantly and increasingly changing over to modern design.

New buildings with their interiors planned to fulfill the tenant's fondest desires, with quiet high-speed elevators, well-lighted rooms, absence of ornate abutments, filigree and the like are now generally accepted.

Automobiles which reflect grace, speed and stamina in their sleek-

(Continued on Page 10)



The progress of facsimile can be measured by comparing this transmitter with the one shown above.



Photo: Courtesy of Franklin Institute.

An early cash register in which function was subordinate. Compare with modern designs.

ness of line and comfort in their luxuriant appointments and color schemes follow the modern trend.

Airplanes which defy the clock,—and deposit you at your destination all too soon—in any type of weather—through the unseen guidance of radio owe much of their effectiveness to modern design.

Streamline trains which present appearance, comfort and speed undreamed of a few years past, are evidence of the rapid strides made in modernization of equipment.

Commodities for the home—even down to the electric iron, the toaster, the oil-burner or washing machine in your basement,—all are assuming simpler and more pleasing lines and are costing less than the inefficient and more cumbersome devices of the past.

Many readers may feel that these latter items do not appeal to them in spite of their utility, due to lack of harmony with the particular type of furniture in their home—yet, would not think of using a toaster of the same vintage,—nor care to travel in a conveyance of a corresponding period.

Impediment to Change

Cost, whether it be from the manufacturer's standpoint, or the individual furnishing his home, is usually the controlling influence in changing from the old to the new. Not because of the expense of the new—which is usually far cheaper and more efficient—but due to the problem of

disposition of the old. In some instances this is solved by trade-in allowance, but in major items ranging in size up to homes and buildings, time becomes the factor which will terminate the utility of the old, and the new will not only be necessary but desired.

Modern Design Not a Fad

I have been asked many times, how long the Modern design "fad" would remain in vogue. The answer is simple; modern design which is functional is not a fad, but a new fundamental type and method of designing. It analyzes preceding articles, corrects their faults, adds new features and materials to enhance appearance and operation through the creation of a form to permit or facilitate carrying out its function most efficiently.

These are not just "so many words," since an organization of such ramifications as RCA would not be increasing its lead in all phases of "modern" equipment in radio, sound, motion picture and allied fields if this were not an established fact. Therefore the answer to the foregoing might also be that, although minor appearance changes will follow trends, the fundamental of "form following function" is believed to be here to stay, since variation would only impair the degree of efficiency of the unit. The trim,

color combinations and the like are all that will vary. These are the last consideration of the engineer-stylists since, all phases of operation, controls, dials, meters, etc., are the first and prime consideration.

To such pioneers of modern design as John Vassos (consultant stylist for RCA) must go much of the credit for having established the new mode of thinking and method of application of practical art to modern industry.

Modern Versus Period Design

In the foregoing portion of this article the reader was asked to reserve opinions on Modern versus Period designs. It is now believed that the reader has a brief, but possibly more clear conception of the fundamentals governing modern design, and can draw his own conclusions as to the adaptability of the various modes of period designing to the requirements of today.

Further, any questions or consultation on problems of appearance design or styling for any type of equipment, studio, theatre or allied subject, will gladly be complied with through response in this publication.

The closing thought—and one which is believed predominant in every master craftsman's mind is—"that which is worth doing—is worth doing well."

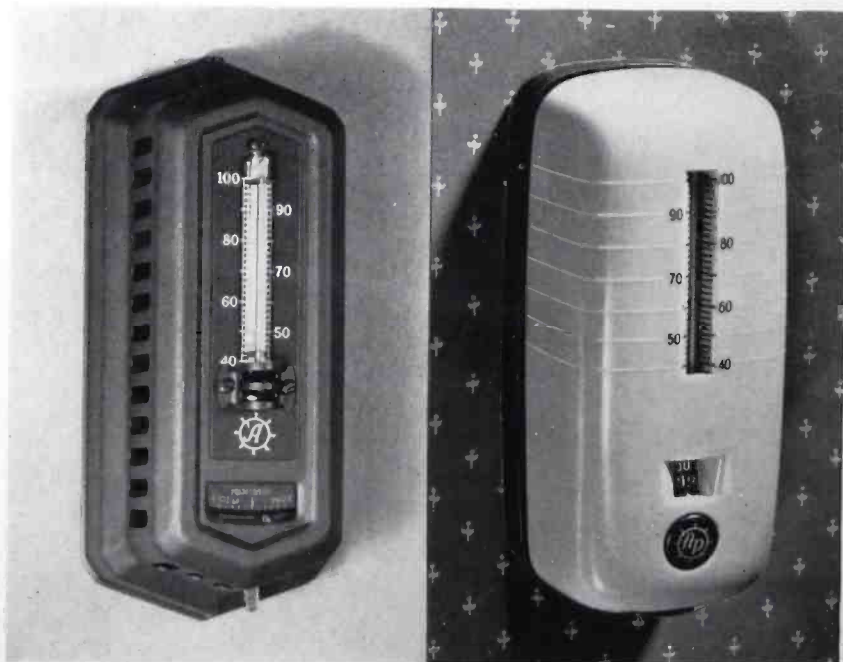

Photo: Courtesy of "Instruments."

The designer makes even the common place attractive as proved in the "before and after" photograph shown above.

"BETTER THAN RATINGS"

St. Cloud's KFAM Finds RCA Equipment Exceeds Claims

RCA equipped throughout, KFAM, the Times Journal Station, St. Cloud, Minnesota began unlimited time operation in service to Central Minnesota June 4, 1938. St. Cloud is the fourth city in the state and the second largest granite producing center in the world.

The station is owned and operated by the Times Publishing Company of which Mr. Fred Schilplin, a prominent citizen of Minnesota, is president and treasurer.

KFAM was built under the direction and supervision of George B. Bairey, one time Westinghouse engineer, and for years manager of prominent northwestern broadcasting stations. The installation of RCA equipment is of unusual efficiency and merit, the 250G transmitter arrangement being unique. As will be seen from the illustration, the transmitter together with two rack cabinets housing the 96-A limiting amplifier and the frequency measuring equipment, have been mounted on a concrete base and framed to comprise



Fred Schilplin, President-Treasurer of the Times Publishing Company.

one unit. Adequate blank panel space anticipates mounting facilities for equipment which may be required at any future time.

The transmitter building was constructed from the ground up with the idea of combining the utmost in efficiency and utility, reliability and permanence, together with modern architectural beauty. Accordingly, adequate space was provided for the operating and transmitter rooms, visitor's observation foyer, operators' quarters, garage and boiler room for the water, heating and air conditioning systems. The

structure is of monolithic concrete, with strips of dark finished granite and glass brick adding a modern tone.

All wiring is through conduits laid in concrete floors, with spare conduits to anticipate any future needs. The power lines, telephone and broadcast loops, concentric radio frequency transmission line, tower lighting circuit, and remote antenna line are all underground,



George B. Bairey, General Manager.

with no exposed wiring of any kind within or without the building and grounds.

The site for the antenna-ground system is a typical Minnesota peat bog, wet at all seasons of the year. While almost ideal from an electrical standpoint, construction of the tower foundation presented many physical difficulties. The solution was accomplished by sinking a huge caisson to a depth of twenty-five feet to reach load bearing gravel, excavating and filling with concrete laid under water, resulting in a reinforced concrete base of some ninety tons on which rests the 173 foot Truscon vertical radiator.

(Continued on Page 14)



The modern transmitter building of KFAM.

TRANSMISSION LINES

(Continued from Page 6)

The loaded sags and tensions where plotted by the same method. Note that in this case w and w_0 are the same, vis., 0.155 lb. per foot.

The maximum vertical sag (S) occurs in the unloaded state (weight of wire only) at +140° F. From curve Fig. 4 this sag is 4.65 in. The design limit in this case was the side swing which is greatest at 140° F. with 12 lb. wind. See broken line deflection curve in Fig. 4.

$$Z = \frac{hD}{w}$$

$$11.4 \text{ inches} = .950 \text{ Ft.}$$

$$Z = \frac{.146 \times .950}{.155}$$

$$= .895 \text{ Ft.} = 10.75 \text{ in.}$$

This case is, however, theoretical, as a thin wire such as No. 8 would probably never attain a temperature of +140° F. with a 12 lb. wind (approx. 80 miles an hour.) Figure 5 below shows the wire position at the middle of a 100 ft. span for this condition of side swing.

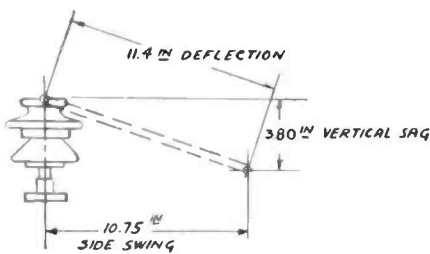

Fig. 5.

The minimum vertical sag (S) occurs at +30° F. in the unloaded state (weight of wire only) from Fig. 4.

$$S = 2.09 \text{ in.}$$

Open Wire Transmission Line for Medium Load Zone

Table III below gives the maximum loaded values for deflection and tension of the medium load zone, i.e., see table I and map Fig. 1.

STRINGING CHART
#8 STRANDED UNLOADED (WEIGHT OF WIRE ONLY)
75 FT POLE SPACING

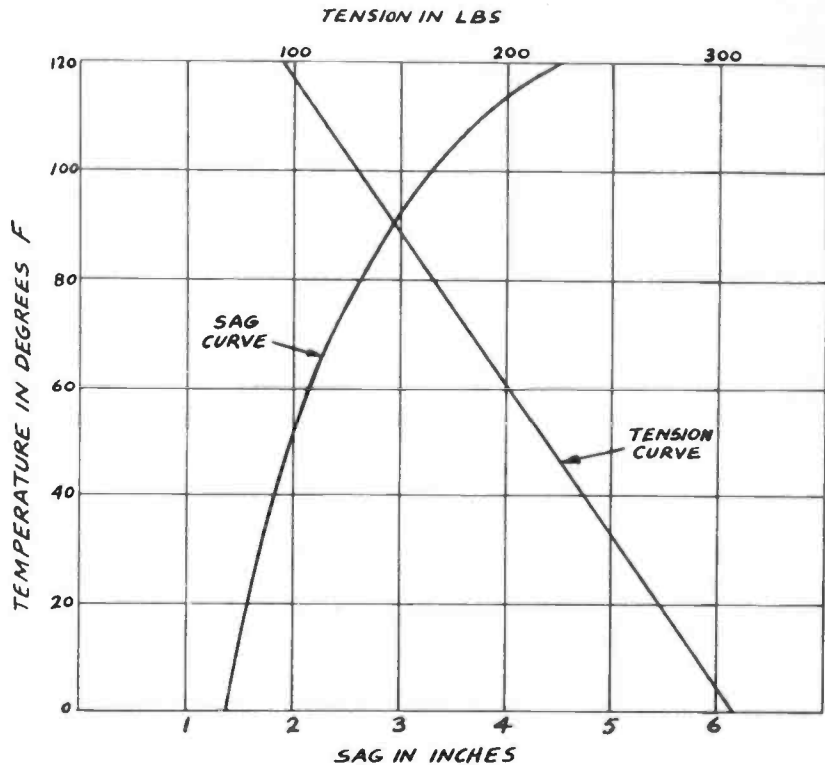

NOTE: THE TEMPERATURE OF THE CONDUCTOR CARRYING CURRENT AND EXPOSED TO THE SUN MAY RISE AS MUCH AS 30° F ABOVE THE AMBIENT AIR TEMPERATURE

Fig. 7.

TABLE III

No. 8 Hrd. Drawn Stranded Copper Wire	Max. Loaded Wire Values With 1/4 in. Radial ice and 8 lb. Wind at 0° F. Span = 75 ft.
Deflection	.837 ft. = 10.04 in
Tension	390 lbs.
Factor of Safety	2

The maximum loaded wire position in the middle of the 75 ft. span is shown below for the values given in table III.

The curves shown in Fig. 7 give the stringing tensions and deflections plotted against temperature, so that the maximum allowable stress or sag values given in table III will not be exceeded.

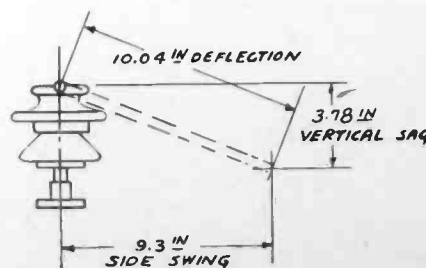

Fig. 6.

The minimum vertical sag (S) from the figure above at 0° F. in the unloaded state (weight of wire only)

$$S = 1.39 \text{ in}$$

The maximum vertical sag (S) occurs at +30° F., wire loaded with 1/4 in. ice wall and no wind.

$$S = 5.55 \text{ in.}$$

The maximum side swing (Z) also occurs at +30° F., wire fully loaded, vis., 1/4 in. ice wall, +8 lb. wind.

$$Z = 10.5 \text{ in.}$$

Open Wire Transmission Line for Heavy Load Zone

Table IV below gives the maximum loaded values for deflection and tension of the heavy load zone, i.e., see table I and map Fig. 1.

TABLE IV

No. 8 Hrd. Drwn. Stranded Copper Wire	Max. Loaded Wire Values With 1/2 in. Radial Ice and 8 lb. Wind at -40° F. Span = 50 ft.
Deflection	.705 ft = 8.46 in.
Tension	390 lbs.
Factor of Safety	2.0

The maximum loaded wire position in the middle of the 50 ft. span is shown below for the values given in table IV.

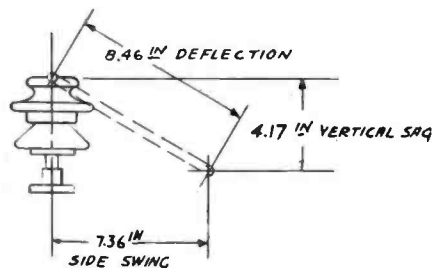

Fig. 8.

The curves shown in Fig. 9 give the stringing tension and deflections plotted against temperature, so that maximum allowable stress or sag values given in Table IV will not be exceeded.

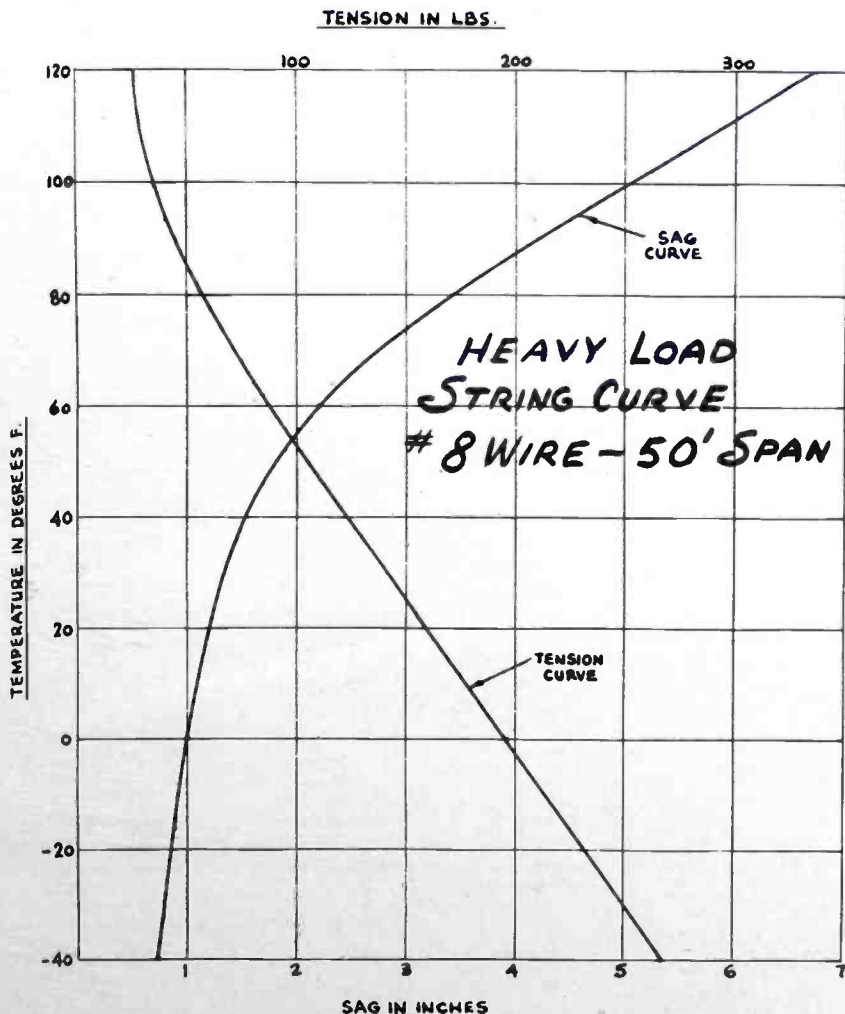

Fig. 9.

The minimum vertical sag (S) occurs at -40° F. in the unloaded state (weight of wire only). See Fig. 9.

$$S = .7152 \text{ in.}$$

The maximum vertical sag (S) occurs at +30° F., wire loaded with 1/2 in. ice wall and no wind.

$$S = 7.55 \text{ in.}$$

The maximum side swing (Z) also occurs at +30° F., wire fully loaded, vis., 1/2 in. ice wall plus 8 lb. wind.

$$Z = 9.28 \text{ in.}$$

Extra Heavy Loading

When local loading conditions exceed the rating given in Table I the design engineer and erecting contractor should be notified, so that the line can then be designed to meet these exceptional requirements. A condition, for example, which would cause extra

heavy loading would be a locality where heavy fogs are prevalent around freezing temperatures. This would cause excessive ice or sleet accumulations on conductors.

A maximum load table for such a condition is given below. Note that in this case it was necessary to use A.W.G. No. 6 hard drawn solid copper wire and the span reduced to 40 feet.

TABLE V

No. 6 Hrd. Drwn. Solid Copper Wire	Max. Loaded Wire Values With 1 3/8 in. Radial Ice and 8 lb. Wind at -40° F. Span = 40 ft.
Deflection	1.04 ft. = 12.5 in.
Tension	640 lbs.
Factor of Safety	2.0

The maximum loaded wire position in the middle of the 40 Ft. span is shown below for the values given in table V.

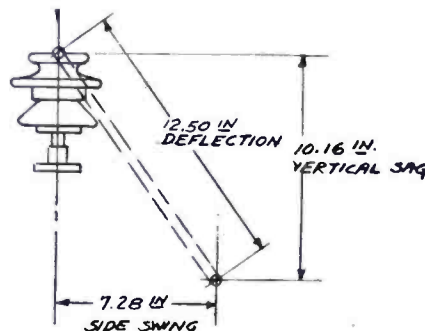

Fig. 10.

The curves shown in Fig. 11 give the stringing tension and deflections plotted against temperature, so that maximum allowable stress or sag values given in table V will not be exceeded.

The minimum vertical sag (S) occurs at -40° F. in the unloaded state (weight of wire only.) See Fig. 11.

$$S = 2.64 \text{ in.}$$

The maximum vertical sag (S) occurs at +30° F., wire loaded with 1 3/8 in. ice wall and no wind.

$$S = 13.2 \text{ in.}$$

The maximum side swing (Z) also occurs at +30° F., wire fully loaded vis. 1 3/8 in. ice wall.

$$Z = 8.16 \text{ in.}$$

(Continued on Page 20)

KFAM

(Continued from Page 11)

The ground system of seven and one-half miles of copper consists of 240 radials, 120 radials approximately a quarter wave length long and 120 one-eighth wave length long, the shorter radials connected at their extremity



Robert Witschen, Engineer at KFAM.

to the midpoint of the long radials and all radials converging in a ground screen. All connections were brazed. The copper was laid with precision and dispatch with a special knife plow fitted to

a tractor. This attachment slit the surface without turning a furrow, eliminating time and labor.

The entire installation, tuning and testing, was performed by the station staff in a minimum of time. The usual country wide response by way of cards and letters from many states was made to the initial test programs and the practical daytime coverage in regular operation is an intense signal in nine counties surrounding St. Cloud within a radius of 50 miles and daytime reception reports in many instances exceeding 100 miles.

Factory performance of the 250-G transmitter as to power output, efficiency, and response have been duplicated in the field and all ratings have been found to be equal to, or better, than the advertised performance of this transmitter.

The transmitter is located southwest of the city of St. Cloud on the Military Highway on a portion of the Atwood Golf Course. Two new structures, the

transmitter building and the new club house, with their landscaping make this one of the beauty spots of the city. The combination of red signal lights on the radiator in the background, the green KFAM neon sign and the indirect lighting through glass brick presents an unusually striking night effect.

Studios are centrally located in down town St. Cloud in the Weber Building, comprising two studios, control room, visitor's foyer and hallway, artists lounge, transcription room and general and private offices.

The studios are extremely attractive due to the use of pleasing combinations of contrasting colors with floors in modernistic designs.

The control room represents the last word in operator convenience. The 76-A consolette provides all switching facilities with two 70-B turntables closely grouped. The 70-B turntables with diamond point pickups deserve special mention for the unusual fidelity of reproduction and unfailing reliability of operation.

A veritable battery of microphones including several 44-BX, 74-B, Junior velocity, 50A Inductor and the 77-A Unidirectional provide facilities for every occasion. All microphones are terminated in Cannon plugs and any combination of microphones is instantly available. The 62-A portable amplifiers are equipped for ac-dc operation with standard Cannon microphone inputs for use with any microphone or combination of microphones.

KFAM took to the air smoothly handling a full schedule of remote and studio programs with all equipment functioning perfectly, providing a high fidelity signal which brought a flood of cards, letters and comments concerning the remarkable clarity and realism of the programs.



◀ Studio Control Room.

Speech input racks ► and transmitter forming a single unit.

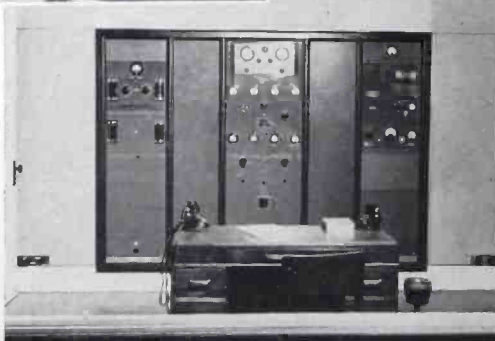

NEW STUDIOS IN WASHINGTON

Department of Interior Setup Features Modern Design and Equipment

THERE are two studios and a control room, as well as a conference and audition room, artists' lounge, waiting room, and offices, all air-conditioned. The rooms are appointed in chromium and leather furniture and fittings.

Modern acoustic treatment of the studios insures their being acoustically isolated from external noises and in addition "live" enough to render good pickup. The studios are floating—the floors of cork tile. The small studio is designed chiefly for speakers or interviews. The large production studio is 40 feet long, 24 feet wide, and 16 feet high. It has an observation gallery which will seat 50 persons. Both studios have double entrance doors providing a "sound lock" which will keep out extraneous noises in case it is necessary for someone to enter or leave during a program. Warning lights are located next to each door to indicate when that studio is on the air. Similar lights are also located in each studio indicating "STANDBY" and "ON THE AIR." In each studio is a loudspeaker for cueing

and talk-back and auditioning.

The control room is located between the two studios with large double-glass windows allowing easy view into each.

The speech input equipment is RCA De Luxe. There is an operator's console at each of the two studio windows. Each console contains a four position mixer, volume indicator, microphone and attenuator switches, and switches for cueing and programs and auditions. High level mixing is employed; a 41-C and a 41-B providing the necessary preamplification. A monitoring loudspeaker is mounted directly over each console. These speakers and the studio speakers are all controlled by interlocking relays and switches which prevent acoustic feedback. Talkback microphones allow the program director or the operator to speak to those in the studios.

The main program amplifier is a 40-D and the main monitoring amplifier is a 94-C. There are also three 82-A monitoring amplifiers. Switching equipment is provided for feeding the output of the program amplifier to one or several

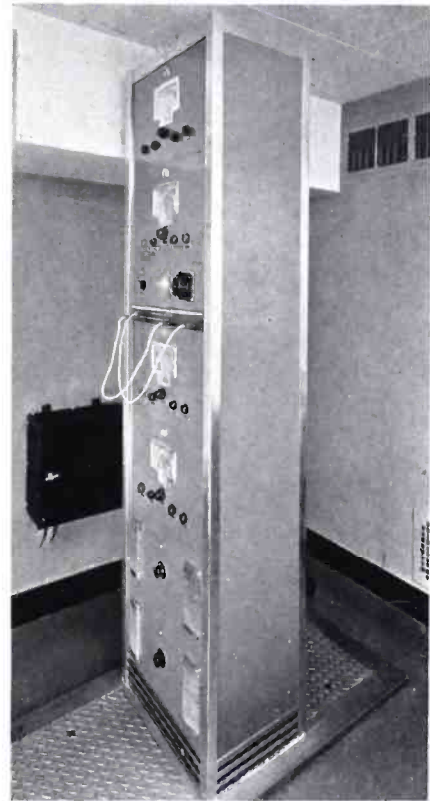

One of the speech input racks installed.

telephone lines for transmission to commercial broadcast stations. Terminating equipment is provided for twelve remote lines and order wires.

A separate rack mounts four RCA all-wave receivers whose outputs are connected to busses which distribute the four programs from the receivers, as well as any studio program, to various points in the Interior Department building. At each of these points any of the programs may be selected and the volume may be adjusted to any desired level.

Jacks have been provided for patching where necessary but the regular program circuits are normal through. Microphones are RCA 44-B velocity and 50-A inductor types. All the racks have been finished in an attractive gray with chromium strips and fittings. Meters have illuminated faces. A volume indicator has been provided for adjusting the program level

(Continued on Page 23)

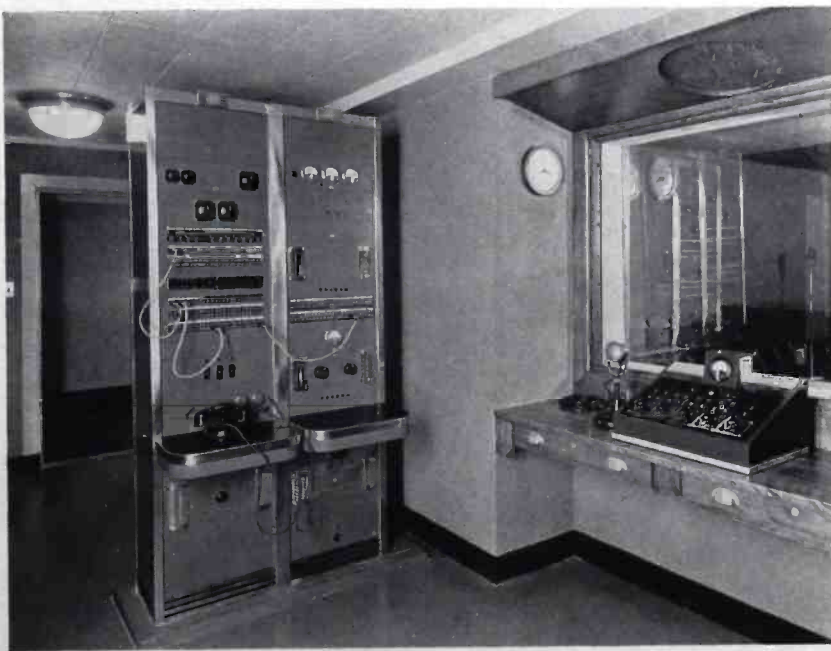

Twin racks in the control room.

SOMETHING NEW IN SPEECH INPUT EQUIPMENT

Compact design of 80-A Desk Advantageous

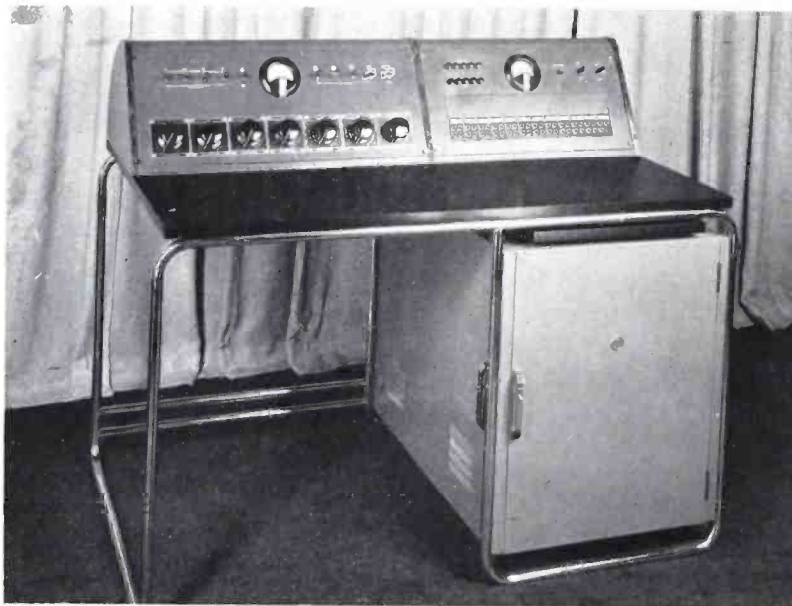

Front view of the 80 A, indicating modern design at its best.

DURING the past few years broadcast engineers have been expressing their desire for a speech input assembly which would combine the conveniences of the console design with the flexibility and other advantages of the time-proved rack-mounted installations. These engineers wanted an assembly which is delivered to them as a single unit completely factory assembled, wired and tested. It should use full sized, standard, stock amplifiers and a complete double jack strip with normalled jacks in all important circuits. It should use a switching and mixing circuit which permits a maximum of operating flexibility and convenience. Last but not least, it should provide all these requirements in a unit which presents an attractive, modern appearance and at the same time, can be easily serviced.

RCA Designs a Desk Assembly

The RCA Speech Input Engineers decided to attempt the design of a unit fulfilling the above requirements. They were fortunate in having available the stock line of RCA "Economy" ampli-

ers which because of their simple mechanical design fit perfectly into almost any conceivable unit construction arrangement. Many assemblies were proposed, carefully considered and discussed with broadcast engineers before the one now used with the 80-A was adopted.

Almost everyone working on the problem arrived at the same general solution—a desk which combines all the functions of three usual studio control room items. These are (1) the rack of amplifying equipment and jack strips, (2) the operating console, and (3) the operator's desk.

WMCA Adopts the 80-A Desk Design

Early in the development of the RCA speech input desk, Mr. Frank Marx, Chief Engineer of WMCA, New York, became interested because he was then planning the extensive WMCA studio installation, now completed. With Mr. Marx's cooperation, slightly modified versions of the 80-A Desks were designed and built for WMCA by RCA. These desks were installed by WMCA

early in 1938 and have proved by actual performance the desirability of such a design.

Advanced Mechanical Design

The particular mechanical design of the 80-A Desk has been chosen because it is sufficiently compact to fit into small control rooms and reasonable light to facilitate shipping and installing.

The chromium plated steel frame is functionally modern and attractive. It is strong and scratch-proof to withstand hard usage. The ventilated amplifier cabinet provides mounting space for all amplifiers, the chassis of which are hinged to permit ready servicing and inspection of all components. Doors are provided on the front and left side, and easily removable shields on the right side and back of the cabinet.

The desk top is made of wood which has a bakelite finish. A sliding shelf is provided for the convenience of the program director or others interested in assisting the operator.

A control turret with removable panels is mounted on the desk for the mixing and switching components. The panels are properly sloped for convenient operation and maximum visibility of mixers, keys and meters. The



From the left, the neat lines are apparent.

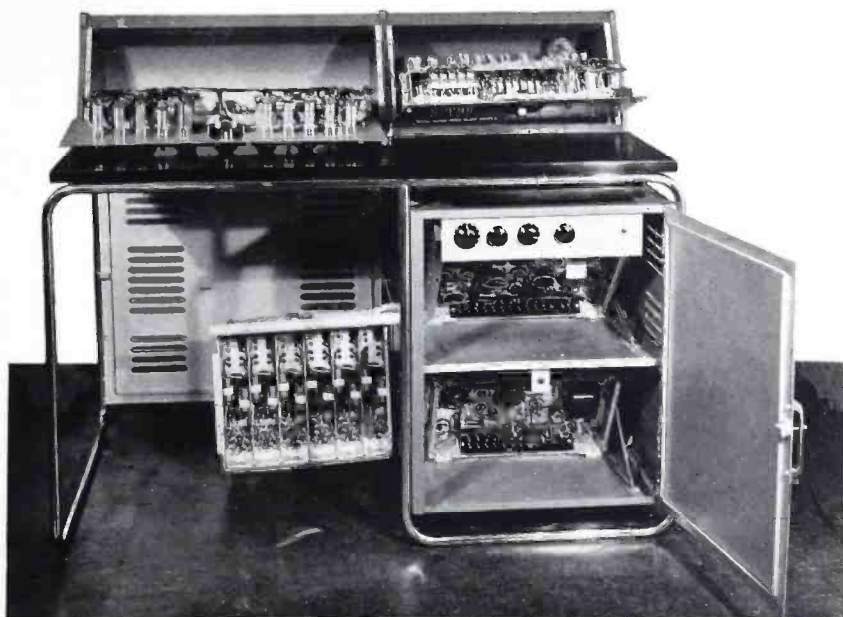

Accessibility, featured in all RCA equipment, is clearly shown in the 80-A.

back of the turret is rounded to permit good visibility into the studio if the desk is located directly in front of the studio window.

Flexible Control Circuit

In order to make the 80-A adaptable to the usual studio installation it is designed to handle two studios, two turntables, and several remote lines. A simplified design (80-B) has also been made available for single studio control rooms in multi-studio installations. Six low impedance, contact-type, mixing attenuators are provided and the output of any, or all of them, may be connected to either the program channel or the audition channel. Thus, either studio may be used for broadcasting, while the other studio, turntables, or remote lines are being auditioned.

The inputs of the first four mixers are connected to the outputs of four standard (85-A) pre-amplifiers so that two microphones may be used simultaneously in each of the two studios. A third studio microphone is made available by patching.

The fifth mixer position is used for transcriptions and may be connected to either of two turntables by means of key switches. The same switches permit one turntable to be connected to the audition circuit for cueing while the other is being used for program.

The sixth mixer connects to the remote line equalizer, isolation transformer and selector switch. The equalizer is variable and may be quickly adjusted for the best performance of the line being used. A five-position, mechanically-interlocked, push-key switch permits any one of five remote lines to be instantaneously connected. Panel mounting space is provided for an additional 24 pair jack strip, thus providing facilities for 31 remote lines.

An identical attenuator is used for the "Master" and is located at the right of the sixth mixer.

High-Fidelity Program Channel

The program channel utilizes the RCA Type 84-A Amplifier. The overall maximum gain from

microphone to line is 116 db and for an output level of plus 10 db* the RMS distortion over the audio band is approximately 0.5%. The hum and noise level does not exceed a minus 60 db* for normal settings of the gain controls. The frequency response is uniform within plus or minus 1 db between 30 and 10,000 cycles.

8-Watt Monitoring Channel

The monitoring channel utilizes a Type 82-A, three-stage, eight-watt amplifier which is connected for driving four loudspeakers through interlocked cut-off relays. The maximum gain of the monitoring channel when operating in the audition position is approximately 115 db and the output is 8 watts with less than 4% RMS distortion. For an output of 4 watts the distortion does not exceed 2%. The frequency response is uniform within plus or minus 2 db from 30 to 10,000 cycles. However, the monitoring amplifier may be compensated to provide a 4 db rise at 60 and 10,000 cycles, if desired.

Emergency Program Channel

A most important function performed by the monitoring channel is that it may be instantly switched to operate as an emergency program channel.

Talk-Back to Studios and Remote

A non-locking key-switch permits the monitoring channel to be

(Continued on Page 36)

* 0 level = 12 1/2 milliwatts.

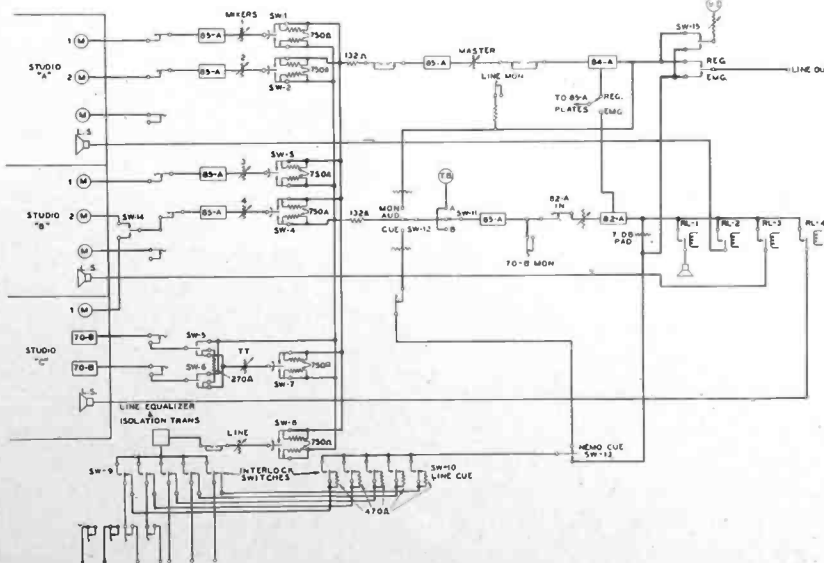

Block diagram of the 80-A.

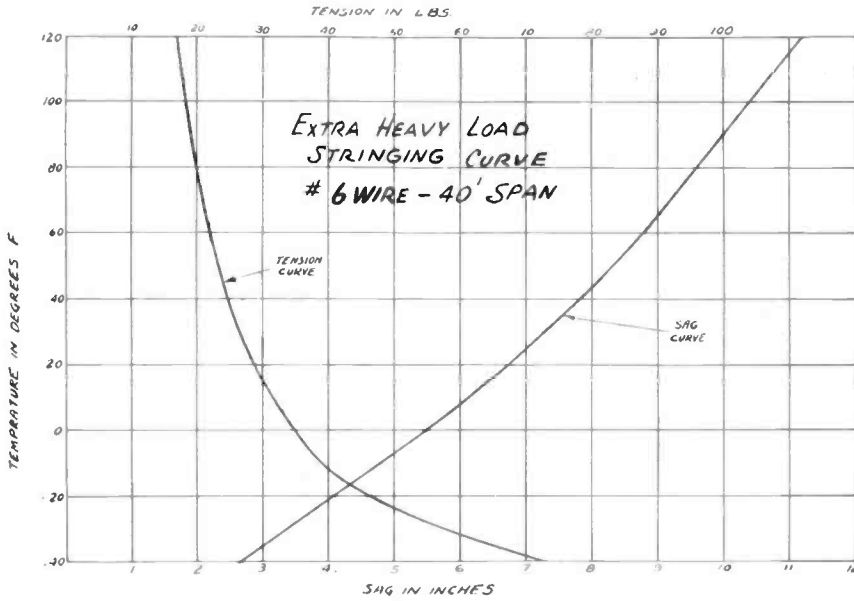

Fig. 11.

(Continued from Page 13)

After a careful study of the tables for maximum load at minimum temperatures and their corresponding stringing curves, it can readily be seen that the greatest care must be taken in stringing the lines at their proper tension and sag. Excess sag in stringing the line will result in objectionable sag in the unloaded state at the higher temperatures. Insufficient sag in stringing the line will result in failure due to overstress in the loaded condition at minimum temperature.

A properly designed and installed transmission line is a hard worked piece of mechanical equipment. The curve shown in Fig. 11, for example, has an unloaded tension at +120° F. of 17 lb. or a factor of safety of seventy-five. The maximum loaded values at minimum temperatures, -40° F., (Table V) give a tension value of 640 lb. and a factor of safety of two.

Forces Acting on a Pole

The principal forces tending to break a pole are wind pressures on pole and conductors when the wind blows transversely. These tend to break it by cross bending. Let

- S_1 = stress lb. per sq. in. caused by wind on pole.
- S_2 = stress lb. per sq. in. on pole caused by wind on wires.
- S = maximum stress of the pole, 15,000 lb. per sq. in. for wrought iron.

A properly designed pole is one that conforms to the following conditions:

$$S_1 + S_2 < S$$

Stress of Wind on Pole

$$S_1 = \frac{P_1 D_1 H_1^2}{2Z}$$

- P_1 = wind pressure in lbs. per sq. ft. of projected area of pole.
- D_1 = diameter of pole in inches.
- H_1 = height of pole in feet.
- Z = section modulus of the cross section of the pole.

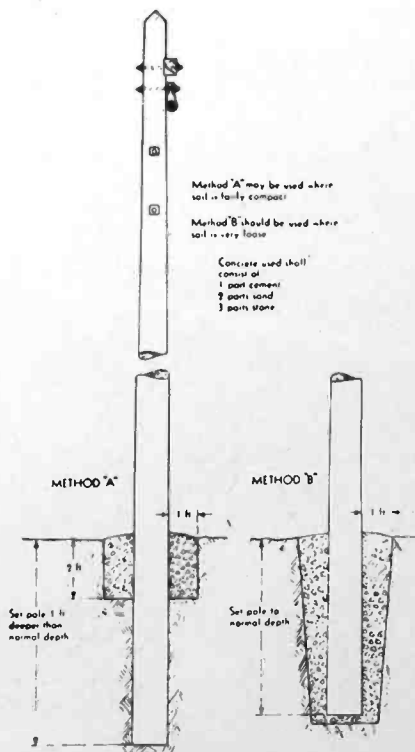

Fig. 12.

Pole Stress Due to Wind on Wires

$$S_2 = \frac{dnSP_2H_2}{Z}$$

- d = diameter of wire (including ice) in inches.
- n = number of wires.
- S = span in feet.
- P_2 = wind pressure in lbs. per sq. ft. of projected area of wires.
- H_2 = height of wires above ground in feet.
- Z = section modulus of the cross-section of the pole.

TABLE VI

Depth of Pole Settings

Over-all Length of Pole	Depth of Setting		Height Above Ground (Set in Soil)	Height of Mess. Support Clamp*
	In Soil	In Rock		
25	5	3	20	18
30	5½	3½	24½	22½
35	6	4	29	27
40	6	4	34	31½
45	6½	4½	38½	36
50	7	4½	43	40½

*The height of the messenger supporting clamp as given above represents average practice.



The transmission line for WLS looking towards the antenna.



Looking away from the WLS antenna.

HERE AND THERE IN THE RADIO WORLD



LEFT: A. H. Hammerschmidt, Technical Supervisor of WOSU, Ohio State University, Columbus, Ohio, at the controls of the 80-A desk.



ABOVE: R. C. Higgy of WOSU at the RCA 80-A desk.



ABOVE: Glenn Callison, Chief Engineer at WGIL.



LEFT: Howard A. Miller, President and General Manager of WGIL.



Above: Sperry-RCA automatic direction finder installed in an American Airlines plane.

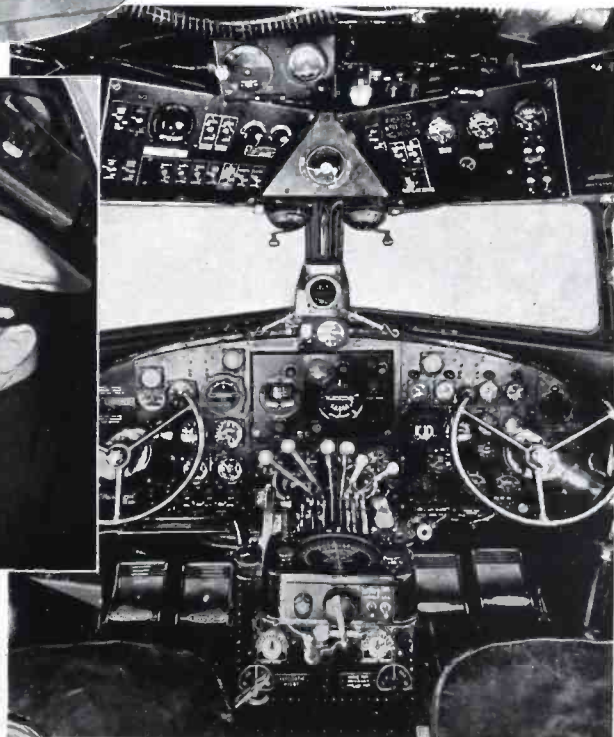

RIGHT: The control panel with the automatic D F in the center.

KSFO

(Continued from Page 18)

The major and medium size studios embody many new features of construction and reverberation characteristics.

“Room Within a Room”

Studios are all of the spring-mounted or “room within a room” type and provide exceptional isolation, which is necessary, inasmuch as Market Street, San Francisco’s busiest with its four street car lines, is half a block away. An exceptionally fine basis for the production of wide acoustical range dramatic and musical programs is thus provided.

Functional Design

Functional to the last word are the studios. No unnecessary items—just clean lines. Even the acoustic rock wool blankets, set in their welded steel studs, are recessed. The perforated rock board, flush with the wall, is painted with washable paint. Color is the main decorative feature, with each studio a different color harmony.

All lighting in the studios is by means of recessed glass reflectors. This gives 30 foot candles at floor level and thus assures the musician or actor of adequate lighting for his script or arrangement, and at the same time entirely eliminates shadows. It is possible to hold the hand six inches above the script and read the copy with ease.

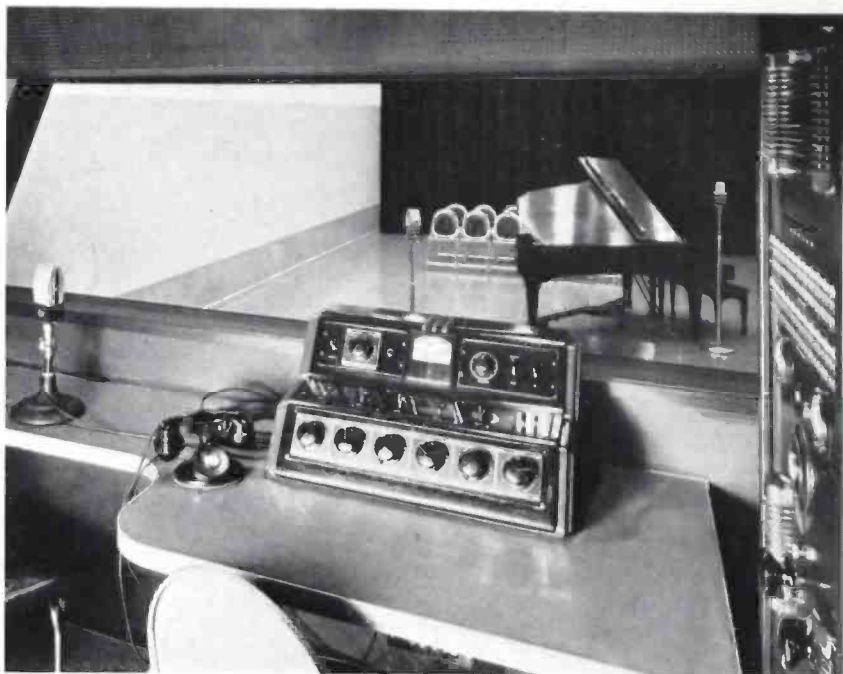

Control Room and Studio 1. Mike on desk is talk-back.

Each studio is equipped with four microphone outlets, two utility outlets, (which terminate on jacks in the control room) and two additional outlets for a PBX telephone extension. A.C. outlets with lock type plugs are distrib-

uted at convenient points around the studio. This prevents unauthorized individuals plugging heavy loads into the outlets.

Every facility for the production programs has been provided from the rehearsal-break microphone to the clients’ observation gallery. Each studio (with the exception of studio 3) has its own monitoring booth for direct contact with the particular program emanating from that studio.

(Continued on Page 23)

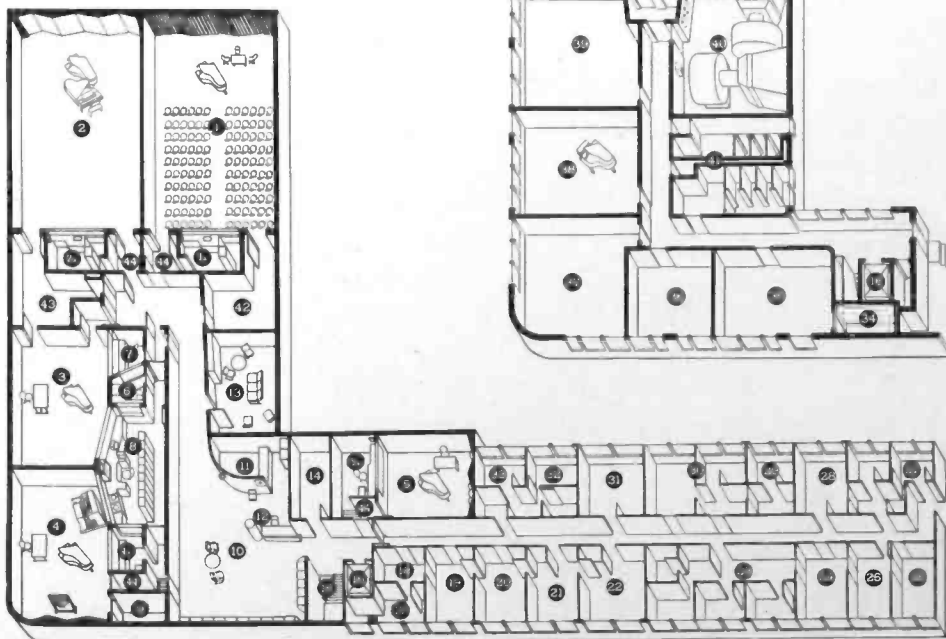

Key to Floor Plan			
K S F O			
Affiliated Station			
Columbia Broadcasting System			
1	Studio—Double Height	18	Traffic Executive
1a	Control Room	19	Executive
1b	Clients’ Observation Gallery	20	Secretarial Executive
2	Studio—Double Height	21	Executive
2a	Control Room	22	Sales Executive
2b	Clients’ Observation Gallery	23	Secretarial Executive
3	Studio	24	Teletypes
4	Studio	25	Publicity Production
4a	Control Room	26	Production
5	Studio—Clients’ Auditions	27	Writers and Production
5a	Control Room	28	Sales
6	Transcription Studio	29	Promotion
7	Press Studio	30	Engr. Dept.
8	Master Control Room	31	Emergency Motor Generators
9	Echo Chamber	32	Engineering
10	Lobby	33	Engr. Dept.
11	Check Room	34	Office
12	Receptionist	35	Office
13	Musicians’ Lounge	36	Library and Arrangers’ Room
14	Telephone Switchboards	37	Offices
15	Stairs	38	Air Conditioning Plant
16	Elevator	39	Rest Rooms
17	Accounting	40	Studio Storage
		41	Sound Effects
		42	Sound Locks

WASHINGTON STUDIOS

(Continued from Page 15)

on the busses. Provision has been made for future expansion of the technical facilities.

KSFO

(Continued from Page 22)

Master Control

Master Control, the heart of the system, is centrally situated in relation to the studios. Here is located all equipment not placed in the studio control rooms. From Master Control the engineer may look through double glass windows into studios 3, 4, 6 and 7. Studio 3 is monitored from the 78-C console placed in Master Control. This enables one-man operation of early and late night programs when local studio productions are few.

The dispatcher's panel is placed in the center of a "U" shaped table and on it are placed all gain controls, dispatching keys, monitoring loudspeaker selector keys, and volume indicators on all outgoing circuits. These volume level indicators are operated from the 40-D amplifiers used to feed the circuits and incorporate the new standard scale developed by the CBS engineering department. To the right of the operator is placed the Private Line PBX board connecting to all program sources, transmitter, etc.

Directly behind the Master Control operator are the audio racks, only a step away. Here are installed three 78-C studio channels, cueing amplifiers, loudspeaker amplifiers for Master Control and the repeating 40-D amplifiers. These latter amplifiers feed KSFO, CBS North of San Francisco; CBS South of San Francisco and the Eastern TC, RCA Communications to Honolulu and the Orient; and a spare or recording channel. Also in the same section are the incoming Remote Channels "X" and "Y" and incoming CBS 40-D amplifiers, to bring the outside program levels up to about 10 milliwatts before switching. This enables the Master Control operator to set remote

programs to the proper level before going on the air. For aural monitoring four loudspeakers with their associated RCA 82-A's are mounted in Master Control.

In Master Control are located the energizing buttons for the emergency A/C power supply. (The actual generating equipment is located in a room on the second floor adjoining the Chief Engineer's office). The emergency apparatus supplies all audio equipment, control room lights and a portion of the studio lights. This equipment starts automatically in the event the metropolitan power should fail. It may also be manually controlled for testing.

As the KSFO transmitter is also equipped with emergency power generators, the station is prepared to render public service in almost any emergency. Even the regular and spare telephone broadcast loops between the studio and the transmitter go by different routes to reduce possible interruption.

An interesting feature is that all the master control racks are directly connected with the main ventilating exhaust system by placing a hollow wall over the racks, which have ventilating holes in their tops. This allows the room temperature air to be taken in through the ventilating louvres through the equipment and out the top. The apparatus is thus kept at room temperature, and the heat from the equipment does not radiate into the control room. It is expected that this method of heat reduction will add materially to the equipment life.

Two RCA 70-A's - 71-A's, with the 72-A recording attachment, and their driving amplifiers are also located in Master Control to enable the recording of any desired program from any source. Transcriptions may also be played from these tables into any circuit. These tables, however, are normalled through to Studio 5.

Acoustical Problem

Studio 5, although a normal studio, has been equipped as a client or audition studio where every facility has been provided for the convenience of the sponsor.

A new angle of attack on the acoustical problem was made in connection with this studio. Predicated upon the non-parallel wall theory, this room was constructed so that the walls "toe in" one foot in ten from the floor to the ceiling, and the end wall heavily staggered. The floor is carpeted and all walls and ceilings (with the exception of the staggered "Saw tooth" end) were covered with acoustical plaster.

Studio 6, a small studio, is used almost exclusively as a local announce booth and transcription room. Through this studio all programs to the KSFO transmitter are routed. All station breaks and spot announcements are made from here. By installing this booth equipment as a repeater, before it is fed to the transmitter, there is no danger of station call letters being fed to the network. All programs destined for KSFO are switched into Studio 6 by Master Control where it appears on one attenuator of the mixer and therefore, studio 6 has no switching to do. A key, thrown to normal position, will return this studio to the master board where it can be switched like the others. Positive interlocks prevent errors.

Local Switching

This arrangement frees the Master Control operator of the local switching problem between the end of one program and the start of another at the time when he is busiest. He, of course, retains absolute final control over the levels as they leave the studio for the transmitter. This repeater studio arrangement has been in use for a number of years and has proven to be the simplest device for the handling of this problem.

Construction lasting 14 months, under the supervision of J. L. Middlebrooks, CBS Liaison Engineer, was brought to a close on August 12, 1938, with a nationwide broadcast and dedication ceremony.

In charge of technical operations at KSFO is Royal V. Howard, under whose direction a staff of 14 operates the new transmitter and the new studios.

SIMPLIFIED NETWORK SYNTHESIS

Building Circuits to Specified Performance Requirements

By EDMUND A. LAPORT

RADIO circuit design involves the use of many types of electrical networks. An intimate knowledge of network design and analysis is essential to those who operate radio transmitting apparatus as well as to those who design it. Most published information on networks is hidden behind a mathematical screen, so far as the average engineer is concerned, with the result that many simple physical facts regarding networks are not widely understood.

Fortunately, a graphical approach to network problems can remove most of the mathematical haze especially in the case of the simple ladder-type, one and two stage networks most commonly encountered in radio practice. Vector diagrams, qualitative and quantitative, are widely employed for analysis of a given network. The following notes will demonstrate the use of vectors for network synthesis, by a method which is extremely simple and apparently new. Network synthesis is the reverse of analysis. Given a certain performance, we solve for the network which produces it.

Graphical Method

The following graphical method of calculating networks for phasing, impedance-matching, coupling, filters, single-generator-multiple-load problems, single-load-multiple-generator problems, single phase to polyphase transformations, equivalent circuits, directive antennas, etc. is theoretically rigorous, correct within practical tolerances, easily learned and easily remembered, rapid in its application and vividly informative regarding the entire problem, or variation of the problem. Its use is not mechanical, but requires in the user a sense of practical judgement, the same as for formal mathematical solution. The graphical method, aside from its simplicity, largely satisfies the

desire to know the "why" as well as the "how" from a physical standpoint.

One need make no apologies for utilizing graphical methods of calculation, thinking they lack elegance and classical appearance. Correct graphical procedure is as elegant as any method, and in some respects, perhaps more so. Graphical calculation is limited to what can be drawn in two dimensions, which is a serious drawback, but within its proper scope, geometrical calculation is a thing of beauty.

An accomplished mathematician would probably find no advantage in graphical methods. The average engineer, however, who strangely enough is seldom a mathematician, will find the graphical way much quicker to use, because much of the red-tape of symbolic representation is eliminated.

The method is illustrated by the solution of type problems, following a natural step-by-step procedure. A number of the problems will be included in this series of articles, covering the networks most frequently encountered in radio transmitter practice.

Something Concerning the Technique of Graphical Calculation

Familiarity develops with experience, for which there is no substitute. Practice in geometrical calculation is required to achieve an effortless, rapid solution. The technique, while largely individual, may be standardized to some extent.

1. Set up vectors representing the load as reference vectors and work backward through the network to the input. This gives vector addition throughout for currents and potentials.

2. Reasonable care with drawing will produce 10-in. slide rule accuracy on letter size paper.

3. It is a great convenience to use polar coordinate paper for vector calculations using the

printed decimal divisions for scales. Radial vectors and angles are thus directly revealed while non-radial vectors can be measured with dividers and referred to the basic scale of the paper. This eliminates protractor and rule.

4. When drawing on plain paper, the L-scale of a slide rule, in combination with dividers, gives a handy dimension base.

5. Work carefully with a sharp pencil.

6. An impedance is represented by the ratio of a potential vector of assigned value, and a current vector of assigned value, related by some phase angle.

7. All potentials are drawn to one scale for potentials and all currents are drawn to another scale for currents, which are rigidly maintained in any single vector diagram. There is no relation between the scales adopted for potentials and currents, except that the indicated vector ratios be correct for the resistances, reactances or impedances involved.

8. For multiple networks operating from a common generator, it is sometimes more convenient to set up the input (generator) potential as a reference, as will be indicated by examples.

9. When designing an unknown network to accomplish a specified result, set up the known terminal vectors and the known input vectors in the desired mutual relationship, such as phase shift angle between input and output currents or potentials. Complete the diagram by drawing in the unknown intermediate vectors from elementary considerations which will be discussed later.

10. To avoid confusion between current and potential vectors, use the closed (A) arrowhead for current and the open (V) arrowhead for potential.

11. Use the triangle method of addition instead of the parallelogram method, wherever conven-

ient, because it makes a simpler, clear diagram by conservation of lines.

12. Where a network includes two or more stages, solve each stage separately as an individual problem. Solve the stage which includes the ultimate load, and take the input impedance of this as the terminal impedance for the next succeeding stage, etc. By this method, quite complicated networks can be handled easily.

13. A vector diagram represents steady state conditions at a single frequency. To analyze the performance of a network at several frequencies, a new vector diagram is required for each frequency.

14. Following generally accepted conventions, advance in time is counter-clockwise. A potential across an element leading the current through the element 90° is an inductive reactance, and vice-versa, a capacitive reactance. A current in phase with a potential is a positive resistance, and a current 180° with respect to a potential is a negative resistance.

Transformation between the equivalent series and parallel components of a given complex impedance.

When using the r-f impedance bridge for circuit measurements by direct or substitution methods it is frequently necessary to convert a given impedance from its series components to its parallel components. Transformation of this sort is frequently required in circuit design calculations. To transform $R_s \pm jX_s$ (series) to $R_p \pm jX_p$ (parallel)

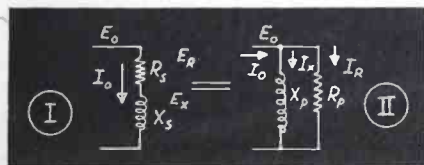

Fig. 1

For example

Assume a current I_0 in I through the circuit with a potential drop E_R in R_s and a drop E_X in X due to this current. $|E_X| + |E_R| = |E_0|$ (vectorially).

Then draw to scales which give correct values to R_s and X_s , the

vectors I_0 (reference), E_0 , E_X and E_R ,

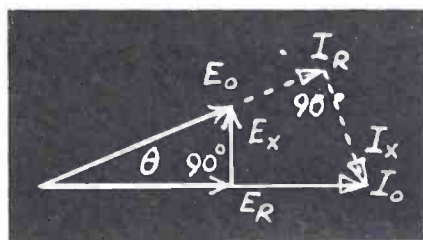

Fig. 2

which is the vector diagram for circuit I.

To find I_X and I_R for II resolve the components of I_0 as shown by dotted vectors, and find

$$R_p = \frac{E_0}{I_R} \text{ and } X_p = \frac{E_0}{I_X}$$

It can be seen that

$$Z_{in} = \frac{E_0}{I_0} \angle \theta$$

is the same for both circuits so that they are exact equivalents.

Graphical Solution of Network Problem

Problem—Design a pure reactive network which will transform a 500 ohm pure resistance load to 100 ohms, with a phase shift of -30° through the network.

Procedure—Draw a potential vector and a current vector in phase in a reference direction representing, according to some convenient scale, the 500 ω load. (e.g.— $E_0 = 500$ V and $I_0 = 1$ amp.). According to this arbitrarily chosen scale for the vectors, the power represented would be 500 watts. If the impedance matching network is to be pure reactances, the power input to the net must equal the power represented in the load.

The next step is to draw a potential vector and a current vector, in phase, according to the same scale of vectors, which will have a ratio representing the input resistance, a product which gives a power equal to that in the load, and a direction which gives the specified phase shift.

Since $W_0 = 500$ watts,

$$E_{in} = \sqrt{500 \times 100}$$

and

$$I_{in} = \sqrt{\frac{500}{100}}$$

Then draw

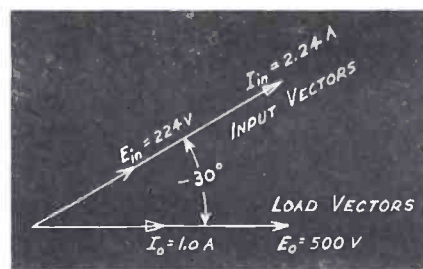

Fig. 3

This figure, therefore, represents the original problem written vectorially.

For vector circuit calculations in general, the first step is to set up the original problem in vector form using convenient scales for potentials and currents, and taking the power derived therefrom into consideration.

After having set up the problem vectorially, we have a choice of a T or a π solution. Let us choose a T network first, and label all the potentials and currents in the load, network and input in a manner which will satisfy Kirchoff's laws:

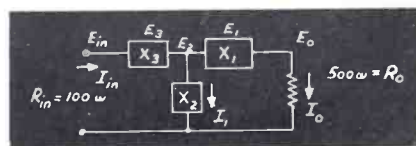

Fig. 4

At this stage we know E_0 , I_0 , E_{in} and I_{in} , R_0 and R_{in} . We represent the network elements as X 's because we don't know what is required yet. We also know, from elementary A-C theory that

$$I_{in} = I_0 + I_1 \text{ (vectorially)}$$

$$E_2 = E_0 + E_1 \text{ (vectorially)}$$

$$E_{in} = E_2 + E_3 \text{ (vectorially)}$$

Similarly, we know that the direction of E_1 is perpendicular to I_0 , the direction of E_3 is perpendicular to I_{in} , and that E_2 and I_1 are mutually perpendicular.

These facts give us enough information to complete the vector diagram for the entire network. This vector diagram has all the information necessary to reveal the nature and magnitude of X_1 , X_2 and X_3 .

(Continued on Page 26)

NETWORK SYNTHESIS

(Continued from Page 25)

There are only 3 currents in the circuit and at the outset of the problem we already know 2 of them. Therefore I_1 can be drawn immediately by connecting the tips of I_0 and I_{in} , and identify the direction of I_1 , as that which, when added to I_0 gives a vector sum I_{in} . Thus, I_1 is directed toward I_{in} . Its magnitude is determined by its length according to the scale for the current vectors.

The intersection of perpendiculars through E_0 and E_1 locates E_2 . The directions are found from considering that

$$E_0 + E_1 = E_2 \text{ vectorially}$$

and

$$E_{in} = E_2 + E_3 \text{ vectorially}$$

From the scales for the diagram, we measure

- $E_0 = 500 \text{ V}$
- $E_1 = 418 \text{ V}$
- $E_2 = 670 \text{ V}$
- $E_3 = 611 \text{ V}$
- $E_{in} = 224$
- $I_0 = 1.0 \text{ A}$
- $I_1 = 1.5 \text{ A}$
- $I_2 = 2.24 \text{ A}$
- $I_{in} = 2.24$

Now

$$X_1 = \frac{E_1}{I_0} = \frac{418}{1.0} = -j 418 \omega$$

(E_1 lags I_0 by 90°)

$$X_2 = \frac{E_2}{I_1} = \frac{670}{1.5} = -j 448 \omega$$

(E_2 lags I_1 by 90°)

$$X_3 = \frac{E_3}{I_{in}} = \frac{611}{2.24} = j 273 \omega$$

(E_3 leads I_{in} by 90°)

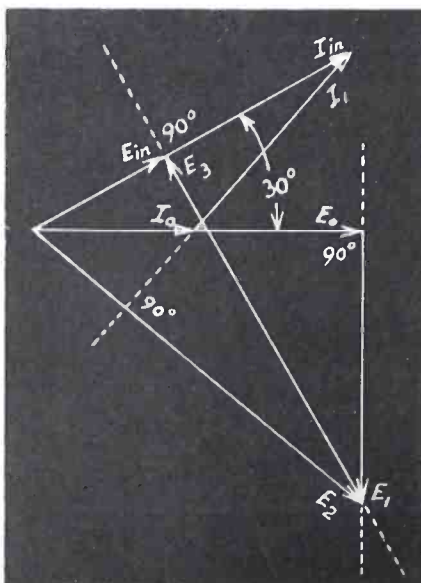

Fig. 5

The network becomes

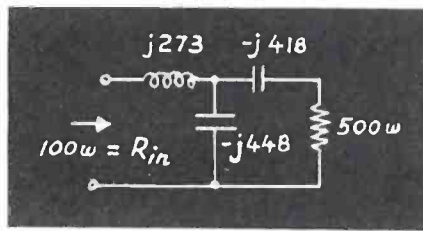

Fig. 6

A check on the accuracy of construction is offered by the angle between I_1 and E_2 vectors, which should be 90° .

The problem specified a phase difference between E_0 and E_{in} . A different solution results from each different value of phase shift through the network. If phase shift is immaterial, we can find a solution where $X_1 = 0$, and the circuit is economized to 2 reactive elements. It is the case where E_3 passes through E_0 and E_1 vanishes, also $E_2 = E_0$. The phase shift ϕ becomes $\cos^{-1} E_{in}/E_0$. For values of ϕ greater than the value where $X_1 = 0$, the sign of X_1 changes from $-j$ to $+j$. When ϕ is positive instead of negative, the signs of all the elements reverse likewise.

Taking now the π network solution for the same problem—

The circuit becomes

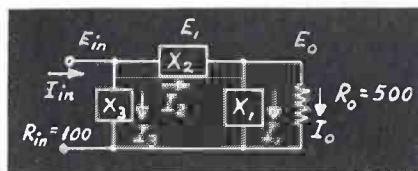

Fig. 7

Here, we know E_0 , I_0 , E_{in} , I_{in} and ϕ . We also know that, for X_1 , X_2 and X_3 to be pure reactances

I_1 must be perpendicular to E_0

I_2 must be perpendicular to E_1

I_3 must be perpendicular to E_{in}

Since we know E_0 and E_{in} , we can draw E_1 immediately.

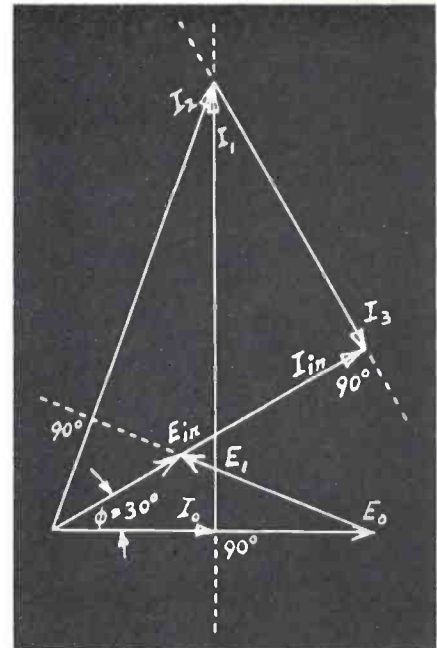

Fig. 8

- $E_0 = 500 \text{ V}$
- $E_1 = 325 \text{ V}$
- $E_{in} = 224 \text{ V}$
- $I_0 = 1.0 \text{ A}$
- $I_1 = 2.76 \text{ A}$
- $I_2 = 2.95 \text{ A}$
- $I_3 = 1.9 \text{ A}$
- $I_{in} = 2.24 \text{ A}$

$$X_1 = \frac{E_0}{I_1} = \frac{500}{2.76} = -j 181 \omega$$

$$X_2 = \frac{E_1}{I_2} = \frac{325}{2.95} = j 110 \omega$$

$$X_3 = \frac{E_{in}}{I_3} = \frac{224}{1.9} = j 118 \omega$$

The network becomes

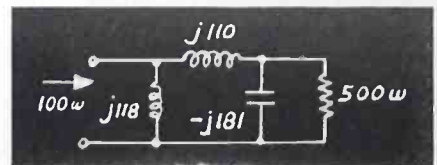

Fig. 9

If the value of ϕ is immaterial there is a value at which $I_3 = 0$ and $X_3 = \infty$. This particular solution economizes the circuit to 2 reactive elements. For values of ϕ greater than this particular value, the sign of X_3 reverses. Study of the vector diagram enables one, by inspection, to foresee the influence of variations in the network for a given impedance transformation, and to select a design for maximum circuit economy or energy economy.

To demonstrate the solution for the 2-element circuit to obtain this transformation, we set up input and output vectors, but do not specify a phase shift, but instead allow the input vectors to

assume a position which, in the T case, causes E_3 to pass directly through E_0 , and in the π case causes I_1 to pass through I_{in} .

Draw the loci of E_{in} and I_{in} for variable ϕ . Erect I_1 perpendicular to E_0 through I_0 . Where this cuts the locus of I_{in} locates the vector I_{in} .

In the case of the T approach, X_1 becomes 0. In the case of the π approach, X_3 becomes ∞ . Thus, the T and π solutions merge into a common solution at this value of ϕ where 2 reactive elements suffice to solve the problem.

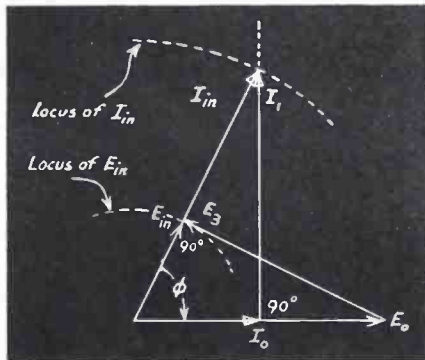

Fig 10

The circuit.

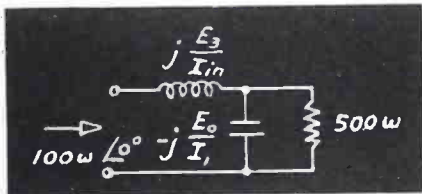

Fig 11

Where ϕ is larger, T case, the diagram becomes

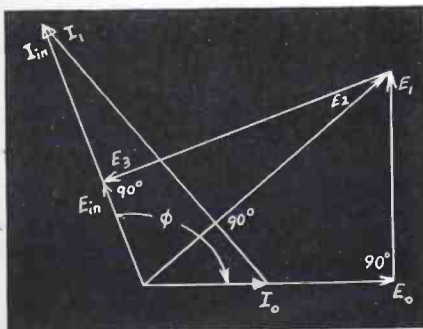

Fig 12

and the circuit becomes

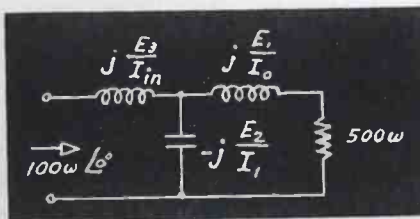

Fig 13

Complete curves of reactances

for both π and T networks for this transformation as a function of ϕ are reproduced in the following

two figures to show the nature of the variations.

(To Be Continued)

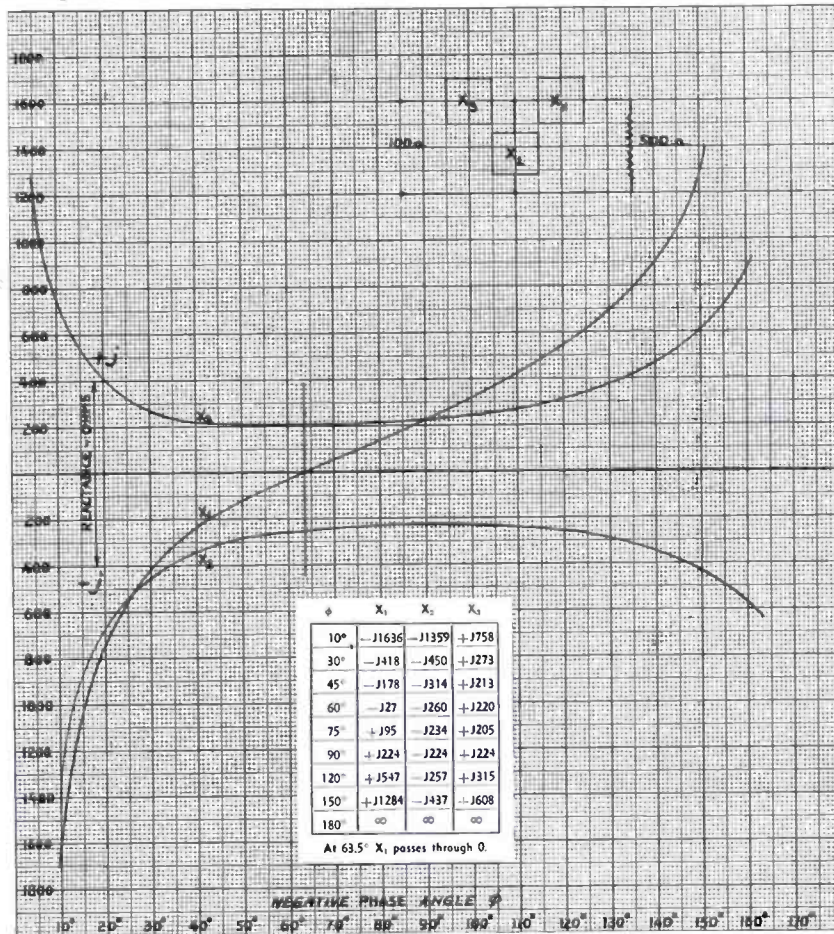

Fig 14

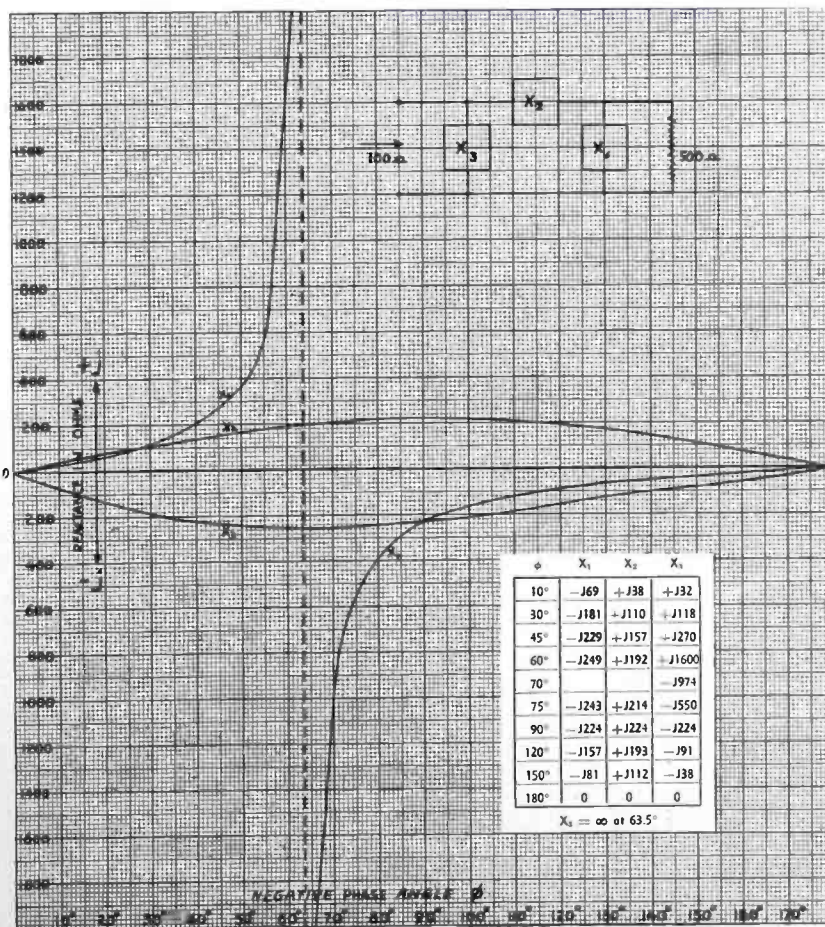

Fig 15

DIRECTIONAL ANTENNAS

A Development of Analytical Method Applicable to General Problems in Array Design

DR. G. H. BROWN

Reprinted through the courtesy of Proceedings of the I. R. E.

We shall first consider two antennas placed broadside to the wave front (Fig. 30).

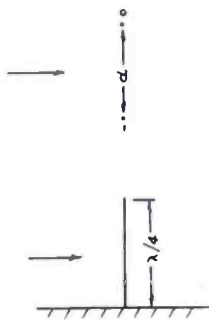

Fig. 30

Then,

$$\bar{E}_0 = \bar{I}_0 \bar{Z}_{00} + \bar{I}_1 \bar{Z}_{10} \quad (99)$$

$$\bar{E}_1 = \bar{I}_0 \bar{Z}_{10} + \bar{I}_1 \bar{Z}_{11} \quad (100)$$

where \bar{E}_0 and \bar{E}_1 are the voltages induced by the impinging wave. Let us next assume that each antenna is self-resonated so that $X_{00} = X_{11} = 0$.

Since,

$$\bar{E}_0 = \bar{E}_1, \quad \bar{I}_0 = \bar{I}_1,$$

so that,

$$I_0 = \frac{\bar{E}_0}{R_{00} + \bar{Z}_{10}} \quad (101)$$

The current in a single antenna with the other antenna absent is

$$I_0' = \frac{\bar{E}_0}{R_{00}} \quad (102)$$

and,

$$I_0/I_0' = \frac{1}{1 + \bar{Z}_{01}/R_{00}} \quad (103)$$

The absolute value of this ratio is shown by Fig. 31. The experimental points are those given by C. R. Fountain.¹⁰

The experimental values shown on Fig. 31 are obtained by taking the square root of Fountain's measurements, since he apparently used a square-law indicator.

Suppose the antennas are placed in the line of propagation of the wave. (Fig. 32.) Then the induced voltages are related thus:

$$\bar{E}_1 = \bar{E}_0 \angle -2\pi d/\lambda \quad (104)$$

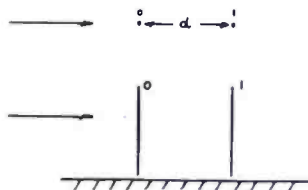

Fig. 32

Then we assume that $X_{00} = X_{11} = 0$, and the current in antenna 0 becomes

$$I_0 = \frac{\bar{E}_0 [R_{11} - \bar{Z}_{10} \angle -2\pi d/\lambda]}{R_{00} R_{11} - \bar{Z}_{10}^2} \quad (105)$$

As shown in (102), the current in a single antenna with the other antenna absent is

$$I_0' = \frac{\bar{E}_0}{R_{00}} \quad (106)$$

Dividing (105) by (106) and noting that $R_{00} = R_{11}$,

$$\frac{I_0}{I_0'} = \frac{1 - \frac{\bar{Z}_{10}}{R_{00}} \angle -2\pi d/\lambda}{1 - \bar{Z}_{10}^2/R_{00}^2} \quad (107)$$

Fig. 33 shows the mode of variation of (107) as a function of spacing. The results shown on the left side of the figure, where antenna 1 is in front of antenna 0 with respect to the impinging wave, were obtained by changing $-2\pi d/\lambda$ to $+2\pi d/\lambda$ in (107).

The results of Fig. 33 were verified experimentally in the following manner. Two half-wave rods were arranged as shown by Fig. 34, many wave lengths from a transmitting antenna. A series circuit consisting of an inductance and a capacitance were

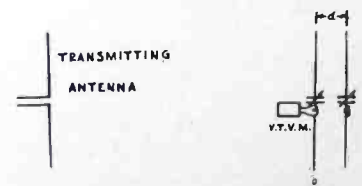
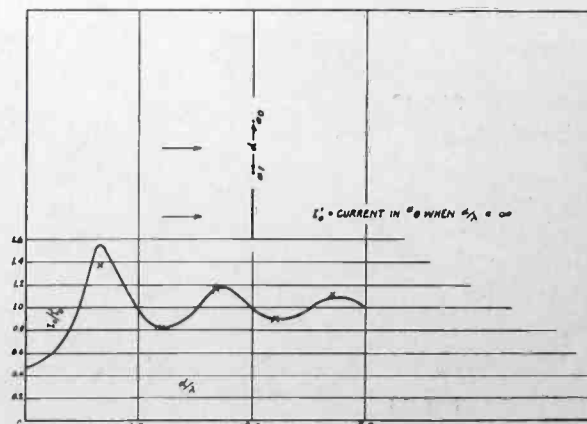

Fig. 34

Fig. 31
Two receiving antennas in broadside



¹⁰ C. R. Fountain, "Phys. Rev.," ser. 2, vol. 43, p. 384; March 1, (1933).

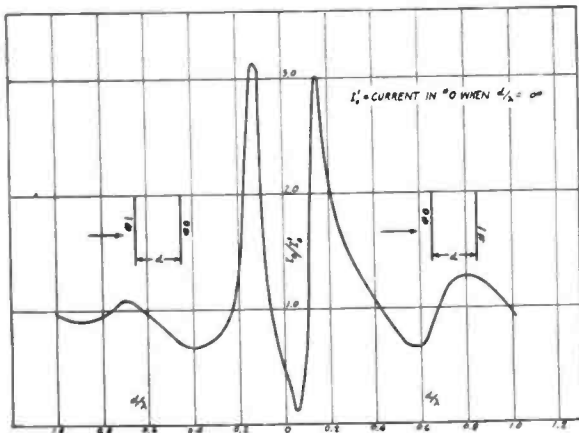

Fig. 33—"End-on" array of a receiving antenna and a single reflector. Both antennas are self-resonant.

placed at the middle of each rod. A vacuum tube voltmeter was connected across the coil in antenna 0. Since the coil was fixed, the reading of the voltmeter was proportional to the antenna current. The condition, $X_{00} = X_{11} = 0$, was achieved by tuning each antenna to maximum response with the other antenna removed.

The value I_0' was found by removing antenna 1. The experimental results, which bear a striking resemblance to the theoretical curve of Fig. 33, are illustrated in Fig. 35.

If the wave is arriving at an angle, ϕ , Fig. 36, and the anten-

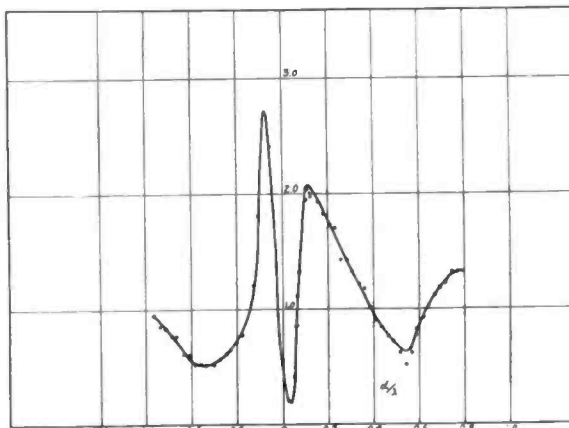

Fig. 35—An experimental verification of Fig. 33.



Fig. 36

nas are not self-resonated, the current in antenna 0 becomes

$$\frac{I_0}{I_0'} = \frac{R_{00} \left[R_{11} + jX_{11} - \bar{Z}_{01} \angle -\frac{2\pi d}{\lambda} \cos \phi \right]}{(R_{00}R_{11} - X_{00}X_{11}) + j(R_{00}X_{11} + R_{11}X_{00}) - \bar{Z}_{10}^2}$$

(108)

In the transmitting case, we achieved maximum fields when X_{00} and X_{11} were not equal to zero. We shall now attempt to maximize (108). In the first step we shall assume that $R_{00} = R_{11} = 36.6$ ohms, and that X_{11} is fixed. Since the spacing is fixed, the only variable is X_{00} . We see that the numerator of (108) is independent of X_{00} . Thus we need find only the condition which makes the denominator a

(Continued on Page 30)

NOTES ON THE USE OF OSCILLOGRAPHS

By B. W. ROBINS

THREE types of 3-inch Cathode Ray Oscillographs have been manufactured and sold by RCA Manufacturing Company. The first was the TMV-122B, which is a general purpose oscillograph; the second the TMV-122D, which is similar to the 122B except that the timing axis range and amplifier response are extended to very low frequency; and the third is the Stock No. 155, which is the recently released general purpose oscillograph. These equipments have proved very satisfactory for the general service and industrial applications for which they were designed. When radio frequencies beyond the range over which they were designed to operate are

impressed on the vertical input binding posts, however, some im-

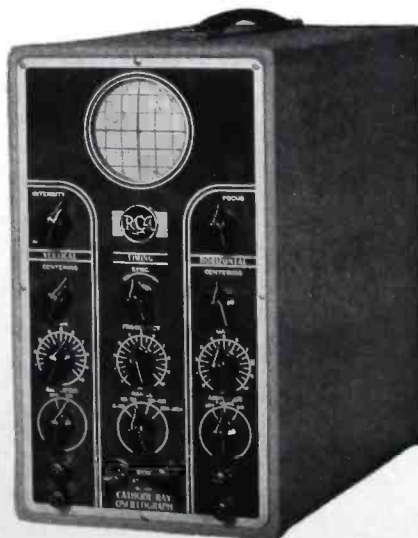

No. 155 Oscillograph

perfections in operation are naturally to be expected.

If it is desired to check the operation of high-frequency transmitters with any of these oscillographs certain minor changes can be readily made which will extend the range of good performance to include these frequencies.

One difficulty which sometimes occurs is that of the timing axis oscillator being blocked by r-f pickup and stopping oscillation. This, of course can be recognized by the complete absence of linear horizontal deflection. In all known cases of this difficulty a mica bypass condenser of the order of 0.002 microfarads shunted across the RCA-885 cathode bias resistor has corrected the trouble.

(Continued on Page 36)

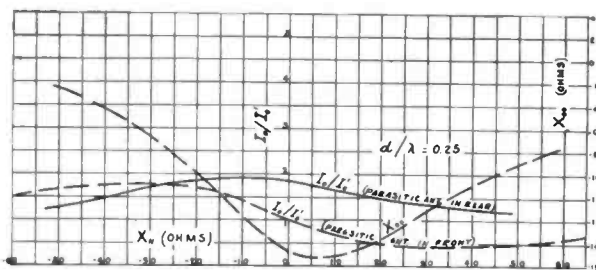

Fig. 37

while $\phi = 180$ degrees correspond to placing antenna 1 in front. Fig. 37 shows the results of substituting the values of (116) in (108) with $\phi = 0$ degrees and $\phi = 180$ degrees. Fig. 38 is similar to Fig. 37 except that $d = 0.1\lambda$.

From Figs. 37 and 38, and similar diagrams, it is possible to pick off values of the maximum current obtainable for each spacing. The results of such procedure are shown by Fig. 39. The circles on this diagram were obtained experimentally using the arrangement of Fig. 34. For each spacing, the capacitors in each antenna were juggled simultaneously to obtain maximum deflection on the voltmeter.

DIRECTIONAL ANTENNAS

(Continued from Page 29)

minimum. The denominator is

$$D = R_{00}R_{11} - X_{00}X_{11} - |Z_{01}|^2 \cos(2\theta_m) + j\{R_{00}X_{11} + R_{11}X_{00} - |Z_{01}|^2 \sin(2\theta_m)\} \quad (109)$$

or,

$$D/R_{00}R_{11} = 1 - \frac{|Z_{10}|^2}{R_{11}^2} \cos(2\theta_m) - \frac{X_{00}}{R_{11}} \cdot \frac{X_{11}}{R_{11}} + j \left\{ \frac{X_{11}}{R_{11}} + \frac{X_{00}}{R_{11}} - \frac{|Z_{10}|^2}{R_{11}^2} \sin(2\theta_m) \right\} \quad (110)$$

Let,

$$a = 1 - \frac{|Z_{10}|^2}{R_{11}^2} \cos(2\theta_m)$$

$$c = X_{11}/R_{11}$$

$$b = \frac{X_{11}}{R_{11}} - \frac{|Z_{10}|^2}{R_{11}^2} \sin(2\theta_m).$$

Then,

$$\left(\frac{D}{R_{00}R_{11}}\right)^2 = \left(a - c \frac{X_{00}}{R_{11}}\right)^2 + \left(b + \frac{X_{00}}{R_{11}}\right)^2 \quad (111)$$

Differentiating (111) and setting equal to zero yields

$$\frac{X_{00}}{R_{11}} = \frac{ac - b}{c^2 + 1} \quad (112)$$

or,

$$\frac{X_{00}}{R_{11}} = \frac{\frac{X_{11}}{R_{11}} \left(1 - \frac{|Z_{01}|^2}{R_{11}^2} \cos(2\theta_m)\right) - \frac{X_{11}}{R_{11}} + \frac{|Z_{01}|^2}{R_{11}^2} \sin(2\theta_m)}{\frac{X_{11}^2}{R_{11}^2} + 1} \quad (113)$$

This becomes

$$X_{00} = \frac{|Z_{01}|^2}{\sqrt{R_{11}^2 + X_{11}^2}} \times \frac{R_{11} \sin(2\theta_m)}{\sqrt{R_{11}^2 + X_{11}^2}} - \frac{|Z_{10}|^2}{\sqrt{R_{11}^2 + X_{11}^2}} \times \frac{X_{11} \cos(2\theta_m)}{\sqrt{R_{11}^2 + X_{11}^2}} \quad (114)$$

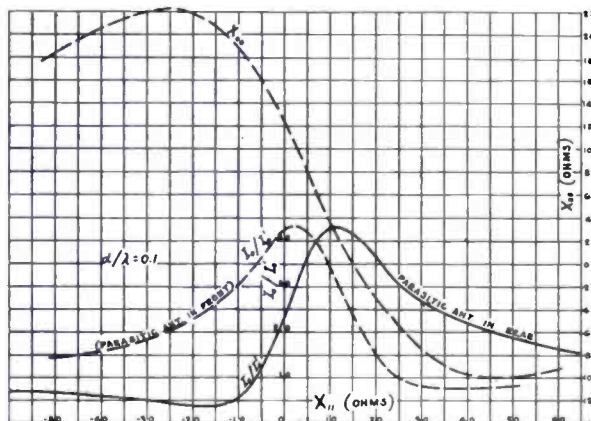

Fig. 38

Let,

$$\tau = \tan^{-1} \frac{X_{11}}{R_{11}} \quad (115)$$

and (114) becomes

$$X_{00} = \frac{|Z_{10}|^2}{|Z_{11}|} [\sin(2\theta_m) \cos \tau - \sin \tau \cos(2\theta_m)] = \frac{|Z_{10}|^2}{|Z_{11}|} \sin(2\theta_m - \tau) \quad (116)$$

Thus X_{00} must have the same value as that given by (81a) for the transmitting case. The value assigned to X_{00} is independent of the angle of arrival of the wave. Fig. 37 shows the value X_{00} , for maximum current, plotted as a function of X_{11} , when the spacing, d , is 0.25λ .

When the parasitic antenna 1 is farther from the transmitter than antenna 0, we shall say it is in the rear of the main antenna, while in the reverse position we shall say it is in front. When in the rear, $\phi = 0$ degrees in (108),

Fig. 40 shows the horizontal polar diagram for a number of cases. In each case, the signal was maximized with the parasitic antenna in front of the main antenna. The left-hand figure is cal-

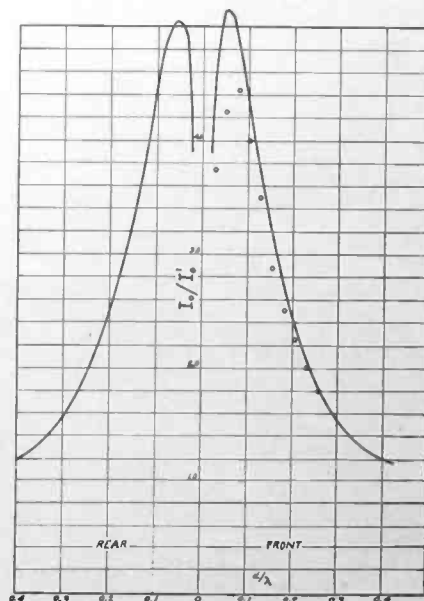

Fig. 39—The maximum increase available from a receiving antenna and a single tuned reflector.

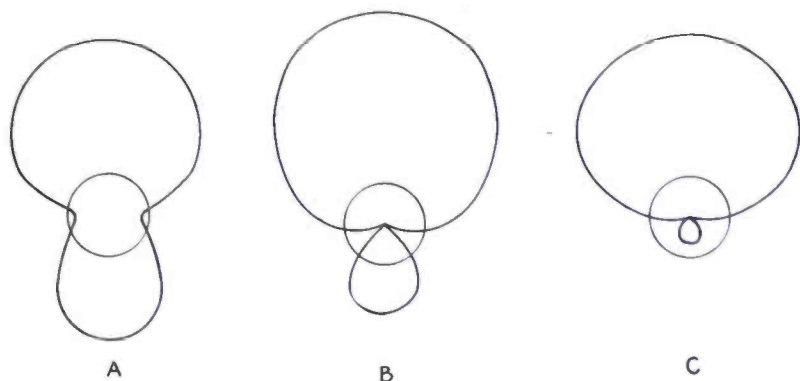

Fig. 40—A. $d/\lambda = + 0.1$
 $X_{00} = + 10.3$ ohms
 $X_{11} = + 25.0$ ohms
 B. $d/\lambda = 0.05$

$X_{00} = + 19.1$ ohms
 $X_{11} = + 10.0$ ohms
 C. $d/\lambda = 0.075$ (experim'l)

culated for the following conditions:

$$d/\lambda = +0.1$$

$$X_{00} = +10.3 \text{ ohms.}$$

$$X_{11} = +25.0 \text{ ohms.}$$

The figure in the center corresponds to the conditions below

$$d/\lambda = 0.05$$

$$X_{00} = + 19.1 \text{ ohms}$$

$$X_{11} = +10.0 \text{ ohms}$$

while the figure on the extreme right is an experimentally determined curve for $d = 0.075\lambda$.

Let us next assume that our receiving device has a finite resistance so that it is necessary to abstract as much power as possible from the wave. Then to get the proper energy transfer, our detector will be connected to antenna 0 through an impedance matching network. This circuit will then offer a resistance R to the circuit of antenna 0. Then the total resistance R_{00} of this antenna will be the sum of the radiation resistance, $R_r = 36.6$, and the load resistance, R . The resistance, R_{11} , will be only that of radiation. The equivalent circuit is shown by Fig. 41. The object is to adjust, in order, X_{00} and R to give maximum power in R for a fixed spacing and a fixed value of X_{11} .

When antenna 1 is removed the power dissipated in R , located at the center of antenna 0, is

$$P'_0 = \frac{E_0^2 R}{(R_r + R)^2} \text{ watts.} \tag{117}$$

The power dissipated is maximum when $R = R_r$, so that

$$P'_0 (\text{maximum}) = E_0^2 / 4R_r. \tag{118}$$

The power dissipated in R when the parasitic reflector is present is $I_0^2 R$. We shall obtain the current by means of Thevenin's theorem, which may be stated in its steady-state form as follows:¹¹

"If an impedance Z be connected between any two points of a circuit, the resulting (steady-state) current I through the impedance is the ratio of the potential

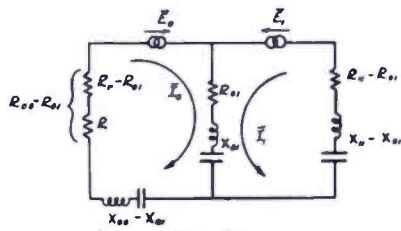

Fig. 41

difference V between the two points, prior to the connection and the sum of the values of (1) the connected impedance and (2) the impedance of the circuit, measured between the two points."

That is,

$$I = \frac{V}{Z + Z'}$$

¹¹ T. E. Shea, "Transmission Networks and Wave Filters," D. van Nostrand, Inc., Chapter II, p. 55.

The impedance Z' measured between the two terminals is given by (81) and (81a). Then for maximum power extraction, the impedance, Z , must be the conjugate of Z' . That is, the added resistance will be,

$$R = R_0$$

$$= R_r - \frac{|Z_{01}|^2}{|Z_{11}|} \cos(2\theta_m - \tau)$$

while enough reactance must be added to cancel the self-reactance of the antenna itself and the transfer reactance,

$$- \frac{|Z_{01}|^2}{|Z_{11}|} \sin(2\theta_m - \tau).$$

Then,

$$I_0 = \frac{V}{2R_0} \tag{119}$$

When antenna 0 is open-circuited, the voltage V is

$$\bar{V} = \bar{E}_0 - \bar{I}_1 \bar{Z}_{10} \tag{120}$$

where,

$$\bar{E}_1 = \bar{E}_0 \angle - \frac{2\pi d}{\lambda} \cos \phi = \bar{I}_1 \bar{Z}_{11}. \tag{121}$$

Then,

$$\bar{V} = \bar{E}_0 \left[1 - \frac{\bar{Z}_{10}}{Z_{11}} \angle - \frac{2\pi d}{\lambda} \cos \phi \right]$$

$$= \bar{E}_0 \left[1 + \frac{|Z_{10}|}{|Z_{11}|} \angle \beta - kd \cos \phi \right] \tag{122}$$

where,

$$\beta = 180^\circ + \theta_m - \tau$$

$$\tau = \tan^{-1} X_{11}/R_{11}.$$

(Continued on Page 36)

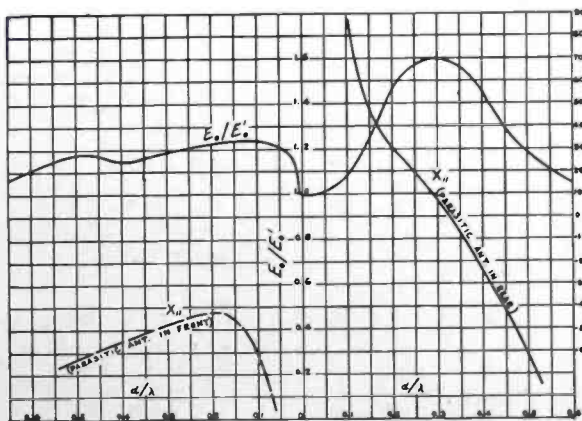

Fig. 42

WCOU ENLARGES AREA

New Equipment Aids Maine Station

By LESLIE R. HALL

WITH the first broadcast from WCOU on Sunday, August 21, 1938, the residents of Lewiston-Auburn, Maine experienced a real treat in radio reception. Serving a community with a population of over 70,000, WCOU is steadfastly living up to its slogan of "Serving Androscoggin Valley Eighteen Hours Daily."

The opening broadcast was presented to a visible audience of nearly 2000 at the Music Hall in Lewiston. With an RCA HF 4 receiver on the stage, the audience not only saw most of the broadcast, but also heard other programs originating at the studios, and a remote program from the Air Rendezvous at Augusta Maine. The program features talks from Augusta by Governor Lewis O. Barrows and Mayor Frederick G. Payne of that city, and at Lewiston, the former Governor Louis J. Brann and Congressional Candidate Harold Dubord of Waterville, spoke to both the visible and radio audience. Out of state guests included Mr. Thomas Littlepage, Jr., of Washington, D. C., Attorney



Leslie R. Hall, Chief Engineer at WCOU.

for the station, and Mr. Russell P. May of the RCA Manufacturing Company, Camden, N. J.

WCOU, operating on a frequency of 1210 kilocycles with a power output of 100 watts, is an associate of the Mutual, Yankee and Colonial networks, and is on the air 18 hours daily except Sundays. In keeping with its policy to be the first to serve the public, WCOU keeps its listeners informed with all the important local and world wide news, and special events. Through this policy, WCOU has captured the goodwill, admiration and appreciation of its large audience of listeners. Our first "scoop" was on September 12th, at which time the station was on the air continuously for 42 hours with returns of the State of Maine elections, and was the first agency in Maine to inform the public with complete and official returns. The reward for our efforts, was the many letters of appreciation for this service received from listeners all over Maine and New England.

"RCA All the Way"

We could discourse at great lengths on how completely satisfied we are with the equipment purchased of the RCA Manufacturing Company of Camden, N. J. However, we shall confine ourselves to a short description of the installation and supplement

it with photographs. The small but comfortable transmitter building on East Avenue in Lewiston, Maine, houses a 100G RCA transmitter and a rack of equipment consisting of a 475B frequency monitor and 681 deviation meter, a 96A limiting amplifier, one 66A modulation monitor, one 33A jack panel, one 82A monitor amplifier, one 96A power supply, and also at the transmitter, a 64A speaker.

The Ground System

The 199½ ft. series fed Lingo radiator is 275 ft. from the building and is fed by means of a four wire transmission line. The ground system consists of 120 radials of No. 10 H.D. copper wire 204 ft. long. The studios are the most modern in Maine if not in New England. All attention was given to acoustics and sound proofing. The Johns - Manville built the studios and the work was personally supervised by one of their engineers. The studios are located at 223 Lisbon Street in Lewiston. Studio "A" is 35 x 22, Studio "B" 25 x 15, and Studio "C" 13 x 10. The Control Room is 14 x 12 and is located between studios "A" and "B" giving a complete view of these two stu-

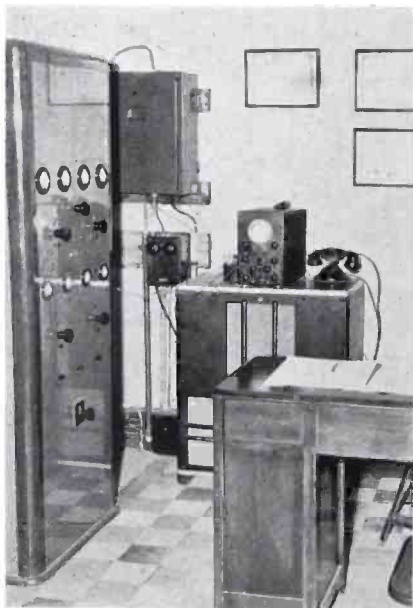

Transmitter and associated equipment at WCOU.



In case you didn't notice it, the "mike" in the left hand corner is a 44-BX.



RCA Turntables in action.

dios. The Control Room faces a reception room, which opens into the two large studios. The reception room is the same size as the control room. The air conditioning for the studios was installed by Westinghouse and the lighting by Holophane.

In keeping with its policy of quality and efficiency, WCOU has installed a Steinway studio grand piano in Studio "A", and a Steinway baby grand in Studio "B".

All studios are equipped with cue speakers, and 3 RCA 64A speakers are also used. One is installed in the manager's office for auditions and monitoring, one in the control room, and one in the reception room.

The Control Room

The Control Room houses a new RCA 80A desk type control console, two RCA 70B turntables and RCA recording equipment. The new RCA 44BX microphones are used in all studios, with two RCA 74B and inductors for remote and emergency service. Other equipment consists of an RCA OP 62A remote amplifier, an RCA audio oscillator, and an RCA oscillograph.

We believe it notable to mention the speed with which WCOU was constructed. The studios are in a building that had to be remodeled from the foundation up to accommodate them. Eighty-eight days from the time construction was started the station was completed and on the air with their schedule of broadcasting.

No actual field survey to determine coverage has been made as yet. However, it is a certainty

that Lewiston—Auburn and Androscoggin County are now receiving excellent radio service, and the many letters received from listeners throughout Maine indicate that our coverage is far beyond our fondest dreams and expectations.

Studio and building designing, plans and specifications were by Leslie R. Hall, Chief Engineer, and all construction was under his supervision.

WCOU is owned and operated by the Twin City Broadcasting Co., Inc. The officers are Mr. Jean B. Coutre, Pres.; Mr. O. Coutre, Treas.; Mr. Valdore Coutre, Sec.; Mr. Bernard R. Howe, General Manager; and Mr. Leslie R. Hall, Chief Engineer.

The production staff is composed of Varner Paulsen, Roger Levenson, Lanny Pike, Guy La-

douceur, Bert Coté and Oscar Normand.

Engineering staff: Conrad T. Beardsley, Donald R. Mason and Merle L. Towle.

NEW RCA EQUIPMENT

In the field of internal-combustion engine research, experimentation, and design, accurate figure-work is essential to the success of the work. However, the needed accuracy in engine-indicator diagrams has been difficult of attainment in the past.

The answer to this need, however, is now found in the new RCA ENGINE-INDICATOR DIAGRAM EQUIPMENT.

The Cathode-Ray Oscillograph, which is part of the equipment, is an instantaneous curve-tracing instrument, and affords an excellent means for indicating pressure diagrams.

Another important part of this equipment is the Engine-Pressure Conversion Unit, which utilizes the piezo-electric properties of quartz crystals to instantly convert pressures into electrical charges.

Also included in the equipment is a Synchronizer Unit which synchronizes the time axis on the pressure diagrams with the rotation of the crankshaft. It likewise provides a marker, when desired, so that any point on the pressure diagram may be oriented with respect to the crank position.

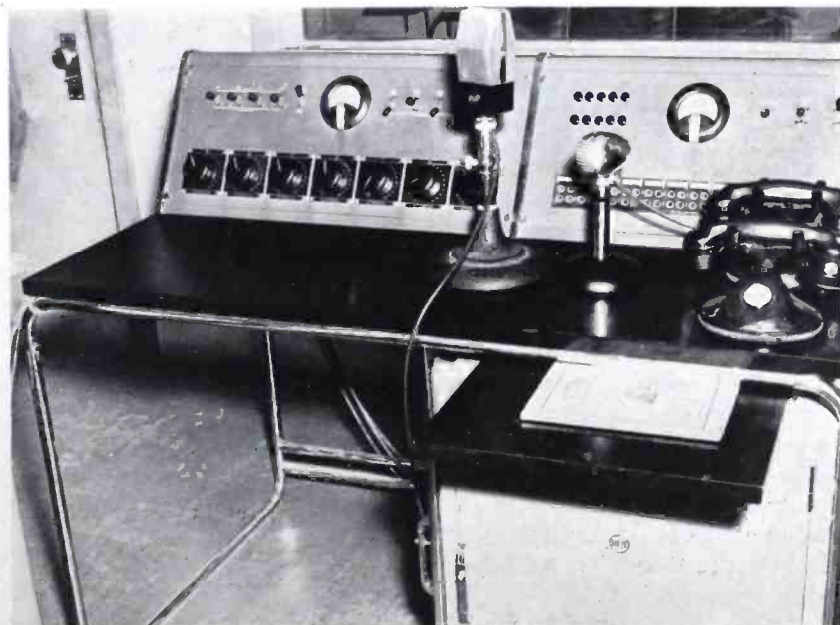

The 80-A Desk at WCOU which is fully described in this issue.

FACSIMILE

(Continued from Page 3)

which is desirable in view of the fact that they have a much more ready access to late edition newspapers than their rural friends.

Simultaneous broadcasting of both sound and facsimile programs is expected to develop a new technique of broadcasting for some types of programs. Recipes for cooking schools, for example, can be sent by facsimile while the regular sound program is in progress and listeners will have a printed copy for future reference.

This would reduce the cost of "servicing" programs as some stations report that they have been put to the expense of printing and mailing thousands of copies of recipes for such programs.

Television stations will be able to broadcast simultaneous facsimile-sound programs over their picture and sound transmitters during the parts of the day and evening that they are not broadcasting television programs. This will allow them to make more efficient use of their equipment and wavelength facilities.

Simultaneous service can also be furnished by sending sound on the standard band transmitter and facsimile on a separate ultra high frequency transmitter; by sending sound on one and facsimile on another separate ultra high frequency transmitter or by sending both sound and facsimile on the same ultra high frequency transmitter, separating the two services by special filters as was done by RCA in 1934 when three separate services were sent over one transmitter.

Many of the newspaper facsimile enthusiasts anticipate broadcasting initial brief news over their facsimile system and referring their audience to their newspaper for more complete details of the various stories.

Morning newspapers can broadcast bulletins during the day and thus give a more complete service to their circulation. Evening papers can likewise supplement their "off the street" period during the morning hours.

Many other supplementary types of service will suggest

themselves to those familiar with commercial broadcasting.

The RCA Manufacturing Company is in the unique position of being able to keep in close contact with both broadcast stations and the radio public and expects to cooperate with the facsimile broadcast stations closely, assisting broadcasting stations to build a facsimile audience as rapidly as the stations are in a position to furnish the public service of facsimile broadcasting.

Design Problems

The problem of designing a facsimile receiver for the home use is a difficult one. The home receiver must operate reliably over reasonable periods of time without attention from trained engineers and with but very little attention from the non-technical owner, in contrast to the more elaborate commercial facsimile receivers which are monitored by skilled engineers.

The home receiver must be simplified mechanically so that its cost is only slightly more than the cost of a good radio receiver. It must not only meet initial requirements but its basic standards of design should lend themselves to possible future design requirements.

Among the desirable features of a home facsimile receiver are these:

1. Wholly automatic except for periodic servicing.
2. Black on white reproduction like that of standard periodicals.
3. Sound proofing is necessary for night time operation in order to avoid awakening sleepers in adjacent rooms.
4. A compact "all in one" unit is highly desirable, especially for these initial tests, in order to obtain standard results, which are readily comparable, from all of the receivers. This is also essential if broadcast stations are to avoid the expense and variable results of modifying a large number of various kinds of home receivers every time they move the facsimile recorders to new locations during the test.

RCA Facsimile Receiver

Bearing the above general requirements in mind, the RCA re-

ceiver has been designed to employ the simple carbon paper printing system which is the only black on white facsimile reproduction method that has proved practical to date.

The receiver includes an automatic time clock which controls the electric power to the receiver and printing mechanism. Two types of time clocks are furnished. The clock with the standard band receivers furnishes one on-off duty cycle per twenty-four hours as these can only be operated during the early morning hours. The clock with the ultra high frequency receiver allows for three on-off cycles per day. For instance, ultra high frequency stations can set their time clocks to allow for three separate program periods during each twenty-four hours, such as one in the forenoon, one in the afternoon and one in the evening.

The printing mechanism is located in the top part of the cabinet and enclosed with sound proofing material while the radio receiver and time clock are located in the lower part of the cabinet with the clock accessible for checking and setting. The only necessary external connections when installing the RCA receiver are the antenna and ground and power supply. The receiver can be pre-tuned to the broadcast station's wave length and the volume control pre-adjusted so as to give correct half-tone renditions.

The practical advantages of combining the recorder with a special radio receiver are readily apparent when a home user realizes that the unit automatically turns itself on and off for every scheduled program with no attention from him and that he does not have to remember each night to switch his receiver over to facsimile position, disconnect his loudspeaker, tune the receiver to the correct broadcast station and accurately adjust the volume control.

While a self-synchronized receiver will undoubtedly be required in some localities for regular commercial facsimile service, it is not an absolute requirement for the initial field tests of the

broadcast stations as they can confine their very first tests to those areas whose power supply is synchronous with that of their scanner location. They can make separate tests with the receivers located in other non-synchronous areas by feeding their scanner motor from an audio amplifier of about 25 watts output which amplifies a synchronous 60 cycle tone fed to the amplifier over a telephone line from the power system in the area where they wish to test.

Omission of the self-synchronizing equipment from these first receivers reduces their cost considerably because a really accurate self-synchronizing receiver must be built in fairly large quantities in order to be economical.

RCA has employed various types of self-synchronizing systems in their commercial radio facsimile service receivers. In order to be satisfactory, the self-synchronizing system must not only be low in cost but it must be highly accurate or the resulting facsimile reproductions will not be satisfactory to the general public.

It is expected that these automatic synchronizing units will be offered as an attachment for the present facsimile receivers within a short time.

It is beyond the scope of this article to go into complete technical details of the RCA broadcasting facsimile equipment. Those who are not familiar with these details are referred to the article in the April 1938 RCA REVIEW, entitled "Equipment and Methods Developed for Broadcast Facsimile Service," by Charles J. Young, of the RCA Victor Research Laboratory.

There is one very important fundamental design feature of the RCA facsimile system which should be stressed, however. This is the fact that the RCA receiver employs a uniform rotary motion. This rotary unit is inherently capable of being operated at much higher speeds than the present receivers utilize and the fact that its rotary motion is uniform in nature instead of stopping and starting makes it much more efficient. This means that the

ultimate maximum speed obtainable will be considerably faster than the maximum speed practicable with other methods.

An interesting analogy between reciprocating and rotary speeds and mechanisms is the comparison between the old style, relatively low speed reciprocating printing press which is totally unable to approach the high speeds obtained with modern high speed rotary printing presses.

We expect to make various new features available as rapidly as the broadcast stations develop facsimile broadcasting to the point where we are justified in offering such receivers for general sale to home users.

OHIO STATE UNIVERSITY ANNUAL CONFERENCE

IN an attempt to bring together leaders in the industry and practicing engineers from all parts of the United States and Canada in a comprehensive discussion of a few of the most important technical problems, The Ohio State University is sponsoring the Second Annual Conference, or short course, on Broadcast Engineering, during the period of February 6 to 17, 1939.

The first week of this session will be primarily concerned with transmitter problems, while the second week will involve the studio proper and associated equipment.

The program will basically include three topics each day, a period of two hours being assigned to each topic. The first hour will be devoted to a formal lecture by the leader, and the second hour will be a round-table discussion participated in by all those in attendance.

The men who have consented to act as leaders will be recognized by all broadcast engineers as outstanding authorities on the topics which they are to discuss.

An important feature of the Conference will be the opportunities for informal association and discussion with those who attend.

The number of men who can be accommodated at the Conference is limited so that all attending may benefit from the round-table discussion. For that reason an

early registration is desirable. Those who wish further information may obtain it by correspondence with the Director of the Conference, Dr. W. L. Everitt, The Ohio State University, Columbus, Ohio.

General Information

Fee—The fee for the Conference is twenty (\$20) dollars, payable at the time of registration. This fee includes the cost of the banquet and the dinner and the inspection trip to the WLW transmitter scheduled in the program. Checks should be made payable to The Ohio State University.

Registration—Registration should be made in advance and not later than January 20. The registration blank should be filled out and mailed with remittance. Those unable to attend the complete session should take the matter up with the Director of the Conference, Dr. W. L. Everitt.

Living Accommodations—The Fort Hayes Hotel has offered special rates for the Conference. Rooms with twin beds and bath are available to \$1.50 per night per person and single rooms with bath are available for \$2.50 per night. Those who wish reservations should so indicate on their registration blank.

Recreation—Through the courtesy of the Physical Education Department, the gymnasium and swimming pools of the University will be available to the members of the Conference. These facilities are among the best in the country, including three pools, six handball and squash courts, badminton, basketball, volleyball, and shuffle board courts and ping pong tables.

On Thursday, February 9, a dinner will be held at the Fort Hayes Hotel and a banquet will be held Thursday, February 16, at the same place.

Dr. J. O. Perrine of the American Telephone & Telegraph Company will give a special lecture-demonstration, "Waves, Words and Wires" on Tuesday evening, February 7 at 8:00 p. m.

Other opportunities for recreation will be planned and announced at the time of the Conference.

OSCILLOGRAPHS

(Continued from Page 29)

Another difficulty which has been observed is that of extraneous horizontal deflection due to r-f pickup on the horizontal amplifier grid. The TMV-122-D, having larger metal-encased coupling condensers for obtaining better low-frequency response, is the worst offender in this respect. The TMV-122B oscillograph is appreciably better than the 122-D in this regard, but the Stock No. 155 is the best of the three. On this latter unit the leads from the binding post to the cathode-ray tube deflecting plates are better isolated, and practically no "cross-talk" results.

In using the TMV-122B or 122-D, filters will give improvement in lessening the cross-talk, but the simplest and most effective remedy is to disconnect the oscillograph wiring from the free vertical deflecting plate of the cathode-ray tube and connect the r-f signal directly to the tube. This may be done by disconnecting the black and red, 50/50, lead from the rear of the RCA-906 socket and connecting the r-f pickup coil between this socket terminal and the arm of the vertical beam shift control. Extraneous 60-cycle deflection can usually be avoided by employing a ground-



3" Oscillograph.

ed shield around the line from the pickup coil to the oscillograph, or by connecting an r-f choke coil across the oscillograph end of the line. If the pickup circuit itself is grounded it should be capacity-coupled to the oscillograph if it is desirable to retain the action of the vertical positioning control.

80-A DESK

(Continued from Page 17)

used for talk-back to either studio. A second switch permits a padded output to be fed from the monitoring amplifier to the remote lines as cue for the remote operator. This arrangement also per-

mits the output of the talk-back microphone to be fed to the remote operator.

Complete Metering

An illuminated rectifier-type VI meter is located on the main control panel. This meter is mounted in the attractive RCA streamlined case. A meter of similar appearance is located in the right hand panel for indicating the plate currents of any tube in the program channel.

External Relay Rectifier

The power supply for operating the relays is designed for wall mounting. It uses one Rectigon bulb and is rated at 12 volts, 1 ampere. It is relatively quiet in operation and has been designed to provide trouble-free operation with continuous use.

Conclusion

The enthusiasm of the broadcast engineers who have seen the 80-A Desks indicate that the facilities are complete and practically all operating requirements have been anticipated. Of particular interest to broadcasters is the fact that, through correct design and quantity production, RCA has been able to establish a surprisingly low price on these new assemblies.

DIRECTIONAL ANTENNAS

(Continued from Page 31)

Then the power dissipated in R is

$$P_0 = I_0^2 R = \left(\frac{V}{2R_0} \right)^2 R_0$$

$$= \frac{E_0^2}{4R_0} \left| 1 + \frac{|Z_{10}|}{|Z_{11}|} \angle \beta - kd \cos \phi \right|^2 \quad (123)$$

The power gain over a single antenna is found by dividing (123) by (118).

$$\frac{P_0}{P_0'} = \frac{R_r}{R_0} \left| 1 + \frac{|Z_{10}|}{|Z_{11}|} \angle \beta - kd \cos \phi \right|^2 \quad (124)$$

Comparison of (124) and (83) shows that the voltage gain across the detector in the receiving case is identical with the field intensity gain in the transmitting case. We can then use the information of Section VI (a) to supply the story of the receiving antenna operating into a detector of finite resistance.

Another case of some practical importance will be treated. The main antenna is so detuned (or has so much impedance in its base that the current flowing in this antenna is very small compared to that in the parasite). This condition may be met where a high impedance detector is inserted directly into the antenna circuit or when the antenna feeds directly into a transmission line.

The voltage induced in antenna 0 by the wave alone is E_0' . The voltage induced by the current in the adjacent antenna is $-\bar{I}_1 \bar{Z}_{10}$ so that the total induced voltage is

$$\bar{E}_0 = \bar{E}_0' - \bar{I}_1 \bar{Z}_{10}. \quad (125)$$

But,

$$\bar{E}_1 = \bar{E}_0' \angle - \frac{2\pi d}{\lambda} \cos \phi = \bar{I}_1 \bar{Z}_{11} \quad (126)$$

so that (125) becomes

$$\frac{E_0}{E_0'} = 1 - \frac{\bar{Z}_{10}}{Z_{11}} \angle - \frac{2\pi d}{\lambda} \cos \phi. \quad (127)$$

Fig. 42 shows the voltage gain as a junction of d/λ for $\phi = 0$ degrees and $\phi = 180$ degrees.

At each d/λ , X_{11} is adjusted to give the maximum voltage gain. This reactance is also shown on Fig. 42.

Notes About Our Contributors

DR. G. H. BROWN. Dr. Brown was born at North Milwaukee, Wisconsin, in 1908. After completing his course in Electrical Engineering at the University of Wisconsin he continued work for his M.S and Ph.D. degrees at the same institution. Dr. Brown has been a frequent contributor to this publication and his authoritative work on antennas has been universally recognized.

ROYAL V. HOWARD—Class of '27 (Electrical Engineering) University of Oregon. Received Sc. D., 1934 Polytechnic College, Oakland. Pioneered high frequency commercial communication between Alaska and Seattle 1924-27, establishing first commercial circuits. 1928-29 Chief Engineer KXA Seattle. 1929-30 Research Engineer TWA. 1931-32 Vice President in charge of Engineering United Broadcast Company, Los Angeles. 1933 to date Chief Engineer, Associated Broadcasters, KSFO, San Francisco.

HOWARD M. KEARNEY, born in Pittsburgh, Penna., in 1901, graduated from Drexel Institute in 1924 with a B.S. degree in Mechanical Engineering. He immediately joined the E. G. Budd Manufacturing Company in Philadelphia, acting as Mechanical and Technical Advisor to the Patent Department until 1929. In that year he joined the forces of the Westinghouse Electric & Manufacturing Company, assigned to the Industrial Control and General Engineering Divisions of that company in East Pittsburgh. In 1933 he was transferred to the Steam Division of the Westinghouse Company, located in South Philadelphia, continuing in this division until 1935. Since 1935 he has been associated with the Transmitter Engineering Division of the RCA Manufacturing Company, Inc., and at the present time is one of the mechanical engineers specializing on high power transmitter design.

EDMUND A LaPORT actively began his career in 1921 with the Westinghouse Electric & Manufacturing Company, New York City, as a member of the Radio Service Department, where he remained until 1923. He then transferred to the General Electric Company in Schenectady, and for a period of one year engaged in transmitter development work. In 1924 he returned to

Westinghouse, in the Transmitter Test Division at Springfield, Mass., and from 1925 until 1933 was connected with the Transmitter Engineering Department of that company in Chicopee Falls. 1933 and '34 found him in the capacity of Consulting Engineer, and 1934 with Wired Radio, Inc., Ampere, N. J. in Transmission (Modulation) Development. In 1936 he joined the RCA Manufacturing Company, Inc., and is now in charge of the High Power Section of the Transmitter Engineering Department.

J. L. MIDDLEBROOKS received his degree in Electrical Engineering from Georgia Tech. Following this he studied Architectural Engineering at Alabama Polytechnic Institute, and in 1924 entered the construction business in Birmingham. He became Chief Engineer for WAPI and then became associated with CBS, in charge of construction, and was instrumental in the building of WKRC in Cincinnati, WEEI Boston, KSFO San Francisco, and KNX Hollywood. He is at present Liaison Engineer with CBS.

BEN W. ROBINS. Born at Hattiesburg, Miss., 1908. Wireless operator on board ship during two summer vacations from college. Graduated from Mississippi State College in 1928. Joined G. E. Company in Schenectady in 1928 and RCA Engineering Department in 1930.

H. C. VANCE was born in Wallace, Idaho. Graduated in Electrical Engineering from Washington State College, Washington, in 1923. He entered General Electric test course in 1923 and continued with General Electric Company—first in Engineering Department and later in Commercial Department specializing, first on power line carrier current telephony and then handling sale of broadcast transmitter equipment. Mr. Vance left General Electric in 1930 to take charge of RCA Broadcast Transmitter Sales in the Middle West with headquarters at Chicago.

He remained in charge of Central District RCA Transmitter Sales until the summer of 1937 when he was transferred to the home office at Camden to handle commercial development of facsimile and special communication equipment.

RCA

Broadcast Equipment



High Fidelity Broadcast Transmitters, 100 watts to 500 KW

Ultra High Frequency Transmitters

Mobile transmitters and receivers

Microphones for Every Purpose

Microphone Stands

Mixers

Monitoring Amplifiers

General Purpose Amplifiers

Pre-Amplifiers

Program Amplifiers

Line Amplifiers

Portable Broadcast Amplifiers

Frequency Monitors

High Quality Station Monitoring Equipment

Complete Studio Installations

Modulation Indicators

Portable Remote Pickup Equipment

Transcription Turntables

Instantaneous Recording Equipment

Sound Effects Equipment

Field Intensity Measuring Equipment

Beat Frequency Oscillators

Cathode Ray Oscillographs

Television Equipment

Measuring Equipment

Facsimile Equipment

Transmitting Power Tubes for Every Purpose

