

AM • FM • TELEVISION
BROADCAST
NEWS

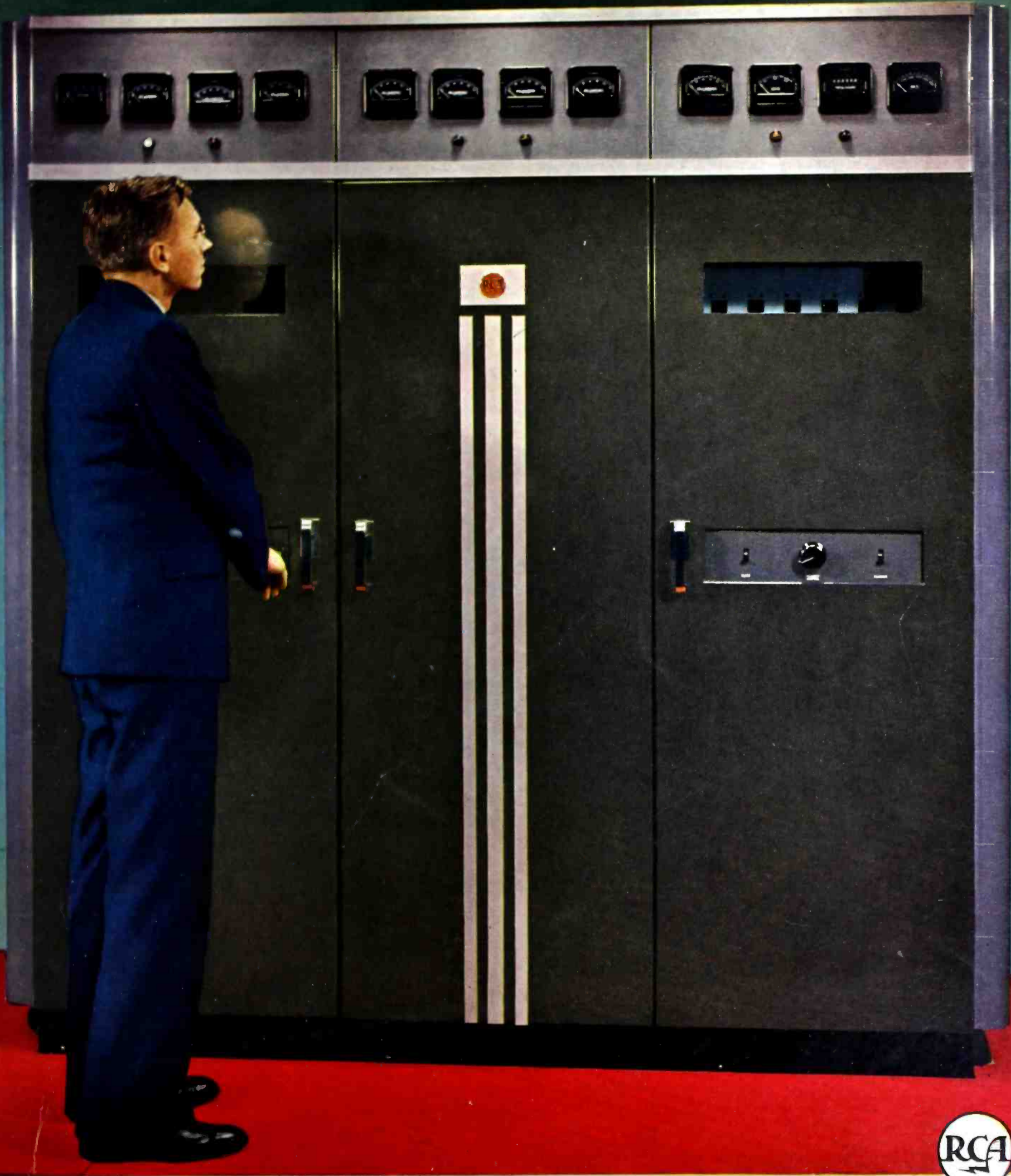

New FM Transmitters Story on Page 6

What does

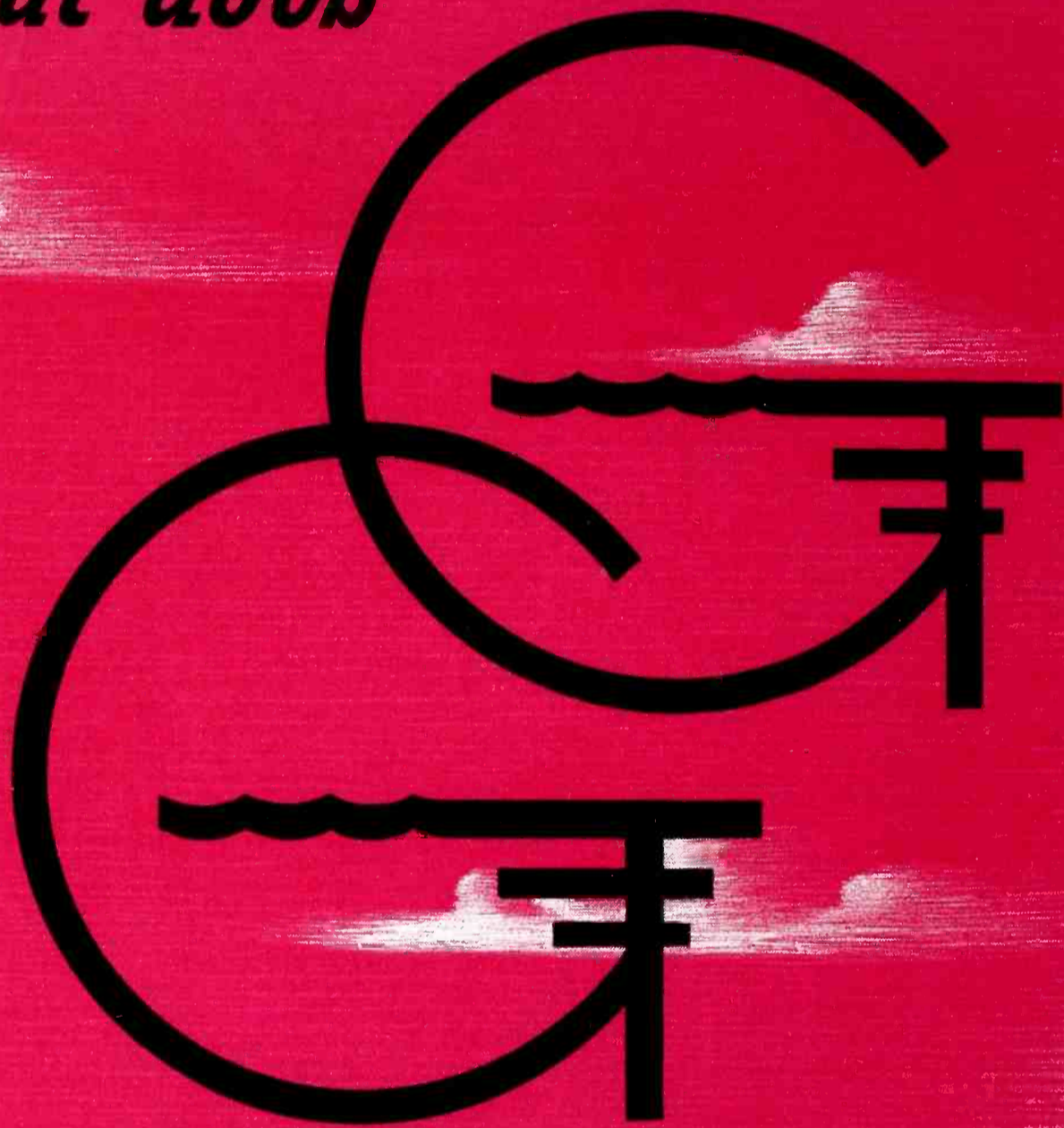

stand for?

Broadcast News

AM • FM • TELEVISION

• • •

Published by the

RADIO CORPORATION OF AMERICA

RCA VICTOR DIVISION..CAMDEN, NEW JERSEY

Subscription Rate \$1.50 per year.

Single copy 50c.

NUMBER 42

JANUARY, 1946

JOHN P. TAYLOR, Editor

J. B. EPPERSON, Technical Editor

JUDY J. ALESI, Ass't Editor

Contents

NEW FM TRANSMITTERS NOW IN PRODUCTION . . .	by R. J. NEWMAN	6
A NEW FM EXCITER UNIT OF GREATLY IMPROVED PERFORMANCE . . .	by N. J. OMAN	24
THE GROUNDED-GRID AMPLIFIER	by C. J. STARNER	30
MULTI-UNIT CONSTRUCTION—A FEATURE OF NEW FM TRANSMITTERS . . .	by JOHN L. CIBA	36
RANGE PREDICTION CHART FOR FM STATIONS . . .	by F. C. EVERETT	40
THE SUPER TURNSTILE ANTENNA	by R. W. MASTERS	42
WCAU PLANS NEW STUDIO BUILDING		45
NEW RATIO DETECTOR SIMPLIFIES FM RECEIVER DESIGN . . .	by STUART W. SEELEY	46
RCA'S NEW HIGH-SENSITIVITY CAMERA REVOLUTIONIZES TELEVISION PICKUP TECHNIQUE		48
ARMY DEMONSTRATES TWO RCA RADIO RELAY SYSTEMS		53
GIMBELS AND RCA TEST INTRA-STORE TELEVISION . . .	by JUDY J. ALESI	54
RCA MICRO-WAVE RELAY SYSTEM	by H. F. MICKEL	58
ABC'S VANDERBILT STUDIOS	by BEN ADLER	61
CANADA'S LOUDEST VOICE		66
THE 77-D POLYDIRECTIONAL MICROPHONE	by J. B. EPPERSON	71

Copyright 1945, Radio Corporation of America
Printed in U. S. A.

OUR COVER for this issue is reproduced from a 4-color photograph of the new RCA 3 KW FM Transmitter. This photograph was made in the engineering laboratory by Rod Allen of our photographic section. We think it's a right nice picture even though the limitations of space prevented really adequate lighting—and this, in turn, resulted in a reproduction which does not give an entirely correct impression of the transmitter coloring. Actually, these new transmitters are finished in the two tones of umber gray which were standardized before the war for all RCA broadcast transmitter equipment. For those not acquainted with this color it may be described as a smooth, brown-gray which is very attractive in itself, but is of sufficiently neutral tone that it will blend pleasingly with room surroundings of almost any color. The main front panels of the transmitters are finished in the dark tone of umber gray while the streamlined end pieces and the meter panels are finished in the light tone. Style strips and door handles are chrome-plated.

THE NEW FM TRANSMITTERS, because of their timeliness, come in for most of the attention in this issue of BROADCAST NEWS. There are no less than four articles—36 pages in all—on the transmitters themselves, and a fifth article on the new Super-Turnstile Antenna. In reading these articles you may get the impression that we are mighty proud of these new FM transmitters. You'll be right, we are. And, there are plenty of reasons why. One of these is the number of new features—things like Grounded-Grid and the new 7C24 tube—which they incorporate. Our engineering groups, headed by J. E. Young (that's Jack on the cover), Tom Boerner, and Nils Oman, had many months when war work kept them away from broadcast designing—but they could, and did, think in their spare moments of the new ideas they were going to put in these new postwar transmitters. As a result, when the lid came off and Bill Tucker and his design group went to work on the transmitters described in this issue, they had a hatful of new ideas to work with.

GROUNDED-GRID operation is, of course, the big feature of these new transmitters. Grounded-Grid gets rid of neutralization, makes 100 mc operation as stable as 50 mc operation, and provides a big advantage in add-on-amplifier design. Why all this is so can be best appreciated by studying Charlie Starnes' article (Pg. 26). We think this is one of the best "how-it-operates" articles we've ever published. Here's our tip on reading it: First, read it through rapidly (not stopping to resolve the minor points). This will take about fifteen minutes and will give you the general idea. Then start over again and take a half hour or an hour to study it through carefully. When you've done that you should understand Grounded-Grid; and when you understand it you'll be sold on it.

BEAUTY is as beauty does, and the attractive design of the new FM transmitters would not be justified if it did not serve a functional purpose as well. The several outstanding features of Multi-Unit construction (as made use of in these transmitters) are pointed out in the article by John Ciba on Pg. 32. Not the least of these features is the fact that this type of construction provides a "unified front" appearance while at the same time allowing the equipment to be broken down into units small enough to be easily handled on passenger elevators or trucked to remote locations.

JOE EPPERSON joins the staff of BROADCAST NEWS with this issue. Joe's been in broadcasting quite a while and will need no introduction to many broadcasters, particularly those in the southeast. Before the war he was chief engineer of the Scripps-Howard Stations, WNOX, WMPS and WCPO. During the war he was with Dr. Everitt's group in the Office of the Chief Signal Officer, Washington, D. C. The article on the new 77-D Microphone on Pg. 65 is, we expect, just the first of many good technical



stories Joe will do for us. His knowledge of broadcast engineering will also be evident in the editing and arrangement of much of the other material in future issues of BROADCAST NEWS.

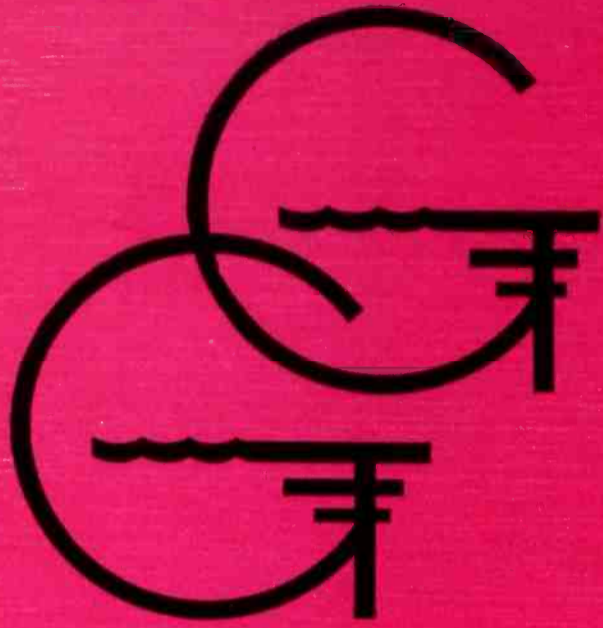

is for...

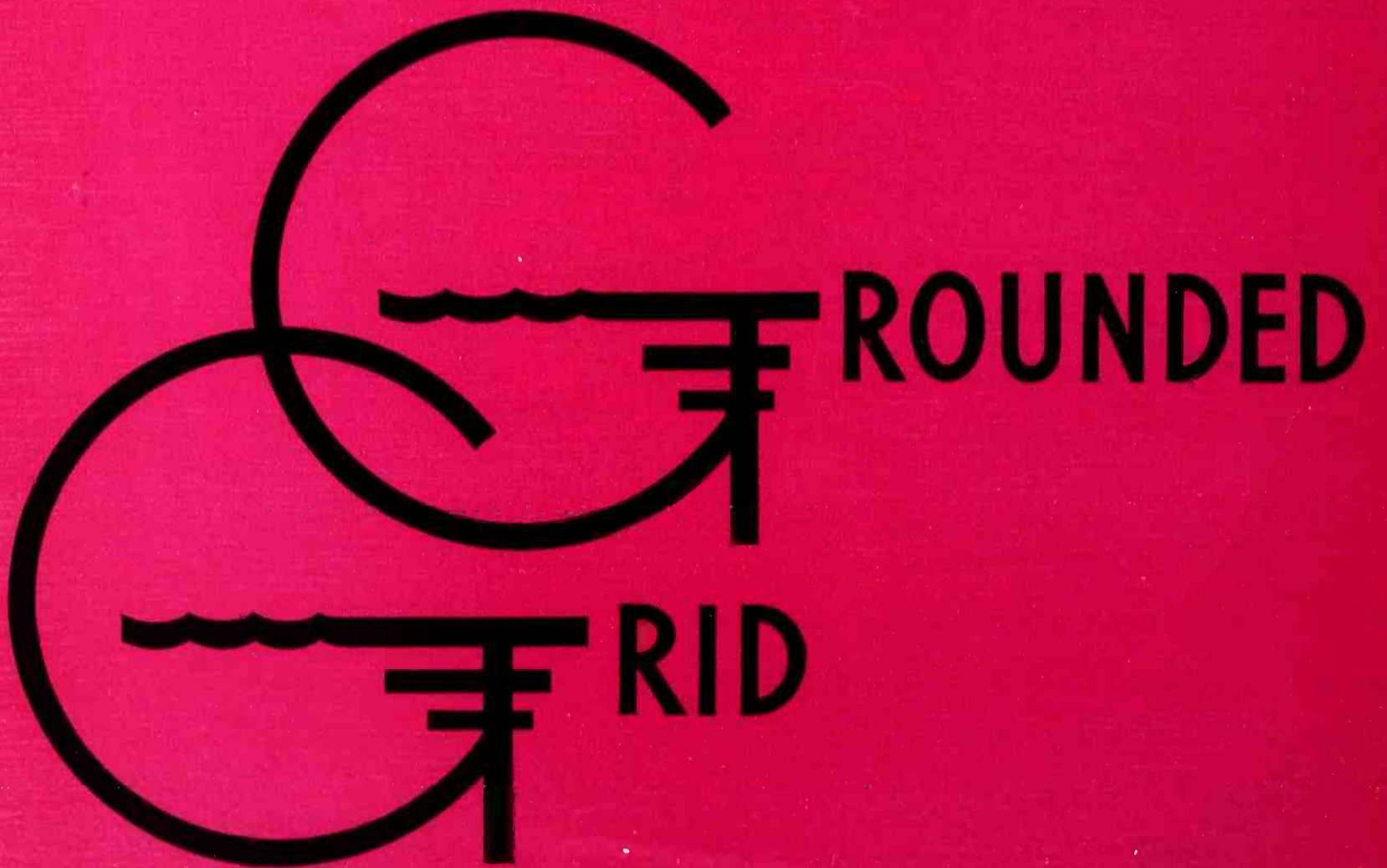

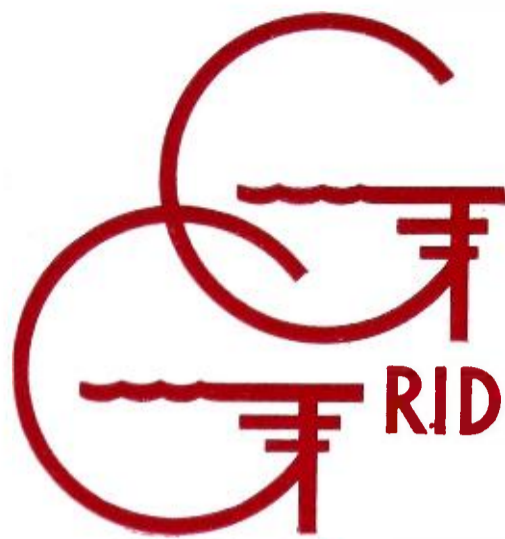

ROUNDED
RID... *AMPLIFIERS* are a
feature of the new
RCA FM Transmitters



ROUNDED *means money*
RID... *in your pocket*
... and here's why!

1. GROUNDED-GRID circuits provide greater output from an amplifier using a tube of given size—thus making possible the use of smaller, less-expensive tubes. Only a relatively few types are used, thereby reducing number of spares required. Overall *tube costs are less.*

2. GROUNDED-GRID amplifiers are more stable and require less critical adjustment than conventional-type 100 mc. amplifiers. Neutralizing is very simple—and not required at all for low powers. Maintenance problems are fewer and *maintenance costs are lower.*

3. GROUNDED-GRID circuits make feasible and economical an arrangement of amplifiers that are integral units. These units are small in size, easy to handle, and require

a minimum of inter-unit wiring. Their use simplifies installation problems and *reduces installation costs.*

4. GROUNDED-GRID circuits are simpler and require fewer components than conventional amplifiers. They tune easier, introduce less distortion—thus *insure better program quality.*



See Page 30

*What is
Direct FM*



Direct FM is the system in which the oscillator that determines the "mean" or "carrier" frequency is modulated directly by the voice or audio frequency

Such a system is

- ...Simpler*
- ...Requires fewer tubes*
- ...Needs less adjusting*
- ...Introduces less distortion*
- ...Is less susceptible to noise interference*

*- and remember
in RCA FM Transmitters
you get*

GROUNDING
GRID *for the best* **FM**

New FM TRANSMITTERS

NOW IN PRODUCTION

By **R. J. NEWMAN**

Engineering Department
Engineering Products Division

Three new FM Broadcast Transmitters—in powers of 250 watts, 1000 watts, and 3000 watts—have been placed in production at Camden. Transmitters of still higher power are nearing completion of design. These new transmitters, which have been designated the “BTF” series (for B-roadcast T-ransmitters F-requency modulated), are completely new from exciter to power amplifier. They employ new circuits, new tubes and a new kind of construction. Features include a new exciter of entirely different type, a new tube especially designed for 100 mc operation and the use of new *grounded-grid circuits* which are at once simpler and more stable than any heretofore employed.

Possibly the most striking feature of the new BTF transmitters (three of which are shown on following pages) is the manner in which the several power categories have been integrated in design. As a result of the wartime restrictions on transmitter construction, an opportunity was presented to design a whole new line, and RCA engineers grasped this chance to show what they could really do in designing an integrated line. They began by standardizing on a unit enclosure which could be used on all power sizes, thereby insuring absolute match in appearance

and facilitating installation. Next, they worked out the use of *grounded-grid* amplifier circuits—circuits which are simpler and more stable at 100 mc than conventional circuits—and which make amplifier step-up ratios of three-to-one not only economical, but actually more efficient than higher step-up ratios. Then, in conjunction with RCA tube engineers, they developed a tube which was especially suited for use in these circuits, and which could satisfactorily and economically be used in the 1 kw and 3 kw stages. Finally, the engineers added a whole host of other features based on RCA's experience in installing more than 300 of the country's present-day broadcast stations of both amplitude and frequency modulated types.

On pages 8 to 17, which follow, will be found a more complete description of the numerous features which are common to all of the BTF transmitters. On pages 18 to 23 are the specifications of the three types on which design work has been completed. And, in the remaining pages of this issue, will be found several articles of a technical nature on such subjects as the new exciter and the grounded-grid amplifier.

IMPORTANT FEATURES OF THE NEW RCA FM TRANSMITTER

1. GROUNDED-GRID CIRCUITS

Eliminate need for neutralizing amplifier stages, improve high-frequency stability and greatly simplify circuits and wiring. *See pages 12 and 30*

2. NEW 7C24 TUBE

Especially designed for Grounded-Grid operation. Makes possible simple circuits of high efficiency. Used as output tube in 1 KW and 3 KW, as driver in higher powers. *See page 13*

3. DIRECT FM EXCITER

An entirely new design; uses small number of tubes, all of inexpensive types; no trick circuits. Provides crystal-controlled stability. *See pages 11 and 24*

4. ADD-ON-AMPLIFIER DESIGN

Design of all transmitters integrated so that adding an amplifier (in any power category) entails very little extra equipment or cost. *See page 9*

5. UNIT CONSTRUCTION

All transmitters made up of basic units only 25 inches square by 84 inches high. Easily handled in tight places, or trucked to remote locations. *See pages 10 and 36*

6. VERTICAL ASSEMBLY

All units feature vertical chassis construction providing unimpeded up-draft ventilation. Full-length, full-width doors provide quick access to all parts. *See page 14*

7. COMPLETE DUST-PROOFING

Only openings into cabinets are through dust filters in base. All units have either blowers in base or ventilating fans in top. *See page 15*

8. UNIFIED APPEARANCE

Matching appearance and full-width doors on all units provides appearance of “unified” front while retaining advantages of unit construction. *See pages 7 and 8*

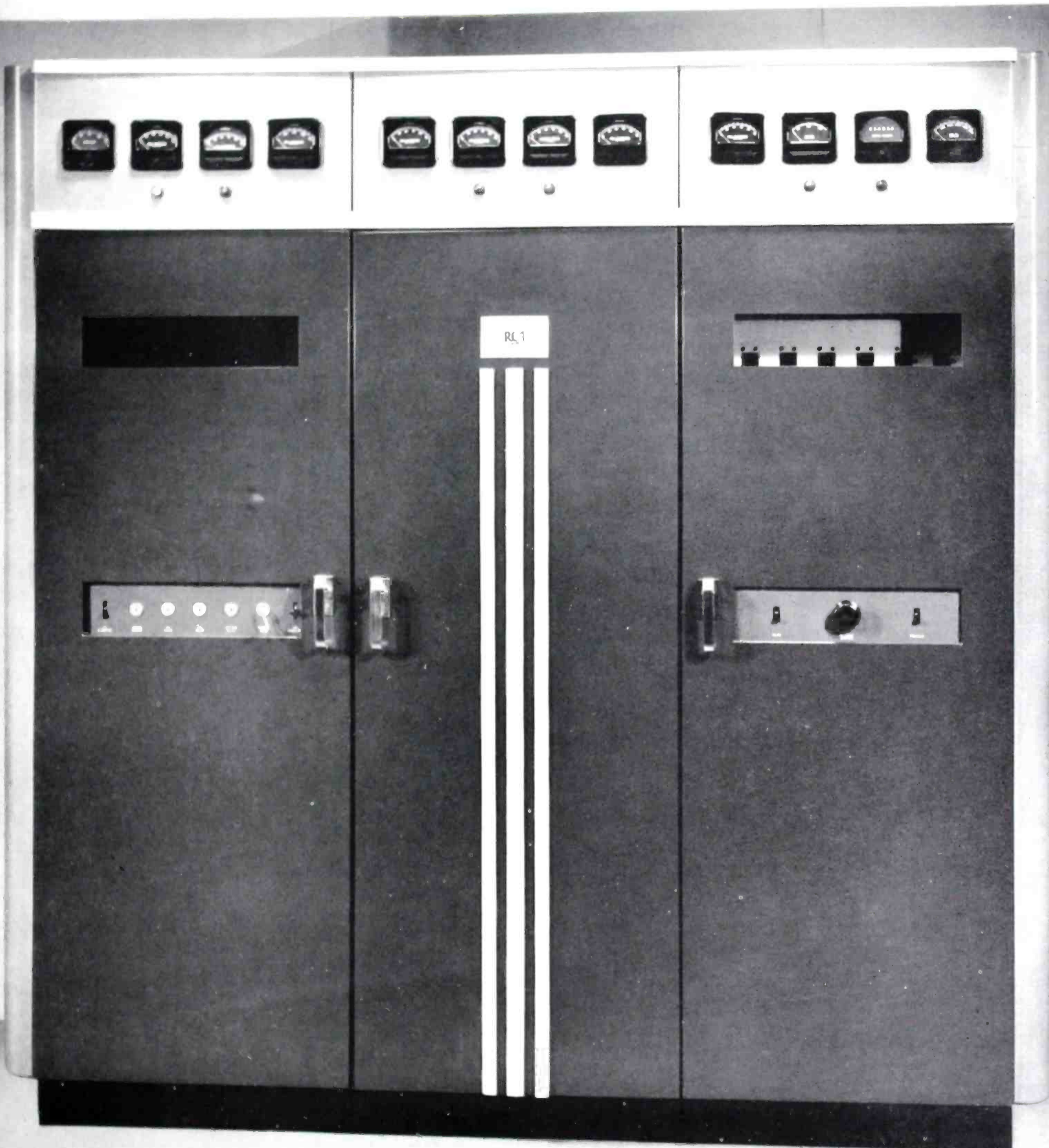

RC 1

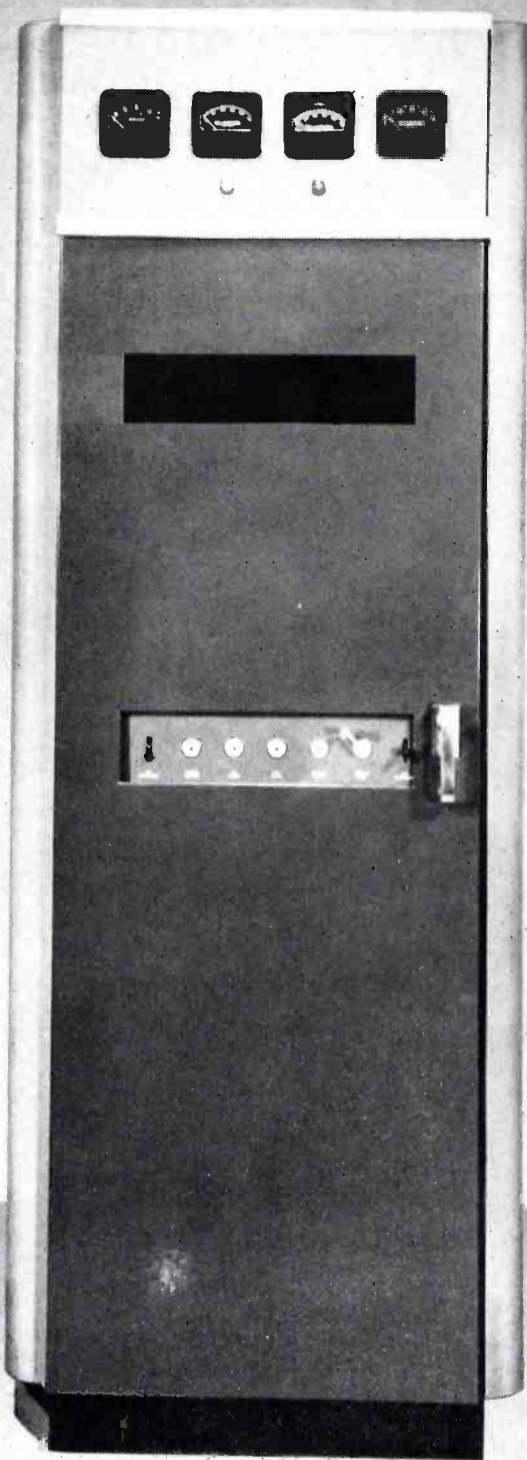

(Left)—The new RCA Type BTF-250A Transmitter for 250-Watt FM station. For specifications, dimensions, etc., see Page 18.

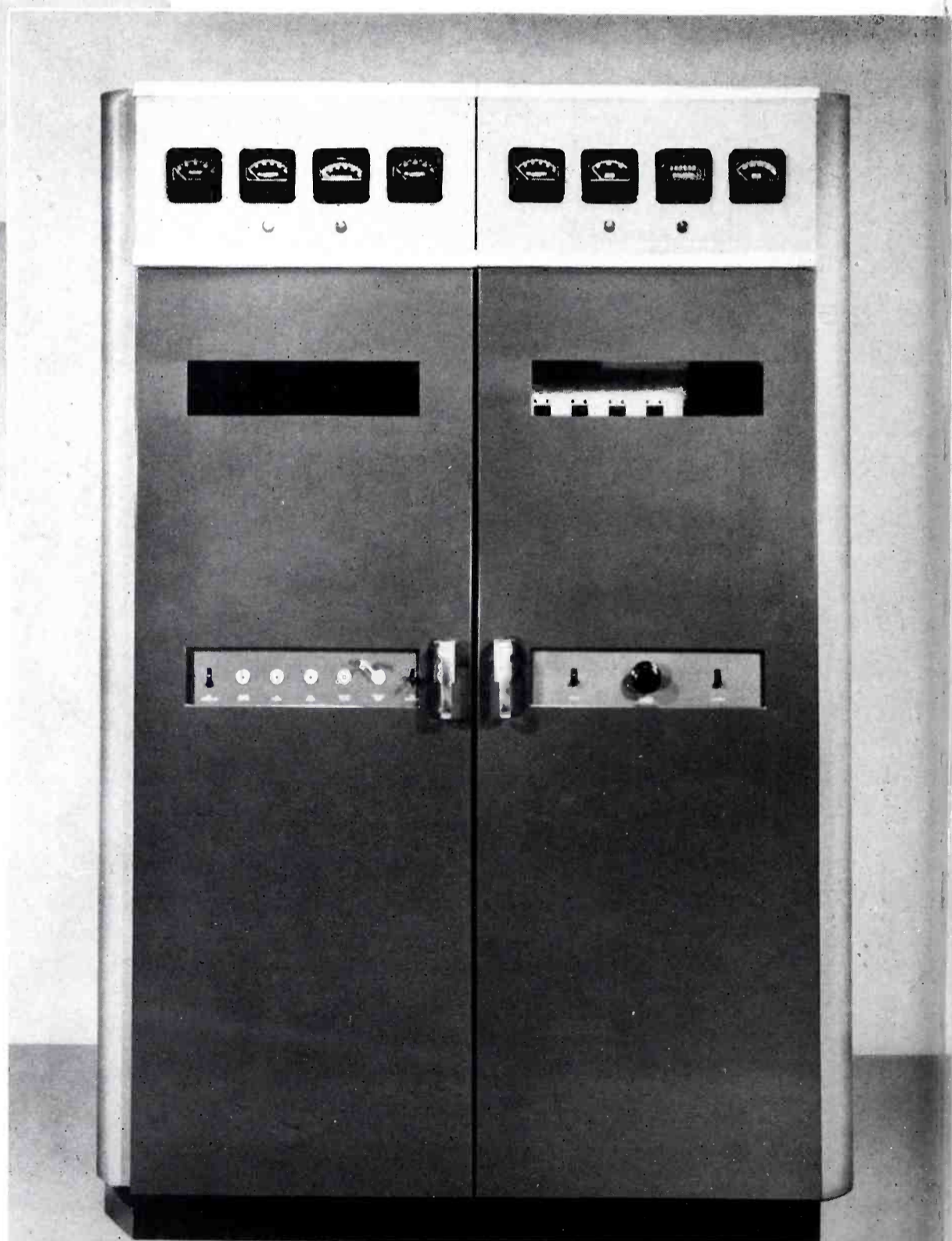

(Right)—The new RCA Type BTF-1C Transmitter for 1000-Watt FM station. For specifications, dimensions, etc., see Page 20.

FEATURES OF NEW FM TRANSMITTERS

NO. 1. ADD-ON-AMPLIFIER DESIGN PROVIDES FOR EASY EXPANSION

In the new RCA FM transmitters increase of power is made easy by the fact that each successive power category is formed by adding an amplifier to the next lower-powered unit. Thus, the BTF-250 (250 watt) transmitter plus an amplifier becomes the BTF-1C (1000 watt) transmitter; the BTF-1C plus an amplifier becomes the BTF-3B (3000 watt) transmitter, and so on.

Ordinarily, it would not be economical to add an amplifier for a three-to-one step up in power because conventional tubes and circuits are usually designed for, and operate most efficiently at, step-up ratios of the order of ten-to-one. As a result, with conventional amplifiers, the combination of a low-power unit plus an amplifier costs more than a unit built originally for the higher power. However, when grounded-grid amplifiers are used, as in the new RCA FM Transmitters, this is not true—for with grounded-grid circuits the driver stages also contribute to the actual antenna output of the transmitter. Thus, a much smaller amplifier tube can be used (than in conventional circuits) and a three-to-one step up becomes more economical and

more practical. The new RCA FM transmitters have been designed to facilitate the addition of amplifiers to increase power.

It is worth noting also that another feature of the new FM transmitters adds naturally to the ease of power increase. This is the aptly titled Multi-Unit construction whereby all of these transmitters are made up of standard cabinet units which go together like building blocks. With this type of construction the addition of amplifier units is relatively easy. The extra units fit directly on the original units: no additional air or wiring ducts are required. And, not the least important, the overall installation has a matching appearance; it looks like an equipment designed originally as a single unit, which, as a matter of fact, it was.

Even for the station that never actually makes use of the add-on-amplifier feature, it has some value. This is because standardization greatly increases the quantity of low-power units manufactured and thereby substantially reduces the cost of each. This is one of the features which makes it possible for RCA to offer transmitters which truly represent more for the money.

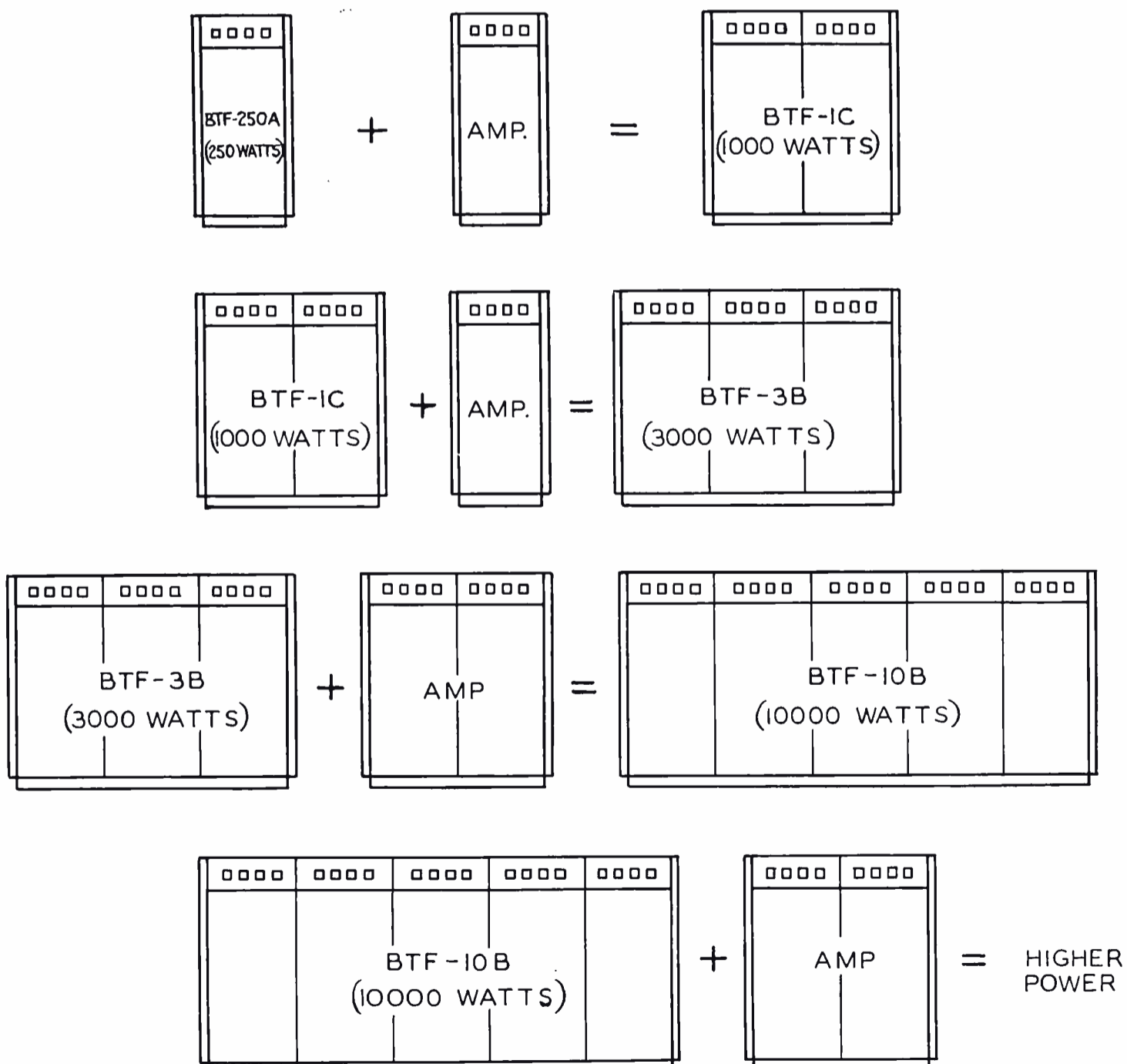

The new RCA FM Transmitters are designed for easy power increase.

FEATURES OF NEW FM TRANSMITTERS

NO. 2. MULTI-UNIT CONSTRUCTION SIMPLIFIES INSTALLATION

All the new RCA FM Transmitters are housed in unit enclosures of a unique new design. The number of these unit enclosures varies with the power of the transmitters. Thus, there is one unit for the 250 watt transmitter, two for the 1000 watt transmitter and three for the 3000 watt transmitter. But, while the number of these unit enclosures or cabinets varies, all of them are basically alike. They all have the same framework, the same front and rear doors, the same air filter arrangement, the same meter panel, etc. And they are, of course, all of exactly the same dimensions.

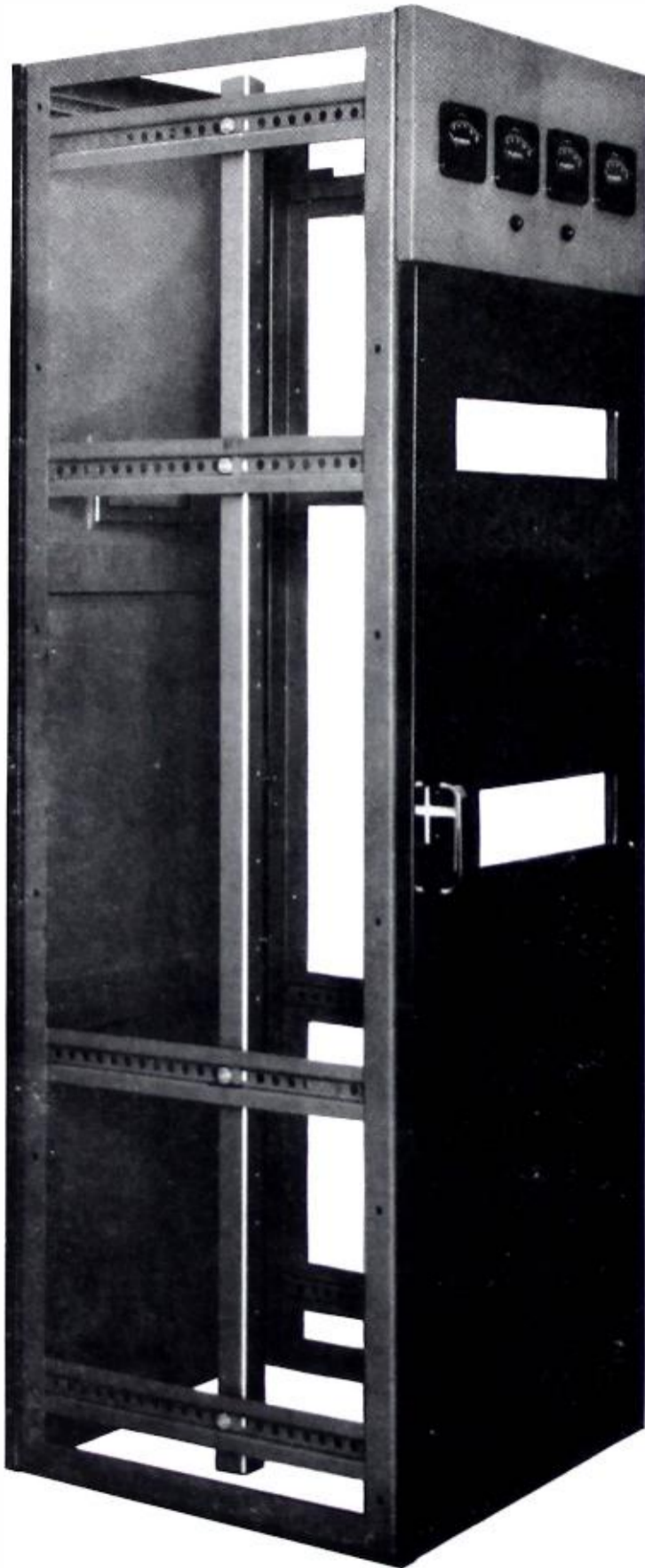

The basic cabinet unit from which all of the new FM Transmitters are built up.

This type of construction has several advantages. The most important is that it simplifies and reduces the cost of installation. Many FM transmitters will be located in relatively inaccessible locations so that moving equipment into place is, in itself, quite a problem. For example, they will, in many instances, be located on the top floors of tall buildings. In such cases the available elevators, as well as the various passageways to be negotiated, will limit the size and weight of units. Other FM transmitters will be located on mountain tops—often accessible only by very poor roads. Here again size and weight of units is a consideration.

The unit enclosures of which the RCA FM transmitters are made up (see illustration at left) have maximum dimensions of 25" x 28" x 80". They can be easily handled by two men; can be wheeled on a small dolly; can be taken through an ordinary door; and can be easily managed on even small passenger elevators. The heaviest unit weighs less than 500 pounds. This weight is less certain demountable units, such as the heavier transformers, which are shipped separately.

A second advantage of this type of construction is that it results in a lower manufacturing cost. The type of enclosure used in these transmitters has been standardized and will be used in many other RCA transmitters as well. As a consequence, relatively large quantities can be manufactured at one time and the costs of tools and of setting up production (major items) may be spread over many units. Once again the station owner benefits because he thereby obtains a far better equipment than could be offered if the units were manufactured in small quantities. A careful comparison will bear this out.

The frames and enclosures used in these FM transmitters have been carefully engineered. The basis of the enclosures is a rigid frame fabricated from $\frac{1}{8}$ " steel angle. The construction of the door is particularly noteworthy. Fabricated from sheet steel these doors are braced to form a particularly rigid and durable structure free of weave or whip. Although they open full length, they always close smoothly and fit snugly against the frame. They are the same width as the frames so that when closed they appear to form a continuous panel. Windows in both front and rear doors provide for observation of the interior during operation. (For further information on this new development in transmitter construction see "Multi-Unit Construction, A Feature of New FM Transmitters" on page 36.)

Another feature of these transmitters, which makes installation simpler and less expensive, is the provision of a base frame on which the unit enclosures are mounted. This frame, which is four inches high, has screened openings at the front through which air enters to reach the filters. In this way, no air duct is required. At the rear of the frame is a 4" x 4" wiring duct through which all inter-unit wiring runs. Complete wiring kits are furnished with each transmitter. All that is required is to make the few external connections needed and the equipment is ready for tune up. In transmitters of 3 kw and less, no other wire duct or conduct is necessary except for incoming power, audio, and monitoring leads.

FEATURES OF NEW FM TRANSMITTERS

NO. 3. NEW EXCITER USES "DIRECT-FM" CIRCUIT

An exciter unit of entirely new design is one of the features of the BTF Transmitters. This exciter, shown below, is used in all models from 250 watts up. In the 3 kw and higher-powered transmitters, space is provided for mounting an additional or "spare" unit. When it is desired to provide a spare with the 250 watt or 1 kw transmitters, an additional standard cabinet can be added. This cabinet can also be used to house the monitors and other transmitter accessories.

The circuit employed in the new RCA FM Exciter Unit retains the advantages of simplicity and fewer tubes which are inherent in "Direct-FM" while at the same time it provides the frequency stability of crystal control. In the "Direct-FM" circuit the "carrier," or center frequency is generated by an oscillator operating at a medium frequency. This oscillator is modulated by push-pull reactance tubes. Thus, frequency modulation is accomplished directly and without the necessity of proceeding through numerous multiplier and converter stages, each of which would unavoidably add its contribution of noise and distortion products. All components are mounted on a single vertical panel and are easily accessible. An oscilloscope for checking circuits is built in.

Center-frequency stability is maintained by comparing a sub-harmonic of the modulated signal with a standard frequency developed by a temperature-controlled precision-ground quartz-crystal oscillator. Any difference between the mean frequency of the modulated signal and that of the standard actuates a two-phase motor which drives a frequency compensating condenser mounted on its shaft and connected across the tuned-circuit of the modulated oscillator. The motor turns until the condenser reaches a posi-

tion at which the center frequency is exactly synchronized with the proper multiple of the standard frequency. Thus the transmitted frequency is maintained to the same precision as that of the crystal.

This automatic frequency control circuit is completely independent of the modulation circuit. Frequency subdivision is obtained through locked-in oscillators used as frequency dividers. Two quartz-crystals are provided for the frequency standard. The standby unit is maintained at operating temperature and is connected into the circuit by the flick of a switch. For complete details on the FM Exciter refer to "A New Exciter of Greatly Improved Performance" on page 24 of this issue.

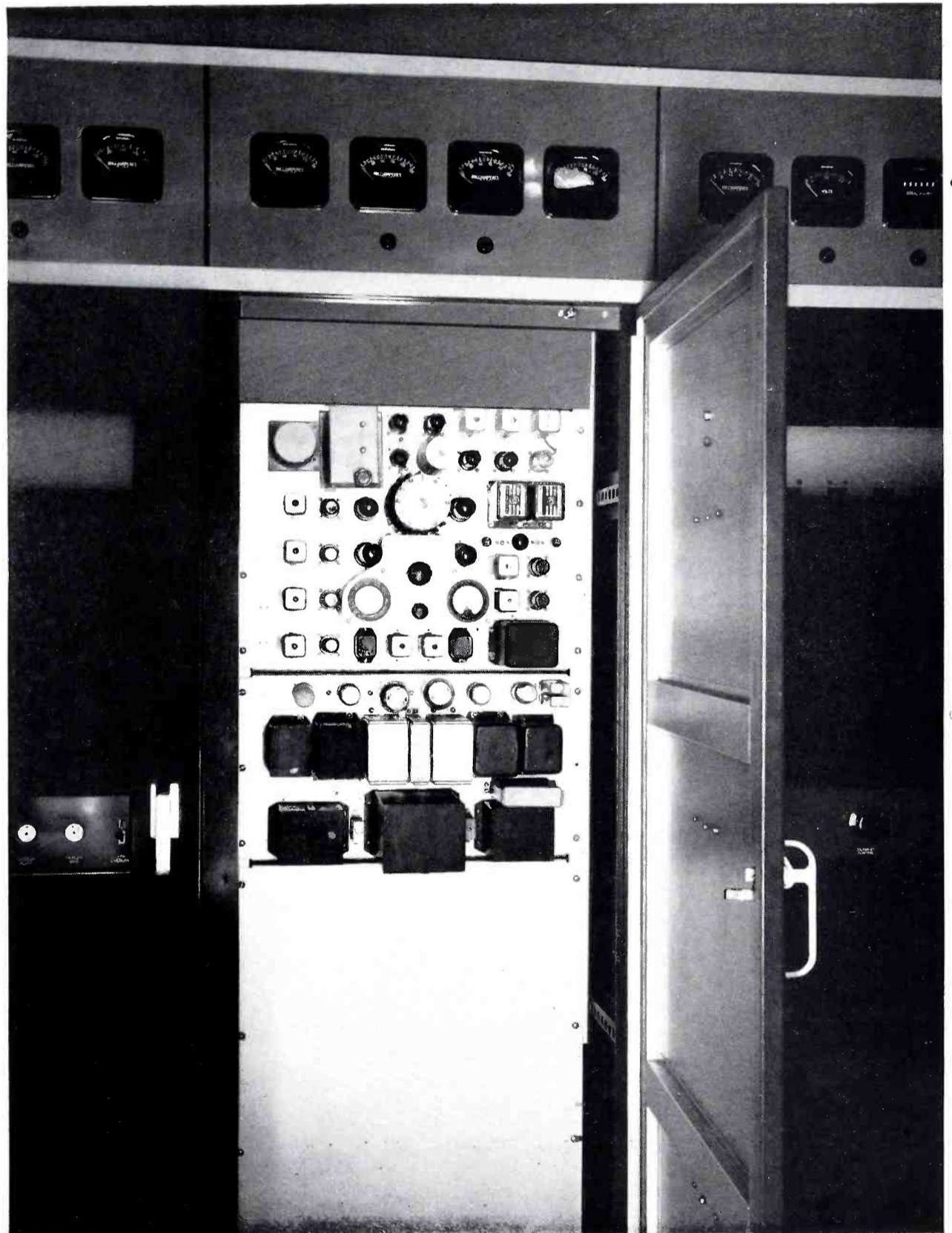

Exciter unit used in all of the new FM Transmitters. In the 3 KW and larger sizes space is available for mounting a spare exciter unit.

FEATURES OF NEW FM TRANSMITTERS

NO. 4. GROUNDED-GRID AMPLIFIERS SIMPLIFY CIRCUITS AND ADJUSTMENTS

Grounded-grid amplifiers are used in all of the BTF transmitters of powers above 250 watts. Amplifiers of this type are extremely stable, and in this respect are superior to either conventional triode circuits or those employing screen grid tubes. This fact is particularly important at frequencies above 50 mc where circuits must be kept simple and where feedback, either through tube or circuit, is particularly hard to control. They require no neutralizing, and the associated circuits are simpler and require fewer components. Moreover, more power output can be obtained from an amplifier using a tube of a given size, thereby making possible the use of smaller, less expensive tubes with a consequent reduction in overall operating cost.

In the grounded-grid amplifier, as the name indicates, the grid of the tube is at r-f ground potential (instead of the filament as in conventional amplifiers). Normal bias is necessary and is supplied in the same manner as that of the conventional grounded-

cathode circuit. Since the grid is at ground potential, it performs the dual function of acting as the control grid, and as a screen between plate and cathode circuits. It follows that if a tube which has been properly designed to take advantage of the screening action is used, no neutralizing circuits are required.

Grounded-grid amplifiers require more power from the driver stage than do conventional amplifiers. This, however, does not represent a loss of efficiency for *all the extra driver power actually appears in the plate circuit of the amplifier tube as output power*. In other words, in this type of amplifier the actual output power comes partly from the amplifier stage and partly from the driver stage. This characteristic is used to advantage in the BTF transmitters since it makes possible the efficient use of amplifiers of three-to-one step-up ratio. Moreover, it allows the same type of tube to be used in the 1 kw and 3 kw stages. (For more information see "The Grounded-Grid Amplifier", page 30.)

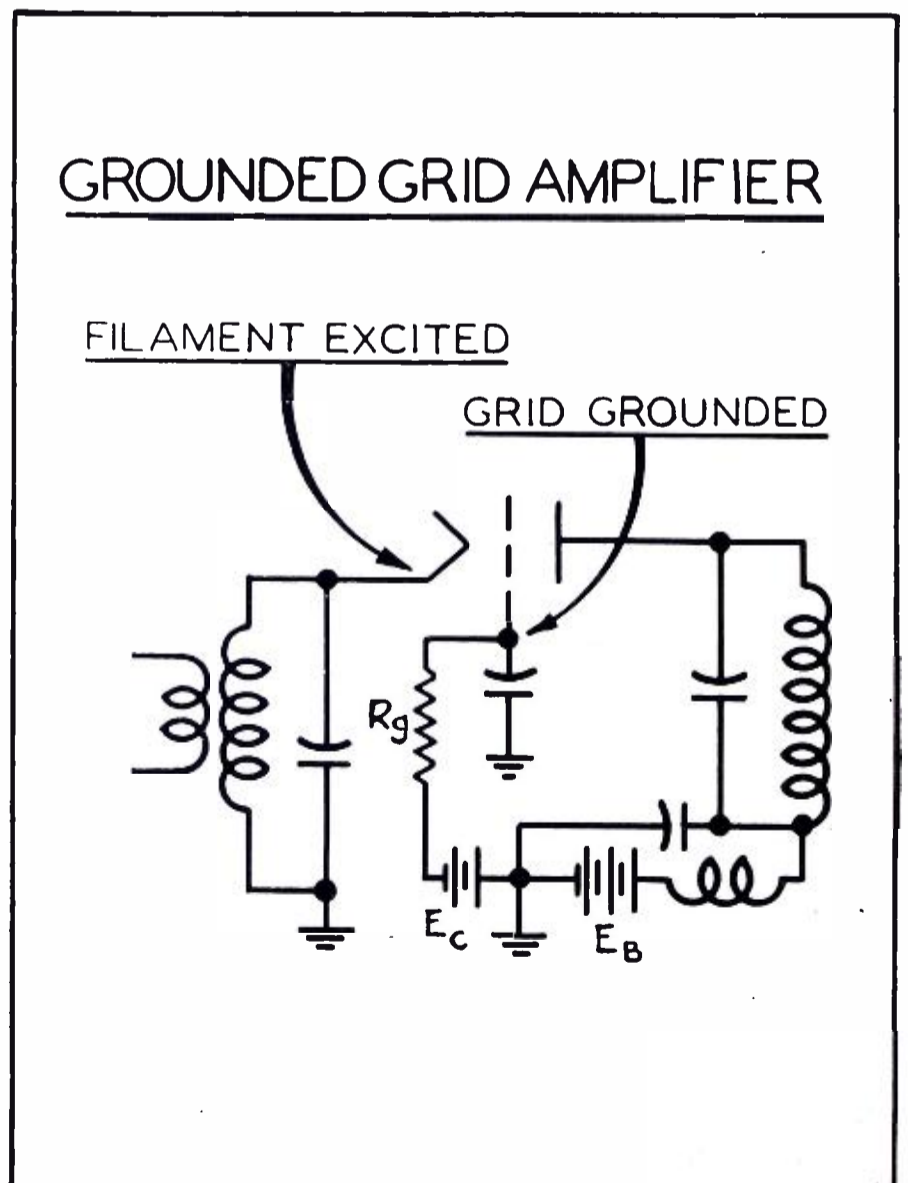
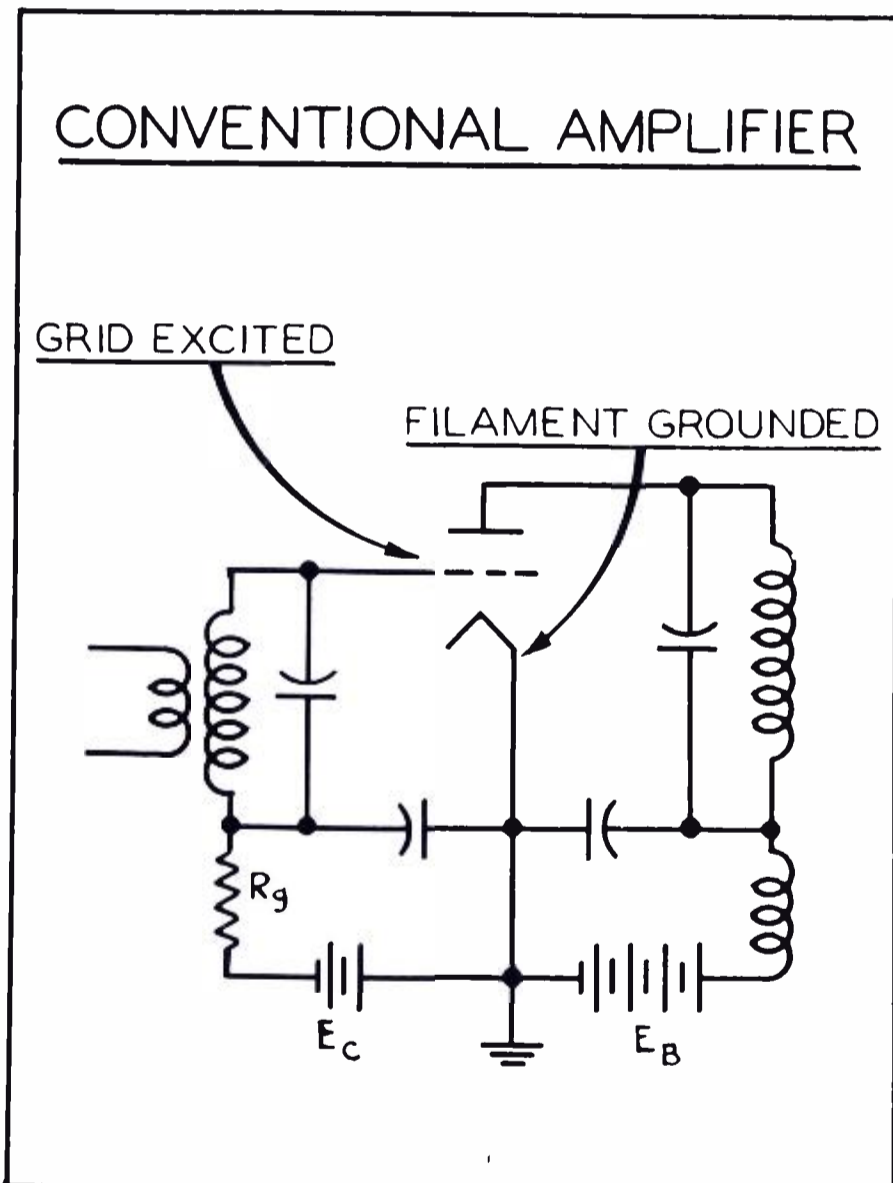

FEATURES OF NEW FM TRANSMITTERS

NO. 5. ESPECIALLY DESIGNED AMPLIFIER TUBE FOR 100 MC STABILITY

In order to obtain the most out of the grounded-grid amplifier circuits in the BTF Transmitters, an entirely new type of tube was developed especially for the purpose. This new tube—the RCA 7C24 shown below—resembles in size and appearance the RCA 827-R which was a popular and very successful feature of RCA prewar transmitters. In design, however, it differs markedly from the 827-R. For one thing, it is a triode, while the former was a tetrode. Moreover, the construction is quite different. The 7C24 is provided with a grid structure specifically designed to offer a maximum of shielding between the plate and filament electrodes, resulting in a very low plate filament

capacity. The grid connection is a disc seal brought out through the glass all the way around the tube. When this is utilized in connection with an external shield, the input (filament) and output (plate) circuits of the amplifiers are very well isolated.

The RCA 7C24 tube, in combination with the grounded-grid amplifier circuits of the BTF Transmitters, results in a unique arrangement; namely, the use of the same type tube in the 1 kw and 3 kw stages. This has the very considerable advantage of reducing the number of types used and thereby lessening the number of spares that must be kept on hand.

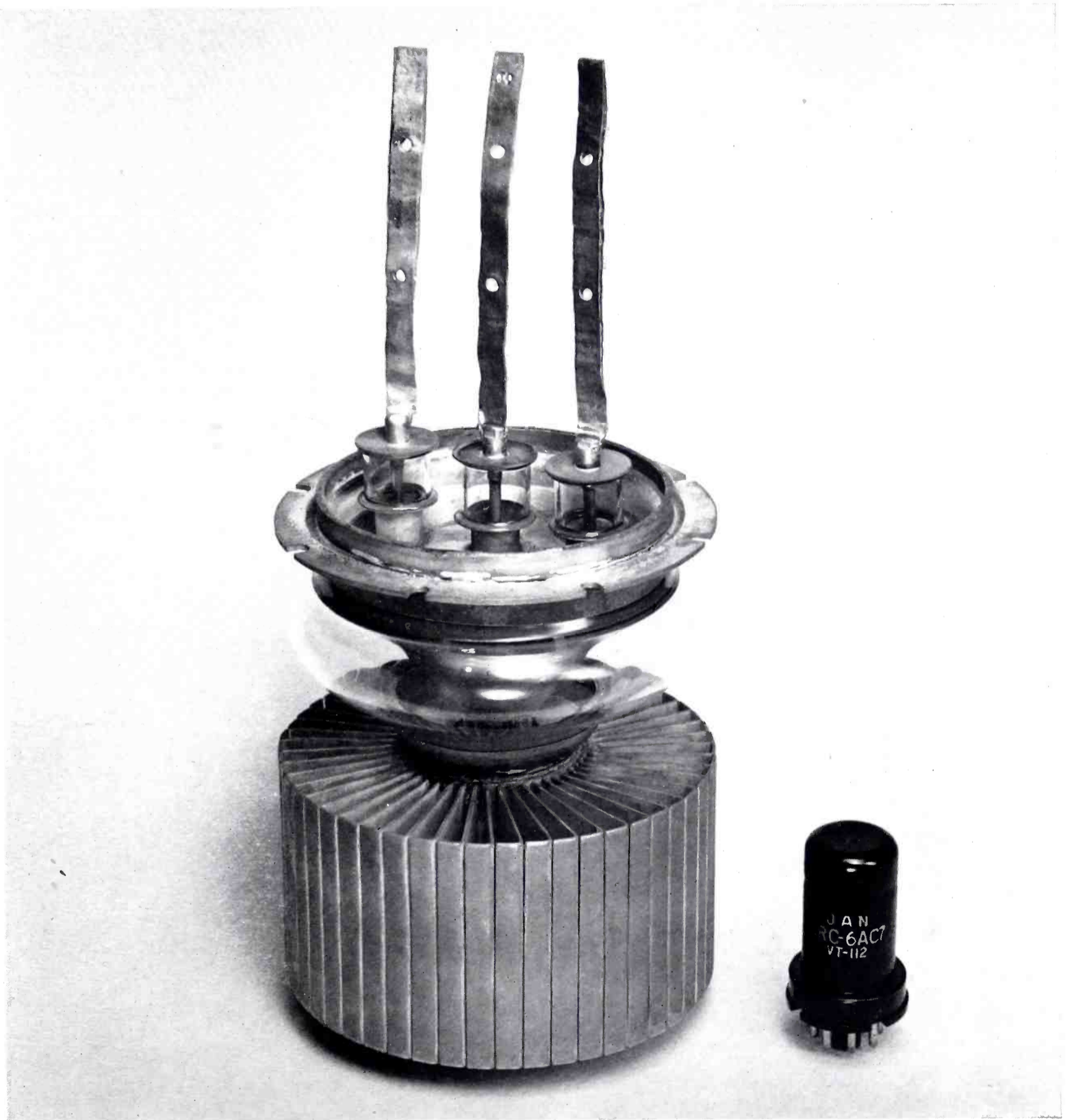

The new RCA 7C24, a tube especially designed for Grounded-Grid operation (reproduced approximately full size).

FEATURES OF NEW FM TRANSMITTERS

NO. 6. VERTICAL PANELS FOR ACCESSIBILITY

One feature of the new BTF transmitters is new only in the way it is used; this is the vertical panel construction. RCA engineers first used vertical panel construction in AM transmitters some ten years ago, and in recent years all RCA Broadcast transmitters, and many others as well, have been built in this fashion. This type of construction, in which all components are mounted on vertical panels (as shown in the view below) has numerous advantages. Most obvious is that air entering through the filters at the bottom travels upward in an unobstructed manner, thus providing most efficient cooling. This is in contrast to the old-style shelf-mounted types in which components were mounted on

horizontal shelves or chassis which almost completely blocked air passage. Another important advantage is in accessibility. The front doors of the BTF unit-enclosures give immediate access to the front of the vertical panels on which the circuit components are mounted, while the rear doors afford access to the wiring and other parts on the rear of the vertical panels. (All wiring is in the clear with every terminal legibly marked and easily accessible for check). Still another advantage is the fact that these panels can be assembled and wired on a bench and, after completion, mounted in the enclosure proper. This results in better assembly and better wiring.

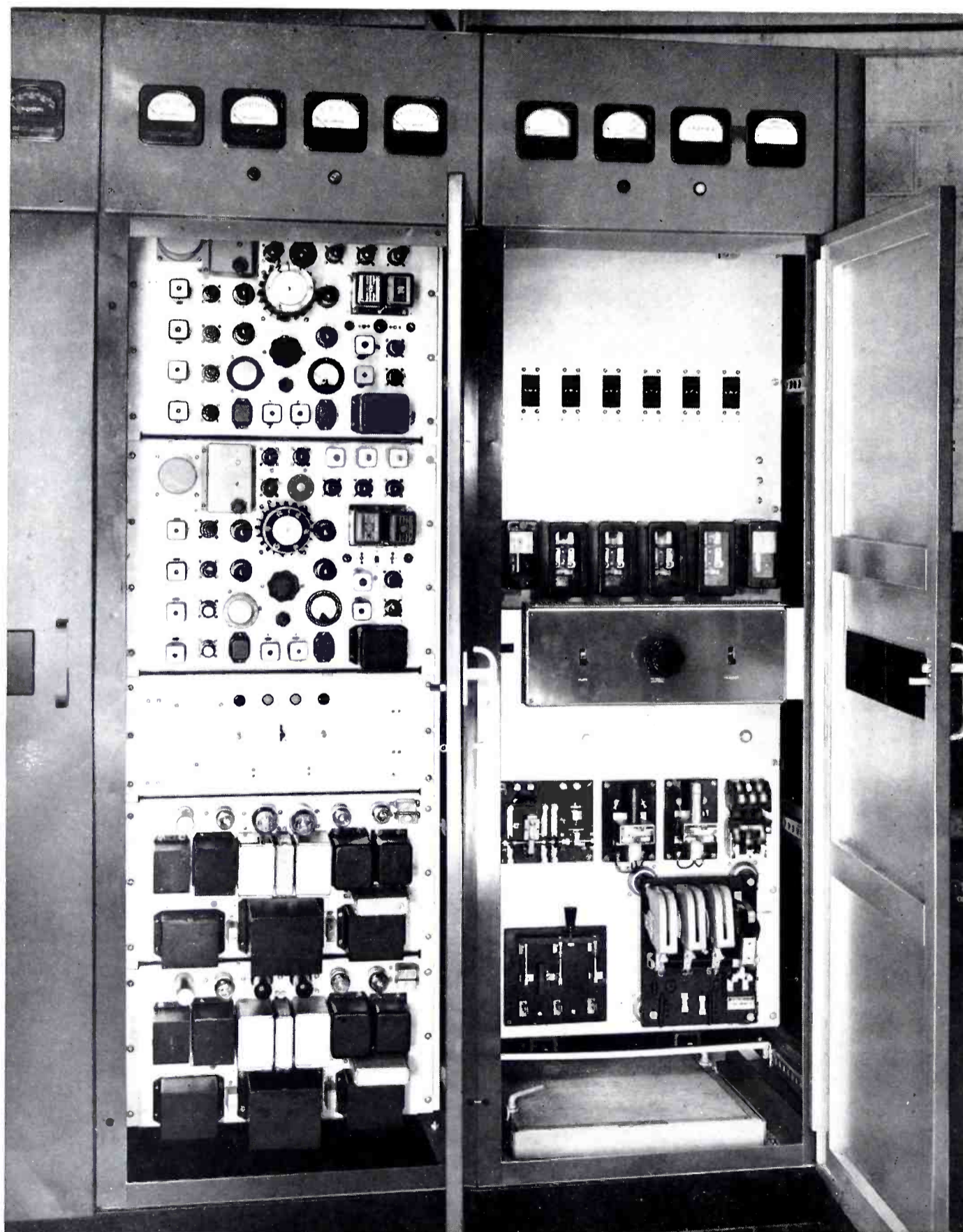

Interior of the center and righthand units of the 3 KW Transmitter shows front panel accessibility.

FEATURES OF NEW FM TRANSMITTERS

NO. 7. AIR FILTERS PROTECT EQUIPMENT, REDUCE MAINTENANCE

Early broadcast transmitters had open sides, or sides with many louvres. Circulation of air was uncontrolled and dust in great quantities collected on all the components. Several years ago, when RCA engineers introduced forced-air-cooled tubes, they provided dust filters in the inlets. Low power stages, however, were still unprotected. In the BTF transmitters the trend has been carried a step further.

Each compartment is equipped with an air filter located in the bottom of the compartment frame. The four-inch base contains cutouts along the front side which act as individual air inlets. In compartments containing air-cooled tubes, individual blowers pull the air through the filter and deliver it to the tubes. The exhaust air is expelled out the top. Compartments not containing forced air-cooled tubes also receive their air through a filter and exhaust it by means of an exhaust fan located in the roof of the compartment. Special dust shields prevent dirt from settling inside the cabinet while the transmitter is shut down. There are no louvres in the BTF transmitters and the doors close snugly so that no air can enter. Thus, very little dust can enter the enclosures either during operation or standby. As a result, troubles due to dust on contacts are lessened; maintenance time and cost are reduced. Moreover, cooling is more efficient, components operate well below temperature ratings and failures are less likely to occur.

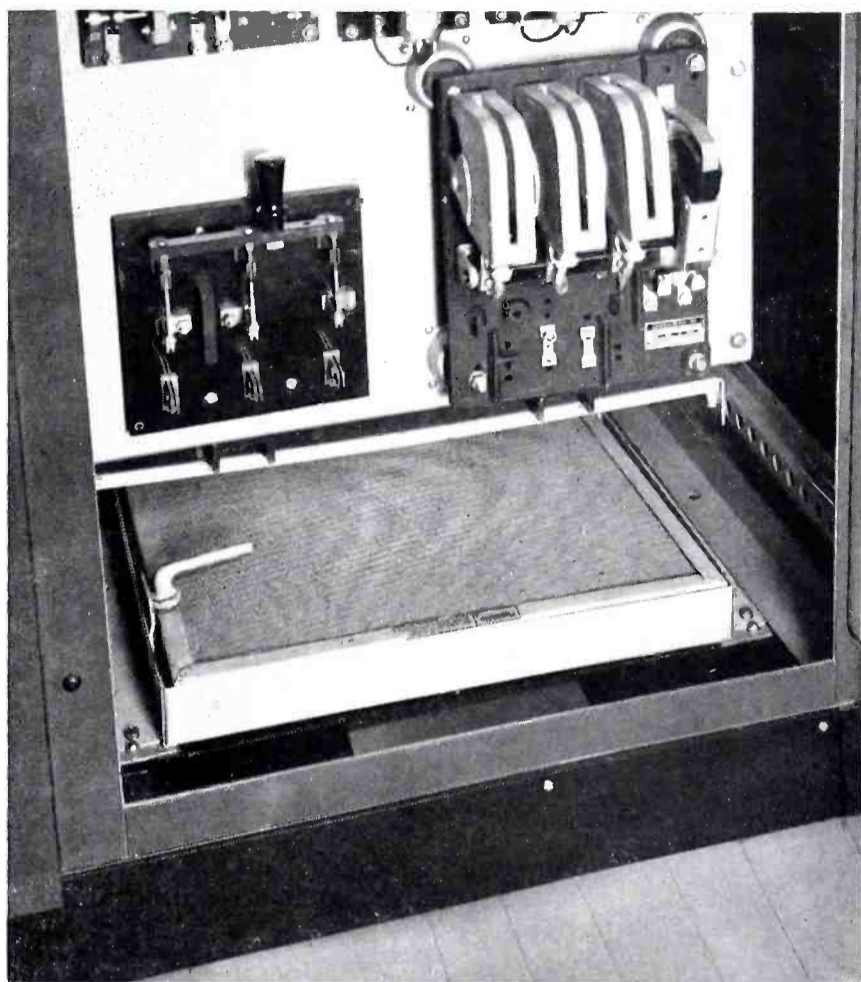

A spun-glass dust filter is located in the base of each unit. A wiring duct (the openings are visible in this view) is located just in front of the filters.

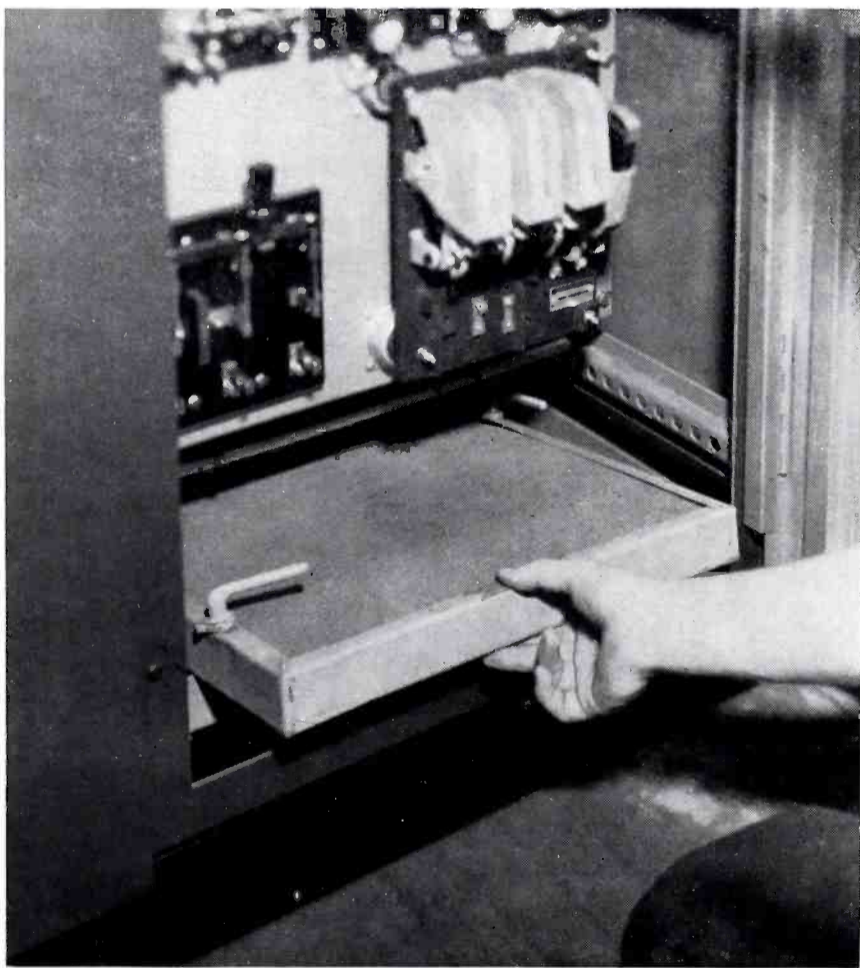

The dust filters are standard units which may be easily removed and cleaned (by washing). Their use insures a nearly dust-free transmitter, thereby reducing maintenance costs.

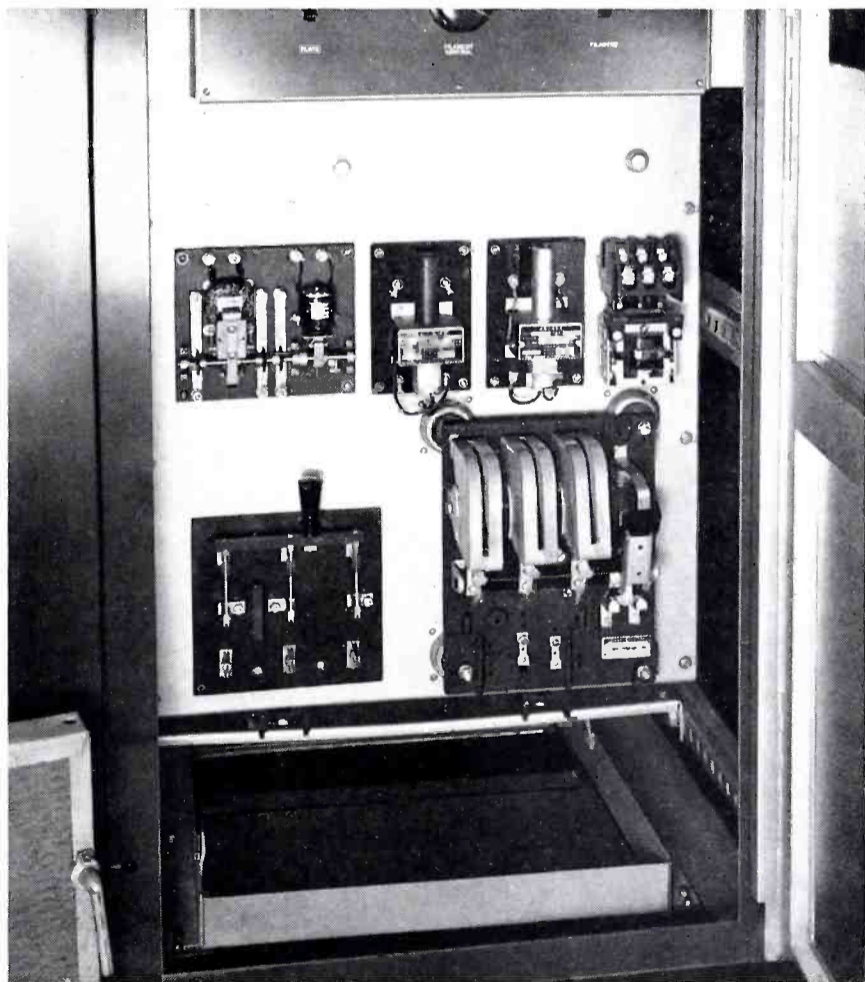

The dust filters mount on top of the base frame. Air is drawn in through openings in the rear of the base frame (or may be supplied by a floor duct).

FEATURES OF NEW FM TRANSMITTERS

NO. 8. AUTOMATICALLY-TRIPPED OVERLOAD PROTECTION

In the BTF Transmitters, all power circuits are protected by magnetically or thermally-tripped circuit breaker switches. These circuit breakers automatically open under overload conditions and thus isolate the fault from the a-c bus. They are used in high power, filament, blower and low-power circuits. Their use eliminates the delay and danger involved in replacing fuses in these circuits. (The only fuses in these transmitters are the two in the crystal heater circuits for the exciter unit.) In the 3 kw transmitter, high-speed overload relays are provided in the high power circuits in order to give additional protection to expensive components. In all transmitters, an interlocking control prevents the application of plate power until the rectifier filaments have reached operating temperature.



Circuit-breaker switches are located in all power circuits.

NO. 9. AUTOMATIC STARTING AND RECYCLING

In the BTF-3B both manual and automatic starting are provided. When in the Automatic position, a 3-shot recycling sequence is provided by the control "brain center" which automatically returns the transmitter to the air up to three times in case of repeated overloads and then, if the overload condition persists, automatically shuts the transmitter down. The carrier monitor is connected to this circuit; hence, any arc on the transmission line will cause the transmitter to shut down momentarily to permit the arc to clear. A special hold-in circuit permits the transmitter to return instantly to the air in case of a momentary power line failure, thus avoiding the 30 second delay required for the plate time-delay relay to close. A power reduction switch located in the primary circuit of the main rectifier provides a reduced power position for tune-up and emergency operation.

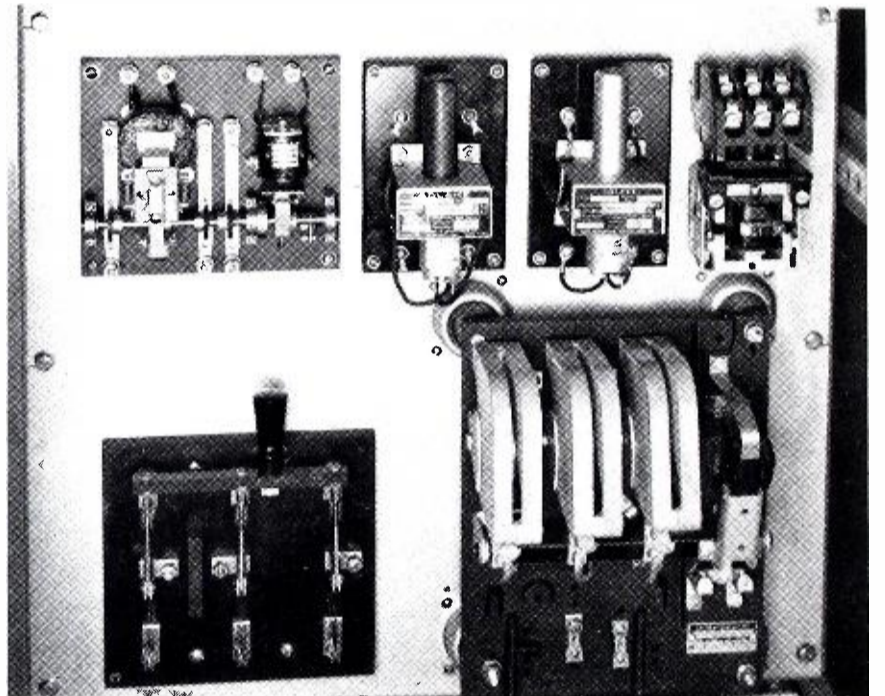

Automatic starting and recycling relays and power reduction switch.

NO. 10. NEW TYPE RECTIFIER TUBES

In the BTF-3B transmitter a new type rectifier tube—the RCA 8008—is used. In prewar transmitters of this power category 872 or 872-A's were used. While these tubes have ratings sufficient for the service, it was found that many transmitter outages resulted from rectifier failures (because of the number of these tubes involved). Since the cost of these tubes is relatively small it seemed worthwhile to consider means of obtaining longer life. However, to go to the next larger size would entail using tubes altogether too large. This problem has been solved by the production of the RCA-8008. Essentially the same internally as the 872/872A, the 8008 has a larger base and pins, and an improved anode cap. It is expected to give much less trouble and considerably improved life.

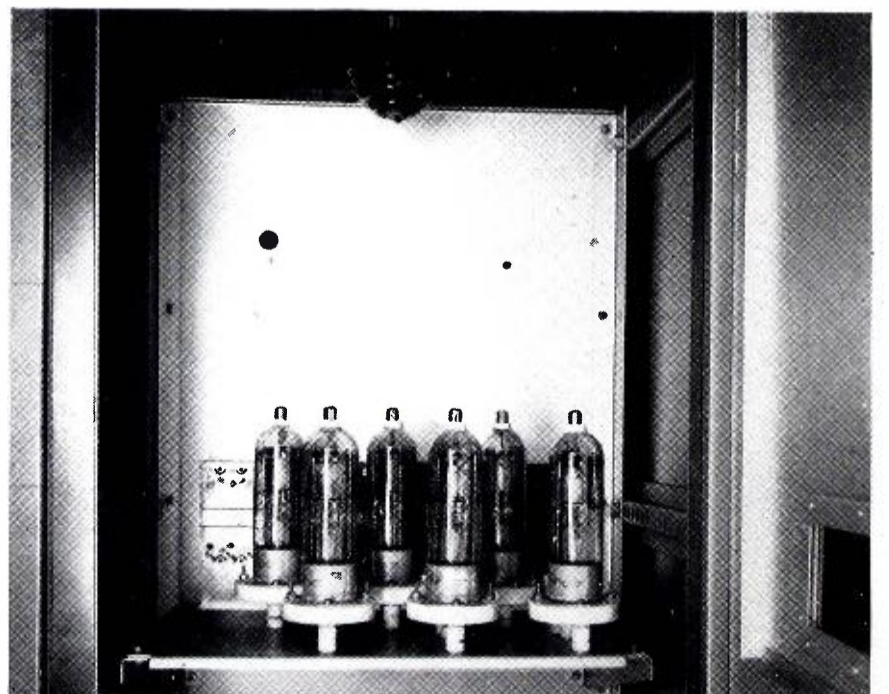

RCA-8008 Rectifier tubes are used in 3 KW and higher powered transmitters.

NO. 11. EASILY-READ, BLACK-FACE METERS

All the meters and indicator lights in the BTF Transmitters are grouped on meter panels at the top of the standard enclosures. Four-inch-case meters are used, with the meters arranged four to each unit. White letters on a dark face make reading easy under any type of lighting. In addition to line voltage, filament voltage, and plate and grid current meters, there is an "output" meter which can be adjusted to read "100 per cent" for the output power determined as necessary to serve the specified area.

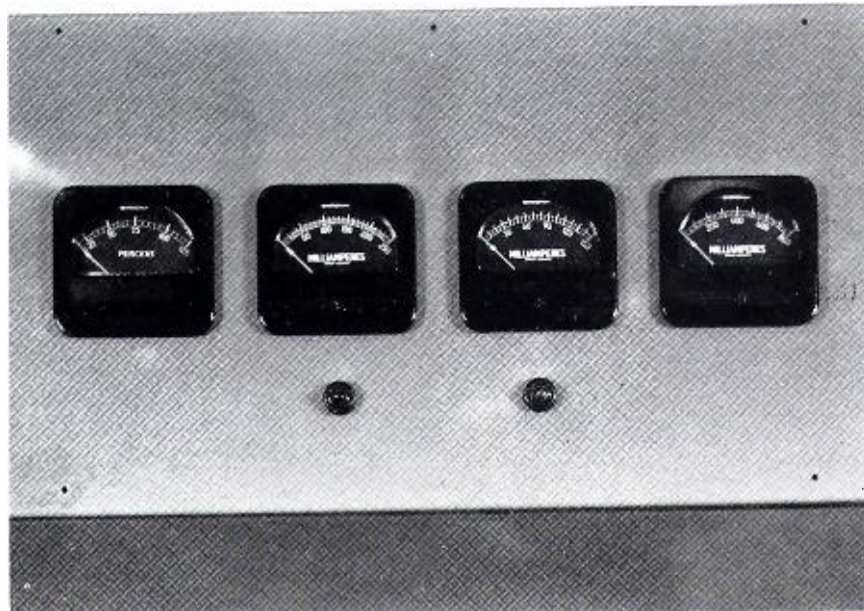

Easily-read black face meters with scales marked in white.

NO. 12. ALL CONTROLS CENTRALIZED ON CONTROL STRIPS

For neatness and convenience, all the necessary power and tuning controls of the BTF Transmitters are grouped on control strips which are rigidly mounted on the inner frames of the individual enclosures. Openings in the doors of the enclosures are provided so that the panel is flush when the door is closed—while the controls project just enough for satisfactory operation. As shown here, these panels have a painted finish; however, the production models will have brushed-chrome finish in order to set them off better against the grey panels.

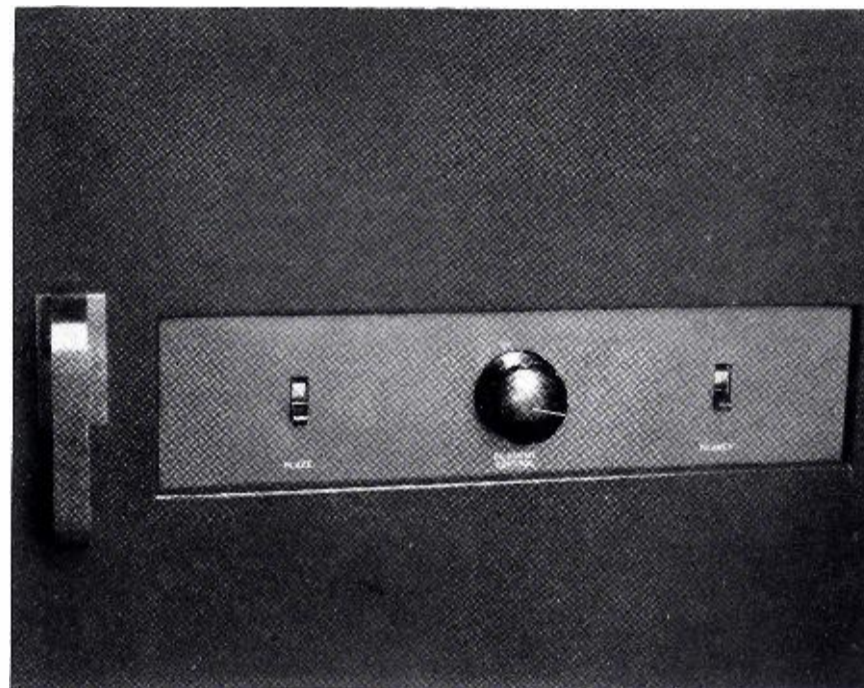

All controls are grouped on waist-high panels.

NO. 13. VERNIER-TYPE REMOTE TUNING CONTROLS

The tuning controls of each r-f unit are grouped on a control strip similar to the one shown at the right. In general there is a control for each tuned circuit plus an additional control which allows the power output to be smoothly varied through a ratio of three or four-to-one. The controls shown here are of two types: the vernier control and the lever switch. The vernier type is operated by a hand crank and incorporates a calibration dial which provides pre-set tuning information for future reference. The tuning handle is inserted only during actual tuning, thereby avoiding possibility of inadvertent detuning during operation. The lever type switches control the motors used in the motor-driven tuning units of the grounded-grid amplifiers.

NO. 14. HARMONIC ATTENUATOR

Another distinctive feature of the new line of RCA Transmitters is the fixed-tuned harmonic attenuator included as standard equipment with 1 kw and higher power types. This attenuator is designed to reduce all harmonics by 30 db or more. Located in the transmitter output circuit this unit requires no adjustments and guarantees a transmitted carrier free of spurious signals.

NO. 15. MONITOR FOR ANTENNA AND LINE PROTECTION

In the past, little attention has been given to the protection of the antenna and its transmission line against excess voltage, arcs or the danger of serious burnout. To guard against such contingencies, a carrier monitor is supplied with the BTF Transmitters. Located in the transmission line, this unit acts as a watchman over the carrier. Any discontinuity will actuate the monitor and cause it to shut down the transmitter. This protective feature is further improved on the BTF-3B by combining the operation of the monitor with the three-cycle overload circuit so that carrier power is automatically removed long enough for the fault to clear itself. Then the carrier is reapplied. Should the fault persist the transmitter, after three successive attempts, will "lock itself out."

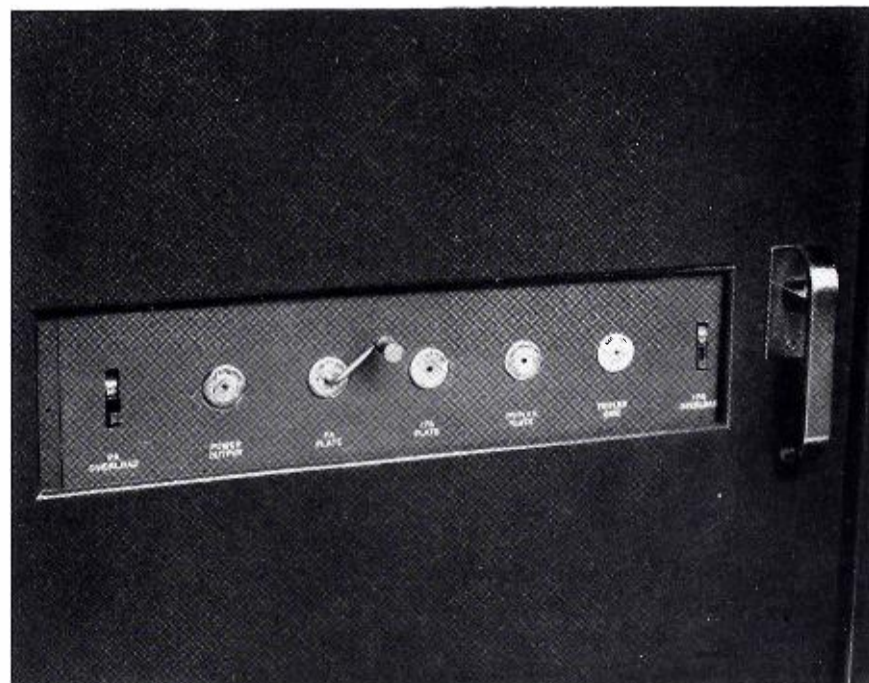

Low-power controls are mechanical, vernier-type; high-power are motor-driven.

SPECIFICATIONS OF THE TYPE BTF-250A TRANSMITTER

The Type BTF-250A Transmitter is designed for operation at output powers of 50 watts to 250 watts. While this transmitter is the smallest of the new RCA FM Transmitters, it incorporates the same circuits as those in the larger transmitters, uses the same type of components and is built to the same standards as the larger equipments. In fact, this same unit is used, with minor modifications, as the driver unit of the higher-powered transmitters. Thus it makes available to "community" stations and educational stations a transmitter which, although of relatively low power, will nevertheless meet the same standards of performance and reliability as the largest and most deluxe types. Moreover, because of the saving effected in manufacturing standardized units in large quantities, it costs no more than similar powered equipments which are built in much less substantial manner.

Electrically the BTF-250A consists of a standard exciter (described on page 24) followed by two r-f amplifier stages. The output frequency of the exciter falls in the range of 44 to 54 mc. This is doubled to the final operating frequency in the first 4-125A stage. This stage drives a final amplifier which employs two Type 4-125A tubes in parallel. There are two rectifiers; a low-voltage unit utilizing one RCA 5U4G and a high voltage unit employing two RCA 866A/866's.

Mechanically, the BTF-250A consists of a single cabinet of the type standardized for all RCA FM Transmitters. In this

cabinet (drawing is shown on opposite page) are the FM exciter unit, its power supply, the r-f amplifiers, their power supplies, and the necessary control circuits.

PERFORMANCE SPECIFICATIONS

Frequency Range.....	Any specified frequency between 88 and 108 mc
Power Output (into transmission line).....	50 to 250 watts
R-F Output Impedance.....	35 to 75 ohms
Carrier Frequency Stability....	Deviation less than 2000 cycles
Modulation Capability.....	± 100 kc
Audio Input Impedance.....	600 ohms
Avg. Program Level.....	$+4 \pm 2$ vu.
100% Modulation Level.....	$+12 \pm 2$ dbm
Audio Frequency Response (30 to 15,000 cycles, 1000 cycles reference)	Within ± 1 db
Audio Frequency Distortion (30 to 15,000 cycles, including all harmonics up to 30 kc/s at ± 75 kc swing)	Less than 1.5% rms
FM Noise Level, below ± 75 kc swing.....	65 db
AM Noise Level, below 100% amplitude modulation.....	50 db
Power Line Requirement—Transmitter	
Line Voltage	208/230 volts
Frequency	50/60 cycles
Power Consumption	1050 watts
Power Line Requirements—Crystal Heaters	
Line Voltage	115 volts
Frequency	50/60 cycles
Power Consumption	28 watts

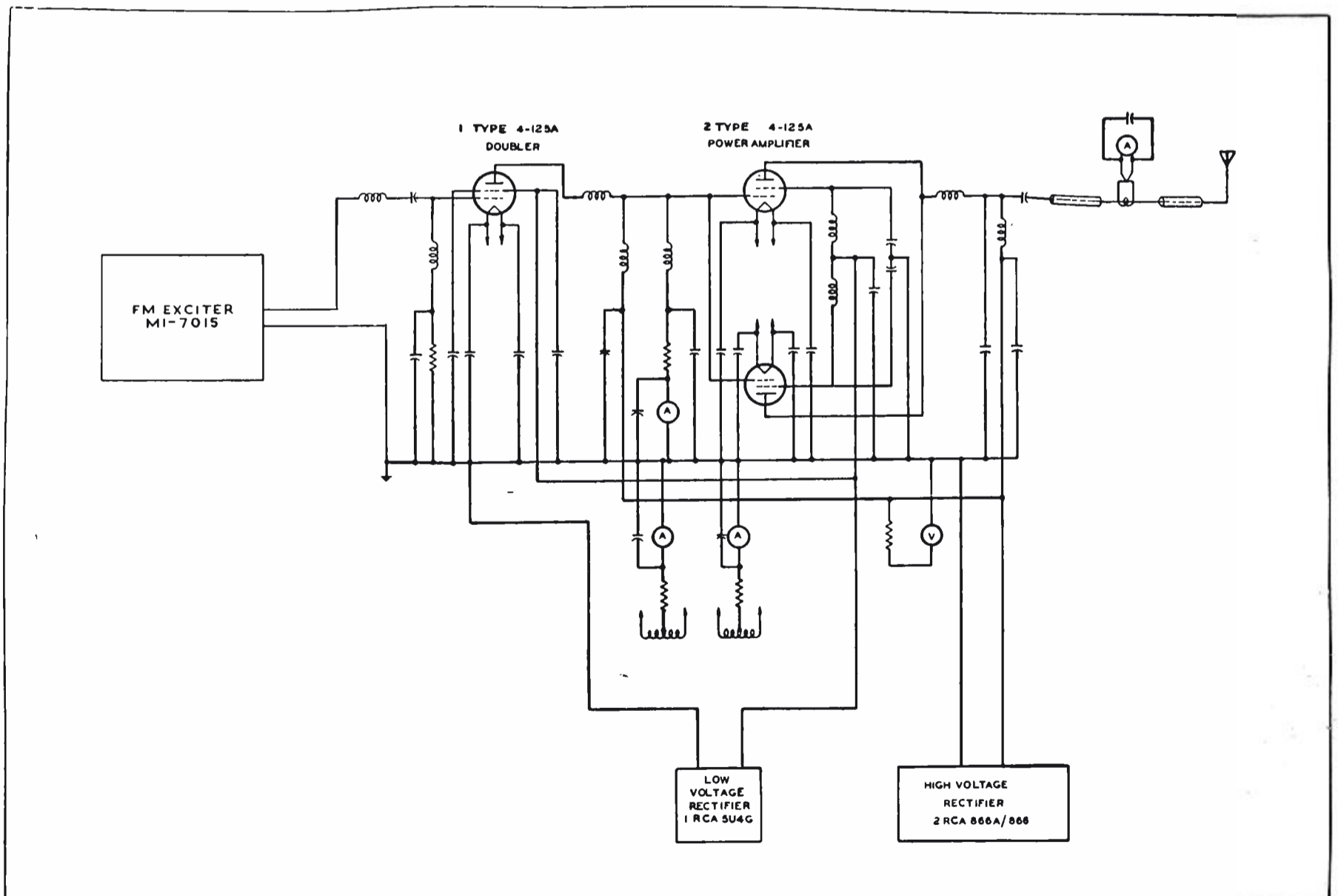

Simplified schematic diagram of the BTF-250A Transmitter. Schematic of the exciter is shown on Page 29.

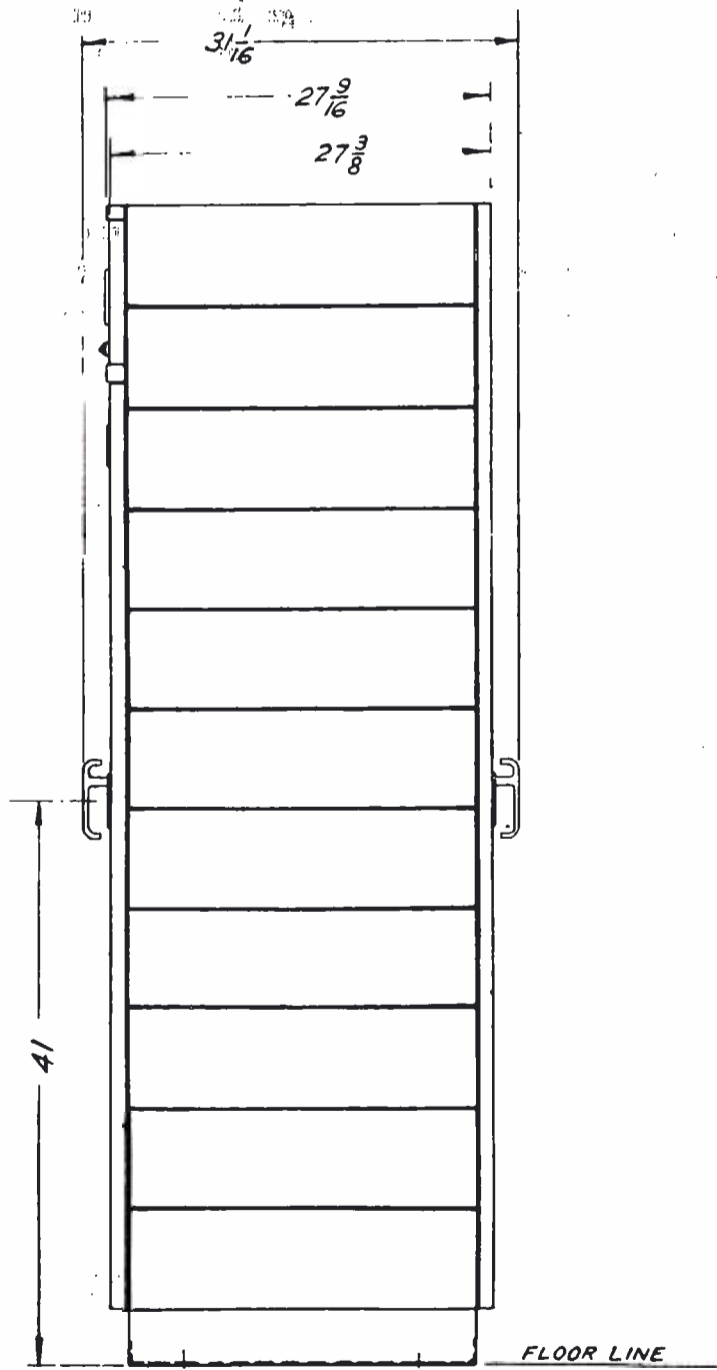
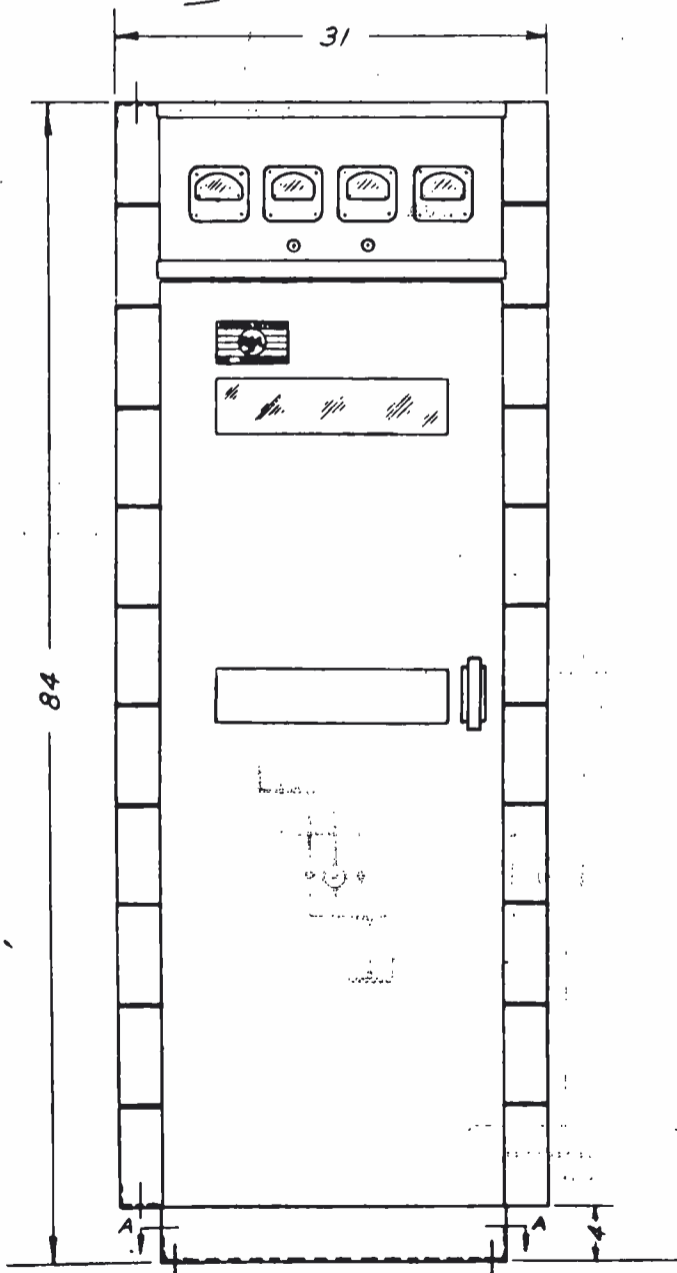
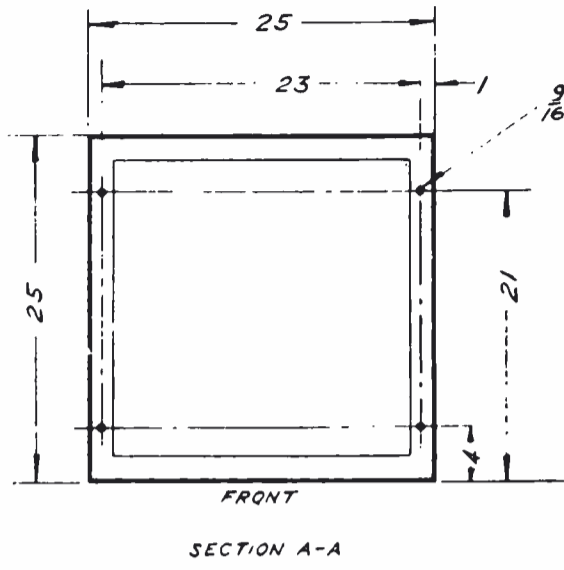
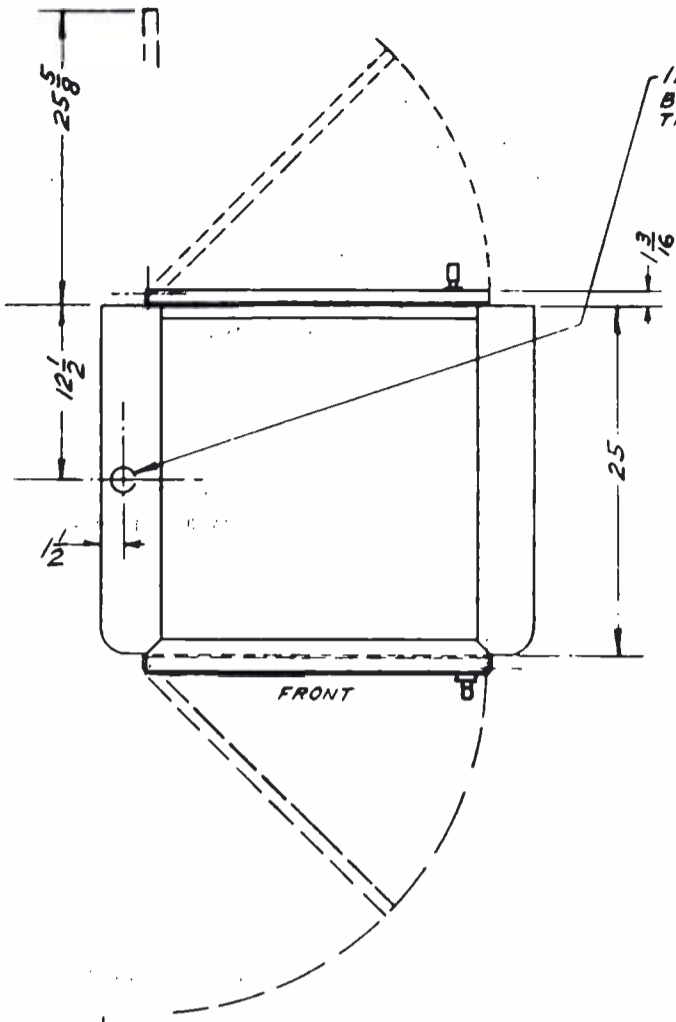

12 1/8 DIA. KNOCKOUT PROVIDED IN TOP AND BOTTOM OF END SHIELD FOR ANTENNA TRANSMISSION LINE.

SPECIFICATIONS OF THE TYPE BTF-1C TRANSMITTER

The type BTF-1C Transmitter is intended for operation at output powers of 250 watts to 1000 watts. It is built in the same manner as the larger RCA FM Transmitters, uses the same circuits and components and can, at reasonable cost, be increased in power by addition of standard amplifier units. It is well suited for the requirements of stations in metropolitan centers of medium size and may also be used by larger educational stations when the very highest standards of performance and reliability are desired.

The electrical circuits of the BTF-1C are similar to those of the BTF-250A with the addition of an extra amplifier stage to give the increased power. A standard exciter is followed by a Type 4-125A as a doubler. This doubler is followed by an intermediate r-f stage employing two Type 4-125A's in parallel. This stage acts as the driver for a grounded-grid amplifier stage in which one of the new RCA-7C24's is used to furnish the required power to the antenna transmission line. In addition there is a low-power rectifier using one RCA 5U4G and a high-voltage rectifier using four RCA 8008's.

All the components of the BTF-1C are mounted in two of the new standard transmitter cabinets. In the right-hand cabinet are mounted the high-voltage rectifier and the standard FM exciter unit; in the left-hand cabinet, the r-f amplifiers. Additional space in this cabinet is utilized when it is desired to increase output power above 1000 watts.

The controls on the right-hand door are the filament rheostat and filament and plate switches. The controls located in the left-hand door are for tuning purposes. From right to left they

tune successive stages. The final control on the extreme left varies the power output from 250 to 1000 watts, the level being indicated in per cent by the power output meter above, which is adjusted to read 100 per cent when the output is determined for the specified coverage.

PERFORMANCE SPECIFICATIONS

Frequency Range.....	Any specified frequency between 88 and 108 mc
Power Output (into transmission line).....	250 to 1,000 watts
R-F Output Impedance.....	35 to 75 ohms
Carrier Frequency Stability....	Deviation less than 2,000 cycles
Modulation Capability	+100 kc
Audio Input Impedance	600 ohms
Avg. Program Level.....	+4 ±2 vu.
100% Modulation Level.....	+12 ±2 dbm
Audio Frequency Response (30 to 15,000 cycles, 1,000 cycles reference)	Within +1 db
Audio Frequency Distortion (30 to 15,000 cycles, including all harmonics up to 30 kc/s at ±75 kc)....	Less than 1.5% rms
FM Noise Level, below ±75 kc, swing.....	65 db
AM Noise Level, below 100% amplitude modulation.....	50 db
Power Line Requirement—Transmitter	
Line Voltage	208/230 volts
Frequency (50 cycle available at slightly higher cost)	50 or 60 cycles
Instantaneous Regulation (maximum).....	5%
Power Consumption (approximate).....	3000 watts
Power Line Requirements—Crystal Heaters	
Line Voltage	115 watts
Frequency	50/60 cycles
Power Consumption	28 watts

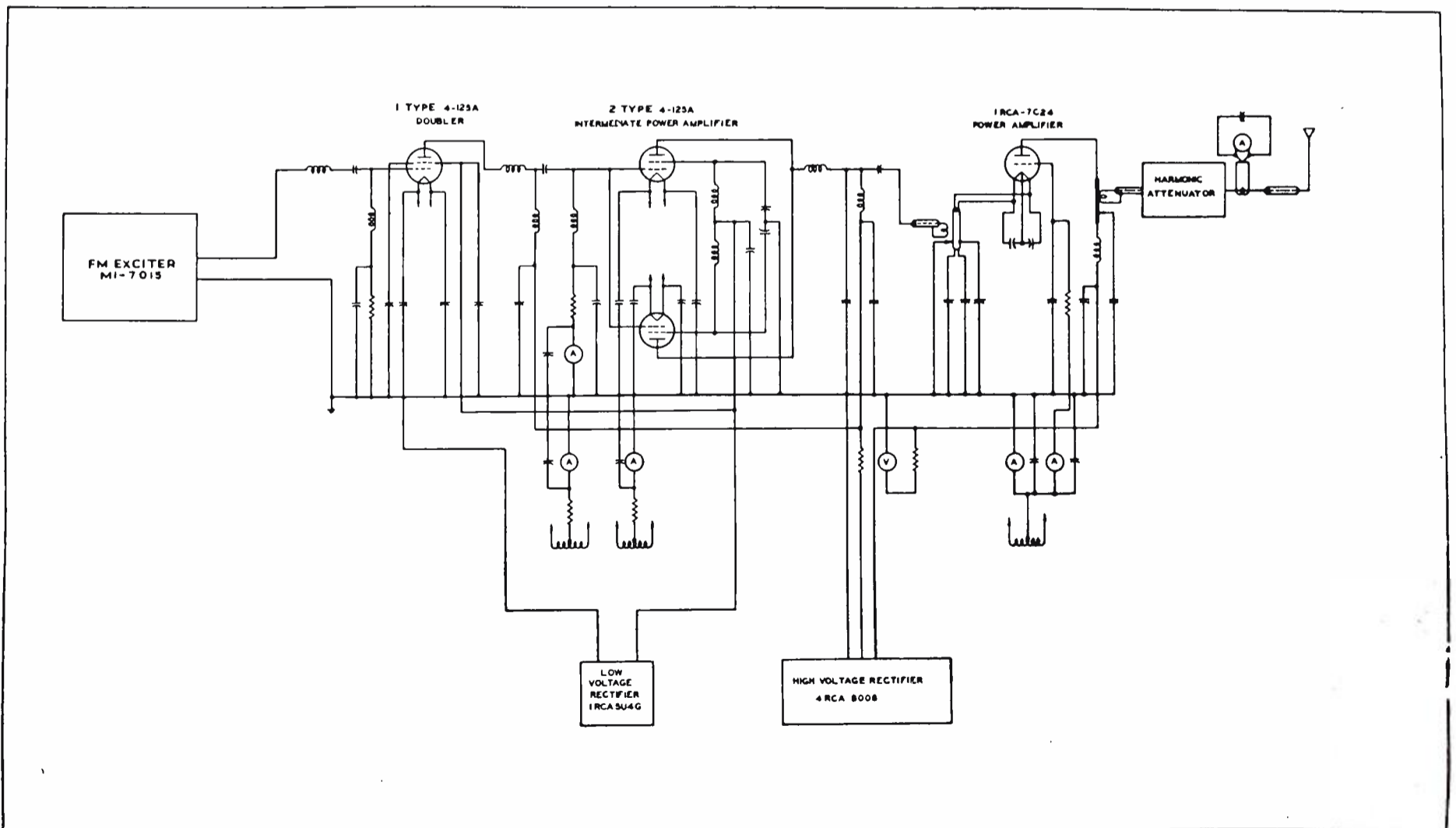

Simplified schematic diagram of the BTF-1C Transmitter. Schematic of the exciter is shown on Page 29.

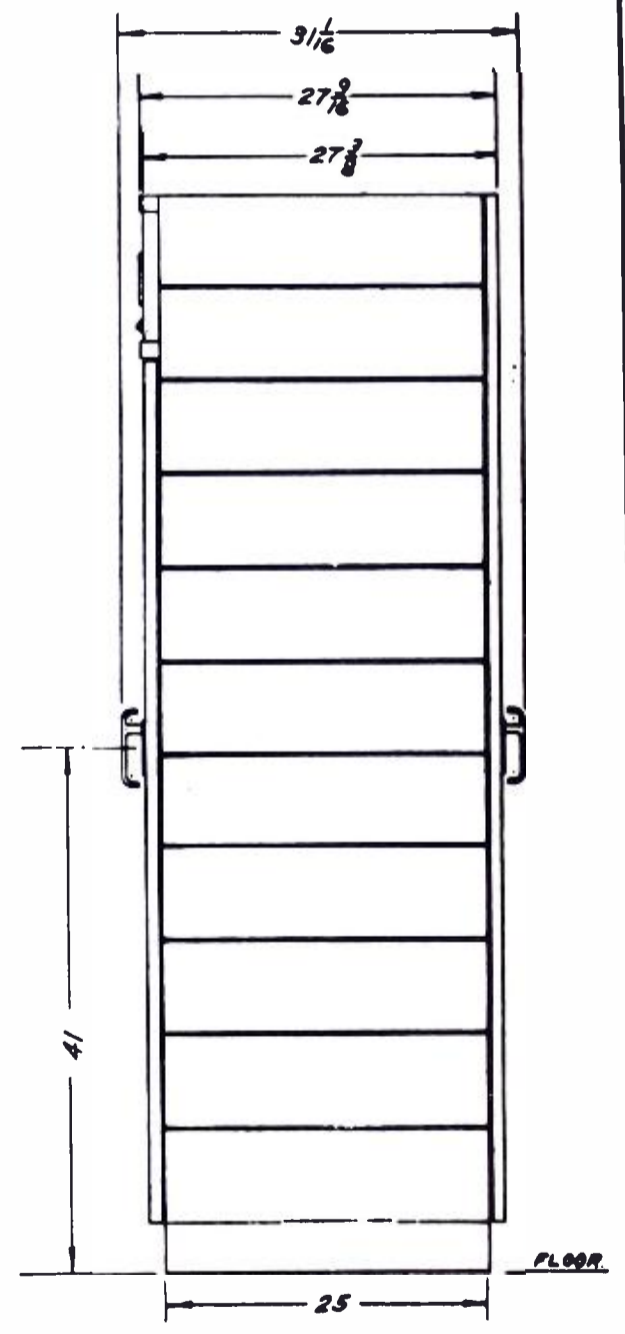
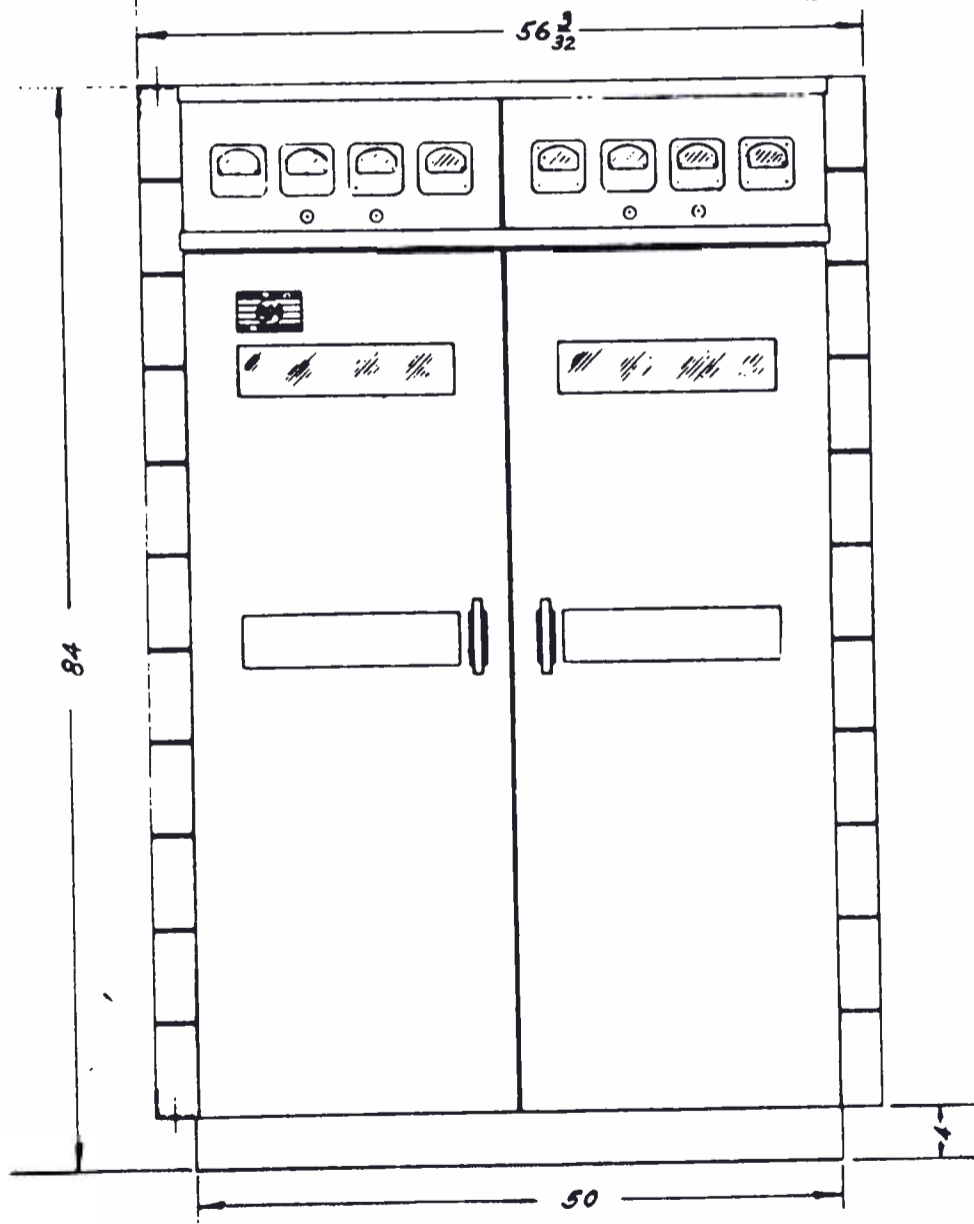
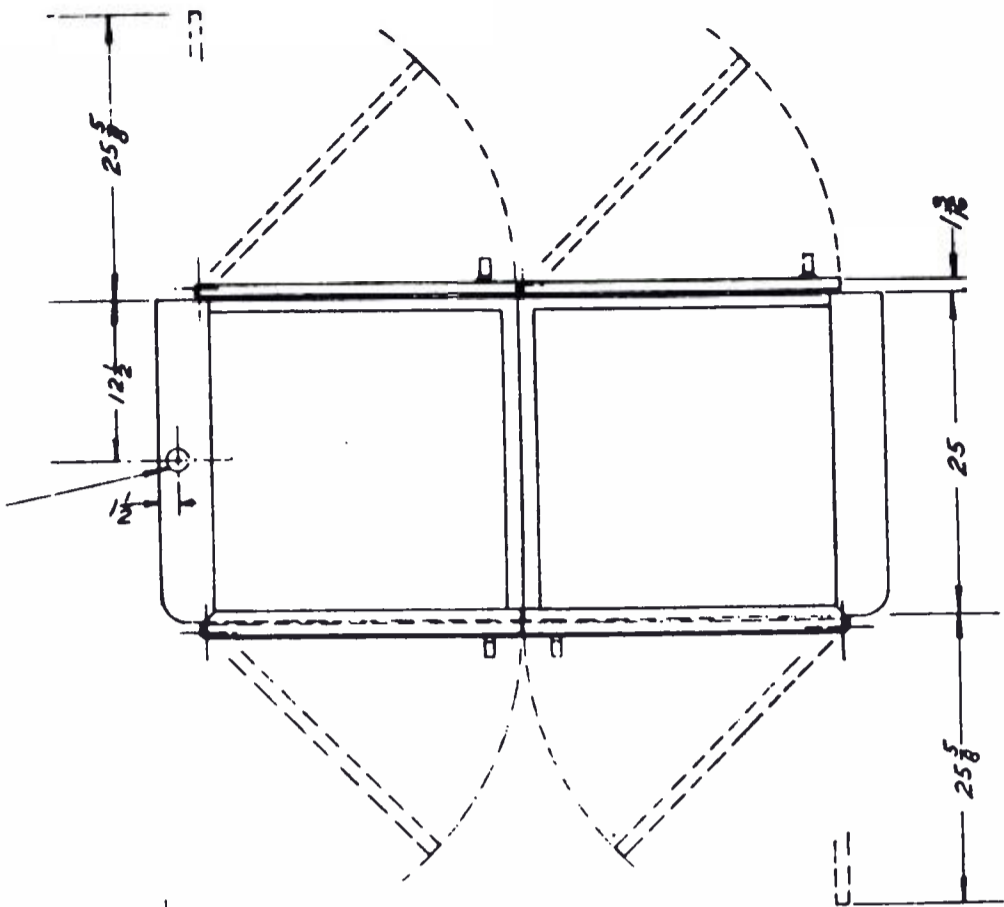

SPECIFICATIONS OF THE TYPE BTF-3B TRANSMITTER

The Type BTF-3B Transmitter is suitable for stations requiring a power output (to the transmission line) of 1000 to 3000 watts. Circuits, components and construction are essentially the same as those of the other BTF transmitters. All of the features listed in pages 8 to 17 of this issue are included in the BTF-3B. It is probable that this transmitter will be used by many stations in metropolitan areas and this possibility has been given special consideration in the design. Space in which a spare exciter unit may be mounted is one of the features.

Electrically the BTF-3B has the same circuits as the BTF-1C plus an additional amplifier stage. The standard exciter unit is followed by a doubler stage using a Type 4-125A and two r-f amplifier stages using, respectively, two Type 4-125A's and an RCA 7C24 (the latter operating as a grounded-grid amplifier). This stage acts as the driver for a final output stage which consists of another RCA-7C24, also using a grounded-grid circuit. The use of the same size tube in both driver and output stages is made practical by the fact that with the grounded-grid circuit (see page 24) the driver stage contributes a substantial share of the output power, thereby making it possible to use a much smaller tube in the output stage than would be required with a conventional grounded-filament circuit. Rectifiers included in the BTF-3B included a low-voltage unit using one RCA 5U4G and a high-voltage unit using six RCA 8008's. The control circuit includes the automatic starting and recycling described on page 16.

Structurally the BTF-3B consists of three of the standard transmitter cabinets. The exciter (and a spare, if used) and its power supply are located in the center cabinet. The r-f amplifier circuits are located in the left-hand cabinet and the high-voltage power supply and control circuits are in the right-hand cabinet.

PERFORMANCE SPECIFICATIONS

Frequency Range.....	Any specified frequency between 88 and 108 mc
Power Output (into transmission line).....	1,000 to 3,000 watts
R-F Output Impedance.....	35 to 75 ohms
Carrier Frequency Stability....	Deviation less than 2,000 cycles
Modulation Capability	± 100 kc
Audio Input Impedance.....	600 ohms
Avg. Program Level.....	$+4 \pm 2$ vu.
100% Modulation Level	$+12 \pm 2$ dbm
Audio Frequency Response (30 to 15,000 cycles, 1,000 cycle reference) uniform within.....	± 1 db
Audio Frequency Distortion (30 to 15,000 cycles, including all harmonics up to 30 kc/s at ± 75 kc swing)	Less than 1.5% rms
FM Noise Level, below ± 75 kc swing.....	65 db
AM Noise Level, below 100% Amplitude Modulation....	50 db
Power Line Requirement—Transmitter	
Line Voltage	208/230 volts
Frequency	50 or 60 cycles
Power Consumption (approximate).....	8300 watts
Power Line Requirements—Crystal Heaters	
Line Voltage	115 volts
Frequency	50/60 cycles
Power Consumption	28 watts

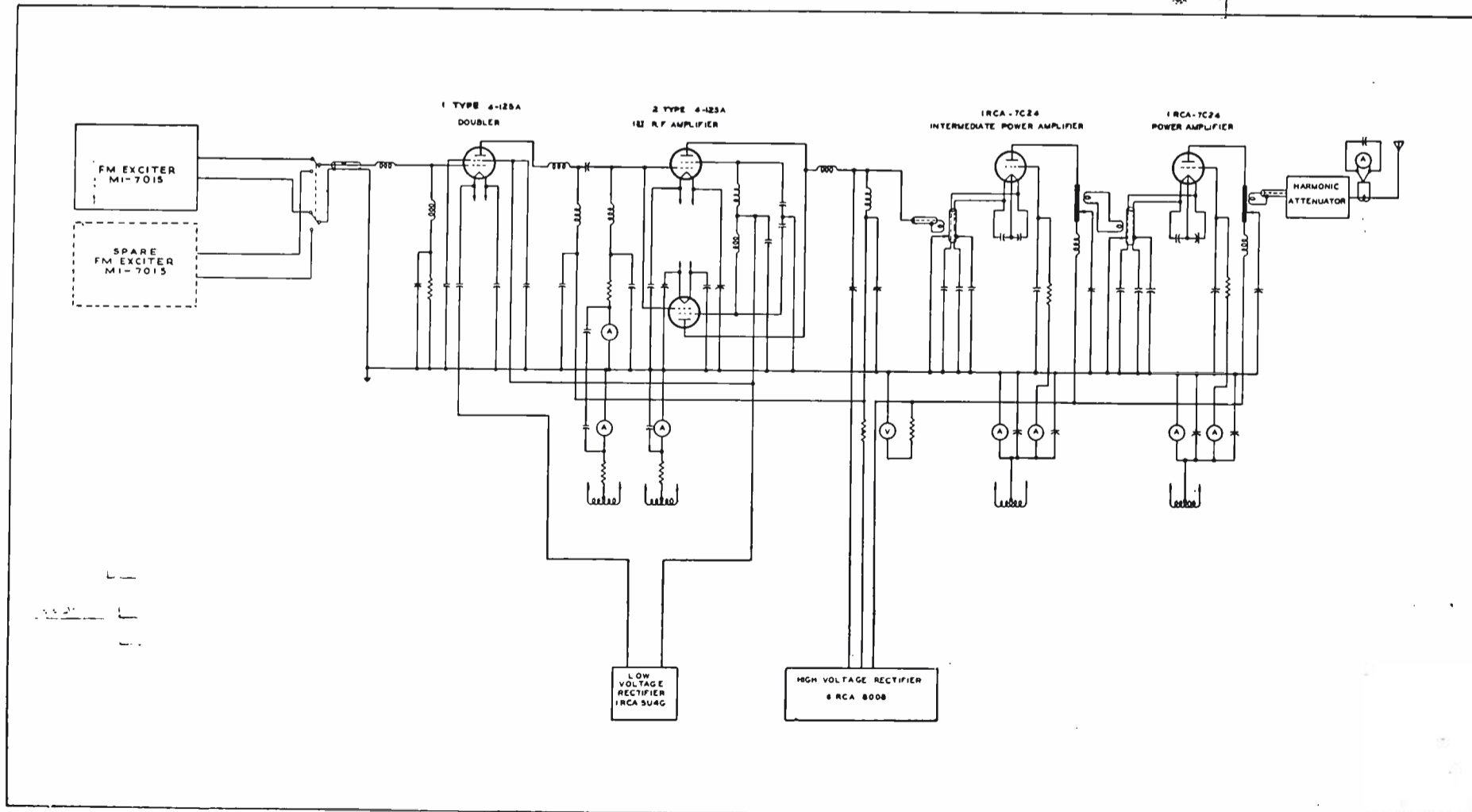

Simplified schematic diagram of the BTF-3B Transmitter. Schematic of the exciter is shown on Page 29.

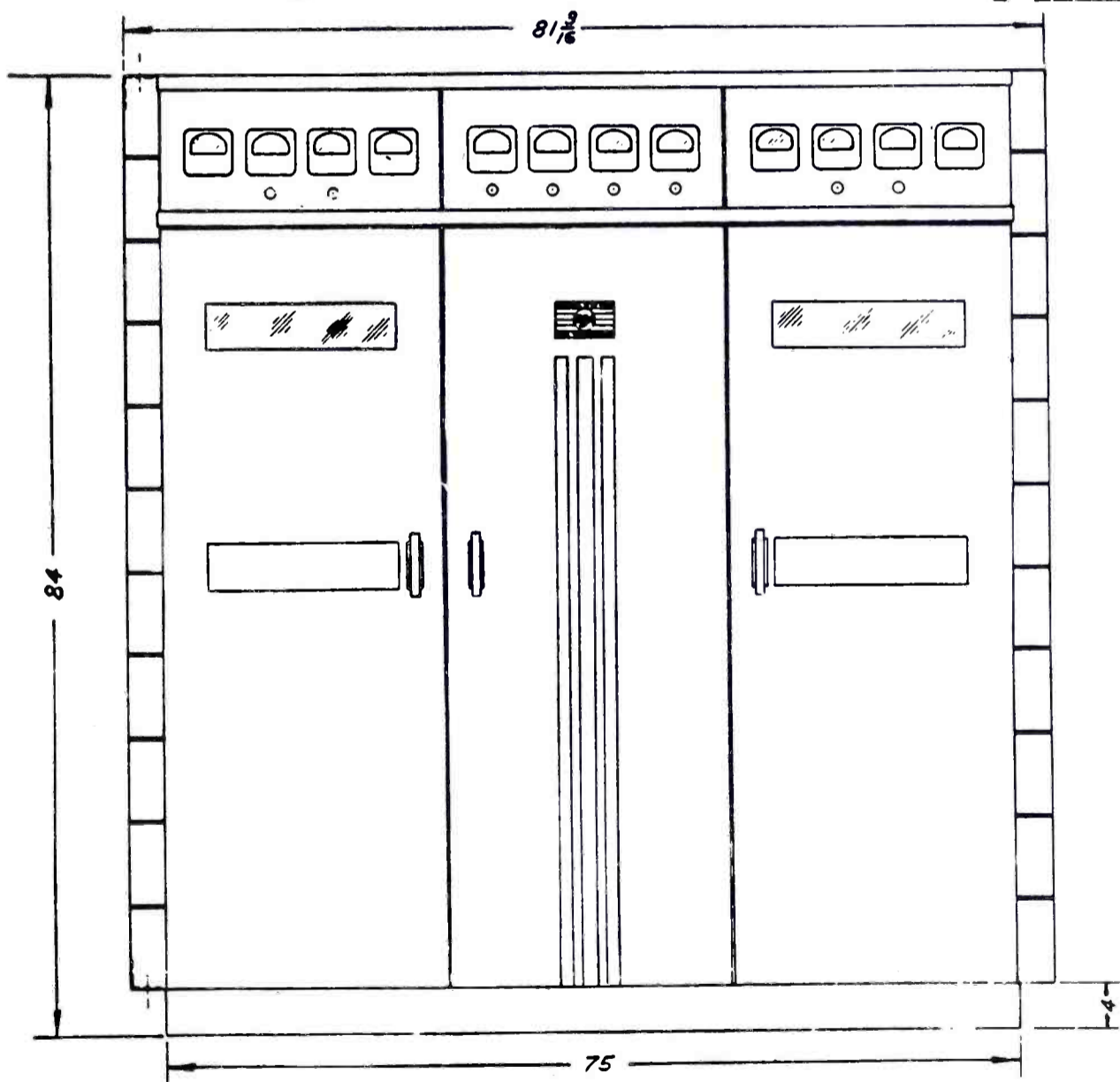
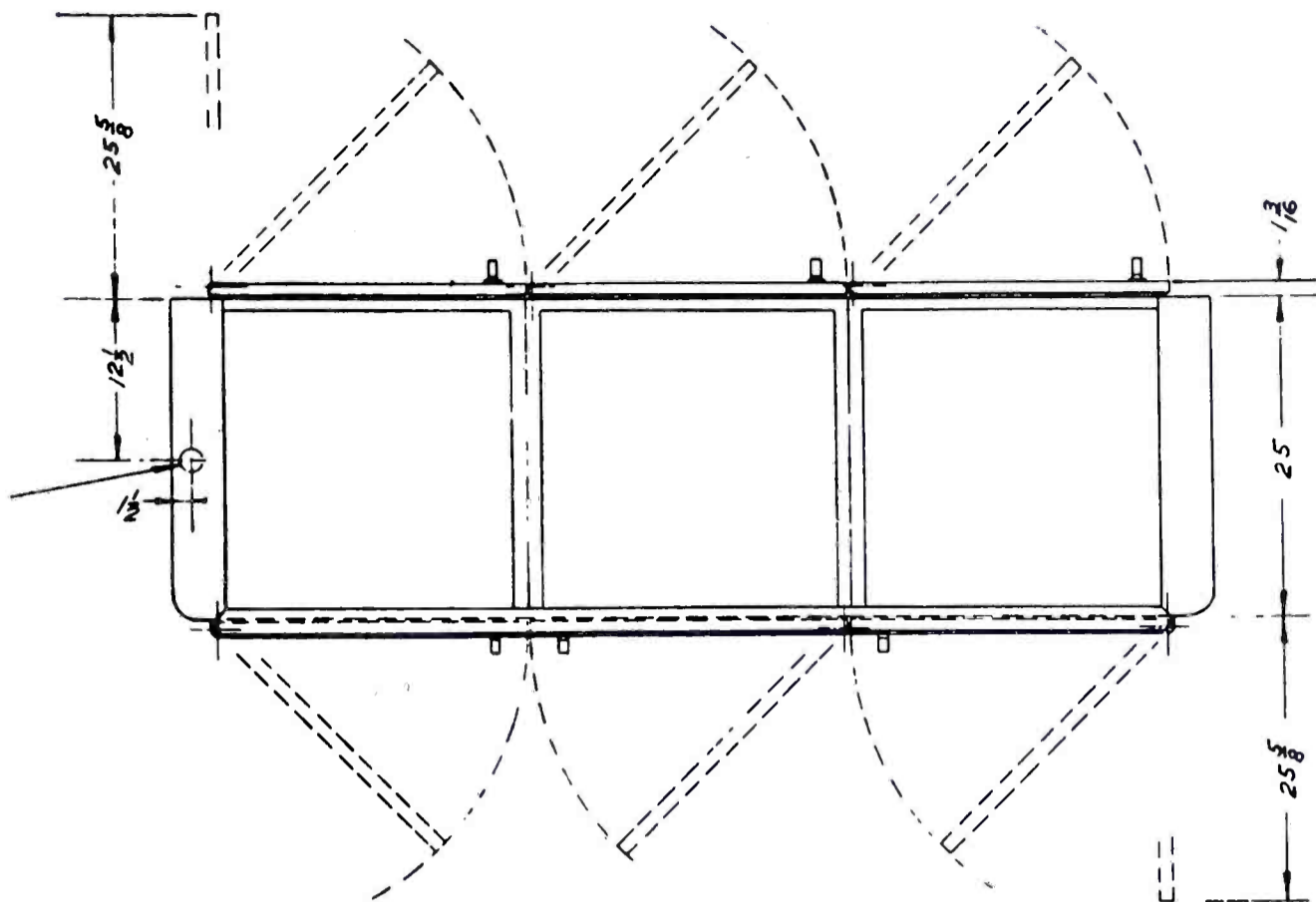

A NEW FM EXCITER UNIT OF GREATLY IMPROVED PERFORMANCE

by N. J. OMAN

Transmitter Engineering Department
Engineering Products Division

An Exciter Unit of entirely new design is a feature of the new line of RCA FM Broadcast Transmitters and is used in all of the new models.

Mechanically, the new Exciter consists of two vertical panels, as shown in Figure 1. One panel contains the r-f and modulator circuits and the other the regulated power supply. These panels are mounted in one of the standard cabinet units of which all of the new FM transmitters are made up. The construction employed in the units themselves provides a degree of accessibility

seldom realized in this type of equipment. All tubes and main components are mounted on the front of the panel. Wiring on the rear of the panel (Figure 2) is "in the clear" with all terminals clearly marked and easily accessible. Doors on the front and back of the cabinet provide quick access to either side of the panel.

In the transmitters of 3 KW and higher power ratings, space is provided for permanent mounting of an additional Exciter Unit; thus providing a spare which may be quickly cut-in in case of failure. If it is desired to provide a "spare" unit with the lower power transmitters, an additional cabinet unit can be furnished which may be used to house this and other accessories.

Electrically, the new Exciter includes all of the frequency generating, modulating, and frequency multiplying circuits of the transmitter (except the final doubler). A new and greatly improved form of the *direct FM circuit* developed by RCA engineers is employed. Features of this new design include:

- (1) Simplicity of reactance-tube modulation system.
- (2) Crystal-controlled frequency stability.
- (3) Distortion of less than 0.5% through entire range of 30 to 15,000 cycles.
- (4) Stability independent of circuit adjustments.
- (5) Frequency dividers of relatively high ratio and simple design; thus fewer tubes and circuits are required.
- (6) Only crystal unit is temperature controlled.
- (7) Every component and connection is easily accessible.
- (8) An ingenious built-in checking device which includes everything necessary for checking performance of frequency control circuits, frequency multipliers and reactance modulators.

In evaluating the importance of these features a discussion of the development and operation of the circuits used in the new exciter should be of assistance.

FIG. 1. Front view of the new-type exciter unit used in all of the new RCA FM Transmitters. Other photos of this unit are shown on pages 11 and 14.

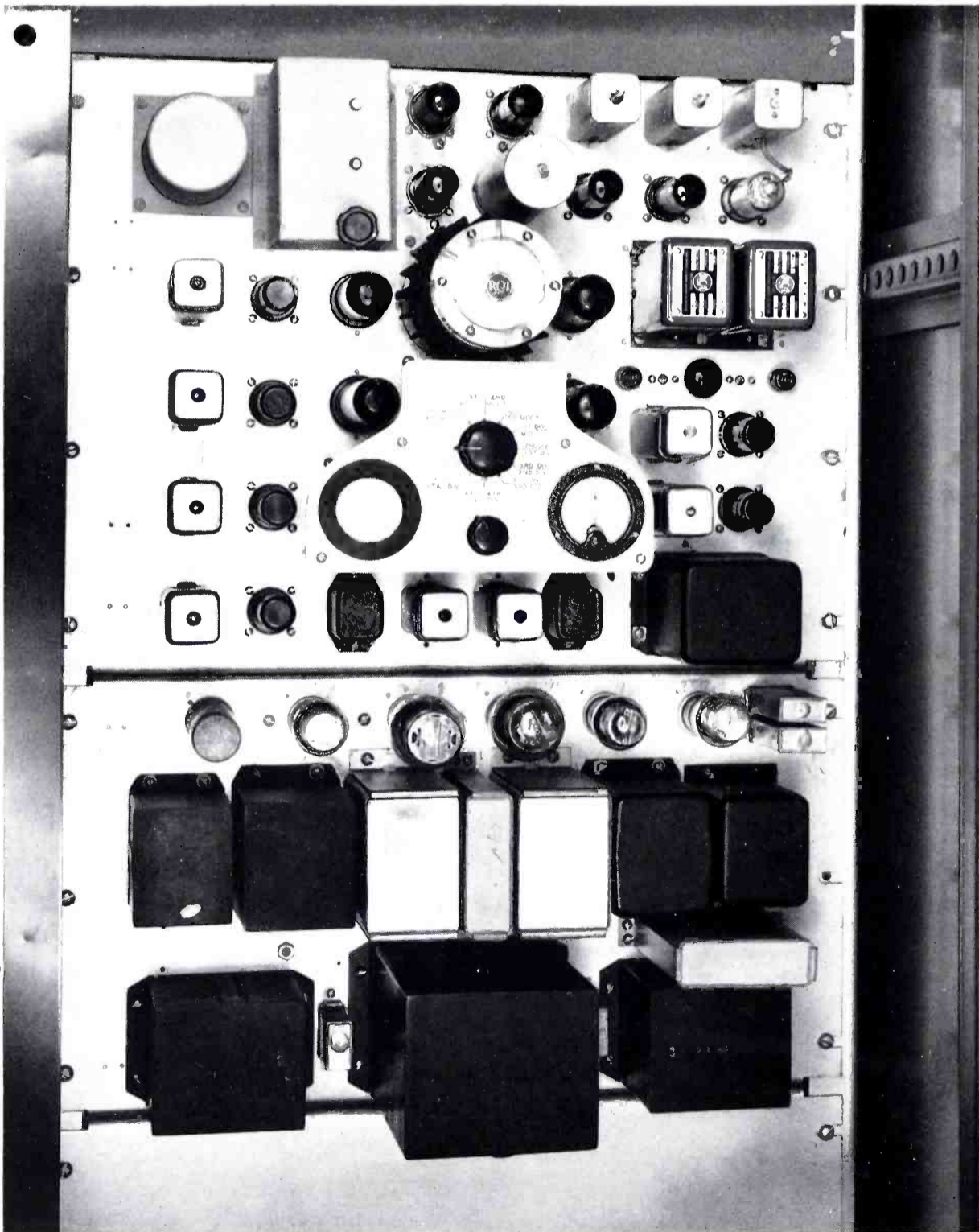

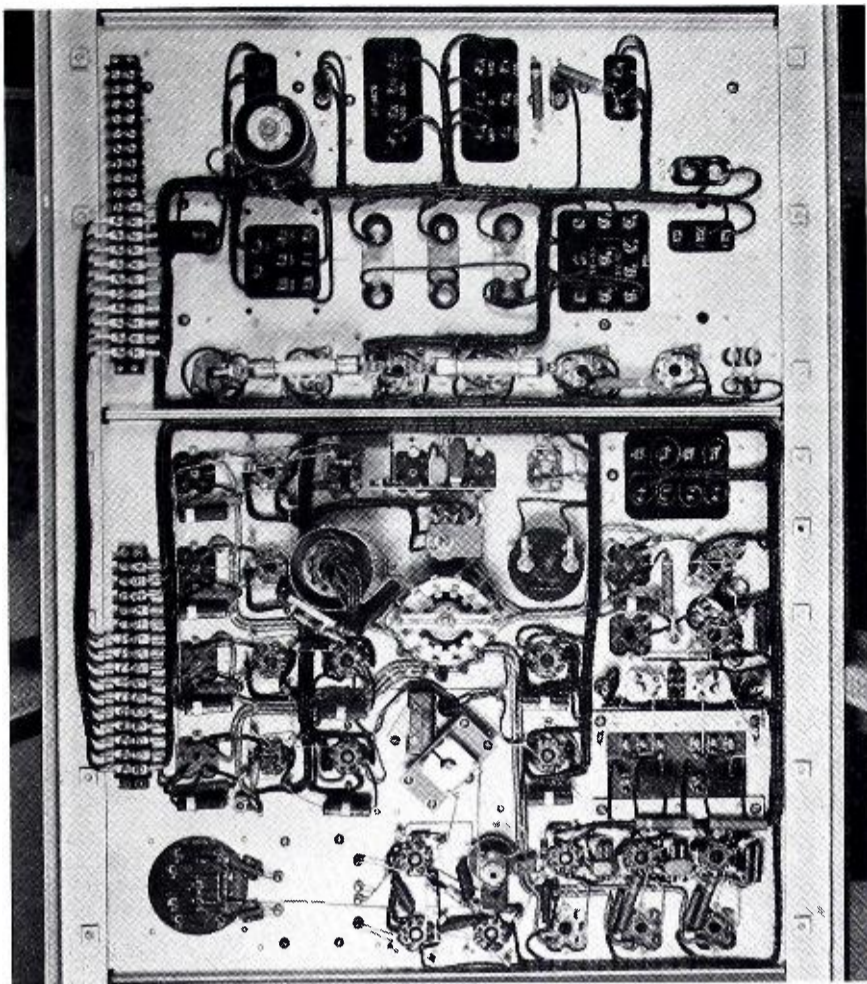

FIG. 2. Rear view of the new exciter unit. All the wiring is "in the clear" and all terminals are plainly marked for easy identification.

ADVANTAGES OF "DIRECT" FM

A good exciter for a frequency-modulated transmitter should be capable of producing a variation of frequency about a mean frequency in very exact duplication of the program material. In addition, the stability should be such that any shift in frequency is in response to signal voltage and nothing else; thus, when modulation is not present, the frequency will be the exact center of the band assigned to that particular broadcast station.

There are a number of methods of producing the desired frequency modulation. These are generally classified under two headings—"Direct" and "Indirect." The Direct method, developed by RCA engineers, uses fewer tubes and introduces less audio distortion (especially at extreme high and low frequencies) than the Indirect method. In this system the mean or "carrier" fre-

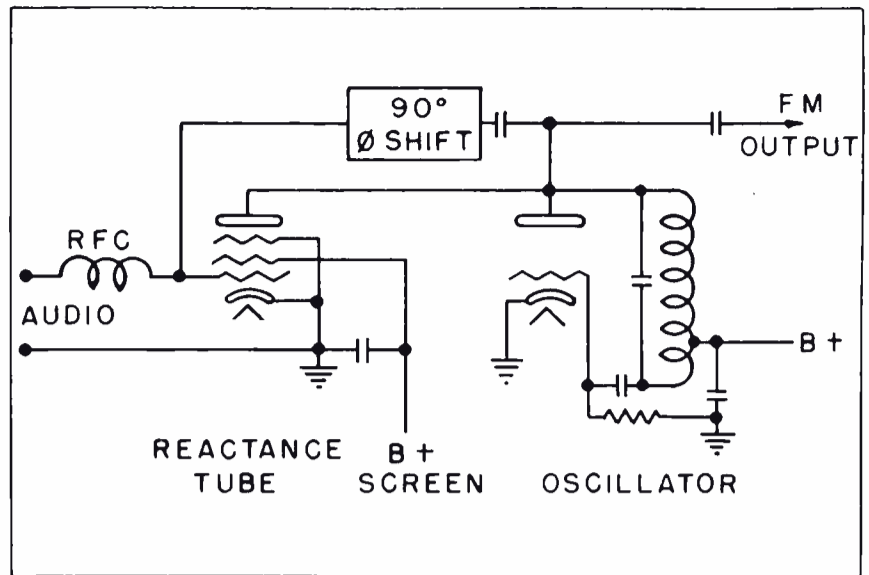

FIG. 3. Simplified diagram of the reactance modulator circuit developed by RCA engineers. This circuit accomplishes frequency modulation directly without need of trick tubes or circuits.

quency is produced in simple and straightforward fashion by a master oscillator, operating at a medium frequency, followed by a relatively small number of multiplier stages. Frequency modulation of the master oscillator is accomplished directly by means of a reactance tube modulator. A simplified diagram of such a system is shown in Figure 3. With this arrangement a change in voltage on the grid of the reactance tube causes a change in the reactance which it places across the tank circuit of the oscillator, and hence a change in the oscillator frequency. When an audio modulating voltage is fed to the grid of the reactance tube the frequency of the oscillator is caused to vary in exact accordance with the modulating frequency. This is unquestionably the simplest method of producing high-fidelity frequency modulation.

THE PREWAR MODEL

In the past the problem with the Direct FM circuit has been that of compensating for the drift in frequency of the master oscillator. The RCA prewar FM Exciter (Figure 4) accomplished the frequency regulating function by beating the master oscillator with a signal from a crystal-controlled oscillator to produce a beat note at approximately one megacycle. The fluctuation in the one megacycle frequency caused by variation of the master oscillator frequency was converted to a varying d-c potential by

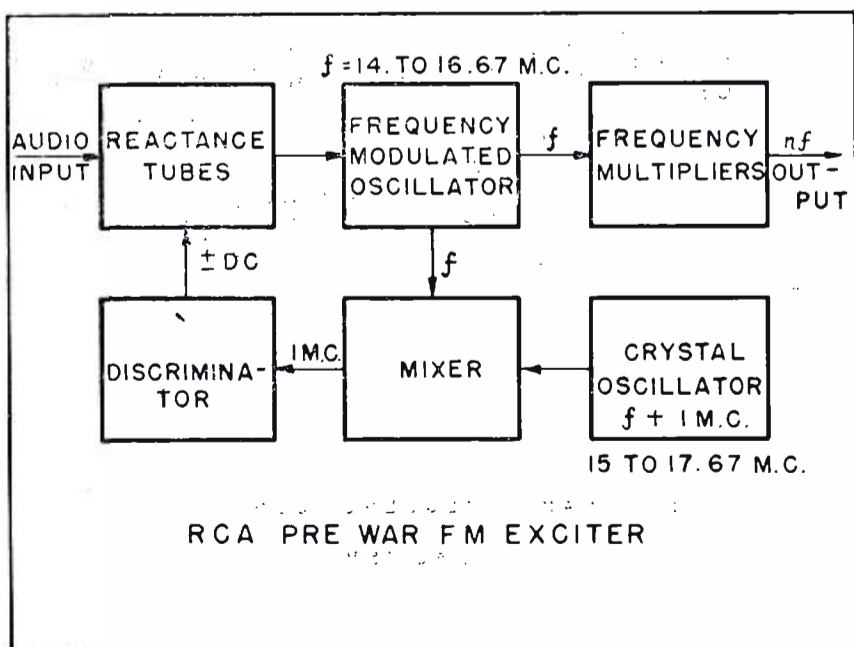

FIG. 4. Block diagram of the RCA prewar FM exciter (shown for purposes of discussion only).

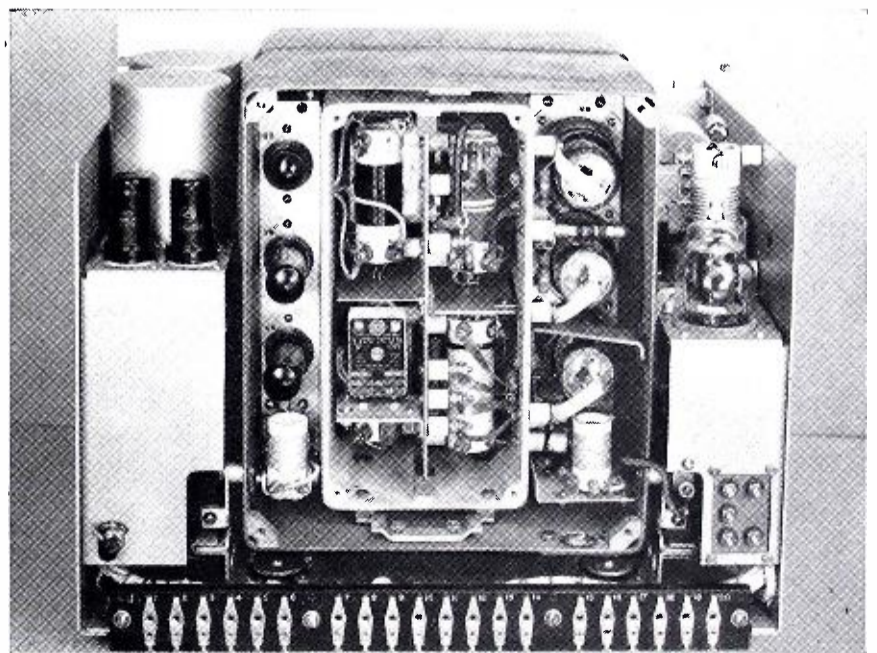

FIG. 5. Rear view of prewar exciter. Comparison with Figure 2 shows advance made in mechanical construction and arrangement.

means of a discriminator. The varying d-c potential so obtained was passed through a filter to remove rapid fluctuation, such as would be caused by modulation. The filtered Direct current was used to control the grid potential of one of the reactance tubes in such polarity as to reduce any change in frequency of the master oscillator.

This method of frequency control is very simple and its operation is easily understood. However, the d-c control potential is dependent on the discriminator characteristic; it fluctuates because of changes of contact potential of the rectifier required for operation of the discriminator. By placing the master oscillator, the reactance tube modulator and the discriminator in a temperature controlled oven, as shown in Figure 5, it was possible to obtain very good performance. From an operating standpoint, however, the oven tended to offset the desirable feature of circuit simplicity because it made access to circuit elements difficult and time consuming.

NEW METHOD OF FREQUENCY CONTROL

The new RCA FM Exciter has been designed to overcome these objections. As noted previously, all the parts are mounted on a flat panel with ample area so that they are readily accessible. The only temperature-controlled part is the crystal unit of the reference oscillator. The frequency control circuit adopted represents a considerable improvement over previous circuits of this type. In particular it reduces the number of parts and required adjustments. Another big advantage of the circuit is that no adjustment has any effect on the accuracy of frequency control.

Referring to the block diagrams, Figure 6, the operation of the control may be described as follows: Two balanced modulators are set up to obtain in the output of each a beat frequency corresponding to the difference between the crystal reference frequency and that of the master oscillator. The signal output from the crystal oscillator divides and feeds through phase shift networks designed to give a 90° displacement in phase between the inputs to the two modulators. The signal from the master oscillator is of the same phase in both modulators. It is rather obvious that the 90° displacement in the crystal oscillator signal will result in a 90° displacement of the beat frequencies in the output circuits of the two modulators. Not so obvious, but nevertheless true, the direction of rotation of the two 90° vectors, that might be considered as generating the two-beat frequency out-

puts, changes from clockwise to counterclockwise depending on whether the master oscillator frequency is higher or lower than the crystal frequency. In other words, there is a reversal of one phase of the two-phase output of the two modulators when the master oscillator frequency passes thru zero beat with the crystal frequency. If the two-phase output of the two modulators is utilized to energize the field windings of a two-phase motor, the direction of rotation of the motor shaft will be clockwise if the master oscillator frequency is higher than that of the crystal oscillator, and counterclockwise if the master oscillator frequency is lower than that of the crystal. The motor can therefore be used to turn a capacity or other tuning means to effect a correction of the master oscillator frequency should it depart from that of the crystal oscillator. A preliminary arrangement of this kind is illustrated in Figure 7.

DIRECT MOTOR DRIVE

If the frequency control is to be a precision device the method of drive (or the mechanical coupling) between the motor and the tuning element is very important. It will be recognized that the system, as described so far, has a very desirable feature in that the rate of rotation of the free motor shaft would, within limits, be proportional to the difference of the oscillator frequencies, as opposed to an on-off device that would give full motor speed up to correct frequency. This characteristic of the system helps reduce difficulties with hunting so prevalent with automatic controls of similar type. In preliminary tests of this control a worm-and-pinion speed-reduction gear was used between motor and tuning condenser. This method of drive proved to be unsatisfactory. When sudden large frequency corrections were required, a relatively long time was consumed by the operation. For small frequency deviations the action was sluggish, since the motor turned very slowly. It had first to take up lost motion in the gearing and it had to develop enough torque to overcome static friction.

To correct the above-mentioned condition the tuning condenser rotor was mounted on an insulator on one end of the motor shaft. The fixed plates of the condenser were split in half, one half was grounded, the other half was connected to the master oscillator plate circuit (see Figure 8). This construction eliminates all backlash or lost motion, and also eliminates friction other than that of the motor bearings. With this construction the motor

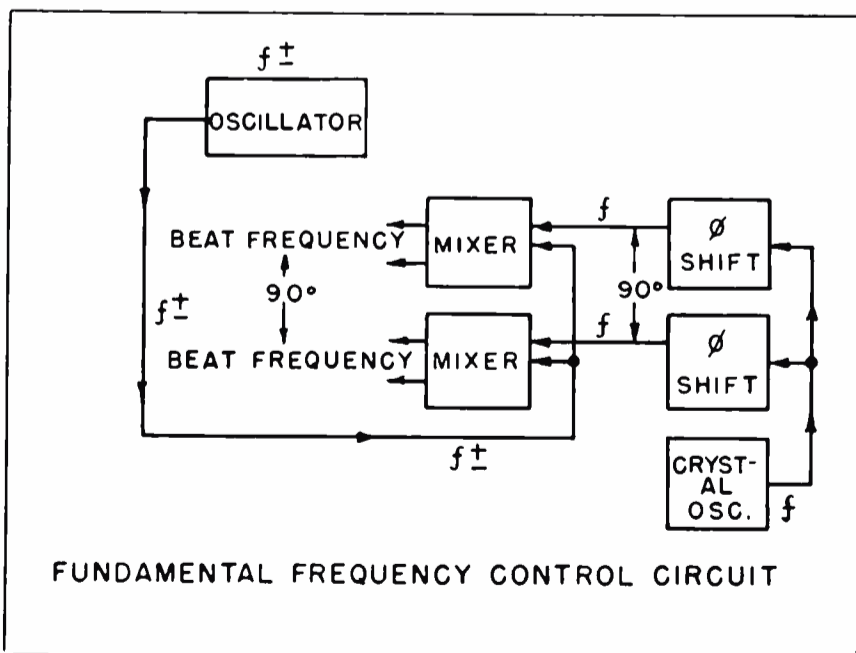

FIG. 6. This is the basic control circuit used in the new exciter. Two beat frequency voltages, 90° out of phase, are used to drive a two-phase motor which controls the position of the frequency-determining condenser.

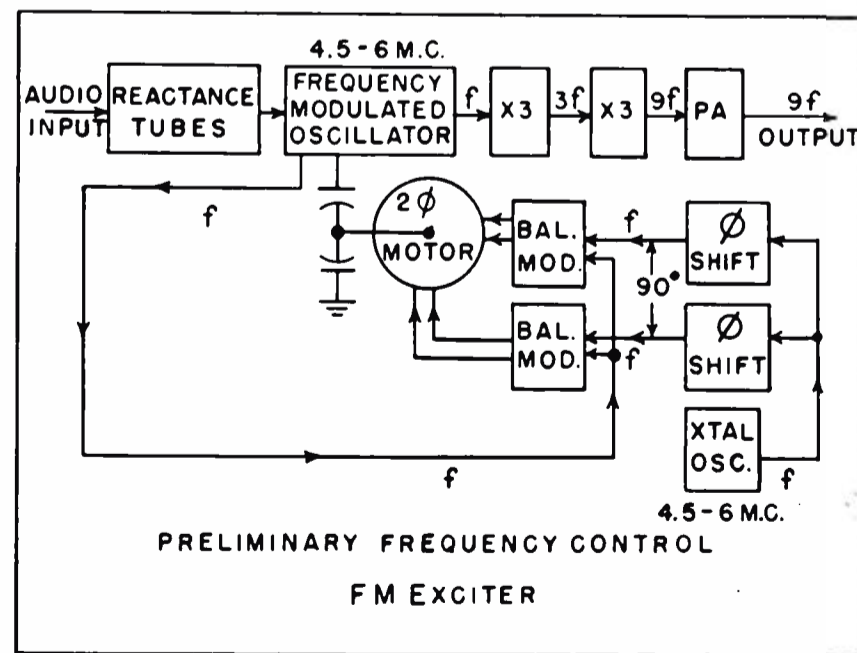

FIG. 7. Block diagram of the preliminary form of the new exciter unit. In this arrangement the crystal-controlled oscillator operates in the 4.5 to 6.0 megacycle band, thus permitting direct comparison with modulated oscillator frequency.

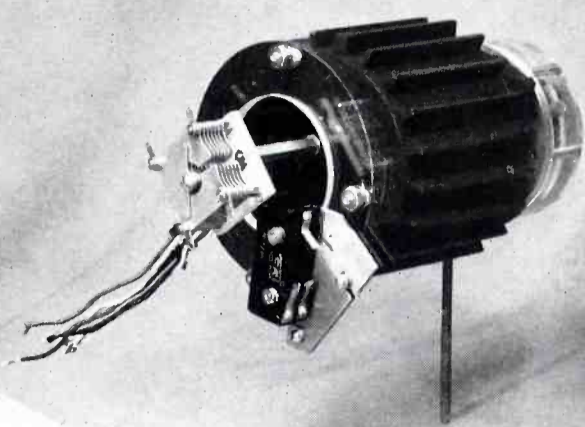
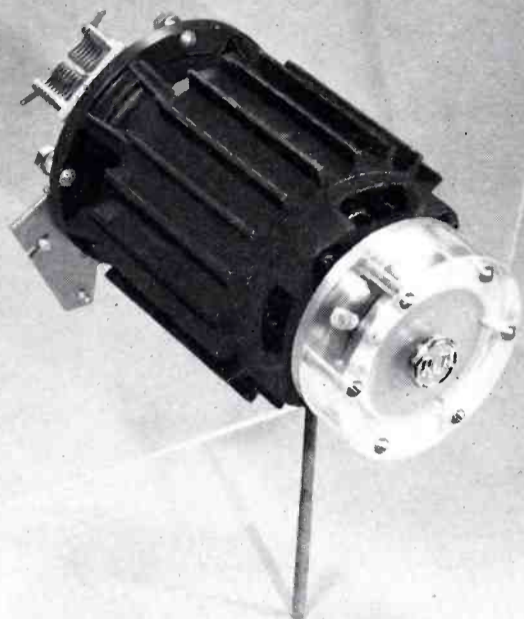

FIG. 8. Front and rear views of the two-phase motor with the frequency-determining capacitor mounted directly on the motor shaft. On the front end of the shaft (enclosed in the Lucite case) is an oil dampening unit which prevents overshooting.

is never required to turn more than $\pm 45^\circ$ to include the full range of control, and friction is reduced to a minimum. The action is fast and positive. The motor can easily follow the slightest variations in frequency. The rate of frequency correction is limited only by the requirement of not causing demodulation of the lowest signal frequency.

ADVANTAGE OF INDUCTION-TYPE MOTOR

Several types of two-phase motors were considered for the control. One was of synchronous type with a permanent magnet rotor. This motor provided very accurate control, but none tested would start if the initial frequency exceeded 60 cycles-per-second. No damping could be used with this synchronous motor and inertia had to be kept low so as not to hamper starting. A second type tested was an induction motor. This had torque enough to start at frequencies up to 1000 cycles-per-second. Further tests with this induction motor, with viscous damper and direct-mounted condenser, demonstrated that it would respond to the slightest rotation of its magnetic field. This motor, therefore, was selected as most suitable for the control.

REASON FOR FREQUENCY DIVISION

Since the limit on the control range with this system is the high frequency response limit of the motor, an increase in the range of control can be obtained by dividing the modulated oscillator frequency, so that it can be compared to a crystal oscillator at a lower frequency. The range of control can thus be increased by a factor equal to the division in frequency. There are several ways of accomplishing the required frequency division. One is by the use of frequency dividing stages employing the principle of regenerative modulation, whereby a sub-harmonic is obtained by a modulation process. Since the output energy is obtained by a modulation process involving both the

input and output waves, the output signal will appear only when an input wave is applied and bears a fixed frequency ratio with respect to it. The circuit makes use of copper oxide modulators and the output circuit is tuned to one-half the input frequency. The tuned circuits are made sufficiently broad to permit substantial output voltage over a frequency range of $\pm 1.5\%$. The disadvantage of this circuit is the number of tubes and circuits required.

Another possible way to obtain frequency division would be to make use of multi-vibrators. The wave shape would be poor, but it would be possible to get higher division per stage.

LOCKED-IN OSCILLATORS AS DIVIDERS

The third circuit considered was the locked-in oscillator frequency divider as shown in Figure 9. This circuit reduces the number of circuit components to a minimum. The wave shape

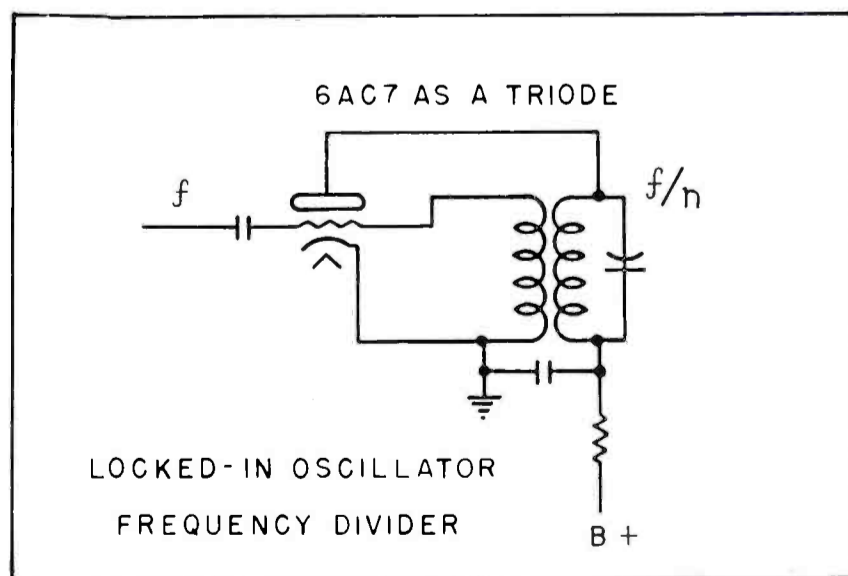

FIG. 9. Circuit of the Beer's Locked-In Oscillator as used in the new exciter unit. This circuit permits division ratios of as much as five-to-one, thereby reducing the number of frequency divider stages which are required.

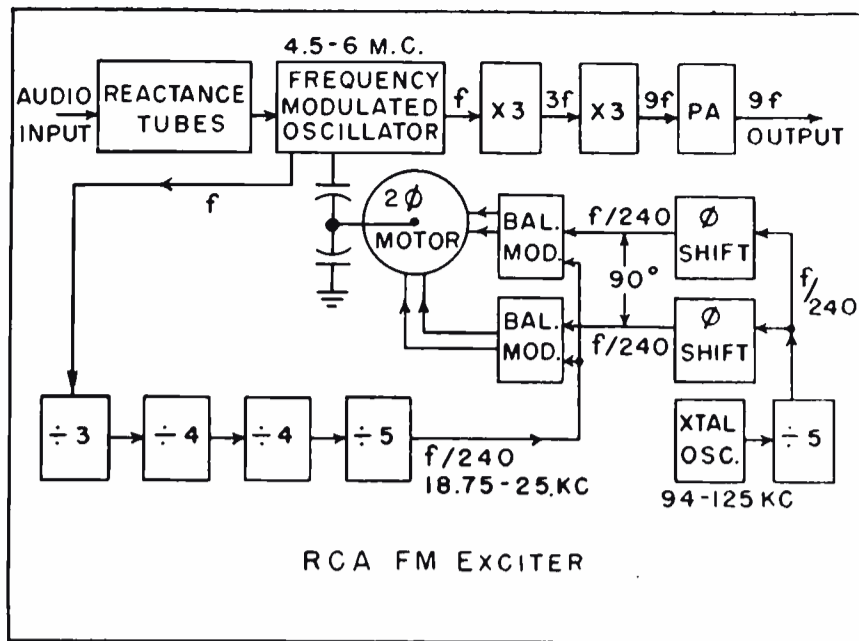

FIG. 10. Block diagram of the final arrangement of the exciter unit. The crystal-controlled oscillator operates in the 94 to 125 kilocycle band.

of the output is sufficiently good for the purpose. It will cover the tuning range required for the exciter by means of an adjustable iron slug in the coil. The lock-in range may be as high as $\pm 5\%$.

FREQUENCY OF COMPARISON

Having selected a circuit for frequency division the next consideration was to fix the frequency at which the comparison of frequencies was to be made. During the war the RCA crystal group has developed a crystal and holder designed to operate in the frequency range of 90 to 125 kc. The performance of these units has been very good and they, therefore, were selected for use as a frequency standard for RCA postwar FM exciter.

A preliminary test of the performance of the frequency control with frequency comparison made at 100 kc gave excellent

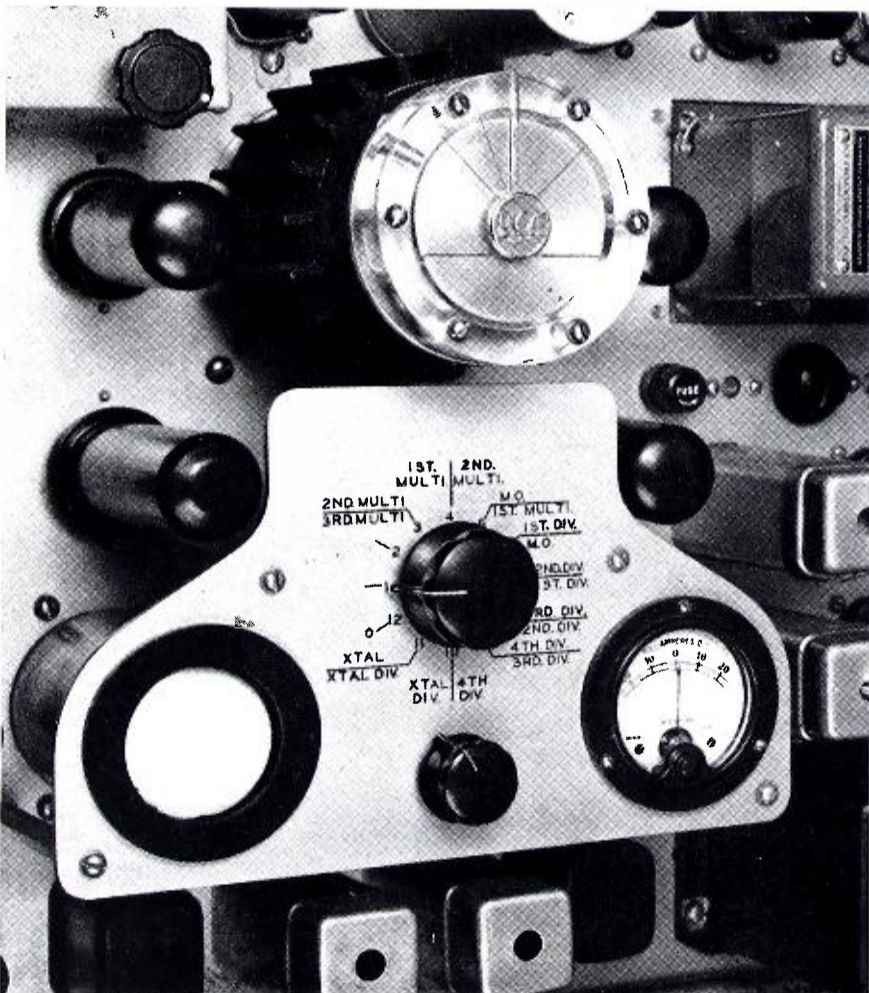

FIG. 11. Closeup of the built-in oscilloscope checking device. The switch in the center is used to select the stage to be monitored.

performance, except for loss of control in the presence of tone frequency modulation when the modulating frequency was below one hundred cycles. A fundamental characteristic of frequency modulation is that the power output (or the energy in the modulated signal) does not change with the degree of modulation. However, as the amount of modulation is increased from zero, there is a transfer of power from the carrier to the sidebands lying above and below the carrier frequency. This effect continues with increasing modulation until a point is reached where all the energy is in sidebands and there is no power in the carrier. With further increase in modulation, or frequency swing, the carrier again reappears. With the ± 75 kc swing of frequency used for broadcasting, there are several cycles of this effect at low modulating frequencies. In early experiments where the frequency comparison was made at 5 mc (Figure 7) this phenomenon showed only as a loss of torque in the motor.

Theoretically we should have been able to find conditions of modulating frequency and degrees of modulation where there was no torque. Actually these points were so critical and sharply defined that it required some care to find them. In actual operation with program modulation, the condition of no-torque would not exist long enough to lose control.

The effect of frequency division is to reduce the swing of frequency with modulation, along with the reduction of carrier frequency. This is carried far enough (when the frequency comparison is made at 100 kc) that carrier loss occurs only at frequencies of modulation below 100 cycles and for 100 cycle modulation only with full frequency swing of 100% modulation.

This effect was not serious with program modulation, but in taking performance data on a transmitter with tone modulation it would be apparent. An additional division by 5, to 20 kc eliminates this trouble except for modulation below 20 cycles which is low enough to be neglected.

OVERALL CIRCUIT OF EXCITER

The final circuit of the new exciter is shown in this block diagram of Figure 10. The tubes in the top row are, from left to right, the reactance tubes, modulated oscillator, a frequency tripler, followed by a second tripler, and a power amplifier. The power amplifier is used to get sufficient power to feed through a transmission line to the main transmitter. The output frequency of the exciter will fall in the range of 40.5 to 54 mc. With a multiplication of two in the main transmitter a frequency range of 81 to 108 mc is provided.

A lead shown at the left in Figure 10 conducts synchronizing voltage from the modulated oscillator to the first divider at the lower left. The dividers are set up as shown with four stages, giving a total division of 240. This places the output frequency of the last divider in the range of 18.75 to 25 kc. The output of the last divider is connected directly to the two balanced modulators.

The crystal oscillator shown at the lower right may operate at any frequency between 94 and 125 kc. This is accomplished without the use of any tuning adjustments. The crystal output synchronizes a divider at one-fifth the crystal frequency. This frequency is also fed to the balanced modulators, but in this case a phase shifting network is included in the lead to each modulator adjusted to maintain a 90° displacement in phase between the modulators over the range of frequencies involved. The only tuning required in the crystal or reference frequency part of the circuit is to set the slug in the divider so that its frequency is locked to one-fifth of the crystal frequency.

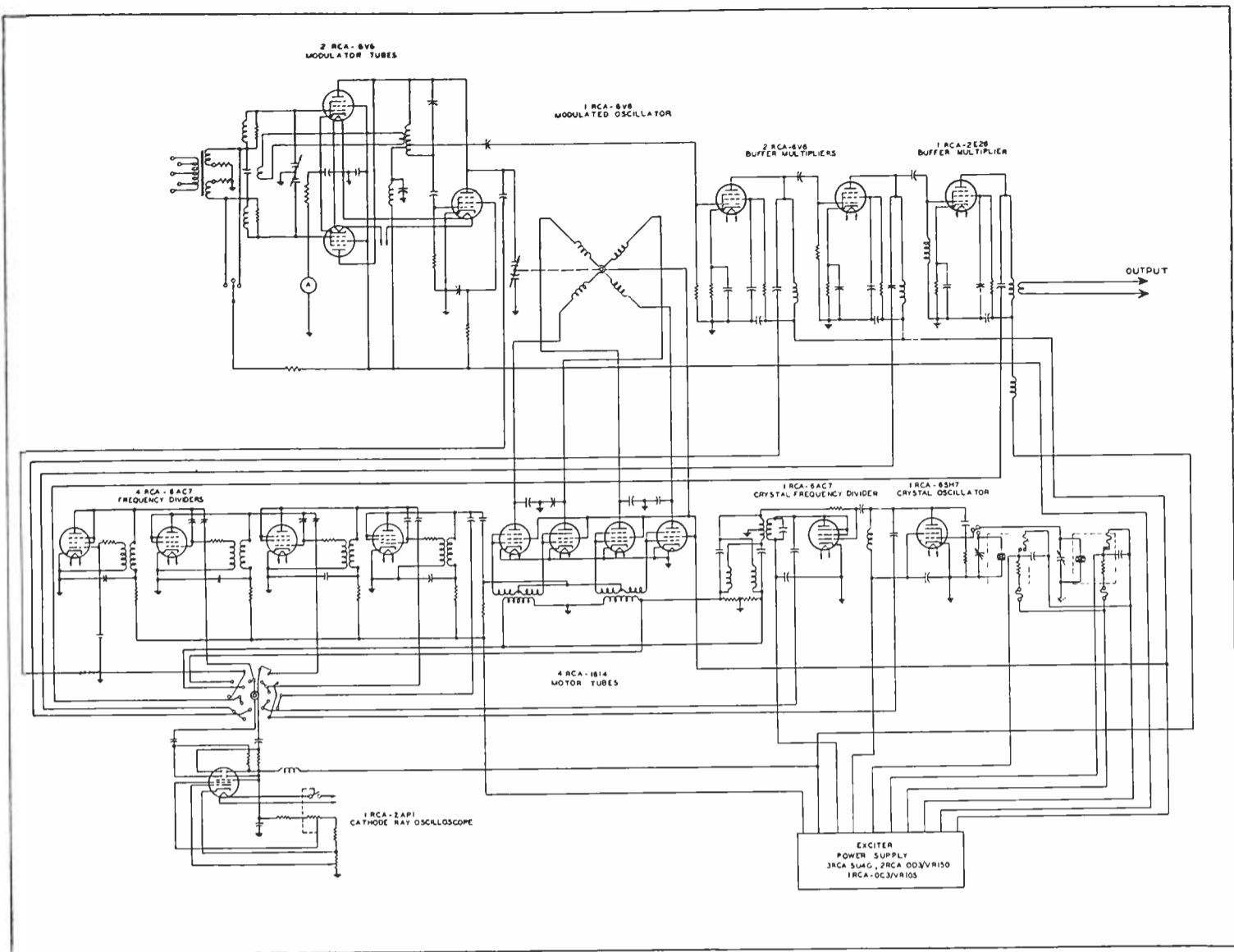

FIG. 12. Schematic diagram of the new exciter unit used in all RCA FM Transmitters. Note that all tubes are of inexpensive, well-known types available everywhere. The circuits are simple and straightforward, easily checked. Only one crystal is in actual use, the second being a spare provided for emergency operation.

OPERATION OF FREQUENCY CONTROL MOTOR

Each balanced modulator has a pair of 6L6 tubes biased to cut off and connected push-pull. The induction motor used has high impedance center-tapped windings on each phase so that it can work in the plate circuit of the balanced modulator tubes without the use of matching transformers. In this way the motor receives full voltage down to d-c beat frequency. The need for this is evident when one considers that the motor must respond to a beat frequency lower than one part in a million at 20 kc. This comes out to be .02 cycles-per-second or 1.2 cycles-per-minute. This rather surprising performance from an induction motor is largely made possible by the elimination of load on the motor. The absence of gearing and the use of viscous damping establish a condition in which there is little or no resistance to small or slow rotation of the motor shaft. The motor responds to frequencies up to 1000 cycles whereas the motors used in previous exciters of this general type were limited to 60 cycles, thereby requiring comparison at about 5 kc instead of the higher frequency.

BUILT-IN CHECKING DEVICES

The operation of the circuits may be checked easily and rapidly by means of test equipment built into the exciter. A cathode-ray oscilloscope, with a selector switch, is provided making it possible to check the operation of each divider and also the tripler amplifiers by means of lissagous figures. A three position selector switch enables the operator to apply a d-c potential to either reactance tube grid, causing the frequency of the modulated oscillator to shift high or low over a range considerably in excess of the range encountered due to ambient temperature

humidity or line voltage variation. The behavior of the frequency control motor and the relative rotation of the shaft required to correct the artificial frequency shift may be observed on a dial on the motor shaft. This operation gives a rapid check of the performance of the reactance tubes and the frequency control mechanism. A meter is provided to read the plate current of the reactance tubes and the modulated oscillator. A buzzer, operated by a cam switch on the frequency control capacitor shaft, gives warning if for any reason the frequency control is about to fail because of passing through maximum or minimum capacity. The buzzer will sound only if there is maladjustment of oscillator tuning control or for the failure of all but a few of the frequency control circuit elements.

PERFORMANCE OF EXCITER

The accuracy of the frequency control is limited by the heat cycle of the crystal oven. On test this effect shows a regular variation of ± 40 cycles at 100 mc as the thermostat of the crystal oven goes on and off. The control action is smooth and rapid. There are no critical adjustments. The range of control can be as high as ± 1000 cycles at 20 kc or $\pm 5\%$. At 100 mc this amounts to ± 5 mc.

In case of failure of the frequency control during a program, operation can be continued with manual frequency control by locking the motor shaft and adjusting frequency with a vernier tuning control on the master oscillator tank coil.

The distortion in the frequency modulated output of the exciter is of the order of .5% for modulating frequencies from 30 cycles to 15,000 cycles. The noise level in the output is 74 db below 100% modulation.

THE GROUNDED-GRID AMPLIFIER

by

C. J. STARNER

TRANSMITTER ENGINEERING DEPARTMENT
ENGINEERING PRODUCTS DIVISION

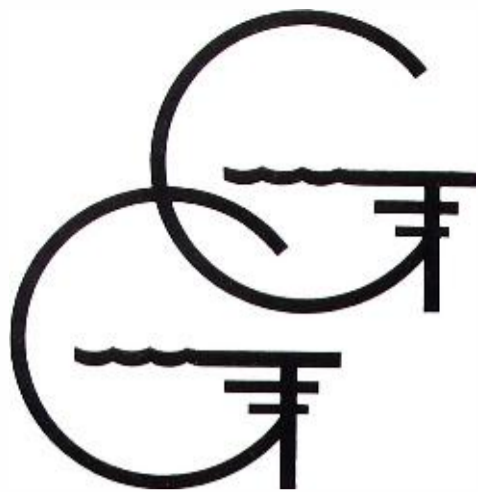

The use of Grounded-Grid amplifiers is one of the outstanding features of RCA's new line of FM Broadcast Transmitters. The grounded grid circuit has several very important advantages at FM frequencies and its use in the new RCA FM Transmitters makes these units superior in a number of respects to transmitters using amplifiers of conventional type. These points of superiority include:

- (a) Circuits which are simpler and require fewer components than conventional amplifiers.
- (b) Neutralizing, when necessary, is very simple. It is not required at all for low powers.
- (c) Stability and lack of critical adjustment not previously obtained in 100 mc transmitters.
- (d) Greater output from an amplifier using a tube of a given size, making possible the use of smaller, less expensive types.
- (e) Use of same tube types in driver and power amplifier—reducing number of tube types required.

This list of advantages naturally prompts the question: what is a grounded-grid amplifier? As the name implies, in a grounded-grid amplifier the grid is at a-c ground potential and the drive is applied between cathode and ground, either element being at the necessary d-c bias potential. The d-c and a-c potentials and currents are the same in the conventional and in the grounded-grid circuits as far as the tube itself is concerned; consequently, ratings that apply to one apply equally to the other. As will be shown, however, the power output of the grounded-grid circuit will be greater as will be the driver power requirement. Neutralization is either unnecessary, depending on frequency, or, if necessary, it is very easily achieved. Circuit simplicity is a direct result with better stability and easier adjustment at higher frequencies than otherwise attainable. Such a circuit is therefore particularly useful at high frequencies.

THEORY OF OPERATION

Simplified circuit diagrams of a grounded-grid amplifier and a comparable conventional amplifier grounded cathode are shown in Figure 1 and Figure 2. In order to aid in visualizing the operation of the two circuits the variations of the plate, grid and cathode voltages for each circuit are shown for a complete cycle. For the sake of simplicity no neutralizing circuits are shown. The effect of neutralization will be considered later.

Operation to the diode line (i.e., the point at which maximum positive grid voltage equals the minimum plate voltage) is assumed here; hence, for the conventional circuit the maximum plate swing will be the plate supply voltage minus the positive grid swing. In the grounded-grid amplifier the grid is held constant at zero a-c potential while the cathode voltage varies about the zero potential line. When the cathode swings negative, it produces the same effect as the grid voltage swing positive in the conventional circuit (i.e., both cause the plate voltage to drop). In other words the cathode voltage E_g is in phase with the plate voltage E_p , and the limit of downward swing is now $-E_g$ instead of the positive grid swing. Thus the a-c plate volts to ground, in terms of the conventional circuit, will be the plate voltage swing E_p , plus the grid voltage swing E_g .

$$E_L = E_p + E_g \quad (1)$$

In order to meet the original conditions (i.e., that tube potentials and currents are the same in both cases) the load resistance R_L must increase to a value R'_L , to keep I_p the same in both cases.

$$R'_L = R_L \left(1 + \frac{E_g}{E_p} \right) \quad (2)$$

If P_o is the power output, E_g the grid voltage, E_p the plate voltage swing, P_g the drive power required, R_L the load resistance, and I_p the peak a-c plate current (all values being those applying to conventional operation) then P'_o , the power output as a grounded-grid amplifier, is,

$$P'_o = \frac{I_p \times E_L}{2} \quad (3)$$

Since the normal power output of a conventional amplifier is

$$P_o = \frac{I_p \times E_p}{2} \quad (4)$$

and since $E_L = E_p + E_g$, the ratio of the power output of the grounded-grid amplifier to the power output of the conventional amplifier is:

$$\frac{P'_o}{P_o} = \frac{I_p (E_p + E_g) \times 2}{I_p \times E_p \times 2} \quad (5)$$

$$\text{or} \quad P'_o = P_o \left(1 + \frac{E_g}{E_p} \right) \quad (6)$$

and the power increase is

$$P_o \left(\frac{E_g}{E_p} \right) \quad (7)$$

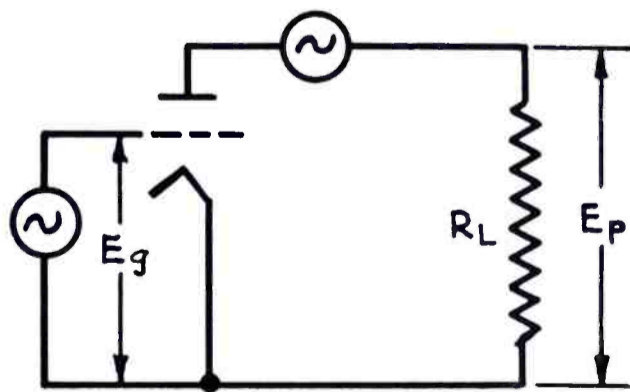
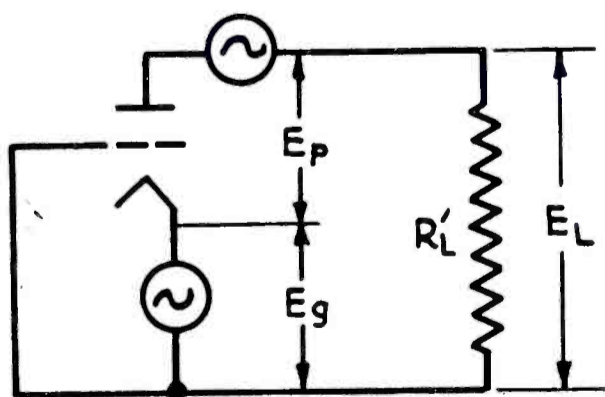
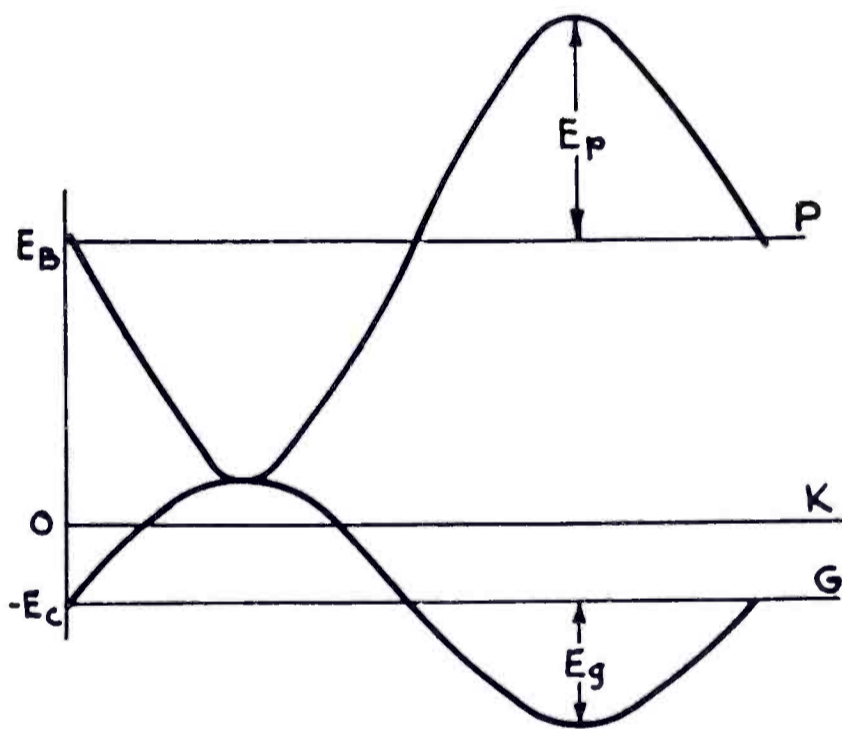
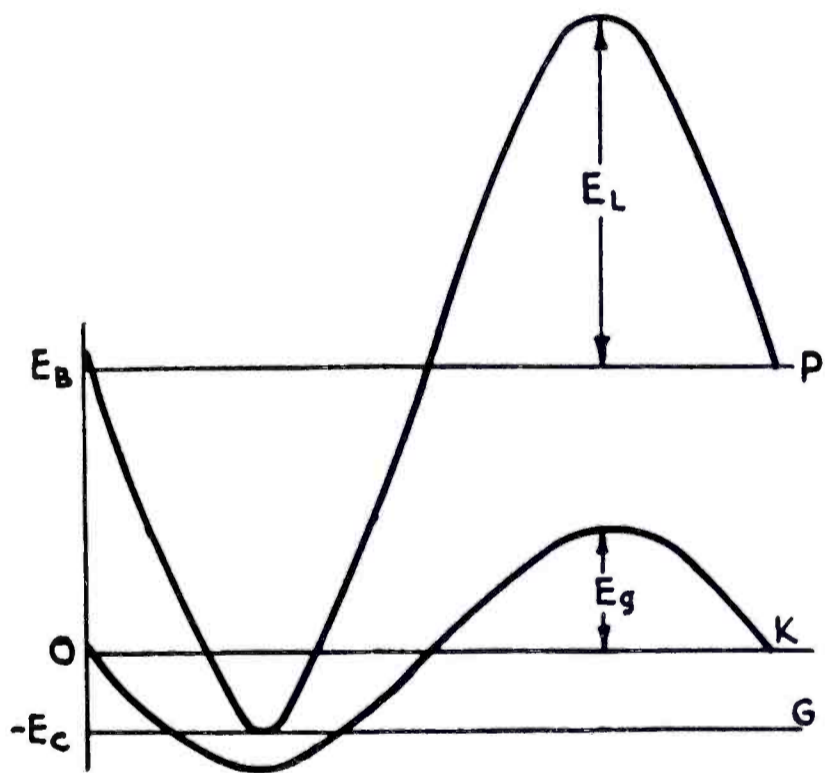
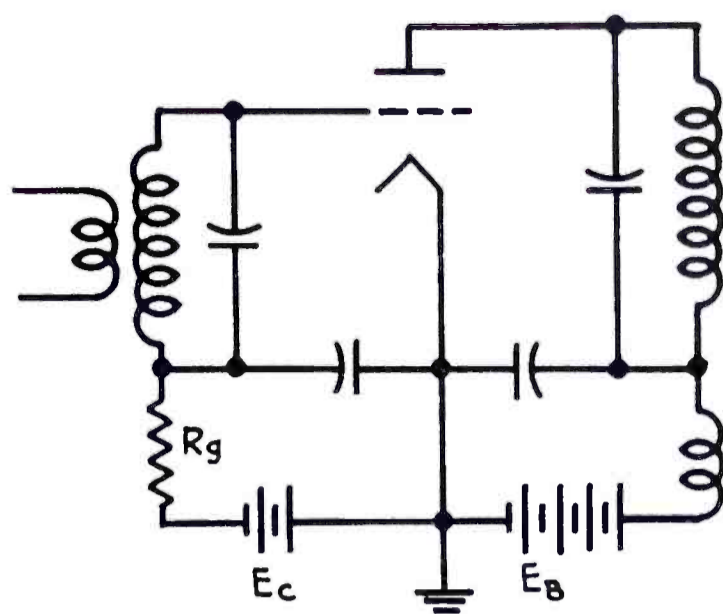
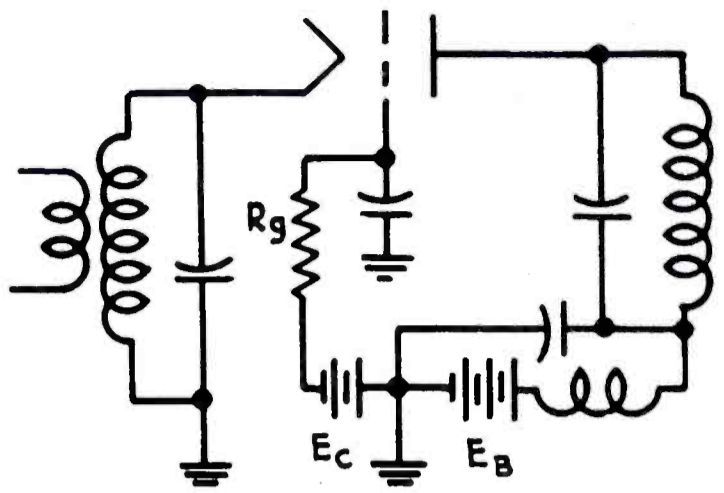

FIG. 1.

FIG. 2.

This power increase does not come from the tube itself, but must be supplied by the driver; therefore, the driver power must be increased by this same amount. Thus the power required from the driver of a grounded-grid amplifier is

$$P'_g = P_g + P_o \left(\frac{E_g}{E_p} \right) \quad (8)$$

Note here that the power required from the driver increases but that the actual power into the grid of the power amplifier tube remains the same, and that the extra power appears as useful power in the output circuit.

The grounded-grid amplifier may be represented as two generators in series as shown in Figure 3.

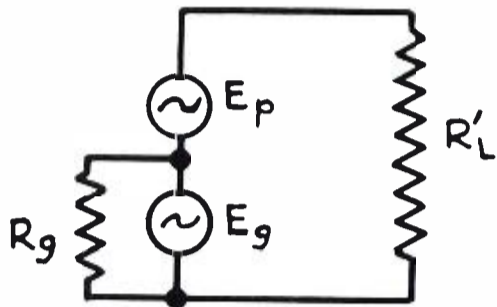

FIG. 3.

Here E_g is the input voltage and E_p is the plate to cathode voltage. Actually the driver must furnish both power to the load and the grid losses of the tube and bias resistor. These latter we may represent by R_g , remembering that the generator E_p supplies no power to R_g (a requisite of neutralization).

Referring to the input, the exciting power supplies the losses in the grid circuit ($R_g I_g^2$), and at the same time supplies the load with power $\frac{E_g I_p}{2}$. From the driver viewpoint, the load

presented to it becomes two resistances in parallel,

$$R_g \text{ and } \frac{E_g}{I_p} = R_o, \text{ as shown in Figure 4.}$$

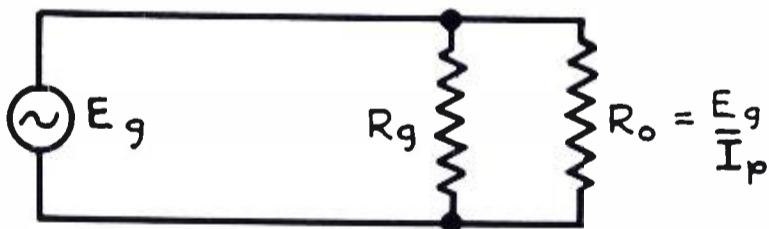

FIG. 4.

R_g , representing the grid losses, is substantially a constant resistance, if E_g is constant, but the value of R_o varies inversely as the plate load current, becoming infinite if no load current flows (plate circuit open) and being the lower of the two resistances at normal load. The total resistance presented to the driver varies inversely as the plate load current, and since the driver is required to develop substantially the same value of E_g into lower resistance, more power must be supplied by the driver. The circuit is thus seen to be highly degenerative, demanding increased power from the driver in proportion to any increase in plate load current. This increase in power shows up as an increase in output power.

NEUTRALIZATION

Neutralization of a grounded-grid amplifier may be necessary at higher frequencies either because of the presence of inductance between the active grid element and the common returns of the input and output circuit (due to tube lead inductance) or because of the plate-to-cathode capacitance, (i.e., the feed-through capacitance) which may have to be neutralized if it is of appreciable magnitude. The cathode-to-plate capacitance of tubes designed for grounded-grid operation will usually be low enough so that neutralization will not be necessary. Also at these frequencies the inductance from the active portion of the grid-to-ground (tube lead) will be small enough to be ignored, since it will have a tendency to neutralize the plate-to-cathode capacity. From the standpoint of stability a certain amount of capacity feed-through may be tolerated, since the degeneration of the circuit causes the input impedance to be lower than in the conventional amplifier, and so calls for considerably more power transfer from output to input in order to sustain oscillation.

However, as the frequency is raised a point will be reached at which either or both of these effects will cause the feed-back energy to be sufficient to overcome the degeneration, and neutralization will be necessary.

Neutralization, where required, may be accomplished by inserting an inductance in series with the grid. For values of plate-to-cathode capacity normally encountered in tubes adaptable to grounded grid use, the inductance in the grid-to-ground circuit will be sufficient and in some cases even series capacitance may be required. The tube electrode capacities are shown in Figure 5A. These can be represented by an equivalent star connection of three capacitors as shown in Figure 5B. If we connect a suitable inductance L_n (Figure 5C) in series with C_c , so that C_c and L_n are resonant, then the point O is at ground potential. This will prevent any transfer of energy from P to K, since there now exists no common coupling impedance. The value of C_c in terms of C_{pk} , C_{pg} and C_{gk} is

$$C_c = \frac{C_{pg} C_{pk} \pm C_{pk} C_{gk} \pm C_{gk} C_{pg}}{C_{pk}} \quad (9)$$

and the inductance required is

$$L_n = \frac{1}{(2 \pi f)^2 C_c} \quad (10)$$

It is apparent that when C_{pk} is small compared with C_{pg} and C_{gk} that C_c is a large value and the required value of L_n is small. In practical cases the value of L_n needed can be adjusted closely enough by proper choice of the bias blocking capacitor (L_n being supplied by the tube and lead inductance) to give neutralization over a wide frequency range. At frequencies where the physical size of the tube becomes an appreciable part of a quarter-wavelength, it may become necessary to use a tuneable bias blocking capacity to reduce the tube element inductance to a value low enough for neutralization. As has been noted before, depending on the tube design and size, operation without neutralization may be accomplished up to frequencies of the order of 40 megacycles, for certain high power tubes, and to hundreds of megacycles for smaller ones. When neutralization is required, we have a circuit as shown in Figure 6 where C is a blocking capacitor to allow application of bias potential to the grid. From Figure 6, it is apparent that the actual neutralizing circuit is a bridged-T network adjusted to a null, the current through the T being advanced 270° in phase, and that through the capacitor bridge C_{pk} being advanced 90° . There is then

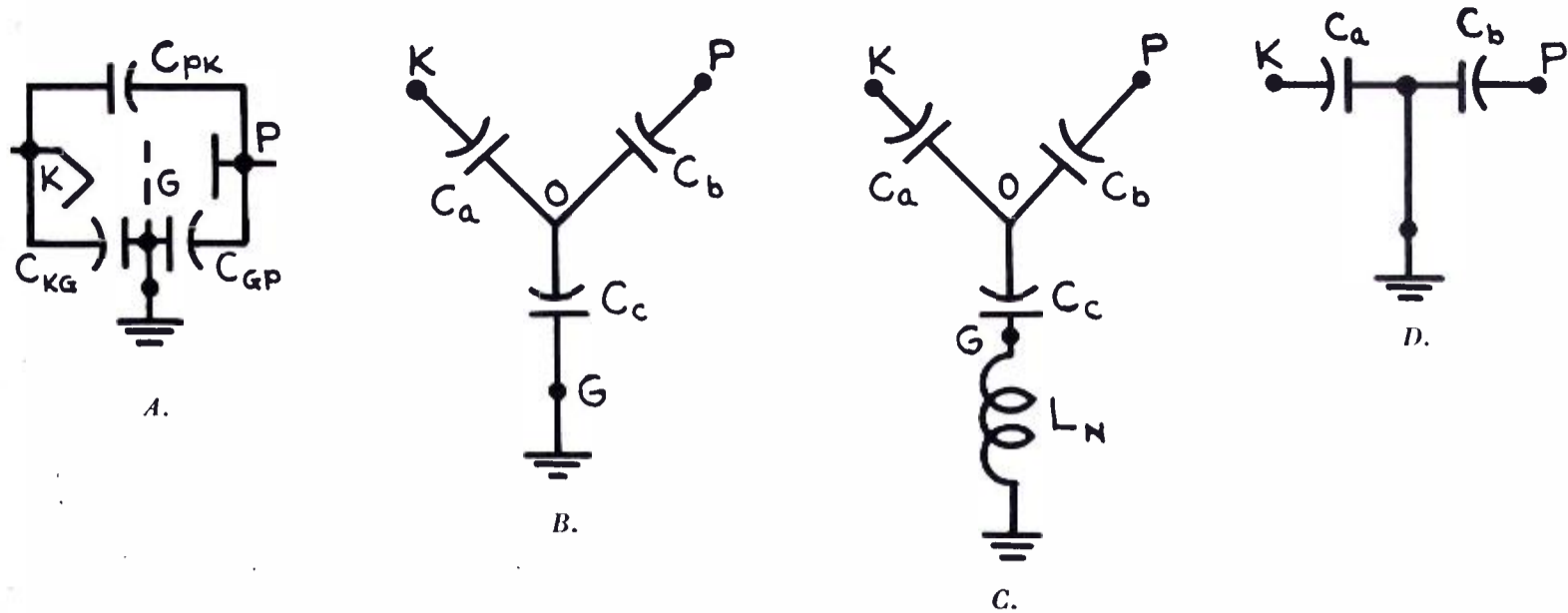

FIG. 5.

($270^\circ - 90^\circ$) a 180° phase difference, and when the amplitudes are equal, the net transmission is zero. However, while there is no transmission of energy through the tube, the grid is now above ground by whatever voltage is developed in L_n . From Figure 6, it is apparent that some circulating current from the output circuit flows through L_n and that the grid is raised above ground by the reactive drop in L_n . This drop is always regenerative and the voltages as shown in Figure 1 must be modified to those shown in Figure 7, where E'_g is the voltage developed across L_n . The net result is a lowering of drive power requirement, with a subsequent increase in power gain (ratio of input to output power) at the cost of somewhat lowered power output. In tubes having a large ratio between C_{pk} and C_{pg} , the change is small and is desirable since the increase in power gain is usually more important than the slight loss of power output capability.

TUBE REQUIREMENTS

From the above it is apparent that the first requirements of a tube for a grounded-grid amplifier is that it have a low value of C_{pk} , since this dictates the necessity for neutralization. Or, more properly, it should have a high ratio of C_{pg} to C_{pk} since the improvement in high-frequency performance is directly proportional to this ratio. (C_{pg} is the feed-through capacitance for grounded cathode operation, while C_{pk} is the feed-through capacitance in the grounded-grid case.) Low grid to ground inductance

is important since the minimum attainable is usually more than required for neutralization. Economy of grid drive and high efficiency have the same importance here as in the conventional amplifier.

POWER GAIN

If we define power gain as the ratio of driver power to total output power, then the power gain becomes

$$\frac{P_o}{P_g} = \frac{P_o \left(1 + \frac{E_g}{E_p}\right)}{P_g + P_o \left(\frac{E_g}{E_p}\right)} = \frac{P_o + P_o \left(\frac{E_g}{E_p}\right)}{P_g + P_o \left(\frac{E_g}{E_p}\right)} \quad (11)$$

Thus we see that both the actual grid drive power and the voltage at which this power is required control the power gain, with the latter being the larger factor. This is obvious when we note that the driver must furnish two components of power,

one being $\frac{E_g \times I_g}{2}$ (power dissipated by grid) and the other $\frac{E_g \times I_p}{2}$ (power supplied to output). When the amplifier is

loaded the latter term is much the larger factor. To have a high power gain we must then have a large ratio of E_g to E_p , and since the bias voltage affects the value of E_g , while affecting

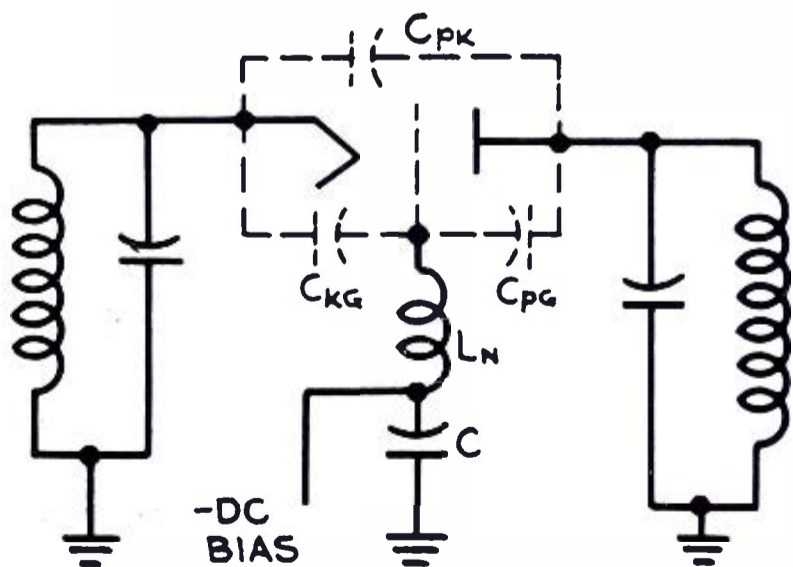

FIG. 6.

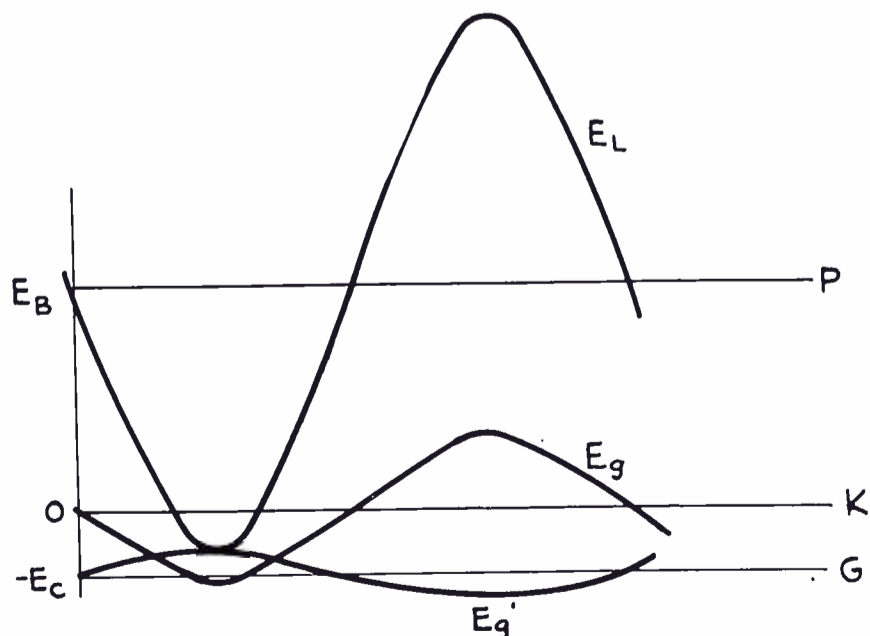

FIG. 7.

the value of E_p by a much smaller percentage, we can adjust the power gain by changing the grid bias. Tubes are available which will give power gains of from 5 to 7 when used in a class C grounded-grid amplifier and operated at normal conditions of bias. These power gains can be adjusted downward to values of the order of three if we wish to divide power output between driver and amplifier output. The usual limit here is the maximum bias potential allowed by the tube rating.

This is the case when a tube is used as a grounded-grid driver for two tubes of the same rating in a grounded-grid amplifier. Here the driver stage is operated at the lowest bias compatible with tube efficiency to get maximum power gain. The final amplifier stage is operated with a high bias, so that low power gain results. Consequently, a larger amount of power is required from the driver, the greater part of which appears in the output. If the power gain of the final amplifier is in the order of three, then the driver will contribute approximately one-fourth of the total output, or approximately seven-tenths of the power contributed by each of the two final tubes.

EFFICIENCY

Since the tube does not know which of its elements are grounded (i.e., all potentials and currents are the same) the efficiency of the tube is the same in either the grounded-grid or conventional case. However, since the driver supplies power to the output, the usual efficiency equation

$$\text{Viz. } \eta = \frac{P'_o}{P_{in}} \times 100 \text{ in per cent.} \quad (12)$$

(Where P_{in} is the plate input of the final amplifier) does not give the true efficiency of the amplifier, and must be corrected to take care of the power contributed to the output by the driver.

The true efficiency is

$$\eta' = \frac{P'_o - P_o \left(\frac{E_g}{E_p} \right)}{P_{in}} \times 100 \text{ in per cent.} \quad (13)$$

with the power contributed by the driver being represented by the factor $P_o \left(\frac{E_g}{E_p} \right)$. The quantity $P_o \left(\frac{E_g}{E_p} \right)$ is a function of tube parameters and operating conditions, varying directly as the amplifier plate current. The driver contribution has been shown to be

$$P_o \left(\frac{E_g}{E_p} \right) = \frac{E_g \times I_p}{2}$$

If we hold the drive constant, the driver contribution to the output is directly proportional to plate current, and will be a fixed percentage of the measured output at any value of amplifier plate input, if the plate input is varied in the usual manner (i.e., by changing the plate current). This analysis is not rigorous, but the errors involved are small and compensate each other. Hence, it is possible to assign an efficiency to any given grounded-grid amplifier design, which will apply in the same manner as that for a conventional amplifier, that is,

$$P'_o = \frac{P_{in} \times \eta'}{100} \quad (14)$$

where η' has a value determined by measurement, and applies to one amplifier design only.

At high frequencies, the true amplifier efficiency will usually be better than that of the conventional amplifier since the inherent stability of the circuit eliminates the necessity for para-

sitic suppressing chokes or resistors, with their attendant power loss.

AMPLITUDE MODULATION

If the grounded-grid amplifier is to be plate-modulated, the driver rating obtained from the foregoing must be its carrier rating when operated as a plate-modulated amplifier, since it is necessary to modulate the driver simultaneously with the power amplifier to obtain satisfactory distortion characteristics. If we refer to Figure 4, it is apparent that as the power amplifier is modulated, the resistance represented by R_o will change. R_g will also change slightly, and in a direction to unload the driver on upward modulation, which gives a slight but beneficial rise in excitation voltage. However, in grounded-grid service, this change is swamped out in the change of R_o . Since I_p is proportional to modulation, the driver load will change from R_g at the trough of modulation to R_g in parallel with $\frac{R_o}{2}$ at the peak of modulation. No economical driver can be expected to supply constant voltage into such a load, and since the regulation which does occur is in such a direction as to increase non-linearity of the PA, the driver must be modulated simultaneously with the PA. If the ratio of E_g to I_p is to be held constant, the driver must be modulated 100%.

If the driver operates at the same plate supply voltage as the power amplifier, and the same modulator is used for both, the modulator will work into a load resistance

$$\frac{E_b}{I_{PA} + I_{Driver}} \text{ d-c values} \quad (15)$$

Where I_{Driver} includes the screen current if the driver is a pentode. If the modulator power required is compared to that for a conventional PA, of the same efficiency and carrier output, the modulator power output is larger by the amount required to modulate the drive. If η' and η'' are the efficiencies of driver and PA respectively, then the modulator power output required for the grounded-grid amplifier is

$$\frac{1}{2} \frac{(P_o + P'_g)}{\eta'' \eta'} \quad (16)$$

as compared to

$$\frac{1}{2} \frac{(P'_o)}{\eta''} \quad (17)$$

for the conventional amplifier. (For simplicity a conventional amplifier large enough to supply the same output as the grounded-grid amplifier is assumed.) Assuming that $P_g = \frac{1}{10} P'_o$ and $\eta' = 70\%$, the grounded-grid amplifier will require $\frac{1}{10\eta'} \times P'_o$, or about 14% increase in power. If the driver of the grounded-grid amplifier were not modulated, then the modulator power would be the same as that for the conventional amplifier of the same carrier output, but the load resistance would be higher; $R = \frac{E_p + E_g}{I_{PA}}$ since the plate voltage must then be carried negative E_g volts (in excess of E_p) to bring the output to zero. Hence, in a grounded-grid amplifier, failure to modulate the driver has the effect of increasing the plate supply voltage of the PA, while modulating the driver effectively puts the two in parallel and their r-f outputs in series. There are three sources of distortion in an amplitude modulated grounded-grid amplifier. These are, (1) Distortion arising from non-linearity of the PA. (2) Distortion due to non-linearity of the driver, which is intro-

duced directly into the output, and (3) distortion due to reaction of the non-linear elements on the modulator. In order to make the distortion arising from (1) a minimum, approximately 60% driver modulation is necessary, while it is necessary to use 100% driver modulation to make (2) a minimum. This same ratio holds for (3). These conflicting driver modulation requirements make a compromise value necessary, which experience has shown to be approximately 80%. This gives a minimum overall distortion value when these three distortion factors are considered as adding to give the overall distortion product. With careful design the distortion of the grounded-grid amplifier will be somewhat less than that of the conventional amplifier.

OPERATING NOTES

The adjustment and operation of a grounded-grid amplifier presents no unusual problems. Some differences in adjustment do appear, but on the whole, adjusting and operating procedures are quite familiar. Freedom from instability and lack of spurious oscillations is marked.

Where neutralization adjustment is necessary, a somewhat different procedure must be followed. Since the cathode is driven negative rather than the grid positive, the plate and grid will have a positive potential relative to the cathode over part of the r-f excitation cycle. If a path is provided for d-c plate current flow (plate supply grounded or left with rectifier filaments excited) the plate ammeter will indicate plate current even though neutralization is complete. At the same time the a-c components flow through the plate circuit and cathode circuit, developing a-c voltage in both of these circuits. The a-c component

of power will be delivered to the load while the d-c component is supplied to the rectifier. Under these conditions the output power cannot be reduced to zero by neutralization. Consequently, neutralization can be accomplished only by removing the filament power from the amplifier tube. Neutralization for minimum feed-through under this condition (cold filament) may not be exact when the tube filament is excited, due to changes in tube capacity, and neutralization may be checked by observing behavior under power conditions.

The usual criterion of neutralization may be accepted, that is, if maximum grid current coincides with minimum plate current, and the degeneration is symmetrical on both sides of resonance, the amplifier is exactly neutralized.

The fact that d-c plate current appears in the amplifier with the application of drive, may be used to tune the plate circuit to resonance and, to a certain extent, to adjust the loading, before applying plate voltage to the amplifier. Since the grounded-grid circuit is highly degenerative, the driver power demands will vary over a wide range according to the amplifier plate input. Accordingly, the drive must be readjusted for each value of amplifier plate load, in order to maintain the required value of d-c grid current. The design of transmitters utilizing grounded-grid amplifiers requires a somewhat different approach from that of the ordinary circuits because of the output power by the driver. However, the simplicity of the circuits, and the remarkable freedom from parasitics and self-oscillations experienced with such amplifiers make them extremely attractive, not only to the designer, but to the operator as well.

THE RED SEAL DELUXE RECORD—A PLASTIC “PLATTER” FOR HOME USE

RCA announced the greatest improvement in phonograph records during the past 45 years when they introduced, recently, their new non-breakable Red Seal DeLuxe record. This is the record which home record users have been waiting for ever since “talking pictures” originated.

The need for a “quiet” record became imminent with the arrival of sound films in the motion picture industry. The surface noise from the regular shellac records was being magnified by the sensitive equipment used for sound transmission. After much experimentation, a suitable record was evolved by the use of a plastic compound which does not require a mineral filler, such as is used in shellac records. Besides reducing the surface noises, this record had the added advantage of being flexible and, therefore, far more durable. Plastic discs were soon being used for radio broadcasts and later for V discs used by our armed forces overseas.

These same “extras” attracted home record users, too, since there is such a breakage of the brittle shellac discs. The cost of plastics, however, made the use of these records prohibitive for home use. To remedy this situation, RCA engineers continued their research in an effort to produce a comparable record at a reasonable price. The Red Seal DeLuxe record was the achievement of their goal. It was made possible by the development of a formula for a compound composed almost entirely of vinyl-resin plastic. The result was a new translucent, ruby-red colored record which is far lighter in weight than ordinary records, has the same flexibility as the expensive transcription records, a fidelity of reproduction which truly has a concert-hall quality, and is inexpensively priced.



MULTI-UNIT CONSTRUCTION A FEATURE OF NEW FM TRANSMITTERS

by JOHN L. CIBA

Transmitter Engineering Department
Engineering Products Division

Use of a standardized unit-enclosure is one of the features of the new series of RCA FM Transmitters. The basic design of this unit-enclosure provides sufficient flexibility that it can be used equally well for audio, r-f, or power-supply circuits. Thus transmitters of powers up to 10 KW can be made up by combining, in

straightforward fashion, the number of units that may be needed to house the equipment components. A 250-watt transmitter, for instance, will be housed in a single unit—while a 1 KW transmitter will occupy two units, a 3 KW, three units, and a 10 KW, five units.



1. BASIC ELEMENT of the unit-enclosure is a frame which is 25 inches square and 80 inches high. This is constructed of heavy gauge steel angle welded at the corners. Horizontal channel sections having a series of mounting holes are welded on the inside left and right side of the frame.

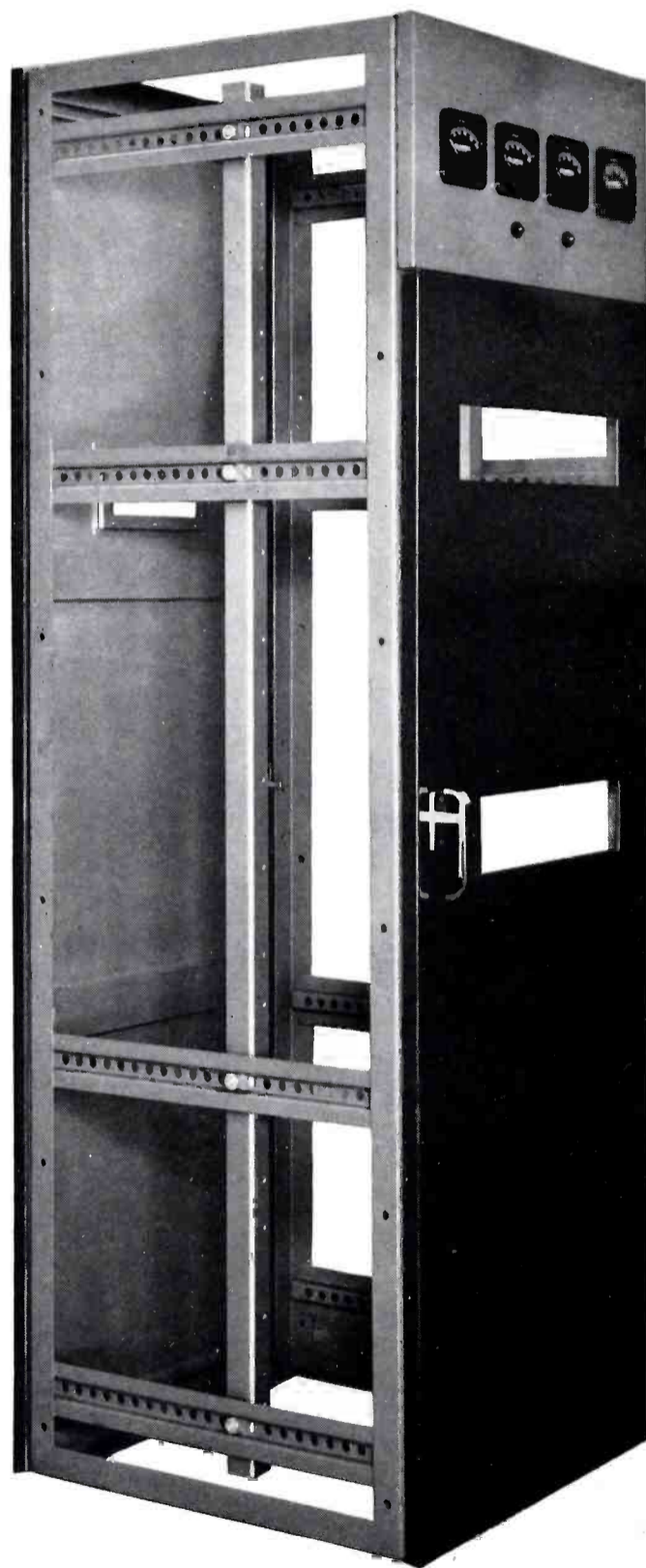

2. DOORS provided on both front and rear of the unit enclosure open the full width of the unit and the full length except for the meter panel on the front. Access is thereby provided to both the front and back of the vertical panel on which the equipment is mounted.

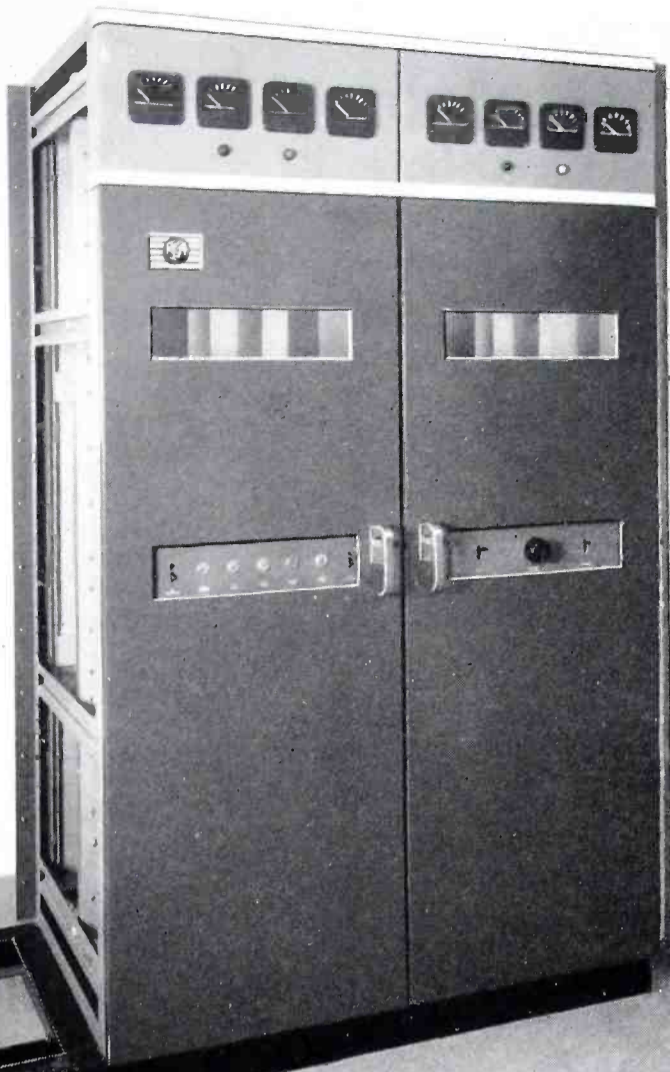

3. BASE FRAME made of channel iron is provided. A continuous trough, which is a part of the base, provides a practical space for inter-unit wiring.

5. CURVED END PIECES are used to give a finished appearance to the assembly. These end pieces are easily removed when it is desired to add additional units.

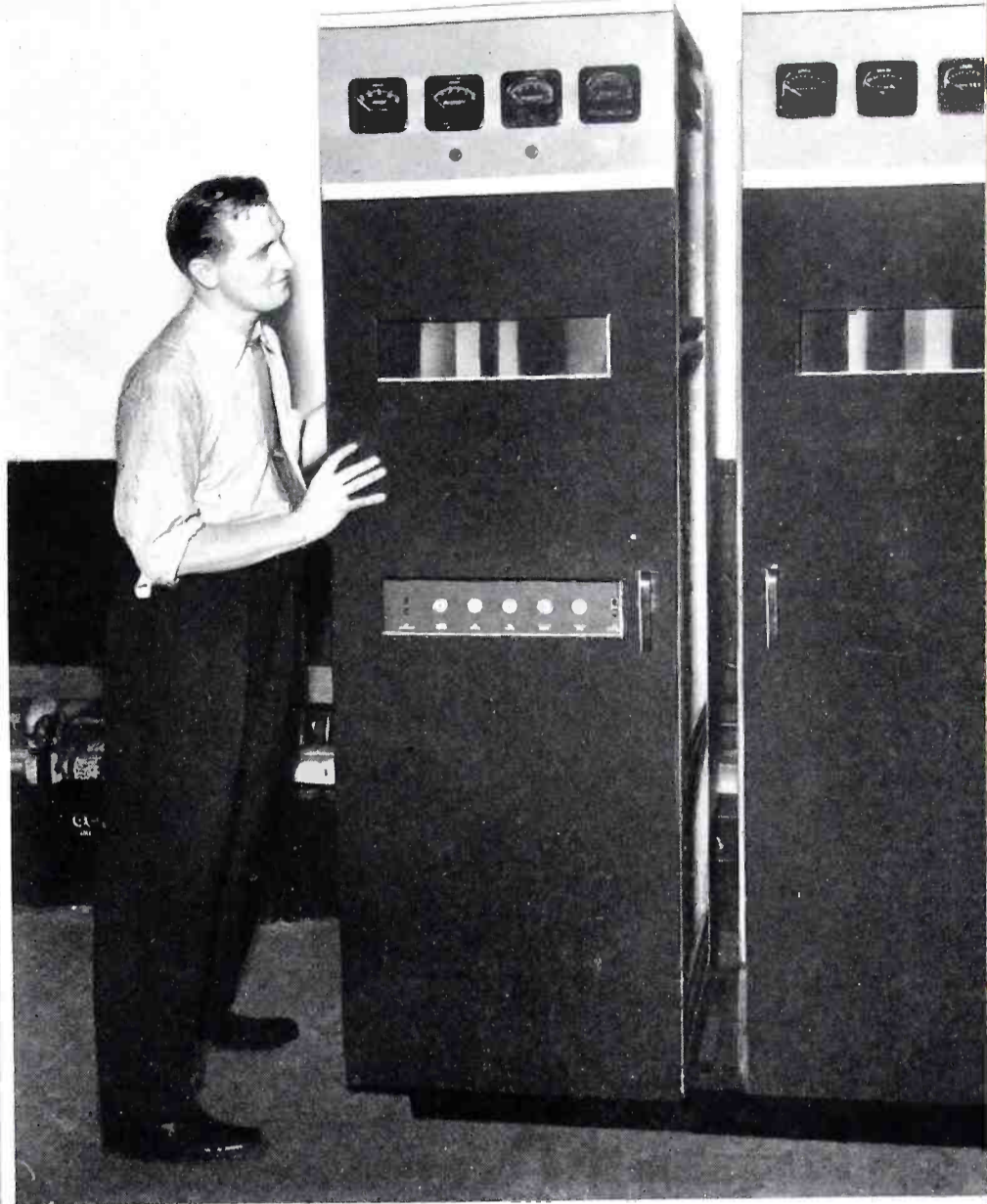

4. UNIT-ENCLOSURES are bolted to this frame. When several units are used together, as in larger transmitters, this frame serves to hold them together.

6. COMPLETED ASSEMBLY of these units presents the appearance of a single overall front panel; the doors on adjacent units fit flush together at the intersection.

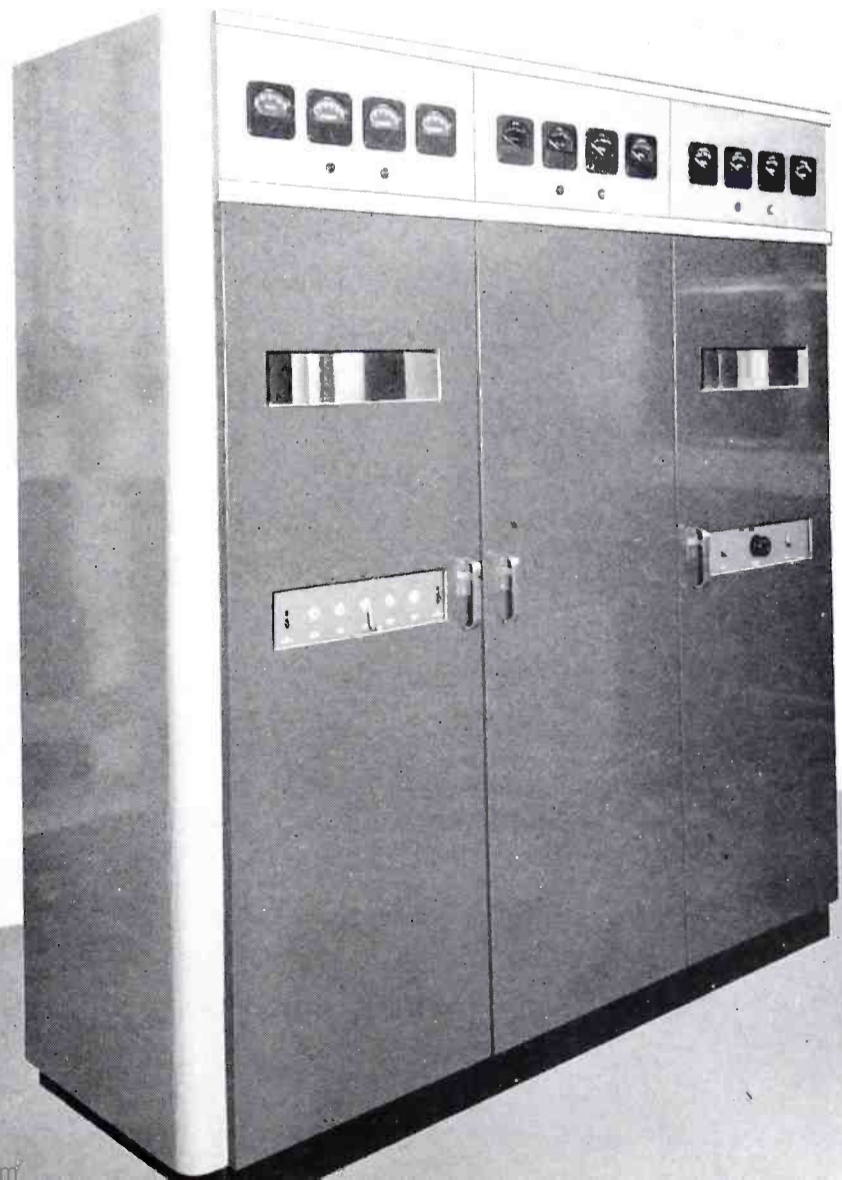
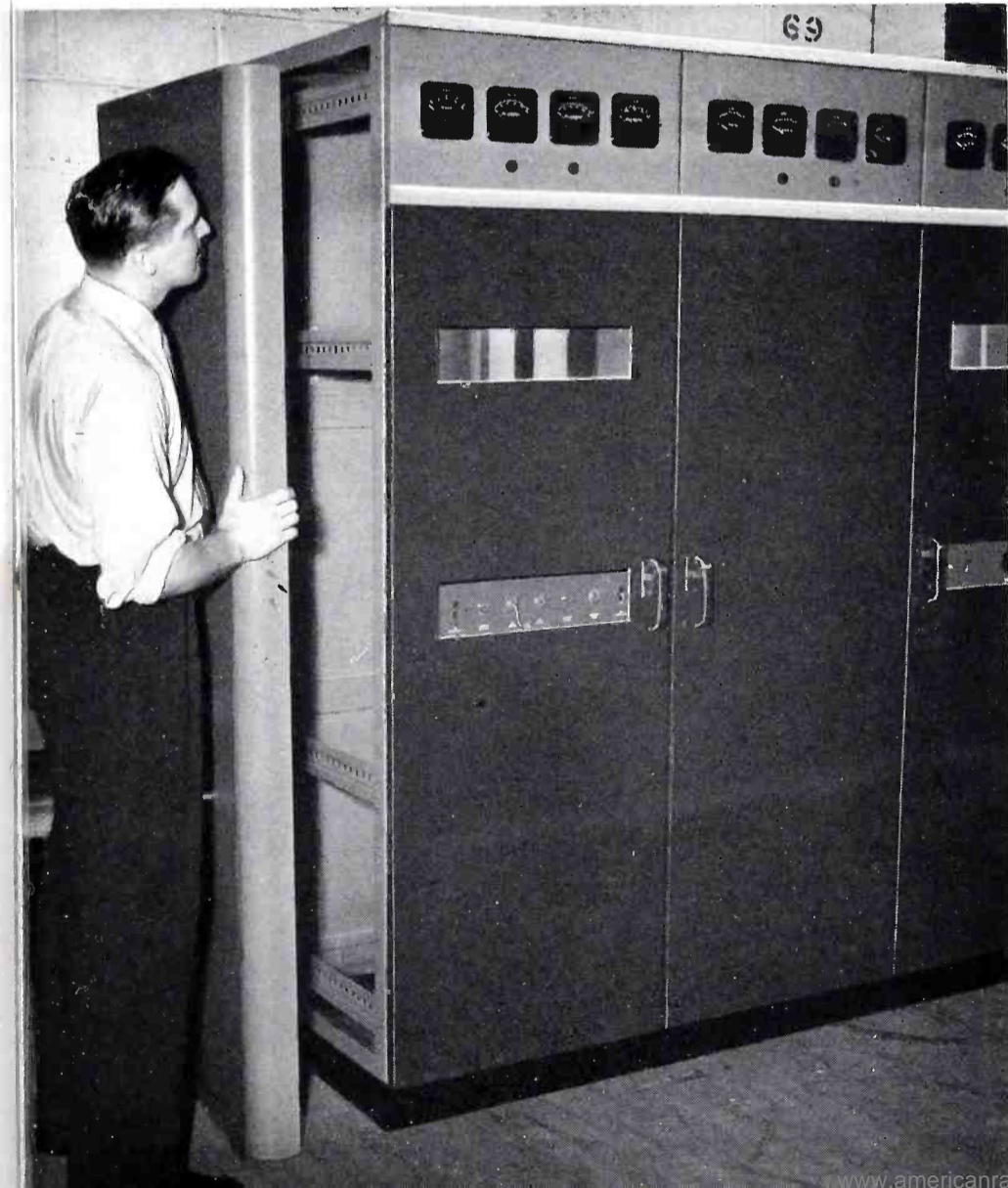

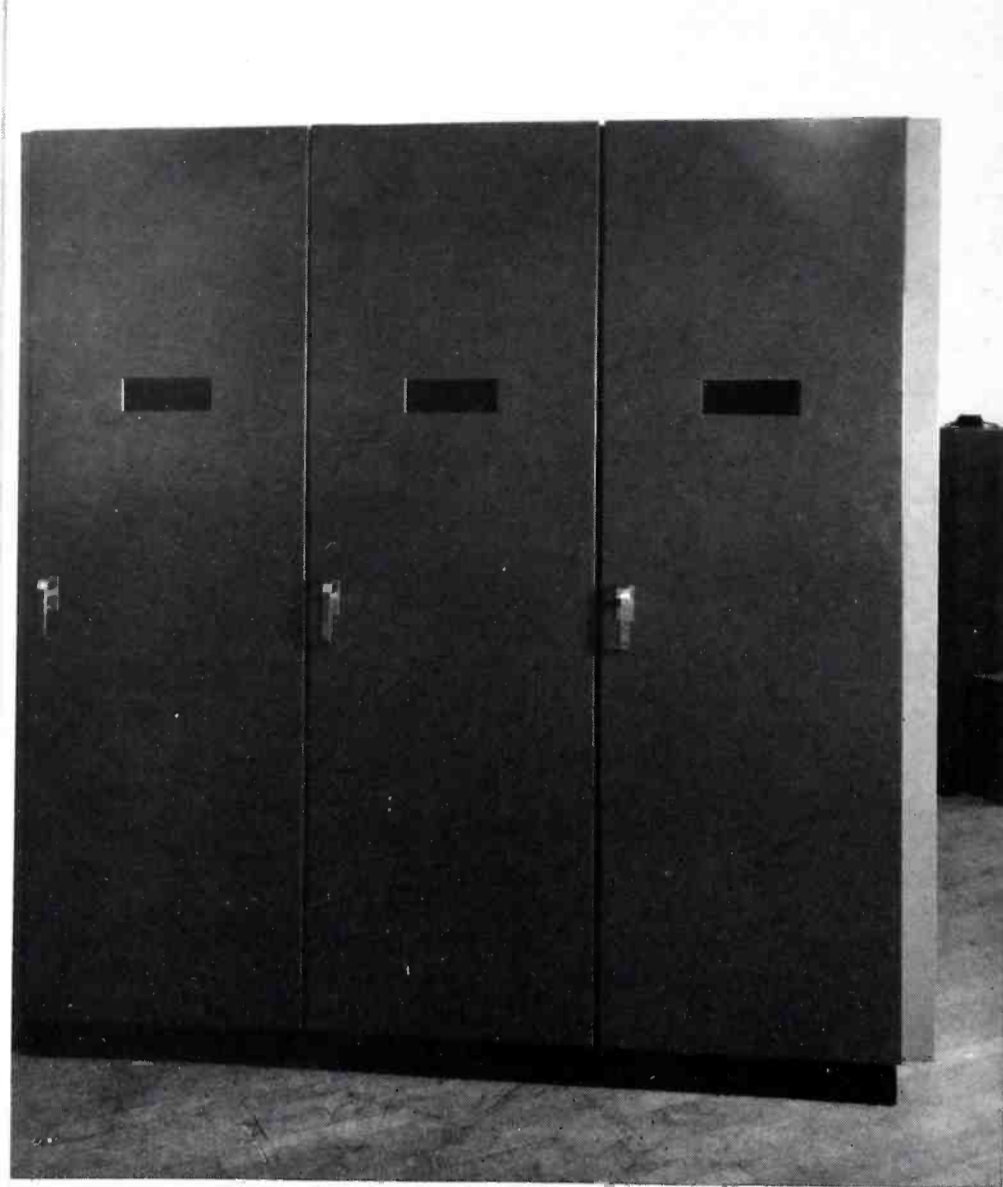

7. REAR of the unit-assembly shown on the preceding page. Full-length, full-width doors provide easy access. Peep-holes in door allow observation of equipment in operation.

9. INSIDE of one of the cabinet units taken before equipment panels were mounted in place. Vertical arrangement of panels provides good ventilation.

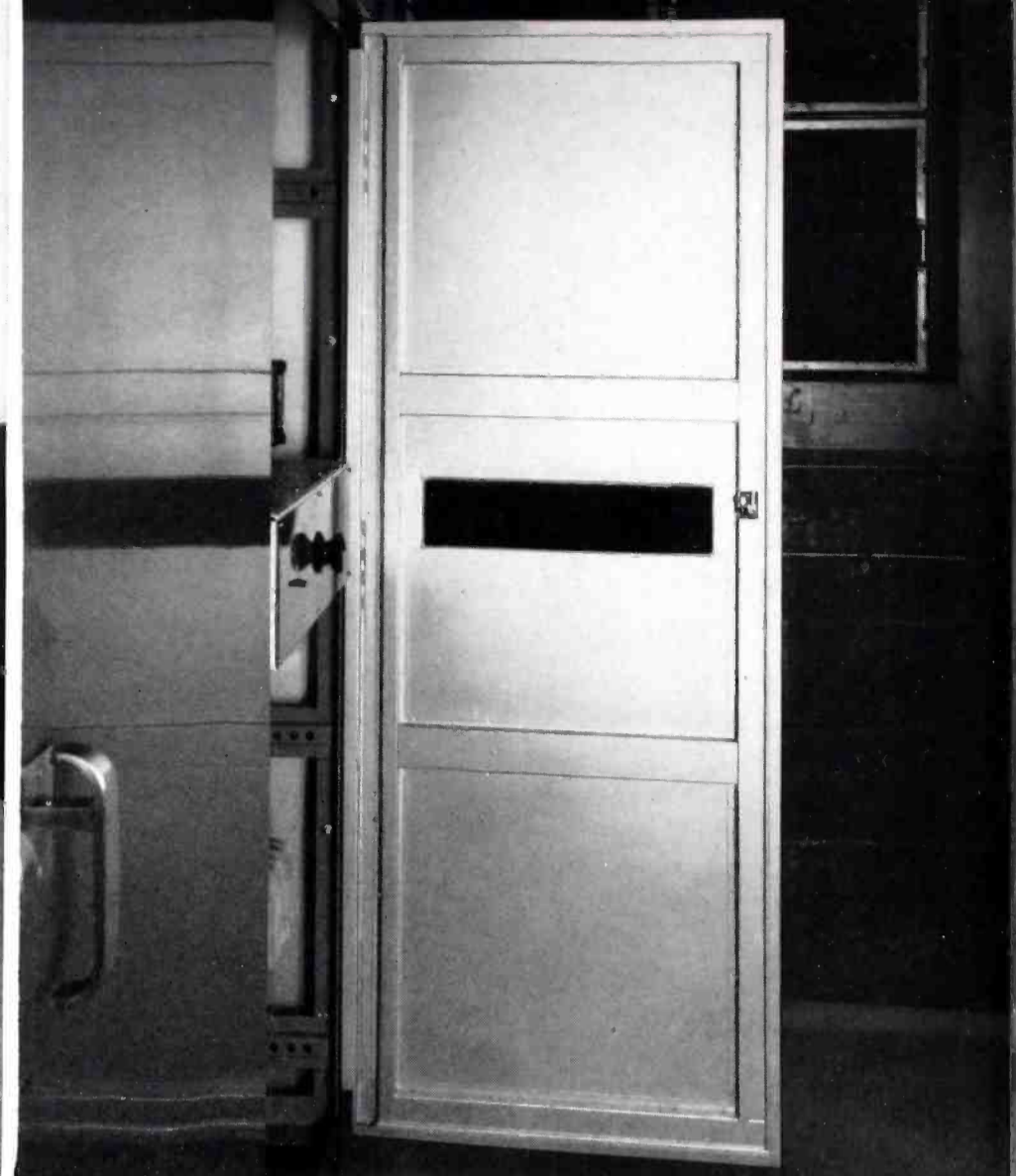

8. CONCEALED HINGES are one feature of the door construction. Another is the use of a single panel structure with channel section reinforcing around the periphery.

10. EQUIPMENT PANELS are mounted on the vertical side members. These panels may be moved forward or backward as required in order to provide for various sizes of components.

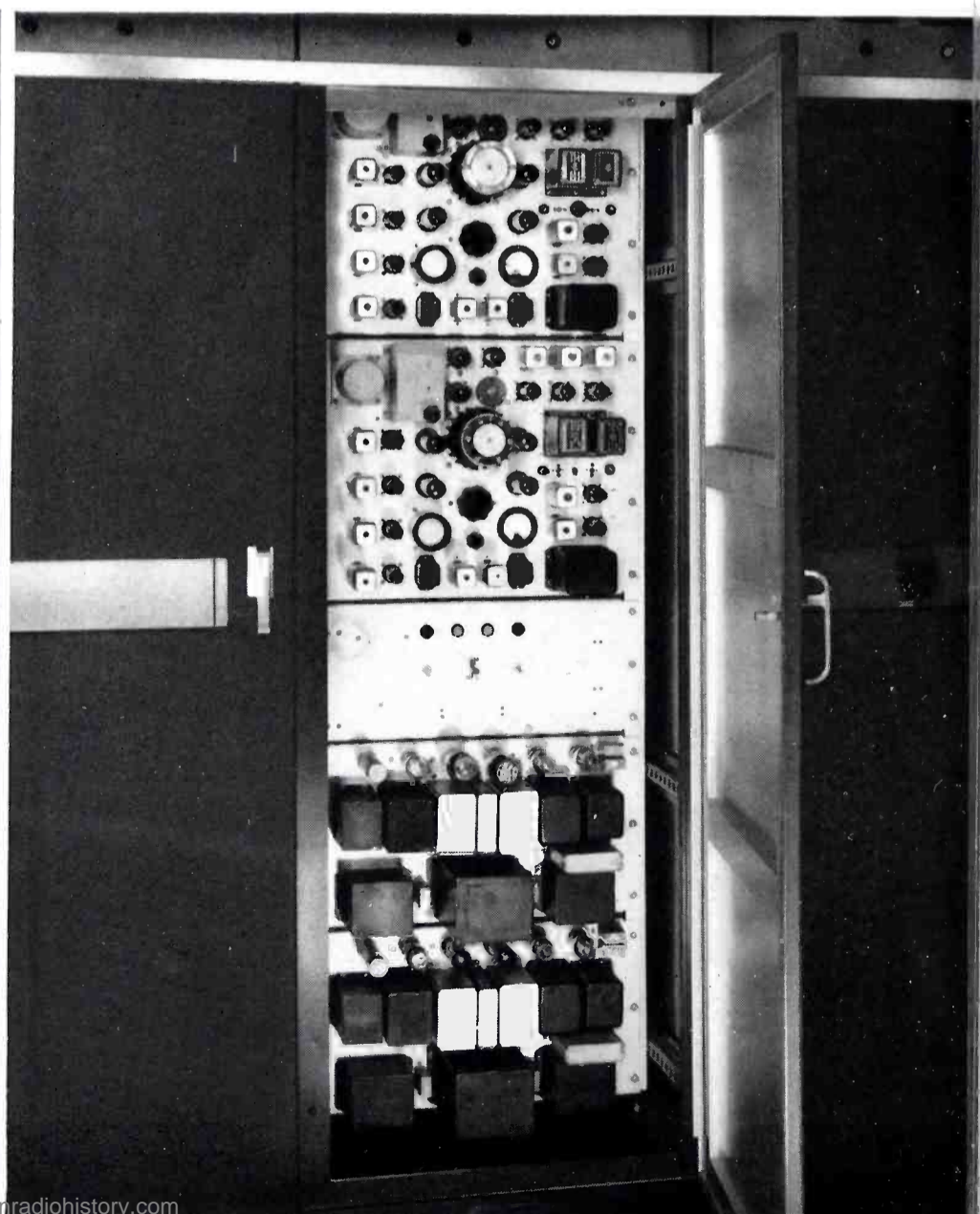

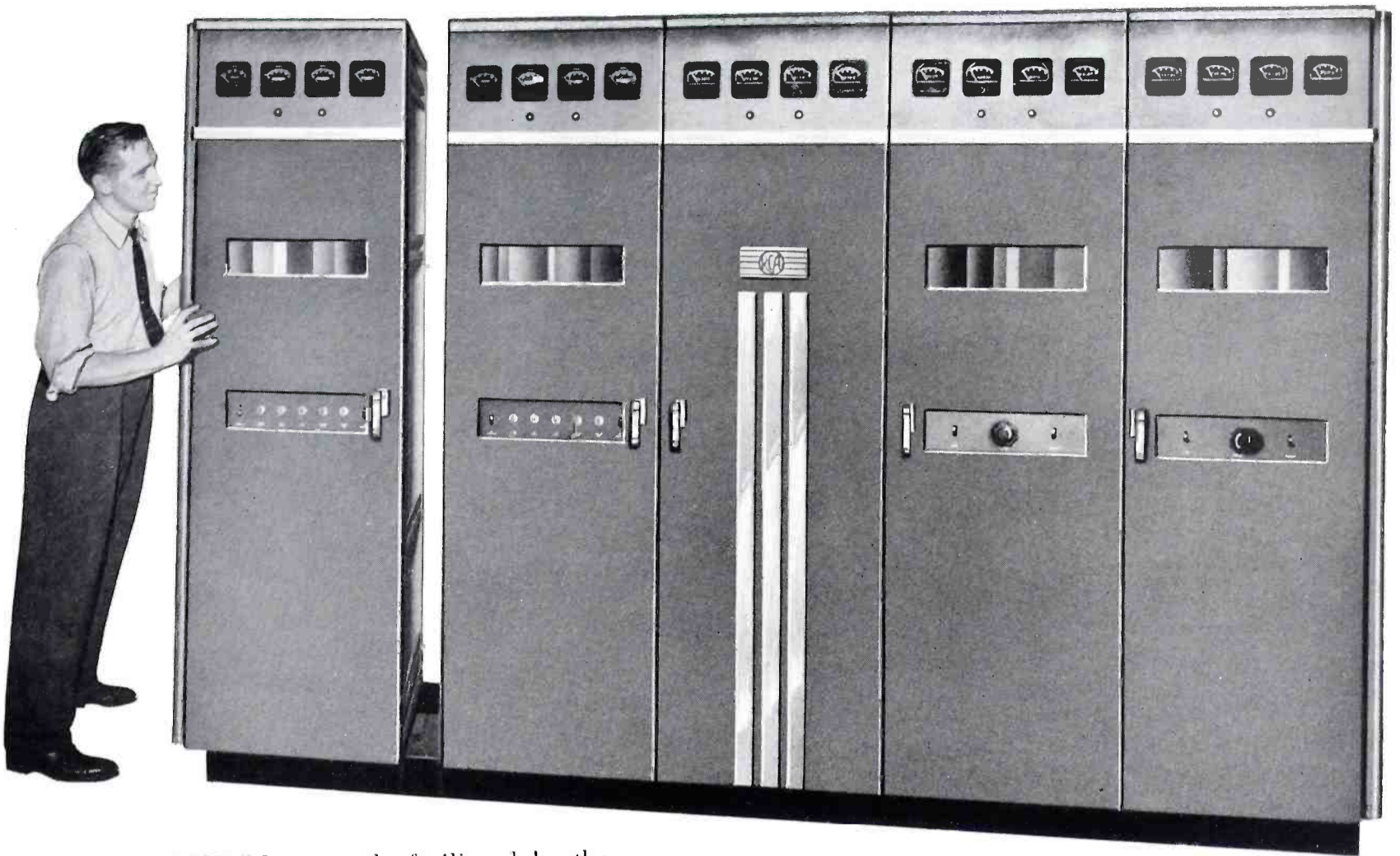

11. ADDING AMPLIFIERS is greatly facilitated by the unit cabinet arrangement. For example, the 3-unit combination shown on preceding pages is a 3 KW transmitter; adding 2 more units, as above, converts this to a 10 KW transmitter. Since the added units are of matching size and appearance the completed installation presents a pleasing "unified" appearance.

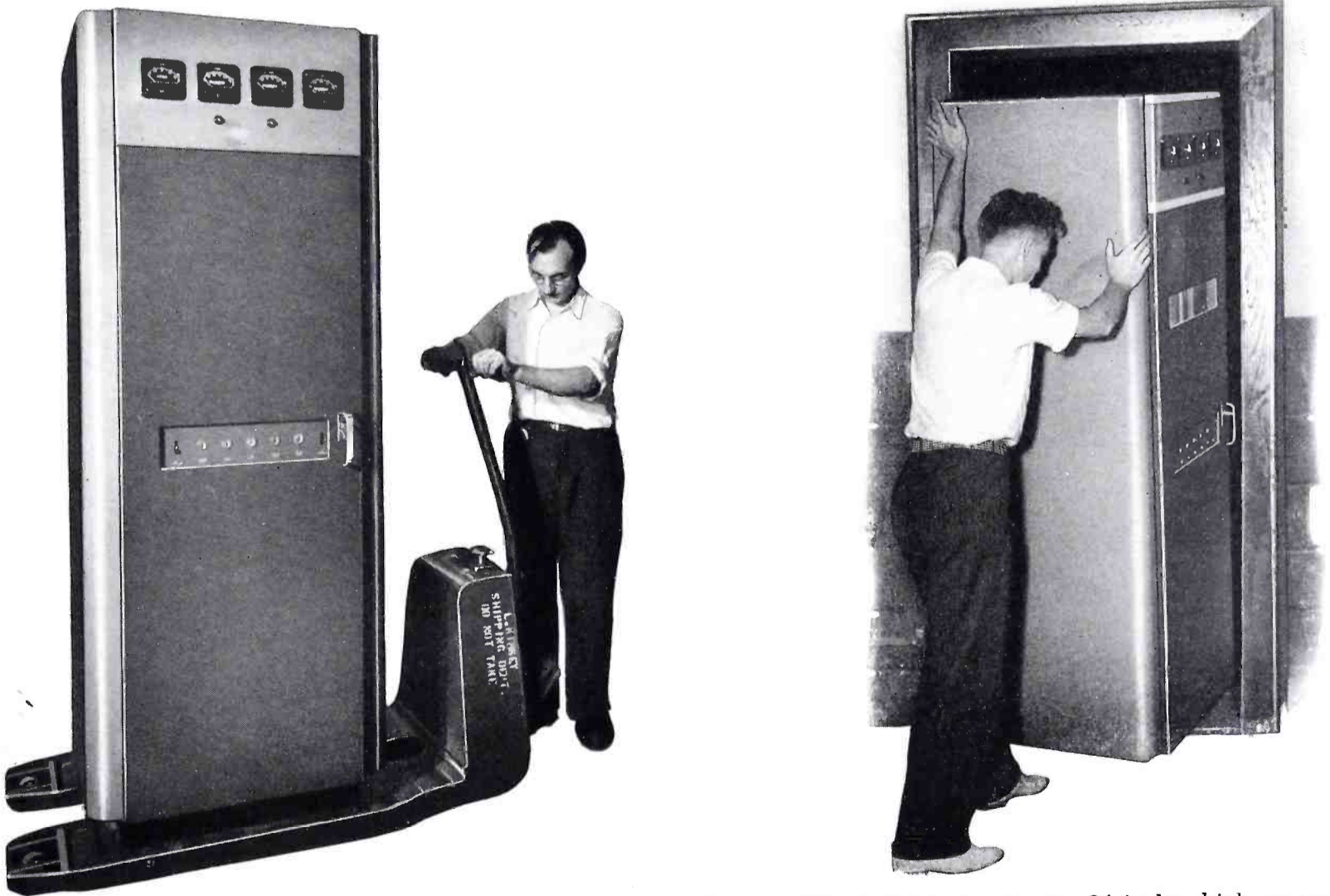

12. HANDLING these units is much easier than with old-style equipments. The individual units are 84 inches high, approximately 25 inches square (less curved end pieces)—the heaviest weighs less than 500 pounds (less demountable units). They can be easily handled on a dolly by one man; can be moved through ordinary doors and taken up on passenger elevators. When equipment is to be installed at a remote mountain-top location—or on the relatively inaccessible top floors of a tall building, their small size and weight is a great convenience.

RANGE PREDICTION CHART FOR FM STATIONS

by **FREDERICK C. EVERETT**

Radio Facilities Engineering Group
National Broadcasting Company

With the assignment of the 88 to 106-mc channels to FM (106 to 108 mc in the Northeastern area), it has become necessary to analyze many transmission factors such as station ranges. The prediction of these ranges can be simplified by a chart,¹ as we have at the right. With this chart it is possible to determine the signals that can be expected with various powers, antenna heights and distances.

The heights indicated in the chart are those of the transmitting antenna over the average terrain to the point in question and a receiving antenna height of 30 feet. This average height is ordinarily obtained by plotting a ground contour profile between the transmitter and the indicated point. Since such effects as shadows, reflection and diffraction will be important, the values obtained can be taken as median values of intensity to be expected.

EXAMPLES

To illustrate the use of the chart, two examples are offered; one for a Northeastern metropolitan station and another for a transmitter site 1,000 feet high with a 50-microvolt signal 70 miles away.

The range of a Northeastern metropolitan station is predicted on the range provided by 20 KW radiated at an antenna height of 500 feet to 1-millivolt contour.

In example 1 we have a dotted line drawn between 20 KW and the 1 millivolt/meter field intensity. We note that this line intersects the microvolt plot for 1 KW at 224 microvolts. Drawing a solid line between this point and the 500-foot transmitting antenna height plot indicates a distance of 32 miles. Thus we find that a station with an antenna height of 500 feet over the average ground, and radiating 20 KW will give a 1 millivolt-per-meter signal at 32 miles. According to the FCC plan of allocation, metropolitan stations with higher antennas will be assigned powers such that the 1-millivolt signal will be at the same distance away.

In example 2 we have the case of a transmitter site, 1,000 feet high and the need for a 50-microvolt (0.05 millivolt) signal 70 miles away. The dotted line connecting 70 miles and 1,000 feet indicates that a 1-KW station operating at this height would radiate 21.5 microvolts at 70 miles. If we draw a solid line between this point, the 0.05-millivolt point and the power scale, we find that a power of 5.5 KW would be required to produce the desired 50 microvolts at the 70-mile distance with a 1,000-foot antenna height.

¹ Chart has been prepared from data supplied by the FCC in their "Standards of Good Engineering Practice"; with 98 mc, horizontal polarization, used as a basis of computation.

² Reprinted by courtesy of COMMUNICATIONS from their November, 1945 issue.

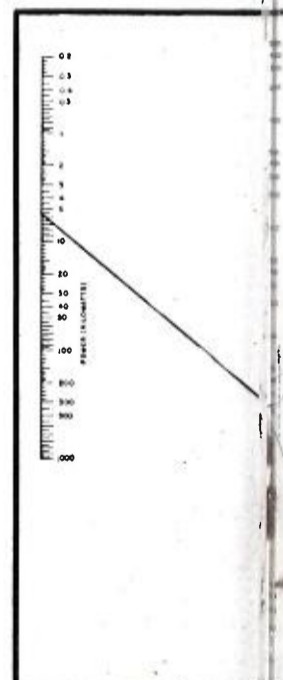
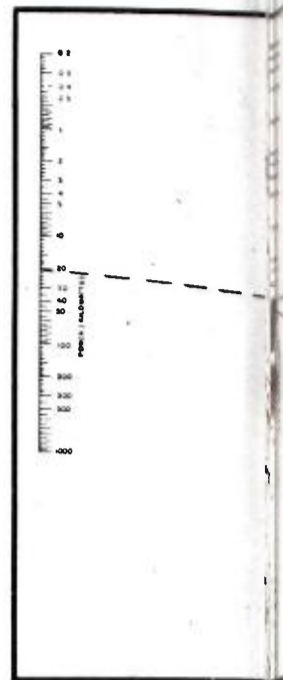
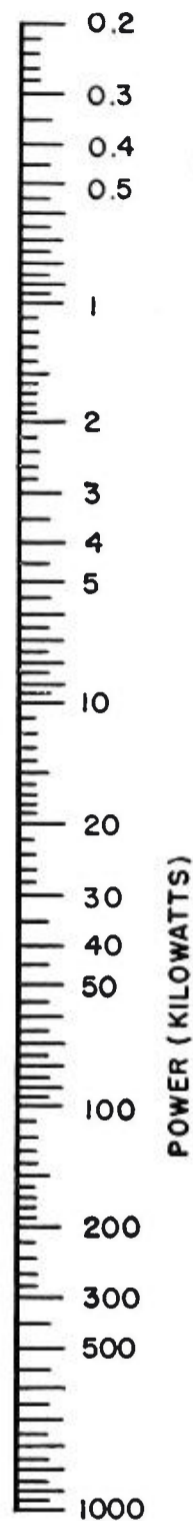

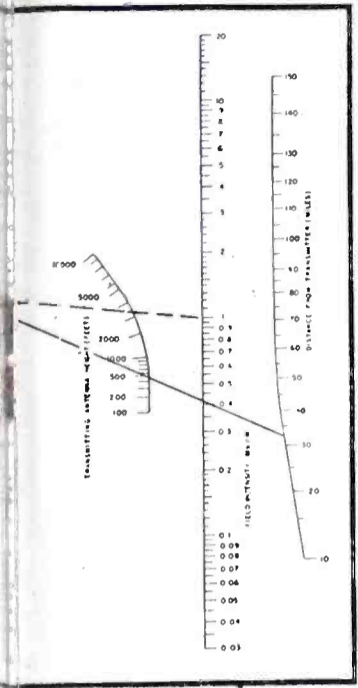

EXAMPLE ONE

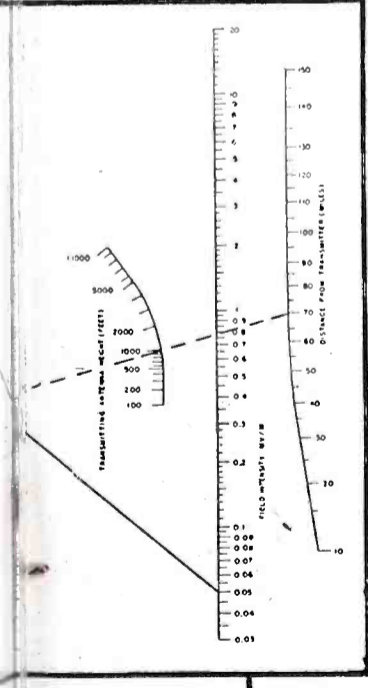

EXAMPLE TWO

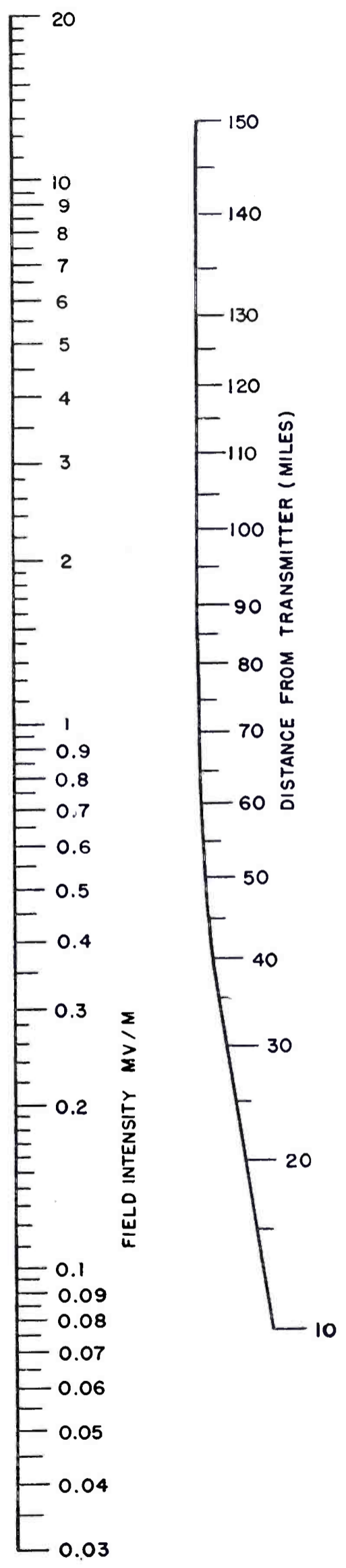
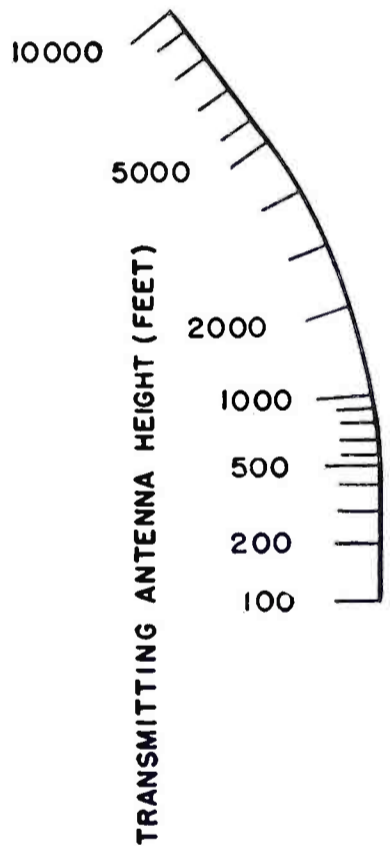
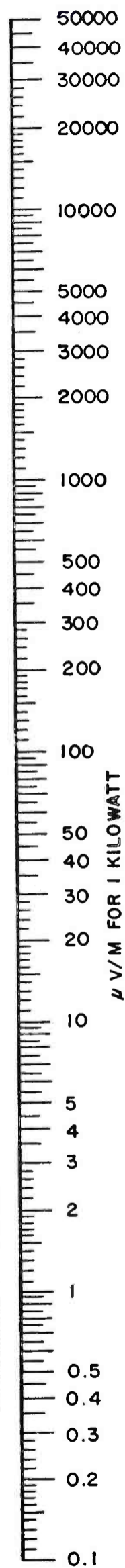

THE SUPER

by **R. W. MASTERS**

Television Engineering Department
Engineering Products Division

A new type of antenna which has been developed for FM and Television stations promises to lessen installation difficulties materially and, at the same time, to improve performance and reliability. This antenna features a broad-band operating characteristic, simplified feed system, and durable construction. A single antenna design will operate equally well over the entire allocated FM band for any transmitter power up to 20 KW. Because this new antenna resembles, to some degree, the original Brown Turnstile—and because it is, in a sense, a super-version of the original, it has been dubbed the “Super Turnstile.”

ADVANTAGES FOR FM USE

The prewar turnstile antenna had many factors in its favor, among them being the inherently circular field pattern, the suitability for mounting on a single pole, the low wind resistance, the relatively large gain and the ease of installation.

The broad-band characteristic of the Super Turnstile offers two additional important advantages for FM use. One is that it eliminates the tricky field adjustments necessary with the early turnstile and with other FM antenna types. The second is that it makes possible a degree of standardization which has, heretofore, been out of the question. This is due to the fact that it is now possible to design and build one antenna which will operate equally well at any frequency in the FM band (instead of having to cut the radiators to different lengths for each frequency, as was previously required). Actually, in the new RCA FM antenna, this standardization has been carried a step further by making a single model which is good for all powers up to 20 KW.

The standardization achieved in the production model of the Super Turnstile means, of course, lowered production costs and, for the station owner, “more for the money.” The latter is evident in such features as the heavy durable construction.

A summary of the advantages of this antenna for FM use make up an imposing list. They include:

- (a) High-gain wide band.
- (b) Can be used at any frequency from 88 to 108 mc.
- (c) Can be used at any power up to 20 KW.
- (d) A “package” item—comes complete.
- (e) Is easy to install.

FIG. 1. Model of three-section Super Turnstile before transmission lines are added. Pole is designed to carry airways beacon.

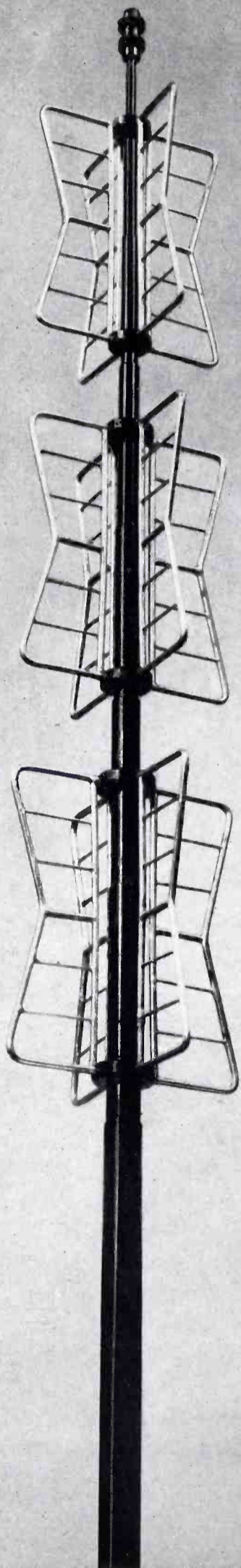

TURNSTILE

- (f) No field adjustment whatever—just put it up.
- (g) Small number of feed points.
- (h) Power rating easily increased by substituting a kit of larger feed lines.
- (i) Permits diplexing of more than one carrier on same antenna.
- (j) Simple structure—single pole mounting.
- (k) Entire structure grounded.

To appreciate the advantages of the Super Turnstile Antenna over the standard turnstile, it is necessary only to note that the required number of end seals in the feed system is reduced by one-half, while the bandwidth has increased from a few percent to 40%. This hitherto undreamed-of extension in bandwidth has made it possible to design a single antenna which will prove more than adequate in covering the entire allocated FM band; i.e., about 23%.

The attendant economies and advantages gained in design, quantity manufacture (with its resultant cost reduction), and the stocking of a single packaged unit, have resulted in the adoption of the Super Turnstile for Television, as well as for FM broadcasting.

ADVANTAGES FOR TELEVISION USE

For some time there has been an obvious need for a television antenna which would combine a relatively high gain with a bandwidth which would accommodate the 6-megacycle television channel. The success of the standard FM turnstile (used by a great majority of the FM stations on the air today) led, very naturally, to an investigation of the turnstile for television broadcasting. For television use, this type of antenna enjoys an additional advantage over all other types; namely that, due to the nature of the turnstile itself, both sound and picture transmitters can be fed into the same antenna.

Television requirements, however, are stringent in that the antenna impedance must remain so constant as to cause a very low reflection on the transmission line over the whole television channel. The necessity of finding a reasonably simple radiator capable of handling such a range led to the discovery and development of the wide-band, current-sheet radiator. These current-sheet radiators, when connected in turnstile fashion, retain all the advantages of the standard turnstile and at the same time provide the desired bandwidth (with some to spare).

FIG. 2. *Experimental Engineering Model of single section Super-Turnstile installed at a Television Station. Two transmission lines are used to permit use of single antenna for sound and picture. For FM, only one line is required between the transmitter and the bottom of the current sheets.*

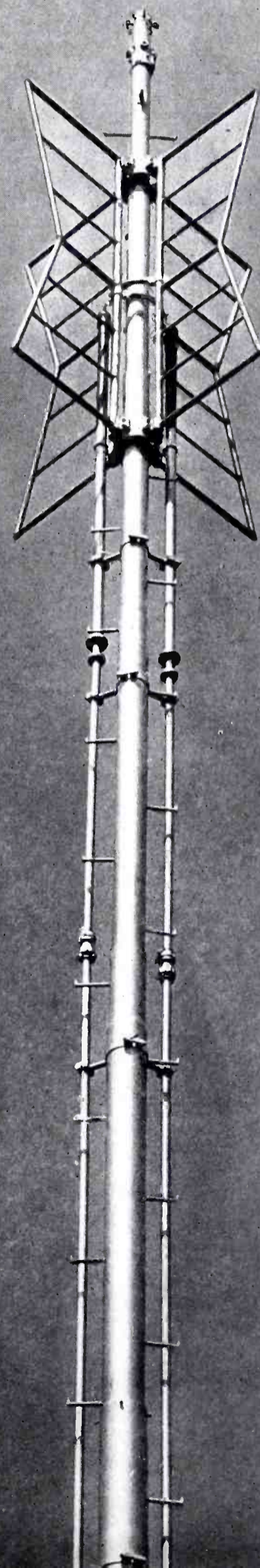

HOW IT WORKS

The most noticeable feature of this new Super Turnstile (see illustrations) is the use of "current-sheet" radiators in place of the simple "dipole" arms in the prewar turnstile. In the original model, these batwing-shaped elements were solid pieces of sheet metal; hence the term "current-sheet." Later it was found that the same result could be achieved with an open framework. In the production model this framework is made up of steel tubing with cross members of solid steel.

The chief effect of the "current-sheet" radiators is to broaden the antenna characteristic so that the impedance reflected on the transmission line will be nearly equal to that of the line itself over a frequency range of plus or minus 20% which, of course, is nearly twice the entire FM band of 88 mc to 108 mc.

The current sheets are attached to the pole (ground) at top and bottom. The r-f currents in the radial members radiate more or less proportionately to the length of the member and to the magnitude of the current in the member. The longer members have a far greater effect in radiation than the shorter ones; hence, a very close approximation to the radiation pattern of two simple dipoles, spaced one-half wavelength apart, is obtained.

The radiators were originally worked out at high frequency where solid sheets of metal were the easiest medium to employ. The solid sheet has been replaced by a steel tubing framework with cross rods of solid steel as the practical embodiment of the design. This design reduces wind resistance.

CONSTRUCTION

The antenna and feed system of the Super Turnstile has been designed to handle 20 kilowatts of power. For lower powered stations, a reduction fitting may be used at the junction point, so that a smaller line may be used to the transmitter. In cases where a line length in the order of several hundred feet is required, however, it may be desirable to use a large-size coaxial line even for low power so as to avoid a high attenuation loss.

Sleet melting protection may be provided if desired. The vertical tube of the current-sheet is at ground potential on the ends; hence, a heater unit can be connected into this vertical tubing. This will prevent ice formation between the current-sheet and the pole; this being the only place that might undergo an impedance change due to ice formation. The structural design is such that the antenna can withstand a half-inch ice coating under high wind conditions or thicker ice under reduced wind conditions.

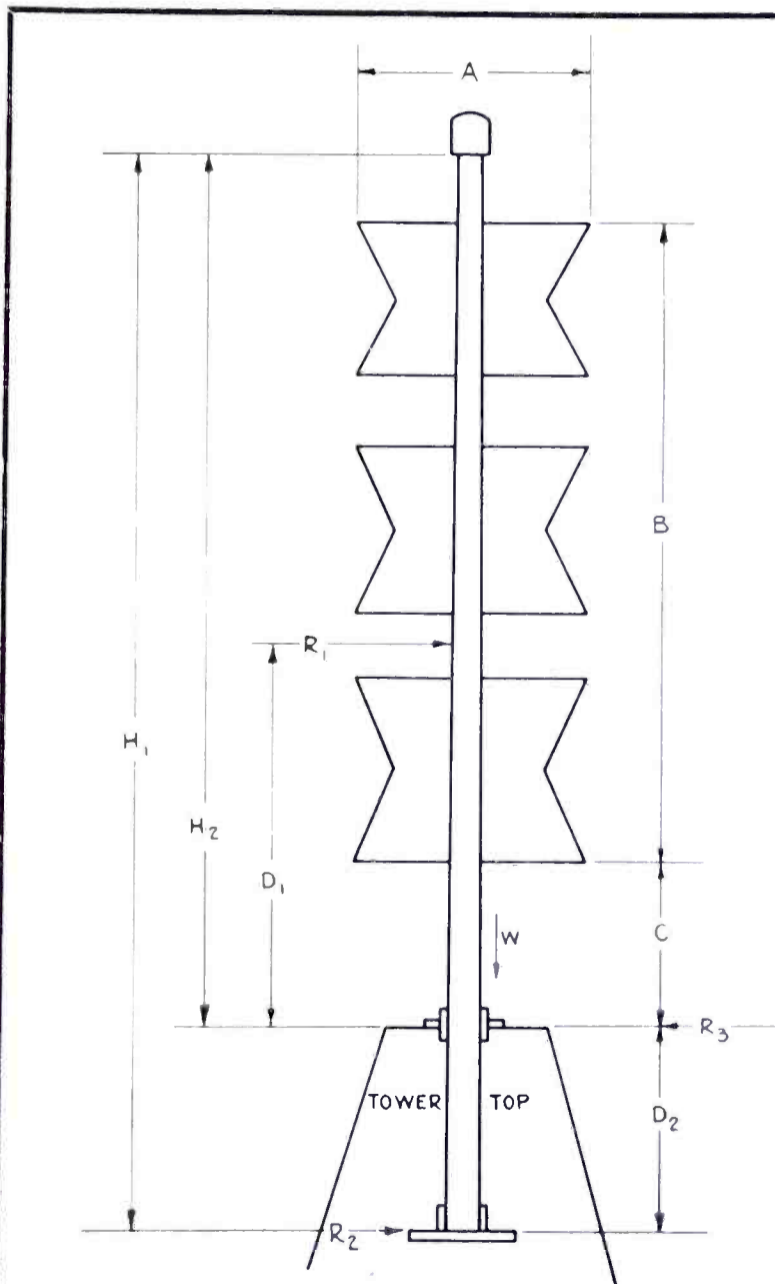

FIG. 4. Approximate Engineering Data for Super Turnstile FM Antennas.

The following information has been prepared for antennas covering frequency bands from 88 mc. to 108 mc.

The antennas are designed to withstand a maximum wind velocity of 85 miles per hour when coated with $\frac{1}{2}$ " radial ice and a maximum wind velocity of 95 miles per hour when there is no ice. The antennas are designed for total transmitter power, no greater than 20 KW. Maximum unit stress, 20,000 lbs./in.²

No. Sections	1-Section	2-Section	3-Section	
Power Gain (nominal) . . .	1.25	2.5	4.0	
Field Gain (nominal) . . .	1.12	1.58	2.0	
Frequency Band	88-108 mc.	88-98 mc.	98-108 mc.	88-108 mc.
W ** Lbs.	625	1,286	1,286	1,763
A	5' 2"	5' 5"	5' 5"	5' 5"
B	6' 11½"	15' 5"	16' 5"	25' 8"
C	5' 0½"	6' 7"	5' 7"	5' 4"
D ₁	3' 4"	13' 4"	13' 4"	17' 0"
D ₂	5' 0"	7' 0"	7' 0"	8' 0"
R ₁ * Lbs.	594	1,083	1,083	1,640
R ₂ * Lbs.	990	2,065	2,065	3,490
R ₃ * Lbs.	1,584	3,148	3,148	5,130
H ₁	18' 0"	30' 0"	30' 0"	40' 0"
H ₂	13' 0"	23' 0"	23' 0"	32' 0"
Diameter at Tower Top . . .	4½"	6⅝"	6⅝"	8⅝"

* Reactions R₁, R₂ and R₃ as shown in table are for estimating purposes only and are figured on the basis of 20 lbs./ft.² of projected area with $\frac{1}{2}$ " ice. All sections are rounds.

** W = Total weight, including pole, guide flange, pole socket, 300 mm Beacon, pole steps and miscellaneous hardware.

WCAU PLANS NEW STUDIO BUILDING

Plans for the first radio and television center to be erected in this country exclusively for television and sound broadcasting were announced recently by WCAU, the 50,000 watt CBS affiliate in Philadelphia. Costing \$2,000,000, the center is expected to be completed, even to a specially constructed landing field on the roof for helicopters which will be used for television broadcasting from outside points, in December, 1947. At this time the present building and facilities will be abandoned.

John G. Leitch, technical supervisor of WCAU since 1929, is in charge of plans for the new WCAU center. Mr. Leitch has just returned after four years with the Navy, where he served as a commander. In 1932 Mr. Leitch supervised the planning and construction of the present WCAU Building, which at the time of its completion was the finest and most modern radio station building in the world. The new building will dwarf the present one in size and facilities and will, of course, provide facilities for FM and Television—neither of which were even dreamed of when the present building was planned.

The plot on which the new WCAU building will be erected takes up 81,756 square feet, an entire city block, on Philadelphia's famed Broad Street with the main building of the center a four-story structure, 252 feet by 207 feet, built of limestone and stainless steel. Piercing the city's skyline will be a television and FM tower extending 612 feet above ground level, more than 70 feet above the famed William Penn statue atop Philadelphia's City Hall, the highest building in the city.

The main floor will have two large showrooms and a 500-seat auditorium for both sound and television broadcasting. The seating will be horseshoe style with two stages that will raise and lower by hydraulic pressure, one directly in front of the other. The first stage will be located in the center of the horseshoe and can be raised independently. This will enable television cameras to move all around it so that the action on the stage, as well as the audience, can be televised. The stage directly in back can also be raised independently and join the forward stage for larger settings when necessary.

(Right)---Architect's drawing of the radio and television center which will be erected by WCAU, the 50,000-watt CBS affiliate in Philadelphia.

There will also be a large television studio which will permit the setting up of several sets at one time so that action can be swung from one camera to another. This studio will have a sound-proof collapsible partition so that it can be divided into two sections if necessary. Also included are rehearsal studios for television, film projection rooms, dressing rooms, carpenter shop, paint shop and property storage space.



Commander John G. Leitch

The other part of the building will contain seven broadcasting studios, administrative offices and the latest facilities to be found in a modern radio and television center, including lounges for employees and artists, music library, news room, special writers' rooms and audition rooms, and many other facilities. All studios will have the latest development in acoustics with a combination of polycylindrical construction and adjustable vanes.

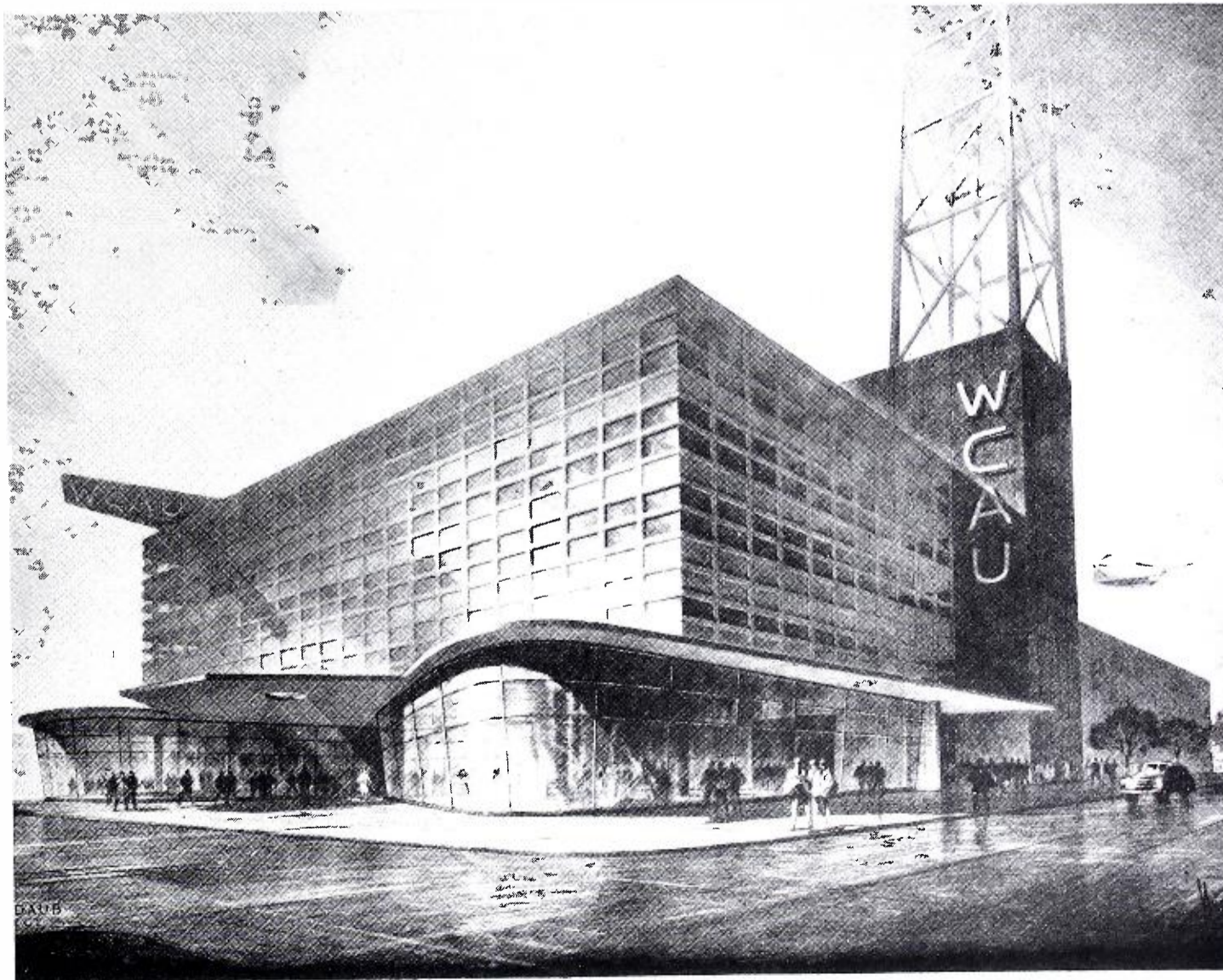

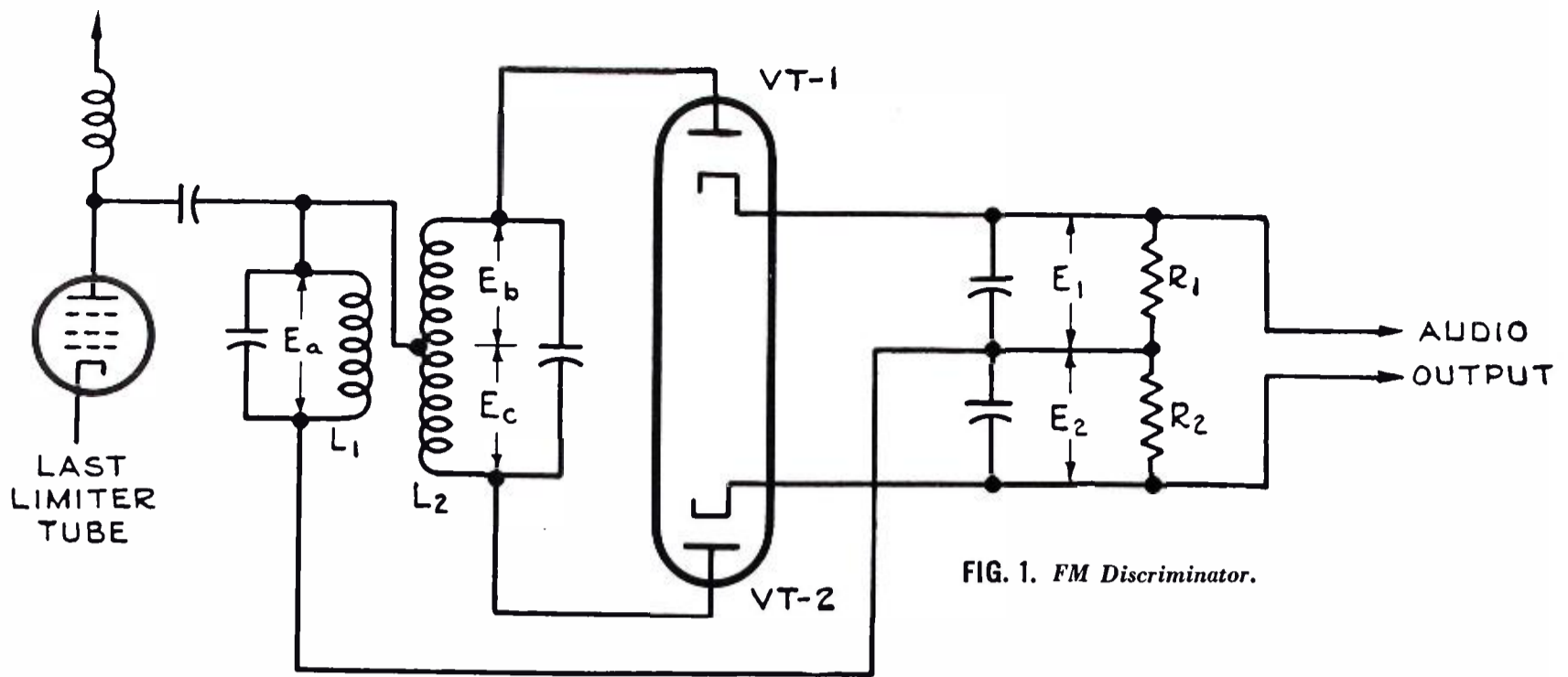

FIG. 1. FM Discriminator.

NEW RATIO DETECTOR SIMPLIFIES FM RECEIVER DESIGN

by **STUART W. SEELEY**
 Manager, Industry Service Section
 RCA Laboratories

Until recently it had been more or less taken for granted that any detector in a frequency modulation receiver (usually called the discriminator) would also respond to amplitude variations. For this reason limiters were used ahead of the discriminator in most FM sets in an attempt to "level off" the applied signals before they were detected. Limiters need large signal amplitude for proper operation which in turn requires excessive preceding amplification with attendant regeneration and over-load difficulties. Furthermore, limiters often act as phase modulators converting peaks of interference into frequency variations, thus indelibly impressing them upon the program content of the received signal.

Recent circuit developments made in RCA Laboratories have produced simple FM discriminators insensitive to amplitude modulations and amplitude interference. There are many variations of these new discriminators and they give a new concept of the design of FM receivers. With them it is no longer necessary to provide the extremely high intermediate-frequency amplification for satisfactory noise "quieting," for limiter stages are omitted entirely.

Furthermore, while they are performing their normal function of detecting frequency modulations, they also produce the correct amount of automatic volume control voltage to regulate the amplification of preceding tubes. Thus they prevent over-load and cross-talk as well as phase modulation by amplitude interference in those stages and result in much improved receiver performance.

The name Ratio Detectors for these new FM circuits was derived from the fact that they utilize the ratio of two developed intermediate-frequency potentials whose relative amplitudes are

a function of frequency, rather than the difference of those potentials as has been done in the past. The ratio of those potentials remains constant in the presence of amplitude variations whereas the difference varies with the amplitude.

The diagrams above afford an interesting comparison of the operation of the ratio detector and that of the standard FM discriminator. (Note: In order to make the comparison simpler these circuits have been drawn somewhat differently than usual; however, the basic circuits have not been changed.)

Figure 1 is a simplified diagram of the discriminator circuit widely used in prewar FM receivers. Fundamentally, this is an adaptation of the so-called Seeley Discriminator which was first used in AFC circuits (D. E. Foster and S. W. Seeley, Automatic Tuning, Simplified Circuits, and Design Practice, PROC. I.R.E., 25, 289, 1937).

The operation may be briefly described as follows: L_1 and L_2 form an interstage coupling transformer tuned to the mean or "carrier" frequency. The r-f voltage E_a in the primary induces a voltage in the secondary which, for purposes of discussion, may be divided into two components E_b and E_c . The r-f voltage in the secondary is fed to the anodes of a pair of diodes as shown. However, there is also a direct connection from one side of L_1 to the center of L_2 . This places L_2 directly in the cathode return circuit of the diodes. Thus, the total r-f voltage on the anode of the first diode (VT-1) is $E_a + E_b$. These voltages must, of course, be added vectorially. Figures 3 and 4 show the effect of this addition. When the frequency of the r-f voltage from the limiter is equal to the resonant frequency of the tuned circuit, the voltage in the secondary is 90° out of phase with that in the primary, and voltage addition is as shown in Figure 3. The r-f voltages E_1 and E_2 , which are fed to the diodes, are equal and the d-c (or a-f) output of the diodes are also equal. Since the output connections of the diodes are opposed, no voltage will appear at the audio output terminals.

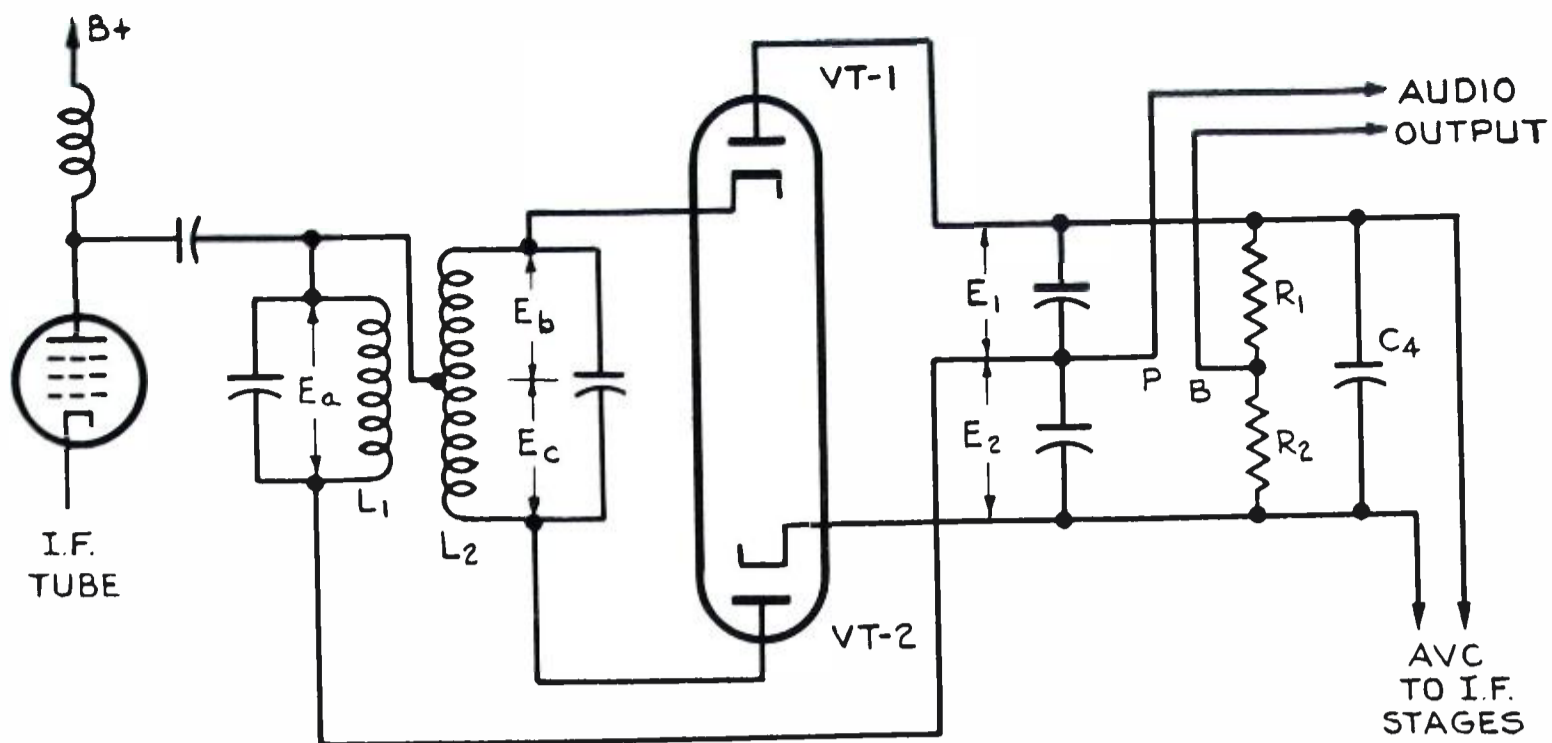

FIG. 2. Ratio Detector.

Now consider what happens when the r-f input frequency is different from the resonant frequency of the tuned circuit (as occurs in the normal frequency swing, or "modulation"). The secondary voltage leads the primary voltage by something less than 90° and the voltage addition is as shown in Figure 4. The r-f voltages E_1 and E_2 fed to the diodes are now different and the rectified outputs are also of different values. Thus, a d-c (or a-f) voltage, proportional to the frequency swing, is caused to appear at the audio output terminals.

An important disadvantage of this standard FM circuit is that while it is well-suited for FM detection, it is also sensitive to AM fluctuations in the input. This will be evident from a study of Figure 4 (i.e., the voltages E_a , E_b and E_c vary proportionately with AM modulation, but E_1 increases more than E_2 , thus causing distortion in the audio output). In order to overcome the effects of AM modulation in receivers using the standard FM discriminator, it has been necessary to resort to the use of one or two limiter stages between the i-f stages and the discriminator.

The ratio detector, a simplified schematic of which is shown in Figure 2, is insensitive to AM modulation and hence requires no limiter stages. The reason for this may be understood by studying the two diagrams above. As will be noted, the input sections of both diagrams are alike. The r-f voltages fed to the diodes in the ratio detector are the same as those in the standard FM discriminator and they vary with frequency swing in exactly the same manner. However, in the ratio detector the diodes are

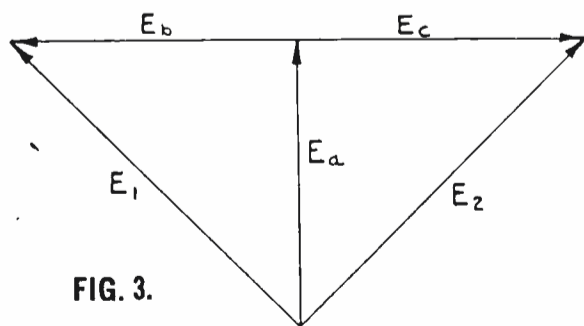

FIG. 3.

connected in series, so that the d-c (or a-f) voltages which they develop are additive (rather than being opposed as in the standard discriminator). Moreover, the sum of these voltages ($E_1 + E_2$) is prevented from varying at audio frequencies by the bypass condenser C-4.

While the sum of the diode output voltages E_1 and E_2 is thus held constant, the ratio of these voltages varies as the ratio of the input voltages. Thus, if audio connections are made at points "P" and "B" (i.e., in the cathode return circuit) an audio voltage proportional to the frequency swing is made available. In this way, the ratio detector provides an FM detector equally as good as the standard discriminator and free from the latter's unwanted sensitivity to AM modulation.

Since the ratio detector does not respond to AM modulation, it is unnecessary to use limiter stages. This reduces the number of tubes required for the same performance. Moreover, since it

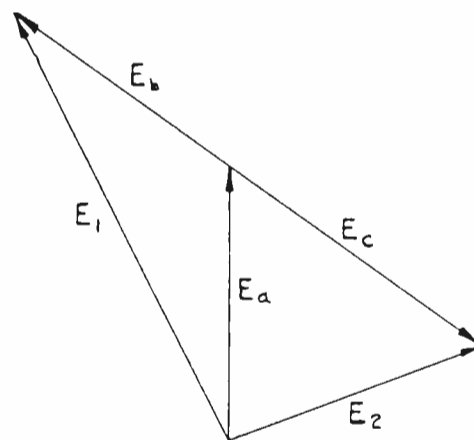

FIG. 4.

is not necessary to saturate a limiter, much weaker signals can be used and, therefore, a receiver using this circuit need not have the extremely high i-f gain which is necessary for satisfactory limiter action. This may make it possible to use fewer tubes in the i-f stages. (A laboratory model with only one i-f stage, and no limiters, has given very satisfactory performance even on weak signals.)

Another advantage of the ratio detector which, although a "by-product", is of some importance is that it provides a source of AVC voltage much more satisfactory than that available in the standard discriminator circuit. This voltage can be fed back to the amplifier stages thus maintaining the proper gain of the set for any incoming signal and thereby preventing overloading of the amplifier stages. Thus, interfering noises are less likely to cross-modulate the received signal. This effect also results in quieter and smoother reception.



RCA'S NEW HIGH-SENSITIVITY CAMERA REVOLUTIONIZES TELEVISION PICKUP TECHNIQUE

A hitherto secret television camera tube of revolutionary design and sensitivity was demonstrated last month by engineers of the Radio Corporation of America. In a series of studio and remote pickups it not only transmitted scenes illuminated by candle and match light, but performed the amazing feat of picking up scenes with infra-red rays in a blacked-out room.

The new tube, known as the RCA Image Orthicon, was demonstrated to newspaper and magazine writers in a studio of the National Broadcasting Company, Radio City, with the cooperation of NBC's engineering and production staff. Ben Grauer, NBC announcer, acted as program commentator. In the exhibition, members of the audience saw themselves televised under lighting conditions that convincingly proved the super sensitivity of the new electronic "eye" which solves many of the major difficulties of illumination in television programming and makes possible round-the-clock television coverage of news and special events.

Further evidence of the tube's superiority came in the transmission of scenes from a special rodeo show arranged at Madison Square Garden for the visiting United States Navy Fleet. Exciting cowboy acts were picked up by the Image Orthicon and transmitted to the studio in a comparative demonstration showing its advantage over conventional television pickup tubes in providing greater depth of perception and clearer views under shifting light conditions.

RCA-NBC engineers capped the demonstration by blacking out the studio where the writers were assembled and providing the unprecedented spectacle of picking up television scenes in apparent darkness. Unseen infra-red (black) lights were turned on, but it was so dark that a member of the audience could not see the person next to him. Then on the screens of television receivers in the studio appeared bright images of a dancer and other persons who were in the room. The Image Orthicon tube, it was explained, achieved the feat through its sensitivity to the infra-red rays.

ALADDIN'S LAMP OF TELEVISION

"This is the Aladdin's Lamp of television," declared John F. Royal, NBC Vice-President in charge of television. "Its revolutionary effect on lighting problems means that many of our major difficulties of illumination will be eliminated.

"This new instrument, which is easily portable and suitable for use in every field of television, opens new vistas that challenge the imagination. It assures television of twenty-four-hour coverage, in daylight, twilight, or moonlight—in good weather and in bad.

"It is, in a word, revolutionary!"

Declaring the Image Orthicon to be 100 times more sensitive than conventional pick-up tubes, E. W. Engstrom, Research Director of RCA Laboratories, Princeton, N. J., explained details of the development of the tube. He said that early models were built before the war in efforts of RCA television scientists and engineers to improve the quality of television transmission. When war came, the armed forces found urgent need for television applications, and throughout the conflict RCA research and development continued at an accelerated pace in response to military requirements. Many advances were made.

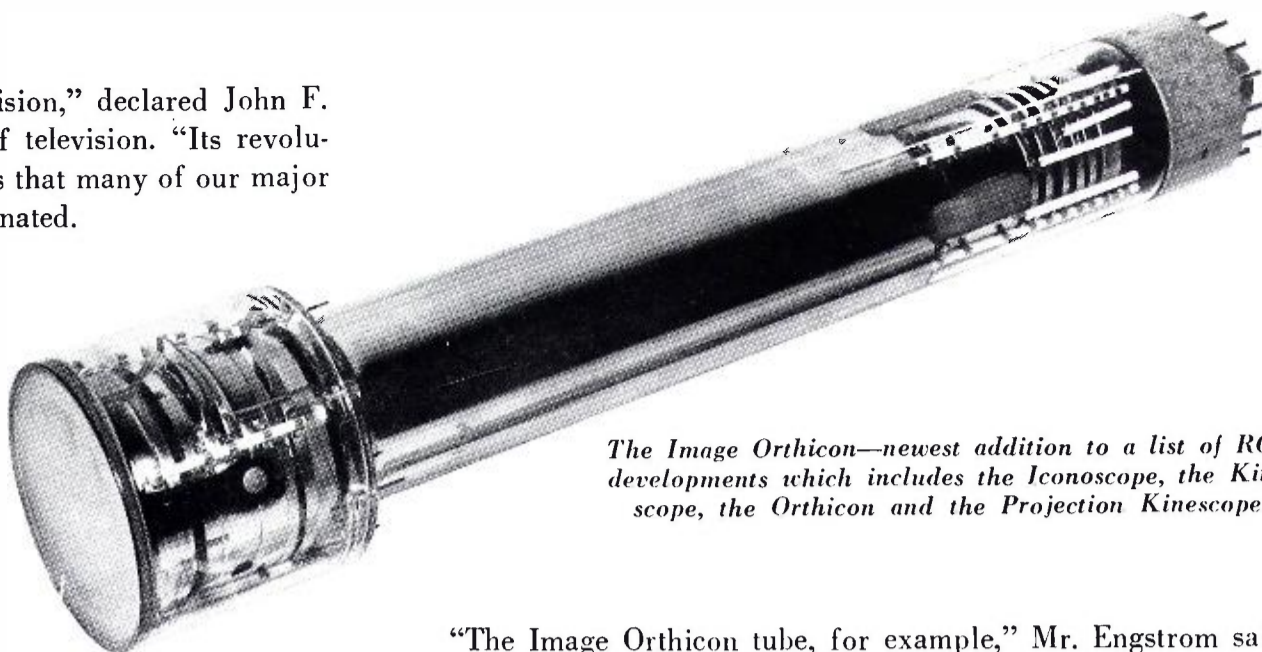

The Image Orthicon—newest addition to a list of RCA developments which includes the Iconoscope, the Kinescope, the Orthicon and the Projection Kinescope.

"The Image Orthicon tube, for example," Mr. Engstrom said, "emerged in its present form much sooner than would normally have been the case. A military secret until now, it can be revealed that it makes use of the most advanced results of more than twenty years of research not only in television pick-up tubes, but in electron optics, photo-emission processes, electron multipliers, and special materials."

MEN WHO DEVELOPED THE IMAGE ORTHICON

Credit for the tube's development goes to three members of the RCA research staff: Dr. Albert Rose, of Middletown, N. Y.;

RCA IMAGE ORTHICON TUBE

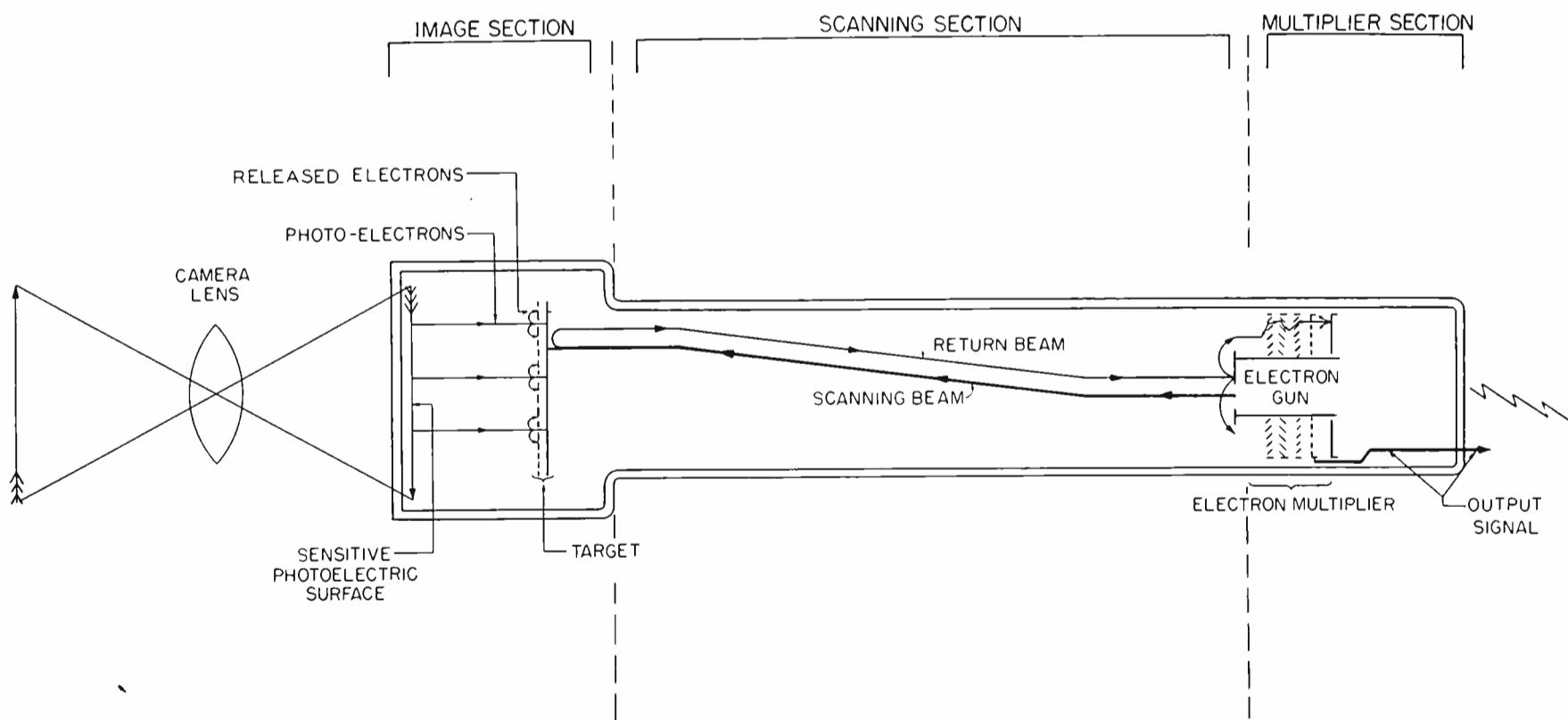

HERE'S WHAT HAPPENS IN RCA'S NEW "IMAGE ORTHICON" PICK-UP TUBE

This simplified functional drawing of the new RCA Image Orthicon, an ultra-sensitive television camera pick-up tube, shows how the tube's response to the light of a single candle, or even a match, is built up to provide a signal which can reproduce images on home receiver screens. A light image from the subject (arrow at extreme left) is picked up by the camera lens and focused on the light-sensitive face of the tube, releasing electrons from each of thousands of tiny cells in proportion to the intensity of the light striking it. These electrons are directed on parallel courses from the back of the tube-face to the

target, from which each striking electron liberates several more, leaving a pattern of proportionate positive charges on the front of the target. When the back of the target is scanned by the beam from the electron gun in the base of the tube, enough electrons are deposited at each point to neutralize the positive charges, the rest of the beam returning, as indicated, to a series of "electron multiplier" stages or dynodes surrounding the electron gun. After the returning "signal" beam has been multiplied many times, the signal is carried out of the tube to the television broadcast transmitter.

Dr. Paul K. Weimer, of Wabash, Ind.; and Dr. Harold B. Law, of Kent, Ohio. The project is a continuation of RCA Laboratories' work on the pick-up tube over the past twenty years under the direction of Dr. V. K. Zworykin, Associate Director of RCA Laboratories. During part of that period, the work was headed by B. J. Thompson, Associate Director of the Laboratories, who was killed in action overseas in July, 1944, while on a special mission for the Secretary of War.

Engineers of the tube division plants in Lancaster, Penn., and Harrison, N. J., have been engaged in development of the Image Orthicon for military applications and will be responsible for the final commercial design of the tube for television uses.

Announcing incorporation of the image Orthicon in a new super-sensitive television camera to be manufactured by RCA Victor, Meade Brunet, General Manager of the Company's Engineering Products Division, said that deliveries on the camera are expected to be made to television broadcasters in about six months.

"The new super-sensitive RCA Victor television camera will fill a long-felt need in the television broadcasting field," said Mr. Brunet. "This equipment is especially well-suited for televising events remote from the studio and those where brilliant lighting is either impracticable or undesirable. The portable camera is lightweight, simple to operate, and can be quickly set up and placed in operation. It is particularly adaptable for use in televising out-of-door sports and news events and for remote indoor pick-ups such as in theaters, concert halls, schools, churches, courtrooms, and other public buildings."



The New High-Sensitivity Camera (foreground) in use at Madison Square Garden. Scenes which could not be picked up with the older field camera (rear) are now seen with perfect clarity.

ADVANTAGES IN PERFORMANCE

RCA engineers listed these specific advantages in performance of the Image Orthicon:

1. Ability to extend the range of operations to practically all scenes of visual interest, particularly those under low-lighting conditions.
2. Improved sensitivity, permitting greater depth of field and inclusion of background that might otherwise be blurred.
3. Improved stability which protects images from interference due to exploding photo flash bulbs and other sudden bursts of brilliant light.
4. Smaller size of tube, facilitating use of telephoto lens.
5. Type of design that lends itself to use in lightweight, portable television camera equipment.
6. Improved gain control system that provides unvarying transmission, despite wide fluctuations of light and shadow.

(Left)—In this illustration the girl operating the monitoring unit of the new RCA Field Equipment is looking at her own image on the screen. The only illumination of this scene was light coming over a transom from another room. The light incident on the scene measured 3½ foot-candles.



HOW THE TUBE WORKS

Resembling a large tubular flashlight in size and appearance, the advanced development model of the Image Orthicon has an overall length of about 15 inches, with the shank about 2 inches in diameter and the head about 3 inches in diameter and 3 inches long. It has three main parts: An electron image section, which amplifies the photoelectric current; an improved Orthicon-type scanning section, smaller and simpler than those built before the war; and an electron multiplier section, the function of which is to magnify the relatively weak video signals before transmission.

The principle which makes the new tube super-sensitive to low light levels is similar to that which enables RCA's famous multiplier phototube to measure starlight. This principle, known as secondary electronic emission, involves the use of electrons

emitted from a primary source as missiles to bombard a target or a series of targets, known as stages or dynodes, from each of which two or more electrons are emitted for each electron striking it.

Light from the scene being televised is picked up by an optical lens system and focused on the photo-sensitive face of the tube, which emits electrons from each illuminated area in proportion to the intensity of the light striking the area.

Streams of electrons, accelerated by a positive voltage applied to a grid placed directly behind the photo-sensitive face and held on parallel courses by an electromagnetic field, flow from the back of the photo-sensitive face to a target. Secondary emission of electrons from the target, caused by this bombardment, leaves on the target a pattern of varying positive charges which corresponds to the pattern of light from the scene being televised.

The back of the target is scanned by a beam of electrons generated by an electron gun in the base of the tube, but the electrons making up this beam are slowed down so that they will stop just short of the target and return to the base of the tube except when they approach a section of the target which carries a positive charge. When this occurs, the beam will deposit on the back of the target enough electrons to neutralize the charge, after which it will again fall short of the target and turn back until it again approaches a positively-charged section.

The returning beam, with picture information imposed upon it by the varying losses of electrons left behind on the target,

is directed at the first of a series of dynodes near the base of the tube; secondary electrons "knocked out" of this electrode by the bombardment strike a second dynode, and this process continues, with the strength of the signal multiplying at each stage until it reaches the signal plate and is carried out of the tube through an external connection.



These three illustrations show three widely different degrees of lighting of the same subject. With the new RCA High-Sensitivity Camera all three were picked up with almost equally good results. In the top picture the model faces a strong spot-light; the illumination on her face measured 800 foot-candles. In the center picture the only illumination was the desk light turned away from the model; the illumination measured 10 foot-candles. In the lower picture the light was furnished by a single candle; the illumination was measured as approximately 3 foot-candles. The ability of this new camera to pick up scenes of widely varying intensity is as important as its great sensitivity because it makes video operations much less critical.





Photograph of scene being
picked up by the new
sensitive camera.

The two illustrations on this page represent an attempt to show the actual sensitivity of the new camera by direct comparison. The picture above is a direct photograph of the model's face with the illumination of a single candle. The photographer's camera was at approximately the same position as the television camera.

Photograph of above scene
as reproduced on
monitor screen.



This picture is a photograph of the screen of the television monitoring unit; illumination, exposure, etc., being the same as in the picture at the top of the page. In comparing these pictures the difficulties of photographing a television screen should be borne in mind, as well as the loss of resolution which results from the screening process used in making the electro-plates from which these illustrations are printed. Allowing for the effect of some loss of resolution, it will be observed that the televised picture has as great or greater range of light values (i.e., from the bright light of the candle to the dim light on the model's hair and dress) than has the photographer's camera,

ARMY DEMONSTRATES TWO RCA RADIO RELAY SYSTEMS

Two of the radio relay systems which were demonstrated in California last month by the U. S. Army Signal Corps showing wartime developments in military communications which may revolutionize peacetime civilian telephone and teletype operations were developed by the Radio Corporation of America.

These two systems—known officially and in the Catalina Island-San Francisco demonstration as the AN/TRC-5 and the AN/TRC-8—eliminate the necessity of long lines in certain types of long-distance telephone communication, according to Dr. H. H. Beverage, Associate Research Director of RCA Laboratories, which developed the system in collaboration with the Camp Cole Ground Signal Agency.

Operating at radio frequencies well above those used before the war, the systems provide multiple voice channels on a single carrier. The AN/TRC-8 has a capacity for four voice channels, which may in turn be used to provide four teletype channels. The AN/TRC-5 provides eight simultaneous voice channels on a single carrier. In each instance, operation requires no wires, since transmission is carried out efficiently by automatic radio relay stations which "bounce" the high frequency waves from one point to another completing the desired circuit.

A unique feature of the AN/TRC-8 set is its flexibility. The carrier frequency is held constant by a device which can be adjusted to any carrier frequency in a 20-megacycle band in a matter of seconds. Transmitter and receiver function without radiation of spurious frequencies or harmonics. This is regarded as a marked improvement in the field where a number of units must be used at a single location.

While the four-channel system operates on FM (frequency modulation), the AN/TRC-5 operates fundamentally on a system of the time-division multiplex employing very short pulses. The radio frequency energy is radiated in a series of short bursts or pulses, each somewhat less than one-half of a millionth of a second in duration.

Special means are used to separate these pulses into their respective channels. These pulses remain constant in frequency and amplitude, but their incoming voice-sounds modulate the phase or time interval between the pulses.

At the repeater points these interspersed pulses are retransmitted without demodulation. Finally, at the terminal receivers, means are provided to separate the pulses into their respective channels and to convert the pulse phase or time modulation back into the original voice currents for transmission to the standard telephone instruments associated with each channel.



(Above)—Portable antenna system used with the AN/TRC-8 transmitting-receiving equipment designed and built for the Army by RCA.



(Left)—Transmitter unit of the AN/TRC-8 "pulse" equipment built by RCA. The receiver unit is contained in a similar case of somewhat smaller dimensions.

Gimbels and RCA Test Intra-Store Television

by JUDY J. ALES, Assistant Editor

Intra-Store Television had its first full-scale test in Philadelphia last month. From October 24th to November 14th Gimbels' Department Store operated a full-sized intra-store television system on a 10-hour-a-day basis. This demonstration was given in conjunction with RCA Victor, who supplied the equipment and engineering supervision. Although the pros and cons of Intra-Store Television have long been discussed, this was the first time an actual store-wide test has been made under conditions close to those which would exist with a permanent equipment installation. Success of this test was such that Gimbels, which was the first department store to install and operate a radio broadcasting station in Philadelphia, may have set an equally outstanding precedent in the television field.

The purpose of this demonstration was, primarily, to prove that a dramatic presentation of the store's merchandise could be instrumental in directing the store's traffic to parts of the store which are ordinarily neglected. Statistics show that a great number of people who enter a store each day, all presumably with the intention of buying, either leave without making a purchase or else buy only the items prominently displayed in convenient locations. This is probably due to the fact that these prospective customers do not want to waste their time or energy to investigate what is being sold in out-of-the-way departments. Telecasts,

by giving a preview of what will be found in these departments, could arouse customer interest enough to create a desire to see the merchandise being displayed. In this way attention could be attracted to special sales being held in different departments. In addition, product demonstrations, which are proven sales getters, could be shown simultaneously to people in every part of the store. This should prove especially valuable for merchandise which is difficult or expensive to demonstrate.

In the Gimbels' experiment, the programs shown originated every half hour in the store's auditorium. Receivers were strategically placed throughout the store so that 500 persons could watch each performance. It was estimated that approximately 250,000 persons saw these demonstrations during the first week. The type of programs used included fashion shows, beauty tips, and household hints; however, many other types of demonstrations are possible and the consumers will be the final judges in the decision as to the type programs to be used.

The first trial of intra-store television received some very favorable comments. An indication of the value Gimbels has attached to television as a department store merchandising medium was shown in a full-page advertisement which they placed in Philadelphia newspapers titled, "Report To The Public." It stated that intra-store television "may change the

You can be in two places at the same time! Shown below is Gimbels' Beauty Salon where customers are finding out, on the television screen, what's being featured in the rest of the store while waiting their turns for treatments.



BEGINNING TOMORROW, 12 TO 9, AND UNTIL NOVEMBER 14th!
Join with us in an experiment that may change the shopping habits of a nation!

for the first time ever! **SHOP by TELEVISION** in **GIMBELS**

10-MINUTE SHOWS—EVERY HALF HOUR
AT THESE 20 GIMBEL TELESITES!
(viewing locations)

7TH FLOOR

- 1. Foyer of Gimbel Restaurant
- 2. Credit Department
- 3. Co-workers' Cafeteria

6TH FLOOR

- 4. New Century House
- 5. Living Room Furniture
- 6. Radio Hall of Fame

5TH FLOOR

- 7. Upholstery Department
- 8. Rug Department

4TH FLOOR

- 9. House Furnishings
- 10. Lamps

3RD FLOOR

- 11. Uncle Wip's Youth Center
- 12. Coat Salon
- 13. Dress Circle
- 14. Silver Salon for Beauty
- 15. Mayfair Shop

2ND FLOOR

- 16. Art Needlework
- 17. L'Algon Shop
- 18. Men's Clothing
- 19. Fabric Center

BALCONY-STREET FLOOR

- 20. Foyer of Rest Rooms

AND—SEE COMPLETE TELEVISION STUDIO IN GIMBELS AUDITORIUM*
FROM WHICH THE SHOWS WILL BE BROADCAST TO ALL THE TELESITES

- * See living model Fashion Shows of glamorous famous fashions, see housewares, furniture, toys, nurseries—all on Television—coming from the studios to 20 different spots in our store!
- * See merchandise presented in a new way, in comedies, dramas, with music, magicians, in 10 wonderful shows every half hour on the half hour.
- * See RCA Victor's Electronic exhibit including the famous Electron Microscope in the Foyer of The Gimbel Auditorium.
- * Come see an actual Television Studio—see a Control Room (plans enclosed so you can watch how it operates) in The Gimbel Auditorium, Fifth Floor, Chestnut.
- * See the thrilling "Story of RCA Victor's Electronic Television", told by magnificent displays in our Market Street windows!

Wouldn't it be wonderful if hours of weary shopping could be reduced to one wonderful, walloping piece of entertainment? Because we feel nothing in this modern age is impossible—not even being in three places at the same time—we're going to try to make these things come true. It all started with an idea—an idea that through the electronic wonder of our time, the almost magic, mysterious, scientific miracle—TELEVISION—you could relax in any one spot in our store, see a whole parade of products, and decide on anything from playpens to permanent waves without wasting a step. We've toyed with this brainchild for some time, and now, thanks to the efforts of RCA Victor's engineers, we're going to launch it on a scale more spectacular than we ever dreamt possible. We've had 10,000 feet of cable, both axial and audio, stretched throughout the seven floors of our store. We're ready with a television control room and studio, with 20 telesites, with 10 professional shows and actors and directors raring to go—and we're holding our breath! Tomorrow the incredible idea comes to life. Will it work? Is shopping by television such a fantastic dream? Can you actually choose a Sally Victor hat or a mink jacket or shoes or a sofa while shopping for a roaster? We don't know—but we're going to have the thrill of a lifetime finding out. Maybe it'll be the same thrill as the first trans-Atlantic flight, or the first talkie movie. This may be one of those firsts you'll share with your grandchildren, in years to come, so don't miss it.

*FIFTH FLOOR CHESTNUT

GIMBEL BROTHERS • RCA VICTOR

One of the full-page advertisements used in the Philadelphia newspapers during the "Television Goes To Work" demonstration. The publicity given it is an indication of the importance Gimbels attached to the first public showing of this new medium for department store advertising.

shopping habits of the nation." It also reported that Philadelphians' reaction to the use of this medium for merchandising ranged from "sheer amazement at seeing television for the first time, to the excitement of being able to shop by television—an entirely new and exciting way."

Many outstanding television experts, interested in the results of this experiment, also visited Gimbels during the demonstra-

tion. Reporters from "Television" magazine took a day-long poll in the store which showed some very interesting results. Among the people questioned, 82% were able to name the merchandise shown; 29% indicated their intention of going to the departments to see the products televised, 22% intended to buy as a result of the telecasts; and 57% intended to buy television receivers as soon as possible. It was also noted that 86% would like to see Gimbels continue to use intra-store television.

THIS IS THE WAY INTRA-STORE TELEVISION IS SET UP

1. Gimbel Brothers' auditorium, which housed both the studio and control room (small room at the side of the stage). Capacity crowds were on hand to watch each program which was televised.

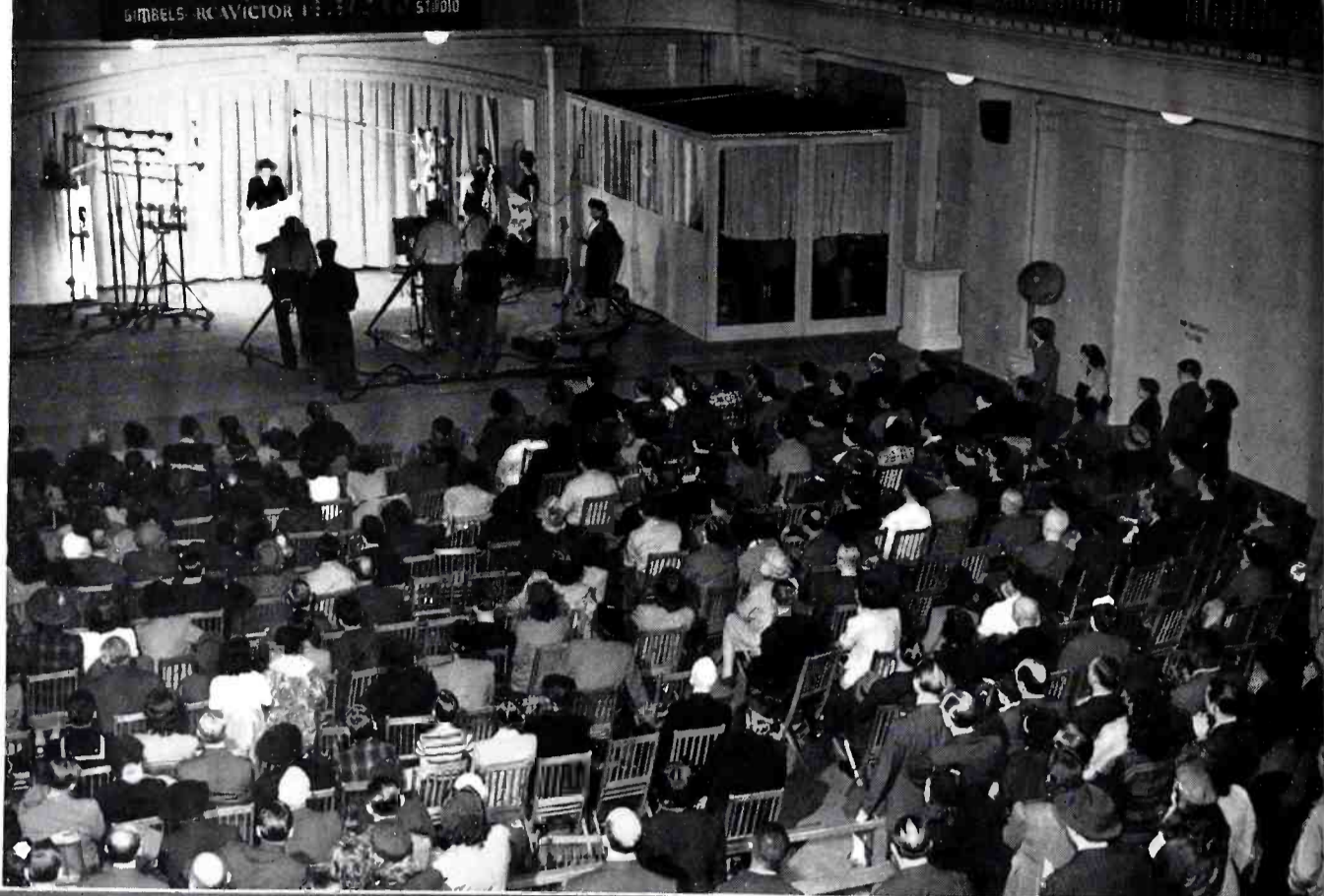

2. The stage being set for the next telecast. Shown are the 2 RCA Iconoscope cameras and the type 77-D microphones which were used. The camera cable carries extra conductors for sound power phones, thereby providing communication between the camera men and the program director in the control room.

3. A close-up of a scene being televised which featured the store's newest fashions in footwear. A telephoto lens on one of the RCA cameras provided a close-up view on the television receivers.



THIS IS THE WAY INTRA-STORE TELEVISION SELLS

4. Models display merchandise from Gimbels' Jewelry Department during telecast for intra-store television.



5. "Spellbound" seems to describe the reaction of this audience as they watch the above scene in one of the 20 telesites set up throughout the store. Each of the store's 7 floors had at least 2 receivers in operation and some floors had 3 or more.

6. One of the 29% who went to see the merchandise they saw televised. Here's a customer examining the necklace being demonstrated in top picture.



RCA MICRO-WAVE IN OPERATION FOR BETWEEN NEW YORK

by **H. F. MICKEL**

Manager, Communications Equipment Sales
Engineering Products Division

The development and successful field test of a new-type micro-wave relay system was revealed on October 22 in simultaneous announcements by the Radio Corporation of America and the Western Union Telegraph Company.

Equipment of an entirely new type has been installed by RCA engineers in a "chain" of stations stretching from New York to Philadelphia. Since last March this circuit has been used by the Western Union Company on an experimental basis between their New York and Philadelphia offices. As a result of these tests—believed to have been the first actual tests of a micro-wave relay "chain" under every day operating conditions—the Western Union Company has applied to the FCC for permission to install similar equipment in New York to Pittsburgh, Pittsburgh to Washington and Washington to New York circuits. These are the first links of what Western Union has indicated will eventually be a nation-wide network.

The new micro-wave radio relay system used in these tests by the Radio Corporation of America and the Western Union Telegraph Company was made practicable by wartime progress in the field of high-frequency communications.

Operating on wave lengths heretofore used only for radar and other military equipment, this new system promises to provide the means whereby nation-wide network, not only for telegraph and telephone, but also for television, frequency modulation, facsimile, and other services, may become a reality in the very near future.

In the relay system now in use in the test circuit between New York and Philadelphia—ordinary poles and wires are replaced by a chain of elevated radio relay stations spaced 25 to 50 miles apart. Each station receives the transmissions from the preceding station and automatically passes them on to the next following station. Installation of two receivers and two transmitters at each station provides for simultaneous two-way operation. Because the equipment is relatively simple and easy to install, "chains" of such stations may be installed more quickly and cheaply than wire lines. Because the stations operate automatically and hence require no attendants, they are inexpensive to maintain. Moreover, each radio circuit is capable of carrying many voice or telegraph channels simultaneously so that one such line may well serve the needs of most cities. Finally, such service has the advantage of being less vulnerable to storms or electrical disturbances than are land lines.

DEVELOPMENT OF THE MICRO-WAVE SYSTEM

RCA engineers, envisioning the day when radio relay networks would connect all parts of the country, have been working for

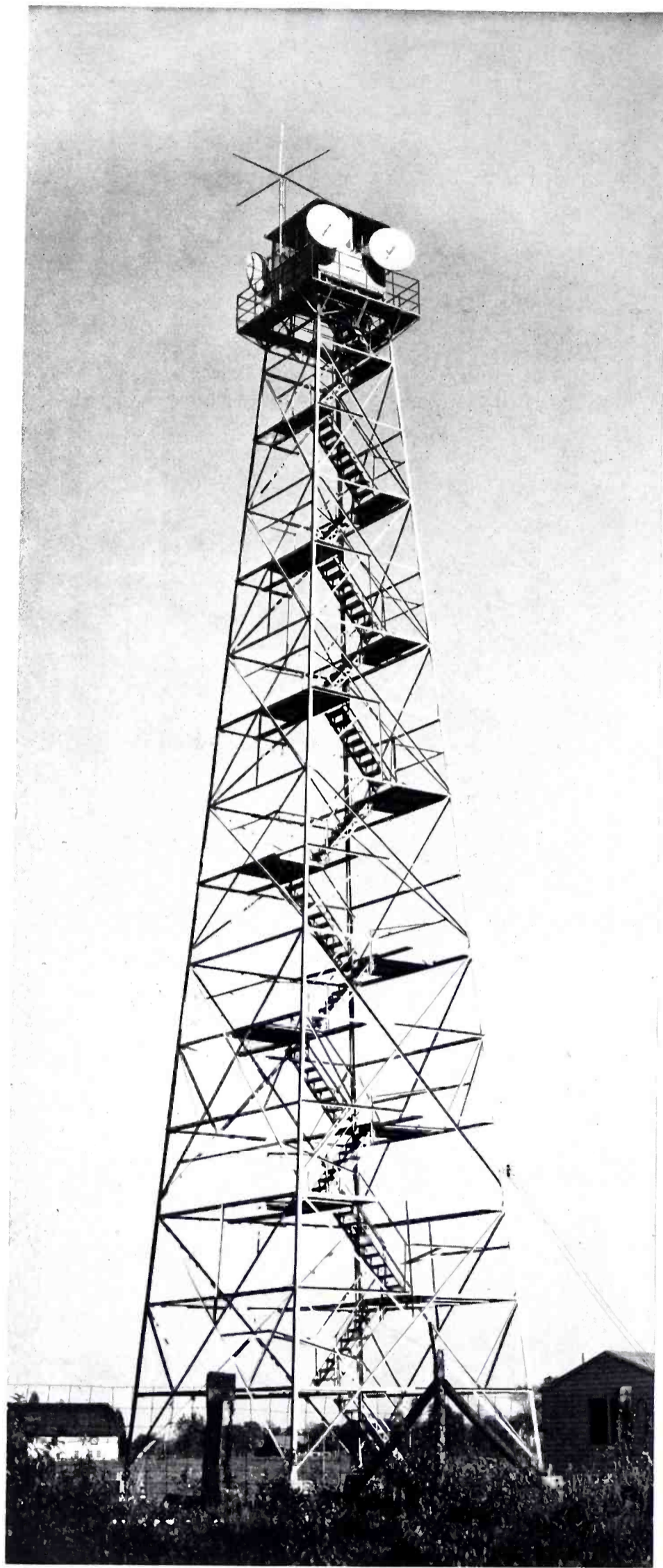

One of the 100-foot towers used at the repeater stations on the New York-Philadelphia circuit. These towers have an eight-foot square cabin at the top in which all of the equipment is located.

RELAY SYSTEM

THE PAST YEAR

AND PHILADELPHIA

fifteen years on the development of equipment suitable for the purpose. Prior to the war they had installed several such systems on an "experimental" basis and had publicly demonstrated, in 1935, a television relay system operating on the same basic principle. However, prewar radio relay systems necessarily operated at frequencies of 300 Megacycles or below. At these frequencies the equipment was relatively bulky, the "gain" of the antenna was low and methods of modulating the carrier left something to be desired.

The new type RCA equipment, which is used in the circuit between New York and Camden, New Jersey, operates on frequencies in the band of 3900-4450 Mc. At these frequencies a wave-

(Right)—Two of the bowl-shaped reflector antennas used with the RCA Micro-Wave System. The small disc-shaped units at the focus of the parabola house a tiny dipole unit.

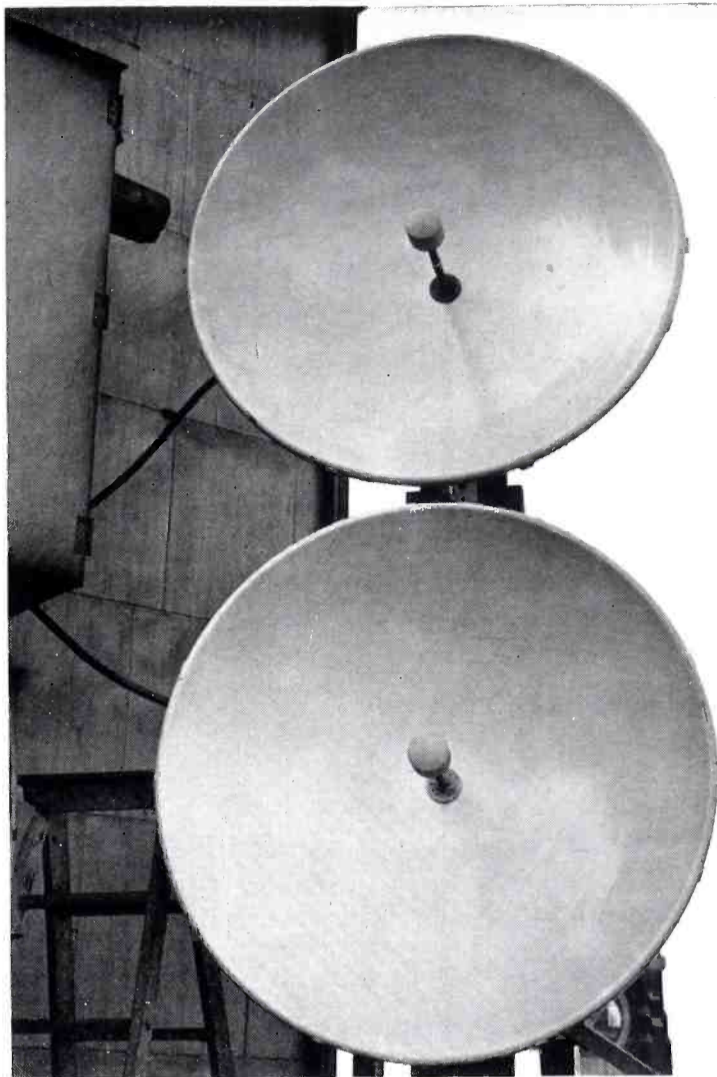

(Below)—Map of the New York-Philadelphia Micro-Wave Relay Circuit which has been in operation for over a year.

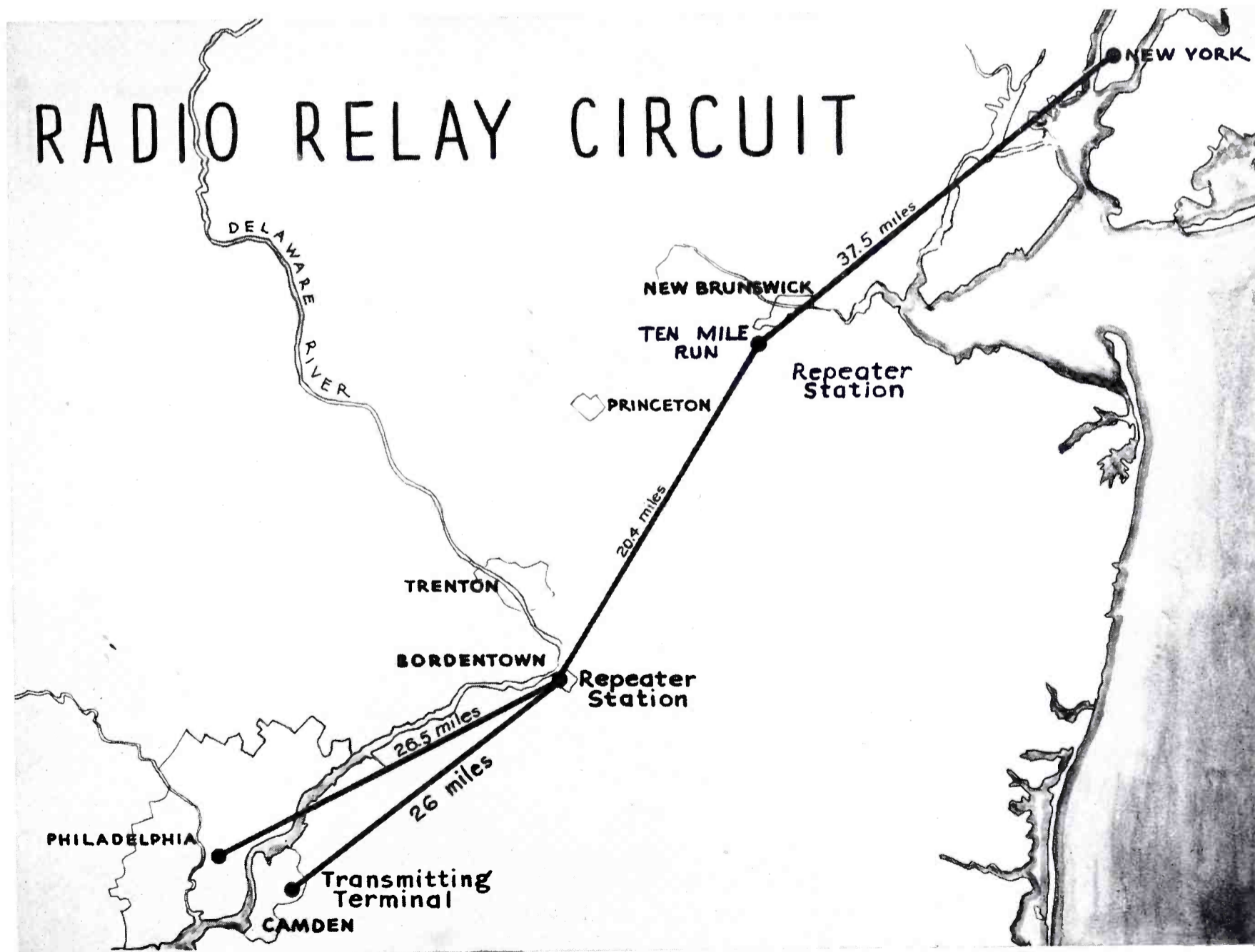

length is only about three inches; hence, antennas of high directivity can be used. The consequent antenna "gain" is such that only very low powers are required and therefore the equipment is relatively simple.

As a complement to the use of these extremely high frequencies, RCA engineers developed an entirely new system of "modulating" the carrier signal. In this system the carrier is only partially demodulated at each station, thereby avoiding the increase in noise level which would otherwise occur. As a result, the distortion and noise levels are very low even for a chain of many stations.

Three engineers of the RCA Victor Division are credited with development of the new microwave system. They are Donald S. Bond, head of the project; L. E. Thompson, contributor of original ideas for the circuit; and Gerald G. Gerlach, supervisor of field installations and tests. Engineers of RCA Laboratories and RCA Communications, Inc., who have devoted twenty-two years to developing radio relays, provided much of the basic research information used. Western Union engineers developed special terminal channeling equipment with which to apply the radio signals to telegraph use.

DESCRIPTION OF THE NEW YORK-PHILADELPHIA CIRCUIT

Two intermediate relay stations are required in the New York-Philadelphia circuit. One of these is located near Bordentown, New Jersey and the other at Ten-Mile Run near New Brunswick, New Jersey. At each point a 100-foot steel tower has been erected on top of which is an 8-foot square enclosed cabin. On the outside of the cabin are four bowl-shaped reflectors at the

center of which are the tiny high-frequency antennas. One bowl-antenna on the east side of the tower feeds the East-to-West receiver, while the other feeds the West-to-East transmitter. The two bowl-antennas on the west side of the tower feed, respectively, the West-to-East receiver and the East-to-West transmitter. The transmitters and receivers, together with the demodulating and modulating circuits, are housed in the cabin. The transmitters in the present system put out about one-tenth of a watt. However, when it is considered that the antennas have a power gain of 900 (so that the receiver-antenna to transmitter-antenna gain is 810,000) it will be noted that the equivalent non-directive power is 81 kilowatts.

The band or channel width transmitted by the present system is 150 kilocycles. It has been estimated that this is sufficient for 270 multiplex or 1080 single telegraph circuits. It could probably handle at least 25 ordinary telephone circuits, or if used for high-quality FM broadcast service, possibly eight channels. The present bandwidth is insufficient for television, but it is expected that new equipment, of higher power, which is soon to be available may provide the necessary 6-megacycle television bandwidth.

In its six months operation to date, this new radio circuit has performed admirably in the face of the rigid requirements of regular commercial operating practice. As a result of this experience the Western Union Company has filed an application with the Federal Communications Commission requesting permission to install equipment of a similar type in lines from New York to Pittsburgh, Pittsburgh to Washington, Washington to New York, and New York to Philadelphia. These are the first links of what Western Union has indicated will eventually be a nation-wide network.

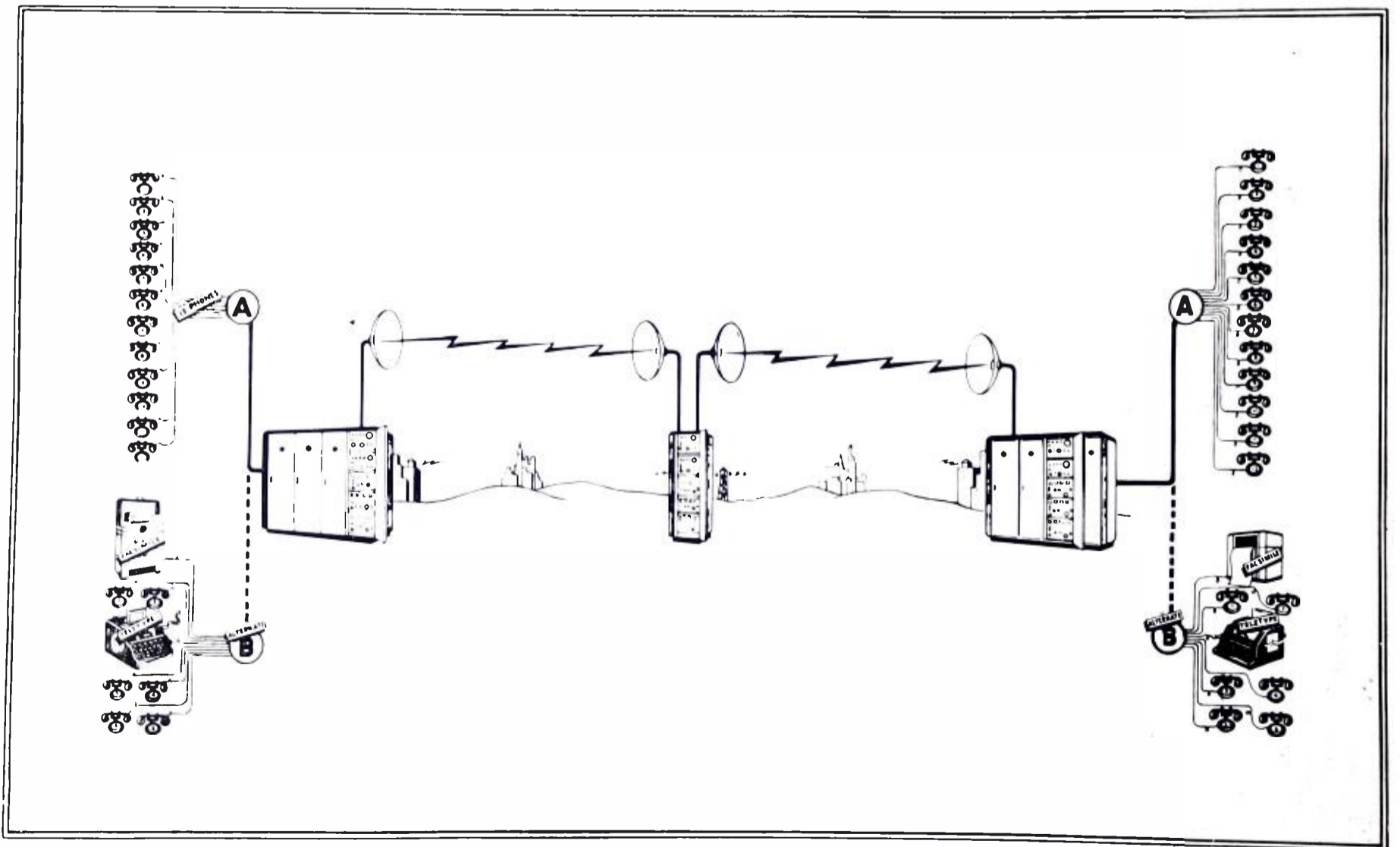

The RCA Micro-Wave Relay Circuit, tested out in conjunction with Western Union engineers, will handle a dozen two-way phone circuits or a combination of facsimile, teletype, and telephone circuits.

ABC'S VANDERBILT STUDIOS

by **BEN ADLER**

Facilities Engineer — General Engineering Department — American Broadcasting Company, Inc.

In the fall of 1941 ABC was faced with the problem of equipping the Vanderbilt Theater in New York to render it suitable for broadcasting purposes. To add to the ordinary difficulties of accomplishing such a task in wartime, we were told that it would be necessary to be on the air within about ten weeks. As it worked out, we were able to place the theater in operation within six weeks after the priority was received from the WPB in Washington.

Operating requirements for this installation were obtained from American Broadcasting Company's Production and Operations Departments before an attempt was made to locate suitable equip-

ment. It appeared that with the type of shows that ABC was to produce in this theater, it would be necessary to have a minimum of ten microphone mixer positions on the studio control console. In order to get on the air within the allotted time, it was necessary to select existing equipment rather than to have equipment custom-built for the job. It was found that RCA had two 76-B2 consolettes in stock and a priority was requested for these particular items. Each of these consolettes had only four microphone mixer positions, but it was felt that the two auxiliary mixer positions on each consolette could easily be adapted for microphone use by adding a preamplifier for each position. Of course, locating the preamplifiers was a separate problem which



FIG. 1. *View of Vanderbilt Theater Studio showing control booth overlooking stage.*

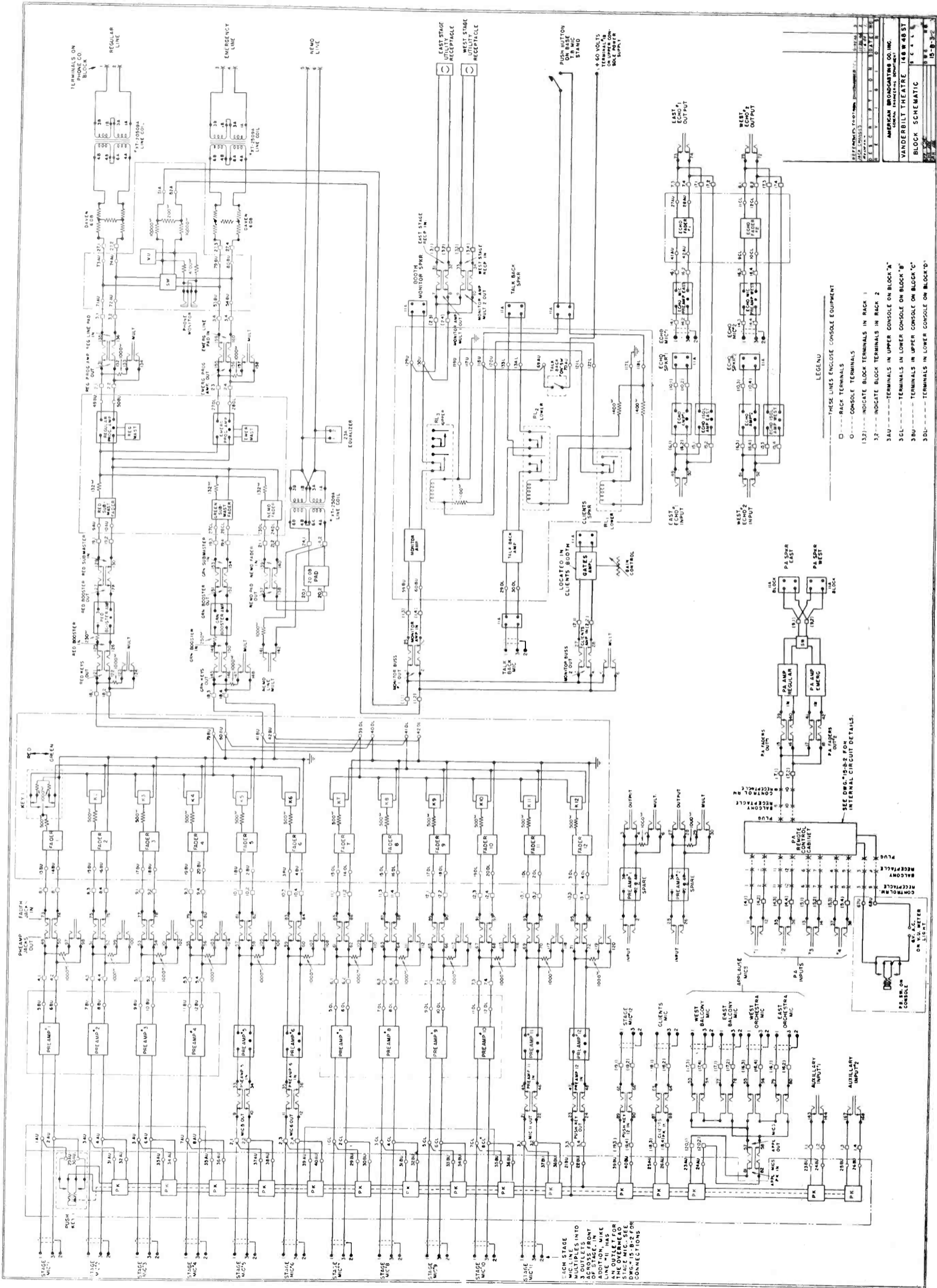

FIG. 3. Block Schematic Diagram—Vanderbilt Theater Studio Installation.

we finally solved after many indications of possible failure. In selecting the two consolettes for this particular use, many ideas were discussed as to how the two of them could be combined to permit a single studio operation with all twelve microphone mixer positions tied together.

Among the various ideas was the one that was finally used. The mechanical arrangement for combining the two consolettes is shown in Figures 4 and 5. It was necessary to design and construct a special desk to house the two consolettes in the manner shown, i.e., with one mounted above the other. Before this desk could be designed it was necessary to find out from the various control engineers the optimum panel angles and control knob locations relative to the desk itself. The answers to these questions were arrived at through the use of a full-size cardboard model. This model was so arranged that the angle of the part which represented the two consolettes could be adjusted. The final answer was arrived at by taking the average of votes of some twenty control engineers, any of whom might be called upon to operate the equipment at the Vanderbilt Theater.

Figure 6 shows the final console with the upper unit raised and the bottom unit lowered for servicing. The bottom unit is suspended by a system of counterweights and pulleys so that it is easily opened and closed for maintenance. The upper unit is opened and closed in the usual manner.

In addition to working out a mechanical arrangement for combining the two consolettes, it was necessary to change the circuits so that the final result would be a single console with a twelve-position microphone mixer. The final circuit of the entire system is shown on the block schematic diagram Figure 3. It will be noted that any of the mixer positions of the twelve-position mixer may be assigned by means of key switches to either of two output channels, which are designated as red channel and green channel. A booster amplifier has been provided in each of the two output channels to compensate for the loss in the twelve-position mixer. Each output channel is equipped with its own submaster control. The outputs of the two submaster controls are combined, together with a nemo fader, to feed both regular program amplifier and emergency program amplifier. Both program amplifiers are in active use at all times, each feeding its own telephone line to master control back at Radio City. The monitoring bus, which also feeds the VU meter on the console, may be switched from regular to emergency by means of a key switch on the front panel of the upper consolette. Most of the push keys in the two consolettes were disconnected. The upper right-hand bank of push keys was reconnected so that the outputs of all sixteen keys are tied together. These outputs feed into preamplifier No. 12 which is located on the equipment racks. The input to each key may be connected across the input of its corresponding microphone preamplifier. This provides an emergency setup which permits switching preamplifier No. 12 into any of the other eleven positions in the event of failure.

The monitoring amplifier in the upper console is used for control booth monitoring. The monitoring amplifier in the lower console is used for studio address during rehearsals.

FIG. 2. Another view of the Vanderbilt Studio Auditorium.

The relays in both upper and lower consolettes have been rewired as shown on the diagram in order to accomplish this.

Sound reinforcing in the theater is handled by means of an RCA 82-C amplifier that feeds loudspeakers on each side of the proscenium arch. The circuits are so arranged that any four individual microphones may be reinforced at the same time. This is accomplished through the use of a portable four-position mixer which may be plugged into a receptacle in the control room or into one located underneath one of the balcony seats. The portable mixer box is shown on the shelf in the photograph of the control room racks (Figure 7), where it may be reached by the control engineer. For elaborate shows the portable mixer is used by a separate control engineer seated in the balcony. In this way he can control the sound reinforcing to suit the audience. A signal system is provided between the control engineer in the booth and the one located in the balcony. Arrangements are included for reinforcing the entire program or for feeding the house speakers with program material arriving over a telephone line from a remote source. This particular feature is required where the same program originates in more than one studio. Through this means the audience in the Vanderbilt Theater may listen in on the portion of the program which originates elsewhere.

Four applause microphones are distributed throughout the audience, two of them being suspended under the balcony to pick up orchestra applause and two others suspended from the corner of the balcony booths to pick up balcony applause.

Twelve microphone receptacles are provided in three groups across the front of the stage. No. 1 of the first group is paralleled with No. 1 of the second and third groups. This scheme was used so that any microphone located anywhere on the stage may be assigned to any of the twelve microphone mixer positions on the console without the use of jacks. No. 11 is duplicated in the fly loft to provide for a hanging microphone when required.



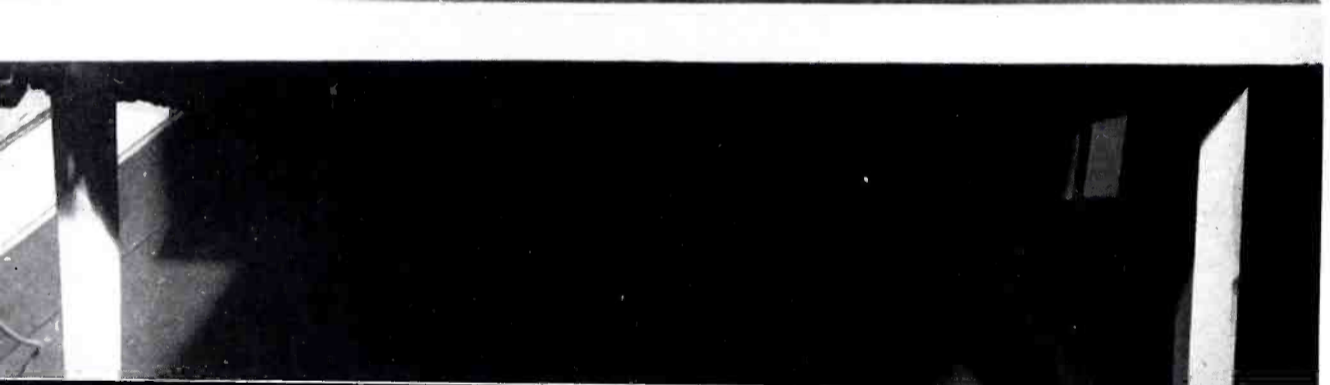
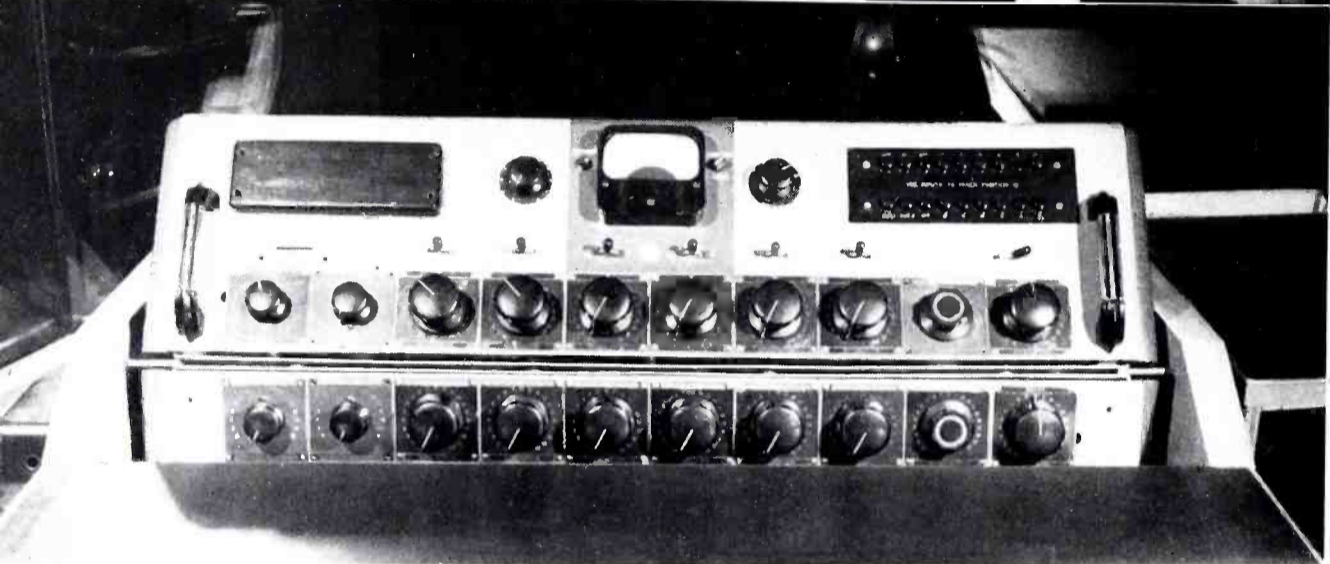

Associated with the microphone receptacles on the stage is a system of troughs for concealing the microphone cables while they are in use. This concealment is mainly for the purpose of eliminating the possibility of an artist tripping over the cable and, of course, provides a much neater setup than the usual arrangement in which cables are strewn along the floor. This is shown in Figure 9.

In order to prepare the theater for use as a broadcast studio, it was necessary to construct a control room and a clients' booth. Because of a lack of space anywhere else in the theater it was necessary to place these booths on each side of the balcony. The booth housing the control equipment is so arranged that the audio equipment racks are accessible through double doors in the rear.

Two dressing rooms were selected for use as echo chambers. These were completely sealed up and plastered for maximum reverberation with a loudspeaker and microphone placed in each. The circuits showing connections to these units in each echo chamber are shown on the block schematic diagram. Arrangements are provided for patching the echo circuit into any microphone position or into the overall program if required. The echo controls are located on the console.

Since the entire theater was originally operated on d-c from the public service supply, it was necessary to bring a-c into the building. In doing this two separate phases of a Wye distribution system were brought up to the distribution panel in the control room. Automatic contactors are provided for switching to the emergency phase in the event of failure of the preferred phase. If both phases go out, automatic contactors start an alternator in the basement which operates from the house d-c. With this system it is possible to continue operation without any interruption whatsoever in the event of an a-c failure. Other emergency features for preamplifier power supplies and for the consolettes are included so that in the event of a failure it is simply necessary for the control engineer to operate any one or all of three toggle switches located on the wall behind him to substitute emergency plate and filament supplies for the various amplifiers.

FIG. 4. (Top): Control desk construction.

FIG. 5. (Center): Front view of consolettes.

FIG. 6. (Bottom): Consoles opened for servicing.



FIG. 7. Audio equipment racks. On the wall shelf is a portable mixer box.

The control console design has been entirely satisfactory without a single program interruption during the ten months that it has been in operation. Even though the equipment was accumulated and placed in operation on extremely short notice, many novel features have been introduced. It is expected that some of these will be adopted as standard in future equipment layouts for the American Broadcasting Company.

One of the most desirable features from an operations standpoint is the arrangement for assigning any group of microphone mixer positions to one submaster. This is particularly advantageous in a variety type of show where a group of four or five

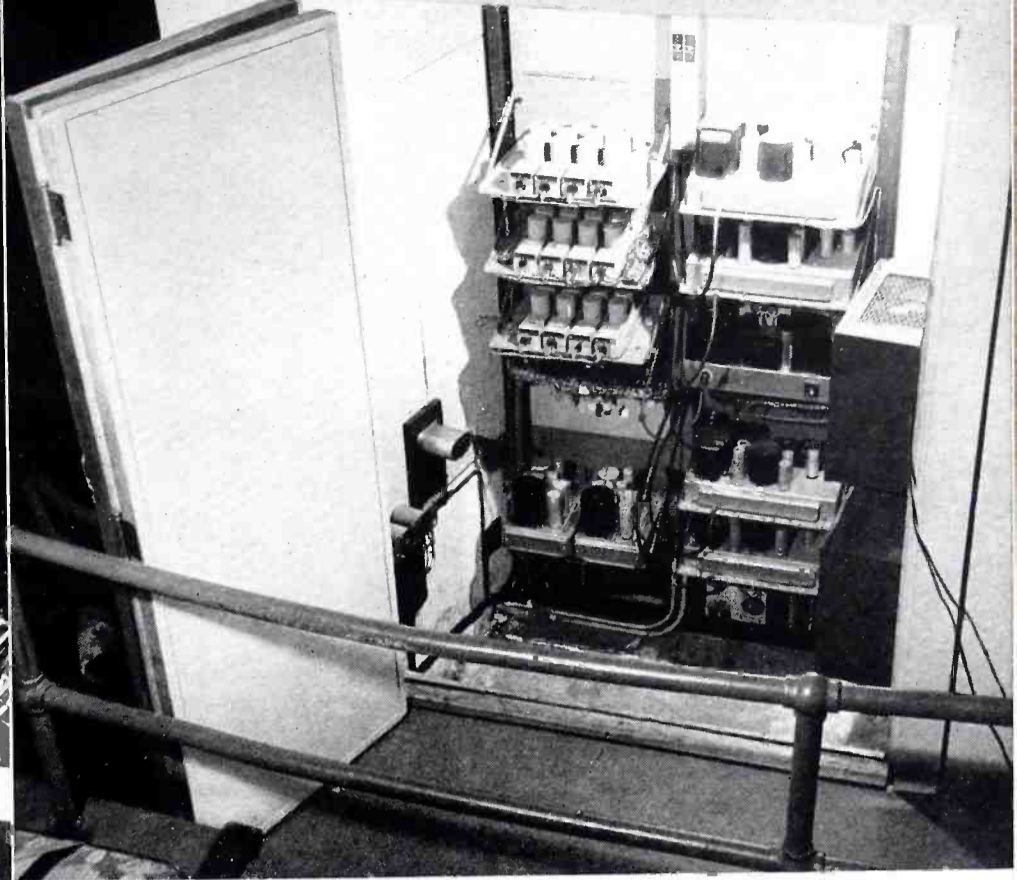
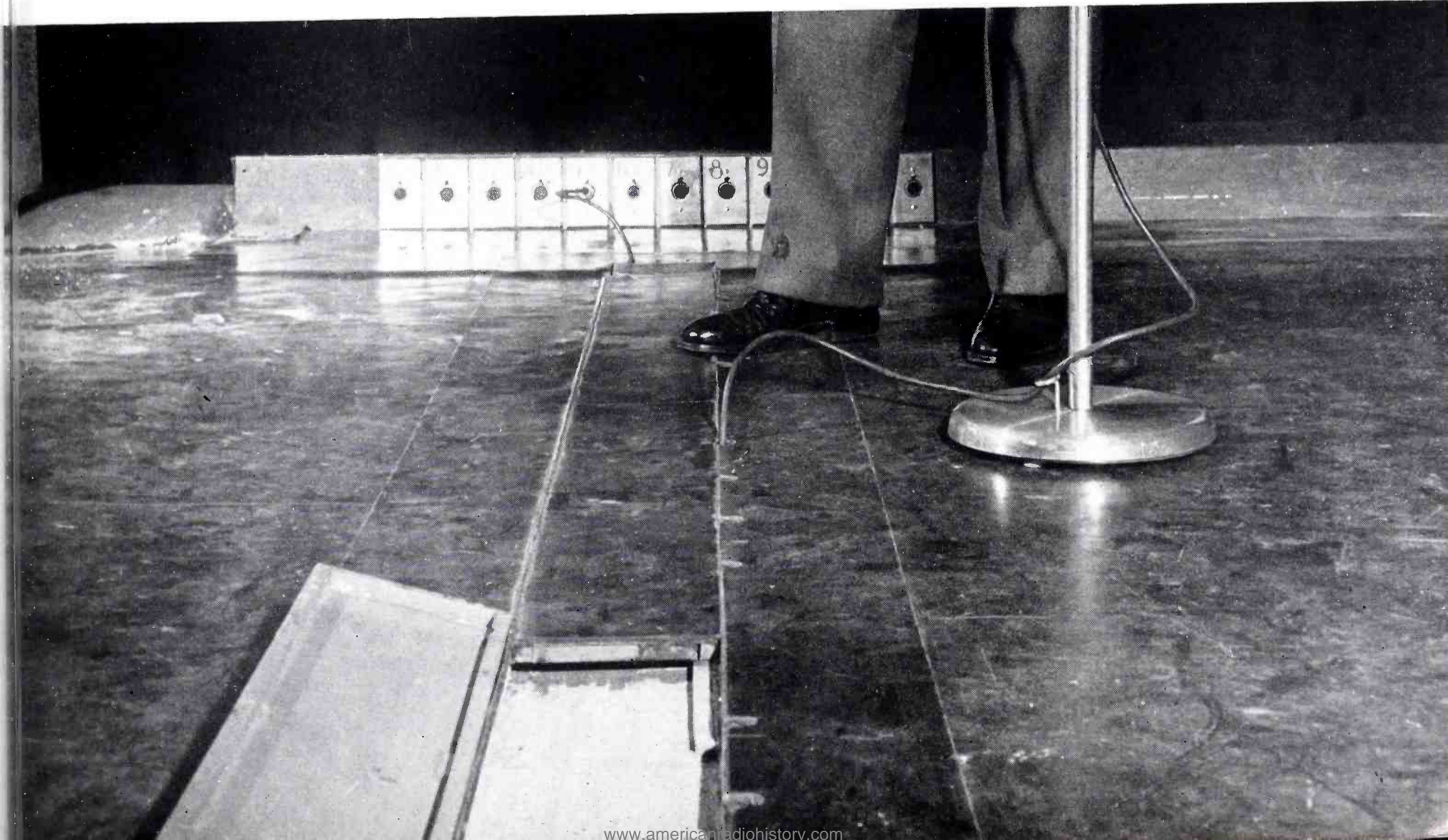

FIG. 8. Equipment racks are accessible through double doors in rear of control booth.

microphones are used for orchestra pickup. The entire orchestra may be wiped out and brought back again with the submaster without affecting setting of the mixer positions or microphones used for other purposes on the same show. Of course, the idea of combining two consolettes which were originally designed for entirely different purposes would not be considered practicable under normal conditions of equipment availability.

All construction work on this project was planned by and carried out under the direction of Mr. Rene C. Brugnoli, ABC architect. The entire project was under the direction of Mr. Frank L. Marx, Director of General Engineering.

FIG. 9. Twelve microphone receptacles are mounted across the front of the stage. Note hinged floor boards for mike cords.



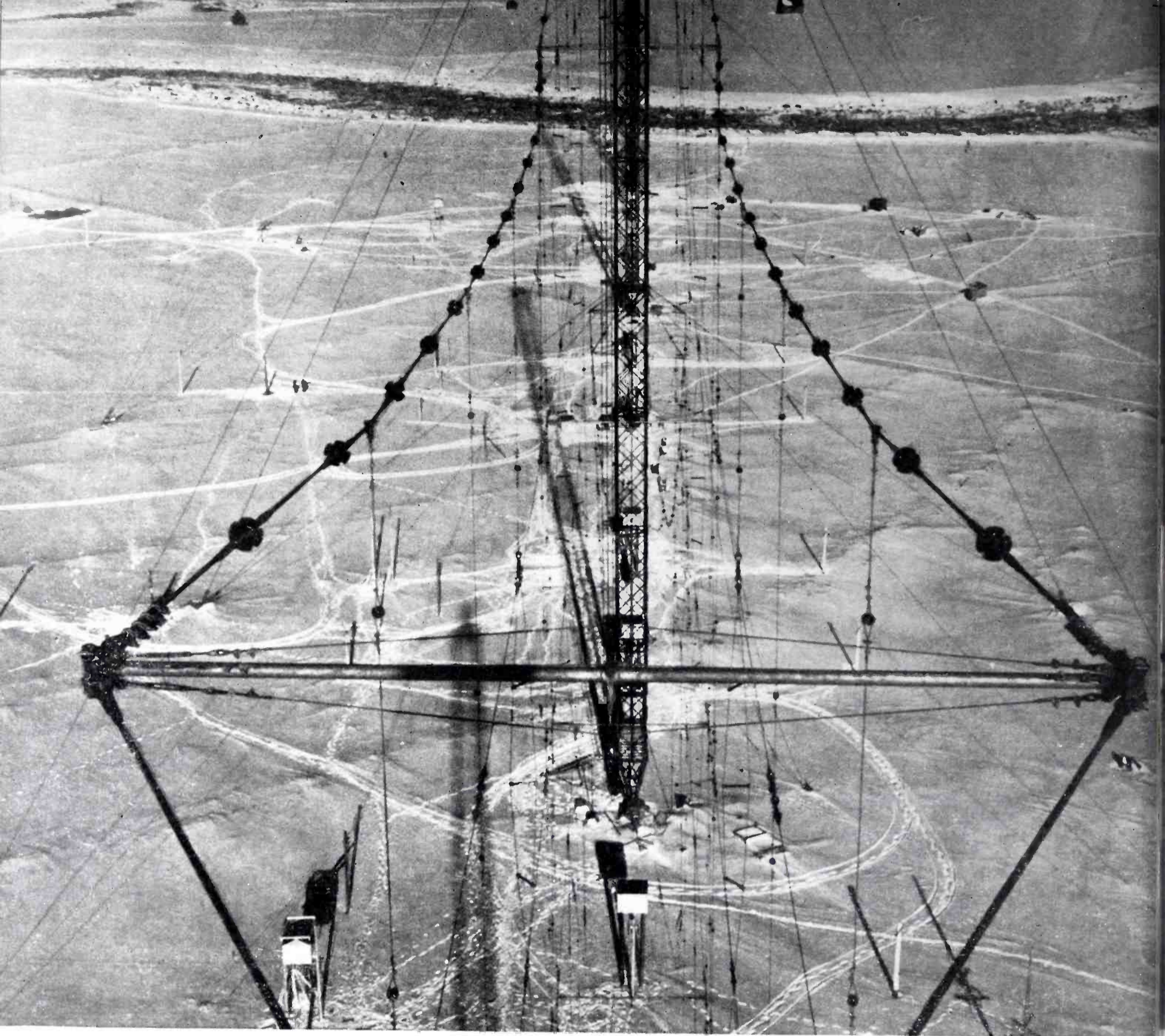

FIG. 1. *Bird's-eye view of the multi-element curtain arrays at Sackville, New Brunswick.*

CANADA'S LOUDEST VOICE

Reflecting the strength and virility of a young and powerful country, Canada's new voice has been made strong and clear by the application of the latest developments in broadcast engineering.



FIG. 2. This modern structure houses three RCA 50 KW transmitters—two Type 50-SW and one Type 50-D.

“The towers beside the River Tantramar are talking, and the sound of Canada’s new voice is strong in the lands of Europe.”

These were the poetic words CBC’s Gerald Noxon used to describe Canada’s entry into the field of international broadcasting. The towers to which he referred are those of CHTA, the CBC’s shortwave station located on the Tantramar Marshes near Sackville, New Brunswick. And the “voice”, of course, is the signal CHTA puts into Western Europe. Located some 500 miles nearer to Europe than U. S. stations—and, using a highly directional antenna, CHTA has often been reported by European listeners as the strongest station on the North American continent.

A DELUXE INSTALLATION

CHTA, which went on the air Christmas Day, 1944, is Canada’s only shortwave broadcast station—but is certainly one of which all Canadians may well be proud. And they are! Some of them have called it “the best shortwave radio station in the world.”

Remembering the installations at Bound Brook, Wayne, Dixon, Delano and San Francisco, this may seem like rather a broad claim; however, there is no question that it is one of the world’s outstanding stations. The location is nearly ideal; the building is spacious, well designed, and of attractive appearance. The equipment is the very latest and very best throughout. The antennas follow the most advanced designs and are arranged in flexible and convenient manner. Even the sometimes neglected factors such as convenience and living quarters for personnel have been carefully considered.

IDEAL LOCATION

In planning a shortwave transmitter of this type, the location of the plant and its antenna is a matter of primary and vital importance. Three main points have to be considered: First, the site must be located in a part of the country enjoying the maximum freedom from magnetic conditions unfavorable to shortwave reception and transmission. Second, the site must be



FIG. 3. On the mezzanine floor are two RCA 50-SW transmitters with monitoring, test and control equipment at center. On the lower floor is CBA'S standard band RCA Transmitter Type 50-D.

as near as possible along a great circle course to the area of the globe where the best and most reliable service is desired—in this case, Britain and Western Europe. Third, the local ground conditions should be favorable to the reflection of radio waves.

The marshlands near Sackville meet all three of these main requirements and the location was particularly suitable because the CBC already had a medium-wave transmitter (Station CBA)

established there. Experienced personnel were already living in Sackville and it was clear that considerable economies in operating costs could be achieved by merging the new transmitter with the old one. For these reasons it was decided that Canada's short-wave transmitter should be built at Sackville, while the program and administrative setup was to be established in Montreal, a distance of 600 miles—the two units to be connected by telephone lines.

MODERN BUILDING

When plans for CHTA were made, it was decided to erect the new building over the then existing CBA transmitter house, as only in this way could the normal and uninterrupted operation of the existing Standard Broadcast 50 KW transmitter be maintained. The Engineering Department, headed by G. W. Olive and his assisting engineers in this project—Messrs. D. G. McKinstry, Nicholls, Hayes, and Werry—went into a huddle and finally evolved the building shown in Figure 2. This building is of two-level construction—with ground floor and mezzanine. On the ground floor is the RCA 50-D transmitter, known to radio listeners in

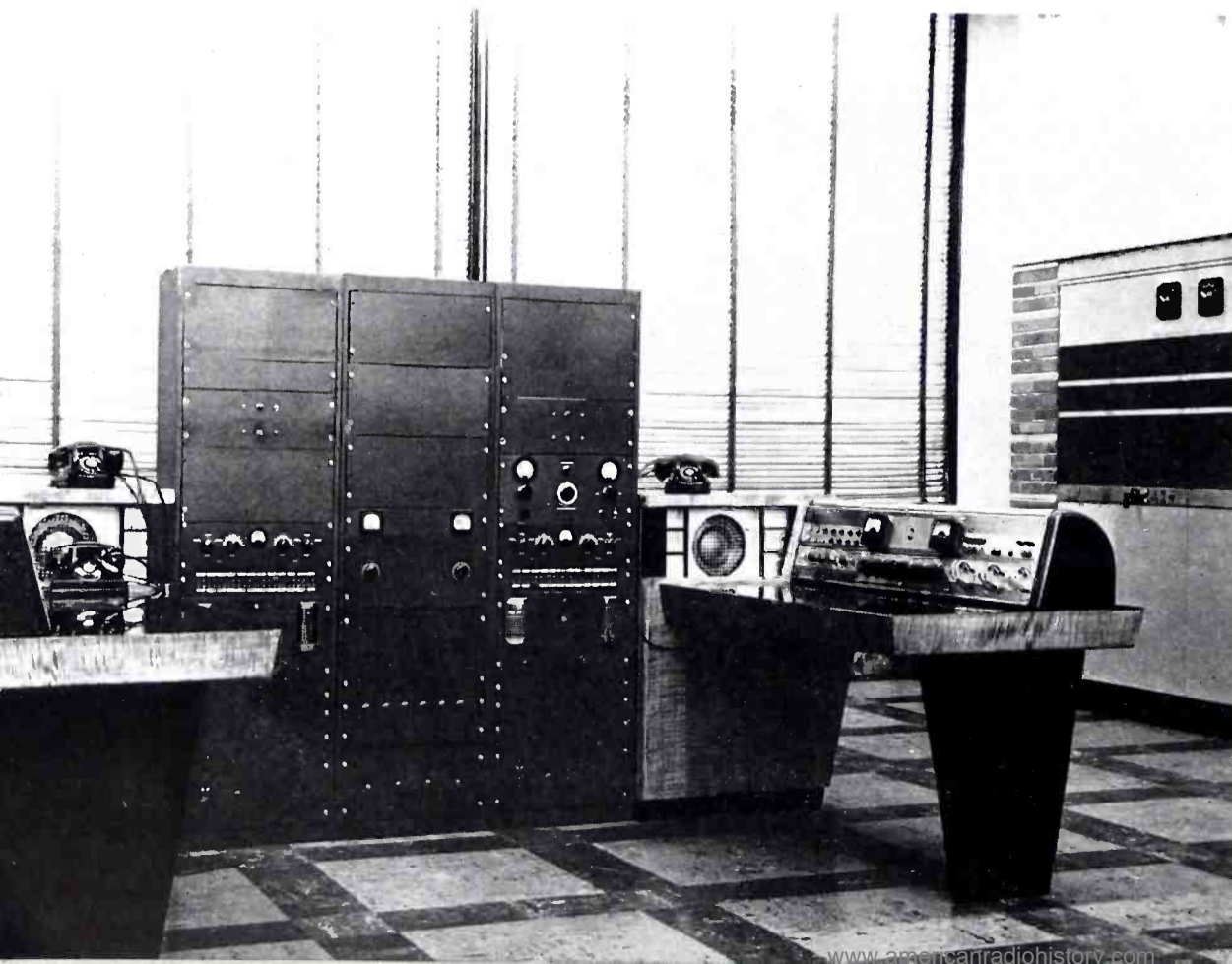

FIG. 4. Close-up of operating consoles for the two 50-SW transmitters. Centered between the consoles are three racks containing audio, test and monitoring equipment.

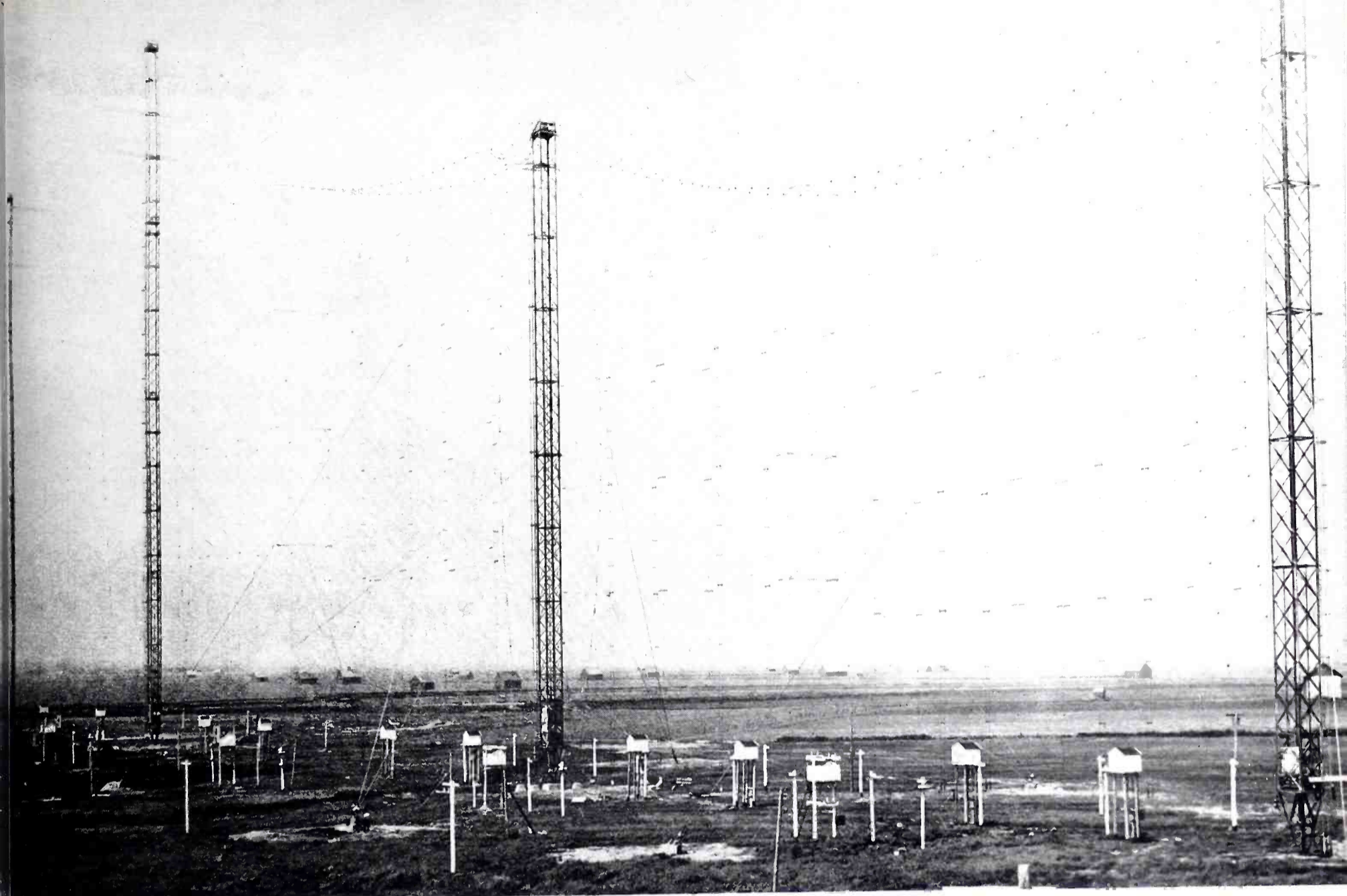

FIG. 5. *The directional antennas include a high-gain array which directs a beam to Europe and, in reverse, to Central America and New Zealand, and smaller arrays directed to South America and Asia.*

the Maritimes as CBA. On the upper floor, facing each other and separated by approximately 60 feet of floor space, are the two high-frequency RCA MI-7330-A 50 KW S-W transmitters (see Figure 3). A room is also available in which to install an RCA MI-4750 7½ KW shortwave transmitter.

On the mezzanine floor, looking down on the CBA transmitter, are four offices occupied by (1) the regional engineer, H. M. Smith; (2) his secretary; (3) two supervisors, Messrs. Merrill Young and Meurillo Lapate; and (4) the operating staff. On this floor level, too, is located the master control room which handles all incoming programs, shortwave and standard broadcasts, as well as four announcer-operator control booths, one studio, and one recording control room.

An innovation in transmitter building design has been incorporated in this plant at Sackville. It is possible for visitors to walk around behind the transmitter enclosures and actually see these powerful transmitters in operation (Figure 8). Normally, this cannot be done without interrupting program service.

On the ground floor is the staff lounge. The CBC has provided all the comforts of home for its Sackville staff, including two showers and—in case of snow-ins—emergency sleeping quarters, complete with kitchenette, refrigerator, cook stove, etc. Also on this floor are the central registry office where all files and records are kept, and a shielded laboratory for measurements and general test. Two offices, occupied by the field engineers, a class

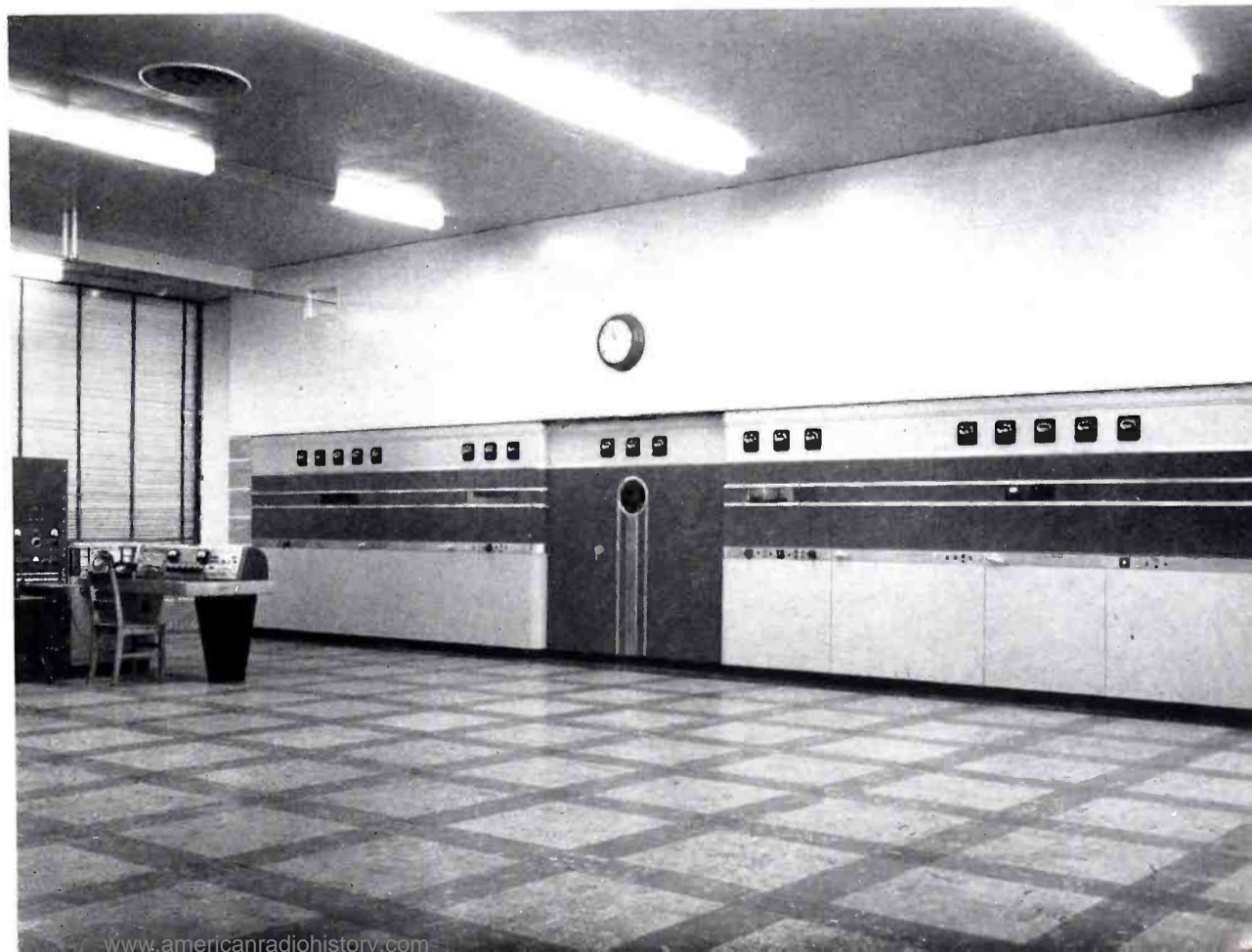

FIG. 6. *Front view of RCA Type 50-SW #2 with control console and audio rack at left.*

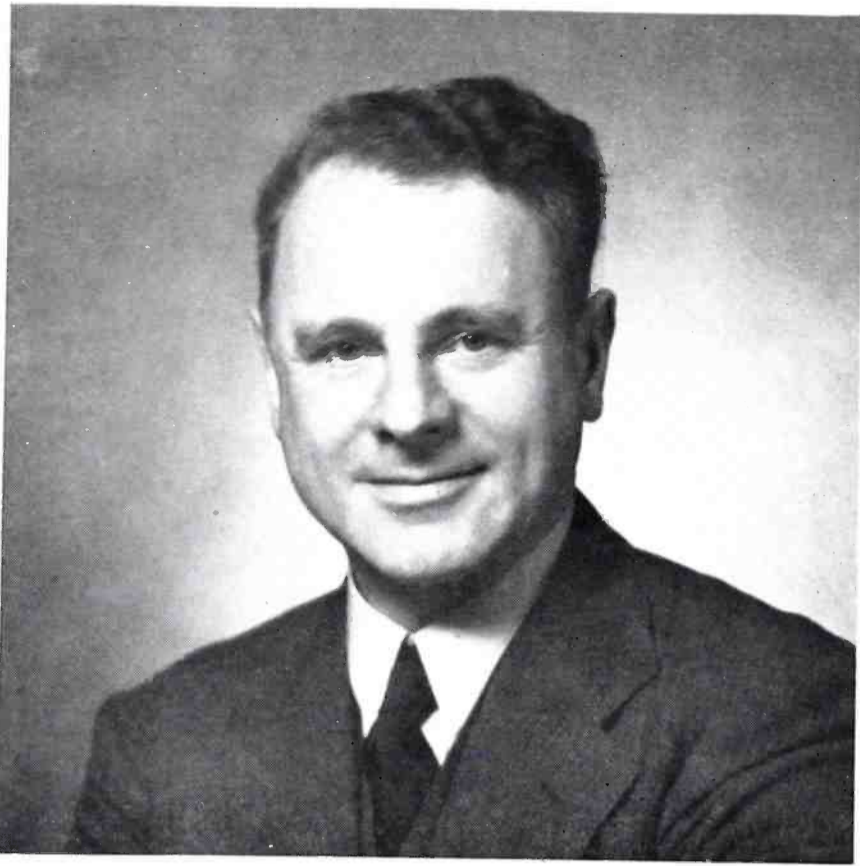

FIG. 7. *G. W. Olive, Chief Engineer of The Canadian Broadcasting Corporation.*

room and an up-to-date workshop, equipped to handle emergency repairs and general maintenance, complete this floor picture.

NEWEST TYPE EQUIPMENT

CHTA is completely RCA equipped—with the newest types of apparatus being used throughout. Chief items of the equipment are, of course, the two big shortwave transmitters. As previously mentioned, these are mounted on the mezzanine floor in facing positions with a space of about sixty feet between the front panels (see Figures 3 and 6). At the far end of the floor,

and centered between the transmitters, are three racks containing test and monitoring equipment. At the left and right sides of these racks are the transmitter control consoles. These consoles (Figure 4) contain all of the switching and monitoring controls for complete operation of the transmitters.

The transmitters at CHTA are standard RCA Type 50-SW Shortwave Broadcast Transmitters. Each of these transmitters includes a single modulator and a high-power rectifier (center panels) which may be switched to either of two power amplifiers. Each amplifier is capable of putting out 50 KW at any frequency from 6 mc to 21 mc. Provision of two amplifiers facilitates frequency changeover, since all r-f circuits can be adjusted on one unit while the other is in operation. Thus, changeover requires only the switching of modulation and high-power connections.

In addition to the two 50 KW shortwave transmitters there is, in the same building, the 50 KW standard-band transmitter of CBA. This is an RCA Type 50-D installed just before the war. The transmitter is on the lower level. The control console and the far left-corner of the transmitter can be seen in Figure 3. Besides these three 50 KW's, space has been left for an RCA 7½ shortwave transmitter to be added later this year.

HIGHLY-DIRECTIONAL ANTENNAS

CHTA has three antenna systems in operation at the present time. One is the high-gain array which is beamed toward Europe. It has approximately 11 db. gain and is sectionalized with curtain arrays for 17, 15, 11, 9, and 6 megacycle bands. 600 ohm transmission lines are used to feed all the arrays. These terminate in an antenna switch room located behind one of the transmitters. Remote operation is to be provided for reversing the radiator and reflector on each array and for slewing of the individual arrays. There are, in addition to this high-gain array, two medium-gain arrays directed to South America and South Africa. These operate on the same band of frequencies and can also be reversed and slewed.

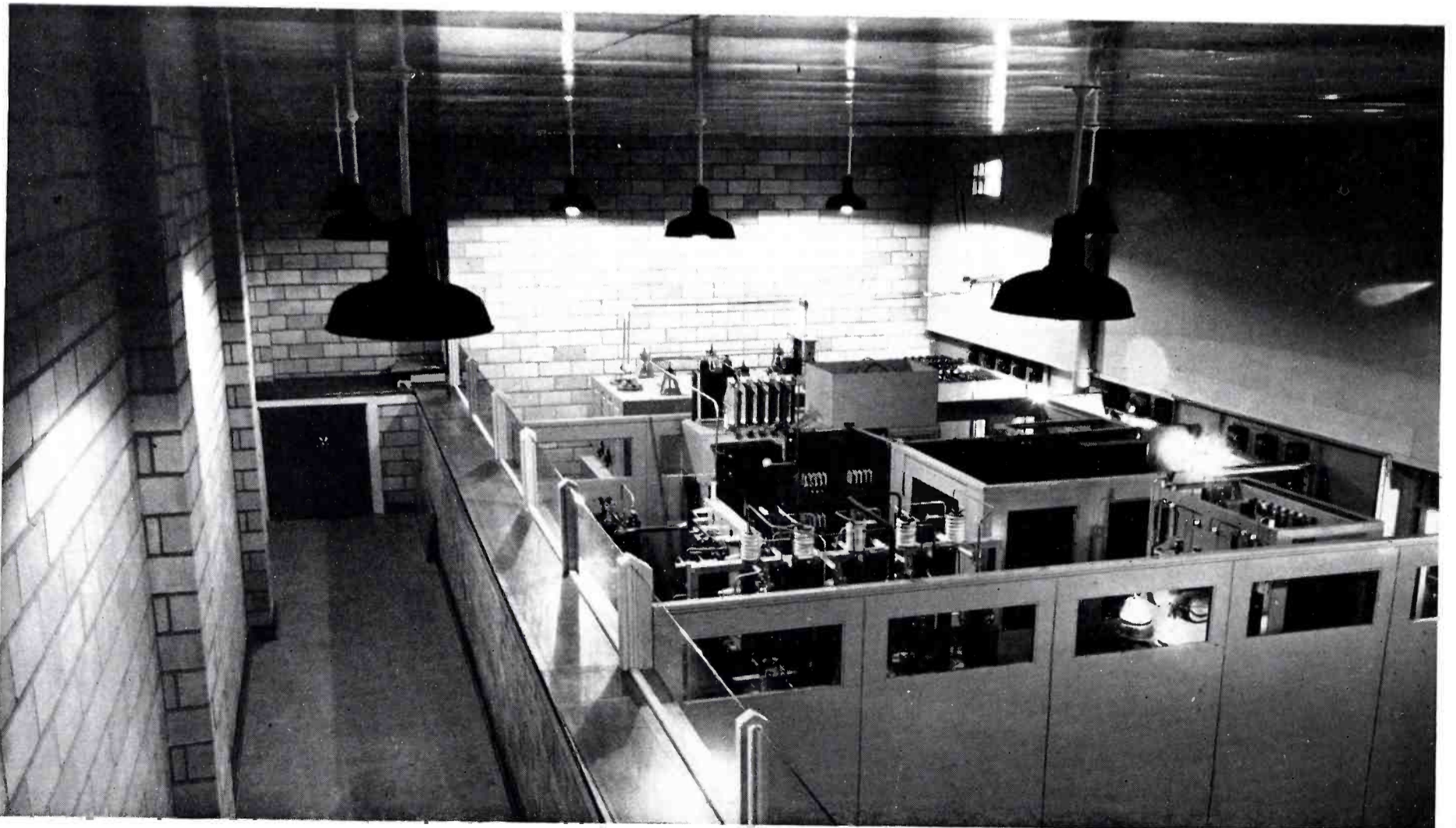

FIG. 8. *Rear view of one of the RCA 50-SW Transmitters showing walkway for visitors.*

THE 77-D POLYDIRECTIONAL MICROPHONE

by J. B. EPPERSON

ENGINEERING PRODUCTS DIVISION

An outstanding new design, the 77-D offers advantages over any microphone previously manufactured. Using only a *single* ribbon unit this polydirectional microphone may be set to give an infinite number of directional pickup response patterns ranging from bidirectional through all variations of unidirectional to nondirectional. Response changes are quickly and easily made by means of the slotted shaft screwdriver adjustment conveniently located on the rear of the microphone. A three position "voice-music" switch on the bottom of the microphone alters the low frequency response to provide the best operating characteristic for voice or music. Other features include: excellent frequency response, directivity at all frequencies, shielded output transformer, shock mounting and spring type cord connector.



FIG. 1. Front view, Type 77-D Microphone.



FIG. 2. Rear view, Type 77-D Microphone.

INTRODUCTION

For the past 12 years, broadcasters have acclaimed the Ribbon Velocity Microphone Type 44-BX (44-B) which has become the symbol of the broadcast industry. Its uniform bidirectional characteristics and smooth frequency response quickly established the superiority of this microphone over other microphones then in use. Pickup problems were simplified since the ratio of direct-to-reflected sounds was much improved and undesirable pickup and other unwanted sounds could be greatly reduced by proper microphone placement.

It was realized, however, that a microphone with unidirectional pickup characteristics would offer still greater advantages for overcoming excessive reverberation and undesirable sound pickup. Accordingly the Type 77-A Unidirectional Microphone was developed to fill this need. This microphone consisted of a combination of two ribbon microphone units; one operated

as a bidirectional pickup device while the other operated as nondirectional. The outputs of these two microphone units were connected in series and the resultant vector addition of the voltages generated in the ribbons produced a unidirectional pickup pattern of the cardioid type.¹ Later redesigns of this microphone resulted in the Types 77-B, 77-C, and 77-C1. The last named microphone contained a switch for selecting the output of either the velocity unit, the pressure unit, or a combination of the two units to produce either a bidirectional, nondirectional, or unidirectional pickup response.

Subsequent development work on the 77-C1 Microphone led to a new design with a *single* ribbon unit which not only gave the three main directional patterns of the Type 77-C1, but provided an infinite number of directional patterns which could be obtained by operating a continuously variable control conveniently located on the rear of the microphone. The new microphone is similar in outward appearance to its predecessor, the Type 77-C1, but differs in operating principle.

DESCRIPTION

Whereas two ribbon units were used in the Type 77-C1 Microphone, only one ribbon unit is required for the new Type 77-D. An ingenious design of a single ribbon unit combines the action of a velocity-operated and pressure-operated unit as required with the previous design.

¹ See "The Uni-directional Microphone" by Dr. H. F. Olson; BROADCAST NEWS, May 1939.

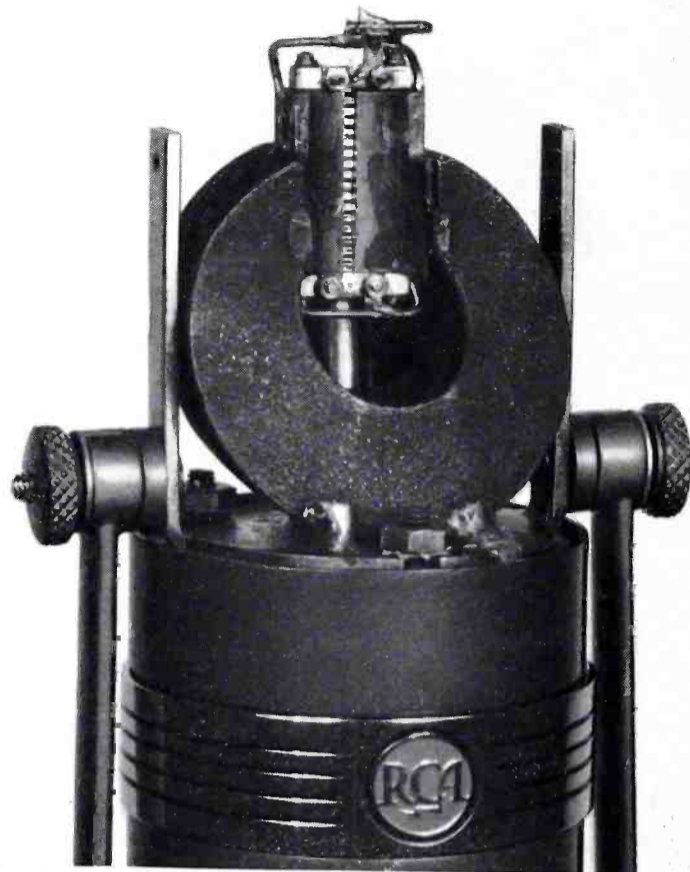

FIG. 3. Front interior view showing ribbon construction.

Figure 3 is a front view of the Type 77-D, with cover removed, showing how the thin metallic ribbon is suspended between the pole pieces of a permanent magnet. If the ribbon was continually exposed to the medium on both sides its operation would be similar to that of the conventional velocity microphone. In this case, however, the microphone must also function as a pressure-operated device and the rear side of the ribbon must be enclosed. The rear cannot just be blocked off, because reflections would occur and the frequency response would be impaired. Reflections can be prevented only if the proper acoustic impedance is presented to the back of the microphone. The ideal acoustic impedance would be an infinitely long tube. Since the ideal in this case is unobtainable, a satisfactory substitute was developed. The substitute consists of a connector tube running from the rear of the ribbon to an acoustic labyrinth or damped pipe located in the lower microphone shell. Figure 4 is a side view of the Type 77-D showing this connector tube. An opening in the connector tube is made variable in size by a rotating plate control as shown in Figures 5, 6 and 7.

The directional characteristics of the microphone are controlled by varying the size of the opening in the labyrinth connector. When the aperture is wide open as shown in Figure 5, the pickup is bidirectional and the microphone is velocity-actuated. When the aperture is completely closed, as shown in Figure 7, the pickup is nondirectional and the microphone is pressure-operated. When the opening is about one-half closed, as shown in Figure 6, the pickup is unidirectional and the microphone operates both as a velocity-actuated and pressure-actuated device so that the vector sum of the generated ribbon voltages produces the familiar cardioid pattern.



The microphone directivity control adjustment, which is located on the back side of the microphone wind screen, may be seen in Figure 2. This control is furnished with a designation plate which is marked "U," "N," and "B," as designations for the unidirectional, nondirectional, and bidirectional response curves. Three additional markings are used as reference points for other patterns which may be obtained with the continuously variable control. An auxiliary designation plate marked "U" is furnished with the microphone. When this plate is substituted for the plate normally used, it locks the microphone control in the unidirectional position. This plate is for use where it is desired to use the microphone as a single purpose unidirectional microphone only.

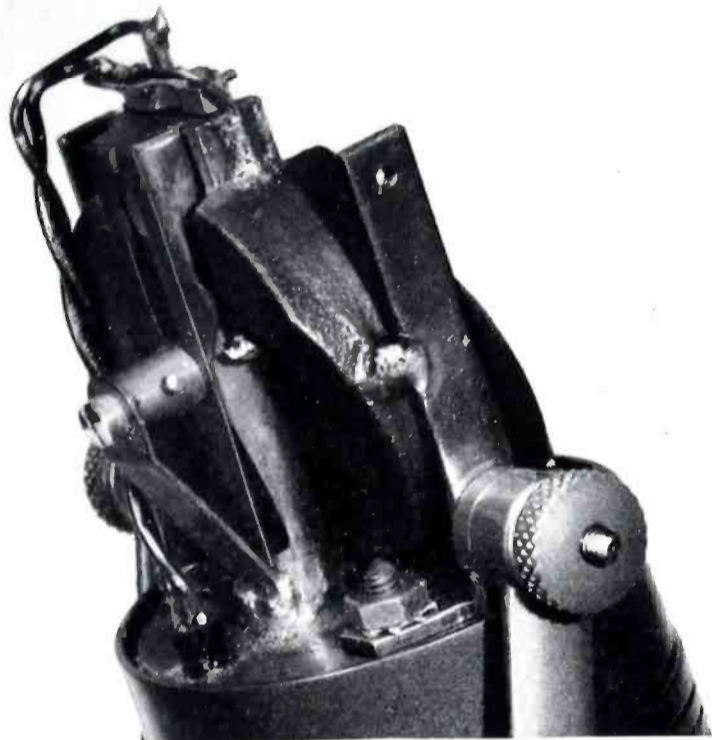

FIG. 4. Side view showing connector pipe.



FIG. 8. Bottom view showing voice-music selector switch.

In addition to housing the acoustical labyrinth, the lower half of the case contains the output transformer and a selector switch for voice or music. The switch will attenuate the low frequencies below 300 cycles for voice pickup and has three positions designated as "M," "V₁," and "V₂." The switch, operated by a screwdriver, is accessible from the bottom of the lower cylindrical shell as shown in Figure 8.

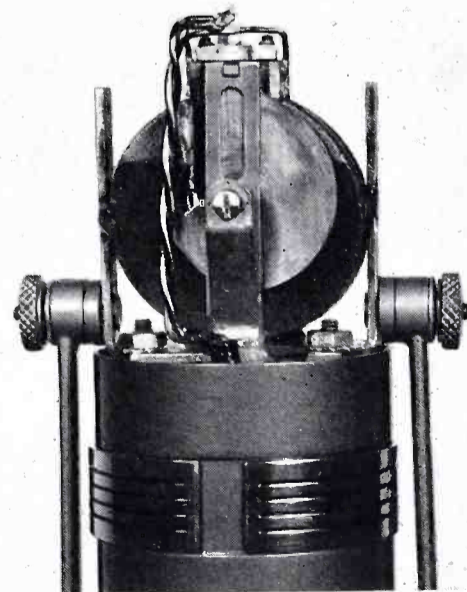
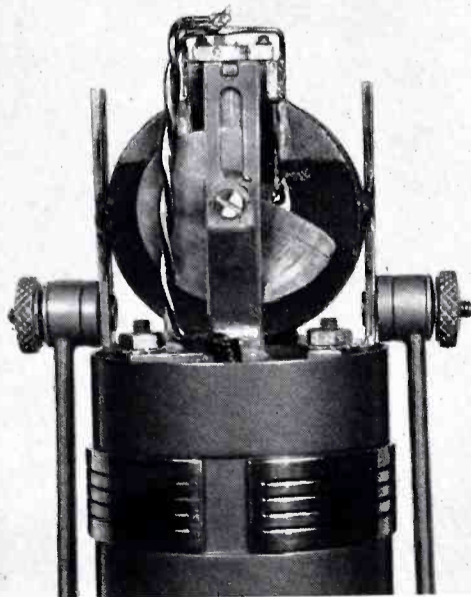
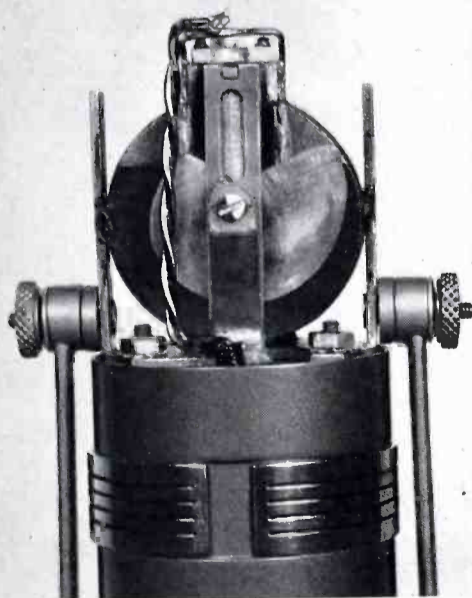

FIG. 5. Rear internal view—aperture wide open.

FIG. 6. Rear internal view—aperture approximately $\frac{1}{2}$ open.

FIG. 7. Rear internal view—aperture closed.

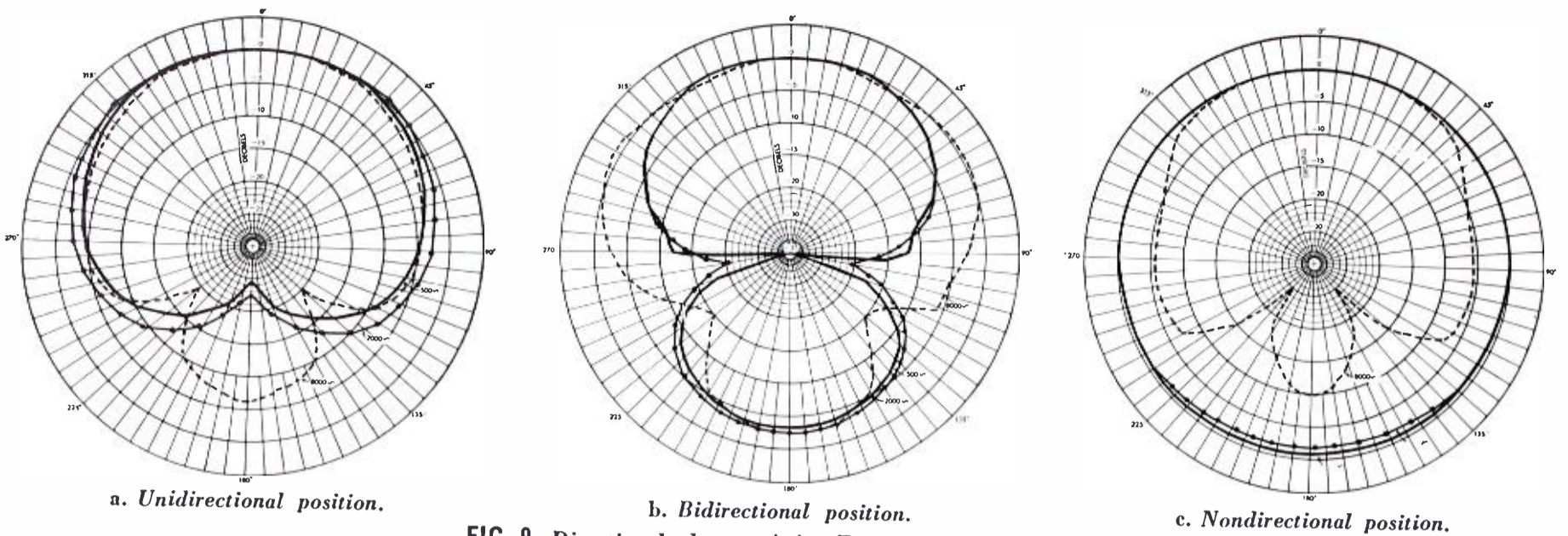

FIG. 9. Directional characteristics Type 77-D Microphone.

POLAR DIRECTIONAL CHARACTERISTICS

Figure 9, a, b, and c, shows the directional characteristics in polar form for the unidirectional, bidirectional, and nondirectional control settings. For the unidirectional position, as shown in Figure 9-a, the response from the front, or operating side of the microphone, is very uniform while at the rear of the microphone sounds are attenuated by an average of 14-20 db. or approximately a 10-to-1 ratio of desired to undesired pickup. Sound waves originating in front and along an axis perpendicular to the plane of the ribbon will naturally have the maximum effect. The bidirectional pattern shown in Figure 9-b is similar to that of the conventional 44-BX microphone except that the response from the rear is down approximately 3 db. as compared with the response from the front. The nondirectional pattern, shown in Figure 9-c, is similar to that of other pressure microphones.

Figure 10, a, b, and c, shows the frequency characteristics for the unidirectional, bidirectional, and nondirectional control settings. For each setting of the directivity control, frequency response curves are given for the three positions of the voice-music switch which alters the microphone's low frequency response.

Figure 11, A through L, shows how the directional patterns change as the size of the opening in the labyrinth connector is varied. At "A," the directivity control is set for bidirectional operation and the aperture is wide open. As the control is rotated (decreasing aperture size) the back lobe of the pickup pattern becomes less and less until a unidirectional pattern is obtained as shown at "G." As the aperture size is further reduced the pickup pattern becomes more and more nondirectional until the nondirectional pattern at "L" is obtained.

SPECIFICATIONS

The Type 77-D Microphone has an effective output level of -57 db. when referred to one milliwatt at a sound pressure of 10 dynes/cm². It has tapped transformer output impedances of 50/250 and 600 ohms. It is finished in brushed-chrome and umber gray, mounts on a stand having 1/2 inch pipe thread and weighs but three pounds unpacked but complete with mountings. The overall dimensions are: height 11 1/2 inches; width, 3 3/4 inches; and depth, 2 1/2 inches. The microphone is shipped with a three conductor shielded cable less microphone plug.

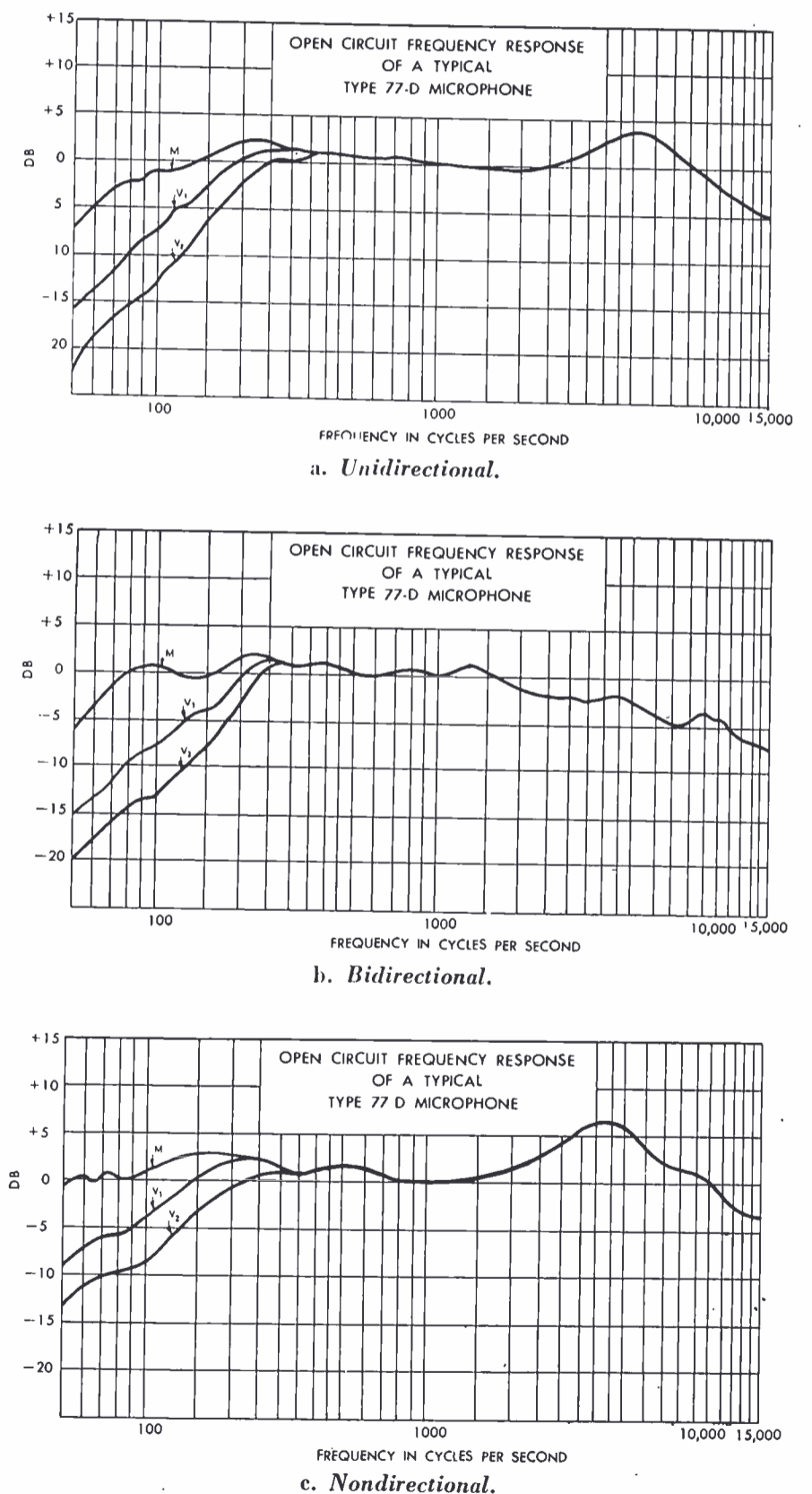

FIG. 10. Frequency response characteristics Type 77-D Microphone.

REFERENCES

Research work on the Polydirectional Microphone was done at RCA's Princeton Laboratories under the direction of Dr. H. F. Olson. For a more complete technical description of its operating principles the reader is referred to an article entitled "Poly-

directional Microphone" which appeared in the "Proceedings of the Institute of Radio Engineers," for February 1944. The commercial design of the 77-D was developed by L. J. Anderson of RCA's Indianapolis Plant.

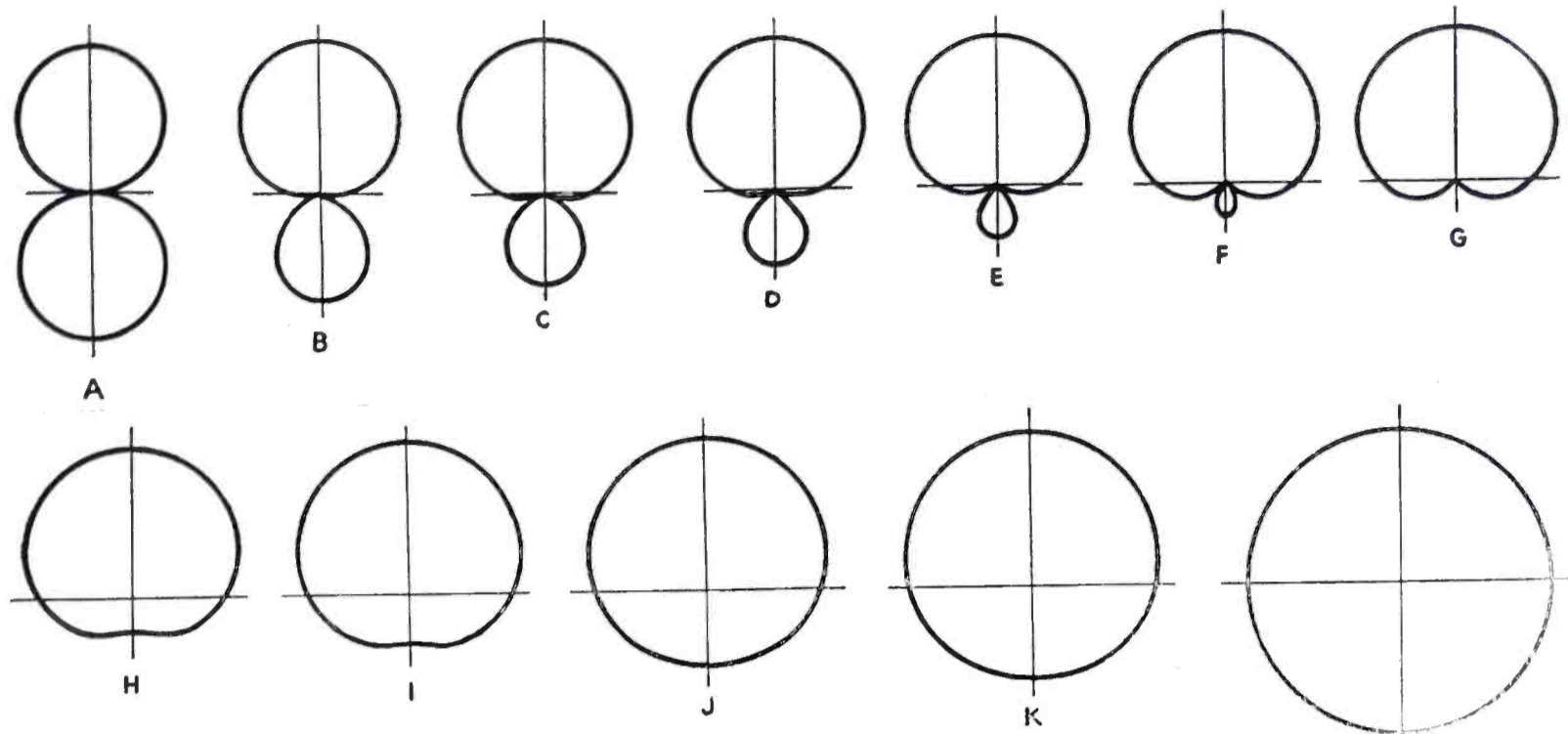

FIG. 11. A few of the directional response patterns obtainable with the Type 77-D Microphone when the aperture is varied from wide open as at "A" to completely closed as at "L."



Back in June, Commentator Fred Macpherson of KTAR in Phoenix scoffed at reports that the Japs might be on the verge of defeat. And he asserted that if Japan were defeated before the end of this year, he would eat his script. Well, here the Arizonan makes good, with listeners of the Arizona Network listening in. Fred rushed out for a cup of coffee just after this task was completed.



EVERYTHING **NEW** FOR FM

for **NEW** operating economy....

NEW RCA POLYDIRECTIONAL MICROPHONE

(Type 77D)—The polydirectional feature helps you obtain better balance, clarity, naturalness, and selectivity in studio pickups.

By means of a screw adjustment at the back of the microphone a variety of non-directional, uni-directional, and bi-directional characteristic patterns can be produced. Undesired

sound reflections can be quickly eliminated merely by switching to the proper pattern. A three-position, VOICE-MUSIC switch permits the selection of the best operating characteristic.

This lightweight, multi-purpose microphone is finished in two-tone umber grey.

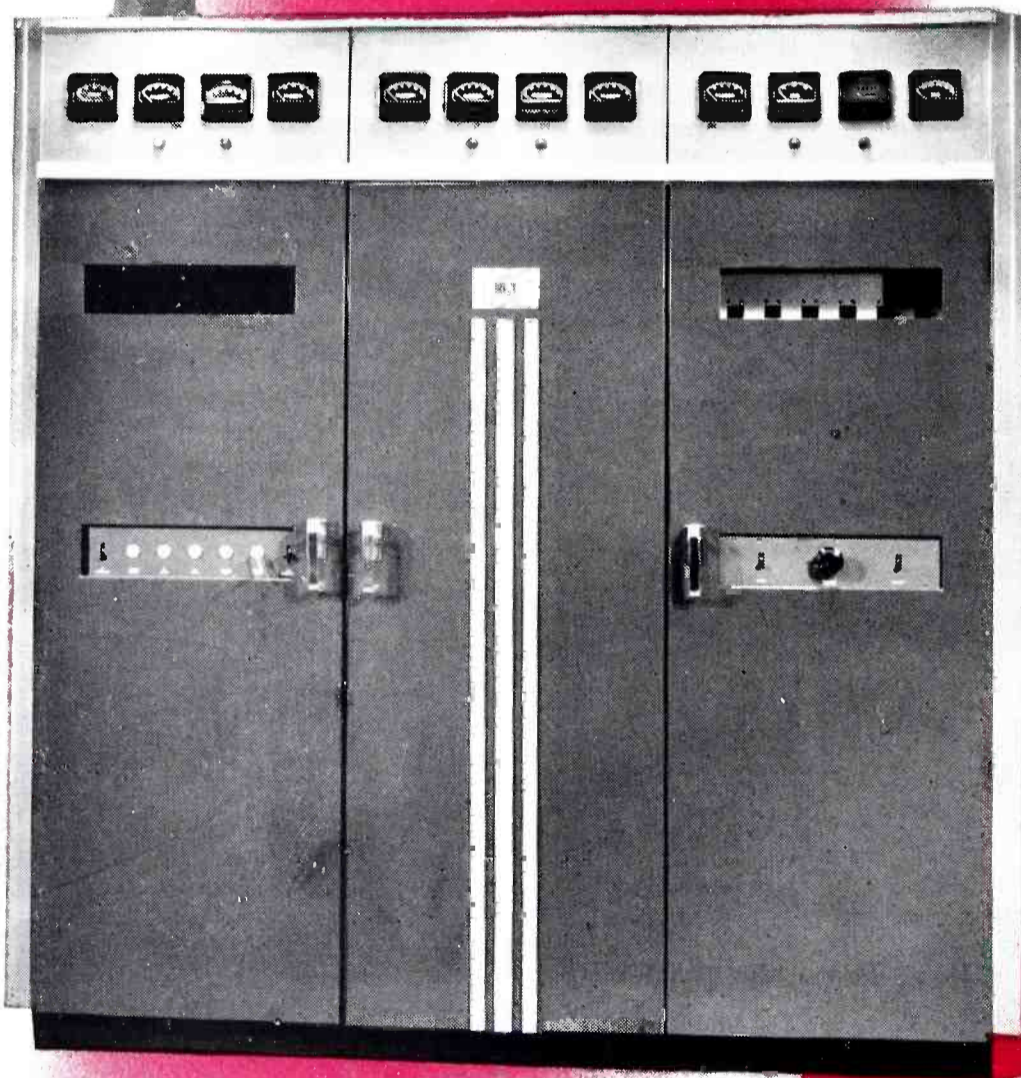

NEW RCA TRANSMITTERS

RCA's line of FM transmitters (250 watt, 1, 3, 10, 25, and 50 kw) are completely new from exciter to power amplifiers—new circuits, new tubes, and a new type of construction.

The frames of all power sizes have been standardized thus assuring uniformity of dimensions, appearance, and easing installation problems. When increased power is desired, you merely add an amplifier. Appearance is equal to that of a single unit. Curved-end pieces add to the finished appearance.

A new, hollow base frame provides space for inter-unit wiring, and eliminates the need of wiring through units or conduits in the floor.

Air filters, flush-mounted centralized control panels, and concealed hinges are other features of the new RCA construction—*standardized* to assure you a better product at lower cost.

NEW CIRCUITS

The new RCA Grounded-Grid amplifier circuits are at once simpler and more stable than any heretofore employed. As the name indicates, the grid of the tube is at r-f ground potential (instead of the filament as in conventional transmitters). The drive is applied between cathode and ground, either element being at the necessary d-c bias potential.

Special tubes have been developed for these circuits. Neutralization is either unnecessary, depending on frequency, or, if necessary, very easily achieved.

Other advantages: easier tuning, fewer tube types to stock, smaller, less-expensive tubes, lower operating costs, less distortion, and better program quality.

RCA's new "Direct FM" circuit for the exciter is something entirely different, too.

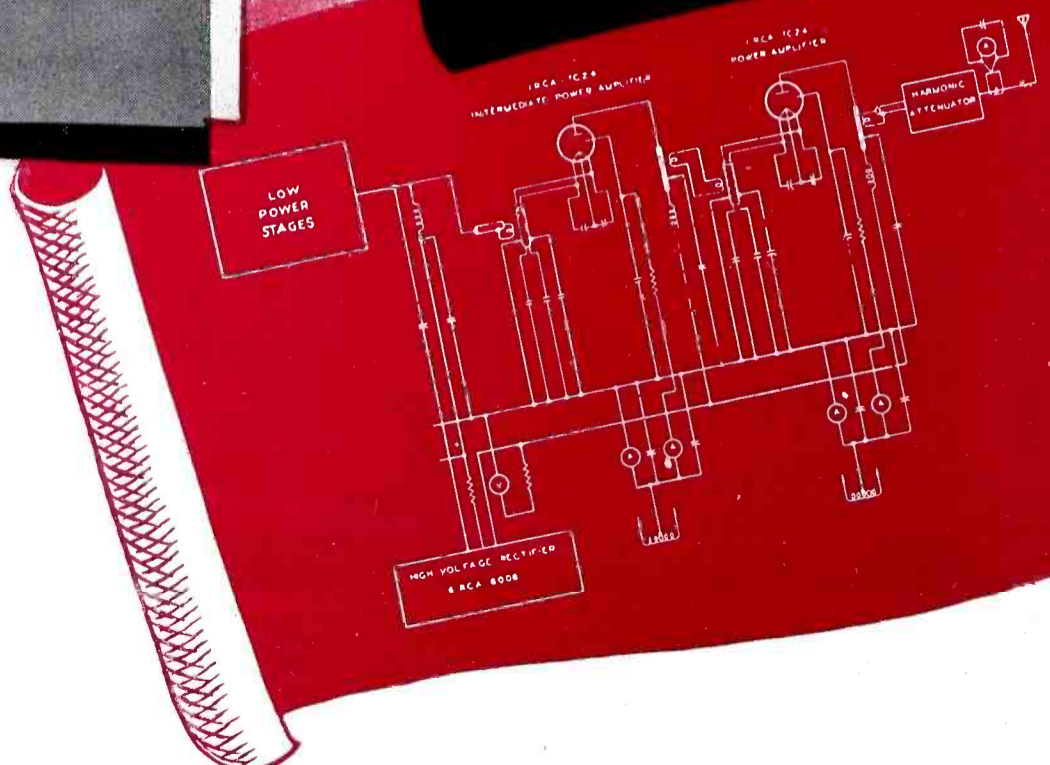

—from MICROPHONE to ANTENNA

NEW convenience, and NEW performance

THE NEW RCA equipment shown here is merely indicative of the advances that have been made by RCA in FM broadcast equipment. Similar improvements have been made on every item that goes into a completed broadcast station, including test and measuring equipment, monitoring assemblies, turntables, and recorders.

The resumption of broadcast-equipment construction, after wartime restrictions, offered us a unique opportunity to design an entirely new line—integrated in every detail. The various units incor-

porate all the latest FM improvements that have grown out of RCA's advanced war work on communications equipment for the armed forces.

If you are planning to build a new FM station, we believe that "RCA all the way" will help you to make it a *better* station. You will be assured of the same efficiency, convenience, operating economy, and performance that have made RCA's AM equipment the undisputed first choice of broadcast stations for the past decade. Radio Corporation of America, Camden, N. J.



NEW RCA CONSOLETTA

(Type 76-B2)—Provides a complete high-fidelity audio system for FM, AM, and television at a price even the smallest station can afford.

Compact (39 by 17 by 10½ inches), it includes all the amplifying control and monitoring equipment needed to handle two studios, an announcement and a control-room microphone, two turntables, and six remote lines.

It enables simultaneous auditioning and broadcasting from any combination of the studios, turntables, or remote lines. The talk-back system is independent of program channel—no feed-back. Emergency amplifier and power supply circuits help prevent time off the air.

Differs from two previous RCA models now giving satisfactory service in more than 300 stations primarily in its frequency response—now extended to 15,000 cycles.

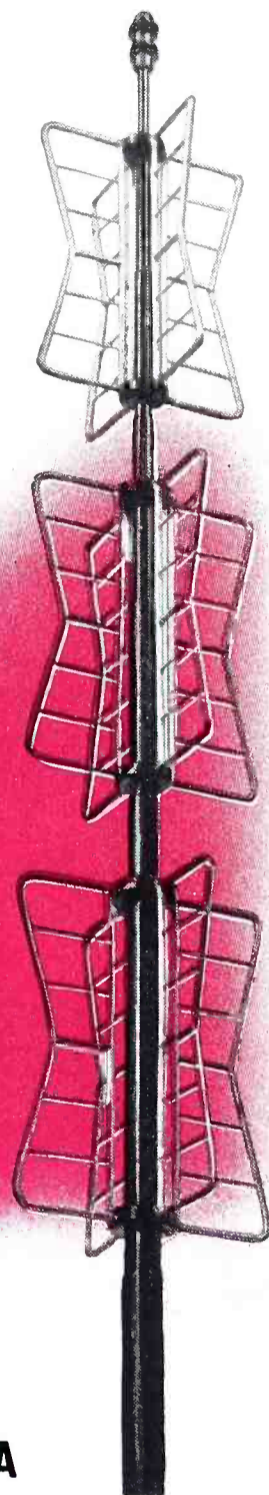

NEW RCA SUPER TURNSTILE ANTENNA

The advantages of this antenna make up an impressive list. A few include: high-gain, permits the use of a lower transmitter power for a given coverage, full performance at any frequency from 88 to 108 mc, handles up to 20 kw, easy to install, wide band, pretuned at factory, no field adjustments whatever, a standardized low-cost "packaged" item—comes complete, de-icer units easily added, fewer end seals, entire structure can be grounded.

In addition, it has the usual advantages of any turnstile antenna: an inherently circular field pattern, low wind resistance, and simple, inexpensive, single-pole mounting.

The antenna, because of its relatively high gain and extended band width, is also ideal for television. Naturally, since it is of the turnstile type, both sound and picture transmitters can be fed into the same antenna.



FM BROADCAST EQUIPMENT

RADIO CORPORATION of AMERICA

ENGINEERING PRODUCTS DIVISION, CAMDEN, N. J.

RECEIVER MANUFACTURERS:

RCA TEST EQUIPMENT

to help speed your television-receiver production

If your television-receiver program has been held up because of inadequate test and measuring equipment, here's the answer. RCA will begin to deliver the instruments shown here in 60 to 90 days. They are not experimental or first post-war models, but service-tested equipment—developed before the war and perfected as a result of RCA's extensive television-research and manufacturing work during the war for the armed forces.

With items 1 through 4, a complete video signal can be produced, making it possible to measure and adjust accurately the focus, contrast, resolution, and scanning linearity of your television receivers.

Items 5 through 8 are other instruments we believe you will also find useful in easing your laboratory and testing problems.

An early indication from you of your test and measuring requirements will assure prompt delivery of this hard-to-get equipment.

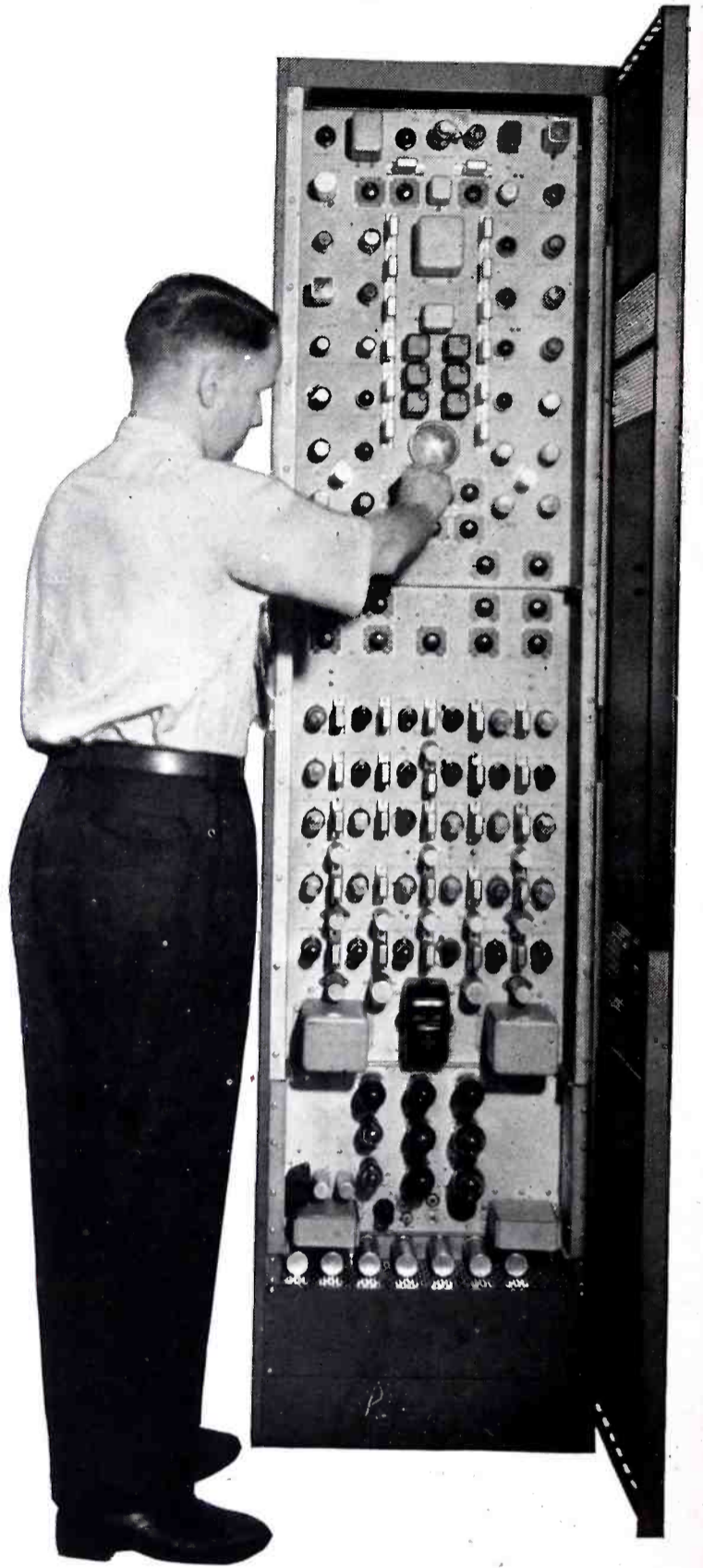

1 MONOSCOPE CAMERA

Produces a fixed television signal for aligning and testing equipment such as television receivers, transmitters, and monitors. The signal is produced by scanning a stationary pattern mounted permanently inside the monoscope tube. It is designed for rack mounting for use with the distribution amplifier and the synchronizing generator (items 2 and 4). The filament supply is self-contained, but a separate regulated plate supply is required. The 580-C unit (item 3) is ideal for this purpose.

2 DISTRIBUTION AMPLIFIER (TYPE TA-1A)

For use with the synchronizing generator and monoscope camera. Applications include: transmission over coaxial lines of pictures and synchronizing signals to various locations, feeding signals from program line to monitors, for isolating distributed pulses, as a mixer to combine synchronizing with picture signals to form the complete video signal. Designed for standard rack mounting, the unit requires a regulated plate supply.

3 REGULATED POWER SUPPLY (TYPE 580-C)

For supplying the plate power required by the monoscope camera and distribution amplifier. Regulation is better than .25 per cent over the range between 50 and 400 milliamperes; output voltage is adjustable between 250 and 300 volts; output ripple is lower than .012 per cent of the d-c output voltage. This unit may also be used for general-purpose work around the laboratory. Designed for standard rack mounting.

4 SYNCHRONIZING GENERATOR (TYPE TG-1A)

Ideal for design and production testing of television receivers, and for application work in experimental laboratories engaged in television work. Provides "synchronizing" pulses of suitable wave shape and frequency for the production, in conjunction with camera equipment, of 525-line interlaced television signals. It keys together the scanning beams of the camera Iconoscope and the receiver Kinescope to form a perfectly synchronized picture. Conforms with proposed FCC Standards of Good Engineering Practice.

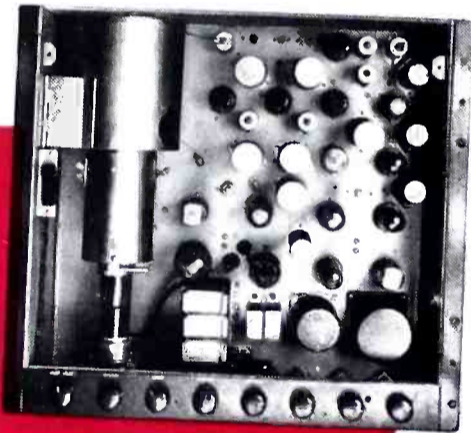

AVAILABLE SOON



5 VIDEO SWEEP GENERATOR (TYPE 711-A)

A quick, accurate, convenient means of testing and adjusting wide-band video amplifiers. When this generator is connected to the input of a video amplifier, and the output of the amplifier is connected to an oscilloscope, a trace is produced on the screen that accurately shows the amplifier's dynamic-frequency characteristic. The lower-output-frequency limit of this unit is normally set at 100 kc, and the high frequency at 8 mc (but the latter can be easily adjusted to any frequency between 2 and 9 mc). The sweep to high frequency and return is smoothly accomplished in one cycle of the powerline frequency.



8 LABORATORY-TYPE OSCILLOSCOPE (TYPE 715-B)

Especially designed to permit close examination of extremely short, sharp-fronted pulses and other unusual wave forms. Produces steady, clear traces even with random recurrence of signal. Some of its advantages for modern development work include: Extended range (flat to 11 megacycles), triggered sweep (individually triggered by each signal), time-base marker (one microsecond intervals), input calibration meter (to permit direct determination of amplitude of any voltage component in signal), and many other new features.



6 HIGH-FREQUENCY, WIDE-BAND SWEEP GENERATOR (TYPE 709-B)

When used in conjunction with an oscilloscope, this instrument will help you save time in accurately aligning the i-f and r-f stages of wide-band receivers. Stage-by-stage alignment is practical as the generator output voltage is continuously variable between .001 and .4 volts RMS over the entire frequency range. A calibration marker permits constant checking of band-width characteristics.



7 U-H-F SIGNAL GENERATOR (TYPE 710-A)

Provides an r-f signal of a known frequency and amplitude for easily obtaining the data needed to check the performance of high-frequency devices. This instrument provides smooth and complete attenuation throughout its range, plus precision frequency control. Output frequencies from 370 to 560 mc—just right for citizens' radio-phone and other development work within these bands.



HERE'S A QUICK WAY TO GET DETAILS



Radio Corporation of America
Test and Measuring Equipment Section
Box T9083A, Camden, N. J.

Please send me complete data on the RCA products corresponding to the numbers circled:

1 2 3 4 5 6 7 8

Name _____ Title _____

Company _____

Address _____

City _____ Zone _____ State _____



RCA TEST AND MEASURING EQUIPMENT

RADIO CORPORATION of AMERICA

ENGINEERING PRODUCTS DIVISION, CAMDEN, N. J.

Now Ready!

NEW RCA FM POLICE and FIRE

Features - New Advantages

New RCA 26-42 MC (Mobile or Station) Transmitter Features

1. Superior audio quality sets new standard. Sounds better. Easier on the ear. Easier to get message.
2. Positive modulation threshold limiter. Adjusts automatically to input of low or loud voices. No "blasting."
3. Low spurious emission. Less extraneous noise interfering with other services. Fewer energy leaks to make trouble.
4. Improved phase modulator requires no tuning. No more bother with modulator.
5. Excellent stability over wide temperature range. Temperature change has minimum effect on operation of equipment.
6. Adjustable to exact, specified frequency. Easy, precise tuning in a hurry.
7. All tuning adjustments are from top of transmitter. Easily accessible. (Remember those times you have had to turn the chassis over?)
8. No high voltage exposed above chassis. All dangerous voltage out of reach. (Many times a slip of the hand might have given you a shock.)
9. Provision for two-frequency operation. Useful when you want to switch over from talking between car and station to talking between car and car (and in lots of other ways).
10. Single control cable—also accommodates receiver. One cable, instead of three or four, running from front of car to rear. Simplifies installation and maintenance.
11. Mobile cables equipped with separable connectors. Add flexibility in operating equipment. Equipment removable without using special tools. All cables plug in and lock.
12. Chassis readily detached from base. Easier to inspect and service.
13. Single-unit construction saves space.
14. Easy to install. Mounting hardware supplied. Comes complete, down to bolts and nuts.
15. Start-stop switch on chassis to facilitate adjustment. (Think how much better this is than having to go up front and press a button to turn on the transmitter.)

New FM 26-42 MC (Mobile or Station) FM Receiver Features

1. Superior adjacent-channel selectivity. You hear the station you want to hear.
2. Low spurious response. Won't pick up unwanted signals.
3. Excellent stability over wide temperature range. Variations in temperature have minimum effect on operation.
4. Single-unit construction. Fewer interconnecting cables. Easier to service.
5. Easy to install. Mounting hardware supplied. Comes complete, down to last nut and bolt.
6. Chassis readily detachable from base. Easy to remove for inspection and servicing.
7. Mobile cables fitted with separable connectors. Cables plug in and lock. Require no special tools. (Another important point—you can't plug in the wrong cable!)
8. Low battery drain. Less battery servicing.
9. Class B output tube saves power on standby. Output stage takes very little power except when signal is being received.
10. Provision for carrier-operated relay. Can be used to operate other circuits for auxiliary signalling—turn on light, ring bell, etc.—or operate retransmitting equipment.
11. Single crystal. Eliminates potential trouble with matching crystals.
12. Attractively styled. And we mean darned good-looking.

This is news!

RCA—the leading prewar manufacturer of police- and fire-department radio equipment, and wartime manufacturer of the most advanced types of military radio and radar equipment—has a complete new line of FM equipment rolling off the factory line and ready for delivery . . . now!

When you see it, operate it, hear it—observe its superior convenience, performance, and facilities for easy, quick servicing—



1. FM Mobile Receiver: Ultra-modern circuits, construction and styling. Small, compact, rugged. Easily removed from mounting base. Simple to service. Provided with either dynamotor or vibrator type power supply.



2. FM Station Receiver (for shelf-mounting): Same chassis unit as #1, but intended for shelf-mounting in headquarters control room. Easily and quickly installed. Attractively styled cover adds to station's appearance.

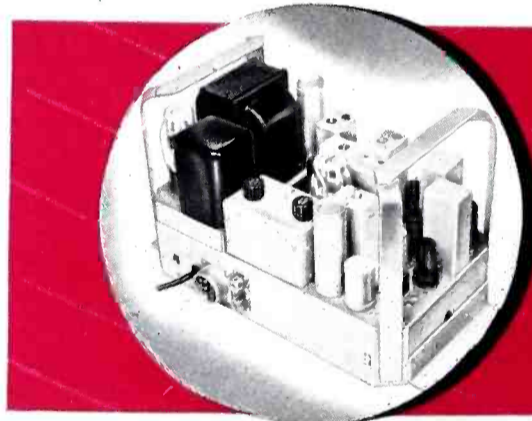

6. 30-Watt FM Station Transmitter: Uses same chassis unit as #4. Can be furnished with dust cover (as shown in #4) for shelf-mounting, or with brackets for mounting in standard RCA cabinet-rack, such as shown in #8.

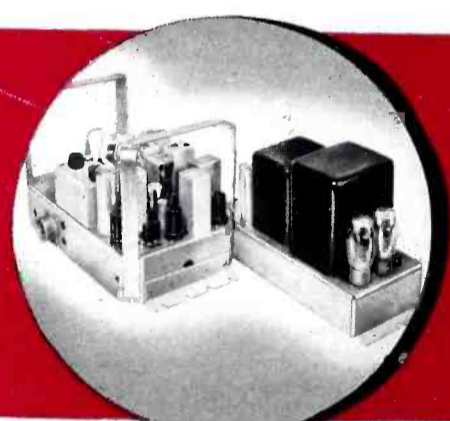

7. 60-Watt FM Station Transmitter: Uses same chassis as #5, but is furnished with chassis brackets for rack-mounting. A.C. power supply is a separate chassis unit. Not furnished for shelf-mounting.

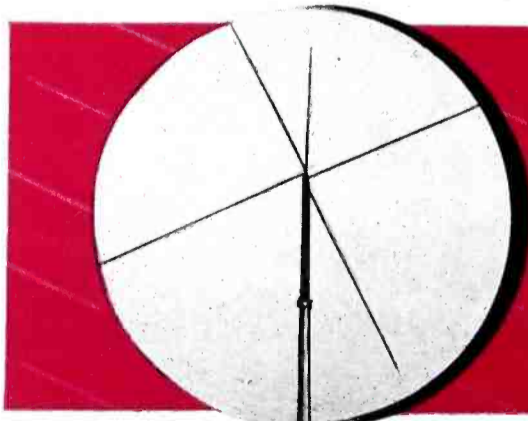

11. Station Antenna: A standard RCA design of proved performance. Consists of vertical radiator plus four "ground" rods. Easy to install, neat appearing, and provides more gain than simple rod type.



12. Mobile Antenna: Furnished with FM mobile transmitters shown above. Two models, one for roof-top, the other for fender mounting. Simple one-hole mounting. Supplied complete with connecting coaxial line.

RADIO EQUIPMENT *for* DEPARTMENTS *- New Design - New* *- An Entirely New Standard of Performance*

you will agree that this new RCA equipment sets a new standard of radio usefulness for police- and fire-department requirements.

It tunes easier, sounds better, is more stable. It operates simply, smoothly, surely. It is more selective, requires fewer adjustments, and less maintenance, yet can be serviced more quickly, easily, and safely.

These are strong claims. They are claims you should investigate—and we invite you to do so. For your convenience, a

coupon is at the lower right-hand corner of this page to bring you the whole story. But first, read the column at the left—study the pictures below, read the captions under them—then fill in the coupon. And remember that at any time you wish an RCA engineer will show you how these new RCA equipments can be used to best advantage for the special needs of your police or fire department.

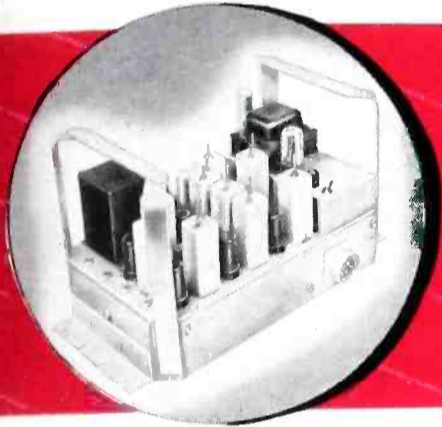

3. FM Station Receiver (for rack-mounting): Also, the same chassis unit as #1, but without cover, and provided with brackets for mounting in a cabinet-style rack. This is the type of mounting used in most larger installations.



4. 30-Watt FM Mobile Transmitter: Mounted in attractively styled housing matching the receiver unit. Makes use of improved phase-modulator circuits providing better quality and better stability. Arranged for two-frequency operation, if desired.



5. 60-Watt FM Mobile Transmitter: Similar to #4 in over-all size and appearance, but provided with additional tube in output stage, in order to obtain full 60-watt carrier. Both transmitters use built-in dynamotor supply.

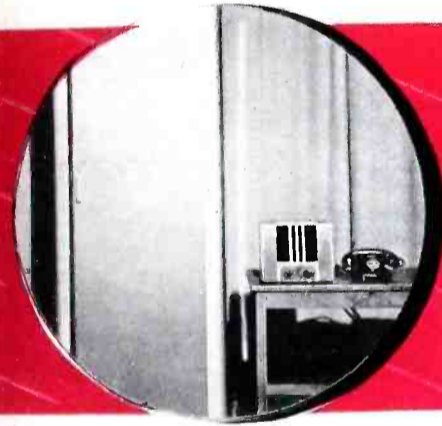

8. 250-Watt FM Station Transmitter: Consists of the two chassis shown in #7 (as an exciter), plus a 250-watt amplifier, mounted on a similar-type chassis. All assembled in an attractively styled cabinet rack.



9. Station Handset and Control Unit: Furnished with the FM Station Transmitters shown here. The control unit contains a loudspeaker, plus controls for adjustment of "volume" and "squelch." Also, "transmit," "receive," and "stand-by" signal lights.

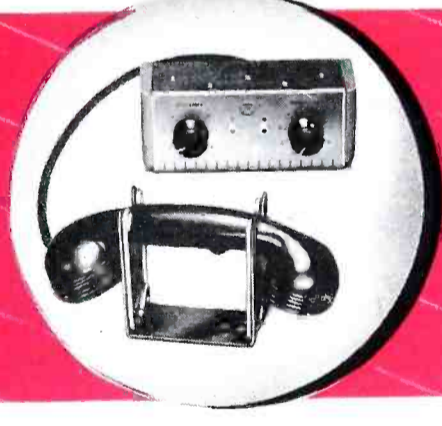

10. Mobile Handset and Control Unit: Furnished with the FM Mobile transmitters shown above. The two units can be conveniently mounted on the dash in any desired position. Control includes "volume" and "squelch." Signal lights indicate "transmit" and "stand-by."



Buy War Bonds

RADIO CORPORATION OF AMERICA

RCA VICTOR DIVISION • CAMDEN, N. J.

In Canada, RCA VICTOR COMPANY LIMITED, Montreal

Mail this Coupon and get New Bulletin!
For Complete Information, Specifications, Pictures, Diagrams—Use This Coupon

EMERGENCY COMMUNICATIONS EQUIPMENT SECTION
Radio Corporation of America, Camden, N. J.
Please send me complete data about your new FM Radio Equipment for Police and Fire Departments.

Name.....
Title.....
Employed by.....
Street Address.....
City and State.....

127X