

AM · FM · TELEVISION

# BROADCAST

NEWS



TRANSMITTER CONSOLE

TRANSMITTER ROOM

EQUIPMENT RACK

TRANSMITTER PART  
DUMMY LOAD  
Power Output Measur

CONSTRUCTION  
1. Cut along heavy Solid Lines  
2. Fold on dotted lines & Fold along  
inside on continuous Solid lines  
3. Apply rubber cement to all cut,  
lapping overlaps and cut of the  
4. Press out air bubbles

TO FOLD AND PASTE  
1. Paste on  
2. Paste on  
3. Apply  
4. Press

TRANSMITTER CONSOLE

MODEL CUTOUTS AID TV PLANNING

See pg. 8





*The one company that  
has everything for  
every broadcaster*

**AM**

**FM**

**TV**

**At each of the following locations you  
will find a broadcast specialist who is  
ready to help you with your problems:**

36 W. 49TH ST.  
NEW YORK 20, N. Y.

718 KEITH BLDG.  
CLEVELAND 15, OHIO

666 N. LAKE SHORE DRIVE  
CHICAGO 11, ILLINOIS

1355 MARKET ST.  
SAN FRANCISCO 3, CALIF.

221 W. 18TH ST.  
KANSAS CITY, MO.

530 CITIZENS & SOUTHERN BANK BLDG.  
ATLANTA, GA.

1907-11 McKINNEY AVE.  
DALLAS 1, TEXAS

1560 N. VINE ST.  
LOS ANGELES 14, CALIF.



**BROADCAST EQUIPMENT  
RADIO CORPORATION of AMERICA  
ENGINEERING PRODUCTS DEPARTMENT, CAMDEN, N.J.**

In Canada: RCA VICTOR Company Limited, Montreal

# Broadcast News

AM • FM • TELEVISION

Published by the

RADIO CORPORATION OF AMERICA

ENGINEERING PRODUCTS DEPARTMENT . . . CAMDEN, NEW JERSEY

NUMBER 52

DECEMBER, 1948

Subscription Rate \$2.00 per year.

Single copy 50c.

JOHN P. TAYLOR, Editor

JUDY J. ALES, Ass't Editor

W. O. HADLOCK, M. L. GASKILL, Associate Editors

## Contents

WSAV ENLARGES FM BROADCASTING FACILITIES . . . . .	6
SCALE MODELS MADE FROM PAPER CUTOUTS AID TV STATION PLANNING . . . . . by MARVIN L. GASKILL	8
PRACTICAL EQUIPMENT LAYOUTS FOR TELEVISION STATIONS . . . . .	12
SECOND ANNUAL FMA CONVENTION . . . . . by R. S. MANNHEIMER	40
WWNC ON-AIR WITH NEW 5 KW TRANSMITTER . . . . .	44
WJAC-FM INSTALLS RCA TRANSMITTER . . . . .	48
AMERICAN TV SHOWN IN SPAIN . . . . . by EDW. K. PRICE	52
PLANNING RADIO AND AND TELEVISION STUDIOS . . . . . by GEORGE M. NIXON	58

Copyright  
Radio Corporation of America  
RCA Victor Division  
Camden, N. J.

PRINTED  
IN  
U.S.A.

**OUR COVER** for this issue departs a bit from recent practice in that it is *not a Kodachrome*. Several efforts were made to get just the right color photo of the TV cutout models—but for one reason or another they didn't seem to have the outstanding quality we wanted. So we had a commercial illustrator do this one. How do you like it?

**SCALE MODELS** are something that every technically-minded person—man or boy—has a sort of itch for. If you are one of those unfortunate males without a son and heir (and hence no excuse for buying an electric train) you may be able to relieve some of the frustration by getting yourself a set of the paper cutout books described in the article on Pg. 8. It is, perhaps, only fair to warn you that cementing them together takes a bit of time. However, if you have the patience you can use these models for all kinds of interesting projects—not only in planning, but also in promotion. As we have not publicized them much outside of broadcast engineering circles, you can probably “be the first in your town to own one.”

You can get these books from the RCA broadcast equipment salesman who calls on your station regularly—or write: Broadcast Equipment Section, RCA Victor Division, Camden, N. J. Price of the books is one dollar each.

**TV PLANNING** is a subject in which a good many station engineers—and managers, too—are very much interested. We've published descriptions of several of the TV stations which are on-the-air and we've more TV station stories in the works. These should form a good background of information on “how the other fellow did it.” We've also had a good story on TV building design (see “Facilities Housing For TV,” BROADCAST NEWS No. 50). In this issue we take up another aspect of TV planning—namely the arrangement of equipment for stations of various sizes. The article “Practical Equipment Layouts for Television Stations” (Pg. 12) is not only the most exhaustive treatment of the subject to date—it is also, by long odds, the most authoritative. The six equipment layouts described were carefully selected to be representative of all types from the smallest to the largest. The items of equipment included in each layout, and the arrangement of these, has been worked out with the greatest care by our TV Systems Engineering Group. In fact, most of these layouts (either exactly as is, or with only very minor changes) were originally worked out by this group for TV stations now on-the-air or in the process of construction. Most of the equipment photographs were, perforce, made in our own studio where we could conveniently try various arrangements of units with a view to picking the most convenient from the operating standpoint.

It will be noted that in all of the larger layouts there are a number of alternative ways in which the individual units can be arranged. We have found that there is still quite a difference of opinion among TV operators on some questions . . . such as, whether control room equipment should be on one level or two levels (or even three) . . . and whether the control room should be at studio level or a floor higher. So, rather than take an arbitrary stand, we've shown various alternative arrangements—some suitable for single floor layouts, other for two.

**FM PROGRESS** is not being neglected by BROADCAST NEWS, even though this particular issue is a little light on the FM side. Our very next issue will go the other way—that is, overboard on FM. There'll be detailed stories on the RCA 50 KW FM transmitters now on the air at WTMJ-FM and WBRC-FM—including lots of photos of each installation—an engineering description of this important new transmitter, and other stories of interest to FM broadcasters. So please be patient. We'd like to have each of our issues balanced as to subject material—and we hope to achieve that goal some day. For the moment, however, it makes life a lot more simple just to run the most interesting stories as they come along.

# This 250-watt

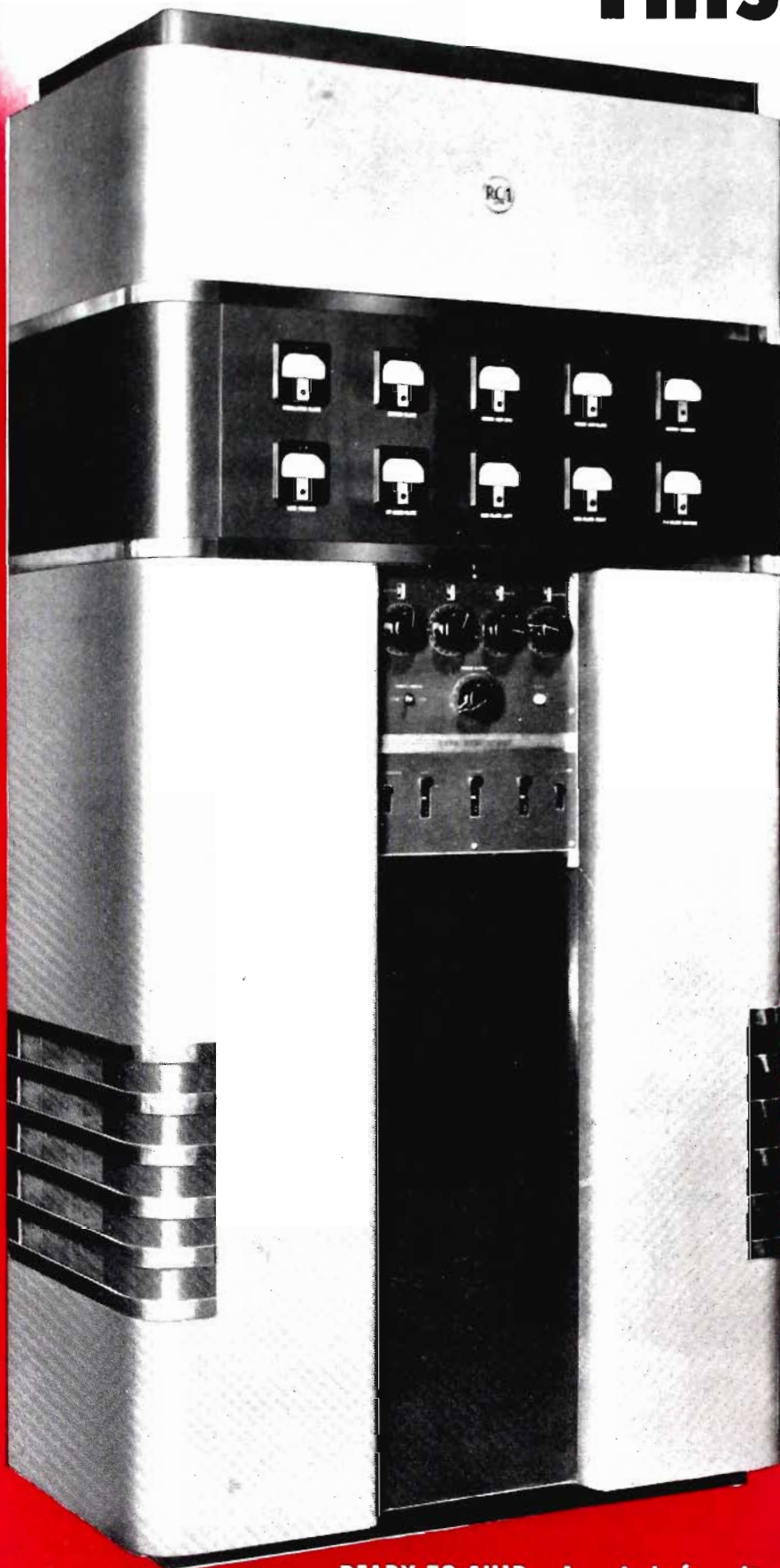

**READY TO SHIP**—America's favorite 250-watt AM transmitter, type BTA-250L

With operating features as familiar to broadcast engineers as station calls, RCA 250-watt AM transmitters—more than 300 of them—have been making friends with station men since 1940.



**From 250 watts  
to 1 KW in  
one easy step**

**Use the BTA-250L as your  
250-watt Transmitter now...**

Type BTA-250L includes all of the latest developments in low-power AM broadcast transmitters. It provides economical, reliable, high-fidelity operation and is completely self-contained. The BTA-250L includes a harmonic filter and antenna matching circuit *built right into the final stage*. No trouble here with dust in the tuning circuits—because this transmitter uses no air capacitors.

# AM transmitter can be stepped up to 1 KW

... *simply*



WITH this 250-watt AM transmitter you can go to 500 or 1000 watts... simply by adding on an RCA 1-kw r-f power amplifier. Your BTA-250L then becomes your driver. Not a penny of your original transmitter investment is lost... because in this conversion there are no power tubes to discard or obsolete equipment left on your hands.

How quick and easy is it to convert? *You can make the change to higher power between "sign-off" and "sign-on"!*

This is one reason why the BTA-250L is a "natural" for stations planning a future power increase... or replacement of old equipment.

And there are many other reasons, too. Here is a transmitter that is *bushed* for quiet operation—uses no fans, blowers, or noisy a-c contact controls. It is designed with all controls and switches grouped on one central panel—and within handy reach. It provides an accurate means for logging... because it uses precision-type vernier tuning indicators. And all meters are located at eye-level for convenience of the operator.

For complete information about the BTA-250L... and how you can add an RCA 1-kw power amplifier to it *inexpensively*... call your RCA Broadcast Sales Engineer. Or write Dept. 19LA, RCA Engineering Products, Camden, New Jersey.

... add on this 1-kw Power Amplifier type BTA-1L for high power later

Completely self-contained, this business-like r-f power amplifier makes it practical to go to 500 or 1000 watts—using a BTA-250L as the driver. The center section houses the power equipment. The right section houses the modulator and r-f power amplifier. Ample space makes it easy to reach all components. Type BTA-1L features fewer r-f stages and simpler operations—your assurance of maximum on-air time.



**BROADCAST EQUIPMENT**

**RADIO CORPORATION of AMERICA**

**ENGINEERING PRODUCTS DEPARTMENT, CAMDEN, N.J.**

In Canada: RCA VICTOR Company Limited, Montreal



**RCA**  
**Remote Amplifier**  
**Type BN2A**

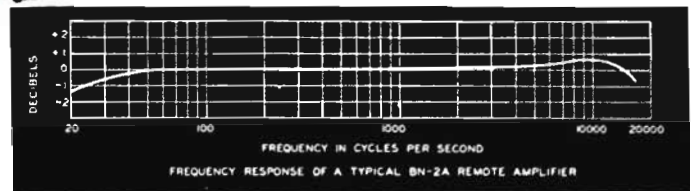

# High-Fidelity Remotes

**-30 to 15,000 cps!**

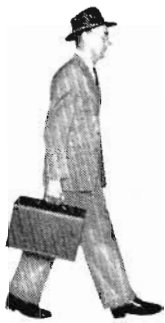

HERE IS ONE of the finest high-quality amplifiers yet designed for remote services. Distortion is less than 1 per cent over the complete frequency range of the instrument. High-level mixing reduces general noise level by at least 15 to 20 db. Stabilized feedback holds program quality steady over a wide range of operating conditions. Each of the three amplifier channels provides an over-all gain of 92.5 db—enough to help high-quality microphones through nearly any situation.

The BN2A is plenty flexible, too. You can feed the program to the output channel and the public address system *simultaneously*. You can isolate the remote amplifier and feed the cue circuit into the PA *direct*. You can monitor both circuits. You can switch in as many as four microphones—through the four microphone inputs provided

(inputs 3 and 4 are switchable to mixer 3). And you can run the BN2A from a battery simply by removing the power line connector—and plugging in the battery cord.

Weighing only 29 pounds, and completely self-contained for a-c operation, this sturdy remote amplifier carries as lightly as a brief case. More about the BN2A from your RCA Broadcast Sales Engineer. Or drop us a card. Dept. 19 HA.

### SPECIFICATIONS

Mixing Channels	Three	Power Source	105-125 v. a. c. (or battery)
Microphone Input Combinations	Four	Size	14½" L., 9½" D., 10" H.
Freq. Response (±1.0 db)	30-15000 cycles	Weight	29 lbs. (complete with a-c cable and spare tubes)
Noise Level	-70 db below +18 dbm	Cabinet	Deep umber-gray metalustre wrinkle. Removable aluminum front cover.
Distortion	Less than 1% rms		
Rated Output Level	+18 dbm		

The One Source for Everything in **Broadcasting**—is RCA



**BROADCAST EQUIPMENT**  
**RADIO CORPORATION of AMERICA**  
**ENGINEERING PRODUCTS DEPARTMENT, CAMDEN, N.J.**

In Canada: RCA VICTOR Company Limited, Montreal

[www.americanradiohistory.com](http://www.americanradiohistory.com)



**RCA Velocity  
Microphone  
Type 44-BX**  
Effective Output Level, -55 dbm  
Hum Pick-up Level, -112 dbm



**RCA Polydirectional  
Microphone  
Type 77-D**  
Effective Output Level, -57 dbm  
Hum Pick-up Level, -126 dbm

# Broadcasting's Best...

**—now available from stock**

These are the network favorites.

Year after year they serve more broadcast and television audiences than any other microphone. Yet, despite their overwhelming popularity, RCA's engineering continues to make both even better than before.

The 44-BX is the bi-directional type—designed for AM, FM, and TV studios where highest quality reproduction is desired. It provides high-fidelity output over the entire audio range—and is free from cavity or diaphragm resonance and pressure doubling.

The 77-D is the polydirectional type . . . quickly adjustable to *any* pick-up pattern you want. A 3-position voice-music switch enables you to select the best operating characteristic for voice and music. *Hum pick-up level, -126 dbm!*

RCA 44-BX and 77-D microphones are yours for immediate delivery. Simply call your RCA Broadcast Sales Engineer. Or write Dept. 19 JB, RCA Engineering Products, Camden, New Jersey.

The One Equipment Source for Everything in **BROADCASTING**—is RCA



**BROADCAST EQUIPMENT  
RADIO CORPORATION of AMERICA  
ENGINEERING PRODUCTS DEPARTMENT, CAMDEN, N. J.**

In Canada: RCA VICTOR Company Limited, Montreal

# WSAV ENLARGES FM BROADCASTING FACILITIES

**WSAV-FM**, the Frequency Modulation station of the "Voice of Savannah," recently switched over to its greatly enlarged FM transmitting plant, according to an announcement by Harben Daniel, President and General Manager of the company.

For the past year and a half, WSAV-FM has been conducting an interim operation from a transmitter located atop the Liberty National Bank Building in downtown Savannah. While both the AM and FM studios remain in the Liberty Bank Building, the new, enlarged FM transmitter and FM Pylon antenna has been installed

on Oatland Island between Savannah and the Atlantic Ocean. The four-section RCA FM Pylon antenna, which is mounted on top of WSAV's center 400 foot tower, was one of the first four-section Pylon antennas to be erected anywhere in the country and was the subject of several articles appearing in national technical trade publications after it came through the Savannah hurricane of last summer, unscathed. (See BROADCAST NEWS No. 47.)

With the switch-over to its enlarged FM transmitter, WSAV-FM is now broadcasting on its maximum authorized power of 15,000 watts, and covers an area of 5,990 square miles. Simultaneously, the

station switched to its new frequency of 100.3 megacycles on FM Channel Number 262, as authorized by the Federal Communications Commission.

WSAV-FM supplements the service of WSAV, which some months ago expanded its coverage to embrace over a million listeners in Georgia, South Carolina and Florida.

## FM and AM Transmitters

WSAV-FM's 3 KW RCA transmitter is installed in one wall of the transmitter house which is located on Oatland Island. The entire FM transmitter is housed in





three standard cabinets as shown in the photo of Fig. 1 below. The cabinet at the extreme left contains the low-power r-f amplifiers (250 watt, 1- and 3-KW)—the center cabinet contains the Direct FM Exciter and the far cabinet houses the H-V rectifier and power control circuits. Both 1- and 3-KW power amplifiers are grounded-grid circuits and each plate tank is concentric with the anode of its 7C24 tube. A feature of the transmitter is its "add-on" amplifier design which makes possible a future increase in power by the addition of a 10-KW grounded-grid amplifier.

The 5 kilowatt AM transmitter is an RCA, BTA-5F. Conservative design of this transmitter also provides for easy increase to 10 kilowatts power output when further expansion is desired—and with only minor modifications. Both the AM and FM transmitters are styled in a two-tone umber gray to blend with each other, as well as with companion station equipment.

FIG. 1 (at left). Transmitter room of WSAV-FM. The RCA 3 KW FM transmitter is shown at the right and the RCA 5 KW AM transmitter at the left, flush mounted in a wall of the transmitter room.

FIG. 2 (at right). Here is the center tower of WSAV showing the RCA four-section FM Pylon antenna mounted on top. This tower withstood a 100-mile wind during the hurricane in Savannah last summer.

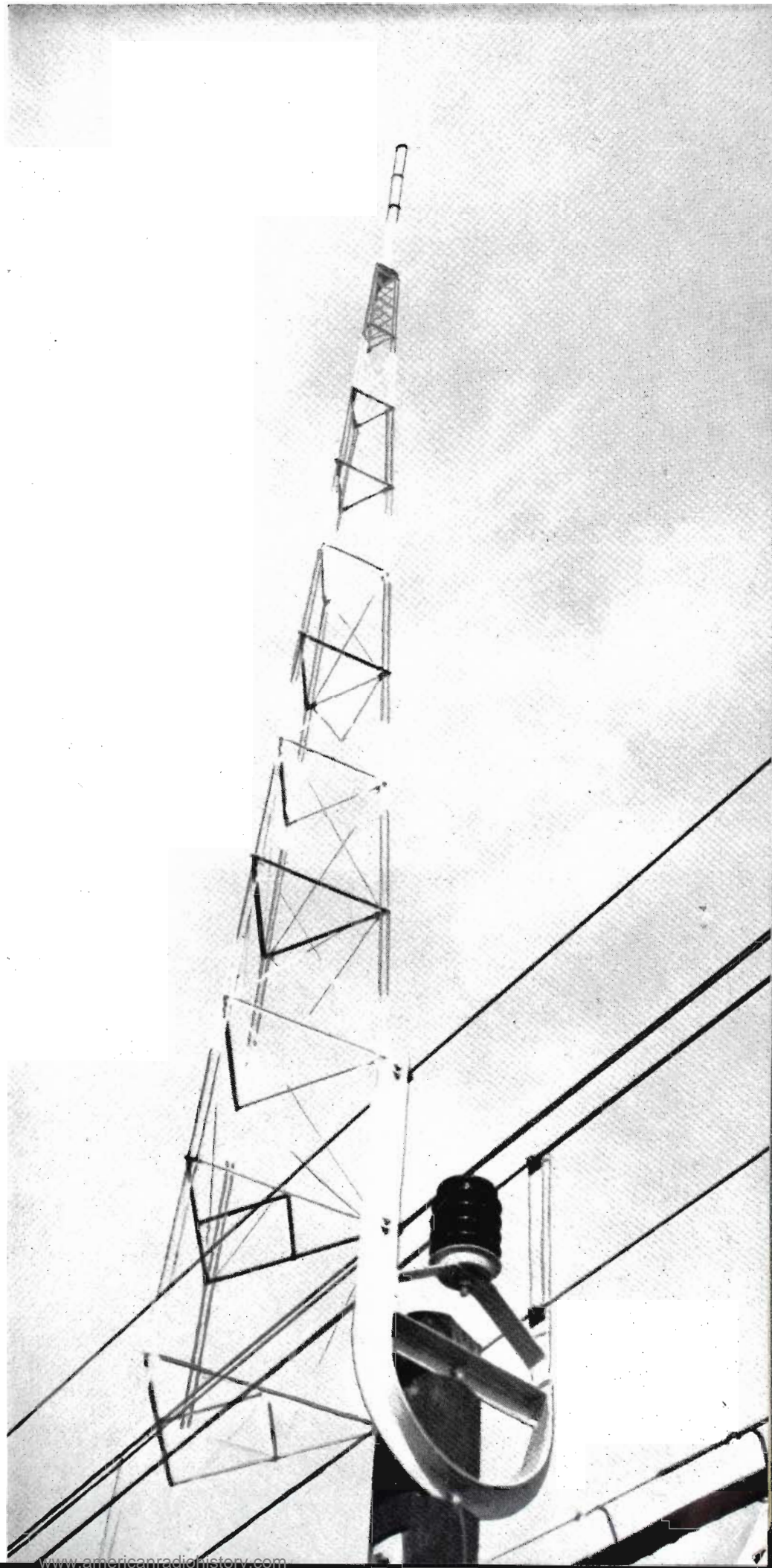

# SCALE MODELS MADE FROM PAPER CUTOUTS AID TV STATION PLANNING

by **MARVIN L. GASKILL**  
Engineering Products Department

Scale models that you can make yourself from paper cutout books (Fig. 1) are a great help in planning the layout of a television station. They can be used to try out various arrangements of equipment, to determine necessary space in control room, projection room, transmitter room and studio—and, if desired, to make a complete scale model of the whole station layout (Fig. 2).

These models are made by cutting out and pasting together the various "cutouts" (Fig. 3) contained in two large size books now available from the RCA Television Sales Section. These cutouts have been carefully planned so that when assembled they are accurately scaled models with the proper height, width and depth to simulate each major unit of RCA TV broadcast equipment.

The cutouts are reproduced in two tones of brown so that the colors duplicate (ap-

proximately) the two shades of umber gray in which RCA units are finished. The panels of the models are photographic reproductions of the panels of the actual units—so that in overall appearance they closely resemble the real thing. Thus a setup of these models, such as that shown in Fig. 2, not only serves as an indication of space required, but in addition gives a rather good idea of how the control room, etc., will appear.

The scale of the models, which is 1 inch to the foot, makes it convenient to use them with pages ruled in 1 inch squares for the floor. This arrangement (Fig. 10) gives an immediate indication of the space between units—which is important in determining whether there is sufficient clearance for easy access to all units, opening of cabinet doors, etc.

In planning the studio layout toy furniture may be used to simulate studio scenes. The plastic furniture now available in every ten cents store is about the right size for this use. If "camera-angle" devices (such as the so-called "Shot-Plot" set) are

used a good idea of the space necessary for various types of studio operation may be determined.

Construction of the models from the cutouts requires a little patience, but is not difficult. (If you're out of practice your kids can show you how.) The cutout books are printed on heavy paper so that they can withstand considerable handling. To make them even more durable they can be cemented to wooden blocks of the proper size and coated with clear lacquer. A heavy coating of lacquer makes them very attractive. Stations with high-powered promotion staffs might as well make them up this way in the beginning—because once the promotion people see them they are certain to want them for store-window displays and other publicity purposes.

Engineering executives can obtain the two Model Cutout Books by requesting them from their RCA Broadcast Sales Engineer. Others may obtain them for \$1 each by writing Engineering Products Department, Section 503, Camden, N. J.

FIG. 1. The paper models shown here include correctly-scaled realistic-appearing models of all the main units of RCA TV Equipment. The transmitter units, video console units, racks, etc., may be grouped to simulate any desired arrangement of equipment.

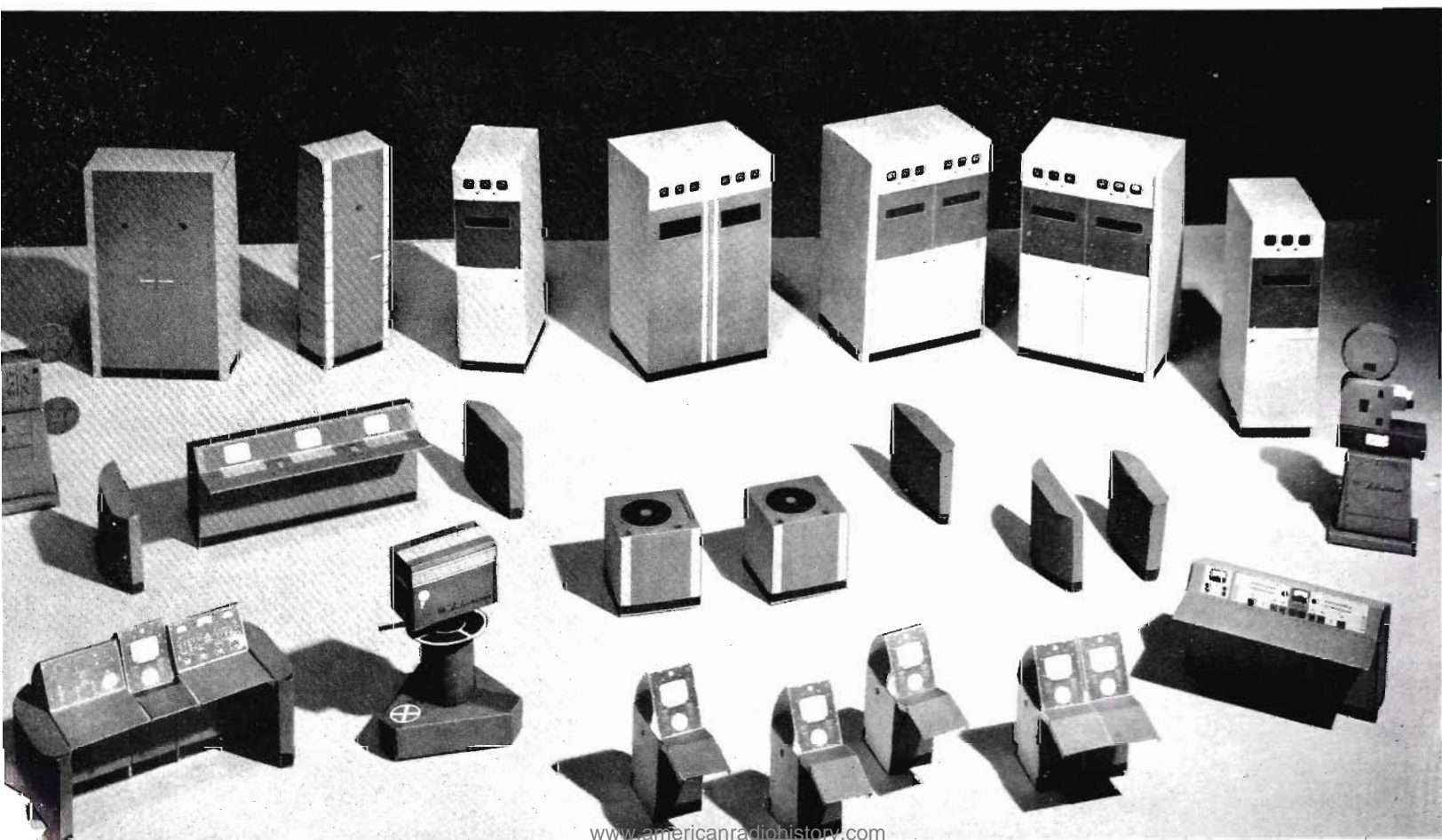



FIG. 2. The assembled models may conveniently be used in planning the best arrangement of TV station equipment. Shown above are Philip G. Lasky, Vice President and General Manager KSFO-KPIX, and A. E. Towne, KSFO-KPIX Director of Engineering.



FIG. 3. The paper cutouts from which these TV equipment models are made are supplied in book form. The two books (top of the illustration at the right) contain not only the properly sized and detailed cutouts, but also instructions for assembling the models. The steps in putting them together, as well as several ways of using them, are illustrated on the following two pages.

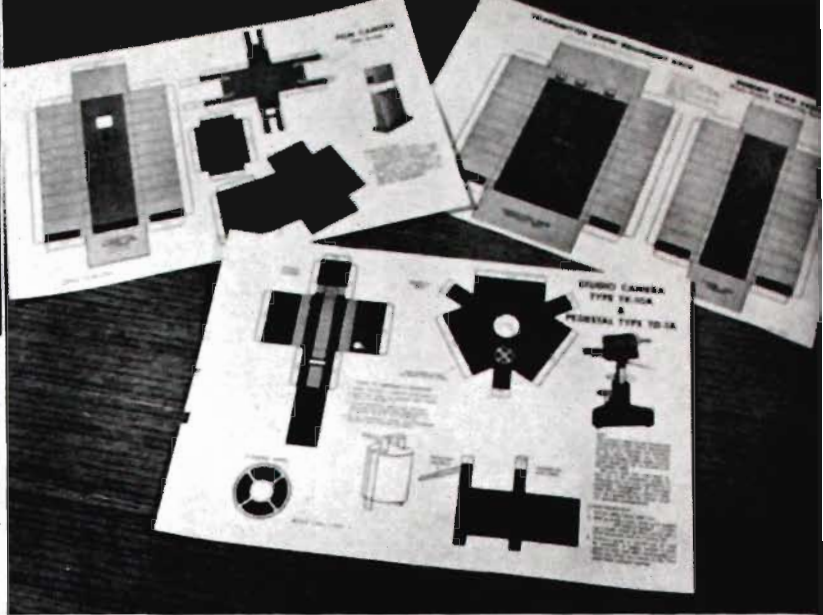
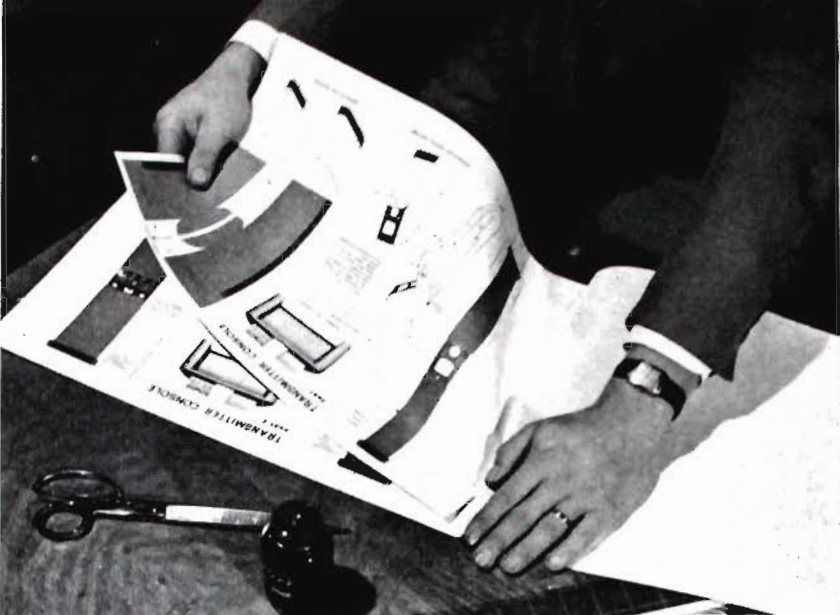

FIG. 4. Only tools needed in assembling the TV equipment models are scissors and rubber cement. First step is to tear the page to be cut from the book (if all models are to be used it is easier to remove the staples).

FIG. 5. Each page contains sections required for one or more models, plus instructions for assembling them. Read these instructions and study the drawings before starting on the actual assembly.

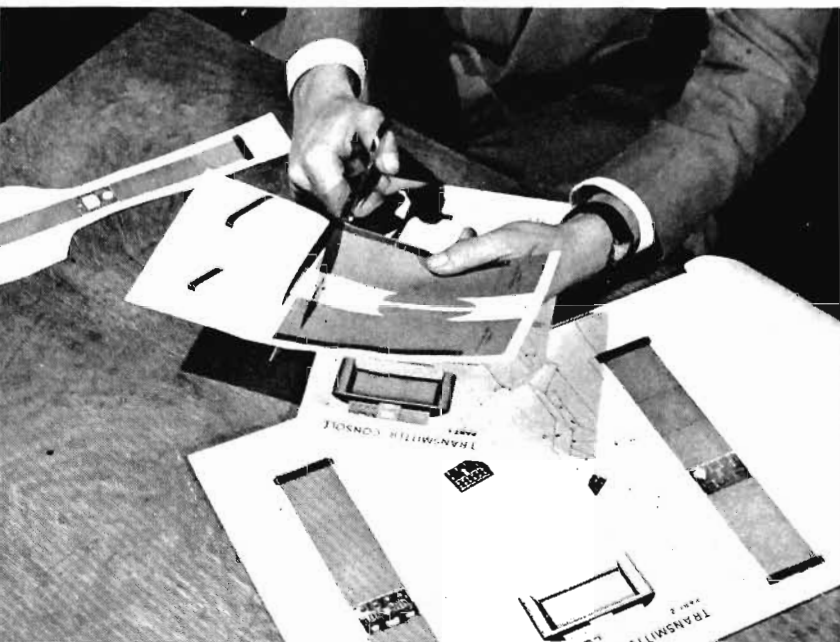
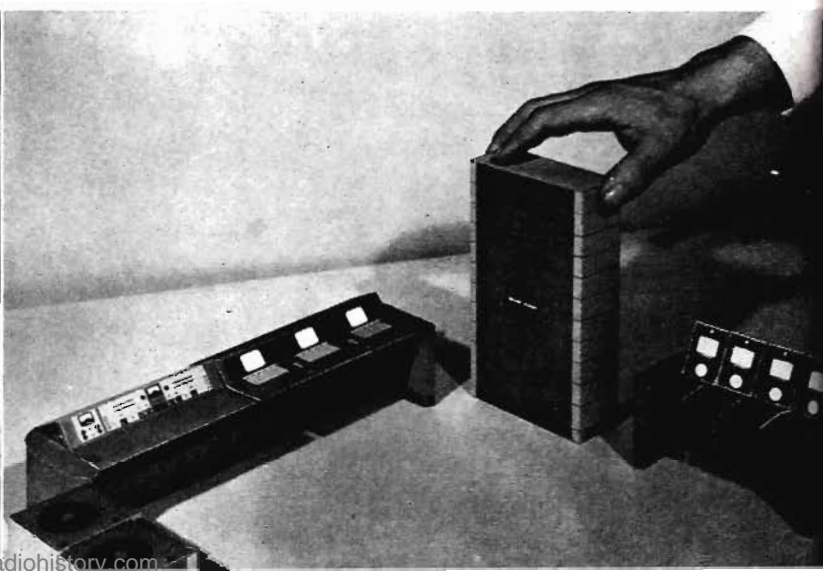
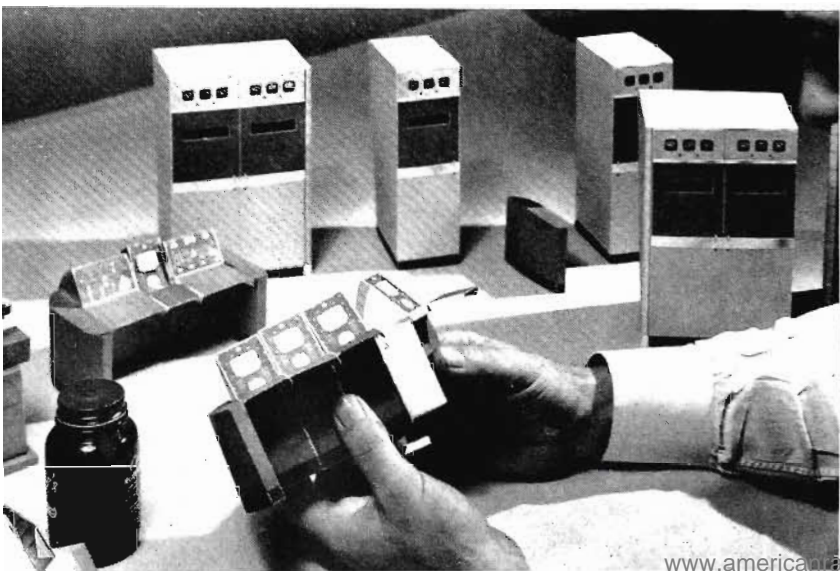

FIG. 6. Cutouts can be cut away without cutting the assembly drawings, which may be needed for reference. After cutting, score fold lines with points of scissors and fold as indicated on drawings.

FIG. 7. Apply thin film of rubber cement to BOTH the surfaces to be cemented together. Allow the cement to dry and then press surfaces together firmly. They should form a strong joint immediately.

FIG. 8. As many video units as necessary may be cemented together, as shown below, to form a video control console of the desired size. Transmitter units and racks also may be assembled in this way.

FIG. 9. Initial use of the models may be in the planning of individual rooms. Equipment for a studio control room is shown below in one of several arrangement possible with RCA "unit-built" equipment.



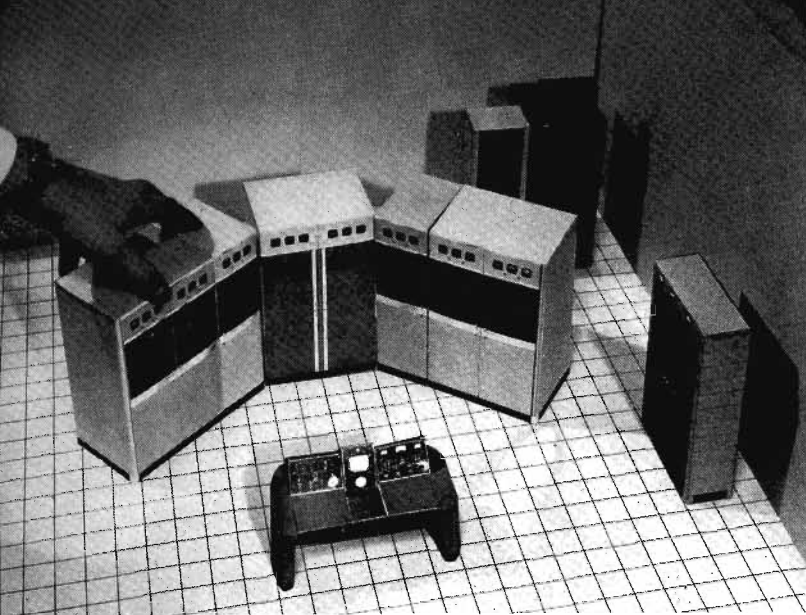

FIG. 10. The models are scaled one inch to the foot. When placed on a card ruled in one inch squares, room dimensions can be determined quickly and easily. Here, the RCA 5 KW transmitter is shown in a "U" arrangement.

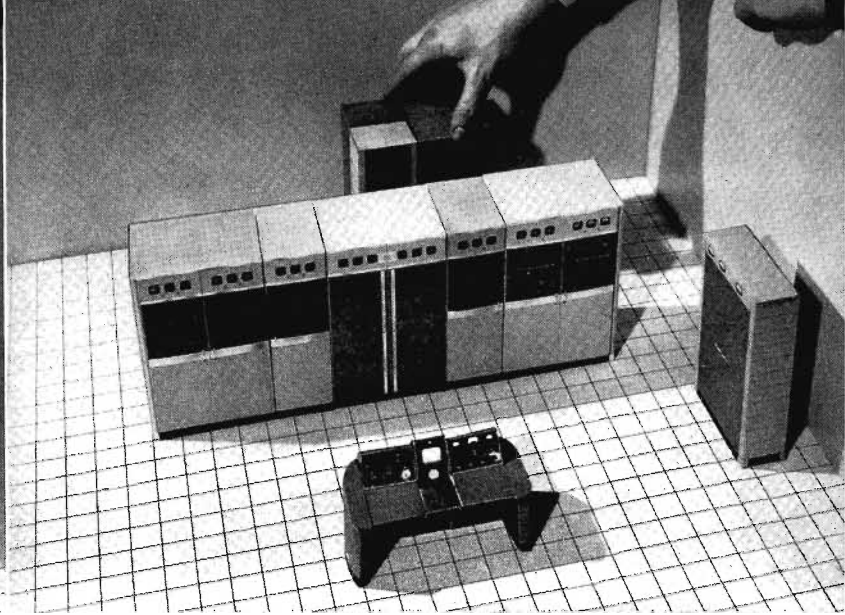

FIG. 11. In this view the same transmitter units are arranged in a straight line and auxiliary units placed nearer the center. By trying various arrangements the best use of the available floor space can be determined.

FIG. 12. A complete TV station layout can be simulated with the models. In the illustration at left J. H. Roe, Supervisor of RCA's TV Systems Engineering Group, is shown working with a setup arranged to simulate a "standard" TV station. In this layout the studio is at the lower left, the transmitter room at the upper left. The small room at the top right is the film projection room. At the center right is the master control room and at lower right the studio control room.

The models in this illustration, and in that below, have been mounted on wood blocks (pre-cut to proper size) and given two coats of clear lacquer. This enables them to withstand harder usage and also gives them a trimmer appearance when they are to be used for promotion purposes.

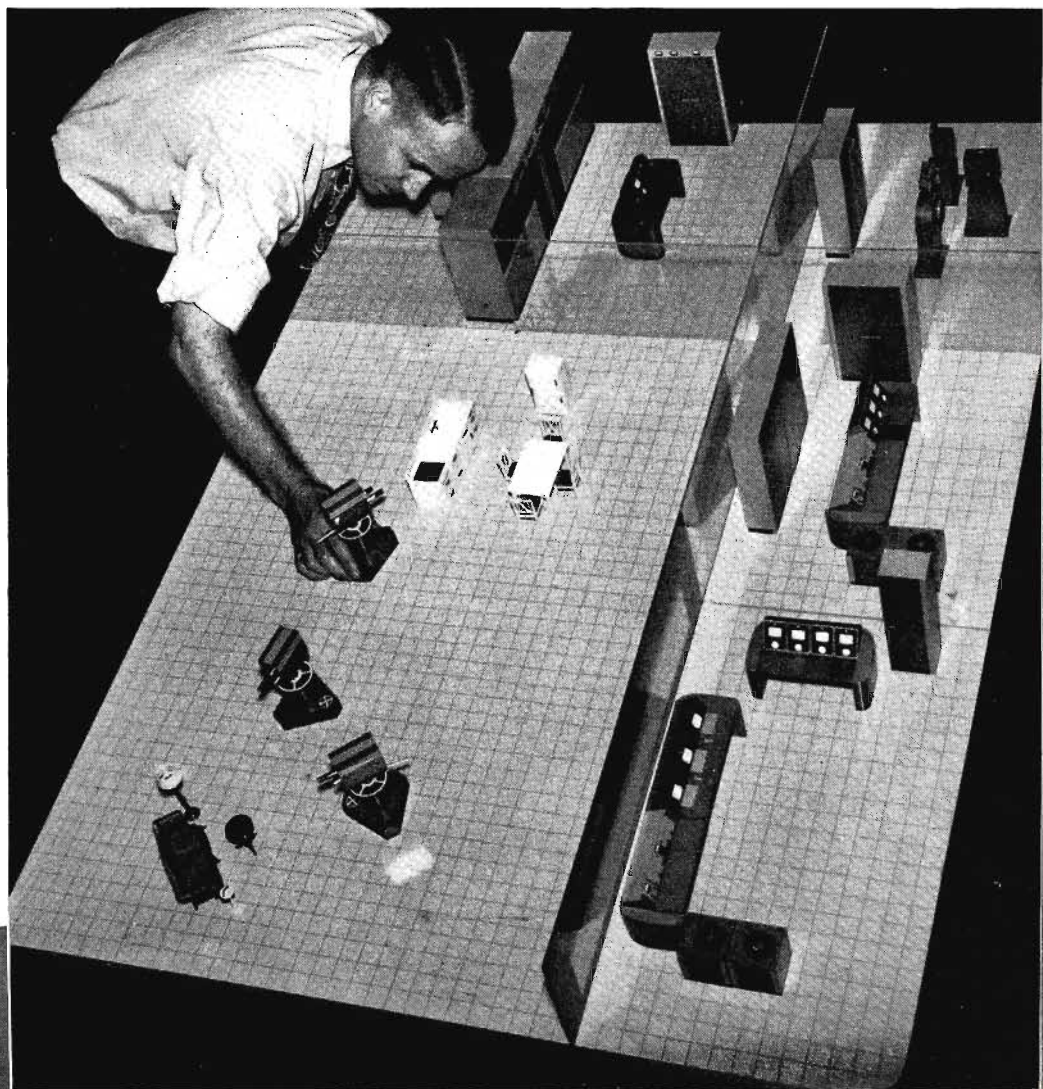
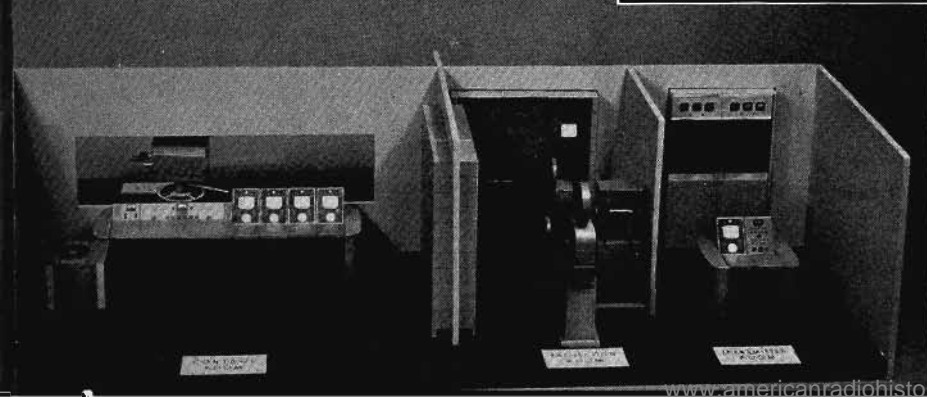

FIG. 13 (left). This model setup simulates a smaller station consisting of a combined studio and master control room, a projection room, and a transmitter room containing a model of the RCA 500-Watt TV Transmitter.





# PRACTICAL EQUIPMENT LAYOUTS FOR TELEVISION STATIONS

## Introduction

The equipment required for a television studio installation varies widely depending on the type of station, the size of the community in which it is located, and the magnitude of the station operation. In this respect it differs greatly from the equipment requirement of the transmitter part of a TV installation which, with the exception of transmitter power, is much the same for all stations.

If the station is a network origination point, located in a large city, it will probably be a multiple-studio installation requiring a large number of cameras, associated control equipment, master control equipment and elaborate distribution facilities. If it is a non-network station in a large city it will probably require almost as much camera and control equipment (due to the fact that it must compete programwise with the network stations), but it will not, of course, require the distribution facilities. On the other hand a network station in a medium-sized community, because it will receive most of its programs from the network, will need only relatively simple studio facilities. In some instances, network stations in small communities may not have any origination facilities except a slide projector for station identification, and a simple film pickup system.

This wide range of requirements, plus the fact that many stations will wish to install minimum equipment and "grow" with the development of the audience, led RCA engineers to the conclusion that TV studio equipment should be made of carefully planned units so coordinated that they could be easily fitted together to provide almost any desired combination of facilities. This is essentially the "building block" idea which is today employed in many types of industrial apparatus. However, in the design of RCA TV units the idea has been carried further in that the equipment has been broken down into smaller units. Thus, when expanding a system made up of RCA TV units it is usually not necessary to add a whole desk or console. For instance, another camera (either studio or film) can be added to an existing system by the addition of a 14 inch wide

section to the video console. Single amplifiers, monitors, relay units or the like can be added at will. Moreover, all of these units are designed to operate at a standard level and into a standard impedance. Thus input and output connections can be brought out to jacks, so that units can be patched in or out as desired (thereby providing for temporary modifications of the system as may be required).

The six system layouts described in this article have been chosen to illustrate the wide range of equipment combinations which are practical. For the most part these are layouts actually in use at existing studios or now being installed at stations under construction. Thus they represent a large amount of thoughtful planning and are based, to the largest possible degree, on actual operating experience. There are, of course, many modifications of these systems, and numerous in-between-designs, which will occur to station engineers. Using RCA TV units it will be relatively easy to make such modifications as may be necessary to meet the specific requirements of individual stations.

Of the six different layouts to be described, types A, B, and C utilize only one live-talent studio and a single control room. The single control room is a combined studio control room, film control room and master control room. The Type D station also has only one live-talent studio; but it has two control rooms, one for the live-talent studio and one for the master control room. The Type E station is a deluxe arrangement of the Type D; including a program console, which provides additional facilities over Type D. Finally, the Type F Station is a master layout employing two studios, each with its own control room, and separate film control and master control rooms.

## General Considerations

All TV studio installations—large or small—are alike in many respects. The difference in size, for instance, is mostly a matter of the number of studios involved. The single studio of a small station with its associated control room is almost identical to one of the studios and associated control room of the large sta-

tion. Thus the general arrangement of the equipment in the control room proper is very much the same in all stations. Moreover, the equipment for all stations is made up from the same basic units. And, finally, the basic control system used in all of them is the same.

Because of these similarities it is worthwhile to discuss some of the basic considerations in a general way before beginning the detailed description of the six equipment layouts. Inasmuch as this part of the discussion has to do with rather elementary aspects of the subject those with some previous background or experience may wish to skip this part and continue with the detailed descriptions of the six layouts which begin on Page 18.

## Basic TV Studio Arrangement

It is not the purpose of this article to discuss the design of TV studio buildings.<sup>2</sup> However, several partial floor plans have been included in order to indicate relative sizes and the general arrangement of studios, control rooms, workshops and dressing rooms.

The dimensions of these studios, as well as the control rooms, may seem large, by broadcast standards. Experience indicates, however, that the dimensions shown are close to the practical minimum. TV studios should be large enough to provide for as many as two or three sets, which may be successive scenes in a program; while control rooms should be made large enough to admit additional equipment as the station grows. As a matter of fact, the floor plan suggested for the Types A and B small stations will serve also for the larger Type C station. Because large studios are used, the control room window can be quite large compared to that of most broadcast stations. This is an advantage in that the control room audio and video consoles when placed end to end require much more space than audio alone. Of course it is not absolutely necessary for all the technical operators to be able to see into the studio. It is important, however, that the program director be able to see all of the studio action from his position in the con-

<sup>2</sup> For a discussion of TV building design see "Facilities for TV Housing", BROADCAST NEWS No. 50, Page 8.

control room. In order to give all of the personnel in the control room a better view of the studio, the control room floor is usually elevated about two feet above the studio floor level.

There are several ways of arranging the equipment in the control room. RCA engineers are inclined to recommend that all the equipment consoles; i.e., audio, video and director's (if used) be placed side by side directly in front of the control room window. A somewhat different method, preferred by some broadcasters, is to place the program director and audio operator on a platform, (Fig. 11) elevated two or three feet above the control room floor. This particular arrangement is illustrated and described more fully in the layout for the Type C station.

At least one announce booth is essential in a TV station layout. Such a booth is provided with the necessary audio facilities and a picture monitor. It enables a commentator, for example, to see the picture upon which he is commenting, so that he can follow the action accurately.

This booth may be located in one corner of the film control room, or it may be

located just outside the master control room. If one announce booth is to serve also for station identification, it may be advisable to locate it outside the master control room, and construct it so that visual "cue" can be given from the master control room.

### Basic TV Studio Equipment

Most of the units which make up the video system of a television station are counterparts of the audio units in a broadcast station. The camera itself corresponds to the microphone, the camera amplifier to the microphone preamplifier and so on.<sup>1</sup> In general, these television units are arranged in much the same manner as the corresponding audio units of a standard broadcast station. The output of each studio or film camera is fed into one of the input positions on a video control console in the control room. At this console position, the video signals from the cameras are mixed (or switched) in the same manner as microphone and transcription inputs are mixed at the audio console. From the video console the picture signal is fed either directly to the transmitter line or to a master control room where it is mixed with signals from the studio, the

network line, or outside points. Here again the operation is directly comparable to that of a standard broadcast setup.

There are several major differences, however, in the video setup. One of these is due to the fact that the video output of the camera has several qualities, such as brightness, contrast and focus, which require constant supervision. This operation is roughly comparable to that of riding gain in an audio setup. It is, however, a much more complicated process, and for this reason is generally separated from the mixing or switching function. In all but the smallest setups, this supervision of the individual camera signals is exercised by a "video operator" who sits at a video console (Fig. 7). This console is made up of sections usually referred to as camera control units. There is one of these control units for each studio camera and one for each film camera. Each unit (Fig. 5) contains a picture monitor showing at all times the picture picked up by the camera

<sup>1</sup>All of the RCA television equipment units referred to in this article are described in detail in individual equipment bulletins available from the Television Equipment Sales Section, RCA Engineering Products Dept., Camden, N. J.

## RCA UNIT-BUILT EQUIPMENT LENDS ITSELF

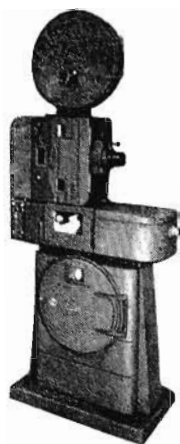

FIG. 1. Type TP-35A 35mm Television Film Projector which enables television broadcasters to use standard 35mm motion picture film as program material.



FIG. 2. Type TK-20A Film Camera. This camera converts motion pictures projected from 16mm or 35mm projectors to video signals for television transmission.

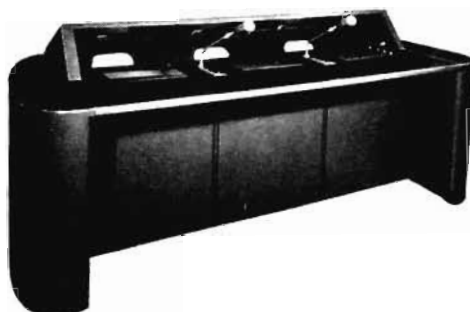

FIG. 3. Type TC-5A Program Director's Console. This console provides the program director in the control room with pictures of the scenes being picked up by the studio cameras, so that he can choose the picture to be transmitted.

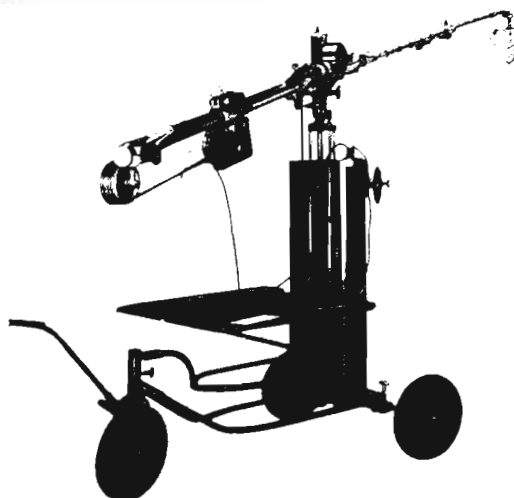

FIG. 4. Microphone Boom and Perambulator. This boom enables the audio man in the studio to pickup the sound while keeping the microphone out of the view of the camera.



it is associated with. It also contains an oscilloscope for "waveform" monitoring and all of the necessary controls for adjusting the brightness, contrast, focus and other attributes of the particular camera picture. The video operator uses these controls to keep the several camera pictures in optimum adjustment at all times. Thus, the technical director, or whoever does the switching, is free to concentrate on the action without worrying about the camera adjustments.

Another major difference in the video setup is occasioned by the fact that video signals cannot be "piped" about quite as freely as audio signals. For this reason it is usually necessary (in all but the smallest systems) to employ relay switching. Thus, the video switching setup of most stations will correspond more nearly to the relay type of audio switching used in the larger broadcast station and network studios.

The audio equipment used in a television station is very much like that used in a standard broadcast station. There are, however, several minor differences. One is occasioned by the fact that the microphones must be kept out of sight. This

usually requires either more microphones or else the use of elaborate boom mounts (Fig. 4). Another is the desirability of being able to add background sound (from a transcription turntable) and have it heard in the studio (which involves some changes in control circuits since most standard audio equipments are interlocked to prevent this).

The audio control requirements for TV also differ somewhat from those used in AM and FM broadcasting. In TV studios, microphones are usually suspended on the ends of movable boom stands. The boom operator, under the direction of the audio engineer, maintains the placement of the boom microphones for best sound pickup. He must also keep the boom and microphone out of the view of the camera. Good communication, therefore, must be maintained between audio engineer and boom operator. This necessity of directing the microphone movement (in addition to his normal job of riding gain) keeps the audio operator much busier than in standard broadcasting.

Because the video and audio operators are so busy exercising their individual monitoring functions, it is standard TV prac-

tice to place the actual switching (or mixing) operation in the hands of a third technician who is usually the technical director. The location and arrangement of facilities for switching varies widely with the type of setup (and with the personal preference of station planners). In medium-sized stations, a simple but effective arrangement consists in adding to the video console two additional monitor sections. These sections (Fig. 5) are similar in size and appearance to the camera control units. One of these acts as a master (or program) monitor. On its screen appears at all times the picture output of the control room (i.e., the picture being sent to the transmitter or the master control room). There is a space on this unit for a panel containing a push-button switching system with lap-dissolve levers, signal lights, etc. The technical director uses these controls to select the picture for transmission. The monitor in the unit gives him a constant visual check on the transmission. Ordinarily a second unit, similar in size and arrangement, is located next to the master monitor. This second monitor is used as a "preview" monitor. The technical director uses a set of push-buttons on it to select the camera input he

## TO A VARIETY OF TV STATION LAYOUTS

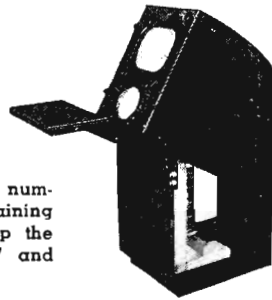

FIG. 5. Video Console Section. A number of these sections, each containing 10-inch picture monitors, make up the video consoles shown in Fig. 7 and in the layout photos.

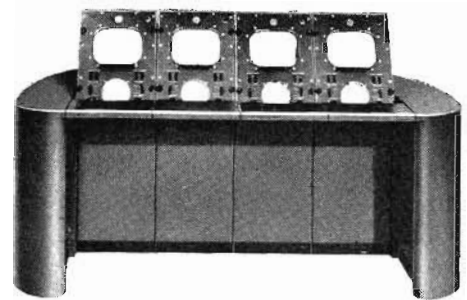

FIG. 7. Video Console. These sections can be individually equipped as TK-10A camera controls, TS-10A camera switching systems, and "preview" and program monitors sections.

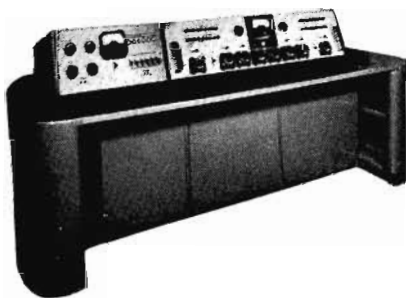

FIG. 6. Television Audio Console. This console is the control center for the audio part of the television program.

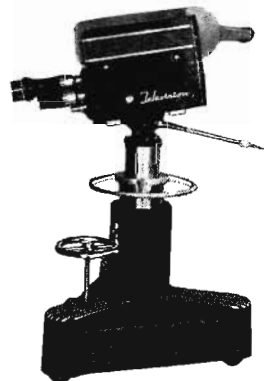

FIG. 8. TK-10A Studio-type Camera and Pedestal.

proposes to use next. This allows him to monitor (for quality and action) his upcoming shot. This monitor may also be used to take visual "cue" from a preceding program by switching to the video line from the preceding origination point.

The "master" and "preview" monitors obviously do not have to be a part of the video console. They may, if desired, be located some distance away as, for instance, on an elevated platform beside the program director's position. Several such alternatives are shown in the equipment layouts which are described in the following pages. Also described are several different types of switching controls. However, the general operation is the same in all cases.

It will be evident by now that the major difference between TV and AM (or FM) equipment layouts is in the relative complexity of the former. In addition to the three technicians mentioned above, the active personnel in a TV studio control booth usually includes a program director and one or more assistants. All of these people must be provided with some monitoring facilities. Here again there are wide differences between setups. In the smallest layouts, the program people simply peek over the shoulders of the technicians. In the most elaborate setups, the program director has his own program console (Fig. 3). Various program monitoring setups are described in connection with the layout description on following pages.

### Basic TV Studio Control System

The control systems included in the television layouts treated in this article are similar in arrangement to those used in broadcast stations of corresponding size. Thus, in this respect also many of the operational procedures used in AM broadcasting are carried over into television broadcasting.

The average television program consists of a succession of studio pickups, plus the occasional inclusion of signals from remote points or other studios. A simple example of the latter is the insertion, into the program, of a station identification slide or short picture sequence originating in the film projection room. Another is the occasional (although less frequent) insertion of outdoor scenes picked up by field equipment and fed to the station by line or microwave relay. Thus, even though the major part of any one program will originate in one studio, with control of the program centered in its control room, some provision must be made for coordinated

control of the remote signals, as well as the signals emanating from the projection room and other studios. In almost any television setup, switching from local to remote signals can be done, of course, in master control. But a feature of the layouts described here (with the exception of Types A, B and C which have a single combined control room) is that the remote signals and the signals from other studios may also be brought into any of the camera switching systems, thereby allowing control of all program source material within any studio control room, as well as in master control. Fig. 9 is a simplified drawing of such an arrangement. Note that video plugs and jacks are employed between the cameras and camera switching relays, and at one point, into the master switching relays. By locating all these jacks and plugs in one room such as master control, remote signals as well as signals from the projection room can be patched into the control rooms of either studio. With this arrangement, the program director in the studio control room can introduce outside signals at any time into the studio

program line. Another useful feature of this system is that the output from a studio camera or film camera can be patched directly into the master switching relays (S7 and S8). This permits a test pattern or announcement slide to be placed on the transmitter line without disturbing the operation of either studio, which may be engaged in rehearsal or feeding a network program.

It will be noted that the system just described closely parallels that used in broadcasting, except that the cameras take the place of microphones and relays are used instead of key switches. The audio equipment used with the video equipment is arranged in the same manner and can be arranged to have the corresponding audio master switching relays (equivalent to the video master switching relays S1, S2, S3 and S4) interlocked so that both sets of relays are operated from one set of controls. For simplification, the description of video and audio facilities in these layouts has been handled separately. The audio facilities are outlined at the end of the article.

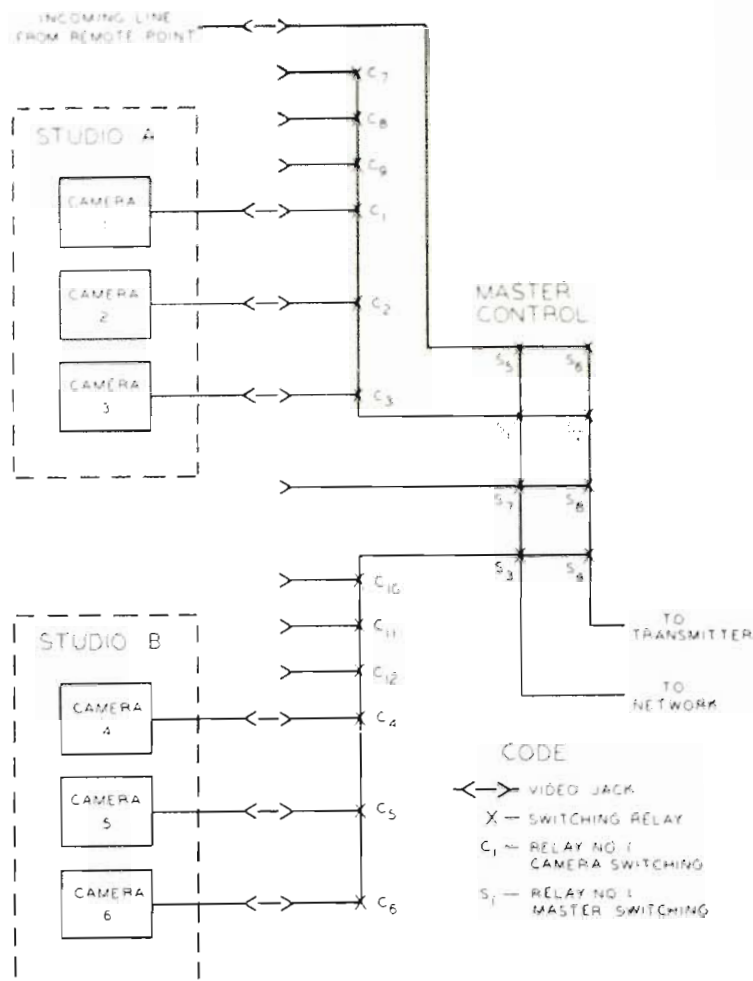

FIG. 9. Simplified diagram of the camera switching and master switching systems. Jack panels, rack-mounted near the switching relays, permit program material to be patched directly into any control position.

FIG. 10. This partial floor plan shows the space and housing facilities required by the standard size station for the origination of studio and film shows. Clients' viewing room is located above the studio control room.

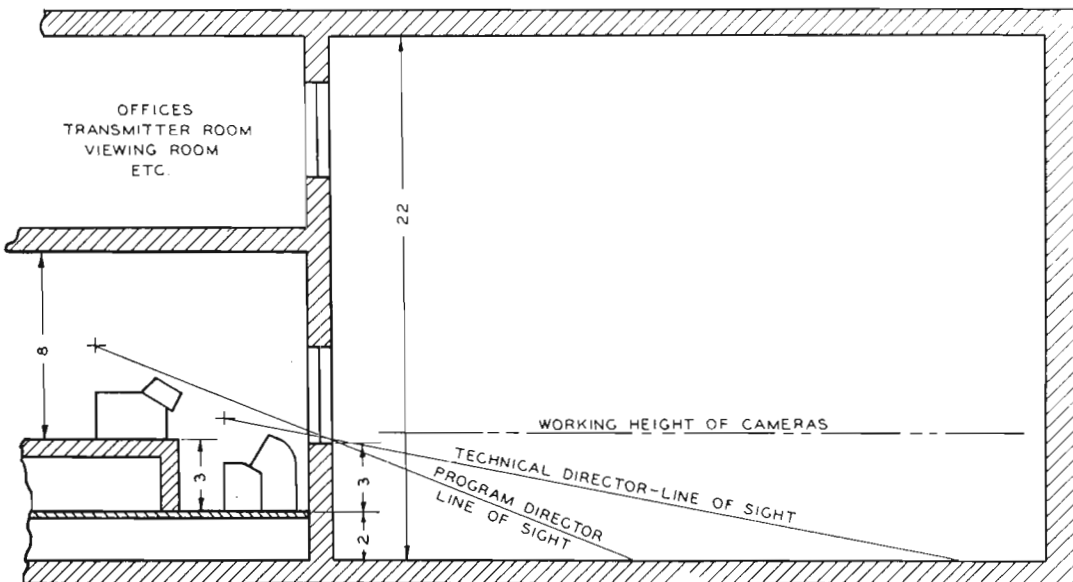
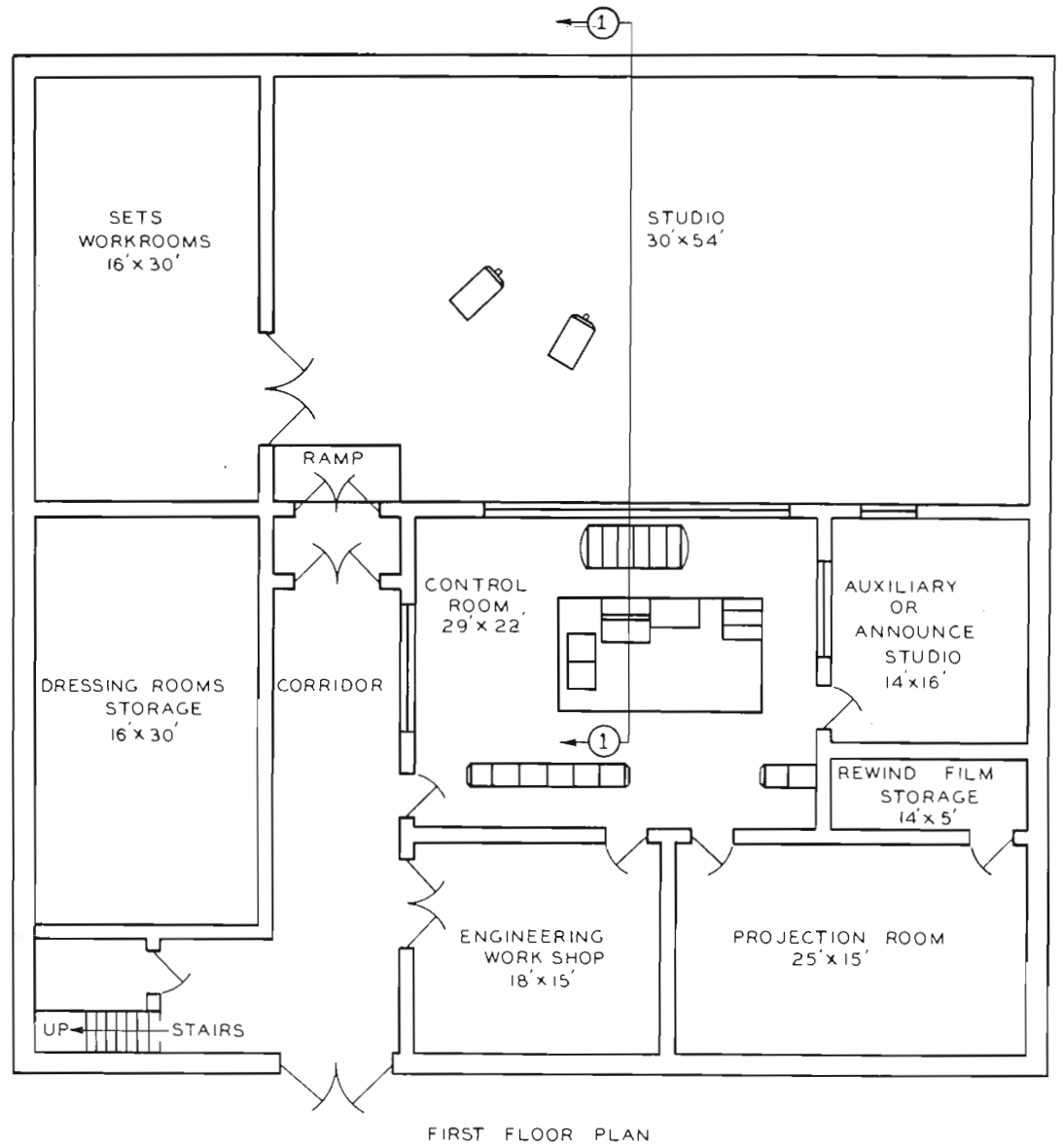

FIG. 11. (Left) Cross-section of control room of Fig. 9, shows elevation of program director to provide him with a good view into the studio.

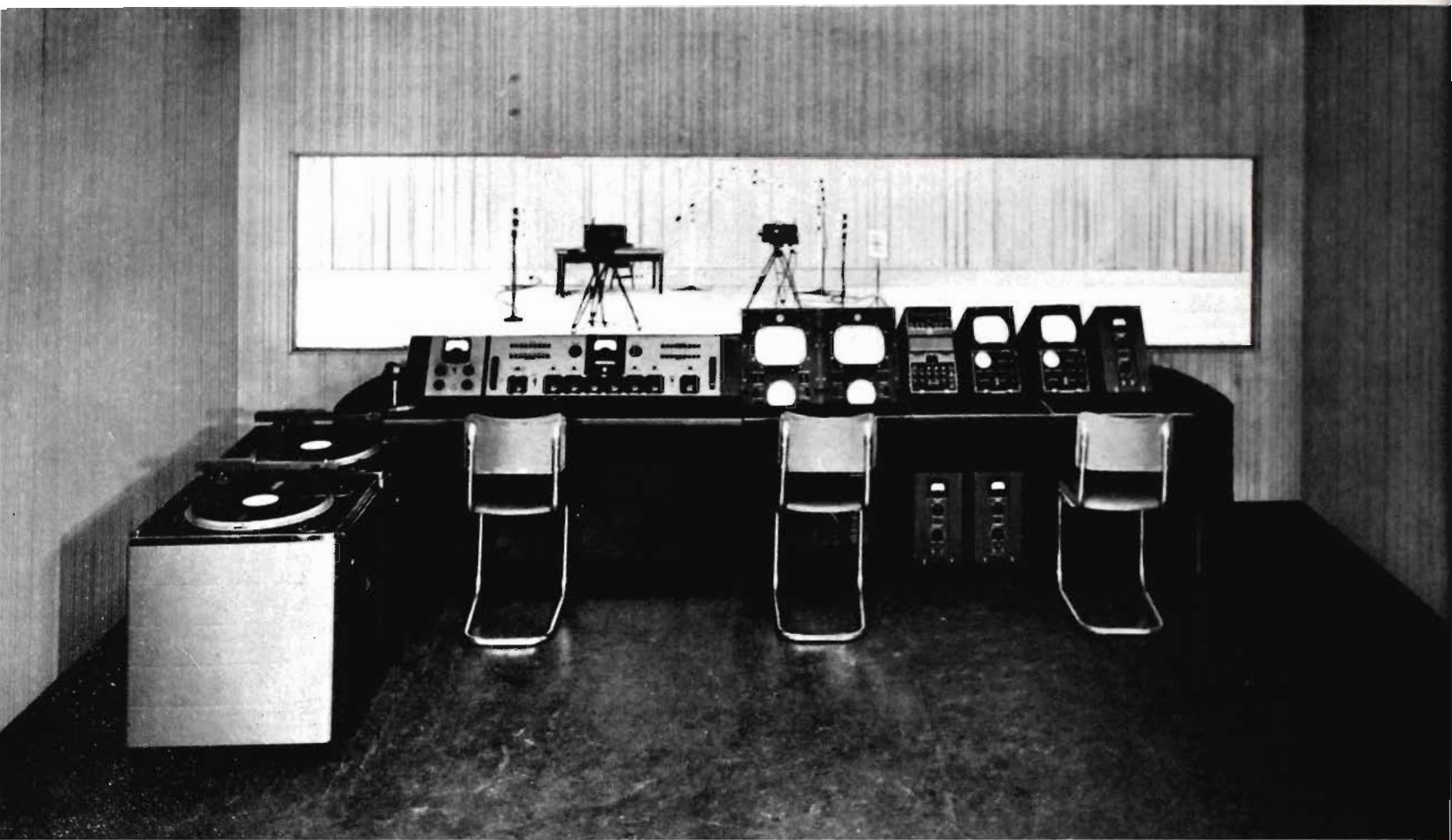

FIG. 12. Typical Control Room for the Type A Small Television Station. Two console sections with picture monitors (center) are standard studio control room units. Portable field-type units on the right, when not used for outdoor pickups, are placed in the control room for production of local studio shows. At left are transcription turntables and the audio control console.

## TYPE A LAYOUT FOR A STATION WITH ONE LIVE TALENT STUDIO, FILM PROJECTOR AND CONTROL ROOM

This plan for a small television station provides the facilities necessary for broadcasting the four main types of television programs; namely, (1) network programs received by coaxial cable from the studios of a network key station, (2) standard 16mm entertainment and commercial films, (3) local studio programs, including live talent, and (4) programs "picked up" at points remote from the studio with portable field equipment, and which are sent to the station via coaxial line.

Broadcasting of these four types of programs with an equipment which represents a relatively low initial investment is made possible by dual use of the RCA Television Field Equipment. This equipment, which consists of portable field cameras, plus small-size, easily portable auxiliary units, is especially designed for use in picking up programs from locations outside the studio—such as boxing matches, football games, nightclubs and the like. In medium-size and larger television stations it will, most likely, be used exclusively for that pur-

pose. However, in small stations (where studio programs may be relatively few in number) it can also be used, at least in the initial stages, as the regular studio equipment. Special, inclined-top tables can be used in the control room to accommodate the camera control units. These tables when placed side by side with the audio or video consoles form an attractive studio control room layout. The field type cameras when used in the studio can be mounted on tripods fitted with mobile dollies. Or, of course, the cameras can be mounted on studio pedestals, or even on crane-type dollies, if desired. Technically, the field type cameras operate very well in the studio.

The facilities for the Type A layout include: one live-talent studio, a film projection room, a combined studio and film control room and an announce booth. In larger stations, the projection room has a control room too, but in this plan for the small station the studio control room houses the film camera control equipment as well as

the studio camera control equipment. Thus, it becomes a combined film and studio control room. Master switching, i.e. between studio, film and remote signals, is also done in the studio control room in this layout.

### Studio Equipment

Equipment for the studio of the small station consists of two RCA field cameras plus the necessary lighting and props required to put on live-talent shows. The field cameras are complete with electronic viewfinders and folding tripod mountings. As previously mentioned, special studio pedestals or crane dollies can be made a part of the studio equipment to enable the cameramen to dolly the cameras, as well as move quickly between two or three "sets" methodically arranged in the one studio. Power for the cameras is supplied through the camera cable from the studio control room. The cameras, microphones, and their mountings, therefore, are the only items of television equipment required in the studio.

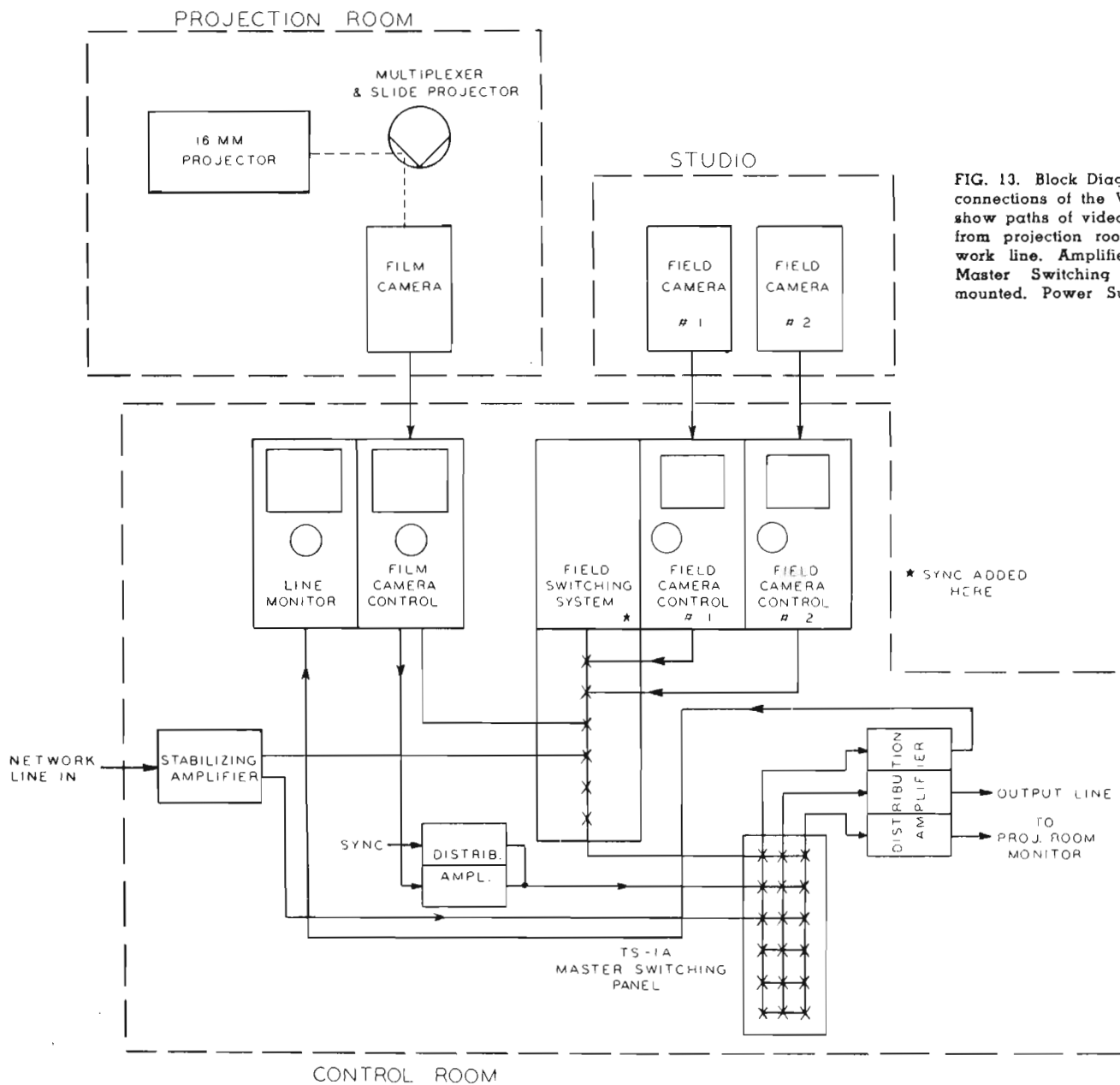

FIG. 13. Block Diagram Showing Interconnections of the Video Units. Arrows show paths of video signals emanating from projection room, studio and network line. Amplifiers and the TS-1A Master Switching Panel are rack-mounted. Power Supplies not shown.

### Control Room Equipment

When the two field cameras are used in the studio for producing live-talent shows, the complete control room equipment will be that shown in Fig. 12. The major items consist of a three-operator console (requiring a program director, one audio and one video operator), two audio turntables, and equipment racks to house the amplifiers, sync generator, and power supplies. The control room console is actually made up of separate audio and video units. But these units are designed to go together to provide a console with unified appearance. The audio control equipment shown in the photos consists of two consolettes. The RCA 76 consolette is the large one next to the video monitors, and the small consolette to the left provides an additional audio channel and private telephone cir-

cuits. This audio equipment is described more fully following the description of these layouts.

At the video operator's position are (a) the two field type camera control units for the cameras in the studio, (b) a field type switching system, and (c) three field type power supplies. Each of the two camera control units contains a 7-inch picture tube, waveform oscilloscope and manual controls for making the necessary adjustments of the picture signals. It is through manipulation of these camera controls that the video operator, while watching the picture produced by each camera, controls its technical aspects. He makes sure each picture has the proper shading and contrast, and that the video and sync levels are correct, as indicated by the built-in oscillo-

scopes. Moreover, he may, at the request of the program director seated beside him, switch the selected signal into the program line; although, it is possible that the director may choose to do his own switching, while at the same time previewing these signals on the picture tubes of the camera controls. The field switcher, which serves for switching any of the incoming signals (including network, film or remote line) to the transmitter room, is located close to the program director for that purpose.

In this plan A setup for the small station, the program director is seated before two standard control room units (a) a line monitor and (b) a film camera control unit. Both of these units are installed in standard studio console housings. In the

upper compartment of each housing is a TM-5A Master Monitor, which has a 10-inch picture tube and a 5-inch CRO tube. This is the monitor which is used in all RCA standard studio and master control room equipments. It is illustrated in Fig. 5, Page 15.

The film camera control has a function similar to that of the field camera control unit in that it supplies the blanking and driving signals for the film camera, and also reproduces a preview picture of the signal generated by the film camera. Controls for adjustment of picture levels and shading are located on the console. The film camera control is located adjacent to the video operator so that he can conveniently observe the picture being displayed on the monitor and keep it at all times technically suitable for broadcasting.

The line monitor alongside the film camera control provides the director with a large bright picture of the video signal being sent (through a rack-mounted master switching panel) to the transmitter room. This picture appears on the monitor as the desired video signal is switched into the transmitter room line. There is a possibility that in some station layouts the control room rack which contains the master switching panel might be located so that the video operator could conveniently reach the switching panel. In this case, the switching panel would then become a master switching position which would enable the operator to view the selected signal on the preview monitor before he switched it to the transmitter room. In either case, of course, the camera control units provide excellent preview pictures, so that a special preview monitor is not an absolute necessity in this layout. Power supplies, for the line monitor and film camera control monitor are mounted in the control room equipment racks.

When the two field cameras are used outside the studio to make remote pickups, the two field camera control units, the three field type power supplies and the field switcher are removed from the control room and taken along with the field cameras and a field type sync generator. These units can be readily removed and replaced without disturbing other equipment in the control room.

During field use of the cameras, there will be three possible sources of program signals: (1) Remotes picked up by the field cameras and relayed by coaxial line to the control; (2) Film signals produced in the projection room; and (3) Signals coming in from an outside network. All

these signals are fed to the rack-mounted switching panel in the control room, from which the program director can select the program signal and route it to the transmitter room. Any one of these signals can be viewed on the monitor, before it is switched to the transmitter line.

### Projection Room Equipment

The film projection room equipment for this typical small station consists of a single 16mm film projector, a film camera for translating the projected picture into a video signal, a rack-mounted picture monitor, and a film multiplexer. The film multiplexer has two mirrors mounted at the re-

quired angle for projecting the images from either one of two projectors on the pickup tube in a single film camera. Use of the multiplexer is suggested in this layout because it is also fitted with a slide projector which can be used for station identification or for projecting other stills.

### Technical Aspects

A functional block diagram of the equipment required by plan A of the small station is shown in Fig. 13. This diagram also shows the schematic arrangement of the various units.

Direction of signal flow between the units is indicated by the arrow-headed lines. Signals brought in through the net-

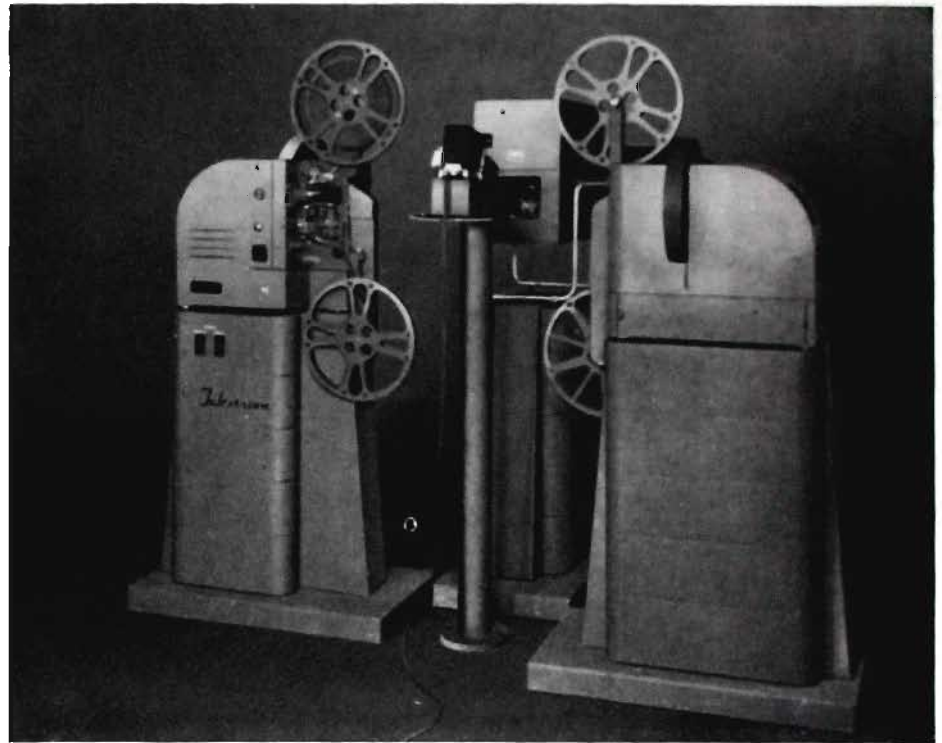

FIG. 14. (Above) Projection Room Setup Consisting of Two TP-16A 16mm Film Projectors, TP-9A Multiplexer (center) and TK-20A Film Camera (rear). Multiplexer operation is illustrated in diagram below. The TP-9A Multiplexer consists of two mirrors and provision for mounting a slide projector. Images from the slide projector, or from either film projector, focus directly into the film camera.

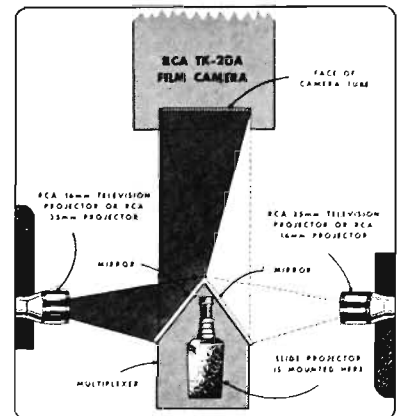
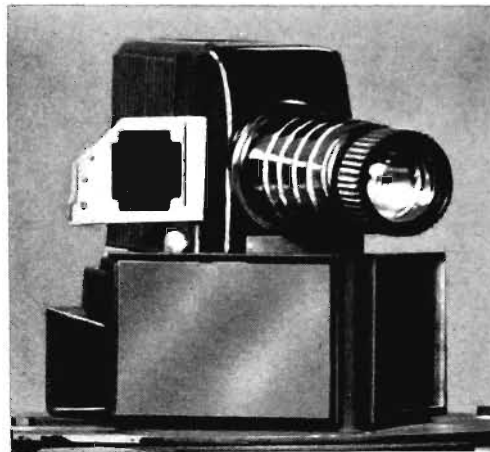
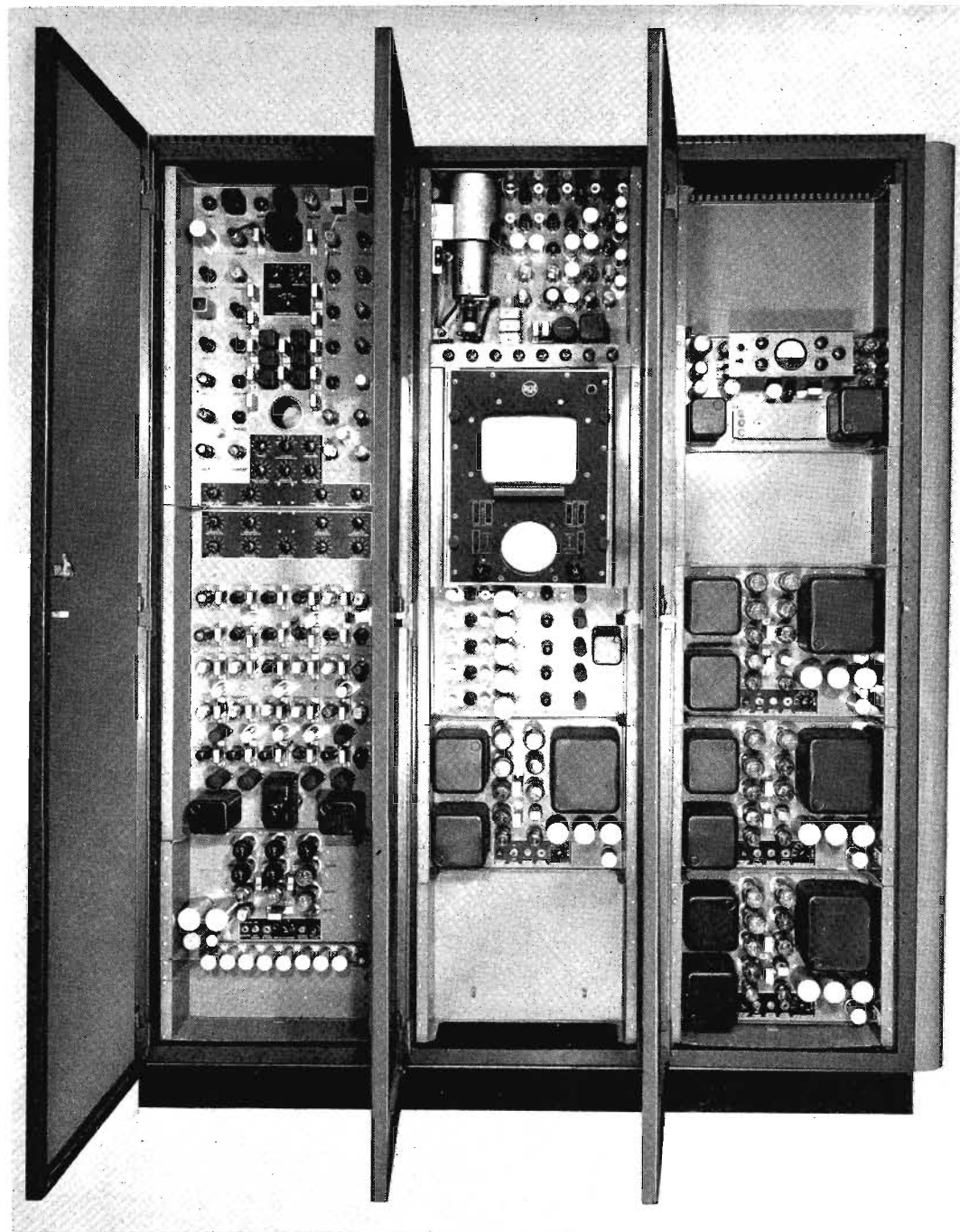

FIG. 15. The synchronizing generator, power supplies, amplifiers, and in some cases, video monitors are rack-mounted items. The three-section rack shown here contains the TG-1A Studio Sync Generator (left section), TK-1A Monoscope Camera, TM-5A Master Monitor, TA-1A Distribution Amplifier (center section), TRR relay receiver control, three WP-33A Power Supplies (right section).



work line or remote pickup line are already mixed with sync. This is the usual condition, the sync being added at the remote source of programming. On the other hand, the video signals from the film camera and from the field cameras (when they are used in the studio) obtain sync from the RCA Type TG-1A Studio Sync Generator (also located in the control room).

The switching system is designed so that the Type TS-1A Switching Panel, a rack-mounted unit, is a master switching point for selection of the major program sources for the transmitter. This makes it possible for the station to use the TS-30A Field Switching System solely for studio re-

hearsals, during which time the TS-1A can be used for switching between network or film signals. Two identical outputs from the film camera feed video to the field switcher and to the distribution amplifier. Sync is added in each of these units. Therefore, when the field switcher is used along with the field cameras to make remote pickups, and the TS-1A panel is in use at the control room, the distribution amplifier will combine sync with the film camera signal. Of course, the Type TG-10A Field Sync Generator can be used as an auxiliary for emergency operation. Like the other field units, this generator is a portable suitcase-type unit. It is used during

outside pickups to supply driving signals to the field cameras and sync to their video outputs.

The Stabilizing Amplifier, through which the network programs pass, is a six-stage video amplifier with special keying and clipping stages. It removes low-frequency disturbances which may be present in the line, and enables the operator to match the sync and video levels of incoming signals to that of the signals generated by the local cameras.<sup>3</sup>

<sup>3</sup> For an explanation of the operation of the Stabilizing Amplifier see "How To Use The Stabilizing Amplifier" by John H. Roe, BROADCAST NEWS No. 49, Page 34.

## TYPE B LAYOUT FOR A STATION SIMILAR TO TYPE A, MODIFIED TO PROVIDE ADDITIONAL PROGRAM FACILITIES

Plan B for the small television station differs from Plan A principally in the technical facilities available for programming. This plan requires slightly more control room equipment and therefore is not quite as economical from an initial investment standpoint. The additional equipment, however, requires no greater floor space than for Plan A, and the added facilities provided permit more flexible programming.

In Plan B, the program director can do more than simply switch from one signal to another. He can fade one camera out, fade the other in, mix the two camera signals in a lap-dissolve, or hold them superimposed. This unique feature, a means for very effective programming, is made possible by the use of RCA's TS-10A Studio Camera Switching System, which supplants the field switcher used in Plan A. This camera switching system (Fig. 17) is described in detail in one of the RCA tele-

vision equipment brochures. It consists of a studio console section identical to the director's monitor section in Plan A. Like this section, it has a large-picture monitor mounted in the upper compartment, but in addition, a mixing amplifier chassis (which performs the technical process of dissolving signals) is mounted in the lower compartment.

In the Type B setup the program director can preview network and relay signals on the monitor directly in front of him before switching them into the transmitter room. There is a selector switch on the TS-10A panel which enables him to do this. Thus, the monitor in this setup can be both a "preview" and "line" monitor for the remote signals. Of course, the monitor in the film camera control section of the console serves for previewing the film signal, and the field camera controls provide preview of the studio cameras, so

that this signal, if desired, is visible to the program director at all times.

The photo, Fig. 16, shows the equipment arranged in the control room. As can be seen, this layout is similar to that for Plan A. Actually it requires somewhat less space than Plan A because the field switching system is not needed in the control room, and the more elaborate TS-10A Switching System occupies space already available in the program director's preview section of the console.

As in Plan A, film facilities are furnished by a film camera, a 16mm projector and a slide projector located in the projection room. The film camera control is a console section similar to the studio camera controls, and is located with them in the control room. The projectionist utilizes a 10-inch picture monitor for cueing and for changeover. This monitor can

FIG. 16. (Below) Control Room for the Type B Small Station. This equipment layout utilizes the Type TS-10A Camera switching and lap-dissolving system, designed for studio control room use. Video units are identified in the block diagram, opposite page.





be mounted in the rack which houses the projector control mechanism, if desired. The Multiplexer is a device which has provisions for mounting a slide projector, and two mirrors mounted at the required angle for reflecting the images from either of two film projectors on the pickup tube in the film camera. Thus, by the addition of another projector, this setup can be easily made to handle multi-reel film shows.

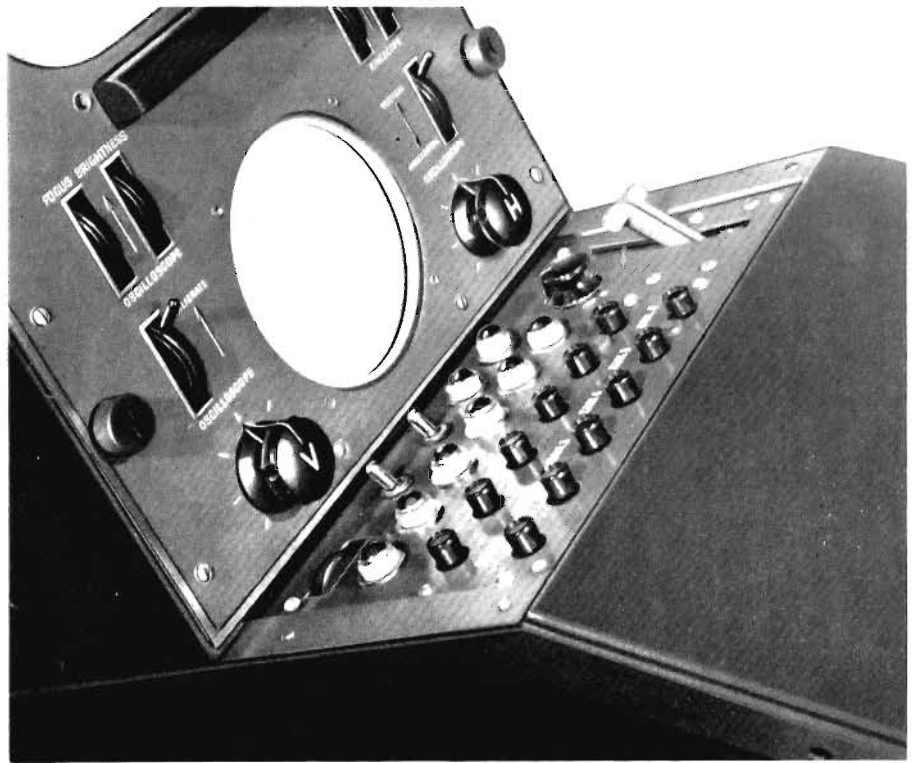
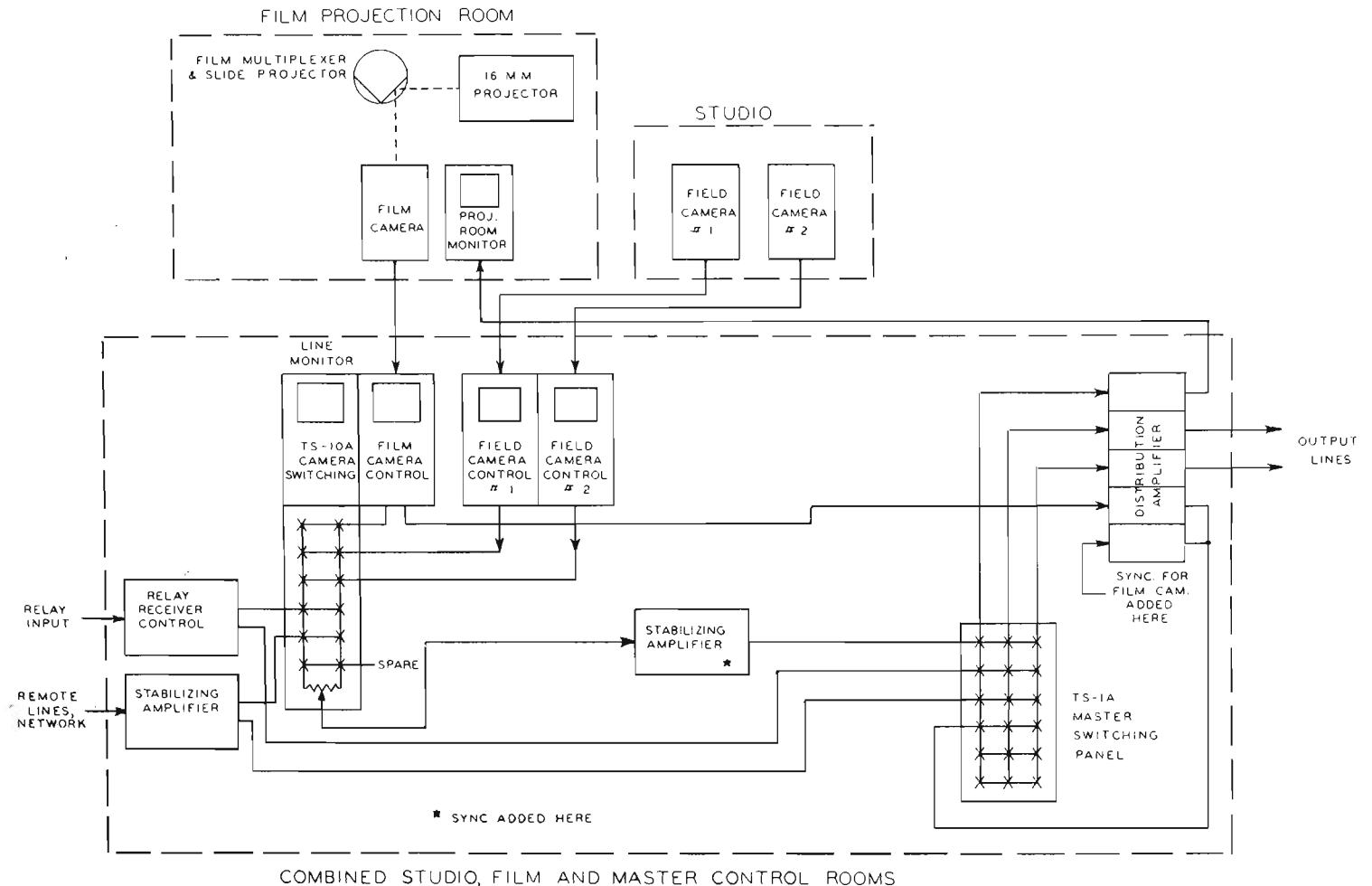

FIG. 17. (Above) Closeup of the TS-10A Switching System. With this system, the program director or the technical director can select the desired camera picture, or superimpose two pictures.

FIG. 18. Block Diagram of the major video items used in the Type B Small Station Layout. The TS-10A Camera Switching System is mounted in a section of the video console. The Master Switching Panel is rack-mounted.



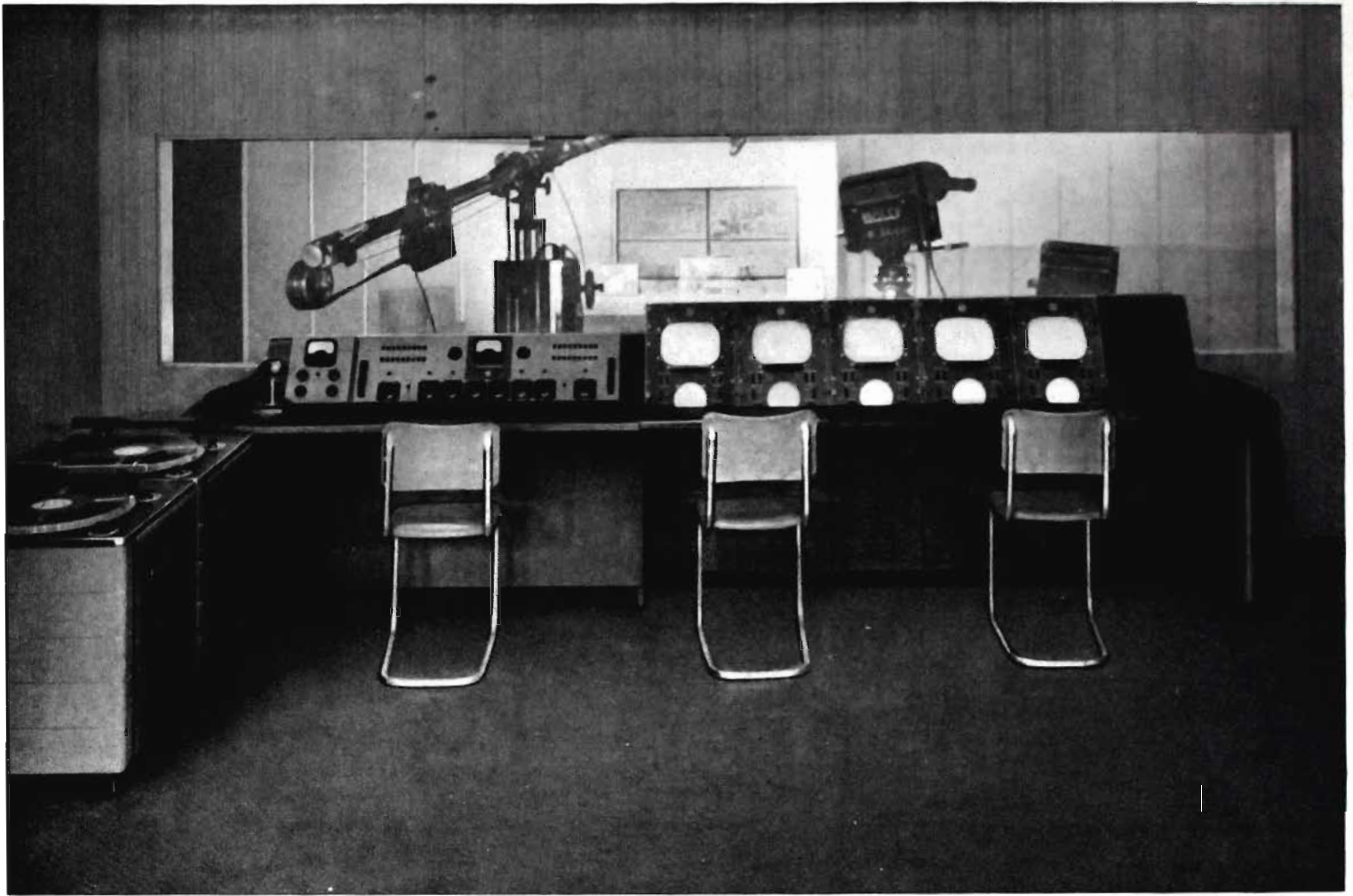

FIG. 19. Control Room of the "Standard" or Medium Size Type C Television Station. This station utilizes Studio-type Cameras and control room equipment. In this layout, field-type cameras and auxiliary control units are used for outdoor and remote pickups.

## TYPE C LAYOUT FOR A STATION WITH INDEPENDENT FACILITIES FOR MAKING STUDIO AND FIELD PICKUPS

The Type C layout is suitable for the so-called "standard" or medium-size television station. In addition to field camera equipment, it includes studio type Image Orthicon Cameras in the studio, and standard RCA studio type control room equipment. Thus, studio programs can be put on even when the field equipment is at some remote location. It has other advantages over the small station layouts previously described, in that, (1) network shows, field pickups, and film shows can be run independently of the studio rehearsals and (2) studio and film productions can be combined with field pickups or other remote signals.

A typical floor plan for the Type C station is shown in Fig. 10. The layout includes a large live-talent studio, a projection room, a combined studio and projection control room, an announce booth, engineering workshop, and props and

dressing rooms. The studio has adequate floor space to accommodate all scenery, property, floor lights, microphone booms, camera dollies, etc. Since there is only one studio in this type station, sufficient space is provided for setting up more than one scene. With sets at either end, for instance, the cameras in the center of the studio can shoot either way. The announce booth is provided with a microphone and video monitor. The video monitor displays a program line picture so that the announcer can see the scene he is commenting on.

In this layout, a program director works directly with one audio and one video operator. The program director is seated at the console located in front of a window looking into the studio, from where he does all the switching, and directs the show through the intercom system. Seated on the director's right is a video operator whose duty it is to get a technically good

picture from each camera. The audio switching and control are done by the audio operator who sits to the left of the program director. Line amplifiers and power supplies for video and audio are located in equipment racks. These racks may be located in an adjoining room if desired. However, it is a distinct advantage to have them on the same floor level, to permit easy movement of video and test equipment between the areas.

Fig. 20 is a functional block diagram of the equipment used in the Type C layout. The combined studio, film and master control room has all the necessary monitoring facilities to monitor and cue the programs emanating from remote points or from both the projection room and the live-talent studio. It also has the switching facilities for routing any of these signals to the transmitter. Video control equipment consists of a TS-10A Switching System, two studio camera controls, one film camera

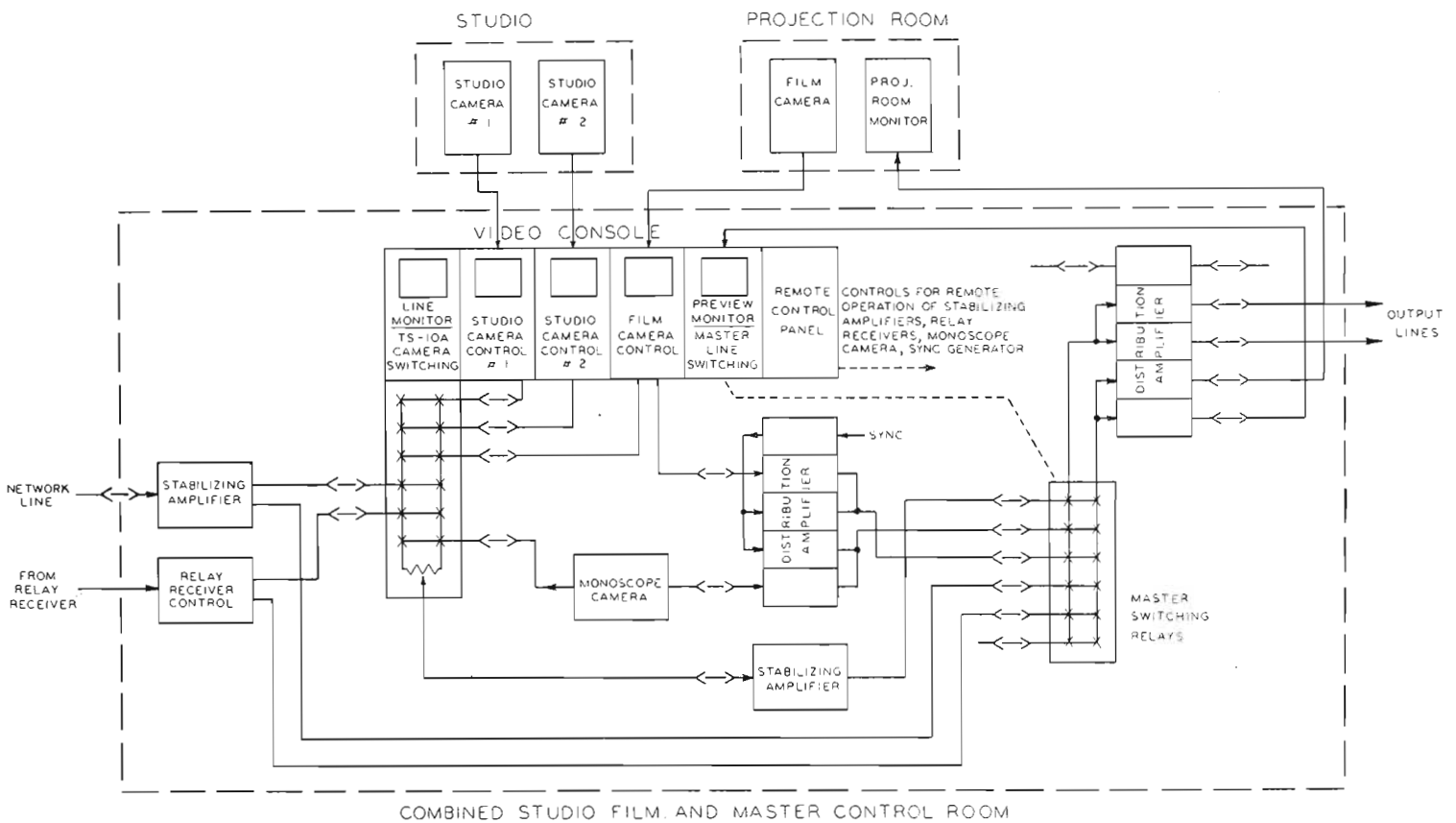
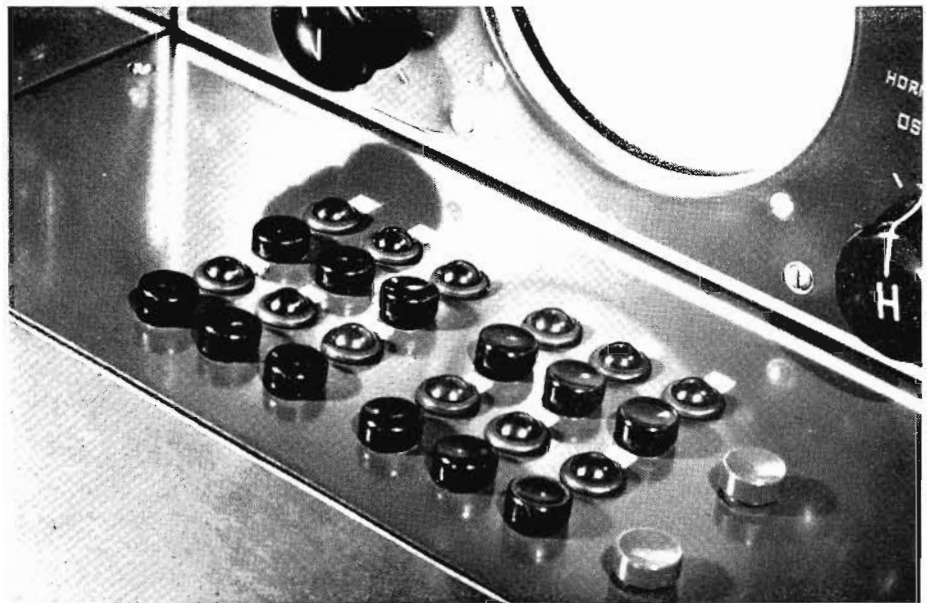

FIG. 20. Block Diagram of the Major Video Units Used in the Type C Station. Master switching in this layout is performed at the video console. Note use of video jacks for patching sources of signal into either the camera or master switching systems.

FIG. 21. (Right) Closeup of Master Switching Position. These pushbuttons, mounted in a console section, electrically operate relays rack-mounted in the control room.



control, a combined preview monitor and master switching section, and a remote control panel. The TS-10A Switching System serves for switching between the two studio cameras, film camera and remote incoming signals such as network or relay signals. The associated line monitor displays the signal going to master control. It also can be used to preview network and relay signals. The remote control panel is mounted in a console section at the right end of the video console. By means of the controls, the operator can make video and sync level adjustments on rack-mounted video amplifiers and sync insertion units.

### Master Switching

The master switching panel is mounted on a sloping portion of the console desk top (see Fig. 21). It consists of a number of pushbuttons which electrically operate the rack-mounted master switching relays. It can accommodate six input lines

and two outgoing lines. One outgoing line is connected to the preview monitor which provides for preview of any of the six inputs. The other outgoing line is connected into the transmitter. The operator, from his position at the console, can preview upcoming signals from all sources on his preview monitor. He can also switch any

desired signal to the two outgoing lines. As can be seen by the block diagram, this layout employs a number of video jacks. These jacks, which are all rack-mounted on panels adjacent to each other, enable operators to patch in any signal either remote or local to either the camera switching system or the master switching system.

### Elevated Platform Setup

Fig. 22 shows another possible arrangement for the equipment in the Type C control room. This arrangement requires another operator (technical director) at the video console. In this plan, the program director and audio operator are located on a platform (2 or 3 feet high) behind the console desk, where they can see all the video monitors as well as all studio action. The video operator is located at the console desk in front of the control room window, to the right of the technical director who has charge of all technical aspects of programming and who does all video switching.

In the platform arrangement, which actually can be used in any of the layouts described, it is important that the program director's desk be as close to the video console as possible to enable the director to look over the heads of the video operator and technical director. Therefore, the distance between platform and console should be kept to a minimum (2 feet, if possible). This, combined with the height of the program director's position gives him a view of the studio and the video monitors. Station layouts Types E and F described later, however, make use of the RCA Director's Console which provides both preview and line monitors in front of the director, and thus obviates the need for a platform arrangement.

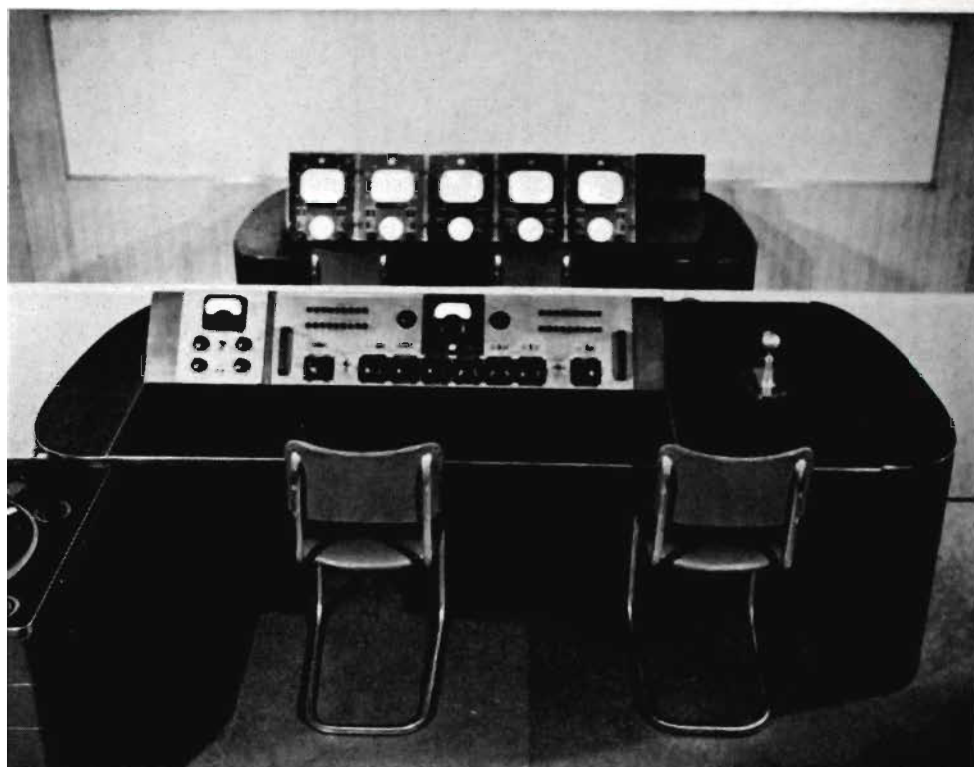

FIG. 22. Some broadcasters prefer to locate the program director and audio engineer on an elevated platform to provide them with a better view into the studio. Shown on the platform in this photo is the audio control console, plus a desk section providing space for the program director and his scripts.

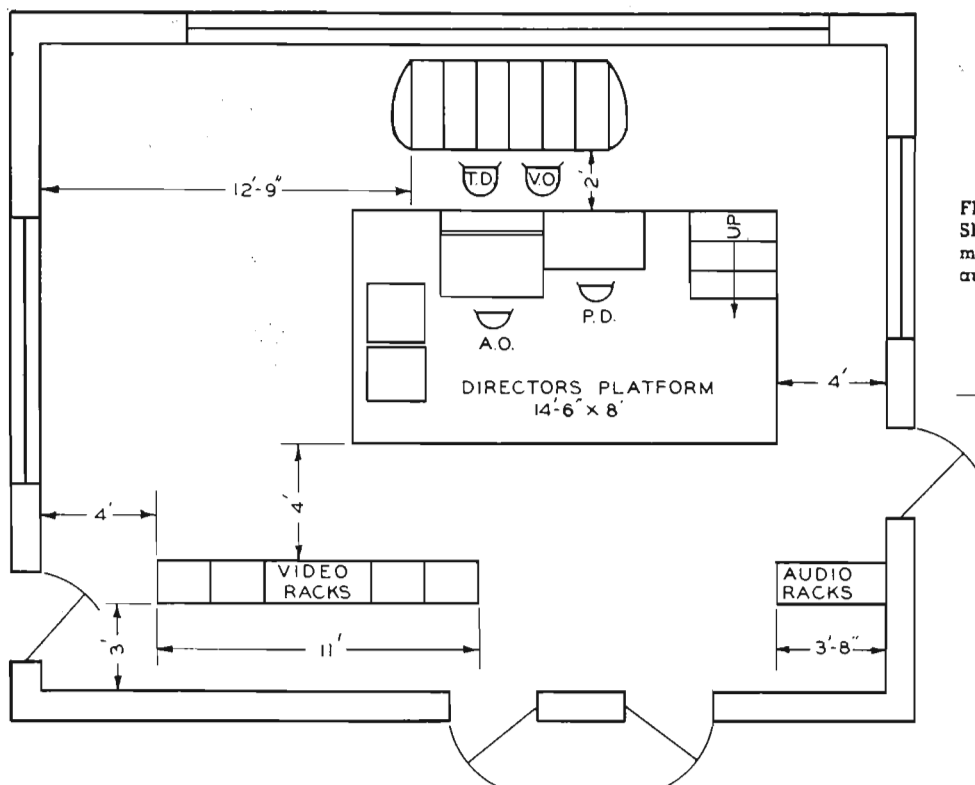

FIG. 23. Plan View of Type C Control Room Showing Program Director's Platform and Arrangement of Control Equipment. The racks contain audio and video amplifiers and power supplies.

A.O. - AUDIO OPERATOR  
 P.D. - PROGRAM DIRECTOR  
 T.D. - TECHNICAL DIRECTOR  
 V.O. - VIDEO OPERATOR

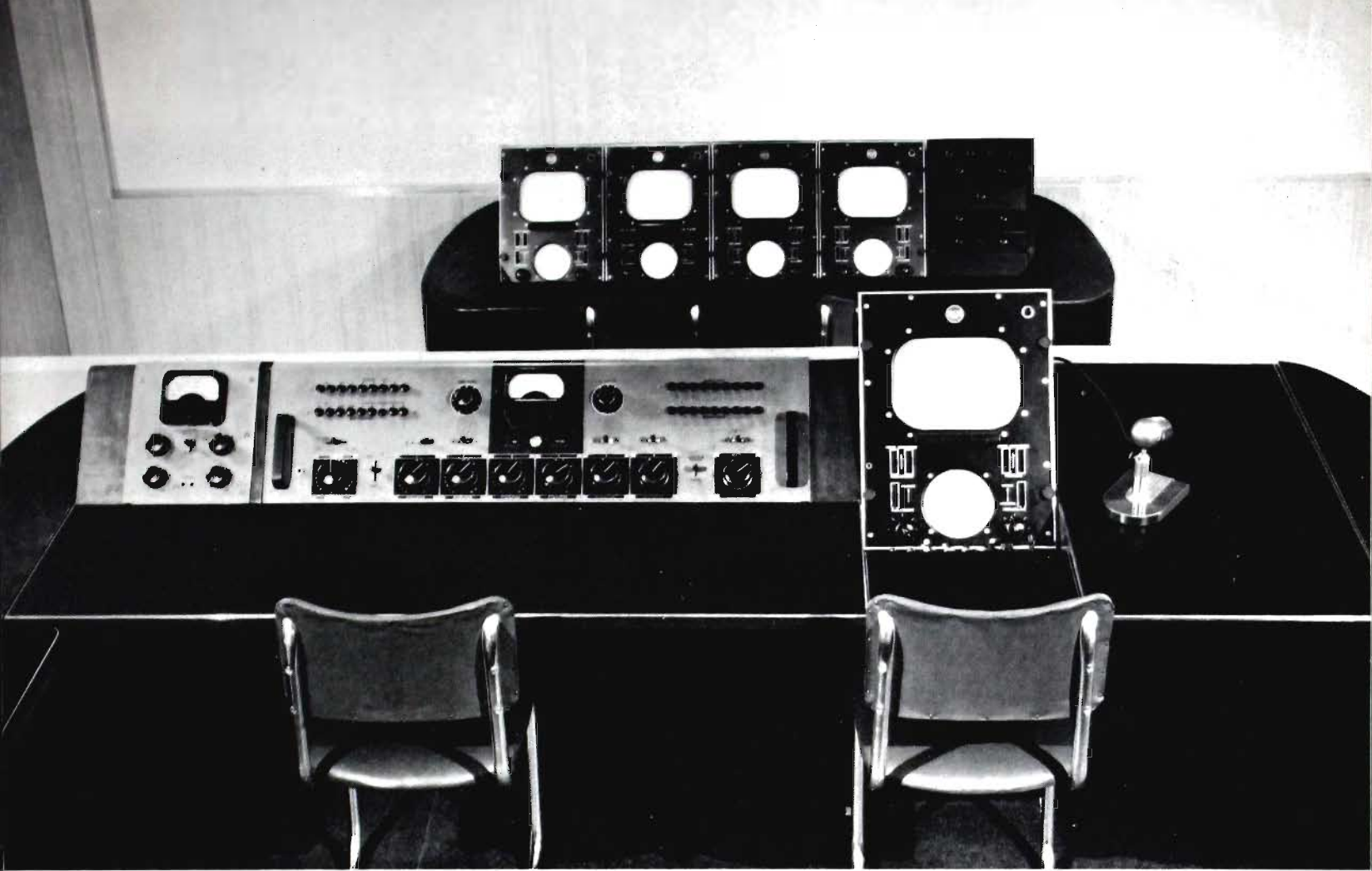

FIG. 24. To provide the director with closer supervision over video switching operations, the TS-10A Camera Switching System can be located on the platform with the audio console, as shown above. Platform setups are possible with any of the equipment layouts described. Photo below shows an arrangement for the Type B station previously described.

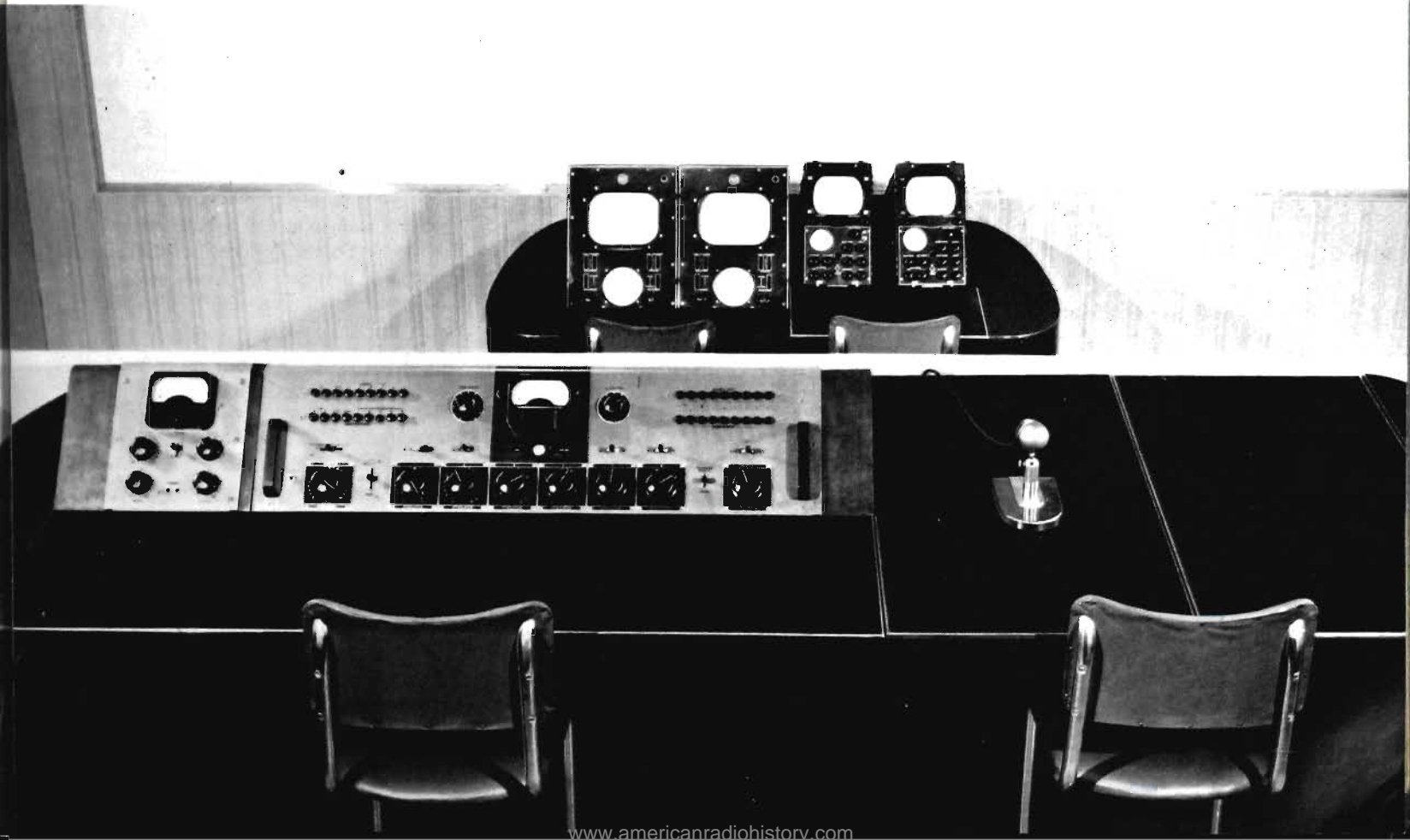



FIG. 25. Studio Control Room of Type D Layout. This layout has a separate control room for the live talent studio, which permits camera rehearsals while remote pickups, network or film shows are being broadcast through master control.

## TYPE D LAYOUT FOR A STATION PROVIDED WITH A SEPARATE CONTROL ROOM FOR ITS LIVE-TALENT STUDIO

A further refinement in the design of the television station is the provision of a separate control room for the live-talent studio. This makes it possible for studio rehearsals to be conducted using the separate control room, while at the same time, broadcasts of network, relay or film programs are being handled in the combined master and film control room. Thus complete camera rehearsals of studio programs can be run without interrupting regular program output of the station.

The studio control room in this case employs a four-section video console comprising a TS-10A Camera Switching System, two studio camera controls and a preview monitor. The combined master and film control room consists of a five-section video console which employs a TS-10A Switching System (for switching and lap-dissolving between the two film cameras), two film camera controls, a transmitter line monitor, a preview monitor and a console section containing the master switching pushbutton and a control panel for remote control of the gain and other functions in

stabilizing amplifiers and relay receivers. The remote control panel is not a necessity, since the units which it controls are usually rack mounted in the control room. However, remote control of these units permits a single operator to make adjustments at the console while watching the picture on the adjacent preview monitor. Also, this system of remote control can be extended to include stopping and starting of film projectors, adjustment of monoscope cameras and shifting of sync generator phase, thus permitting many operations to be carried out from one point in the control room.

A typical arrangement of the equipment in the Type D studio control room is shown in the photo above. This control room is a complete unit capable of putting on live-talent shows, film shows, network programs, outdoor pickups, and slides. The flexible system of jack panels in the master control room enables any of these signals to be patched into, and thus be controlled from, either the studio control room or master control. Another feature, the

use of preview relays (controlled from a switching panel on the preview monitor desk) provides preview pictures of any one of these signals.

Using the studio and this control room, both production and technical aspects of the television program can be carried out. The photo shows positions for three operators: left to right, they are audio operator, program director and video operator. Here, the program director has charge of all camera switching which he can perform by use of the TS-10A switching system in the console section before him. The picture appearing on the monitor in this console section is that from the camera which he selects for program line. The picture appearing on the monitor in this console section is that from the camera which he selects for the program line. The video operator's duty is to keep each of the cameras at the proper contrast and brightness levels and in general maintain good picture quality. Preview pictures from each camera, of course, are viewed on the two

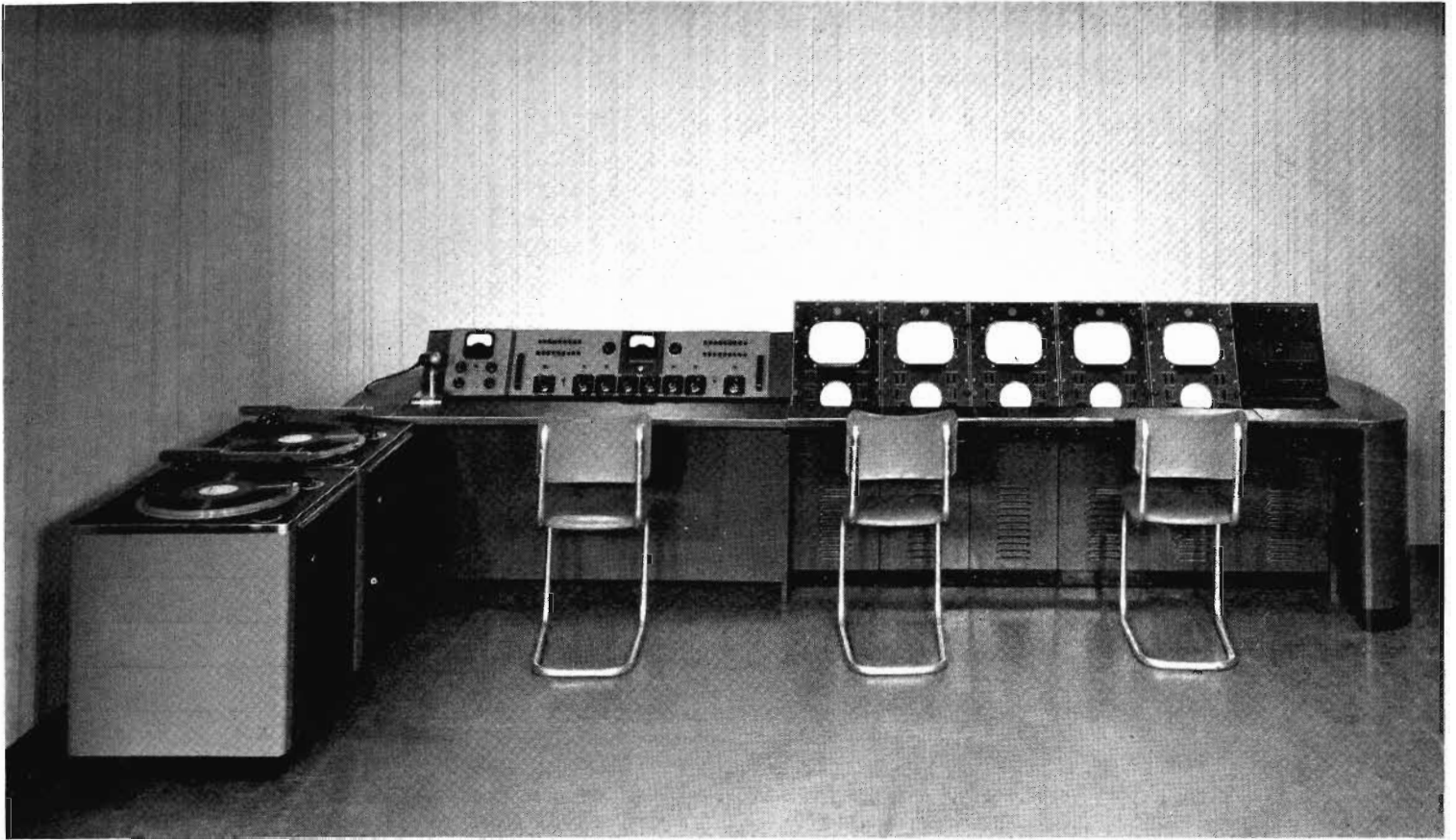
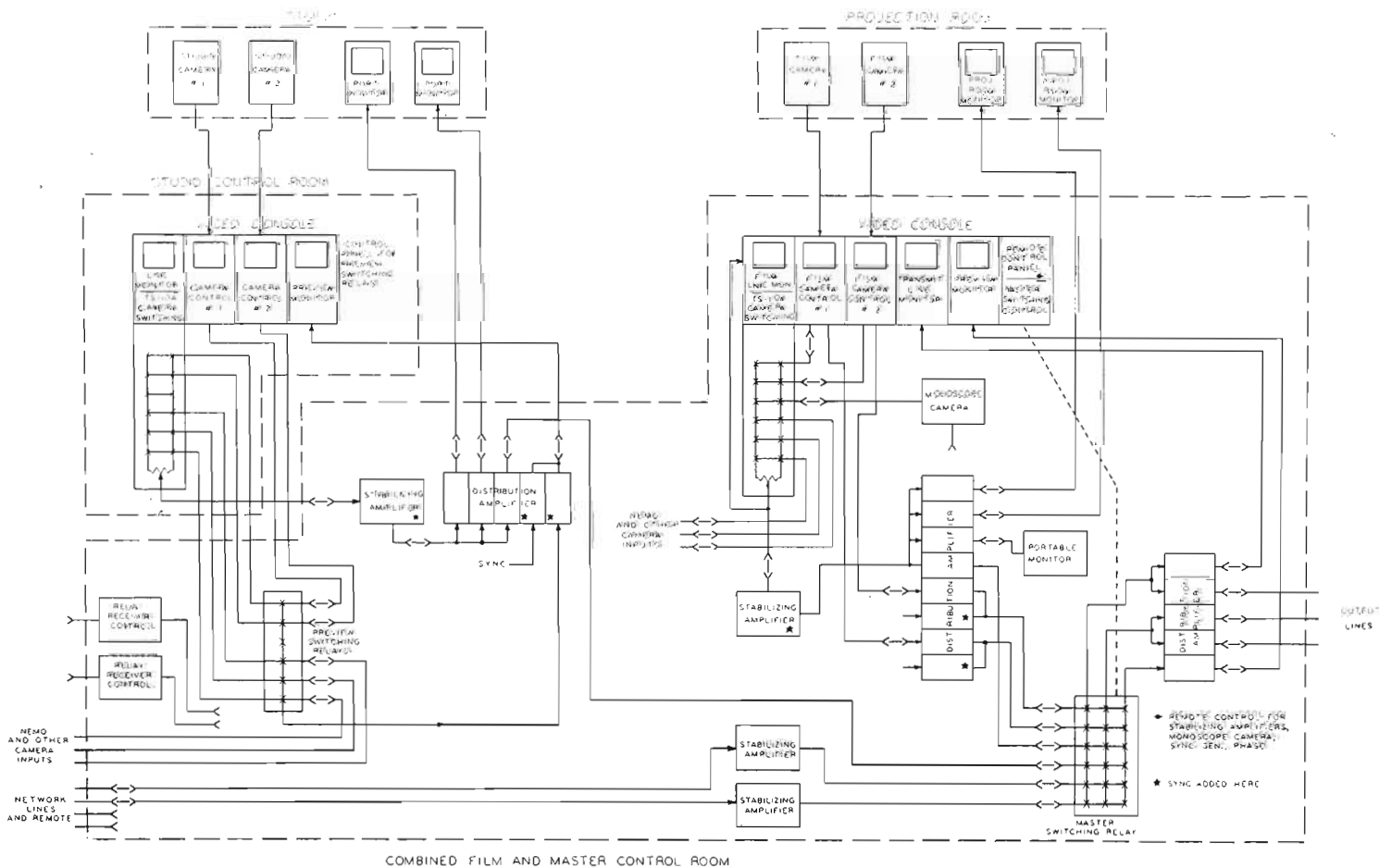

FIG. 26. (Above) Combined Film Control and Master Control Room of the Type D Station. Audio and video console handles output from film projection room, network lines and microwave relay. FIG. 27. (Below) Block Diagram of Video Units in Type D Layout. The video console in each control room contains a TS-10A Camera Switching System. Through a rack-mounted system of jacks, any source of signal can be fed to either control room for cue or insertion into the program.



camera control monitors in front of the video operator. The preview monitor at the right end of the console displays the signal (relay, network, or film) which could be broadcast during studio rehearsals, or switched in as a part of the studio program. Thus, the preview monitor provides a means for cueing the studio show into the program line, when necessary, as well as previewing external cameras to be switched in. Use of patch cords and jacks in master control makes it possible for the program director from his position in the control room to switch films in as part of

a studio show. Films and slides are frequently used during station identification breaks.

The schematic arrangement of the entire video switching system is shown in the block diagram of Fig. 27. Video signals from the studio cameras, film cameras and monoscope test camera are fed to their respective switching systems in the studio control room and in the master and film control room. Output from the studio control room as well as from the projection room is fed to the switching system in the

master and film control room, where the desired program signal can be selected. As in the C type layout, pushbutton operated relays are used for master switching. The master switching system in this layout, however, has an additional bank of relays, which provides an additional output line. These output lines can feed to the transmitter room, to clients' viewing rooms or even to a network line. Switching between film cameras is performed by a TS-10A Camera Switching System identical to that used in the studio control room.

FIG. 28. Partial Floor Plan for the Type D Station. The equipment arrangement shown is for the Type E station described on the following page. The floor plan will serve for both D and E Type layouts. Note location of announce studio so that visual cue can be taken from either control room.

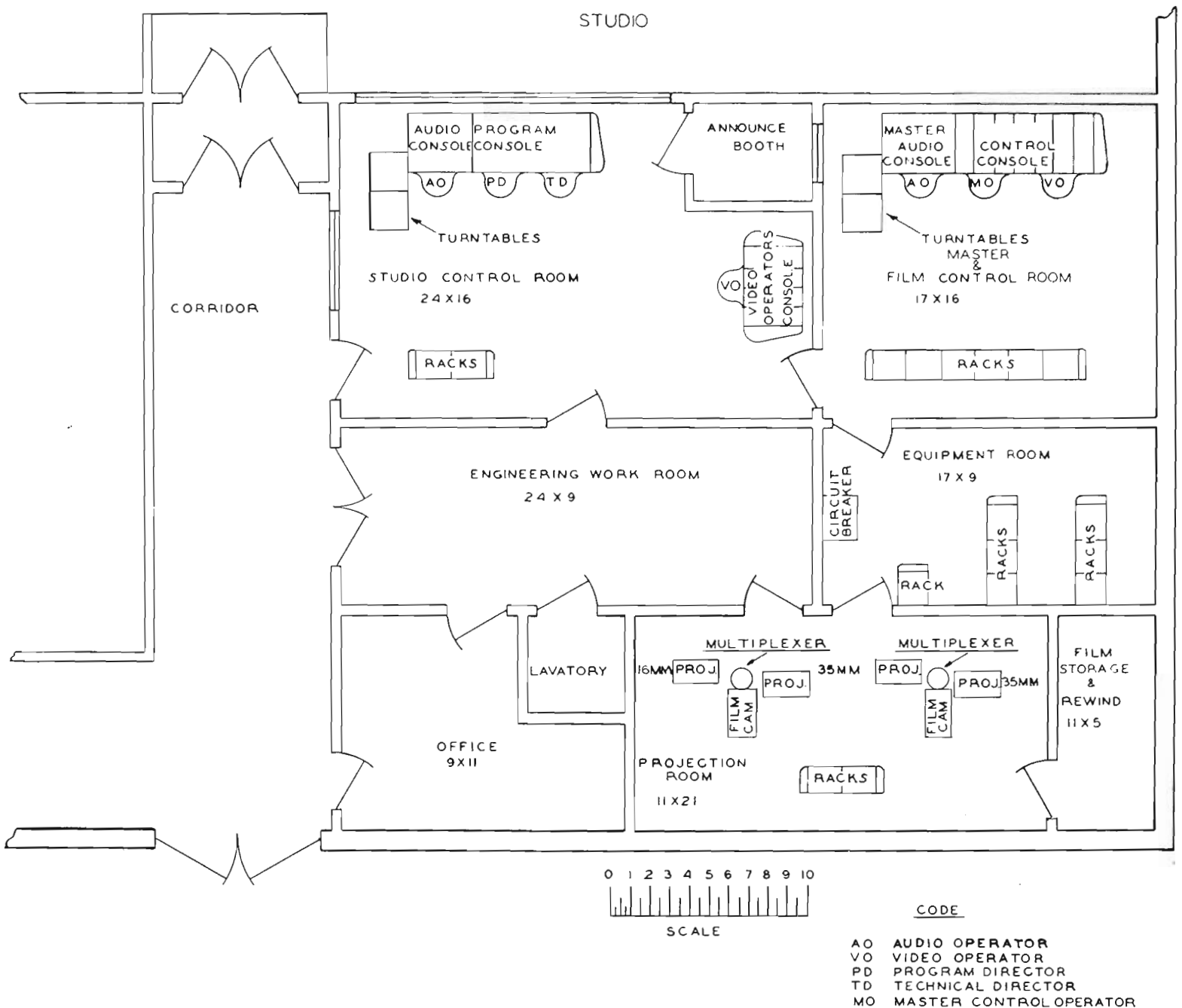



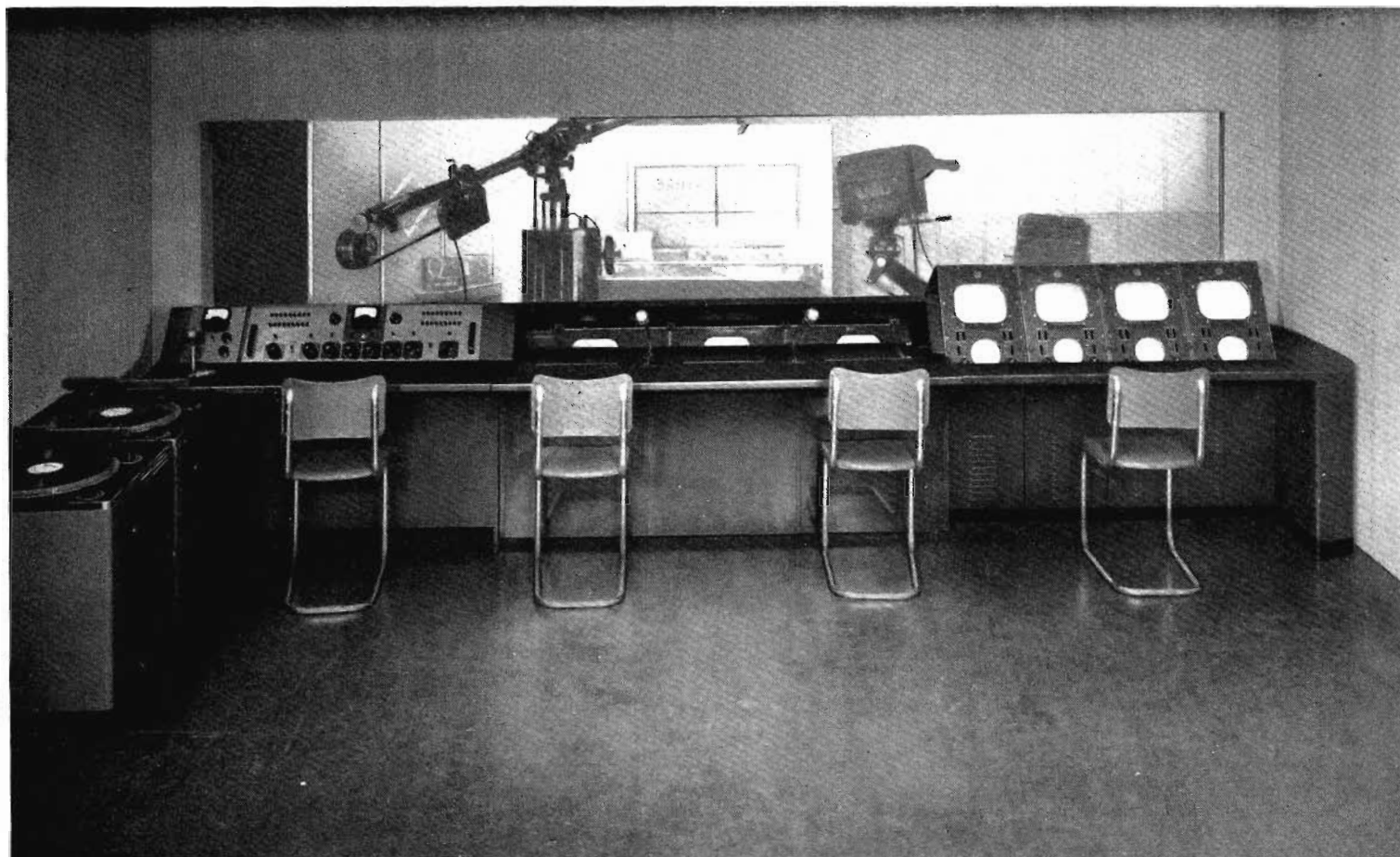

FIG. 29. Studio Control Room of the Type E Layout. This layout employs two control rooms, and features the utilitarian Program Director's Console (center), described in the text. Video Console at right displays pictures from each of three Studio Cameras plus picture on studio output line.

## TYPE E LAYOUT FOR A STATION SIMILAR TO TYPE D, MODIFIED FOR FURTHER FLEXIBILITY IN ARRANGEMENT AND UTILITY

The fifth type of television station is the Type E arrangement. Like the Type D previously described, Type E employs one live-talent studio, a studio control room, a projection room and a combined master and film control room. It differs from the D layout in that an RCA Program Director's Console (center in photo above) replaces the TS-10A Camera Switching System in the video console. The director's console has a pushbutton switching panel which operates rack-mounted relays for camera switching. It also has large picture monitors which provide the director with preview and line pictures. Another difference in the layout is the use of three studio cameras instead of two: Space in the video console section previously occupied by the TS-10A Camera Switching System now houses the camera control chassis for the additional camera. As in layout D, a TS-10A Camera Switching System is used for switching between two film cameras and remote signals. A functional block diagram of the layout is shown above.

Use of electrically-operated relays for studio camera switching adds to the layout flexibility of the system, particularly as to the locations of the control rooms. This becomes even more important when more than one studio is provided. Delay compensation for the different studio runs is simpler when all camera switching is done at one central location.

### Camera Relay System

The camera switching system used here is designated as the Type TS-20A Remote-Control Studio Switching Equipment. Basically it consists of the program console with its monitors, banks of momentary-contact pushbuttons and tally lights, and fader controls mounted on the console desk, plus associated rack-mounted equipment such as relay panels and fader and stabilizing amplifiers. As can be seen in the drawing, signals from all cameras including mono-

scope test cameras, network and relay signals, when patched into the relay system, can be switched to master control. These local signals can also be lap-dissolved and faded.

The Program Director's Console is another outstanding feature of this layout.

This console, which is illustrated in Fig. 30, is designed expressly for use by program and technical directors in supervising studio programs. The console is only 37 inches high (which provides full view of the studio). It can accommodate as many as five 10-inch monitors, which are recessed below the desk top to prevent direct light from striking the screens. These five monitors can provide the directors with preview pictures of all cameras if desired, plus pictures from a network signal and the program line. The photographs show the arbitrary use of three monitors in the console: a preview monitor which displays the picture produced by any one of the three cameras; a line monitor which displays the signal switched to master con-

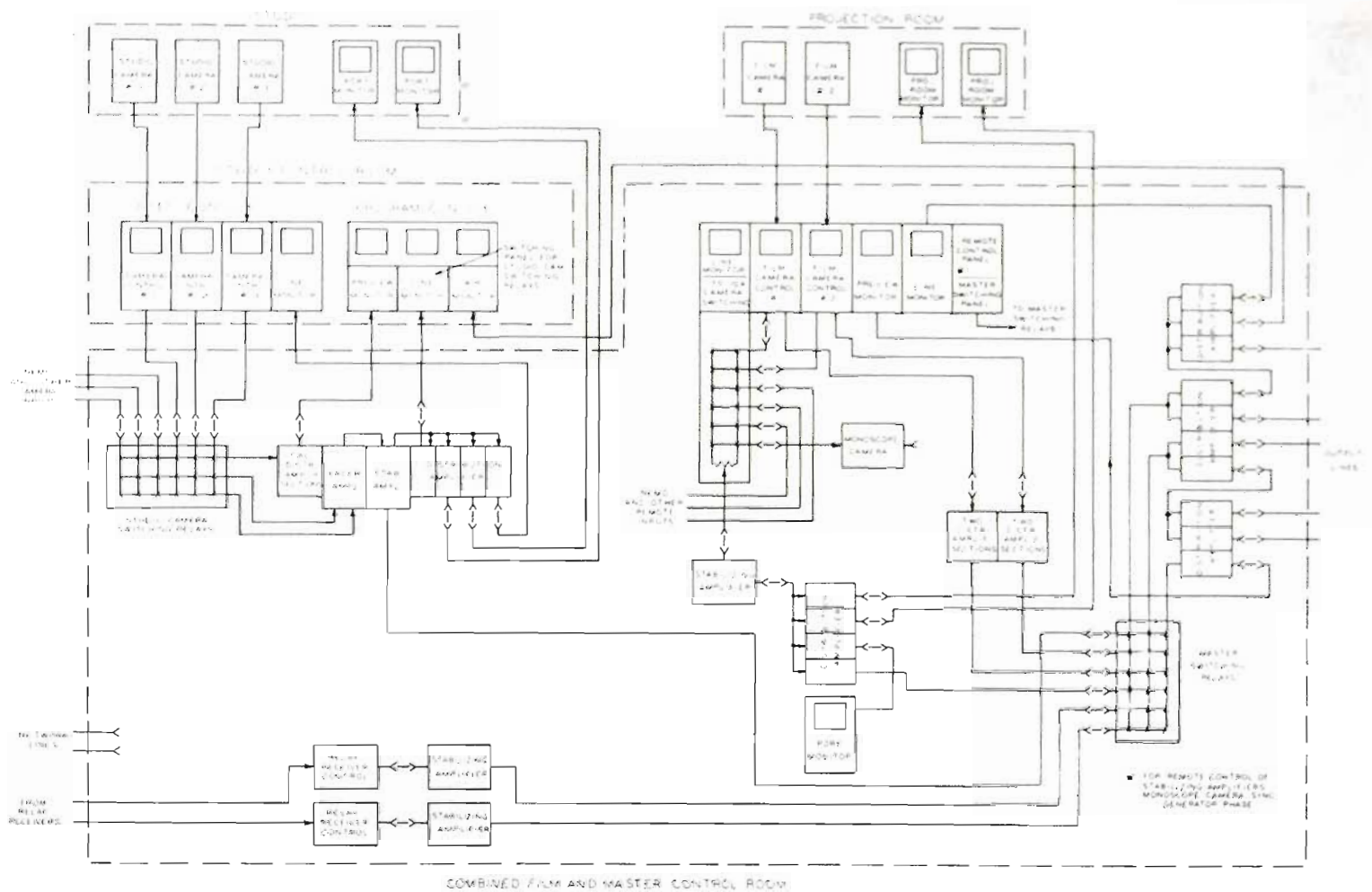

FIG. 31. Block Diagram of the Type E Layout. In this layout studio camera switching is performed at the program director's console. Pushbuttons mounted on the console operate relays rack-mounted in the control room.

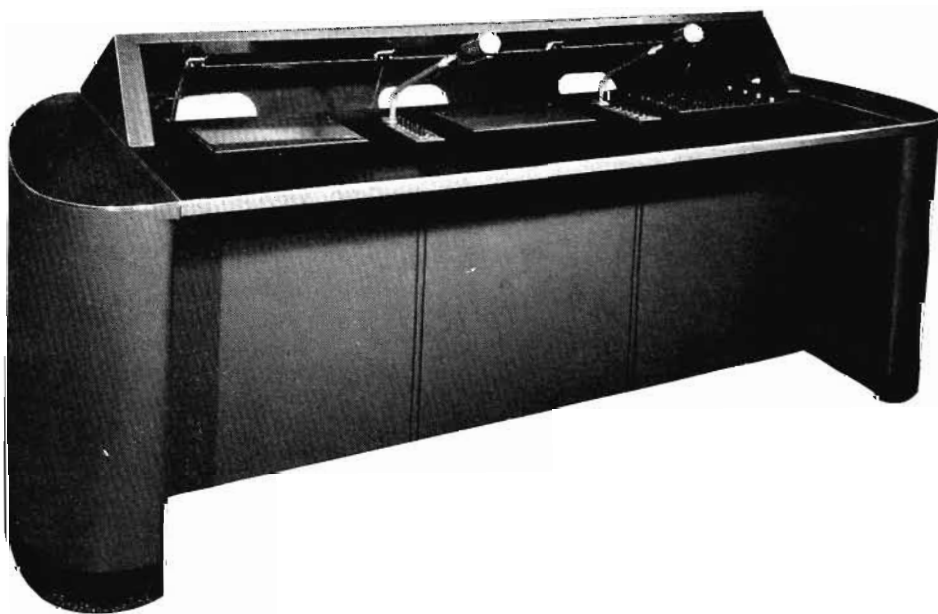

FIG. 30. Type TC-5A Program Director's Console. This modern console provides the program director and technical director with pictures of the scenes being picked up by the individual cameras, from which the program signal can be selected.

control; and an "air" monitor which shows the picture on the output line of the master control room.

The Director's Console is unique in that the program and technical directors have large bright pictures of the program directly before them and need not depend on their ability to see the monitors in the video operator's console, which may be located several feet away. In this setup, the technical director would ordinarily do the necessary switching at the request of the program director. Both directors can use the intercom and talkback system, built into the console, for communicating with production and technical personnel at the cameras and in the control room, projection room, dressing rooms, etc.

Use of a number of distribution amplifiers on the outgoing lines of the master switching system provides in this layout three independently switched output lines from master control. These output lines may be used to feed the transmitter room, clients' viewing rooms, and one or more networks lines.

## TYPE F LAYOUT FOR A STATION UTILIZING TWO (OR MORE) LIVE-TALENT STUDIOS

Type F is a complete equipment layout for a "master" television station with facilities for the production and broadcasting of all types of television programs. It includes facilities for simultaneously originating and rebroadcasting different network shows. Such a station is usually provided with: (1) a film projection room with a projection control room; (2) two or more studios with individual control rooms, so that live-talent rehearsals can be carried out while studio programs are on the air; (3) facilities for picking up outdoor events; and (4) a master control room in which the desired program material can be selected from any of the above mentioned sources.

The Type F layout does not represent the ultimate as far as a station layout

is concerned; but it does illustrate the schematic arrangement of the equipment required for a station employing two studios and providing the facilities needed for the master type station. This layout is designed to furnish a high degree of flexibility in programming. Facilities are provided to handle live-talent shows, films, outdoor pickups and remotely originated shows, while rehearsals are in progress at the station. It consists of a large studio (Studio A) with its own control room; a smaller studio (Studio B) with its own control room; a projection room with its own control room; and a master control room. Each of the studios is a complete unit, capable of producing live-talent shows. Output from film control and from each of the studios, as well as signals from networks and remote pickups

are routed through master control where the signal to be fed to any one of the outgoing lines can be selected. The flexible system of jack panels permits remotes, film and other studio outputs to be switched at either of the studio control rooms as well as at master control.

### Film Facilities

The projection room houses the film projectors, film cameras, and slide projectors. Three film cameras can accommodate as many as six projectors, using the Type TP-9A Multiplexer, a mirror device previously described. However, as suggested in the drawing, a more utilitarian arrangement might be to set up one film camera which will handle slides exclusively, and provide four film projectors (two 16mm

FIG. 32. One of the Studio Control Rooms in the Type F Station. This type station employs two or more studios each with similarly equipped control rooms. Several other physical arrangements of the unit-built control equipment are possible.



and two 35mm) to be used with the other two film cameras. However, the Multiplexers can be obtained equipped with slide projectors so that it is possible to insert slides into any camera chain even though it has been set up with two motion picture projectors.

The switching system for the film camera control room is a relay switching system of the same general type used in the studio control rooms. The pushbuttons which operate the relays are mounted on

the desk section of the video console located in the film control room. The system is capable of switching and fading between any of the three film camera outputs. Jack panels located in master control also provide for patching in remote signals or signals from other cameras to this switching system. In addition to the above, the output of each film chain is connected to the master switching system through a distribution amplifier (where the sync signal is added). This makes it possible to put on film shows or preview a film in a

client's room without use of the camera switching system.

### Remote Signals

Facilities are available for handling a number of remote signals by telephone company lines and by microwave relay. Stabilizing amplifiers are available on the same jack panels as the incoming signals so that they can be connected into the circuits. The stabilizing amplifiers are designed to set the proper synchronizing-to-picture ratio and to improve the quality of the synchronizing signal of incoming remotes. The stabilizing amplifier utilizes clamp circuits to remove hum, bounce, and other line disturbances.

The relay receivers and the stabilizing amplifiers are rack mounted in the master control room and their remote controls are brought to a console section for convenience in setting up and operating the equipment. Each of these pieces of equip-



FIG. 33. The Type F "master" station employs separate control rooms for its studios, projection rooms and for master control functions. Above photo shows the master control console; below is the film control console. Diagram at right is a partial floor plan of the station.

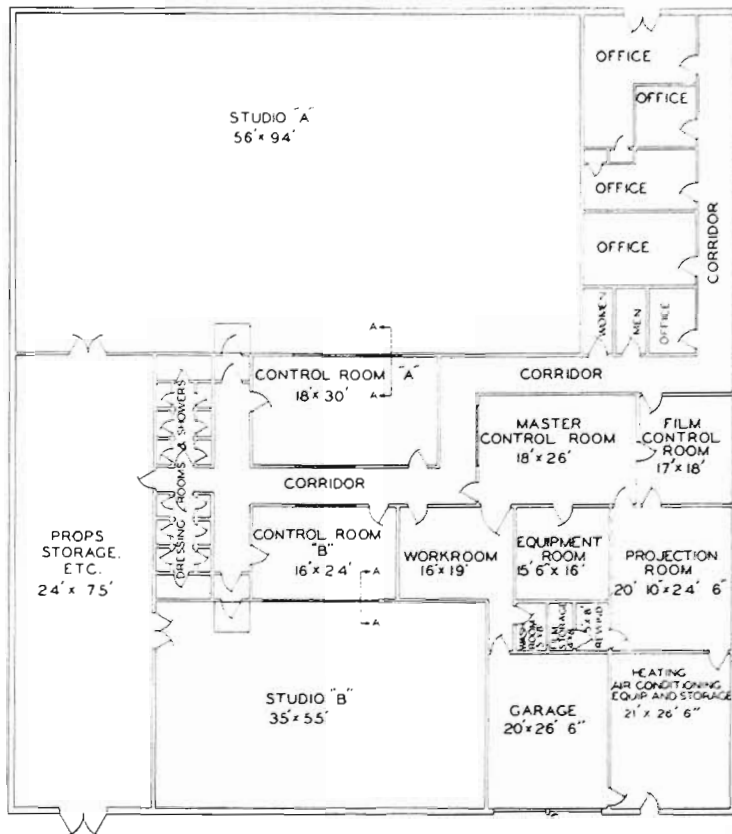
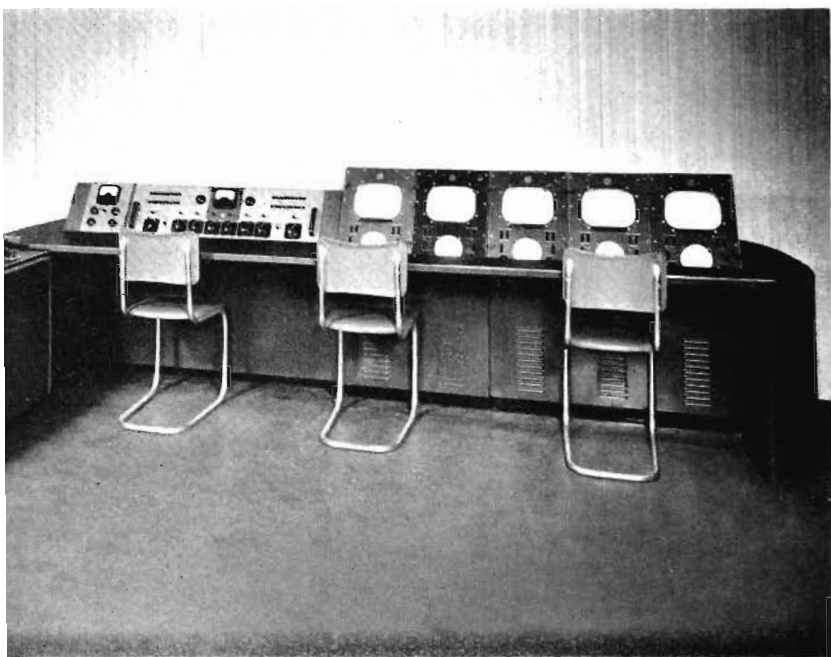

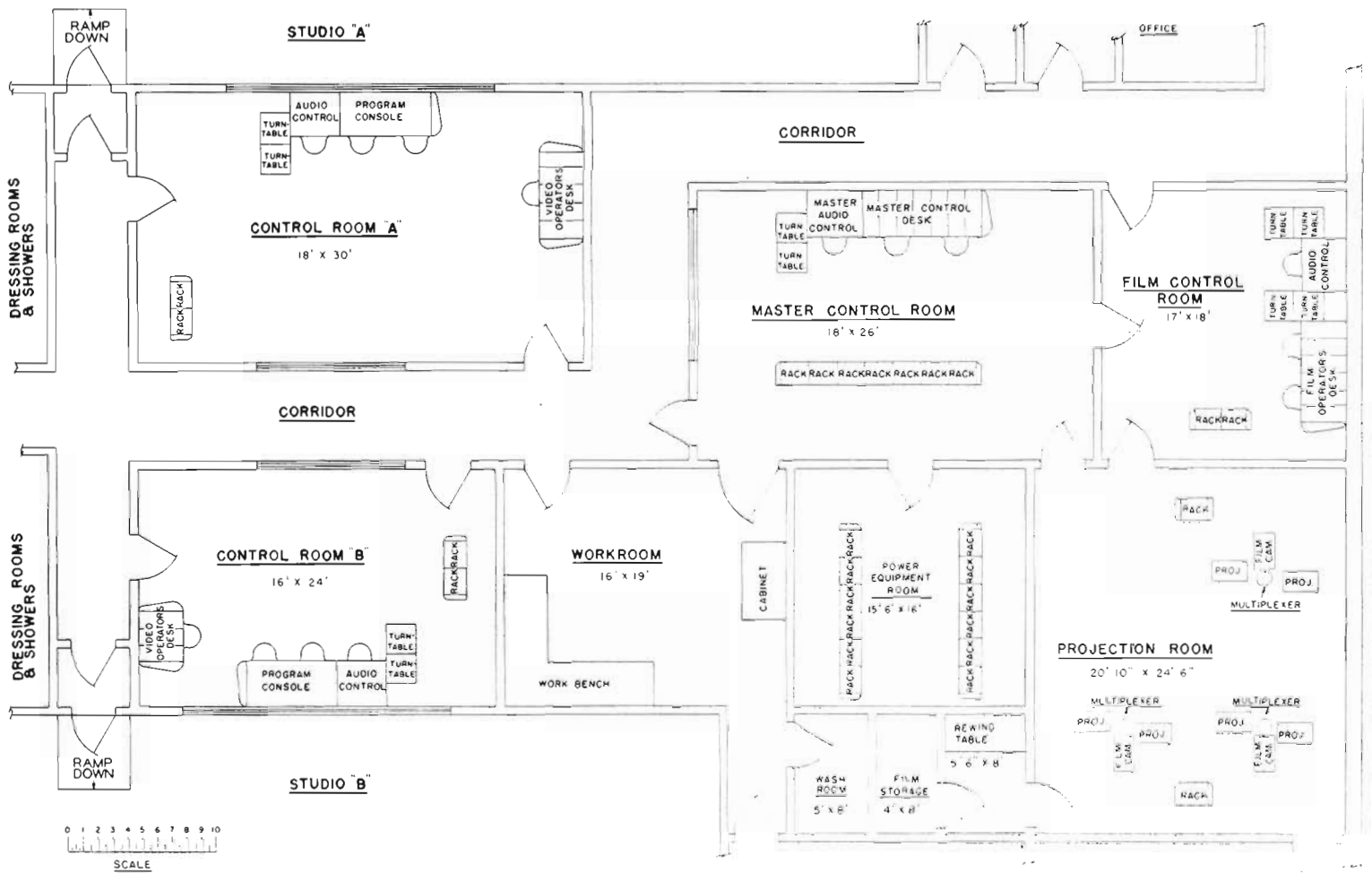

FIG. 34. Diagram showing Layout of Control Rooms and Arrangement of Equipment for the Type F Station.

ment has two outputs available at jack panels so that signals can be fed to the master switching system or to the studio camera switching system independently.

### Master Control Room

All switching for the station (including studio camera switching) is accomplished by relays located in the master control room. Video signals, local and remote, are fed to jack panels where they can be connected into any part of the system. All camera signals are fed to a jackboard where they are normally connected through to the corresponding video switching relays. These relays are controlled from pushbuttons located in the various switching positions. Each studio control room has associated with it three banks of interlocked relays, two for the fader amplifier and one for the preview monitor.

The master control switching selects the desired composite signal for transmission. This system consists of six banks of twelve interlocked relays each, thus providing for six output circuits and up to twelve input circuits. Two of the output circuits are

fed to two preview monitors located in the master control console. The four remaining lines can be switched independently to any of the twelve incoming signals. This provides for four separate programs to be transmitted at one time. Each of the four outgoing program signals can be connected to distribution amplifiers to give additional outgoing lines to feed clients' rooms, viewing rooms, offices, studios, etc.

The master control console itself consists of five video console sections. Two of these contain the two preview monitors, one contains the on-the-air monitor, one the switching controls, and one contains the remote controls for stabilizing amplifiers, relay receivers, and sync generator phasing controls.

Two synchronizing generators (one a spare) are provided in the master control room with a switch to select the desired generator for use. This then feeds distribution amplifiers to distribute the blanking, driving, and synchronizing signals to the various parts of the system. In case

the differences in physical separation of the master control room and the individual studio control room is great, delay compensation can be inserted between the sync generator and the various distribution amplifiers.

This overall system is extremely flexible as it provides numerous combinations of camera facilities for programming and rehearsal. Cameras and remotes can be patched into any studio switching system so that the program director at his console in a studio control room can have complete control over the switching of any studio cameras, film cameras, or remotes that he may require to make up a given program. A complete film program can be run entirely by master control room when so required. In this way the facilities of an individual studio may be used for rehearsals while another studio or film is put on the air. One film chain may be used for a program while other film is previewed in a client's room without interference. Thus almost any combination of facilities may be used to suit the particular requirements that may arise.

STUDIO A

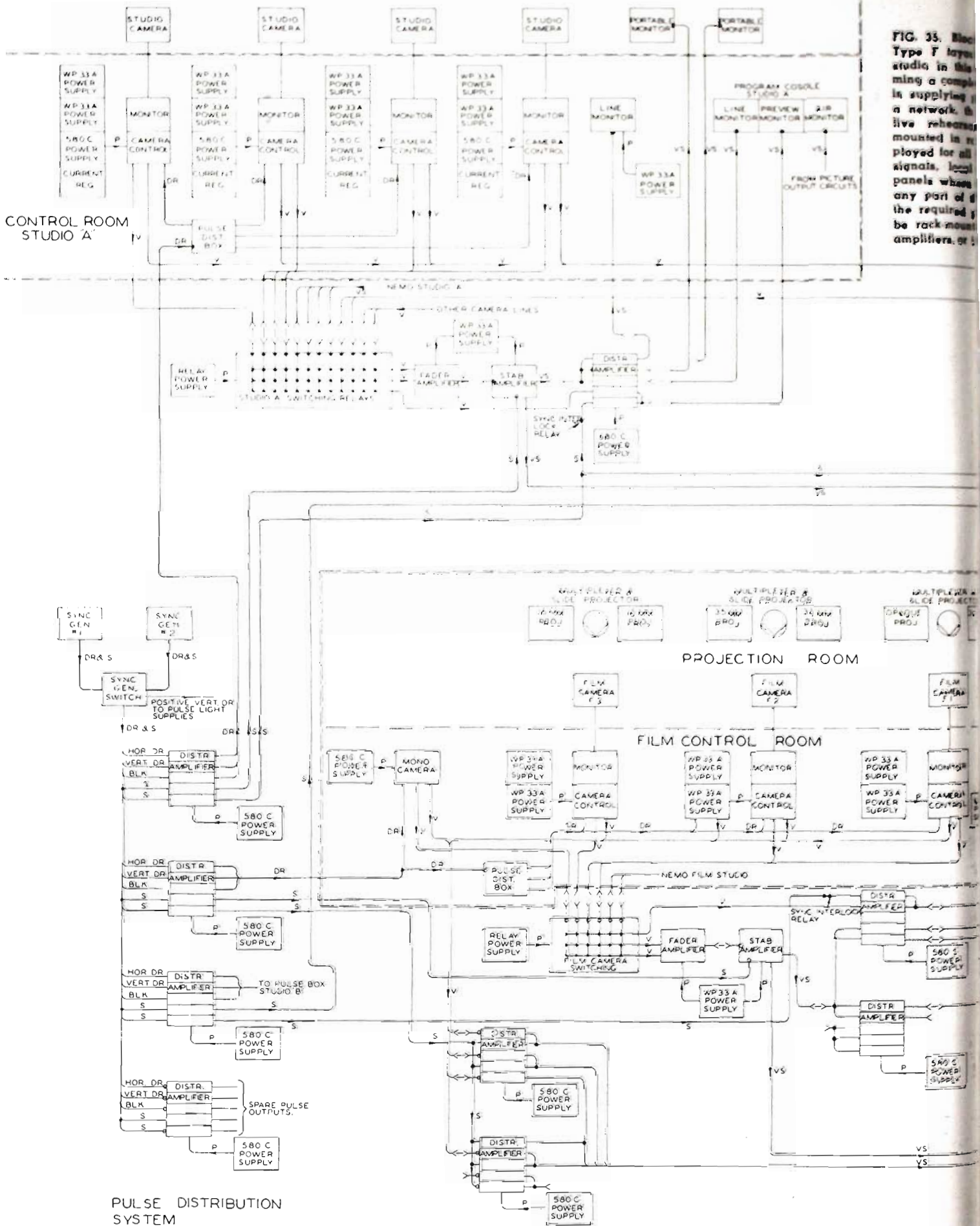

FIG. 35. Block Type F layout studio in this room is supplying a complete network of live rehearsing signals, local panels where any part of the required amplifiers, or

PULSE DISTRIBUTION SYSTEM

- P-POWER
- S-SYNC
- V-VIDEO
- VS-COMPOSITE VIDEO & SYNC
- ← COAXIAL JACK & COUPLING
- ⊙-TERMINATION
- BLK-BLANKING
- VERT-VERTICAL
- HOR-HORIZONTAL
- DR-DRIVING

REMOTE CONTROL SECTIONS FOR STABILIZING AMPLIFIER, SYNC GEN & RELAY RECEIVERS.

Diagram of video units in the  
 employing two studios. Each  
 is capable of program-  
 row. Thus, while one studio  
 m to the transmitter or to  
 the next show. Relays,  
 a master control, are em-  
 of video switching. Video  
 remote, are fed to jack  
 can be inter-connected into  
 system. Diagram also shows  
 supplies. These units can  
 control rooms with video  
 training power supply rooms.

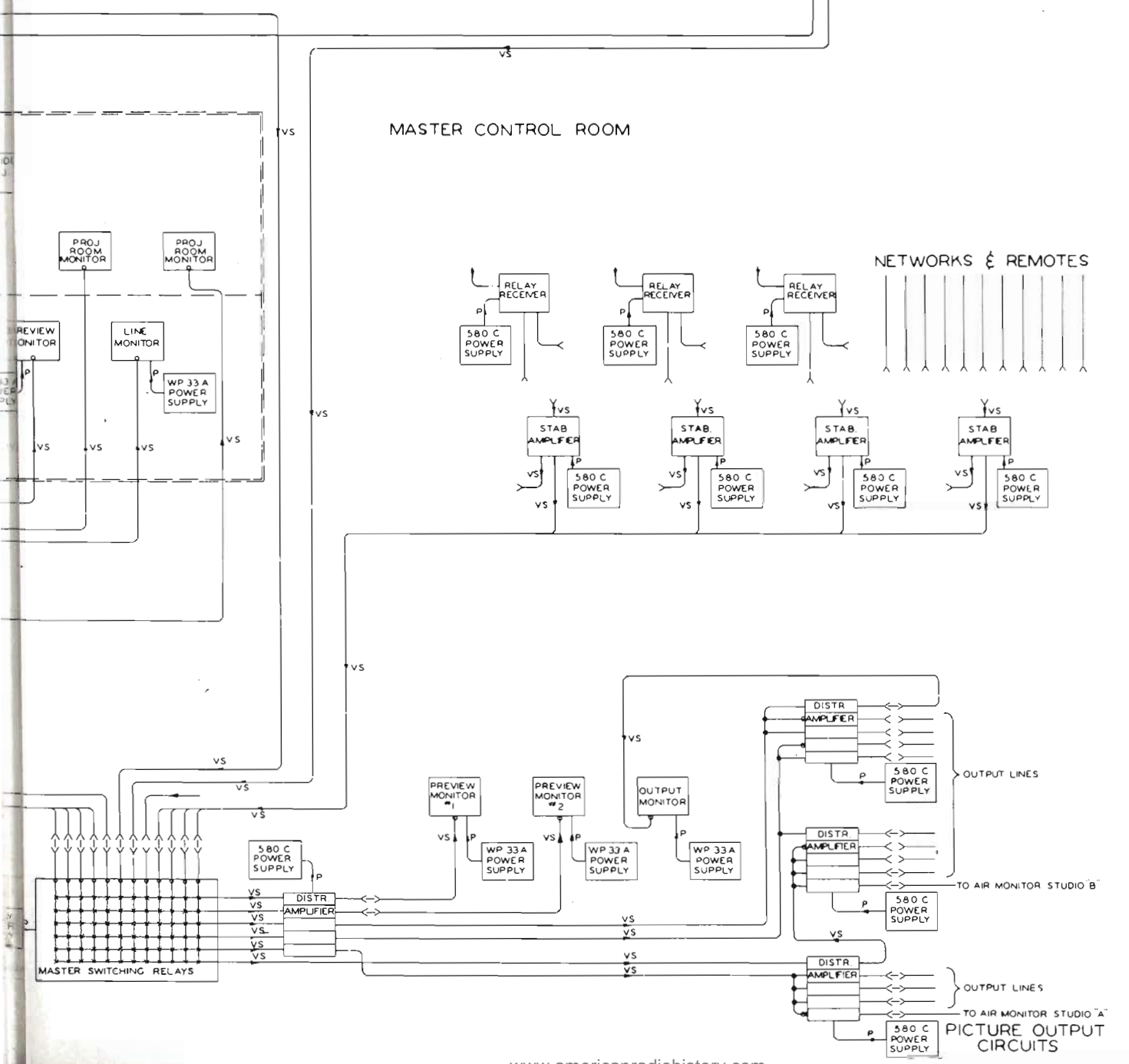
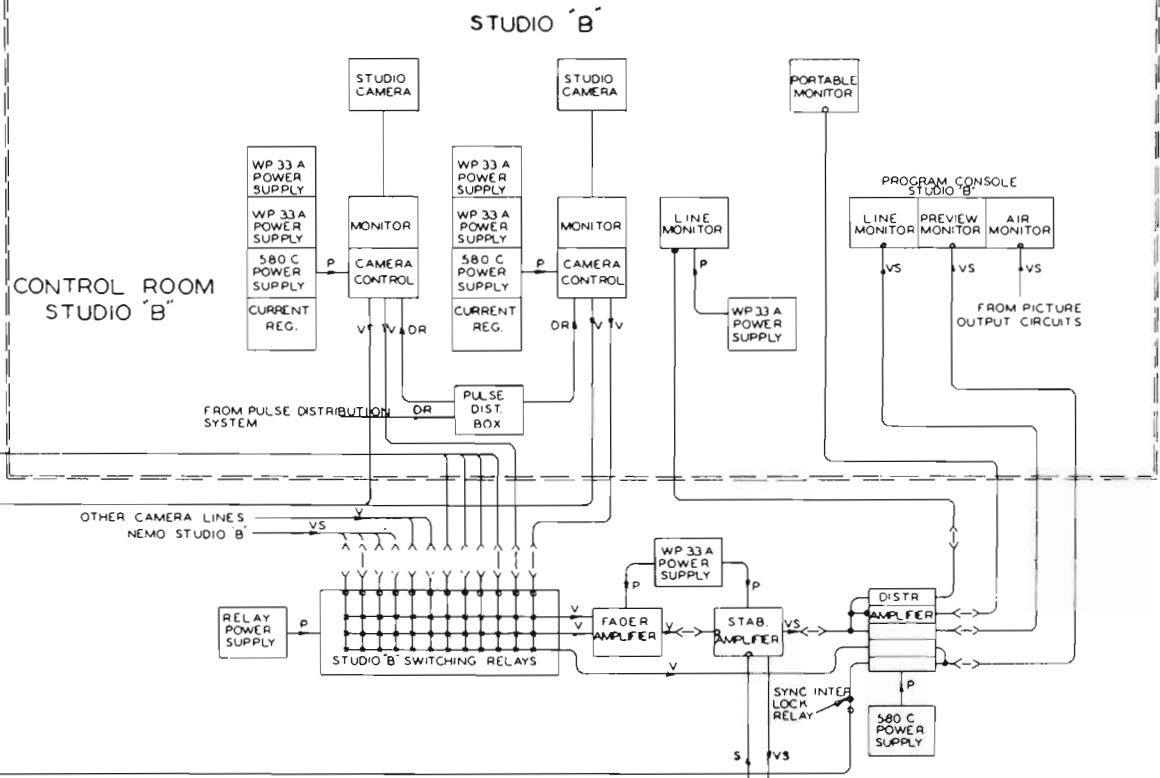

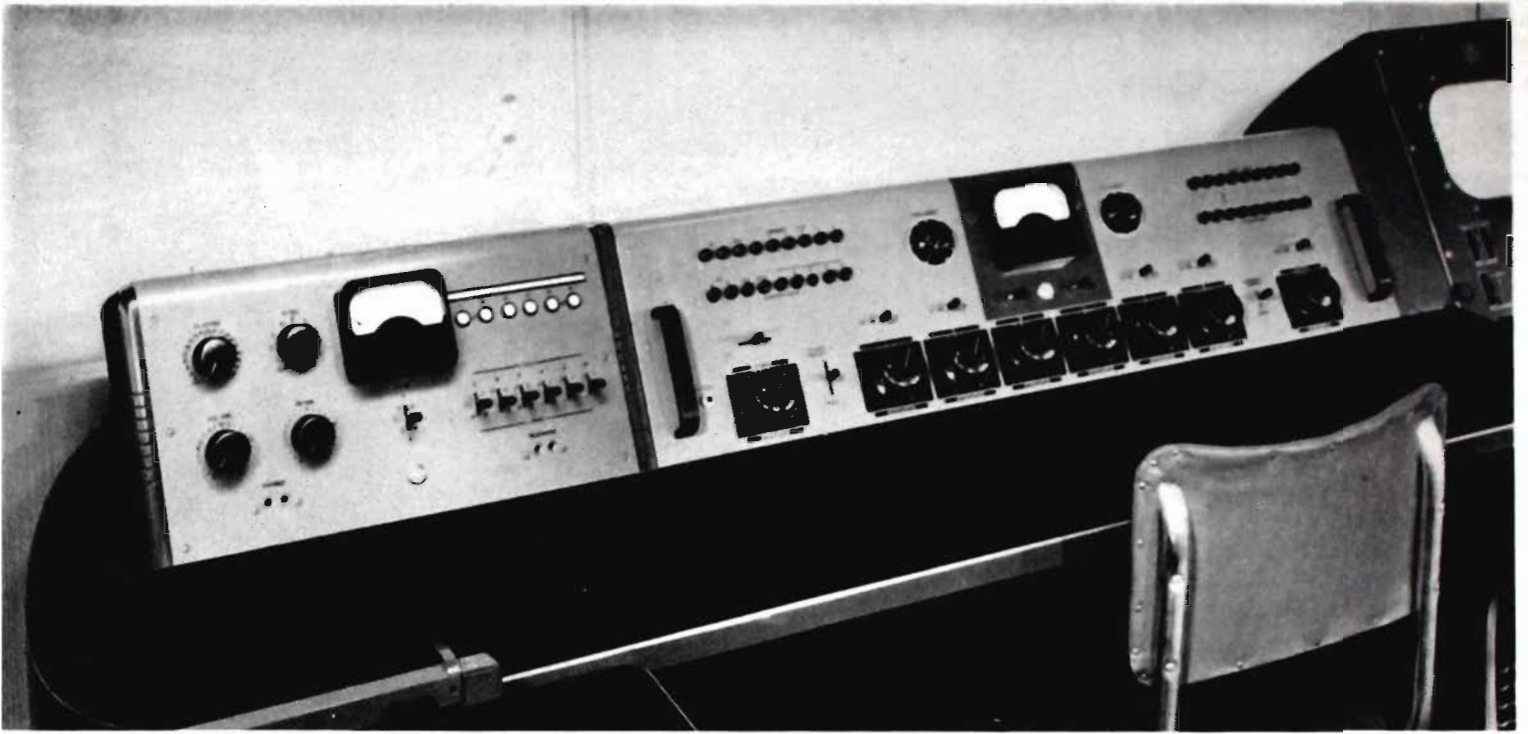
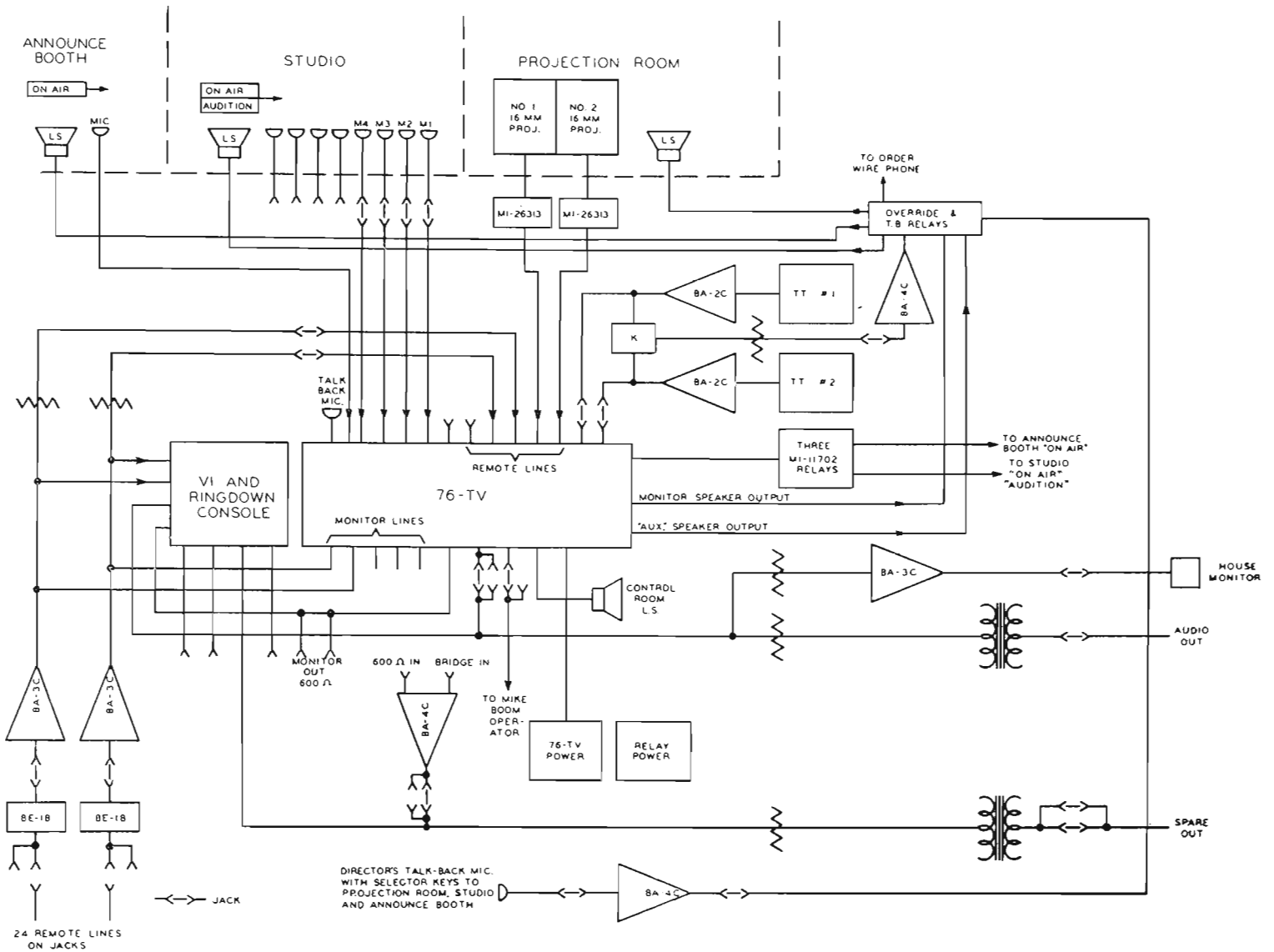

FIG. 36. The audio console above will handle the audio requirements for most television stations. Equipment shown is the Type BCS-3A Auxiliary Switching Unit (smaller unit at left) and the Type 76-TV Console. (Below) Block Diagram of the Audio Control Setup for a Television Station Employing a Single Studio, a Projection Room and Control Room.





# TELEVISION AUDIO AND COMMUNICATION FACILITIES

The audio facilities at a television studio are similar in most respects to those now in use at AM and FM stations. The principal differences are: (1) provision must be made for handling the sound channel of television film projectors; and (2) means must be provided for feeding transcription sound to loudspeakers in the studios for accompaniment of video performers, or for sound effects.

There are, however, basic differences in talkback and intercommunications requirements, these facilities for video being more elaborate than those used in AM and FM studios. In even the most modestly equipped TV station, the communication system at some time will be called upon to perform these functions: (1) *talkback* (override, carrying cue or orders to studio, projection room, and announce booth—a function of the audio facilities); (2) *Order-Wire* (telephone facilities to offices and to outside lines for communication with remote pickup locations); (3) *Intercom* (two separate channels to provide private and conference wire communication—one channel for production and one channel for technical personnel).

## General Considerations

As mentioned at the beginning of this article, the audio engineer is responsible for placement of studio microphones and proper sound pickup. Present practice is to use as few microphones as possible, usually suspended on the ends of movable microphone boom stands. Throughout the show, the microphone boom operator, under the direction of the audio engineer, maintains the correct placement of the boom microphone. He moves it in and out, raising or lowering it as required to secure the best sound pickup. Moreover, the boom operator must keep the boom and microphone out of the view of the camera. Therefore, good communication must be maintained between the audio engineer and the boom operator. Also, the audio engineer should be located so that he has a good view of the outgoing line picture monitor.

Boom stands require the use of lightweight microphones. Moreover, the microphone is subject to considerable movement and, therefore, must be constructed so that it will not pick up wind noise or other noises when the boom is moved about. RCA types 77-D, 44-BX, 88-A, and KB-2C are used for studio pickup. The

77-D, 44-BX and the KB-2C have adjustments to attenuate low frequencies, which is an advantage since it removes some of the boominess present when the microphones are several feet from the source of sound.

## Audio for A, B, and C Layouts

A typical TV setup for the types A, B, and C layouts described in this article consists of a single studio, an announce booth, a film projection room and a combined studio, film, and master control room. In addition to the studio and film programs, part of the station's program probably will be from a video network or remote pickups. Basic audio and communications requirements for these three layouts<sup>4</sup> are then as follows:

### Studio:

- (1) Four studio microphones with four additional microphone lines that can be patched to consolette input circuits.
- (2) Studio loudspeaker for turntable feed and talkback.
- (3) On-Air Signals.
- (4) Intercom and talkback from audio engineer to microphone boom operator.
- (5) Intercom and talkback from director to camera operators and video operator.

### Film Projection Room:

- (1) Control for sound outputs of two film projectors.
- (2) Intercom and talkback from director to film projection room.

### Control Room:

#### A. Mixer Facilities

- (1) Mix and switch four microphone lines.
- (2) Patching facilities for four additional microphones.
- (3) Mix audio outputs of two film projectors.
- (4) Mix and switch remote and network lines.
- (5) Mix and switch outputs of two turntables.

B. Intercom and talkback enabling audio operator to talk to microphone boom operators.

C. Intercom and talkback enabling program director to talk to video operator, camera operator and to film projection room.

D. Feed turntables to studio loudspeaker for background purposes, or for accompaniment of vocalist and other similar purposes. (Possibility for the output of the turntable at the same time to be mixed as a part of the consolette program.)

E. Studio equipment to feed loudspeakers in studio control room, studio, announce booth, and projection room. Studio control room equipment able to feed one regular and one spare program line.

F. Program line to feed house monitors through an isolation amplifier.

G. Program cue to camera and boom operators.

II. Termination and equalization facilities provided for 24 remote broadcast and private lines. Ringdown equipment provided for magneto telephones. Equalization of telephone lines to 15 KC.

I. Switching facilities in studio so that program from air monitor and other studios, etc., can be readily monitored.

### Announce Booth:

Announce booth containing these audio items:

- (1) a microphone
- (2) a monitor loudspeaker.

The audio control equipment to provide the facilities just outlined consists of the Type 76-TV Consolette, plus a Type BCS-3A Auxiliary Unit and one equipment rack. These audio control facilities are illustrated in the photo and block diagram (Fig. 36).

The BCS-3A contains a VU meter, six ringdown relays and control keys for private line telephone facilities. With the BCS-3A, it is possible to feed turntable outputs to a loudspeaker for vocalist accompaniment, or for background purposes. The equipment rack contains the amplifiers, jacks, equalizers and power supplies.

<sup>4</sup> Audio systems for types D, E, and F stations will be described in a forthcoming article devoted to TV audio facilities.

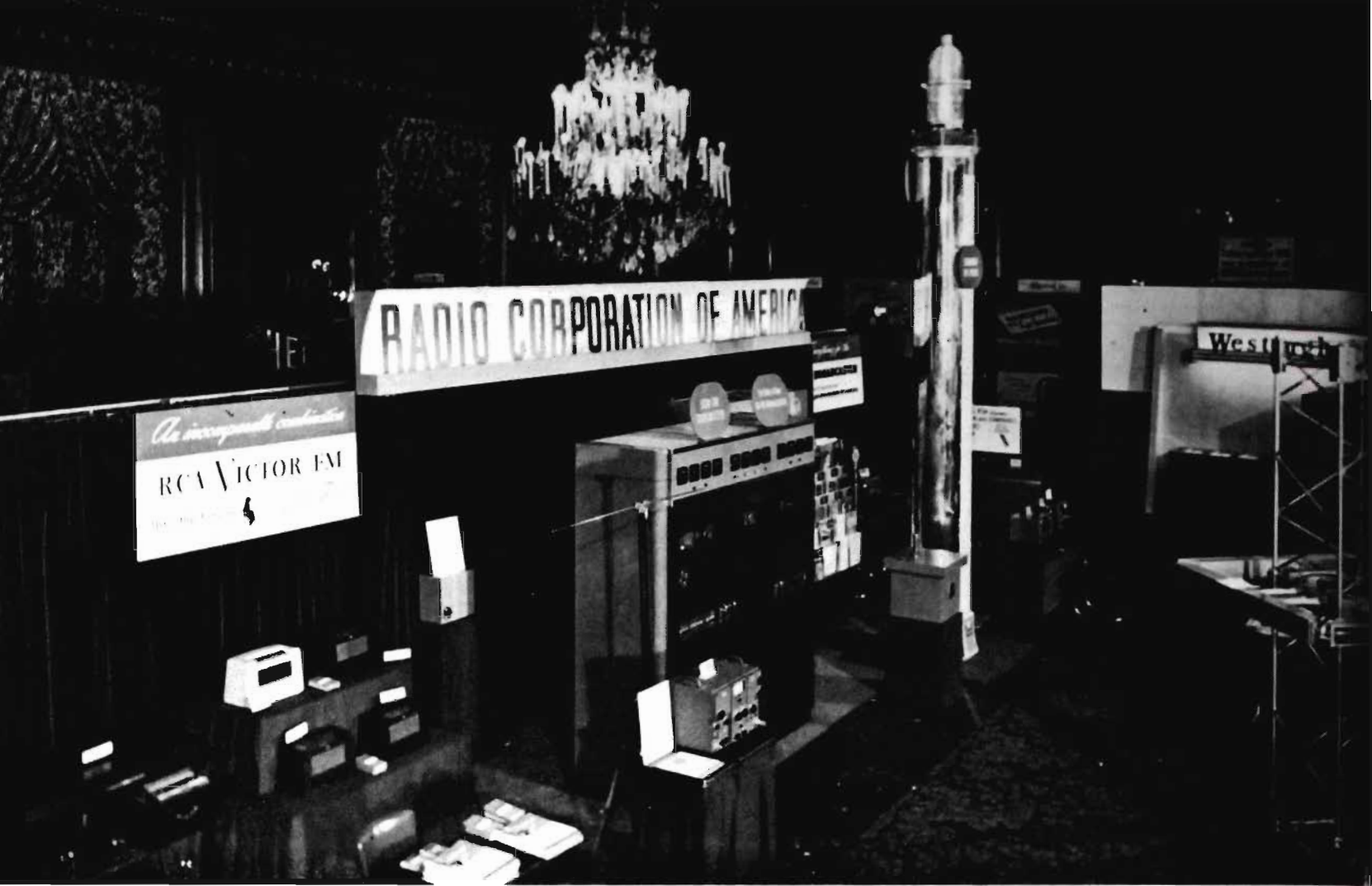

FIG. 1. A representative study of RCA's complete line of FM equipment was provided in more than 300 square feet of display area. Engineering Products and Home Instruments departments shared the 36 foot frontage in the Boulevard Room of the Sheraton Hotel.

# SECOND ANNUAL FMA CONVENTION

by **R. S. MANNHEIMER**  
Engineering Products Department

The second annual convention of the Frequency Modulation Association convened at the Sheraton Hotel in Chicago on September 27, with upwards of 400 FM broadcasters on hand to discuss the future plans, expansion, and new applications of FM.

Following the official opening on the first day by convention chairman Miss Marion Claire, Director, WGNB-FM, Chicago, there followed three days of informative speeches and discussions clearly indicating the enthusiasm and interest of broadcasters in the development of FM.

The discussions covered almost every aspect of FM broadcasting. Leading off was Everett L. Dillard, WASH, President,

FMA, with an address of welcome and an inspirational note for the convention. FMA Executive Director, J. N. (Bill) Bailey, then presented a study of the association with "Your FMA—Looking Ahead."

Following a luncheon with The Hon. Wayne Coy, Chairman, Federal Communications Commission as principal speaker, the assemblage reconvened to cover the dealer's stake in FM. Broadcaster-dealer relationships, the need for cooperative action between the two, and the need for low cost FM receivers formed the basis for discussion of methods necessary to increase net sales. Promoting FM was the subject of a panel discussion which ended the day's activities.

The links between the advertising industry and the FM Broadcasters were

taken up on Tuesday morning. "Transit Radio," "Storecasting," and "The Agency and FM" were amply covered in the well-attended session which provided interesting data on new means of broadening FM coverage. As a climax to the morning, a panel discussion was held on "Selling FM," which pointed out techniques of value in establishing FM in new areas.

FM stations located in colleges and universities across the country shared the spotlight with Facsimile on Tuesday afternoon. Quality broadcasting, not supplemented by commercial time, was the subject under discussion during the college period. The progress and possible applications of Facsimile, along with a market study of Facsimile from the manufacturer's standpoint, aroused much interest among the FM broadcasters.



FIG. 2 (Above). Featuring a comparison test of the LC-1A High-Fidelity Loudspeaker with a normal loudspeaker, the Audio and Test Equipment corner proved to be a very popular spot for the broadcasters.



FIG. 3 (Right). The WX-1A Field Intensity Meter for FM and Television frequencies drew much favorable comment.

The Second Annual Banquet on Tuesday night featured reception of the first Coast-to-Coast Recruiting Broadcast by the U. S. Air Forces Band, transmitted by Magnetic Tape recording and released simultaneously on a transcontinental basis for FM broadcast.

Wednesday morning was devoted to the technical aspects of FM broadcasting. Networks, engineering, relays, tape recordings, antennas, and multiplexing were discussed. The final technical discussion was concerned with the programming of FM.

Between meetings (the only time available due to lack of recess time) conventioners were treated to a fine group of exhibits sponsored by 18 manufacturers in the FM field. The completeness and quality of the exhibits was indicative of the

extensive types of equipment being produced for FM application. Transmitters, antenna and accessory equipment, test and measuring equipment, tape recorders, and many types of studio controls were included in the comprehensive displays.

#### The RCA Exhibit

The Boulevard Room of the Hotel Sheraton was filled completely with FM equipment displays. One of the largest, if not the largest, exhibit was presented by RCA. This FM exhibit, which occupied better than 300 square feet of floor space, provided an extensive cross-section of both the Engineering Products and Home Instruments Departments' equipment.

Central feature was the popular 3 KW FM Transmitter, of which more than 100 have been shipped to FM broadcasters. Its popularity is enhanced, in part, by the "add-on" feature which makes it possible to add grounded-grid amplifier units to the transmitter with only minor alterations, when greater output is required. The Harmonic Filter, giving up to 30 db attenuation of all harmonics, and the AM-FM Isolation Unit were shown, as was the BF-11A Single Section Pylon Antenna, which towered over the exhibition hall.

Among the items of Broadcast Audio Equipment on display were the newest version of the 76-series Studio Consolette



FIG. 4 (Above.) A favorite with FM broadcasters is the RCA 3KW Transmitter, shown above. Behind it, and to the right, is a working display of the well-known Grounded-Grid Tank.



FIG. 5 (Right). Lively Jean Alexander saw to it that everyone was well supplied with RCA literature. On the receiving end here is Glenn Gillett.

FIG. 6 (Left, Below). RCA Chicago representative Ed Tracy (left) and Jim Livesay, Mgr. WLBH, discuss features of the 76-C Studio Consolette.

FIG. 7 (Right, Below). Talking over FM transmitters and antennas are (from l. to r.) John Reilly, RCA Cleveland, Hale Bondurant, Mgr. WJBC, Ed Tracy, and Jim Livesay.



and several studio microphones including the new "bantam" KB-2C, which proved to be very popular with broadcasters. Much interest was also shown in the BN-2A Remote Amplifier which provides true studio quality by the use of high-level mixing. Special demonstrations included a working model of the famed Grounded-Grid tank, and a comparison test of the high-fidelity LC-1A Loudspeaker and an ordinary loudspeaker. The newly released high-frequency WX-1A FM Field Intensity Meter and WA-26A Tone

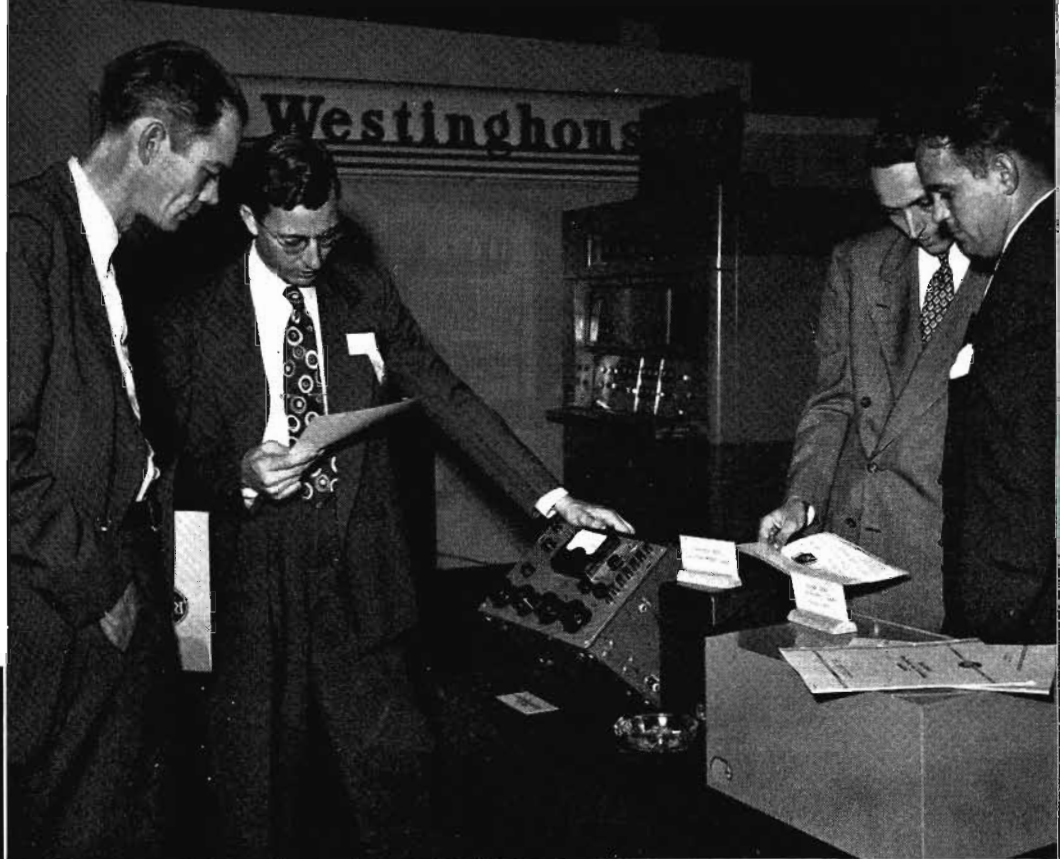

FIG. 8 (Above). Dan Meadows, RCA Camden (l. center) describes the BN-2A Remote Amplifier to A. C. Heck, Ch. Engr. WPIC-FM, while Bob Paulos and Tom Payton, WOKZ, look over data on the WA-26A Tone Generator.



FIG. 9 (Above). Dan Meadows and Ed Tracy, with J. Steele and Prof. Glen Koehler, both from the Univ. of Wisconsin, study performance curves as they listen to loudspeaker comparison tests.

Generator also brought out much favorable comment. A "Literature Bar" provided easy access to brochures and catalog sheets covering the complete FM line.

The Home Instrument Department had on display, in the form of an announcement, the new combination FM-AM table model receiver, which proved itself under test in the interference blanketed business area of Chicago. Complementing the exhibit was the latest design of the famous Crestwood model—shown for the first time at this meeting.

FIG. 10 (Below). The renowned Crestwood, now featuring FM reception, and the new low-priced table model AM-FM receivers were in constant operation throughout the three-day convention.



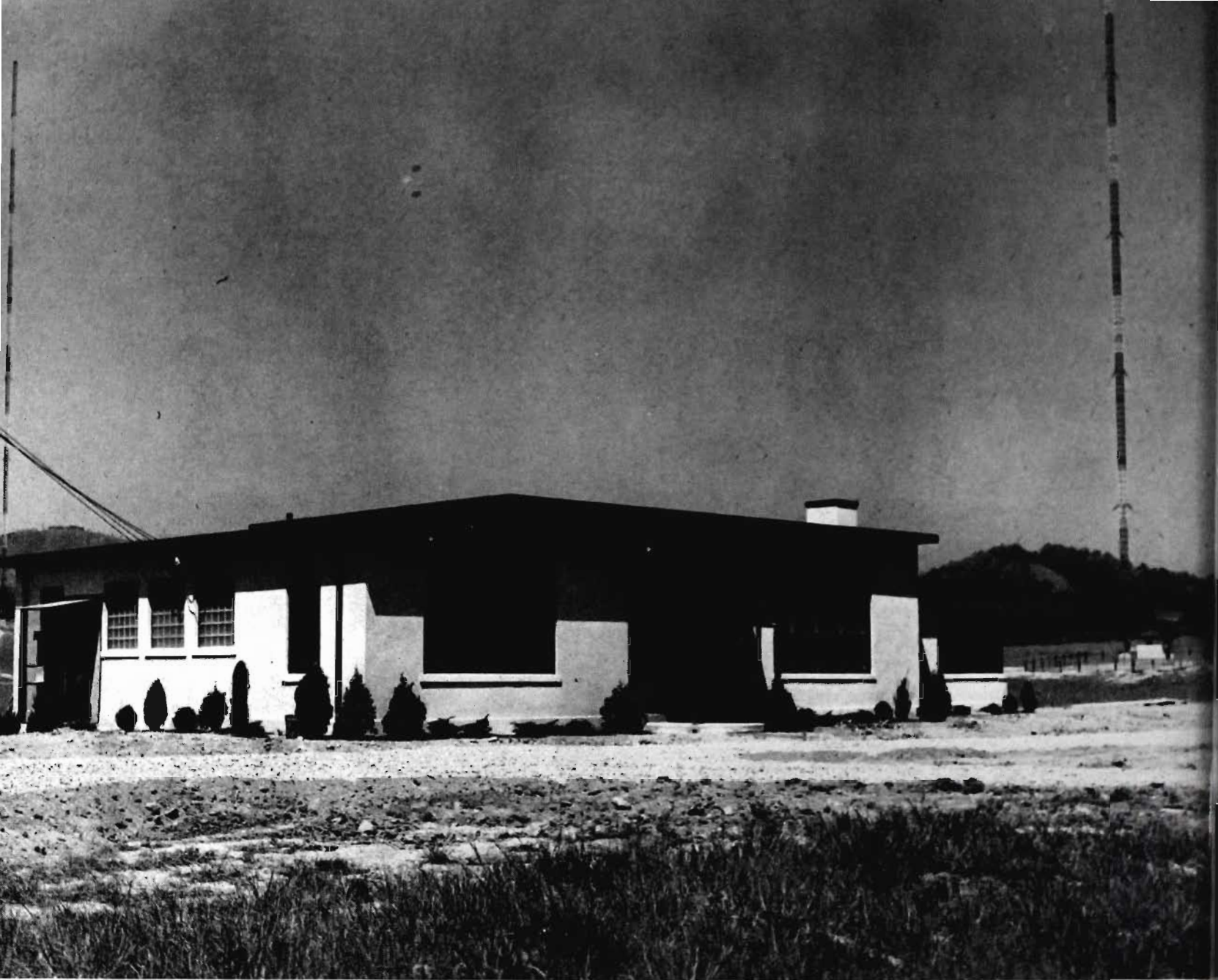

# WWNC ON-AIR WITH NEW 5-KW TRANSMITTER

WWNC, the Pioneer Voice of Western North Carolina, recently increased power five-fold by the installation of a new 5 kilowatt AM transmitter, RCA type BTA-5F. The new transmitter is reaching many thousands of new listeners in the southern Appalachians area which includes twenty mountain counties in Western North Carolina, plus eight eastern Tennessee counties. The total listenership is estimated at 500,000.

## Transmitting Plant

The new transmitting plant of WWNC is located on a 65-acre tract of land near

Emma. The attractively-constructed transmitter house is shown in Fig. 1. The WWNC antenna array consists of four steel towers which reach to a height of 325 feet. As may be seen in the photo of Fig. 2, the lighting system is linked to the power supply through an Austin transformer. Also visible in Fig. 2 is the tuner house located at the base of each tower to protect antenna tuning equipment, motors for remote control and meters for constant checking from the control room.

Around the base of each tower is a 48-foot square area covered with crushed

stone and surrounded by a small picket fence. This space is covered by a copper-mesh screen, brazed together and edged by a strip of copper to which copper wires radiating at three-degree intervals are brazed. These wires extend out 425 feet from the base of the towers. They are buried about eight inches in the ground.

The towers themselves are set in a parallelogram which measures 527 feet on one side and 1,053 on the other side. Where the 425-foot wires extending out from the base of each tower come together, they are brazed to a small copper strip.

FIG. 1 (left). The WWNC transmitting plant is situated on a 55-acre tract near Emma, North Carolina. Two of the four 325-foot antenna towers can be seen in the background.

FIG. 2 (right). Flanked by the tuner house, Austin lighting transformer, and lightning protectors, W. H. Hamrick inspects one of the antenna tower bases.

This makes a continuous ground network of wire under all of the towers.

In all, a total of 190,000 feet or approximately 38 miles of this wire was buried in the ground to form this network.

The building which houses the transmitter and living quarters for the "engineer-in-charge" is of cinder block and stucco construction and is approximately 80 by 40 feet, one story high with a two-car garage in the basement (see Fig. 1).

The main operating and transmitter room, just inside the front door, is 20 by 40 feet. The control desk for the engineer is situated in the middle of the room, with the cabinets containing the transmitter equipment arranged along the rear wall with a working space of some five feet behind them (see Fig. 3).

To the left, from the front door is a wing which contains a large, well lighted workshop, a combination storeroom and switch room, and a lavatory and shower.

To the right, from the front door, opening off the main room, is a three-room apartment equipped and furnished with all modern household conveniences. This serves as the living quarters for the engineer.

Running from the transmitter to each tower are two co-axial transmission lines which carry the power from the transmitter to the antenna system. Each of these includes two copper tubes with an air insulation cushion between them. This air is kept dry at all times and for that purpose a special dehydrator which instantly detects and corrects any such condition is used.



Of course, only one of these lines to each tower is used at one time, the other being in the nature of an emergency line for use should any difficulty develop with the first line.

All steel in the building is brazed to copper strips which are brought to an elaborately constructed copper plate and charcoal "ground" situated in a six-by-six pit in the rear of the building. This grounding is necessary because of the extremely heavy "fields" which emanate from the transmitter.

The transmitter room photo of Fig. 3 shows the new 5 KW AM transmitter, supervisory console, phasing cabinets and audio, test and monitoring equipment racks. The supervisory console is arranged to provide maximum accessibility and visibility of all meters and controls necessary for operation of the transmitter. RCA equipment is used almost exclusively. Six men, working in three shifts of two each,

operate the transmitter with the aid of one utility or service man. This force covers approximately 19 hours each working day, operating on a basic 40-hour week.

The transmitter is linked with the studios in the Citizen-Times Building by two telephone lines for programs and a private, battery operated telephone line for communication with operator in the control room of the studios. Installation of the new RCA transmitter marks the end of a long effort, because the first part of this tract was acquired as far back as 1937.

After the conclusion of the war, work was again started when the Federal Communications Commission lifted the freeze order in the fall of 1945 and renewed the application to erect the transmitter. Since that time, work was pushed with the idea of getting on the air with the transmitter at the earliest possible time. The new station project was under the direction of Mr. D. S. Elias, WWNC Station Director,

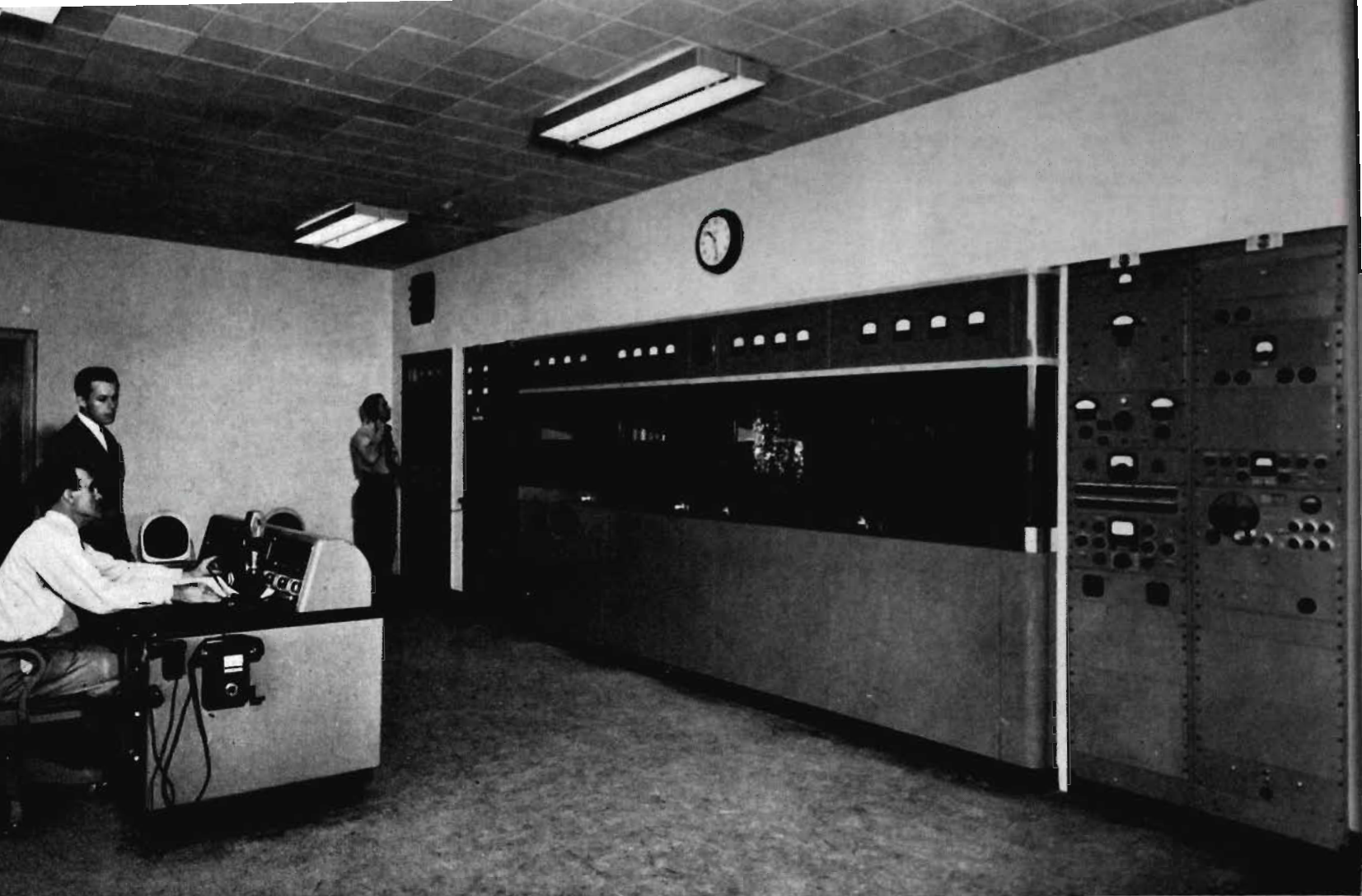

FIG. 3 (above). While Ira A. Smith checks the phasing, W. L. Clements (seated) and W. H. Hamrick watch the RCA BTA-5F transmitter supervisory console. Audio, test, and monitoring equipment are located on the right rack.



FIG. 4 (left). Cecil Hoskins, General Manager and Chief Engineer, (standing) and Don S. Elias, Vice President, Citizen-Times Company, and Director of Station WWNC, discuss policy for future operations.

and the station engineering and installation planning was capably supervised by Mr. Cecil B. Hoskins, WWNC, Manager and Chief Engineer.

The building which houses the transmitter was erected by the Merchant Construction Company, well known Asheville contractors, from plans and specifications prepared by Anthony Lord, architect.

The wiring for the new installation was done by the United Electric Company and the plumbing was handled by H. W. Kindler and Company. The Price Piping Company handled the installation of the heating plant and the grounds around the station were landscaped by the Tennent Nurseries.





REGIONAL ENGINEERING DIRECTORS of the National Broadcasting Company who recently toured RCA's AM, FM and television production facilities in Camden, New Jersey, took time out to have their picture taken. Shown from left to right in the front row are: S. E. Leonard, NBC Cleveland; R. H. Owen, NBC Denver; F. A. Wankel, NBC New York; G. McElrath, NBC New York; H. C. Luttgens, NBC Chicago; A. R. Hopkins, RCA; and J. D'Agostino, NBC New York. Second row in the same order are: A. H. Saxton, NBC Hollywood; C. D. Peck, NBC San Francisco; T. N. Phelan, NBC New York; Al Josephsen, RCA; R. R. Davis, NBC New York; and M. A. Trainer, RCA. In the third row are: D. N. Cooper, NBC Washington; E. Stewart, RCA; H. Vance, RCA; R. Lord, RCA; E. J. Meehan, RCA. In the last row are: R. E. Shelby, NBC New York; D. Pratt; D. Meadows; and C. M. Lewis of RCA.

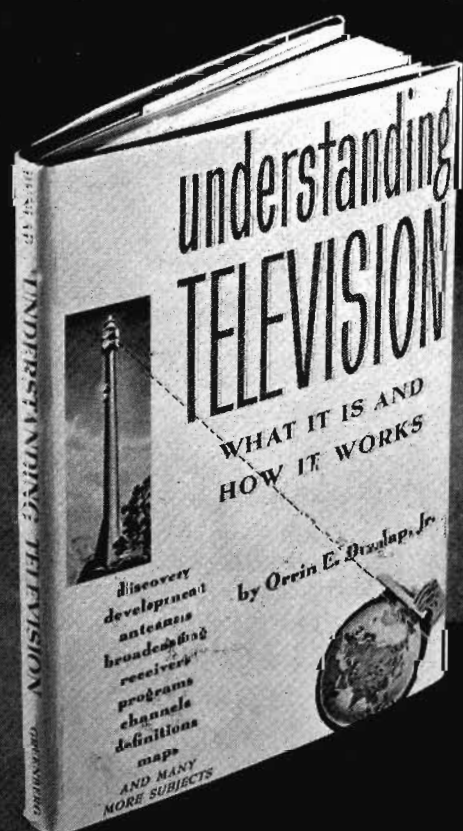

## A NEW BOOK ON TELEVISION

ORRIN E. DUNLAP, JR., who has been very close to the field of broadcasting since its inception, and who is author of almost a dozen books on radio and television broadcasting, has added a new volume to his series. A carefully thought-out primer on television, this latest work is entitled, UNDERSTANDING TELEVISION.

Broadcasters who are called upon to explain in simple language the fundamentals of television operation to program sponsors and advertising agency personnel will find UNDERSTANDING TELEVISION of special usefulness. While it does not purport to lend any new light on television engineering, it does explain the fundamentals of television in simple direct everyday layman's language. Written in interesting style, and illustrated profusely, it provides the answers to the most frequently asked questions about television equipment, television operation and television programming. Broadcasters just entering TV may find it useful as a means of educating prospective sponsors and for other promotional purposes. Price of the book is \$2.50; publisher is Greenberg in New York City.

# WJAC - FM INSTALLS RCA

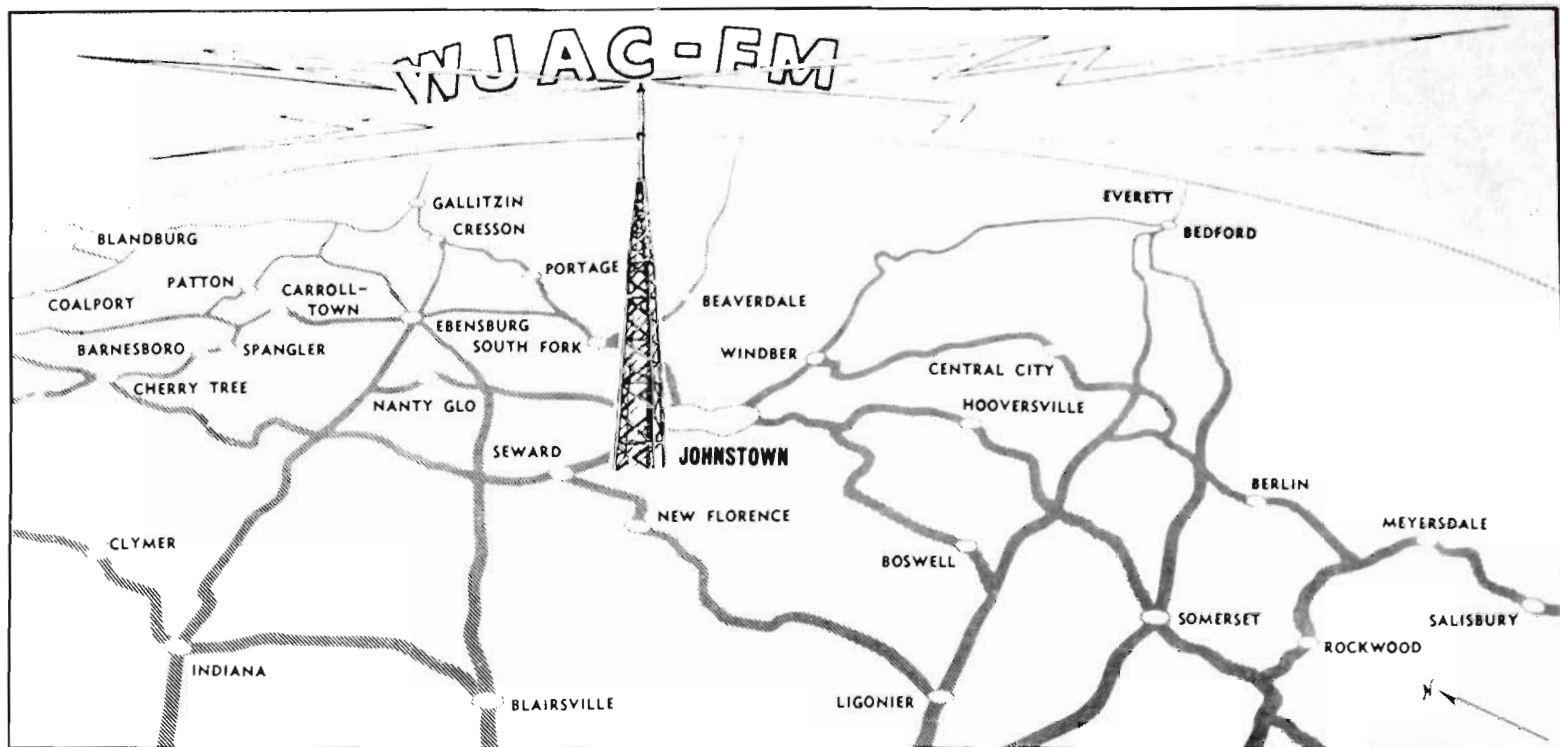

# TRANSMITTER

Climaxing four years of careful planning and construction, WJAC-FM, Johnstown, Pa., made its first frequency modulation broadcast on May 22, 1948. The inauguration of this FM station marks the second major step in the Johnstown Tribune's broad postwar program of broadcasting improvement and expansion. Local listeners are now afforded reception from the most modern, efficient transmission possible in broadcasting.

The new station duplicates entirely the program of its parent station WJAC, National Broadcasting Company outlet, but has a much greater useful area of coverage. WJAC-FM has obtained an effective radiated power of 2400 watts by incorporation of a two-section high-gain FM Pylon with their RCA 1 KW FM transmitter. This compares most favorably with the 250-watt output of WJAC's standard broadcasting station.

Coverage of the FM station is estimated at 20,000 square miles, including the large sprawling Johnstown trading area with its 350,000 residents. Many points in the area previously not reached by WJAC programs now receive excellent reception on the FM band. Good reception has been reported from such distant points as Pittsburgh and Altoona, approximately 40 miles airline distance.

Wider coverage by the FM station is made possible not only by the increase in power, but also by the location of the transmitter and antenna on the highest peak of the region. FM programs are broadcast from the top of Laurel Ridge,  $3\frac{1}{2}$  miles northwest of Morrellville. The ridge stands 2,710 feet above sea level. The antenna adds another 117 feet for an overall "pierce" into the sky of 2,827 feet.

FIG. 1 (at left, above). WJAC-FM has an estimated coverage of 20,000 square miles, blanketing many small towns in the surrounding area.

FIG. 2 (at left). The station house and antenna tower are located atop Laurel Ridge, high above the Johnstown valley.

FIG. 3 (at right). Workmen complete the RCA FM Pylon installation.

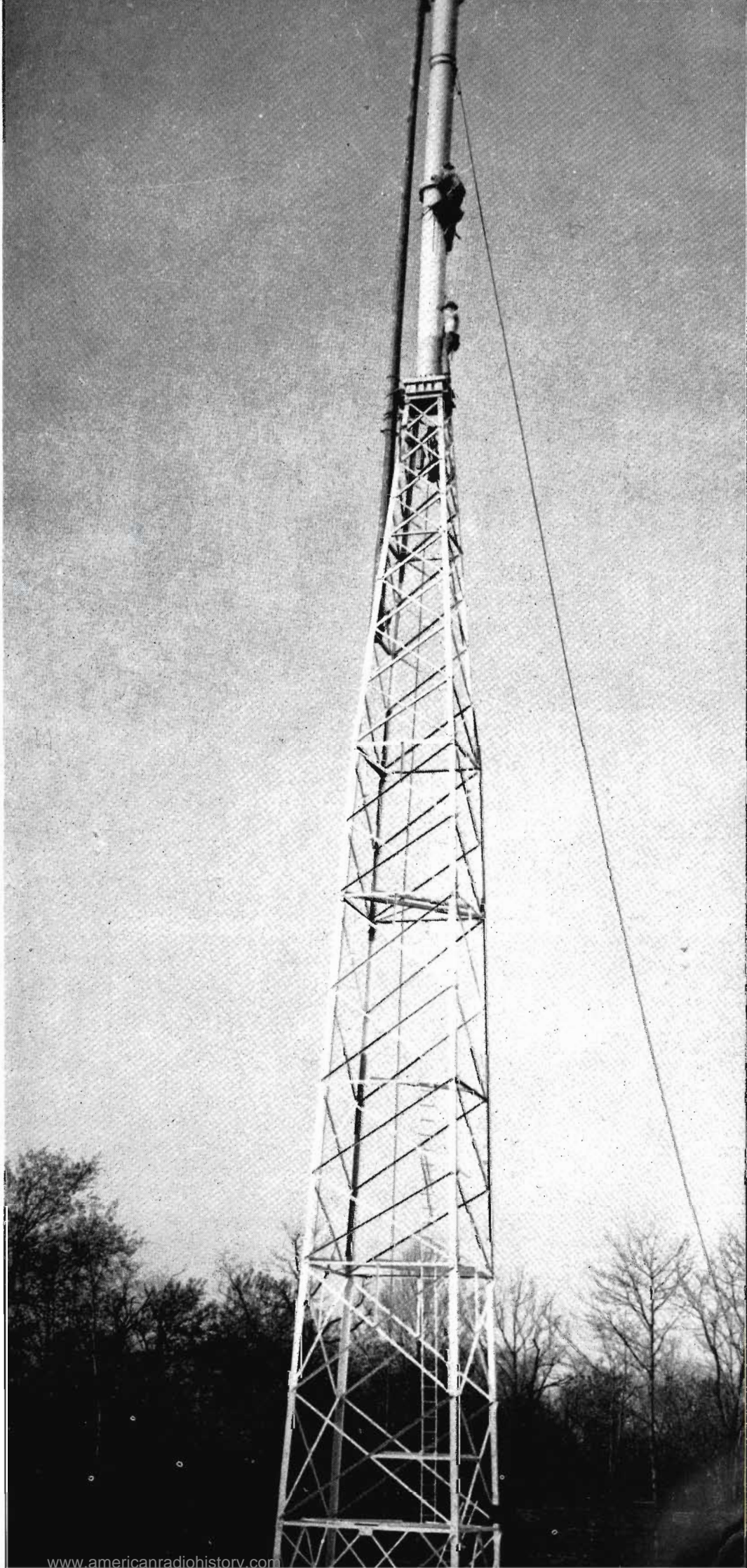



The radio firm applied to the Federal Communications Commission in September, 1944, for authorization to operate an FM station. Due to the war, final approval was delayed until January, 1947.

Work on the new FM station began soon after commission authorization. The remote location of the station in the woods of Laurel Ridge made construction extremely difficult. A new road had to be built as the workers "pioneered" their way three-fourths of a mile into the woodland. Men and materials were hauled by jeep when inclement weather prevented the use of trucks. Special high-power electric lines spanned the mountain. A special telephone cable linked the new transmitter and the new Main Street studios. It was necessary to sink a 250-foot well to provide a source of water.

The modern building housing the mountaintop transmitter is 32 feet wide and 60 feet long. Included are a garage, bedroom, kitchen, workshop, shower-room and a large transmitter room which will be used eventually for television as well as FM. Insulation is provided by walls 13 inches thick. The walls also protect station engineers against danger of stray bullets in this excellent deer hunting territory. The building uses radiant heat furnished by an oil furnace with a 3,000 gallon fuel storage tank.

The antenna tower, located about 60 feet from the transmitter building, is topped by a modern two-section RCA FM pylon antenna. Six super-turnstile units will be added at a later date for the proposed television station.

WJAC—pioneer in Johnstown's radio broadcasting history—early this year moved into its new home, the WJAC Building, 329 Main Street, formerly known as the Bailey Building. The quarters feature the finest equipment available for AM and FM broadcasting. The station undertook the large moving job to the new location without once "losing its voice" by interruption of the normal broadcasting schedule. The station occupies the entire third floor of the building. A modern passenger-operated elevator carries visitors to the floor where they are admitted through an attractive reception hall.

Live program facilities are extensive, with two large broadcasting studios, A and B, and a smaller studio, C, which will be used for auditions as well as for regular broadcast purposes. Most broadcasts are handled in the master control room, located between Studios A and B, with the auxiliary control room, adjacent to C, used primarily for frequency modulation broadcasts. Studios and control rooms are sound-proofed by use of 13 inch walls composed of cinder blocks, felt blankets, plaster on

steel lathe, 2 inches of acoustic element, and perforated transite. Each room is a "room floated within a room."

In the front of the building are the offices of the manager, program director, continuity writers, and announcers. A large general office, well-stocked record library, and news room complete the staff rooms. The news room features its own broadcasting facilities and is equipped with an Associated Press teletype machine providing world-wide news coverage.

A specially-designed air-conditioning and heating system has been installed on the third floor. Equipment for the air-conditioning is housed in a penthouse constructed on the roof of the building. Glass brick walls and fluorescent lighting are used. Thirty miles of wire were required for equipment and lights. Wilson Construction Company had the general contract, with the wiring and installation of equipment under the supervision of Nevin Straub, chief engineer.

With its eye to the future, the firm filed application for a television construction permit in November, 1944. Pushing plans for visual broadcasts sometime next year, Johnstown expects to be one of the first communities in the United States with a population under 500,000 to have a television station.

A contract was signed in May, 1948, with Radio Corporation of America for the most modern television equipment available. The television station will be known as WJAC-TV and will operate on Channel 13, 210-216 megacycles. The transmitter will have effective radiation power of 7000 watts visual, and 6500 watts for sound broadcasting.

The new transmitter building and radio tower atop Laurel Ridge will be used for the television station. A six-bay super turnstile antenna mounted on top of the FM pylon antenna will be used for television.

**FIG. 4 (at left).** Located between the two main studios, A and B, RCA custom-built studio equipment in the master control room handles the AM broadcasts, as well as auditions.

**FIG. 5 (at right).** The third floor of the WJAC Building houses the studios, control rooms and offices of the station.

**FIG. 6 (below).** The auxiliary control room, adjacent to studio C, utilizes the RCA custom-built studio equipment primarily for FM broadcasts.





# VISTA ALEGRE

EL DOMINGO, 8 DE AGOSTO 1948

## GRAN CORRIDA DE TOROS

### LA CORRIDA DE LA TELEVISION

SPATROCINADA POR LA RCAF

SEIS HERMOSOS TOROS DON JUAN B. CONRADI  
 con diestros encarnada y am-  
 rilla, de la muy famosa ganade-  
 ría de los señores HIJOS de  
 de Salamanca.

ESPADAS

**RAFAEL ORTEGA GALLITO**

**MANUEL ALVAREZ ANDALUZ**

**MANUEL ESCUDERO**

ESPADORES: Antonio Díaz y José Juan José Arta  
 Manuel Navarro (Magallán) Rafael Talón  
 (Hernández) y José Fernández (Hernández)

ESCADORES: Sr. SERRA y Sr. Joaquín Salazar  
 Chacón y Eugenio del Hierro.

BANDERILLEROS: Antonio Gordo, Ramón Man-  
 zanares y Manuel Díaz (Carrasco de Matagorda)  
 Manuel Salcedo LA (Carrasco de Matagorda), José Igles-  
 as y José Álvarez, Pedro Martínez José  
 Travesero (Martorell) y José Carreras.

**PRECIOS DE LAS LOCALIDADES**

Localidad	Precio
Plaza	50
Primera	40
Segunda	30
Tercera	20
Cuarta	15
Quinta	10
Sexta	5
Séptima	3
Octava	2
Novena	1
Decimotercera	0,50
Decimoquinta	0,25
Decimosexta	0,15
Decimoctava	0,10
Decimonovena	0,05
Veintiuna	0,02
Veintidós	0,01

La corrida empezará a las SEIS Y CUARTO en punto de la tarde

Una corrida de toros en el estadio de fútbol de la plaza de toros de Madrid.

**¡POR PRIMERA VEZ EN MADRID!**  
 Una corrida y transmisión en directo en una hermosa plaza de toros en la localidad del Pinar de Cima (Bella Vista), magníficamente equipada y rodeada por 5.000 personas, desde una tribuna para **POR TELEVISION** por la máxima cantidad de **QUINCE PESETAS**.

**DISPACHO DE BILLETES** desde el VIERNES, 8 de Agosto, en las dependencias siguientes: Calle de la Victoria, 3, Bar HENO (Pinar de Cima), Bar PEPÉ, Plaza España (Guzanabana), Tuganillo de la Plaza Toros.

El precio por boleto de transmisión en directo en la tribuna será de 15 pesetas más el IVA correspondiente a cada hora de transmisión por hora, por persona y por hora, que se cobrará en el momento de la transmisión y que será devuelto al momento de la transmisión.

Facil y cómodo traslado de Madrid a la Plaza de Toros de Vista Alegre, en un cómodo servicio de autobuses desde la Estación de Atocha y Plaza Mayor. Traslado desde la Estación de Atocha.

# AMERICAN TV SHOWN IN SPAIN

by EDW. K. PRICE  
RCA International Division

All the color and pageantry of the ancient spectacle of "blood and sand" was dramatically combined with the new art form of electronic television to climax a series of demonstrations of RCA equipment and techniques in Spain during the summer of 1948. These demonstrations, made during a two months' tour by a picked crew, included the televising of everything from ballet and boxing to bullfights and stage music. This exhibition of the American television system was arranged by RCA International Division under the direction of Meade Brunet, Managing Director, and carried out with the cooperation of the RCA Distributor in Spain, Rey Soria y Compania and Spanish broadcasting authorities. The RCA crew, which left New York by plane on July 8, comprised four

engineers, under direction of William J. Reilly, Advertising Manager of RCA International. Equipment used was the Image Orthicon field equipment converted to 50 cycle operation, a set of microwave relay equipment, and 24 table and console model television receivers converted to line-driven (coaxial cable) operation.

Upon arriving in Madrid, the RCA crew was pleasantly surprised to find all the field equipment unpacked, set up and ready to operate—this by people who had never seen it other than by instruction book photographs. This kind of cooperation and resourcefulness of the Rey Soria technicians and Spanish Broadcasting authorities was very helpful during our stay in Madrid. Evidence of the Spanish energy and interest in television was seen everywhere. Rey Soria "tecnicos"—engineers—cooperating on the job were Hans Bittman, Fermin Roderiguez, Francisco Rivera and

Fernando Zamora. American RCA personnel were C. E. Davis (who took the photos used in this article), F. W. Millspaugh, T. J. Shipferling and Ed Price.

In addition to bringing television prominently to the attention of official Spain and the public, these demonstrations served to help introduce American standards of television in Europe. Prominent technical, government, and newspaper people from other European countries were on hand to witness American television in action. RCA executives on hand for the exhibition included Vice Adm. Wm. A. Glassford, European Manager of RCA, John F. Royal, Vice President of N.B.C. and Carlos Villalvazo, RCA field representative for Europe.

Demonstrations began with a private showing for General Franco at his palace at El Pardo, 8 miles from Madrid. This was followed by private showings for Gov-

SPANISH LEADERS view RCA television equipment set up at El Pardo, the Spanish Summer Palace. Left to right: Hans Bittman, of Rey Soria y Cia.; Gabriel Rey Soria; General Alfredo Guijarro, Director General of Broadcasting in Spain; General Franco; Carlos Villalvazo, RCA Field Representative for Europe; Ed. Price; Fred Millspaugh.





SPANISH TV DEMONSTRATION entitled "New Horizons" was arranged by RCA International Department and carried out with the cooperation of the RCA Distributor in Spain, Rey Soria y Compania and Spanish Broadcasting Authorities.



SPANISH AND AMERICAN CREWS joined in manning the TV equipment. Rey Soria "tecnicos" on the project were Hans Bitman, Fermin Rodriguez, Francisco Rivera and Fernando Zamora. American crew members were C. E. Davis, F. W. Millspaugh, T. V. Shipterling and E. K. Price.



PLAQUE ERECTED to commemorate introduction of RCA Television in Spain with names inscribed of members of the group. Left to right: W. J. Reilly, Advertising Manager of RCA International Division; Gabriel Rey Soria, RCA Distributor in Spain; Carlos Villalvazo, RCA International Representative in Spain; Antonio Rey Soria.



SPIRIT OF SPAIN. The click of castanets and swirl of costumes came alive on television during nightly television shows from the Belles Artes Theatre in Madrid's Fine Arts Building.



AUDIENCES of 800 persons were accommodated twice daily in the television viewing salons at Bellas Artes Theatre. Programs were originated both from adjoining studio and from remote points.



ernment Ministers, official Madrid, and the directors of the press and the government broadcasting authority. For these and subsequent public showings, studios, stage facilities and lighting were arranged for in the Fine Arts Building (Palacio de Belles Artes), which was chosen for its central location, its facilities for studios and salons, and because it is the second highest building in Madrid, with a tower reaching 300 feet.

The Bellas Artes programs followed a variety format of a definite Spanish flavor and were highlighted by Andalusian ballet dancing in full costume, choral groups, comedy and magician sketches. Two shows were presented nightly for the public. Following each show the public was invited to come downstairs from the viewing salons to hear a short lecture on the television equipment and stage setup, as well as to pass before the cameras to "see themselves." Programming for the second portion of the Madrid television demonstrations originated at the Vista Alegre Arena, 6 miles from Madrid. The microwave relay equipment was used to relay bullfight and sport programs from this point to the Bellas Artes receiver salons. At the beginning of remote operations, power source difficulties made themselves evident due to voltage variations and frequency differences between transmitter and receiver locations. There are several power companies in the city of Madrid. However, the transmitter and receiver points were soon tied in to a common power system; and pictures on the receivers for the following two weeks were clear cut and of fine quality. Enthusiastic comment came from the entire Spanish press.

Bullfight programs were televised on two successive Sundays, while during the week, variety and sports programs were presented from a temporary stage built down on the sand of the bull ring. Sports included boxing, "American style" wrestling and basketball. Programs were transmitted both during the afternoon and at night.

This was the first RCA International television demonstration in which the field equipment got a thorough check-out using the 50-cycle city power mains, and without using auxiliary generators of any kind.

The technical excellence of RCA equipment, cameras, transmitter, receivers—told a story of quality. The results are important not only to RCA, but to the American television system as a whole.

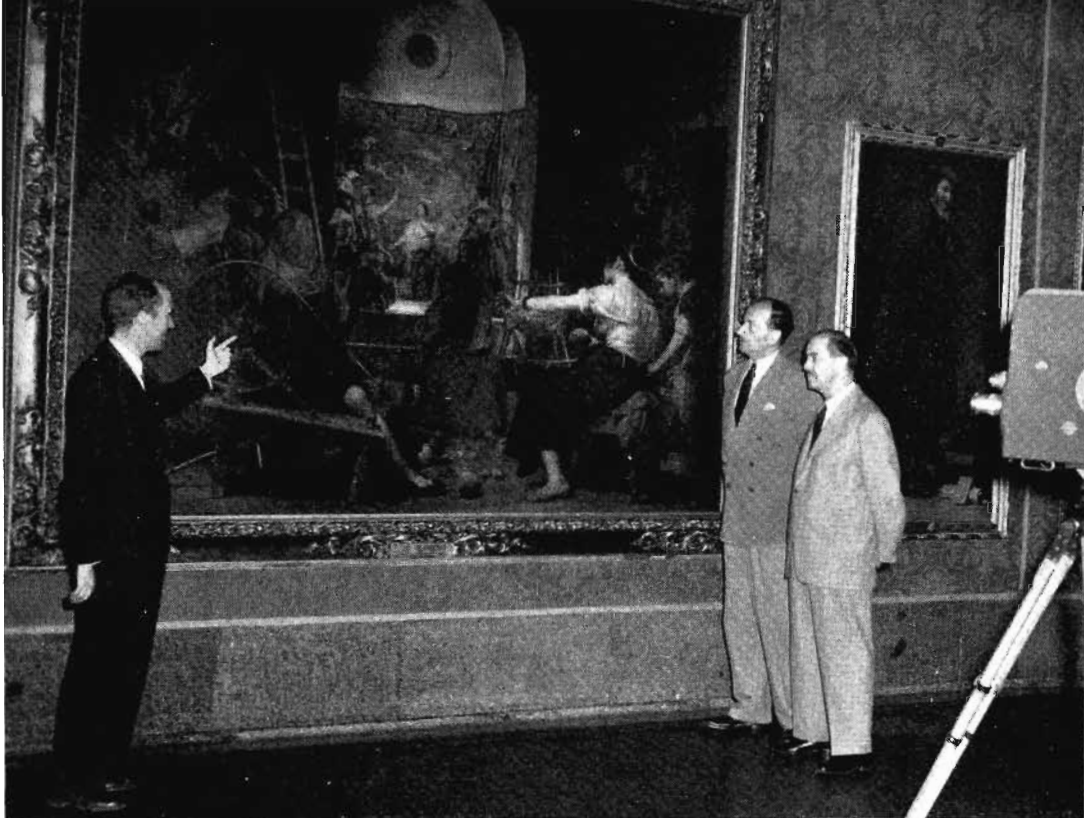

VELAQUEZ'S "THE SPINNERS" is shown by Manuel Lorenti Lunquera, Director Del Prado, to William J. Reilly, Advertising Manager of the RCA International Division, and Gabriel Rey Soria, RCA Distributor in Spain.



REMOTE PICKUPS were made from various points about Madrid. The mobile unit is shown in front of the Museum Del Prado in this view.



# BLOOD AND ... AND

HIGHLIGHT of the Madrid Television Demonstration was a series of remote pickups from the Vista Alegre Arena, eight miles from Madrid. From this point programs were microwaved to receivers in the downtown Fine Arts Building.



CONTROL EQUIPMENT at the Arena was located in a box next to the President's Box. In this view a receiver (used as a monitor) may be seen on the parapet of the control booth. The Microwave Relay Transmitter may be seen on the roof of the control booth.



CAMERA LOCATIONS at the Arena were ideal. One camera was located high up (just in front of the box in the view above). The other camera was located at lowest level, practically on the edge of the ring.

# AND . . . TELEVISION

**LOWER CAMERA** is shown in this view. Many unusually colorful scenes, such as this one of the banderilles, picadores and matadors parading into the building were picked up from this point.



**UPPER CAMERA** picks up a tense moment as the matador flouts his cape in the bull's face. This is an unretouched photo made from just behind the camera position.



**OTHER SPORTS**, including basketball (shown in this view), boxing and wrestling were picked up at the Vista Alegre Arena and micro-waved to the downtown viewing location.



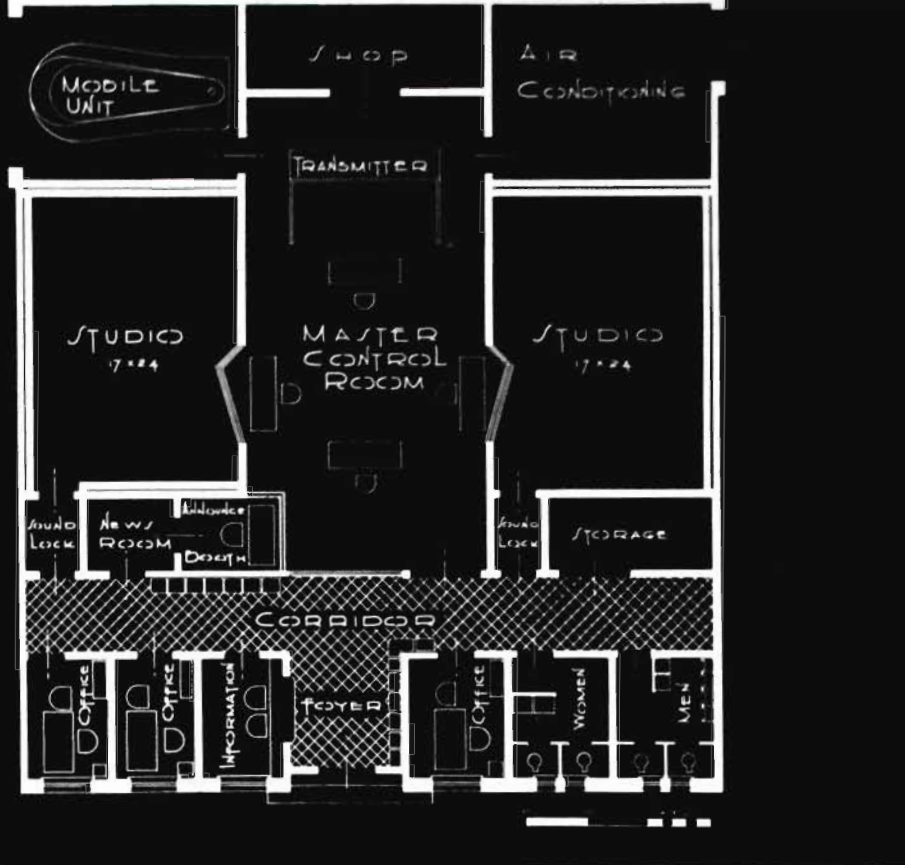

FIG. 1. Floor plan of building designed to house studios, transmitter, offices and other facilities of a small television station.

FIG. 2. More elaborate facilities can be added to building shown in Fig. 1 to make provision for expanding activities of a television station.

# PLANNING RADIO AND

by **GEORGE M. NIXON**



George M. Nixon, Manager, Engineering Development, National Broadcasting Company, Inc., New York, has been a frequent contributor to BROADCAST NEWS. Two of his articles on acoustical design of studios appear in Volumes 40 and 46.

The planning of sound and television broadcast studios requires very careful consideration and coordination of a number of technical and economical factors to insure the satisfaction of present and anticipated requirements and the provision of sufficient means to accommodate future needs. The size of the plant, the number of studios, and similar questions must be answered, in large part by the station management itself as it is best equipped to determine whether it will originate a large number of live talent programs, use recorded material to a considerable extent, or rely to an appreciable degree on receiving programs from a network.

The general technical problems involved in the selection of the studio plant location are in the main quite similar whether the plant is for sound or television broadcasting. Television studio broadcasts involve scenery, props of appreciable size, etc., which must be conveyed to the studio, removed from it and stored so that convenient location near the ground level is to be preferred. Television broadcasting, where live talent studios are involved, will occupy about 3 or 4 times as much space as sound broadcasting, consequently, economic considerations may dictate lower rental space or more economical land.

There is no fundamental difference between the planning of Standard (AM) Broadcasting and Frequency Modulation (FM) Broadcast studio facilities as the difference between these two types of broadcasting occur in the RF portion of the link between the studio and the listener.

## Space

There is considerable experience in sound broadcasting to indicate the space required for the studio plant. The number, size, and types of studios selected influence space requirements particularly if an appreciable audience is to be admitted to the broadcast. The number and type of studios planned should be adequate to accommodate the contemplated types and sizes of performing groups with an adequate allowance for rehearsal time. The total floor space required for the plant varies considerably dependent on the building but is usually 3 to 6 times the area of the studio space.

There is not yet the background or experience in television broadcasting as in sound broadcasting to indicate as definitely the amount of space required except to state generally that, where an appreciable number of live talent programs are to be

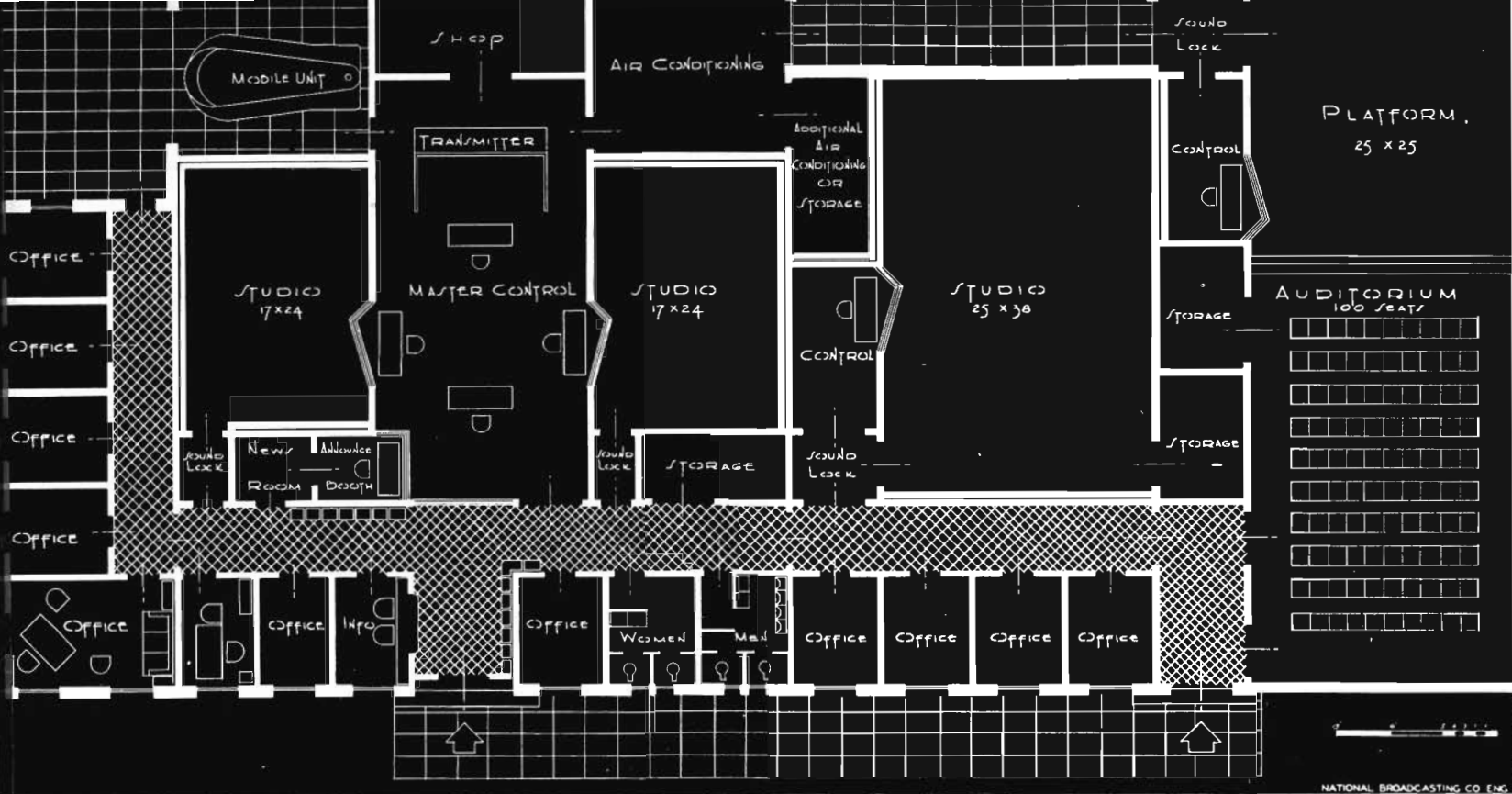

# TELEVISION STUDIOS

originated, the space requirements will be about 3 to 4 times that of sound broadcasting. It is most important in planning that provision be made for future space expansion so that as television broadcasting develops and grows the plant may keep pace with its growth.

There are two main ways in which the studio plant may be developed.

- (a) The horizontal plan
- (b) The vertical plan.

The horizontal plan which involves the location of the studios on the same level is adaptable to existing structures for small plants, but larger plants would require the erection of a building specifically designed to house the studios. The larger plants will involve considerable land area which in some cities might require its location too remote from the business and entertainment areas. Future expansion is in general most easily accomplished by

this type of studio arrangement. A suggested arrangement of studio facilities is shown in Fig. 1, and those same facilities expanded are shown in Fig. 2.

The vertical plan is adaptable to either an existing building or one specifically built to house the studios. Appreciable expansion sometimes results in a scattering of work areas in different parts of the building with resultant inconvenience unless included in the original planning.

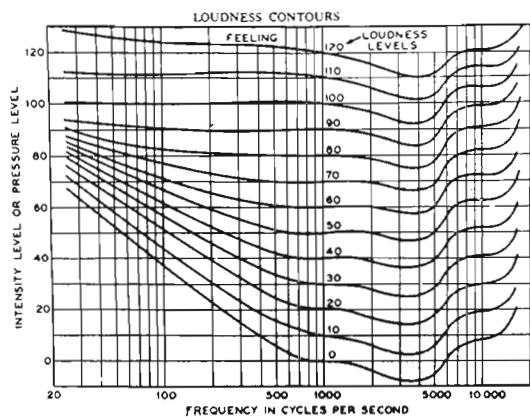

FIG. 3. Loudness intensities of the ear.

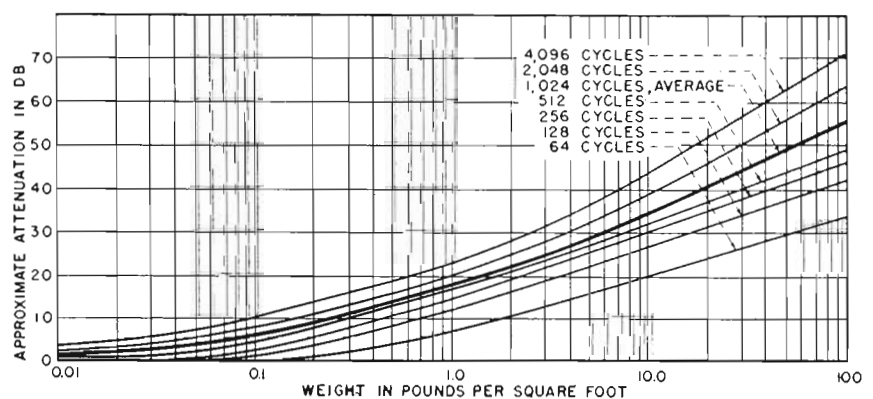

FIG. 4. Increase in sound attenuation in terms of weight of various homogeneous materials

## Location

The location of the studio plant is a most important decision to make. It should be located so that convenient transportation is available to performers, technical personnel and general public.

The major potential technical difficulty to be studied is that of noise. Noise is transmitted in two ways.

- (1) Airborne
- (2) Vibration of the ground or elements of the building structure.

The airborne sounds exterior to the plant include those due to thunder, railways, busses, aircraft, streetcars, industrial activities, automobile traffic, etc. Certain of these such as railways, streetcars, industrial activities, etc., may transmit sound by vibration of the ground to the studio plant. The rental of space in an existing structure requires investigation of the activities of present tenants, and also the restriction placed on future tenants as to their noise producing activities. Major sources of noise within the building may include printing presses, pumps, industrial machinery, punch presses, and the like. Conversely, it should be kept in mind that noise from a broadcast plant can be just as annoying to others, particularly professional people such as doctors, or dentists in the conduct of their work.

The problem of noise is stressed as it is one for which the precautions must be taken in the construction of the studio plant. It is for that reason that a survey should be made at the proposed location with a sound level meter so that the magnitude of the noise is known and the isolation to be provided can be determined.

The use of a sound level meter is preferable but in the event one is not available some indication of the noise level may be obtained by the use of a portable field amplifier which practically all broadcast stations have available. The absolute magnitude of the noise may be calculated approximately by obtaining the sensitivity of the microphone from the manufacturer.

In those cases where the noise is from a source which develops considerable vibration, the solution may not be economically feasible. The location of the studios on the floor directly above or below a bank of large printing presses is such an example. The amount of vibration generated by the presses is of such a magnitude that there is no practical and economic means to reduce it to a satisfactory value. Further, it is not possible to predict accurately the reduction which will be effected

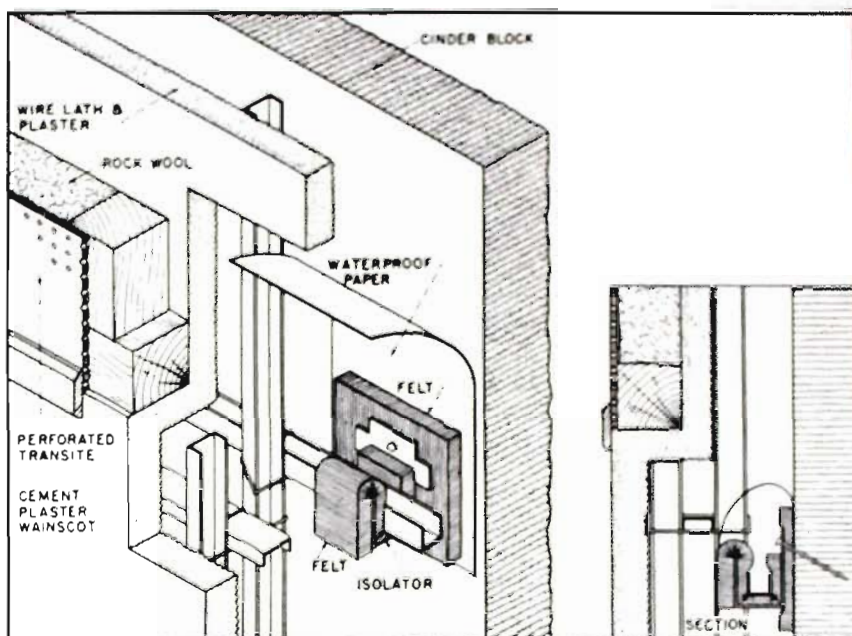

FIG. 5. Construction of a wall for sound isolation between studios.

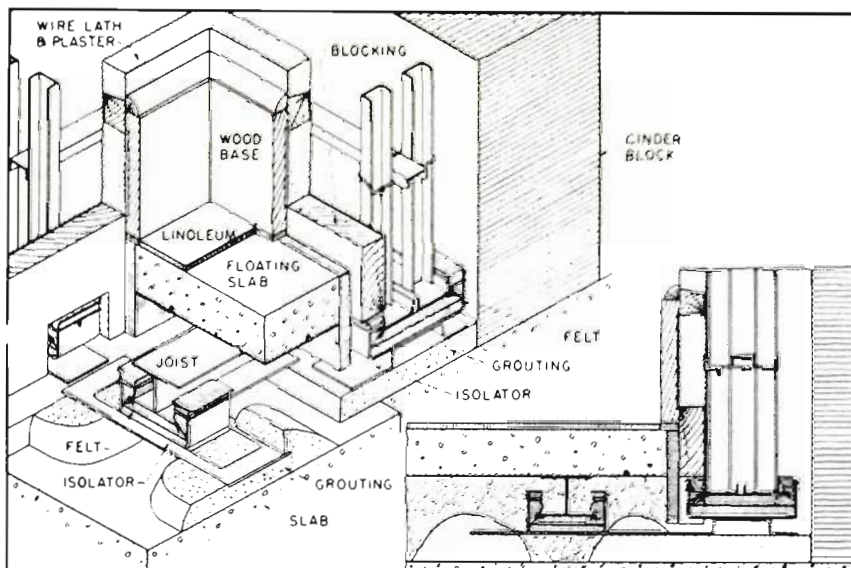

FIG. 6. Typical acoustic treatment for a floor to isolate sound from below.

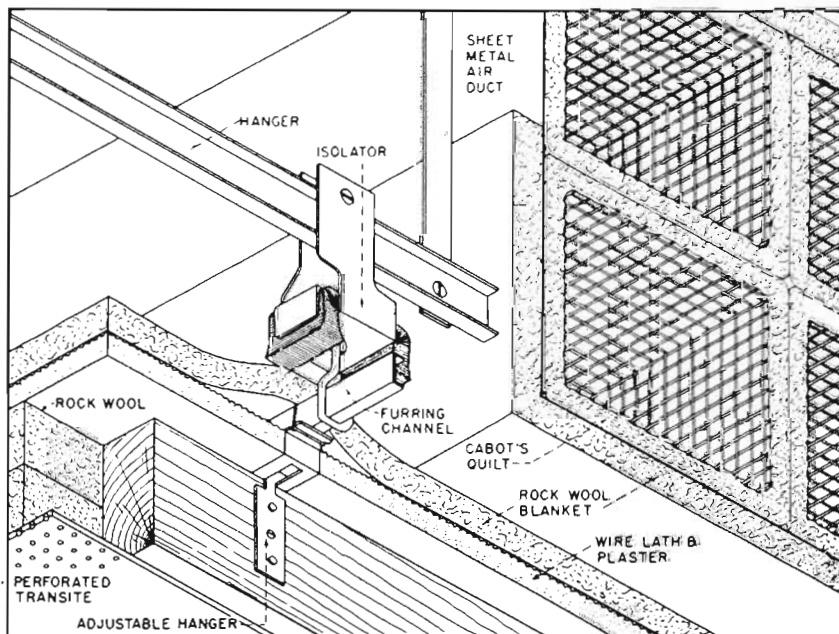

FIG. 7. Mechanical details of suspended ceiling and acoustically treated air duct.

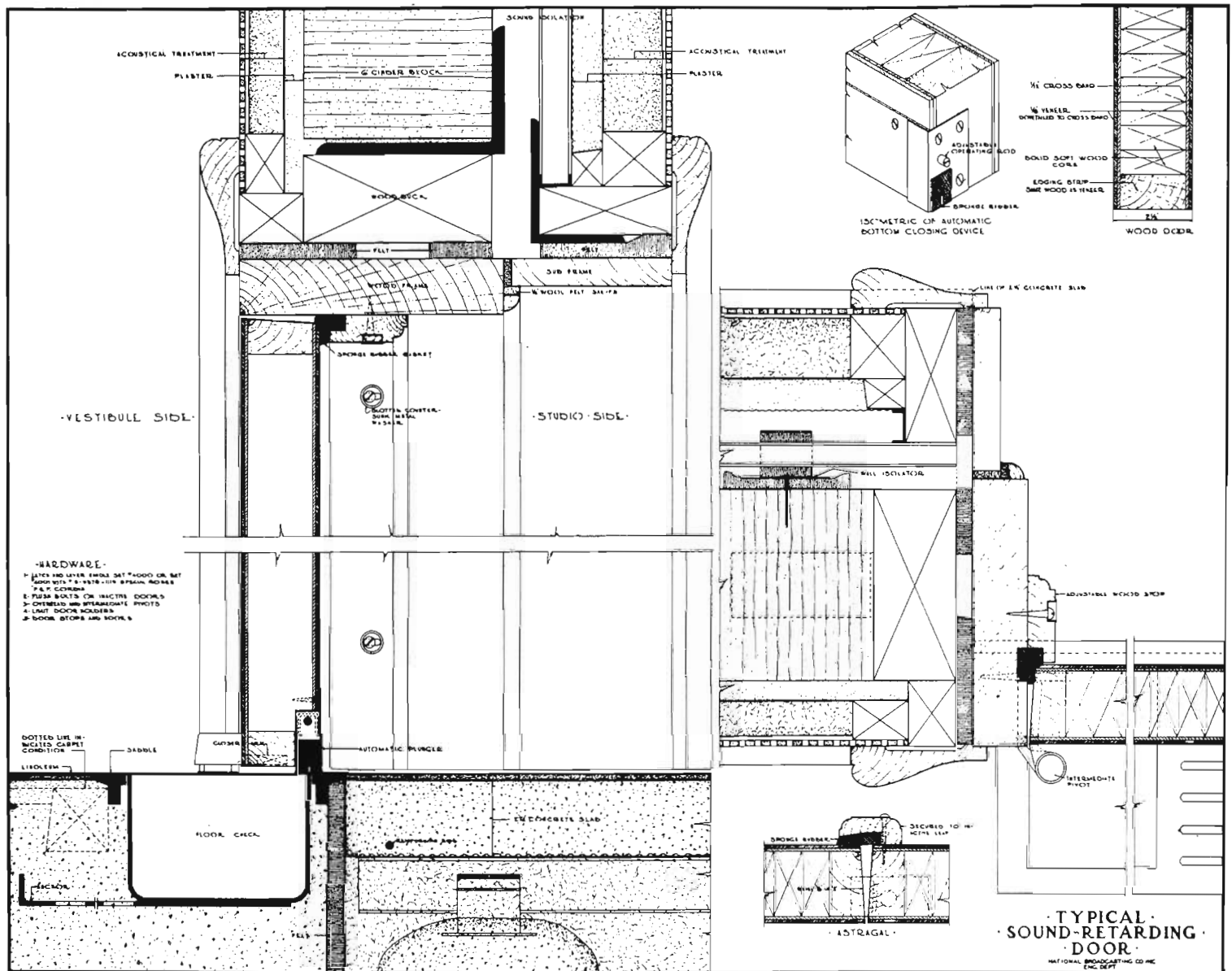

FIG. 8. Construction details of sound retarding studio door.

because of the many related factors. Studios have been built in substantially this type of location and as far as is known trouble has always ensued—sometimes to the extent of making necessary the installation of a high pass filter in the program circuit to reduce the noise and compromise the overall quality.

The maximum tolerable noise level in studios is as follows:

Sound level meter

- Scale A—less than 25 db\*
- B—less than 35 db
- C—less than 45 db

Scale C is substantially "flat" as regards frequency response and Scales B and A correspond respectively to the Loudness Intensity curves of the human ear.

It will be noted in Fig. 3 that the ear at moderate intensities is less sensitive at

\*(db above the threshold of hearing . . .)

the lower frequencies than at medium and high frequencies. This is fortunate as sounds of these frequencies are most difficult to control.

### Sound Control at Boundary Surfaces

The attenuation of airborne sounds is dependent largely on mass of the material rather than other characteristics of the material itself. This is a generalized statement, to which there are some exceptions, and cinder concrete appears to have some advantage over other materials for studio partitions. The increase in attenuation with mass is at a relatively slow rate as may be seen in Fig. 4. For example, a 6-inch wall (45 pounds per square foot) of solid cinder concrete may be expected to have an average attenuation (128 cycles to 4096 cycles) of about 48 db and a 12-inch wall (90 pounds per square foot) about 54 db.

Two 6-inch solid cinder concrete walls with an intervening air space of more than 6 inches may be expected to produce an attenuation of about 60 db. The use of double walls is to be preferred to single walls, because of the increased sound attenuation over a single wall, the reduction of impact sounds, and the lesser weight for a given degree of sound attenuation. The partitions should extend from the floor slab to the under portion of the floor slab above (or the roof). Cinder block walls have appreciable sound absorbing properties which absorb sound in the intervening space between walls and also are fairly free from pronounced resonances which are manifest as reduced attenuation over a band of frequencies.

The use of two 6-inch solid cinder block partitions (each plastered on one side) separated by an air space is the minimum that should be provided between adjacent

studios. The use of partition block of smaller dimensions, say of 4 inches thickness and hollow instead of solid will permit the transmission of more sound than is desirable.

Commercial sound isolation systems are effective in attenuating airborne sounds but experience has shown them to be less effective than is desirable in reducing the transmission of vibration at lower frequencies (of about 100 cycles and lower). There are advantages in their use where weight becomes a factor. Construction details of sound isolation systems for walls, floors, and ceilings are shown respectively in Figs. 5, 6, and 7.

There are types of multiple wall structures of light weight which are effective in reducing sound transmission but usually such walls occupy appreciable space, are relatively expensive and require careful supervision of their installation to insure proper performance.

Attention must also be given to the ceiling and floor surfaces to insure the maintenance of the high degree of sound attenuation provided by the partitions. In the buildings with stone concrete floor slabs of adequate thickness (4 to 6 inches thick), adequate isolation from the floor above is usually obtained by the installation of a "suspended" or "hung" ceiling. (It is presumed in this case that the occupants of the floor above are engaged in "quiet" activities.) Such a ceiling is required for light fixtures, concealing duct work and the like. The ceiling should be supported on resilient mountings, as the increased cost due to their use is quite small, and covered by loose rock wool fill, blanket or similar sound deadening material.

The floor on which the studios are mounted should be also studied as to noise coming from the floor below and additional cinder fill topped by smooth concrete finish added or a sound isolated floor installed.

Buildings with wooden floors present some problems as to loading bearing capabilities which may require re-arrangement of the studio grouping to obtain isolation by "separation" rather than structural means.

If the space surrounding the studios is quiet these precautions may be relaxed somewhat, but the effect of sounds from the studio to the surrounding space should be considered.

The observance of these precautions at the boundary surface of the studio will provide satisfactory noise conditions in most all cases. Practically, these surfaces must be pierced by windows, doors, and duct work and where so pierced every precaution must be exercised to maintain the sound isolation provided originally.

### Doors

Entrance to a studio should be effected through two doors separated by a vesti-

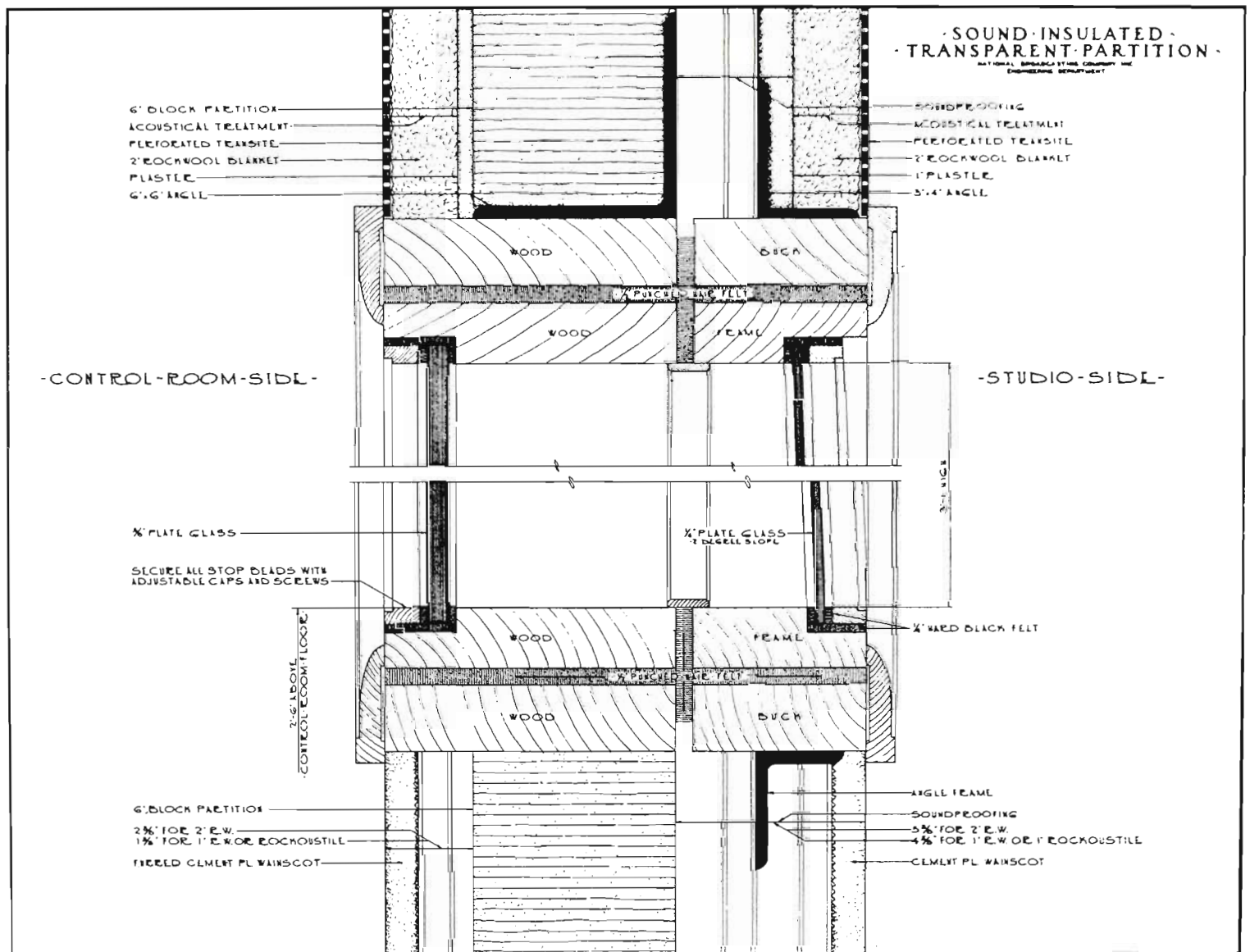

FIG. 9. Details of a sound insulated transparent partition.



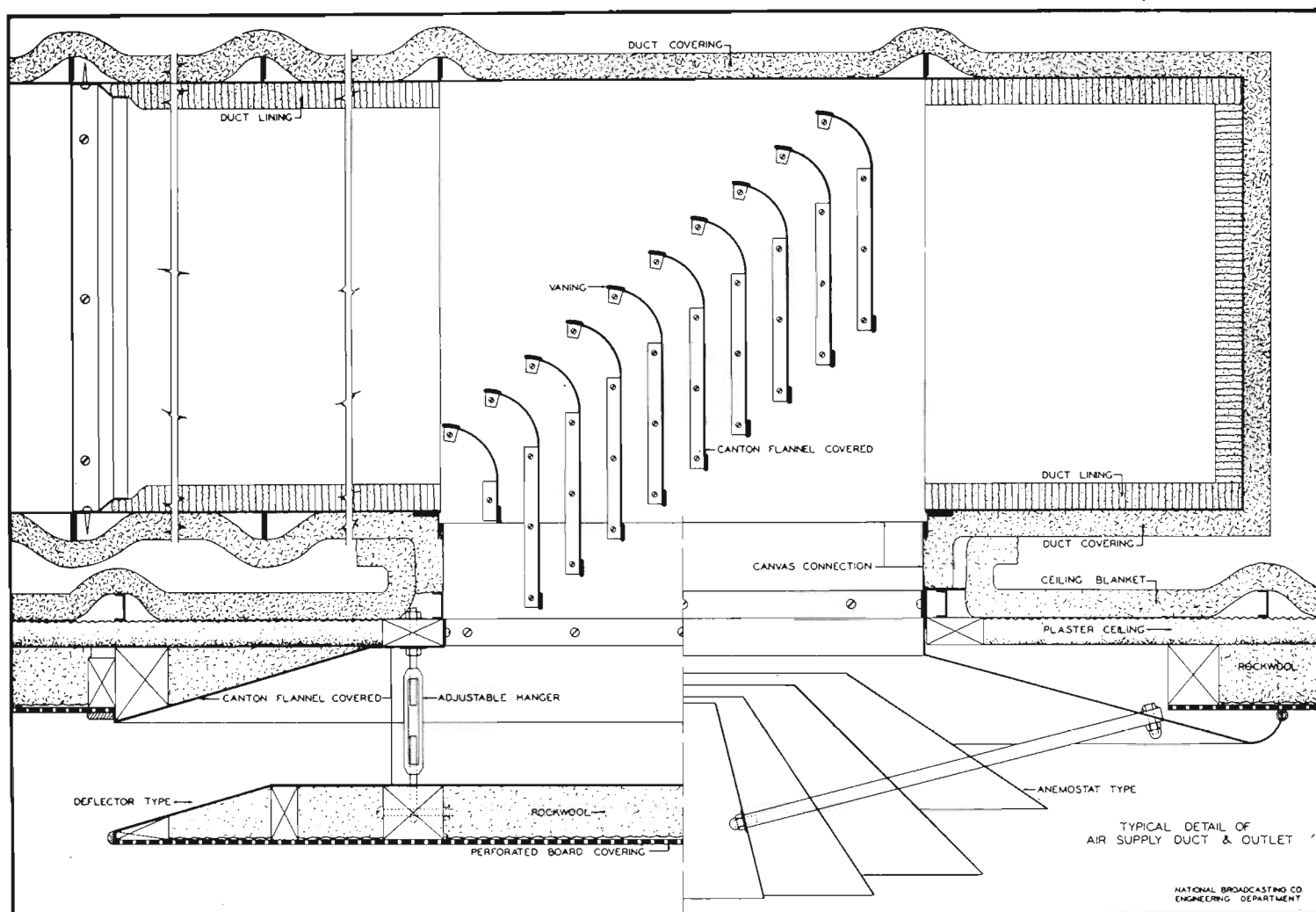

FIG. 10. Mechanical detail of an air supply outlet of deflector or "Anemostat" type.

bule which is acoustically treated over as much of the area as is possible. Experience has shown satisfactory performance with  $2\frac{1}{2}$ " solid wood doors fitted with an automatic bottom closer and gasketed on the head and side, at each end of the vestibule. Construction details of a satisfactory sound retarding door are shown in Fig. 8.

### Windows

Windows are needed for observation purposes in the control booth and public observation booths. The use of double glass of "lights"  $\frac{1}{4}$ " and  $\frac{1}{2}$ " thickness respectively separated as widely as possible will provide sufficient isolation. The isolation is improved to the extent of 6 to 10 db by acoustical treatment of the boundary surfaces between the panes or "lights" of glass. Construction details are shown in Fig. 9.

Outside windows should be "sealed" by masonry or treated in the same general manner as control booth windows if retained, to prevent transmission of sound between the studio and outside spaces. If no ventilating system is provided, and windows must be opened during the sum-

mer, the sound isolation system of the studio is greatly reduced in efficiency. The studio may be oriented so the windows face a quiet location, but thunder, aircraft and similar noises will undoubtedly prove disturbing.

### Air-Conditioning and Ventilating Systems

There are four general sources of noise due to ventilating systems:

- (a) The fan (which inherently generates a fairly turbulent air stream).
- (b) The system of duct work which may transmit sounds through it or along its surfaces.
- (c) The supply and return outlets.
- (d) Rotating or reciprocating machinery such as pumps, compressors, fans (vibration), etc.

All rotating and reciprocating machinery together with its driving sources should be mounted on a sound isolated base. Suitable isolation materials or springs include rubber in shear, metallic coil or leaf springs, cork, etc. The performance of practically all these materials is dependent on loading and the material should be de-

flected as much as possible (within the limits of the material) to obtain as low a natural resonant frequency as possible thereby providing the greatest amount of isolation. All connections to the equipment should be as flexible as possible, electrical wiring should be enclosed in flexible armour rather than conduit, etc.

Duct work should be connected to the fan through a canvas collar and the same procedure employed in connecting the duct work to the supply and return outlets. The duct work should be wrapped where it pierces the wall and wrapped within the confines of the studio. The duct of dimensions of 12" x 12" or smaller should be lined for a distance of 16 feet between the fan and the first outlet; and between outlets in studio and other spaces. Duct work to listening areas, such as control booths when of this dimension or smaller should be lined for a distance of at least 8 feet. The lining should bridge partitions which are pierced by several feet on each side of the partition.

Lining is adequate for small ducts but most studios will require larger ducts, in

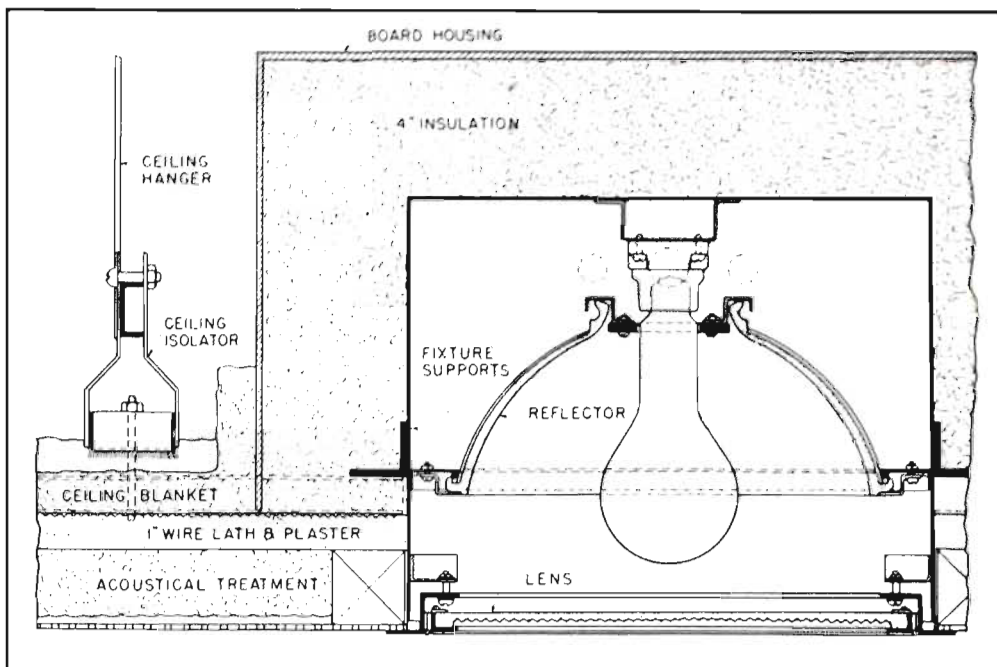

FIG. 11. Detail of acoustical treatment around recessed lighting fixtures.



FIG. 12. A speaker's studio simulating a living room can double as conference or sales room.

which case, lining alone is not sufficient. In the case of a duct 12" x 48", it should be lined as indicated above and divided at 12" intervals or less by absorbing material so that in effect 4 small ducts in parallel are created.

The supply and return outlets are another source of noise if the air velocity is too high or the duct work is not arranged for a smooth flow of air. Guiding radial vanes should be employed as required which will aid in the distribution of the air in the studio and also result in quieter conditions. The details of a

satisfactory supply outlet of the "pan" deflector or "Anemostat" type are shown in Fig. 10.

Air velocities which have been found satisfactory are 1200 feet per minute or less in main duct work; 500 feet per minute or less for supply outlets and 300 feet per minute at return outlets.

Pumps and compressors are sometimes troublesome acoustically as completely flexible joints or coupling to piping are not too practical and also the liquid column may be substantially "solid" so sound is transmitted along the piping in that

way. Such equipment should be located as remotely as possible from the studios and the piping suspended by resilient mounting to prevent transmission of the vibration to the building structure.

Recessed light fixtures pierce the ceiling constructions and the manner in which sound precautions are observed is shown in Fig. 11.

### Types of Sound Broadcast Studios

There are three major types of broadcast studios from which live talent programs may originate:

- (a) **SPEAKERS' STUDIO**—This type of studio is usually small, 12 by 18 feet or similar, designed to simulate a living room and intended only for speech. Where economy is a factor, such a studio may also serve as an audition room, conference room, or sales room. A studio of this type is shown in Fig. 12.
- (b) **GENERAL PURPOSE STUDIO**—This studio is intended primarily for the accommodation of the performers, with the visible audience, if any, of secondary consideration. Its size may range from 15 feet by 25 feet to 50 feet by 80 feet. A photograph of a small studio of this type is shown in Fig. 13.
- (c) **AUDITORIUM STUDIO**—The auditorium studio is intended for accommodating a visible audience and the presentation of the program from a platform or stage, and has no prescribed limits on size. The degree to which stage furnishings are provided is dependent on the amount of "show" desired. Such studios may be used for other purposes, such as demonstrations, cooking lessons, meetings, etc., as a part of the station's activities. A studio of this type is shown in Fig. 14.

### Shape

The proportions of the studio should be pleasing and at the same time technically correct. The desired proportions of 2:3:5 for height, width and length have proven to be a practical guide in studio construction. In larger studios, economy and practical considerations may result in a lowering of the ceiling height to a value somewhat below the proportions stated.

Fig. 15 shows the preferred studio dimensions together with the recommended "maximum occupancy" (including performers and audience) and the "acoustical optimum" which refers to the number of performers only.

The object of incommensurate room dimensions is to avoid a grouping of the

harmonics of natural room frequencies. These proportions will result in reasonably uniform distribution of these frequencies. In the case of larger studios these "resonances" become of lesser importance as the natural frequencies are extremely low and their harmonics within the audible range substantially weaker.

### Reverberation Time Frequency Characteristic

The optimum reverberation time at 1000 cycles becomes larger as the studio size increases. The optimum shown in Fig. 16 is based on practical experience and the critical judgment of a large number of people. Reverberation Time may be defined as the length of time required for a sound, having reached steady intensity in an enclosure, to decay 60 db or to one millionth of its original power. The relation between reverberation time and frequency provides a longer reverberation time at lower frequencies than at medium and high frequencies to compensate partially for the characteristic of the human ear and provide some aural decay period at all frequencies. The Sabine-Eyring Knudsen formula for calculation of reverberation time has been found to provide good correlation between calculated and measured value. Fig. 17 shows the relation between the function  $(\alpha)$  or average absorption and the value  $-\log_e (1-\alpha)$ .

$$T = \frac{.05V}{-S \log_e (1-\alpha) + 4 mV}$$

Where

T = Reverberation time in seconds. (The time required for a sound having reached steady state intensity to decay 60 db).

V = Volume Cubic Feet.

S = Total Surface Area—square feet.

a = Average absorption co-efficients.

$$\alpha = \frac{a_1 s_1 + a_2 s_2 + a_3 s_3}{S}$$

m = Co-efficient of absorption of air at 50% R.H. (varies with frequency).

### Acoustical Treatment

The required total absorption is easily calculated from the optimum frequency reverberation time characteristic by use of the Eyring formula. There remains, however, the selection of the type and thickness of material and distribution in conjunction with reflective areas.

There are several general types of acoustical materials.

- (a) Plaster
- (b) Draperies and carpets
- (c) Tiles
- (d) Membrane covered absorbing materials.



FIG. 13. The acoustical treatment of a general purpose studio.



FIG. 14. A typical auditorium type studio.

*Acoustical plaster* is usually of only moderate absorbing efficiency at medium and high frequencies but the absorption is subject to some variation dependent on job conditions—the manner of mixture, pressure of the trowel (or applicator), etc. Its relatively poor resistance to abuse restricts its use to ceilings, if used at all, in studios.

*Draperies* and *carpets* in general have little absorption at the lower frequencies

and the absorption increases with the frequency. Draperies, lined and interlined, hung 100 percent full (twice the area of material is required for the area of wall to be covered) and 1 foot or so from a wall will have very appreciable low frequency absorption. Draperies are perhaps the most economical means of providing adjustable acoustical conditions. They are useful in this regard particularly on the rear stage wall of an auditorium type

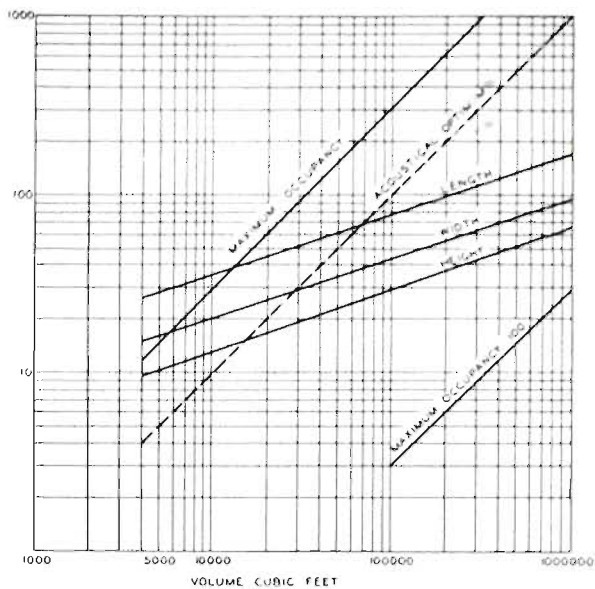

FIG. 15. Preferred studio dimensions and maximum occupancy.

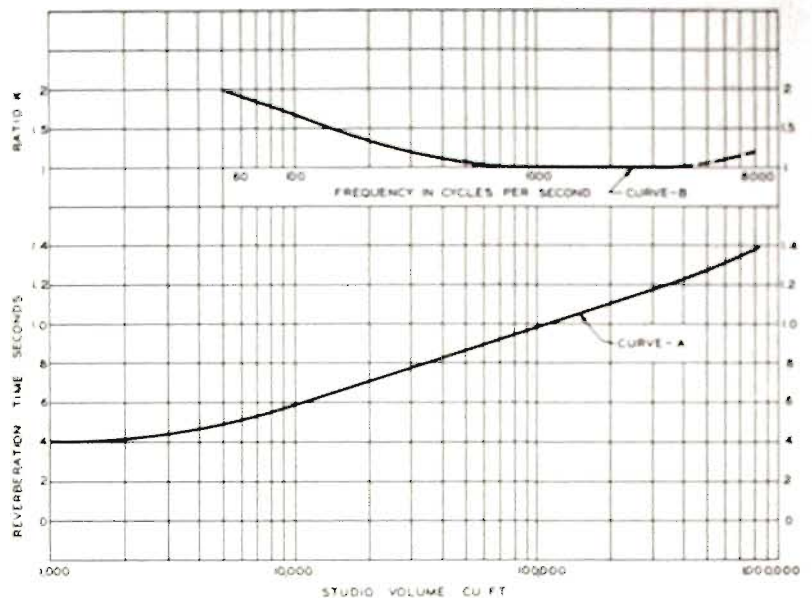

FIG. 16. Optimum reverberation time and frequency characteristics.

studio to provide and acoustical change in that area. Carpeting is useful in seating sections on the walking area of auditorium studios, on the floor of speaker's studios, under microphone stand to reduce "scuffling" of feet and in certain cases to reduce the noise of footsteps in corridors.

*Acoustical tiles* provide fairly high absorption at medium and high frequencies and a lesser degree at low frequencies dependent on the manner in which they are mounted on ceilings or walls. Certain types which are homogeneous and rely on the porosity of the material for absorption tend to be fragile and subject to discoloration due to "breathing." ("Breathing" is the discoloration due to temperature and pressure differentials which tend to entrap the dirt on surfaces due to the passage of air through the tile near the exposed surface.) (Plaster is also subject to this effect.) In common with acoustical plaster, porous tiles may be subjected to indiscriminate painting when redecoration is necessary and even careful painting invariably substantially reduces the absorbing efficiency. Typical cases have shown a reduction from 50 to 60 percent down to 20 to 30 percent.

*Membrane covered absorbing materials* are those in which the perforated membrane whether it be metal, asbestos board, or hardboard, serves as an acoustically transparent covering of the absorbing material up to about 4000 cycles after which the covering becomes increasingly reflective. These coverings are fairly abuse resisting and capable of painting several times without adverse effects on the absorbing efficiency.

The decision as to which type or combination of types of treatments is deter-

mined by the total absorption required, decorative schemes and economy. In general, if it is expected that the treatment is to last for more than five years the best economy ultimately is to provide the best, the most durable and a type capable of re-decoration.

The control of absorption at the low frequencies can be accomplished by an increase in thickness of one or more of the materials selected, the furring or mounting of the treatment at some distance from the wall or the use of large areas of generally "reflective" curved surfaces which have appreciable absorption at low and medium frequencies and almost none at high frequencies.

#### Distribution of Treatment

One objective in studio design is to provide a reasonably diffuse sound field but it is not believed desirable to obtain or even approach complete diffusion as indications are that this results in a "confusion" of sound. The desired diffusion is achieved by the arrangement of acoustical treatment generally throughout the studio interspersed with plane, splayed, serrated and diffusely reflective surfaces. Care should be exercised that any large and opposed flat reflective surfaces are avoided to prevent persistent discrete reflections manifest as "rattles" or "flutters."

*Speakers Studios* to resemble a living room should employ a carpeted floor (with lining) and an untreated ceiling. The walls may be treated with an appropriate area of commercial acoustical treatment or heavy draperies. Since these rooms may be small and used mostly for speech, particular attention should be given to provide adequate low frequency absorption

to avoid a "boomy" and unnatural speech sounds. Where draperies are employed it may be necessary to mount 2 inches or more of rock wool blanket or similar material behind the drapery to raise the low frequency absorption.

*General purpose studios* should have a floor covering of linoleum or similar sound reflective material. The wainscot or chair rail should be of abuse resisting material such as cement plaster about 3 feet 6 inches or 4 feet high.

There are almost an infinite variety of arrangements of wall and ceiling treatments; consequently only generalized suggestions can be made. The peripheral area of the ceiling may be untreated so long as the distance from the side walls is less than 3 to 4 feet. If this distance becomes larger the area should be convexly curved, splayed or a band of acoustical treatment provided. Large areas of reflective surfaces parallel to the floor centrally located must be avoided, because of the danger of persistent vertical reflection in the microphone field. The wall treatment should be arranged in some decorative pattern of curved or serrated reflective surfaces alternated with absorbing areas. It may be noted that convexly curved wooden surfaces are in current use. There is no objection to wood, but the major virtue appears to be in the shape of the curvature rather than the material which forms the curve. (There is some difficulty in certain cities in the use of wood because of fire-proofing requirements of Fire and Building Departments.)

*Auditorium studios* are divided into two sections where the platform is in effect a stage and so equipped. Where the platform is merely a platform the division is less

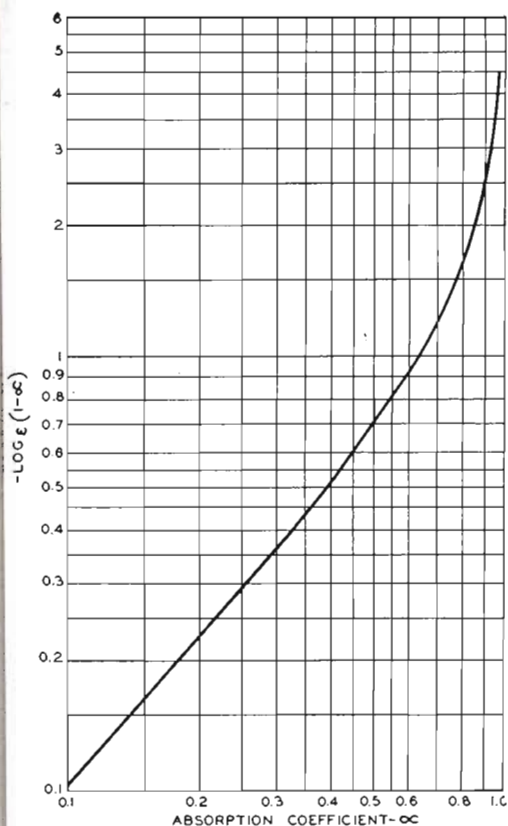

FIG. 17. Value of expression  $-\text{Log}_e(1-\alpha)$ .

obvious but the same general procedure follows.

The stage floor should be linoleum covered. The side walls treated in much the same way as the general purpose studio. The rear wall should be entirely reflective but serrated or contain convexly curved surfaces. The rear wall should be provided with a draw curtain so that adjustment of acoustical conditions is possible. (See Fig. 18.) The stage ceiling should be generally serrated and by a suitable sawtooth arrangement border lights may be concealed from the seating section. This obviates the use of masking borders as their extensive use tends to reduce excessively the reverberation time at higher frequencies.

The seating section should contain upholstered seats thereby providing substantially the same absorption in this area whether empty or fully occupied. The floors on the walking areas should be carpeted to deaden foot falls and scuffling of feet. The ceiling above the seating section may be left untreated as an aid in the propagation of sounds from the stage to the listeners. The forward portion of the side walls (perhaps 2/3 or 3/4 of the distance from the stage) may be untreated provided they are splayed so that opposed surfaces are non-parallel. It may be necessary to treat the rear portion of the side walls to reduce delayed reflection back to the stage. The rear wall should be

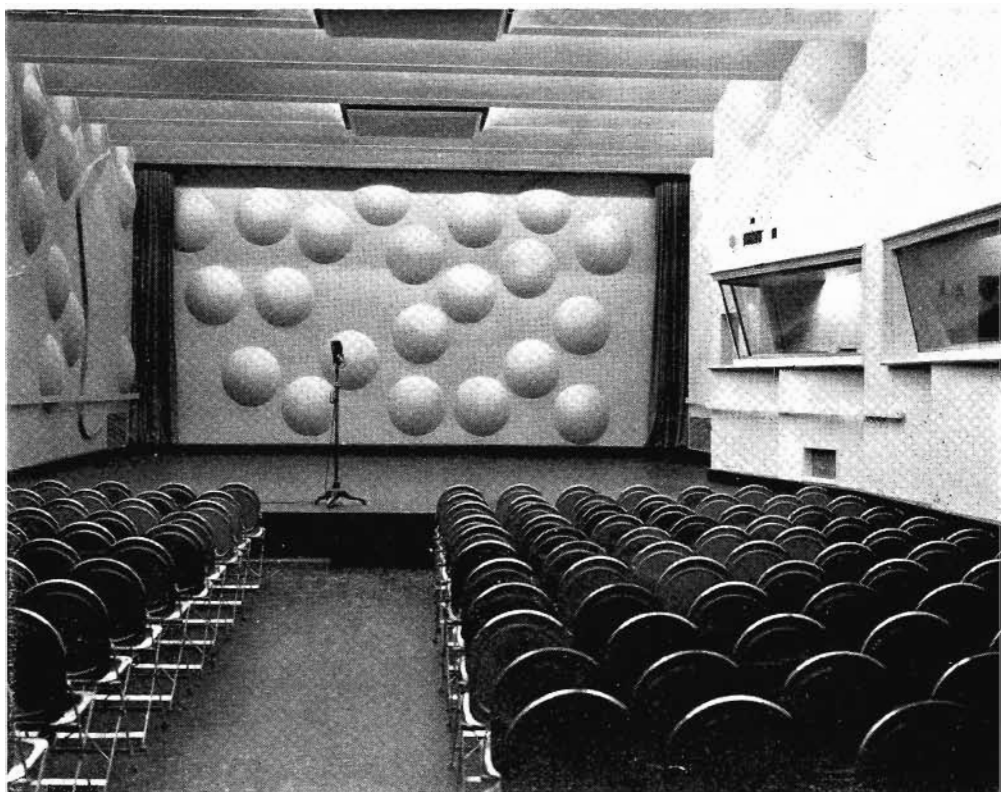

FIG. 18. Rear wall of auditorium stage is reflective with draw curtains to vary acoustical conditions.

heavily treated and if desirable to appear architecturally as curved with a radius near the stage apron, the wall should be arranged in a series of convex curves or serrated. Despite the fact that some 80 percent or more of the sound energy may be absorbed, a relatively large area reflecting sound energy to a concentrated small area can and has caused trouble. Where the difference in path length between direct sound and reflected sound is 50 feet or more the plans should be examined carefully as appreciable reflected sound energy of this path difference will tend to be manifest as a fairly distinct echo.

#### Absorption Due to the Air

The increased attention to higher frequencies in sound transmission and reproduction indicates a review of acoustical techniques in this field. The information of the performance of acoustical materials generally available includes a frequency range of only 100 cycles to 2000 or 4000 cycles as contrasted to reliable information from 30 to 15,000 cycles to most available communications engineers. This is a serious limitation in which only some progress has been made in the extension of the range but the information is not generally available.

The absorption of the air itself becomes a factor at about 4000 cycles and above 10,000 cycles is the controlling factor. At a relative humidity of 50 percent the absorption due to the air itself is such that

even though the walls, ceiling and floor were perfectly reflective, no studio regardless of volume, can have a reverberation time greater than 1.5 seconds at 10,000 cycles and about 1.0 seconds at 15,000 cycles. Fig. 19 shows the reverberation time at various frequencies (regardless of the volume of the enclosure) when the total absorption is that due to the air alone. Attention is called to this factor, not that appreciable control can be exercised, but rather that it be known and recognized in the planning. The absorption due to the air rises gradually to a peak in absorption at 20 to 30 percent relative humidity and at higher values (above 50 percent) decreases appreciably.

#### Control Booths

The floor of control booths should be sound reflective, covered by linoleum or similar material. The ceiling should be treated over about 80 percent of the area with a material equivalent to 2 inches rock wool covered by perforated asbestos board. The treatment of the walls will depend somewhat on the particular booth, but if an entrance door is assumed on one end wall, a general statement may be made. The wall opposite the control booth window and the adjoining wall (opposite the entrance door) should be treated above a wainscot 3 feet or 3 feet 6 inches high over the entire area with a material equivalent to the ceiling treatment. (If the control booth ceiling is 8 feet high, the treat-



FIG. 20. A typical television studio set showing microphone and camera placement.

floor and stopped 7 feet above the floor—in a 4-foot panel.) This would be a more economical procedure as perforated asbestos board is usually supplied in sizes of 2 feet by 2 feet or 2 feet by 4 feet. The same condition would apply horizontally where an additional 6 inches or so would involve cutting and fitting.

#### Television Studios (Live Talent)

There is not the same amount of experience with live talent television studios

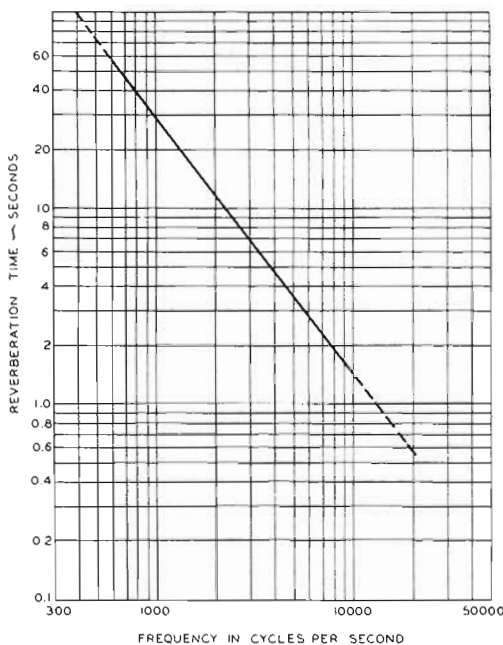

FIG. 19. Reverberation time at various frequencies with total absorption due to air alone.

as in sound broadcasting but the experience of a period of eight years with a studio 30 feet by 50 feet and 18 feet high has taught some lessons. The observations of the experience of others in this field have also proven helpful. The problem in the television studio is different acoustically in that a set with three sides or even two sides tends to determine the acoustical quality of the sound pickup in that set. The studio itself should be substantially non-reverberant or acoustically "dead." The studio, by its very nature, cannot be a showplace in the usual sense so that decorative effects may be subordinated very definitely to practical requirements. It is to be expected that provision must be made for a visible audience in some cases, but the flexible use of the studio and the screening of viewing action by the sets themselves will tend to locate such an audience adjacent to the control booth or at some other location well above the floor level of the studio and in a sense out of it.

The acoustical treatment in a television studio would approximate that of a motion picture studio (not a scoring stage). The entire area of the walls and ceiling should be covered by 2 inch rock wool blanket or similar material. To prevent "dusting" of the material another covering of flame-proof muslin should be applied on the ceiling and upper wall surmount may be started 3 feet above the

faces. The wall surfaces to a height of about 12 feet should be covered with perforated asbestos board or similar material painted a light matte-gray or aluminum color. The upper wall and ceiling surfaces should be covered by  $\frac{1}{2}$  inch or 1 inch mesh screening.

The noise requirements are perhaps more stringent than in sound broadcasting as the microphone is located 3 to 6 feet from the performers and will receive a higher ratio of random to direct sound than in sound broadcasting. Figs. 20 and 21 show typical views of a television studio.

The light levels in sound broadcasting require 20 to 30 foot candles incident on a horizontal plane about 3 feet above the floor. This is roughly equivalent to about 6 watts per square foot of floor area. Television lighting requires between 200 and 500 foot candles of incident light on the set even with the more sensitive pick-up tubes. This amount of light is required for artistic lighting and while the camera pick-up tubes will work at lower light levels, the increased ease of operation with the lens "stopped down" with attendant greater depth of focus is a desirable feature. These light levels are roughly equivalent to 20 to 30 watts per square foot of floor area. The difference is that broadcast studios are uniformly illuminated whereas in television the lighting is concentrated on one or more sets. The lighting may be on two at the same time as in a small studio the proximity of the sets is such that some spilling of light from one to the other is unavoidable. The increased lighting load requires increased air-conditioning (or ventilation) to dissipate and carry away this heat. A noise problem is introduced by reason of the fact that duct sizes become increasingly larger and there will be a tendency to increase the velocity of air to reduce the size of the duct. The increase in velocity in the duct in the main run is not objectionable provided that adequate sized ducts run to the studio properly treated so that the noise generated in the main run due to the velocity of the air is effectively attenuated. The desired practice of introducing the air at a height of about 15 feet above the floor and removing air at the ceiling and floor tends to bring the supply outlets closer to the probable microphone locations.

The same general conditions as to air-conditioning or ventilation apply in the control booth, particularly if appreciable equipment is located in that space. The power load per camera chain dependent on auxiliaries such as monitors, etc., is about 3 KW. A separate exhaust system

over the equipment itself to remove its heat is desirable. The occupants of a sound broadcast control booth may range from a minimum of one to a maximum of two or three. (These numbers refer to persons performing useful functions and do not include the usual onlookers.) The occupants of a television control booth will range from four to seven dependent on the manner in which technical and program production is accomplished. The acoustical requirements for listening are just as critical and the same attention must be given to sound control as in sound broadcasting. It is evident (see Fig. 22) that the television control booth is, of necessity, considerably larger than a sound broadcast booth.

The size of television studios will be appreciably larger particularly as to height to permit light bridges, cat walks and the like. The experience in a studio 30 feet by 50 feet by 18 feet high has shown that the low ceiling is a disadvantage and that this studio is almost the minimum size. A minimum sized television studio would be about 25 feet by 40 feet by 22 feet high. A more desirable minimum size is about 40 feet by 60 feet by 25 feet high.

There is another difference and that concerns the control booth. In sound broadcasting location of the control booth  $1\frac{1}{2}$  to 2 feet above the studio floor level

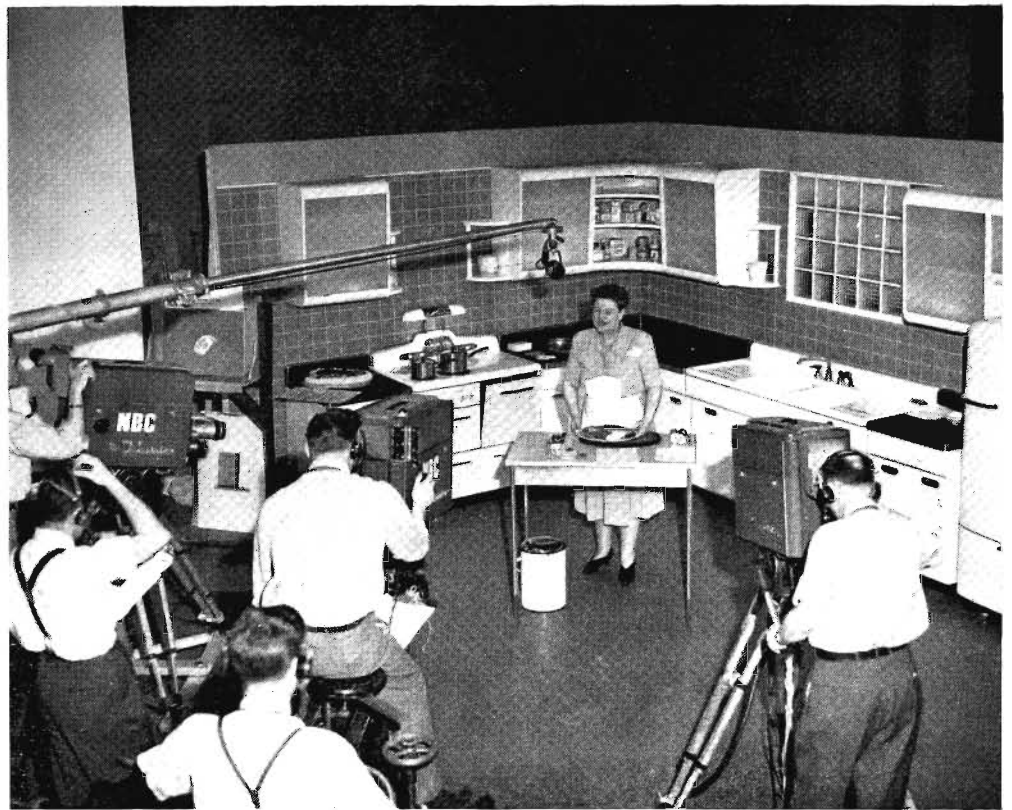

FIG. 21. Another typical television studio set.

and at one end is generally satisfactory. In the case of television for flexibility and adequate vision the control booth floor should be located midway on the long side of the studio and should project into the studio for a distance of several feet.

### General

It is desirable to appreciate that studio planning is based on satisfying the opinions, wishes, and desires of people. That is, the end result is the subjective opinion of people rather than the objective measurements by means of a technical instrument. It is not to be expected that any plant will completely satisfy everyone that uses it or views or hears the product of its output. It is to be expected that the proper planning will satisfy about 70 percent of the people and that the remainder will admit perhaps grudgingly that it is at least tolerable. Because such planning involves subjective judgment there is a probability of change in requirements as tastes in general may change. These changes may not be of a fundamental nature but in details or in a tendency more toward one direction than the other. It is for that reason that mention was made of planning for future expansion so that future requirements may be accommodated. It is hoped that the material presented will be some help to those concerned with present and future planning.



FIG. 22. View of a television studio control room showing video and audio monitoring facilities.

# RCA Announces



**RCA's completely self-contained 500-watt TV transmitter** is designed for locations where low power can provide adequate signal strength and sufficient coverage. In favorable locations it is capable of producing sound-and-picture quality that is comparable in every respect to the output of higher-powered transmitters.



RCA's 500-watt TV transmitter is as easy to operate and tune as a standard broadcast transmitter. Controls for each unit are all within handy reach.

The attractively styled control console (in foreground) is included with the transmitter. It contains all picture-and-sound gain controls, and complete monitoring facilities for picture and sound signals.



# this revolutionary new 500-watt TV transmitter

for community service and big-station stand-by

- Type TT-500A for channels 2 to 6 (54-88 Mc)
- Type TT-500B for channels 7 to 13 (174-216 Mc)

**T**HIS LOW-POWERED television transmitter is designed to serve suburban communities—where terrain is relatively flat and where there are no large buildings to “shadow” the area. Operated in conjunction with an RCA high-gain Super Turnstile antenna, it is capable of radiating over 2 kilowatts of picture power and up to 1 kilowatt of sound power. The transmitter is a “natural” for stand-by work in the metropolitan station where maximum program continuity is required.

As simple to operate and tune as a standard broadcast transmitter, this transmitter uses high-level grid modulation and is capable of delivering the same high-definition picture quality and high-fidelity sound that has made RCA 5-kw TV transmitters famous. A vestigial sideband filter . . . pre-tuned at the factory . . . clips off a portion of the lower sideband and insures against interfering with other TV stations operating on adjacent channels. This feature eliminates the need for complicated stage-by-stage “tuning in” of the sideband and enables the operator to meter-tune each r-f stage as a straight class C amplifier.

RCA's 500-watt television transmitter is furnished in two types—both available for prompt delivery. Type TT-500A is designed for channels 2 to 6. Type TT-500B is designed for channels 7 to 13. Each transmitter is housed in two identical cabinets that can be mounted individually . . . or be readily bolted together as a single, compact unit. *Maximum over-all size of each cabinet of the transmitter is only 31 inches wide, 84 inches high, and 31 $\frac{1}{2}$  inches deep!*

Get in touch with your RCA Television Specialist for the complete facts. And by all means ask for your copy of the new brochure. Dept. 19LB. RCA Engineering Products, Camden, N. J.

*The One Equipment Source for Everything in TV is RCA*

Front view (doors open). Left cabinet houses the r-f driver, FM power amplifier, power supplies, and RCA's famous Direct-FM exciter. Right cabinet houses the TV r-f stages, the 3-stage video amplifier chain—with its sync expander and clamp circuit—and modulator. No neutralizing of r-f stages required. Standard, low-cost air-cooled tubes are used throughout.



**TELEVISION BROADCAST EQUIPMENT**  
**RADIO CORPORATION of AMERICA**  
**ENGINEERING PRODUCTS DEPARTMENT, CAMDEN, N.J.**

In Canada: RCA VICTOR Company Limited, Montreal



RCA Radiomike  
Type BTP-1A

*At both National political conventions, the BTP-1A broke all records for getting first-news **FIRST!***

# Flash Remotes... **NO LINES NEEDED!**

## Immediate delivery on this new RCA Radiomike

### SPECIFICATIONS

Power output . . . 0.2 watt, approx.  
 Frequency range . . . . . 25 to 28 Mc  
 Frequency stability . . . . .  $\pm 0.01\%$   
 Modulation capability. . . . . 85%  
 A-F response (overall)  
                                    $\pm 4$  db 80-6000 cps  
 A-F distortion (90% mod). Less than 8%  
 Battery life . 8 hours, intermittent service  
 Weight (total) . . . . . .6 lbs.  
 Overall size . . . 11" H x 4½" W x 3½" D

**T**HIS IS IT, the perfect portable microphone for unscheduled remotes—fires, accidents, sporting events, conventions, trick broadcasts—any occasion and any place where wire connections are difficult or impractical to install. No waits for equipment set-ups. No delays while recordings are rushed to the studio. Flip the switch—*and you're on the air!*

Combining a 0.2-watt AM transmitter (25-28 Mc), a crystal microphone, a 20" antenna, and batteries—all in one compact unit, here is a complete announcer's unit weighing only 6 pounds that can transmit up to several miles

under ideal conditions. Any communications receiver covering the 25-28 Mc band can be used for reception.

In the BTP-1A, the radio transmitter is crystal-controlled for high frequency stability. Automatic a-f gain control eliminates overloading and distortion. The crystal microphone . . . using three crystal units in series . . . provides extra gain with excellent quality.

Your BTP-1A is ready for delivery—complete with one set of tubes, one crystal, and a battery. Specify your frequency and order it from your RCA Broadcast Sales Engineer, or from Department 191A.

**NOTE:** License application for the BTP-1A can be made simply by informal letter to the FCC.

The One Equipment Source for Everything in **BROADCASTING**—is RCA



**BROADCAST EQUIPMENT**  
**RADIO CORPORATION of AMERICA**  
**ENGINEERING PRODUCTS DEPARTMENT, CAMDEN, N.J.**

In Canada: RCA VICTOR Company Limited, Montreal

**RCA Field-Intensity Meter**  
**Type WX-1A**  
**50 to 220 Mc**



**NEW** *field-intensity meter*  
**—for the television and FM bands**

**SPECIFICATIONS**

- Freq. Range . . . . . 50 to 220 Mc
- Sensitivity . . . . . 5 microvolts to  
20 microvolts/meter,  
depending on frequency
- I-F Bandwidth . . . . . 150 kc
- FM Adjacent Channel  
Selectivity . . . . . 65 to 1
- FM Band Image Ratio . . 130 to 1
- Power Supply . . . . . Built-in 6-v,  
voltage-regulated  
(a-c power supply  
also available)
- Weight  
Meter . . . . . 43½ lbs.  
Antenna  
(including tripod) . . . . 15 lbs.
- Size . . . . . 19" L x 14½" H x 13" D



THE WX-1A meets the strict requirements of FM and TV engineers for a field-intensity meter of laboratory accuracy covering television, FM, and AM services between 50 and 220 Mc. Its high sensitivity permits minimum readings ranging from as low as 5 microvolts per meter at 50 Mc, to 20 microvolts per meter at 200 Mc.

Completely self-contained, the WX-1A includes a very stable superheterodyne receiver. Selectivity characteristic is down 65 to 1 on adjacent FM channels. Image ratio is 130 to 1 at 100 Mc. A 2-stage audio amplifier drives a built-in loudspeaker for continuous audio monitoring of the signals being measured.

Separate output terminals provide for convenient use with the standard Easterline-Angus recorder. The built-in vibrator power supply includes its own voltage regulator. The antenna . . . furnished with each WX-1A . . . is adjustable for horizontal or vertical polarization.

For accurate data on the service area of any TV, FM, or AM station in the uhf —and for authoritative coverage information for FCC proof-of-performance—the WX-1A is second to none. Complete details are available from your RCA Broadcast Sales Engineer. Or from Dept. 191B, RCA Engineering Products, Camden, N. J.

The One Equipment Source for Everything in **BROADCASTING** —is RCA



**BROADCAST EQUIPMENT**  
**RADIO CORPORATION of AMERICA**  
**ENGINEERING PRODUCTS DEPARTMENT, CAMDEN, N. J.**

In Canada: RCA VICTOR Company Limited, Montreal



RCA-5592, used in 50-kw FM transmitters

RCA-5671, with thoriated filament, used in 50-kw AM transmitters

RCA-8D21, used in 5-kw television transmitters

# RCA covers the field

RCA has the most complete and up-to-date line of tubes in the broadcast field.

RCA's years of experience in tube research and development have resulted in new and improved types for AM, FM, and TV broadcasting . . . tubes that have advanced the art of broadcasting in all its phases.

Year after year, RCA tubes have set the pace in quality, performance, and value. They have won an unequalled reputation for engineering excellence, dependability, and

true operating economy. That's why experienced broadcasters buy RCA tubes.

For your convenience, RCA tubes are now available from your local RCA Tube Distributor or directly from RCA. For information on any RCA tube, write RCA, Commercial Engineering, Section FP 36, Harrison, N.J.



The world's most modern tube plant...  
**RCA, LANCASTER, PA.**

THE FOUNTAINHEAD OF MODERN TUBE DEVELOPMENT IS RCA



**TUBE DEPARTMENT**

**RADIO CORPORATION of AMERICA**

**HARRISON, N. J.**