

AM · FM · TELEVISION

BROADCAST

NEWS

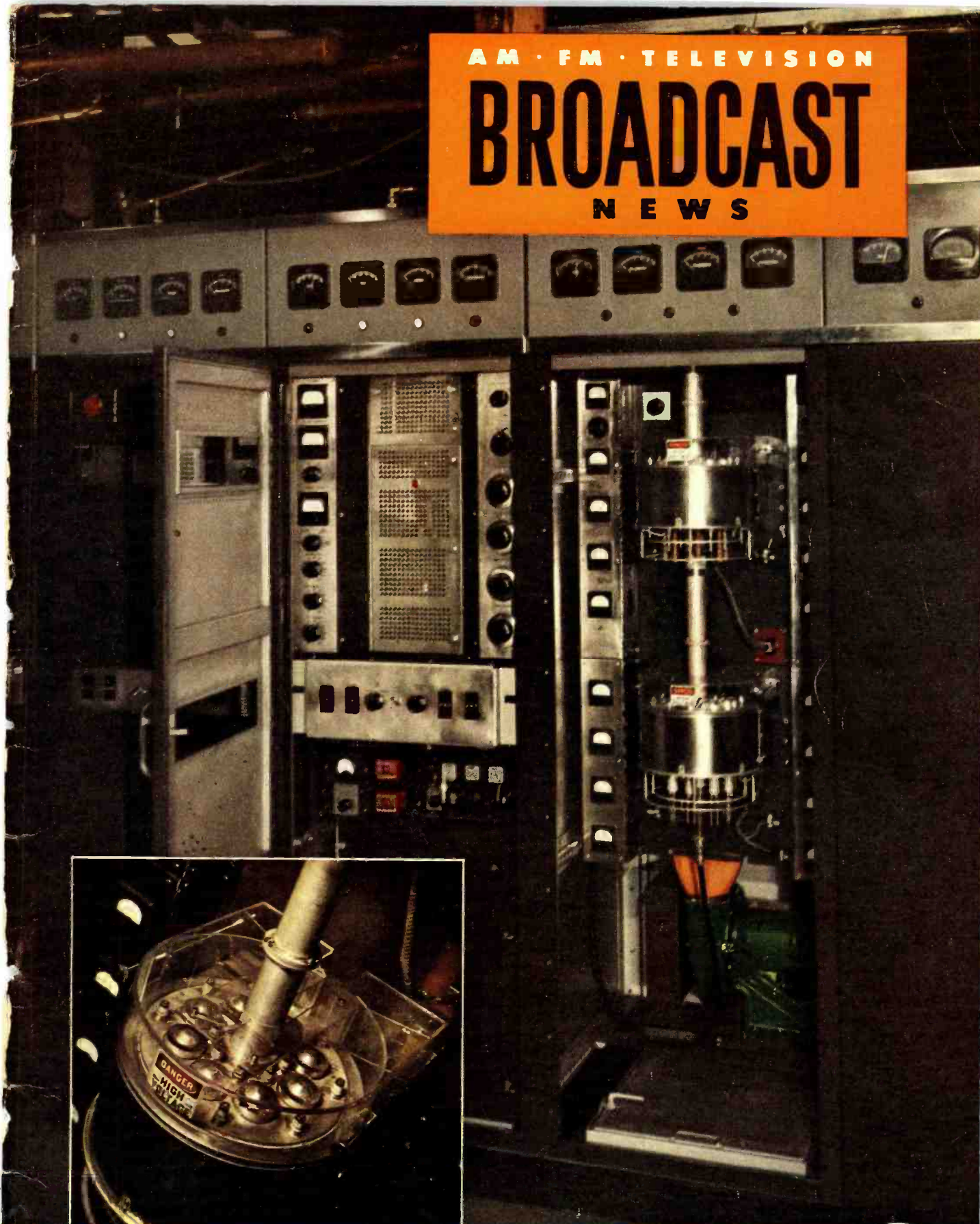

UHF TV TRANSMITTER . . . See pg. 8





RCA Radiomike
Type BTP-1A

At both National political conventions, the BTP-1A broke all records for getting first-news FIRST!

THE RCA RADIOMIKE . . . *ideal as a Roving Microphone*

SPECIFICATIONS

Power output 0.2 watt, approx.
 Frequency range 25 to 28 Mc
 Frequency stability $\pm 0.01\%$
 Modulation capability 85%
 A-F response (overall)
 ± 4 db 80-6000 cps
 A-F distortion (90% mod). Less than 8%
 Battery life . 8 hours, intermittent service
 Weight (total)6 lbs.
 Overall size . . . 11" H x 4½" W x 3½" D

NOTE: License application for the BTP-1A can be made simply by informal letter to the FCC.

THIS IS IT, the perfect portable microphone for remotes—fires, accidents, sporting events, conventions, trick broadcasts—any occasion and any place where microphone cable connections are difficult or impractical to install.

Combining a 0.2-watt AM transmitter (25-28 Mc), a crystal microphone, a 20" antenna, and batteries—all in one compact unit, here is a complete announcer's unit weighing only 6 pounds that can transmit up to several hundred yards under ideal conditions. Any communications receiver cover-

ing the 25-28 Mc band can be used for reception.

In the BTP-1A, the radio transmitter is crystal-controlled for high frequency stability. Automatic a-f gain control eliminates overloading and distortion. The crystal microphone . . . using three crystal units in series . . . provides extra gain with excellent quality.

Your BTP-1A is ready for delivery—complete with one set of tubes, one crystal, and a battery. Specify your frequency and order it from your RCA Broadcast Sales Engineer, or from Department 191A.

Broadcast News

AM • FM • TELEVISION

Published by the

RADIO CORPORATION OF AMERICA

ENGINEERING PRODUCTS DEPARTMENT . . . CAMDEN, NEW JERSEY

NUMBER 57

Subscription Rates

JAN.-FEB., 1950

In continental U. S. A. - \$4.00 for 12 issues
In other countries . . . \$5.00 for 12 issues

JOHN P. TAYLOR, Editor

JUDY J. ALES, Ass't Editor

W. O. HADLOCK, M. L. GASKILL, E. B. MAY, Associate Editors

Contents

FIRST UHF TRANSMITTER SHIPPED	8
WMAR-TV, BALTIMORE, MARYLAND <i>by C. G. NOPPER</i>	14
VOICE OF AMERICA'S 150 KW TRANSMITTER <i>by E. L. SCHACHT</i>	24
RADIO ISTANBUL COVERS NEAR EAST WITH 150 KW TRANSMITTER <i>by PAUL C. BROWN</i>	28
WTCN, MINNEAPOLIS <i>by JOHN M. SHERMAN</i>	32
KENI, ANCHORAGE, ALASKA <i>by A. G. HIEBERT</i>	40
HOW TO USE THE TM-5A MONITOR <i>by H. J. MARKLEY</i>	45
THE STRANGE CASE OF THE FIVE BASEBALLS	46
WHIO-TV, DAYTON	48
THEATRE TELE	58
WPTZ's USE OF THE REFLECTAR AND ZOOMAR LENSES	62
KSEI, POCATELLO, IDAHO <i>by HENRY H. FLETCHER</i>	64

Copyright
Radio Corporation of America
RCA Victor Division
Camden, N. J.

PRINTED
IN
U. S. A.

COVER illustration this month shows the visual power section of the new RCA Type TTU-1A Television Transmitter installed for NBC at Bridgeport (story on Pg. 8). Inset is a view looking into one of the very interesting multiple-tube cavities used in the tripler and power amplifier stages of this transmitter. Reproductions are from 4" x 5" Kodachromes made by Rod Allen of our own photographic department.

UHF TELEVISION band, as visualized in FCC's tentative proposals, is provided for by the introduction of this new transmitter. It is designed to operate at any frequency from 530 mc to 830 mc. Output is 1 kw at the low end with slightly less at the high end. Used with the TFU-20A Antenna it will provide close to 20 kw ERP.

COLOR TOO is now pretty well provided for—at least as far as transmitters go—for the TTU-1A, like all of the RCA VHF-TV transmitters, is easily capable of handling all of the proposed systems of color TV. In fact it is notable that nearly all color transmission tests made to date on the standard bands have been made with standard RCA transmitters. Thus today's telecaster can buy a transmitter with good assurance that color, if and when, will not obsolete that part of his equipment.

WE'RE LATE with this issue—very late. The reason, and we consider it a good and sufficient one, is that for the past few months our staff has been engrossed in the Herculean task of preparing our new Broadcast Equipment Catalog. This new catalog contains 412 pages of closely-spaced descriptive material and specifications on 1060 items of broadcast station equipment. A considerable number of these items are entirely new—many others have new (and improved) specifications. Moreover, we wanted to use this opportunity to correct errors in the specifications of some of our older items. Thus, there was not only a very large amount of new material to prepare, but in addition it was necessary to go through all of the old material, page by page, checking every word (well almost every word) with engineering and sales experts. It was a tremendous task—but it's done, and we're rather proud of it. We won't say there are no errors—there are bound to be some in a book this big. And we won't say there are not some items in it that are already obsolete—it wouldn't be a progressing (and interesting) field if it didn't happen. But we do say that it's the most complete, most up-to-date—and by far, the largest—compendium of information on broadcast equipment ever put together.

YOUR COPY of this new catalog should be in your hands by now. We've mailed two copies to every station—one to the manager and one to the chief engineer. There are a limited number of additional copies available for our good customers and fair prospects. You can get one by asking your RCA Field Representative. Those who do not fall in the above categories may obtain a copy, if they so desire, at the approximate cost price of two dollars. We'd like to make the free circulation unlimited, but it's too wasteful and too expensive. So we've elected to make the distribution (beyond our customer list) on a cost basis. This eliminates the waste, while at the same time making the book available at what is really a bargain price to those who may wish to use it as a textbook or manual.

AN ERROR occurred in our last issue in connection with the WBCK article. This article was actually written by Mr. C. E. Dewey in the early part of 1949, at which time he was chief engineer at WBCK. The installation which was described was made under his supervision. Subsequently Mr. Dewey left WBCK to become manager of WKJF. As a result of a misunderstanding the authorship of the WBCK article was attributed to Mr. A. J. Geranis, the present chief engineer at WBCK, rather than to Mr. Dewey, to whom this credit rightfully belonged. Embarrassment was thereby caused to all concerned—for which we are indeed very sorry.

EVERYTHING IN LIGHTING.

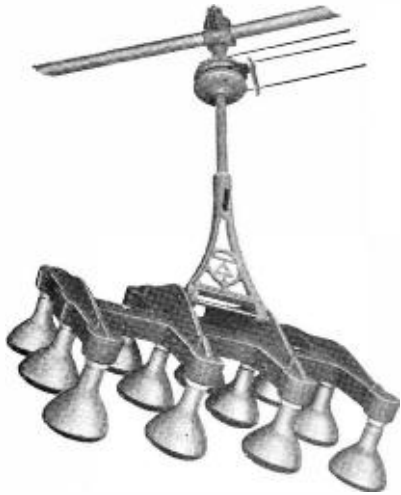

Incandescent Lamp Bank, Type TL-5A

The standard 12-lamp light source for normal studio operation. Ideal for slow fades. Provides equal light distribution on "douses." Maximum load per circuit, 3 kw; Per unit, 6 kw. Single cast aluminum-grille construction. Rotates 360 degrees. Tilts 170 degrees. Noiseless controls.

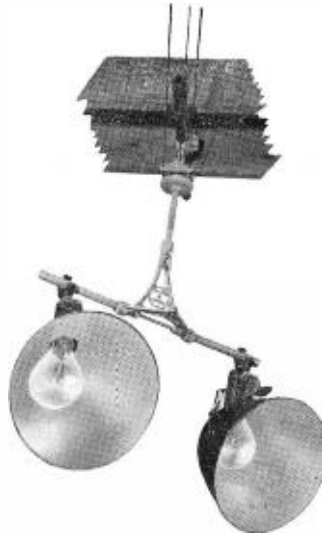

Rotatable Lamp Mount, Type TL-15A

With extension bars for mounting individual or multiple flood lamps. Control swindle can rotate 360 degrees—tilt 170 degrees about the point of support.



Fairleads, Type TL-32A

A practical way to guide mechanical control lines to control board without noise. 170-degree tilt and 360-degree angle of rotation around its point of support provides maximum flexibility for mounting anywhere. Equipped with quick-release gridiron clamp. Nine chromed bushings reduce control-line friction.



High-Intensity Light Dolly, Type TL-26A

The ideal mobile floor unit that puts high-intensity side illumination where you want it. Uses the TL-1A High-Intensity Fluorescent Bank. Rotates the bank from horizontal to vertical position; tilts it through 90 degrees. No high-voltage floor cables, because lamp ballast is right on the dolly.

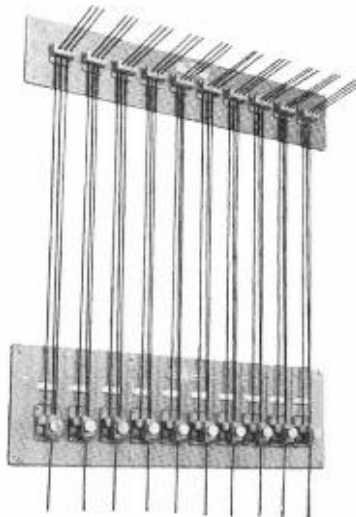

Light-Control Panel, Type TL-31A

Includes ten headlocks and ten rope locks for controlling ten light banks. Available in single units or on ready-to-operate panels, as illustrated.



Spot-Light Fixtures, Type TL-10A—TL-11A

Standard control spindle for use with a Mole-Richardson or Oleson 2-kw Solar Spot, or a 750-watt Baby Spot. Rotates 360 degrees. Tilts 170 degrees about its point of support.

—FOR TV STUDIOS...

New silent-control lighting equipment enables you to "tailor" the lighting system to fit your studio—correctly, without expensive experimenting.

AVAILABLE for the first time—a complete line of studio-tested lighting equipment from a single manufacturer. Available for the first time—packaged studio lighting systems to match the response curves of modern studio cameras.

Combining high-intensity fluorescent banks, high-intensity spots, and incandescent banks for handling any studio set-up, RCA lighting systems are capable of delivering more than 200 foot candles of light energy. All lights can be rotated 360 degrees horizontally and 170 degrees vertically. All lights are designed for pyramid-mounting on studio ceilings. All lights are mechanically controlled through silent-operating fairleads that terminate in a central control board.

With this lighting equipment you can swing each light for basic work, modeling, or back lighting. You can direct each light to more than one acting area. You can "dim" by tilting, rotating, or cutting off half banks—and without upsetting light distribution. All equipment and wiring is off the floor. No ladder hazards or expensive catwalk installations. No danger of burning artists or technicians.

Here is the system that delivers correct illumination with as little as two-thirds to one-half the usual amount of equipment—and with proportionate savings in power. No more experimenting for the individual studio. No more junking of extensive lighting installations.

For help in planning your studio lighting—correctly—simply call your RCA Broadcast Sales Engineer. Or write Dept. 191A, RCA Engineering Products, Camden, N. J.



High-Intensity Fluorescent Bank, Type TL-1A

Assures optimum light response from TV studio Image Orthicon cameras. Uses six 3500-4500 Kelvin slim-line tubes. Only 600 watts connected load. Includes noise-free, double-rubber cushioned, built-in ballast units; heavy-duty jumper cord connections; instant start high-voltage striking circuit. Uses pre-focused individual alzac parabolas. Rotates 360 degrees. Tilts 170 degrees. Noiseless controls.

TYPICAL TV STUDIO-PROVED FLOOR PLANS AND CEILING ARRANGEMENT FOR RCA LIGHTING SYSTEMS

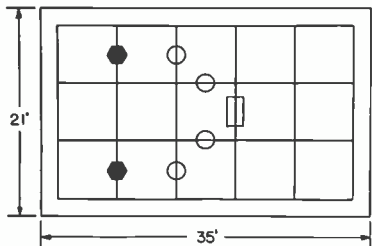

For a small interim-type studio, 21 feet x 35 feet. This plan more than meets the minimum lighting requirements of 200 foot candles and a contrast range of 2-to-1.

NO. REQ.	SYMBOL
1 HI-INTENSITY FLUORESCENT BANK	□
4 INCANDESCENT FLOOD-LITES	○
2 CONTROLLABLE SPOT-LITES	●

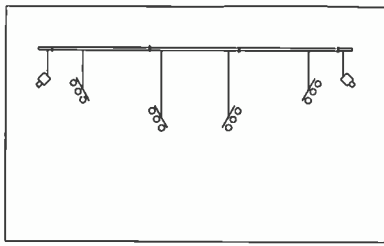

Cross-sectional view of a TV studio, showing RCA's inverted pyramid-type of lighting. This system delivers unobstructed light to every point in the studio.

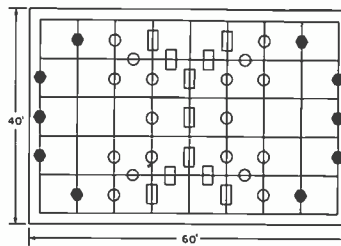

For the average-size studio, 40 feet x 60 feet. This plan more than meets the minimum lighting requirements of 200 foot candles and a contrast range of 2-to-1.

NO. REQ.	SYMBOL
11 HI-INTENSITY FLUORESCENT BANKS	□
16 INCANDESCENT FLOOD-LITES	○
10 CONTROLLABLE SPOT-LITES	●



TELEVISION BROADCAST EQUIPMENT
RADIO CORPORATION of AMERICA
 ENGINEERING PRODUCTS DEPARTMENT, CAMDEN, N. J.

In Canada: RCA VICTOR Company Limited, Montreal

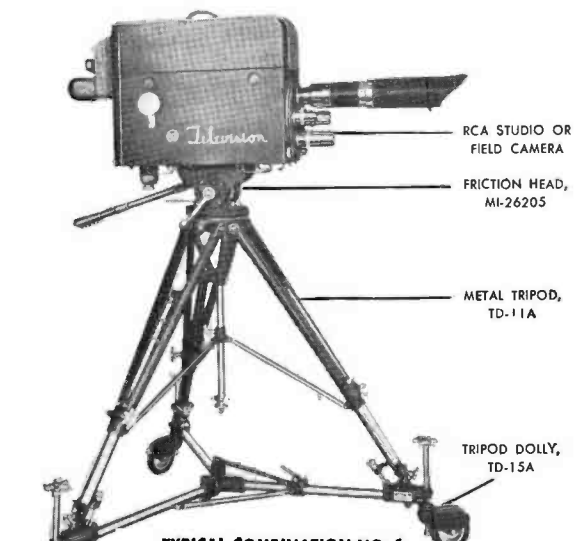

TYPICAL COMBINATION NO. 1

Complete camera set-up for maximum operating convenience. *Friction Head, MI-26205* gives camera 360-degree panning and full tilting action. Has "degree-indicator" scales and locking handles. *All-Metal Tripod, TD-11A* uses individual tie rods and center post for sturdy bracing. Each leg has position calibration and locks. Movable spike points permit set-ups on rough surfaces. Unit folds into compact, self-locking package. *Tripod Dolly, TD-15A* takes up a circular area only 57" diameter. Wheel stops for fixed positions. Folds and carries in a compact package.

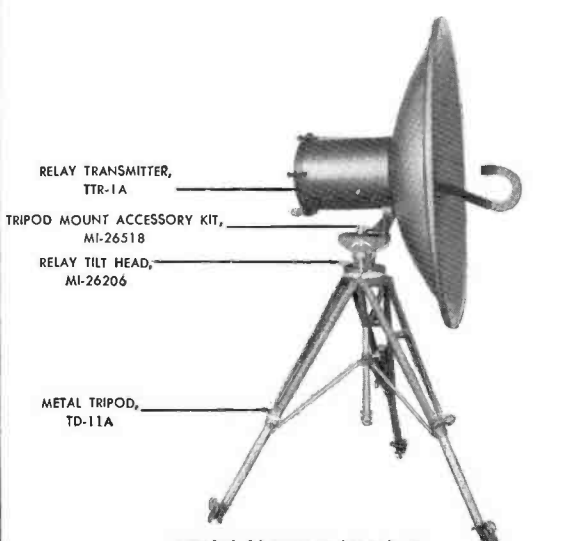

TYPICAL COMBINATION NO. 2

A complete vhf relay transmitter for difficult terrain and long distances, where radio relay is more practical than coaxial cable. *Tripod Mount Accessory Kit, MI-26518* provides means for mounting relay equipment to tripod. Includes mounting plate, saddle, and bolts. *Relay Tilt Head MI-26206* provides wide adjustment angles for vertical tilt and horizontal rotation. Sealed bearings for all-weather service. Accurately calibrated. Individual locking handles. *Metal Tripod TD-11A* same as Combination No. 1.

Dollies, booms, stands,

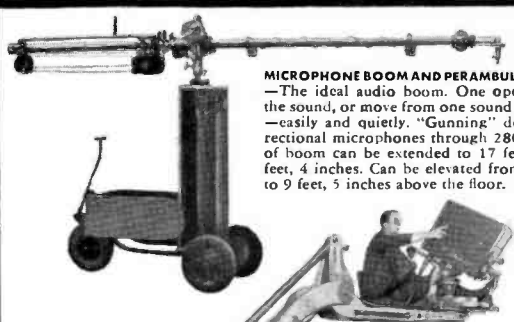

MICROPHONE BOOM AND PERAMBULATOR, MI-26574
—The ideal audio boom. One operator can follow the sound, or move from one sound source to another—easily and quietly. "Gunning" device revolves directional microphones through 280 degrees. Radius of boom can be extended to 17 feet; retracted to 7 feet, 4 inches. Can be elevated from 6 feet, 5 inches to 9 feet, 5 inches above the floor.



"MAGIC LOCK" BOOM STAND, KS-4A—The handiest microphone boom ever designed for TV studios. Convenient locking devices enable operator to control it with one hand. No set screws. No release mechanisms. No slipping. Each adjustment locks into position. Moves in a 180-degree arc and a base radius of 26 inches. Silent in operation.



DE LUXE TV STUDIO CRANE—Specifically for large studios. Enables you to get dramatic viewing angles, smooth panning of big scenes, approaches, retreats. Lens height: from 2 to 10 feet above the floor. Full 360 degrees panning around the crane base. 180-degree panning of the turret table. 100-degree up-and-down lift. Turns in a 6-foot radius.

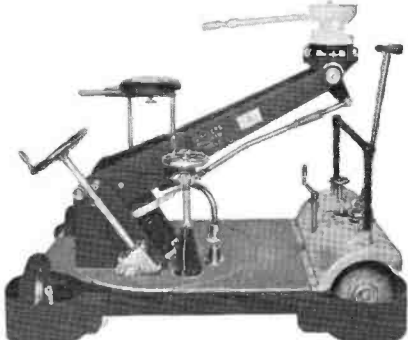

STUDIO CAMERA DOLLY, TD-5A—Similar to the dollies used in film studios—but both front and rear wheels turn to the side. Entire unit can be moved sidewise. Stops lock the dolly in a fixed position. Camera crane boom can be elevated from 23 inches to 74 inches above the floor.

RCA STUDIO OR FIELD CAMERA

FRICITION HEAD, MI-26205

LO-HAT, MI-26190-1

METAL TRIPOD, TD-21A

METAL DOLLY, TD-25A

TYPICAL COMBINATION NO. 3

Another camera set-up for studio and mobile work. Handles RCA Studio Camera or Field Camera. *Friction Head, MI-26205* same as used in Combination No. 1. *Lo-Hat, MI-26190-1* provides greater freedom and height for camera action. *Metal Tripod TD-21A* for fixed or portable set-ups. Cast

aluminum and stainless steel construction. Legs adjustable up to 21 inches. Dual feet; pointed for field work and flanged for fixed service. *Metal Dolly TD-25A*. Non-swiveling. Foot-controls for parallel wheel alignment. Individual wheel and tripod locks.

RELAY RECEIVER, TRR-1A

REFLECTOR AND PARAPET MOUNT, MI-26187

METAL TRIPOD, TD-21A

TYPICAL COMBINATION NO. 4

A complete relay pick-up receiving system. Relay receiver and parabola fasten to tripod through Reflector and Parapet Mount, MI-26187. *Metal Tripod, TD-21A* is set up for rough surfaces.

Field Camera and Friction Head, MI-26205, can be mounted on *High Hat MI-26190-2* for wall or parapet use. Complete assembly is attached to *Parapet Clamp Support MI-26189*.

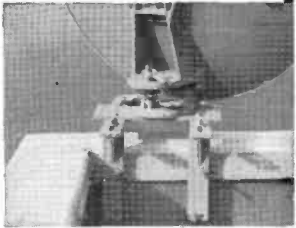

▲ Here, Reflector and Parapet Mount MI-26187 fasten to Clamp Support, MI-26189—which mounts on top of wall. Relay reflector may also be permanently mounted in wall openings by means of "Gimbal" Antenna Ring Mount, MI-26207 (not illustrated).

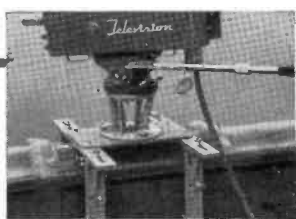

mounts, accessories...

STUDIO CAMERA PEDESTAL, TD-1A— Television's favorite pedestal for studio and other indoor operations. Moves freely, quietly. Crank handle raises and lowers camera to any height between 40 inches and five feet above the floor. Moves in any direction—or about a point. Panning and tilting provided by Friction Head MI-26205.

for every TV set-up

PICTURED on these pages are typical units and combinations from the most complete line of television accessories in the industry—application-engineered to meet every pick-up situation called for in your TV operations.

This line of mechanical accessories enables you to select just the right combination for your station operation. It includes every device needed for providing universal camera action in the studio and the field. It provides additional flexibility for maneuvering and covering shots from any angle.

RCA TV accessories are stoutly built to withstand the tough wear and tear encountered in field and studio operations. Yet each unit is a model of mechanical simplicity—easy to transport, easy to set up, easy to adjust, and easy to handle.

RCA TV accessories like these are used today in nearly every television station in the country. For complete information on the entire line, call your RCA Broadcast Sales Engineer. Or write Dept. 19JD, RCA Engineering Products, Camden, New Jersey.



TELEVISION BROADCAST EQUIPMENT
RADIO CORPORATION of AMERICA
 ENGINEERING PRODUCTS DEPARTMENT, CAMDEN, N.J.

In Canada: R C A V I C T O R Company Limited, Montreal

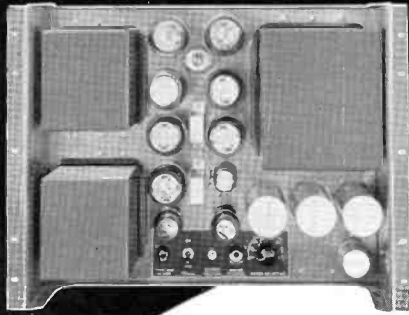

Regulated Power Supply (Heavy-Duty) WP-33B. Provides well-regulated d-c voltage at loads of 200 to 600 ma. Adjustable output, 260 to 295 volts. Voltage variation, less than 0.2 volt between minimum and maximum load.

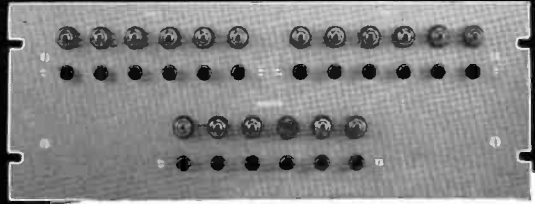

Switching Panel, TS-1A. A convenient way to switch any one of 6 different input video signals to TV transmitter, or to local and remote monitors.

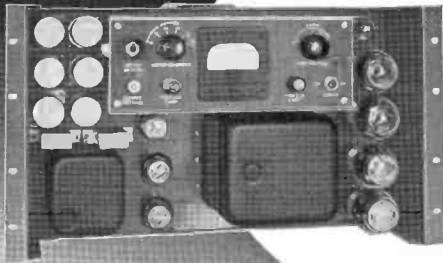

Regulated Power Supply, TY-25A. Provides well-regulated d-c source at loads from 200 to 300 ma. Output is adjustable between 260 and 290 volts. Less than 0.5% variation between minimum and maximum load.

Everything in

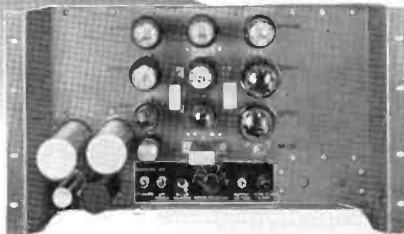

Regulated Power Supply, 580-C. Output adjustable between 260 and 295 volts—at 50 to 400 ma. Less than 0.25-volt variation between min. and max. load. Includes meter selector switch and meter jack.



Current Regulator, MI-26090. Maintains constant current in focus coil of Studio Camera TK-10A. Current can be adjusted over a range of 65 to 85 ma.

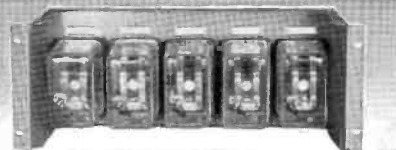

Power Relays MI-26761. Provides remote power switching in conjunction with Power Control Panel MI-26251. Includes 5 separate power relays.



Stabilizing Amplifier Control, MI-26250. Includes three potentiometers. Controls: (1) picture gain; (2) picture clipper; (3) sync level in stabilizing amplifier.

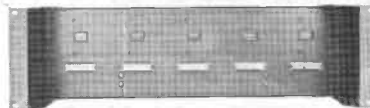

Elapsed Time Indicator, MI-26760. Provides constant record of "hours on" life of tubes, etc. Includes 5 individually-operated counter indicators driven by synchronous motors.



Sync Generator Phasing Control, MI-26249. Provides for phasing one of two local synchronizing generators with one remote synchronizing generator.



Sync Generator Switch, MI-26285. Used to switch outputs of either of two sync generators over to studio equipment. One selector for all 5 signals (horizontal, vertical, blanking, sync, and CRO sync).

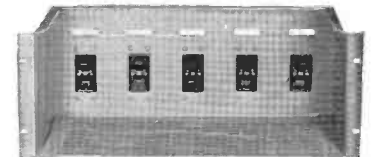

Circuit Breaker, MI-26240. Designed as main switch breaker between power line and TV studio equipment. Accommodates up to 5 breakers (choice of breakers available, extra).



Relay Receiver Control, MI-26247. Controls video gain and receiver tuning. Includes 2 potentiometers, AFC "on-off" switch, tally light, and telephone jack.



Panel Adapter MI-26254. Enables you to mount control panels (shown in left column and below) in any standard rack.

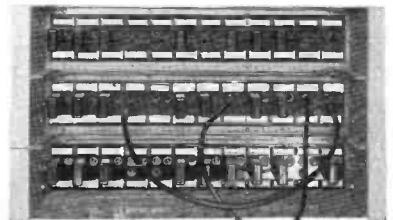

Video Jack Panel, MI-26245. For patching video and/or sync signals. Includes 12 groups of coaxial jack assemblies (3 per group). Video jack plugs and cords, extra.



Monoscope Camera Control, MI-26248. Provides remote control of video gain, and focus of monoscope camera. Includes 2 potentiometers wired to terminal board.



Power Remote Control, MI-26251. Operates up to 5 power supplies through 120-volt relays. Has 5 "on-off" toggle switches and 5 tally lights.

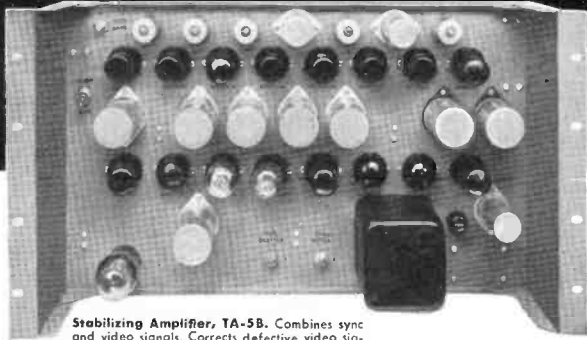

Stabilizing Amplifier, TA-5B. Combines sync and video signals. Corrects defective video signals. Eliminates hum. Corrects low-frequency response. Improves signal-to-noise ratio of sync signals.

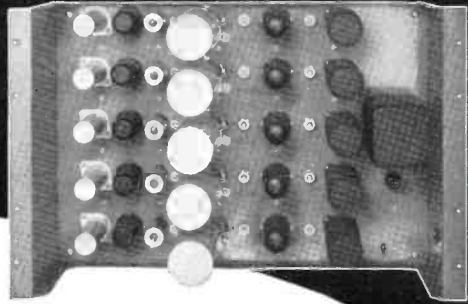

Distribution Amplifier, TA-1A. Well-suited for use as: (1) video and sync signal mixer, (2) isolation amplifier, or (3) for feeding video or pulse signals from a single source to separate outlets.

Rack-mounted Units for TV stations



Mixing Amplifier, TA-10A. Useful as mixing, fading, remote control, or isolation amplifier. Two bridging-type inputs; one output. Positive or negative polarity.



Projector Change-Over M1-26321. Designed for starting, stopping or simultaneous changeover of light and sound in 16- and 35-mm film programming. Handles two projectors in any combination (16mm or 35mm).



Sound Equalizer, M1-26313. Provides proper frequency compensation of 16-mm sound reproduction. Compensator network tilts frequencies above 1000 cps in 2-db steps. Panel and Shelf (M1-26581), available extra.

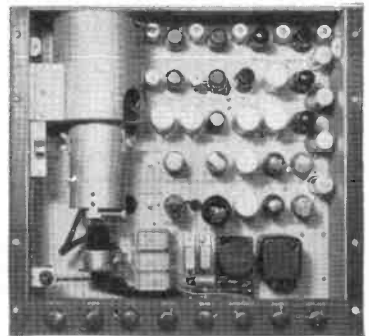

Self-contained Monoscope Camera, TK-1A. Ideal video signal source of known quality for testing: station systems, video amplifiers, picture tubes, TV receivers. Pattern shows scanning symmetry, vertical and horizontal resolution, shading, contrast, and brightness.

... control panels, amplifiers, projector changeover, switch panels, relay and indicator panels, power supplies, circuit breakers, jack panels

Here is your answer for ready-to-operate units that can be installed wherever you need them.

All units are identical in design and construction to those used in RCA's regular station-proved TV Broadcast Equipment—and are built with the same high-quality components. Units are built on recessed, or "bathtub" type chassis. Tubes and components are within handy reach. Controls are centralized and clearly marked.

Representing the most comprehensive line of rack-mounted TV equipment in the industry, these

carefully engineered units can readily be mounted in enclosed-type racks or in standard open-type racks. Many types can be mounted conveniently in RCA console-type housings.

...

RCA rack-mounted units are being used in practically every television station in the country. For information about any one of them ... or the entire line ... simply ask your RCA Broadcast Sales Engineer. Or write Department 19KB, RCA Engineering Products, Camden, New Jersey.



**TELEVISION BROADCAST EQUIPMENT
RADIO CORPORATION of AMERICA
ENGINEERING PRODUCTS DEPARTMENT, CAMDEN, N.J.**

In Canada: RCA VICTOR Company Limited, Montreal

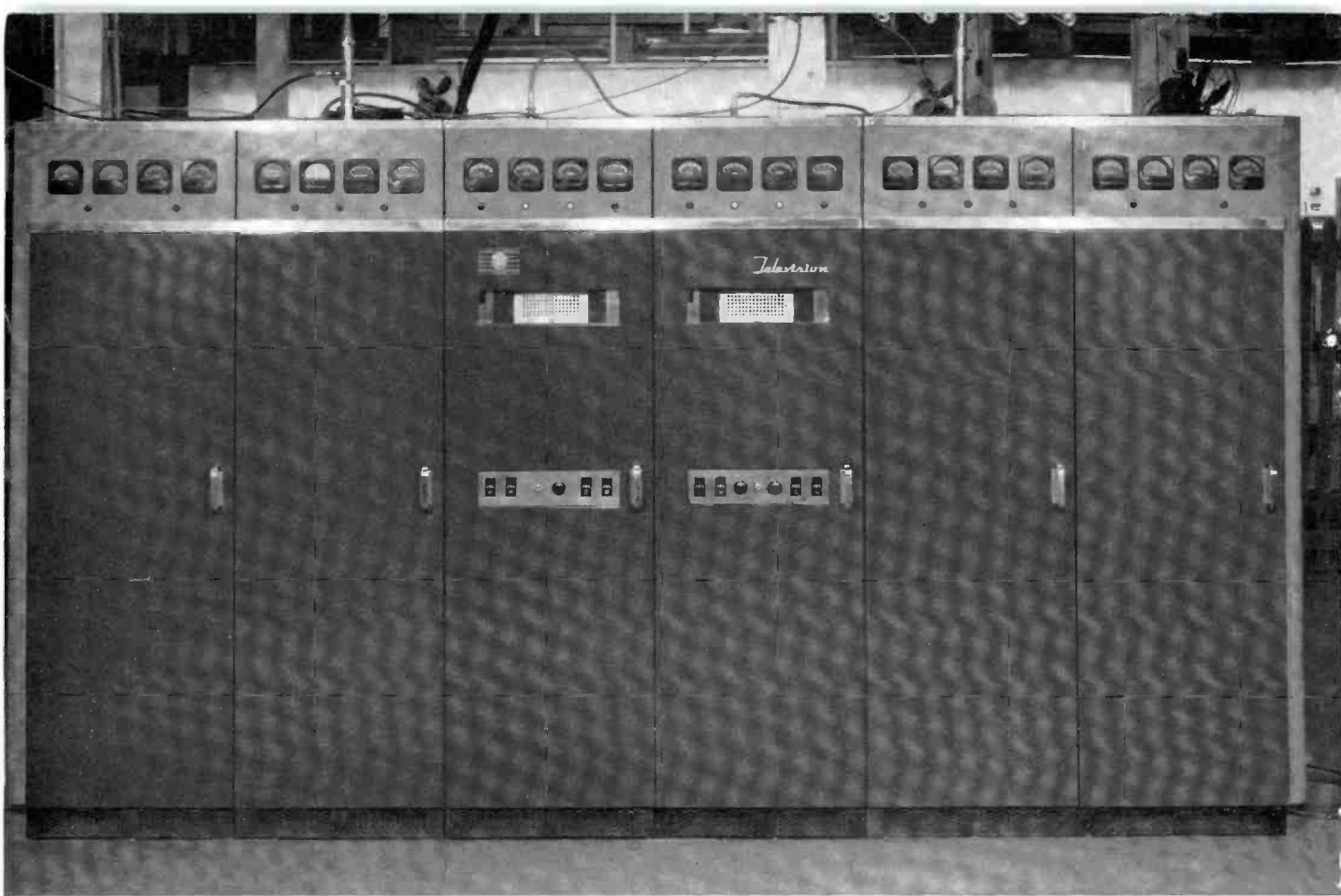

FIG. 1. THE RCA TTU-1A TELEVISION TRANSMITTER, designed for operation in the 530-890 mc band, is completely contained in six cabinet units which match, in appearance and size, the cabinets of RCA VHF transmitters and other RCA TV equipment. Overall dimensions are 150" long, 84" high and 31" deep. The transmitter, which provides an output of 1 kw at low end of the band (slightly less at high end), is completely air-cooled.

FIRST UHF TV TRANSMITTER SHIPPED

RCA Type TTU-1A Television Transmitter Installed at NBC's Experimental "Satellite" Station in Bridgeport, Connecticut

RCA's (and the industry's) first "commercial model" UHF TV transmitter was completed at Camden in December and shipped to NBC for use in its "satellite" station, KG2XAK, at Bridgeport. This transmitter, designated the Type TTU-1A (for *Television Transmitter Uhf*—1 kw) is designed to operate at any frequency in the proposed UHF television band (530-890 mc), and when used with an antenna having a gain of 20 (see below) will comply with the tentative FCC proposal for an effective radiated power of 10 kw at 500 feet height.

The TTU-1A is not the first TV transmitter to operate in the UHF band. A number of laboratory and experimental-type transmitters have been operated in this band on previous occasions—both by RCA and by others. However, most—if not all—of these were temporary-type rigs which were set up for one-shot demonstrations or short period tests. The TTU-1A Transmitter, by contrast, is a commercial model designed to provide all of the features of appearance, operating convenience, ease of maintenance, and low cost of operation which broadcasters have come to expect in commercial-type equipment.

Description of the Transmitter

The Type TTU-1A (UHF) Transmitter (Fig. 1) is similar in appearance and styling to RCA's immensely popular VHF Transmitters—the Type TT-500B (500 watts) and the Type TT-5A (5000 watts). The complete equipment is housed in six cabinet units, each measuring 25 x 25 x 84 inches (see Fig. 2).

The driver section (Fig. 3) of the new transmitter—comprising the two center cabinet units—is identical to the TT-500B Transmitter. This unit has an output (at VHF frequencies) of 500 watts (peak power) for picture signal and 250 watts for sound. The two right-hand cabinet units (Fig. 4) of the TTU-1A contain (1) a tripler stage, which increases the VHF output of the picture driver unit to the required UHF frequency; (2) a power amplifier stage, which provides an output of 1 KW at 530 megacycles (slightly less at 890 megacycles); and (3) a video amplifier stage which is driven by the video amplifier in the driver unit, and which serves to grid-modulate the visual power amplifier stage.

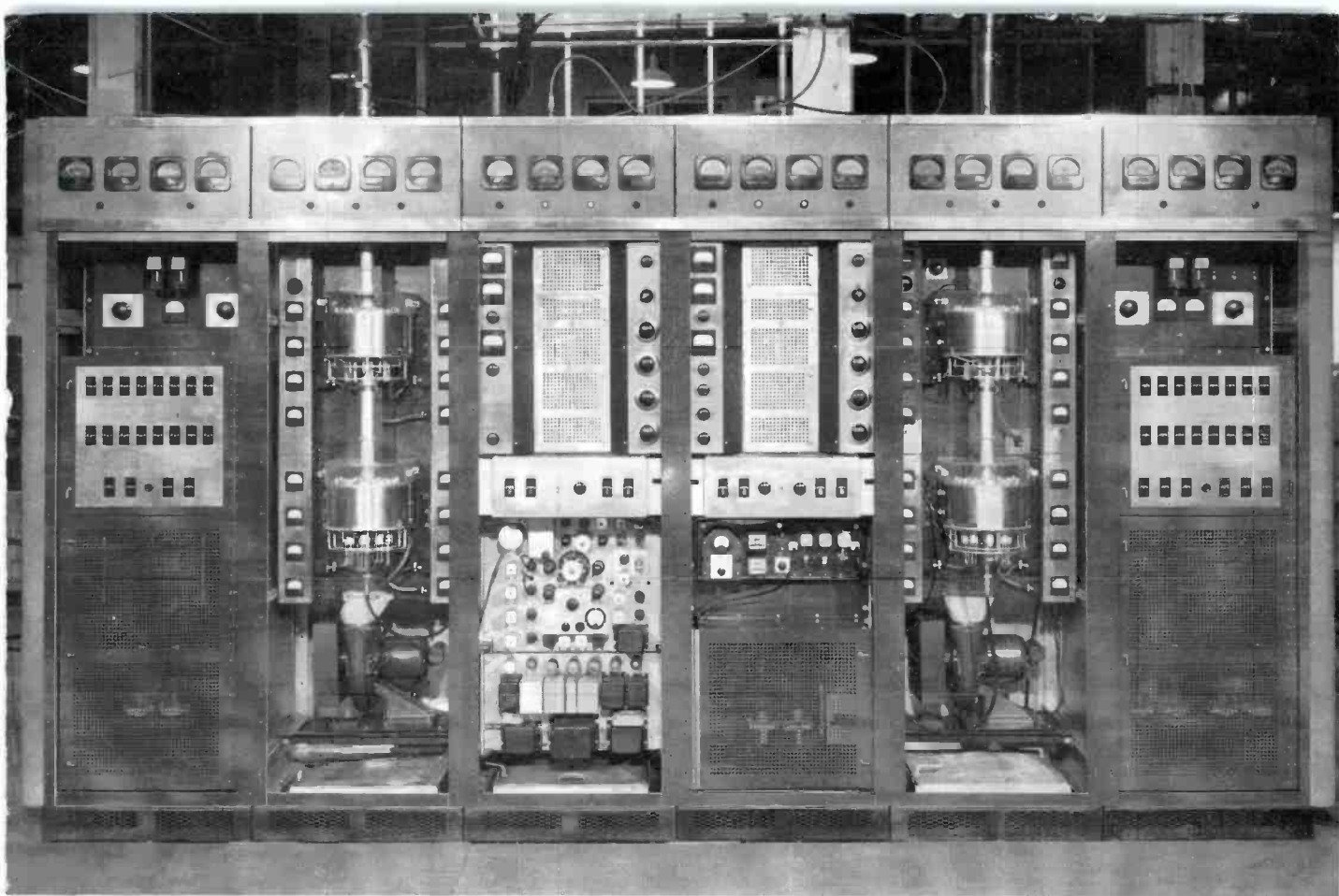

FIG. 2. INTERIOR OF THE TTU-1A TRANSMITTER with doors removed to show construction. The cabinet units, from left to right, contain: (1) the aural section power supplies and control circuits, (2) the aural section tripler and power amplifier stages, (3) the aural driver section, (4) the visual driver section, (5) the visual section tripler and power amplifier stages, and (6) the visual section power supplies and control circuits.

The tripler stage employs eight Type 4X150A's in an annular cavity-type amplifier. The power amplifier stage also uses eight 4X150's in similar arrangement. The two amplifier stages are mounted, one above the other, in the number five (counting from the left) cabinet (Fig. 5). Separate excitation and bias adjustments are provided for the 8-power amplifier tubes, as well as separate meters and overload relays. As a consequence, the PA tubes may be easily adjusted to insure that all tubes are sharing the load equally, and a fault occurring in any one tube may be singled out rapidly.

The video amplifier, which with the high voltage power supplies is contained in the number six cabinet, uses eight tubes in a cathode follower stage which is directly coupled to the grids of the eight tubes in the picture power amplifier. Modulation takes place in the grid of the final amplifier and a sideband filter is employed to suppress the undesired sideband. This greatly simplifies the tuning of the visual transmitter since all of the r-f circuits, except the power amplifier tank circuit, become narrow band circuits with single controls which need only be peaked up to maximum response. Thus no picture degradation can occur because of careless tuning.

The aural section of the TTU-1A is similar to the visual section except, of course, that there are no modulation circuits; modulation being accomplished in the exciter at low-level. The aural sound tripler and power amplifier stages are housed in the number two cabinet, and power supplies for this part of the transmitter in the number one cabinet.

The aural and visual portions of the transmitter, although styled as one complete unit, are electrically independent; and one portion may be operated quite independently of the other. In fact, if it should be desired, the two units, visual and aural, may be physically separated and become independent transmitters. Similarity of construction of aural and visual portions, however, results in reduced number of spare parts and facilitates familiarity on the part of operating personnel with circuit and component details.

Description of the Antenna

The antenna installed at KG2XAK is a standard RCA TFU-20A Slot Antenna (Figs. 6 and 7) having a gain of 20. This antenna, dubbed the "stovepipe", is 10 inches in diameter and approximately 40 feet long. The four-sided slot arrangement, which makes up the radiating part of the antenna, is fed from a power equalizer located on the tower near the base of the antenna. From this equalizer—which serves to minimize reflections from the antenna due to mismatch—a single waveguide transmission line runs to the transmitter control room. The output of the aural and visual transmitters is fed into the line by a notch-type diplexer unit.

Installation at Bridgeport

The NBC station at Bridgeport is intended to provide a full-scale field test of the practicality of UHF TV service. In order to obtain a true impression of problems that might arise in such operation, engineers under the direction of O. B. Hansen, NBC

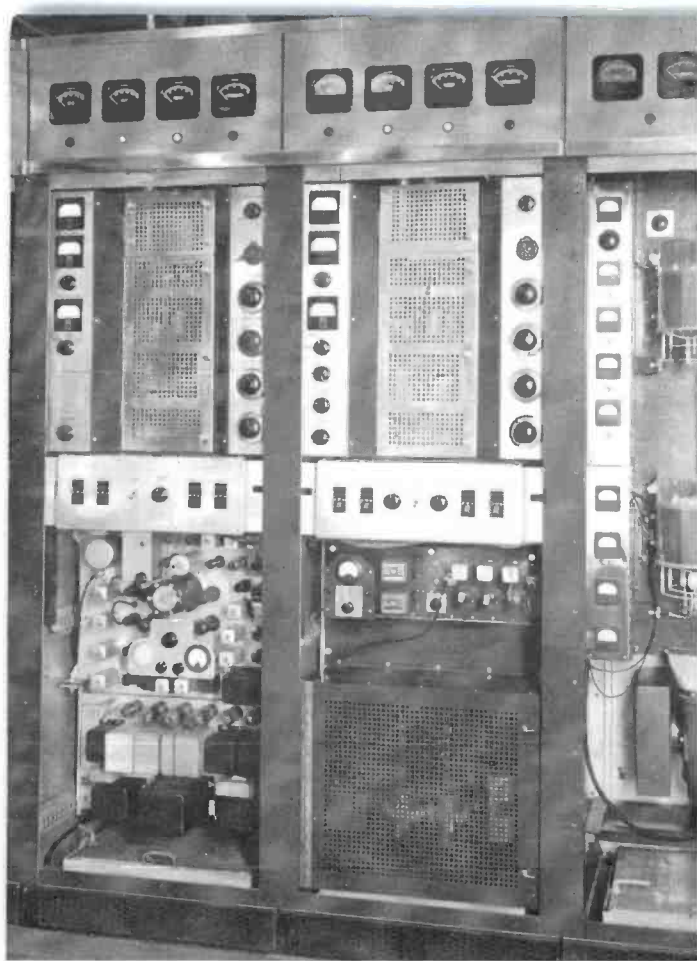

FIG. 3. DRIVER SECTION of the TTU-1A Transmitter, contained in the two center cabinets (shown above), is a standard Type 500-B Transmitter. This unit provides 500 watts visual power and 250 watts aural power on VHF channels 7 to 13. Aural section (in left-hand cabinet) consists of a standard RCA FM Exciter Unit (lower section) followed by a 4-65A as a doubler, a 4X150A as a tripler, and an output stage using four 4X150A's in parallel. These three stages are in the upper part of the cabinet. The r-f circuits of the visual driver section (in the right-hand cabinet) includes a 6V6 oscillator, a 6V6 tripler, a 2E26 doubler, a 4-65A tripler, a 4X150A doubler, and an output stage using four 4X150A's. In the 500-B this stage was grid-modulated by a pair of 807's which formed the final stage of a three-stage video amplifier. However, when used as a UHF exciter, unmodulated r-f is fed to the UHF power amplifier.

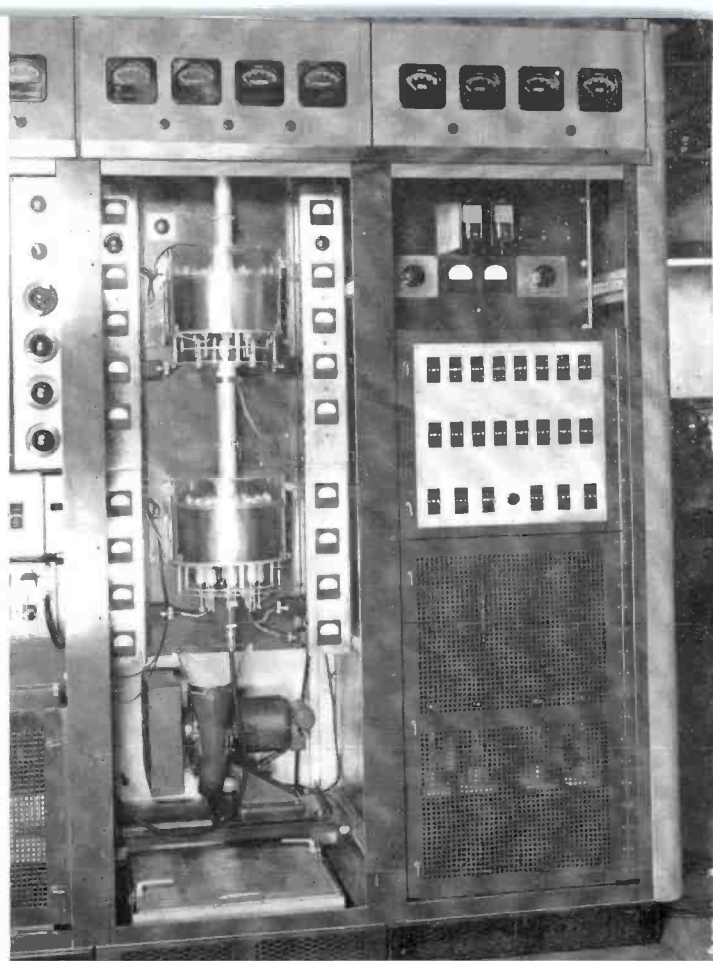

FIG. 4. VISUAL AMPLIFIER SECTION of the transmitter. The r-f and modulator circuits are in the left-hand cabinet, the power supplies and controls are in the right-hand cabinet. The r-f portion consists of two stages, a tripler and a power amplifier. The tripler stage consists of eight 4X150A's connected in parallel and mounted in a single ring-type cavity. This is the drum-like unit in the lower part of the cabinet. R-F power is fed to this unit, from the driver, by the flexible coax at the bottom. A short length of concentric line leads from the top of the tripler cavity to the power amplifier cavity, which is the similar appearing drum directly above. The power amplifier employs eight 4X150A's mounted in a ring-type cavity very similar to that of the tripler stage. The grids of the P.A. tubes are modulated by a video amplifier (made up of eight 6L6's) which is driven by the three-stage video amplifier in the driver unit.

Vice President and Chief Engineer, planned an installation which would be as nearly as possible like that of a station which might be installed for permanent operation in this band. The TTU-1A Transmitter, and associated equipment, are located in a residential-type Cape Cod cottage on Success Hill, about two miles from the center of Bridgeport. The RCA Type TFU-20A "Stovepipe" Antenna (described above) is mounted on a 210-foot tower which is adjacent to the transmitter building. The effective height of the antenna is about 450 feet above average terrain.

In addition to the TTU-1A Transmitter, and the TFU-20A Antenna, the equipment at KG2XAK includes: (1) a transmitter console which serves as a monitor center for the transmitter and provides aural and visual gain controls; (2) a pair of test equipment racks which house the frequency meters, audio amplifiers, jack panels, power supplies for monitoring equipment, etc.; (3) a sideband filter; (4) a visual monitor converter which acts as a TV receiver and furnishes picture information to the console from an r-f probe inserted in the antenna transmission line; (5) a dummy load and power meter for performing off-the-air transmitter tests and calibrating the power output meter contained within the transmitter.

Installation of the equipment was made in record time. The building proper was completed on November 15, 1949. Between that date and December 31st, the tower was erected, the antenna mounted in place, the transmitter and other equipment installed, and the wiring completed. Power was applied on the 31st and the station began operating officially on January 4, 1950.

"Satellite" Type Operation

During the proposed tests—which will extend over a period of 6 to 12 months, KG2XAK will operate as a "satellite" to NBC's key station WNBT in New York. The Bridgeport station is 53 airline miles from the WNBT location on the Empire State Building. Signals will be fed through coax to standard terminal and monitoring equipment in the transmitter control room, and from there to the input of the KG2XAK transmitter.

According to the NBC announcement the selection of the Bridgeport, Conn. area as the site of the new station was made for the following reasons: (1) It is on the edge of the New York television service area and therefore may be typical of possible future "satellites" which might be located in densely populated areas not adequately served by nearby stations located

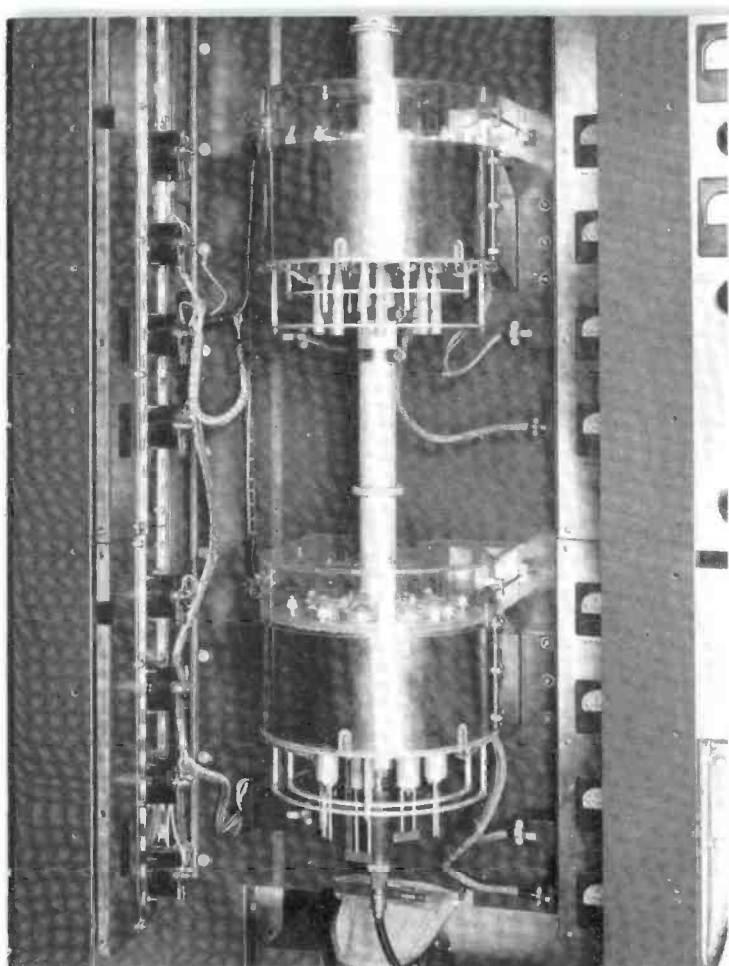

FIG. 5. RING AMPLIFIERS used in the UHF section of the TTU-1A Transmitter. The tripler and P.A. stage, shown above, each consist of eight 4X150A's mounted in a circle in a single cavity and connected in parallel. (A view looking down on one of these cavities is shown on the cover of this issue). Each cavity consists of three concentric cylinders (of which only the outside one is visible). The cylinders are capped by three flat circular plates which form the anode, screen and grid plates. These plates provide a base on which the tubes are mounted. D-C cathode connections are brought out separately so that the tubes may be metered individually. This facilitates proper distribution of load between tubes, and quick detection of tube failures. A plastic shield over the top of the assembly aids in forced air cooling of the tubes and provides a safety cover. The whole cavity assembly is a plug-in unit so that a spare may be easily inserted.

FIG. 6 (right). TFU-20A ANTENNA, officially a slot-type antenna, but unofficially dubbed "the stovepipe", is shown at the right during test setup at Camden. After exhaustive measurements of gain, radiation pattern, impedance characteristics, etc., it was shipped to Bridgeport where it is installed on top of a 250-foot tower.

in large metropolitan centers. (2) Homes in the Bridgeport area are situated in rolling or hilly countryside which will provide an opportunity to study the effects of this type of terrain on UHF propagation and reception.

Tests To Be Made

The primary purpose of the KG2XAK operation is to gather technical information on propagation characteristics and reception problems at UHF frequencies. Special experimental UHF television receivers have been designed by the Home Instruments department of RCA Victor for engineering observation of the test transmissions from the Bridgeport station. In addition, RCA

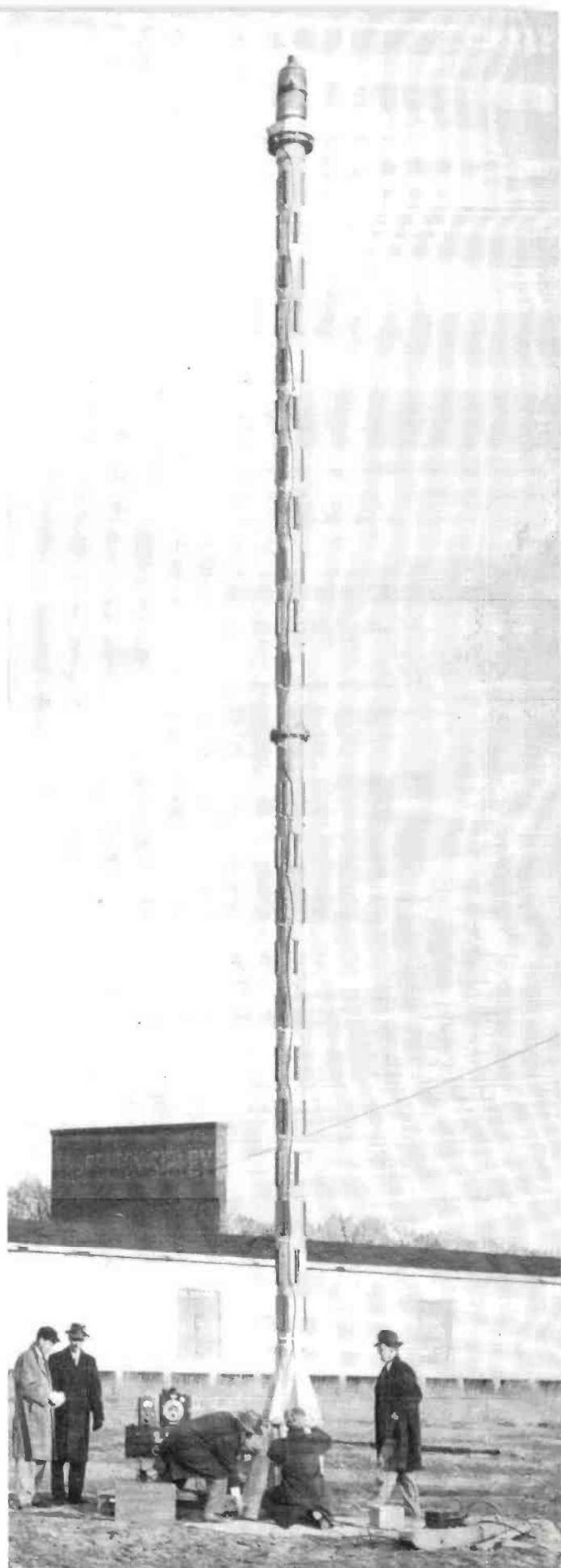

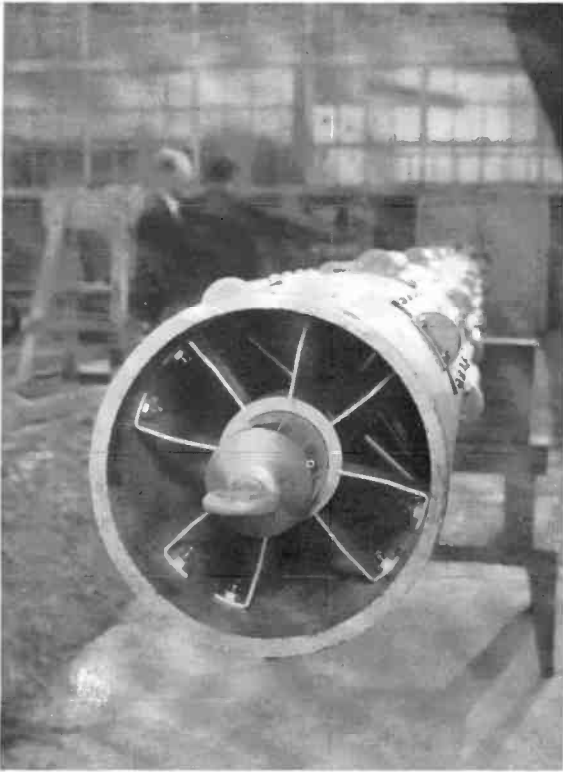

FIG. 7 (above, left). **STOVEPIPE INSIDE** doesn't look like a stovepipe, as this view shows. The 10-inch diameter pipe has 88 slots in its 40-foot length. Slots, which are the radiating elements, are an electrical half-wave long, are fed from inside, as can be partially seen in this end view of the top of the radiator.

FIG. 8 (above, right). **TEST SETUP** at Camden is shown in this view. Antenna is mounted on rotatable base and fed power by signal generator at extreme left. Pickup antenna on roof of small building at right feeds recording equipment located in the building.

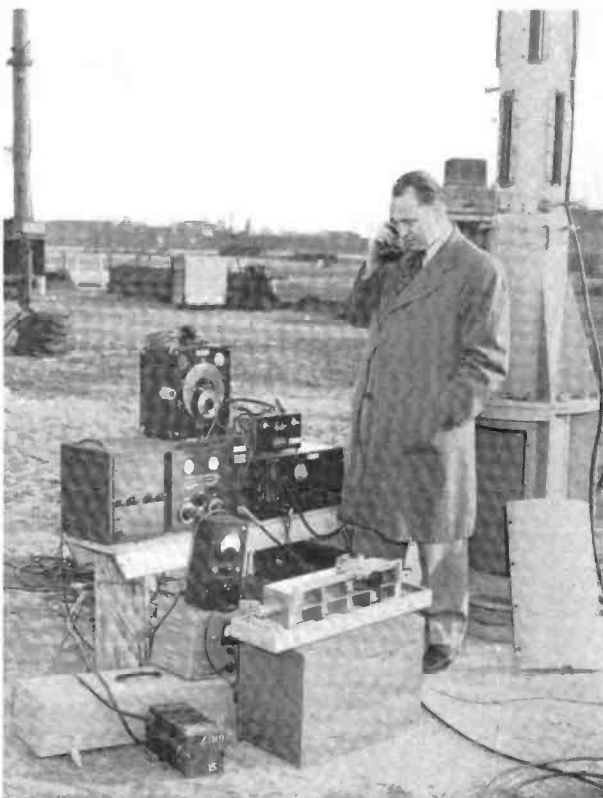

FIG. 9 (left). **ENGINEER-DESIGNER** of the TFU-20A Antenna is Owen J. Fiet, of RCA Transmitter Engineering Section, shown here with test equipment at base of antenna.

has developed an experimental converter which can be attached to present television receivers to make possible reception of these UHF signals.

A limited number of the new receivers will be placed in specially-selected locations in Bridgeport and neighboring areas. Observations of the service will be made in homes within the area where service might be obtained, at distances and under conditions which will determine the extent to which such a station can provide service.

It is proposed to test various types of receiving antennas, investigate shadow areas and multipath problems, to make field intensity measurements, and observations of tropospheric transmission. Some of these measurements will be made at representative receiver locations. The project also will include measurements with mobile equipment on radials, the investigation of field intensity vs. antenna height under various conditions and other factors contributing to UHF propagation and reception. The detailed work will be supervised by Raymond F. Guy, NBC radio and allocations engineer.

RAY GUY ELECTED 1950 PRESIDENT OF INSTITUTE OF RADIO ENGINEERS

Readers of BROADCAST NEWS will be pleased that an old friend, Ray Guy, Manager of Radio and Allocations Engineering for the National Broadcasting Company, has been elected President of the Institute of Radio Engineers for 1950. Ray may rightly be called the daddy of all Broadcast Engineers, since 1950 marks his 30th consecutive year, the longest continuous experience of any broadcaster in the world, so far as we know.

Prior to World War I, he was employed at intervals by the Marconi Wireless Telegraph Company, the Shipowners Radio Service and the Independent Wireless Telegraph Company. During the concluding engagements of World War I he served in France in the Regular Army of the United States. Upon being discharged he entered Pratt Institute, graduating in Electrical Engineering in 1921.

In the Fall of 1921 he resigned his job as Fleet Radio Inspector with the old Shipowners Radio Service to join the staff of a new "Wireless Telephone" Broadcasting Station, WJZ, on the roof of the Westinghouse factory building in Newark, New Jersey. His was the world's second regular broadcasting station. The audience consisted of only a few amateurs, commercial broadcasting was unknown, and practically all operating methods and techniques had to be originated by trial and error. During the ensuing thirty years he has played a leading part in developing

network broadcasting, short-wave broadcasting to foreign countries, frequency modulation and the evolution and development of television.

In 1924 Ray joined the engineering staff of the RCA Research Laboratories. During these years Mr. Guy directed engineering, development and construction of standard and short-wave broadcasting apparatus, stations and systems and participated in RCA's earliest television development. In 1929 he transferred to the National Broadcasting Company to direct its frequency allocations engineering and the planning, design and construction of all NBC transmitting facilities. His activities have included all technical and allied phases of the industry during thirty years in standard broadcasting, twenty-four years in short-wave broadcasting, twelve years in FM and twenty-two years in television.

He became an IRE Associate Member in 1925, a Member in 1931 and a Fellow in 1939. In 1943, he was elected to the Board of Directors and served through 1948, including a term as Treasurer. He has served on a large number of IRE Committees, functioning as Chairman of the Standards, Public Relations, Founders, Transmitters, Membership and Office Practices Committees, and Vice Chairman of the Building Fund and Executive Committees. He is a Fellow of the Radio Club of America, a member of the Radio Executives Club, a charter member of the Radio



RAYMOND F. GUY
Manager, Radio and Allocations Engineering,
National Broadcasting Company

Pioneers Club, a life member of the Veteran Wireless Operators Association, a member of the Society of Professional Engineers and was admitted to practice as a Professional Engineer in New York and New Jersey in 1937. He has served on the Radio Technical Planning Board, represented the Institute in the activities of the American Standards Association and is Chairman of the Engineering Committee of the Television Broadcasters Association.

During World War II Mr. Guy participated in projects of the OSS, the CIAA and the OWI, one of which took him into foreign countries. Since the war he has participated in international radio conferences in Havana, Washington, Atlantic City, Mexico City and Montreal.

PLANS FOR NAB ENGINEERING CONFERENCE NEARLY COMPLETED

Plans for the fourth annual Engineering Conference of the National Association of Broadcasters, scheduled to be held in the Stevens Hotel at Chicago, April 12-15, as a part of the 28th annual NAB Convention, are nearly completed according to Neal McNaughten, NAB Engineering Department director.

A questionnaire, designed to collect suggestions on subjects and speakers for the technical conference on AM, FM and television engineering, was sent in January to broadcast engineers and others interested in the nationally famous gathering, at which noted engineers annually present technical papers on various aspects of their profession. The program of papers is being made up to conform as nearly as possible with the concensus of opinion expressed in the questionnaires returned to NAB office.

The Engineering Conference had its beginnings in 1947, as a part of the Atlantic City NAB Convention, and has grown since into the outstanding technical meeting in the field.

In 1949, at the Chicago meeting, the Engineering Conference was, for the first time, held ahead of the Management Conference portion of the Convention, as it will be held this year. That was also the first year in which three days were devoted to the technical meeting.

The 1950 NAB Convention's Management Conference is scheduled to be held April 17-19, with registration on Sunday, April 16, after the close of the Engineering Conference. As in previous years, the Engineering Conference of the NAB Convention is the only nation-wide engineer-

ing meeting designed solely for and presented by broadcast engineers. Attendance is expected to include about 500 radio engineers, as at last year's meeting in Chicago.

Additional interest will be lent to the engineer's gathering by the traditional NAB Convention exhibition of transmitters, engineering products and developments. The exhibition, largest of its kind in the world, will be open through the Management and Engineering Conference.

EDITOR'S NOTE: As usual we plan to have the largest and, we hope, the most interesting space in the exhibit. We invite all of you—old friends and new—to visit us there, and in our entertaining suite on the fifth floor of the Stevens.

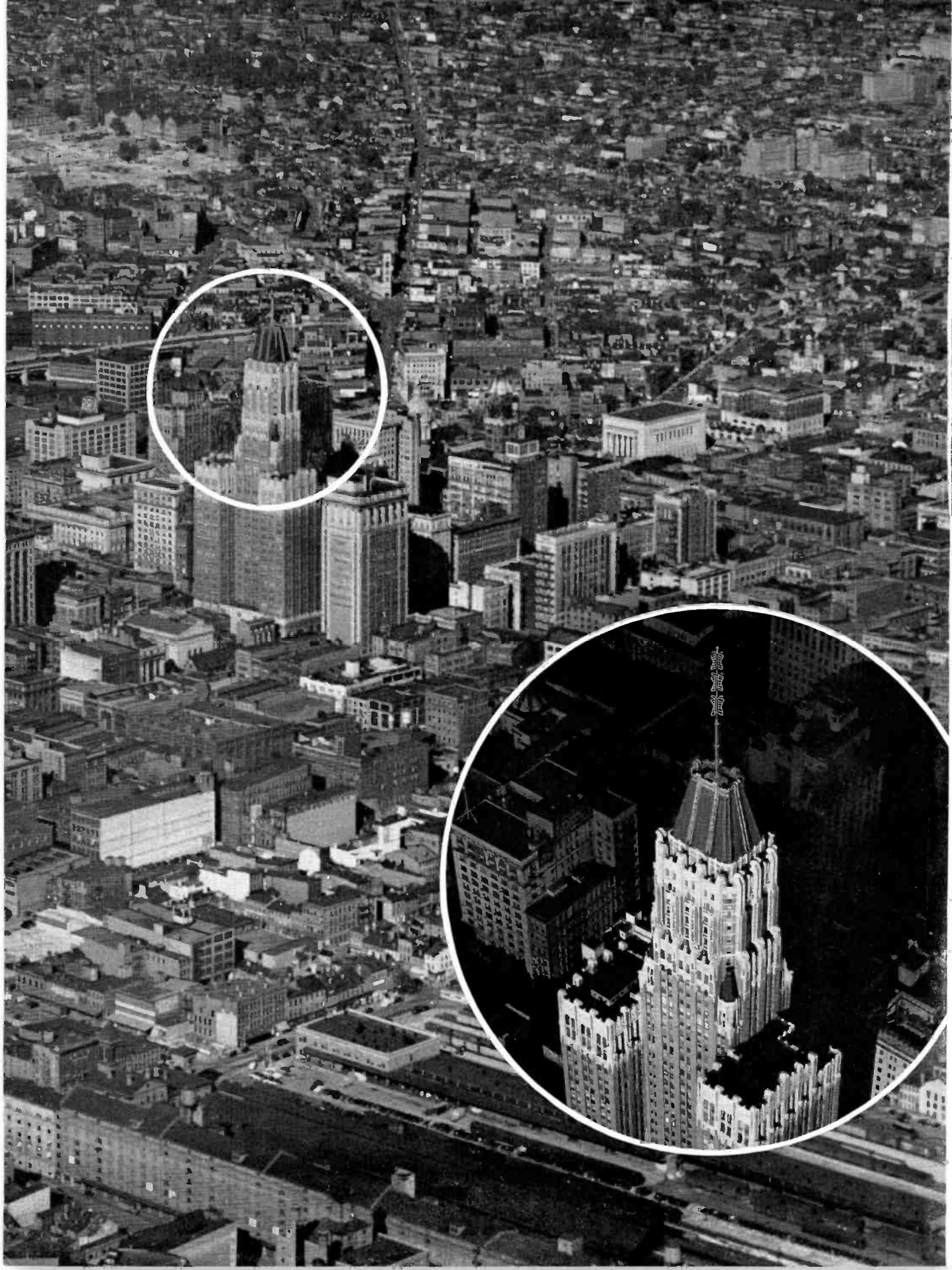

WMAR-TV

BALTIMORE, MD.

by **CARLTON G. NOPPER**
Chief Engineer WMAR-TV, WMAR-FM

WMAR-TV recently celebrated its second anniversary on the air. The two-year mark gave us all the opportunity of looking back to the time when WMAR-TV first brought television to Baltimore . . . when there was only a handful of stations on the air in the country and television was a novelty, not the accepted service it is today.

Since T-day, October 27, 1947, when we first went on the air, our television audience has grown from a scant number of 800 receivers to well over 130,000 on February 1, 1950. The elapsed time meter on WMAR's TT-5A Transmitter as of midnight of the second anniversary indicated 8,296 hours of air time operation. At the same time, our logs showed that we had run up a record of 536 on-the-spot television remote broadcasts, and that our mobile units had covered every important news event in Baltimore. Our remote units had covered everything from football, basketball and yacht club regattas to Pimlico races, science programs, and lectures on art at the Baltimore Museum of Art.

WMAR-TV, owned by The A. S. Abell Company, Publishers of the Sunpapers, is affiliated with the Columbia Broadcasting System and operates on channel two. The station is on the air about 80 hours a week and though it takes about a third of its programs from the net, the station in turn originates numerous network shows. One of these features, the afternoon Sports Parade, is fed to WMAR-TV, Washington, D. C. This station picks up the air signal of WMAR-TV 38 miles away and rebroadcasts the daily show to the Washington audience. WMAR-TV in turn takes several programs off the air from the TV station

in the nation's capital and broadcasts them to the Baltimore area. Should anything of an outstanding news nature occur in Washington, WMAR-TV can instantly broadcast the event to the Baltimore audience.

We believe this to be the first two-market network arrangement of its kind in television and so far it has been very effective. For this purpose, we use two RCA Type 8T-241 table model TV receivers. One of the receivers is used as an emergency standby, with flexible switching arrangements available in case of receiver failure. To date there have been no set failures during the more than 18 months in which RCA receivers have been used.

The WMAR-TV Studio

The interim studio of WMAR-TV is located on the sixth floor of a building which is one block away from the TV transmitter location. The studio is constructed around the FM control room and arranged to fit into the existing building area. The resulting studio space is, therefore, "L" shaped, and measures 59 by 17½ by 14 feet. The lower portion of the "L" is approximately 37 by 14 feet and is used for property storage, boom mike and camera locations (see Figure 5). In spite of its odd shape, the studio has been used for as many as 35 shows weekly. Regularly scheduled sports, science, and children's programs as well as dramatic shows are typical of the type produced weekly from this studio. "Back-to-back" shows in which one live studio feature follows another are also scheduled from here.

Fluorescent lighting is used, consisting of two and three tube 40 watt, 4500 degree units. Additional incandescent spots are used for highlighting purposes.

The acoustical treatment consists of a two-inch Johns Manville rock wool blanket covering the entire studio side walls and ceiling. J. M. perforated Transite blocks are used around the face of the studio

walls to a height of six feet. The blocks act as a protective guard against damage from moving various scenes and props used in the studio productions.

The floor level of the top side of the "L" shaped studio is eight inches higher than the floor level in the remaining area. It was assumed that the difference in floor levels might be a hindrance to studio productions; however, our experience to date indicates that the raised area can be used as a natural stage, depending upon the effect desired.

Sound locks are provided to both studio entrances. The FM Control Room and announce studio is located adjacent to the sound lock. Both of these areas have their floor levels raised six inches to provide proper sound insulation between the TV and FM program areas.

Small dressing rooms are provided on the third floor level. Adjacent to the dressing rooms are located the artists' lounge and the prop workshop.

The studio control room is located on the side of the studio and is approximately 16 by 9½ feet. The floor of this room is raised six inches to permit running of interconnecting cables and to isolate the control room area from the main studio floor level. The walls surrounding the control room, and the studio walls adjacent to the dressing rooms and corridors are of the split-wall type construction, with two-inch rock wool blanket running horizontally between staggered two-inch by four-inch wood studding. Standard wood doors are used, each side fitted with a half-inch thick layer of Celotex board to provide additional soundproofing. The temporary studio construction was completed in approximately thirty days. It took an additional ten days to install the video and audio equipment.

It should be noted that the TV camera power supplies, sync generator, spare tubes

◀
FIG. 1. Airview of Baltimore shows Mathieson Building towering above the city. WMAR transmitters are located in skyscraper penthouse. Overall antenna, consisting of Pylon surmounted by Super Turnstile, is 625 feet above sea level.



FIG. 2. WMAR executive personnel discuss Zoomar lens with its inventor, Dr. F. G. Bach. The group includes, from left to right: Messrs. E. K. Jett, Vice President and Director of Radio of The A. S. Abell Company; R. B. Cochrane, Program Director; Dr. Bach; J. Fegler, President Bach Video Corp.; and C. G. Nopper, Chief Engineer of WMAR.

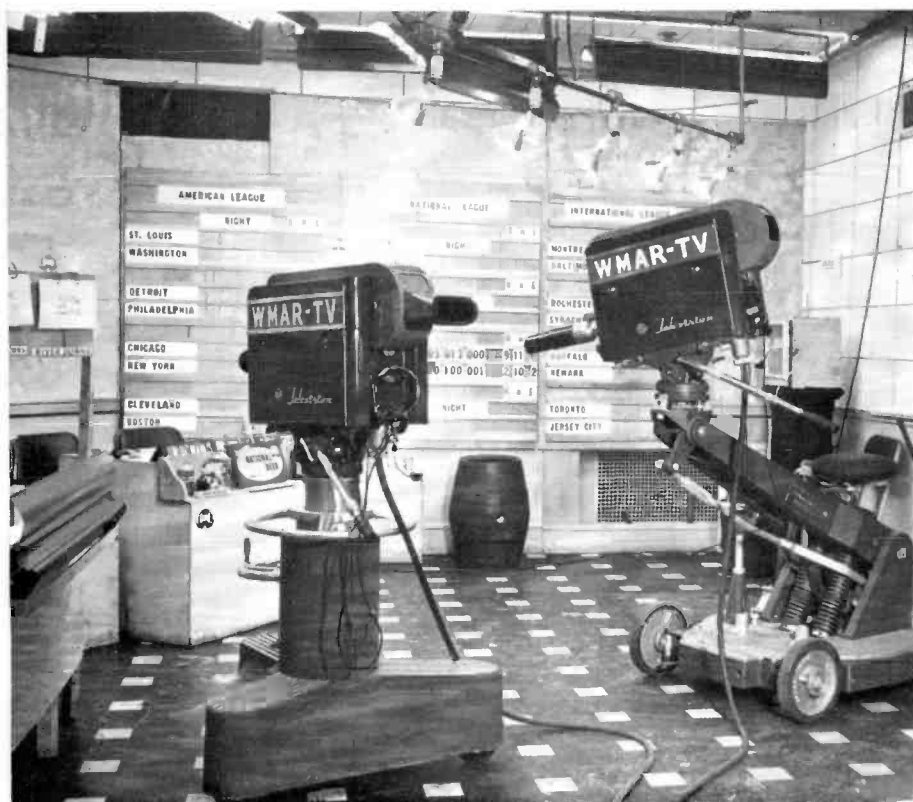

and associated equipment are installed in a separate enclosure across the corridor from the control room. Here the heat producing equipment is cooled by circulating air through input louvres in the lower wall, and exhausting the hot air by a ceiling fan to the outside.

Studio Control Equipment of WMAR-TV

The TV control room contains one of the versatile RCA TS-10A Studio-type Switching Consoles. Adjacent to the Switching Console is an RCA 76B4 Audio Console and two RCA 70-D Transcription Turntables. An RCA 8TS30 TV Receiver is used as an "off-the-air" monitor to display the air picture to control room personnel. To the rear of the control room is located the telephone company's video amplifiers and power supplies, which feed the picture signal via special beaded pair cable to the transmitter located one city block away.

FIG. 3. Studio cameras cover commercials, news, and sports telecasts in the part of the studio known as Stage #1 (see Fig. 5).

Our normal studio technical crew consists of five technicians: one Group Leader/video shader, two cameramen, an audio technician, and one boom-mike operator.

Our overall studio and remote group consists of thirteen members, under the direction of a Supervisor, D. W. Martin. The group is divided into two five-man crews who rotate between Remote and Studio assignments. Two chauffeurs and a helper are employed to drive and maintain the mobile units and to generally assist in the remote or studio set up. During long studio shows, (daily 3-hour sports review) it is standard operating procedure to have the technicians rotate in thirty-minute cycles between their assignments to provide relief to the cameramen. This is arranged by having one cameraman relieve the boom mike operator who in turn relieves the audio technician, who relieves the cameraman, and so on. This arrangement provides fresh crew members on the studio cameras at all times.



FIG. 4. Field cameras are used to telecast remote cooking demonstration. Note overhead mirror technique used in displaying dishes described.

Film Projection Room

The film projection room is located in the transmitter penthouse on the 35th floor one floor above the TV control room. It houses two 16mm RCA projectors, two film cameras and automatic slide projectors. In addition to the slide projectors on

the camera chain shown in Figure 7, is another chain located close by. The monitor shown in Figure 9 consists of camera controls #1 and #2. The third unit contains the outgoing picture monitor and dis-

solve panel. Television sets located above these monitors are used as closed circuit and off-the-air and network monitoring devices. If bouquets were being distributed, a special one should go to the operators in

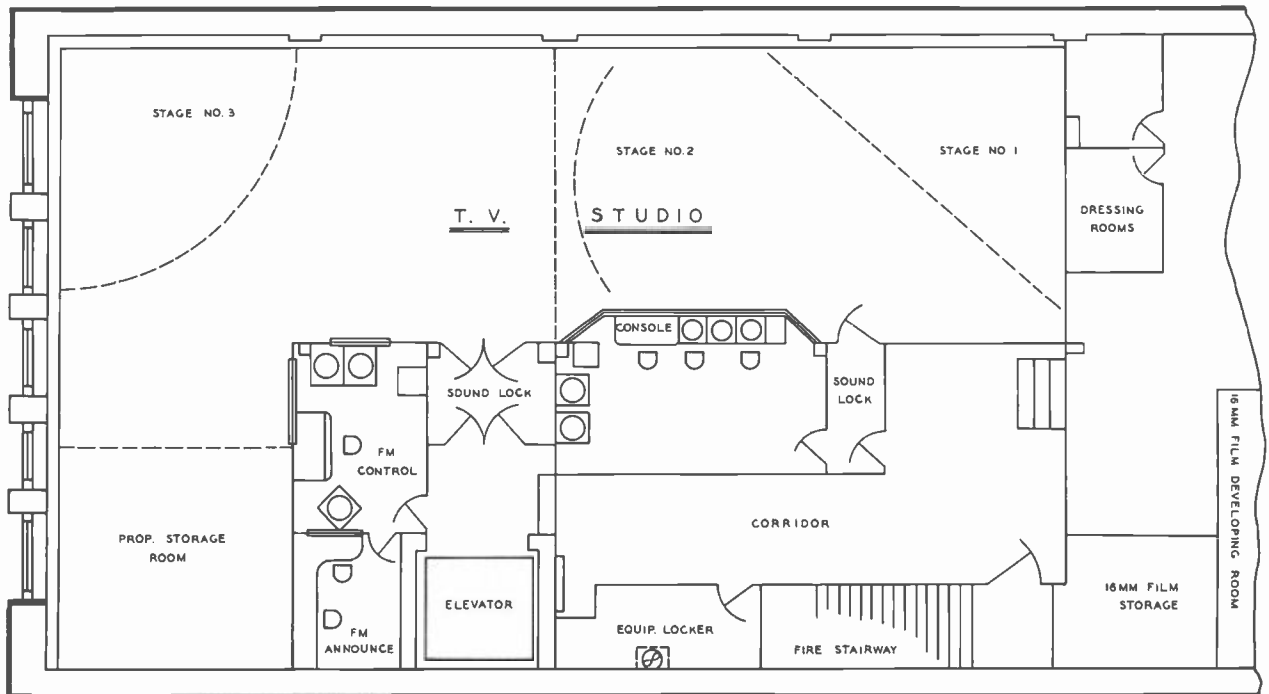

FIG. 5. The above drawing shows layout of studios and control rooms for both FM and television shows. TV programs are relayed to the main transmitter, a block away, via beaded pair telephone cable.



FIG. 6. Studio control room contains two camera controls, a TV switching unit, RCA Type TS-10A, Audio Console, Type 76-B4, and two 70-D Transcription Turntables. TV receiver is used as "Off-Air" monitor.

the projection room. This is certainly the busiest room of our entire division. The RCA Film Camera Chains are in constant operation from 9:00 in the morning to midnight daily, doing film and slide re-

hearsals and putting on regular air time shows. One of the factors which contributes to the film room activity, is the operational order that all slides, newsreel, balopticans, commercial film and spots be rehearsed be-

fore actual air time. This sometimes presents a bottleneck problem. It is circumvented most often by the cooperation of the tower technical crews and producers who make every attempt to rehearse film, commercial spots, and slides during periods when the station is on the air with test patterns or other program commitments.

The Sunpapers' Television News, born October 30, 1947 with the first formal program put on by WMAR-TV, is the oldest continuous television newsreel in the nation. Since its birth, this department has consumed 192 miles of newsreel motion picture film and has never missed an edition since its inception. The station's film group currently uses one mile of film per week raw stock, covering special features and news events in Maryland and Baltimore.

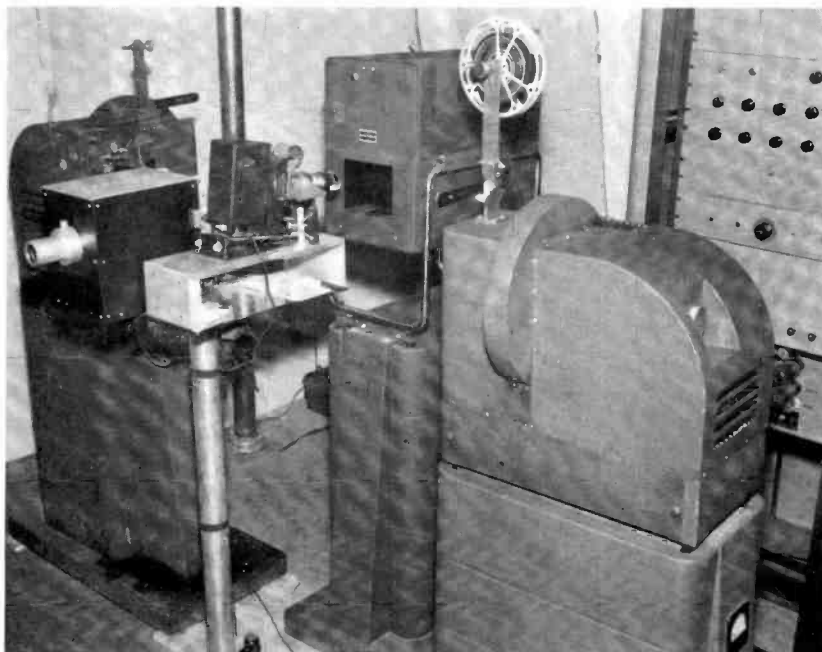

FIG. 7. The film projection room is located on floor above FM transmitter. WMAR uses two 16mm TV motion picture projectors, two film cameras (one not shown) and an automatic slide projector.

FIG. 8. Floor plan, at right, shows layout of TV and FM transmitter facilities in Mathieson Building tower. Unit enclosure construction of RCA transmitting equipment made it possible to use "Breakfront" layouts, fitting units into limited space around the tower.

FIG. 9. Bank of monitors in TV film room include two camera control monitors (lower left), an outgoing picture monitor, and station-built dissolve panel TV receivers, on shelf above, are used as closed circuit and "off-the-air" monitors.

WMAR Film Group

The WMAR Film Group consists of two writers, two film cutters, four cameramen, two laboratory men and a film director. This department's equipment is as follows: 1 Houston Processor, 1 Bell and Howell Printer, 6 Bell and Howell Filmos, 2 Cine-Kodak Specials, 1 Auricon Sound Camera, 2 Zoomar Lenses, 8 other sets of lenses, including 4-inch and 3-inch lenses, 3 film editing tables, 1 station wagon, 1 completely equipped laboratory, 1 Embossing-O-Graph, 1 Film Tinting Machine, 2 Bell and Howell Sound Projectors, and 1 Portable Sound Projector.

WMAR Transmitter Plant

The WMAR television transmitter is located in the penthouse of the Mathieson Building, which is the tallest skyscraper in Baltimore. The antenna, which consists of a Pylon surmounted by a Super Turn-

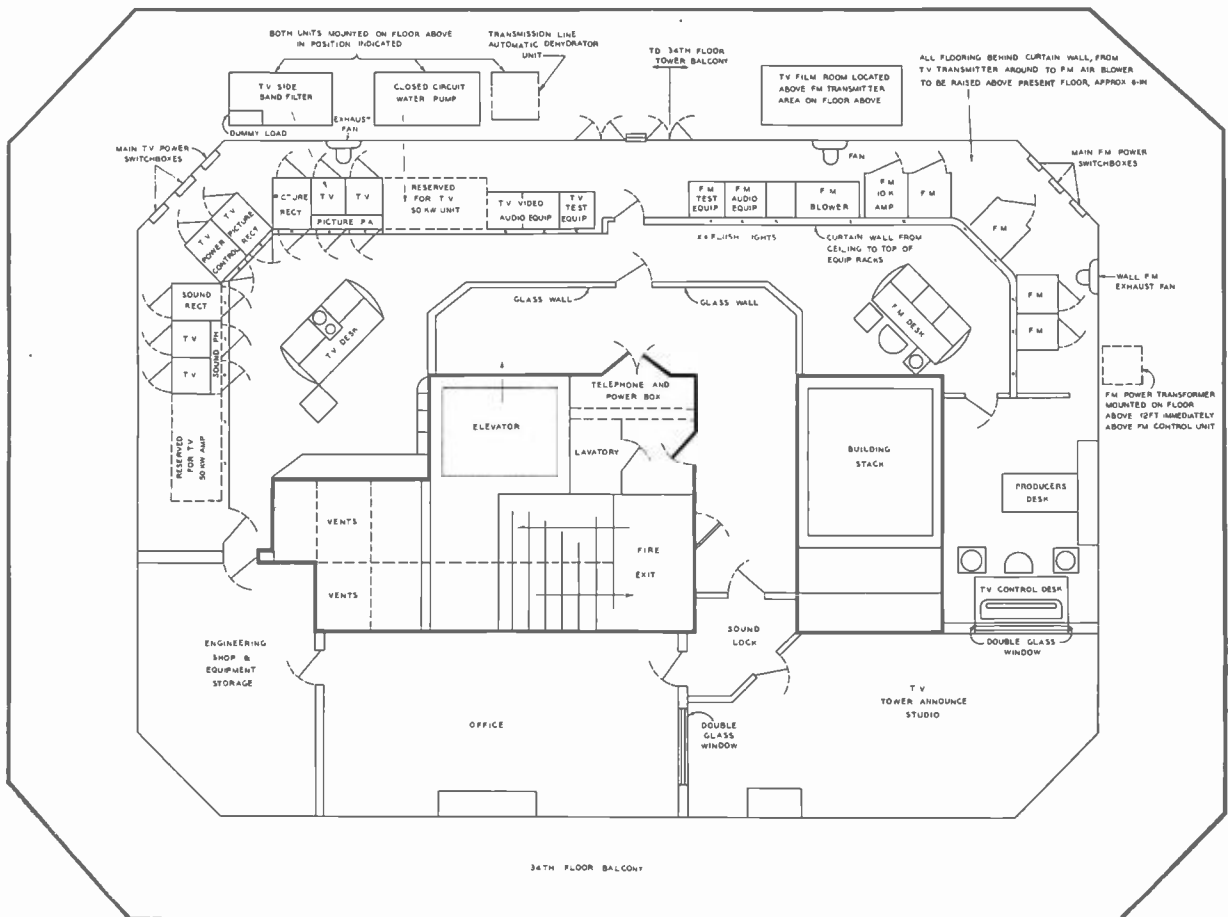
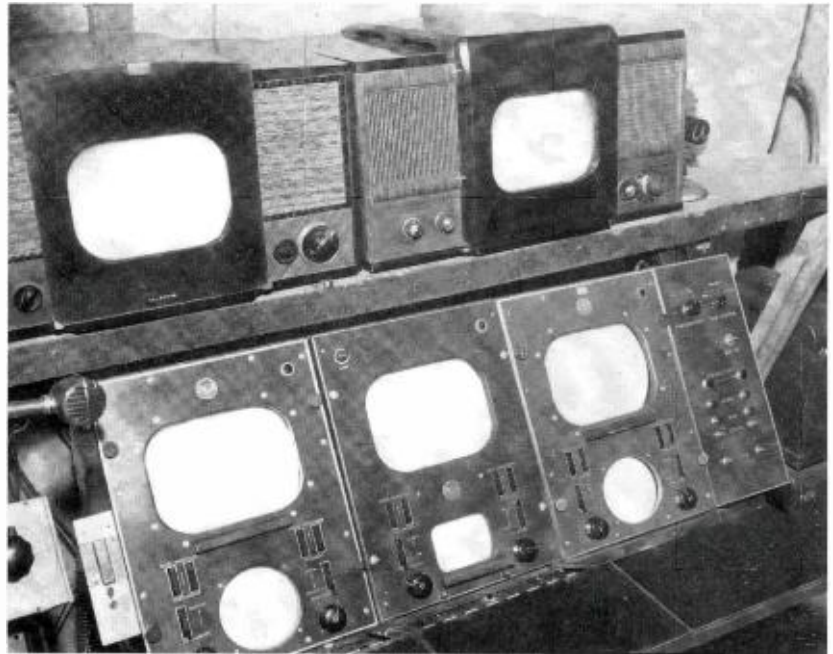



FIG. 10. C. B. Lau, Television Transmitter Supervisor, checks picture quality on TV transmitter control console. Note "U" arrangement of RCA TT-5A TV Transmitter.

stle, is erected on top of the 34-story building which is located in the heart of Baltimore. The overall antenna height is 624 feet above sea level. From this vantage point WMAR-TV commands a line-of-sight path to practically the entire Baltimore area. The transmitter staff consists of 15 technicians, 9 assigned to television and 6 assigned to FM-Transit Radio, under the direction of C. B. Lau, Senior Supervisor.

A floor plan of the penthouse, Figure 8, shows the layout of the transmitter facilities. It is interesting to note that the maximum floor depth at any point is limited to approximately 13 feet. This limited tower space presented a problem of installation initially, but the flexible "unit enclosure" construction of the RCA transmitting equipment made it possible to use the "Breakfront" equipment layout which easily adapted the units to fit into the limited space around the tower. The design of the equipment in small units permitted the installation of the TV and FM units by standard rigging crews. The various equipment units were brought to the penthouse elevation through standard size doorways and standard elevator open-

ings without having to disassemble the equipment as it was received from the manufacturer.

The TT-5A Television Transmitter, which incidentally was the first channel two transmitter delivered by RCA, is located as shown in the upper left corner of Figure 8. The associated video and audio equipments are situated between the television and FM transmitters as can be seen through the glass viewing window in the hall-way. A door from the corridor gives access to a service area which extends along the rear of the entire equipment space. All other working areas with the exception of this are air-conditioned. It can be seen from the diagram that maximum utility was made of the area surrounding the building service facilities such as the elevator shaft, ventilating shaft, and building stack, an area which of course could not be altered. The sideband filter, diplexer, dehydrator and water pump of the TV transmitter are located on the floor above the main transmitter units.

Antenna Goes Up by Unique Method

The combination FM Pylon and Super Turnstile antenna was erected in seven as-

sembly operations. The mast was completely assembled within the bonnet, or cone of the Mathieson Building, 500 feet above the street level. The numerous crates containing bat wings, Pylon sections were hauled up the outside of the building to the roof area by a power winch. These sections were then lowered through a large hole in the roof to the final assembly position two floors below.

Large chain hoists were used to haul the completed sections up through the roof. Each antenna section was maneuvered into the assembly position, welded to its associated top piece and then vertically hoisted up through the roof top. As each section appeared through the roof, a separate rigging crew installed the top beacon fixture, subsequent bat wing sections, and transmission lines. At this point the painters proceeded to place the final paint on the pole and bat wing assemblies. Final RCA and WMAR electrical inspections were made as the antenna sections "grew" out of the building roof.

The overall antenna structure completed weighs approximately 9½ tons. It measures 127 feet in length and protrudes

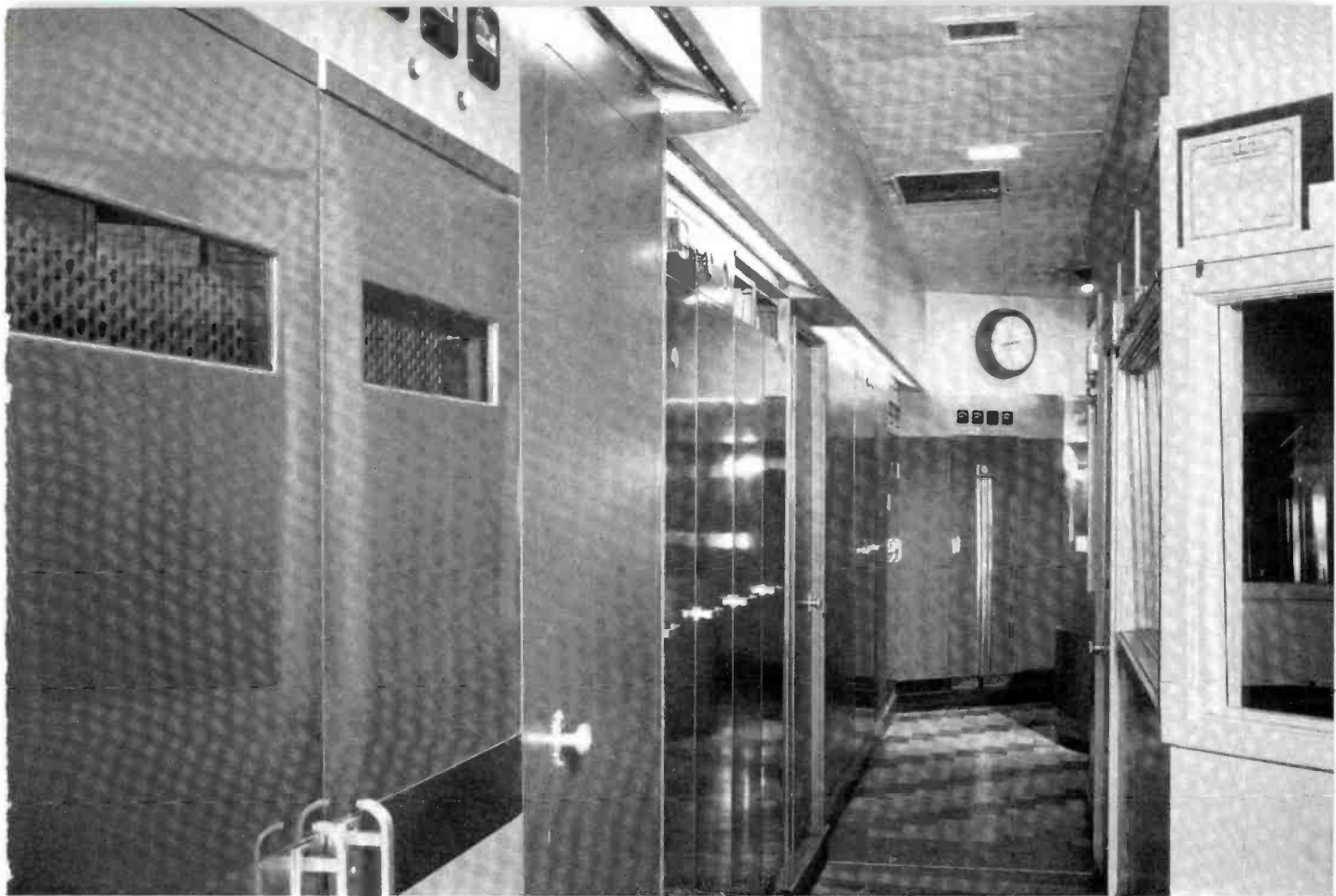

FIG. 11. Line-up of equipment around skyscraper tower presents this impressive array when one looks down corridor from TT-5A to the RCA 10 kw FM transmitter at opposite end.

through the top of the building for a distance of 100 feet. An inspection of the under-side of the beacon light structure reveals that two 100-watt lights in water-proof fixtures are welded to the base of this beacon light assembly. In the event of a failure of the main beacon light, these smaller emergency lights are used until weather conditions permit servicing or bulb replacement.

FM Transmitter

The 10-KW RCA FM Transmitter and associated equipment is installed adjacent to the television control room as shown in the upper right hand corner of Figure 12. The FM installation is a duplicate of the television transmitter layout. The output of the FM transmitter is fed to a two-stacked RCA FM Pylon antenna through 100 feet of $3\frac{1}{4}$ -inch transmission line. The FM transmitter power output is 6.9 KW; the radiated FM signal is 20 KW.

WMAR-TV is presently conducting a Transit Radio survey on sixty Baltimore Transit Company buses which are equipped with special crystal-controlled FM receivers. Each bus has six speakers, strategically located, to provide entertainment inter-



FIG. 12. The model of neat, flush construction is shown in this photo of WMAR-FM transmitter room. Station uses 10 kw RCA FM transmitter which feeds a two-section Pylon Antenna.

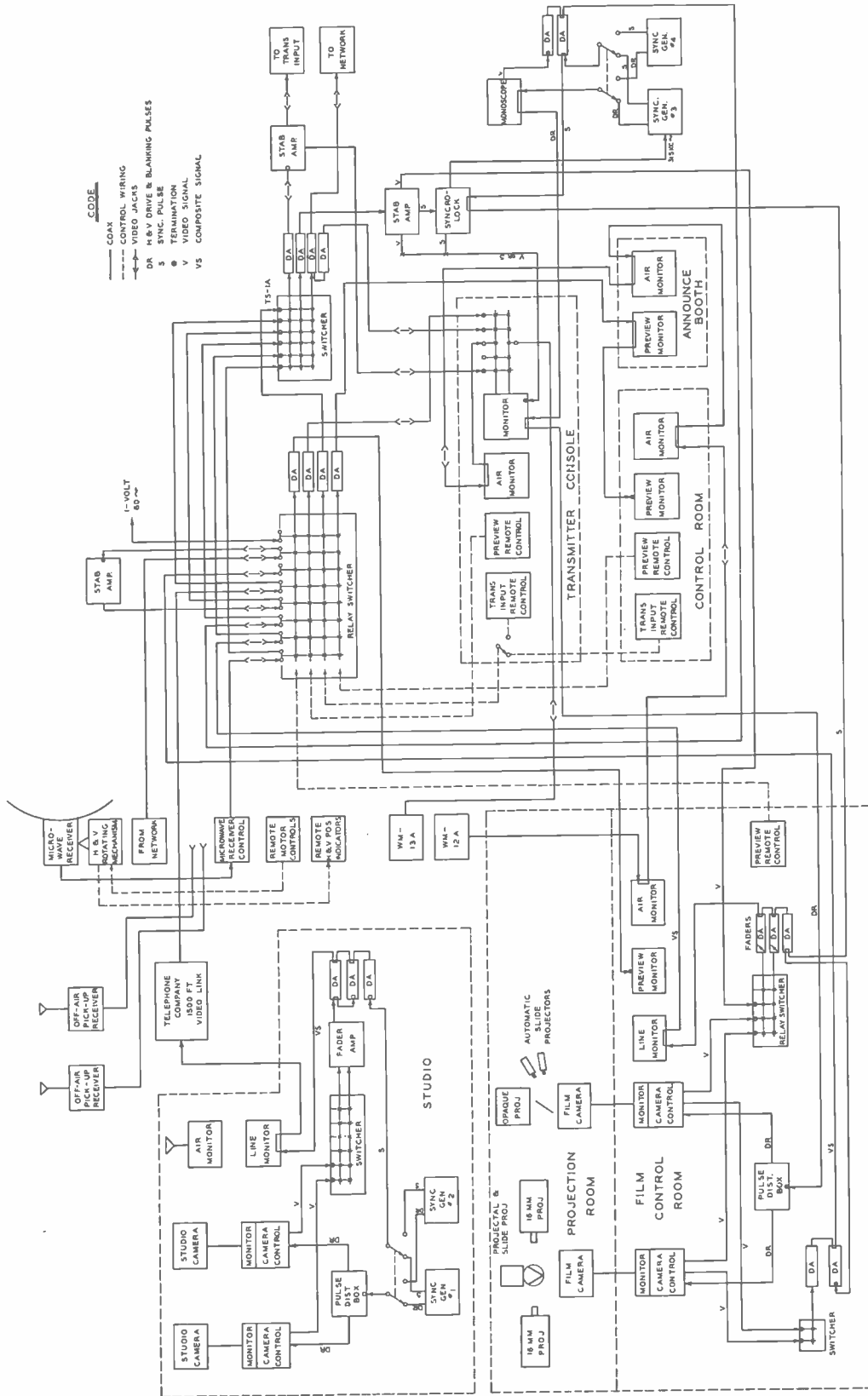

FIG. 13. Simplified diagram of overall video system. Switching facilities permit elaborate program control in the transmitter room. Use of relays simplified video cabling and made installation of additional control positions economical.

persed with time signals, weather and news broadcasts for the bus riders. The present program schedule supports 12 hours of daily programs from 7:00 A.M. to 7:00 P.M., Monday through Saturday. Regular FM programs are continued until 10:00 P.M. Sunday through Saturday.

Microwave Equipment

Figure 14 shows how we have adapted standard RCA Microwave Relay Equipment for use on a Navy Type SO-1 Radar Base. The combined unit is mounted on the top deck area of the Mathieson Building, 80 feet above the transmitter room location. Suitable remote control switches and indicating devices located on a control panel adjacent to the TV transmitter desk, control the horizontal and vertical rotation of this relay equipment. Stops limit the vertical rotation to approximately 60 degrees. Similar stops are placed on the azimuth motor to limit its travel to approximately 320 degrees. The blind segment of 40 degrees is that area in which the main antenna base support is located.

Mobile Units

The first year of operation was devoted to picking up sources of TV shows at the point of origination. This activity proved so successful that a second mobile unit was added to the fleet. In going to the remote scene of action, WMAR-TV captures the actual flavor of the event, thus providing the television audience authentic, on-the-spot realism.

The WMAR-TV mobile fleet consists of two custom built units which are converted Ford Type 69B transit buses, and one Dodge tender truck. The mobile units contain special features such as built-in air conditioning units for use during warm weather, and hot water and gasoline type heaters for winter's use. To keep the equipment heat load at a minimum, all power supplies and sync generator equipments were built into closets with glass panel access doors. Twelve inch exhaust fans installed in these closets are designed to dissipate the heat in these enclosures.

Unit number one normally carries three RCA camera chains, together with an RCA 7000 mc microwave relay transmitter, two audio amplifiers, several EE-8 telephone sets, two RCA off-the-air television receivers, assorted microphones, lenses, tools, and spare parts. Special weather-proof plastic type hoods are carried to cover the cameras and lenses during inclement weather. Mobile unit number two is a duplicate of number one except that only two camera chains are carried.



FIG. 14. Standard microwave relay dish, mounted on a Navy surplus radar base, permits remote control of horizontal and vertical positions.

Each mobile unit requires approximately 5-KW of power at the remote site. When adequate power source is not available one of two 6-KWA gasoline engine driven motor generator trailer units is used.

For most remote assignments a six-man technical crew is used. The men are assigned as follows: group leader in charge of crew (who is also video control man), two cameramen; one audio control operator; one chauffeur, and one helper. On special assignments, however, an additional relief man is used. On long distance remotes where a microwave relay unit is required, two additional men are employed.

The production crew on remotes consists of three members, namely: the producer, who is in charge of the show and makes the outgoing picture selection; an announcer; and a field spotter, who reports a word picture of events about to occur to the producer in the mobile units.

Executive Staff

The executive staff of the Sunpapers Radio Division are: E. K. Jett, Vice President and Director of Radio; C. G. Nopper, Chief Engineer; R. B. Cochrane, Program Director; and E. A. Lang, Commercial Manager. The entire staff for the combined Television and FM Transit Radio Operations numbers 95 employees.



FIG. 15. These custom mobile units carry the necessary field gear for WMAR's heavy schedule of remote telecasts.



FIG. 1. Front panel of the "Voice of America" transmitter as seen from right side of room.

VOICE OF AMERICA'S 150 KW TRANSMITTER

by **E. L. SCHACHT**

Broadcast Sales Section
RCA International Division

The U. S. Department has put a 150 KW AM transmitter into operation in Munich, Germany, to carry the Voice of America programs deeper into Eastern Europe and Russia.

The new transmitter is the RCA Type BTA-150A, developed by the RCA International Division. It augments existing facilities of the State Department in the

FIG. 2 (left). Picture taken from entrance of transmitter building. Control console (center) and measuring racks (at left). Open doors of transmitter show R.F. driver stage on left and power amplifier stage at right.

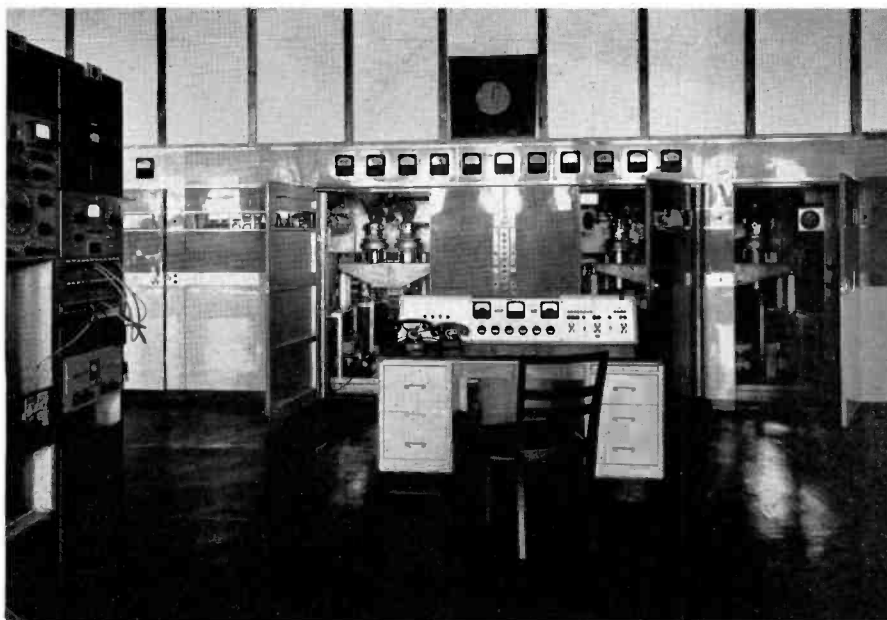

Munich area, which consist of four 100 KW short-wave transmitters. Also included in the Munich installation, but operated independently of the Voice of America, are a 100 KW German broadcast station and a 100 KW Armed Forces Network station. The site covers about 250 acres, with three main transmitter buildings.

The installation was planned and directed by George Q. Herrick, Chief of Facilities Branch, International Broadcasting Division, Department of State. Installation engineer was Jean Seymour. The transmitter was set into place and tested into a dummy antenna within forty-five days.

Regular broadcasting operations began September 1, on a twelve and one-half hour daily schedule. The transmitter relays Voice of America programs as they originate from the United States and are received on short waves by diversity receivers in Germany for re-broadcast. The broadcast period runs from sunset to sunrise, to make use of sky wave transmission. During the day the station carries programs of the Armed Forces Network.

Operating on 1195 KC, the transmitter uses a speech-clipper amplifier to maintain a high average percentage of modulation. Excellent performance is reported under these conditions. It has been operated successfully under test with full modulation with carrier power up to 170 KW. Normally, 150 kilowatts are delivered to the special antenna system, which consists of a 4-element array of half-wave towers. The antenna has three beam patterns, as shown in Figures 3, 4 and 5, with bearings of 60° and 240°, a double lobe of 115° and 355°. These can be

FIGS. 3, 4 and 5. Directional antenna system provides three different patterns, depending on the area to which program is directed. Any one of the three patterns can be selected at transmitter plant by means of pushbutton controls.

FIG. 6. Shown below are the medium and high voltage rectifier units.

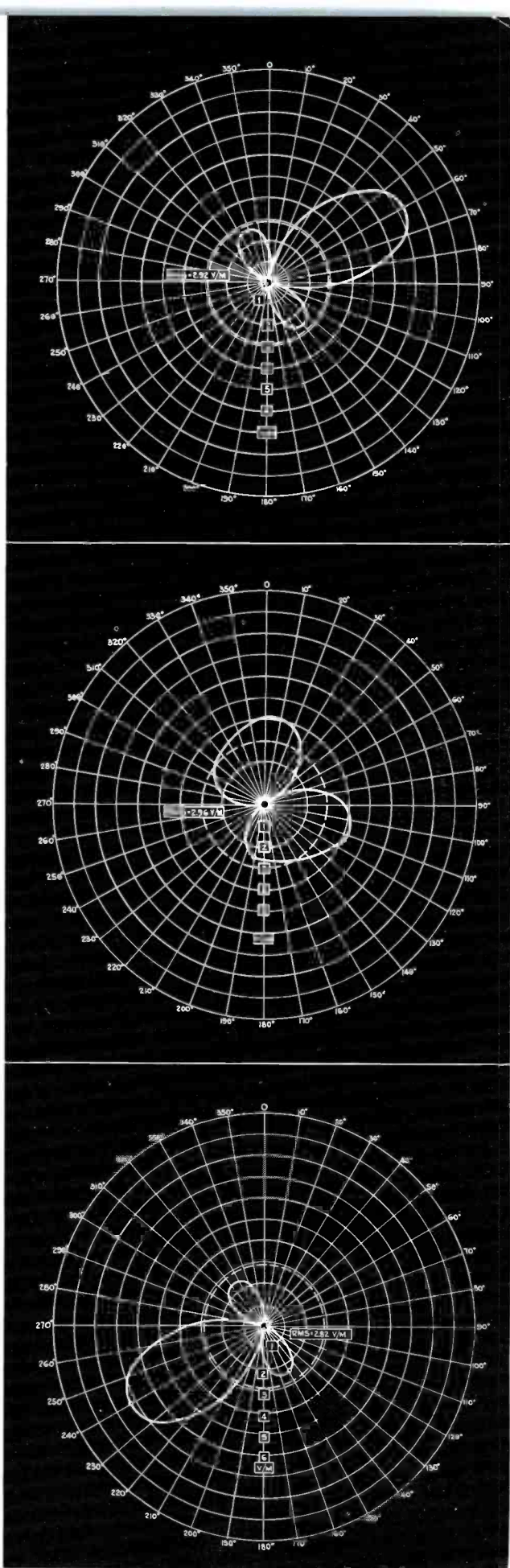
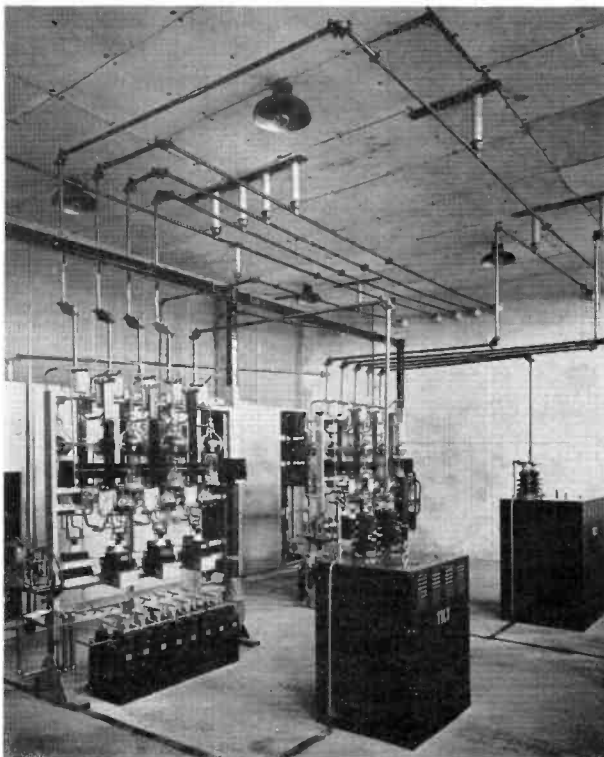

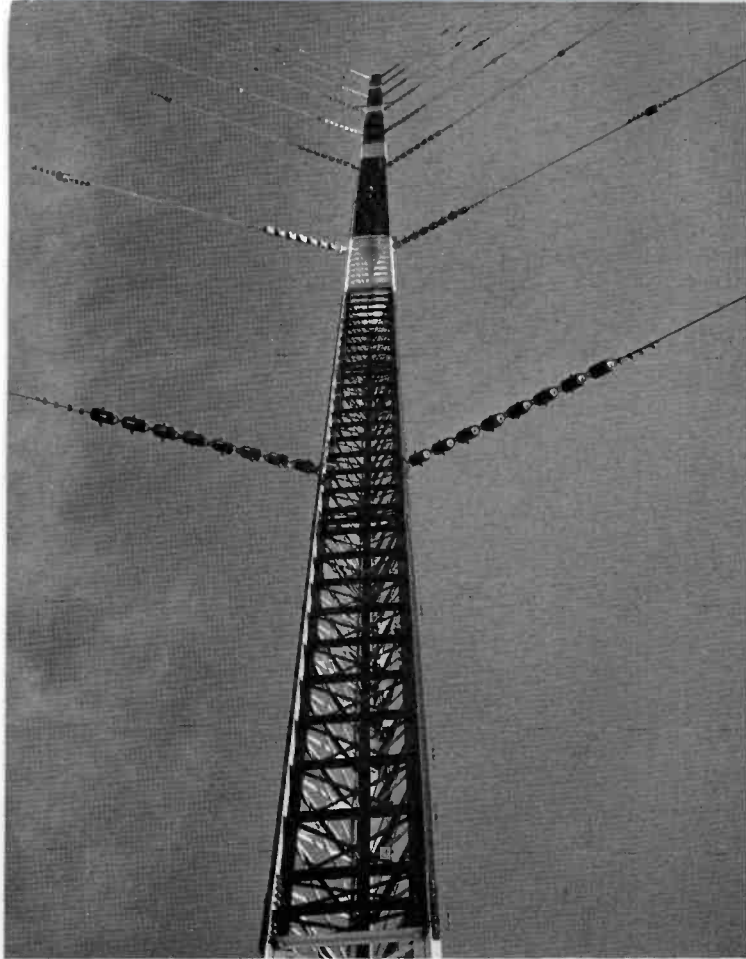

FIG. 7. Vertical view of the four towers of the medium-wave relay transmitter of the "Voice of America."

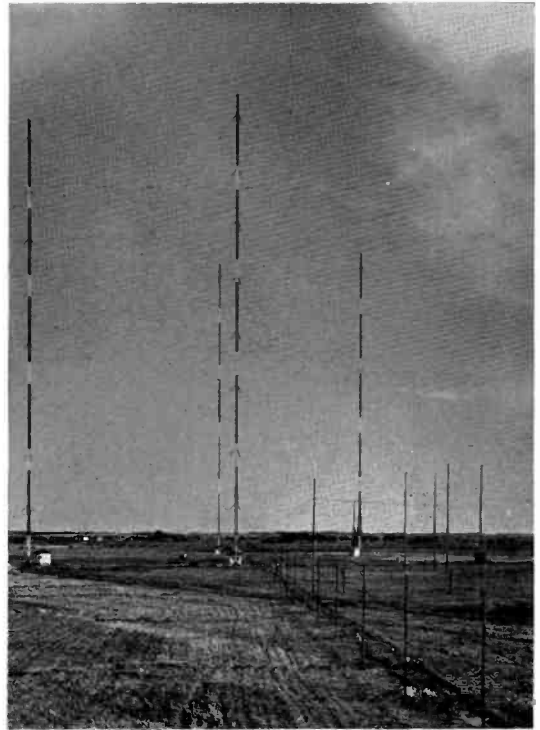

FIG. 8. The antenna area showing towers and main transmission line.

FIG. 9. The phasing networks and pattern transfer switches in the antenna tuning house.

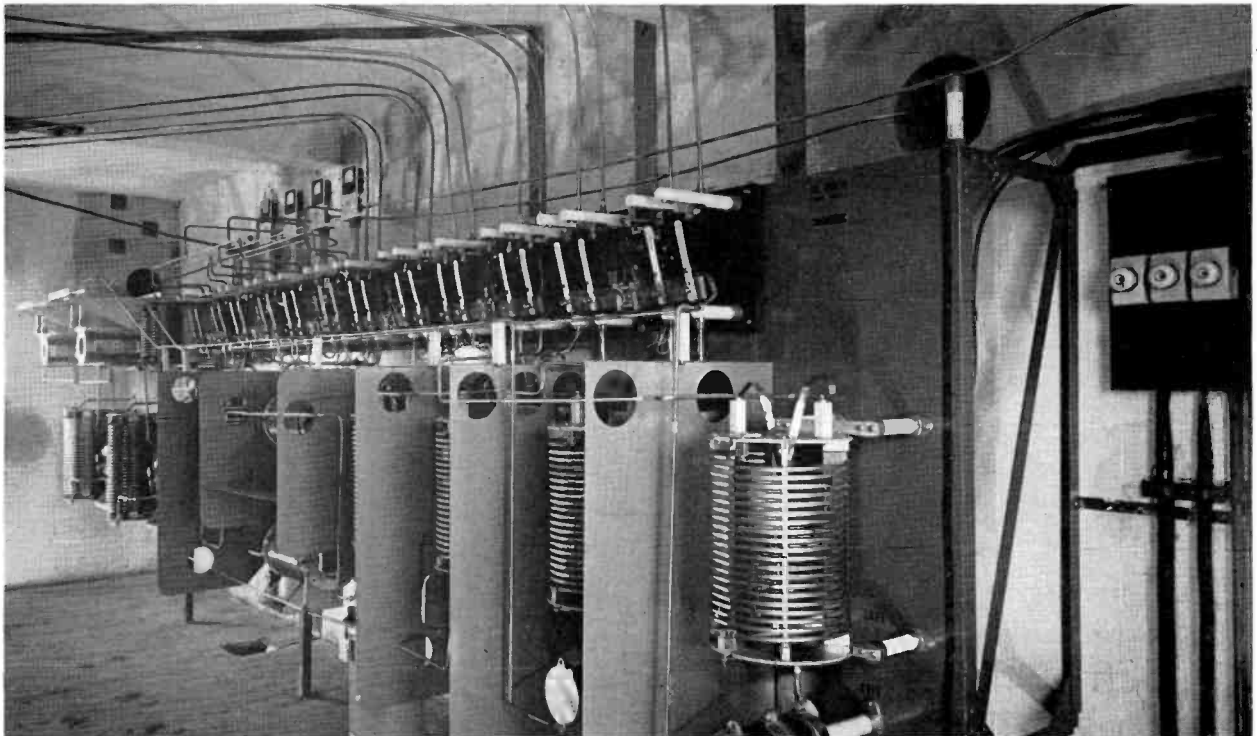



FIG. 10. Transmitter house, as seen from tower No. 1.

selected by switching for transmission in three different directions. The forward power gain on the main lobes is in excess of six. This is the first successful attempt to get so great an antenna gain for use with a transmitter of this size. One radiator can be used alone for non-directive transmission, using the antenna coupling network. The networks and switches for the various directive patterns are shown in Figure 9. The antenna engineering was done by the consulting firm of Weldon and Carr.

The field intensity at night, as measured by the BBC during the period when the beam was directed on England, averaged 1500 microvolts. There have been reports of excellent reception from most of the major capitals of Europe.

The RCA BTA-150A transmitter, as installed at the Munich station, is shown in the accompanying photographs. The 4-element directive antenna system and its feeder is shown in Figure 8, together with other antennas used for high-frequency broadcasting. One tower of the directive array for the 150 KW transmitter is shown in Figure 7. Figure 10 shows a general view of the site and the transmitter buildings.

By coincidence, another RCA 150 KW transmitter, operated by the Turkish Government, went into operation in Istanbul the same day as the Munich station and is also described in this issue.

FIG. 11. The transformer room showing modulation and service transformers.

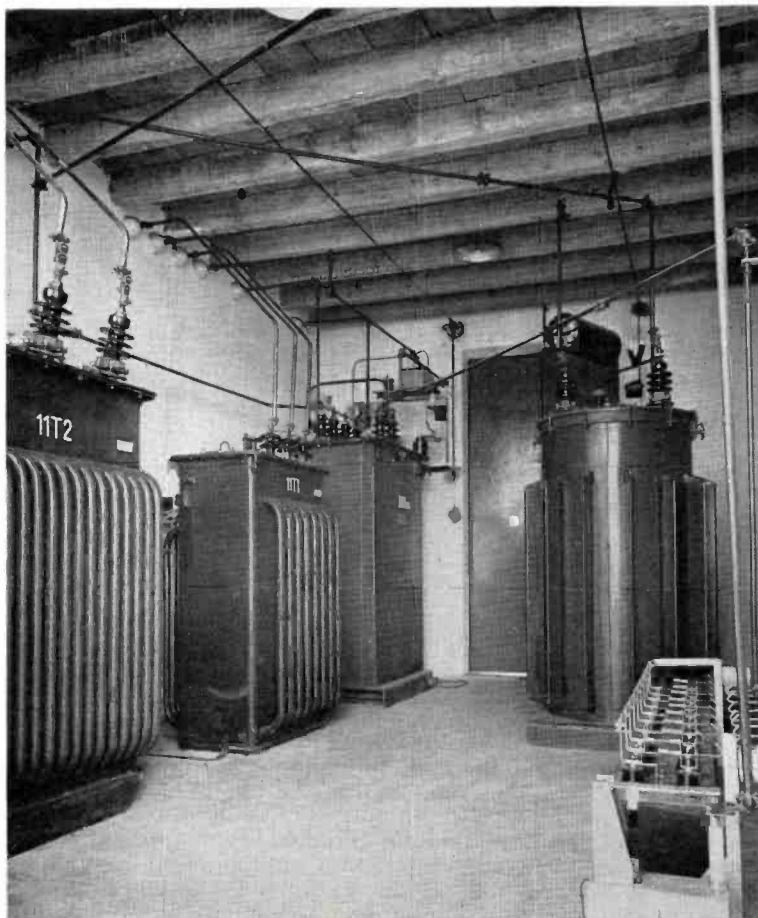



FIG. 1. The RCA Type BTA-150A Transmitter installed at Radio Istanbul, Turkey. The transmitter control console and test and measuring equipment racks are shown at left.

RADIO ISTANBUL COVERS NEAR EAST WITH 150-KW TRANSMITTER

by **PAUL C. BROWN**

RCA Engineer in Charge
Radio Istanbul Installation

Turkey's powerful new broadcast station, Radio Istanbul, has gone on the air with an RCA BTA-150A 150-kilowatt transmitter.

Reports of excellent reception have been received from Athens, Greece, and other points throughout southeastern Europe and the Near East. The transmitter is operating on 704 KC, and radiates 155 kilowatts.



FIG. 2. Shown inspecting one of the voltage rectifiers are some of the members of the Turkish Acceptance Committee, including: Fuat Tokat, Chief Engineer of the Post, Telegraph and Telephone Service; Ibrahim S. Esqun, Head of the Technical Bureau of the Press and Information Department; Muzaffer Eke, Supervising Engineer of Radio Istanbul for the Press and Information Department; Prof. Salih Murat, Head of the Physics Division of the Technic University.

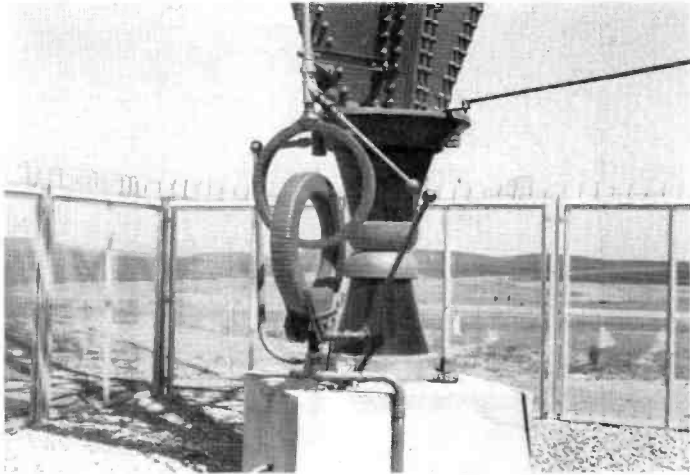

FIG. 3. The antenna tower base, showing toroidal-type lighting transformer and ball gaps.

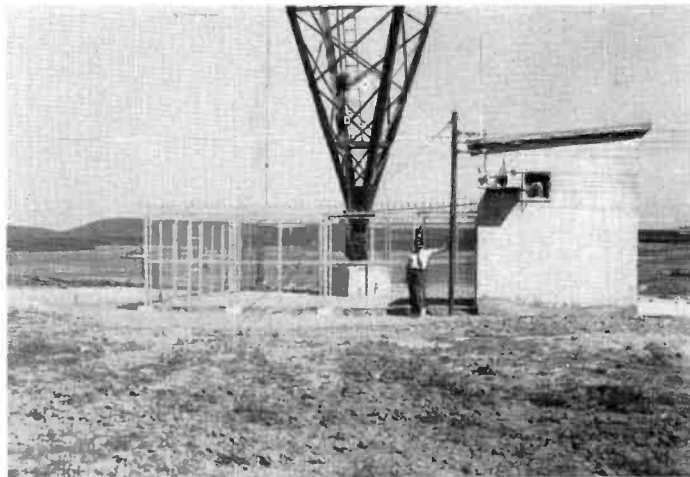

FIG. 4. The antenna tuning house and base of the 725-foot vertical radiator.

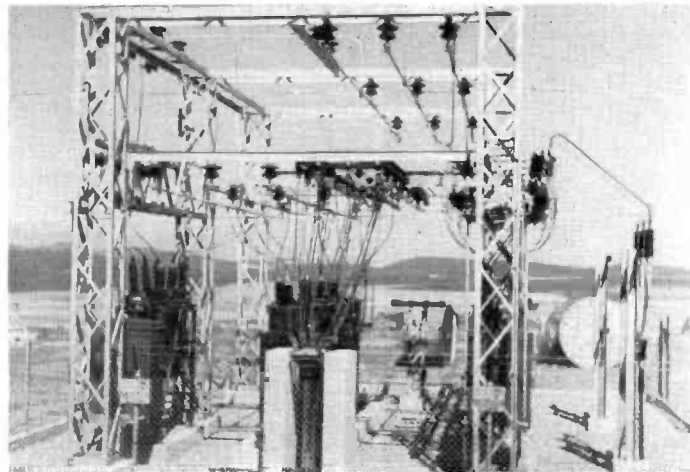

FIG. 5. Outdoor structure of the 35,000 volt sub-station, located at the transmitter site.

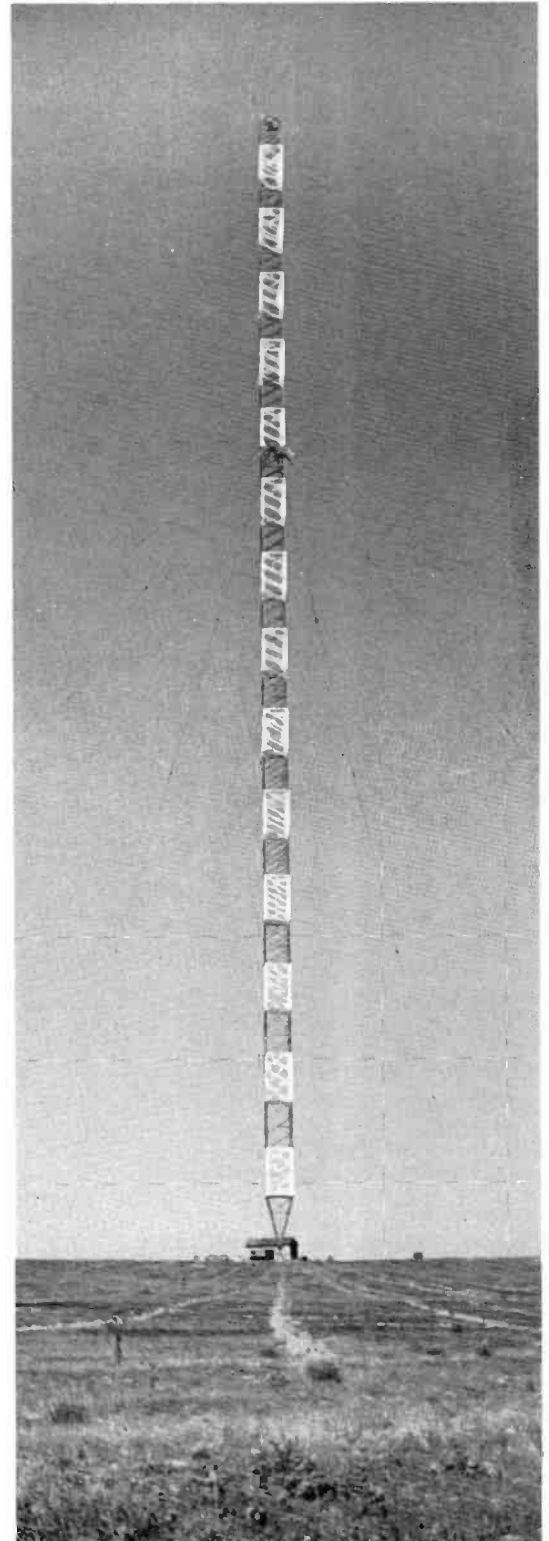

FIG. 6. The 725-foot antenna tower of Radio Istanbul. Note ground wire radials in foreground.

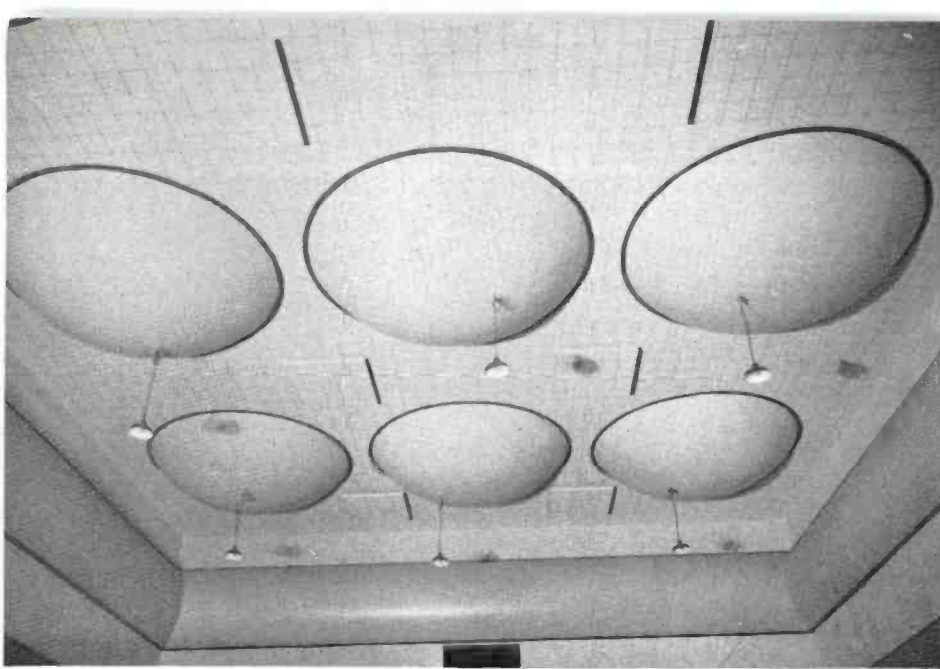

FIG. 7. Up-to-date and modern studios feature all latest improvements in lighting and acoustics. Shown at left is the ceiling of Studio A.

FIG. 8. Studio A, which is large enough to accommodate a full symphony orchestra, employs the polycylindrical diffusers treatment developed by John Volkmann of RCA Victor Division.

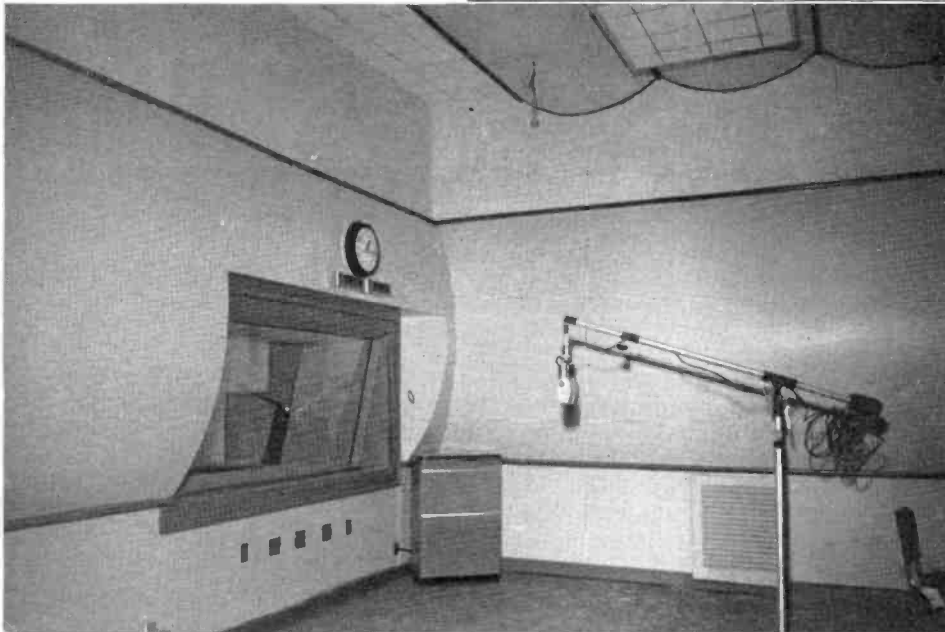
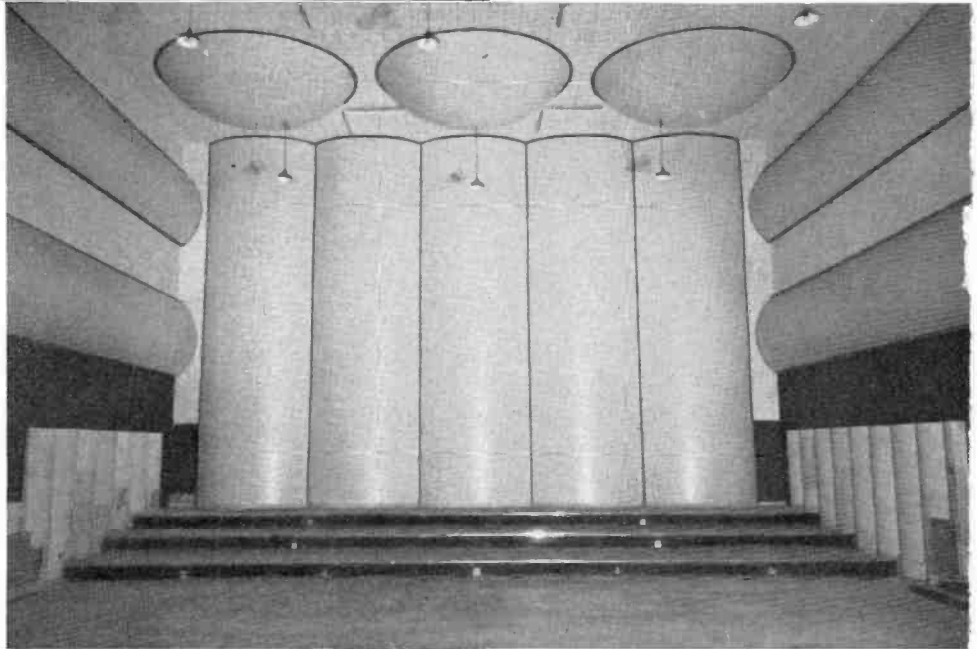

FIG. 9. Shown to the left is Studio D, which is one of the smaller studios.

The newly-constructed station, which was designed by engineers of the RCA International Division, incorporates the most modern and complete radio broadcasting equipment in the Middle East, including a 725-foot antenna.

The studio is located in the center of Istanbul, on the European side of the Bosphorus, while the transmitter is located about nine miles distant on the Asiatic side, in a building especially constructed for the purpose.

Facilities of the completely RCA-equipped studio building include: a radio studio large enough to accommodate a full symphony orchestra and a concert hall audience of two hundred people; three smaller studios and control rooms; three announcers' studios; a sound effects room; a recording room; and a master control room. The studios feature the polycylindrical acoustical treatment which was developed by John Volkmann of the RCA Victor Division, and is used by NBC in their Radio City studios.

Other material supplied by RCA includes: test and measuring apparatus; transmission and recording equipment; un-

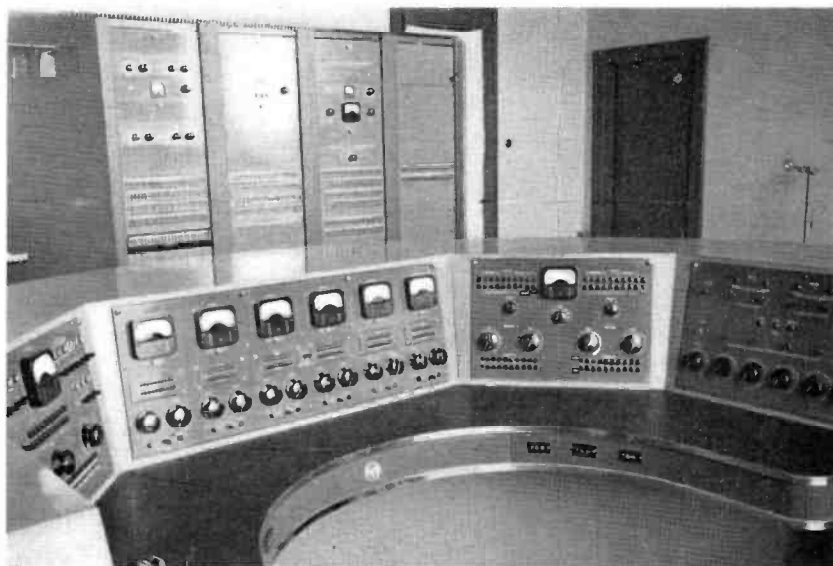

FIG. 10. Close-up of the Studio Master Control Console. Racks are seen in the background.

derground and sub-marine speech cables for crossing under the Bosphorus; and several miles of high-voltage power cable which carries power from the generating plant to the transmitting site.

The installation was effected by the RCA International Division in cooperation with the Turkish Press and Information Service, a government agency under the direction of Ahmet Sukru Esmer.

FIG. 11. Another view of the equipment racks and control desk in the studio master control room.



WTCN

AM • FM • TV



FIG. 1. The Foshay Tower Building, which is the tallest building in the Minneapolis-St. Paul area, houses the WTCN transmitters for FM and TV. The top of the tower is an ideal location for the stacked transmitting antennas and for the microwave relay receivers.

by **JOHN M. SHERMAN**
WTCN Technical Director

On July 1, 1949 WTCN-TV staged its "T" day from a new studio plant in the Radio City Theater Building, Minneapolis, and on the same day WTCN's AM and FM operations were moved from their former home in the Wesley Temple Building to the new Radio City location. From the viewpoint of the WTCN Engineering Department any remark to summarize the pressure of work during the preceding weeks would be an understatement.

The opening of the new studio-TV-FM plant was the culmination of planning

which began immediately following the war. The first step in carrying out WTCN's extensive plans was the procurement of what was considered to be the two most valuable radio properties for FM and TV in the Minneapolis-Saint Paul area. The first of these, the Foshay Tower Building (Fig. 1) is the highest in the Twin Cities (and in Minnesota) and was leased in 1945 for the FM-TV antenna site and the location of the FM-TV transmitters. The second, the commercial addition to the Radio City Theater Building, Minneapolis' lar-

gest and most popular theater (Fig. 3), was leased in 1948 so that its four floors could be modernized for the studios and offices of WTCN's entire AM-FM-TV operations.

The initial installation of antenna tower and FM transmitting equipment in the Foshay Tower Building was made in October of 1946. April of 1949 saw the first WTCN-TV test pattern from the RCA TT-5A TV Transmitter and Superturnstile TV Antenna. Reception of WTCN-TV was immediately reported "solid" for 60 miles

with many satisfactory reception reports to 100 miles and more, when proper receiving antennas were employed. This coverage was predicted after the experience of WTCN-FM in initially serving a radius of well over 100 miles with an interim FM transmitter power of 3 KW and a high gain antenna. Work on the new studios in the Radio City Theater Building started on January 15, 1949, with completion and joint initial operations of AM-FM and TV from this location on July 1, 1949.

WTCN is the basis affiliate for the American Broadcasting Company for AM and for ABC, CBS and Dumont Networks for TV. The WTCN facilities are licensed to the Minnesota Broadcasting Corporation, which is owned jointly by The St. Paul Dispatch-Pioneer Press and the Minnesota Tribune Company, former publishers of the Minneapolis Tribune. Mr. William J. McNally is President and Mr. Robert B. Ridder is Vice President of WTCN. Mr. F. Van Konynenburg is Vice President and General Manager and directed the planning of the new WTCN studio, FM and TV transmitting plants. Details were worked out by the author. Installation of the master control equipment, as well as the AM and TV studio equipment, was entirely accomplished by WTCN engineering personnel; including Jim Kelly, Audio Supervisor—assisted by M. N. Fleming, veteran WTCN technician, and Irvin Stratton, formerly of Lockheed Aircraft engineering and KEX, Portland, who did the layout work. Bill McGinnis, assisted by the TV technical staff, installed the TV studio and remote equipment. Bert Coil, the WTCN transmitter supervisor, handled the installation of the FM and TV transmitters and was assisted by Jerry Ellison, Clyde Green and other technical staff members.

AM-FM Studio Facilities

The AM studios (also provided with wiring facilities for TV later) are located on the second floor (Fig. 9) and consist of Studio "A" (Fig. 13), which is 30 feet by 50 feet plus a 30 foot by 20 foot stage and 25 foot ceiling; Studio "B", which is 18 feet by 25 feet; the control room for Studios "A" and "B"; the TWX News Room and News Studio; and an Announce Booth adjacent to Studio "A." Studio "A" is of the brighter type acoustically with poly diffusers on the ceiling, walls, and adjacent to the stage. Double thickness tile walls are used throughout and panels of standard rock wool treatment where necessary behind transite provide acceptable acoustics in various studios. The remainder of the sec-

ond floor consists of production and technical offices, as well as the program and bookkeeping departments. One additional feature on the second floor is the second floor lounge of the theater, which is actually part of the WTCN space. The elaborate decorations of this part of the WTCN space, with its beautiful lighting fixtures, is a perfect tie between the theater and television.

For large shows from either Studio "A" or "B," where a number of microphones are used, the "A-B" Control Room is used where talkback and sound reinforcement equipment can be controlled. Where only one or two microphones are required for smaller shows, control of these studios is possible from the Master Control Room on the third floor, which has overhanging visibility to these studios.

The third floor houses the Master Control Room, Announce Studio No. 1, Engineering Shop, an office for technicians and announcers, and air conditioning rooms and equipment. Additional air-conditioning equipment for the basement and first floor television offices and studios is located in the basement.

Master control is provided with facilities to handle four utility channels needed for remotes, recordings, and studio shows fed or repeated to the nine ABC affiliated stations in Minnesota, Wisconsin and North

Dakota. The network service for these stations is all repeated, fed and switched by WTCN Master Control. The audio channels from the other AM and TV Studio Control Rooms are also fed to the MC program switching and pre-set system. The pictures (Figs. 14 and 15), show the MC equipment. Master control also has talkback and cue selection for the various studios and remote lines; monitoring and level control facilities for the many outgoing feeds and studio channels; tape and disc recording equipment; and ring-down equipment with permanent "drops" for various control rooms and other local radio stations; as well as the AM and TV transmitters. All of the WTCN audio facilities, including the Master Control Console, were designed and assembled by the WTCN engineering staff. The racks and amplifier equipment are standard RCA units.

The need for such an elaborate control and switching system can be appreciated when it is noted that a "routine" operation for WTCN Master Control may include a local show origination for half of the Dairyland-ABC network, with simultaneous repeats of tapes or disc shows to one or two of these regional stations. Also TV studio shows and perhaps an ABC Coast-to-Coast origination, which might not be carried locally due to time differences during daylight-saving time. In addi-



FIG. 2. View from the top of the Foshay Tower Building shows engineers adjusting one of the RCA microwave relay receiver for line-of-sight reception from the Lexington Ballpark across the river in St. Paul.



FIG. 3. The WTCN broadcasting studios are situated in the Radio City Theater Building which is in the heart of downtown Minneapolis. Window at lower right gives the public a view of the television studio.

tion, several times each day, local remotes are fed to a portion of the regional net and not carried locally.

With the 4-channel custom console it is possible to break into any show, wherever originated, with local announcements or studio sign-on or off.

TV Studio Facilities

The Radio City Theater Building, which houses the largest and most popular theater in the Twin Cities, was chosen as the "ideal" studio site because of the allied interests of the theater and television. The Theater Building is in the heart of the Minneapolis business district and in close proximity to advertising agencies, department stores, etc. The commercial addition to the theater, which formerly housed stores and shops on the first floor and another radio station on the second floor, was completely remodeled from the Master Control Room on the third floor, to the Dressing Rooms, Telecine Processing and Scenery Shops, Artists' Lounge and Producers' and Directors' offices on the basement floor so that the interior of the plant has the appearance of a new building.

The first floor (Fig. 9) contains the 30 foot by 60 foot TV studio, which has garage-type doors opening out to an alley so that automobiles, heavy equipment and scenery can be readily moved into the studio. Adjacent to the studio is the TV Studio Control Room (Fig. 7) with a director's desk and light control switch panels on a level raised above the camera controls and audio console. On the other side of the TV Studio Control Room is a TV Announce Booth, which is used to handle commercials and other commentary for films, remotes or studio shows. The announce booth, as well as the TV Master Control and Equipment Rooms, have RCA receiver-monitors so that the staff may see the pictures in rehearsal or on-the-air. A room adjacent to the TV Master Control Room has been provided with steel wiring ducts so that 35mm film projectors can be accommodated—at present only 16mm films are being used. The remainder of the first floor contains the main lobby and executive offices.

The TV studio (Fig. 6) was equipped with a 1½ inch pipe grid work on which were hung the Kleigl lights of various types. For general studio lighting, 36 six-tube fluorescent fixtures with downward

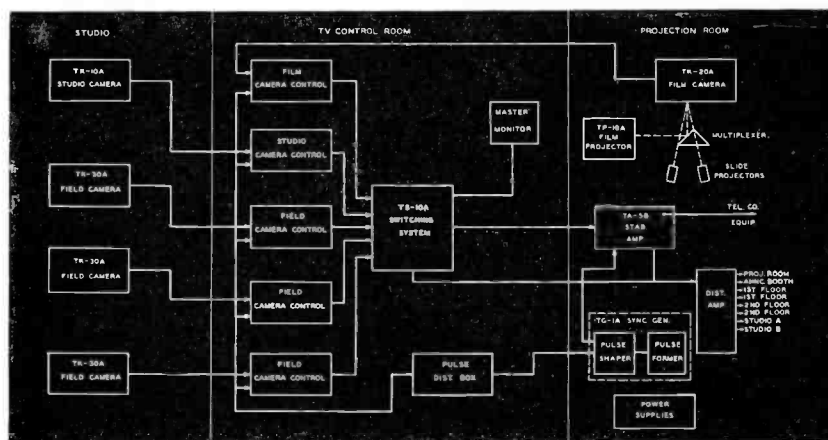

FIG. 4. Simplified block diagram above graphically shows the layout of the WTCN video facilities from the television studios to the coaxial lines going to the transmitter.

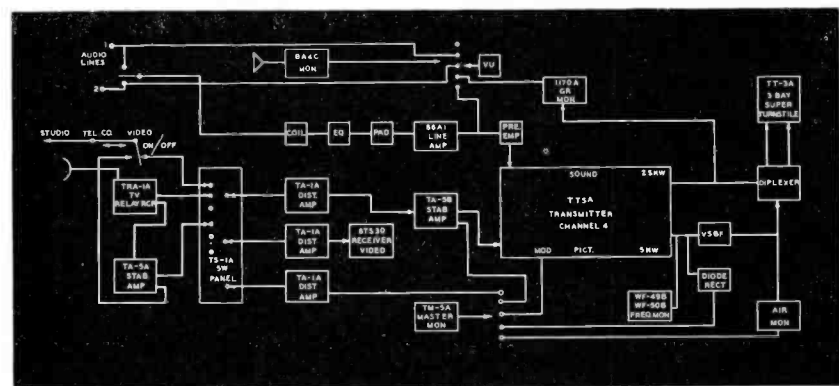

FIG. 5. This drawing shows the facilities at the transmitter. Audio comes in on lines at upper left; video is fed from the studio to tower by coax; remote programs are picked up by microwave relay.

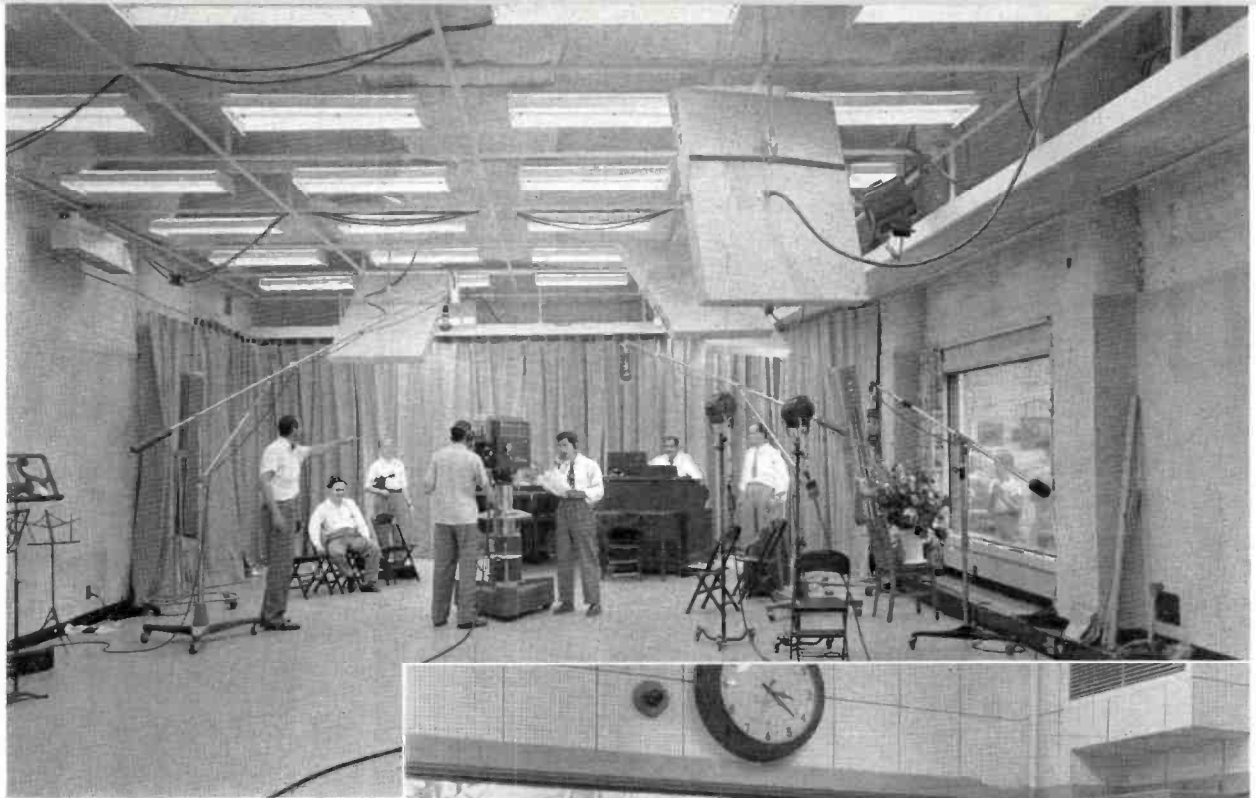

FIG. 6. The photo above shows the lighting facilities of WTCN's television studio which measures 30 by 90 feet. Garage-type doors, in rear, make it a simple matter to move scenery and equipment into the studio. Window at right, which is at street level, permits public to catch a glimpse of rehearsals.



FIG. 7. The television control room has unrestricted view of the studio. Camera controls are flush with window while the director's desk, not shown, is on a raised level overlooking the monitors and the studio. Mr. F. Van Konyenburg, Vice President and General Manager of WTCN, standing at right, and Mr. John M. Sherman, Technical Director, right foreground, watch the rehearsal with great interest.

reflectors were installed. Each fixture is on a 3-phase circuit. The cat-walk down one side and across the back of the TV studio facilitates control and adjustment of strip and spot lights. A portable scaffold on casters is used for other light adjustments and for changing fluorescent tubes when necessary.

All the TV equipment including cameras, transmitter, antenna, as well as the remote unit, is RCA. The Studio Control Room is equipped with a TS-10A Switching Unit and camera controls for three studio cameras and the iconoscope film camera, which is located in the TV Master Control Room. An RCA Type 76-C Console is used for audio control of the TV

studio. All audio lines feed through the AM master control so that the TV studios may be used for AM shows when necessary.

The TV master control, also on the first floor and connected with the TV studio and its control room by 6 inch by 12 inch steel wiring ducts, houses the studio sync generator, the power supplies for the camera controls, the RCA TP-16A 16mm projector, the stabilizing amplifier for the TS-10A Switcher, and the slide projectors and iconoscope film camera. An RCA multiplexer permits the use of two 16mm projectors, two 2 inch by 2 inch slide projectors with one film camera. Also located in the TV master control are the terminal facilities of the telephone company for the video

circuits between the studio and transmitter. This circuit is "flat" to 5.0 megacycles and has a noise level 50 db below the 2-volt (p-p) video signal received at the transmitter.

Throughout all control rooms and studios steel ducts and trenches are installed to house wire and cable requirements. Where both a-c and program circuits are contained in the same trenches, steel separators divide the trench areas to isolate these circuits.

FM-TV Transmitter Facilities

The accompanying illustrations show the facilities installed on the 28th floor of

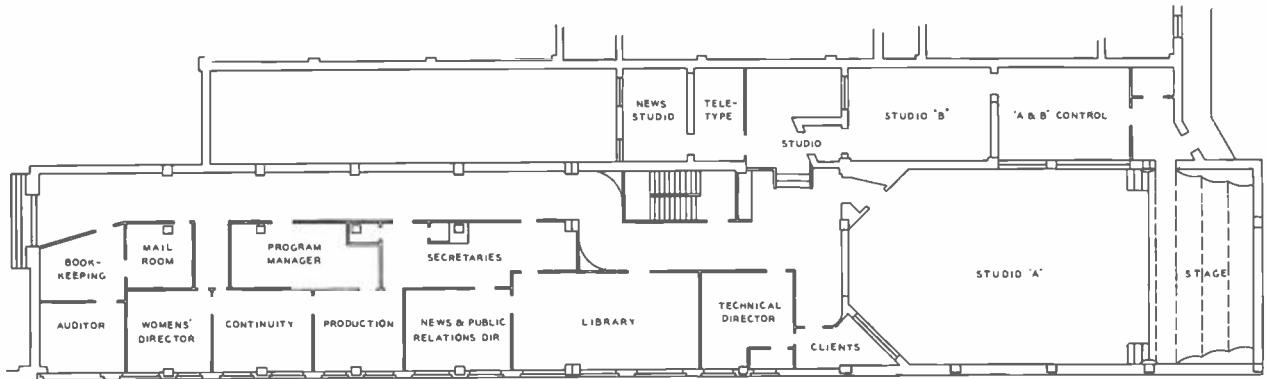

FIG. 8. The second floor plan of WTCN shows layout of offices and the two broadcasting studios.

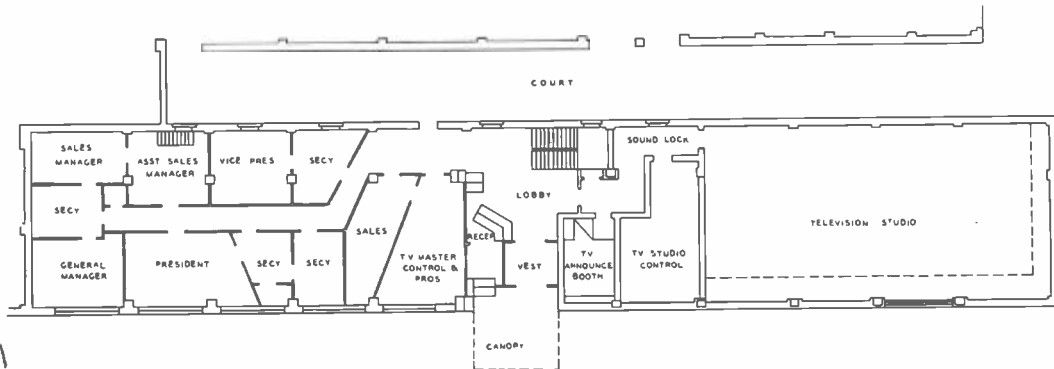

FIG. 9. This plan of the studios, at street level, shows the TV studio, the control room, the announcer's room and the offices.

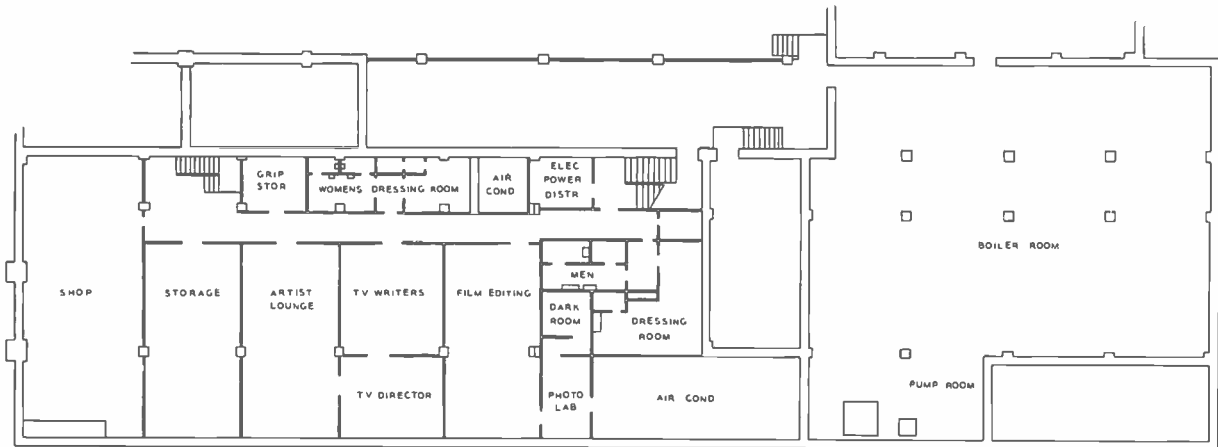

FIG. 10. Basement is used to advantage for shop, storage, film labs, and offices.

the Foshay Tower Building. Before the FM transmitter and antenna were installed for initial operation in 1946, it was necessary to provide a power bus from the transmitter floor to the Utility Company vault under the street, a run of some 700 feet. Four half-million cm cables were installed in anticipation of the FM and TV transmitter loads. The TV and FM transmitters are connected to the antennas on the single mast atop the building by coaxial, gas-

filled lines approximately 125 feet long. The installation of the antenna transmission lines was a problem since "straight" runs were not possible and off-sets had to be provided to obtain clearance around steam lines, elevator machinery, beams, etc.

The TV transmitter is an RCA Type TT-5A. WTCN is licensed for a 50 KW RCA FM transmitter, but is operating with interim power with an RCA Type

BTF-3B FM transmitter. Separate steel ducts for power and program circuits were channeled into the concrete floors to take care of requirements for both TV and FM transmitters and later expansion. Because of limited clearance of door heights and widths, all transmitter equipment had to be moved up into the transmitter space in units and assembled. The RCA Transmitter's mechanical design was ideally suited to meet this requirement. In fact,



FIG. 11. WTCN's television transmitter, TT-5A at left, and the 3 KW FM transmitter in background at right, are located on the 28th floor of the Foshay Building. Mr. Bert Coil, Transmitter Supervisor, is at the transmitter control console.

RCA transmitter design engineers visited the WTCN Foshay Tower transmitter space to be sure that their designs would be satisfactory to meet the limited clearances.

Also installed in this transmitter space is the TV terminal equipment of the Telephone Company, a 50-watt cue transmitter for "talk" to the 153.53 mc FM mobile unit, and receivers for reception from the Mobile Unit. In addition there is the RCA Type TTR/TRR Relay Receiver for the TV microwave system which feeds into an RCA Type TS-1A Switcher and TA-1A Distribution Amplifier so that the remote pix program can be fed to the transmitter, studio, and monitors for pre-checking.

FM-TV Antenna Facilities

The steel tower (Fig. 1) atop the Foshay Tower Building extends 86 feet above the top of the building and 23 feet below the top of the building where it is welded and bolted to central beams and columns. Immediately inside the top of the building a solid concrete ring holds the steel tower rigid so that no strain is placed on the



FIG. 12. Audio racks and patching system are conveniently located within reach of the operator. Messrs. Bert Coil, at left, John M. Sherman, at controls, and Paul Clark, RCA Representative, check video picture at different points in transmitter system. Converted RCA TV receiver, at left, is used to monitor microwave relay receiver.

FIG. 13. Studio A, used for AM broadcasting, measures 30 by 50 feet and has a stage which is 30 by 20 feet. Control room near stage, monitors programs from Studio A and Studio B, shown at extreme left.



special "flashing" on top of the building. The RCA 3-Bay Superturnstile TV antenna is secured to the tower by a special welded section and pedestal. The lower portion of the tower, under the TV antenna, supports the 4-bay FM antenna. On the top of the tower is installed a 153 megacycle receiving antenna for the FM mobile unit. Also on the top of the tower is a lightning rod with voltage divider. A range of 30-40 miles for audio remotes is obtained with the mobile unit. With the two microwave parabolas on opposite corners of the building, and an AM relay medium-frequency transmitting antenna supported on the tower, it is possible for 7 simultaneous radio operations to take place from this single installation.

All of the transmitter, studio and remote equipment was pre-checked and in-

stalled by the staff technicians of the WTCN Engineering Department. The co-operation of the RCA field representatives, factory, sales and engineering personnel,

RCA Service Company, and the WTCN engineering staff, and various local architectural and contractual firms has been deeply appreciated during the planning



FIG. 14. Broadcast master control position is located on the third floor. Mr. Lee Neuman is shown seated at console built by WTCN. Preset program switching system, behind Newman, was also built by the station. Note bank of RCA LC-1A loudspeakers overhead for checking local and network audio quality.



FIG. 15. Located behind the control console, are the racks of audio equipment. Mr. John M. Sherman points to the meters used to monitor regional and network AM lines.



FIG. 16. The WTCN Mobile Television Unit is shown outside the Lexington "Saints" Ballpark in St. Paul. Saints' Manager, Mel Jones, extreme right, distributes passes to group for opening game. From left to right, they are: John M. Sherman and Bob Ridder, of WTCN; Paul Clark, of RCA; and Cully Bloomquist, Manager of WDSM, Duluth Superior, a Ridder Station.

and installation stages of WTCN's TV-FM and studio facilities.

TV Mobile Unit

The television mobile field unit (Fig. 16) is an RCA Type PJ-50 with three remote cameras mounted and used. RCA microwave equipment is used daily on TV remotes and is picked up by one of the two parabolas (Fig. 2). The Saint Paul "Saints" Baseball carried on TV from Lexington Park is an 8-mile hop. A fortunate feature of the Foshay Tower Building is its centralized location for microwave reception and its dominance from almost any point in the Twin Cities.

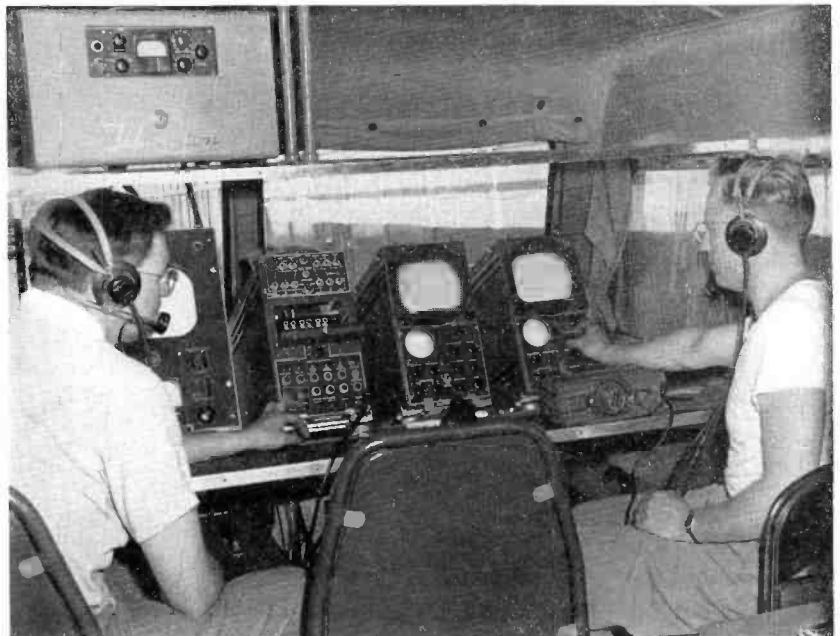

FIG. 17. Interior of WTCN's Mobile Unit shows Bill McGinnis (at left), TV Supervisor, at master monitor, and Ray Hird, at the remote camera controls. Unit at upper left is used to monitor the microwave relay transmitter.

KENI

ANCHORAGE, ALASKA

A. G. HIEBERT
Technical Director
Midnight Sun Broadcasting Co.
Manager, KENI

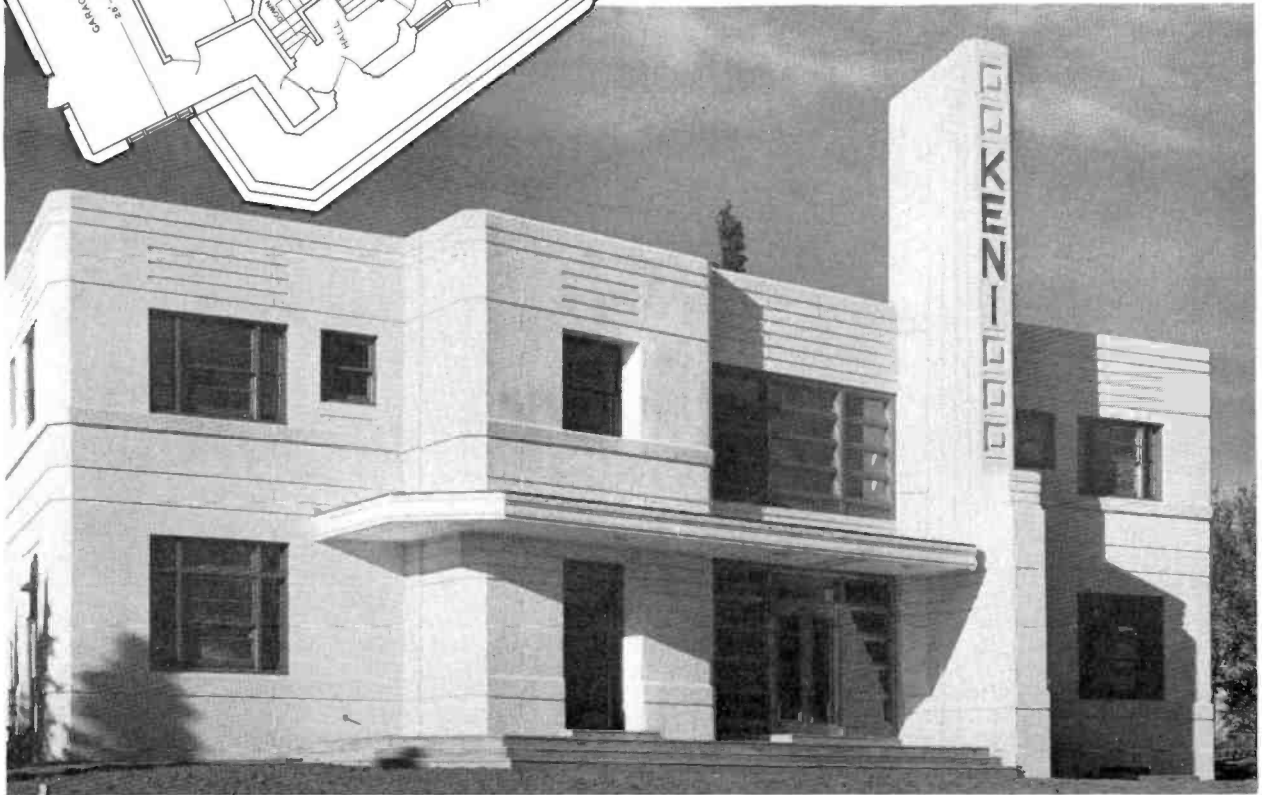
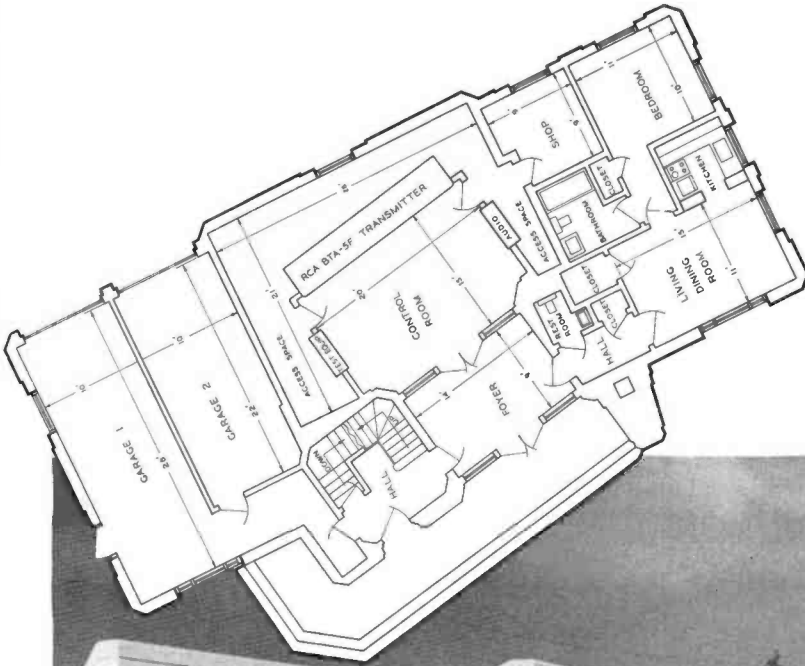

FIG. 1. The modernistic KENI transmitter building is constructed of reinforced concrete. Inset at upper left shows layout of garage, transmitter and bachelor apartment facilities on the main floor of the building.

A typical statement from a visiting tourist can well describe the new KENI studios and transmitter facilities in Anchorage: "I've seen bigger and more powerful stations, but none as smart and luxurious for it's size." And this is just exactly what pioneer industrialist Austin E. ("Capt.") Lathrop would hope to hear them say. Stateside visitors have been making similar statements about KFAR, Capt. Lathrop's Fairbanks station since 1939 when it first

began operation. When the decision was made to expand to Anchorage, Capt's only request was to make it "the best radio station money can buy."

The KENI studios and offices are located on the third floor of the new million dollar Lathrop Building which houses the 4th Avenue Theatre and the Lathrop Company offices. The theatre itself is a masterpiece of design and beauty, and it, to-

gether with the new radio studios, provide a tourist attraction of the first magnitude in Anchorage.

Studio facilities include: studio A, capable of seating 150 people; studio B, designed for group or panel discussions; and studio C, primarily designed for news reporting. Studio B overlooks the main studio A, and serves to double as a client's booth. The control room overlooks both

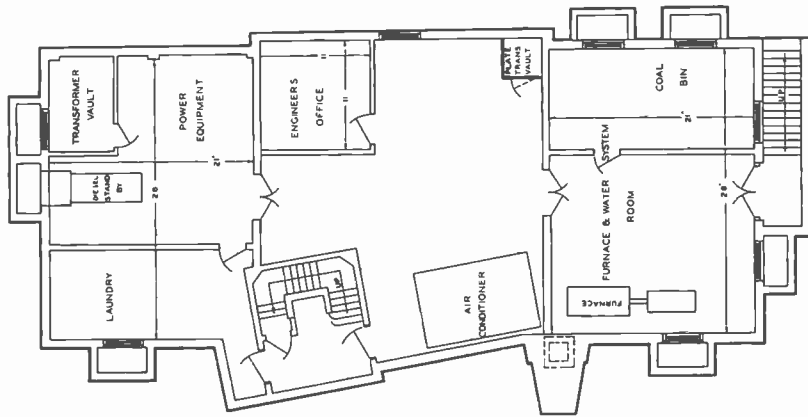

FIG. 2. Floor plan at left shows the layout of facilities in the basement of building. Top floor (not shown) contains two family apartments.

studio A and studio B and is separated from each by triple glass windows of varied thickness which reduce transmission of sound.

The studios are designed and constructed along the accepted Johns-Manville lines of sound isolation and acoustic control. Full floating construction is employed throughout. Floors are isolated by felt-lined metal chairs and ceilings are hung in a similar manner. All walls are isolated and floating free of the structural building.

The floor of studio A consists of a slab of concrete two inches thick floating atop a system of felt-lined chairs, and isolated from the surrounding walls by a one-inch thickness of mastic. Koroseal tile provides the final floor finish. It is anticipated that this type of tile will find wide acceptance in the broadcast industry because of its many advantages. The natural finish resembles a highly polished wax surface, thereby reducing maintenance costs. The tile itself, being plastic, is inert and not subject to the deterioration experienced with some other types of tile in common use.

The walls and ceiling of studio A are non-parallel splayed surfaces, covered with perforated transite backed by rock wool. Mounting of the transite has been handled in an unusual and decorative manner. Each square is separated from the adjacent square by a one-half inch gum-wood bead, thereby eliminating the ragged effect caused by slight edge malformations of the transite, apparent in most installations.

A special effect is created in the ceiling by cove-lighting which casts pattern shad-

ows over the beads. Since each transite square is treated as a unit, the rock-wool backing is cut accordingly, and specific acoustic control can be achieved by removing the square bats or adding additional ones, depending on future control desired.

The auditorium studio is isolated from external noise by an oversize air lock which can more correctly be termed a vestibule. Double sound-proof doors provide adequate isolation for this area which accommodates a substantial number of people and eases the flow of traffic in and out of studio A as well as studio C.

Prescribed sound isolation precautions were taken in the treatment of the air conditioning ducts. All ducts to and from the studios and control room are lined on the inside with regular duct lining and wrapped on the outside with rock wool blankets. The plenum chamber, mounted

above the office area and some distance from the studios, is lined with felt and shock mounted. In addition, all electrical conduit runs connecting to studio walls are broken with flex and wrapped with felt.

Studio control room equipment consists of an RCA Type 76-B4 Console plus auxiliary equipment mounted in two Type BR-84 racks. Three turntables are used by the control operator; two Type 70-C and one Type 70-C2. Since considerable recording is done, the basic design allows a recording feed to the transmitter from any studio without interfering with board operation. Originally, the transmitter engineer carried on all recording activities by using two Type 72-DX Recorders mounted on 70-C Turntables. Installation of two tape recorders at the studio now finds most recording done on tape and handled by the studio control engineer on duty.

The development of magnetic tape recording proved to be a "natural" for Alaskan operation. No network lines exist to the Territory, yet the stations of the Midnight Sun Broadcasting Company have affiliation with two networks. Disc recording in Seattle for delayed reproduction in Alaska was extremely costly. Initial cost plus air-express transportation resulted in almost prohibitive overhead. Tape recording solved both the high cost of transportation and initial expense. A "round-robin" circuit keeps a quantity of tapes moving to

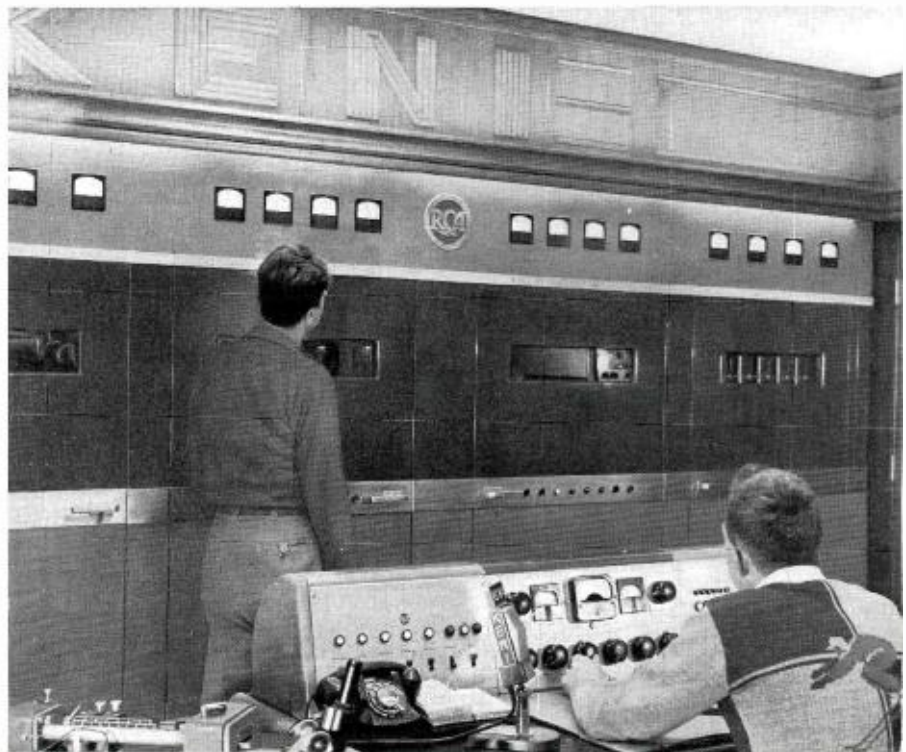

FIG. 3. Engineer Ray Walker checks the meters on the KENI transmitter, RCA Type BTA-5F. Chief Engineer Jack Walden is at transmitter console controls.

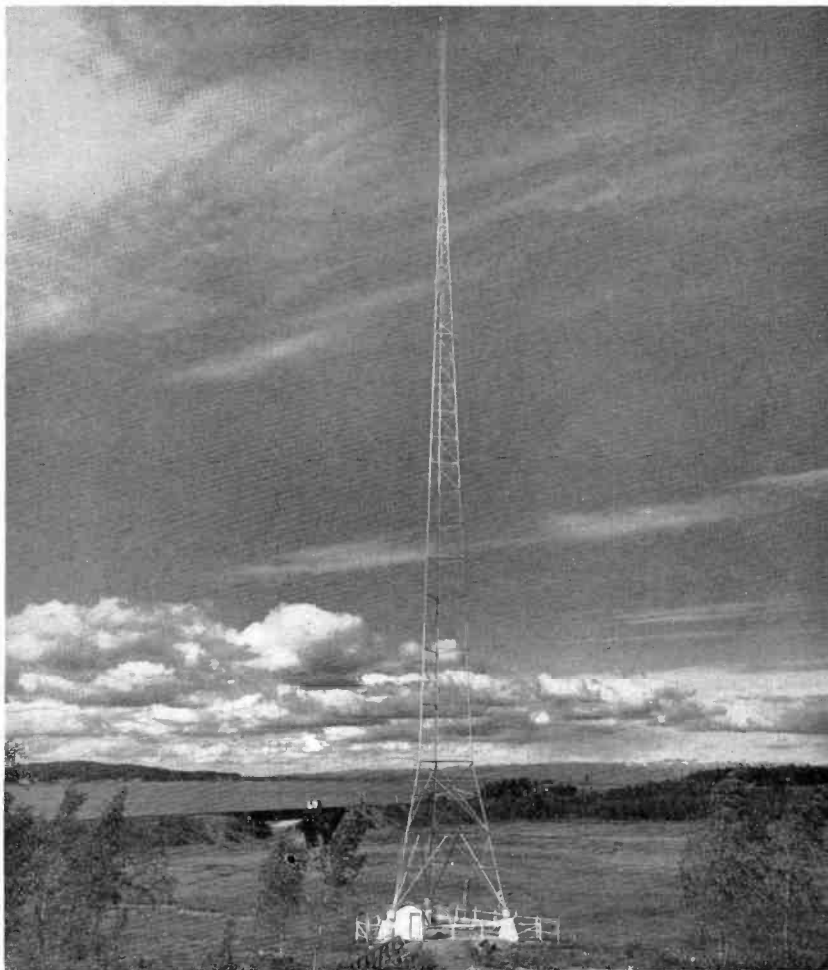

FIG. 4. The KENI antenna tower is located on salt marsh flats overlooking Cook Inlet. 50,000 feet of copper wire buried at base of antenna provides an excellent ground.

and from Alaska with programs fresh from the networks as well as tapes ready for recording again.

Transmitter

The KENI transmitter building is not one to take a back seat in regard to either beauty or functional design. The structure itself is reinforced concrete throughout, consisting of a full basement, main floor and second floor. It is situated on a side slope in a beautiful wooded area overlooking the salt water expanse of Cook Inlet and a convenient 10 minute drive from downtown Anchorage.

The transmitting antenna tower is in an excellent location as far as radiation characteristics are concerned. It is situated in a salt water marsh which is flooded periodically throughout the year by high tides, but protected from the sea by a railroad fill barrier. The comprehensive ground system consists of 50,000 feet of copper radials.

Energy is fed to the tower through a 1 $\frac{5}{8}$ inch co-axial line 475 feet long. A spare line is provided with remotely controlled transfer switches at each end for instant changeover in case of failure. The antenna system contains the first co-axial line installation in the Territory. Probable reaction of the system to the radical differential in temperature at first caused some concern as to reliability. The lines are kept under dehydrated air pressure of 20 to 25 pounds and to date no difficulty has been experienced.

Control room equipment, located in the center section of the main floor, includes an RCA 5-F Transmitter and modified transmitter, control console, four Type BR-84 Speech Racks, and two Type 70-C Turntables with Type 72-DX Recording Attachments. Two speech racks are situated on each side of the transmitter, with space provided for four more, or a total of eight. The racks, control console and transmitter are joined by a metal duct divided into three sections for low level, high level and a-c runs. The duct is accessible from the basement ceiling for any future change or addition in wiring. No radio circuit conduits are "buried" in the concrete. Ports are provided in the floor for the addition

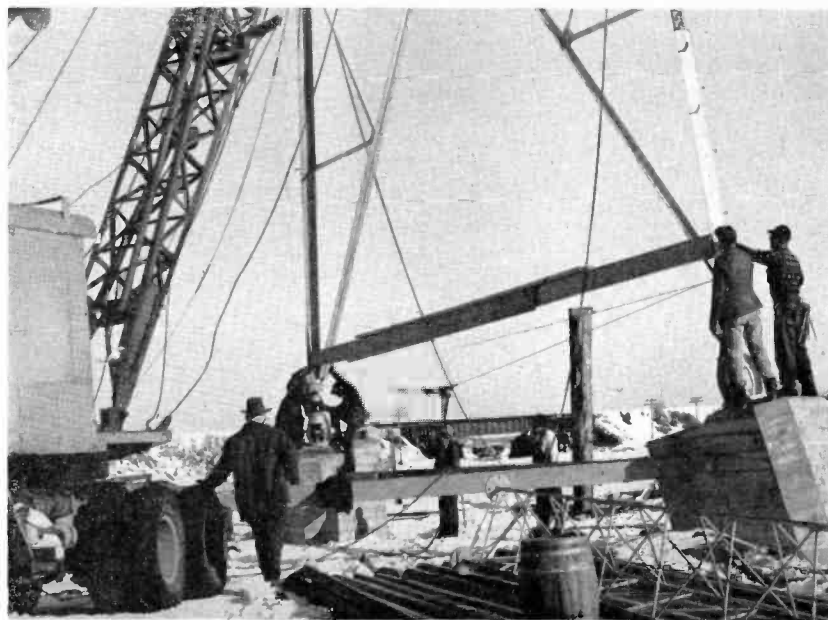

FIG. 5. Capt. A. E. Lathrop (at left) watches construction of the antenna tower on the concrete pilings. Railroad trestle can be seen in background.

FIG. 6. Photo of studio control room taken from Studio B shows Program Director Frank Brink giving familiar cue to Studio A. Announcer-control Engineer Merrill Mael is at the controls of the RCA 76-B4 Consolette.

of extra racks, which in turn can connect to the existing ductwork.

Although there are no directional requirements, a phasing cabinet was added to provide a unified front design. At the present time the cabinet stands empty, but it is expected that a shortwave transmitter will be built into it in the future for the transmission of special event programs to the domestic networks in the States. This has been done very successfully on numerous occasions from Fairbanks via the writer's experimental transmitter, K7XSB.

The control console was modified to provide for recording, selector control, and transfer switching, as well as for additional input mixing channels for shortwave reception. A National HRO receiver is used for rebroadcasting of international shortwave transmission and to provide daily time signals for clock correction. A system of correctable fifteen-inch self-winding clocks has been installed throughout the KENI studios and offices which can be controlled by the transmitter engineer, and set daily by calibrating with WWV.

Unusual precautions were taken to prevent undue interference with the shortwave receiving facilities. All steel in the construction of the building was securely tied and the main runs were electrically bonded together by welding. In addition, the control room itself was thoroughly shielded by wire screen, carefully overlapped, soldered and grounded. As a result, excellent shortwave reception can be accomplished in the same building with the 5-KW transmitter being in full operation. Antennas used at present for shortwave reception are folded dipoles atop the building. However, rhombics situated on the salt flats are to be installed later.

An auxiliary Diesel electric power plant provides power for emergencies, and this is situated in the basement area. Also in the basement is a laundry for the upstairs apartments, the control room air-conditioning unit, an automatic coal stoker, and adequate coal storage. The air-conditioner is designed to either cool the control room area in the summertime, or recirculate the heat generated by the equipment in the wintertime. It also provides a slightly

FIG. 7. Studio A, which shares a control room with Studio B, seats about 150 people. Backstage curtains offer a degree of acoustic control by exposing or covering polycylindrical diffusers.



positive pressure to the rear enclosed areas, thereby preventing dust from entering and accumulating on the equipment.

The second floor consists of two large family apartments, completely furnished and deluxe in every respect. Each apartment has two bedrooms, bath, kitchen, dining room and large living room. These unusual living facilities have been provided for the engineering staff and their families.

All woodwork throughout the entire building is furnished in rich walnut wood, which lends an air of luxury to the whole

transmitter installation not usually found in this type of structure.

The design and construction of both studio and transmitter was accomplished by the author and KENI Chief Engineer Jack Walden, with Ralph Walker joining the engineering staff for the actual construction. Studio and transmitter architect was Augustine A. Porreca of Seattle.

It may be noted here, although a complete story on KFAR appeared in an earlier issue of BROADCAST NEWS, that RCA equipment has been used almost ex-



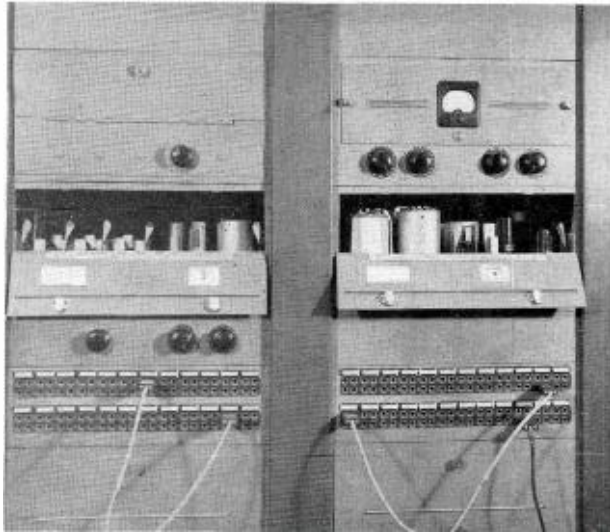

FIG. 8. RCA's plug-in chassis design has been adapted to rather unusual use at KENI. Audio racks at right contain three MI-10253 line transformers, two 56-C line equalizers and one MI-4901-A bridging transformer all mounted on a chassis which plugs into the standard BR-2A panel and shelf assembly. At left is booster amplifier RCA Type BA-2A and three preamplifiers.

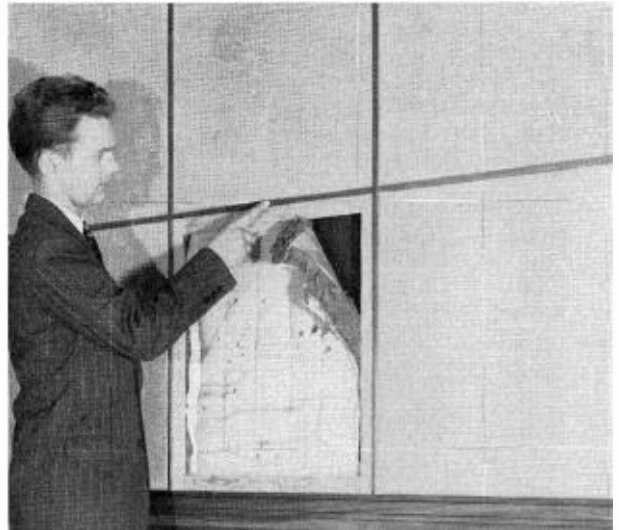

FIG. 9. A. G. Hiebert points out the half-inch gunwood beads used for decorative effect in mounting the perforated transite panels in Studio A. As shown, each panel is backed by two-inch rock wool bat, which can be removed to meet any change in acoustic requirements.

clusively at both stations of the Midnight Sun Broadcasting Company, KFAR Fairbanks, and KENI Anchorage. Early experience at KFAR demonstrated the reliability and quality performance of RCA equipment, therefore when expansion took place it naturally followed that RCA equipment would be installed. In 1942 KFAR replaced its RCA type 1-G transmitter with an RCA 5-DX, and then in 1943 added power to use the RCA 10-DX. Dur-

ing the planning of KENI, it seemed desirable to standardize equipment as much as possible for an interchange of spare parts or tubes in case of emergency. Difficult and uncertain shipping conditions prevail in the service to the Territory occasionally, making rapid replacements of parts an impossibility. This, in addition to fine performance of RCA equipment at KFAR, decided the choice of equipment at KENI. All original KFAR accessory equipment such as turntables, speech amplifiers, com-

pressor amplifier, and studio Consolette are still in use at KFAR, which, on October 1st, celebrated its 10th anniversary. Recording equipment has been modernized by use of 72-DX models, and universal type MI-4875-G pickups replaced the original lateral reproducers.

At KENI, after 16 months of operation, the RCA 5-F transmitter has never lost a moment of air time for any other cause than replacement of tubes.

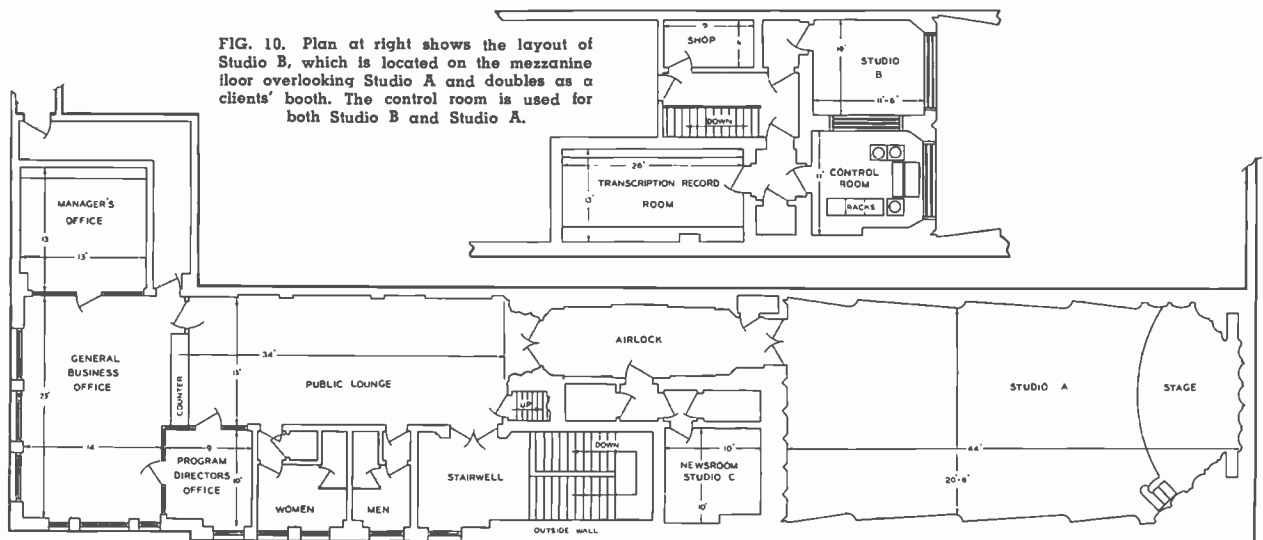

FIG. 10. Plan at right shows the layout of Studio B, which is located on the mezzanine floor overlooking Studio A and doubles as a clients' booth. The control room is used for both Studio B and Studio A.

FIG. 11. Floor plan above shows layout of facilities on the main floor of the KENI Studios. The airlock serves as a vestibule and helps ease the flow of traffic in and out of Studio A and Studio C.

HOW TO USE THE TM-5A MONITOR TO CHECK SYNC SIGNALS BY THE "PULSE CROSS" METHOD

H. J. MARKLEY
 Manager, Communications Service Section
 RCA Service Company, Inc.

The TM-5A Master Monitor may be used to observe the pulse widths and timing relationships in the synchronizing signal. This is accomplished by displacing the scanning raster of the monitor in both the horizontal and vertical directions so that the blanking and synchronizing intervals fall within the normal scanning intervals of the monitor.

When the scanning raster is displaced in this way a dark vertical band appears which provides an indication of the horizontal blanking width, the width of the horizontal synchronizing pulse and the duration of the front and back 'porches.' A dark horizontal band crossing the vertical band represents the vertical blanking and synchronizing interval and permits observation of the vertical blanking time, the width and number of the equalizing pulses and the duration of the vertical synchronizing pulses.

The wiring changes necessary in the TM-5A monitor are shown in Fig. 1. It will be noted that the switch is in the "Calibrate" position for this check and

there is no interference with the normal oscilloscope wave form presentation when the switch is thrown to "Osc" position.

Measurement procedure is obvious for all pulses shown except for the vertical blanking interval. This will be noticed to contain approximately 28 lines from the first equalizing pulse to the start of the next frame. The time interval is, however, that of only 19 lines and the discrepancy is due to the fact that the interval between equalizing and vertical pulse is $\frac{1}{2} H$ instead of H so that the time interval of the 18 pulses is 9×63.5 or 571.5 microseconds. The pulse dimensions shown are based on an estimate of 8% of H for retrace time, which is the average value.

The delay circuit to shift H pulse position may require slight changes in values from those shown to properly position the pulse cross on the raster.

The description above and the diagram below are based on information supplied by J. B. Dearing and T. Griffin of the Technical Products Service Group of the RCA Service Company.

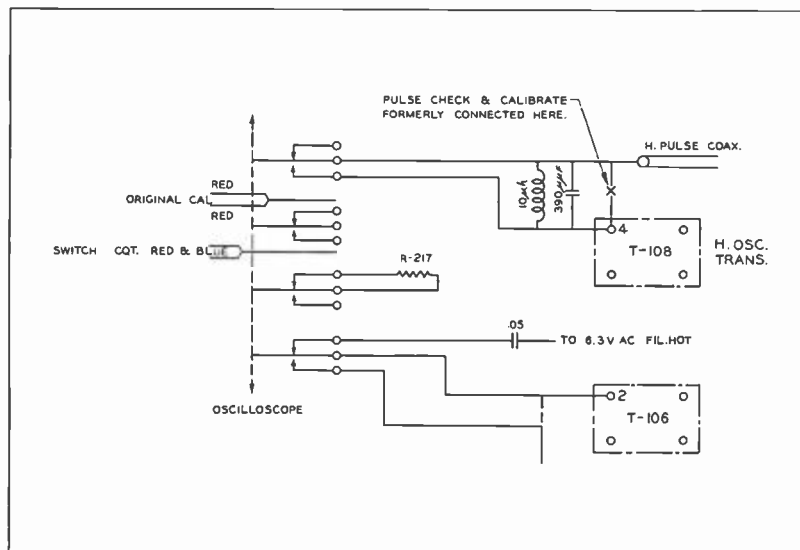

FIG. 1. Circuit changes in TM-5A Monitor for "Pulse Cross" measurements.



Ground-checking a 3-bay TV Super-Turnstile

Field engineering help — Laboratory-accurate measurements

"Shirt-sleeve" engineering assistance
 on all AM, FM and TV Broadcast problems

To meet your requirements for peak technical excellence in station transmissions, RCA now offers the expanded services of its field engineering staff to all radio stations—AM, FM, or TV.

Backed by 25 years experience in helping hundreds of broadcasters, this group of factory-trained specialists works directly with design engineers. It is experienced with all the latest techniques. It uses the finest kind of measuring equipment.

Here are the services

- ✓ **Installation Help.** Installation supervision and measurement of transmitting, studio, and accessory equipment—AM, FM, or TV.
- ✓ **Antenna Measurements.** Measurements and curves on antennas and accessory equipment—including transmission lines, matching networks, diplexers, etc.
- ✓ **Proof-of-Performance Measurements.** Proof-of-Performance measurements on audio, video, and transmitting equipment.
- ✓ **Operating Instruction.** Train your personnel on how to get the best possible performance from your equipment.
- ✓ **Field Engineering Help.** Solve your special problems on performance and maintenance. Prompt help in an emergency.

For complete information, call or write Communications Service Section, RCA Service Company, Inc., Camden, New Jersey.

NOW—restore the original quality of your RCA microphones, transcription pick-ups, and test equipment under the new Factory-Reconditioning Plan. For details, write: Return Apparatus Control, Building 8-2, Camden, N. J.

RCA SERVICE COMPANY, INC.
 A Radio Corporation
 of America Subsidiary
 Camden, N. J.

The Strange Case Of The Five Baseballs

or

How The Mystery Of The Disappearance
Of The Storage Effect Was
Finally Solved



FIG. 1. This is the picture that started it.

NIPPON HOSO KYOKAI (The Broadcasting Corporation of Japan) TOKYO, JAPAN

440 Kamatacho Setagayaku
Tokyo Japan
December 7, 1949

The Editor,
Broadcast News,
RCA, Engineering Products Dept.,
Camden, New Jersey, U.S.A.

Dear Sir:

I have seen with interest the photograph of your magazine, BROADCAST NEWS, September 1949, p. 10, Fig. 2. This photograph shows five images of the ball and the runner which were moving during the exposure (1/12 second) of the photographing camera. As the image of the moving ball has not been shown by one white line, but five white dots, I think, this may show that this pick-up tube has not any storage effect of electron charge, as in the case of the Iconoscope having the line-sensitivity effect. The image-pick-up tube of this photograph, I think, is, maybe, the RCA Image Orthiconoscope, if that is true, there is something strange about this phenomena concluding directly that the RCA Image Orthiconoscope has no any storage effect, and I can not understand clearly this problem. Please let me know this solution and explanation, why the image of a moving small object is shown by a dotted line in the monitoring screen of Television.

Yours very truly,

S. Ogawa
S. Ogawa

Technical Research Laboratory,
Broadcasting Corporation of
Japan.

FIG. 2. This is the letter that kept it going.

The Case of the Five Baseballs is well on its way to becoming a cause celebre. It all started innocently enough. In our last issue, as part of a well-intentioned attempt to explain why still pictures (of action scenes) taken from the kinescope screen are usually disappointing, we reproduced the photograph shown in Fig. 1. The caption which we attached to this picture read as follows:

"THE CASE OF THE FIVE BASEBALLS—OR WHY IT IS SO HARD TO GET A GOOD PHOTOGRAPH FROM THE MONITOR SCREEN. The picture above was taken at an exposure of 1/12 second. During this time the cathode ray beam traced five non-interlaced fields on the kinescope screen—hence, five pictures of the ball. Similarly there are five baserunners coming into view at left. At first glance there appears to be only one picture each of the stationary figures of the umpire and first baseman. This, of course, is an illusion—there are actually five pictures of each of these men, too. In this case, however, the pictures almost coincide—but not quite, because these men also moved a little. As a result the outlines are blurred. And that is what occurs on nearly all kinescope pictures of action scenes. Of course, you can use a shorter exposure—but even at 1/25th you get two fields. The eye, of

course, sees it differently. Instead of five separate pictures it sees a moving picture—with the apparent detail of one of the single pictures. This difference should be kept in mind when looking at 'pictures from the kinescope,' shown on following pages."

When this caption was shown to our engineers there was some mumbling about "over simplification." However, as editors we rather pride ourselves on simplifying things, so we went blithely ahead.

After the picture was published we received a number of questioning comments, most of which concerned photographing techniques. Quite a few readers thought we were just alibing—that the blurred effect was simply due to the fact that we didn't know how to take good pictures. However, most of the supposed "sharp" pictures they submitted (to show it could be done) were closeups of stationary or relatively slow-moving subjects. Thus, although our aplomb is somewhat shaken (and our photographer now admits that better pictures can be taken) the fact is that we've yet to see a really sharp photo of a rapidly-moving object such as a baseball, and we're going to hold out until we do.

There were other questions, too, concerning camera placement, effect of lights and shadows, etc.—most of which were disposed of with little trouble—although the editor is still carrying on correspondence with one or two writers who think he didn't do right by their pet camera setups.

Anyway, months passed and the domestic front had just about quieted down when one morning the Assistant Editor said, "Look, fan mail from Japan." We

looked, casually enough, and started to give it the "nice-to-have-heard-from-you" treatment. Then we took another look—and paused for a little head scratching. If you will read the letter (Fig. 2) you will see why. Mr. Ogawa had tossed us a real hooker.

At this point the Editor, who boasts just a bare nodding acquaintance with the never-never land of electron optics, knew he was out of his depth. So, pitter-patter he went over to the Engineering Department. "Oh! That's easy," they said (looking down their collective noses). Dr. Janes covered it all in his paper (RCA Review, Vol. X, No. 2, June, 1949).

So we took a look at that. But, life is short and Janes is long. So we said, "Look, boys, how's about your answering Mr. Ogawa." This suggestion was received with something less than enthusiasm—however, before too long we had an answer. It's long, but this department is cured (temporarily, anyway) of "simplifying" things—so here is their answer, in toto, with not a word changed, so help us.

In answer to Mr. Ogawa of the Broadcasting Corporation of Japan we submit the following explanation of the apparent lack of signal storage in the image orthicon as illustrated in the now famous picture of the five baseballs!

Mr. Ogawa is correct in assuming that the storage principle would result in a line rather than the five dots marking the path of the ball. However, moving white objects rarely show any storage effect. Under normal lighting conditions the target releases more than enough electrons to raise its potential to that of the target mesh. These uncollected electrons pass through the mesh, turn around and return through the mesh to the nearby positively charged areas on the target and discharge or neutralize those areas.

In other words, the surplus electrons follow the path of the white ball with an erasing action on the storage charge. Thus the ball becomes its own keshi-gonie! (eraser). One might ask why you see the ball at all. The answer is that the erasing action takes place where the ball has just been. When the position of the beam coincides with the position of the ball there has not been sufficient time for the erasing action to take place and the beam "sees" the ball. This redistribution of electrons has the effect of improving the apparent resolution of moving objects.

At very low light levels, the image orthicon operates as a true storage orthicon and the path of the ball may leave a faint grey streak or line. Sometimes, when the sun is low and the shadow of the grandstand crosses the path of the ball, the ball is recorded as dots until it reaches the shadow where it disappears or becomes a light grey streak.

If the characteristic curve of signal output vs light input for an image orthicon is examined it will be apparent that above a certain value of light input the output signal does not increase as rapidly as it does below that point. This point is called the "knee" of the operating curve. It varies with target to mesh spacing and with target and beam adjustment. The effect we have been discussing occurs in the region well above the "knee." If the background is light in tone a moving black object shows a similar result. This is called the white edge effect and is likewise due to the redistribution of secondary electrons.

That disposes of Mr. Ogawa, and secondary electrons—we hope. However, we still have the question of whether or not it is possible to get a good action photo from the kinescope screen. We're still interested—and at the risk of making the five baseballs a permanent feature we invite further comments and photos. In fact, just to add a little zip to it, we hereby offer a 45 RPM record player for the best action-from-the-screen photo (with explanation of how it was made) received before June 1, 1950.

*(To be continued next month—
we're afraid)*

45 RPM ADAPTOR KIT FOR 70-D TURNTABLES

Ask your RCA Field Representative for details

Invest in Friendship

**20 BROAD ST.
NEW YORK 5, N. Y.**

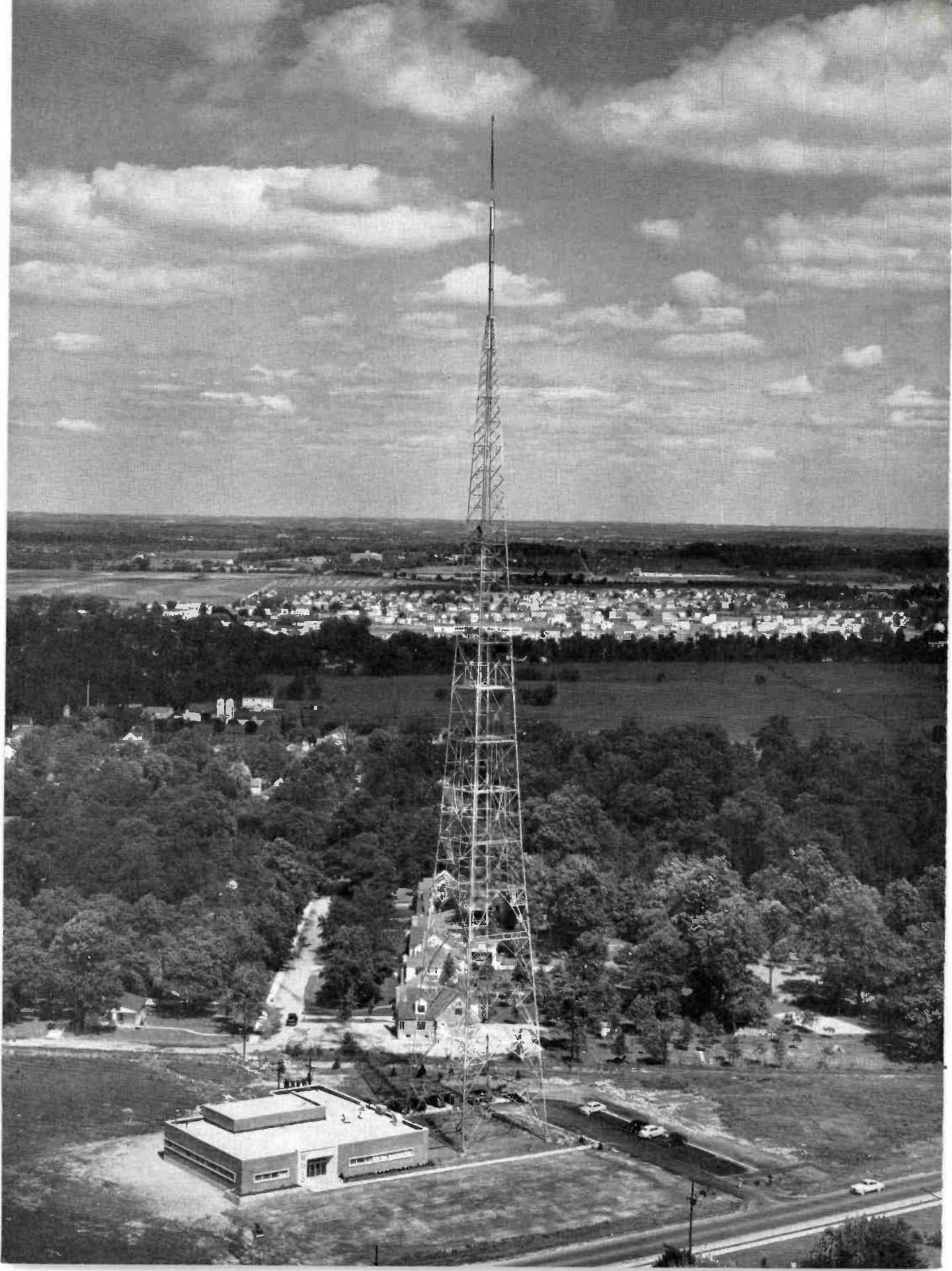



FIG. 2. The clean-cut brick and limestone exterior of the WHIO-TV building is in keeping with the residential atmosphere of surrounding neighborhood.

WHIO-TV DAYTON

Miami Valley Broadcasting Corporation's Unusually Well-Planned Studio Transmitter Plant Was Designed and Erected By The Austin Company

One of the most carefully planned and best arranged television plants in operation today is that of WHIO-TV—Dayton's first television station. The combined studio and transmitter building, which houses all of the WHIO-TV activities, was designed by engineers of The Austin Company after a thorough study of the station's particular requirements and likely operating procedures. Incorporated in this building design are some of the best ideas developed to date in functional layout of television stations. Especially noteworthy features include: (a) grouping of the studio, control room, film room, announcer's booth and other mechanical facilities related to television program production in one area, (b) isolation of this area, by means of a corridor, from the other activities of the station, (c) use of a simple terraced arrangement of descending floor levels to provide visibility from the clients' lounge into the control room and studio, (d) provision of a "street-level" opening from the garage into the studio, (e) completely functional arrangement of all operating units—as illustrated by location of the transmitter room on a direct line from the studio control room to the antenna.

FIG. 1 (left). The WHIO-TV building is located along the Wilmington Pike on the outskirts of Dayton. The building features a compact, multi-level, one-story layout which for convenience, flexibility of operation, and general practicability would be hard to surpass. The six-bay RCA Superturnstile TV Antenna and the four-section RCA Pylon FM Antenna are mounted on a 417 foot tower adjacent to the building.

Illustrations above, and on the opposite page show the outside appearance of the WHIO-TV building. Considering the extent of the facilities incorporated in it, this building is unusually compact. Lines are simple and regular. The clean-cut exterior is of red-face brick and limestone with a modern-type recessed entrance which leads into an attractive—but also very functional—lobby. Views of the lobby and of other interior areas of the building are shown on following pages.

Visitors To WHIO-TV Stations Can See Television At Work

Offices and service areas in the WHIO-TV building are located on three sides of the building—so that they form a “U” around the operating area proper (i.e., studio, control room, film room, announcer’s booth, etc.). This arrangement centralizes production activities and provides a degree of isolation between the program and business functions.

The lobby of the building is at the bottom of the “U” (see plan at right). A window in the lobby wall facing the street entrance (Fig. 4) looks through the clients’ audition room and into the control room and the studio beyond (Fig. 5). The clients’ audition room can be draped off from the lobby completely, when privacy is desired, or can be left open so that persons in the reception lobby can share this full view of television operations. Another window at the end of the lobby looks into the transmitter control room (Fig. 6). The floor level of the latter is lower than that of the lobby so that there is a good view of both control console and TV and FM transmitters. Blond birch wainscoting and trim have been used in the lobby, which has a tan asphalt tile floor, plastered walls—which have been painted aqua-green—and a fiber acoustic ceiling, with recessed fluorescent troffer and spot lighting units.

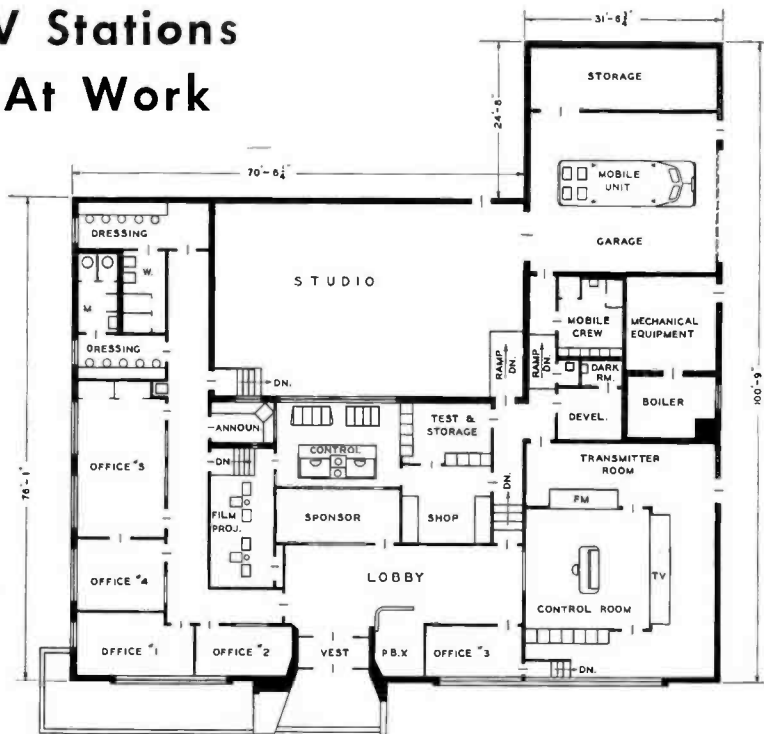

FIG. 3. Floor plan of the WHIO-TV building, elevation plan is shown in Fig. 7.



FIG. 4. Lobby of the WHIO-TV building. Partially draped window at left looks into clients’ room.

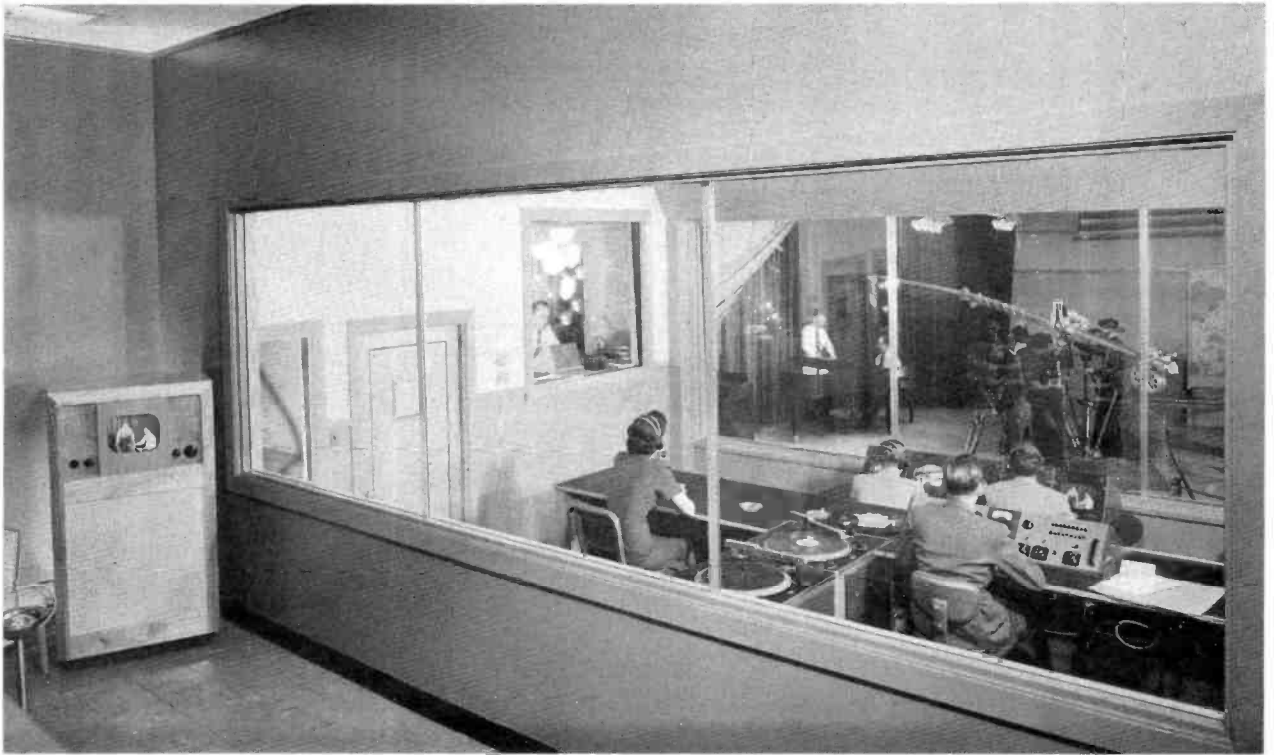

FIG. 5. View from the clients' room looking through the control room and into the studio beyond.

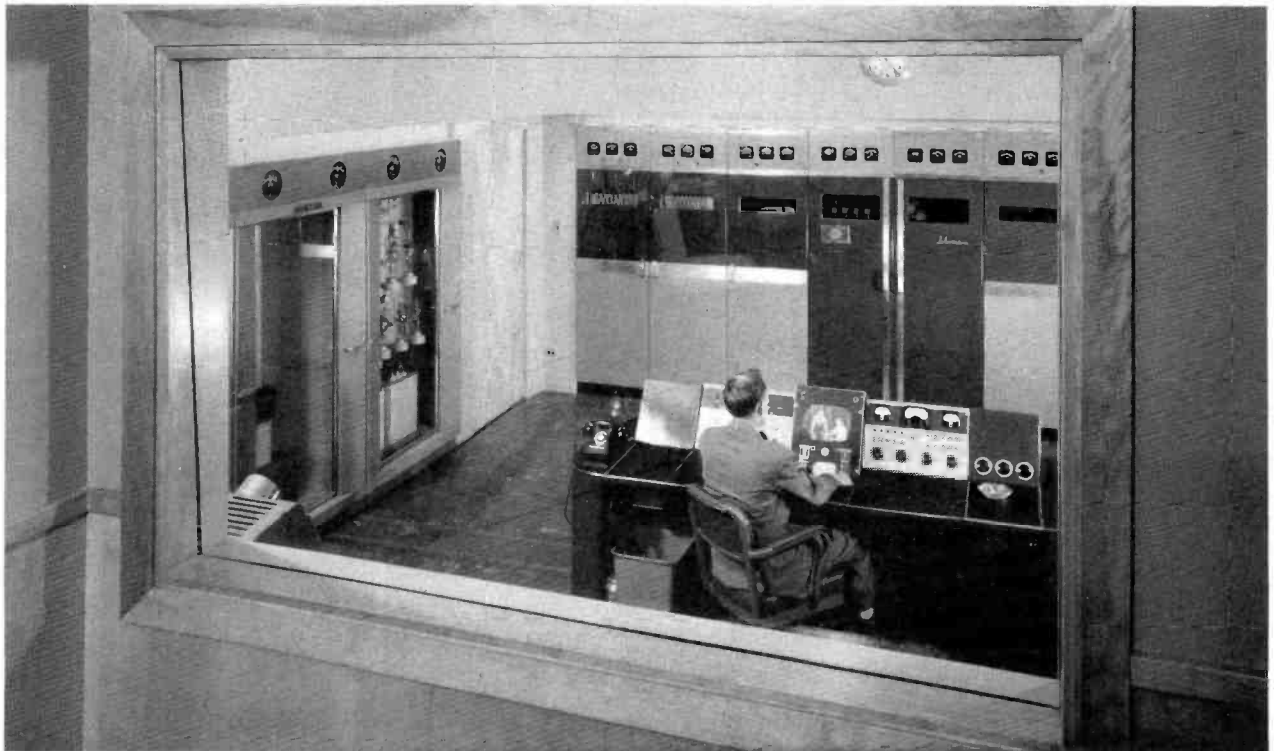
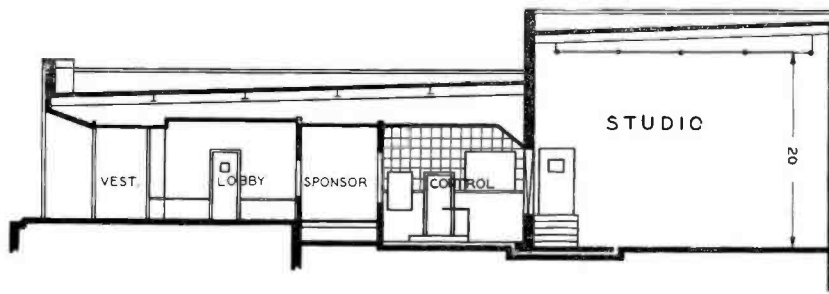

FIG. 6. View from lobby into transmitter control room. FM transmitter is at left, RCA TV transmitter in center.

FIG. 7 (right). Elevation plan of WHIO-TV building as shown by section through center. Operating facilities are located on five different levels, descending from lobby to studio floor in a tiered arrangement.



Terraced Arrangement of Floor Levels Provides Visibility

A tiered arrangement of floor levels is a feature of the WHIO-TV building layout. Elevation of the control room floor above the studio floor—and use of two or three levels in the control room itself—is common practice in TV installations. However, at WHIO-TV this idea has been carried a step further by integrating the clients' observation room and lobby into the scheme—so that there are actually five separate floor levels rising in a stepped effect from the studio to the lobby. The

lowest level, of course, is that of the studio floor. The next higher level is that of the video operators and technical director who sit at the camera control units facing the control room window (see Fig. 8, below). On the next tier, the third level, sit the program director and audio operator. Their position is sufficiently elevated that they can see over the heads of the video operators into the studio. The fourth level is that of the client's room. The floor of this room is elevated above that of the control

room so that the occupants of this room can, in turn, see over the heads of the program director and audio operator. The fifth level, of course, is that of the lobby and corridor. The desirability of providing visibility, not only for the operating staff, but also for clients and visitors is an important consideration, and one which has in some cases led to the use of a two-story structure. At WHIO-TV it has been obtained in a simple and relatively inexpensive manner.

FIG. 8 (below). The announcer's booth at WHIO's new television station is surrounded on three sides by the studio control room (foreground), the studio proper (which is seen through the control room window on the right), and the projection room (through window on left), so that the announcer can see what is going on at any time in all three places. Speakers have been concealed behind flush-perforated panels above the window. The ceiling and upper walls are natural color fiber acoustic tile. The lower walls are plaster painted blue-gray.





FIG. 9. This view shows the terraced arrangement of the control room and the clients' room as it looks from the studio floor. Access from studio to control room is by means of the ramp shown at extreme left of this picture.

Operating Staff Has Constant Visual Contact

Experience in operating TV station installations has indicated that visual contact between members of the operating staff is very helpful. Most stations have placed their announcer's booth adjacent to the control room and visible therefrom. At WHIO-TV the announcer not only sees into the control room, but in addition has a good view of the studio and the film projection room. In fact, he is literally surrounded by studio, control room and film room (Fig. 3), and since the floor of his booth is higher than any of these (Fig. 8) he has a good view of all operations. In addition there is a window from the film room into the control room, so that the program director, too, has a view of all operations and can signal by hand (as well as by intercom) to all members of the operating and production staffs. This arrangement of operating areas with large windows together with the terraced floor levels provides a visibility in the production area which could hardly be exceeded.

FIG. 10 (right). The location of this projection room between the announcer's booth (seen through the narrow window on the left) and the television broadcast control room on the right, facilitates constant visual contact between staff members at all three locations. The concrete block walls of this room have been painted a blue-gray, against which the 16mm film and slide projector (on the left) and the two 35mm projectors stand out effectively.

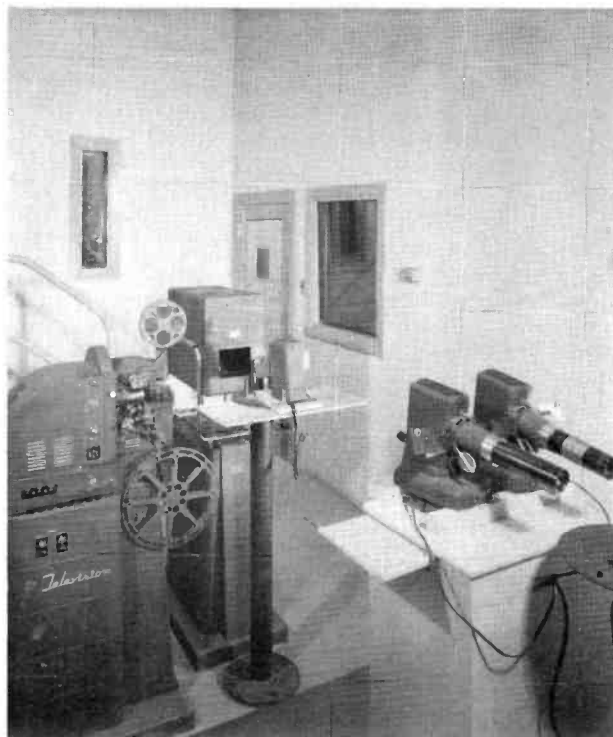



FIG. 11. WHIO-TV's ground level studio, with garage-type doors, allows cars and trucks to be driven directly onto the studio floor—either for bringing in display material or for actual telecasting, as shown here.

Ground Level Studio for Convenience, Flexibility



WHIO-TV's studio has been designed primarily to provide a maximum of operating convenience and flexibility. The location at ground level, the large doors to the garage (and outside), the 20 foot ceiling clearance, the wide control room window, the pipe hangers overhead and other features were planned with future, as well as present, requirements in mind. The studio, which is of steel beam and column construction, is 30 feet deep by 49 feet wide. The lower wall areas are of concrete, which has been painted a blue-gray, while the upper walls on three sides have alternate bands of perforated and flat asbestos cement board to give the desired acoustical control. The fourth wall is faced completely with perforated board. The concrete floor has been painted soft gray. The metal roof deck, which is insulated with fiberglass, has been painted white, but has been left exposed above the pipe grid in order to have flexibility to cope with possible future developments in production techniques.

FIG. 12 (left). WHIO-TV's mobile unit (standard RCA Type TJ-50) is housed in the 29 by 25 foot garage area which is immediately adjacent to the studio. This detail in the compact layout was recommended by Austin engineers as a means of cutting down time loss on television cameras, which can be shifted from studio to trailer in an instant, and in connection with any spot news films brought in from the field for processing and visual broadcast. The studio entrance from the garage is equipped with acoustical doors on the inside and rolling steel fire door with fusible-link controls on the outside.



FIG. 13. View from the transmitter control room through the lobby window to the reception desk just inside the street entrance. Monitoring and test equipment units are mounted in racks at the left. Another view of the transmitter control room is shown in Fig. 6.

Transmitter Control Room Is A Showplace

In some TV stations the transmitter is relegated to an out-of-the-way corner, which is neither good operating practice nor good showmanship. By contrast, WHIO-TV has gone full out to make its transmitter control room a showplace which will help to sell its clients and the public on the efficient and up-to-the-minute job the station is doing. In an unusually spacious area just off of—and in plain view of—the lobby are located the RCA TT-5A TV transmitter (in the center of the room), the FM transmitter (on the left side) and the auxiliary equipment racks (on the right side). All three assemblies are built into the walls, and indirectly illuminated by fluorescent lights concealed behind drop walls. All wiring is run in trenches which are covered with removable floor plates finished with red asphalt tile to match the rest of the floor. Fibre acoustic wall tile, used throughout the room, has been painted pastel blue.



FIG. 14 (right). The control console at WHIO-TV is a standard RCA TV transmitter control desk to which have been added matching end sections containing terminal equipment and FM transmitter controls.

Provisions For Heating And Air-Conditioning Of WHIO-TV's Studio And Transmitter Building

Complete air-conditioning of the relatively large areas of a TV station represents a problem in economics which has not yet been completely solved. The refrigeration capacity required to provide for peak loads is tremendous—and yet by the nature of the operation this capacity is required for only a small part of the day. The problem is particularly onerous in smaller stations.

At WHIO-TV a step-by-step program has been planned. The building itself is designed for the ultimate installation of complete air-conditioning for all areas. However, at present cooling is provided only for the most essential areas. This includes the studio control room, the clients' audition room, the announcer's booth, the transmitter control room, the film projection room, the film processing area and the

mechanical shop. A 25-ton refrigeration unit is adequate for this load and the cost of the system represents a reasonable compromise. Eventually the other areas of the building will also be air-conditioned, but for the time being they are provided only with suitable ventilating systems.

Heating during winter months is furnished by a gas-fired boiler and the usual hot-air distribution system. As in many other stations the heat from the transmitters and the equipment racks is vented either into the control room in cold weather or to the outside in warm weather. Provisions for drawing hot air from the TV transmitter and the TV equipment racks are unusually elaborate (Figs. 14 and 15). This is an installation idea which has been found to pay off in decreased outages and maintenance time, as well as in operating comfort.

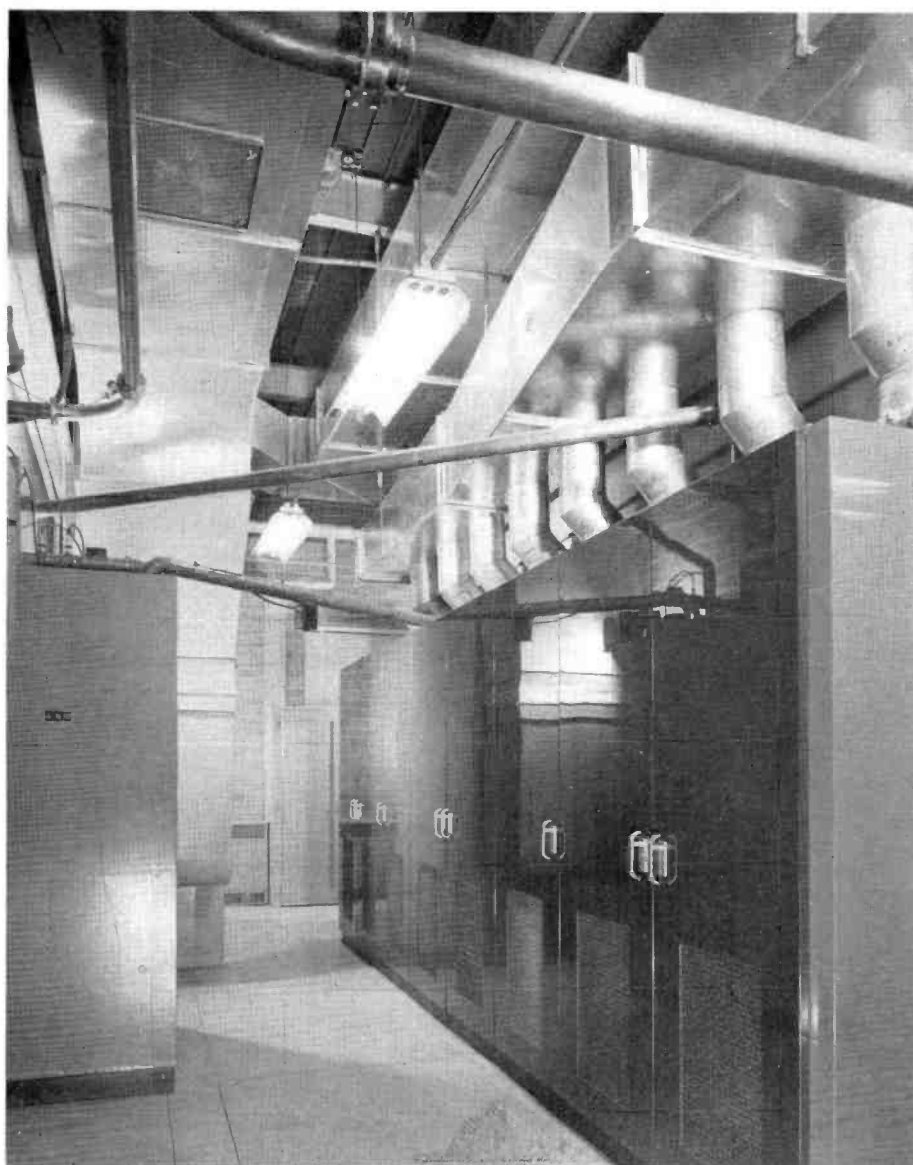

FIG. 15 (left). Scene behind the TV transmitter at WHIO-TV. Each transmitter cabinet is separately vented to the main exhaust duct. The side band filter can be seen on the extreme left, while the FM transmission line is enclosed in the conduit in the foreground above. A special 7,850 cfm. ventilating unit in the left background presently serves the studio and other areas which have been designed for future air-conditioning.



FIG. 16 (left). This is a view in the "test and storage" room adjacent to the studio control room. The back of the video cabinet racks (which face into the control room) is seen here. Ducts are used to exhaust heat from the equipment racks directly to the outside during the summer time, or for recirculating it to the station's heating system in cold weather.

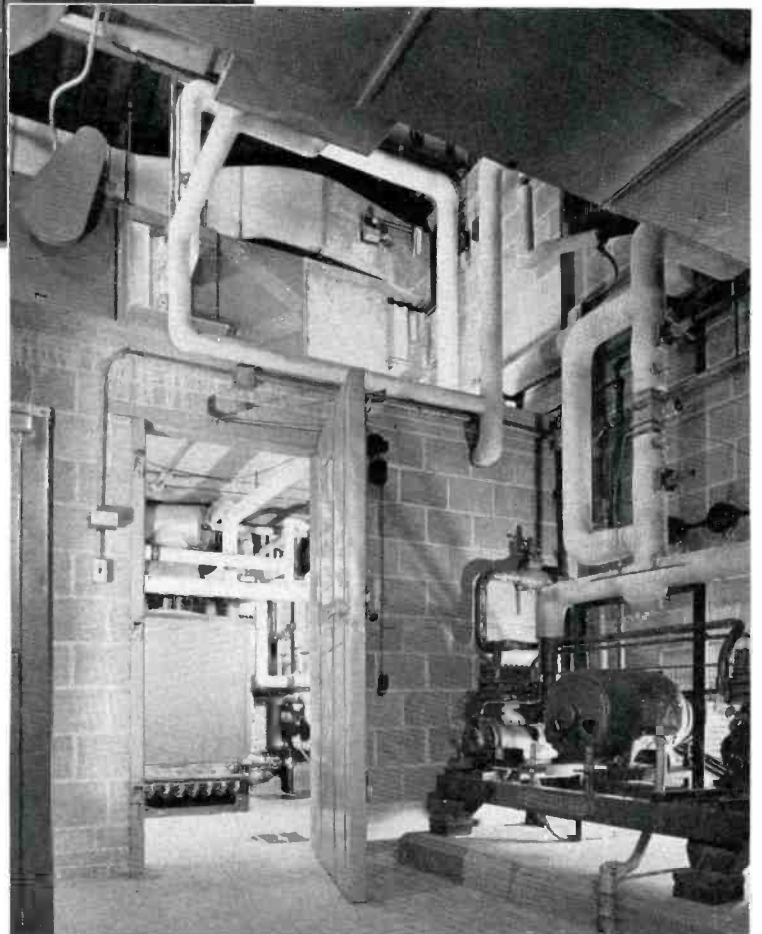
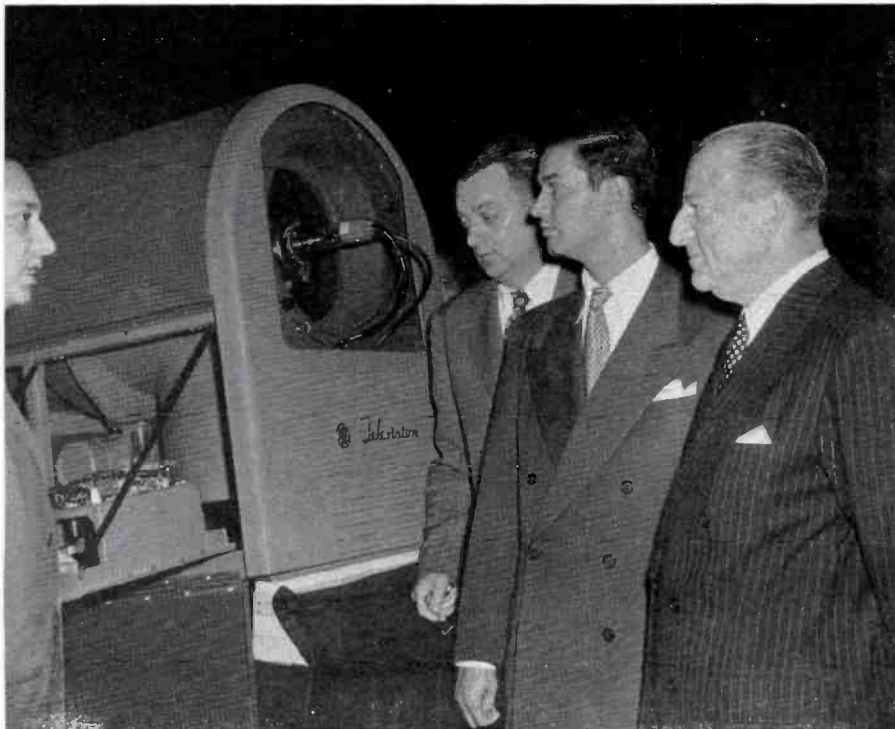

FIG. 17 (right). View in the "mechanical equipment" room (and through door into boiler room). The principal heating and air-conditioning units for the new WHIO-TV station are housed in this area. Heating is provided by a Bryant gas-fired boiler, which can be seen through the doorway. A pair of small Frigidaire compressors operating in tandem provide 25 tons of refrigeration for the McQuay air-conditioning unit, which has been mounted on a concrete floor slab directly above the boiler room. This system handles approximately 7,000 cfm, and is regulated by economizer controls. It serves the television control room, clients' audition room, projection room, announcer's booth, transmitter control room, film processing area, and the mechanical shop. A corner of the water cooling tank serving the television transmitter can be seen on the left, and a portion of the studio return air duct in the foreground above.



FIG. 1. RCA's exhibit—largest in the show—included displays of sound equipment film projectors, several models of in-car-speakers, carpets,

RCA'S THEATRE TELE DEMONSTRATION



Broadcasters would have felt natural at the annual combined convention of the Theatre Equipment and Supply Manufacturers' Association and the Theatre Equipment Dealers Association in the Stevens Hotel, Chicago.

RCA has a complete line of equipment for the theatre—just as it has a complete line of equipment for broadcasting. At the TESMA-TEDA show this equipment was displayed in quantity—just as our broadcast equipment has been displayed at recent NAB Conventions.

And, there was another similarity—for at TESMA-TEDA, just as at NAB—the subject uppermost in everyone's mind—and the subject most talked about everywhere—was television. Television was dis-

FIG. 2. Barton Kreuzer (left) Manager of RCA's Theatre, Sound and Visual Sales Section, and Jack O'Brien, Manager of RCA Theatre Equipment Sales, discussing details of RCA theatre projection equipment with Nat Halpern (second from right), TV consultant for Fabian Theatres, and S. H. Fabian (right) whose Fabian-Fox Theatre in Brooklyn was the first to install this revolutionary new equipment.



chairs and various accessory and auxiliary items (such as power supplies and lamps) from RCA's complete line of equipment for the theatre.

HIGHLIGHT OF THEATRE EQUIPMENT SHOW

discussed formally on the programs, talked about on the exhibit floors and in the corridors—and spectacularly acclaimed by 2,200 people gathered to witness a demonstration of RCA Theatre TV in the grand ballroom of the Stevens on the final day of the meeting.

Boxing bouts, specially staged, were televised in NBC's Chicago studios and piped by coax to the Stevens, where they were projected on a 15 foot by 20 foot screen by one of RCA's new theatre television projectors. This demonstration—plus the first permanent installations of this equipment in theatres in Brooklyn and Boston, has greatly stirred the interest of theatre owners all over the country. The equipment which RCA is supplying for this application is described in the following pages.

FIG. 3. Highlight of the TESMA-TEDA Convention was a spectacular demonstration of RCA Theatre Television in the grand ballroom of the Stevens Hotel. Unretouched photo at right shows the crowd of 2,200 persons watching boxing bouts staged in NBC's Chicago studios and piped to the Stevens by coax.



HOW RCA THEATRE TV WORKS

RCA engineers have pioneered in the development of two basic systems of theatre television. These are (a) the Instantaneous Projection System, and (b) the Intermediate Film System.

In the Instantaneous Projection System the received picture is projected directly on the screen by means of a large-size projector using a reflective optical system. In the Intermediate System the received picture is first recorded on film, which is then passed through a high-speed developer and the picture projected on the screen by means of a standard film projector.

The equipment units which make up the RCA Instantaneous Theatre TV System are shown at the top of the opposite page. The receiver proper, the deflection circuits for the projector, and the low voltage power supplies are mounted in two standard cabinet racks. Start-stop and other operation controls are located in a small "operating station." The high voltage power supply for the 9-inch projection

kinescope is housed in a separate oil-filled container.

The illustration at the bottom of this page shows a typical theatre installation of RCA Instantaneous Projection equipment. The operating station, the control rack, and the power supply rack are ordinarily mounted in the projection room. The high voltage supply may be placed in a transformer vault or generator room. The television projector is normally mounted on the front of the balcony. Where there is no balcony the projector may be suspended from the ceiling.

The arrangement of equipment used in the RCA "Intermediate Film" Theatre TV Systems is shown at the bottom of the opposite page. In this system the received picture is recorded on film by a standard RCA TMP-20B Kinephoto Equipment. The accompanying sound is simultaneously recorded directly on the film. The exposed film is run directly into a high-speed developer where it is developed, fixed,

washed and dried. From the developer the film is fed to a standard motion picture projector (such as the new RCA "100") which projects it onto the screen.

The Instantaneous System has the advantage of lower first cost, lower operating cost (no film, developer, etc.), less space, fewer technicians, and the psychological advantage of instantaneity. Advantages of the Intermediate System are higher screen illumination and availability of a permanent record (for reshowings, etc.).

RCA engineers have designed standard equipment units for both types of operation. Instantaneous type equipments have been installed for the Fabian Theatre in Brooklyn and the Pilgrim Theatre in Boston. A number of others have been contracted for and are in process of construction. Intermediate Film type equipments have been built for two major film producers and are presently being used by these companies for their study and appraisal of the method.

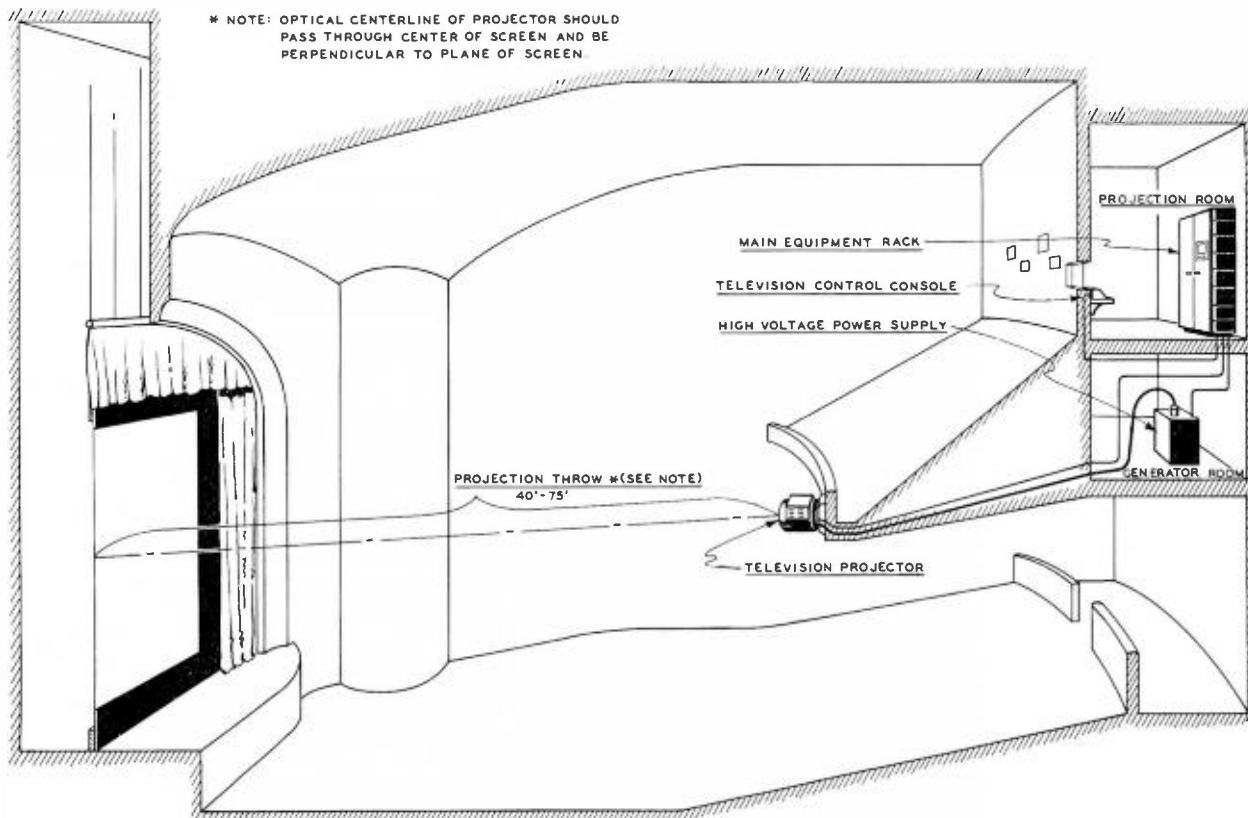

TYPICAL INSTALLATION OF INSTANTANEOUS PROJECTION SYSTEM

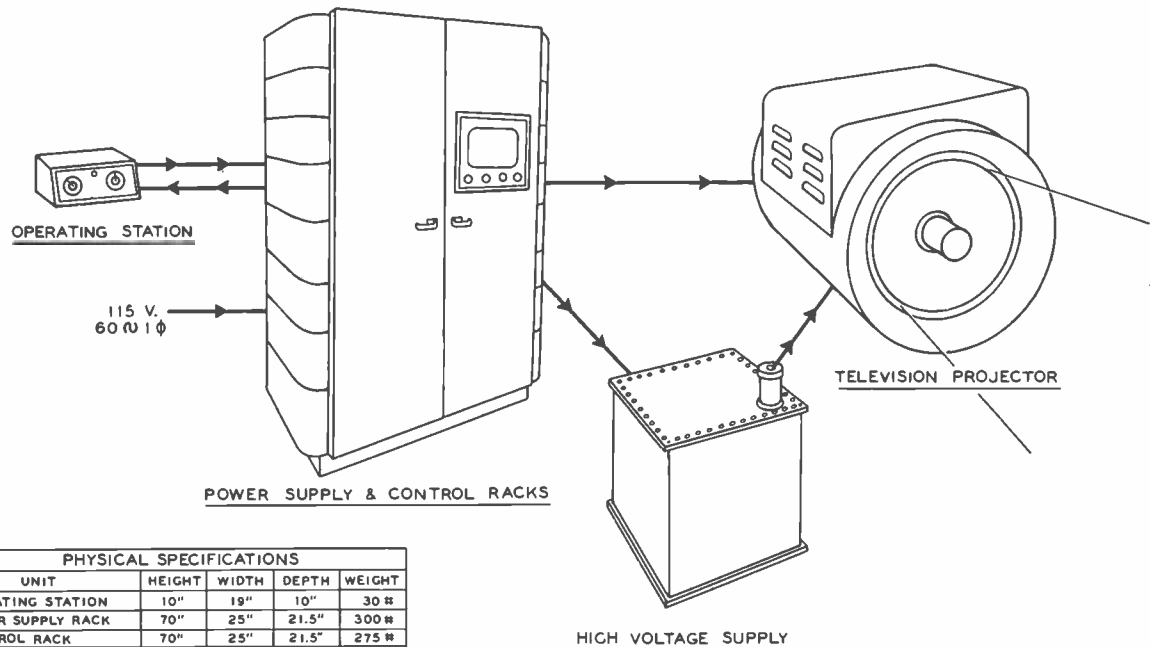

PHYSICAL SPECIFICATIONS				
UNIT	HEIGHT	WIDTH	DEPTH	WEIGHT
OPERATING STATION	10"	19"	10"	30 #
POWER SUPPLY RACK	70"	25"	21.5"	300 #
CONTROL RACK	70"	25"	21.5"	275 #
HIGH VOLTAGE SUPPLY	38"	26"	22"	800 #
PROJECTOR	31"	34"	36"	400 #

RCA INSTANTANEOUS "PROJECTION" THEATRE TELEVISION SYSTEM

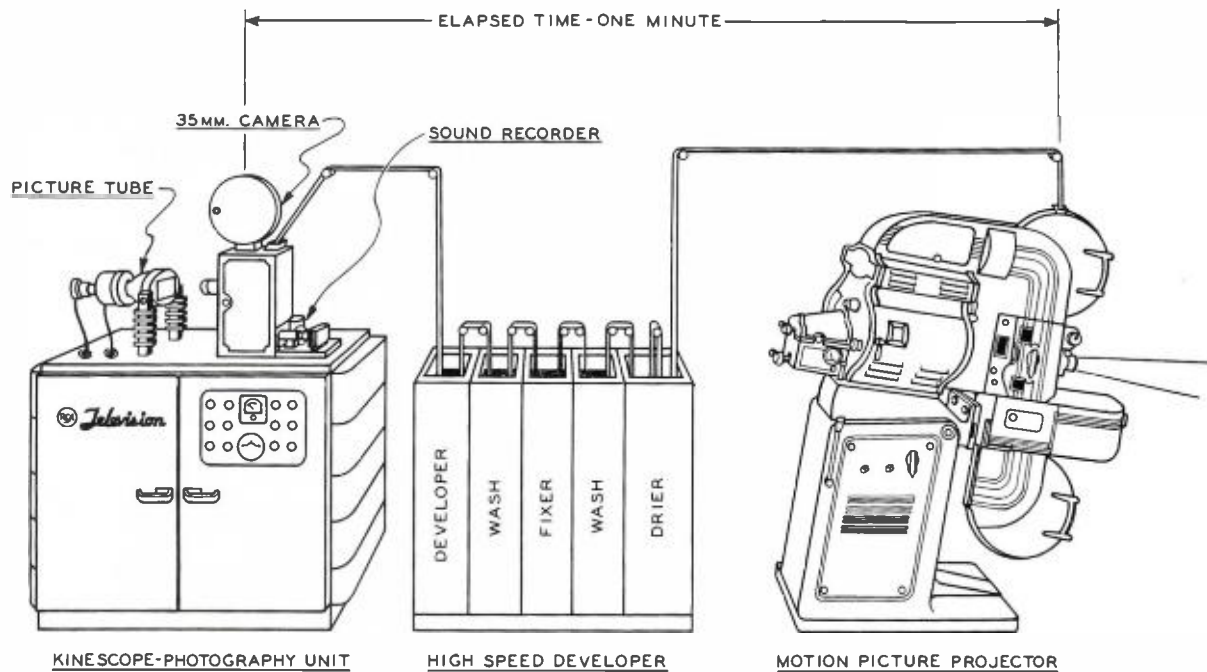

RCA "INTERMEDIATE FILM" THEATRE TELEVISION SYSTEM

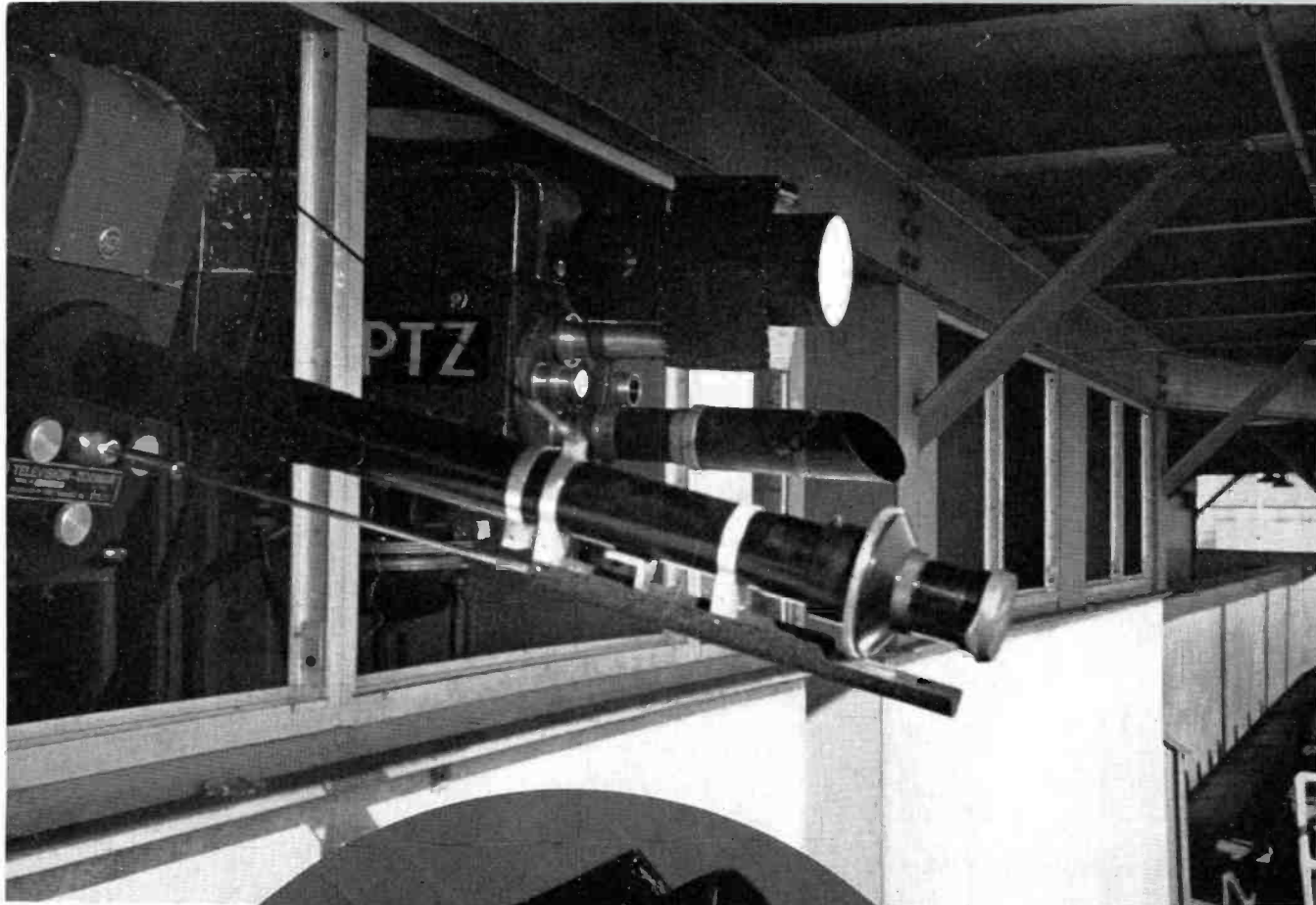

FIG. 1 (above). WPTZ's No. 1 camera (with Zoomar) and No. 2 camera (with Reflector) in press box at Municipal Stadium. Although nearly 300 feet from the field the Reflector's 40-inch focal length made possible closeups of action during the game.

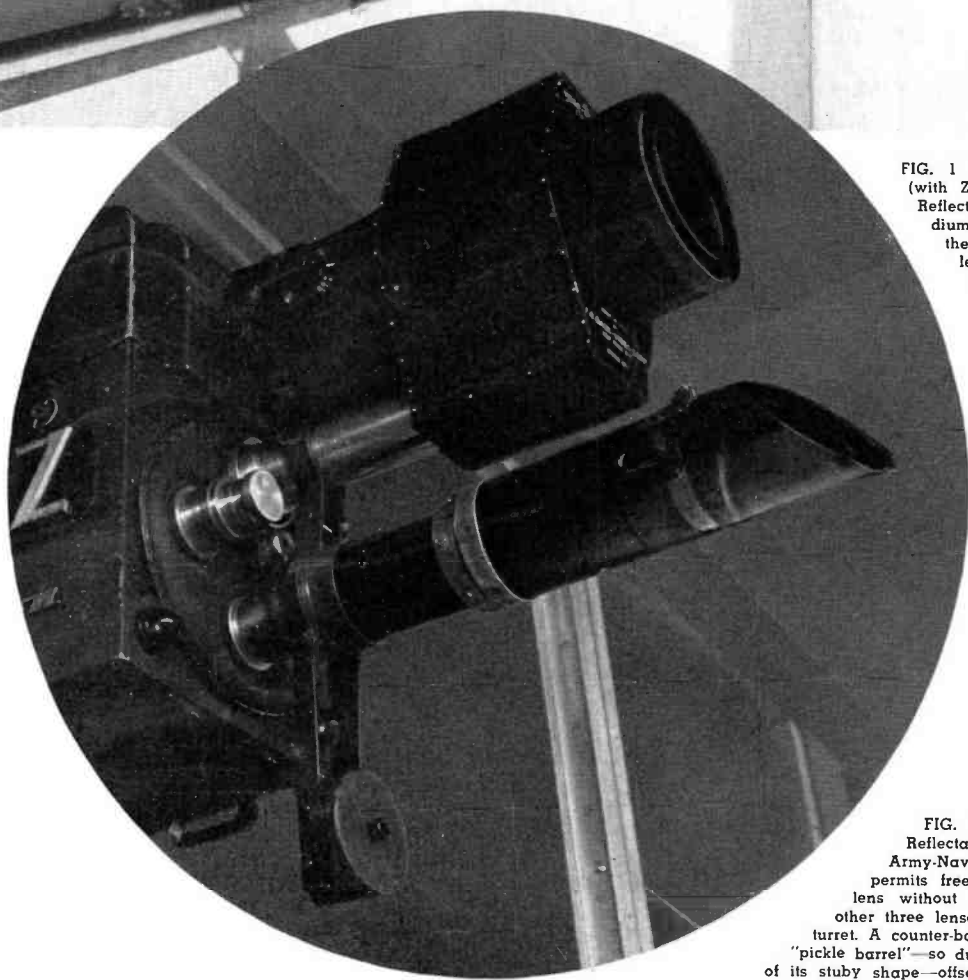

FIG. 2 (left). Closeup of the Video-Reflector on WPTZ's No. 2 camera at the Army-Navy game. The periscope principle permits free use of the 40-inch focal length lens without interfering with the field of the other three lenses in the conventional RCA TK-30 turret. A counter-balance on the opposite side of the "pickle barrel"—so dubbed by the WPTZ crew because of its stubby shape—offsets tension on the turret lock.



FIG. 3. The enormous size of Philadelphia's Municipal Stadium makes television coverage of the Army-Navy football game a difficult assignment.

WPTZ USES REFLECTAR AND ZOOMARS IN WIDELY-ACCLAIMED PICKUP OF ARMY-NAVY GAME

The NBC telecast of the 1949 Army-Navy football game from Municipal Stadium in Philadelphia was rated tops in production technique by most reviewers. Chief credit for this fine job goes to the WPTZ crew who made this pickup, and to Preston Stover, WPTZ's director, who planned and supervised it.

Municipal Stadium is regarded by television men as one of the most difficult places in which to cover a sporting event. Not the least of the obstacles confronting production men working out of this stadium is the fact that the camera positions in the press box are close to 300 feet from the playing field. WPTZ crewmen, in covering

this year's game, overcame this by amassing one of the most unusual concentrations of special television lenses ever used to cover one event.

Of the four cameras used by WPTZ cameramen, two were equipped with Zoomar lenses, a third with the Reflectar lens and the fourth with standard telescopic lenses. The No. 1 camera, with a Zoomar, was located in the press box (Fig. 1). No. 2 camera, at the same point, was provided with a Video-Reflectar lens (Fig. 2), the latest creation of Dr. F. G. Back, inventor of the Zoomar.

The Video-Reflectar has a focal length of 40 inches and used in a conventional

lens turret, permits the free use of the other three lens positions without interfering with their field of view.

In addition to these two cameras WPTZ added a new perspective in their coverage by placing No. 3 camera on a conventional mike boom down on the field. This was moved freely for closeups of President Truman and other attending dignitaries, in addition to eye-level Zoomar shots of the pre-game parade by the middies and cadets. These three cameras were supplemented by a fourth camera located over an exit tunnel, about half as far from the sidelines as the two press box cameras. RCA TK-30A's (cameras) were used.

FIG. 4 (right). WPTZ's No. 3 camera was mounted on a conventional RCA mike boom dolly. This arrangement was originally conceived by WPTZ for its coverage of last summer's American Legion Parade in Philadelphia. It permits smooth on-the-air dolly and truck shots that have heretofore been impossible outdoors without large expenditures of funds for special camera vehicles. Once modified, the transition from mike boom to dolly, or vice versa, requires only a few minutes work by two men.



FIG. 5 (below). WPTZ's No. 4 camera was located over an entrance tunnel about midway between the press box and sideline. This camera effectively supplemented the three others.



KSEI - POCA TELLO, IDAHO

5KW AM - 1KW FM

by HENRY H. FLETCHER
General Manager

KSEI, a pioneer in broadcasting in Eastern Idaho, was the first to bring frequency modulation to this area. Originally an AM station only, operating with 250 watts during the day and 1000 watts at night, KSEI has increased its power to a full time operation of 5000 watts with directional antenna at night.

Operating with an RCA 1000 watt FM transmitter and two element Superturndstile antenna with effective radiated power of 1800 watts, KSEI-FM is housed in the same building as the AM transmitter.

The transmitter building is constructed of cement, brick, and steel, making it a highly fire resistant structure. Steel safety sash and steel doors are used to discourage forcible entry into the transmitter building. The structure measures 34 by 46 feet (Fig. 3) and includes an operator's office, transmitter room, auxiliary studio, workshop, furnace room and service area.

Water is supplied to the installation from a 140-foot well, with an automatic pressure system maintaining constant flow.

The directional AM antenna system consists of two towers manufactured by the Lehigh Structural Steel Company. The tower used for nighttime directional pattern is 255 feet high and the supporting tower for the FM antenna is 227 feet high with the FM antenna making up the balance of 255 feet. The FM supporting tower and the FM antenna are used for the radiation of the daytime non-directional pattern.

The RCA Iso-coupler used to bridge the insulators of the AM tower was connected two years ago and has worked perfectly since it has been in service.

Duplicate coaxial transmission lines (1½") are installed between building and

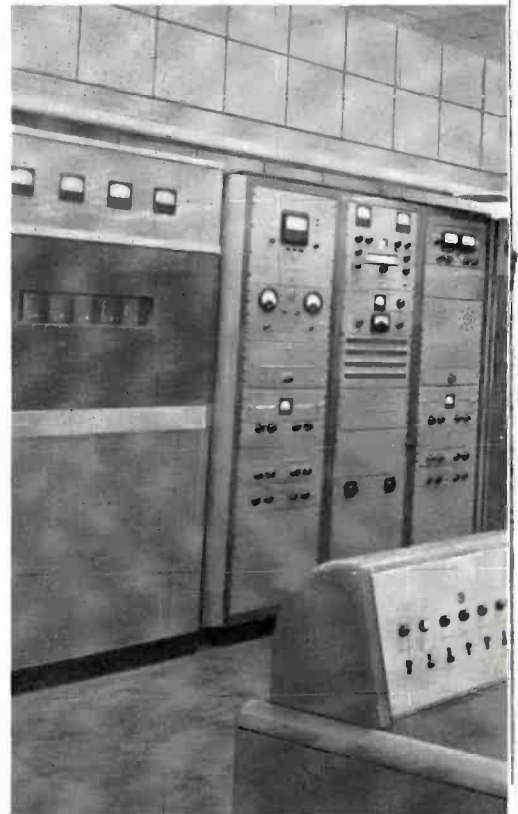

FIG. 2. Another view of KSEI's transmitter room showing one cabinet of the BTA-5F AM transmitter, the speech



FIG. 1. Photo above shows the transmitter control room of Station KSEI. Recessed fluorescent lighting is used to illuminate the meters of the RCA 5 KW AM transmitter and the speech input racks. The transmitter control console is shown at left.

each tower. Each tower is enclosed with a Cyclone fence. A tuning house is erected at the base with facilities provided for plug-in telephone service, electric light, soldering iron, electrical tools, and heat lamp.

The ground system consists of 120 radials from each tower, each 50 feet long and 120 radials from each tower, 300 to 500 feet long, bonded at their intersection points by a four inch copper strip and a four inch copper strip runs from tower to tower. The distance between the two antenna towers is 857 feet.

Coaxial cable supports were designed from four inch cement water pipes, 3½ feet in length. The bell shaped end of the pipe was set in the ground while a metal bracket was cemented into the top end for support of coaxial cables and conduits.

When the transmitter building was designed and the equipment installed, provision was made for future expansion of facilities. The one-kilowatt FM transmitter can be expanded to ten kilowatts if desired.

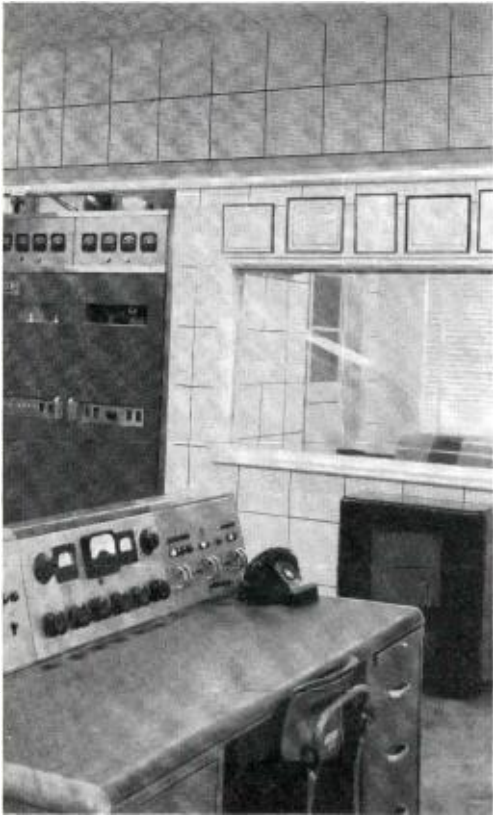

input and monitoring racks and 1 KW RCA FM transmitter, which is adjacent to the emergency control studio.

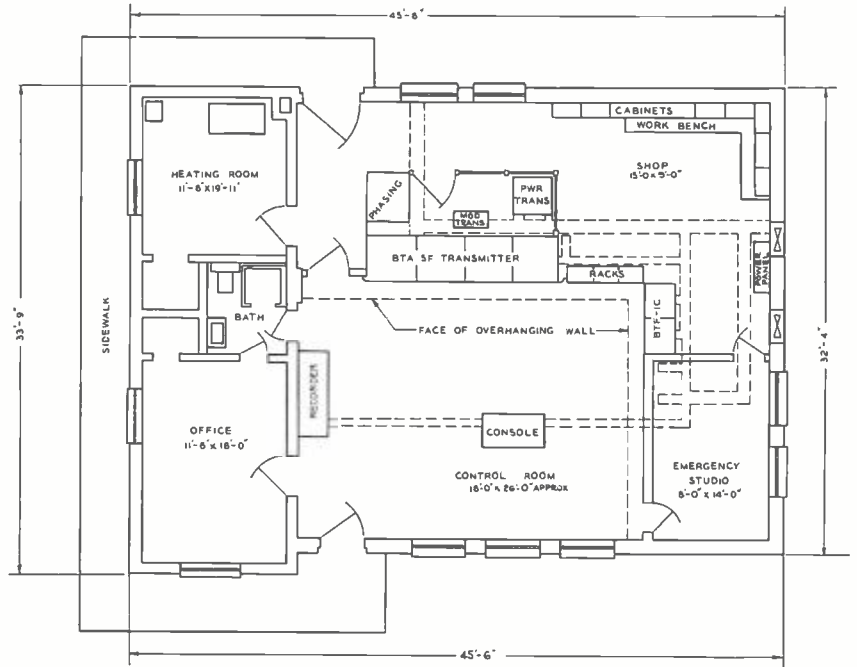

FIG. 3. This diagram shows the well-planned transmitter facilities of KSEI. To provide for increased power, easily accessible wiring ducts were installed in the floor. The ducts are indicated above by broken lines. The 1 KW FM transmitter can be expanded to 10 KW with a minimum of effort.

To facilitate any equipment changes, galvanized wiring ducts were installed with removable covers so that wiring could be changed or additions made at any time. All ducts are lined with copper bonds.

For emergencies and for split AM-FM operation, a small auxiliary studio was built in the transmitter building. It can be operated by the transmitter engineer or by an announcer. (Fig. 4.)

The KSEI transmitter building is equipped with an oil furnace. However, heating is required for a short period only during the early morning hours. Once the transmitters go on the air, the oil burners are shut off and the transmitter heat is adequate to keep the building warm.

Up to a year ago, the studios and offices of these stations were located three miles from the business district of Pocatello. The present location, in the Hotel Whitman, was chosen in the heart of the business district for convenience and efficiency of operation.



FIG. 4. Interior view of the emergency control room showing the RCA 70-C2 Turntables and station's home-made composite control console for combining or separating AM and FM programs. The 5 KW AM transmitter and one monitor rack can be seen through the window.

Practically no construction was necessary for the conversion of the hotel space to studios and offices. Two minor wall partitions were removed and sound-proof windows were installed for visibility between the studios, the control room, and the reception lobby. Acousti-celotex was used on the ceiling and the upper portion of the studio walls. Rubber tile covers the floors and a wallpaper panel covers the lower portion of the walls.

There are two studios connected by a single control room which is completely equipped with RCA turntables and speech input equipment. It can truthfully be said that both KSEI and KSEI-FM are equipped by RCA all the way.

The studios are quite live and have produced pleasing results from the studio programs broadcast. The general run of small city studio programs is carried, including vocal, instrumental and organ programs.

Studio equipment consists of three RCA BR84 series equipment racks. Two receivers are used for monitoring purposes, one tuned to KSEI and one tuned to KSEI-FM. The monitoring system extends to all offices of the station and each RCA wall speaker is equipped with its own volume control and a three-way switch for a selection of any of three program sources.

The studio control room is equipped to record and play-back tape or wire recordings, while disc recording is accomplished at the transmitter location. The racks in the control room are equipped with RCA monitor amplifiers, pre-amplifiers, program amplifiers, variable equalizers and meter panels, installed in such a manner that almost any conceivable combination of equipment and connections may be accomplished.

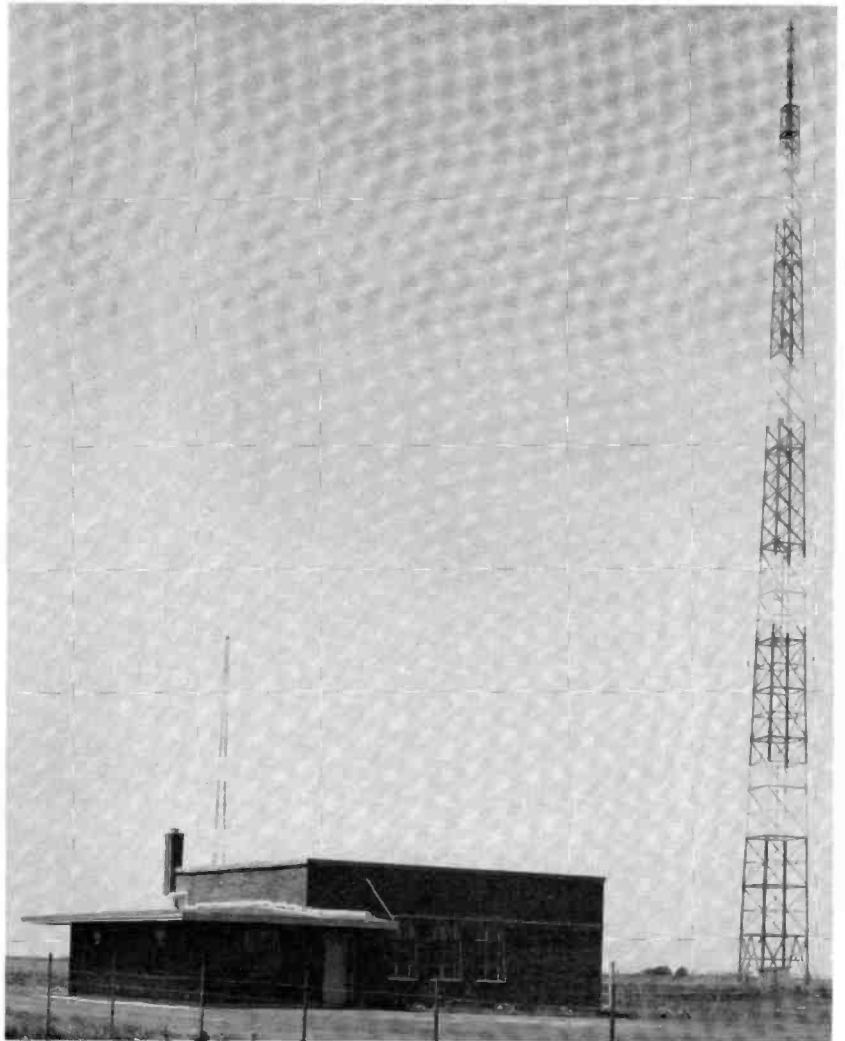

FIG. 5. KSEI employs a two element directional antenna system. The 255-foot tower at left is used for nighttime AM transmission; the one at the right for AM daytime. An RCA two-element Superturnstile FM antenna is mounted atop the AM tower at right.



FIG. 6. Rear view of the speech input and monitor equipment racks shown at left. Protective cage encloses plate and modulation transformers. Wiring ducts with removable covers are shown at base of the cabinet racks.

The speech input console, operated in conjunction with the above racks, is an RCA 76-B4 and the turntables are RCA 70-C2. The monitoring speaker used in the reception lobby is an RCA LC-1A.

The entire installation was made by and under the capable direction of Chief Engineer, Ellis W. Call.

KSEI and KSEI-FM are owned and operated by Radio Service Corporation of Idaho, of which Mr. O. P. Soule is president. KSEI has been affiliated with the National Broadcasting Company for more than 11 years. KSEI-FM operates on a duplicated program basing during the entire 18-hour schedule of KSEI.

Designed for TV⁶⁶⁶

Normal sync pulses in a video amplifier presented accurately by use of the low-capacitance probe.

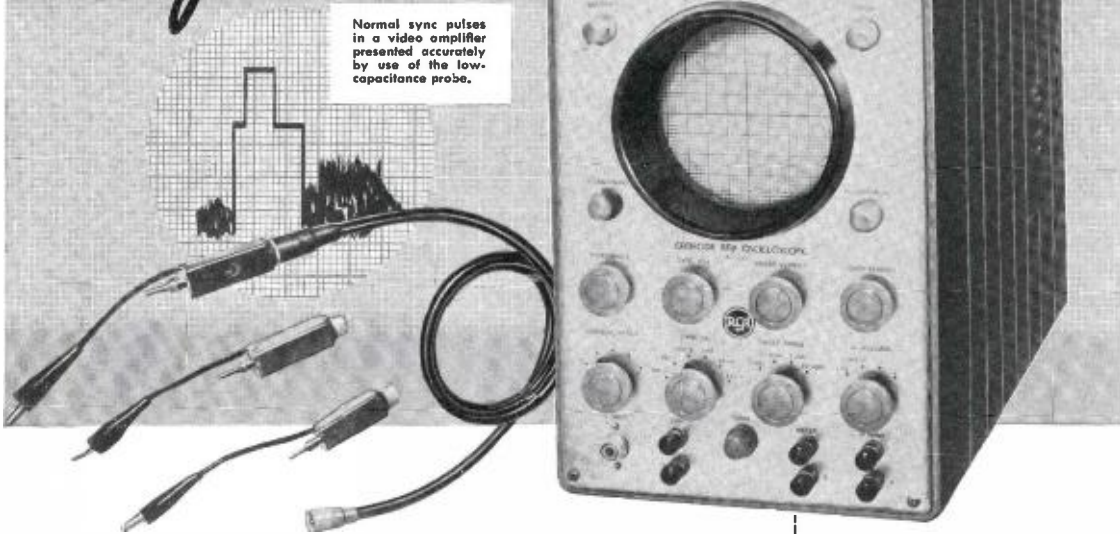

**... the RCA WO-58A —
now priced at \$249.50 — is in a class by itself**

The RCA WO-58A is a wide-band, 5-inch oscilloscope with a useful range of 1 cycle to 4 megacycles. It is expressly designed for the testing and alignment of television equipment in the laboratory or in production and quality-check positions.

The WO-58A displays sync pulses, blanking pedestals, and deflection waveforms accurately. Side-panel terminals are provided for Z-axis (intensity modulation) operation and for direct connection to vertical deflecting electrodes of the c-r tube.

In addition, the WO-58A performs all regular oscilloscope functions. A cali-

brating voltage source and a 5-position frequency-compensated switch providing 3-to-1 voltage ranges make the instrument a direct-reading VTVM. Sweep circuits include a vacuum-tube sawtooth multi-vibrator and an auxiliary 60-cycle sine-wave source with phasing control. *Supplied complete* with crystal probe, direct probe, and low-capacitance probe.

Ask your local RCA Test Equipment Distributor for catalog sheet giving complete details, or write RCA, Commercial Engineering, Section B36Y, Harrison, New Jersey.

Available from your RCA Test Equipment Distributor

RCA 715-B 5-inch Laboratory Oscilloscope—now priced at \$885. For detailed examination of extremely short, sharp-fronted pulses and unusual waveforms. Displays steady, clear traces even with random recurrence of signal. Vertical amplifier flat within ± 1 db from 5 to 11 Mc. Triggered sweep is initiated by signal observed during that sweep. Has built-in time-marker generator, and input calibrating meter.



RCA WO-79B 3-inch Portable Laboratory Oscilloscope—\$550. For detailed observation and accurate measurement of voltages produced by TV sync and deflection circuits, ignition systems, and pulse generators. Horizontal-deflection capability up to twice screen diameter. Calibrating meter for voltage measurements. Built-in delay line. Vertical amplifier flat from 10 cycles to 5 Mc.



RADIO CORPORATION of AMERICA
TEST EQUIPMENT

HARRISON, N. J.

It's Easy to Install a Sound System...

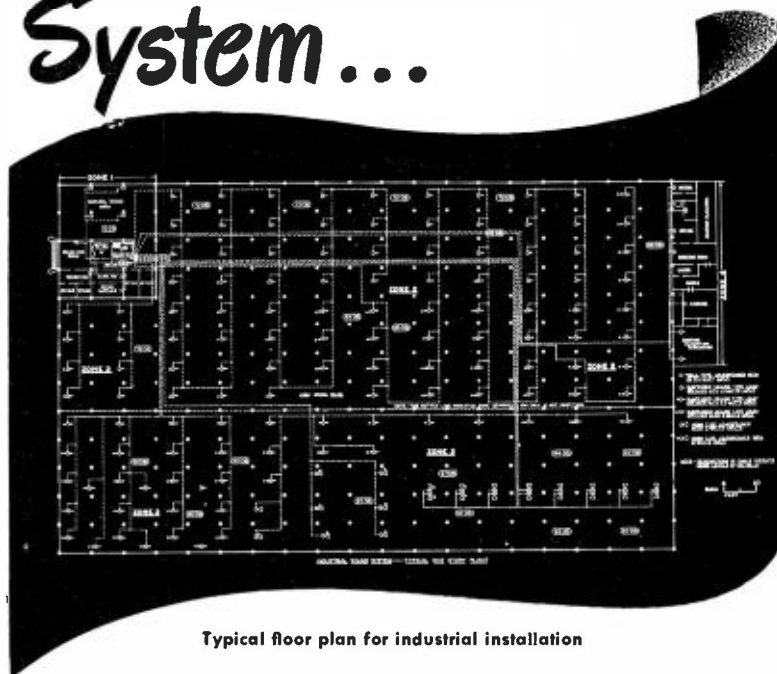

Typical floor plan for industrial installation

—with time-saving RCA Engineering Service

YOU'LL FIND SOUND SYSTEMS easy to install when they are engineered by RCA. All units of an RCA Sound System are designed for easiest possible mounting. You'll save time because RCA Sound System layouts and specifications are easy to follow.

You gain a good reputation when your clients are enthusiastic with the results of your installations. You generate this kind of enthusiasm when you recommend or install an

RCA Sound System. That's because these sound systems are engineered to the requirements of your client's organization.

There is no ready-made "package" sound system that perfectly suits the noise level, type of buildings, needs of various types of plant and office layouts. Working with your nearest RCA Sound Products Distributor, you provide your clients with sound systems that give them the most for

their money.

No matter what size or type of sound system you are asked to bid on, RCA can help you plan and engineer a system that will best fit your customer's requirements.

Contact your nearest RCA Sound Products Distributor or write: Sound Products (Dept. 118-D), Radio Corporation of America, Camden, New Jersey.

----- Let RCA Help You Plan and Engineer Sound Systems For -----

OFFICE BUILDINGS
SCHOOLS
CHURCHES
HOSPITALS
INDUSTRIAL BUILDINGS

HOTELS
INSTITUTIONS
DEPARTMENT STORES
TRANSPORTATION TERMINALS
RECREATIONAL CENTERS

WAREHOUSES AND GARAGES

DO YOU HAVE A COPY?

The Architect's Manual of Engineered Sound Systems. The most authoritative work book and reference manual published on sound systems. Typical plans, and specifications for all types of buildings. 288 pages. Price \$5.00 (\$5.50 foreign).



SOUND PRODUCTS
RADIO CORPORATION of AMERICA
ENGINEERING PRODUCTS DEPARTMENT, CAMDEN, N.J.

In Canada: RCA VICTOR Company Limited, Montreal

CONTRAST Makes the Picture Realistic!

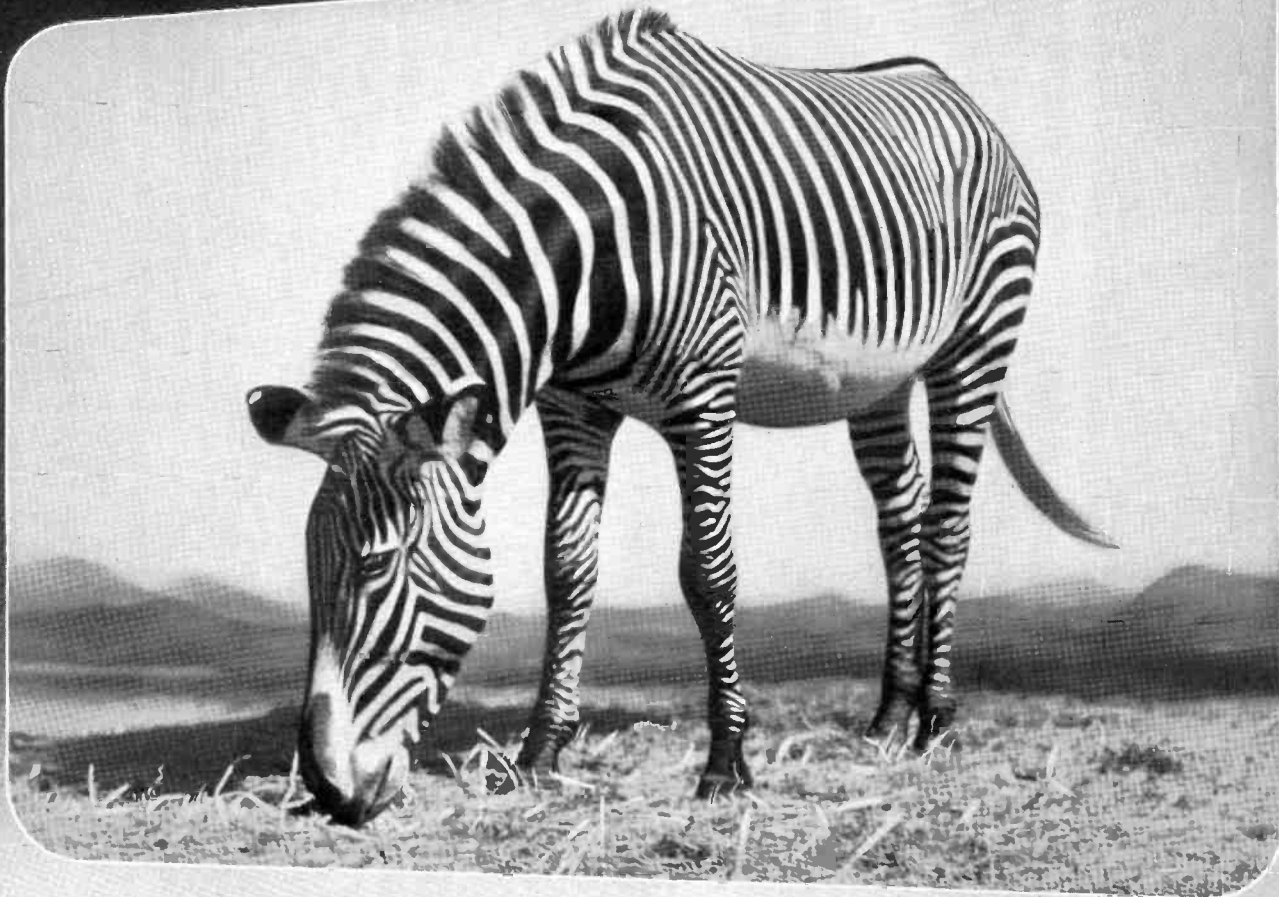

GET HIGHEST QUALITY PICTURES by projecting your 16mm films with the

RCA "400"

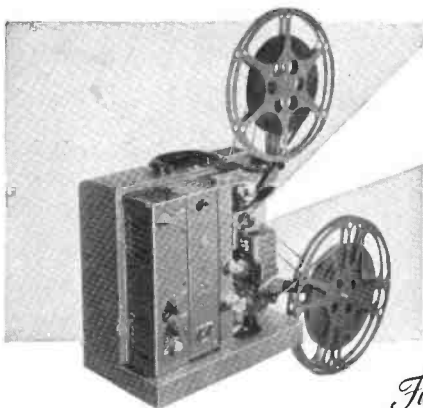

The screen image stands out clear and crisp because of the superiority with which the RCA "400" projects contrast between the light, middle and dark values on the film. Pictures are sharp to the edges of the screen.

Striking contrast of light and dark areas brings out the finest characteristics of form and texture. Greater contrast makes black-and-white scenes more effective and more dramatic . . . re-creates glorious color values in full-color pictures.

You'll find audience reaction more responsive . . . your 16mm film showings more appealing—when the scene is projected with the RCA "400".

Owners say the RCA "400" is the best buy for the money . . . the easiest projector to thread . . . simple to operate . . . provides maximum protection to valuable films.

Don't overlook the RCA "400" when buying 16mm sound projectors for use in schools, churches, business or industry.

RCA "400" JUNIOR. *The only single-case standard 16mm sound projector of fully professional quality.*

RCA "400" SENIOR. *Provides theatre-quality reproduction of 16mm sound and pictures for larger audiences, auditoriums or larger rooms.*

*First in Sound...
Finest in Projection*



**VISUAL PRODUCTS
RADIO CORPORATION of AMERICA
ENGINEERING PRODUCTS DEPARTMENT, CAMDEN, N. J.**

In Canada: RCA VICTOR Company Limited, Montreal

MAIL COUPON FOR MORE DETAILED INFORMATION

VISUAL PRODUCTS (Dept. 62A)
Radio Corporation of America, Camden, N. J.

Please send me complete information on the RCA "400" Sound Projector.

Name _____
School _____
Street _____
City _____ State _____

NEW HIGHER POWER

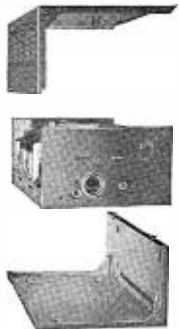

New "Sandwich" assembly

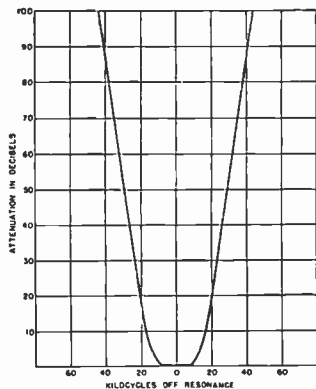

"CANYON-CURVE" SELECTIVITY

The new RCA FLEETFONE is a mobile communication equipment designed to meet the special requirements of the 30-50 mc band. The FLEETFONE provides not only for the longer distances common on 30-50 mc and the higher power usually required, but also introduces a new high degree of compactness and installation convenience.

Compact "Sandwich" Construction. Within this ultra-compact housing is contained the complete transmitter, receiver, and power supply. The single-package "Sandwich" construction takes the difficulty out of installation. Simply bolt the base to the desired surface in the desired position. Insert the chassis. Fasten the cover. Connect the cables. It's as simple as that.

Mounting Versatility. The FLEETFONE is designed for mounting in practically any location or position. It may be mounted on its bottom, side, or attached to a vertical surface. This is especially important to operators of large fleets of vehicles of various types. The FLEETFONE is just as much at home in an automobile, a light pick-up, or a ten-ton trailer-truck.

30 or 60 Watts Output. In order to meet the coverage requirements of your particular area, the FLEETFONE gives you a choice of either 30 or 60 watts of transmitter output. In both cases, it's the same size, single-package unit.

6- or 12-Volt Operation. The 6-volt FLEETFONE is standard equipment for general, mobile application. In addition, many mobile vehicles, such as trucks, fire engines, etc. use a 12-volt battery. In these vehicles the 12-volt FLEETFONE (30 watts) eliminates the need for power-wasting, voltage dropping resistors, or the necessity to impose too heavy a drain on half of the battery.

Extra Features. "Canyon-Curve" Selectivity protects you against interference from stations on neighboring channels. The exclusive "Transducer Modulator Control" maintains a constant modulation level whether you whisper or shout into the microphone. High receiver sensitivity assures reliable reception at extreme distances and in the roughest terrain.

GET THE COMPLETE FACTS:

DEPARTMENT 31H
RCA ENGINEERING PRODUCTS
CAMDEN, NEW JERSEY

Gentlemen: Send me the free brochure telling all about the All-New RCA FLEETFONE.

Name _____

Address _____

City _____

State _____

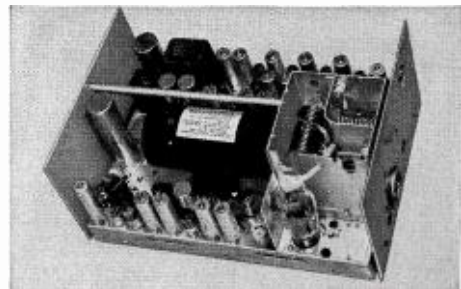

Inside view of the 30-watt FLEETFONE showing transmitter portion (foreground) dynamotor and receiver (background).

WITH SMALLER SIZE-
The RCA FLEETFONE
30-50 Mc
MOBILE 2-WAY RADIO

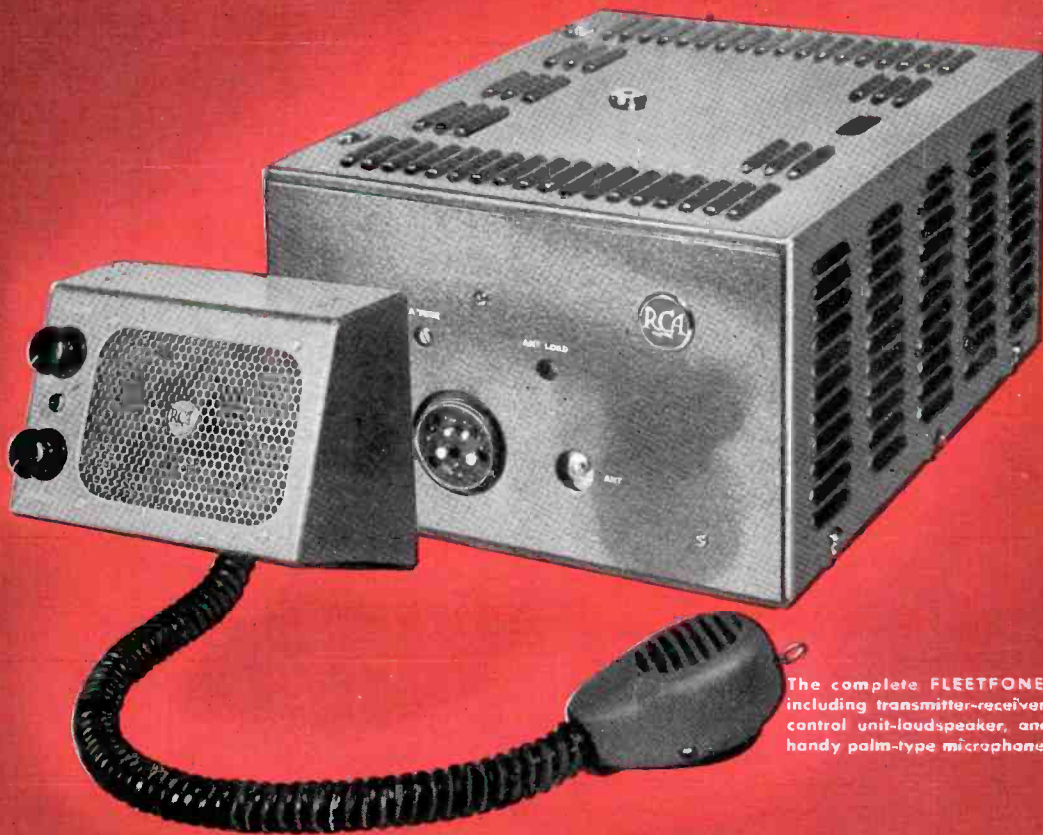

The complete FLEETFONE, including transmitter-receiver, control unit-loudspeaker, and handy palm-type microphone.



MOBILE COMMUNICATIONS SECTION
RADIO CORPORATION of AMERICA
ENGINEERING PRODUCTS DEPARTMENT, CAMDEN, N. J.

In Canada: RCA VICTOR Company Limited, Montreal

RCA Type WX-2C
540-1600 kc.



The new Portable Field-Intensity Meter, RCA Type WX-2C shown one-third actual size. A loop antenna is built right into the lid!

a truly portable Field-Intensity Meter

● Weighing only 12½ pounds—including batteries, here's a small, compact field-intensity meter of high accuracy that carries around like a portable radio . . . and operates almost as simply. You tune in a signal, adjust a *built-in* calibrating oscillator and receiver gain . . . and *read signal intensity directly in microvolts-per-meter*. No charts, curves, or correction factors to worry about. No computations to make.

Designed with a wide sensitivity range of 10 microvolts/meter to 10 volts/meter, Type WX-2C enables you to make field-strength readings anywhere—from the very shadow of your transmitter, to the toughest location "down-in-the-

noise." Plenty of front-end selectivity, too. Loop antenna Q is approximately 100 at one megacycle; An r-f amplifier stage provides a very high order of image rejection.

Power supply; Ordinary flashlight dry cells for the quick-heating tube filaments—and a 67-volt battery of the size used in camera-type radios for the B supply.

A lot easier now to get the facts on your coverage, service area, and antenna efficiency . . . with RCA's new portable WX-2C. Ask your RCA Broadcast Sales Engineer for the facts. Or write Department 19-HB, RCA Engineering Products, Camden, New Jersey.



TELEVISION BROADCAST EQUIPMENT
RADIO CORPORATION of AMERICA
ENGINEERING PRODUCTS DEPARTMENT, CAMDEN, N.J.

In Canada: RCA VICTOR Company Limited, Montreal

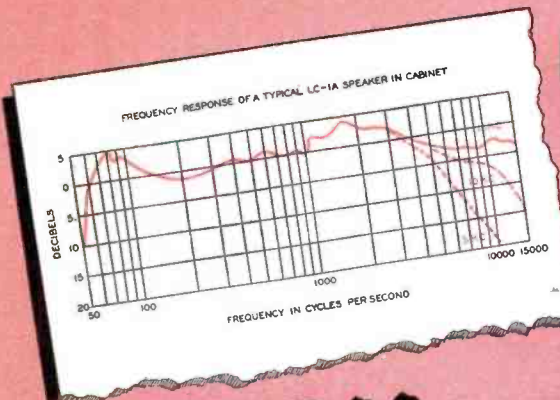

True FM Response

FOR CONTROL ROOMS... OFFICES...
AND HOME MONITORING

...with the new RCA LC-1A Duo-Cone Speaker



The RCA LC-1A speaker is expressly designed for monitoring FM programs and high-fidelity recordings in broadcast stations. Its response is exceptionally free from distortion—over the full FM range. Read these highlights:

Uniform response, 50 to 15,000 cycles. Audio measurements prove RCA's new speaker free from resonant peaks, harmonic and transient distortion . . . at all usable volume levels.

120 degrees radiation at 15,000 cycles! The LC-1A is unique in its ability to project a wide cone of radiation through a constant angle of 120 degrees. And frequency response is uniform throughout! Advantages: It eliminates the familiar sharp peak of high-frequency response usually present in other systems. And exact location of the LC-1A in control or listening rooms is not critical.

Remarkably smooth crossover-response. Both cones are mounted on the

same axis and have the same flare angle to place their surfaces in line. Thus the possibility of undesirable interference between H-F and L-F units over the crossover range is eliminated.

Controlled "roll-off" at 5 and 10 kc. Because of the LC-1A's exceptional high-frequency response, the surface noise and high-frequency distortion present in many recordings is accentuated. Therefore, a panel-mounted switch is provided to control and restrict the LC-1A's high-frequency range for this type of program material (see response curve).

Two fine LC-1A bass-reflex cabinets (optional) are designed to match the Duo-Cone speaker. One is finished in the familiar RCA two-tone gray. The other is finished in dark walnut.

For data and further details on Duo-Cone speakers . . . now in production . . . write Dept. 23-C.

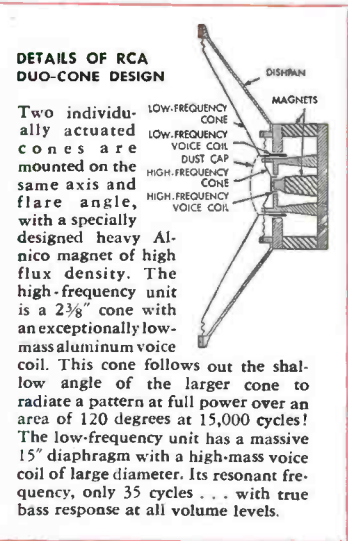

A boost for FM...



The RCA-7C24 Power Triode used in the new RCA FM Transmitter

... an important contribution to FM broadcasting

DESIGNED from the ground up to meet the special requirements of FM . . . this RCA "metal header" power triode is a striking example of RCA's leadership in modern tube development. In addition to increased ruggedness and unusual operating economy, the RCA-7C24 offers you these important benefits:

1. The flanged header effectively shields the filament input from the plate output in grounded-grid circuits . . . and provides a low-inductance path from grid to ground. Hence, neutralization is not necessary.

2. The mid-tapped, double helical filament minimizes lead inductance.

3. The copper conical grid support holds grid firmly in position . . . reduces lead inductance . . . provides more efficient grid cooling.

4. The thoriated-tungsten filament offers important savings in filament power.

The RCA-7C24 power triode is used in RCA 1-kw, 3-kw, and 10-kw FM Transmitters.

For your convenience, RCA tubes are available from your local RCA Tube Distributor or direct from RCA. For information on any RCA tube, write RCA, Commercial Engineering, Section 36KP, Harrison, New Jersey.



The world's most modern tube plant . . .

RCA, LANCASTER, PA.

THE FOUNTAINHEAD OF MODERN TUBE DEVELOPMENT IS RCA



RADIO CORPORATION of AMERICA
ELECTRON TUBES
HARRISON, N. J.