

AM · FM · TELEVISION

# BROADCAST

NEWS



New Studio Console . . . See Pg. 8

July-August 1951

Vol. No. 65



Good-bye...  
"ROLL-OVER"

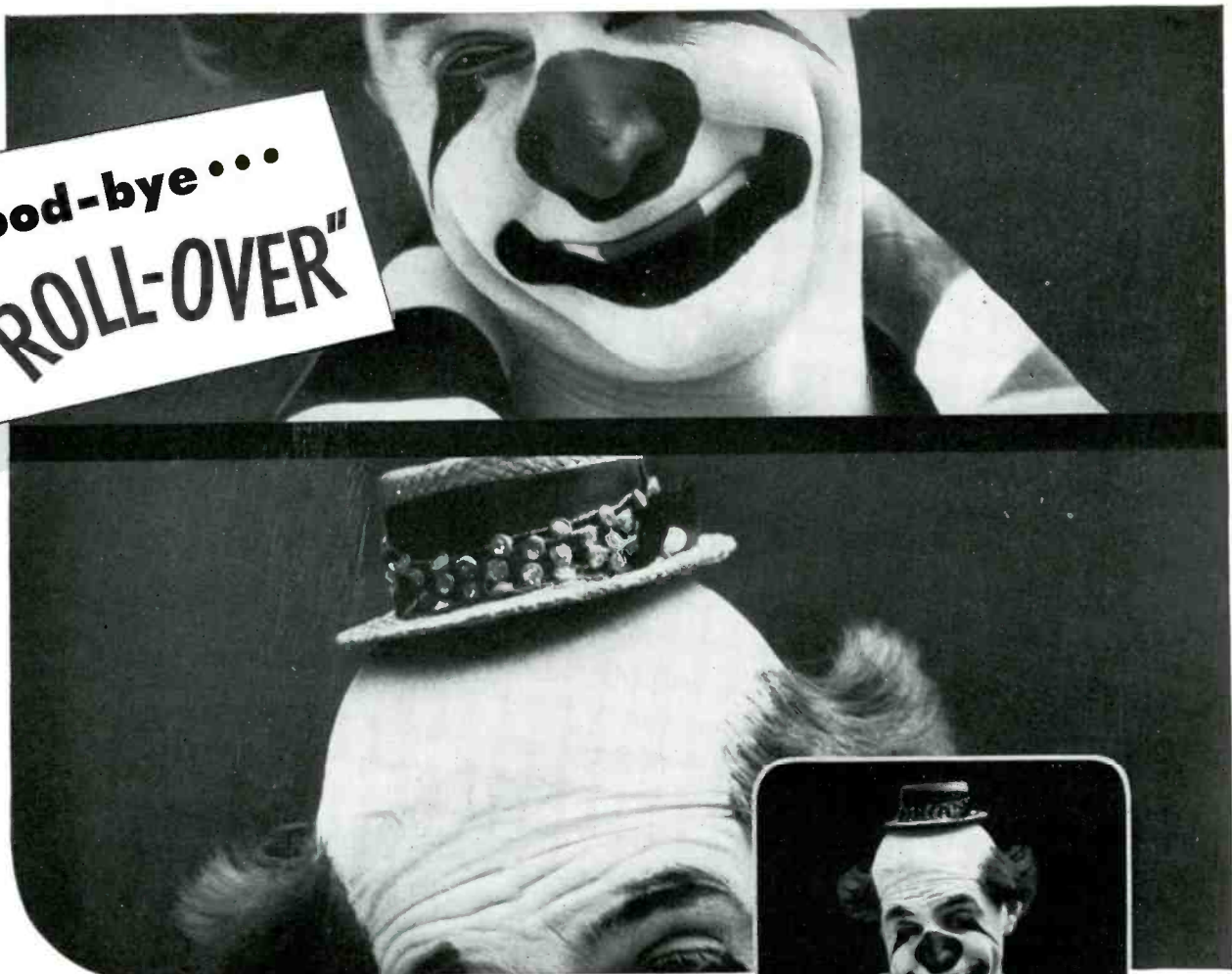

Annoying "Roll-over"—starts up in TV sets when you mix remotes with locals

RCA's TV Genlock TG-45 ends picture slipping when you "lap dissolve" and "superimpose."

Now you can lock two entirely different programs together—remote or local—and hold pictures steady *right through switching!* No manual adjustments of phasing to fiddle with. No extra equipment needed at remote pick-up points. Here's how the GENLOCK works.

Located in your main studio, this simple unit compares the signal of your remote sync generator with the signal of your local sync generator. The difference in the phasing of the pulses produces an "error" signal which locks your local generator as a "slave" to your remote generator as a master. This enables you to treat remote signals as local signals—and switch back and forth without picture "roll-over," *no matter where your program originates!*

The RCA GENLOCK is simple in design, completely automatic in operation—"locks-in" much faster than you can switch. It fits any standard 19-inch TV rack.

Give your programming a lift. Switch as you please between programs for variety and for special effects. It's easy with a GENLOCK. For more information call your RCA TV equipment representative. Or write Dept. 19AE, RCA Engineering Products, Camden, N. J.

Good-bye "Roll-over"! The RCA TV GENLOCK tightly locks your local and remote sync generators together—*instantaneously and automatically.*

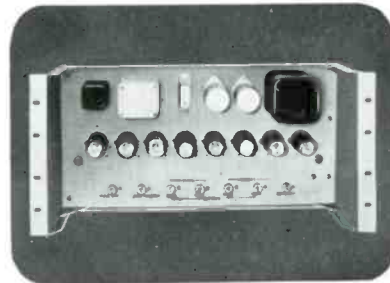

RCA GENLOCK, Type TG-45. This is the simple, automatic system that electrically locks two separate television pick-up systems together.



**TELEVISION BROADCAST EQUIPMENT**  
**RADIO CORPORATION of AMERICA**  
**ENGINEERING PRODUCTS DEPARTMENT, CAMDEN, N.J.**

In Canada: RCA VICTOR Company Limited, Montreal

# Broadcast News

AM • FM • TELEVISION

Published by the  
**RADIO CORPORATION OF AMERICA**  
ENGINEERING PRODUCTS DEPARTMENT . . . CAMDEN, NEW JERSEY

NUMBER 65

JULY-AUGUST, 1951

### Subscription Rates

In continental U. S. A. - \$4.00 for 12 issues

In other countries - - - \$5.00 for 12 issues

JOHN P. TAYLOR, Editor

W. O. HADLOCK, Managing Editor

M. L. GASKILL, E. B. MAY, Associate Editors

## Contents

A CARRIER-AUDIO ALARM CIRCUIT FOR MONITORING BROADCAST TRANSMITTERS . . . . .	by STAN BENNETT	6
A NEW AM-FM-TV CONSOLE . . . . .	by P. W. WILDOW AND G. A. SINGER	8
NEW "TV PEAK" IN SAN FRANCISCO . . . . .	by AL ISBERG	14
WNAG's NEW "250," BTA-250M . . . . .	by ROBERT MCRANEY	28
STANDARDIZING AND MEASURING VIDEO LEVELS IN A TV STATION . . . . .	by J. H. ROE	30
RADIO AT INDIANA STATE TEACHERS . . . . .	by DR. C. M. MORGAN	34
WTAR, AM-FM-TELEVISION . . . . .	by WTAR ENGINEERING STAFF	36
A LABORATORY TELEVISION SYSTEM . . . . .	by R. L. HUCABY	48
TELEVISION STUDIO ACOUSTICS . . . . .	by M. RETTINGER	55
KNBC's NEW AM VERTICAL . . . . .		58
HAM FORUM . . . . .	by M. L. GASKILL	61

Copyright 1951  
Radio Corporation of America  
RCA Victor Division  
Camden, N. J.

PRINTED  
IN  
U.S.A.

**OUR COVER**, this issue, is reproduced from a Kodachrome of the new Type BC-2B Audio Console. Photo was made by Rod Allen of our photographic staff. Description of this new console will be found in the article starting on Page 8.

**"ABOUT TIME"** is what some of our friends (?) have said about the new console. They refer, of course, to the fact that it has been some twelve years since we've announced a completely new console design. But is that bad? Let's look at the record.

In our 1939 catalog we showed the Type 76-B Console for the first time. In our 1950-51 catalog it was still there . . . still the most popular audio package in the business. In the intervening years many competitive consoles appeared. Some enjoyed a certain amount of popularity. But the 76-B remained the champ, year in and year out. All told, nearly three thousand 76-B's rolled out of our Camden plant . . . and, so far as we know, every one of them is still in use. Certainly none has been discarded because of obsolescence . . . for the first 76-B's made meet today's quality standards with something to spare. And we don't think any have been replaced because they wore out. Old 76-B's don't wear out, they just go on working year after year, with only very rare and usually very minor replacements.

Originally the 76-B was conceived as a package audio equipment which would provide small stations with all of the quality and a reasonable degree of the flexibility which large stations achieved with elaborate and expensive custom-built equipments. It did this very well. But it was also found suitable for many other purposes. For example, as a control booth equipment in large multiple studio layouts. With the addition of a switching console it has been used as a master control console. It has been widely used in large mobile units. It has even been used as a field equipment (we well remember our pleasure in finding ABC and CBS using 76-B's in their booths at the 1948 political conventions). Last, but not least, in a majority of all those glamorous 108 TV stations on the air today we find, believe it or not, the ubiquitous 76-B.

That's the record on the 76-B. It's a record that speaks for itself, we think . . . and for the far-sightedness of the engineering design work that went into the 76-B.

**NOT TOO UNUSUAL**, however, is the record of the 76-B. Many, if not most, of our broadcast equipment units have records for popularity and longevity which approach that of the 76-B. In audio equipments, for instance, the 70-B Turntable, the 72-D Recorder, and the 77-D Microphone—all designed at about the same time as the 76-B—have been continuously, and still are, the largest selling units of their kind.

It is significant that a large part of our sales volume in these lines is "repeat" business; that is, sales of additional units to stations already using them. Such "repeat" orders obviously are based on experience, and as such they are the best possible proof that these equipments really do the job.

What does the fact that RCA design stays current so long mean to you? Well, we think it is important in two ways. First it means that the equipment you buy does not become obsolete overnight. It not only lasts a long while—but it has a high resale value for a long time. If you don't believe this, do a little checking in the used equipment market.

The second, and to us even more important fact, is that when you buy a new RCA equipment you can do so with assurance that it is not a spur-of-the-moment idea, but rather a carefully nurtured design based on our twenty-five years of experience in this business. The new BC-2B Console is such an equipment. It incorporates some new ideas, yes. But they are all proven ideas: most of them, in fact, pre-tested in our deluxe custom-built equipments. You get them in the BC-2B at a "package" price. Take a look at this new console—you'll like it, we guarantee.

# How to get any TV

**TAKE ONE OF THESE  
TV TRANSMITTERS...**



500 watts, for **VHF**  
Type TT-500 A/B  
(All Air-Cooled)

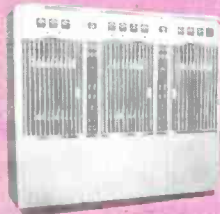

1 kw, for **UHF**  
Type TTU-18  
(All Air-Cooled)



2 kw, for **VHF**  
Type TT-2AL/H  
(All Air-Cooled)

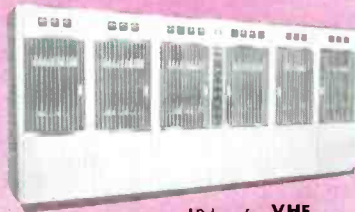

10 kw, for **VHF**  
Type TT-10AL/H  
(All Air-Cooled)



10 kw, for **UHF**  
Type TTU-10A



20 kw, for **VHF**  
Type TT-20BL/H  
(All Air-Cooled)



50 kw, for **VHF**  
Type TT-50AL/H

# power up to 200 KW!\*

...ADD ONE OF THESE  
TV ANTENNAS...

# = YOUR POWER

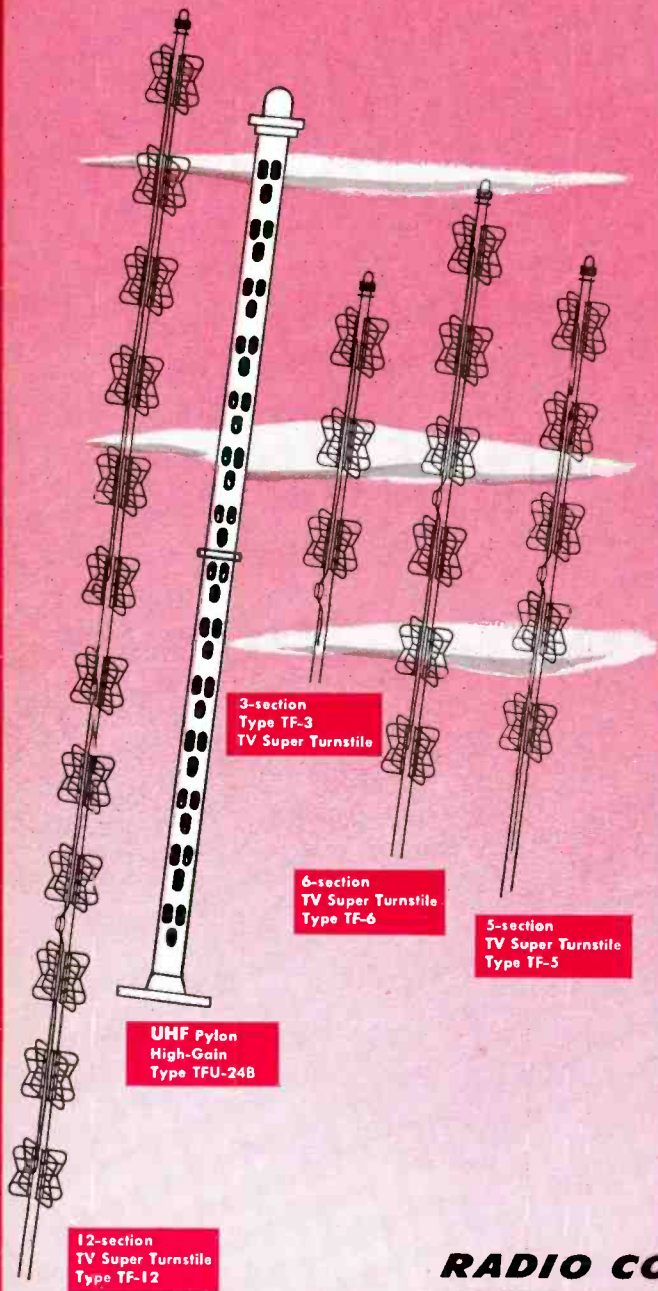

3-section  
Type TF-3  
TV Super Turnstile

6-section  
TV Super Turnstile  
Type TF-6

5-section  
TV Super Turnstile  
Type TF-5

UMF Pylon  
High-Gain  
Type TFU-24B

12-section  
TV Super Turnstile  
Type TF-12

With RCA's complete line of transmitters (seven different models), you can get any ERP\* up to 200 kw—on any channel from 2 to 83. And in most cases, you can get the power you want in several different ways!

If your requirements are best met with a low-power transmitter and a high-gain antenna, *RCA has the combination!* However, if your needs are better met with a higher-power transmitter and a lower-gain antenna, *RCA has that combination too!*

Ask your RCA Sales Representative to sit down and help you plan the most practical and economical equipment setup for your station. He has an intimate knowledge of station planning—knows TV equipment from A to Z. He can tell you exactly what you'll need to get "on the air" . . . with the power you want . . . at the lowest cost.

Call him today. Or write RCA Engineering Products Department, Camden, N. J.

\*Effective radiated power



**RADIO CORPORATION of AMERICA**  
ENGINEERING PRODUCTS DEPARTMENT CAMDEN, N. J.

# The one and only...

**Type TT-10AL/AH...and an  
will deliver 100 kw (ERP)**



**IT'S ALL**  
*Aircooled!*

# 10-kw TV transmitter

for VHF

## RCA high-gain antenna... at the lowest cost per kilowatt

• This remarkable new 10-kw TV transmitter, and an RCA high-gain antenna (type TF-12AM), will provide up to 100 kilowatts of effective radiated power. More than twice the

power of any commercial TV transmitter operating today—and AT SUBSTANTIALLY LOWER COST PER RADIATED KILOWATT than other transmitter-antenna combinations!

Using an improved type of air-cooled tetrode in the final power amplifier stages, this transmitter removes all former restrictions on interior cooling and floor-space requirements. No water supplies to bother about. No problem setting up the transmitter in tight quarters (it takes approximately half the floor area of previous

5-kilowatt models and weighs substantially less).

The new RCA 10-kw transmitter is available in two types. Type TT-10AL covers channels 2 to 6. Type TT-10AH covers channels 7 to 13.

For complete information on this new 10-kw... call in your RCA Broadcast Specialist. He can show you what you'll need to get "on the air"—with the power you want—at lowest possible cost. Phone him. Or write Dept. S-E18, RCA Engineering Products, Camden, New Jersey.

### FOR ANY TV POWER UP TO 200 KW—GO RCA!

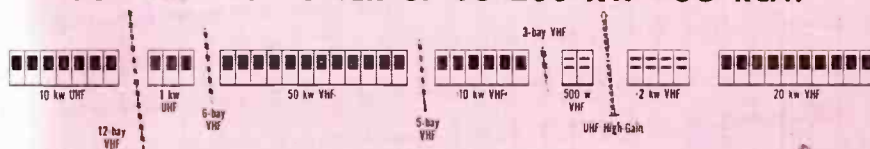

#### The Key to High Power and Low Cost

Improved RCA Air-Cooled tetrode—used in the aural and visual finals. Proved for long life, easy to handle.



**RADIO CORPORATION of AMERICA**  
ENGINEERING PRODUCTS DEPARTMENT  
CAMDEN, N. J.

# A CARRIER-AUDIO ALARM CIRCUIT FOR MONITORING BROADCAST TRANSMITTERS

By **STAN BENNETT**  
Assistant Chief Engineer  
KOMO, Seattle

## Summary

A simple reliable alarm device has been developed to indicate instantaneously at the studio location any interruption of the transmitter carrier where the transmitter may be located some miles from the studio site and where "off the air" monitoring is not continuous. Also incorporated in the circuit is a time delay alarm which sounds in case of audio failure for any pre-determined time period between 10 and 30 seconds. The attachment is applicable to any superheterodyne type monitor receiver.

## May Save Time and Money

When an emergency occurs at a transmitter station that puts the equipment off the air, the first thought of the transmitter engineer should be to analyze the cause of the trouble and return the equipment to normal operation; usually, the secondary consideration is to call the studio informing them they are off the air. This may be some minutes later in cases of serious trouble. Meantime spot announcements, programs, etc., have been going into a dead transmitter with studio personnel blissfully unaware.

It has been the experience here at KOMO that this automatic alarm device has "paid off" several times during its past two years of operation. It gives immediate warning of such things as power failure at the transmitter site and sometimes allows re-scheduling a commercial spot announcement or possibly delaying the program material until the emergency is over. Often the transmitter engineer is not called by the studio until the station returns to the air, knowing that he is extremely busy during moments of equipment trouble or when placing the auxiliary into operation.

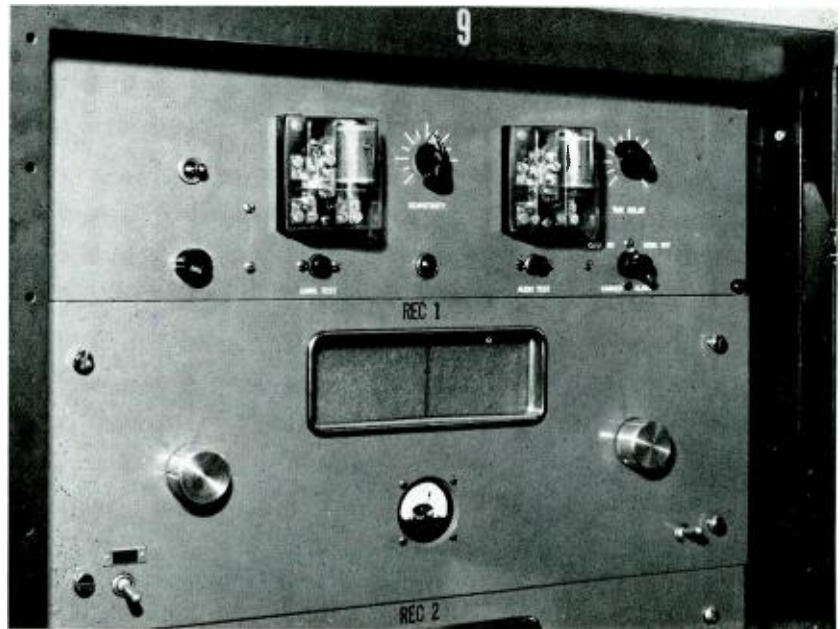

FIG. 1. View of the Carrier-audio alarm (top panel) mounted in KOMO monitoring rack. Bottom panel includes Kappler Hi-fidelity Tuner furnishing "Off-the-air" monitoring plus AVC and audio voltage to the alarm circuit.

The alarm device also offers a sense of security in the situation of KOMO studios where both program line and order wire circuits are in the same submarine cable to the 50-kw transmitter located 15 miles away on Vashon Island. A dragging anchor from a ship conceivably could cut all cable communication. Warning from the audio-failure alarm circuit would allow studio personnel to re-route circuits or set up the emergency studio-transmitter link in the most rapid manner.

There are many reasons why stations with remote studio locations do not continuously monitor "off the air". Some lack high fidelity receivers, some have serious noise pickup at the studio site, etc. Many studios seem to ignore operation of their transmitters unless informed it is inoperative. The device described herewith consists of two tubes, simple circuitry, made primarily from junk box parts at a total

cost of a few dollars. There seems no good reason why every remote studio location should not have one, except perhaps the engineering personnel are just too busy to do the necessary experimenting on a "gimmick" of this sort; or perhaps they just need a bit of urging on the value and convenience of such a device. At any rate, that is the reason for this article.

## Carrier/Audio Alarm Operation

When the device shown in Fig. 1 is attached to the AVC circuit and the audio output of any superheterodyne "off the air" monitor receiver and sensitivity controls of the alarm circuit are properly adjusted, the following functions under the specified conditions are performed:

- (1) Transmitter carrier failure — instantaneous operation of relay RE-1 with control contacts operating buzzer, fire gong, or suitable warning device.



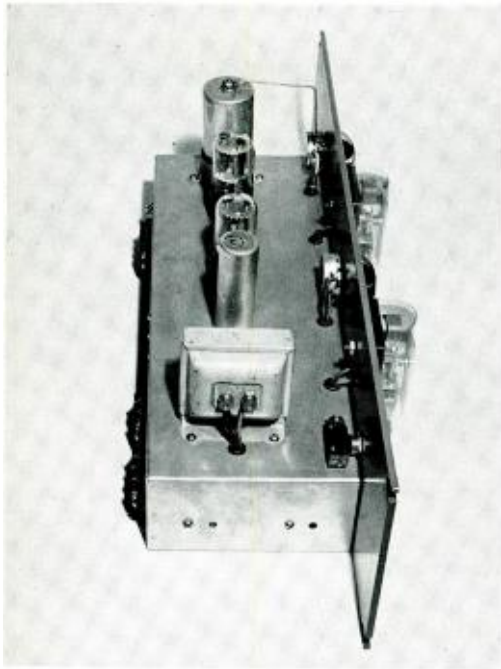

FIG. 2. Chassis view of the KOMO Carrier-audio alarm. It consists of a 5 inch by 14 inch chassis mounted on a standard 19 inch by 5 1/4 inch panel

- (2) Audio failure (any cessation of audio either at studio or transmitter) for pre-determined time of 10 to 30 seconds—relay RE-2 actuated with control contacts operating bell, siren or suitable warning device distinguishable from the carrier alarm.
  
- (3) Carrier failure of several minutes—alarm sounds continuously until "Carrier Switch" is thrown to "Carrier Off" position. Warning alarm will then cease until the transmitter carrier is returned to the air at which time alarm again sounds indicating to studio engineer that the transmitter is again on the air. "Carrier Switch" is then returned to normal "Carrier On" position.

By noting the time at the start of the carrier alarm and again when the alarm sounds upon carrier return, the transmitter outage time may be obtained for program log purposes. The aforementioned outage time may also be recorded automatically by operation of two electric clocks, one of which stops and one which starts upon actuation of the carrier relay

control contacts. The time difference of the two clocks then gives the carrier-off time.

### Circuitry

Carrier alarm operation is controlled by plate circuit relay RE-1 of one section of a 6SN7, normally biased to cut-off by  $-3$  to  $-5$  volts available from the AVC circuit of the monitor receiver. The 50K control in the plate circuit along with relay spring tension and armature spacing can be used for sensitivity adjustment. The back contact of relay RE-1 is used for the carrier switch "off" position. When carrier returns, the relay RE-1 opens, thus completing circuit of the carrier alarm and warns operator that carrier is back on the air.

### Audio Time Delay

Two to ten volts of audio should be available from the monitor receiver output for operation of the audio time delay alarm. In this case a zero level output was amplified by utilizing one section of a 6SN7. The output of this tube is rectified by two 1N34 crystal diodes and used as the charging voltage for an R-C circuit in the grid of the second half of the 6SN7 working as a relay control tube for plate circuit relay RE-2.

The R-C time constant can be made any reasonable value; in this case 8 mfd. and 3 megohms maximum resistance gave approximately 30 seconds delay. A 1.5 megohm potentiometer allows setting of the time constant for any variation less than maximum delay. Care should be taken in choosing a condenser with a high leakage resistance. Failure to do so will cause variation in the time delay and may cause occasional tripping of the audio alarm on prolonged low symphony passages and similar material of low average level.

Note that the back contact of the audio alarm is in series to ground through the back contact of the carrier alarm relay. Thus the audio alarm does not sound when the carrier failure relay is operated, which allows only the properly identified alarm to sound.

Components can be and were in this case mostly typical spares around a station with exception of the two plate circuit relays. An old buzzer and a door bell were used for the two carrier and audio alarms respectively powered from an ordinary door bell transformer. Two test buttons for checking operation of the relays were put in the circuit and found to be convenient.

FIG. 3. Schematic diagram showing the circuitry employed for the KOMO Carrier-audio alarm.

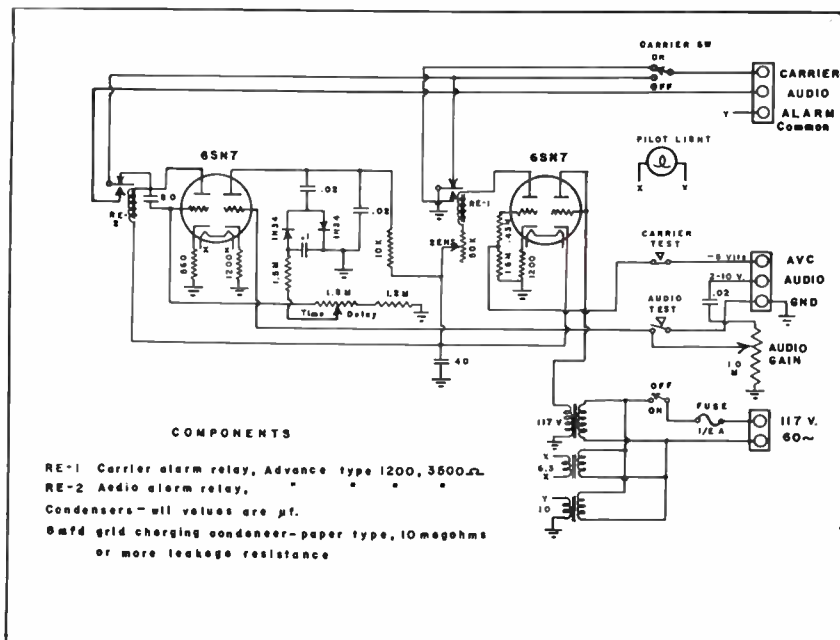

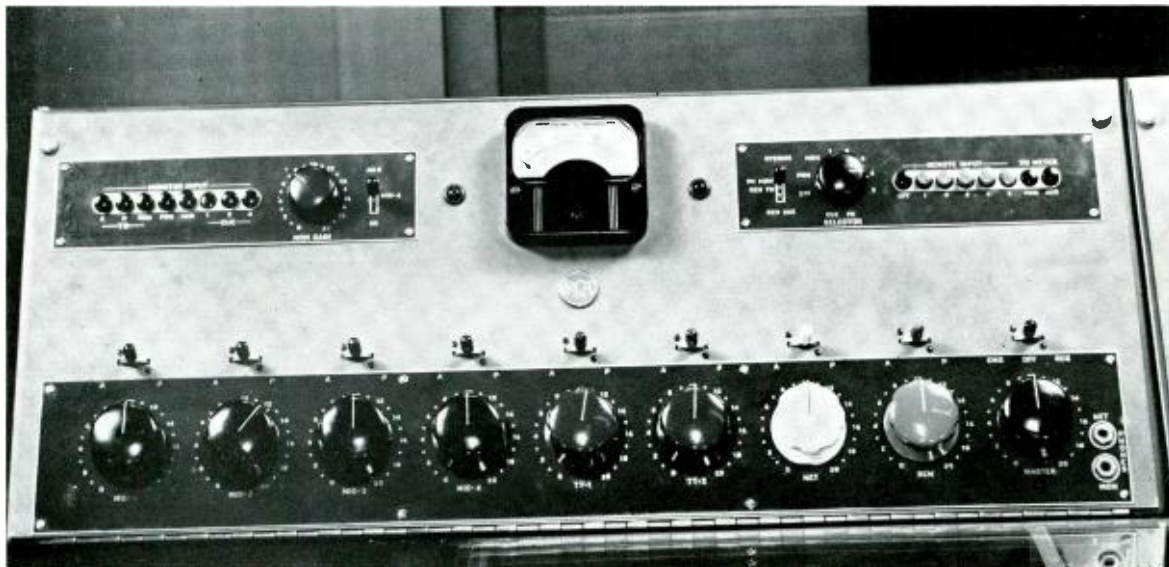

FIG. 1. View of the new BC-2B Console shown in operating position. Eight mixer positions are provided, colored knobs and switches enable quick identification of the important circuits.

# A NEW AM - FM - TV CONSOLETTA

## Introduction

Many different types of audio systems are available for use in the broadcasting studio control room to perform the functions of amplification, mixing, switching and regulating of the program. These systems may range from elaborate custom built equipments utilizing rack mounted amplifiers and control desks containing only the operating controls—to very simple portable equipment adapted to studio use.

The consolette which is in between these extremes offers the advantage of containing in a single package all the essential elements necessary for efficient programming. It requires a minimum of wiring at the installation and takes up very little space. Because regular factory production methods are used, its cost is appreciably lower than that of more complex equipment.

The type BC-2B Consolette described in this article is a new design, engineered to fulfill the control room requirements of the majority of AM-FM and TV broadcasting stations. The final design of this consolette reflects the combined thinking of Broadcast engineers with long experience in the

By  
**P. W. WILDOW  
& G. A. SINGER**

operation and design of broadcast audio equipment. As a result, several new operating features, and recent developments in tubes and components are incorporated in its construction.

## Facilities

The consolette may be used to control either one or two studios. In addition, it will serve an announce booth, a control room microphone, two turntables, a network and five remote lines. The monitor amplifier may be used for monitoring, auditioning, receiving and sending cues, talk back to studios, and as an emergency line amplifier. Except for the power supply, the consolette is completely self-contained.

## Simplicity of Operation

The arrangement of circuits and controls is such that operation is simple and straight forward. Switches and faders are clearly marked with their function, and

related control knobs are made of the same color plastic material. Electrical and mechanical interlocks are provided in the audio and control circuits to prevent improper operation. Even inexperienced or new personnel are able to learn quickly how to operate the consolette.

## Styling and Visibility

The consolette is designed to mount on a flat topped desk or table, yet the sloping front panel design affords maximum visibility into the studio floor area. The consolette which is finished in two-tone umber gray will blend in well with other RCA television studio control equipment.

## Ease of Installation and Maintenance

All external connections are made to two terminal blocks which become accessible by lifting the top cover. Every electrical component is easily accessible for inspection, adjustment, cleaning and replacement.

The front panel swings forward bringing switches and attenuators in full view. The amplifiers are mounted on a movable frame which swings up, making the underside accessible. (The amplifiers are on individual chassis which can be removed.)

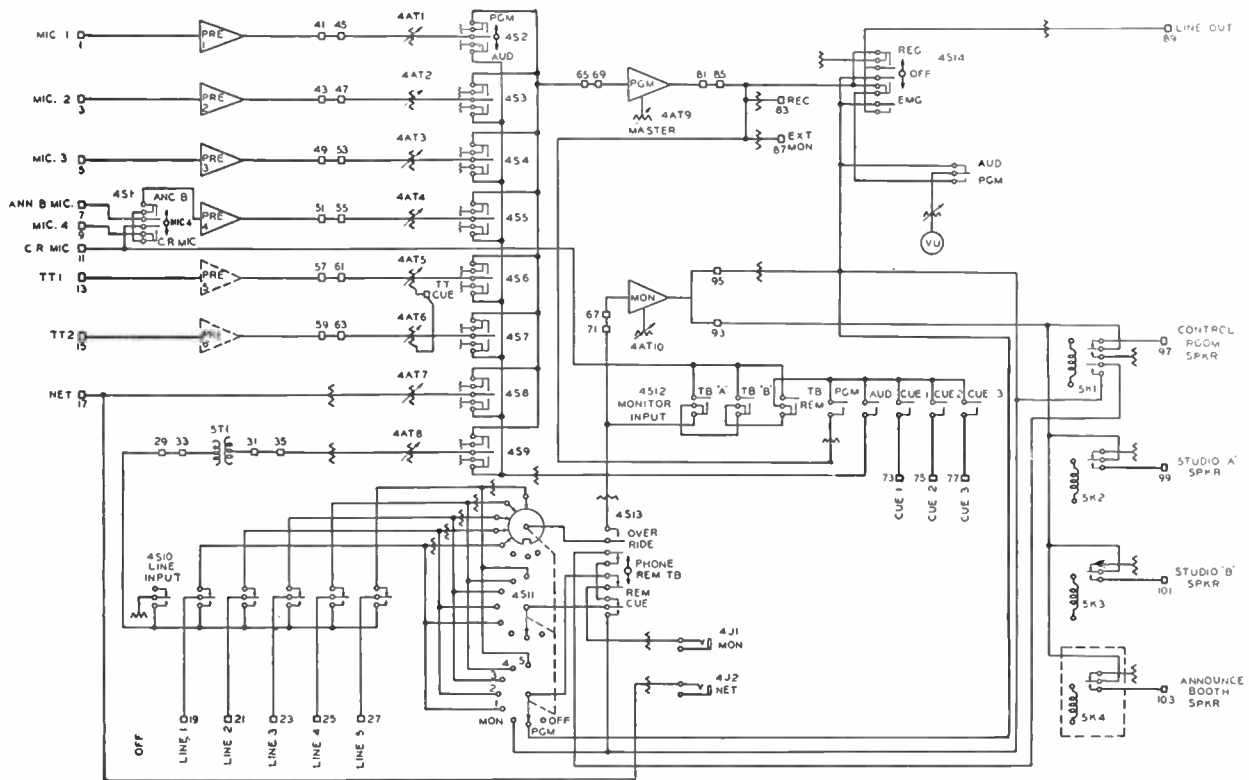

FIG. 2. Simplified block circuit diagram of the BC-2B Console.

**General Description—Electrical**

Fig 2 shows the block diagram of the BC-2B console. Of the six microphone inputs, three studio microphones are connected directly to the pre-amplifiers, and the input to the fourth pre-amplifier may

be selected by means of a switch from the control room, the announce booth, or the fourth studio microphone. The two turntable inputs connect directly to the mixers. In application where a booster amplifier is not included as part of the turntable, an additional dual-preamplifier (MI-11241)

may be installed in a space provided within the console. One input is reserved for a network line and one of five remote lines may be selected by means of a push-button switch. A line transformer is included for isolation and impedance matching.

FIG. 3. View of the BC-2B Console as displayed at recent NAB Convention where it was mounted next to companion Master Control switching unit.



Each of the eight possible simultaneous inputs is controlled by a high level mixer. The mixer circuit is of the series-parallel type which offers the lowest loss. Both turntable mixers have "built-in" cueing switches which connect the turntable outputs to an external cueing amplifier when the mixer control is turned to the "off" position.

By means of key switches, the output of each mixer may be connected to either the program bus or the audition bus. The program bus is permanently connected to the input of the program amplifier. The output of the program amplifier is connected through the "line-out" switch and a 6 db pad to the output line terminals. The purpose of the pad is to equalize amplifier and line impedances.

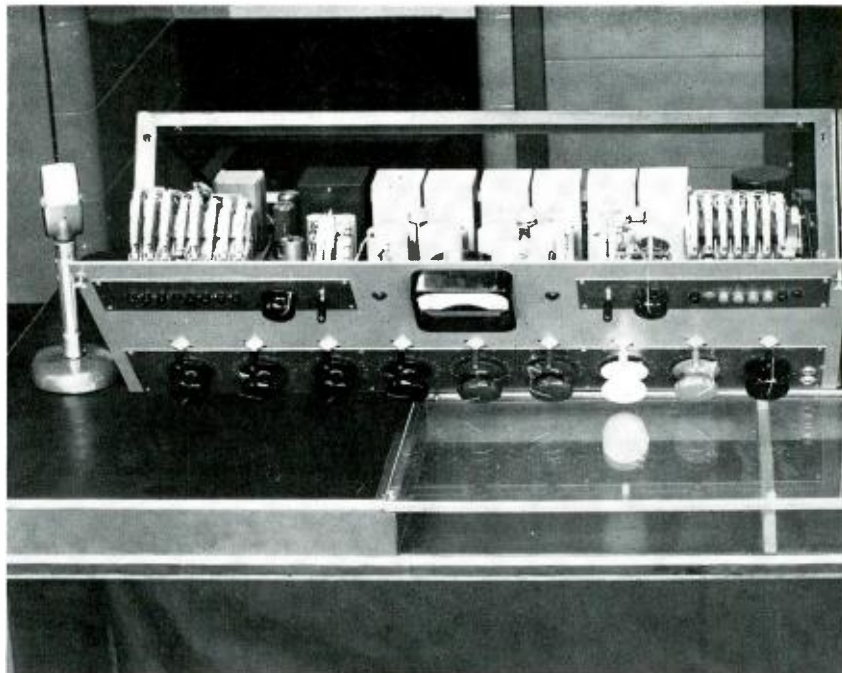

FIG. 4. View of the BC-2B with front panel swung forward to show how every component is accessible.

**MORE AND MORE BROADCASTERS  
ARE TAKING ADVANTAGE OF  
THIS SPECIAL SERVICE**



The RCA Service Company maintains a complete factory repair shop for overhauling and repairing broadcast equipment. More and more AM, FM and TV broadcasters are taking advantage of this special service to make worn or damaged Microphones, High Fidelity Recorder Heads, Tape Recorder and Reproducer Heads and Test and Measuring Equipment perform like new again.

Broadcasters like having skilled, factory-trained experts work on their expensive equipment. They can be sure that all replacement parts are genuine factory originals. They like the way their equipment is repaired and returned in only a few days. And cost—even for major rebuildings—is low.

Lengthen the life of your equipment . . . increase efficiency . . . eliminate unnecessary replacement costs. Send your equipment in now. An estimate will be submitted, if you wish, before work is started. Address . . . . .

**RETURN APPARATUS CONTROL  
RCA SERVICE COMPANY, INC.  
CAMDEN, NEW JERSEY**

The input of the monitor amplifier can be selected by means of a pushbutton switch. There are three talkback buttons which connect the control room microphone to the monitor amplifier and permit the operator to talk to Studio A, Studio B and the remote lines respectively. The fourth push-button bridges the monitor input across the output of the program amplifier for monitoring the outgoing program. The fifth button connects the input of the monitor amplifier to the audition bus and the remaining three pushbuttons connect it to cue lines.

Sometimes it is not known over which remote line a program will be fed. In such a situation, the "override" feature is helpful. By operating the "override" switch (4S13) all remote lines are connected to the input of the monitor amplifier and a call coming in on any one of the lines will override the signal coming from the monitor speaker.

The monitor amplifier may also be used to send cues over a remote line, and this is accomplished by throwing the "override"

switch (4S13) to the "Remote Cue" position. The remote line, over which the cue is sent, is selected by the switch (4S11). An electrical interlock on the line selector switch (4S10) prevents cue from being sent over a line which is "in use" to receive a program from a remote location.

With switch 4S13 on the "phone-remote talkback" position, the monitor phone jack 4J1 is connected through 4S11 to the remote lines, the program and the monitor amplifier. This position is also used to talkback over any remote line. It is thus possible to carry on a two-way conversation between the control room and a remote location.

Should the program amplifier fail, the monitor amplifier may be used as a line amplifier. To do this, the mixer output switches are thrown from the program to the audition position. The audition button of the monitor input switch 4S12 is depressed and the line out switch 4S14 is thrown to the "emergency" position. The monitor gain control acts as the master gain control under those circumstances.

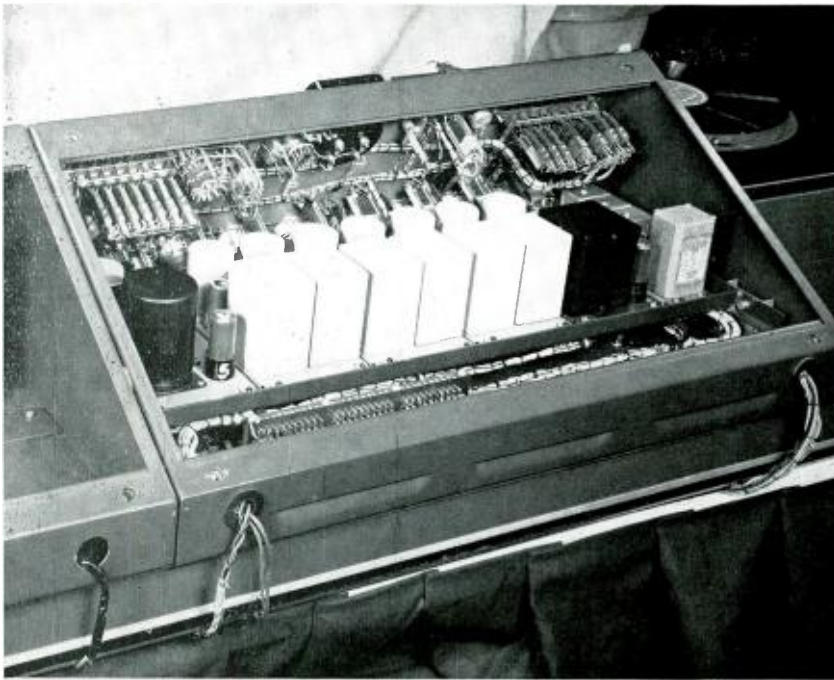

FIG. 5. Rear view of the BC-2B with cover removed to show accessibility and position of amplifiers and wiring.

The VU meter can be switched to indicate the output level of either the program line or the monitor amplifier. Brightness of the lamps illuminating the meter scale is adjustable to suit operating conditions. The two sets of pushbutton switches are of the cam-operated type with leaf-spring contacts which are inherently quiet, easy to maintain and give many years of reliable service.

Although this consolette is primarily designed for single channel operation, a remote line may be used as a second channel

### Mechanical

The consolette housing is made of steel and finished in dark amber gray except for the front panel which is light amber gray. The overall length is 33 inches, the depth 21½ inches, and the height 11¼ inches. The total weight is 114 pounds. Knock-outs for cable conduits are provided in the bottom and rear sides.

FIG. 6 (below). Block diagram showing the functions performed by the BC-2B Consolette as used in a typical broadcast installation.

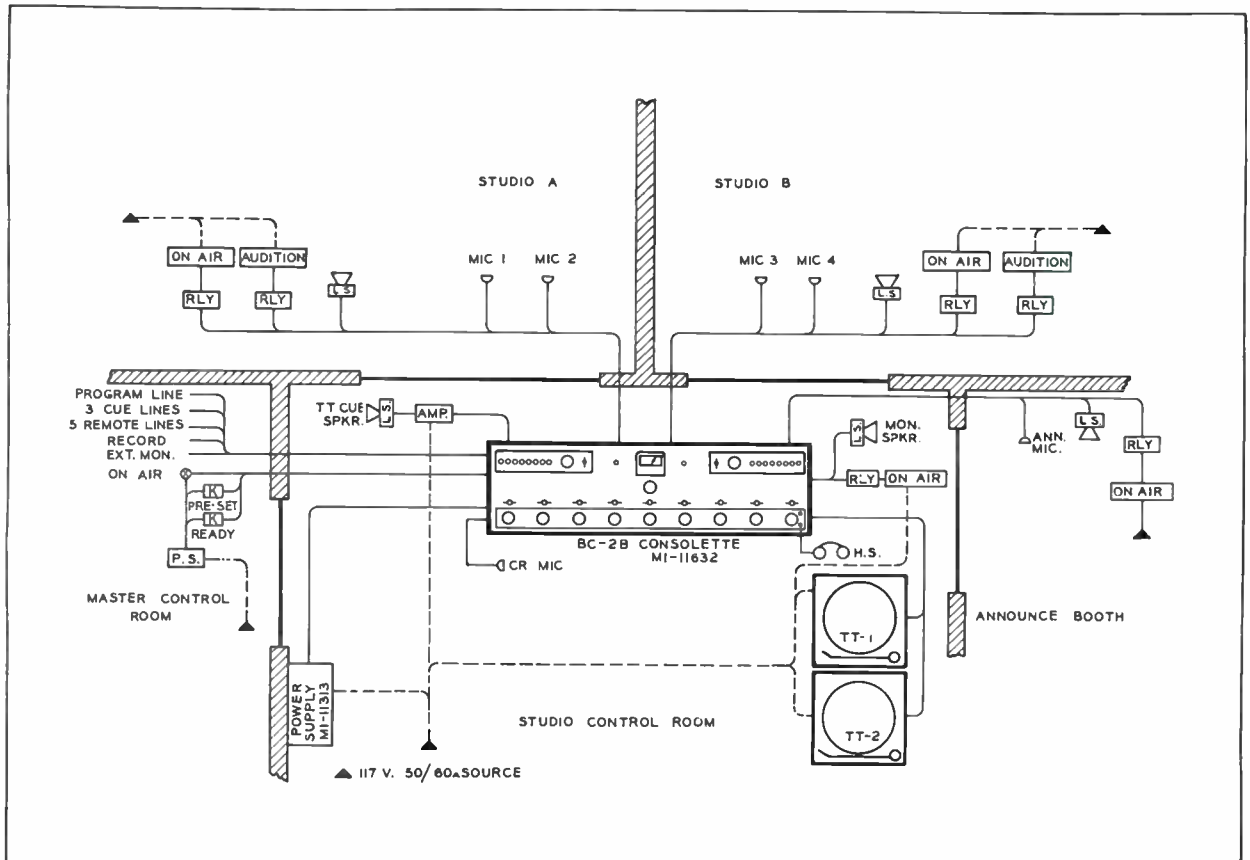

## Amplifiers

The amplifiers are of a new design which utilizes miniature tubes in all stages except the output stage of the program and monitor amplifiers. Negative feedback is employed to stabilize gain and to reduce noise and distortion.

The preamplifier utilizes a 12AY7 twin triode for its two stages of amplification. This tube is designed especially for low level amplifiers. However, to obtain exceptional low hiss, hum, microphonics and pops, the tubes should be selected for those characteristics. Tubes which meet these test specifications and are equivalent to the type 1620 in regard to these characteristics may be obtained as MI-11299. The 12AY7 is also used in the input and 2nd stages of the program and monitoring amplifiers. Two identical preamplifiers are mounted on a chassis.

The program amplifier consists of four amplifier stages. A potentiometer type gain control is inserted between the first and second stage. A 5879 pentode, which is also a low noise tube is used in the third stage, and a 6V6-GT beam power tube is employed in the final stage. The first and second stages of the monitor amplifier are similar to those of the program amplifier. The third stage and phase inverter utilize

a 12AX7 twin triode. The output stage consists of a pair of 6V6-GTs in a push-pull circuit.

Long tube life was considered in the choice of all tubes and in the selection of operating conditions. Pin jacks provided for measuring the cathode voltages of the amplifier tubes facilitate checking the condition of tubes and circuits. The amplifiers chassis float on rubber gromets which diminish the transmission of vibrations and further reduce microphonics. Transformers used in the BC-2B are of the same high quality as those employed in the standard line of RCA broadcast audio amplifiers.

## Speaker Muting and Warning Light Relay Circuits

As shown in the installation diagram Fig. 6, a loudspeaker may be installed in each of the studios, the control room and the announce booth. These speakers may be used for monitoring, cueing, and talk-back from the control room. In order to prevent acoustical feedback, it is essential that a speaker be turned off whenever a microphone is turned on in the same room. Also, when a studio is on the air, it should be impossible to talk back or otherwise interrupt the program progress.

Fast acting speaker muting relays are therefore provided for both studio and the

control room speakers. Space and wiring are provided for the customer to add a relay to control the announce booth speaker if desired.

The relays are operated from a 24 volt d-c supply which is part of the console power supply. Contacts on the microphone selector (S-1), the mixer (S-2, 3, 4 and 5), and the line out (S-14) switch provide the necessary control and interlocking features.

If studio warning lights such as "On Air" and "Audition" (MI-11706 series) are to be used, these lights may be controlled by a set of warning light relays (MI-11702-A). Power for actuating these relays is furnished by the console power supply and operation is controlled by the speaker relays and additional contacts on the console key and push button switches.

The control circuits are normally connected for two-studio operation. If it is desired to use all microphones in a single studio, the circuit may easily be adapted for this type of service by changing a few jumpers on a terminal board.

## Power Supply (MI-11313)

The power supply furnishes plate and heater power to the amplifiers and 24 volts d-c to the relays. It requires an input power of 150 watts at 100-130 volts, 50-60 cps. The B voltages are rectified by a 5R4-GY and filtered through separate RC filters for the preamplifiers, program amplifier and monitor amplifier. Two potentiometers are provided to adjust the hum level to a minimum; one for the preamplifiers, the other for the program and monitoring amplifier. Power for the relays is obtained from a separate transformer and rectified by a selenium rectifier. The power supply is housed in a dark amber gray cabinet which may be hung from a wall, or by means of suitable brackets (MI-11650) be mounted on a standard amplifier rack. The power switch and fuses are accessible from the front. After opening the cabinet door, the chassis may be swung out to provide access for installation and service. The external dimensions are  $10\frac{3}{8}$  inches high by  $14\frac{3}{4}$  inches wide and  $8\frac{1}{8}$  inches deep and the weight is 32 pounds.

Where extreme reliability of service is required, a standby power supply, of the same type as the regular power supply (MI-11313) may be installed. A switch is used to transfer power from one supply to the other.

FIG. 7. Overall view of the Console Power Supply, MI-11313.

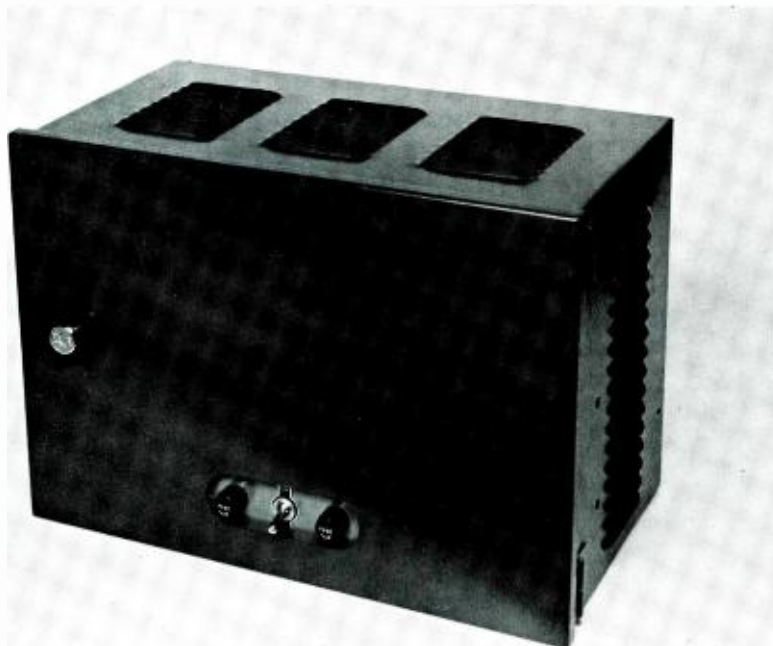



BOB HOPE  
"Comedy Hour," NBC

**In the act...**  
without hiding the star

**RCA's**  
**"STARMAKER"**

... a ribbon-pressure microphone that is so slim ... so skillfully styled ... so unobtrusive ... you must look twice to see it.

Despite its slim construction, the STARMAKER meets the exacting quality standards of other RCA professional Broadcast microphones. Pick-up is non-directional. Frequency response is substantially uniform, 50 to 15,000 cps. It is free from wind rumble and air blast ... and virtually impervious to mechanical shock.

The STARMAKER fits any standard microphone stand ... can be used in place of and RCA microphone. *No extra attachments needed.*

For delivery information call your RCA Broadcast Sales Engineer, or write: Department QA-19, RCA Engineering Products, Camden, N. J. (In Canada write: RCA Victor Limited, Montreal.)

# Get Full Details how **RCA** **2-WAY** **RADIO**

**provides more efficient service  
and increases profits**

Here's a booklet that describes the advantages of 2-way radio ... "what it is" ... "what it does" ... "how it works."

Explains how 2-way radio enables taxicabs to serve more people faster ... cut down on "dead" mileage ... boost cab profits. Tells you how trucking companies use 2-way radio to handle a greater volume of freight and maintain supervisor of trucks en route. Shows the use of 2-way radio by inter-city and urban bus and trolley lines for more efficient handling

of peak loads ... emergencies caused by breakdowns or traffic jams.

Contains information about RCA's service ... on problems of usage, coverage, obtaining a construction permit. Every transportation executive should send for a copy. (In Canada, write: RCA VICTOR Limited, Montreal.)

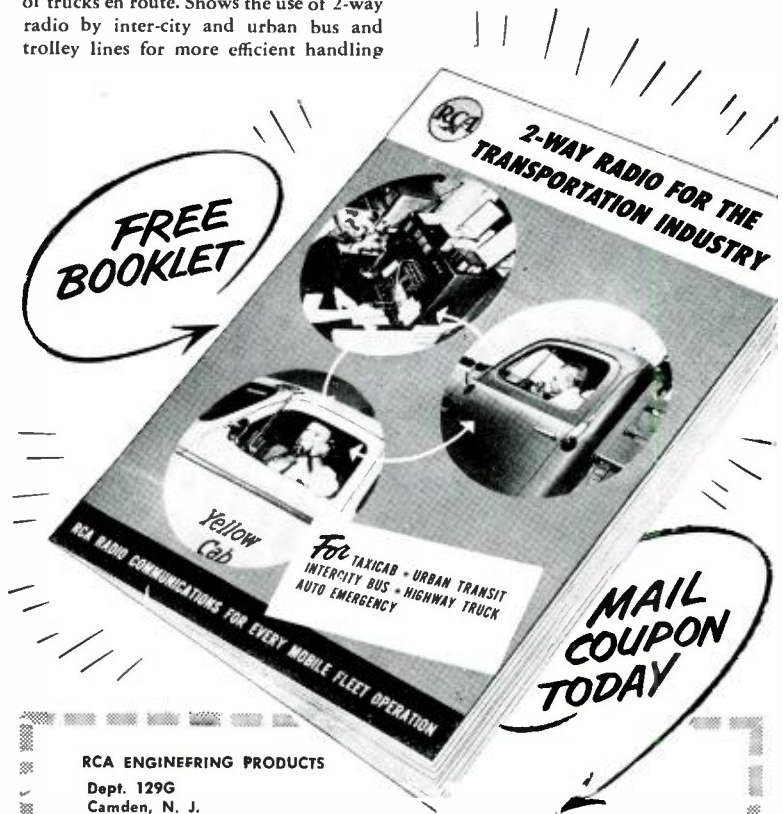

RCA ENGINEERING PRODUCTS

Dept. 129G  
Camden, N. J.

Send me a copy of "2-way Radio for the Transportation Industry."

Name \_\_\_\_\_

Firm \_\_\_\_\_

Address \_\_\_\_\_

City \_\_\_\_\_ State \_\_\_\_\_



**RADIO CORPORATION of AMERICA**

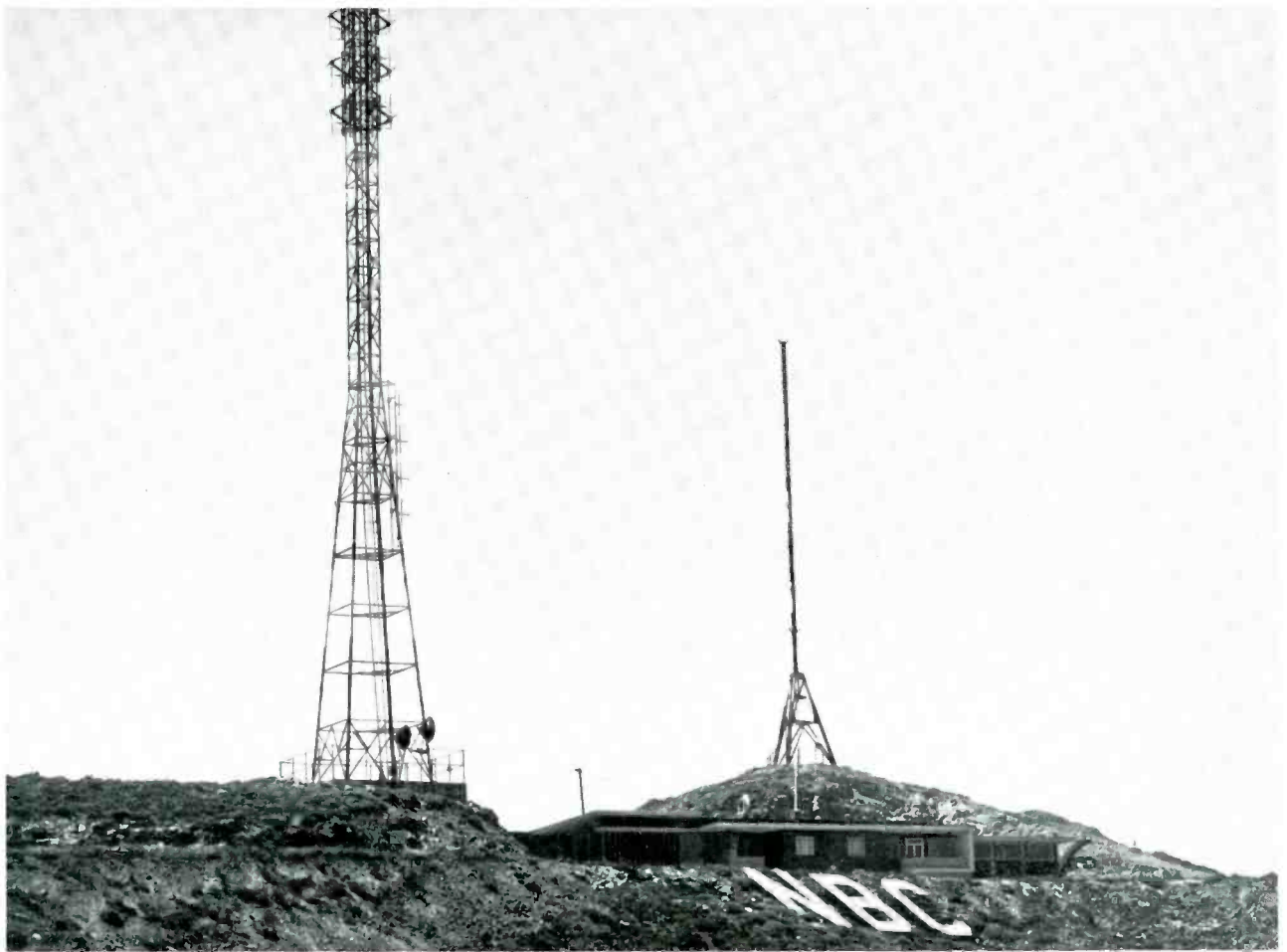
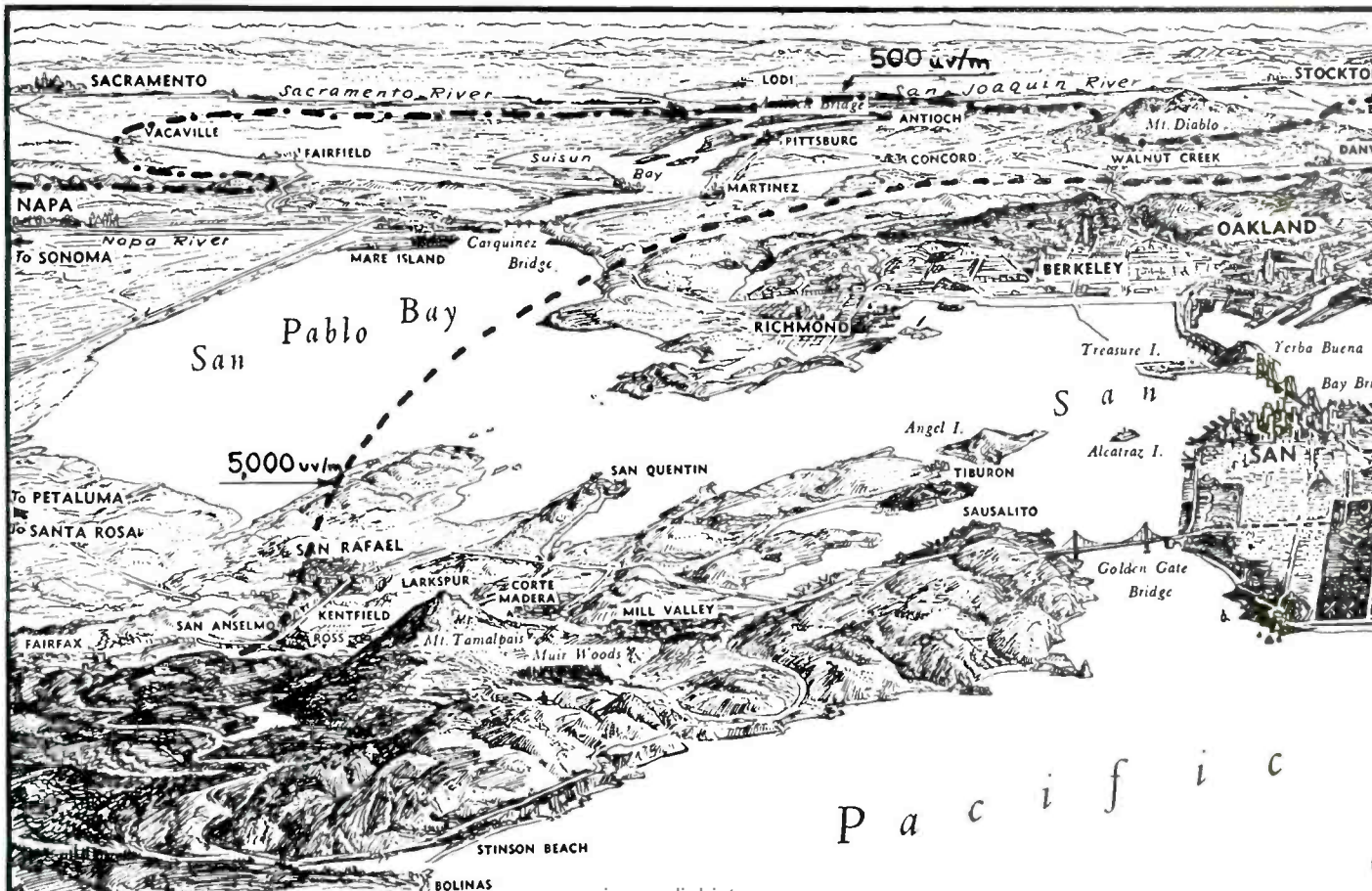

FIG. 1 (above). The new KRON-KNBC transmitter building atop San Bruno mountain, the highest point on the San Francisco peninsula. Towers, left to right, include: KRON television radiator, with two parabolic receiving antennas at the base and the KNBC-FM radiator with its receiving dish installed near the steel fence. All signals reach the San Bruno site via microwave.





# NEW "TV PEAK" IN SAN FRANCISCO

by **AL ISBERG**

**Electronic Systems Consultant  
Chief Engineer, KRON-TV,  
San Francisco, Calif.**

Dominating San Francisco's south skyline is San Bruno mountain, the peak of which is marked by KRON-TV, KRON-FM and KNBC-FM antennas. Recently installed RCA equipment is now broadcasting sight and sound programs at this point from a common transmitting plant (one building houses the transmitters of both KRON and KNBC).

Television Peak is not only the top of San Bruno mountain but it is also the culmination of a new three-lane highway that snakes up through a residential section, an army receiving station, and pastures with grazing cattle. At the end of the road stand the two towers and the KRON-KNBC building. The long, low-slung, light and dark green structure combines the one-story spaciousness of California ranch style with the crisp, clean-cut lines of modern design.

The two antenna towers (TV and FM) overlook the entire bay area just south

of San Francisco—at an elevation of over a quarter of a mile above sea level. Tips of the towers average 1,325 feet above all terrain within a ten mile radius. Illustrated on these pages are the estimated 5-milivolt and .5-milivolt coverage contours obtained with KRON's TF-DA three-section omni-directional antenna. In this illustration the surrounding countryside and terrain may be studied. The transmitter site is located near the boundary which separates San Francisco from San Mateo County, and this location will ultimately become the center of population as the Metropolitan Bay Area expands. The peninsula is rather narrow and the ocean is only four miles to the west of the

transmitter site with a very low density of population on that side of the mountain.

## KRON's (TF-DA) TV Antenna System

Since it appeared unwise to waste a large percentage of the station's power over the ocean, RCA's engineers suggested that we consider a directional antenna and increase the effective radiated power over the populated areas.

The proposed antenna was the TF-DA with eight dipoles and screen reflectors mounted on each of two sides of a square tower. The resulting pattern will cover the densely populated areas surrounding San Francisco Bay and will provide an improved signal-to-noise ratio compared to the same transmitter power into an omni-directional antenna.

The antenna gain of the directional array consisting of eight radiators on each of two adjacent sides of the tower is esti-

FIG. 2. Overall map of surrounding terrain showing the 500 and 5000 microvolt coverage contour lines. Note that black arrow indicates position of San Bruno mountain, KRON site.

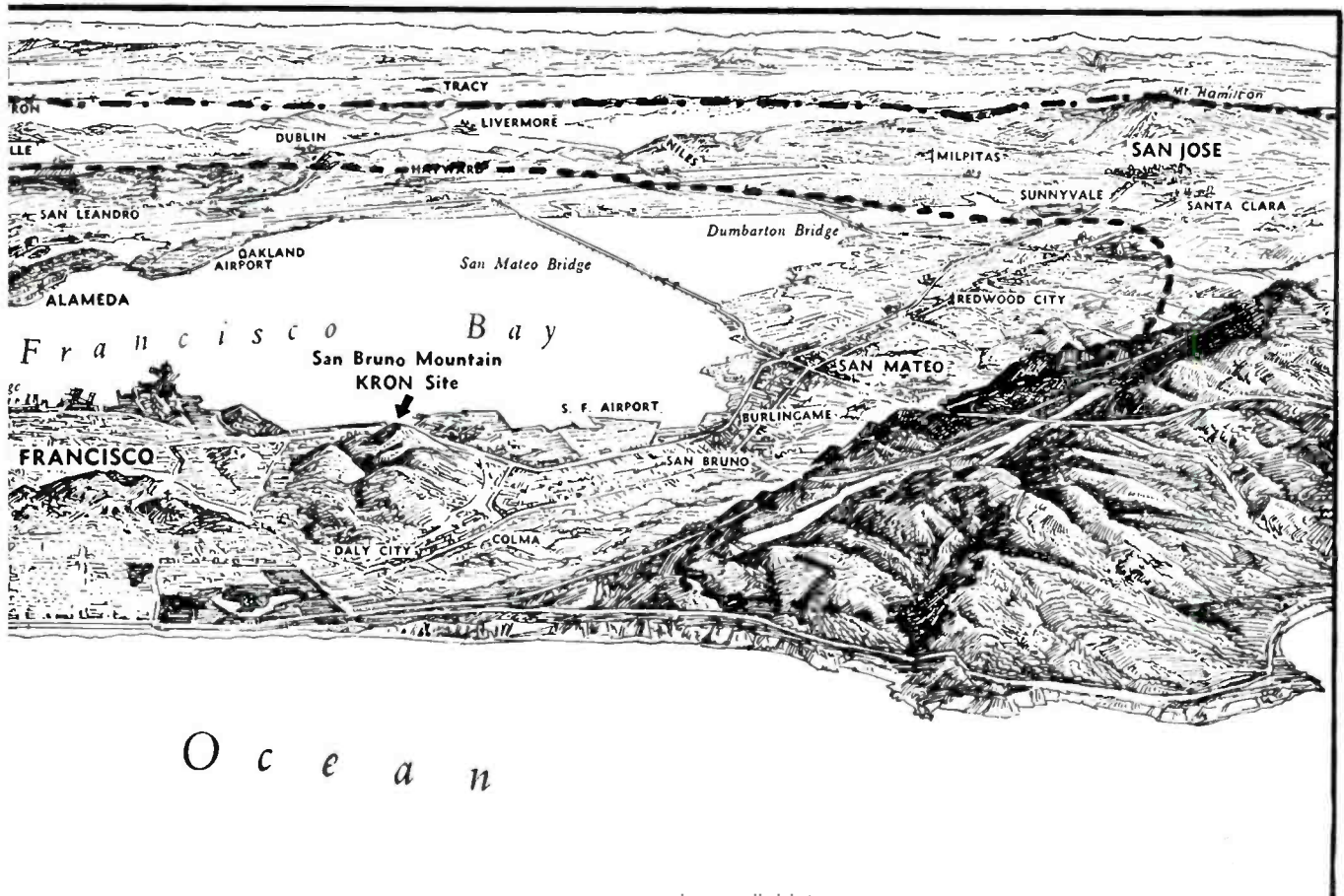



FIG. 3. The KRON-TV Ideco tower and TF-DA three-section antenna which will later be made directional by moving back screens to front side. Note gradual curve of transmission line which follows ladder girls inside tower to eliminate special angle and reduce discontinuity of line.

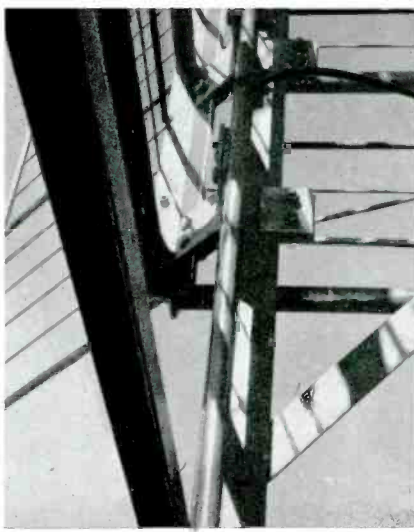

FIG. 4. Close-up view at top of tower showing how antenna screens are clamped to tower upright angles. The Ideco tower was custom made to fit RCA antenna screens exactly.

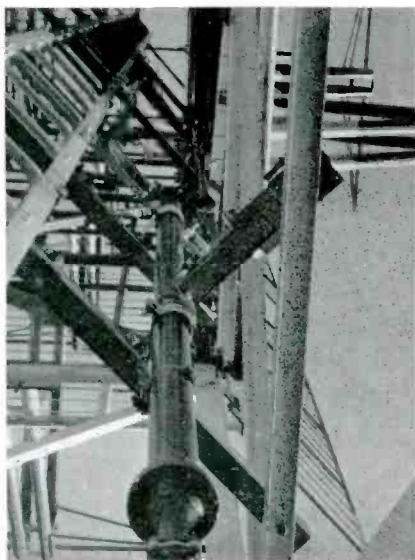

FIG. 5. At top is E-W junction box and at top right, N-S junction with  $\frac{1}{4}$   $\times$  straight length of line for 90° phasing. A termination resistor on power equalizer absorbs reflected energy from antenna mismatch to present resistive load to transmission line. This avoids energy reflections back to transmitter.

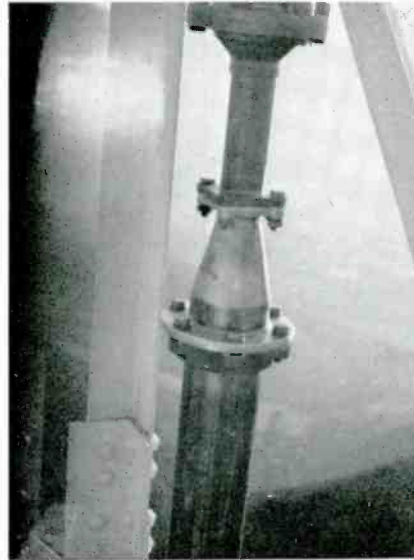
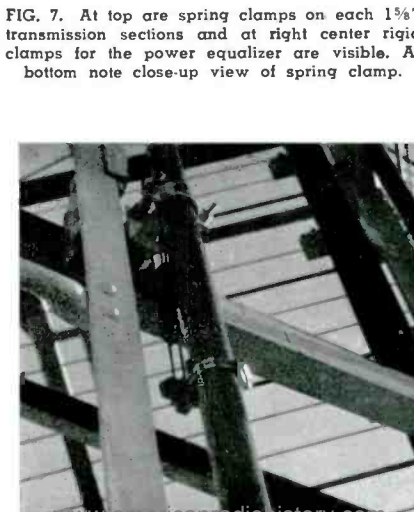

FIG. 6. The power equalizer and transformer assembly is spring supported by standard transmission line brackets so that it may be separated from the  $3\frac{1}{2}$ " line for maintenance and inspection. Note long taper  $3\frac{3}{8}$ " to  $1\frac{1}{2}$ " reducer used to reduce discontinuity.



FIG. 7. At top are spring clamps on each  $1\frac{1}{2}$ " transmission sections and at right center rigid clamps for the power equalizer are visible. At bottom note close-up view of spring clamp.



## KRON'S (TF-DA) Antenna System (Cont'd)

mated by RCA engineers from work done on scale models and from calculations to be 20.1. This figure includes the losses in the feed system within the antenna and is multiplied by the efficiency of the transmission line from transmitter to antenna to obtain the gain of the system. This is the gain in the maximum direction, as distinguished from average gain through some designated horizontal angle. The vertical beam width is empirically given as  $6\frac{1}{8} = 7.6$  degree.

Although the FCC freeze precluded the erection of a directional antenna at the time the station was built, the tower was designed and positioned with future directionalization in mind. It will be made directional in the future by moving elements on the ocean side to the sides facing the densely populated areas. Early tests of the transmitter were conducted with a single section Super Turnstile mounted approximately 30 feet above the building roof. A comparison of the tests with the low antenna having a power gain of 1.2 compared to the TF-DA with a gain of 3.3 is very interesting, because it shows a greater than expected increase in signal strength for the higher antenna at line-of-sight locations, and sometimes a slight decrease in signal strength in shadowed locations behind hills.

The antenna arrived by air freight late on a Saturday night, it was spray painted on Sunday, hoisted up on the tower and bolted in place on Monday and Tuesday, and the electrical installation was completed and tested on Wednesday.

The 200-foot Ideco tower was designed to accommodate the Channel 4 TF-DA antenna on the sides of its upper 100 feet of uniform cross-section framework. The accompanying pictures show the antenna installation as it was being made.

FIG. 8. Photo showing support of transformer sections of Fig. 7. Note additional rigid clamps are added to reduce movement of line during high winds. Vibrations of line otherwise cause steel springs around inner conductor to dig pieces of copper which short insulators, causing overloads.



FIG. 9. Top view of the junction boxes and transformer assemblies for the TF-DA antenna. Each junction box has six RG 34 U cables of equal length which terminate at the dipoles. Coaxial transformer assemblies are made up of sections having different size inner conductors.



FIG. 11. All work was personally supervised by R. A. Isberg, Chief Engineer of KRON-TV, shown here checking junction box at the center of the antenna. The feed lines were taped to the supporting structures with Scotch electrical tape and then painted with red Glyptal. Aereosal clamps were used to secure the cable to the structure.

FIG. 14 RG 34/u cables were supplied with threaded brass sleeves attached to the shield braid for connection to the end of the dipole feed section. The center conductor was soldered to a fitting which connects to a strip of metal for feeding the other half of the dipole. The workman has attached the cable to a special "fishing line" so that it can be pulled up to connect to the dipole.



FIG. 10. At right top on N-S transformer and junction box and at center E-W transformer and junction box. Junction boxes are secured by rigid clamp. Cables are dressed and secured so transformers and equalizer may be raised one foot or more for checking transmission line with calibrated termination.

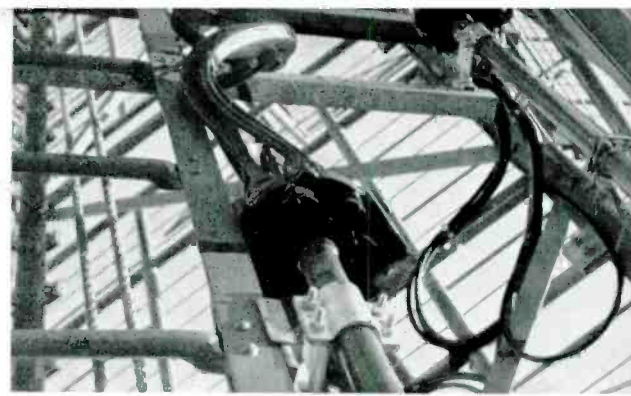

FIG. 12. Close-up view showing how feed lines were run and how any excess cable was carefully coiled and taped. Also note how clamps are used to secure coils in position.

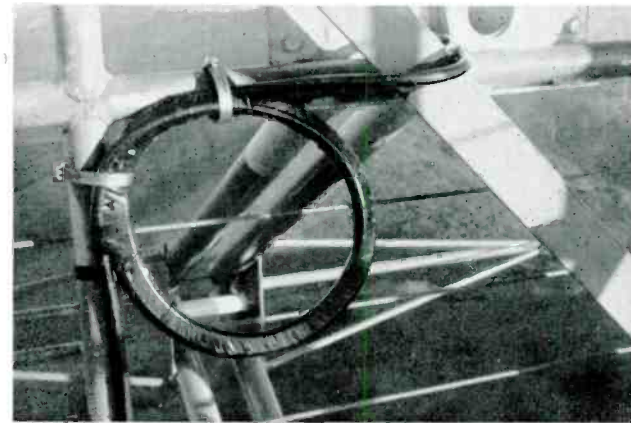
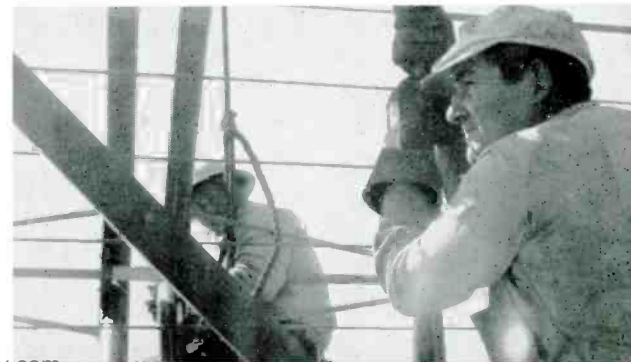

FIG. 13(A). All electrical connections to the antenna were made by erectors under the chief engineer's supervision.



FIG. 13(B). In this view riggers are showing making electrical connections to the antenna dipoles. Some of this work was done from a bosun's chair outside the screens.



### Transmitter Building

A streamlined all-concrete building houses the KNBC-FM, KRON-FM and KRON-TV transmitters on Television Peak. The building architecturally appears to be one unit but is actually two buildings with a common wall. This construction was deemed desirable to take advantage of protection from the prevailing winds and for security reasons. KRON-TV occupies about half the building at the San Bruno site. Owned and operated by the San Francisco Chronicle and affiliated with NBC, KRON-TV serves as KNBC's television outlet.

Both KNBC and KRON-TV maintain convenient studios in downtown San Francisco, however, KRON-TV's quarters on Television Peak also include a 19-by-12 foot studio for simple telecasts. The new plant also provides dining and sleeping facilities and storage space for film and slide projection equipment. Rain water collected on the roof is stored for sanitary purposes in four 5,000 gallon tanks. Bottled water is used for drinking. (See building floor plan for location of equipment and facilities.)

### FM Equipment

The KNBC-FM transmitter is an RCA 10-kw, BTF-10B. KNBC-FM's new eight-section Pylon antenna increases the station's effective radiated power from 4,500 watts to 45,000 watts. With high power, plus the high elevation, KNBC assures high quality FM reception far beyond the bay area.

The KRON-FM transmitter is BTF-3B and utilizes a directional 4 layer dipole and screen reflector antenna which is a prototype of the future directional TV antenna. Field strength measurements and a

FIG. 15. San Bruno floor plan showing the location of TT-5A transmitter and video control facilities. Note that auxiliary TV studio is provided.

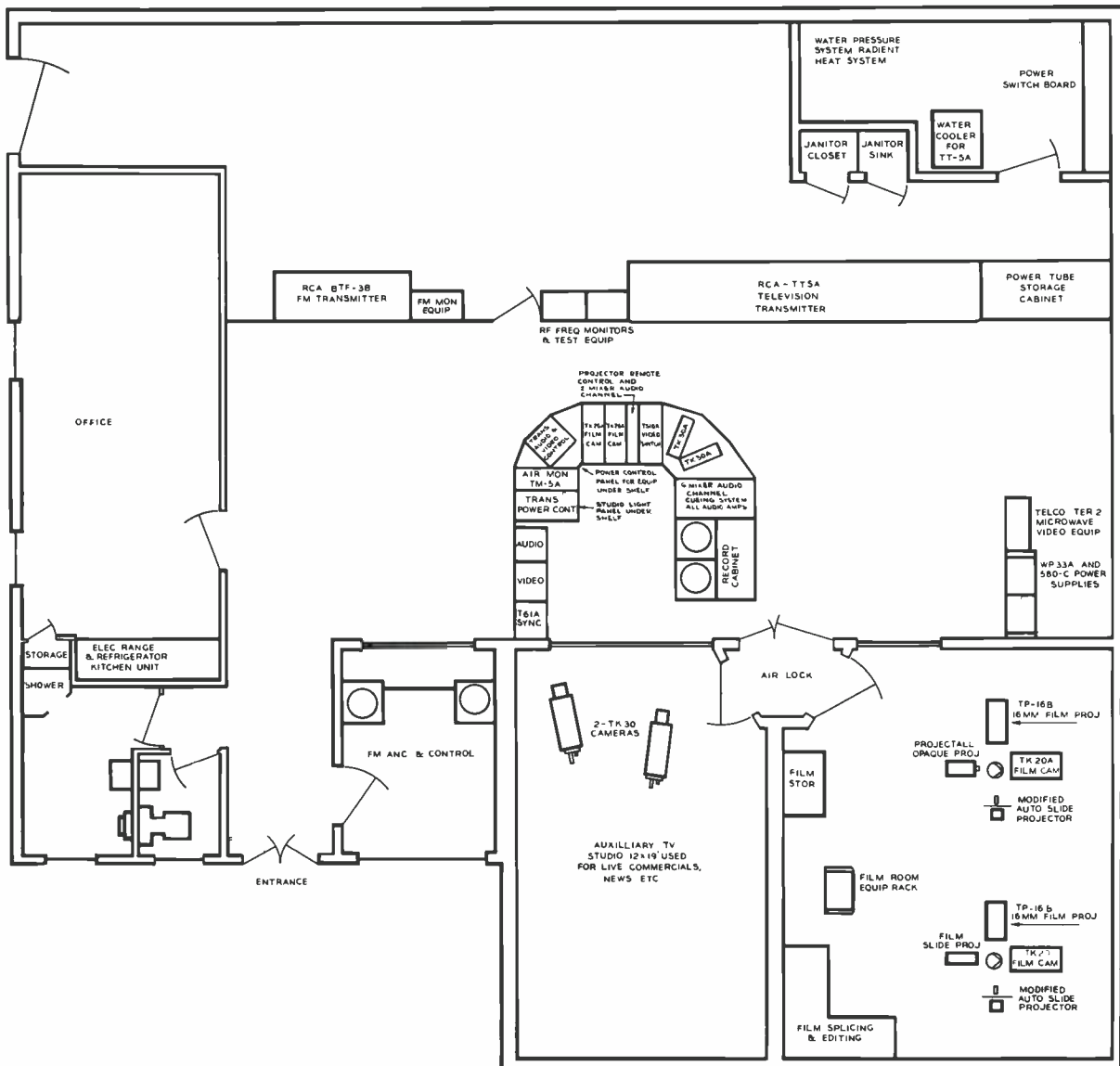
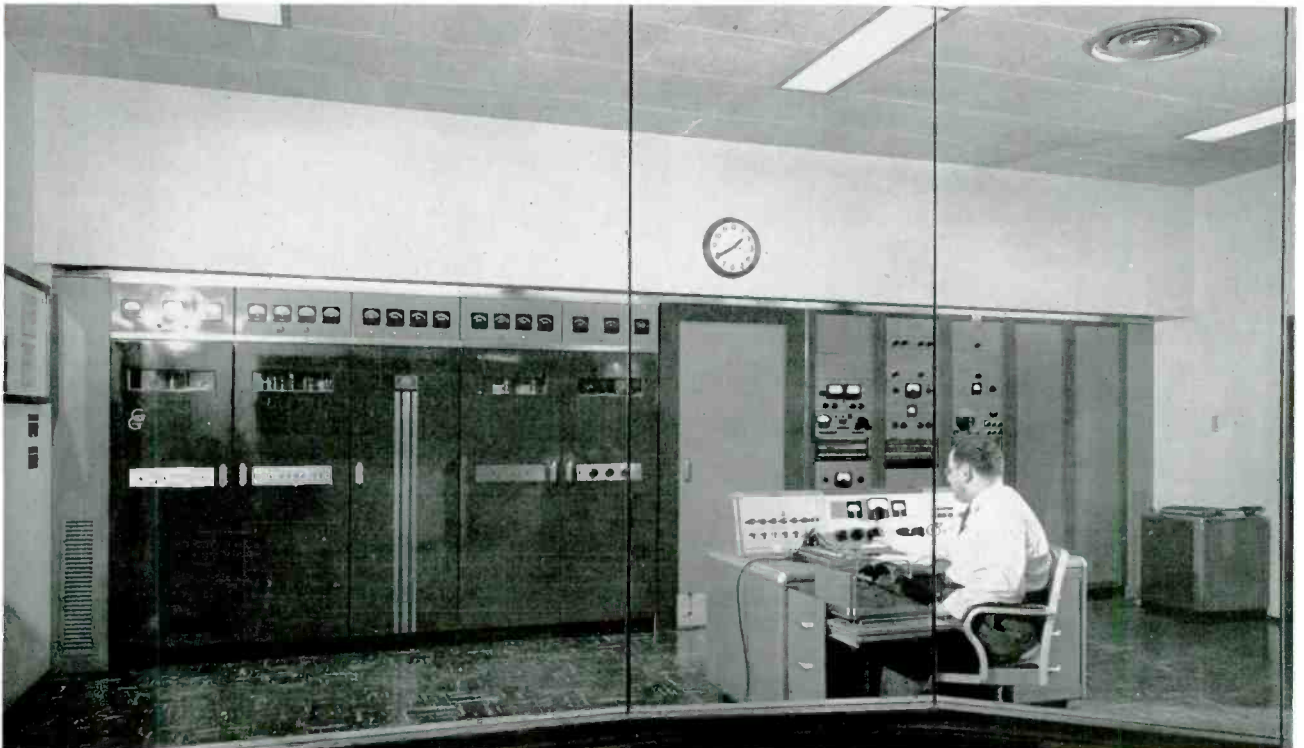



FIG. 16. View of the KRON-KNBC all-concrete building which is situated atop San Bruno mountain.

FIG. 17. Front view of the KNBC-FM transmitter and FM monitoring and test equipment at right. All equipment is installed "in-line." Sam Melnicoe is the engineer on duty.



study of reception on the null side of the antenna indicates that the proposed antenna pattern is satisfactory and that no multipath problems are encountered. This antenna is mounted on the same tower as the TV antenna.

The KNBC-FM transmitter operates on 99.7 megacycles and KRON-FM utilizes 96.5 megacycles. No RF interference in video systems has been experienced.

### KRON Video Facilities

Under the guidance of Mr. Charles Thieriot, Manager of KRON-TV, and Mr. Harold See, Director of Television, the technical operating requirements were determined first by studying scale models and then by building full scale mockups. Experienced technical operating and program personnel assisted in the "dry runs" in the mocked-up control room and as a

result an unusual "U" shaped control area was adopted which satisfies all the requirements of efficient television station operation—with only two technicians on duty.

This operation includes the television transmitter; two film cameras; three slide projectors; one opaque projector; two 16mm motion picture projectors; a two camera (fixed position) live studio; the studio-transmitter microwave link; a sec-

FIG. 18. Simplified diagram showing the interrelated KRON-TV video equipment and facilities employed.

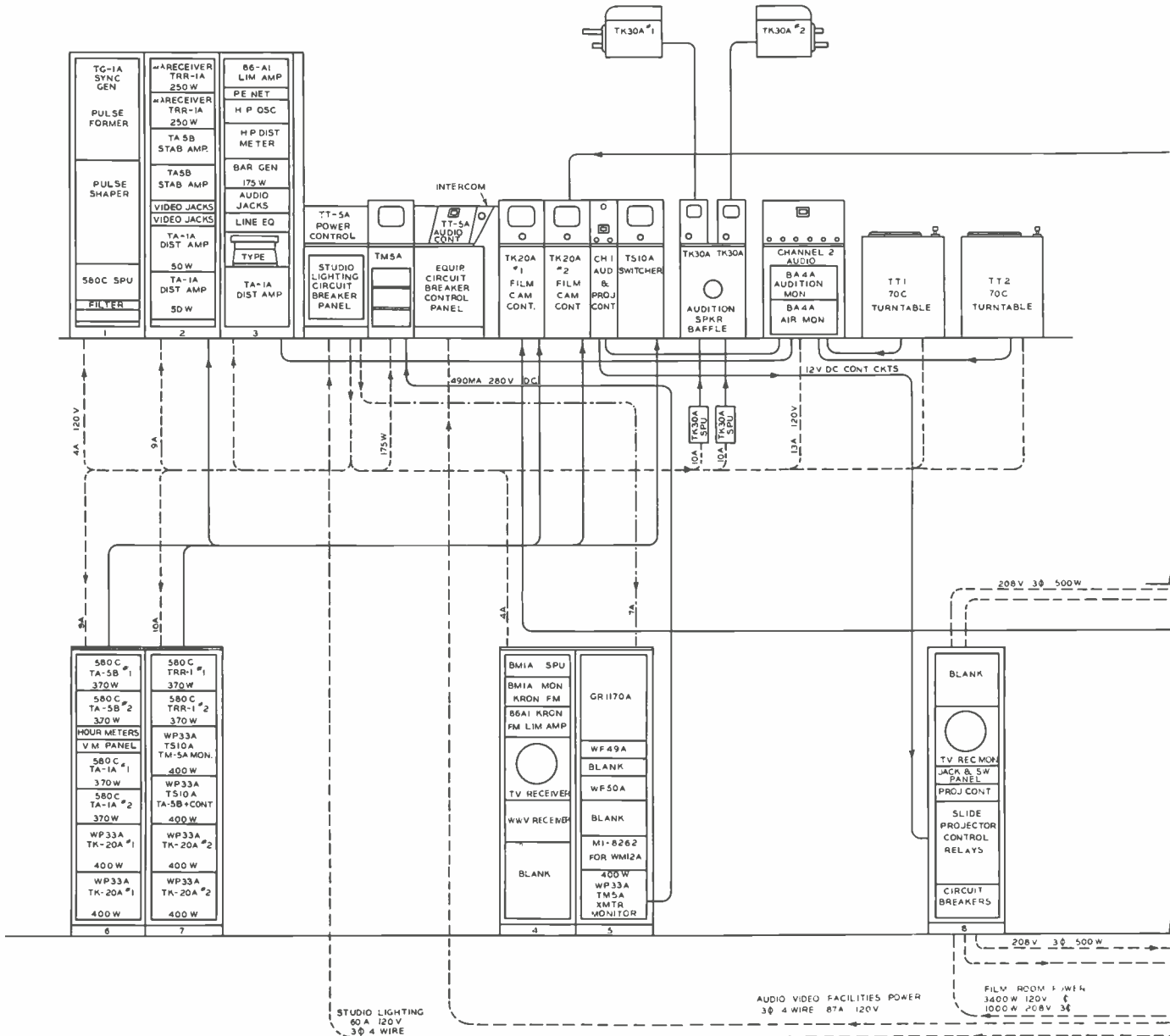
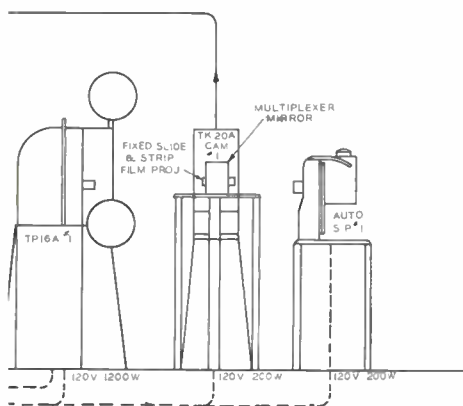
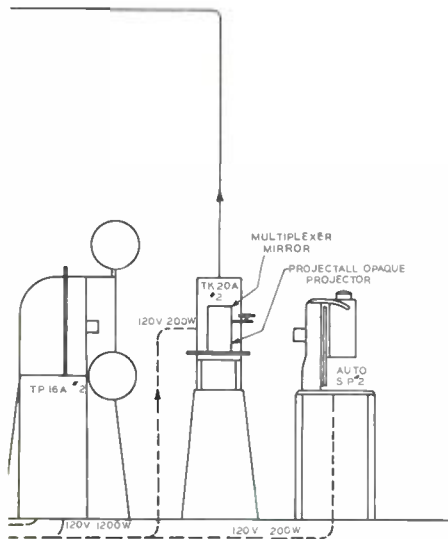



FIG. 19. View of the KRON-TV transmitter (RCA TT-5A) and master control position which includes both audio and video control equipment. At right, audio control and 70-D Turntables are visible.



ond microwave link, and a two-channel audio system complete with magnetic tape recording facilities. A third man is assigned when it is necessary to dolly or change camera positions.

Everything that has a switch or a knob is within a few feet of either operator, whose chairs are on casters. The technicians are trained to handle any function and during periods when either of the men is absent from his chair attending other duties, such as, loading the automatic slide or film projectors, taking meter readings of the transmitters, or setting up the live cameras, the other man assumes his responsibilities. This is possible when the sound portion of the program has been previously monitored as in the case of downtown studio shows, remote broadcasts, film programs, network programs, tone with test pattern, long playing records or sound recorded on magnetic tape.

Although two men are normally assigned when switching operations involves both aural and visual systems such as the beginning and ending of any film program, transition from film to studio or remote, live programming from the mountain stu-

dio, etc., the system is designed so that one man can perform both operations which he customarily does during test pattern transmission.

Innovations in the film room design include automatic slide projectors which are controlled from the video operator's console; remotely controlled 16mm film projectors with rapid braking; modification of the 16mm film projectors to utilize reels with up to 3600 feet of capacity; and eliminating film make-up and splicing from the operation function makes it unnecessary to man the film room except for loading the projection equipment. In the event of splice breaks or loss of a film loop, the audio man takes over the camera control as well as audio, and the video man covers the film room which is only a few feet behind his normal operation position.

Directly behind the operating console is located a 12-by-19 foot TV studio large enough for two studio sets and two TK-30 cameras. By means of rolling backdrops this studio is readily converted from a TV news room to a set where commercial demonstrations may be made. Hot and

cold water, sewer connections, and outlets for electrical appliances are provided for such demonstrations. This studio is especially useful on weekends, holidays and for late night operation, and since it is not necessary to keep the downtown studio manned for more than five days a week, there is considerable saving in operating cost.

For some shows, two fixed-position unmanned cameras are often used. For shows requiring panning and focusing of two cameras, one technician is assigned to handle both of them. This may seem hazardous on first thought, but in the small studio he merely has to move three feet to pan and focus the other camera, and the production is directed accordingly.

Most of the live productions have an established format or are entirely extemporaneous. The unusual sequences of the shows from the mountain studio are rehearsed, but it has been found that with the small crew of two or three skilled technicians and a producer-announcer, organization and teamwork prior to and during the show always results in a satisfactory performance.

The operating console and rack arrangement is shown in Figs. 18 and 19. The RCA TG-1A Synchronizing Generator is on the left. The video equipment rack is adjacent and contains two RCA TRR-1A microwave receiver control units, two RCA TA-5B Stabilizing Amplifiers, a modified RCA TV Jack Panel, and two RCA TA-1A

Distribution Amplifiers. The third rack contains the RCA 86-A1 Limiting Amplifier, Audio Oscillator, Magnetic Tape Recorder, Audio Jack Strips, Video Bar Generator, Line Equalizer and one RCA TA-1A Distribution Amplifier.

The first section of the console is the RCA TT-5A transmitter power panel. In the space below the operating shelf is located a circuit breaker panel for the TV studio lights.

The second section of the console is an RCA TM-5A Master Monitor associated with monitoring input and output of the TT-5A Transmitter. The third section is an RCA 90-degree desk section which accommodates the aural and visual control

FIG. 20. Block "System" diagram showing the interconnection of KRON video facilities.

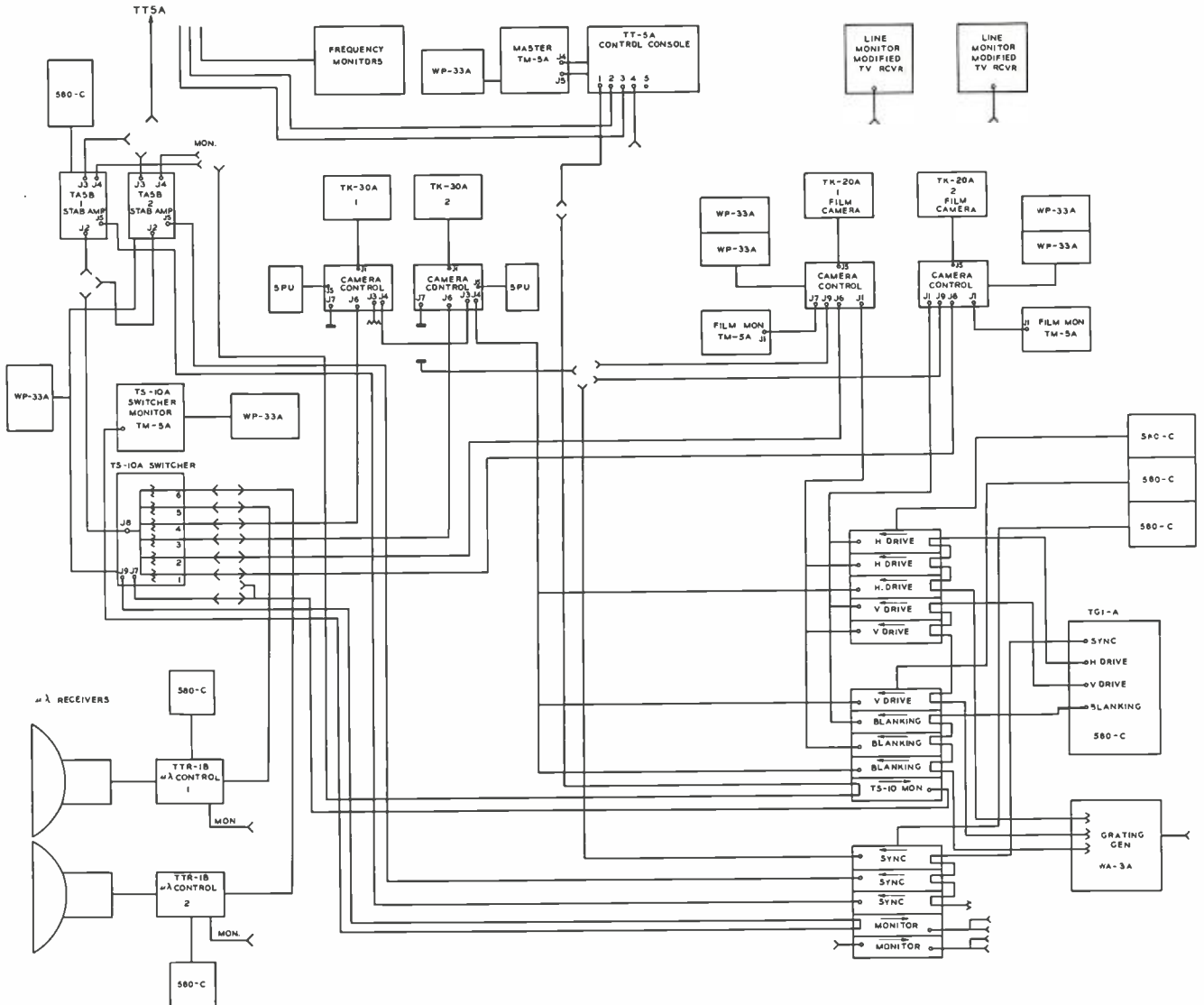





FIG. 21. Close-up view of part of the KRON-TV master control desk. Shown left to right are: William Sadler at video controls, Jule Vetter at audio control position, and Marc Spinelli, producer-announcer.

panel for the TT-5A, and the intercom equipment from master control to TV studio, film room, front door, FM studio, and shop. The circuit breaker panel for all TV and audio equipment (other than the film room and the transmitter) is located under the operating shelf on this console section.

Next are located control equipment for two RCA TK-20 film cameras; a special panel for remote control of all slide and motion picture projectors; a two-channel audio mixer having a choice of ten input circuits selected by push buttons; and an RCA TS-10A Switcher.

Two TK-30 Camera Control Units are mounted on an adjacent composite corner console within easy reach of either the video or audio man. While the video man is shading a film chain, the audio man sets up the TK-30 cameras. During a live show, the audio man monitors audio levels and the video man conveniently operates the camera controls which are adjacent to the TS-10A Switcher. The block diagram of the video facilities is shown in Figs. 18 and 20.

The audio console contains the equivalent of a relay rack of RCA audio equipment and was specifically designed and

built for our operation by KRON-TV engineers. Two mixer channels are provided, Channel 1 being the two mixer channel for the video control position, and Channel 2, which is a six-position mixer located in the audio console. A unique circuit arrangement permits transferring a program from one channel to the other or simultaneous operation with both channels feeding the program buss. This feature is very useful for auditioning live shows, film, etc., and also permits feeding recorded music for aural backgrounds into the studio and on the air simultaneously without danger of acoustical feedback. Fig. 22 shows the block diagram of the audio system.

The remote control of the projection equipment, turntables and magnetic tape equipment is accomplished by means of a 12-volt d-c power supply and relay system. Turntables and magnetic tape machines may be started and stopped from either the Channel 1 or Channel 2 audio console positions. Transcribed aural station identifications or sound on film are normally used unless an announcer is available in the studio.

The automatic slide projectors were carefully selected from a number of com-

mercial models and were modified to suit our requirements. The modification consisted of a new cam, a reversible motor, a new lens barrel, a modification of the blower system to keep the slides cool, a variac for the lamp, control relays and rewiring.

The location of the power supplies in racks removed from the operating area reduces the heat and eases ventilation requirements for the operating personnel. All power leads were shielded wires run in trenches. All a-c power circuits were run in conduit. A grid of copper strips was laid on the ground prior to pouring the concrete floor slab and tabs from this ground system appear in the trenches at intervals of approximately four feet. R-f interference and cross talk has been a minor problem in the entire installation with the exception of the necessity for some additional filtering of the plate supply of the microwave receivers to eliminate a "wind shield wiper" on microwave programs caused by a beat between synchronizing generators. The ground system was planned to avoid "ground loops," paint was removed from the rails which support rack mounted equipment and bonding proce-

dures were given careful attention during the assembly of the transmitter.

### Downtown Studios

The KRON-TV studios were constructed on the ground floor of the Chronicle Building in downtown San Francisco. The floor plan is shown in Fig. 25, offices and a rehearsal studio are located on the second floor. The noise isolation problems in a newspaper building are numerous and except for other compelling factors, the construction of TV and radio studios in such a building is not always a wise choice.

The noise levels and vibration amplitudes were measured during all anticipated hours of operation of the station and under every condition of noise usually encountered in the building. Test floor slab sections and wall sections were constructed

and likewise were checked during noisy operating periods.

Consideration was given the ambient noise level in a TV studio with camera blowers, ventilation noise, rustle of clothes, etc., as well as the relation of the microphone with respect to the source of noise. It was decided that an ambient noise level due to the above causes will average between 30 and 35 db below program level under usual operating conditions with present equipment, but 98% of the TV receiver owners will not hear this noise because their small loudspeakers will not reproduce the low frequencies.

The walls enclosing the studio space were constructed of hollow tile with plaster on both sides, both brown and white coat, and will isolate airborne sound levels of the order of 40 db. However, these walls contain all the vibration in the building, and

the inner walls of the studio are designed to reduce the conducted vibration noise as well as to provide desired absorption characteristics.

Adjacent to the tile wall is an overlapping layer of 1/2" celotex wallboard, then an air space, then a free standing 2" x 4" stud wall on 16" centers with 1/2" celotex panels adjacent to the air space and bridging between studs. The bridging serves two purposes: it stiffens the wall and also supports the glass wool bats which fit between the studs. The walls were then covered with flame-proof white muslin and poultry netting was stretched over the muslin as an outer protection. The stud wall rests upon a celotex pad at its base.

The ceiling already existed as metal lath and plaster suspended on wires but with no isolators. Since quiet office areas were

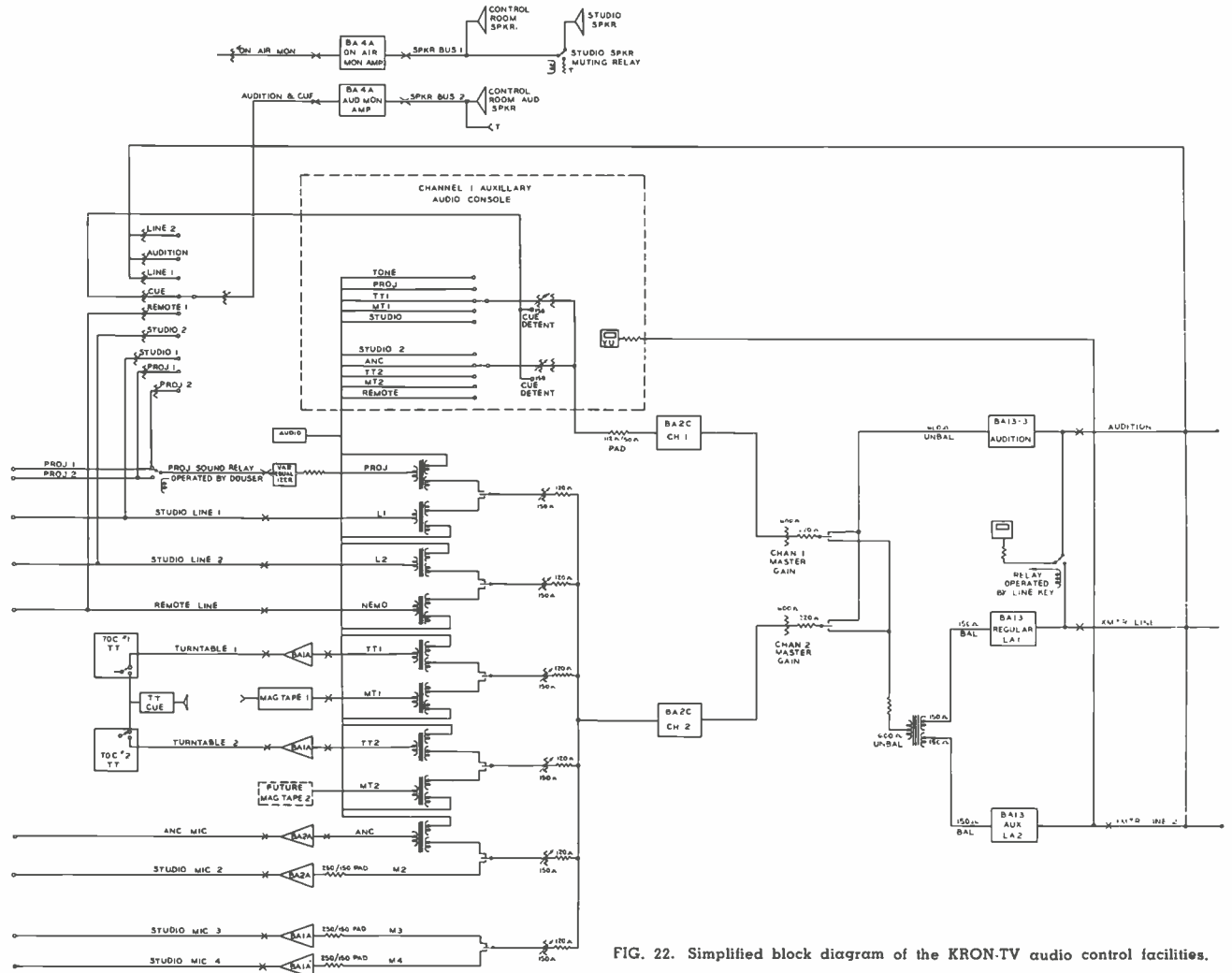

FIG. 22. Simplified block diagram of the KRON-TV audio control facilities.



FIG. 23. View of the KRON-TV mountain studio in operation as seen from the master control desk. At left, audio control position is partially visible.

above the studio, this ceiling was not modified with isolators but was merely furred down to accommodate the fiberglass batts, muslin and chicken wire.

It was decided to leave the floor isolation to the last and to decide about it after the entire studio was enclosed. Because of the fact that the printing presses are mounted on isolators, very little noise is transmitted from them to the building. The airborne noise level in the press room is of the order of that in a subway with two express trains passing each other, but this noise is very effectively isolated by the wall construction of the studio and other partitions which exist between the studio and the press room.

After several weeks' operating experience, it was decided that since the studio ambient noise was much greater than the press room and other building noise transmitted through the floor, the isolation of the floor would be of little value and might aggravate the situation, since if its natural frequency was in the range of the building vibration frequencies, resonance could occur.

The concrete floor was leveled with mastic pave and then covered with rubber tile of a light shade. The rubber tile absorbs foot falls and is more satisfactory for studio use than asphalt tile. The light

shade was chosen to aid lighting by reflection and for its appearance on the monitor screens.

The studio sets are arranged so that they may be lighted and left unmolested from week to week. Eight sets including a complete electric kitchen may be so arranged. A combination of 40-percent 4500 white fluorescent light for overhead and general illumination with 60-percent incandescent flood and spotlights for modeling, back light and key lighting is used. The fluorescent lighting is from Allen Olsen 600 ma slim-line units, and the reactors are mounted in a cabinet in the basement. All lighting circuits appear on 3-wire twist-lock and Cannon receptacles mounted on the pillars in the studio. Cords from the lighting fixtures, which are mounted on a ceiling pipe grid, are protected by circuit breakers located in the control room.

Normal studio operation requires a technical staff of five men. The group supervisor customarily acts as camera control operator and switcher, two men are each assigned cameras, one man audio and microwave, and a junior technician is boom operator. All men are licensed operators and can rotate in assignments.

An air lock between the control room and the studio is designed as an announce

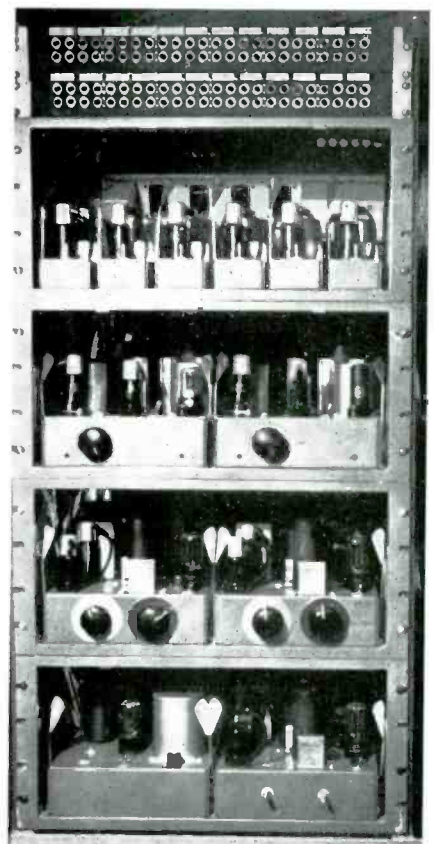

FIG. 24. Partial rear view of the KRON-TV audio console with panels removed to show RCA plug-in amplifiers. Two BA-4A Amplifiers are mounted on front side under operating shelf.

booth and permits the producer of a show to also serve as an announcer. An off-the-air monitor receiver is provided and the announcer has control of his microphone switching and communication with the control room.

Provision is made in the equipment room for future film projection facilities, but at present all film originates at the transmitter. By comparing the phasing of the two synchronizing generators prior to a show, it is possible to make switches from studio to transmitter without rolling frames on home receivers.

For approximately the first year, KRON-TV operated six days a week with a test

pattern schedule of 12 hours, a live program schedule of 20 hours, and approximately 30 hours of film including kinescope recordings. Eight technicians and a chief engineer comprised the technical staff; and three producer-announcers, one film editor, and a program director comprised the program department. The station is now in its second year of operation and it operates on a seven-day schedule. It has doubled its operating time; increased its studio space 50 percent; its program staff, 200 percent; and its technical staff, 250 percent.

The achievement of the goal to make KRON-TV an economical and practical

television station would not have been realized without the wholehearted interest and cooperation of Mr. Charles Theirot, Manager of KRON-TV; Mr. Harold P. See, Director of Television; and the program staff. Credit is especially due Mr. William Nielsen for the construction of the audio consoles, William Sadler for the video system installation, Jule Vetter for the transmitter installation, Donald Anderson for projection remote control, Roger Woodruff for power circuit engineering, Fred Street for studio plans, Ed Price and Hal Simpson for studio techniques, Lee Berryhill and Granville Esch for the studio-audio installation.

FIG. 25. Floor plan, showing the studios and other facilities located at the Chronicle Building in San Francisco.

FIG. 26. The control room at the Chronicle Building studio. Two RCA TK-30 Cameras are normally utilized but four can be used when necessary. Two TTR-1A Microwave Links and STL facilities are used to send visual portion of program to San Bruno mountain.

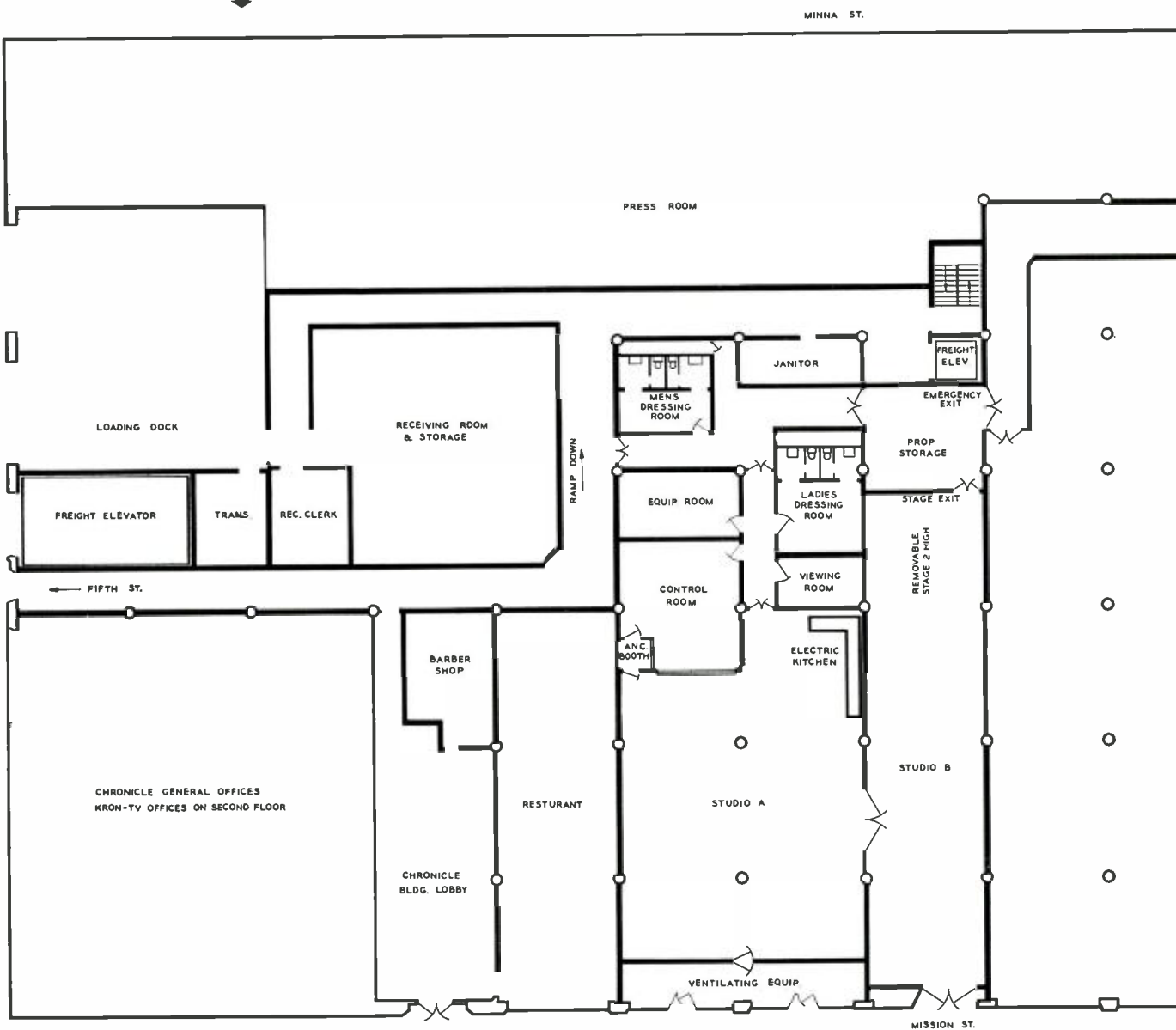

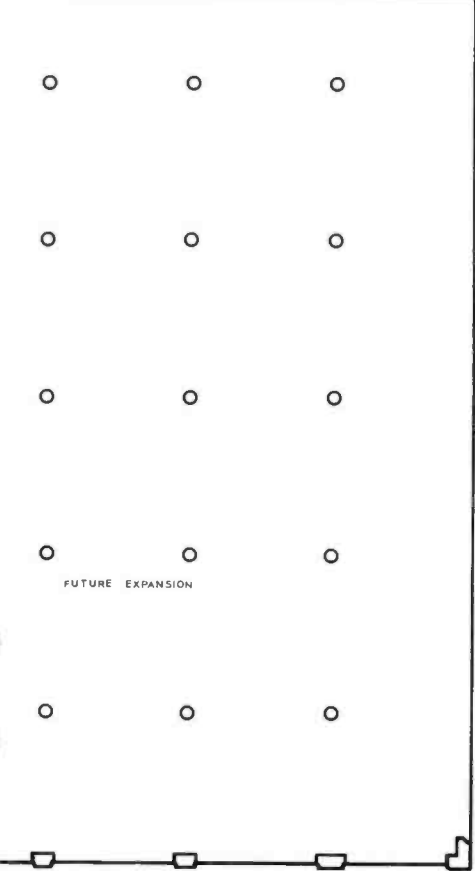
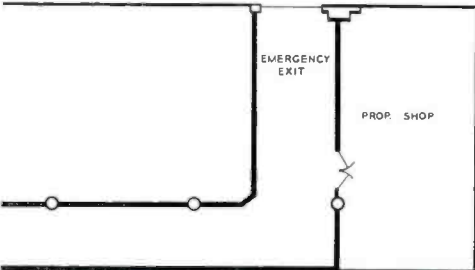
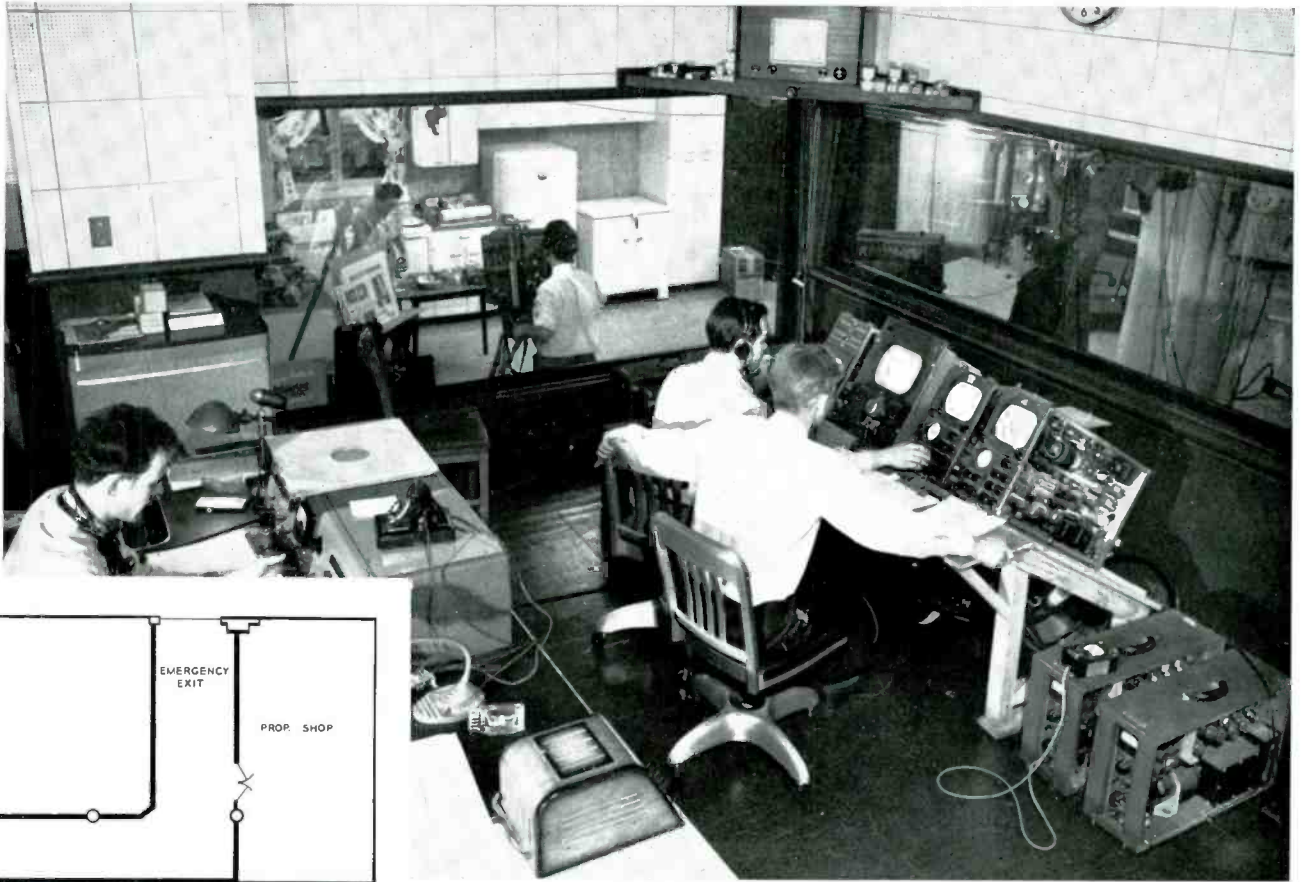

MARY ST



## Field Engineering Service to Broadcasters...AM, FM, TV

RCA Service Company engineers are experienced in all the latest techniques and are equipped with the most modern specialized measuring equipment. The RCA Service Company has been working hand in hand with the nation's broadcasters for over 25 years.

### OUR SERVICE TO BROADCASTERS...

- Installation supervision and measurements of transmitting, studio and accessory equipment . . . AM, FM or TV.
- Instruction and training of station operating personnel.
- Measurement and curves on FM and TV antennas and accessory equipment, including transmission lines, matching networks, diplexers.
- Prompt help in emergencies. Technical advice, service, and assistance on special problems.
- Performance measurements and adjustments for station compliance with FCC regulations.

For further information call or write Communications Service Section, RCA Service Company, Inc., Camden, N. J.

*(For service outside the U. S. A., consult your Authorized RCA Distributor)*

NOW—restore the original quality of your RCA microphones, transcription pick-ups and test and measuring equipment under the new Factory-Reconditioning Plan. For complete details, write: Return Apparatus Control, Building 8-2, Camden, N. J.



**RCA Service Company, Inc.**  
A Subsidiary of the Radio Corporation of America  
CAMDEN, NEW JERSEY

# WNAG'S NEW "250", BTA-250M

By **ROBERT McRANEY**

General Manager  
The Mid-South Network

**WNAG** of Grenada, Mississippi, which is now operating full time with a brand new RCA BTA-250M, is affiliated with the Mutual Broadcasting System and the Mid-South Network. The WNAG installation represents one of the first (if not the first) of the new RCA transmitters to be put into service. Transmitter operation has been exceptionally stable and



Mr. Robert McRaney, General Manager,  
Mid-South Network.

reliable. It is well suited for the "combination" type of operation employed at WNAG where the announcer is also the engineer, etc.

## WNAG Building Facilities

WNAG is housed in the building formerly occupied by the Administration offices of the old Grenada College for Women. The Barwin Hotel, which now occupies the old dormitory of the school, converted the administration building into apartments, leaving the entire ground floor for WNAG facilities. Because the school had a large campus area, we were able to locate the tower adjacent to the "studio-transmitter" building to effect a combined and compact setup.

As shown in the floor plan, the ground floor layout provides adequate room for the transmitter and associated test equip-

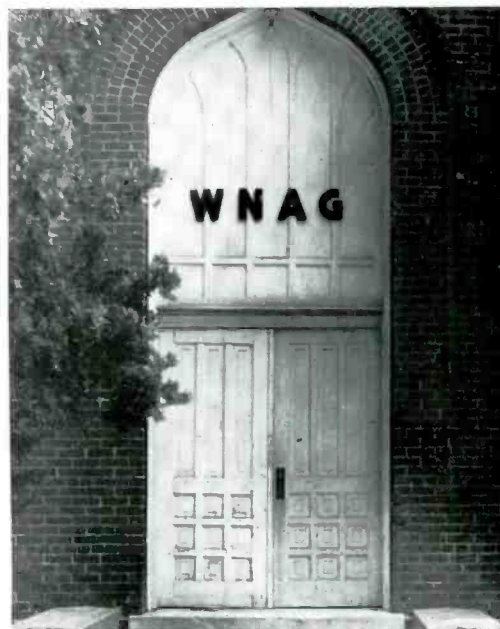

FIG. 3. View of the entrance to WNAG's station building.

ment, two studios and associated control, lobby, offices and workshop.

## The New BTA-250M

The new transmitter occupies the central part of the "transmitter room" space and is flanked by a relay rack containing RCA Frequency and Modulation Monitors and patch panel on one side—and the old RCA 250-D Transmitter on the other side. The old transmitter is now employed as a "standby" and is a converted exciter unit of an RCA 1-D which gave many years of excellent service, first at KITE, Kansas City, later at WROX, Clarksdale, Miss., and finally at WNAG.

The new BTA-250M transmitter employs a pair of 813 tubes in parallel as power amplifier, modulated by a pair of 813's operating class B. The oscillator employs the TMV-129B temperature-controlled crystal unit. The output of the oscillator feeds a single RCA 807 tube operating as a buffer amplifier. The 807 buffer in turn drives the power amplifier.

New circuit design in the BTA-250M simplifies transmitter adjustment and operation. There is only one tuning control



FIG. 1. View of WNAG's transmitter room.

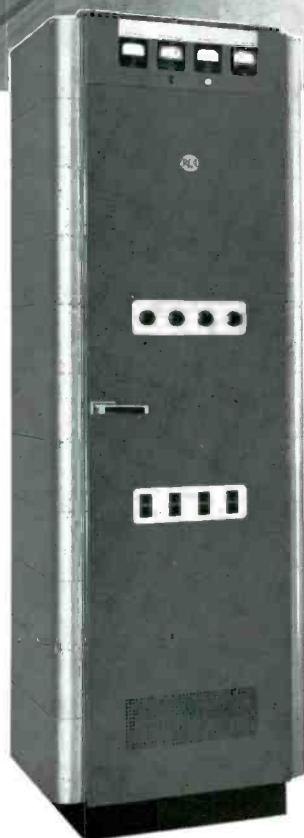

FIG. 2. Close-up of the BTA-250M transmitter which is mounted in a standard cabinet rack for maximum convenience.

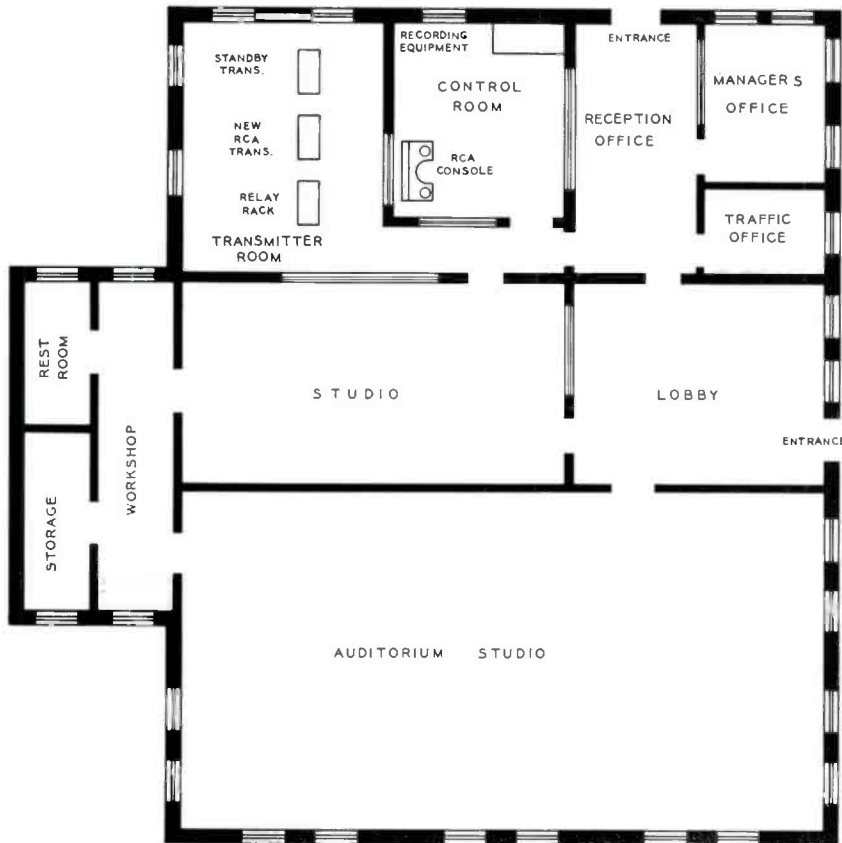

FIG. 4. Floor plan showing layout of building to accommodate transmitter and studio facilities.



WNAG coverage contour map.

and one power output control in the entire transmitter. The tuning control is a variable capacitor in the plate circuit of the power amplifier, and the power output control is a variable resistor in the cathode circuit. For the low level r-f stages, the 807 crystal oscillator plate is broadly tuned by an inductor with suitable taps to cover the broadcast band. The 807 buffer plate is also broadly tuned for the entire broadcast band.

#### Studios

WNAG studio facilities consist of two studios (one an "auditorium" type) and a studio control room which houses the audio control, turntables and recording equipment. The RCA Console is arranged so that the operator has visibility into the transmitter room and adjacent studio. This facilitates operation since at WNAG the engineers also serve as announcers in a "combination" type opera-

tion. In addition, WNAG employs RCA microphones, sound system, and remote pickup equipment.

#### Staff

Tom McFerrin, Chief Engineer for the Mid-South Network, was in complete charge of the WNAG transmitter installation which proceeded smoothly in all respects.

The WNAG station staff includes three who can double as full-time engineer-announcers. Mr. Monroe Looney, Station Manager, holds a first class license himself and can also double as Chief Engineer and announcer. The balance of the staff consists of a part-time announcer-salesman, a receptionist-copy writer and a bookkeeper.

FIG. 5. A view of the control room of Radio Station WNAG. The RCA console and varicoustic mike are shown. The console operator faces a window separating the control room and the transmitter of WNAG. At WNAG the engineers also serve as announcers in a "Combination" type operation.



Monroe Looney, Station Manager for WNAG.

FIG. 1. Waveforms showing significant levels and details of the standard scale for measuring video levels.

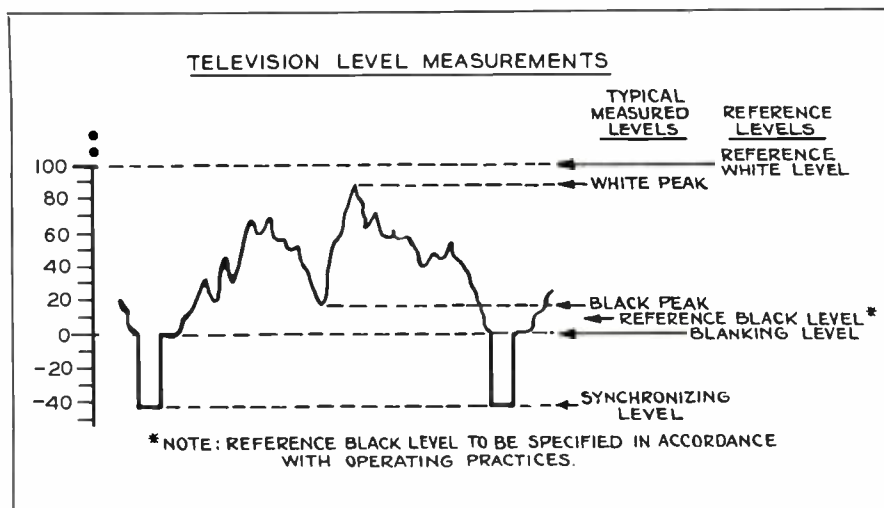

# STANDARDIZING AND MEASURING VIDEO LEVELS IN A TV STATION

## Introduction

The subject of video levels in television broadcasting, from standpoints of both standardization and measurement, has been going through a slow process of evolution ever since the early experimental broadcasts in the 1930's. At first, as should be expected, the significance of all the factors was not fully appreciated, and, as a result, accepted values and methods have been changed from time to time in an effort to keep pace with the advances in techniques and equipment. There is no assurance that this evolution has now reached its final stage, but substantial changes which have developed recently are a sufficient reason for restating the situation as it appears to be at present.

## Review of Past Practices

In 1936, the first major installation of television broadcasting equipment in New York was made in the studios of NBC in Radio City. One feature of this installation which bears on the subject of levels was a mile and a quarter of coaxial transmission line connecting the studios to the transmitter in the Empire State Building. With the lines and equalizers used at that time, it was thought necessary to feed the input of the line at a level of about 5 to 10 volts, peak-to-peak, in order to secure an acceptable signal-to-noise ratio at the transmitter input. This situation set the pattern for line amplifiers at the studio

by **J. H. ROE**

TV Terminal Equipment Engineering

output until the approach of the development of commercial equipment during the last year of World War II. Video levels within the studio plant during that period were generally set at about 1 volt, peak-to-peak.

In connection with post-war developments, there was activity in technical committees of the Radio Manufacturers' Association (now the RTMA) to evolve suitable standards for commercial television equipment. Among the standards adopted by these committees in 1946, was one which specified that studio output amplifiers should be capable of producing a level of 2 volts, peak-to-peak, of composite picture signal, including about 0.5 volt of sync. At that time, there were some wire line interconnections in use in New York provided by the Telephone Company and consisting of ordinary telephone cable pairs with equalizers spaced at frequent intervals. The 2-volt level was considered high enough to avoid objectionable noise, and low enough to avoid noticeable cross talk in the telephone cables. Furthermore, it appeared to be possible to develop this voltage efficiently with acceptably low distortion, on a 75-ohm transmission line load by using a single 6AG7 tube in the output stage of a studio amplifier. It was also felt that the use of a 2-volt level

would permit simple and economical designs of picture monitors with a minimum amount of video signal amplification. In RCA pickup equipment, the 2-volt level was adopted as standard on nearly all 75-ohm interconnecting circuits carrying composite signals, and a 1.5-volt level on 75-ohm circuits carrying non-composite signals (no sync present).

The cathode ray oscilloscope (CRO) has been used universally, during all these various stages of evolution, primarily as a level indicator, but in addition as an indicator of quality of the picture signal. One typical example of its use as a quality indicator is found in the adjustment of shading signal controls where the CRO gives a more critical indication of uniform background than does the eye by direct observation of the monitor kinescope.

## Recent Trends

The rapid and continuing growth of network facilities, together with the almost unbelievable expansion of studio facilities in some of the larger stations with all their highly complex interconnections, has made evident some weaknesses in the adopted video level standard as related to the design of equipment which is in widespread use at present. It has become apparent that the earlier concept of acceptable amplitude distortion limits in line amplifier stages has to be modified when applied to a large system where the number of equipment units is greatly increased as compared



to that involved in a small operation. For example, a signal originating in an outlying studio of a large station may be passed through as many as ten line amplifier stages before arriving at the transmitter. If the signal is fed through a cross-country cable network, it may pass through several hundred repeater amplifiers before reaching its destination. It is obvious that the distortion in any one amplifier must be held to an extremely low value if the cumulative distortion in such a system is to be tolerably small.

Amplitude distortion of a television picture signal results in unnatural tones of gray in the reproduced scene. The most common type of distortion changes tonal gradation in the light grays and near-whites. Faces may look too white and washed-out, and lack any appearance of depth. In order to illustrate the significance of a small amount of distortion in a single amplifier unit which is part of a large system of many similar units, let us assume that the permissible limit of compression of the whites accumulated in the entire system is 25%. This particular value has no special significance, but it is an amount of compression which is observable, and may be assumed for purposes of discussion. In the case of a system having 100 amplifiers in cascade, the compression per unit would have to be less than 0.3 of 1% to stay within the assumed limit.

Fortunately, the network equipment is designed to avoid distortion to an acceptable degree. On the other hand, many studio amplifiers do not have adequate linearity to provide satisfactory operation in cascade in large numbers with a level of 2 volts. Rather than recommend modification or replacement of the large number of such amplifiers now in use, with attendant high cost and inconvenience, it seemed preferable to recommend a reduction in the standard signal level which would make possible a noticeable decrease in distortion without an appreciable increase in noise.

This problem came to a head early in 1950 in New York which had by that time become the principal source of network programs on television. Another problem had also been adding to the confusion, namely, that in spite of the RTMA standard 2-volt level for video amplifiers, there was no adherence to any operating standard in this matter. The levels put out by the New York stations were nearly all different, determined largely by requirements of common carrier equipment used for interconnections and for networking. These varying requirements resulted from the fact that common carrier terminal equipment had grown up with the demand; it represented, in some cases, different stages of development, and did not adhere to one standard in the matter of levels.

The situation was given special attention by an informal committee composed of representatives of the six television stations in New York City and of the Telephone Company and of some interested manufacturers of television equipment. This group held several meetings between May and September and proposed a standard operating level of 1.4 volts, peak-to-peak, of composite signal as outlined in Fig. 1. The new level has subsequently been adopted by the New York stations as well as by some others. It has been agreed that this level will be satisfactory in the common carrier operations though there will be a transition period required for modernizing some of the existing equipment during which it may be necessary to continue the use of other levels.

### The IRE Standard Scale

The choice of the new level of 1.4 volts was guided, of course, by the need for reduced distortion, but in addition, it was influenced by the recently adopted IRE Standard\* which included, among other things, a standard scale for measuring video levels. This scale is shown in Fig. 1 which is a reproduction of the diagram in the IRE Standard. The special committee of

New York broadcasters and television manufacturers decided to recommend correlating the new video level in volts with the arbitrary units in the IRE scale. The desired relationship is given by the expression:

$$\text{Video Signal in Volts} = \frac{\text{Number of IRE Scale Units}}{100}$$

### Practical Scales for CRO Tubes

The three scales shown in Figs. 2, 3, and 4 were recommended by the Special Committee for practical use on the faces of 5-inch CRO tubes as follows:

#### SCALE 1 (Fig. 2)

To be used with either studio or film camera controls where non-composite (no sync) signals are used. Blanking level is at 0; reference black is indicated at 10; and reference white is at 100. Total deflection is 2 inches between 0 and 100.

#### SCALE 2 (Fig. 3)

To be used at studio or master control outputs, or for preview monitors, or for any monitor where composite signals are present. Sync peaks are at -40; blanking is at 0; reference black is indicated at 10; and reference white is at 100. Total deflection is 2 inches between -40 and 100.

#### SCALE 3 (Fig. 4)

To be used at the transmitter location where composite signals are present and where it is desired to measure depth of modulation. Scale numbers on the left

\* STANDARD, 50 IRE 23.S1—TELEVISION: METHODS OF MEASUREMENT OF TELEVISION SIGNAL LEVELS, RESOLUTION, AND TIMING OF VIDEO SWITCHING SYSTEMS, 1950. This standard was published in the May, 1950 issue of Proceedings of the IRE. Reprints may be purchased from the Institute of Radio Engineers, 1 East 79th Street, New York City, for \$0.70 each.

FIG. 2. Operating scale No. 1 for use at camera controls.

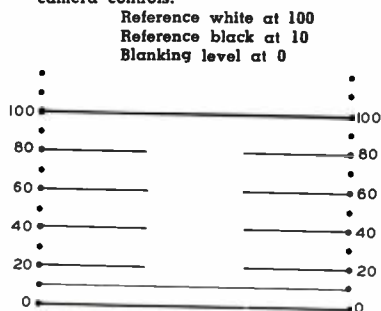

FIG. 3. Operating scale No. 2 for use with composite signals.

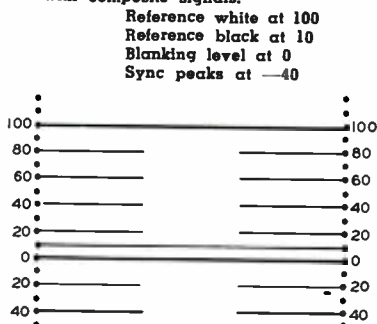
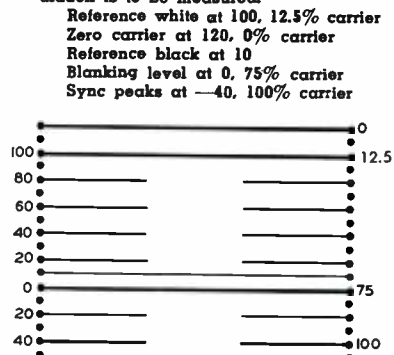

FIG. 4. Operating scale No. 3 for use at a transmitter location where depth of modulation is to be measured.



hand side are the same as for Scale 2. On the right hand side, the numbers are per cent of modulation. Total deflection is 2 inches between -40 and 100, or between 100 and 12.5 on the per cent scale.

The value of 2 inches for vertical deflection on the CRO using the new scales was adopted after tests which indicated that this deflection was reasonably linear in present equipment. Units which were not linear at 2 inches of deflection were found to contain subnormal amplifier tubes.

A fortuitous relationship between the IRE standard and the proposed operating level is evident in Fig. 4. Here the numbers on the right hand side of the scale indicate per cent of modulation of the r-f carrier and show how it relates to the IRE scale. By setting zero carrier opposite 120 on the IRE scale, and maximum carrier opposite -40, blanking level (or zero) corresponds with 75% of maximum carrier, and reference white (or 100) corresponds to 12.5% which is the minimum allowable carrier level. Thus the F. C. C. specifications on carrier levels are embodied in this same scale.

#### Recommended Use of New Scales

Experience over several months of operation in a number of television stations has shown that the new voltage level and the new scales are a substantial aid in attaining improved performance. As a result of this experience, a recommendation has been sent to the RTMA that its standard be revised to specify a video level range of 1.4 volts, peak-to-peak, for studio equipment. The recommendation is now being considered in the technical committees of the RTMA.

It is highly recommended that all television stations adopt this level in operating practice as soon as practicable. It will not only improve performance, but it will do a great deal to facilitate the interconnection of stations and the exchange of programs through the networks.

#### Availability of Printed Scales

For those users of Master Monitors, or other equipment employing 5-inch CRO tubes, scales, similar to those shown in Figs. 2, 3, and 4, printed in black on thin clear plastic, may be obtained by writing to the Editor, BROADCAST NEWS, Building 15-7, RCA Victor, Camden 2, New Jersey. These scales may be applied to the faces of CRO tubes with pieces of transparent adhesive tape. This type of scale is not as durable nor as easily visible as is consid-

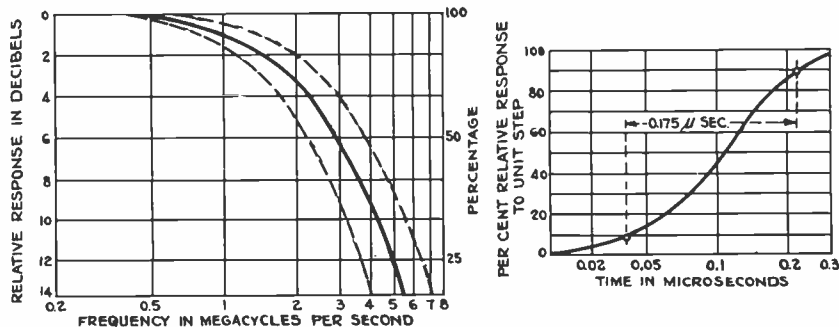

FIG. 5. Curves showing frequency and time response for a standard oscilloscope.

ered desirable, but it is being made available as a temporary measure until the design of a more satisfactory type can be completed.

#### Setup

The term setup, though not officially recognized, has been, for a long time, applied to the difference in level between blanking level and reference black. In a perfect television system, it might be possible to hold setup to zero with satisfactory results. By doing so, it would be possible to obtain the most efficient utilization of video, r-f, and i-f amplifier characteristics. However, perfect signals would be required, without amplitude distortion (overshoots in the black direction), and very careful adjustment of the background controls in receivers would be required to avoid retrace lines or clipping of blacks in the kinescope.

By raising setup to some reasonable value, it is possible to realize much more practical operating conditions. Small black overshoots can be present without extending into sync territory, and in the receiver it is possible to adjust the background control so that retrace lines are surely blanked out without clipping black peaks in the picture signal.

In the PICTURE LINE AMPLIFIER STANDARD OUTPUT adopted by RTMA (Revised Oct. 9, 1946)\*, the recommended amplitude of setup is 5% of the difference between blanking level and reference white level. This corresponds to 5 units on the IRE scale. Experience in most stations has shown the desirability of increasing this amplitude to about 10%. The increase reduces the utilization of amplifier characteristics, but it improves overall performance by allowing more tolerance for overshoots in the blacks, and by permitting final clipping at blanking level in stabilizing ampli-

fiers in order to eliminate overshoots in the sync region. This clipping usually reduces setup somewhat below 10%, a process which would not be permissible if the initial value of setup were only 5%. For these reasons, the scales adopted for operating use include a line at 10 to indicate the maximum amount of setup. This 10% line, as well as the zero line, is made continuous across the scale to emphasize its importance.

The maintenance of constant setup, at all times, is extremely important in order that brightness adjustments in receivers should not require changing. This is important in successive scenes in any one program, and it is equally important in successive programs, whether they originate in the same station or not. It is, therefore, urgent that all stations adopt uniform procedures and uniform instrumentation which will make possible accurate measurement of this and other video levels.

It is recognized that the proposed scales do not permit a high degree of accuracy in measurement, but universal use of the same methods and tools will at least provide the first step on the way toward achievement of uniformity.

#### Instruments for Measuring Video Levels

The cathode ray oscilloscope has been regarded almost universally as the only suitable instrument for the measurement of video levels. Probably, the principal reason for this is that the television signal is a composite of several signals, each having levels that need accurate measurement individually and in their relationship to each other. Circuitry is rather well known which would make it possible to measure any of these quantities by means of a meter with the same advantages that are inherent in the use of audio level meters. However, it is not possible to provide simultaneous measurement of all the quantities in a single meter, and the circuit com-

\* See "The Philosophy of Our TV System," by J. H. Roe, Fig. 5, BROADCAST NEWS, No. 53.

plexities involved in using several meters at each monitoring position would be greater than those associated with a CRO. Furthermore, because of inherent sluggishness, both electrical and mechanical, the meter system is incapable of indicating the presence or amplitude of isolated narrow peaks in the signal. It is also incapable of indicating any information about waveshape in the measured signal, and therefore fails as a monitor of quality.

Because the CRO does measure all levels simultaneously, at the same time giving detailed information about waveshape, and because it has no appreciable sluggishness, it can serve as a universal instrument for indicating both level and quality. Its use as a level indicator over such a long period has undoubtedly established an acceptance which would be difficult to change. In any case, there has been no definite trend as yet away from the use of the CRO in television monitors.

#### The IRE Standard Frequency Characteristic for CRO's

Post-war experience gained in the use of television equipment has shown that the presentation on the face of a CRO tube is easily misinterpreted in the measurement of levels if there are any spurious overshoots in the signal. Overshoots may arise from any of several causes such as faulty circuits or tubes, or from a type of distortion introduced by single-sideband transmission circuits. Sometimes, the overshoots may arise in the measuring instrument (CRO amplifier) itself. It has been found that when spurious peaks are present, different operators do not interpret their significance in the same way. In measuring levels, one operator may discount the presence of the overshoots completely, while another may regard them as a part of the signal to be measured. In network operation, it is particularly important that levels be measured on the same basis at all monitoring points, and it is hardly less important in studio equipment. A desirable solution to the problem of uniformity is to make the measuring instrument insensitive to such spurious overshoots, and thus remove the human factor of interpretation.

To accomplish this result, the previously mentioned IRE Standard also includes a specification of a frequency characteristic for CRO's which are to be used for measuring levels only. This characteristic is reproduced in Fig. 5 from the IRE Standard. The bandwidth is considerably re-

stricted and the "roll-off" at the upper end of the band is gradual. The resultant effect is to eliminate most of the higher frequency components in the signal, including most of the overshoots. Corners of the pulses in normal signals become rounded, but the amplitudes of blanking pulses and low frequency signal components are not affected. Because nearly all scenes contain at least a few relatively large areas of average contrast, the loss of high frequency response in the CRO amplifier does not often affect the accuracy of level measurement. Practical experience indicates that use of CRO's with this response characteristic does help to reduce disagreements among operating personnel about levels.

It should be emphasized that this type of restricted bandwidth is not suitable for gauging the quality of a picture signal, but *only* for measuring levels, and then only to minimize the errors introduced by spurious overshoots. It is rather interesting to note that one early type of television studio monitor (RCA Type KE5, designed in 1936) employed CRO's with a restricted pass band very similar to that in the present IRE Standard. In later versions (RCA Types 542 and TM5) the pass bands were extended to several megacycles to make them more suitable for judging quality. Present design trends are to make both types of frequency characteristic available by switching.

To illustrate the effect of reducing the frequency response, several oscillograms are reproduced in Figs. 6 to 9 inclusive. The wide-band CRO used to obtain the pictures in Figs. 6 and 8 was an RCA Type 715B. The narrow-band CRO used to obtain the pictures in Figs. 7 and 9 was a modified TM-5B Master Monitor. The signal source in every case was a TK-1B Monoscope Camera. Overshoot distortion for Figs. 8 and 9 was produced artificially, and is more severe than is usually encountered, but nevertheless, it serves to show the effect of the restricted band pass of the CRO. Horizontal sweep rate in each case is at one half of scanning line frequency.

#### Modification of Master Monitors

A discussion of methods by which the RCA TM-5A and -B Master Monitors may be modified to provide the IRE roll-off characteristic will appear in a future issue of BROADCAST NEWS.

FIG. 9 (at right). Oscillogram showing the same signal as in Fig. 8, but shown on the Master Monitor with IRE roll-off in the CRO amplifier.

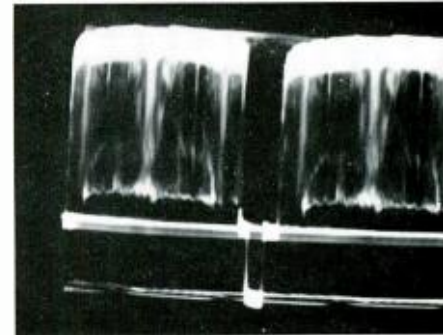

FIG. 6 (above). Oscilloscope showing a normal monoscope signal on a wide-band CRO (RCA Type 715B).

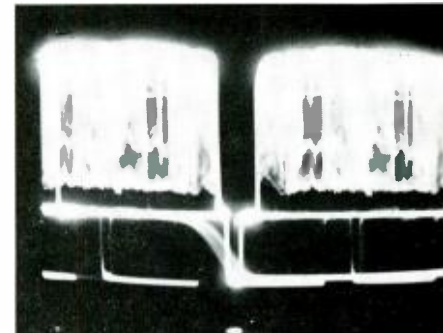

FIG. 7 (above). Oscillogram showing a normal monoscope signal on CRO in a modified TM-5 Master Monitor (CRO amplifier with IRE roll-off).

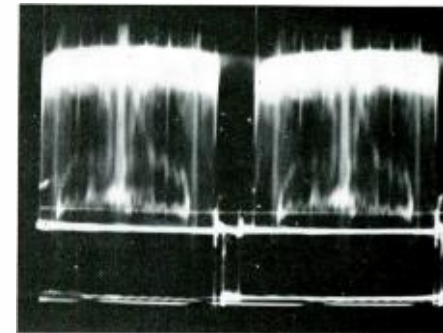

FIG. 8 (above.) Oscillogram showing the monoscope signal with severe overshoot distortion as shown on a wide-band CRO (RCA Type 715B). Note black overshoot in sync region.

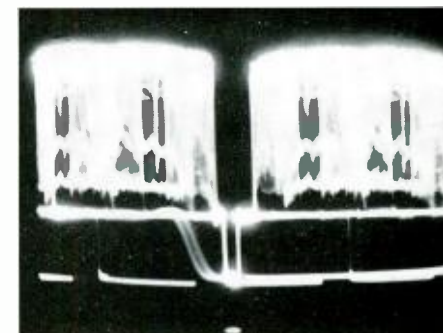



FIG. 1. View of the Radio Division's Studio "B" during a regular program. Visible in back of the studio is the audience room.

# RADIO AT INDIANA STATE TEACHERS

If one word were to be chosen to describe the new radio suite at Indiana State Teachers College, that word would be "accessibility."

Sixteen years of consecutive broadcasting by the college over commercial radio station WBOW resulted in a knowledge of basic fundamentals which should be incorporated in the construction of a radio division. These included: (1) accessibility to the control room during broadcast periods; (2) ease of entrance into each studio when on or off the air; (3) ready movement of guests in and out of the radio center; (4) an auditorium type audience room to accommodate visiting listeners and students; (5) an elevated control room to facilitate cueing; (6) an announcer's room from which perfect control over voice level is possible; (7) an air conditioning system; (8) storage rooms for electrical transcriptions and recordings; (9) a script room; (10) a sound effects display room; (11) a maintenance shop; (12) an adequate office suite; and (13) high fidelity equipment with both rehearsal and broadcast units.

In 1949, when the "go" sign for new radio studios was given, the floor plan shown below was placed in the hands of the architects. This plan fulfilled the requirements listed above as necessary for an efficient broadcasting unit and became the new radio suite.

To equip the radio suite, RCA equipment was used throughout. In the con-

By  
**DOCTOR C. M. MORGAN**  
Director of Radio  
Indiana State Teachers College  
Terre Haute, Indiana

rol room was placed an RCA console, type 76-C with an RCA recorder, type OR-1AX/OR-1A with RCA monitoring and recording amplifier, type BA-14A. The floor of this control room was elevated 14 inches in order to enable the engineers and directors to have complete visibility of studios "A" and "B" and the Audience Room. Studio "A", used for "talks" programs, round-tables, and an announcer's room was equipped with two Bantam Velocity Microphones, Type KB-2C. These were selected because of their sensitivity, narrow dead sides and the fact that these microphones do not obstruct the faces of the speakers.

Studio "B" is the main studio of the radio unit. From this point originates all drama and music shows broadcast from the college. To handle this multiple use, three RCA Velocity Microphones, Type 44-B and one Type 77-D Poly-directional Cardioid Microphone were selected. A unique feature of studio "B" is the RCA Sound Truck built to furnish backgrounds of mood and transitions music and sound effects used in the drama shows. The Sound Truck has two dual speed turntables, an interior speaker plus connections for a re-

mote speaker, gain controls for each turntable, an off-on switch for speakers and facilities for cueing transcriptions by means of a headset. Ample storage space is provided in the Sound Truck for transcriptions and recordings to be used on the shows.

The Audience Room of the Radio Division serves a dual capacity. Throughout the school day it is used as a college classroom for students enrolled in the field of radio. During the broadcast periods, this room becomes an audience room to accommodate visiting college dignitaries, alumni, college students, and hundreds of children from the listening area who come each week to see the programs being broadcast for their class room use. This room has elevated tiers upon which movable chairs have been placed. This makes it possible for various size groups and individuals to be accommodated. For example, small chairs may be brought in to accommodate children of the elementary grades. To adequately serve the listeners, an RCA duocone Type LC-1A Speaker was installed.

To complete the equipment of the radio suite, test equipment and supplies were placed in the maintenance shop. Metal files for the storage of transcriptions and scripts were installed in the transcription and script rooms, and the sound effects room was supplied with manual sound effects within the construction range of school groups. This room is so located that

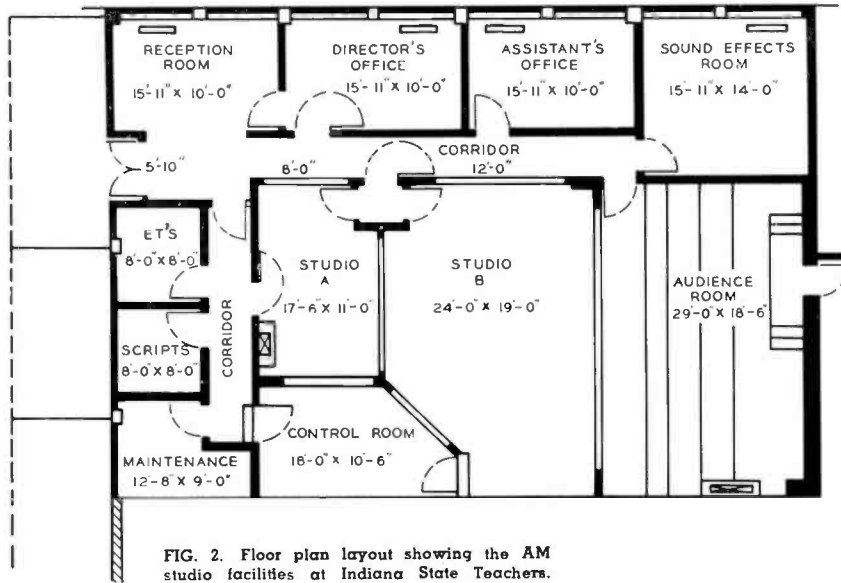

FIG. 2. Floor plan layout showing the AM studio facilities at Indiana State Teachers.

the sound effects may be moved into the audience room for demonstrations.

All rooms in the Radio Suite have acoustically treated walls. The use of dual glass in windows separating the studios and the Audience Room satisfactorily blocks all sound. Air-conditioning units operated from switches within the studio guarantee an adequate supply of fresh air any time during the day or night.

From the studios originate 16 programs each week—programs designed to supplement construction within the classrooms in the service area of WBOW and to provide a furtherance of education for adult listeners. The present broadcast schedule is:

#### MONDAY

- 11.30 a.m. "For Parents" Dr. Wenonah Goshorn
- 11.42 a.m. "Weather Analysis" Dr. David Koch

FIG. 3 (below). View of the Announce or News studio used for script or interview work. Recording room is visible in background. Personnel in the photo are: Mr. James R. Boyle, Mrs. Ruth H. Morgan, Dr. Morgan, and Miss Peggy Molter.

- 1.45 p.m. "Fun With Music" Mr. James Barnes

#### TUESDAY

- 11.30 a.m. "Sportscasting" "Campus News" (Alternate) College Students
- 11.42 a.m. "Weather Analysis" Dr. David Koch
- 1.45 p.m. "Guidance Guideposts" Miss Helen Ederle

#### WEDNESDAY

- 11.30 a.m. "Places In The News" Dr. David Koch
- 11.42 a.m. "Weather Analysis" Dr. David Koch
- 1.45 p.m. "Science Talk" Dr. William P. Allyn

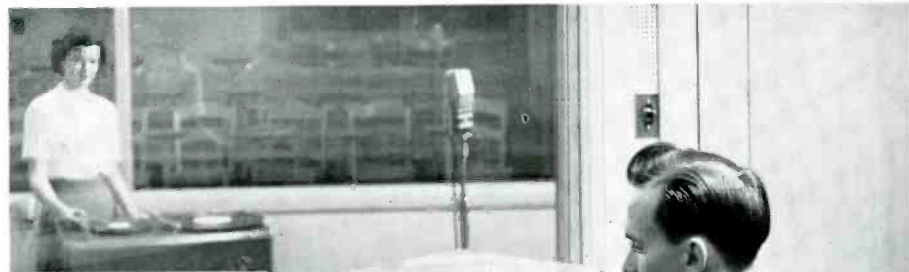

- THURSDAY
- 11.30 a.m. "Portholes to Learning" Mr. V. L. Tatlock
- "We, the Students Speak" (Alternate) Dr. Fred Brengle
- 11.42 p.m. "Weather Analysis" Dr. David Koch
- 1.45 p.m. "Peter Rabbit News Service" College Students

#### FRIDAY

- 11.30 a.m. "Stairway to the Stars" "Sinfonia" "Sigma Alpha Iota" (Alternate) College Students
- 11.42 a.m. "Weather Analysis" Dr. David Koch
- 1.45 p.m. "The Story Princess of the Music Box" College Students

Programs from the college are written, directed, engineered, and produced by college students trained in the Radio Division. To give this training, the college offers the following undergraduate courses:

- 314 Radio Music
- 315 Use of Radio in the Classroom
- 316 Radio Workshop
- 317 Introduction to Radio Broadcasting
- 318 Radio Speech
- 319 Radio Writing
- 320 Radio Program Production
- 421 Radio Control Room Technique
- 422 Advanced Control Room Technique
- 423 Fundamentals of Radio Directing
- 424 Advanced Radio Directing

For graduate students, advanced work is offered in each of the above fields. The success of the program is evidenced by the men and women of Indiana State now operating behind the scenes or being heard on stations throughout the United States.

FIG. 4 (below). View of the Control Room with Mr. Dean Cannon at the RCA 76 Console. At left in Studio "A", Miss Betty Ann Skelton is shown operating turntables.

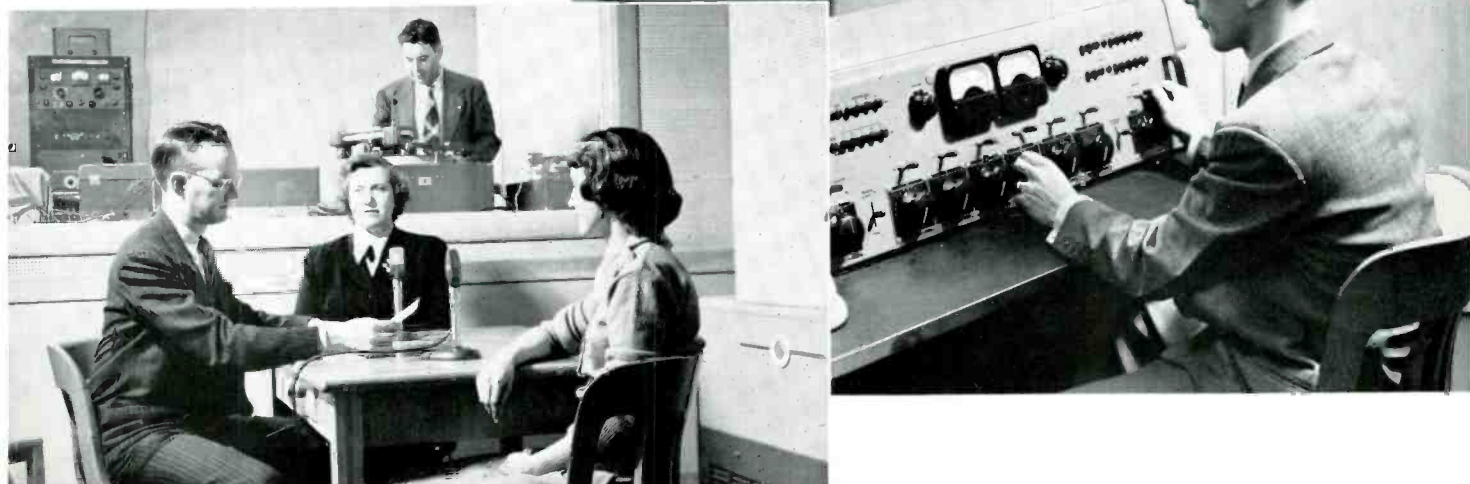

# WTAR, AM-FM-TELEVISION

**WTAR** has grown from the tiny 15 watt AM transmitter that came on the air in 1923 to the present 5,000 watt AM, 50,000 watt FM, 24,000 watt TV installation of the present day.

In 1947 WTAR instituted FM broadcasting with the 3,000 watt interim transmitter which was located on the top floor of the National Bank of Commerce Building in Norfolk. The following year the 10 kw transmitter was installed at the AM plant location and by using the 4 section Pylon antenna, the radiated power was upped to 50,000 watts.

In 1948, WTAR began its plans for TV operations. After months of engineering and planning, work was commenced on the new AM-FM-TV Center. April 2, 1950 saw the culmination of these plans, and WTAR-TV made its inaugural telecast on Channel 4.

WTAR-AM-FM-TV is owned by the WTAR Radio Corporation. The parent company of WTAR-AM-FM-TV is Norfolk Newspapers, Inc., who publish the evening Norfolk Ledger-Dispatch and the morning Virginian-Pilot newspapers.

The president of WTAR Radio Corporation is Mr. Campbell Arnoux, who is also the General Manager of WTAR-TV. Col. S. L. Slover is Chairman of the Board; Mr. Henry S. Lewis, Vice-President and



Mr. John C. Peffer, Operations Manager,  
WTAR Radio Corp.

## by WTAR Engineering Staff

Treasurer; Mr. C. Ralph Beamon, Secretary; Mr. Robert Lambe, General Sales Manager. Among the managing, producing and directing echelon are TV Operations Manager, John C. Peffer; Chief Engineer (AM-FM-TV), Richard L. Lindell; TV Production Manager, Winston Hope; AM Program Manager, Joel F. Carlson; and Frederick N. Lowe, Promotion Manager.



Mr. Campbell Arnoux, President and General  
Manager of WTAR Radio Corp.

WTAR's AM-FM-TV Center building is located on Boush Street near the center of town. This new radio center houses the AM studio installation, the TV transmitter and two TV studios. The general business offices are located on the third floor. The building was planned and designed for TV from the very beginning, and has proven ample in every respect.

The building has been built in such a manner as to make it almost vibrationless. The studios, AM, FM, and TV, are built on the principal of a room within a room, the inner room, or studio, being floated on springs to isolate it from all extraneous sound and the interior surfaces acoustically treated to insure complete fidelity of reproduction. All studios must be entered through sound locks protected at either end by sound proof doors. The building itself rests upon 407 forty-foot wooden piles supporting concrete pile caps five-feet

wide and three-feet deep. The exterior and interior bearing partitions are sixteen inch solid masonry. The lobby walls are of black and gold Italian marble while the black granite on the building front was imported from Sweden (Fig. 2). All floors are nine inches thick solid concrete. Four inches is considered a heavy floor but the extra thickness insures against impairing the structural quality of the floor should it be necessary to reach the conduits under the floor by drilling. There are twenty-five miles of wires in the building.

Perhaps one of the most unusual qualities of the building is the purity of its atmosphere. A Precipitron has been installed which removes all dust from the air and electrocutes foreign objects such as flies. Perhaps an even more spectacular feature is the Glycol unit. This mechanism instills triethylene glycol in vapor form in the air being circulated in the building by the air conditioning unit. This compound which is absolutely undetectable, immunizes against colds and many other diseases while in the building and for eight hours after leaving.

WTAR houses the first installation of this kind in Virginia. Tested first by the federal government in its office buildings, it has only recently become available for commercial use. The air conditioning unit itself has a capacity of one hundred tons. To reduce the problem of maintenance all the walls lining the corridors are built of



Mr. Richard L. Lindell, Chief Engineer,  
AM-FM and Television, WTAR.

FIG. 1. Front view of the WTAR new "Radio Center" building located at 720 Boush Street in downtown Norfolk.



FIG. 2. The lobby of WTAR's new building. Walls are of black and gold Italian marble.

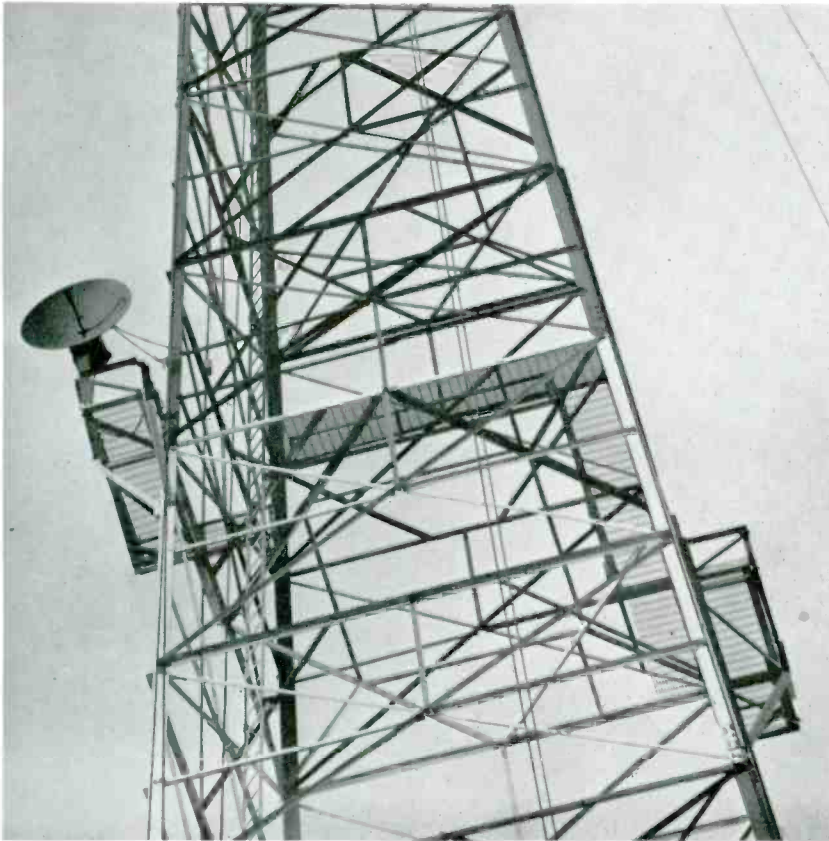

structural units of tile. The roof has been so constructed of asphalt plank that it may be used as an open air television studio for outdoor and garden sets.

Just behind the building is the tower that supports the Five Bay RCA Super Turnstile. Same was hoisted into place in one piece. The overall height is 400 feet and the height above average terrain is 367 feet. Directly under the tower and utilizing the space between the four legs a brick building of two story height was constructed which is a combination garage and storage place.

On the 210 elevation of the tower, two platforms with a connecting cat-walk were installed for mounting the micro-wave receiving dish for WTAR-TV's video remotes. Each position allows the dish to be rotated something over 200 degrees and with the two locations the dish can be set to pick up a signal on any point of the compass. A two inch steel conduit carries the various wires and coaxial cables down to the receiver control which is located in the TV control room.

FIG. 3. WTAR-TV's micro-wave receiving dish on the 210 foot elevation of the tower. Two platforms with connecting catwalks were provided so that the dish can pick up a signal on any point of the compass.



FIG. 4. WTAR-TV's mobile unit in action. This photo shows the unit being used to televise a Memorial Day parade.



WTAR-TV's mobile unit is an RCA Type TJ-50A using two RCA field cameras type TK-30A, a type TG-10A field synchronizing generator, a type TS-30A field switching system, an MI-26293 mobile power control unit, a TM-5A master monitor and type TTR-1B television relay transmitter. To date, it has been used to cover baseball games and special events such as parades.

The auditorium studio—complete with stage, dressing rooms and lighting controls—lends itself to a wide variety of radio and television productions with the added advantage of being suitable for studio audiences. Seating facilities in the auditorium have been provided for seventy persons. Acoustically it is designed just as the radio and television studios. Many modern and unusual features have been incorporated here. The stage itself is thirty-two feet wide and forty-eight feet long, large enough to accommodate a symphony orchestra. The curtains are motor driven. A set of buttons on the control panel start and stop them at the desired place with just the flick of a finger. The spotlights on either wall may be trained on the audience as well as the stage. The footlights at

the front of the stage are so constructed that they may be made to disappear completely. The TV Mobile Unit is backed into a space provided directly in back of the stage and is used for the Video Control Room. A permanently installed Audio Control Room is located on the left hand side of the stage and utilizes an RCA 76B consolette. Directly above this control room the stage lighting switch room was installed—each has sound-proofed viewing windows facing the stage and audience. A viewing window is also provided in the Client's Lounge which permits viewing of any programs taking place on the Auditorium Stage.

Network shows are not the sole delight of Tidewater television audiences. In its first summer of operation WTAR produced live shows from its studios averaging not less than nine hours of local programming a week. The TV Studio is so constructed that automobiles may be driven directly from the street for televising. One man operates the banks of overhead lights which are mounted on a pipegrid, by cables from a steel cat-walk on the far wall of the studio. These lights may be rotated vertically or horizontally. The cameras are

mounted on rubber wheeled dollies for quick maneuvering as the action demands. Just to the rear of the studio is the prop room where scenery and stage properties are stored. A viewing room on the mezzanine permits visitors to watch TV shows in the process of production.

The TV Control Room is located on the first floor with wide view windows that look into the TV studio. It was built with a two foot higher elevation than the studio so as to give the operating personnel a better view into the studio. The equipment shown includes the console studio-type camera controls, two film camera controls, two studio camera controls, TS-10A type switcher, and preview monitor. The audio console includes a 76B TV consolette with BCS-3A TV switcher. The talk-back switches have been mounted between the consolette and the preview monitor for convenience to the switchers. The whole audio installation is so arranged on its custom built table to give the entire operating position an unbroken appearance. The arrangement of the camera control monitors and audio consolette was made as per accompanying picture bearing in mind that a program man was to do the



◀  
**FIG. 5. WTAR's auditorium studio. The stage measures 32 feet wide by 48 feet long. Seating facilities are provided for 70 persons.**

video switching and that the audio man as well as the video switcher should have unrestricted view of the preview monitor. It also permits one man to take care of the studio camera controls as well as the shading on the film camera controls. From left to right, the monitors are as follows: #4 and #3 are the film camera controls; #2 and #1 are the two studio camera controls; next is the switcher or "on air" monitor and to the right of that we have the preview. The equipment racks were placed far enough from the wall to permit easy accessibility for trouble-shooting from the back as well as the front. The racks as shown, include the first, which holds the synchronizing generating equipment. The second rack contains the monoscope, miscellaneous power supplies and grating generator. The third in line contains the microwave receiver control, the network stabilizing amplifier, the switcher stabilizing amplifier, jack panels and TS1A switcher; below the switcher are 2 banks of distribution amplifiers. The fourth, fifth and sixth rack contain power supply equipment for studio cameras and more dis-

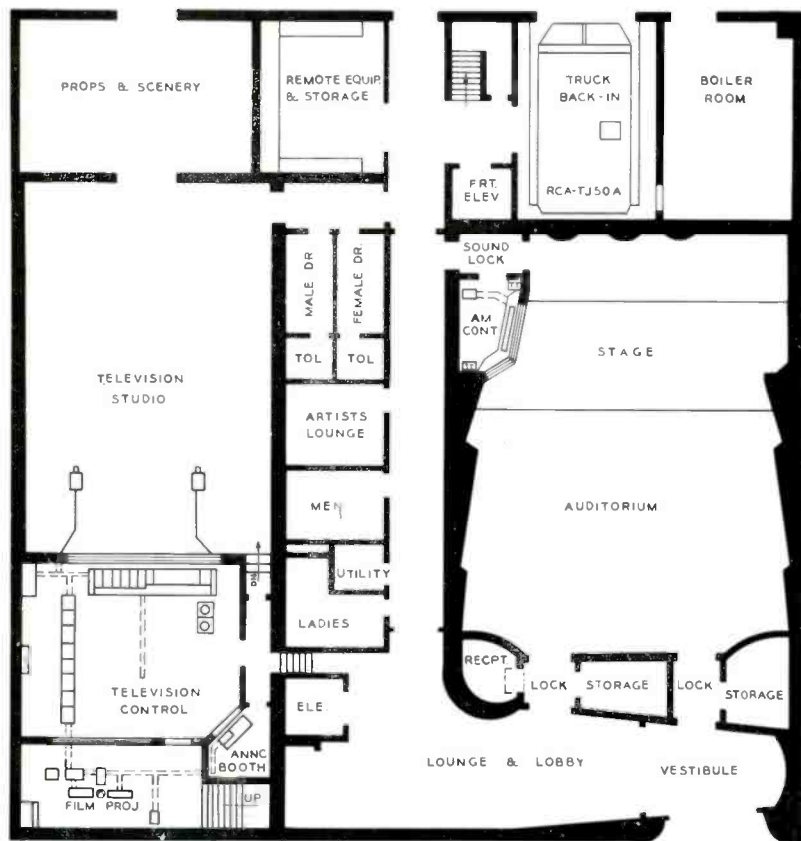

FIG. 6. First floor plan of WTAR layout showing auditorium studio, stage, and other studio facilities.

FIRST FLOOR

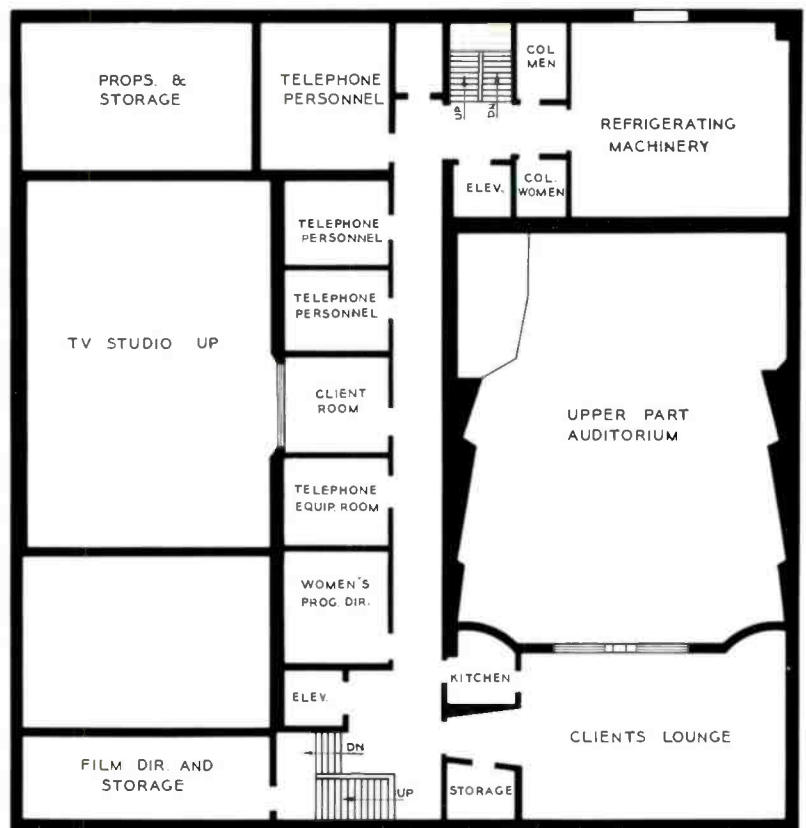

FIG. 7. This closeup shows a corner of WTAR's studio set up ready for a show.



FIG. 8. This shows another corner of WTAR-TV's studio with the steel catwalk in the background. From this point the lighting man can switch the lights on or off and rotate same vertically or horizontally.

FIG. 9. Floor plan showing the utilization of the mezzanine floor for clients and director's accommodation and film and props storage.



MEZZANINE FLOOR

tribution amplifiers. The seventh and final rack contains the TV audio equipment. (Fig. 11.) Just behind the control room is the film projection room. Located in this room are the two RCA TP-16C 16mm projectors, two RCA TK-20 film cameras, and the new super Projectal Belopticon with two 35mm slide projectors. (Fig. 14.) Directly above this room is the film room where films are previewed, spliced, etc. A coaxial switch is provided in the Projection Room so the projectionist can select the video output of either the two film chains or the TS10A switcher for his monitor.

All the a-c power, video and audio wiring was run in steel trenches (6 inches wide and 4 inches deep) which extend underneath the audio console and the various camera controls and from there under the racks which house the power supplies, etc. From there it extends on to the projection room and thence into the announcer's booth. Wherever the trenches were exposed, they were covered with removable linoleum covered steel plates making for ease in accessibility. The a-c power wiring was isolated from the audio and video by running same in steel conduit and in some cases removing from the trenches entirely.

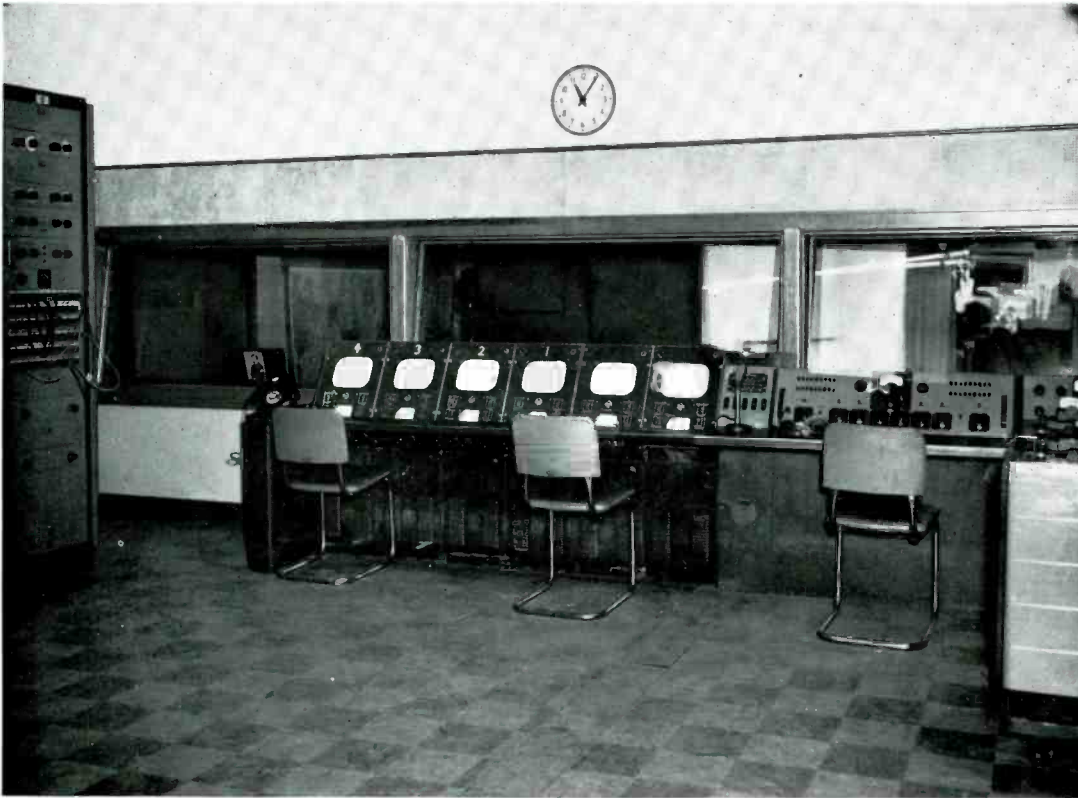
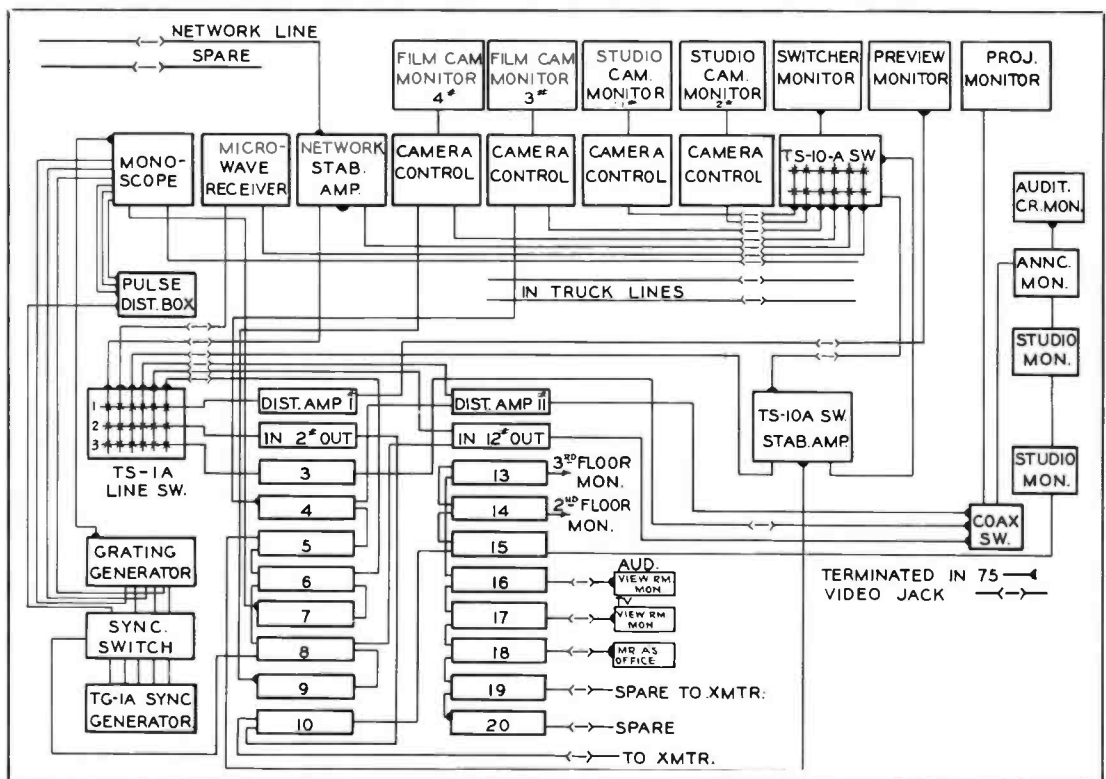

FIG. 10. WTAR-TV's control room. From left to right, the monitors are: #4 and #3, the film cameras; #2 and #1, the studio cameras; next in line is the switcher monitor with the preview to the right of it. An RCA 76B Audio Console with a BCS-3A switcher is used.

FIG. 11. Block schematic diagram showing WTAR's video system.



The wiring coming to the racks containing the power supplies, stabilizing amplifiers, D.A.'s etc., (except the video) was brought up to terminal strips mounted in the lower back part of said racks. From there the wires branched off in forms to the various pieces of equipment. When completely wired all forms were laced up giving a neat workmanship appearance. A record was made of what appeared on the various terminal strips which greatly simplifies trouble-shooting.

The video wiring is best explained by referring to the accompanying diagram. The use of an RCA TS-1A line switcher makes it possible to switch the output on network, micro-wave, film cameras or Monoscope direct to the transmitter on the second floor, freeing the TS10A switcher for audition purposes. The TS1A switcher also provides for direct feed from these points mentioned to the preview and projection room monitors. The use of two banks of video jacks and 20 distribution amplifiers gives extreme flexibility to the operation.

A dark room was provided for and was located on the second floor. It was made sufficiently large to house a Houston film developer although present plans do not call for its installation in the near future.

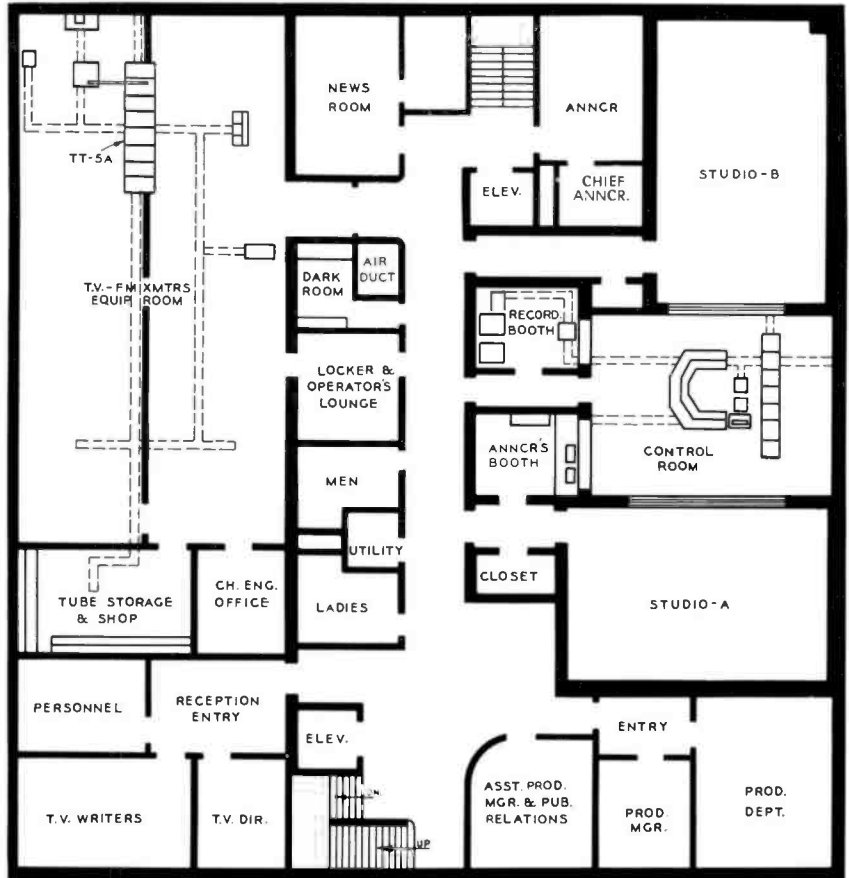

DOTTED LINES INDICATE WIRING TRENCHES

FIG. 12. Second floor layout plan showing the location of TV master control, rack equipment, studio "A", transmitter and associated offices.

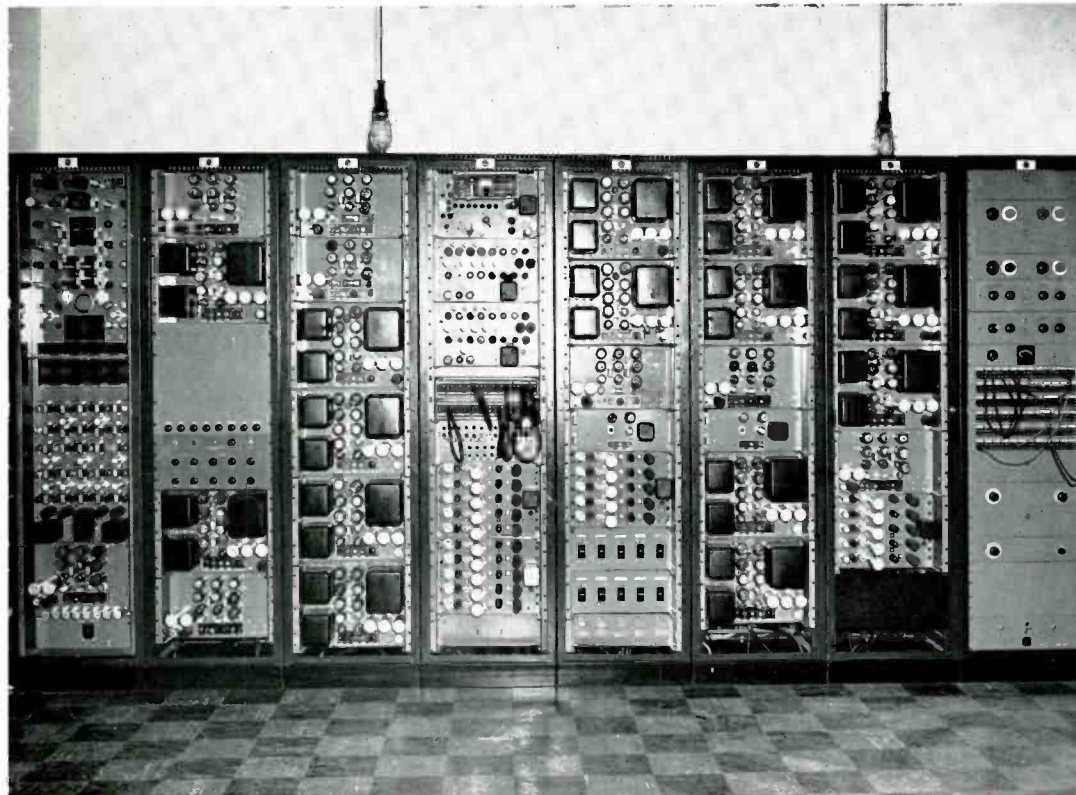

FIG. 13. Front view of the eight TV equipment racks located in the master control room.

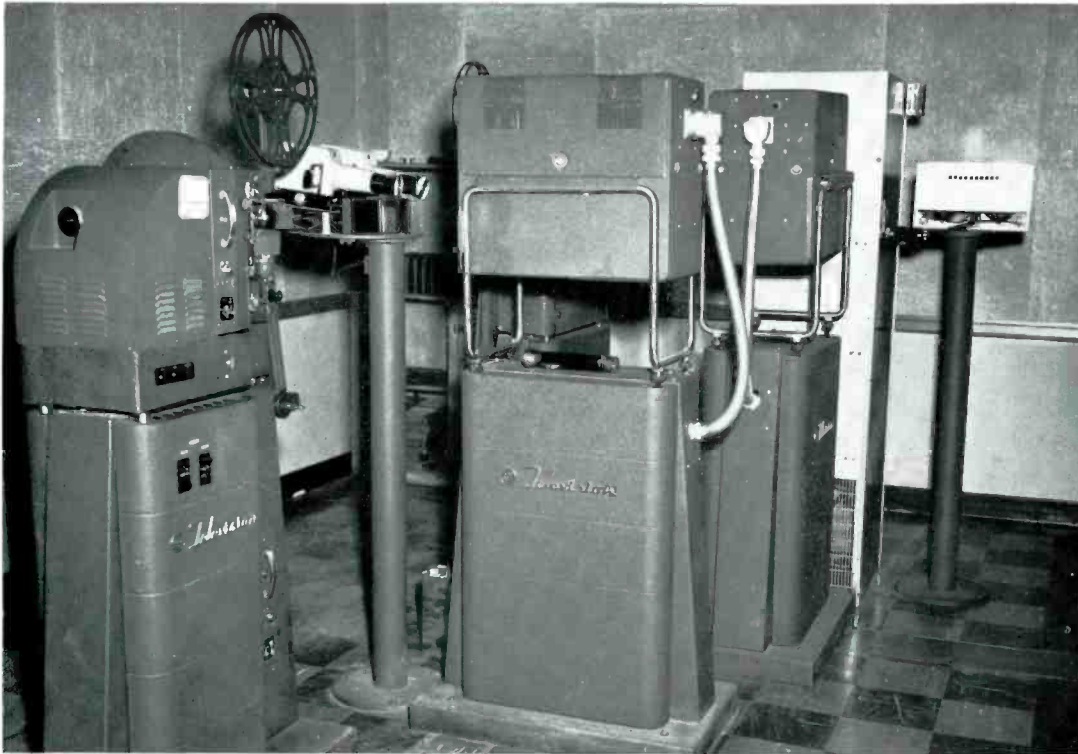
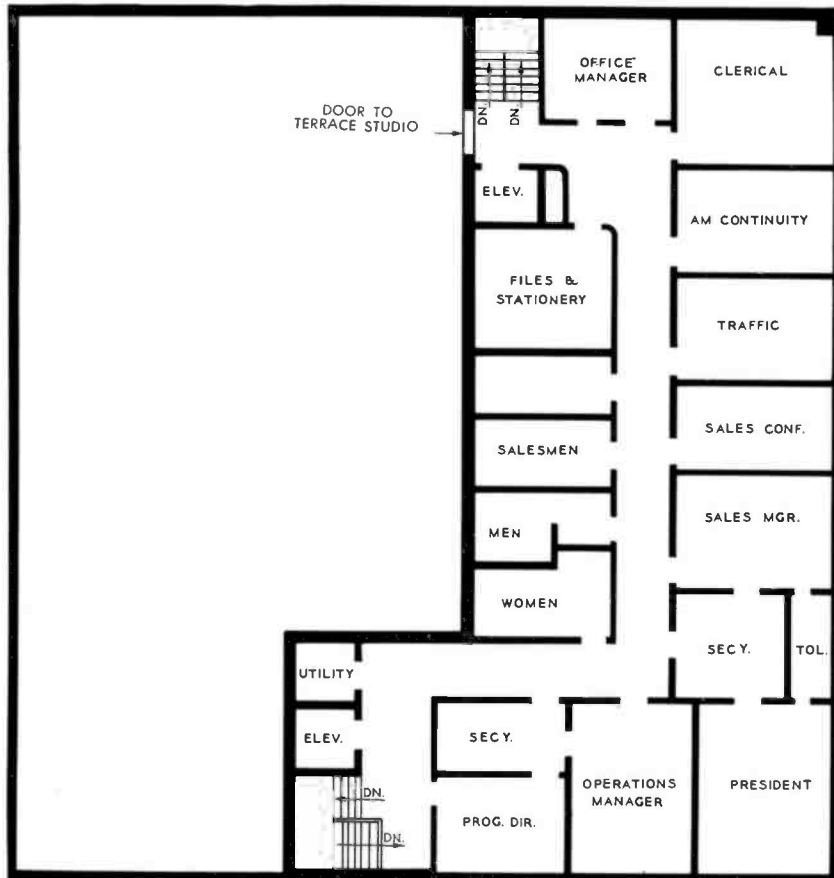

FIG. 14. The projection room directly back of the TV control room. Two RCA TP-16C 16mm projectors, two RCA TK-20 film cameras and a Super Projectal are shown.



However, recognizing the necessity of having the slides used on the air of uniform specifications and standards, equipment for making these was installed and today WTAR-TV makes up practically all the slides used. W. Browning, the video supervisor devotes one day per week for this work.

The TV transmitter room is located on the second floor and space has been provided for future expansion as well as spaces for an additional TV transmitter in the future. The coaxial lines come out of the transmitter room and are supported by a bridge across the street behind the building to the TV tower.

The client's lounge located on the mezzanine is designed to afford the maximum of gracious comfort to WTAR's patrons. A wide viewing window on the left wall enables visitors to see clearly the auditorium stage below.

Just to the left as you enter the lounge is a small, but completely furnished kitchenette from which light refreshments may be served. WTAR strives not only to fulfill its essential duties to its audience and advertisers, but also in the performance of those duties to fulfill the tradition of true Southern hospitality.

FIG. 15. Plan of WTAR's third floor which is devoted to sales and executive offices.

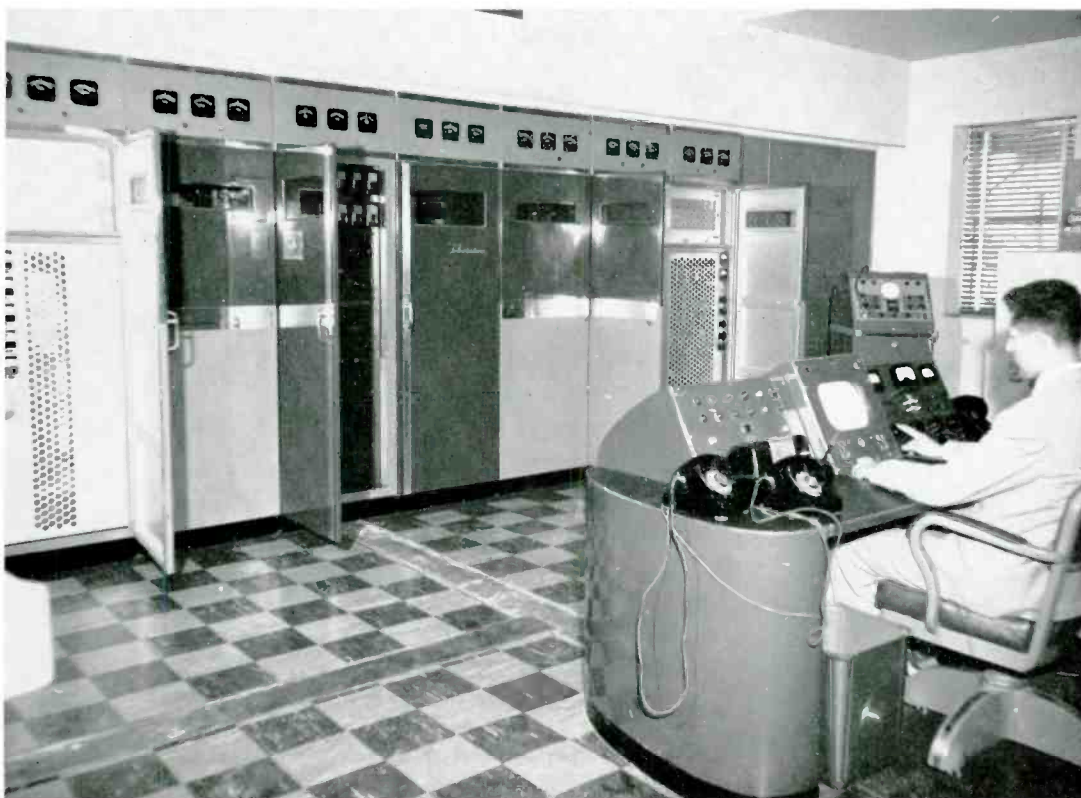
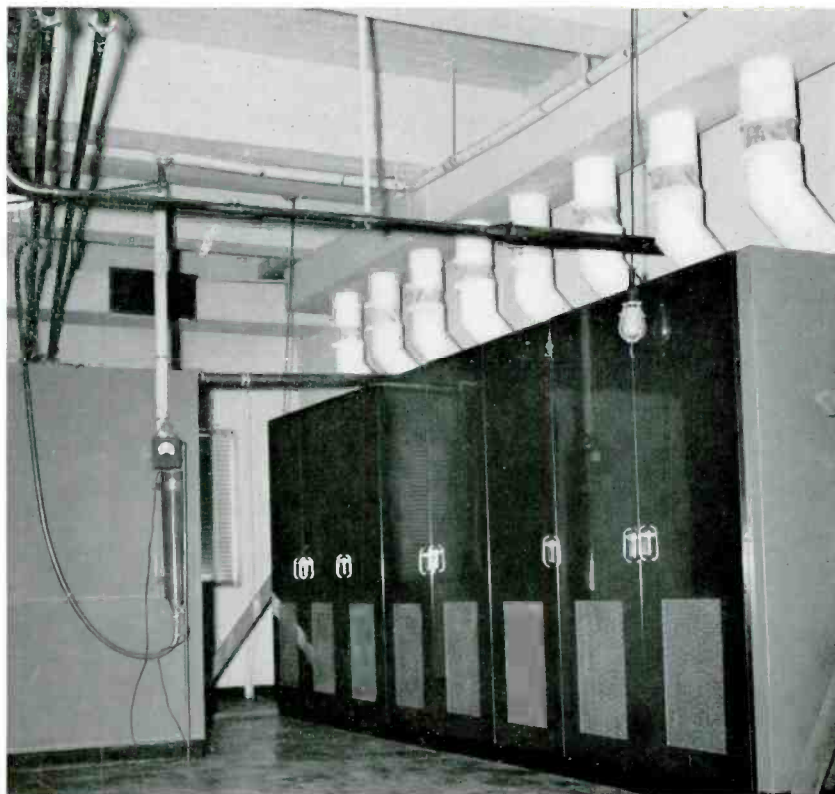

FIG. 16. Front view of the RCA TT-5A television transmitter. Charles DuVal, TV Transmitter Supervisor, at the controls.

WTAR's new Center Building is furnished with two large AM-FM radio studios located on the second floor. From these studios most of the local programs are broadcast. Local programs account for 43 per cent of WTAR's time on the air. Separating the two studios is the control console, designed and built by WTAR engineers, the announcer's booth, record turntables, and broadcasting equipment for all kinds of programs including line terminations for remote broadcasts.

Each of the studios is equipped with six mike outlets, each of which has associated with it cue lines into which any desired program may be fed. Each mike outlet appears on jacks and circuits are normalled complete through its associated pre-amps-keys-relays-pots and console. The input and output of each stage appears on jacks so that cross patching makes the operation versatile. The announcer's mike circuit is so set up that it can be controlled from the control room, or, as is normally

FIG. 17. Back view of the television transmitter. Each individual cabinet has the warm air removed by means of duct-work as shown. The dummy load is mounted on the side of the vestigial side band filter. The water cooler is also connected to air exhaust and is located behind the side band filter.



the case, may be set so the announcer on duty can open and close his own mike. This is the only control he has over his mike while operator is on duty as the operator rides gain.

The operator on duty spins discs as required and the turntables for this are readily available. These turntables are provided with foot-pedal control cueing circuits. These foot controls operate a twelve (12) volt vacuum sealed relay which, when operated, feeds the output of the turntable amplifier to the cueing circuit. When pressure is released from foot-pedal, circuit returns to normal and is again clear to air. The use of vacuum sealed relays here has reduced to practically zero the loss of transcriptions due to faulty relay contacts.

An RCA tape machine is available with remote control to make possible the transcribing and playback of programs off the line possible by the operator on duty.

Installed in the console are two identical control panels referred to as control room #1 and control room #2. Number 1 faces studio A and #2 faces studio B. Though these consoles are exact duplicates in every way, interference of one with the other is prevented through a priority system. Control room #1—facing studio A—has priority over control room #2 for all

studio A circuits. Control room #2—facing studio B—has priority over control room #1 for all studio B circuits. This system follows throughout to best advantage.

Each console and announcer's booth has its own monitor input selector, its own monitor amplifier and its own monitor gain control. Head phone jacks are also pro-



FIG. 18. Looking into the AM announcer's booth and the recording room at right. Marybelle Darden, WTAR's hillbilly disc jockey doing her daily show.

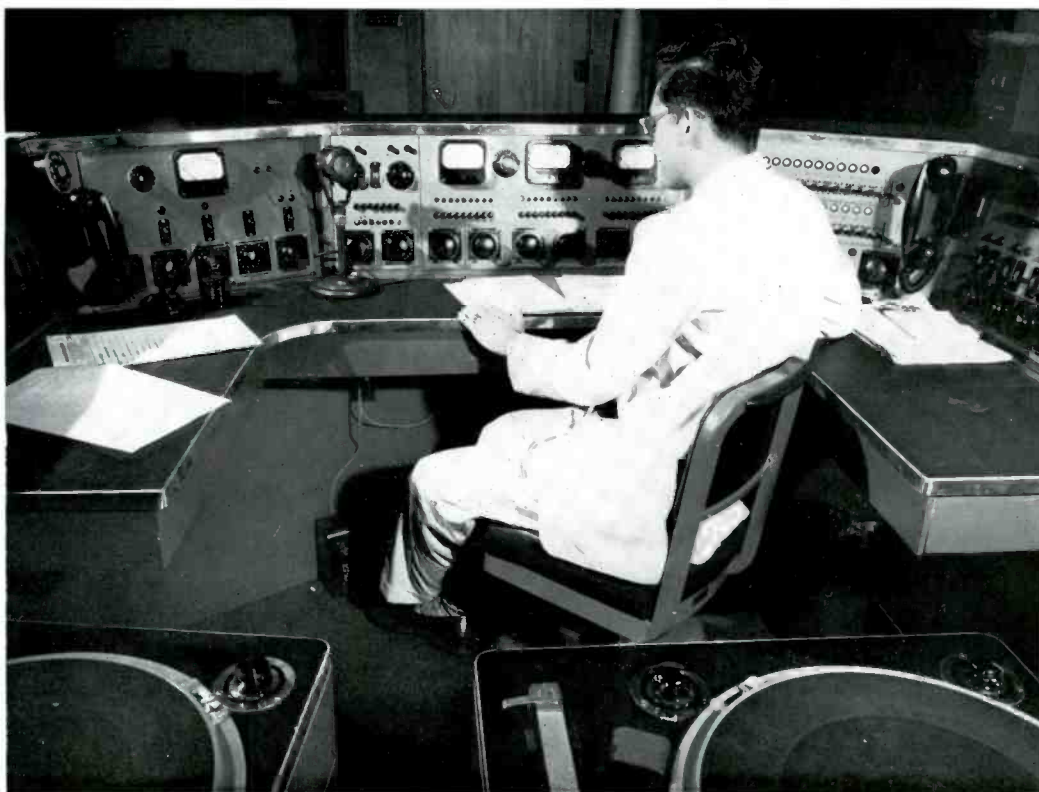

FIG. 19. The recording room. Two RCA type 73B recorders are used. Choice of program is achieved through selector switches.

FIG. 20. "Looking down on the AM master control console, designed and built by WTAR engineers. Richard King at controls.





or units of speakers are terminated on jacks and thus any program desired may be fed to any location in the building. The program of WTAR normally appears on these speakers.

In order that there might be a common ground system for the radio and television equipment, a solid sheet of copper ten feet square was placed twelve feet under the center of the building. To this were soldered several heavy copper straps which branch off to the various parts of the building and appeared in the trenches of the various equipment rooms. To this all the individual pieces of equipment were bonded.

The overall technical planning and the technical installation was under the direction and supervision of John C. Peffer, who was Chief Engineer of WTAR at this time. He was assisted greatly by Richard L. Lindell, who was assistant Chief Engineer at the time of taking to the air on Channel 4.

Since then, Mr. Lindell has been promoted to Chief Engineer of the combined operation and Mr. Peffer, as Operations Manager has been given the responsibility of directing all TV departments.

The architect for the building proper was Mr. George Van Leeuwen, who worked in the closest cooperation with the engineers in developing one of the most modern and compact television installations in the country today, that really is an engineer's dream.

The general contractors on the job were the R. R. Richardson Company of Norfolk, who did a most commendable job on the entire project.

Other engineers of the staff who worked hard and diligently are:

- Stanley S. Busby, Video Supervisor (now in the U. S. Armed Forces)
- William I. Browning, Jr., Present Video Supervisor
- Willis J. Robert, Mobile Unit Chief
- Charles N. DuVal, TV Transmitter Supervisor
- Julian W. Craps, AM and FM Transmitter Supervisor
- Zack Yates, Audio Supervisor
- Patrick C. Arnoux, Cameraman
- Orville K. Gibboney, Video Engineer
- John O. Bishop, Jr., Audio Engineer
- Myrle M. Harrison, Audio Engineer
- Richard King, Audio Engineer (now in the U. S. Armed Forces)
- William D. Hayth, AM and FM Transmitter Engineer
- William L. Herndon, AM and FM Transmitter Engineer.

vided across each of these circuits to be used according to individual requirements.

Talkback facilities are provided so that the operator on duty may talk to each of the studios, the announcer's booth, the recording booth and the announcer's lounge. The announcers, from their booth, can talk back to control room and both studios. The recording booth can talk to the control room only.

In the center of the console we have three channels of line amplifiers and our line selector channels to select our feed to the transmitters. We are set to be able to feed to any line the output of any of the consoles or any of the channels. We can feed a total of twelve lines with six different programs simultaneously should the occasion arise.

Our twenty-four remote lines are all terminated on our ring-down panel which will bring up both signal buzzer and light whenever anyone comes across the lines to contact us. Through this same ring-down panel also connects the AM operation with every other operational point throughout the building and our transmit-

ter at Glenrock. This ring-down panel is located in the control console and an exact duplicate is in the announcer's booth.

The announcer's booth is also equipped with a complete console and when control is turned over to them, they have readily accessible two mikes in each studio, six remote lines, incoming network, and two turntables in addition to their own mike. This operation is used only when program schedule is light or in case of emergency.

Our recording booth is within easy reach of the control room, but is a complete operation within itself. We have two of the RCA Type 73-B Professional Recorders, each with its own associated amplifiers, equalizers, and matching networks. Choice of program is achieved through selector switches to bridging inputs of line amplifiers. Should the occasion arise where the program desired is not available on selector switch, it is readily available through simple patching as input and output of all circuits appear on jacks.

The thirty-three monitor speakers throughout the building are fed by six monitor amplifiers. Each of these speakers

# A LABORATORY TELEVISION SYSTEM

By R. L. HUCABY  
Television Terminal Engineering

## General

A television system for a development laboratory is unique in that it must provide a degree of flexibility not ordinarily needed in a broadcast station installation. Recently, we were confronted with the problem of designing such a system in the Television Terminal Equipment Laboratories. The installation was required to perform three primary functions. First, it was to provide a dependable source of synchronizing and driving pulses, video signals—both with and without sync—and other necessary signals and was to distribute these signals to the various laboratory locations for use in the design and development of television broadcast equipment. Second, the system was, as far as possible, to take the form of a typical television studio that could be used in demonstration for Broadcast Station Personnel. As such, it was to include at least one sample of most items of equipment designed in these laboratories, all co-ordinated into an operating system similar to that found in any medium-sized television station. This demonstration function was to be independent and self-contained so as to provide a minimum of interference with the laboratory distribution function. Third, but by no means the least important, the facilities were to provide a means of life-testing the equipment since it would be in practically constant use during a forty-hour week. Fig. 1 shows a simplified block diagram of the system that was developed to fulfill these three requirements. This has now been in use for over a year with very good results. Various sections of this functional diagram will be referred to and discussed in the following sections.

## Signal Sources

Any laboratory television system must have several dependable picture sources of high quality. The four primary video signal sources may be found at the extreme left of the block diagram in Fig. 1. These consist of a studio camera, a film camera, a monoscope camera, and a modified television receiver that produces an "off-the-air" signal. They will be discussed in the order mentioned.

The image orthicon studio camera is located in a small studio (shown in Fig. 2), complete with lighting equipment and the other facilities necessary for the production of small television shows. The camera is mounted on a movable dolly which allows the cameraman to adjust the elevation of the camera or to move it about the studio floor to obtain views from different angles and distances. An electronic viewfinder is incorporated in the camera, permitting the cameraman to view the picture being televised. The camera control and monitor are located in the control room in the extreme right hand console section as shown in Fig. 3. The signal source has been very useful—particularly for the presentation of demonstration programs to customers, and for the investigation of new camera circuits and studio lighting techniques.

In order to provide facilities for the investigation of film pickup, a small room is equipped for a film studio. The film camera, employing an iconoscope pickup tube, is located in this studio with the projectors (see Fig. 4). A mirror arrangement called a "multiplexer" makes it possible to feed one film camera with any one, or any combination of three optical images without changing the physical location of either the

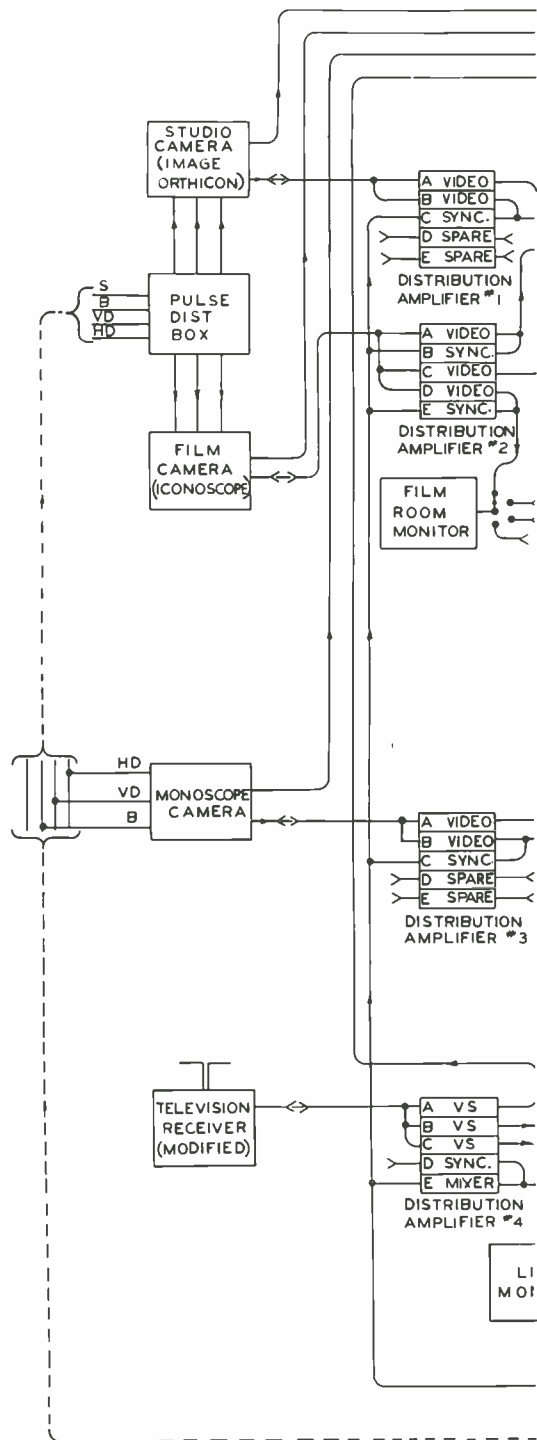

projectors or the camera. The three picture sources consist of a 35mm film projector, a 16mm film projector, and a 2 x 2 inch slide projector for transparencies. The control rack shown in the background of Fig.

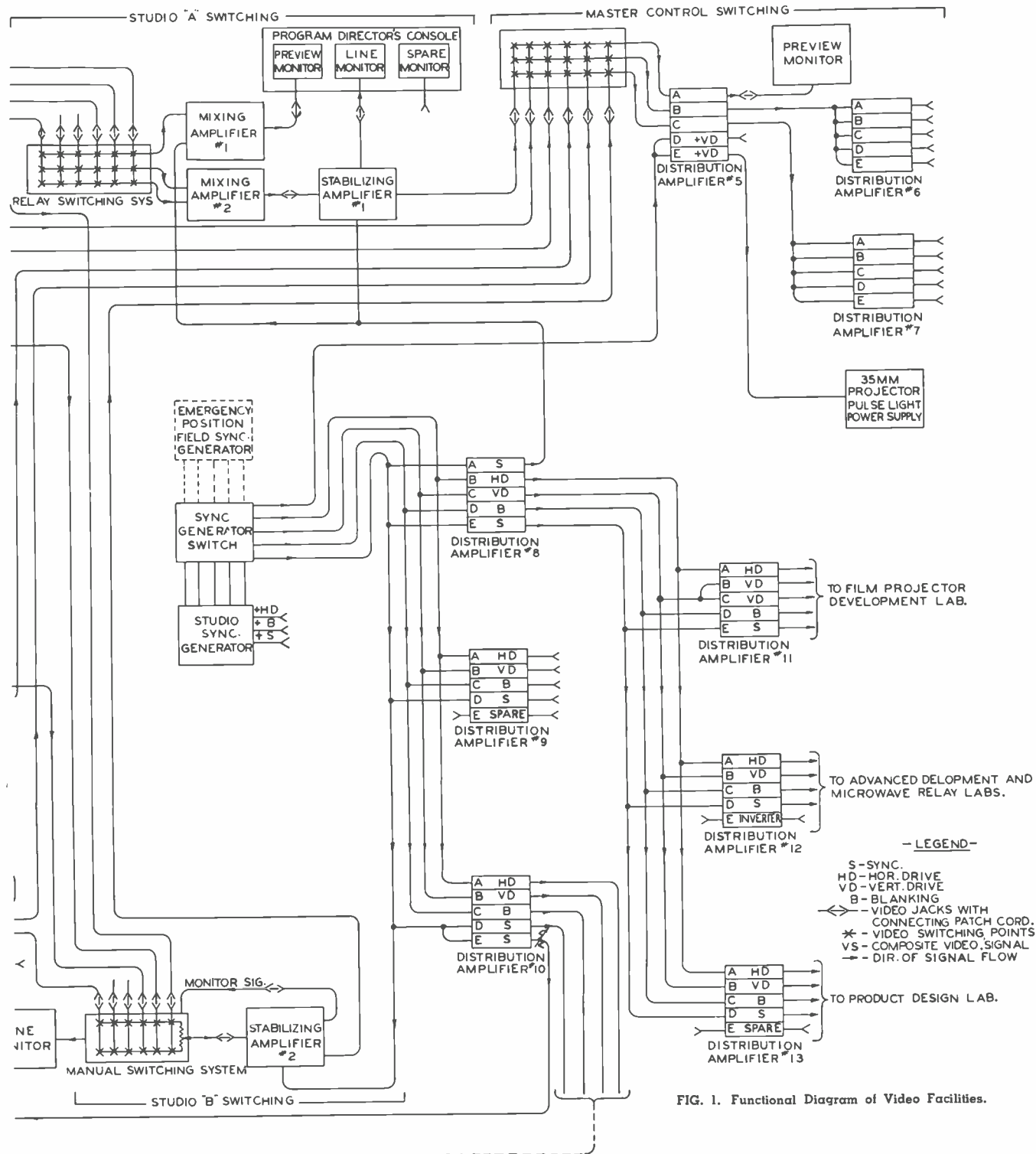

FIG. 1. Functional Diagram of Video Facilities.

4 contains a video monitor, projector control panel, and a power supply for the pulsed light source on the 35mm projector. The video monitor may be switched by the projectionist from the film camera output

to any one of three predetermined signals for video cueing purposes. The projector control panel provides facilities for remotely starting or stopping either film projector or for effecting an optical change-

over between projectors. The slide projector lamp may be turned on or off or its brightness controlled from this panel also. The film camera control and monitor are in the second console section from the right

in Fig. 3. These film facilities permit the testing of new ideas and improvements on equipment identical with that in general use. They also make possible experimentation with new film camera tubes, and provide film pictures for use in demonstration programs for customers.

The third signal source is a monoscope camera which is rack-mounted in the control room. It employs a tube containing a fixed test pattern and provides a signal which may be used to check other equipment for scanning linearity, resolution in both horizontal and vertical directions, and low frequency phase shift. The fact that this camera delivers a constant signal of fixed amplitude and quality makes it the most-used test signal by the laboratory engineers.

The rack-mounted television receiver shown in Fig. 5 forms the final signal

source of this television system. It is a standard home receiver that has been modified to provide both video and audio outputs for connection to the picture and sound switching systems. This picture source has been indispensable for demonstrating the capability of the switching facilities to handle programs originating from a remote point as well as those of local origination. It has also been useful to those engineers engaged in the design of equipment to handle remote signals that have been subjected to disturbances such as those often encountered in coaxial network or microwave relay transmission.

### Switching Systems

To realize maximum flexibility, provisions must be made for quick selection of any signal source for distribution to any given point in the laboratories. For this

purpose, three different types of video switching equipment have been incorporated into the design of this layout. Fig. 1 designates these three as "Studio A" Switching, "Studio B" Switching, and Master Control Switching, all using the various video sources described above. "Studio A" Switching will be discussed first. This is composed of RCA's standard Type TS-20A relay equipment. The switching is done by means of remotely-controlled, rack-mounted relays, and the fades and lap dissolves are effected electronically through the use of a mixing amplifier which is mounted together with the relays and which is also remotely controlled. A Program Director's Console (extreme left of Fig. 6) is a part of these facilities and contains three video monitors to assist the technical and program directors in conducting the program. The Technical Director, seated at the left, has at his

FIG. 2 (below). Small studio containing Lights, Microphone Room, and Image Orthicon Camera.

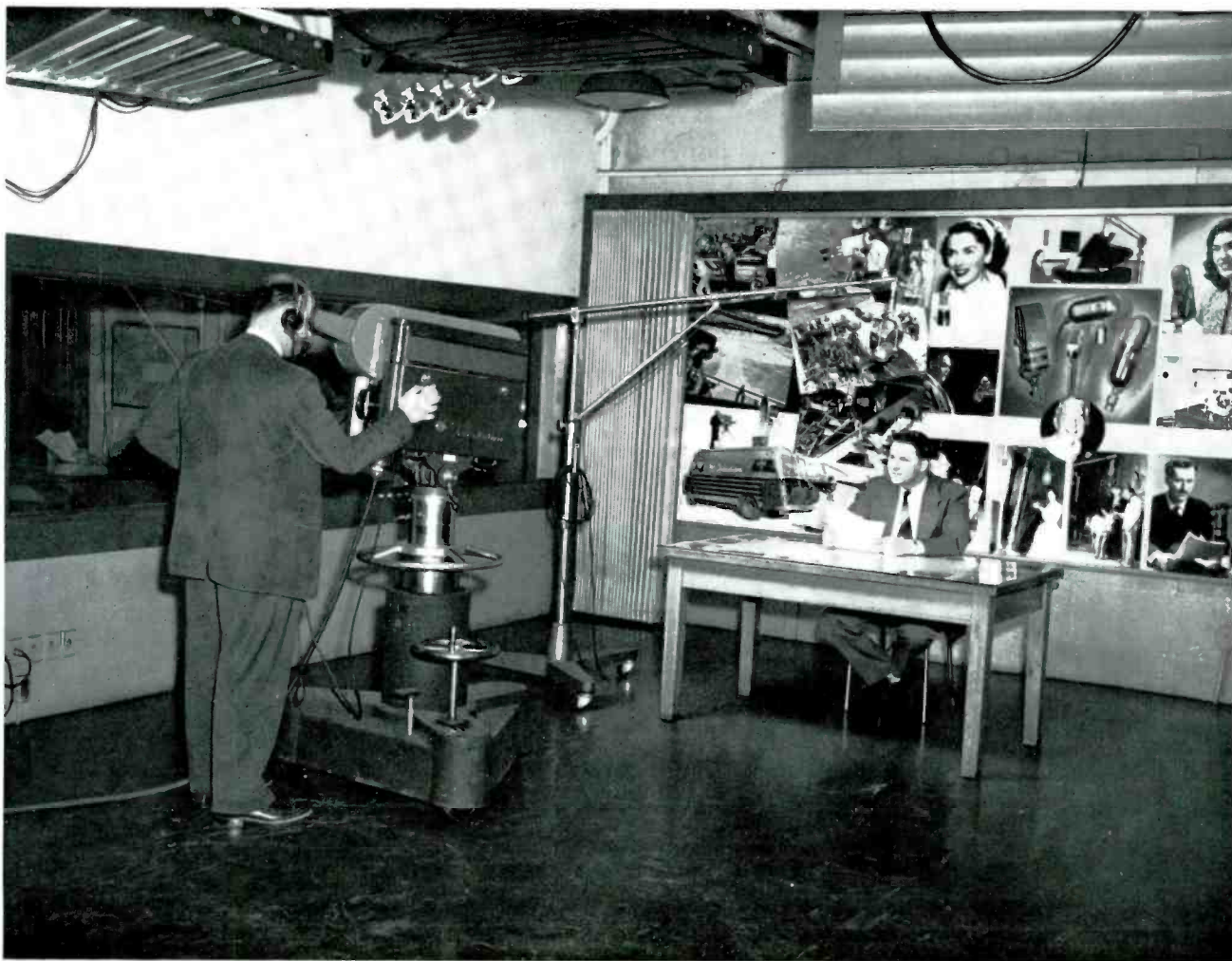



before they are routed to Master Control Switching. A monitor output from this amplifier feeds a line monitor in the console so that the directors may observe the outgoing picture at all times. The third console monitor is a spare monitor to be used as the occasion demands.

“Studio B” Switching is less elaborate, but performs the same basic functions as that of “Studio A”. Here RCA’s Type TS-10A switching equipment (fourth console section from the right in Fig. 3) is used and is denoted on the block diagram of Fig. 1 as a *manual* switching system. This means that all video signals are brought directly to the switching unit instead of being routed to rack-mounted relays as in the “Studio A” system, and that fades and lap-dissolves are done by means of potentiometers in the video circuits rather than electronically in a mixing amplifier. The TS-10A output is fed to Stabilizing Amplifier #2 which functions in this arrangement as Stabilizing Amplifier #1 does in the “Studio A” system. A monitor

FIG. 3 (at left). Video Console containing Camera Controls, “Studio B” Switching, and Master Switching Preview Monitor.

fingertips all the remote controls for operating the relays and fading amplifier, while the Program Director, seated on the right, has ample desk room for scripts, etc. Both have adequate intercom facilities for talking with all pertinent points in the laboratories.

The rack-mounted relay chassis contains special video relays accommodating six inputs and three outputs. One output is used to feed a preview monitor in the console with which the Directors may preview any of the six inputs prior to using them “on-the-air”. Mixing Amplifier #1 (see Fig. 1) serves as a sync interlock amplifier by adding local synchronizing pulses to all local video signals but passing any composite remote signals to the monitor without sync addition. The other two outputs are connected to the inputs of Mixing Amplifier #2 which serves as the electronic fade and lap-dissolve amplifier. Its output is in turn fed to Stabilizing Amplifier #1 where any switching transients and low frequency disturbances are removed, and synchronizing pulses are added to all local video signals



FIG. 4 (at right). Slide Projector in the Projection Room being adjusted by the Author. Film Camera in foreground, 16mm Projector at right, 35mm at left, and Control Rack in background.

output drives a line monitor so that the program director, who also serves as technical director, may have constant check on the outgoing picture. Preview provisions are limited to remote signal inputs only, of which there are two in the TS-10A. Since this switching unit is located where the director may view all local signals on the camera control monitors, it is not necessary to provide preview facilities for them. Intercom circuits are built into this switching equipment enabling the director to talk to all necessary points.

The Master Control Switching System (Type TS-1A) is a rack-mounted panel with provisions for six inputs and three outputs. Push buttons on the panel permit the manual connection of any input to any or all outputs. This unit is shown directly below the video jack panels in Fig. 7. The six inputs consist of the four previously described signal sources plus the outputs of "Studio A" and "Studio B". Of the outputs, one feeds a master-control preview monitor, and the other two feed

Distribution Amplifiers #6 and #7 thus providing a total of ten signal outputs that may be routed via the jack panel to the various laboratories through permanent trunk lines. Sections A, B, and C of Distribution Amplifier #5 serve as "buffers" between the TS-1A and its distribution system. Although extremely simple, this master switching system is quite adequate and dependable.

#### Interconnections Between Signal Sources and Switching Systems

Planning the distribution of the four signal sources to each of the three switching systems presented no special problems, but a discussion is given here to provide a clear understanding of the installation. For an example of the necessary interconnections, refer to the studio camera chain in Fig. 1. The studio, film, and monoscope cameras have two outputs each; one of these connects directly to the "Studio A" switching equipment. The other terminates at the inputs of sections A and B of Distribution

Amplifier #1. The output of section A then goes to the "Studio B" switching facilities. Since only composite signals are fed to Master Control Switching, synchronizing pulses must be added to the camera signal before it is sent to the TS-1A. This is done in sections B and C of Distribution Amplifier #1. Section B carries the video, section C supplies the sync, and the two are mixed to form a composite signal by simply tying these amplifier outputs together. This same interconnection procedure is used with the film camera and monoscope with the exception that an extra sync mixer is used with the film camera to supply a composite signal to the film room monitor switch.

The interconnections used with the "off-the-air" receiver are somewhat simpler. Since this signal is already composite when received, no sync mixing sections are necessary.

The flexibility of this television system has been kept to a maximum by the extensive use of coaxial video jack boards. Equipment failures may be quickly patched out, additional signal sources may be patched in, signals may be re-routed through the system, and many other unusual situations and requirements are easily met through the medium of the patch panel shown in Fig. 7.

#### Pulse Distribution System

The heart of any television installation is the synchronizing generator and the pulse distribution amplifier. In this layout it was not only necessary to supply pulses to the camera chains, but also to supply them to all laboratories for use in equipment design. The pulses distributed include sync, horizontal drive, vertical drive, blanking, and positive vertical drive—the latter being used to key the power supply for the 35mm projector pulsed light source. (An improved design of this power supply using negative vertical drive is now available but has not yet been installed in this system.)

The source of these basic pulses is an RCA Type TG-1A Sync Generator which occupies one of the racks shown in Fig. 5. A sync generator switch makes it possible to switch instantaneously to another generator which can be connected and operated as a standby. By referring once more to Fig. 1, it is fairly easy to trace the

FIG. 5 (below). Operator adjusting Rack-Mounted Television Receiver.





FIG. 6. Program Director's Console at left with Audio Console and Turntables in foreground.

pulse routes after they leave the sync generator switch. Due to the rapid accumulation of input capacity, only a limited number of distribution amplifier sections may be bridged across a given coaxial line without disturbing rise-time or wave-form. For this reason, Distribution Amplifier #8 was included as a "buffer" to isolate from the coaxial lines the input capacities of Amplifiers #11, #12 and #13 which supply the laboratories with the basic pulses.

Distribution Amplifier #9 supplies the pulse signals to the jack panels so that they may be patched to the various labs to take care of unusual requirements that arise from time to time in development programs. Amplifier #10 provides the pulses that are used by the monoscope, film and studio cameras. Since Section E of this Amplifier performs a special function, it is worth mentioning here. The normal amplitude of the sync signal from the generator is approximately four volts, peak-to-peak. The sync mixing amplifiers, such as Section C of Amplifier #1, require

only 0.5 volt to add to the normal 1.5 volts of video in order to produce the standard 2.0 volts of composite signal fed to Master Switching. Therefore, some means must be utilized to reduce the 4.0 volt signal to 0.5 volt. This was accomplished by placing a variable attenuator at the output of the above mentioned Section E.

#### Special Considerations

It might be of interest here to explain why so many distribution amplifiers have been used in this system design by giving a brief description of the amplifier and its uses. Each amplifier chassis contains five individual amplifier sections, each of which has unity gain (a small amount of gain variation is possible), high input impedance and an output designed to work into a 75 ohm load. Their characteristics make them especially useful for isolation between a signal source and its load, for bridging a 75 ohm line without upsetting its termination, for providing multiple outputs from a single input, for mixing video and

sync to obtain a composite signal, and for increasing a signal amplitude by paralleling two or more amplifier sections. Three of these chassis may be seen at the bottom of the rack shown in Fig. 7.

In this television system, spare distribution amplifier sections have been brought out to the jack panel for use in meeting special requirements. One section (Section E of #12) has been modified to serve as a signal inverter for changing the polarity of a video signal from negative to positive, or vice versa—a situation that occasionally arises.

#### Power Supplies

The five racks of regulated D.C. power supplies necessary to operate this system have been located in a separate room primarily to isolate the heat from the working area of the control room. The D.C. load has been distributed among the power supplies with an eye to maximum efficiency and the ability to shut down certain parts of the system independently without disturbing other parts.

Nine RCA Type WP-33B supplies (600 ma at 280 volts), fourteen Type 580C (400 ma at 280 volts), and three Type TY-25A (300 ma at 280 volts) were used in this installation.

#### Audio Facilities

The primary objective of this discussion is that of describing the video system, but brief mention should be made of its companion audio system. It was designed by Mr. R. E. Bailey of RCA and embodies most of the latest equipment types and techniques. The facilities are built around a Type 76B Consolelette which provides for auditioning, monitoring, switching, and mixing the audio signals associated with this television system. The input signals to the consolette are derived from two turntables, four microphones, two film projectors, a communications receiver, and a television receiver. Fig. 6 shows the consolette and turntables located between the "Studio A" and "Studio B" video switching consoles to promote close coordination with the program director at either console. The rack-mounted audio equipment may be seen in Fig. 8.

The audio system design is quite conventional with one possible exception. Arrangements were made to permit feeding a turntable output into the studio loudspeaker even though a studio microphone is in use. This is useful for providing a low level of music in the studio to aid a vocalist who wishes to sing with the transcription on the turntable. This technique is used occasionally in certain types of programming. No attempt has been made to allow simultaneous switching of both audio and video signals since this presents specialized problems which vary with each installation. The audio facilities are entirely independent of the video and have given excellent results to date.

#### Conclusion

The system described here has worked very well and has shown itself flexible enough to meet 95% of all the conventional and unconventional situations that can and do arise in a television engineering laboratory. However, some additions and modifications (as described below) could be made to increase the flexibility.

Experience has indicated that, in addition to feeding the video from each camera chain to each of three switching systems, a fourth output, without sync, appearing at the jack panel would be very useful. A stabilizing amplifier, placed between the "off-the-air" television receiver and distribution amplifier #4, would allow gain, sync stretching, and other adjustments to be made prior to using the signal with any of the switching systems. Another output channel could be added to the relay switching system of "Studio A" and used to make the spare monitor in the Program Director's Console function as a second preview monitor. More spare distribution amplifier sections could be provided as well as more coaxial lines between the control room and the laboratories. Six lines to each lab might be considered as a workable minimum.

#### Acknowledgment

The writer wishes to express his appreciation to Messrs. W. J. Poch, John H. Roe, H. N. Kozanowski, and Eric Lind of the Radio Corporation of America for their assistance in the preparation of this article.

FIG. 7 (at left). Video Equipment Rack with door opened to show Jack Panels, Master Control Switching, and the Distribution Amplifiers.

FIG. 8 (at left). Audio Equipment Racks and Portable Oscilloscope.



# TELEVISION STUDIO ACOUSTICS

by  
**M. RETTINGER**  
RCA Victor Division  
Radio Corporation of America  
Hollywood, California

Sound recording in television studios differs from that in radio studios chiefly by the greater microphone distances which have to be employed to keep the pick-up device outside the camera angle. In order to maintain, for maximum intelligibility, a low enough ratio of reflected to direct sound at the microphone, the reverberation time in television studios must be made considerably shorter. This applies both to the television stage proper, as well as to any auditorium area, if such exists.

The acoustic treatment of the stage should be highly absorbent as well as durable and fire-proof. Perforated hardboard or asbestos board backed by 2 inches of rock wool constitutes an effective treatment, if large flat surfaces of the board are avoided. A large perforated hardboard panel gives rise to very pronounced high frequency echoes, even when the board is backed by rock wool. For this reason it is desirable to install the material on the stage walls and ceiling in the form of triangular corrugations, none wider than 3 feet, and at least 6 inches deep; or better still, to apply it in the form of cylindrical sections. In this manner the sound becomes dispersed, and the effect of echoes is re-

duced to a negligible degree. As is well known, the wavefront of a beam of sound reflected from a convex surface is considerably longer than that from an equally large flat surface, provided that the wavelength of the incident sound is small compared to the dimensions of the reflecting surface. Fig. 1 shows this relationship graphically, and it is seen that the wavefront reflected from the convex splay is, for the condition illustrated, several times longer than the sum of the two reflected from the flat panels. The figure shows also the construction of the wavefronts, analogous to the optical case. The center of the reflected wavefront coming from the curved surface is one-half the radius of the convex splay (assuming the source to be at some distance from the surface).

Fig. 2 shows how, in Television Studio E at NBC Hollywood, a convex reflective stage splay is being planned to be converted to a convex absorptive splay em-

ploying perforated hardboard for the "facing" and 2 inches of rock wool for the sound absorbent. This studio had previously been used for radio programs only, and was found to be too live for television programs.

Many television programs employ the music of a band for accompaniment or effect. If the orchestra is placed in front of the stage, the intelligibility of the performers' dialogue is sometimes markedly reduced in the auditorium during high music levels. This is so even when the transmitted program has considerable intelligibility, because music and dialogue microphones can be controlled individually, although in small rooms and at moderately high music levels it may become difficult to secure enough acoustic separation between speech and music at the dialogue microphone to obtain there an adequate balance.

For this reason an orchestra pit or lateral placement of the band in the room is desirable. The latter means is not too effective, since some scenes may at times have to be laid on the same side of the room where the orchestra is located. An orchestra pit, on the other hand, may extend partly

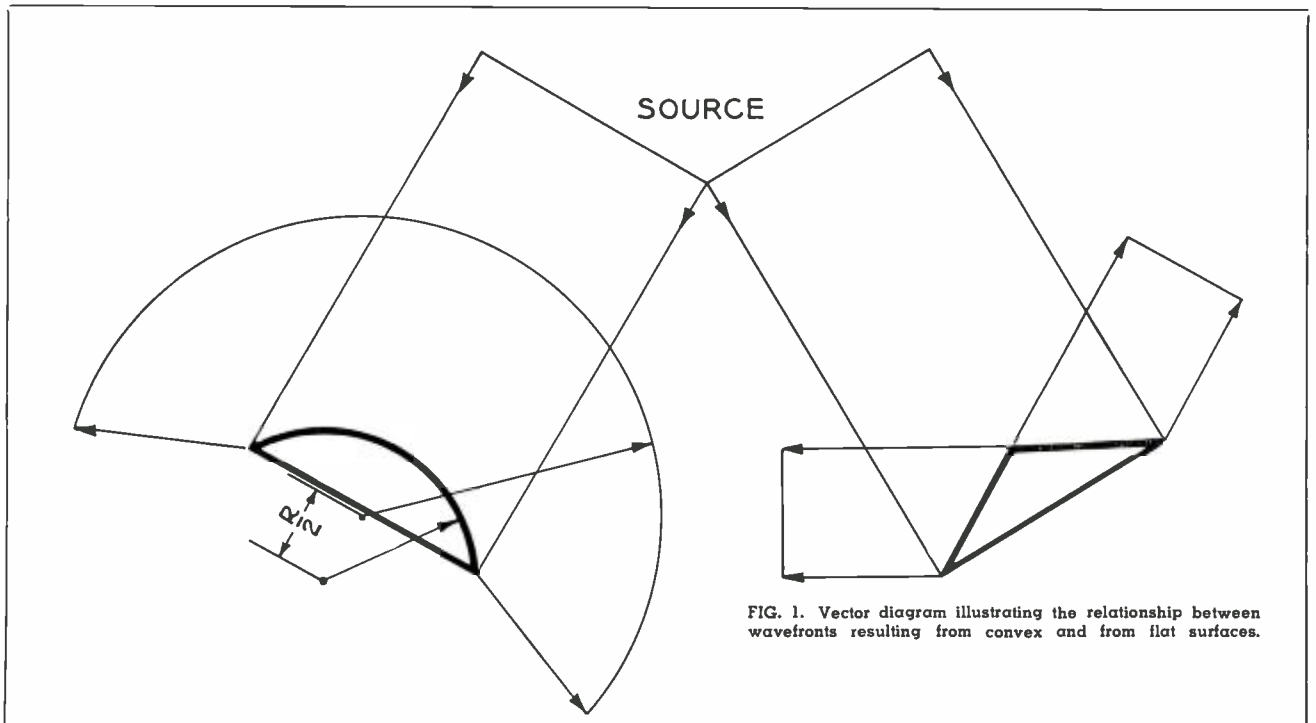

FIG. 1. Vector diagram illustrating the relationship between wavefronts resulting from convex and from flat surfaces.

below the stage, and provides considerable acoustic screening between the individual pick-up units.

It is a frequent complaint of television program attendants that their attention is distracted and their sight to the stage obstructed by the various booms and lights and their operators on the stage. For this reason it may be desirable to have a suspended platform along each side of the stage some 10 or 12 feet high on which these devices can be placed, together with the personnel. At the KECA Studio in Hollywood, for instance, (previously the "Tom Brennaman Breakfast Studio" and converted by the writer), the sides of the stage are dressing rooms, the roofs of which are strong enough to accommodate light, booms, and operators.

Television cameras appear far less disturbing, however, and may be assumed to be part of the show. Even so, an auditorium level which is higher than the stage does much to improve observation for the spectators as shown in Fig. 3. For this rea-

son, television studios of the future, which are intended to accommodate an audience, may have a balcony, even when the studio is not very large.

No less important than the acoustic treatment of the stage is that of the auditorium proper. Durability of wall and ceiling treatment appears somewhat less important in this part of the studio, however, while decorativeness or appearance become more significant. For this reason a fire-proof tile which is soft, and hence a good low-frequency absorbent, represents a desirable material. Many such products can be painted without impairing their absorptivity, quite unlike porous ceramic tiles.

Much as in a theatre, the rear wall should carry the most effective treatment. The side-walls as well as the ceiling should be covered with sufficient treatment to secure in the house a reverberation time no longer than two-thirds that accorded to the auditorium were it used for radio shows only. Needless to say, the rear wall should

not be made concave, even when it is intended to treat it heavily acoustically, and the side-walls should not be parallel but should be angled and/or splayed.<sup>1</sup>

Television stages without audience accommodations should have as low a reverberation time as possible. The reason for this is that, in general, the ratio of (set-) reflected-to-direct sound at the microphone is sufficiently high to provide enough of an impression of reverberation quality so that the pictured scene will have a natural character. If the stage walls are insufficiently absorptive, the added reflections will tend, not only to destroy the illusion of the picture, but also to reduce the intelligibility of the dialogue. It has, therefore, become almost customary to line the stage walls either by nailing a 2 inch rock wool blanket to the wall studs or by packing the space between the studs with rock wool. As a protective measure, muslin and wire mesh are usually applied over the wool. Fiberboard, hair felt, cork, acoustic plaster, etc., are useless for the purpose of treating the stage acoustically. A glance through absorptivity tables of acoustic materials will quickly show that mineral wool, also called rock wool, has by far the highest absorption for the frequencies in the recording spectrum.

Rock wool is made by melting silica and other compounds (notably magnesia, alumina, and lime) and shredding the molten mass into fine fibers by one of many patented processes. Some manufacturers prefer to use glass for the raw material, calling the final product either glass wool or referring to it by a trademarked name (Red Top Insulating Wool, for instance). This type of wool is characterized by a relatively low density (1.5-3 pounds per cubic foot) and a very clean, white appearance. Ordinary mineral wool varies in density from 3 to 12 pounds per cubic foot, the average run being 7.5 pounds per cubic foot. In color, it ranges from a very dark gray, almost black, to a white resembling that of glass wool. The density of the material has a considerable bearing on its absorptivity, the light wools being less absorptive than those of higher density.

Regarding its color, it can be said that dark wool indicates the presence of certain elements (phosphorus, sulfur, etc.) or the lack of silica, which may have a bearing on the longevity of the wool. A recently examined installation of very dark wool

<sup>1</sup> For further details of auditorium design, see "Applied Architectural Acoustics," by M. Rettinger, Chemical Publishing Company, Brooklyn 2, N. Y.

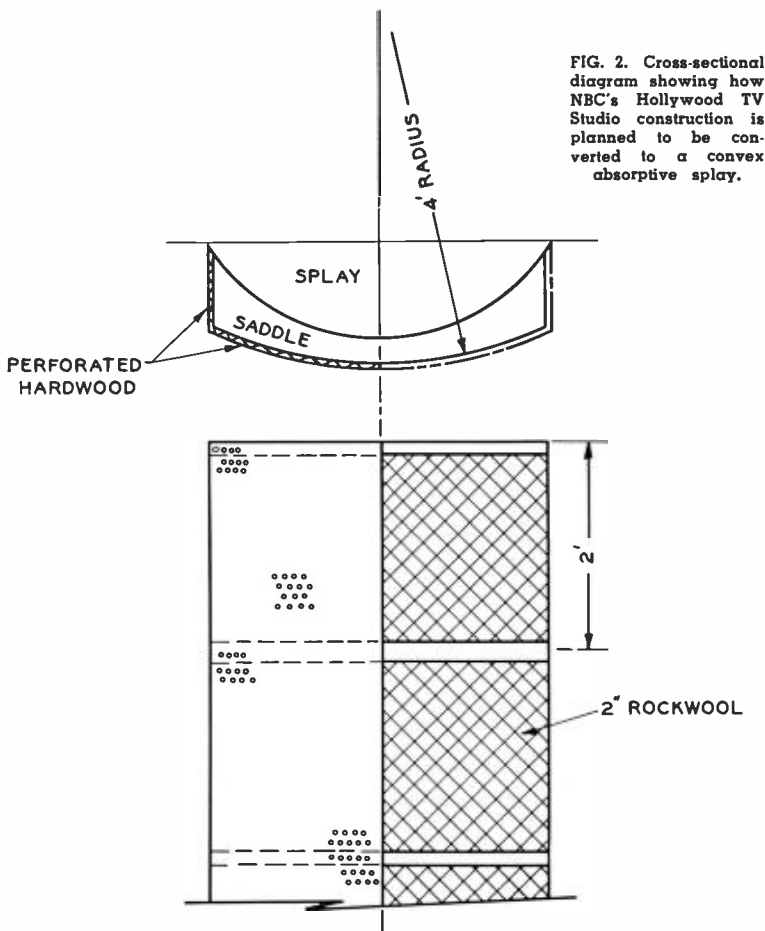

in a motion picture sound stage over twelve years old, showed that a considerable portion of the wool had disintegrated and had settled, in a more or less powdery form, to the lower portions of the structure. However, other portions of the same installation, either because of less contact with a moist atmosphere or because less subject to vibrations, had stood up considerably better.

Regarding the texture of the wool, so-called shot (solid globules of material) is of course useless for sound-absorptive purposes. Studio specifications usually exclude wool with shot having a diameter in excess of  $\frac{1}{8}$  inch. Another shot restriction excludes wool having solids in excess of 30 percent by weight or 2 percent by volume.

The preferred method of applying rock wool to stage walls consists in nailing 2-inch thick blankets directly to the studs of the walls, rather than packing the space between the studs with the wool. The latter method is undesirable from a workman's point of view (since the incident mineral dust is injurious to skin and lungs), and also because it provides neither increased absorptivity nor a saving in cost. This is true even in the case where the blanket carries heavy wrapping paper on one side (the one facing the studs) and muslin on the other, instead of muslin on both sides, as did the early and more expensively manufactured mineral wool blankets. The use of the paper in no way detracts from the absorptivity of the product, and even tends to increase it at the low frequencies. Some manufacturers (particularly of low-density wool) glue the paper to the wool, and then merely stretch muslin over the face of the blanket after its application to the studs. For heavier wools, however, muslin and paper are sewed together, approximately every four inches, with a special sewing machine, the stitch running the length of the (usually) four-foot-wide and fifteen-foot-long blanket. The type of paper used varies from forty-pound (per ream) basis Kraft paper to the very strong sixty-pound paper. The muslin is frequently specified as 44-40 count, weighing six ounces per square yard.

If a blanket has been fabricated this way, it can be nailed to the studs with ordinary box nails, although so-called foundry nails (large-headed nails) are sometimes thought to provide greater security. Certainly the use of 1-inch diameter tin washers in conjunction with the nails to give greater security to the installation appears superfluous, judging from the many blankets which have been nailed

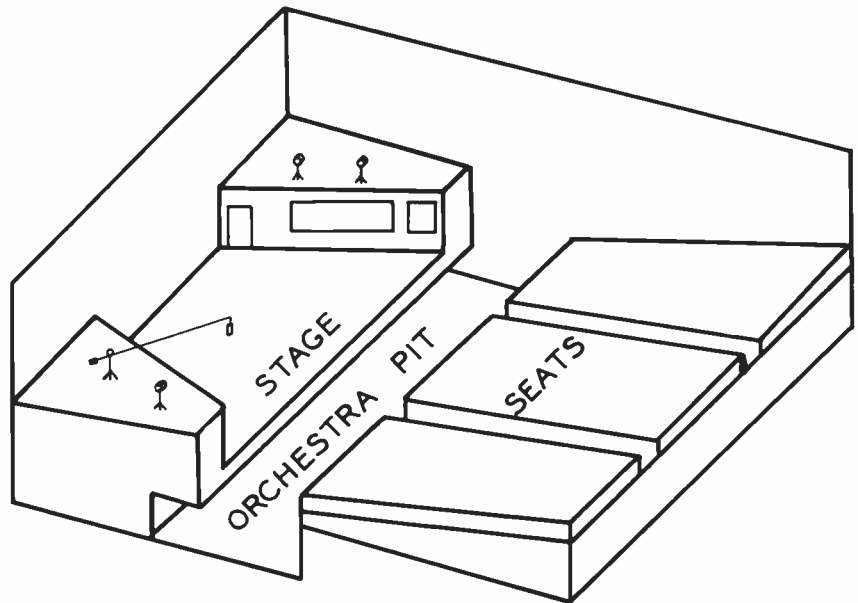

FIG. 3. An auditorium level higher than that of the stage and the removal of mike booms and lights to a raised level at the sides improves the viewing for spectators.

to the studs with no more than  $2\frac{1}{2}$ -inch long plasterboard nails 2 feet on center.

The use of a wire mesh over the blanket for protective purposes is recommended. This mesh need not extend from floor to ceiling, but may be applied to a height of approximately 16 feet from the floor. Ordinary  $\frac{1}{2}$ -inch chicken-wire is frequently employed for the purpose, although 1-inch hexagonal wire mesh (somewhat more expensive) is used by some studios. A 6-inch baseboard and a 2-inch by 6-inch nailer 4 feet from the floor usually complete the treatment of such a stage wall.

If for any reason the recorded dialogue is to sound reverberant, this can be accomplished by means of a reverberation chamber. The sound is reproduced in this chamber and the output from a microphone in it is mixed with the original. Unlike other methods, electrical or mechanical, of adding a reverberating note to a recording, the chamber method provides both the proper growth characteristic and the decay quality of sound in a live enclosure. Delay networks, magnetic tape recordings, and other devices for achieving synthetic reverberation usually permit only provision for the decay characteristic; no attempt is made to introduce the growth characteristic since the latter is held less essential in an approach to total reverberation.

The following recommendations for reducing acoustic difficulties on television sets are presented as a guide in set design to reduce sound pick-up difficulties often encountered during programs.

1. All alcoves, window recesses, concave spaces of any type, should be made of cloth to eliminate boominess.
2. Avoid parallel walls in sets such as kitchens, offices, boat interiors, etc., unless opposite walls are made of cloth. When opposite hard walls are angled, the slope should come to 1 foot in 10 feet.
3. Where ceilings are used, they should be made of cloth. It may be noted that dialogue can well be recorded by placing the microphone on the other side of the "ceiling", that is, above the thin cloth representing the ceiling.
4. Whenever possible, the treads of stairways should be covered with soft material and the stairs so constructed as to eliminate squeaks.
5. The use of glass in windows should be kept to a minimum. Wherever possible, black gauze or narrow glass borders should be used. Large plane surfaces reflect a large percent of the incident sound which reinforces the direct sound, particularly at the low frequencies, causing these frequencies to be over-accentuated. Indeed, "boominess" of recorded dialogue is probably the most common acoustic defect experienced on television sets.
6. Noise from footsteps, vehicles, etc., on gravel walks can be reduced through the use of chipped cork in place of gravel, which gives the identical appearance of gravel when televised.

# KNBC'S NEW AM VERTICAL



FIG. 1. Dramatic close-up view of the new vertical "articulated joint" AM radiator installed at Belmont. Distance between the upper and lower guy wires is 150 feet. The "articulated" joint is just a few feet above the point of attachment of the lower guy wires.

**KNBC**, the 50 kw NBC station in San Francisco, recently completed the installation of a new vertical antenna tower having unique features of design. Located at the edge of San Francisco Bay near the foot of San Bruno Mountain, the new structure rises 550 feet above the Belmont Marsh flats. Operating on the frequency of 680 kc the new tower adds 10,000 square miles to the KNBC primary service area

and during the evening and night hours greatly increases the area free of fading.

#### The New Vertical

The new structure incorporates an "articulated joint" at the 400-foot level which in effect provides two separate guyed sections one above the other. The lower section is supported by a single set of three guy wires. At the top of this section there

is another porcelain cone insulator. Rising above this point, there is an additional 150 feet of tower, supported by an additional single set of three guy wires. At the top there is a "top hat" to increase the effective electrical height. To further increase the effective electrical height loading is provided across the upper insulator. Fig. 1 shows the stub provided to accomplish this loading.

To increase the conductivity of the steel structure, NBC engineers incorporated  $\frac{3}{4}$ -inch copper tubing bonded to each corner of the tower throughout the entire length of the steel members. The ground system consists of 1-inch copper ribbon .02-inch thick which extend 500 or more feet from the base of the tower. One hun-

dred and twenty radials are incorporated, spaced three degrees mechanically. In addition, the center pier is shielded and connected to a 50-foot square copper mesh ground screen around the base.

The design and erection of the structure was executed under the supervision

of Raymond F. Guy, NBC Manager of Radio and Allocations Engineering. An investigation of earthquake hazards in this area indicated the possibility of horizontal wave motion through the mud flats in the event of severe transverse earthquake shocks. In order to contain the tower sec-

*(Continued next page)*

FIG. 2. A closeup of the base of the vertical radiator, showing equipment used to increase conductivity; three-quarter-inch copper tubing along each corner of the tower, copper radials extending outward from the base, and fifty feet of copper mesh screen surrounding the base. Structure at left houses condenser and induction coils.

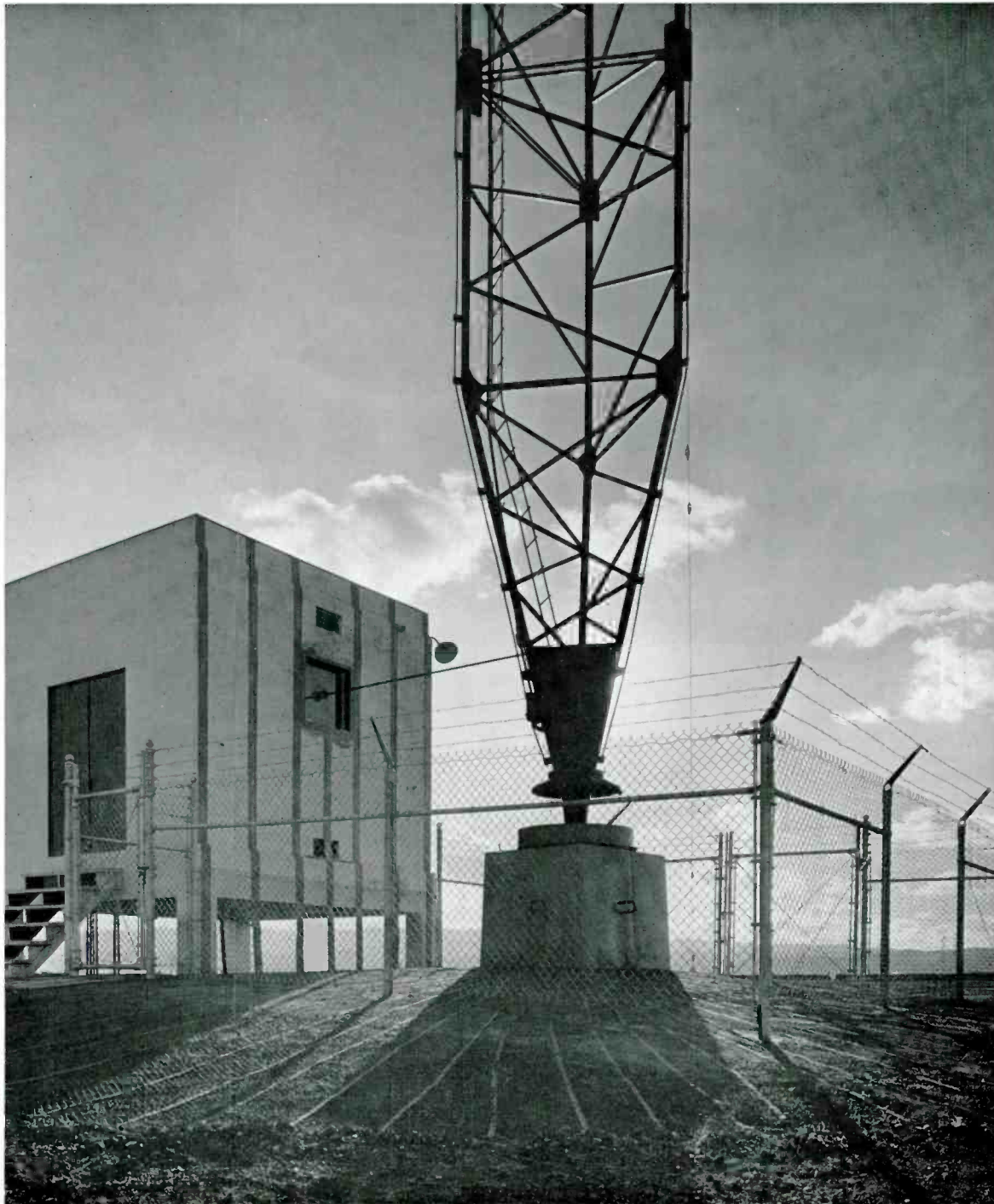

tions in the event that transverse shocks were to destroy the porcelain cone insulators, a circular steel rim is provided to confine the tower sections on their pedestals.

The 600-foot long transmission line is the familiar RCA 6-wire type of 230 ohms impedance insuring high efficiency transfer and low radiation.

The tower is of the familiar welded type of construction having structural specifications designed further to give protection against transverse earth shock waves.

The construction of this new vertical radiator insures radiation efficiency in keeping with a 50,000 watt non-directional, clear channel station—the only one north of Los Angeles, south of the Canadian border, west of Salt Lake City and east of the Orient.

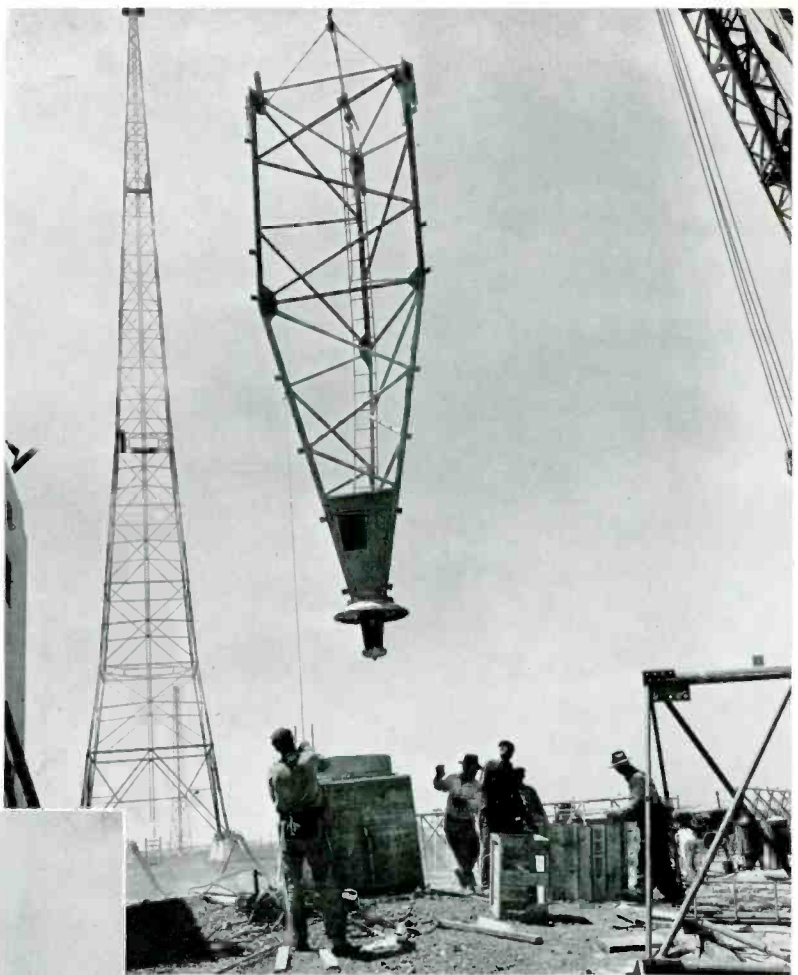

FIG. 3. The ten-inch insulator cone at base will support the entire 90 tons of KNBC's new vertical radiator tower. The tower shown in the background is part of the old antenna and was kept intact for use during construction of the new radiator. It is now available for future emergency use.



FIG. 4. Close-up view of the insulator cone which will support upper part of the tower at the articulated joint.

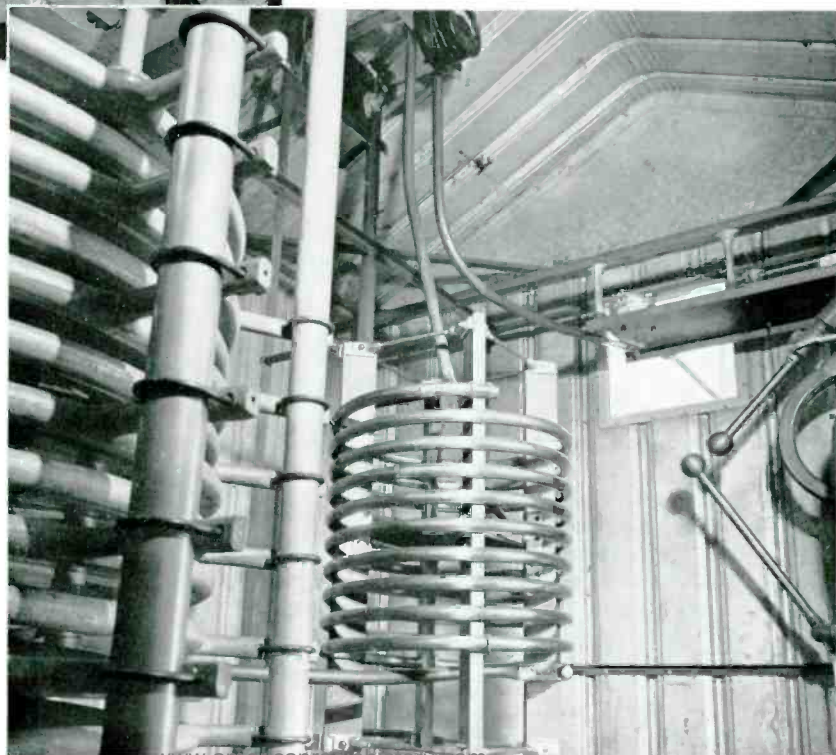
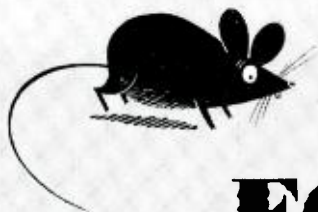

FIG. 5. Close-up photo showing the impedance matching network for KNBC's new vertical radiator at Belmont, California.



# HAM FORUM



## A DEPARTMENT FOR THE BROADCAST RADIO AMATEUR

Latest news from Florida indicates plenty ham activity in Coral Gables and Miami. Larry Mennitt, W4IVF, Chief Engineer of WVCG, Coral Gables, is on 10 fone with 15 watts. He also has a mobile 30-watt Nemo (26 mc.) rig into which he plugs a 10-meter crystal for ham work. The rig in the transmitter building uses a vertical antenna suspended from a tower guy. . . . Larry would like to see a broadcast calling frequency on 10 meters. . . . We do not know of any on 10, but on 20, 14260 kc is held down every Saturday at 10 am by W3HUV, "Grif" Griffith of RCA; W4SW, Wilson Raney, Chief Engineer of WREC, Memphis; W5GSY, Harold L. Sudbury, owner and Manager KLCN, Blytheville, Ark.; and W5AY, K. Tracy, Chief Engineer of KLRA, Little Rock.

. . . Can anybody supply a 10-meter calling frequency?

. . . Dave Traer, W4AZK, of WIOD, Miami, says someone is pouring QRM on his dx . . . while he is having fireside chats with the rare ones . . . blames it on 50 kw QSY stations.

### EAST COAST TELETYPE

W2JAV, Phil Catona, Supervisor of RCA Test Section, is South Jersey's "King pin" in the 2-meter Teletype Net which is gradually being extended up and down the East Coast from New England to Virginia. Phil, whose QTH is Hammonton, N. J., has been keeping regular skeds with W3LMC, Baltimore and W4JCV, John Gill, BC Consultant Engineer. 153 miles away in Leesburg, Va. High gain antennas and fairly high power are used by practically all stations in the net. However, as Phil points out, low power is practical too. From High Point, N. J., using a 20-watt mobile rig, he succeeding in starting auto-printer of W2PAU, some 100 miles distant in Westmont, N. J. (also an active member of the net).

There are several other hams active in this (147.96 mc.) net. Among them Charles Brown, W2ER, Chief Engineer, and Dave Winter, W2AUF, Transmitter Supervisor of WEVD and WEVD-FM, Long Island,

N. Y. Dave is also President of the Amateur VHF Institute of New York, which was organized in 1947 to advance VHF techniques, and comprises several of the local clubs in the Long Island area. The Maspeth Radio Club was the original group to which was added the 235 (mc) Club, the Brooklyn VHF Club and the VHF Teletype Society.

### Pioneers in Teletype

According to Dave, the latter group has greatly increased its membership due to a tremendous interest in Amateur Teletype. First successful Radio Teletype contact on 2 meters was carried out between this club and W2BFD, John Williams, pioneer of Amateur Teletype. . . . Also with WEVD is Vern Calame, W2YSO.

The teletype system on the net utilizes carrier shift for calling. The receiving apparatus is on "auto-call" during intervals (clock-controlled) during which the calling station can lock the printer on. At the close of transmission, the sending station can close the printer down. This system is useful for call-back signalling, should an operator be away from his station.

### HORIZONTAL OR VERTICAL FOR VHF?

W2PAU, Miles Brown, RCA Engineering, and W4AO, Ross Bateman (National Bureau of Standards) Falls Church, Va., have been keeping regular skeds on 2 for the past year over 120 miles using first horizontal and then vertical beams. . . . "Brownie," who packs up to 500 watts to a pair of 4-125A's, says he is squarely on the fence as to which polarization is the best . . . he uses a mechanical "flip-flop" arrangement since both vertical and horizontal antennas are widely used.

. . . It is with regret that we record the passing of W2GX, Russ Valentine, Chief Engineer of WQXR, N. Y. Russ will be remembered by many because of his keen interest in the Amateur Fraternity and his technical contributions to its progress.

73 W2BCV

Address correspondence to:  
**HAM FORUM**  
**Marvin L. Gaskill (W2BCV)**  
**Associate Editor, Broadcast News**  
**RCA, Camden, New Jersey**

The rack in the center of the W2JAV operating room contains the original teletype gear which has been superseded by the very small unit partially visible at the extreme right. To the left of this is a teletype Model 14 tape printer, and on the left side of the rack is a Model 12 roll printer. The rack in the background is Phil's low-frequency transmitter.



# The finest custom-built control

...are



*KOMO, Seattle. This master control console—with 9 deluxe audio equipment racks (at rear, not visible)—is one unit of KOMO's completely new and modern 7-studio system. It incorporates complete center panel switching for 10 studios and 6 outgoing channels (KOMO-AM, KOMO-FM, network plus 3 emergency).*

*WNEW, New York. This master control installation—in WNEW's 7-studio lineup is flanked on each side by 5 deluxe audio equipment racks. It has complete facilities for control and preset switching of 7 studios to 10 outgoing lines . . . and for feeding cue from any channel to any studio.*

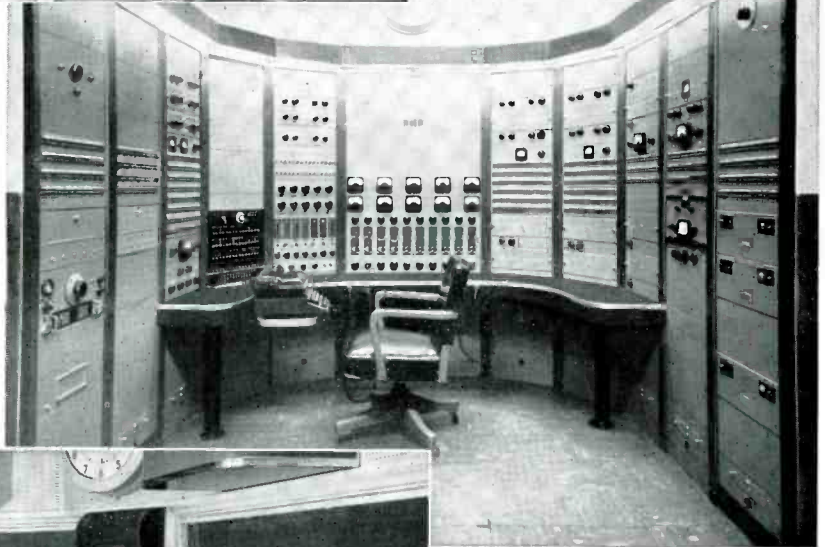

*WJPG-FM, Green Bay. One of the specially-built studio-control consoles in WJPG-FM's 4-studio arrangement. Complete two-channel operation (AM and FM), simultaneous audition and broadcast from any combination of studios, remote lines, cueing and talkback are provided.*



# studio installations RCA

*WJBP, Baton Rouge. Here is a specially-built console which combines master and studio control operations at one location. Master control incorporates mechanically interlocked push-button switches to avoid the possibility of program overlap.*

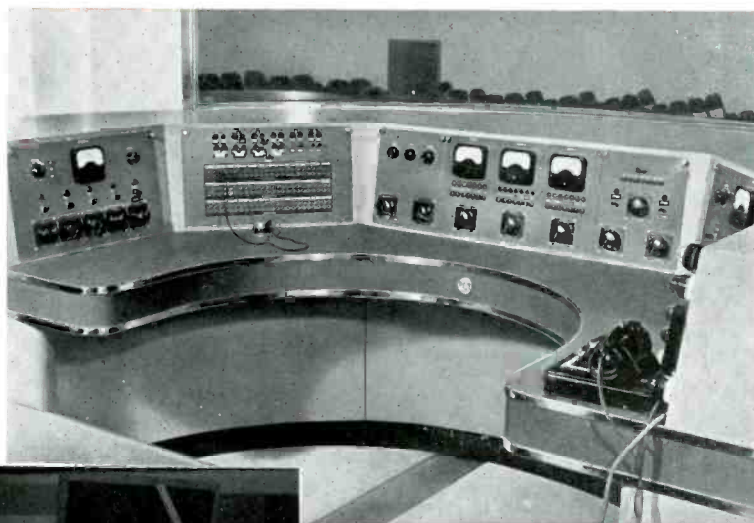

*WMGM, New York. This deluxe custom-built studio console provides complete facilities for the control of auditorium-type studio "A", largest of WMGM's 6 studios.*

*WJAC, Johnstown, Pa. In this speech input layout, custom-built matching-end consoles contain auxiliary switches and controls. They are used in conjunction with a standard 76-series consolette to provide increased flexibility and convenience.*



# SOUND TRANSLATION.

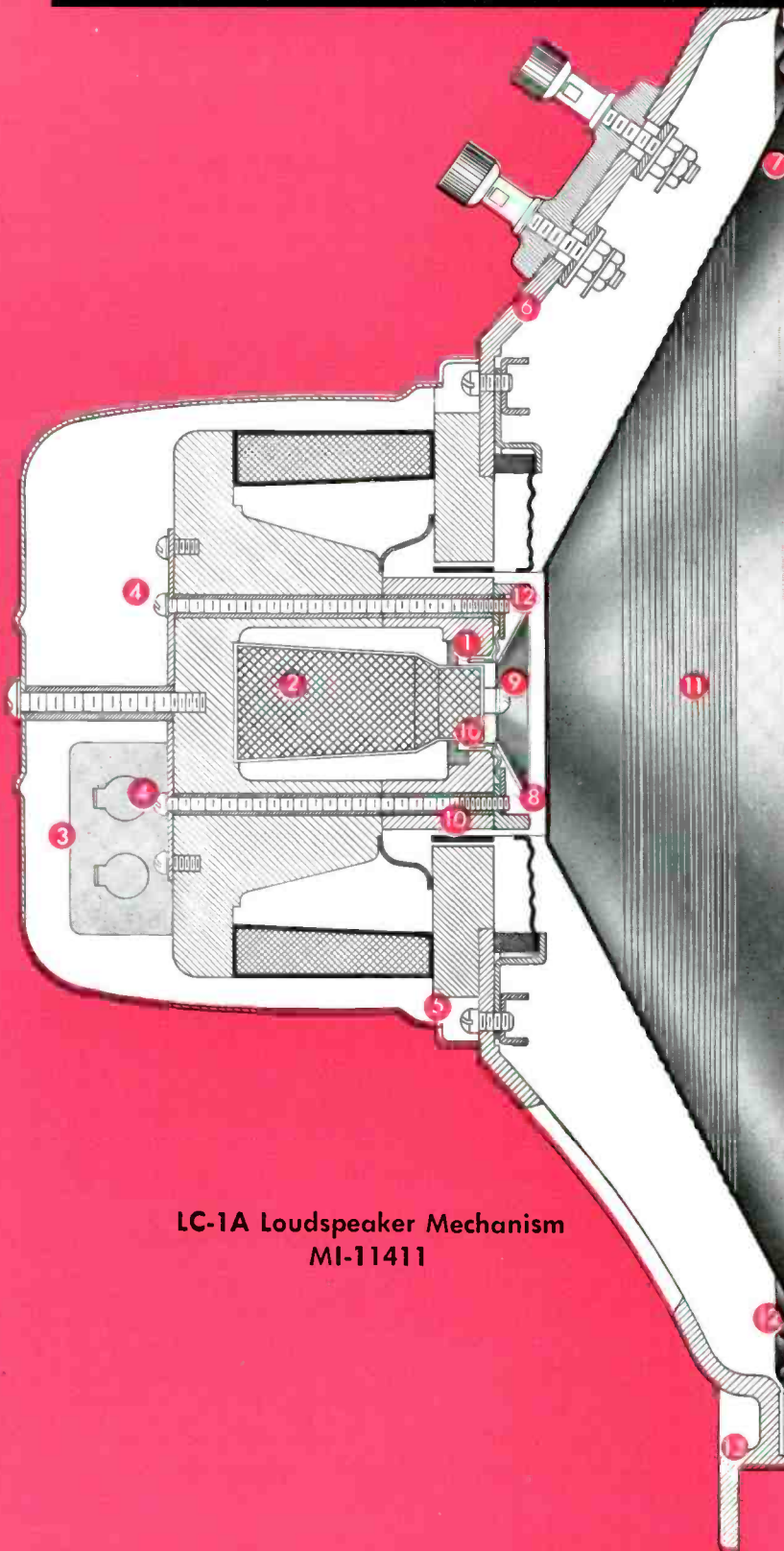

LC-1A Loudspeaker Mechanism  
MI-11411

- 1 H-f voice coil, aluminum wire-wound, to deliver full h-f range
- 2 Heavy ALNICO V magnets
- 3 Cross-over condenser
- 4 Centering adjustment for h-f cone
- 5 Centering adjustment for l-f cone
- 6 Sturdy die-cast aluminum frame
- 7 Shallow cone for smooth response and greater angle of distribution
- 8 H-f and l-f cones coaxially-mounted, mechanically independent
- 9 H-f cone. Diaphragm diameter only 2 3/4". Wide-angle distribution to 15,000 cycles
- 10 Ample gap clearances
- 11 Massive 15" l-f cone. Bass response 35 to 2000 cycles at all volume levels
- 12 Cone rim treated to minimize edge reflections for smoother response
- 13 Offset mount eliminates front cavity — insures smooth response

..... **next to perfect!**

## The Famous LC-1A Speaker

Among the great achievements of the RCA Princeton Laboratories is the development of the most advanced speaker in the world—the RCA Duo-Cone, Type LC-1A.

Expressly designed to give sound its true translation, this professional speaker is matched by no other high-quality sound reproducer.

Unique duo-cone design (originated by Dr. H. F. Olson of RCA Princeton Labs) provides a smooth response from 50 to 15,000 cycles—with no resonant peaks, harmonics, or transient distortion. Full power is radiated over 120-degrees at 15,000 cycles—makes it possible to enjoy high-fidelity sound *any place in the room!* Smooth crossover response around 2000 cycles eliminates all undesirable interference between the high-frequency unit and the low-frequency unit. Controllable “roll-off” at 5 and 10 kc... when used with the MI-11707 filter... restricts the h-f distortion and surface noises present in many recordings.

Today, more than 3000 of these speakers are serving in station control rooms, listening rooms, auditioning booths, lobbies, clients' offices, and private homes.

For more information, mail the coupon.



### New Wall-Ceiling Housing for LC-1A

Ideal for sound reinforcement in control rooms, auditioning booths, hallways, talkback positions, elevators,

executive offices. Part provided for increasing bass response. Finished in harmonizing 2-tone umber gray.

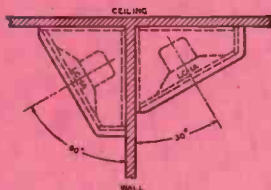

### It's Easy to mount

The Wall-Ceiling Housing can be mounted for long or short “throws”—makes the wall and ceiling a part of the acoustical system.

### The LC-1A Monitoring Speaker, with Console cabinet and MI-11707 filter

The finest reproducer in the business. Available in a choice of 2-tone umber gray or walnut finish.



**AUDIO BROADCAST EQUIPMENT**  
**RADIO CORPORATION of AMERICA**  
ENGINEERING PRODUCTS DEPARTMENT, CAMDEN, N. J.

In Canada: RCA VICTOR Company Limited, Montreal

Department 19-IC,  
RCA Engineering Products  
Camden, N. J.

Send me price and information on

- LC-1A Speaker Mechanism, MI-11411
- LC-5A Wall-Ceiling Cabinet, MI-11406
- LC-1A Speaker with Console Cabinet, MI-11411/11401

Name \_\_\_\_\_

Station or firm \_\_\_\_\_

Address \_\_\_\_\_

City \_\_\_\_\_ State \_\_\_\_\_



The Fountainhead of Modern Tube Development is RCA

## The "Eyes" of Modern Television

The extraordinary picture quality your television audience sees is due in great measure to RCA research and engineering in developing pickup tubes for specific TV broadcast services.

The three RCA pickup tubes you see here meet the requirements of modern TV stations. Each tube has features which make it particularly suitable for delivering superior pictures in its special field of service.

**For general-purpose use.** The RCA-5820 has exceptional sensitivity and ability to handle a wide range of brightness in the scene. It portrays colors in appropriate gradations of gray tones . . . has good resolution capabilities.

**For "live" work in the studio.** The RCA-5826 with its high sensitivity and improved signal-to-noise ratio is capable of producing excellent picture quality. It portrays colors in the same gray tones as RCA-5820 . . . can be used

with low studio light levels...has good resolution capabilities.

**For film pickup.** The RCA-1850-A has good sensitivity and resolution . . . can handle a wide range of light levels in the same scene. Its cost factor is low.

In addition to pickup tubes, RCA has a complete line of electron tubes for every type of broadcast service. The entire line is available through your local RCA Tube Distributor.



**RADIO CORPORATION of AMERICA**  
ELECTRON TUBES

HARRISON, N. J.