

AM · FM · TELEVISION
BROADCAST
NEWS

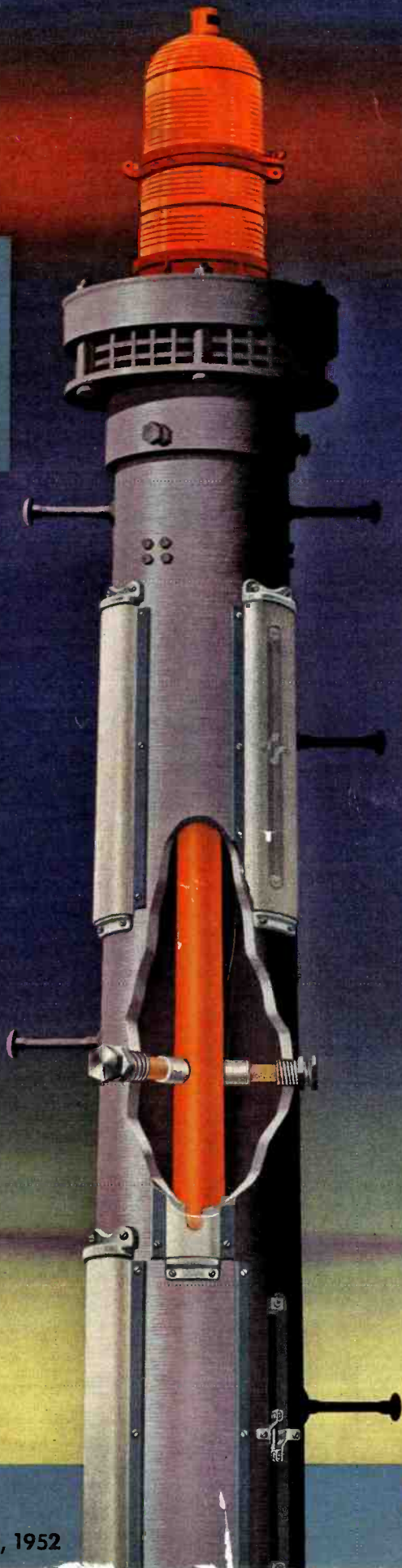

New UHF Antenna . . . Pg. 8

Vol. No. 68

March-April, 1952





IT'S UNOBTUSIVE. Umber gray coloring blends it right into the TV picture. Minimum reflection.

In the show . . . without stealing the act

RCA's new ribbon-pressure **"STARMAKER"***

SO SLIM YOU MUST LOOK sharply to see it . . . so skillfully styled its shape and coloring fade right into the scene . . . this tubular microphone has won the favor of entertainers and announcers wherever it has been shown.

Designed by RCA Laboratories after more than three years of painstaking research, the STARMAKER meets the long need of broadcasting, television, and show business for a high-fidelity microphone that—will not hide the features of performers—is easier to handle—and yet retains all the high-quality features of RCA professional microphones. Pick-up is non-directional. Frequency response is uniform, 50 to 15,000 cps.

Here is a "carry-around" microphone free from wind blast and air rumble. It contains no tubes, no condensers, no high-impedance circuits, no special amplifiers, or power supplies—is virtually impervious to mechanical shock.

The STARMAKER fits any standard microphone stand . . . and can be substituted for any professional high-quality RCA microphone. *No extra attachments needed!*

For price and delivery, call your RCA Broadcast Sales Engineer. Or write Dept. PB 19, RCA Engineering Products, Camden, N. J.

**Selected from entries submitted by Broadcast Stations in national contest.*



IT'S COMFORTABLE TO HANDLE . . . weighs only 1 lb.



IT'S SMALL. Diameter of body is only 1¼ inches. Diameter of pick-up point is only ⅜ inch!



AUDIO BROADCAST EQUIPMENT
RADIO CORPORATION of AMERICA
ENGINEERING PRODUCTS DEPARTMENT, CAMDEN, N. J.

In Canada: RCA VICTOR Company Limited, Montreal

Broadcast News

AM • FM • TELEVISION

Published by the

RADIO CORPORATION OF AMERICA

ENGINEERING PRODUCTS DEPARTMENT . . . CAMDEN, NEW JERSEY

NUMBER 68

MARCH-APRIL, 1952

Subscription Rates

In continental U. S. A. - \$4.00 for 12 issues
In other countries . . . \$5.00 for 12 issues

JOHN P. TAYLOR, Editor

W. O. HADLOCK, Managing Editor

M. L. GASKILL, E. B. MAY, E. C. MASON, N. J. RIVKEES, Associate Editors

Contents

PLANNING AND BUILDING A RADIO AND TELEVISION CENTER	by RAYMOND A. BOWERS	4
A NEW UHF TELEVISION ANTENNA, TFU-24-B	by O. O. FIET	8
WSBT, SOUTH BEND, IND.	by H. G. COLE AND W. A. SWEITZER	24
WNAG MEASUREMENT REPORT ON NEW BTA-250M		29
A NEW TELEVISION CAMERA FOR STUDIO AND FIELD USE	by A. REISZ	30
KSOO INSTALLS FIRST BTA-10G TRANSMITTER	by MAX E. PIERCE	42
TV STATION OPERATING COSTS	by J. HEROLD	50
TENTH TELEVISION TRAINING PROGRAM		55
A NEW MASTER MONITOR	by N. P. KELLAWAY	56
VERSATILE NEW MODERNPHONE		62
WHAT ABOUT TOWER LIGHTING?	by MARTIN S. PHILLIPS	64
HAM FORUM	by M. L. GASKILL	70

Copyright 1952
Radio Corporation of America
RCA Victor Division
Camden, N. J.

PRINTED
IN
U.S.A.

OUR COVER for this issue is reproduced from a beautiful (we think) artist's conception of our new UHF antenna, the TFU-24B. This drawing was rendered by artist Robert Held under the supervision of Jack Parvin, Art Director for the RCA Victor Division. The TFU-24B is completely described (this is probably the understatement of the year!) on Pg. 8, from the bottom slot to the beacon. Of slotted tubular steel construction, the antenna provides features not available in any other UHF broadcast antenna.

NEW CAMERA, described by Al Riesz in article starting on Pg. 30, is something we've been looking forward to for a long time. Our old camera models, the TK-10A and the TK-30A, were so successful, and in such demand, that we were beginning to wonder whether they would be with us forever. So far as we know there has never been a piece of broadcast equipment (of anybody's make) which has been the preponderant choice by such a large margin as have the RCA TV cameras, Types TK-10A and TK-30A. They were the first post-war cameras to be announced, the first to use the image orthicon, and the first to be shipped in quantity. Since their announcement in 1946 a number of other cameras have come on the market. Some of these other cameras had minor features not found in the TK-10A and TK-30A. However, for one reason or another they never measured up, and never made any appreciable dent on the popularity or sales of the TK-10A and TK-30A. Even among stations which did not go RCA all the way, most bought RCA cameras. In fact, there are only a few stations today who do not have some RCA cameras. The three largest networks have pretty much standardized on them, as have nearly all the largest independents. All told more than 800 TK-10A's and TK-30A's are in use. We probably could have gone right on selling them for another five years, but our engineers have been working for several years on a new camera design. And now it's too good to keep under wraps any longer. So it's goodbye to the TK-10A/30A, and welcome to the TK-11A/31A.

The new camera was shown for the first time at the NARTB Convention, and it is described in detail in the article on Pg. 30. Nevertheless, we can't resist the impulse to emphasize here some of the features which impress us (and, we think, will impress you).

IT'S ALL NEW, is one point we would especially like to make. With an old design as successful as the TK-10A/30A there might be an inclination just to modify it and give it a new number. But this was not the case. The TK-11A/31A is, as somebody said, "new from the yoke up". And that is literally true, for even the yoke has been redesigned to give better performance. Similarly, practically every other part of the camera has been changed in some degree. The result is a completely new camera.

IT'S BETTER, by a considerable degree. Performance has been appreciably improved, and a number of new features which add to operating convenience have been incorporated.

IT'S MORE ACCESSIBLE in every way. Use of plug-in amplifiers, hinge-out chassis and provision for quick IO change provide instant access to every component.

IT'S COMPLETELY FLEXIBLE. The same camera unit will be used in the studio as well as in the field. Only difference is in the camera control supplied. The TK-11A comes with a field-type camera control unit, the TK-31A with studio-type camera control unit. The camera units themselves are interchangeable.

IT'S COMPLETELY INTERCHANGEABLE with older camera units: same interconnections, same plugs and receptacles, same lens mounts, even a somewhat similar appearance. Thus it can be mixed with older cameras without inconvenience.

RCA's TV "Basic"

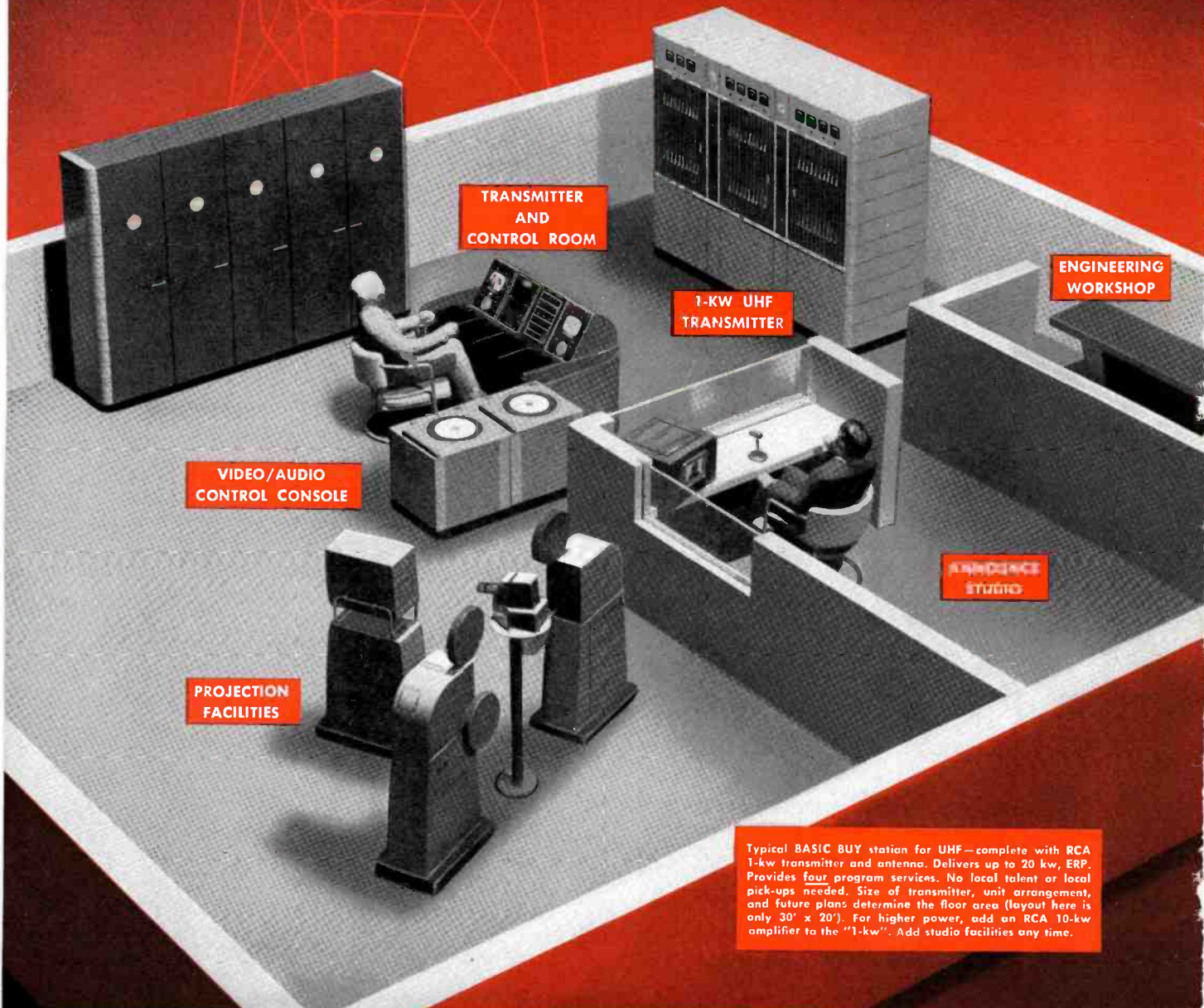

TRANSMITTER
AND
CONTROL ROOM

1-KW UHF
TRANSMITTER

ENGINEERING
WORKSHOP

VIDEO/AUDIO
CONTROL CONSOLE

AUDIENCE
STUDIO

PROJECTION
FACILITIES

Typical BASIC BUY station for UHF—complete with RCA 1-kw transmitter and antenna. Delivers up to 20 kw, ERP. Provides four program services. No local talent or local pick-ups needed. Size of transmitter, unit arrangement, and future plans determine the floor area (layout here is only 30' x 20'). For higher power, add an RCA 10-kw amplifier to the "1-kw". Add studio facilities any time.

"Buy" does the most

**-with the least TV equipment
-VHF or UHF!**

4 PROGRAM SERVICES

- no local studios needed!

- Network programs
- Local films (16mm)
- "Stills" from local slide projector
- Test pattern from monoscope (including individualized station pattern in custom-built tube)

THIS PICTURE ILLUSTRATES what we think is the minimum equipment a TV station should have to start with—and earn an income. The arrangement can handle any TV show received

from the network and provides station identification and locally inserted commercials as required. In addition, it offers an independent source of revenue—by including film and slide facilities for handling local film shows and spots, or network shows on kine recordings.

The BASIC BUY includes: A transmitter and an antenna (necessary for any TV station); monitoring equipment (required by FCC); film and slide equipment (for local programs—and extra income); monoscope camera for reproducing a test pattern of known quality (important for good station operation and as an aid to receiver adjustment); and a control console that saves operator time and effort (it enables one technical

man to run the station during nearly all "on-air" periods).

RCA's BASIC BUY can be used in combination with any RCA TV transmitter and antenna, of any power—VHF or UHF. Matched design and appearance make it easy to add facilities any time (you need never discard one unit of a basic package). And note this: *RCA BASIC UNITS ARE IDENTICAL TO THE RCA UNITS USED IN THE BIGGEST TV STATIONS!*

RCA's BASIC BUY is already being adopted by many TV station planners. Let your RCA Sales Representative work out a flexible package like this for you—show you how to do the most with the least equipment!

This is what the BASIC BUY includes!

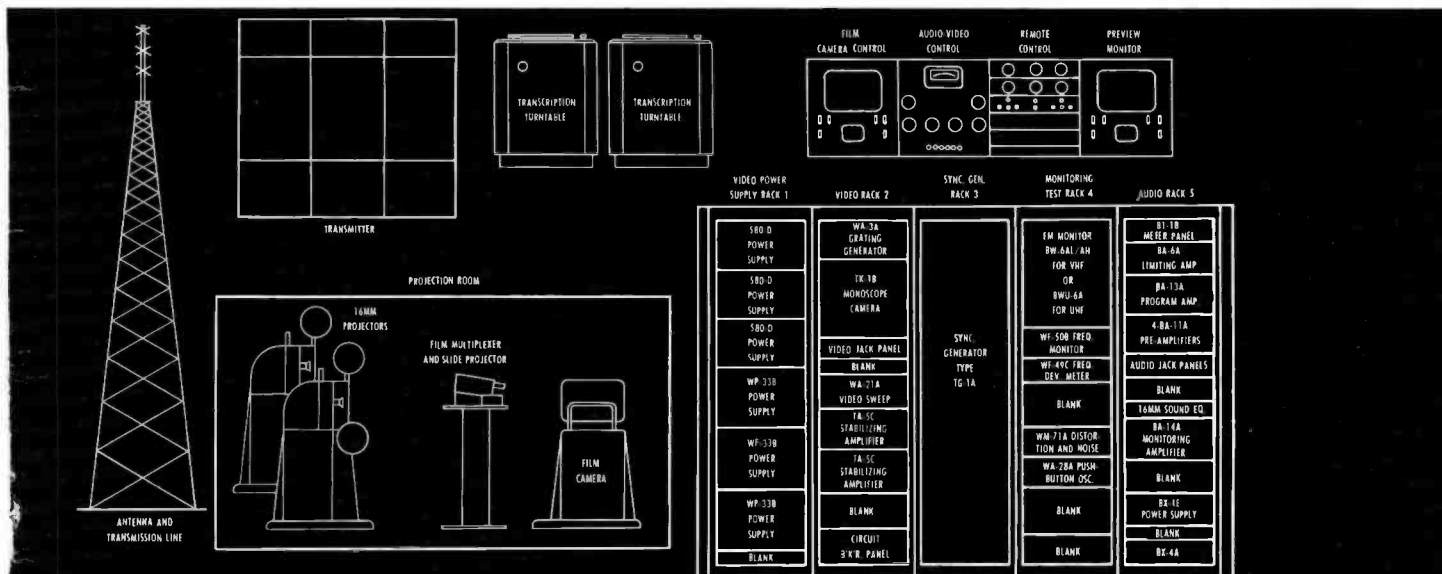

RADIO CORPORATION of AMERICA
ENGINEERING PRODUCTS DEPARTMENT
CAMDEN, N.J.

W
F
B
M



FIG. 1. Front view sketch of WFBM's new radio and television center shows modern design and complementing landscaping.

PLANNING AND BUILDING A RADIO AND TELEVISION CENTER

By **RAYMOND A. BOWERS**
of Lewis C. Bowers & Sons, Inc.
Princeton, N. J.

When the officials of WFBM, Indianapolis, realized that they were outgrowing their facilities, the question arose "How do we build a new building, buy new equipment for expanded facilities, and still keep the cost at a reasonable figure?"

Lewis C. Bowers & Sons, Inc., of Princeton, N. J., were called in to make a study of their building needs. The Bowers' designers worked closely with the staff of WFBM. First they determined the space requirements, from the standpoint of present and future needs. The layout was then studied from a technical aspect. The solution was a building with the most liveable space, fitted to the technical requirements

of a combined TV and radio broadcasting studio.

When it is considered that the number one consideration of the problem was economy, with the slogan being "No changes—no extras," planning was of top importance. Only through the cooperation of Harold Holland, chief engineer of WFBM, and the Bowers staff, was it possible to erect a finished building with such economy.

Basically, the structure is a two story building, with a basement. Upon entering the main lobby (see first floor plan), the receptionist separates the visitors into two classifications. Business visitors are directed to the second floor, where a business office

receptionist takes over. Program viewers go into the various studios through the door behind the receptionist's desk. Note that access to any studio is only a few steps from the lobby. Unnecessary traffic of visitors in the halls of the operating section of the studio is thus minimized.

Employees and program participants ordinarily enter the building by the rear entrance, after parking their cars in the parking lot. Thus they can go directly to dressing rooms or working stations. Studios "A" and "B" can be entered through the property room, which can double as an overflow dressing room for mass participation programs.

Studios "B" and "C" are AM studios, with one master control room. The record library is just a few steps from "C" which is used for disc jockey shows and as a news studio. "B" studio will accommodate groups up to 40 in number and handles most of the live shows.

The TV operation is the heart of the entire setup. Studio "D" handles all general programs, while "A" handles special programs, such as the cooking school and

others with fixed props. By way of the ramp from the basement to the property room, props such as automobiles can be taken into the studios with little difficulty.

The telephone room is situated directly under the TV control room. The distance between these two complicated nerve centers is thus kept at a minimum, resulting in lower upkeep and reducing interference from other sources.

The basement also houses film projection and storage rooms, which are in a unit and fireproofed. The remote control engineers, and general help are housed in this area, with props, a general purpose shop, mail room, and lounges.

Business visitors, upon reaching the second floor, are met by a business office receptionist, who directs them either to the general manager or the sales manager. The general office houses the sales force, who

FIG. 2. Floor plan showing WFBM FIRST FLOOR layout. The Property Room with ramp to Basement Storage Room allows easy flow of props and equipment to main TV studios.

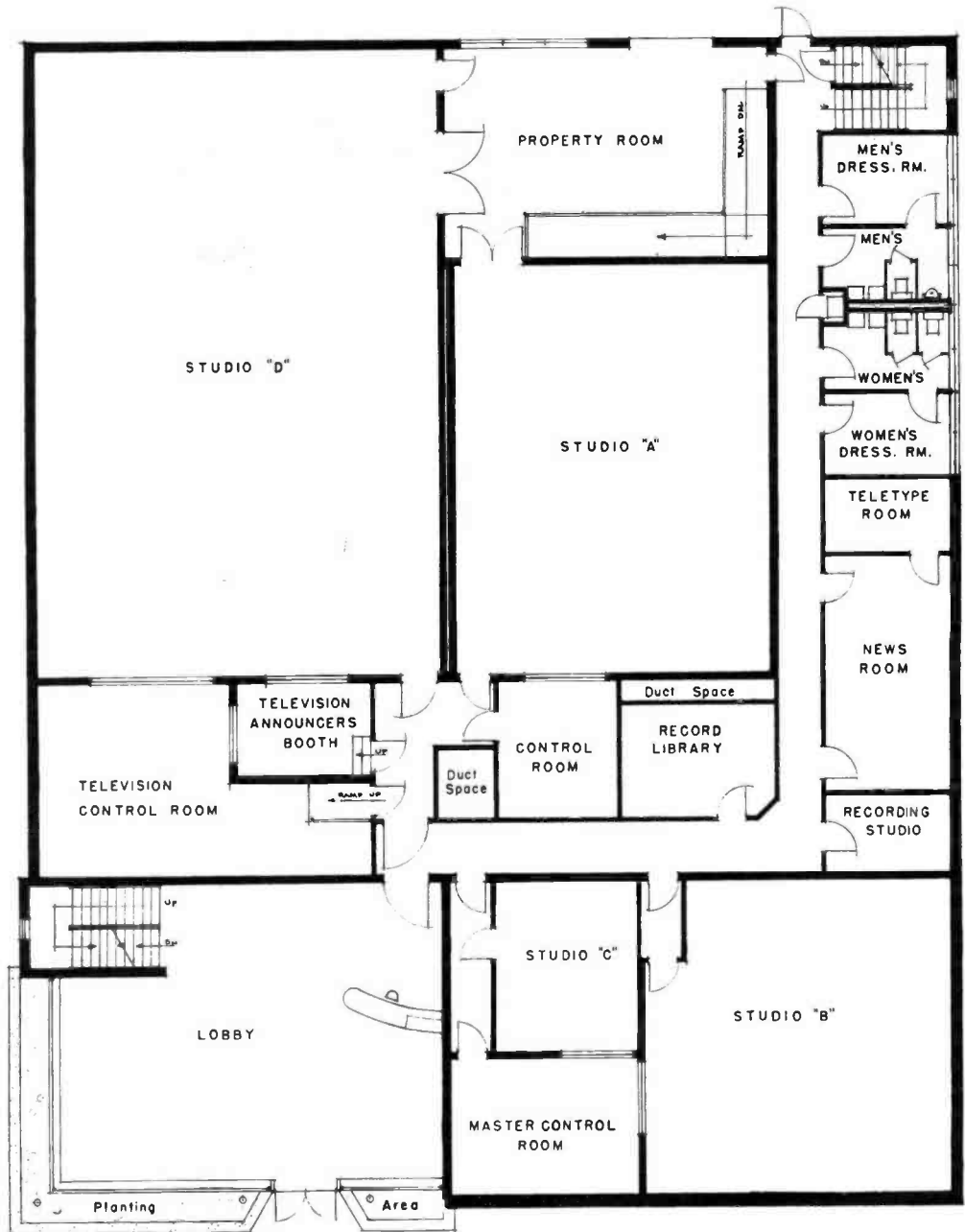

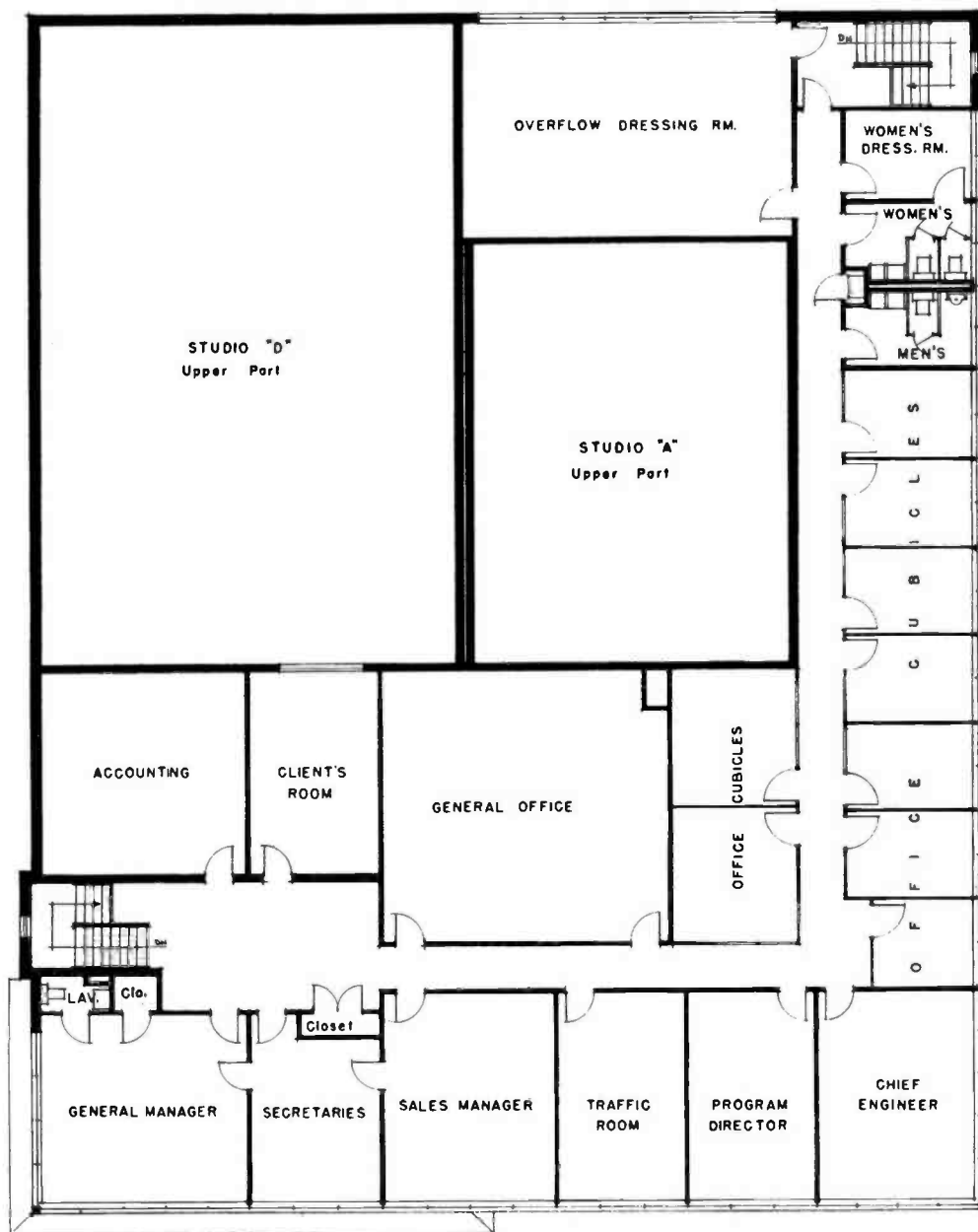

FIG. 3. SECOND FLOOR plan showing WFBM's Business Offices. Overflow Dressing Room provides facilities for mass participation programs, and Client's Room permits viewing of TV studio.

SECOND FLOOR PLAN
Graphic Scale

are thus directly across from the sales manager's office for accessibility. Salesmen are also next to the client's room for TV viewing or for private conferences.

The office cubicles along the wing are used by the program director's people, such as writers, program units, and others engaged in program preparation.

From the standpoint of general construction, the first floor lobby is the only ornate

room in the structure. As a public relations gesture, the room was beautifully finished and tastefully decorated.

The studios obtain excellent acoustics from the use of basic structural materials. The ceilings and walls were built with sound absorbing materials, with the wall areas given a further covering of fiber glass.

The air conditioning equipment is set up in the utility room which is situated in

the basic center of the building. Heat is from city steam. The building is 100% air-conditioned, with a system made flexible by the installation of four separate units with one return system. One unit handles the TV control; another the "A" and "D" studios; a third the master control and "C" and "B" studios, while the fourth handles the balance of the building. The TV control room must always be kept between 70 and 80 degrees at all times.

Studio "D" must be heated if the camera lights are not on; if on, the studio must be cooled because of the terrific heat generated by the lights. If it is being cooled, the return system distributes the heat liberated into other parts of the building, to help heat them. Such flexibility of the system has resulted in cutting heat bills to a minimum.

As in all TV and radio stations, the electrical wiring is highly complicated. Provision is made for intercommunicating telephones, general telephones and radio and TV reception in all areas.

The building itself faces on a main street, giving a very pleasing front view. Clean, modern lines are softened by shrubbery, and a 65-foot lawn, setting the build-

ing well back from the street. In the rear, a parking lot will accommodate 150 cars. If necessary, the building can be expanded straight back, on all floors. Completed in 1951, the structure was designed, engineered and constructed by Lewis C. Bowers and Sons, Inc., of Princeton, New Jersey.

FIG. 4. Generous areas are provided in the BASEMENT plan for the storage of props and scenery. Note separate rooms for Film Editing and Storage, and Film Projection.

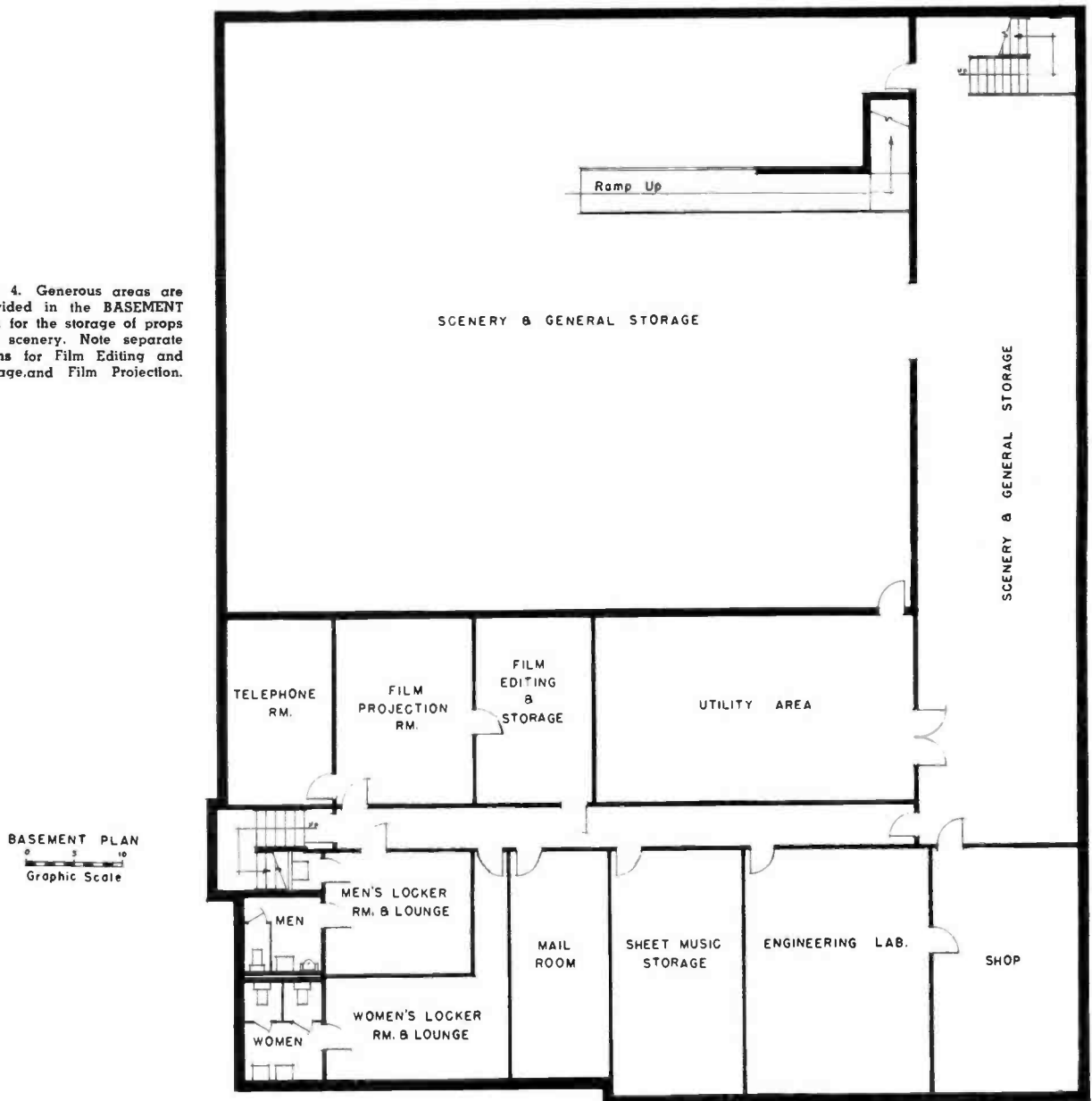

A NEW UHF TELEVISION ANTENNA

TFU-24B

By O. O. FIET*
RCA Broadcast Engineering

RCA has pioneered in research and development of UHF transmitting equipment since World War II.^{1, 2, 3, 4, 5, 6, 7} Much work has been done on UHF transmitting antennas^{1, 2, 6} and two experimental television transmitting installations were made by RCA using slotted cylinder antennas.^{2, 6} This experience, combined with that obtained with the RCA 8-section Pylon FM broadcast antenna^{8, 9} having a power gain of about 12, has contributed to the design of the new RCA Type TFU-24-B commercial antenna.

The TFU-24-B antenna has the highest gain of any omni-directional antenna yet developed for high frequency transmission. The improvement in performance and simplicity of the TFU-24-B antenna is readily apparent when comparison is made with its prototype antenna installed at Bridgeport, Conn. during 1949⁶, which has given continuous trouble-free operation for more than a two-year period.

The many features of the Bridgeport⁶ model antenna which contributed to its excellent reliability have been included in the commercial TFU-24-B antenna. However many improvements which have been made are evident when the typical experimental performance data are considered.

The RCA TFU-24-B antenna is of slotted tubular steel construction as shown in Figs. 1, 2, 3, 4, 5 and 6. Each radiating layer consists of 1-inch wide slots approximately 1.3 wavelengths long parallel to the axis of the cylinder and equally spaced around the circumference of the cylinder. Adjacent layers of slots are staggered or rotated 60° to obtain maximum mechanical strength and a circular horizontal pattern. The energy is distributed to the 16 to 18 layers of slots by means of a single coaxial line feeder system within the self-supporting slotted cylinder radiator. The

inside of the slotted steel radiator serves as the outer conductor of the coaxial line and a coaxial copper tube within the cylindrical radiator serves as the inner conductor. A coaxial line is installed within the inner conductor to obtain center feed with attendant benefits of adjustable vertical pattern tilt, symmetrical patterns for any frequency, and greater bandwidth than obtainable with an end-fed antenna.

The antenna incorporates many mechanical features and qualities not available in any other high frequency broadcast antenna. The slotted cylinder is constructed of hot-rolled open hearth structural steel, hot dip galvanized to obtain a structural life which is expected to exceed 50 years. The outer fiber stress for the highest wind loadings (50/30 lbs./sq. ft.) is less than half that permitted by most building and structural steel codes as shown in Fig. 7. Particular attention has been given to all parts of the antenna to assure maximum durability; all parts and materials are selected for high corrosion resistance and galvanic compatibility. Slot cover end caps are cast aluminum; small hardware and metal parts aluminum or stainless steel; pole steps hot dipped galvanized forged steel; mounting flange bolts stainless steel or hot dip galvanized high strength alloy steel; leveling plates hot dip galvanized steel; transmission line copper with brass or bronze parts and teflon insulators; coupling loop capacitors teflon; shorting plugs brass and bronze; beacon mounting and ventilator aluminum or hot dip galvanized steel; and slot covers polyethylene containing antioxidant and ultra-violet inhibiting dye.

The pole mounting flange is of special high strength alloy steel having high impact resistance at temperatures of -60°C. This is particularly important since ordinary carbon structural steel does not have

* Part of a Dissertation to be submitted to the Graduate School of the University of Pennsylvania as partial fulfillment of the requirements for a degree of Doctor of Philosophy in Electrical Engineering.

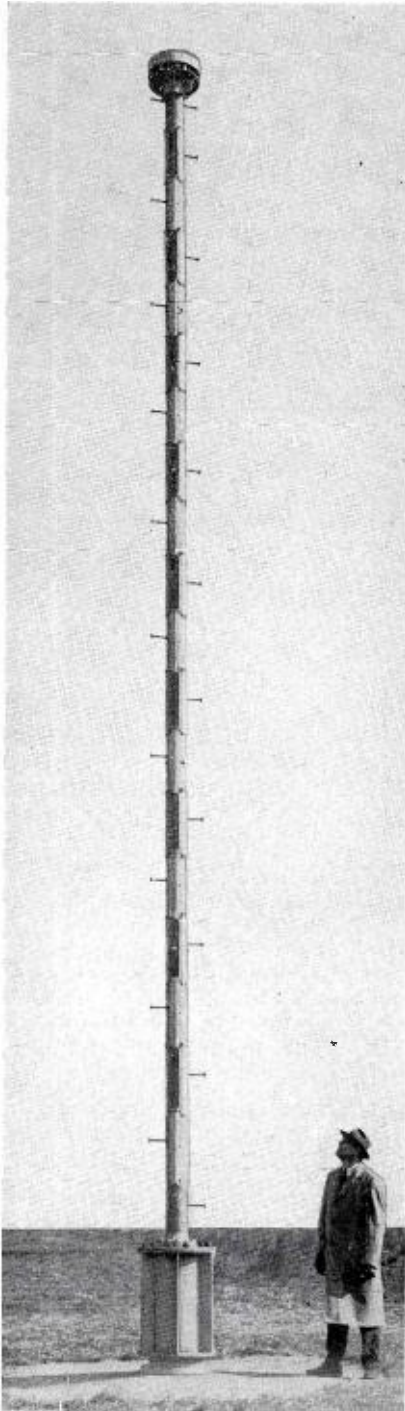

FIG. 1. TFU-24-BH Antenna Setup for Icing and Horizontal Pattern Tests.

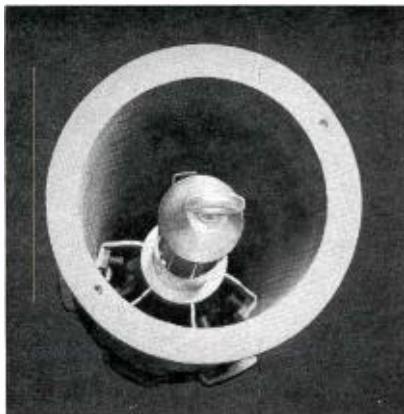

FIG. 2. Top View of TFU-24-BH Antenna with Beacon Mount Removed Showing Spoke Type Shorting Plug and Transmission Line. Harness is moved by use of Ring for Electrical Pattern Tilt Adjustment.

very good impact resistance at low temperatures. The weld neck mounting flange is welded to the structural tube by an automatic machine and the weld is "gamma rayed" using a radium capsule within the tube and a photographic film around the outer circumference of the weld. The weld exceeds requirements of the American Welding Society. Each weld photograph is filed by the fabricator for a period of 10 years.

The slots are cut in the steel cylinder by an automatic oxyacetylene cutting torch. This process is fast, less expensive and produces tolerances and finish comparable to those of milled slots. The automatic cutter utilizes a photo-electric or magnetic follower following a master template or layout and has sufficient "intelligence and skill" to cut the semi-circular slot ends without the necessity of drilling holes at each end of the slot.

The entire antenna is a complete one-piece assembly which is shipped to the customer completely tested and adjusted. Experience has indicated that UHF antennas shipped "knocked-down" will require a large amount of adjustment and test after installation to obtain satisfactory performance for UHF television. The cost of such extensive field adjustment and test greatly exceeds the small additional shipping cost of an antenna completely assembled and tested. Because of the critical

nature of UHF antenna equipment, it is recommended that an RCA Service Company Television Broadcast Engineer "check out" the antenna system on arrival and after installation to assure a minimum of installation trouble and expense. Experience has shown that many outages of television transmitting antennas are caused by lack of specialized installation experience and tests.

The TFU-24-B antenna (see Fig. 7) is inexpensive and easy to install and in most cases may be installed in one or two hours after the rigging is set up. Two wedge-shaped disk leveling plates are installed under the antenna mounting flange to provide a level base for the antenna mounting. The leveling plates may be adjusted prior to the antenna installation by using a sensitive machinist's level to obtain a very accurate adjustment. If desired, the antenna may be tilted mechanically using a level and feeler gauges to adjust the leveling plates to the required slope. Electrical tilt may be incorporated by shifting the

harness a few inches during or after the initial installation. The simplicity of this adjustment permits determination of optimum tilt by field experiments after the antenna has been put into operation.⁸ A combination of mechanical tilt and electrical beam tilt is desirable for many terrain conditions existing at suitable UHF television antenna sites.

Both types of beam tilt adjustment assure that the high gain of the TFU-24-B antenna will give the best possible coverage with presently available UHF transmitter powers. If the FCC should decide upon no limit, or a very high ERP limit for UHF-TV, a station will obtain maximum Class A service area when a combination of highest practical gain and highest available transmitter power are used.

Where economical operation is not an essential consideration and UHF transmitters of sufficiently high power are available, perhaps some UHF stations may consider the use of 500 to 1000 KW UHF transmitters and low gain antennas. Propagation

FIG. 3. Bottom View of TFU-24-BH Antenna Mounted on Turntable for Vertical Pattern Measurements. Showing Mounting Flange and Transmission Line Connection.



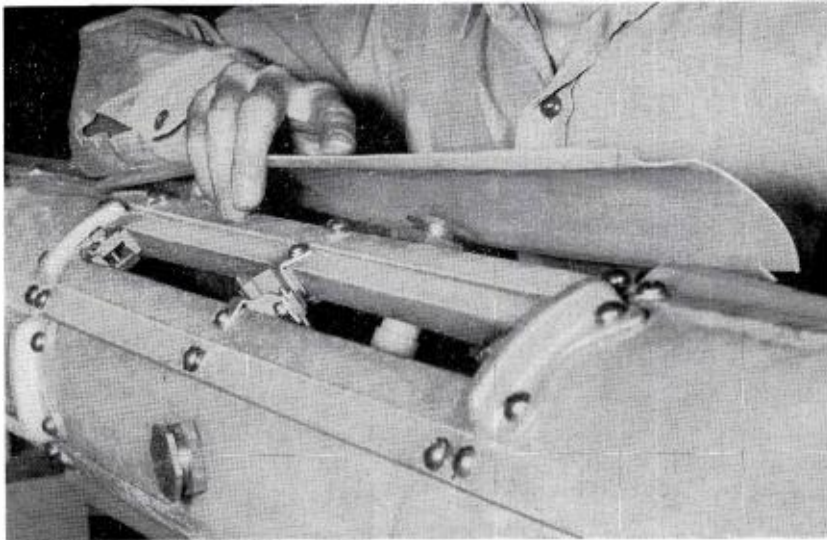

FIG. 4. Closeup of TFU-24-BH Antenna Showing Removal of Slot Cover.

measurements made at Princeton, N. J. on UHF signals transmitted from Bridgeport, Connecticut indicate that interfering signals beyond the useful service area of a UHF station can be greatly reduced by tilting the vertical pattern of a high-gain antenna down a suitable amount.¹⁰

A high-gain tilted beam antenna can give greater ERP within its service area than at the horizon. If ERP limitations by the FCC are based upon interference signals at and beyond the radio horizon and stated in terms of maximum permissible ERP directed at the horizon, stations with high-gain tilted beam antennas will have the advantage of greater signal strength within their service areas. Fig. 8 shows the relative advantage of a TFU-24-B antenna (Directivity gain 27.3) compared with a low gain horizontally polarized isotropic radiator (Directivity gain .61) which radiates equal signal in all directions. Fig. 8 considers both mounted on a 5000-foot tower and driven by a 10 KW transmitter. The advantage of higher signals within the service area is characteristic of the TFU-24-B antenna.

Recordings of field strength of Bridgeport UHF Station KC2XAK made on top of the RCA Building in New York City during 40 to 50 miles an hour winds at Bridgeport, Connecticut indicated received

field strength variations of approximately $\pm 10\%$.^{3,4} The tower used in the Bridgeport installation is self-supporting and does not provide an antenna base stability nearly as great as that of most guyed towers supporting a similar antenna load.

This experience is particularly significant because width of the main beam and locations of first nulls are almost identical for the Bridgeport antenna and the new TFU-24-BH antennas. Greater field strength variations were observed at some close-in locations at Bridgeport during high winds. However, satisfactory reception was obtained at all locations since the signal variations were well within the control range of the receiver A.G.C. system. Experience indicates that A.G.C. is required on all UHF TV receivers to obtain satisfactory reception for many reasons. Consequently, signal variations caused by mechanical oscillations of a properly installed high gain transmitting antenna will not cause unsatisfactory reception during high winds which occur occasionally. Exceptionally strong storms may cause unfavorable reception in some locations.

The effect of high winds on lead in and receiving antenna stability will have a more disastrous effect on the quality of reception than any possible transmitting antenna variation for a well designed trans-

mitting antenna and support installation. The bending stresses in the TFU-24-B antenna at the highest wind velocities are quite conservative (about 9000 psi) in comparison with permissible structural stresses (about 20,000 psi) to minimize bending and deflection of the antenna structure during high winds.

Horizontal Pattern

The horizontal pattern in the principal plane of the TFU-24-B antenna may be calculated from assumed boundary conditions on the outside surface of a perfectly conducting slotted cylinder.^{11, 12, 13} In the case of the TFU-24-B antenna, excellent agreement is obtained between calculated and measured results as shown in Figs. 9 and 10.

Assume an infinitely long perfectly conducting cylinder of radius, a , with three slots parallel to the axis equally spaced around the circumference. The slots are excited with equal in-phase voltages and the field is assumed to be uniformly distributed across the slot and polarized to produce only a circumferential component of electric intensity E_ϕ (in cylindrical coordinates). In the case of the principal plane pattern, E_ϕ through the center of the array normal to the axis of the cylinder, the amplitude and phase of the field along the slot does not affect the pattern. This is true for the TFU-24-B antenna whose horizontal pattern may be computed from an array of six equally spaced in-phase slots on the circumference of a cylinder.

FIG. 5. Closeup of TFU-24-BH Antenna Slot Showing Tuned Coupling Loop.

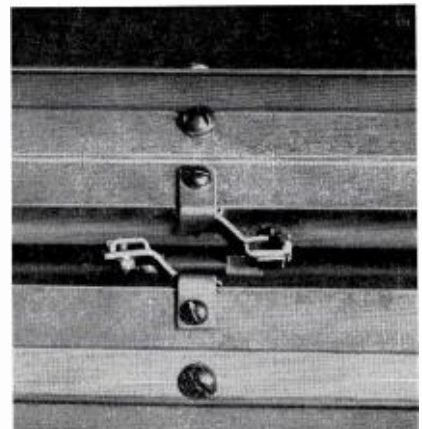

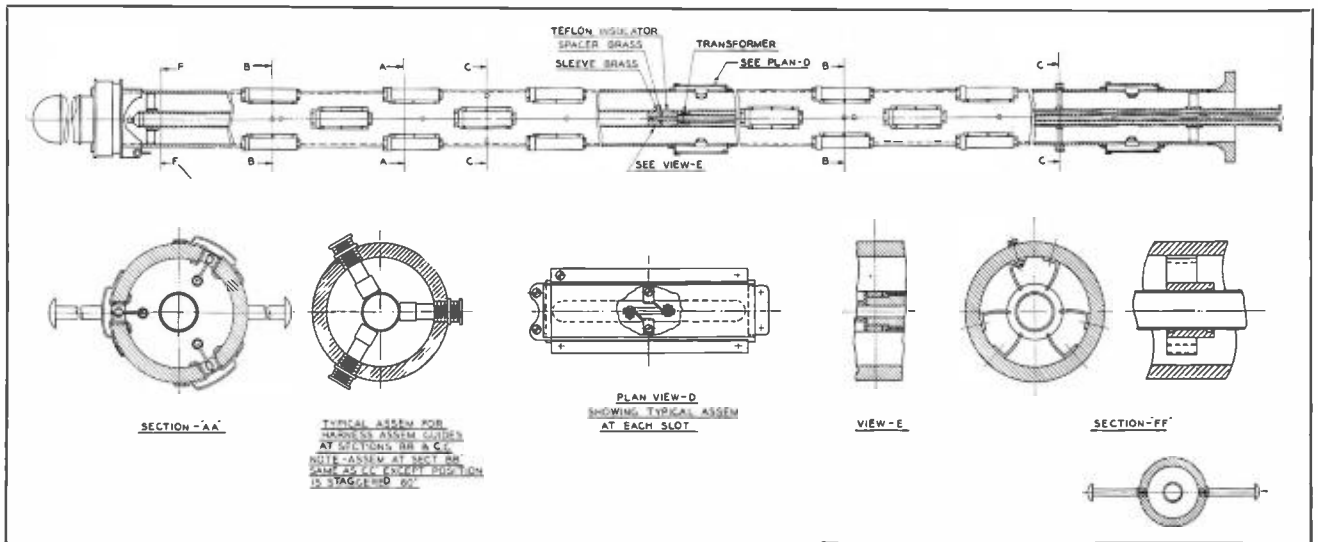

FIG. 6. Cross Section of TFU-24-BH Antenna Assembly.

der or by vector addition of two 3-slot patterns similar to Figs. 9 and 10 rotating one pattern 60° relative to the other.

For a 3-slot cylinder with slots equally spaced around the circumference and parallel to the Z axis, a is the radius of the cylinder and 2δ is the angular width of the slots. The boundary conditions are:

$$E_{\phi} \Big|_{r=a} = E_0 e^{jn\phi} \text{ for } \begin{cases} -\delta < \phi < \delta \\ -\delta < \left(\phi - \frac{2\pi}{3}\right) < \delta \\ -\delta < \left(\phi - \frac{4\pi}{3}\right) < \delta \end{cases} \quad \text{Eq. 1}$$

$$E_{\phi} \Big|_{r=a} = 0 \quad \text{for all other real } \phi$$

These boundary conditions may be expressed by a Fourier Series of the cylindrical field distribution on the surface of the conducting cylinder of the form:

$$E_{\phi} \Big|_{r=a} = \sum_{n=-\infty}^{\infty} C_n \left\{ \begin{aligned} &e^{j[n\phi + \omega t]} \\ &+ e^{j\left[n\left(\phi - \frac{2\pi}{3}\right) + \omega t\right]} \\ &+ e^{j\left[n\left(\phi - \frac{4\pi}{3}\right) + \omega t\right]} \end{aligned} \right\} \quad \text{Eq. 2}$$

The coefficient C_n is:

$$C_n = \frac{E_0}{n\pi} \sin(n\delta) \quad \text{Eq. 3}$$

The field at any radius r outside the cylinder may be represented by an infinite series of Hankel Functions.¹¹

$$E_{\phi} = jk\mu\omega \sum_{n=-\infty}^{\infty} a_n H_n^{(2)'}(kr) \left\{ \begin{aligned} &e^{j[n\phi + \omega t]} + e^{j\left[n\left(\phi - \frac{2\pi}{3}\right) + \omega t\right]} \\ &+ e^{j\left[n\left(\phi - \frac{4\pi}{3}\right) + \omega t\right]} \end{aligned} \right\} \quad \text{Eq. 4}$$

where $H_n^{(2)}(Z)$ = Hankel Function of Second Kind

$$H_n^{(2)'}(Z) = \frac{d}{dZ} H_n^{(2)}$$

$$\left. \begin{aligned} k &= \frac{2\pi}{\lambda} \\ \lambda &= \text{wavelength in space} = \frac{v}{f} \\ v &= \text{velocity of light in space} \\ \mu &= \text{permeability} \end{aligned} \right\} \text{ in M.k.s. units}$$

When $r = a$, equation 4 must be equal to equation 2 and the coefficients of the exponentials are therefore equal.

$$\frac{E_0}{n\pi} \sin(n\delta) = jk\mu\omega a_n H_n^{(2)'}(ka)$$

$$a_n = \frac{E_0 \sin n\delta}{jk\mu\omega n\pi H_n^{(2)'}(ka)} \quad \text{Eq. 5}$$

The horizontal radiation pattern may then be determined at a large fixed radius r_a from the antenna.

For $r_a \gg a$ and $r_a \gg \lambda$ we may use the asymptotic expression for Hankel functions.

Also for narrow slots

$$\frac{\sin n\delta}{n} \cong \delta \text{ for } |n| \leq n_0 \quad \text{Eq. 6}$$

where n_0 is defined as the largest n for which the approximate equation 6 is true.

If the maximum number of terms n of the Hankel function series is such that $n \leq n_0$ for good accuracy, then

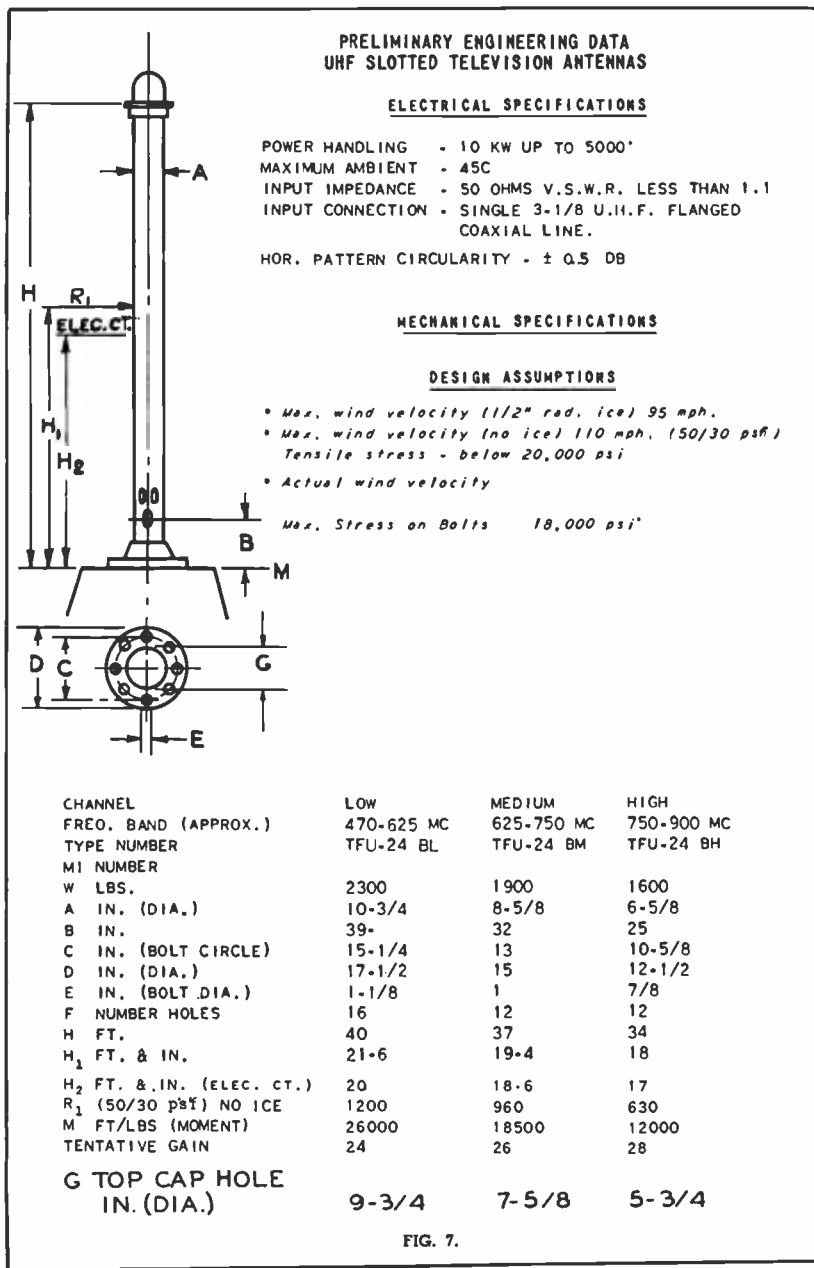

$$a_0 = \frac{1}{2 H_0^{(2)'}(ka)}$$

$$a_n = \frac{j^n}{H_n^{(2)'}(ka)}$$

$$ka = \frac{2\pi a}{\lambda}$$

a and λ are in the same units.

Inspection of equation (9) will show that the coefficients of a_n are ≡ 0 except for n ≡ 3m, where m is any positive integer. For the TFU-24-B antenna, the single layer pattern may be evaluated with good accuracy by using only a₀ and a₃. Substitution of the following numerical values in equation (9) will give the horizontal pattern shown in Fig. 9.

$$f = 850 \text{ Mc.}$$

$$\lambda'' = \frac{11800}{f_{mc}}$$

$$D = 2a = 6\frac{5}{8}''$$

$$\text{Slot Width} = 1''.$$

The relative phase of the field given in Fig. 9 is shown in Fig. 10. Vector addition of the field pattern of Fig. 9 with a similar pattern rotated 60° will give the field pattern of 6 equally spaced slots on the 6 $\frac{5}{8}$ " diameter cylinder which is the horizontal pattern in the principal plane of the TFU-24-BH antenna at 850 Mc. for an even number of layers. Fig. 12 shows the measured and calculated horizontal pattern for the TFU-24-BH antenna in the principal plane for which the angle of elevation = 0.

For one layer of the TFU-24-B antenna, the horizontal pattern becomes from equation (9) for θ = 0°.

$$E_\phi \Big|_{r \gg a} = \frac{A}{j2\pi} \frac{\sum_{n=-n_0}^{n_0} e^{j[n(\phi + \frac{\pi}{2}) + \omega t]} + e^{j[n(\phi - \frac{\pi}{6}) + \omega t]} + e^{j[n(\phi - \frac{5\pi}{6}) + \omega t]}}{H_n^{(2)'}(ka)} \quad \text{Eq. 7}$$

$$E_\phi \Big|_{r \gg a} = \frac{3A}{j\pi} \left\{ \frac{1}{2H_0^{(2)'}(ka)} - j \frac{\cos 3\phi}{H_3^{(2)'}(ka)} \right\} \quad \text{Eq. 10}$$

θ = angle of elevation.

The horizontal pattern of a TFU-24-B antenna with an even number of layers is, by vector addition of two patterns, given by equation (9) which are shifted relative to each other 60°.

$$A = 2E_n \delta \sqrt{\frac{2}{\pi kr}} e^{-j(kr - \frac{\pi}{4})} \quad \text{Eq. 8}$$

$$E_\phi \Big|_{r \gg a} = \frac{A}{j\pi} \left[3a_0 + \sum_{n=1}^{n_0} a_n \left\{ \cos n\phi + \cos n(\phi - 120^\circ) + \cos n(\phi - 240^\circ) \right\} \right] \quad \text{Eq. 9}$$

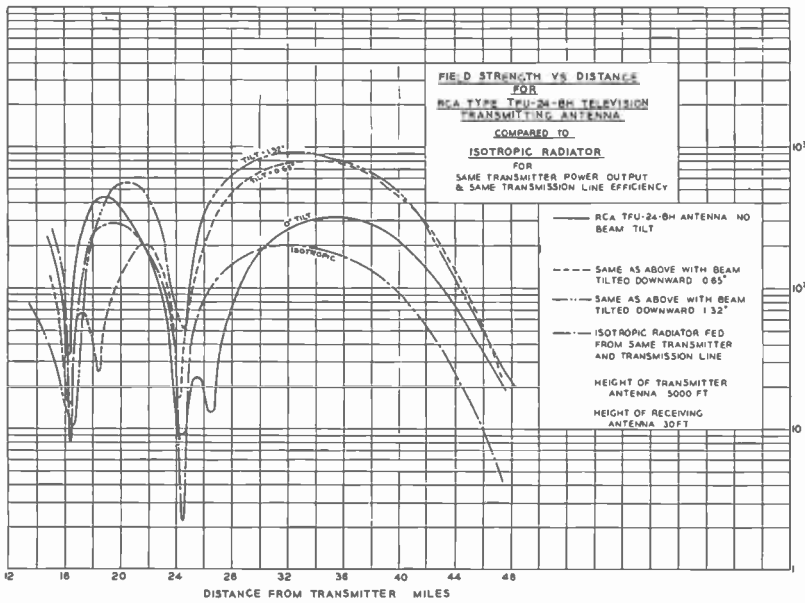

FIG. 8. Relative Field Strength Comparison for Low and High Gain Antennas with Same Power Input.

For $\theta = 0^\circ$

$$E_\phi \Big|_{r \gg a} = \frac{A}{j\pi} \left[6a_0 + \sum_{n=1}^{n_0} a_n \left\{ \begin{array}{l} \cos n \phi^\circ + \cos n (\phi^\circ - 60^\circ) \\ + \cos n (\phi^\circ - 120^\circ) \\ + \cos n (\phi^\circ - 180^\circ) + \cos n (\phi^\circ - 240^\circ) \\ + \cos n (\phi^\circ - 300^\circ) \end{array} \right\} \right]$$

Eq. 11

Inspection of coefficients of a_n in equation (11) reveals the coefficients of a_n are $\equiv 0$ except for $n = 6m$, where m is any positive integer; therefore, considering only a_0 and a_6 we obtain the horizontal pattern of the TFU-24-B antenna with an even number of layers:

for $\theta = 0^\circ$

$$E_\phi \Big|_{r \gg a} = \frac{6A}{j\pi} \left[\frac{1}{2H_0^{(2)'}(ka)} - \frac{\cos 6\phi}{H_0^{(2)'}(ka)} \right]$$

Eq. 12

From equation 12, it is apparent that the phase of the field does not vary with ϕ . If a_6 were neglected, the horizontal pattern would be a perfect circle. For the TFU-24-BH antenna at 850 Mc. a_6 is .232 percent of a_0 . Consequently, the horizontal pattern is theoretically a perfect circle within $\pm .232\%$. Fig. 12 confirms this within the accuracy of measurement for

$\theta = 0^\circ$. If each layer of the TFU-24-B antenna had six slots instead of three slots, the horizontal patterns shown in Fig. 12 for other values of θ would approach a perfect circle as closely as the measured pattern for $\theta = 0^\circ$. The calculation of Figs. 9 and 10 was done by H. B. Yin.

Directional horizontal patterns may be obtained using TFU-24-B antenna components to suit special applications. Fig. 13 illustrates a horizontal pattern obtained by using 1 set of colinear slots in a TFU-24-BM antenna cylinder. Directional UHF antennas would be custom designed for a particular application and the RCA Broadcast Transmitter Engineering Department should be consulted regarding directional UHF antennas.

Vertical Pattern

The measured vertical pattern of the TFU-24-B antenna closely resembles the

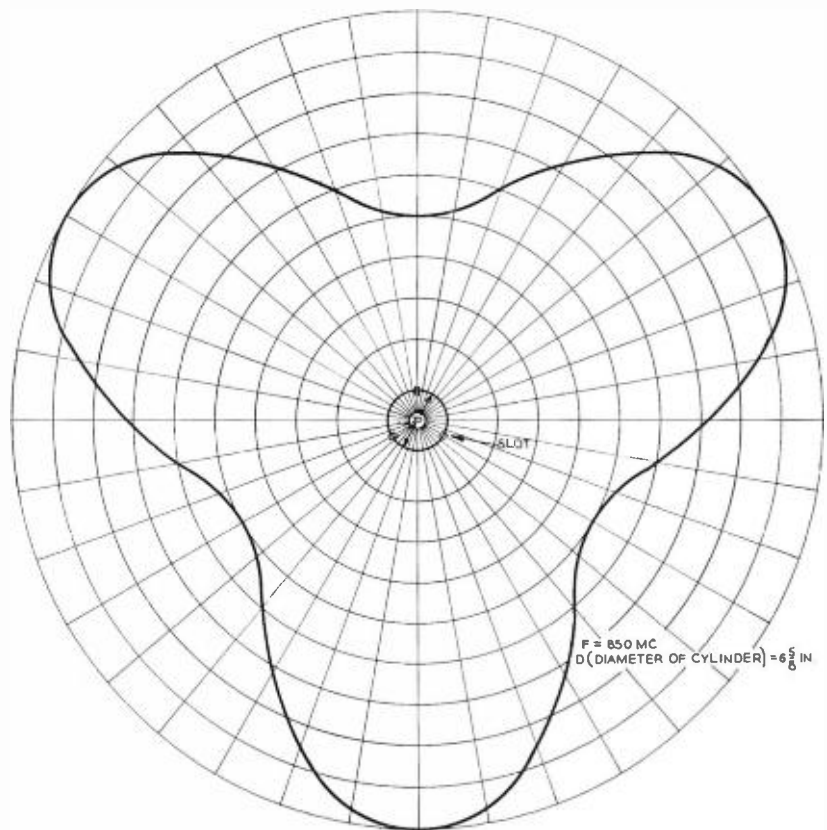

HORIZONTAL PATTERN FOR ONE-LAYER TFU-24-BH ANTENNA
THREE EQUALLY SPACED SLOTS 1" WIDE FED WITH
EQUAL IN PHASE VOLTAGES

FIG. 9. Horizontal Pattern of One-Layer of TFU-24-BH Antenna at 850 Mc.

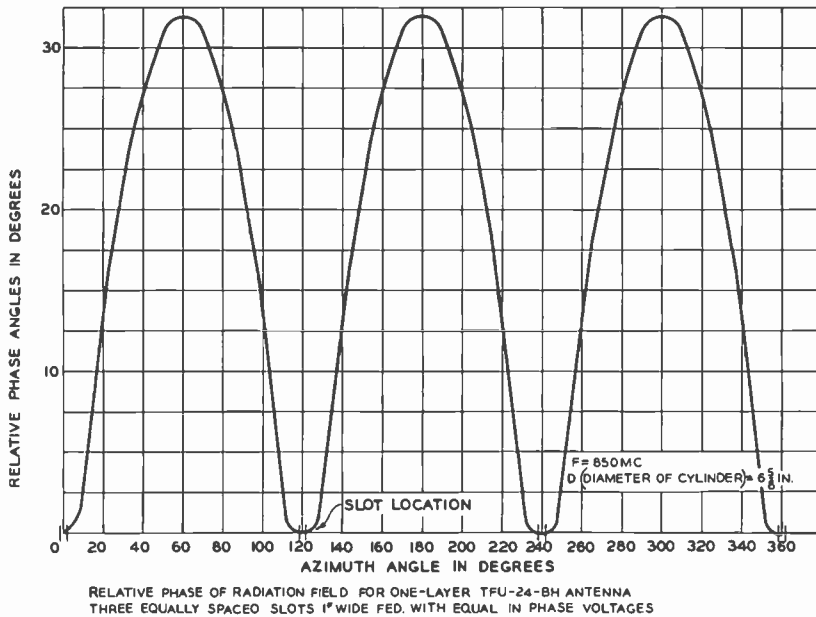

FIG. 10. Relative Phase of Radiation Field for One-Layer of TFU-24-BH Antenna at 850 Mc.

calculated pattern obtained by the product of an array factor for a colinear broadside array and a suitable element pattern.¹³

For the 18-layer TFU-24-BH antenna, the vertical pattern for the horizontally polarized component of electric field, E_ϕ , is given by the equation:

$$E_{\phi 18}(\theta) = \frac{\sin \left[\frac{9(1080^\circ)}{2} \cos \theta \right]}{9 \sin \left[\frac{1080^\circ \cos \theta}{2} \right]} E_{\phi 2}(\theta) \quad \text{Eq. 13}$$

where $E_\phi(\theta)$ = the relative field intensity, E_ϕ , of the array at a fixed radius, r , as a function of θ , maximum $E_\phi(\theta) = 1$.

$E_{\phi 2}(\theta)$ = the vertical field pattern of the radiating element, maximum $E_{\phi 2}(\theta) = 1$, at a fixed radius r . To obtain symmetry in the TFU-24-B case $E_{\phi 2}(\theta)$ is the field pattern of two layers of a slotted cylinder spaced 1.5λ between centers. A typical $E_{\phi 2}(\theta)$ is shown in Fig. 14.

θ = angle from Zenith, in the spherical coordinate system shown in Fig. 17.

For a 16-layer TFU-24-BL and TFU-24-BM antenna, the theoretical vertical pattern is given by the equation:

$$E_{\phi 18}(\theta) = \frac{\sin \left[\frac{8(1080^\circ) \cos \theta}{2} \right]}{8 \sin \left[\frac{1080^\circ \cos \theta}{2} \right]} E_{\phi 2}(\theta) \quad \text{Eq. 14}$$

The TFU-24-B antenna may be considered approximately as an array of infinitesimally spaced circular current loop antennas whose diameter is the same as the TFU-24-B antenna. The total aperture is equal to the TFU-24-B antenna. Each loop has a uniform in-phase circumferential current.

Such an idealized array of uniform current loop antennas would radiate only a horizontally polarized component of electric field, E_ϕ .¹³ Actual measurements of E_ϕ and E_θ on a TFU-24-BH antenna show the cross or vertically polarized component of electric field, E_θ , to be very small, as shown in Fig. 14. The power radiated by the E_θ component shown in Fig. 14 is about .3% of the total power radiated and hence causes a .3% reduction in measured gain. It is quite possible that the measured E_θ component is greater than that actually radiated due to non-ideal conditions in the measuring site, which

¹³ Ibid. page 163.

cause conversion of some of the E_ϕ component of polarization. This polarization conversion could be caused by irregular terrain, trees, weeds and brush, fences, wires, etc.^{13,14} In any case, the E_θ component of field in the TFU-24-B antenna is negligible for broadcast applications. However, it should not be concluded that all omni-directional antennas intended to radiate only an E_ϕ or E_θ component of field have negligible radiation in the undesired plane of polarization. Antennas whose radiating elements yield elliptic polarization may depend on interfering fields in adjacent elements to cancel undesired polarization in the principal plane. Such cancellation in the principal plane can still leave large amounts of cross polarized energy at other elevation angles. A measurement made on an antenna construction using the polarization interference principle indicated the gain was reduced approximately 25% by the undesired E_θ component of electric field. Some omni-directional VHF television broadcasting antennas radiating predominantly horizontal polarization have been shown theoretically and experimentally to have a gain reduction of 5 to 15% due to radiation of the E_θ component of field. It has been commonly accepted practice in the past to measure only the polarized component for which the antenna was intended to radiate and ignore the cross polarized undesired component. This was often justified by theory and measurements which showed the undesired cross polarized field to be zero or negligible in the principal horizontal plane. However, a later, more detailed study has shown the power radiated at other angles may represent 5 to 15% of

¹³ Ibid. page 431.

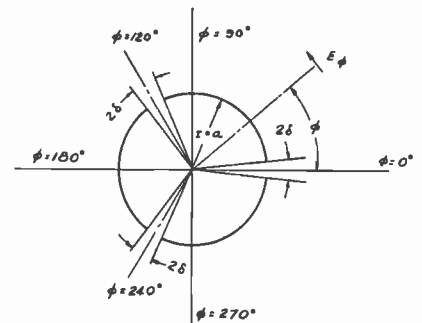

FIG. 11. Cylindrical Coordinate System Used for Three Slots in a Circular Cylinder.

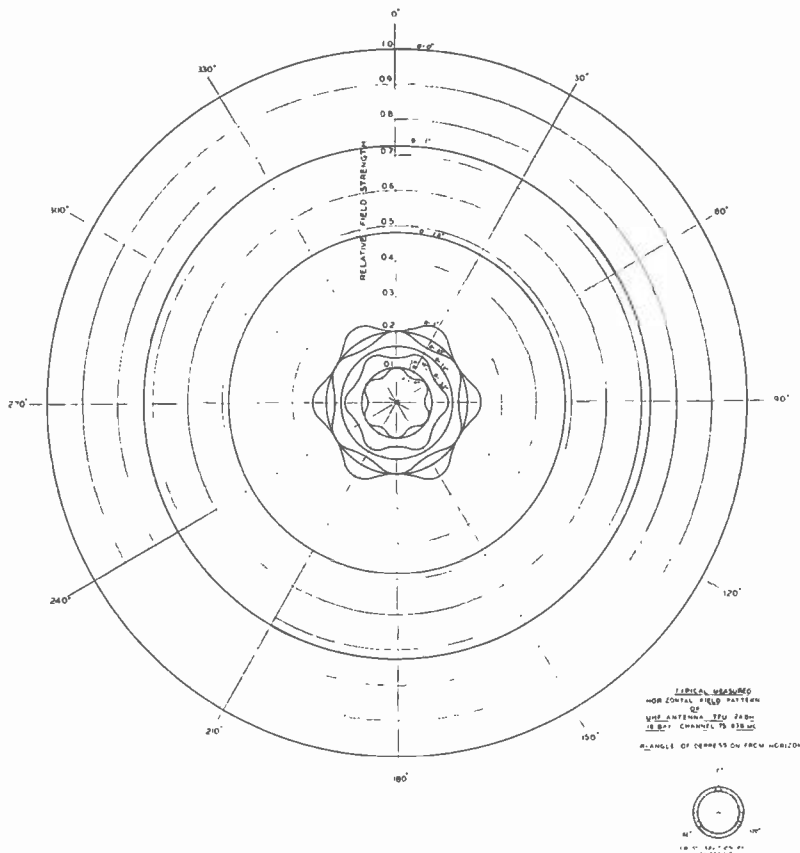

FIG. 12. Typical Measured Horizontal Patterns for TFU-24-BH Antenna.

the total power. The practical effect of 15% reduction of ERP on the coverage is negligible, and such an error should be acceptable; but as the state of the art developed and more accurate measuring techniques were used, an attitude approaching perfectionism has appeared. For this reason and because some more recent antennas have undesired cross polarized radiation which is not negligible, it is very desirable in pattern and gain measurements to account completely for both the E_ϕ and E_θ components of electric field.

Power gain and patterns are measured in a setup where the antenna whose pattern is to be measured is set on a rotating spindle with its center of radiation over the axis of the spindle as shown in Figs. 1 and 3. The plane of the antenna in which it is desired to measure the pattern is placed parallel to the ground.

The antenna whose pattern is to be measured is used as a receiving antenna

which drives a recording voltmeter. The recorder chart is driven by a gear and servo system connected to the antenna spindle. A transmitting antenna which provides the received signal of the desired frequency is located at a point sufficiently distant to obtain nearly the lowest possible relative field strength in the nulls of the vertical pattern. In the case of the setup shown in Fig. 3, the transmitting antenna is about 2400 feet from the turntable and results in a waveform phase error of less than 15.7 electrical degrees at the extremities of the antenna aperture. Both components of electric field E_θ and E_ϕ are measured for each antenna position. The polarization of the distant fixed transmitting antenna may be changed from the pattern recording position by means of a remote controlled motor drive which rotates the dipole in the parabolic disk from horizontal to vertical as desired. Remote control of the dipole motor is obtained by use of a telephone dial selector system. Many

other functions are controlled remotely such as frequency, transmitter power output and 60 cycle power by the same dial system. The remote control system and an automatic computer is being developed which will integrate the radial component of Poynting vector to obtain the relative power radiated while the antenna is rotated.

Although the TFU-24-B antenna is omnidirectional and it might be assumed that the total radiated power could be evaluated by the single integral of one vertical pattern,⁹ assuming rotational symmetry of the vertical pattern, such an approach can produce errors for patterns in certain meridians as great as 10% in power gain due to the slight variation from rotational symmetry shown in Fig. 12. The power gain should be computed from a sufficient number of vertical patterns for both components of polarization E_θ and E_ϕ to produce the desired accuracy. The magnitude of the vertical pattern field should be normalized to agree with the corresponding relative field intensity in the principal plane horizontal pattern, Fig. 12, for the corresponding meridian angle ϕ . In the case of the TFU-24-B antennas, the vertical patterns in the plane of any line of slots are all the same and the vertical pat-

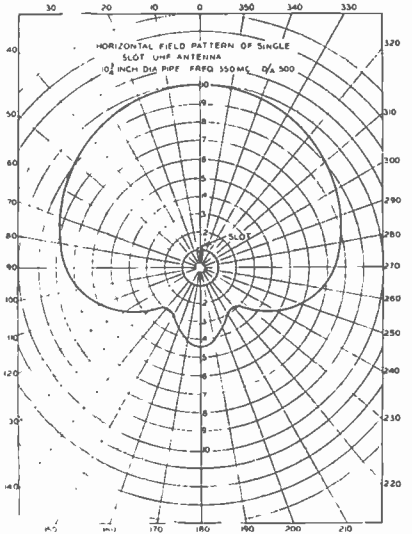

FIG. 13. Horizontal Pattern at 550 Mc. for a Pipe the Same Size Used for the TFU-24-BM Antenna Except for Slots in One Side Only.

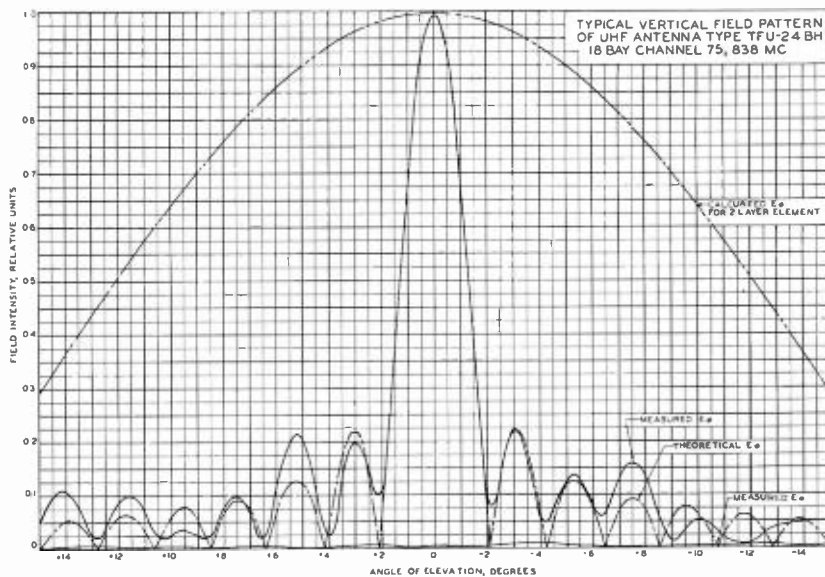

FIG. 14. Typical Calculated and Measured Vertical Patterns for TFU-24-BH Antenna.

terns in a plane half way between slots are the same. The variation with ϕ of the field between the two vertical patterns at any particular angle from Zenith, θ , is approximately sinusoidal, as shown in Fig. 12. Consequently, the average of the two vertical patterns mentioned above may be used in a single integral to evaluate the gain of the TFU-24-B antennas.

Referring to Fig. 17, the power radiated may be integrated over the surface of a sphere whose radius is sufficiently great. For purposes of this derivation, the radial component of power flow at the surface of the sphere may be assumed to be dissipated (or radiated) in the intrinsic impedance of free space which is approximately 120π or 377 ohms per square. If the tangential components of electric field, E_θ and E_ϕ , at a particular point on the surface of the sphere are measured the power dissipated in the intrinsic impedance (or radiated) at the particular point is simply

$$\frac{E^2}{R_s} = E^2 G_s \text{ watts per square meter.}$$

$$R_s = \frac{1}{G_s} \text{ Intrinsic impedance of space}$$

accounting for both E_θ and E_ϕ then the total power dissipated (or radiated) in the particular square meter on the surface of the sphere is

$$\frac{E_\phi^2 + E_\theta^2}{377} = P \text{ watts/sq. meter}$$

where E_ϕ and E_θ are in volts per meter.

The total power radiated is obtained by integrating the power density at the surface of the sphere over the entire surface as shown in Fig. 17.¹³

¹³ Ibid. pages 540-543.

$$P_{\text{radiated}} = \frac{r^2}{377} \int_0^{2\pi} \int_0^\pi \left\{ E_\phi^2(\theta, \phi) + E_\theta^2(\theta, \phi) \right\} \sin \theta d\theta d\phi \quad \text{Eq. 15}$$

where r is in meters.

It is usually convenient for purposes of gain calculation to normalize the maximum value of $(E_\phi^2(\theta, \phi) + E_\theta^2(\theta, \phi))$ to unity.

The directivity gain, D , relative to an isotropic radiator is the ratio of powers required to produce unit field strength at a fixed radius r in the direction of maximum field.

$$D = \frac{P_{\text{radiated isotrope}}}{P_{\text{radiated TFU-24-B}}} \quad \text{Eq. 16}$$

The power radiated by a horizontally polarized isotrope is

$$P_{\text{isotrope}} = \frac{r^2}{377} \int_0^{2\pi} \int_0^\pi E_\phi^2 \sin \theta d\theta d\phi \quad \text{Eq. 17}$$

$$P_{\text{isotrope}} = \frac{4\pi r^2}{377}$$

Since E_ϕ^2 is normalized to unity and is constant for an isotropic radiator.

Substituting equations 17 and 15 in equation 16, we obtain the gain relative to an isotropic radiator, D

FIG. 15. Typical Measured Vertical Pattern of TFU-24-BH Antenna with Phasing Adjusted for .92° Pattern Tilt.

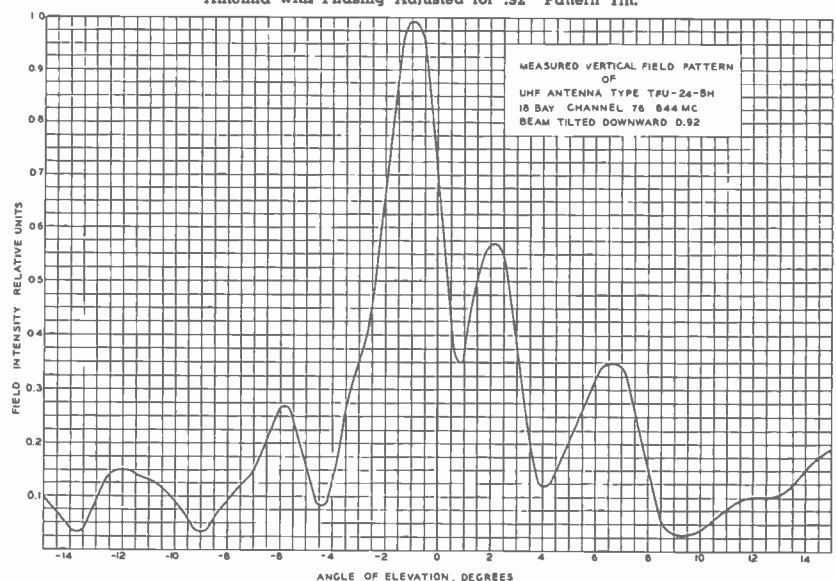

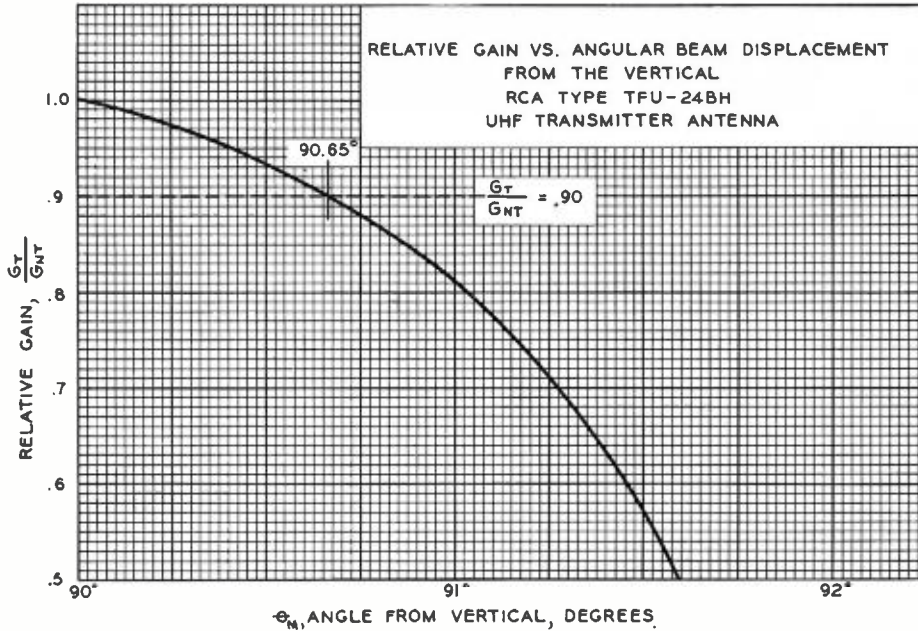

FIG. 16. Typical Relative Gain vs. Pattern Tilt for TFU-24-B Antennas.

$$D = \frac{4\pi}{\int_0^\pi \int_0^{2\pi} \left\{ E_\theta^2(\theta, \phi) + E_\phi^2(\theta, \phi) \right\} \sin \theta d\theta d\phi}$$

Eq. 18

Now, the directivity gain of a half wave dipole $D_{\lambda/2}$ is:⁹

$$D_{\lambda/2} = \frac{4\pi}{2\pi \int_0^\pi \frac{\cos^2\left(\frac{\pi}{2}\cos\theta\right)}{\sin\theta} d\theta} = 1.641$$

Eq. 19

The gain, G , of any antenna relative to a half wave dipole, using equations 18 and 19 is then given by:

$$G = \frac{4\pi}{1.641} \frac{1}{\int_0^\pi \int_0^{2\pi} \left\{ E_\theta^2(\theta, \phi) + E_\phi^2(\theta, \phi) \right\} \sin \theta d\theta d\phi}$$

Eq. 20

Consider the integral of equation 20 for a particular angle from Zenith

$$\int_{\theta=b}^{\theta=b} \int_0^{2\pi} \left\{ E_\theta^2(\theta, \phi) + E_\phi^2(\theta, \phi) \right\} d\phi$$

Eq. 21

Now $\int_{\theta=b}^{\theta=b} E_\phi^2(\theta, \phi)$

is a scalloped circular pattern for a particular value of θ as shown in Fig. 12. The magnitude of the scallop is quite small in comparison with the magnitude of E_θ , par-

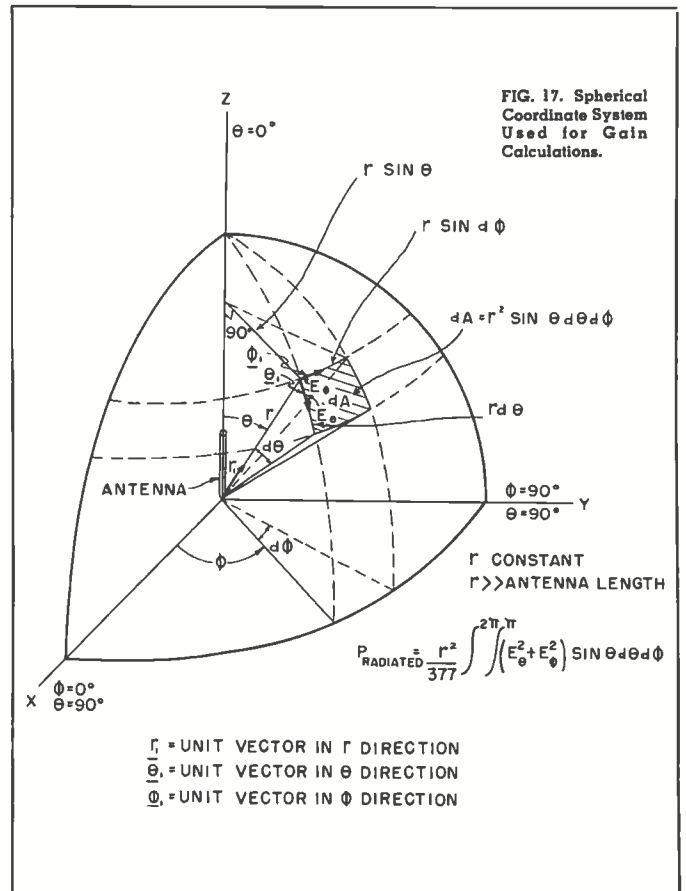

FIG. 17. Spherical Coordinate System Used for Gain Calculations.

ticularly when E_ϕ is large and contributes appreciably to the total radiated power. By inspection of the measurements shown in Fig. 12, we can express any horizontal pattern by the equation

$$|E_\phi(\phi) = A + B \cos 6\phi|_{\theta=b}$$

where B and A are functions of θ only and $B/A \ll 1$

$$|E_\phi^2(\phi) = [A + B \cos 6\phi]^2 = A^2 + 2AB \cos 6\phi + B^2 \cos^2 6\phi|_{\theta=b}$$

$$|E_\phi^2(\phi) = A^2 + 2AB \cos 6\phi + B^2 \left(\frac{1 + \cos 12\phi}{2} \right)|_{\theta=b} \quad \text{Eq. 22}$$

A similar expression results from measurements of $E_\theta(\phi)$

$$|E_\theta^2(\phi) = C^2 + 2CD \cos 6\phi|_{\theta=b}$$

$$+ D^2 \left(\frac{1 + \cos 12\phi}{2} \right)$$

where $D/C \ll 1$ Eq. 23

C and D are functions of θ only.

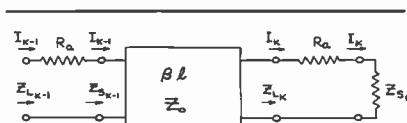

FIG. 18. Equivalent Circuit of One Section of Antenna Feeder System Used for Gain Calculations.

Substituting equations 22 and 23 in equation 21.

$$\int_{\theta=b}^{2\pi} \{E_\theta^2(\theta, \phi) + E_\phi^2(\theta, \phi)\} d\phi = \int_{\theta=b}^{2\pi} \left\{ A^2 + C^2 + 2(AB + CD) \cos 6\phi + (B^2 + D^2) \left(\frac{1 + \cos 12\phi}{2} \right) \right\} d\phi = 2\pi \left\{ A^2 + C^2 + \frac{B^2 + D^2}{2} \right\}$$

$$\text{since } \int_0^{2\pi} \cos n\phi d\phi = \frac{\sin n\phi}{n} \Big|_0^{2\pi} = 0$$

where n is any integer Eq. 24

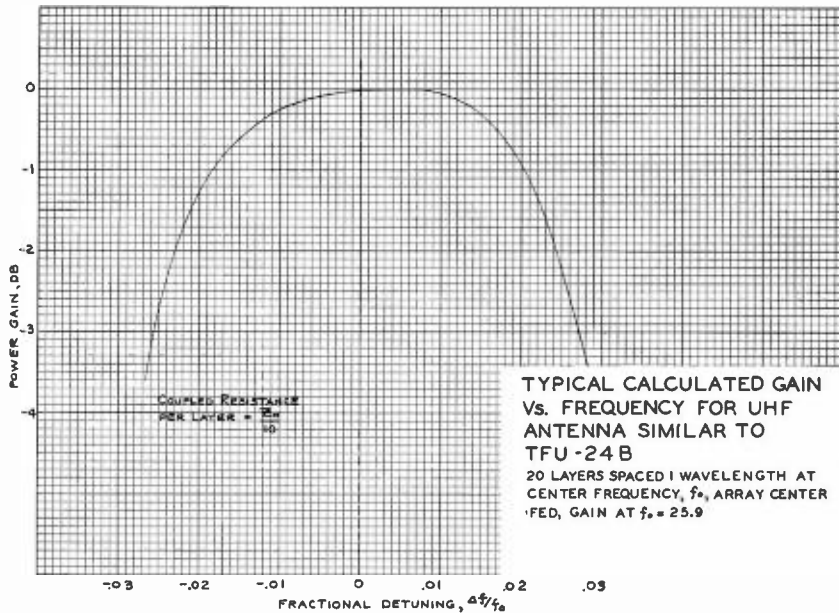

FIG. 19. Calculated Gain vs. Frequency for Early UHF Antenna.

Since $B \ll A$ and $D \ll C$ we may neglect the second order terms containing B and D in equation 24.

$$\int_{\theta=b}^{2\pi} \{E_\theta^2(\theta, \phi) + E_\phi^2(\theta, \phi)\} d\phi = 2\pi \{A^2 + C^2\} \quad \text{Eq. 25}$$

where

$$A = \left| \frac{E_{\theta \max}(\theta, \phi) + E_{\theta \min}(\theta, \phi)}{2} \right|_{\theta=b}$$

and

$$C = \left| \frac{E_{\theta \max}(\theta, \phi) + E_{\theta \min}(\theta, \phi)}{2} \right|_{\theta=b}$$

$$\int_{\theta=b}^{2\pi} \{E_\theta^2(\theta, \phi) + E_\phi^2(\theta, \phi)\} =$$

Eq. 26

$$= 2\pi \left\{ \left(\frac{E_{\theta \max}(\theta, \phi) + E_{\theta \min}(\theta, \phi)}{2} \right)^2 + \left(\frac{E_{\theta \max}(\theta, \phi) + E_{\theta \min}(\theta, \phi)}{2} \right)^2 \right\} |_{\theta=b}$$

Consequently for the TFU-24-B antenna we may take the average of 2 vertical patterns A(θ) and C(θ), one taken in the plane of the slots and one half way between slots and evaluate the gain by a single integration of the average E_θ and E_ϕ fields. Substituting equation 25 in equation 20 we obtain a simplified equation which can be used to accurately evaluate the gain, referred to a half wave dipole, G_0 .

$$G = \frac{2}{1.641} \int_0^\pi \{A^2(\theta) + C^2(\theta)\} \sin \theta d\theta \quad \text{Eq. 27}$$

The indicated integration is readily performed on a rectangular coordinate plot

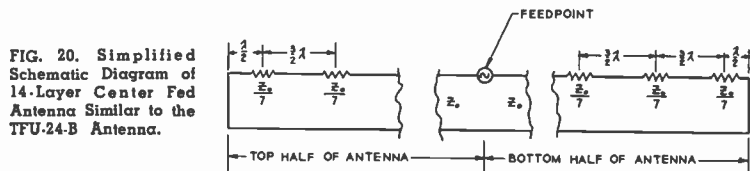

FIG. 20. Simplified Schematic Diagram of 14-Layer Center Fed Antenna Similar to the TFU-24-B Antenna.

using a planimeter.⁹ In the case of the TFU-24-BH antenna considered here, the gain calculated from measured patterns was about 1.3% below theoretical, .3% of this is accounted for by the cross polarized field component E_{θ} and 1% is due to filling of the nulls in the measured vertical pattern.

The filling of the nulls in the vertical pattern may be caused by slight departures from uniform, in-phase, current distribution assumed for the theoretical pattern calculations. In a practical antenna using an iterated feed system for the

radiating system, shown in Figs. 6, 20 and 24, small dimensional errors and variations in impedance of different layers due to different mutual impedances will produce the null filling shown in Fig. 14, which helps to assure adequate field strength at all locations within the service area. It is probable, however, that even without null fill-in a high gain antenna will produce greater field strength in its low signal areas than a low gain antenna with the same power input; because ground reflections and scattering help to distribute the signal from a highly directive source. With a low gain antenna which radiates signals of com-

parable magnitude at all angles of elevation, low signal areas are produced by interfering reflections. Fig. 8 shows a field strength radial comparing the TFU-24-B antenna with a low gain antenna having the same power input and height. A null fill-in of 2% of the maximum field was assumed for the high gain antenna. The actual null is approximately 10% of the maximum field for the antenna null at greatest distance from the high gain transmitting antenna, consequently, the field strength in this null may be expected to be about 5 times greater than shown in Fig. 8. This is clearly much better than obtained with a low gain antenna using the same transmitter, tower and locations. In general, a high gain antenna (gain 20 to 30) will produce field strengths 4 to 7 times greater than a low gain antenna (gain approx. 1 or 2), with the same power input over most of the service area.

FIG. 21. Block Diagram of RCA UHF Antenna System.

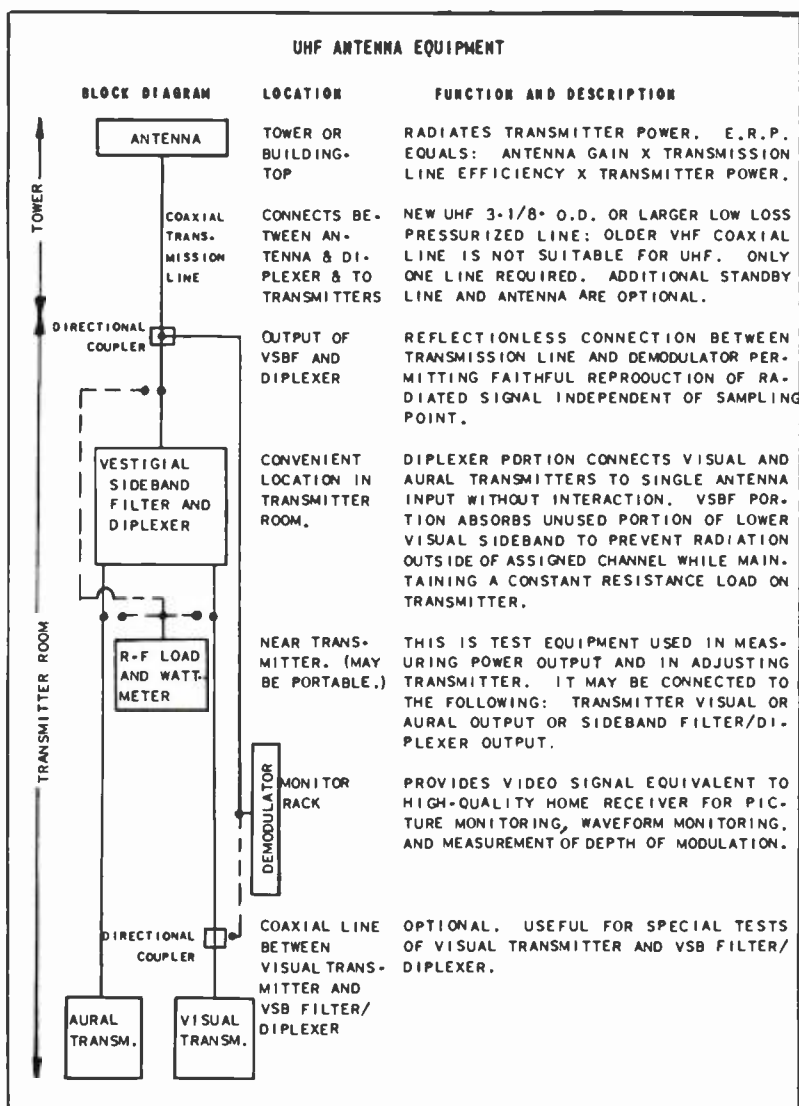

Electrical Vertical Pattern Tilt

By shifting the feed point from the center of the array, the phases of the top half and the bottom half of the array are shifted relative to each other, causing the vertical pattern to tilt up or down as desired. This is mechanically accomplished by loosening the clamp on the hub of the lower shorting bar which holds the harness in position, as shown in Fig. 6, and shifting the harness longitudinally as required. This may be easily accomplished in the field to assure optimum coverage as was described for the 8 section Pylon,⁸ or it may be preset to a calculated position.

In the case of the TFU-24-B antenna the spacing between the radiating centers, d , of the upper and lower half of the array is 12 to 14 wavelengths, consequently the mutual impedance between the two halves of the array is very small in comparison with the self impedance of each half and the driving point impedance is therefore equal to the self impedance and practically independent of the relative phase of the current of the upper and lower half of the antenna. Since the input impedance of each half stays constant for any phase adjustment, δ , the current and power distribution on each half is independent of the adjustment.

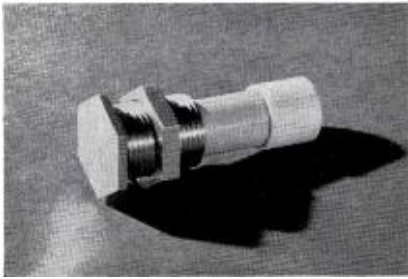

FIG. 22. Antenna Transmission Line Centering Insulator Showing Teflon Bearing Cap.

For the TFU-24-B antenna, the relative gain for various phase adjustments depends only upon the value of δ or beam tilt angle θ_{maximum} required for the particular antenna.¹³

The ratio of the gain tilted, G_T , to the gain without tilt, G_{NT} , is

$$\frac{G_T}{G_{NT}} = \left\{ F_{1/2}(\theta_{\text{max}}) \cos \left[\frac{\beta d}{2} \cos \theta_{\text{max}} + \delta \right] \right\}^2 \quad \text{Eq. 28}$$

where θ = angle from Zenith or the axis of the array; 2δ = relative phase of current or voltage driving each half of the array; $F_{1/2}(\theta)$ = vertical field pattern of the upper or lower half of the TFU-24-B array; $F_{1/2}(\theta_{\text{max}})$ = value of field intensity (normalized to $F_{1/2}(\theta=0^\circ) = 1$) at the angle θ_{max} , measured from the Zenith, for which the total field produced by the entire antenna is a maximum when the two halves are driven 2δ out of phase. βd is the spacing between the centers of the upper and lower arrays of the antenna.

The expression $\cos \left[\frac{\beta d}{2} \cos \theta + \delta \right]$ in equation 28 is the array factor for 2 radiators separated βd electrical degrees and driven with a phase difference of 2δ electrical degrees.

To find the value of θ_{max} at which the total field $F(\theta)$ becomes a maximum one would set $\frac{d}{d\theta} F(\theta) = 0$; neglecting constants:

$$\left\{ \frac{d}{d\theta} \left\{ F_{1/2}(\theta) \cos \left[\frac{\beta d}{2} \cos \theta + \delta \right] \right\} \right\} = 0 \quad \text{Eq. 29}$$

$$\theta = \theta_{\text{max}}$$

Equation 29 may be solved for θ max. using Newton's method, or successive approximations, for various values of δ . Fig.

16 is a typical solution, obtained by use of equations 28 and 29. Fig. 15 shows a measured vertical pattern for the TFU-24-BH antenna with $.92^\circ$ of pattern tilt.

Theoretical Impedance and Gain vs. Frequency Calculations

As early as September 1949, performance characteristics of antennas with feed systems similar to the TFU-24-B antenna had been calculated by use of simple transmission line theory and Smith Charts.

Calculations were based on a simplified schematic similar to Fig. 20 except for 20 layers center fed. Fig. 25 illustrates the method of using the Smith Chart for impedance calculations. A similar chart calculation is used for each value of fractional detuning. In the case shown, the center frequency, f_0 , is the frequency for which the spacing between layers is exactly one wavelength in the transmission line. Fig. 26 shows a voltage standing wave ratio vs. frequency characteristic calculated by use of the Smith Chart using constant coupled resistances per layer of $\frac{Z_0}{10}$ and $\frac{Z_0}{5}$. It is apparent from Fig. 26 that a coupled impedance per layer which produces a minimum ratio of stored energy to energy dissipated in the feeder system should

produce the maximum impedance bandwidth. The use of a pure resistance coupled impedance is a reasonably accurate assumption for long arrays similar to the TFU-24-B since the bandwidth is largely determined by the Q of the feeder system. Later impedance calculations for the TFU-24-B were made using measured image parameters for a symmetrical section; each section being 1.5 wavelengths long at f_0 , and having a complex iterative impedance and propagation constant. The use of charts¹⁵ of complex hyperbolic functions, facilitated the calculation of the required input impedance for 8 or 9 sections or layers.

By making some simplifying assumptions which are fairly accurate for antennas similar to the TFU-24-B antenna, we may calculate the relative gain vs. frequency characteristic of the antenna system using data obtained from Smith Chart calculations similar to Fig. 25. The assumptions are:

The loss in the transmission line feeder is negligible and all dissipation occurs in the coupled radiation resistance of each layer of the antenna. Mutual impedance between layers is small and can be neglected in comparison with the resistance component of self impedance. The coupled

FIG. 23. Typical Measured Power Gain vs. Frequency for TFU-24-BH Antenna.

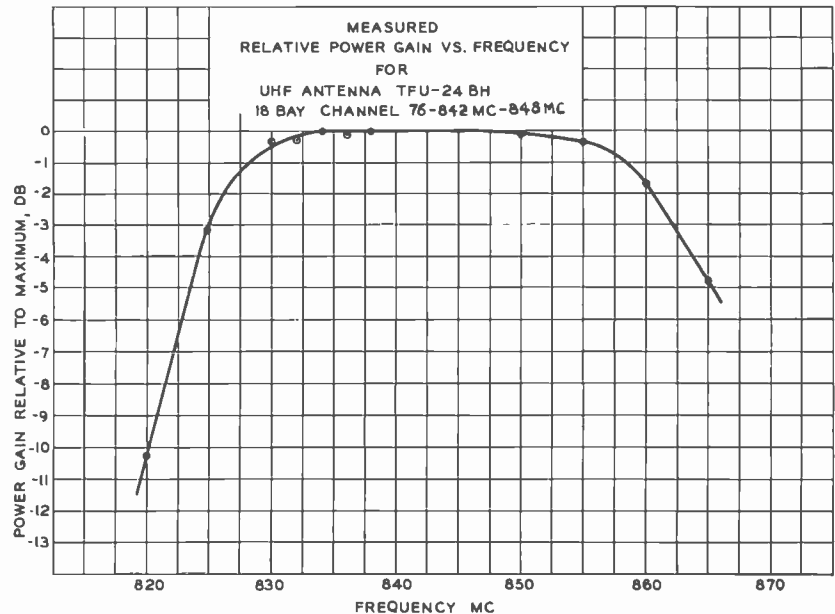

¹³ Ibid. pages 292-295.

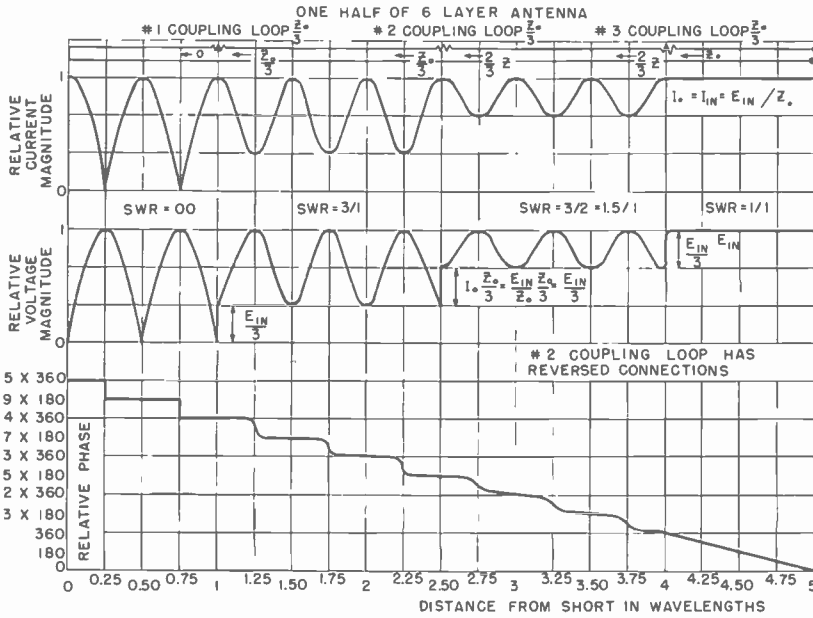

FIG. 24. Simplified Illustration of Current and Voltage Distribution Principle Used in the TFU-24-B Antenna Feed System.

impedance per layer is constant and equal to a pure resistance. The coupled resistance is lumped at a discrete point on the feeder.

Since the coupled resistance is lumped, the currents I_k in and out of the coupled resistance R_a must be equal. (Fig. 18).

$$I_{k \text{ in}} = I_{k \text{ out}} = I_k$$

The power in and out of the transmission line connecting two adjacent coupled resistances is equal

$$I_k^2 R_k = I_{(k-1)}^2 R_{k-1}$$

$$R_k = \text{Re}(Z_{Lk}); R_{k-1} = \text{Re}(Z_{S_{k-1}})$$

Eq. 30

$$R_k = \text{Re}(R_u + Z_{S_k})$$

The current ratio, m , between adjacent antenna layers is

$$m = \left| \frac{I_{k-1}}{I_k} \right| = \sqrt{\frac{R_k}{R_{k-1}}}$$

For a zero loss transmission line

$$\frac{I_k}{I_1} = \cos \beta l + j \frac{Z_L}{Z_0} \sin \beta l$$

$$\frac{I_k}{I_1} = m \angle \theta = \frac{I_{k-1}}{I_k}$$

$$m \angle \theta = \cos \beta l + j \left(\frac{R}{Z_0} + j \frac{X}{Z_0} \right) \sin \beta l$$

$$m \angle \theta = \cos \beta l - \frac{X}{Z_0} \sin \beta l + j \frac{R}{Z_0} \sin \beta l$$

$$\sin \theta = \frac{R_k \sin \beta l}{m Z_0}$$

where θ is the phase angle of the current in the $k-1$ section relative to the k th section.

Power gain at f_n

$$G_0 = \frac{N \left| \sum_{n=1}^k I_{nf_0} \right|^2}{W_T}$$

where W_T is the total power input at any frequency f and N is a constant.

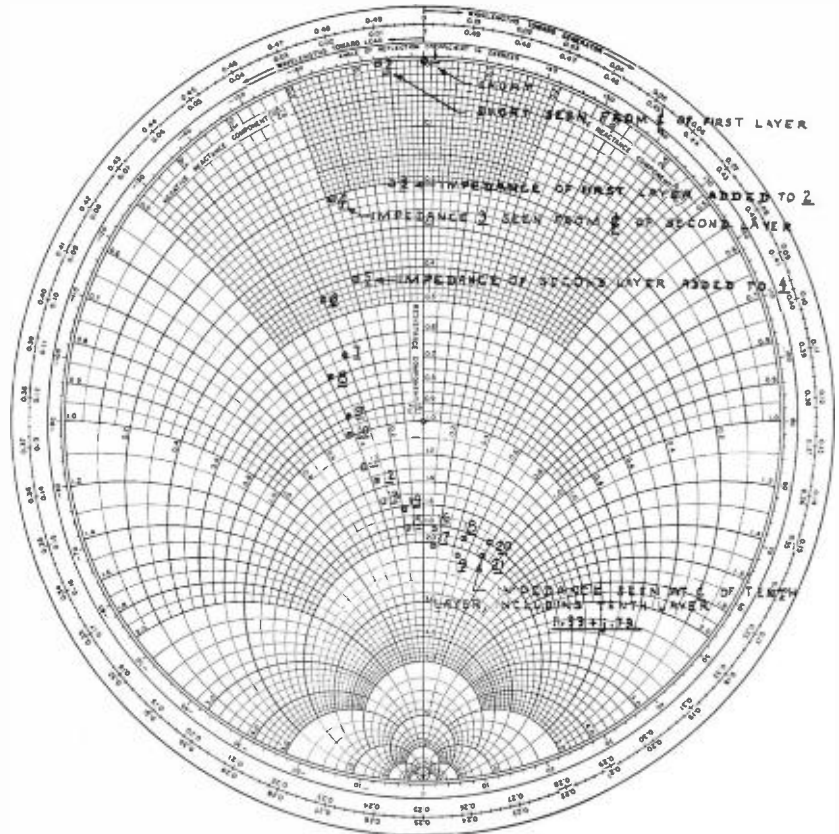

TYPICAL IMPEDANCE CALCULATION FOR UHF ANTENNA SIMILAR TO TFU-24B

20 LAYERS SPACED 1 WAVELENGTH AT CENTER FREQUENCY f_0 ; COUPLED RESISTANCE PER LAYER $\frac{R_0}{5}$; DISTANCE FROM SHORT TO FIRST LAYER $\frac{1}{2}$ WAVELENGTH AT f_0 . IMPEDANCE CALCULATED FOR $f = 0.98 f_0$ WHERE DISTANCE BETWEEN LAYERS BECOMES 0.98λ . ($\frac{\Delta f}{f_0} = -0.02$)

FIG. 25. Example of Method Using Smith Chart to Calculate Input Impedance of TFU-24-B Type of Feeder Systems.

Power gain at any frequency f

$$G_f = \frac{N \left| \sum_{n=1}^k I_{nr} \right|^2}{W_T}$$

If there are K layers in an equivalent circuit similar to Fig. 20 between the feed point and the shorting plug, the gain ratio is

$$\frac{G_f}{G_{f_0}} = \frac{\left| \sum_{n=1}^k I_{nf} \right|^2}{\left| \sum_{n=1}^k I_{nf_0} \right|^2} \quad \text{Eq. 31}$$

Now the power input must be maintained constant if power gain at f is compared with power gain at f_0 .

For equal power input:

$$I_{f_0}^2 R_{1f_0} = I_f^2 R_{1f} \quad \text{Eq. 32}$$

Where the R_1 and I_1 are respectively the input resistance and currents to the array at the feed point which is shown at the center of Fig. 20.

If $\sum I_{nr}$ is written as

$$I_{1r} \left\{ \sum 1 + \frac{I_{2r}}{I_{1r}} + \dots \right\}$$

and $\sum I_{nr_0}$ is written

$$I_{1r_0} \left\{ \sum 1 + \frac{I_{2r_0}}{I_{1r_0}} + \dots \right\}$$

then equation 31 becomes

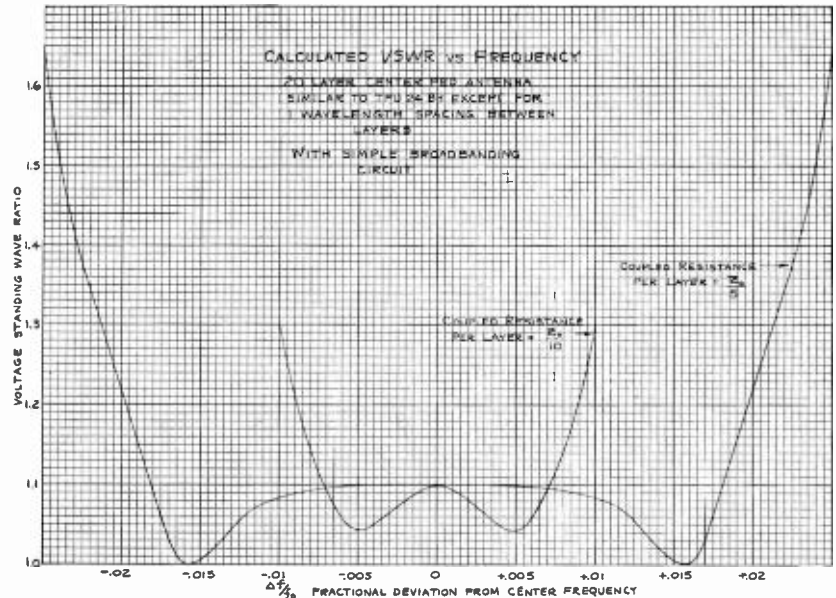

FIG. 26. Calculated Voltage Standing Wave Ratio vs. Frequency for an Antenna Using a Feeder System Similar to the TFU-24-B Antenna.

$$\frac{G_f}{G_{f_0}} = \frac{I_{1r}^2 \left| \sum_{n=1}^k I'_{nr} \right|^2}{I_{1r_0}^2 \left| \sum_{n=1}^k I'_{nr_0} \right|^2} \quad \text{Eq. 33}$$

where $I'_{nr} = \frac{I_{nr}}{I_{1r}}$ and $I'_{nr_0} = \frac{I_{nr_0}}{I_{1r_0}}$

Combining equations 32 and 33, the gain ratio becomes

$$\frac{G_f}{G_{f_0}} = \frac{R_{1f_0} \left| \sum_{n=1}^k I'_{nr} \right|^2}{R_{1f} \left| \sum_{n=1}^k I'_{nr_0} \right|^2} \frac{f}{f_0} \quad \text{Eq. 34}$$

The ratio $\frac{f}{f_0}$ is introduced to correct for the constant physical length of aperture which would make the gain directly proportional to frequency if properly illuminated.

FIG. 27. Typical Measured Voltage Standing Wave Ratio vs. Frequency for TFU-24-BH Antenna.

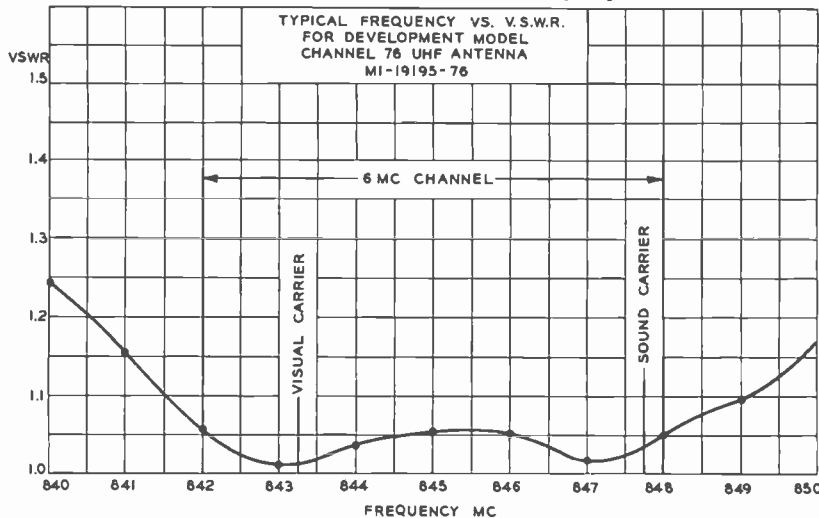

Mechanical Features of Antenna Harness

The harness may be removed from the antenna by loosening the same clamp which was loosened for the beam tilt adjustment. Low loss ceramic pin centering insulators similar to those shown in Figs. 6 and 22 support the transmission line harness in the center of the antenna cylinder. A teflon cap on the end of the ceramic pin prevents abrasion of the transmission line during removal or installation, and when the antenna is swaying in the wind. This same type of support insulator was used in the Bridgeport antenna which has given trouble-free operation for a period greater than two years. The teflon end cap has a hard waxy feel with a very low coefficient of friction which permits easy adjustment,

removal, or installation of the transmission line within the antenna, without disturbing the centering insulator adjustment.

Icing

Voltage standing wave ratio measurements were made on the antenna at Bridgeport during a severe ice storm and the change in voltage standing wave ratio was found to be small. The antenna system and transmitter were able to operate with the antenna in an iced condition without difficulty, and the transmitted picture was of normal quality. Because of the improved performance characteristics, it is believed the TFU-24-B antenna may not require de-icing. However, if further tests indicate de-icing is desirable in locations where icing is very frequent and severe, de-icing equipment will be available as an accessory. Fig. 1 shows the TFU-24-B antenna setup at Camden, N. J. A sprinkler is included—at the top for icing tests. These tests will be made as weather permits.

* * *

The data presented here on the TFU-24-B antenna is representative of the gen-

eral characteristics and principles. Since the development and design of this antenna is intensively continuing, improvements and minor changes may be incorporated in the first production units delivered. At the present time, engineering work is being done on a large number of engineering model antennas to obtain statistical data for production. Two TFU-24-B UHF TV transmitting antennas will be shipped to experimental UHF transmitting stations about April 1952.

Acknowledgment

The TFU-24-B antenna is a result of contributions of many engineers in the Broadcast Antenna Engineering Section of RCA. Particular credit is due to Charles Polk who did much of the electrical development, E. H. Shively who was responsible for the field pattern work, and A. Mathern who accomplished the mechanical design.

Bibliography

1 "Comparative Propagation Measurements: Television Transmitters at 67.25, 288, 510 and 910 Megacycles," G. H. Brown, J. Epstein and D. W. Peterson, RCA Review, June 1948.

2 "Field Test of Ultra-High-Frequency Television in the Washington Area," G. H. Brown, RCA Review, Dec. 1948.
 3 "UHF Television Field Test," R. F. Guy, Electronics, April 1950.
 4 "Bridgeport UHF-TV Test Results," R. F. Guy, FM-TV, May 1950.
 5 "Experimental Ultra High Frequency Television Station in the Bridgeport, Connecticut Area," R. F. Guy, J. L. Seibert and F. W. Smith, RCA Review, March 1950.
 6 "Ultra-High-Frequency Antenna and System for Television Transmission," O. O. Fiet, RCA Review, June 1950.
 7 "A New Ultra-High-Frequency Television Transmitter," J. R. Bennett and L. S. Lappin, RCA Review, June 1950.
 8 "8-Bay Pylon Antennas," O. O. Fiet, BROADCAST NEWS, Aug. 1948.
 9 "Measured Characteristics of the Pylon Antenna," O. O. Fiet, BROADCAST NEWS, Dec. 1947.
 10 "Some Experiments With 850-Megacycle Television Transmission In the Bridgeport, Connecticut Area," G. H. Brown.
 11 "Electromagnetic Theory," J. A. Stratton, McGraw-Hill Book Co., New York 18, New York, 1941, pp. 488-490.
 12 "Measurement of Aircraft Antenna Patterns Using Models," George Sinclair, E. C. Jordan, and Eric W. Vaughan, Proc. IRE., Dec. 1947, Vol. 35 #12, pp. 1461-1462.
 13 "Antennas," J. D. Kraus, McGraw-Hill Book Co., New York 18, N. Y.
 14 "Elektrische Schwingungen und drahtlose Telegraphie," F. Braun, Jahrbuch der drahtlosen Telegraphie und Telephonie, Vol. 4, No. 1, 1910, pg. 17.
 15 "Chart Atlas of Complex Hyperbolic and Circular Functions," A. E. Kennelly, Harvard University Press, Cambridge, Mass.

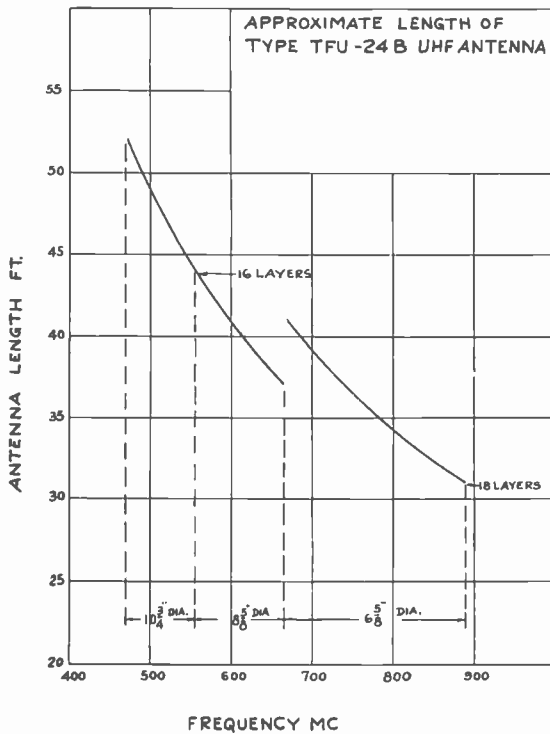

FIG. 28. Approximate TFU-24-B Antenna Length vs. Frequency.

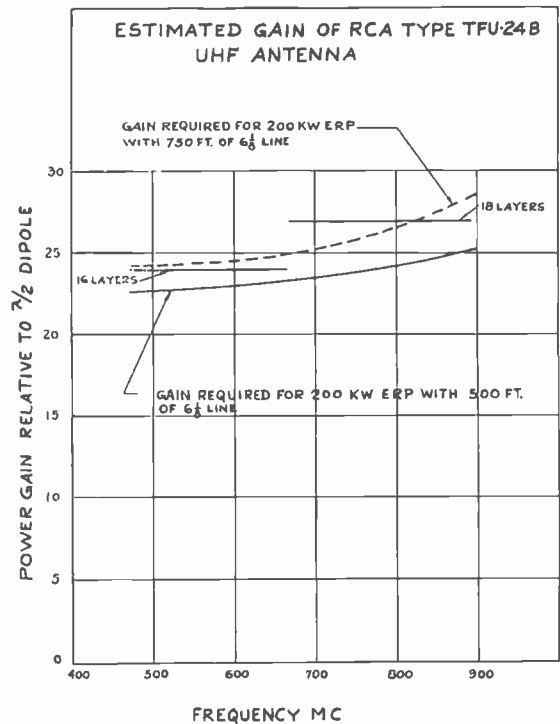

FIG. 29. Approximate TFU-24-B Antenna Gain vs. Frequency.



FIG. 1. This modernistic reception lounge greets the visitor to WSBT, now housed in its new plant. Studio "A", the audience participation facility, opens to the right behind the receptionist, and "audition" and "on-air" lights indicate the status of the activity within. In the center of the lounge, an LC-1A Speaker affords guests high-fidelity reception of the station's programs.

SOUTH BEND, INDIANA

By **H. G. COLE**, Chief Engineer WSBT
and **WALTER A. SWEITZER**, Promotion Manager

Thirty years ago, in the fall of 1921 to be specific, a new means of communication was created within the walls of the then practically new Tribune Building in South Bend, Indiana. It was The Tribune's radio broadcasting station, occupying a small room on the top floor of the three-story building. The station's facilities consisted of crude handmade equipment powered by a maze of storage batteries. Entering the radio broadcasting field in that year, The Tribune became the 34th newspaper in the nation to own a station.

From this meager beginning, WSBT has progressed with the fabulous radio industry to its present ultra modern studios on the third floor of the now greatly expanded Tribune Building which occupies almost a full quarter of a block in downtown South Bend.

The Tribune's extensive enlarging and remodeling program got under way in May, 1949. The additions to the building were completed in mid-summer of 1950. A short time later, the studios and business offices of WSBT were moved into temporary quarters in the newly constructed portions of the building while the entire third floor space of the old building was torn out and the new WSBT was constructed. The difficult job of moving to temporary studios and staying on the air with construction work in progress on all sides was accomplished by the WSBT staff without a minute's loss of air time. A great deal of credit for this accomplishment goes to WSBT's capable engineering staff.

The station's new and modern studios and offices were completed in May, 1951 and operations began at about that same

time from the new quarters. The station's new operating layout consists of four studios; three control rooms, master control; recording room and engineering workshop.

The Tribune's giant Goss Presses are located on the first floor of the building and the vibration set up by the presses running at high speed posed quite a problem for the engineers when they designed the sound-proofing for the studios and control booths. Special acoustic treatment of all the ducts for heating and air-conditioning along with expert sound treatment solved the problem.

A master control console, two RCA 70-D turntables, three LC-1A speakers in wall-ceiling housings and five Deluxe Audio equipment racks make up the master control room. The five equipment racks are built into the wall on one side of the room.

FIG. 2. The comprehensive floor plan to the right shows the careful planning of the studio facilities which Architect Ernest A. Young of South Bend exercised in handling the problem. The utility of the floor plan is readily visible. The studio-control combinations are located in the central section of the floor where the floating floors and sound-proofing of air ducts could be compactly handled.

Note the easy accessibility of one studio to another, and the associated control rooms. The area along the outside wall of the building with plenty of natural light available is ideal for subdivision into office space. The special lines from master control feed monitor-speakers in each of the offices, on which each office occupant may select programs off-the-air, off the CBS line, or off a monitor receiver in master control set for monitoring two local competitive stations.

A small air-conditioned area at the rear of the racks, entered through the recording room, enables the engineers to conveniently service the equipment. The master control console contains five operating panels. Panel One contains ring-down circuits for remote lines, three studios, recording room, transmitter, chief engineer and telephone company. Also in Panel One are jacks for studio remotes and net terminations. Panel Two contains gain controls for net and remote amplifiers. Panel Three contains four outgoing channels with Preset, On Air Lights, relays and gain controls for each channel; it's a fully automatic panel for switching incoming and outgoing programs. Panel Four contains controls for monitoring-speakers and for the two turntables in master control. Panel Five contains controls to operate Studio B, the only studio

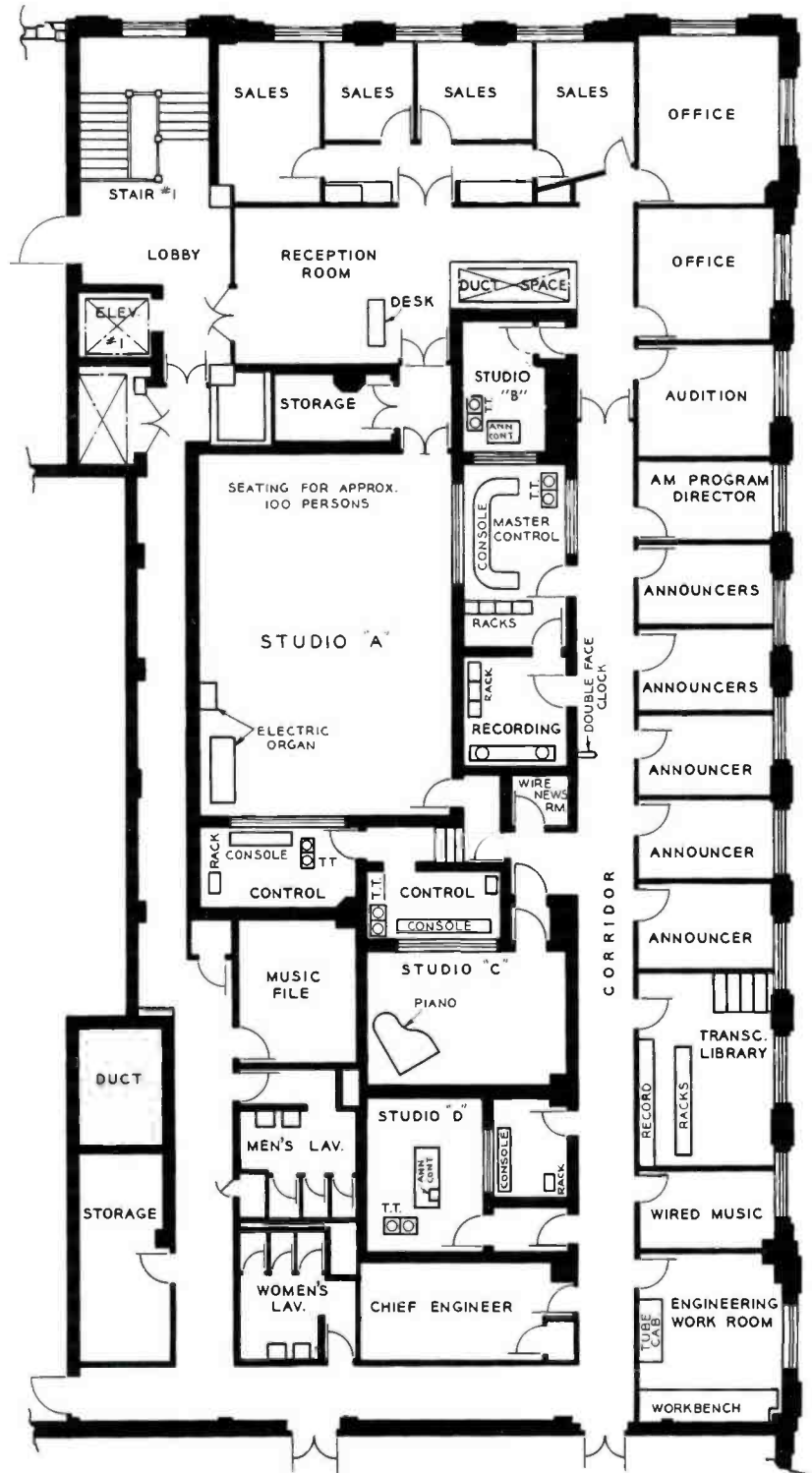



FIG. 3. The Master Control Console is an RCA custom unit, designed for great versatility. The left-hand panel handles the telephone ring-down circuit for 24 remote program lines which can be patched into jack panel. Four lines go to each studio, and four order wires to remote locations. The buttons are for feeding cue to any of the remote lines.

The remote panel controls four remote lines, one network, and a utility line at extreme left of panel. The center metering panel handles ten input, four output channels. The Studios A, B, C, D are interlocked so each can have only one program fed to one channel.

The Monitor Panel, next right but not visible in photo, has built-in intercomm. microphone. The Panel also contains one and two monitor volume controls and selector switches as well as attenuators for the 70-D turntables with the on-off keys. Besides the headphone jack, there is a headphone selector switch and volume control.

The last panel (not visible) controls Studio B (below), and has talk-back microphone, and flasher button to call announcer's attention. A bank of LC-5A Wall Speakers complete the unit.



FIG. 4. The baby console position in Studio B looks directly into Master-Control. The unit controls the volume for the two turntables and the microphone, allowing operator to cue turntables and to control announce microphone. The lever-key cuts in microphone and cuts off studio speaker. There are also a pair of jacks for headphone monitoring, an indicator light to show when the microphone is live, and a push button buzzer to signal master control.

visible to the operator at the master control console.

Studio A is the audience studio with a seating capacity of approximately 100 persons. Control A and C are each equipped with a special custom-built console, two 70-D turntables, and LC-1A monitor-speaker in a wall ceiling housing and an equipment rack. Studios D and B are equipped with two 70-D turntables with an announcer's sub-control console allowing the announcer to control his own program.

The studios, control rooms, and recording room occupy a large area in the center section of the building, with a wide corridor around the entire layout. Along this corridor, on the outside wall of the building, are built the announcers' offices, news room, engineering workshop, record library, client audition lounge and business offices. Specially installed lines from the equipment rack in master control feed monitor-speakers in each of the offices. By means of a selector-switch, each office occupant may

FIG. 5. Studio A Control Rack has a metering panel; 9 pre-amplifiers; 1 monitor amplifier and a program amplifier; 4 ring-down telephone circuits to Master Control with Magneto; studio volume control; 5 33-A Jack Panels; Sound effects filter; Monitor Amplifier; 2 Pre-amplifier power supply; 24-volt relay power supply; the switch and fuse panel behind which is located connecting terminal boards.

The console and rack are the same as Studio C. In each studio control, the color scheme follows the dominant hue of its associated studio.

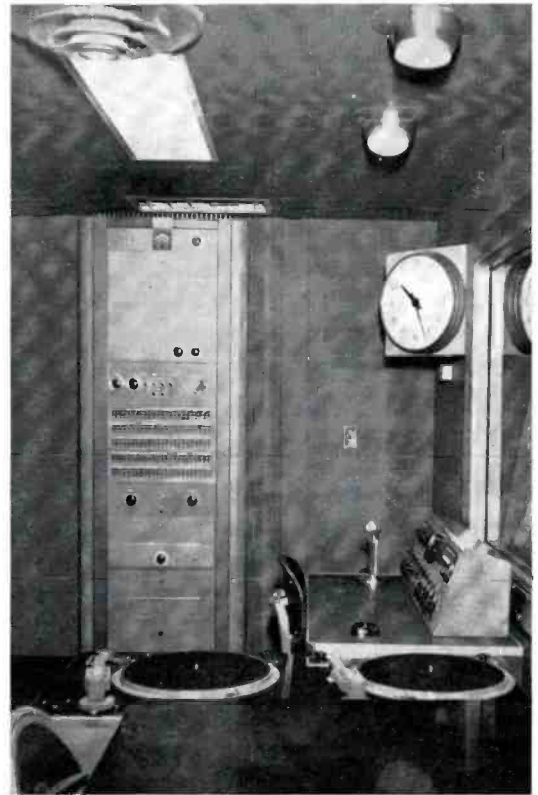

FIG. 6. This is a view of Studio A which seats an audience of approximately 100 persons. The station's call letters are inlaid on the floor. The LC-5A Wall Speakers are here shown mounted at the proper angle for a long throw — as is needed in this room.





FIG. 7. Studio C's Console has many desirable features for a functional program studio. This RCA Custom-Built Console is equipped to handle four microphone inputs, two turntables, and facilities for remotes 1-2, 3-4, and a network control. A special feature is the Echo Effects circuit built into the console, highly desirable for dramatic programs.

and C. This latter entrance is a quick and convenient means for announcers and engineers to get to and from studio and control, and, to recording and master control.

WSBT has a staff of 30 people to carry on its 18-hour-a-day broadcasting schedule. The station has been an affiliate of the Columbia Broadcasting System since 1932. WSBT's transmitting station is located 7 miles southeast of the city. A five-tower directional antenna array is fed by a 5-kw RCA BTA 5F transmitter. WSBT operates at 960 kilocycles, unlimited time.

The station has a contingency order with RCA for a full complement of television equipment. The entire plant layout has been designed with TV in mind so that the station can go into this phase with the least amount of inconvenience to WSBT's AM operation, both at the studios and the transmitter. Whenever the FCC grants WSBT its TV license, the station will be ready to put TV on the air with very little delay.

select programs off-the-air, off the CBS line or off a monitor receiver in master control set for monitoring two local competitive stations.

The broadcasting facilities of WSBT have been designed so that each studio-control combination can operate independently allowing the station to handle four program lines simultaneously. Every bit of flexibility possible has been incorporated in the installation by WSBT's engineers to cover almost every conceivable need. Each studio-control room has its own individual color scheme with an eye toward comfort and warmth.

The visitor to WSBT steps off the elevator and looks directly into the station's beautiful reception lounge through a wall of plate glass and enters the lounge through large plate-glass double doors. The entrance to Studio A is directly off the reception lounge. There is also an entrance to Studio A off a small corridor at the rear of the studio which leads to control A

FIG. 8. In the photo of Studio D (below), one looks directly into the announce booth, containing another unit for disc-jockey operation. The Sub-Control Console shown here duplicates the Studio B control built into Master Control, with the exception that "B" microphone is built in. Since the announcer controls his own turntables, only one turntable control is needed here.



WNAG Measurement Report on New BTA-250M

Since the past issue of BROADCAST NEWS went to press, the equipment performance measurements for WNAG at Grenada, Mississippi have been received. This station was the first to install the RCA BTA-250M transmitter.

Taken on May 6, 1951, the measurements were made on the equipment adjusted for normal program operation, except that no compression amplifier was in the circuit at the time of measurements. The data presented here is for the overall performance of all circuits between the main studio amplifier input and the antenna output.

The audio harmonic graphs are based on the RSS value of all audio harmonics as measured at the frequencies indicated by points shown on the graphs.

The frequency response graphs indicate relative response to a reference level of zero DB at one kilocycle.

Hum and noise level is shown as measured at frequencies indicated by dots on the graphs. The connecting lines are for convenience in noting the location of measurement points.

Carrier shift is graphically shown with dots indicating modulation percentage at which measurements were made and connecting lines utilized as explained above.

Testing apparatus included a Hewlett-Packard resistance tuned audio oscillator, a General Radio (1932-A) distortion and noise meter, Weston decibel meter and a General Radio (1931-A) modulation monitor. The entire equipment provided accuracy of plus-minus 5% of full-scale for all measurements, with a residual distortion level of .05% below 7500 cycles and .10% above 7500 cycles. Mr. Thomas L. McFerrin, Chief Engineer, WCBI, was in charge of the tests.

FIG. 1. The first set of measurement results made on a BTA-250M Transmitter in actual operation were made by Chief Engineer Thomas L. McFerrin of the Mid-South Network last spring when WNAG went on the air at Grenada, Mississippi.

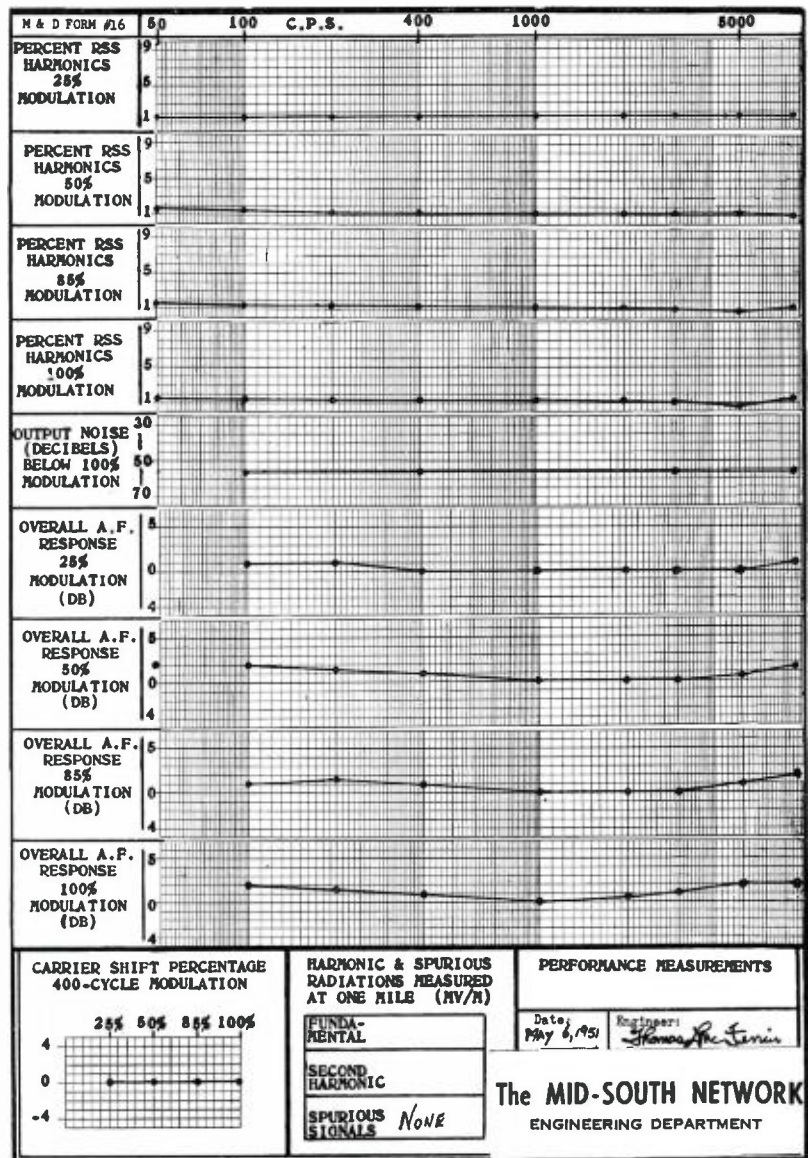



A *New* TELEVISION CAMERA for Studio and Field Use

Twenty years of development in our laboratories and extended customer experience as television was growing to its present stature have reached a natural fruition in the new TK-11A and TK-31A Image Orthicon Camera Equipment.

The new image orthicon camera equipment for monochrome television pickup is a successor to the TK-10 and TK-30 equipments which have won universal acceptance during the past six years in television broadcasting. The new equipment embodies many improvements and features not found in earlier or competitive types, and continues to include all of the desirable basic characteristics of the earlier models which have proved so successful in daily field and studio operations.

In contrast to the previous models, the new design is centered around a single type of all-purpose camera which may be used for either field or studio applications. Associated with the camera is a new electronic view finder, also available in only a single design which matches the camera. Past practice in the packaging of studio and field camera controls and power supplies has been continued, but with improvements and new features. The general appearance and characteristic styling of the RCA equipment have been preserved, making it possible to mix new and old equipment without sharp contrast in appearance.

Almost complete interchangeability with the TK-10 and TK-30 equipments has been achieved. To owners of the previous types, this is a valuable feature which permits substitution of new units for old, or vice versa, in case of emergencies. The

by **A. REISZ**

RCA TV Terminal Equipment Engineering

terchangeability extends to all of the major units, lenses, and interconnecting cables with the exception of the field power supply. In this case, the older unit may *not* be substituted for the new unit because of the increased power requirements of the new field camera chain. However, the new field power supply may be substituted for the old unit.

For the most part, operating techniques are the same as for the older models. The

principal operating controls have been retained in the same form and in the same locations. However, because of new features, many of the secondary controls have been relocated or eliminated, and some of the secondary controls have been relocated or eliminated, and some new controls have been added.

The over-all objectives of greater stability and flexibility in performance have been achieved, together with greatly improved mechanical design which will permit less expensive and more rapid manufacturing and greater ease in servicing.

◀ FIG. 1 (at left). Front or overall view of the TK-11A Studio Camera which is also used for Field application (in this case designated TK-31A). Note it is shown mounted on all-metal, lightweight tripod.

FIG. 2. Closeup of the camera from the cameraman's operating position. ▶



New "I. O." Camera and Companion Equipment

Hand in hand with the evolution of the new Image Orthicon Camera came the design of associated studio equipment necessary for a complete TV camera chain. Such equipment includes the new viewfinder, the new studio camera control, the new field camera control and a redesigned field power supply. It is obvious that this equipment does not comprise all of the necessary operating units of a camera chain and, therefore, in our reference to the TK-11A and TK-31A chains we intend to also include familiar units of previous designs that are necessary to make the equipment chains complete. Refer to Figs. 3 and 4 for block diagram of items making up the camera chain.

The Master Monitor (TM-6A) is a completely new design which is not described in this article.

General Description of Camera and Viewfinder

The camera comprises a mounting for the image orthicon pickup tube together with its focus, deflection, and alignment coils, complete horizontal and vertical deflection circuits, a video pre-amplifier, and an optical system consisting of a turret with four lens positions and means for adjusting optical focus and iris openings. It is entirely self-contained except for a B power supply and certain electrical controls which are located, for operating convenience, at the camera control. All electrical connections are made through a single

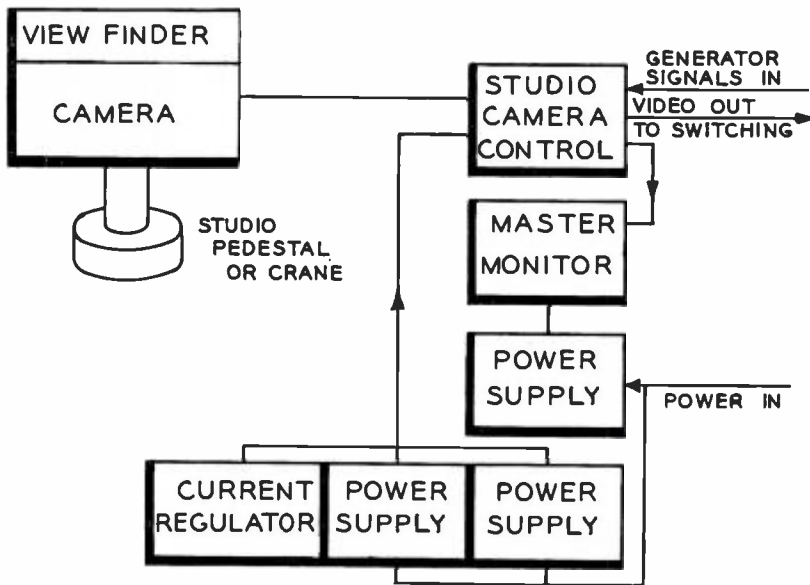

FIG. 3. The Studio Camera chain includes associated control equipment and power supplies as shown above.

FIG. 4. Typical equipment lineup showing the Field Camera chain.

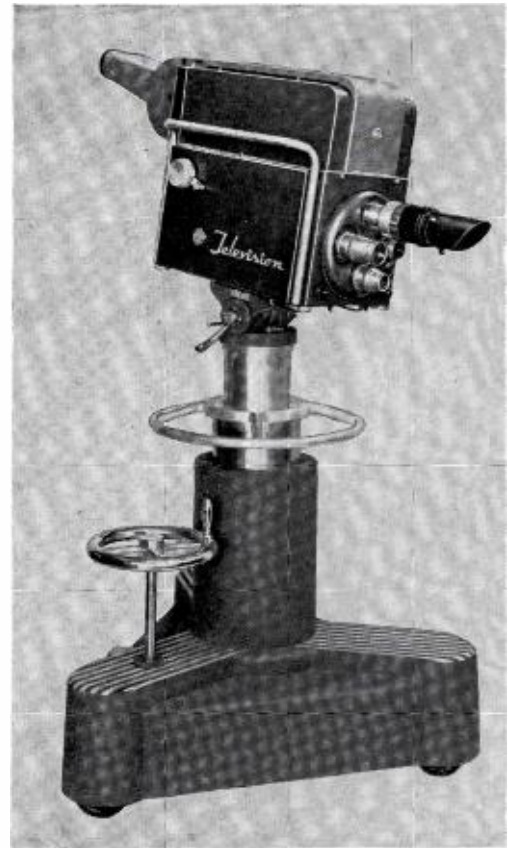
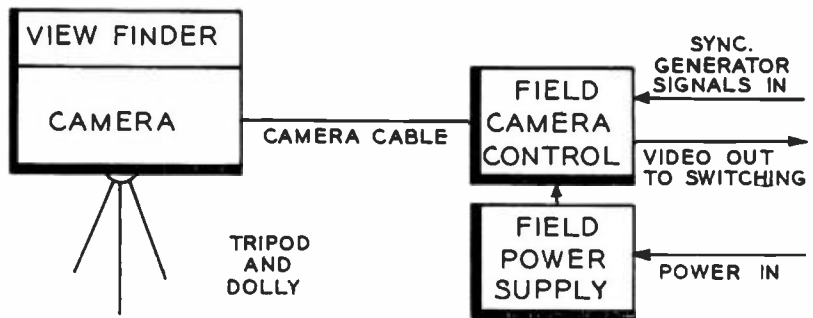

FIG. 5. View of new camera mounted on a TD-1A Studio Camera pedestal.

cable and plug which carry input power and sync generator signals to the camera, and video output and control circuits from it.

Physically, the camera is divided into three main compartments. In the center compartment is located the pickup tube with its deflection, focus and alignment coils. The two side compartments, access-

ible by opening the side doors, contain the video and deflection amplifiers respectively. On the front end of the camera is the lens turret, and on the rear are some of the electrical controls and the control handle for rotating the turret. On the right-hand side of the camera (from the rear or operating position) is the optical focus control handle. This focus control and the turret handle are normally the only two controls which require the attention of the camera man during a program.

An essential adjunct of the camera is the viewfinder which permits the camera operator to evaluate his framing, focus, field of view, and scene content.

Design Features of the New Camera

Perhaps the best way to analyze or evaluate the qualities of any electronic equipment is to study the actual operating and design features provided.

Inasmuch as the majority of Television Station personnel are well acquainted with the features of the TK-10A and -30A Camera Equipment, this article will be confined to the following descriptions of design features of the new TK-11A and TK-31A equipments.

Accessible, Smooth-Operating, "Focus-Deflection" Assembly

The camera focus coil-yoke-alignment coil assembly moves on ball bearing slides.

Although rigidly fastened to the frame when in position, the entire assembly is removable in a few moments for servicing because it is indeed a plug-in unit. This suspension is smoothly driven through its entire travel for optical focusing by $2\frac{1}{4}$ turns of a focus knob. The knob remains in place when the side door is opened. This remarkably simple yet rugged drive mechanism imparts a non-linear motion so that relatively great image orthicon motion per degree of knob rotation is obtained for long focal length lenses and close ups. In contrast, a vernier motion is provided near infinity focus and when short focal length lenses are in use where rapid motion would make accurate focussing difficult.

FIG. 6. "Inside-out" accessibility seems to best describe the mechanical layout and design which makes camera and viewfinder circuits easy to reach.

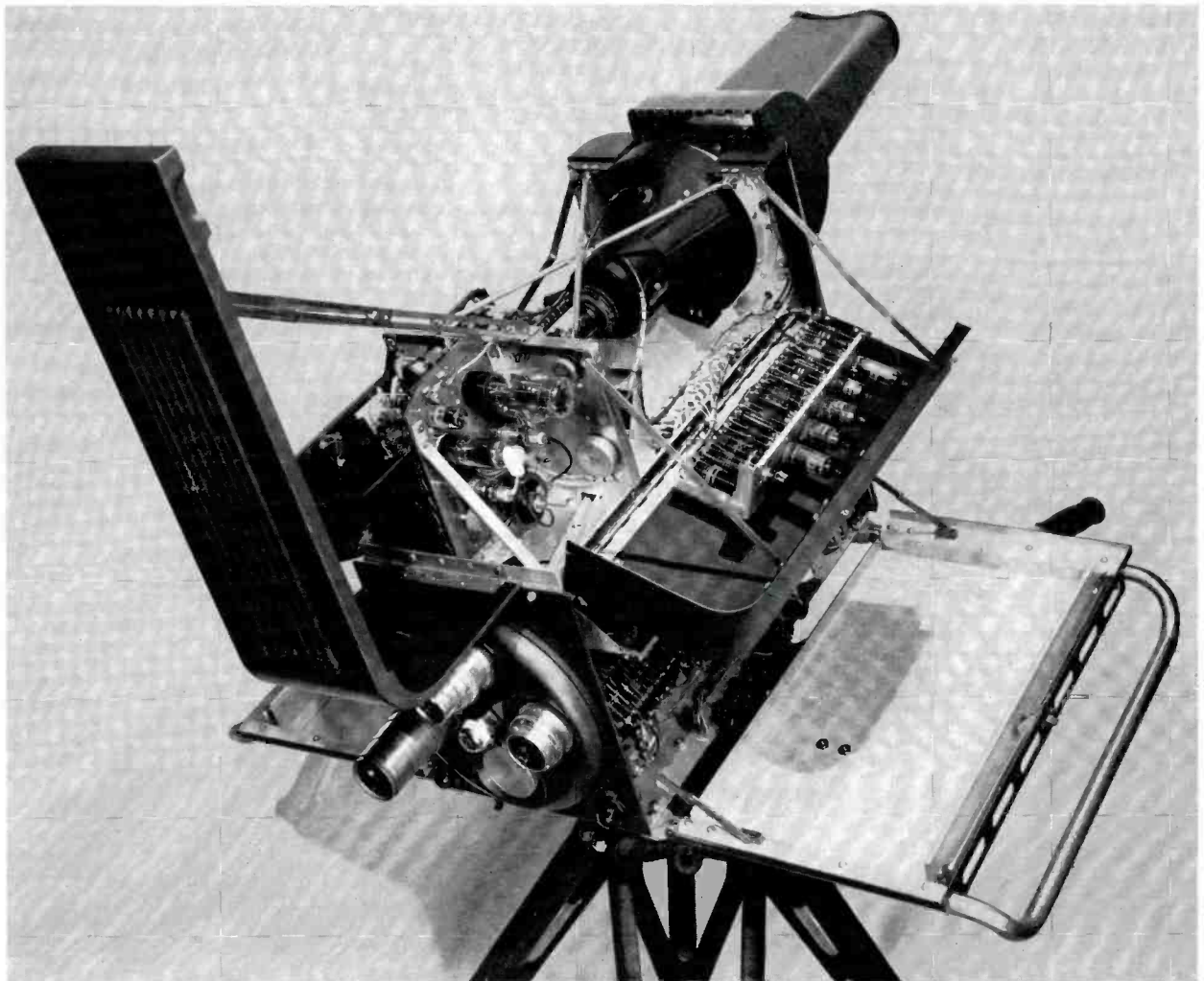

Improved Yoke—Better Resolution

The improved yoke provides better shading, less geometric distortion and improved shielding of deflection fields from the image section. A simple wrap-around mu-metal shield extends from the image end past the alignment coils for quite complete shielding against external magnetic fields.

Simplified Alignment

An entirely new alignment coil assembly has been incorporated in the camera. It comprises two pairs of coils in space quadrature so that independent control of currents in the two pairs of coils will produce a correcting cross field in any direction required. In this system, no mechanical adjustment of the coil is required; it is rigidly mounted. The alignment procedure involves the simultaneous adjustment of two potentiometer controls which determine the currents in the two sets of coils.

In order to simplify the alignment procedure, an auxiliary orthicon focus control has been included in the camera. Temporary control of orthicon focus at the camera may be selected by operating a switch on the rear of the camera. The camera man himself may then "rock" the focus back and forth to check the setting of the alignment controls without requiring the services of a second operator at the camera control position. At the conclusion of his adjustment procedure, the selector switch



FIG. 7. Side view of camera with viewfinder removed. Note convenient carrying handles.

may be returned to normal, and the control of orthicon focus is thereby restored to the camera control position.

Improved Cooling—Easily Removed Blower

The blower is readily unplugged and removed from underneath the camera and

when slipped in place makes connection with a gas mask type hose which directs clean cooling air to the base end of the image orthicon. This air is restrained at the base end by a gasket and is forced between the tube and deflection coils and between the yoke and focus coil where space has now been provided. A redesigned shoulder socket and retaining mask permit exit of air in the front while a preset thermostat contained in the mask (in intimate contact with the photocathode) samples tube temperature to activate a relay-rectifier circuit for blower cycling free from electrical surge. This arrangement is capable of automatically maintaining proper orthicon operating temperature for stable performance and longer tube life. Provisions are also made for continuous operating of the blower and the target heater to meet extreme conditions.



FIG. 8. Yoke assembly and focus drive mechanism removed from the camera. Note blower hose fitting and plug for electrical connections.

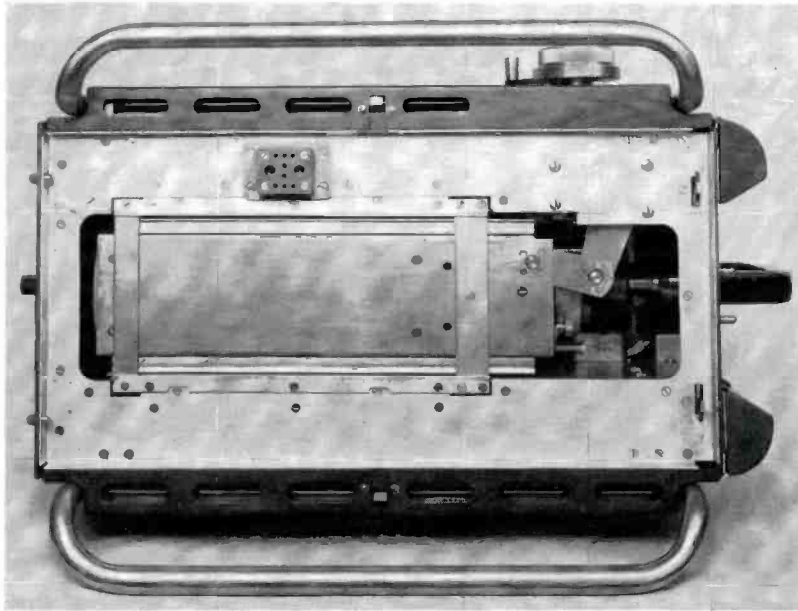

FIG. 9. Top view of the camera with viewfinder removed. Note the yoke assembly mounting and rigid focus drive mechanism.

Lens Turret Incorporates Remote Iris Control

To facilitate proper adjustment of the light reaching the photocathode of the pickup tube, a system for remote control of the iris in the objective lens has been included in the camera. The system includes both control and indication of iris setting. This is provided at the camera control position. The movement of the iris is obtained with a small d-c motor and gear train mounted directly on the lens and coupled to the control circuit through brush contacts on the turret. A potentiometer, also part of the motor assembly, geared directly to the iris gives an electrical potential which indicates the iris position. This indication is presented on a meter at the control position. The circuit connections for both motor control and indication are made through the camera cable by superimposing these circuits on the existing program sound circuit. The only operating control is a two-way lever key (telephone type) which provides for reversal of the motor for opening or closing the iris. Motion over the whole range is accomplished in about 6 seconds. A control panel, including motor power supply, control key, and meter, is available as part of either the field or studio type of camera control.

Lens turret control is positively indexed with an improved hand grip and a hollow shaft for the use of special lenses. A one-piece turret shaft, with a large opening

from end-to-end, is employed. Space is provided behind the turret for a filter disc to control light without impairing control of focus depth. Write-in tabs indicate the lens in use.

Functional Doors

Side compartments are enclosed by hinged covers. Sturdy handle bars on the doors provide easy portability. Adequate ventilation is allowed but a splash plate protects the camera interior. A strong catch mechanism holds the door secure but can be easily released with one finger. When open, the doors are held horizontal with knuckle type stays to provide a ready service shelf.

Improved Circuitry Throughout

Protection of the valuable Image Orthicon is assured through the use of a protection circuit which cuts off the tube when there is a loss of driving signals, deflection circuit failure, or failure of the activating relay.

Vertical deflection incorporates feedback and phase correction for excellent linearity

FIG. 10. View (from cameraman's position) of lens changing handle and camera "setup" controls.

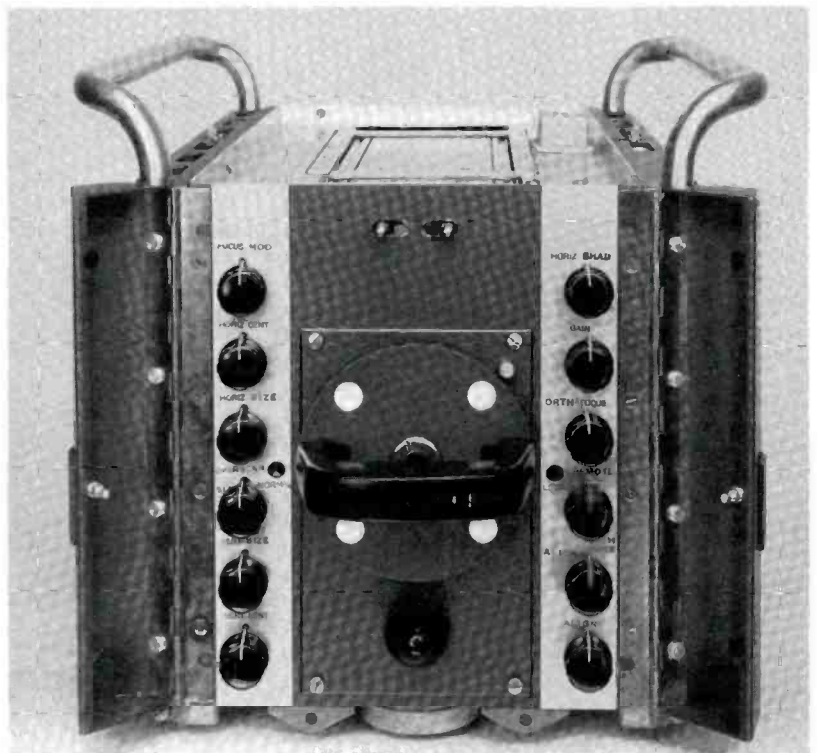

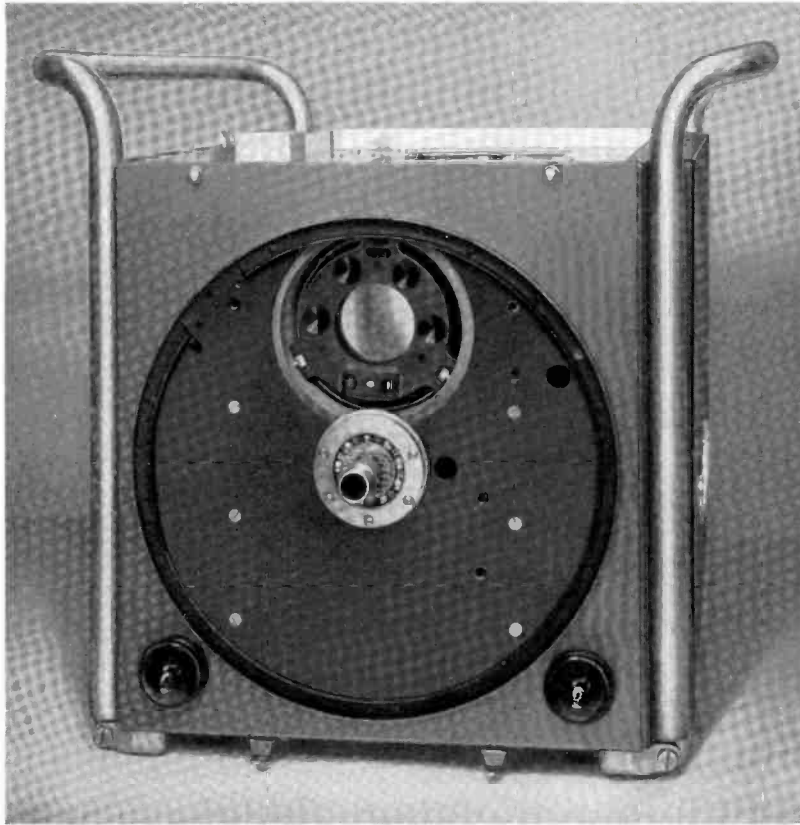

FIG. 11. Front of camera with lens turret removed. Note turret indexing and blower thermostat mounting in mask.

and stability without need for linearity adjustments. Target blanking insertion is at low impedance to eliminate crosstalk problems. Horizontal deflection has excellent linearity, single knob linearity control, and freedom from transients by an improved push-pull type circuit and a novel ferrite output transformer. A seven microsecond return time insures good operation even with the extreme delay conditions associated with 1000 foot camera cable operation. Adequate and symmetrical centering controls are available. Both deflection circuits can be switched from normal scan to 15% over scan to guarantee against burned target areas during warm-up and rehearsals, while maintaining linearity and aspect ratio.

A pulse type high-voltage supply provides stable picture tube operating potentials and, incidental to this, a resistive configuration maintains constant loading on the -500 volt supply as image focus is varied to speed the narrowing-down process

when operation is being optimized during setup.

Focus modulation circuitry provides low-impedance feed of horizontal and vertical parabolic waveshapes in a 4/3 aspect ratio to the orthicon wall to provide continuous beam focus over the usable target area. Improved corner resolution results as does also the possibility of defocussing all multiplier blemishes simultaneously with a minimum of sacrifice in resolution.

The decelerator control is now continuously variable from 0-120 volts for accurate "port hole" control. Image accelerator control provides "S-distortion" correction. Vertical deflection reversal is provided by a switch for quick transformation to operation with our TP-10A portable film projector for field film insertions. Switch is made at the same time to a preset centering potentiometer to insure operation with the same target area. Horizontal deflection reversal is possible in that two coaxial leads feed the yoke so that a simple change of the yoke connections at the yoke plug will permit, for example, multiplexer operation.

Horizontal shading at the camera position allows shading the viewfinder picture. A multiplier video gain control allows a cure in the rare case of dynode overload.

FIG. 12. Underside view of the new camera. Note at right, blower assembly is made to pull out easily.

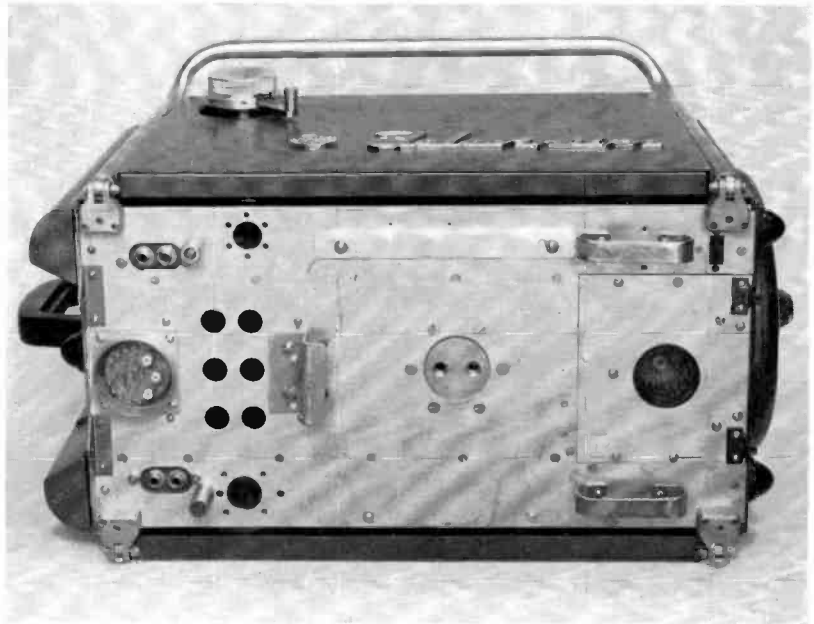

A line voltage tap switch compensates for line voltage drop associated with different cable lengths. An elapsed time indicator records hours of tube operation conveniently.

Three miniature sensitive 24 volt relays are used—one for tally light service. Interchangeability with existing units is maintained but it is a simple wiring change here and in the new field control if 24 volt tally operation is desired.

The video pre-amplifier is a plug-in unit with all power connections made through a single plug and receptacle, and with three small coaxial connectors for the input, main output, and view finder output signal connections. The amplifier is mounted on rubber to minimize the effects of vibration and shock.

Ample gain insures a bright viewfinder picture with even a low-limit camera tube. Two stages of cathode high peaking eliminate overshoot and smear by very accurately compensating for the amplifier input loss of high frequencies while reducing microphonics associated with conventional high peaking. Low frequency response is excellent here and on into the new controls to insure against "clamped-in streaking", which otherwise would appear as long "contrasty" streaks. A response uniform to 8.5 Mc transmits faithfully the entire orthicon capability. A feedback pair output stage adds viewfinder isolation, sending-end cable termination, linearity, and stability.

New Viewfinder Design Advantages

The new viewfinder is an engineer's dream and does a better job as well. With its top lifted and sides open, components and circuitry are an open book. A new 7-inch kinescope (used also in the field control) provides the cameraman an excellent monitor to evaluate his operation better. Aluminized backing, a flat face, and a good gun with electrostatic focus yield high brightness, excellent contrast, improved spectral characteristics, good overall focus, and resolving power such that the kinescope is not the limiting factor in detail reproduction. The front is easily detached for kinescope removal.

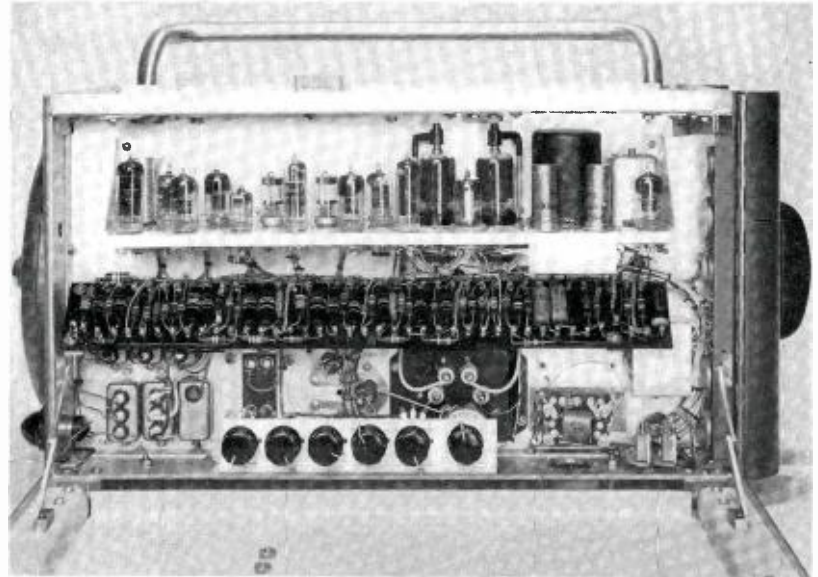
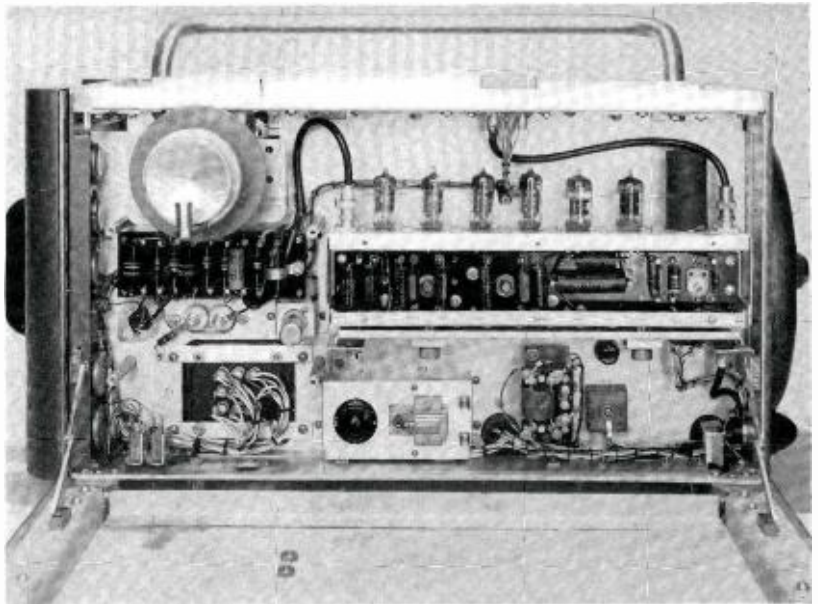

FIG. 13. View of deflection side of camera with door opened. Note miniaturized components, accessibility and convenient grouping of "setup" controls.

Variable-width blanking permits the cameraman to see the "on-the-air" picture for accurate framing. Horizontal deflection is highly efficient; vertical deflection is a duplicate of the camera circuit; the video amplifier is wide band; and a driven clamp provides accurate DC restoration. An improved release mechanism is a two-finger, one-hand type.

A detachable viewing hood may be rigidly mounted to the mask assembly to prevent stray light from striking the face of the kinescope. The number of exposed operating controls has been reduced to three (contrast, brightness, and focus) with rim-type control knobs protruding through the rounded corners of the kinescope mask assembly. Other controls are normally pre-set

FIG. 14. Video side of the new camera. Cover is removed to show "plug-in" amplifier mounted in place. Note that focus knob is still in place for use.



and are located on the amplifier chassis. No interaction exists between the viewfinder and the camera.

General Description—Studio and Field Camera Controls

The basic functions performed by either camera control are the following:

1. Provide control of electrical performance of the pickup tube in the camera (electrical focus, beam current, etc.).
2. Synthesize the picture signal to be delivered to the video switching equipment (adjust signal level, add picture blanking signal, insert d-c component and shading, and provide monitoring signal).
3. Provide terminal facilities for the camera cable and other cable connections to the camera and the rest of the system.

FIG. 15. Viewfinder opened up to show accessibility to 7" Kinescope and components. ▶

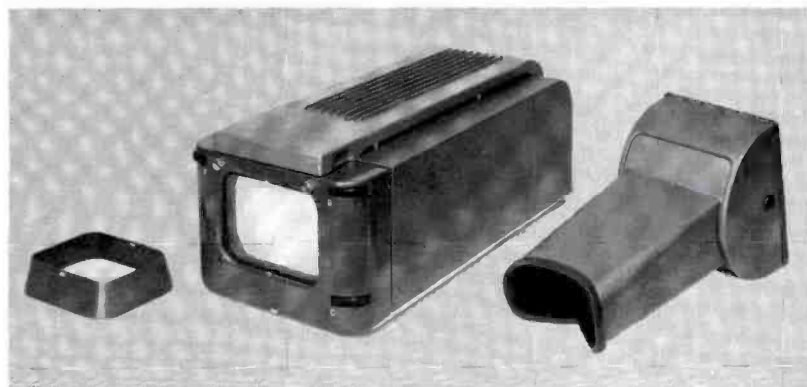
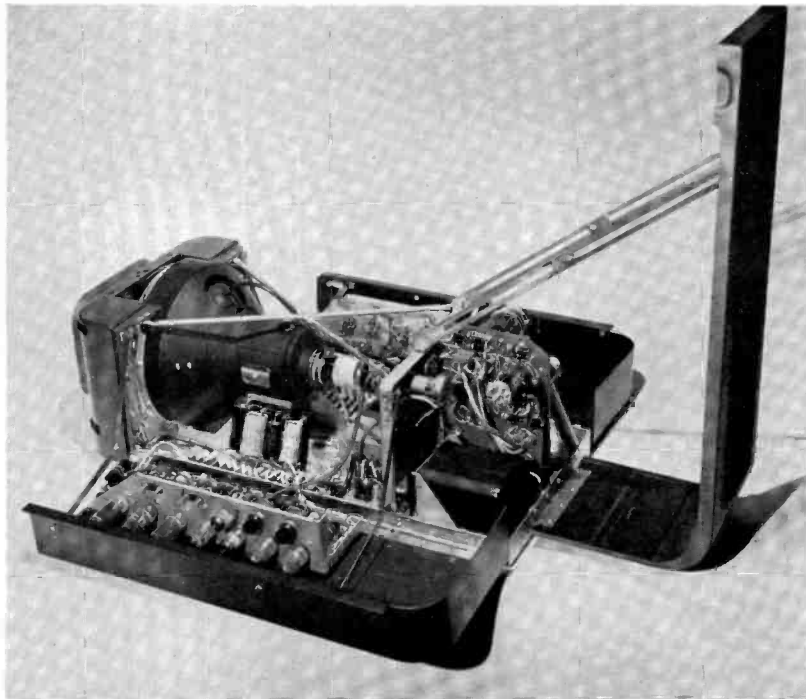

field operations. The field camera control is housed in a suitcase which is slightly higher than the earlier model, but otherwise is the same in size, making it possible to utilize the same shock mounts, consoles, and arrangements of equipment. Familiar placement of major controls and cable connectors has likewise been retained.

◀ FIG. 17. Left to right: Light Shade, "Plug-in" Viewfinder and Viewing Hood.

The new field camera control for use in remote pickups employing RCA image orthicon cameras is a suitcase type of unit similar in appearance to other existing and newly designed units of field equipment. It may be used interchangeably with either the new or old designs of image orthicon cameras. However, the increased power drain of this unit requires the use of a new field power supply. In comparison with older designs, it provides new features and improved performance which will facilitate

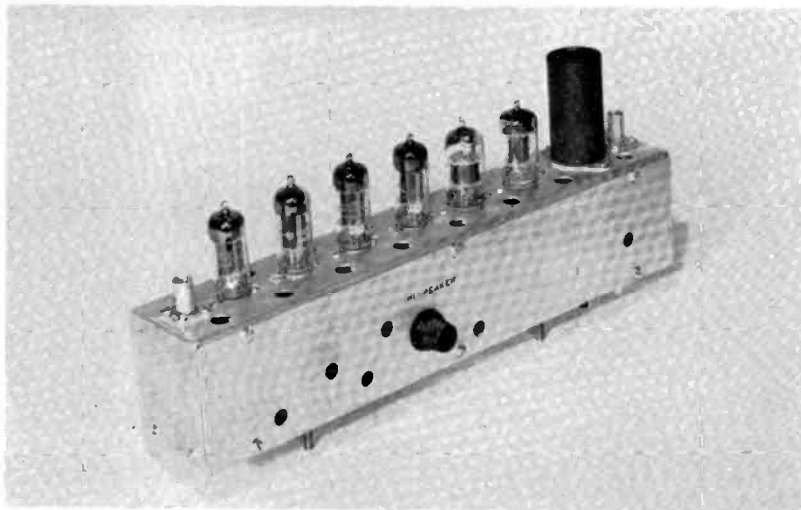

▶ FIG. 16. "Plug-in" video amplifier of the new TK-11A and TK-31A Cameras.

The mechanical construction of the suitcase has been modified to realize the benefits of sub-assembly construction as far as possible. The addition of several new features has been made possible in only slightly increased space by the use of miniature tubes in the majority of sockets and the use of other miniaturized components. New features have resulted in increased power drain and, therefore, increased heat dissipation. This has made necessary the inclusion of a small blower to give better cooling of parts of the unit. Though the number of circuits and components has increased, the accessibility is notably improved, thereby making servicing much easier.

The new studio camera control is packaged in the same general manner as its earlier counterpart, and may be used as a direct replacement for it with either old or new types of image orthicon cameras. The chassis and attached control panel are intended for mounting in the standard console housing.

In the new unit, the connectors for camera cable, power cable, pulse input, and intercommunication cables are located on the rear apron of the chassis in order to provide additional space for tubes and components on the main panel, and to simplify the process of withdrawing the unit from the console housing. Only the coaxial cable connectors for signal outputs are located on the front (tube) side of the main panel.

Field Camera Control Design Features

The related field camera control embodies much new thinking. Its improved kinescope has been described. Video-frequency response in no way limits the system. New sine-wave clamping employed at three places effectively establishes black level and guarantees gray scale rendition while providing no high-frequency unbalance to damage the blanking waveform. A regenerative type blanking circuit stabilizes blanking insertion. Fixed blanking set-up

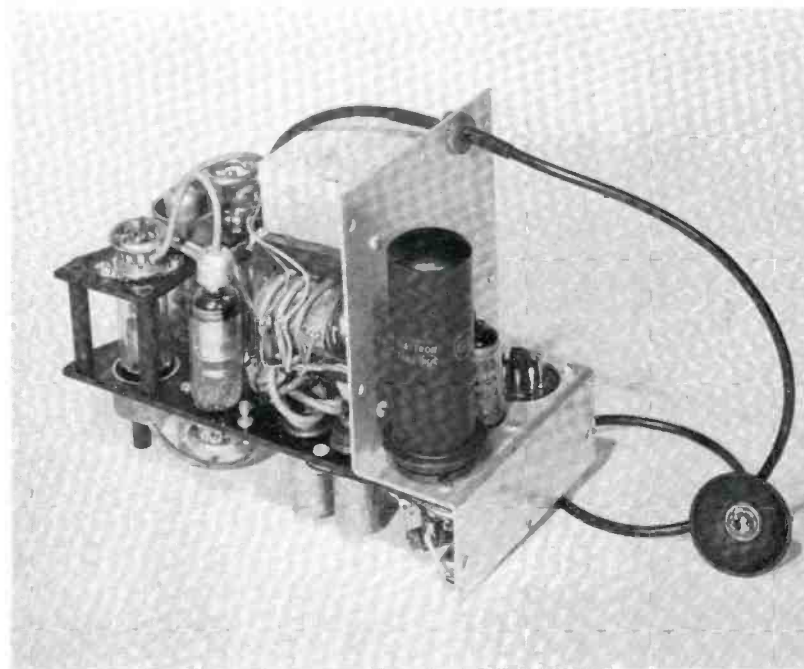

FIG. 18 (Top right). TK-31A Field Camera Control is mounted in a "suitcase" type housing.

FIG. 19 (Bottom right). New "plug-in" R-F Power Supply for Field Camera Control. (Also used in new Master Monitor.)

adds a controlled amount of "blacker-than-black" blanking. Two "black-white" stretch circuit switches permit selection of four different conditions of gray scale alteration while keeping overall video amplitude constant. The amount of stretch desired has previously been established by screw-driver adjustment. Synchronizing signals can be added with bridging of this signal to other units for eventual termination.

Two identical isolated video outputs are available from a feedback output stage for direct outgoing-line monitoring. This circuit also yields sending-end termination, improved linearity, and stability by virtue of its feedback nature.

Horizontal kinescope deflection is almost identical to its camera counterpart, as is vertical deflection. An extremely compact, efficient, and well shielded plug-in rf high voltage unit supplies regulated 10-KV to kinescope second anode, as well as kinescope focus, waveform monitor second anode, and bias voltages for the control unit divorcing it in large measure from the power frequency for "off-frequency" operation.

The waveform CRO is fed from a wide band video amplifier with stable half-line or frame horizontal sweep speeds selected by a switch. Astigmatism control yields a well defined spot. An illuminated standard

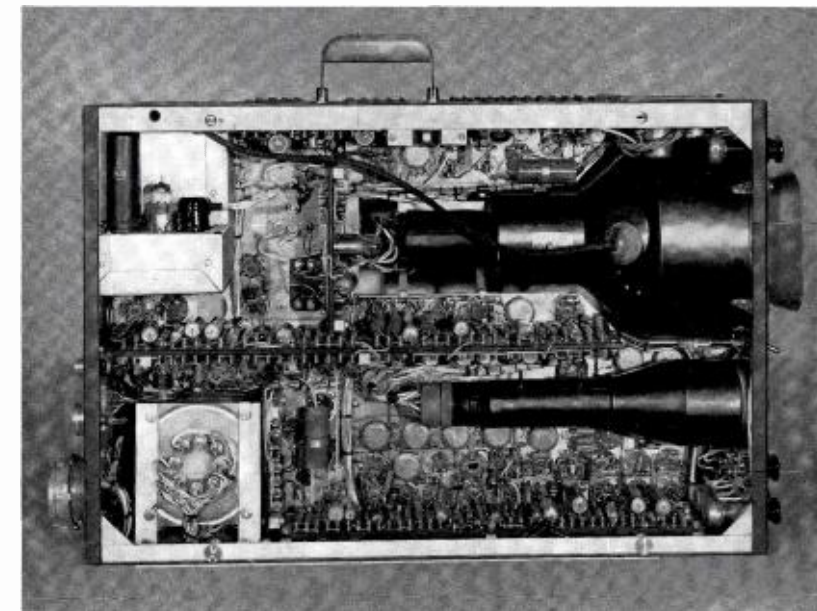

FIG. 20. View of the Field Camera Control unit with side removed to show access to Kinescope, CRO, r-f power supply wiring and small components.

scale with simplified calibration permits accurate level setting.

Camera operating controls are, of course, provided with "target-set" made automatic. Both vertical and horizontal sawtooth shading signals of either polarity are available. Video response is compensated by a "3-position" switch for various cable lengths in common use.

Studio Camera Control Design Features

The companion *studio control* closely duplicates the field control unit in so far as video circuitry is concerned. Regenerative blanking, gray scale alteration, sine-wave clamping, fixed blanking set-up, shading addition, synchronization insertion, and feedback output are again provided. Synchronizing signals for preview monitoring are added to only one of the three identical outputs provided here. Convenient "tip-jack" test points permit quick check of the unit by removing only the front console cover.

A special lucite panel with matte black surface and edge lighting permits soft illumination of panel lettering without stray light, thus facilitating darkened control room operation.

New Field Power Supply

A new field power supply has been provided to operate the field chain because of an increased power drain required by the added features. Essentially, it is the same rugged, dependable, relatively light unit as before.

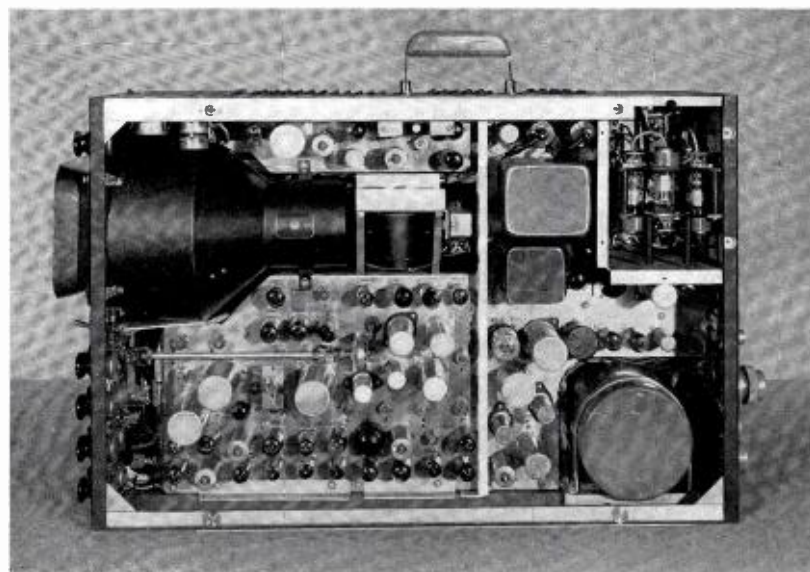

FIG. 21. Tube side of Field Camera Control unit showing how components are made accessible.

FIG. 22. View of the TK-11A Studio Camera Control chassis which mounts in a standard console housing. All controls are accessible on removal of console front panels.

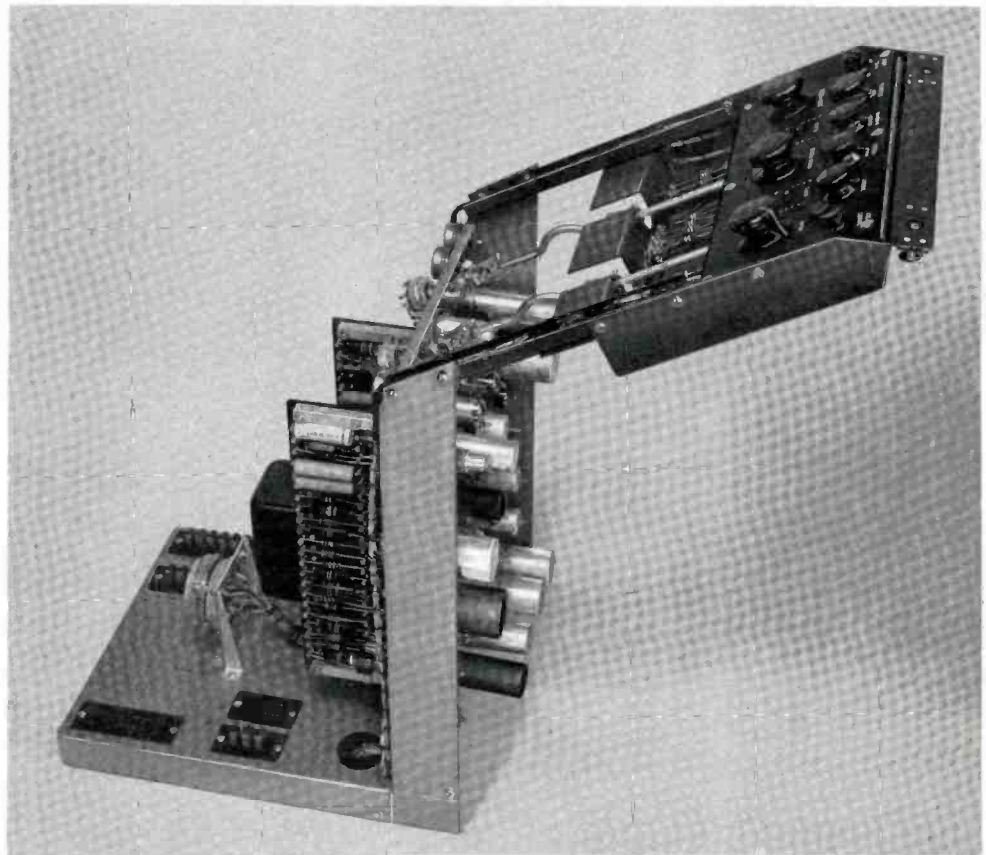
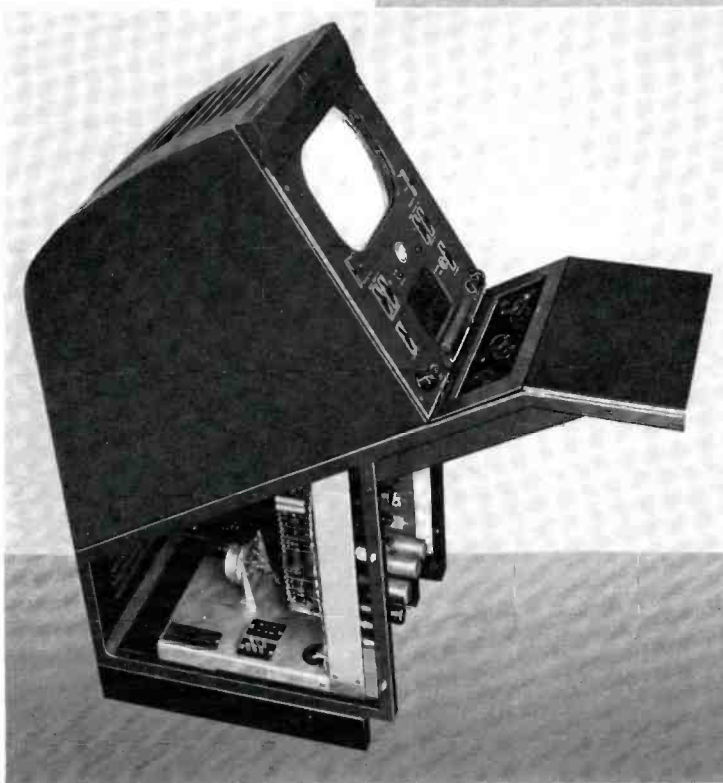

FIG. 23. View of the Studio Control chassis shown mounted in standard console housing.



A different power transformer, new reactors, the addition of a relay to withdraw a series regulator under light load, thus providing a regulating range from 1.25a at 285 volts down to about 400 MA, and an improved cooling system separate it from its predecessor. This supply is readily usable with previous field equipment but here we must modify the interchangeability feature in that the former field supply can't be used with the new field chain.

It is naturally difficult to ascribe proper credit to all concerned with such an extensive development project as this has been. However, J. H. Roe who supervised the project during development, F. E. Cone who is at present supervising the group working on the project, and A. H. Lind, the engineer responsible for the basic development, must be mentioned. Engineers intimately concerned were: S. L. Bendell, W. F. Fisher, R. S. Griswold, R. J. Smith, H. C. Weber, and the author with invaluable help during certain phases from R. C. Dennison, N. L. Hobson, B. F. Melchionni, and N. J. Oman.

KSOO Installs First BTA-10G Transmitter

By
MAX E. PIERCE
Chief Engineer

On February 14, 1951, KSOO was granted a construction permit to increase power from 5 KW to 10 KW day and to operate 5 KW DA nighttime. Now approximately one year later as KSOO rounds out a quarter century of service we are ready to start operations from the new transmitter. KSOO is proud to be the first station to install the new RCA 10G transmitter. This transmitter has very aptly proven itself during our tuning up period, when, at times the transmitter was given some pretty rough treatment. The technical features of this transmitter were discussed very thoroughly in the September-October issue of BROADCAST NEWS.

KSOO Transmitter Building

Since our CP specified that our nighttime pattern be beamed towards the Northwest, it was necessary to move from the present transmitter location west of town. A site was secured approximately seven miles southeast of the city of Sioux Falls in a swampy section of land. The site con-



FIG. 1. Max E. Pierce, Chief Engineer, KSOO, seated at desk in the office.

tains three swamps with one to two feet of water, as shown in Fig. 11. KSOO's five towers are in a line between two of these swamps and the northernmost tower actually stands in the water.

Construction on the transmitter building was started on August 1, 1951. The 38' by 58' building is of Hadite block construction with Oriental Stucco finish on the outside and smooth plaster walls inside. Special

precautions had to be taken to prevent moisture from seeping into the building due to the extremely damp location.

The transmitter building has a main transmitter room, a heating and storage room, a large work shop, a combined office, emergency studio, complete kitchen and a shower room. There is a large two car garage, with provision for a small work bench. The building is completely fireproof.

Since our nighttime pattern is quite critical, it was decided best to select a site as far removed from power lines and other overhead wiring as possible, to reduce the problem of re-radiation. Power is brought into the building underground from the Northern States power lines, approximately one-quarter of a mile south of the transmitter. All telephone lines come into the building underground from Northwestern Bell lines one-half mile north of the transmitter building. The property line fence and all fences around towers were constructed of wood, to prevent any possibility of re-radiation from these sources.

Hot air heating is used throughout the building. An 8" by 28" duct was run from the rear of the transmitter underneath the floor to the cold air intake of the furnace so that the heat from the transmitter could be used to aid in heating the building. In effect the furnace takes the pre-heated air from the transmitter and circulates it throughout the building. An exhaust fan is installed in the roof immediately behind the transmitter to get rid of this heat in summer time.

The transmitter and two matching phasing cabinets are installed along the east wall of the main transmitter room. The transmitter, including phasing cabinets, is only 16' 4" long, 7' high and 32" deep. Since the only piece of equipment external to the transmitter is the plate transformer, and all transmitter doors are of the sliding type, a working space four feet deep behind the transmitter is quite adequate.

FIG. 2. Exterior view of KSOO's new transmitter building. Private power substation can be seen at right.

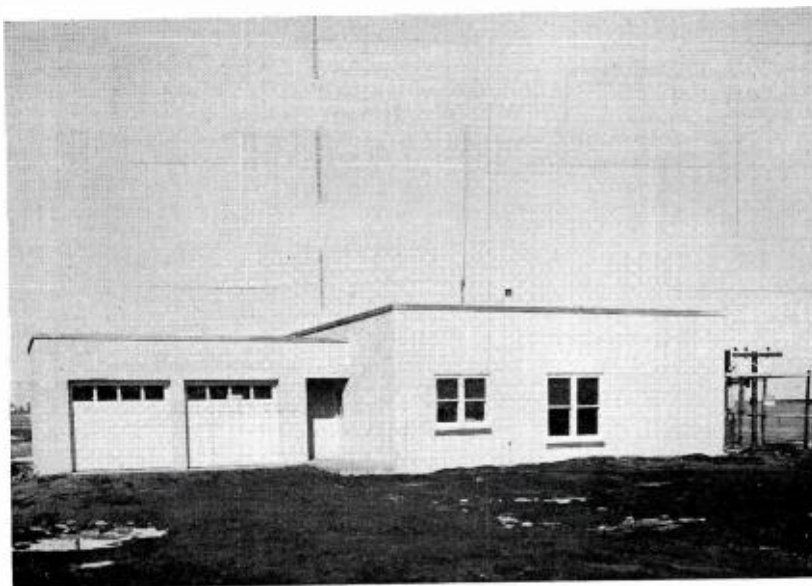

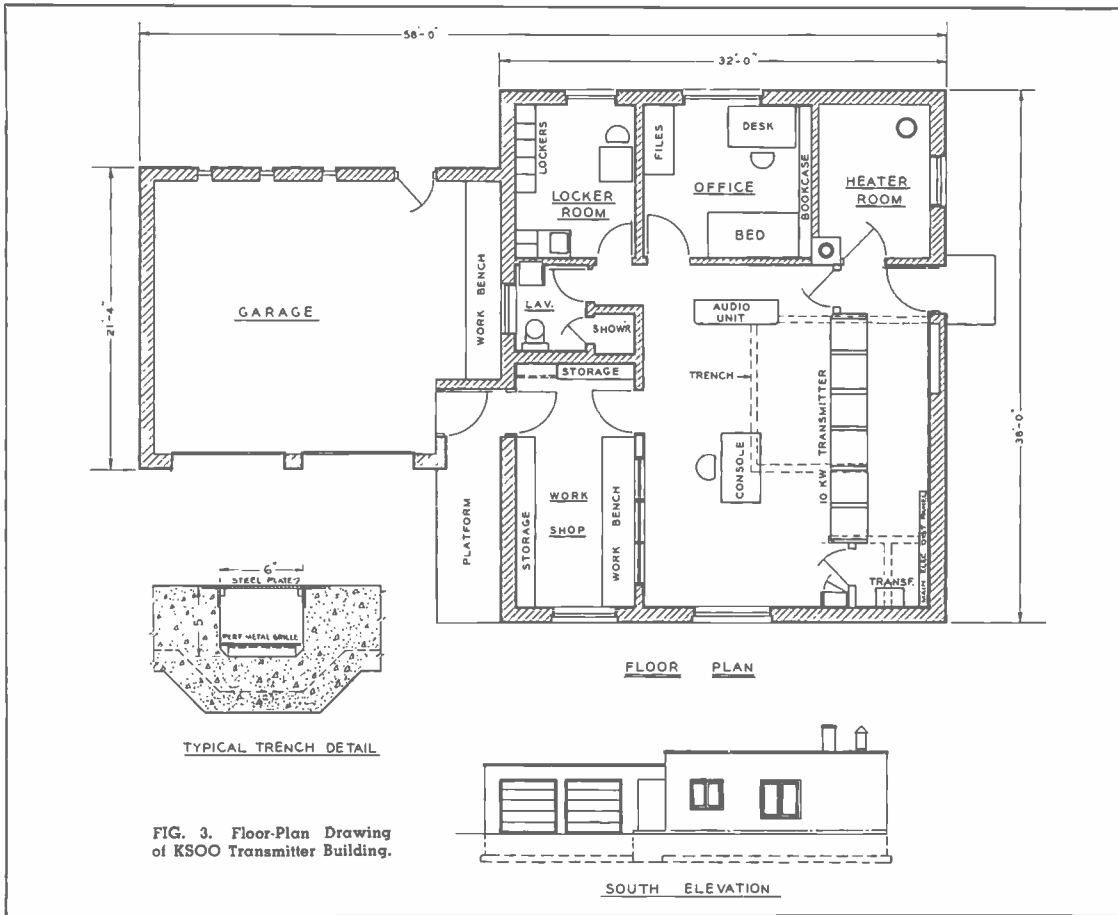

FIG. 3. Floor-Plan Drawing of KSOO Transmitter Building.

FIG. 4. View of KSOO transmitter room showing RCA BTA-10G with matching phasing cabinets to the left. Audio control racks can be seen at extreme left. Mark Boese, KSOO engineer, is seated at the controls.

The audio racks are located at the north end of the transmitter room with the phase monitor adjacent to the phasing controls. Directly underneath the phase monitor are the push buttons for the remotely controlled tuning motors located in the tuning houses at the base of each of the towers. The audio racks also contain the limiting amplifier, monitoring amplifier, radio receiver, frequency and modulation monitors, audio oscillator and noise and distortion meters.

The RCA transmitter control console is located directly in front of the transmitter. The power distribution panel is located on the wall behind the transmitter, as is the dehydrator for the transmission lines.

The heating room contains the furnace and hot water tank and room for storage of equipment. The furnace room can be





FIG. 5. Mark Boese, KSOO engineer, checks current ratios and phases at Phase Monitor. Push button controls for remotely controlled tuning motors and supervisory lights for the pattern change relays are shown.



FIG. 6. Rear view of RCA BTA-10G Transmitter installed at KSOO. Power distribution panel may be seen at left. Power transformer for transmitter is shown at the rear center.

cut off from the rest of the building by means of a fire door.

The well is located externally to the transmitter building. The pump and pressure tank are housed in an insulated house of the same size and shape as the tuning houses. The temperature inside the well house is controlled by means of a thermostat and electric heater. This has proven to be a very satisfactory means of keeping the pump and pressure tank from freezing even in 30° below weather.

The office contains a desk and filing cabinets and the station's library, as well as a combination studio couch that can be made up into twin beds in case of a sudden South Dakota blizzard, when the operators are required to remain at the transmitter overnight. Provision has also been made to use the office for an emergency studio, with microphone, turntable and speaker outlets.

A completely furnished kitchen, kept stocked with food during the winter months is a prerequisite for a remotely located transmitter in this part of the country, as the weather can get pretty rough.

The workshop is located to the rear of the control console. A large window provides visibility of all meters and transmitter from this room. Several spare loops were run from the audio rack to the workshop for test purposes. Storage space for

spare parts and equipment has also been provided in the workshop.

The two-car garage was regarded as a necessary item for protection of the employees' cars from the weather and for additional working and storage space.

KSOO studios and business offices are located at 317½ South Phillips Avenue in downtown Sioux Falls. The entire second floor of the Vallet Building is occupied by our studios and business offices. Recently the third floor of the State Theatre Building, located directly across the street, was leased and our Sales and Continuity Departments are now at this location.

RCA equipment is used quite extensively in KSOO's studios. A type 76-B studio control console is employed. Two RCA 70-D and two RCA 70-C turntables are used. The 70-D turntables use RCA Universal pickup heads. RCA Microphones are used exclusively.

KSOO Transmitter Installation

KSOO placed an order with RCA for a new BTA-5F just prior to its design completion. Fortunately, as KSOO's Construction Permit was to be granted, the first BTA-5G was nearing completion. Delivery of this transmitter as well as all other associated equipment was immediately requested.

Delivery of the transmitter was made in mid October and three days later all

units were in place and wired. By far, the largest part of this time was spent in uncrating the units! The actual installation of the BTA-10G was extremely simple. Most all parts were shipped in place and it was only necessary to install the heavier items such as modulation transformer and chokes and filter reactors, after the individual cabinets were in place. The wiring harness furnished with the transmitter made the job of interconnecting the individual cabinets an extremely simple one. After the plate transformer was connected, the transmitter was ready to be checked out.

Tuning up is also a simple job as there are only two tuning controls. Wide band neutralization is employed, making that job unnecessary. By following the instructions, the taps on the buffer, driver, and final stages can be set fairly close so that very little further adjustment is required.

Since this was the first of an entirely new series of transmitters, we requested that RCA send a field engineer out to aid in tuning and adjusting. This precaution proved to be unnecessary due to the simplicity of installation and tuning of this transmitter. However, RCA did send their engineer, Mr. W. B. Fletcher, and while here made the necessary proofs and tests for type approved for the FCC. The distortion and audio frequency characteristics of this transmitter approach those for an F.M. transmitter.

The plate transformer is the only piece of equipment external to the transmitter. This transformer is well protected, so that a fence in back of the transmitter to protect personnel, is unnecessary. (See Fig. 6). The main power distribution and fuse panel is located directly behind the main rectifier cabinet, on the wall of the transmitter building. This makes a very convenient and efficient installation.

Two matching cabinets were also ordered at the time the transmitter was ordered, to house the RCA custom built phasing equipment. RCA engineers worked very closely with our consulting engineer Mr. George C. Davis in designing and building this equipment. (See Figs. 7, 8, 9). The right phasing cabinet contains the main distribution tank, current dividing networks for each tower and pattern change relay (DA to non directional), while the left cabinet contains the phasing networks for each of the five towers. Each transmission line has its own meter. These meters are also located in this cabinet, while the five remote reading antenna current meters and the common point meter are located above the doors of the two phasing cabinets to conform with the metering in the rest of the transmitter.

Three RCA audio rack cabinets are used to house the monitoring and audio equipment. A Clarke Model 109 Phase Monitor was installed in the cabinet closest to the phasing cabinets (see Fig. 5). This instrument is extremely accurate and phase readings to one-tenth of a degree can be

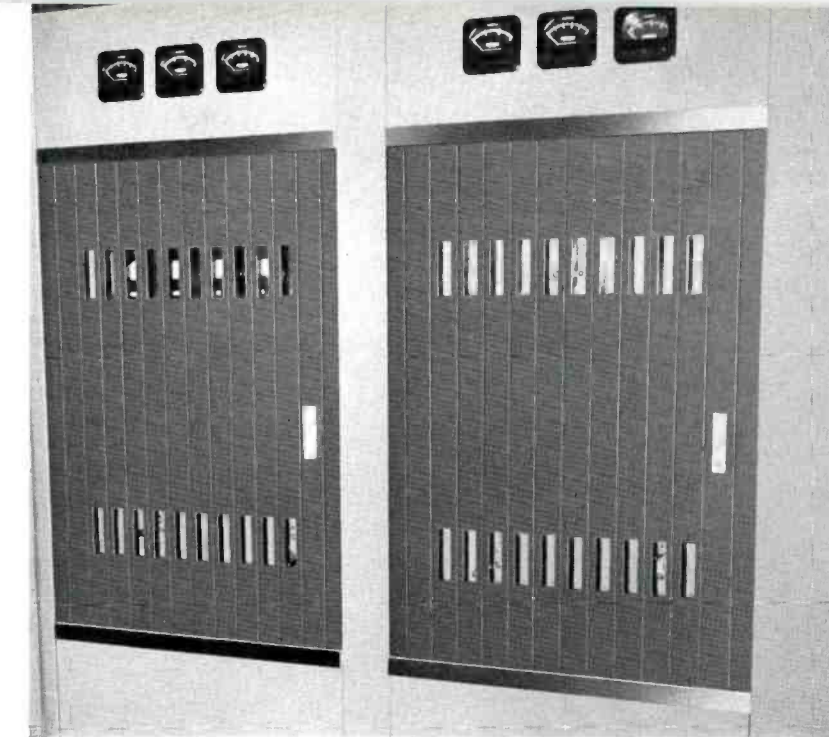

FIG. 7. Front view of both phasing cabinets with doors closed.

made repeatedly. The push buttons for operating the remotely controlled tuning motors at the towers are located below the phase monitor, thus all controls for phasing are centralized, which makes for an efficient system for adjusting the directional array.

The control console is located directly in front of the transmitter and all normal transmitter switching can be done from this position.

The power change and pattern change

system employed at KSOO's transmitter is of the preset type. Since it is necessary to change operating power from 10 KW to 5 KW at the same time we go to directional operation, it was decided to wire the power change circuit in with the pattern change circuit. The power change switch is inserted into this circuit so that it may be thrown to the desired position ahead of schedule so that at the moment the transmitter is switched to directional operation the transmitter output is dropped.

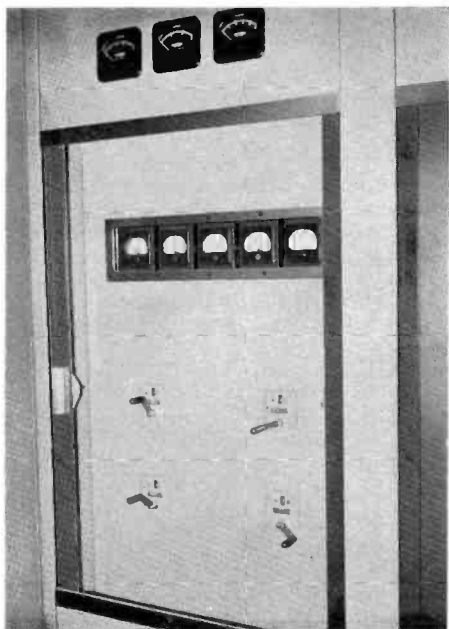

FIG. 8. Front view of left phasing cabinet with sliding door open.

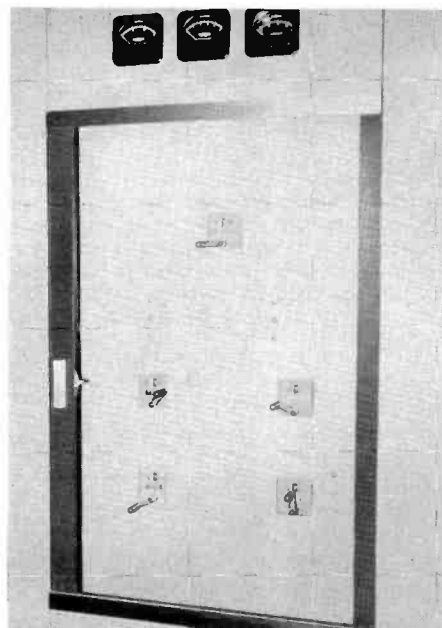

FIG. 9. Front view of right phasing cabinet with sliding door open.

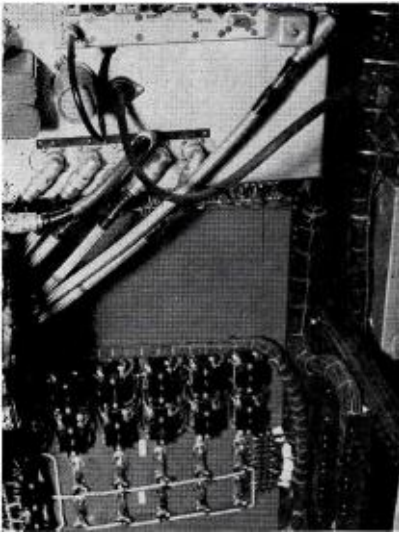

FIG. 10. View showing RG 12/U sampling lines entering Phase Monitor. Also some of the wiring of the push buttons and supervisory lights for pattern changing.

Power change and directional switching is accomplished by means of eight impulse type, double pole double throw relays. One at the base of each tower, one in the phasing cabinet, one in the power amplifier cabinet and one in phase monitor cabinet. This latter relay is used to short out the sampling line from tower number 3 which is the daytime and reference tower, in order to prevent damage to the current indicating meter for tower number 3 when operating 10 KW. This relay is also used to insert a resistance in series with the RF line to the modulation monitor when operating 10 KW so that the carrier level meter in this instrument will read correctly.

Also, since one of these impulse type relays are located at the base of each of the five towers and inspection of these for operation would be a problem, supervisory lights were installed on the pattern change control panel and connected to auxiliary contacts on the relays. Correct operation can be determined immediately upon switching from non-directional to directional operation, by merely glancing at these lights. This pattern change control panel is located directly below the push buttons for the remotely controlled tuning motors.

An RCA WO-56A Oscilloscope and an RCA Master Volt Ohmyst proved to be two very useful test instruments in completing our installation. Although this

transmitter was the first of an entirely new type, there were surprisingly few "bugs" in it, to be exterminated.

Antenna and Ground System

KSOO's antenna system consists of five Stainless towers 220' high above insulators and 15" triangular cross section. The towers are erected in line and spaced 240' apart. The towers are set at an angle of 146° north of true east. The antenna and ground system was laid out so as to be as symmetrical as practicable, both electrically and mechanically.

We had a lot of fun erecting the northernmost tower, as this tower is located 120' out in a swamp. It was decided to fill in the swamp with a dirt runway out to the tower position and then widen the runway at the tower base so that a 30' by 30' fence could be erected around the tower.

The dirt runway served several purposes; it allowed the trucks hauling the dirt to build their own road out to the tower location, it provided footing for the transmission line supports, and it makes for easy access to the tower to read meters

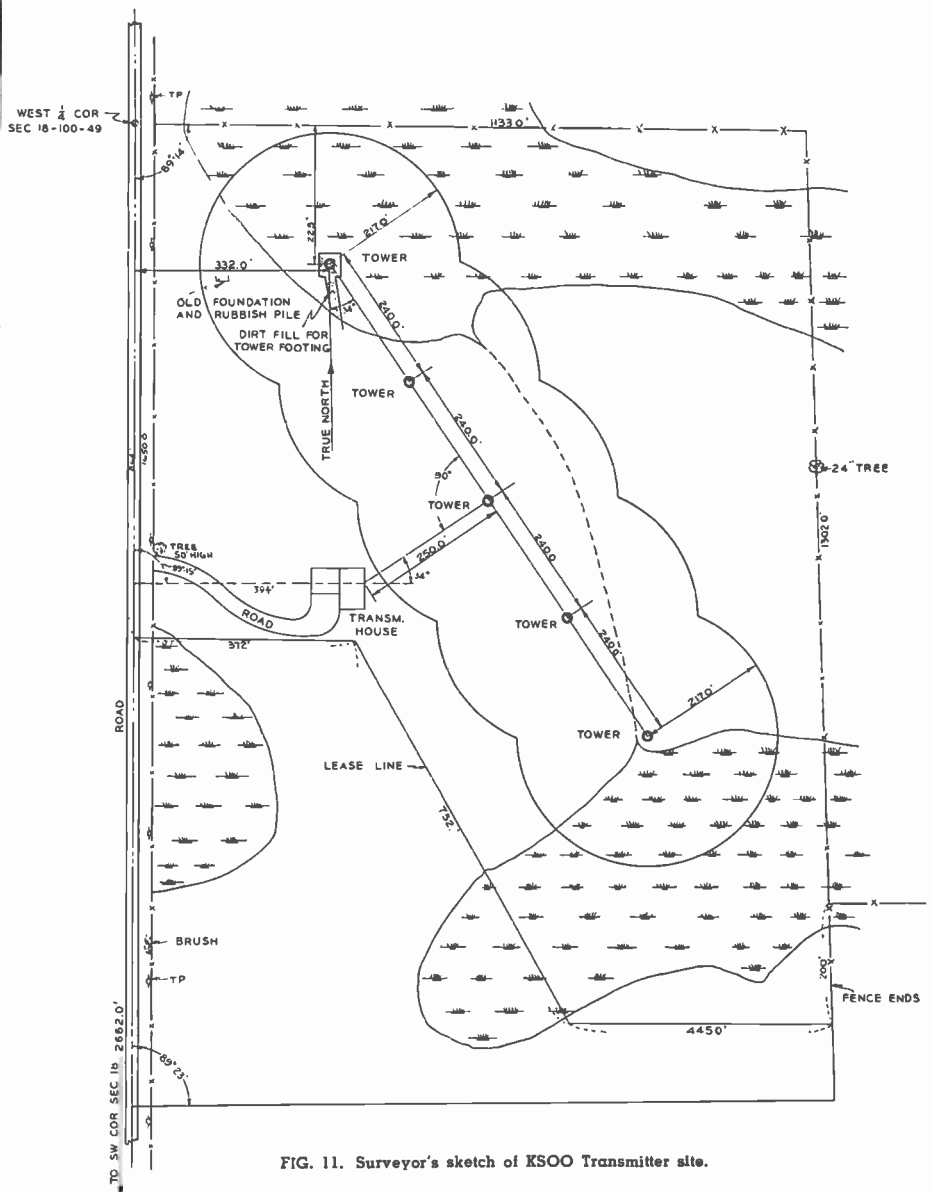

FIG. 11. Surveyor's sketch of KSOO Transmitter site.

and check equipment. Approximately 1600 cubic yards of dirt were hauled in to make this fill (see Fig. 11). After the dirt fill was completed, a hole was dug down through it to the swamp bed which consisted of "hard pan" and then forms set up and concrete poured to complete the tower base. This problem was solved, but there still remained the problem of getting the guy anchors set, even farther out in the swamp. This was finally solved by constructing guy anchor forms of plywood and floating them to position. The forms were then sunk part way by means of a jack hammer, then the water was pumped out, after which a session of digging was in order until the water was too deep to work in. Then the plywood form was driven down again as far as it would go and another session of pumping and digging was carried out. This process was repeated until the forms were down to the desired depth.

Now we had the forms for the guy anchors in place, but a revolting development occurred. How were we going to get them filled with concrete? It was then decided to built catwalks from the man made peninsula at the tower base out to the plywood form 120' away.

The cement truck was then able to come out to the tower base and the concrete for the guy anchors was transported the rest of the way in wheelbarrows over the catwalks. Since our site is so swampy several of the guy anchors had to be constructed in this manner but no more catwalks had to be built! The catwalks were left in place so that the guy wires could be easily inspected.

The ground system consists of a 24' by 24' ground screen at the base of each tower. 120 radials 217' long per tower, except where they meet the radials of the adjacent tower. Here the ground wires of both towers are banded to a 4" wide copper strap 400' long. A continuous copper strap 3" wide runs from the base of the south tower to the base of the northernmost tower.

Mention might be made here of this copper strap. At the time construction was started no copper strap was available so we made our own from copper sheets which were first cut into the desired width strips, and the strips then brazed together to form the copper strap.

Most of the ground wires for towers number 1 and number 5 lie under water in the swamps previously mentioned. At

first we tried to install these ground wires by fastening them to a small caterpillar and dragging them out in the swamp, since the water was thought to be quite shallow. The first few wires were installed in short order, but as we worked our way out in the swamp the water became deeper until even the caterpillar bogged down. A truck with a winch and cable was brought to the scene and the "cat" hauled out. After it was thoroughly dried out this procedure was tried again with exactly the same results. After finally becoming discouraged with our troubles with a waterlogged "cat", the ground wires were put in place by wading them in by hand and tying a brick on the end of each wire and sinking it in the mud at the bottom of the swamp.

In order to completely shield the wires for tower lighting, tuning meters, and remote antenna meter wiring it was decided to run two 2" steel conduits to each tower. Enough conduit to make these runs was procured, however, it was originally desired to also construct the transmission line supports of this conduit. Due to the shortage of steel we were unable to obtain the additional amount required for the transmission line supports. A quick tour of all the local steel supply houses disclosed a supply of rigid steel fence posts, 6' long. We purchased 175 of these and then proceeded to have a U shaped bracket just wide enough to allow two 2" steel conduits to lay side inside, welded to the top of the rigid steel fence posts.

FIG. 12. View of all five towers and transmitter building. Tower Number Five is shown in the foreground.

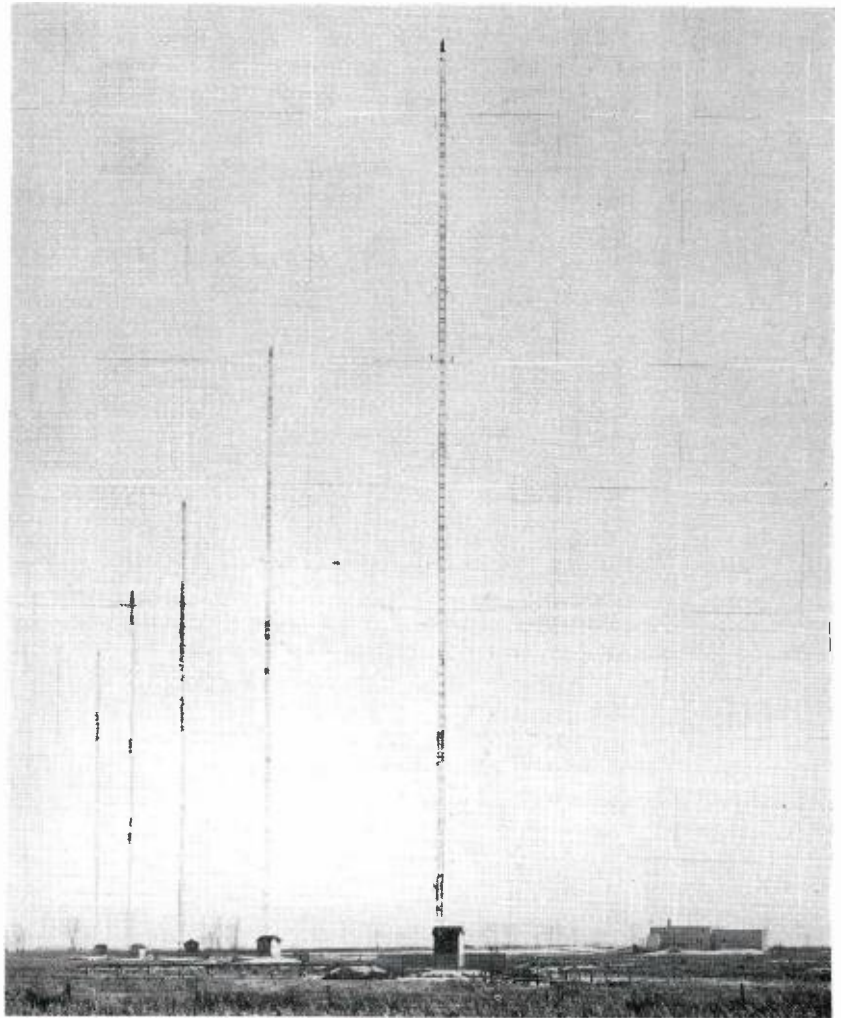

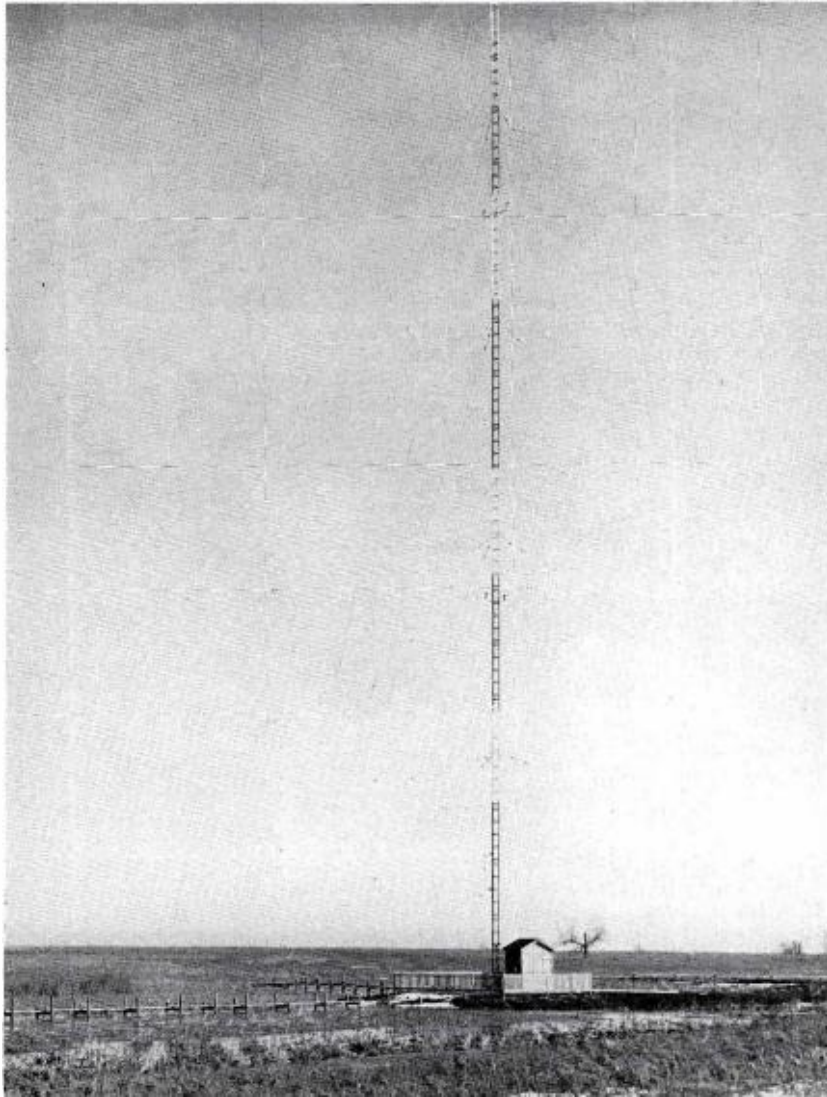

FIG. 13. View of Tower Number Five showing man made peninsula in swamp to support tower and transmission line. Also shown are two catwalks leading to guy wire anchors in the swamp as explained in text.

These posts were then set in 30" of concrete every 15' to make a support for the steel conduit for each tower. After the conduit had been placed in the U shaped brackets, the control and tower light wiring was run in one conduit and the sampling line and remote antenna current meter wiring was run in the other. A total of approximately 25 wires per tower was required. The wire was pulled through the conduits by means of a small winch. After the wiring had been placed in the conduits, the $1\frac{3}{8}$ " coaxial transmission line was installed. This was accomplished by bolting 2" by 3"

by 6" oak blocks to the steel conduit every $7\frac{1}{2}$ ' and the transmission line laid on top of these blocks. This line is held in place by U shaped brackets over the transmission line and fastened to the oak blocks by 1" wood screws. This allows independent expansion and contraction of the steel conduit and the copper transmission lines. No expansion joints were used even in the longest runs of 600'. The expansion is allowed to take place in the tuning houses at the base of each tower. The tuning units are connected to the transmission lines through a length of $\frac{5}{8}$ " diam-

eter copper tubing which allows for the expansion of the transmission line.

A 1" copper strap was buried about 8" in the ground parallel with the transmission line supports. The transmission line and conduits were then grounded to this strap at every post, or every 15'. The straps were bonded together at the transmitter house end and connected to the main transmitter ground. Also these straps were bonded to the ground wires and straps where they crossed, as well as to the base of the antenna. All ground wires and straps were buried to a depth of 8" except in the swamps where they are covered with two to three feet of water.

The transmitter and phasing cabinets are bonded along the top and bottom with a 3" wide copper strap. These and the copper straps in the wiring ducts are bonded together and to the transmitter ground which consists of a copper sheet 4' by 8' buried in charcoal four feet underground immediately outside the transmitter building.

Each tower has its own 6' by 6' by 7' wooden tuning house, in which is installed the tuning unit and transmission line termination, as well as a telephone which is connected to the transmitter building and all other towers. Provision is also made for plugging in a small electric heater or soldering iron. This latter provision proved very valuable during the tuning up procedure carried on in 25° below zero temperature.

The custom built RCA tuning units for each tower proved very easy to install and adjust. The open panel type was used as they are well protected from the weather inside the tuning houses, and for their easy accessibility.

Due to the rigid requirements of our Construction Permit, it was thought feasible to have remote controlled tuning motors installed for fine adjustment of the antenna leg of the "T" networks at the base of the towers. Tower number 5, the northernmost tower, is "negative" and has tuning motors in both the transmission line and the antenna legs of its "T" network.

These motors proved to be of great help in the final stages of adjustment. However, the motors came shipped from the factory packed with heavy grease. These motors were installed in mild weather and ran very nicely, but by the time we were ready to use them the temperature had dropped below the zero mark and the grease had become so hard that the motors were unable to turn. It became necessary to remove each of the motors and clean the grease from the gear boxes and replace with a much lighter lubricant.

The towers and ground system were installed by the Racine Tower Erection Company in a very efficient and workmanlike manner.

The Care and Feeding of Five Element Arrays

Construction was completed around the 20th of November. RCA's Service Engineer arrived a few days later to complete type approval tests for the F.C.C.

Approximately six weeks were spent in the actual adjustment of the array. This work was done during one of the worst winters South Dakota has seen for a good number of years, and we have seen some bad weather. During this period we had blizzards, sleet storms and ice storms and temperatures ranging to 27° below zero

with winds up to 50 miles per hour. Since a great deal of the work had to be done at the antenna coupling units, the tuning houses and portable electric heater was really appreciated.

The management purchased a four wheel drive Jeep station wagon with snow plow attachment at the start of construction for use by the engineering department. The Jeep proved to be an indispensable item before construction was completed. The snow plow was installed after the first heavy snow and several times it was used to plow out a path from the transmitter building to the towers through four-foot drifts and to plow out the road to the transmitter building.

On January 10th we received the worst type of weather, a freezing rain, after which the temperature dropped leaving a coating of ice about one inch thick over everything. The Jeep and a standard station wagon were used during adjustment, for cross radial measurements. Chains were required for all four wheels of the Jeep and it became a daily occurrence to haul the other station wagon out of the ditch with it, due to ice all over everything. The ice stayed with us until the final adjustment was made, then as the proof of performance was started Old Man Winter dealt us a final blow, a two-day blizzard!

By means of the Jeep, with chains on all four wheels, and the snow plow we were able to keep right on making measurements through this blizzard. However, the snow drifts finally got higher than the doors on the Jeep so we had to delay a day while the roads were plowed out.

We highly recommend the above means of transportation to anyone else, feeble minded enough to attempt the adjustment of a five element array in the middle of winter.

The Jeep also had to be fished from the swamp. It was being driven out on the ice one day and the ice gave way under its weight. Fortunately the water was quite shallow and all occupants escaped unharmed. No major difficulty was encountered during adjustment, outside of the foregoing difficulties with the weather, and the usual number of bugs one encounters with a new installation. The use of the Clarke Phase Monitor greatly facilitated adjustments as well as the WX2C Field intensity meter—which proved to be a very rugged little instrument.

Program tests were begun February 29, 1952 and so far the installation has proven to be very satisfactory. Preliminary reports from listeners indicate that our coverage may even be somewhat greater than the proof of performance report indicated.

FIGS. 14 and 15. (Left) View showing transmission lines leaving building. Substation for terminating underground power line can also be seen. (Right) Additional view of transmission lines leaving building. Two 2-inch conduits carry tower light and control wiring for each tower. Some of the 3-inch grounding straps may also be seen.

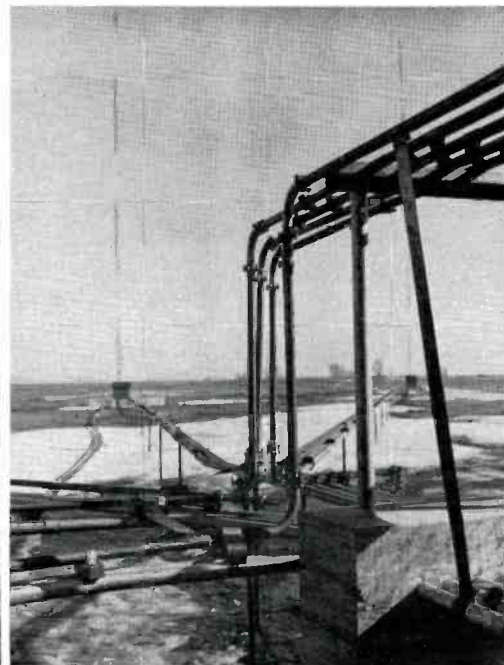
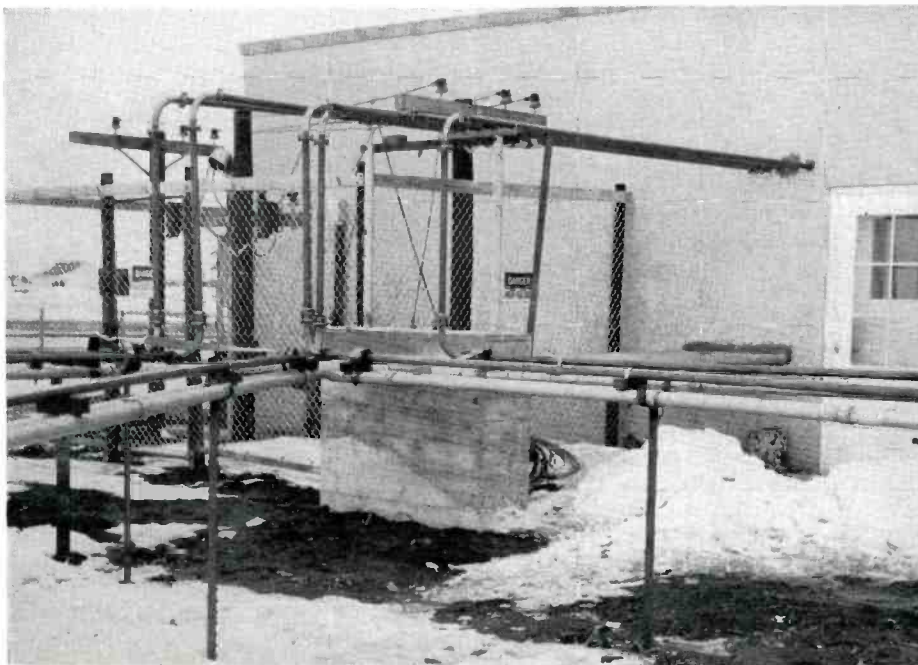

TV STATION OPERATING COSTS

Predicted or estimated TV station operating costs are, perhaps, the most important factor in the early planning of any television station. Unfortunately, it is a subject on which little has been published. About the only successful way of collating such valuable information is to actually "operate" a TV station or gather data from existing stations.

Therefore, the information on television station operating costs presented here is based on the author's actual operating experience in television stations, plus data compiled from surveys and studies of operating stations.

Considerations in Using Cost Estimates

The detailed "cost" information given in the following tables is intended as a guide to the "TV Planner" in predicting his own costs of operation. All estimates represent well-equipped and adequately staffed operation for each category. Station categories are broken down into four groupings—Classes "A", "B", "C", and "D", ("A" being the least complex and "D" representing a large independent station operation). Both overall and detailed cost analysis for groups "A", "B", and "C" are included in the following material. For group "D", only the overall summary is given since this class of station will undoubtedly call upon consultants to assist in a detailed analysis.

by **J. HEROLD**

**TV Station Planning Consultant
Engineering Products Dept.**

Since these estimates are, at best, only typical figures, the TV "planner" should be cautioned to make the appropriate adjustments in such items as salaries, program expense, amortization, and rents. This will be necessary in order to conform with local conditions, as considerable variance is to be experienced.

In compiling the cost estimates, certain factors, such as "daily program hours", amortization time, etc. were established.

In these tables, 12 hours of daily programming was assumed, and an amortization rate of ten years was selected.

Several factors which can affect total predicted costs are discussed below, and the particular station's predicted cost will depend on these considerations.

Personnel

In groups "A" and "B", doubling of responsibilities will be possible to reduce personnel requirements. Such doubling should not lessen employee performance and efficiency. An example of practical doubling, where local labor agreements

permit, is the use of operating engineers to operate projectors, control lighting and act as cameramen. Announcer-Salesman combinations may be very practical. Other possibilities will occur to the applicant depending on the capabilities and experience of the operating personnel.

Technical Expense—Tube Costs

There will be considerable variation in expenses in this classification due to different programming activities, transmitter power, and local salary levels.

Estimated tube and power costs per hour are listed for convenience in arriving at estimates for different transmitter powers.

<i>Transmitter</i>	<i>Cost per Hour</i>
TT-2AL (2 KW, chan. 2-6)	\$0.22
TT-2AH (2 KW, chan. 7-13)34
TT-10AL (10 KW, chan. 2-6)88
TT-10AH (10 KW, chan. 7-13)	1.00
TT-20BL (20 KW, chan. 2-6)	1.86
TT-20BH (20 KW, chan. 7-13)	2.03
TT-50AL (50 KW, chan. 2-6)	4.70
TT-50AH (50 KW, chan. 7-13)	4.70
TTU-1B (1 KW, UHF)	1.28
TTU-10A (10 KW, UHF)	4.90

Space Considerations

It may be desirable to combine some of the office functions to reduce space requirements to a minimum. On the contrary, additional space may be required above the minimum due to expanded office activities



ABOUT THE AUTHOR

JOSEPH HEROLD, whose broadcast experience dates back to 1930 when he joined the Engineering Staff at WOW, Omaha, Nebraska—studied at the Milwaukee School of Engineering. In 1935, Mr. Herold became Studio Engineering Supervisor and in 1945, Technical Director for WOW, Inc. (WOW, KODY). In 1947, he inaugurated WOW-TV Staff Training Program in cooperation with Creighton University (see BROADCAST NEWS, May, 1948). This pioneering resulted in many TV technical and programming techniques in use today. Responsible for building planning and equipment installation, Mr. Herold became Manager of Television and Technical Director for WOW, Inc. in 1949. At WOW, he established many firsts in microwave-links, "remotes", educational programs and low-budget line commercials. He conducted detailed cost analysis through weekly surveys of TV station operating costs. In 1950, Mr. Herold was Television Consultant for Union Radio and Television (CMUR-TV) Havana, Cuba, where he supervised staff training and installation. In 1951, he supervised installation and staff training for Radio Televisao, Paulista, Sao Paulo, Brazil.

and expanded program schedules. In planning the station, consideration should be given to possibilities for future expansion: also, accommodation of visitors, clients, and others that may be involved in a television station operation. For maximum efficiency, studies should be made of traffic flow, relation of operational functions and storage requirements. Combining transmitter, studios, and offices whenever possible will improve efficiency and reduce operating expense.

A well-planned layout can reduce space requirements and improve operating efficiency at the same time.

Programming

Since programming emphasis will vary for stations in the different categories, it is important that program personnel be well-qualified to fit programming needs.

Experienced personnel in key program positions, such as Program Director, Film Manager, Production Manager, Stage Manager, and Art Director will assist in keeping program costs to a minimum. Production of live programs and purchase of film for sustaining or commercial programs are examples of some of the expense items involved. Detailed cost budgeting, with talent and other program expenses charged to proper accounts, is an important function in this department. Program expense is the "highest cost" item for stations in each group and will require much planning by experienced personnel.

Sales

The Sales Department should be planned to meet the requirements for sales to the major income sources such as networks, national spot, or local advertisers as they vary with the station category and local conditions. Sales salaries may be planned

on a straight salary or commission basis or combinations of both. Most stations will contract with national station representatives to assure proper representation at the national level. Such agencies receive compensation for sales on a commission basis. Numerous trips may be necessary by sales personnel, thus adding to sales expense.

If planning a station for a non-TV area, higher sales promotion costs may be incurred.

Administrative

Professional services include compensation for attorney, engineering consultant, and outside auditor. This item does not

include special fees in connection with special applications, hearings, engineering surveys, or special audits.

Equipment is depreciated on a 10-year basis. It may be necessary to depreciate at a higher or lower rate. Technical equipment and buildings will have different rates of depreciation.

The item for amortization will vary with capital investment. Make adjustments here accordingly.

No provision for future expansion or power increase is included in this estimate. Station planners should consider this possibility and provide a reserve accordingly.

SUMMARY FOR GROUP "A" STATION

PROGRAM SOURCES; NETWORKS, FILM & SLIDE. NO LIVE STUDIO

2 KW TRANSMITTER

TECHNICAL EXPENSE	-----	\$ 40,140.00
PROGRAM EXPENSE	-----	64,180.00
SALES EXPENSE	-----	24,700.00
ADMINISTRATIVE AND GENERAL	-----	55,028.00
TOTAL YEARLY OPERATING EXPENSE	-----	\$ 184,048.00
TOTAL BASIC PERSONNEL	-----	22
BASIC FLOOR SPACE REQUIREMENTS	-----	2,624 SQ. FT.

GROUP "A" STATION

2 KILOWATT VHF TRANSMITTER. PROGRAM SOURCES, NETWORKS.
FILM AND SLIDE. NO LIVE PROGRAMMING.

Detailed Estimates

	<i>Total Sq. Ft.</i>	<i>Technical Expense:</i>	<i>Yearly Expense</i>
<i>Floor Space Requirements:</i>			
Technical Plant (Transmitter, Film Projection, Engineer Lab, Film Edit, Video and Audio Control).....	896	Chief Engineer	
Manager's Office	216	Four (4) Operating Engineers	
Program Office	360	Two (2) Projectionists	
Sales Office	216		
General Office	360		
Reception	216		
Storage	360		
* Total	2,624	Total Technical Salaries.....	\$31,460.00
		Transmitter (Tubes and Power @ \$0.34/hr.).....	1,480.00
		Tubes (Iconoscope, Misc.).....	2,000.00
		Power	2,600.00
		Repairs and Miscellaneous.....	2,600.00
		Total Technical Expense.....	\$40,140.00

* NOTE: This total used at \$2.00 per square foot to arrive at yearly rent item.

GROUP "A"—Continued from preceding page

<i>Program Expenses:</i>	<i>Yearly Expense</i>	<i>Administrative and General:</i>	
Program-Director		General Manager	
Traffic Manager-Secretary		Secretary	
Film Manager		Auditor-Bookkeeper	
Secretary		Receptionist-Stenographer	
Two Announcers		Building Maintenance	
Total Program Salaries.....	\$27,820.00	Total Administrative Salaries.....	\$23,260.00
Film (sustaining)	28,080.00	Professional Services (Attorney, engineer, outside auditor)	\$ 2,000.00
Royalties	3,600.00	Insurance	520.00
News Services	4,680.00	Depreciation (\$200,000.00, 10-yr. basis)	20,000.00
Total Program Expense.....	\$64,180.00	Rent	5,248.00
<i>Sales Expenses:</i>		Miscellaneous (Telephone, telegrams, office supplies, etc.).....	4,000.00
Sales Manager			
Two Salesmen		Total Administrative Expense.....	\$55,028.00
Secretary			
Total Sales Salaries.....	\$19,500.00		
Other Sales Expense (Sales Promotion, etc.).....	5,200.00		
Total Sales Expense.....	\$24,700.00		

GROUP "B" STATION

10 KW VHF TRANSMITTER. PROGRAM SOURCES, NETWORKS,
FILM, SLIDE, AND ONE STUDIO FOR LIVE PROGRAMMING.

<i>Floor Space Requirements:</i>	<i>Sq. Ft.</i>
Transmitter	500
Eng. Lab. Storage.....	216
Studio	896
Announce Studio	80
Control Room	240
Film Projection	360
Film Storage, Editing, Screening....	360
Two (2) Dressing Rooms (ea. 120 ft.)	240
Prop Storage	600
Commercial Artist	216
Scenery	600
Manager's Office	216
Program Office (Includes Private Office)	560
Sales Office	216
General Office	360
Engineering Office	120
Reception Room	120
Storage (Office Records, etc.).....	360

Total Space Requirement.. 6,260

<i>Technical Expense:</i>	<i>Yearly Expense</i>
Chief Engineer	
Six (6) Operating Engineers	
Two (2) Cameramen	
Two (2) Projectionists	

Total Technical Salaries...\$48,100.00

	<i>Yearly Expense</i>
Transmitter (Tubes and power @ \$1.00 per hour) ..	4,368.00
Tubes (Image, Orthicon, Iconoscope, others).....	6,500.00
Power	2,400.00
Repairs and Miscellaneous	3,900.00
Total Technical Expense.....	\$65,268.00

Program Expense:
Program Director
Traffic Manager

Film Manager
Film Assistant
Producer
Secretary
Three (3) Announcers
Commercial Artist (Titles, Backgrounds, etc.)
Continuity
Stenographer

Total Program Salaries.....\$ 49,400.00

SUMMARY FOR GROUP "B" STATION

PROGRAM SOURCES, NETWORKS, FILM, SLIDE, SINGLE LIVE STUDIO

10 KW VHF TRANSMITTER

TECHNICAL EXPENSE -----	\$ 65,268.00
PROGRAM EXPENSE -----	103,350.00
SALES EXPENSE -----	28,720.00
ADMINISTRATIVE AND GENERAL -----	77,380.00
TOTAL YEARLY OPERATING EXPENSE -----	\$ 274,718.00
TOTAL BASIC PERSONNEL -----	31
BASIC FLOOR SPACE REQUIREMENTS -----	6,260 SQ. FT.

GROUP "B"—Continued from preceding page

	<i>Yearly Expense</i>	<i>Administrative and General:</i>	<i>Yearly Expense</i>
Talent	7,800.00	General Manager	
Film and Sustaining Programs.....	37,650.00	Secretary	
Royalties	4,000.00	Auditor-Bookkeeper	
News Service	4,500.00	Receptionist-Stenographer	
		Building Maintenance	
Total Program Expense.....	\$103,350.00	Total Administrative Salaries.....	\$23,260.00
<i>Sales Expense:</i>		Professional Expenses (Attorney, Eng. Audit).....	2,000.00
Sales Manager		Insurance	2,000.00
Salesmen (Two)		Depreciation (Technical Equipment \$280,000—	
Secretary		10-year basis)	28,000.00
Total Sales Salaries.....	\$22,220.00	Rent	12,520.00
Other Sales Expense (Sales Promotion, Travel,		Taxes	2,100.00
Entertainment)	6,500.00	Miscellaneous (Telephone, Telegrams,	
		Office Supplies, etc.).....	7,500.00
Total Sales Expense.....	\$28,720.00	Total Administrative Expense.....	\$77,380.00

GROUP "C" STATION

25 KW TRANSMITTER. PROGRAM SOURCES, NETWORKS, FILM,
SLIDE, LIVE STUDIOS AND REMOTES.

<u>SUMMARY FOR GROUP "C" STATION</u>	
PROGRAM SOURCES; NETWORKS, FILM, SLIDE, LIVE STUDIO AND REMOTES - 20 KW. TRANSMITTER	
TECHNICAL EXPENSE — — — — —	\$ 116,144.00
PROGRAM EXPENSE — — — — —	186,480.00
SALES EXPENSE — — — — —	34,700.00
ADMINISTRATIVE AND GENERAL — — — — —	107,308.00
TOTAL YEARLY OPERATING EXPENSE — — — — —	\$ 444,632.00
TOTAL BASIC PERSONNEL — — — — —	50
BASIC FLOOR SPACE REQUIREMENTS — — — — —	15,835 SQ. FT.

Studio 2	840
Rehearsal	196
Scenery	2,400
Prop Storage	2,400
Art Room	216
Dressing Rooms	600
<i>Offices:</i>	
General Manager	216
Program Manager	120
Production Manager	120
Program Office	360
General Office	360
Sales Manager	120
Sales Office	216
Reception	216
Audition-Conference	216
Continuity	120
Engineering Office	120
Storage (Office Records, etc.).....	360
Garage	240
Total Space Requirements.....	15,835

<i>Floor Space Requirements:</i>	<i>Total Sq. Ft.</i>	<i>Technical Expense:</i>	<i>Yearly Expense</i>
Transmitter	1,400	Chief Engineer	
Eng. Lab., Storage.....	240	Supervisor	
Film Projection	360	Ten (10) Operating Engineers	
Film Screening, Storage	196	Four (4) Camera Men	
Control Rooms	720	Two (2) Film Projectionists	
Studio 1	3,375	Total Technical Salaries.....	\$ 85,020.00
Announce Studios	108		

GROUP "C"—Continued from preceding page

Transmitter (Tubes and Power @ \$1.86/hr.).....	8,124.00
Other Tubes (Image Orthicon, Iconoscope, others)	8,600.00
Power	4,800.00
Repairs. Other Expenses.....	9,600.00
Total Technical Expense.....	\$116,144.00

Program Expense:

Program Director	
Production Manager	
Film Manager	
Traffic Manager	
Art Director	
Stage Manager	
Film Assistant	
Three (3) Secretaries	
Four (4) Announcers	
Two (2) Producers	
Two (2) Staging and Property Men	
Continuity Editor	
Stenographer	
Total Program Salaries.....	\$ 88,280.00
Talent	25,000.00
Royalties	12,000.00
Film, Live Sustaining, other.....	55,000.00
News Service	6,200.00
Total Program Expense.....	\$186,480.00

Sales Expense:

Sales Manager	
Two (2) Salesmen	
Sales Secretary	
Total Sales Salaries.....	\$ 24,300.00
Other Sales Expense (Sales Promotion, Travel, Entertainment, etc.)	10,400.00
Total Sales Expense.....	\$ 34,700.00

Administrative and General:

General Manager	
Secretary	
Auditor	
Bookkeeper	
Two (2) Receptionist-Stenographers	
Two (2) Building Maintenance	
Total Administrative Salaries.....	\$ 35,660.00
Professional Expense (Attorney, Engineer, Auditor)	3,000.00
Insurance	2,648.00
Depreciation (Technical Equipment).....	35,000.00
Depreciation (Building)	10,000.00
Taxes	6,000.00
Other Expenses (Telephone, Telegram, Office Supplies, etc.).....	15,000.00
Total Administrative Expense.....	\$107,308.00

SUMMARY FOR GROUP "D" STATION

PROGRAM SOURCES; NETWORK, FILM, SLIDE, TWO OR MORE LIVE
STUDIOS & REMOTES. MASTER CONTROL ROOM. MAXIMUM ERP.

TECHNICAL EXPENSE -----	\$ 180,725.00
PROGRAM EXPENSE -----	222,312.00
SALES EXPENSE -----	65,800.00
GENERAL AND ADMINISTRATIVE -----	166,045.00
TOTAL YEARLY OPERATING EXPENSE -----	\$ 614,882.00
TOTAL BASIC PERSONNEL -----	70

◀ The GROUP "D" cost summary shown here represents that of a large independent station operation. Only the overall summary is included in this article since this class of station will undoubtedly require consultants to assist in a detailed analysis.

TENTH TELEVISION TRAINING PROGRAM

Broadcast engineers and consultants, representing twenty-seven states and one Latin American nation, gathered in Camden, to participate in RCA's 10th Television Technical Training Program. The five day program included lectures and laboratory visits at RCA Victor's Camden site, as well as a visit to the David Sarnoff Research Center at Princeton, New Jersey. Listed below are the names of participants:

- Alabama:* Raymond B. Hurley, WALA, Mobile.
- Arizona:* R. H. Holsclaw, KVOA, Tucson.
- Colorado:* John Cullen and T. G. Morrissey, KFEL, Denver.
- Connecticut:* Gerald J. Morey, WNLC, New London.
- Florida:* Don E. Compton, WHOO, Orlando; James C. Smith, WEAR, Pensacola.
- Indiana:* H. G. Cole, WSBT, South Bend; Edward Lockwood, WXLW, Indianapolis; Harold Rothrock, Consulting Engineer, Bedford.
- Iowa:* Eldon Kanago, KICD, Spencer; Robert Moore, KBOE, Oskaloosa.

Kansas: K. W. Pyle, KFBI, Wichita; G. Voiles, WIBW, Topeka.

Kentucky: Steve Cisler, WKYW, Louisville.

Louisiana: Don Allen, WAFB, Baton Rouge; William Bland, KFLY, Lafayette; Patrick Weathersby, WJBO, Baton Rouge.

Maine: Merle Towle, WCSH, Portland.

Maryland: William Bareham, Harrison Brooks, Ray Brunner, John Wilner and Louis Wagner, all of WBAL, Baltimore; Ross Beville, WWDC, Tacoma Park; George McIntyre, WJEJ, Hagerstown; B. F. Sparks and Jack Ward, WBOC, Salisbury.

Massachusetts: W. T. Ayer, WBEC, Pittsfield; George Jaspert, Consultant, Lawrence; Leonard Lavendol, WBRK, Pittsfield; Vernon P. Wilson, WNEB, Worcester.

Michigan: Elwood Brown, WABJ, Adrian; Edward Clark, WJLB, Detroit; Richard Groenevelt, WGRD, Grand Rapids; Munson Robinson, WHFB, Benton Harbor; Marion J. Stoner, WTTH, Port



R. I. Smith, of RCA TV Engineering, describes video control equipment to training group in the Engineering Laboratory TV Studio.

Huron; Stanford Wolf, WWJ-TV, Detroit.

Missouri: Kenneth Hildenbrana and Harold Kopler, St. Louis; Oscar C. Hirsch, KSVS, Cape Girardeau; Karl Troeglen, KCMO, Kansas City.

Nebraska: Howard A. Shuman, KLMS, Lincoln.

New Jersey: Theodore Kilmer and Chester Sunderland, WTTM, Trenton.

New York: William Dacosta, WOR-TV, New York City; George Heuther, Naval Special Devices Center, Sands Point, L. I.; Elmer F. Koehler, WPIX, New York City.

North Carolina: J. W. Dean and C. Howard Sugg, WPTF, Raleigh; William H. Hamrick, WWNC, Asheville; Elmer Troutman, WIRC, Hickory.

Ohio: Frank Barnato and Donald Rowley, WICA, Ashtabula; George T. Cowen, WTRF, Bellaire; J. P. Gill, WTVN, Columbus; Charles Shepherd, WSTV, Steubenville.

Pennsylvania: Anthony Hogg, WHLN, Bloomsburg; Elwood Tito, WAZL, Hazleton.

South Carolina: Herbert Eidson, WIS, Columbia; W. E. Garrison, WFBC, Greenville.

Tennessee: Edward Frase, WMCT, Memphis; Thomas Phillips, WKPT, Kingsport; Wilson Raney, WREC, Memphis.

Texas: J. T. Allen, KXOX, Sweetwater; Hudson Collins, KGKB, Tyler; Ben Hughes, KTRM, Beaumont; Kenneth R. Hyman, KCOR, San Antonio.

Virginia: Richard Lindell, WTAR, Norfolk.

West Virginia: Harry R. Bowen, WGKV, Charleston; R. C. Hough, WPDX, Clarksburg.

Wisconsin: Joseph Baisch, R. R. Funderburg, C. Ewing, Gran Enterprises, Milwaukee; Vincent Vanderheiden, WKOW, Madison; Donald A. Weller, WISN, Milwaukee;

Peru: Alfonso Pereyra, Lima.



Image Orthicon camera chain operating techniques are discussed by Al Reisz of RCA TV Engineering during laboratory visit.

Engineers and consultants gathered daily for lectures which included discussions of TV theory, audio systems, antenna systems and test equipment.



A New MASTER MONITOR

Over the past few years the need for more critical video monitoring and for greater accessibility of monitor controls and operating adjustments has become vital in the successful handling of modern Television programming.

To fulfill these needs, a new Master Monitor, Type TM-6A (successor to and

By
N. P. KELLAWAY

RCA TV Terminal Equipment Engineering

interchangeable with the TM-5A), is now available for use by Television Broadcasters. It not only meets the requirements set forth by TV stations, but also provides

many benefits derived from recent circuit developments. It employs new CRO "time-base" expansion which permits the detailed observation of blanking and sync intervals, and provides the necessary circuits and calibrated scales to comply exactly with recommended IRE standards of measuring video levels.

For simultaneous examination of the composite sync signal, a delay circuit has been incorporated to produce a "pulse-cross" display on the kinescope. Overall circuit design permits a uniform control of video signal levels, closer observation of deflection linearity, and an accurate check of picture resolution. To facilitate operation, all circuit and adjustment controls are brought out on the front panel except those alignment controls which are purposely located behind the front panel to avoid accidental mis-adjustment. These design features plus others such as frequency stability, new deflection circuits of greater linearity, improved cooling, and increased accessibility are described in greater detail below.

New and Improved Deflection Circuits

Particular emphasis has been placed on improving the deflection circuits. The vertical deflection employs negative feedback with a shaping network introduced ahead of the output stage to make the feedback more effective. The schematic of the horizontal deflection circuit shown in Fig. 5 is very similar to a push-pull output stage of audio practice and it differs in that the damper winding returns to ground. As in the "Schade" circuit, the damper controls the energy supplied by the driver tube and thus requires no plate current directly from the power supply. It is advantageous, however, to use the same tube types for both driving and damping functions since better waveform symmetry is achieved when

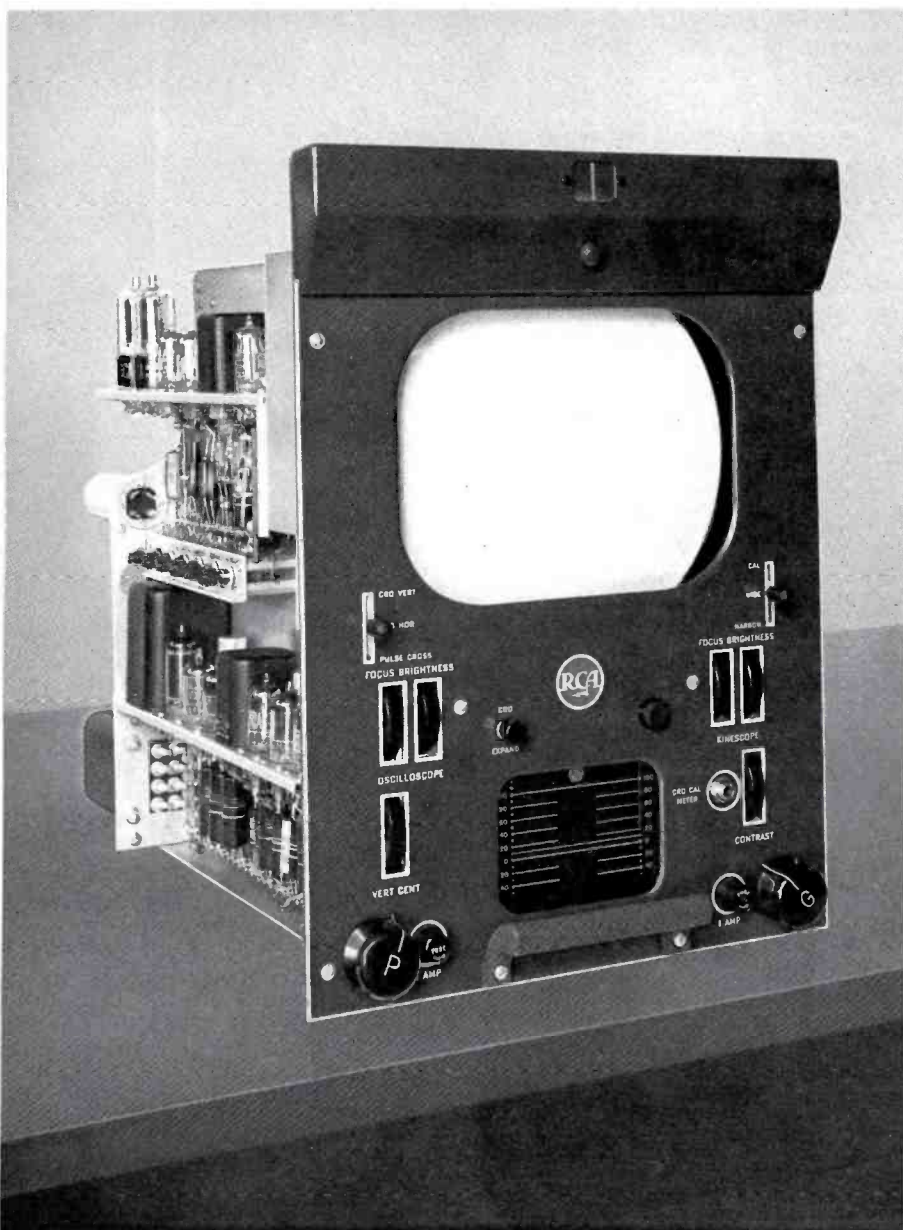

FIG. 1 (at left). View of the new TM-6A Master Monitor which incorporates a host of new features. Note cover at very top which protects several additional controls and operating adjustments.

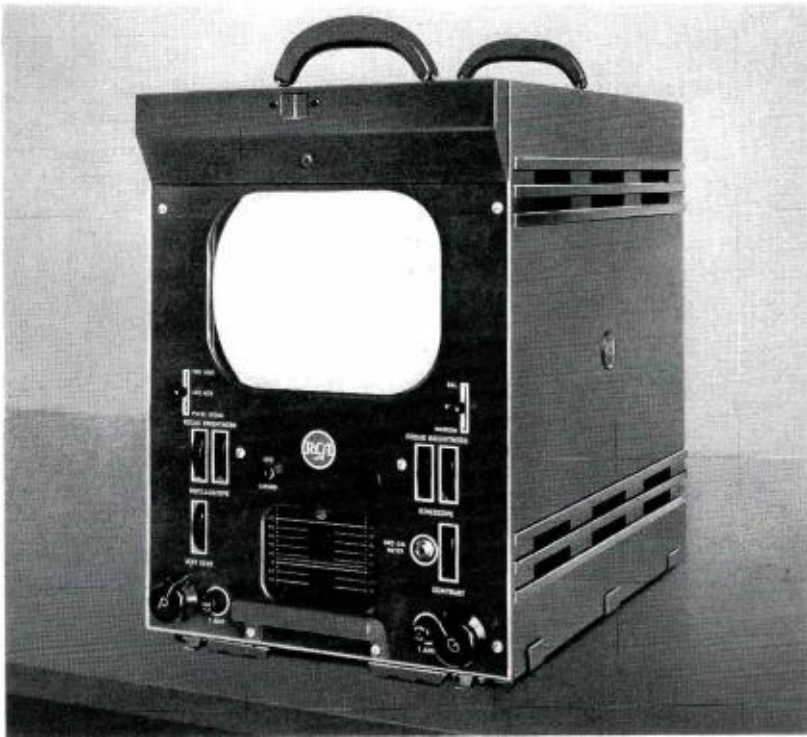

FIG. 2 (above). View of the TM-6A Master Monitor mounted in suitcase type enclosure for field use.

this is done, and linearity is essentially independent of reasonable width variations.

Better CRO Frequency Stability

Fig. 6 depicts the half frequency circuit for the CRO time base and illustrates how tubes required for frequency division and sawtooth generation functions have been reduced to one dual triode. The change in sweep frequency from 7825 cycles to 30 cycles is accomplished by changing the capacitance across the grid of the second tube. To explain the operation of this circuit, let us assume that V-2 is cut off and the grid and cathode of V-1 are at 60 volts. At the same time, the grid of V-2 is rising as its grid capacitor charges through a high resistance towards +B. When this tube starts to conduct, the feedback from the plate of V-2 to the grid of V-1 biases V-1 beyond cut-off and the grid of V-2 conducts. The grid capacitor of V-2 discharges rapidly through the 5600 ohm cathode resistor in series with the "cathode-to-grid" resistance of V-2 while V-1 is cut

off. As the cathode voltage drops, the point is reached when V-1 again conducts and the charging cycle repeats. This circuit has exhibited a much more stable frequency characteristic than the previous "frequency division" circuits investigated.

New Sweep-Expansion Circuit

Another circuit feature has been the addition of the CRO expansion circuit shown in Fig. 7 which gives an eight-to-one expansion of the center of the sweep, allowing a close inspection of either the horizontal or the vertical sync and blanking intervals in a composite signal. The circuit used is a cathode-coupled clipper which clips most of the lower, then most of the upper half of the sawtooth. With sweep expansion, the time base trace on the CRO is increased about 20% to permit the fast, linear portion of the trace to occupy the usable area of the screen.

Accurate CRO Calibration

To minimize circuit drift and to make adjustment simple and quick, the calibra-

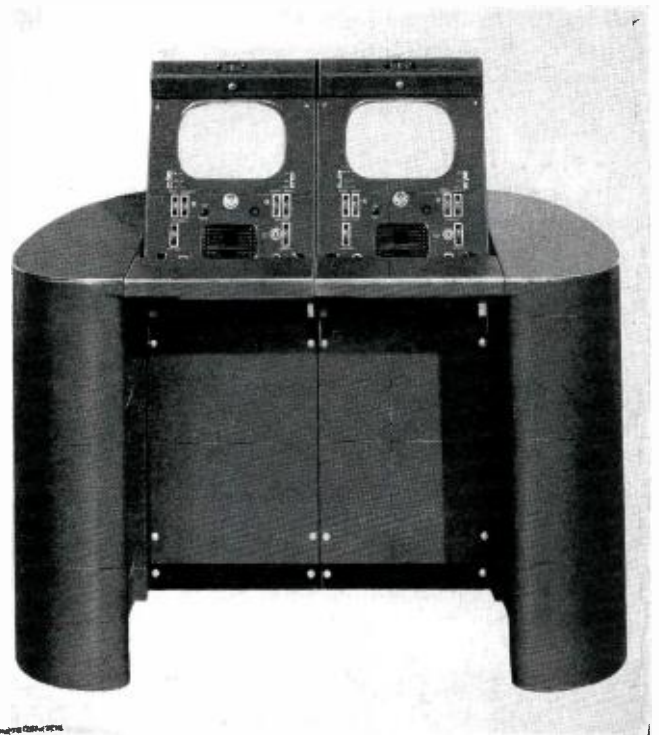

FIG. 3 (at right). The TM-6A Master Monitor may be mounted in a standard console housing for control room use as a part of video control setups.

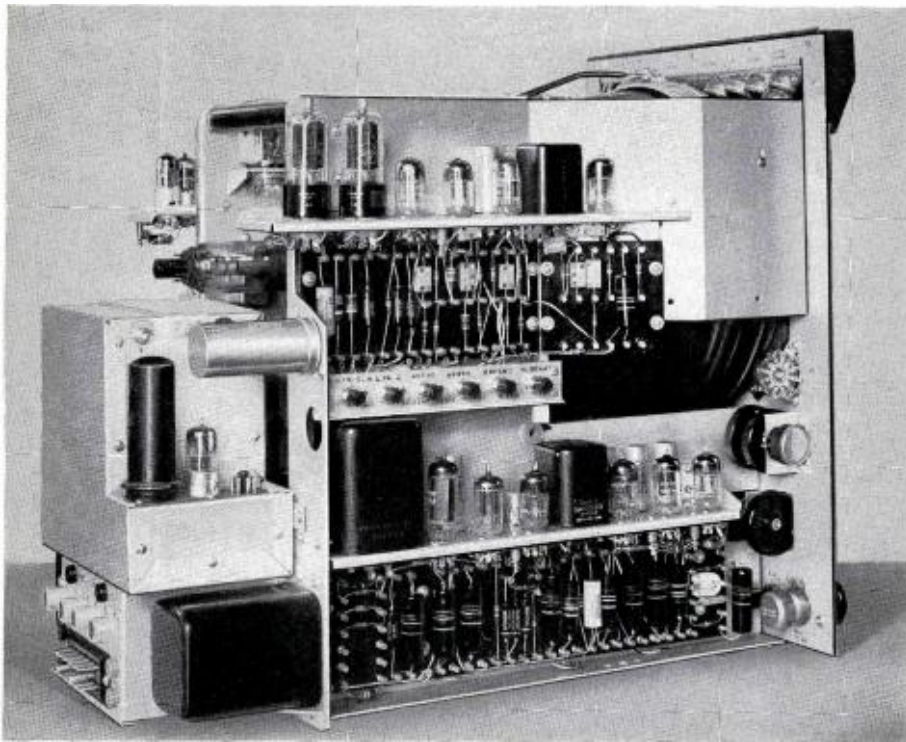

FIG. 4. Photo of the "deflection" side of the TM-6A showing circuitry and components.

tion circuit has been revised as shown in Fig. 8. The plug-in meter (MI-21200-C), already in extensive use with RCA Television Terminal Equipment for current and voltage measurement, has a 1.5 milliamperere current sensitivity and measures 940 ohms within 2%. When 1.4 ma flow through the 940 and the 60 ohm resistors, 1.4 volts are developed across the series combination. Interruption of current by the pulses which cause XTAL #1 to conduct and XTAL #2 to be cut off causes the voltage across the 940 and 60 ohm combination to alternately change from 1.4 volts to zero. The insertion of the meter plug interrupts the gating process and the current flowing is then direct-current. The multiplying resistors are 2% wire wound units to insure accuracy and use of the same meter to calibrate all monitors provides the additional advantage of insuring consistent metering by all monitors so calibrated (aging of the diodes over long period of time will not introduce errors). To simplify the calibration process, both CRO amplifier gain and calibration adjustment controls are on the front panel.

Simplified Sync Arrangement

The monitor has been made to operate on externally supplied sync in addition to the previous arrangements of operating on drive pulses or separated sync information (the switching arrangement is illustrated in Fig. 10). This eliminates the necessity of providing supplementary equipment to add

sync to the video signal in order to drive the master monitor. Supplementary equipment consisting of either a mixing amplifier or two sections of a distribution amplifier, together with their required power supplies is not necessary. This reduces expense and space requirements of a typical broadcast station installation.

Miniaturization of Components

Some broadcasters have indicated a reluctance to change from octal to miniature tubes. Since poor quality tube sockets made it difficult to keep tubes in their sockets and introduced electrical contact trouble. The use of a suitable socket employing silver-plated, beryllium copper contacts was adopted in the TM-6A Monitor and has overcome all possible objections to miniature tubes. Moreover, the use of miniature tubes has resulted in smaller more compact assemblies.

Wide usage has been made of high quality miniaturized oil capacitors which provide additional assurance of trouble-free operation as well as reducing space requirements. Consistent with previous RCA design practice on broadcast equipment, resistors and potentiometers are operated below 50% of wattage rating. Capacitors are operated below 75% of voltage rating.

FIG. 5. Simplified diagram showing the horizontal deflection circuit of the new monitor.

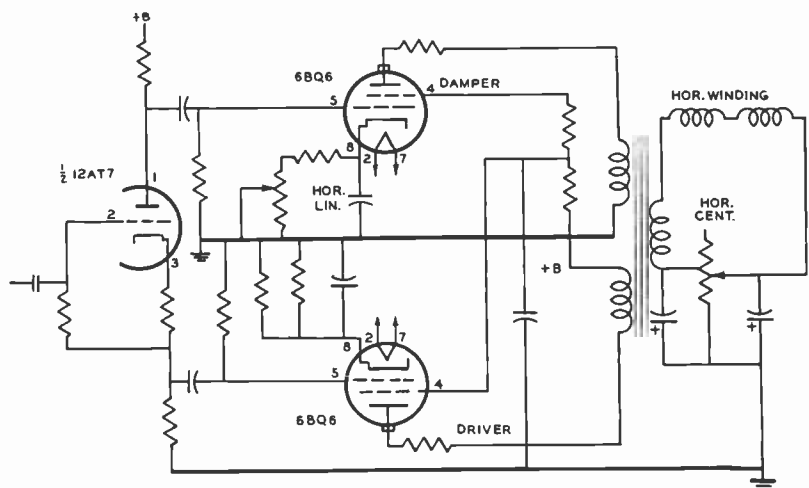

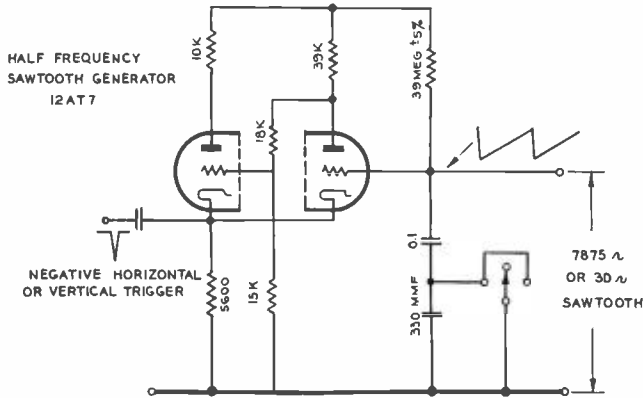

FIG. 6. Diagram of the half-frequency sawtooth generator circuit.

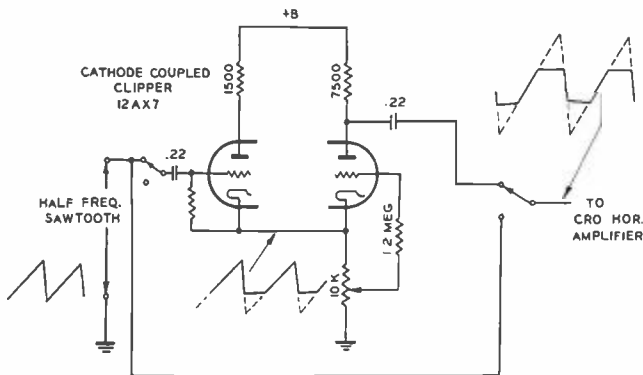

FIG. 7. TM-6A CRO Sweep Expander circuit diagram.

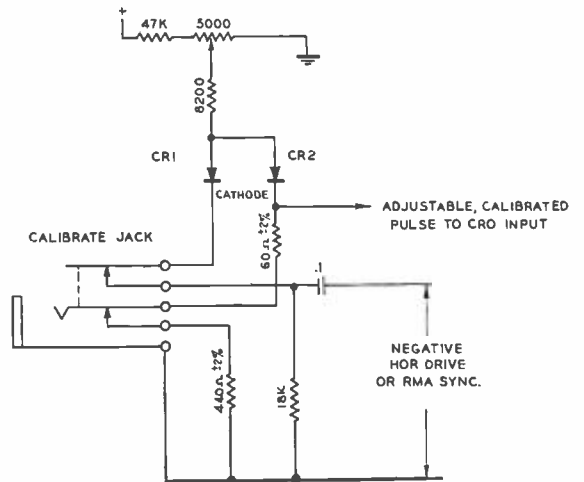

FIG. 8. Sketch showing the "Calibration Circuit" arrangement.

ment, has virtually eliminated regulation problems in the high voltage supply.

5. A 20% reduction in overall power requirements for a more efficient cooler operation, and lighter unit.

4. A new electrostatically focused kinescope designed especially for the new monitor.

Additional Electrical Features

There are still many more design features which result in greater versatility of operation (the most important of these are listed in detail below).

1. An improved CRO vertical amplifier in which the filament and plate requirements have been reduced by 50%.

2. The convenience of both the IRE roll-off* and 4.5 mc response of the same amplifier.

3. The regulated high voltage supply, which in itself has been a major develop-

* "Standardizing and Measuring Video Levels in a TV Station", J. H. Roe, BROADCAST NEWS, Vol. No. 65.

FIG. 9. Photo of the "Video side" of TM-6A Monitor. Tubes and components are all easy to reach.

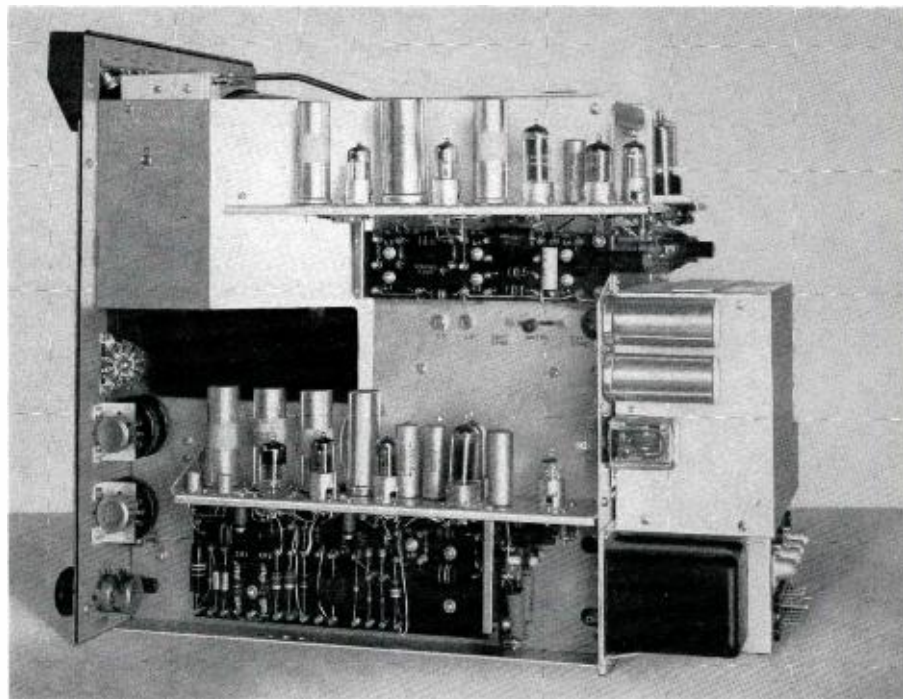

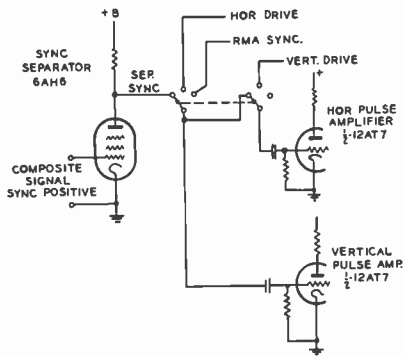

FIG. 10. Diagram showing the TM-6A Sync switching arrangement.

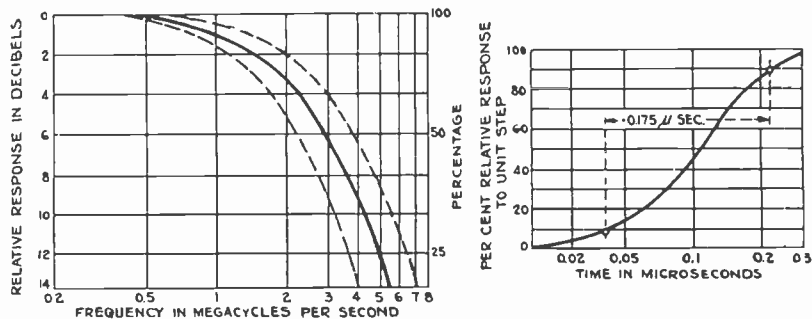

FIG. 11. The CRO circuitry now provides a response that is flat to 4.5 mc, making it possible to observe transient effects on blanking and sync pulses. It also provides a response with the IRE recommended roll-off characteristic. Choice of either response is made by a switch on front panel.

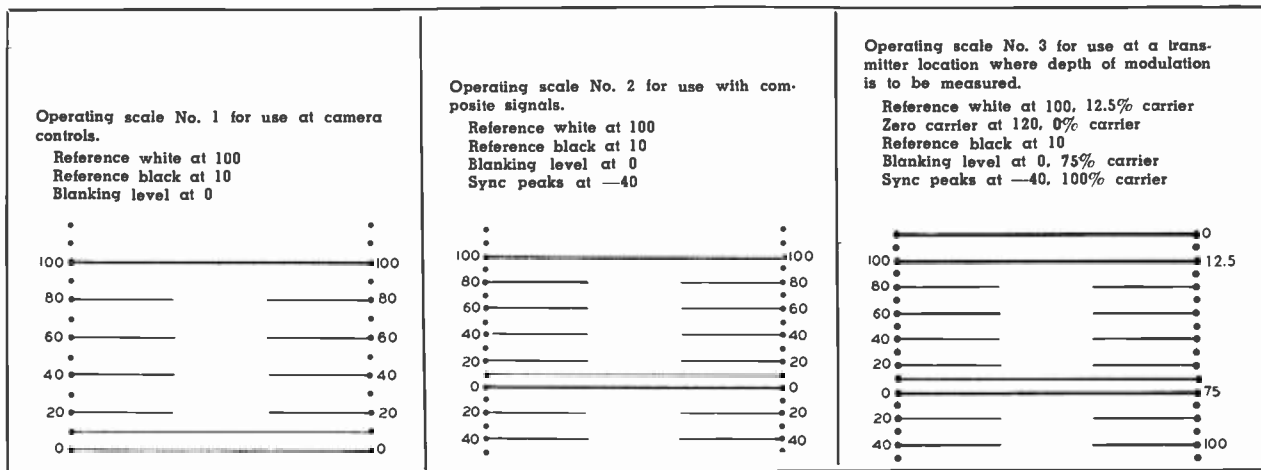

FIG. 12. The above scales (as recommended by the IRE committee concerned with the measurement of video levels) are incorporated in the new TM-6A.

FIG. 13. Closeup view of the top portion of the Monitor with cover lifted to show further convenient controls and adjustments provided.

6. An extended frequency response and increased sensitivity of the kinescope video amplifier.

7. A balanced centering arrangement for CRO centering combined with an astigmatism control.

8. Addition of a pulse cross display.

Mechanical Features

The mechanical redesign has been carefully worked out to take full advantage of the space gained in using miniaturized components. Because the lower shelves extend close to the front panel, it has been possible to switch video and the half-frequency CRO Sweep circuits directly without requiring relays. A high quality lever switch

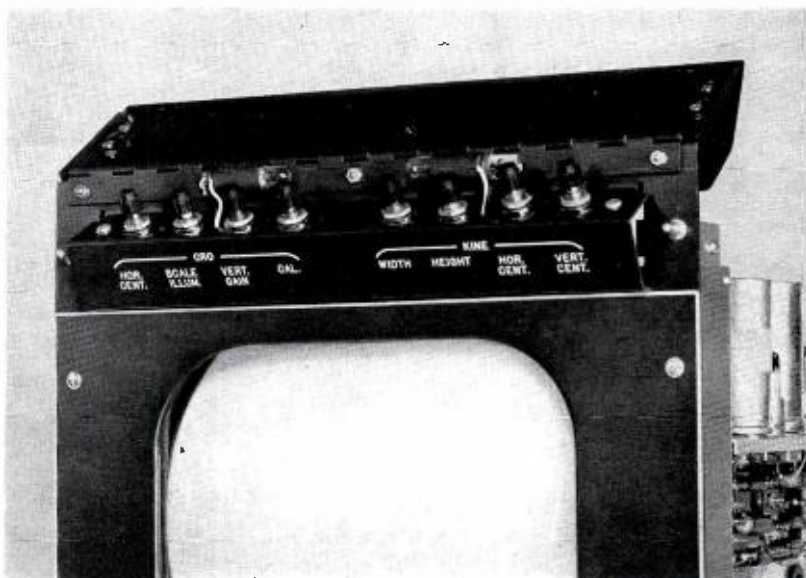

with wiping contacts of coin silver performs this function. These front-panel switches eliminate the possibility of dust collection on relay contacts.

To facilitate manufacture, a video amplifier shelf and its associated terminal board comprises a complete sub-assembly which is tested and aligned before final assembly. The video peaking coil construction has been arranged so that peaking adjustments are more easily made and distributed capacity in the video circuits has been materially reduced by keeping wiring and component capacities to a minimum.

Improved Cooling—Greater Accessibility

To prevent any tendency to trap heat, the space between the vertical panels contains a minimum of components, and filament transformers have been placed at the extreme rear of the unit on a sub-chassis in such a manner that they are essentially in the open. This placement of filament transformers and cathode ray tubes has resulted in greatly improved non-synchronous operation of the unit.

The same open construction of the center compartment plus a plug-in-yoke assembly permits quick and easy removal of the kinescope from the top and the CRO from the bottom. In addition, yoke adjustments are readily accessible and easily performed.

Maximum ventilation was accomplished by locating the horizontal driver and damper tubes at the rear of the upper left shelf. Console housings and field cases have ventilating louvres directly over this area so that heat is carried away without passing over components and chassis. The video output tubes are also placed at the rear of their respective shelves for the same reason. By reducing distributed capacities in the output stage, two less tubes are used in the CRO vertical amplifier than would otherwise be needed.

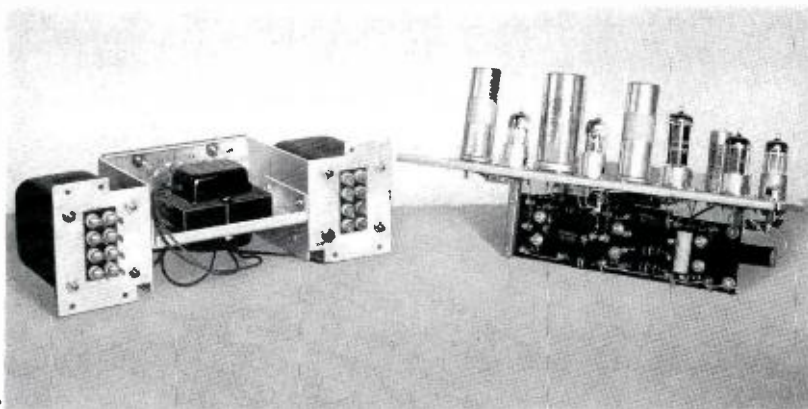

FIG. 14. This view of sub-chassis assemblies illustrates advanced mechanical design employed.

Additional Front-Panel Controls—New "Scope" Scales

Eight additional controls and one extra switch as well as a metering jack for the calibration circuit have been included. Engraved CRO scales having adjustable intensity edge illumination have been provided and, as shown in Fig. 12, are supplied so that a suitable scale can be used for each application. A two-light system of monitor designation which employs an edge-lighted lucite block is located at the top of the front panel. A tally light relay switches the light from white to red as the monitor is switched from "stand-by" to "on-the-air". The additional controls at the top are

covered since they only require occasional adjustment.

Another important mechanical feature of the new monitor has been the weight reduction which reduces the overall weight to fifty-four pounds.

In summary, it should be emphasized that the development of a unit of this type involves contributions from many people. The author wishes to acknowledge in particular the work done by (1) J. D. Spradlin, (2) A. H. Lind, (3) N. S. Oman and (4) S. L. Bendell and (5) P. C. Harrison.

FIG. 15. Photo of the TM-6A looking down at the top of the unit. Note the open construction which provides greater accessibility and cooler operation.

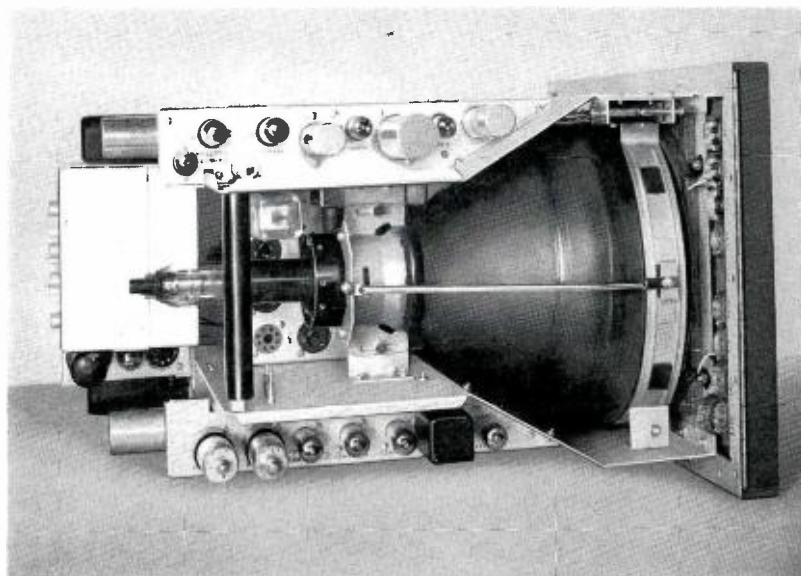

VERSATILE NEW MODERNPHONE

A Telephone-Type Intercom That Fulfills Broadcast Needs

A recently announced intercommunication system promises to gain the wide acceptance of broadcasters as an efficient, low cost unit featuring flexible operation and easy adaptation to individual applications. RCA's new telephone-type intercom—Modernphone—is available for broadcast uses in several categories of equipment which satisfy almost every intercommunication need.

Numerous Uses—Adaptable to Broadcasting

This new system of intercommunication, suitable for such varied uses as offices, professional suites, storerooms, warehouses, and manufacturing plants, appears par-

ticularly well suited for adaptation to the requirements of modern broadcasting installations.

The complexity of modern studio-station operations necessitate a means by which such key administration figures as the

Chief Engineer or Program Director may instantly contact personnel at remote parts such as the transmitter or control rooms. RCA's new Modernphone allows vital communication like this while telephone lines remain free, thus considerable switch-board traffic and congestion is eliminated.



FIG. 1. Light weight and compactly built, the Modern Minor occupies less desk space than a telephone and can be conveniently wall-mounted if desired.

Operation and Construction Simplified

Speedy contacts are made by merely lifting the handset and pressing a button to call. This sounds a buzzer on the other instrument where, to reply, it is only necessary to lift the handset and speak. This eliminates any need to dial numbers or manipulate "press-to-talk" keys. Modernphone occupies less desk space than a standard telephone—and is extremely easy to handle. Units may be placed on the top of a desk, or mounted on the side of a desk, or on a wall.

RCA's Modernphone line is characterized by simplified construction which avoids costly service problems (no tubes or complicated circuits). Installation is simple and can be performed by nearly anyone who is handy with tools. Of particular interest is the flexibility obtained through the minimum cable requirements. One cable—having four "common" wires plus one additional wire which is connected to each intercom telephone—fills the bill.

With variations, allowing for particular studio-station design, a typical Modernphone installation links together the entire staff—operating, functional, technical, non-

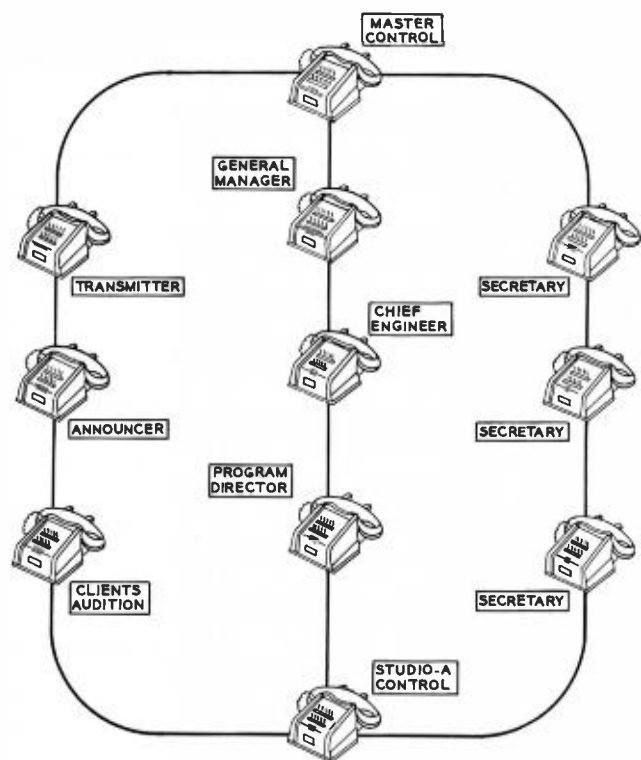

FIG. 6. RCA Modernphone is a complete Telephone-Type Intercommunicating System using up to 200 Intercom Stations with Loudspeaking and Paging features, if desired. Pictured here is a typical installation—one of the many possible for broadcasters' needs.

INSTALLATION DIAGRAM

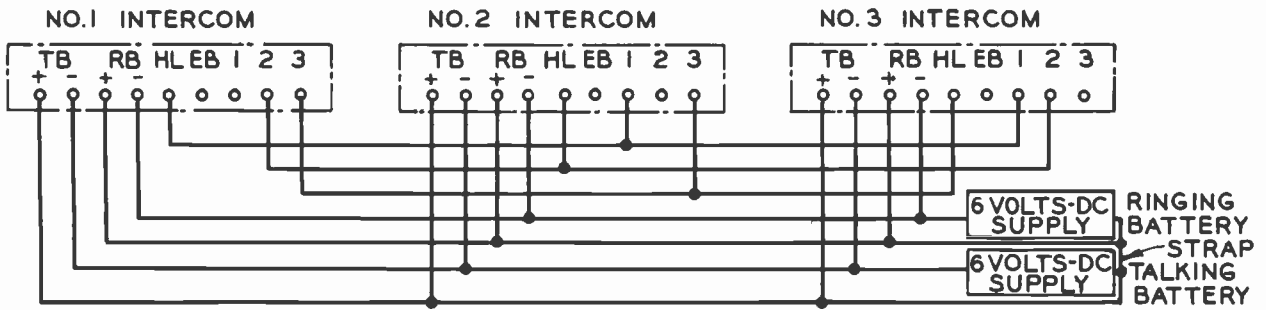

FIG. 3. Modernphone installation requires a minimum of wires and is simple. Two wires supply the talking current and another pair supply the ringing current—to ALL the instruments. In addition to this the "homeline" connects buzzer and speech circuits of instrument to pushbutton on all others.

technical—into an efficiently operating team. Broadcast installations would bring the General Manager, Program Director, Chief Engineer, their staffs, Master Control Room, Transmitter Room, Announcers, Studio Control Rooms, Studios, and Audition Rooms into instant communication with each other.

Answers "Small Station" Intercom Problem

Especially adaptable to small station setups, the "Modern Minor" offers high-quality performance at low cost. Operating from a six-volt battery or rectifier, the "Modern Minor" permits communication between two to six people. It fills the need for an efficient, low cost intercommunication system, lends itself to expansion, and assures small station builders of continued use in the future.

The "Standard" for 6 to 120 Communicating Points

The "Standard RCA Modernphone Intercom" is designed to serve from 6 to as many as 120 "intercom stations". Its use in larger broadcasting stations permits instant contact with even the most "remote" offices, studios, control rooms or other operational headquarters. Powered by two six-volt batteries or rectifier, the Standard Modernphone Intercom combines all the advantages of privacy, selective ringing, selective talking, and full trunkage. Available to broadcasters in 5, 10, 15, 20 and 30 button instruments, the Standard Modernphone Intercom offers a wide range of applications which assure the system's ability to be modified as needs dictate.

Satisfies Complex Broadcast Requirements

Stations of still larger size having more complex internal organization would find

the "RCA Modernphone Master System" an extremely useful and vital member. This system assigns an Executive Master to the principal of the organization, and also provides Staff Stations for his staff members. These units are equipped with colored lights and buttons, allowing the full advantages of complete privacy of the executive's conversation as well as executive priority on calls.

Other arrangements such as "RCA Modernphone Paging" and "RCA Modernphone Tele-Sound" are equipped with an amplifier system tied in with loudspeakers. The

Modernphone instruments, having been designed for this use, allow the paging to originate at the basic unit. They are designed so as to eliminate interference between regular communications and paging. The Modernphone Tele-Sound allows two-way intercommunication between a telephone handset and a loudspeaker, yet maintaining telephone privacy in office areas where loudspeakers may be objectionable. These systems could be used to meet the needs of the largest and most complex broadcast station installations where specific operations require specialized equipment.



FIG. 4. This fast, new telephone-type intercom brings efficiency into broadcast operations with instant, natural voice communication that eliminates walking and keeps telephone lines free for outside calls.

WHAT ABOUT TOWER LIGHTING?

By
MARTIN S. PHILLIPS
Hughey and Phillips
Tower Lighting Division

The growth of the Broadcasting industry parallels to a large extent that of aviation. Since this article treats the subject of antenna tower lighting, and since the need for tower lighting is prompted as essential to the safety of air navigation, it is appropriate at this point to outline something of the history and evolution of lighting as it applies to night markings of radio towers.

Perhaps more than any other Agency, the Post Office Department furthered the development of night flying. The first air-mail tests were, of course, conducted during daylight hours. For a period of one week, September 23rd to 30th, 1911, letters and postcards were flown from Nassau Boulevard on Long Island to nearby Mineola, the pilot dropping the pouches over the side of the plane to the waiting Postmaster.

Not until 1918, when Congress appropriated \$100,000.00 was official recognition given to flying the mail. That appropriation was used to develop a route between New York City and Washington, D. C., which began May 15th of that year. Army pilots were employed to fly the mail until August 12th, at which time the Post Office provided its own pilots and equipment, and assumed full responsibility for its operation. One round trip was flown daily except Sunday until May 31, 1921, at which time this particular experiment was concluded.

That same year the Post Office started cross-country air-mail delivery. Aircraft was used during daylight hours, then transferred to waiting trains for night transportation. This resulted in a saving of 22 hours in moving the mails from coast to coast. The Department was convinced of the feasibility of night flying, and the additional saving in time that could be realized. Improvising as best they could, an experimental coast-to-coast flight took place on February 21, 1921, which was

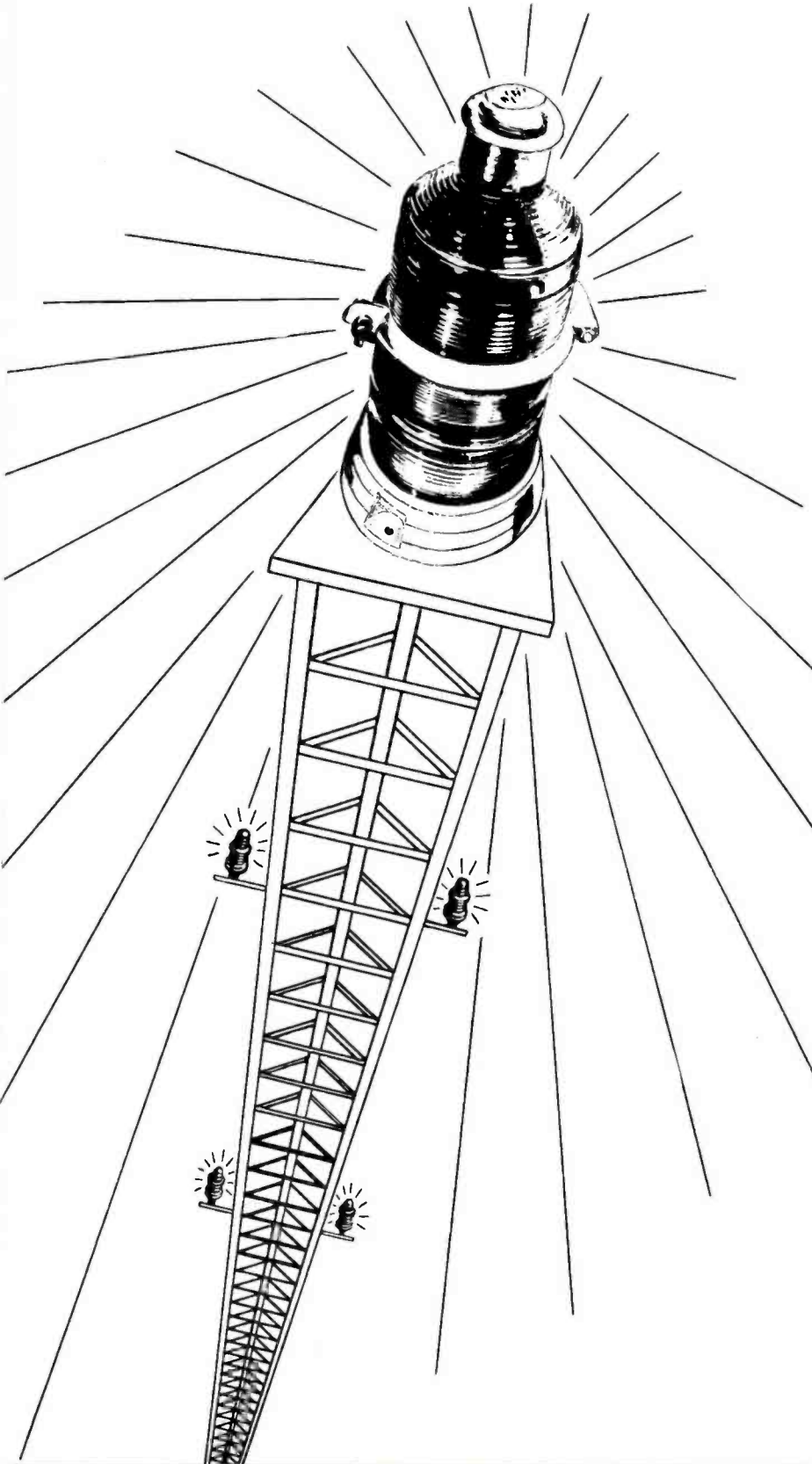

completed in 33 hours, 21 minutes of elapsed time. Through flights having proved practical, the Department then provided radio facilities and airway lighting. Scheduled transcontinental air-mail service began on July 1, 1924.

As private Carriers began scheduled operations, the Department arranged for flying the mail on a contractual basis. This same year the Post Office transferred its jurisdiction of lighted airways to the Department of Commerce, Civil Aeronautics Administration. The CAA, through the development of equipment, enactment of safety legislation, disbursement of weather information, licensing of pilots and equipment, and efficient policing of all phases of civilian aviation, has advanced the cause of aviation to the high level it has attained, which we in this country take for granted. If the reader has ever had occasion to fly aircraft in certain foreign countries, private or commercial, he would have new found respect for the manner in which our air navigation laws are enforced.

During the early stages of night flying, pilots flew at much lower altitudes than now, relying almost entirely on visual contact. It was not uncommon for a pilot to fly as low as 200 feet in order to get his bearings, and this perhaps more than any other reason placed radio towers in

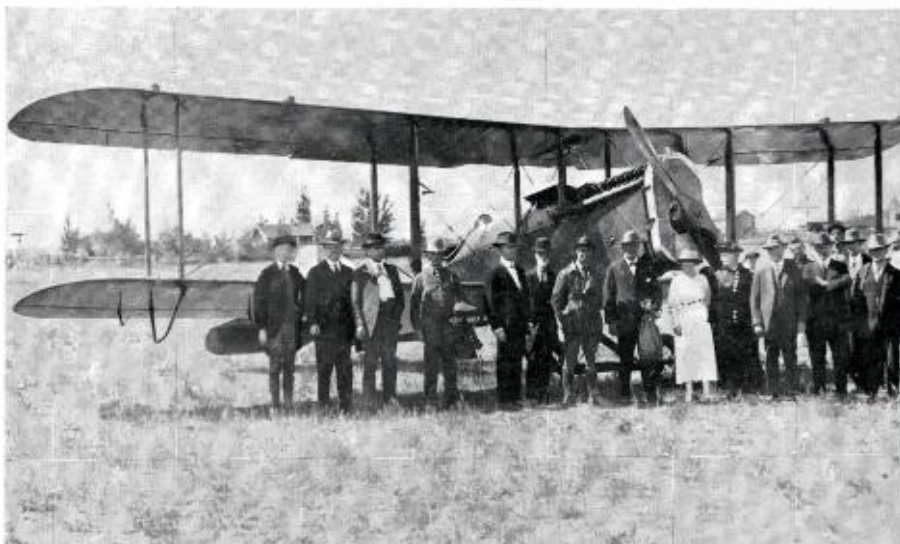

FIG. 1. Photo of the first air-mail plane into Reno, Nevada, September 9, 1920.

the classification of hazards to aerial navigation. Painting standards for daylight flying, and lighting standards for night flying were adopted. The type of lighting, such as A-1, A-2, A-3, A-4, etc., would indicate the height range of a particular tower, and the pilot would be guided accordingly.

Since it was mandatory to light radio towers to identify them as hazards to aircraft, such lights were certified as 'fixed' or 'true' lights, and were so shown on air

maps. When a 'true light' is certified, it must be maintained in a manner that will comply with performance requirements set forth by CAA. Failure to do so exposes the owner of such light(s) to a possible fine up to \$5,000.00 or imprisonment up to 5 years, or both. If this article does no more than to bring to the attention of owners of radio towers the importance of proper maintenance and compliance, bearing in mind the possible penalties in the event of failure, it will have served its purpose.

FIG. 2. Schematic diagram showing latest type 'fail-safe' beacon flasher.

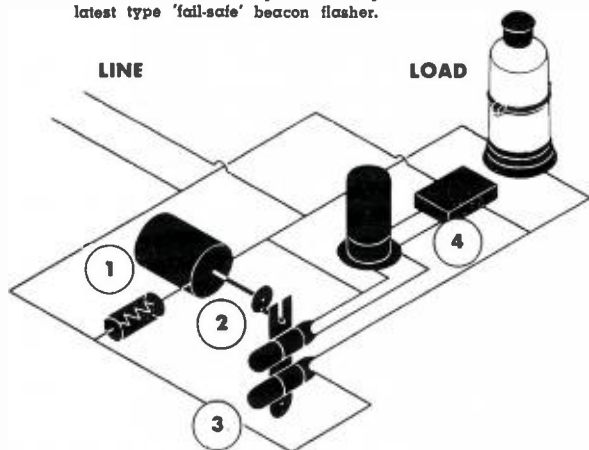

1. **Motor** — Synchronous type, totally enclosed for complete protection against dust and moisture. Its more than ample torque permits operation at well below rated voltage. Efficient at ambient temperatures of -40° to 130° .
2. **Gears** — Precision-cut to close tolerances, resulting in quiet operation. Gear plates are heavy sheet steel, flattened and relieved to assure proper alignment and to eliminate warpage and creep. Gears are permanently lubricated at the factory.
3. **Mercury Switch** — Hydrogen-filled, heavy duty tube is housed in plastic to eliminate breakage through handling. Mercury-to-mercury contact adds years of service.
4. **Electronic Monitor** — Positive acting time-delay relay. In event of failure of any component part, lights ALWAYS go on automatically and remain on until condition is manually corrected.

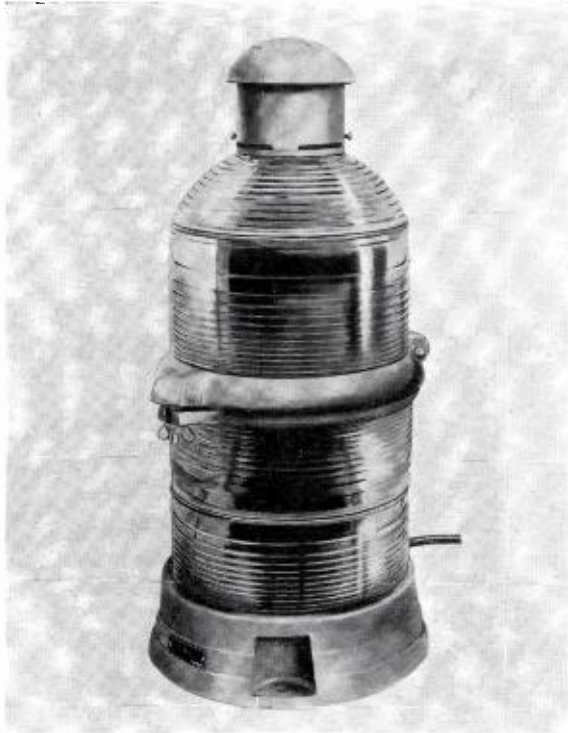

FIG. 3. Photo of a 300 MM Code Beacon designed for rugged service.

study of this subject. By Executive order, the Air Coordinating Committee (ACC) was organized, which consisted of members of FCC, CAA and the Department of Defense, and this Committee was charged with the responsibility for the development and coordination of aviation policy. A part of the ACC, the "Airspace Subcommittee" was set-up to make aeronautical studies of hazards to air navigation, and on this point, Broadcasters who contemplate erection of new antennas will find it prudent to familiarize themselves with the objectives of this committee insofar as it involves locations and heights in relation to airways and airports, painting and lighting of such antennas.

While the Airspace Subcommittee follows an established formula, their authority is broad and they may recommend, as in the case of lighting, more or less precaution than the height of the tower would normally require. Their recommendations are influenced primarily by the location and height of the tower in relation to the

If at any time lighting is to be out of service during hours of darkness, the nearest CAA office should be notified, either by phone or telegraph. They then alert aircraft within the area. If the tower itself were to fall, which for all practical purposes would eliminate the hazard for which lighting is provided, the CAA should be advised how long the tower will be down, and when lighting will be resumed. If the station were to discontinue operations, the tower must continue to be lighted until application is made, and permission granted for discontinuance. It is suggested that management responsible for maintenance of lighted radio towers obtain from CAA a copy of their "Rules and regulations governing establishment and certification of Aeronautical lights", so that if and when the occasion arises it will be available for reference.

Effect of Television

As the inevitable growth of television becomes a reality, and taller antennas become a part of the national landscape, the problems presented to air navigation by these taller structures prompted further

FIG. 4. Sketch showing the construction of the 300 MM Code Beacon. Note that ventilated dome "circulates" air to reduce internal temperature and increase lamp life.

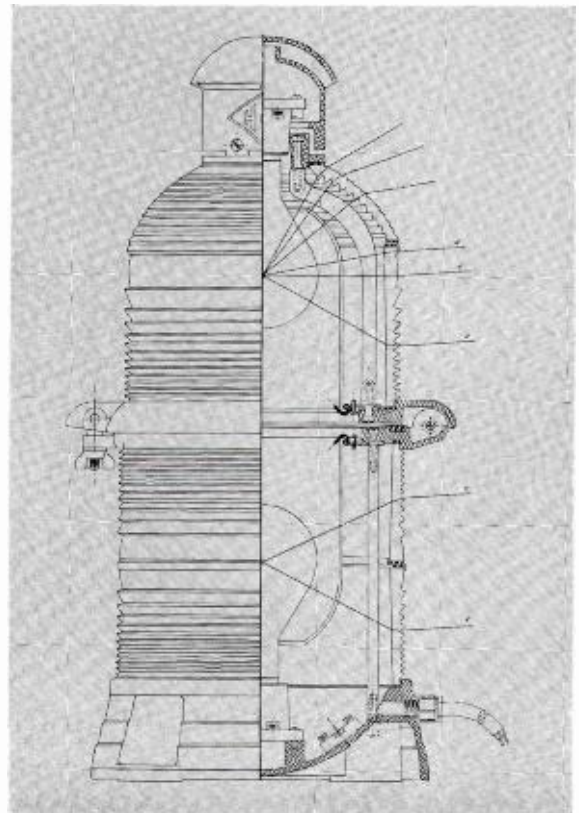

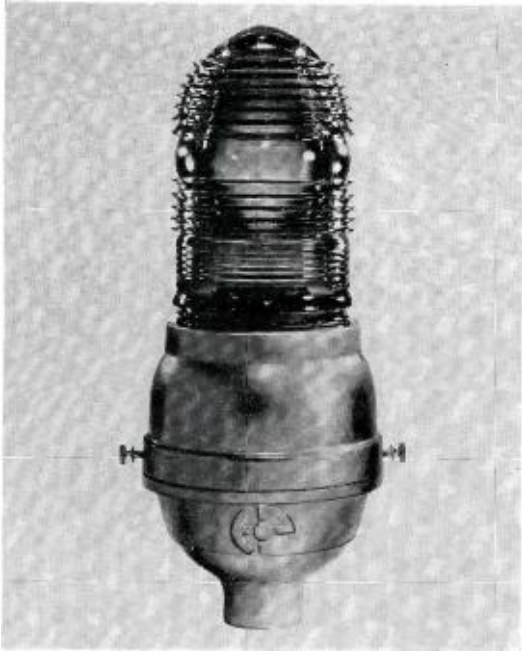

FIG. 5. Single Obstruction light is supplied with prismatic globe and meets all the C.A.A. light specifications.

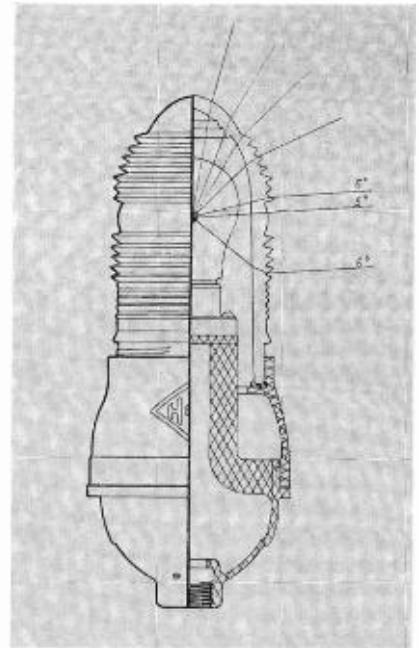

FIG. 6. Cutaway view showing the construction of the Single light. A drain port is provided to allow condensation and moisture to escape.

direct hazard to aerial navigation, rather than previously followed standards of lighting which depended upon height of tower, regardless of location.

Standard tower lighting consists generally of 300mm code beacons, single or double obstruction lights, flasher mechanisms, and timing devices for automatically turning lights on and off, wiring materials such as junction boxes, condulets, conduit or exposed wire, all of which should be inspected periodically and serviced as necessary. Many broadcasters follow the policy of making this inspection whenever relamping service is required. The following suggestions may be helpful in establishing a maintenance program:

Code Beacon

Remove lamps. Check for presence of moisture or foreign matter. If either are evident, inspect gaskets at all points, entrance fittings, glassware and castings. Defective parts should be replaced immediately. Because the cost of climbing a tower represents the greatest cost of maintenance, it is recommended that ALL lamps be replaced at such time. All bolts and screws, including bolts holding beacon to base plate, should be tightened. After servicing inside of beacon, be sure hinge

is tightly sealed. Wipe outside glassware with moist rag, making certain to remove accumulated dust in prisms.

Obstruction Lights

Check for presence of moisture or foreign matter. If either are evident, check gasket, glassware and castings. If any of these are defective, they should be replaced immediately. Relamp, and make certain that globe is securely screwed to globe ring, globe ring securely held to base, and the complete unit secured to conduit arm in a manner that does not permit vibration.

Flasher Mechanism

Manufacturers usually include a set of instruction data applicable to their particular instrument, and these instructions should, of course, be followed. Most flasher units are of the mercury type, and for maintenance purposes these differ from the mechanical type only insofar as checking the mercury switch leads for condition and flexibility. The life of mercury switches can be indefinite, but when they do fail, they usually do so without warning. For this reason a spare switch should always be on hand. In the case of mechanical flashers, the silver contacts should be checked for pitting and contact. If they are badly

pitted, the contacts should be replaced, and here again a set of spare contacts should be kept on hand. Lubrication should be applied at least twice a year to all moving parts. Flashers are usually housed in aluminum boxes, and moisture or foreign matter that is permitted to enter can ruin the instrument. It is important to make certain the door gasket makes a good seal, and that conduit is so attached to the entrances so that moisture resulting from condensation is trapped before it can enter the housing. If water-tight connectors are used, the rubber grommets should be checked for aging. DO NOT let unauthorized persons tamper with this mechanism.

Timing Devices

Mechanical clocks are often used for turning lights on and off at set intervals. These mechanisms are quite simple, and maintenance varies according to type and manufacturer. Maintenance instructions are usually shown on the inside of the cover. Photo-electric controls are preferable to and recommended by CAA because in the event of an overcast the lights will automatically turn on. Generally, it is more economical to use photo-electric controls because they can be set to turn on at 35 foot candles, and off at 58 foot

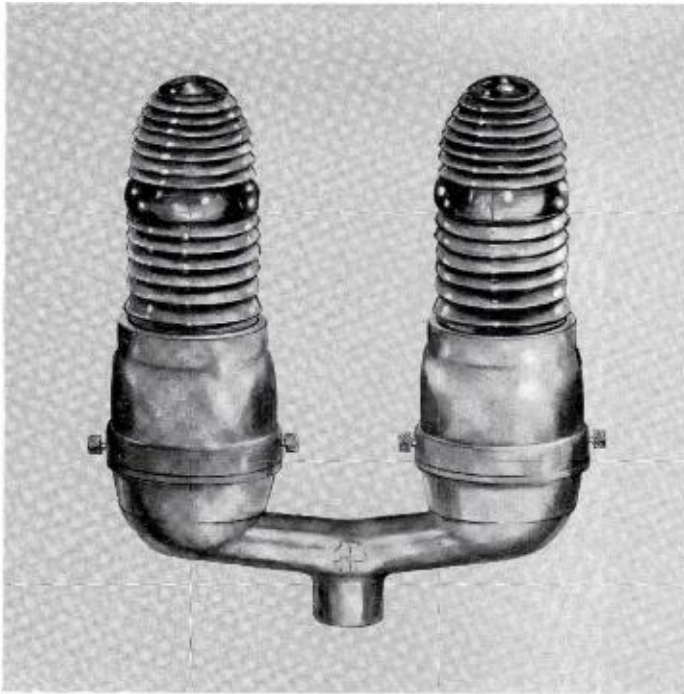

FIG. 7. Double Obstruction light for use on A-2 towers in place of 300 MM Code Beacon.

candles, whereas mechanical clocks must allow a safe margin, and perhaps turn lights on before they are required, and off later than necessary. As in the case of flasher units, it is of utmost importance that moisture does not enter the housing, and here again the points to check are the cover gasket, conduit entrances and window opening. Other than replacing tubes periodically, no other service is necessary. If trouble develops, follow the circuit attached to the inside cover as furnished by the manufacturer. These are usually simple circuits, and parts can usually be obtained locally.

Wiring Materials

As good practice would dictate, make certain wire or conduit is securely attached to the tower, and that wind or vibration has not caused bolts or wraplock tape to become loose. Junction boxes should be opened once a year to determine that connections are tight, and that gaskets are keeping moisture out. Water-tite connectors and conduit couplings should be checked and tightened if necessary.

When parts are required which are not available locally, it is always advisable when contacting the manufacturer or distributor to give the model and serial number, and if available, the part number. This

eliminates any doubt on the part of the supplier, and frequently avoids double handling and the resultant inconvenience. If parts lists covering specific material are not in your possession, the manufacturer is always glad to furnish such data without charge, and it is desirable to have such information on file.

As mentioned above, the greatest expense to tower maintenance is the cost of climbing the tower. If a lamp burns out, the cost of the replacement lamp may be less than \$2.00, but the cost of making the replacement is usually many times that figure. Beacon and obstruction light lamps until quite recently have been made for 1000 hour service. Now there are available lamps of the same physical dimensions and light center which are designed for 3000 hour service, and these are recommended by CAA as well as tower lighting manufacturers. The beacon lamp is identified as #620PS40/P, and the obstruction light lamp is #111A21/TS. The cost of these lamps is approximately the same as the 1000 hour lamps.

Beacons and obstruction lights must be CAA approved, and glassware is interchangeable with lights of all manufacturers. The illustrations in this article show the principle by which these units operate and magnify. On the 300mm code beacon, the beams from both lenses are directed upward slightly about 5 degrees above the horizontal, and are visible around the horizon. Failure of either lamp does not leave any particular angle of approach unprotected. On the obstruction light lens, the principle beam is directed outward in a broader band extending from the horizontal up to 10 degrees above. Glassware in both types is prismatic and heat resistant.

Microwave installations have been built in all sections of the country, and most of these stations are unattended. Since personnel is not available to check lighting,

FIG. 8. View of code flasher control which is constructed for long service.

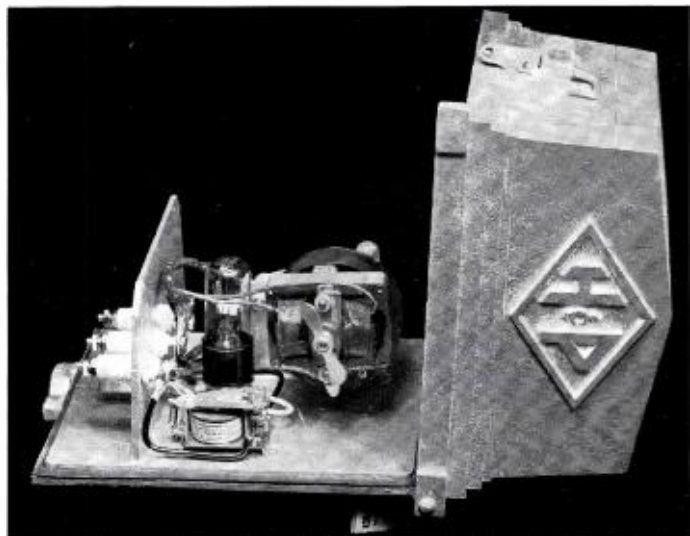

and since these are certified 'true lights', alarm circuits have been developed which throw a radio signal whenever a light fails. This informs the control station that a light has failed, and as pointed out earlier, he then informs the CAA of the location of the tower.

In the limited space available here, it is quite impossible to cover all phases of tower lighting. As in all things, there are ramifications for which the average broadcaster need not concern himself. After the original installation is made, normal attention will enable approved equipment to deliver many years of trouble-free service. Sensible policy will insure such service.

LIST of MATERIAL for Diagram at Right

Key	Qty	Description
A	1	300MM Code Beacon, Complete with Two (2) Red Color Filters
B	4	Single Obstruction Lights, Complete with Red Fresnel Globes
C	1	Mercury Flasher with Water-Tight Housing
D	1	Switch
E	3	Junction Boxes
G	3	Junction Box Gaskets
H	3	Junction Box Covers
I	*	Feet Service Entrance Cable (2-8's, 1-10)
J	4	Conduit Fittings
K	4	Conduit Fitting Gaskets
L	4	Conduit Fitting Covers
M	9	1" Lock Nuts
N	3	1"x24" Galvanized Conduit Nipples
O	1	1"x8" Galvanized Conduit Nipple
P	1	Package Wraplock Tape
Q	4	Feet 12-2 RC Cable, Connected to Beacon
R	5	1"x2" Conduit Nipples
S	2	Amp Plug Fuses (1 Spare)
T	25	Feet No. 12 Type TW Moisture-Proof Wire
U	4	500 Watt Mogul Pre-Focused Airway Beacon Lamps (2 Spares)
V	8	100 Watt A-21 Traffic Signal Lamps (4 Spares)
W	4	1/2"x2" Bolts
X	4	1/2" Nuts
Y	4	1/2" Lock Washers
		Detail Print
		Bill of Material

* Height of Tower, Plus 15 Feet.

The above includes every item of material necessary to equip an A-3 Tower with an exposed wired installation. When specifying complete kit as outlined above, signify Kit No. A3-EWK and give height of tower.

• • •

OPTIONAL EQUIPMENT

- Tower Lighting Choke with Water-Tight Housing
- Relay Cabinet with Transfer Relay
- Pilot Light with Water-Tight Housing
- Photo-Electric Control

FIG. 9. INSTALLATION SKETCH BELOW SHOWS AN "A-3" EXPOSED WIRED LIGHTING KIT FOR TOWER HEIGHTS OF 150 TO 400 FEET.

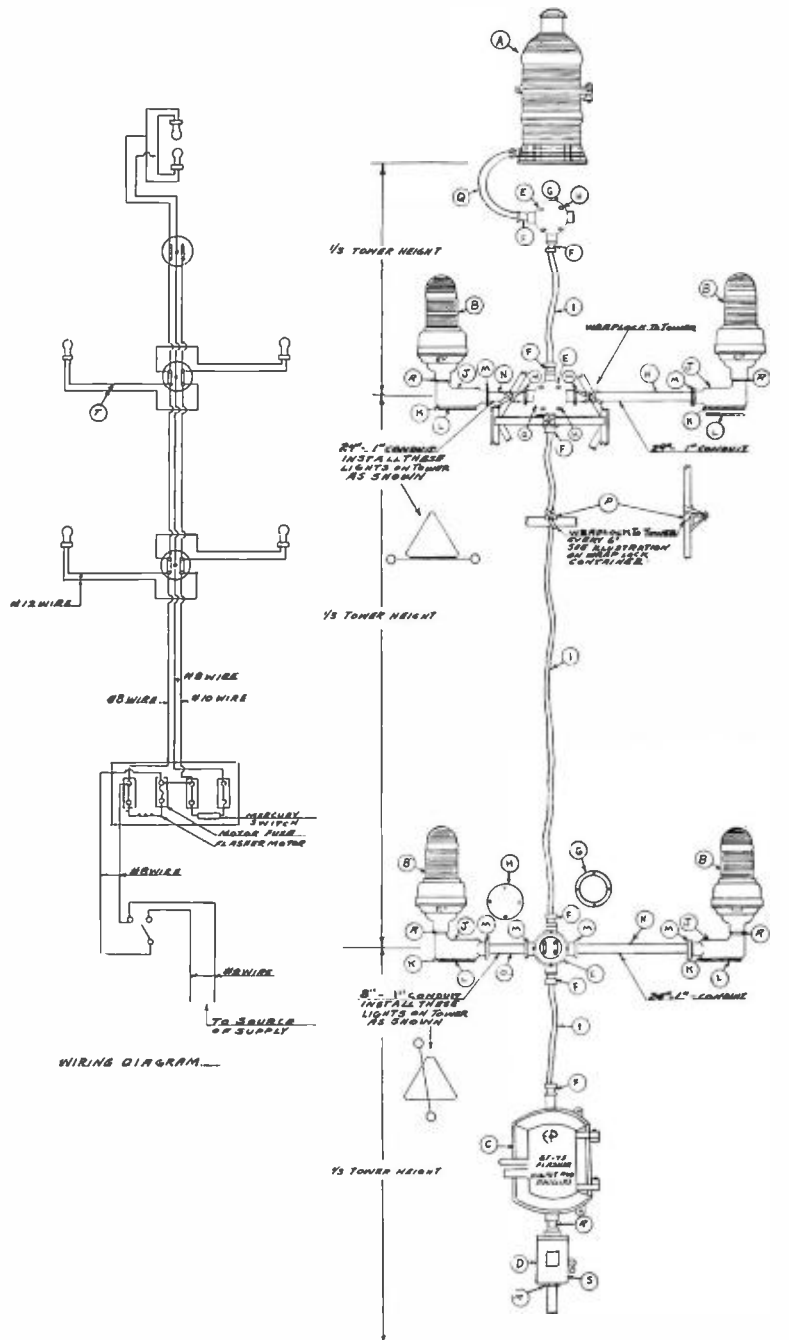

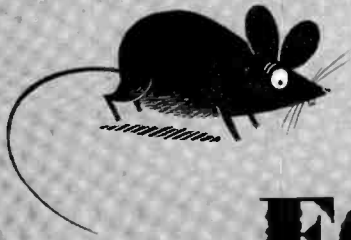

HAM FORUM



A DEPARTMENT FOR THE BROADCAST RADIO AMATEUR



BRASS POUNDER AT 16

Anthony J. Rokosz, W2BQI, of WNBT, N. Y., sent in this photo of his son Bob busily pounding brass in their shack at Valley Stream, L. I. Bob is 16—has had his ticket, W2FDX, since October, 1950. Their transmitter (center of picture) is a 500-watt rig for 20 and 10. The well-known ART-13 (at the left) tunes 2-18 mc. A 522 2-meter transmitter (not shown) is also part of the gear at W2BQI and W2FDX. Skywires include a 2-meter dipole, 20-meter shortened beam, and all-band single wire 67-foot antenna. The OM formerly held W2AQR (1926) and W2ALB.

Bob Rokosz, W2FDX, shown working his dad's 500-watt rig in Valley Stream, L. I. Bob is 16. His father is W2BQI, of WNBT.

GILA BROADCASTING NET

Roland Wiseman, W7RJN/W7MAM, KCKY Chief Engineer, and Earl Hickman, Transmitter Supervisor, keep skeds several times a week with Paul Merrill, W7PMJ, General Manager of the Gila Broadcasting Company. . . . GBC consists of KGLU at Safford, KWB at Globe and KCKY at Coolidge, Ariz. . . . Earl has a kw installed in the spare studio of KCKY, and is on 3,865 kc most of the time. . . . Roland is rebuilding his all-band rig (pair of RCA 809's which have been in use since 1939).

George Grammer, W1DF, Technical Editor of QST (center) shown with Bill Zaun, RCA Service Co., (left) and Wally Brown, W2OQN, former President of South Jersey Radio Assn., during a visit to the RCA Camden Plant.



**Address Correspondence to: HAM FORUM
Marvin L. Gaskill (W2BCV)
Associate Editor, Broadcast News
RCA, Camden, New Jersey**

RCA'S "MATT" BERGIN, POPULAR W2U(ncle) A(ble) ON TEN

We are proud to introduce one of radio's outstanding "ole-timers", M. L. ("Matt") Bergin, W2UA, Moorestown, N. J. Matt, who is an RCA Product Distribution Administrator in Camden, pioneered some of the earliest advances made in communication gear over 40 years ago, using the self-assigned call NI. Today, as if to prove his unswerving devotion to hamming, 2UA is constructing a completely new transmitter to replace the 18-year old 500-watt job presently in use.

Worked on First Fight Broadcast

It was not until we visited his shack that we uncovered impressive memoirs that any ham would be extremely proud to display. (We had to "pry" these things from modest Matt.) One of the rare trophies we saw was a testimonial to his work in helping put on a broadcast of the Dempsey-Carpentier fight. This fight, staged in Jersey City in 1921, was the first to be broadcast. The testimonial, now yellowed with age, bears the signatures of Jack

Dempsey, George Carpentier, Franklin Roosevelt (then Assistant Secretary of Navy), Tex Rickard, and Major J. Andrew White, the announcer. Matt also showed us an old original Marconi coherer, the first device ever used to detect wireless signals.

Sea Duty (1912-1919)

Another "old document" we discovered in the shack was a "Certificate of Skill" issued in 1912 by Examining Officer W. D. Terrell of the Dept. of Commerce and Labor-Navigation Service. This certificate, which other old-timers will recognize as the first official radio operating ticket, required operators to pass exams in both American Morse and Continental codes, and was signed by E. T. Chamberlain, the Commissioner of Navigation, Washington, D. C. It was this certificate that enabled Matt to begin his radio career at sea, which continued for about seven years.

During these years, Matt had sailed on some 17 different ships, and had had many experiences. He sent three S.O.S. calls, the

first while on the *S. S. Camino* loaded with relief supplies for the Belgians. The freighter lost her rudder and the boiler exploded. They were adrift for 13 days 300 miles off Cape Race until towed into Halifax by *Kanawha*, a British Furness Line freighter, and *Lady Laurier*, a Government Cable Ship. For this Matt received the Veterans Wireless Operators Association "Citation". The OT also saw enemy action during World War I while aboard the American Liner *St. Louis* which was attacked by enemy submarine 300 miles off Lands End, England. The *St. Louis* was the first American ship to leave the U. S. shores during World War I equipped with guns.

Assigned Amateur 2JJ

Of course Matt spent his time at sea prior to any official Amateur call letter assignments. It was not until 1920 that he was assigned 2JJ, his first official Amateur call. At this time Matt lived in New York.

(Continued on next page)

"Matt" Bergin, W2UA, devoted 10-meter man, and Communications Officer in Moorestown's Civil Defense net. His CD equipment can be seen at left, AR-88 and Panadaptor, center.

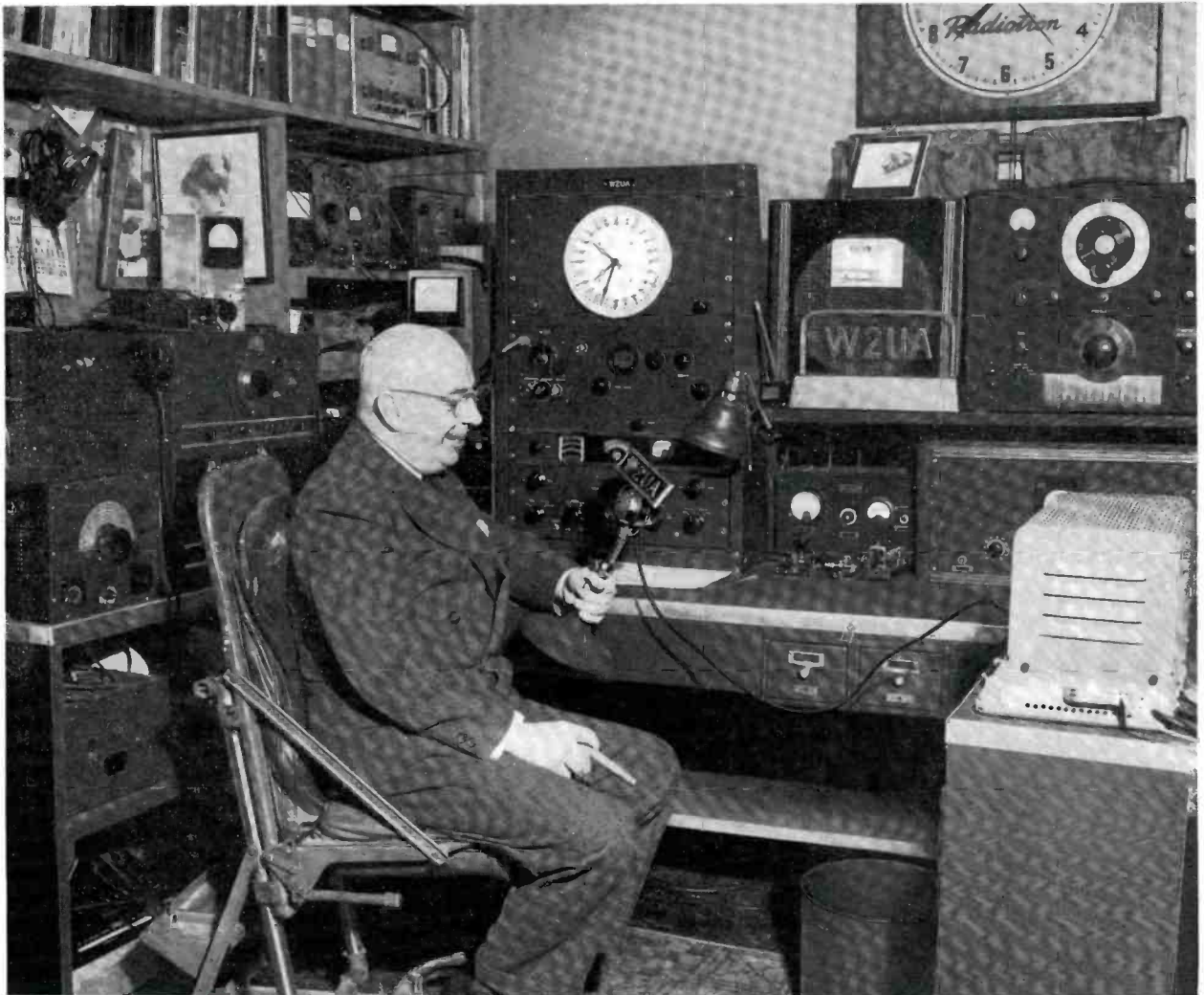

He first worked as an instructor at RCA Institutes and later became Director in Charge. His hamming hours were spent on 200 meters, using two 203's in parallel as a self-excited oscillator. Absorption modulation was applied to this rig by connecting a transformer in the ground lead. Matt says "it was 75% hum and 25% voice", but notwithstanding, he received replies from spark and occasionally one of the few cw stations on at the time. In 1932 Matt moved to New Jersey with the call W3JAR.

He Is C-D "CO"

A significant part of 2UA's operating time is devoted to civilian defense communications in his home town, Moorestown, N. J., which has a total population of about 7500. Matt is Communications Officer of the organization which boasts nine operators and six cars equipped with ten-meter gear. His CD equipment, which is installed in the ham shack, consists of an RCA AVT-114 Aircraft Transmitter, the frequency of which was converted from 122 mc. to 29.5 mc., to provide about 10 watts input. The antenna used for CD work is a 10-meter vertical ground plane on a 50-foot steel pole. Matt also has a 4-element wide-spaced rotary beam on ten which he



W2UA's 10-meter beam is mounted on a 40-foot steel tower. Antenna in background is a 10-meter ground plane used for local civil defense work.

uses for ham work. The receiver is an RCA AR-88 with Q5'er second i-f strip, audio filter for CW, and Panadaptor for viewing 200 kc of the spectrum.

New KW Under Construction

Two projects Matt now has underway are the construction of a new bandswitching TVI-proof KW, and installation of a 3-element wide-spaced 20-meter beam on his 40-foot steel tower. Installation of the beam is awaiting milder weather, but the new transmitter is nearly completed. This new transmitter will be a commercial-looking job using 4-250A's modulated by 4-125A's. The present transmitter at 2UA uses a pair of 805's modulated by 805's. TVI-proofing of this rig was accomplished by installation of coax line to replace an open-wire feeder, and by inserting filters in the coax and ac lines.

Until conditions on the band became so poor, Matt spent most of his operating time on 10 meter fone. His most cherished QSL is from Ethiopia's ET1IR, as he says, not because it's the most distant contact but because there are so few hams in that country that they are hard to get.



His present 500-watt transmitter (center) will be augmented with the new bandswitching KW under construction at the left.



New RCA Fleetfone Station Console

Announcing...

RCA's new 2-way radio Fleetfone "DESK STATION"

Now . . . a 60-watt transmitter plus receiver in a single case. Saves space. Simplifies operation. Makes maintenance easier. Read how . . .

Good news for 2-way radio users! A "desk station" you can install 'most anywhere . . . on a desk, a table, or even on a shelf against the wall.

60-watt transmitter exceeds FCC and RTMA requirements

Precision controlled by RCA ovenless crystal unit, with spurious emission reduced to minimum. Two-frequency or three-frequency transmission possible. Very economical to operate. Most tubes work at less than 70%

capacity. Result: longer tube life, less maintenance. Uses standard tubes.

Receiver gives adjacent channel selectivity

Exceptionally sharp selectivity. Circuits specially designed to give clear reception from mobile transmitters, even in high-interference areas. Two-frequency reception possible by adding another frequency kit. Receiver uses only 5 tube types. Allows minimum spare-tube stock.

Console built for easy operation and servicing

Sloping front panel, easy access to controls. Built-in direct reading electric clock. Transmitter-receiver chassis

slides out at the top for ready access.

Get full details . . . mail coupon today Find out all about this great new "desk station" that gives you full-power performance from a single package. All backed up by RCA . . . world leader in radio. Service available from RCA Service Company if desired.

FREE BOOKLET . . . MAIL COUPON

Dept. 127D, RCA Engineering Products, Camden, New Jersey

Please send me full information on your new RCA Fleetfone Station Console.

Name _____

Title _____

Company _____

Address _____

City _____ State _____

Also, please send me information on use of 2-way radio in industry checked below:

- General Industry (Utilities, Construction, Petroleum, Lumber, Mining, etc.)
- Transportation (Truck, Bus, Taxi, etc.)
- Public Safety (Police, Fire, Ranger, etc.)



RADIO CORPORATION of AMERICA

RCA's new "400" Junior

Lightweight (Complete Single-Case Portable)

16mm Sound Movie Projector

The new "400" Junior has all the features you have looked for in a 16mm sound projector. It is compact and portable. Speaker in lift-off cover, projector, and connecting cables are all contained in an attractive lightweight, single-case unit.

Easy and quick to set up. So simple to

thread, even a child can do it. Pictures at their best in brilliance and contrast. Sound reproduced with dramatic realism and full tonal range. Meets every requirement of fully professional quality. Priced within limited budget requirements of schools, churches, business and industry.

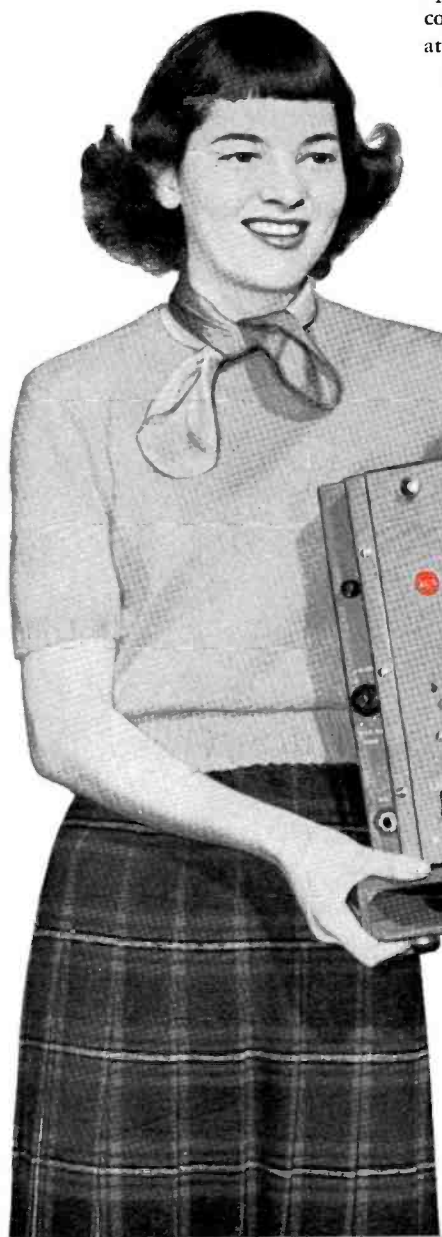

Convenient to handle.
Easily carried.

So light in weight
a schoolgirl can pick it
up to place on a table.



VISUAL PRODUCTS
RADIO CORPORATION of AMERICA
ENGINEERING PRODUCTS DEPARTMENT, CAMDEN, N. J.
In Canada: RCA VICTOR Company Limited, Montreal

All new

RCA Limiting Amplifier BA-6A

For high-fidelity AM and FM speech input systems

FEATURES

- No matched tubes required
- Choice of single or dual time constant
- Greater reliability—push-pull stages throughout
- High gain—Low noise level
- Adjustable T-pad in output
- Standard plug-in mounting—for new handling convenience

SPECIFICATIONS

- Output level at verge of limiting, 30 dbm
- Gain, 54 db
- Noise level—down 83 db at verge of limiting
- Frequency response ± 1 db, 30-15,000 cycles
- Distortion (12 db gain reduction), 1%
- Takes only $8\frac{3}{4}$ inches of rack space. Weighs only 37 pounds.

This represents the ultimate in useful performance...at lower cost

Save yourself hundreds of dollars when you buy your limiting amplifier. Specify a BA-6A. For complete details, call your RCA Broadcast Sales Engineer. Or write Dept. PA-19, RCA Engineering Products, Camden, N. J.



AUDIO BROADCAST EQUIPMENT
RADIO CORPORATION of AMERICA
ENGINEERING PRODUCTS DEPARTMENT, CAMDEN, N. J.

In Canada: RCA VICTOR Company Limited, Montreal

Television on

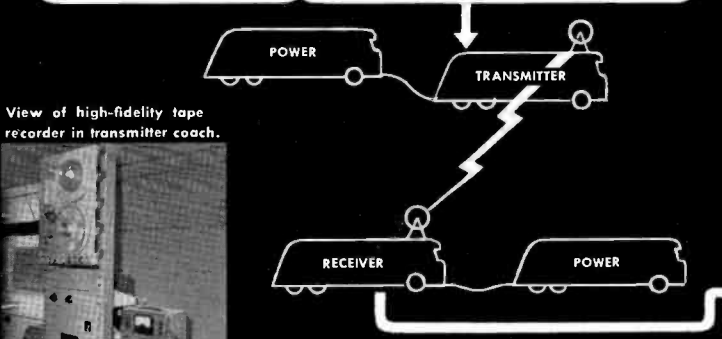
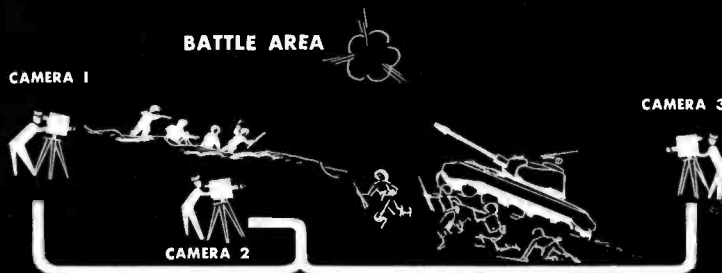

View of high-fidelity tape recorder in transmitter coach.



Camera monitoring position in transmitter coach.



TV amplifiers and power supplies in receiver coach.

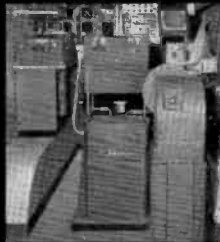

TV film camera and projector in receiver coach.

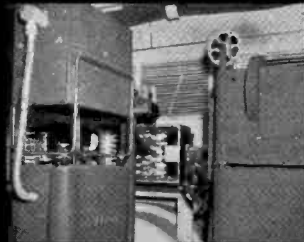

10 TV SETS

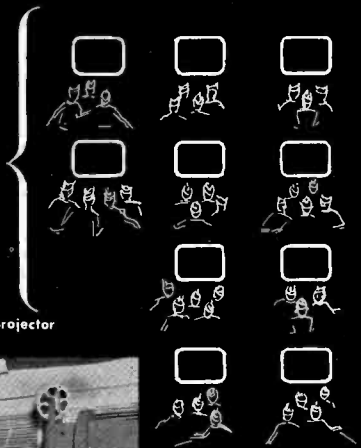

Wheels



—new “electronic eyes” for the Army

THIS fast-moving mobile television system recently delivered by RCA to the U.S. Army Signal Corps flashes eyewitness views of intricate field exercises to expert observers, maneuver umpires, or to Army classrooms.

Pioneering a new concept in military instructional techniques—a major advancement for on-the-spot coverage in military observation and communication—exploring the feasibility of TV for field instruction and tactical use are a few of the jobs assigned to this equipment.

This new mobile TV system is the most complete television station ever mounted on wheels. It consists of four 10-ton coach-trucks fitted with

custom-built bodies, each 31 feet long.

THE FIRST COACH contains the cameras and transmitter units . . . three complete TV field camera chains . . . microwave transmitter for video signals . . . 45-watt FM transmitter for sound signals . . . four microphone inputs . . . tape and disc recording equipment . . . complete TV monitoring and switching control equipment.

Transmitter power supply equipment, consisting of two powerful 15-KVA gas-driven generating units is contained in the **SECOND COACH**.

The receiver-display unit forms the **THIRD COACH**. This unit houses the FM and microwave receiving equipment . . . ten 16-inch TV picture monitors

. . . a 16mm TV projector and film camera . . . slide projector . . . and a large-screen TV projector.

Housed in the **FOURTH COACH** is another 15-KVA generator power supply for the receiver-display unit. All coaches in the system are in communication with one another by means of an RCA 15-watt Carfone two-way radiotelephone.

This mobile television system, built for the U.S. Army Signal Corps, is another example of RCA applied engineering, manufacturing and service activities. RCA, through its extensive facilities, is constantly striving to provide our armed forces on land, sea and in the air with better military equipment.



RADIO CORPORATION of AMERICA
ENGINEERING PRODUCTS DEPARTMENT
CAMDEN, N.J.

Completely **NEW**

5-kw AM...*

New small size-



1. Increase power to 10 kw with this simple kit

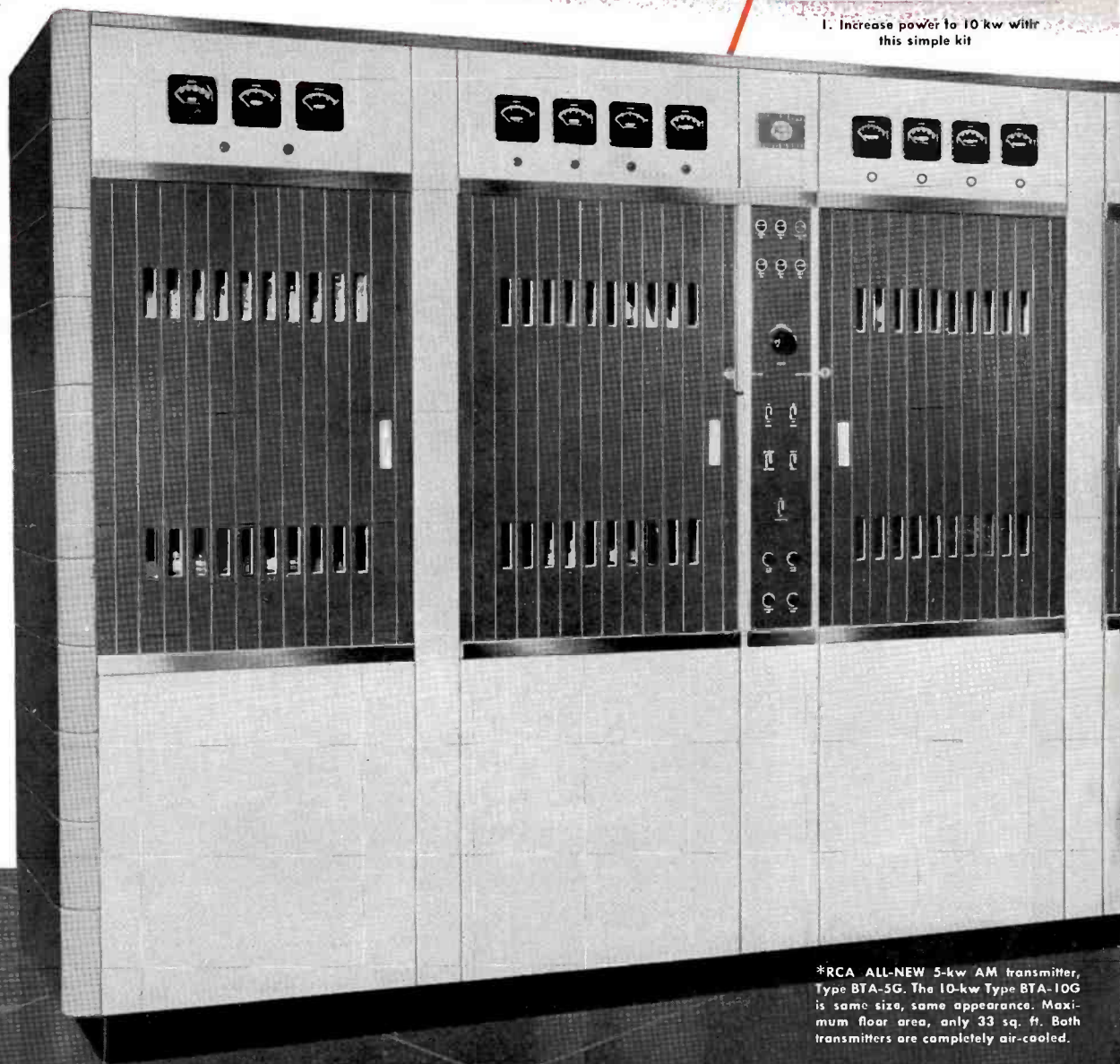

*RCA ALL-NEW 5-kw AM transmitter, Type BTA-5G. The 10-kw Type BTA-10G is same size, same appearance. Maximum floor area, only 33 sq. ft. Both transmitters are completely air-cooled.

..with a "10-kw" future!

New operating convenience - New operating economy

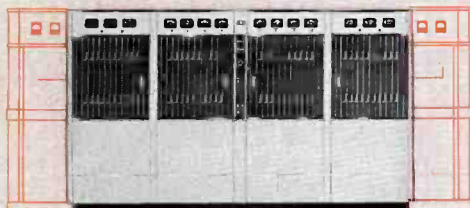

2. Up to 40% less floor area than previous "5 kw's"



3. Power tube costs reduced

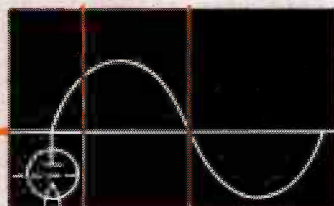

4. 1/60th second arc-back protection



5. Lower power bills



6. Sliding doors—front and rear

Just read these exclusive features . . .

- 1 It is a 5-kw AM transmitter you can increase to 10 kw—easily—inexpensively—quickly. No lost air time for conversion. One simple kit makes it easy to increase power overnight. (Yes, you can buy this transmitter ready-built for 10 kw, too).
- 2 It requires less "operating" floor space than other 5 kw's—saves up to 40% floor area. Entire transmitter is only 84" high, 130" wide, 32½" deep.
- 3 It's the ONLY "5 kw" with such low tube costs. Power and modulator stages use the new small size, lightweight RCA-5762—costing less than half that of power types in most "5 kw's".
- 4 It's the ONLY "5 kw" with "split-cycle" overload and voltage protection—using thyatron-controlled rectifiers. Circuits work so fast audiences cannot detect "off-air" breaks.
- 5 It holds power bills to the LOWEST in the "5-kw" field—through smaller power tubes, fewer stages, fewer tubes (only 24 tubes and 8 different types).
- 6 It's the ONLY "5 kw" with horizontally-sliding doors *front and back*. Benefits:
 - ✓ Saves over 60 square feet of floor area
 - ✓ Provides more elbow room for operator
 - ✓ Makes it easier to get at transmitter

For all the facts about this basically new transmitter . . . newest of nearly three hundred RCA "5-kw's" now on the air . . . call your RCA Sales Representative.



RADIO CORPORATION of AMERICA
ENGINEERING PRODUCTS DEPARTMENT

CAMDEN, N. J.



Now 9 Television Stations in Latin America, RCA Equipped!

New Transmitters add millions to audience of TV—the New Teacher

ONE YEAR AGO there were five television transmitters supplied by RCA in operation, or on order, in Latin America. Today *nine* are completed or planned for early inauguration, all RCA equipped. These are: three in Mexico; three in Cuba; two in Brazil; one in the Dominican Republic.

RCA is First in Television in the U. S. A. . . . and in all the Americas.

RCA welcomes creative video talent around the world . . . as Television the New Teacher helps to advance educational programs of nations both old and new.

Your RCA Distributor will be glad to keep you fully informed on RCA television, or write the RCA International Division.



RCA Television receivers embody the experience of over 2,000,000 instruments in use in the U.S.A., Canada, and Latin America.

First in Radio — First in Sound — World Leader in Television



RCA INTERNATIONAL DIVISION

RADIO CORPORATION of AMERICA

RCA BUILDING

30 ROCKEFELLER PLAZA, NEW YORK, N.Y., U.S.A.

*For TV
station planners*

... from your
nearest **RCA**

Sales Representative

**TELEVISION TRANSMITTER
and ANTENNA EQUIPMENT**

(V-H-F and U-H-F)

for Any Radiated Power to 200,000 Watts

Channels 2 to 83



This 64-page book is prepared specifically for TV station management, chief engineers, architects, consultants, and attorneys connected with station designing, planning, building, and operating. In a single reference it contains concise descriptions of RCA's entire line of TV transmitter and antenna equipment—including transmitter plans and layouts, general application data, and cost charts.

For your copy, get in touch with the RCA Broadcast Sales Representative nearest you:

New York 20, N. Y.
36 W. 49th Street
Telephone: Circle 6-4030

Dallas 1, Texas
1907-11 McKinney Ave.
Telephone: R-1371, 1372, 1373

Cleveland 15, Ohio
718 Keith Building
Telephone: Cherry 1-3450

Atlanta 3, Ga.
522-533 Forsyth Bldg.
Forsyth and Luckie Streets, N. W.
Telephone: Walnut 5946

Kansas City 8, Mo.
221 W. 18th Street
Telephone: Victor 6410

Hollywood 28, Calif.
1560 North Vine Street
Telephone: Hollywood 9-2154

San Francisco 3, Calif.
1355 Market Street
Telephone: Hemlock 1-8300

Chicago 11, Ill.
666 North Lake Shore Drive
Telephone: Delaware 7-0700

Washington 6, D. C.
1625 K Street, N. W.
Telephone: District 1260

Boston 34, Mass.
John Hancock Building
200 Berkeley Street
Telephone: Hubbard 2-1700



RADIO CORPORATION of AMERICA
ENGINEERING PRODUCTS DEPARTMENT

CAMDEN, N. J.

Hinged front panel—and "Swing-up" amplifier frame make all underside components easily accessible.

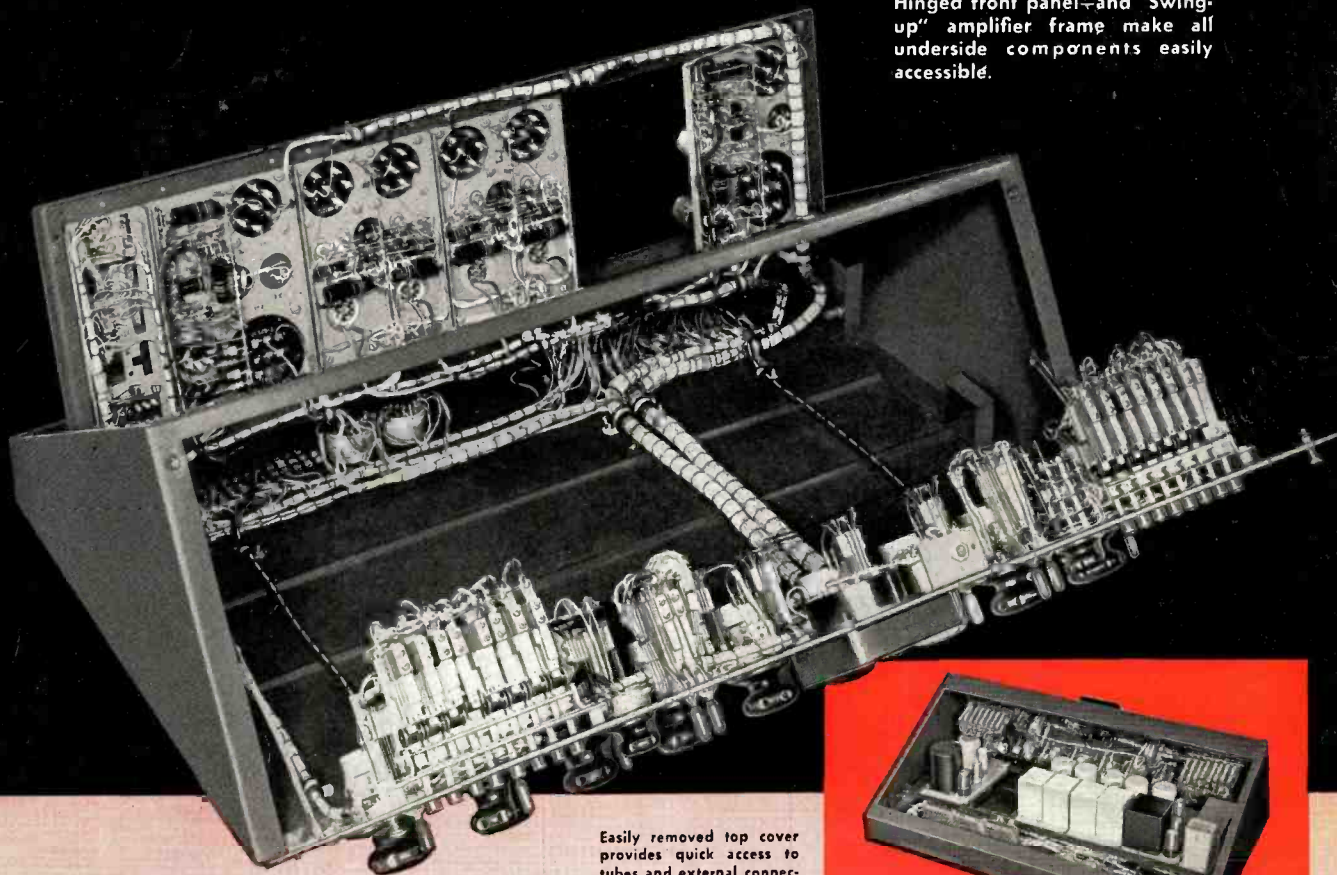

Easily removed top cover provides quick access to tubes and external connections. The BC-2B will fit snug against the studio window.

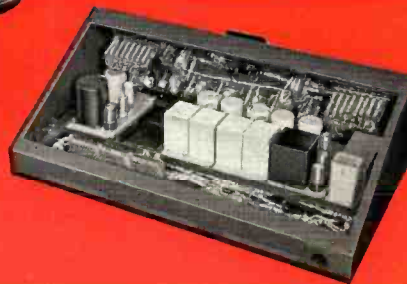

NEW DESIGN *consolette*

Color coded for "error-proof" control

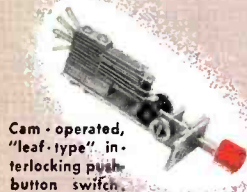

Cam-operated, "leaf-type" interlocking push button switch.

The new consolette BC-2B provides all the essential audio facilities needed by most AM, FM, and TV stations—plus many extra operating advantages not previously available in a standard consolette. It speeds up switching operations substantially over previous

designs. It provides for complete control of all studio operations. *The BC-2B gives your station "deluxe" features at a "standard" price.*

Read the list of exclusive "extra" features the new BC-2B offers you. Then ask your RCA Broadcast Sales Representative for complete details. His service is as near as your phone.

11 extra features!

- "Color-coded" controls quickly identify and tie related functions together.
- New, leaf-type cam-operated interlocking, push-button switches.
- New hinged front panel for easy access to switches, gain controls, and contacts.
- Amplifiers mounted on "swing-up" frame; chassis easy to remove.
- New 30° sloping top panel for maximum studio visibility—styling compatible with modern AM and TV practice.
- New compact amplifiers use low-noise, long-life, miniature tubes.
- Improved, faster-operating speaker relays eliminate key clicks and audio feedback.
- Lamp dimmer for VU meter (ideal for TV service).
- 8 high-level mixing channels, separate gain controls for network and remote.
- Turntable mixers with "built-in" cueing switches.
- No clearance required at rear—can be installed up against walls and control room windows. Uses less desk space, too.



RADIO CORPORATION of AMERICA
ENGINEERING PRODUCTS DEPARTMENT CAMDEN N. J.