

AM · FM · TELEVISION

# BROADCAST

NEWS

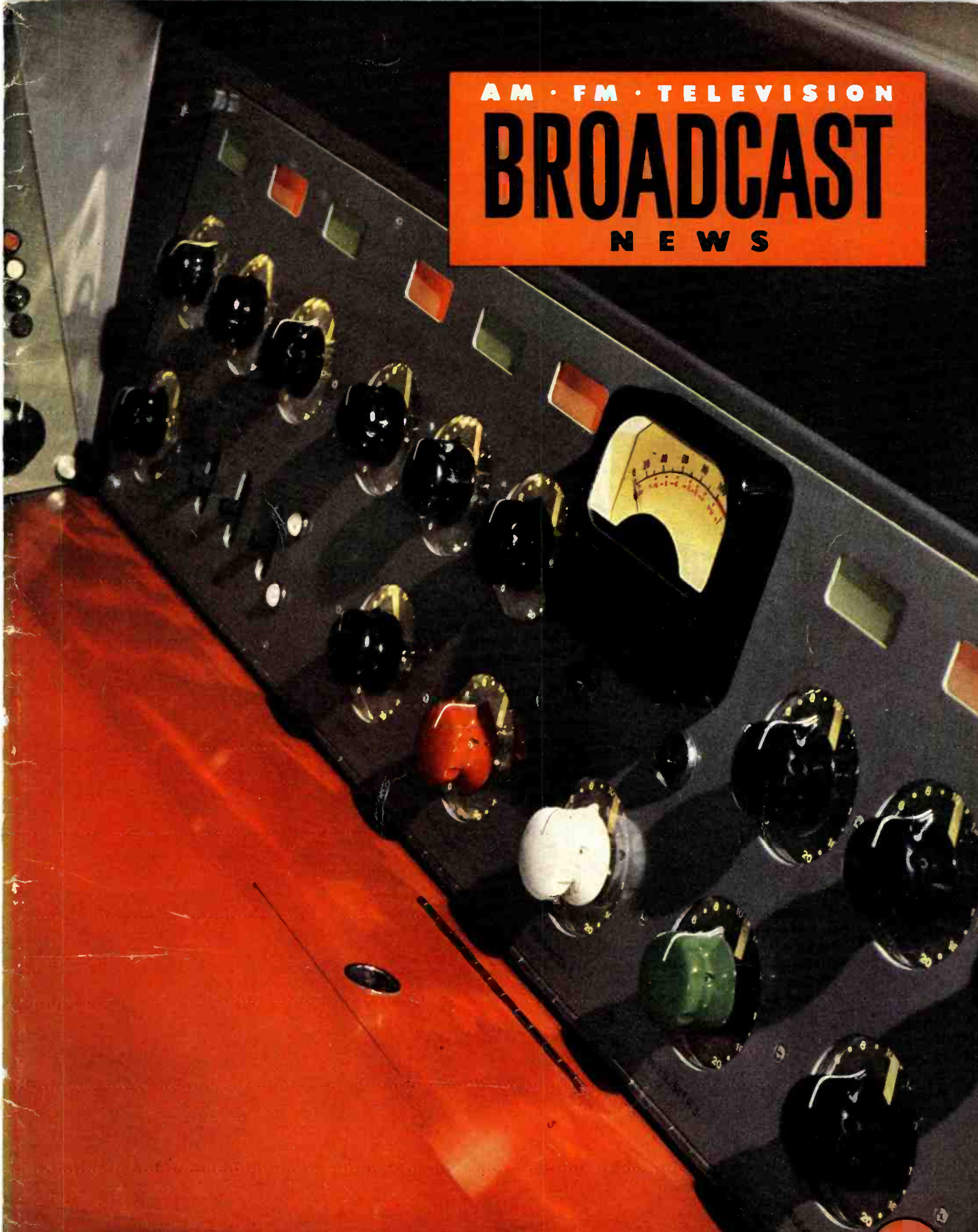

Combination TV Studio-Audio Consoles . . . Pg. 8

Vol. No. 69

May-June, 1952



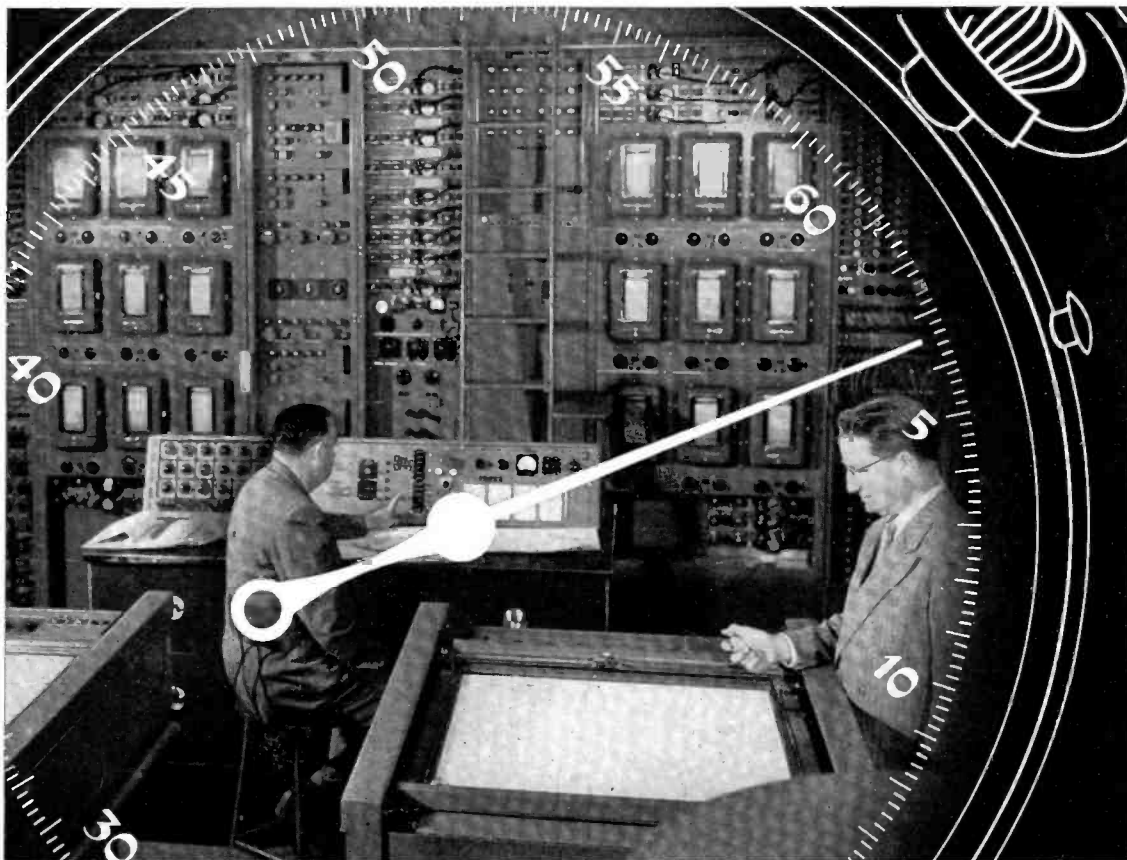

Control desk of electronic analog computer with two plotting tables on which the paths of the missile and target are plotted. Some of the panels containing thousands of electron tubes, in the background.

# Navy's "Electronic Brain"

**Solves complex design problems in seconds**



Scale model used to simulate the behavior of a guided missile under actual flight conditions.

THE world's largest and most accurate analog computer—designed and built by RCA for the U. S. Navy Air Development Center, Johnsville, Pa.—solves complex mathematical problems in a matter of seconds. The computer's "thinking" processes, which can be compared to the operation of a slide rule, employ some 4000 tubes and 600 high-speed relays.

In a typical guided missile design problem involving 250 additions, 67 multiplications, 30 integrations, and 20 aerodynamic functions, all carried on simultaneously with continuously variable factors—this giant "electronic brain" gave the so-

lution for an infinite number of points in less than 60 seconds. A mathematician and an assistant would require 6 months to compute a solution for a required minimum number of points to give an approximate answer.

This electronic analog computer will permit the U. S. Navy to evaluate the performance of guided missiles, ships, airplanes and submarines. It is another example of RCA's research, development, applied engineering, and field service activities which are providing our armed forces, on land, sea and in the air with better military equipment.



**RADIO CORPORATION of AMERICA**  
ENGINEERING PRODUCTS DEPARTMENT CAMDEN, N. J.

# Broadcast News

AM • FM • TELEVISION

Published by the

RADIO CORPORATION OF AMERICA

ENGINEERING PRODUCTS DEPARTMENT . . . CAMDEN, NEW JERSEY

NUMBER 69

MAY-JUNE, 1952

### Subscription Rates

In continental U. S. A. - \$4.00 for 12 issues  
In other countries - - - \$5.00 for 12 issues

JOHN P. TAYLOR, Editor

W. O. HADLOCK, Managing Editor

M. L. GASKILL, E. C. MASON, Associate Editors

## Contents

OPERATION VAGABOND . . . . .	4
INTERNATIONAL TV . . . . . by MEADE BRUNET	6
A DELUXE TV-AUDIO CONSOLE CUSTOM BUILT BY RCA FOR NBC STUDIOS . . . . . by ROBERT W. BYLOFF	8
TV FACILITIES FOR NBC HOLLYWOOD STUDIO "D" . . . . .	13
NBC CONVERTS EL CAPITAN FOR TV THEATRE . . . . .	20
CONSIDERATIONS IN THE EARLY PLANNING OF TV STATIONS . . . . . by J. HEROLD	24
HOW TO HANDLE FILM IN YOUR TV STATION . . . . . by W. L. MURRAY	38
PATTERN-TESTING THE TFU-24B UHF ANTENNA . . . . . by E. H. SHIVELY	42
NEW EQUIPMENT FEATURES RCA's NARTB SHOWING . . . . . by W. O. HADLOCK	52
TELEvised FILMS . . . A Review of Current and Proposed Methods . . . . . by P. J. HERBST	56
MEN ON THE WAY UP . . . . . by E. C. MASON	64
MUSICAL ENGINEERING, Book Review . . . . .	66
RADIO ANTENNA ENGINEERING, Book Review . . . . .	66

Copyright 1952  
Radio Corporation of America  
RCA Victor Division  
Camden, N. J.

PRINTED  
IN  
U.S.A.

**OUR COVER**, this issue, is a closeup of the very fancy "audio console for TV" which our engineers have designed and built (according to NBC engineers' specifications) for the newest NBC television studios. The features of this console are described in the article by Bob Byloff, starting on Pg. 8. Illustrations showing these consoles installed in NBC's newest West Coast studios are part of the immediately following stories.

The Kodachrome from which the cover illustration was reproduced was made by Rod Allen of our own photographic department. Which reminds us, to remind you, that we are (as always) looking for good color shots for our cover. But please, no 35mm (they're too difficult to reproduce). We must have 3 x 4 or larger.

**NARTB CONVENTION**, that is, RCA's part in it, is reported on Pg. 52. For those of you who weren't there, we can sum up the technical part of the convention in three words, "Television, it's wonderful!" This is not too surprising. For several years now, TV has been getting a larger and larger share of the attention—Neal McNaughten's laudable efforts to keep a "balanced" program notwithstanding. This year Neal stopped trying to stem the tide, and as a result all of the papers presented at the Engineering Conference were on TV.

The exhibits too were mostly TV. Is this bad? We don't think so. It does not mean that we have lost interest or confidence in radio! It simply recognizes that engineers are most interested in the new, the advanced . . . the future. And for most broadcast engineers the future is TV. It seems to us only natural that they are anxious to learn more about it.

**CONVENTION RETROSPECT**. Always the NARTB Convention is for us the busiest time of the year. Getting forty to fifty thousand pounds of equipment, worth upwards of a half million dollars, shipped to Chicago set up, and operating is no mean task. And after we get it set up comes the back-breaking job of demonstrating it for several thousand eager beavers. Usually we come back in a daze. But occasionally something stands out through the blur, remembered in spite of the confusion. For me, this year, it was young Dwight Clark, Jr.'s ringing presentation of "I Speak For Democracy". At a time of steadily increasing regimentation, of censorship, and of do-gooders proposing to give the people programs that are good for them (instead of what they want) it seemed to me that he rang a bell for true liberalism with his quotation from Dr. Harry Emerson Fosdick:

*"Democracy is based on the conviction that there are extraordinary possibilities in ordinary people."*

**I SPEAK FOR DEMOCRACY** was the title of the five-minute talk prepared by over a million high school students in this year's Voice of Democracy Contest. Dwight Clark, Jr., of Ft. Collins (Colorado) High School was one of the four co-equal national winners. That he should have been chosen to present his entry before the NARTB was natural—for Dwight is a part time announcer at KCOL.

The Voice of Democracy Contest, now in its fifth year, is sponsored by the RTMA, the NARTB, and the U. S. Junior Chamber of Commerce. Bob Richards, of NARTB, is Chairman of the Committee.

**INTERNATIONAL TV**—More about the future of TV and its growth on an International scale (see story by Meade Brunet, Pg. 6). Latin America alone can point to nine television transmitters in operation or contracted for by RCA International. Four countries now have regular Telecasting schedules. And, as we go to press, two more are preparing to join the Television scene—The Ministry of Communications of the Venezuelan Government with an RCA 10-KW TV Transmitter—and Radio Station KCU, Hawaii, also with an RCA 10-KW TV Transmitter.

# WBAP-TV

**RCA EQUIPPED**

## The Fort Worth Star-Telegram Station

WBAP-TV's PLANT is one of the largest and finest in the country. Its facilities are unmatched in its area. The pioneer station in the Southwest—in TV as in AM—WBAP has established an enviable reputation for leadership in programming, production, and prestige.

The Star-Telegram backs its No. 1 position by using the very best of equipment throughout its whole plant. Like other leaders in TV, it has found that by doing so it ensures, not only top performance, but also its position

of prestige with advertisers and the public.

Naturally we are proud that for more than fifteen years the Fort Worth Star-Telegram has used RCA equipment almost exclusively—not only in its TV operations, but also in its AM, and FM stations.

When YOU plan TV... or add facilities to your present station... follow the choice of America's leading stations. Go RCA! Your Sales Representative can show you *exactly* what you will need to do the job—at lowest cost.



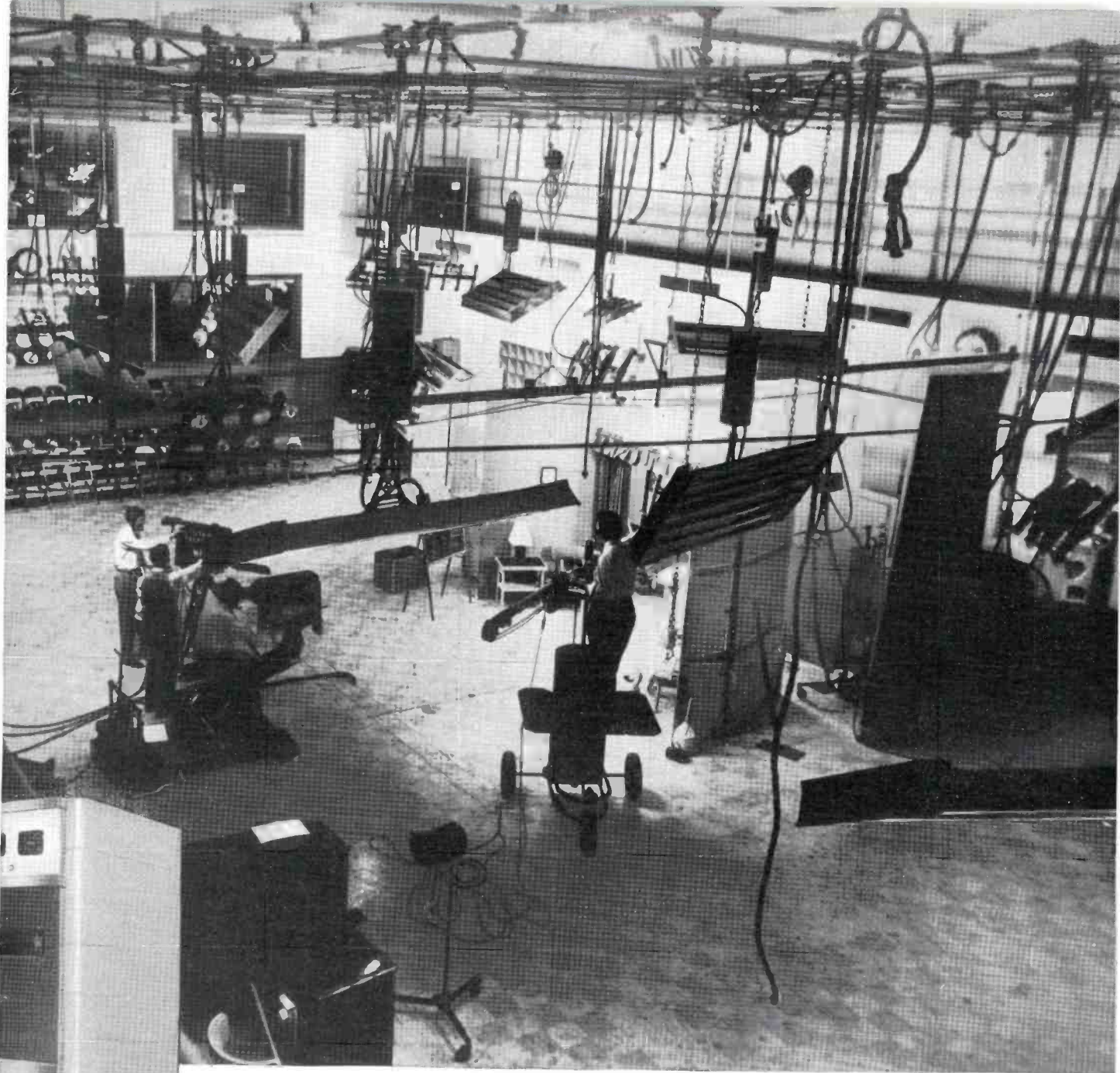

Transmitter room — complete with RCA control console, antenna diplexer, side-band filter, dummy load, and a 5-kw TV transmitter Type TT-5A.

Big enough to march a circus through it, WBAP-TV's studio No. 1 has housed elephants, trucks, fire engines, the famous Budweiser horse-and-wagon team, sailboats, and air gliders. WBAP-TV shoots big events—direct! Studio One is RCA-equipped with cameras, microphones, dollies, booms, mounts—lighting system!



**RADIO CORPORATION of AMERICA**  
ENGINEERING PRODUCTS DEPARTMENT  
CAMDEN, N. J.

# Operation Vagabond

## RCA 150 KW TRANSMITTER INSTALLED ON THE "COURIER"

The U. S. Coast Guard Cutter "Courier", the State Department's first seaborne radio station, has recently sounded its mighty 150 KW voice as the new sea arm addition to the vast Voice of America network. The "Courier"—first in a proposed series of broadcast ships—was developed under a project known as "Operation Vagabond", one phase of a State Department plan to open new listening areas to Voice of America broadcasts which include more than 120 separate programs daily in 45 languages.

Aboard the "Courier" is a giant 150 KW transmitter purchased by the State Department's International Broadcasting Division from the RCA International Division. The floating transmitter development provides maximum mobility and 24-hour all-weather operation. Scheduled to relay Voice of America programs while anchored at undisclosed locations, the "Courier" is also



U. S. Coast Guard Official Photo

FIG. 1. The Coast Guard Cutter "Courier" carries an RCA 150-KW Medium Wave Transmitter in her hold. The 338-foot, 5,800 ton ship is diesel-powered.

fully equipped to originate its own programs, broadcasting from the open seas, should such operations become expedient.

Below decks is the heart of the "Truth Ship"—its RCA 150,000 watt medium wave transmitter, shock mounted on a plinth of reinforced concrete which in turn is mounted on a thick layer of cork. For operations at sea, this transmitter

works into a non-directional antenna which is supported by a large helium filled balloon but may also use land-based antennas for transmissions in port. The transmitter, RCA type BTA-150A, is designed for AM operation in the standard broadcast band of 540 to 1600 kc and is constructed in three basic sections including a 3-KW exciter unit, a 15-KW intermediate power amplifier section and the 150-KW final amplifier.

Broadband transformer neutralizing is provided in radio-frequency amplifiers equipped with triode tubes to the 3-KW power level. Inductive neutralizing is used in the higher power stages. Tuning of the lower power amplifiers is accomplished by means of variable inductors in combination with fixed mica capacitors. Fixed tapped inductors, in combination with gas pressurized variable capacitors, are used for tuning the final amplifier and its driver. A high-level modulation system, using a Class B modulator, is employed in the transmitter. Motor driven tuning elements which are remotely controlled by switches located on the front panel are used for normal daily tuning adjustments during operation. A carefully engineered control system is provided to assure proper starting sequence and automatic protection for such faults as air, water, or tube failures.

Another hold below decks in the "Courier" houses diesel engines capable of generating 1,500,000 watts of electrical power for the big transmitter and for two smaller transmitters and accompanying communications equipment.



FIG. 2. This helium-filled balloon carries the antenna for the RCA 150-KW transmitter 1000 feet into the air.

U. S. Coast Guard  
Official Photo

The non-directional antenna is carried 1000 feet into the air by a 69 x 35-foot helium filled barrage balloon. A 100-foot flight deck amidships provides launching space for the balloon, and a winch under this deck spools the balloon cables in and out.

The diesel-powered U. S. Coast Guard Cutter, "Courier", a 5,800 ton, 338 feet, converted Navy cargo vessel was commissioned on February 15, 1952. A carefully screened Coast Guard crew of 80 men, including 10 officers with technical training in radio, form the operating complement under the leadership of Captain Oscar Wev, U.S.C.G., of Richmond, Virginia, the commanding officer of the "Courier". Top flight Voice of America engineers supervise the operation of the transmitting equipment.

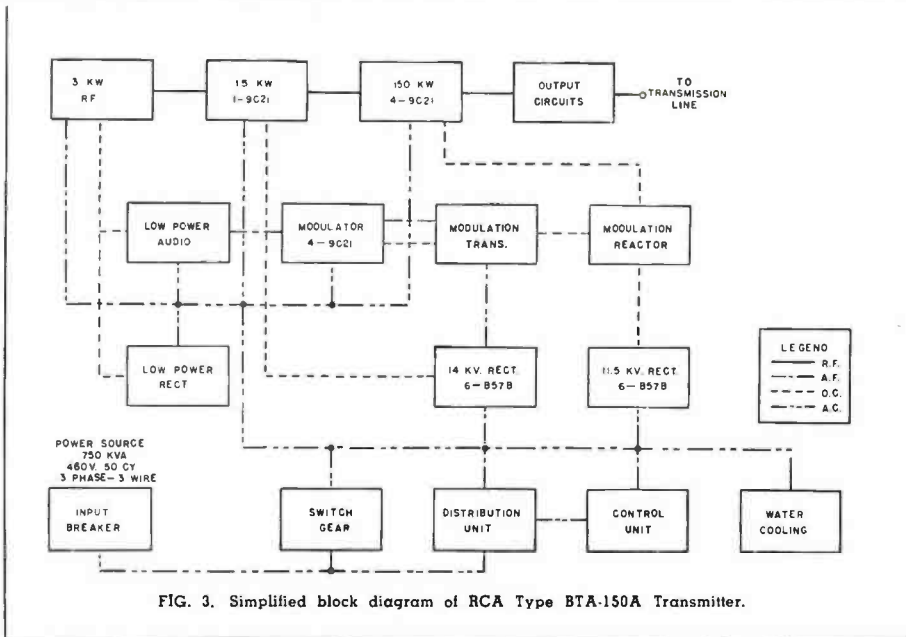

FIG. 3. Simplified block diagram of RCA Type BTA-150A Transmitter.



U. S. Coast Guard Official Photo

FIG. 4. The master control console is shown in the center foreground. The racks on the sides house control and test equipment.

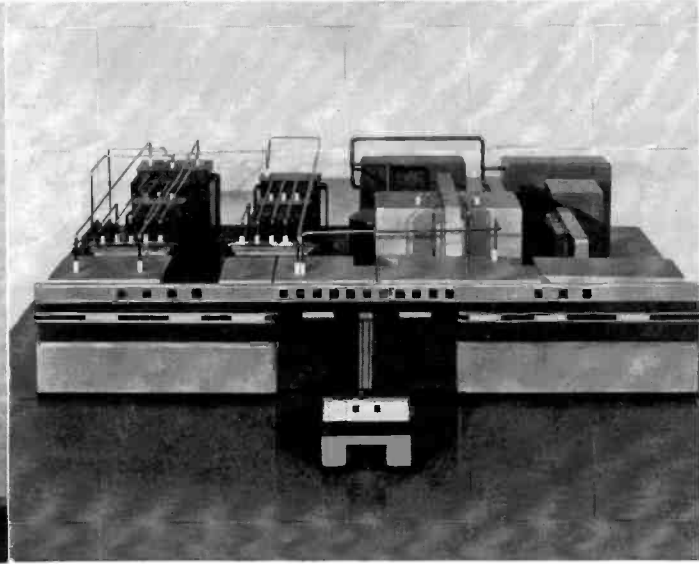

FIG. 5. A scale model of the Truth Ship transmitter showing a typical installation.

FIG. 6. U. S. Coast Guard crewmen on the 100-foot flight deck carefully prepare to send the balloon aloft.

U. S. Coast Guard Official Photo

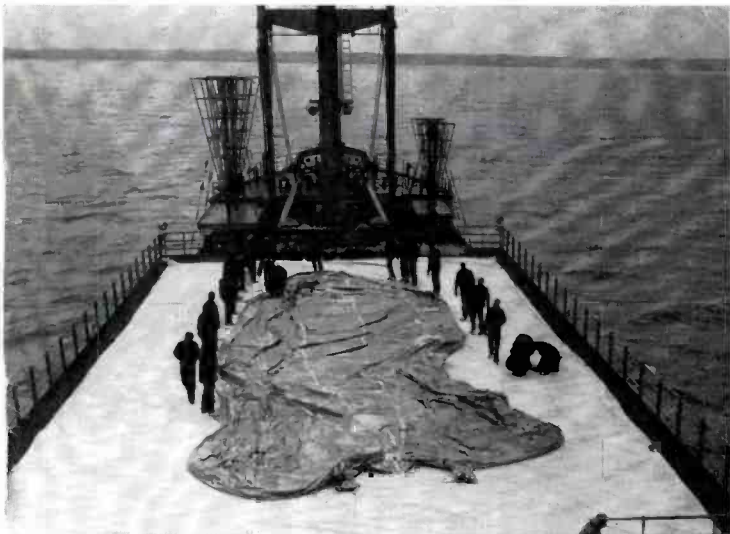

FIG. 7. Antenna attached, the 69 x 35-foot balloon is ready for release. The balloon holds 150,000 cubic feet of helium.

U. S. Coast Guard Official Photo



# INTERNATIONAL TV

*A project of achievement linking vast geographical areas together*

The continued expansion of world wide communication facilities includes TV planning of a rather crucial nature and imposes upon nations in Asia, the Middle East, South Africa, Europe and the Western Hemisphere the responsibility of developing a practical, universal, common Television standard, leading to the development of an international network for the exchange of television programs.

Growing strides of International Television have carried this new medium across national borders introducing it to many new fields of service. At home and abroad, national groups are being linked together through telecasts of timely topics carrying messages of common interest.

## TV Planning Abroad

In Japan, Thailand, Burma, Pakistan, India, Indonesia and other Asiatic countries where preparations for television are being made, challenges and ideological menaces could be more adequately met through the establishment of common television standards. The next step for Radio Istanbul—Turkey's powerful voice in the Middle East—is TV. The possibility of a Middle East and Mediterranean television network in the future is realistic, but uniform telecasting standards must be decided upon before such a network can evolve.

## by MEADE BRUNET

Vice-Pres., Radio Corporation of America  
and Managing Director of  
RCA International Division

England, though well established in telecasting, is limited to one program only, while France conducts TV programs on an experimental basis. European countries including Spain, Italy, Belgium, Germany, the Scandinavian countries and others have been hosts to TV demonstrations and, in some instances, are carrying out tests under supervision of their communication engineers. Plans have been announced for TV in Italy in 1952.

Latin American television has shown rapid growth—with nine television transmitters having been equipped or contracted for by the RCA International Division by the end of 1951. Mexico, Cuba, Brazil and Argentina are currently telecasting regularly while Chile, Peru, Colombia, Venezuela, Uruguay and Puerto Rico are close to adding TV to their own broadcasting facilities. TV construction is currently under way in the Dominican Republic.

So that International Television can be established and fully utilized not only as a means of entertainment, but also as an instrument of education and as an important aid to enlightenment to achieve world peace, decisions must be carefully weighed



FIG. 1. Meade Brunet.

and efforts extended to attempt to establish a workable world-wide common standard system.

## The Problem of Different Standards

British TV operates on 405 lines, 50 fields and the French system is 819 lines, 50 fields. The U. S. standards are 525 lines, 60 fields. While these systems produce satisfactory results within the individual countries, direct exchange of programs is not possible because of technical differences.

Brazil's power systems, varying from area to area, from 50 cycles to 60 cycles have raised difficult problems for television. The Rio TV system, supplied with power at 46 to 50 cycles, uses 625 lines, 50 fields; while in Sao Paulo, where the power supplied is 56 to 60 cycles, the system used is 525 lines, 60 fields. Thus networking within Brazil is impossible, but a solution to the problem is near at hand with the changing of Rio standards to 525 lines, 60 fields.

Argentina's power supply is nominally 50 cycles and it uses the European stand-



FIG. 2. The Dominican Republic joins the march of international television, as Colonel J. Arismendi Trujillo Molina, president of "La Voz Dominicana", signs a contract for an RCA 5,000 watt TV Transmitter.





FIG. 3. Union Radio TV studio facilities are the originating point of Cuba's popular "Foto-Crimen" mystery series. This program won top honors for writing, directing, camera work and programming.

ards of 625 lines, 50 fields. From Canada to Argentina on the East Coast and from Canada to Chile on the West Coast, possibilities of hemisphere unity—through TV—are being studied. Uruguay is faced with the very important decision of whether to adopt Western Hemisphere standards or European standards. Current television decisions are vital to the future life of this new medium of International Television. Farsighted planning can bring tremendous contributions toward educational and political advancement through the interplay by television of social, cultural and other humanitarian aspects of life. Such unity among the Americas, as well as other parts of the world, can only be achieved through the use of uniform television standards.

#### A Solution to the Standards Problem

Because they represent a good balance of technical and economic performance and have been proved satisfactory by a very extensive experience, it is felt that American television standards offer the best solution for universal adoption. Nearly sixteen million television homes have enthusiastically approved the 107 television stations operating in the United States. Both artistic and technical experience has been gained through comprehensive TV applications which have regularly crossed and recrossed a continent—a distance of 3500 miles—weaving a video network from coast to coast.

This vast experience has proved the basic correctness of the 525 line, 60 field

American television standard for public service. Popular acceptance of Mexican, Cuban and Brazilian television broadcasting, using the same standards, has also been indicated. Canada, the Dominican Republic, and Colombia are soon to enter active telecasting using these standards.

#### International Networks — A Reality

International exchange of television programs on a grand scale will very probably become one of the great achievements of the Twentieth Century. Today, it is technically and economically feasible to link vast geographical areas together by television. Television program exchange throughout the length and breadth of the Western Hemisphere, or throughout Europe or Asia is now made practical by radio relays.

RCA pioneered non-synchronous reception, unaffected by power frequency or voltage fluctuation, will aid many countries where the power frequency varies more than one per cent. Because there is no known method of directly converting from one standard to another except by the slow and expensive method of recording the program on cinema films, the only barrier to these international networks will be the adoption of different operating television standards by different countries.

International Television is more than a dream. Though its coming can be impeded and delayed, its realization is as inevitable as was international telephony and telegraphy. However, the advent of TV relays around the world also permit a vast improvement in long-distance telephone and telegraph services which are easily carried over the same radio-relay systems that will carry TV programs.

FIG. 4. ECA, in cooperation with the U. S. High Command of Germany sponsored RCA's recent two-week TV demonstration in West Berlin. A 500 watt VHF TV transmitter was used to carry television action to over a million Germans.

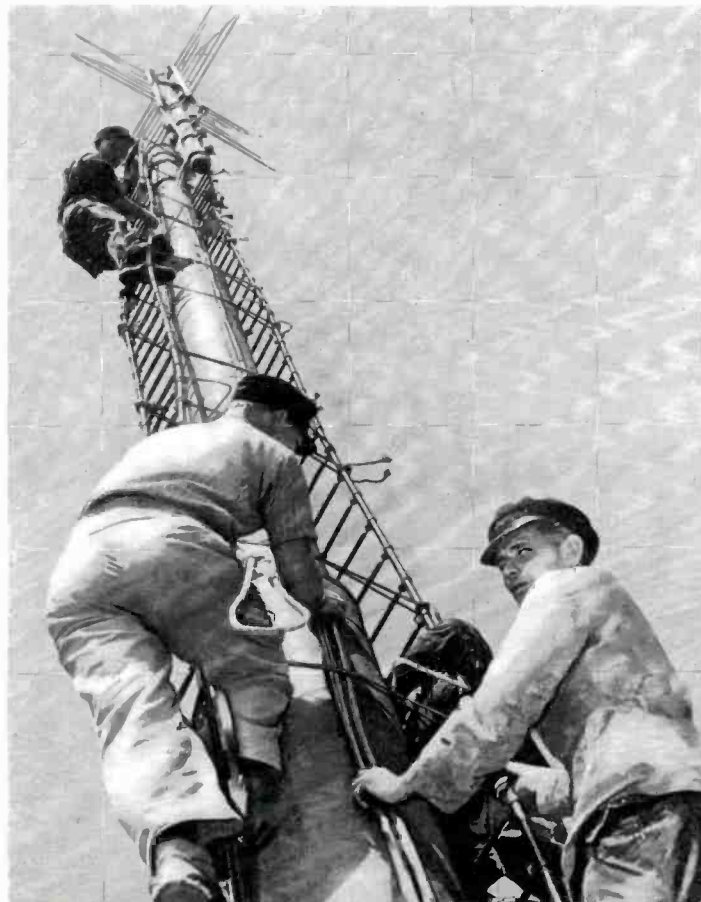



FIG. 1. Front view of the Combination Video/Audio Console which has already been installed in several TV studios.

## A DELUXE TV-AUDIO CONSOLE CUSTOM BUILT BY RCA FOR NBC STUDIOS

By

**ROBERT W. BYLOFF**

Engineering Department, WNBT  
NBC Inc., New York

As the size and complexity of television studio productions have grown, it has become obvious that a studio audio system specifically designed for television was needed. Such a system had to incorporate not only the special facilities demanded by television but, at the same time, in the interests of standardization, it was necessary that it be equally usable for radio production. This last requirement was given added importance when it became the practice to use the same program simultaneously for television and sound radio.

An investigation of the requirements of such a studio audio system disclosed that it must be more flexible and larger than one to be used for sound broadcasting alone. Specifically, the investigation showed that the system must include more fader positions, more facilities for combining or mastering these faders, a simple way of handling program sources (nemos) outside the studio, special equalization to compensate for unavoidably poor microphone placement, a switching system for special

effects filters, special control lighting and indexing, automatic gain control, and provision for built-in video monitoring.

A system, designed from these requirements and described herein, has been built by RCA and is installed in several new television studios. Among these are New Studio D and the El Capitan Theatre, Hollywood, originating point for NBC's television network.

### Mechanical Features

The principles used in the mechanical design of the console were as follows:

1. The console to be as small as possible in all dimensions to allow its use in the normally crowded spaces allotted to television control rooms, and to allow good visibility over the console.
2. All controls to be within easy reach.
3. Space to be provided for a script or cue sheet.
4. Primary operating controls to be on the front panel and properly indexed, and secondary and preset controls to be on the side panels.
5. Space to be provided for five video monitors in the console, since video monitoring for the audio operator is essential in keeping the microphone boom out of the picture.
6. The video monitor portion to be attachable as a separate item to allow use of the console in radio studios or any locations not requiring picture monitoring.
7. The console equipment to be accessible for maintenance from the front of the console to the extent necessary to provide maximum flexibility of console location in the control booth.
8. All equipment, not requiring manipulation by the operator, to be mounted elsewhere to save operating space and to permit easy maintenance.

Fig. 1 is a view of the console. The unit as shown is 66 inches long, 36 inches deep, and 41 inches high. Without the video monitoring portion, the depth is reduced to 23 inches and the height toward the front to 36 inches. The distance from the center of one side panel to the other is 45 inches, which permits easy reach to either side. The desk top is wide enough to allow legal size sheets of paper, which is normal script size, to be placed on it without overhang. The sloping portions of the top allow the panels to be set down and thus reduce overall height. This feature also allows the operator's hands to reach the top controls on the front panel more comfortably. On the right side of the desk top is a sliding panel which covers a well in which the microphone preamplifier inputs appear on drop cords. These drop cords (similar to telephone switchboard cords) are used for microphone selection, and can be patched into the microphone receptacle jacks in the jackfield directly above the well.

The front panel, sloped at 20 degrees from vertical for maximum operating ease, has in its top row of controls 12 microphone faders. The center group of controls in the lower row are the red, white, and green submaster faders, a studio master fader and a remote master fader. These submaster

faders are color coded to provide a convenient visual tie-in with fader assignments as described below. The controls on the ends of the panel are for studio playback and reverberation. All faders on the front panel have dials, which are illuminated when they are in use. Each dial is calibrated and, in addition, contains an illuminated pointer enabling the operator to tell at a glance the position of the fader. Above each microphone fader is a translucent window which lights up red, white, or green depending on whether the fader is assigned to be mastered by the red, white, or green submaster. The window is dark when the fader is unassigned. The surface of the window is roughened to allow the operator to pencil and erase any supplementary information he wishes on it. He may, for example, write "orchestra" or "cast" or "boom" on these windows, and the light behind the window makes this writing show up in the darkened control room. Thus these windows indicate to the operator whether or not the fader is connected, the submaster to which it is connected, and any other information about that channel he may wish to indicate. Lever keys on the front panel select remote programs, sound preview remote programs, control sound effects filter, and do auxiliary switching. An illuminated volume indicator in the cen-

ter of the panel shows the volume level on the output of the system.

The right side panel contains a jackfield for patching up effects, equalizers, microphones, and other program sources and for emergencies. This panel also contains equalizer controls for microphone equalization, and a control for the selection of limiting or compression in the program amplifier.

The left side panel at the top contains four microphone faders in a separate four position auxiliary mixer which is used for audience reaction and is normally preset. Controls for monitoring and sound effects filter frequency response and gain are contained at the bottom of the panel. In the center of the panel are push buttons, for assigning faders to submasters. There are four buttons for each fader: a red, a white, a green, and a black one for "off". Pressing the red button for fader 1, for example, connects it to the red submaster and lights up the indicator window above fader 1 in red. Another set of push buttons on this panel is used for effects switching as described below.

The housing attached to the back of the console allows five 10-inch video monitors, set on dollies with their kinescope faces up, to be placed in the console. These kine-

FIG. 2. Simplified block diagram showing the overall system operation.

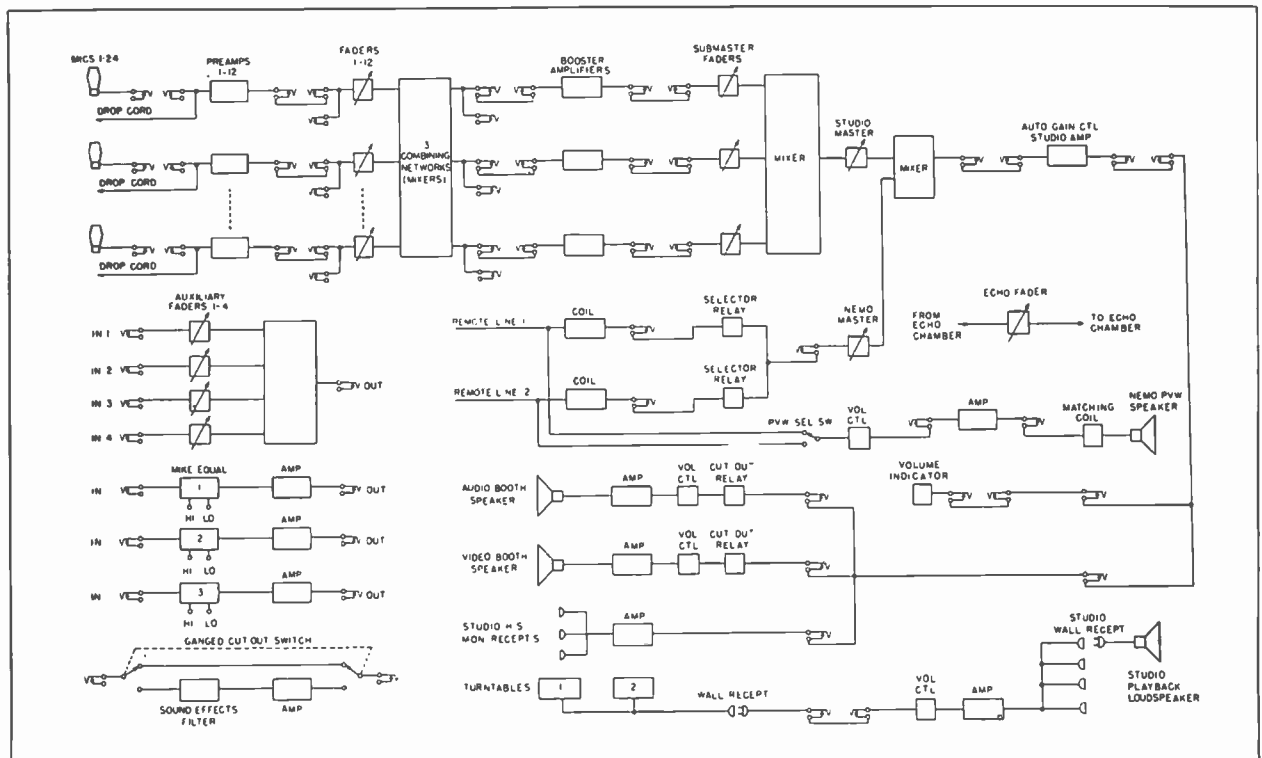

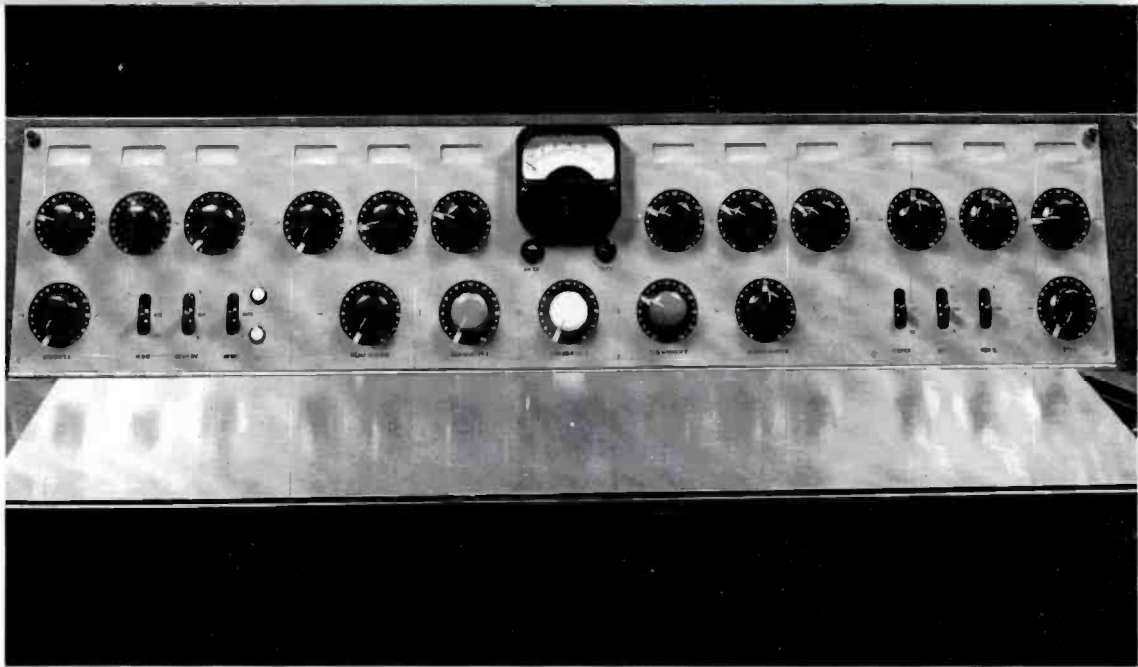

FIG. 3. Closeup of Console Front Panel which employs vari-colored knobs, lights and switches for the quick identity of key functions.

scopes are viewed by reflection from a front surfaced mirror set in the housing. These monitors enable the audio operator on a television program to observe the outputs of all of the cameras and also the program leaving the studio. This is particularly important to him from the standpoint of keeping the mike out of the picture. The housing is completely independent of the rest of the console and may be removed if not required.

The three panels inside the kneehole of the console are removable for maintenance of the equipment. The front panel is hinged and drops forward; the side panels are removable with thumb screws.

The jackfield located in rack equipment is used primarily for maintenance check-

ing. The racks contain preamplifiers, boosters, power supplies, relays, and monitoring amplifiers for the system.

#### Electrical Features

Fig. 2 shows a simplified block diagram of the over-all system. No attempt has been made in this drawing to show specific circuit components, which are known to anyone familiar with audio practices.

Twenty-four microphone outlets are available at the console, and may be connected to the twelve preamplifier inputs by drop cords. These sources are then normalised through preamplifiers to the twelve regular faders. A push button control system as described previously at the fader outputs enables each fader to be connected to any of three mixers. The reason for having three mixers is to permit mas-

tering in three groups. This grouping reduces the need for individual fader manipulation and confines much of the operator's attention to three controls. The outputs of these mixers, following amplification are connected to the three submaster faders. The outputs of the submasters are then mixed and routed to the studio master fader. The studio master fader output is mixed with a nemo (or remote) master output which in turn goes to the studio amplifier to bring the program level to studio bus level, or to line level if the output is to feed telephone lines. The studio amplifier is a special automatic gain control amplifier with selection of either limiting or compression characteristics. The characteristic to be used is selected by the audio operator by means of a key at the console. One of the advantages of an amplifier of

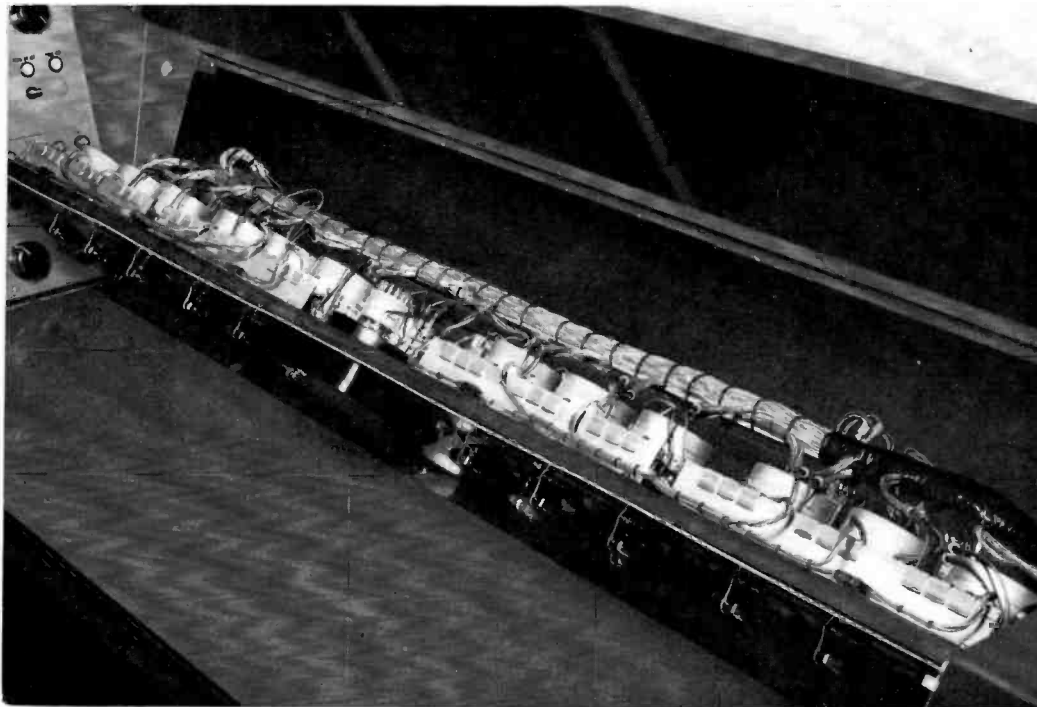

FIG. 4. The front panel tilts forward for quick access to components and wiring.

this type in the system is that it permits greater latitude in gain settings and thus assists the operator in that respect on a program.

The input of the nemo master fader comes from selector relays, which choose one of two remote program inputs which are sent to the studio by the transmission section of the studio plant. Selection of the proper nemo program is made either by the audio engineer with a key at his position or, if he desires, it may be accomplished by the picture switcher. When this set-up is used, audio and video switching to remote programs is done together automatically. Having the nemo master fader and studio master in parallel enables the audio operator to fade out his studio program and fade in the remote program with these two knobs alone. This feature is desirable particularly for commercial film insertions in a studio program.

Bridges are taken off the remote lines as they enter the studio system and are brought to a key for selection. The selected program is then amplified and sent to a small loudspeaker so that the audio man may listen to the remote program on a preview speaker before he puts it on the air.

Two turntables are usually provided in television studios for bridge music, themes, and actions where a voice intending to portray the thoughts of the actor is heard. These bits must be played back to the studio so that the actors may better know what is happening. In the console the turntable outputs are normalized to the input of the studio loudspeaker volume control which goes to a loudspeaker amplifier, the output of which is sent to outlets in the studio. A portable loudspeaker may be placed near the scene of the action and plugged into the nearest outlet. This placement enables low volume level on the loudspeaker and avoids excessive echo in the studio. Actual program from the turntables is connected to a program fader for transmission and control.

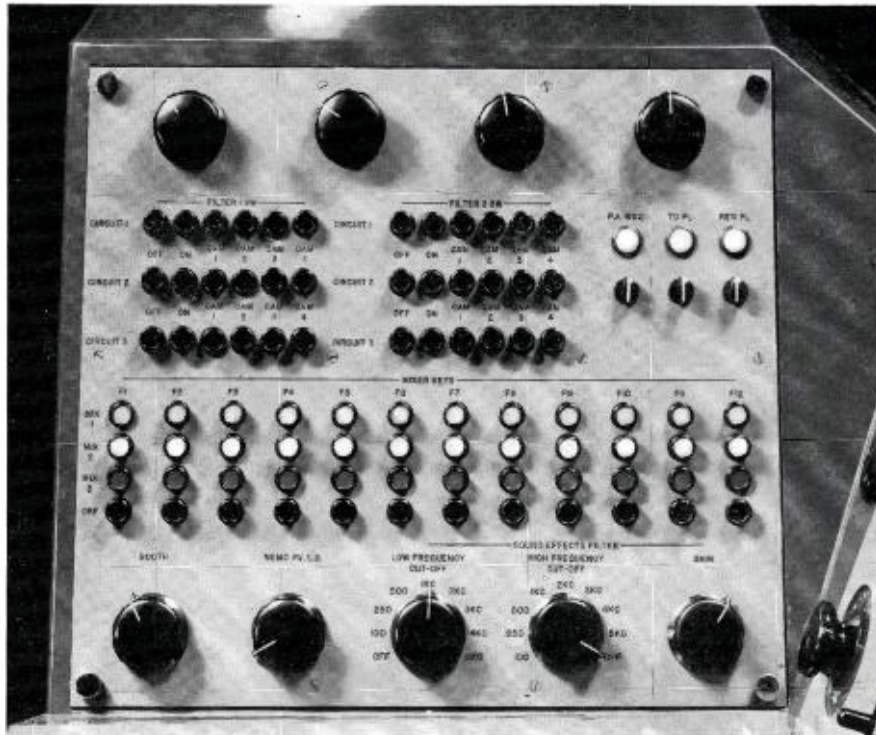

FIG. 5. Closeup of left-hand turret wing which accommodates sound effects control switching.

The auxiliary four-position mixer has four input jacks going to four faders. These fader outputs are combined and appear on a jack which may be used to patch this system to any console input. This mixer allows applause control of four microphones using only one regular fader position.

Monitoring feeds from the studio bus or line go to the console volume indicator, to the video and audio booth speaker amplifiers, and to a headset monitoring amplifier. The booth speaker amplifiers have cutoff relays on their inputs to avoid feedbacks when the studio address system in the control booth is used. The headset monitor amplifier output is fed to studio

receptacles for the use of sound effects technicians, orchestra leaders, and stage managers.

All equalizers and sound effects filters in the system are arranged for zero insertion loss by providing amplification in these circuits to compensate for filter losses. The three microphone equalizers have low- and high-frequency control and are on jacks, so that they may be connected to any microphone channel desired. The sound effects filter has a by-pass switch around it, so that it may be inserted on cue, and a gain control to compensate for different settings of the filter.

The effects switching system is shown in Fig. 6. This is a relay switching system with three inputs and three outputs. If three microphone channels are connected through this system, they may each be connected, through operation of appropriate relays, to any effect required such as a sound effects filter, an echo chamber, or simply a volume control. This switching then allows an echo chamber, for example, to be inserted in different microphone channels during a program without repatching. In television audio work this facility is important because a special filter or echo microphone cannot be assigned for use by the actors as the program demands, and so these effects must be available on several

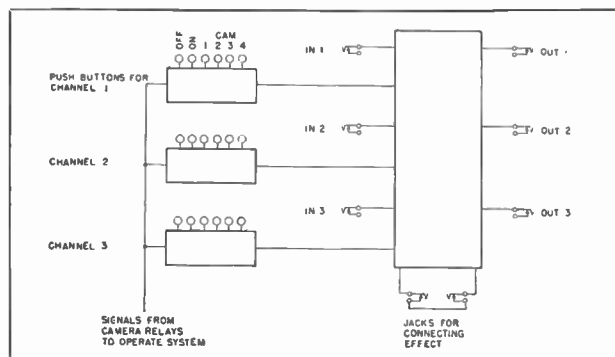

FIG. 6. Simplified diagram showing the operation of "effects" switching system.

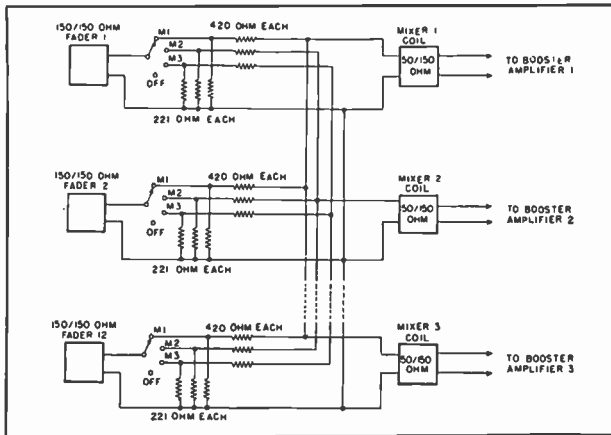

FIG. 7. Simplified sketch showing the mixing system employed in the console.

microphones. The system is also useful in telephone conversation effects where both ends of the conversation are shown with first one party on filter, and in the next instant, the other party on filter. Control of these relays is provided at the console. This control may be done either by the engineer at the console with simple on-off buttons or he may elect to tie the system to camera switching. If so, the filter switching is caused by the switching of cameras. A tally panel in the console shows the audio operator which camera is on the air.

In addition to the above facilities, the system contains contrast controls on the console for the video monitors, rack to console tie trunks, jack multiple strips, auxiliary isolation coils, talkback facilities to the studio address speaker and to the headphones of the boom operator, telephone facilities to other studios and to master control, and telephone facilities to other audio operator in the same studio. Multiple jacks on microphone channels are provided for connecting to an auxiliary public address system if the console is used in an audience studio. The provision allows for individual microphone public address, which has been found to be essential for television studio public address systems.

An unusual feature of the console is the microphone channel mixer. In the past when a split mixer was provided, it was necessary to have switching keys of complex configuration for connecting the microphone channel to one or the other mixer. This complexity was required because the mixer was a matched impedance system and whenever a fader was removed, a resistor of the same impedance had to be substituted for the fader in order to keep the same loss through the mixer. If the mixer must be split three ways, the complexity of the switching key becomes so great as to be impractical. Therefore, a bridging

mixer was employed. In this system, the series resistors going to the faders are large enough to keep the mixer from knowing whether a fader is connected or not. Ter-

FIG. 8. Complete and convenient jack facilities are provided on the right-hand turret of the console.

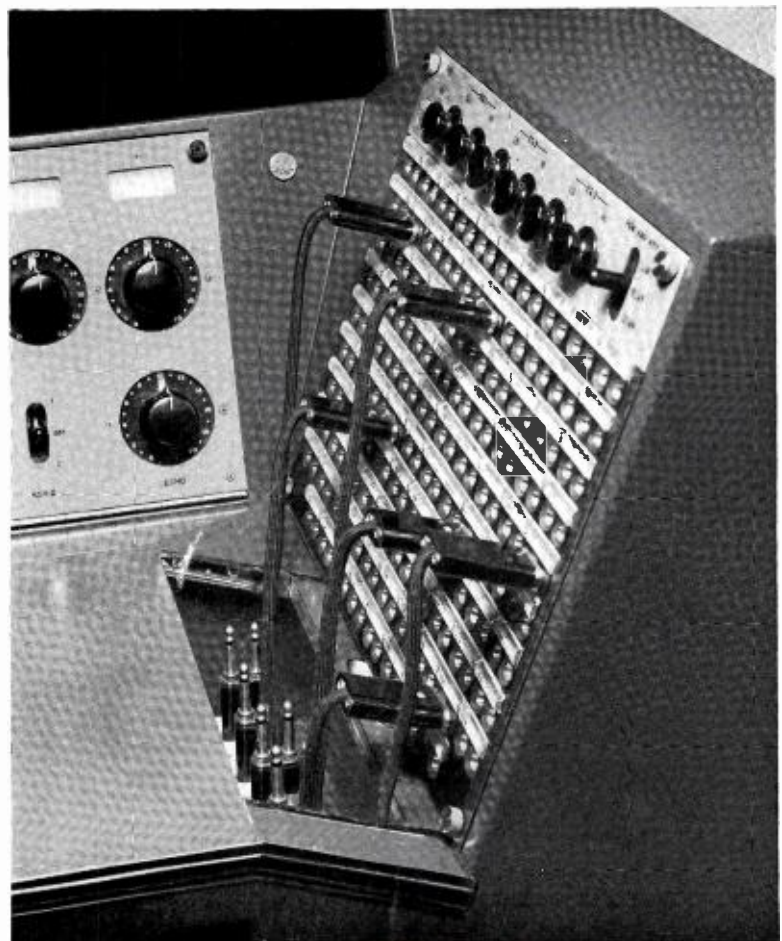

minating resistors are provided at each of the twelve inputs to terminate the faders properly. Some compromise must be made in this system to prevent excessive loss of level. The compromise agreed on was to allow a 2-decibel variation in mixer loss between the extremes of having one or twelve faders connected to the same mixer. With this compromise it was possible to design a mixing system with approximately 7 decibels more loss than in a conventional matched impedance mixer. This loss is easily made up in modern high-gain amplifiers. The mixing system employed is shown in Fig. 7.

#### Performance Data

Performance of the overall system is of interest. Frequency response is essentially flat from 30 to 15,000 cycles per second. Distortion at 10 decibels higher than normal level through the system is less than 0.5 per cent and the signal-to-noise ratio is 77 decibels below the level at which the distortion measurements were made.



FIG. 1. Operating space of Studio D stage area includes this recess into audience seating area which allows movement of cameras for stage or audience shots.

# TELEVISION FACILITIES FOR NBC HOLLYWOOD STUDIO D

*Deluxe Installation Includes Custom-Built Audio and Video Equipment, Latest Lighting Control Arrangements, Complete Intercom and PA Facilities*

Once used as the originating point for many Hollywood network radio programs, NBC's Studio D now includes facilities permitting its use in network productions for television. Specifically planned for the variety type of television program, the studio is designed and equipped as a small theatre, including complete production facilities normally associated with theatres. Custom audio and video control equipment is provided to assure adequate facilities for handling varied operations and a "studio-coordinating" communications system is

included to assure smooth production of shows. Studio D planning also incorporates two separate studio address systems as a solution to the "performer-audience" reaction problem peculiar to television variety show production.

## **Studio-Stage Area Lighting**

The studio's 50 x 45-foot working area includes a 50 x 32-foot stage area, as well as technical equipment operating space, on the stage level, to allow free move-

ment of equipment between these two areas. The stage area has been rigged with 26 counterweighted pipe battens controlled by rope sets from the stage level. Sixteen battens are used for production facilities while the ten remaining battens are utilized for rigging lighting equipment which includes four borderlights and six spotlight battens, eight stage ladders over the stage area, as well as three fixed spotlight battens rigged over the technical equipment area to provide front lighting for stage and audience shots.

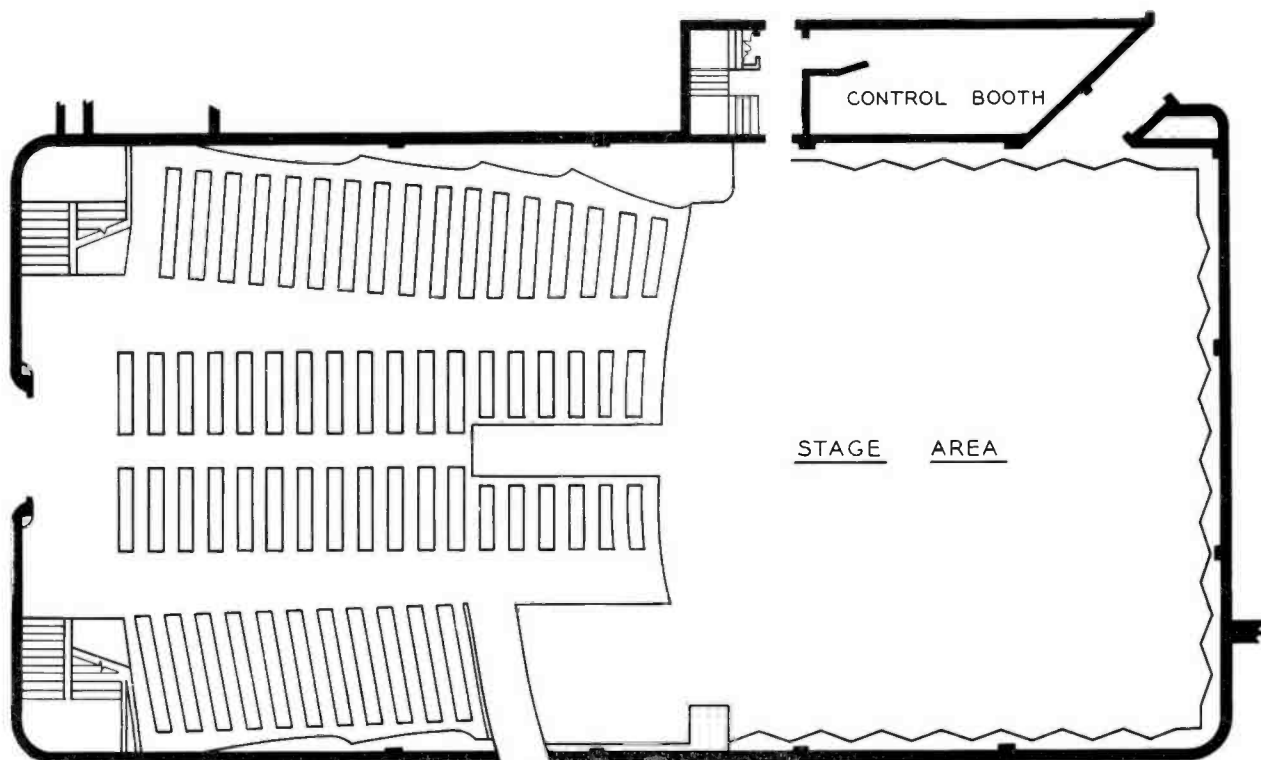

FIG. 2 (above). Shows the Studio D main floor plan. The control booth at stage right houses the video, audio and production control facilities. The 50' x 45' studio working area includes a 50' x 32' stage area. Operating space is at stage level to allow mobility of equipment between these areas.



FIG. 3 (left). The stage area of Studio D as seen from the center of the seating area. Note arrangement of lighting fixtures in overhead area.



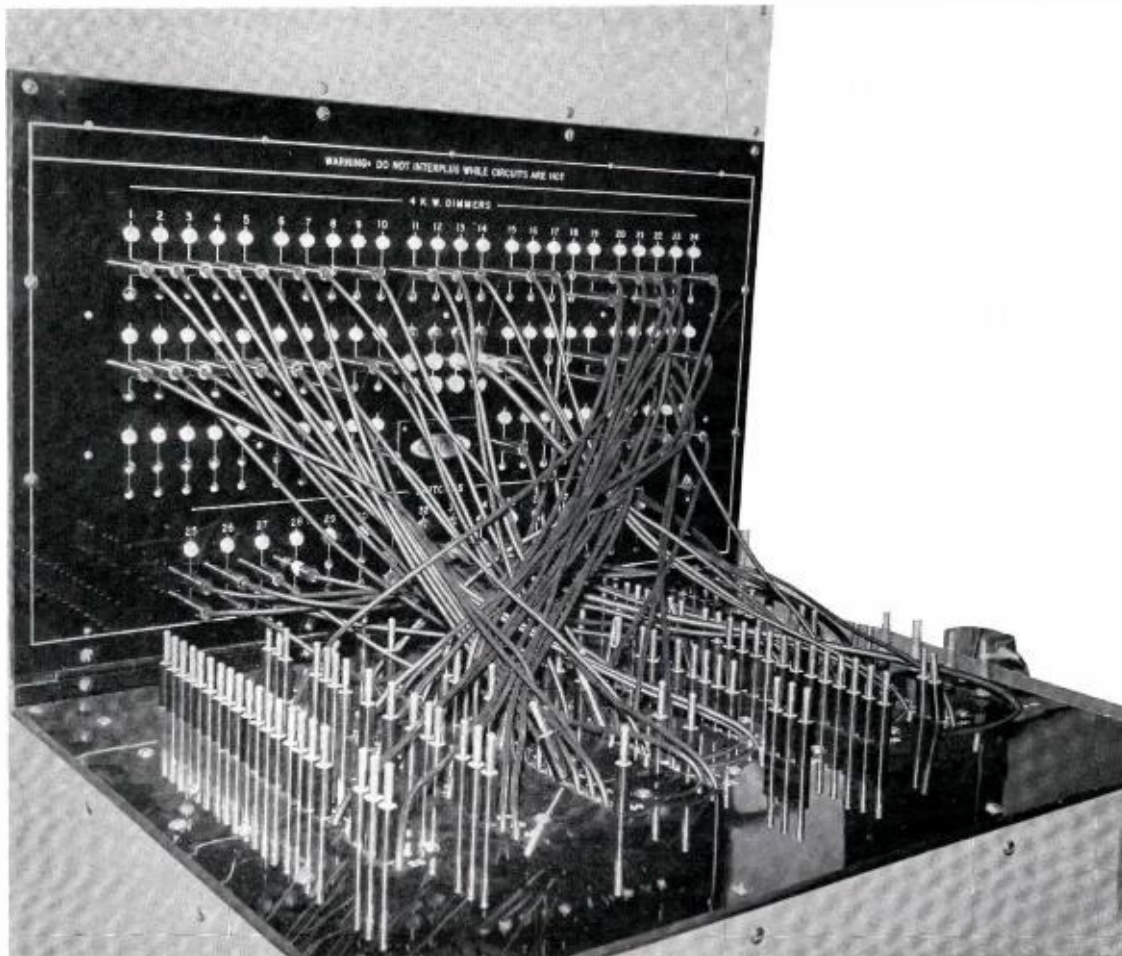

FIG. 4. Spotlight, ladder and stage circuits are patched by means of six-foot retractable patch cords. Neon indicator lamps are provided to prevent patching loads to hot circuits.

The desired lighting effects are easily achieved as the result of a complete lighting control system which includes a borderlight dimmer board and a spotlight, ladder and stage patching panel and dimmer board. Each of the six groups of thirteen fixtures which make up each borderlight are wired to a separate dimmer in the borderlight dimmer board. The board is designed to allow these individual dimmers to be mechanically interlocked for simultaneous dimming of all the groups on one borderlight by means of a single sub-master handle. Sub-master handles, one for each borderlight, can also be mechanically interlocked to permit simultaneous dimming of all borderlight circuits from a single master handle.

Spotlight, ladder and stage circuits terminate in a patching panel in the lighting control booth. Use of six-foot retractable patch cords permits patching of each cir-

cuit to any one of twenty-four 4-KW dimmers or sixteen disconnect switches in the stage dimmer board, which—like the ladder, stage and spotlight circuits—are terminated in jacks on the patching panel. Similar to the borderlight interlocking provisions, the dimmers on the stage dimmer board can also be interlocked to permit simultaneous dimming of all stage circuits. As a precaution against patching loads to hot circuits, neon indicator lamps are provided for each jack.

Studio lighting also includes twelve 20-ampere and ten 30-ampere floor circuits, at stage level, for use with floor lighting equipment. Two raised platforms at the rear of the audience section are used to accommodate two 2-KW Kliegl follow spotlights.

#### Audio-Video-Production Control

The heart of Studio D operations—the video, audio and production control facil-

ities—is the control booth located below the light control booth at stage right. In addition to standard RCA studio console equipment used to control the four camera video system, an RCA TM-5A Master Monitor is installed at the video control position with controls for a separate preview switching bus to enable the video engineer to adjust levels and match pictures of all cameras, using one monitor as a reference.

All video cables from the central television equipment room, as well as all cables to the stage and control booth monitor circuits, are terminated in a video patching panel, adjacent to the video console. Such use of a patch panel assures flexibility in monitoring facilities and also stands ready for repatching in the event of equipment failure.

The control and video relays and associated amplifiers which comprise the NBC

FIG. 5 (right). The Borderlight Dimmer Board. Mechanical interlocking allows simultaneous dimming of borderlight units. The Mezzanine Plan shown in FIG. 6 (middle) illustrates the lighting control equipment layout and is located above the main floor control booth. The Control Dimmer Board, seen in FIG. 7 (bottom), in a manner similar to the Borderlight Dimmer Board allows the simultaneous dimming of all stage circuits.

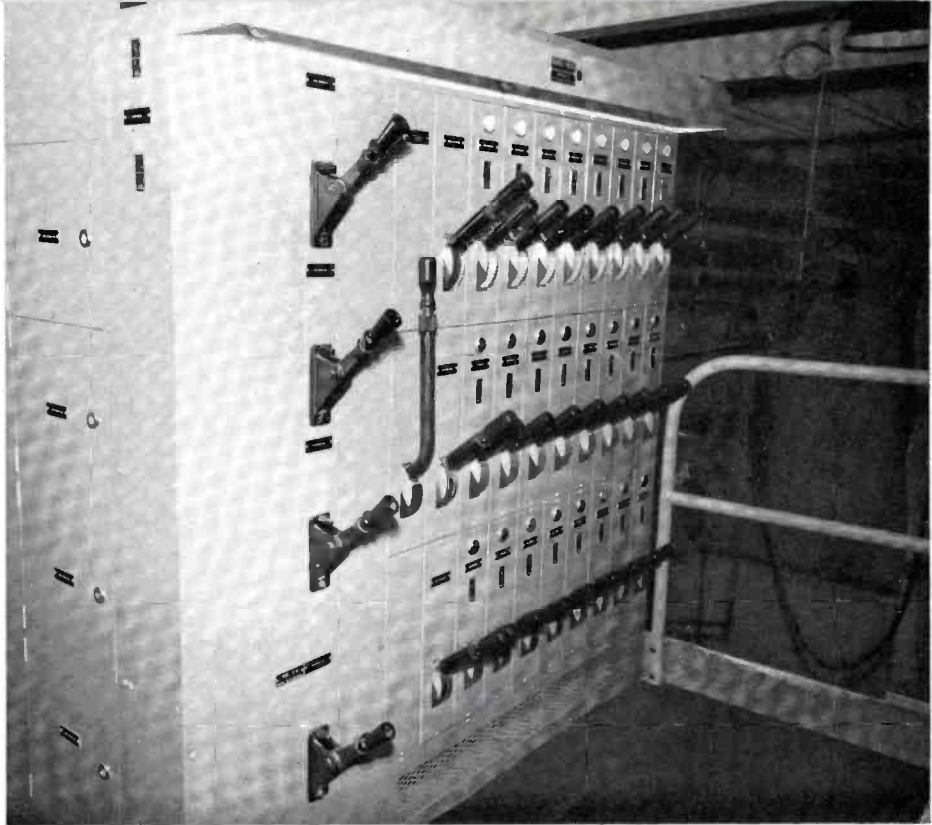

FIG. 6 (below). Arrangement of facilities in the Lighting Control Booth which is located above the Main Control Booth at stage right.

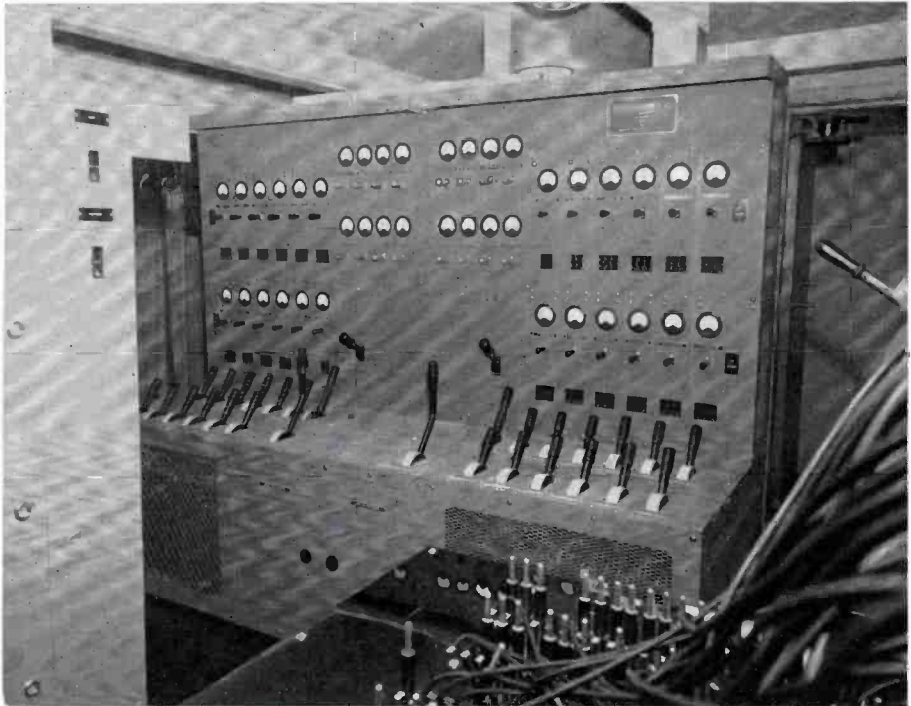
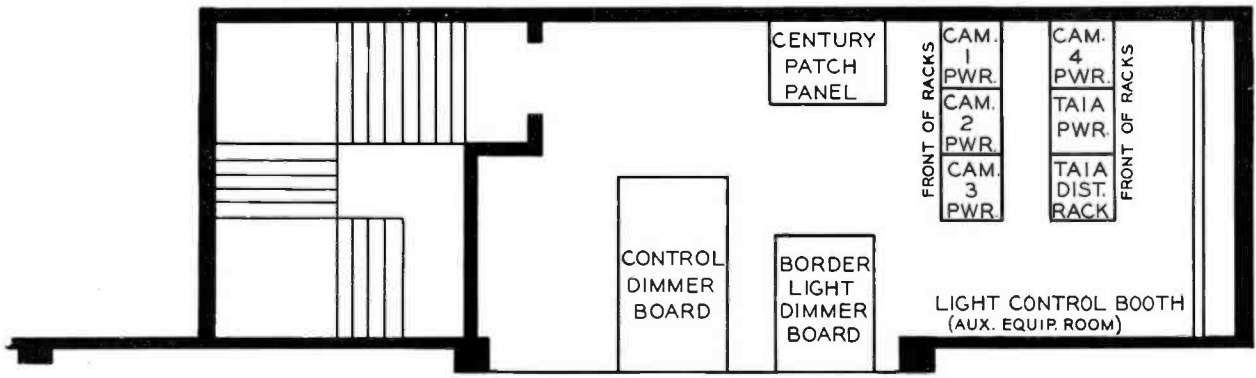

FIG. 7 (left). Main lighting control board which allows simultaneous dimming of all stage lights.

designed video switching system for Studio D are located in the central equipment room in the basement. The switching controls incorporated in a switching panel in the Technical Director's Console—and associated switching equipment, provide facilities for switching, program, preview (1 and 2), and fade (A and B) buses. The 6 inputs make possible switching of integrated film sequences from the central film studio, as well as live program inserts from other studios within the Sunset and Vine plant. Switching from a remote location or the four cameras within the studio is also possible.

A monitor table in front of the Director's Console contains seven RCA TM-2B Video Monitors, four of which are fed

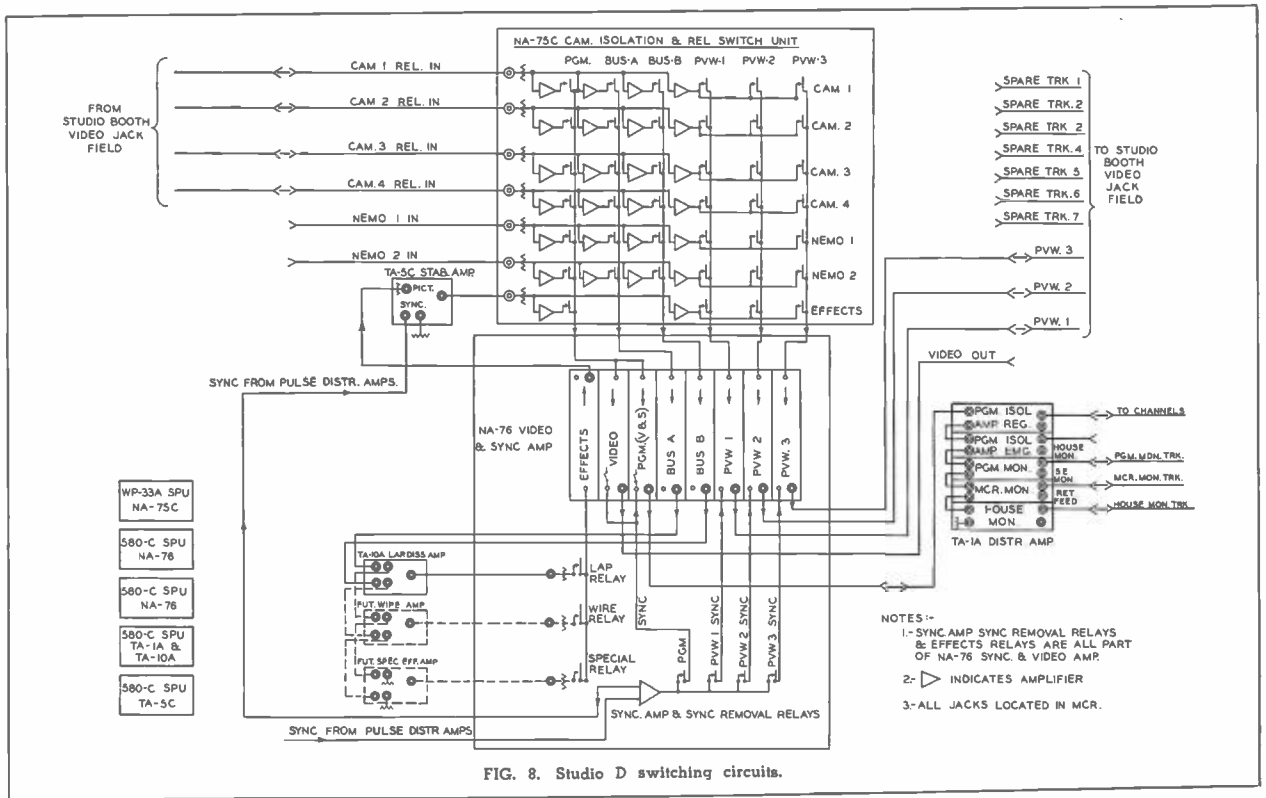

FIG. 8. Studio D switching circuits.

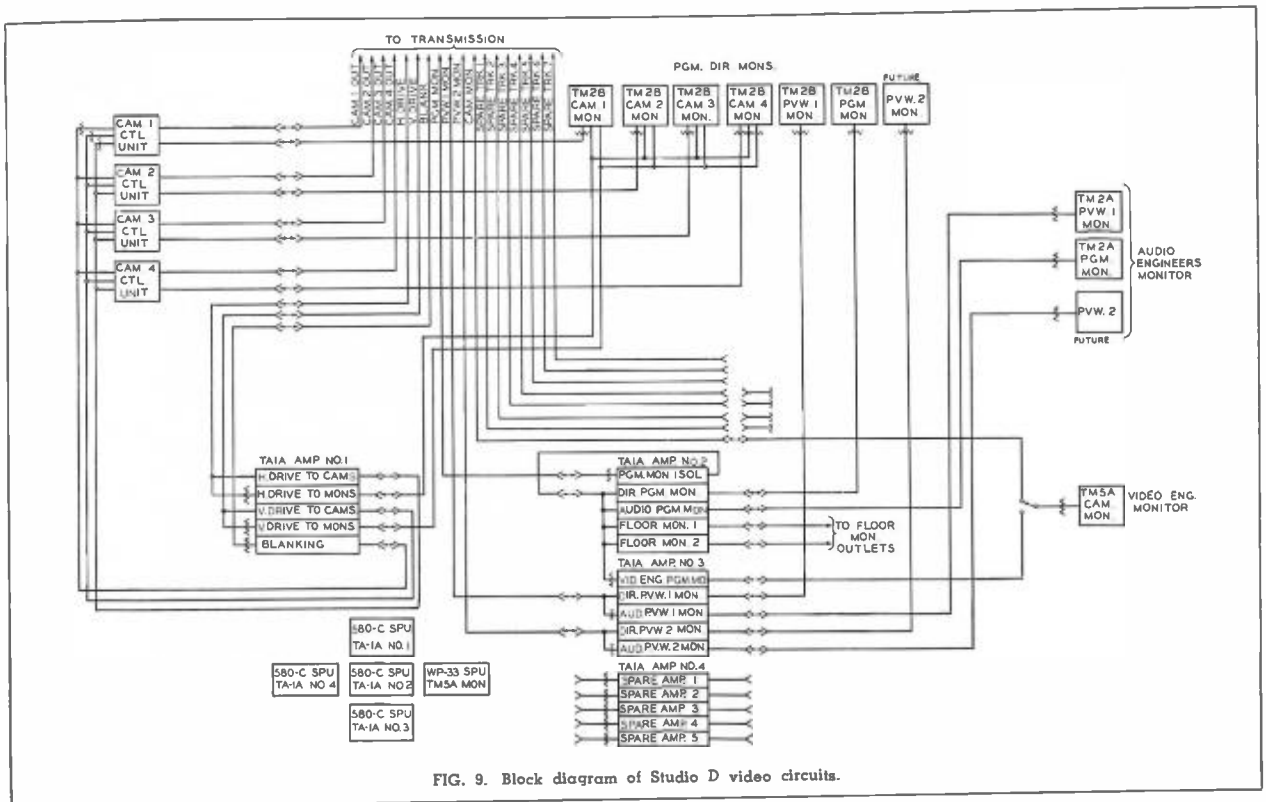

FIG. 9. Block diagram of Studio D video circuits.

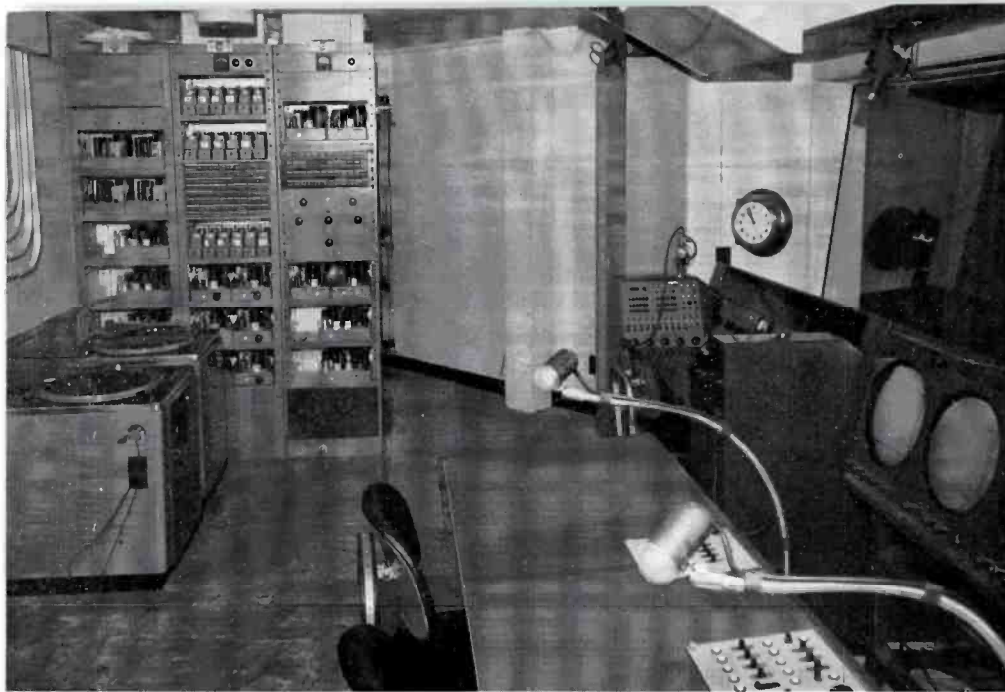

FIG. 10. Visible in this control booth photograph are the Audio Racks (left), the Audio Control Console (right), and part of the Director's Console (lower center).

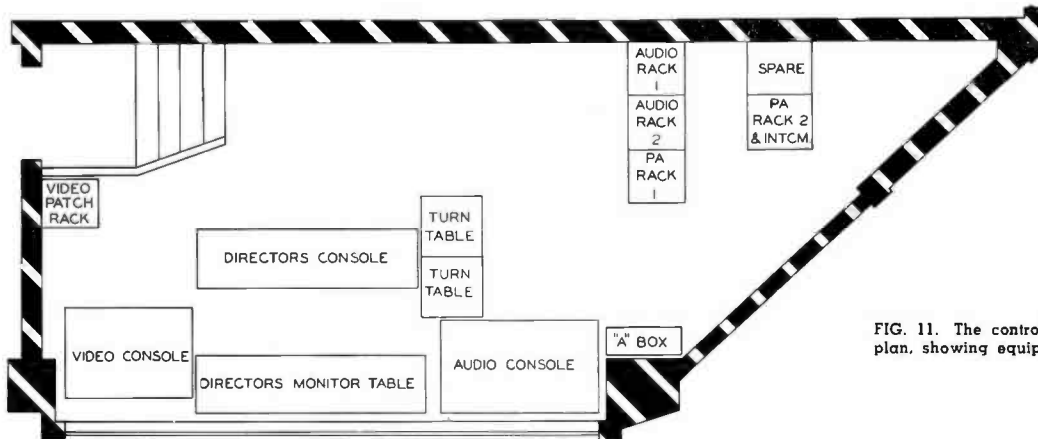
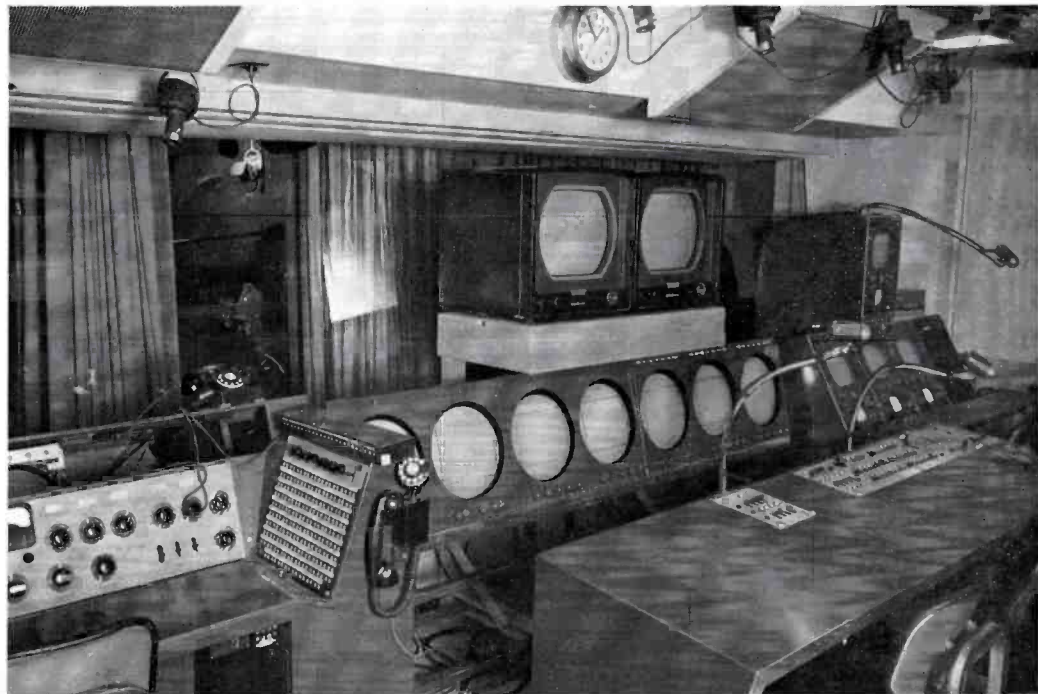

FIG. 11. The control booth floor plan, showing equipment layout.

FIG. 12. View in the control booth, looking toward the stage. Part of the Audio Control Console can be seen at the left. The Director's Monitor Table and the Director's Console are in the center, the Video Console at the far right.



from the remote monitoring outputs of the camera control units. This arrangement permits the technical director and program director to see at all times what shots are available from each camera and, therefore, is of great value for unrehearsed shows, such as an audience participation program when the sequence of camera shots cannot be determined prior to going on the air. The three remaining monitors are fed respectively from the program and preview (1 and 2) outputs of the video switching system. The preview monitors are used by the technical and program directors to check camera shots on a rehearsed show before they are switched on the air. Two monitors are provided so that one is available to check the readiness of film inserts or remote program inserts while the other is being used to check studio camera shots.

Audio control and associated equipment located in the control booth was custom built by RCA for NBC Studio D use. The control console provides twelve fader positions and a three-position split mixer. Facilities are included for feeding twenty microphones from the stage as well as six microphones from the audience area . . . primarily for audience reaction. Also incorporated in the console are two remote inputs corresponding to the two available remote video inputs which can be switched manually by the audio control engineer, or by relay operation to correspond to the proper remote video switches. Three sound equalizers, an RCA variable cutoff sound filter and controls for an echo chamber—all built into the console—can be used in conjunction with the effects switching system. This system enables the audio engineer to switch microphones on and off an effects filter, equalizer or echo chamber, either manually or automatically corresponding to appropriate camera switches.

#### Answer to Audience Reaction Problem

Further exemplifying the complete and thorough planning embodied in the Studio D conversion is the inclusion of communications facilities to properly direct and coordinate the cast, stage crew and technical crew to assure smoothly running shows. These include a two-way telephonic communication system and a one-way system which consists of a microphone at each console position which feeds the BA-14A Amplifiers to headset monitor outlets on stage.

The one-way system is used where it is necessary to communicate information from

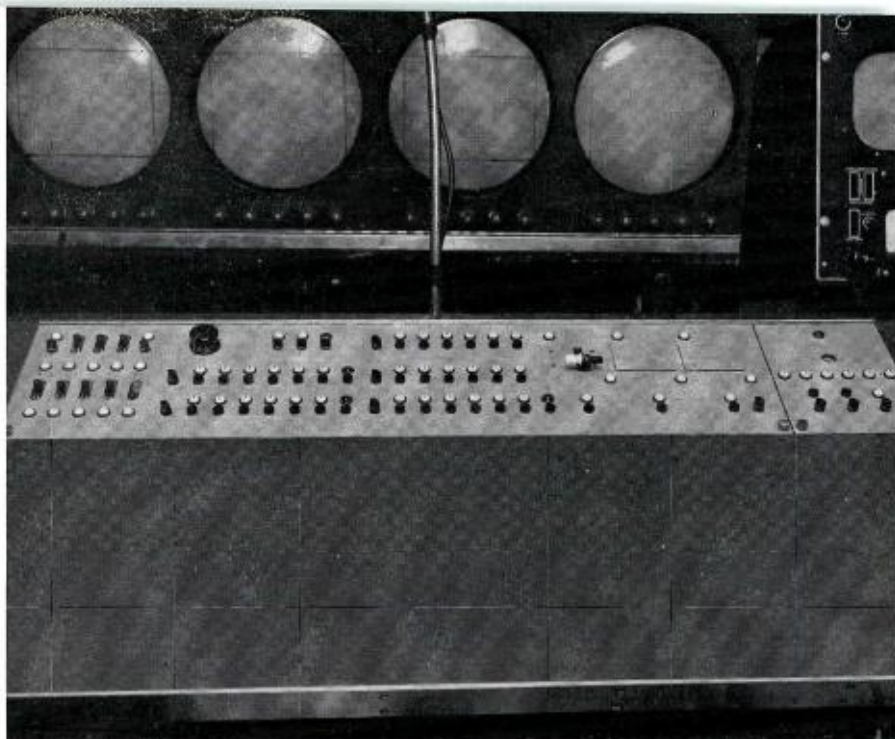

FIG. 13. A closeup view of the technical director's console showing the video switching controls incorporated in a switching panel.

the control booth to the operating personnel—so that it can be understood above stage noise, music, audience reaction and other such disturbances. A system of relays permits isolation of each communications circuit from all others allowing the technical director and the program director to talk to any one group such as cameras or audio without the danger of interruption by an unwanted party.

Because a telephone cable or a headset extension would limit the extensive movement of stage managers, a cue transmitter (which is modulated by the output of the program director's microphone) has been installed and the stage managers are provided with 5-tube miniature radio receivers which can be attached to their belts or carried in a pocket.

The reaction of the studio audience to the performer, and the transmission of this reaction to the performer is a problem peculiar to the production of television variety shows. Because of the deadened walls of a television studio, comedians who rely upon audience reaction for their timing are often unable to judge reactions properly. The greater spacing between the performers and the microphones necessi-

tated by wide angle camera shots is a further complication. Since higher fader settings must be used to insure normal program audio levels, the possibility of feedback is increased.

Studio D planning embraces an apparent solution to this problem which entails the use of two separate address systems in the studio. The audience address system which feeds program audio to the audience has facilities for six fader inputs and one remote audio input. The output of the system drives three BA-13A Audio Amplifiers which, in turn, drive eight RCA 7-inch Accordion-type Speaker mechanisms suspended from the ceiling over the audience section. A console located in the audience section houses controls of the audio levels which enable the operator to mix the sound so as to be heard to best advantage by the audience and still avoid audio feedback.

The actors' speaker system, used to feed audience reaction to the performers on stage, has a single audio input which drives a BA-14A Amplifier which, in turn, drives three 7-inch speakers suspended from the ceiling above the stage. Volume controls in the audio section of the control booth provide control of the levels on each of these speakers.

# NBC CONVERTS EL CAPITAN FOR TV THEATRE

The El Capitan Theatre, which prior to its acquisition by NBC had been the home of such long run legitimate shows as Ken Murray's hit "Blackouts", has been converted for use as an originating point for shows for the NBC television network. In most respects the facilities provided at the El Capitan are identical with those installed at Studio D in the main plant; therefore, this discussion will be confined to points of difference between the two installations.

Prior to conversion the theatre had a stage area of 70 x 35 feet behind the proscenium arch. This has been supplemented by covering what was formerly the orchestra pit and the first five rows of the main floor seating area to provide an additional

area of 55 x 25 feet in front of the proscenium. The staging facilities which existed at the El Capitan have been retained and renovated for further use. In addition eight counterweighted battens have been installed to serve for rigging the stage lighting equipment. The stage area is lighted from four adjustable height spotlight battens, four borderlights and eight stage ladders. The side stage areas are rigged with adjustable grids holding three battens each which are raised or lowered by means of winches. Front stage lighting is provided from fifteen 20 ampere circuits in pans mounted on the front of the balcony.

The four borderlights and their controls are identical with those in Studio D. The spotlight circuits are similar differing only

in the method of selection of control dimmers. Each circuit is terminated in a Rotolector which is a 24 point rotary selector switch by means of which any circuit can be connected to any one of the 24 dimmers on the spotlight dimmer control board.

The borderlight dimmer board, the Rotolector board and the spotlight dimmer board are located on a platform 14 feet above stage level at stage right. Full communications facilities to the main control booth and to auxiliary lighting positions on stage and in the balcony have been provided at the light control position.

The control booth is located at the left rear of the main floor audience area. The

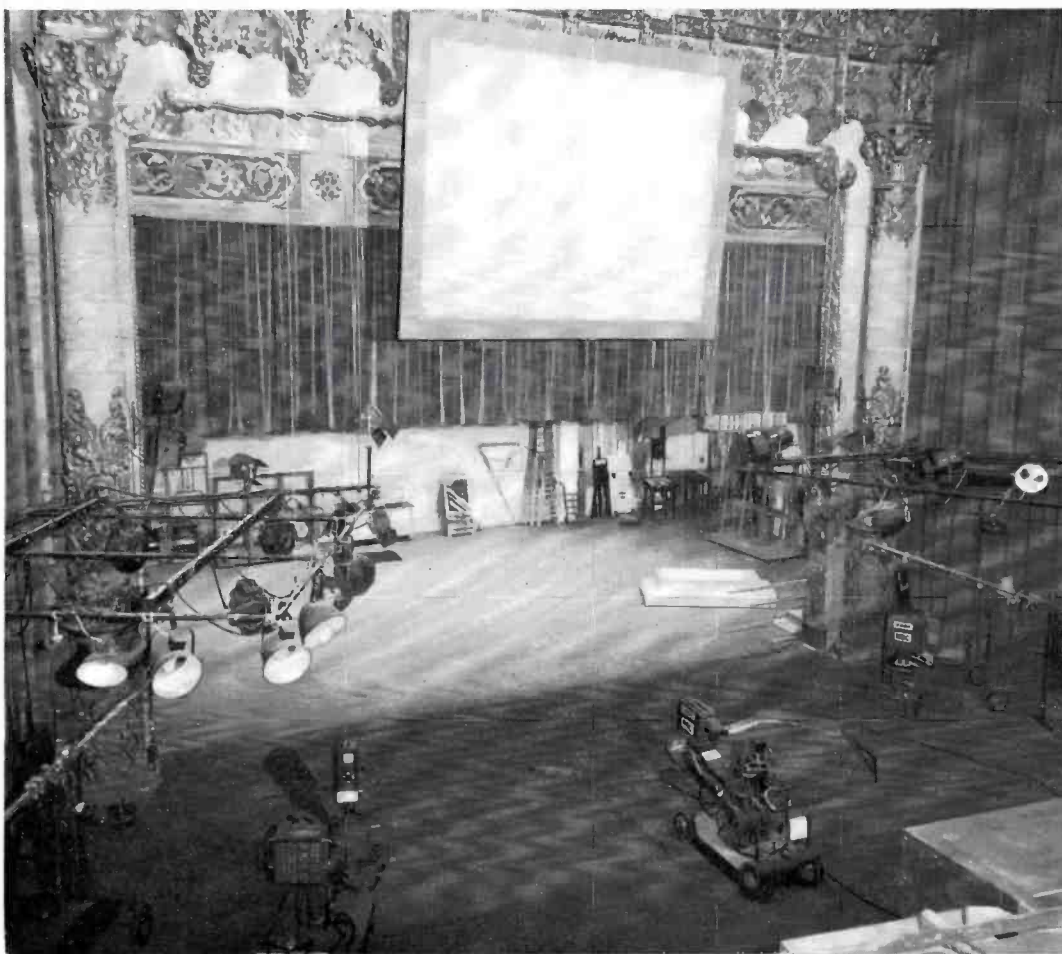

FIG. 1. View of the El Capitan stage and operating areas. An RCA PT-100A Theatre TV Projector is used to show the picture being transmitted on the large screen above the stage. Note the camera "pit" at the lower right.

FIG. 2. Photo showing the seating area of El Capitan Studio and the ramp at front over which cameras can be dollied.

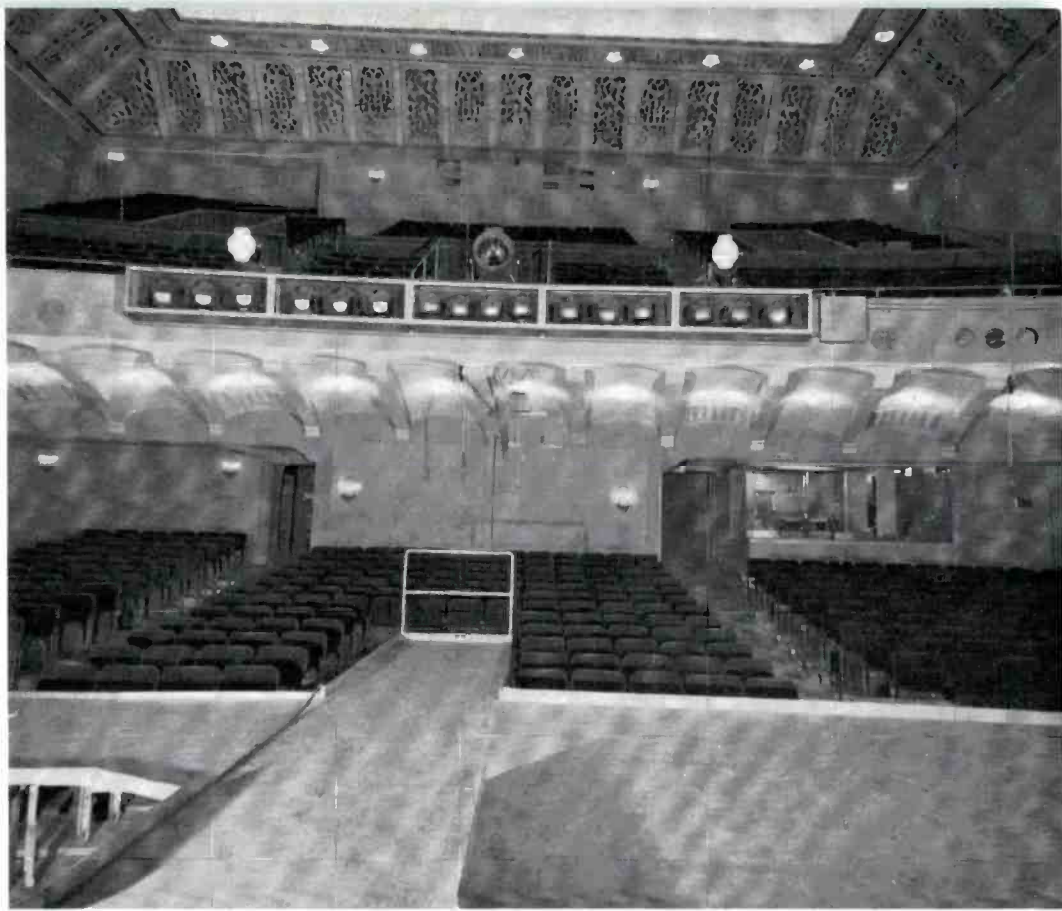

FIG. 3. Floor plan of El Capitan TV "Theatre-Studio."

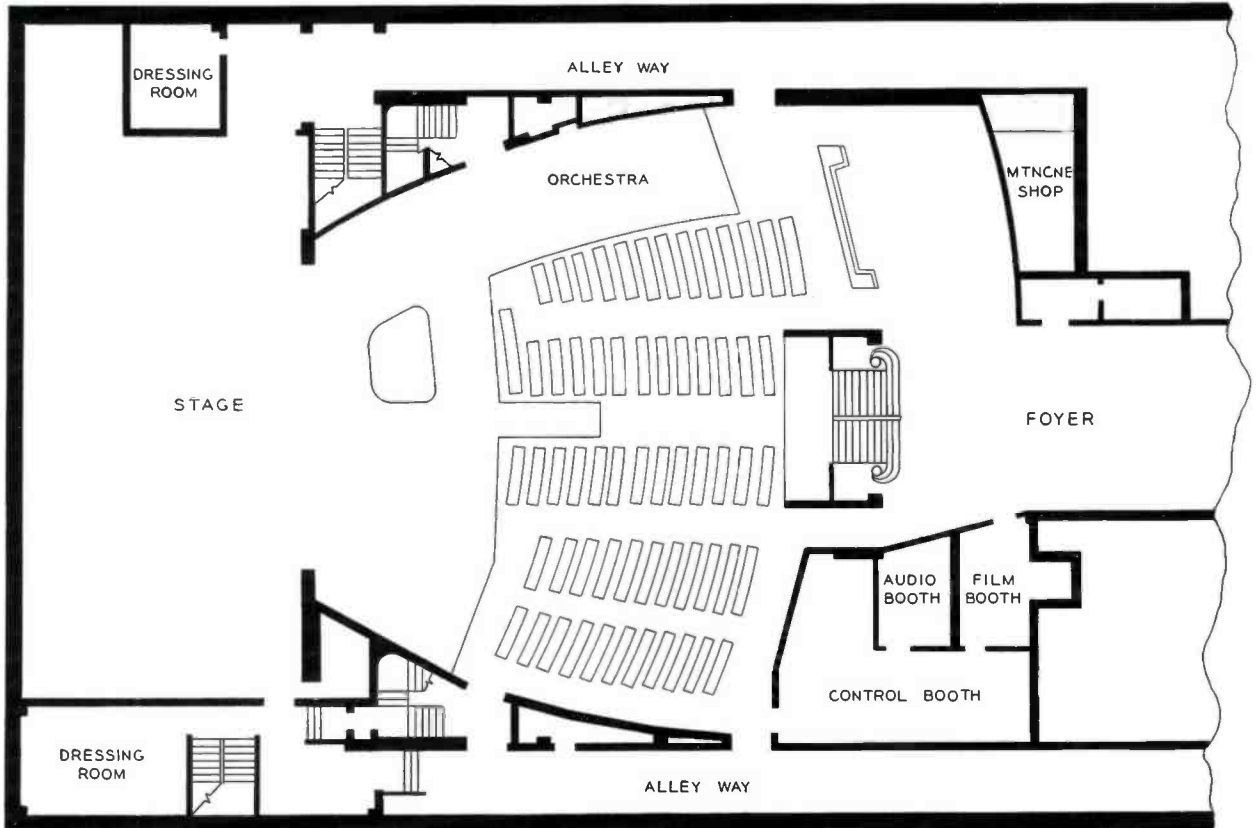



FIG. 4. Front view of video control console at El Capitan. Five monitors in console are associated with four live and one film cameras. Unit mounted above is master monitor.

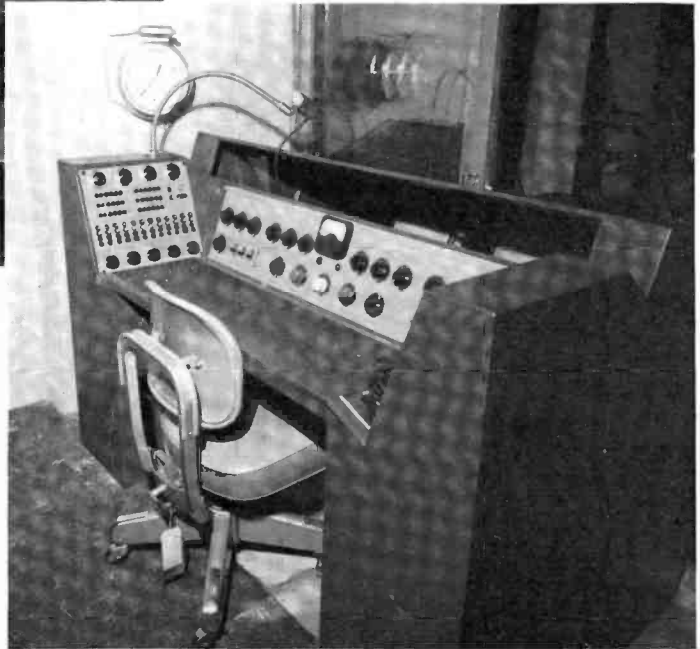

FIG. 5. The NBC Custom TV-Audio console shown installed at El Capitan theatre studio.

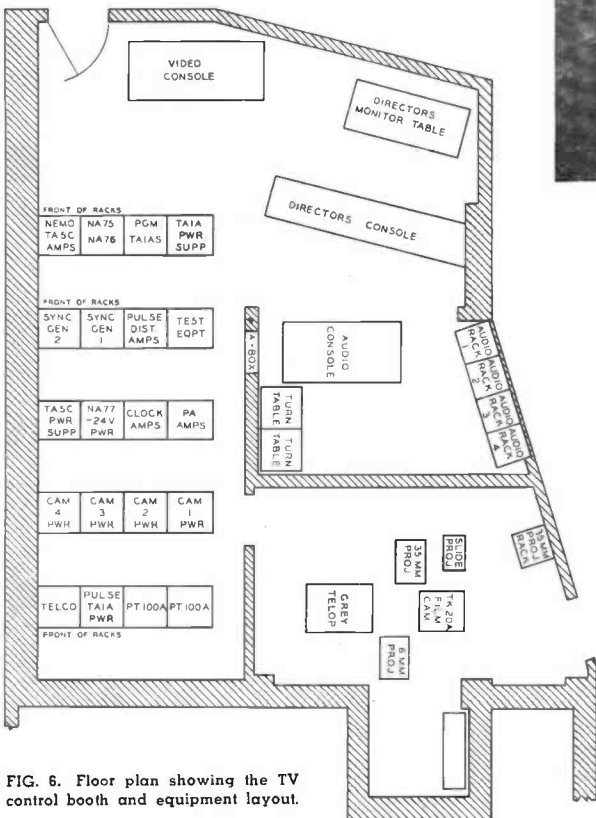

FIG. 6. Floor plan showing the TV control booth and equipment layout.

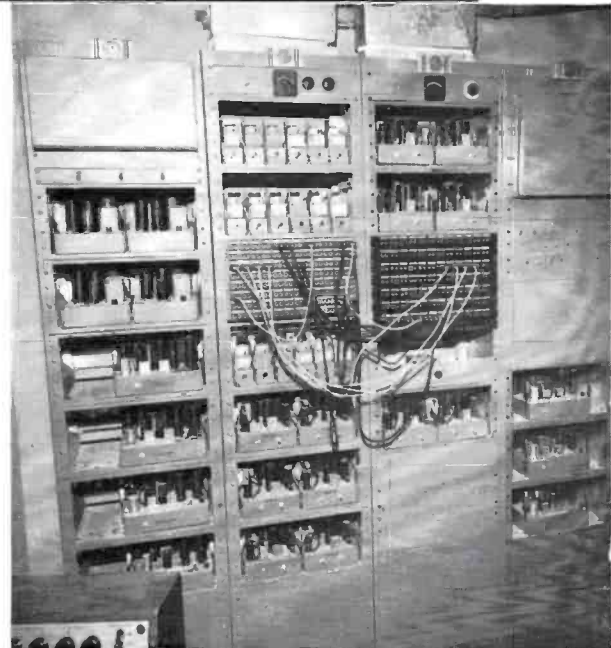

FIG. 7. View of four audio equipment racks utilized in the El Capitan studio.



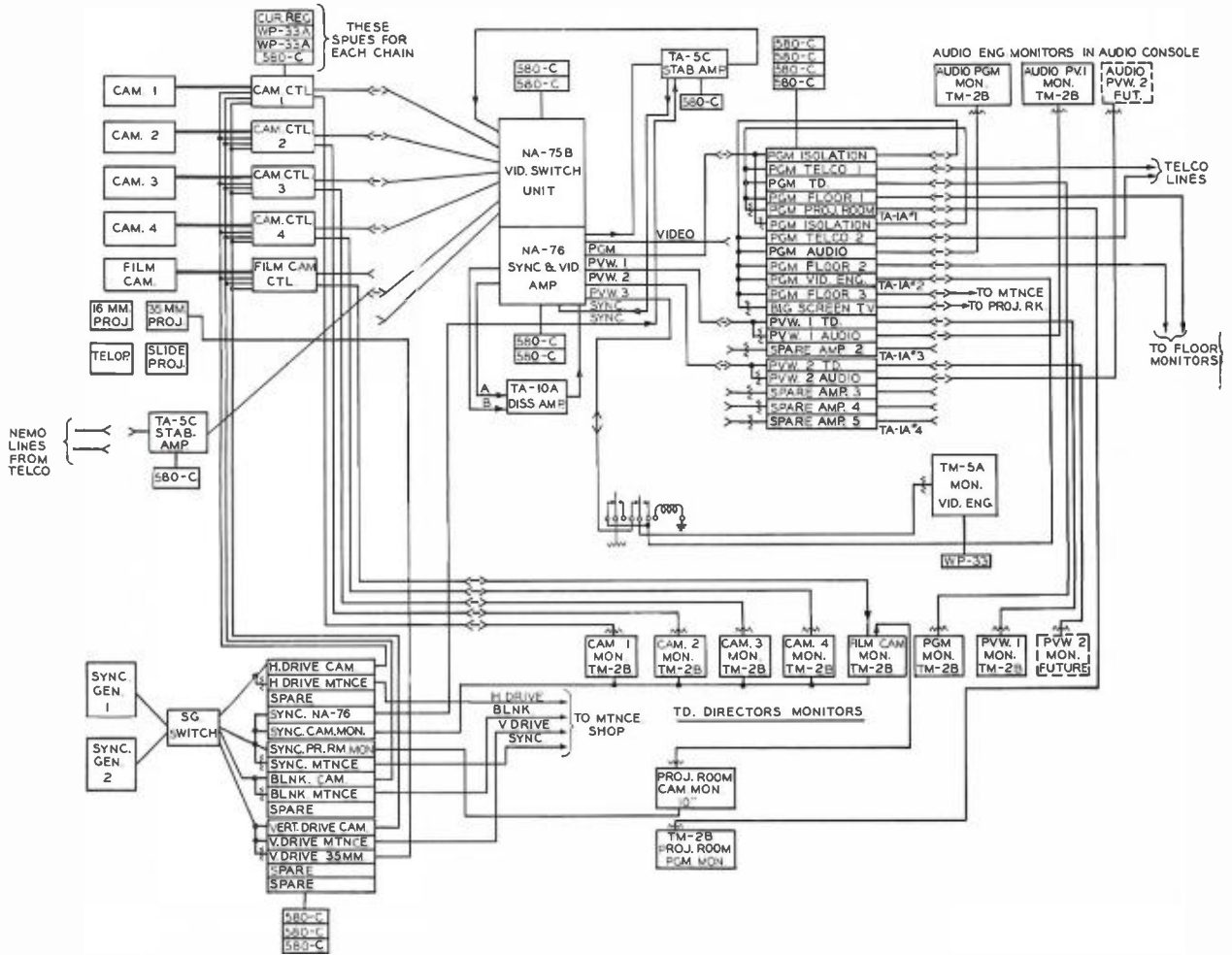

FIG. 8. Block diagram of the video system at the El Capitan.

video and audio systems for the theatre are similar to those provided for Studio D; however, being a remote origination point some additional audio and video equipment is required to feed the telephone lines which carry the studio output to the main plant master control.

In addition a film camera and complete projection facilities have been installed so that film commercials and filmed program sequences can be integrated at the theatre. The projection booth equipment consists of an RCA TK-20A iconoscope camera, RCA 16 and 35mm television film projectors, a two-by-two slide projector and a Grey Telop for projection of opaque slides.

To insure proper audience reaction both audio and video monitoring facilities have

been provided for the theatre audience. Video monitoring is provided by the use of an RCA PT-100A large screen projector. The control racks for the projector are located in the main control booth and equipment room and the projector barrel is located in the balcony giving a 50-foot projection throw to the 11 x 15 foot screen which is suspended 21 feet above stage level immediately in front of the proscenium arch. The projector controls have been modified to permit operation of the unit from a remote control console located in the balcony.

Audio monitoring has been provided in the form of an audience address system. The system and its controls are similar to

that provided in Studio D; the control console being located in the balcony adjacent to the large screen projector console. The output of the system drives three BA-13A amplifiers. One amplifier drives the main speaker which is an RCA sectionalized acoustic horn. The other two amplifiers drive five auxiliary speakers which are RCA 7-inch accordion type speakers mounted one on each side of the stage and three at the rear of the auditorium under the balcony.

The El Capitan Theatre has been equipped with an actor's reinforced loud-speaker system and an intercommunications system identical with those installed in Studio D.

# CONSIDERATIONS IN THE EARLY PLANNING OF TV STATIONS

By J. HEROLD

TV Station Planning Consultant  
Engineering Products Dept.

In planning a television station, the first step is the establishment of the legal, financial, and technical qualifications of the owner. Moreover, evidence is necessary to show that the proposed station will be in the public's interest and convenience. This can best be established through the services of an Engineering Consultant and Legal Representative qualified to practice before the Federal Communications Commission. The Consultants will also advise on television station channel availabilities and will assist in development of the basic planning in preparation of the application in its final form for submission to the FCC. Lists and addresses of such Legal and Technical Consultants can be obtained from the Broadcasting Magazine Yearbook or from the Television Factbook, published by TV Digest, both of Washington, D. C.

## BASIC STEPS

The basic steps in planning follow in logical progression and are listed below, followed by considerations in connection with each step.

### Basic Steps in Planning

1. Determine area of market, radius of coverage required to serve the area, TV channel availabilities, and estimate potential income.
2. Select site. Determine antenna height, antenna gain, and transmitter power.
3. Determine sources of program material, program policies, outline tentative program schedules, and plan extent of programming facilities.
4. Estimate total capital investment.
5. Estimate yearly operating expense.
6. Fill in FCC Form 301 (Revised) and file with the Federal Communications Commission.
7. Project probable future expansion.
8. Determine personnel requirements and begin training.
9. Plan the building and the design, construction, and installation of technical equipment.

EDITOR'S NOTE: Nine logical steps to follow in the early planning of TV Stations are outlined and discussed in this article. As the author points out, all factors warrant the careful consideration of the Planner. Market Areas, Sites, Coverage, Programming, TV Floor Plans, Capital Investments and Operating Costs are discussed. A detailed article on "TV Operating Costs" by Mr. Herold previously appeared in BROADCAST NEWS No. 68 and may be used as an additional reference.

## Market and Potential Income (Step 1)

In determining market areas, market trends, and income potentials, a number of market analysis surveys are available. Perhaps the one best suited to TV Market analysis is "Population and Its Distribution" by the J. Walter Thompson Company. In this survey the market analysis of various cities is considered in terms of the cen-

FIG. 1 (below). Market Area considerations.

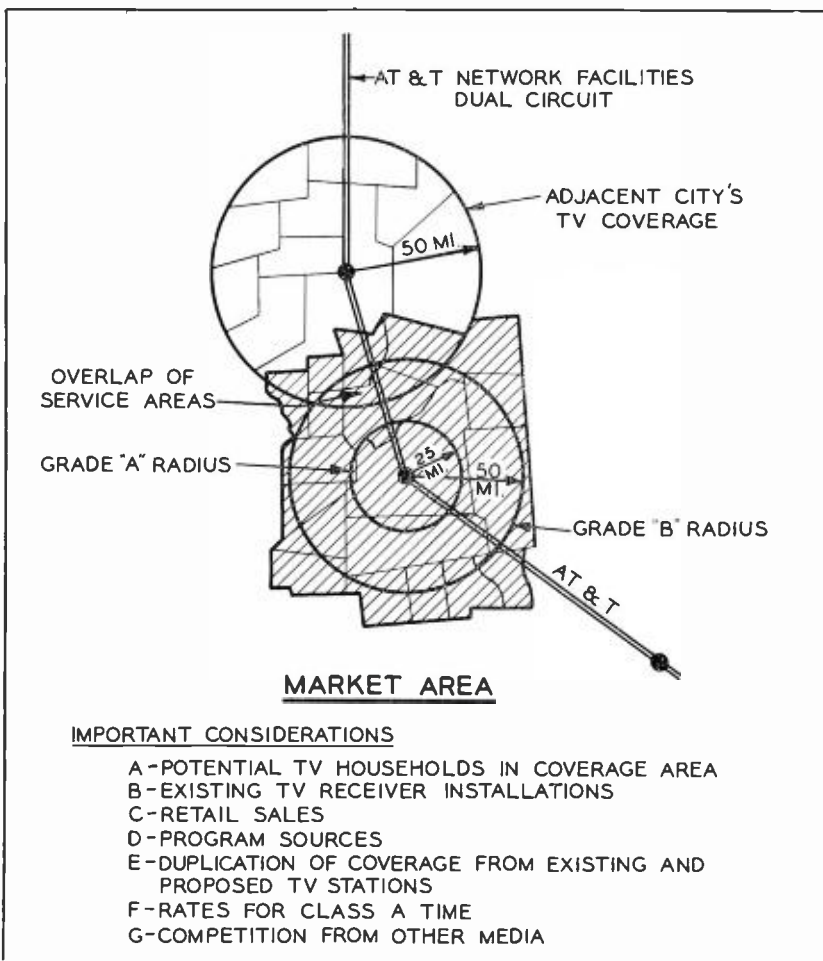
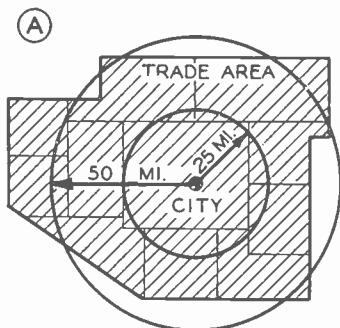
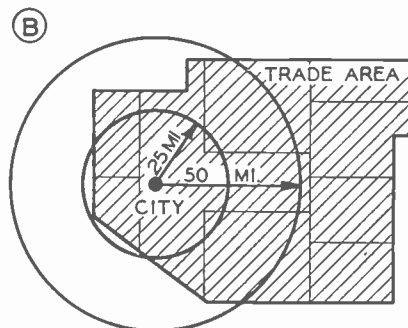

FIG. 2.

**MARKET AREA CONSIDERATIONS**



Where the trade area of a city is more or less symmetrical, a site near the city will give the most uniform coverage.



Where the area is not symmetrical about the city, it will usually not be possible to cover the whole area with a non-directive antenna.

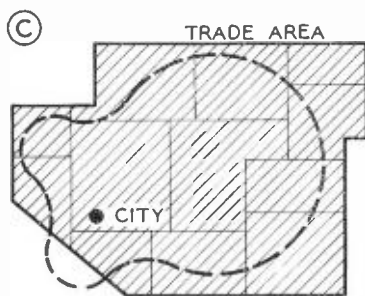

Directional antennas are a possibility, but usually involve non-standard designs which should be avoided when possible.

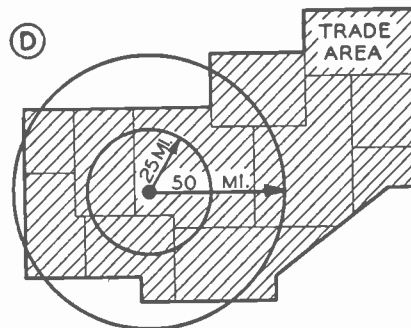

When the trade area is very large or of irregular contour, it will probably not be possible to provide coverage of the whole area.

tral city and the surrounding territory dominated by that city.

From this, the total households in the area to be served can be determined and potential receiver circulation estimated. Since television station card rates are adjusted in accordance with receiver circulation, gross income will depend on the number of receivers in the area and the competition for the advertising dollar from other television stations and advertising media.

In areas already receiving television service, some ideas of income may be gained by studies of rate cards of existing stations and their commercial schedules.

Following is an average figure of the Class "A" Time Rates per hour and minute for existing TV stations, based on receiver circulation.

<i>Receivers</i>	<i>Hour Rate</i>	<i>Minute Rate</i>
12,000	\$225.00	\$27.50
60,000	300.00	54.00
100,000	400.00	75.00
130,000	500.00	90.00
190,000	600.00	110.00
500,000	800.00	145.00
1,775,000	1,500.00	300.00
3,000,000	3,000.00	550.00

Income potentials of a locality can be estimated by studies of market surveys,

market trends, potential and actual number of receivers installed, program sources, and studies of existing TV station histories.

**Selecting the Site (Step 2)**

In this consideration, antenna and transmitter are primarily involved, since, if necessary, the studios can be separated from the transmitter plant and located at a more accessible or convenient location with coaxial cable or microwave relay circuits linking the studio to the transmitter. However, combined studio-transmitter sites are most efficient and will reduce operating expense.

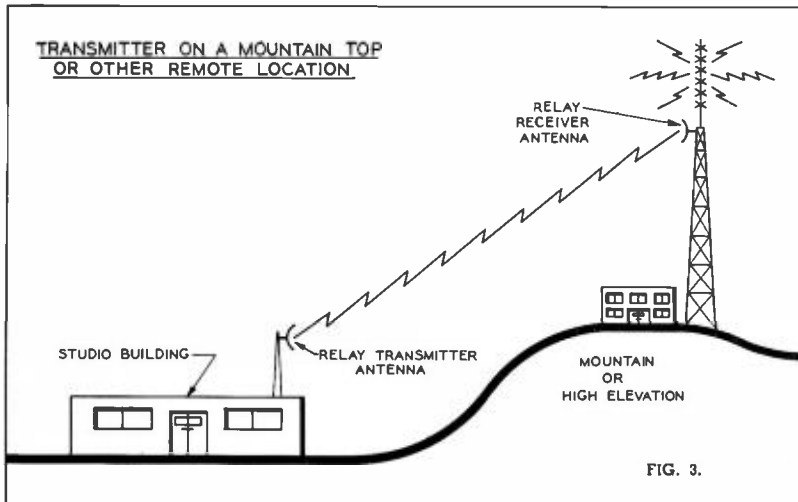

**Selecting the Site (Step 2 Cont'd)**

It is most desirable that the transmitter and antenna be located at the highest point above average terrain, nearest the center of the area to be served. This may be a tall building, a mountain, or other points with terrain or structural advantages in height.

Adaptability of existing plants, such as AM or FM transmitter sites, etc., should be explored as possible TV transmitter sites. Existing AM or FM antenna structures may be used to support the television antenna. Tower manufacturers will advise if this is possible.

Other factors of major importance to be considered are:

- Space. Possibilities for expansion.
- Land and construction costs.
- Access to public utilities, (power, transportation, water, telephone, etc.).
- Freedom from interference, such as high radio frequency field strength signals from AM stations or high audio noise levels.

The site should be selected only after exhaustive studies have been made, including (when doubt of coverage exists) experimental transmissions from the proposed

site so that field strength measurements can be made to predict, accurately, the coverage of the proposed station.

**Antenna Supporting Structures**

The area covered at the television frequencies increases almost directly with the increase in antenna height. Therefore, it is advisable to plan for maximum antenna height above average terrain, consistent with supporting structure costs, interference with air lanes (Subject to Civil Aeronautic Authority approval), and building restrictions. Tower costs depend on whether

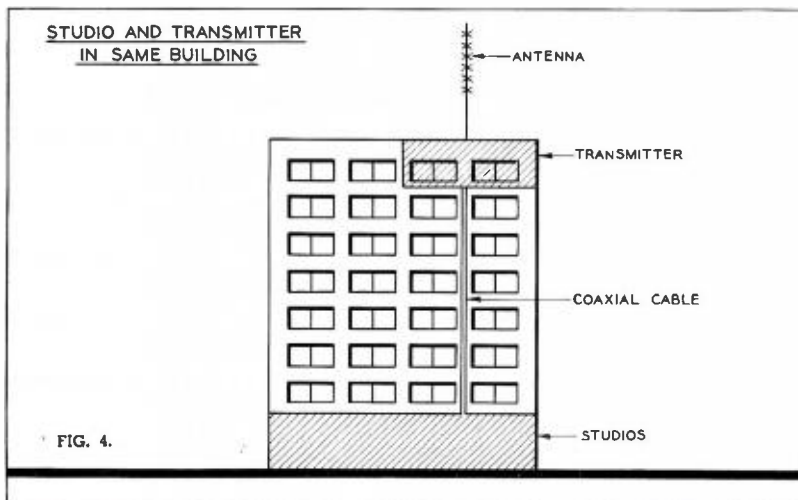
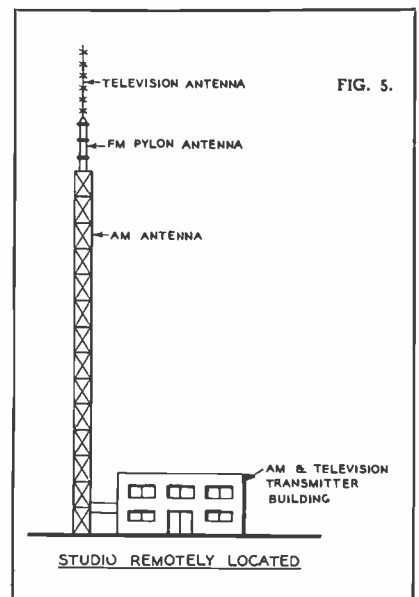

the structure is guyed or self-supporting, height, wind loading, footing, and installation complications.

Guyed towers are most practical, when space permits, since costs are much lower than the self-supported types of structures.

**Antenna Gain and Transmitter Power**

The Federal Communication Commission uses the *Effected Radiated Power* (ERP) of a television station in determining coverage and power. This is the product of transmitter power less transmission line loss times antenna gain.

Maximum and minimum values of ERP are specified by the FCC for the various TV channels and are based on frequency and population.

“Antenna gain” is derived from antenna arrays designed to concentrate radiation toward the earth at a low angle. Gain is calculated with reference to a single element antenna. Additional elements stacked vertically and properly excited will give the effect at the horizon of an increase in transmitter power. Gain per element in the array is usually near unity.

Antenna gains of from 3 to 30 times can be obtained, depending on the channel frequency. In some instances directional patterns may be desirable, and directional radiation can be obtained from the “Super Gain” and “Super Turnstile” types of radiators. “Beam Tilting” is possible, and in some instances, may be desirable since it provides tilting of the beam vertically and makes possible concentration of the signal in certain areas within the coverage radius.

Transmission line loss represents a loss in power and is minimized by keeping line runs as short as possible and by use of low-loss types of line.

Wave guides may be used at the Ultra High Frequencies to reduce transmission losses.

There are cases requiring special antenna design and installations. These may occur for the following reasons:

1. Special gain requirements not met by standard antenna.
2. Directional pattern requirements.
3. Installation of multiple TV antenna on one tower. (Common antenna sites.)

The Engineering Consultant will assist in determining antenna specifications best suited for coverage of the market area.

**Coverage**

The family of coverage curves for various channel classifications included as Figs. 10 and 11 will give some idea of coverage to be expected. Fig. 10 shows effects on coverage radius in miles with a fixed an-

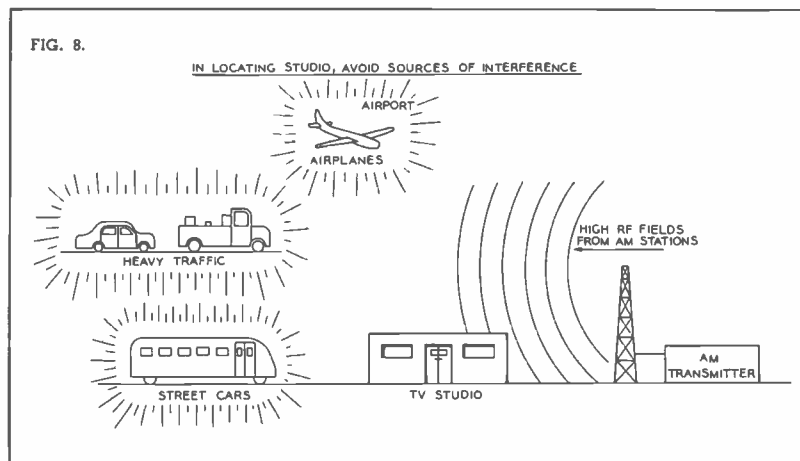
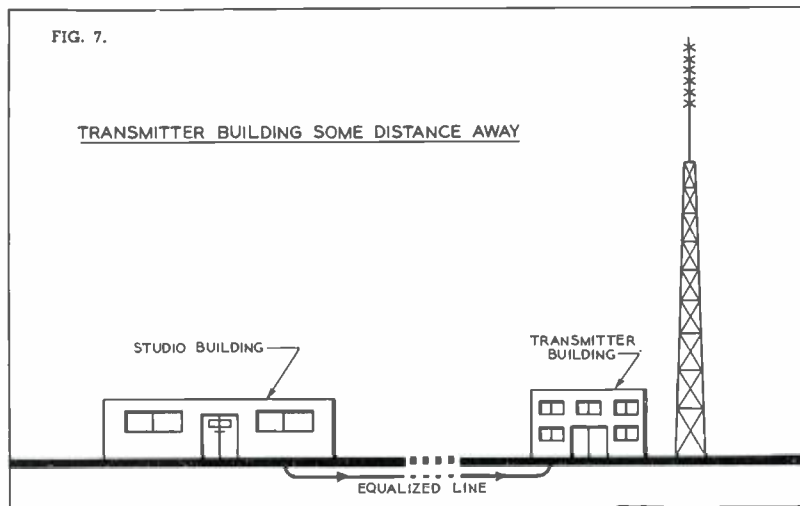
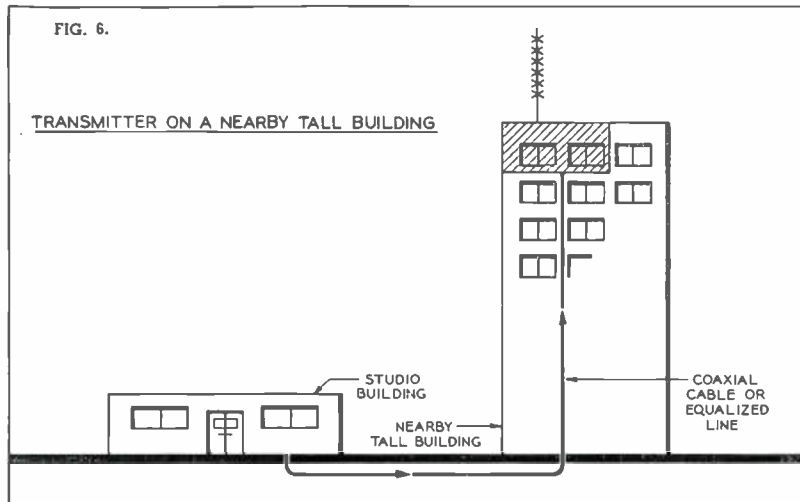

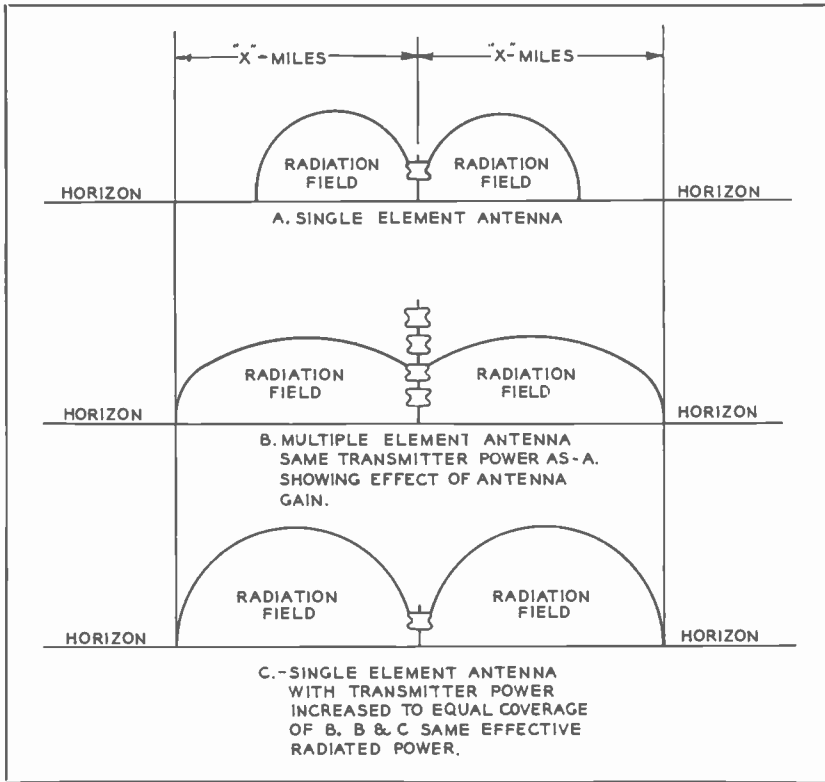

FIG. 9 (above). Coverage patterns showing effect of antenna gain on radiation field.

tenna height of 500 feet and effective radiated powers from 1 to 1000 kilowatts. Fig. 11 shows how radius of coverage in miles is affected by changes in antenna height with fixed effective radiated powers.

Although the curves of Fig. 10 show little increase in the radius of the outer coverage

contour (Grade "B" service) above effective radiated powers in excess of 200 kilowatts, the signal strength at the receiver within the area increases considerably.

The curves are for average terrain and, under actual conditions, true coverage may vary greatly from that predicted.

FIG. 10. Coverage curves showing "ERP" versus "Miles Coverage".

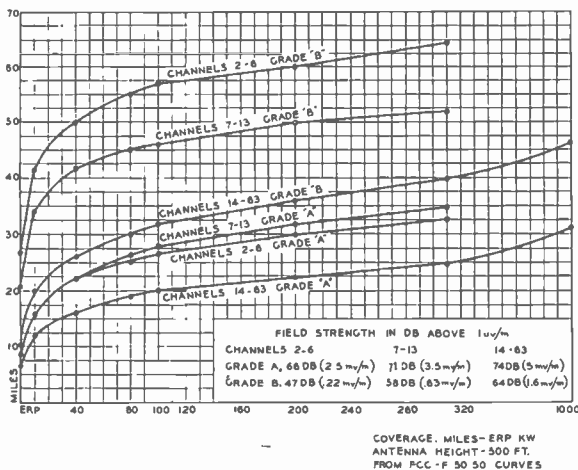
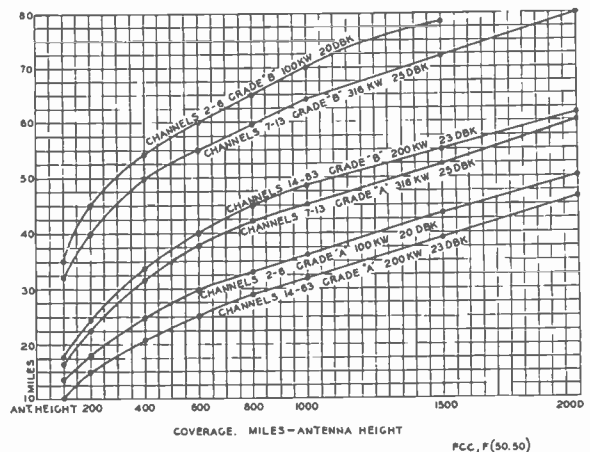

FIG. 11. Coverage curves showing "Miles Coverage" versus antenna height with fixed "ERP" values.



### Programming the TV Station (Step 3)

Sources of program material must be determined in arriving at an overall program policy.

There are four major sources of program material—network, film and slide, live studio and remotes. The program facilities required will depend on the above sources, expanding greatly with the live studio and remote originations. Effects of such activities on operating expenses are shown in the TV station operating expense analysis. Of primary consideration is the amount of program expense which can be incurred consistent with a sound operation, financially.

In planning costs of program facilities, consideration must be given to the extent of programming activities from the various sources and the provision made for adequate facilities to support such program planning. Items to be considered in connection with facilities are: Studio size, lighting, acoustic treatment, air conditioning, staging, scenery, properties, special effects, cameras, camera dollies, audio systems, inter-communication systems, mobile units, microwave facilities, availability of network connections, etc.

The best approach to the problem of the extent of the technical facilities is through a systems layout plan showing both video and audio facilities. Manufacturers of television equipment have experienced personnel to assist your engineering consultant or chief engineer in analysis of facilities required, based on program plans, in development of facilities planning.

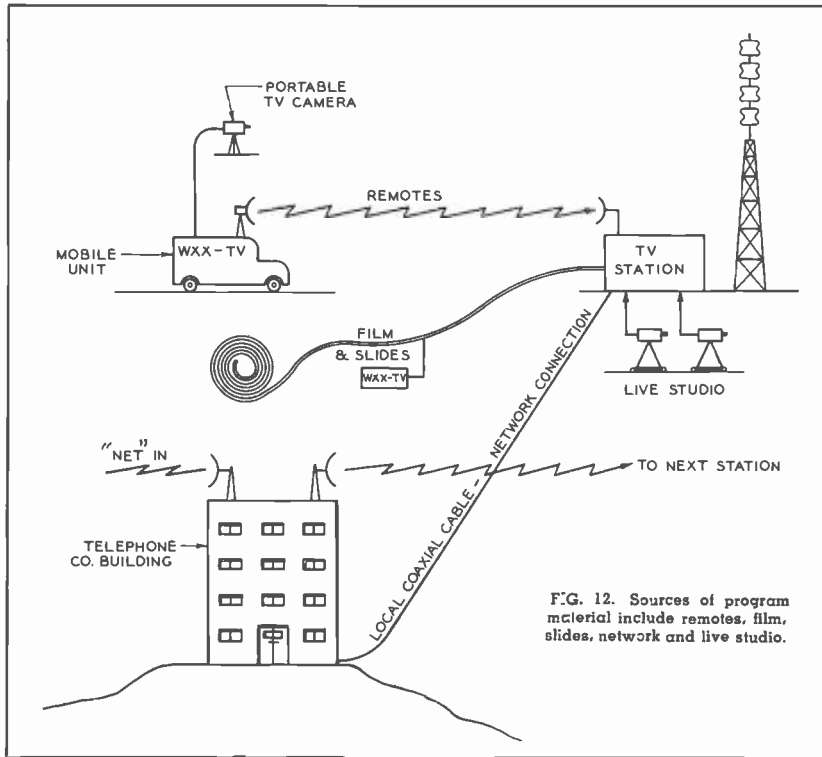

Company, Columbia Broadcasting Company, American Broadcasting Company, and the Dumont network. The map of A T & T existing and proposed TV network facilities and the list of existing stations and their network affiliations, shown here, may be helpful in determining the availability of network facilities to the TV station. Although the map may show the Telephone Company network facilities as serving your city, it is advisable that the A T & T commercial office in your city be advised, at an early date, of your plans for a television station in order to establish availability of facilities to your station. In the event the Telephone Company's facilities by-pass a city, it will be necessary to install microwave links to the nearest telephone company terminal. This has been done by a number of existing TV stations. If local facilities must be used in connection to the telephone company's network facilities, the microwave stations will be a capital investment item and should be included in the estimated capital investment. Costs for microwave facilities vary greatly depending on terrain and distances and are available from manufacturers on request.

**Studios**

Studio size should be large enough to allow freedom of motion in production of programs and should include plans for expansion. Ground level studios, whenever possible, are preferred. Doorways should be provided for easy entry with large props, scenery, and even automobiles. Good acoustics and lighting demands ceiling heights of 16 feet or more. Proximity of scenery and prop storage, scenery and art rooms, and artist dressing rooms, will have an important bearing on operating efficiency. Consideration should be given to space for audiences in event audience participating programs are planned. Proximity of high power AM stations and noise levels from street traffic will determine the amount of electrical and acoustic shielding required. The experience of a number of operating stations is that storage space for scenery and props in the ratio of two square feet of storage, or more, to each square foot of studio space is desirable. Rehearsal rooms are advantageous in most operations.

**Networks**

Program sources from networks will depend on the number of TV stations in the city and the availability of Telephone Company facilities for relaying the network programs to the television station. There are four major companies now supplying television programs for networks of stations. They are National Broadcasting

“Line Charges” for use of the telephone company's network facilities are usually deducted by the network company from the compensation it receives from the advertiser for the TV station's air time. The amount deducted is set forth in the network-station agreement, usually near two-thirds of the station's card rate.

(Continued on Page 32)

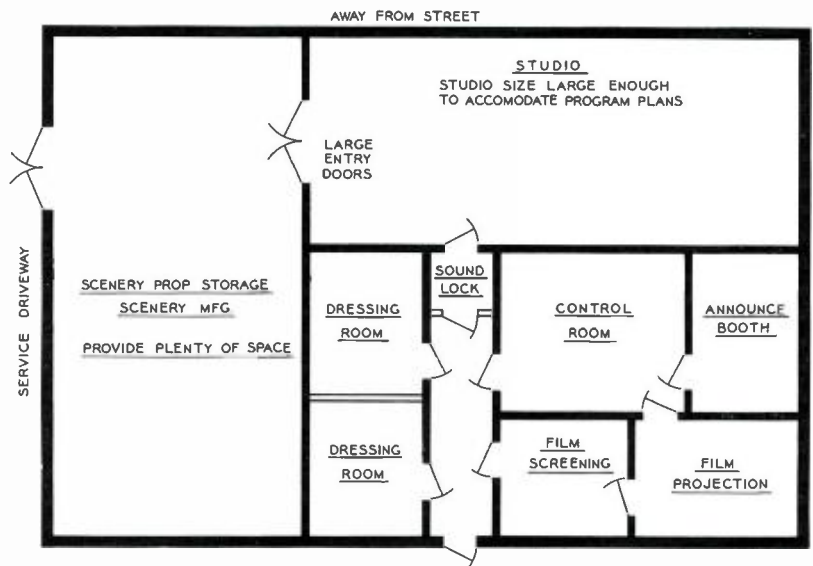

FIG. 13 (at right). Typical TV Studio floor plan.

# TELEVISION STATIONS ON THE AIR

(AS OF FEBRUARY 1, 1952)

City and State	Call Letters	Licensee	Began Commercial Operation	Network Affiliation	Network Service Available	
					Bell Sys.	Cust. Owned
Albuquerque, N. M.	KOB-TV	Albuquerque Broadcasting Co.	Nov. 29, 1948	NBC, CBS, ABC, DUM		
Ames, Iowa	WOI-TV	Iowa State College of Agriculture and Mechanical Arts	Feb. 21, 1950	NBC, CBS, ABC, DUM	Now	
Atlanta, Ga.	WSB-TV	Atlanta Newspapers, Inc.	Sept. 29, 1948	NBC	Now	
	WAGA-TV	Fort Industry Co.	Mar. 8, 1949	CBS, DUM	Now	
	WLTV	Broadcasting, Inc.	Sept. 30, 1951	ABC	Now	
Baltimore, Md.	WBAL-TV	Hearst Corp.	Mar. 11, 1948	NBC	Now	
	WMAR-TV	A. S. Abell Co.	Oct. 30, 1947	CBS	Now	
	WAAM	WAAM Inc.	Nov. 2, 1948	ABC, DUM	Now	
Binghamton, N. Y.	WNBF-TV	Clark Associates, Inc.	Dec. 1, 1949	NBC, CBS, ABC, DUM	Now	
	WAFM-TV	Voice of Alabama, Inc.	July 1, 1949	CBS, ABC, DUM	Now	
Birmingham, Ala.	WBRC-TV	Birmingham Broadcasting Co., Inc.	July 1, 1949	NBC	Now	
Bloomington, Ind.	WTTV	Thomas S. Lee Enterprises, Inc.	Nov. 11, 1949	NBC, CBS, ABC, DUM		Now
Boston, Mass.	WBZ-TV	Westinghouse Radio Stations, Inc.	June 9, 1948	NBC, DUM	Now	
	WNAO-TV	Thomas S. Lee Enterprises, Inc.	June 21, 1948	CBS, ABC, DUM	Now	
Buffalo, N. Y.	WBEN-TV	WBEN, Inc.	May 14, 1948	NBC, CBS, ABC, DUM	Now	
Charlotte, N. C.	WBTV	Jefferson Standard Broadcasting Co.	July 15, 1949	NBC, CBS, ABC, DUM	Now	
Chicago, Ill.	WBKB	Balaban and Katz Corp.	Sept. 6, 1946	CBS	Now	
	WENR-TV	American Broadcasting Co., Inc.	Sept. 17, 1948	ABC	Now	
Cincinnati, Ohio	WGN-TV	WGN, Inc.	Apr. 5, 1948	DUM	Now	
	WNBQ	National Broadcasting Co., Inc.	Jan. 7, 1949	NBC	Now	
	WKRC-TV	Radio Cincinnati, Inc.	Apr. 4, 1949	CBS	Now	
	WLWT	Crosley Broadcasting Corp.	Feb. 9, 1948	NBC	Now	
	WCPO-TV	Scripps-Howard Radio, Inc.	July 26, 1949	ABC, DUM	Now	
Cleveland, Ohio	WEWS	Scripps-Howard Radio, Inc.	Dec. 17, 1947	ABC, CBS	Now	
	WNBK	National Broadcasting Co., Inc.	Oct. 31, 1948	NBC	Now	
Columbus, Ohio	WXEL	Empire Coil Co., Inc.	Dec. 17, 1949	ABC, DUM	Now	
	WLWC	Crosley Broadcasting Corp.	Apr. 4, 1949	NBC	Now	
	WTVN	Picture Waves, Inc.	Sept. 30, 1949	ABC, DUM	Now	
	WBNS-TV	Dispatch Printing Co.	Oct. 5, 1949	CBS	Now	
Dallas, Tex.	KRLD-TV	KRLD Radio Corp.	Dec. 3, 1949	CBS	July 1952	
Davenport, Iowa	WFAA-TV	A. H. Belo Corp.	Sept. 17, 1949	ABC, DUM, NBC	July 1952	
Dayton, Ohio	WOC-TV	Central Broadcasting Co.	Oct. 31, 1949	NBC	Now	
	WLWD	Crosley Broadcasting Corp.	Mar. 15, 1949	NBC	Now	
Detroit, Mich.	WHIO-TV	Miami Valley Broadcasting Corp.	Feb. 23, 1949	CBS, ABC, DUM	Now	
	WWJ-TV	Evening News Assn.	June 3, 1947	NBC	Now	
	WXYZ-TV	WXYZ, Inc.	Oct. 9, 1948	ABC	Now	
	WJBK-TV	Fort Industry Co.	Oct. 24, 1948	CBS, DUM	Now	
Erie, Pa.	WICU	Dispatch, Inc.	Mar. 15, 1949	NBC, CBS, ABC, DUM	Now	
Fort Worth, Tex.	WBAP-TV	Carter Publications, Inc.	Sept. 29, 1948	NBC, ABC	July 1952	
Grand Rapids, Mich.	WOOD-TV	Grandwood Broadcasting Co.	Aug. 15, 1949	NBC, CBS, ABC, DUM		Now
Greensboro, N. C.	WFMY-TV	Greensboro News Co.	Sept. 22, 1949	NBC, CBS, ABC, DUM	Now	
Houston, Tex.	KPRC-TV	Houston Post Co.	Jan. 1, 1949	NBC, CBS, ABC, DUM	July 1952	
Huntington, W. Va.	WSAZ-TV	WSAZ, Inc.	Nov. 15, 1949	NBC, CBS, ABC, DUM		Now
Indianapolis, Ind.	WFBM-TV	WFBM, Inc.	May 30, 1949	NBC, CBS, ABC, DUM	Now	
Jacksonville, Fla.	WMBR-TV	Florida Broadcasting Co.	Oct. 16, 1949	NBC, CBS, ABC, DUM	Now	
Johnstown, Pa.	WJAC-TV	WJAC, Inc.	Sept. 15, 1949	NBC, CBS, ABC, DUM	Now	
Kalamazoo, Mich.	WKZO-TV	Fetzer Broadcasting Co.	June 1, 1950	NBC, CBS, ABC, DUM		Now
Kansas City, Mo.	WDAF-TV	Kansas City Star Co.	Oct. 16, 1949	NBC, CBS, ABC, DUM	Now	
Lancaster, Pa.	WGAL-TV	WGAL, Inc.	June 1, 1949	NBC, CBS, ABC, DUM	Now	
Lansing, Mich.	WJIM-TV	WJIM, Inc.	May 1, 1950	NBC, CBS, ABC, DUM	Now (1)	Now
Los Angeles, Cal.	KHJ-TV	Thomas S. Lee Enterprises, Inc.— Don Lee Network Division	Aug. 25, 1948		Now	
	KLAC-TV	KMTR Radio Corp.	Sept. 17, 1948		Now	
	KTIA	Paramount Television Prod., Inc.	Jan. 22, 1947		Now	
	KNXT	Columbia Broadcasting System, Inc.	May 6, 1948	CBS	Now	
	KTTV	KTTV, Inc.	Jan. 1, 1949	DUM	Now	
	KNBH	National Broadcasting Co., Inc.	Jan. 16, 1949	NBC	Now	
	KECA-TV	American Broadcasting Co., Inc.	Sept. 16, 1949	ABC	Now	
	WAVE-TV	WAVE, Inc.	Nov. 24, 1948	NBC, ABC, DUM	Now	
	WHAS-TV	WHAS, Inc.	Mar. 27, 1950	CBS	Now	
Memphis, Tenn.	WMCT	Memphis Publishing Co.	Dec. 11, 1948	NBC, CBS, ABC, DUM	Now	
Miami, Fla.	WTVJ	Southern Radio & Telev. Equip. Co.	Mar. 21, 1949	NBC, CBS, ABC, DUM	July 1952	
Milwaukee, Wis.	WTMJ-TV	The Journal Co.	Dec. 3, 1947	NBC, CBS, ABC, DUM	Now	
Minneapolis, Minn.	WTCN-TV	Mid-Continent Radio-Television, Inc.	July 1, 1949	CBS, ABC, DUM	Now	
Nashville, Tenn.	WSM-TV	WSM, Inc.	Sept. 30, 1950	NBC, CBS, ABC, DUM	Now (2)	Now
Newark, N. J.	WATV	Bremer Broadcasting Corp.	May 15, 1948			
New Haven, Conn.	WNHC-TV	Elm City Broadcasting Corp.	Apr. 15, 1948	NBC, CBS, ABC, DUM		Now
New Orleans, La.	WDSU-TV	WDSU Broadcasting Services	Dec. 18, 1948	NBC, CBS, ABC, DUM	July 1952	



City and State	Call Letters	Licensee	Began Commercial Operation	Network Affiliation	Network Service Available	Bell Sys.	Cust. Owned
New York, N. Y.	WABD	A. B. DuMont Labs., Inc.	May 2, 1944	DUM	Now		
	WCBS-TV	Columbia Broadcasting System, Inc.	July 1, 1941	CBS	Now		
	WJZ-TV	American Broadcasting Co., Inc.	Aug. 10, 1948	ABC	Now		
	WNBT	National Broadcasting Co., Inc.	July 1, 1941	NBC	Now		
	WPIX	WPIX, Inc.	June 15, 1948		Now		
Norfolk, Va.	WOR-TV	Thomas S. Lee Enterprises, Inc.	Oct. 5, 1949		Now		
	WTAR-TV	WTAR Radio Corp.	Apr. 2, 1950	NBC, CBS, ABC, DUM	Now		
Oklahoma City, Okla.	WKY-TV	WKY Radiophone Co.	June 6, 1949	NBC, CBS, ABC, DUM	July 1952		
	WOW-TV	Radio Station WOW, Inc.	July 9, 1949	NBC, DUM	Now		
	KMTV	May Broadcasting Co.	Sept. 1, 1949	CBS, ABC, DUM	Now		
Philadelphia, Pa.	WCAU-TV	WCAU, Inc.	Mar. 15, 1948	CBS	Now		
	WFIL-TV	Triangle Publications, Inc.	Sept. 13, 1947	ABC, DUM	Now		
	WPTZ	Philco Television Broadcasting Corp.	Sept. 1941	NBC	Now		
Phoenix, Ariz.	KPHO-TV	Phoenix Television, Inc.	Dec. 4, 1949	NBC, CBS, ABC, DUM			
Pittsburgh, Pa.	WDTV	Allen B. DuMont Labs., Inc.	Jan. 11, 1949	NBC, CBS, ABC, DUM	Now		
	WJAR-TV	Outlet Co.	July 10, 1949	NBC, CBS, ABC, DUM	Now		
Richmond, Va.	WTVR	Havens and Martin, Inc.	Apr. 15, 1948	NBC, CBS, ABC, DUM	Now		
Rochester, N. Y.	WHAM-TV	Stromberg-Carlson Co.	June 11, 1949	NBC, CBS, ABC, DUM	Now		
Rock Island, Ill.	WHBF-TV	Rock Island Broadcasting Co.	July 1, 1950	ABC, CBS, DUM	Now		
Salt Lake City, Utah	KSL-TV	Radio Service Corp. of Utah	June 1, 1949	CBS, ABC, DUM	Now		
	KDYL-TV	Intermountain Bestg. and Telev. Corp.	July 1, 1948	NBC	Now		
San Antonio, Tex.	KEYL	San Antonio Television Co.	Feb. 15, 1950	DUM, ABC	1952		
	WOAI-TV	Southland Industries, Inc.	Dec. 11, 1949	NBC, CBS	1952		
San Diego, Cal.	KFMB-TV	Kennedy Broadcasting Co.	May 15, 1949	NBC, CBS, ABC, DUM			Now
San Francisco, Cal.	KPIX	KPIX, Inc.	Dec. 25, 1948	CBS, DUM	Now		
	KGO-TV	American Broadcasting Co., Inc.	May 5, 1949	ABC	Now		
	KRON-TV	The Chronicle Publishing Co.	Nov. 15, 1949	NBC	Now		
	WRGB	General Electric Co.	Dec. 1, 1947	NBC, CBS, ABC, DUM	Now		
Seattle, Wash.	KING-TV	King Broadcasting Co.	Nov. 25, 1948	NBC, CBS, ABC, DUM			
	KSD-TV	Pulitzer Publishing Co.	Feb. 8, 1947	NBC, CBS, ABC, DUM	Now		
	KSTP-TV	KSTP, Inc.	Mar. 23, 1948	NBC	Now		
	WHEN	Meredith-Syracuse Telev. Corp.	Dec. 1, 1948	CBS, ABC, DUM	Now		
	WSYR-TV	Central New York Bestg. Corp.	Feb. 15, 1950	NBC	Now		
Toledo, Ohio	WSPD-TV	Fort Industry Co.	July 10, 1948	NBC, CBS, ABC, DUM	Now		
Tulsa, Okla.	KOTV	Cameron Television, Inc.	Oct. 22, 1949	NBC, CBS, ABC, DUM	1952		
Utica, N. Y.	WKTV	Copper City Broadcasting orp.	Dec. 1, 1949	NBC, CBS, ABC, DUM	Now		
Washington, D. C.	WMAL-TV	Evening Star Broadcasting Co., Inc.	Oct. 3, 1947	ABC	Now		
	WNBW	National Broadcasting Co., Inc.	June 27, 1947	NBC	Now		
	WTTG	Allen B. DuMont Labs., Inc.	Jan. 1947	DUM	Now		
	WTOP-TV	WTOP, Inc.	Jan. 16, 1949	CBS	Now		
Wilmington, Del.	WDEL-TV	WDEL, Inc.	June 30, 1949	NBC, DUM	Now		

As of February 1, 1952	
Stations on the Air	108
Cities Involved	66
Interconnected by Bell System	
Stations	86 (Note 3)
Cities	46 (Note 4)
Interconnected by Privately Owned	
Stations	8
Cities	8
Non-Interconnected	
Stations	14
Cities	12

**Notes:**

1. Connection and local channel from Detroit TR to the microwave location of WJIM-TV at Detroit. Bell System facilities from Detroit to Lansing will become available some time in 1952.
2. Connection and local channel from Louisville TR to the microwave location of WSM-TV at Louisville.
3. Excludes microwave transmitting locations of WSM-TV Nashville at Louisville and WJIM-TV Lansing at Detroit.
4. Excludes Albany, N. Y.; Des Moines, Ia.; South Bend, Ind.; Danville, Ill. and Denver, Colo.

FIG. 14. Network routes of the Bell System.

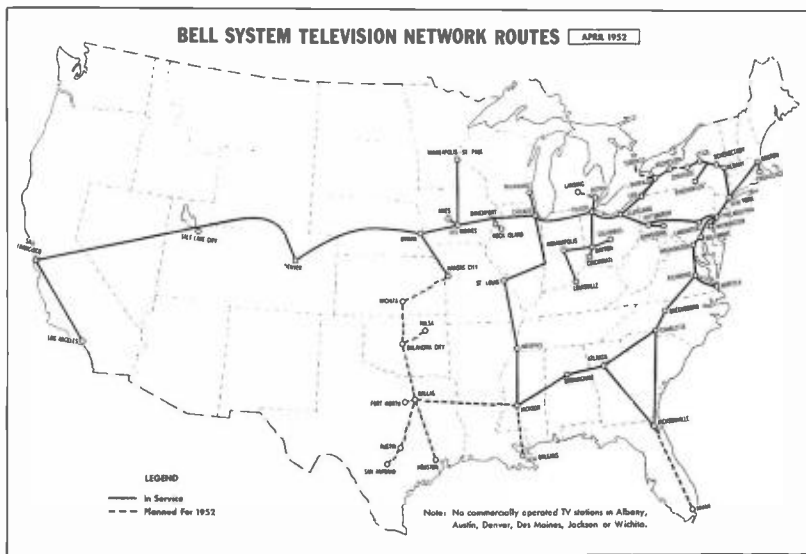

**Networks (Cont'd)**

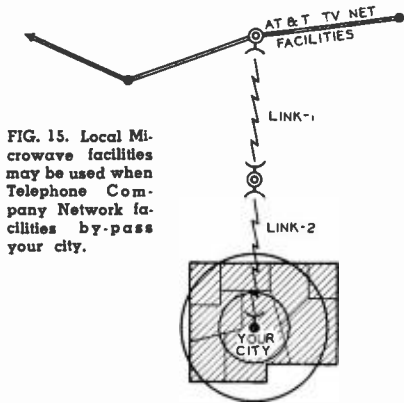

FIG. 15. Local Microwave facilities may be used when Telephone Company Network facilities by-pass your city.

**Remote Pickup**

Television stations in a great number of markets will find remotes a good source of program material. Remotes include all events picked up outside the studios. Remote pickup facilities could include equipment for either direct pickup for immediate rebroadcast or filming of the event for delayed broadcast, or both. Microwave transmitters and receivers are used, in the direct method, to relay images to the main transmitter over a narrow microwave beam. This method has the advantage of imme-

diacy which adds considerably to the viewer's interest.

In film pickup, motion picture cameras (usually 16 millimeter) are used, either sound on film or silent, to record the images on motion picture film for rebroadcast at a later, "delayed" time. In this method, the exposed film is rushed to the studio (the amount of rush depending on time between filming of the event and the rebroadcast time) and is processed by automatic film processors. Film has the advantage of the possibility of editing and thereby deleting undesirable portions of the program and condensation to fit available time segments. Both methods are used in coverage of sporting events, such as baseball, football, basketball, hockey, boxing, and wrestling, in addition to special events, such as parades, meetings, and all events of newsworthy nature.

The planner should decide on whether facilities for remote programming are desirable, and, if so, estimate capital investment requirements.

For direct "live" pickups, a mobile unit, television cameras and microwave relay equipment will cost approximately \$66,000. For film pickup, silent and sound on film cameras, processors, editors, screening equipment, etc., will cost about \$12,500.

**Film Department**

Film facilities will be a capital investment item. The basic film department will be equipped to screen, time, edit, schedule, store, receive, and tranship film.

First step in film facilities expansion is the filming and processing of slides. In most stations, this is a necessary service facility with good income possibilities. Cost of equipment required for slides only is considerably less than that of motion pictures.

Second step in film department expansion is the filming and processing of motion picture film, silent, or sound on film. This step will require a fairly large investment in motion picture and processing equipment. However, depending on commercial services available locally, this can be a very profitable department. Filming of commercial announcements and auditions will assist greatly in sales and service to the advertiser. Also, addition of motion picture filming equipment will make possible the filming of special events, news, interviews, sporting events, and public service features.

According to the extent of activity in this field, film room facilities will include dark room, processing, storage, editing, screening, receiving and transhipment space.

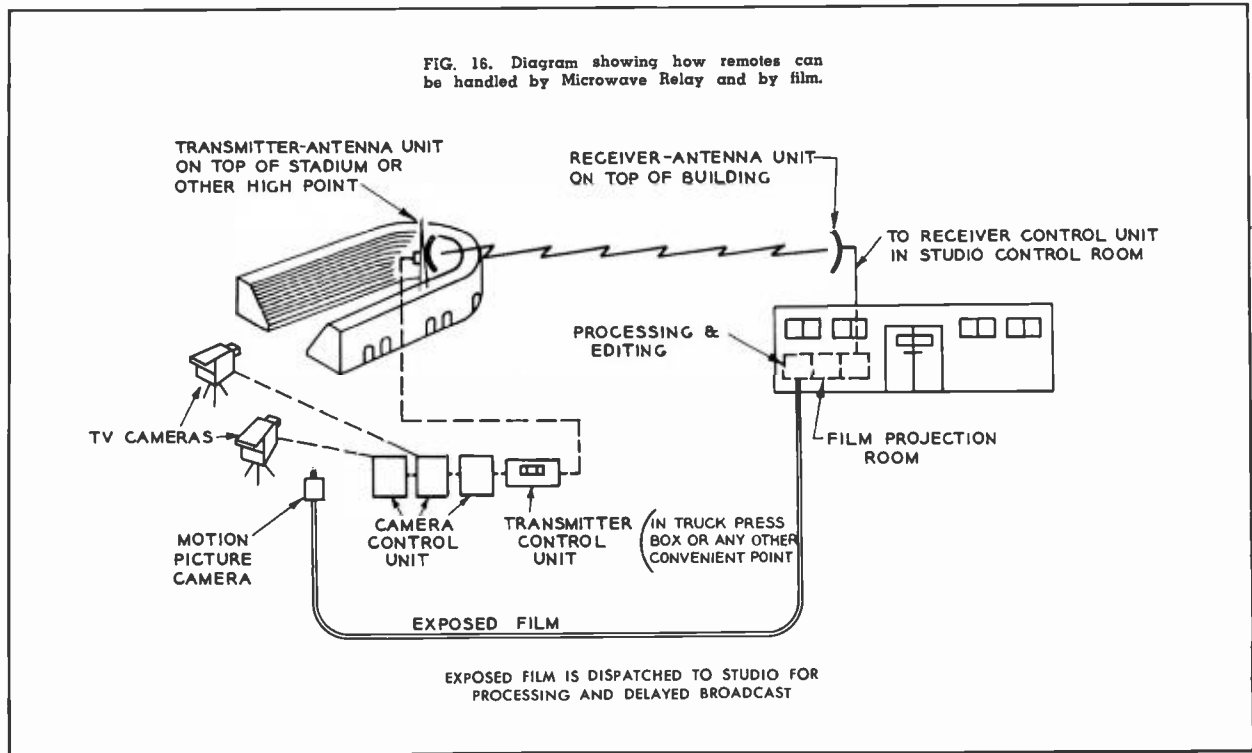

FIG. 16. Diagram showing how remotes can be handled by Microwave Relay and by film.

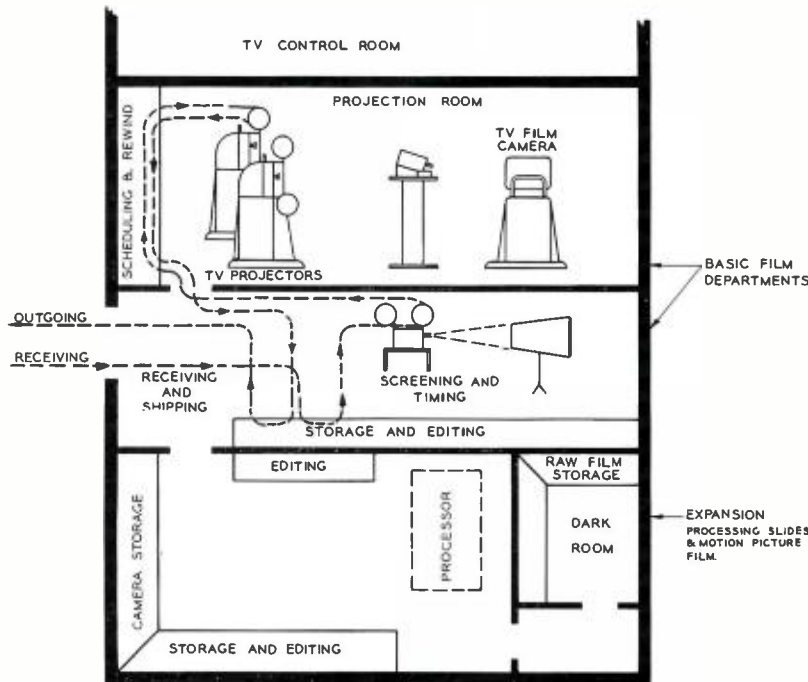

FIG. 17. Routing of film, future expansion, storage and the processing of film are all factors worthy of careful planning.

**Antenna and Diplexer**

Antenna	Channels	Approx. Gain	Approx. Cost
3-Section	2-3	3.3	\$11.4
3-Section	4-5-7	4	9.8
6-Section	2-3	6	30.8
6-Section	4-6	7	27.5
6-Section	7-13	6.8	13.2
12-Section	2-3	12	89.5
12-Section	4-6	12	67.5
12-Section	7-13	13	38.5
Super Gain	2-3	11.5	120.0
Super Gain	4-5-6	11.5	90.0
Super Gain	7-13	11.5	57.5
UHF Antenna	14-40	24	10.0
UHF Antenna	40-60	26	10.0
UHF Antenna	60-83	28	10.0

ESTIMATED ANTENNA COST . . . . . \$ \_\_\_\_\_

**Tower Costs**

Approximate tower costs, including installation, in thousands of dollars (guyed, non-insulated towers).

Tower Height	Antenna	Price
200'	3-Sect., Chan. 2-13,	\$ 7.9
	6-Sect., Chan. 7-13,	
	and UHF	
400'	"	12.6
500'	3-Sect., Chan. 2-13,	26.9
	6-Sect., Chan. 7-13,	
	and UHF	
600'	"	50.6
800'	"	104.9
1000'	"	139.0
200'	5-Sect., Chan. 2-6,	18.8
	12-Sect., Chan. 7-13,	
	6-Sect., Chan. 4-6	
400'	"	24.8
500'	"	28.9
600'	"	52.6
800'	"	79.7
1000'	"	141.0
200'	6-Sect., Chan. 2-3	22.4
400'	"	34.4
500'	"	41.0
600'	"	53.6
800'	"	107.9
1000'	"	143.0

ESTIMATED TOWER COST . . . . . \$ \_\_\_\_\_

**ANTENNA SYSTEM, INCLUDING TRANSMISSION LINE**

(Add transmission line, antenna, and tower costs) . . . . . \$ \_\_\_\_\_

**Estimated Total Capital Investment (Step 4)**

At this stage of the planning, decisions on factors already considered will permit an accurate estimate of the capital investment.

The applicant for a television station construction permit must include, in addition to other items, estimated costs of the following items, in the Form 301 application, which appear in the order shown.

A column for estimating capital investment is included for convenience.

Exact quotations of equipment costs can be obtained from manufacturers' representatives. Approximate cost tables follow, and are listed for convenience.

**Transmitter Costs**

Estimated transmitter costs representing various powers and including side band filter, one set of tubes, one set of FCC spare tubes. All amounts are in thousands of dollars:

Transmitter Output Power	Channel	Price
500 Watts	2-6	\$30.1
500 Watts	7-13	35.1
1 KW	UHF 14-83	55.6
2 KW	2-6	44.6

2 KW		7-13	49.7
5 KW	UHF	14-83	80.75
10 KW		2-6	85.0
10 KW		7-13	90.2
10 KW	UHF	14-83	133.5
25 KW		2-6	149.9
20 KW		7-13	152.5
50 KW		2-6	212.7
50 KW		7-13	216.0
50 KW	UHF	14-83	250.0

ESTIMATED TRANSMITTER COST . . . \$ \_\_\_\_\_

**Frequency and Modulation Monitors**

Including standard monitoring and test equipment:

VHF	\$ 2.6
UHF	2.7
Miscellaneous Test Equipment	2.4

ESTIMATED FREQUENCY AND MODULATION MONITOR COST . . . \$ \_\_\_\_\_

**Antenna System, Including Transmission Line**

Transmission line, 3 1/8", approximately \$1.6 per 100 ft., dual run (Channels 2-13).

Transmission line, 3 1/8", approximately \$0.8 per 100 ft., single run (UHF Channels 14-83).

ESTIMATED TRANSMISSION LINE COST . . . . . \$ \_\_\_\_\_

	ESTIMATED COST
1. TRANSMITTER INCLUDING TUBES	_____
2. ANTENNA SYSTEM INCLUDING TRANSMISSION LINE	_____
3. FREQUENCY AND MODULATION MONITORS	_____
4. STUDIO TECHNICAL EQUIPMENT INCLUDING MICROPHONES TRANSCRIPTION EQUIPMENT AND OTHER EQUIPMENT USED IN CONNECTION WITH PRODUCTION OF TV PROGRAMS	_____
5. COST OF ACQUIRING LAND	_____
6. ACQUIRING OR CONSTRUCTING BUILDINGS	_____
7. OTHER ITEMS	_____
TOTAL ESTIMATED COST OF STATION	-----

FIG. 18. The summary sheet above will prove handy in quickly estimating the Total Capital investment.

### Studio and Technical Equipment

Studio equipment, for film and network facilities only, no live studio	\$34.3
Additional film camera	10.6
Live studio programming, 2 cameras, lighting, audio equipment, video switcher	50.4
Remote pickup, mobile unit, 2-camera field equipment, microwave, audio	66.2
Additional live camera (each)	15.4
Basic film accessories	1.3
Complete film department. Sound on film camera, silent camera, film processor, storage facilities, etc.	12.5

TOTAL STUDIO TECHNICAL EQUIPMENT .....\$ \_\_\_\_\_

COST OF ACQUIRING LAND.....\$ \_\_\_\_\_

ACQUIRING OR CONSTRUCTING BUILDINGS .....\$ \_\_\_\_\_

(An experienced architect will make tentative drawings and estimate building costs. (Varies from \$10 to \$20 per square foot.) Equipment manufacturers will assist in development of floor plans and technical facilities).

### Other Items

Installation costs (approximately 3% of Capital Investment for technical equipment). (Varies greatly with installation complications).

Scenery manufacturing equipment, art equipment.

Landscaping and miscellaneous.

TOTAL ESTIMATED COST OTHER ITEMS .....\$ \_\_\_\_\_

For the purpose of illustration a sample estimate is shown below for a typical station, with figures obtained from the preceding tables. Thus, the estimated cost of the TV station can be determined.

For this example, the Group "A" class of station would total up about like this: A Group "A" station has a 2 KW Transmitter, network, film and slide facilities, with no facilities for live programming.

TRANSMITTER, INCLUDING TUBES (CHANNEL 7-13)	\$49.7
ANTENNA SYSTEM, INCLUDING TRANSMISSION LINE (6-Section, Channel 7-13, Antenna)	\$13.2
500' Tower, installed	26.9
650' Dual Run, Transmission Line	10.6
FREQUENCY AND MODULATION MONITORS (VHF)	2.6
STUDIO TECHNICAL EQUIPMENT (For Film and Network only)	\$34.3
Basic Film Accessories	1.3
COST OF ACQUIRING LAND (EXAMPLE ONLY)	5.0
ACQUIRING OR CONSTRUCTING BUILDINGS (Cost listed for example only)	25.0
OTHER ITEMS (Installation \$4.0. Attorney and Engineering Fees, \$3.0. Misc. 1.5).	8.5

TOTAL ESTIMATED COST.....\$177.1

Estimated capital investment costs of Groups "B", "C", and "D" stations also can be derived from the preceding tables and will vary according to facilities desired.

### Estimated Yearly Operating Expense (Step 5)

The next logical step in the early stages of planning (and an important one) is the careful prediction of operating expense. A detailed analysis of predicted operating costs appeared in the "March-April" issue of BROADCAST NEWS. Reprints giving full details are available from the nearest RCA Field Representative, or from RCA Broadcast Equipment Sales, Camden, New Jersey.

However, as a convenience, sufficient information is included here to arrive at predictions in early cost studies. Therefore, a table is included below which summarizes estimated overall operating costs included in the earlier detailed analysis. In this earlier analysis, careful thought was given to all facets of operations, such as (1) personnel, (2) technical expense, (3) tube costs, (4) space considerations, (5) programming, (6) sales staff, and (7) administrative.

All estimates below represent well-equipped and adequately staffed television stations. Station categories are broken into the following four groups, defined below.

#### A. GROUP "A" STATION:

Program Sources: Networks, Film, and Slide. No Live Studio.  
2 KW Transmitter.

#### B. GROUP "B" STATION:

Program Sources: Networks, Film, Slide, Single Live Studio.  
10 KW VHF Transmitter.

#### C. GROUP "C" STATION:

Program Sources: Networks, Film, Slide, Live Studio and Remotes.  
20 KW Transmitter.

#### D. GROUP "D" STATION:

Program Sources: Network, Film, Slide, Two or More Live Studios and Remotes. Master Control Room. Maximum ERP.

### Filing Application with FCC (Step 6)

At this stage in the planning of a television station, FCC Form 301 Revised, an application for a television station construction permit, can be filled in, with the guidance and assistance of the legal and technical consultants in preparation of exhibits concerning legal qualifications, financing, programming, and engineering data.

A period of from three months on, depending on channel availabilities, conflicts with other applications, conflicts with FCC regulations, and CAA approval of antenna site and height, will be required before action is taken on the application.

During this period, basic planning should continue in preparation for the granting of a construction permit. The construction permit specifies a date for commencement and another for completion of construction.

#### Project Probable Future Expansion (Step 7)

Probably the first need for expansion will come in programming and program facilities. Therefore, it is of utmost importance that consideration be given in the basic plan, to the possibilities for such expansion.

The experience of existing stations has been that properties and scenery storage is the first to feel the pinch. Technical facilities will, of necessity, expand with program activities so this possibility should be included in the planning. Increases in transmitter power may require additional floor space. Increases in live studio originations may require construction of additional studios. Addition of remote pickup facilities will require garage space. An expanding office staff will require additional space.

It is important that the economics of expansion requirements be considered and a reserve fund planned accordingly.

Buildings are amortized on a 20-year basis. Therefore, planning should anticipate use of the basic building as a nucleus, as is, for a long time, with additions at later periods according to the rate of expansion. Whenever possible, expansion in the horizontal plane is most practical and least expensive.

#### Personnel Requirements (Step 8)

A detailed listing of personnel required for various classes of stations was shown in an article on "TV Station Operating Costs", BROADCAST NEWS No. 68, March-April issue.

The personnel problem for TV station is a serious one and will continue, for some time, to be the number one problem in planning a successful television station operation. The shortage of experienced personnel is quite acute and steps should be taken at an early date to train key personnel for television operations. Attendance of key personnel at television seminars,

COMPARISON TABLE				
GROUPS A, B, C, & D				
	A	B	C	D
FLOOR SPACE -----	2,624 SQ. FT.	6,260 SQ. FT.	15,835 SQ. FT.	
TECHNICAL SALARIES-----	\$ 31,460.00	\$ 48,100.00	\$ 65,020.00	
TECHNICAL EXPENSE-----	40,140.00	55,268.00	116,144.00	160,725.00
PROGRAM SALARIES-----	27,820.00	49,400.00	83,260.00	
PROGRAM EXPENSES-----	64,180.00	103,350.00	186,480.00	222,312.00
SALES SALARIES-----	19,500.00	22,220.00	24,300.00	
SALES EXPENSE-----	24,700.00	28,720.00	34,700.00	65,800.00
ADMINISTRATIVE SALARIES--	23,260.00	23,260.00	35,660.00	
ADMINISTRATIVE EXPENSE--	55,028.00	77,380.00	107,308.00	166,045.00
TOTAL YEARLY EXPENSE----	\$ 184,048.00	\$ 274,718.00	\$ 444,632.00	\$ 614,882.00
BASIC PERSONNEL	22	31	50	70

FIG. 19. Overall summary of Operating Costs for four classes of stations (for elaborate detail, see BROADCAST NEWS No. 68).

conventions, and inspection trips to existing TV stations are most helpful. The RCA Training Program for TV station technical personnel has been most successful in the technical field.

Whenever possible, it is good planning to provide cameras and equipment for preliminary training and experimental purposes considerably in advance of the "on-the-air" date. (See BROADCAST NEWS, May 1948 issue, for the description of such a program.) This equipment is most valuable in staff training, program experimentation, closed circuit demonstrations, etc.

It may be possible to utilize personnel from existing AM or FM stations. It is the general experience that AM and FM technical personnel can easily acquire knowledge of TV operating techniques and technical theory. Knowledge of AM scheduling and timing practices are essential and traffic and program personnel may be transferred to TV.

In production, it may be advisable to draw from other sources, with no previous prejudices or carry-over practices which might not be suited to the limitations and capabilities of the television system.

A good source of program and production personnel is from the various colleges and universities, including television training in their educational programs.

The station planner will find that existing TV station operators are willing to cooperate in development of television personnel. "Visits" can be easily arranged and advice and information is freely given.

#### Building and Technical Installation (Step 9)

If at all possible, an architect with experience in TV station design should be employed. If the architect does not have experience in TV building design, trips to existing stations should be included in his study of TV building requirements. Whenever possible, facilities layouts should be on a horizontal plane. Vertical layouts are the least efficient.

The architect will complete detailed drawings of all parts of the building, including electrical, plumbing, heating, and air conditioning facilities. It is important that a key member of the television station staff (usually the Chief Engineer) work closely with the architect during this stage of planning.

The Engineering Department will also prepare detailed layout and wiring drawings of the technical installation and will submit specifications to the architect for special construction required in connection with technical equipment installation.

Careful timing of building construction, scheduling delivery of building and technical equipment to match building progress, will reduce storage charges and delays in construction.

RCA has experienced personnel available to assist the station engineering staff or consultants in floor plans, technical layouts, systems layouts, etc.

## **USUAL TV STATION OPERATING PERSONNEL RESPONSIBILITIES**

### **Chief Engineer**

The duties of the Chief Engineer are similar to those commonly associated with the position in the AM field. In the Groups "A" and "B", it may be necessary for the Chief Engineer to assume responsibility for working of relief shifts (regular operator's days off), or maintenance schedules, in addition to his regular duties.

### **Program Director**

The Program Director has full responsibility for programming (subject to management policies) and the program department personnel. In Groups "A" and "B" he may also be required to assume the duties of Production Manager. Responsibilities as Program Director will include scheduling of programs (program construction), evaluation of programs, employing talent, originating new program ideas, etc. In many instances the responsibility will include purchase of film for sustaining and commercial programming. The Program Director will cooperate very closely with the Sales Manager in development and sale of commercial programs. A continual analysis of program costs will be submitted to the Manager.

### **Traffic Manager**

The Traffic Manager's responsibilities will include all traffic in connection with program schedules, time availabilities, station program logs, and program copy. A regular listing of time availabilities will be maintained for the Sales Department and Management. This position is directly responsible to the Program Director.

### **Film Manager**

The Film Manager will be responsible for the screening, editing, storage, receiving, and transhipment of film. Where film photographic and processing facilities exist, the Film Manager will assume responsibility for filming costs, and will submit a detailed cost accounting, in addition to the other responsibilities for such activities.

### **Production Manager**

The Production Manager works closely with the Program Director in the actual production of TV programs. Supervision of production personnel, production techniques, program rehearsals, casting, announcing, audio effects, visual effects, titles, formats, staging, and commercial effects usually are the responsibility of this position.

### **Sales Manager**

In the smaller Groups "A" and "B", the Sales Manager is usually responsible only

for local and regional time sales with the General Manager assuming responsibilities for national and network sales. Larger stations may add Commercial Managers, National and Local Sales Managers with division of sales responsibilities.

### **General Manager**

The General Manager is responsible for the entire station operation, and duties are those commonly associated with the position in the AM field. Through detailed operating cost analysis of various departments, a close check is maintained on operating expenses. The General Manager works closely with the Sales Department, and, usually, assumes responsibility for national sales contacts in addition to certain local sales.

The General Manager, through department head meetings, supervises coordination between departments and general station planning.

## **PITFALLS TO AVOID IN TV STATION PLANNING**

### **Dangers of Overplanning**

Danger to the financial investment, station prestige, and staff morale are the result of too much optimism in planning. Failure to analyze properly the income potential, service, and facilities requirements of the various departments may force cut-backs in operations and personnel after a short period of operation. It is far better to build solidly, beginning with a sound basic operation and expanding slowly to meet expanded service requirements and commercial activities. Each step in the considered expansion should be analyzed for its long-term place in the operation.

Two departments frequently overplanned are the film and remote pickup departments. The planner should consider carefully the basic requirements for these departments and should include facilities which will continue to be useful in an expanded operation.

A sound basic TV station plan is one that matches the market, with an investment neither too high nor too low, planned to grow with the potential of the market.

### **Space Limitations**

Probably the most costly error in planning is failure to take into consideration the requirements for expansion. The most practical and efficient plant is one that can expand horizontally with minimum of remodeling of existing facilities and structures. Errors in equipment and building

layout can result in highly inefficient operations.

### **Programming**

Program activities are frequently overplanned, with "island programming" complicated productions, costly scenic effects, talent, etc., the major items of expense.

Too often public service programs, such as educational, religious, and civic programs are neglected. *Public Service* is a must in the basic philosophy of television programming.

Rehearsals should be held without cameras up to final dress rehearsals. Excessive use of cameras in rehearsals will add considerably to program costs.

Scenery can be planned to fill basic requirements, with changes in minor units and properties to accommodate various programs. Permanent sets for use with regularly scheduled programs such as news, interviews, home demonstrations are of vital importance in reducing production costs. Rear screen projection of backgrounds is practical and this technique is coming into prominence as a staging aid.

### **Administrative**

A detailed system of accounting for program and production costs, with all costs amortized and charged to the advertiser, should be inaugurated with the first day of operation. Detailed reports from Engineering, Arts, and Film Departments are very important in keeping a check on expenditures.

Overtime commitments above an average of 10-15% is considered the result of poor planning.

Coordination of staff activities and relaying program information is difficult without frequent staff meetings. Daily meetings of department heads for discussion of program, sales and planning will assist in reducing confusion and failures.

Responsibilities of department heads should be clearly defined.

### **Rate Cards**

The rate card of the TV station sets forth charges for air time, classification of time, details on sales policies, and charges for various services, and usually includes a list of facilities. Special deals and rate concessions are serious evils and should not be permitted. Adherence to rate cards may

be difficult at times, but it is of utmost importance. "Concessions" to one advertiser will lead to the necessity for like concessions for others.

When building an audience through increases in TV receiver circulation, long term sales contracts may be undesirable since rates are usually increased at six month intervals during the early, fast growing stages.

### Caution in Combining AM and TV Personnel Functions

Combining of AM and TV station personnel functions should be avoided in the Sales and Production Departments. As an example, TV sales and AM sales may be, at times, competitive. Therefore, the salesman will promote sales of one medium to the disadvantage of the other. In production, AM and TV producers' responsibilities are not at all similar and practices and techniques of one medium may be harmful if carried over to the other. In other departments, responsibilities perhaps can be combined, and will reduce operating expenses. However, analysis of efficiency and productivity should be made at intervals to determine practicability and extent of such combinations.

### VHF-UHF Considerations

With the FCC's Sixth Report, released April 14, 1952, seventy new channels were opened in the radio frequency spectrum for television stations. The new channels fall in the spectrum from 470 to 890 megacycles and are appropriately named Ultra High Frequency, or UHF, channels. The channels 2 to 13 allocated to television earlier are known as Very High Frequency, or VHF, channels since they are considerably lower in the radio frequency spectrum, channels 2 to 6 being from 54 to 88 megacycles and 7 to 13 from 174 to 216 megacycles.

The channels are identical in width in the spectrum and TV standards now in effect apply to all channels.

Differences in propagation characteristics exist for the channels. The FCC recognized this in permitting maximum powers of 100 kilowatts effective radiated powers for channels 2 to 6, 316 kilowatts for channels 7 to 13, and 1,000 kilowatts for channels 14 through 83. Reference to the coverage curves for various antenna height and effective radiated powers will demonstrate the differences in propagation. Although UHF channels will not equal VHF coverage when antenna height and effective radiated powers are equal, adjustments in

	ESTIMATED
TRANSMITTER - INCLUDING TUBES	55.6
ANTENNA SYSTEM - INSTALLED, (500 FT. TOWER)	41.7
FREQUENCY AND MODULATION MONITORS	2.7
STUDIO TECHNICAL EQUIPMENT, INCLUDING FILM PROJECTION EQUIPMENT, LIVE STUDIO CAMERA, LIGHTING, AUDIO EQUIPMENT, FILM ACCESSORIES, SYNC GENERATOR, MISC.	51.0
COST OF ACQUIRING LAND (ESTIMATE FOR EXAMPLE ONLY)	5.0
ACQUIRING OR CONSTRUCTING BUILDING (ESTIMATE FOR EXAMPLE ONLY)	20.0
OTHER ITEMS, INSTALLATION 2.0, ATTORNEY AND ENGINEERING 3.0, MISC. 1.5.	6.5
TOTAL ESTIMATED COST	182.5
ALL VALUES SHOWN IN THOUSANDS OF DOLLARS	

FIG. 20. Estimated cost of the typical 1-KW UHF station shown in Fig. 21. This includes one live studio and a 500-foot tower with high-gain antenna which provides an ERP of approximately 20 KW.

planned antenna heights and power for UHF will place the new channels on good competitive basis with the lower VHF channels. Further, man-made interference and natural static are non-existent at the Ultra High Frequencies, which will allow excellent pictures, depending on receiver noise and sensitivity, under low signal levels. Your engineering consultant will assist you in planning a UHF station which

will place you in a good competitive position with respect to the VHF stations in your area.

### For Further Details in Planning

For further details in all phases of TV station planning, or for specific cost studies, the nearest RCA Broadcast Equipment Specialist is available to assist in your station planning.

FIG. 21. Typical floor layout of a 1-KW UHF station which represents a good "starting-point" for planning. Broadcasters planning to increase power later with RCA high-power UHF amplifiers should allow more space now or expand size later. Note that each square on floor plan equals one square foot.

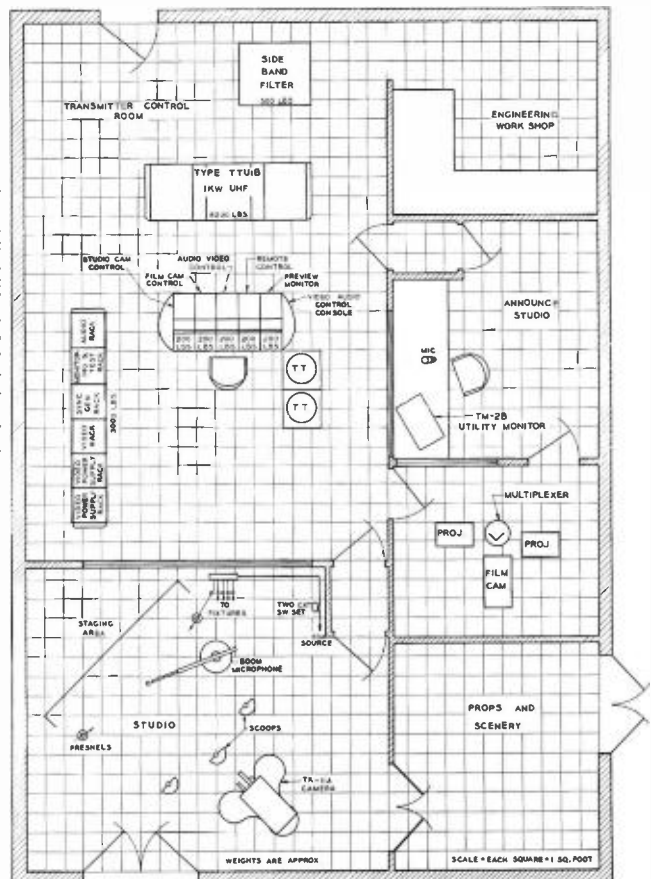

# HOW TO HANDLE FILM IN YOUR TV STATION



By  
**W. L. MURRAY**  
Video Products Section  
Engineering Products Department

Film plays a very important part in the program structure of the television station. When you consider that the average television station's "air time" is between 30 and 40% film, it then becomes apparent that as much sound planning and thinking is required in providing adequate facilities for handling this important program source as that of any other department in a television station. Film is just as important to television as disc and tape are to AM broadcasting. While it is not the intent of this rather brief discussion to imply that handling film in a television station is extremely difficult, we do intend to point out to the broadcaster some problems not ordinarily encountered in AM broadcasting.

## Care and Cleanliness Pay Off

Film is delicate, and should receive careful attention at all times. Just as in an instantaneous recording a certain degree of deterioration occurs each time the film is used. The exact amount depends entirely on the treatment it receives in projection, rewinding, previewing, handling, and shipping. To produce good pictures, cleanliness

is a *must*. As it is projected and rewind (due to certain atmospheric conditions) a static charge will build up on the film and it actually becomes a magnet for the attraction of dust and dirt particles. Therefore, wherever film is handled in the station, it should be kept as clean and dust free as possible. A very good and quick method of cleaning film during rewind is to allow it to pass through a "hand-held" Kleenex which has been moistened with carbon tetrachloride. There are, of course, many other special application cleaners, restorers, and film cleaning devices that can be considered.

## Space Considerations

Space requirements for handling film will vary with the various station installations. However, there are two focal points in planning film facilities; (1) the projection room and (2) the area required for inspecting and previewing film. In the projection room, adequate space should be provided for editing, splicing, rewinding, commercial insertion, and daily storage for shows that are to be aired. Just as it is in

any other line of business, permanent storage is always a serious problem and perhaps a good rule to follow is to double whatever your space requirements might figure to be. This really is not as foolish a statement as it might at first appear. Some of your film suppliers have incorporated a very useful method to help themselves, but it may present a real problem to you. They will often advise you to hold film and ship upon receipt of their advice. However, it usually turns out that a considerable length of time has elapsed and you are left with the filing problem. So it is a good practice to return every foot of film that you do not own or do not intend to use in the very near future.

In this article it is impossible to cover the problem of fire and permanent storage of film. It is suggested that a copy of "Special Bulletin No. 283", published by the National Board of Fire Underwriters, be obtained and also a booklet published by Eastman Kodak Company called "Handling and Storage of Nitrate and Safety Motion Picture Film" be secured. Briefly, 16mm film used in television stations is a



safety type film. The word safety doesn't mean that it will not burn, but means that it can be handled easier and will not present the problems connected with handling and storing nitrate film. Safety film will burn, but it won't blow up. Normal safety precautions that apply in an office concerning waste baskets, trash, etc., apply also in the handling of 16mm safety motion picture film. The handling and storage of nitrate film is in itself a subject of its own, and the only thing that need be said is—extreme caution should be observed whenever any nitrate film is found in a television station. Your local fire authorities should be consulted as to what their requirements will be in your film department installation.

#### Editing Area Is Needed

In addition, an editing area should be situated to best accommodate last-minute, hurry-up changes so frequently encountered in the preparation of film for airing. The actual design of the editing table or bench will depend on local conditions and the particular likes and dislikes of the operat-

ing personnel. However, the following basic equipment will be needed.

- 1 Film Splicer
- 1 Pair Rewinds
- 1 Measuring Machine
- 1 Small Viewer
- 1 Editing Table or Bench
- 1 2" x 2" Slide File Cabinet
- 1 3¼" x 4" Slide File Cabinet
- 1 Open Face Rack for Storing Large Reels that will be Aired During the Day
- 1 Permanent Type Storage Cabinet
- 12 2000' Flat Steel Reels
- 12 1600' Flat Steel Reels
- 12 400' Flat Steel Reels
- 50 100' Flat Steel Reels
- 1000' Blank Leader
- 1 14" Steel Rewind Flange
- 1 Small Screening Projector
- 1 34" x 50" Screen on Tripod or Wall Mount.

These are minimum requirements and larger operations will call for larger quantities of the various items.

#### Film Equipment Accessories

A word now about some of the film equipment accessory items that are needed in the successful handling of film in a TV station.

**FILM SPLICER**—This instrument is used to splice film and should be considered as a precision instrument. A word of caution about film splicing! One faulty splice can cause a show, commercial, or presentation to be either a success or a flop. Even though time is important in a television station, **THERE IS NO SHORT CUT TO MAKING A SPLICE IN FILM.** There are certain basic operations to be performed, in the proper order, and a definite amount of time is required to make a good splice. Faulty splices can usually be traced to dirty splices, incomplete removal of emulsion, wrong kind or old cement, improper adjustment of splicer, and insufficient drying time of the splice.

**SCRAPING TOOLS**—The usual instruments used in scraping off the emulsion of the film to be spliced are single edge razor



FIG. 1. View of a typical TV film editing bench setup for Television stations. Note that rewinds, splicer, viewer and measuring machine are needed.

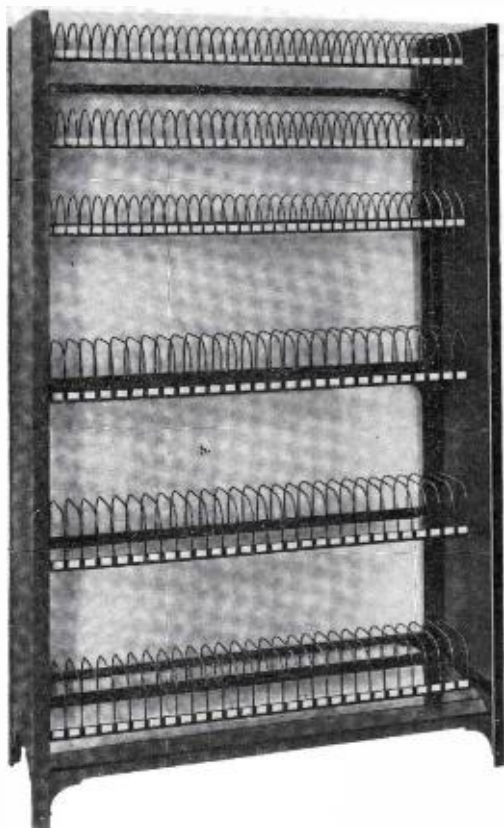

FIG. 2. A sturdy, metal type film storage cabinet is a necessary convenience for any TV film room.

blades, emery boards, and various types of commercial scrapers. Double edge blades should never be used.

**FILM CEMENT**—Used in cementing the splice together after it has been prepared for splicing in the film splicer. It should be placed in a handy applicator bottle and when not in use kept tightly sealed. If the cement is allowed to become exposed to air for a period of time, its adhesive properties are destroyed and weak splices are sure to result.

**SMALL VIEWER**—This is used for "quick" editing and is very handy for previewing short sequences, interchanging spots or scenes and checking continuity of film strip or show.

**REWINDS**—Most TV projectors do not incorporate automatic rewinding mechanisms so these are, of course, needed for rewinding film after it has been aired, and for editing purposes.

**FOOTAGE COUNTER**—Used for accurately measuring the time of a spot or any length of film. Previewing projectors are not nor-

mally equipped with sync motors and accurate timing cannot be secured by projecting and timing with watch or clock. A 16mm. sound film is projected at a speed of 36 feet per minute and by measuring the length of the film on the footage counter, it is, of course, very easy to determine the exact amount of time it will take to air the film.

**DAILY STORAGE RACK**—Some form of rack must be provided in the projection room for the temporary storage of daily films to be aired. This rack should be able to accommodate at least a week's film supply. A very good method is to set up the file according to days of the week. This will enable the scheduling department to keep ahead of projection and save a frantic hunt at the last minute for a film that is to be aired immediately.

**SLIDE STORAGE CABINET**—A filing cabinet to accommodate both 2 x 2 and 3 x 4 slides must be provided in the projection room for storing slides used every day or even occasionally.

### "Screening" or Previewing

Volumes could probably be written on the subject of "Whether Film Should be Previewed Before It Is Aired." However, in pointing out some of the things that *have* happened and omitting many things that *could* happen, it will at least stimulate your thinking and the decision rests with you as to whether film should be inspected or previewed before it is aired. Even today stations receive film that is patched together with tape. You obviously are aware of what happens when you try to run a tape slice through a projector. It just won't work. Brand new prints have been received with the sound track printed backwards, wrong sound with wrong picture, picture printed backwards, torn sprocket holes, commercials left in by the previous station, and many other difficulties too numerous to mention at this time. In other words, you can't tell what the film is or its condition just by looking at it on the reel, and we suggest that some method of inspection or previewing be set up in your station. A complete previewing report form should be filled out for each film listing all the necessary data that would be required by the Sales and Program Departments.

If space is provided for screening and previewing film, a small projector and screen will be necessary.

### Scheduling Commercials

Just as in AM broadcasting, an accurate system must be used in scheduling spots. In TV the spots appear in the form of 10 second, 20 second, and one minute, lengths of film. If not furnished by the agency or supplier, leader must be spliced to these short lengths of film so they may be threaded in the projectors. Scheduling must provide all parties concerned with the proper information as to whether a spot is to be tacked on the head of a certain show, tail of a certain show, or run individually.

### Receiving and Transshipment

A responsible party should be assigned these duties; they are important. An accurate receiving and transshipment record should be made on all film and should contain the following basic information: date, time received, source, type, PPD or collect, disposition after airing, person receiving film, mounted on reel or core, shipping case.

You will receive film from many sources. Let's consider commercials first. Most of these spots will, as in AM, come from the advertising agencies or their suppliers direct



FIG. 3. The careful and orderly filing of slides in cabinets like the above is recommended.

to you. (In some cases, the client will furnish it.) Films will be in various quantities and physical size. Some of them will be tied together and it will be necessary for you to break these down, place on small reels, catalogue them, and file for future reference. Others will come to you individually on plastic cores or sometimes on small 100-foot reels. A word about reels—especially the larger size. Inaugurate this rigid policy at the very beginning:

(a) If you receive a film on a plastic core, ship it back on a plastic core after you are finished with it.

(b) If you receive a film on a reel, ship it back on the same size reel after you are finished with it.

(c) Reels are expensive! In other words, if you receive a film on a plastic core and ship it back on a professional reel, *you* lose. Over a period of a year, this can amount up to a very sizable figure.

Under the present system of bicycling kinescopes, the following procedure is fairly well established by now. The network or originating station will film the show and release to various stations throughout the nation for a delayed play date. The network will advise each station where it should forward the film after it has aired the film and from what station it will receive its next film. So remember that you are just as dependent on a station for getting your show in good condition and on time as he is dependent on you for the same service. This is a responsible duty and conscientious personnel should be selected to supervise these duties. Many packaged shows and "kines" are open-ended, and

space is allowed for insertion of local cut-ins or individual commercials. Needless to say, it is extremely important to see that the show leaves you in as good or better condition than you received it.

#### Mailing Charges

This brings us to the subject of express or mailing charges, which is a very important item. For an average station film operation, the express charges for film directly chargeable to program expense will run between \$5000 and \$7000 per year. When you consider that kind of expense, the need for constant vigilance is apparent in select-

ing air express versus regular express. Check and recheck your play dates, and whenever possible, ship and order all film to be shipped by regular express.

#### Slide Making and Film Processing Facilities

The local advertiser, along with many national accounts, cannot incorporate in their advertising budgets the price of having commercials made by a professional 16mm. producer. The average price of a one-minute, sound-on-film television spot made by a 16mm. producer is between \$250 and \$1000 upwards, depending on the type of spot desired. This means the advertiser will turn to the television station operator for an economical answer, and the operator, who can provide slide making and film processing facilities, will be in a better position to sell the air time. It is another instrument to help the Sales Department in providing a complete customer service and will help lower sales resistance. This is especially true with slides. Virtually every commercial or show will require very frequent changes in slides. Slides are inexpensive to make and if handled properly can provide the station operator an additional source of revenue.

As we said in the beginning, handling film in a television station is not difficult, but it does warrant serious preliminary planning and thinking when the facilities are laid out. Your nearest RCA Field Representative can tell you about the complete RCA line of accessories available and will be glad to assist you in your planning.



FIG. 4. Since films are expensive, a good sturdy shipping case is suggested.

# PATTERN-TESTING THE TFU-24B UHF ANTENNA

By E. H. SHIVELY  
RCA Broadcast Engineering

In September of 1951, the first TFU-24-BH antenna, designed for channel 76, was completed at Camden, and after preliminary impedance tests and adjustments there, was taken to the Medford site for pattern tests. The following material outlines the principles involved and describes the test procedure, including data.

The pattern testing of a television broadcast antenna leads to two important results: (1) The radiation field intensity as a function of direction (radiation pattern) is measured and recorded; (2) The ratio of total radiated power from a dipole required to produce a given field intensity at a specified distance to the power radiated by the antenna when yielding equal maximum field at equal distance is measured. This is the directivity gain of the antenna.

## The Basic Principle

Consider the antenna to be placed at the center of a sphere of radius large compared to the dimensions of the antenna, Fig. 1. All of the radiated power will flow through the surface of the sphere, and the surface integral of the radiated power density on the sphere will yield this total power.<sup>1</sup> That is

$$W = \iint P \cdot ds$$

where  $P$  is the Poynting vector and  $ds$  is an increment of surface.

If then, a half-wave dipole be placed in the center of the sphere and the total radiated power adjusted so that the field intensity at the maximum point on the sphere is equal to the maximum field obtained with the unknown antenna, the gain of this unknown compared to the dipole will be:

$$\text{Power Gain} = \frac{W \text{ of dipole}}{W \text{ of unknown}} = \frac{\iint P_d \cdot ds}{\iint P_u \cdot ds}$$

The total radiated power of each antenna is obtained by integrating the power density over the surface of a sphere. In the case of the dipole, this can be calculated by analytic methods. The total radiated power of the unknown must be determined graphically, since it is related to the recorded pattern which is not readily expressible as an analytic function.

<sup>1</sup> "Antennas," by J. D. Kraus, McGraw-Hill Book Company, 1950, pp. 11-40.

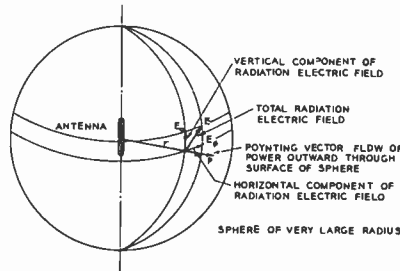

FIG. 1. Antenna in Imaginary Sphere.

The spherical coordinate system is shown in Fig. 2. The incremental power radiated is that flowing through the area  $dA$ . In this system  $dA = r^2 \sin \theta d\theta d\phi$ , and the total power is

$$W = \int_0^{2\pi} \int_0^\pi P(\theta, \phi) r^2 \sin \theta d\theta d\phi$$

Since  $P = E \times H$ , the normal component

$$\text{of } P = \frac{E_T^2}{n} = \frac{E_T^2}{377}$$

where  $E_T$  is the rms tangential component of the electric field on the surface of the sphere and  $n$  is the intrinsic impedance of free space, 377 ohms. Thus

$$W = \frac{r^2}{n} \int_0^{2\pi} \int_0^\pi E_T^2 \sin \theta d\theta d\phi$$

The total tangential electric field  $E_T(\theta, \phi)$  is ordinarily determined by its components  $E_\theta(\theta, \phi)$  and  $E_\phi(\theta, \phi)$ , which, by reference to Fig. 1, are the vertically and horizontally polarized components, respectively, so that

$$W = \frac{r^2}{n} \int_0^{2\pi} \int_0^\pi (E_\theta^2 + E_\phi^2) \sin \theta d\theta d\phi$$

For practical measurements, it is necessary to be able to express the definite integral of  $\theta$  as a function of  $\phi$ . In the TFU-24-B antenna, where the horizontal pattern is perfectly circular in the horizontal plane and the scallops are not appreciable at

FIG. 2. Spherical Coordinate System.

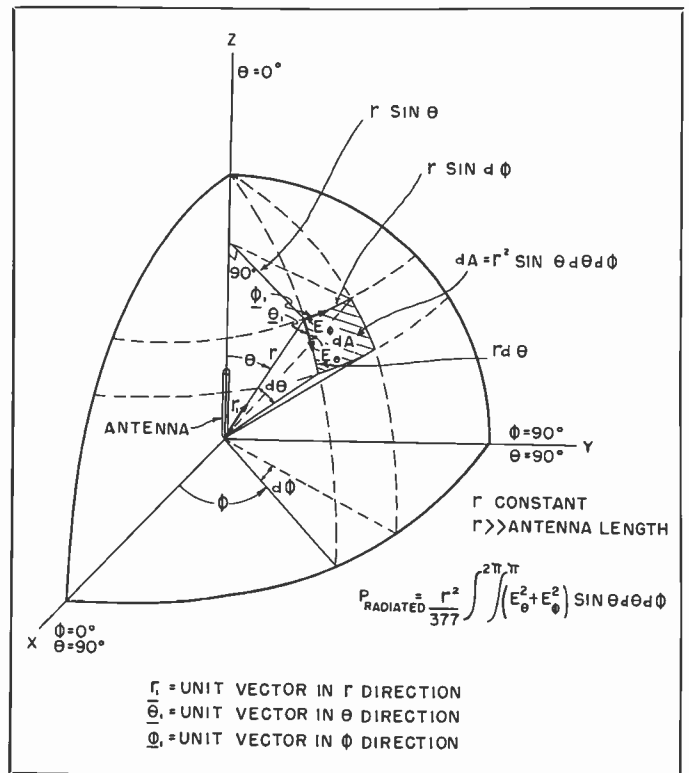

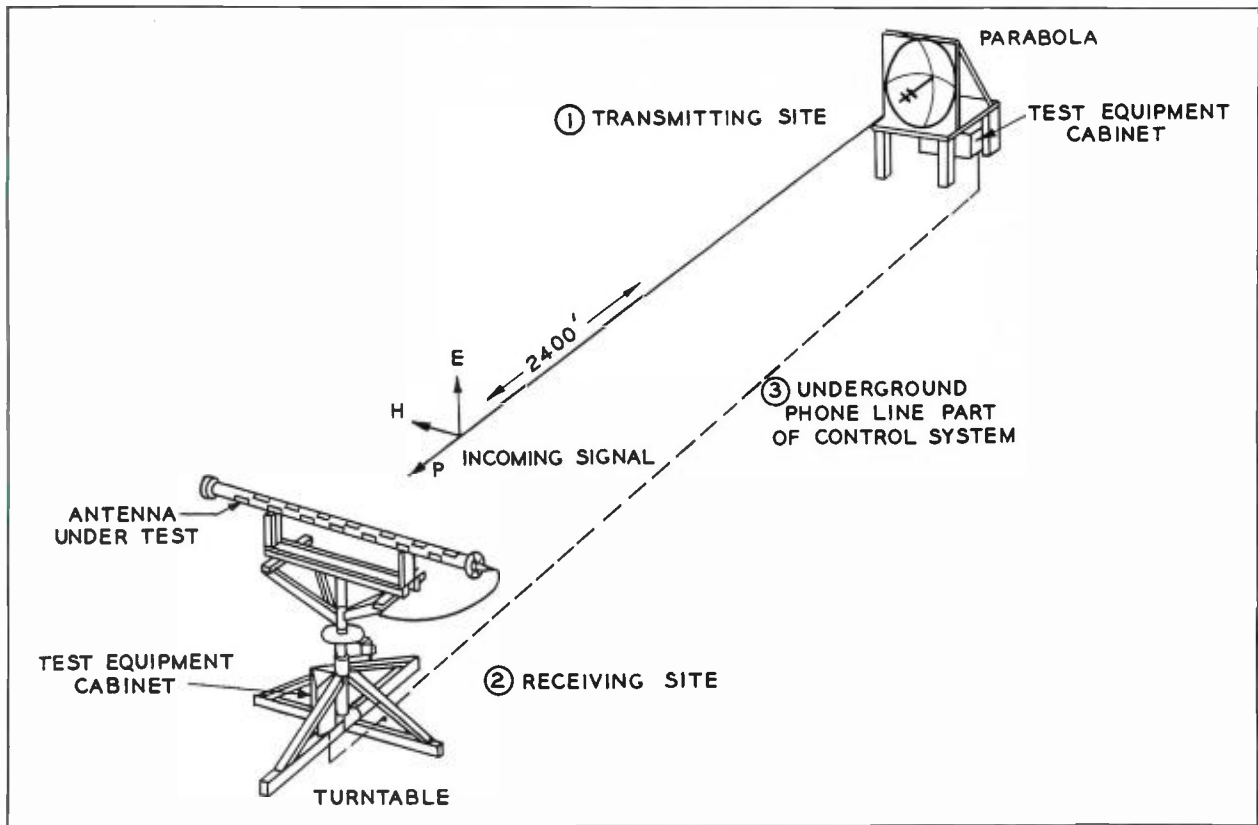

FIG. 3. Pictorial View of Antenna Test Ground.

higher angles, it has been shown that it is sufficient to measure a vertical pattern in the plane of the peak of a scallop and in the valley and average the readings point by point during the plotting process.<sup>2</sup>

### The Practical Considerations

The radiated field intensity as a function of  $\theta$ , the latitude angle, for any fixed  $\phi$ , the longitude angle (Fig. 1), may be found by mounting the antenna horizontally on a turntable and rotating it while the radiated signal is received at a remote point. Due to the principle of reciprocity,<sup>3</sup> the antenna may just as well be tested in receiving, and this is usually preferred, since the major quantity of test equipment is at the receiving location.

In order for the pattern to be accurately recorded, the chart of the recorder must be driven in synchronism with the antenna turntable. This is done at present by a

selsyn link driven from a ring gear on the turntable shaft.

The antenna test ground thus comprises (Fig. 3):

1. A transmitting site, from which the signal is beamed.
2. A receiving site at a distance, where the antenna under test is located, together with the turntable and associated test equipment.
3. A control system to link the transmitting and receiving sites so that operations may be carried on from one point.

The receiving site, shown in Fig. 4, comprises a wooden framework turntable carrying the antenna in a horizontal position and provided with anti-friction bearings so that the entire upper half may be very easily rotated. A gin pole (extending out of the picture to the right) may be raised to a vertical position and guyed to permit placing antennas on the turntable by chain hoist. A light framework is provided so that a tent may be set up in inclement weather.

A closer look at the turntable base, Fig. 5, reveals the test equipment. The signal from the antenna is received on the UHF converter (lower left corner), where it is transformed into a VHF signal and enters the RCA type WX-1A field intensity meter (lower center). The DC output current from this instrument drives the recorder pen (center). The chart is driven by the receiving selsyn according to information from the selsyn transmitter geared to the turntable spindle (upper right center). The angular position of the antenna thus automatically positions the chart. This position may also be read directly on the compass rose (behind recorder) which is provided with a vernier to permit angular readings to be taken to within  $\pm 0.10^\circ$ . In setting the compass, the antenna is "aimed" at the transmitting site by mounting a pair of sights, similar to rifle "peep sights" on the pipe. With the axis of the antenna thus pointing at the distant site, a clamp is loosened and zero on the rose set to zero on the vernier.

A heterodyne frequency meter is provided to check oscillator frequency. The cable is

<sup>2</sup>"A New UHF Television Antenna, TFU-24-B," by O. O. Fiet, BROADCAST NEWS, Vol. 68, March-April, 1952, pp. 8-23.

<sup>3</sup>"A Generalization of the Reciprocal Theorem," by J. R. Carson, Bell System Technical Journal, 3, July, 1924, pp. 393-399.

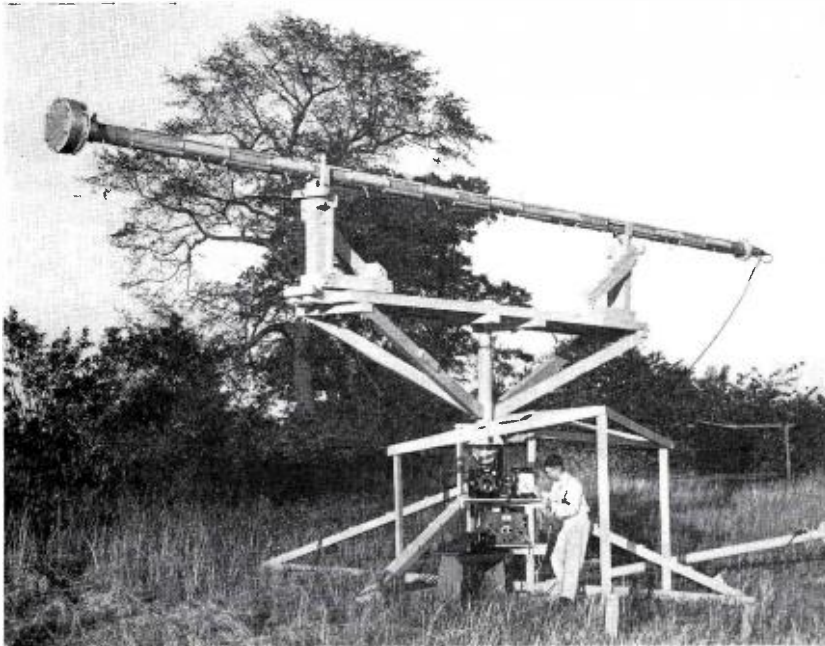

FIG. 4. The Receiving Site with UHF Antenna.

removed from the UHF converter, the antenna signal is applied directly to the frequency meter, and the oscillator frequency at the transmitting site is adjusted through the dial system.

At the transmitting site, Fig. 6, is located a high gain parabolic antenna supplied by a signal generator housed in a cabinet under the platform. This enclosure is shown in Fig. 7 and contains, beside the oscillator, the telephone stepping equipment, the motors for oscillator control, a sound powered telephone handset, and a constant voltage transformer. The phone permits contact with the receiving site when it is occasionally necessary to do so.

The knobs were removed from the oscillator and small geared motors of high ratio were coupled to the shafts through friction clutches. In this way, the motors could drive the shafts to the limit of travel without damage to either. A similar motor rotates the dipole assembly in the parabola in order to change the plane of polarization of the transmitted signal remotely.

The switching equipment (contained in the steel case with lid raised) is shown in schematic in Fig. 8. The system comprises a standard stepping switch (upper left in both schematic and in case) together with the necessary power and auxiliary relays. Ten operations may be performed inde-

pendently by dialing the appropriate number at the receiving site. Two separate AC power circuits and three motors may be controlled.

As currently connected the phone book reads:

- #1—AC outlet #1 on
- #2—AC outlet #1 off
- #3—AC outlet #2 on
- #4—AC outlet #2 off

After each of these operations the step switch is automatically returned to its home position. In positions 5-9 the stepper remains on the contact until "O" is dialed and it is released.

These operations are:

- #5—raise frequency
- #6—lower frequency
- #7—increase signal output
- #8—decrease signal output
- #9—rotate dipole assembly

Once any of these are started the operation will continue until "O" is dialed.

All relays in this cabinet operate from 110 volts AC and there are no power supplies or rectifiers to cause a continual current drain. The metallic rectifiers shown in the schematic are used for time delay operations only. The only exception is the

stepper, which is supplied by the DC pulses from the dial and its power supply. The overall schematic is shown in Fig. 9. The talking-dialing isolation, though not perfect, is sufficiently good that phone conversations may be continued while dialing is in progress. The only failure of the switching equipment in one year of service consisted of an "open" appearing in the step relay coil, in contrast to contact troubles, which might be expected.

#### Null Fill-In

Since all pattern calculations are made on the basis of parallel rays from the various elements of the antenna, the transmitting site should be at infinite distance from the receiving site. Obviously, the best compromise is to separate the sites as far as possible and then make allowances for discrepancies in the pattern due to the departure from a plane wave front as the wave arrives at the antenna. These discrepancies are caused by the currents at the various layers differing slightly in phase along the aperture.

This is shown in Fig. 10, wherein the wave front from the transmitting site is assumed to be spherical. In this case, the separation distance is  $r$ , the antenna aperture is  $a$ , and the distance from antenna center to any point A is  $l$ . The phase error, or time delay distance  $\delta$ , at A is for  $l < r$

FIG. 5. Test Equipment at the Receiving Site.

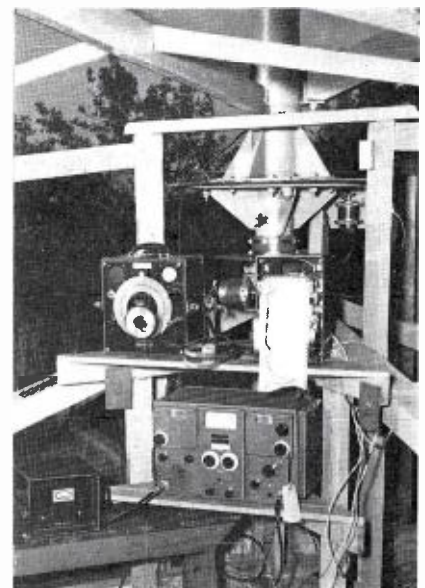



FIG. 6. The Transmitting Site at Marlton-Medford Airport.

$$\delta = \frac{l^2}{2r} \text{ in units of length.}$$

$$= \frac{360 l^2}{2 r \lambda} \text{ in elec. degrees.}$$

Thus, the phase variation along the array due to finite separation may be calculated, and this variation used to predict the amount of null fill-in to be expected.

Using the concept of the Fourier series representation of the antenna pattern, the far field at any angle  $\theta$  from the axis of an array of in-phase sources whose amplitudes are distributed symmetrically about the center of the antenna (Fig. 11) may be represented by the series:<sup>4</sup>

$$E = 2 \sum_{k=0}^N A_k \cos K \psi$$

where  $N = \frac{n-1}{2}$

- $n$  = Number of sources (here assumed to be odd)
- $\psi = d \cos \theta$
- $d$  = distance between sources in elec. deg.
- $A_k$  = Amplitude of  $K^{\text{th}}$  source.

All sources are in phase, and the nulls in the pattern are clean, that is, are theoretically zero.

If the sources also have differing phase angles the Fourier series representation may be considered as the sum of two series:

<sup>4</sup> "Antennas," by J. D. Kraus. McGraw-Hill Book Company, 1950. p. 99.

$$E = 2 \left[ \sum_{k=0}^N A_k \cos K \psi + j \sum_{k=0}^N B_k \cos K \psi \right]$$

where the first series is due to the "in-phase" components of the sources and the second, the "quadrature" components.

$$E = j 2 \left[ 0 + \left(\frac{1}{4}\right)^2 B \cos \psi + \left(\frac{1}{2}\right)^2 B \cos 2\psi + \left(\frac{3}{4}\right)^2 B \cos 3\psi + B \cos 4\psi \right]$$

However, since the distribution of the B's is in general different from that of the A's, the nulls in the two series will not occur at the same  $\theta$ , and, therefore, the far field will have a phase angle and the nulls will be filled in generally.

Since the main field (due to A components) is zero at a null position, it is merely necessary to calculate the field due to the B components at this position and this yields the theoretical null fill-in.

$$E = j 2 \sum_{k=0}^N B_k \cos K \psi$$

The eighteen layer TFC-24-BH antenna is equivalent electrically to nine sources spaced  $3 \lambda$  and arranged symmetrically about the center source, so that the quadrature field is:

$$E = j 2 \left[ B_0 + B_1 \cos \psi + B_2 \cos 2\psi + B_3 \cos 3\psi + B_4 \cos 4\psi \right]$$

For phase angles due to finite separation, the B's vary as the square of the distance from the array center, so that

$$B = \text{Amplitude of end source} = A \tan \delta$$

For example:

The first null of the TFC-24-BH 844 Mc. antenna occurs at  $\theta = 88^\circ$ . How much null fill-in is expected for the Medford site?

$$r = 2060 \lambda \quad l = \frac{a}{2} = 12 \lambda$$

$$\delta = \frac{360 l^2}{2 \lambda r} = \frac{360 (12 \lambda)^2}{2 \lambda (2060 \lambda)} = 12.6^\circ$$

$$B = A \tan \delta = \frac{1}{9} \tan 12.6^\circ = 0.0248$$

$$\psi = d \cos \theta = 1080 \cos 88^\circ = 37.7^\circ$$

FIG. 7. The Test Equipment Cabinet at the Transmitting Site.

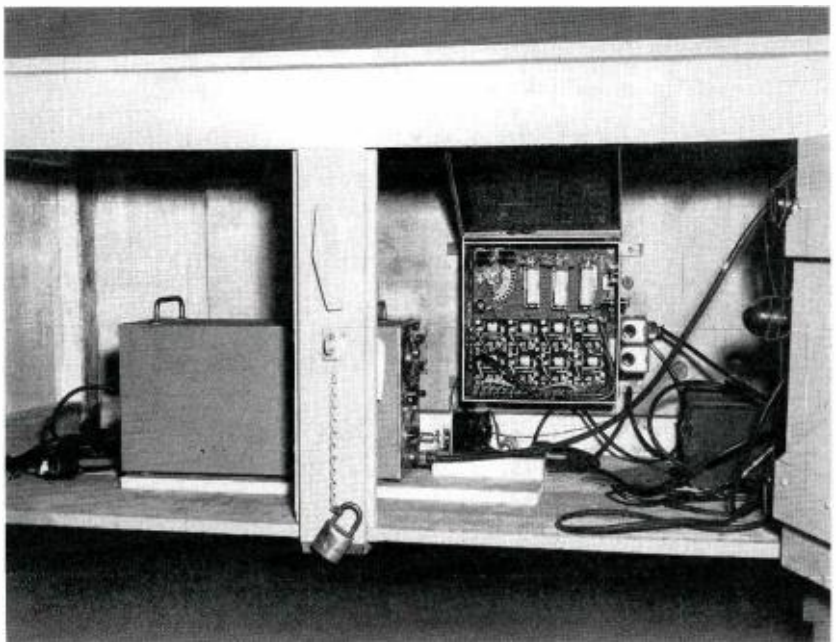

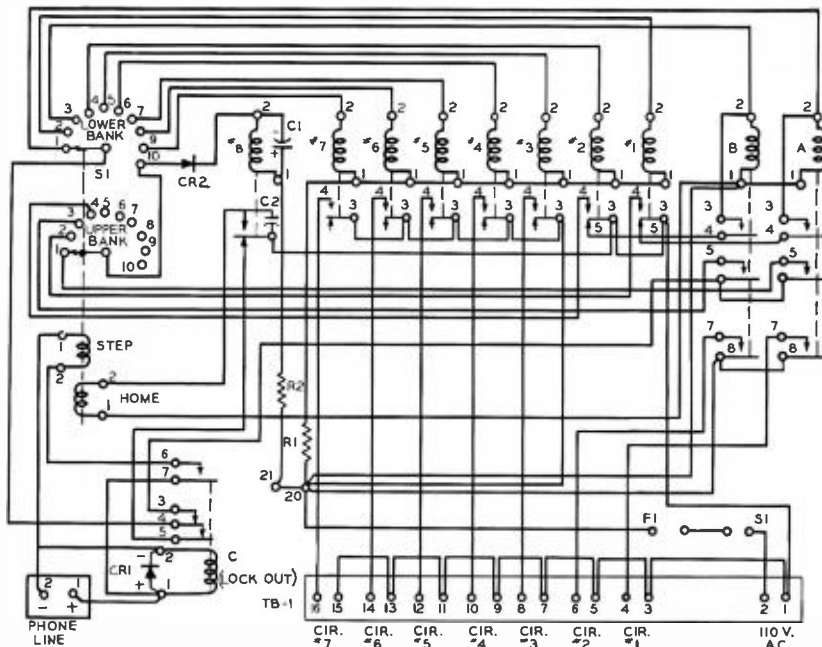

FIG. 8. Schematic Diagram of Telephone Step Equipment.

$$E = j 2 \left[ \frac{1}{16} B \cos 37.7^\circ + \frac{1}{4} B \cos 75.4^\circ + \frac{9}{16} B \cos 113.1^\circ + B \cos 150.8^\circ \right]$$

$$= -j 1.96 B = .049 \angle -90^\circ$$

This, then, shows a theoretical null fill-in of 4.9% due to finite separation between transmitting and receiving sites, at 844 Mc.

Reference to Fig. 10 will show that since the path length error is a fixed distance for any given aperture, the phase error is a function of frequency, being much less at lower frequencies.

As shown in Fig. 12, the measured null fill-in is about 10%, and consideration of this result will reveal that the actual null at this point will have a fill-in of from 5 to 15%, depending on the phase of the far field of the array relative to that of the site.

Greater fill-in than that shown in Fig. 12 may be provided by several methods, such as operating the antenna above design frequency, Fig. 13, beam tilting, Fig. 14, and by minor design changes. However, experience at the Bridgeport, Connecticut transmitter KC2XAK with the prototype of the present antenna has shown adequate signal uniformity in that region covered by the side lobes and nulls.<sup>5</sup>

<sup>5</sup> "Experimental Ultra-High Frequency Television Station in the Bridgeport, Connecticut Area," R. F. Guy, J. L. Seibert, and F. W. Smith, RCA Review, March 1950.

In general, the signal received at any point will be the vector sum of the direct and ground-reflected waves. The geometric relations are as shown in Fig. 20, in which a plane smooth earth is assumed. Since, for a horizontally polarized wave, the electric field reverses direction on ground reflection, there will be cancellation of the fields at the receiving antenna for path length differences of integral multiples of a wavelength.

As a receiving point is moved outward at constant height, the path length differ-

ence of the two waves will continually decrease, and there will be cancellations and reinforcements as this occurs. The cancellations are ordinarily not complete since the ground absorbs part of the signal and the direct wave is always stronger at the receiver.

With an isotrope or low gain antenna, the wave at the angle a is equal to that at angle b for D large compared to the antenna height h<sub>1</sub>.

Near a cancellation point, the vectors are as shown in Case I and since E<sub>r</sub> and E<sub>g</sub> are almost equal, the resultant field will be very small.

With a high gain antenna, the waves at angles a and b will, in general, differ in magnitude so that, as in Case II, the cancellation is less complete and a greater field results. If, for example, the wave at either a or b comes from a null there will be no cancellation and the resultant field strength at the receiver will be greater than in either of the previous cases.

Fig. 23 shows a radial calculated for a transmitting height of 500 feet and receiving height of 30 feet over plane earth of common characteristics

$$(\sigma = 5.10 \cdot 10^{-14} \text{ e.m.u., } E = 15),$$

wherein the less severe effects of ground reflection interference can be seen and in which the effect of antenna nulls is subordinate to that of reflection. These curves are for equal effective radiated powers. For equal transmitter powers, the isotropic curve must be lowered by the gain of the antenna relative to an isotrope, i.e., by approximately 16 DB. Calculations must, of

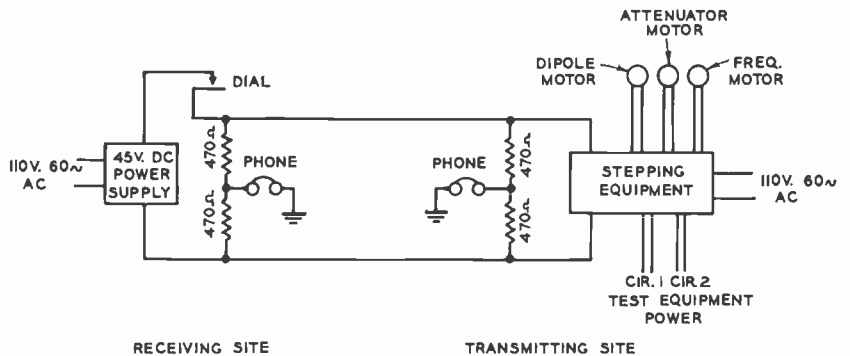

FIG. 9. The Control System.



course, be made on the basis of an earth surface of simple geometry, such as plane or spherical, but the same theory holds for other earth surface shapes, except that the interference positions may not occur at the same distances from the transmitter.

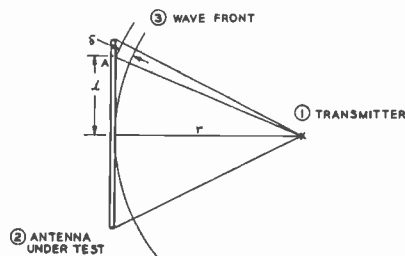

FIG. 10. Geometry of Path-Length Difference.

### Recording System Accuracy

With high gain antennas having half-power beam widths in the order of 2 degrees, the recording accuracy requirements become quite critical, especially when it is

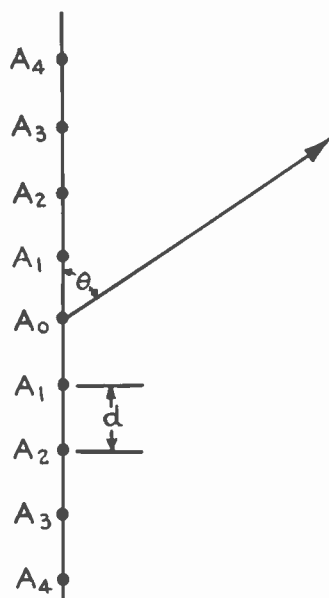

FIG. 11. Array of Point-Sources.

necessary to measure beam tilts. In this particular application, it is necessary to be able to record to within  $\pm 0.1^\circ$ .

With the recording of narrow beams, it is necessary to "spread out" the chart, i.e.,

make each degree of turntable rotation equal to a considerable space on the chart. In the test here described, one degree equalled  $\frac{3}{4}$  inch of chart. At these low gear ratios between selsyn and recorder, the input frictional torque supplied by the selsyn is considerable and the machine will drop behind its theoretical angular position until it develops sufficient torque to pick up the load.

A gear train of appropriate type must be interposed between selsyn and recorder to prevent the angular error in the selsyn from causing the recorder to fall back too far. These considerations are shown in Fig. 15.

Notation:

$$\text{All gear ratios} = \frac{\text{Driver teeth}}{\text{Driven teeth}}$$

$$N_1 = \text{Ratio turntable to selsyn transmitter.}$$

$$N_2 = \text{Ratio selsyn receiver to recorder.}$$

$$K_T = \text{Selsyn torque constant} = \frac{\text{Degree of rotational lag}}{\text{Inch-Oz.}}$$

$$K_R = \text{Recorder constant} = \frac{\text{Unit of chart}}{\text{Degrees of drum rotation}}$$

$$\delta = \text{Angular error of recorder, in chart units.}$$

$$\delta' = \text{Angular error of receiver selsyn, in degrees.}$$

$$T = \text{Frictional torque required to drive drum, oz.-in.}$$

$$\theta = \text{Degrees of rotational movement of turntable.}$$

Torque seen by receiver selsyn (neglecting acceleration) is  $N_2 T$ .

A perfect gear system is here assumed.

The receiver selsyn will drop behind the transmitter until sufficient torque is developed to carry load.

$$\delta' = N_2 T K_T$$

This angular error appears at the recorder drum multiplied by  $N_2$ —

$$\delta = N_2^2 T K_T \text{ (in degrees of drum rotation)}$$

$$= N_2^2 T K_T K_R \text{ (in chart units)}$$

However, it is convenient to refer this error to  $\theta$ , that is, express it in degrees of turntable rotation—

$$\delta = \frac{\text{Angular error of recorder drum}}{\text{Gear ratio, turntable to recorder drum}}$$

$$= \frac{N_2^2 T K_T}{N_1 N_2}$$

$$= \frac{N_2}{N_1} T K_T \text{ (in degrees of turntable rotation)}$$

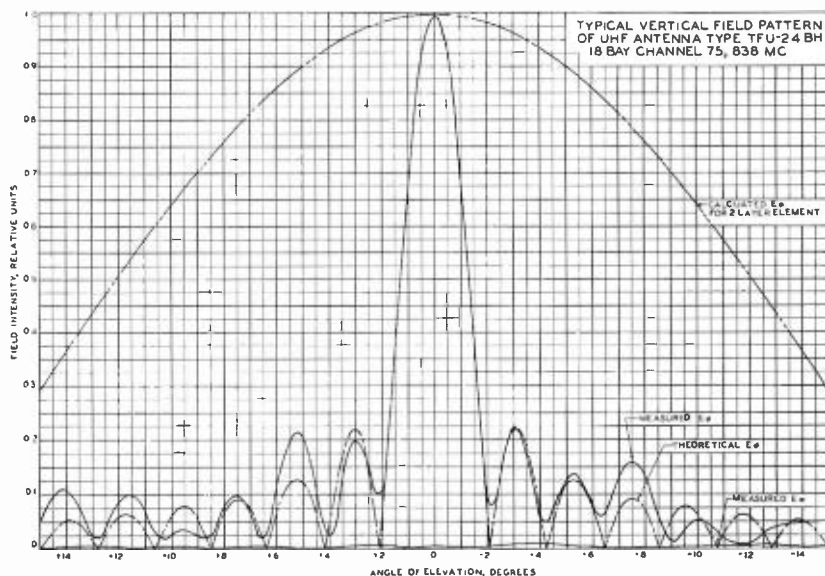

FIG. 12. Vertical Pattern of TFU-24BH.

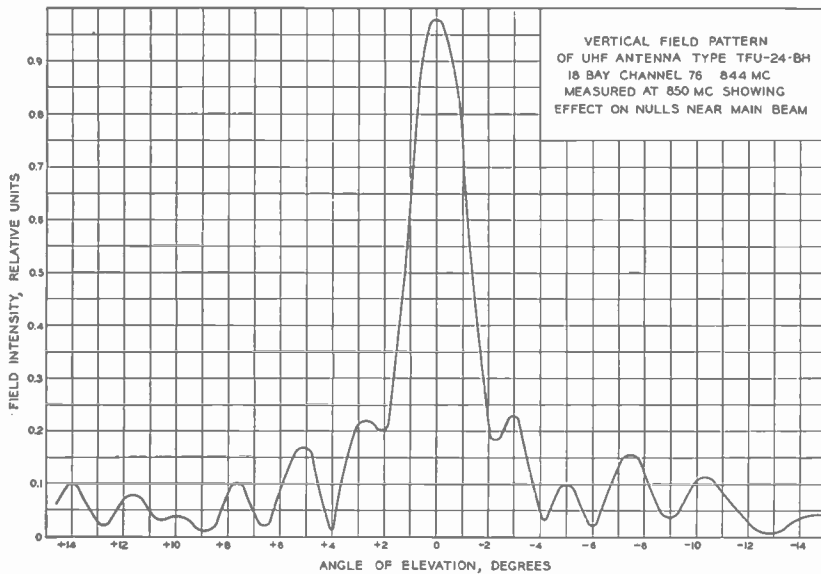

FIG. 13. Vertical Pattern of TFU-24BH Operated 6 Mc. above Center Frequency.

Usually, that ratio  $\frac{N_2}{N_1}$  is to be determined which will allow recording to a specified accuracy. In this case:

$$(1) \frac{N_2}{N_1} = \frac{\delta}{TK_T}$$

However, the overall ratio is determined by the degrees per unit of chart.

$$(2) N_1 N_2 = \frac{1}{K_R}$$

If  $N_2$  in (2) is substituted in (1):

$$(3) N_1 = \sqrt{\frac{TK_T}{\delta K_R}}$$

This allows a direct determination of the gear ratio required to drive the transmitter selsyn. The second half of the overall train is determined by equation (2). Thus  $N_1$  and  $N_2$  are specified for any allowable recording accuracy.

For example, for the recorder in use at Medford during this period,

$$K_T = 2.84^\circ/\text{oz.-in.}$$

$$T = 3.5 \text{ in.-oz.}$$

$$\delta = 0.1^\circ$$

$$K_R = \frac{1}{60} \text{ chart division/drum degree}$$

$$N_1 = \sqrt{\frac{3.5 (2.84)}{0.1 (1)}} = 77.5$$

$$N_2 = \frac{1}{N_1 K_R} = \frac{60}{77.5} = 0.775$$

In the actual Medford installation, the nearest lower combination for  $N_2$  was 2/3. This dictated  $N_1 = 90$ , and is the ratio now in use.

Many quantities not ordinarily considered assume prime importance. For example, some elastic angular deflection of the turntable and shaft will appear between antenna and bearings due to the bearing frictional torque, since the turntable is

rotated by torque applied to the top of the rotating members. Because the selsyn must be mounted on a fixed support, its position is necessarily at the top bearing, and it will read the position of the shaft at that point with respect to the bearing.

The actual position of the antenna deviates from this due to the elastic angular deflection, and thus the antenna and its pattern (which appears at the pen) are ahead of the chart; consequently, a recording error results.

This effect is complicated by the fact that the bearing (on which the selsyn is mounted) itself is constrained by the elasticity of the mounting timbers, so that as force is applied to the top of the turntable and the antenna begins to rotate, first the lower bearing then the shaft and timbers at the top twist until the static bearing friction is exceeded, thus putting the antenna further ahead of the chart.

The effects are exaggerated in this description, being in the order of 3 to 5 minutes of arc; nevertheless, they do affect the results. The deflection of the bearing mounts has been measured by mounting a mirror on the bearing and sighting a transit on a distant object. Torque is applied until the turntable is on the verge of rotation,

FIG. 14. Tilted Vertical Pattern.

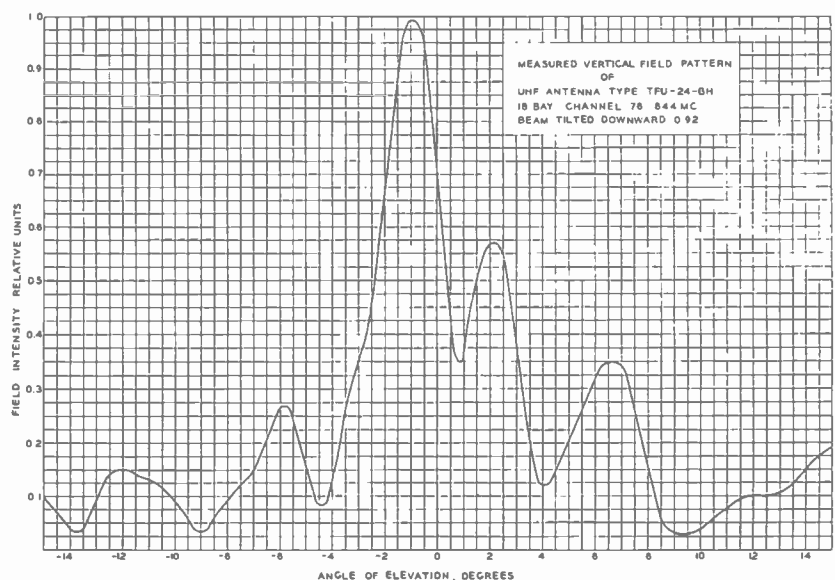

and the movement of the object measured in minutes of arc. If the transit shows  $\theta$  minutes, the bearing rotates  $\frac{\theta}{2}$  minutes.

An overall test of the system was made during this period. A transit was set up on the turntable beside the center of the antenna, Fig. 16, and a push button arranged in a circuit to apply a voltage pulse

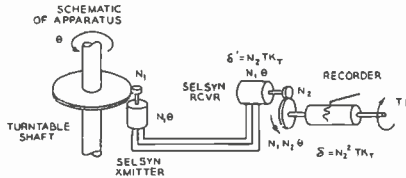

FIG. 15. The Recorder Drive System.

to the recorder. The transit was first sighted on the center of the transmitting parabola, 2400 feet away, and the recorder set on a main chart division. Then, as the turntable was slowly rotated, an observer set the transit ahead by ten degrees, locked it down, and waited for the cross-hairs to reach the center of the parabola. As they crossed, the button was pushed and a pulse appeared on the recorder. Enough readings were taken to average out the human errors, and from one of the charts shown in Fig. 17, it can be seen that the pulses do not lag the main divisions by more than  $0.1^\circ$ .

#### The Test Procedure

In taking a pattern, the antenna is turned approximately broadside to the incoming signal and the cable connected to the heter-

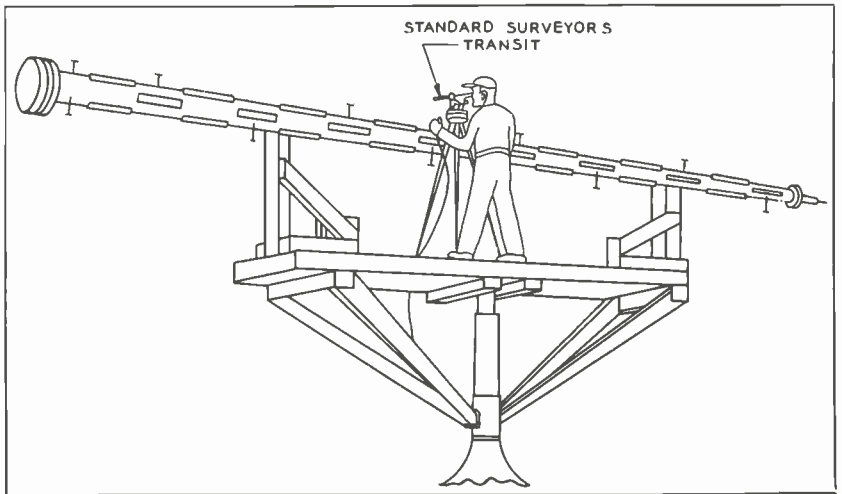

FIG. 16. Transit Test on Overall Recording Accuracy.

odyne frequency meter. The oscillator frequency is then measured and set to the desired value by dialing the appropriate numbers.

With the cable connected to the field intensity equipment and the antenna rotated until maximum signal is obtained, the correct gain and zero adjustments are made on the equipment.

The antenna is returned to zero (axis pointing at the transmitter) by means of the large compass rose and vernier. After exciting the selsyns and setting the recorder chart so the pen is on a main division, the run is begun. At this time, any aircraft in the vicinity of the airport invariably decide to land. Since the transmitted beam crosses

the runway, an anomalous pulse is applied to the pattern which is marked and discounted later. The same effect which started radar development operates here also.

It is always desirable to check the power wasted in crosspolarized radiation in a new antenna. For this test, a small dipole, isolated from the re-radiated field of the main antenna by a metal reflecting sheet, is set up on the turntable and oriented parallel to the main antenna's normal radiation. The received field strength is read in relative units to give  $E_\phi$ .

The transmitting dipole is then rotated by the dial system until a null occurs, at which time the incoming signal is a plane

FIG. 17. Transit Test Recorder Chart.

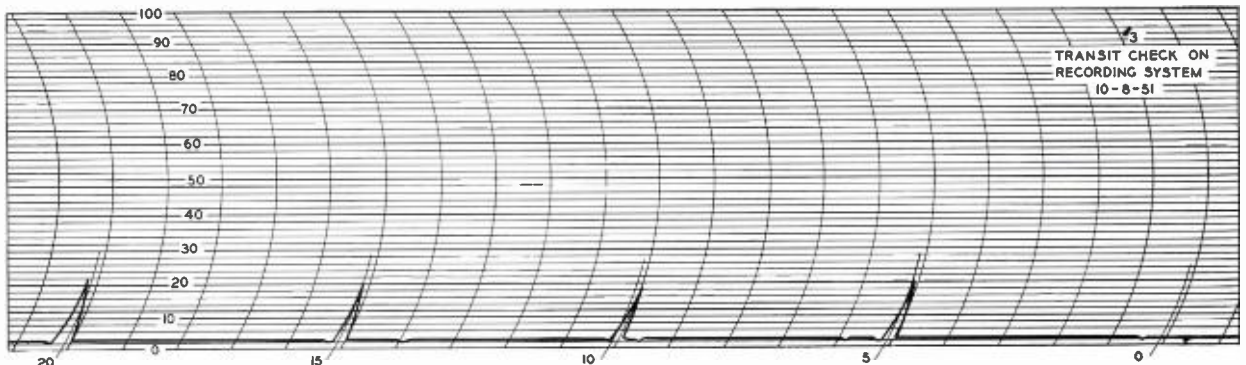

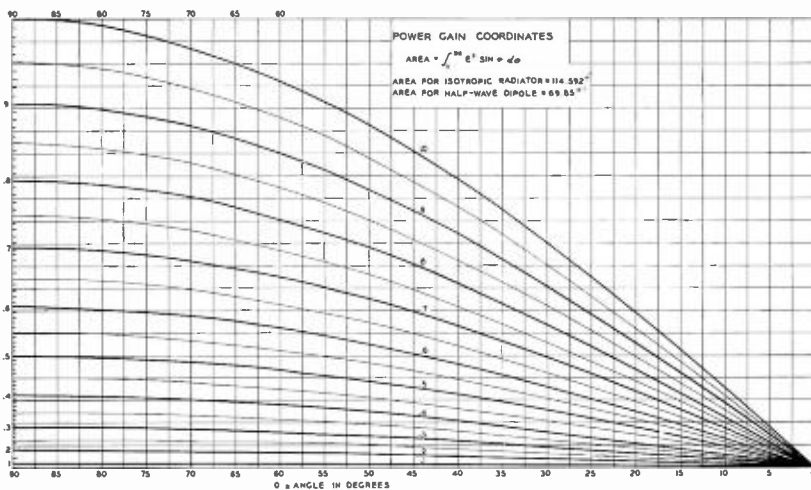

FIG. 18. Power Gain Coordinates.

FIG. 19. Power Gain vs. Frequency.

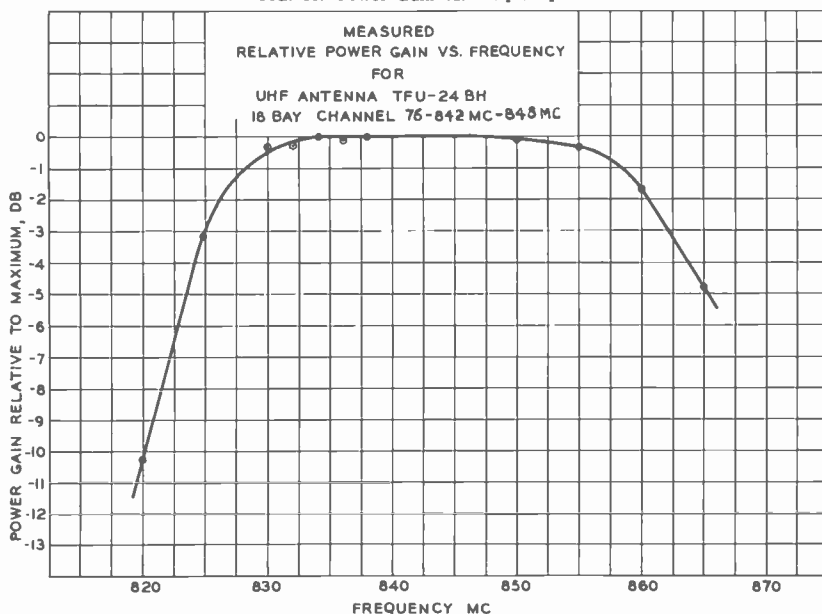
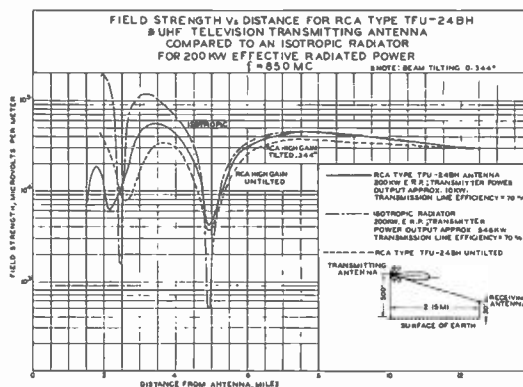

FIG. 21.



wave with electric field perpendicular to the receiving dipole axis. Then, the receiving dipole is positioned for maximum signal and this read in relative units to give  $E_{\theta}$ .

In general  $E_{\theta}$  will differ from  $E_{\phi}$  because the reflection coefficient of the ground varies with polarization. However, the gain of the field intensity meter may be varied to give  $E_{\theta} = E_{\phi}$ .

A pattern is taken in this condition, though with antennas having very low cross-polarized radiation such as the TFU-24-B series, the attenuator on the field intensity meter must be decreased 20 db. to allow a readable chart to be recorded.

Patterns are taken in this way in both "vertical" planes (which are actually horizontal because the antenna axis is horizontal) through a line of slots ( $\phi = 0^{\circ}$ ) and halfway between a line of slots ( $\phi = 30^{\circ}$ ). These two patterns are each repeated six times in going around the antenna in a plane normal to its axis.

A typical vertical field pattern of the TFU-24-BH is shown in Fig. 12, where the very low crosspolarized radiation can be seen.

In computing gain, the average of field values in the two planes vs.  $\theta$  is plotted on power coordinate paper, Fig. 18, in which the ordinates are squared and multiplied by  $\sin \theta$ , so that it is merely necessary to plot the normalized field values vs.  $\theta$  on this paper and integrate the result by planimeter. The area under the

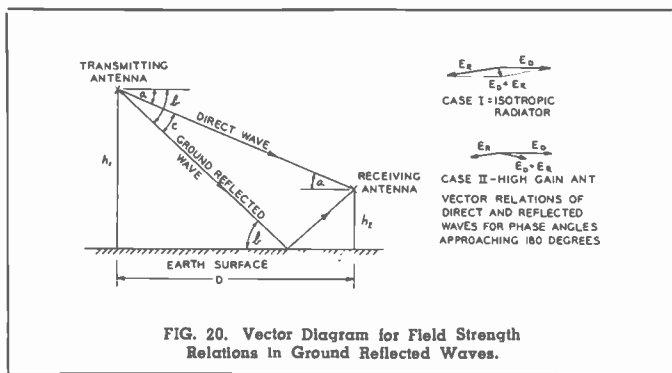

FIG. 20. Vector Diagram for Field Strength Relations in Ground Reflected Waves.

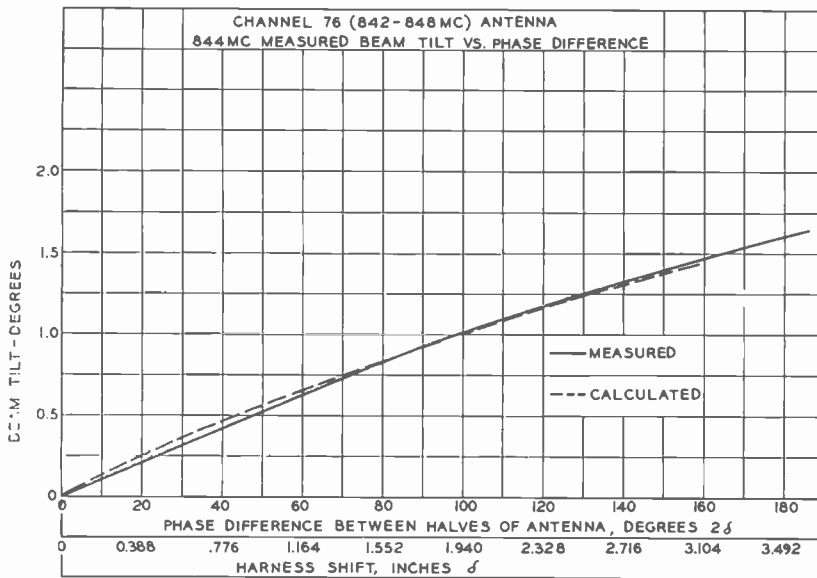

FIG. 22. Curve of Beam Tilt vs. Harness Shift.

curve is proportional to the power radiated, and so the gain is:

$$G = \frac{K}{\int_0^\pi E_n^2 \sin(\theta) \sin \theta d\theta} = \frac{K}{\text{area}}$$

Where  $E_n$  is the normalized field pattern, average of patterns in the two principle planes,  $\theta$  is the angle from vertical, and  $K$  is a constant determined by the paper dimensions, the gain of the reference antenna, etc.

As was mentioned previously, as long as the solid pattern is a figure of revolution, or at least has cyclic variation of small magnitude, so that the average of the field patterns in two vertical planes may be used, vertical patterns in those planes of the  $E_\phi$  and  $E_\theta$  components describe the total field and thus the total power radiated. This does not apply to some other types of antennas in which the vertical pattern varies greatly around the axis, or is not cyclic.

Accordingly, a plot is made of each on power coordinate paper and the resulting areas added in order to get the total gain:

$$\int_0^\pi (E_\theta^2 + E_\phi^2) \sin \theta d\theta = \int_0^\pi E_n^2 \sin \theta d\theta + \int_0^\pi E_\phi^2 \sin \theta d\theta$$

This procedure is followed for a number of different frequencies and the curve of power gain vs. frequency, Fig. 19, is obtained.

A number of patterns are taken for various harness positions at the center frequency of the antenna. The position of the maximum of the main beam is measured and the gain evaluated for each position. Curves of beam-tilt vs. harness shift, Fig. 22, and of gain vs. beam-tilt, Fig. 23, result.

The process of antenna pattern measurements is continually undergoing changes in the direction of higher accuracy and greater speed; and this naturally points the way to greater mechanization. Effort, at the present time, is being directed along these lines in order to yield better patterns faster.

#### Acknowledgment

Appreciation is expressed to those members of the Broadcast Antenna Engineering Section who were connected with the pattern testing, especially to O. O. Fiet for many helpful suggestions both in the tests and in the preparation of this material, and to D. C. Stock and A. Feller for calculations and processing of test data.

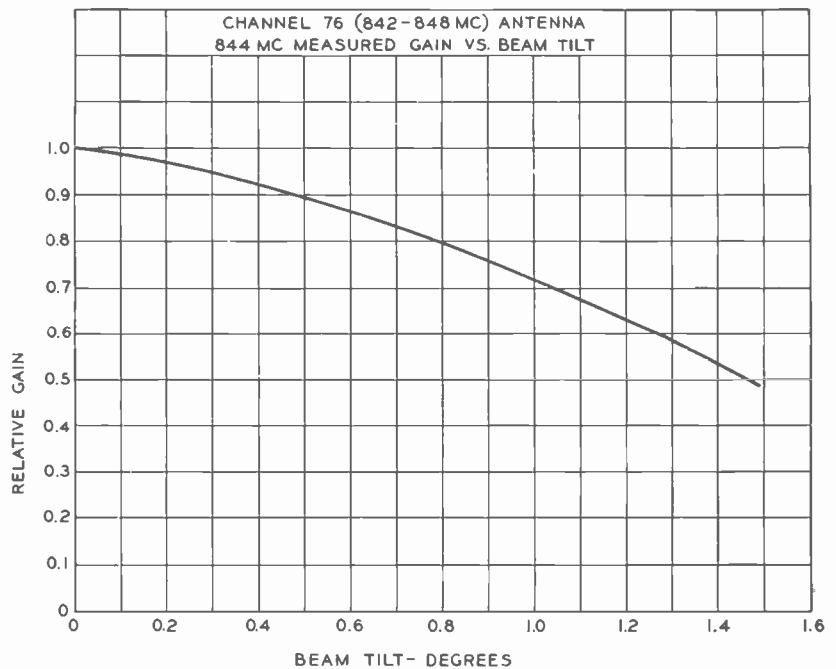
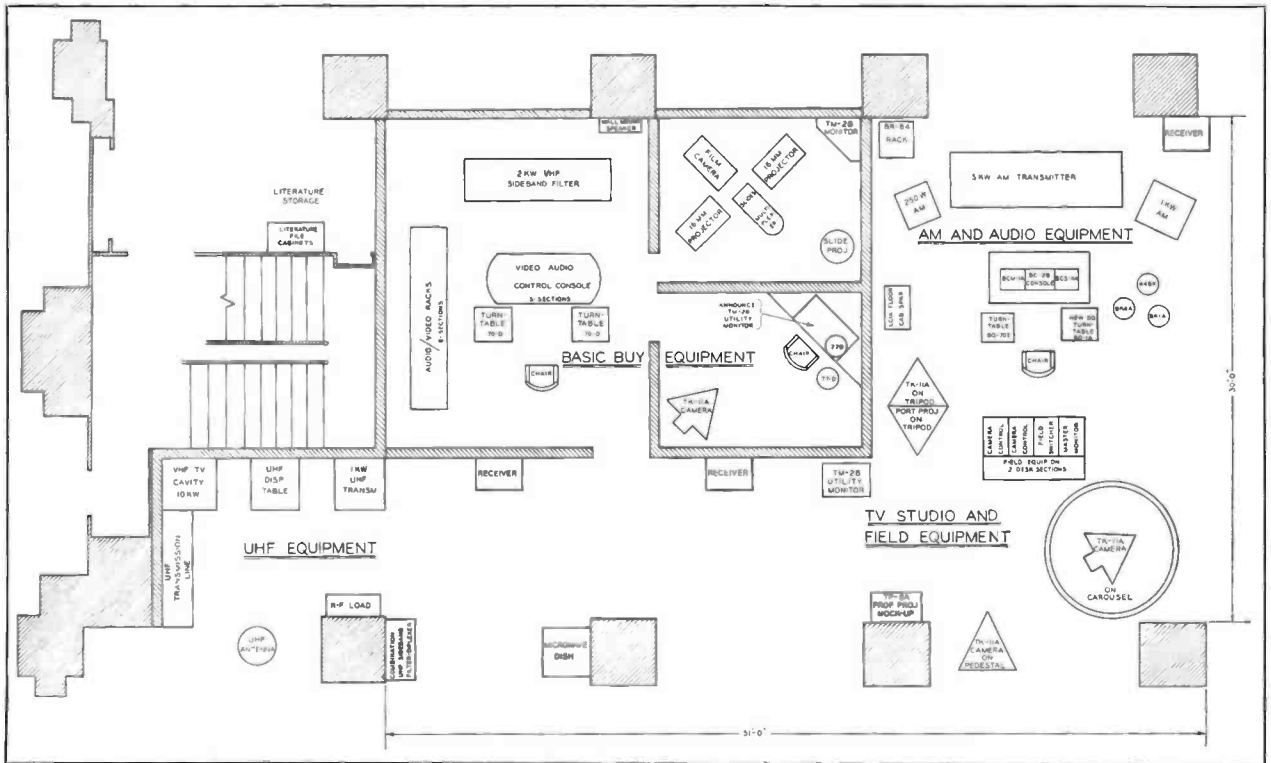

FIG. 23. Curve of Gain vs. Beam Tilt.



FIG. 1. RCA's all-new camera was a top attraction at NARTB Convention. A. Reisz, RCA Video Engineer, is shown at the controls.

FIG. 2. Floor plan of the RCA exhibit layout.



# NEW EQUIPMENT FEATURES RCA'S NARTB SHOWING

With nearly 2000 Broadcasters in attendance at the 30th Annual Convention at Conrad Hilton Hotel in Chicago, RCA presented an extensive display of new Television and AM equipment. Occupying about 1700 square feet of floor area (see Fig. 1 plan), RCA's exhibit space buzzed with activity as Broadcast station owners, managers and engineers examined the new equipment. As might be expected (with the TV freeze nearing an end), TV planning was uppermost in practically all discussions.

By

**W. O. HADLOCK**

**Engineering Products Department**

Constructed as a single, coordinated display, yet arranged into four equipment groupings—RCA's exhibit included:

- (1) TV Studio and Field Equipment
- (2) AM and Audio Equipment
- (3) "Basic Buy" Equipment Package
- (4) UHF Equipment

## TV Studio Equipment Features All-New Camera

Near the main entrance of the RCA exhibition space, the all-new TK-11A Studio and TK-31A Field Cameras could be seen. One camera was displayed on a colorful revolving carousel complete with camera-man and ballet manikins. Two "live" cameras were used for picking up scenes which could be viewed on monitors and TV receivers throughout the RCA exhibit area. And a third "live" camera was located in the "Basic Buy" announce studio. "Inside-Out" accessibility seems to best describe

FIG. 3 (below). An innovation in Convention displays was the Complete Television Setup, the RCA "Basic Buy" Transmitter and control room at left, announce studio and film projection facilities at right.

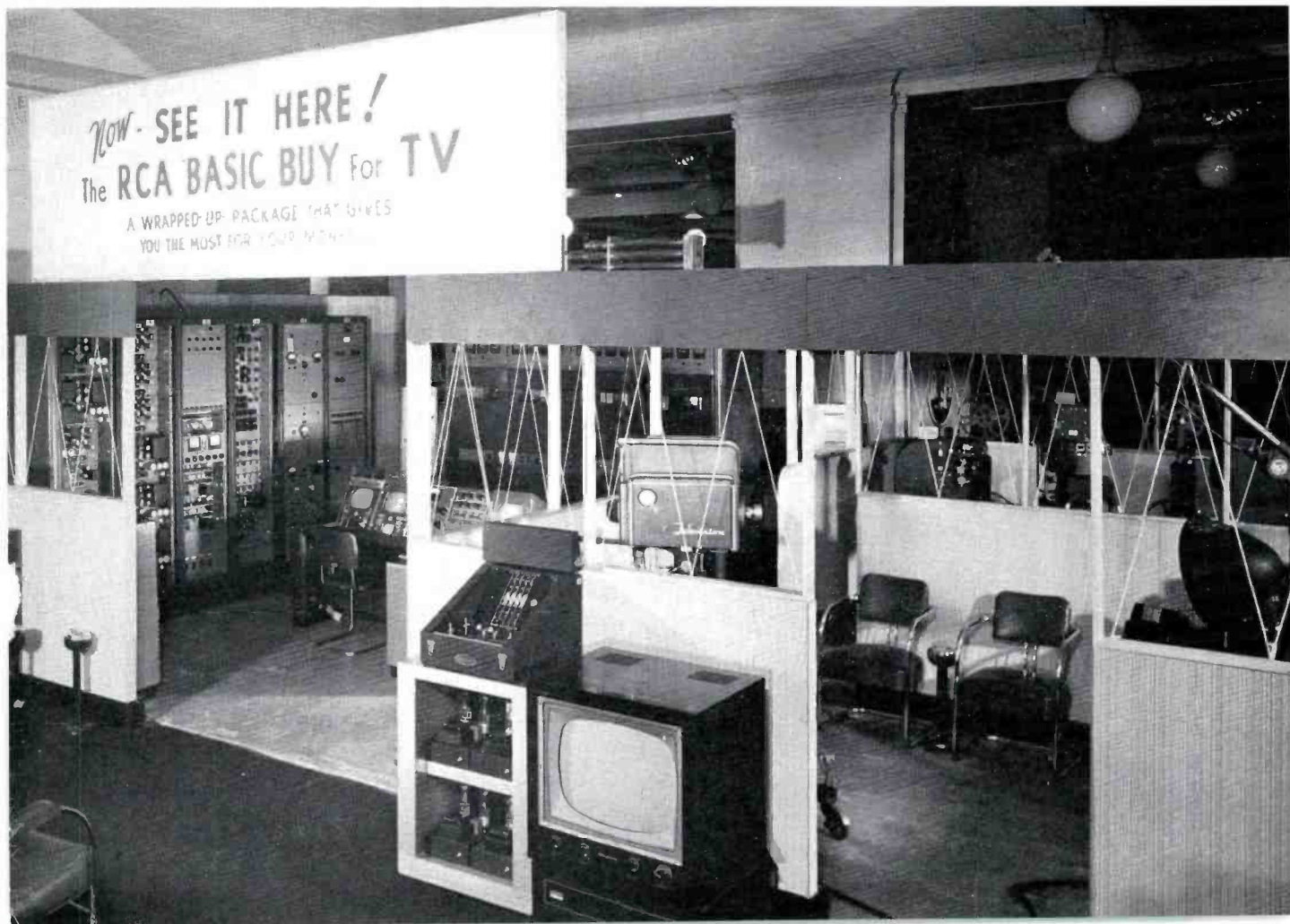

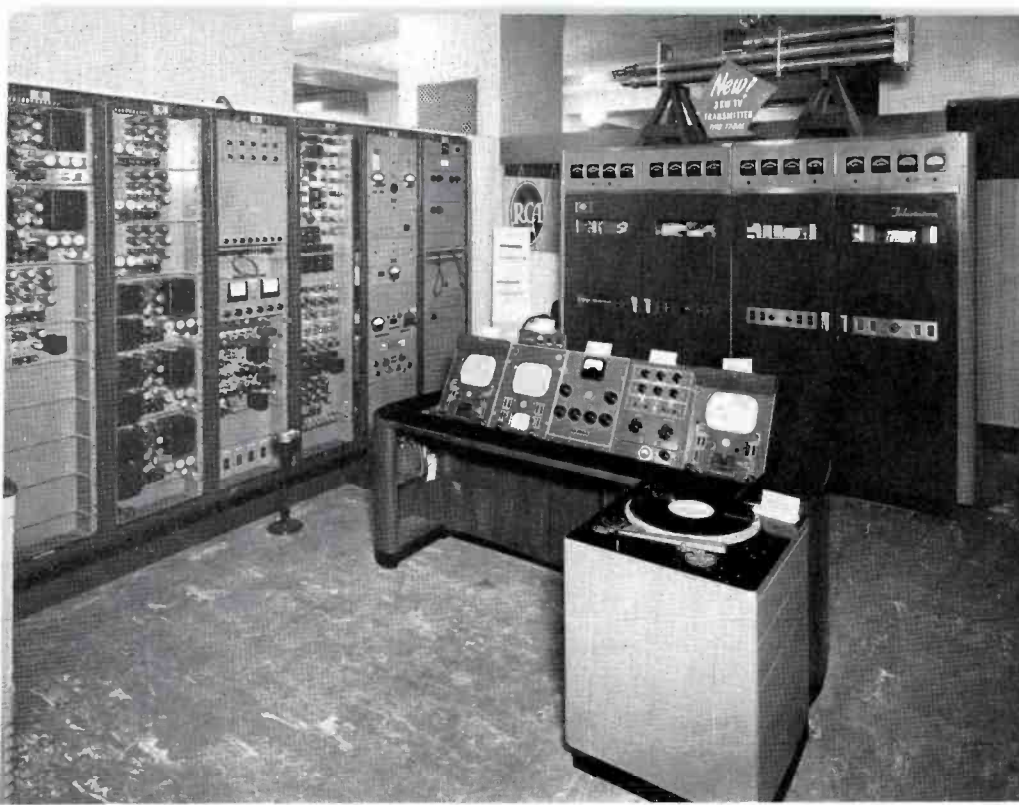

FIG. 4. Closeup of the Basic Buy transmitter and control room. Video control racks at left, TC-4A Audio-Video Console center and 2-KW Transmitter at rear.

the unique fold-away construction of the new camera—a feature which received much attention and favorable comment. “Even better” performance and complete interchangeability with older camera units are other important features. A complete setup of RCA TV field control equipment was used in conjunction with the “live” cameras.

#### The “Basic Buy” Package

Simulating almost exactly the appearance and operation of a small Television station, RCA’s “Basic Buy” package “stole the show” from a TV planning standpoint.

Dominant feature of the “Basic Buy” station, which was arranged in a compact three-room layout, was the Audio-Video TC-4A Control Console which facilitates

this type of economical, centralized operation. One room of the “Basic Buy” layout was devoted to the control console, six TV equipment racks and an RCA 2-KW TV Transmitter, TT-2AL/AH . . . a second room to films and slide projection facilities including the new TK-20C Film Camera, TP-16D Projector and TP-2A Automatic Slide Projector . . . and a third room with

FIG. 5. View of the exhibit near the aisle entrance where Carousel, AM transmitter and audio equipment and RCA field equipment were visible.





studio camera, lighting equipment and announce facilities.

Of pertinent interest to TV planners was the fact that the "Basic Buy" setup exemplified reduced investment and manpower, yet makes a steady income possible by providing four types of programming— (1) network, (2) local films, (3) local slide projection and (4) small studio shows.

### New AM and Audio Equipment

Interests of the AM Broadcasters were more than casually attracted to RCA's new 250 watt, 1-KW and 5-KW AM Transmitters. The new 1-KW and 5-KW models featured sliding or "roll-away" door front and rear for easy accessibility and reduction of operating floor area requirements. Featured in the Audio equipment line were a brand new fine groove, professional turntable, the new BC-2B Console, BCS-11A Master Switching Console, BCM-1A Auxiliary Mixer and the new BK-1A Microphone. Operating equipment provided the Broadcaster an opportunity to play fine groove records and observe the quality reproduced through LC-1A Loudspeakers.



FIG. 6. A complete line of UHF equipment including the 1-KW transmitter and the TFU-24 antenna was displayed.

FIG. 7. View of the display portraying RCA's complete transmission line accessories for UHF.



### New UHF Equipment

RCA's complete line of UHF Television equipment was typified by displays of the 1-KW Transmitter (TTU-1B), UHF Antenna (TFU-24B), combination UHF Sideband Filter and Diplexer, complete UHF Transmission Line, R-F Loads and a rather extensive display of RCA UHF converters, receivers, and receiving antennas.

Feature attraction of the UHF Section (to TV Planners) was the 1-KW, UHF Transmitter which is one unit of RCA's complete line. RCA transmitters used with the TFU-24B Antenna will enable Effective Radiated Powers up to the maximum of 1000 KW. The 1-KW transmitter permits the Telecaster to start small and "add-on" RCA high-power amplifiers later for increased power.

# TELEVISED FILM . . . .

## *a review of current and proposed methods*

by **P. J. HERBST**  
Engineering Administrator  
Standard Products  
Engineering Products Department

The flexibility afforded by filmed program material has given it a role of steadily increasing importance in television broadcasting. However, while excellent quality is frequently obtained from such material, the average performance leaves much to be desired. In the search for a method which can provide optimum results under practical conditions of operation a number of systems have been conceived and have received enthusiastic support from their pro-

ponents. There have been so many of these suggestions, each with its claims of superiority, that confusion is likely to be injected into the comparative evaluation of the merits and potential usefulness of the various systems. This article is therefore an attempt to re-examine the characteristics of the available tools and the systems into which they may be combined in the light of the specific performance which we hope to achieve.

Any proposed system should be examined to determine its performance with respect to detail, gray-scale rendition, noise, spurious signals and flicker. It should also be scrutinized from the standpoint of operating convenience, simplicity, reliability and cost. Finally, it should be investigated to determine its adaptability to possible future developments in broadcasting techniques. The experiences described below represent several years of thorough investigation by RCA technical personnel.

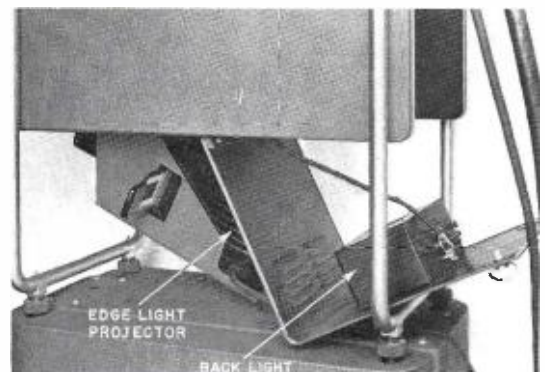

FIGS. 1 and 2. Shown at the left and top right, is RCA's improved TK-20C Film Camera. Refinements include improved edge lighting systems, improved back lighting and beam current control, therefore eliminating shading during programs. FIG. 3 (bottom right), is a closeup of the RCA Type TK-3A Flying Spot Camera optical system.

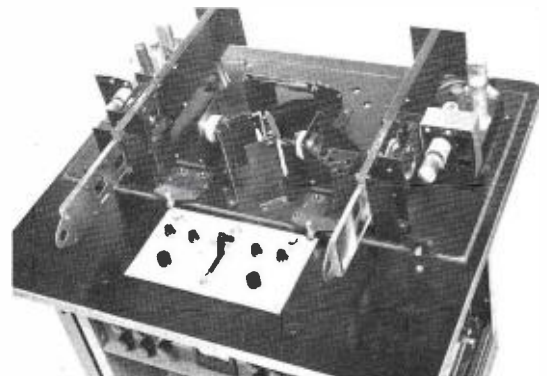

**What Tools Are Available?**

To a large extent the pickup device employed in the equipment determines the possible designs which may be used in the remainder of the apparatus and is especially important in the selection of the type of the associated projector. Only three types of pickup devices which are suitable for broadcast film pickup service are currently in use in the United States. These are the Image Orthicon, the Iconoscope and the Flying-spot Scanner. All of these devices have been studied in the RCA Laboratories at Princeton and in the Engineering Products Department at Camden. The first two are "storage" devices, that is, they are capable of storing an image presented during an extremely short interval so that it can be scanned while the unilluminated film is being moved. The flying-spot scanner does not provide these characteristics and therefore requires a projector in which the film is illuminated during the entire scanning process.

It will be noted that intermittent projectors can be used with the image orthicon or the iconoscope although the five-to-two ratio between the television field rate and the film frame rate introduces considerations not encountered in normal direct pro-

FIG. 4. The Flying Spot Camera, TK-3A, is designed for use in producing high-quality video signal from 2 x 2 inch photographic transparencies, and for "special effects."

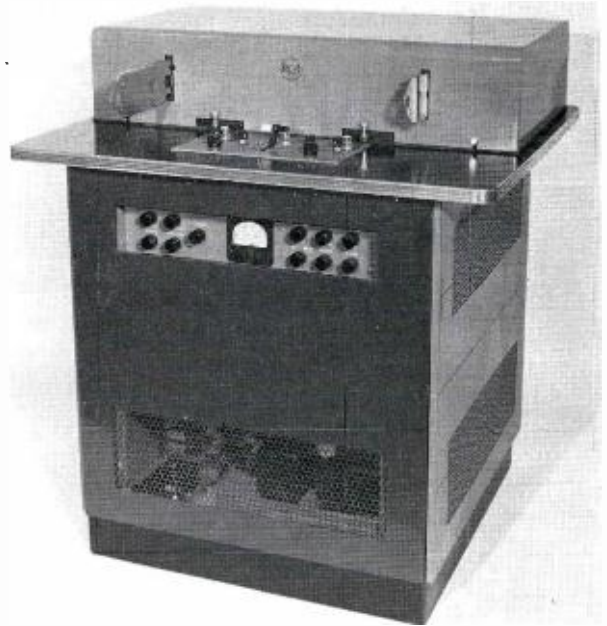

jection on a screen. These tubes can also be employed with some type of projectors in which the film is continuously illuminated since they will operate satisfactorily and, to some extent, with improved results under such conditions. The flying-spot

scanner, however, cannot be used with an intermittent projector unless the film pull-down takes place during the television blanking interval so that the frame is stationary and may be illuminated during the entire scanning process.

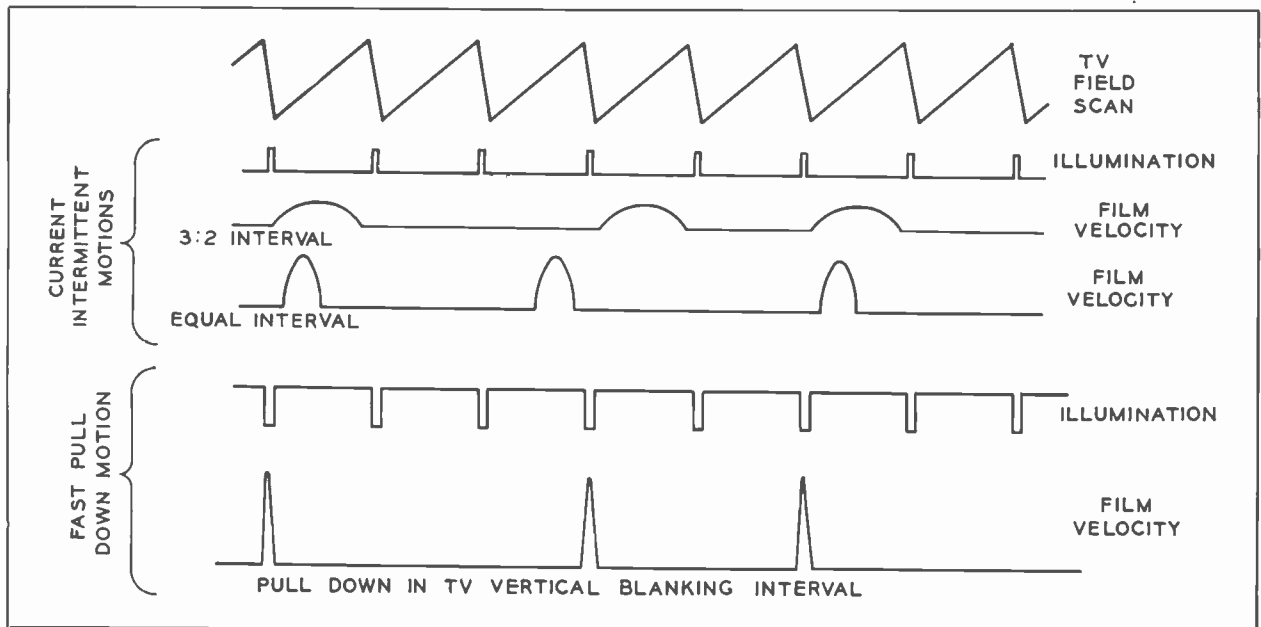
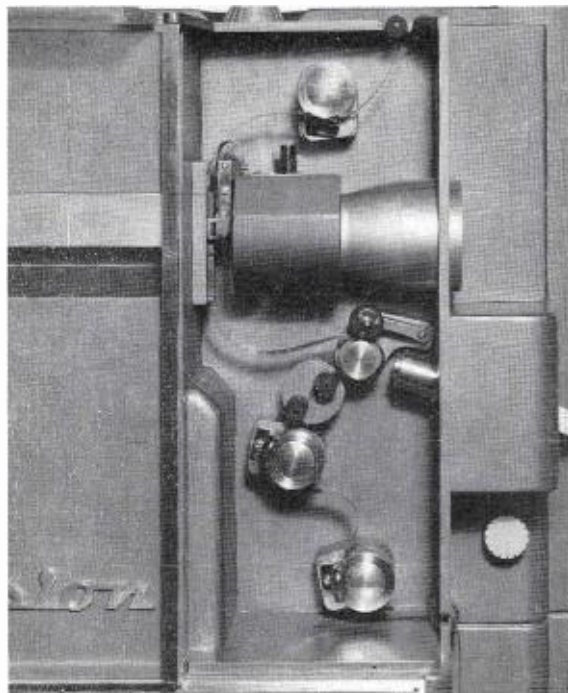

FIG. 5. Timing relationships in TV intermittent projectors.

## The Image Orthicon

Perhaps the most simple method of obtaining a television signal from film is merely to point a television studio camera at a screen on which the image from the film is being projected. It has all the attractiveness of economy of means since the only equipment which need be added to the normal studio apparatus is a film projector. Much of this apparent economy is offset by the complexity which such a procedure introduces into station operation. The shifting of cameras to new locations, the necessity of locating the film studio adjacent to the live talent studio and the

FIG. 6 (left). The Professional 16mm TV Projector which features 2-3 claw pull down, precision optics, and quick-change exciter lamp. This projector accommodates 4000-foot reels and has compensated take-up. FIG. 7 (right) is a closeup of the threading and optical system of the TP-6A 16mm Projector.



adjustments required to accommodate differences in light levels would seem to make this method of little interest to all except the most modest stations where the amount of local origination is small and where the quality of such material is relatively unimportant.

This method was tested in the engineering laboratories in Camden shortly after the development of the first image orthicon cameras. It was immediately observed that the dispersion of light by any screen lessened the contrast in the image and destroyed the fine detail. The pictures thus obtained had a flat, lifeless appearance. Attempts to restore some of the snap and brilliance of the image by electronic compensation were only partially successful because of the relatively high noise level of this tube. The method was therefore discarded some years ago as offering little hope of approaching optimum quality. In 1948 an improvement on this technique was tested. This consisted of arranging an optical system to project the image directly on the photocathode of the image orthicon. This method eliminated the dispersion in the projection screen but did not affect the inconvenience encountered in operation. Moreover, it was found that the limited range of the image orthicon made it difficult to handle film of varying density and background brightness without readjust-

ment of the light level. Even when a remote iris control was employed it was necessary for the operator to ride this control. Furthermore, while the resolution obtainable from this tube was adequate for direct pickup it was not as good in this respect as the iconoscope or the flying-spot scanner.

This approach is therefore not recommended except in cases where filmed material is employed infrequently and where the inconvenience of this method can be tolerated.

## The Iconoscope

No device has suffered more indignities from over-familiarity than the iconoscope. When it was first introduced it was hailed as the "magic eye" that made television possible. Later it was displaced by the image orthicon for both studio and field use, but continued to maintain its position in film pickup apparatus. It has always been capable of high resolution since a finer spot can be obtained with the higher operating potential employed but has produced spurious signals known as "shading" and "flare" which required compensation by electrical means and which tended to vary with the scene brightness and content. By controlled edge and back lighting these effects were minimized and RCA film cameras (Figs 1 and 2), are currently capable of providing creditable results

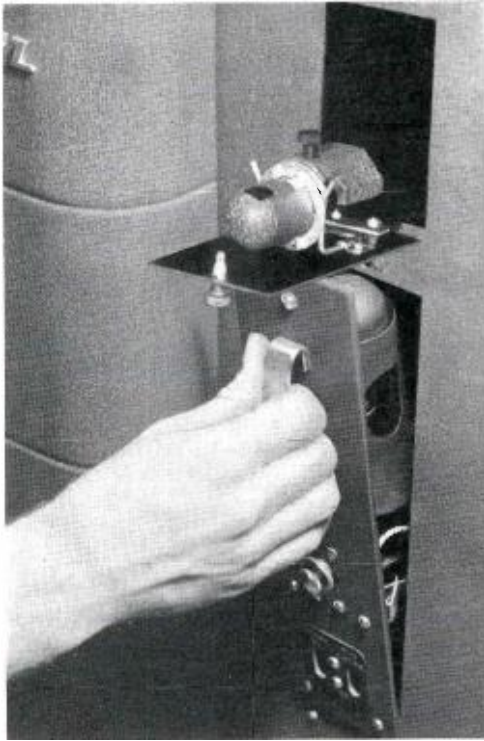
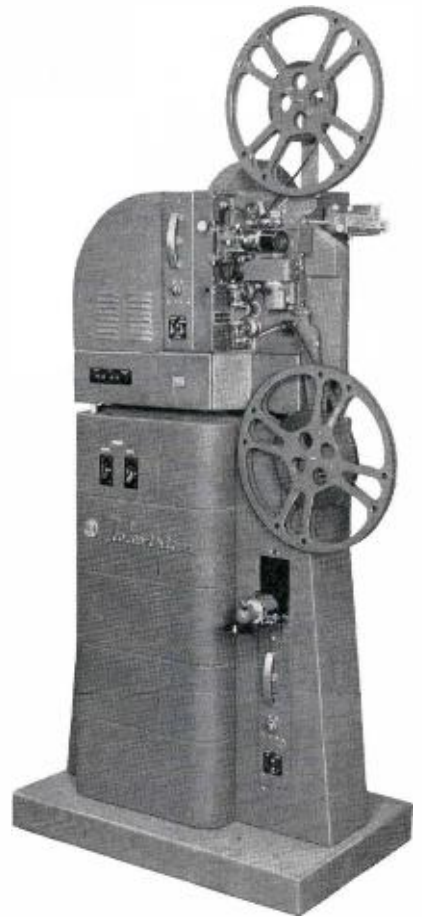

FIG. 8 (left). Shows a closeup of the TP-16D Quick Change Exciter Lamp Assembly. FIG. 9 (right) RCA Type TP-16D 16mm Film Projector features new long-life intermittent. Design advancements include sapphire rails and precision ball bearings to improve picture stability.



under all except the extreme conditions. During the past eighteen months RCA engineers have further improved iconoscope operation and circuitry to reduce these objectionable effects to negligible proportions. The methods of applying these improvements to equipment already in service have been published so that broadcasters may take advantage of these developments with a minimum of interruption. When properly

applied these new techniques permit the iconoscope to deliver pictures approaching the quality of good studio pickup.

The iconoscope has several desirable characteristics which make it attractive for film applications. Its gray-scale response is not linear but has a curve which approximately complements that of the cathode ray picture tube in home receivers. For this

reason it can accommodate a relatively high range of brightness in the image focused upon it and requires appreciably less compensation than a device in which

FIG. 10. 30 Frame Alternate Path Projector using a shutter to alternately open each of two optical paths.

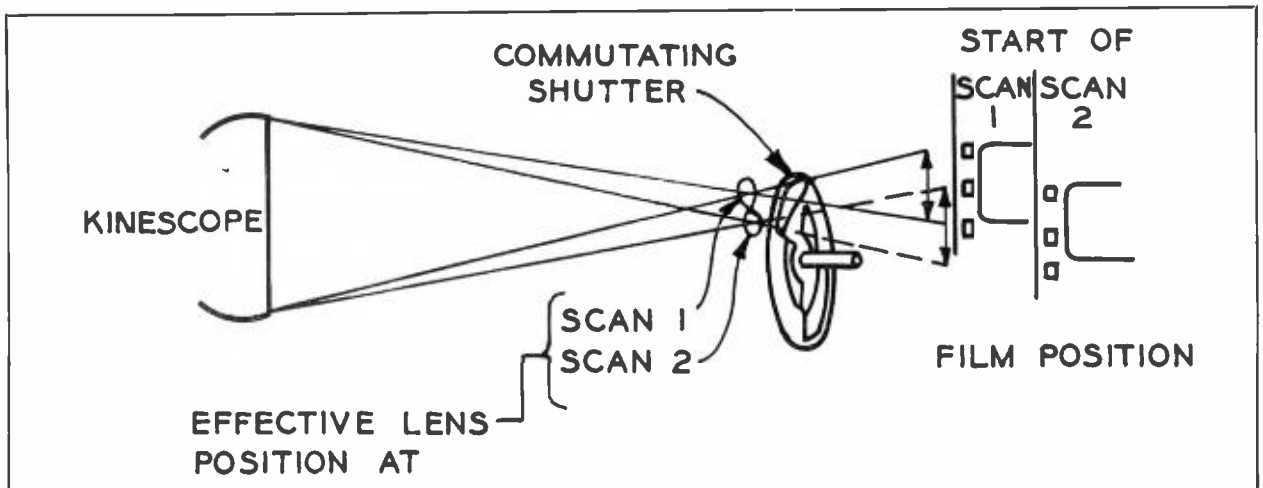

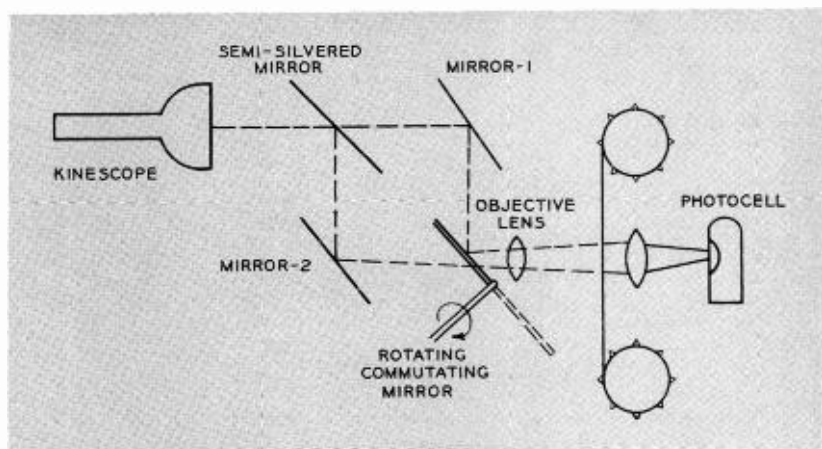

FIG. 11. 30 Frame Alternate Path Projector using a mirror system and a rotating mirror shutter to switch the scanning.

the signal is directly proportional to the output. When the brightness is adequate and the tube employed under proper conditions, the images obtained are crisp, sharp and without objectionable noise. Moreover, the new improvements provide a good reference from which black level can be established automatically. This permits the handling of a wide variety of film material without demanding the constant attention of the operator.

### The Flying-Spot Scanner

This device has been under investigation by RCA engineers for a number of years. Cathode ray tubes specifically designed to have the short persistence, high light output and fine scanning spot required for this application have permitted demonstrations of excellent quality. This type of equipment (Figs. 3 and 4), is currently produced by RCA for scanning "still" transparencies. It is also in use in Europe for film pickup where the fifty-field television standard greatly eases the problem of constructing a suitable projector.

The flying-spot scanner is capable of high resolution, is inherently free from shading and flare if properly constructed, and provides a constant reference for the establishment of black level. However, the linear response, which does not complement the characteristic of the receiver's picture tube, requires compensation. Unless this is done, the pictures produced from normal film are excessively contrasty with little or no detail in the shadows. One solution to this problem is to employ prints of lower than normal contrast. This is undesirable since it does not permit the use of films processed for normal projection. The more

practical approach is to employ electrical compensation. This increases the gain in the shadows while reducing the gain in the highlights. Furthermore, optimum performance demands the employment of aperture compensation to correct for the finite area of the scanning spot. Both of these corrections have been satisfactorily demonstrated. This is only possible when the signal-to-noise ratio in the signal from the device is excellent since both circuits tend to accentuate the apparent noise in the picture. With currently available cathode-ray tubes and photocells the light gathering power of the optical system (i.e., the optical "speed") must be high in order to realize sharpness and proper gray scale rendition without objectionable noise.

### The Vidicon

After a number of years of research and development, this tube had been introduced by RCA in industrial television equipment. The Vidicon has attractive characteristics for film pickup service. It is a storage device and may therefore be used with practically all types of projectors designed for television. It provides a constant black reference level and is extremely simple to adjust and operate. Such tubes have been tested as film pickup devices under laboratory conditions. The results have been encouraging and further efforts are being made to increase the sharpness and the signal-to-noise ratio so that adequate compensation may be applied without introducing excessive noise. The vidicons currently available, while well suited for industrial applications, require further improvement to approach the optimum broadcast quality.

## Projectors

Film projectors are essentially of two types: those in which the film is moved intermittently in the gate and those in which the film moves past the gate at a uniform and continuous rate. Projectors of the first type are in constant use in television service while experimental projectors of the second type have been constructed in attempts to meet the requirements of the flying-spot scanner.

### Intermittent Projectors for Television

Intermittent projectors may be grouped according to the time required for the film to be moved into position in the gate. The relationships between the television field scanning, the illumination, and the film motion are illustrated in Fig 5. The longest pull-down time, and therefore the least acceleration of film and moving parts, is provided by an unequal spacing of the pull-down intervals. This "2/3" motion is employed in the recently announced RCA projector for 35mm film and in the 16mm "Professional" seen in Figs. 6, 7, 8 and 9. By using a pull-down time slightly less than one-half of the television field interval it is possible to use equal spacing. This is the system employed in current RCA television projectors for 16mm film. In order to use an intermittent projector with a non-storage device such as the flying-spot scanner, it is necessary to move the film during the short interval afforded by the vertical blanking time. Projectors capable of accomplishing this operation have been successfully demonstrated in the research and engineering laboratories of RCA. While these experiments have been highly encouraging the devices must undergo careful study to determine operational characteristics and to insure long life in the mechanical parts as well as low wear on the film for the protection of the ultimate user.

Experiments have also been conducted with projectors having moderately short pull-down intervals and long periods of illumination. When a device having good storage, such as the iconoscope, is used the surge produced by the application of light to the mosaic is small compared to the signal produced by the scanning process. It has been found possible to reduce the appearance of this surge in the picture so that it is not noticeable under most conditions of scene content and brightness. This method appears to offer promise of eliminating the synchronism between the projector and the television

field rate. Of course the very fast pull-down projector would provide the longest application time and would afford the greatest advantages for this type of operation.

### Continuous Projectors

There are three basic types of continuous projectors for television service. The first employs electronic means for obtaining the horizontal scanning and allows the film motion to accomplish the scanning in the vertical direction. The second method shifts the scanning raster after each television field, so that the new position corresponds with the changed position of the film frame due to its vertical motion. In these "alternate-path" projectors the vertical scanning is accomplished partly by electronic means and partly by the film motion. In the last type moving optical systems are employed to compensate for the motion of the film and the vertical scanning is then accomplished by electronic means alone.

The single line scanning projectors have the serious disadvantage that they require the film frame rate to be equal to the television field rate. This would necessitate special film which could be projected at a rate of 60 frames per second. Excellent re-

sults have been obtained by RCA engineers using a flying-spot scanner and special film. In one test the vertical size of the film frame was reduced during printing to permit a lower film velocity to be employed. Although excellent registration was obtained and the pictures demonstrated the excellent results possible from a properly compensated flying-spot scanner, this approach was abandoned because of the requirement that special film must be used.

Several types of alternate path projectors have been offered to provide a means of employing the flying-spot scanner. The principle is most readily illustrated by the two-path system, which is popular in Europe and which could be applied in the United States if 30 frame film were available. Although several versions of this system are in existence the method shown in Fig. 10 is most frequently employed. In this unit a shutter is used to alternately open each of two optical paths which are arranged to provide images of the scanning raster which are displaced by one-half of the height of a film frame. The beginning of each television scanning cycle is then located at the top of each film frame. This requires that the film motion be accurately synchronized with the television signal. An-

other version of this type of projector has been built and demonstrated in the engineering laboratories at Camden, N. J. This unit is illustrated in Fig. 11. A mirror system and a rotating mirror shutter were used to switch the scanning between the two paths. Although good results were obtained with this device it was considered to be impractical since it required the film to be transported at a 30 frame per second rate and would not be suitable for standard prints.

In order to use this approach with standard 24-frame film and the present 60 field television standards five optical paths are required since the film moves two-fifths of the height of a frame during each television field interval. The relationship between the film position and the optical paths is illustrated in Fig. 12. It is possible to construct a device using five lenses instead of two, which is similar to that shown in Fig. 10. This approach is not satisfactory because the close spacing of the several paths places a serious limit on the size of the opening through which light can be passed and results in inherently low optical speed. The RCA laboratories have investigated a somewhat different approach to the alternate path projector. This unit

FIG. 12. Relation between positions of film and scanning raster in Alternate Path Projectors for 24 frame film and U. S. TV standards.

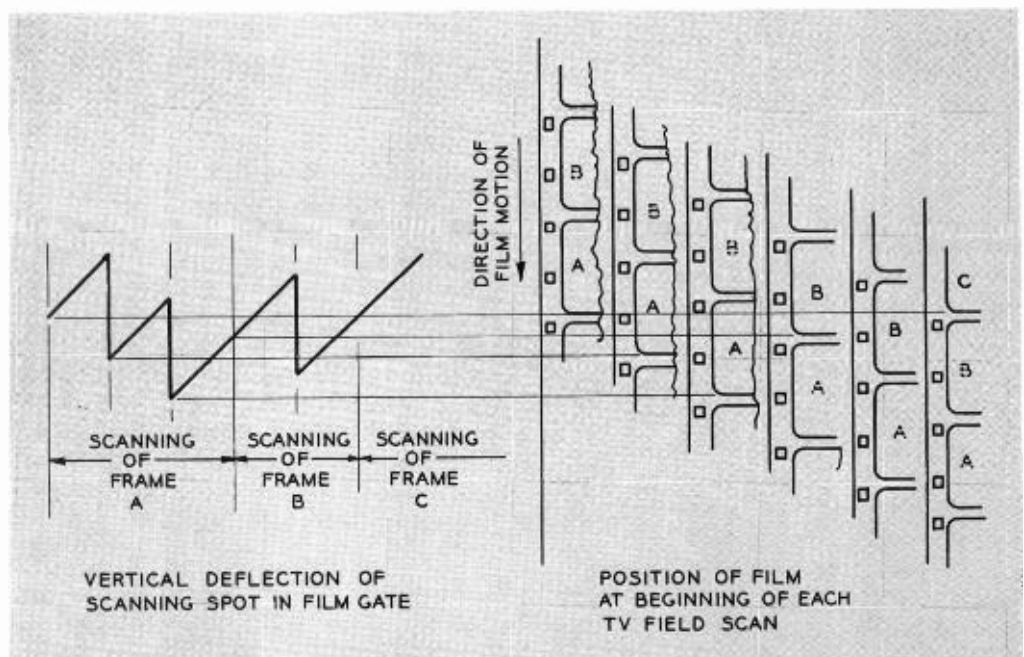

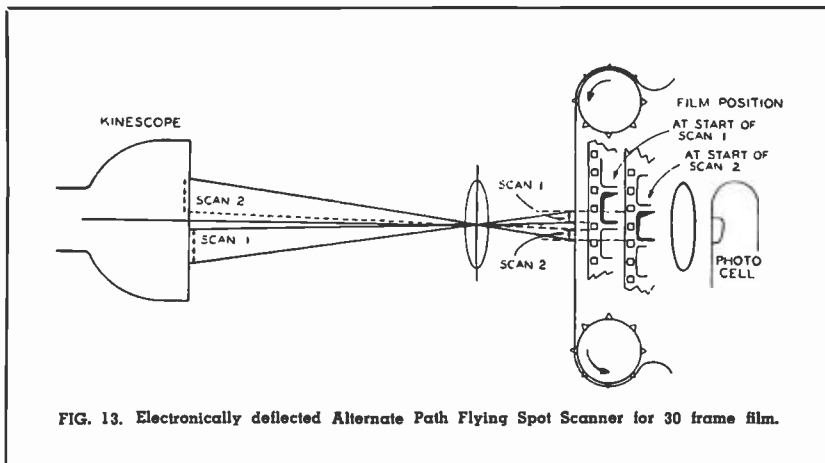

FIG. 13. Electronically deflected Alternate Path Flying Spot Scanner for 30 frame film.

is basically the same as that shown in Fig. 11 except that the two mirrors labeled (1) and (2) are adjusted by cams to five different positions. Mirror (1) is changed in position while the light passes through mirror (2) which is held stationary and vice versa. This permits high optical speed to be achieved and provides almost a full television field interval for mirror adjustment. The device is capable of producing good results but is objectionable because the precise positioning of the two mirrors in five positions represents an extremely difficult manufacturing problem and appears to be expensive.

Another type of alternate path projector has been proposed from time to time. This unit has no moving optical parts and no shutter. The positioning of the scanning spot in the film gate is achieved by electronically shifting the raster on the face of the scanning cathode-ray tube. The diagram shown in Fig. 13 illustrates this method as applied to a two-path unit. Five such raster positions would be required for normal film and U. S. television standards. Attempts to construct a film scanner of this type were made at Princeton and at Camden, where it was found that the linearity required in the deflection of the beam over the several areas required extreme precision of the deflecting field, careful selection and orientation of the cathode ray tube to insure alignment of the beam with the field, precise correction of the slight keystone effect and a cathode-ray screen of extreme uniformity and free from blemishes. Any

variation of light from the five areas produces a flicker at a twelve cycle rate which is very objectionable. Since some portions of the screen are scanned for a greater proportion of the time than others the screen ages unequally. Flicker rapidly develops from this source. For these reasons this approach was not considered to be highly attractive.

Projectors in which full optical compensation of the film motion is employed are of three types. One type uses a series of moving lenses which continuously displace the image of the scanning raster so that it remains in register with the film. Such a projector using a rotating drum of lenses is illustrated in Fig. 14. This device has high optical efficiency and for this reason was experimentally evaluated at Princeton. This arrangement is subject to several limitation. Firstly, it is difficult to realize the optical precision required in the grinding and mounting of the numerous lenses. Secondly, it is not possible to achieve exact registration by a simple lens system of this type since the path length and angle differ as the drum rotates. Thirdly, the optical efficiency varies, especially as the light passes from one lens to the next, producing a flicker at a twenty-four cycle rate. While it is conceivable that these deficiencies might be overcome by careful fabrication and by employing other moving optical elements to introduce the corrections required to maintain registration and eliminate flicker the result seems likely to be

a very complex mechanism of high cost which would demand excessive maintenance. A similar version of this type of projector uses a disk of lenses instead of a drum but is open to the same objections.

The second type of projectors in which full optical compensation is attempted involves the use of prisms to accomplish the deflection of the image of the scanning raster. One version uses a rotating prism and is illustrated in Fig. 15. It is subject to the same limitations as the multiple lens device described above and in addition places a severe restriction on the optical speed. Careful study of this method indicated that the deficiencies far outweighed the apparent simplicity of the construction. A similar device employing a disk of prisms instead of the optical element shown in Fig. 15 has been proposed but has not been attractive because it involves the same limitations and in addition poses serious problems in the fabrication and mounting of the prisms.

A third type of projector for the flying-spot scanner employs a series of mirrors to accomplish registration of the raster and the moving film. The principle is illustrated in Fig. 16. In this case precise registration is possible by adjustment of the mirror position during rotation. These projectors have high optical efficiency and have been used in Europe for some years. Recently the Bell Telephone laboratories demonstrated a television projector which uses this principle in a design of reduced mechanical complexity. Precise registration was demonstrated to be attainable by the use of a servo which causes the image to track the film. Although requiring a high degree of precision in construction, this type of unit presents a practical method of applying continuous motion techniques with the flying-spot scanner. This is particularly interesting in the case of 35mm film where the possibility of constructing a fast pull-down unit appears to be remote.

It will be noted that registration of the scanning raster and the film can be accomplished by rotating a mirror pivoted at the center of a curvature of a curved gate. In



this case the mirror must be moved into position for the next film frame during the television blanking period. Synchronization between the projector and the television field frequency is also required. A unit of this type has been built and successfully demonstrated under experimental conditions in the RCA Laboratories. The high acceleration of the mirror required in this "vibrating mirror" type of projector can be avoided by employing two optical systems and switching between them. This allows one mirror to be moved into position while the other is tracking the film.

### Film Shrinkage

This is no problem in intermittent projectors since the registration of each frame is accomplished by the teeth of the claw or the sprocket. No such automatic positioning is provided in continuous projectors. Since prints of varying age and condition are frequently spliced together for program purposes it is impractical to employ an adjustment which must be preset. Adjustments which can be made while the machine is running are possible but should be fully automatic to realize the best operating techniques. Servos which make the required adjustment have been operated by measurement of the length of the film over several frames. Another approach is to employ an electronic means of determining the height of the frame and making the required correction by adjusting the scanning raster. Considerable experimentation will be necessary before the comparative merits of the several systems can be evaluated.

### Color

While it is conceivable that tubes of the storage type might be employed for the transmission of color film in full color, it is likely that the flying-spot scanner will prove to be a more suitable device for this purpose. This is largely because of the truly linear characteristic of the device which makes possible the maintenance of proper color balance over a wide range of light intensity. Since all color systems involve a loss of light due to the necessity of deriving three color signals it will be neces-

sary to realize high light efficiency in the projector if noise free color images are to be transmitted. This eliminates devices of low optical speed from practical consideration.

### Summary

The results of the investigations which have continued over a number of years and which have embraced practically all types of scanning and projection devices lead to the following conclusions:

1. The *image orthicon* is not especially attractive for film pickup because of its technical performance characteristics and because of the high replacement cost of such tubes in continuous service. It is not recommended except where initial cost is the only consideration and where film is not an important part of the program material.
2. The *iconoscope*, with the recently developed improvements, approaches the optimum quality which is realizable under present television standards. It

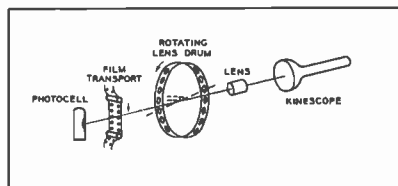

FIG. 14. Continuous Projector using a series of moving lenses.

is especially attractive since projectors which have been refined in design over a period of years can be employed and since its initial and operating cost is low.

3. The *flying-spot scanner* offers the possibility of some improvement in black-and-white television and, at the present time, appears to be the most attractive solution for televising color film. The principle objection to its immediate employment is the necessity of using

FIG. 16 (right). Continuous Projector which uses a series of rotating mirrors.

projectors of novel design, all of which require a high degree of precision in the electrical circuits or mechanical components.

4. The *fast pull-down* principle can be applied to 16mm film but will require unique and untried film transport mechanisms in order to accommodate 35mm film.
5. *Alternate path* projectors are not attractive for U. S. standards because of the mechanical and optical complexities involved.
6. Of the *continuous projectors* the types which employ moving mirror systems are preferable since precise registration can be achieved with a minimum of optical and mechanical complexity and since the optical speed is high. With foreseeable kinescopes and photocells this high optical efficiency will be necessary in order to realize an adequate signal-to-noise ratio.

### References

- 1 H. N. Kozanowski, BROADCAST NEWS, Vol. No. 67.
- 2 O. H. Schade, "Electro-Optical Characteristics of Camera Systems", RCA Review, Vol. 9, No. 3, Sept. 1948, p. 497.
- 3 P. J. Herbst, R. O. Drew, S. W. Johnson, "Electrical and Photographic Compensation in Television Film Reproduction", Journal of the SMPTE, Vol. 57, Oct. 1951, pp. 297-299.
- 4 O. H. Schade, "Image Structure and Transfer Characteristics", Journal of the SMPTE, Vol. 56, Feb. 1951.

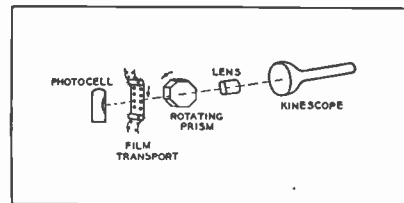
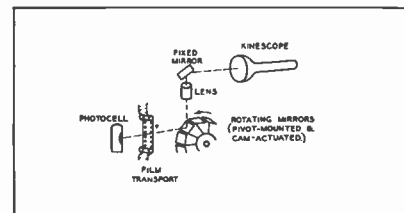

FIG. 15 (above). Continuous Projector using a rotating prism.



# MEN ON THE WAY UP . . .

by **E. C. MASON**

RCA Engineering Products Dept.

On April 30 and May 1, RCA played host to thirty-five representatives from twenty antenna and tower erection firms. The representatives were owners, managers, erectors and antenna maintenance men.

The two-day meeting was designed to present the Erector with information that would assist him in the erection of RCA transmitting antennas. It was stressed by RCA that exchange of ideas between the Erector and manufacturer is mutually beneficial and necessary to provide the best possible installation.

The meeting opened Wednesday morning, April 30, at 9 a.m. in the Camden Plant's "Little Theater" where the group was welcomed by T. A. Smith, Assistant General Manager of RCA Engineering Products Department. General announcements, introductions and program activities were conducted by A. H. Super of RCA Broadcast Product Department.

The Wednesday morning session included a lecture on VHF Superturnstile Antennas by H. Westcott of RCA Broadcast Antenna Engineering Section. The basic theory of how television signals are propagated through space and theory of the superturnstile design was described. The prescribed methods of assembly and final test of the antenna were discussed.

After a brief morning recess, the subject of RCA UHF Antennas and Transmission Line was discussed by O. O. Fiet, the engineer responsible for design of the new UHF Slot Antenna, TFU-24B.

An interesting display board contained sections of RCA's new  $3\frac{1}{8}$ " and  $6\frac{1}{8}$ " UHF transmission line and accessories such as miter elbows, a matching transformer and a  $6\frac{1}{8}$ " line hanger.

Following a noonday luncheon in Camden, the group was transported by bus to one of the nearby RCA antenna proving grounds. A complete afternoon demonstration was prepared to show the Erectors the many types of transmitting antennas that were available to broadcasters and to describe specifically the procedure required

*a story describing an RCA training session for construction engineering firms who erect and maintain antennas*



FIG. 1. B. T. Bailey, RCA, points out methods of mounting antenna elements and feed lines.



FIG. 2. Prefabricated lengths of Styrolflex Feed Line being prepared for antenna assembly.

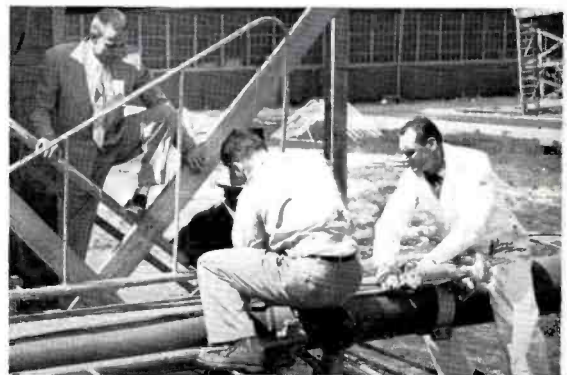
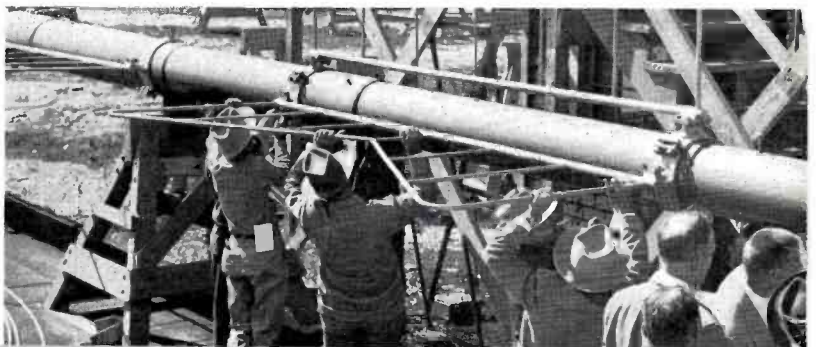

FIG. 3. Erectors participating in assembly of a six-section RCA Superturnstile antenna shown connecting feed lines to junction box.

FIG. 4. Erectors are shown fastening the bat-wing radiators in place—part of the "how-to-do-it" course.



for successful installation and operation of each type.

Some of the demonstrations held on the first day of the meeting (and shown pictorially in this story) were: "How Power is Delivered to the Antenna Radiating Elements and the Conditions that can Occur in a Transmission Line to Cause Power Loss—such as 'Standing Waves'," by W. F. Hanson, RCA; "Features of the UHF Antenna TFU-24B and How the TFU-24B May be Rigged for Mechanical or Electrical Beam Tilt," by E. H. Shively, RCA; "Feed Line and Radiator Assembly on the TF-12AH Twelve-Bay Superturnstile Antenna," by B. T. Bailey, RCA; "How to Detect Electrical Faults in Superturnstile Antenna Installation," by R. H. Wright, RCA; "Checking Antenna Impedance by Use of a Reflectometer," by R. L. Phares, RCA and "Superturnstile Antenna Accessories," by G. A. Kumpf, RCA.

On Thursday morning—the second day of the meeting—the Erectors donned their "overalls" and went to work—actually performing the steps required to assemble a six-bay superturnstile antenna. Engaging in the first step (see Fig. 2), they became a busy group of "Hoop-rollers" as prefabricated lengths of styroflex feed lines were unrolled in preparation for attaching to junction boxes. Then a section of "Batwings" was attached. Following this, a junction box was secured to the pole by a clamp bracket and feed lines were attached and run to their respective radiators.

Since television service may utilize a second type of VHF Antenna, the "Supergain" was described by H. E. King and D. W. Balmer of RCA. A typical installation of the RCA Supergain Antenna is located atop the Empire State Building.

After a Thursday noon luncheon, the delegation returned to the RCA Camden "Little Theatre" where a review and discussions were held by Owen Fiet and Hank Westcott until the close of the meeting.

Much information was gathered "on each side"—the Erectors made valuable recommendations for expediting the erection of antennas and RCA dispensed the many years of "know how" acquired through years of service to the broadcasters. A sixteen-page booklet containing "hints and kinks" was distributed to serve as a ready reference or guide in erecting Superturnstile Antennas.

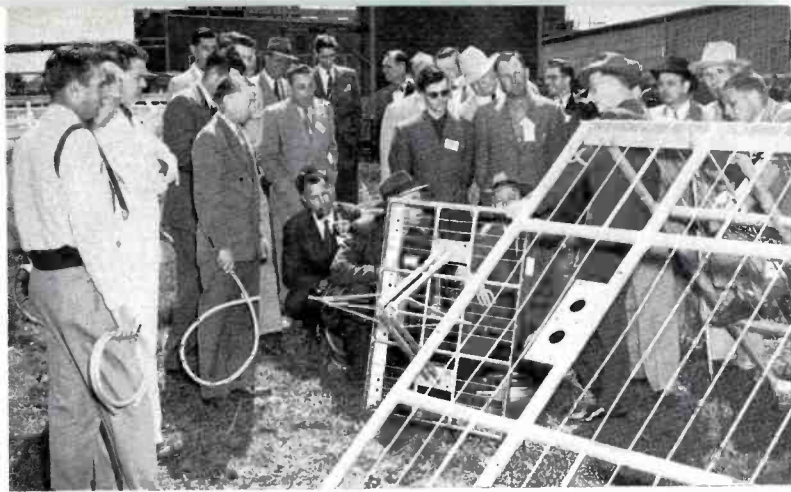

FIG. 5. D. W. Balmer, RCA, explains construction of the RCA "Supergain" VHF antenna.



FIG. 6. E. H. Shively, RCA, describes features of the new TFU-24BH UHF antenna.

FIG. 7. W. F. Hanson, RCA, demonstrates the effect of standing waves on transmission line.



# MUSICAL ENGINEERING



Dr. Harry F. Olson, author also of *Dynamical Analogies and Elements of Acoustical Engineering*, is a leading authority on acoustics and sound reproduction. Associated with RCA since 1928, he has pioneered in work on directional microphones and developed a variety of loudspeakers, phonograph pick-ups, sound absorbers, ultrasonic transducers, underwater sound equipment, and other devices.

Among new books of interest to broadcast engineers is *Musical Engineering*, written by Dr. Harry F. Olson, Director, Acoustical Laboratory, RCA Laboratories, Princeton, New Jersey. The text analyzes and illustrates each aspect of sound production, pick-up and reproduction from a physical, scientific, and practical standpoint. This book should be useful to broadcasters because it covers all phases of the entire subject of music from the notation on paper to the ultimate destination of all useful sound, the human hearing mechanism.

*Musical Engineering* explains the properties of sound waves and describes in detail the various performance characteristics of musical instruments and of the human voice: timbre, directional patterns, volume range, frequency range, growth, decay, and duration. It correlates musical terminology with the physical aspects of music, and utilizes engineering diagrams and mathematics to explain musical scales. Vibrating and resonating systems of all musical instruments—string, wind, reed, brass, percussion and electrical instruments, are analyzed.

Acoustical properties and problems encountered in theaters, studios and rooms are taken up, as are various techniques for sound pick-up and sound reproduction used in recording, sound motion pictures, radio broadcasting and TV.

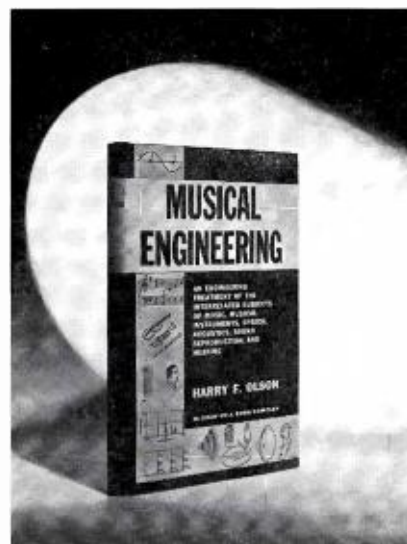

*Musical Engineering* also discusses the physical and psychological characteristics of music and speech, describes the human hearing apparatus, and supplies several recently developed musical aptitude tests.

Published by McGraw-Hill Book Company, 330 W. 42nd St., New York 36, N. Y. 369 pages . . . price, \$6.50.

# RADIO ANTENNA ENGINEERING

Another new book which broadcasters will find well worth while is "Radio Antenna Engineering." Mr. Edmund A. Laport, Chief Engineer of RCA International Division, has written this book to fill the need for a comprehensive source of information on antenna design techniques and provide practical guidance for antenna construction. Practical applications are

emphasized and the approach is so effective that non-specialists are enabled to produce creditable antenna designs. This is the first work of its kind in any language.

Proved methods, formulas, and structures covering world-wide engineering experiences of the past thirty years are arranged in what resembles handbook style. The book is profusely illustrated and includes 95 photographs of proved engineering practices in structural details as developed by some of the world's leading radio organizations.

Mr. Laport treats radiation engineering, circuit engineering and mechanical engineering aspects separately for each type of antenna. Considerations of operational requirements, band width, propagation engineering and system engineering are included.

Subjects such as: choosing station sites, plotting layouts which have application to broadcasting, point-to-point, aviation, marine and military communication are adequately covered. In addition, there is comprehensive coverage of the

electrical and mechanical design of transmission lines, electrical design of impedance-matching networks by direct simplified graphical methods (including techniques for directive antenna feeder systems) and the engineering applications for the theory of logarithmic potentials.

Published by McGraw-Hill Book Company, 330 W. 42nd St., New York 36, N. Y. 561 pages . . . price, \$9.00.

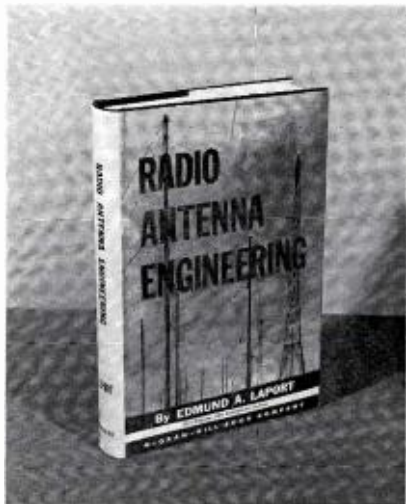

Edmund A. Laport, Chief Engineer, RCA International Division, has had many years of experience in setting up Radio Broadcast stations and major communication installations in foreign countries. He headed up such projects as Middle East Tapline covering over 1000 miles of desert communications and has guided the installation of many Latin American Television stations.



# Now! Record your own sound on 16 mm film!

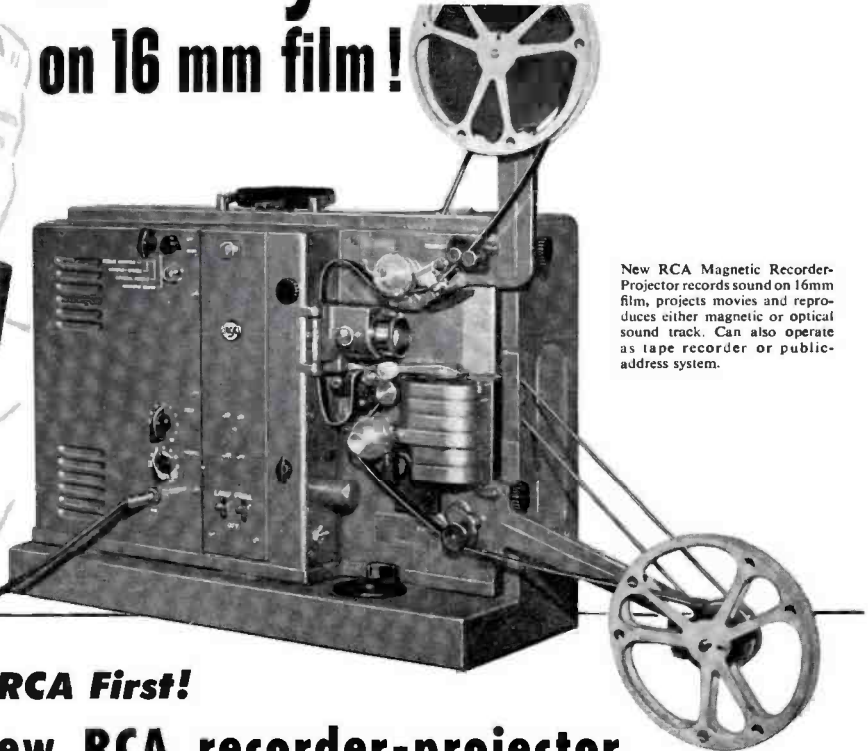

New RCA Magnetic Recorder-Projector records sound on 16mm film, projects movies and reproduces either magnetic or optical sound track. Can also operate as tape recorder or public-address system.

## Another RCA First!

## Amazing new RCA recorder-projector

### Think of it!

An easy, low-cost way to put *your own sound track* on any single-perforation 16mm movie film . . . thanks to RCA's revolutionary new magnetic recorder-projector. Now you can:

- Record voice or music or both
- Play back instantly
- Erase mistakes and re-record

. . . and it's all so simple that anyone—yes *anyone*—can do a top-quality job right from the start!

### Records on Magnetic Stripe

It's *magnetic* sound—recorded on a narrow stripe of magnetic iron oxide, applied along one edge of your single-perforation movie films. (If your film is *double* perforated, a *single*-perforation duplicate print must be made.) Once this magnetic sound stripe has been added, you can do all sorts of wonderful things. For instance, you can . . .

1. Add sound to all your old silent 16mm films, at either 16- or 24-frame speed.
2. Record new, up-to-date sound on all your old 16mm sound movies.

3. Add the new *magnetic* sound track without destroying the old *optical* sound track. Thus you can play back *either* sound track from the same film. (Example: Have English and Spanish on the same film.)

4. Erase and re-record the magnetic sound whenever necessary to keep it up-to-date or to adapt it to any requirement.

### All this and superb movies too!

It's really two machines in one: a complete magnetic recorder plus a 16mm film projector. It projects film with clean sharp professional quality and it reproduces sound (from either optical or magnetic track) with clear-cut, lifelike realism. It's the kind of *quality* you'd expect from RCA—builder of big theatrical-type 35mm movie projectors—world famous for sound and film recording.

### Best of all . . . it pays for itself!

You'll save enough on your first few film-recording jobs to pay for this new RCA machine. You can put new sound on a 10-minute movie for a cost of only a few dollars . . . actually about 11% of the cost of optical sound! *Salvage all your old movies*—make them useful again. Here indeed is the greatest tool ever developed for folks who use 16mm films. All built and backed by RCA—fore-

most pioneer in 16mm sound-film projection. Performance proved by months of tests and on-the-job use.

### Here's how easy it is

No special facilities needed. Anyone can do it 'most anywhere. Here's how:

**First**—you have a stripe of magnetic iron oxide added to your existing 16mm single-perforation films. (This service is now available, costs only a few cents a foot.)

**Second**—you project this film in the new RCA Magnetic Recorder-Projector.

**Third**—as you watch the projected picture, you speak into a microphone and record *your own sound track* on the film. Add recorded background music if desired. Erase mistakes and re-record. Play back instantly.

And that's all there is to it. It's actually so simple you can *sound like a professional* the first time you do it!

### More information? Mail coupon Today

Visual Products, Dept. 92DB  
RCA, Camden, N. J.

Without obligation, please send me full story on new RCA Magnetic Recorder-Projector that puts *my own sound track* on 16mm movie film.

Name \_\_\_\_\_  
 Position \_\_\_\_\_  
 Company \_\_\_\_\_  
 Address \_\_\_\_\_  
 City \_\_\_\_\_ State \_\_\_\_\_



**RADIO CORPORATION of AMERICA**



## It's the 1000-mile Trans-Arabian Pipeline's desert marvel, TAPLINE . . . RCA radio equipped

From Persian Gulf to Mediterranean Sea . . . across more than a thousand miles of shifting sands and rugged desert . . . runs TAPLINE, one of the world's greatest oil-carrying systems, built by Trans-Arabian Pipeline Company.

Tribute to the engineering resourcefulness of many organizations, TAPLINE takes its place as a marvel of modern vision and commercial achievement. RCA engineers were among the first in the field, in 1947 . . . to provide radio

communication as the oil line was built.

The great system, now in complete operation, is RCA radio equipped. Desert vehicles receive and transmit with mobile radio units of new design. Aviation radio directs air traffic serving TAPLINE. Marine radio aids tankers off shore. Fixed control and relay stations, that operate in all the weather of 1000 desert miles, keep up the flow of radio communication that is vital to the flow of oil.

RCA's experience in radio is world-wide. Its equipment is recognized as the standard for highest performance. The international facilities of RCA are ready to help industry or government in all fields of radio. Consult your RCA distributor or RCA International Division.

The interesting booklet "Sand, Oil and Radio," the story of TAPLINE, may help you. It is free. Simply write for it.



RCA INTERNATIONAL DIVISION  
**RADIO CORPORATION of AMERICA**  
RCA BUILDING  
30 ROCKEFELLER PLAZA, NEW YORK, N.Y., U.S.A.



New RCA Fleetfone Station Consolelet

*Announcing...*

**RCA's new 2-way radio Fleetfone "DESK STATION"**

Now . . . a 60-watt transmitter plus receiver in a single case. Saves space. Simplifies operation. Makes maintenance easier. Read how . . .

Good news for 2-way radio users! A "desk station" you can install 'most anywhere . . . on a desk, a table, or even on a shelf against the wall.

**60-watt transmitter exceeds FCC and RTMA requirements**

Precision controlled by RCA ovenless crystal unit, with spurious emission reduced to minimum. Two-frequency or three-frequency transmission possible. Very economical to operate. Most tubes work at less than 70%

capacity. Result: longer tube life, less maintenance. Uses standard tubes.

**Receiver gives adjacent channel selectivity**

Exceptionally sharp selectivity. Circuits specially designed to give clear reception from mobile transmitters, even in high-interference areas. Two-frequency reception possible by adding another frequency kit. Receiver uses only 5 tube types. Allows minimum spare-tube stock.

**Console built for easy operation and servicing**

Sloping front panel, easy access to controls. Built-in direct reading electricclock. Transmitter-receiver chassis

slides out at the top for ready access.

**Get full details . . . mail coupon today** Find out all about this great new "desk station" that gives you full-power performance from a single package. All backed up by RCA . . . world leader in radio. Service available from RCA Service Company if desired.

**FREE BOOKLET . . . MAIL COUPON**

Dept. 129, RCA Engineering Products, Camden, New Jersey

Please send me full information on your new RCA Fleetfone Station Consolelet.

Name \_\_\_\_\_

Title \_\_\_\_\_

Company \_\_\_\_\_

Address \_\_\_\_\_

City \_\_\_\_\_ State \_\_\_\_\_

Also, please send me information on use of 2-way radio in industry checked below:

- General Industry (Utilities, Construction, Petroleum, Lumber, Mining, etc.)
- Transportation (Truck, Bus, Taxi, etc.)
- Public Safety (Police, Fire, Ranger, etc.)



**RADIO CORPORATION of AMERICA**

This Summer and all year through...  
 enjoy 5-way Air Conditioning!



1. COOLS room temperature.
2. FILTERS the air.
3. REMOVES excess moisture.
4. VENTILATES in all weather, summer or winter.
5. CIRCULATES fresh air.

## The NEW RCA ROOM AIR CONDITIONER !

*Only RCA offers you ALL these advantages:*

**"AIRFLOW" GRILLE** . . . with finger-tip control. Affords widest, fullest air circulation to all parts of the room.

**"HEART-OF-COLD" COMPRESSOR** . . . proved definitely superior in performance and efficiency. 5-year warranty on entire hermetically sealed cooling system.

**RCA FACTORY SERVICE** . . . The only direct factory service of its kind in the air conditioning industry . . . assures correct installation . . . carefree performance!

**PLUS** . . . Matchless beauty . . . quiet operation due to rubber mounted motors and specially designed fans . . . a size for every room!

### RCA VICTOR DIVISION

RADIO CORPORATION OF AMERICA



*RCA makes your home a better place to live!*



Good-bye...  
"ROLL-OVER"



Annoying "Roll-over"—starts up in TV sets when you mix remotes with locals



Good-bye "Roll-over"! The RCA TV GENLOCK tightly locks your local and remote sync generators together—instantaneously and automatically.

RCA's TV Genlock TG-45 ends picture slipping when you "lap dissolve" and "superimpose."

Now you can lock two entirely different programs together—remote or local—and hold pictures steady *right through switching!* No manual adjustments of phasing to fiddle with. No extra equipment needed at remote pick-up points. Here's how the GENLOCK works.

Located in your main studio, this simple unit compares the signal of your remote sync generator with the signal of your local sync generator. The difference in the phasing of the pulses produces an "error" signal which locks your local generator as a "slave" to your remote generator as a master. This enables you to treat remote signals as local signals—and switch back and forth without picture "roll-over," *no matter where your program originates!*

The RCA GENLOCK is simple in design, completely automatic in operation—"locks-in" much faster than you can switch. It fits any standard 19-inch TV rack.

Give your programming a lift. Switch as you please between programs for variety and for special effects. It's easy with a GENLOCK. For more information call your RCA TV equipment representative. Or write Dept. 19AE, RCA Engineering Products, Camden, N. J.

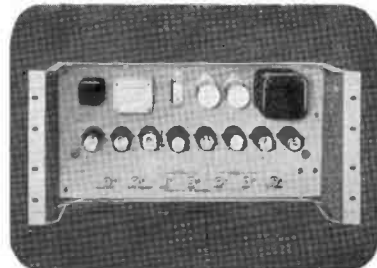

RCA GENLOCK, Type TG-45. This is the simple, automatic system that electrically locks two separate television pick-up systems together.



**TELEVISION BROADCAST EQUIPMENT**  
**RADIO CORPORATION of AMERICA**  
**ENGINEERING PRODUCTS DEPARTMENT, CAMDEN, N. J.**

In Canada: RCA VICTOR Company Limited, Montreal

# RCA's TV "Basic"

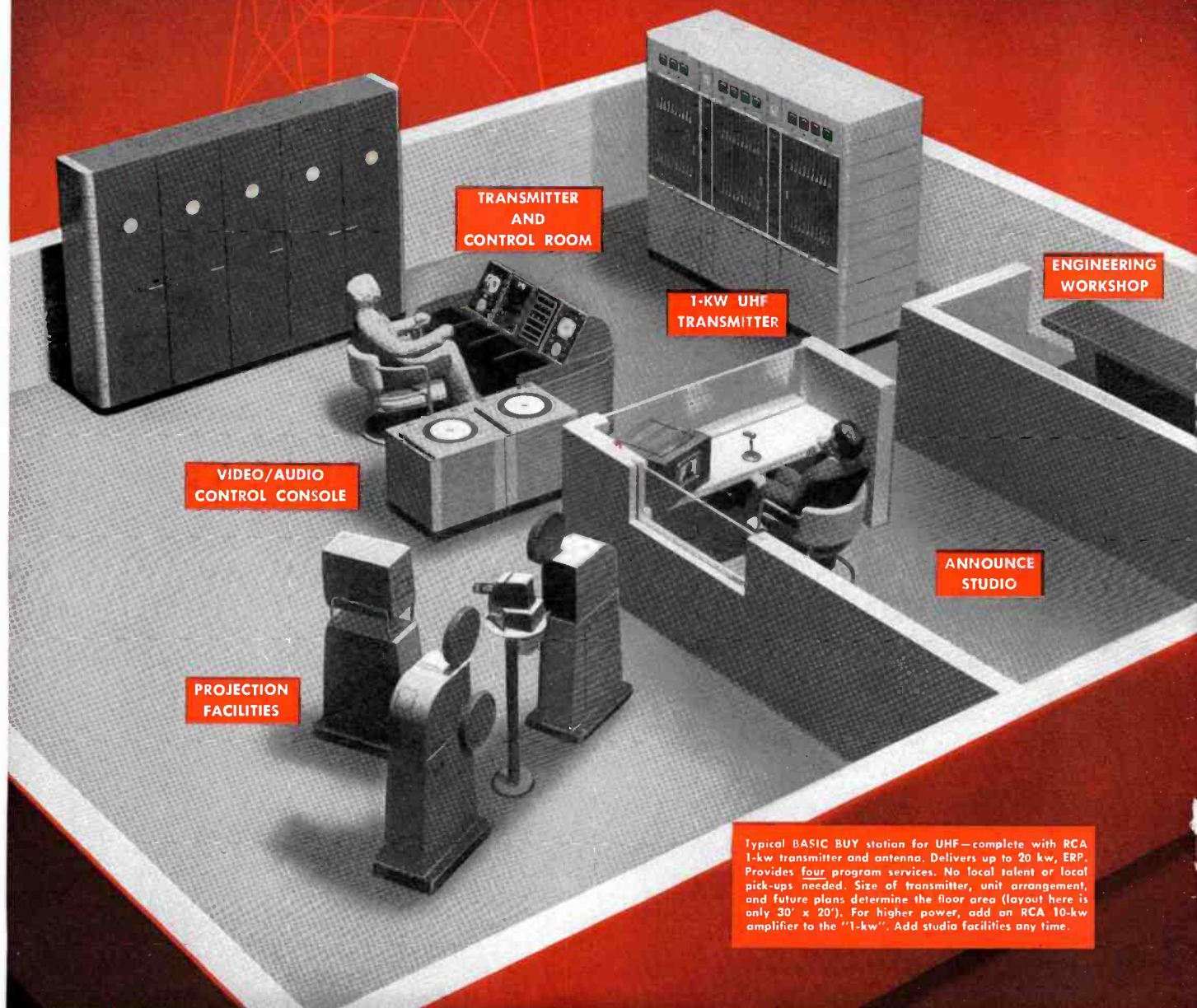

TRANSMITTER  
AND  
CONTROL ROOM

1-KW UHF  
TRANSMITTER

ENGINEERING  
WORKSHOP

VIDEO/AUDIO  
CONTROL CONSOLE

ANNOUNCE  
STUDIO

PROJECTION  
FACILITIES

Typical BASIC BUY station for UHF—complete with RCA 1-kw transmitter and antenna. Delivers up to 20 kw, ERP. Provides four program services. No local talent or local pick-ups needed. Size of transmitter, unit arrangement, and future plans determine the floor area (layout here is only 30' x 20'). For higher power, add an RCA 10-kw amplifier to the "1-kw". Add studio facilities any time.

# BUY<sup>TM</sup> does the most

**-with the least TV equipment  
-VHF or UHF!**

## 4 PROGRAM SERVICES

- no local studios needed!

- Network programs
- Local films (16mm)
- "Stills" from local slide projector
- Test pattern from monoscope (including individualized station pattern in custom-built tube)

THIS PICTURE ILLUSTRATES what we think is the minimum equipment a TV station should have to start with—and earn an income. The arrangement can handle any TV show received

from the network and provides station identification and locally inserted commercials as required. In addition, it offers an independent source of revenue—by including film and slide facilities for handling local film shows and spots, or network shows on kine recordings.

The BASIC BUY includes: A transmitter and an antenna (necessary for any TV station); monitoring equipment (required by FCC); film and slide equipment (for local programs—and extra income); monoscope camera for reproducing a test pattern of known quality (important for good station operation and as an aid to receiver adjustment); and a control console that saves operator time and effort (it enables one technical

man to run the station during nearly all "on-air" periods).

RCA's BASIC BUY can be used in combination with any RCA TV transmitter and antenna, of any power—VHF or UHF. Matched design and appearance make it easy to add facilities any time (you need never discard one unit of a basic package). And note this: *RCA BASIC UNITS ARE IDENTICAL TO THE RCA UNITS USED IN THE BIGGEST TV STATIONS!*

RCA's BASIC BUY is already being adopted by many TV station planners. Let your RCA Sales Representative work out a flexible package like this for you—show you how to do the most with the least equipment!

This is what the BASIC BUY includes!

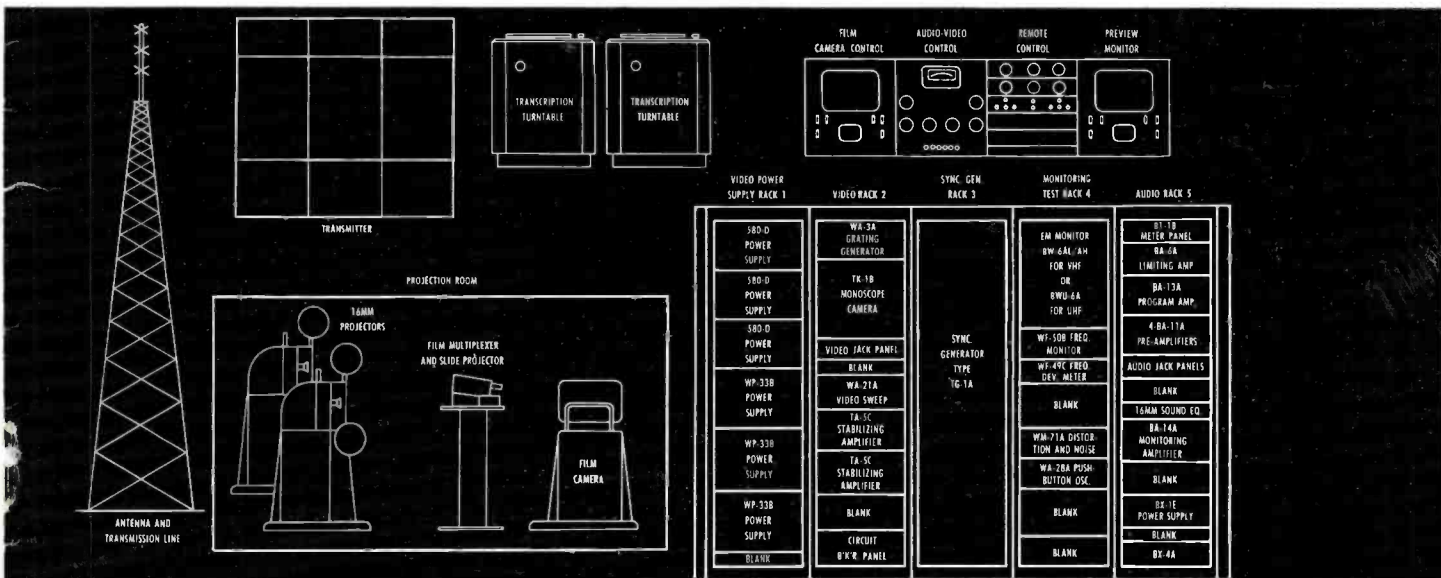

**RADIO CORPORATION of AMERICA**  
ENGINEERING PRODUCTS DEPARTMENT  
CAMDEN, N.J.



**RCA Velocity  
Microphone  
Type 44-BX**  
Effective Output Level, -55 dbm  
Hum Pick-up Level, -112 dbm



**RCA Polydirectional  
Microphone  
Type 77-D**  
Effective Output Level, -57 dbm  
Hum Pick-up Level, -126 dbm

# Broadcasting's Best...

These are the network favorites.

Year after year they serve more broadcast and television audiences than any other microphone. Yet, despite their overwhelming popularity, RCA's engineering continues to make both even better than before.

The 44-BX is the bi-directional type—designed for AM, FM, and TV studios where highest quality reproduction is desired. It provides high-fidelity output over the entire audio range—and is free from cavity or diaphragm resonance and pressure doubling.

The 77-D is the polydirectional type . . . quickly adjustable to *any* pick-up pattern you want. A 3-position voice-music switch enables you to select the best operating characteristic for voice and music. *Hum pick-up level, -126 dbm!*

Call your RCA Broadcast Sales Engineer for prices and delivery information. Or write Dept. 19 JB, RCA Engineering Products, Camden, New Jersey.



**BROADCAST EQUIPMENT**  
**RADIO CORPORATION of AMERICA**  
**ENGINEERING PRODUCTS DEPARTMENT, CAMDEN, N.J.**

In Canada: RCA VICTOR Company Limited, Montreal