



AM · FM · TELEVISION
BROADCAST
NEWS

50-KW Superturnstile

V.I. No. 75

See Page 10

July-Aug., 1963





Changing the map of the world

—with *RCA Shoran*

A SHIP SANK in these remote straits—because a chart was wrong. But that won't fool navigators any more. Modern aerial survey . . . using **RCA Shoran** and photography together . . . recorded the *true* shoreline (the lines in white). Now, the charts are right!

Surpassing any optical survey system now in use, this radar "yardstick" can map land-and-water areas never explored by man—and do it at flying speeds as high as 600 mph. Accuracy is better than 50 feet in 100 miles or more. Here's how it's done.

Two widely separated **SHORAN** stations on the ground (or aboard ship) form the base of a triangle. The plane becomes the apex. Pulsed radar signals from the **SHORAN** are received by each ground station and retransmitted back to the pilot. On a radar screen the pilot sees one "pip" for each station signal. He calibrates the "pips" and gets his fix. Cameras used with the **Shoran** equipment simultaneously photograph the calibrations—and the ground along his course. *Result: a highly accurate and permanent record of every square foot he covers.*

Just another application of **RCA Shoran**—added to its use in locating oil wells, plotting microwave radio relay and pipeline routes, detecting mine fields, and precision bombing.



RADIO CORPORATION of AMERICA
ENGINEERING PRODUCTS DEPARTMENT

CAMDEN, N. J.

Broadcast News

AM • FM • TELEVISION

Published by the

RADIO CORPORATION OF AMERICA

ENGINEERING PRODUCTS DEPARTMENT . . . CAMDEN, NEW JERSEY

NUMBER 75

JULY-AUGUST, 1953

Subscription Rates

In continental U. S. A. • \$4.00 for 12 issues
In other countries . . . \$5.00 for 12 issues

JOHN P. TAYLOR, Editor

W. O. HADLOCK, Managing Editor

E. C. MASON, M. G. MOON, Associate Editors

Contents

NARTB HONORS SARNOFF	4
"NARTB" CONVENTION	7
KTBC-TV, AUSTIN, TEXAS, COMPLETES 50-KW RCA 12-SECTION SUPERTURNSTILE ANTENNA AND 10-KW HIGH BAND TRANSMITTER INSTALLATION by BEN HEARN	10
TELEVISION STAGING AIDS by ROBERT J. WADE	16
WCCO-TV AND ITS 100,000 WATTS (ERP) by JOHN M. SHERMAN	26
THE RCA BW-5A TELEVISION SIDEBAND RESPONSE ANALYZER by J. A. BAUER AND F. E. TALMAGE	32
TELEVISION TOWERS by D. W. BALMER	40
HOW TO MODERNIZE THE RCA 715-B OSCILLOSCOPE by RAY R. EMBREE	46
TELEVISION MICROPHONE MIXER TYPE BCM-1A by GEORGE A. SINGER	50
VIDEO OPERATIONS, LIGHTING, AND GOOD TELEVISION PICTURES by H. N. KOZANOWSKI	54
NEWS OF PERSONNEL	56-57
KGNC-TV, AMARILLO, INSTALLS RCA 12-SECTION ANTENNA FOR CHANNEL FOUR	57

Copyright 1953
Radio Corporation of America
RCA Victor Division
Camden, N. J.

2J8630

TMKS ©

PRINTED
IN
U.S.A.

OUR COVER for this issue is reproduced from a dramatic watercolor drawing of our new 12-section High-Power Superturnstile Antenna. This drawing was rendered by artist Joe Krush of Wayne, Pa.—under the supervision of Jack Parvin, Art Director for the RCA Victor Division. The installation of this new High-Gain Superturnstile Antenna at KTBC, Austin, Texas is described in the story starting on page 10.

HI-FI RAGE is now in the boom stage. The small coterie of hi-fi "bugs" who have been nursing their hobby in quiet (?) seclusion for many years has suddenly been joined by a shouting mob of tin-eared enthusiasts. Teen-agers, boy scouts, doctors, lawyers, indian chiefs—they vociferate into the late hours about the importance of flat response to 80,000 cycles (!**!!), pontificate loudly about circuits they cannot follow on a diagram, and (to the delight of the manufacturers) wildly spend their money adding one unit after another to their "systems".

Mixed in with these fans, however, are many true music lovers. These people are not interested in the equipment per se. Neither are they interested in hearing just one note out of a recording. They are not even interested in the range as such. All they want is to hear—in their own home—fine music finely reproduced. These music lovers are the key to the eventual value of the present high-fidelity rage.

Like all booms, the hi-fi boom will come to an end. But when it does it will leave behind it an important legacy which will include: (1) a lot of pretty good equipment, (2) a great improvement in all types of recording, and (3) a much greater awareness (if not actual appreciation) of the possibilities of true high-fidelity reproduction.

Already this is having its effect. The RCA Home Instrument Department has announced new "High-Fidelity" phonographs which are a truly great improvement over anything of this kind previously available. These units are being produced in quantity for the fall market. This influence is almost certain to spread to radio sets and to that most maligned of all, TV sound. Thus, from what started out as a minor hobby, may eventually come a major revolution in sound reproduction.

HI-FI EQUIPMENT components intended for custom assembly are being manufactured by a number of companies. Some of these components are very good, some not so good. But good or bad, when these separately designed units are put together indiscriminately the likelihood of correct matching is rather slim. To remedy this, and give the non-technical hi-fi fans a better break, the Distributed Products Section of the RCA Engineering Products Department has just announced a complete line of fully "intermatched" high-fidelity units including players, tuners, amplifiers, speakers and cabinets. In each category there are several units to choose from, so that the true music lover will be able to put together his own home music system—according to his own desires. Because these units have all been designed to work together ("intermatched" we call it) he can follow his personal choice and still be sure of having the kind of performance obtainable only from a correctly matched system. In the next issue we will have an article describing this RCA Hi-Fi Equipment which will be sold through RCA Electronic Distributors. Meantime, if you can't wait, write us for a descriptive brochure. No charge, no obligation.

TV EYE is another of our new products which is certain to come to your attention. This is a very simplified vidicon camera which is designed to work into any TV receiver to provide a small-scale wired TV system. Easy to use, and low in cost (\$995 for camera and control unit with tube, but less receiver) it promises to be a very popular gadget. The picture, although surprisingly good for the price, is not broadcast quality and is not interlaced—so that it is not suitable for on-air use. However, it will be very handy for demonstrations, "see-yourself on TV" exhibits, etc. Write us for a descriptive bulletin.

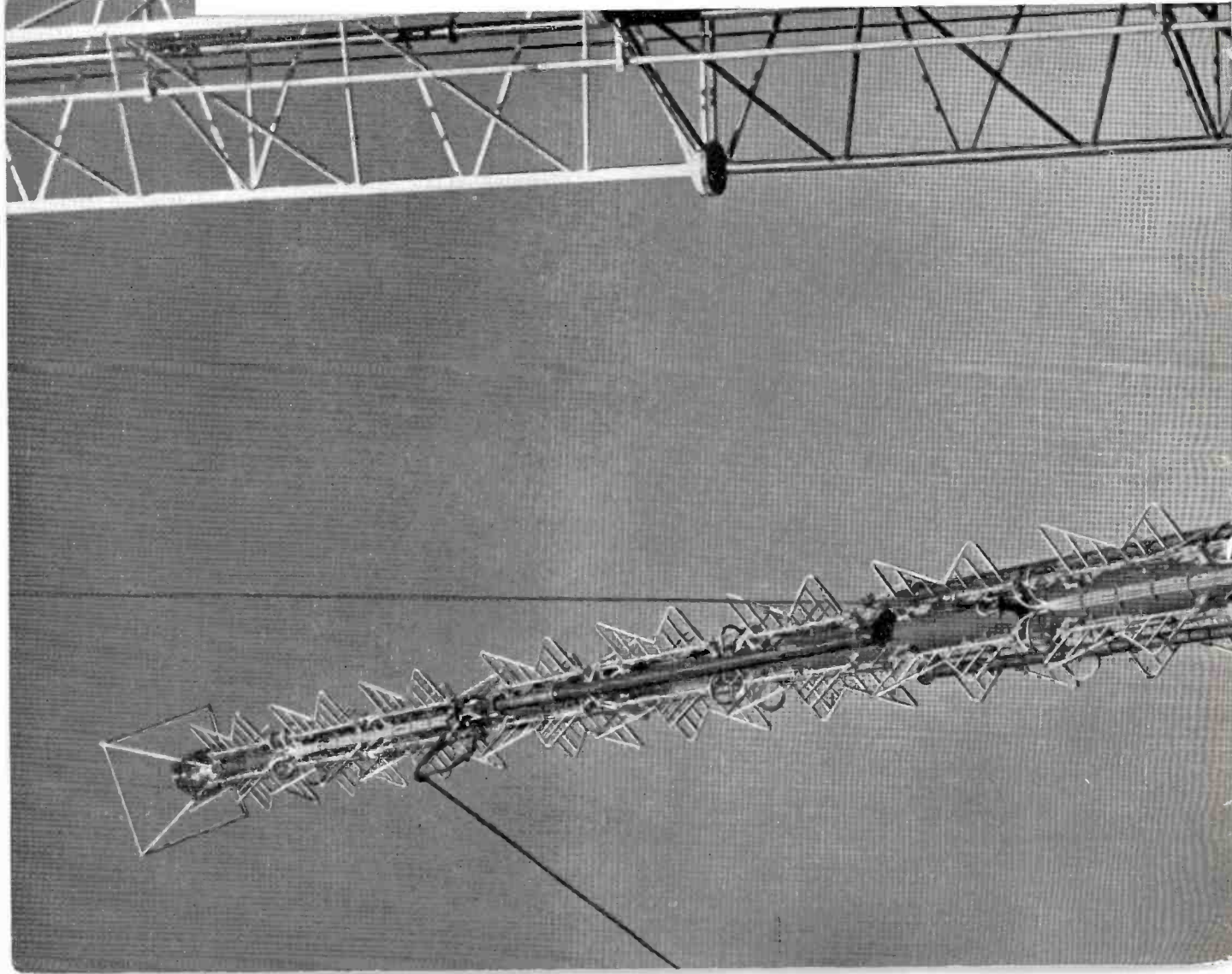

High-gain VHF antenna

—with a 50-kw rating!

**It delivers up to 316 kw ERP—
with plenty of power leeway**

RCA's 12-section, 50-kw Superturstile, in combination with a high-power VHF transmitter, meets FCC maximum power limits—with plenty of gain to spare.

It has adjustable beam tilting

Optional with all RCA 12-section 50-kw Superturstiles, this feature insures best possible coverage and maximum reinforcement of your vertical pattern. It's done simply by phase-shifting the power between upper and lower halves of antenna—using standard feedline.

It provides null fill-in

With RCA 12-section 50-kw Superturstiles, you can virtually eliminate first null with practically no loss of gain. Result: Effective close-in coverage, and vertical field-pattern shaping for constant field.

It uses a switchable feed system

Advanced-type junction boxes, new feedlines, and a section-alized line-connecting system, enable you to switch power from one part of the antenna to another. *An important feature for emergency operation!*

RCA 50-kw Superturnstiles to fit your need

Sections	Channel	Type No.
12	2 and 3	TF-12AL
12	4 to 6	TF-12AM
12	7 to 13	TF-12AH
6	2 and 3	TF-6AL
6	4 to 6	TF-6BM

Specially matched Styroflex line

No VHF antenna operates right without close matching with the transmission line. RCA's Styroflex transmission line *matches* the impedance of Superturnstile sections, handles higher power, holds center conductor in position—even when line is coiled.

Complete VHF Antenna Accessories

RCA has all equipment for VHF 50-kw Superturnstile systems—transmission line fittings, towers, r-f loads and wattmeters, diplexers, etc. Everything is "system-matched" for maximum performance.

Remember

RCA makes five different types of high-gain 50-kw antennas for VHF. RCA has all 50-kw antenna accessories. RCA can supply high-gain 50-kw antenna systems—*tailored specifically for your VHF channel, power, and service area.* Play it safe. Let your RCA Broadcast Sales Representative help plan your TV antenna system.

This picture was taken during erection of an RCA TF-12AH, 12-section 50-kw Superturnstile at KTBC-TV. Interim transmitter power was 2 kw when KTBC-TV went on the air. Now it's 10 kw.

KTBC-TV can still increase power many times without a single change in its antenna system. Here's TV antenna planning—that insures the station for the future!



RADIO CORPORATION of AMERICA
ENGINEERING PRODUCTS DEPARTMENT
CAMDEN, N. J.



(Left)—Brig. General David Sarnoff accepting plaque symbolizing first annual Keynoter Award from Harold E. Fellows, President of NARTB.

NARTB HONORS SARNOFF

RCA Chairman Presented With First Annual Keynoter Award At Los Angeles Convention of Radio and Television Broadcasters Association

On April 29 Brig. General David Sarnoff, Chairman of the Board, Radio Corporation of America, received the NARTB's first annual Keynoter Award. The presentation of the award followed General Sarnoff's keynote address to the opening session of the 1953 NARTB Convention in the Biltmore Theatre, Los Angeles. In presenting the award, Harold E. Fellows, president of the NARTB, referring to General Sarnoff's early predictions (of a music box in every home) and noting his many contributions

to the development of the broadcasting industry, observed that "David Sarnoff is that most fortunate among men who lived to see his dream come true". And, speaking for the many broadcasters present he said, "We are the legatees of that dream".

General Sarnoff's address, which was presented before the largest gathering of the convention, was a sober and carefully prepared analysis of the future of the radio and television industry. Referring briefly to

his 1947 address at Atlantic City (where he expressed unbounded faith in TV and urged broadcasters to seize the opportunity opened up by television) General Sarnoff said: "It takes an effort of memory to realize that this was only six short years ago. What a phenomenal growth this great new medium of mass communication has enjoyed since that time! How deeply it is already rooted in the everyday life of our people!"

(Right)—The plaque which was presented to General Sarnoff following his keynote address at the opening session of the 1953 NARTB Convention.

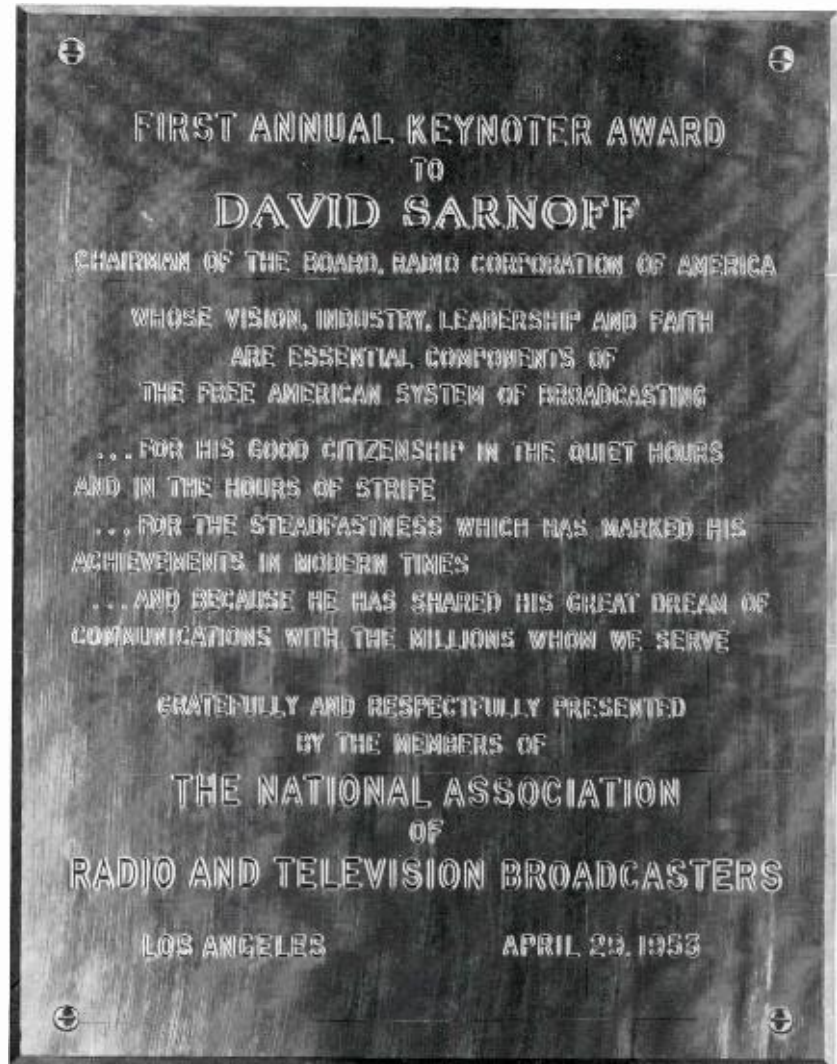

Turning to the future, General Sarnoff discussed at length the opportunities—and the challenges—which the industry now faces. While not discounting the problems to be solved, he nevertheless foresaw a glowing future for both radio and television broadcasting. Speaking of TV's future he said, in part: "Within the next few years we may see annual advertising expenditures in television go far beyond the billion dollar mark. We will see more than 1000 stations in operation. They can develop local programs not only reflecting but adding to the interest of their own communities. Television's special advantages as a local salesman and a community shopping service can be realized.

"We will also see networks reaching into all parts of the country, supported by many more large and small national advertisers. Together they will provide a national program service that will make the

present schedules seem primitive. The potentialities of television as yet have barely been sketched. They stir the imagination. For all of us connected with the new medium it holds out the vision of a great adventure."

While thus painting a rosy picture of TV's future, General Sarnoff was careful not to write off radio broadcasting. Noting that in 1949 the cry went up that radio is doomed, he said: "I did not join that gloomy forecast in '49, nor do I now . . . radio broadcasting is still with us and rendering nation wide service. It plays too vital a role in the life of this nation to be cancelled out by another medium."

Summing up the situation as it exists today, General Sarnoff said: "Broadcasting is a dynamic and changing enterprise. It goes through cycles of development and adaptation; reaches plateaus; then surges

to higher levels of service. The industry is now in the throes of one of these great cycles of transition to a higher level.

"Although the problems of transition are large, the prospects are correspondingly promising. We have in radio a very flexible, inexpensive medium with powers of resilience and adjustment greater than some may realize. We have in television an unparalleled communications system which has become an indispensable tool of American salesmanship and a major influence in American life.

"The public wants both radio and television. It will use each of them to the extent that it serves and satisfies the public interest. Our economy needs both mediums, and it is big enough to support both, provided they will conscientiously meet its requirements for effective and economical advertising."

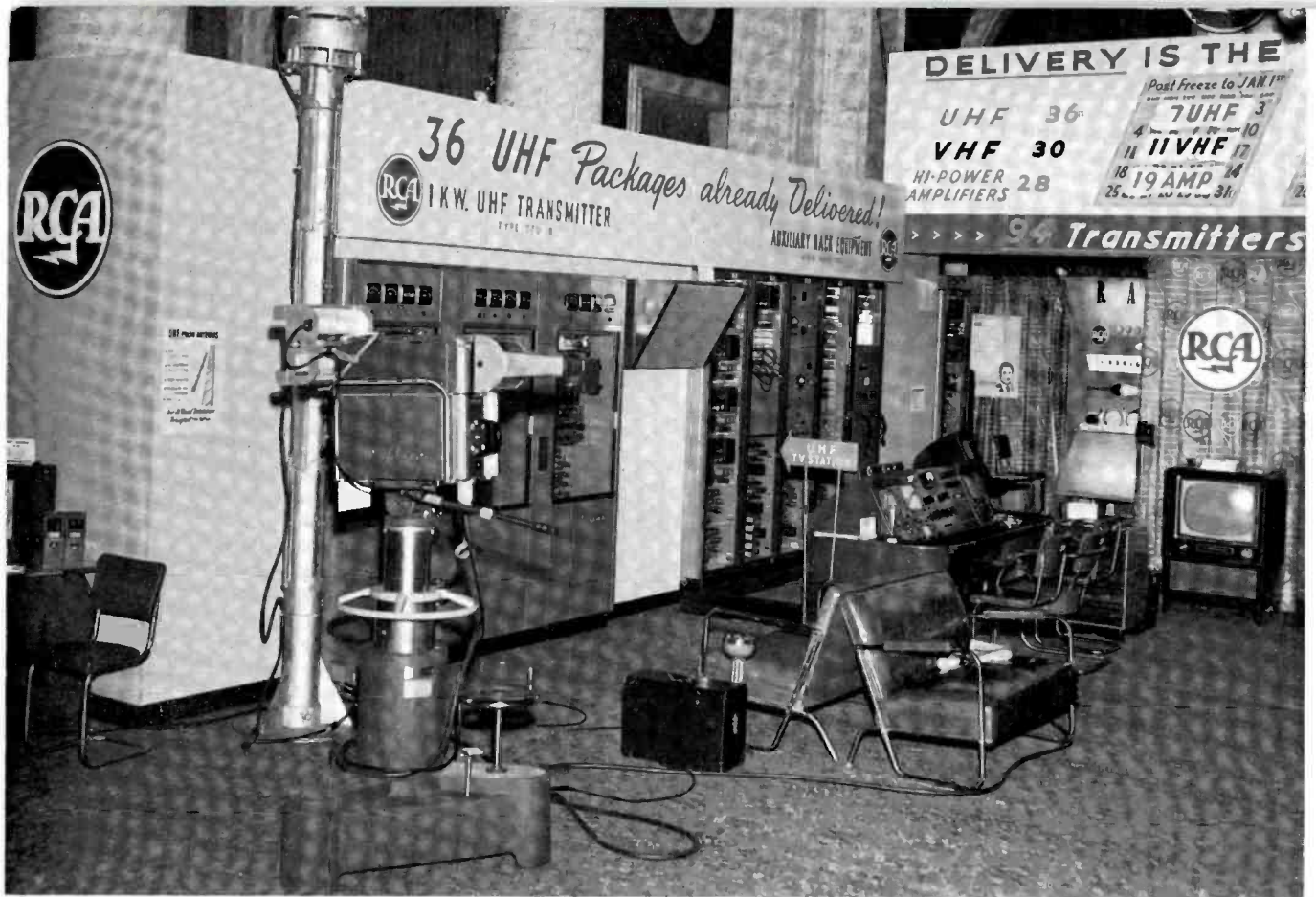

FIG. 2. The left wing of the RCA Exhibit in the Renaissance Room consisted of a complete operating (except for r-f) 1-KW UHF television station with network, film and live camera facilities, combination operating console, monitoring and test equipment.



FIG. 1 (left). Brig. General David Sarnoff, Chairman of the Board, Radio Corporation of America, who delivered the keynote address of the convention, chatting with Clair R. McCollough of the Steinman Stations, Chairman of the NARTB's Convention Committee.



FIG. 3. The right wing of the RCA Exhibit featured two full-size transmitters—the new 10-KW VHF television transmitter, and the deluxe 5/10-KW AM transmitter—plus audio and control consoles, microphones and turntables.

"NARTB" CONVENTION

1800 TOP BROADCASTERS SEE RCA EXHIBIT FEATURING "PACKAGE" TV STATION, NEW TV TRANSMITTERS, AM AND AUDIO EQUIPMENT

On April 28 the 31st Convention of the National Association of Radio and Television Broadcasters opened in Los Angeles' Biltmore Hotel. Committee and special group meetings were held on the 28th. These were followed by the first business meeting on the 29th, a feature of which was the keynote address by Brig. General David Sarnoff, Chairman of the Board, Radio Corporation of America. (See story on page 4.)

This year the engineering group held their meetings concurrently with the management meetings, thus enabling managers, if they desired, to attend technical sessions, and vice versa. The total registration for

the two groups was 1,806—a record second only to that of 1946 (the first post-war convention).

The equipment exhibits, which have been increasing in size each year, were easily the largest ever assembled. The ballroom, ballroom foyer, Renaissance Room and Galleria Rooms were required to provide room for the heavy equipment manufacturers.

The RCA exhibit occupied the whole rear half of the Renaissance Room, over 2,500 square feet. The equipment, over twenty tons in all, was shipped cross country in three Greyvan trucks. Arrived at the Biltmore, it was arranged in a U-shape, as

shown in Figs. 2 and 3 above. On the left was a complete 1-KW UHF TV station with transmitter, live camera, video control units, equipment racks, filterplexer and antenna. In the center was the RCA Tube Department's display of all types of broadcast tubes. On the right two transmitters, a brand new 10-KW VHF and a 5/10-KW AM were "built-in" to simulate actual installations. In the center area, control consoles, audio items and cameras were on display.

The 1 KW UHF Package

Easily the most popular item in the whole show was the 1 KW "package" which, as noted above, was assembled com-



FIG. 4. View of the "Basic Buy" Film Projection Room where visitors could inspect, view films, and operate TV, 16mm Projectors—and the dual-disc slide projectors.

FIG. 5. A view of the 1-KW station's "Single-Camera" Studio. Scenes televised this studio were fed to TM-2C Utility Monitors located throughout the Exhibit Area. Barely visible at right is the RCA UHF Pylon Antenna.



plete so that broadcasters could see exactly what is needed to start telecasting with the minimum setup considered feasible for profitable operation. The inclusion of a live camera, as well as film and network facilities, in this "package" greatly increases the programming flexibility of the station and provides an extra source of local revenue. Thus at a relatively small increase in cost over the very absolute minimum of equipment (no live camera) this "package" provides considerably greater revenue-producing facilities. The attractiveness of this arrangement is attested by the very large number of stations which have already installed "the package".

In order to give visiting broadcasters the "feel" of this equipment the whole package was interconnected and placed in operation (except for the r-f section of the transmitter). The picture picked up by the live camera (Fig. 5) and the picture from the film camera (Fig. 4) were brought to the switching position on the Type TC-4A Control Console (right center in Fig. 2). At this point visitors could switch these pictures to the monitoring position and otherwise operate the whole setup to their own satisfaction. Push-buttons allowed them to start and stop the projectors remotely, thus illustrating how this entire setup could, if necessary, be operated by one man during periods when no live camera activity was anticipated.

Live Cameras

Two of the new Type TK-11A Cameras were included in the display. One of these was kept in operation so that the quality of the picture could be easily demonstrated. The second camera was purposely left unoperative so that it could be opened up and pulled apart for inspection. One of the outstanding features of this new camera is the way it opens up like a jack-knife to provide instant easy access to every part, including easy quick replacement of the image orthicon camera tube. This accessibility not only facilitates maintenance but also provides for quick replacement of components in an emergency.

TV Studio and Film Equipment

The film projection room of the 1-KW package was used to demonstrate RCA's New Professional 16mm Film Projector, TK-20D, dual-disc slide projector and film editing accessories.

The RCA, TC-4A Control Console was used as a part of the station setup to provide control, monitoring and switching of video and audio circuits. The entire five-section console consisted of a studio camera

control, film camera control, audio/video section, and a remote control section, and a TM-6A Preview Monitor. The console was provided with switches so that the film projectors could be started or stopped at the console position.

Other Television Studio Equipment items of interest included the Monitran, a newly developed house-monitoring device; and a new special effects amplifier, used for creating dramatic effects in Television programming.

New 10-KW VHF Transmitter

Another feature of the equipment display was RCA's new 10-KW VHF Television Transmitter, the TT-10AL/AH—which is also currently being delivered to Television Stations. Representing the nation's only 10-KW VHF TV Transmitter, it provides (when used with RCA high-gain antennas) Effective Radiated Powers up to 100 kilowatts. A complete TV Supervisory Control Console was displayed with the transmitter, as were items of test and measuring equipment, diplexers, and monitoring equipment. New test equipment included the BW-5A Sideband Response Analyzer and two Field Intensity Meters (one for UHF, one for VHF).

TV Station Planning

Post-freeze Television planning shared the interest of a number of Broadcasters who were given the opportunity to examine and study several miniature Television Stations. Complete in almost every detail, the model stations included "true-scale" transmitters, cameras, people, props, scenery, benches, equipment racks, lighting equipment, and office furniture for easy visualization.

AM Equipment

For the AM Broadcaster, RCA displayed its modern 5-KW AM Transmitter, audio control equipment, a new console tape recorder, a new fine-groove transcription turntable, as well as loudspeakers, microphones and amplifiers.

Arranged in a typical AM Station grouping in front of the transmitter, the audio equipment was in operation so that a choice of tape, 45 rpm, or 33½ rpm, programs could be selected and controlled at the centralized console.



FIG. 6. Partial view of "Planning Headquarters" which included a model "Plan B" Station—illustrating the use of a full-size, "two-camera" studio, film projector room and complete facilities.

FIG. 7. A centralized group of AM audio and control equipment was located in front of the AM transmitter. At left of the console is the new tape recorder, and at right the new fine-groove turntable.



KTBC-TV AUSTIN, TEXAS, CO RCA 12-SECTION SUPERTURNSTILE 10-KW HIGH BAND TRANSMITTER

By
BEN HEARN
Chief Engineer, KTBC

In 1948, KTBC prepared an application for a television station in the city of Austin, Texas; however, all applications were frozen before the application could be submitted to the Commission. This application was for Channel 10, utilizing an RCA 6-Section Superturnstile Antenna atop the existing 400-foot AM tower. At that time, very little emphasis was placed on height and practically none on power.

The application would have provided about 400 feet above the average terrain and about 2 KW ERP. In 1951, when the Commission indicated that the freeze was to be lifted, this thinking had changed and KTBC conducted an investigation to see

just what power and height would best serve Austin and vicinity. After a great deal of work and calculations, it was decided that the power should be about 100 KW ERP and the height above average terrain about 700 feet for the best service to the Austin area.

It was now necessary to decide how best to reach the desired power and height. The

FIG. 1. Ground view of the RCA 12-section Superturnstile high-power, high-gain antenna—Type TF-12AH. Feed lines and transmission line are receiving final check before hoisting.



FIG. 2. Completely assembled, the 12-section Superturnstile starts its journey through space. Hoisting cable is strategically fastened and tag line at top left provides additional control.

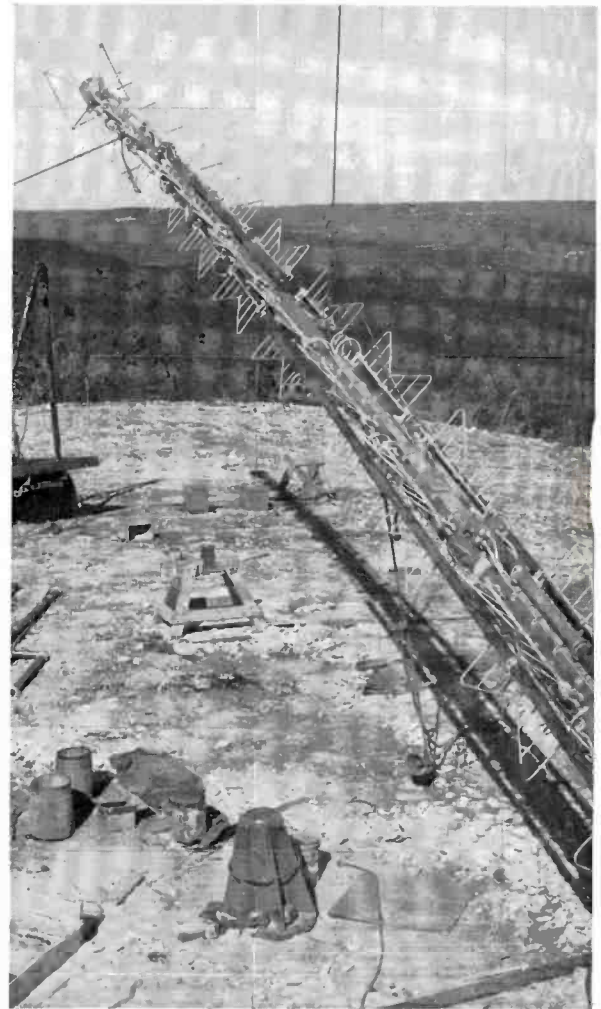

MPLETES 50-KW ANTENNA AND INSTALLATION

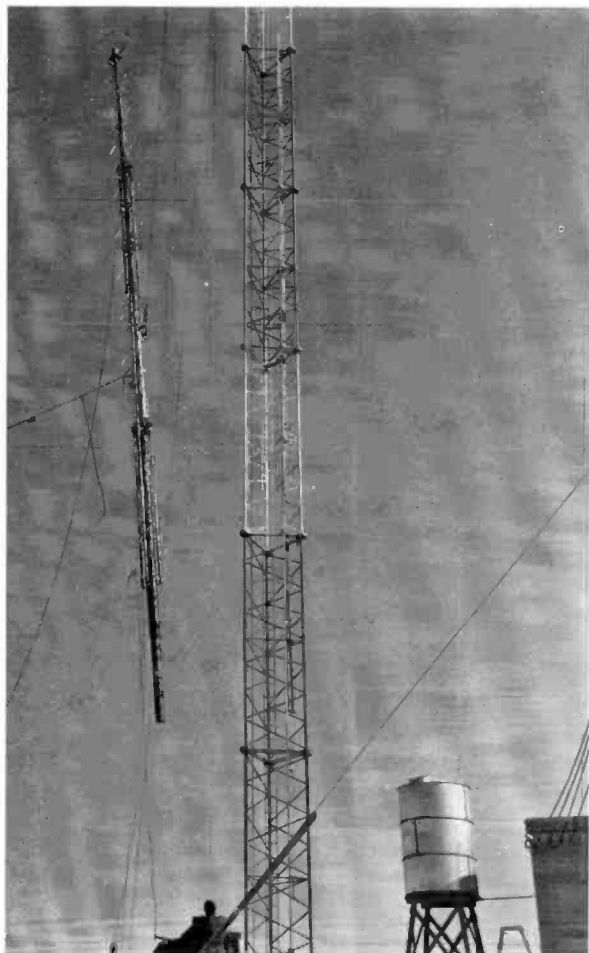
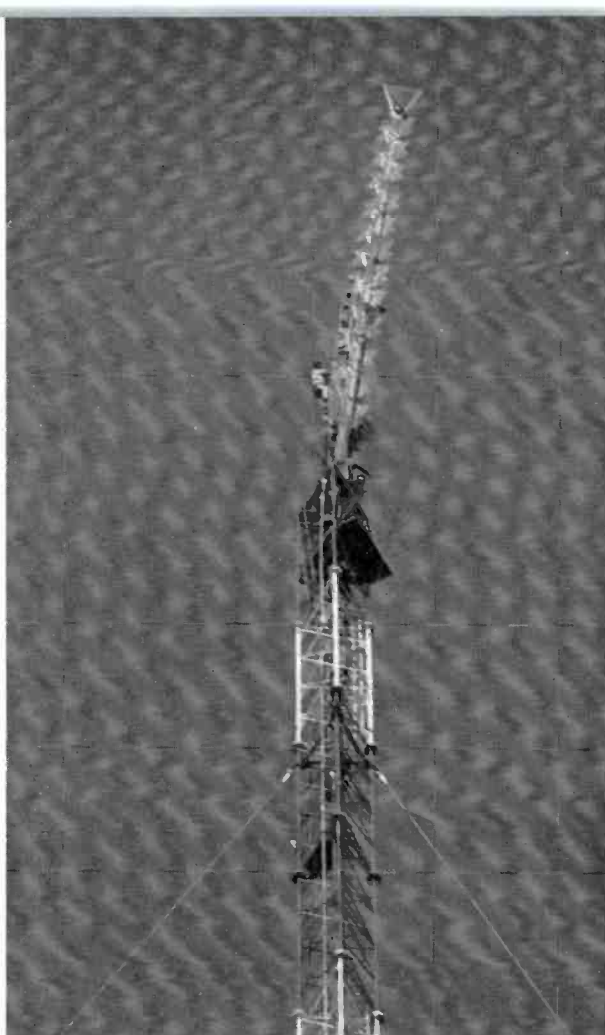

FIG. 3. On its way for a 500-foot journey the completely-assembled-antenna with lightning protector and beacon mounted on top is an impressive sight.

new RCA 50-KW-rated, 12-Section Superturnstile Antenna was one answer to obtaining the desired power. It provided the high gain combined with an ideal vertical and horizontal radiation pattern for the proposed service area. Its reserve power rating insured the possibility of future expansion without costly antenna changes. The rugged mechanical construction of the RCA 12-Section Superturnstile is certified for wind loads in excess of those which are anticipated for this area and tower height. Flexibility is inherent in the feed system and the facility for power division is in-

corporated in its design. The antenna is sectionalized, permitting continued operation on half of the antenna while servicing the other half. The new RCA 12-Section Superturnstile Antenna in conjunction with the 10-KW transmitter offered the necessary power but the existing AM tower would not provide the height. It was therefore necessary to provide more power or find a new location. Further investigation revealed that the existing tower would have to be reduced considerably to support the 12-Section Antenna, so a search was begun to locate a new site.

FIG. 4. Resting atop the 500-foot tower, the antenna is being prepared for its final vertical mounting. The specially-constructed steel gin pole can be seen at the lower left side of the antenna before its separation.



Just to the west of the city is a mountain range. A study of topographical maps revealed several mountain tops overlooking the city that are about 400 feet higher than downtown Austin. It was decided to take advantage of this height rather than to construct an extremely tall tower. Several of these locations were investigated on the ground and our consultant, Mr. A. Earl Cullum, called to make the final decision. After choosing the ideal location, Mr. Cullum then prepared the application using this location. An RCA 10-KW Transmitter and the RCA TF-12AH, 12-Section Superturnstile, supported by a 500-foot Ideco guyed tower, was selected as the most plausible equipment combination.

KTBC submitted its application in June, 1952 and was granted a construction permit the 14th of July. At this time, no final decision had been reached on location of the studios. Considerable thought had been given to using the transmitter location. The land had been cleared and a road built but it was felt that the location was too remote from downtown. In order to get on the air as soon as possible, it was decided



FIG. 5. The completed antenna installation is shown here on its triangular, 500-foot guyed tower. It was erected through the combined efforts of the KTBC engineering staff, RCA engineering, Ideco and the Seago Construction Co., erectors.

to go ahead with network and film operation at the transmitter when the transmitter building was completed, while deciding upon and constructing a studio. A short time later, it was decided to build a large



FIG. 6. Shown here is the RCA TT-2AL interim transmitter and control console. Directly behind the 2-KW unit is the TT-10AL ready for the change to higher power.

announce booth (10' x 10') at the transmitter and use this for some live newscasts and interviews. This room was to be constructed with large glass windows so the camera could be used on the outside of the windows shooting through the glass, thus providing more room inside.

A final decision was necessary on the equipment order. While RCA was readying a 10-KW Transmitter, arrangements were made for a 2-KW unit for interim operation. Since we now planned some live production, it was necessary to have some type of switching equipment. If we purchased the TS-10A Switcher, it would make a move at some later date to permanent studios rather difficult. It was decided to order equipment suitable for the interim opera-

tion and then use this equipment as a transmitter console when we moved to a permanent studio location. Later, this worked out to be the most economical and satisfactory method and greatly simplified the move.

A contract was then let to C. Ben Hibbitts for construction of the transmitter building. This was to be a 35' x 35' yellow-brick building with the 10' x 10' room in one corner for live shows. It was decided to place the transmitter in one corner to give a maximum of room for projectors and film working. Actually, a part of this space would be used for making shots outside of the sound-equipped corner "studio". Space for the interim 2-KW Transmitter was reserved in front of the

FIG. 7. Ben Hearn, Chief Engineer at KTBC, points out features of the Bridge Diplexer and transmission line run to Elmer Mason of the BROADCAST NEWS staff.



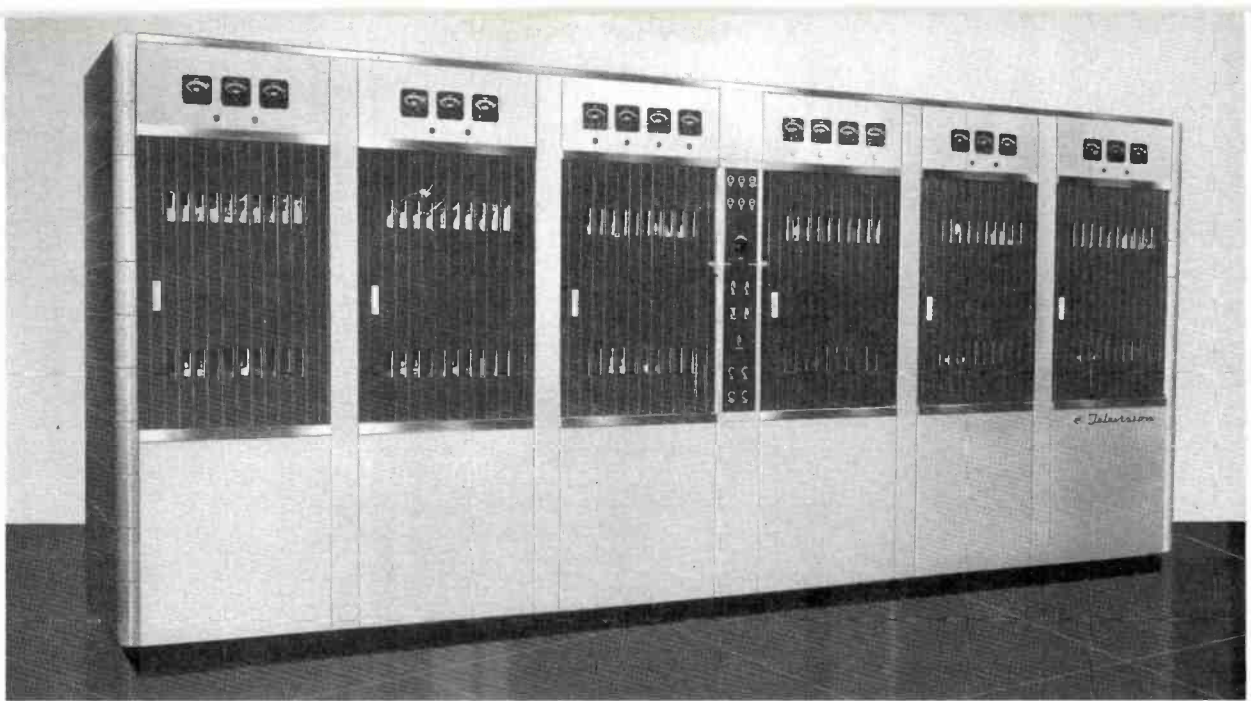

FIG. 8. An overall view of the new RCA TT-10AH 10-KW high band transmitter—"on-air" at KTBC as of June 9, 1953.

location planned for the 10-KW Transmitter so that it might be installed and the changeover made without loss of air-time. The transmitter building was so placed that at some later date sufficient space immediately adjacent was available for a large studio and office space as well as a control room and storage space.

Completion of Transmitter Building

The transmitter building was finished about the first of October, 1952. RCA started delivery of equipment about the middle of October with most of the equipment shipped by the first of November. During this time, the Ideco tower manufacturers were fabricating the 500-foot antenna tower. We were very anxious to be on the air November 17th in order to carry the Texas vs. Texas A & M football game which has wide local interest. With the able assistance of John Thayer and Ed McKenna of the RCA Service Company, we were able to have the transmitter, cameras and associated equipment ready. Dick Phares of the RCA antenna development department, arrived to make final checks of the antenna and Mr. Paul Tiner of the Seago Construction Company handled erection of tower and antenna. All work was completed on the 16th of November, a test pattern put on the air that night, and the

opening program was telecast the next day as scheduled.

Response to KTBC-TV was terrific with indications that we were getting coverage with 20 KW beyond that calculated for 100 KW "B" contour. However, it was decided not to have a coverage proof-of-performance run until after we were in operation with the 10 KW Transmitter. We were able to do a surprising amount of live programming from the small studio. The TC-4A Console Switcher did an excellent job for interim operation.

Selecting Location for Downtown Studios

A decision had now been reached and negotiations were being made with the Driskill Hotel in downtown Austin for studios.

An order was placed with RCA for studio equipment including a TS-10A Switcher, a second film and studio camera, and lighting equipment.

The studios were completed the first of March and equipment was installed. The balance of the equipment at the transmitter was moved the night of March 13, 1953 and operation was started on March 14th from the new studios without loss of air-time. One week later, the AM studios were moved to the same downtown location as well as the office force for both operations.

Microwave Studio-Transmitter Link

RCA microwave equipment was installed on the top of the Driskill Hotel and the transmitter building as a video link. Because of the long run of 550 feet from the

FIG. 9. View showing ice-deflecting canopy over transmission line run to tower. The line from building exterior to a point near the antenna is 3½" 50 ohm ultra-low-loss UHF Teflon line. MI-19089-9 50 ohm to 51.5 ohm transformers are used at antenna and building ends for impedance matching. Note transformers at the building wall.

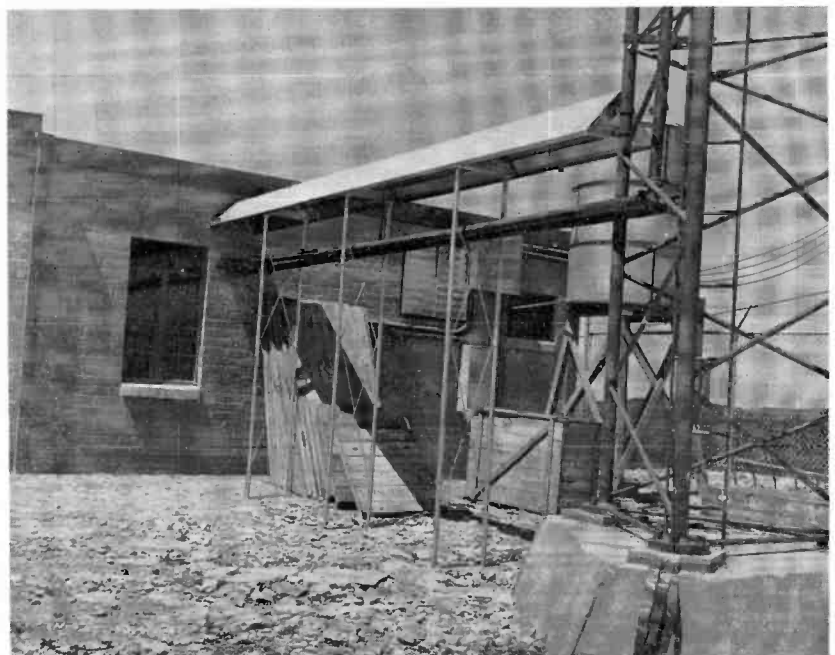

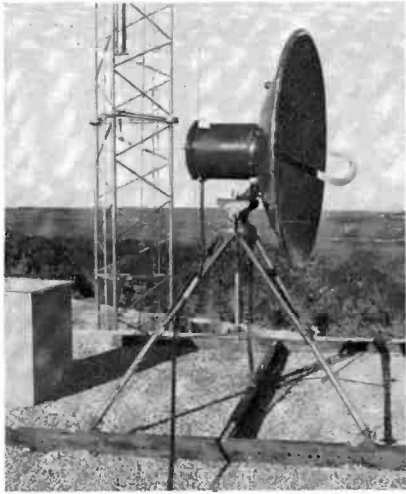

FIG. 10. Microwave studio-transmitter link. Photo shows parabolic receiving antenna on transmitter building roof. Transmitting antenna is mounted on Driskill Hotel roof—studio location in downtown Austin.

transmitter control unit in the studios to the transmitter on top of the Hotel, it was believed that special cable might be necessary. However, we ran the camera cable that is ordinarily used and tests revealed that there was no loss of fidelity between the studios and transmitter.

Film Equipment

The film equipment, which is now located in the downtown studio consists of two RCA TK-20C Film Camera Chains, two TP-16D Film Projectors, two TP-2A Automatic Slide Projectors and two TP-9C Multiplexers with slide projector mounts. Each film camera chain provides pick-up for its own individual film projector or slide projector. Film constitutes a great percentage of a station's programming—and of course, is a substantial revenue source. For this reason, it was deemed a

worthwhile investment to include a duplicate film camera chain. This insures the availability of film programs at all times. The flexibility of this arrangement allows "off-air" rehearsals or preview, equipment maintenance during convenient hours, and provides future expansion of film and opaque facilities.

KTBC Now "On-Air" with First High Band 10 KW VHF Transmitter

KTBC is now operating at five times its former power with the RCA TT-10AH Transmitter—the first installation of its type. This combination of a high power transmitter and high gain antenna, selected during earlier stage of planning is now providing 100 KW ERP. The service area has been extended considerably. So-called fringe areas are now receiving pictures comparable to those received in the immediate Austin area.

FIG. 11. Floor plan of studios at Driskill Hotel in downtown Austin.

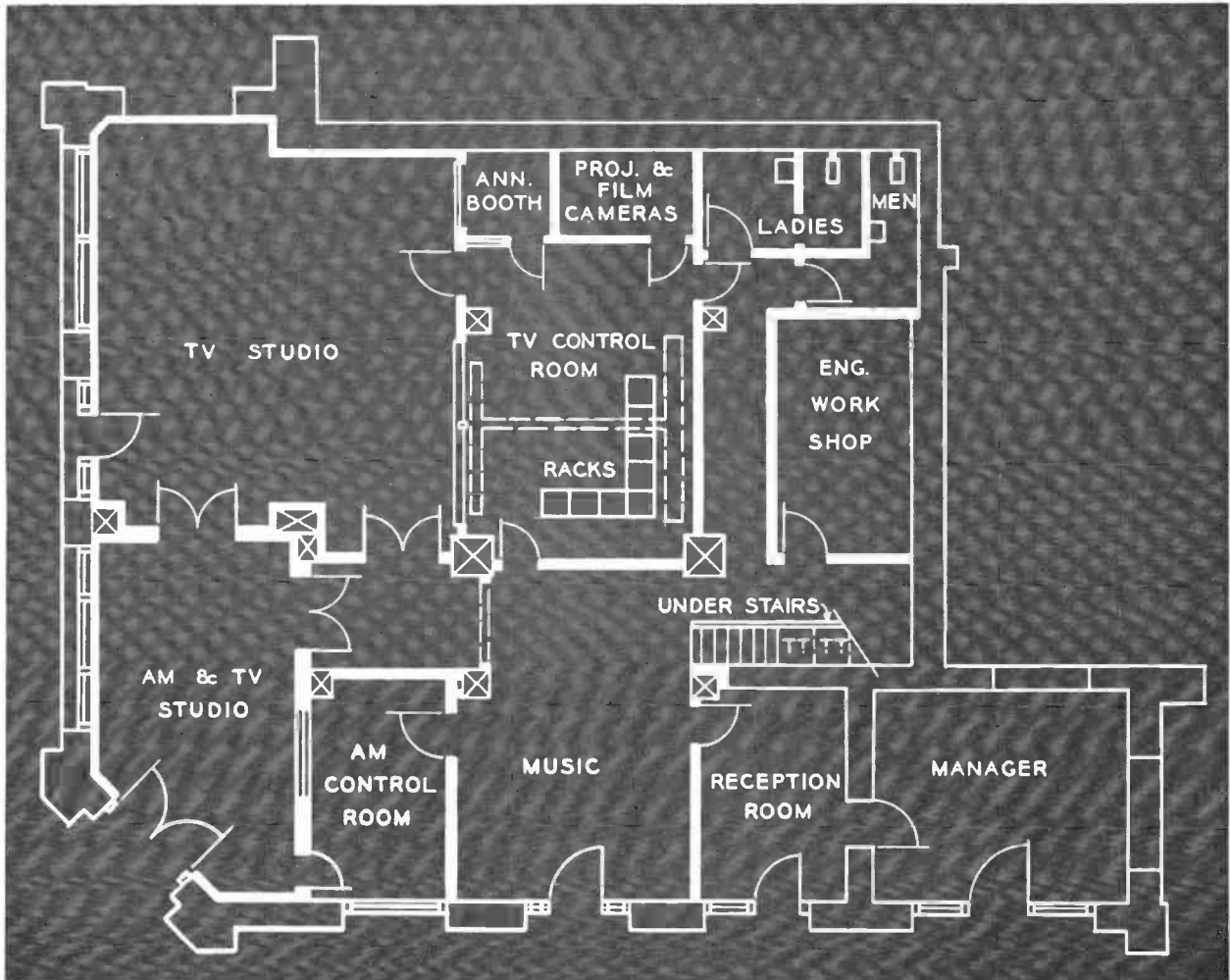

Our new transmitter is housed in six space-saving cubicles with horizontal sliding doors, both front and rear. Left to right, the six cubicles contain (1) the aural power amplifier, employing the 6166 tetrode; (2) the aural driver; (3) the aural rectifier and control unit; (4) the visual rectifier and control unit; (5) the visual driver; (6) the visual power amplifier and modulator.

The TT-10AH Transmitter is a high-level-modulated unit providing a power output of 10 kilowatts peak visual power and 6 kilowatts of aural power. The output stages, both visual and aural, employ the RCA 6166 air-cooled tetrode.

The visual section employs a crystal oscillator followed by RF amplifiers and a grid-modulated power amplifier which permits the operation of all drivers as high-efficiency, narrow band, class "C" amplifiers. These stages can be tuned easily and quickly while observing front panel meters. A cathode follower stacked class "B" video modulator with feedback, using the RCA 6146 tube, provides excellent performance. A clamp circuit for d-c restoration is employed at the grid of the video modulator



FIG. 12. E. B. Kothman and L. Ray Sanford, station engineers at studio master control console.

stage. Meters are provided for checking power output of both visual and aural transmitters. These meters also indicate VSWR and connect to the protective circuit which removes transmitter plate power when VSWR exceeds a predetermined value. Picture monitoring is possible at various points in the system. Aural and visual sections and their control circuits

are independent for maximum operational flexibility.

KTBC is now achieving phenomenal coverage—delivering powerful signals to its greatly-increased televiewing audience. Basically a CBS station, network from NBC, ABC and Dumont are at present being carried, providing KTBC's vast audience with the utmost in programming.

FIG. 13. Main Television Studio at KTBC (see floor plan of Fig. 11). Equipment includes two RCA TK-11A Cameras.

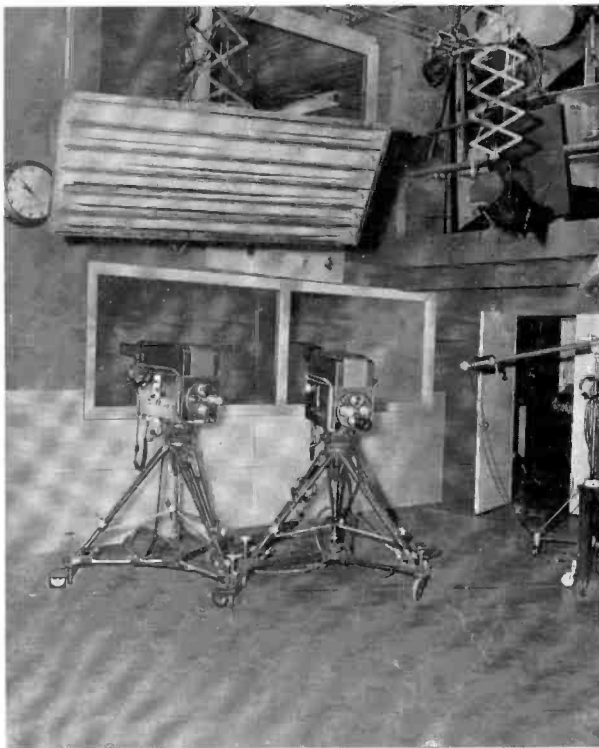

FIG. 14. Film room equipment consists of two RCA TK-20C film camera chains, two TP-2A Automatic Slide Projectors and two TP-9C Multiplexers.





FIG. 1. Because titling and displays are important in live studio commercials, the Graphics Dept. is an essential production facilities service. Above, Harry Wayne, WWJ Detroit, art director, develops a background in gray-scale values.

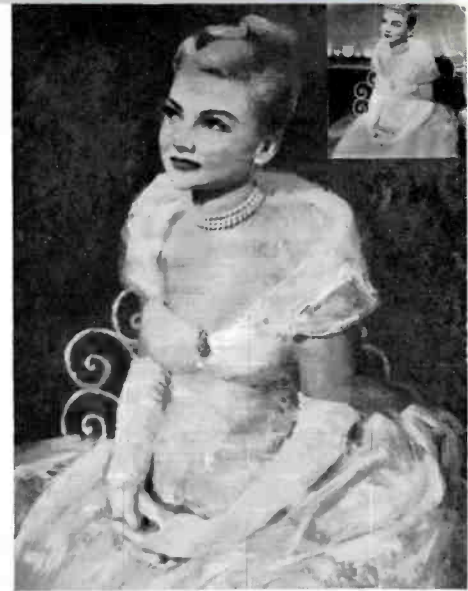

FIG. 2. A "genuine" oil painting 36" x 45", required in a production. Small photograph was blown up photostatically, mounted, and the oil paint technique applied in black-and-white and intermediate values.

FIG. 3. A Miniature Setting for a Commercial: Simple two- and three-dimensional models of a non-realistic nature provide novel, eye-catching backgrounds for selling by television.



FIG. 4. Books are frequently used as a titling device in providing introduction and cast credits. Tip-ons are printed on a hot-press (see Fig. 18) and affixed to a blank cover. Cast credits are also printed and pasted to inside sheets. Pages are usually turned by hand on camera.



FIG. 5. "Be Happy, Go Lucky": A portion of one of the "Lucky Strike Hit Parade" live commercials featuring Dorothy Collins. Crew men stand by to lower a miniature drop carrying an advertising message at the conclusion of the cigarette jingle.



TELEVISION STAGING AIDS

by **ROBERT J. WADE**
 Designer and Television Production Consultant
 P. J. Rotondo Construction Co., New York City

THE GRAY SCALE IN TELEVISION

Gray-Scale vs. Colored Pigments

There is no scientifically tenable reason for using colored scenic paint on TV settings when pigments (or values) in a neutral gray-scale, or a sepia scale, give the required result on the system; however, there are two practical purposes served in working with colored paints: (1) on theatre programs the usage is effective and appealing to the live audience, (2) many dark values can be made up without em-

ploying heavy, flat backs that often darken the tonality of the entire setting, which then requires additional lighting.

Since camera color responses differ, it is advisable that the Art Director conduct local tests over an extended period before deciding on a TV palette. In New York, NBC scenic artists, after several years of experimentation, now work in both monochromatic and mixed values of green, blue and violet. Sepia or soft black-and-white grays to which earth colors, siennas or umbers, are added are sometimes pre-

ferred. Red and yellow are not used except in small quantities as yellow tends to reflect substantial amounts of light with resultant "bloom". Color arrangements used on audience programs should, of course, be restricted to those that are effective on the TV system.

Achromatic Television¹

Achromatic television does not offer the artist the wide range of values that normally exists in black-white photography, half-tone engraving or, for that matter, in motion picture film. Although all engineers

¹ Television images free from color, or composed of various values of gray.

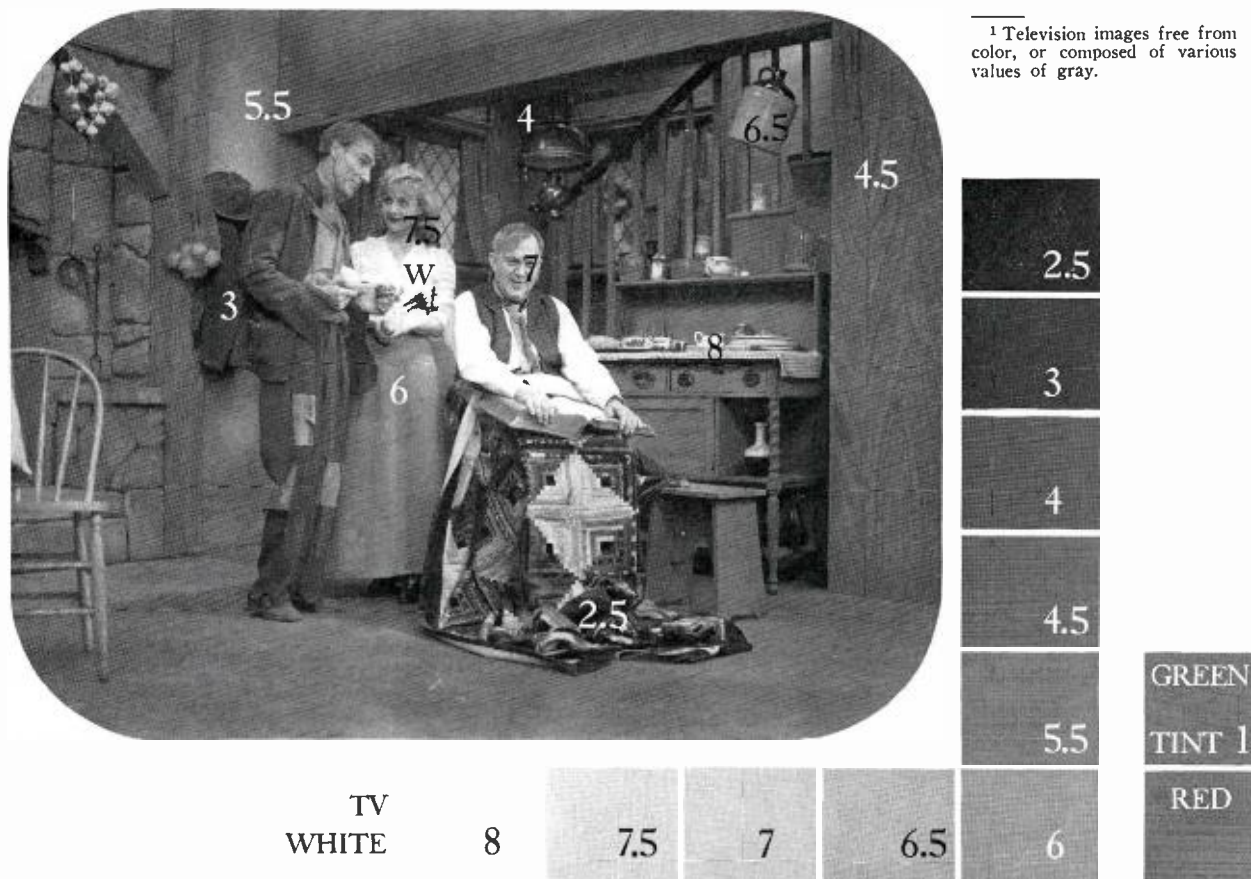

FIG. 6. The Gray Scale: An analysis of a single TV shot in a dramatic program, showing the range of achromatic values from Munsell Neutral 2.5 (TV Black) to Munsell 8.5 (TV White). In this shot, the high values are concentrated on costumes worn by leading players (the girl's white blouse is actually dyed a very light blue-green) and the darker tones applied to the scenic background. The chart also indicates the gray responses on the TV system of two colors, GREEN (Tint 1) and medium RED, which normally have the same gray equivalent. To ascertain the gray responses of color objects, costumes and props (like the multi-colored "afghan", center) the producer and designer refer to a Color Gray-Scale Guide. These guides provide the approximate response of 125 or more colors regularly used in telecasting. Setting designed for Theatre Guild by R. J. Wade, for NBC program.

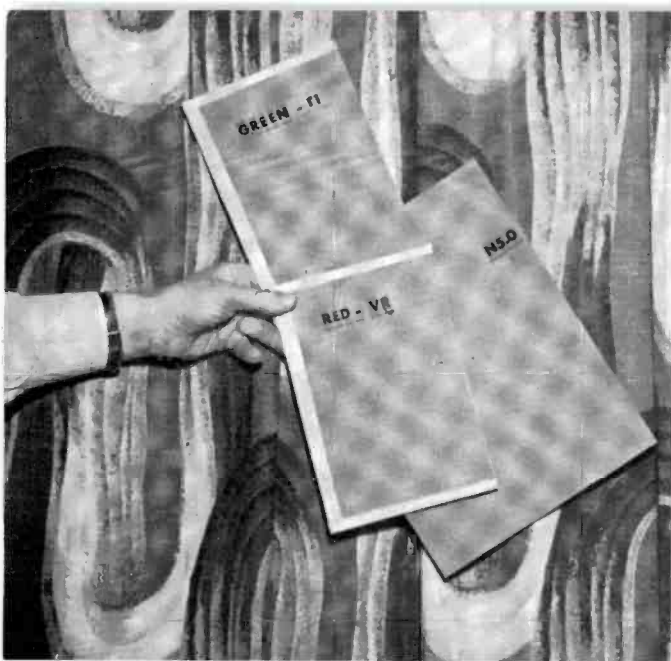

FIG. 7. Camera tests reveal that Green Tint 1 and Red-Violet-Red have identical gray responses (Neutral 5.0). See Fig. 8.

Color-aid Co.) assemble 9 consecutive gray values from off-white to black, that in the opinion of an experienced engineer and the art director, are nearest the values observed in a transmitted image.

2. Lay out these swatches, each cut about 9 inches square, on a heavy piece of cardboard so that the entire arrangement may be easily fastened to a studio easel: the swatches may be pasted on in two groups of four, or as segments of a circle, or in any way which will permit the camera to "pan" over the values sequentially.

3. Prepare 50 to 75 sample color swatches (in all hues and varying values and intensities) on cards about 9 inches square of mounted colored paper (some, at the discretion of the art director, may be coated with scenic paint). These samples should have a mat surface.

4. Set up a television camera and a receiving set (monitor) in the studio, and as colored cards are compared to gray values on the system, mark each color with the number of gray which it most closely resembles. It is convenient to mark certain colors with intermediate gray responses as plus or minus. Thus a medium tint of

do not agree as to the exact number of gradations that can be transmitted by the electrical and electronic system, it is generally admitted that 8 or 9 values, including a near black, is average. Observing under ideal laboratory conditions, some technicians have claimed a count of 18 or 20 values, but of course this finding does not take into consideration light losses and other degradations incidental to transmission of the image to remote points.

Working with a scale of approximately 8 black-and-white gray values (off-white to black) would ordinarily present no problem to the artist. Indeed, this palette restriction often forces the television graphic artist to produce simple and effective copy of posterousque clarity. But the set and costume designer, the set dresser and the make-up specialist cannot operate so readily in a world of gray. Their media—draperies, furnishings, fabrics, furs, accessories, cosmetics, and the skin tones of actors and performers—have color expressed in hue value and intensity. Since it is impractical to attempt to reduce all these staging elements and adjuncts to chromatic neutrality, the art director must become acquainted with the gray responses of colors as reported via the camera system. If he does not know color responses, he will be at a complete loss as to means of obtaining contrast; and draperies, furniture, costumes, and even patterns on wallpaper may melt into backgrounds.²

² In an actual experiment the walls of a setting, painted pale blue-green, were stencilled in light vermilion (coral). While the pattern was easily discernible in the studio, it completely disappeared "on camera" because the two tints, although different in color and unequal in value, had the same gray response.

Because of variances in equipment and lighting methods it is advisable that each station record its own response chart for the information of producers and the entire art staff. The process is simple:

1. From any collection of standard colored papers or color swatch cards (such as Color-aid, compiled by Sidney Beller,

FIG. 8. Color Response Chart. After extensive studio tests during which the gray response of colors has been calibrated with the gray-scale range of the image orthicon tube, it is necessary for the art director to provide a color guide, indicating approximate responses of as many different hues, tints and shades as possible. In the picture below, color chips representing a group of 200 different colors are being assembled for a gray-scale guide.



Warm Colors . . .

GRAY
VALUES

. . . Cool Colors

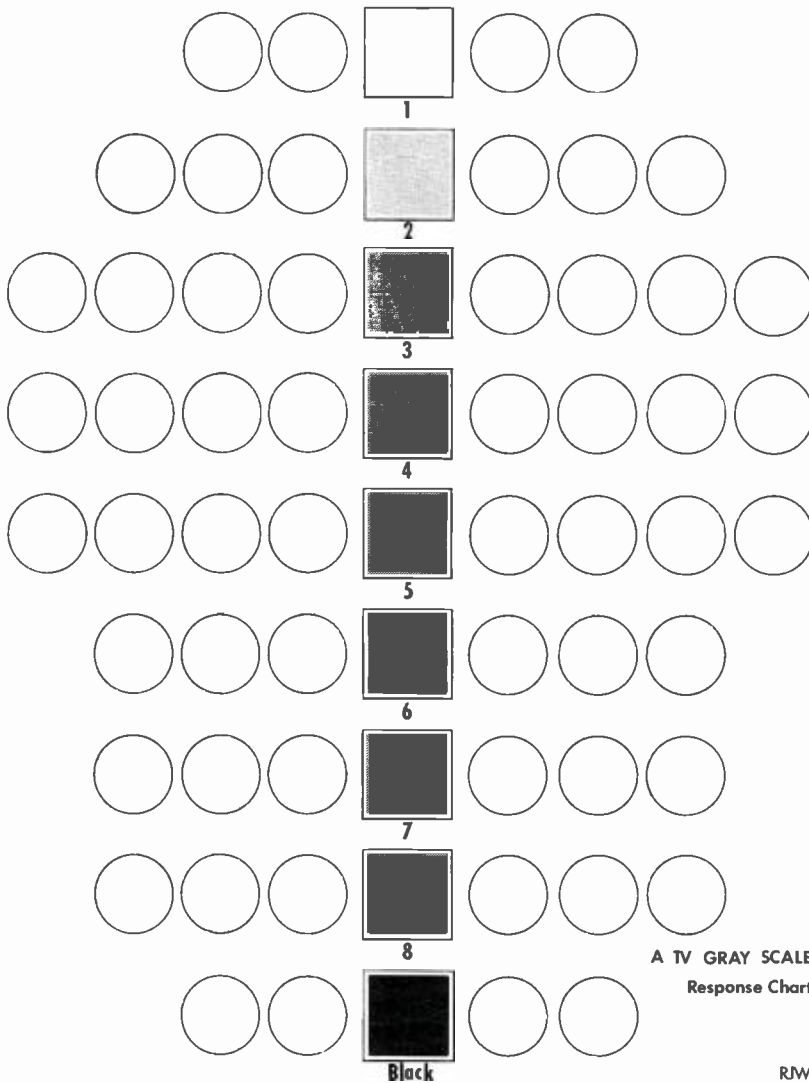

FIG. 9. A diagrammatic layout of a TV color, gray response chart showing another method of preparing a gray-scale chart in addition to the Munsell scale shown in Fig. 6. Swatches or color chips may extend, right and left, to include as many hues and values as desired.

green may have a response of 5; a medium tint of blue, 5 plus, or slightly darker.

There is nothing absolute about the results of this analysis, but the responses, properly numbered, and subsequently reduced in size for convenient handling (see Figs. 8 and 9) are extremely helpful in arranging those elements of a setting that must be in color.

The engineer handling the video signal on a program cannot "stretch" the range of values, but he can alter them occasionally for certain types of effects. If, however, in a night scene he "bats down

the blacks," the entire scale of values descends and the off-white approaches a light gray. If he "hits the whites," the darker grays and black lose their punch, the transmitted picture looks pale and washed out, and highlights are likely to be too brilliant. The decision on the control must be made by the technical director and the producer and depends entirely on the effect to be achieved. The artist, however, if he adheres to an established gray-scale color response chart and places contrasting colors in the proper juxtaposition will find that his work does not lose clarity when the range is raised or lowered. By analogy,

the procedure is something like playing a tune in a different key on an instrument with limited scope.

In general, pure white should be used only for accents and highlights, and in very limited quantities. Flashes of pure white (clear light) on the kinescope "screen" are likely to be surrounded by an unwanted aura of black in ugly splotches.

THE GRAPHICS STUDIO

Because of the sales promotional aspects of television broadcasting, the various activities incidental to the production of artwork, photographs, displays and general titling are especially important. Stations will find in the requirements of local commercials substantial demands for all kinds of slides, advertising display cards for live studio usage, commercial product repackaging or enlargement, photo retouching and general illustrative material.

Ideally, a small photographic laboratory equipped with a suitable camera, enlarger, dark room and slide printing facilities operates economically in conjunction with the graphics function, especially at stations in small cities. In metropolitan areas, photo work or slide making may be contracted to commercial suppliers. However, the Graphics Supervisor is frequently obliged to furnish photos of commercial products or special program material at short notice, or on holidays or weekends and an integrated photo unit is indicated. Unless operations are complex, an assistant title artist can take on most normal photographic duties.

In addition to drawing or drafting desks, racks, filing cabinets and general art supplies, the Graphics Unit requires the following equipment for a staff of two artists:

- 1 cut-awl
- 2 airbrushes
compressor or compressed air tanks with pressure gauges
- 1 large paper and cardboard cutter
- 1 Kodak dry mounting press
- 2 adjustable cardboard punches—approx. \$300
- 1 hot-press printer (with selected fonts of metal type)—\$500-\$750.

Special titling effects are normally achieved by processing film or by utilizing mechanical and optical devices installed in an engineering special effects studio. If film costs are prohibitive or if special effects equipment is not available, certain live-studio mechanical developments are practicable.

TITLES

In the trade, almost any piece of artwork other than a scenic background is described as a "title" because, organizationally, lettering, cartoons, illustrations and photography are executed by a titling or graphics department. It is normal rather than exceptional for the producer to combine many kinds of techniques in one title, and, of course, titles and artwork may be projected into the video system in many different ways. The following material describes copy and style only; processes (slide, film, etc.) are discussed under Titling Devices, on opposite page.

Lettered Titles

Lettered Titles, generally used to announce name of program, cast and staff credits, locale, opening advertising message ("billboards") are printed or hand-lettered cards usually 11 x 14 inches or 20 x 30 inches. Type matter or lettering is composed in a field with a ratio of 3:4, which must include allowance for margins. Because receiving screens are relatively small, only good, clear Roman or Gothic type faces are normally acceptable for creating a readable image. On an 11 x 14 inch piece of copy (set within a field of 6 x 8 inches or 7 x 9.33 inches), any type under 48 point (about one-half inch on face) may blur. It is generally safe to assume that no type should be less than 1/7th of the height of the field.³ For maximum clarity, handlettering should be executed even larger since outlines are generally not as precise as in printing.

Several value combinations are effective: white lettering on black, black on off-white, black on gray and white on gray. Shadows and highlights are useful in separating letters from backgrounds and making them stand out.

Long lines of type extending beyond the field should be avoided because on certain receiving screens left and right letters may be masked off. Occasionally, ornaments on initial letters or portions of cursive type may extend slightly beyond the established field in a vertical direction. Basically, however, in all typography and lettering, the best results are achieved if all matter is kept within the field, plus liberal side allowances for safety.

Decorative Titles

Decorative titles involve copy that includes ornaments, borders, brackets,

³ In direct printing on balopticon slides, 24, 30 and 36 point type may be specified. See *Printing* on opposite page.



FIG. 10. A Studio Title Device: A mechanical method of creating a "crawl" title from the floor of a live studio. Prepared by the Graphics Section, the printed title is affixed to a specially constructed drum which is revolved on cue by manually- or motor-driven equipment.

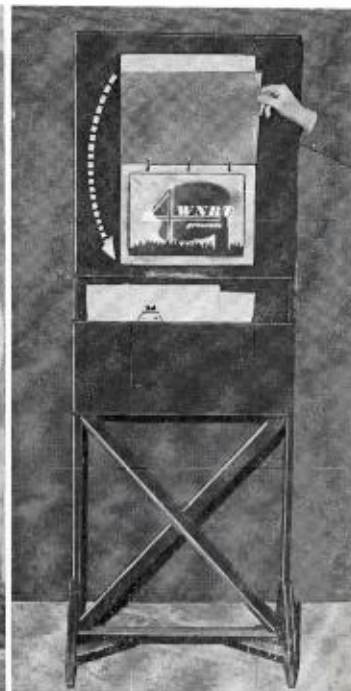
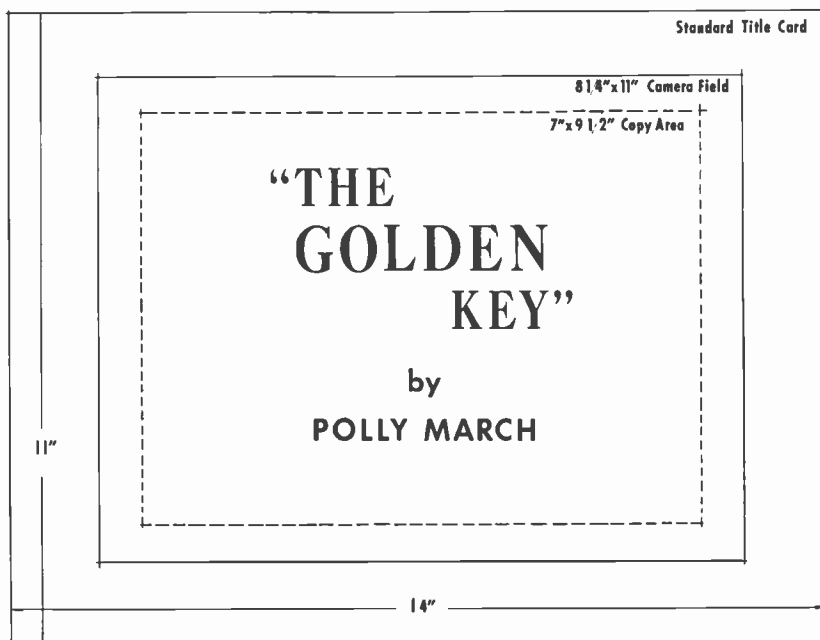

FIG. 11. Flip Stand: An elementary live-studio easel. Cards are dropped on cue as required. Note the tray below for holding additional titles. "Flipcards", hand-lettered or printed (white type, dark gray backgrounds) are effective in superimposition.

FIG. 12. Layout of the standard title card. While any area with a 3:4 ratio may be used for title copy, most artists find an 11" x 14" overall space sufficiently large for detail. In addition, this size is compatible with large hot-press type sizes.



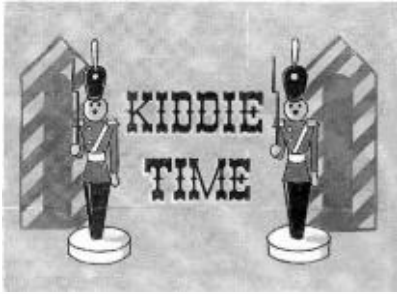

FIG. 13. A typical illustrative title with free-hand lettering, used on a WWJ-TV program.

cartouches, barouques, and so on, usually hand-executed with or without lettering or printing. Frequently, seals, insignia, flags, trademarks, emblems (sometimes logotypes), and symbolic abstractions are drawn or painted on titles and lettering imprinted or rendered over them. When this is done, the background figure must be sufficiently simplified in terms of detail and value so that it will not interfere with the legibility of the imposed wording.

"Crawl" Titles:

The effective crawl or roll title may be made mechanically by printing or hand-lettering titles on a long strip of heavy paper, and rotating this strip on a drum. The application of gears provides for adequate control (see Fig. 10).

"Flip" Titles:

Printed or hand-lettered cards which fall, one after another, to provide a continuous message. Good for credit lines, verses of songs, slogans, etc. The cards are punched and are fastened to an ordinary notebook ring-binder which is mounted on a display board (see Fig. 11). For simple "flips", cards may be knocked off an easel, one by one, but the chances of accident are great.

FIG. 14. Compare this figure with Fig. 15. These two illustrative titles show how the Graphics designer can provide helpful expository program information. Here the same program title has received two different treatments in background and typography. Each background suggests program content to the viewer.



"Cartouche" Titles:

A cut-out cartouche or decorative panel in one live title card may serve to display several other titles by the device of sliding small titles in a groove behind the main title (see Fig. 17).

"Proscenium" Titles:

For dramatic programs, a miniature stage may be used with main titles and credits printed or hand-lettered on cardboard "drops" which rise in succession to reveal additional cards.

TITLING DEVICES

Before discussing the various techniques and processes involved in preparing copy for an actual title, illustration or display unit, it is necessary to explore the methods by which this information is picked up by camera tubes and introduced into the electronic system for transmission. This introduction is effected in two different



FIG. 15. An illustrative title. Read Fig. 14 caption.

ways: (a) material is reduced in size for opaque slides, or developed on film, film strip or transparent slide and projected into the system from various devices physically placed in the master control room, or (b) artwork, titles or illustrations are placed on suitable easels or stands in the studio and picked up by one of the studio cameras on cue during the course of staging the program. In both instances, the results are the same and, although the superiority of one method over the other is certainly debatable as regards operational efficiency, this matter is not the concern of the artist. It will suffice to indicate here that ideally, all titling material should originate from a so-called special effects studio or master control room at a point removed from the program studio. This will keep bulky easels, stands and titling devices off the busy sound stage, which is normally cluttered with scenery, props, cameras, booms, lights, actors, stagehands, musicians, floor managers, coordinators, integrators, and vice-presidents. Producers can preview

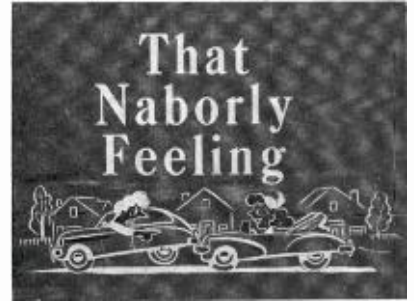

FIG. 16. Telop Copy: Cartoon-style artwork on 4" x 5" opaque cards.

artwork and combine it with program material on cue very easily. But frequently, the master control room becomes overcrowded with film commercials and various types of slides to a degree that it is difficult, perhaps impossible, to provide service. Thus, in network broadcasting, some live studio title display during periods of peak activity seems indicated for some time to come until the television cities of the future are steel and concrete realities. For control efficiency, most producers now prefer the use of live titles.

PRINTING

Because of its commercial nature, television broadcasting involves the transmission of a substantial amount of printed copy despite the claim of the admen—and the Chinese—that a picture is worth 10,000 words. In their silent days, the movies too depended on subtitles for description and dialogue and, except for occasional opening titles which were hand-lettered, employed printing for such literary touches as:

Lester, imprisoned by the Arabs, believes Pauline has married Lord Binley.

These subtitles were printed on cards, subsequently photographed and, after processing, edited into the finished film. Television production employs a similar

FIG. 17. A cartouche title suitable for motion picture, slide, or live usage. Courtesy of National Screen Service.



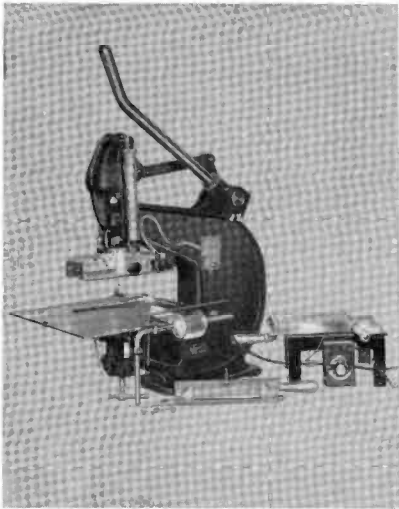

FIG. 18. Most printing in television graphics is done on hot-press, shown above and described in text. Model can print several lines simultaneously.

method except that the title information is generally reduced to slides or picked up in the live studio directly by a camera.

Because only one copy is normally necessary for such practice, the employment of letterpress printing (gauged to produce impressions by the hundreds or thousands) is somewhat expensive and superfluous. Another method, involving a "hot-press" (see Fig. 18) is more suitable for printing one or two good, clear "proof" copies cheaply; because of its simplicity, a trained printer is not essential unless production demands

warrant a full-time operator. An apprentice artist or clerk can easily learn to stick type in the large sizes indicated for television titling.

Regular standard, all-metal type (24 point to 72 point and over) is used in the hot-press; type is set in a special stick, pre-heated and locked in the press where its temperature is slightly increased. When sufficiently heated, the lines of type are brought down to rest on a plastic ribbon and this plastic is melted, so to speak, and neatly bonded to cardboard, fabric, photograph or other title background. No ink or rollers are required. By changing the ribbon, other copies may be pulled on cells in contrasting values, color, or in metallics to produce dropped shadow or three-dimensional effects.

Another printing device, manufactured for window and price-card work and widely used in department stores may be adapted to television purposes. This apparatus involves the use of regular, standard all-metal type, which is set and locked in a form with the face of the type uppermost. The type is inked from a hand roller and an impression pulled by exerting pressure from the top on board or paper. The cost of this device is less than that of a hot-press but impressions, while usable, normally require considerable touching-up because inks recommended appear to be weak and somewhat watery. Title artists, in general, do not feel that this proof press is adequate for fast production work but deserves consideration (see Fig. 19).

FIG. 19. A poster press similar to the type used by department stores is a graphic arts adjunct at Station WWJ-TV. As many as twelve "headlines" for a news show can be set up in an hour.



FIG. 20. Any number of prop books may be made up by the Graphics Department by developing photostated dust jackets and the finished jacket wrapped around prop books.

In general, most conventional titles can be efficiently and effectively produced by the hot-press process. Matter imprinted on 20 by 30 inch or 11 by 14 inch cards is readily picked up live by the studio camera and can be reduced photographically for transparent or opaque slides. In fact, the 4 by 5 inch balopticon size can be printed directly with 36 point to 48 point type over artwork, textured papers or photographs. When plain typography is too prosaic for special effects, copy is printed with the initial letters of words omitted so that decorative or cursive hand-lettered artwork may be added.

Television production demands a great deal of printed material other than straight titles and the acquisition of a hot-press

FIG. 21. Headlines for mock-up newspapers are printed on the hot-press. Note how the sub-headlines are partially obliterated or "Greeked out" so that concentration in the shot is on the main headline message.



is indicated for the preparation of faked newspaper mastheads, headlines, advertisements, doctors' prescription blanks, small placards, name plates, labels, forms and letterheads and fictitious books as shown in Fig. 20. Dramatized commercials also require printed price tags, counter signs and announcement cards.

Newspaper mastheads and headlines are printed on the hot-press and pasted over real newspapers. It is usually customary to "greek out" other headlines by obscuring type matter with oblique or curved pencil lines (or dashes of opaque white) so that they cannot easily be read by the viewer (see Fig. 21). Magazines and brochures are handled in a similar manner. If additional copies are needed, essential material is photostated and pasted-up over suitable dummies or actual publications of the right character.

search material which is essentially a program function. Most published maps are copyrighted and portions cannot blithely be cut out and transferred to film, slide or live title without clearance. When required clearance should be provided by the program producer.

Once approval is obtained to adapt material, there is no great problem in simplifying maps for television usage. Only very restricted areas should be included in titling effects, but wall maps may be made in any convenient size since the camera can pan from point to point as the newscaster indicates areas of action.

Charts, weather maps and pictographs are sometimes used in titling and are executed much in the manner of newspaper line-plates, except that great simplification is indicated. Black or dark gray on off-

There would not be time to prepare or ship film.

2. The advertiser wishes to feature many products, perhaps only one or two each time on weekly programs. The quantity of film required might be too expensive as infrequent usage would provide no basis for amortizing costs.

3. The sponsor proposes to show the star of the program using the product, or otherwise to integrate the product into the program material.

4. The sponsor prefers to do a straight selling commercial with live displays and an announcer or apparent salesman in shot discussing products which do not usually lend themselves readily to slick movie treatment or cartoon animations; e.g., certain types of packaged bakery products, rugs, linoleum and some household appliances.

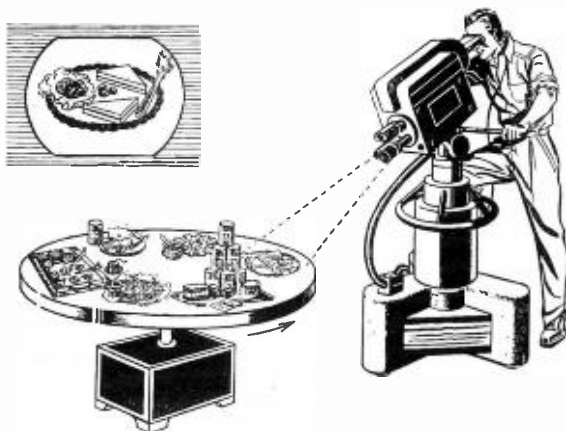

FIG. 22. Lazy Susan: This NBC motorized device displays canned goods, prepared foods, soda pop, shoes and other products for most interesting "down-shots".

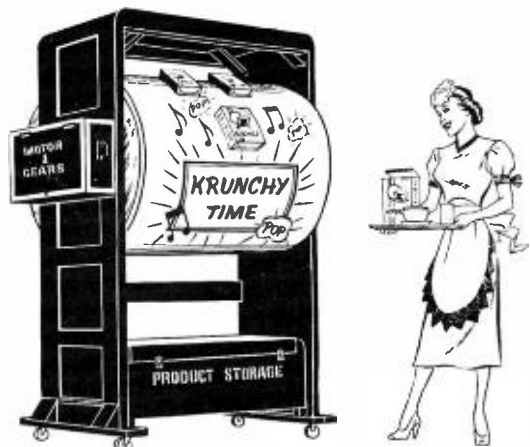

FIG. 23. Product Drum: This motorized device effectively displays commercial copy, cereals, cigarettes, linoleum, rugs, clothing accessories and many other similar products.

There are many other fakes required of the graphics department. It is impractical to list them all here since the range is wide, but the foregoing examples have been included to indicate that the work of the title artist extends beyond drawing, lettering and rendering.

MAPS AND CHARTS

Maps and charts are frequently required for news shows, educational programs and special events. When a television station is operated by a newspaper, the graphics department usually has access to press service maps of battlefronts, devastated areas and the like, and can readily redraw or adapt these to copy for various types of titling processes. But without news services, the staff artists or commercial art shop cannot be expected to provide re-

white or light gray background is suggested. For election returns, charity drives or forums on economic matters, the title artist can often develop ingenious ways of expressing facts graphically and thus contribute to the success of the program.

STAGING THE LIVE COMMERCIAL

Because of the control factor, film is a favored medium for the commercial portions of TV programs, but there are several valid reasons why many commercials are produced in live studio:

1. The demand for the advertised product fluctuates with varying and uncontrollable conditions; e.g., when a severe cold wave is suddenly forecast, a certain sponsor may wish to display the advantages of an anti-freeze radiator solution, cancelling a previously scheduled oil commercial.

5. A department store advertising a variety of items for local shoppers' "sales" and faced with the problem of exploiting rapidly changing styles and innovations in cosmetics, millinery and so on, cannot justify the cost of film for local sales promotion.

LIVE COMMERCIAL TYPES

Live commercial settings, including properties and staging adjuncts may range from expansive facilities, suitable for the display of automobiles, to miniature turntables for showing varieties of pocket lighters. Here-with are listed several methods of staging with collateral production notes:

1. Table-Top

For displays of small products; food packages, toys, small radios, dishes and silverware and the like. Set-up usually re-

quires a low table, with a backing fastened to the top to prevent accidental over-shooting. Camera is ordinarily placed high for a "down shot". Depending on the product, table and backing are covered with a tightly-stretched textured fabric such as monks' cloth, burlap, repp or simulated rough linen. Stations planning on small live commercials of the display type should stock such fabrics in a *commercial dressing kit*, which may be castered and wheeled to the studio when sets are being decorated. The kit should contain:

a. An assortment of variegated fabrics in dark and medium light values, in pieces about 2½ yards long. Material will last longer if edges are hemmed.

b. Magnetic tack hammer, hand staple gun, thumb tacks, scissors, small tools and assorted hardware—cup-hooks, tacks, screw-eyes, Scotch tape, bias tape.

c. An assortment of sheets of novelty cardboard of the type used in window display dressing, odd pieces of rayon velvet for jewelry, watches, etc., several pieces imitation brocade, damask or Toile de Jouy, Fortuny cloth or similar for "quality" backgrounds.

d. Several types of tablecloths, lunch cloths, napkins. These items must be laundered and ironed after use.

This commercial kit is a valuable studio aid and its use will conserve time especially in preparing those commercial displays that must be assembled quickly without previous detailed planning. The table-top live commercial, may, of course, be fairly elaborate, especially if it includes the showing of food preparation, complete dinner or picnic servings. If kitchen, bathroom or laboratory locale is to be suggested, table-top and backing may be covered with sheets of imitation tiling. Picnic commercials, promoting the use of iced tea or coffee, sandwich spread, etc., are usually laid out on *grass mats* on the studio floor, with additional dressing, and sometimes a portion of a setting if the display includes actors.

Other arrangements, classified under Table-top displays, require various types of store counters, "dealers' shelves", and other character display backings. A stock assortment of small boxes, pedestals and decorative plaster display ornaments which may be obtained from firms selling window dressing equipment is helpful in arranging table-top commercials.

2. Moving Displays

Some years ago, there was a trend towards the use of studio "gimmicks" developed to animate displays, or to slide or



FIG. 24. An unusual development of a product in magnascale. This three-dimensional dispenser of Scotch Cellophane Tape was enlarged 35 times for a live commercial. Note piece of Lucite which simulates the end of the tape.

move various commercial products into the camera shot. While many of the devices were ingenious, it is obvious that movement is most safely achieved on film. However, when film is impractical, the following effects may be produced "live" at small expense:

(a) **TURN-TABLE**—any round, revolving table top that will move at various speeds by hand or motor, from 12 to 48 inches in diameter. Products—packages, dishes of dessert, shoes, etc.—are placed on outer edge, and the table is revolved before a stationary camera (see Fig. 22).

(b) **DRUM**—a moving cylinder about 30 inches wide and varying from 18 to 36 inches in diameter on whose convex surface small commercial products may be mounted. Cylinder moves in front of stationary camera, bringing products into view. See Product Drum, Fig. 23.

(c) **SLIDER**—products are mounted on a 10 inch board which slides through a shadow box in front of camera.

(d) **ANIMATIONS**—mechanically opening packages, popping-up of contents, tools or devices doing work without obvious activation, etc., have been successfully employed in the live studio; however, these effects are best produced by single frame animation on film, as a corps of trained mechanics is necessary to operate live studio apparatus.

(e) **OTHER MOTION DEVICES**, such as the Kraft Television Theatre's "Little Man" used for several years as a standard opening, are effective and nearly fool-proof.

3. Commercial Demonstrations

Commercials that involve actors or other participants who discuss or demonstrate products in simulated living-rooms, stores, offices, kitchens, or showrooms employ all staging facilities.

Scenery for live commercials (which may be set in many diversified locales) is of course similar to that used in staging other portions of programs, except that the commercial settings are likely to be smaller. When the same commercial set is used week after week, it is normally economical for the advertising agency to purchase the scenery for its client, amortizing the cost over thirteen or more weeks. Some clients prefer also to furnish counters, furniture, draperies, and other set dressings.

Commercial scenery need not be as high as program backgrounds since most of the camera work is close; eight feet is ordinarily sufficient. In local commercials, large photo murals reproducing a portion of the clients' store front or the façade of his place of business are excellent backgrounds. The "murals" are actually photographic enlargements mounted on Upson board or developed on sensitized canvas.

In design, scenery and properties for commercials are usually realistic or suggestive. *Special effects* are frequently indicated; e.g., running water in sinks, steam escaping from radiators, small (flash-powder) explosions or smoke to illustrate dangers of inferior products. It is often necessary for the Art Director to design or to assist in the conception of character or comedy-abstract costumes worn in commercials. For example, an actor or announcer may appear in a commercial for a tobacco company dressed as an old-style, pseudo-Southern gentleman. In certain types of commercials, stylized costumes for girl singers or dancers who introduce the show must be developed from product-ideas. The Old Gold program features a dancer whose costume is an enlarged package of cigarettes; "Teddy Snow Crop" appears in a specially made white bear costume.

Whether a live commercial is a dramatization or a frank demonstration of the sponsor's products, dialogue exposition and advertising message usually indicate requirements for incidental properties other than the actual articles being advertised. If, for example, a new sandwich spread is featured, the demonstration may require not only the product but a portion of a kitchen set with work-table, bread, crackers, knives, plates, napkins and other accessories intended either for use or atmospheric dressing. Thus the property requirements on a live commercial may equal or even exceed those of a program scene.

The commercial products themselves are, of course, furnished by the sponsor through the advertising agency. Many items are expendable, such as jars of mayonnaise, packages of processed food products, and other material actually used on the program for demonstrational purposes. Other articles of a more substantial nature, such as radios, television sets, automobile tires,



FIG. 25. A studio "transitor" used for special effect and montage shots. The crewman controls the speed of the disc.

furniture and rugs, dummy displays and other large promotional and advertising adjuncts that are used from week to week must usually be stored by the station which, although perhaps not legally responsible for the safety of these commercial product properties, is ethically obliged to protect them from injury, loss and theft.

During the past two years, live commercials have employed an increasing number of products in magnascale—enlarged packages, jars or other containers blown-up to several hundred times their original size. Note the Scotch Tape display, Fig. 24. These enlargements are usually constructed "in the round" (although occasionally a cylindrical can or bottle is halved for convenience) over an armature: light pine, whitewood, thin plywood and veneers,

papier-mâché and balsa-wood are materials normally used. For greater verisimilitude the original label is photostatically enlarged, possibly to 12-15 diameters, and affixed to the finished giant-sized package or container. Since the making of magnascale articles involves highly skilled workmanship, enlarged commercial products are likely to be expensive. If, however, they are well constructed of plywood and *papier-mâché* rather than plaster of Paris, their use may be extended through two or more years. New wrappers or labels may occasionally be needed.

A less expensive substitute for magnascale products is frequently as effective in gaining attention value: photographs of products or containers may be photographically or photostatically enlarged, mounted on Uson board or plywood and cut out in profile. A back brace or jack holds the unit erect. Additional re-touching with air-brush and the darkening of printed matter are usually indicated.

The superficial altering or re-touching of commercial products in order to achieve compatibility with the system's gray-scale and to show the product most effectively requires camera tests before the Art Director or Sales Manager can determine what action to take. The basic, natural wood tones in a certain company's television sets happen to register satisfactorily; another manufacturer had to rub down and bleach wood finishes before his sales staff would approve the commercial picture. Similarly, some labels and packages printed in full color televise effectively without change; others need a photographic reduction to values of black and white for good reproduction of details.

A complete expanded treatise on all phases of Television Designing and production is found in Mr. Wade's book, shown below.

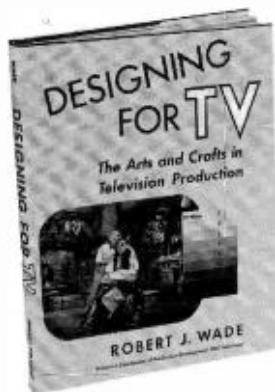

ABOUT THE AUTHOR

Robert J. Wade, a pioneer in network programming, formerly with NBC, is Designer and Television Production Consultant for the P. J. Rotondo Construction Company of New York City.

He joined NBC in 1944 as art director. His designs have been reproduced in John F. Royal's "TV Production Problems," in "Theatre Arts Anthology" and in other books on the subject. He became manager of NBC production facilities, then manager of staging services as NBC-TV expanded. He was assigned a developmental post in 1951, subsequently working with color and color responses.

Last year he wrote and illustrated "Operation Backstage" for NBC and edited a complex gray-scale guide. His book, "Designing for TV," a 50,000 word reference work, is illustrated by many of television's top artists and designers and contains art and technical data.

Wade was graduated from the Swain School of Design, Boston University and Emerson College. He was an art director in stock for 12 years and served on the consultant and teaching staffs of several colleges. He is a member of the American Television Society. Several of his articles and production detail brochures have been translated into Spanish and Portuguese for Latin-American distribution.



WCCO-TV

AND ITS 100,000 WATTS (ERP)

By **JOHN M. SHERMAN**
 Director of Engineering—WCCO-TV

On February 9, 1953, the viewers in five states of the Upper Midwest actually saw, on the screens of their TV sets, the effect of the increase in effective radiated power of WCCO-TV, channel No. 4 to 100,000 watts during the "Cedric Adams" news program, 6:00-6:15 P.M. on that date. A signal, to make the power increase

effective, was originated in the Statler Hotel, Washington, D. C., by Minnesota's U. S. Senators Thyne and Humphrey. The WCCO-TV camera was at that time focused on a Weston Meter, with full scale reading to 100 KW. During the power increase the meter reading increased to indicate the actual effective power being rad-

FIG. 1 (below). This map shows WCCO-TV's coverage after the increase in Effective Radiated Power to 100 kilowatts. It is based on mail received during period February 9th-20th. (See description "Operation Success".)

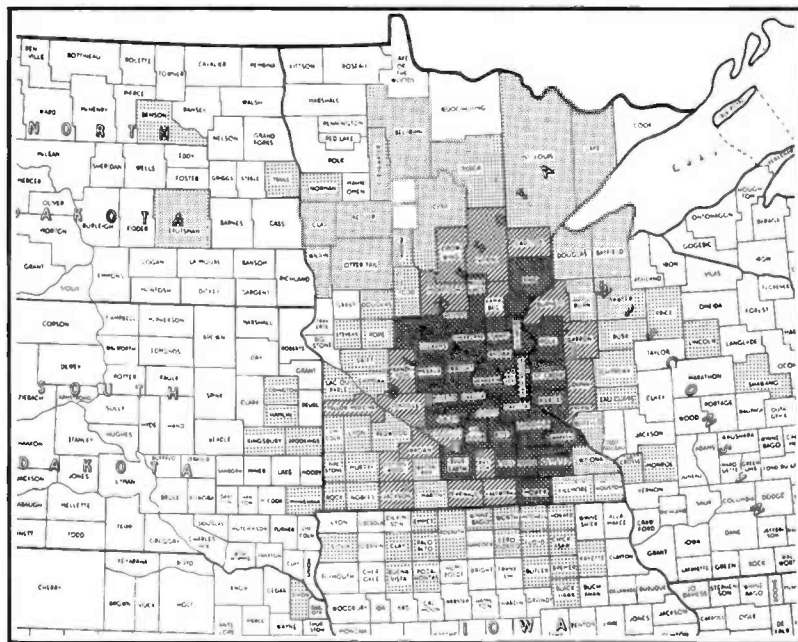

WCCO-TV MAIL MAP

FEB. 9-20, 1953

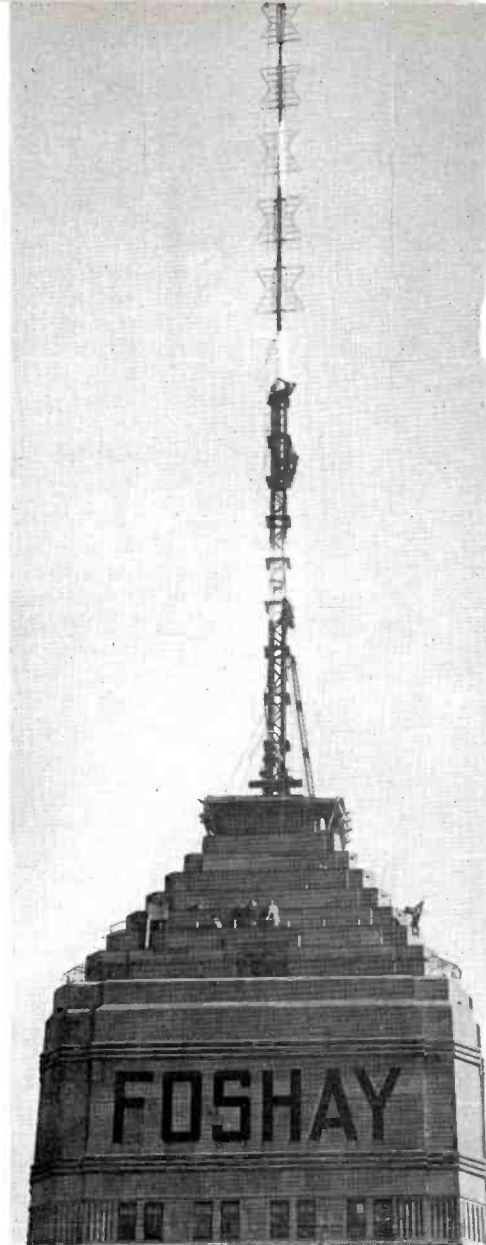
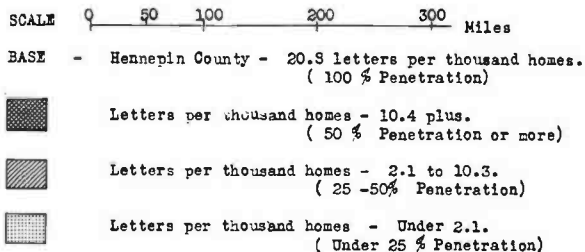

FIG. 2. Closeup view of the Foshay Tower Building with the WCCO-TV, six-section antenna mounted on the "multiple-use" structure. It is designed to also accommodate nine-section supergain antennas for channels 9 and 11.

AUTHOR'S NOTE

Since the manuscript for this article was prepared, WTCN-TV, Minneapolis, and WMIN-TV, St. Paul were granted shared use of Channel 11 by the FCC and have signed leases with the Foshay Tower Building to mount their common antenna on the multiple-use tower of this building. They have ordered an RCA 9-Section Supergain Antenna and an RCA 50-KW, Channel 11 Transmitter which they will jointly use. The Transmitter will be installed on the 29th floor of the building. Applicants for Channel 9 are still in the hearing status at this writing, but it is expected that the successful applicant for Channel 9 will also utilize this multiple-use structure.

iated. Hundreds of viewers from such points as Duluth, Rochester, Mankato and Austin, in Minnesota; Mason City, Spencer and Waterloo, in Iowa; Brookings and Sioux Falls, in South Dakota; Eau Claire, Wausau and Marshfield, in Wisconsin, and North Dakota points up to 260 miles reported clearer and brighter reception.

WCCO-TV (formerly WTCN-TV) first took the air with regular programs on July 1, 1949. The story of this initial operation was described in the January, 1950 issue of BROADCAST NEWS. This initial operation was on the assigned channel No. 4, with 17,900 watts, video, effective radiated power.

Thus, WCCO-TV, Minneapolis-Saint Paul, was one of the first maximum power TV stations in the United States to commence regular program operations using 100,000 watts and with TV coverage probably not exceeded anywhere. WCCO-TV and WHAS-TV were the first maximum power TV stations on the CBS TV Network.

WCCO-TV is licensed to Midwest Radio-Television, Inc., also licensee of WCCO-Radio which operates with 50,000 watts on 830 KC and together provide one of the most attractive "cleared channel" Radio-TV "maximum power" coverage combinations anywhere. CBS owns 47% of the stock in Midwest, while 53% is owned by Mid-Continent Radio-Television, Incorporated, in which the owners of the St. Paul Dispatch-Pioneer Press and the Minnesota Tribune Company have equal interest. Mr. William J. McNally is Chairman of the Board of Midwest, while Mr. Robert Blair Ridder is President and Mr. F. Van Konynenburg is Executive Vice-President and General Manager of both WCCO-TV and WCCO-Radio.

The overall engineering planning and the installation of a new RCA type TF-6AM, 6-Section Superturnstile antenna and RCA type TT-25AL 25 KW power amplifier as well as the coordination of the design of the new "community" supporting structure atop the Foshay Tower Building, Minneapolis, was under the direction of the author. The antenna supporting structure is designed to also accommodate two 9-section supergain antennas for TV channels 9 and 11, which are allocated to Minneapolis-Saint Paul for commercial TV stations. Floor space is also available in the Foshay Tower Building for the transmitters of the two additional stations when the Construction Permits are finally granted to the two successful of the eight mutually exclusive applicants applying for



FIG. 3. Shown (l to r.) are Neil B. Coil, Transmitter Supervisor and John M. Sherman, the author, checking the output meter which indicates 100 kw power.

these two channels.* The Foshay Tower Building (see Fig. 2) and its supporting structure, thus, will be second only to the Empire State Building as a multiple use TV supporting antenna structure.

This story of the installation and operation of the necessary antenna and transmitting equipment to permit WCCO-TV to be one of the first maximum power TV stations in the United States is divided into three parts, i.e.: Part I, "Operation-Foresight" which reports the factors leading to the design and installation of the 6-section antenna and supporting structure; Part II, "Operation-Shoehorn" which reports the installation of the TT-25AL power amplifier equipment on the 28th floor of the Foshay Tower Building, Minneapolis, in space which had to be carefully planned and laid-out for the efficient operation of this high-powered equipment; and Part III, "Operation-Success." WCCO-TV has doubled its studio space and tripled its camera equipment since its initial operation.

Operation—Foresight

As early as June, 1950, WCCO-TV had in the works, plans to improve its TV coverage by the installation of a new higher gain 6-section Superturnstile TV transmitting antenna. The original antenna was the well known TF-3B, 3-section antenna of

the same type. It was not until the FCC's "Third Notice" of March 21, 1951, that effective radiated powers of 100 KW and higher first seemed to have some future promise of reality.

The first step towards the new antenna was a conference at Camden with Les Wolf of the RCA Engineering Department and RCA Broadcast Sales representatives, to determine the requirements for a supporting structure for the 6-section job. The wind loading and other specifications of this antenna were then referred to Mr. R. A. Troman of Blaw Knox, whose structural engineering contemporaries came through, in the usual cooperative and friendly manner with a new supporting mast design for the famous Foshay Tower Building, which would accommodate the new radiator. It was while in Camden at this early conference that we had the opportunity to preview the Empire State Building multiple TV-FM antenna project, and during which we gave birth to the idea of a similar multiple use TV antenna project for Minneapolis' Foshay Tower Building.

The idea of having a supporting structure on the Foshay Tower Building capable of supporting 3 or 4 TV antennas was later given the green light by the building owners as well as station management. Another conference was then arranged to be held with the same Broadcast Engineering

* See Author's Note.



FIG. 4. Photo showing a closeup of the "multiple-use" TV antenna supporting tower located atop the Foshay Building. The seven diaphragms on lower portion are for strengthening and permit supergain elements to be mounted in between them.

Group at Camden, where several multiple TV antenna assemblies were considered. The estimated weight and wind-loadings of these proposals were then referred to the architectural firm of Magney, Tusler, and Setter, Minneapolis.

Shown in Fig. 5 is the multiple use antenna arrangement finally decided upon as the most desirable for the Minneapolis TV service. This proposal, it turned out, would provide for TV antenna power gain

of better than 6.0 for TV channel No. 4, assigned to WCCO-TV and channels Nos. 9 and 11, also allocated to the Minneapolis-Saint Paul area for commercial TV stations.

RCA Engineering was able to furnish data, similar to that used in the design of the Empire State TV antenna structure, showing the sizes of the supergain antenna elements and screens for the various TV channels. Two changes were necessitated later, as suggested by Edwards and Hjorth,

New York City, the structural consultants retained for the Empire State project and also retained to check the Foshay Tower structure design. These changes were, namely, use of "inset" instead of "clip-on" supergain screens, resulting in two improvements, (1) use of a larger cross-section structure core with greater strength and (2) use of 9-section supergain antennas for channels 9 and 11 instead of the originally proposed 8-section units, occupying less aperture and resulting in more power gain.

The structural design and detail (see Fig. 4) was worked out by Gilbert MacMillan, Minneapolis, of the Magney, Tusler and Setter architectural firm. Fig. 4 also shows the overall structure, antenna sections and sizes of the steel members. Fig. 6 shows the allocation of core space for the rigid coaxial transmission lines, and power conduits for beacon and de-icing circuits for the several antennas.

The structure was completed, including the WCCO-TV 6-section Superturnstile antenna, but less the channel 9 and 11 TV antenna radiators and was placed in operation on November 10, 1952, permitting WCCO-TV to immediately increase its effective radiated power from 17,900 to 28,400 watts. A single section "Bat-wing" antenna was mounted on one of the side steps of the building and used during construction, permitting 5.5 KW, ERP from 430 feet above average terrain. Pictures of the new antenna and supporting structure are shown in Figs. 2 and 4.

Actual tear-down of the old 3-section antenna began on September 10, 1952 and the new 6-section antenna was first placed in regular program operation on November 10, 1952. The new TF-6AM antenna was first assembled on the ground in the horizontal position and checked out by RCA Service Company Engineer, Frank Porter. The VSWR was less than 1.1 during the preliminary tests. It was necessary to completely disassemble the antenna before hoisting its components as well as the long 22-foot steel members up the outside of the building more than 450 feet on a trolley-cable. The four 29-foot pole lengths for the TF-6AM channel No. 4 antenna, the heaviest of which was 2600 pounds and 16 inches in diameter at its widest point, gave these sure-footed structural workers no problem.

Operation—Shoehorn

WCCO-TV (formerly WTCN-TV) first took to the air with regular programs on TV channel No. 4, using an RCA type TT-5A, 5 KW transmitter. While increases

in effective radiated power to 100 kilowatts did not become possible until the FCC's Sixth Order and Report, adopted April 11, 1952, WCCO-TV entered into a contract with RCA Victor in August, 1950 for a TT-20AL power amplifier (later modified to TT-25AL). This 25 KW video, 15 KW aural power amplifier equipment, along with the TF-6AM superturnstile TV transmitting antenna which was also on order, made it possible for WCCO-TV to be one of the first maximum power TV stations in actual operation and provides adequate reserve power if the antennas are derated.

The 28th floor of the Foshay Tower Building had already been housing the TT-5A RCA transmitter under the usual restrictions of a commercial office building. Space options had been negotiated in December, 1945 to provide for the ultimate installation of FM and TV transmitting equipment. A station owned 3 phase power feeder from the 28th floor to the Public Utility Transformer Vault under the street had been installed originally in 1946 to handle a 50 KW FM transmitter. Mr. Starner, of RCA-Victor Transmitter Engineering Department, had checked the building entrance clearances as early as 1946. RCA had adopted these minimum entrance specifications for all broadcast transmitters. There seemed to be little doubt that the additional 25 KW TV amplifier equipment could be transported to the space on the 28th floor and installed. It was later found that the limited ceiling clearances resulted in a "shoe-horn" installation.

The WCCO-TV amended application based on the "Standards" adopted by the FCC's "Sixth" order was filed on November 1, 1952, and granted December 18th. The 25 KW amplifier equipment was shipped December 26th, arrived in Minneapolis January 6, 1953 and went into regular program operation with full 100 KW ERP on February 9th.

Much credit is due to Neil B. Coil, Transmitter Supervisor, and to Transmitter Engineers, Clyde Green, Jerry King-Ellison, Stan Allison and Edward Welcome for their ability and continued effort to get the equipment installed.

The installation of separate floor trenches, to house video and power wiring, extending those already available, was completed before the equipment arrived. It was necessary to relocate the transmitter-console, side-band filter and diplexer. It was also necessary to plan the location of all of the power amplifier units so that exact lengths of interconnecting 3/8-inch transmission line could be determined

and ordered as suggested in IB-36113—(TT-25AL Installation Instruction Book).

A closed fresh-air intake and hot-air removal air duct system was designed and installed to meet the requirements for the video and aural power amplifier units as well as the power supply and control units as shown on Fig. 8. This system takes outside air, or recirculated air on warmup, to the blower in the base of the power amplifiers, exhausts the hot air into a closed plenum. This hot air is drawn off by an exhaust fan which pushes this hot air out-

side so as to not overtax the air-conditioning system for the operating room. Intake and exhaust thermometers are installed in this closed air-cooling system. The drawing on Fig. 8 shows the location of major amplifier units and the air-cooling duct system for both the video and aural power amplifiers as well as for the TT-5A driver. Photograph, Fig. 7, shows the video power amplifier, power supply, and control units, beyond the video side of the TT-5A driver. The hot air exhausts into a plenum in the false ceiling which can be noted as

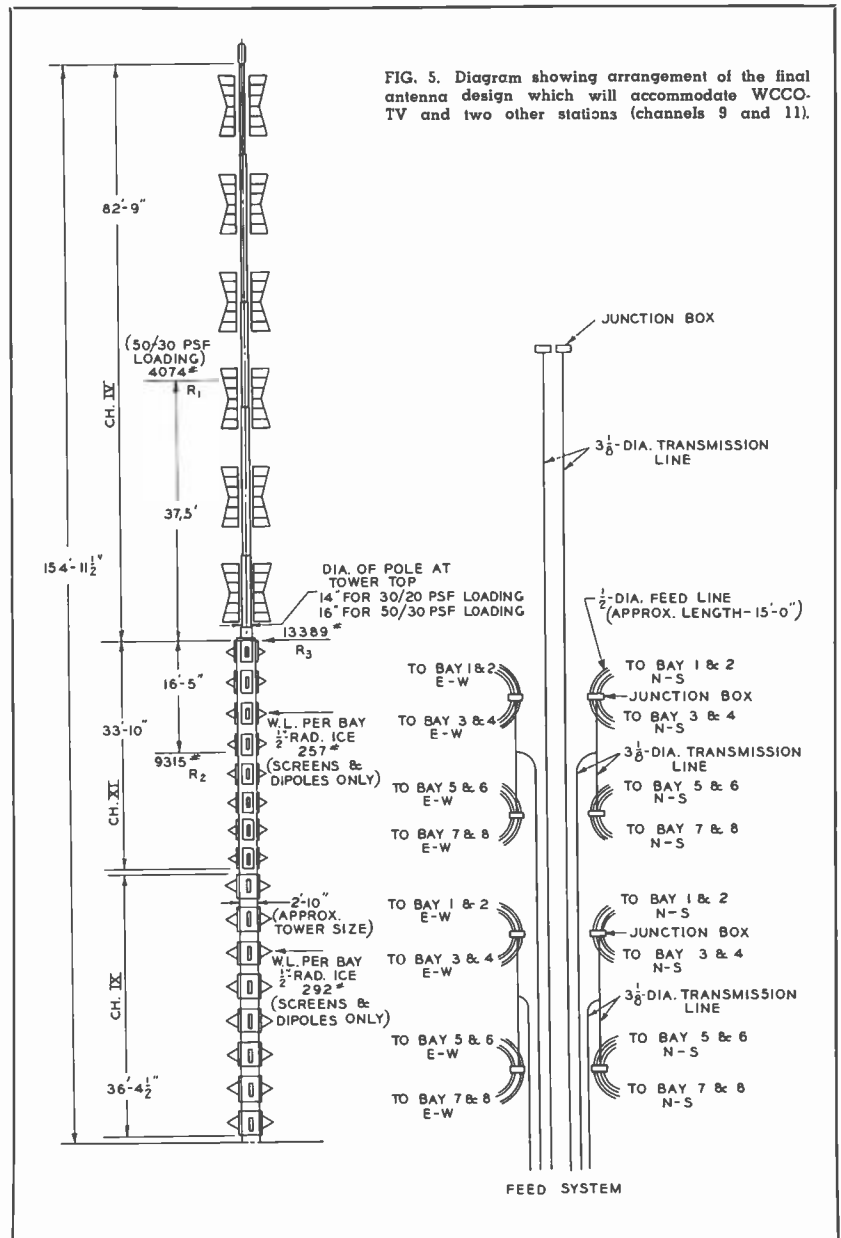
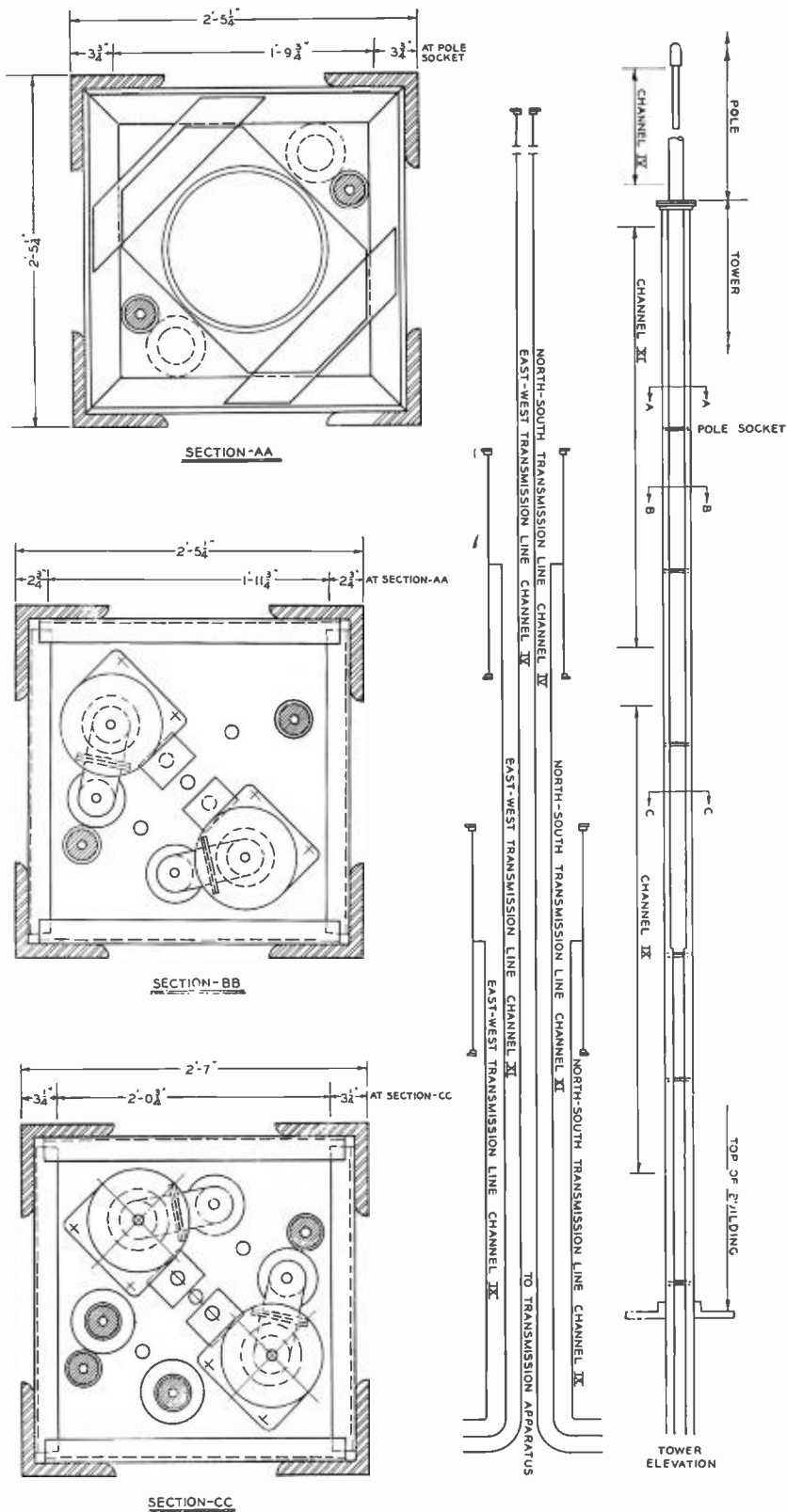

FIG. 5. Diagram showing arrangement of the final antenna design which will accommodate WCCO-TV and two other stations (channels 9 and 11).



well as some of the inter-connecting and output transmission lines.

Before RCA Service Company Engineer, Frank Porter, and his assistants, Jack Britton and Bob Martin arrived to check out the high power equipment, WCCO-TV transmitter engineers had made up and installed all the inter-unit control wiring and external power supply cables. During the installation of the power amplifier equipment the sideband filter had been removed and converted for the required attenuation characteristics. The aural amplifier was first put on the air at low power, then the video feed to the diplexer was cut over from the TT-5A to the TT-25AL equipment and broadbanded between sign-off on February 7th to sign-on February 8th. The entire equipment was given a program operation check during the day of February 8th, first at low power and finally at the full 100 KW ERP. The big power increase program was scheduled and telecast on February 9th. We met this deadline with 24 hours to spare.

Operation Success

The success story of the increase in effective radiated power of WCCO-TV from 17,900 watts to 100,000 watts, utilizing the 6-section antenna and 25 KW amplifier on TV channel No. 4, is effectively told by the map of Fig. 1. On this map we have marked the counties from which considerable "program" (unsolicited) mail has been received, the counties have been marked in a manner which might be interpreted as showing "primary", "secondary", and "fringe area" coverage. The mail used on the map of Fig. 1 was received between February 9-20, 1953 after WCCO-TV had been upped to 100,000 watts, ERP. The formula is based on a widely accepted mail standard of letters per 1000 homes. The number of such letters received from the home county (Hennepin) is regarded as 100% concentration. Then the percentage of concentration in the outlying counties can be shown. We feel, as time goes on, that the percentage of concentration will show an increase since the period analyzed for the 100,000 watt operation has been very limited.

FIG. 6. Sketch showing transmission line runs, conduit requirements, and location for the core of the "multiple-use" Foslay antenna structure.

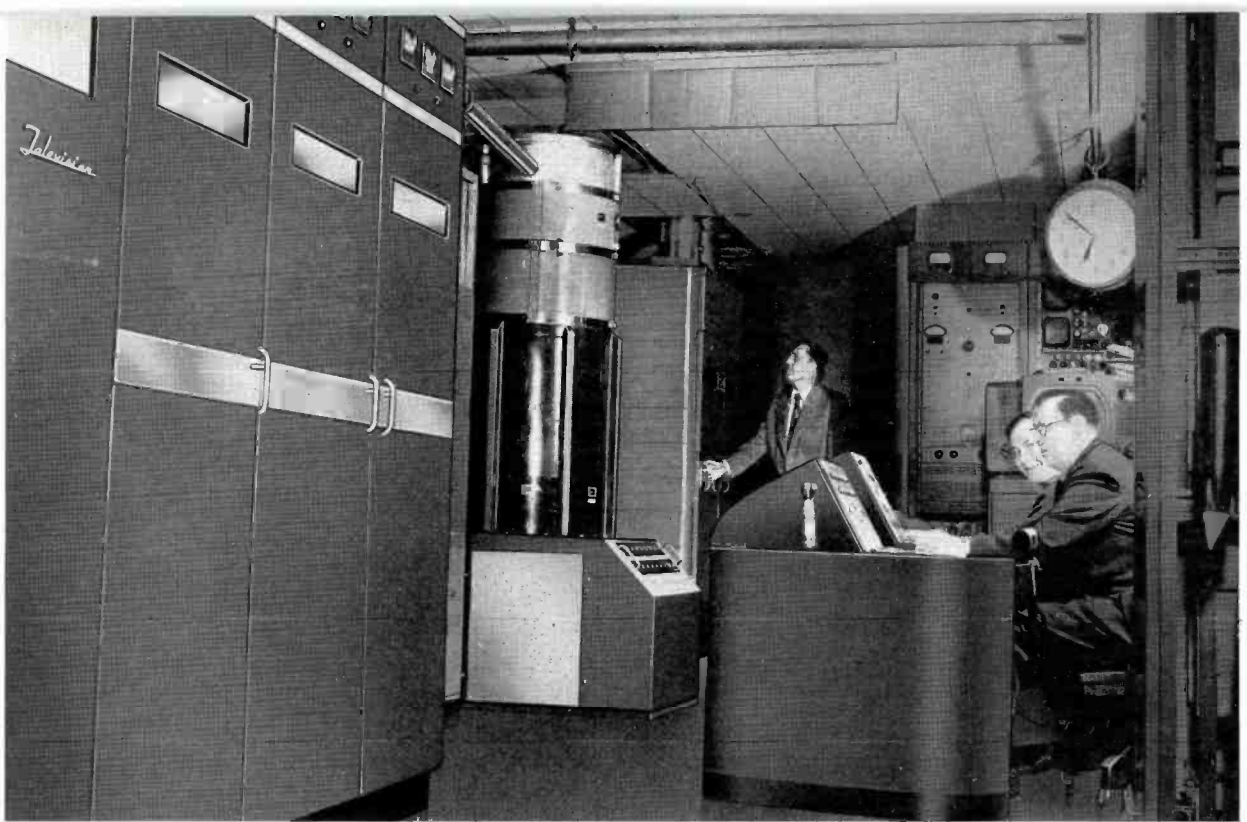

FIG. 7. View of the TT-25AL high-power amplifier and TT-5A driver unit. Jerry King-Ellison is shown at the power amplifier cabinet and Clyde Green and Ray Johnson at the transmitter console.

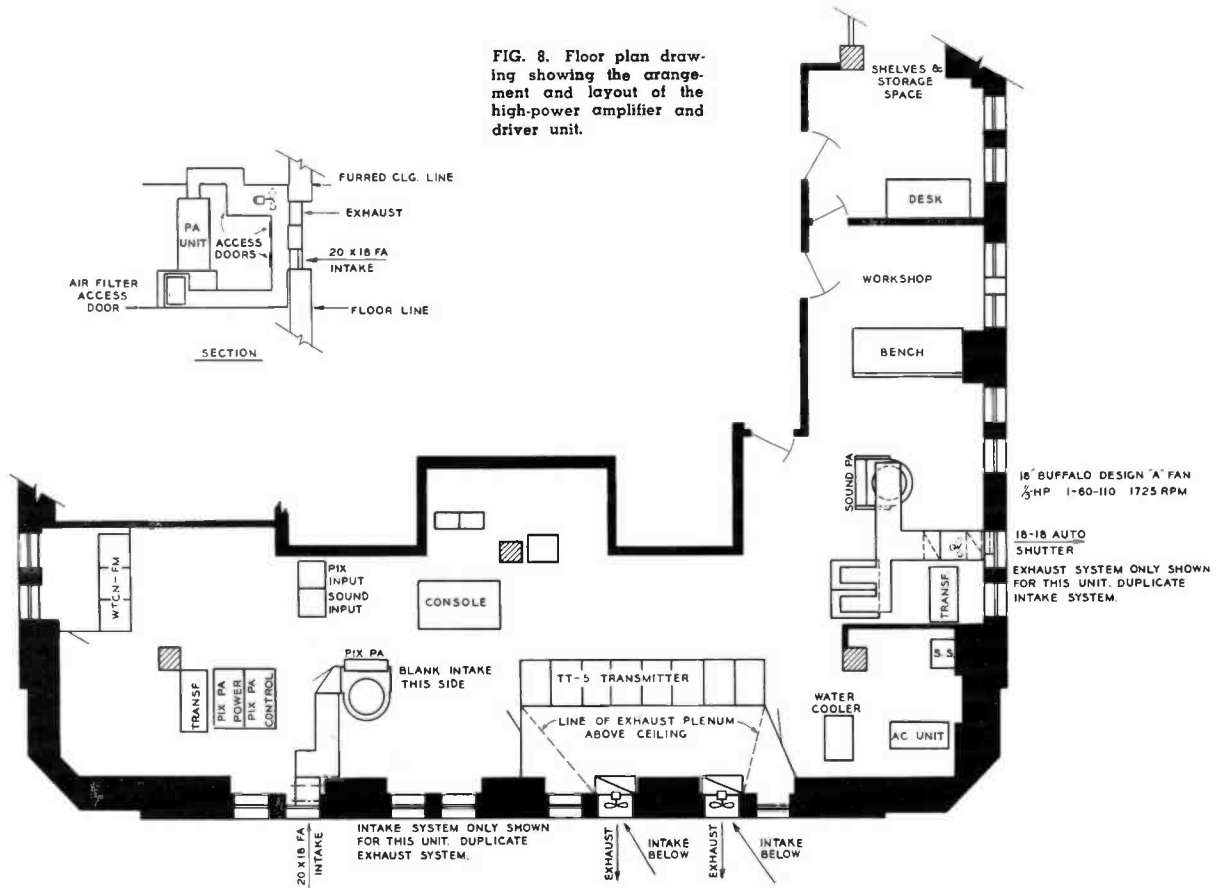

FIG. 8. Floor plan drawing showing the arrangement and layout of the high-power amplifier and driver unit.

THE RCA BW-5A TELEVISION SIDEBAND RESPONSE ANALYZER

By
J. A. BAUER & F. E. TALMAGE
Engineering Products Division

Introduction

Accurate information on the RF bandwidth of his transmitter is important to any broadcaster who wishes to deliver a higher quality picture to his television viewers. Improvements being made in picture quality at the studio and from film projectors are daily adding to the importance of this question. The television audience should enjoy the full benefit of these improvements.

Broadcasters realize that every bit of information picked up by the camera and delivered in the form of video signal is combined with blanking and synchronizing signals to form the composite video signal. This composite signal is then used to modulate the picture carrier which is then radiated together with the resultant sideband frequencies which are informative of the picture being transmitted. While most commercial television transmitters which meet with RTMA Standards are capable of transmitting high quality pictures, one of the principal operational problems is to provide means for optimum tuning adjustment of the transmitter so that none of the picture information sidebands will become lost or degraded.

While this is important for monochrome television operation it will become still more important if the NTSC Color Standards are adopted. The amplitude versus frequency response of the transmitters will then have to be maintained to closer standards of accuracy to insure that the Color Subcarrier will not become degraded.

The new UIIF band also offers special problems brought about by the higher fre-

quencies and greater number of channels which commercial transmitter equipment must now be capable of handling.

The solution was to devise a simple method of accurately measuring and displaying the amplitude versus frequency response of the transmitter circuits while simultaneously observing the effect of the tuning adjustments. The BW-5A Television Sideband Response Analyzer shown in Fig. 1 is the practical new tool which now enables the broadcaster to see the sidebands as he tunes his transmitter. In this way he is assured that his public is receiving all the information that is required for a high quality picture, that his transmitter has

optimum tuning and is operating at peak efficiency.

The BW-5A Sideband Analyzer accomplishes this by the special arrangement of a highly selective receiver which remains continuously tuned to the sidebands as they are generated by a video sweep generator. The output of this receiver then furnishes the signal for the continuous display of the transmitter's overall frequency response characteristic on a CRO. This will be discussed in greater detail as we progress further with the article.

Fig. 2 presents a brief review of the frequency response to be expected throughout a television transmitter. Curve A is the ideal response for the video input signal.

FIG. 1. Front view of the BW-5A.



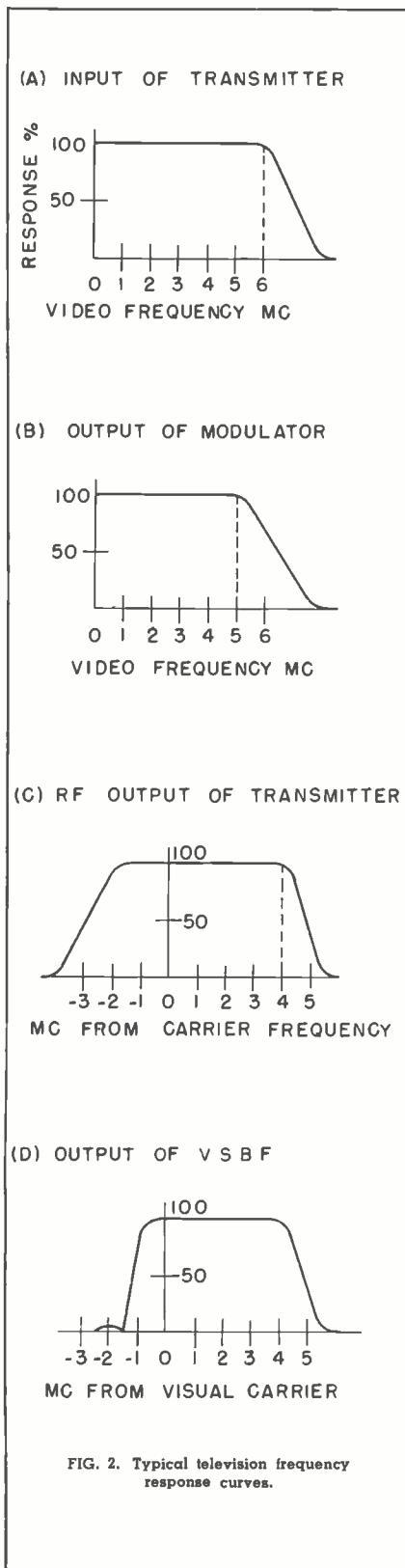

Curve B is the response of the video modulator. Curve C is a typical overall response of transmitter RF circuits before the sideband filter, while Curve D is the overall response showing the lower sideband sharply cut off by the vestigial sideband filter. While the last curve shows the desired overall response, Curve C is probably the one more often seen during transmitter tune-up, particularly when one or more stages of linear RF amplifiers are employed. Note that the lower sideband is only partially attenuated. To cut this off too sharply would result in distortion of the overall response. To pass too much of the lower sideband would lower the transmitter efficiency. It can be seen therefore that an instrument which accurately and quickly shows both the upper and lower sideband response is of great value to the transmitter operator in obtaining and maintaining the proper transmitter tuning adjustments.

At this point it would be well to examine briefly other methods which have previously been used in an attempt to obtain the desired information.

Video Sweep and Diode Method

One method of measuring the overall frequency response of a television trans-

mitter is shown by the block diagram in Fig. 3. Here, a video sweep generator is connected to the video input terminals of a television transmitter and a diode is coupled to the output transmission line. The output of the diode is rectified and fed to a CRO. Since the diode is a broadband detector it will average both upper and lower sidebands yielding a typical CRO presentation as shown in Fig. 4. Here the diode has been connected to the output of the sideband filter and it will be noted that both the upper and lower sidebands in the immediate neighborhood of the carrier add up. This method has been satisfactory where a pre-tuned sideband filter is available and where only one RF stage is used. The chief disadvantage is that it does not separate upper and lower sideband response. Fig. 5 further shows the limitation of the frequency response obtained with a diode. Here, the lower sideband is only partially cut off and it is obviously difficult to evaluate the effect of tuning adjustments on these circuits without being able to observe separately the effect on upper and lower sidebands.

RF Sweep Method

Fig. 6 shows the block diagram of another method commonly used in attempting to adjust the RF circuits of television

FIG. 3. Block diagram of diode method.

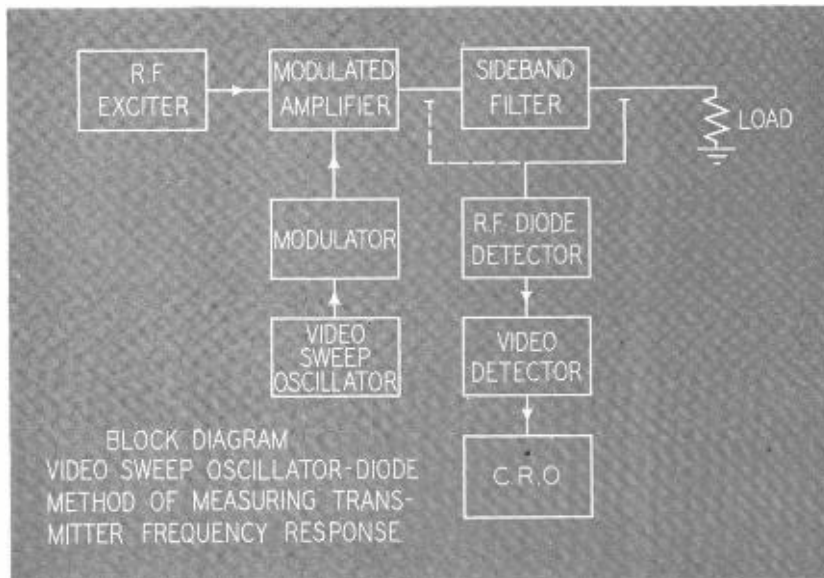

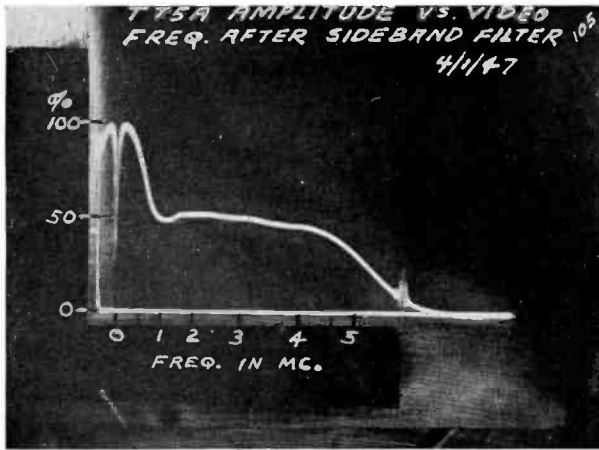

FIG. 4. Amplitude vs. Video Frequency after sideband filter using video sweep and diode method.

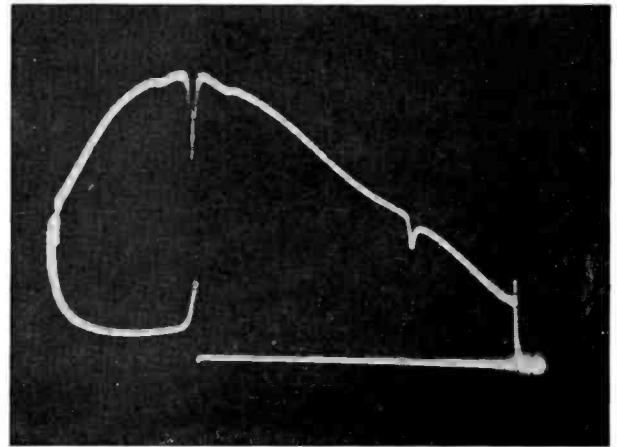

FIG. 5. Another response obtained by the diode method when the lower sideband is partially cut off.

transmitters. In this method, an RF sweep oscillator is coupled to the input of the circuit to be tested and a diode detector is coupled to the output as shown. The rectified output of the diode is then connected to an oscilloscope to obtain a visual indication of the response. There are several disadvantages to this method:

A. Extreme care must be taken in coupling the sweep oscillator and diode to the circuit under test in order to minimize

errors introduced by the method of coupling.

B. Video resonances in the plate, grid and cathode return leads will not show up since there is no video component in the currents produced when an RF sweep is used. Note: An actual example of cathode lead resonance is shown in Fig. 7 as displayed by the BW-5A Analyzer. This is shown both before and after damping was applied to the cathode lead.

C. When the circuit is excited by an RF sweep oscillator the dynamic voltages are often at a much lower level than when the transmitter is in actual operation. Unless suitable compensating measures are taken the frequency response of the circuit may actually be different during operation due to changes in tube loading, etc. This is particularly true if the driven load on the circuit is the input of a linear amplifier where the amount of grid current determines the amount of loading.

D. The response indicated by the RF sweep method will not include the modulator response. A separate video sweep oscillator must then be used to check and adjust the modulator.

E. Any errors (such as would be caused by improper neutralization) introduced by the modulated amplifier itself would not show up by this method. Note: An actual example of this condition as displayed by the BW-5A Analyzer is seen in Fig. 8. Here, the inequality of the upper and lower sidebands in the immediate neighborhood of the carrier indicates improper neutralization. A second curve shows the condition obtained with proper neutralization.

F. The new UHF channels have introduced other special problems. It is a relatively

FIG. 6. Block diagram of RF sweep method.

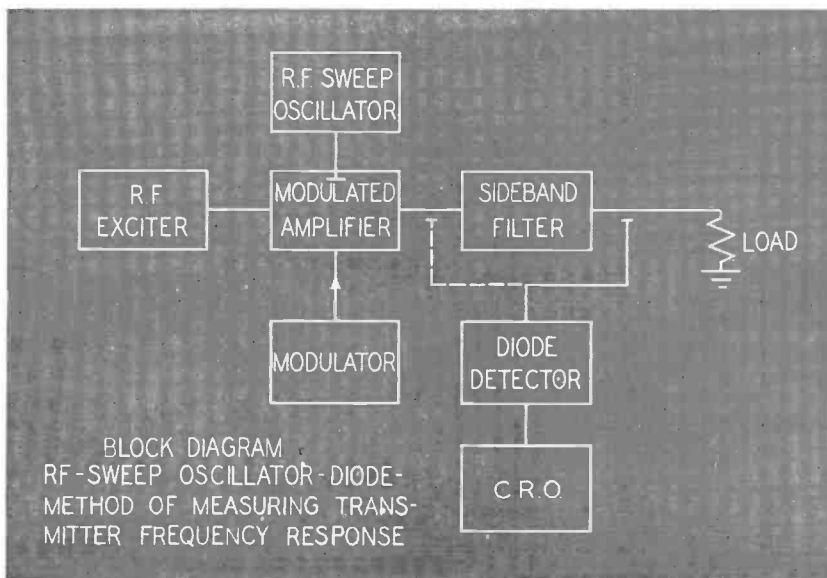

difficult matter to design an RF sweep oscillator which will have sufficient output with flat enough frequency response for the large number of new channels. Accurate markers also present a problem because ultra-high frequencies are involved.

Advantages of the BW-5A Sideband Analyzer Method

The BW-5A Sideband Analyzer has none of the disadvantages outlined in the two methods above and has several features which are found in neither. These are worthy of special notice:

A. No internal changes are required to be made in the transmitter while measurements are being made. The transmitter is operating under normal conditions of power output, drive, etc., while adjustments are being made.

B. For input signal the video sweep output may be plugged into the modulator at the jack panel. Only a small amount of RF output signal is necessary to feed to the Sideband Analyzer.

C. Practically all of the more critical circuits in the BW-5A such as the sweep oscillator, video amplifier and marker are independent of the transmitter carrier frequency. These are accurately adjusted at the factory before shipment.

D. While the frequency of the narrow band detector must be changed in accordance with the picture carrier frequency assignment this adjustment is no more difficult than tuning an ordinary broadcast receiver. Also, it is not critical since any detuning will affect the amplitude but not the shape of the response curve.

E. The design of this equipment necessarily includes a video sweep oscillator which is therefore available for aligning the modulator and other video amplifiers normally associated with the television transmitter.

F. If there are any harmonics present in the output of the transmitter they will not affect the shape of the response curve. This is because any beats with harmonics produced in the mixer will not be of the proper frequency for acceptance by the narrow band detector.

Theory of Operation

One method of obtaining a check on a transmitter's performance with regard to upper and lower sidebands is to use a very fundamental point by point method. For example, a 61.25 Mc picture carrier fre-

FIG. 7. Cathode lead resonance shown by BW-5A before and after damping.

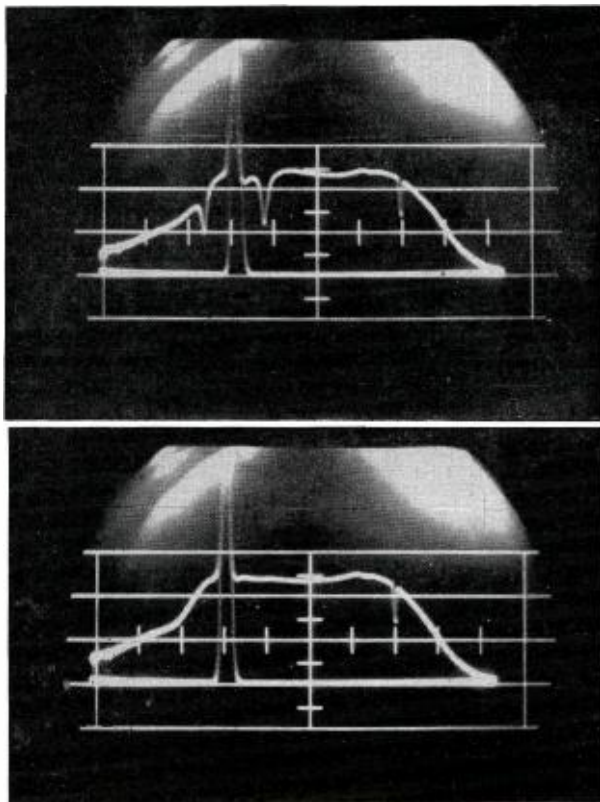
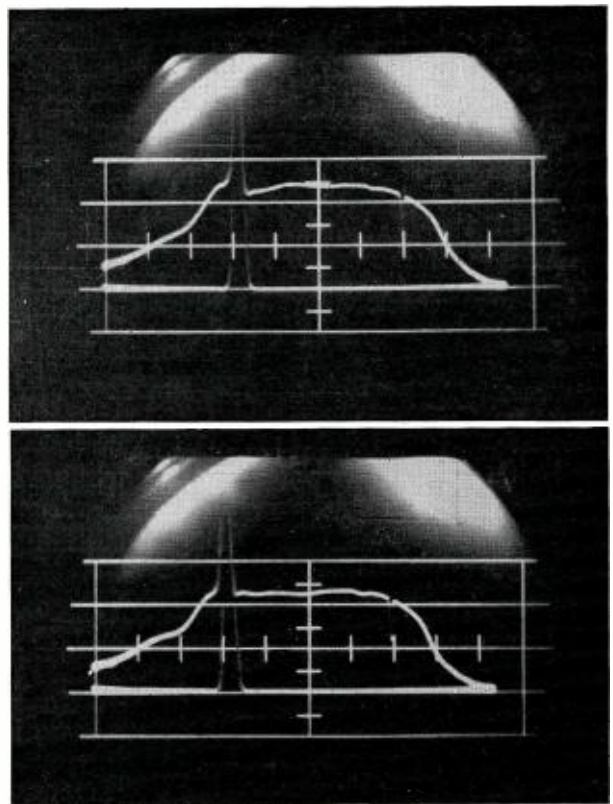
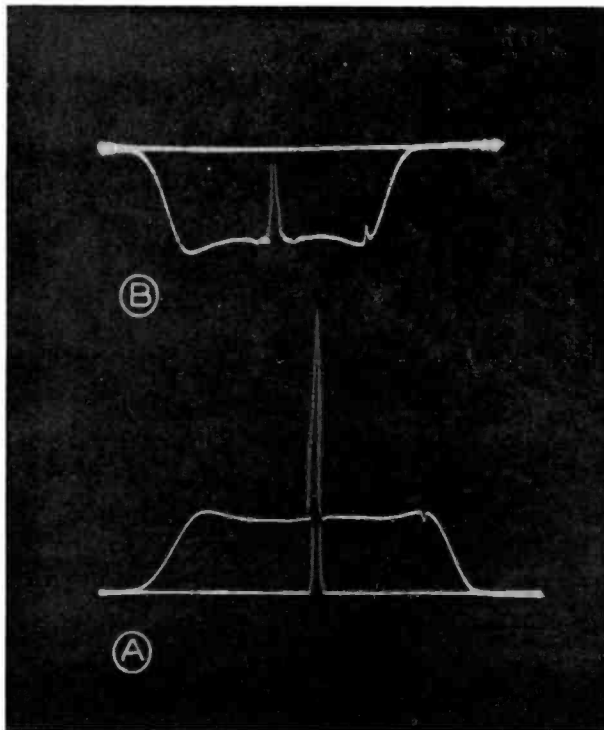
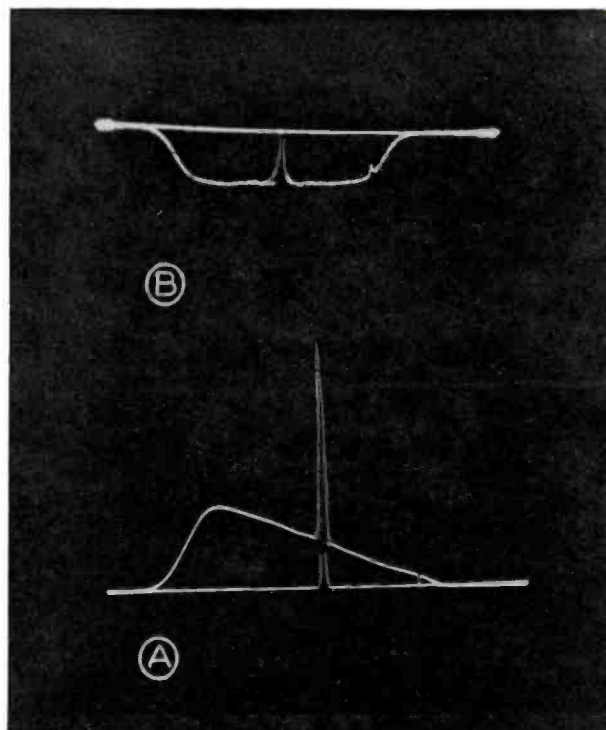

FIG. 8. Upper and lower sideband inequality shown before and after proper neutralization using the BW-5A.





9A. Sideband response—transmitter properly tuned.
9B. Diode response—transmitter properly tuned.



10A. Sideband response—transmitter improperly tuned.
10B. Diode response—transmitter improperly tuned.

FIGS. 9 & 10. Sideband analyses of small laboratory TV transmitter compared with diode response.

quency may be modulated with a sine wave of 2 MC to create sideband frequencies of 63.25 and 59.25 MC. A selective receiver can readily be tuned to these frequencies which are present in the output of the transmitter. If the receiver has sufficient linear response and is equipped with an output indicator we may measure the relative amplitudes of these sideband frequencies by comparing them with the carrier used as 100% reference. After recording these values the modulating frequency may be changed to 3, 4 or 5 MC, or 1000, 500, 200 or 100 KC. Upon retuning the receiver corresponding sideband amplitudes may again be measured and recorded. Provided that the percentage of modulation has been maintained constant during the test run a curve may then be plotted using the recorded data which will indicate the amplitude of the sidebands with respect to each other and the carrier.

If a truly smooth and representative curve is desired the points must be plotted closer together so as to search out any irregularities which may show up between the very few modulating frequencies suggested above. Moreover if the amplitudes of the sideband frequencies are not satisfactory and an adjustment of the transmitter is required, such as a change in the output tuning, then the curve must be re-plotted for each adjustment until a satisfactory response curve is obtained. Following this procedure would be tedious and so time consuming as to make it impractical for regular daily performance checks.

Now suppose a very large number of points could be measured in sufficiently rapid succession to permit display of the response curve on an oscilloscope. The BW-5A TV Sideband Response Analyzer does this, and yields the following kind of results. . . .

Performance and Results

The usefulness of the BW-5A Sideband Analyzer will be better appreciated by referring to Fig. 9A. This is the sideband analysis of a small laboratory type TV transmitter with double sideband output as displayed by the BW-5A. The symmetry of both upper and lower sidebands indicates that the output stage has been prop-

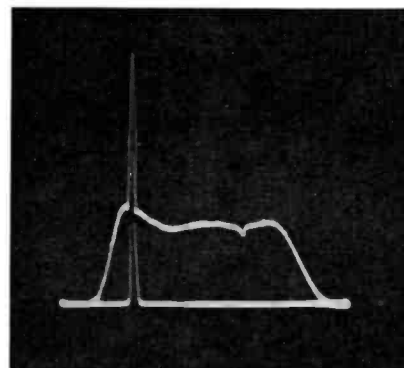

FIG. 11. Sideband analysis of a typical station signal sampled after sideband filter.

erly aligned, the tall spike in the center of the pattern represents the transmitter carrier while the marker pip appearing in the upper sideband indicates satisfactory response out to 5.5 MC above the carrier. The marker position is controllable and can be moved into the lower sideband region as required. Fig. 9B shows the diode detector response for the same condition of transmitter alignment (this happens to be in a negative direction). Fig. 10A shows the same laboratory transmitter with its output stage deliberately misaligned to favor the lower sideband. Under the same tuning conditions the diode response, Fig. 10B, would seem to give evidence of satisfactory performance even though the transmitter is misaligned. This is due to the fact that the diode detector averages both upper and low sidebands in the detection process as has been mentioned before.

Fig. 11 indicates a typical sideband analysis of a Channel 4 station recently obtained. The sampling was obtained from the transmission line after the vestigial sideband filter. An excellent job of lopping off the lower sideband is apparently accomplished by the filter and the marker is at 4 MC indicating essential flatness even beyond this point.

Several curves taken from a 20 KW transmitter in our Camden plant are shown in Figs. 12 A, B, and C and illustrate the

use of this equipment in aligning multi-stage transmitters. The overall sideband analysis shown in Fig. 12C indicates flat response to 4 MC. Fig. 12D indicates the effect of too-tightly coupled RF circuits and shows the typical dip in the frequency response when this condition exists. With this type of display it is a relatively simple matter to re-adjust the circuits for a flat response.

How the BW-5A Sideband Response Analyzer Works

The operation of the BW-5A Sideband Analyzer is basically very similar to the point by point procedure outlined above. As before, a selective receiver is required to tune in the particular sideband frequency. But the BW-5A provides means to do this automatically as the sideband is generated. The resulting output is displayed on an oscilloscope. Referring to Fig. 13 the block diagram shows a receiver having an IF of 10.7 MC and an input tuning range of approximately 40 to 85 MC.

If the case of a transmitter operating on Channel 10 is followed through, the operation of the Analyzer will become clear. The heart of the new instrument is the FM Sweep Oscillator in the center of the Fig. 13 diagram. If at one instant the sweep oscillator frequency is 130 MC, the same as the frequency of the fixed oscillator, then the output frequency of the RF mixer will

be 0. The output frequency of the TV transmitter will simply be the carrier at 193.25 MC. This carrier mixed with 130 MC from the FM oscillator in the RF converter will yield the difference frequency of 63.25 MC to which the receiver is tuned. If, at the next instant the FM oscillator is on 132 MC, then mixing with 130 MC the difference frequency of 2 MC appears in the output of the RF mixer. When this is applied through the video amplifier to modulate the transmitter its output then consists of 193.25 MC with sidebands of 191.25 and 195.25 MC. These frequencies mixing with the 132 MC in the RF converter will yield the difference frequencies of 59.25, 61.25 and 63.25 MC. These represent the lower sideband, carrier and upper sideband respectively. Since the receiver is tuned to 63.25 MC, it will therefore detect the upper sideband and give information on its amplitude. Because the receiver is highly selective other frequencies appearing at the output of the converter will be rejected. Similarly if the FM oscillator frequency is 129 MC at a later instant the output from the transmitter will be 192.25, 193.25 and 194.25 MC. The corresponding output of the converter will be 63.25, 64.25 and 65.25 MC. The receiver being tuned to 63.25 MC will therefore detect the lower sideband and give information on its amplitude. It will therefore be seen that as the frequency

FIG. 12A. Response of driver incorrectly aligned for double sideband response.

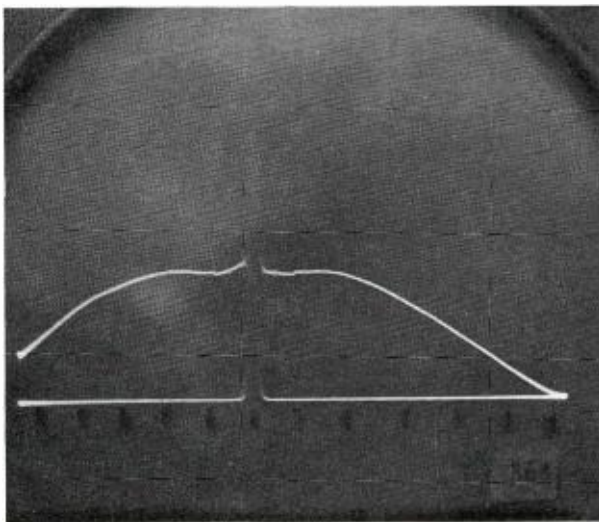
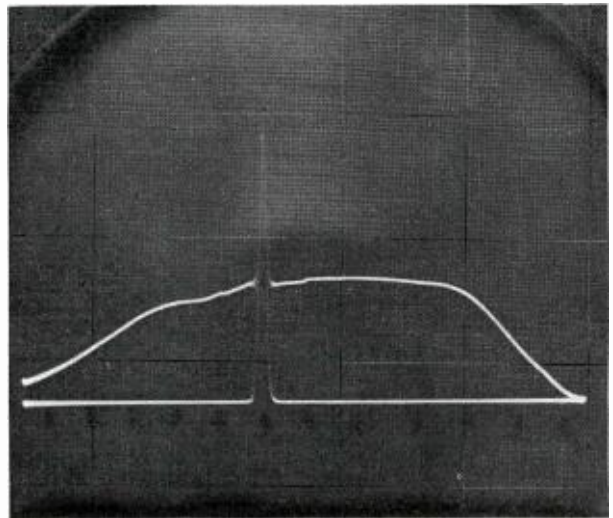

FIG. 12B. Response of driver correctly aligned with carrier offset.



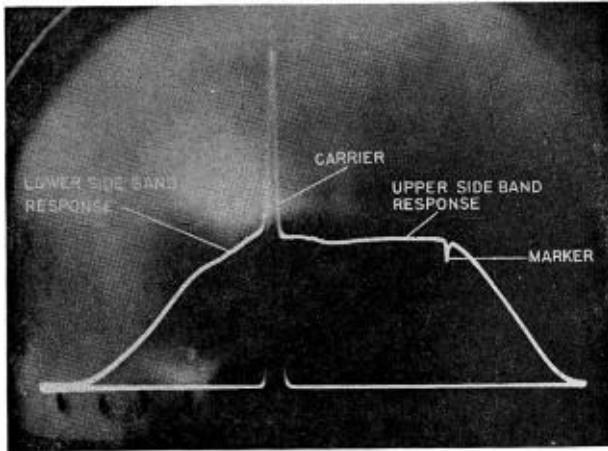

FIG. 12C. Overall response of 20 KW transmitter including amplifier but less sideband filter.

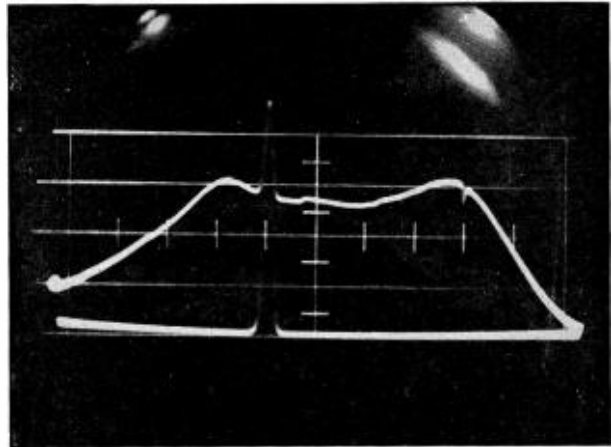

FIG. 12D. Overcoupled RF circuits.

modulated oscillator swings through the range of 123 to 137 MC continuous information on both upper and lower sidebands generated by the transmitter will be displayed on the face of an oscilloscope. The blanking circuit provides an optional zero output base line during the retrace time.

By studying Fig. 13 more closely it can readily be seen that by obtaining an appropriate sample of RF, sideband analyses can readily be obtained at various points:

- A. 5 KW Driver Transmitter Output
- B. 20 KW Linear Amplifier Output
- C. Vestigial Sideband Filter Output
- D. Antenna Feed Line.

Point B is a particularly valuable spot for using the Sideband Analyzer since its use is practically essential in aligning the linear amplifier with ease and rapidity.

In many cases suitable RF pickup loops are already installed in Broadcast Stations such as those used to feed demodulators. Simple loop or capacity coupling may be used but directional couplers will yield more consistent results, especially if reflected waves are present during initial tune-up.

Preliminary results obtained from tests both in Camden and in the field indicate that a great deal will be learned with regard to television system performance when the sideband analyzers come into more common use. It is easy to see, for example,

FIG. 13. Block diagram of BW-5A sideband analyzer.

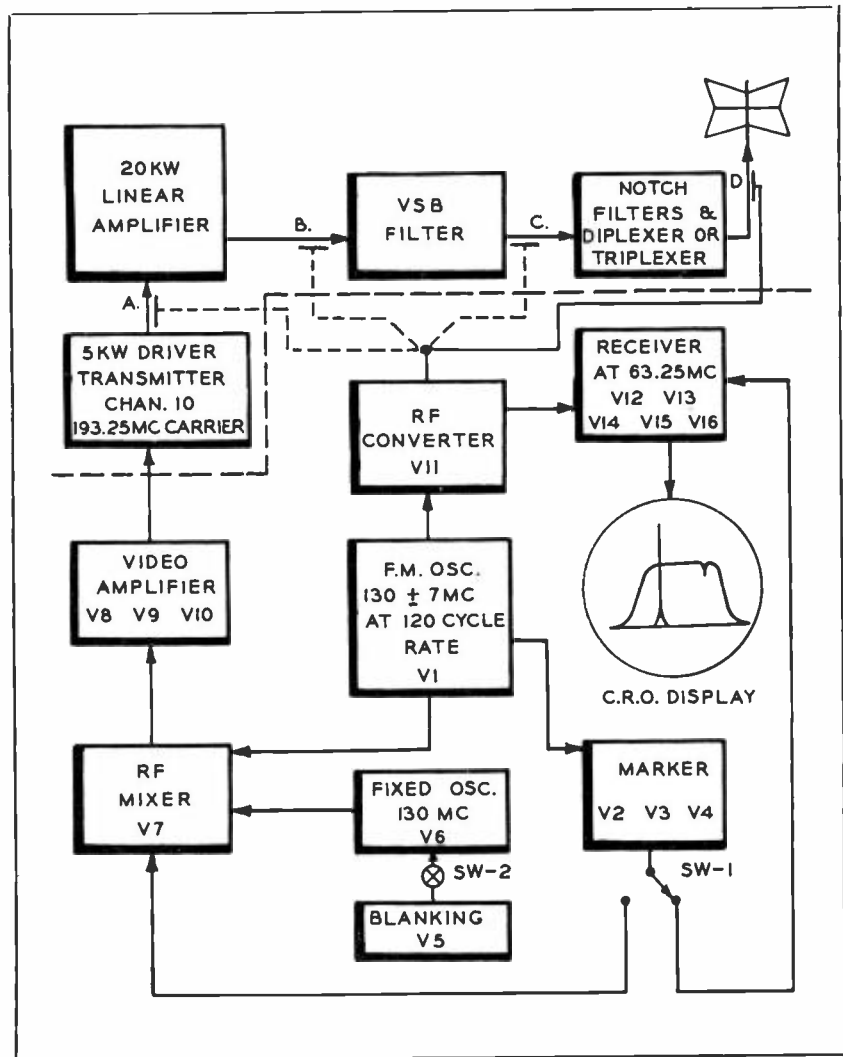

that best results can not be expected from a monitoring demodulator if the transmitter is not putting out the necessary sideband information. Moreover, a diode detector placed between the transmitter and the vestigial sideband filter may not indicate the true quality of the picture radiated because the diode can not differentiate the upper and lower sideband response. The Sideband Analyzer provides a reference with which visual monitoring equipment can be compared.

Physical Description

By studying Fig. 1 again and looking at Fig. 14, familiar with the performance features of the Sideband Analyzer will be gained and the simplicity of the instrument will be appreciated. An RF sample from an appropriate point in the transmit-

ter system is brought to a coaxial chassis connector in the rear of the chassis. Another coaxial chassis connector in the rear supplies the video to modulate the transmitter. The female plug on the panel supplies both vertical signal and horizontal sweep voltage to the oscilloscope to be used.

The top right-hand knob on Fig. 1 is the video sweep output control. This control in conjunction with the meter above it governs the amount of video sweep signal modulating the transmitter under test. The detector peak control serves as a vernier tuning control for the selective receiver in the analyzer. The detector gain knob controls the amount of output fed to the oscilloscope by the receiver. The marker knob controls the frequency of the marker

pip seen in the sideband analysis pictures. The frequency of the marker is indicated on the dial above the control. Dial markings are in megacycles and confusion is avoided by having only one marker to indicate whether this is above or below the carrier frequency. The scope phasing knob is useful when the instrument is used without blanking so that the "go" and "return" traces may be superimposed. The sweep position knob controls the center frequency of the FM oscillator which produces a change in position of the carrier on the oscilloscope.

Fig. 14 shows the sub-assembly method of constructing the analyzer. The box located near the left hand edge of the front panel near the hinge houses the FM oscillator. The perforated box next to it houses the marker circuits. The box near the right hand edge of the front panel contains the RF converter. The box in the bathtub chassis shields the receiver.

The new instrument makes use of a relay rack mounting bathtub type chassis. This type chassis has been a favorite in the past for broadcast monitoring equipment. The front panel swings out on hinges to permit ready access to circuit components, while tubes are accessible from the rear. Ten and one-half inches of panel space are required for mounting and the depth is 14½ inches. The color is dark umber gray in keeping with our transmitter apparatus.

Type BWU-5A Sideband Analyzer is the companion unit for the UHF channels.

Acknowledgments

Credit must be given to members of the Transmitter Engineering Section under Mr. C. D. Kentner, who first conceived the idea of the Sideband Analyzer. These were Messrs. F. E. Talmage, S. C. Stribling and W. T. Douglas, Jr. Mr. A. J. Grange was responsible for the actual development of the instrument under the immediate supervision of Mr. E. M. Brown, both members of the Measurement and Requisition Engineering Group. Our thanks to Mr. N. M. Brooks and Mr. V. E. Trouant for their encouragement during the progress of this development.

FIG. 14. View with door open and cover removed.

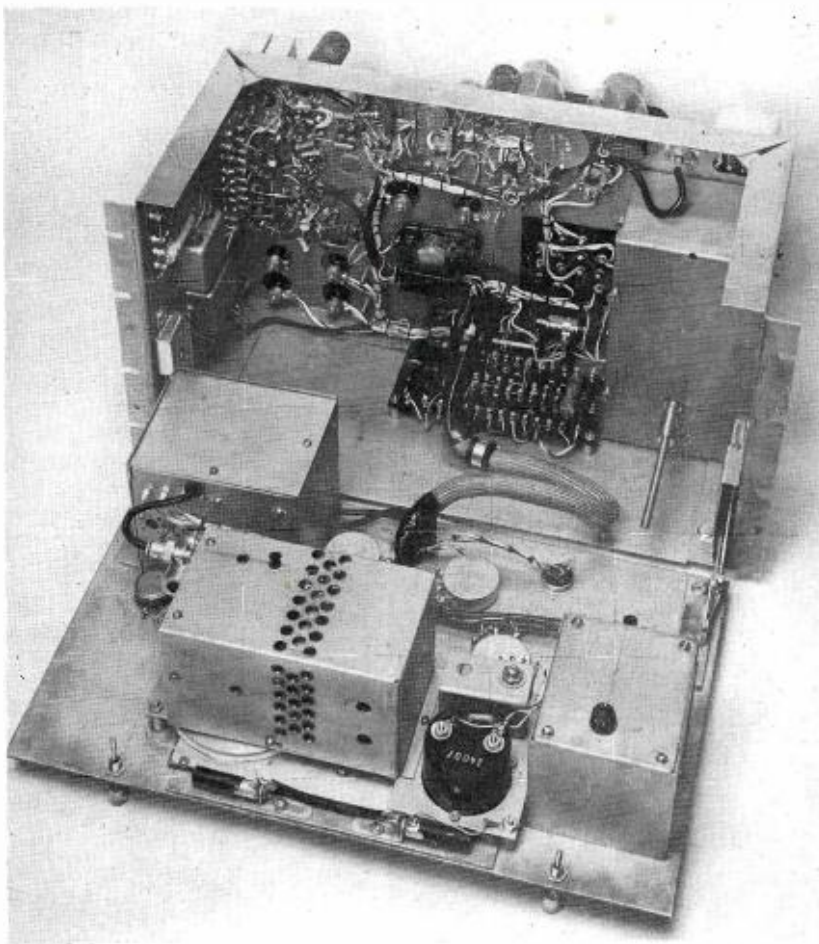

TELEVISION TOWERS

By **D. W. BALMER**
RCA Engineering Products

Station engineers are frequently called upon to assist in the planning and selection of supporting structures for television antenna installations. Special tower designs are occasionally necessary but in most instances standard structures will be specified. In either case selection will be facilitated if the engineer has a basic knowledge of mechanical design principles, installation and maintenance problems. It is with this thought in mind that the following article is presented.

Tower Types

The transmission of television signals requires the transmitting antenna to be mounted as high in the air as possible because field strength at the receiver location is proportional to antenna height. The antenna should also be mounted in the clear so that the transmitted signal will not be reflected by close in objects. Mountain top installations are of course ideal from the standpoint of elevation and non-interfering objects. Wind and ice conditions, however, as well as accessibility in bringing up equipment, may present problems.

Relatively flat country with low surrounding hills lends itself well to the installation of tall supporting structures. Towers over 500 feet in height are usually guyed and the normal cross sectional shape is triangular so that three point guying can be used (Fig. 1). Guyed tower costs are normally lower than for self supporting structures because less steel is used and smaller foundations are required. The availability of land and the area involved for guy anchorage are the main disadvantages of this type of tower. A useful method for estimating the land required for a guyed structure is to consider the distance to the farthest guy anchorage as being approximately $\frac{3}{4}$ the tower height.

Self supporting towers are especially advantageous in city and congested districts where land is expensive. For estimating required space for a self supporting tower, the distance between tower legs can normally be considered as $\frac{1}{4}$ the height of the structure. Fig. 2 shows a self-supporting tower located in a congested area. The installation is at KMTV, Omaha, Nebraska.

Two interesting views of the same tower are shown in Figs. 3 and 4.

Construction of towers upon tall buildings is often good planning. This normally results in smaller towers and shorter transmission lines, especially if the building is high enough to conform to the desired antenna height. Building frameworks, however, must usually be reinforced and erection problems sometimes become quite serious (See Fig. 6.)

The use of a single tower by two or more TV stations is good engineering from the standpoint that all receiving antennas will automatically be oriented in the right direction for all channels so used. The advantage of a community tower, the sharing of operational expenses and CAA approval of such installations, will normally offset the expensiveness of such a structure.¹

Where an existing tower can be used for the replacement of a new antenna it may become necessary to modify the structure. Complete mechanical specifications should be sent to the tower builder for analysis. If the new antenna is larger and its loading exceeds the old one, it may mean that a section of the tower must be removed or replaced with a stronger section. If a tower section must be removed for structural strengthening, it will of course reduce the height of the tower.

Location

Since wind and ice conditions vary throughout the world, the geographical location of the tower will determine the design parameters. Regardless of height, land area involved or type of structure, the wind load specifications for the particular location are of great importance. The wind pressure map shown in Fig. 5 was prepared for RCA by Edwards and Hjorth, structural consultants of New York. It indicates by means of shaded areas the wind pressure that should normally be specified for any section of the United States. This information is based on United States weather bureau records and has been adjusted to an assumed 750-foot elevation. Mountains and other topographical features and areas subject to heavy icing conditions should be given special consideration. Wind pressures for these localities should be determined only after a careful study of local problems.

¹ Empire State Antenna. H. E. Gihring, BROADCAST NEWS No. 70, 1952.

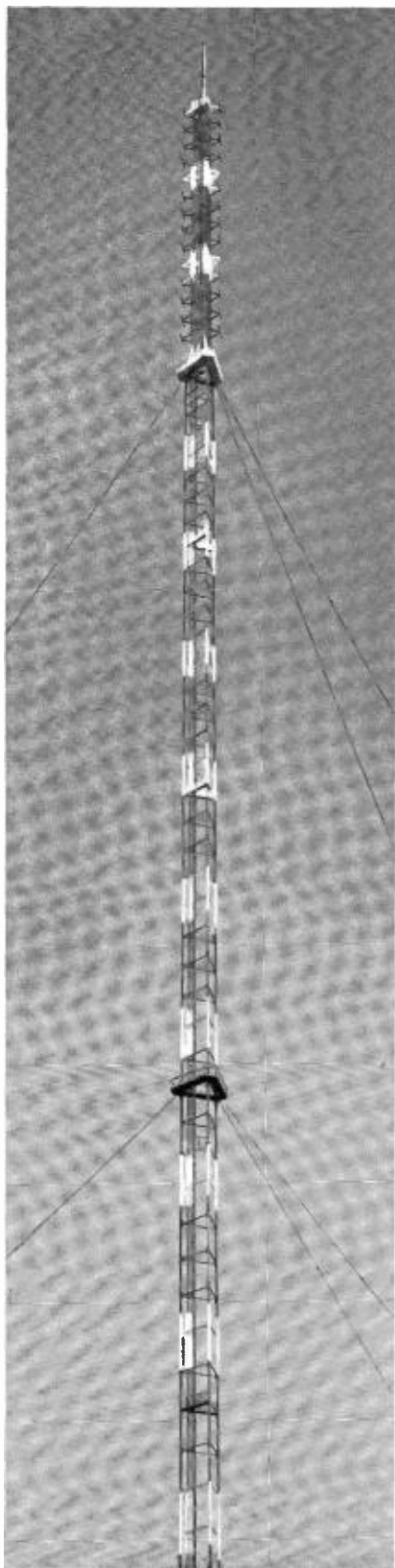
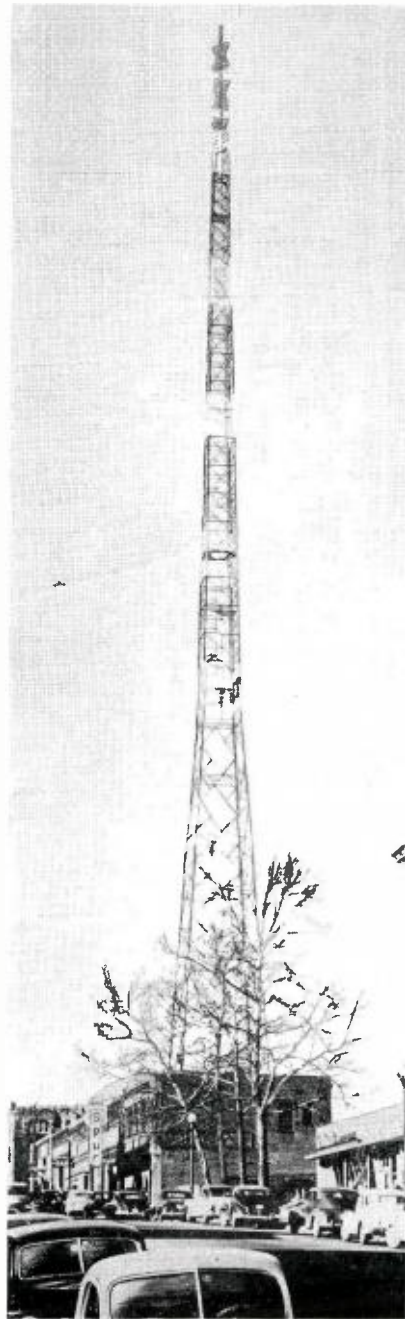

FIG. 1. A 1000-foot guyed tower at WSB-TV, Atlanta. A similar 1000-foot tower is installed at WBEN, Buffalo.

Wind Load

Experienced tower builders rarely design for less than a 30/20 lb. loading. This means that the tower members are designed to resist a horizontal wind pressure of 30 lbs. per square foot of projected area on all flat surfaces and 20 lbs. on round surfaces. This is the equivalent of an actual

FIG. 2. A Lehigh self-supporting tower, located in the city-section of Omaha, Nebr. Station KMTV.



wind velocity² of 85 miles per hour. Provision should be made for all additional loadings caused by the attachment of guys, antenna, ladders, transmission and power lines, etc. and should be applied to the projected area of the structure. The total load specified should be applied in the direction which will cause the maximum stress in the various members. Where high winds or heavy icing is prevalent a 50/30 loading is often specified.

Antenna Types

RCA transmitting antennas both VHF and UHF are designed for 50/30 loading as this is normally adequate for practically all sections of the country. The standard VHF transmitting antenna is the RCA superturnstile. It is mounted by means of a guide flange at the tower top which holds the antenna pole perpendicular and a pole socket mounted approximately 15% of the pole length below the tower top to support the weight of the antenna and balance the overturn moment (Fig. 7). Where superturnstiles are mounted on FM Pylons a pedestal type mounting is the standard method of installation. Here the pedestal supports the antenna weight and also holds it perpendicular. In special cases a pedestal type mounting can be arranged instead of the standard guide flange and pole socket installation. This, however, will require a special tower top plate.

When a twelve-section superturnstile is used, an r-f combining network is necessary to combine the upper and lower six sections of the antenna. As this network must be accommodated below the tower top, provision must be made so that tower cross bracing does not interfere. (See Fig. 8.)

In the application of VHF supergain antennas, the cross sectional dimensions of the tower must conform to electrical requirements. The face to face dimension of the screens must be held to one half wave length. (Fig. 9.) Tower construction can be either square or triangular. If a triangular structure is used, outrigger framing or brackets attached to the screens will be necessary to permit a square screen array. Guys are permissible in the screen area if four point guying is used. By guy-

² RCA data sheets refer to true (actual) wind velocities as distinguished from indicated velocities. As an example, 150 mph indicated is the equivalent of 110 mph actual wind velocity. These (indicated) figures were measured with a Robinson 4 cup anemometer. They were formerly used in the industry with an instrumental error correction applied, but have been discontinued by most designers since 1928 when a change was made to a 3 cup unit which had smaller errors. Since 1932 corrections for instrumental errors were applied to the data before publication.

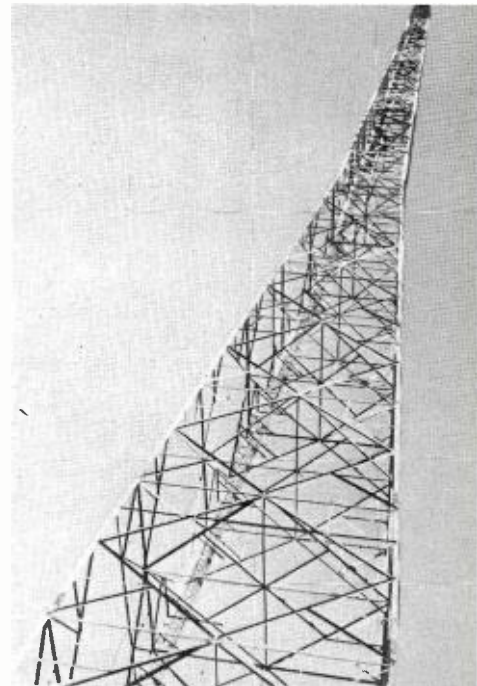
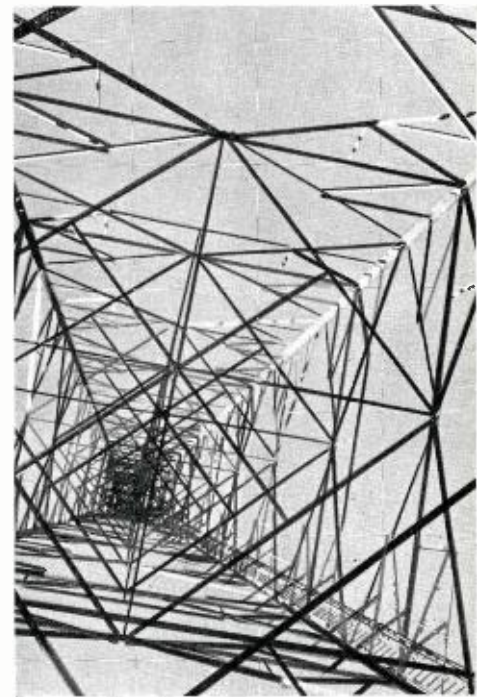

FIG. 3. Another view of the KMTV antenna tower. Transmission line run is located along side of ladder. This affords accessibility for periodic inspection and maintenance.

FIG. 4. An interesting view, looking up through the supporting structure. Close inspection will reveal transmission line run at right of the ladder.



ing at the corners of the screen location (45° to face of screens) the guys will not cross the screen surface, thus any electrical effect is eliminated.

The standard UHF transmitting antenna is the UHF Pylon. It is flange mounted directly to the tower top plate. A set of tapered leveling plates is provided to align the antenna vertically if the tower top plate is not exactly level. These plates are also used to obtain mechanical beam tilting of the antenna. If the tower top plate is level, and no mechanical beam tilting is contemplated, the leveling plates may be left out and the antenna bolted directly to the tower (Fig. 10).

Excessive tilt of a superturnstile or UHF Pylon in relation to its base, caused by high winds, may result in variations in the received signal strength. The choice of the rated velocity should be determined by consideration of the number of times per year that partially affected service is acceptable. Wind velocity records throughout the country based on a twenty-five times a year average (approximately 44 miles per hour) can be used as a basis for allowable tilt of the tower top plate. This de-

gree of tilt should be specified to the tower builder from RCA antenna data sheets. The installation of RCA-UHF antennas requires that the tilt of the tower plate be held to a somewhat closer figure than superturnstiles since higher gains are realizable at UHF.

Tower Construction

Steel towers are usually hot dip galvanized, especially where corrosive action due to fumes, salt air, etc., are likely to occur. When CAA regulations require painting, galvanizing can sometimes be omitted if the tower sections are heavy and painting is done frequently. Climbing ladders should be located inside the tower if at all possible and preferably near the tower legs. By placing the ladder within the tower, the lattice braces form a safety cage for the serviceman. The ladder is also an excellent support for transmission line runs as it is accessible at all times. The type of hangers (usually direct mounting) should be specified so that proper supporting members can be provided in the tower.

Platforms for rest and maintenance purposes should be planned at convenient in-

tervals. Where railings at the tower top are required, it is preferable that the platform level be lower so that the height of the railing does not extend above the top of the tower. Structures over 750 feet in height may be equipped with elevator facilities. Hoist or man lift elevators can be supplied by the tower builder.

Transmission Lines

Before ordering transmission line or fittings, it is suggested that a dimensional layout be made of the tower with antenna mounted. The proposed routing of the line can then be shown from the antenna to the transmitting room. From this layout an idea can be gained as to the length of line and fittings required. Methods of installation for VHF and UHF line are essentially the same.

The general practice for supporting the main transmission line is to space the hangers at approximate 10-foot intervals. The line section at the tower top is firmly secured by two fixed hangers and the lower sections are suspended by spring hangers to allow for differential thermal expansion and bending of the line. Fig. 11 shows a

FIG. 5. A wind pressure map prepared for RCA by Edwards and Hjorth, Structural Consultants.

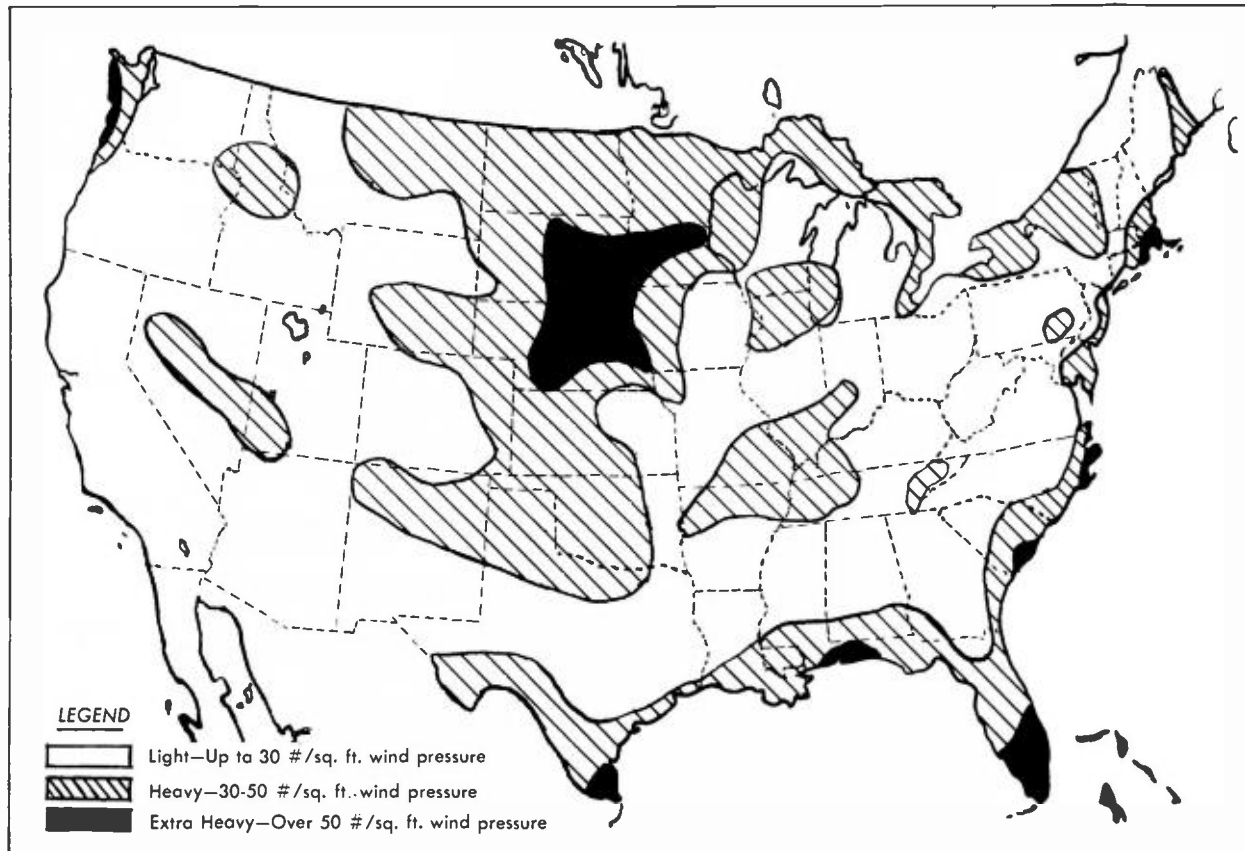

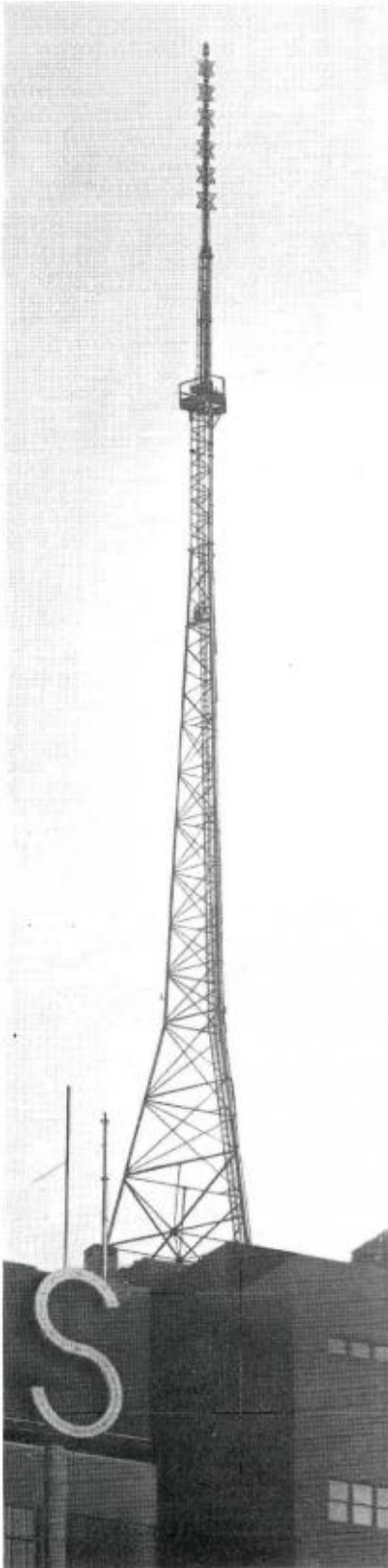

FIG. 6 (at left). The WCAU-TV antenna and tower atop the Philadelphia Saving Fund Building, Philadelphia—a congested downtown district.

FIG. 7 (at right). Guide flange and pole socket installation.

typical installation of TV transmission line. Roughing in dimensional drawings are available for all types of transmission lines and should be used when making a layout. These are shown in the RCA catalog.

Maintenance

Materials of construction, fastenings, climatic conditions and required length of life, determine maintenance requirements.

About six months after a tower has been erected, or after its first winter, all bolts should be tightened and any corrosion

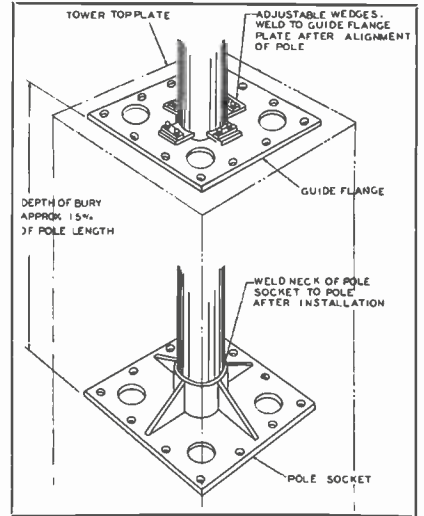
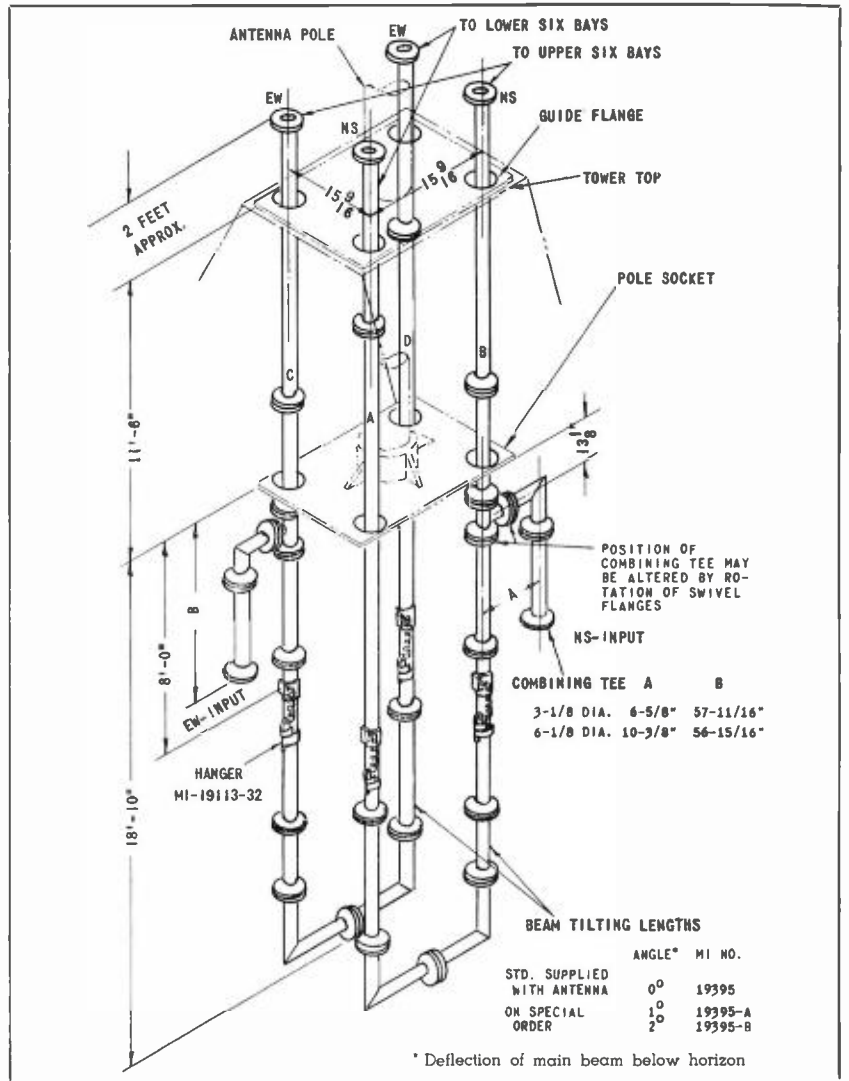

FIG. 8 (below). Combining network (Type "A"), TF-12AH Tower Mounting 3/8" Feed Line and TF-12AH-D Tower Mounting 6/8" Feed Line.



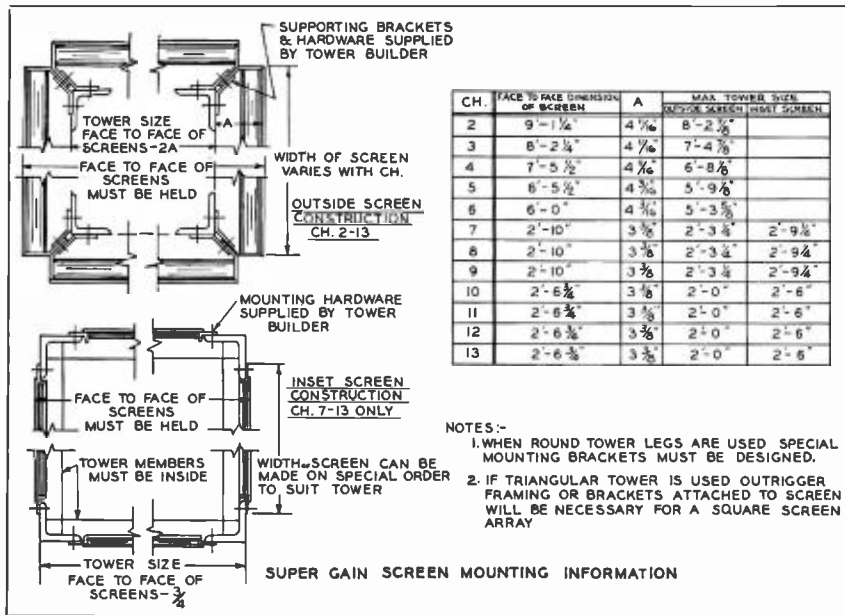

FIG. 9. Face-to-face dimensions of supergain antenna screens.

eliminated by painting or repair. Subsequent tightening need only be done once a year, but signs of misalignment or damage should be attended to promptly.

Guys should be checked four times a year or after severe storms. Painting is the most repetitive expense item and the one most often neglected. It should be done before signs of corrosion become evident.

The following procedure may be helpful in approaching the tower problem:

1. Determine station location with respect to service area. This study which will involve among other things joint operation with other stations, CAA approval, cost of land, zoning restrictions, local regulations, etc., will result in a decision to use:

- a. A self-supporting tower when land is unavailable as in city limits or on top of a building where total height of a tower is 500 feet or less.
 - b. Or a guyed tower if land is available and a greater height is desired.
2. Determine design parameters:
 - a. Wind load for area in which tower is located.
 - b. Deflection at tower top for type of service required.
 - c. Type of antenna which is to be supported.
 3. Determine tower accessories such as:
 - a. Ladders.
 - b. Platforms.
 - c. Railings.
 - d. Lighting.
 - e. Microwave dishes.
 4. Determine method of routing transmission line taking into account:
 - a. Accessibility.
 - b. Location of structural members.
 - c. Location of special networks below tower top.

The planning and selection of television towers and antenna systems carries with it the responsibility of securing the services of competent tower builders and riggers. Improper designing and poor installation technique can prove very costly. RCA, through its field sales engineers will be glad to assist in selecting the tower and erectors best suited for the customer's requirements.

FIG. 10. Tower top installation drawing for 8 1/4" UHF antenna.

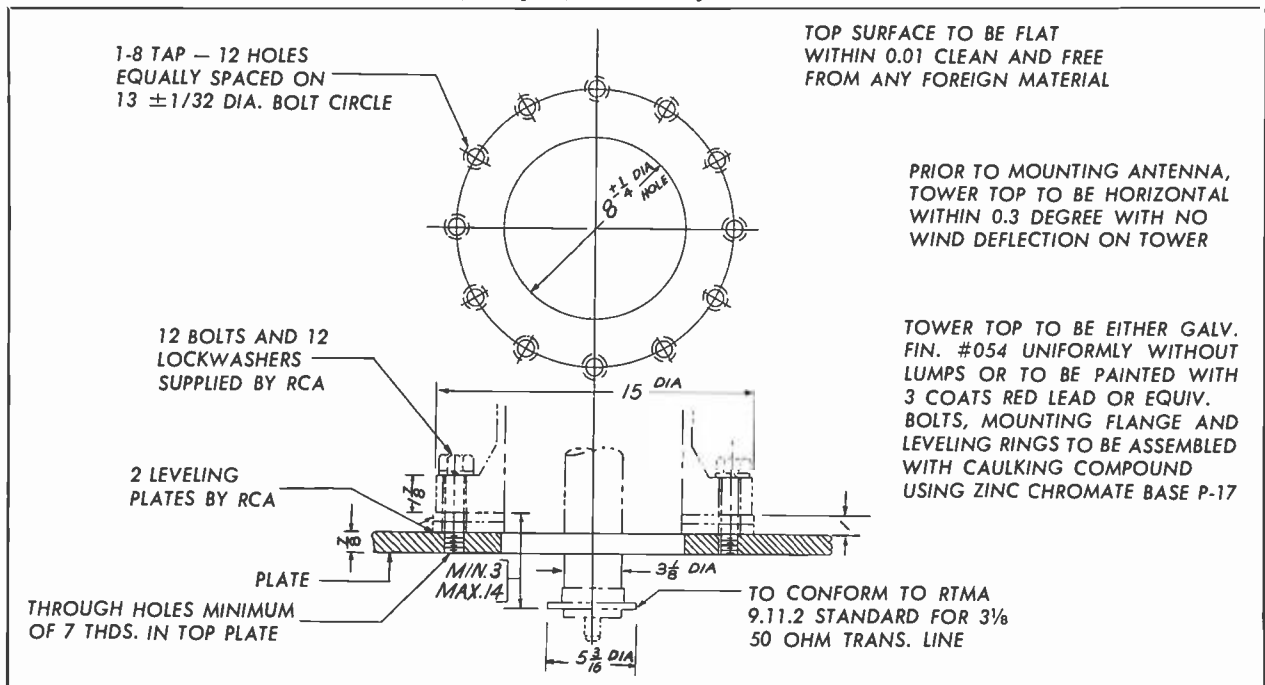

TYPICAL INSTALLATION OF TV
TRANSMISSION LINE ON TOWER
DUAL LINES ARE USED FOR TV
REFER TO TABLE BELOW FOR SYMBOL DESIGNATIONS

SYMBOL DESIGNATIONS

SYMBOL	DESCRIPTION	1 5/8" DIA. MI NO.	3 1/8" DIA. MI NO.	6 1/8" DIA. MI NO.
A	TRANSMISSION LINE	19112-1	19113-1	19314-1
B	90° ELBOW	19112-2	19113-2	19314-2
C	REDUCER 3 1/8" TO 1 5/8"	19112-6	19113-6	
C	REDUCER 6 1/8" TO 3 1/8"			19314-4
D	GAS STOP	19112-5	19113-5	
E	ADAPTER	19112-4	19113-4	
F	GASSING ACCESSORIES	19112-12	19113-12	
G	FIXED HANGER	19112-15	19113-15	
H	SPRING HANGER	19112-14	19113-14	
J	LATERAL BRACE	19312-36	19313-36	
K	HORIZONTAL ANCHOR	19312-18	19313-18	
M	ROLLER ASSEMBLY	19312-35	19313-35	
N	SWIVEL HANGER	19312-38	19313-38	
P	45° ELBOW	19112-3	19113-3	19314-3
R	DEHYDRATOR		ON APPLICATION	

WHEN SHAPE OF TOWER CHANGES
ADD HANGER SUPPORTS TO TOWER
THE FOLLOWING BENDS ARE MAX.
12" BEND FOR 20' SECTION 1 5/8" LINE
6" BEND FOR 20' SECTION 3 1/8" LINE
1" BEND FOR 20' SECTION 6 1/8" LINE

INSTALL VERTICAL LINE SECTIONS
WITH ROLLED GROOVES AT LOWER
END TO SUPPORT INNER CONDUCTOR.

SPACE SPRING HANGERS APPROX.
10 FEET APART.

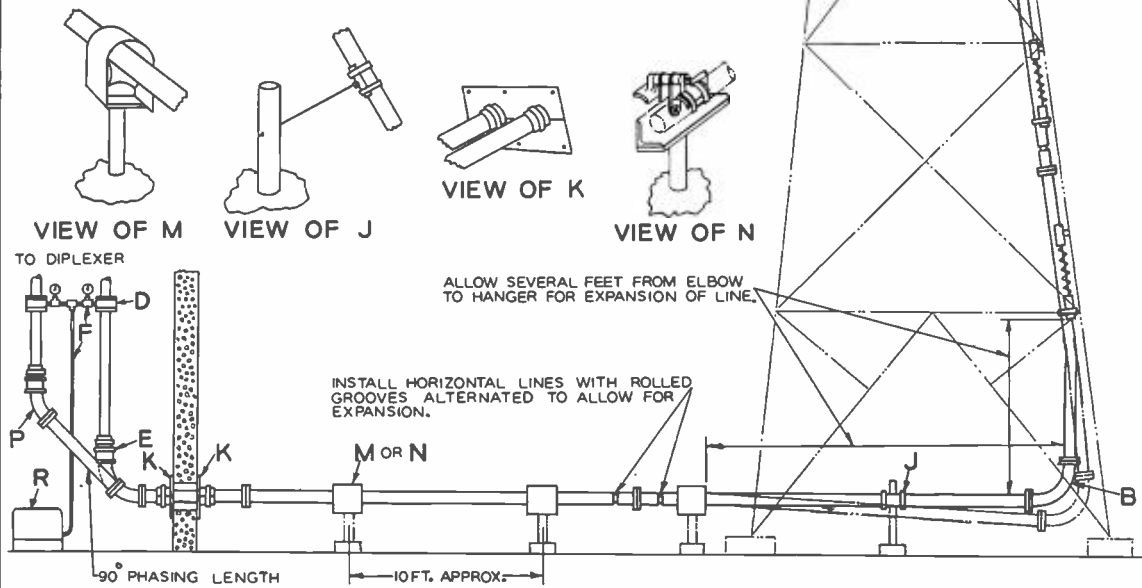

FIG. 11. Typical installation of VHF transmission line run on tower.

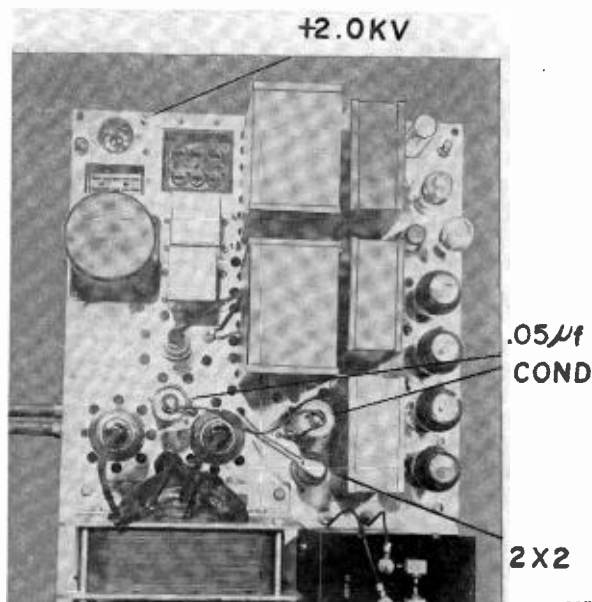

FIG. 4. Top view of the modified 715-B Power Supply.

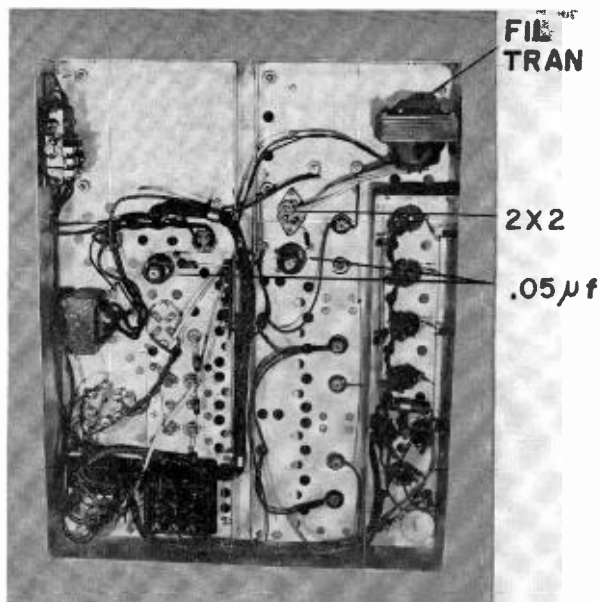

FIG. 5. Bottom view of modified 715-B Power Supply.

detailed explanation of the phanastron is not given here as this has been covered quite thoroughly in literature. The limit controls at the low and high end of the Helipot are adjusted as follows. The 20K control is set by first setting the Helipot at minimum and adjusting for minimum pulse width at the 6SA7 cathode. The 10K control is set by first setting the Helipot to maximum and adjusting for a pulse duration somewhat greater than a 60 cycle period viewing at the same point. As can be seen these limit adjustments are interactive one on the other and a "touch-up" will be necessary on one when the other is adjusted.

Now, in order to make use of the output pulse from the phanastron to synchronize the time base oscillator in the scope, it is only necessary to differentiate it. Since the trailing edge of this phanastron pulse is "positive-going", it is applied directly through the sync gain control R-171 to the time oscillator. Since short durations of phanastron pulses are lower in amplitude, it will be necessary to readjust the sync gain when a major change of the Helipot is made.

The Video Stripper is fed a composite video signal through K-2b. The polarity of the sync into this is positive provided the operator chooses the setting of the sync input to correspond to that at the scopes'

probe. The 10K clipper control is adjusted as follows. The fine and coarse vertical input is adjusted to about 1½ inches of vertical deflection. The sync input control is as usual set to match the vertical input. The "normal-delayed-start" switch is closed and energizes the relays to feed composite video to the stripper. Now, with another scope on the plate of the input section of the 6J6, adjust the clipper control to a point just past the adjustment where the video reduces to a minimum. It will be noted that a long RC time constant is used to the grid of the 6AK5. This insures more complete clipping by retaining a high negative on the grid except during the peaks of sync when grid current flows. Otherwise the video removal is quite conventional.

The S.P.G. (Sliding Panel Generator) is fed the integrated output of the 6AK5 via the RG59U coax. These pulses from the output of the Video Stripper are identical to those fed the vertical oscillator in a TV receiver or monitor.

OUTLINE OF CHANGES AND CONSTRUCTION

2kv Positive d-c Supply

No schematic of this h-v supply is included since the primary problem here is locating suitable mounting space. High voltage a-c is taken from T3 terminal #5

to the plate of the new 2X2 tube. The filter consists of a 2.2 meg. resistor input to a pi section consisting of two .05 uf cond. and a 2 meg. resistor. The output connects through a 330K resistor to a ceramic, feed-through, insulator mounted between and just to the rear of j2 and j3. A bleeder made up of 5-10 meg. resistors is used. Other resistors are two watt. The additional filament transformer required has h-v insulation and is mounted in back of the shield partition under L3. A top and bottom view of the modified power supply are shown in Figs. 4 and 5 respectively.

5 UPI to 5 CPI

The duodecal socket must be replaced with diheptal type. The changes in numbers on the new socket are obvious. A new mounting bracket for the 5 CPI must be made. A "c" shaped clamp was formed so that it could be tightened about the base. The clamp was in turn soldered to a rectangular bracket that is slotted at the opposite or bottom side. This slot permits the vertical stud (used with the old mounting) to be used to tighten the bracket in place. The conical shield must be flared at the small end to pass the larger neck of the 5 CPI. The flared shield may then be secured to the top front of the rectangular bracket. The h-v lead that connects to anode #3 goes to a ceramic feed through insulator at the rear of the scope chassis.

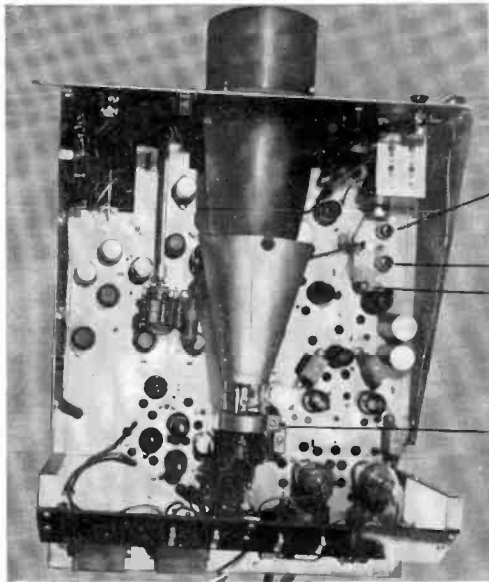

6AK5

6J6
L102

CLAMP

FIG. 6. Top view of the main "Scope" chassis showing the 5CPI as now mounted in the chassis. Note that new "C" clamp is installed.

FIG. 7. Bottom view of the main "Scope" chassis which illustrates the position of cables, stripper, relays and selenium rectifier.

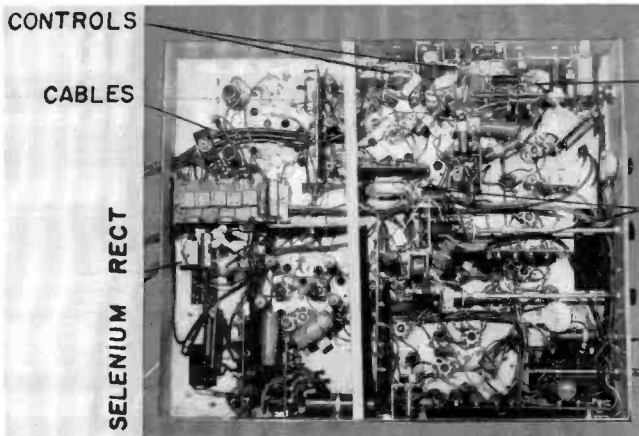

CONTROLS

CABLES

SELENIUM
RECT

STRIPPER

RELAYS

Fig. 6 shows the 5 CPI mounted in place.

Video Stripper

The circuit was constructed as a unit except for the 10K potentiometer and the 20 uf, 150v condenser associated with it. The unit is bolted to the under side of the chassis with the tubes protruding through holes above the chassis. The place chosen in the scope sub-chassis is just to the rear of R101. In order to mount it here conveniently, L102 was relocated slightly. The 10K clipper control is mounted just to the rear of R 130 on a bracket also holding the two limit controls for the Helipot. The plate and filament power was stolen from the main scope. Figs. 6 and 7 show top and bottom views of the main scope chassis after modification.

FIG. 8. A view of the modified 715-B "Scope" with phanastron driver unit shown mounted in place.

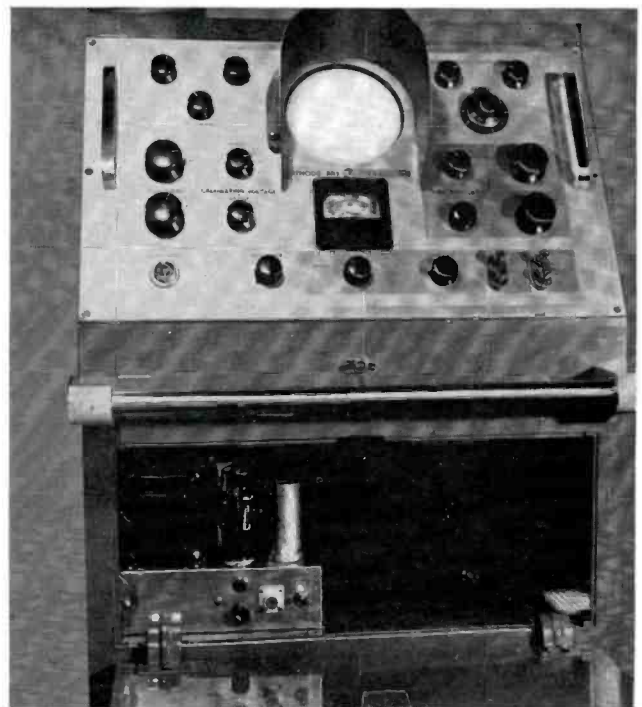

The Sliding Pulse Generator

This unit with its regulated power supply was constructed on an 8 x 10 x 2½ inch chassis. The place chosen to locate this unit was the front left hand corner of the storage compartment. The size was limited by the desire to save as much as possible of this compartment for its intended use. Since the power transformer required the greatest vertical clearance it was located on the front top of the chassis. The front end of the chassis which shows when the door is opened has a coax connector, a jewel light, a fuse holder, and a field toggle switch. The rear end of the chassis contains the 8-pin Jones connector and input selector toggle switch. The interconnections are made to the scope chassis via a cable made up of 2-RG59U, a 3-conductor shielded, and a 2-conductor. A hole was cut through the perforated metal at the rear of the compartment large enough to pass the 8-pin female Jones plug. The other end of the cable is wired into the scope entering through a grommeted hole.

The power supply for which there is no schematic included uses a 5V4G and 2-OA2 tubes. It was found necessary to use some means to stop a relaxation oscillation in the voltage regulators. The combinations of a 30 uf, 450v condenser in series with a 68K resistor was connected across the OA2 tubes which are in series.

The layout is not critical and no difficulty was encountered in rebuilding the circuit from the original experimental model. The 8 m.h. inductance used in Phanastron driver plate should have a low d-c resistance and a powder core. This unit is pictured in its place in Fig. 8.

TELEVISION MICROPHONE MIXER TYPE BCM-1A

by **GEORGE A. SINGER**
Engineering Products Department

Production techniques of the more elaborate television shows require an extensive and flexible audio system. In particular, a much larger number of microphone inputs are needed in television than are required for a similar radio show. There are two basic reasons for the use of more microphones in a television production. First, the microphone has to be kept in close proximity of the actor to reduce noise pick-up from the audience or changes of props. As the scene shifts, the microphone has to follow the action or when this is not practical—as is frequently the case—other microphones, distributed at strategic locations, have to be used to pick up the sound.

Unlike radio it is not usually possible for the actor to step up to the microphone to deliver his lines, then to step aside to make room for the next actor, thus reducing the number of microphones required.

The second reason for the need of additional microphone input facilities in television is the fact that frequently more than one set or staging area is used in a single

studio. Each area requires its own complement of microphones. However, usually only one area is in use at a time, and it is therefore possible by providing suitable input selector switches to reduce the number of microphone mixer channels needed.

Many of the television stations which have been on the air for some time are faced with the need of expanding their audio facilities. Similarly, the many new stations which are now springing up all over the country will require or are at least planning for more microphone inputs than the standard broadcast studio console affords.

Auxiliary Unit Needed

There is, therefore, a definite need for a unit which may be added to a studio console to provide additional microphone switching, amplifying, and mixing channels. Such a unit should of course not only match in styling the other studio equipment but also be convenient to use and easy to install.

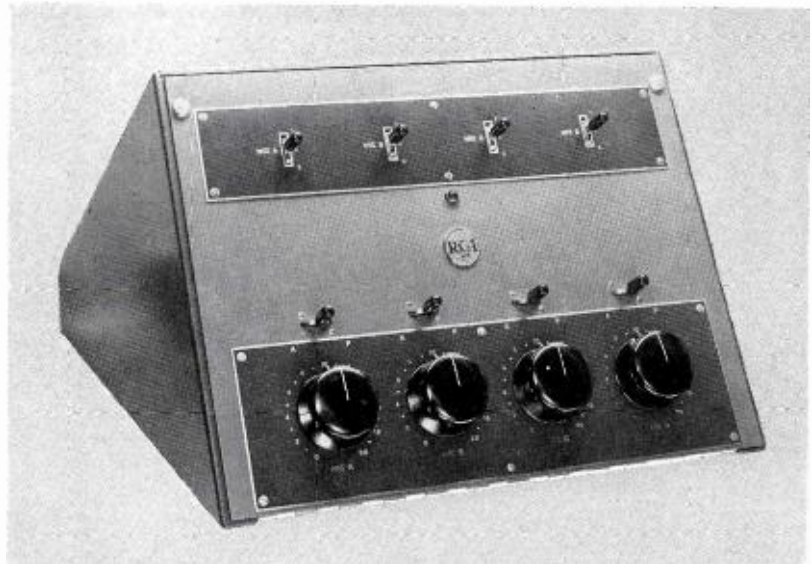
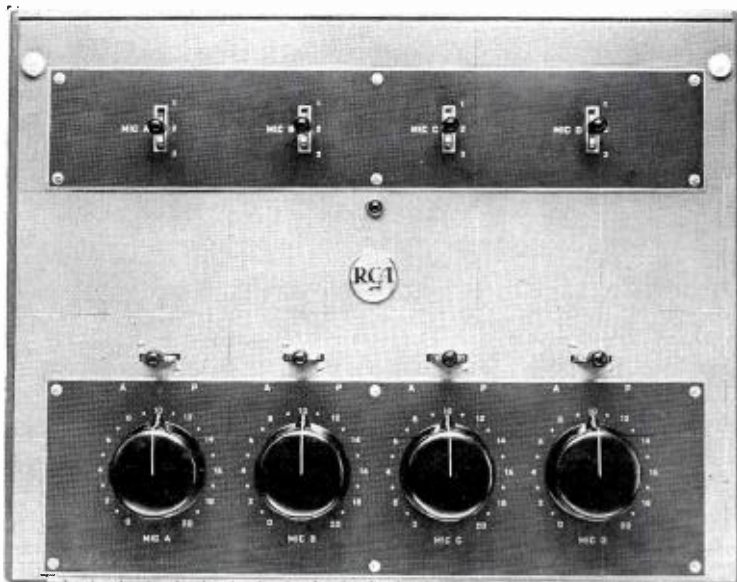

FIG. 1. Overall view of the new BCM-1A Auxiliary Mixer Console which provides additional microphone input positions when added to studio consoles.

FIG. 2. Closeup front-panel view of the BCM-1A console showing microphone switches and mixer controls.



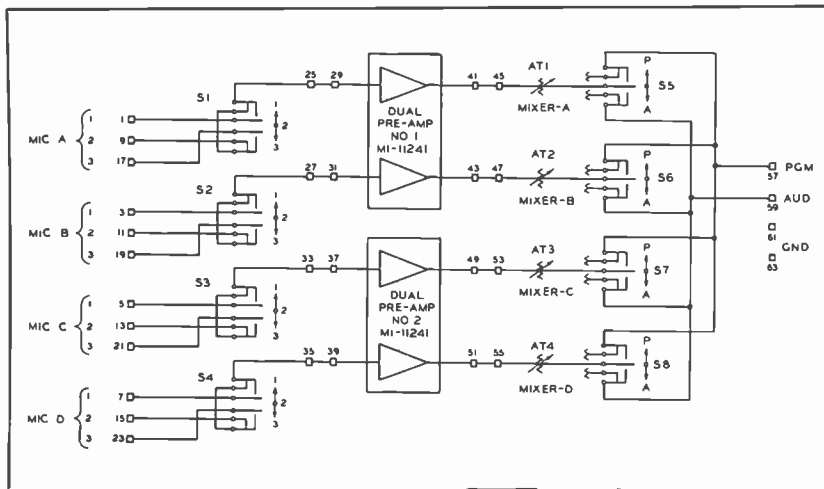

FIG. 3. Block diagram of the BCM-1A which permits the use of any of four of 12 additional microphone inputs.

With these considerations in mind, the BCM-1A Auxiliary Mixer was designed to supplement the facilities of the type BC-2B Studio Console.¹ The new unit is shown alone in Fig. 1, and in its normal operating position alongside the console in Fig. 5.

As shown in the block diagram of Fig. 3, the Auxiliary Mixer provides four mixing channels. The input selector switches S_1 to S_4 permit a selection of any one of three microphone inputs for each of the four preamplifiers, making available a total of twelve microphone inputs.

The preamplifiers employ two stages of amplification with inverse feedback to reduce distortion and stabilize gain. Low-noise tubes are used to obtain a high signal-to-noise ratio. The amplifier chassis are secured by vibration mounts to eliminate microphonics.

Following the preamplifiers are the ladder type attenuators AT_1 to AT_4 . These attenuators have 20 steps of 2 db each except for the last three steps which taper to infinity. The lever key switches S_5 to S_8 connect the output of the mixer attenuators to either the program bus or the audition bus.

To make convenient external connections for special applications, the inputs and outputs of the selector switches and the amplifiers have been brought out to

¹ P. W. Wildow and G. A. Singer, "New AM-FM-TV Studio Console," July-August, 1951 BROADCAST NEWS.

terminals on the audio terminal block, as shown at the bottom of Fig. 4, which shows the internal appearance of the mixer with the top removed and the front panel tilted forward.

Flexible Mixer Circuit

The mixing circuit itself was designed so that the mixer busses of the auxiliary mixer can be paralleled with the mixing busses of the console. This was accomplished by making the output impedance of the auxiliary mixer the same as the resistance of the load resistors in the mixing circuit of the console. These load resistors are removed when the two units are connected together. In addition, the auxiliary mixer circuit was designed so that its proper load impedance would be that of the mixing circuit of the console.

The imposition of these conditions resulted in an output impedance of 370 ohms and a load impedance of 255 ohms. It is

FIG. 4. View of BCM-1A with front panel lowered and back panel removed. All components are easily accessible and neatly arranged.

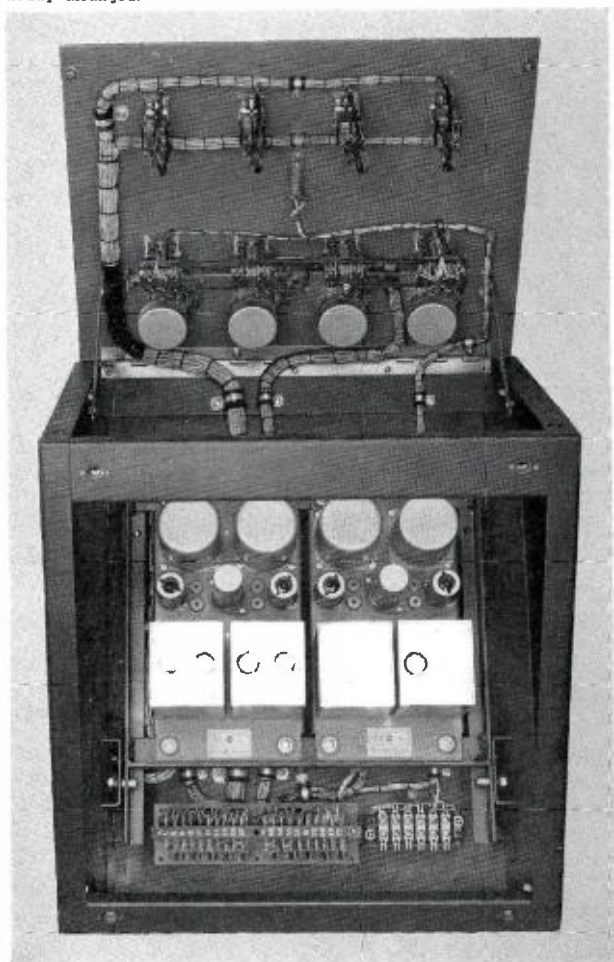

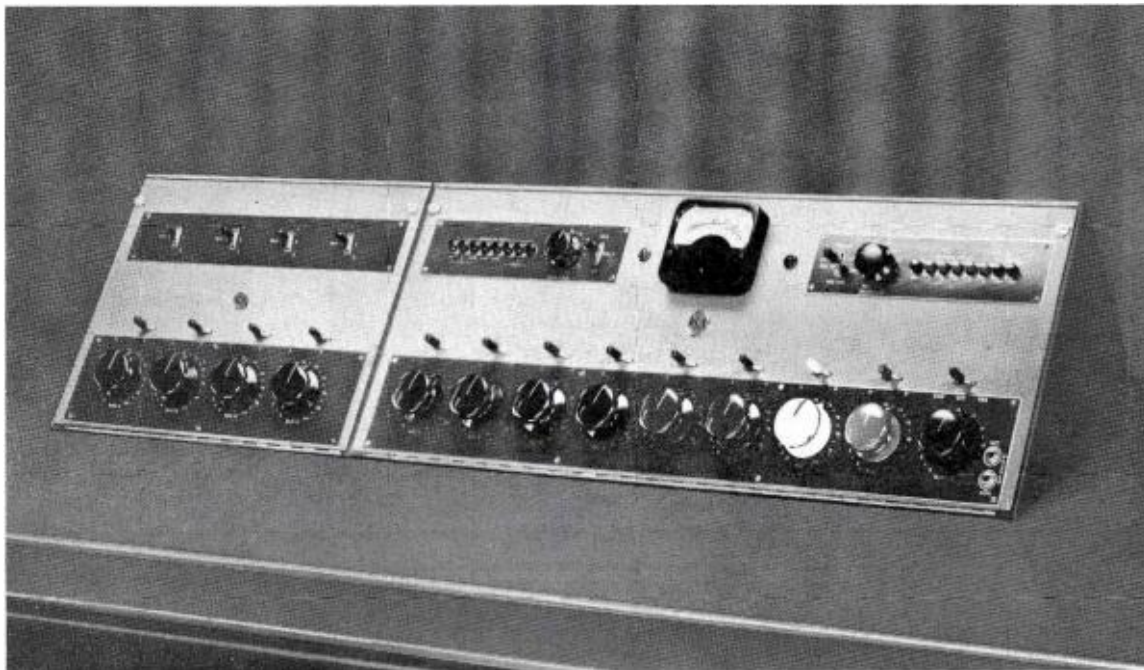
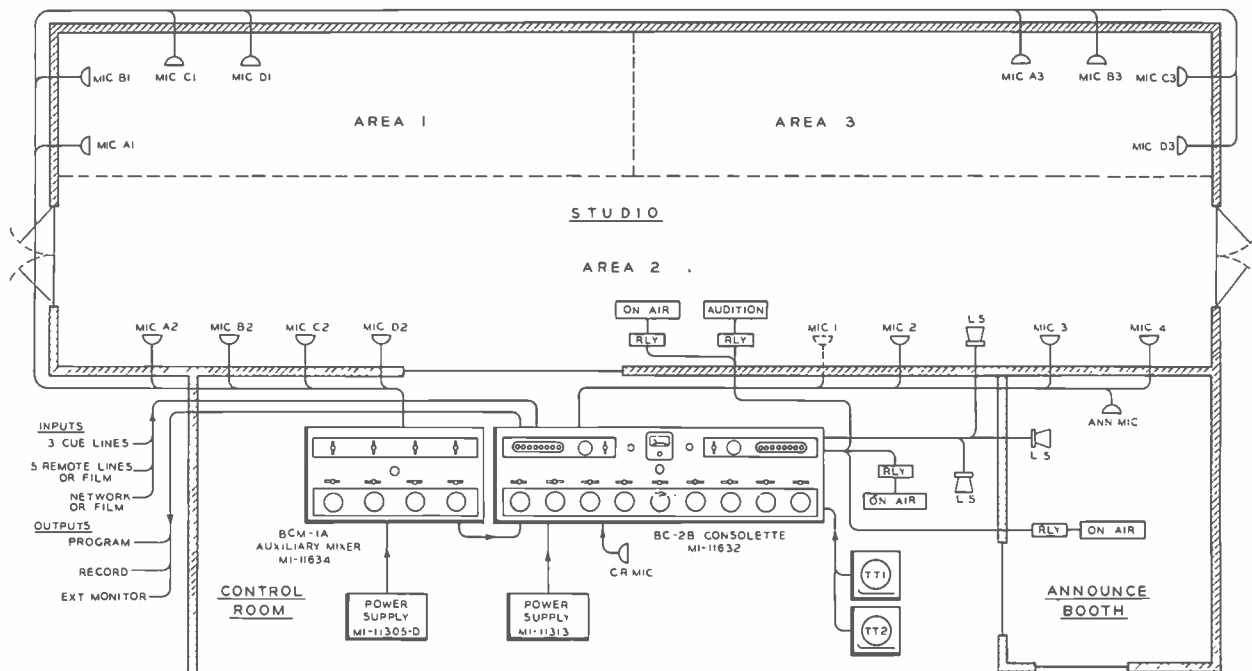

FIG. 5. View of the BCM-1A mounted alongside the BC-2B Studio Console. Panel slopes are identical and consoles match in appearance.

FIG. 6. Diagram showing a typical layout of the BCM-1A Auxiliary Mixer and BC-2B Studio Console.



therefore necessary to use a matching pad when the output of the auxiliary mixer is fed into a 150 or 250 microphone input of either the consolette or another amplifier.

The program-audition switches are also equipped with contacts for interlocking circuits which activate the speaker muting and studio warning light relays of the consolette.

Thus there are two ways in which the auxiliary mixer can be connected to the consolette:

1. Paralleling of the mixer busses.

The program and audition busses of the auxiliary mixer are connected directly to the consolette. Eight connections are required between the interlocking circuits of the two units. This type of installation results in 12 mixing channels—8 of which are microphone mixing channels—and a total of 18 possible microphone inputs.

2. Using the Mic 1 mixer of the consolette as a sub-master gain control.

In this type of connection, the program bus of the auxiliary mixer is connected through a matching pad to the Mic 1 input of the consolette. The audition bus of the auxiliary mixer may be connected through a matching pad to an external monitor amplifier if so desired. No interlocking connections are required for this case since

the program-audition switch of the Mic 1 channel in the consolette controls the speaker muting and warning light relays. The Mic 1 mixer attenuator of the consolette may be used as a "sub-master" gain control for the auxiliary mixer. This type of installation reduces the number of possible microphone mixing channels by one. The added feature of a sub-master gain control, however, simplifies operation as it makes possible to fade four channels in and out simultaneously.

Typical Application in Studio

The audio facilities of a typical TV studio are illustrated in Fig. 6. The studio is divided into three staging areas. Each of these areas contains four microphone inputs to the auxiliary mixer. In the main staging area #2, are an additional three or four microphone inputs leading directly to the consolette. (The microphone 1 input is shown dotted because it cannot be used if the output of the auxiliary mixer is fed to the Mic 1 input of the consolette.) The control room and announce booth microphones, turntable, cue, remote line, network, and film inputs are handled in the usual manner.

This is only one of many possible arrangements, but it shows the flexibility of the auxiliary mixer. The microphone inputs can also be divided between two studios

which may be used simultaneously—one for program, the other for audition purposes.

The BCM-1A auxiliary mixer should be installed adjacent to and to the left of the consolette. Both units are identical in cross-section and similar in styling. The auxiliary mixer is 16¾ inches in length, and the combined length of the two units is only 49¾ inches. All controls are therefore within convenient reach. The front panel of the auxiliary mixer is hinged and tilts forward as shown in Fig. 4 to provide access to the attenuators and switches for inspection, cleaning and service. The sloping top cover is removable to expose the tubes and tube test jacks. The amplifier wiring becomes accessible by raising the pivoted amplifier mounting frame. Power for operating the speaker muting and warning light relays is supplied through the consolette. Only an external plate and heater supply is required for the operation of the auxiliary mixer.

The BCM-1A auxiliary mixer is another example of the building-block type of broadcast equipment which may be placed in operation at the initial installation or may be added later to existing equipment as the need for greater facilities becomes apparent, and although this unit was designed specifically to supplement the type BC-2B studio consolette, it is possible to use it also with other types of studio consoles.

FIG. 7. Further use of the BCM-1A can be made adjacent to Preset Switching switching arrangement like the one above. Left to right, BCM-1A Auxiliary Mixer, BC-2B Studio Consolette, and the BCS-11A Master Switching Console.

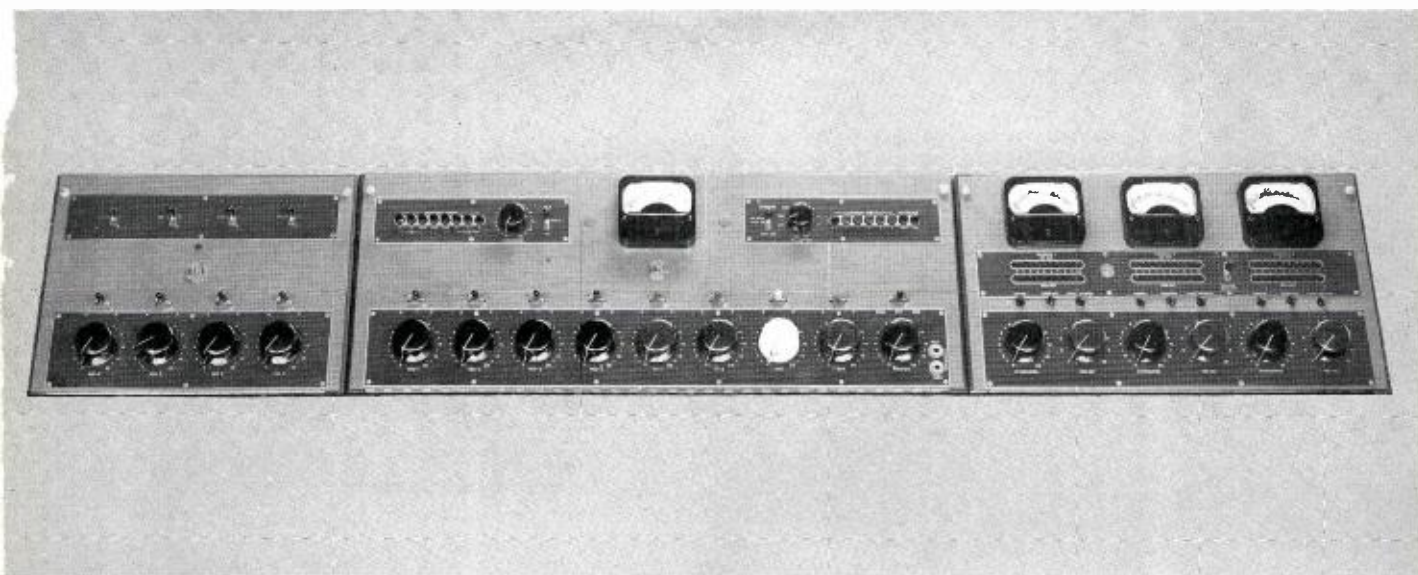

VIDEO OPERATIONS, LIGHTING, AND GOOD TELEVISION PICTURES

Good lighting techniques are without question a most important basis for producing good television pictures which are both technically acceptable and dramatically interesting. However, the effect of the most excellent lighting of a set can be completely nullified by careless video operations or by poor choice of video operations techniques. As experience is gained in television, it becomes increasingly apparent that television lighting and video operations are so interdependent that complete cooperation between the two activities is absolutely essential for high-quality performance.

As both fields have their limitations, an appreciation of video operations problems by the Lighting Director, and an equal understanding of the aims of television lighting by the Video Operator is essential. This does much to develop the teamwork necessary for production of television pictures which represent the highest quality of which the system is now capable.

It is reasonably safe to start with the assumption that in the camera such factors as orthicon focus, image focus, beam alignment, scanning size, linearity and related variables are under control and that all such adjustments have been made *before* a camera is used in a transmitted program. "On-the-air" adjustments of operating controls produce effects for the viewer which are almost as distasteful as switching lenses on the turret or "looking" for optical focus.

We can thus restrict video operations comments to the setting of target potential, lens iris opening, beam current, and black level reference. Only by careful choice and setting of these parameters can one produce a good picture, no matter how much effort has been spent on application of good lighting techniques.

Target Potential

Extensive tests on modern image orthicon tubes have shown that operation of the target at 2 volts above cutoff is necessary to obtain good gray-scale reproduction and adequate signal-to-noise. The details of a pushbutton circuit for accurate and easy setting of target potential are given in an

By **H. N. KOZANOWSKI**
TV Terminal Equipment Engineering

article by J. H. Roe, "How to Modify RCA Cameras for Setting Correct Target Voltage," BROADCAST NEWS, No. 60, Pages 26-27, July-August, 1950. A detailed discussion of practical requirements for good image orthicon camera operation is given in an earlier article by H. N. Kozanowski, "How to Get the Best Picture Out of Your Image Orthicon Camera," BROADCAST NEWS, No. 54, Pages 74-77, April, 1949.

It is poor practice to attempt to control "sensitivity" by shift of target potential, since penalties in gray scale, signal-to-noise, and resolution are immediately incurred. Once the correct target potential is selected, the proper lens opening and beam current are easily determined.

Scene Lighting and Lens Setting

Good operation demands that the light reaching the camera be carefully controlled. Tests of the performance of "average sensitivity" image orthicon camera tubes have shown that the minimum lighting level for a television picture of good technical quality lies between 32 and 64 foot candles, incident, with the lens opening set at f:8.

However, it is desirable that the average television lighting installation should be capable of producing 200 foot candles on a given scene in order to permit flexible control of lighting and lens stops.

It is evident that the light *reflected* from the set towards the camera lens is responsible for producing the television picture. However, this is very difficult and tedious to measure, even with special means, since it will vary continuously within a scene area in accordance with the reflectance of any object or component of the set being measured.

A standard and much simpler method of controlling lighting on a set involves the measurement and control of *incident* light on the set. Such a measurement can be made using a Weston Model 915 Foot Candle Meter specially built for television service. By utilizing information readily

acquired from experience on the reflectance behaviour of average components in a set, the lighting control problem is reduced to a standard procedure which produces repeatable and reasonably predictable results. The incident illumination is measured by locating the Weston meter with its sensitive surface pointing *toward* the camera lens, perpendicular to the lens axis at the point in the set which is being studied.

Experience has shown that the *useful* contrast range in a scene should never exceed a ratio of 30-to-1 to permit good gray-scale reproduction in the television picture. The reflectance of various areas in a scene can be measured using the Weston foot candle meter. With the sample areas located in the *same* incident light field and the light sensitive surface of the meter *facing* the area under test, the ratio of meter readings for various samples gives the reflectance ratio. Isolated highlights produced by reflection from jewelry, buttons, or other mirror-like objects can be troublesome in production. They should be suppressed to fall within the maximum contrast range of 30-to-1 previously mentioned.

When the lighting has been adjusted in accordance with the previous discussion, the lens opening or iris should be set so that operation is only slightly above the knee of the image orthicon "signal-output-light-input" characteristic. This point can be determined rather easily by observing the video signal amplitude on the oscilloscope associated with the picture monitor. As the iris is opened, starting with a "full-closed" lens, the signal grows uniformly until a point is reached where the highest highlights start to "flatten" or no longer increase in amplitude at the same rate as the lower levels of the gray scale. The point of departure from uniform increase of amplitude is the knee of the curve. A slight increase of iris opening above the knee is permissible to improve the picture signal-to-noise ratio. Excess light to the tube produces the well-known, easily-recognized, and very annoying redistribution or halo effects, as well as deterioration of gray-scale reproduction. This iris adjustment is particularly important for kine-

scope recording where excess light to the tube produces a permanent record in film of poor gray scale and halo effects for subsequent showings to condemn.

It is apparent that iris opening determines the amount of light reaching the image orthicon *and* the depth of focus of the reproduced scene. Thus it may be necessary to set the scene lighting at an appropriate level so as to obtain correct image orthicon operation at the depth of focus which is required to portray a scene dramatically.

Beam Current

Only enough beam current should be used to just discharge the highest highlight. Excess beam current gives poor signal-to-noise ratio and a cluttered background which is particularly annoying in low-key scenes.

Black Level Set

In order to get uniform performance in a systems operation, a 10% set-up above blanking has been adopted as a black reference. Each Video Operator starts with this value and attempts to hold the blackest portion of his picture at this set-up level. *Very small changes in this adjustment have a great effect on blacks at the home receiver.* Since the setting is so sensitive and the practical difficulties for accurate control are rather large, this variable is very probably the one most open to criticism in video operations. It is not unusual, in fact a frequent occurrence, that switching of cameras on the same set often requires re-orientation or re-acquaintance with the scene, principally in terms of blacks. Thus a given object may be jet black as transmitted by one camera, dark gray in a second, and light gray in a third. The departures are due entirely to inaccuracies in setting blacks. An accurate method for checking performance of cameras in black level setting is to switch all signals into the *same* monitor. In this case, all identical blacks will be identically reproduced if the individual camera adjustments are correct. Errors in black level settings are, in addition, frequently observed in switching from studio to film, program to program, and station to station. The subject deserves careful and detailed attention.

This short discussion, touching only the highlights of problems in video operations, makes it clear that good television pictures can be produced only by careful and understanding cooperation by Lighting and Video Operations engineers.

FREE to communications men
...this big new illustrated book:

"What is MICROWAVE?"

Just off the press! Jam-packed with facts about microwave . . . what it is, how it works, what it can do for you! For your **FREE** copy, mail coupon now!

Here's the beautiful brand-new "how-and-why" book you've been waiting for . . . 20 fact-packed pages that *show you exactly how microwave can help you in your operations.*

Here are 5 of the many subjects covered:

1. The 4 basic advantages of microwave.
2. 5 actual case histories showing microwave at work for . . .
 - a big power utility.
 - a long-distance pipe line.
 - a fish and game commission.
 - a 300-mile turnpike.
 - a 1000-mile Western Union system.
3. How microwave operates a pumping station by remote control.
4. What goes into a typical microwave system.
5. How RCA helps you install your microwave system.



Are you keeping up to date on microwave?

Microwave is one of the most versatile communication tools developed in the 20th century. No wonder industry has been so quick to adopt it for power lines, pipe lines, highways, railroads, and similar applications. You just can't afford *not* to be up to date on microwave. So get your *own copy* of this big new **FREE** book . . . mail handy coupon . . . **RIGHT NOW!**

Big FREE book . . . mail coupon

Communications Section, Dept. 129S, RCA, Camden, N. J.

Without obligation, please send me my own **FREE** copy of your big brand-new book: "WHAT IS MICROWAVE?"

Name _____ Position _____

Company _____

Address _____ City _____ State _____

Please give me additional information on microwave for the application following: _____



RADIO CORPORATION of AMERICA

NEAL McNAUGHTEN APPOINTED MANAGER OF RCA BROADCAST MARKET PLANNING SECTION



NEAL McNAUGHTEN, internationally known radio and television engineer, and formerly NARTB Director of Engineering,

has joined the RCA Victor Division, Radio Corporation of America, as Manager of the Broadcast Market Planning Section of the Engineering Products Department. In this position he will supervise the long-range planning of the company's broadcast equipment business.

Mr. McNaughten had been director of engineering for the National Association of Radio and Television Broadcasters since August 1, 1949. He joined that organization on January 1, 1948, as assistant director of engineering.

During the time he headed NARTB's engineering operations Mr. McNaughten has performed many services for the nation's broadcasters. The most recent was the successful broadcast engineering conference held during the NARTB Convention in Los Angeles.

From January 1941 to December 1947, Mr. McNaughten served with the Federal Communications Commission in various capacities that brought him into international prominence. From 1945 to 1947 he was Chief of the Standard Allocation

Section, and for two years prior to this he was Assistant Chief of the FCC's Treaty Section, during which time he was a representative of the President's Interdepartmental Radio Advisory Committee. During his early years with the FCC he was a Monitoring Officer serving in Puerto Rico, Denver, and the Great Lakes Monitoring Area.

Mr. McNaughten's radio activities began as a "ham" operator in Pueblo, Colo. He assisted in the construction of the first transmitter for Station KGHF in Pueblo. He later was chief operator, and then chief engineer of Station KRGV in Weslaco, Texas.

Mr. McNaughten, during the past two years, has served on such important committees as: the National Television System Committee; the American Standards Association; the NARTB Recording and Reproducing Standards Committee; the NARTB Television Engineering Advisory Committee; and the Committee organized by the FCC and the Air Defense Command to study a wartime broadcast operational system.

"ANDY" INGLIS JOINS RCA AS MANAGER OF BROADCAST STUDIO EQUIPMENT PLANNING

A. F. ("Andy") INGLIS, widely known Broadcast and Television Consultant, has been appointed Manager of the Broadcast Studio Equipment Product Planning Group of the RCA Engineering Products Department. The work of this group includes the planning of new studio products with due consideration to all phases of application and commercial engineering.

Before joining RCA, Mr. Inglis was a partner in the firm of McIntosh and Inglis, Radio Consultants, Washington, D. C.—where he had practiced for nearly seven years. Prior to this he was an instructor in Electronics at the University of Chicago, and at the Naval Training School, Bowdoin College. He also worked as a development engineer in the Naval Research Laboratory.

Mr. Inglis' radio, television, and electronics experience as a Consultant involved close and detailed contact work with many broadcast station installations: he designed and adjusted approximately fifty Directional Antenna Systems; planned transmitting installation and technical data in connection with FCC requirements for approximately thirty Television Stations and Applicants; and has made comparative studies of Color Television Systems.

Mr. Inglis' activities also included studies of the transmission of Theatre TV Programs, Studio Equipment and Projection System Requirements, and Microwave Propagation. He is a senior member of the Institute of Radio Engineers and a member of the Society of Motion Picture and Television Engineers. He is the author of technical articles on the subject of "Multivibrator Circuits" and "Color Television".



KGNC-TV, AMARILLO, INSTALLS RCA 12-SECTION ANTENNA FOR CHANNEL 4

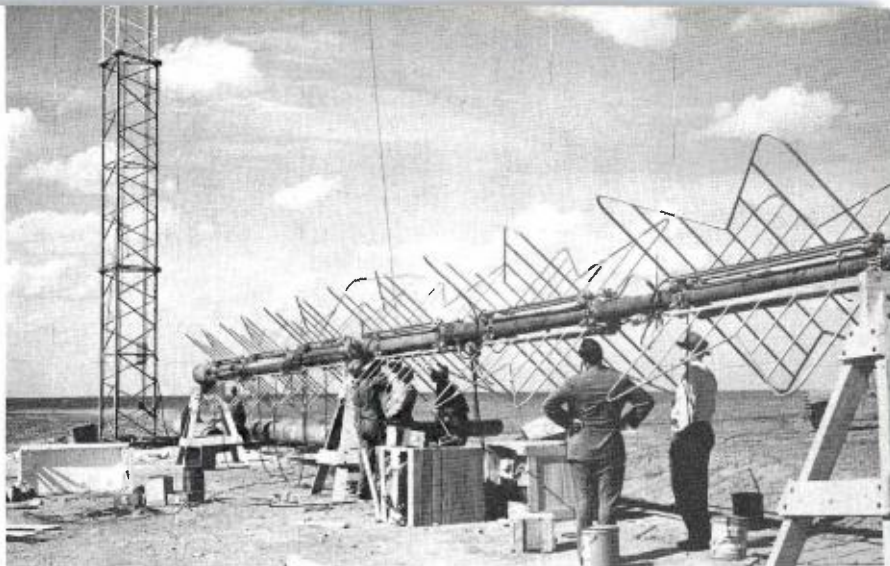

The first step in plans of KGNC-TV, Amarillo, to increase power was completed recently as workmen raised a 12-Section RCA Superturnstile Antenna for installation atop the station's 833-foot tower. The 166-foot antenna weighs 42,000 pounds and is the first antenna of its kind designed to operate on Channel 4.

KGNC-TV has been operating at interim power with a 2-KW RCA transmitter and a single-section antenna. The station

is scheduled to receive soon a new RCA 10-KW transmitter which, along with their present 12-Section Superturnstile, will allow the station to operate at 100 kilowatts effective radiated power.

New radio and television studios are now being constructed. When these have been completed, General Manager Tom Kritser says the station will switch to the new tower and transmitter.

High interest is developing in the an-

tipicated increase in coverage to be obtained from the station's new RCA equipment. No antenna of this type has ever been operated in such a plains area as the Texas Panhandle and excellent coverage is anticipated.

Technical installation of KGNC-TV is supervised by Chief Engineer Bill Torrey. Installation of the new transmitter equipment will be performed by KGNC-TV engineers, with the assistance of RCA experts.

A. P. WALKER SUCCEEDS NEAL McNAUGHTEN AS MANAGER OF NARTB ENGINEERING

A. PROSE WALKER, formerly Eastern Supervisor of Conelrad for the Federal Communications Commission has assumed the post of Manager of Engineering for the National Association of Radio and Television Broadcasters, succeeding Neal McNaughten, who joined Radio Corporation of America, as Manager of Broadcast Market Planning.

In announcing the appointment of Mr. Walker, Harold E. Fellows said, "Our Association is extremely fortunate in securing the capable services of Mr. Walker who is well known in the broadcasting field. He will ably represent our membership in all matters dealing with the complexities of broadcast engineering."

Mr. Walker has thirteen years of service with the FCC. He was formerly Eastern Supervisor of Conelrad for the FCC, reporting to FCC Commissioner George Sterling. In this capacity, he was responsible for providing technical assistance to the Air Defense Command effecting plans for the Control of Electromagnetic Radiation (Conelrad) concerning all non-government radio services licensed and regulated by the FCC.

Mr. Walker originally joined the FCC in 1940 and served in the capacities of Section Chief, Supervisor, and Radio Operator with the former Radio Intelligence Division until he assumed the post of General Radio Engineer with the Broadcast Bureau.

RCA Makes Old Cameras Perform Like New!

RCA CAMERA OVERHAUL
INCLUDES:

- Modification of circuits on RCA cameras, models TK-10 and TK-30 so that they are completely up to date—original picture quality restored.
- A complete check of all mechanical parts and their replacement where necessary.
- Refinishing of exteriors of camera and viewfinder cases.
- Thorough circuit and performance checks to insure original picture quality.

To schedule your studio or field camera for reconditioning, call WOODLAWN 3-8000, Ext. PG-327, or write Broadcast Service Section, RCA Service Company, Inc., Camden, N. J.



RCA SERVICE CO., INC.
A Radio Corp. of America Subsidiary
Camden 2, New Jersey

RCA TAPE RECORDER Type RT-11B

50 to 15,000 c.p.s. (± 2 db) at 15 in/sec
50 to 10,000 c.p.s. (± 2 db) at 7½ in/sec

COMPLETE—with motor board, plug-in type recording amplifier, plug-in playback amplifier, two standard NAB reels, power supply and panel and shelf.

• Split-second start and stop

• Push-button operation

• Extremely accurate timing—
with synchronous capstan

• Smooth tape runs—via
sapphire guides

• Automatic tape lift for fast
"forwards" and rewinds

• Microswitch "tape-break"
control—no tape spills, snarls

• Remote control of all
operations

• Rack or console mounting

• Plug-in amplifiers

• Interlock system for vital
controls

• 3 heads; Erase—Record—
Playback

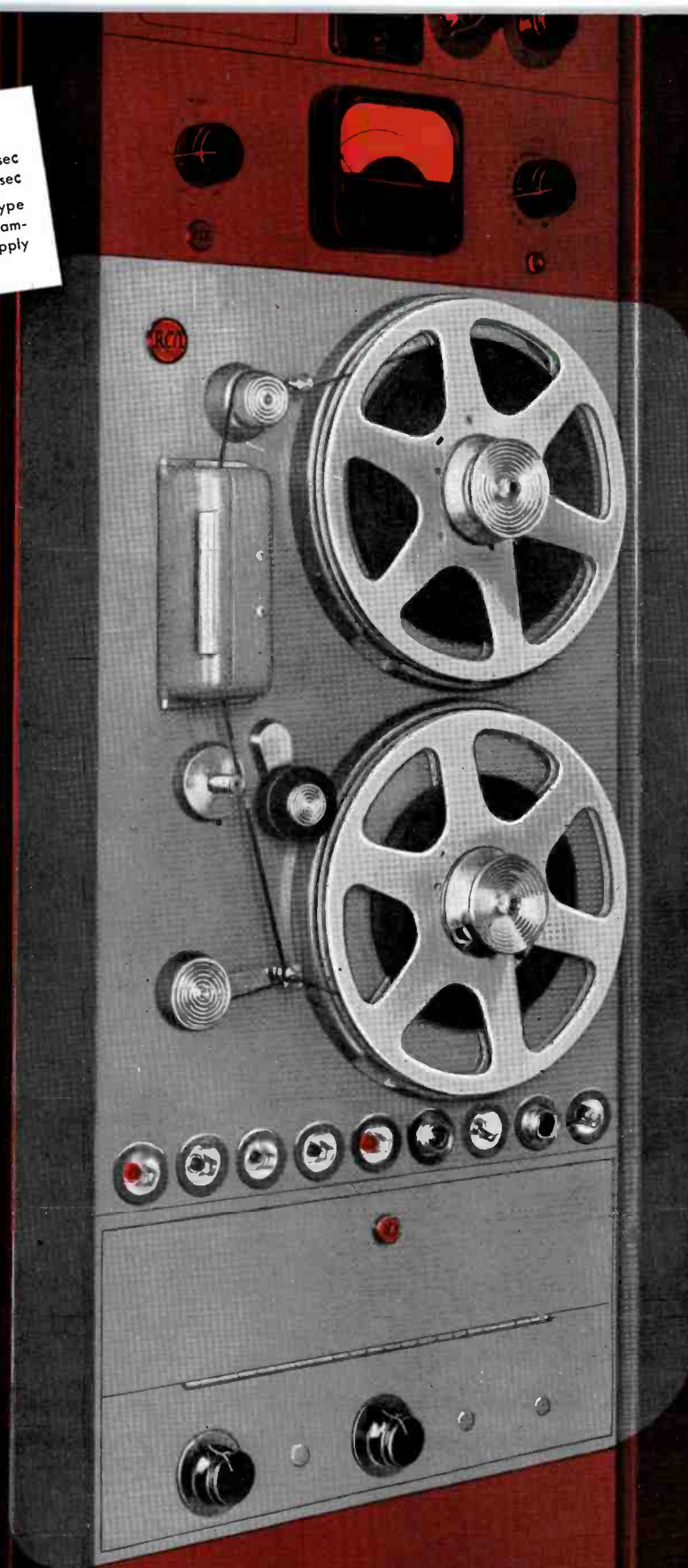

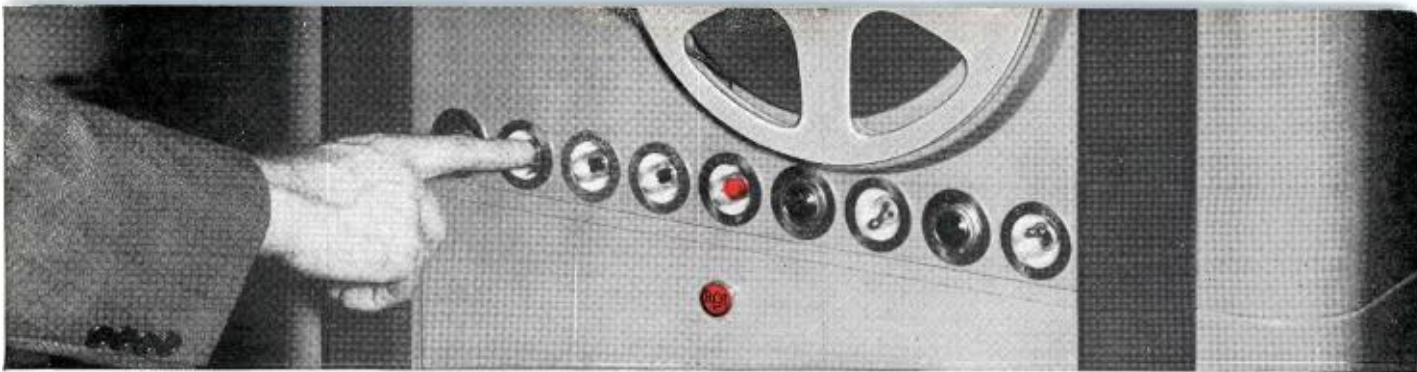

PUSH-BUTTON CONTROL puts tape recording facilities at your fingertips.

The RCA RT-11B

High-Fidelity Tape Recorder

-the finest money can buy!



Remote Control Unit, MI-11948. Available extra.

This is the world's foremost professional tape recorder, the one recorder that has *everything*—accurate timing, low wow and flutter, plus quick starting. All operations are push-button controlled. All functions—including cueing—can be extended to remote positions.

Designed for applications where operating **TIME** and **RELIABILITY** are prime factors, the new Type RT-11B Recorder offers a number of exclusive features. For example, you can start or stop the tape in 0.1 second. You can jockey the tape back and forth for cueing without stopping. You can rewind a standard 10½-inch reel in one minute!

A synchronous capstan makes it practical to hold recording time to $\pm 2\frac{1}{2}$ seconds in a 30-minute run.

And with synchronizing equipment . . . for which provision is made . . . *timing can be held to 0.3 second on any length program!*

Many more important features, too.

Self-centering "snap-on" hub adaptors assure perfect reel alignment with either RMA or NAB reels. A complete system of control interlocking virtually eliminates the possibility of accidentally erasing a program—makes it impossible to snarl or "spill" the tape. "Microswitch" control stops the machine if the tape is severed—applies reel brakes instantaneously. The tape automatically lifts *free and clear* of heads during fast forward runs or re-winds. Tape alignment over the heads is held precisely by a floating casting. Starting wow is reduced to the vanishing point.

BY ALL MEANS, call your RCA Broadcast Sales Representative for complete details. Or mail the coupon.



RADIO CORPORATION of AMERICA
ENGINEERING PRODUCTS DEPARTMENT CAMDEN, N.J.

Broadcast Audio Sales,
RCA Engineering Products,
Camden, New Jersey

Send me more information (including price and delivery) on your new De Luxe Tape Recorder, Type RT-11B.

NAME _____

ADDRESS _____

STATION OR FIRM _____

CITY _____ STATE _____



The ONLY professional turntable
tailored specifically for
"fine groove" 33 $\frac{1}{3}$ or 45

- **New, smaller size** . . . only 28" high, 20" wide, 16 $\frac{1}{2}$ " deep
- **Faster starts.** Full speed in less than $\frac{1}{4}$ turn
- **Easier cuing** . . . through faster starts and disengaging of driver idlers
- **Goodbye operating errors.** Center hole diameter changes

automatically with speed changes

- **No record slippage.** The center of the platter is recessed to handle the inside shoulder of 45's. Easy to handle
- **Wow and flutter** as low as RCA 70 series turntables

SMALLER than any Professional Broadcast turntable . . . yet capable of delivering the same high-quality output as RCA's famous 70 series . . . Type BQ-1A is your answer for a simple-design turntable matched and styled to meet the trend in transcription requirements. It enables you to take full advantage of the vast library of 45's and 33 $\frac{1}{3}$'s now available. It takes up less space in your control room. It enables you to take advantage of the important space-saving features offered by "fine-groove." AND NOTE THIS FACT: *The price is right!*

Type BQ-1A is ready for immediate delivery, complete—or mechanism only. For details, call your RCA Broadcast Sales Representative.

RCA Type BQ-1A Fine-Groove Transcription Turntable. There is ample room for a booster amplifier—and plenty of shelf space for program records.



RADIO CORPORATION of AMERICA
 ENGINEERING PRODUCTS DEPARTMENT
 CAMDEN, N. J.

RCA FREQUENCY MEASURING SERVICE

For accuracy...
for reliability...

**OBTAIN YOUR
FREQUENCY MEASUREMENTS
FROM RCA
WORLD LEADER IN
RADIO AND TELEVISION**

- Enables the station operator to:**
- 1. maintain transmitting equipment within licensed limits.**
 - 2. detect and correct harmonics, parasitics, and spurious radiations.**

Accuracy: 4 parts in 10,000,000

SCOPE OF SERVICE

Measuring service is provided for the frequency spectrum from 13 kilocycles to 500 megacycles—and for all classifications including:

Amateur	ST Link
Aviation	Citizen's Radio
Broadcast	Experimental
AM, FM, and TV	Transportation
Educational (FM)	Land
High Frequency	Maritime
(International)	Public Safety

Service is also provided to stations in many foreign countries.

FM and TV measurements are limited to areas within 300 miles of Riverhead, New York and Point Reyes, California.

TYPES OF MEASUREMENTS

Three types of measurements are available. They meet every need of the station operator for measurement service.

The three types are:

- 1. Regular Measurements**—a periodic service calling for measurements to be made to a prearranged schedule.

Upon request, "Off Frequency" Reports are also made to stations using this service. These latter reports are unscheduled and are rendered by the laboratories when technicians scanning the bands discover a station operating outside its limits.

- 2. Single Measurements.**

- 3. Group Measurements**—which provide for more than one measurement to be made at a given time, such as the frequencies of more than one transmitter, of different adjustments of the same transmitter, or of 2 or more signals interfering with each other.

MEASURING EQUIPMENT

The equipment used in RCA Frequency Measuring Laboratories has been designed solely for precision frequency measuring operations.

In general, the method of measurement is a comparison of the received signal with exacting frequencies produced by harmonic generators, which are controlled by the output of a 100 kilocycle primary standard.

Accuracy is better than 4 parts in 10 million.

RCA COMMUNICATIONS, INC.
A SERVICE OF RADIO CORPORATION OF AMERICA



Service Mark ®

FREQUENCY MEASURING SERVICE

140 Moriches Road
Riverhead, New York

28 & 36 Geary St.
San Francisco 8, Calif.

WRITE ADDRESS NEAREST YOU FOR ADDITIONAL INFORMATION

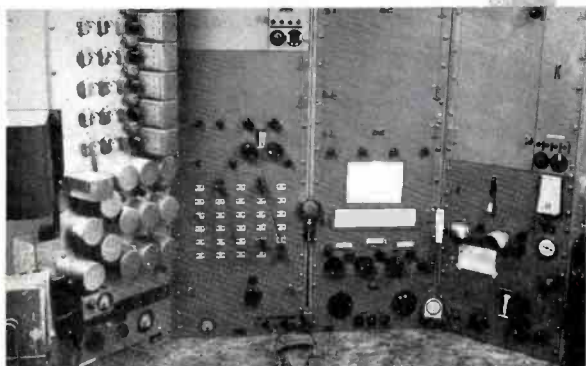

RCA Communications frequency measuring installation

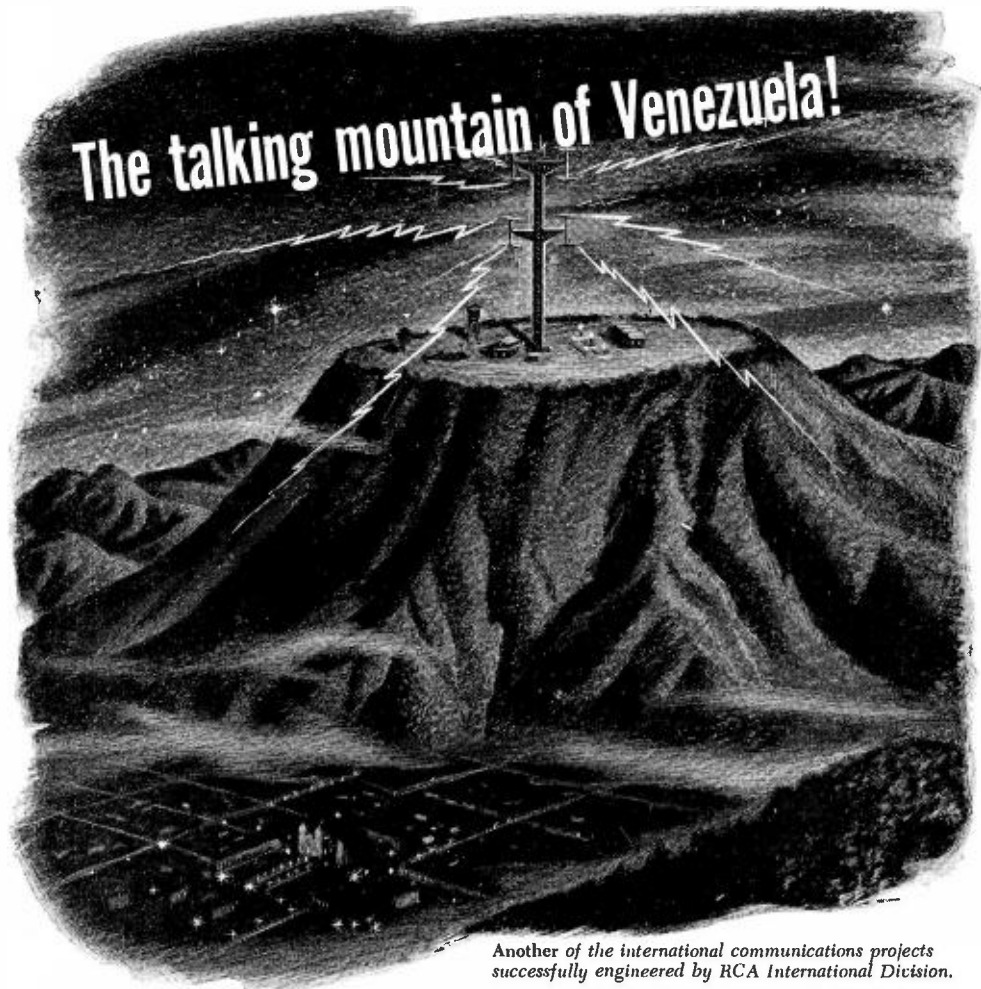

Another of the international communications projects successfully engineered by RCA International Division.

A modern industrial adventure . . . in which a mountain is moved, cities are built, and distances are annihilated through radio communication.

It's a mountain called "Cerro Bolivar." Separating it and its iron ore from Fairless Works in Morrisville, Pennsylvania, and other plants of United States Steel, are thousands of miles of open sea, jungle, grassy tablelands and rivers. The problems . . . to provide engineering, mining equipment, personnel, living quarters, transportation . . . and instant communication between all operational points.

Today the mountain "talks." A city is rising where the Caroni River joins the great Orinoco. A 90-mile railroad is pushing up the tablelands to the mine. Roads are being built. Dredges are

deepening almost 200 miles of the Orinoco to open sea to float specially designed ore ships.

RCA radio knits the entire operation together through instant voice communication between all executive and operating units. The mountain "talks" to the dredges, ore vessels, automotive vehicles and railway, the crews in their floating quarters, survey parties and water taxis . . . a flexible system of continuous 2-way radio.

Co-ordination of high degree was required. Communications experts of RCA joined hands with Venezuelan officials; Orinoco Mining Company,

subsidiary of U. S. Steel; with Bechtel International; Morrison-Knudsen, Gahagan Overseas Construction Company and McWilliams Dredging Overseas Corporation, The Paul Godley Company and other international engineering firms.

RCA products and services are available in all world markets open to trade, through RCA distributors and associated companies. The new book, "Communications, Key to Progress" tells the inspiring story of radio at work in many countries. Simply write to RCA International Division, 30 Rockefeller Plaza, N.Y., U.S.A.

World Leader in Radio
First in Recorded Music
First in Television



RCA INTERNATIONAL DIVISION

RADIO CORPORATION of AMERICA

RCA BUILDING

30 ROCKEFELLER PLAZA, NEW YORK, N.Y., U.S.A.

® "Marcas Registradas"

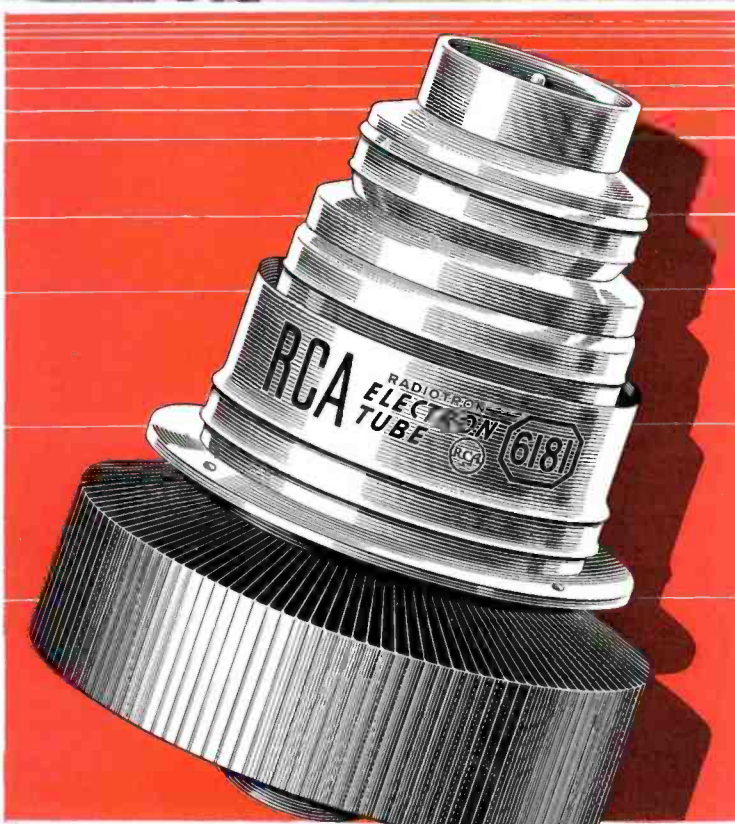

New RCA-6181 power tetrode used in RCA 1-Kw UHF television transmitter type TTU-1B.

New UHF Stations



with the RCA-6181

UHF TELEVISION is now a reality! And the RCA-6181 power tetrode is playing a vital role in new station operations.

Many features have been incorporated in this new tube which provide important operating advantages. The use of forced-air cooling permits substantial operating economies: ceramic bushings are used between

terminals to reduce power loss. The coaxial-electrode structure of the 6181 is designed especially for use with high-power circuits of the coaxial-cylinder cavity type; its indirectly heated, low-temperature, coated cathode assures long serviceability.

Specify RCA when you need tubes for replacement.

KEEP IN TOUCH WITH YOUR LOCAL RCA TUBE DISTRIBUTOR FOR THE LATEST TUBE DEVELOPMENTS.



RADIO CORPORATION of AMERICA
ELECTRON TUBES

HARRISON, N. J.



**IDEAS
from RCA**



No speed limit ON THIS SKY HIGHWAY

**RCA Microwave Radio Relay offers fast, all-weather route
for two-way communication and control**

For high-speed, multi-channel communication—for communication that knows no weather problems—RCA now offers industry a new miracle in practical form—RCA Microwave Radio Relay.

At any instant this new electronic development can handle up to 24 simultaneous messages—relaying a narrow UHF radio beam from tower to tower—over distances of several miles to several thousand miles. Without the vulnerability of wire lines—without the installation and maintenance problems of wire lines—RCA Microwave carries telephone, teletype, and tele-

graph messages, remote-control impulses, and meter readings at close to 100% continuity of service.

Because "RCA Microwave stays in service when you need it most," it is fast becoming the top communication tool of all types of right-of-way organizations. Pipeline companies, utilities, turnpikes, and government agencies consider it the most dependable way to conduct business over long distances.

For your copy of RCA's informative booklet, "INTRODUCTION TO MICROWAVE," check item (1) in the coupon at right.



RADIO CORPORATION of AMERICA
ENGINEERING PRODUCTS DEPARTMENT

CAMDEN, N.J.



**IDEAS
from RCA**

5 Trucks do the work of 7 with RCA 2-Way Radio—Industrial trucks can (and do) pay off when they're available 100% of the time. At Standard Pressed Steel of Jenkintown, Pa., dispatcher keeps in contact with all trucks—locates operators and dispatches trips without deadheading—with RCA 2-Way Radio. Before radio was installed, Standard Pressed Steel planned a seven-truck fleet to take care of its heavy materials handling load. With RCA 2-Way Radio, five trucks do the job.

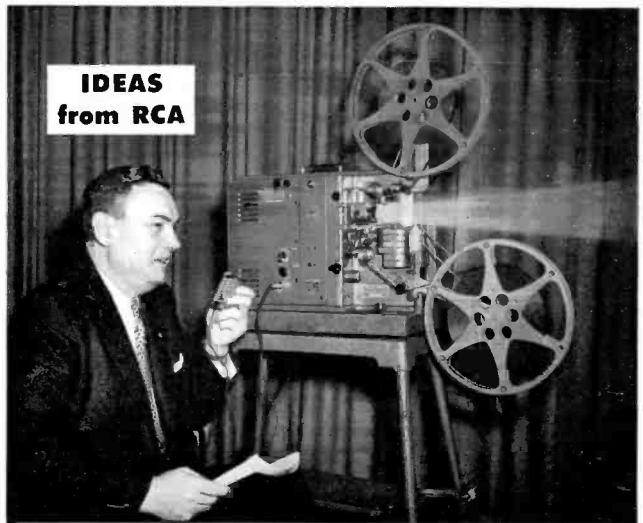

**IDEAS
from RCA**

Now make your own sound films. RCA now puts two ideas to work in its new magnetic recorder-projector—(1) the finest in 16mm projectors and (2) the speed and savings of magnetic recording. Using a magnetic stripe, applied to film, this new projector lets you add your own sound to new or old films—lets you make a complete sound film for less than \$1,000. Change your sound track at any time. Play it back instantly. Use it to make a single film talk to various audience levels.

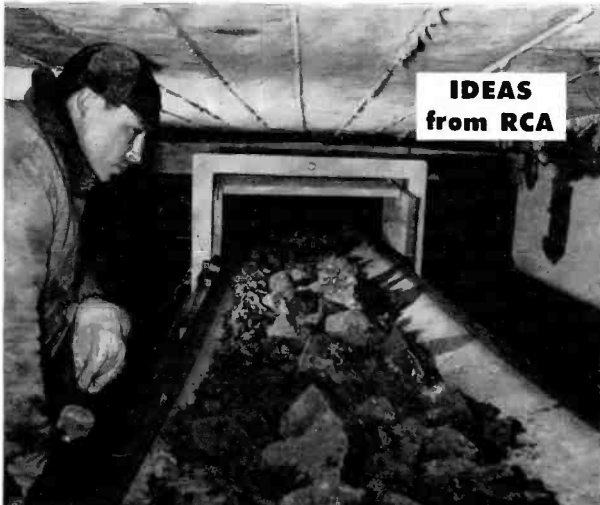

**IDEAS
from RCA**

Metal detector probes through rock. RCA Electronic Metal Detector—for years the standard method of locating stray metal in foods, textiles, plastics, rubber, tobacco, and explosives—has recently taken on a man-sized job in a rock quarry. Its assignment? Locating digger teeth and drill bits to prevent damage to crushers. For normal, in-plant applications, the RCA Metal Detector searches through bulk material or packaged goods to find metal contamination as small as a steel sphere, 0.039" diameter.

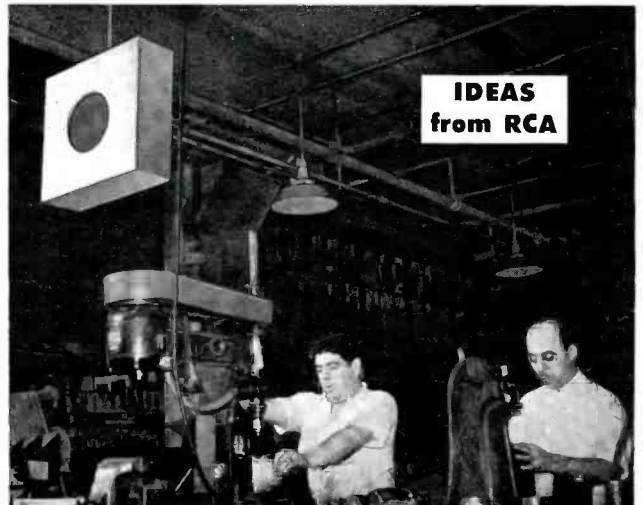

**IDEAS
from RCA**

Plant sound system proves up. Personnel men used to say, "We think work music is an important answer to high production costs." Now, the figures are in, and they make an impressive argument for sound in the plant. In recent checks, RCA discovered work music, provided by an RCA Sound System, "relieved monotony"—increased efficiency. (When music was cut off, rejects increased.) Results like these are evidence of RCA's broad background in the techniques of enjoyable in-plant listening.



FOR INFORMATION MAIL COUPON NOW

RCA ENGINEERING PRODUCTS
Dept. 26QE, Building 15-1
Camden, New Jersey

Please send me literature on:

1. RCA Microwave
2. RCA 2-Way Radio
3. RCA Magnetic Recorder-Projector
4. RCA Metal Detector
5. RCA Sound

Name _____ Title _____

Company _____

Address _____

City _____ Zone _____ State _____

Completely New!

RCA TV CAMERA

TYPE TK-11A

Leading network engineers proclaim the TK-11A the finest television camera ever produced—the easiest camera in the world to handle—and the simplest one to get at. It has all the proved performance advantages of the world-famous RCA TK-10 camera—PLUS THESE NEW FEATURES:

NEW 7" viewfinder picture tube produces larger, brighter, sharper pictures to help the cameraman.

NEW plug-in, high-stability video amplifier—with frequency response uniform to 8.5 Mc.!

NEW fixed-position alignment coil for the Image Orthicon. Electrical control of coil eliminates all mechanical adjustments!

NEW plug-in blower for cooling the deflection coil and Image Orthicon!

For complete information on the TK-11A, call your RCA Broadcast Sales Representative.

NEW electronic-protection system guards Orthicon against deflection failure, or loss of driving signals.

NEW "overscan" control takes burden off Orthicon during warm-ups and rehearsals; new vertical reverse switch for film pickups.



One latch opens both hinged sides and top. Dual bar handles provide better grip and easier carrying.



RADIO CORPORATION of AMERICA
ENGINEERING PRODUCTS DEPARTMENT CAMDEN, N.J.