

AM · FM · TELEVISION

BROADCAST NEWS

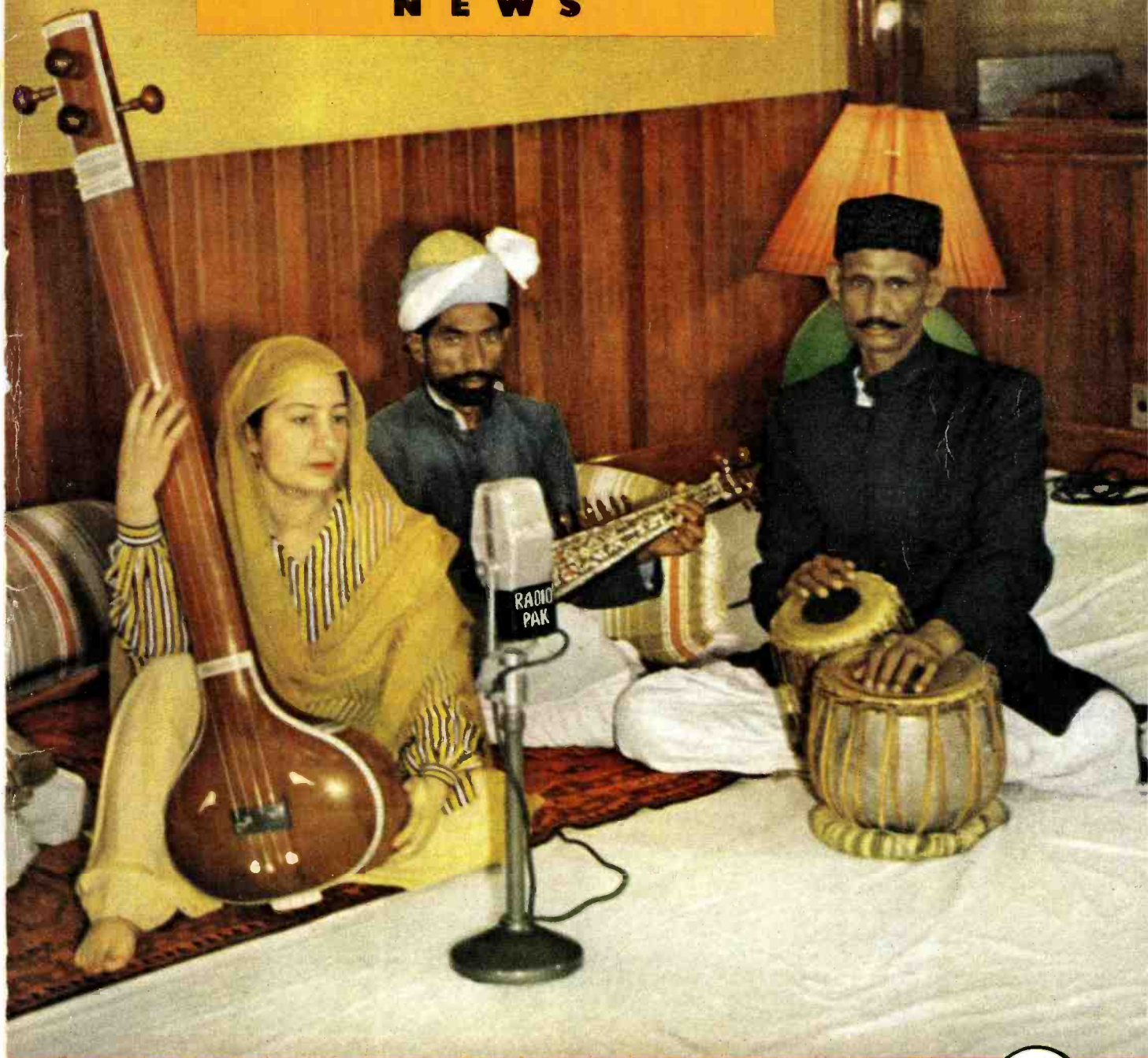

Radio Joins East and West Pakistan . . . See Page 6

Vol. No. 76

Sept.-Oct., 1953



Ever the East meets West...in Pakistan

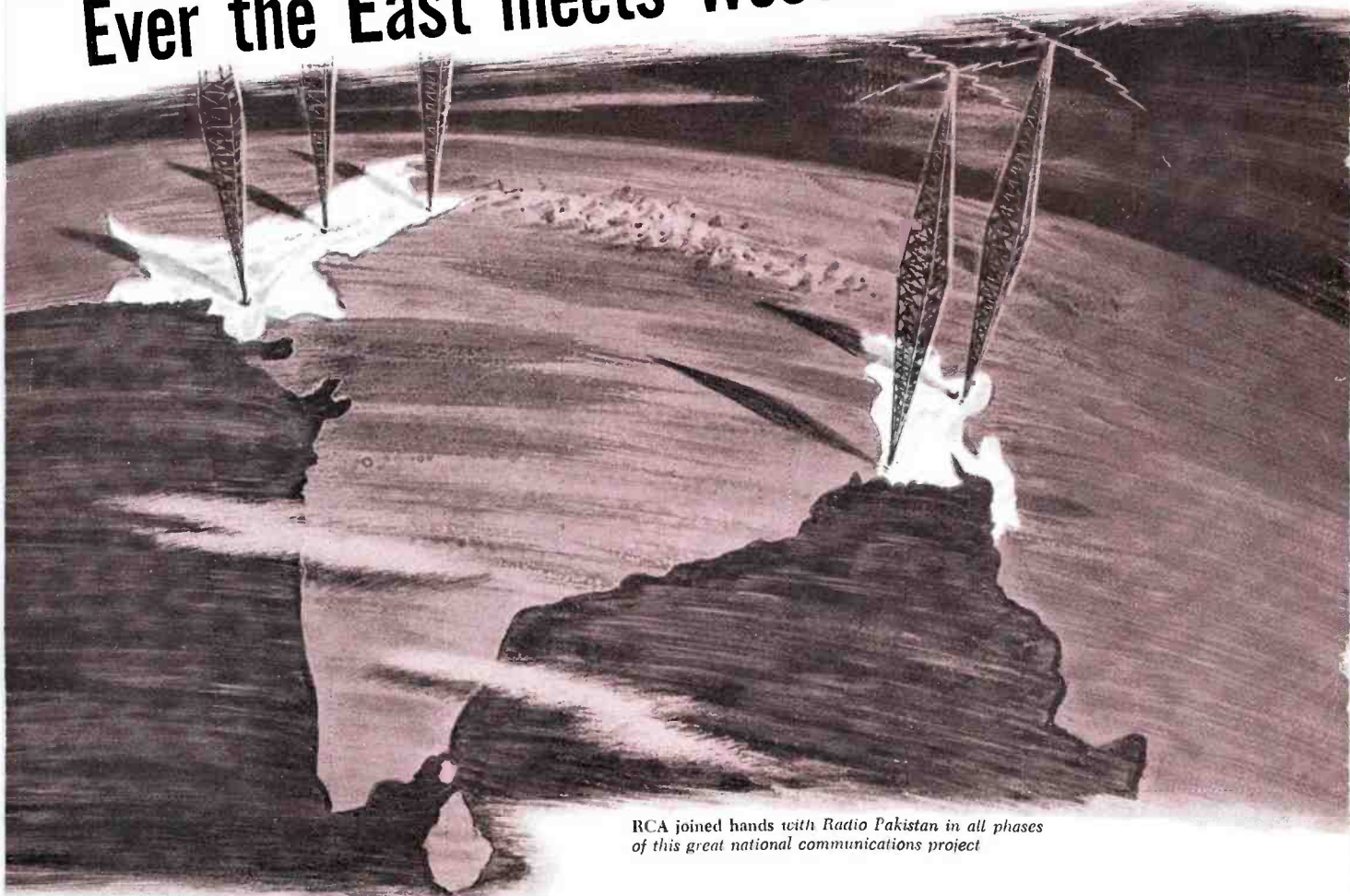

RCA joined hands with Radio Pakistan in all phases of this great national communications project

How the two parts of a great country achieve unity in spite of a 1,000-mile separation... by means of modern radio broadcasting

Six years ago Pakistan had neither a government nor a capital. There were over 77 million people and 360,000 square miles of land, but commerce was almost at a standstill... transportation and communications were disrupted. And the greatest migration in history was taking place... 7,000,000 displaced persons crowding into the as yet unorganized nation.

The years have wrought an astounding change. Today Pakistan is far advanced in a co-ordinated program of enlightenment and education for its own people... and deeply concerned in helping to promote greater understanding, tolerance and friendship among the peoples of the world.

Radio has played a great part in Pakistan's rapid development. From the very birth of the new nation, radio was used as the quick and sure medium of communication, of enlightenment. Radio Pakistan came into being... attracted competent engineers to its program... developed into a compact powerful voice. To RCA was given the job of providing the powerful radio equipments installed by Radio Pakistan.

Today in Pakistan there are two 50 KW shortwave stations operating on an international schedule. A 7½ KW shortwave transmitter at Dacca is used to link East with West Pakistan. A 5 KW broadcast transmitter at Dacca covers East Pakistan. Others

join the great network at Lahore, Peshawar and Rawalpindi... operating a total broadcast time of 96 program hours a day.

Radio Pakistan is completely co-ordinated. Its nine transmitters link all sections of the nation into one united network... as well as being an enlightened voice heard 'round the world.

RCA products and services are available in all open world markets, through RCA distributors and associated companies. The new book "Communications, Key to Progress" tells the inspiring story of radio at work in many countries. Write to RCA International Division, 30 Rockefeller Plaza, N.Y., U.S.A.

"Marcas Registradas"

World leader in radio,
first in recorded music,
first in television



RCA INTERNATIONAL DIVISION

RADIO CORPORATION of AMERICA

RCA BUILDING 30 ROCKEFELLER PLAZA, NEW YORK, N.Y., U.S.A.

Broadcast News

AM • FM • TELEVISION

Published by the

RADIO CORPORATION OF AMERICA

ENGINEERING PRODUCTS DEPARTMENT . . . CAMDEN, NEW JERSEY

NUMBER 76

SEPTEMBER-OCTOBER, 1953

Subscription Rates

In continental U. S. A. . . \$4.00 for 12 issues
In other countries \$5.00 for 12 issues

JOHN P. TAYLOR, Editor

W. O. HADLOCK, Managing Editor

E. C. MASON, M. G. MOON, Associate Editors

Contents

RADIO BRIDGES 1000 MILES — JOINS EAST AND WEST PAKISTAN	6
THE GROWTH OF WHBQ — MEMPHIS, TENN. <i>by</i> WELTON ROY	12
WBAP — "WHERE THE WEST BEGINS"	18
CUSTOM BUILT STUDIO CONTROL CONSOLES FOR WBAP <i>by</i> A. S. KARKER	42
DELUXE MASTER CONTROL ROOM EQUIPMENT AT WBAP <i>by</i> M. E. GUNN	48
NOVEL LOCATION OF TERMINAL BOARDS MAKES WIRING EASY AT WBAP	54
KDKA CHOOSES RCA TYPE RT-11 PROFESSIONAL TAPE RECORDERS <i>by</i> T. C. KENNEY	56
NEW RCA EQUIPMENT COMPONENTS FOR HIGH FIDELITY FANS	58
ACTION OF THE CONICAL DOMES IN THE LC-1A LOUDSPEAKERS	64
WABI-TV REMOTES LOCAL BASKETBALL TOURNEYS	66

Copyright 1953
Radio Corporation of America
RCA Victor Division
Camden, N. J.

TMKS ®

2J8770

PRINTED
IN
U. S. A.

OUR COVER this issue, it is hardly necessary to say, is a scene in the studios of Radio Pakistan in Karachi. The story of Radio Pakistan (Pg. 6) is one of disheartening and perplexing difficulties overcome by determination and ingenuity. We think that the accomplishment of Radio Pakistan engineers in the face of such overwhelming obstacles will be of interest to radio engineers the world over.

EAST IS EAST, and west is west, and never the twain shall meet—according to Kipling. But in this issue of BROADCAST NEWS they do. (See Pg. 6 and Pg. 18.)

Not that we planned it that way! In fact quite the opposite. The Pakistan story—and the ad on the inside cover—were sent to us by Bill Reilly, who, as Advertising Manager of the RCA International Division, is sort of ex-officio foreign editor of BROADCAST NEWS. The editor, meanwhile, was working up the WBAP story. When Managing Editor Bill Hadlock put the two stories together in his makeup we were all surprised at the juxtaposition.

Our first impulse was to change the story titles a bit to reduce the confusion. On second thought we decided to let them stand. So we're a little confused as to where east ends and west begins. Who cares. The important point is that wherever you go—all around the world—you find RCA broadcast equipment. And everywhere you find it rated tops in performance and in prestige. Those who have RCA equipment are proud of it—those who don't wish they did.

ENGINEERS ARE VIPS, we've said it before, we'll say it again. Installations like WBAP's are the proof. Consider the simple facts. An installation of this kind represents an investment of perhaps two million dollars. On this basis a difference of 5% in plant operating efficiency represents a difference of possibly \$100,000 in investment. And who contributes most to the planning that pays off in operating efficiency? Almost always it is the chief engineer of the station. He is the one who says how much space is needed for production and operating functions, what the relative arrangement of these spaces should be, and how they should be equipped. An architect may draw the plans—but it is the chief engineer who tells him what, how much, and where. To do this the engineer must have knowledge (based on experience), vision (to foresee future expansion), and ability to communicate his ideas. That's a potent combination. And the engineer who has it is a mighty valuable man.

WBAP gets a lot of attention in this issue. For this we make no apologies. As all can see, it is one of our favorite stations! Not just because it is big and beautiful. And not just because we personally know and like the people at WBAP. But also because WBAP is one of a score of big stations who have been our very best customers for a long, long time. Most of these stations have used our equipment for over twenty years—through AM, FM and TV. They've seen us make mistakes (who wouldn't in this complex business). They've lived with some of the monstrosities we've built—and they've helped us take the bugs out of them. And all the while they've kept on buying our equipment. Their confidence in us gives us confidence. The kind of confidence that enables us to modestly say "year in and year out, you do best with RCA."

KGMB-TV

"During our construction period we received the most unusual co-operation from everyone at RCA. Since going ON-AIR, the quality and continuity of equipment service has been gratifying."



C. RICHARD EVANS
VICE-PRESIDENT & GENERAL MANAGER
KGMB-TV

WSBT

"...our 1-KW UHF transmitter and UHF Pylon Antenna are giving us far greater coverage than we anticipated. We are more than pleased with the excellent results."



NEAL B. WELCH
GENERAL MANAGER, WSBT-TV

WKBS BROADCASTING CORPORATION

"...our confidence in UHF television, and 'RCA All The Way,' was not misplaced."



WARREN P. WILLIAMSON, JR.
PRESIDENT & GENERAL MANAGER,
WKBS-TV

What Telecasters say

WABI-TV

"Our TT-500A is putting out a beautiful picture every day--with practically no maintenance whatsoever."



MURRAY CARPENTER
MANAGER, WABI-TV

WJTV Channel 25

"RCA can feel justifiably proud of their 1-KW UHF Transmitter, UHF Pylon Antenna, studio, and remote equipment installation. Our RCA transmitter is giving us a signal far in excess of what our engineers originally calculated."



JOHN ROSSITER
GENERAL MANAGER, WJTV



WBRE

"Our 1-KW UHF Transmitter has proved to be all that could be desired. Since our first day of operation we have consistently maintained 100% power."



PETER B. KENNEY
STATION MANAGER



JULIAN GROSS
PRESIDENT

WBRE

"...our RCA 1-KW UHF Transmitter is working so well our coverage has exceeded our wildest expectations. We are delighted with our fully RCA-equipped dual studio, film room, and control room layout."



DAVID M. BALTIMORE
GENERAL MANAGER, WBRE-TV

KFDM Beaumont, Texas
KFDX Wichita Falls, Texas

"For 20 years we have operated our Radio Stations on the policy that our equipment must be nothing less than the best. Naturally we chose an RCA 10-kw transmitter and associated RCA TV equipment for KFDX-TV."



DARROLD A. CANNAN
PRESIDENT, KFDM KFDX-TV

Radio Station **KTRC**

"The RCA 12-section Antenna is performing in splendid fashion. As a matter of fact, its performance exceeds the promise made by your Sales Representative."



J. C. KELLAM
GENERAL MANAGER, KTRC-TV

KTSM

"We are glad we are RCA ALL THE WAY...RCA personnel has been helpful at all times... I'll recommend RCA equipment any time."



KARL O. WYLER
PRESIDENT, KTSM-TV

WFPQ

"Your constant attention and service has earned our deepest appreciation and has made it possible for us to render maximum, dependable TV service..."



FRED WEBER
PRESIDENT, WFPQ-TV

about **RCA** Equipment

FOR A PROFESSIONAL OPINION on the finest TV equipment you can buy, ask the management man who operates a modern television station.

For a professional analysis of your TV station requirements, ask the experienced equipment man who *knows* his TV station planning . . . YOUR RCA BROADCAST SALES REPRESENTATIVE!



RADIO CORPORATION of AMERICA
ENGINEERING PRODUCTS DEPARTMENT, CAMDEN, N. J.

RADIO STATION **KR0D**

"KR0D-TV is completely RCA equipped... Our RCA 500-watt transmitter (temporarily installed) has done a very satisfactory job... Coverage (because of our high mountain-top location) has been phenomenal."



VAL LAWRENCE PRESIDENT & GENERAL MANAGER
DORRANCE D. RODERICK CHAIRMAN OF THE BOARD

KBTU

"Our new RCA Studio and Transmitter equipment combination produces the best picture I have ever seen on a receiver."



JOSEPH HEROLD
STATION MANAGER, KBTU

WROV

"...in addition to having excellent equipment, RCA personnel is certainly qualified to assist the telecaster."



FRANK E. KOEHLER
GENERAL MANAGER, WROV-TV

Put your UHF

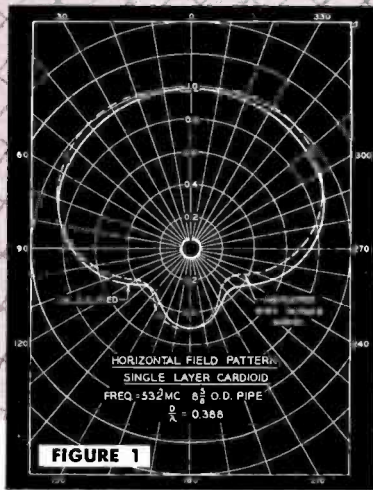

Do you require "single-direction" coverage?

If so, RCA has UHF Pylons that can produce horizontal field patterns shaped like a Cardioid. Figure 1 shows the calculated pattern, and a measured model pattern, of a "Cardioid directional" Pylon. Operating frequency, 532 Mc.

Do you require "elongated" coverage?

If so, RCA has UHF Pylons that produce a horizontal field pattern shaped like a peanut. Figure 2 shows the calculated pattern, and a measured model pattern, of this type of directional Pylon antenna.

Do you require "circular" coverage?

If so, RCA has a wide selection of UHF Pylons that produce equal signals in all directions.

Do you want BETTER overall coverage—lower signal losses?

All RCA UHF Pylons (directional and circular patterns) have built-in "Beam Tilt." Easily adjusted at your station by moving the inner conductor of the antenna up and down, this feature assures best possible coverage, with *minimum power loss in vertically polarized radiation.*

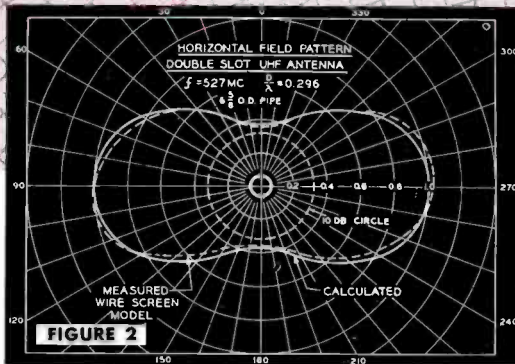

Do you need BETTER "close-in" coverage?

New, advanced null fill-in system, used in conjunction with beam-tilting, offers excellent close-in coverage—even for the "difficult" sites. Figure 3 is a typical measured vertical field pattern of an RCA UHF Pylon. Figure 4 is a nearly ideal field-distance curve produced by a "contour-engineered" UHF Pylon (actual record of a commercial TV station now "ON-AIR").

How much UHF gain do you need?

RCA UHF Pylons (standard circulars and directionals) can be furnished with gains in the order of 3, 6, 9, 12, 21, 24 and 27 (see table). No tuning compromises in RCA UHF Pylons—with resultant loss of gain (such as caused by cross-polarized components). *The gain that's published is the gain you get!*

RCA UHF Pylon design is simplicity—plus! Just one feedpoint for the line input

You find no protruding elements on RCA UHF Pylons. The smooth surface of the metal cylinder is the antenna itself. No physical connections on the antenna. Nothing to bend or break under ice or wind load. Signal loss in rain or heavy icing is negligible.

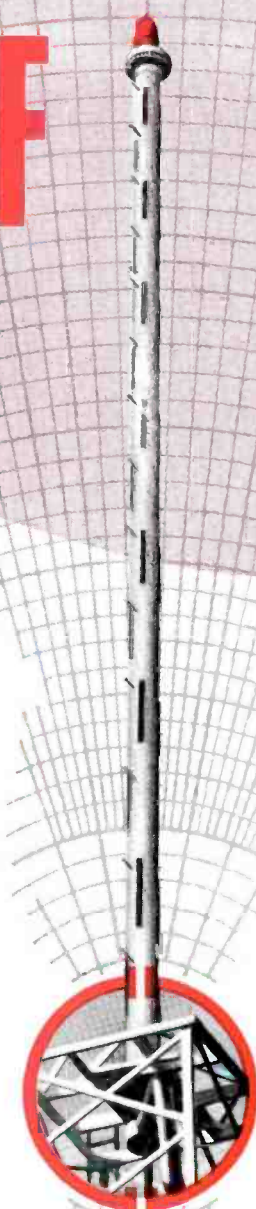

Typical installation of an RCA Adjustable Beam, High-Gain UHF Pylon

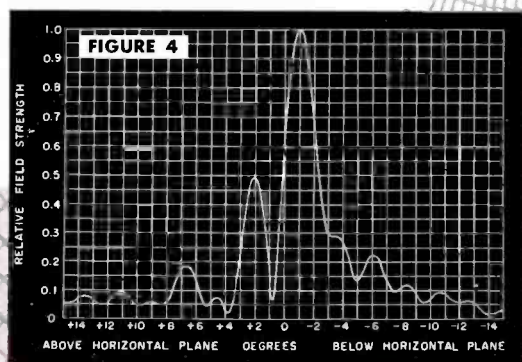
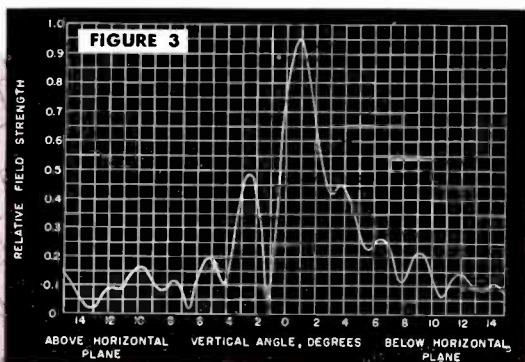

signal where the population is

—Use an RCA “contour-engineered”
UHF Pylon Antenna

Select the RCA UHF Pylon to meet your requirements

Channels	Relative Gain	Gain (DB)	Sections	RCA Type
14-30	3	4.77	2	TFU-3BL
31-50	3	4.77	2	TFU-3BM
51-83	3	4.77	2	TFU-3BH
14-30	6	7.78	4	TFU-6BL
31-50	6	7.78	4	TFU-6BM
51-83	6	7.78	4	TFU-6BH
14-30	9	9.54	6	TFU-9BL
31-50	9	9.54	6	TFU-9BM
51-83	9	9.54	6	TFU-9BH
14-30	12	10.79	8	TFU-12BL
31-50	12	10.79	8	TFU-12BM
51-83	12	10.79	8	TFU-12BH
14-30	21	13.22	14	TFU-12BLS
14-30	21	13.22	14	TFU-21OL
14-30	24	13.8	16	TFU-24BLS
14-30	24	13.8	16	TFU-24DL
31-50	24	13.8	16	TFU-24BMS
31-50	24	13.8	16	TFU-24DM
51-83	27	14.31	18	TFU-27BHS
51-83	27	14.31	18	TFU-27DH

No picture deterioration with an RCA UHF Pylon—Transmitter Combination, even when the antenna is covered with four inches of ice.

RCA UHF Pylons are shipped complete in one unit—“custom-tuned” for your frequency at the RCA factory—and tested by the most modern methods known to the television industry. You can put up a Pylon, connect the line, and throw the switch. *Tuning is not required at your station!*

RCA supplies specially-matched
UHF transmission lines

No UHF antenna functions properly unless your transmission line matches your antenna closely. RCA-designed line, not available anywhere else, has measured performance (VSWR) that is better than 1.05 to 1.0.



RCA supplies complete UHF accessories



Only when everything in your transmitting system is *matched*—from transmitter to antenna—can you be sure of maximum performance. In this respect, RCA can supply each and every accessory required to complete a UHF antenna installation, including the tower; mitered elbows, line transformers, spring hangers, dummy loads, wattmeters, frequency and modulation monitors, filterplexers, and hardware—down to the very last bolt. Everything is designed specifically to work with the UHF Pylon. And remember, everything is available from ONE responsible equipment manufacturer—RCA!

An antenna can make or break a TV station. The way it works depends on planning NOW. Take advantage of RCA's antenna-engineering “know-how” when you talk UHF—and be sure your antenna installation will meet your horizontal and vertical radiation requirements EXACTLY. Your RCA Broadcast Sales Representative is at your service.



RADIO CORPORATION of AMERICA
ENGINEERING PRODUCTS DEPARTMENT
CAMDEN, N. J.

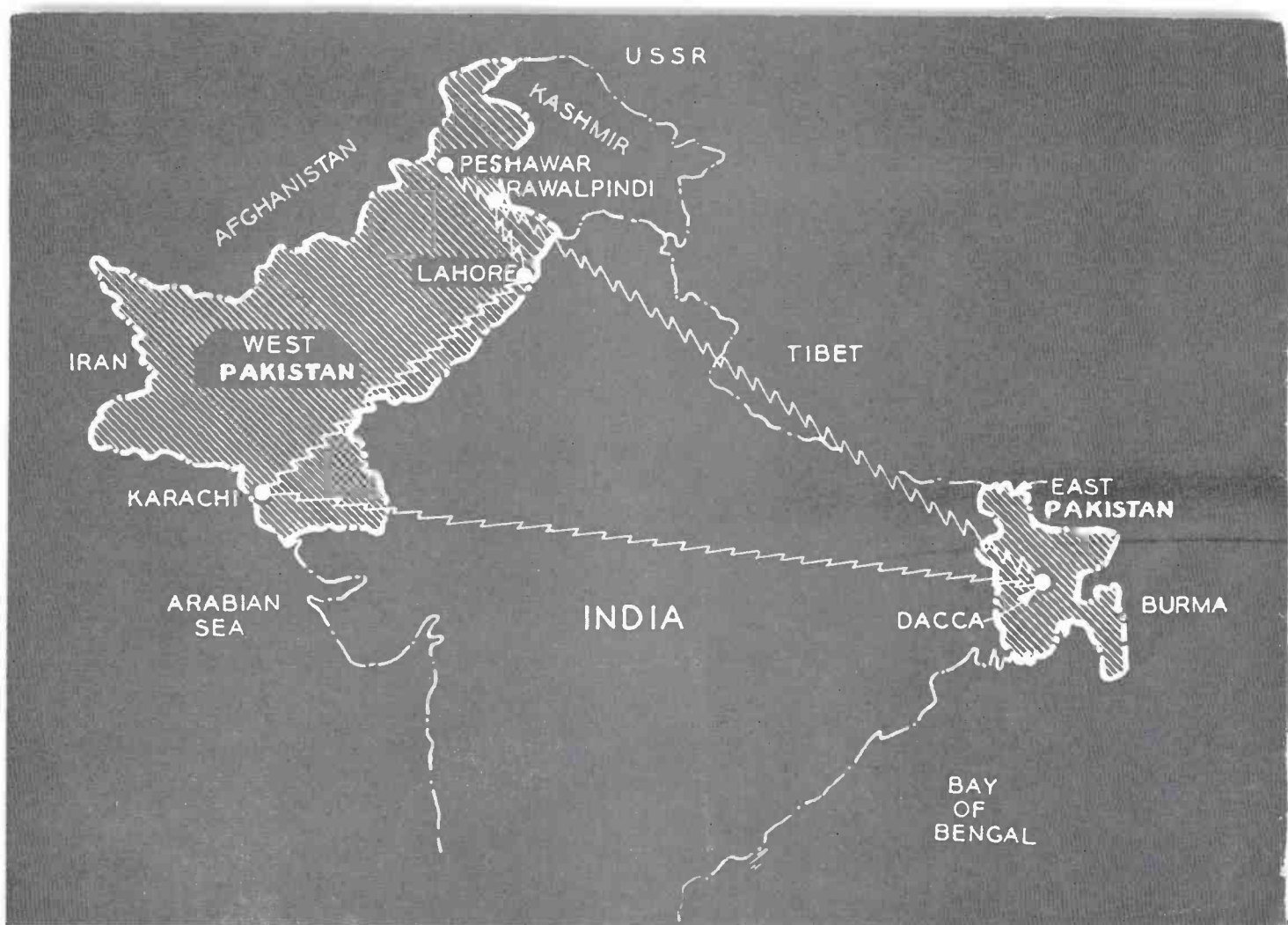

RADIO BRIDGES 1000 MILES -- -- JOINS EAST AND WEST PAKISTAN

Between East Pakistan and West Pakistan, a thousand miles of India intervenes. One of the world's mightiest radio networks, born with a new nation, speaks many languages to its people and the world.

Pakistan found its place on the world map only six years ago. This State of 80 million people is divided into two parts with one thousand miles of alien territory separating them. The new sovereign State was heralded by the chime of the midnight hour of the 14th of August, 1947. It had inherited three low power medium-wave stations from British India—one at Peshawar, in the Northwest Frontier Provinces; one at Lahore, the Capital of Punjab, 300 miles away from Peshawar; and one at Dacca, in East Pakistan, over a thousand miles

away from Lahore. And there were not more than nineteen engineers to man these three stations. Karachi, the Federal Capital, had no radio station at all.

Some of the problems which confronted the handful of Radio Pakistan workers on the morning of the 14th were: how to man the existing stations—there was chaos in the country and no recruitment was possible; how to maintain the technical efficiency of the three stations when spare parts were left unredeemable at Delhi; how

to centralize the news; and how to provide and where to locate a radio station to serve the Federal Capital.

The questions of maintaining the stations and the procuring of spare parts were left in the hands of Providence. News Units were created at Lahore and Dacca which also fed Peshawar on telephone lines. The News Units at these two places had to solve the problem of supplying news for, at that moment, there was no News agency in the country. The telephone wires connecting East and West Pakistan passed through India and, consequently, were of no real aid to Pakistan at the time. The small number of News Editors available to the Service struggled hard and managed to

broadcast at least four news bulletins a day in four different languages.

To secure equipment for the new State, the Chief Engineer of Radio Pakistan was flown first to England then to America; however, the equipment was just not available. The war had recently ended and the manufacturing countries were busy putting their own house in order. After a great deal of investigation, Radio Pakistan decided that the terms and the date of delivery of RCA were best, and an order for three short-wave and two medium-wave transmitters was placed.

A search was soon begun to select a suitable site for the location of these transmitters in Karachi, the Federal Capital of Pakistan. Karachi, at that time, had eleven aerodromes, and Radio Pakistan had to keep five miles away from each of them for the erection of its masts. It appeared as if Radio Pakistan would have to locate its facilities fifty-five miles away from the population of Karachi. This introduced another set of difficulties. Would the reception of medium-wave stations be good from such a distance? Since there was no public transportation available, how could personnel be transported to and from Karachi and the transmitter site? After a considerable search, a piece of land (suitable from a technical point of view) was discovered only seventeen miles from the town. Suggested designs for the building were obtained from RCA and the work was soon begun.

In the meantime, it was still necessary to serve the town of Karachi with broad-

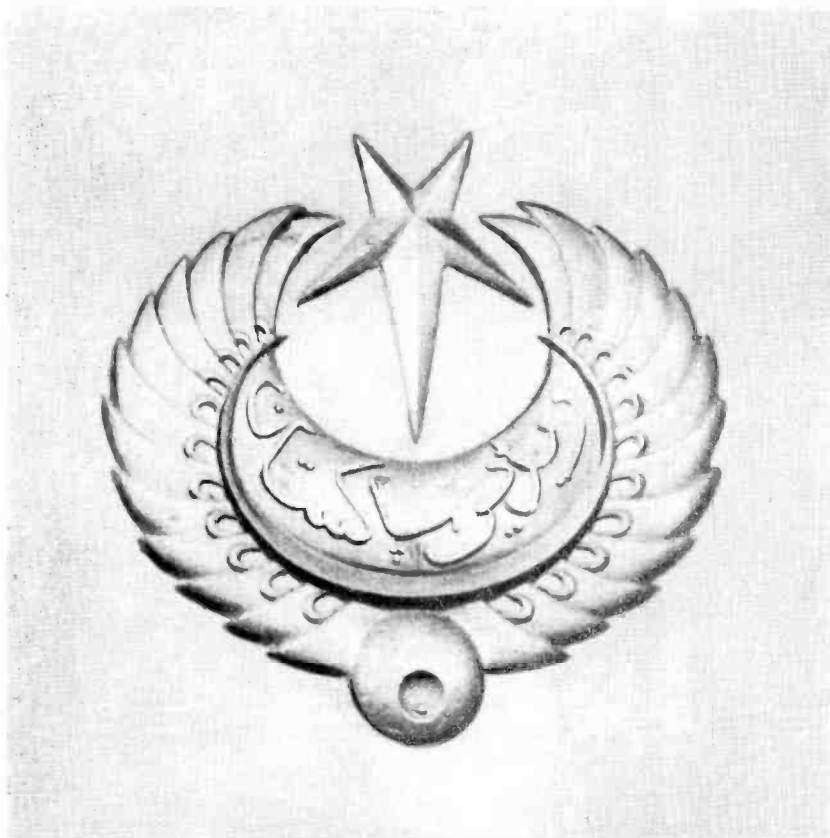

▲ The modern Center of Radio Pakistan, 17 miles outside of Karachi (see map, left hand page), bears the insignia of the organization. The Islamic reference is clearly defined while the eye and the wings of the falcon are symbolic of radio broadcasting and those whose lives are devoted to that service.

▼ The new Radio buildings provide the facilities where the high power transmitters and electric power generating equipments are installed, as well as offices for the engineering staff. The building in the foreground contains the transmitter hall, offices and emergency studio and associated speech input and transcription recording equipment. The electric power generators are housed in the building to the rear.

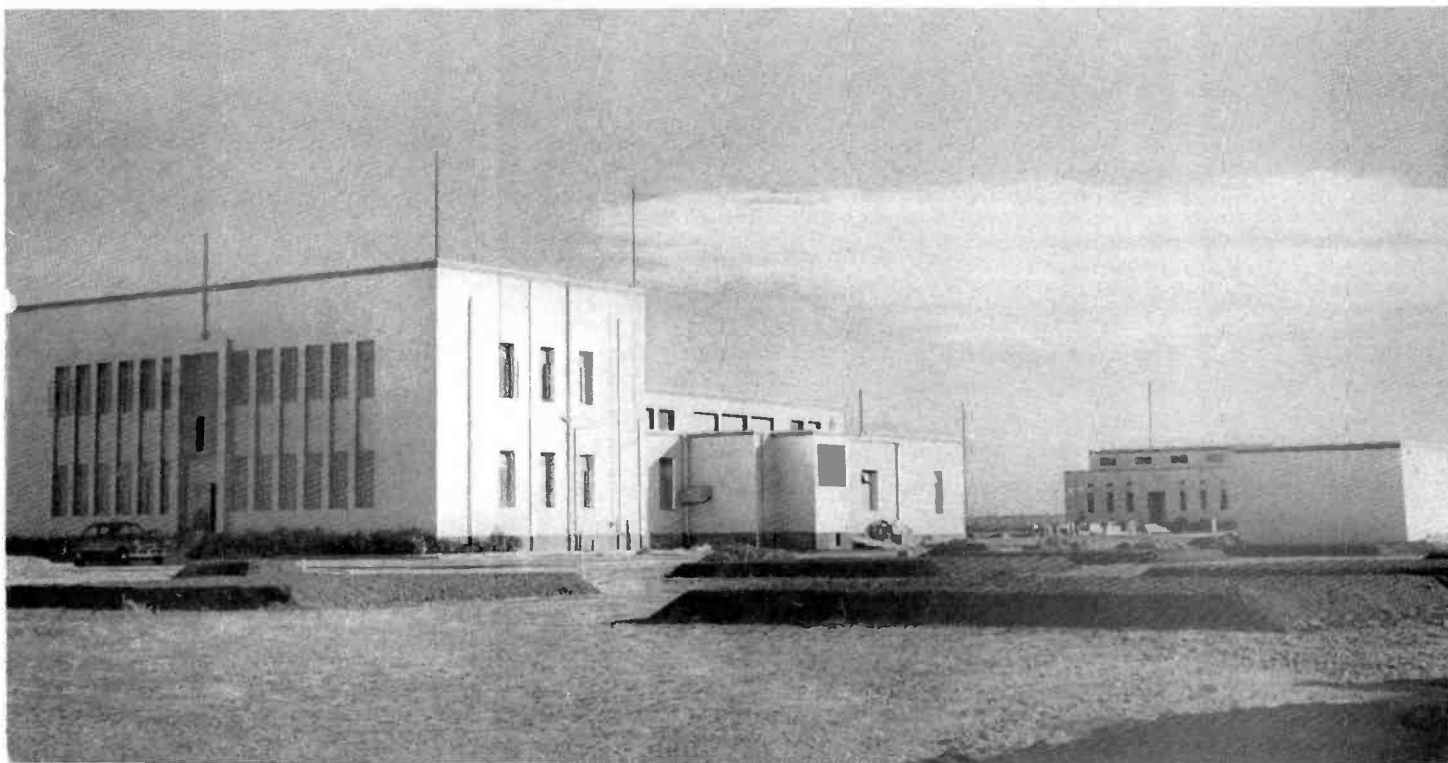



The spacious Transmitter Hall is equipped with two RCA 50 kilowatt, dual-channel, high frequency broadcast transmitters and one RCA 10 kilowatt medium frequency broadcast transmitter. The building has been designed so that additional equipment may be installed and additional construction carried out for future expansion.

casts. A discarded 200-watt medium-wave transmitter (Army-type) was discovered in a junk shop. This was installed in a hut to provide an interim of program service to the town. Offices were located in tents surrounding the transmitter.

Erection of the High Power Transmitter building took longer than Radio Pakistan had anticipated. Meanwhile, Radio Pakistan engineers erected masts for the antenna at the selected site and located a 10-kw medium-wave transmitter, supplied by RCA, in a 20' x 20' building on the other side of the road. This transmitter replaced the 200-watt station previously set up while improvised studios and the tents still remained to provide program service. As soon as the main building was ready, the transmitters were installed by Pakistan engineers. The local electric supply company

could not meet its commitments to supply power to the transmitters so generators were obtained from RCA—two to run 50-kw short-wave transmitters and two to run the medium-wave transmitter.

The 10-kw medium-wave transmitter at Karachi came into operation in November, 1948. The installation of a short-wave transmitter at Dacca (in East Pakistan) was completed on January 15, 1949. This short-wave transmitter was meant to give an extended program service to East Pakistan and, also, to serve as a link between East and West Pakistan. The East-West link, however, was completed on the 14th of August in the same year when the first 50-kw transmitter went on the air. The inauguration of this transmitter coincided with Pakistan's Second Anniversary. It was on this day, too, that Radio Pak-

istan centralized its Home News Service, and started four external program services directed toward its immediate neighbors—Burma on the east, and Afghanistan, Iran and the Middle East on the west. Even though reception of such external program services was uncertain in the target areas, the conviction that Pakistan had something to say of interest to the rest of the world sustained Radio Pakistan. Every effort was made to provide as effective a signal as was possible under the circumstances.

Meanwhile, installation of the second 50-kw transmitter was speeded up and Radio Pakistan was able to put it on the air on December 25, 1949, the birthday anniversary of the Father of the Nation, Mohammad Ali Jinnah. Radio Pakistan had installed three short-wave and one 10-kw medium-wave transmitters in addi-



▲
View of No. 2 RCA transmitter in Radio Pakistan's Transmitter Hall. The front panels of the transmitter are designed to allow ready access to the various units of equipment. Door actuated switches connect to an interlocking system to protect personnel against exposure to dangerous voltages.

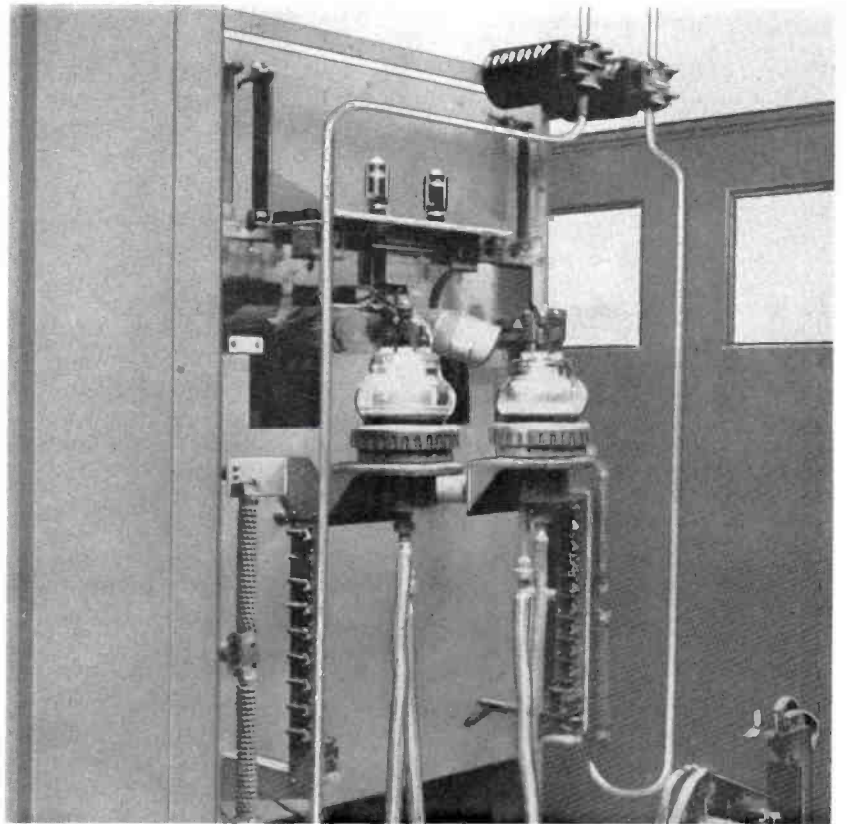

▶
The tube complement for the RCA transmitters has been carefully selected so that the number of different types is kept to a minimum in order to simplify the stocking of spares. The tubes shown here are those in the last modulator stage of one of Radio Pakistan's 50 kilowatt transmitters. These are the same type as those used in the radio frequency power amplifier.

لاہور گنت سنہ ۱۹۵۷ء	روز	سیر	۶:۱۰ پم	۱۰:۱۰ پم
۱۔	پنجشنبہ	۱۰ جولائی	۱۔ ۲۔	۱۔ ۲۔
۳۔	جمعہ	۱۱ جولائی	۱۔ ۲۔	۱۔ ۲۔
۴۔	ہفت روزہ	۱۲ جولائی	۱۔ ۲۔	۱۔ ۲۔
۵۔	جمعہ	۱۳ جولائی	۱۔ ۲۔	۱۔ ۲۔
۶۔	ہفت روزہ	۱۴ جولائی	۱۔ ۲۔	۱۔ ۲۔
۷۔	جمعہ	۱۵ جولائی	۱۔ ۲۔	۱۔ ۲۔
۸۔	ہفت روزہ	۱۶ جولائی	۱۔ ۲۔	۱۔ ۲۔
۹۔	جمعہ	۱۷ جولائی	۱۔ ۲۔	۱۔ ۲۔
۱۰۔	ہفت روزہ	۱۸ جولائی	۱۔ ۲۔	۱۔ ۲۔
۱۱۔	جمعہ	۱۹ جولائی	۱۔ ۲۔	۱۔ ۲۔
۱۲۔	ہفت روزہ	۲۰ جولائی	۱۔ ۲۔	۱۔ ۲۔
۱۳۔	جمعہ	۲۱ جولائی	۱۔ ۲۔	۱۔ ۲۔
۱۴۔	ہفت روزہ	۲۲ جولائی	۱۔ ۲۔	۱۔ ۲۔
۱۵۔	جمعہ	۲۳ جولائی	۱۔ ۲۔	۱۔ ۲۔
۱۶۔	ہفت روزہ	۲۴ جولائی	۱۔ ۲۔	۱۔ ۲۔
۱۷۔	جمعہ	۲۵ جولائی	۱۔ ۲۔	۱۔ ۲۔
۱۸۔	ہفت روزہ	۲۶ جولائی	۱۔ ۲۔	۱۔ ۲۔
۱۹۔	جمعہ	۲۷ جولائی	۱۔ ۲۔	۱۔ ۲۔
۲۰۔	ہفت روزہ	۲۸ جولائی	۱۔ ۲۔	۱۔ ۲۔
۲۱۔	جمعہ	۲۹ جولائی	۱۔ ۲۔	۱۔ ۲۔
۲۲۔	ہفت روزہ	۳۰ جولائی	۱۔ ۲۔	۱۔ ۲۔

SINDH, AUGUST		STATION CALLS
Karachi		
۳۶۵.6 metres (95 Kc/s)		
A.M. TRANSMISSION		
7-50 Urdu by Urdu and others	7-55 Arabic (Madrassah)	7-55 Arabic (Madrassah)
7-55 Urdu by Urdu and others	8-00 Urdu by Urdu and others	8-00 Urdu by Urdu and others
8-00 Urdu by Urdu and others	8-05 Urdu by Urdu and others	8-05 Urdu by Urdu and others
8-05 Urdu by Urdu and others	8-10 Urdu by Urdu and others	8-10 Urdu by Urdu and others
8-10 Urdu by Urdu and others	8-15 Urdu by Urdu and others	8-15 Urdu by Urdu and others
8-15 Urdu by Urdu and others	8-20 Urdu by Urdu and others	8-20 Urdu by Urdu and others
8-20 Urdu by Urdu and others	8-25 Urdu by Urdu and others	8-25 Urdu by Urdu and others
8-25 Urdu by Urdu and others	8-30 Urdu by Urdu and others	8-30 Urdu by Urdu and others
8-30 Urdu by Urdu and others	8-35 Urdu by Urdu and others	8-35 Urdu by Urdu and others
8-35 Urdu by Urdu and others	8-40 Urdu by Urdu and others	8-40 Urdu by Urdu and others
8-40 Urdu by Urdu and others	8-45 Urdu by Urdu and others	8-45 Urdu by Urdu and others
8-45 Urdu by Urdu and others	8-50 Urdu by Urdu and others	8-50 Urdu by Urdu and others
8-50 Urdu by Urdu and others	8-55 Urdu by Urdu and others	8-55 Urdu by Urdu and others
8-55 Urdu by Urdu and others	9-00 Urdu by Urdu and others	9-00 Urdu by Urdu and others
9-00 Urdu by Urdu and others	9-05 Urdu by Urdu and others	9-05 Urdu by Urdu and others
9-05 Urdu by Urdu and others	9-10 Urdu by Urdu and others	9-10 Urdu by Urdu and others
9-10 Urdu by Urdu and others	9-15 Urdu by Urdu and others	9-15 Urdu by Urdu and others
9-15 Urdu by Urdu and others	9-20 Urdu by Urdu and others	9-20 Urdu by Urdu and others
9-20 Urdu by Urdu and others	9-25 Urdu by Urdu and others	9-25 Urdu by Urdu and others
9-25 Urdu by Urdu and others	9-30 Urdu by Urdu and others	9-30 Urdu by Urdu and others
9-30 Urdu by Urdu and others	9-35 Urdu by Urdu and others	9-35 Urdu by Urdu and others
9-35 Urdu by Urdu and others	9-40 Urdu by Urdu and others	9-40 Urdu by Urdu and others
9-40 Urdu by Urdu and others	9-45 Urdu by Urdu and others	9-45 Urdu by Urdu and others
9-45 Urdu by Urdu and others	9-50 Urdu by Urdu and others	9-50 Urdu by Urdu and others
9-50 Urdu by Urdu and others	9-55 Urdu by Urdu and others	9-55 Urdu by Urdu and others
9-55 Urdu by Urdu and others	10-00 Urdu by Urdu and others	10-00 Urdu by Urdu and others
10-00 Urdu by Urdu and others	10-05 Urdu by Urdu and others	10-05 Urdu by Urdu and others
10-05 Urdu by Urdu and others	10-10 Urdu by Urdu and others	10-10 Urdu by Urdu and others
10-10 Urdu by Urdu and others	10-15 Urdu by Urdu and others	10-15 Urdu by Urdu and others
10-15 Urdu by Urdu and others	10-20 Urdu by Urdu and others	10-20 Urdu by Urdu and others
10-20 Urdu by Urdu and others	10-25 Urdu by Urdu and others	10-25 Urdu by Urdu and others
10-25 Urdu by Urdu and others	10-30 Urdu by Urdu and others	10-30 Urdu by Urdu and others
10-30 Urdu by Urdu and others	10-35 Urdu by Urdu and others	10-35 Urdu by Urdu and others
10-35 Urdu by Urdu and others	10-40 Urdu by Urdu and others	10-40 Urdu by Urdu and others
10-40 Urdu by Urdu and others	10-45 Urdu by Urdu and others	10-45 Urdu by Urdu and others
10-45 Urdu by Urdu and others	10-50 Urdu by Urdu and others	10-50 Urdu by Urdu and others
10-50 Urdu by Urdu and others	10-55 Urdu by Urdu and others	10-55 Urdu by Urdu and others
10-55 Urdu by Urdu and others	11-00 Urdu by Urdu and others	11-00 Urdu by Urdu and others
11-00 Urdu by Urdu and others	11-05 Urdu by Urdu and others	11-05 Urdu by Urdu and others
11-05 Urdu by Urdu and others	11-10 Urdu by Urdu and others	11-10 Urdu by Urdu and others
11-10 Urdu by Urdu and others	11-15 Urdu by Urdu and others	11-15 Urdu by Urdu and others
11-15 Urdu by Urdu and others	11-20 Urdu by Urdu and others	11-20 Urdu by Urdu and others
11-20 Urdu by Urdu and others	11-25 Urdu by Urdu and others	11-25 Urdu by Urdu and others
11-25 Urdu by Urdu and others	11-30 Urdu by Urdu and others	11-30 Urdu by Urdu and others
11-30 Urdu by Urdu and others	11-35 Urdu by Urdu and others	11-35 Urdu by Urdu and others
11-35 Urdu by Urdu and others	11-40 Urdu by Urdu and others	11-40 Urdu by Urdu and others
11-40 Urdu by Urdu and others	11-45 Urdu by Urdu and others	11-45 Urdu by Urdu and others
11-45 Urdu by Urdu and others	11-50 Urdu by Urdu and others	11-50 Urdu by Urdu and others
11-50 Urdu by Urdu and others	11-55 Urdu by Urdu and others	11-55 Urdu by Urdu and others
11-55 Urdu by Urdu and others	12-00 Urdu by Urdu and others	12-00 Urdu by Urdu and others

Multilingual Radio Pakistan prints its daily station logs in both English and Urdu; broadcasts regularly in seventeen languages and dialects, speaking to Europe, the Middle East, Africa, East Asia, Australia, and New Zealand.

tion to a low power short-wave transmitter at Lahore in little more than a year. Scores of newly graduated students had been recruited and intensively trained to do the job. Their zeal to serve the State enabled them to do it successfully.

The Federal Capital of Radio Pakistan was no longer without an effective broadcasting station. However, the studios were still located in a two-room barrack and program services and production units were still working in tents. Radio Pakistan had not succeeded in obtaining any suitable site for its Broadcasting House. One site after another was approved, obtained, and then lost to those with better or more pressing claims. Finally, Radio Pakistan decided to postpone any new construction for an indefinite period. A building was selected at Bunder Road in the Federal Capital and plans were made to modify the location to suit the requirements of a broadcasting house. The ground floor was converted to accommodate the various offices. The second floor was selected to house fourteen studios but, when the plans were finalized,

it became apparent that the second floor was too heavy for the ground floor to support. This disheartening and perplexing situation led Radio Pakistan technicians to design a novel plan of construction. It would not be an exaggeration to say that the studios at the Broadcasting House, Karachi, are the only hanging studios in the world. Supported by a mechanism from above, the roof of the ground floor does not have to carry any of the weight from the second floor. These streamlined, multi-colored studios of the Broadcasting House were completed in 1951. Personnel of Radio Pakistan moved from their tent city which, in the past three years, had been mistaken by many a passerby for a gypsy village.

The inauguration of the Federal Broadcasting House, which completed the first phase of development was preceded a few months by the installation of a low power medium-wave station at Rawalpindi, a district nearly 120 miles from Peshawar and 180 miles from Lahore. This station was to cater to an area that previously had not been effectively served by either of the two

older stations. The first phase of Radio Pakistan Development had ended. The second phase is actively in hand and some of its projects are making considerable headway. The low power medium-wave transmitter at Rawalpindi has been replaced by a 10-kw medium-wave transmitter, and the installation of two 10-kw short-wave transmitters at Karachi is well under way.

Today, after six years, Radio Pakistan is no longer a disorganized Broadcasting system consisting of three low power zonal stations. It is a small, compact organization meeting the internal as well as the external needs of the fifth largest State in the world. Although still far from its ultimate goal, it is an organic system with a Central Directorate and Central News Organization having departments of installation, research, and maintenance and a staff training school. It broadcasts thirty-nine news bulletins as against the four original ones, and puts out ninety-six program hours in seventeen different languages, as against twenty-seven program hours in seven languages at its inception.



▲
Pakistan's Radio City is the Broadcasting House at Karachi. This center of program activities houses studios, executive offices, news bureaus and the many facilities marking a modern radio network. Here one of Radio Pakistan's mobile units prepares to leave for a remote province from which a series of broadcasts will be initiated.



►
The brain of Radio Pakistan is this master control room in the Karachi transmitting station. In this room the link is forged between Pakistan and the outside world, as well as between the stations of the Pakistan network.



FIG. 1. The WHBQ 5000-watt transmitter building, with its solar-type front facing south. Two of the five 315-foot towers are visible in the background.

THE GROWTH OF WHBQ MEMPHIS

When Station WHBQ went into operation on March 18, 1925 with a 100-watt transmitter broadcasting from the basement of St. John's Methodist Church, the population of the City of Memphis was approximately 227,000. Licensed by the late T. T. Thompson, the station in its 100-watt infancy produced programs primarily of a religious nature. It later moved to the Dermon Building in Memphis on a commercial basis.

FIG. 2. John Cleghorn, General Manager WHBQ-AM-TV.



By
WELTON ROY

Chief Engineer, WHBQ, AM-TV

In 1932, expansion made more floor space a necessity, and a transfer to the Claridge Hotel (with about 1,000 square feet of station floor space) was effected.

The station went to 250 watts in 1939, and again the plea was "more room". So, in 1942, studios were taken over in the Hotel Gayoso with approximately 2,000 square feet of floor space. Later 700 square feet of office space was added. Affiliation with the Mutual Network occurred in 1944.

Power was raised to 5,000 watts on March 11, 1949, at which time WHBQ moved to 560 on the dial.

Today, WHBQ operates with 5,000 watts and the population of Memphis has grown to 420,550. From 23 square miles in 1925, the city has expanded to 121 square miles in 1953 and there's even more growth imminent. But growth paralleling

that of the city in which it is located has been rather natural for WHBQ Radio.

WHBQ's development made a great leap this fall when its Television station (Channel 13) went "on-air" with the 10 KW driver portion of their RCA TT-50AH 50 KW VHF Transmitter. It is anticipated that WHBQ-TV, Memphis' newest Television station will achieve maximum power of 316,000 watts within a short time.

FIG. 3. Welton Roy, Chief Engineer WHBQ-AM-TV.



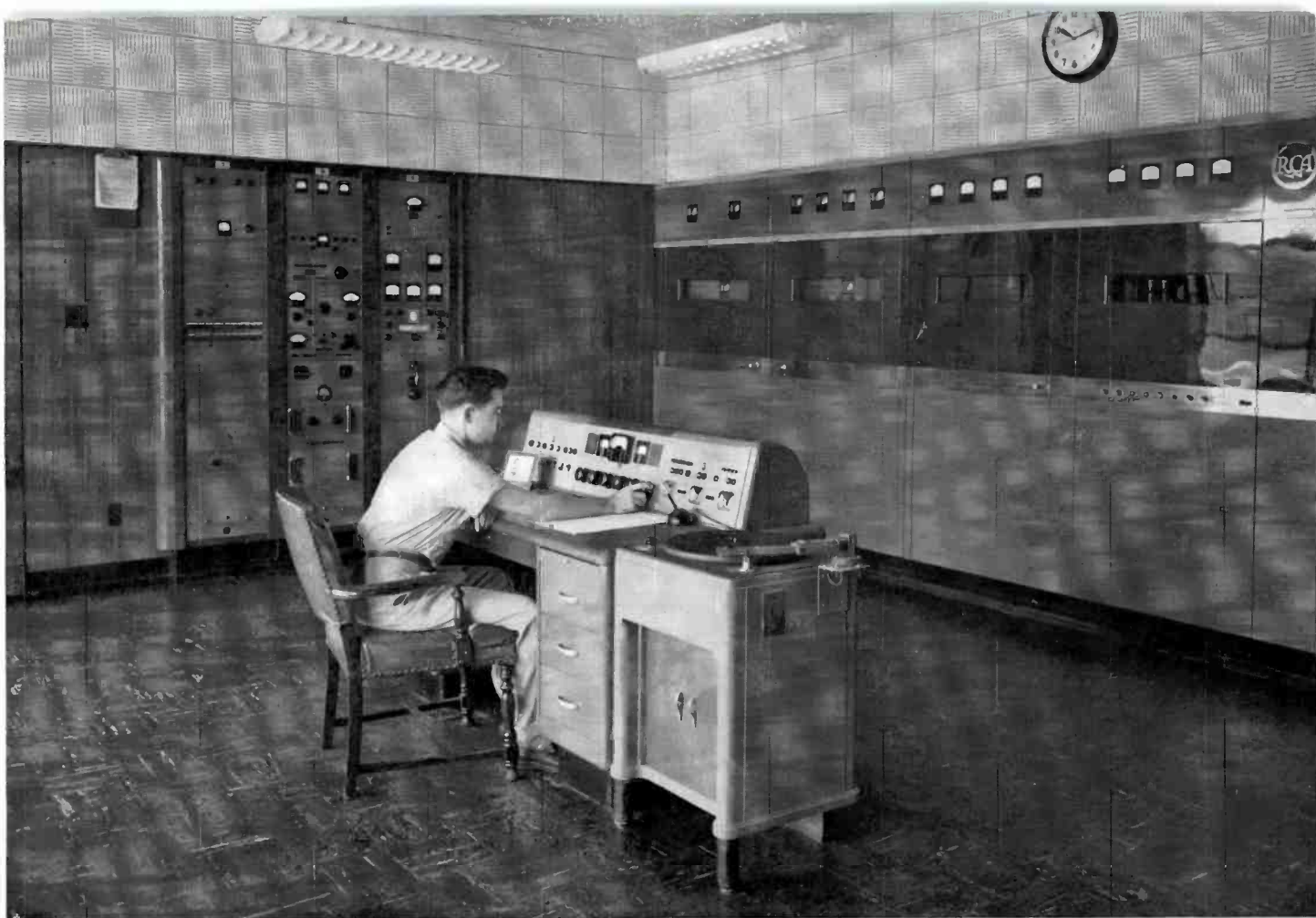

FIG. 4. This is the WHBQ 5000-watt transmitter, and RCA Type BTA-5-F. The first rack on the left contains speech input equipment; the second rack holds test equipment; and the third rack contains frequency phase monitors.

The latest move of the AM facilities to the Hotel Chisca in Memphis was the result of a need for more floor space for AM production. On January 9, 1953, the new studios in the Hotel Chisca were occupied. The exterior of the studio was designed to fit into a half-million dollar project for remodeling the 41-year-old Chisca Hotel. Located on the mezzanine—the entrance is set off in green and white marble with shrubbed planter boxes on either side of the all-glass doors (see Fig. 7).

The receptionist's desk is trimmed in oak, as is a translucent half-wall separating the lobby from the business offices. Immediately to the right of the foyer is the clients' audition room, tastefully furnished and softly lighted for clients' comfort, and equipped with a speaker for audition purposes.

A corridor runs the entire length of the station at right angles to the foyer. To the right are the business offices. These include the general manager's office, as well as the offices for local sales, traffic,

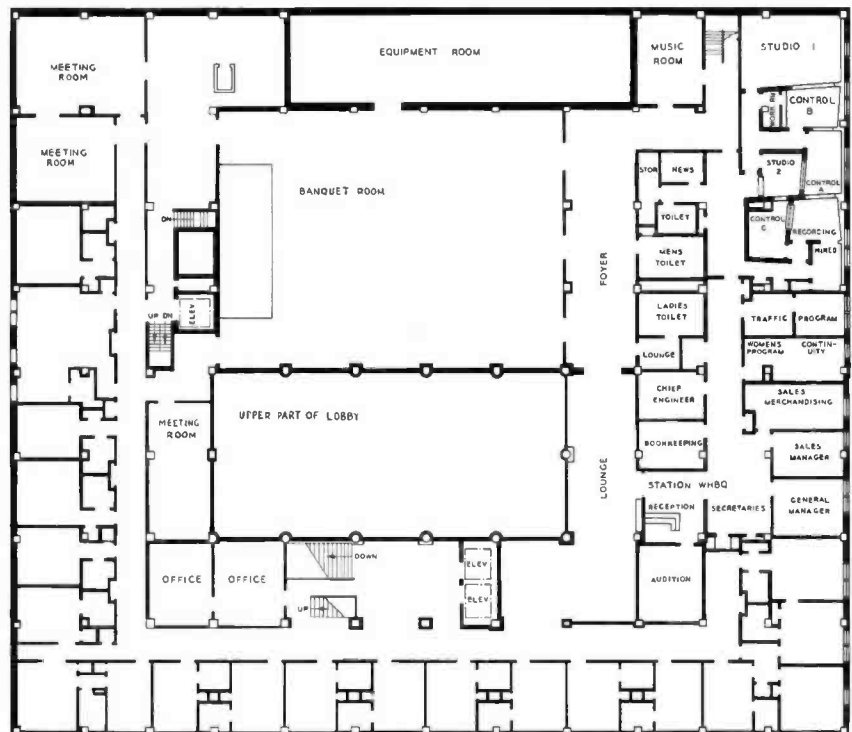

FIG. 5. Floor plan of WHBQ Studios in the Chisca Hotel, Memphis.

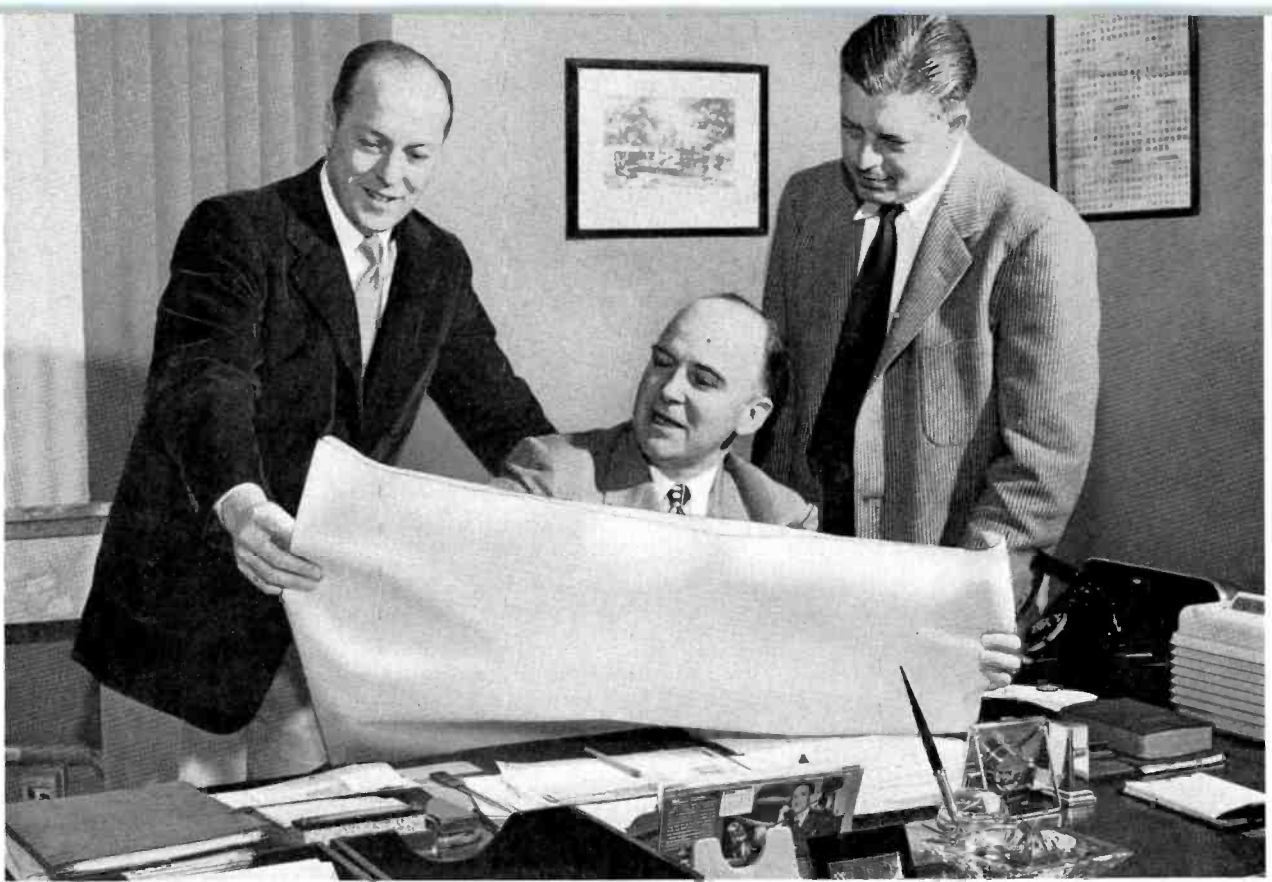

FIG. 6. Planning WHBQ's new studios which will be housed in a completely new, modernistic building, is John Cleghorn, center, General Manager of WHBQ, along with William Grumbles (left), Operational Manager; and Welton Roy (right), Chief Engineer.

national sales, and the program director. To the left of the corridor is the accounting office as well as that of the chief engineer. This represents the "front" section of the station, which can be completely cut off from the production section simply by closing a door if necessary.

The production segment of the station is arranged for speed and ease in operation. All control rooms are entered along rubber-covered ramps, facilitating the movement of portable equipment. All doors are of the Riverbank type to close out sound.

Control Room "B" is the center of operations, flanked by the recording room and Control Room "A", and visually accessible to Control Room "C" as well as a small speech studio. Control Room "B" is equipped with the most modern equipment of the three control rooms. Announcers work from a BC-2B console with Fairchild 530-D turntables. Within a few inches of the announcer's hands is a tape recorder. Note Fig. 8.

To the left of the console operator in Control Room "B" is the recording room (Fig. 11). Here are dual RCA-73B professional recorders with a 50-watt McIntosh amplifier, equalizers and matching network. Selector switches permit program choices with bridging inputs to 20 monitoring busses.

The recording room is separate from but directly accessible to Control Room "C" and easily visible to Control Rooms "A" and "B". Acoustical treatment of the re-



FIG. 7. The entrance to the new studio in the Hotel Chisca is decorated in green marble. Visible through the double glass doors is the oak-trimmed foyer and the translucent half-wall which divides the foyer seen from the business offices. The clients' room is through the door at the right.



FIG. 8. "B" control room is, in effect, the center of operations, with its BC-2B console. Through the window to the right—partially visible—is the small speech studio and Control Room "C". Beyond the announcer is the recording room.

recording room makes it equally effective as a listening room. "C" Control Room, with a 76-B console, two 70-C turntables and two fixed tape recorders, is utilized primarily for recording operations. The third Control Room, "A" (Fig. 12), operates the large studio, and is used alternately to "B" for general purposes. It is equipped with an RCA 76-B console and two RCA 70-D turntables. All equipment for terminating

FIG. 9. A front view of the speech input equipment, which has the latest ACA amplifiers, all of which are plug-in type. This rack is in Control Room "A".

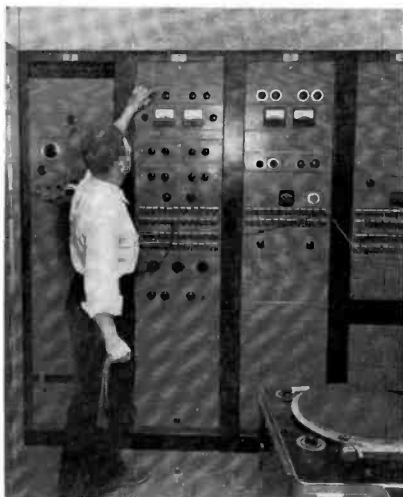

telephone lines and studio equipment is mounted in the wall. Control room windows are five feet above the studio level to provide a better overall view.

The small studio is treated for speech only, with programs channelled through either "B" or "C" Control Rooms. It is completely encased in perforated Johns-Mansville Transite, and it is extremely effective for newscasts and small-group interviews.

The large studio (shown in Fig. 15) is our pride. Polycylindrical diffusers are mounted adjacent to each other on one side and end, with perforated Transite with blankets opposite. The ceiling is serrated, or sawtoothed, and covered with acoustical tile. Halophane lights are set flush into the ceiling. From this studio emanate shows which involve participation of large groups, as well as musical programs.

Also in the general production section are the production manager's office, a printer room for the news machine, and a bathroom with shower. A general work-room for the engineers adjoins the recording room.

Across the hall, to the rear of the studio, is the music room, with more than 10,000

discs mounted in pigeon-hole files which were designed and built to speed up the selection of recordings. A large storage room for equipment is to the rear of the music room.

There are certain features of design which are general throughout the station and the control rooms. For example, all the control rooms are floating in felt for max-

FIG. 10. This rear view of speech input equipment demonstrates the adequacy of jacks which increase flexibility of operation. The neatness of wiring also is apparent.





FIG. 11. The recording room with 73-B professional recorder. A 50-watt McIntosh amplifier drives the recording heads which is so flexible it can record from 20 monitoring busses.

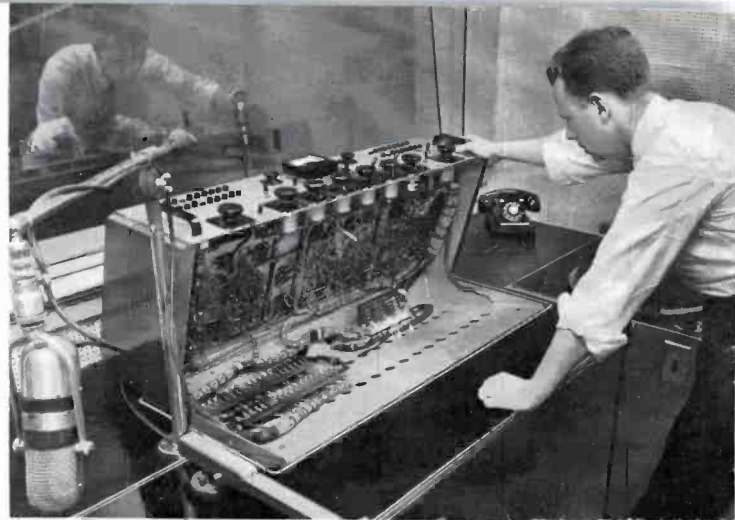

FIG. 12. This 76-B console is countersunk into the table and tilts to rest on the table at 90 degrees. This arrangement maintains same angle of slope for all consoles.

imum isolation from outside vibration and sound. This also brought about, in part, the increased height of control rooms above the studios.

Possibilities of sound interference were eliminated by installing air conditioning for the production unit separate from the office unit. Air conditioning ducts are installed independently from each control room and studio to the conditioning equipment to prevent transfer of sound along

ducts from one studio to the other. Each duct is completely insulated.

Complete monitoring units are placed in all offices, with high fidelity receivers for each network station in Memphis feeding monitor busses. Each office has its own speaker and associated amplifier.

All control boards are inset at angles in black formica-topped tables. All consoles are at the same height and face the oper-

ator at identical angles of slope. In addition, the boards tilt back to rest at 90 degrees on the tables, making repairs much simpler.

The radio station now encompasses approximately 5,000 feet of floor space, and for special presentations a ballroom of 35,000 square feet can be utilized.

WHBQ has advanced a long way since it opened up in the basement room of a

FIG. 13. This 100-watt control room, shown in the Hotel Claridge around 1931, had as its only commercial equipment the RCA 12-A amplifier, 600-A carbon microphones, and a 106-B speaker. All other equipment was composite.



FIG. 14 (right). This was the WHBQ 250-watt control room in the Hotel Gayoso, with its 76-B console, 70-C turntables, 64-B loudspeaker and 40-C amplifier mounted in the rack at right. To the right is the original small studio, later converted to a control room. To the left is the large studio. WHBQ outgrew these facilities, moved to the Hotel Chisqa January 9, 1953.



FIG. 15 (center). This view of the latest large studio shows the junction of the polycylindrical diffusers with a blanket wall under Transite. A part of the serrated ceiling is also visible. The control room at the right has a full view of the entire studio.



church in 1925. And with 15,000 square feet, 5,000 watts AM, a 1,000-foot television tower and ultimately 316,000 watts for TV, WHBQ is still growing.

On April 20, 1946, Harding College at Searcy, Arkansas, contracted to purchase the station and has held ownership ever since. However, WHBQ is strictly a commercial station.

John Cleghorn, veteran of more than 22 years in radio, was named general manager in 1949. C. L. Ganus of New Orleans is chairman of the radio committee which shapes the station's broader policy. On the committee, also, are: Dr. George S. Benson, president of Harding College; and Dr. L. M. Graves, R. D. Fuller, and R. V. Lovinggood, all of Memphis. William H. Grumbles is operational manager of the station.

FIG. 16. The studio entrance in the Hotel Gayoso as it appeared when WHBQ moved there in 1942.



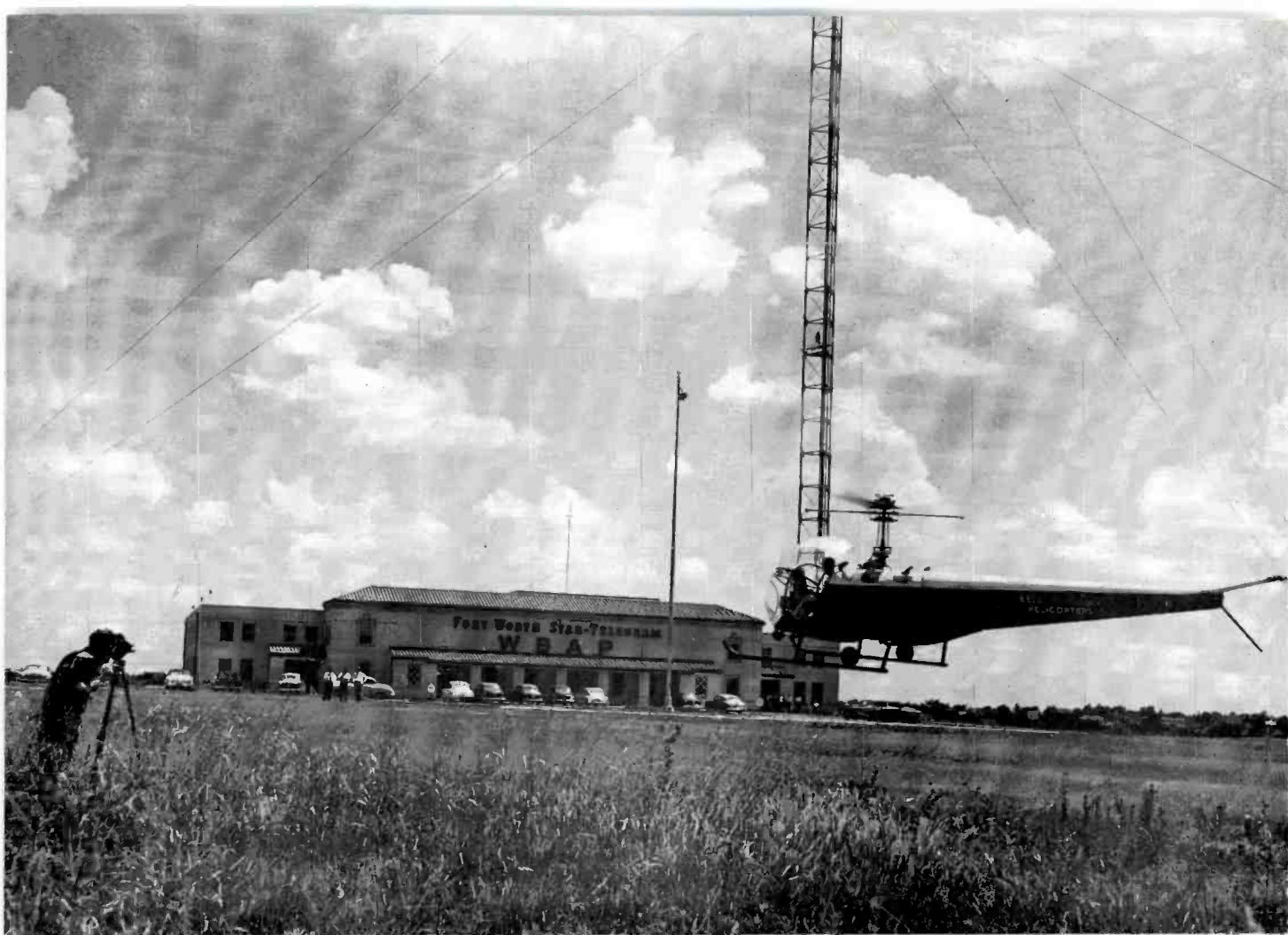

FIG. 1. WBAP's ten studios (three TV, seven AM-FM), its business offices, and its FM and TV transmitters are housed in this impressive and beautiful building. Completely air-conditioned and ultra-modern in construction, the brick and sandstone exterior gives it an authentic southwestern flavor. Helicopter in the foreground was used to take the aerial views on the following pages.

WBAP *"where the West begins"*

COMBINED AM-FM-TV STUDIO PLANT OF THE FT. WORTH STAR-TELEGRAM STATIONS IS ONE OF THE FINEST INSTALLATIONS ANYWHERE

Everything in Texas has to be big. Everyone knows that. So when WBAP decided to build a TV studio it was only natural that Harold Hough should say, "Make it big enough to run a herd of cattle through."

And sure enough they did—with a plant on a scale to go with it.

But WBAP wasn't always so big, nor, in all likelihood, was Mr. Hough always so confident. When WBAP was born back on May 2, 1922, it boasted the tremendous power of 10 watts. As someone said, it

blasted the ether "for blocks around". The studio was a temporarily vacant office in the Star-Telegram Building. And not the least anxious of those present was Harold Hough. That feeble 10-watt squawk was his baby, his brain child. It had been built from a bushel basket full of parts bought and assembled on a \$250 budget, all with misgivings of Mr. Hough's boss, Amon G. Carter.

However, success crowned the venture from the very start. In a short time Harold Hough, as the "Hired Hand", endeared

himself to ranchers and farmers from the Trinity to the Rio Grande. Speaking to them in their own language, about their own interests, he won their confidence and their undying devotion to WBAP. Before long Ft. Worth was known far and wide as the place "where the West begins"—and WBAP was its voice.

Today WBAP is one of the nation's leading stations. Under the skillful guidance of Mr. Hough, now radio director for Carter Publications, Inc., and George Cranston, manager of WBAP, the original



FIG. 2. The WBAP building is located on a small hill about four miles from downtown Ft. Worth (top center in this view). It is 26 miles from Dallas. With its 500-foot antenna and 16.4 kw radiated power the station provides good coverage of both cities, plus the whole Ft. Worth-Dallas trading area.

10 watts has grown to 50,000 watts on 820 kc and 5,000 watts on 570 kc.*

However, the "Hired Hand", belying his name, has never been one to sit on his hands—as the industry can and will testify. Not satisfied with the tremendous growth in power and prestige of WBAP he has insisted that the station maintain its early reputation as a pioneer. Thus when TV became a possibility he insisted that "Ft. Worth must have it first". To those who don't know Mr. Hough very well this may have sounded like another "Texas brag". To people in the industry it was prophecy of TV's future. If the Hired Hand was for it, it must be good

* WBAP shares time on these two frequencies with WFAA, Dallas, maintaining continuous operation from 5:30 A. M. to 12:00 midnight Monday through Saturday, and from 7:00 A.M. to 12:00 midnight on Sunday. WBAP-820 is an NBC affiliate (since 1928) and WBAP-570 (organized as KGKO in May 1938) has been affiliated with ABC since the network began operation.

business. And, as it turned out, it was—mighty good business.

Planning for WBAP-TV was started in 1945, and the station officially went on the air September 29, 1948. It was the first TV station in the South, and the first between St. Louis and Los Angeles.

Combined AM-FM-TV Plant

When it came time to build a plant for WBAP-TV it was recognized that convenience, efficiency and economy would result if all of WBAP's operations (except the AM transmitters, which are located at Grapevine, Texas, midway between Ft. Worth and Dallas, in a plant shared with WFAA) could be brought together at one point.

This is where Technical Director R. C. ("Super") Stinson and his engineers came in. Working with the station's consultants they located a site which was suitable for the TV and FM transmitters and still convenient for the commercial and studio operations. Then they sat down to plan a

building which would house all the station's commercial, programming and producing activities, its AM-FM studios, its TV studios, its FM transmitter and its TV transmitter. Their orders were to build for WBAP a plant that would be the finest in the Southwest, and that would stay the finest for some time to come. That they succeeded well is evidenced by the description which follows. So certain aspects of the installation might be treated in detail this description has been divided into sections. The subject matter of each of the sections is as follows:

The WBAP Building and Antenna	20
Floor Layout of WBAP Building	22
WBAP TV Studio #1	24
WBAP TV Control Room	28
WBAP Projection Studio	29
WBAP TV-FM Transmitter Room	30
WPAB TV Remote Equipment	34
WBAP AM-FM Studios	36
WBAP AM-FM Studio Control Rooms	38
WBAP AM-FM Recording Room	39
WBAP AM-FM Master Control Room	40

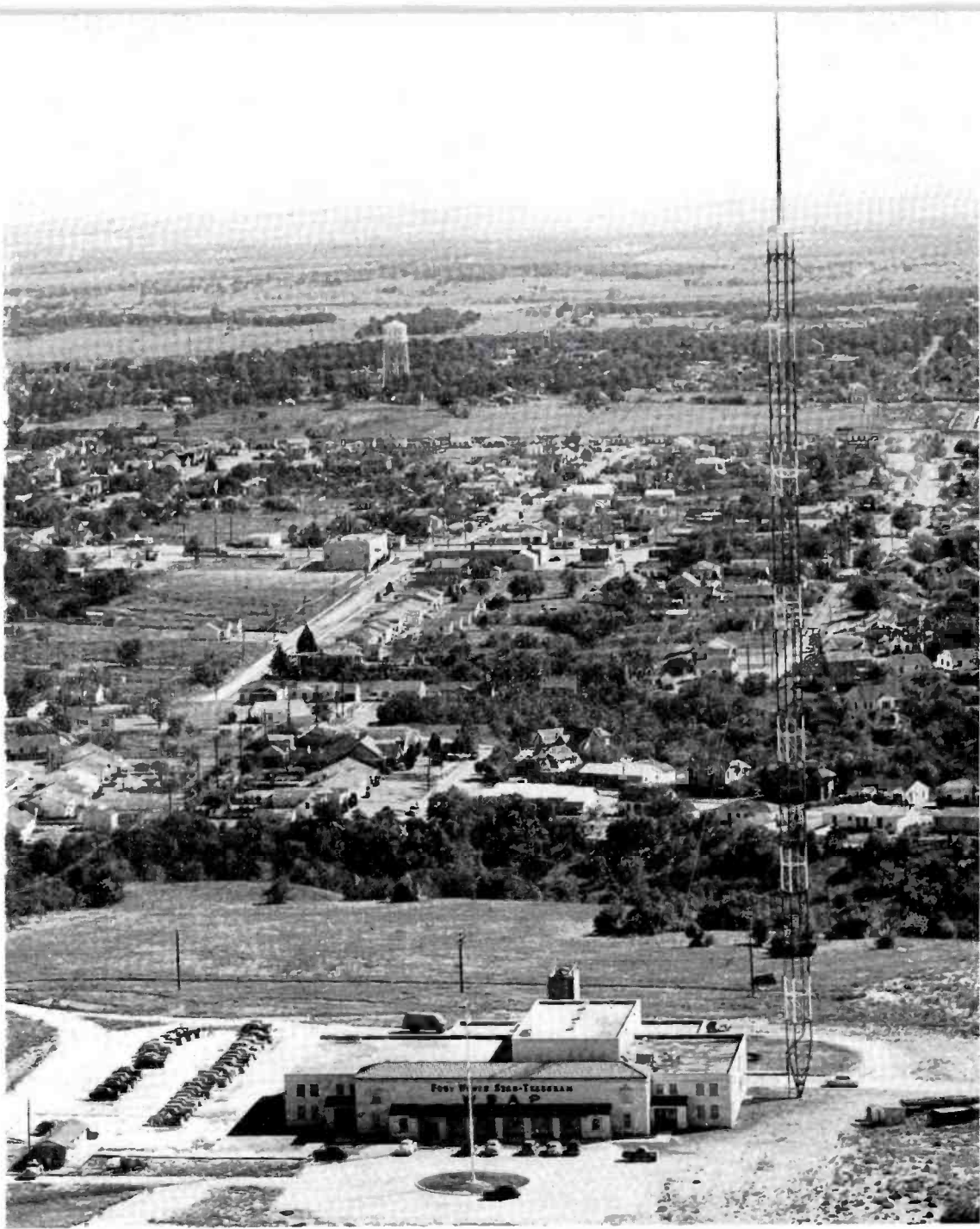

FIG. 3. Front of the WBAP building from the air. The antenna tower is 25 feet from the building and is located immediately adjacent to the transmitter room so that transmission lines are as short as possible.

WBAP BUILDING

The WBAP building, which sits on the top of a small hill, four miles from downtown Ft. Worth, is a beautiful and impressive sight. The illustration on this and the facing page give some idea of its size and construction, but hardly do justice to its beauty.

The building is very modern in design but the exterior treatment (sandstone-colored brick walls and red tile roof) gives

it a very Southwestern flavor, so that it seems to blend into the community. Most of the building is two stories high, but the ceiling over the TV studio in the center is elevated to give an equivalent height of three stories. The service building in the rear is one story high.

The main section of the building is 196 feet wide by 168 feet deep. The service building extends 96 feet further back.

The antenna tower is 25 feet from the building and is located just opposite the transmitter room so that very short transmission lines can be used. The FM antenna is a 4-section RCA Pylon, while the TV antenna is a three-section RCA Super Turnstile which is mounted on top of the Pylon. The total height of the structure, above ground, is 502 feet.

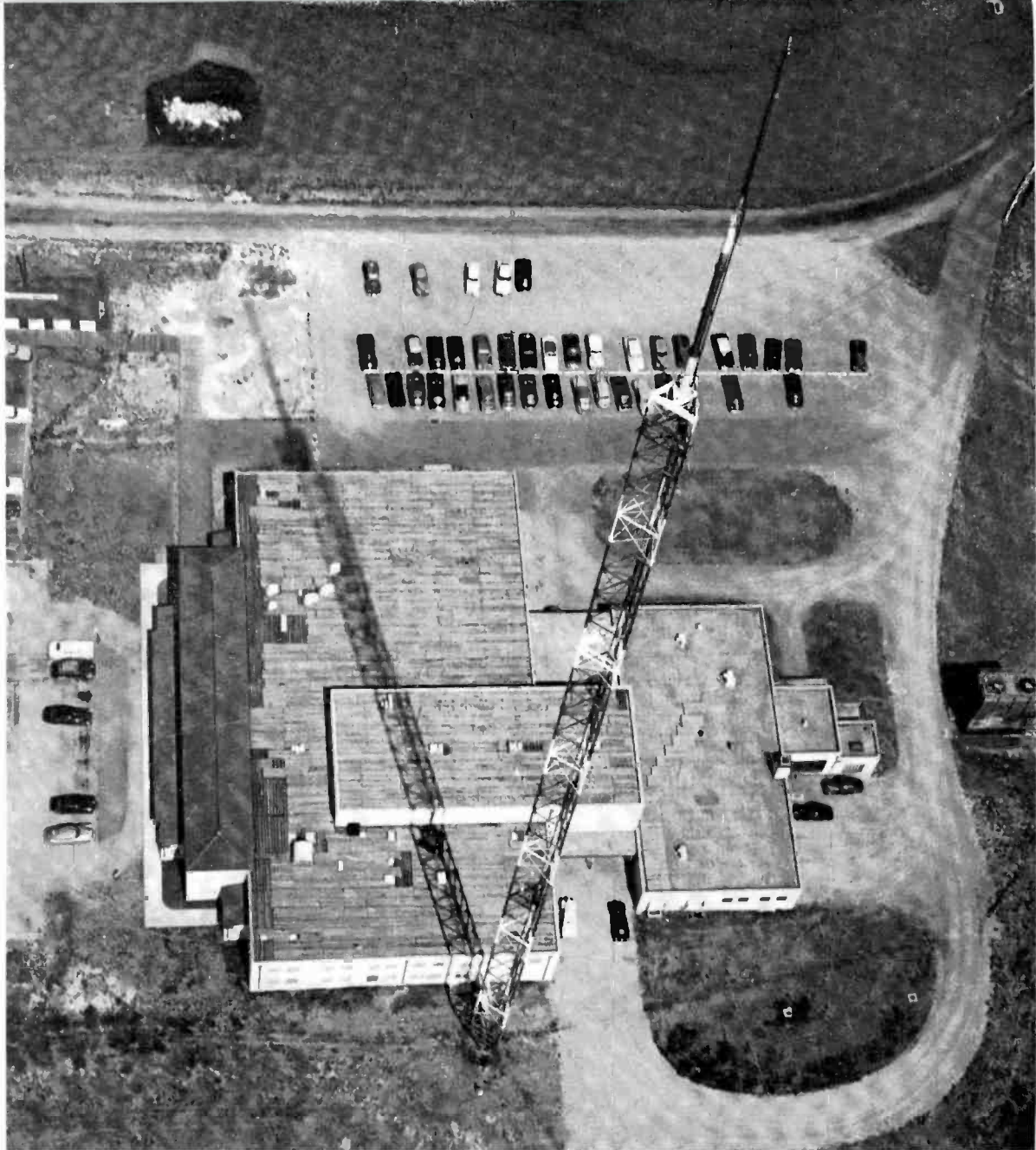

FIG. 4 (above). The WBAP building which is 196 feet wide by 264 feet deep is mostly of two-story construction. However, the ceiling over the TV studio area (center of the building) is the equivalent of three stories in height so that a ceiling height of 28 feet is provided in the main TV studio. The service building in the rear (which includes the TV storage area) is a single story in height.

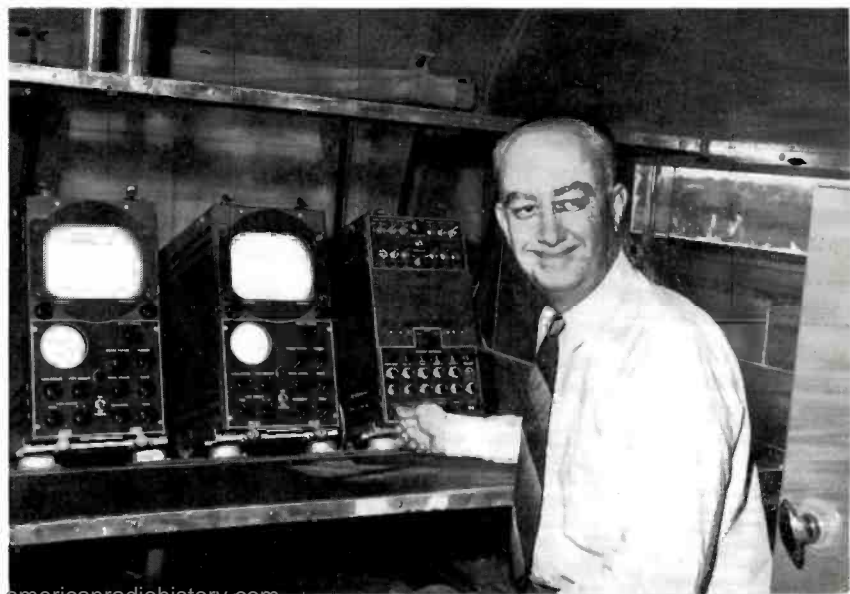

FIG. 5 (right). Planning of the WBAP building, its construction, and the installation of equipment were supervised by the WBAP engineering staff under the direction of R. C. ("Super") Stinson, Technical Director of the Ft. Worth Star-Telegram stations. Picture at the right shows Mr. Stinson in WBAP's TV mobile unit.



FIG. 6. Ground floor plan of the WBAP building. The front of the building is at the top. The famed "video lane" is indicated by a broken line. Scale of drawings, as reproduced here, is approximately 36 feet to the inch. Since these illustrations were made WBAP has added a 58 x 68-foot extension adjoining the carpenter shop. This is used as an additional storage space.

FLOOR PLANS OF WBAP BUILDING

WBAP's seventy-thousand square feet of plant floor space is arranged according to the most modern concepts of "area usage" and "traffic flow". Thus the total floor space of the building is divided into six sub-areas, each of which contains space for all of the activities associated with one main function. Although these areas are not specifically marked as such they may easily be identified on the first and second floor plans shown in Fig. 6 and Fig. 7.

For example, on the first floor of the main building (Fig. 6) there is a TV Production Area, an AM-FM Production Area and a News Area. It will be noted that each of these areas is pretty much self-contained and each has a corridor running length-wise through it, from the front of the building to the rear. Access to these corridors is from a lateral corridor that runs across the front of the building. This arrangement satisfied the two basic tenets

of modern "traffic flow" design in that (a) it is very easy for traffic (people) to move around within a sub-area, and (b) traffic (people) can enter any one of the sub-areas from outside the building without going through any part of any other area.

Editor's Note: This method of traffic division, i.e., into "TV", "AM-FM", etc., might be called the "vertical" method as contrasted to the "horizontal" method suggested by Dr. Duschinsky (in his recent series of articles) wherein traffic is divided into "technical", "artist" and "public" groups. The latter has obvious advantages for large metropolitan stations, but would not be economical in buildings such as WBAP's.

On the second floor of the main building (Fig. 7) there is a Commercial Office Area and a Program Area. As on the first floor, each area has its own corridor and each can be reached without going through any part of another area. This means, for example, that any one visiting the Commercial Department can go there without mixing with program or production traffic. Similarly, artists coming in for rehearsal or production can do so without interrupting the business end of the operation.

The sixth sub-area—the Service Area—comprises the single-story service building which is at the rear of the main building and is appended to the rear of the main TV studio (Fig. 6).

TV Production Area

Looking at the six sub-areas more closely it will be noted that each provides for a number of sub-functions (varying according to the main function) and that in most cases there are some exceptions to the straightforward division of functions between areas. For example, the TV Production Area includes not only the two live TV studios, the film-projection studio, the TV master control room, and TV transmitter, but also the FM transmitter (which is located here for operating convenience and proximity to the antenna).

TV Production Area also includes the storage room (which opens off the rear of the TV studio), the carpenter shop and the film processing room. All three of these are actually located in the "Service Building", but are conveniently located with respect to the studio. Similarly, the Film Library, and the Men's and Women's dressing rooms (although located on the second floor) may be considered a part of the TV Production Area. It will be noted that there is a rear stairway which provides quick access from these rooms to the studio.

AM-FM Production Area

The AM-FM Production Area includes six AM-FM studios (identified as A, B, C, D, E and F in Fig. 6), each of which has its own studio control booth. Entrances to all of these is from a longitudinal corridor running straight back through the building. This corridor can be entered either from the lateral corridor at the front of the building, or directly from the parking area at the rear.

The master control room (audio), the recording room and the two radio production offices which are located along the front of the building might also be considered part of the AM-FM Production Area. In any event they are conveniently located with respect to the AM-FM studios.

News Area

The third of the functional areas on the first floor is the News Area. All of the news services for both AM-FM and TV are located in this area. It will be noted that this area also can be entered either from the front or the rear of the building. Another noteworthy feature is the news booth located in a corner of the news room. This booth is acoustically treated and provided with microphones and its own audio control facilities. News broadcasts made from this booth do not tie up regular studio facilities.

Commercial Office Area

All of the business offices of the station are located on the left side of the second floor of the building. Here they are well removed from the normal traffic flow of the production area, and yet are just around the corner from the programming department (with whom they will have the most contact).

Program Area

The AM-FM Programming offices are along the front of the second floor and the TV Programming offices are around the corner (along the right side of the building). Thus they are convenient to each other, but are close (by conveniently located stairways) to the production areas with which they are associated.

Service Area

Most of the service facilities are located in the single story section at the rear of the building. These include the boiler room, air conditioning room, motor room, maintenance shop and garage. The deep section of the latter has been designed to house the TV mobile unit. It will be noted

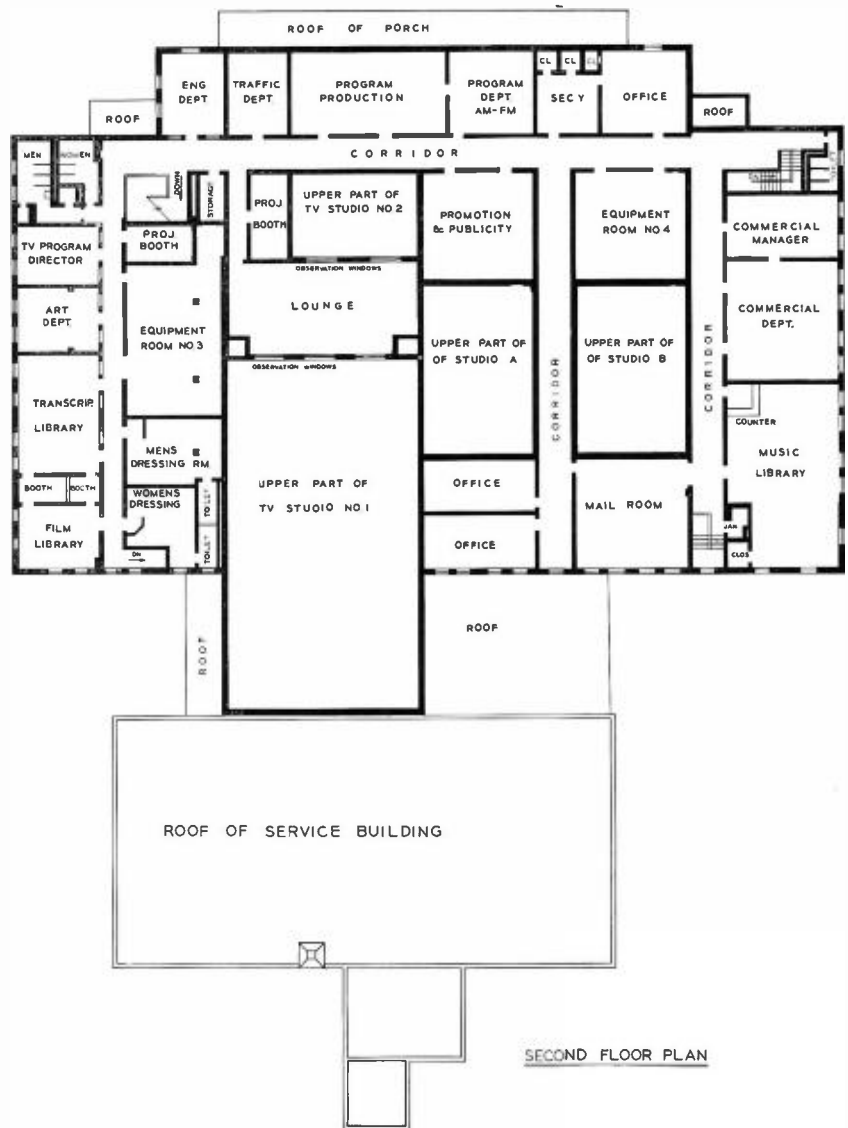

FIG. 7. Second floor plan of the WBAP building. Stairways at each corner of the main building, together with six main building entrances (three in front, and three in the rear) make it possible to enter any of the six sub-areas, from either the front or back of the building, without walking through any of the other sub-areas. Recently a 68 by 58-foot extension has been added to the left side of the Service Building to provide additional storage area.

that there is a door providing easy access from this point to the corridor which is the main artery of the TV Production Area. This facilitates movement of equipment from the studio area to the truck or vice versa.

Traffic Flow

Integration of functions by area is only one half of the WBAP building story. The other part of the story is the careful arrangement of these areas with respect to each other and with respect to outside access. Study of the plans (Fig. 6 and Fig.

7) will show that it is possible to go from any one of the six areas to any other area without traversing any large part of a third area. Similarly, any of the areas may be entered from outside the building by two different ways (front or rear) without going through any other area. This remarkable accessibility is gained by having stairways and outside doorways at each corner of the building. Together with the carefully planned corridor layout it thus eliminated the confusion which otherwise would be attendant on an operation of the size and complexity of WBAP's.

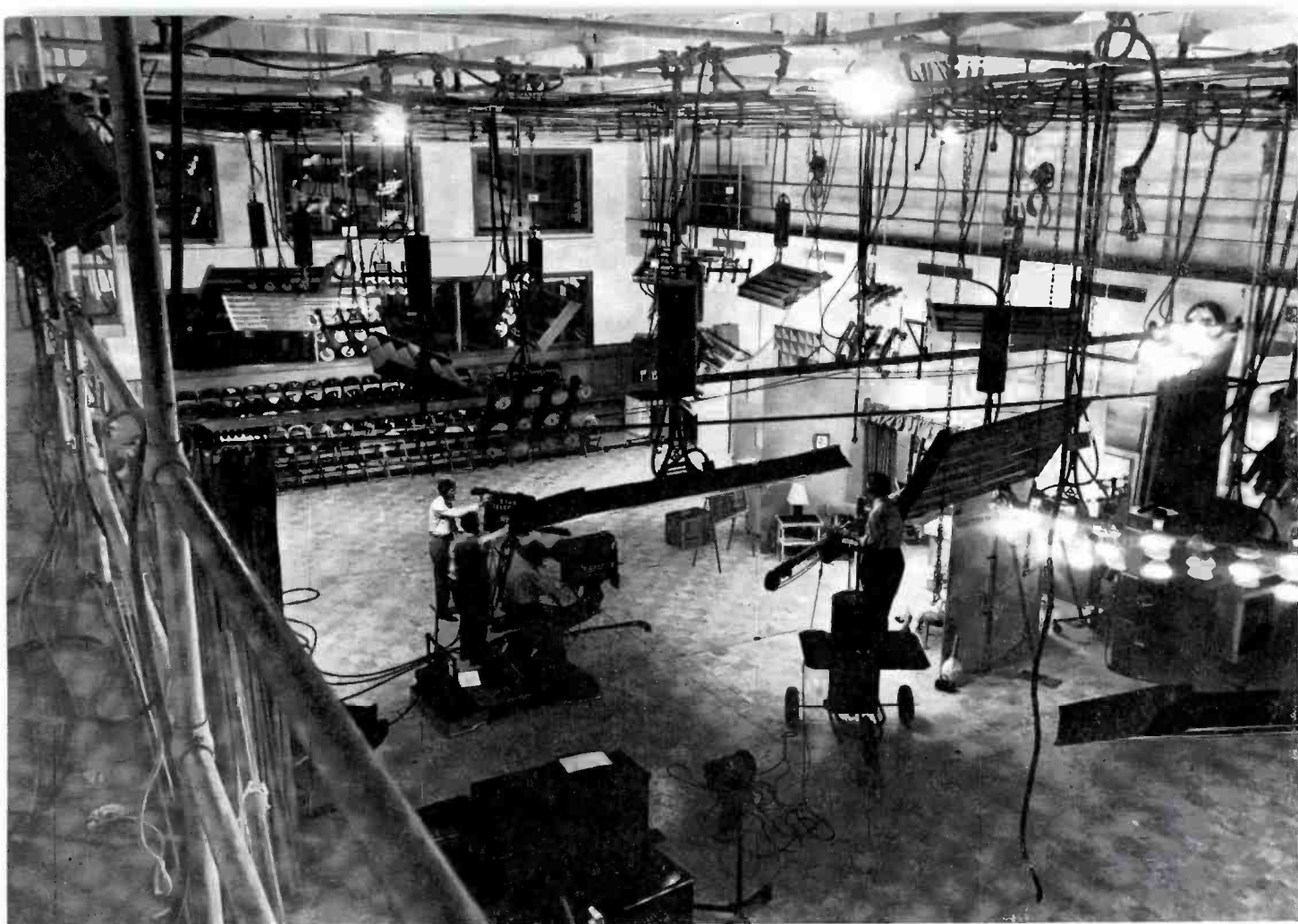

FIG. 8. View of WBAP's Studio #1 from the far end. Control room windows are just behind the several tiers of folding type seats. Above the control room windows are the windows of the "lounge", which also functions as a deluxe clients' booth. A catwalk, which is 14 feet above the studio floor, runs the full length of both sides of the studio. Air conditioning ducts are suspended beneath these catwalks.

WBAP TV STUDIOS

Three TV studios are provided for in the WBAP building (see Fig. 6, page 22). Studio #1 is 82 feet long, 45 feet wide and 28 feet high. Studio #2 is 30 feet long, 20 feet wide and 20 feet high. Studio #3, which is the film projection studio, is 14 feet wide by 18 feet long.

Studio #1, which is shown in several accompanying illustrations (Figs. 8, 9), is the origination point for most of the station's locally-produced programs. The illustrations do not give a true impression of the size of this studio. When walking into this studio one actually gets the impression of entering a medium-sized gymnasium, and the measurements confirm this as being so.

WBAP was one of the first stations to provide a studio of this size (and thereby established a trend which is being followed by more and more stations). Although the station originates only a few programs which require the entire studio space, nev-

ertheless they feel that it was a good investment. It enables them to do "deluxe productions" (whenever they are called for without the need for hiring a theatre or auditorium). In connection with the "Video Lane" facility (see below) it provides for handling the most unusual and special shows.

Convenience of a Large Studio

In the meantime, the WBAP-TV production staff finds the large studio of great convenience for every-day shows. The relatively large available space allows them to have as many as five or six complete sets in place simultaneously. These are arranged around the sides and back of the studio. The center of the studio is reserved for the cameras which can then be easily turned to face into any one of the sets. On some days it is possible to take care of all the shows for that day with sets which are erected in the morning before the station goes on the air. Even on days with

complicated schedules it is seldom necessary to make quick changes of scenery since there will almost always be occasional breaks (during film or network shows) during which several new sets may be put in place. As a result the station can operate with a much smaller production staff than would be required if many quick changes of scenery were necessary. Similarly, less camera equipment is required than would be necessary if the same number of shows were to be produced in several smaller studios instead of the one large one. It does, however, require that rehearsals be scheduled at times when the studio is not originating a show.

Video Lane

The most publicized feature of WBAP is euphemistically referred to as "video lane". Briefly, this consists of an arrangement whereby automobiles, trucks, elephants, "herds of cattle", or what have you, may be not just brought into the



FIG. 9. This view shows the opposite end of WBAP Studio #1. All lights are suspended from a pipe framework and can be rotated by means of rope controls which are operated from a "lighting bridge" (extreme right in this picture). In normal operation a number of "sets" are arranged along the sides of the studio. Cameras, operating in the center area, move from set to set.

FIG. 10 (right). The stepped platform with folding chairs (Fig. 8) accommodates up to 150 persons. When a large audience is expected folding chairs are placed on studio floor; for children's programs the kids take over everything but the cameras.

studio but actually passed through it—so that the viewer sees them in motion. How this is done can be understood by studying the illustrations on this page and layout diagram on page 22, (Fig. 6).

It will be noted that there are two large doors (15 feet by 12 feet), one on each side of the studio, and directly facing each other. The studio floor is at ground level and these doors open directly to the outside of the building. Thus anything which will go through a 12-foot door can be driven right through the studio—without stopping. This not only allows motion, but also enables the station to show attractions which because of their length couldn't be shown in the studio all at one time. For instance, WBAP is probably the only station which ever ran the Budweiser commercial "live": certainly the only one that ever did it in their studio. It is also possible to stage "round robin" parades by having actors, animals, cars, etc., go out one door,





FIG. 11. WBAP has yet to "run a herd of cattle through" the studio. But it had a herd of elephants in it almost before it was finished. The large size doors on either side of the studio are plainly visible in this view. These doors, opening directly to the outside (see Fig. 6, page 22), make it possible to bring the largest attractions into—or through—the studio. Some of these, such as the famous Budweiser Horses shown on the opposite page, are too long to get into the studio all at once. The two doors, however, make it possible to pass them through the studio, thus producing "outside" shots with all the advantages of studio lighting and camera technique. Needless to say, the balmy Ft. Worth climate makes this more practical than it would be in colder climates.

around the back of the building and back in the other door.

Video lane, as can be seen from Fig. 6, is near the back of the studio. Also at this end is a pull curtain and provisions for flying screens and backdrops. Thus it is possible to provide dramatic settings for the video lane productions or for other large scale productions.

Camera Equipment

Three cameras are used in Studio #1. Two of these are TK-10A's mounted on TD-5A studio (two-man) dollies; the third is a TK-30A on a tripod dolly. One TK-30A Camera on a tripod dolly is used in Studio #2.

The method of handling the camera cables is rather interesting. In constructing the studios, "Q-ducts" were installed for this specific purpose. One duct runs from the control room down the length of the studio. Three evenly-spaced cross-wise ducts intersect this longitudinal duct. The camera cables may be brought up out of the ducts at any desired point. Thus it is unnecessary to have long lengths of cable strung across the floor. Microphone cables are handled the same way. This, together with the fact that very few floor lights

are used, results in less cluttering up of the floor area than is usual. For this type of operation (i.e., where cameras are moved frequently from one set to another) this is an important advantage.

Studio Lighting

All general illumination in Studio #1 is "off the floor". The main battery of lights consists of the following:

- 16 Incandescent Banks
- 15 High-Intensity Fluorescent Banks
- 6 Spots hung from ceiling
- 6 Spots on catwalk rails

Several floor dollies (spots, incandescents, fluorescents) are available when required for modeling or special effects but are used as little as possible in order to keep the floor free for camera movement.

The main banks of lights are suspended from a pipe framework which covers the upper part of the studio. The position of these are normally fixed (in a grid pattern). However, they may be moved if special occasion requires. All 31 banks may be rotated by means of rope controls which are grouped on a "lighting bridge" at one side of the studio. The bridge is reached by a catwalk which runs along both sides of the studio. An interesting feature of the

FIG. 12 (opposite page). WBAP is probably the only station to run the Budweiser commercial live. Upper picture shows the team prancing into (and through) studio. In lower picture they have stopped for an "on the street" interview. Note how provision of two doors allows 80-foot long wagon-and-team to be brought into 45-foot wide studio.

catwalk is that the ventilating ducts are suspended beneath it. This means that the ceiling area of the studio (where the ducts are usually placed) is free for lighting fixtures, battens for flying props and scenery, etc.

Audience, Clients' Area

An audience of 100 to 150 people can be accommodated regularly in Studio #1 by placing folding chairs on a stepped platform at the end of the studio nearest the control room (Fig. 8). If desired, a much larger audience can be handled by placing chairs on a part of the studio floor area.

Clients are really provided for in style. Referring to Fig. 7 (page 23) it will be noted that there is an area, marked "Lounge", directly over the TV Master Control Room. In this case lounge is probably more descriptive than "clients' booth", for this is a beautiful and spacious (20 feet by 45 feet) room with large wing chairs. On one side are three large windows which provide a full view of Studio #1. On the opposite side are two similar windows looking into Studio #2. When this room is not being used as an observation gallery, it is utilized for meetings with clients, previews of films and similar activities.





FIG. 13 (above). WBAP's television master control is combined with TV Studio #1 control as shown above. Five camera monitors (3 live, 2 film) and a preview monitor are on the lower level, next to the studio window. The program director and technical director sit on the raised platform. The TD, who does the camera switching, has a master monitor as well as the switching controls on his console. The audio operator sits at a floor-level console to the left of the program director (just behind the raised platform in this view).

FIG. 14 (below). Behind the raised platform, on which the technical and program directors sit, are eleven equipment racks which contain the sync generators, amplifiers, power supplies and auxiliary equipment. This makes for a very convenient operating and maintenance setup. Moreover, the close grouping of equipment, with short interconnecting runs, made for ease and economy in installation. Since these photos were made the audio console has been moved over to a position directly beside the raised platform.

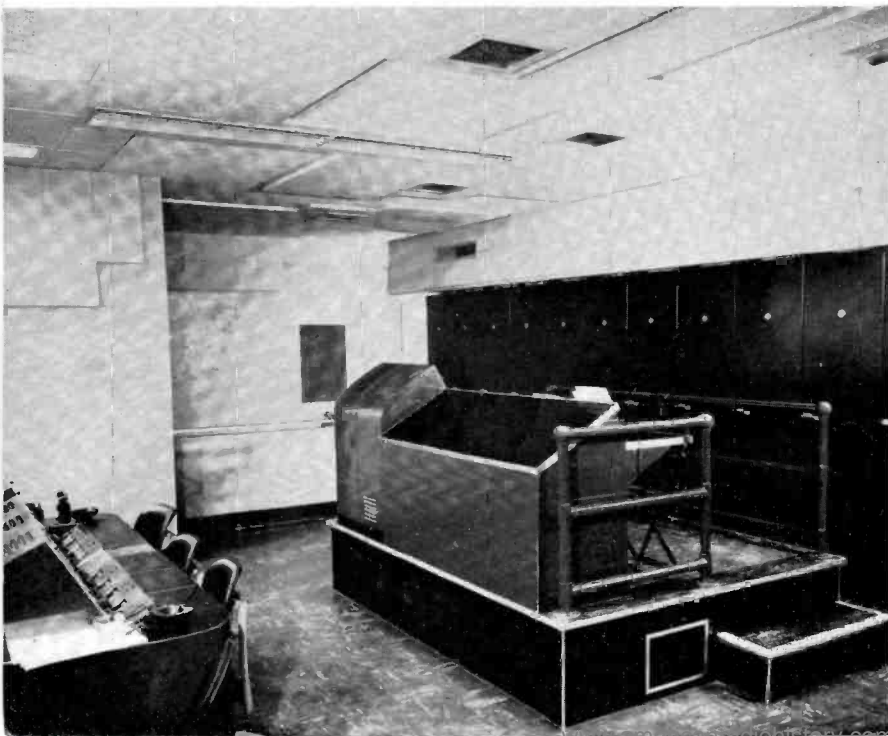

WBAP-TV STUDIO

At WBAP the facilities of Studio #1 control and master control are combined, as is common practice in this type of operation. This arrangement provides important operating economies and reduces the amount of equipment required, although it does complicate somewhat the carrying on of "camera" rehearsals.

The WBAP-TV Master Control Room is good-sized (approximately 20 feet by 30 feet) which makes it possible to locate the equipment racks right in the control room and still have plenty of room for audio, video and director's consoles.

Fig. 13 and Fig. 14 show the arrangement of the equipment. The video console is at booth floor level (which is 24 inches above studio floor level). It is made up of six camera monitor units (four live, two film) and a preview monitor. The audio



FIG. 15 (above). This is a view looking into the studio from approximately the audio operator's position. (A part of the audio console is visible at the lower left). For the type of operating procedure used by WBAP (and by most independent stations for local programming) a good view of the whole studio, by all control room personnel, is essential. The wide windows looking into WBAP studio provide a view not only of the whole width, but also most of the height of the studio.

MASTER CONTROL

console (a modified 76-B) is also at floor level on the left side of the room (behind the platform in Fig. 15). The director's console is on an 18-inch platform in the center of the room, directly behind the video console (so that the program director can see the camera monitors). Both the program director and the technical director sit at this position. The TD has in front of him a master monitor with a TS-20A Camera Switching System built into it. He also has the controls for the stabilizing amplifiers and the relay receiver.

Fifteen cabinet type racks at the rear of the control room contain all of the sync generators, distribution amplifiers, power supplies and other rack units required for the operation. This plus the fact that the film studio and Studio #2 are immediately adjacent, makes for an exceedingly compact equipment installation with video runs kept to an absolute minimum.

FIG. 16 (below). View looking from the control room into the film projection room. Equipment in the projection room includes two RCA TP-16D Film Projectors and two RCA TK-20A Film Cameras. The latter are mounted on revolving type pedestals so that they may be turned to face one of several projectors. In addition to the film projectors there is Grey Telop and a Selectroslide projector, with space provided for a second.





FIG. 17. WBAP's RCA TT-5A Television Transmitter as seen through the window from the corridor which runs the length of the TV area of the building. The control console contains the operating controls for both the TV and the FM transmitters.

FIG. 18 (below). View looking toward the TV end of the transmitter room. The three cabinet racks at the far end house the television amplifiers, monitors and the auxiliary equipment.



WBAP TV AND FM

WBAP's TT-5A TV Transmitter and its BTF-10B FM Transmitters are located in one large room (see Fig. 17 above) and are operated from a single combined control console. Originally this was two adjacent rooms. However, the partition was removed and the two control consoles combined so that one man could operate both.

The transmitter room is in the right wing of the first floor. There are large windows between it and the corridor so that visitors going to and from the TV studio have a good view of the whole room. The two transmitters, built into the back walls and lighted from overhead valances, are a very impressive sight.

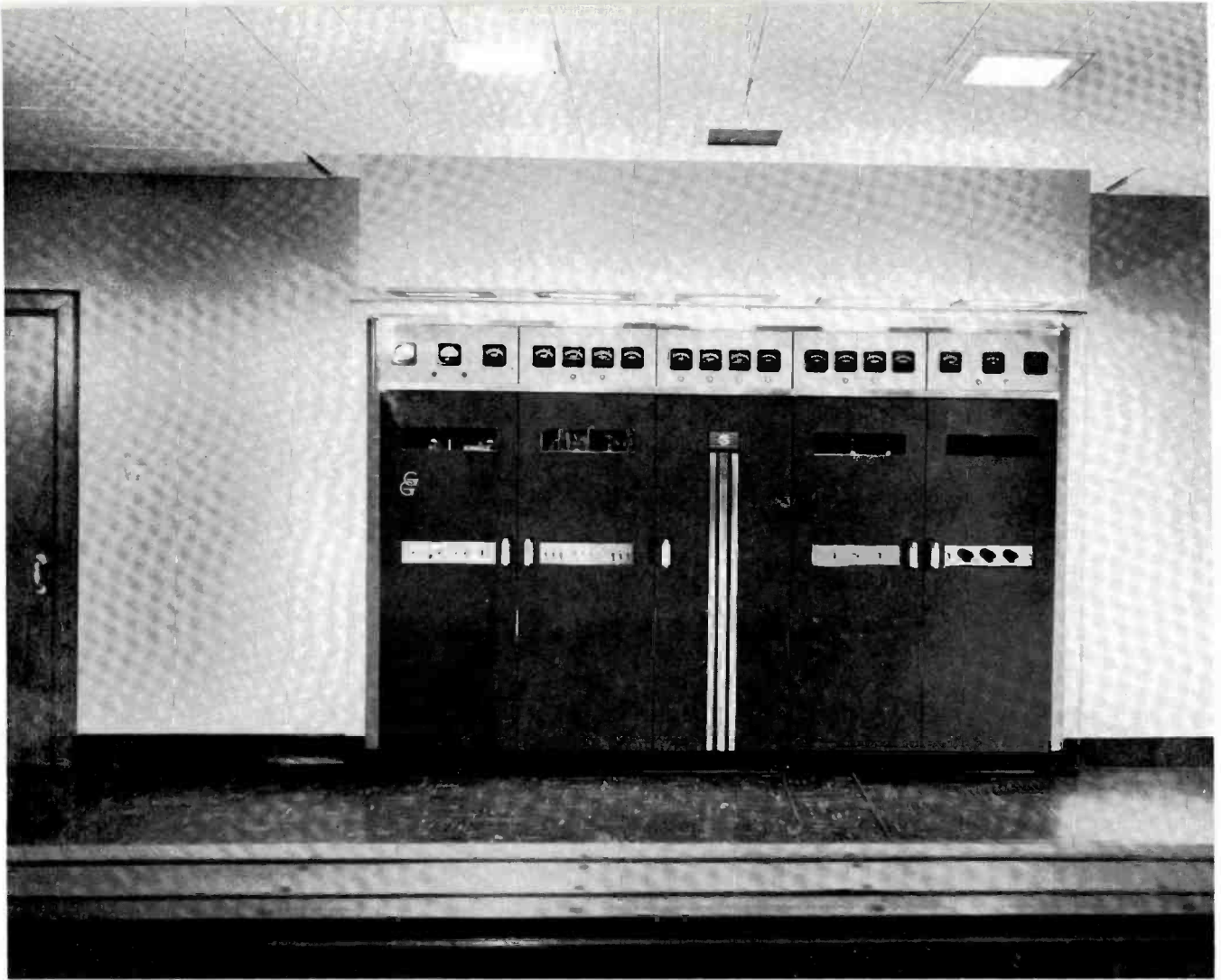

FIG. 19. WBAP's RCA BTF-10B FM Transmitter as seen through the corridor window. The TV and FM transmitters are built into the wall of the room and are provided with recessed overhead lighting. Behind transmitters is the large work room.

FIG. 20 (below). Looking toward the FM end of the transmitter room. The three cabinet racks at the far end contain the audio input and monitoring amplifiers, monitors and test equipment.

TRANSMITTERS

At one end of the room are three cabinet racks containing the TV test and monitoring equipment while at the other end are three matching racks containing the FM test and monitoring equipment. The control console, which is made up of standard units, occupies a position in front of the TV transmitter.

At the rear of the transmitter room is a large work area, a portion of which is partitioned off for storage of tubes, equipment and spares. (See floor layout, Fig. 6, page 22). A door from this area leads out to the antenna tower which is located close to the building so that transmission lines may be kept as short as possible.



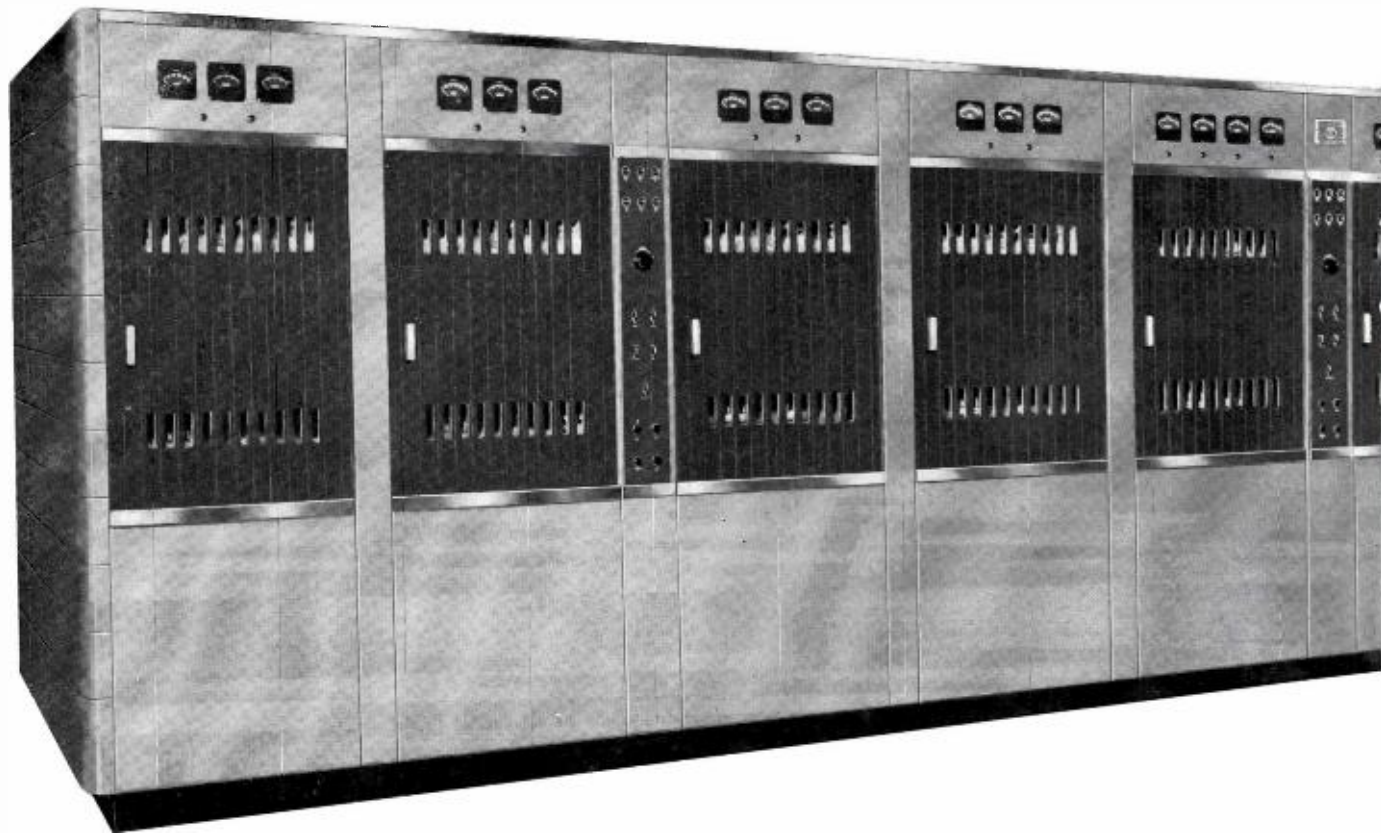

WBAP-TV PLANS FOR POWER INCREASE

The WBAP-TV transmitter facilities described in the preceding pages are those presently in operation (September, 1953). They seem like the ultimate in size and completeness. But WBAP-TV has further and bigger plans in the works.

At the present time WBAP-TV operates on Channel 5 with an effective radiated power of 16,400 watts. The most recent rules of the FCC allow a maximum radiated power of 100,000 watts on Channel 5. WBAP-TV is well along with its plans to increase to this maximum power and expects to be operating at 100,000 watts by early next year.

At the same time that it goes to higher power, WBAP-TV expects to start using a new tower which will be 1113 feet high. This compares to the 502-foot height of the present tower. This increase in antenna height, together with the added power, will

increase WBAP-TV's area of "top reception" from about 6,000 square miles to over 17,000 square miles.

In order to accomplish the changeover to higher power without interruption of programs, WBAP-TV plans to install an entirely new transmitter and antenna system. A complete new RCA 25 kw TV transmitter which will be capable of color telecasts as well as black-and-white has been ordered. A new 1113-foot guyed tower will be erected at a point 1000 feet west of the present tower. A modern brick-and-steel building will be constructed at the base of the new tower. This building, which will have 4000 square feet of floor space, will house the new transmitter, monitoring and test equipment. It will be styled to match the main studio building.

The new tower, which will be one of the tallest TV towers in this country, will be guyed at nine points on three levels. It

will be so located and constructed that even if bombed at the base its fall would hit nothing. The erection of this tower at a location which is actually within the city limits of Fort Worth has been approved by the Air Space Committee.

A six section RCA Type TF-6BM Superturnstile will be mounted on the top of the new tower. The site of the tower is on a small hill so that the actual elevation of the antenna will be 1749 feet above sea level.

The combination of the new high power transmitter, the higher gain antenna, and the twice-as-high tower will provide a tremendous increase in WBAP-TV's service area. A conservative estimate of this increase is indicated in the map on the opposite page. It is almost certain that many viewers far beyond the largest circle will receive good service, giving WBAP-TV one of the largest service areas in television.



RCA's newest high-power television transmitter (Type TT-25A) which will be installed in WBAP-TV's new transmitter building in the near future.

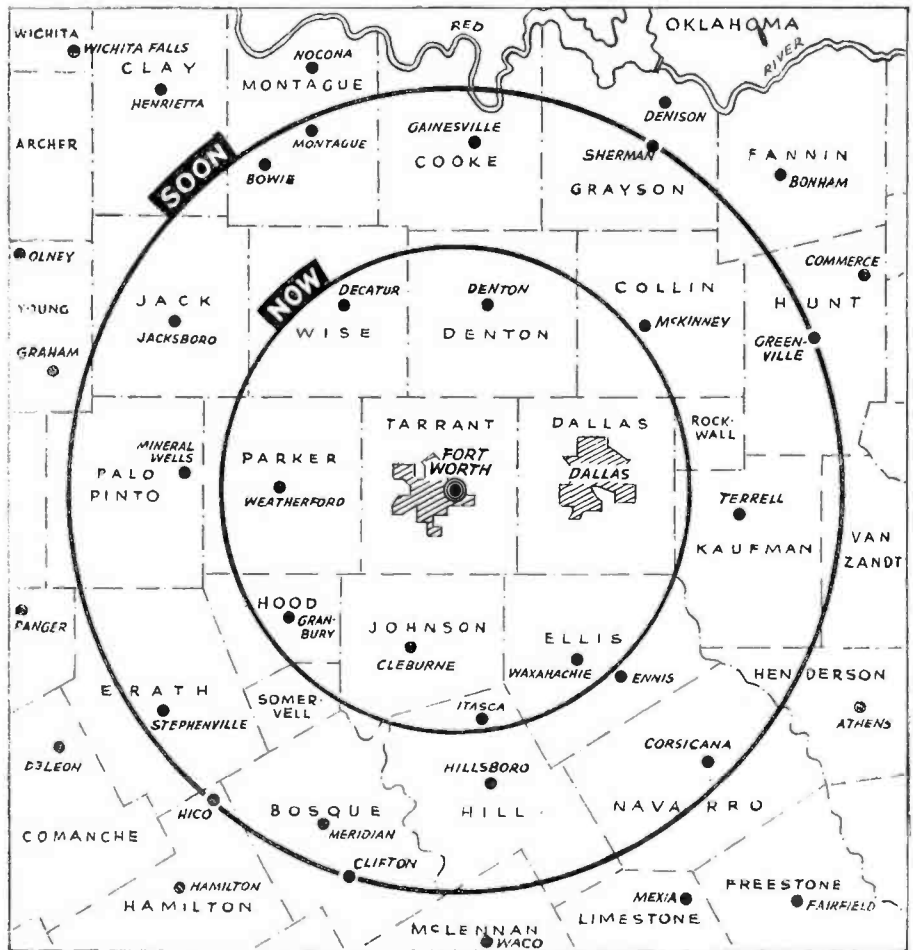

Present and future TV coverage. The inner circle shows the measured "top reception" area now being reached by WBAP-TV's 16.4-kilowatt signals from the present 502-foot tower. Outer circle shows the area tripled by next year when a 100-kilowatt signal goes out from an 1113-foot tower to be erected 1000 feet from the present one which will be retained as a stand-by. Towns far outside the larger circle will get "fringe" reception, in many cases as satisfactory as in the strength-measured area.



FIG. 21. WBAP-TV's field unit is an RCA TV-50A Mobile Unit with complete equipment, including RCA TK-30A Cameras and RCA TTR-1A Microwave Relay Equipment.

FIG. 22 (below). WBAP engineers have made a number of modifications in the TV-50A, most important of which is the addition of ventilating blowers. These were mounted in the rear windows as shown in this view. On a hot summer day this is much appreciated. Another modification provides for operation of four cameras instead of the usual three.

WBAP-TV FIELD TRUCK

WBAP's TV remote unit is a standard RCA TV-50A Mobile Unit equipped with Type TK-30A Cameras, Type TTR-1A Microwave Relay and auxiliary equipment. A number of minor modifications of this unit have been made by WBAP engineers. One of these which is especially interesting is the addition of ventilating blowers. These were mounted in the two rear windows, as shown in Fig. 22, and the staff reports that they have made the lives of the operators much more bearable (which anyone who has operated in one of these closed-in units on a hot day will readily believe).

WBAP has two pickup points for their microwave. One is located on a platform on the roof of the studio building. Because of the elevation of the site this is a vantage point which provides a clear shot for miles around. For those points which are shadowed by downtown buildings WBAP has another pickup point on the Medical Arts Building in downtown Ft. Worth. In addition it has a cable connection (AT&T) available for pickups in the Dallas area.



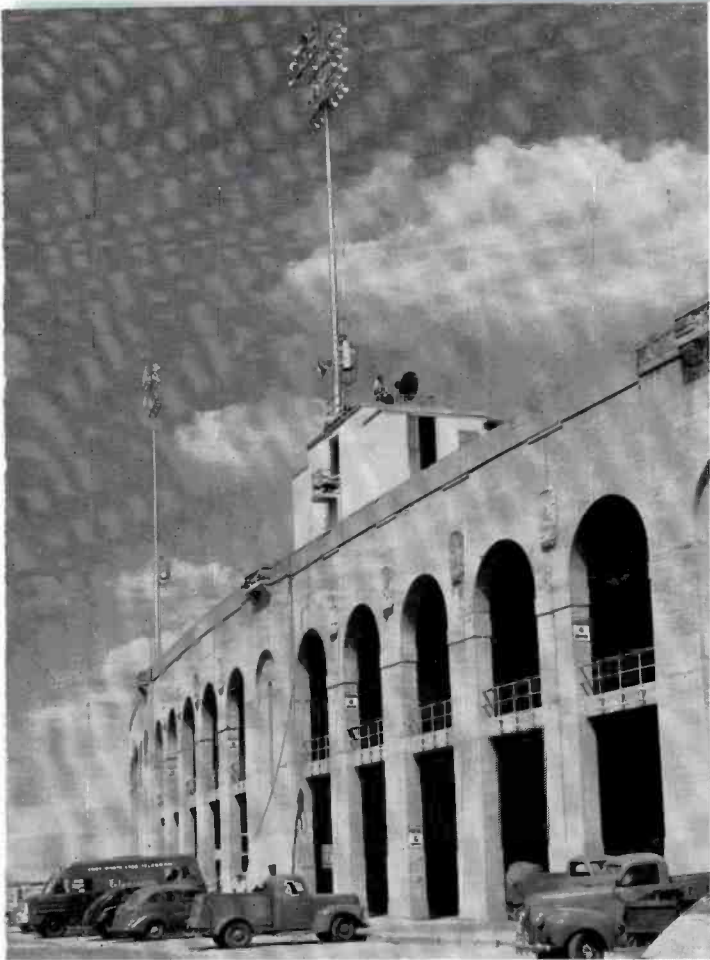

FIG. 23. For pickups at the stadium, ball park and similar events, WBAP leaves the control equipment in the mobile unit, uses long cables to cameras and microwave parabola located at vantage points.



FIG. 24. WBAP has two microwave relay pickup points: one is this parabola on the roof of the studio building, another is on the Medical Arts Building in downtown Ft. Worth.

FIG. 25 (below). WBAP cameras on the roof of TCU Stadium provide panoramic view of field.

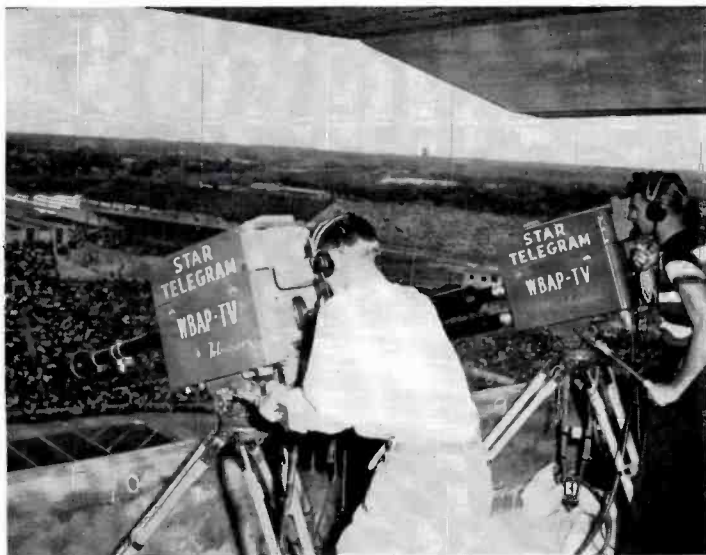

FIG. 26 (below). To improve their baseball pickup (cameras in press box were too high) WBAP engineers rigged up this "cowboy camera" in the Ft. Worth ball park.





WBAP AM-FM STUDIOS

The attention and publicity given to WBAP's television facilities might lead the uninitiated to the assumption that radio had been overlooked, or at least relegated to special place, in the planning of WBAP's new plant. Such an impression would be entirely wrong.

Television was entirely new to the Southwest at the time WBAP-TV went on the air. It was only natural, therefore, that the cameras and other TV facilities should catch the eye of the public. However, to the professional broadcaster the most notable feature of WBAP's plant is the completeness and perfection of its audio (AM-FM) facilities.

Planning a Deluxe Studio Layout

Only a few stations in the country have larger studio setups. None has finer equipment. Technical Director R. C. "Super"

Stinson, and his Audio Supervisor, Bruce Howard, have both been with the station many years. But they are both "old telephone men", which as every broadcast engineer knows, means they still are, and always will be, slightly fanatical on the subject of perfectionism in audio circuitry.

For years Bruce and Super (as he is affectionately known to broadcast men all over the Southwest) dreamed of the studio setup they would some day build. Many engineers have such dreams. But Super and Bruce had several things not many such engineers have. First of all between them they had over fifty years of audio experience—from the first days of broadcasting right down to the present. Second they worked for a station, which because of its many network ties, really needed an elaborate audio setup. And third, they worked for a man who for thirty years has

had a vision of broadcasting's ability to grow and grow and grow.

Thus, when WBAP finally decided to build an all-new plant three things happened in rapid succession. First, Super Stinson dusted off the plans for his many-years-dreamed-of super audio installation. Second, Harold Hough said, in effect, "Okay, shoot the works." Third, Super brought his plans to RCA design engineers who undertook to build exactly the facilities he wanted. The result, to which the description on the following pages hardly does justice, is something which engineers visiting WBAP are wont to drool over.

Six "Independent" Studios

Reference to the floor layout plan (Fig. 6, page 22) will show that in the new WBAP plant approximately the same floor area is given to audio (AM-FM) as to video (TV). In effect, this means that radio is given the larger share of the operations (since it uses its spaces more efficiently than TV).

FIG. 27 (opposite page). View in WBAP's AM-FM Studio A. This studio, like Studio B with which it is identical, is 26 feet by 40 feet by 20 feet high. Acoustical treatment consists of hard-surfaced polycylindrical diffusers on all four walls and ceiling. Control of reverberation is accomplished with acoustical sinks in the form of cylinders mounted along walls and suspended from the ceiling.

FIG. 28 (right). A corner of Studio B, which is identical to Studio A, thereby giving added flexibility for rehearsal and programming. Each studio has an "announcer's delight" control box (far corner) from which position he can do his own switching when he makes announcements. Note the cowbell (WBAP's identification for thirty years) at each announce position.

FIG. 29 (right). A corner of AM-FM Studio C which, like Studio D with which it is identical, is 17 feet by 26 feet by 11 feet high. In these studios, as in Studios E and F, acoustical treatment consists of splayed flat surfaces on walls and ceilings plus a calculated amount of acoustical absorbing material in irregular patches.

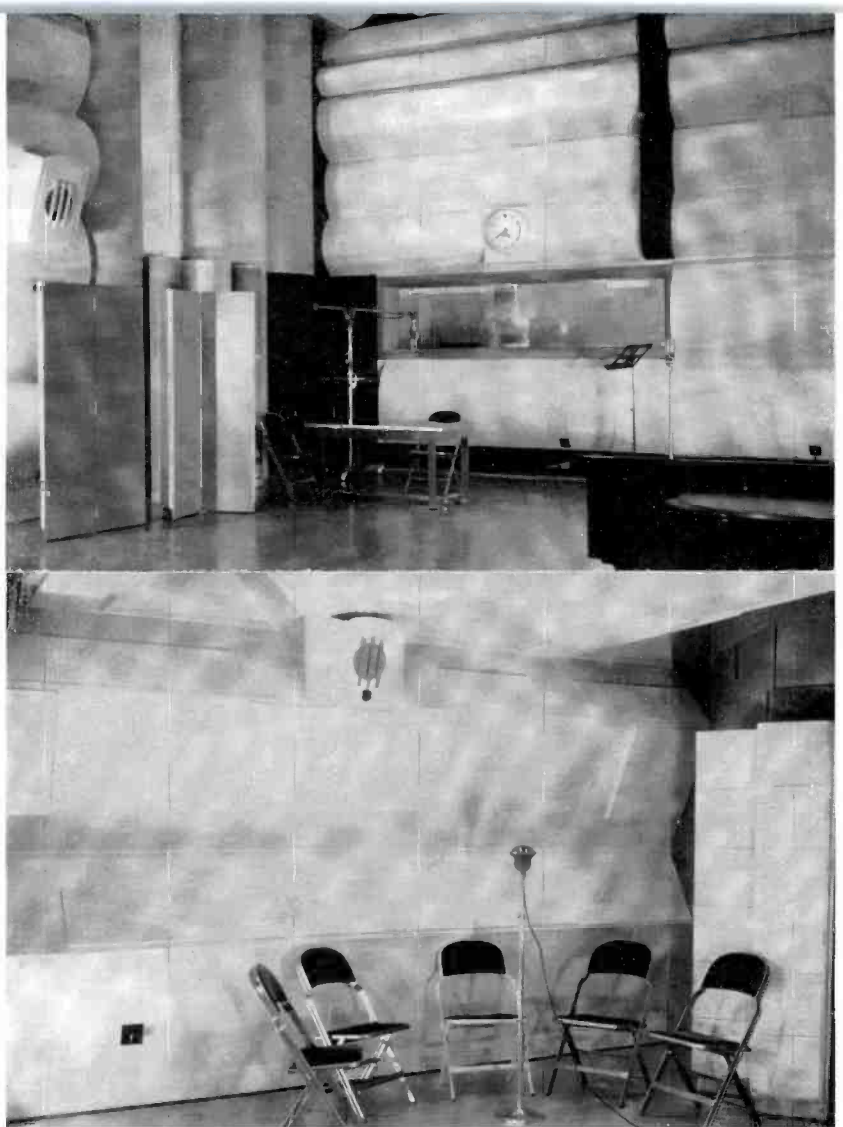

There are six individual radio studios, all of which are entered from the "audio corridor" that runs the length of the building. Each studio is entered through a sound lock. Each has its own studio control booth, so that it may be used as an entirely independent operating unit. This is of great advantage for rehearsals or when making recordings (of which WBAP does a large number).

Two of the studios (A and B) are relatively large (26 feet by 40 feet by 20 feet high). They are practically identical in construction as well as size. Studios C and D, also identical, are of medium size (17 feet by 26 feet by 11 feet high). Studios E and F, intended for news, interviews, etc., are smaller (16 feet by 17 feet by 11 feet high).

Unusual Acoustical Treatment

A number of illustrations of these studios are shown on this and the following pages. It will be noted that the idea of

using broken-up non-parallel surface walls has been carried out to the ultimate degree. In the two large studios the walls and ceilings are composed entirely of cylindrical surfaces of hard-faced materials. Required sound absorption is obtained with "acoustic sinks" in the form of cylinders or "barrels" which are mounted along the side walls and suspended from the ceilings (Fig. 27). An advantage of these is that they can be moved about to obtain desired measured characteristics. They were suggested by Dr. Rudimose of Southern Methodist University who was employed as acoustical consultant in the design of the plant.

In the smaller studios sound "breakup" is accomplished by the use of splayed flat surfaces on walls and ceilings (Fig. 29). A carefully calculated amount of acoustical material is placed on these splays in irregularly located patches.

In both the large and small studios acoustical "flats" are available for con-

trolling the acoustical effect according to the type of program. These flats (visible in Figs 28 and 29) are made up like "Chinese Screens". They have a hard flat surface on one side and are covered with acoustical material on the other. They may be used to obtain special effects or to compensate for the size of the talent group, presence of an audience, etc.

News Studio

In addition to the six regular studios there is a "news booth" in the news room itself. This booth is acoustically treated and provided with permanent microphone and control facilities. It is used not only for emergencies but for most of the station's regular newscasts. Thus there are really seven studios in constant use, each a complete independent operating unit. With all of these facilities WBAP is superbly prepared for any type of program, and for rehearsals, recordings and other activities in any sequence or combination.

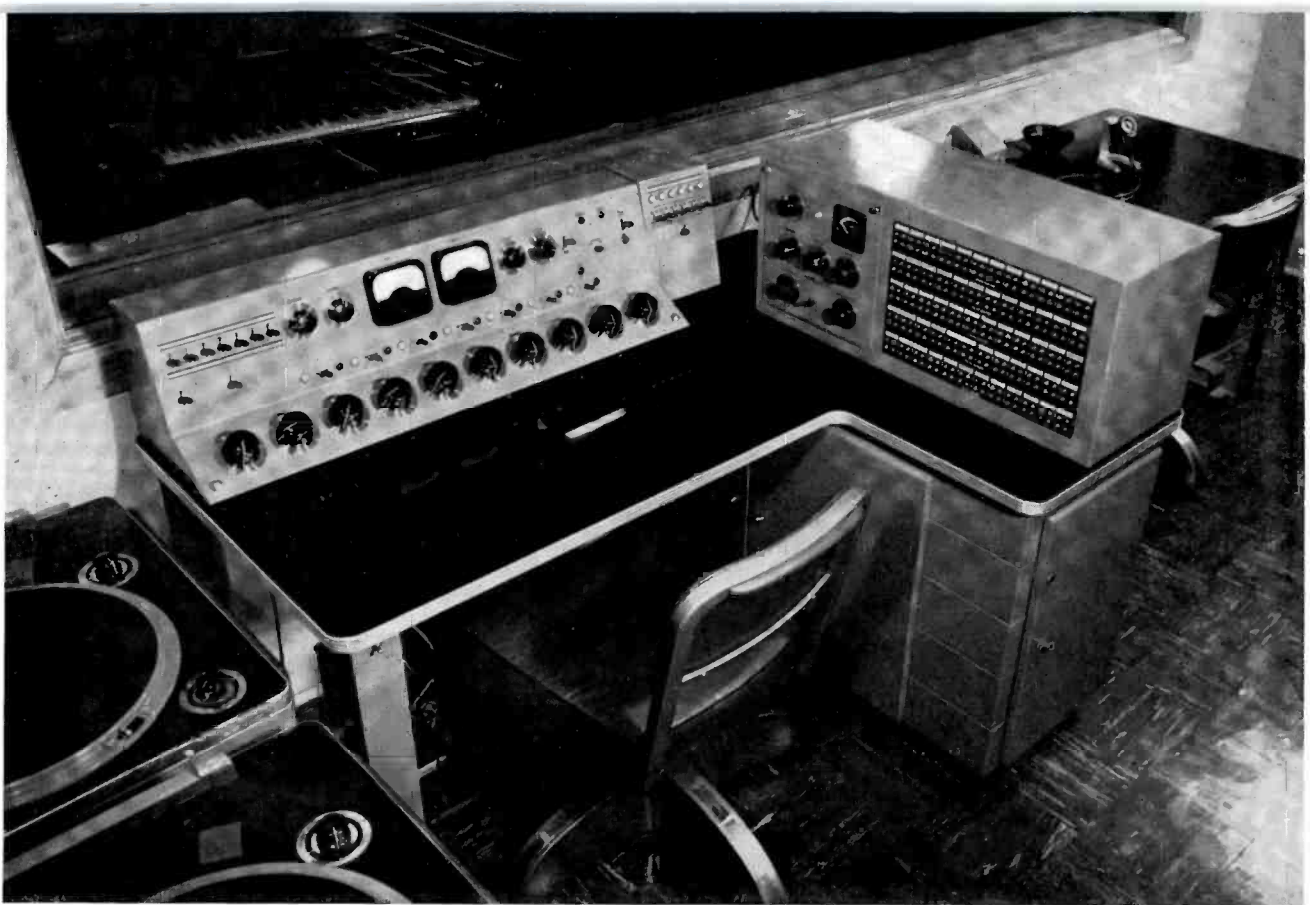

FIG. 30. Each of WBAP's six main AM-FM studios has its own control booth. The booths are identical in size and construction and each is equipped (as shown above) with either two or three RCA Turntables (left), a special RCA custom-built control console (center) and a program director's table (right). The RCA LC-1A Loudspeakers are mounted in the ceiling overhead.

WBAP STUDIO CONTROL BOOTHS

WBAP not only produces a large proportion of its own shows locally, but in addition it originates programs for two regional networks and makes a very large number of recordings (for use in stations throughout the Southwest). With so many shows, and attendant rehearsals, it is not unusual to have four or five studios in use at the same time. An operation of this magnitude is possible only if each studio unit is complete in itself.

WBAP's studios are planned that way. Each has its own control booth, and each booth is completely equipped with every needed facility. The equipment in all booths is identical and consists of (1) an operator's console, (2) a program director's desk, (3) either two or three transcription turntables, and (4) two loudspeakers mounted in the ceiling.

The operator's console, which is the heart of the operation, is an unusually complete deluxe-type unit designed and custom-built to WBAP's specifications by RCA engineers. On the top of this console are two turrets. One, directly facing the

operator, contains all the regularly-used controls. These include a seven-position mixer which by means of key selector switches will handle fourteen inputs, including: five studio microphones, three turntables, two networks, two remotes, newsroom and spare. Any of the mixer positions may be fed independently or in combination to either of two program buses. This turret also contains the announce microphone control and the two master controls.

The second turret (at the right or left side of the operator depending on which way the control is arranged) contains a large jack field plus auxiliary controls which are used only occasionally. The jack field contains normalled inputs and output of all amplifiers, mixers, bus circuits, etc. The operator can use patch cords to set up any special circuit arrangement he needs, or to "patch out" a defective unit in an emergency. (This operator's console is described in detail in the article entitled "Custom-Built Studio Control Consoles for WBAP", by A. S. Karker on page 42 of this issue.)

The operator's console and the program director's desk are arranged in front of the booth window as shown in the illustrations on this page. The window extends almost the full width of the booth, giving an unusually good view of the studio. The window, however, is very narrow in the vertical dimension so that the amount of glass surface in the studio is kept relatively low.

The turntables are in the corner of the booth at the left (or right) of the operator. Each booth has at least two (two booths have three). This is another provision designed to make each studio an autonomous producing unit. Booth monitoring speakers are mounted in the ceiling. In addition, there is a speaker in the studio for talkback and cueing.

The announce microphone is located on a small announcer's shelf in the corner of the studio (per NBC practice). A rather unusual feature is that this microphone does not feed into the regular mixer but rather directly to either bus (following the master channel mixer). This allows the studio microphones to be faded down simultaneously while bringing the announce microphone up.



FIG. 31. WBAP's recording room is one of the finest station recording setups in existence. At left, in the view above, are the RCA 73-B Professional Disc Recorders. At right are two studio-type tape recorders. Racks in the center house line amplifiers, recording amplifiers, monitoring amplifiers, power supplies, switching facilities and the auxiliary equipment.

WBAP RECORDING ROOM

WBAP records a surprisingly large number of programs for firms whose headquarters are in Ft. Worth and who distribute over the whole southwest. These programs, cut at WBAP, are used at dozens of local stations over an area several hundred miles in radius. This requires an elaborate recording setup—and WBAP has it!

The recording room, which is just off AM-FM master control, has five racks of equipment including line amplifiers, recording amplifiers, monitoring and switching facilities. Programs originating in any of WBAP's nine studios, from any of four networks, or at remote points can be recorded on either disc or tape. The disc recording equipment consists of two RCA 73-B Professional Recorders. Tape equipment includes two studio type tape recorders and four portable tape recorders for field work. The equipment also includes an RCA 70-B Turntable for checking records or dubbing.

FIG. 32 (right). Vacuum pumps for WBAP's disc recorders are located in basement directly beneath recording room. The starting switch on the recorder also starts the vacuum pump. Switching is arranged so that should one pump fail, the vacuum line and the control can be shifted so that either pump will serve either machine.

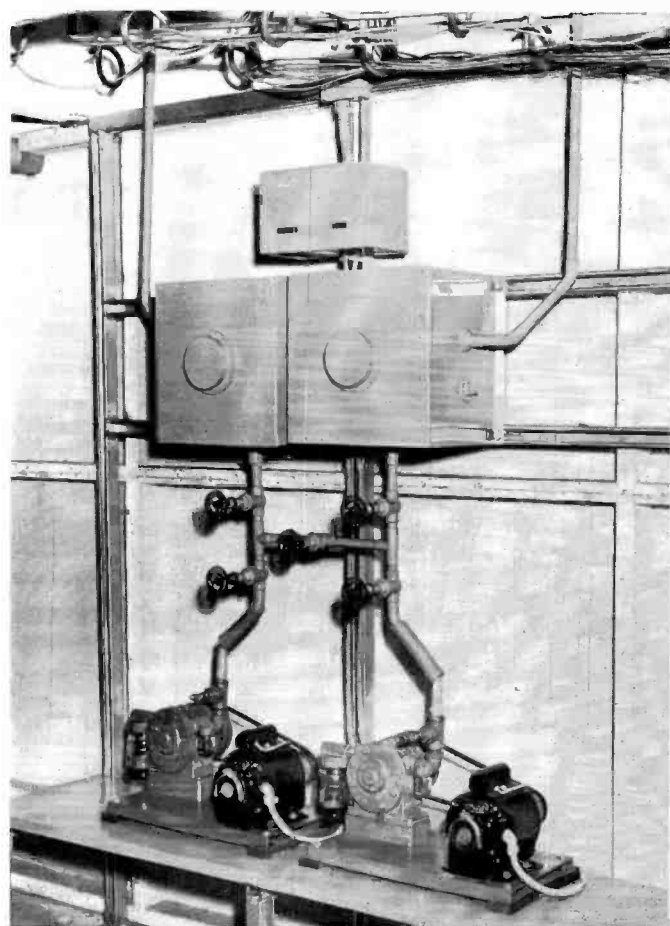

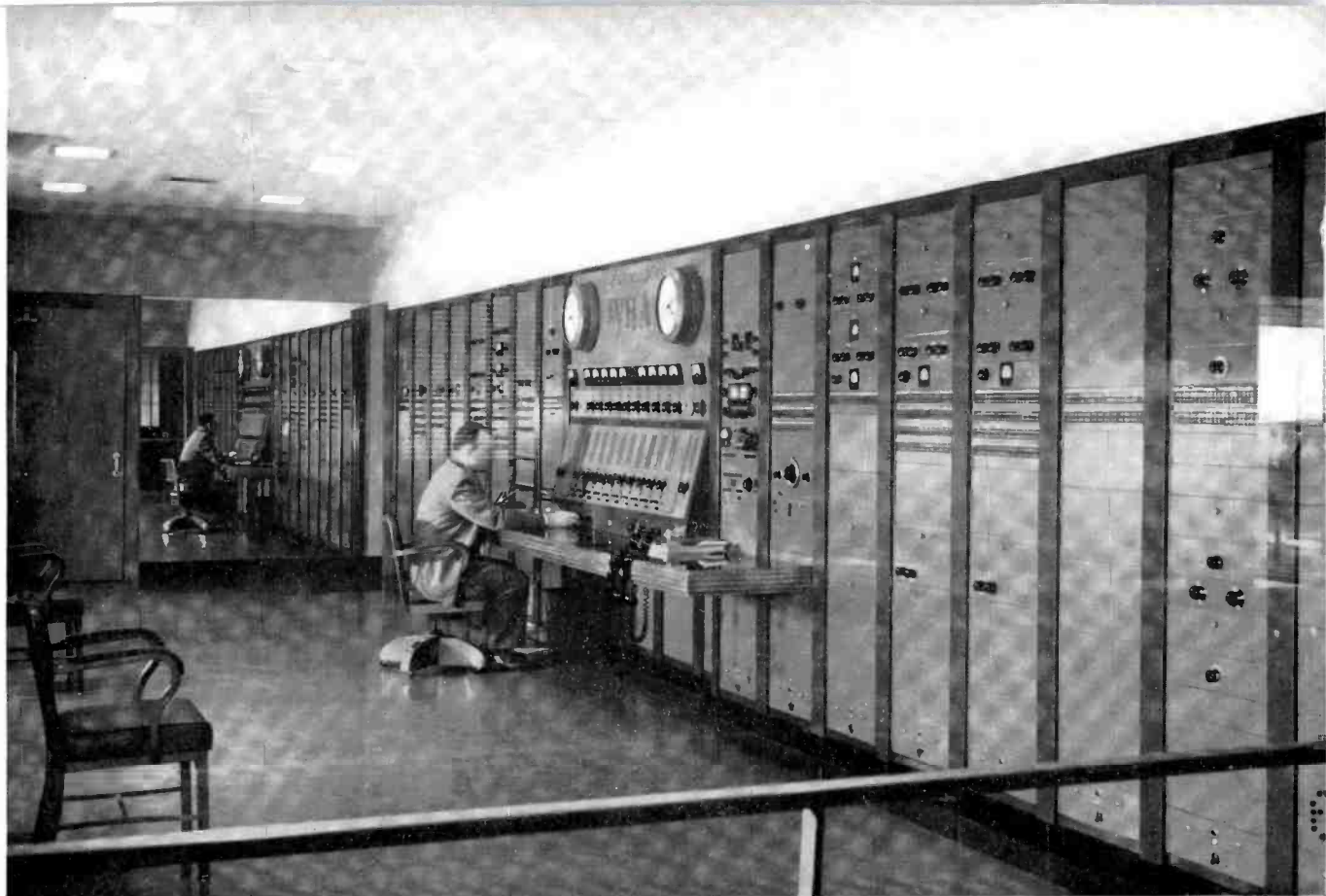

FIG. 33. View of WBAP's AM-FM Master Control Room as seen through the window from the main lobby. Twenty racks of equipment (with the main control position in the center) line one side of the room. The opposite side of the room (left in this view) is made up of three huge floor-length observation windows which divide the master control room from the corridor which runs across the front of the building (see floor plan, Fig. 6).

WBAP AM-FM MASTER CONTROL ROOM

The master control room shown in Figs. 33 to 37 is the "brain" of the whole WBAP radio operation. Into this room flow programs from sixteen different sources. Out of it flow programs to ten different transmitting or recording points or networks. Briefly these are:

Programs incoming from:

- 7 AM-FM Studios
- 2 TV Studios
- 2 Remotes
- 4 Networks (ABC, NBC, TQN, Lone Star)
- 1 Spare line

Programs outgoing to:

- 2 AM Transmitters (WBAP-820, WBAP-570)
- 1 FM Transmitter (WBAP-FM)
- 4 Networks (ABC, NBC, TQN, Lone Star)
- 3 Spare lines (used for feeds to recording room, or for emergency)

At any moment any one incoming program may be going to all ten outgoing channels, or ten incoming programs may

be going each to a different one of ten outgoing channels. Or there can be any combination in between. Moreover, the combination usually changes every fifteen minutes (sometimes every five).

WBAP regularly feeds two transmitters (WBAP-820 and WBAP-570) from two different national networks (NBC and ABC). It is the origination point for two regional networks (Texas Quality Network and Lone Star Network) which it occasionally feeds while carrying a different program itself, and it has a very heavy recording program. Thus the "despatching" load is in itself something of a problem.

The control equipment which takes up practically the whole side of the fifty foot long control room is made up of sixteen standard RCA equipment racks plus a four-rack-wide center unit which was custom-built by RCA to fit WBAP's needs.

All controls regularly used in the switching operation are grouped on this center unit. On a sloping panel directly in front of the operator's position are ten vertical

rows of controls. Each row is associated with one of the outgoing channels. Each includes a selector switch by means of which the operator can select one of the sixteen incoming lines he wishes to connect to that outgoing line. A series of sixteen lights just above shows him which one is connected at any time. Another set of sixteen lights indicates the one he has selected or "preset" for the next upcoming program period. With this preset arrangement he can, if he wishes, "preset" all his lines and at the proper moment cause them all to be changed by pressing a single "operate" button. Above each set of lights is the master volume control and VU meter associated with that line. Or, if he prefers, he can switch each outgoing channel separately to the preset line by putting a key in the "single" position and pressing the "operate" button for that line only.

By means of this arrangement the most complicated switching operations are made to look easy. Actually the circuits are extremely complicated. For example, no less than 170 relays are required for the switch-



FIG. 34 (above). Main entrance to the WBAP building is through this door into reception lobby.



FIG. 35 (above, right). View of the reception lobby. Reception desk is at the right, window into master control at the left center.

FIG. 36 (right). Looking down the corridor which runs across the front of the building (see floor plan, Fig. 6). The windows on the right side look into the master control room. The doorway at right leads to the reception lobby; the doorway at left leads into the side corridor which runs the length of the AM-FM studio part of the building.



FIG. 37 (right, below). View of the center part of the master control room as seen through the corridor windows. Operating controls are grouped in the four-rack-wide center section of the equipment racks.

ing operations alone. In addition, there are circuits necessary for automatic interlocking, automatic switching of power supplies, correct loading of circuits, necessary amplification, etc. All of this equipment is mounted on the sixteen racks which flank the center panel on either side.

The twenty Equipment Racks (counting center section) line one side of the control room. The other side (toward the corridor) is practically all glass (as is the end facing the reception lounge). Thus visitors entering the building are immediately brought face to face with this huge control setup. It's an impressive sight. Locating it at this point was a stroke of showmanship which certainly pays off in the impression it makes on everyone entering the station for the first time.

All of the equipment in WBAP Master Control Room was custom-built for the station by RCA. It is described in detail in the article "Deluxe Master Control Room Equipment at WBAP" by M. E. Gunn (page 48 of this issue).



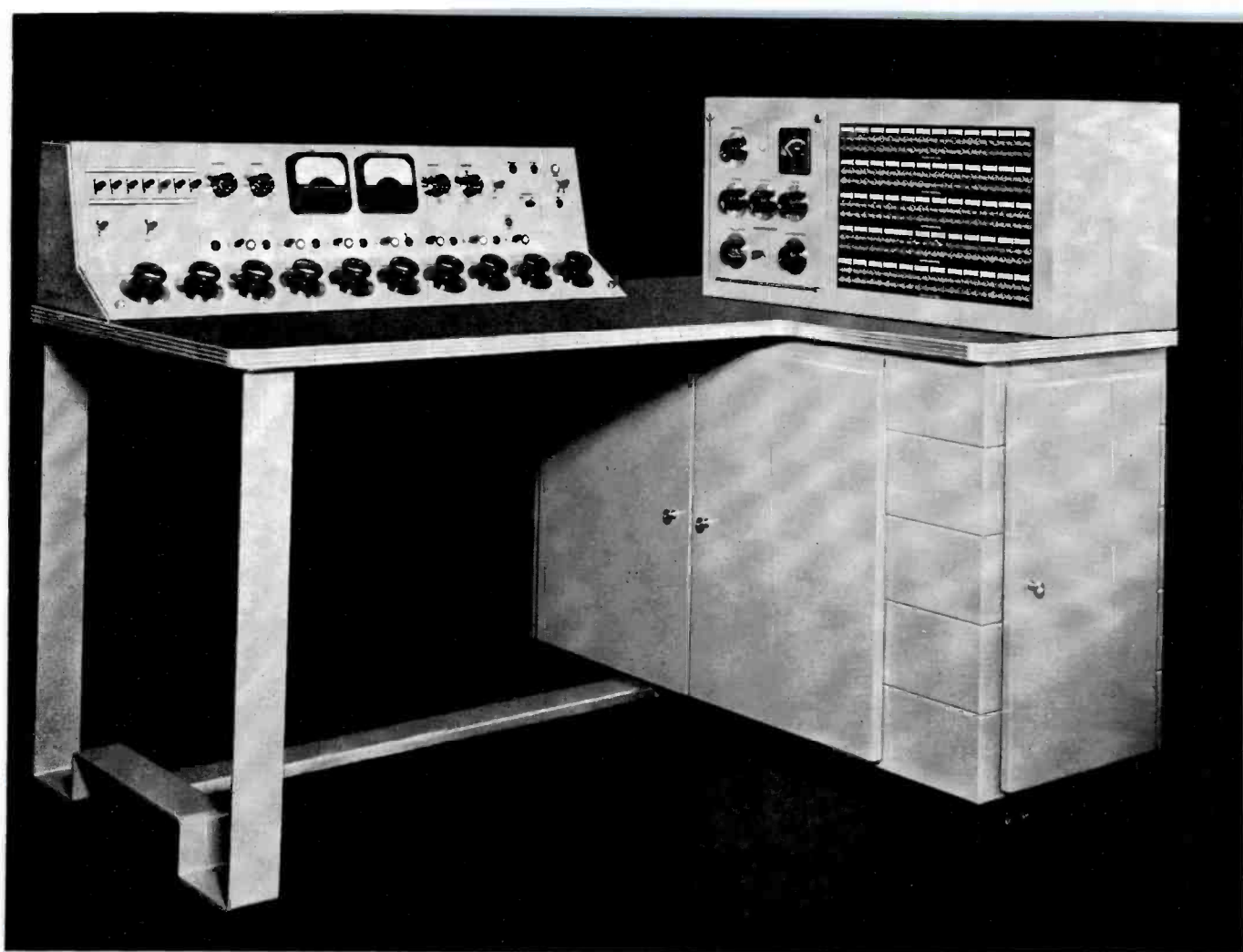

FIG. 1. Each of WBAP's six AM-FM studios has its own control booth, and each booth is provided with a control console like the one shown above. These all-steel consoles, custom-built for WBAP by RCA, contain all the equipment facilities (except microphones, loudspeakers and turntables) which are required for complete independent operation of the studio for all conceivable types of programming. Additional views of console shown on following pages.

Custom-Built Studio Control Consoles for WBAP

By **A. S. KARKER**
Engineering Products Department

The studio consoles designed and built by RCA for WBAP, Ft. Worth, provide in a single unit all of the operating facilities for the control of a completely independent studio unit. It was intended that these studio consoles should offer the maximum in fidelity, flexibility, reliability and convenience of operating. Appearance was also an important factor in the design.

The desk is constructed entirely of steel and completely replaces conventional rack equipment (usually associated with the console) by providing a housing for all

amplifiers, power supply, relays, etc. These components are mounted and housed in the pedestal which, in a conventional type of desk, would be reserved for drawer space. Three of these consoles were constructed with the pedestal on the right side and three on the left side. The pedestal is provided with a 2-inch connection for a forced cool air connection from the floor. The overall dimensions of the console are: length, 62 inches; depth, 42 inches; and height, 38 inches. With this low overall height, there is no obstruction of vision into the studio.

The pedestal has two compartments. Doors to these compartments are each supported by a continuous piano hinge. The

doors are latched by bullet type catches which assure ease of opening and closing. There is one large compartment with double doors opening to the inside of the desk. There are three shelves in this compartment on which are mounted twelve preamplifiers RCA type BA-1A, two power supplies RCA type BX-1C, two program amplifiers RCA type BA-3C, and three monitor amplifiers RCA type BA-4A. Amplifiers and power supplies are of the plug-in type, and the removal of these units for any reason is a simple matter.

The smaller compartment which opens to the front contains the speaker volume control, power switches, fuses, pilot lights and terminal blocks for external connec-

tions. The placement of terminal blocks in this convenient location facilitates trouble shooting when it is necessary to check external circuits to the desk. Needless to say, the desk installation is less a problem than with the terminal blocks in some out of the way place. Wiring to the terminal blocks comes up to the terminal block compartment through the floor.

FIG. 2 (right). All of the amplifiers, power supplies, relays, etc., associated with the operation of the studio and control booth are housed in the pedestal of the console. This eliminates the need for an equipment rack in the control booth and greatly simplifies and reduces the cost of equipment installation. The amplifiers, which are all standard RCA units of the plug-in type, are located on shelves as shown in the view at right. The top shelf contains eleven BA-1A Booster Amplifiers, the middle shelf two BA-3A Line Amplifiers and two BX-1C Power Supplies, and the bottom shelf three BA-4A Monitoring Amplifiers. The small compartment at the front of the pedestal (right in this view) houses power switches, fuses and terminal blocks for external connections. This very convenient positioning of the terminal blocks is another contribution to ease and convenience of installation.

FIG. 3 (right, below). The custom-built console installed in one of the studio control booths at WBAP. The control turret is relatively low so that it does not obstruct the view of the studio. The program director sits at a matching table (just beyond the side turret in this view). Turntables are at the operator's right, loudspeakers in the ceiling overhead.

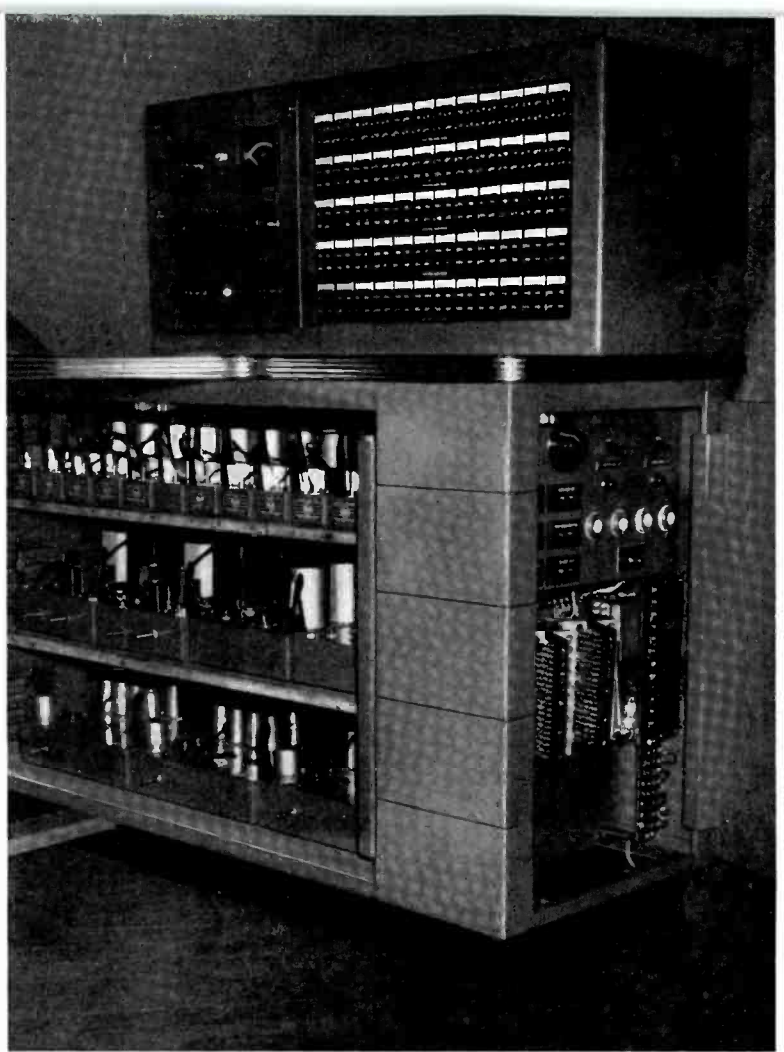

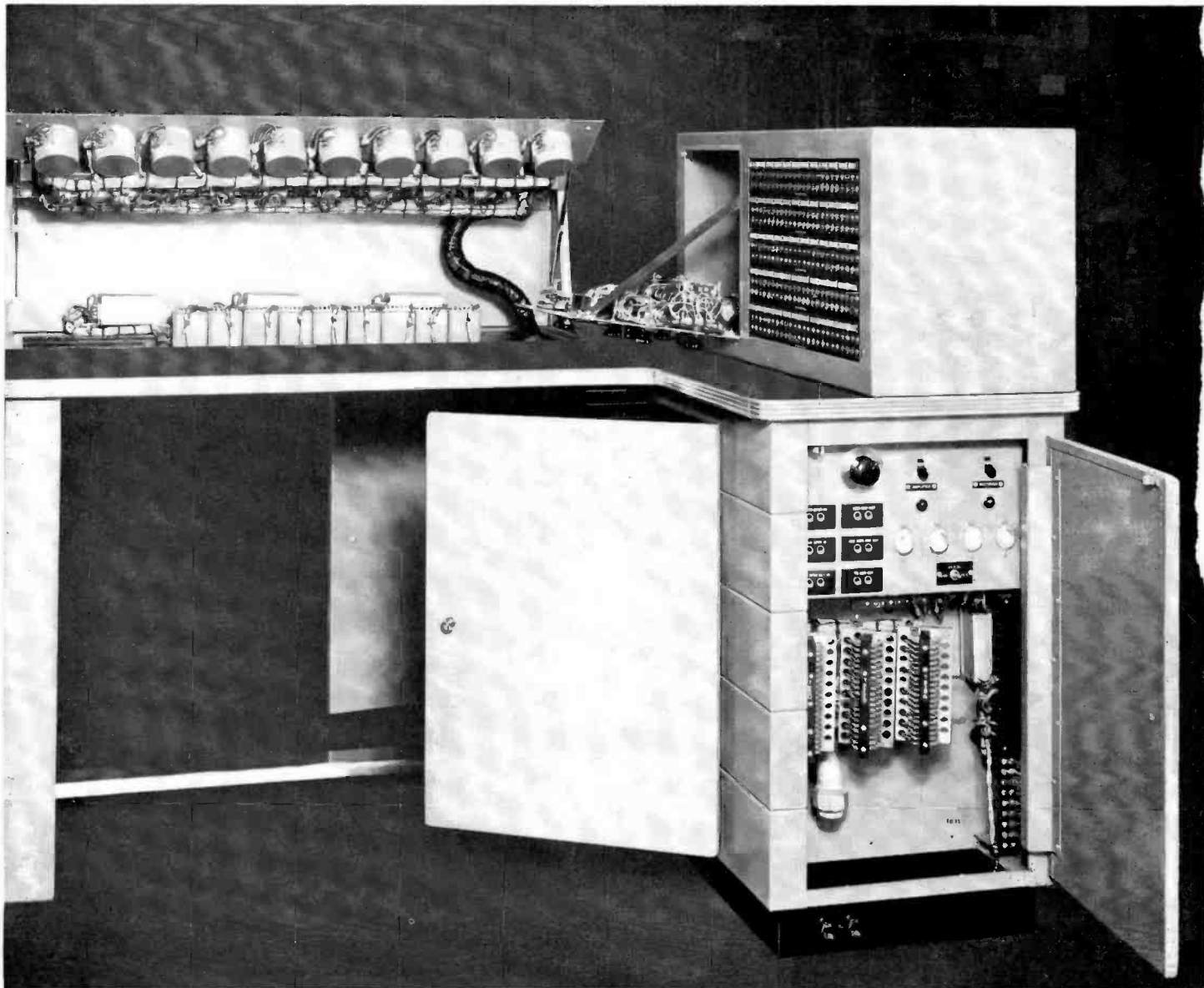

FIG. 4. Accessibility is a feature of the WBAP console. The front panel of the operating turret is hinged at the top so that it can be raised to provide quick access. The control section of the side turret is hinged at the bottom so that it can be lowered as shown in the view above. The amplifier and power control compartments in the pedestal have hinged doors.

The side or end of the desk pedestal which is fastened with concealed screws was removed during the time the desk was being wired to provide easy accessibility to all amplifier plug terminals.

There are two turrets built on the desk top. The turret directly in front of the operator has a hinged panel so it can be raised to gain access to any parts which are mounted on it that may require maintenance. There are two slopes on this control panel to provide maximum operation convenience. The mixer controls are mounted

at a sixty degree angle (from the vertical plane) which permits long periods of operation with maximum comfort and minimum fatigue even though these controls usually require continuous adjustment during programming.

The part of the panel containing the VU meter, master gain controls and switches is on a fifteen degree slope. This places the meter in a position to give maximum advantage to the operator.

The side turret contains a jack bay which contains 120 pairs of jacks. Access

to the jack wiring is gained by the removal of a panel in the back of the turret. Mounted along side the jack bay towards the front is a meter for checking cathode bias voltages of BA-1A and BA-3C amplifier tubes. A selector switch picks up the metering terminals of these amplifiers. Sound effects controls, cue selector, head phone selector and volume control are mounted on this panel. These controls required only occasional adjustment but are within reach of the operator. Access to this section is by lowering the hinged front

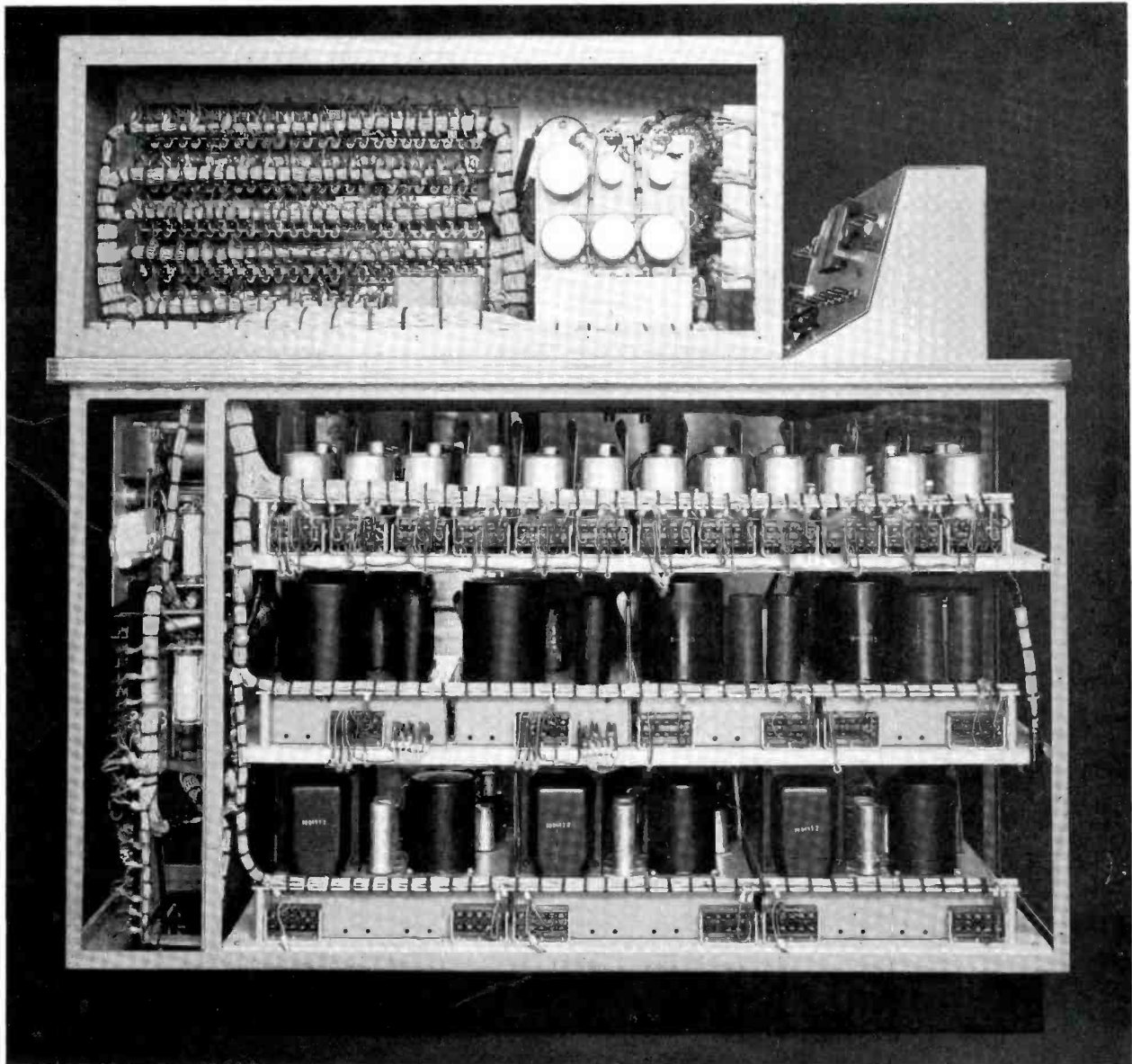

FIG. 5. A side (or end) view of the console with the side panels (fastened with concealed screws) removed to show arrangement of components in the pedestal and the side turret. The amplifiers (front view in Fig. 2) are all of the plug-in type so that they may be removed easily for servicing or replacement. The fact that all inter-unit wiring and complete check-out is done in the factory makes for fast, economical installation.

panel which is held in place with thumb screws.

The desk top is wood with a cigarette burn proof black micarta top. The edge is trimmed with aluminum moulding. The desk is finished with a baked enamel, light umber gray with panels in a contrasting dark umber gray. These color tones produce a pleasing and harmonizing blend with studio and control room decorating.

All dial plates are nickel silver and machine engraved characters are used throughout.

Control Facilities

The circuit block diagram, (Fig. 7), embodies a seven mixer position. Each mixer has associated with it a lever key. This provides a choice of two inputs to each mixer adding to the flexibility of the overall system. The seven mixer controls are centrally located on the control panel with the selector keys grouped at the upper left section of the panel. Located above each mixer control are two supervisory lights which indicate the channel (reg. or aux.) to which the mixer is switched. Each

channel has its own booster amplifier and master gain control. The output of each master gain control feeds into its respective BA-3C program amplifier. From these amplifiers, two way branching networks feed the associated VI circuit, monitor bus and program line. Selection of the reg. or aux. channel to the outgoing program line is made by the on-air key switch and indicated by supervisory lights. The announce mixer is combined with the reg. and aux. channels following the program master gain control. This arrangement allows the stu-

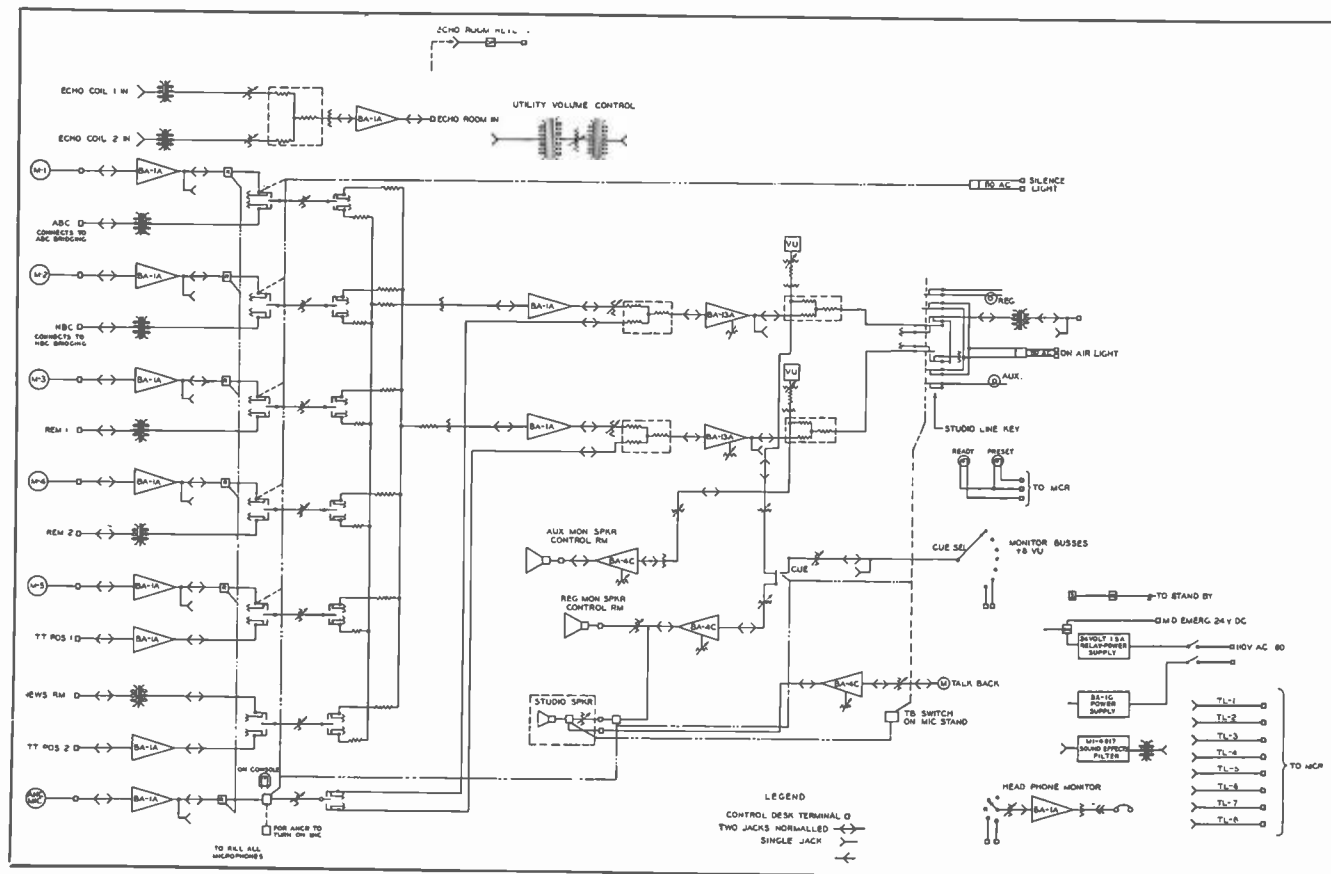
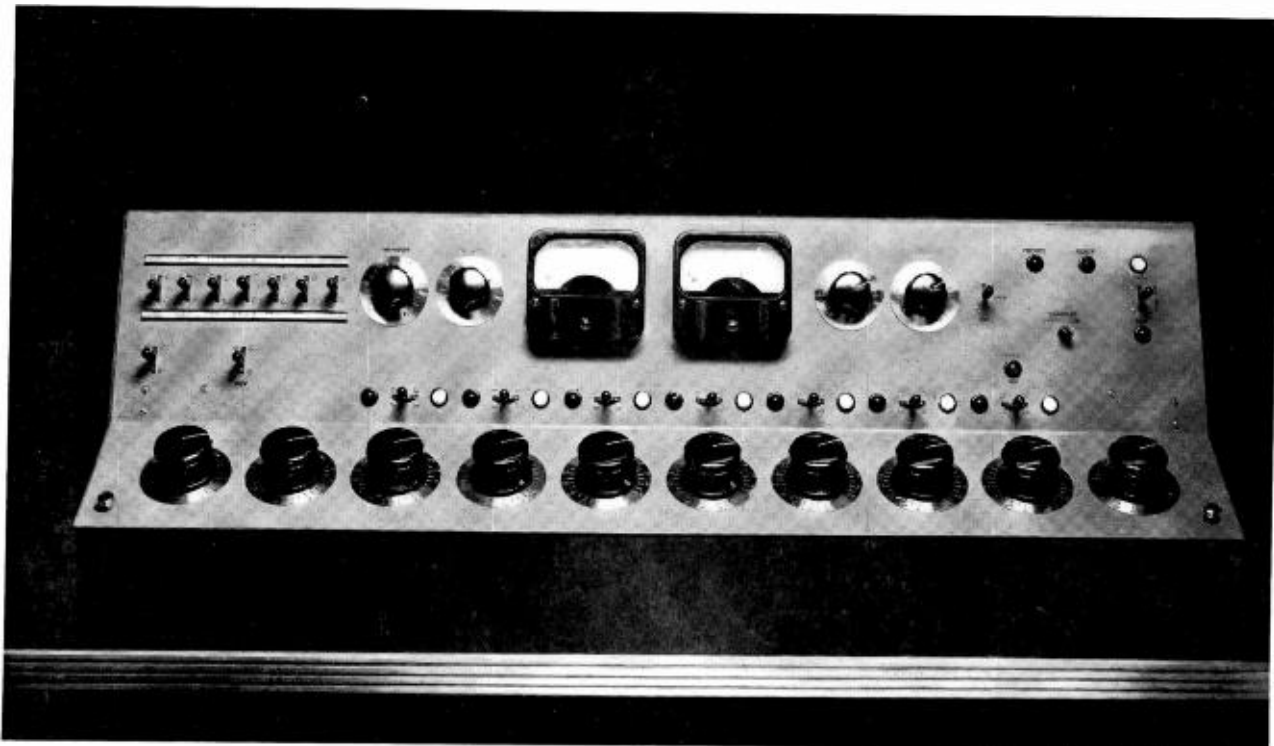

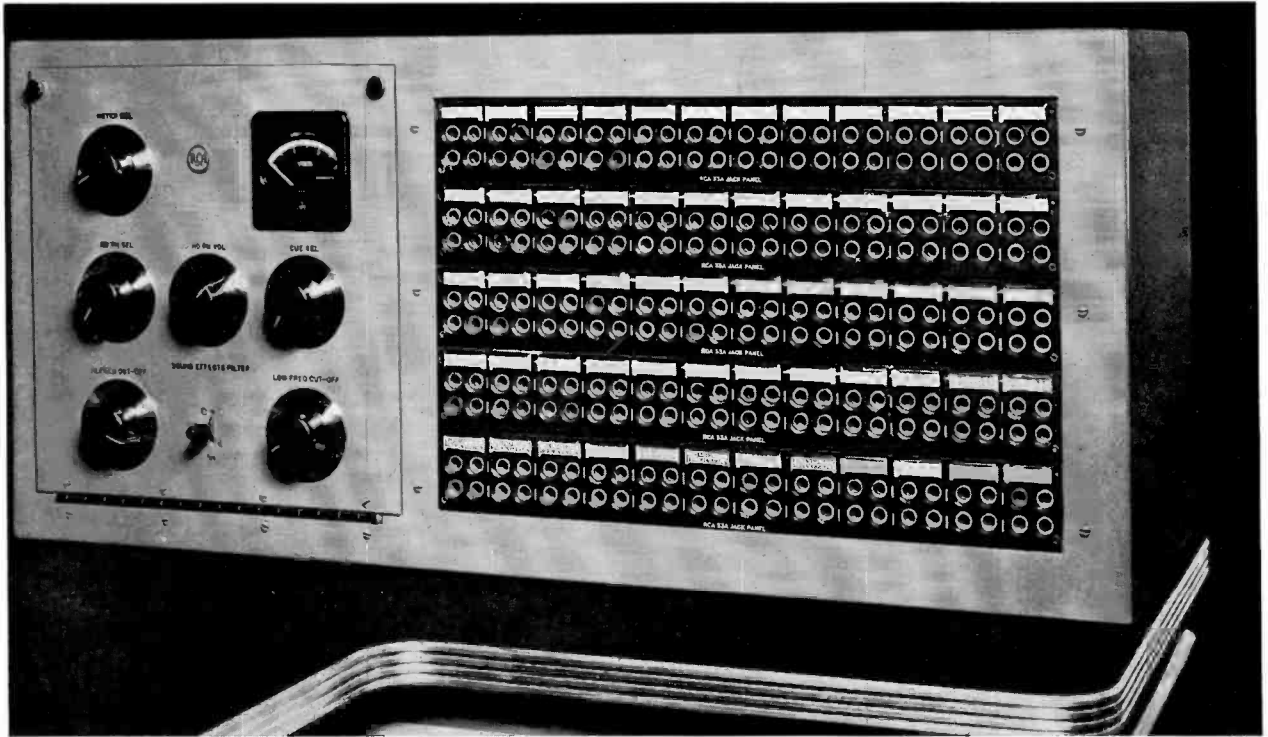

FIG. 6 (opposite page, top). Closeup of the front turret. Mixer controls are mounted on lower part of panel which is sloped at an angle of sixty degrees (from vertical) to provide maximum comfort for operator. VU meters, switches, masters and monitoring controls are on upper part of panel which is at fifteen degree angle for best observation of meters.

FIG. 7 (opposite page, bottom). Simplified schematic diagram showing electrical circuits included in the WBAP consoles. Seven mixer positions, each with two-position input key, provide for handling fourteen inputs without patching. Output keys in each position allow them to be switched independently to either of two program/monitor busses.

FIG. 8 (above). Closeup view of the side turret of the WBAP consoles. On the control panel at the left are: (1) a meter and selector switch for checking the cathode-bias voltages of tubes in BA-1A and BA-3A amplifiers, (2) selector switch and volume control for headphone monitoring of all important circuits, (3) cue selector switch for obtaining cue from any of house monitoring busses, (4) sound effects filter switch with controls for high and low cutoff. The jack bay contains sixty pairs of double jacks. Most of these are normal-through jacks located at the points in the circuit indicated in Fig. 7. They provide for quick check at any point in any circuit and, when necessary, for "patching around" any component in the equipment.

dio microphones to be faded out simultaneously while switching or fading in the announce position.

A two position echo mixer circuit with bridging transformer inputs and a BA-1A booster is supplied. Reverberation characteristics may be applied to two microphone channels by patching the output multiple of one of the microphone or turntable pre-amps to one of the bridging transformer inputs. The output of the booster amp appears on jacks on a rack in the master control room from which it can be patched into an RCA BA-4A which drives a speaker located in the echo chamber. A microphone in the echo chamber picks up the output from the speaker and feeds it into an RCA BA-2B amplifier, the output of which also appears on jack in master control. This circuit is then patched back to the studio control booth where it can be patched into an unused mixer to be combined with the normal program. The reverberation key on

the panel opens and closes this echo return circuit. A sound effects filter is supplied to obtain a wide variety of effects.

An RCA type BA-4A monitor amplifier bridges the aux. monitor bus through a bridging volume control and feeds a speaker in the control room. The reg. channel monitor bus is bridged to an RCA type BA-4A monitor amplifier through a bridging volume control. A key switch transfers the input of the amplifier to a rotary switch for selecting a cue for the studio monitor buses. The studio speaker and a control room speaker are fed from this amplifier. The volume control for each of these monitors is mounted beside the respective channel master gain control.

The talk back circuit uses an RCA BA-4A amplifier which feeds the studio speaker. A relay which turns on the studio speaker for talk back is operated by a push button switch on the microphone stand. This switch is interlocked with the line key

and is inoperative when a program is on the air.

A separate relay is used to cut off the studio speaker when a microphone is switched in to prevent feedback.

The announce microphone switch operates a relay which cuts out all the studio microphones and turns on the announce microphone. Constant amplifier loading is always maintained by a system of back loading all relays.

An eighteen position head phone monitor switch and volume control with an RCA BA-1A preamp is provided. These controls are in easy reach located on the side panel for adjustment to the operator's desired volume.

Other facilities provided on the console are a utility key, utility attenuator, standby switch, preset and ready indicator lights.

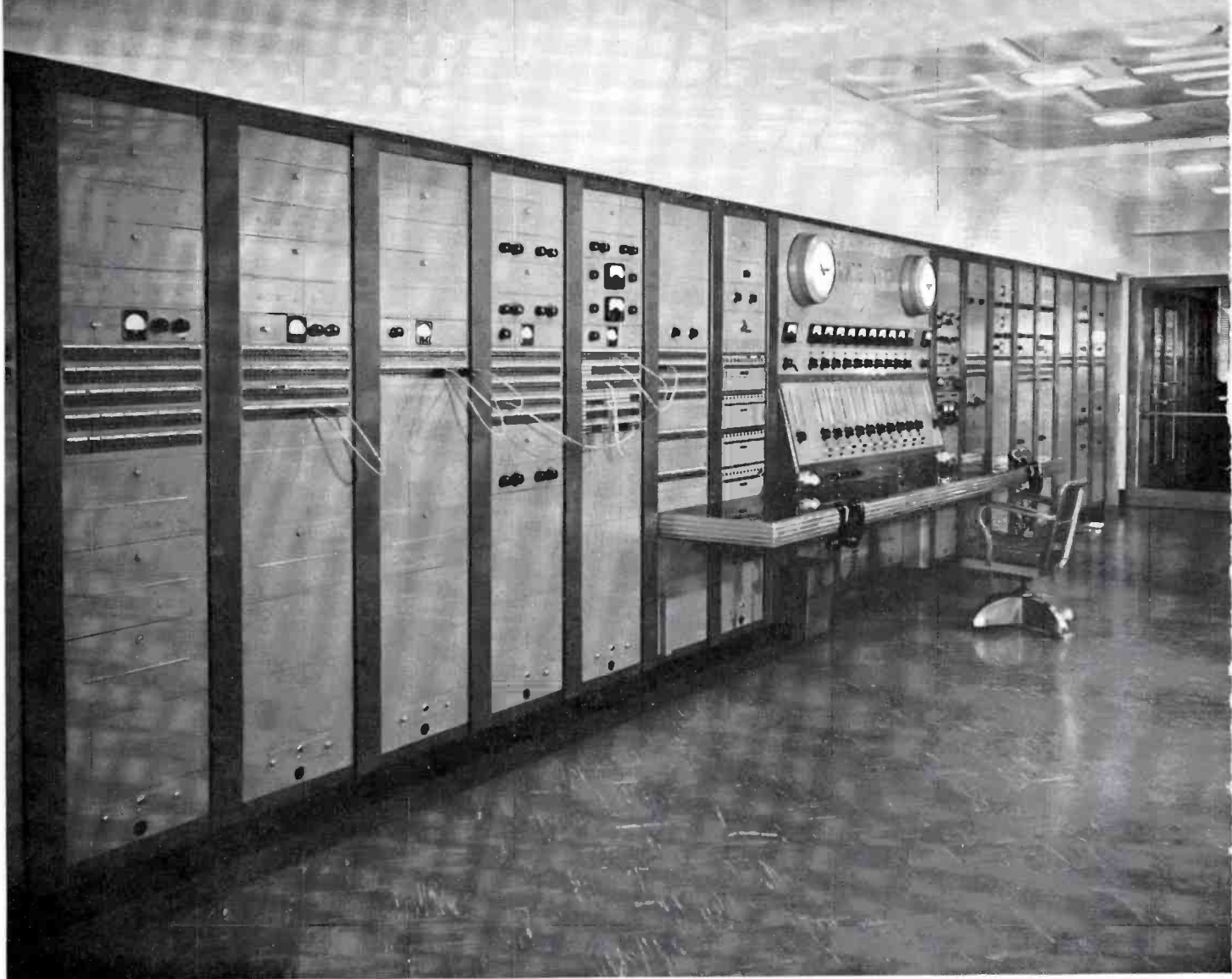

1	STUDIO LINE TO DIAL SYSTEM	OUTPUT CHANS TO DIAL SYSTEM	HD PHONE AMPS	INCOMING BROADCAST LINES	REM-NET	SERVICE LINES	REM-CUE	M C
BLANK	BLANK	BLANK	BLANK	BLANK	BLANK	BLANK	BLANK	
SPARE SHELF	6-BA-1A BRG VC STUDIO 1-6	6-BA-1A BRG VC CHAN 1-6	3-BA-1A BRG VC 570-820-FM	2-BA-3C LSC TON	2-BA-3C NBC LINE ABC LINE	BLANK	1-BA-4C 8 BRG COIL REM-CUE	
6-BA-1A BRG VC RECORDING	6-BA-1A BRG-VC STUDIO 7-12	4-BA-1A BRG-VC CHAN 7-10	2-BA-1A HD. PHONE AMPS	2-BA-3C REM-1 REM-2	VU METER NBC	BLANK	REM CUE SEL	
BI-2A METER	BI-2A METER	BI-2A METER	BI-1A METER	BI-1A METER	VU METER ABC	UTL. VOL CONTROLS 1+2	EMG MAGNETO	
2-33-A JACKS	5-33A JACK PANELS	4-33A JACK PANELS	2-33A JACK PANELS	5-33A JACK PANELS	BI-1A METER	3-33A JACKS	12 POS RD	
BLANK	4-BA-1A BRG-VC STUDIO 13-16	BLANK	BLANK	2-BA-3C SPARE INPUT	5-33A JACK PANELS	1-33A JACK	12 POS RD	
BLANK	2-BX-1C POWER SUPPLIES	2-BX-1C POWER SUPPLIES	1-BX-1C POWER SUPPLY	16 LINE COILS 600 150	24 INCOMING LINES	BLANK	12 POS RD	
IBX-1C POWER SUPPLY	1-BX-1C POWER SUPPLY	BLANK	BLANK	SWITCHING INPUTS	14 COILS NET BRG TO STUDIO AVC NET FEED TO STUDIOS SPACE FOR 36 TYPE 23A EQUALIZERS	1-33A JACK	12 POS RD	
BLANK	16-BRG COILS FOR HDPHONE MON BUS	10 BRG COILS FOR HDPHONE MON BUS				BLANK	12 POS RD	
57-C SW PANEL	57-C SW PANEL	57-C SW PANEL	57-C SW PANEL	57-C SW PANEL	57-C SW PANEL	BLANK	57-C SW PANEL	
								SEE DETA

Deluxe Master Control Room Equipment at WBAP

by M. E. GUNN

RCA Engineering Products Department

The WBAP master control room equipment is one of the largest and most complete installations of its kind in existence. One of the most recent of a number of large-size deluxe installations designed and built by the RCA custom engineering group, it includes the best features of preceding designs plus a number of new features which broadcast station engineers will find of interest. These include:

- (a) Complete facilities for handling simultaneously sixteen incoming and ten outgoing lines with provision for any desired input-to-output combinations.
- (b) All-relay-type switching with provision for "pre-setting" all desired combinations so that at changeover time the operation of one key accomplishes all required switching operations.
- (c) In-line arrangement of twenty equipment racks along one side of room so

that visitors have a full view of all control room operations.

- (d) Control position "built-into" rack setup so that wiring interconnections are reduced to a minimum, operation made more convenient.
- (e) Unusually complete provision of auxiliary equipment for monitoring, testing and servicing.

Design of the Equipment

The general specifications for the master control room equipment were drawn up by the WBAP engineering staff headed by L. C. ("Super") Stinson, Technical Director, and Bruce Howard, Audio Facilities Engineer. Both of these men have made audio equipment their chief interest for many years. Thus, when it came time to plan a new studio layout they knew exactly what they wanted. Moreover, they knew how to lay down "tight" specifications on performance. The requirements they set up represented a degree of performance heretofore unequalled in a system of this size.

Engineers of the RCA custom audio engineering group took the WBAP specifications and planned an equipment layout which would provide the facilities desired by the station. Their plans were checked and rechecked with WBAP engineers until all were in accord. Thus the final design of the equipment represents the combined thinking of WBAP and RCA engineers.

Construction of the Equipment

The individual racks which make up the WBAP master control equipment were assembled and wired by the RCA Engineering Products Department in Camden. All of the racks are standard Type BR-84 Cabinet Racks and most of the rack-mounted amplifiers, jack panels, meter panels, etc., are also standard units. The 4-section control unit in the center was, of course, specially designed and manufactured (see Figs. 5 and 6) to order. However, even in this unit regular cabinet rack frames were used so that standard methods of assembling and wiring components could be followed throughout.

FIG. 1 (opposite page). WBAP's AM-FM Master Control Room equipment consists of sixteen standard racks of equipment units plus special four-rack-wide center section on which main operating controls are grouped. These racks take up one whole side of the forty-foot long control room. The opposite side of the room and one end (far end in this view) consist of floor length windows through which visitors to the building can observe the control operation.

FIG. 2 (below). This drawing of the equipment racks in the WBAP master control room shows the placement of the individual units on the racks. In general these units are grouped according to the part of the circuit they are in. The function of the units in each rack is indicated by the legend over the rack. Details of the four-rack center section are shown in Fig. 4 on the following page.

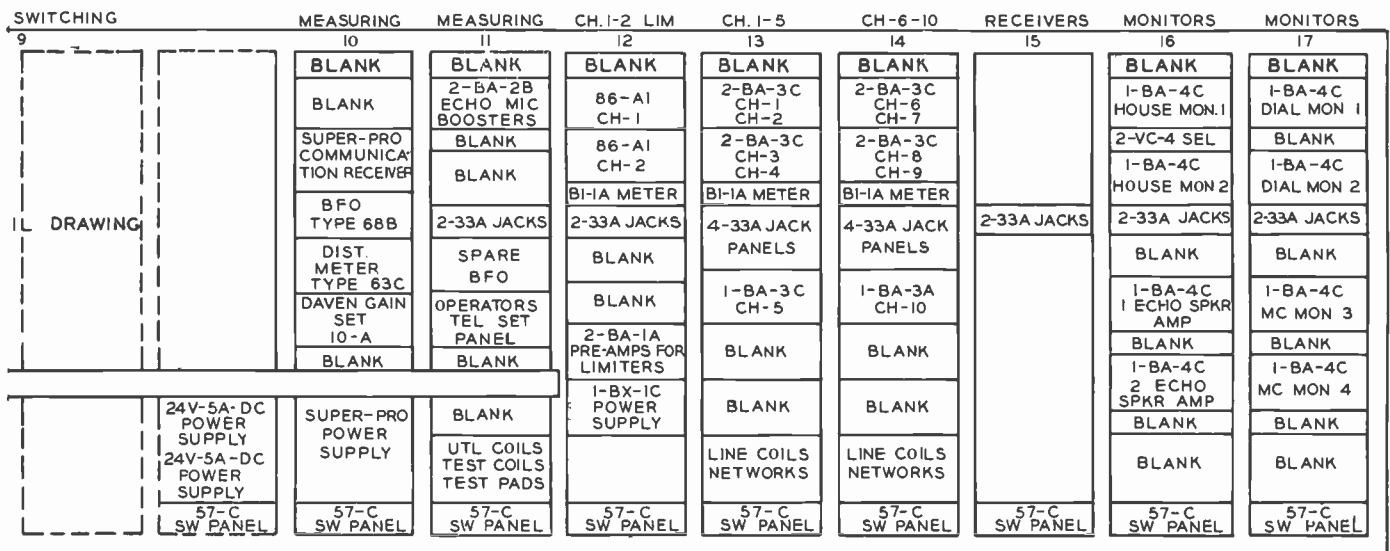



FIG. 3. This is a closeup of the main operating position of the WBAP master control position. The special four-rack-wide control section was custom-built by RCA to WBAP's specifications. It provides means of switching sixteen incoming circuits to any or several of ten outgoing circuits with complete "preset" facilities. Arrangement of controls is shown in diagram, Fig. 4, on opposite page. Operation is described in the text. Shown in this view are, at left, R. C. Stinson, Technical Director of WBAP, under whose direction this equipment was planned and installed; and, at right, Roy Bond, of the WBAP engineering staff.

Arrangement of Equipment

The general arrangement of the equipment in master control is shown in Fig. 1. The location of the various equipment units on the sixteen racks is shown in Fig. 2. It will be noted that these units are grouped according to function. The function of the equipment in each rack is indicated by the title over the rack in Fig. 2.

All controls regularly used in the switching operation are grouped on a four-rack-wide unit. A diagram of this unit is shown in Fig. 4. On a sloping panel directly in front of the operator's position are ten vertical rows of controls. Each row is associated with one of the outgoing channels. Each includes a selector switch by means of which the operator can select one of the sixteen incoming lines he wishes to connect to that outgoing line. A series of sixteen lights just above shows him which one is connected at any time. Another set of sixteen lights indicates the line which has been selected or "preset" for the next upcoming

program period. With this preset arrangement he can, if he wishes, "preset" all his lines and at the proper moment cause them all to be changed by pressing a single "operate" key. Or, if he prefers, he can switch each outgoing channel separately to the preset line by putting a key in the "single" position and pressing the "operate" key for that line only.

Above each set of lights is the master volume control and VU meter associated with that line. At either end of the panel there is a "utility" VU meter with a selector switch which allows the meter to be placed across any line for checking purposes. Between these VU meters and the ten regular channel selector systems there are spaces which make it possible to add two additional outgoing line facilities if they are needed at a later date.

A small vertical panel, just below the large sloping panel, contains monitor selector and volume controls for four monitor speakers which are mounted in the ceiling

above the control position, and for two headphone monitoring circuits which by means of selectors can be placed across all important operating circuits.

Circuit Details

The simplified circuit diagram shown in Fig. 10 indicates the arrangement of circuits in the master control room equipment. There are sixteen input circuits. Seven of these are from AM-FM studios, two from remote positions and one is a spare. All incoming program circuits (except those from the studios) are provided with Type BA-3A booster amplifiers to compensate for equalization plus line losses.

The sixteen input circuits feed into a switching system which uses 170 relays to provide presetting features plus interlocking to prevent more than one program on the same channel. Each of the ten output circuits incorporates a Type BA-3A booster amplifier, volume control and VU meter. In addition, the two main lines to

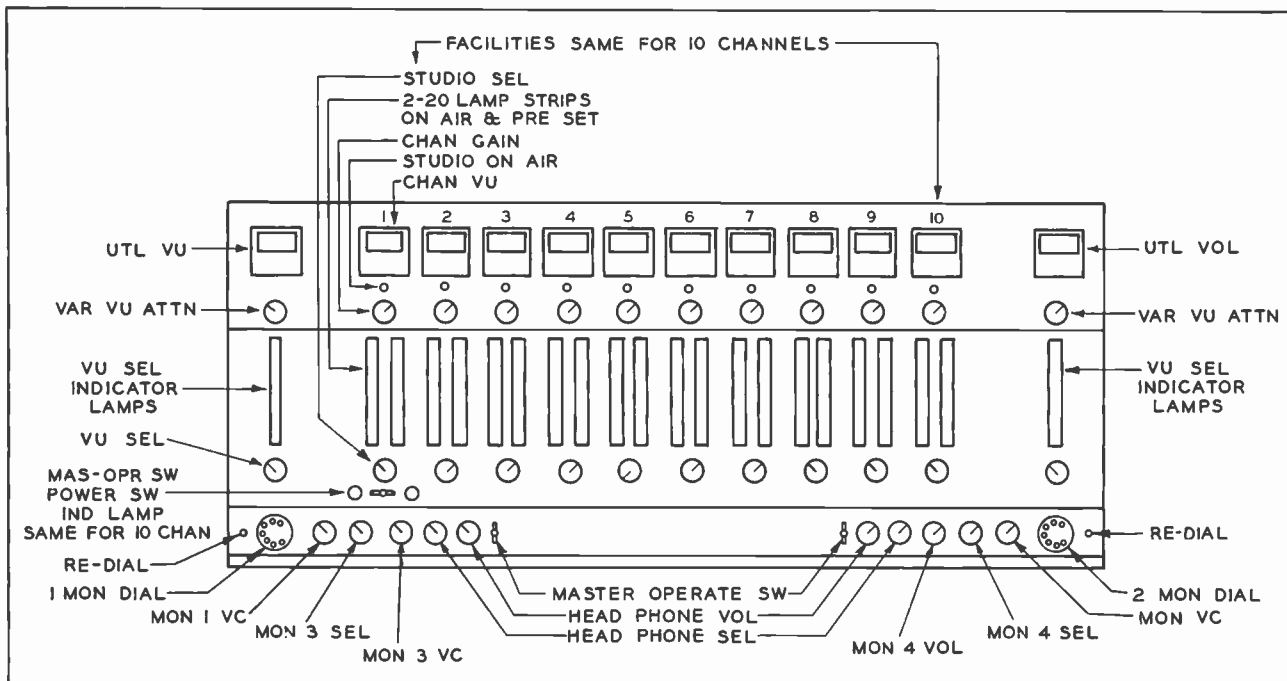
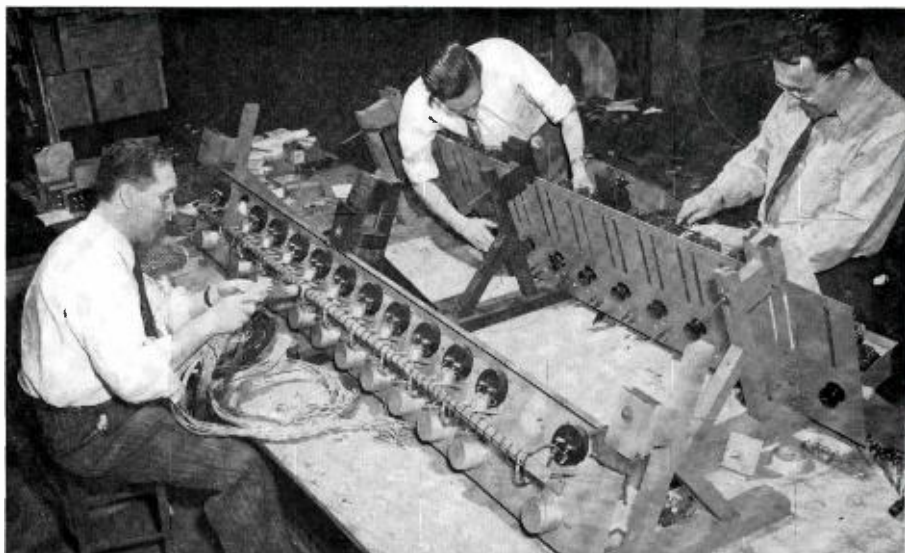

FIG. 4 (above). Location of the various controls and indicating lights on the center section of the WBAP master control are shown in this drawing.

FIG. 5 (right). Wiring the panels of the center control section. In the foreground is the meter panel; in the rear is the panel containing output circuit selector switches and indicator lights.

FIG. 6 (right, below). This picture shows the maze of wiring in the back of the indicator light panel. Uncounted miles of wire went into this job. All of the assembly, wiring and unit check-out was done in the Camden Plant of the RCA Engineering Products Department.



the AM transmitters (570 and 820) are provided with Type 86-A Limiting Amplifiers. The main purpose of these is to equalize the apparent difference in level between network programs (which are more or less compressed by the long lines and narrow frequency band) and local station announcements (which have wider frequency range and higher peaks).

ABC and NBC networks are fed to each studio through bridging coils and variable attenuators. Once the program is equalized and level adjusted in master control, the studio engineer need only open the proper fader on his console to obtain program.

Four master control monitors provide a complete check of all audio circuits. Type BA-4A Amplifiers are used to drive LC-1A Speakers mounted overhead.

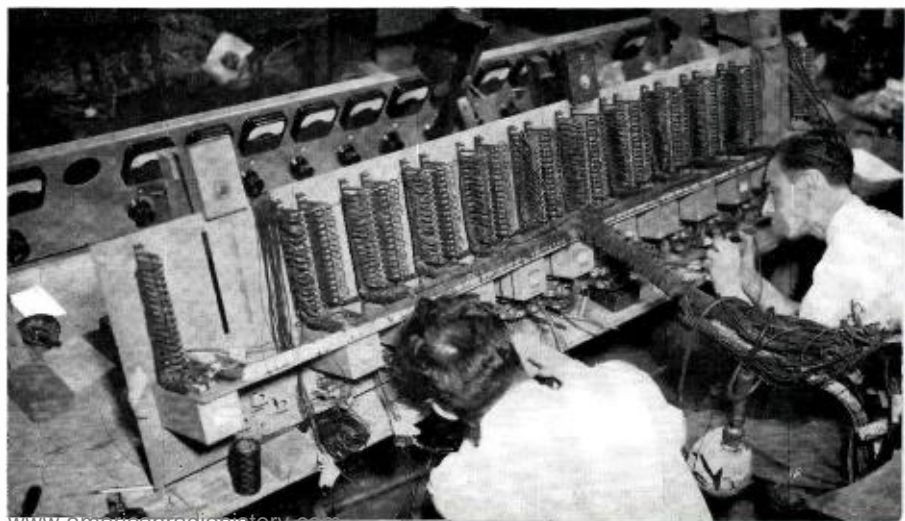

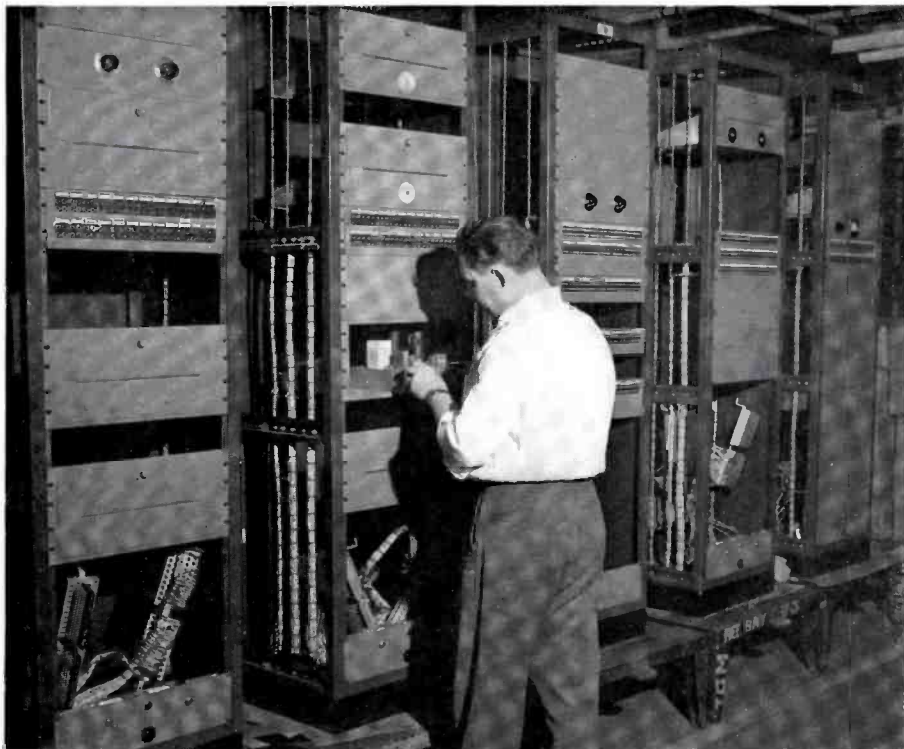

FIG. 7 (left). All of the equipment racks for WBAP, as well as the master control section, and the studio booth control consoles, were assembled and wired in the factory. Here are some of the racks nearly ready for final check.

Two of the monitors have rotary switches for selecting program. The other two are equipped with dial selectors which operate stepping switches.

In addition to the speaker monitors, there are two headphone circuits with selectors to provide program checking of twenty-eight important circuits.

A rack containing stepping switches for twenty stations is included in the overall system.

Forty-eight rack mounted ringdown circuits make it possible to permanently connect an extensive private telephone network to inside and outside locations.

Auxiliary equipment in the master control room allows almost any conceivable type of setup and service. There are amplifiers for house monitors, amplifiers for echo facilities and plenty of extra pads and transformers which may be used in emergency or special setups.

FIG. 8 (below). It is not feasible to take a complete "systems" test at the factory on a project of this size. However, the completed racks are usually "circuit checked" individually as shown here.

FIG. 9 (below). More than 170 relays are required at WBAP to provide complete "preset" switching plus necessary interlocking protective circuits. Note terminal boards with extra length of cable for dropping through floor to mounting rack in basement.

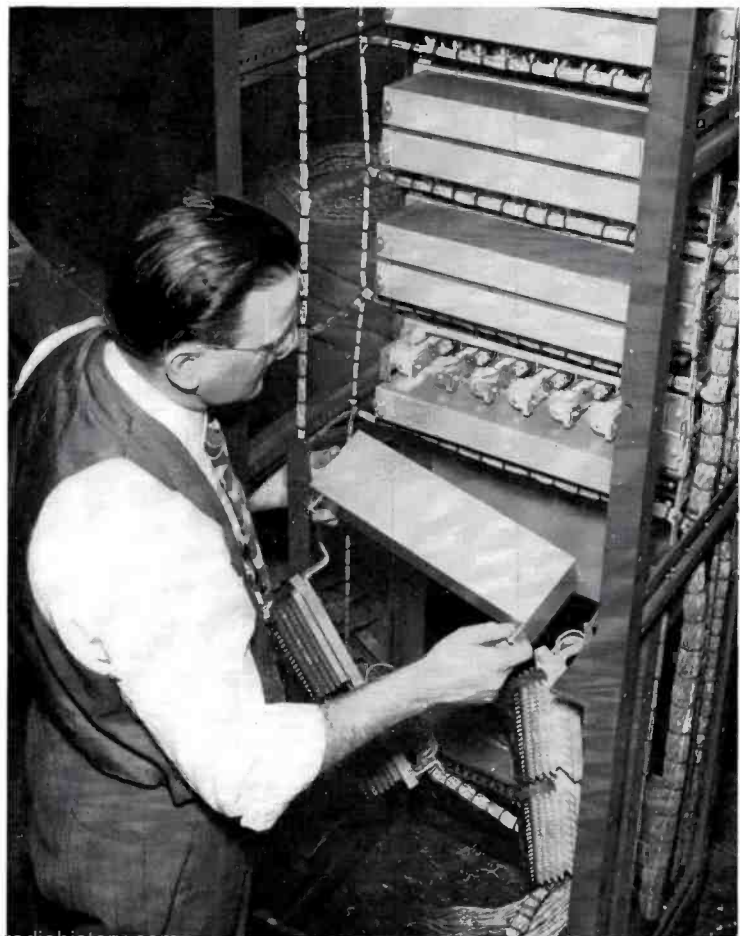
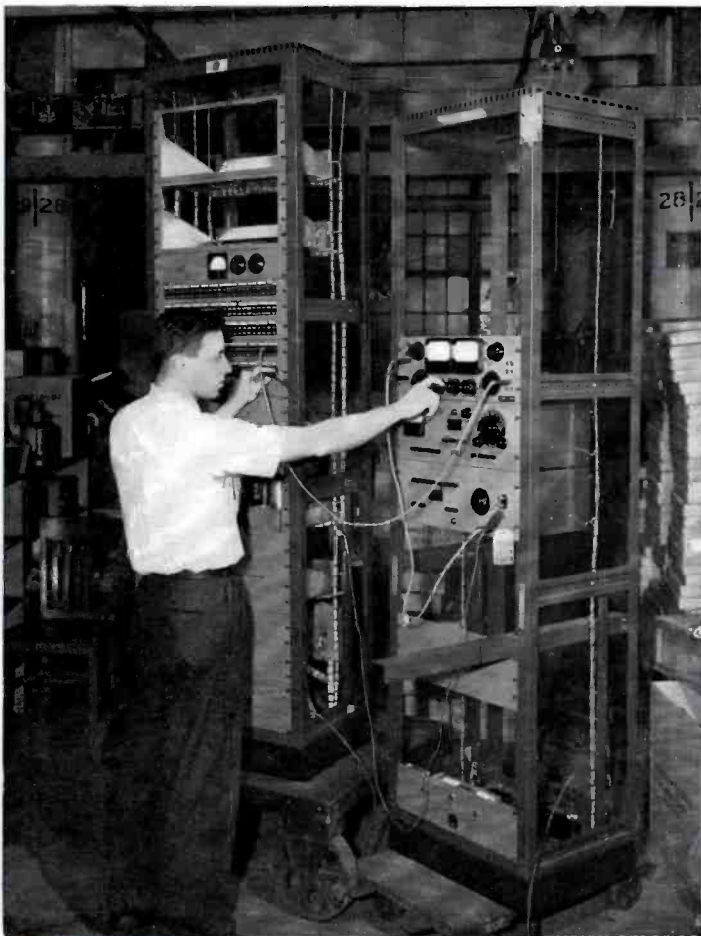

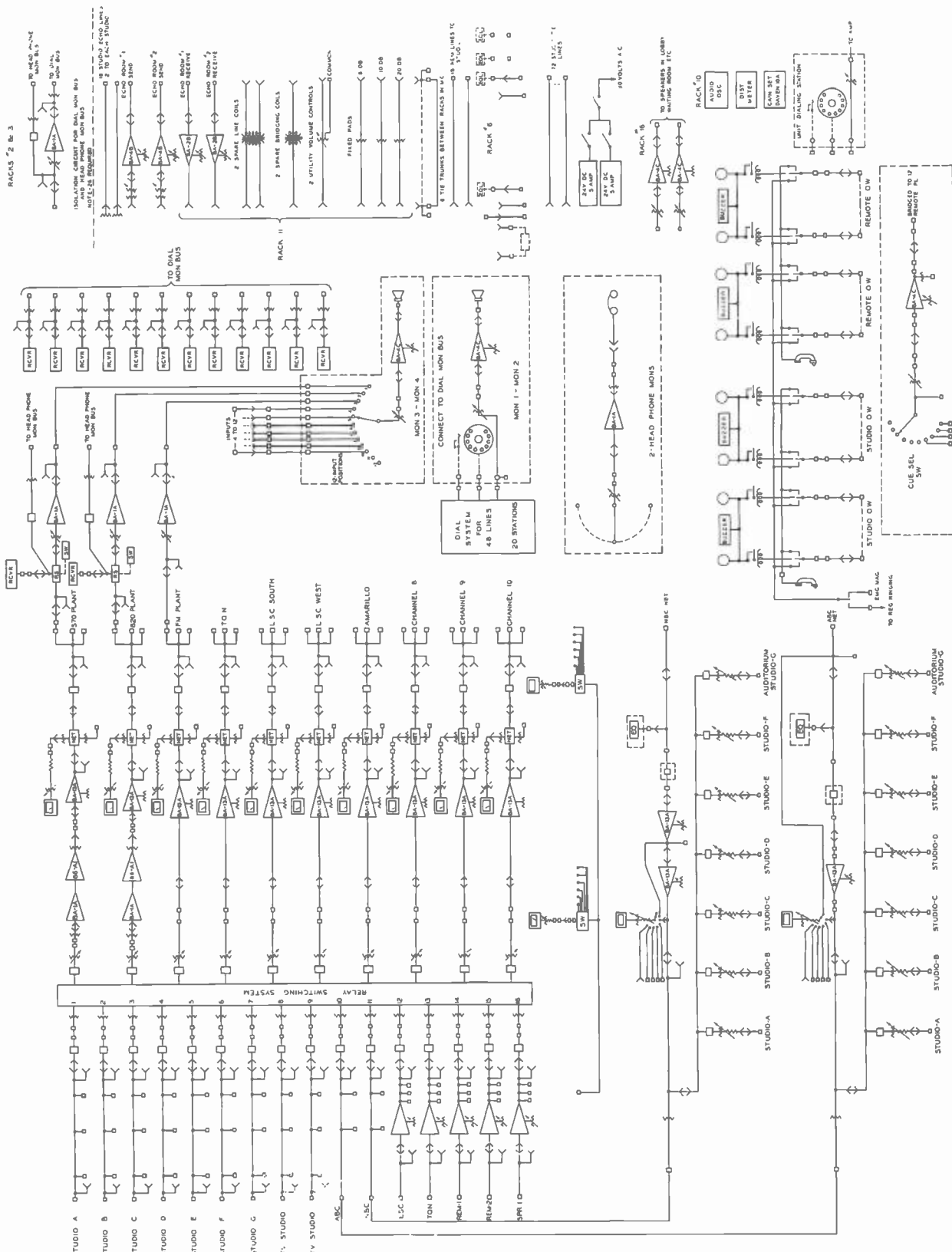

FIG. 10. Simplified schematic diagram of the facilities included in WBAP's master control room equipment. Complete manual or "preset" switching of sixteen inputs to ten output lines is provided.

Novel Location Of Terminal Boards Makes Wiring Easy At WBAP

Many an engineer, working on his hands and knees in the cramped space behind a row of equipment racks, has had occasion to wonder (some not too politely) what so-and-so thought up that particular form of medieval torture. No one knows who first started putting terminal blocks at the bottom of racks. And certainly no one who has had to use them thinks well of the practice. Still, it has persisted for years. Possibly because no one came forward with a better idea.

In a few instances the terminal blocks have been put at the top of the racks. But with only mild success. True, there's more room—sometimes. And you don't have to stoop. But you do need to stretch. And

you are a long way from your ducts and outside connections.

WBAP found a better way! Bruce Howard, their Audio Supervisor, is a big fellow. He doesn't like that hands and knees stuff worth a darn (expurgated word!). The more he thought of those twenty racks for WBAP's control room the more unhappy he became. Finally he had a "brain storm". The wiring was going in the basement. Why not the terminal boards too?

To make a long story short, that's where they went. RCA wired all the racks with extra long leads so that the terminal blocks could be located eighteen inches below the bottom of the rack (Fig. 2). WBAP cut holes in the floor, dropped the terminal

blocks through, and mounted them on a frame in the basement (Fig. 1). The frame is a handy height for working on *standing up*. If you are nearsighted you can get your nose within an inch of the terminals, without contortions. There are even handy outlets in the a-c conduit for plugging trouble lights or soldering iron.

WBAP also ran its wiring between studios and master control in the basement. Angle iron frames with rubber covered pipe hooks were fastened on the walls of the basement corridors (where necessary on the ceiling) and all wiring hung in these (Fig. 3). This arrangement saved the cost of running long lengths of ducts. And it's far more convenient for trouble hunting or pulling additional cables.

FIG. 1 (below). Terminal boards for all of the twenty racks of equipment in WBAP's master control room are mounted on a framework in the basement just beneath the rack positions. This puts the terminals at eye level where they are very convenient for wiring and easily accessible for changes which may be made later. Note handy a-c receptacles in conduit overhead.

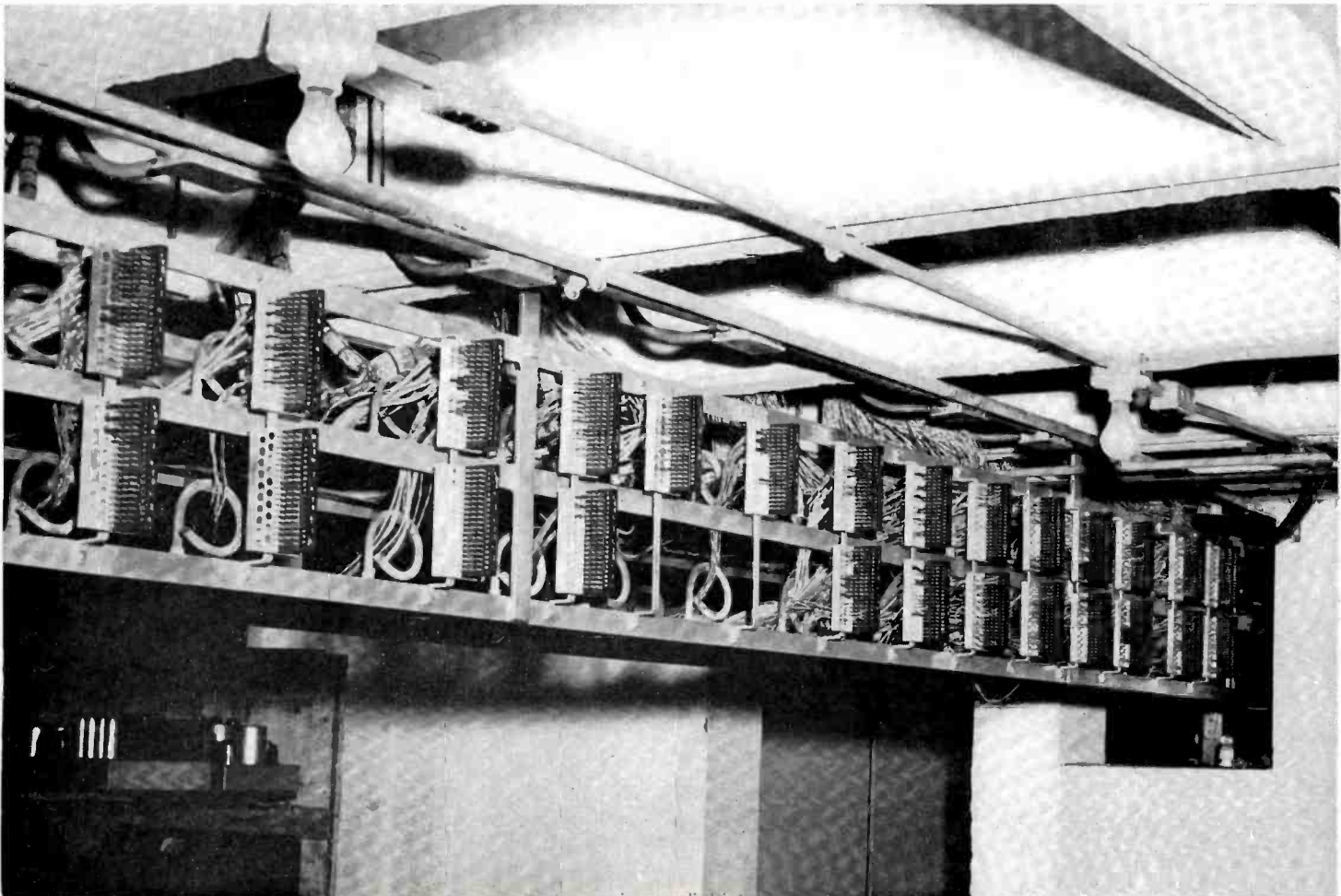

FIG. 2 (right). All of the WBAP racks were wired in the RCA plant at Camden. Cables to terminal boards were made about three feet longer than usual. After racks were set in place at WBAP the terminal boards were dropped through holes in the floor and mounted on a frame in the basement as shown in Fig. 1.

Also located in the basement at WBAP are the studio control room power supplies. They are grouped at one convenient point so that maintenance is simplified.

It might be of interest to note that WBAP, like many of the new one and two story buildings, does not have a basement under the whole structure. They do, however, have a basement under the front part of the building and, in addition, they ran basement corridors (tunnels if you will) under the building corridors. This provided a convenient space for their heating and ventilating pipes, as well as their inter-studio wiring. This might be an idea for some of the new TV buildings being planned now.



FIG. 3. Wiring between studios, control booths and master was run in open hangers located in basement corridors. These hangers are made of angle iron and rubber covered pipe hooks. This arrangement is cheaper than ducts and more convenient for trouble hunting or pulling additional cables.

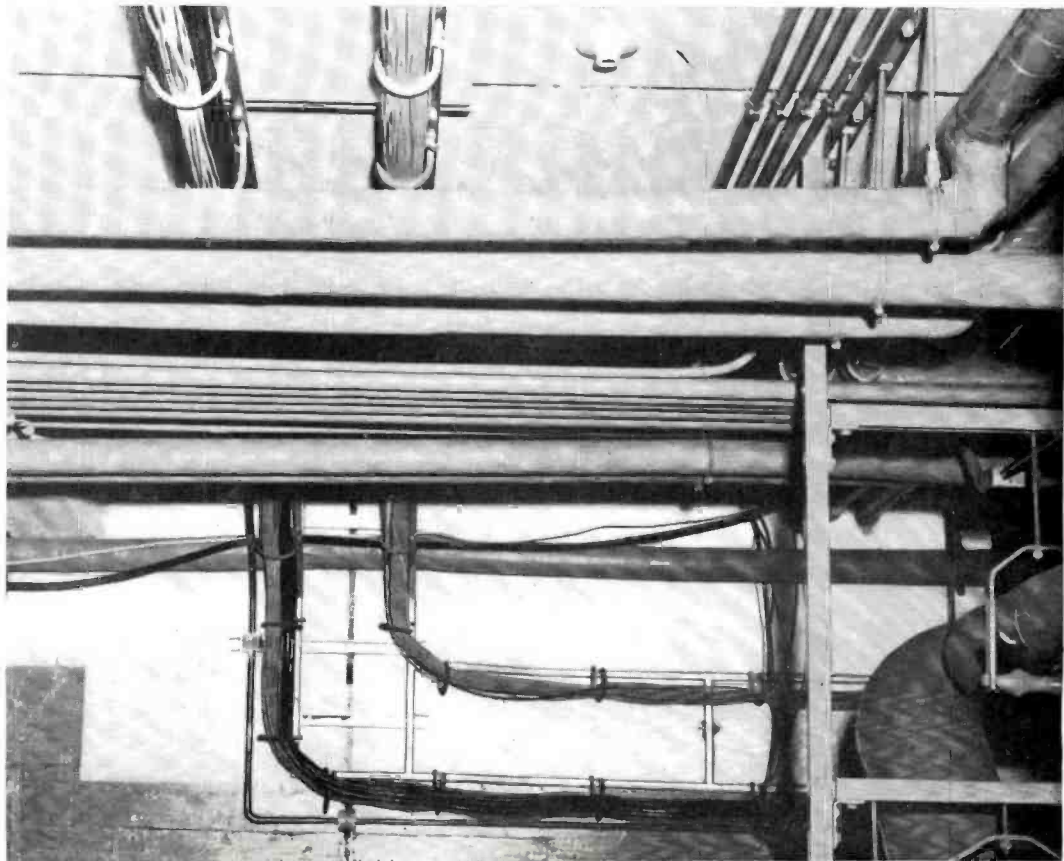

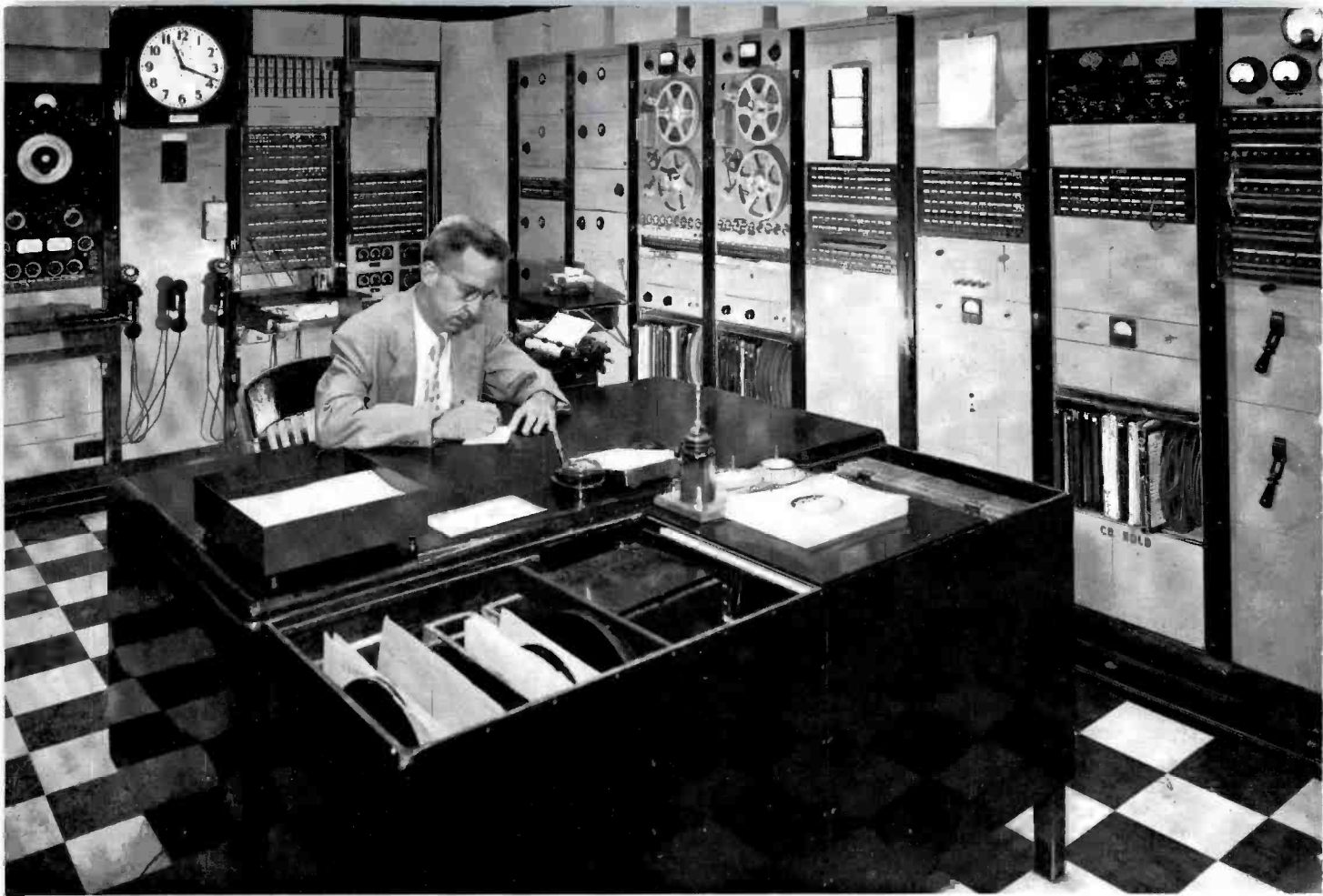

E. B. Landon, Assistant Studio Supervisor of Radio Station KDKA, Pittsburgh, Pa., seated at desk in master control room. The two rack-mounted tape recorders are RCA Professional Type RT-11.

KDKA, PITTSBURGH, PENNSYLVANIA CHOOSES RCA TYPE RT-11 PROFESSIONAL TAPE RECORDERS

by **T. C. KENNEY**
Chief Engineer, KDKA

Recognizing the growing demand for recorded messages of all kinds, whether for radio broadcasting or for personal records of memorable occasions, Westinghouse Radio Station KDKA, Pittsburgh, has instituted KDKA Recordings, the largest recording studio between New York and Chicago.

To meet the requirements for such an undertaking, KDKA installed two RCA Professional Broadcast Tape Recorders,

for delayed broadcasts, tape interviews, distributed tapes to the Armed Forces, audition checks for clients and other unique applications

which were obtained from the first batch that came off the production line. KDKA had been looking forward with enthusiasm to the receipt of these recorders following a demonstration of a pre-production model which had proved their superiority. The Type RT-11 Recorders have more than

lived up to expectations in taking over KDKA's heavy recording load.

The two recorders are panel mounted in the Master Control Room. From the beginning they were found to be so dependable that remote control appeared feasible, and the studio control rooms were wired

so that the engineer handling the program to be recorded could also control the tape recorders, "Start", "Stop", "Fast Forward", "Fast Reverse", and "Record". This speeds up operation by improving coordination and a single engineer handles the whole job, even when two machines are used to get special effects.

Taking advantage of the easy editing, dubbing and redubbing without loss of quality, afforded by these machines, all recording is done first on tape, even though the order is for acetate. This saves time and avoids spoiled discs, since several cuts can be made until a satisfactory one is arrived at from a production standpoint, before dubbing to discs.

The members of KDKA's Engineering Department have become very adept at handling unusual assignments on these versatile machines, and have earned the reputation of being willing and able to tackle any job, no matter how involved, and to turn out excellent work.

The equipment is primarily used for delayed broadcasts, taping interviews or round table discussions, School of the Air programs and the Westinghouse School Science feature, Adventures in Research, which is distributed to 187 stations throughout the country, and the Armed Forces Radio Service.

The station's uses of the recorders are only a part of the purpose for which they were intended. KDKA Recordings offer a wide variety of service for auditions and air checks for clients and agencies. They also provide an opportunity to build and recheck air shows for future use.

The business world has been quick to realize that the human voice is the most effective means of delivering a message. Progressive companies have found recordings an ideal medium for use in their business. Sales managers use recordings for training classes, special sales meetings and for reports.

KDKA Recordings has a library of 200 10½-inch reels (2,400 feet of tape to each reel) which were made for clients. Tapes have been made for slides, motion pictures and orchestral and vocal music for juke boxes.

ABOUT THE AUTHOR

THEODORE C. (TED) KENNEY, chief engineer of KDKA, has been with the station 27 years having started as a transmitter operator at what was known as the "Hill Station" at East Pittsburgh in 1926.

He became a studio operator in 1931, studio supervisor in 1934, assistant chief engineer in 1941 and gained his present title May 20, 1943.

During his years in broadcasting, Ted has handled practically every kind of program and every kind of transmission. In the early days at the "Hill Station" he assisted in the first Westinghouse experiments with frequency modulation and television.

As for programs, he has done remote pickups from everything but a submarine, and would have handled that too, had there ever been a submarine in Pittsburgh. Offhand, he can remember pickups from planes, trains, motor boats, barges, blimps, coal mines, mills, Conestoga wagons, and dozens of such ordinary events as rallies, parades, and baseball and football games.

One of the high spots of his career was a broadcast of an eclipse of the sun, from an airplane 20,000 feet over Pittsburgh. The

broadcast was successful, but on the way down through the clouds the plane's radio beam receiver failed, and the pilot was unable to find the airport. For two hours they circled over Western Pennsylvania. Finally, the pilot broke out of the clouds, recognized Grove City below him, and followed Route 19 back to Pittsburgh.

A less hazardous but equally exciting incident occurred during a broadcast from a roller coaster. Kenney, sitting beside the announcer, was holding the portable short wave transmitter through which the program was relayed to the studios. Suddenly, the car shot down a steep decline and the transmitter flew out of Kenney's hands. He caught it in the air, just as it was going over the back of the car.

Outstanding among his engineering achievements was the installation of the special antenna system in Pittsburgh's famous Liberty Tunnels, which made possible radio reception in automobiles going through the tubes.

Kenney is a native of Scottsdale, Pa. He received his engineering knowledge at Carnegie Tech.

T. C. Kenney, Chief Engineer, KDKA, operates RCA Professional Tape Recorder Type RT-11.

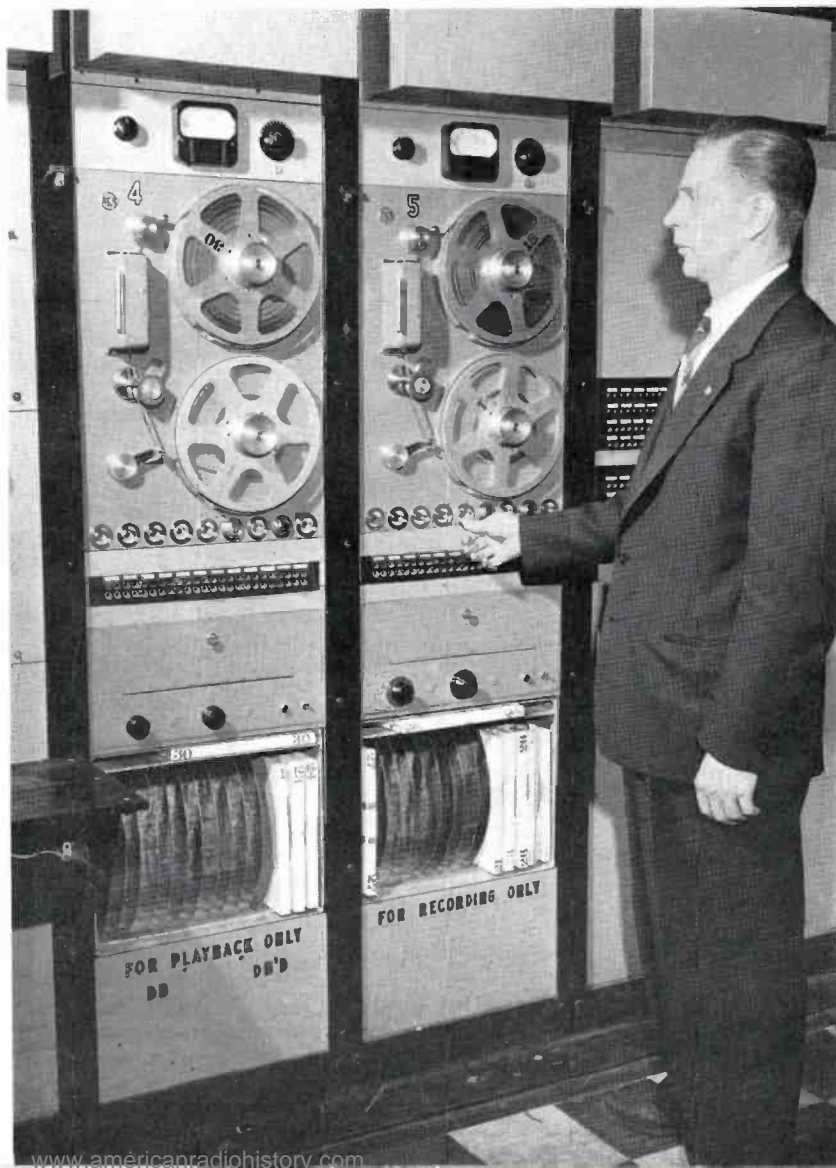

NEW RCA EQUIPMENT COMPONENTS FOR HIGH-FIDELITY FANS

Broadcasters have been talking up high-fidelity for over twenty years. For at least nineteen of the twenty nobody—but nobody—seemed to be listening. Nevertheless, they kept at it. And suddenly the idea caught. Why did it happen just at this particular moment? Nobody knows! Explanations are a dime a dozen . . . and worth just about that. But the fact is that all of

a sudden millions of people have gone slightly nuts about high-fidelity.

Possibly the announcement of a line of RCA Hi-Fi Equipment should also be classified as “it had to happen.” Broadcast operators have been making up hi-fi systems out of odd broadcast units for a long, long time (over twenty years that we personally know about). Gradually the idea

spread to hobbyists who were not broadcasters. Orders for LC-1A's began to come in from the most unlikely places. Amplifiers too, and even for our professional-type turntables—ridiculous as it seems.

It took quite a while for our professionally-minded product planners to get used to the idea that non-professionals, too, wanted “broadcast quality” equipment. But came-the-dawn, and now we have it, a complete line of professional-type equipment specifically designed for custom-built high-fidelity home music systems. Whether or not you plan to build a hi-fi system you should know about this equipment because it is something your non-technical friends will expect you to advise them on.

WHAT THE RCA HI-FI LINE INCLUDES

The new line of RCA High-Fidelity Equipment includes players, tuners, amplifiers, speakers, enclosures and accessory items of matched design. In each classification there are several models so that a choice of features, range and power output is available.

Illustrations and detailed descriptions of the individual units of the new RCA Hi-Fidelity line will be found on the following pages. There are also diagrams indicating how these units may be combined in various ways to form complete hi-fidelity systems. Those whose immediate interest is in details should turn to these pages.

Those who would like to know more about the RCA Engineering Products Department's thinking on high-fidelity equipment, the principles followed in the design of this equipment, and the reasons for emphasizing certain features, will find the following of interest.

THE SEPARATE UNIT IDEA

High-fidelity reproduction in the home is not an exactly definable quality. It depends on the type and source of music one wants to listen to, the size and furnishings of the listening room, and even on the hearing of the individual listener. Thus, to a considerable degree, it is a matter of determining personal satisfaction rather than blindly complying with a set of absolute standards.

Most high-fidelity enthusiasts believe that for each of them individually the end



FIG. 1. Dr. Harry F. Olson, director of the acoustical laboratories of the David Sarnoff Research Center, shows the new model of the LC-1A speaker. This justly-famous unit—originally designed for broadcast monitoring use—is being made available to hi-fi fans as part of the new RCA line. Action of the acoustical domes, which are a feature of the new LC-1A, is explained on Page 54.

WHERE TO BUY IT

RCA *Intermatched* High-Fidelity Equipment components are sold through authorized RCA Electronic Distributors. Your local distributor will be glad to give you full information or you may write to RCA Engineering Products, Department 503-BN, Bldg. 15-1, Camden, N. J.

result of pleasing reproduced sound is attainable only through their personal selection and arrangement of components. For this reason RCA Hi-Fidelity Equipment is made up of separate units, each with a single function. There are five main categories: players, tuners, amplifiers, speakers and enclosures. In each category there are several types to choose from. Thirty or more different combinations of these units are feasible. In addition they can be used with most existing equipment. Thus the "hi-fi" builder has plenty of room for individual expression. Also he has "flexibility"—allowing him to rearrange his system at will. Finally, and perhaps most important, he has provision for expansion, for "growing," in easy steps, by replacing one unit at a time or by supplementing with new units.

WHERE DID THE "SEPARATE UNIT" IDEA START?

It is interesting to speculate on the origin of the "separate units for hi-fi" idea. There is an impression that it is an outgrowth of the fact that "hi-fi" had its beginnings among hobbyists who liked to "build their own." And that is partly true. But it is also true that most of these hobbyists assembled their systems by making use of separate units already available. These separate units—turntables, amplifiers, speakers—were usually those which had been originally designed for professional applications, such as broadcasting, recording or public address systems.

Equipment for these fields has always been designed on a "quality-first" basis. Moreover, it has always been built in separate units, so that standard units could be custom-assembled to fit any application. These professional attributes of quality and flexibility appealed to the early hi-fi enthusiasts. To build their systems they picked up these professional units wherever they could. Such units as the RCA LC-1A Speaker became collectors' items. Gradually each hobbyist completed a system of such "commercial" units to his own liking. Thus a pattern was set, and the industry has followed it.

MATCHED DESIGN OF UNITS

The early hi-fi enthusiasts had the right idea in selecting top units in each category

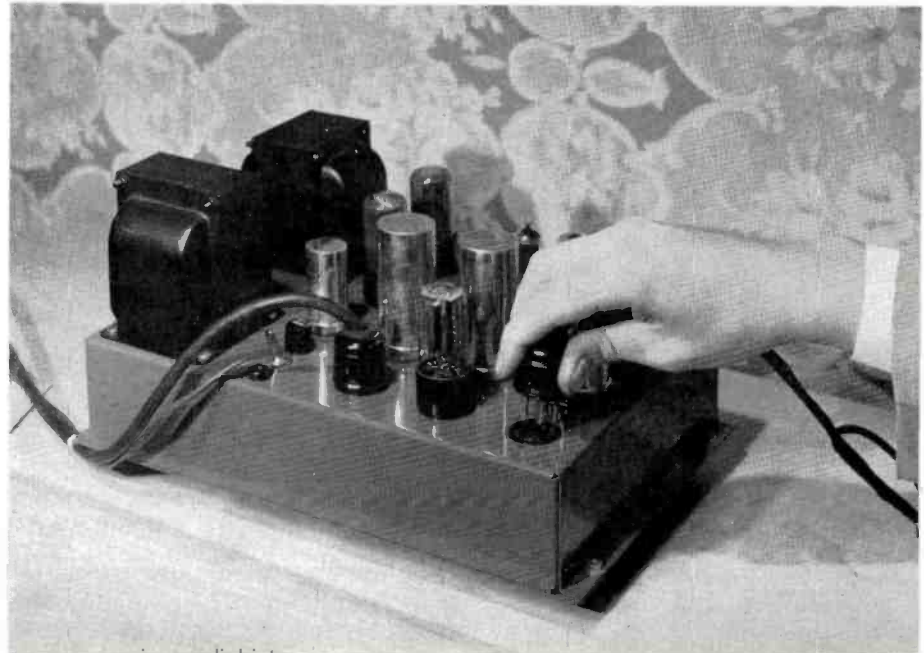

FIG. 2. Type SRC-51 three-speed automatic record changer designed for hi-fi music systems.



FIG. 3. Type SV-1 Deluxe Preamplifier provides selection of characteristics, separate bass and treble controls.

FIG. 4 (below). Type SP-10 Deluxe Power Amplifier. All units have cables with plug-in connectors.



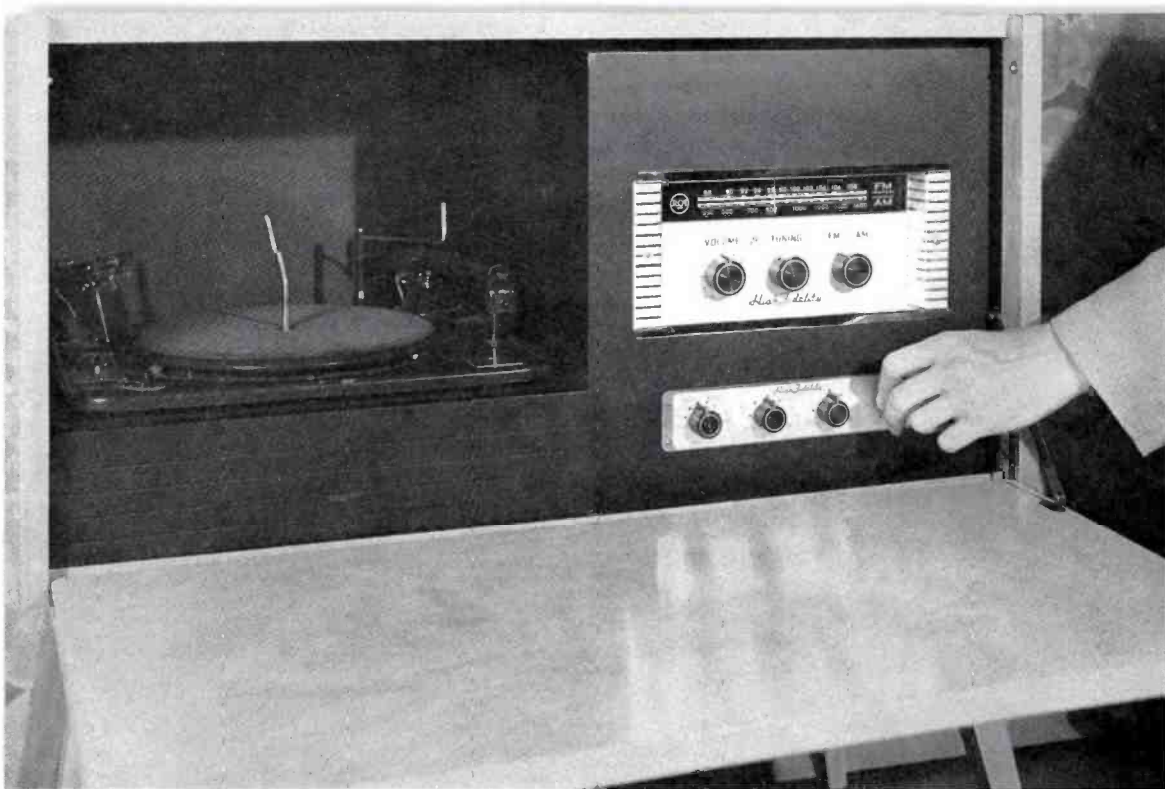

FIG. 5. The player, preamplifier and tuner may be easily mounted in this convenient equipment cabinet. The cabinet shown here has a hinged door. However, production models have a door which slides up under the top. This gets the door out of the way and looks better when cabinet is left open.

of equipment, and putting them together to form a system. However, the final results were often disappointing, either because impedances weren't matched, driving voltages were insufficient, or power was incorrectly coupled. And this same disappointment often occurs today.

Only an expert on circuiting can buy units of various makes and put them together with certainty of satisfaction with the final result. The average buyer, lacking such knowledge, takes a chance. To avoid this, RCA units have been designed to "work together" as systems. They are provided with input and output impedances so that when connected, according to simple instructions, all units are "matched." Volume controls provide correct inter-unit voltages at normal settings and with minimum noise levels.

AVAILABILITY OF UNITS IN SEVERAL RANGES

Not everyone likes the same kind of music. Not everyone has a perfect listening room. And not everyone has the same amount of money to invest. Thus, there is need for several different ranges, or degrees of high fidelity. For those whose interest is simply in standard recordings, a rather modest system will probably suffice. Such a system will reproduce to the limit of the recordings, and it will be incomparably better than a standard radio-phonograph. But it will cost much less than the elaborate

system demanded by the perfectionist. To provide for both extremes, and for intermediate states, RCA offers a number of models of each type of unit. Selection of these will allow a system to be made up to fit any requirement.

COMPLETE INTERCHANGEABILITY OF UNITS

True satisfaction with a high-fidelity music system is a matter of individual taste and of a particular setting. A music lover may select, in a distributor's showroom, a system which he thinks sounds just right. When he gets it set up in his "soft" living room it doesn't suit him. This usually leads to a desire to change one or more units—to "experiment" until he gets it just right. With a separate unit system such substitution is easy *if* all units are interchangeable as to impedances, driving power and connections. In the RCA line they are!

This is also convenient for the enthusiast whose taste for quality grows. He can start with the least expensive units, gradually change them as his taste grows.

"PLUG-IN" CONNECTING CABLES

To make assembly of RCA Hi-Fi units easy for even the non-technical, each unit is supplied complete with connecting cables. Audio inputs to the preamplifier are of the pin-jack type. Main amplifiers have plug-in connectors of the type shown in Fig. 4.

Speaker leads have spade terminals. Thus, any system of RCA units can be interconnected in minutes, without the use of a soldering iron, and even without a screwdriver (you can use a dime on the speaker terminals). This not only facilitates installation (and service) but also makes it easy to interchange units.

30 (OR MORE) POSSIBLE COMBINATIONS

There are at least thirty different practical combinations of the RCA Hi-Fi units (not counting those arrived at by possible multiple speaker combinations). The choice will depend on (a) what use the system is intended to serve; (b) the amount one is willing to spend; and (c) the desired physical arrangement of components.

Fig. 6 illustrates diagrammatically the possible combinations of units using the ST-1 tuner. This unit does not contain a preamplifier. It is necessary, therefore, to use with it either a separate preamplifier (SV-1) or a main amplifier (SVP-10) which contains a built-in preamplifier. Dyed-in-the wool enthusiasts prefer a separate preamp. This increases the cost but provides greater flexibility, especially in arrangement of units. An alternative is to use the SVT-1 tuner which has a preamp built into it. Possible combinations using this tuner are diagrammed in Fig. 7.

Amplifiers are either 10 watts or 20 watts. The engineers say that 10 watts is

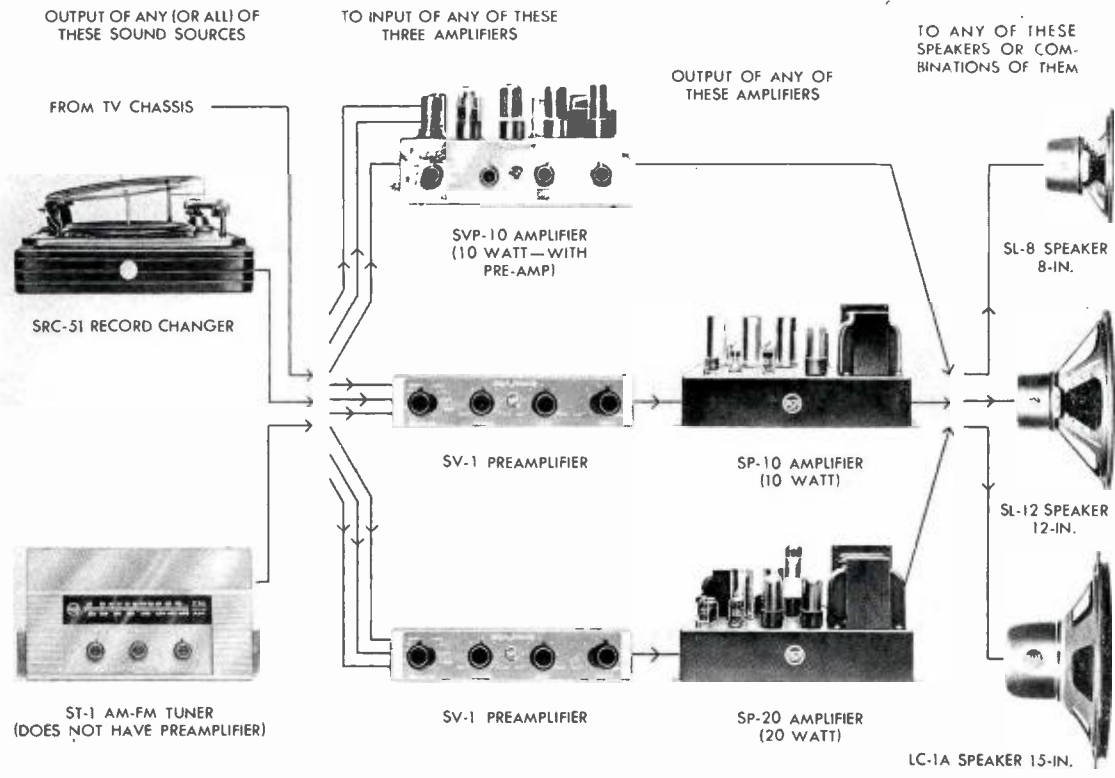

FIG. 6. This diagram indicates possible combinations of RCA Hi-Fi units using the Type ST-1 Tuner. This tuner has sufficient output to drive a power amplifier directly. However it does not include a preamplifier or provisions for handling record player input. It is necessary, therefore, to use with it, either the Type SVP-10 Amplifier (with built-in pre-amp) or the separate Type SV-1 Preamplifier feeding into either an SP-10 or an SP-20 Power Amplifier.

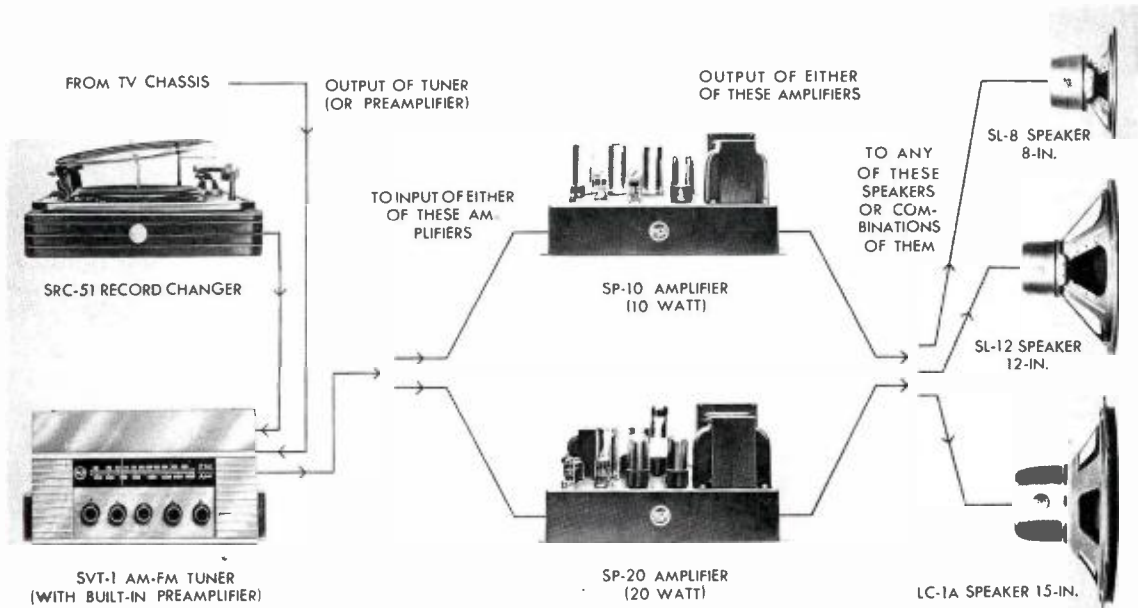

FIG. 7. Possible combinations of RCA Hi-Fi units using the deluxe Type SVT-1 Tuner. This tuner has a built-in preamplifier together with an input selector switch for player, radio, television, auxiliary and tape inputs. Thus its output may be fed directly to the input of an SP-10 or SP-20 Power Amplifier. In these combinations, or those shown above, the output of any amplifier may be fed to any of the three types of speakers.



FIG. 8. This equipment cabinet, in style matching the speaker cabinets, is available in blonde or mahogany. It provides space for the player, preamplifier and tuner as shown in Fig. 5. The power amplifier may be mounted in the speaker cabinet or in any convenient place.

sufficient for most living rooms—but 20 watts is a more or less standardized size and is insisted upon by some audiophiles. Choice of speaker depends on size of enclosure, size of room (and to some extent on size of pocketbook). The SL-8 is very good for its size—and recommended for cramped quarters. The SL-12 is good in anybody's league—probably the best moderate-priced speaker ever offered. The LC-1A, of course, is the peer of them all—the finest speaker unit ever made. But expensive, of course. Unless you're a fanatic you'll be well satisfied with the SL-12.

MOUNTING THE UNITS

Many hi-fi fans like to build their own enclosures, or to mount their equipment units in an existing cabinet, closet, or what have you. All RCA Hi-Fi units have been designed for easy mounting. The player is provided with a wooden base enclosure so that it can rest directly on a shelf, or the base may be removed and the motorboard used by itself. The tuners have a demountable face plate. Thus an oblong hole can be cut in any horizontal or vertical surface and the unit mounted with a minimum of work. The face plate of the preamp is also

removable so that it can be mounted outside the supporting panel. Long shafts are provided for controls (with notches so that they can be easily shortened for shallow mountings).

For those not so mechanically inclined, RCA has designed equipment and speaker cabinets. The equipment cabinet, Fig. 8, has space for the player, a tuner, a preamp and a power amplifier. The cabinet has a "slide-up" door on the side. The three speaker enclosures all have the same appearance, Fig. 9, but are sized in proportion to the size of the speaker units to be used. Both equipment and speaker cabinets are available in blonde or mahogany.

DESCRIPTION OF THE UNITS

The various units of the new RCA Hi-Fi line are described in detail in a catalog which we will be glad to send to all interested readers of BROADCAST NEWS. In the meantime, here is a brief description of these units.

Type SRC-51 Record Player

The Type SRC-51 record player is a three-speed automatic record changer with two interchangeable spindles, for standard

center hole and "45" records. Center hole records are handled by a gentle pusher-type platform. There is an easily inserted spindle for 45 rpm records. The spindle remains stationary when the record is played, thereby eliminating wear of the center hole of the record. Reproducer heads are of the plug-in type, designed for the users' choice of cartridges.

Type ST-1 AM-FM Tuner

The AM-FM tuners, Types ST-1 and SVT-1 include separate tuned r.f. stages and triode converters on both AM and FM to insure low noise reception. Wide bandwidth in the i.f. stages insures broad response. Sharp skirts on the band pass characteristics of the i.f. sections provide good selectivity. A 10-kc narrow band elimination filter cuts out the beat note produced by interchannel interference in AM reception. A completely shielded chassis minimizes oscillator radiation and insures electrical isolation of the tuner. Double-shadow tuning eye and "no drift" a.f.c. on FM simplifies tuning. There are three controls: bandswitch, volume and tuning.

The Type ST-1 tuner provides adequate output to drive an amplifier such as the Type SVP-10 which contains a preamplifier, but requires a preamplifier such as the Type SV-1 to drive straight power amplifiers such as Types SP-10 or SP-20. Sensitivity is better than 5 microvolts. Output is 2 volts with less than 0.5% distortion. Response is within ± 1 db from 40 to 15,000 cycles.

Type SVT-1, AM-FM Tuner

The SVT-1 Tuner is similar to the ST-1 Tuner but has a built-in preamplifier which provides power to drive a Type SP-10 or SP-20 Amplifier. Connections are provided so that the record changer Type SRC-51 may be fed through this preamplifier. The tuner is provided with the following controls: input selector switch for phonograph (Ortho, LP, AES, 78 compensations), radio, television, auxiliary, and tape; volume; tuning; bass; and treble.

Type SVP-10 Amplifier

Type SVP-10 Amplifier contains both preamplifier and power amplifier. In addition, it is provided with the following controls: selector for phonograph (78, LP, AES, Ortho compensations), radio, television, auxiliary and tape; volume control; separate bass and treble controls and an "off-on" switch. The response frequency characteristic of the amplifier with the tone controls in the mid-position is within ± 1 db from 30 to 18,000 cycles.

Type SV-1 Preamplifier

The RCA preamplifier, Type SV-1, is a deluxe unit designed to be used with the RCA power amplifiers, Types SP-10 and SP-20. There are five input jacks with a control for selecting the following inputs: input selector switch for phonograph (Ortho, LP, AES, 78 compensations), radio, television, and auxiliary, one volume control for all inputs, a bass control, and a treble control with an "off-on" switch. With the tone controls in the mid position, the response frequency characteristic is within ± 1 db from 20 to 20,000 cycles. The distortion is less than 0.5 per cent for 1.5 volts output.

Type SP-10 Amplifier

The RCA power amplifier, Type SP-10, is a high quality unit with 10 watts output. The response frequency characteristic is within $+0.5$ db, -0.2 db over the frequency range from 20 to 20,000 cycles. Full output is obtained for an input of 0.5 volts. The SP-10 supplies 6.3 volts a-c at 1.2 amperes and 250 volts d-c at 8.0 milliamperes for operation of the RCA preamplifier Type SV-1.

Type SP-20 Amplifier

The RCA power amplifier, Type SP-20, is a deluxe high quality unit with 20 watts output. The response frequency characteristic is within $+0.3$ db, -0.2 db over the frequency range from 20 to 20,000 cycles. Full output is obtained for an input of 0.5 volts.

Type SL-8 and SL-12 Loudspeakers

The RCA Loudspeakers, Types SL-8 and SL-12, are extended range 8 and 12 inch single cone loudspeakers developed and designed for High Fidelity applications. These loudspeakers were especially designed for a smooth response frequency characteristic. A loudspeaker with a ragged and nonuniform response frequency will introduce frequency discrimination, will not exhibit good transient response, and will tend to accentuate noise.

The smooth response frequency characteristic of these loudspeakers was obtained by employing a particular shape for the curvilinear cone, a special pulp for the material of the cone, and a damping ring in the outer suspension which provides a matched terminating acoustical impedance. The shape and material of the cone play the important roles in determining the directivity pattern of the loudspeaker. In wide frequency range loudspeakers the directivity pattern should be broad in order to reduce frequency discrimination for observation points removed from the axis. The material and shape of the cone were

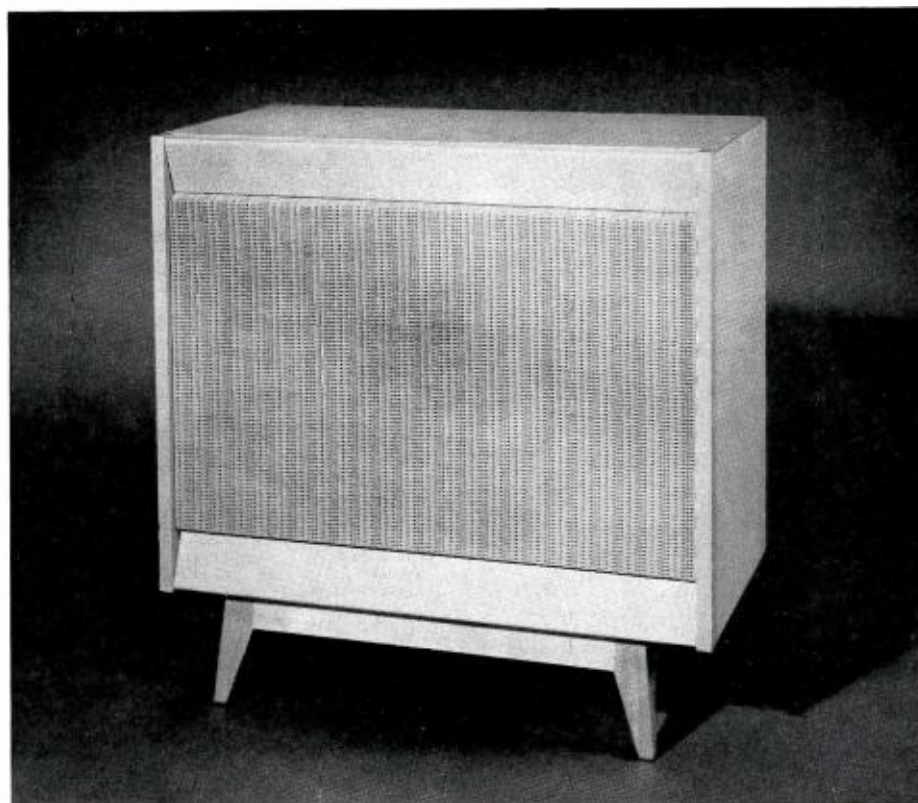

FIG. 9. Decorator designed speaker cabinets such as the one shown here are available in three sizes (for the three speaker units) and in either blonde or mahogany finish. The two larger sizes can be mounted horizontally, as shown here, or vertically.

selected through extensive research and development so that a very large distribution angle of more than 40 degrees was obtained in these two loudspeakers. The SL-8 has a good response from 65 to 10,000 cycles; the SL-12 from 50 to 16,000 cycles.

Type LC-1A Loudspeaker

This is an improved model of the famous "Olson" speaker developed especially for broadcast monitoring. One of the outstanding features of the original LC-1A loudspeaker was the broad directivity pattern. This has been broadened even further so that now uniform response is obtained over an angle of 140 degrees. The response frequency characteristic is even more uniform than in the preceding model.

New features of the LC-1A include: a series of conical domes placed on the surface of the large cone, a damping ring in the suspension system, and a multiple vane deflector in front of the high frequency cone.

Equipment and Speaker Cabinets

The cabinets designed for these speakers are of the phase inverter type. The walls

are of heavy construction combined with bracing which minimizes cabinet wall vibration. The internal damping is provided by diagonally placed sound absorbing material. The absorbing material is located away from the cabinet walls, which places it where the sound volume current is high, giving high absorbing efficiency. This way effective damping of standing waves is obtained and excessive low frequency absorption, which would reduce the efficiency in the low frequency range, is avoided. The design of the cabinets combines functionalism from an acoustic diffraction standpoint with beautiful styling. While the cabinets are contemporary in spirit, they can be combined with virtually any decor. They may be used either horizontally or vertically. These cabinets are available in blonde or mahogany.

An equipment cabinet, Type SE-1, which matches the loudspeaker cabinets is available in the same finishes. This cabinet will house a record changer, tuner, and preamplifier. These units may be mounted either horizontally or vertically depending upon mounting of the cabinet.

ACTION OF THE CONICAL DOMES IN THE IMPROVED TYPE LC-1A LOUDSPEAKER

Broadcasters, looking at the new version of the LC-1A, will probably moan. "What have they done to it?" The irreverent may say even stronger things. For the LC-1A that once was a deceptively-simple looking unit has now blossomed out with wings and other things (politely called "conical domes").

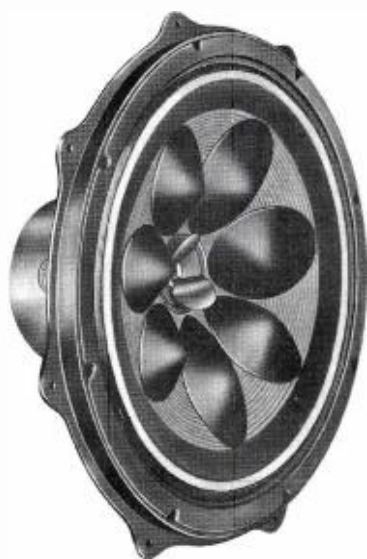

FIG. 1. The "new" LC-1A Speaker has seven conical "domes" mounted on the low-frequency cone plus a small vane-type diffuser mounted at the center of the high-frequency cone.

This jazzed-up model is going to be blamed on the advertising men, sure as anything. But so help us, fellows, we didn't have a thing to do with it. The appurtenances (another polite term) were added in the acoustical lab at Princeton. We were just as surprised to see them as you were. And, at first, just as quizzical. Since then, however, Dr. Olson has given us a detailed explanation of the action of the "domes" and now that we understand it we feel he really has something. In fact we suspect that this may start a whole new trend in speaker design.

Before we give you Dr. Olson's explanation, a little of the background of this new development is in order. This is particularly so in that there has been some misunderstanding of the features of the original LC-1A (and the 64-B which preceded it). Most everyone knows that these speakers have a wide frequency range and very low distortion. But what is not so well understood are two other properties which are even more unique. One of these is that the frequency response is unusually smooth. To a large degree it is free of the sharp dips and peaks found in most speaker response curves. The second is the wide listening angle (nearly 120°) through which the response stays nearly uniform. There are other speakers with a frequency response as good as the LC-1A—providing you stay on or near the axis when listening. There are none, to our knowledge, with as wide an angle of high frequency response.

These two important properties of the LC-1A are due largely to the fact that the

high frequency and low frequency units are not only co-axially mounted, but additionally have the same effective center point. The two units (which are electrically and mechanically independent) are mounted so that the angle of their cones makes a single line (Fig. 2). This reduces interference patterns between units and thus smooths out the response curve. In addition the low frequency cone decreases the angle into which the high frequency cone works, thereby improving its efficiency. Finally, the shallow angle of the low-frequency cone broadens the angle over which good response is obtained.

These special properties of the original LC-1A speaker are inherent in the duo-cone design. By keeping this in mind it is easier to understand the following explanation of the action of the "domes" as given to us by Dr. Olson.

Dr. Olson's Explanation

The new RCA Type LC-1A Loudspeaker incorporates three new features which improve its performance. They are the damping ring in the outer suspension of the low-frequency cone, the conical domes fastened on the surface of the low-frequency cone, and the high-frequency, vane-type diffuser.

The conical domes attached to the surface of the low-frequency cone improve the performance in three ways: by decreasing the angle into which the high-frequency cone feeds, thereby increasing the output of the high-frequency cone; by diffusely reflecting some of the sound

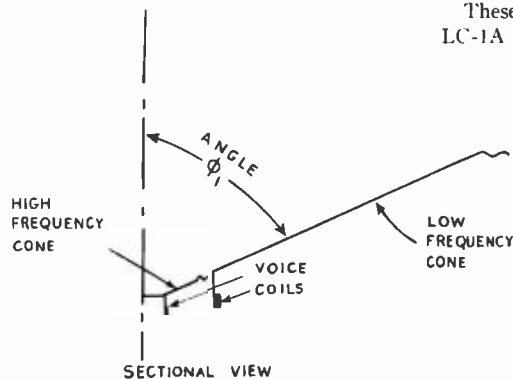

FIG. 2. The angle ϕ_1 into which the high-frequency cone feeds without the "domes" is relatively wide.

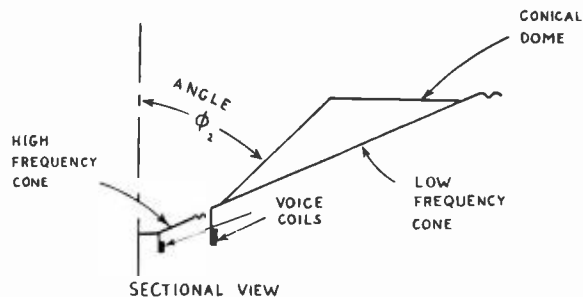

FIG. 3. When the "domes" are added the angle ϕ_2 is much smaller, thereby improving high-frequency efficiency.

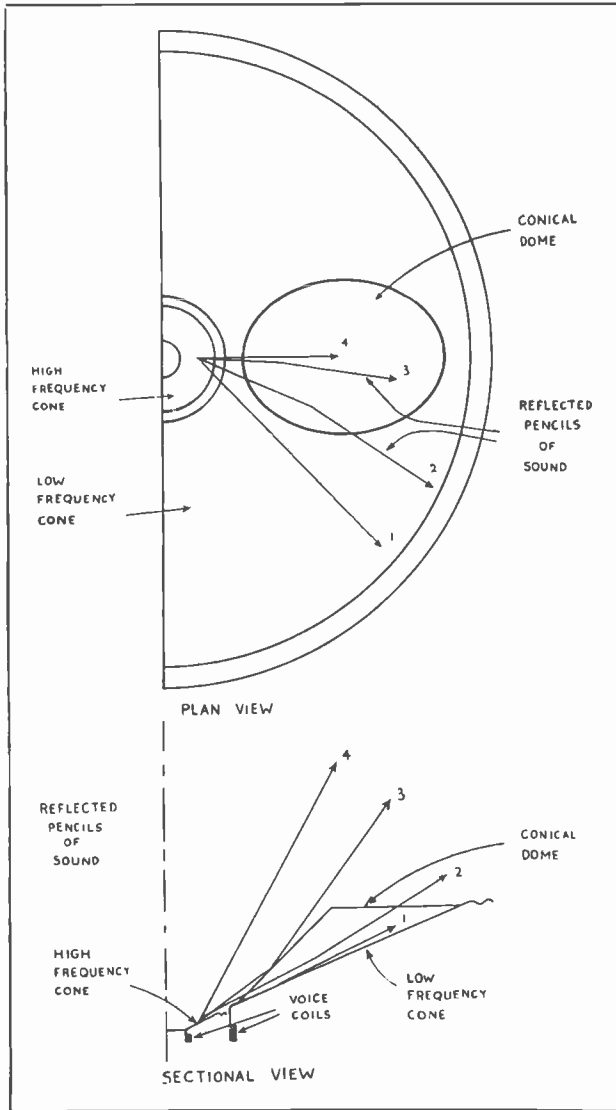

FIG. 4. Some of the sound emitted by the high-frequency cone is diffusely reflected by the "domes", thereby smoothing out response curve.

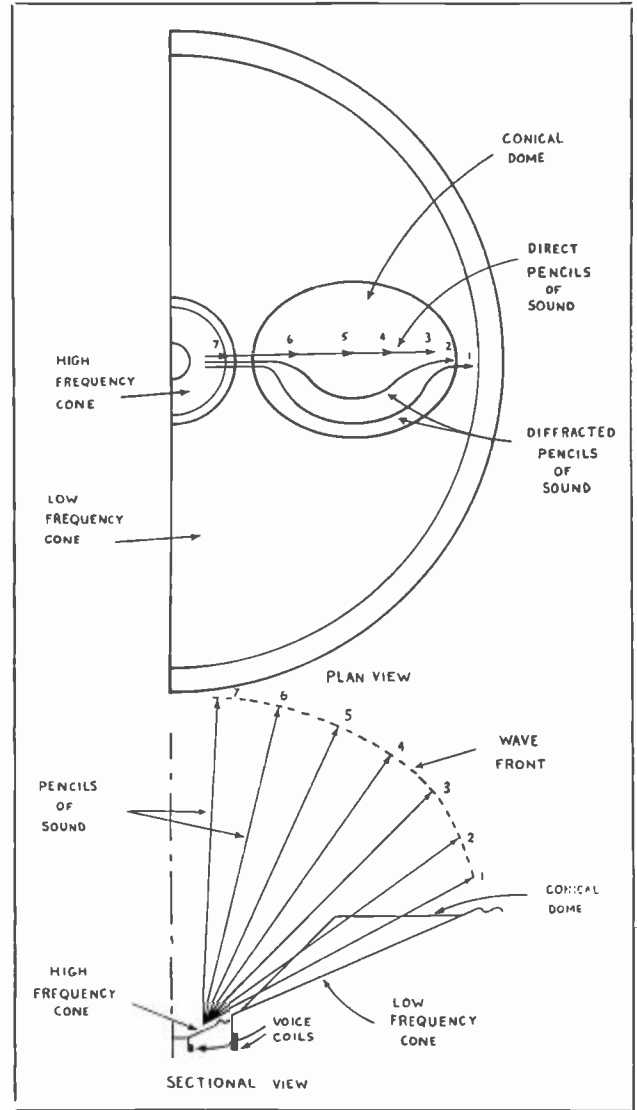

FIG. 5. Some of the sound emitted by the high-frequency cone is diffracted by the "domes", decreasing the curvature of the wavefront and broadening the pattern.

emitted by the high-frequency cone, thereby eliminating discreet reflections; and by diffracting some of the sound emitted by the high-frequency cone; thereby broadening the directivity pattern.

The angles into which the high-frequency cone feeds, without and with the conical domes applied to the low-frequency cone, are designated as ϕ_1 and ϕ_2 , respectively, in Figs. 2 and 3. Since ϕ_2 is smaller than ϕ_1 , the acoustic radiation load upon the cone is greater with the conical domes than without them. When the acoustic radiation load upon a direct radiator loud-speaker is increased, the sound power output is increased. Thus it will be seen that

the conical domes increase the high-frequency sound radiated by the high-frequency cone. In other words, the high-frequency efficiency is improved.

Some of the sound emitted by the high-frequency cone is diffusely reflected by the conical domes, as shown in Fig. 4. Without the domes, there would be many similar reflections which would lead to reinforcements and cancellations with the direct radiation. The result would be corresponding peaks and dips in the response of the high-frequency cone. With the domes, the symmetry of the low-frequency cone is upset and there are many reflections in different directions and of different path

lengths. The reflections therefore cancel out and the net result is a smooth response-frequency characteristic.

Some of the sound emitted by the high-frequency cone is diffracted by the conical domes as shown in Fig. 5. By diffraction is meant the bending of the sound around an obstacle. The pencils of sound designated 1 and 2 in Fig. 5 are diffracted. The pencils of sound designated 3 to 7 inclusive are radiated directly from the high-frequency cone. It will be seen that the effect of the diffracted sound is to decrease the curvature of the wavefront in the direction of 1, 2, and 3. As a result, the directivity pattern is broadened.



RCA personnel assist WABI-TV in telecasting local basketball tournaments. Shown at controls behind the table are Fred Brown (left) and George Closs, RCA Service Company engineers. Just beyond Brown is Jim McCarvill, of the Shows and Exhibits Division. On camera are Walter Dickson (left), WABI-TV Chief Engineer, and Elmer Snow, engineering assistant at the station.

WABI-TV Remotes Local Basketball Tournaments

Upper New Englanders take their high school basketball seriously. Fans in and around Bangor, Maine are much happier of late, thanks to RCA Victor's Shows and Exhibits Division.

During recent high school basketball championships in Bangor and Orono, Maine, an RCA Shows and Exhibits crew lent a helping hand to WABI-TV in Bangor. The station had been in operation less than two months when the tournaments occurred. It had been operating on a small scale, its equipment consisting of transmission facilities, a single camera, and a two-projector film camera chain. Programming had been fairly well limited to film and Kinescope recordings.

WABI-TV management sensed that the tournaments offered an excellent oppor-

tunity to present live programs of great local interest to their viewers. However, they were faced with a shortage of personnel trained in remote pickups of athletic events, as well as a lack of equipment required to do the job.

Having heard of the work and facilities of the global television demonstration crew of RCA Victor's Shows and Exhibits Division, they placed a request through Broadcast Field Sales Representative, J. E. Hill. A crew of three engineers and a television director was dispatched to Bangor, along with a two-field camera chain, a microwave relay system and supplementary lighting equipment.

Installations were in turn set up at the Bangor Auditorium (about six miles from the transmitter site) and at the University

of Maine (about fourteen miles from the transmitter site). From these two locations, four tournaments (a total of twenty-four games) were telecast to anxious basketball fans.

Three of the station's engineers were trained in camera operation by the Shows and Exhibits crew. Video direction and video console operation were handled by an RCA director and two RCA engineers, one of whom assisted in camera operation. Another RCA engineer assisted at the transmitter where he advised regarding technical and production problems at that point.

Descriptive and transitional announcing and audio control was handled by station personnel. Overall program control and the insertion of commercials was handled at the studio.

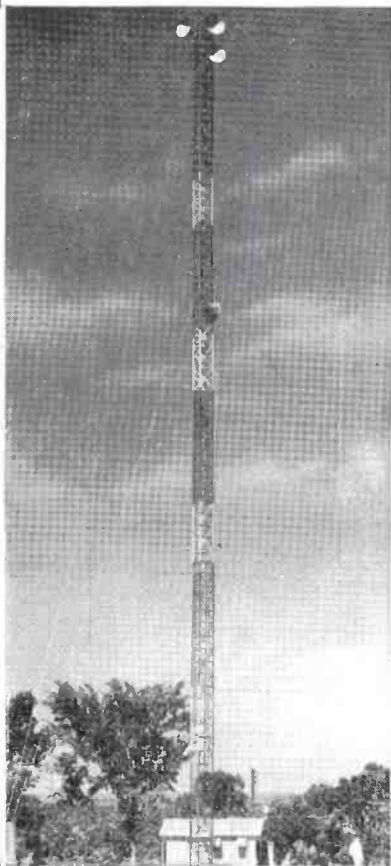

RCA Microwave radio relay installation at High Ridge, Mo. Towers are rugged, designed to withstand 100-mph winds under severe icing conditions.



RCA MICROWAVE
radio-relay communication
and remote control

Osage Hydroelectric Power Plant installation of Union Electric Company of Missouri, at Bagnell Dam, Mo.—served by RCA Microwave.

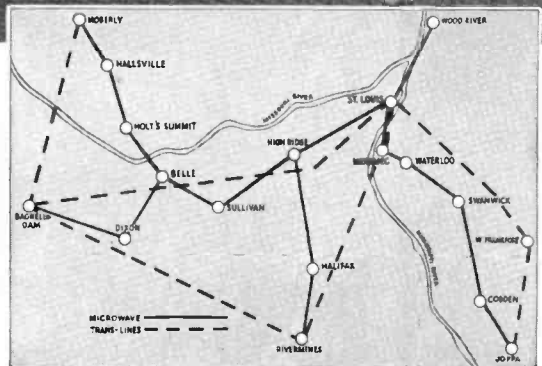

Union Electric Co. Microwave system stretches out 425 miles in 3 directions from St. Louis.

How UNION ELECTRIC solved today's communication problem

Two years ago Union Electric Company of Missouri ran into the communication problem which sooner or later confronts all growing utilities: their high-line carrier transmission system had become inadequate.

The 150 kc bandwidth, allotted for power line carrier operation, permits the use of only a relatively few channels which are not sufficient to meet all the requirements of a modern communications system. Direct wire lines were ruled out as too costly.

That prompted engineers to adopt Microwave, supplemented with mobile radio at major relay points. RCA Microwave provides channels for remote control of load dispatching, telemetering, teletype and voice communication. It results in close co-ordination of vehicles, field crews, executive and service personnel at outlying offices and stations. And, 70% of the RCA Microwave system is available for future expansion.

RCA Microwave can be interconnected with existing phone lines and switchboards. It uses familiar channeling circuits and readily available tubes. It provides as many channels as needed with minimum use of frequency space.

Now Union Electric has dependable, year-round communications over the full length of its operations. RCA "dish" antennas atop 100- to 300-foot towers, spaced 11 to 46 miles apart, send concentrated beams of radio energy from

station to station. The radio beams follow a line-of-sight path—approximately parallel to the transmission lines.

You, too, can plan now for tomorrow's problems—prepare for your expanding communications needs before they develop. The booklet listed below provides quickly digested facts for future thinking, with no obligation on your part. Mail the coupon. Remember, only RCA can provide the nation-wide service facilities of the RCA Service Company.



RADIO CORPORATION of AMERICA
COMMUNICATIONS EQUIPMENT
CAMDEN, N. J.

DEPT. 129 U, Building 15-1

Please send me your re-print describing Union Electric Microwave system, "Microwave Relines Overcrowded Circuits."

Name _____ Title _____
Company _____ Address _____
City _____ Zone _____ State _____

Have an RCA representative get in touch with me.

Good-bye . . .

"ROLL-OVER"

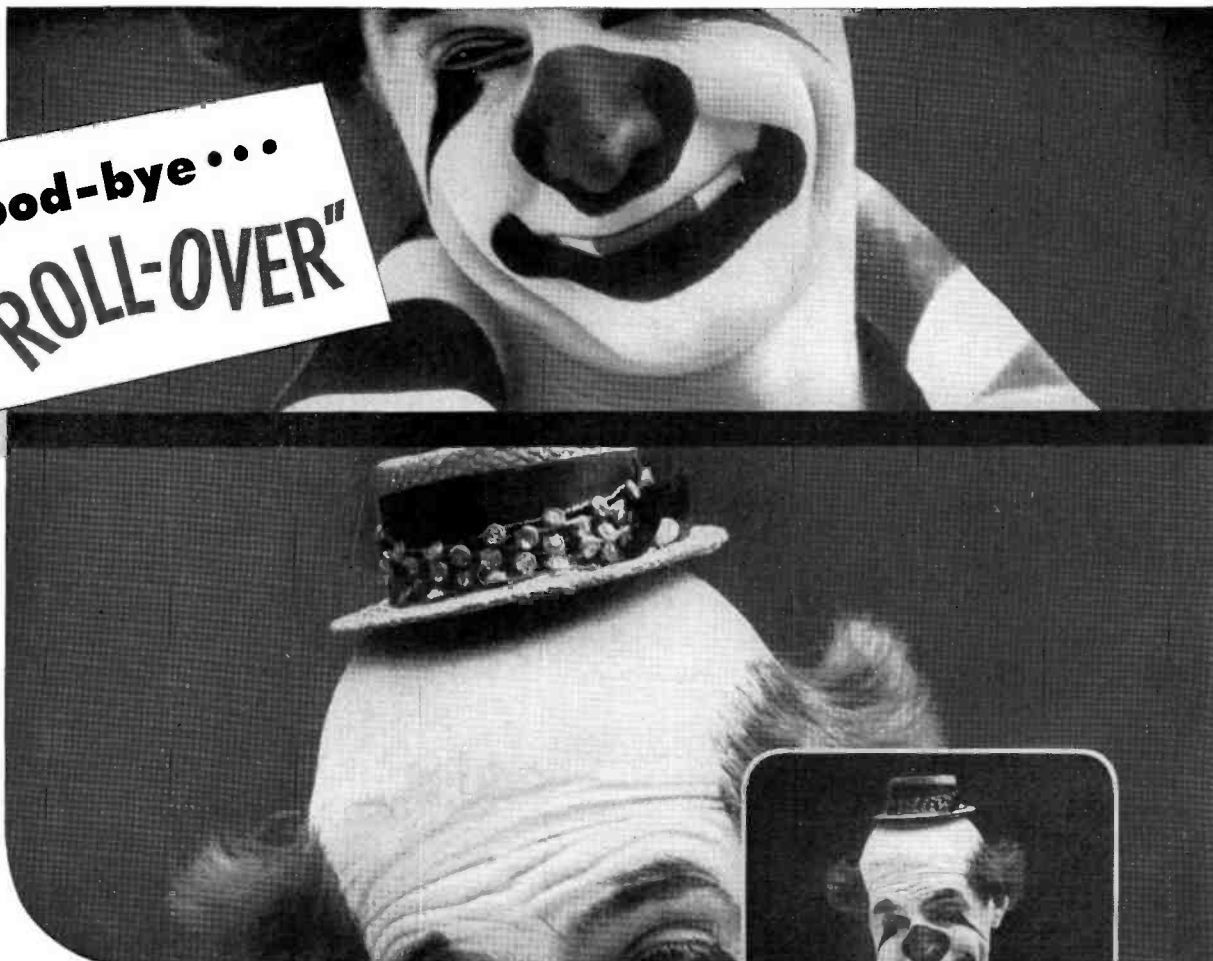

Annoying "Roll-over"—starts up in TV sets when you mix remotes with locals



Good-bye "Roll-over"! The RCA TV GENLOCK tightly locks your local and remote sync generators together—instantaneously and automatically.

RCA's TV Genlock TG-45 ends picture slipping when you "lap dissolve" and "superimpose."

Now you can lock two entirely different programs together—remote or local—and hold pictures steady *right through switching!* No manual adjustments of phasing to fiddle with. No extra equipment needed at remote pick-up points. Here's how the GENLOCK works.

Located in your main studio, this simple unit compares the signal of your remote sync generator with the signal of your local sync generator. The difference in the phasing of the pulses produces an "error" signal which locks your local generator as a "slave" to your remote generator as a master. This enables you to treat remote signals as local signals—and switch back and forth without picture "roll-over," *no matter where your program originates!*

The RCA GENLOCK is simple in design, completely automatic in operation—"locks-in" much faster than you can switch. It fits any standard 19-inch TV rack.

Give your programming a lift. Switch as you please between programs for variety and for special effects. It's easy with a GENLOCK. For more information call your RCA TV equipment representative. Or write Dept. 19AE, RCA Engineering Products, Camden, N. J.

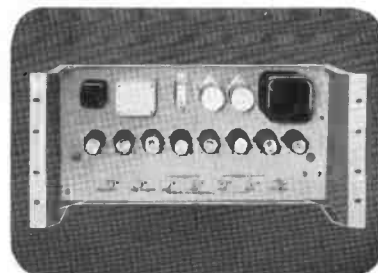

RCA GENLOCK, Type TG-45. This is the simple, automatic system that electrically locks two separate television pick-up systems together.



TELEVISION BROADCAST EQUIPMENT
RADIO CORPORATION of AMERICA
ENGINEERING PRODUCTS DEPARTMENT, CAMDEN, N.J.

In Canada: RCA VICTOR Company Limited, Montreal



High-gain VHF antenna

—with a 50-kw rating!

It delivers up to 316 kw ERP: RCA's 12-section, 50-kw Superturnstile, in combination with a high-power VHF transmitter, meets FCC maximum power limits—with plenty of gain to spare.

It has adjustable beam tilting: Optional with all RCA 12-section 50-kw Superturnstiles, this feature insures best possible coverage and maximum reinforcement of your vertical pattern. It's done simply by phase-shifting the power between upper and lower halves of the antenna—using standard feedline.

It provides null fill-in: With RCA 12-section 50-kw Superturnstiles, you can virtually eliminate first null with practically no loss of gain. Benefits are: Effective close-in coverage, and vertical field-pattern shaping for constant field.

It uses a switchable feed system: Advanced-type junction boxes, new feedlines, and a sectionalized line-connecting system, enable you to switch power from one part of the antenna to another. *An important feature for emergency operation!*

Specially matched Styroflex line: No VHF antenna operates right without close matching with the transmission line. RCA's Styroflex transmission line *matches* the impedance of Superturnstile sections, handles higher power, holds center conductor in position—even when line is coiled.

Complete VHF Antenna Accessories: RCA has all equipment for VHF 50-kw Superturnstile systems—transmission line fittings, towers, r-f loads and wattmeters, duplexers, etc. Everything is "system-matched" for maximum performance.

REMEMBER: RCA makes five different types of VHF 50-kw antennas to fit your needs. RCA has all 50-kw antenna accessories. RCA can supply high-gain 50-kw antenna systems—*tailored specifically for your VHF channel, power, and service area.* Let your RCA Broadcast Sales Representative help plan your TV antenna system.

This picture was taken during erection of an RCA TF-12AH, 12-section 50-kw Superturnstile at KTBC-TV. Interim transmitter power was 2 kw when KTBC-TV went on the air. Now it's 10 kw

KTBC-TV can still increase power many times without a single change in its antenna system



RADIO CORPORATION of AMERICA
ENGINEERING PRODUCTS DEPARTMENT

CAMDEN, N. J.

Completely **NEW**

5-kw AM...*

New small size-



1. Increase power to 10 kw with this simple kit

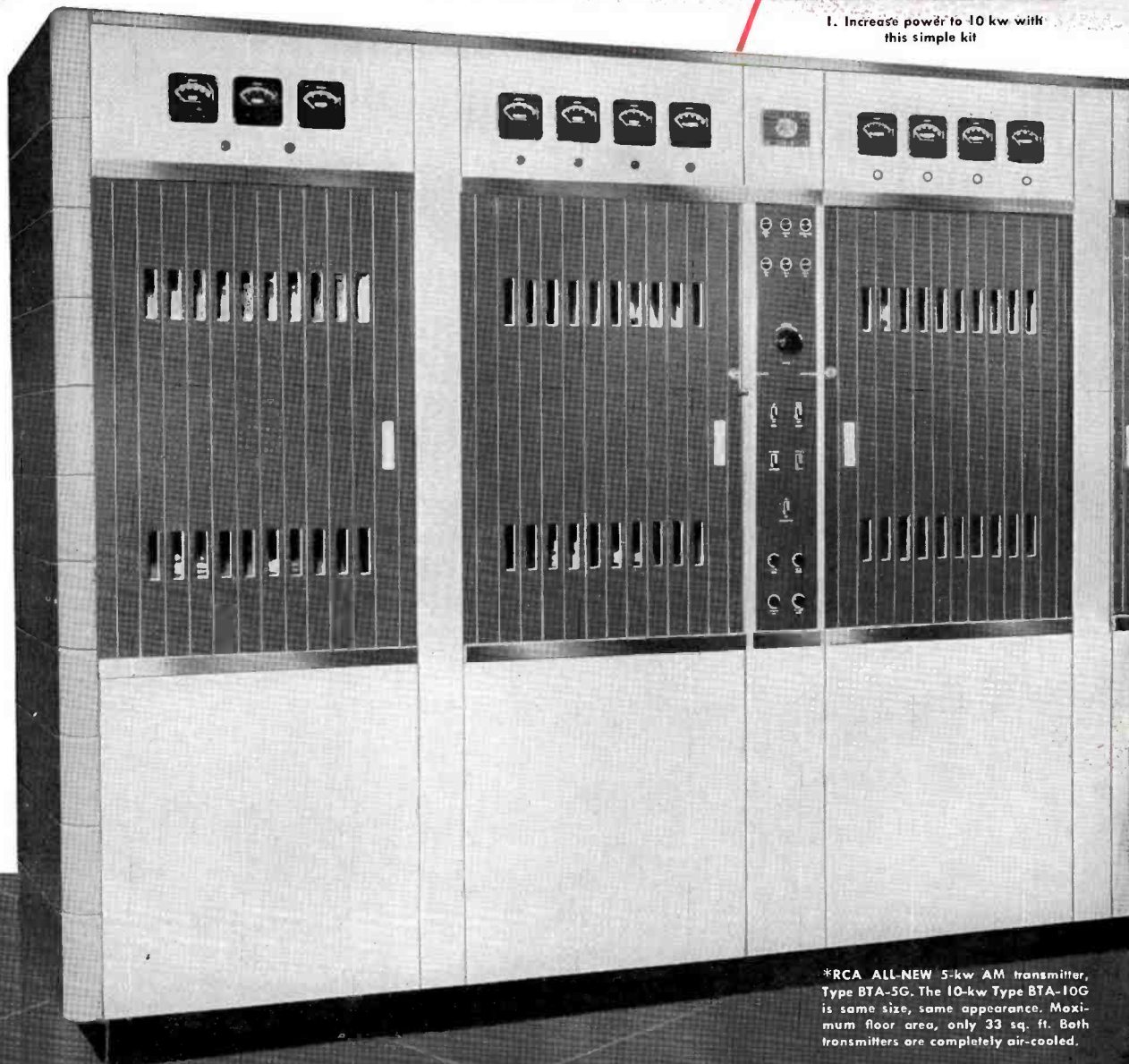

*RCA ALL-NEW 5-kw AM transmitter, Type BTA-5G. The 10-kw Type BTA-10G is same size, same appearance. Maximum floor area, only 33 sq. ft. Both transmitters are completely air-cooled.

..with a "10-kw" future!

New operating convenience - New operating economy

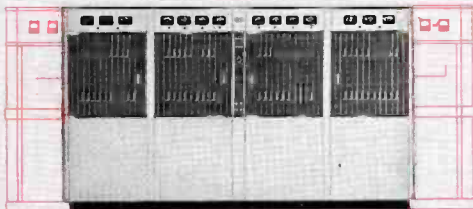

2. Up to 40% less floor area than previous "5 kw's"



3. Power tube costs reduced

Just read these exclusive features . . .

- 1 It is a 5-kw AM transmitter you can increase to 10 kw—easily—inexpensively—quickly. No lost air time for conversion. One simple kit makes it easy to increase power overnight. (Yes, you can buy this transmitter ready-built for 10 kw, too).
- 2 It requires less "operating" floor space than other 5 kw's—saves up to 40% floor area. Entire transmitter is only 84" high, 130" wide, 32½" deep.
- 3 It's the ONLY "5 kw" with such low tube costs. Power and modulator stages use the new small size, lightweight RCA-5762—costing less than half that of power types in most "5 kw's".
- 4 It's the ONLY "5 kw" with "split-cycle" overload and voltage protection—using thyatron-controlled rectifiers. Circuits work so fast audiences cannot detect "off-air" breaks.
- 5 It holds power bills to the LOWEST in the "5-kw" field—through smaller power tubes, fewer stages, fewer tubes (only 24 tubes and 8 different types).
- 6 It's the ONLY "5 kw" with horizontally-sliding doors *front and back*. Benefits:
 - ✓ Saves over 60 square feet of floor area
 - ✓ Provides more elbow room for operator
 - ✓ Makes it easier to get at transmitter

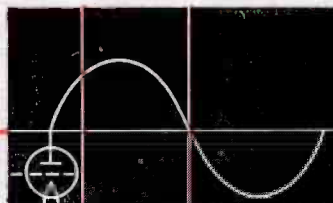

4. 1/60th second arc-back protection



5. Lower power bills



6. Sliding doors—
front and rear

For all the facts about this basically new transmitter . . . newest of nearly three hundred RCA "5-kw's" now on the air . . . call your RCA Sales Representative.



RADIO CORPORATION of AMERICA
ENGINEERING PRODUCTS DEPARTMENT
CAMDEN, N.J.



Now...
SEALED
for your protection

TO MAKE SURE the new Image Orthicon you buy is "factory-fresh," RCA now seals each 5820 for replacement use in its own sturdy, tamper-proof container. The unbroken red seal is your assurance that no hand has touched your tube since it left the RCA factory. *You are the first to use it.*

Customer protection like this is typical of RCA's never-ending effort to bring broadcast and TV stations the most dependable tubes the industry can offer.

Your neighborhood RCA Tube Distributor is especially experienced in meeting your tube needs. For fast service on Image Orthicons . . . and all types of RCA tubes . . . phone him.



RADIO CORPORATION of AMERICA
ELECTRON TUBES

HARRISON, N.-J.

Now Delivering...

10-kw TV transmitters

for VHF

The RCA TT-10AL/AH, newest and finest of all VHF Transmitters, is now being produced in quantity—and shipments are being made every week. Already a number of stations are on the air with the TT-10AL/AH. Other stations have received their TT-AL/AH Transmitters and will be on soon. Before long this new transmitter will be the most widely used television transmitter in the world.

The list of stations going on the air in rapid succession with the TT-10AL/AH is RCA's "proof-of-production." You too can be on the air soon with an RCA 10-kw transmitter.

ECONOMICAL...TODAY AND TOMORROW

- This 10-kw VHF transmitter—operated in conjunction with an RCA high-gain antenna—can produce 100 kilowatts ERP at substantially lower cost per radiated kilowatt than any other transmitter-antenna combination now available.
- If you go to higher power, this 10-kw VHF transmitter can be used as the basic driver for RCA's high-power 25-kw amplifier—such as now in operation at WAVE-TV. (RCA's 50-kw rated, high-gain antenna can handle the extra input—with another 25-kw to spare for any future increase.)

For complete details—and delivery information—call your RCA Broadcast Sales Representative.



*Have you
ordered yours?*



RADIO CORPORATION of AMERICA
ENGINEERING PRODUCTS DEPARTMENT CAMDEN, N. J.

All THE FEATURES YOU WANT

. . . in a Popularly
Priced **TAPE
RECORDER**

COMPLETE WITH:

- Microphone
- Reel of RCA Sound tape
- Spare Reel
- Bridge Input Cord
- Instruction Book



RCA **PUSH-BUTTON** TAPE RECORDER

- **EASY TO RECORD** . . . Just push the clearly marked "record" buttons, set the gain control and you are recording.
- **EASY TO PLAY** . . . Push the "play" button, set the volume control of the built-in amplifier and speaker for listening level.
- **EASY TO USE** . . . Just push-a-button to start, record, rewind, stop, fast forward or play . . . what could be easier! It's virtually automatic — ideal for announcers and non-technical personnel.

TECHNICAL DATA . . .

Size.....	14" x 12" x 9"
Weight	26 pounds
Reel Capacity.....	Uses all sizes up to 7" reels
Recording/Playing Time....	2 hrs. max. for 1200' tape
Two Operating Speeds.....	3.75" and 7.5" per second
Voltage.....	105 to 125 volts
Current.....	.60 cycles, a.c. only
Power70 watts

- ◆ Handsome styling—dignified carrying case
- ◆ Right price for your budget
- ◆ Better tone through RCA electronic engineering
- ◆ Longer life through RCA mechanical design



ENGINEERING PRODUCTS DEPARTMENT

RADIO CORPORATION of AMERICA

Camden, New Jersey

PRINTED
IN
U.S.A.