

AM · FM · TELEVISION

# BROADCAST

NEWS

G. E. MILLER

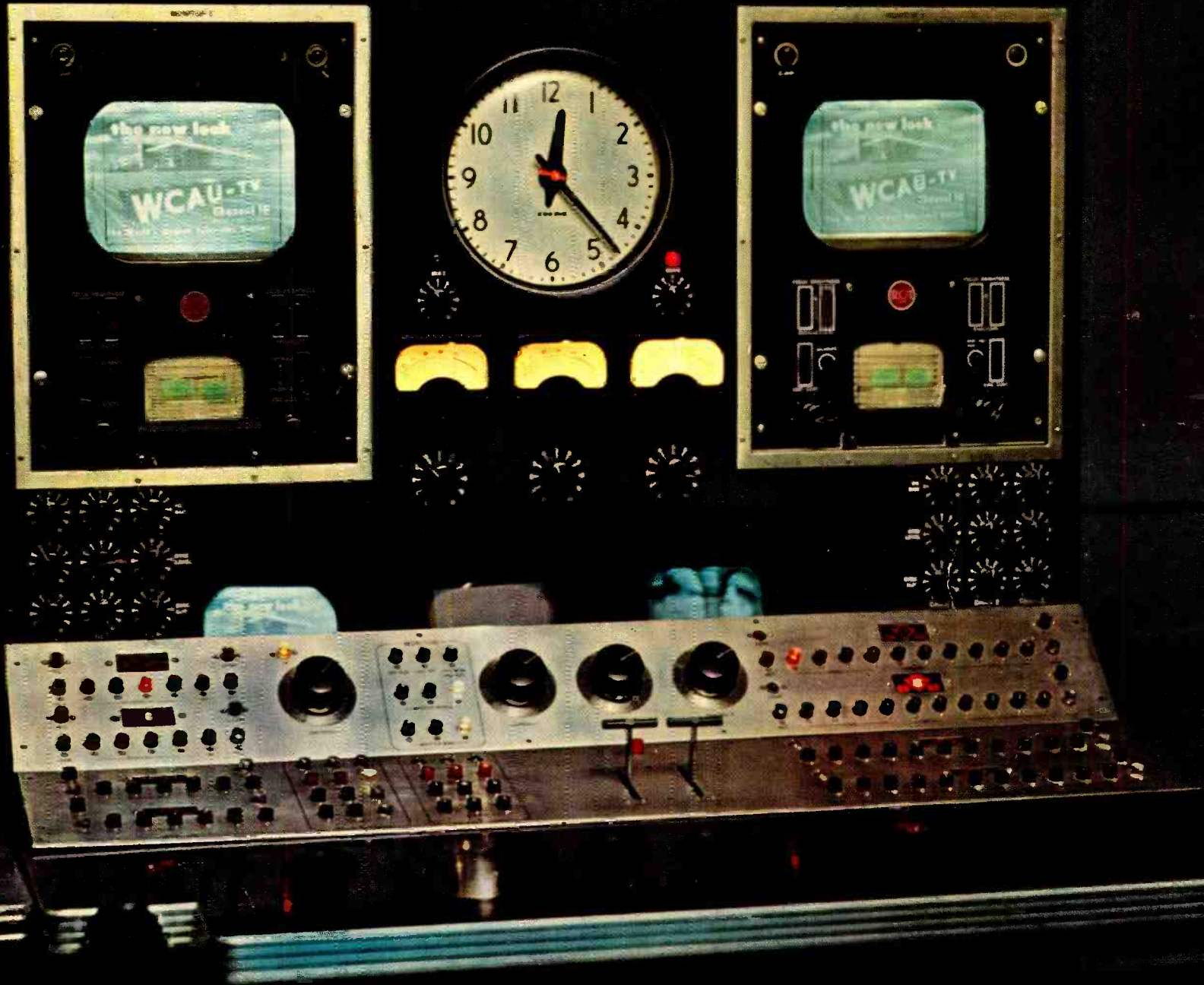

WCAU-TV Master Switching Console Custom Built by RCA





*Round the world...*

**RCA Transmitting Stations  
are spreading the wonders of television**

NATION AFTER NATION adopts RCA television... as more millions of people welcome this great educational medium.

A world network of TV stations is coming into being. Already there are dozens of RCA transmitters in operation or in process of installation. The total audience is increasing by millions each month.

Abroad, as in the U.S.A., where it is the preferred system, RCA has everything for television... from camera to antenna, from studio to transmitter to receiver. RCA also provides the service of distributors

and companies long versed in the electronic needs of their countries.

Only RCA provides this complete, co-ordinated TV service... manufacturing, installation facilities, instruction, servicing... *everything* that goes to make RCA TV such a dependable instrument of education and enjoyment throughout the civilized world.

\* \* \*

Your RCA Distributor or company will be glad to tell you about RCA Television; or write to RCA International Division, New York.

\*\*Marcas Registradas\*\*

World Leader in Radio  
First in Recorded Music  
First in Television



**RCA INTERNATIONAL DIVISION**  
**RADIO CORPORATION of AMERICA**  
RCA BUILDING  
30 ROCKEFELLER PLAZA, NEW YORK, N.Y., U.S.A.

C. E. MILLER

Number 78

Mar.-Apr. 1954

# BROADCAST NEWS

published by

**RADIO CORPORATION OF AMERICA**  
ENGINEERING PRODUCTS DIVISION      CAMDEN, NEW JERSEY

PRICE      *In continental U.S.A. --- \$4.00 for 12 issues*  
                 *In other countries ----- \$5.00 for 12 issues*

## CONTENTS

UHF SUCCESS STORY . . . . .	by Ed Jones	8
RCA DEVELOPS NEW UHF TELEVISION WAVEGUIDE . . . . .	by O. F. Wagner	14
KBTU, COLORADO TELEVISION CORPORATION . . .	by Joseph Herold	18
KBTU STUDIO FACILITIES . . . . .	by James Butts	20
KBTU'S FILM FACILITIES . . . . .	by W. L. Murray	24
KBTU TRANSMITTING FACILITIES . . . . .	by Carl Bliesner	26
SENSITIVITY OF MICROPHONES TO STRAY MAGNETIC FIELDS . . . . .	by L. J. Anderson	30
AIR FORCE USES VERSATILE TV "STATION-ON-WHEELS" . . . . .		34
WFTL-TV ROUNDS OUT A YEAR OF SUCCESSFUL UHF TV BROADCASTING . . . . .		38
SURVEY OF TRANSISTOR DEVELOPMENT . . . . .	by B. N. Slade	42
VIDICON FILM CAMERAS . . . . .	by H. N. Kozanowski	54
THE NEW TF-12BH HIGH-GAIN ANTENNA by Irl. T. Newton, Jr. and H. H. Westcott		60

**"RCA PIONEERED AND DEVELOPED COMPATIBLE COLOR TELEVISION"**

Copyright 1954, Radio Corporation of America, Engineering Products Division, Camden, N.J.

PRINTED  
IN  
U.S.A.

# NOW high

## ...with Conventional

### New RCA 12.5-KW UHF Transmitter

combines simplicity and reliability with high-quality performance for color

THIS IS the high-power UHF transmitter you've waited for. A transmitter as simple, as reliable, and as easy to operate as your standard broadcast transmitter. A transmitter with no trick tubes, no trick circuits, no cumbersome dollies. A transmitter which requires no modification to meet FCC color specifications (or superior monochrome quality standards).

This new RCA 12.5-kw UHF Transmitter uses conventional-type tubes

throughout, including the new small-size RCA-6448's in the aural and visual output stages. These are the kind of tubes your engineer knows and understands, and they are used in the kind of circuits he is used to working with. Not only are these tubes better than complicated types, but you can get them from any RCA tube distributor.

This new RCA 12.5-kw UHF Transmitter is the result of several years of intensive development work. Actually,

RCA could have shipped high-power UHF transmitters sooner if the engineers had been content to meet ordinary performance standards. But RCA engineers insisted on performance which would provide both superior monochrome pictures and excellent color performance. This turned out to be much harder than expected. Obtaining wide-band response, straight-line linearity and constant phase shift necessary for color is difficult. However, one by one the necessary circuits were worked out until finally the design was perfected.

Now we have it. A transmitter that is *designed for color*. With this trans-



#### OK FOR COLOR

The TTU-12A Transmitter, like all RCA TV Transmitters now in production, is designed to meet fully the new FCC Color Standards and to provide high-quality color picture transmission when used with RCA Color Video Input Equipment.

# power UHF

## Type Tubes

mitter, when color comes to your station, you will have no extra cost for transmitter conversion.

Those who have waited for this transmitter will be happy they did. Those who have not ordered yet, may now do so with assurance. Those who still have doubts may see it in operation at Camden. See your RCA Representative to arrange an inspection trip.

**ASK FOR BULLETIN . . .** For complete information on the RCA 12.5-kw UHF Transmitter—call your RCA Broadcast Representative. Ask for the fully illustrated, 12-page brochure describing RCA's Hi-power UHF transmitter.

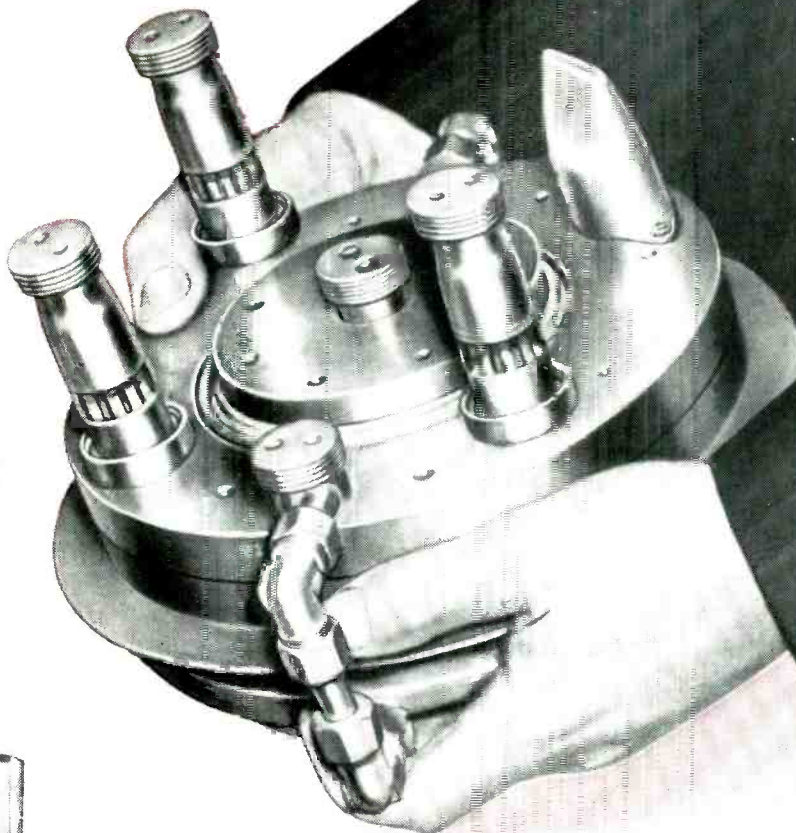
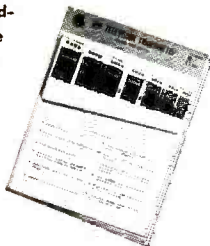

### Conventional, small-size, RCA 6448 Tetrode used in the RCA 12.5-kw UHF Transmitter.



RCA-6448 Power Tetrode—heart of the TTU-12A, 12.5-kw UHF Transmitter.



It is used in the kind of circuits every station man knows how to tune.



It saves power and tube costs (up to \$34,000 over a ten-year period).



It's small, fits into easy-to-handle cavity assembly.



It's a standard type—can be obtained from your local RCA Tube Distributor.



One type covers the entire UHF band, 14-83.

**RCA PIONEERED AND DEVELOPED COMPATIBLE COLOR TELEVISION**



**RADIO CORPORATION of AMERICA**  
ENGINEERING PRODUCTS DIVISION  
CAMDEN, N.J.

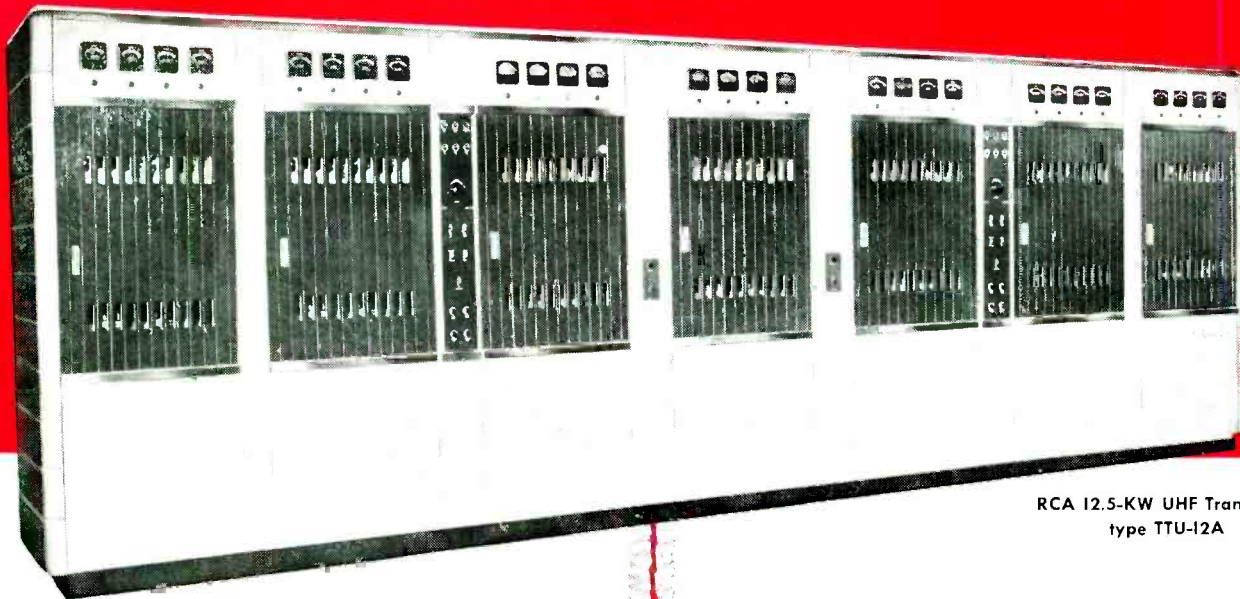

RCA 12.5-KW UHF Transmitter  
type TTU-12A

### ① 12.5-KW UHF Power Available

With RCA's new transmitter, you get full 12½-kilowatt output (at the low end of the band). Moreover, you get this with all adjustments made for optimum color transmission—and with an extra-large allowance (10%) for losses in the Filterplexer. In most cases, loss is actually much less, so that output on some channels is nearly 14 KW.

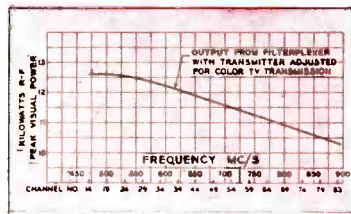

### ② 300-KW to 500-KW Effective Radiated Power (ERP)

Operated in combination with a non-directional RCA high-gain UHF Pylon Antenna, this 12.5-KW transmitter is capable of providing an ERP of 300 KW. With a directional RCA Pylon Antenna, powers up to 500 KW are possible (in a given direction).

### ③ Designed for Color

Performance requirements for color are much more stringent than for monochrome. The TTU-12A was designed to meet color requirements. Over-all linearity is virtually a straight line—from white level to sync signal peaks. Wide band width provides excellent response out to 4.2 MC. And the very important phase vs. amplitude response is constant over the whole operating range.

Curve illustrating the linearity characteristic of the RCA TTU-12A transmitter.

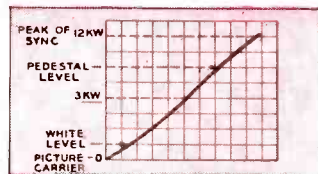

A linearity trace (taken directly from an oscilloscope) of the TTU-12A transmitter at 12 KW "peak-of-sync."

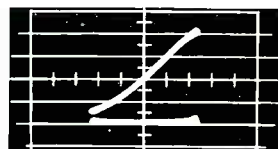

Another linearity trace (taken directly from an oscilloscope) of the TTU-12A when driving the TTU-12A to 12 KW "peak-of-sync." "P.A." output.

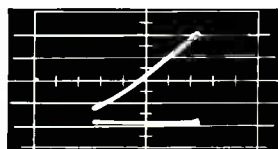

### ④ Unsurpassed Monochrome Quality

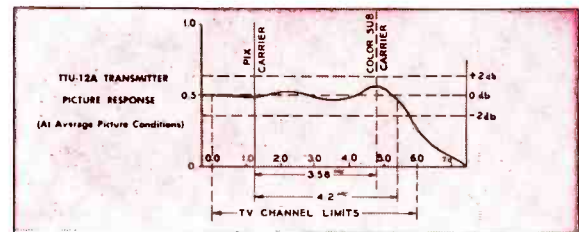

Equally important—you get SUPER MONOCHROME QUALITY with this RCA UHF transmitter. It exceeds FCC requirements for satisfactory monochrome operation by a wide margin! Since the RCA transmitter is adjusted for the more stringent color requirements, it is particularly good for monochrome.

### ⑤ Conventional Tubes Throughout



The latest circuit principles and techniques are employed in the TTU-12A—but they are easily understood by all station operators. That's because *only conventional type tubes are used*. For example, the RCA-developed high-power tetrode (RCA-6448) is used in both aural and visual "P.A.'s". This tube is small and easy to handle—fits into a unique "glide-in" cavity assembly that can be interchanged quickly and easily. The result is a high-power UHF transmitter that is as simple, reliable, and convenient to operate as standard broadcast transmitters.

### ⑥ Economical To Operate

Average power consumption of the TTU-12A is less than other UHF transmitters of equivalent power. Tubes are designed for long operating life. At conservative estimates, these provide total savings up to \$34,000—based on a 10-year operation. See the typical readings and performance characteristics in Table I.

TABLE I

#### (Typical Transmitter Specifications and Meter Readings)

Transmitter Power Consumption (approx.):		
Average Picture	.85 KW	
Power Factor	.0.9	
Transmitter Output Meter Readings:		
Peak of Sync	14.0 KW	8.4 KW
Power Output (transmitter)	12.6 KW	7.6 KW
Power Output (Filterplexer)	47.6%	33.3%
Plate Efficiency		
Transmitter Overall Dimensions:		
Width (front line cabinets)	.235"	
Height	.84"	
Depth	.32-9/16"	
Weight	.6000 lbs. (approx.)	

# Only the RCA 12.5-KW "UHF" has all these 11 features!

## ⑦ RCA 1-KW Driver—Plenty of Reserve

The RCA 12.5-KW UHF transmitter uses the famous RCA TTU-1B 1-KW UHF transmitter as the driver. This transmitter, now used by nearly a hundred UHF stations, has established an outstanding record for performance and reliability. If you want to begin UHF operations with one kilowatt now, you can do so with an RCA TTU-1B 1-KW transmitter. Then add an RCA 12.5-KW UHF power amplifier later.

## ⑧ Space-Saving Mechanical Features

Horizontally sliding doors, front and back, save on workable floor space—give the operators more elbow room. Small cubicles (27" wide, 32" deep, 84" high) enable you to move them through standard doorways and in and out of standard elevators. Pre-formed inter-cabinet connecting cables reduce installation costs.



## ⑨ 10 Micro-Second, Fault-Protection

Unique electronic overload protection completely safeguards power tubes and circuitry against momentary or sustained overload. (For example, the protection circuit will remove power so fast it will prevent damage to a wire as fine as 0.005-inch diameter shorted across the 7000-volt power supply!)

## ⑩ Hi-Lo Cutback Reduces "Off-Air" Time

With the TTU-12A transmitter you can cut back to a generous 1-KW power level—and stay "on-air" while making emergency repairs to the 12½-KW amplifier. Moreover, small size tube cavities in the power amplifiers may be interchanged in less than 5 minutes—enabling you to return to full power promptly.

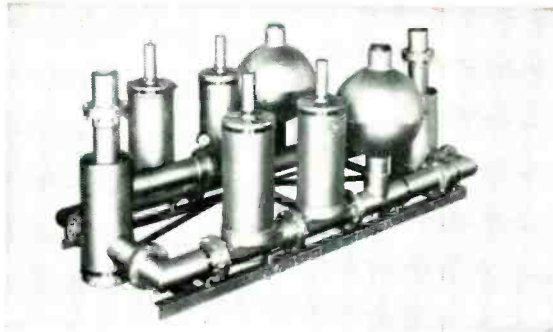

RCA TTU-12A Filterplexer

## ⑪ You Pay Nothing for "Extras"

The price of the RCA 12.5-KW UHF includes the complete transmitter package. No "extra" charge for UHF Filterplexer (combination sideband filter and diplexer). No "extra" charge for one complete set of tubes. No "extra" charge for two sets of crystals, two P.A. "glide-in" cavity dollies, one spare cavity, two water pumps, and pyranol-filled plate transformer.

## Specify a Completely Matched UHF System

RCA can supply a completely matched system to meet any station requirement. This includes the antenna and tower, transmitter, console, monitoring equipment, transmission line or waveguide, and the many other accessories needed to put a UHF station on the air. Everything is matched for peak performance and you get everything from one reliable source—RCA!

RCA UHF Waveguide Section

For complete information on the RCA 12.5-KW UHF transmitter—and RCA UHF accessories—call your RCA Broadcast Sales Representative.

New brochure on the RCA 12.5-KW UHF transmitter. Includes technical specifications, floor plans. Free from your RCA Broadcast Sales Representative.

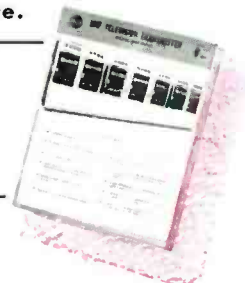

RCA PIONEERED AND DEVELOPED COMPATIBLE COLOR TELEVISION



**RADIO CORPORATION of AMERICA**  
ENGINEERING PRODUCTS DIVISION  
CAMDEN, N. J.

# Put your UHF

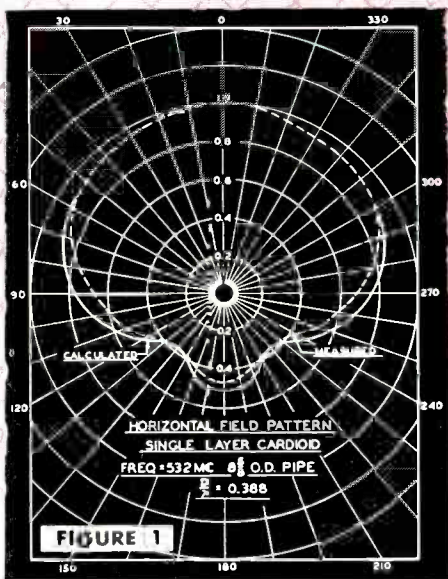

### Do you require "single-direction" coverage?

If so, RCA has UHF Pylons that can produce horizontal field patterns shaped like a Cardioid. Figure 1 shows the calculated pattern, and a measured model pattern, of a "Cardioid directional" Pylon. Operating frequency, 532 Mc.

### Do you require "elongated" coverage?

If so, RCA has UHF Pylons that produce a horizontal field pattern shaped like a peanut. Figure 2 shows the calculated pattern, and a measured model pattern, of this type of directional Pylon antenna.

### Do you require "circular" coverage?

If so, RCA has a wide selection of UHF Pylons that produce equal signals in all directions.

### Do you want BETTER overall coverage—lower signal losses?

All RCA UHF Pylons (directional and circular patterns) have built-in "Beam Tilt." Easily adjusted at your station by moving the inner conductor of the antenna up and down, this feature assures best possible coverage, with *minimum power loss in vertically polarized radiation.*

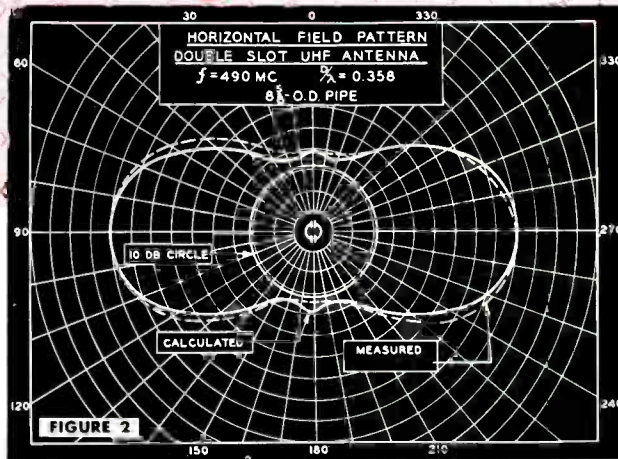

### Do you need BETTER "close-in" coverage?

New, advanced null fill-in system, used in conjunction with beam-tilting, offers excellent close-in coverage—even for the "difficult" sites. Figure 4 is a typical measured vertical field pattern of an RCA UHF Pylon. Figure 3 is a nearly ideal field-distance curve produced by a "contour-engineered" UHF Pylon (actual record of a commercial TV station now "ON-AIR").

### How much UHF gain do you need?

RCA UHF Pylons (standard circulars and directionals) can be furnished with gains in the order of 3, 6, 9, 12, 21, 24 and 27 (see table). No tuning compromises in RCA UHF Pylons—with resultant loss of gain (such as caused by cross-polarized components). *The gain that's published is the gain you get!*

### RCA UHF Pylon design is simplicity—plus! Just one feedpoint for the line input

You find no protruding elements on RCA UHF Pylons. The smooth surface of the metal cylinder is the antenna itself. No physical connections on the antenna. Nothing to bend or break under ice or wind load. Signal loss in rain or heavy icing is negligible.

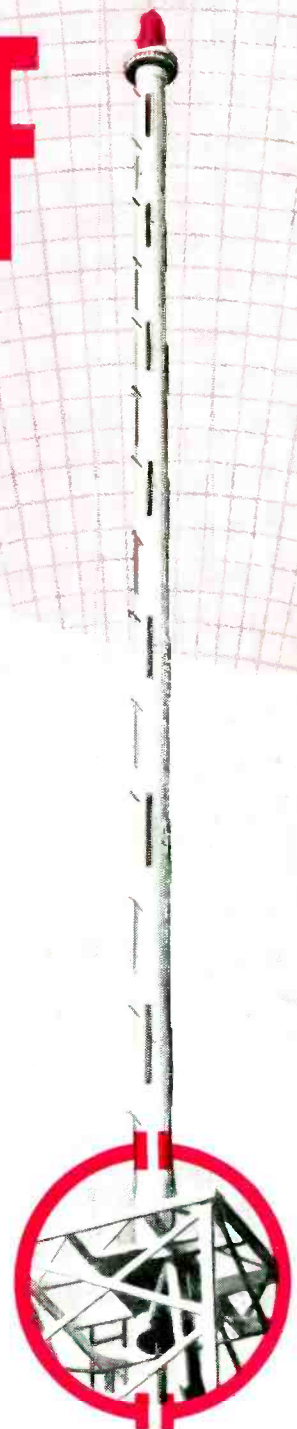

Typical installation of an RCA Adjustable Beam, High-Gain UHF Pylon

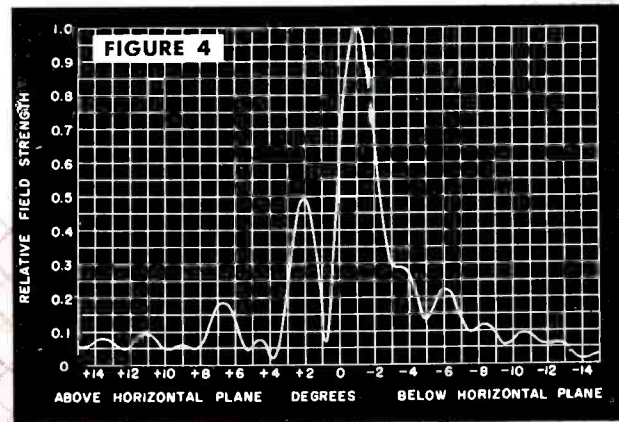
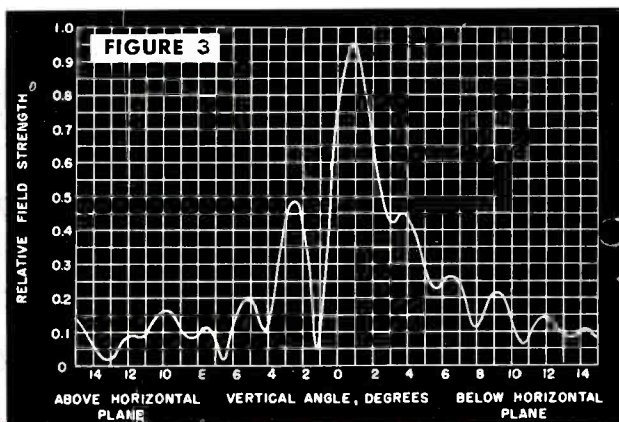



# signal where the population is

**—Use an RCA “contour-engineered”  
UHF Pylon Antenna**

## Power input ratings up to 50 KW!

Select the RCA UHF Pylon to meet your requirements

Channel	Type	No. of Sections	Gain in Db	Power Gain	TV Power Rating**	
					KW	DBK
14-83	TFU-24C*	16	13.8	24	50.0	17.0
14-30	TFU-21DL	14	13.22	21	10.0	10.0
14-30	TFU-24DL	16	13.8	24	10.0	10.0
31-50	TFU-24DM	16	13.8	24	10.0	10.0
51-83	TFU-27DH	18	14.31	27	10.0	10.0
14-30	TFU-21DAL (Custom)	14	Directional Types: Horizontal pattern shapes, RMS and maximum power gains depend on channel. Beam-tilting and null fill-in features are included. All directional antennas are custom-built and specifications are subject to individual study and application.			
14-30	TFU-24DAL (Custom)	16				
31-50	TFU-24DAM (Custom)	16				
51-83	TFU-27DAH (Custom)	18				

\*Preliminary data. \*\*Power ratings given are maximum visual power to input of antenna and assume aural carrier of one-half peak of visual sync-rating. For other values of aural carrier the total average power is 1.1 X TV power rating listed above.

No picture deterioration with an RCA-UHF Pylon-Transmitter Combination, even when the antenna is covered with four inches of ice.

RCA-UHF Pylons are shipped complete in one unit—“custom-tuned” for your frequency at the RCA factory—and tested by the most modern methods known to the television industry. You can put up a Pylon, connect the line, and throw the switch. *Tuning is not required at your station!*

#### 4 NEW BOOKS ON UHF

- 12-page brochure on RCA-UHF TV Pylon Antennas
- 12-page brochure on RCA-UHF TV Waveguides
- 12-page brochure on RCA's 12.5 Kw UHF Transmitter
- 28-page brochure on RCA-UHF Transmission lines and fittings

Ask your RCA Broadcast Sales Representative for copies.

RCA supplies specially matched UHF transmission lines

No UHF antenna functions properly unless your transmission line matches your antenna closely. RCA-designed line, not available anywhere else, has measured performance (VSWR) that is better than 1.05 to 1.0.

RCA UHF TV Waveguide

RCA supplies complete UHF accessories



Only when everything in your transmitting system is *matched*—from transmitter to antenna—can you be sure of maximum performance. In this respect, RCA can supply each and every accessory required to complete a UHF antenna installation, including the tower, mitered elbows, line transformers, spring hangers, dummy loads, wattmeters, frequency and modulation monitors, filter-plexers, and hardware—down to the very last bolt. Everything is designed specifically to work with the UHF Pylon. And remember, everything is available from ONE responsible equipment manufacturer—RCA!

For planning help, call your RCA Broadcast Sales Representative.



**RADIO CORPORATION of AMERICA**  
ENGINEERING PRODUCTS DEPARTMENT CAMDEN, N.J.

# UHF SUCCESS STORY

## IN LESS THAN 30 DAYS ON THE AIR WAFB-TV WAS OPERATING IN THE BLACK

By

**ED JONES**

RCA Engineering Products Department



T. (Tom) E. Gibbens, Vice President and General Manager, whose administrative and business ability contributed greatly to the financial success of WAFB.

### PRESCRIPTION FOR SUCCESS

Take one very congenial Vice President and hard hitting Sales Manager, one just bubbling over with enthusiasm; mix well with an exceptionally clever Chief Engineer well versed in every phase of electronics as it applies to Broadcast Station Operation; add an extremely efficient crew of station and office personnel—then shake well with a group of very appreciative radio distributors, dealers and service men who realize that their businesses depend on good broadcasting.

Intrigued by the success of WAFB-TV and anxious to learn how it was accomplished, the writer paid a visit to the offices of Modern Broadcasting Company of Baton Rouge—owners and operators of WAFB-AM and WAFB-TV.

Baton Rouge, the capital of the State of Louisiana, with a population of 132,000, is the home of LSU, the world's most complete oil center, the farthest inland deep water port in the U. S. A., and is the fastest growing city in the state.

Thumbing through the pages of their old and new scrapbooks and discussing the details of their very profitable AM and TV operations was a most pleasant experience. It became evident that these people, intentionally or otherwise, had actually developed a success formula that could easily be applied universally. Here is the way we interpreted it:

From the very first broadcast, April 19, 1953, the television viewers of the city accepted WAFB-TV as a vital part of Baton Rouge. This was mainly due to the very fine public relations established by this organization throughout the years of their AM broadcasting activities. WAFB-AM always gave the finest service possible to its very large and appreciative listening audience. They also enjoyed extremely good relations with the trade and this relationship paid off handsomely. Long before the station went on the air, Radio Dealers and Service Men contacted every TV equipped home located within WAFB-TV's anticipated-coverage area and were successful in selling and installing conversion equipment to a majority of these TV enthusiasts. This operation enthusiastically encouraged and supported by the Modern Broadcasting Company, resulted in WAFB-TV enjoying a substantial number of viewers the moment the transmitter made its debut on the air. In fact, there were 32,000 TV sets in operation and it is expected that the (local) near-saturation figure of 40,000 sets will be reached by early 1954. Most important, from a financial standpoint, is the fact that a very encouraging number of local sponsors jumped

Below: WAFB-TV's tower and RCA 21-BL antenna rises 501 feet above the ground. The fabulous State Building—the house that Huey (Long) built—appears in the upper left portion of the picture.



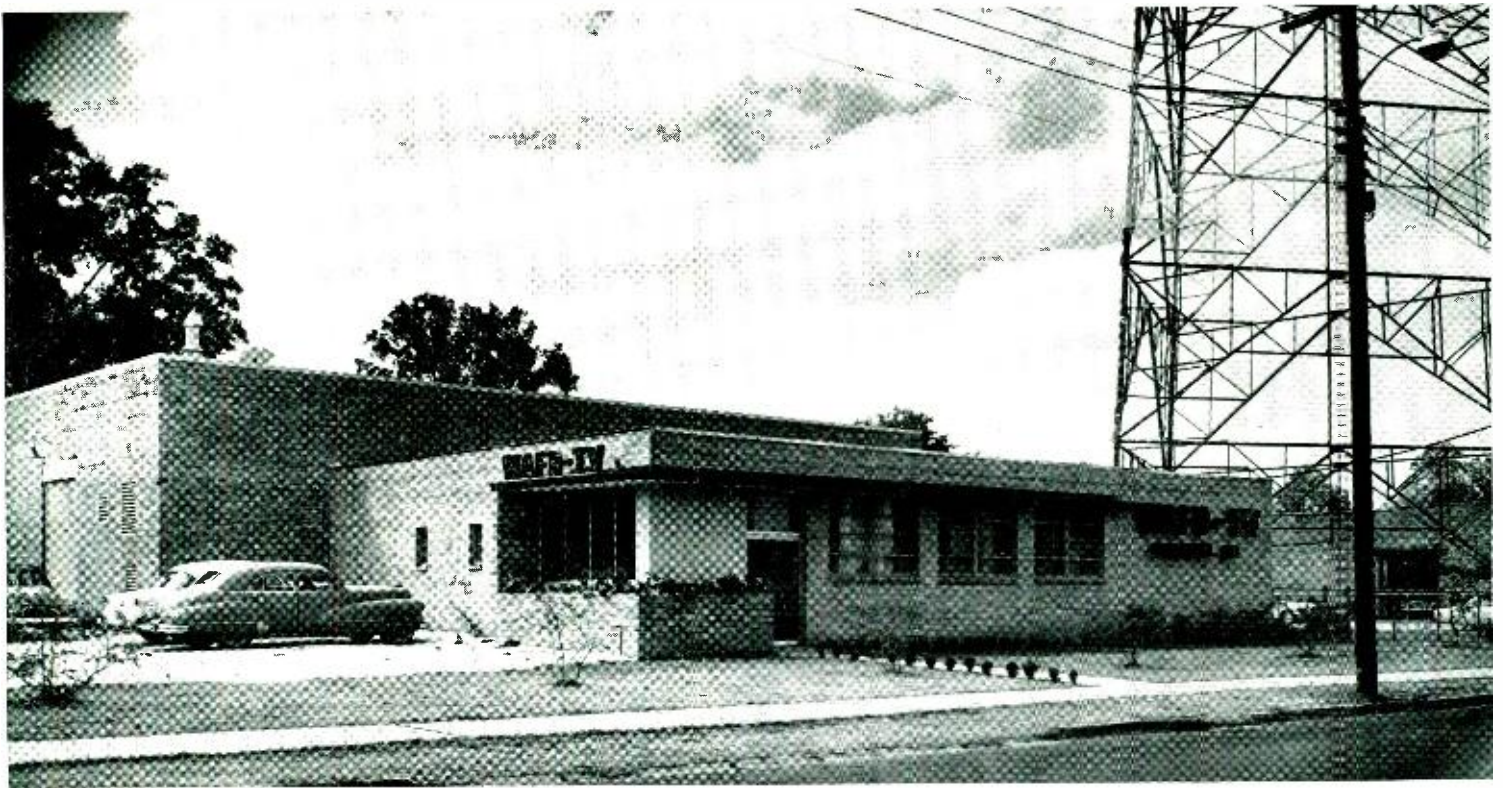

This modernistic transmitter and studio building is located right on the main street. Together with the tower, it provides a "Gigantic Billboard" that constantly sells WAFB-TV to the residents as well as visitors.

on the Channel 28 bandwagon. In fact, the Fall and Winter schedule on page 10 looks like a "Who's Who on TV".

#### **SPONSORS KEEN ABOUT EFFECTIVENESS OF UHF**

W. BOGAN QUINE

*Wholesale Automobile Supplies*

"We should have gone into television sooner! The overall increase in sales has been all the more amazing, because now we have customers walking in the door requesting 'those tires we saw on Television'. It is nice to have the backing of your know-how in the solution of merchandising problems."

UNITED ENGINEERING COMPANY OF LA.

*Insulation, Aluminum Screens, etc.*

"Using WAFB-TV, our sales during the month of June were the greatest in many years of advertising. We have received many inquiries from Lafayette, Plaquemine, New Roads and many other neighboring towns due directly to our advertising on WAFB-TV."

COMMERCIAL TIRE COMPANY

*General Tire Headquarters*

"With almost no increase in our advertising budget for 1953, we are more than pleased that we have used television for direct merchandising. This year during our vacation Tire Sale, we experienced a thirty-three percent increase in passenger tire sales."

RIDER JEWELRY COMPANY

"Enough listeners already know how to react to make 'Favorite Story' more than pay its way on direct sales response. We're glad we climbed

on the TV Bandwagon when we did. Our sales records prove it. We intend to stick with WAFB-TV. You can look forward to seeing us around for many years to come."

HOUSE OF FASHION

*Exclusive Style Shop*

"HOUSE OF FASHION is more than pleased with its television advertising in Baton Rouge. Results have exceeded our expectations. It gives me a great deal of pleasure to tell you that HOUSE OF FASHION is more than satisfied."

#### **WAFB-TV STATION PERSONNEL**

The complement of station operating personnel at WAFB-TV includes the following:

- General Manager
- Operations Manager
- Chief Engineer
- Commercial Manager
- Program Manager
- Program Director
- Announcers (4)
- Engineers (12)
- Traffic Personnel (2)
- Bookkeeper and Secretary
- Receptionist and Secretary
- Artists (2)
- Photographer
- Film Editors (2)
- Salesmen (3)
- Studio Floorman
- Promotion Director
- Porters (2)

The sales, program, clerical and management offices are located across the street on the fourth floor of a separate building. The office of the combined Operations Manager and Chief Engineer is located in the TV building proper.

Donald (Don) K. Allan, Operations Manager and Chief Engineer, Pioneer Broadcaster who planned and supervised the construction of WAFB-TV.



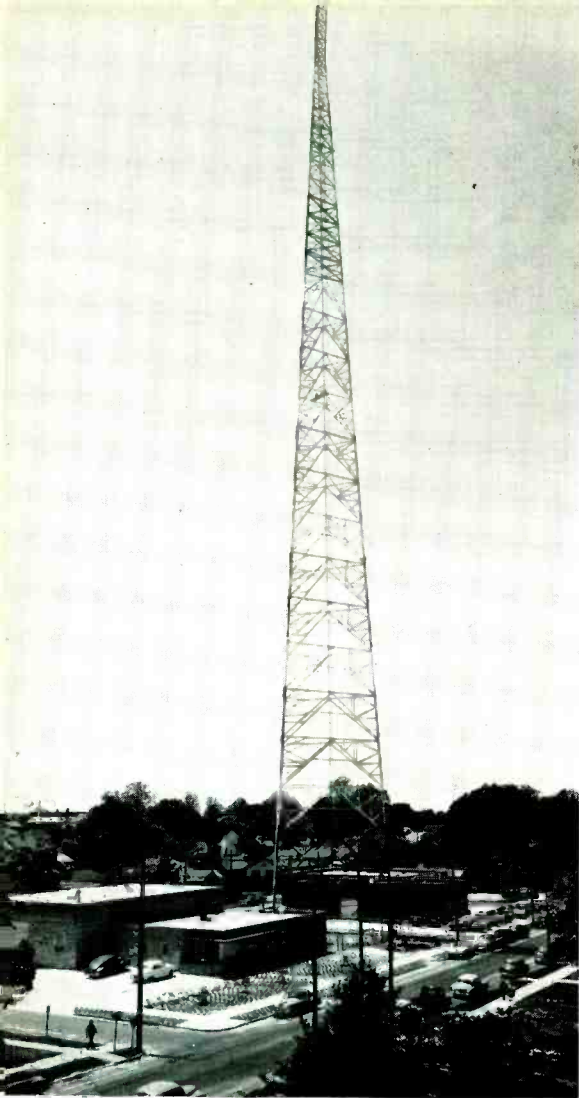

WAFB-TV building with tower directly adjacent.

### WAFB-TV TRANSMITTER/STUDIO BUILDING AND FACILITIES

WAFB-TV with its RCA TTU-1B, 1 KW UHF transmitter and RCA UHF Pylon Antenna provide signals with an Effective Radiated Power of 16,000 watts. The UHF Pylon Antenna incorporates a beam tilting feature which results in good coverage within the city as well as consistently snow free pictures as far away as 40 miles.

The overall transmitter and studio facilities of WAFB-TV are contained in a single, one-floor, brick-constructed building located on the main street of Baton Rouge. The 500-foot tower and antenna are immediately adjacent to the station. The "combined" type of operation keeps all technical operations closely knit and conveniently centralized at one point. Space and facilities are efficiently planned to accommodate a maximum number of programs during a short period. Provisions are made for handling live shows, film shows, slides, and network programs. Studio equipment consists of an RCA film camera, two studio cameras, film projectors, slide projectors, camera control units, monitors, switching and sync generator equipment.

## PROFITABLE FALL AND WINTER SCHEDULE

### PROGRAM

### SPONSOR

Kit Carson	Coca Cola
You Are There	Prudential Insurance
George Jessell	B & B Pen
Gene Autry	Wolf's Bakery
Private Secretary	American Tobacco
Jack Benny	American Tobacco
Fred Waring	General Electric
TV Playhouse	Philco & Goodyear
T Men	Borden Company
Ray Bolger	American Cigarette & Cigar Co.
All Star Theater	Kean's Laundry
TV Theater	American Bank & Peterson Chev.
Weatherman	City National Bank
Esso Reporter	Esso Standard Oil
Range Rider	Tasty Bakery
Favorite Story	Riders Jewelry
Place the Face	Toni
Burns & Allen	Goodrich Rubber Co.
Robert Montgomery	American Tobacco & Johnsons Wax
Captured	Ozburn-Abston
Main Event Wrestling	Gordon Jewelers
Hollywood Wrestling	Tafon
Milton Berle	Buick
Bob Hope	General Foods
Fireside Theater	P & G
I've Got a Secret	Reynolds Tobacco
Boston Blackie	Kirby Bowers
Bob Considine	Mutual of Omaha
Arthur Godfrey	Toni & Pillsbury
Strike It Rich	Colgate
This Is Show Business	Carter Products & Schick
Danny Thomas Show	American Tobacco & Spiedel
Groucho Marx	DeSoto-Plymouth
Four Star Playhouse	Singer Sewing
Dragnet	Liggett-Meyers
Life Is Worth Living	Admiral
Royal Playhouse	Capitol Stores
Play of the Week	Commercial Tire
Ozzie & Harriet	Hotpoint & Lambert
Dennis Day	RCA
Life of Riley	Gulf Refining
Playhouse of Stars	Schlitz Brewing Company
I Love Lucy	Phillip Morris
Comedy Hour	Colgate
Big Playback	Ethyl Corp.
Sky King	Derby Foods
Johnny Jupiter	M & M Candy
Two for the Money	Old Gold
Toast of the Town	Lincoln-Mercury
Amateur Hour	Pet Milk
Medallion Theater	Chrysler Corp.
Hit Parade	American Tobacco & Crosley
Fight of the Week	Mogen David Wine
Football Scoreboard	Southern Terminex
Football Forecast	Baton Rouge York Co.
Talent Show	Petrolane Gas & Holsum Bakery
Coke Time	Coca Cola
Fashion Parade	House of Fashion
Industry on Parade	Wright Insurance Agency
Dancing Party	Arthur Murray
Garraway at Large	Pontiac
LSU Football	Holsum Bakery
Country Store	Holsum Bakery
Heart of the City	Capitol Bedding Co.
Thrilling Bible Stories	Welsh Funeral Home & State Nat'l Life Ins.
Doorway to Danger	American Cigarette & Cigar
My Friend Irma	Brown & Williamson Tobacco Co.
Fashion Review	Godchaux
News	W. Bogan Quine
Racket Squad	Woodfin Smith Pontiac
News	Links Appliances
News	Louisiana Radio & TV
News	Davis Wholesale Drug Co.
Weather	Baton Rouge Building & Loan

# WAFB-TV STUDIO / TRANSMITTER BUILDING LAYOUT

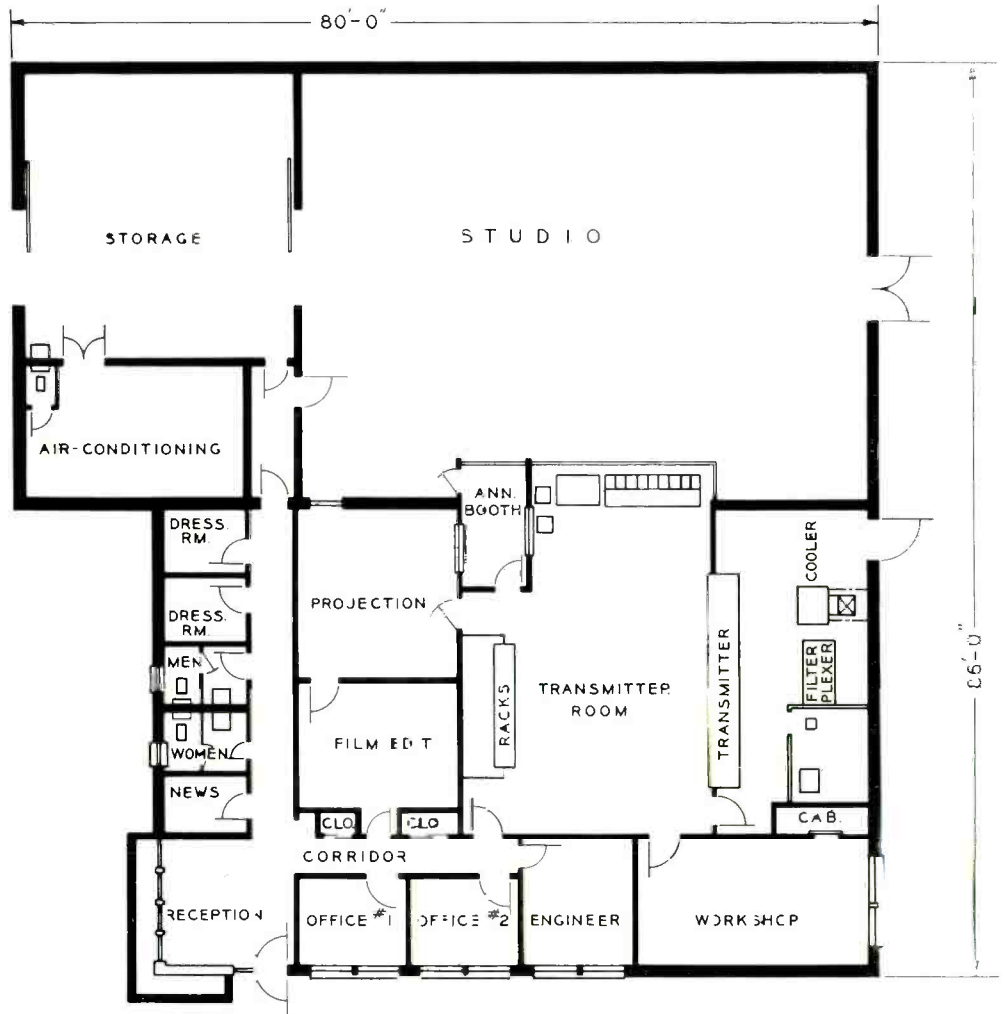

Studio measures 40 by 52 feet with an 18-foot ceiling. As many as a dozen live shows can be (and are) produced during a six hour period. All shows are under the direction of Donald G. Hallman, Program Manager, who makes every prop "earn its keep." A very elaborate lighting arrangement is in use which provides more than 50 scoops, spots and flood lights. All lights are suspended from the ceiling and catwalk.



**AN INDICATION OF HOW WELL ADVERTISERS THINK OF UHF IN BATON ROUGE  
IS REVEALED IN THE FOLLOWING LIST OF SPOT ADVERTISERS**

ABC Cleaners & Laundry  
Abbott-Wimberly  
Allen Radio Service  
Air-Tol Engineering  
American Sta-Dri  
Audubon Motors  
Autin Packing Company  
Autocrat Foods  
Barnett's Appliances  
Ben Peabody Esso Station  
Bert's Camera  
Blue Plate Margarin  
Bardwell-Holloway  
Brown & Damare  
Bynum & Grace  
Bonnie Maid Tile  
Breedon Tractor  
Bulova Watch  
Bendix  
Bama Food Products  
Balcon Supply Company  
Bell Radio & Sound  
Borden Company  
Capitol Building & Loan  
Capitol Piano  
Capitol Stores  
Capitol Airlines  
CDR Roder Antenna  
Chevrolet (McInnis)  
Community Coffee  
Cosselman's  
Colorado McClure Potatoes  
Craft Hosiery  
Clement Lumber Company

Crosley  
C. L. Adams  
Daltons  
Dixie Beer  
Davis Drug  
Dr. Tichenor  
DX Motor Oil  
Delois Repollivill: Pharmacy  
Evinrude  
Empire Furniture  
Elmer Candy Company  
Falstaff  
Fidelity National Bank  
Fritos  
Firestone Stores  
Friden Calculator  
Glueck & Stanton  
Globe Storage Company  
Gordon Theatre  
E. J. Gonzales Finance  
Godchaux  
Gully & Poor  
Hearin, Collins Insurance  
Home Finance  
Hollingsworth Candies  
Home Oil Company  
Harrison Paint Company  
Holsum Bread  
Jax Beer  
Kirby Bowers Radio & TV  
Kirk's Esso Service  
Kool Cigarettes  
Koolvent Awning  
Kirkland's Jewelry

Louisiana State Rice  
Lightcrust Flour  
Moran Motor Company  
Morning Treat Coffee  
Miller Buick  
Mayer, Knox & Amiss  
Norman's Jewelers  
Oldsmobile  
Orkin Exterminating Co.  
Paper Mate Pens  
Pepsi Cola  
A. C. Pierce  
Pillsbury  
Professional Optical  
Pugh's Flowers  
Regal Beer  
Alvin Roy Health Salon  
R & O Electric  
7-Up  
Soiloff  
Southern Airways  
Schenvert's Clothing  
SOS Company  
Standard Motors  
J. Paul Smith  
Russell Stover  
Tenilhist  
Tic Toc Shoe  
United Engineering  
Union Federal Savings & Loan  
United Credit  
Viceroy Cigarettes  
Wright Insurance Agency

WFAB-TV opening day parade—April 19, 1953.



WFAB-TV Receptionist, Rita Werner.

WAFB-TV Control Room. ▶



Engineer Leon Maxson operates film equipment consisting of two RCA TP-16D Projectors and Dual-Disc Slide Projector TP-3A. ◀

▶ Don Allan, Operations Manager and Chief Engineer, chats with "Cowboy" Bill Gillis.



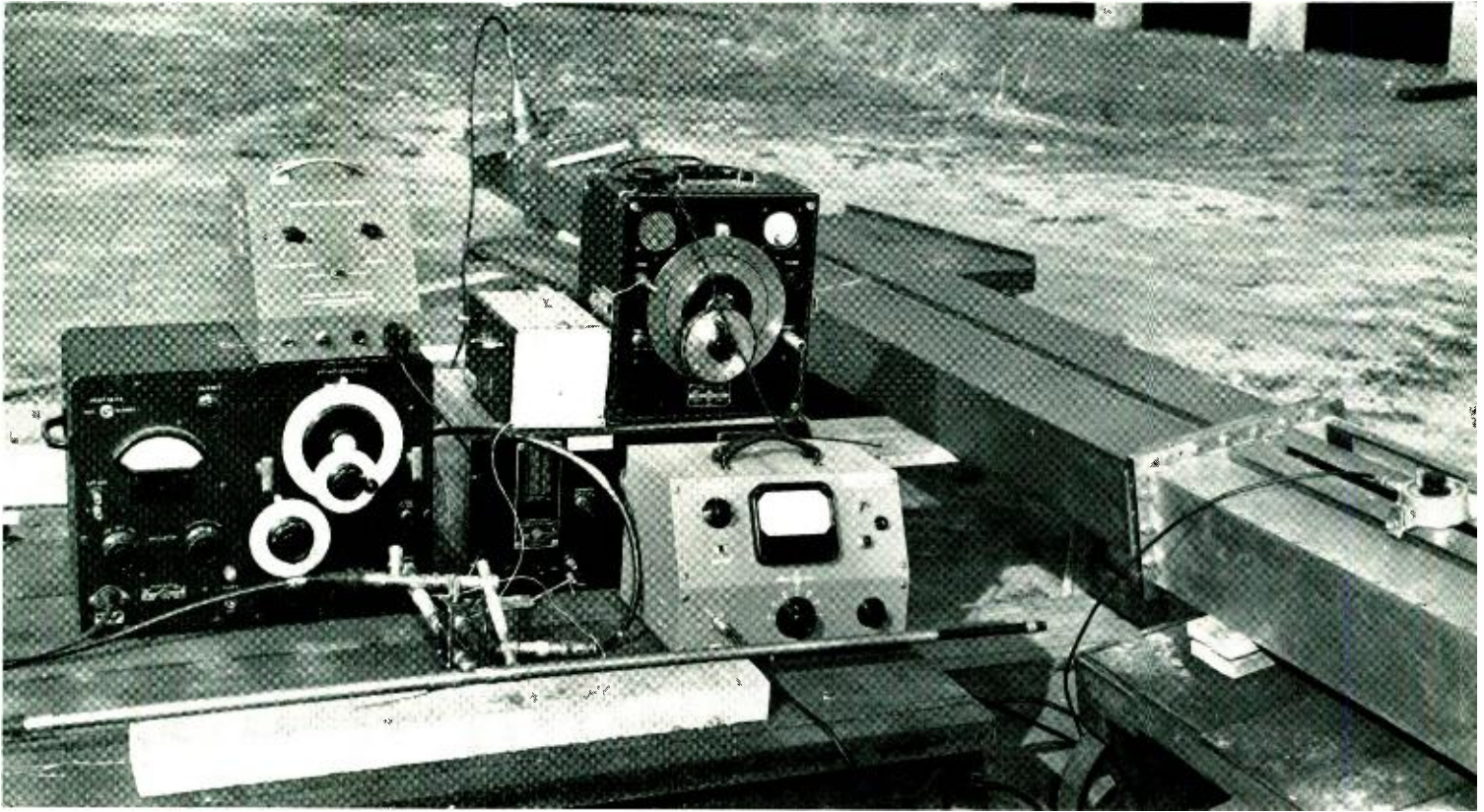

FIG. 1 (above). Test equipment used by RCA engineers for accurately measuring waveguide attenuation and standing wave ratio. Frequency adjustment is made to .001% accuracy by use of an interpolating frequency standard. A precision slotted waveguide section is used for standing wave and impedance measurements. Precautions are taken to minimize error due to incidental frequency modulation and noise.

# RCA DEVELOPS NEW UHF TELEVISION WAVEGUIDE

*for Maximum UHF Power Transfer from Transmitter to Antenna*

by

**O. E. WAGNER**

RCA Engineering Products Department

The inherent efficiency of waveguide for high frequency energy transfer has been a deciding factor in selecting it for use in UHF Television installations. Waveguide for UHF Television provides a very efficient method of transferring power from the transmitter to the antenna.

The new line of RCA waveguide consists of WR-1150 (MI-27311) for channels 44-83, and WR-1500 (MI-27310) for channels 14-60. A complete complement of "E" and "H" plane bends and transitions to  $3\frac{1}{8}$ " or  $6\frac{1}{8}$ " UHF coaxial line are available for a complete UHF installation.

RCA Waveguide used in conjunction with coaxial transmission line or for a complete run possesses many unique advantages. Copper clad steel has been selected as the material for waveguide fabrication because of its low attenuation and high tensile strength. The high conductivity of the copper surface gives copper clad steel waveguide the lowest attenuation of any presently used transmission system. Waveguide is made even more desirable because of its inherent character-

istic of decreasing attenuation as frequency is increased. The measured attenuation of RCA copper clad steel waveguide is .0852 db maximum per 100 feet at 800 mc for WR-1150, and .0612 db maximum per 100 feet at 600 mc for WR-1500. These values represent actual measured attenuation data taken by engineers on long runs of RCA waveguide. It is important to point out the necessity of using stabilized measured data in calculating waveguide transmission efficiencies, and not theoretical or calculated data as is usually represented. This assures the broadcaster of accurate data that may be used in planning a waveguide transmission system. In addition to the lowest attenuation, copper clad steel waveguide has the highest power handling capabilities of any presently used transmission system. Waveguide provides more power to the antenna and greater coverage for equal antenna heights. RCA waveguide safeguards

power transmission to the antenna and assures a system that is capable of delivering maximum power for maximum ERP.

In fabricating RCA Waveguide, copper is hot rolled on both faces of steel sheet and then cold rolled to obtain a smooth surface. This combination of copper and steel provides the waveguide with the strength of steel and the electrical characteristics of copper. These sheets are then formed into 10' and 10½' "U" shaped sections, placed together and spot welded at the seams to form a tube 11½" by 5¾" for Type WR-1150 and 15" by 7½" for Type WR-1500. Different lengths are used to avoid accumulative junction effects at ½ wavelength multiples of the frequency being transmitted. This practice is desirable because junctions cannot be produced mechanically which have perfect VSWR characteristics even with the best control of manufacturing tolerances possible at the present state of the art. Therefore, even small junction mismatches (1.001 or better) per junction may be additive at channels where a multiple of a ½ wavelength





FIG. 2. F. J. McMenamin adjusts temporary shorting plate at end of a test length of waveguide (shown below, Fig. 3) for product development test.

is close to the length of the section. For very long runs this additive effect may exceed the specification limit 1.1/1.0 unless precautions are taken to avoid accumulative effects.

All individual sections contain a copper alloy flange attached to each end for direct bolting to another section. Two alignment dowels are placed in diagonal corners of one flange face of each section. Precision

FIG. 3. At RCA Camden plant a 700-foot test length of waveguide is used to obtain VSWR and attenuation data.

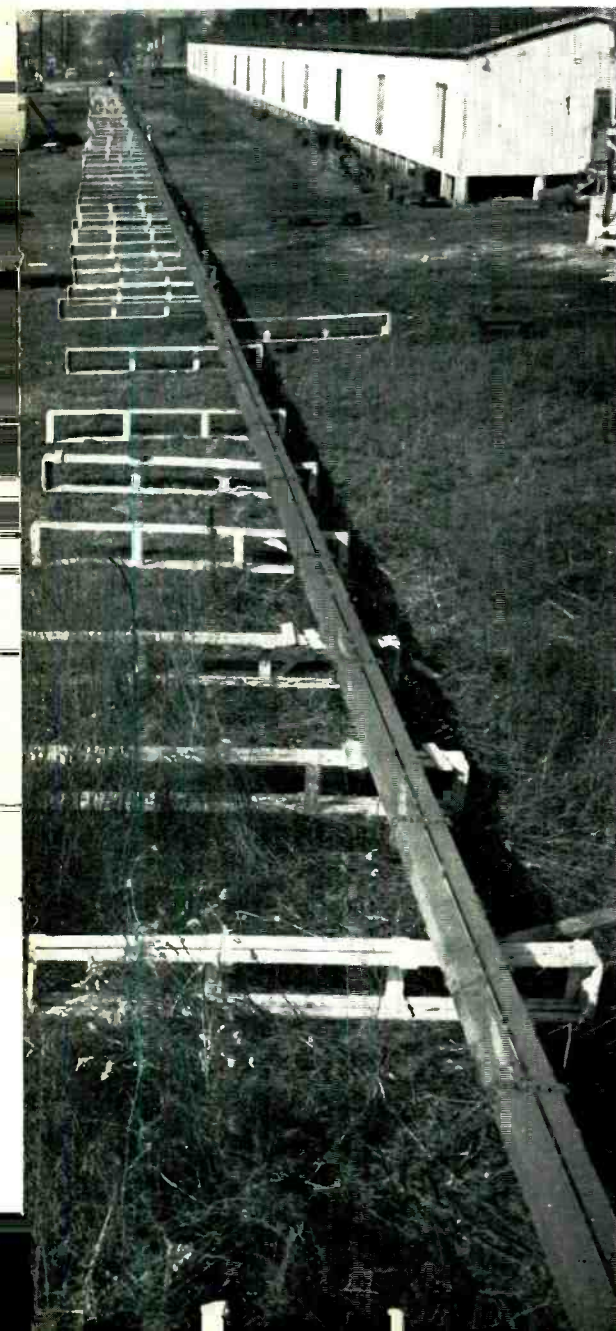
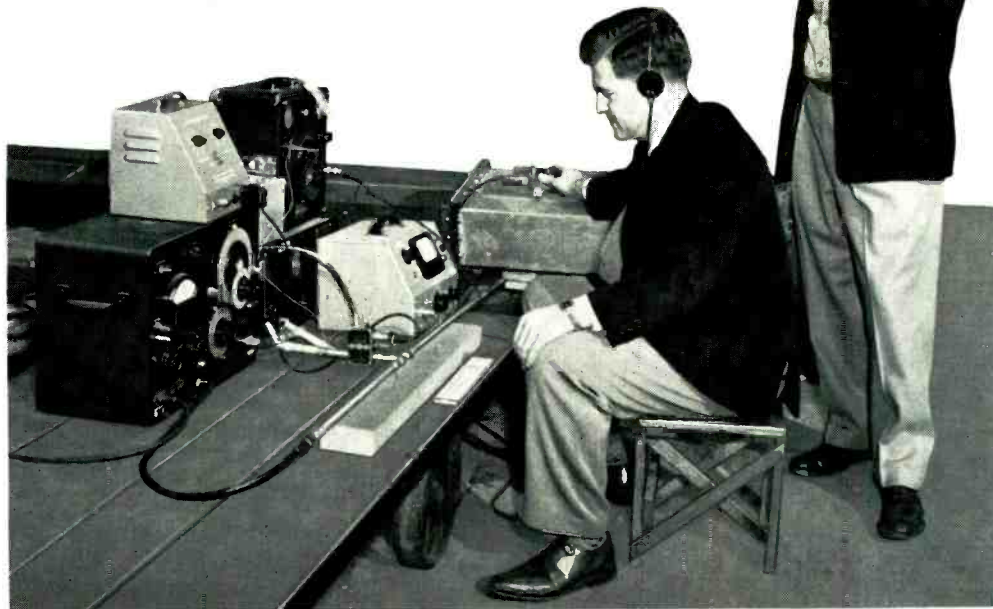

FIG. 4. RCA Development Engineers, W. N. Moule and L. A. Brockwell run tests on 700-foot length of waveguide.



holes are drilled in the opposite flange face to receive the dowels and assure correct alignment of the waveguide sections when assembling. Any one waveguide section may be easily mated with any other section. Each section may be securely bolted to an adjacent section by special silicon copper (Duronze) bolts. All sections are soft soldered at the junction of the tube and the flange on both the inside and outside of the waveguide. Two coats of special primer and protecting paint are used over the entire surface of each waveguide tube to prevent any possible corrosion. Custom lengths of waveguide and bends for specific requirements are available upon request.

In order for energy to move through a waveguide system without reflections, the cross-section must not change abruptly throughout the entire run from the transmitter to the antenna. Therefore, to change the direction of the waveguide without resulting reflections, RCA has developed a series of special bends. A bend may be made either along the "E" plane or the "H" plane. All bends are designed for a 45° turn. A 90° change of direction is made with two 45° bends in series. The center line radius of curvature of two 45° "E" plane bends in series (for Type WR-1150) is 44¼", and that of two 45° "H" plane bends in series is 47⅛". The center line radius of curvature of two 45° "E" plane bends in series (for Type WR-1500) is 57¾", and that of the two 45° "H" plane bends in series is 62½". Each bend weighs approximately 60 pounds for Type WR-1150 and 75 pounds for Type WR-1500.

High frequency energy is introduced into the waveguide through the use of a special

transition section. This transition section adapts either 3⅛" or 6⅛" UHF coaxial line to the waveguide. A transition section is also required to couple the waveguide to the 3⅛" coaxial input to the antenna. Energy is transferred either to the waveguide or from the waveguide with equal efficiency. Impedance matching between the coaxial line and the waveguide is accomplished by the positioning of a probe assembly located in a coaxial connector on the transition surface. Each transition is matched to a VSWR of 1.1 or less for a bandwidth of 10% of the frequency. Custom adjustment provides a VSWR of 1.03 or less for a given channel. Transition sections are custom-built to a specific channel. An end cover plate is permanently attached to each transition for protection against weather and foreign objects. A standard flange is attached to one end for direct bolting to another waveguide section. A gas stop is also provided in each transition section to allow normal pressurization of the connecting coaxial line. The length of each transition section is approximately 24". Each transition weighs approximately 40 pounds.

Waveguide lends itself to simple erection. No center conductor with coupling devices or insulators are used. All waveguide sections are mounted rigidly to the tower structural members by direct mounting hangers. The coefficient of expansion for the copper clad steel waveguide and the tower are essentially the same—this avoids the need for spring expansion hangers. All hangers are made of heavily galvanized steel and dip coated with primer and aluminum paint to prevent galvanic



FIG. 5. Ten-foot Waveguide Rigid Sections, Type WR-1150 and Type WR-1500 placed side-by-side to demonstrate their comparative physical size. Type WR-1150 (in foreground) is MI-27311-1. Type WR-1500 is MI-27310-1.

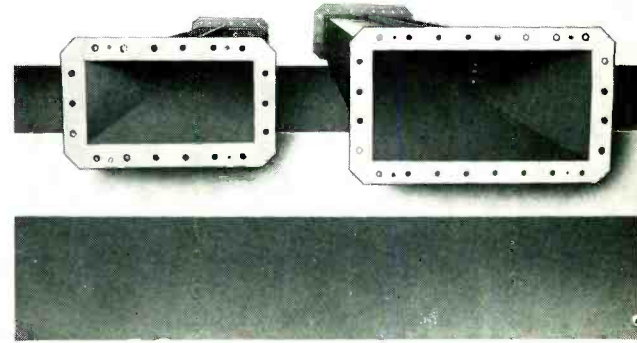

FIG. 6. End view of Waveguide Rigid Sections. Cross-section of WR-1150 (left) is  $5\frac{3}{4}'' \times 11\frac{1}{2}''$ —18 holes in flanges. Cross-section of WR-1500 is  $7\frac{1}{2}'' \times 15''$ —24 holes in flanges.

corrosion against the waveguide surface. Generally, one hanger is required for each waveguide section. The fixed direct mounting hanger provides  $\frac{3}{4}''$  clearance between the waveguide and the tower. An adjustable hanger has been developed for special applications allowing an adjustable clearance of 1" to 5" between the tower and waveguide. This hanger may be used to adapt a horizontal or vertical run of waveguide to a slight contour of a tower or other supporting structure. A special clamp kit is also available to adapt any hanger to horizontal round members of the tower. All lengths include hardware for one complete joint. Wooden end plates are attached to all flanges for protection against damage during shipping and erection. The horizontal run of waveguide may be supported by the standard hangers from any appropriate steel or wooden truss arrangement. A metal or wood shelter should be provided over the top of the horizontal run of the waveguide for protection against damage

of falling ice from the tower. See transmitter building and tower layout in the illustration below for complete typical installation. A numerical reference at the end of this article identifies the components in the Typical Installation according to the encircled numbers.

Since there is no center conductor, pressurization or dehydration of the waveguide is not required. The possibility of gas leaks at junctions, etc., of long coaxial pressurized lines is eliminated. A short section of coaxial line from a transition at the top of the tower to the antenna may be gassed

through an MI-19315-1  $\frac{3}{4}''$  soft drawn copper line from the tank providing gas for the filterplexer. The gas from the single tank may be fed to a manifold section providing individual valve control of the lines to the filterplexer, the top coaxial line to the antenna, and the line between the filterplexer and the waveguide transition if gassing of this section is desired. Some provision should be made to dispose of water accumulation resulting from condensation in the waveguide. Small holes may be drilled at lowest points of the waveguide installation for this purpose.

FIG. 7. The transmitter building layout shown here represents a typical installation. However, the location of the transmitter, the method used to mount the Filterplexer and other interior arrangements will dictate what components are required. The horizontal run and vertical run on the tower (right hand page) were enlarged approximately twice the size of the building interior components for clarity of detail.

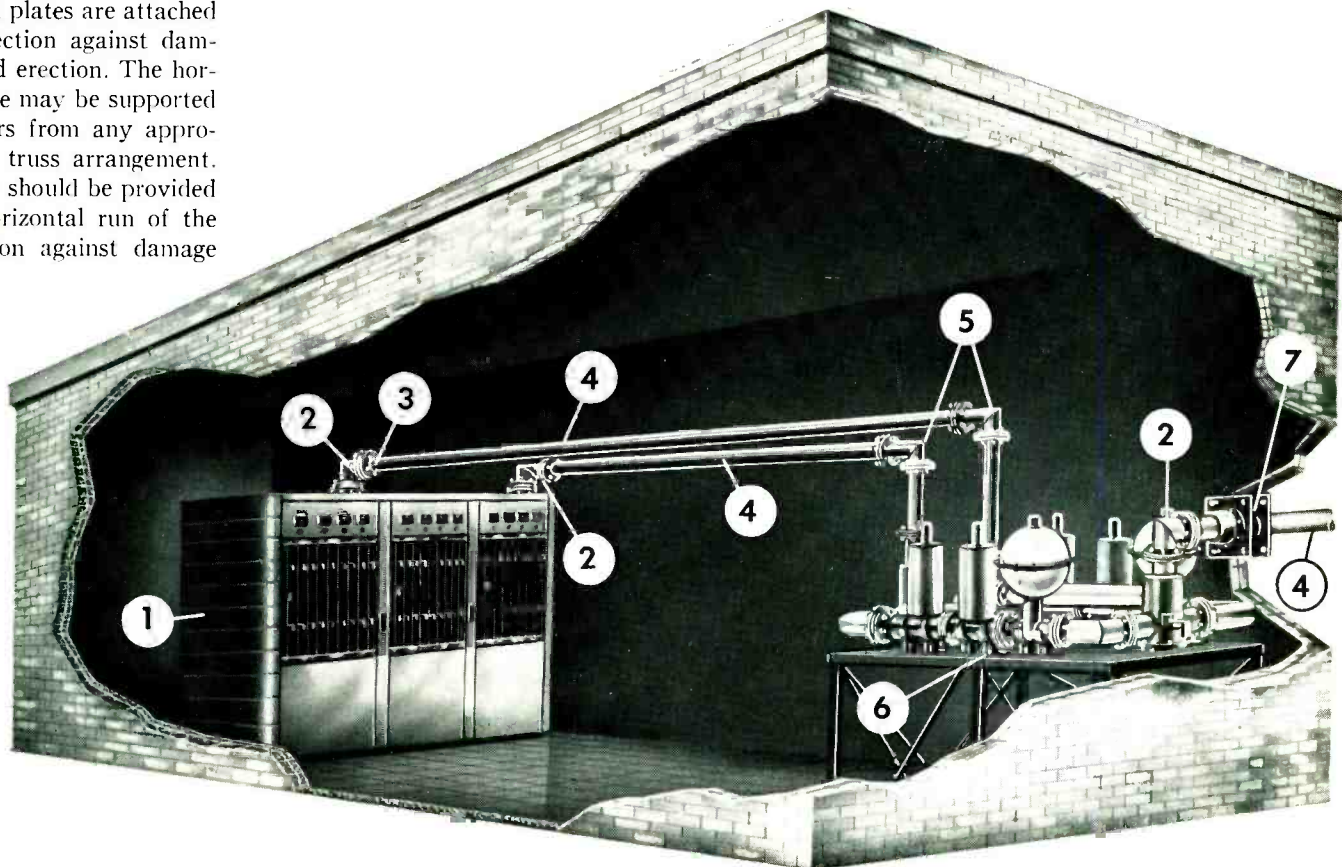

The use of waveguide for UHF television provides power handling capabilities which far exceed any future requirement, thus future changes in waveguide transmission systems to accommodate higher power are unnecessary. The transition sections have the same power rating as the  $3\frac{1}{8}$ " (MI-19089) or  $6\frac{1}{8}$ " (MI-19387) UHF coaxial line associated with the transition.

Fig. 1 is a typical layout of a UHF transmission system using waveguide for extremely low loss transmission facilities. Many different modifications of this system are possible depending on specific installation requirements.

Standard RCA  $3\frac{1}{8}$ " UHF coaxial line and couplings are used from the transmitter output to the filterplexer, and from the filterplexer output to a  $3\frac{1}{8}$ " waveguide transition. The gas stop in the transition section allows gassing of the connecting coaxial line if this is desired.

The general method of handling a waveguide run is as follows: a horizontal run may be installed from the transmitter building—made up of 10' straight sections. In order to change direction of the waveguide to start the vertical run, two 45° "E" or "H" plane bends are employed in series to form a 90° turn. The waveguide continues to the top of the tower where a second transition is located to adapt the waveguide to the  $3\frac{1}{8}$ " UHF coaxial input to the antenna. Standard  $3\frac{1}{8}$ " line and couplings are used from the transition to the antenna input. The waveguide run is terminated approximately 15' below the base of the antenna to allow for sleet melting equipment for the UHF antenna. Fixed or adjustable direct mounting hangers may be used along the entire waveguide run, depending on the design of the tower.

In the transmitter building provisions should be made for additional coaxial fittings and line in each specific installation so as to facilitate easy insertion of an R-F

load and wattmeter. This avoids unnecessary work or possible damage to coaxial lines in forcing them apart.

All items are packaged separately for shipping. Hardware for one joint is included in the packing of each section. End protectors are provided over each flange for protection from damage in shipping and erection. WR-1150 10' sections weigh approximately 125 pounds, and WR-1500 sections weigh approximately 175 pounds.

#### WR-1150 Waveguide

Waveguide 10' long, rigid section	
$5\frac{3}{4}$ " x $11\frac{1}{2}$ "	MI-27311-1A
Waveguide 10 $\frac{1}{2}$ ' long, rigid section	
$5\frac{3}{4}$ " x $11\frac{1}{2}$ "	MI-27311-1B
45° "E" plane bend	MI-27311-4
45° "H" plane bend	MI-27311-5
Transition to $3\frac{1}{8}$ " coax line	
(MI-19089) specify channel	MI-27311-6
Transition to $6\frac{1}{8}$ " coax line	
(MI-19387) specify channel	MI-27311-6
Fixed Hanger (direct mounting)	MI-27311-8
Adjustable Hanger (direct mounting)	MI-27311-9
End cover	MI-27311-12

#### WR-1500 Waveguide

Waveguide 10' long, rigid section	
$7\frac{1}{2}$ " x 15"	MI-27310-1A
Waveguide 10 $\frac{1}{2}$ ' long, rigid section	
$7\frac{1}{2}$ " x 15"	MI-27310-1B
45° "E" plane bend	MI-27310-4
45° "H" plane bend	MI-27310-5
Transition to $3\frac{1}{8}$ " coax line	
(MI-19089) specify channel	MI-27310-6
Transition to $6\frac{1}{8}$ " coax line	
(MI-19387) specify channel	MI-27310-7
Fixed Hanger (direct mounting)	MI-27310-8
Adjustable Hanger (direct mounting)	MI-27310-9
End cover	MI-27310-12

Note 1: Hanger Kits are available to adapt all hangers to horizontal round tower members 1"-5" in diameter.  
 Note 2: A 90° bend consists of two 45° bends in series.

#### KEY TO TRANSMITTER LAYOUT NUMBERS

1. 1 KW UHF Transmitter (Type TTU-1B) ES-19250.
2.  $3\frac{1}{8}$ " 90° Mitre Elbow (Special Single Bullet Type) MI-19089-2S.
3. Solder Type Flange Adapter, MI-19089-14.
4.  $3\frac{1}{8}$ " Transmission Line (Special Section Less Anchor Insulator) MI-19089-1NA.
5.  $3\frac{1}{8}$ " 90° Mitre Elbow, MI-19089-2.
6. UHF Filterplexer, MI-19086.
7. Horizontal Anchor Assembly, MI-19314-48.
8. Transition to  $3\frac{1}{8}$ " Coaxial Line (MI-27311-6 for Type WR-1150 Waveguide) or (MI-27310-6 for Type WR-1500 Waveguide).
9. Waveguide Rigid Section (MI-27311-1 for Type WR-1150 Waveguide) or (MI-27310-1 for Type WR-1500 Waveguide).
10. Direct-Mounting Adjustable Hanger (MI-27311-9 for Type WR-1150 Waveguide) or (MI-27310-9 for Type WR-1500 Waveguide).
11. 45° "E" Plane Bend (MI-27311-4 for Type WR-1150 Waveguide) or (MI-27310-4 for Type WR-1500 Waveguide). Two 45° "E" Plane Bends in series comprise the 90° "E" Plane Bend.
12. Direct-Mounting Fixed Hanger (MI-27311-8 for Type WR-1150 Waveguide) or (MI-27310-8 for Type WR-1500 Waveguide).
13. UHF Pylon Antenna (Type TFU-21/24/27) MI-19304.
14. Beacon Assembly, 114-KG.
15. Lightning Protector (Supplied with Antenna).

NOTE: It is important to remember that this list does not represent any specific installation. However, it will serve as a guide in planning and selecting the proper components.

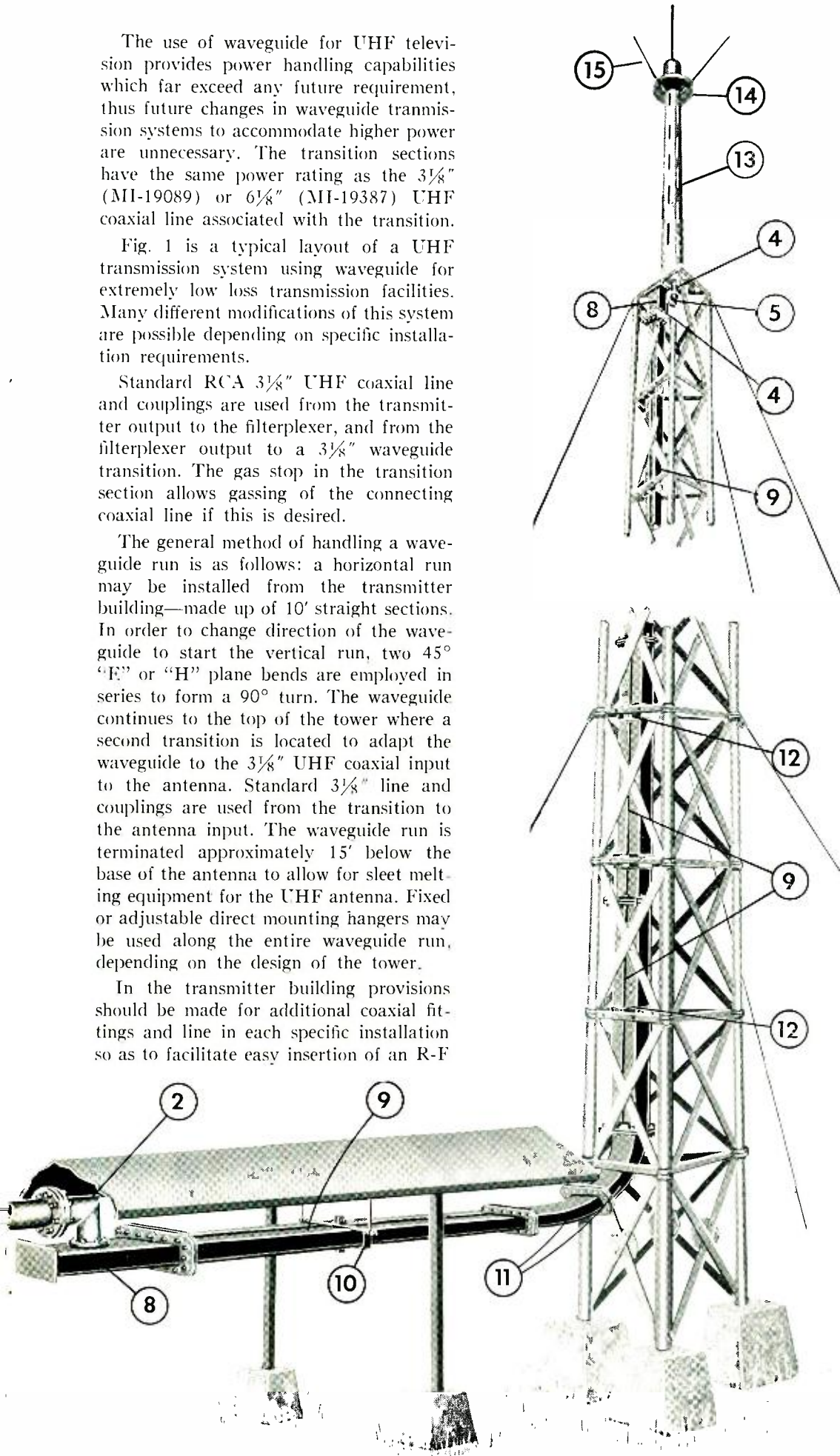



Joseph Herold, Manager, TV Station  
KBTV, Denver.

# Colorado Television Corporation

By **JOSEPH HEROLD**  
Station Manager

KBTV, Channel 9, Denver, was the second VHF station to go on the air after the lifting of the freeze. For a period of eight months, the operation was from temporary quarters with interim facilities and during this eight-month period a building was purchased and modified to accommodate the present studios and offices. The

permanent tower, high power antenna and transmitter are installed on Lookout Mountain and today, KBTV (an ABC-TV affiliated station) is a "maximum-power" station, fully utilizing all its new facilities.

The story of KBTV actually goes back to 1951 when W. D. Pyle and T. C. Ekrem, owners of radio station KVOD, formed the Colorado Television Corporation and laid plans to apply for Channel 9 and to build a transmitter on Lookout Mountain.

On September 12, KBTV was assigned by the FCC as the call letters for KVOD's Channel 9. A 75-foot antenna was erected on Lookout Mountain, the transmitter building was completed and the installation of transmitting equipment was accomplished in time to air pictures in October, 1952. This was done by use of an interim RCA 2-KW Transmitter plus a six-section RCA Superturndstile Antenna. Late in November, the power was further increased and recently the power was "upped" to 282,000 watts by use of RCA high-power transmitting and antenna equipment. This makes KBTV one of the most powerful TV stations in the country and increases its range of receptivity tremendously, as well as increasing the clarity of its picture (see Fig. 2).

It has been the consistent policy of the Directors of the Colorado Television Corporation to place particular emphasis on *public service* to make station facilities available to worthwhile causes or controversial matters of the day. It has also been general station policy to insist on the very best entertainment possible with excellent picture quality. We also feel that our success has been due in a great measure to the careful selection of well-trained and well-qualified personnel. Our operation is broken down into the following specialized groups



FIG. 1. This attractive neon sign hovers over the doorway of KBTV's excellent television facilities. It is also appropriate to state that "through these doors pass Denver's finest television talent."

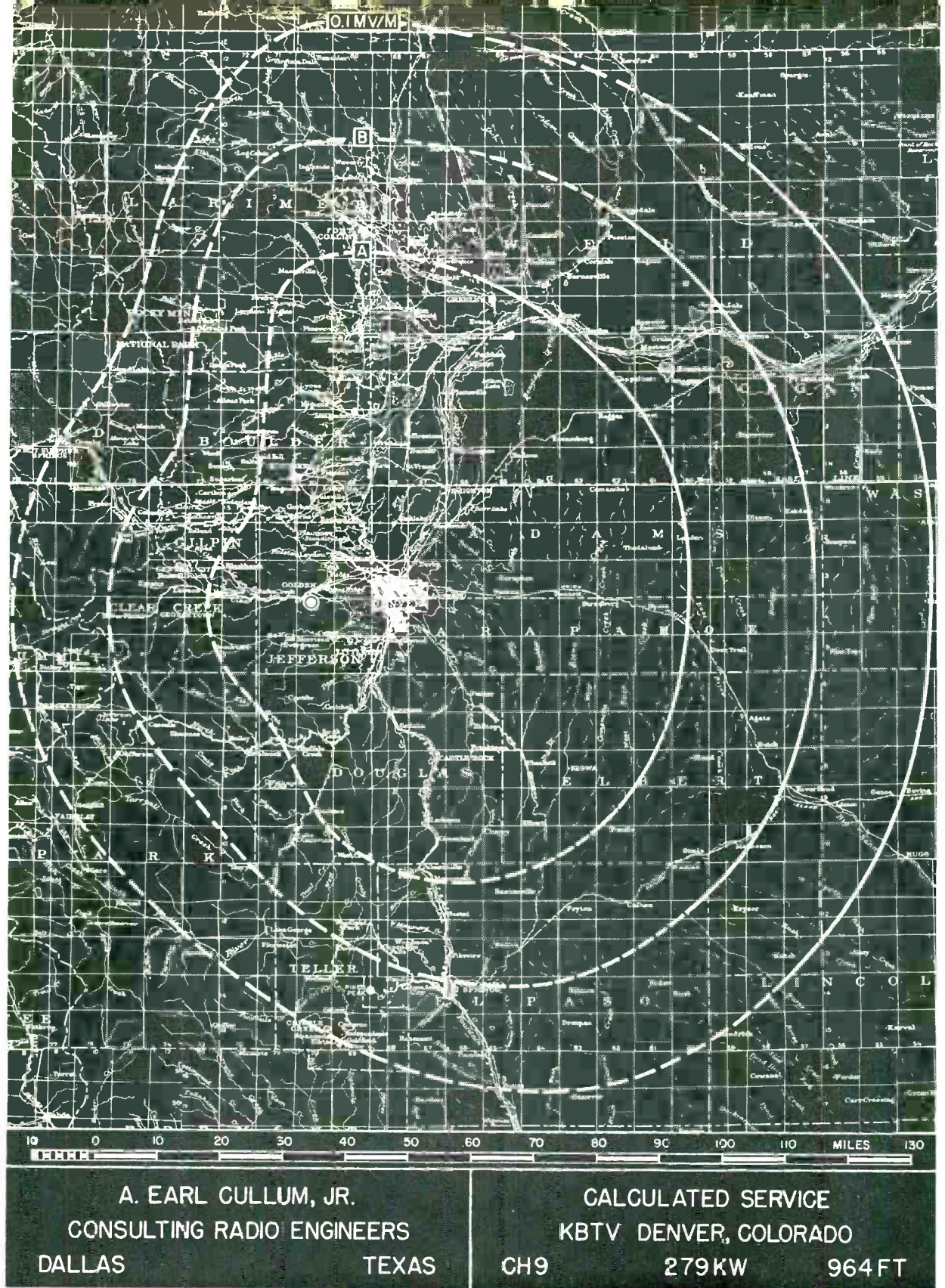

FIG. 2. This is the effective coverage area of KBTV's 282,000 watt signal into Colorado and neighboring states. Actual reception has been reported from many areas not on this map. A strong signal goes into Cheyenne, Wyoming consistently. Cheyenne is off the map to the top.

or departments for maximum efficiency: Station Manager, Commercial Manager, Program Manager, Film Manager, Office Manager, Studio Supervisor. Publicity Director, Production Manager, Local Sales Manager, Continuity Editor, News Editor, Traffic Manager, Stage Manager, and Transmitter Supervisor.

KBTV's new half-million dollar studios (which are described on subsequent pages)

occupy over 30,000 square feet of floor space and include one major auditorium accommodating a dozen or more sets; a smaller studio; carpenter shop, film editing room, news rooms, dressing rooms, storage and loading rooms; projection room, engineers' and sponsors' booths, and offices. Equipment, acoustics, lighting and other physical facilities are of the most modern and advanced types.

We hope the following photographs and the descriptive narrations of the KBTV Studios, Film Department, and Transmitting Facilities will present adequately the story of the new KBTV. The Technical Facilities were planned for maximum operating efficiency without any sacrifice in quality. KBTV's facilities are also planned to adequately serve the market with provision for future expansion as the market grows and our activities increase.

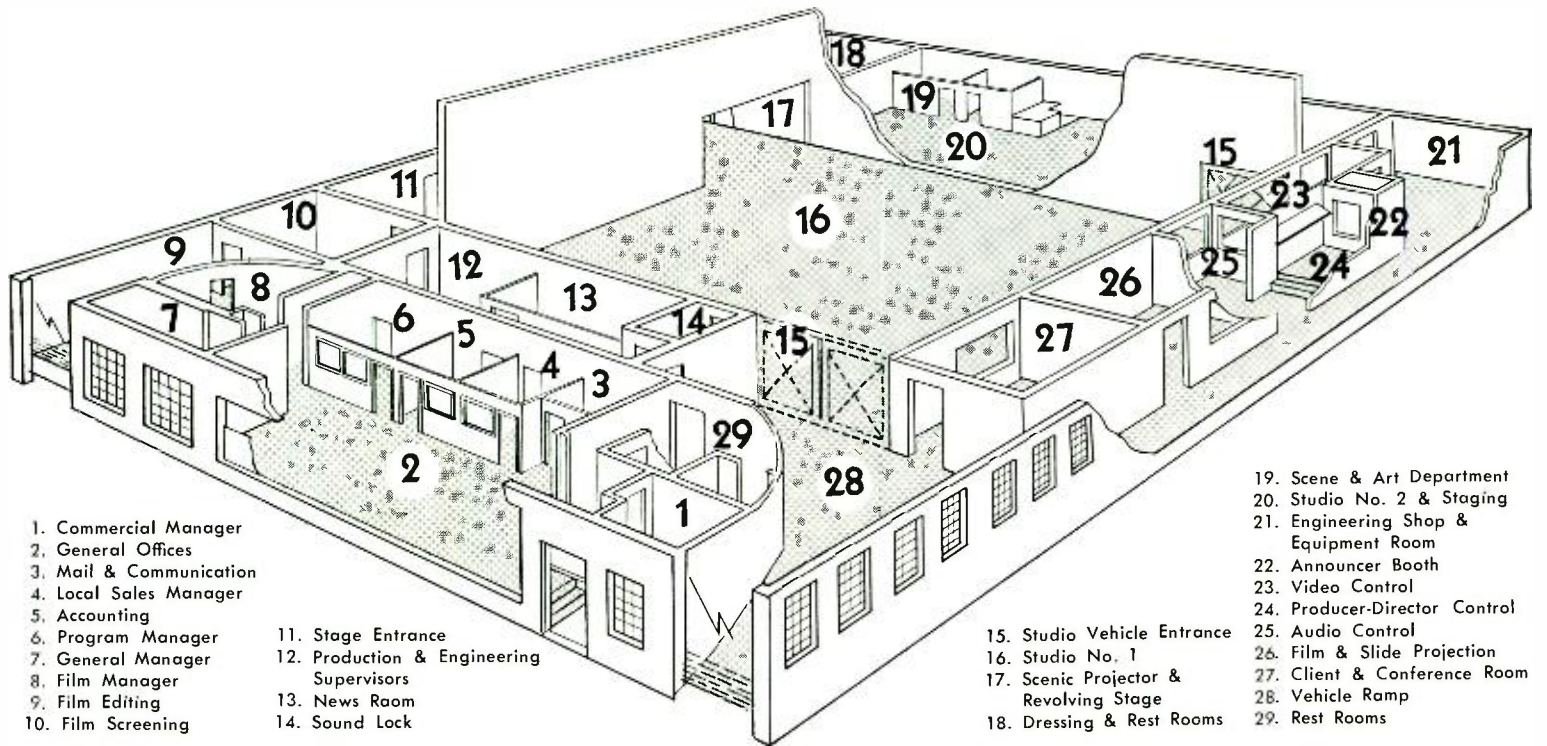

FIG. 1. Operational facilities at KBTV are graphically shown in this cut-away sketch of the station's new building. All facets of the operation are conveniently laid out for ease of operation.

# KBTV STUDIO FACILITIES

In the KBTV station layout, we have attempted to achieve maximum efficiency with respect to manpower.

Studio "1", 60' x 80', was designed for complete flexibility. All the larger shows, generally on a weekly basis, originate from this studio. It includes such special devices as a rotating stage, rear projection and dimmer board light control. The rotating stage was built from an old grease rack. The platform is built of wood and steel mounted to the rack with a one horsepower reversible drive motor located in the basement. The motor belt drives a gear box with a shaft through the floor, which in turn couples to a gear mounted to the frame of the rack. The motor pulleys allow three speeds—1 rotation for either 28, 55 or 84 seconds. Microswitches controlling the motor are mounted at each quarter turn allowing the stage to rotate continuously, or any combination of quarter turns, in either direction. Its control panel is located next to the light control board seen in Fig. 4.

Lighting is controlled from the board in Fig. 4. Each load plug seen on the hori-

By **JAMES BUTTS**  
Formerly Studio Supervisor

zontal shelf is connected to a pigtail outlet on the light grid. The load plug can then be associated with a jack on the jack field and power supplied to the jack through the small circuit breaker switches. These circuit breaker switches are in turn supplied from a main control switch for each bank

James Butts, formerly KBTV Studio Supervisor.



of jacks. This permits a complete sequence of shows to be lighted ahead of air time and controlled by throwing one switch. This is time and manpower saving during back to back shows. Of course any special lighting during shows is easily controlled also.

The studio is accessible from the street to allow the showing of trucks, automobiles, etc., Fig. 3. The rotating stage has proved to be excellent for this purpose. The rotating stage area is also used for the rear projector. The projection screen is flown (as are several sets) and tied to a pin rail on one side of the studio. The 26-foot ceiling height permits sets to be raised and lowered in the same manner as theater sets, thus a saving in stage personnel. Once the set is constructed, one man can quickly raise and lower each set. Sufficient lights have been purchased to permit lighting of each staging area so the light set up for each regular show does not require the moving of lights. One man can then light the set, put it in place and be ready to act as floor manager in a period of a few minutes.

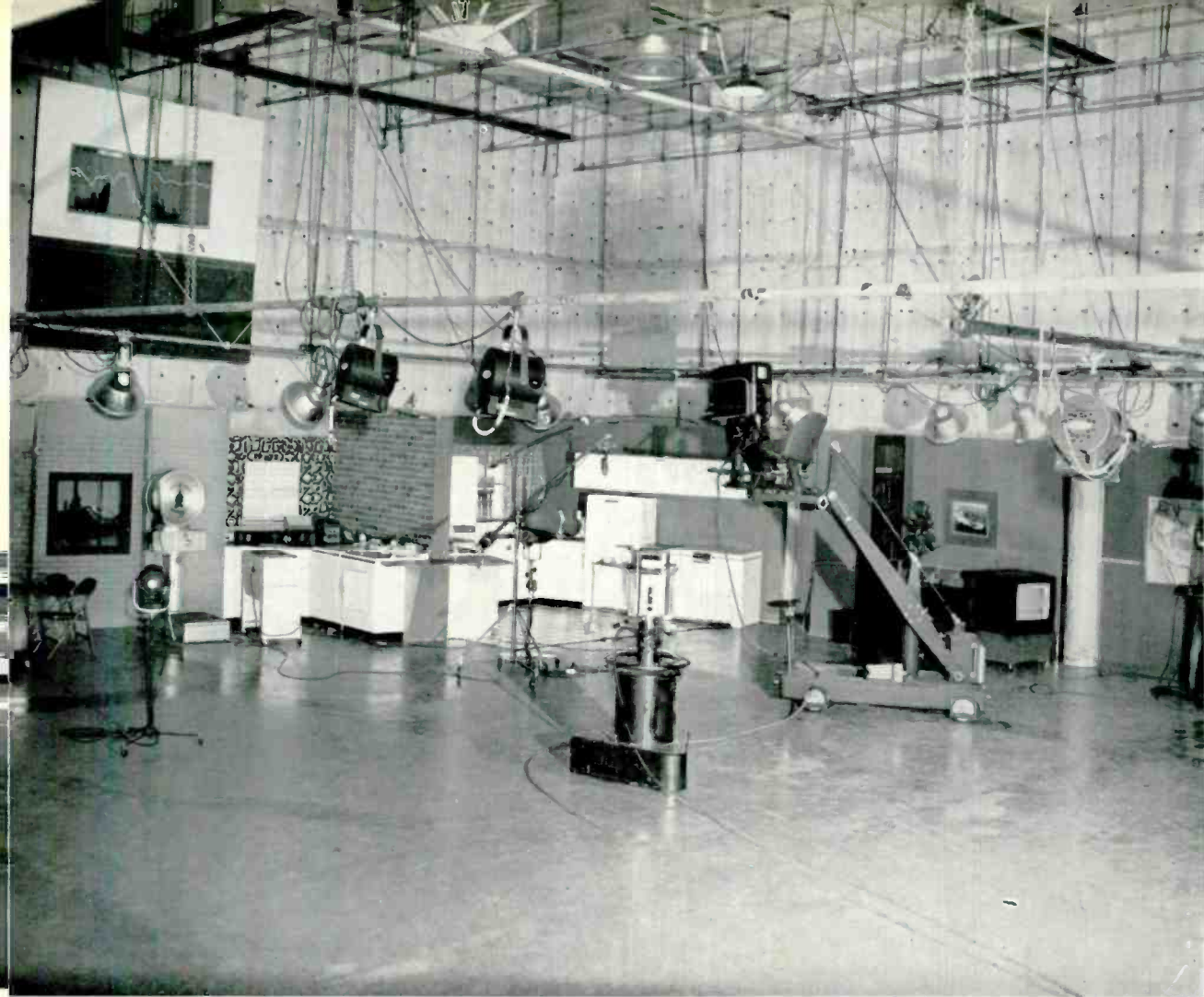

◀ FIG. 2. This corner shot of KBTV's main Studio #1 shows a few of the permanent sets used on daily programs. On the left is a portion of a western home. A utility room and kitchen stand out in the center. To the right are the news and weather sets.



▶ FIG. 3. A convenient ramp from the street leads directly to KBTV's main Studio #1. Here is an automobile ready for a commercial program. KBTV's unique rotating stage, conceived from a hydraulic lift, is used to vividly demonstrate automobiles, household goods, etc. Hal Taft of KBTV, with the assistance of Maryadelle Ramey, describes the high points of a brand new automobile. This rotating stage can be controlled to stop in any number of different positions.

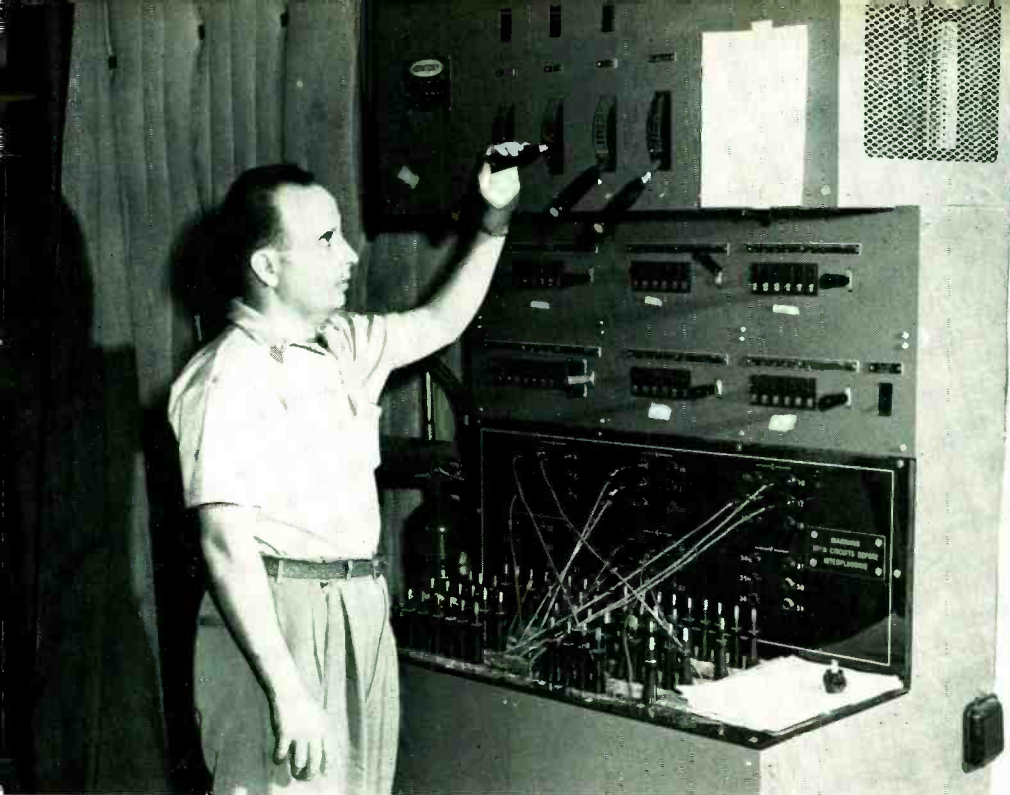

FIG. 4. The highly important aspect of proper lighting for any given program is adequately assured by use of this Light Control Switchboard—especially designed for KBTv. Complex appearing switches and jacks give KBTv light technicians complete control of all lighting problems.



FIG. 5. KBTv's compact yet highly efficient Audio Control area where the audio engineer controls all sound going out over the air.

The control room layout seen on the diagram, Fig. 1, is designed to permit each individual to operate with a minimum of distraction, but with sufficient proximity to each other to permit easy coordination. A TS-20 relay switching control panel and driven monitors are used by production personnel for monitor purposes. The "well" immediately in front of the director's operating position is vacant. It was felt that rather than install the video operation area here, as is customary, that this space could be better utilized as a light control position if and when Denver becomes sufficiently a live production center to warrant the inclusion of electronic light controls. The

video operations area thus was moved to the right. It is perhaps somewhat unusual for a station of this size to use a relay switching system. The extreme flexibility of this system, however, far outweighed the added expense. Complete rehearsals of studio productions while a film or network show is on the air is a daily occurrence. Since no master control, as such, is used, this is a must feature.

The driven monitors are placed so they are just above eye level and the studio can be seen almost simultaneously through the window below. Each individual picture source has its own monitor with indicator

lights to indicate which is in use. Intercommunication is provided by 110 volt ac-relays operated by the switches to the right and left of the switcher control. These relays control the output of one BA-14A monitor amplifier which feeds all intercommunication. It was found in our original studio that very little shading and level riding was necessary with the TK-20D film cameras, so that it was felt that video control could be consolidated under the jurisdiction of one man. This has proved to be quite successful, although some care in selecting video personnel is required to assure uniform picture quality. Four TK-31 Field type image orthicon chains are used. Portions of this portable equipment are also removed for remotes. Camera, pulse and power cables were extended so that only the control unit is in the control room. Power supplies are located in the equipment room. Pulses are distributed to each camera from the pulse distribution box located behind and below the operating desk, permitting the removal of the camera without interruption of the others. The film and image orthicon camera pulses are fed separately from distribution amplifiers for isolation purposes. Camera cables are run under the floor of each studio and terminate in a 4 outlet box in each studio. The TM-6A line monitor is mounted on a section of garage door runner so that it can be moved easily from one end of the control room to the other. This enables the operator to have it where it can be seen from any position. If it becomes necessary to feed a program from each studio simultaneously, a field switcher is provided in the end of the video control area and can be supplied video and intercommunication through the jack field. Its output is fed to a position on the TS-20 which then operates as a sub control for Studio "2" and control for Studio "1". If necessary three outputs could be fed simultaneously.

The audio is controlled from a room completely separated from the video control, Fig. 5. This gives the audio control operator an opportunity to check mike balances and set levels without the disturbances caused by blower and other noises usually present in TV control rooms. The BCM-1A associated with the BC-2B audio control console allows the mixing of eight microphone outlets in the studio.

Rack mounted equipment, plus the field power supplies are mounted in two bays about four feet apart in a room separate from the control room. This was done mainly for heat and sound isolation and ease of maintenance.





FIG. 6. Western music for westerners. . . . Here is shown the setting of KBTV's "Studio Party" show, featuring Captain Ozie Waters. KBTV's modern pedestal and crane type cameras are used on the show affording Channel 9 viewers a great variety of shots.

Studio #2, which is seen here, has been used until recently as a Scenery and Art Shop. As the program schedule has expanded, it has become necessary to use portions of this area as a studio with the ultimate goal being to move the Scenery and Art Shop to the basement. 15,000 square feet of added space is available in the basement. Most of the permanent sets—news, weather, etc.—will be moved to the smaller, 60' x 40', studio. At present one daily show and one weekly originate from this partially converted studio.

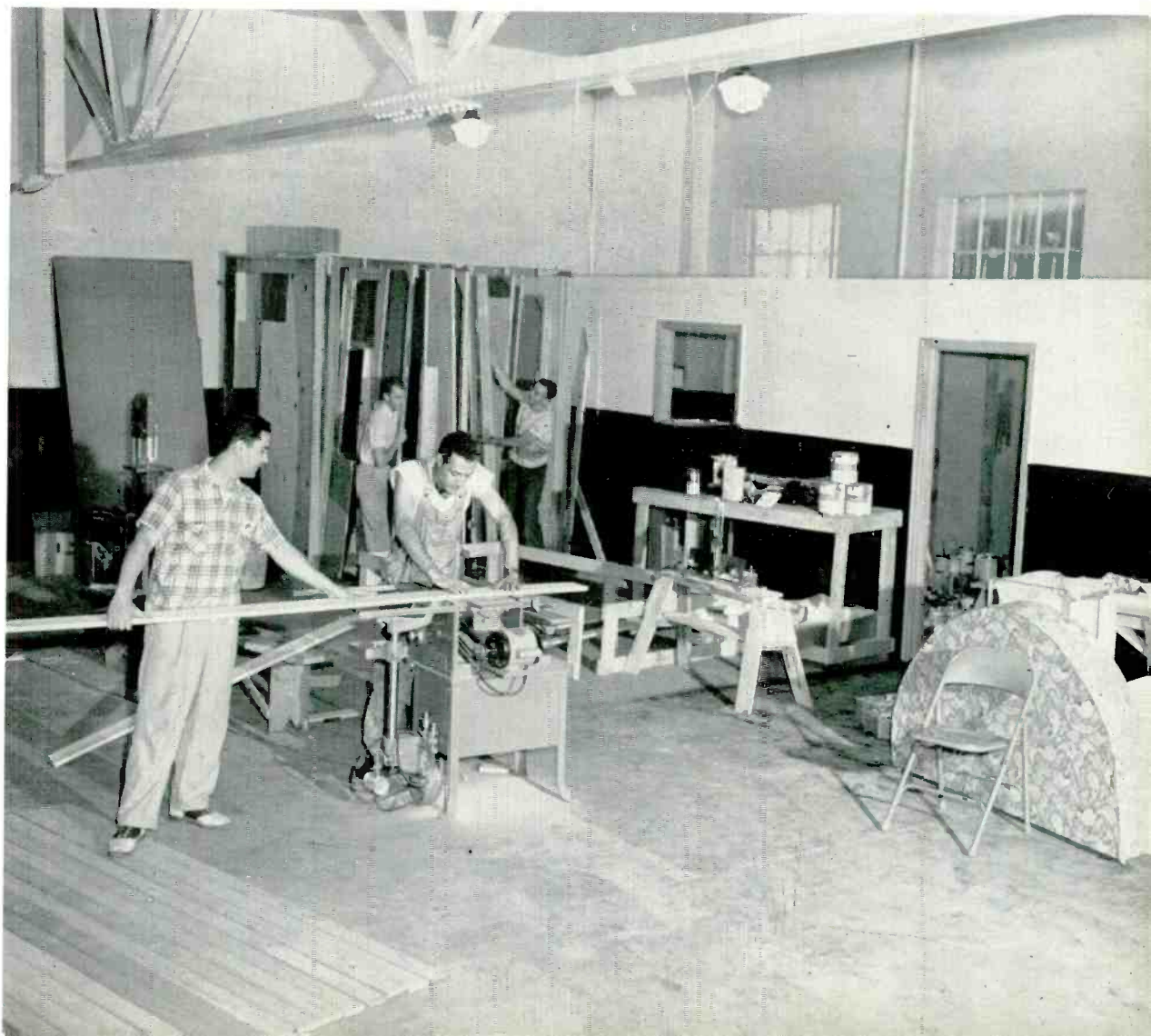

FIG. 7. Skilled craftsmen construct the numerous flats and sets needed on local television programs in the spacious Scene Shop. In this manner KBTV can construct the kind and type of scene to fit the occasion and prepare "props" for several shows ahead.

# KBTV's FILM FACILITIES

By **W. L. MURRAY**  
Manager, Film Department

In programming better than 60 hours of film per week at KBTV, we have endeavored to incorporate a compact and fool-proof system to handle this important task.

Shown in Fig. 1 is Miss Kathleen Machlan who is responsible for the pre-viewing and inspecting of all film aired on the station. Using two RCA 400 series projectors all film is screened and timed in this screening room. The RCA 400 series projectors are ideally suited for this purpose as their gate mechanisms are similar to the RCA TP-16D air projectors and any film not passing through the screening projectors is sure not to pass through the air projectors, thus costly failures and errors are often eliminated.

Normally the screening room is working about three days in advance of air time which enables us to keep ahead of projection and save a frantic last minute search for a film or show that is to be aired.

Immediately after the film shows are received and unpacked, they are placed in



W. L. Murray, Manager, Film Department.

their proper bin and are ready for timing and screening. When all film for any certain day is screened and timed, it is placed in the film transporting cart, shown at the left in Fig. 1, and then moved into the projection room as a complete unit, with all film for that particular day in place and ready for airing.

Fig. 3 shows the specially constructed film shipping and receiving table. The morning after a day's film has been aired, it is brought back as a complete unit in the film transporting cart, sorted out, each film placed in its proper forwarding bin and shipped on to another television station or the original film supplier. Directly above the work table you will notice the bicycling schedule, showing where every film aired on any particular day is to be forwarded.

As can be seen from Fig. 2, the projection room uses two TK-20 cameras mounted on circular track. This permits free movement of the cameras and considerable expansion capability. Two RCA TP-16D 16mm TV picture projectors are used with the Gray Telejector, 2 x 2 slide projector and the Tressel Projectal for 3 x 4 opaques. Camera cables run up the center of the circle and overhead to the conduit entrance at the extreme left rear of the room. Power and control circuits to the projectors run under the floor and come up under each projector.

FIG. 1. Miss Kathleen Machlan shown in KBTV's Film Screening Room where convenient racks for all incoming film programs are located. All film is screened on projectors before going on the air.

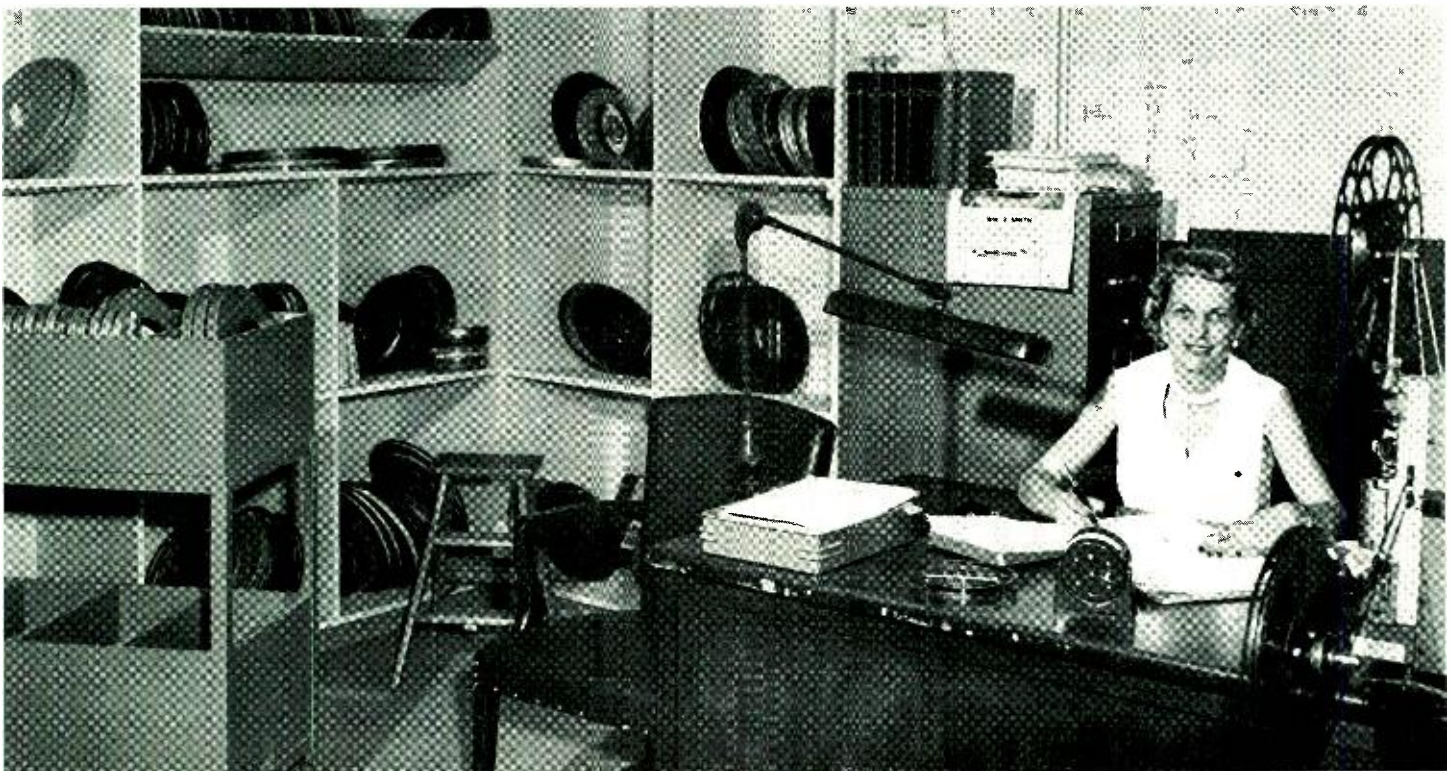

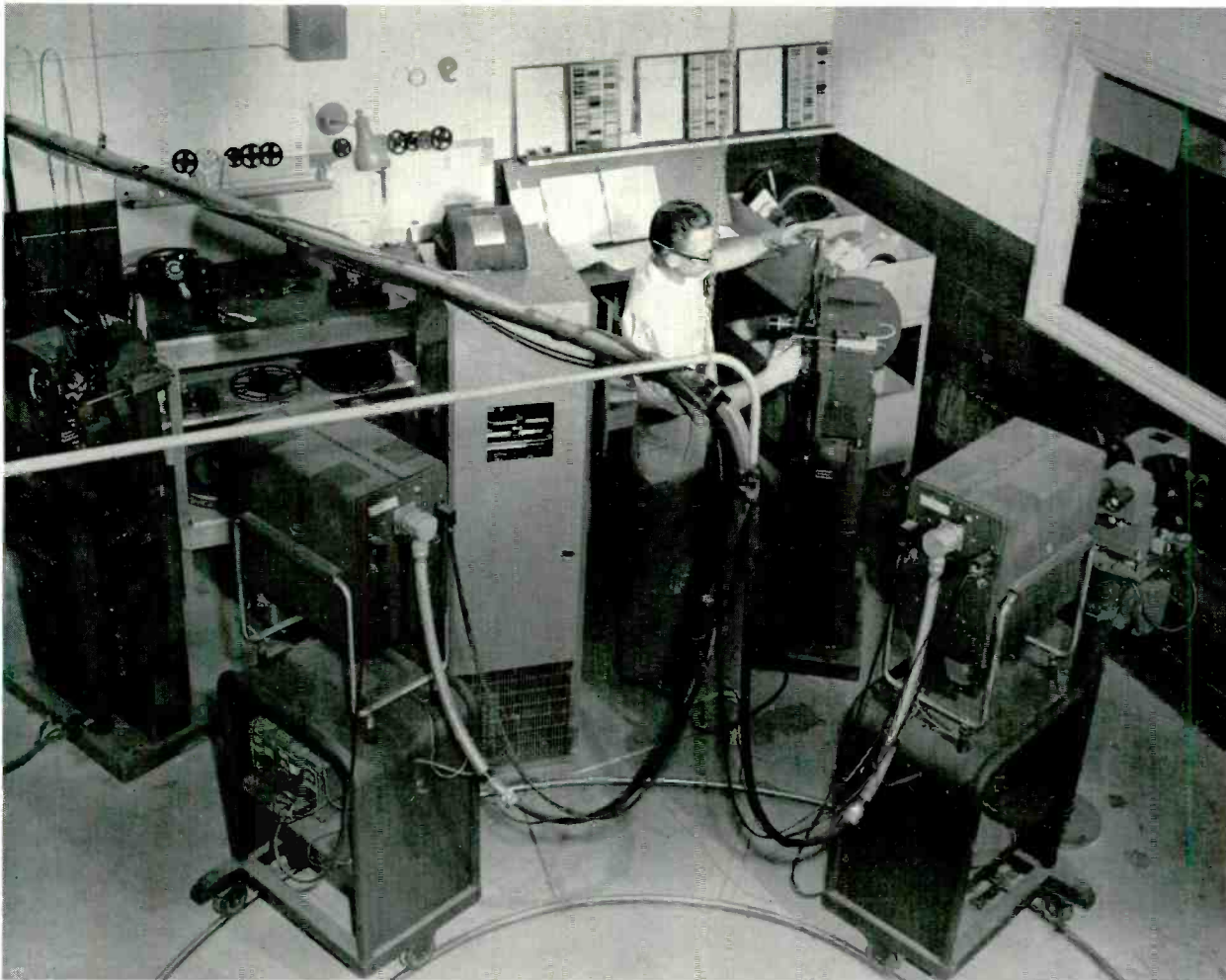

◆  
FIG. 2. The film projection room at KBTV allows for complete simplicity of operation. Two film projectors and slide projector are conveniently located for speed.



◆  
FIG. 3. The complicated but necessary job of film shipping is conducted in the KBTV Shipping Room. Here, Bob Beegle, film technician, prepares to mail a film on to another station.

# KBTV TRANSMITTING FACILITIES

By **CARL BLIESNER**  
Transmitter Supervisor

KBTV's transmitter site on Look-out Mountain is 15 airline miles west of the City of Denver. Lookout is at the foot of the Eastern Slope of the Rockies, and as its name implies, affords an excellent location for "Line of Sight" coverage of the City and the Great Plains Region. In this part of the state, where distances are measured vertically rather than horizontally, determination of "Antenna Height Above Average Terrain", is purely an engineering study. The severely rising terrain to the North and West of the transmitter site reduces this average to 964 feet. Actually,

the antenna system is one half mile above the Mile High City.

## The Antenna System

A Blaw-Knox self supporting tower, 200 feet high, supports the RCA, 12-Section, TF-12AH antenna (see Fig. 1). The antenna is fed with two 215-foot lengths of  $3\frac{1}{8}$ " Teflon line. The line is run down through the center of the tower, rather than down one side and, in our installation, better line symmetry, fewer elbows and greater protection from lightning is realized with this method of suspension. Two

FIG. 1 (at left). Towering 280 feet into the air is the KBTV 12-Section RCA Antenna and Transmitter Tower located on Lookout Mountain—a few miles west of Denver. Transmitter and antenna deliver a 282,000 watts power signal to Colorado television viewers.

FIG. 2 (below). Shown is the base of KBTV's tower and antenna and the exterior of the transmitter building.

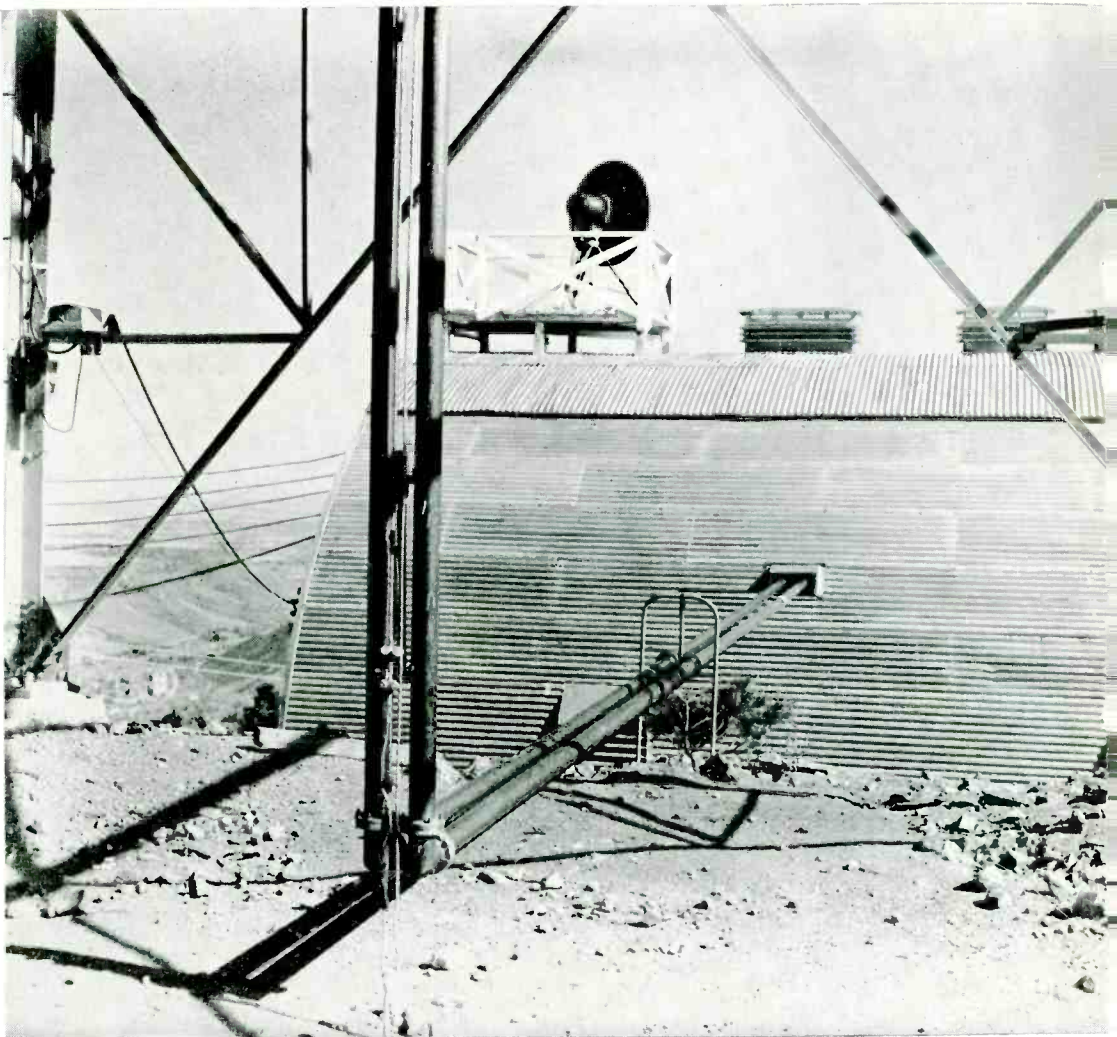
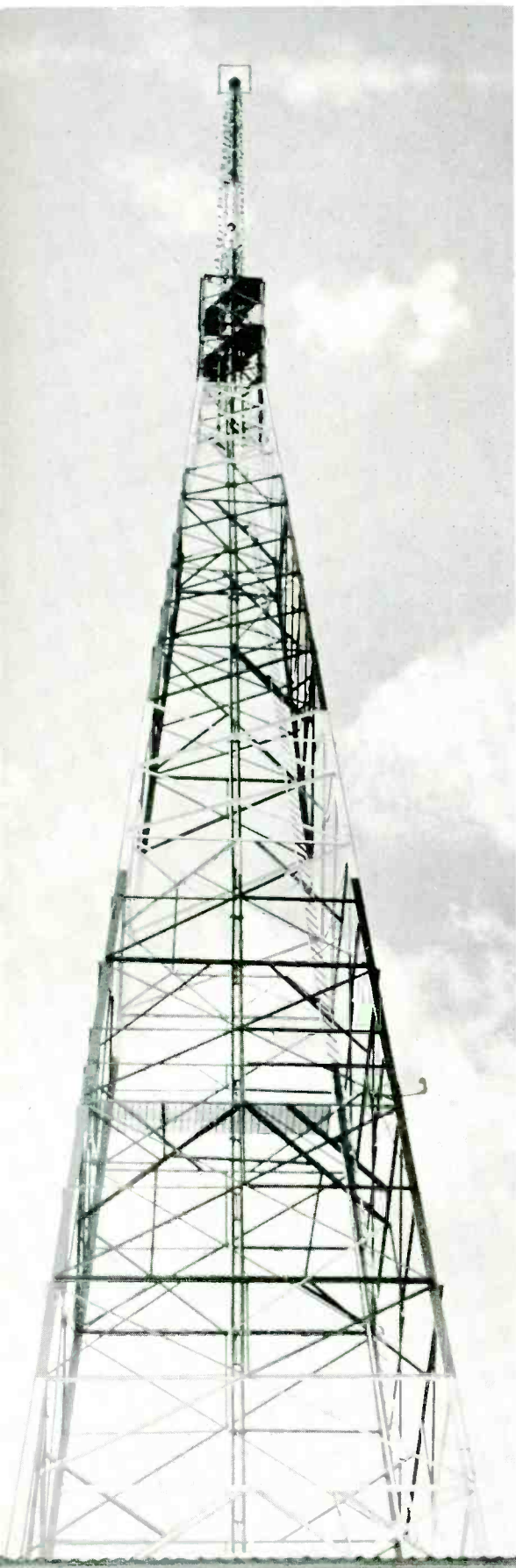



Mr. Carl Bliesner, Transmitter Supervisor.

$\frac{3}{8}$ " messenger cables, anchored to the top of the tower and to a guy anchor in the ground, support the line. Spring hangers, fastened to the line in the usual manner and located at 10-foot intervals are secured to the messenger cable with cable clamps. Lateral movement is prevented by tying the line to the tower with  $\frac{1}{4}$ " messenger cable every 20 feet. Messenger cable, clamps and anchors were obtained from the local Power Company.

The lightning protection ground system for the antenna, consists of two 36" wide lengths of Cooper mesh, buried 3" deep and extending from the North and South sides of the tower to the station property line. The mesh is silver soldered to a 4" wide strip of copper strap, buried around the outside of the tower and connecting to each tower leg. In addition, the Quonset building and equipment grounds are connected to the antenna ground and to a 4" strap which circles the building and connects to water and sewer pipes. Obtaining a good ground system is difficult where such poor ground conductivity exists.

Like most mountain top TV transmitter sites, KBTB is subjected to the severity of winter weather conditions. Snowfall is frequent and heavy from October through May. Successful operation of the station during the winter months with non-resident Technicians is made possible by the efforts of the road maintenance crews of the Colorado Department of Highways. To them we owe our thanks.

**The Transmitter Building and Equipment**

The transmitter building, a 32 x 48-foot Quonset with full basement, is quite adequate for an operation of this size. The walls and ceiling are fully insulated and

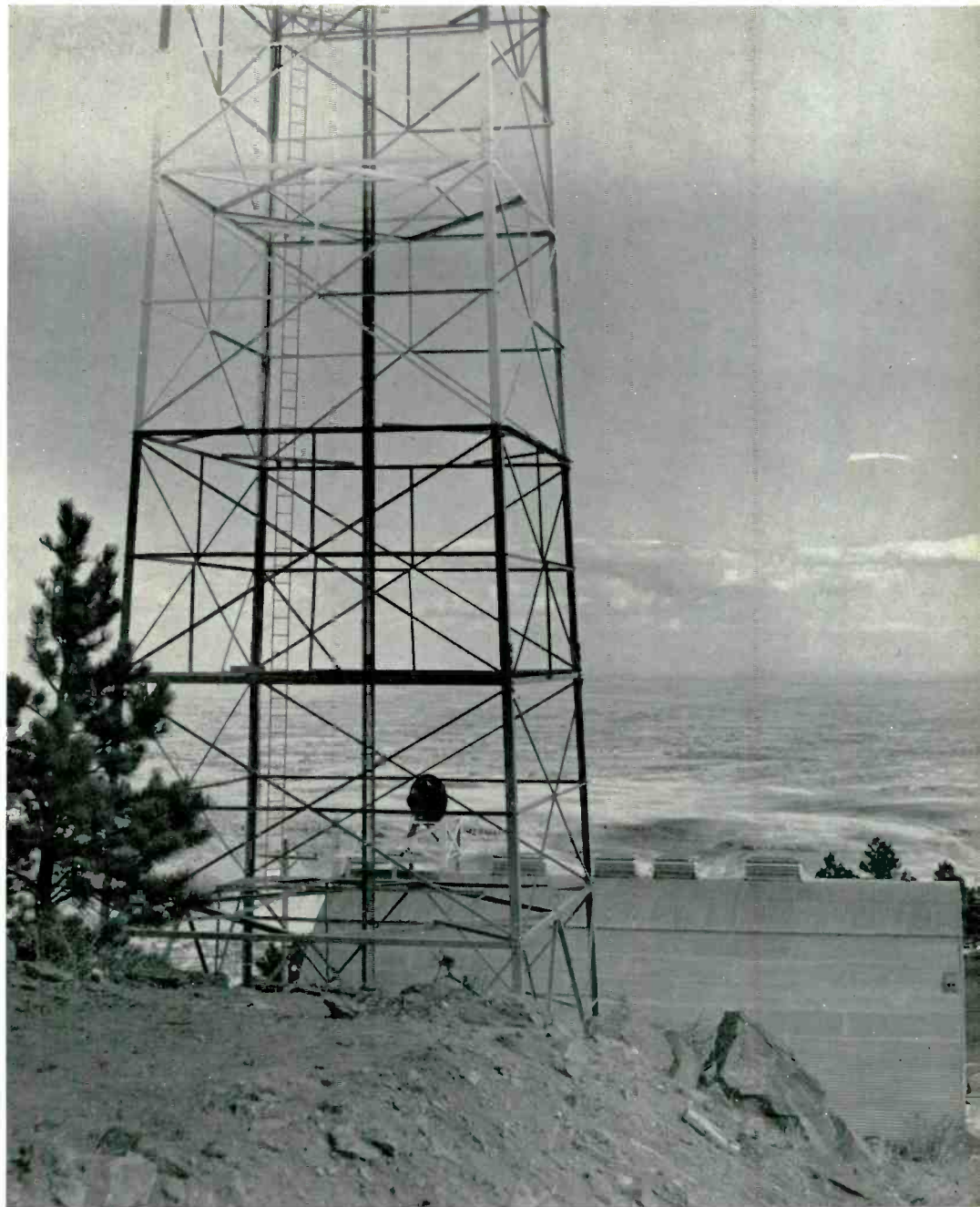

FIG. 3. The plains surrounding Denver stretch out for many miles from the site of the KETV transmitter high atop Lookout Mountain.

covered with compressed asbestos sheeting. Oak floors are supported by steel "I" beams running the full length of the building. Living quarters and emergency rations are available for operating personnel, when needed. Two Propane heaters on the main floor and one in the basement, heat the building during off-air hours. Two 1500 gallon water tanks are pumped to capacity during warm weather and supply sufficient water for extended cold periods.

Fig. 5 shows the "In Line" arrangement of the cubicles and Fig. 6 illustrates the position of the P.A.'s with respect to the 10 KW transmitters. The P.A.'s are placed

back to back to facilitate transmitter output switching. The output Coax of the 10's can be rearranged to feed the Diplexer in a matter of seconds. Suspending the Diplexer vertically reduces elbow and Coax requirements and simplifies feeding. The quarter wave phasing section consists of three 90 degree elbows on the long side and one 90 degree elbow plus a straight section on the short side. The Sideband Filter is mounted vertically between the two P.A.'s. The Control Console (see Fig. 4) is located 5 feet from the transmitter and 4 feet from the Terminal Equipment Racks, providing good transmitter meter visibility and quick access to patch panels

and other rack equipment. The four plate transformers were placed in the basement to provide more work room back of the transmitter. The four blowers were also installed in the basement, primarily to reduce mechanical noise, although accessibility for inspection and lubrication during the operating period are worthwhile advantages.

Air ducts over the main transmitter and the P.A.'s feed into a common duct in the attic. Dampers discharge the exhaust air through ports on top of the building dur-

ing summer months, or recirculate the air through the main floor during the winter. Wire duct beneath the floor connects to all equipment and the power distribution panel. Two primary disconnect switches, one for each transmitter, provide "Cold" transmitters for cleanup and maintenance work.

#### Coverage

The coverage map included in Mr. Herold's introduction (see page 19) shows the predicted field strengths of KBTV.

Actual mail response extends far beyond the predicted service area and reception in the mountains is better than expected. We are received in Granby, sixty miles west of the transmitter and on the other side of the Continental Divide. In the Plains area, we have received reception reports from Eastern Colorado, Western Kansas, Southwestern Nebraska and Southeastern Wyoming. Coverage that is surely in excess of what Advertisers would term the Denver Market.

FIG. 4. Transmitter Supervisor Carl Bliesner operates the KBTV Transmitter Control Console located directly in front of KBTV's TT-25A (25-KW VHF transmitter).

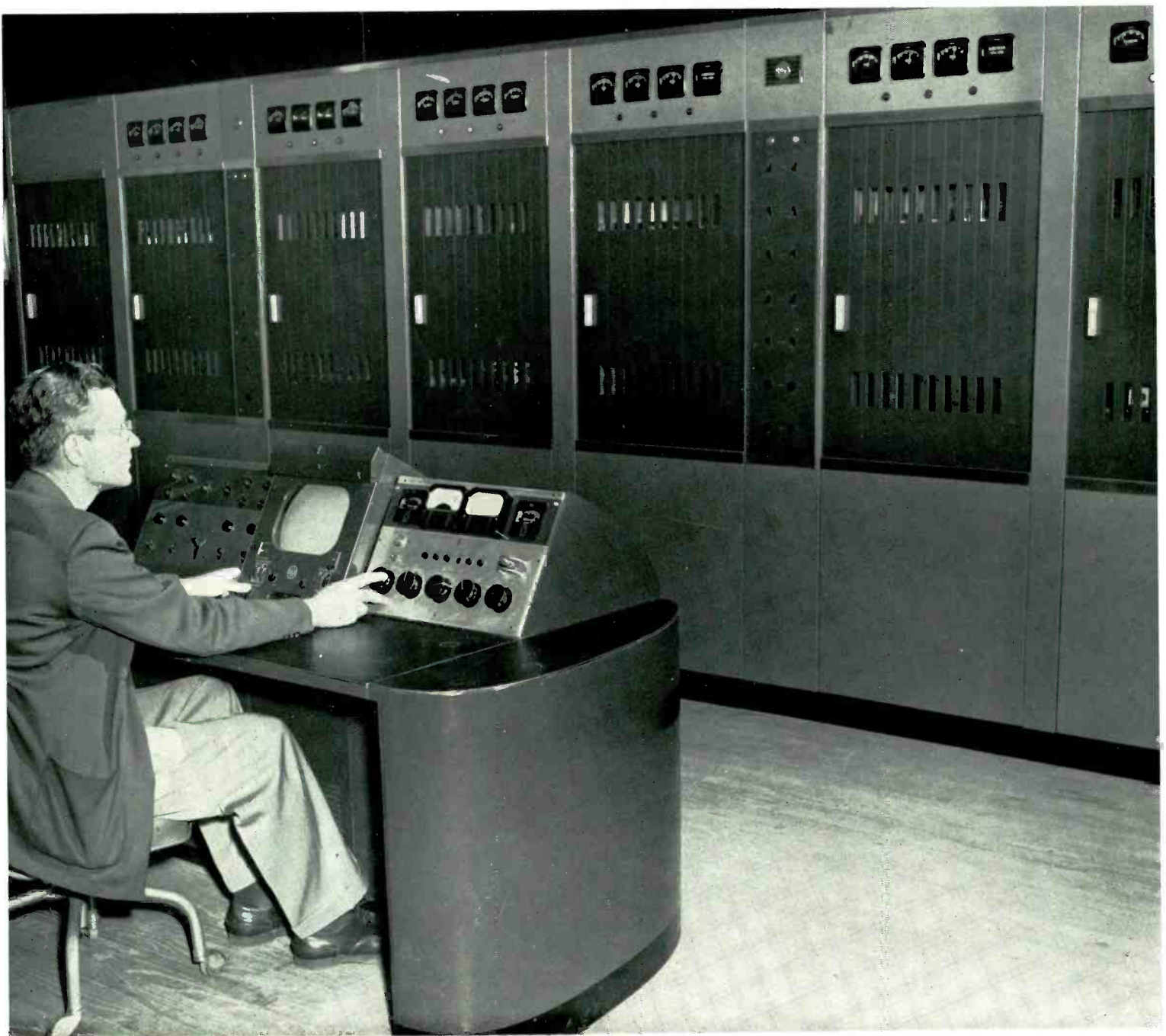

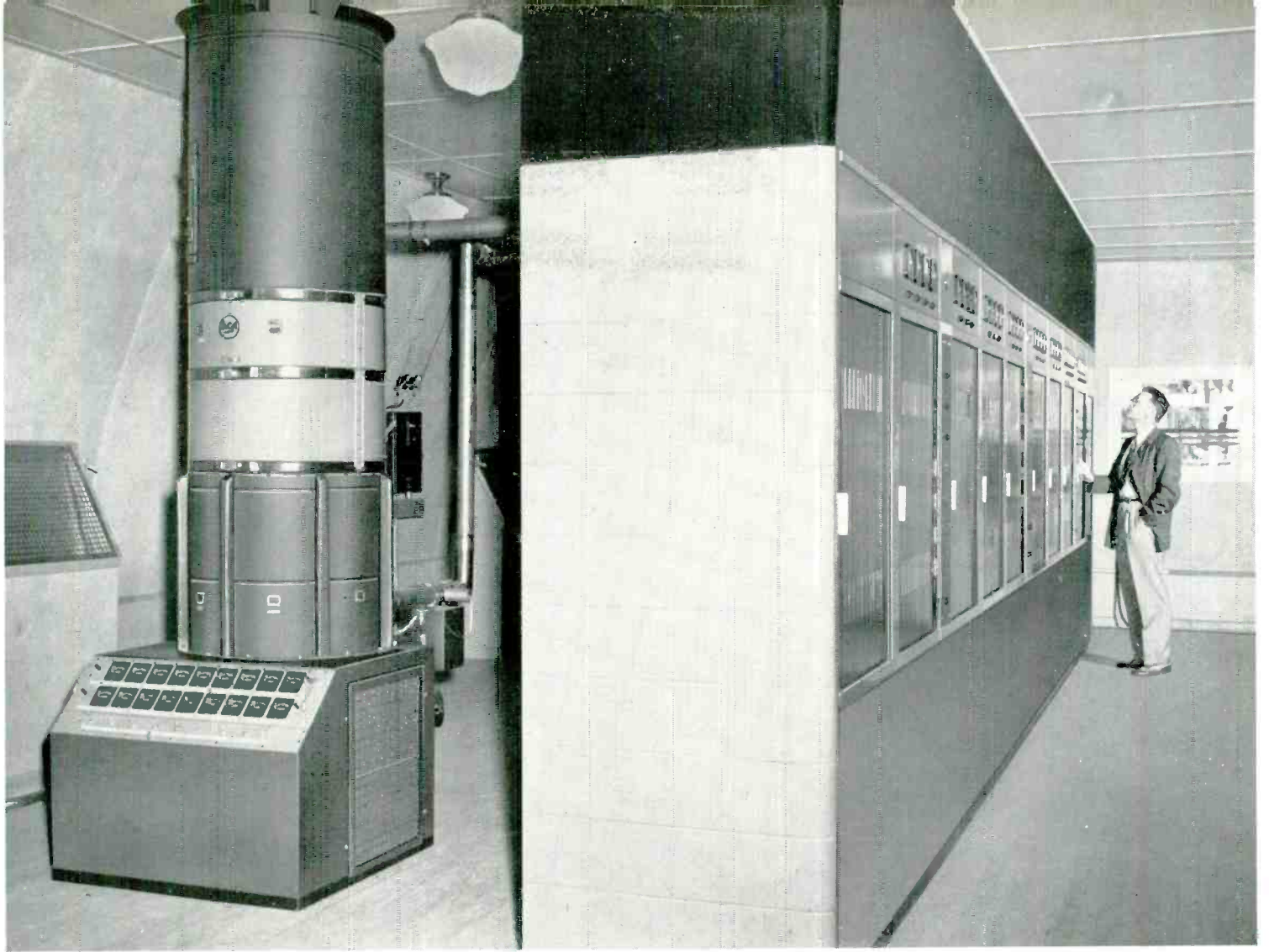

FIG. 5. Full length view of KBTB's new 25-KW VHF transmitter (RCA TT-25BH). At left is one of the high power amplifiers.

FIG. 6. Shown is a front view of the KBTB 25-KW Aural Power amplifier.

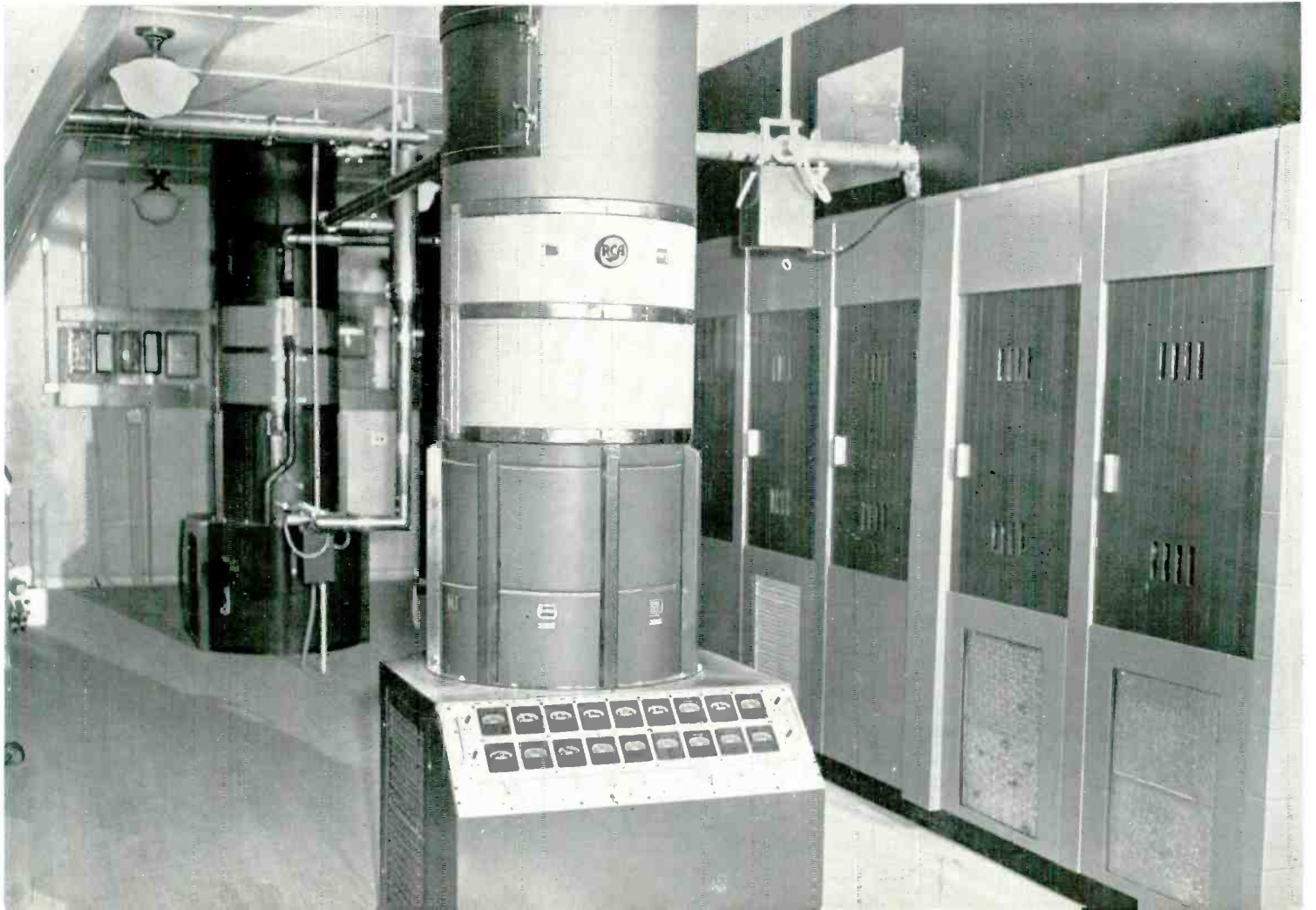



FIG. 1. Sensitivity tests are performed on RCA Type 77-D Polydirectional Microphone by employing field intensity measurements.

# SENSITIVITY OF MICROPHONES TO STRAY MAGNETIC FIELDS

**L. J. ANDERSON**  
RCA Victor Division of RCA  
Camden, New Jersey

In addition to the usual attributes of a microphone which are commonly measured, such as sensitivity, response-frequency characteristics and directional properties, there are secondary attributes which may be of equal importance in specific applica-

tions. Most significant are the following: sensitivity of the microphone to stray magnetic fields of low frequency, sensitivity to wind and sensitivity to mechanical shock.

The purpose of the following discussion is to describe a possible standard method for evaluating one of these factors, namely: the sensitivity of microphones to stray magnetic fields of low frequency, such as are commonly referred to as hum fields.

Electrodynamic transducers, and all types of microphones in which a coupling transformer is included as a part of the microphone, are sensitive in some degree to hum fields. The evaluation of this sensitivity has always been of some importance for microphones used in Broadcast applications, and of late it has become increasingly important where microphones are used in Television programming, because



of the number, strength, and closeness of the hum sources.

Hum fields may originate from any device operating on alternating current or from the incident wiring, and of course the strength of the source and the relative proximity to the microphone are factors which are of equal importance. The most likely sources of stray fields are motors, power transformers, voltage regulating transformers, fluorescent light-fixtures, electric clocks, wiring incident to high power lighting, power supplies, and amplifiers with self-contained power supplies. Some sources are a serious handicap because of their strength and others because of their closeness to the microphone.

Within the microphone and associated circuit, excluding the microphone preamplifier, there are several hum sensitive elements as follows: the microphone cable, the microphone transformer, the internal wiring, the moving conductor and compensating reactor if any.

The problem is two-fold. First, it is necessary to have a standard hum source which will allow various microphones to be compared with regard to their sensitivity to hum fields, and second, equipment is required to properly evaluate hum fields in microphone locations in order that the performance of a microphone may be predicted with reasonable accuracy.

#### Hum Excitation Equipment

A large diameter coil of small cross section is best for this purpose because of the uniformity of the field close to the center and the resulting non-critical positioning of the microphone during testing. The field intensity at the center of the coil may be calculated from the following:

$$(1) \quad H = \frac{.2\pi NI}{r}$$

$H$  = magnetizing force (Oersteds)  
 $N$  = number of turns  
 $I$  = current (Amperes)  
 $r$  = radius (Centimeters)

For practical reasons, values of  $H$  between 0.1 and 0.5 Oersted are most suitable. Values lower than 0.1 are likely to approximate ambient fields in magnitude and values above 0.5 pose difficulties from

heating of the coil and acoustic noise. A 60-cycle power source is most convenient for the coil excitation because of its availability and the similarity of the resulting field to those usually encountered in practice.

The measurement is quite simple. The microphone is placed at the center of the coil and oriented until a maximum output is indicated on a voltmeter whose input impedance is high enough to assure that the open circuit voltage is being measured. If no such meter is available a voltage substitution method may be used. The sensitivity of the microphone to hum is then expressed as follows:

$$(1) \quad G_{HI} = (20 \log_{10} \frac{E_{HI}}{H} - 10 \log_{10} R_{MR}) - 50 \text{ db}$$

where the reference values are 0.001 watt and a field of 0.0002 Oersteds.

The value of  $G_{HI}$  is without practical significance because the criterion of the performance of the microphone is the signal-to-noise ratio. This is obtained as follows:

$$(2) \quad G_{MH} = (G_M - G_{HI}) \text{ db}$$

where  $G_{HI}$  is as expressed above and

$$*G_M = (20 \log_{10} \frac{E_p}{P} - 10 \log_{10} R_{MR}) - 50 \text{ db}$$

( $G_M$  = Microphone Sensitivity)

$G_{MH}$  then reduces to:

$$(3) \quad G_{MH} = (20 \log_{10} \frac{E_p}{P} - 20 \log_{10} \frac{E_{HI}}{H}) \text{ db}$$

(\* See RTMA Standard SE-105 Microphones for Sound Equipment.)

In the preceding equations,

$E_{HI}$  = the open circuit hum voltage

$H$  = field strength

$E_p$  = the open circuit signal voltage

$P$  = sound pressure dynes  $\frac{2}{\sqrt{\text{cm}}}$

$R_{MR}$  = microphone rating impedance

A suitable exciting coil is sketched in Fig. 2.

#### Evaluation of Hum Fields

Hum fields may be very easily evaluated for a given location by means of an exploring coil and a voltage indicating device.

FIG. 2. Sketch of exciting coil set-up pictured in Fig. 1.

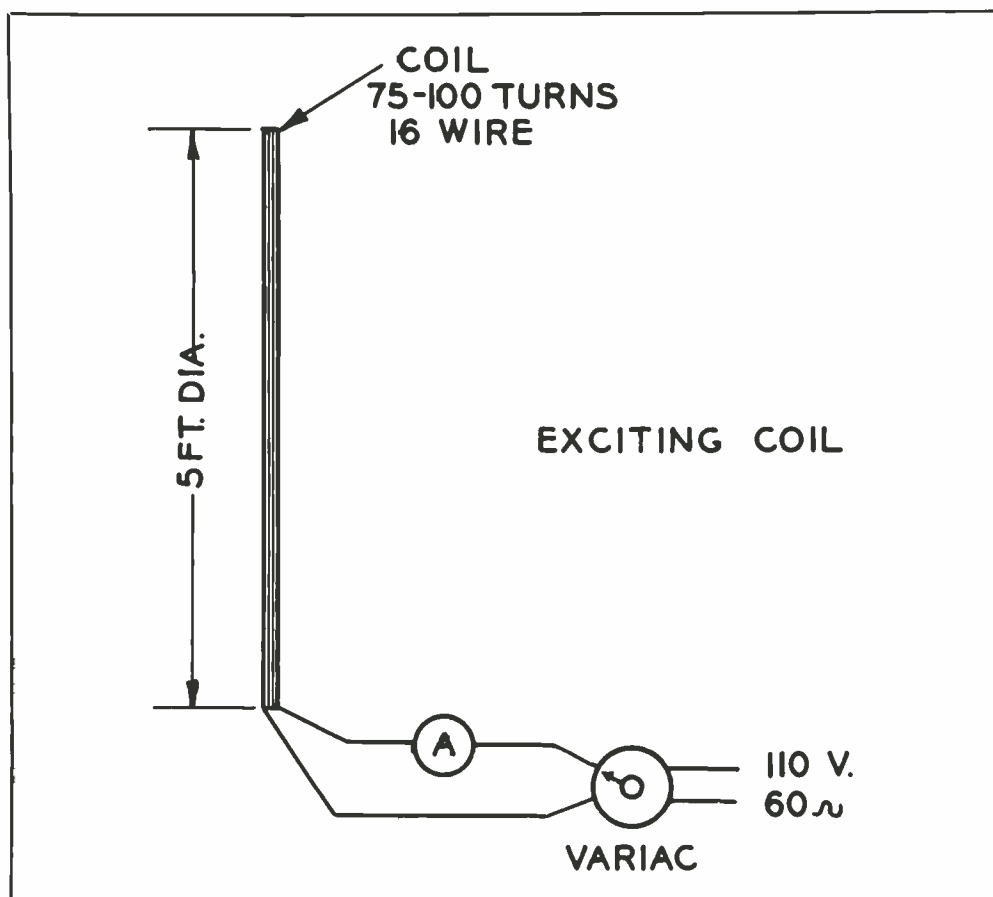

The coil used should be air core so that the magnetic field is not disturbed. For such a coil:

$$(1) E_s = \frac{Nd\phi}{dt} 10^{-8}$$

where

$N$  = number of turns

$\phi$  = flux through the coil

$E_s$  = open circuit voltage due to the stray field

$$(2) \phi = A_c B \sin \omega t$$

where

$B$  = flux density =  $H$  for air

$A_c$  = area of coil

(assuming a sinusoidal variation for  $B$ )

$$(3) \frac{d\phi}{dt} = A_c \omega B \cos \omega t$$

dropping time function and substituting (3) in equation (1).

$$(4) E_s = NA_c \omega B \times 10^{-8}$$

$$(5) B = H = \frac{E_s \times 10^8}{NA_c \omega}$$

If  $E_s$  is measured in RMS volts  $B$  and  $H$  will also represent RMS values.

In order to obtain the maximum value of the field, readings are taken for three mutually perpendicular axes. Then,

$$(7) H_t = \sqrt{H_x^2 + H_y^2 + H_z^2}$$

Where  $H_x$ ,  $H_y$  and  $H_z$  represent the field strength along the three axes.

$H_t$  is then referred to a zero level of .0002 Oersteds.

$$(8) \text{Field level} = 20 \log_{10} \frac{H_t}{.0002}$$

Fig. 3 shows the schematic arrangement of a field measuring set. The number of turns on the pickup coil will depend upon the sensitivity of the voltmeter and the strength of the fields to be measured. If an electronic voltmeter is used, the pickup coil must be kept far away enough from it to assure that the field due to the voltmeter is not contributing to the results.

### Typical Results

Hum fields encountered are not entirely 60 cycles as can be seen from the analysis shown in Figs. 4, 5 and 6. Since the effectiveness of a given value of  $H$  is proportional to frequency for both the hum measuring coil and for most microphones tested, the effect of assuming the entire hum voltage measured to be 60 cycles results in a correct signal-to-noise voltage ratio. On the basis of correlation with actual listening to such a signal there may be some merit in considering rating the microphones on a 120- or 180-cycle field.

### Hum Levels in Typical Locations

Voltage Regulating Transformer (10 ft.)	+26.7 db
Recording Studio	+16.2 db
Broadcast Studio	+15 db
Broadcast Control Room	+14 db
Fluorescent Fixture (80 watt) (36 inch distance)	+18 db

$G_M$  and  $G_H$  for Microphones

	$G_H$	$G_M$
RCA—Type 77-D Polydirectional Microphone	-139 db	-151 db
RCA—Type 44-BX Velocity Microphone	-129	-149
RCA—Type BK-1A Pressure Microphone	-116	-145
RCA—Type BK-4A Starmaker	-139	-153

From the above data the signal to noise ratio may be predicted for any given location if the sound pressure level and hum field levels are known. The following is an example of such a calculation.

$G_M$ for Type 77-D Microphone	-151 db
Sound Pressure Level (assumed)	+ 94 db
Output Level from Microphone	- 57 db
$G_H$ for Type 77-D Microphone	-139 db
Hum Level in Typical Location	+ 16 db
Hum Level from Microphone	-123 db
Signal-to-Hum Ratio $G_{MH} = (G_M - G_H)$ or	+ 66 db

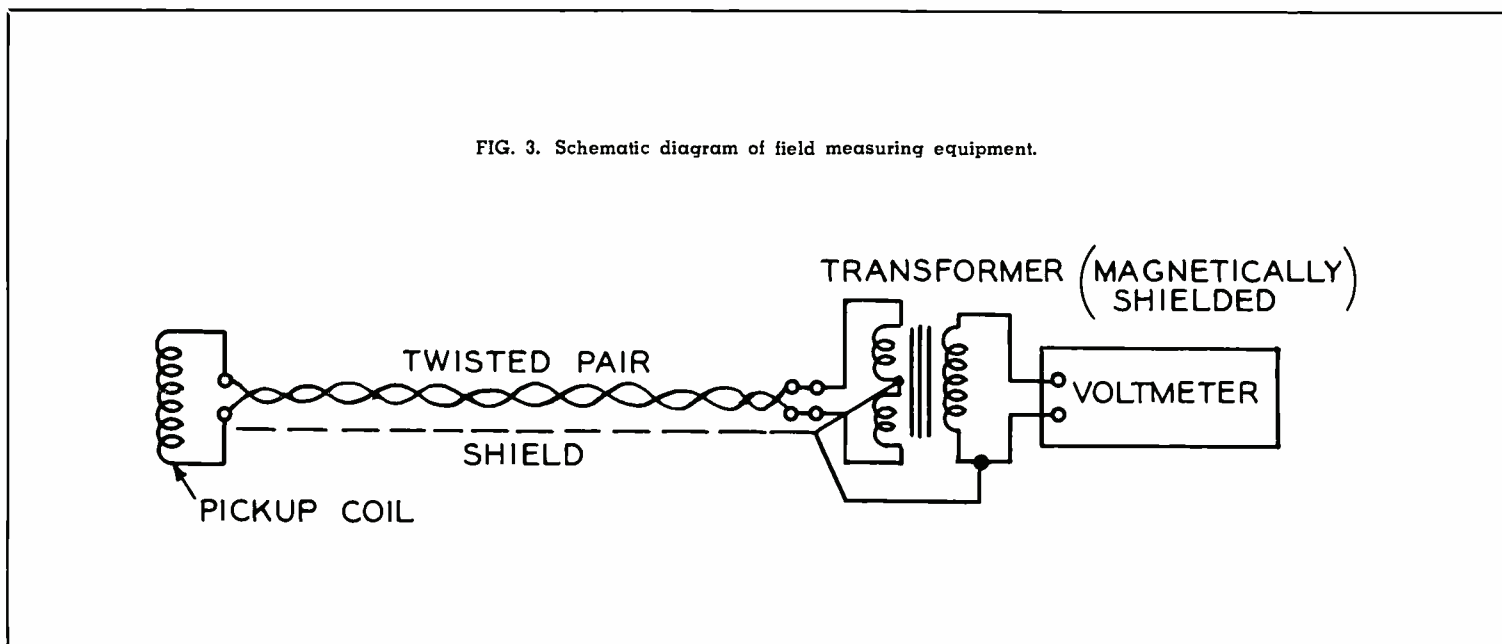

FIG. 3. Schematic diagram of field measuring equipment.

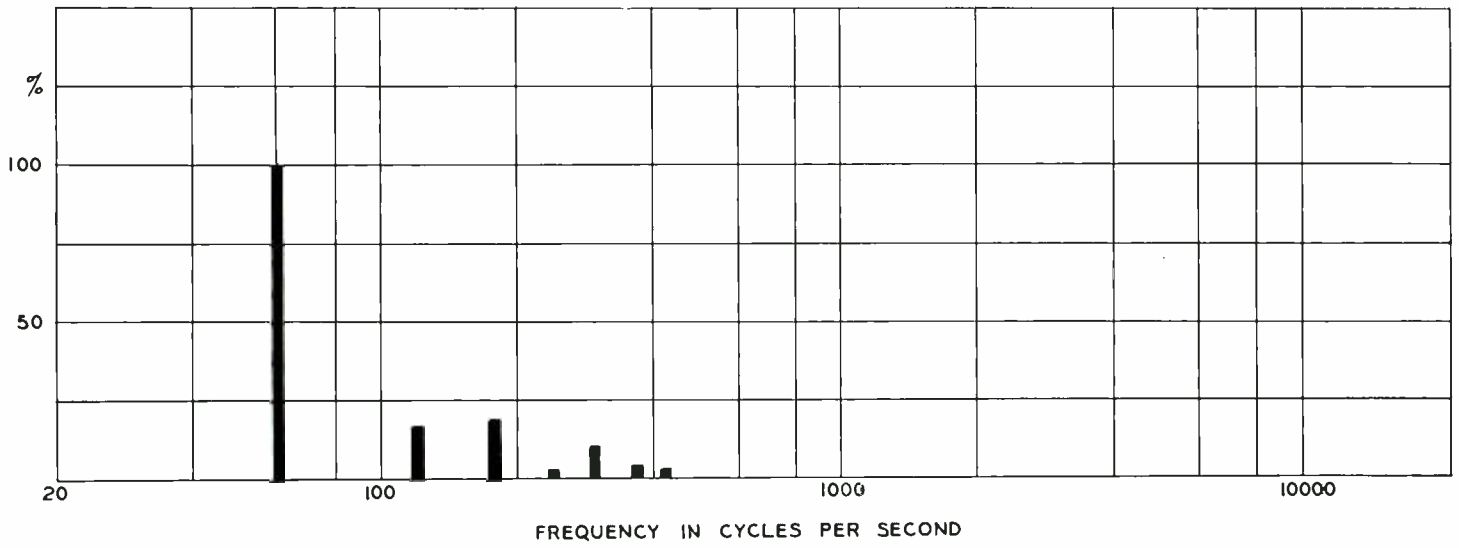

FIG. 4. Field analysis in a typical Broadcast studio.

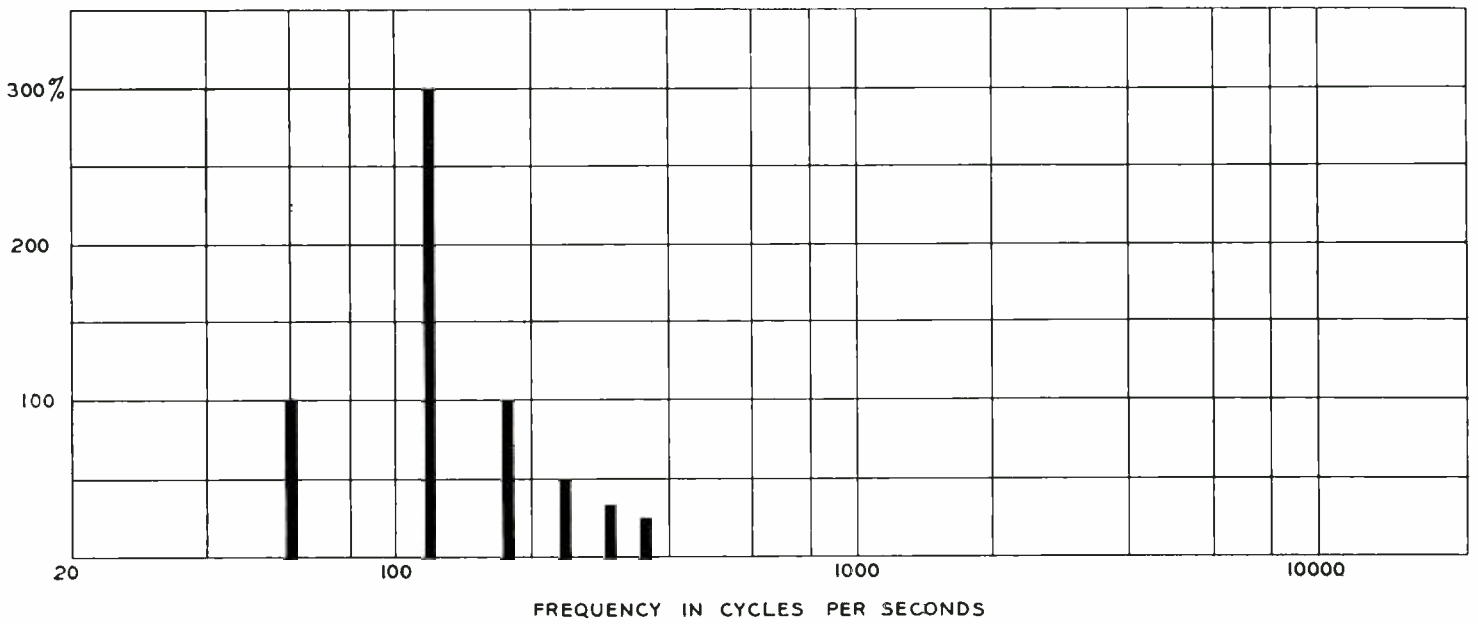

FIG. 5. Field analysis near power amplifier.

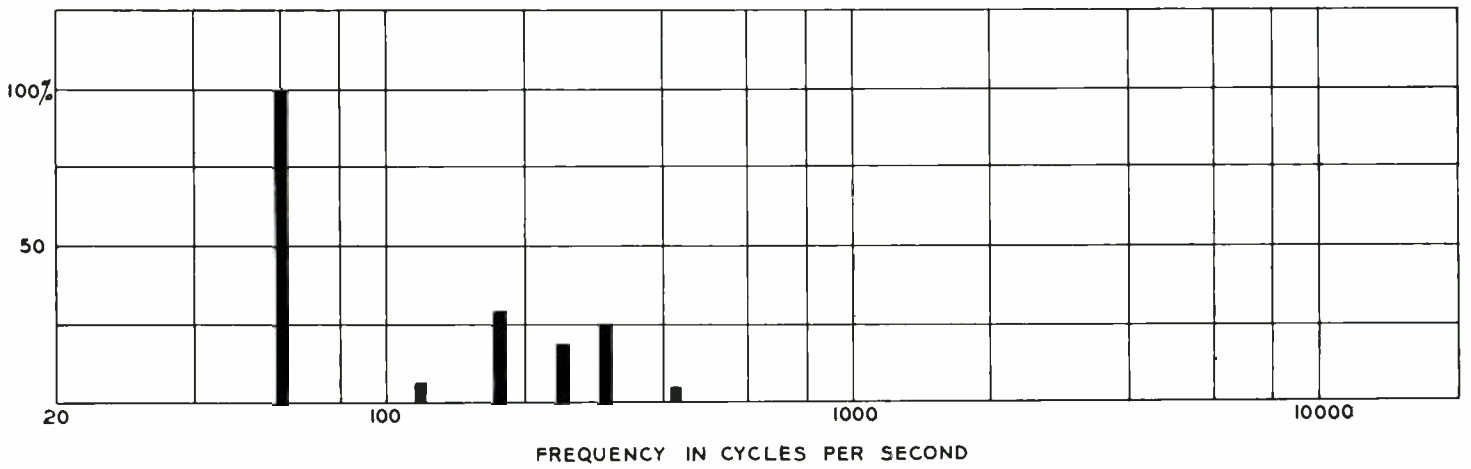

FIG. 6. Field analysis near 80-watt fluorescent fixture.

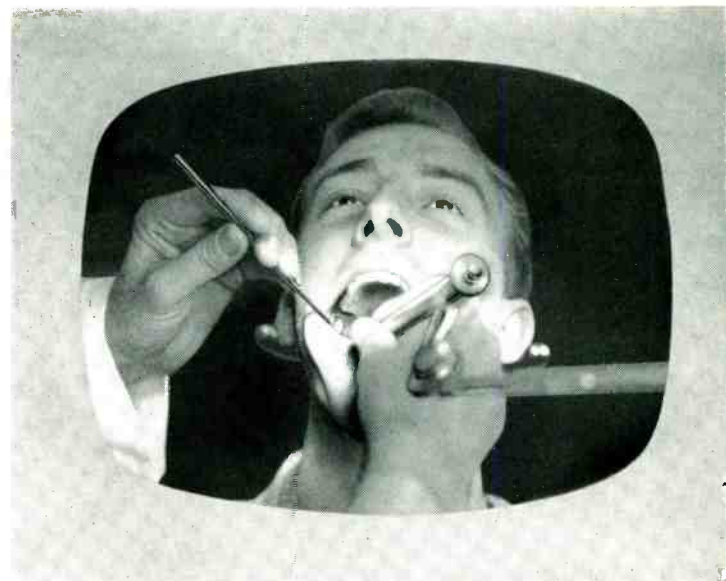
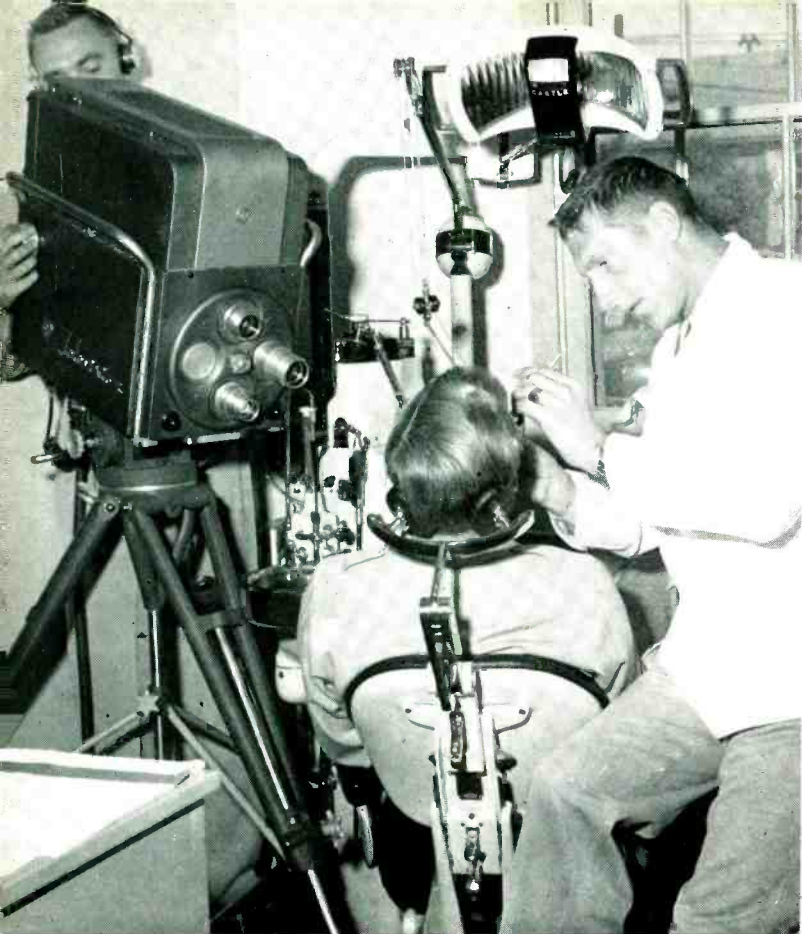

FIG. 1. Large groups can get a "dentist's-eye" view of a demonstration of new dental techniques through the advent of the Air Force's Television "station-on-wheels."

## AIR FORCE USES VERSATILE TV "STATION-ON-WHEELS"

In a search for new applications of Television to military requirements, the 1354th Video Production Squadron of the U. S. Air Force makes daily use of their new Television "station-on-wheels". This unique mobile unit was designed by Air Force personnel, coordinating with RCA who built the unit.

Three 35-foot vehicles comprise the unit. One serves as a personnel carrier, seating as many as thirty-six people and featuring an aft compartment for use as a conference room, announcer's booth or for small Television pickup.

Another vehicle houses two gas-driven generators capable of producing approximately 40,000 watts of power for equipment operation. Storage space in this unit accommodates compact cable reels holding nearly three miles of cable for power con-

trol, Television pickup and distribution; eight 21-inch receivers; seven large-screen projectors and a supply of spare tubes and parts for equipment maintenance. A work bench for maintenance work is installed in the vehicle.

The third vehicle carries the operational engineering equipment. Included are four TV cameras; a master monitor; switching unit and sync generator; a 21-inch receiver

for monitoring use; a 16mm film projector; 16mm slide projector; flying spot scanner for 35mm slides; special effects amplifier; distribution amplifiers; audio equipment including a control console, two turntables and two tape recorders; kinephoto equipment; and a rapid film processor mounted in the aft section. Two complete microwave relay links, oscilloscopes and other test equipment are among other items stored in this unit.

FIG. 2. Complete Television facilities are housed in three 35-foot vehicles of special design.





FIG. 3. Lt. Colonel Melvin E. Williamson, commanding officer of the video unit, checks out equipment. A veteran of more than 30 years in radio and television, the Colonel, more than four years ago, recommended Air Force television activity in a report "Horizons Unlimited".

Each of the vehicles is equipped with a VHF inter-communication system which permits communication between vehicles as well as with fixed locations. The scope of operation with this highly flexible unit is basically unlimited since it can operate as a closed circuit network; beam its signal to a local or network station; receive from commercial stations and "dub" in live spots, slides or film and then transmit the program on to another station; kine-record every telecast and develop, process and print this film within one minute; and televise from air-to-ground to a limited degree with potential expansion of facilities to permit air-to-air and ground-to-air telecasts.

Television film recordings incorporate sound and can be produced in either positive print or negative form by reversing the polarity of the image on the television tube.

Captain Joseph Leaming, chief of the squadron's modification and design section, was chief engineer of the planning and installation project and worked closely with Lt. Colonel Melvin E. Williamson, commanding officer of the unit, in locating all of the operational equipment in one vehicle, while utilizing the second one for power and storage.

Present responsibilities assigned to the newly organized production squadron include: rapid production or revision of Air



FIG. 4. Captain Joseph Leaming (second from right) was chief engineer for design and installation of equipment. Plans for the proposed mobile unit are being discussed here with RCA engineers who assisted in the project.

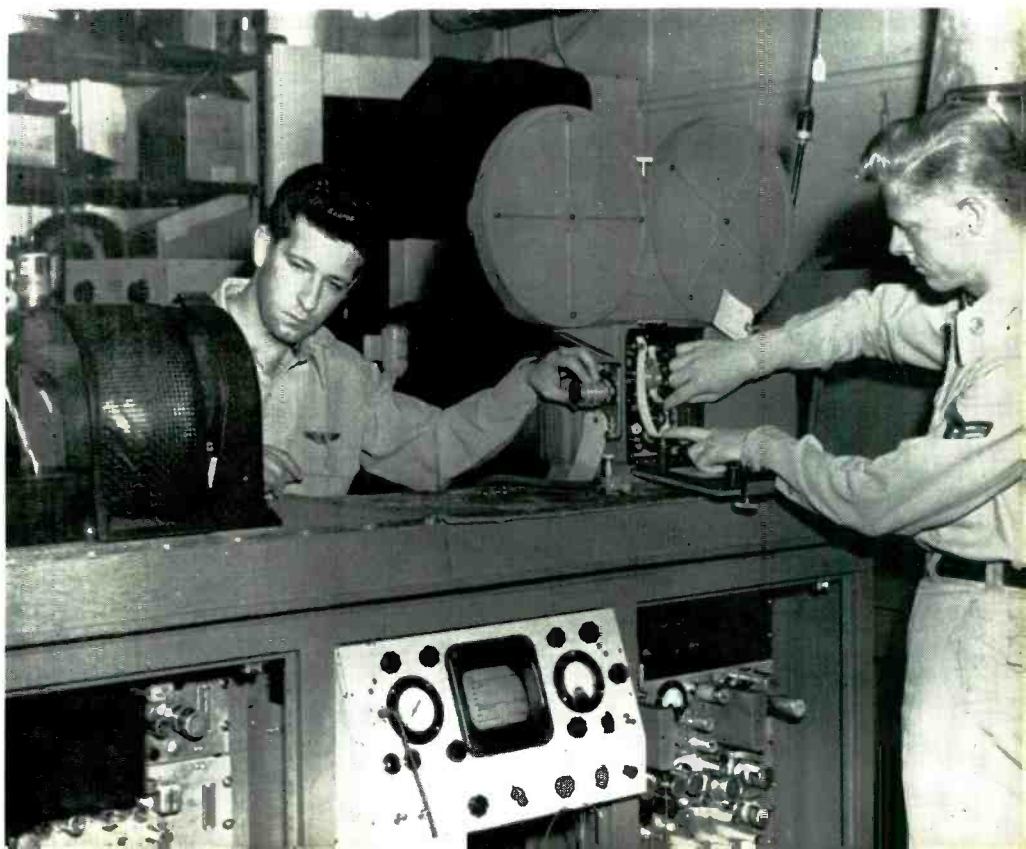

FIG. 5. Television video engineers of the Air Force are shown here loading the video recording camera which is located in the aft section of the studio control vehicle.



▲  
**FIG. 6.** Visitors at a recent Hamilton Air Force Base weather project inspect the compact control vehicle and watch as the director (with hand to earphones) calls the camera shots during the briefing program.

**FIG. 7.** In the briefing room at Hamilton Air Force Base, members of the 1354th Video Production Squadron prepare equipment for fifteen-day 'round-the-clock weather transmissions.



Force films by means of kinephoto recordings; mass training at designated installations through the simultaneous presentation of picture and sound without prior recording; medical and surgical studies; information and education activities for internal distribution to Air Force personnel; reserve personnel training; supplementing Air Force public information activities; determining the tactical application; exploring Television's potential use as an aid to psychological warfare; and indoctrination of other Air Force agencies in television techniques.

After a series of shake-down test projects, the squadron recently completed an operational test of its facilities at Hamilton Air Force Base, California, to determine the effectiveness of presenting weather briefings to remote crews and stations from a single central weather station. A closed network to eight operational sites was established with each agency having a 21-inch monitoring receiver to pick up the 'round-the-clock briefings. In this schedule, briefings and information were transmitted at ten-minute intervals, day and night. The first briefing was for air defense type operations, a use of television that might be considered an important milestone in Air Force research.

When special requests were received from pilots viewing the telecasts, an immediate verbal and visual answer was returned by the weather forecaster on duty. The project was carried on for fifteen days and the immediate reactions were very satisfactory.

Lt. Colonel Paul M. Huber, Commanding Officer of the 4th Weather Squadron and program director during the test, stated that TV with its instantaneous transmission, relayed weather reports to outlying stations 30 minutes faster than teletype.

Participating units and top Air Force officials are evaluating this new Television operation as the 1354th explores new horizons. This exploration promises the Air Force new eyes for its operational tasks, training and safety and adds a new weapon to our arsenal of defense.

mately 960 degrees Centigrade and is formed into ingots. After the ingots are formed, they may be subjected to one or more stages of purification. In one type of purification process, the germanium ingot is placed in a furnace of an inert-gas atmosphere, is melted, and then is progressively cooled from one end to the other. During this cooling process, impurities present in the germanium tend to concentrate at each end of the ingot. The inner portion of the ingot, therefore, has a higher purity than the ends where the impurities are concentrated. The low-purity ends of the ingot may be cut off and the process repeated if additional purification is needed.

The germanium ingot formed by these purification techniques is polycrystalline. Greater uniformity is obtained in a further process in which a single crystal is formed from this polycrystalline ingot. In this process the polycrystalline germanium is placed in a graphite pot and melted. A small single crystal of germanium is dipped into the surface of the melt, then withdrawn very slowly, pulling with it some molten germanium which solidifies on the crystal seed. The speed of withdrawal may be about  $\frac{1}{4}$  inch per minute. The temperature of the germanium is controlled very closely during the crystal "growing," with



**FIG. 8.** Toy "piano" operated by one transistor and small battery. This experimental electronic keyboard contains one developmental junction type transistor and eight frequency-selecting circuits—one for each key. Complete scale is produced when "transmitting" to standard broadcast receiver.

a permissible variation of no more than  $\pm 1$  degree Centigrade.

Fig. 3 is a photograph of a crystal-growing apparatus. Single crystals ranging in diameter from 0.050 inch to one inch and having lengths up to many inches have

been formed using this method. Fig 12 is a photograph of the part of a single crystal which subsequently is to be cut into pellets for assembly into transistors.

At the present time the price of the germanium dioxide powder is about 300 dollars per kilogram. The quantity of germanium used for each transistor, however, is very small (about 0.002 gram). The single crystal pictured in Fig. 12 can provide as many as 7000 pellets for as many transistors, and many single crystals of this size can be obtained from one kilogram of germanium dioxide. Although a portion of the germanium is scrapped during the processing from powder to final crystal form, much of this germanium may be reclaimed for further use.

The finished crystal specimen is tested electrically to determine whether it has the proper impurity concentration, resistivity, and physical characteristics for use in transistors. The crystal is then sliced into wafers about 0.020 inch in thickness and diced into small pellets approximately 0.050 inch square. The pellets are chemically etched before the transistor is assembled to insure the absolute cleanliness of the crystal so necessary for good transistor operation.

#### Conductivity in Germanium

The germanium crystal is composed of millions of germanium atoms, each consist-

**FIG. 9.** The cigar-size experimental microphone-transmitter, made to explore transistor possibilities of a low-cost wireless microphone-transmitter. Effective within radius of 25 feet.

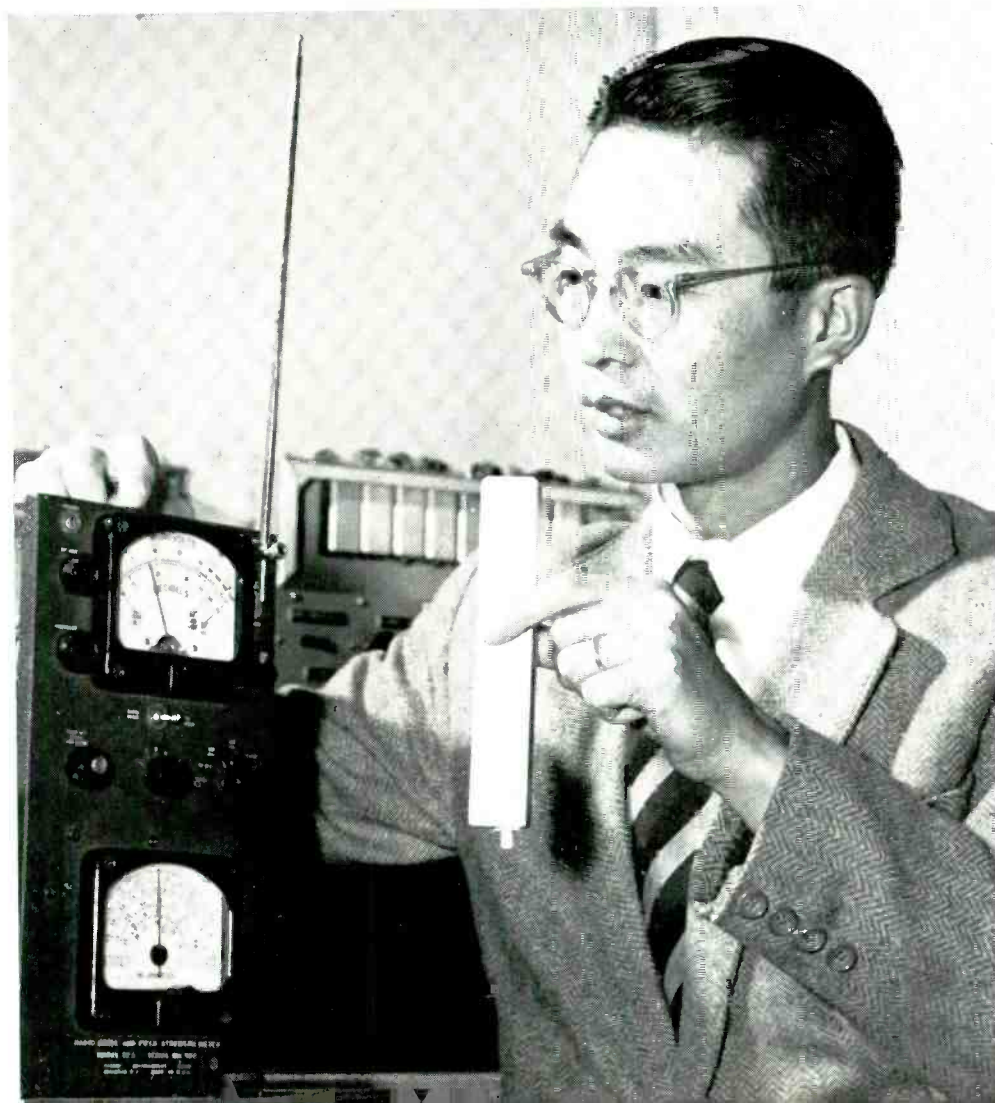

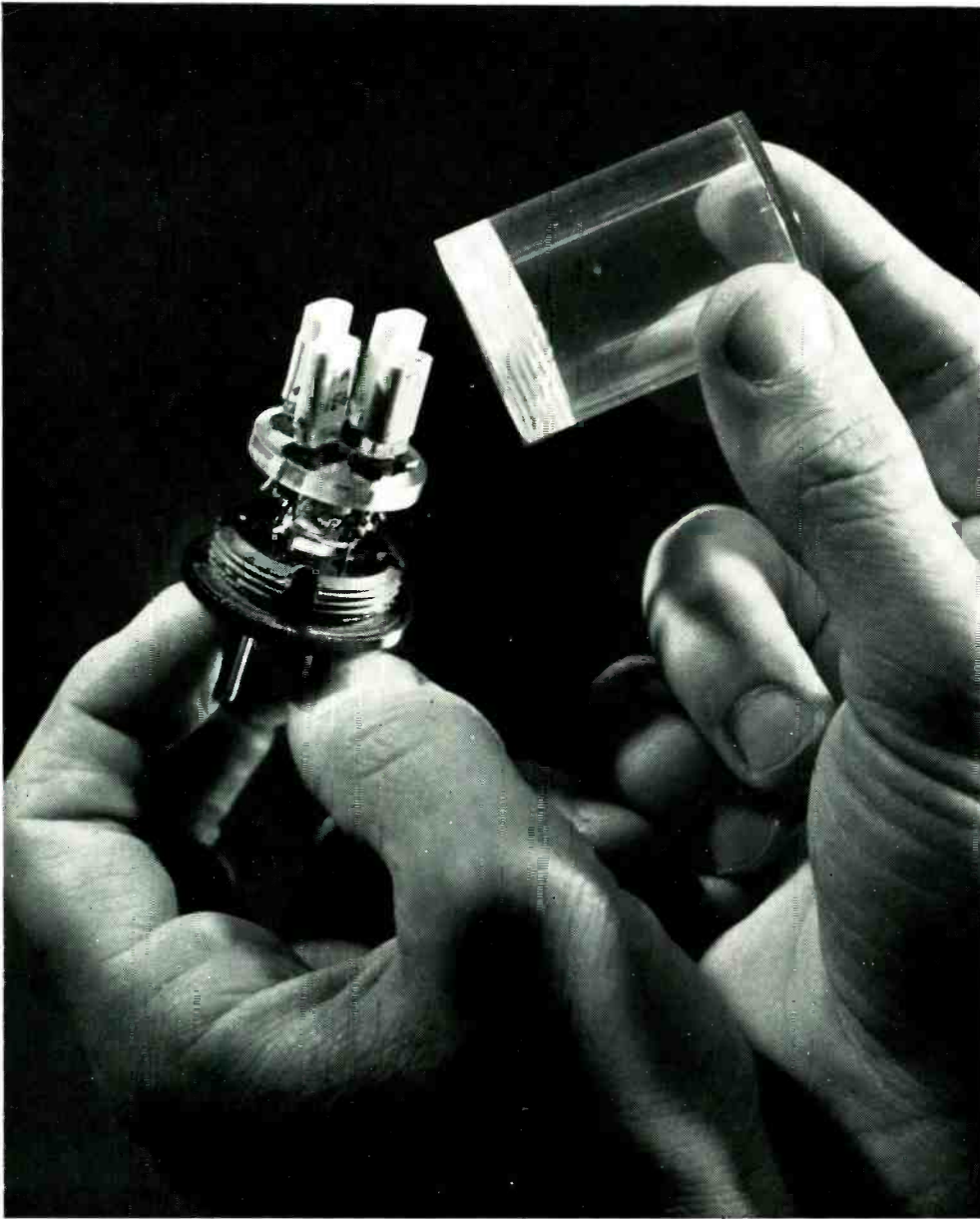

ing of a positively charged nucleus and a number of negatively charged electrons. All but four of the electrons are tightly bound to the nucleus and cannot enter into chemical reactions with electrons of other atoms. The remaining four electrons, which are able to enter into chemical processes, are called valence electrons. In the pure germanium crystal, however, the atoms are arranged in such a fashion that the valence electrons are fixed in place and contribute only slightly to electrical conductivity. The resistivity, which is the reciprocal of conductivity, of the pure germanium, therefore, is higher than that of germanium containing impurities.

Fig. 13 is a photograph of a model of the atomic structure of a tiny portion of the germanium crystal. Each round ball represents the nucleus of an atom, and each bar connecting two nuclei represents two valence electrons, one from each of the two atoms joined by the bar. Each of the four valence electrons of an atom forms a bond with a valence electron from an adjacent atom. Electrons which are fixed in these electron-pair bonds cannot contribute to the conductivity of the crystal except under the influence of an applied force. This condition is similar to that existing in an insulator, where there are no conduction electrons and, consequently, there is little or no conductivity. If sufficient electrical or thermal energy is exerted on the germanium crystals, however, the forces hold-

**FIG. 10.** Complete experimental audio amplifier stage in which four junction type transistors, mounted on a small plug-in base, perform the combined functions of two or more electron tubes, an output transformer and other components.

**FIG. 11.** An auto radio operating solely from 11 developmental transistors. Eliminates the usual high-voltage power supply. Transistors operate from 6-volt storage battery. Receiver operates at 10% of usual battery drain.

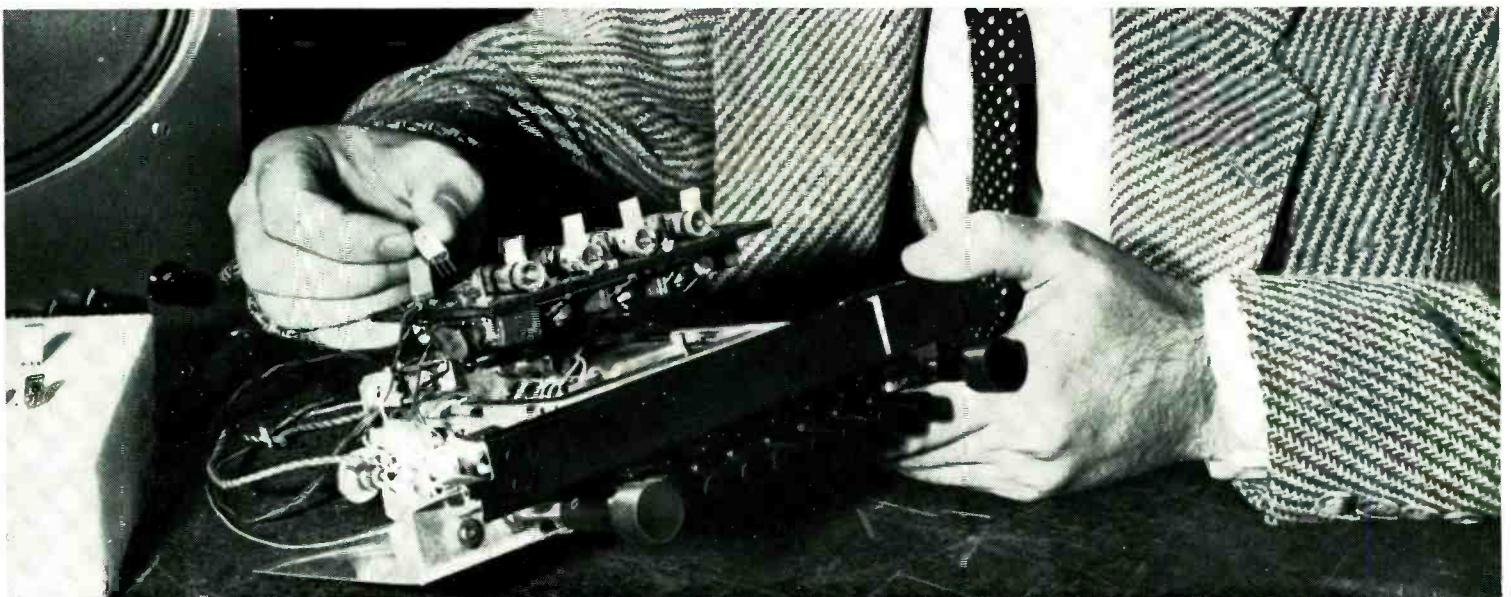



FIG. 8. Electronic eyes enable video teams to record historic military events. Ceremonies shown here are relayed to the video truck where they are recorded on film.

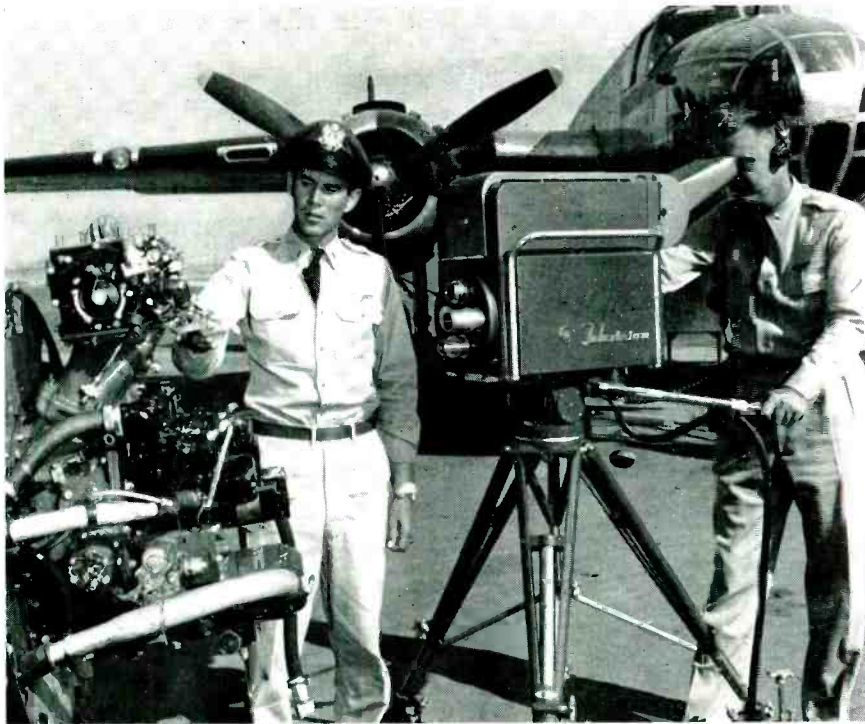
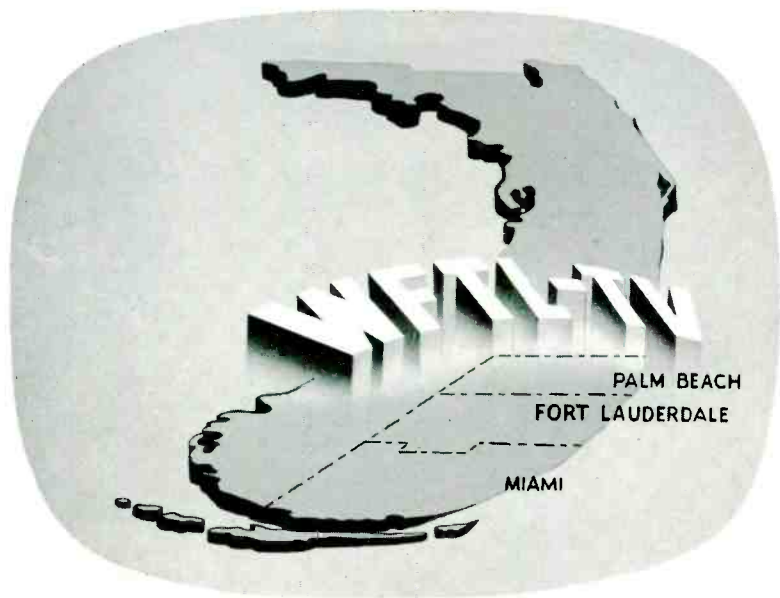

FIG. 9. Realistic training lectures are televised and shown to hundreds of Air Force technicians simultaneously. These telecasts may be recorded on film for even more widespread distribution.

FIG. 10. Television microwave relay units are installed at Hamilton Air Force Base to relay transmissions to outlying areas during the televised weather project.





# WFTL-TV ROUNDS OUT A YEAR OF SUCCESSFUL UHF TV BROADCASTING

FIG. 1. Artist's conception of the building which houses the WFTL-TV, WFTL-AM studios and offices. The exterior bears a moderne motif in striking cobalt blue and deep coral colors.

by **RICHARD NORTHEY**  
Chief Engineer, WFTL-TV-AM



On this first anniversary of the cornerstone laying of WFTL's UHF television station in Southeastern Florida the highlights of the year can be expressed in just two words, "hard work". This, and the cooperation of many who have devoted their careers to the betterment of this wonderful new means of entertainment and education has written success to our first year of broadcasting.

Since early February, 1953, Florida's first Ultra High Frequency station has been beaming its programs over the Southeastern Florida Coast with great success. WFTL-TV, channel 23, began its actual programming on May 5, 1953. Complete coverage extends throughout the Tri-County area of Broward County (Fort Lauderdale area) . . . Palm Beach County to the north and Dade County (Miami area) to the south. Reception is excellent . . . and consistent throughout this entire area.

After a year of rapid progress, the new UHF Station now occupies its own ultra-modern studio building in the heart of Fort Lauderdale's busy downtown section. A striking cobalt blue and deep coral color scheme lends a distinctive touch to the exterior walls of the 4-story building, while the modern reception room, offices and studios carry out a blending theme. The studios are equipped with the very latest in RCA live and film cameras. A complete on-the-premise art service provides rapid creation of commercial cards and titles. Any type of slide and orthographic copy can be telecast. The live camera facilities include a 46 by 31-foot Arena Studio, a "special" studio (25 x 26 feet), and a beautiful roof patio studio . . . appropri-



**NORAN E. KERSTA**

*Executive Vice-President, General Manager  
Tri-County Broadcasting Company*

Before assuming the position of general manager of WFTL-TV and WFTL Mr. Kersta devoted more than 17 years to the development of television with the National Broadcasting Co. As director of television operations with NBC, he directed the advancement of the organization's network TV operations.

Mr. Kersta acted as a consultant on many phases of the industry's development and served with every major industry group including Television Broadcasters Association where, as a director, he collaborated in the formulation of many policies which are currently standard in the industry. He is the author of over 100 television articles and business reports which have appeared in leading magazines and industry journals.

After leaving NBC, Mr. Kersta was affiliated with a New York advertising agency as Vice President in charge of Radio and Television, and a member of the Plans Board. During his stay the company's billing achieved second place in the industry. He also founded the Noran E. Kersta Company TV Consultants, and served sixteen clients in the United States and Canada.

Mr. Kersta received his formal education at Georgia School of Technology, Atlanta, New York University, and The Massachusetts Institute of Technology. He came to Fort Lauderdale in February of 1953 to supervise the installation of and purchase part interest in WFTL-TV. He has made Fort Lauderdale his permanent home.

ately designed for fashion shows. Garden shows and other picturesque outdoor television presentations are skillfully handled . . . all year 'round, of course!

The complete film facilities include a 12 by 14-foot studio, news and film edit-



**FIG. 2. "On-the-Air" shot in main arena studio portrays vivid view of operational layout. RCA Boom and Perambulator supports TV-famous 77-D microphone.**

ing rooms, along with an excellent "Little Theater" viewing room. Equipment includes two RCA film cameras, a "flying spot scanner", two Auricon sound movie 16mm cameras, and a Huston sound movie developer.

The master control room, studios, an-

nouncer's booths, and observation rooms are located on the fourth floor. All general offices are on the floor below. As the visitor steps off the elevator, he is greeted by a gracious informationist in the station's beautiful reception lounge. To the left is the "Little Theater", and dressing rooms.

**FIG. 3. "On-the-Air" shot of popular "Hi Neighbor" show, featuring Jack and Peggy Barry. Seen daily on WFTL-TV, Channel 23.**





FIG. 4 (above). Master control in operation at WFTL-TV. This bank of RCA monitors, switching and control equipment faces main arena studio.

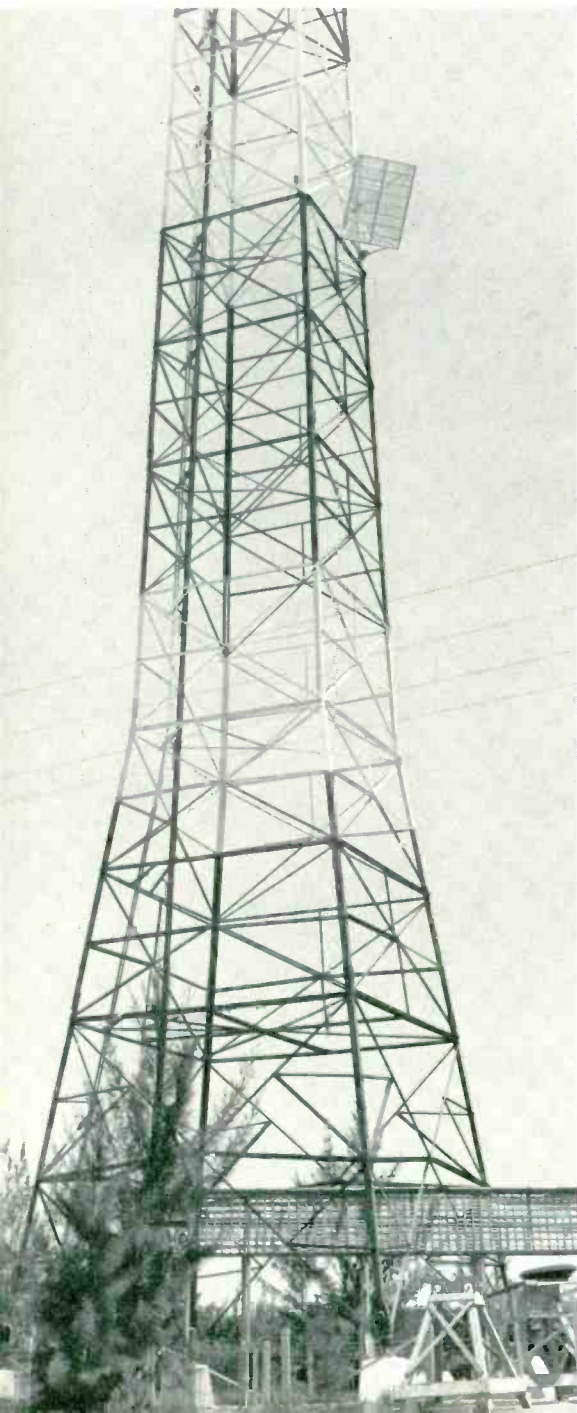

The well-planned offices are separated from the entrance room by large, colorful double doors. Behind these doors are executive headquarters, a main center office area, and cialized departments such as: news, traffic, individual side offices for the various spe-sales, bookkeeping, and art . . . along with a film laboratory (which includes a film make-up and film shipping room).

WFTL-TV has a staff of forty people who combine their services with Fort

FIG. 5. A segment of the AM tower on outskirts of town which supports the UHF TV antenna. Note passive reflector which intercepts STL signal from downtown studio building.

FIG. 6. Microwave relay receiver "dish" at base of tower which delivers signal to transmitter.

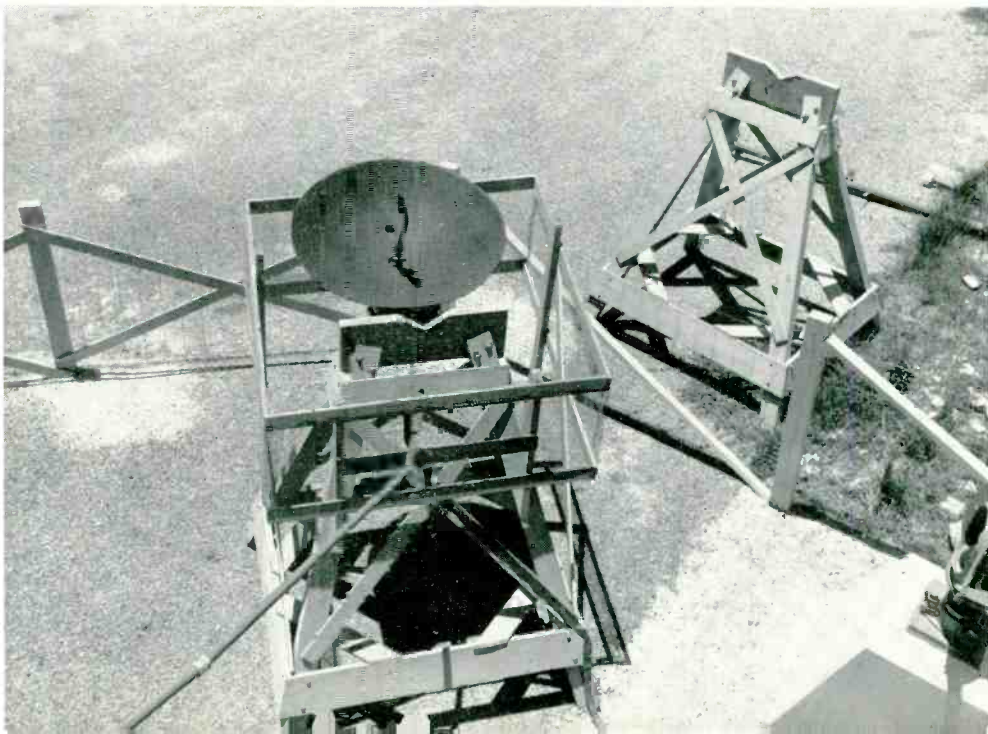

Lauderdale's leading AM radio station, WFTL. The co-working television and radio staffs occupy the entire third floor. Both stations are owned and operated by the Tri-County Broadcasting Company, and are affiliated with Broward County's strongest, fastest-growing newspaper, "The Fort Lauderdale Daily News".

WFTL-TV is also affiliated with the National Broadcasting Company. The UHF transmitter is located in the Southeast section of the city.

WFTL-TV is located in the approximate center of a seventy-four mile contiguous market strip, from Palm Beach to Miami. No longer is the city of Miami considered the focal point of Southeastern Florida.

In the 1950 to 1953 era the "Gold Coast" has become nationally recognized as the fastest growing area in the United States. The City of Fort Lauderdale itself has doubled its population in that time. The twenty mile area North of the City of Fort Lauderdale has increased its population 64% since 1950, and the area twenty miles South of Fort Lauderdale, which reaches the Northern limit of the city of Miami, has increased 58.7% in population since 1950. The natural restrictions on this market have literally forced the trend Northward from Miami. This seventy-four mile strip is bounded on the West by the Everglades, and on the East by the Atlantic Ocean. Therefore this market is unique in design. More like a "race track" than a "blossom".

WFTL-TV went on the air commercially with an estimated 5,000 circulation in UHF receivers. Current reports from the Florida Power & Light Company indicate that the present circulation is in the order of 116,000. WFTL-TV was the "second" station in a TV-starved market. Therefore, it



FIG. 7. Microwave transmitter "dish" atop downtown studio building delivers TV program signal to transmitter building via passive reflector and receiver dish shown in Figs. 5 and 6.



FIG. 8. Exterior view of transmitter building located at 1785 Southeast 15th Street, Fort Lauderdale.

is easy to realize how the viewing audience can grow from a mere 5,000 to a phenomenal 116,000 in such a short time. This growth is also significant in what the future holds.

One of the best reasons why WFTL-TV has achieved such a vast viewing audience

in such a short period is the fact that the network programming has been second to none. In the fall of 1953 the NCAA Football series was carried on Channel 23. The "Camel News Caravan", "My Little Margie", "Dennis Day", "Eddie Fisher", "Circle Theatre", "Life of Riley", "The

Dave Garroway Show", "Treasury Men in Action", and many other distinguished NBC shows are seen regularly over Channel 23. With the present pace of top programming and excellent reception, WFTL-TV expects to continue growing by leaps and bounds!

FIG. 9. Interior of transmitter building. (Left-to-right), RCA TTU-1B television transmitter, (foreground) TTC-1B transmitter control console, (racks, left-to-right) 1—relay receiver control, audio oscillator, 2—power supplies and audio equipment, 3—monitoring equipment.

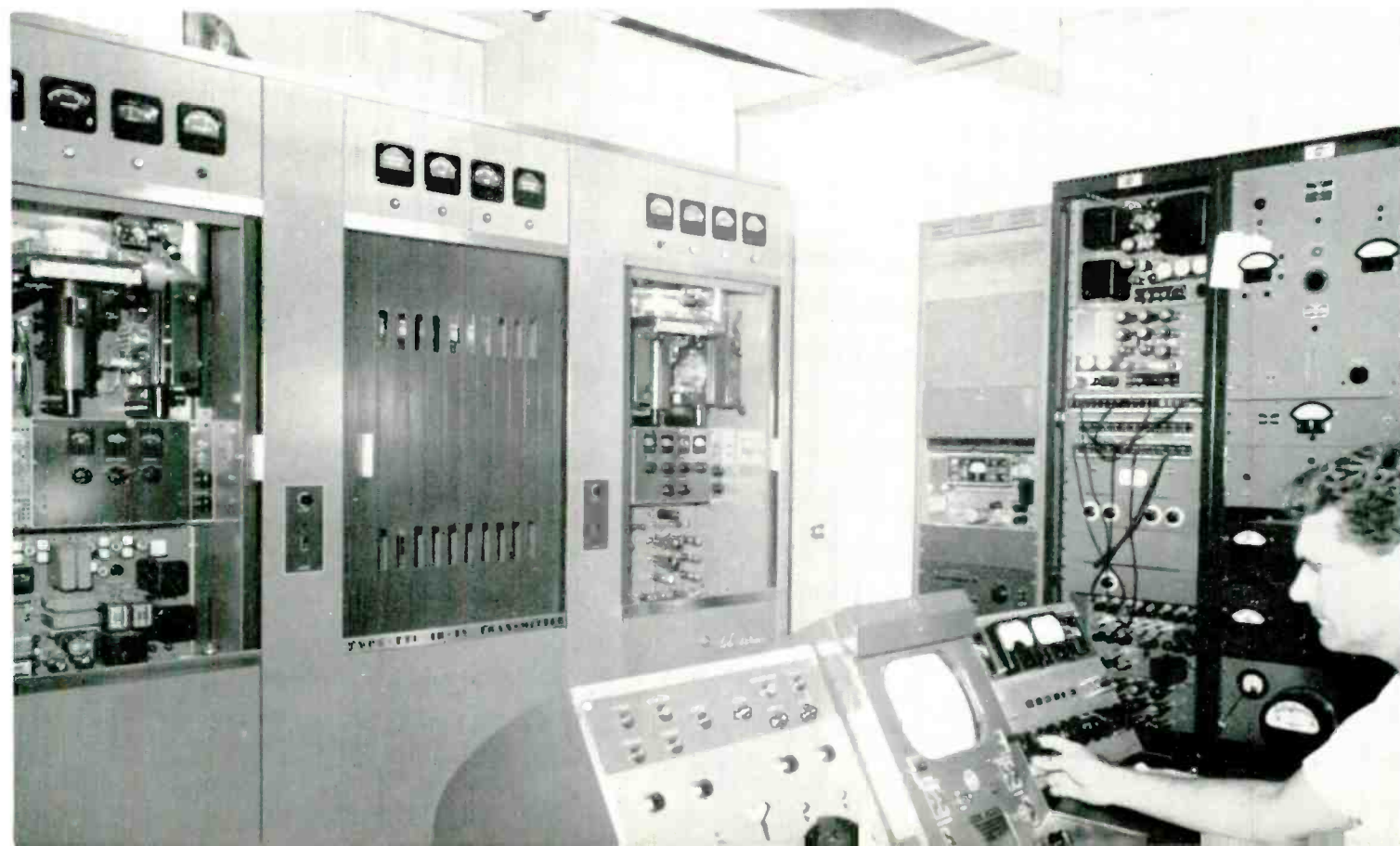

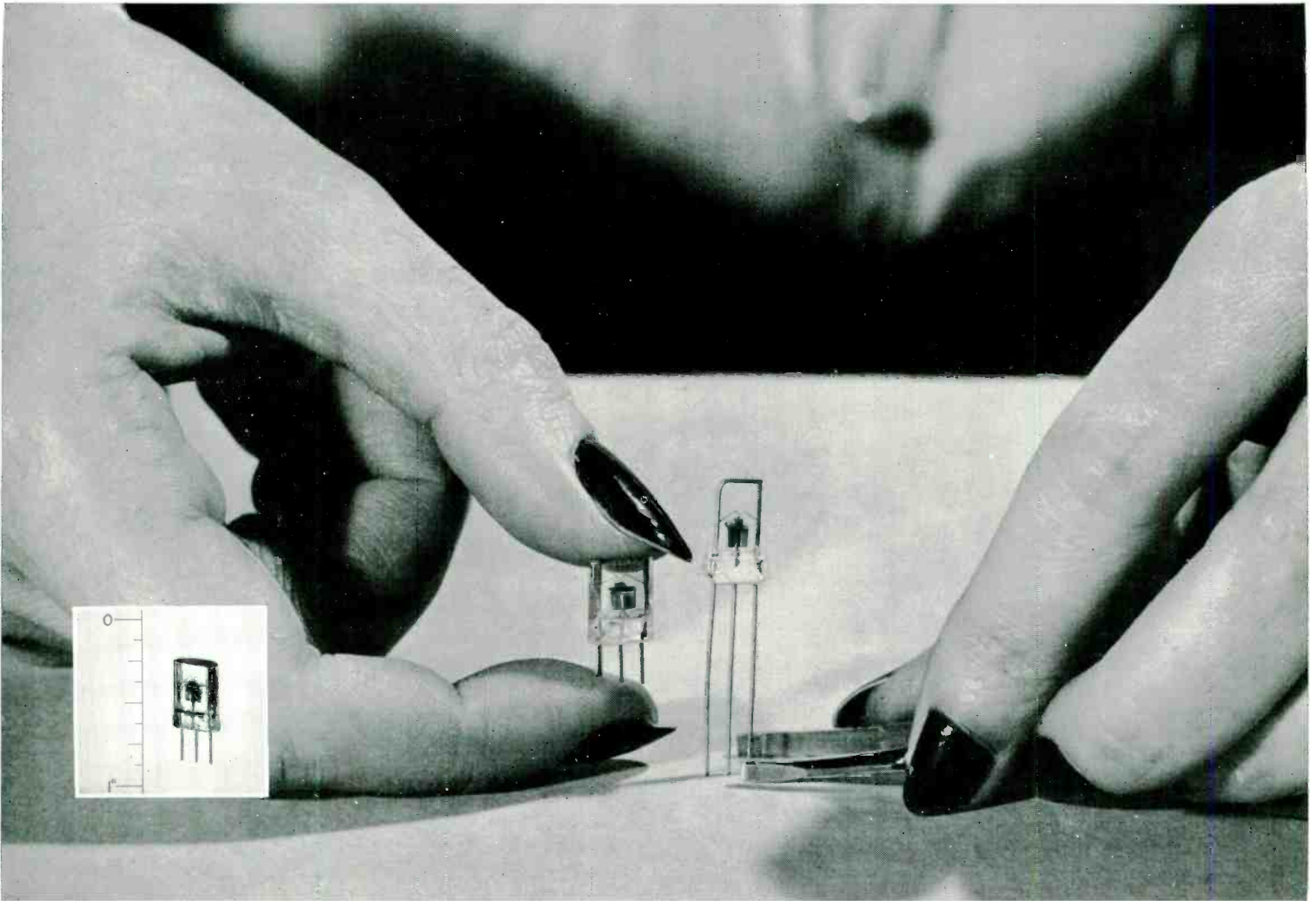

FIG. 1. Less than half the size of a metal paper clip, the diminutive transistor points the way to development of many types of miniaturized electronic equipment.

# SURVEY OF TRANSISTOR DEVELOPMENT\*

EDITOR'S NOTE: From time to time we have had requests from readers for an authoritative article on transistors. After looking into the subject we decided that the best introductory article on this subject was one written a little over a year ago by B. N. Slade of our Tube Division and which appeared in RADIO AND TELEVISION NEWS originally.

In reproducing this article here we have added a number of illustrations not originally included. Most of these are photographs of transistorized equipment items produced by RCA Laboratories. They are included to give an idea of the kind of products in which transistors may be used commercially at some time in the future.

It should be noted that since this article was written further progress in transistor development has occurred. It is our intention to cover these more recent developments in a second article which will appear in a forthcoming issue.

By **B. N. SLADE**  
 Tube Division  
 Radio Corporation of America  
 Harrison, N. J.

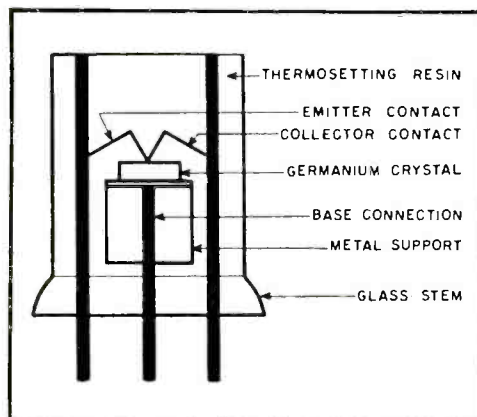

As a result of the progress made in the design and manufacture of the transistor, a germanium-crystal triode, this electronic device looms today as a desirable supplement to the electron tube in many applications. The development of the transistor may make possible new types of electronic equipment which will use not only transistors, but also electron tubes, and other electronic components in increasing quantities. In fact, the commercial application of transistors appears to be not too distant, although a considerable amount of time is

FIG. 2. Construction details of the RCA developmental point-contact transistor.

\* Reprinted in part from "Radio and Television News," September, October and November, 1952 issues.

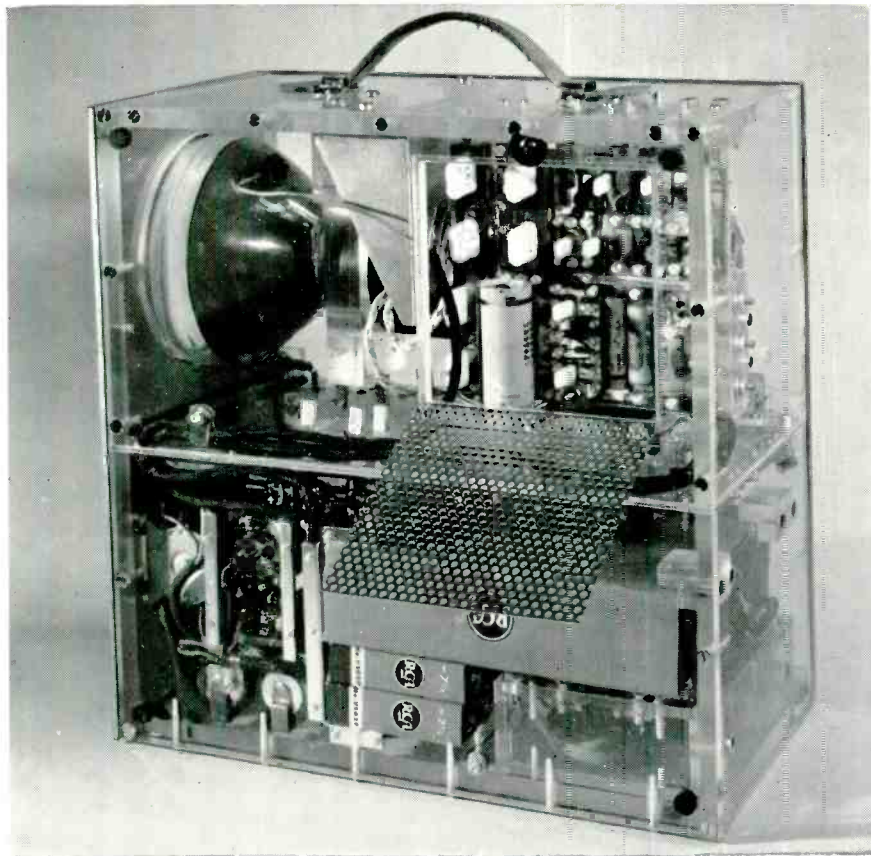

FIG. 4. Side view of the experimental portable battery-operated television receiver. Housed in a cabinet 12 x 13 x 7 inches—about the size of a portable typewriter case—its weight is 27 pounds. It operates from a self-contained loop antenna.

probably still required before these units become commercially available on any sizable scale.

The intense interest in the transistor shown by electron-tube research and development engineers may be attributed to the fact that the transistor performs functions similar to those of triode-type electron tubes, although the mechanism of conduction is quite different. The transistor is of particular interest to equipment designers, who see many circuit possibilities in its characteristics. It is very small in size, and the power requirements for its operation are extremely low. When suitable circuits are developed, space and power requirements for complex electronic equipment may be simplified to a large degree by the use of transistors. Another promising feature is that the operating life of certain types of transistors shows indications of being very long, thus minimizing replacement problems. The physical ruggedness of

FIG. 5. The portability of an experimental battery-operated television receiver which uses transistors and no tubes except kinescope is demonstrated by George C. Szeklai, staff member of the David Sarnoff Research Center of RCA at Princeton, N. J.

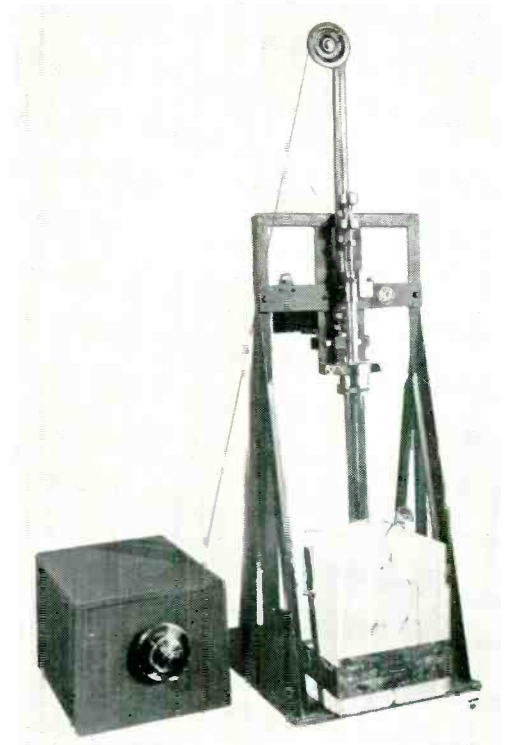
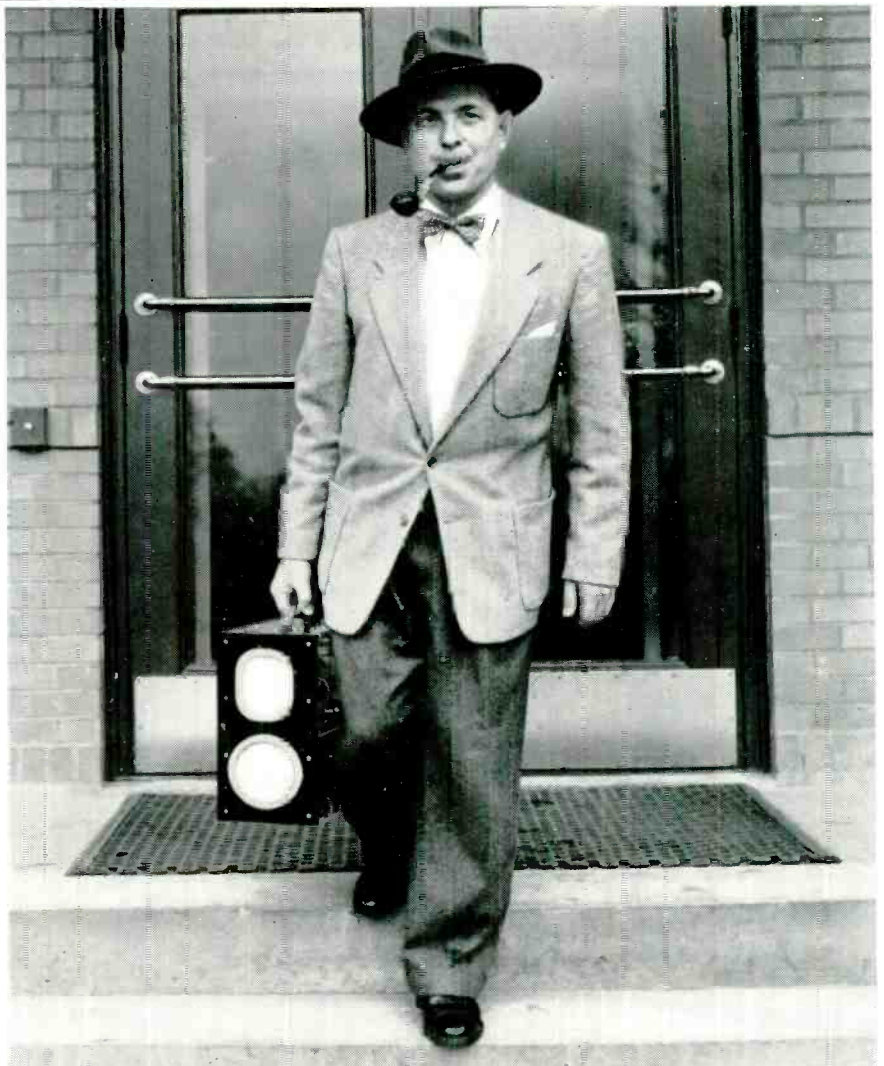

FIG. 3. RCA's apparatus for "growing" the single germanium crystals used in making transistor units.



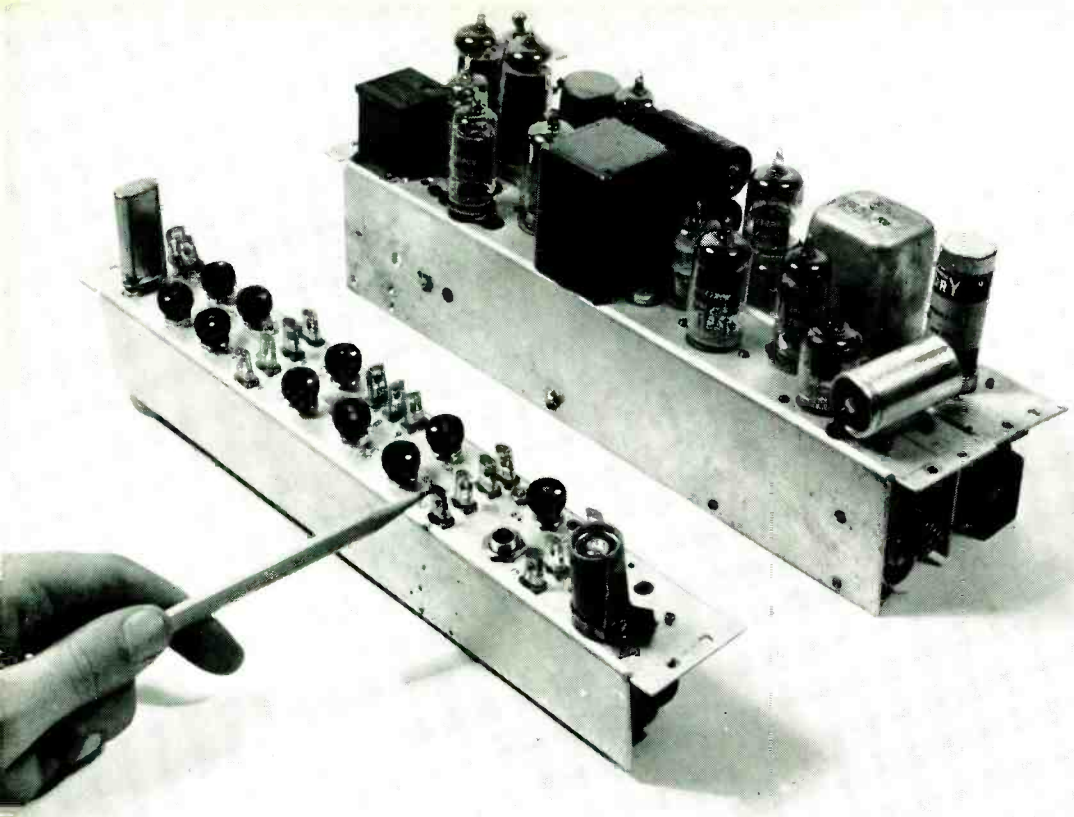

FIG. 6. In the foreground, a unit of an experimental "Walkie-Lookie" in comparison with a corresponding tube-equipped unit which was used in earlier experiments. Seventeen point-contact transistors perform the function of twenty-two tubes.

the transistor offers other obvious advantages. In addition, the transistor requires no "warm up" time but will operate instantaneously upon application of voltage to its electrodes.

The limitations of the present developmental transistors, however, must not be overlooked. Transistor characteristics vary with ambient temperature changes, the noise is high compared with that of electron tubes, and the power output is relatively low. Nevertheless, when the favorable characteristics of the transistor are weighed against its limitations, it appears that this device, even in its present developmental stage is destined for use in many applications. Further improvements in its characteristics undoubtedly will create new and expanding fields for its use. At the same time, the principles of semi-conduction in solids may be expected to play an increasing part in the development of many new electronic devices, of which the present transistor is but the first.

Two types of transistors, the point-contact type and the junction type, will be discussed in this series. The point-contact transistor will be discussed first, and at greater length, because the development of this device has reached a more advanced stage and more is known about its performance with respect to frequency of operation, life, and uniformity of characteristics. However, the junction transistor promises to be at least as important as the point-contact transistor in many applications.

The heart of the transistor is the germanium crystal. Germanium is a semi-con-

ductor, a metallic-like substance having conductivity greater than that of an insulator but less than that of a conductor. Its resistance, in contrast with that of metals, decreases as its temperature is raised. Other types of semi-conductors, such as silicon, lead sulphide, and selenium, have been used in transistor work, but, to the present time, germanium has proved the most successful.

Germanium is known mostly for its use in point-contact diode rectifiers which have been available commercially for several years. These devices have achieved widespread use in many present-day applications.

In the United States germanium is obtained most frequently as a by-product of zinc mining. It has also been obtained in considerable quantities in Great Britain from flue dust residue. Manufacturers of germanium products receive this substance in the form of a germanium dioxide powder. The conversion of the dioxide into crystals for use in transistors involves some of the most important and critical processes in the manufacture of germanium devices. The electrical characteristics of the transistor are dependent to a considerable degree upon the characteristics of the germanium. The control of transistor characteristics to acceptable tolerances depends upon the uniformity of the germanium.

FIG. 7. A cigar-size experimental microphone-transmitter, modulated by a tiny built-in dynamic microphone. Employs two developmental junction type transistors, coil and battery.

The resistivity of the germanium, an important factor in transistor operation, is dependent upon the presence in the germanium of minute quantities of certain impurities. If no impurities are present in the germanium crystal, no transistor action takes place. If too many impurity atoms are present, however, the germanium becomes too conductive and transistor action is adversely affected. The impurities which enhance the transistor operation should be present in the ratio of less than one atom to every 10,000,000 germanium atoms. Because of their exceedingly low concentration, it is quite difficult to detect the quantity of impurities present in the germanium crystal. Some of these impurities are actually present in the germanium dioxide as it is delivered to the manufacturer. It is desirable, however, to remove as many impurities as possible by purification techniques so that controlled amounts of them may be added to obtain the desired values of resistivity.

The initial process in the conversion of germanium dioxide to the final crystals for transistor use is the reduction of the dioxide to a germanium metallic powder. This process is performed in a hydrogen atmosphere at a temperature of approximately 650 degrees Centigrade. The powder is then melted at a temperature of approxi-





ing the electrons in their bonds can be overcome, and a few electrons may be released from their bonds. Because of the release of electrons by thermal energy at room temperature, germanium does have some conductivity even in its pure state. The resistivity of pure germanium, a semiconductor, is 60 ohms per centimeter cube at room temperature. The resistivity of insulators is much higher than that of semiconductors; that of metal conductors is much lower. In a metal conductor, there are a large number of conduction electrons which are not bound in a fixed position but are free to flow throughout the metal, thus contributing to a very low resistivity. Table 1 gives a comparison of resistivities at room temperature of pure germanium, insulators, and conductors.

The normal conductivity of germanium must be increased to obtain transistor operation. This additional conductivity is obtained by adding impurities to the crystal, as was mentioned previously. The impurities which may be present in germanium are of three types. Fig. 15 illustrates how one type of impurity can add conduction electrons to the crystal. If impurities having five valence electrons per atom are added, each impurity atom (A) takes the place of a germanium atom and four of the five valence electrons form bonds with four electrons of adjacent germanium atoms. The fifth electron (B) from the impurity atom is free to wander about the crystal and contributes to its conductivity in a manner similar to that of free electrons in a metallic conductor. As more impurity atoms of this type are added, the conductivity of the germanium increases and the resistivity decreases. Germanium having an excess of electrons due to the addition of such impurities is known as "n"-type germanium, that is, germanium having an excess of negative charges. "N"-type impurities are also known as "donor" impurities because they donate electrons to the crystal conductivity. Typical donor impurities are arsenic, antimony, and phosphorus.

Conduction in germanium may also be increased by adding a second type of impurity such as aluminum, boron, or indium. Fig. 14 illustrates how these impurities, known as "p"-type impurities, create a deficiency of electrons. If impurities having three valence electrons per atom are added, each impurity atom (A) takes the place of a germanium atom and its three valence electrons form electron-pair bonds with electrons of neighboring germanium atoms. In order to fit completely into the valence bond structure of the crystal, the impurity atom borrows an electron from

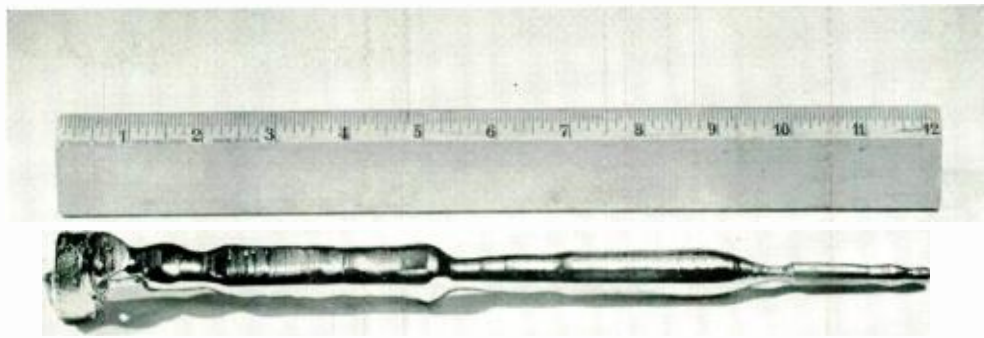

FIG. 12. A single germanium crystal grown in the crystal-growing apparatus of Fig. 3.

an electron-pair bond from somewhere else in the crystal (B), thus leaving a net positive charge in the half-empty bond. This positive charge is known as a "hole"; these holes contribute to the conductivity of the crystal in much the same manner as electrons because they also can move from atom to atom. As more "p"-type impurities are added, more holes are formed and the conductivity of the crystal is increased. The main distinction between the two types of germanium is that the "n"-type has an excess of electrons while the "p"-type has an excess of holes. Both "n" and "p" types are used in transistors; in certain types of transistors both exist in different parts of the same crystal. The "n"-type germanium is used predominantly in the present point-contact transistors.

The third type of impurity includes those which do not have three or five valence electrons. These impurities, which are present in very small quantities, may not affect the conductivity of the germanium, but may disturb the crystal structure and adversely affect transistor properties.

The role which "p"-type and "n"-type impurities play in determining the resistivity of germanium may be appreciated by noting the change in resistivity which occurs with a change in the ratio of impurity atoms to germanium atoms. The density of germanium atoms in pure germanium is approximately  $4.5 \times 10^{22}$  atoms per cubic centimeter; there are approximately  $3.7 \times 10^{19}$  germanium atoms in the average pellet used for a transistor. If  $4.5 \times 10^{14}$  "n"-type impurity atoms are

FIG. 13. A three-dimensional model of the atomic structure of the germanium crystal.

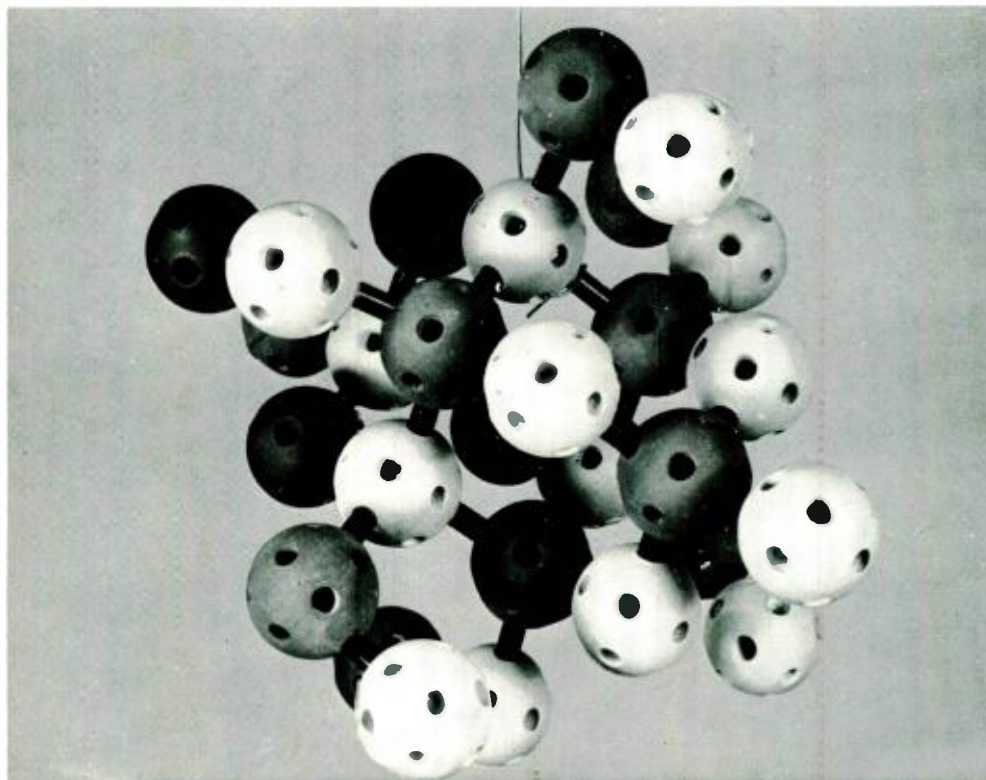

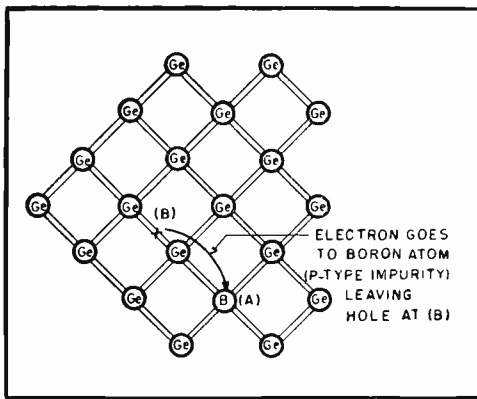

FIG. 14. The effect of "p"-type impurities on the conductivity of germanium crystals.

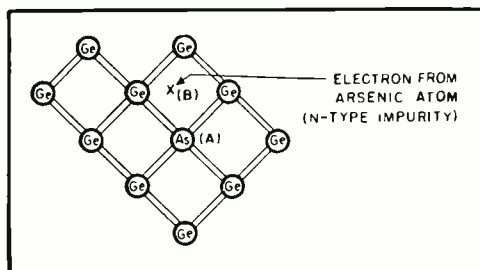

FIG. 15. The effect of "n"-type impurities on the conductivity of germanium crystals.

MATERIAL	RESISTIVITY (ohms per cm <sup>3</sup> )
Semi-conductor:	
Germanium	60
Insulator:	
Glass	$9 \times 10^{13}$
Mica	$9 \times 10^{15}$
Conductor:	
Copper	$1.7 \times 10^{-6}$
Platinum	$10 \times 10^{-6}$

TABLE 1. Resistivity of pure germanium, insulators, and conductors compared.

added to each cubic centimeter of pure germanium, or one impurity atom for every 100,000,000 germanium atoms, the resistivity of the germanium drops from 60 ohms per centimeter cube to approximately 3.8 ohm per centimeter cube, a value which is satisfactory for use in a point-contact transistor. If  $4.5 \times 10^{15}$  impurity atoms are added to the germanium, however, the resistivity drops to 0.38 ohms per centimeter cube, a value which is too low for transistor use. This example illustrates how critical are the quantities of impurities which must be added. The problem is further complicated by the fact that "p"-type impurities may be present in the germanium ingot when the "n"-type impurities are introduced, and the holes and electrons furnished by the two types of impurities may cancel each other out. If both

type of impurities were present in equal amounts, the resistivity would be the same as if no impurities were present.

### Fabrication Process

An appreciation of some of the unique characteristics of the transistor may be obtained from an examination of its construction. A photograph of an RCA developmental point-contact transistor is shown in Fig. 1. Fig. 2 is a diagram of its construction. This transistor consists essentially of two rectifying point electrodes which make contact with a small pellet of germanium. These electrodes are known as the emitter and the collector. A third electrode, the base, is in low-resistance contact with the germanium crystal. The emitter, collector, and base form the three electrical connections to this germanium-crystal triode. The complete assembly is then embedded in a thermosetting plastic to provide ruggedness and freedom from atmospheric contaminants. The final process, and one of the most important, in transistor fabrication is electrical forming. In this process, relatively large surges of current are passed through the collector to the base.

### Point-Contact Rectification

Before the operation of the transistor in specific circuits is covered, it is important to discuss briefly the current rectifica-

tion obtained when the metal point electrode makes contact with the germanium-crystal surface. When this contact occurs, a nonlinear relationship exists between a voltage applied to and the current flowing through the point of contact. A so-called "barrier" to the flow of current will be present or absent depending upon the polarity of the voltage applied to the metal point. For instance, if a metal point contacts the surface of an "n"-type germanium, the barrier will be absent and a large forward current will flow if the metal point is biased positively with respect to the crystal. If the point is biased negatively with respect to the crystal, the barrier will be present and only a small reverse current will flow. If the germanium is a "p"-type, the forward current will flow when the point is biased negatively with respect to the crystal. One explanation of this barrier is that it is a very thin layer at the surface of the crystal which acts as an insulating layer. If the germanium resistivity is too low, this insulating barrier at the surface does not exist because of the large number of current carriers present both in the interior and on the surface of the germanium, and poor rectification results.

Fig. 18 is a diagram of a transistor amplifier circuit utilizing the "n"-type transistor. In this circuit the collector is biased

FIG. 16. (Foreground) Transistors point way to new small-size units in electronic computers. Pencil points to one of five developmental point-contact transistors which do the job of the four tubes and four transformers of the rear unit.

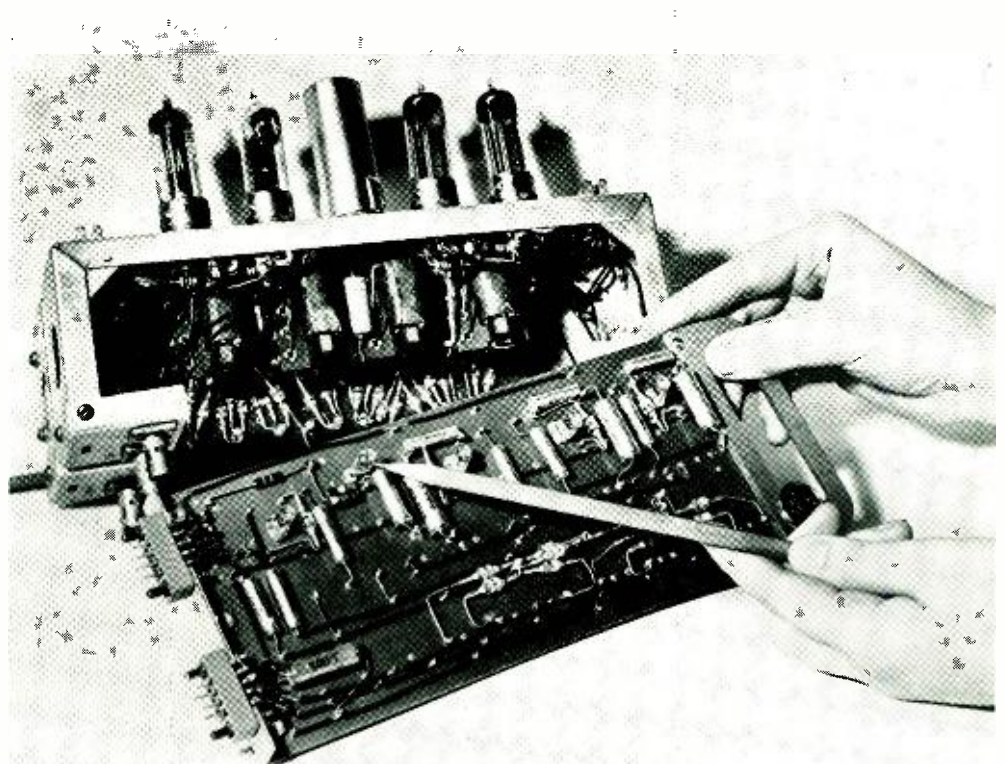

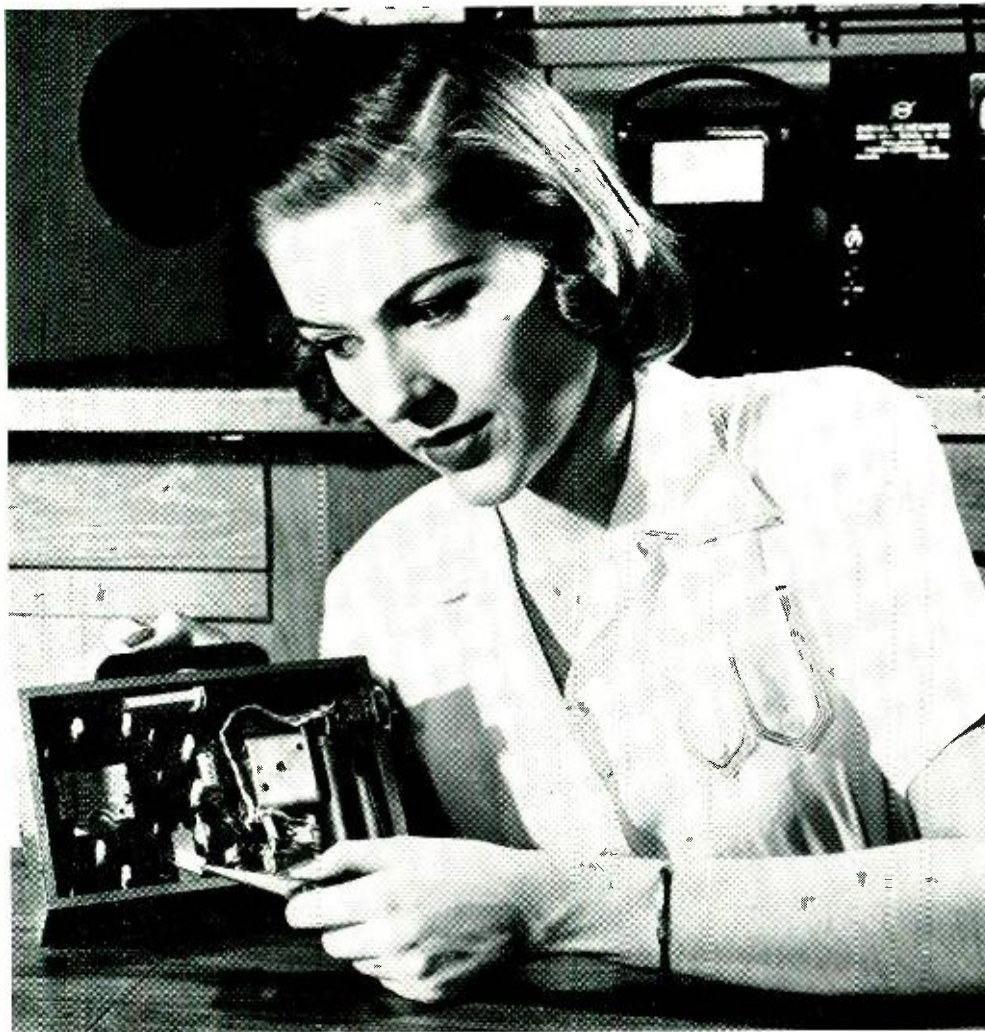

FIG. 17. Transistors in an experimental personal-type AM receiver developed at the David Sarnoff Research Center of RCA at Princeton, N. J., permit tremendous reduction in size, battery weight and power consumption.

negatively with respect to the base. The emitter, also shown in Fig. 8, is biased positively with respect to the base. If we first assume that no voltage is applied to the emitter, the collector will draw approximately 0.5 milliamperes if a negative voltage of 25 volts is applied to the collector contact. Then, if a positive voltage is applied to the emitter contact, electrons will be drawn into the emitter and a flow of holes from the emitter will be attracted to the negative field of the collector, thereby increasing the collector current appreciably. Now, with both the emitter and collector drawing current, a small signal voltage is applied to the transistor as indicated in the circuit diagram. As the applied voltage swings positive, the emitter current will increase, thereby increasing the collector current by supplying additional holes. On the negative swing of the signal voltage, the collector current will decrease. If the assumption is made that every unit of hole current which leaves the emitter reaches the collector, it follows that a small change in emitter current will result in an equivalent change in collector

current, producing a current amplification factor of one. The current amplification factor is defined as the ratio of the change in collector current to a change in emitter current when the collector voltage is maintained constant. A very significant characteristic of the transistor, however, is that this current amplification factor may actually be two or greater. Factors greater than unity are made possible by the electrical "forming" process. One explanation of the results of this process is that a space charge of holes is formed around the collector point. It appears that this positive charge increases the electron flow from the metal collector to the germanium and account for the increased current amplification.<sup>1</sup>

The transistor amplifies not only input current, but also power. Because the emitter is biased in the forward direction, only a small impedance to the flow of current exists; therefore, the input impedance of the transistor is fairly low, on the order of 500 ohms. The collector, on the other

<sup>1</sup> Shockley, W.: "Electrons and Holes in Semiconductors," D. Van Nostrand, 1950.

hand, is biased in the reverse direction; it offers a higher impedance, therefore, to the flow of current. The collector resistance comprises the greatest portion of the output impedance of the transistor. The load resistance, to provide a proper impedance match, must be fairly high, on the order of 10,000 to 20,000 ohms. With the input signal applied to the transistor at a low impedance and the output taken from a high impedance, power amplification results.

In the "p"-type transistor, electrons are emitted from a negatively biased emitter and are collected at a positively biased collector. In general, the "p"-type transistor<sup>2</sup> has characteristics similar to the "n"-type unit, except that in operation all battery polarities are reversed.

### Transistor Frequency Response

The frequency response of the point-contact transistor is limited by the transit time of the holes or electrons; transit time is the time it takes the holes or electrons to travel from the emitter to the collector. The transit time in seconds may be calculated approximately through use of the expression  $S^3/\rho\mu I_e$ , where  $S$  is the contact spacing or the distance between the emitter and collector in centimeters,  $\rho$  is the resistivity of the germanium in ohm-centimeters,  $\mu$  is the mobility of the holes or electrons in centimeters squared per volt-second, and  $I_e$  is the emitter current in amperes. Since an improved frequency response results from a small transit time, it can be seen from this expression that the response can be improved by using germanium of high resistivity and small contact spacings. The mobility of the holes or electrons is the velocity with which they move through the germanium when an electric field is applied. In the case of "n"-type germanium, holes travel from the emitter to the collector; in the case of "p"-type germanium, electrons travel from the emitter to the collector. The mobility of electrons is greater than that of holes and, consequently, the frequency response of "p"-type germanium is slightly better than that of "n"-type germanium, provided that the contact spacings and resistivities are comparable.

The frequency response may be defined as the measure of the change in current amplification with increasing frequency. The current amplification factor of certain types of close-spaced point-contact transistors drops approximately 3 db. at 10 mc. A 3-db. drop in gain has been chosen to

<sup>2</sup> Pfann, W. G. and Scaff, J. H.: "The P-Germanium Transistor," Proceedings of the I.R.E., Vol. 38, pages 1151-1154, October, 1950.

define the cut-off frequency. This method of measuring frequency response, however, defines only one parameter as a function of frequency. If the power gain of the device is measured as a function of frequency in an amplifier with a high-impedance load, the response of the transistor deteriorates more rapidly. A transistor having a 3-decibel drop in the current amplification factor at 10 megacycles may have a cut-off of voltage or power gain at 4 megacycles or less.

### Wide-Spaced Transistors

The frequency of operation of point-contact transistors decreases fairly rapidly with increased point spacings. Since the transit time of the electrons or holes increases as the point spacing increases, in theory the frequency response of the transistor varies inversely as the cube of the spacing. However, some interesting studies have been made of "n"-type transistors having wide spacings between contacts,<sup>3</sup> and these devices appear to have some useful characteristics. If germanium having high resistivity is used, transistor power gain and current amplification are relatively independent of the separation of the points up to approximately 0.015 inch. As

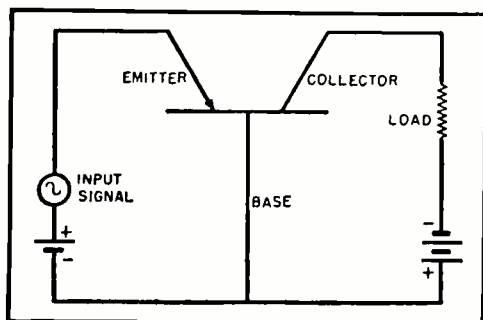

FIG. 18. Transistor amplifier circuit.

the spacings increase, however, the effect of the collector upon the emitter decreases, that is, the feedback resistance decreases. A transistor having a feedback resistance of 200 ohms at 0.002-inch spacing of the contacts would have only 50 ohms at 0.015-inch spacing. This value of feedback resistance for the wide-spaced transistors is low enough to assure short-circuit stability while values of power gain as high as 23 decibels are maintained. Even though the frequency-response limit varies inversely with the point spacing, the cut-off of the current amplification factor of the wide-spaced transistor is approximately 100 kilocycles because the resistivity of the germanium is higher than that used in

<sup>3</sup> Slade, B. N.: "A High Performance Transistor with Wide Spacing Between Contacts." RCA Review, Vol. XI, No. 4, page 517, December, 1950.

narrow-spaced units. The other characteristics, except for the low internal feedback, are similar to those of the close-spaced transistor.

### Power Considerations

The power capabilities of point-contact transistors are low and considerably limit the use of these devices. Most point-contact transistors do not withstand a collector power dissipation greater than 200 milliwatts. If the efficiency of operation as a class A amplifier is assumed to be 30 percent, only 60 milliwatts of power output may be obtained from one stage of a transistor amplifier. A conservative figure for operation would be somewhere between 30 and 40 milliwatts. There are, however, many applications in which some benefit may be obtained from a device which operates at low power dissipations. Consequently, the greatest opportunities for the use of point-contact transistors lie in those applications where power output is of relatively little importance and conservation of power is of primary importance.

The power-handling capacity of the point-contact transistor is limited largely because of thermal effects at the collector point. Considerable heat is generated at this point of contact when a current is passed through it. Germanium is a fair conductor of heat and, consequently, some of the heat is conducted away from the point of contact through the germanium crystal and away from the crystal by the metal support. If too large a value of current is passed, however, the germanium and adjacent parts are unable to carry the heat away rapidly enough. If the collector point becomes too hot, the collector resistance decreases and a change occurs in the collector bias current and also in the voltage drop across the collector. Some permanent damage may occur if the transistor is operated at too high a dissipation. It is desirable, therefore, that the mechanical construction of the transistor be designed for the best possible heat conductivity away from the crystal. By increasing the size of the crystal support and adding cooling fins, the allowable dissipation of the transistor may be increased to 500 milliwatts or more, thus increasing the power output of the transistor.

The amount of conduction of heat away from the contact area varies inversely with the ambient temperature. As the ambient temperature is increased, the temperature at the point of contact becomes too great and the collector resistance is reduced. Changes in other properties of the transistor, such as the emitter resistance, transfer resistance, and internal feedback re-

sistance, may also occur. The net result of these changes is a loss of power gain, changes in bias conditions, and possible permanent damage to the transistor. For best operation, germanium transistors should be operated at temperatures below 60 degrees centigrade. The maximum dissipation ratings of the device should also be reduced as ambient temperatures are increased above normal room temperature. At ambient temperatures below 25 degrees centigrade the situation is less critical, and if the temperature is low enough higher dissipations may be used without loss of stability.

### Junction Transistors

Other developmental germanium-crystal devices, known as "p-n" junction transistors, have somewhat different characteristics from those of the point-contact transistor. In comparison with currently produced point-contact types, the junction transistors have lower noise, higher power gain, greater efficiency of operation, and higher power-handling capabilities. These improved characteristics, however, are not obtained without some loss in frequency response. Table 2 compares average values of several characteristics of the two types of transistors.

Two types of junction transistors have been developed. The "n-p-n" junction transistor<sup>4</sup> is composed of alternate n, p, and n layers of germanium grown from a single crystal, as illustrated in Fig. 19. The center layer of "p"-type germanium is very thin; its thickness may be as little as 0.001 inch. Low-resistance contacts to the "n"-areas form the emitter and collector, and a low-resistance connection to the "p"-layer constitutes the base terminal. The principle of operation of the junction transistor is somewhat different from that of the point-contact transistor in that the rectification takes place at the junctions between the p- and n-type layers rather than at point contacts. In the point-contact transistor, holes or electrons drift from the emitter to the collector under the influence of electric fields. In the "n-p-n" junction transistor, electrons diffuse through the p-type layer and are attracted to the collector. The center layer has an excess of holes, but if this layer is thin enough, most of the electrons entering the base region from the emitter will reach the collector region without recombining with the holes. Practically all the electrons leaving the emitter reach the collector, thus resulting in a current amplification of approximately one,

<sup>4</sup> Wallace, R. L., Jr. and Pietenpol, W. J.: "Some Circuit Properties and Applications of N-P-N Transistors." Proceedings of the I.R.E., Vol. 39, No. 7, pages 753-767, July, 1951.

but this type of transistor cannot attain current amplifications greater than one unless more complex junctions are introduced. High power gains are obtained as a result of the tremendous impedance step-up between input and output circuits. The emitter junction is biased in the forward direction, and since the forward resistance of the junction is very low, the input impedance of the device is as low as 25 to 100 ohms. The resistance of the collector junction, which is biased in the reverse direction, is very high, on the order of several megohms, thus resulting in a very high output impedance. This tremendous difference in impedances can result in power gains of over 40 decibels.

Another junction device, the "p-n-p" transistor (see inset Fig. 24), is formed by diffusing two "p"-type impurity metals on opposite faces of a piece of "n"-type germanium. Atoms diffuse from these impurity metals into the germanium at high temperatures converting a portion of the "n"-type germanium to "p"-type, thus forming "p-n" junctions.<sup>5</sup> In this transistor, the emitter is biased positively with respect to the base, and the collector is biased negatively with respect to the base. Hole carriers are injected by the emitter and arrive at the collector, resulting in a current amplification factor of approximately one, as in the "n-p-n" transistor.

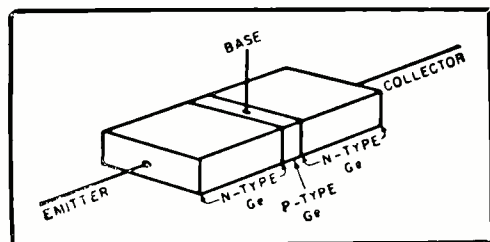

FIG. 19. Arrangement of "n" and "p" layers in an "n-p-n" type junction transistor.

An appreciation of some of the most outstanding qualities of the junction transistor may be obtained from a study of the output characteristics. The junction transistor has a constant current amplification factor and output resistance down to very low collector voltages. Operation with power inputs as low as 0.6 microwatt have been reported. This input is about one-ten-thousandth the power dissipation required to operate the point-contact transistor, and less than one-millionth the power required to heat the cathode of most vacuum tubes. The almost ideal static characteristics show that the junction transistor can operate close to 50 per-cent effi-

<sup>5</sup> Saby, J. S.: "Recent Developments in Transistors and Related Devices," Tele-Tech, Vol. 10, No. 12, December, 1951.

ciency as a class A amplifier. Although the junction transistors for which these characteristics are plotted can operate at only limited power dissipations, approximately 50 milliwatts, design of these devices for operation at 2 watts or greater is possible.

### Transistor Amplifier Circuits

It is interesting to compare the amplifier circuit properties of the point-contact transistor and the junction transistor. A number of amplifier circuit connections are possible to obtain several combinations of input and output impedances. In the case of the point-contact transistor, however, special consideration must be given to the circuitry. If the internal feedback resistance is too large, and if the current amplification factor is greater than unity, the circuit may become unstable and oscillations will occur. The internal feedback resistance varies with the operating point. The current amplification factor may also vary somewhat with collector voltage, thus making the circuit stability dependent upon the d.c. biases. Resistance placed in series with the emitter and collector leads helps to suppress these oscillations, but may decrease the power gain of the circuit. For example, the input impedance to the grounded-base amplifier circuit shown in Fig. 21 is approximately 500 ohms and the output impedance is approximately 10,000 ohms. If the internal feedback resistance is too large, additional resistance necessary to stabilize the circuit will exceed these impedance values and, therefore, reduce the gain of the circuit. Point-contact transistors which have a very low value of internal feedback resistance, less than 100 ohms, for example, usually have such low feedback that amplifier circuits require no special stabilization. It is desirable in some r.f. circuits, particularly, that the transistor be stable under low impedance conditions such as off-resonance of a parallel-tuned circuit.

In the case of the simple junction transistor, the current amplification factor is always less than unity, and oscillations

cannot occur. Ryder and Kircher<sup>6</sup> have pointed out that the grounded-base circuit is analogous to an electron-tube grounded-grid circuit if the emitter, base, and collector of the transistor are compared to the cathode, grid, and plate of the electron tube, respectively. The grounded-grid electron-tube circuit also has a low input and high output impedance. The comparison is particularly appropriate in the case of the junction transistor, which, like the tube circuit, is stable even under extreme short-circuit conditions.

If the emitter is grounded, as in Fig. 22, higher input impedances and lower output impedances may be obtained. Higher power gains may be obtained with this circuit configuration than with the grounded-base circuit, but in point-contact transistors the feedback may become large and lead to instability. If junction transistors are used, this type of circuit is similar to an electron-tube grounded-cathode circuit.

Higher input impedances and lower output impedances may also be obtained if the collector is grounded, as in Fig. 23. This circuit can become unstable if a point-contact transistor is used, and the power gain which may be obtained is low. However, the junction transistor can be used to good advantage in this circuit, because power gains ranging from 10 to 20 db may be obtained with input impedances and output impedances on the order of 200,000 and 50,000 ohms, respectively. In fact, appreciable gain may be obtained using equal input and output matching impedance, thus making cascading of several stages of amplification feasible. This circuit is similar to the electron-tube grounded-plate or conventional cathode-follower circuit.

Table 3 shows typical values of input and output impedances and power gains for all three types of circuits for both junc-

<sup>6</sup> Ryder, R. M. and Kircher, R. J.: "Some Circuit Aspects of the Transistor," Bell System Technical Journal, Vol. XXVIII, pages 367-401, July, 1949.

TABLE 2. Average values of several characteristics for two types of transistors.

	Point-Contact Type	Junction Type
Power Gain (Grounded base).....	23 db	40 db
Current Amplification Factor.....	2.5	0.98
Noise Figure (db above thermal at 1000 cycles) ..	55 db	10 db
Minimum d.c. dissipation for satisfactory operation	5 to 15 mw.	0.6 microwatt
Efficiency, Class A operation.....	30%	49%
Frequency Cut-off (3 db down in current amplification factor) .....	10 mc.	1 mc.

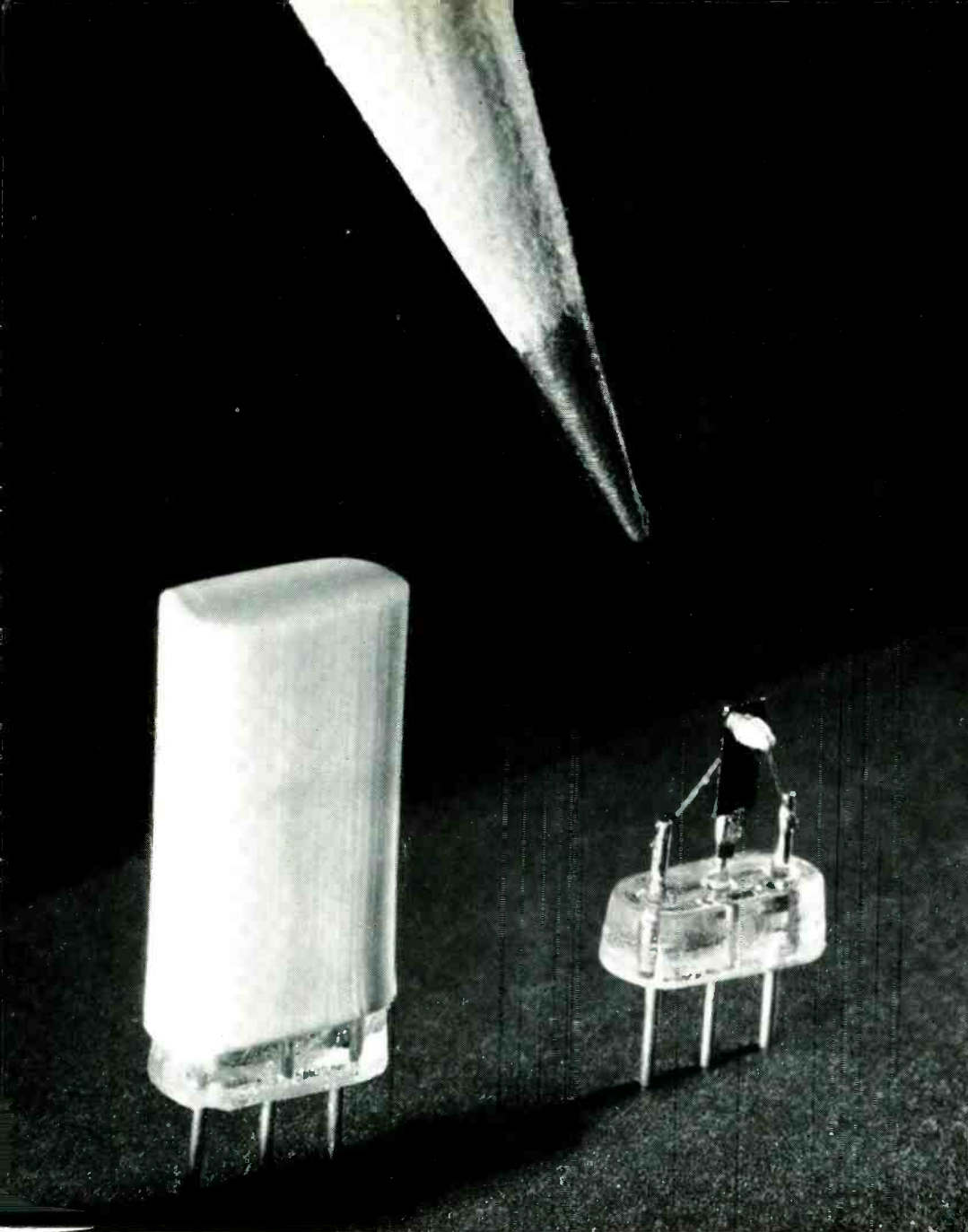

FIG. 20. At right, pencil points to developmental junction-type transistor before embedment in plastic container. At left, the sealed unit.

tion-type and point-contact transistors. It will be noted that in the grounded-emitter and grounded-base circuits the input and output impedances of the point-contact transistor may actually become negative values, a condition which indicates that these circuits are potentially unstable. These characteristics of the point-contact types, which lead to potential instability in amplifiers, are of great advantage in oscillators and trigger devices.

#### Other Circuit Applications

When considering the possible circuit applications for the two types of transistors, one must be aware of the advantages and limitations of both types.

At the present time, the advantages of high gain, low noise, and greater stability of the simple junction transistor can be

utilized at frequencies up to several megacycles in applications such as r.f. and i.f. amplifiers of standard broadcasting receivers. In addition, power outputs greater than one watt appear to be possible in oscillator and amplifier applications in the audio frequency and low frequency ranges. Another feature of the junction transistor is its ability to amplify and oscillate with microwatt power inputs.

The frequency response of the point-contact transistors, on the other hand, is somewhat higher than that of junction types. As with junction types, point-contact types which are currently available can be made to oscillate and amplify over the broadcast-frequency band. When used as an amplifier, point-contact transistors have a relatively flat response over the entire broadcast band and beyond. Types

now under development will operate at considerably higher frequencies. Feedback in these units has been reduced to values which make stable operation at radio frequencies practical. The point-contact transistor, therefore, may also have considerable application in radio circuits and may be used in intermediate-frequency amplifiers, radio-frequency oscillators, and other circuits not associated with the high-power stages of r.f. systems. Point-contact transistors have been developed which are capable of oscillating at frequencies well over 100 mc. Oscillations at frequencies higher than 200 mc. have been obtained. One developmental unit has oscillated at a frequency over 300 mc.

One of the most important uses of the point-contact transistor probably will be in counter circuits. A number of recent publications<sup>7</sup> describe some basic circuits which utilize the negative resistance properties of one or more transistors. These circuits generate pulses of various waveforms, store information for varying periods of time, add, subtract, multiply, and divide. Up to the present time these functions, and many others, have been performed in electronic computers by large numbers of electron tubes for which the heater-power supplies alone have been considerable. Use of the transistor would obviously alleviate this situation since no heater power is required. Furthermore, little d.c. power is necessary for operation. The adverse characteristics of transistors with regard to frequency response, noise, and power output are relatively unimportant factors in computer circuits. Computers which employ germanium devices would have the advantages of small size, ruggedness, and economy of operation and maintenance.

#### Other Germanium Devices

The progress in the field of germanium devices is not limited to the field of transistors. While the point-contact germanium diode has already attained commercial acceptance, new types of diodes utilizing the "p-n" junction rectification characteristics are being developed. One diode power rectifier which utilizes a p-type or acceptor impurity metal diffused onto a pellet of germanium has already been described.<sup>8</sup>

<sup>7</sup>Eberhard, E., Endrey, R. O., and Moore, R. P.: "Counter Circuits Using Transistors," RCA Review, Vol. X, No. 4, page 459, December, 1949.

<sup>8</sup>Saby, J. S.: "Recent Developments in Transistors and Related Devices," Tele-Tech, Vol. 10, No. 12, December, 1951.

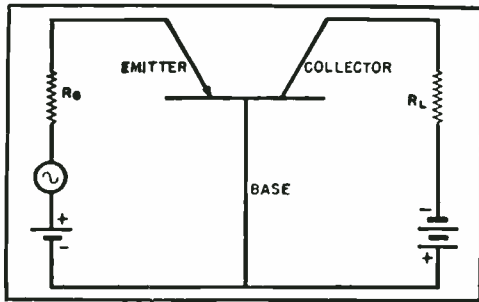

FIG. 21. Layout whereby the transistor is used in grounded-base amplifier circuit.

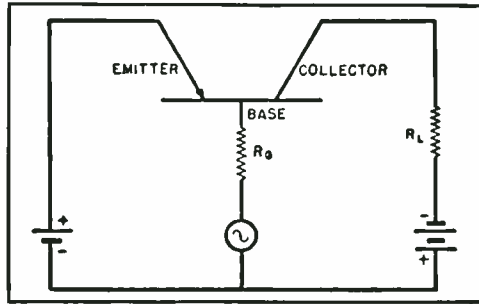

FIG. 22. A transistor grounded-emitter amplifier circuit, as discussed in the text.

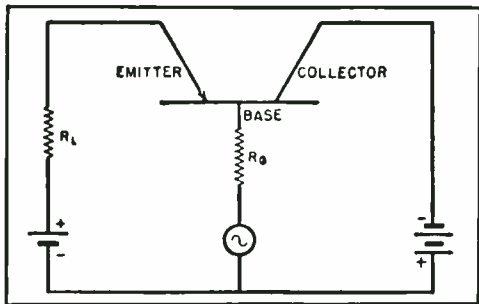

FIG. 23. The transistor grounded-collector amplifier circuit. See the text for details.

ductivity. In the phototransistor, a point contact acts as the collector and draws a small amount of current. Light in the vicinity of the collector increases the conductivity of the germanium and the current through the collector.

The first transistor was announced only three and one-half years ago. Great strides have been made in learning the fundamental theory of operation of transistor devices, and much progress has been made in the knowledge of the control of transistor characteristics and manufacturing processes. There appear to be a number of

fields in which transistors will be used widely and to great advantage. Further improvements in their characteristics may be expected as research and development continue.

#### Acknowledgment

The author wishes to acknowledge the advice and contributions of Mr. E. W. Herold and Dr. J. Kurshan of the RCA Laboratories Division, Princeton, N. J., and of Mr. R. M. Cohen and Mr. H. Nelson of the RCA Tube Department, Harrison, N. J.

TABLE 3. Typical values of input and output impedances and power gains for all three types of circuits for both junction-type and point-contact transistors.

GROUNDED-BASE AMPLIFIER CIRCUIT		
	<i>Junction Transistors</i>	<i>Point-Contact Transistors</i>
Input Impedance .....	90 ohms	180 ohms
Output Impedance .....	0.4 megohm	14,000 ohms
Power Gain .....	37 decibels	20 decibels
GROUNDED-EMITTER AMPLIFIER CIRCUIT		
	<i>Junction Transistors</i>	<i>Point-Contact Transistors</i>
Input Impedance .....	620 ohms	1800 ohms
Output Impedance .....	54,000 ohms	—8000 ohms
Power Gain .....	37 decibels	28 decibels
GROUNDED-COLLECTOR AMPLIFIER CIRCUIT		
	<i>Junction Transistors</i>	<i>Point-Contact Transistors</i>
Input Impedance .....	40,000 ohms	—37,000 ohms
Output Impedance .....	1000 ohms	—10,000 ohms
Power Gain .....	17 decibels	14 decibels

FIG. 24. Dr. C. W. Mueller of the research staff of the David Sarnoff Research Center of RCA Princeton, N. J., points to a "blown-up" model of the heart of an RCA developmental junction-type transistor. Complete interior model is seen at right. A "p-n-p" junction-type transistor is shown in the inset at lower right.

Peak inverse voltages of 400 volts are permissible with these devices which have very low resistances in the forward direction and current-carrying capabilities as high as 350 milliamperes. When the relative infancy of the germanium power rectifier is considered, it is difficult to estimate the ultimate importance of these devices. Because of improved efficiency, however, they appear to be suitable both as a replacement for the selenium rectifier and as an advantageous substitute for certain types of rectifier tubes.

Another germanium device of considerable significance is the phototransistor.<sup>9</sup> This photocell is a photo-conductive device and operates on the principle that light absorbed by germanium changes its con-

<sup>9</sup> Shive, J. N.: "The Phototransistors," Bell Laboratories Record, Vol. XXVIII, No. 8, pages 337-342, August, 1950.



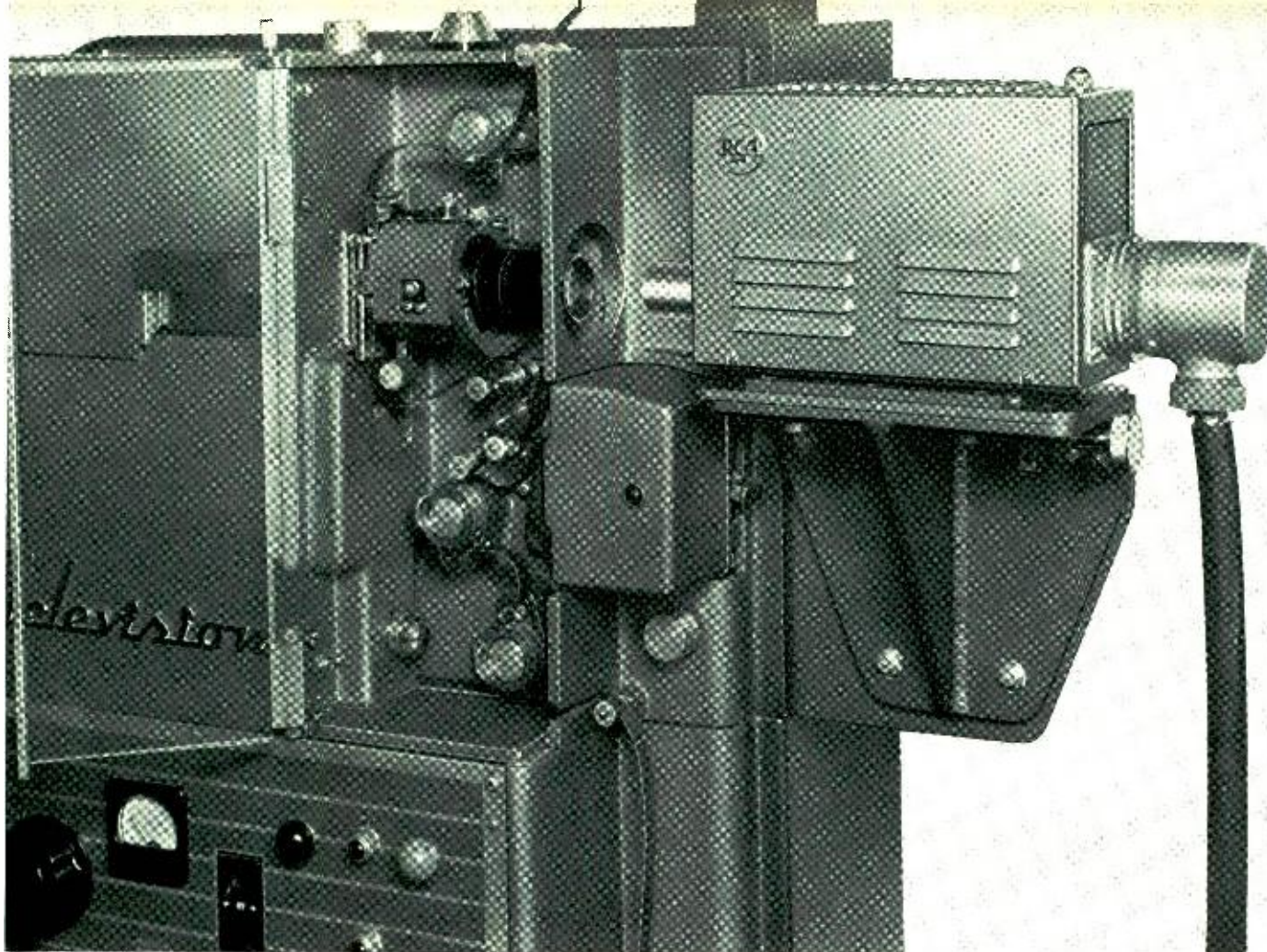

FIG. 1. View of the Vidicon Film Camera shown coupled to an RCA TP-6A Professional 16mm Television Projector.

# VIDICON FILM CAMERAS

By **H. N. KOZANOWSKI**  
 Supervisor, Special Projects  
 Broadcast Studio Section

Since the earliest days of television, both in its experimental phases and in commercial television broadcasting, the problem of reproducing motion picture film has received concentrated and continued attention. Motion picture film originally offered a wide choice of readily available program material as compared to the production of live-studio shows which require more elaborate facilities, long rehearsal time, and considerably greater expense. With the development of better studio pickup cameras, such as those based on the image orthicon tube, it became possible to produce high-quality studio programs with relatively modest lighting requirements. Under these conditions, it was apparent that improvements were required in the film system to bring it up to the new standards of studio quality. The iconoscope camera, which has been almost universally used for film reproduction, was re-examined thoroughly and many improvements were made in circuits and operating techniques. These improvements have resulted in a substantial gain in picture quality and have been widely introduced into current film reproducing equipment in television

broadcasting stations. With high-quality film and careful operating techniques, the pictures compare favorably with those which originate in studios.

However, within the last few years, there has been a definite trend in the direction of recording certain programs directly on film for reasons of smoother performance, possibilities of editing, less strain on actors, and the increased versatility provided by the application of well-developed motion picture techniques. Such a program is, therefore, no longer considered as a substitute for live-studio programs, but as a direct competitor. In this case, the ultimate goal is picture quality which will make it impossible for the home television viewer to know whether the program material is live or is recorded on film. The same goal is called for in kinescope photography for delayed broadcast, program storage, and distribution by network affiliated stations. The formation of these new trends in television broadcasting spurred on an intensive

program of evaluating many hitherto unexplored methods of film reproduction. Our investigations showed that the Vidicon pickup tube offers the greatest possibility for realizing these new objectives. Work on the Vidicon film camera during the past two years has convinced us that it comes closest to meeting the requirements for an ideal film camera. Figs. 1 and 2 show the Vidicon in use—(1) mounted directly on a projector and (2) with a multiplexer.

## Performance Requirements for a Television Film Camera

Before describing the Vidicon camera, it may be of interest to tabulate the main factors in any television reproducing system which are the criteria for good performance. These are:

- A. Resolution or aperture response.
- B. Available signal-to-noise ratio.
- C. Possibility of aperture response correction.
- D. Gray scale or transfer characteristic.
- E. Film reproduction range and film latitude.
- F. Light source requirements.



- G. Effect of spurious signals or shading.
- H. Black level reference.
- I. Non-synchronous projector operation.
- J. Possibilities for unattended operation.

The Vidicon tube was invented at RCA Laboratories and developed into a commercial product at the RCA Victor Tube Development Group at Lancaster. The capabilities and potentialities of the Vidicon for high-quality film reproduction were first clearly recognized and demonstrated by R. G. Neuhauser of Lancaster.

We can most effectively evaluate Vidicon performance by referring to the previously mentioned factors and reporting observations and measurement on these characteristics. They are:

- A. Resolution. The 1 inch Vidicon with a 0.62 inch picture diagonal ( $\frac{3}{8} \times \frac{1}{2}$  inch picture) has a limiting television resolution of 800 lines in the center of the raster, with a measured response of 35% at 350 lines compared with zero line number as a base.
- B. The signal-to-noise ratio, measured as peak-to-peak signal to RMS noise can be as high as 300-to-1. It is determined mainly by the shot-noise characteristics of the input stage of the camera amplifier. High performance, low noise, cascode amplifiers are used for this application.
- C. The possibility of aperture response correction is particularly inviting with the Vidicon because of the excellent signal-to-noise relation. For example, it is possible to raise the aperture response from 35% to 100% at 350 lines resolution by suitable techniques and still maintain a signal-to-noise ratio of 100-to-1. This improves horizontal resolution, but does not affect vertical resolution. Over-all tests indicate that the process is definitely necessary for all pickup tubes, but can be used only where signal-to-noise performance is not sacrificed.
- D. The gray-scale or transfer characteristic, which is inherent in the Vidicon surface itself, has a log-log slope of 0.65 when signal output current is plotted against light on the photoconductive signal electrode. (This is complementary to the kinescope transfer characteristic, requiring no further correction in the video amplifiers.) A dynamic range of 150-to-1 or more in the usual gray-scale logarithmic test wedge can readily be demonstrated. With the iconoscope, 50-to-1 represents a value which can be attained only with special precautions. The slope is constant over a wide range of lighting

and does not have the "rubbery" or variable transfer handicap of the iconoscope.

- E. Film reproduction range and latitude are wide, due both to the low gamma and to the constant character of the signal output-light input characteristic. Normal shifts in print density produce very little change in quality since these can be compensated by either a change of video gain or projector light output. The high signal-to-noise ratio initially available makes this possible.
- F. Light source requirements under the most favorable conditions, and using commercially available lenses, are of the order of 300 foot candles, average, measured at the film gate. Since practically all intermittent-type television motion picture film projectors used with the iconoscope have an exposure shutter opening of approximately 7%, phased under blanking, this 300 foot candle average corresponds to about 4000 foot candles peak. Optimum Vidicon results are obtained using approximately 1/3 of the maximum light output available in standard television projectors designed for use with the iconoscope. Sensitivity is deliberately reduced by the use of a low signal electrode voltage in order to obtain overall improvement in performance. The decrease in light requirement nevertheless prolongs projector lamp life greatly.

G. Since the Vidicon tube is essentially an orthicon or low-velocity device as far as the scanning process is concerned, there is inherently no spurious shading signal developed. This contrasts very favorably with the iconoscope where elaborate precautions in edge lighting and wave form cancellation are necessary to minimize a normally large spurious signal. In the Vidicon, no electrical shading cancellation signals are required, thus resulting in equipment and operational simplifications. In early models of Vidicons, there were problems of maintaining uniform sensitivity of the photoconductive surface, so there was unequal signal output at the edges as compared to the center of the raster. Improvements in production techniques have made such variations small.

By operating the Vidicon Signal Electrode at low voltages for motion picture film use, the decreased dark current of the device and the improvement in lag and burn characteristics greatly outweigh the loss of light sensitivity. High light sensitivity is vital for direct pickup cameras, but is only of casual interest in motion picture reproduction.

H. Black level reference in the Vidicon is clean-cut and definite since the output resistor signal voltage, even on a d-c basis, is a function only of light on the raster. Thus the zero signal or black

FIG. 2. The Vidicon Film Camera shown in multiplexed use. Here two TP-16 Projectors and a 35mm Slide Projector are directed into the Vidicon Multiplexer (center).

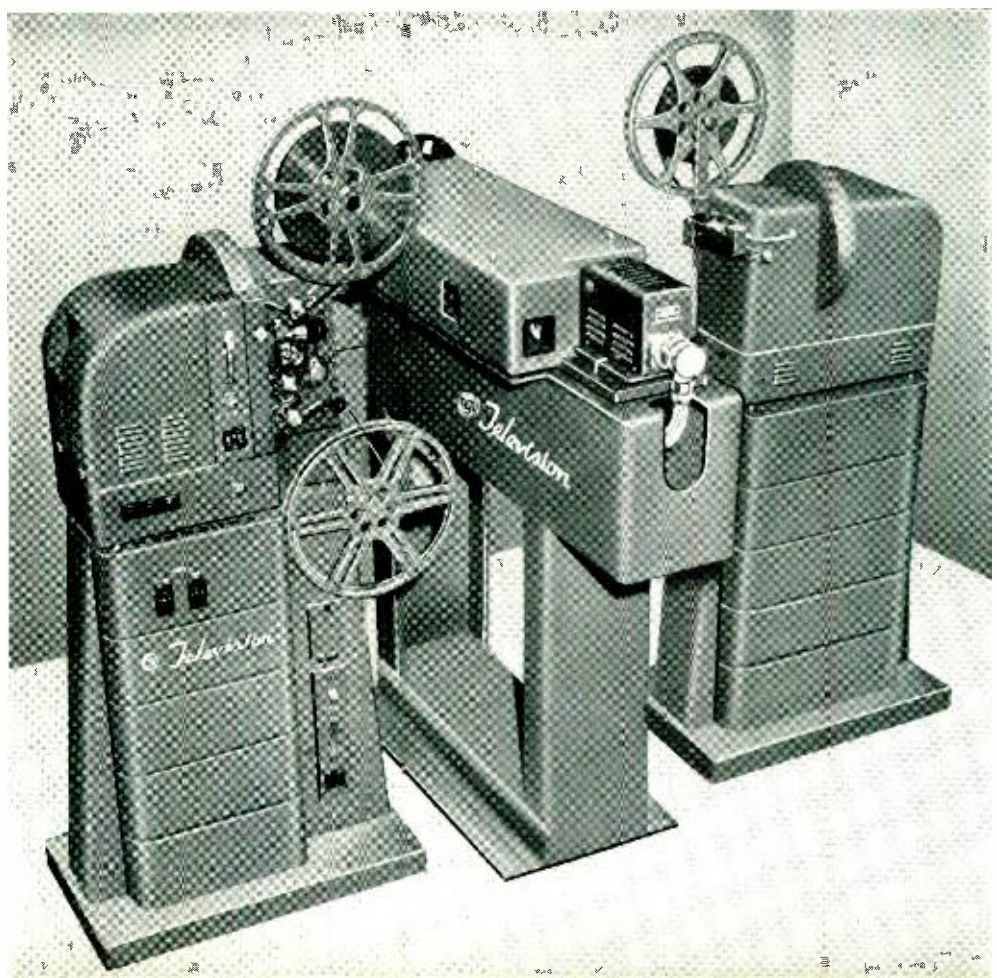

reference is obtained directly, merely by blanking the scanning beam during the horizontal return interval. Standard clamping techniques can thus be used for automatic d-c set or black level control.

- I. Non-synchronous operation of the projector with respect to the sync generator is a desirable attribute of a film reproduction chain. In smooth network operation, it is often necessary to insert commercials or local film material in station-break intervals. Present techniques call for fading to black; dropping network synchronizing signal; switching to local sync generator, which is locked to and properly phased with the local a-c power supply; and operating the iconoscope film chain conventionally. All of this is essential because of the necessity for exposing the iconoscope during the vertical blanking interval. Misphasing or non-synchronous operation produces the well-known iconoscope application bar whose amplitude may be 10 to 20 times the useful normal video signal. Several synchronous projector drives, providing driving power with frequency controlled by the sync generator, have met with some success in solving this problem. By comparison, the Vidicon behaves beautifully under non-synchronous projector conditions. With a projector light exposure of 7% of vertical field time, standard iconoscope exposure conditions, the "application pulse" signal is perceptible to a critical viewer, but is not particularly annoying. With longer application times, 30 to 65%, available with present 3-2 television projectors, such as the RCA TP-6A, the transition from "Light On" to "Light Off" is not detectable even to the most critical viewer. Long-application time also cuts down the peak illumination requirements. This means either smaller projector lamps or increase in projector lamp life by a factor of 10, or even more. Inserts in network program can be made merely by operating the projector from the local power supply with the local sync generator tied to network through a Genlock or similar device. The importance of such a feature will increase as network-local operation techniques are refined.
- J. The "unattended operation" possibilities of the Vidicon camera appear unusually attractive. Tests with a wide range of film material have shown that it is practically unnecessary to ride video gain. Black level control is completely automatic, and there are no



FIG. 3. Overall view of the Vidicon Camera unit when removed from projector setup.

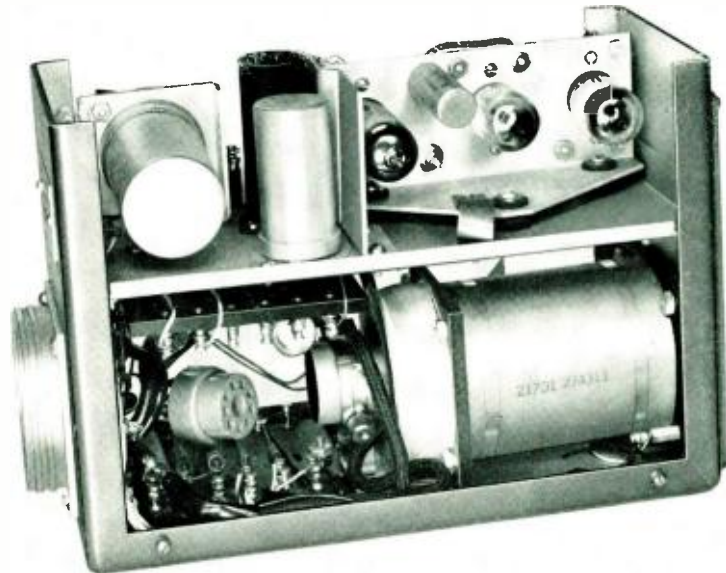

FIG. 4. Closeup of the Vidicon Camera with cover removed to illustrate mechanical details.

shading knobs provided or required. The controls are inherently stable and simple. In principle, the only two variables which require adjustment are wall voltage, which determines electrical scanning beam focus and therefore picture resolution; and beam bias controlling the number of electrons available for discharging the target. Even this last adjustment is non-critical in that the top beam current requirement can easily be set by simple operational procedures, and any excess produces only secondary deteriorations in resolution due to increased scanning spot size at lower grid biases. The Vidicon is far less critical to set up and operate than the image orthicon

tube. That this is so, follows from the fact that in the Vidicon the useful video signal is generated only by the electrons flowing through the photoresistive target, while in the image orthicon, the video signal is obtained from the "return" electrons of the scanning beam, making it essential to adjust beam current very carefully to maintain "percentage modulation" at a high value.

Extensive tests show that the inherent stability of the Vidicon tube and camera circuits is sufficiently high to make "unattended operation" using only a bare minimum of monitoring and adjustments a practical reality

This is believed to be of great importance to the television broadcaster.

This paper up to the present moment encroaches on the territory which is normally the province of the pickup tube development engineer. However, tube and camera performance are so intimately related that it is practically impossible to draw a sharp dividing line between the two activities and still present an informative picture of developments and progress.

### Features of Vidicon Camera Design

The Vidicon camera system, which will now be described, is the third model resulting from information acquired in the advance development phases of the study.

The general philosophy of approach was based on the following goals:

1. The camera itself should be as small as possible so that it can be mounted directly on either a 16mm or 35mm projector or integrated into an optical multiplexing system.
2. The control circuits should be rack-mounted for ease of maintenance and performance check.
3. The control panel containing the various operating and set-up controls should be capable of location remote from the rack, should contain no electron tubes, and its connecting cables should not carry any signals except variable d-c voltages.

Following this approach, the camera contains only the Vidicon tube, focus and deflection coils, a high performance cascade amplifier, a low-impedance video output stage, and a Vidicon blanking amplifier. Views of the camera are shown in Figs. 3 and 4.

Since the deflection requirements are relatively modest, horizontal deflection is supplied to the camera from a rack-mounted deflection amplifier through a coaxial conductor in the standard camera cable (see Fig. 5). A constant resistance termination is used, with the horizontal deflection coils as one of the termination elements. Suitable circuits are used for protection of the Vidicon tube in the event of scanning failure. Regulated focus field current and other required operating wave forms are supplied to the camera from the rack chassis by conventional methods.

Other elements of the rack chassis assembly perform such functions as high peaking to compensate for the effect of Vidicon input shunt capacity, aperture compensation, final blanking, clamping, clipping, and sync addition (see Fig. 6). A standard RMA signal of 1.0 volt is pro-

duced across the usual 75 ohm co-axial distribution line.

Fig. 7 shows a block diagram of the essential portions of the system.

In an actual operational installation, all of the units except the control panel are mounted in a standard broadcast-type rack and are interconnected by suitable plugs and cables as shown in Fig. 8. The control panel is usually installed horizontally below a master monitor for convenience in operation (see Fig. 9).

### Television Film Projectors

It can be mentioned that the Vidicon, because of its well-behaved storage characteristics, can be used with any projector, continuous or intermittent, with long or short-application time, which has suitable television conversion features. These are implied in the requirement of translating 24 film frames per second into 30 complete television rasters in the same interval. Thus there is a wide field of choice and the possibility of continuing to use, with complete satisfaction, the large number of projectors which are already in commercial broadcast operation.

### The Multiplexing Problem

One of the major problems of the television broadcaster is to provide smoothness or continuity in programming without paying a high price in complexity of duplicated equipment, operating procedures, and space requirements. This is particularly true with the smaller broadcasting stations which generally may show a film feature, insert 15-second film spot commer-

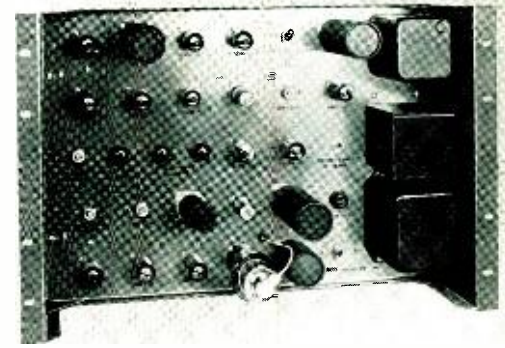

FIG. 5. The Vidicon Deflection Chassis.

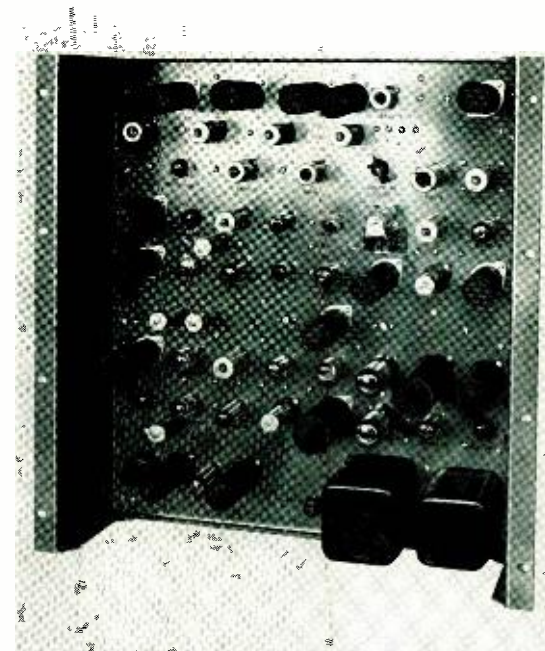

FIG. 6. The Vidicon Processing Amplifier.

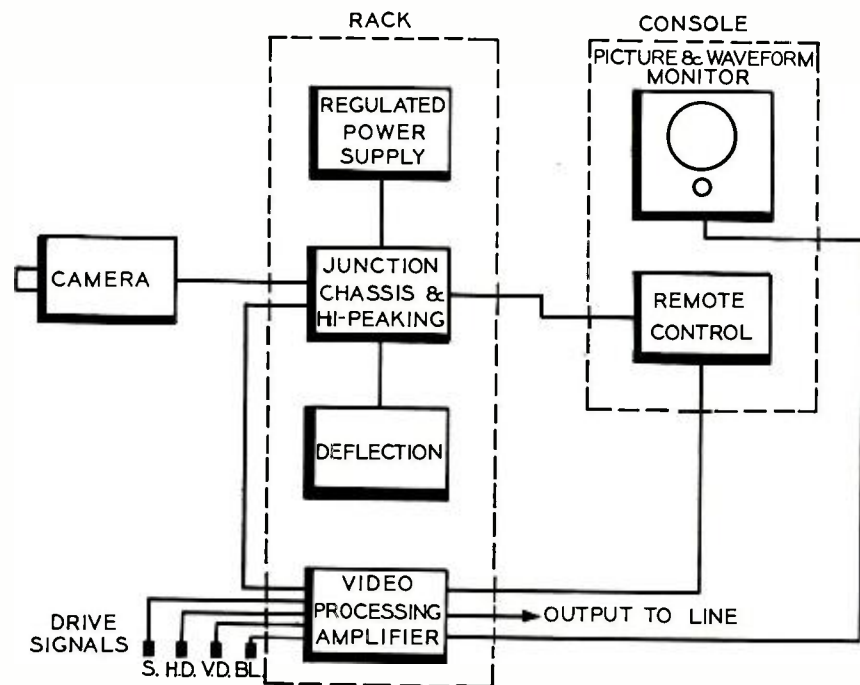

FIG. 7. Block diagram illustrating the components making up the Vidicon Camera Chain. Although shown by two boxes, the Junction Chassis and Video Processing Amplifier are physically one unit.



FIG. 8. View of the Vidicon power supplies and amplifier units which are rack mounted for convenience.

cials, slide or opaque commercials, then station identifications, and go back to film. They have become thoroughly accustomed to going through such split-second tactics using only a single iconoscope film camera and multiplexing the information from two projectors, a Telop for opaques, and one or more transparency projectors onto the iconoscope mosaic in the required sequence by means of mirror and douser techniques. They naturally expect that any improved device such as the Vidicon camera will give them the same, or even more, operational flexibility.

With the iconoscope, the multiplexing problem is quite easily solved since the diagonal of the photosensitive mosaic is 5 inches and the projector lens throw for the required magnification from 16 or 35mm film is about 50 inches. This 50-inch working distance is utilized for suitable mirror and projector source locations so that any one of three or more projection devices can be selected at will for program continuity.

The Vidicon, on the other hand, has a picture diagonal of slightly less than  $5\frac{1}{4}$

of an inch, giving practically a unity magnification ratio for 16mm film and a 2-to-1 demagnification for 35mm frames. This consequently gives a lens throw of the order of 7 to 10 inches, which is far too small for conventional multiplexing techniques. This, however, works out very conveniently for mounting a camera directly on the projector and gives the possibility of electrically multiplexing the outputs as required by program needs. There seems to be a definite trend in this direction by network originating stations.

This technique does not solve the problem for the small broadcaster who cannot afford the increased equipment, personnel, and floor space required. A method of multiplexing has been devised and tested which provides an excellent answer. The basis for operation is the creation of a working distance for accommodation of the required multiple mirrors and projector sources. This is done by projecting a real image in space, whose diagonal is 5 inches, and picking up this image with a lens on the Vidicon camera itself. A suitable field lens in the 5-inch image plane is used to direct the peripheral rays into the Vidicon lens aperture.

This technique allows the use of standard high-quality 16mm motion picture lenses which are available at reasonable cost.

A similar application of relay lens techniques has been used in the RCA color camera and has given very good results from the viewpoint of resolution and detail contrast. With a carefully designed optical multiplexing system, the degradations introduced in the television picture by the additional lens process are definitely of second order. If the camera is made as an integral part of the optical system, the effects of projector vibration on image quality are no different from those with the iconoscope and direct projection. These are quite small in commercial operation.

A simplified block diagram showing a typical film room setup employing the Vidicon camera is shown in Fig. 10.

The TP-11A Vidicon Multiplexer was developed especially for use with the Vidicon Film Reproduction System. It is shown in Fig. 11. The multiplexer has been designed as a sturdy, stable device for commercial film and transparency programming, using either 16 or 35mm projectors. In addition, it will accommodate the standard Telop as a source for opaques. All critical optical surfaces are protected by dust seals and dust covers which need not be disturbed after initial adjustments are completed. Light-entrance ports from the various sources are dust-sealed and easily kept clean by routine methods.

FIG. 9. Closeup view of the Vidicon Camera control unit and the remote control panel which is mounted in the sloping section of the console.

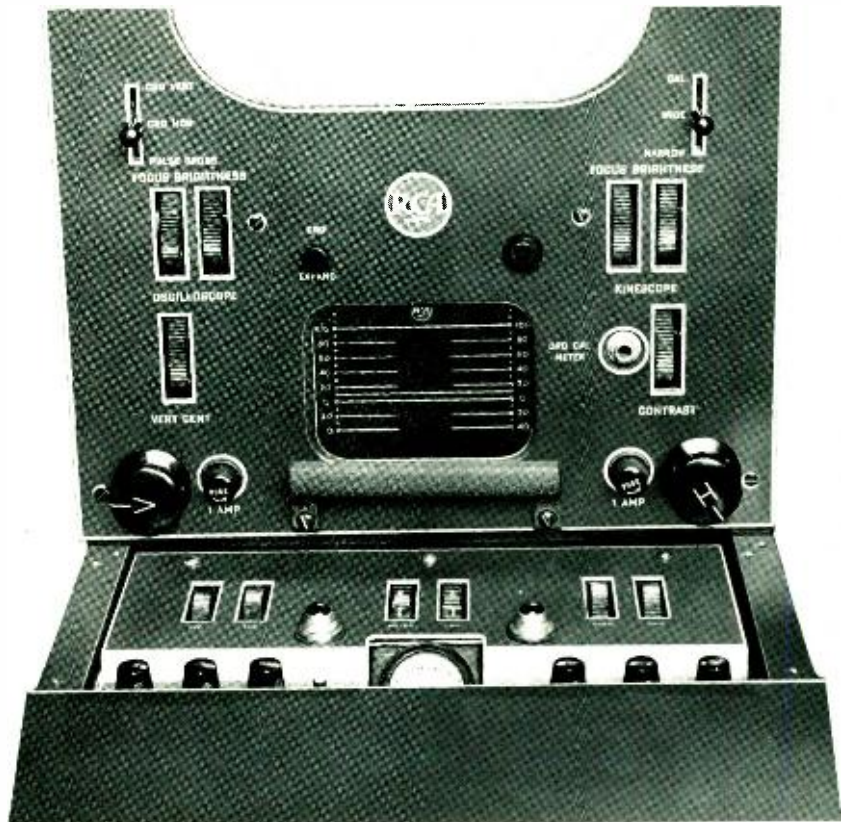

## 16mm and 35mm Film Material

The question of film quality for television reproduction has been the subject of much study. Even though it is realized that 16mm film has tremendous commercial advantages in first cost, projector cost, storage requirements, air express shipping charges, fire code restrictions, and many other factors, the fact still remains that the best 16mm prints are none too good for television. An equivalent limiting television resolution of over 400 lines with 16mm release prints is rare. This contributes nothing to over-all quality. By comparison, 35mm prints on the average have much higher performance from the standpoint of resolution, gray scale, and grain. A great deal of the difference may well lie in the more careful control of exposure, step-printing, and processing of 35mm film. It may be economically unsound to expend the same effort on production of 16mm film subjects. While there seems to be practically no likelihood of using 35mm film, except for network originations where the demands for high quality are extremely exacting, it is important to stress the fact that any technical improvements in 16mm film quality will be directly reflected in improved television picture quality.

A question often asked by broadcasters who have witnessed film reproduction with the Vidicon camera is: "What are the results using the Vidicon with poor quality film?" The answer, unfortunately, is: "Poor quality." No television system, including the Vidicon camera, can do very much to make film of poor technical quality look better on television than it looks on direct critical viewing. Perhaps a conservative way of expressing the same idea is to say that the system should introduce a minimum amount of deterioration in the translation of the optical information into a television picture signal.

## Conclusions

Our study of the possibilities inherent in the use of the Vidicon camera for high-quality reproduction of motion picture film has been going on for about two years. During the last year, the results have been observed by a wide range of critical television broadcasting observers, both in the laboratory and at the NARTB Convention at Los Angeles. The comments on reproduction fidelity, gray-scale reproduction, signal-to-noise ratio, and operational stability have been extremely gratifying. We believe that the Vidicon approach to motion picture reproduction represents the most promising method of high-quality reproduction now available, and hope that its use in commercial broadcasting will

continue to justify the enthusiasm which has been aroused during its development.

## Acknowledgments

We acknowledge the cooperation of R. G. Neuhauser, F. S. Veith and Dr. R. B.

Janes, of RCA Lancaster, and the help of Dr. O. H. Schade. Also Messrs. E. M. Gore and S. L. Bendell of the Advanced Development Section and Messrs. N. L. Hobson and F. E. Cone of the Broadcast Equipment Section.

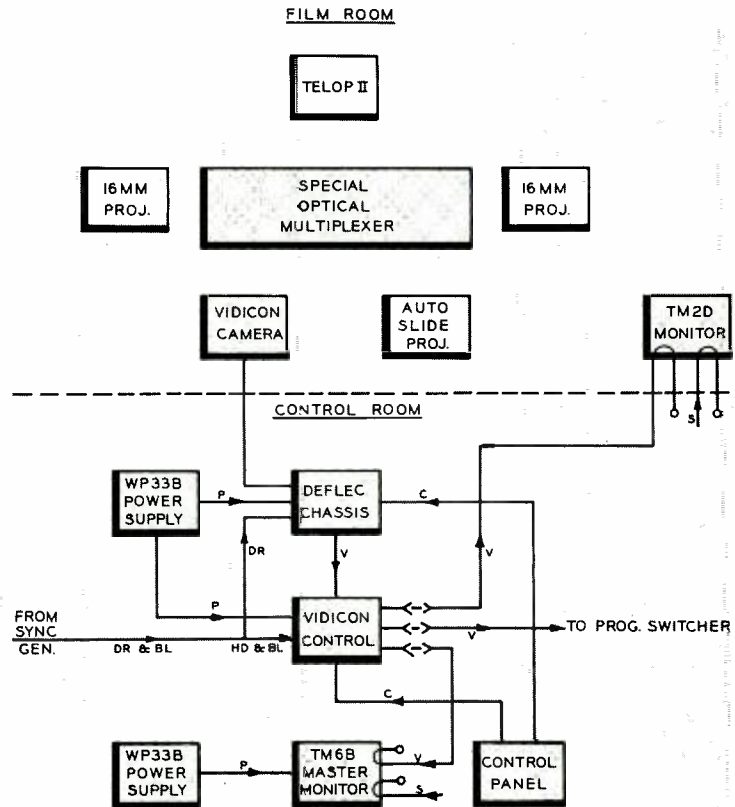

FIG. 10. Simplified system block diagram showing a typical film room setup employing the Vidicon Camera with film projectors, slide projector and multiplexer.



FIG. 11. The Vidicon Multiplexer, TP-11A, has been designed especially for use with the Vidicon Film Camera. This unit will accommodate two 16mm or 35mm film projectors, a 35mm slide projector and a Telop slide and opaque projector.

# THE NEW TF-12BH HIGH-GAIN ANTENNA

By  
**IRL T. NEWTON, Jr.**  
Broadcast Product Planning  
and  
**H. H. WESTCOTT**  
Broadcast Engineering

Coincident with the publication of this issue of BROADCAST NEWS, RCA is announcing the new TF-12BH Antenna for VHF television broadcasting on channels 7 to 13. Rated for 50 kw, this newest member of the RCA Superturnstiles uses new techniques of vertical pattern shaping for better fringe area and close-in coverage than any standard antenna on the market today. The TF-12BH, developed from the foundation of the proven TF-12AH, has been tailored to the industry requirements for maximum ERP operation with optimum coverage at all distances within the

service area. It is the purpose of this article to tell the story of this newest member of the RCA antenna family. (See Figs. 1 and 2.)

## Planning Considerations

Television station planning inevitably involves consideration of two major factors—effective radiated power (controlling coverage), and economics. The advantages, in terms of advertising rate cards and listener satisfaction of using maximum ERP must be balanced against high initial cost.

The principle of using high gain for maximum utilization of transmitter power is, within reasonable limits, unanimously accepted in television practice. Concentration of the radiated energy in a thin horizontal

FIG. 1 (below). View of the new 50 KW TF-12BH Superturnstile shown during field tests (space cloth is visible under platform). From left to right: I. T. Newton of Antenna Planning, with M. R. Johns and H. H. Westcott (back to camera) of the Broadcast Antenna Engineering Group.



beam prevents wasteful upward radiation and overloading in nearby areas below the antenna. In the past, there has been some hesitancy to use high gain antennas because of vertical pattern nulls resulting in areas of low field strength within a few miles of the antenna. By proper design, these can be practically eliminated by sacrificing a small amount of gain. The TF-12BH was conceived as an optimum balance of these pertinent design considerations with a "null-free" vertical pattern.

### Design Requirements

Ideally, each installation with its peculiar site, height and terrain features would yield different vertical pattern shaping requirements under critical analysis. It is economically impractical to design and build a different antenna type for each individual television station. Therefore a practical commercial design must recognize the range of variations in terrain, tower height, transmission line length, and population distribution.

Initial design requirements were formulated for the TF-12BH from a combination of operational experience of established stations and performance considerations outlined by the principal Radio Engineering Consultants. The minimum design thus established is truly an "industry specification". RCA has surpassed the following minimum requirements in all respects with the completion of the TF-12BH:

1. A vertical pattern with no region of zero signal.
2. A pattern shape which would, assuming a 1000-foot height, provide a field intensity (FCC 50,50 curves) of 100 mv/m from the base of the tower out to the distance where attenuation dominates.
3. A power gain which would permit maximum allowable ERP with a transmission line of at least 1400 feet of  $3\frac{1}{8}$ -inch VHF teflon line with existing transmitter power levels.

Fig. 3 illustrates the "null" problem of conventional antennas contrasting as it does the pattern of relative field strength of a typical omni-directional antenna, of the Superturnstile type, having three radiators (and a gain of 3), fed with equal power and in phase, with that of an an-

FIG. 2. Closeup view of the 12-section Superturnstile as it appears when installed in normal upright position. The new 12-section (with a gain of 9 approximately) retains all of the inherent features of previous Superturnstile plus the desirable feature of much improved close-in coverage.

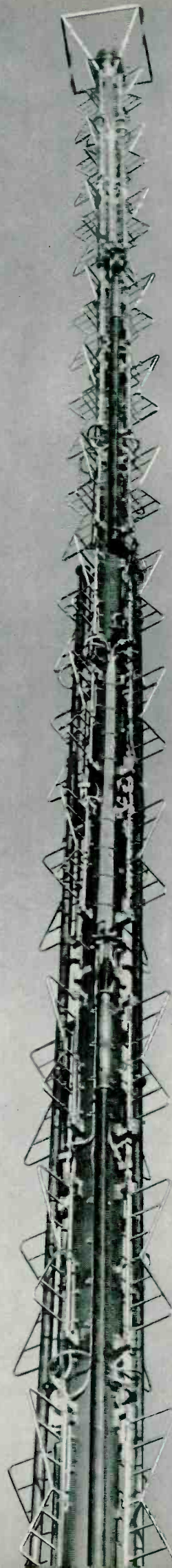

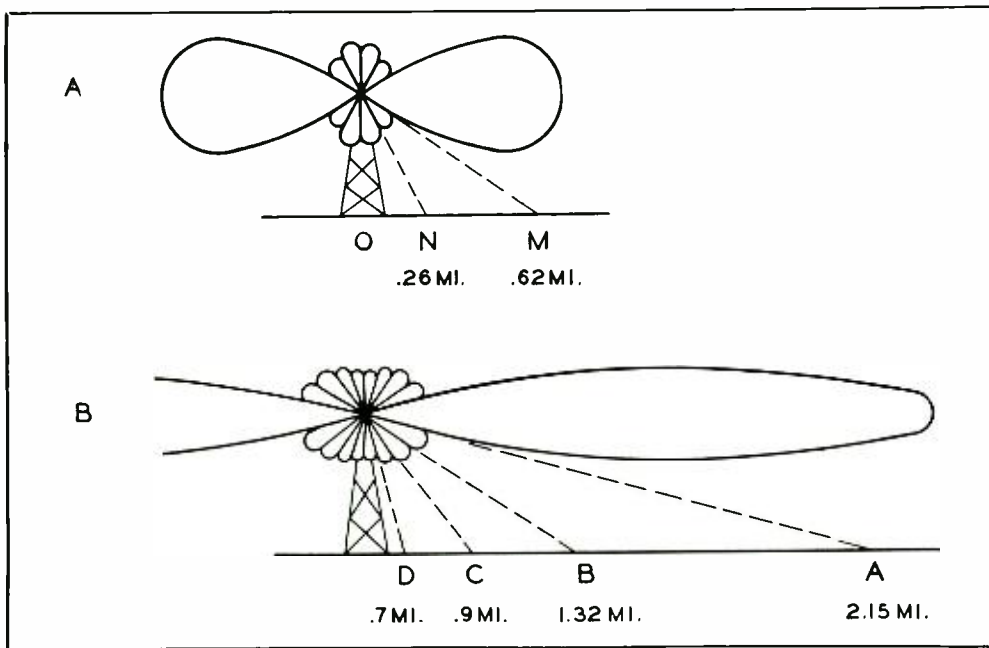

FIG. 3. Pattern curves which illustrate the areas of minimum signal experience with the usual antenna (note points "O", "N", "M", "D", "C" and "B").

FIG. 4. Curves showing the vertical field patterns of the TF-12BH and TF-12AH antennas. Note how the minimum signal areas are "filled-in" with the TF-12BH.

tenna having 12 radiators and a gain of 12. Due to cancellation of the signals received at M, N and O, from the various radiators of the three-section antenna, the total signal strength in these areas is low. Similarly, with the high gain antenna, A, B, C, D and eight other areas still nearer the antenna receive signals of relatively low power.

Although the low gain antenna requires a power input four times as great to achieve the same strength signal at the horizon (and so the same ERP rating) it has only three areas of minimum signal strength as contrasted with the twelve areas of lower strength inherent in the pattern of the antenna with a gain of 12.

Theoretically, in a uniformly fed antenna, these areas of minimum signal strength receive no signal at all. Actually, the antenna does not, for mechanical and electrical reasons, radiate a signal from all radiators exactly at the same time or with the same power, and the spacing between radiators varies slightly, within mechanical tolerances. In addition, the affected areas almost always receive some signal reflected from ground, trees, or man-made objects in other areas. Due to these variations from ideal conditions, some amount of signal is practically always present. Experience indicates that this is usually of the order of five per cent of the strength of the signal in the horizontal direction at this same distance. As a result, "null" areas close to the antenna still receive signals of considerable strength.

This condition, fortunate as it is, still leaves something to be desired. Where areas contain terrain features or many

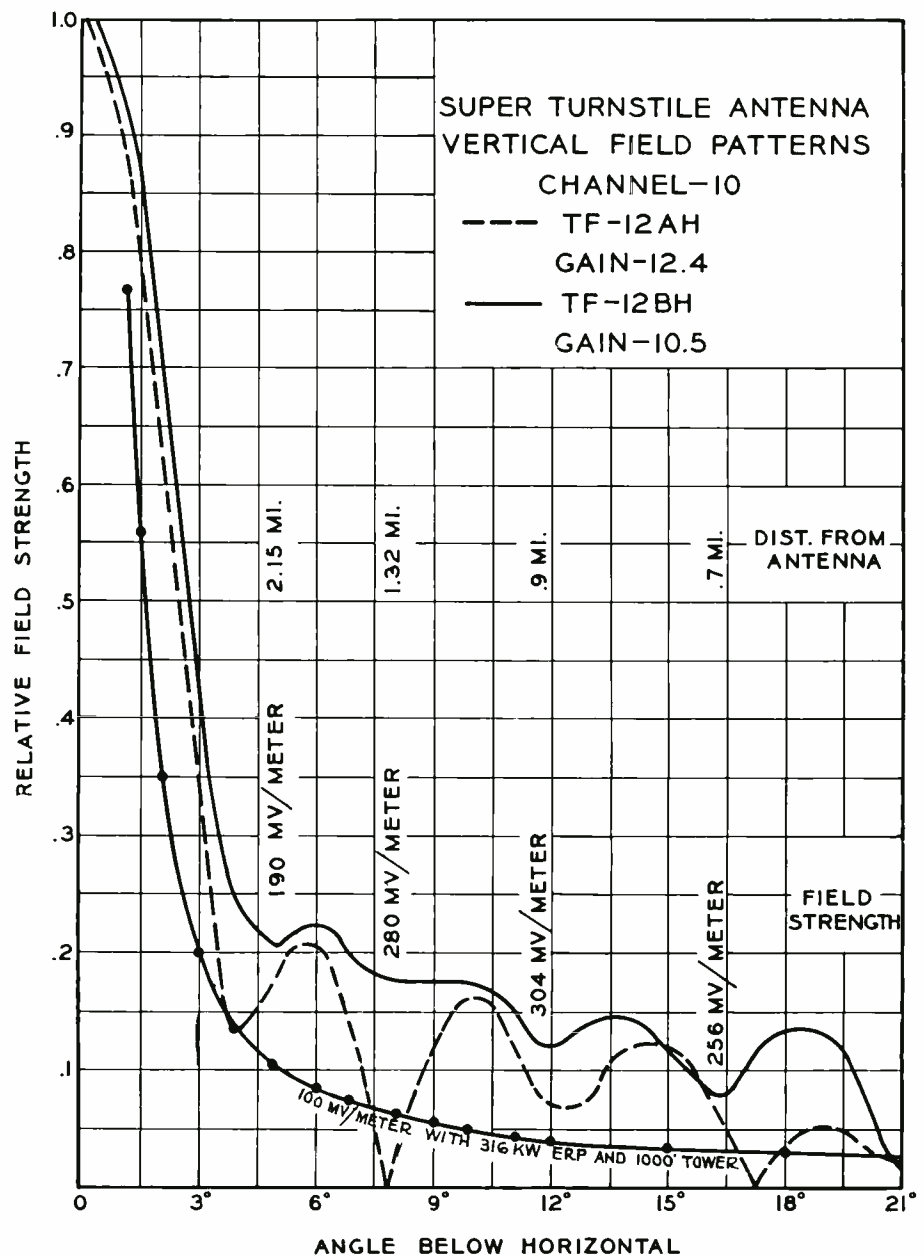



buildings making for strong multiple reflections of the signal, "echoes" may result which reduce the quality of the received picture.

It would be much more satisfactory to have a positive signal strength in these regions which would be great enough to exceed by a considerable margin any chance reflections which might exist and which in the minimum areas farthest from the antenna would be comparable to the strength in regions close to but not in the minimums.

**Techniques in Pattern Shaping**

Pattern shaping can be achieved in high gain antennas in several ways:

1. Unequal amounts of power may be fed to individual radiators in the antenna.
2. The signal may be fed to and radiated from the separate radiators in different relative phase.
3. A combination of 1 and 2 may be employed.
4. In particular cases where need for horizon distance coverage is secondary, the main lobe of the pattern may be tilted downward. This does not necessarily alleviate the condition of "null" formation but does increase signal strength below the horizon.

The RCA TF-12AH employs the first of these methods by dividing the input power to radiate 70 per cent from the upper six sections and 30 per cent from the lower six sections. This provides a substantial positive signal in the first null below the horizon—normally the most critical of the null conditions. It also gives a similar improvement in the third null. The fourth method is optional in the TF-12AH. This antenna has been enthusiastically accepted by broadcasters all over the country and has become the most popular of the RCA line.

**TF-12BH Coverage**

Not content with this, however, RCA now presents the TF-12BH, Figs. 1 and 2, to give added coverage of close-in areas, while maintaining strong signal at the horizon and beyond, for channels 7 through 13.

This new design was developed on the basis of minimum requirements, presented on a preceding page.

Employing the second method of obtaining "null fill-in" outlined above, that is, diverse relative phasing of the various radiator sections, RCA's new TF-12BH provides double and in some cases triple the desired field strength with ample gain to

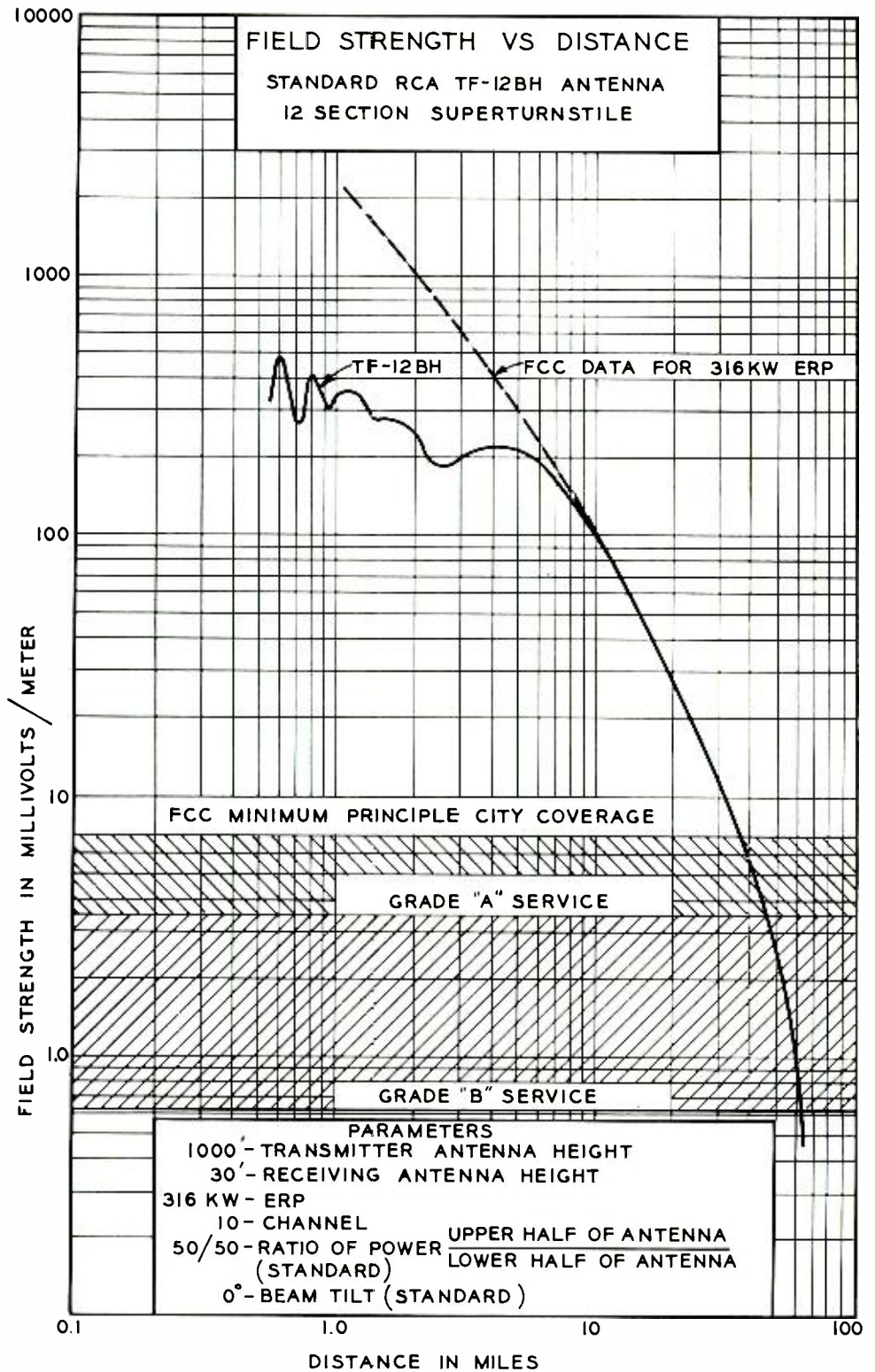

FIG. 5. "Field Strength vs. Distance" Curve for the new TF-12BH as compared to ideal FCC curve for 316 KW ERP.

achieve 316 kw ERP, even on a 1000-1500-foot tower, using existing type transmitters.

New vector analysis techniques were developed to permit proper phasing determination to optimize fill-in in each pattern minimum. In addition to pattern improvement, the phasing method of pattern shap-

ing permits more gain per unit length for a given shape and permits more conservative power ratings by uniform power distribution rather than increasing the power which must be handled by a few feed lines.

The new phasing is accomplished by providing feed lines of unequal length to the various radiator sections.

Thorough testing of pilot models by slotted line insertion and sweep techniques established excellent radiator-feed line impedance match on each individual line. The tolerances employed assure correct phase and current distribution in the antenna and permit a substantial safety factor in the 50 kw power rating with a high ambient temperature and black picture.

The overall VSWR specification at the antenna input is maintained to less than 1.1 to 1.0.

Fig. 4 shows typical field strength coverage curves for the TF-12AH and TF-12BH in terms of per cent of main beam field strength versus distance from the antenna. For purposes of comparison, a curve is also given showing percentages corresponding to 100 millivolts per meter, with an antenna operating with full 316 kw ERP on a 1000-foot tower. Corresponding figures in regions of signal minimum are shown on the TF-12BH curve. Values for other channels are very close to those shown for channel 10.

Another method of presentation of this same information is shown in Fig. 5. Here, field strength, in mv/m, is plotted against distance. The ideal FCC data for 316 kw ERP is also given.

A minimum sacrifice in gain has been made to accomplish the increased coverage. Values for the TF-12BH vary between 9.6 and 10.5, as compared with the 11.5-12.4 for the TF-12AH. Shown below is the power gain for each channel.

GAIN (at Visual Carrier)							
Channel	7	8	9	10	11	12	13
Gain	9.6	9.6	10.0	10.5	10.5	9.8	9.8

Fig. 6 shows attainable ERP with corresponding tower heights using various transmitter powers and types of tower transmission line.

Embodying all of the mechanical and electrical advantages of the TF-12AH (see BROADCAST NEWS, No. 74, 1953), the TF-12BH is rated at 50 kw of input power. It may be tower or pedestal mounted and is designed to withstand a 110-mile per hour windload.

This windload specification was selected as adequate for most locations with a high factor of safety. For unusual locations or

conditions, a substantially higher loading specification can be furnished at a nominal cost increase. A number of the "heavy-duty" designs for the proven TF-12AH have been supplied to tropical typhoon areas.

Its four 51.5 ohm input transmission lines may be combined in any one of a large number of ways to match one, two, or four transmission lines going up the tower (see BROADCAST NEWS, No. 71, 1952). The Combining Network which accomplishes this also makes it possible to sectionalize (and operate only a part of the antenna) in event of mechanical or electrical trouble, and provides a simple method of phasing of the top and bottom halves of the antenna to obtain any desired amount of tilt of the main radiated beam.

Except for lengths of feed lines, mechanical specifications of the TF-12BH and TF-12AH are identical. The mechanical construction employs steel pipe with 5-inch to 12¾-inch outside diameter. Under maximum windload conditions the maximum stress in the pipe will not exceed 20,000 pounds per square inch, providing a high safety factor. The junction boxes are connected with 3⅛-inch teflon coax and the individual feedlines are styroflex. Three stage transformers are used at each junction box to provide excellent bandwidth.

Practical necessity dictates "knock-down" shipment of the antenna. Assembly supervision and complete electrical tests are provided by an RCA Service Co. Field Engineer assuring a satisfactory installation and service.

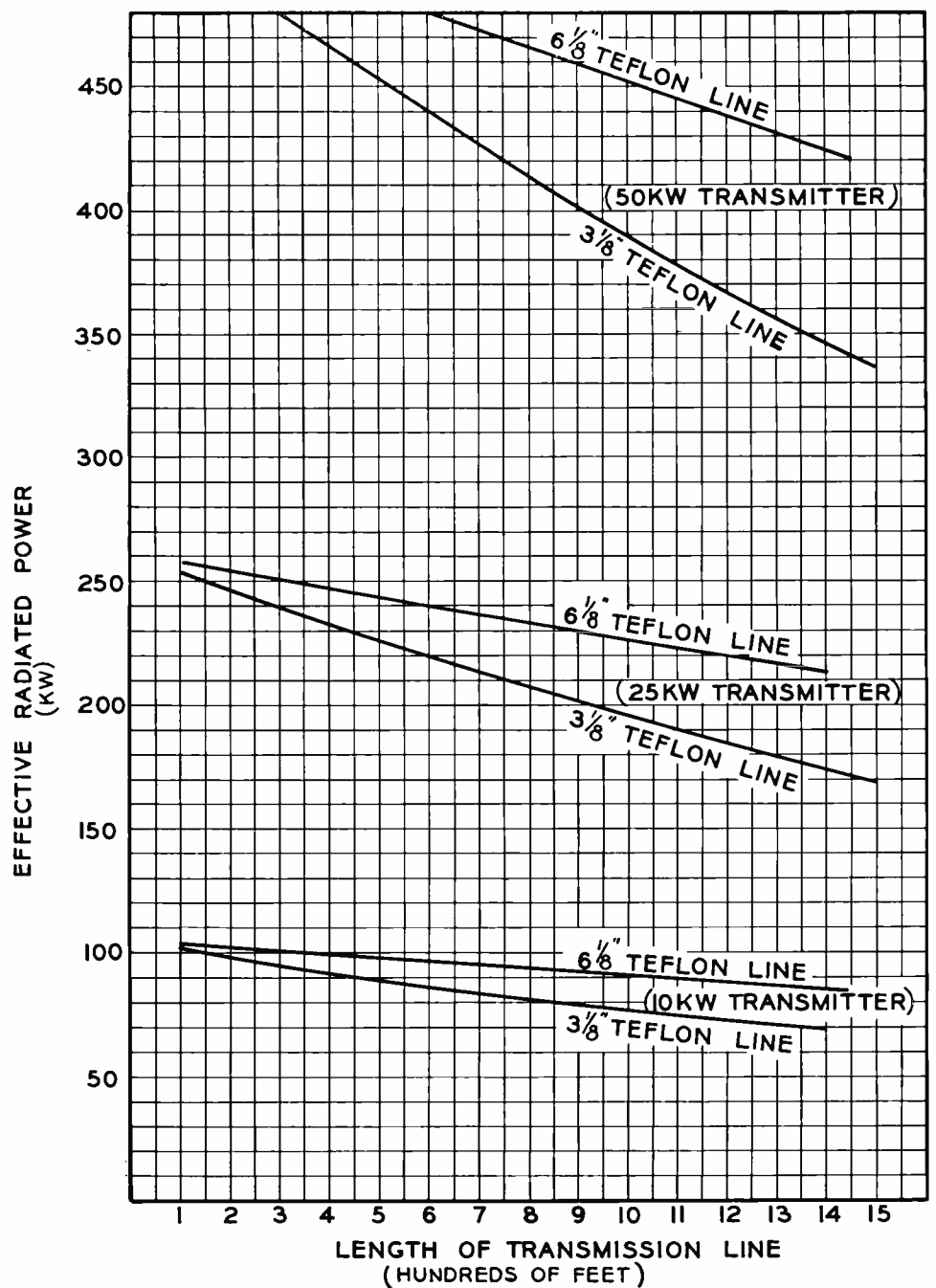

FIG. 6. Curves showing the various values of Effective Radiated Power obtained with various transmitter ratings and transmission line sizes.



# High-gain VHF antenna

—with a 50-kw rating!

**It delivers up to 316 kw ERP:** RCA's 12-section, 50-kw Superturnstile, in combination with a high-power VHF transmitter, meets FCC maximum power limits—with plenty of gain to spare.

**It has adjustable beam tilting:** Optional with all RCA 12-section 50-kw Superturnstiles, this feature insures best possible coverage and maximum reinforcement of your vertical pattern. It's done simply by phase-shifting the power between upper and lower halves of the antenna—using standard feedline.

**It provides null fill-in:** With RCA 12-section 50-kw Superturnstiles, you can virtually eliminate first null with practically no loss of gain. Benefits are: Effective close-in coverage, and vertical field-pattern shaping for constant field.

**It uses a switchable feed system:** Advanced-type junction boxes, new feedlines, and a sectionalized line-connecting system, enable you to switch power from one part of the antenna to another. *An important feature for emergency operation!*

**Specially matched Styroflex line:** No VHF antenna operates right without close matching with the transmission line. RCA's Styroflex transmission line *matches* the impedance of Superturnstile sections, handles higher power, holds center conductor in position—even when line is coiled.

**Complete VHF Antenna Accessories:** RCA has all equipment for VHF 50-kw Superturnstile systems—transmission line fittings, towers, r-f loads and wattmeters, duplexers, etc. Everything is "system-matched" for maximum performance.

**REMEMBER:** RCA makes five different types of VHF 50-kw antennas to fit your needs. RCA has all 50-kw antenna accessories. RCA can supply high-gain 50-kw antenna systems—*tailored specifically for your VHF channel, power, and service area.* Let your RCA Broadcast Sales Representative help plan your TV antenna system.

This picture was taken during erection of an RCA TF-12AH, 12-section 50-kw Superturnstile at KTBC-TV. Interim transmitter power was 2 kw when KTBC-TV went on the air. Now it's 10 kw

KTBC-TV can still increase power many times without a single change in its antenna system



**RADIO CORPORATION of AMERICA**  
ENGINEERING PRODUCTS DEPARTMENT  
CAMDEN, N.J.

# **FIRST** **RCA** **50 KW VHF**



Type TT-50AH  
RCA 50-kw VHF transmitters are in production!



**RADIO CORPORATION of AMERICA**  
ENGINEERING PRODUCTS DIVISION  
CAMDEN, N.J.

# ...NOW "ON-AIR"

at WMIN-TV and WTCN-TV  
Channel 11  
Minneapolis-St. Paul

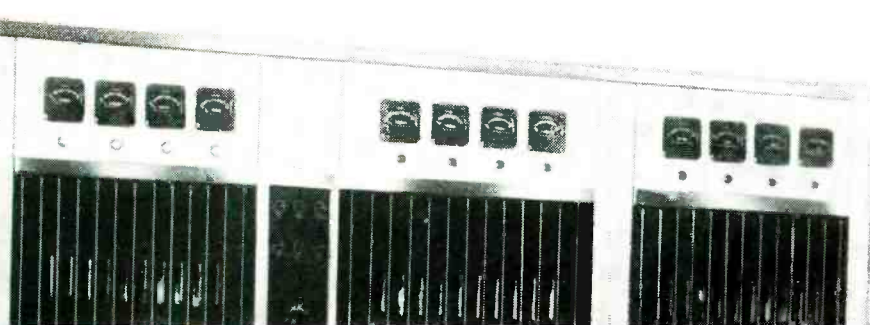

Here is the one high-power VHF transmitter that easily delivers a "full" 50 kilowatts of peak visual power . . . measured at the output of the side-band filter! And you get this full power output for monochrome—and for Color Operation!

The RCA TT-50AH is designed for the same conservative type of operation that has made RCA AM "Fifties" famous. It is the ultimate in high-power transmitters for channels 7 to 13. Operated in conjunction with an RCA 50-kw antenna (type TF-12BH) you can saturate your service area with strong signals. Even with antennas of medium gain, this transmitter develops Effective Radiated Power of 316 kw with power to spare!

Air-cooled throughout, the TT-50AH uses RCA-6166 high-gain tetrodes in both aural and visual "PA's" (RCA-6166 tetrodes are readily available from any RCA Tube Distributor). R-F amplifier and modulator circuits employ the very latest design principles which result in superior transmission fidelity.

Flexible mechanical design makes it convenient and practical to set up cabinets and power components in a variety of compact arrangements. Small size cabinets are moved in and out of standard elevators, doors, and hallways with ease.

For delivery information on the RCA 50-kw transmitter—call your RCA Broadcast Sales Representative.

RCA PIONEERED AND DEVELOPED COMPATIBLE COLOR TELEVISION

#### WMIN-TV and WTCN-TV PLANT . . .

. . . atop Foshay Tower Building in Minneapolis

The remarkable mechanical installation flexibility of the RCA 50-kw VHF makes it easy to set up in compact areas. Small-size cabinets can be moved in and out of standard elevators, doorways. Benefits: (1) You save floor space (2) You save on installation expense.





**RCA Velocity  
Microphone  
Type 44-BX**  
Effective Output Level, -55 dbm  
Hum Pick-up Level, -112 dbm



**RCA Polydirectional  
Microphone  
Type 77-D**  
Effective Output Level, -57 dbm  
Hum Pick-up Level, -126 dbm

# Broadcasting's Best...

These are the network favorites.

Year after year they serve more broadcast and television audiences than any other microphone. Yet, despite their overwhelming popularity, RCA's engineering continues to make both even better than before.

The 44-BX is the bi-directional type—designed for AM, FM, and TV studios where highest quality reproduction is desired. It provides high-fidelity output over the entire audio range—and is free from cavity or diaphragm resonance and pressure doubling.

The 77-D is the polydirectional type . . . quickly adjustable to *any* pick-up pattern you want. A 3-position voice-music switch enables you to select the best operating characteristic for voice and music. *Hum pick-up level, -126 dbm!*

Call your RCA Broadcast Sales Engineer for prices and delivery information. Or write Dept. 19 JB, RCA Engineering Products, Camden, New Jersey.



**BROADCAST EQUIPMENT  
RADIO CORPORATION of AMERICA  
ENGINEERING PRODUCTS DEPARTMENT, CAMDEN, N.J.**

In Canada: RCA VICTOR Company Limited, Montreal



The **ONLY** professional turntable  
*tailored* specifically for  
 "**fine groove**" 33 $\frac{1}{3}$  or 45

- **New, smaller size** . . . only 28" high, 20" wide, 16 $\frac{1}{2}$ " deep
- **Faster starts.** Full speed in less than  $\frac{1}{4}$  turn
- **Easier cueing** . . . through faster starts and disengaging of driver idlers
- **Goodbye operating errors.** Center hole diameter changes automatically with speed changes
- **No record slippage.** The center of the platter is recessed to handle the inside shoulder of 45's. Easy to handle
- **Wow and flutter** as low as RCA 70 series turntables

**S**MALLER than any Professional Broadcast turntable . . . yet capable of delivering the same high-quality output as RCA's famous 70 series . . . Type BQ-1B is your answer for a simple-design turntable matched and styled to meet the trend in transcription requirements. It enables you to take full advantage of the vast library of 45's and 33 $\frac{1}{3}$ 's now available. It takes up less space in your control room. It enables you to take advantage of the important space-saving features offered by "fine-groove." **AND NOTE THIS FACT: *The price is right!***

*Type BQ-1B is ready for immediate delivery, complete—or mechanism only. For details, call your RCA Broadcast Sales Representative.*

RCA Type BQ-1B Fine-Groove Transcription Turntable. There is ample room for a booster amplifier—and plenty of shelf space for program records.



**RADIO CORPORATION of AMERICA**  
 ENGINEERING PRODUCTS DEPARTMENT

CAMDEN, N.J.

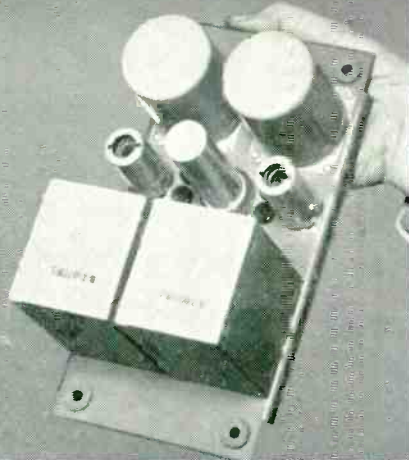

New compact amplifiers—use low-noise, long-life, miniature tubes.

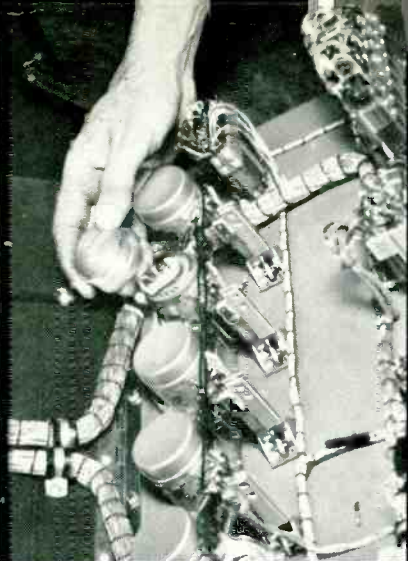

Every component is easy to get at for inspection and maintenance.

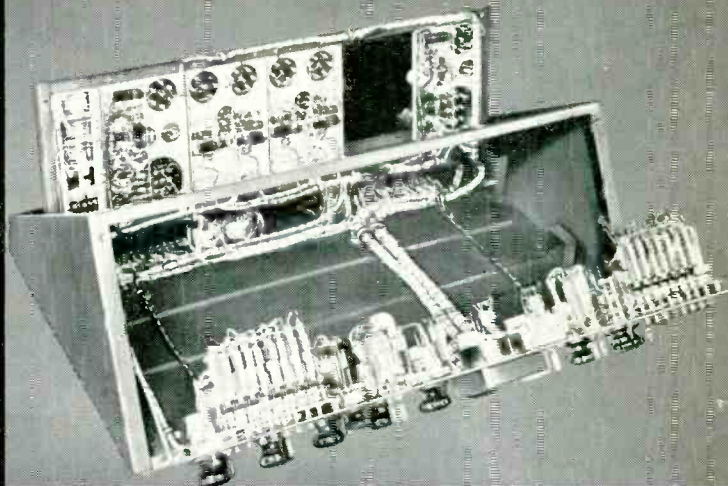

Accessibility, plus! New hinged control panel swings down; amplifier frame swings up.

# 9 EXTRA FEATURES of the

**THE EASY WAY** the BC-2B Consolette handles is due in great measure to the careful attention RCA engineers have given to construction details—and to a number of unique operating features (not found in their entirety in any standard console). Some of these advantages are pictured on these pages.

For example, see how easy it is to get at

the amplifiers and components. Note how every inch of wiring can be reached without disturbing the installation. See how the consolette fits snugly into the control room—unobtrusively. See how the styling matches other RCA audio and video equipments.

Based on more than 25 years of experience in building studio consolettes, type

BC-2B is in our opinion a high point in consolette design. The instrument includes all essential elements needed by most AM-FM and TV stations. And every feature has been operation-proved—many in RCA deluxe custom-built equipment. *Type BC-2B is available at a "package" price.*

For details, call your RCA Broadcast Sales Representative.

Type BC-2B is styled to match RCA video equipment—like this familiar video console

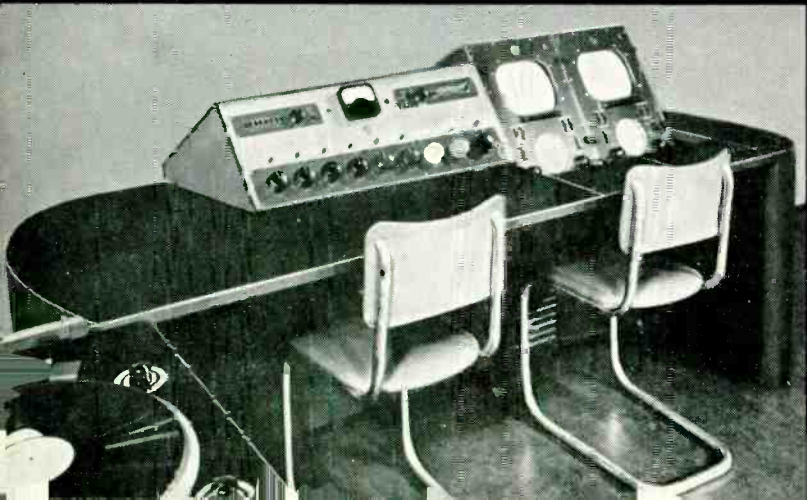

... and it's styled to match other RCA audio equipment, too—like this master switcher, for instance.

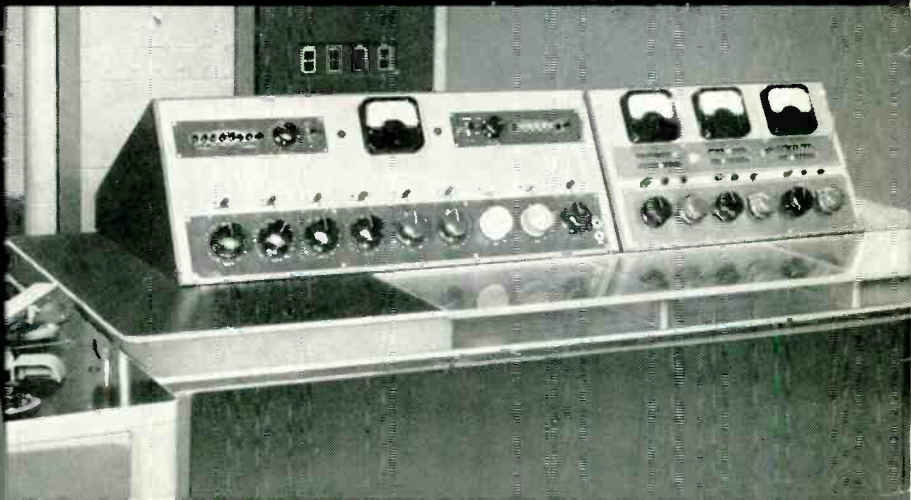



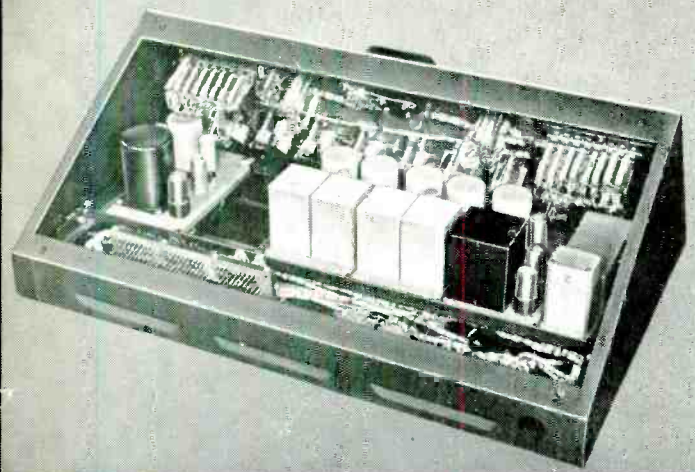

All external connections are made to two terminal blocks. To get at them, just lift the cover.

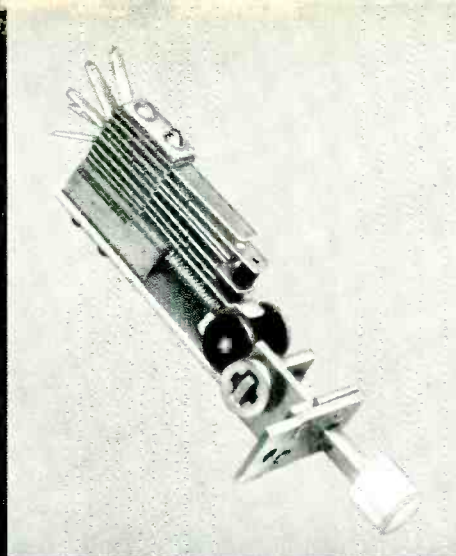

New, reliable interlocking push-button switches are leaf-type and cam-operated.

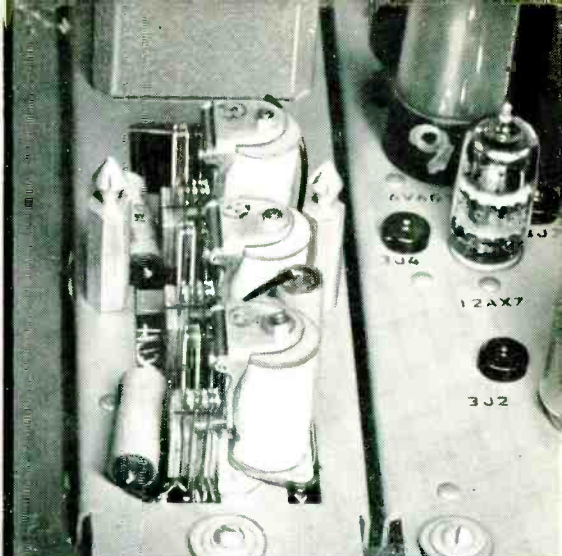

Improved, faster-operating speaker relays eliminate key clicks and audio feedback.

# new consolette



Low height, and 30-degree sloping front and top offer maximum studio visibility. You can install the BC-2B tight up against your studio window. There are no rear connections.



**RADIO CORPORATION of AMERICA**  
ENGINEERING PRODUCTS DEPARTMENT  
CAMDEN, N. J.

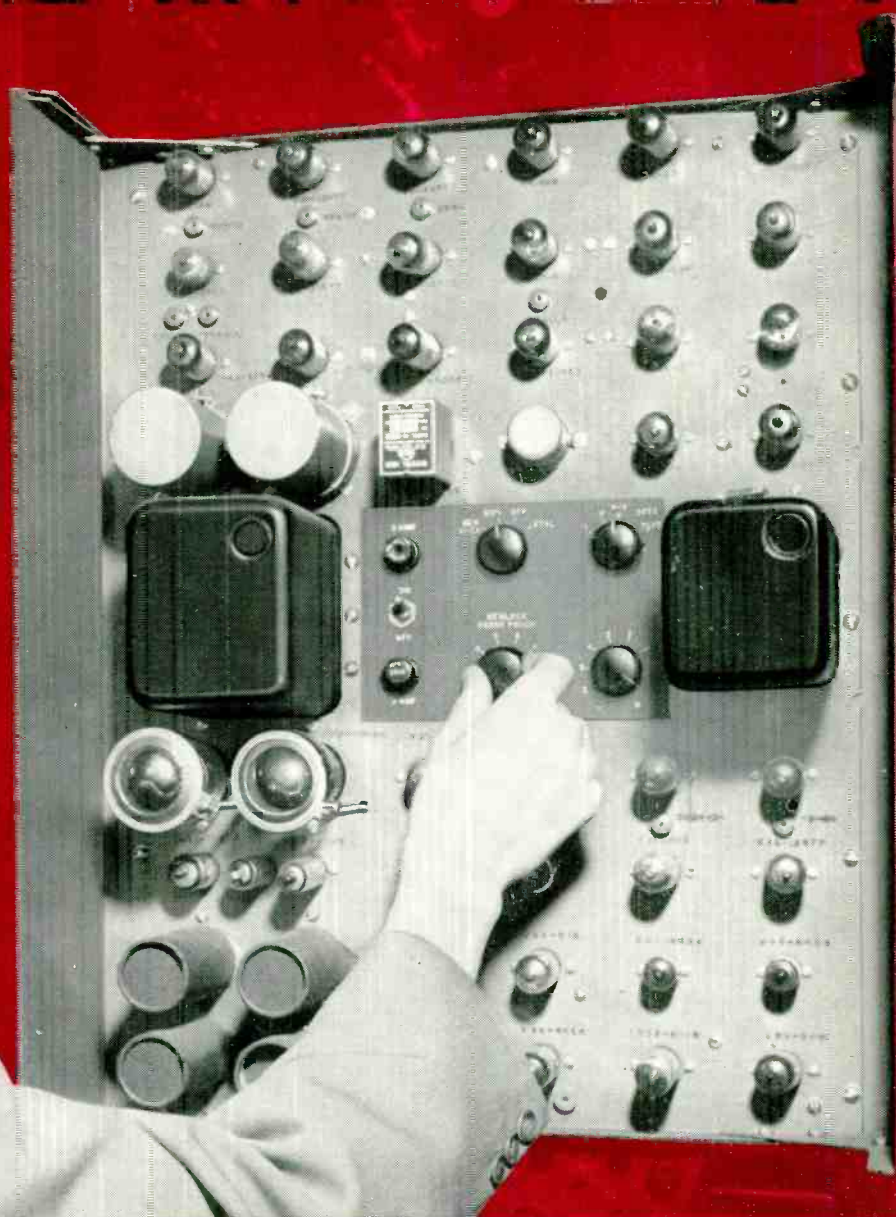
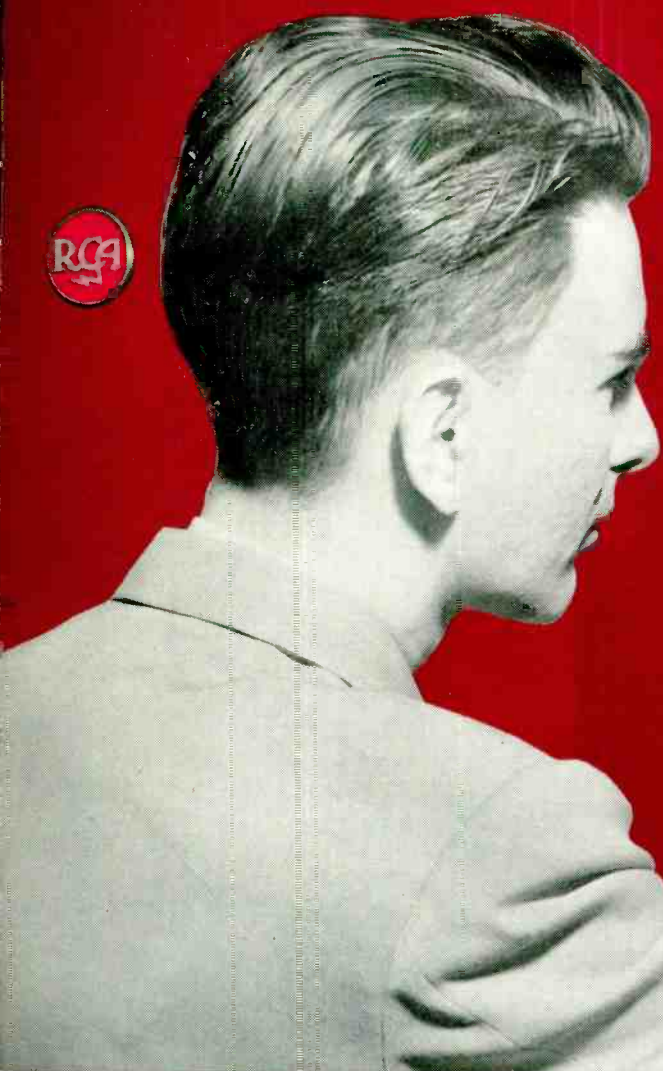

New RCA single-unit Sync Generator takes less than one-third the rack space needed by other sync systems

## Smallest, finest Studio Sync Generator ever built!

### RCA Type TG-2A

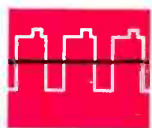

COMPLETELY NEW THROUGHOUT—and incorporating a revolutionary new multivibrator circuit—Type TG-2A is, we believe, the *ultimate in synchronizing generators*. It combines all synchronizing functions into a single chassis (includes a Genlock, a Dot Generator, a grating generator, and a regulated power supply). It takes only 21 inches of rack space (one-third that required by other sync generators)—is so compact you can easily install two of these units (one a stand-by) and an RCA changeover Switch MI-26289 in a single rack. It uses fewer tubes than other sync generators (38 miniatures, 2 rectifiers). And, of course, the TG-2A can be operated in conjunction with a Color Frequency Standard.

RCA Type TG-2A's are now available for all TV stations—VHF and UHF. For technical details and delivery information, talk to your RCA Broadcast Sales Representative.

#### Only RCA's TG-2A has these features

- In a SINGLE standard chassis it includes:
  - a synchronizing generator, Genlock, dot generator, grating generator, regulated power supply
- Entire unit takes only 21 inches of rack space
- Only 4 operating controls
- Adjustable pulse output voltages
- Pulse outputs have sending end-terminations
- Adjustable "front porch" width
- Operates with Color Frequency Standard
- Can be remotely-switched to Genlock operation
- Provides Dot Convergence Pattern
- Fewest tubes of any sync generator (38 miniatures, 2 rectifiers)
- Test jacks for circuit checking
- Pulse widths and delays STABILIZED against tube aging
- Choice of 5 ways to control basic frequencies
- Characteristics more than meet FCC and RETMA standards



**RADIO CORPORATION of AMERICA**  
ENGINEERING PRODUCTS DEPARTMENT

CAMDEN, N. J.

# RCA FREQUENCY MEASURING SERVICE

For accuracy...  
for reliability...

OBTAIN YOUR  
FREQUENCY MEASUREMENTS  
FROM RCA

WORLD LEADER IN  
RADIO AND TELEVISION



- Enables the station operator to:
1. maintain transmitting equipment within licensed limits.
  2. detect and correct harmonics, parasitics, and spurious radiations.

Accuracy: 4 parts in 10,000,000

## SCOPE OF SERVICE

Measuring service is provided for the frequency spectrum from 13 kilocycles to 500 megacycles—and for all classifications including:

Amateur	ST Link
Aviation	Citizen's Radio
Broadcast	Experimental
AM, FM, and TV	Transportation
Educational (FM)	Land
High Frequency	Maritime
(International)	Public Safety

Service is also provided to stations in many foreign countries.

FM and TV measurements are limited to areas within 300 miles of Riverhead, New York and Point Reyes, California.

## TYPES OF MEASUREMENTS

Three types of measurements are available. They meet every need of the station operator for measurement service.

The three types are:

1. Regular Measurements—a periodic service calling for measurements to be made to a prearranged schedule.

Upon request, "Off Frequency" Reports are also made to stations using this service. These latter reports are unscheduled and are rendered by the laboratories when technicians scanning the bands discover a station operating outside its limits.

2. Single Measurements.

3. Group Measurements—which provide for more than one measurement to be made at a given time, such as the frequencies of more than one transmitter, of different adjustments of the same transmitter, or of 2 or more signals interfering with each other.

## MEASURING EQUIPMENT

The equipment used in RCA Frequency Measuring Laboratories has been designed solely for precision frequency measuring operations.

In general, the method of measurement is a comparison of the received signal with exacting frequencies produced by harmonic generators, which are controlled by the output of a 100 kilocycle primary standard.

Accuracy is better than 4 parts in 10 million.

**RCA COMMUNICATIONS, INC.**

A SERVICE OF RADIO CORPORATION OF AMERICA



Service Mark ®

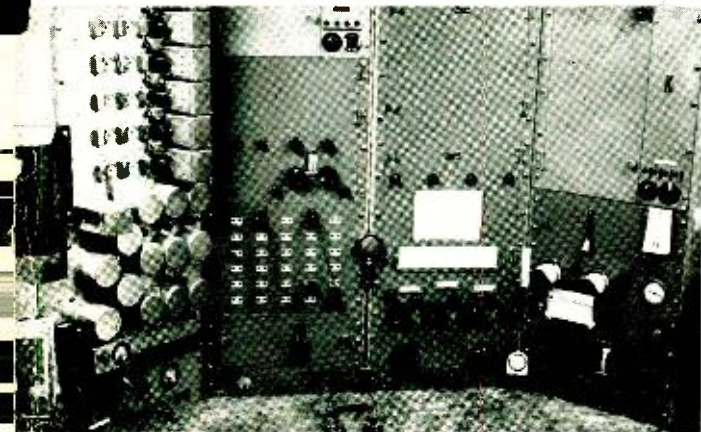
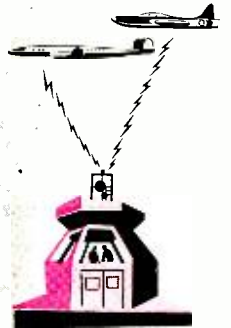

RCA Communications frequency measuring installation

## FREQUENCY MEASURING SERVICE

140 Moriches Road  
Riverhead, New York

28 & 36 Geary St.  
San Francisco 8, Calif.

WRITE ADDRESS NEAREST YOU FOR ADDITIONAL INFORMATION

# How to prepare

# for

# Color TV



## The indispensable equipment guide for every TV Station planning color operations

### What's in the Color Edition

- The RCA Color TV System
- What Color TV Means to the Broadcaster
- Television Transmitter Operation with Color Signals
- How to Plan for Color TV
- RCA Color Studio Camera, TK-40A
- RCA Color Slide Camera, TK-4A
- RCA Color Film Camera, TK-25A
- RCA 16mm Color Film Projector, TP-20A
- RCA Color TV Monitor, TM-10A
- RCA Colorplexer, TX-1A
- Test Equipment for Color Television
- RCA Color Sync Generator Equipment
- Video Amplifiers in Color Signal Transmission

THIS SPECIAL 80-page issue of RCA Broadcast News has been prepared specifically for the TV station man who is getting ready to work with color. Filled with authentic information not found in its entirety anywhere else, this issue includes important facts you'll want to know about color Now . . . such as general operating theory of the color telecast-

ing system, how to plan studios and stations for color, types of equipments and systems required, how to make equipment changeovers for color.

Copies of this special color issue of Broadcast News may be obtained from your RCA Broadcast Sales Representative. Or write Section 503, RCA Engineering Products, Camden, New Jersey.

### The only 100% engineering-operations journal for station men



Read by broadcasters and telecasters longer than any technical magazine of its kind in the industry, RCA BROADCAST NEWS is prepared specifically to keep station men up-to-date on equipment-and-station operations. It includes straight-to-the-point facts on planning installations, testing and operating station equipment—newsy stories about stations from the stations themselves—interesting articles on “how-it-works” and “how-to-do-it” for the everyday job—plus equipment information you can find in no other periodical. RCA BROADCAST NEWS is published every other month. Ask your RCA Broadcast Representative to put you on the list to receive it regularly.



**RADIO CORPORATION of AMERICA**  
ENGINEERING PRODUCTS DIVISION

CAMDEN, N. J.