



# BROADCAST

NEWS



VOL. No. 83  
MAY 1955



## How an RCA projector brings a bulldozer into the boardroom!

Whether *your* product is too big for a briefcase or too small to be seen, you'll find RCA 16 mm Film Projectors are marvelous sales clinchers.

These tough, lightweight portables help many a sales force *persuade* with motion, sound and color. Hundreds of businesses use RCA 16 mm Projectors to transform sales meetings into professional shows . . . cut sales training time . . . make each presentation a dramatic event. Churches, schools and civic groups also use RCA Projectors for audio-visual programs.

An RCA 16 mm Projector is so easy to operate that it can be set up with a picture on-screen in less than three minutes. And it's trouble-free . . . because it is manufactured to the same exacting standards as RCA's famous professional line of theatre projection equipment.

For more information on the many uses of RCA 16 mm Projectors, or other RCA electronic products, write to RCA Engineering Products Division, Dept. R-163, Bldg. 15-1, Camden, New Jersey.



The world's best name for quality

**RADIO CORPORATION of AMERICA**

Choose RCA electronic  
products for  
better business



**RCA MOBILE 2-WAY RADIO** provides instant 2-way communication between the office and vehicles in the field. It cuts costs, speeds service, reduces mileage and telephone expense, soon pays for itself.



**RCA SOUND SYSTEMS** are engineered to give the best in internal communications. Widely used by industrial plants, schools and large institutions for spoken messages or music . . . to any or every in-plant location.



**RCA METAL DETECTOR** finds metal particles (magnetic and non-magnetic) in textiles, plastics, foods, rock products and other belt-conveyed materials. Protects machinery from damage and product from foreign bodies.



**RCA INDUSTRIAL TV** lets you see where it's too hot, too dangerous or too impractical to go. Camera "eye" provides a high-definition, high-contrast picture that permits constant centralized control.



**RCA THEATRE EQUIPMENT** leads the field with installations in a majority of U. S. theatres . . . indoor and outdoor. The complete line includes everything for a modern theatre . . . from projectors to carpeting.

OUR COVER for this issue pictures the installation of the RCA Ultragain UHF Pylon at WBRE-TV, Wilkes-Barre. An RCA 25 KW UHF Amplifier plus this Ultragain Pylon made WBRE-TV the nation's first million-watt station.

Vol. No. 83	May, 1955
-------------	-----------

# BROADCAST NEWS

*published by*

**RADIO CORPORATION OF AMERICA**  
ENGINEERING PRODUCTS DIVISION      CAMDEN, NEW JERSEY

**PRICE**      *In continental U.S.A. --- \$4.00 for 12 issues*  
*In other countries ----- \$5.00 for 12 issues*

## CONTENTS

PLANNING THE WTOP "BROADCAST HOUSE" . . . . .	by Clyde M. Hunt	8
WTOP TELEVISION OPERATIONS . . . . .	by L. A. Wilkinson	14
WTOP TV REMOTE FACILITIES, HOUSE MONITORING AND STUDIO CLOCK SYSTEM . . . . .	by Granville Klink, Jr.	19
WTOP RADIO FACILITIES . . . . .	by Donald H. Saunders	22
REPUBLIC STUDIO MULTIPLE STAGE DESIGN . . . . .	by D. J. Bloomberg, John Pond and M. Rettinger	24
THE STORY OF A 1 KW-AM AT WCBI . . . . .	by Bob McRaney	28
HOW TO MAKE AN "ILLUMINANT C" GREY SCALE MONITOR . . . . .	by E. P. Bertero	32
PROGRESS REPORT ON COLOR TELEVISION . . . . .		36
THE BK-5A UNIAXIAL MICROPHONE . . . . .	by J. W. O'Neill & R. M. Carrell	44
THE BK-6A MICROPHONE . . . . .	by L. M. Wigington & R. M. Carrell	48
THE MEASUREMENT OF WIND NOISE IN MICROPHONES . . . . .	by R. M. Carrell	52
NEW DISTRIBUTION AMPLIFIERS FOR TELEVISION BROADCASTING STUDIOS . . . . .	by Robert G. Thomas	54
CAREFUL PLANNING PAYS OFF FOR STATION KNOE-TV . . . . .	by Ray Boyd	60

**"RCA PIONEERED AND DEVELOPED COMPATIBLE COLOR TELEVISION"**

---

Copyright 1955, Radio Corporation of America, Engineering Products Division, Camden, N. J.

PRINTED  
IN  
U.S.A.

# It's Here! RCA's Production

1   
Performs  
4 Functions



## MORE EFFICIENT

"All-in-one" Processing Amplifier combines the signal processing functions of previous channel amplifier, gamma corrector, shading generator, and monitor auxiliary.

Only   
1 1/3 Racks

## COMPACT

The new equipment utilizes only 100 inches of rack space; can be mounted in only 1 1/3 racks for efficient, compact installation.

  
1/3 Less Tubes

## LOW OPERATING COST

Requires half the ac power needs of conventional equipment and permits elimination of 50% of former dc power supplies. Uses 9 less rack-mounted units, and 134 fewer tubes — conservatively operated for extended life.

## FAST SETUP

Centralized controls minimize setup time, require but a single operator for control functions. In addition, over-all stability, improvement in camera performance and picture quality are assured.

No need to wait any longer for *production* live color TV equipment! RCA has it now... a complete new TK-41 Color Camera chain with new all-in-one Processing Amplifier, which combines four major functions in one. It not only provides important savings in components, floor space and operating costs, but assures highest quality at lowest expense.

This is the complete color camera TV equipment that television stations are now using in their swing to color, or in expanding their color facilities. For complete technical information, call your RCA Broadcast Sales representative. In Canada, write RCA VICTOR Company Limited, Montreal.

## RCA TK-41 TYPE COLOR CAMERA

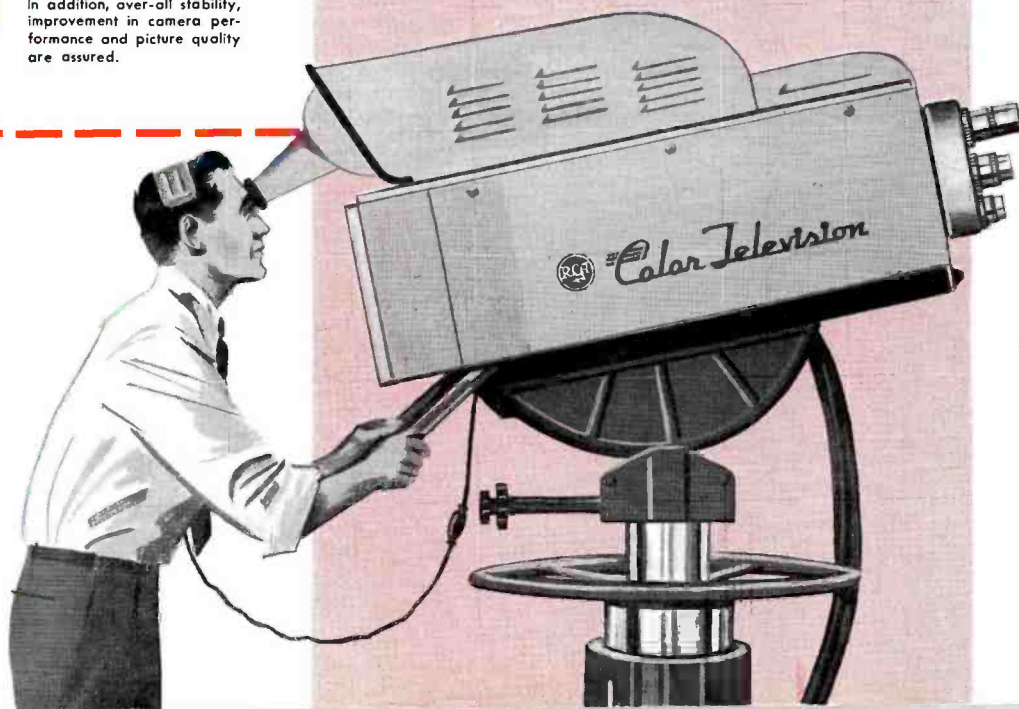

# COLOR CAMERA TV EQUIPMENT

... with the revolutionary all-electronic  
processing amplifier

which combines all  
signal processing  
functions in a  
single chassis.

12-Page Descriptive Brochure  
Available on Request.

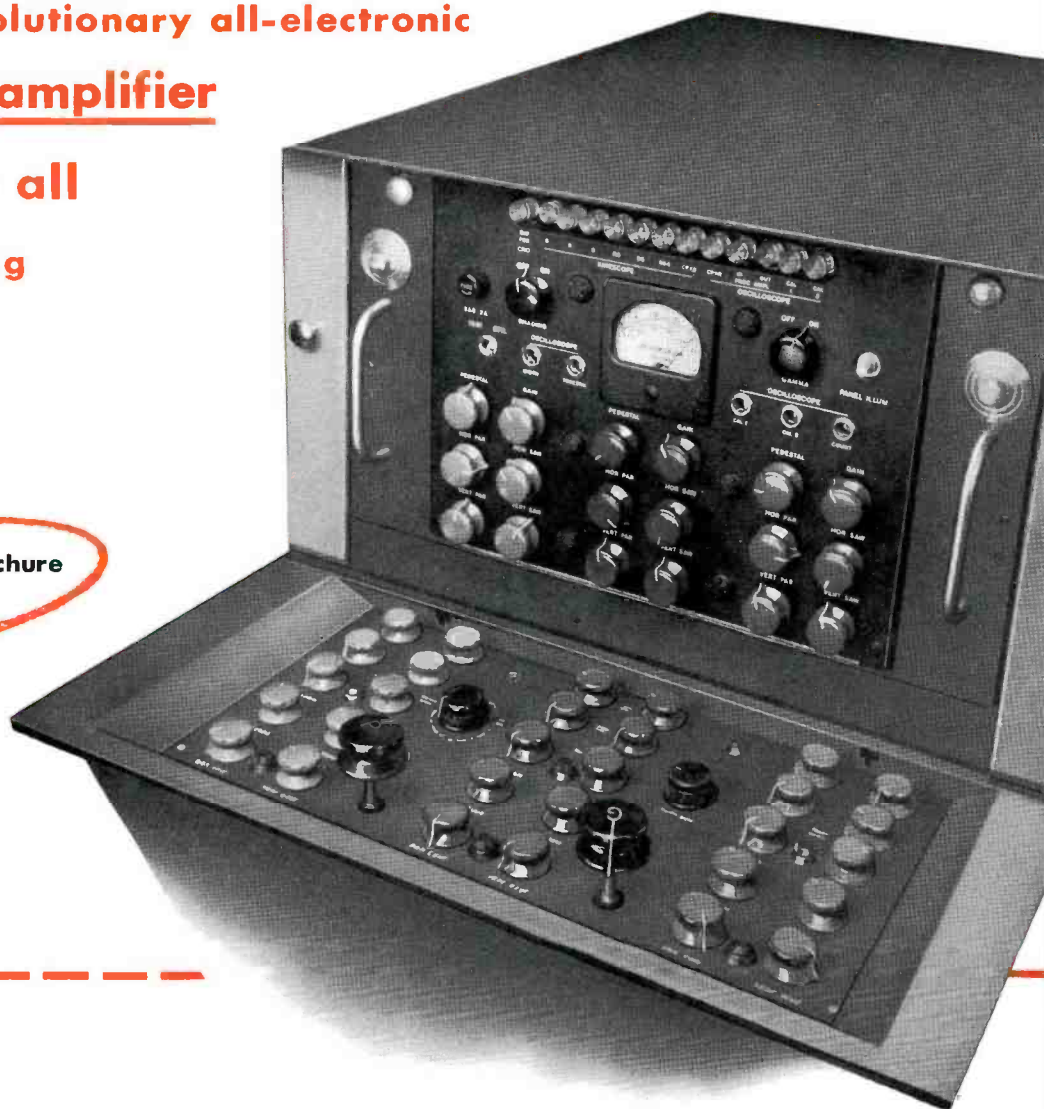

RCA Pioneered and Developed Compatible  
Color Television

View of  
Processing  
Amplifier  
with front  
shelf  
removed



**RADIO CORPORATION of AMERICA**  
ENGINEERING PRODUCTS DIVISION

CAMDEN, N. J.

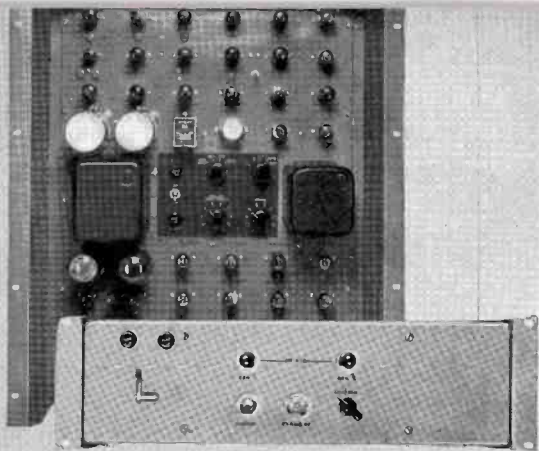

**NEW STUDIO SYNC GENERATOR TG-2A** (Field Generator is Type TG-12A). Combines sync generator, dot generator, Genlock, grating generator, regulated power supply—on a single chassis. Automatic Changeover Switch MI-26289 (illustrated) is a companion unit for convenient switching between two sync generators.

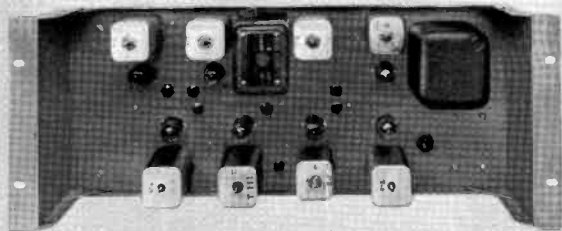

**NEW COLOR FREQUENCY STANDARD MI-40201.** Source of 3.58 mc color subcarrier used with sync generator to complete synchronizing function for color operation. A counter chain is included to provide means for locking the sync generator to the color subcarrier.

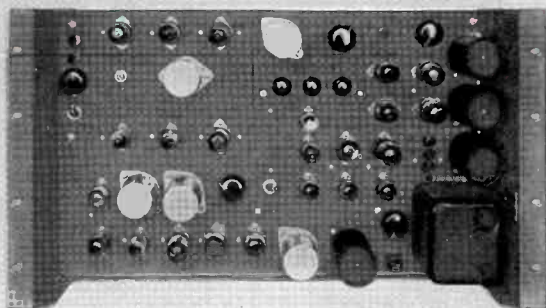

**NEW COLOR STABILIZING AMPLIFIER TA-7B.** In the studio, it performs all normal Stabilizing Amplifier functions—plus improved operation with the Genlock. At transmitter, it provides the white stretch required for color operation. Corrects frequency response for transmission losses.

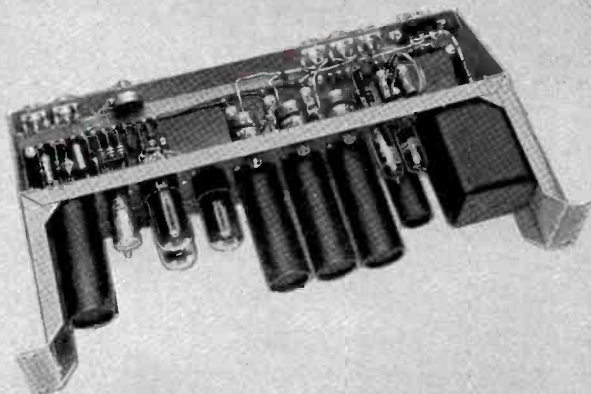

**NEW PULSE DISTRIBUTION AMPLIFIER TA-4A.** Regenerates degraded pulse signals. Restores rise time. Removes overshoots and spikes. Eliminates hum, surges, tilt. Provides sending-end termination for better long-line performance.

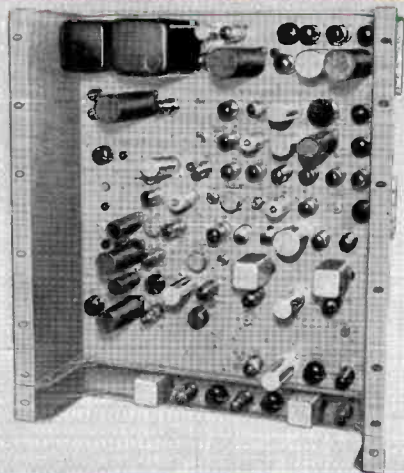

**NEW COLORPLEXER TX-1B** combines on a single chassis all circuits needed to produce a composite color signal from color primary signals of the live camera, film camera, or color bar generator. Newest design features improved stability and retrace blanking.

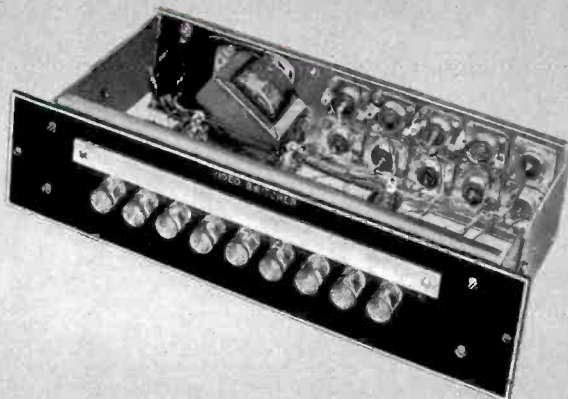

**NEW VIDEO SWITCHER MI-26277.** Ideal for monitor switching in announce booth, projection room, program consoles . . . wherever monitors may be located. The inexpensive means for modernizing your present switching installation.



## NEW TV EQUIPMENTS

*...for better monochrome and color*

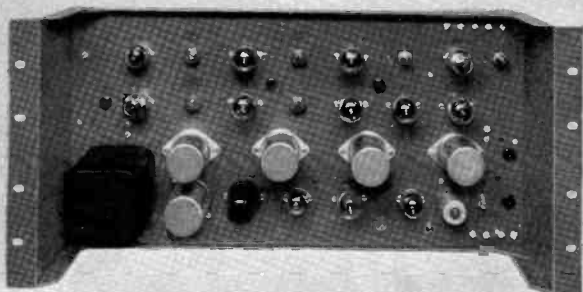

**NEW BURST FLAG GENERATOR, MI-40202A.** Generates keying pulse for injecting subcarrier bursts into Colorplexer. Burst position, burst width, keying pulse amplitude are adjustable with high accuracy. A "must" equipment . . . and a companion to the RCA Color Frequency Standard.

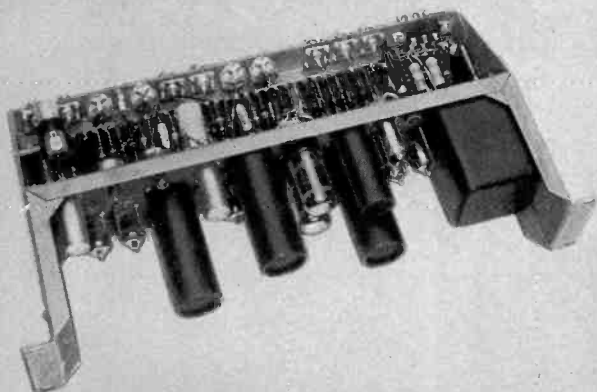

**NEW VIDEO DISTRIBUTION AMPLIFIER TA-3A.** Feeds up to 3 low-impedance lines from single high- or low-impedance source. Has extended low- and high-frequency response. 40-db isolation between output lines. Excellent linearity and gain characteristics. TA-3A is good for color.

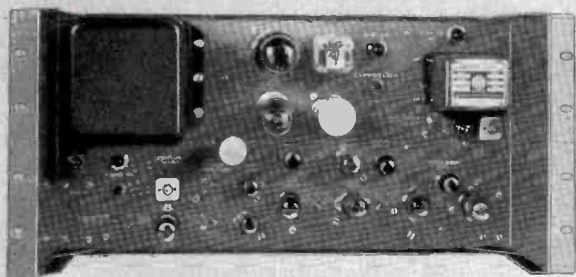

**NEW COLOR STRIPE GENERATOR WA-8A.** Enables you to transmit color test signals along with regular monochrome signal. Useful for receiver adjustment throughout the program day. The inexpensive "must" for TV stations planning color.

Illustrated here are a few of RCA's new, improved video designs for monochrome *and* color operation — *from the most comprehensive line of television equipment in the industry.*

Engineered in accordance with the best television practice, these units are designed for progressive TV stations looking for new ways to keep picture quality "up-to-the-minute." They offer improved operating efficiency and economy. They save as much as  $\frac{2}{3}$  the rack space of previous designs.

RCA improved Video Equipments are already in operation in well-known TV stations throughout the country—on both monochrome *and* color. For complete information on the entire line, call your RCA Broadcast Sales Representative. In Canada, write RCA Victor, Ltd., Montreal.

Free technical folders on RCA Video units. Simply tell your RCA Broadcast Sales Representative the number (listed below).



Item		Cat. No.
TA-3A	Video Distribution Amplifier	B.2502
TA-4A	Pulse Distribution Amplifier	B.2504
TA-7B	Color Stabilizing Amplifier	B.86
TG-2A	Studio Sync Generator	B.3400
TX-1B	Colorplexer	B.878
WA-8A	Color Stripe Generator	B.6067
MI-26289	Sync Generator Changeover Switch	B.3402
MI-40201	Color Frequency Standard	B.872
MI-40202A	Burst Flag Generator	B.874



**RADIO CORPORATION of AMERICA**  
ENGINEERING PRODUCTS DIVISION  
CAMDEN, N.J.

# OVER 30 **RCA** **50 KW VHF**

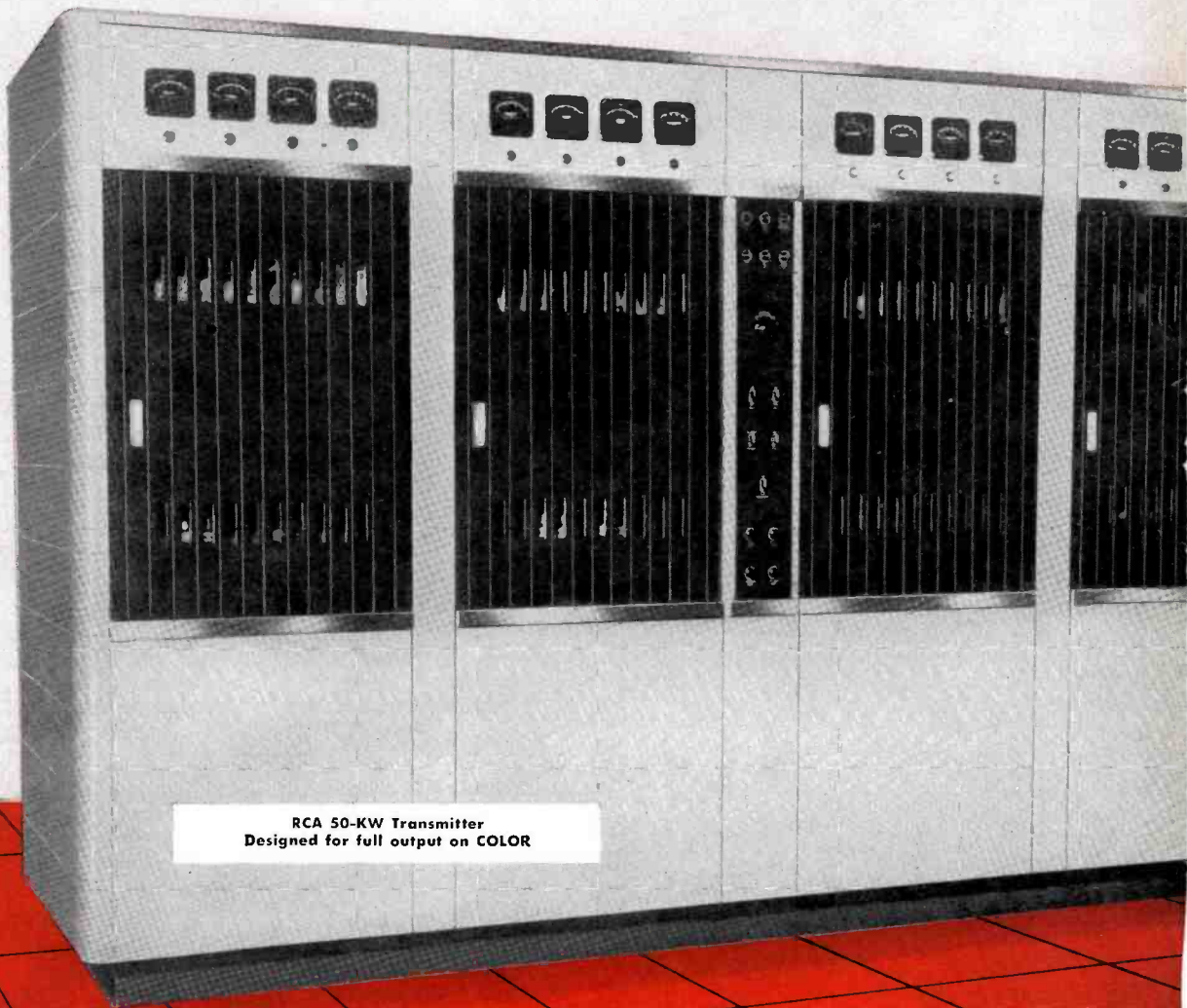

RCA 50-KW Transmitter  
Designed for full output on COLOR



**RADIO CORPORATION of AMERICA**  
ENGINEERING PRODUCTS DIVISION  
CAMDEN, N. J.



# ...NOW "ON-AIR"

## Who's Who among the RCA "50's"

KAKE-TV—Wichita, Kansas  
KEYD-TV—St. Paul, Minn.  
KHJ-TV—Los Angeles, Calif.  
KLZ-TV—Denver, Colorado  
KMBC-TV—Kansas City, Mo.  
KOLN-TV—Lincoln, Nebr.  
KTRK-TV—Houston, Texas  
KTTV—Los Angeles, Calif.  
KWTV—Oklahoma City, Okla.  
WAAM—Baltimore, Maryland  
WALA-TV—Mobile, Alabama

WBAL-TV—Baltimore, Md.  
WBTW—Florence, S. C.  
WCAU-TV—Phila., Pa.  
WCHS-TV—Charleston, W. Va.  
WDEL-TV—Wilmington, Del.  
WFLA-TV—Tampa, Fla.  
WGAL-TV—Lancaster, Pa.  
WHBQ-TV—Memphis, Tenn.  
WHO-TV—Des Moines, Iowa  
WISH-TV—Indianapolis, Ind.  
WJAR-TV—Providence, R.I.

WJRT—Flint, Michigan  
WMIN-TV—St. Paul, Minn.  
WTCN-TV—St. Paul, Minn.  
WNHC-TV—New Haven, Conn.  
WOOD-TV—Grand Rapids, Mich.  
WSFA-TV—Montgomery, Ala.  
WTHI-TV—Terre Haute, Ind.  
WTOP-TV—Washington, D.C.  
WTRF-TV—Wheeling, W. Va.  
WTVT—Tampa, Florida  
WTVW—Milwaukee, Wis.  
WXEL—Cleveland, Ohio

### Saturation Coverage with RCA's 50KW VHF and High-Gain Antenna

Now, over 30 high-power VHF stations are "on-air" and delivering saturation coverage with an RCA 50-kw—operated in conjunction with an RCA High-Gain Superturnstile.

Here are important reasons why you will benefit by selecting RCA's "Fifty" for your high-power station.

**RELIABILITY.** RCA 50-KW equipments are built to operate with "day-in day-out" reliability. (Ask any of the RCA-equipped 50-KW VHF stations already on air.)

**CONSERVATIVE DESIGN.** RCA 50-KW VHF's deliver a full 50 kilowatts of peak visual power—*measured at the output of the sideband filter.* You get full power output on both monochrome — AND COLOR — *with power to spare!*

**SATURATION COVERAGE.** An RCA 50-KW VHF, operated in conjunction with an RCA Superturnstile Antenna, is capable of "flooding" your service area with STRONG SIGNALS—*close*

*in and far out!* With standard antennas, RCA 50-KW's can develop 316 KW ERP—with power to spare.

**AIR-COOLED.** RCA 50-KW VHF's are all air-cooled. You save on installation costs and maintenance. Visual and aural P.A.'s use conventional RCA power tetrodes (Type 6166).

**MATCHED DESIGN.** RCA 50-KW VHF's are "systems-matched" to deliver peak performance in combination with RCA 50-KW antenna systems.

**COMPLETE SYSTEM.** RCA supplies everything in system equipment to match the RCA "50-KW" precisely; Antenna, transmission line, fittings, tower, r-f loads, duplexers — and all other components needed to put a 50-KW VHF signal on the air.

Take advantage of RCA's 25 years' experience in designing and building high-power equipment. Ask your RCA Broadcast Sales Representative to help you plan a completely-matched high-power system. In Canada, write RCA Victor, Ltd., Montreal.

RCA High-Gain  
Superturnstile  
Antenna (TF-12BH)

RCA PIONEERED AND DEVELOPED COMPATIBLE COLOR TELEVISION



John S. Hayes, President, WTOP, Inc., and Vice President for Radio and Television of the parent Washington Post Company.

# PLANNING THE WTOP "BROADCAST

by **CLYDE M. HUNT**  
*Vice-President for Engineering*  
 WTOP, INC.

To plan, design and erect a building to house completely the personnel and all the functions connected with a radio and television broadcasting business and to provide in it all of the facilities and appropriate space for each of the functions, is a complicated and unique experience. Anyone who has been through such an endeavor I am sure will readily admit this and those who have not yet will surely find it to be so. The proportions of the difficulty will vary from station to station, depending upon its size, the city and the diversity of the simultaneous activities which must be anticipated and performed.

In Broadcast House in the Nation's Capital, WTOP INC. had to provide service for something above the average in local facilities and, to be able simultaneously, to carry on functions that are required in connection with key station originations for the Columbia Broadcasting System's radio and television networks. To meet these requirements, Broadcast House was planned and constructed. We moved into our new building in October, 1953 and have been pleased to find that basically, and as a matter of fact, in detail, our planning was good.



Clyde M. Hunt.

## A BUILDING BUILT AROUND A TOWER

Broadcast House has 92,500 square feet of floor space. It is located at 40th and Brandywine Streets, N.W., and the new five-story and basement building completely surrounds the 373 foot tower that supports the TV and FM antennas. Our antenna is 783 feet above downtown Washington. At this location, there had previously been a one-story transmitter building. This one-story structure was still retained after having been altered and incorporated into the new overall structure. In the photograph of Fig. 1 it may be

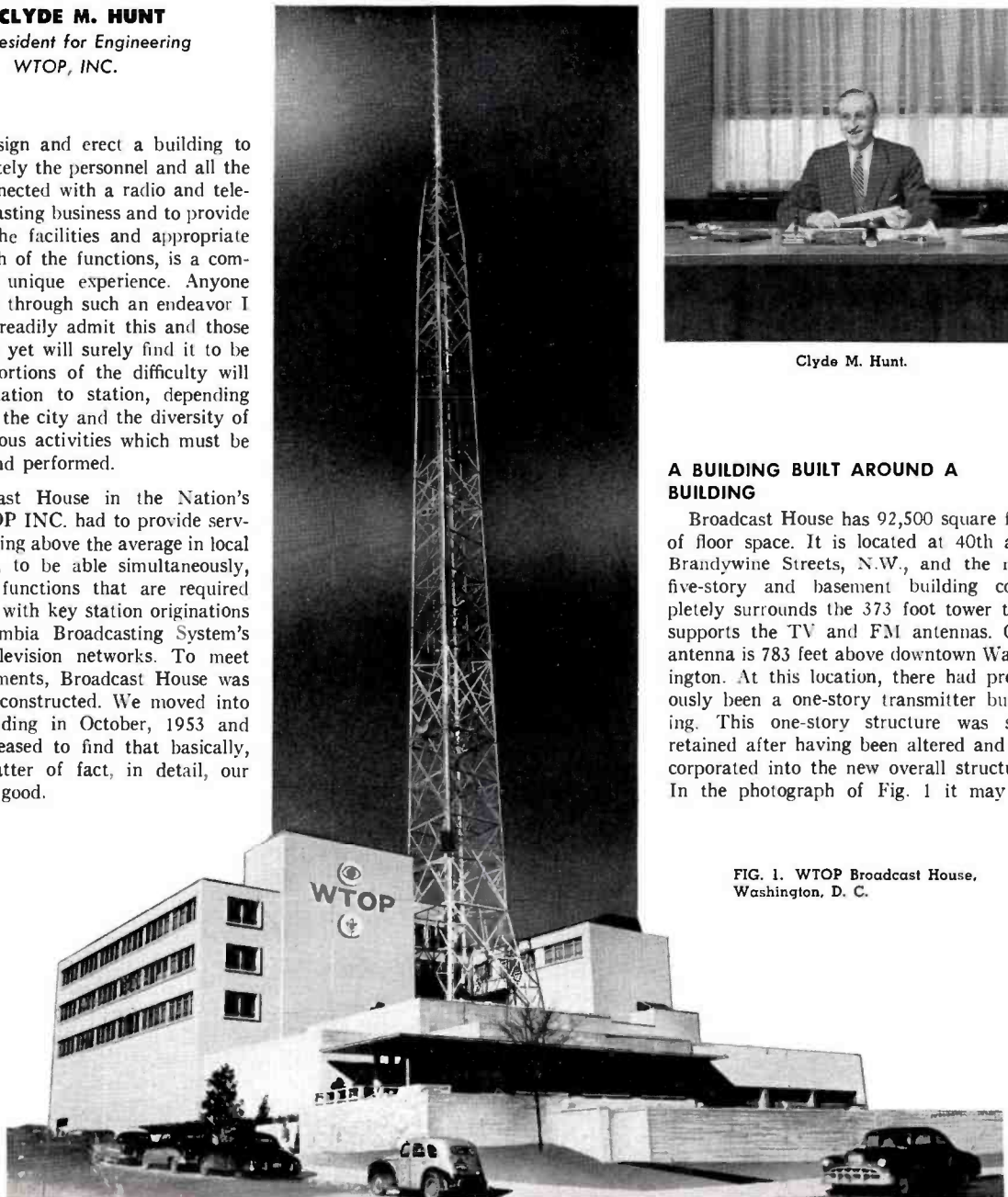

FIG. 1. WTOP Broadcast House, Washington, D. C.

seen that the one-story building section is on the corner and is now the main entrance to the building. Passing through the lobby, switchboard and reception room area, one reaches the two automatic passenger elevators, serving all floors. In addition, there is a freight elevator that serves all floors including the basement and the sixth floor mechanical rooms and penthouses. In addition

are used for miscellaneous requirements of the technical and other divisions of the Company.

### STUDIO FACILITIES

When we planned the move to Broadcast House, the garage was built first and outfitted as a TV studio complete with control room and was used for the origination of

One of these studios is an announce booth in connection with TV master control, but it has with it facilities for local station break originations with the switcher being in control of everything except live cameras. Eight other radio and TV studios are completely equipped with their separate control rooms and can easily handle any of the functions in connection with a par-

## HOUSE" IN THE NATION'S CAPITAL

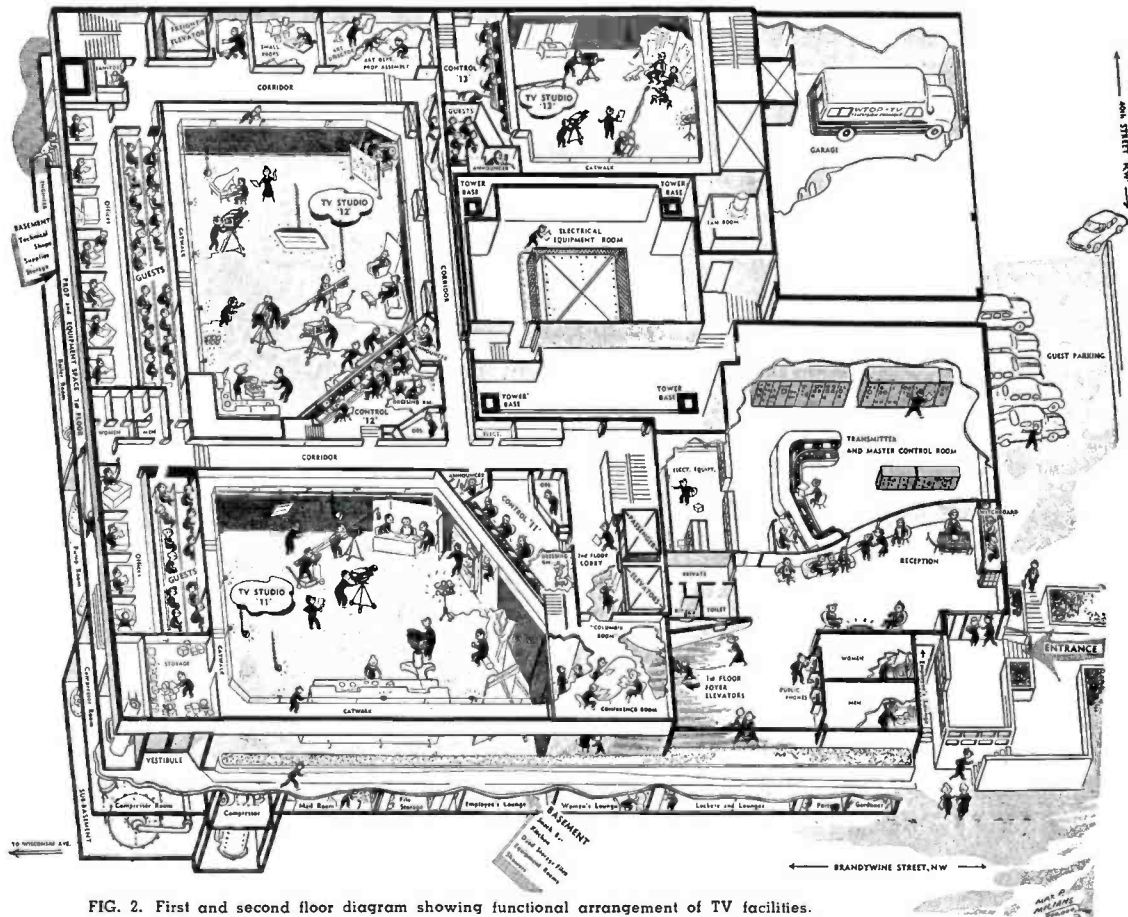

FIG. 2. First and second floor diagram showing functional arrangement of TV facilities.

tion to these elevators there is a hydraulic lift between the ground level garage and the basement. This makes it possible for equipment to be moved in and out of the mobile units to and from any place in the building without the necessity of removing it from a dolly. The garage will accommodate our TV mobile unit, the specially outfitted film wagon, the portable power trailer and four other station wagons which

programs for about a year while the main building was being constructed. It was a difficult year for management and staff. Many temporary expedients were necessary for continuity of operations, requiring duplication of facilities and personal effort through many months, and particularly at times when we were using both the old and the new studios.

Now Broadcast House has nine studios.

FIG. 3. Main entrance reception room and glass-enclosed telephone switchboards.



ticular program. Three of the TV control rooms are equipped with TS-20A switching equipment and in addition to live cameras, can take the output of any of the three film chains fed from telecine, remote programs, or the CBS network without involving TV master control.

Ample space has been allowed for public viewing of live studio programs. By virtue of the 23 foot ceiling height in all studios, the second floor level surrounding Studios 11 and 12 is equipped with large double glass windows through which visitors may watch live shows. One side of these studios has a visitors' gallery equipped with theater seats. From here visitors may watch a live show in progress, as well as seeing the televised result on monitors facing them. Loudspeakers mounted within the galleries bring them the accompanying sound. A visitors' booth at floor level in Studio 13 provides similar accommodations for that studio. In addition to the public viewing areas, Studios 11 and 12 each has an elevated clients' booth located behind the control rooms which provide an excellent view both into the control room and studio.

Presently there are five studios equipped for radio with their centrally located radio master control. Automatic relay switching equipment is used in master control with studio extended controls, making it possible for the studio operator to select his own incoming and outgoing program circuits. One of these radio studios is the same size as the smaller TV studio and has been basically equipped with power and control room space for easy conversion to a fourth TV studio if required.

**TRANSMITTING EQUIPMENT**

In the original part of the one-story building is still located the RCA TT-5A

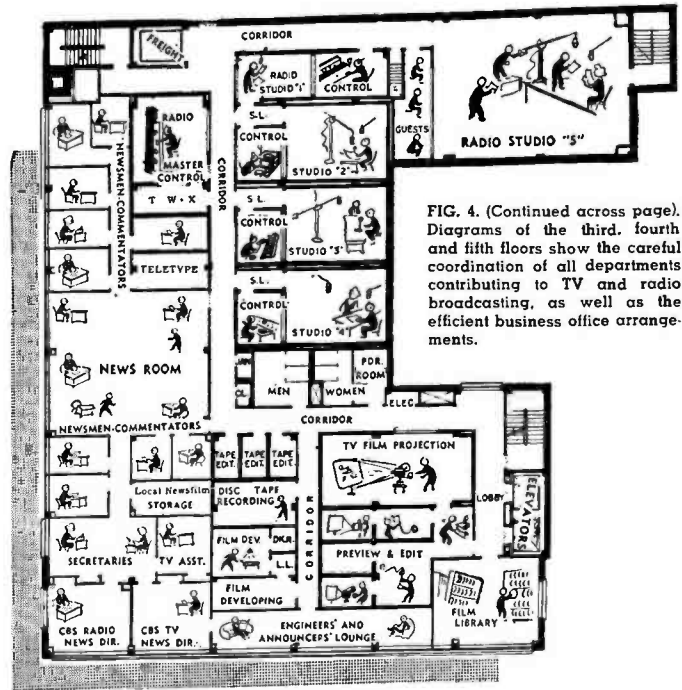

FIG. 4. (Continued across page). Diagrams of the third, fourth and fifth floors show the careful coordination of all departments contributing to TV and radio broadcasting, as well as the efficient business office arrangements.

THIRD FLOOR

transmitter that has been used for about five years. We have just finished the installation of a new RCA TT-50AH transmitter. This new transmitter with the RCA TF-12AH antenna brings our radiated power up to the 316 kw maximum. The RCA TT-5A is maintained in readiness as a standby transmitter. The photograph in Fig. 12 shows our new 12-bay RCA Superturnstile antenna being installed and a single-bay interim antenna mounted on the side of the tower. After the 12-bay was put into use the single-bay was moved up

to its permanent location at the top of the tower as shown in Fig. 28. This emergency single-bay superturnstile will take approximately 30 kw and as this is the normal output of the TT-50, it is possible to feed either antenna without having to make a power reduction at the transmitter. The TT-5A and TT-50 are fed through a coaxial switch, as are also the two antennas, so that either transmitter can be switched to either antenna in a matter of seconds.

FIG. 5. Meticulous power and hand digging was necessary around tower base. Original transmitter building is through the tower and on the right. New garage-studio is on the left.

FIG. 6. One-and-one-half years were required to build the new building and to integrate it with the one-story transmitter building.

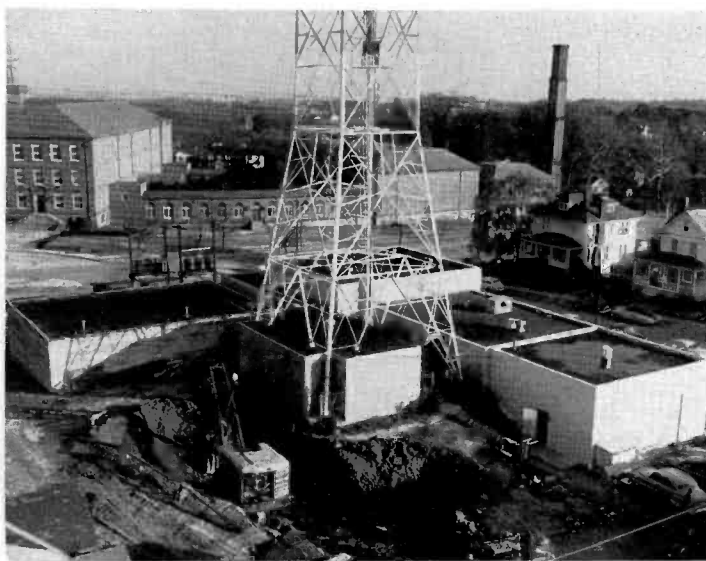

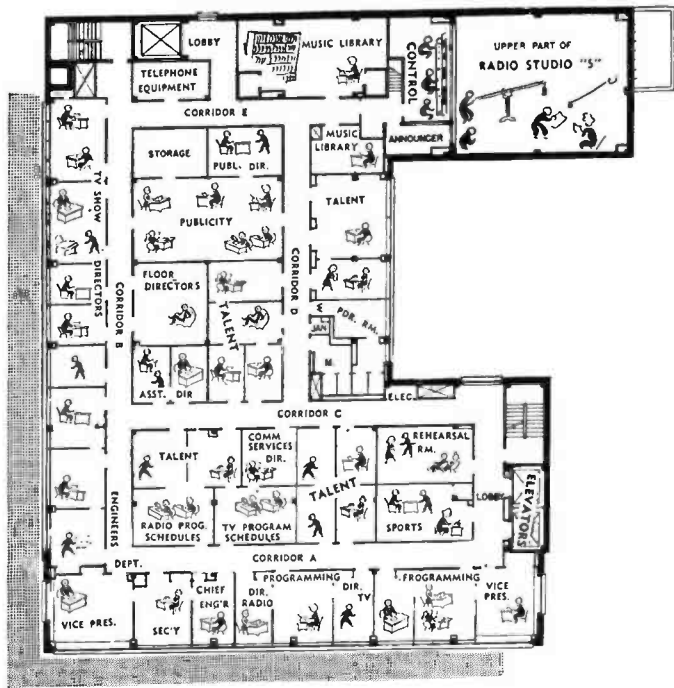

FOURTH FLOOR

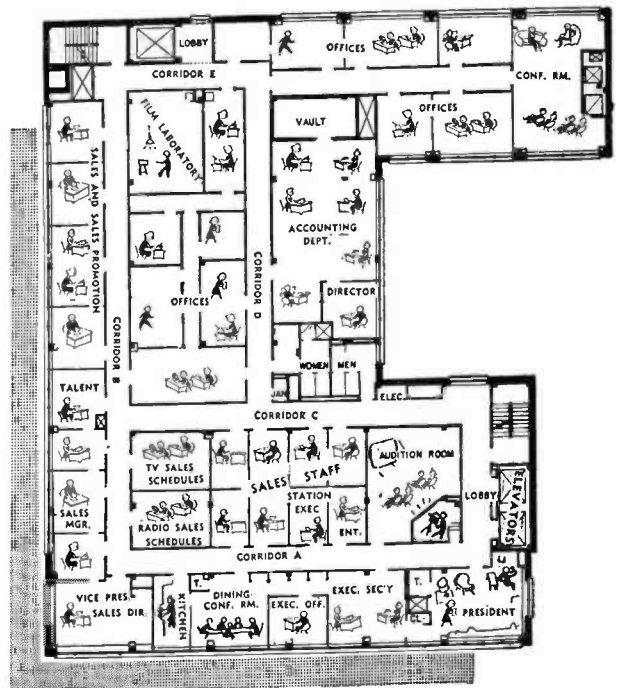

FIFTH FLOOR

**BUILDING CONSTRUCTION AND Q FLOORING**

The building is of welded steel construction above the first floor slab, the basement and TV studio floors having been constructed of reinforced concrete. The steel was welded instead of riveted to reduce noise as we were still originating programs in the adjoining parts of the old building and the new garage. Above the first floor, the floor construction makes use of Robinson Q Flooring. This is a cellular steel panel arrangement that is used as the structural sub-floor. On top of this cellular steel is poured about three inches of light-weight

concrete floor fill. The steel cells that we used are about one and one-half inches deep and three and one-half inches wide and are spaced on six inch centers. The cells are uniformly welded together so that all cells throughout the building run north and south. These cells are crossed by headers running east and west. It is therefore possible to reach any place on any floor within a few inches of where an outlet may be required. We use the network of cells for three separate services. For instance, the first cell is used for electrical service, the second cell for telephones and the third for audio-video circuits. The serv-

ice is therefore very flexible and convenient for making changes in the wiring locations of any facility that might be wanted.

**FLOOR COVERINGS**

The floors of all television studios are covered with 3/16" thick sheet rubber. This comes in rolls about 2½ feet wide and runs the width of the studio. The result is a very smooth floor with a minimum of cracks to be joined. Obviously, the finish on the cement floor had to be held to an extremely close tolerance for the rubber covering. For a camera long shot while dollying, these factors become quite important. All other floors throughout the building are covered with either asphalt or rubber tile, except in several carpeted areas.

**BUILDING EXCAVATION**

Excavation for the basement footings surrounding the existing tower was a tedious and frightening job. The wall of earth around the tower base was held together by hand-digging in alternate four-foot slits, each one being filled with reinforced concrete to prevent slippage of earth under the tower footings before another slit was



FIG. 7. Radio, television and film audition room. Projection booth behind wall on the right.



**FIG. 8.** Jay Cleaves, Building Chief Engineer, shows 3000 amp. and 2000 amp. main electrical breakers with fronts removed.

dug. The zoning height limitation of the building is 60 feet above ground. This, together with the task of excavating below the tower base, presented some very interesting engineering and structural problems. However, it was all accomplished without undue incident.

#### **POWER FOR BROADCAST HOUSE**

The building is supplied from a three phase 208 volt buried transformer bank with a capacity of 1500 kva. There are two separate feeders supplying these transformers continuously. In the event of trouble on either feeder, it automatically drops off, leaving the service uninterrupted. The main switchboard for the electrical power supply is centrally located in an enclosed structure at the tower base. This distribution room also houses the 208 to 460 volt transformer required for the TT-50.

The building is completely air conditioned. Chilled water is supplied from a 400 ton compressor located 22 feet below ground level. See Fig. 11. The compressor is isolated from the building by spring mounts and a floating concrete slab to confine vibration and prevent it from traveling through the steel framing. The cold water is distributed to air handling units for the nine zones of the building. Each of the TV studios is supplied from its own air unit through very large ducts. The ducts are covered inside and outside with fiber glass to reduce noise pickup and transmission. Fifty tons of refrigeration are available to each studio. For winter operation there are two 100 hp marine boilers with thermostatic control that can satisfy the requirements of a particular area. See Fig. 9. There is considerable mechanical equipment in a specialized plant of this size. The maintenance and operation of such equipment, under the supervision of the building chief engineer, must be closely coordinated with broadcast functions.

#### **GUEST ROOMS**

There are many functions and areas throughout the building that will be described in detail by the Chief Engineers who are in charge of General Engineering, Television and Radio Operations in the accompanying articles describing our overall plant. However, I might mention here that there are two rooms of particular in-

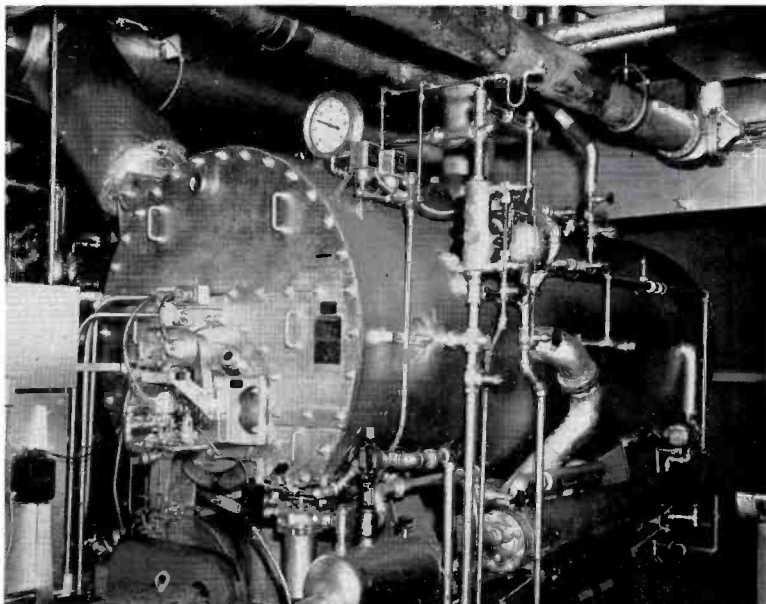

**FIG. 9.** Two 100 h.p. Cleaver Brooks marine boilers are used for year-round heat requirements.

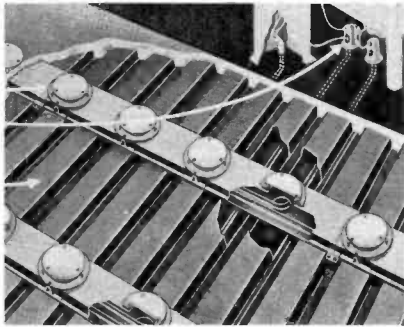

FIG. 10. Q-floor installation similar to that used throughout the building.

terest that are available to the WTOP personnel and their visitors generally. They are known as the Columbia Room and the Audition Room. Both of these rooms have been appropriately furnished for conferences with guests appearing on our programs, or for auditions for radio or TV programs. The Audition Room, see Fig. 7, is complete with its own film projection facilities and with monitoring system for sound or TV programs in black and white and color. Our guests have found these rooms to be of unusual interest functionally, as well as from the standpoint of comfort and appearance. Needless to say, these rooms are beautifully furnished, as are the executive offices, the private dining room, the lobby reception area, the cafeteria, and other special rooms, such as the employees' lounge. All have received care in placement and furnishings.

#### CONVENIENCES FOR PERSONNEL

There are some 250 people at work in Broadcast House. The CBS-WTOP Newsroom adjoining the radio studios covers approximately 3600 square feet. A cafeteria in the basement, operated by Hot Shoppes, Inc., serves three meals a day every day in the year. It is open all night for coffee and snacks for employees who work around

the clock. Also in the basement are the shower rooms and locker rooms for all employees.

In the cutaway diagrams showing the various floors and office arrangements (Figs. 2 and 4) you will see the location of space for the functions and facilities of Broadcast House. The cost has been close to four and one-half million dollars. We believe in our business and like our new place for doing business. We hope you will like it too—and find it interesting—when you come to visit us.

Obviously many people contributed their knowledge, experience and labor in fabricating this plant. Our President, John S. Hayes, was an exceptional person with whom to work. He and Phillip L. Graham, Chairman of the Board of WTOP INC., were there whenever needed with their ideas and counsel. Otherwise, Charles C. Boysen, Floyd Harrison, Directors of WTOP INC., and I, had a free hand with the project. To the architects, Faulkner, Kingsbury and Stenhouse; the builders, Charles H. Tompkins Co.; the mechanical engineers, Wilberding Co.; structural engineers, James M. Gongwer; interior design, Ethel Pilson Warren; landscaping, Cary Millholland; Paul Bergquist of RCA and many of their engineers, together with our own and the CBS engineering and program staffs; the public utility companies with their expert assistance and to the many others who were so cooperative in helping us, this is a note of thanks and appreciation for a big job well done.

I suggest that you review the accompanying stories and photographs in this article for a more complete and detailed picture of Broadcast House in Washington, D. C.

FIG. 12. New RCA TF-12AH being installed while using single bay for interim operation. Square-shaped units on antenna are protectors for bat-wings during installation—are ultimately removed.



FIG. 13. Air conditioning ducts are very large. Some were placed on roof to conserve interior space.

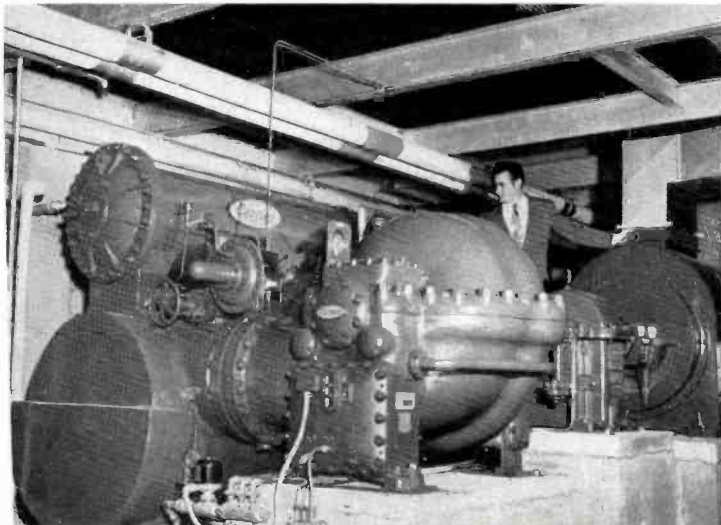

FIG. 11. Four-hundred-ton Carrier compressor for air conditioning.

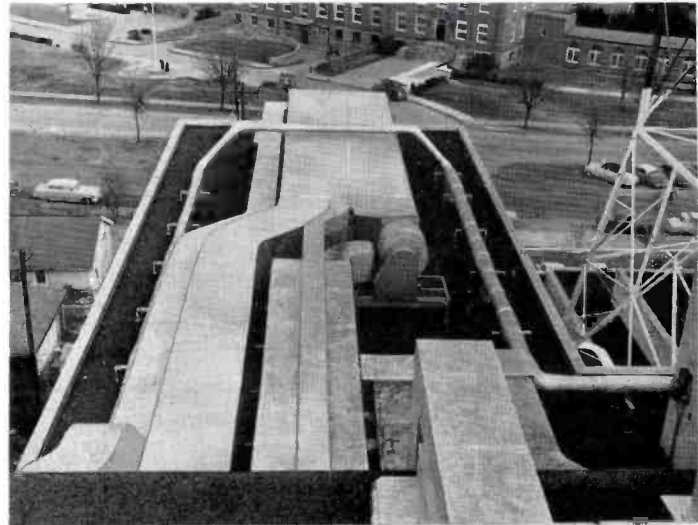



FIG. 14. Studio 11 control room in action. Left to right are video switcher, director, audioman and announcer. Camera control operator sits farther to left (not shown).

# WTOP TELEVISION OPERATIONS

by L. A. WILKINSON, CHIEF ENGINEER, WTOP TELEVISION

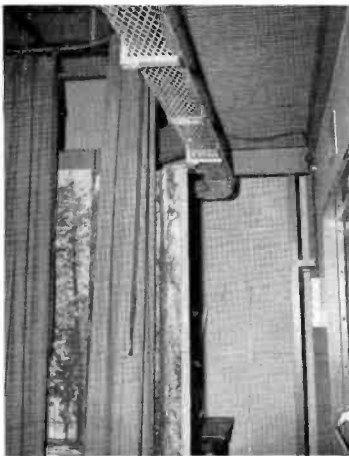

FIG. 15. Catwalks support open-sided cable raceways in all studios.



FIG. 16. Announce booth windows overlook control room and studio. Technical facilities are grouped for functional convenience.



FIG. 17. Control room located across one corner of studio. Lighting grid is shown on left.



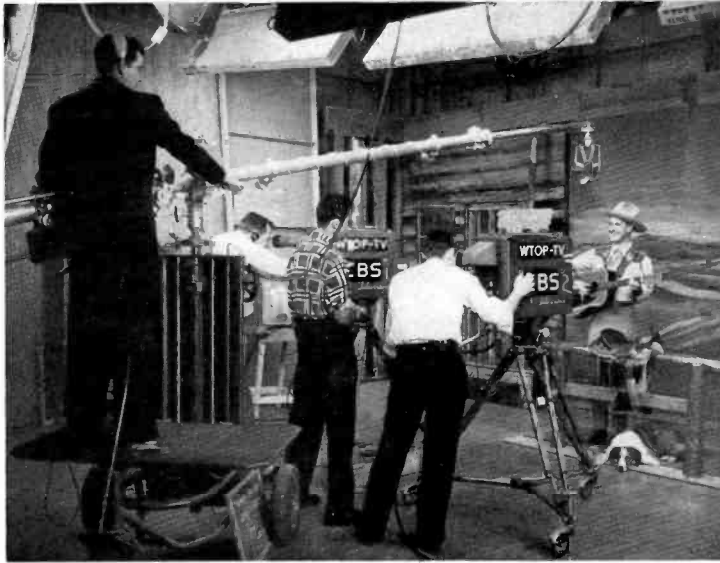

FIG. 18. Part of typical set for local cowboy show.

### TELEVISION STUDIOS

As the point of origin for many public interest shows to the CBS Television Network, Broadcast House Television studios are frequently honored by the presence of distinguished Government officials. Studio 11 has been honored by President and Mrs. Eisenhower on one occasion, which was the first time a president of the United States has come to a television station in Washington for a telecast to the American people. Our studios have also been the point of origin for CBS Network telecasts by Vice President Nixon, Secretary of State Dulles, Secretary of Agriculture Benson, Cabinet members and members of Congress.

To facilitate live program originations to the CBS Television Network while simultaneously rehearsing other shows locally, WTOP Television utilizes three live-show studios and one film—network—

remote studio. These are designated 11, 12, 13 and 14. The first three are live-show studios equipped to use four cameras and fifteen studio microphones each.

The two larger studios (11 and 12) are nearly identical and measure approximately 45 by 65 feet. Their control rooms and announce booths are located diagonally across one corner of the studio, eight feet above the floor. A dressing room is located under each control room, complete with make-up tables, ironing board and rest rooms. The two dressing rooms are within a few feet of each other so that both can be used by talent on a show in either studio. Automobiles may be driven from the street into either studio through the 17-foot wide prop storage area adjacent to these two studios. Completely equipped kitchens are permanently installed in Studios 11 and 12. Plumbing and electrical facilities are roughed-in for the other studio.

FIG. 19. "Man of the Week" CBS Network program—typical of weekly shows originating from WTOP-TV.



Studio 13 measures 35 by 45 feet. Its control room and announce booth are located across one end of the studio, ten feet above the studio floor. All studios have a ceiling height of 23 feet. Steel catwalks two feet wide and ten feet above the floor level support scenery, back lights, cable raceways and curtain track in all studios. The cable raceways carry camera and microphone cables from the control rooms and are open on one side to permit taking off cables at any point around the studios. The use of these ducts obviates the necessity for having cables strewn across the studio floor when working from the far end of the studios.

Continuous curtain track, eleven feet above the floor, is supported by the catwalk rails. This track permits curtains to be rapidly changed from one area to another to simplify program set-up.

### LIGHTING FACILITIES

Lighting at WTOP-TV consists roughly of 25% slimline fluorescent fixtures, 25% incandescent scoops and 50% 500-watt spots. See Fig. 19. A grid composed of 1½ inch pipe spaced 42 inches on centers and 14 feet above the studio floor supports the lighting fixtures in all studios. The catwalk rails are used for clamp-on back-lighting spots. Each fixture mounted to the lighting grid is individually suspended by a counter-balanced scissors. This feature expedites set lighting and reduces the need for floor stand lights. The two larger studios each has 60 lighting outlets, 15 supplied by a portable dimmer panel and 45 supplied by three portable switchboards. A lighting capacity of 72 kilowatts is available in each of these two studios, although only half of this amount is normally used. Studio 13 has 45 lighting outlets with 15 circuits dimmable. In addition to the regular lighting equipment, each studio is well supplied with separately-fused 20-ampere convenience outlets for special requirements, such as power for refrigerators, electric organ, table lamps, etc. Outlets for rear-screen projectors are also provided in several convenient places in each studio.

### STUDIO CONTROL ROOMS

Because of the varied requirements of local and network programming, each control room is essentially a master control center. A typical control room is shown in Fig. 14. TV Master Control is used primarily for routing-switching, as will be described later.

The three live-studio control rooms are nearly identical in equipment layout. Each is an in-line arrangement with its own announce booth to the right. The video and audio control equipment is mounted on a custom built 18-foot desk near the control room windows. The control room crew line-up is: camera control operator, video



FIG. 20. Remote control video buttons installed on BC-2B audio console permit one-man audio/video switching.

switcher, director and audioman. The equipment line-up is: four field camera control units, preview monitor, line monitor (facing video switcher), four TM-2D monitors (facing director, repeating live camera shots), BCM-1A auxiliary mixer console and a BC-2B studio console. Turntables are recessed into the control desk on each side of the audioman. Mounted on a shelf over the control room window are four TM-2D monitors. The first three are film camera monitors and the other is an air monitor fed from the transmitter demodulator.

By the use of a rather copious supply of distribution amplifiers, separate feeds to each control room are run from three film cameras, network and two remote inputs. A TS-20A relay video switcher (Fig. 22) controls the twelve video inputs to each live studio control room. One output bank is used for previewing, one for the "line out," and two banks (with fader) for effects. Montage effects amplifiers also feed into the TS-20A video switchers. Video monitoring is provided to a recessed monitor in each announce booth, and two separate monitors on each studio floor in addition to that required in the control rooms.

Inputs to the audio console (Fig. 20) comprise 15 studio microphone inputs, an announce mike, two turntables, network, two separate film camera sound feeds and four remote inputs. Any studio microphone can be patched to appear on any microphone fader. The director's audio facilities include a one-way P. A. system for aural cues to TV Master Control, projection room and announcer, and a two-way system for communication to other control rooms, master control and projection room. The standard TK-30A camera intercom system is used for communication with the cameramen, mike boom operator and floor director. A separate sound effects system controlled by the audioman feeds into the studio.

### COMBINATION AUDIO/VIDEO SWITCHING

During program periods when no live shows are involved such as "riding network" and during local film shows, a combination video switcher/audioman operates alone from a control room. See Fig. 20. By the simple expedient of connecting a set of push-buttons in parallel with the line bank buttons of the TS-20A switcher, video can be switched remotely at the audio position. Only six of the thirteen functions of the TS-20A line bank are controlled at the audio console. These are: three film cameras, network, remote and "black". This bank of buttons is located midway between the audio monitoring buttons and the microphone switches on the left side of the BC-2B console as shown in Fig. 20. By a simple wiring change the "Remote Cue—Override" audio switch was rewired to control network, film and announce audio to the corresponding preset faders. With the above arrangement, a single operator is able to switch audio and video simultaneously by using his left hand for video switching and his right hand for audio switching.

### TV MASTER CONTROL

The major function of TV Master Control (Fig. 21) is routing switching from the studio control rooms to feed the transmitter, network or to the TM-41A Monitran system for closed-circuit mon-

FIG. 21. TV master control audio/video switching equipment (center). Studio 14 video switcher (left) and line, preview and net feed video monitors (right).

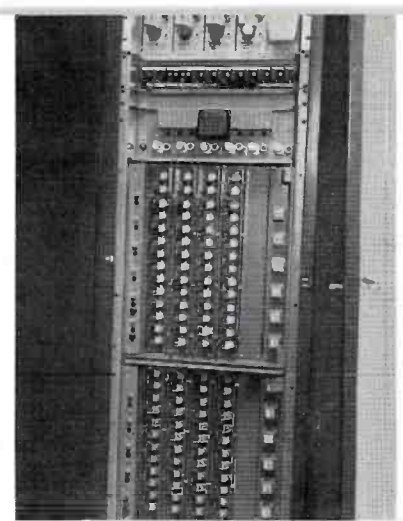
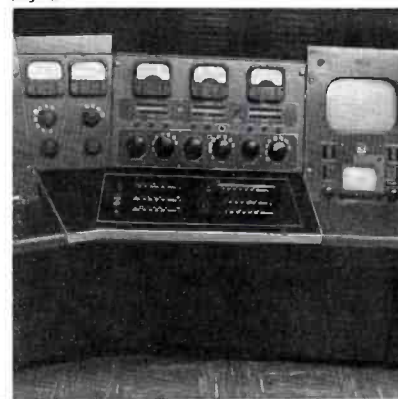

FIG. 22. Control room rack showing TS-20A video relays, distribution and mixing amplifiers.

itoring throughout Broadcast House. Since the studio control rooms function in themselves as master control rooms, switching in TV Master Control is normally necessary only when changing studio feeds as indicated above.

Continuous with the master control console, but functionally separated, are Studio 14 control equipment on one side and the transmitter control console on the other. Studio 14 control equipment consists of a TS-10A video switcher, three TM-2D film camera video monitors, a BC-2B audio console, two 70-D turntables and announce booth. Network and remote programs and local film shows can be controlled by Studio 14. As in the other control rooms, the director's position is between the audioman and video switcher.

The M/C video switching is done by a six-input and six-output TS-20A relay switcher. The six video inputs are from control rooms 11, 12, 13 and 14, network and a spare normally used for remote programs. Two of the six output banks feed the transmitter (one is a spare), one bank feeds to network, one feeds the audition circuit and two feed to the preview monitor. The buttons of the video control panel are mechanically interlocked on each bank so that pre-set video switching can be accomplished. By using the spare input to the switcher, any special video signal can be sent to the transmitter, network or to any part of Broadcast House. Some of these special test signals consists of outputs from a grating generator, dot generator, monoscope camera, stair-step generator, multiburst generator, window generator and color bar generator.

A BCS-11A M/C audio switching panel (Fig. 21) is mounted in front of the video control panel and has been wired to control video switching. The BCS-11A has facilities for switching ten audio inputs to three outputs channels. The three outputs



FIG. 23. Projection room showing film cameras Nos. 1 and 2 and monitoring rack (left).

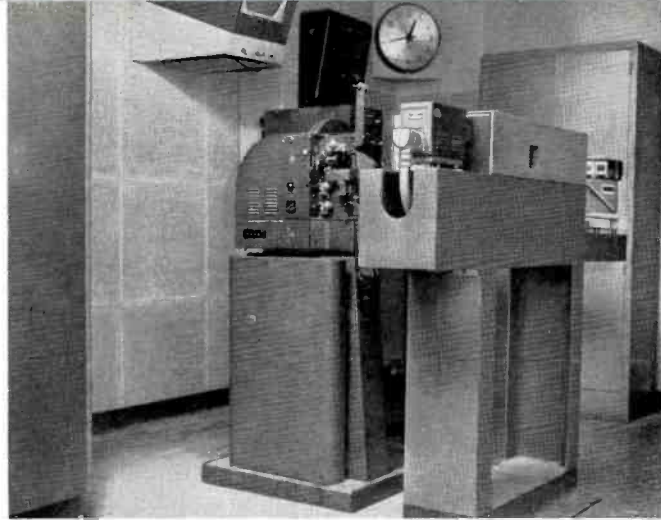

FIG. 25. TK-21 Vidicon mounted in camera No. 3 position.

feed the TV transmitter, network and the audition circuit. The audition channel is bridged to feed to Radio Master Control when needed for recording etc.

The entire system of audio and video switching can be preset and switched simultaneously by throwing one "master" switch on the BCS-11A panel. A local-master switch on each outgoing audio and video channel determines whether that output will be controlled by the master switch. Tally lights in each control room indicate the routing of audio and video being fed at any time from that control room.

Video monitors for transmitter input, preview and net-feed extend to the right of M/C audio/video switching equipment.

A BW-4A transmitter demodulator is the source of picture signal for all "air" monitors. TA-1A Distribution Amplifiers feed this signal to the transmitter console, lobby, projection room and all control rooms.

When required to lock our local sync generator to a remote or network program, the spare sync generator is locked with the incoming remote picture by means of a Genlock prior to being used on the air locally. On taking the incoming program, a switch is made to the spare sync generator by a remote change-over button located on the master control desk. In this manner adjustments may be made to the Genlock without upsetting the sync to a local show in progress.

#### EDITING FACILITIES

A film library, two editing rooms and three film preview rooms are situated adjacent to the projection room. Considerable planning was given to making these areas convenient to each other for maximum efficiency. Experience has shown the desirability of keeping the film storage and editing areas physically near the projection room, particularly in regard to last minute

news film. With this in mind, the news film editing and preview rooms were placed next to the projection room, with the other editing and preview areas and film library just a few steps away.

FIG. 24. Film editing, previewing and storage rooms adjoin projection room.



Since many of the commercial films and some of the feature films are stored in the film library for considerable periods of time, an automatic humidifier is used in that room to keep the film from becoming brittle during the winter heating season.

#### PROJECTION ROOM

Three film cameras with their camera control units are located in the projection room over Studio 11. See Figs. 23 and 25. Two of these are TK-20A Iconoscope cameras and one is a TK-21 Vidicon as shown in Fig. 25. A TP-16D and a TP-6A 16mm film projector plus a TP-2A slide projector operate into camera #1. Two slide projectors and one Telop II opaque projector are used with camera #2. A single 16mm film projector and a slide projector operate into the Vidicon camera. Video monitors mounted over the film cameras show the pictures on each camera. Racks near each end of the projection room contain facilities for monitoring audio and video transmitter outputs, studio outputs and network and remote incoming signals. A remote control panel is also mounted over the film camera control so that the film shader can control the 16mm projectors on camera #1.

Aural cues are used from the directors in the control rooms to the projection room for "rolling film" and changing slides. To permit simultaneous feeds to separate control rooms when one camera is feeding to the transmitter and another to the network, provisions have been made for one projectionist to monitor cues by headphones. The other projectionist and the film shader receive their cues by loudspeaker. Depend-

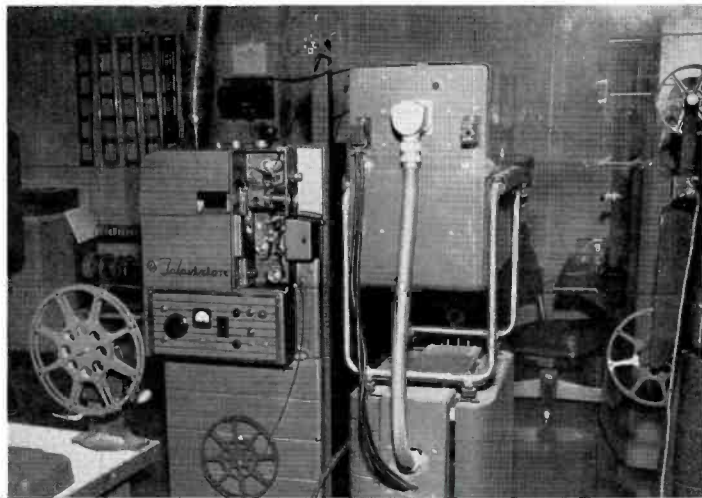

FIG. 26. Film camera No. 1 showing TP-6A (left) and TP-16D (right) projectors.

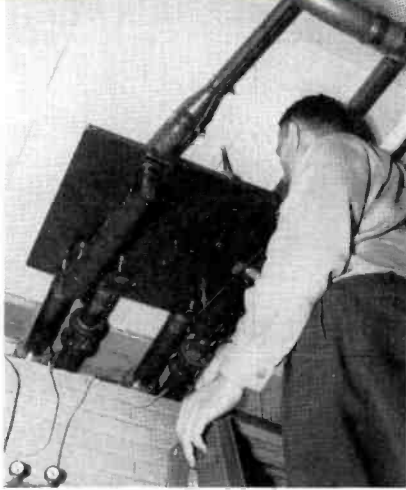

FIG. 27. Ceiling-mounted coaxial switches select R-F feed to either the main 12-bay or the single-bay emergency antennas.

ing on the program requirements, there may be as many as three projectionists and a film shader in the projection room at one time. During the times when there are no live shows or separate network feeds involved, the normal crew consists of one projectionist and a film shader. The shader operates camera controls and starts and stops the film projectors, while the projectionist changes slides and telops during local station breaks.

#### TV TRANSMITTER

WTOP Television's 316 kilowatts effective radiated power is the highest in Washington. We also enjoy the enviable position of having a spare transmitter and an

emergency antenna. See Figs. 29 and 28. Switching transmitters or antennas takes about 45 seconds. Our main transmitter is an RCA 50 KW TT-50AH. The spare is our old RCA 5KW TT-5A. The main antenna is an RCA 12-bay TF-12AH Superturnstile mounted atop a 300-foot Lehigh tower rising up from the middle of Broadcast House. Manual coaxial switches (Fig. 27) are provided for switching transmitters and antennas. By using a pair of these switches immediately following the transmitters, a single set of harmonic filters and a single sideband filter need be used for both transmitters. Following the diplexer, another pair of switches selects the RF feed to either the main 12-bay antenna or to the single-bay emergency antenna mounted on an outrigger flush with the top of the tower. Double 3- $\frac{1}{8}$  inch teilon transmission lines feed each antenna. The emergency antenna was designed to handle the same power input as the normal input to the 12-bay (approximately 30KW). Consequently, either transmitter can feed either antenna without need for reducing transmitted power.

Both transmitters are monitored from one console. The regular TT-5A control console was combined with a monitoring section for the 50KW transmitter, and the combined unit forms an extension of the master control console.

#### FM TRANSMITTER

WTOP's FM transmitter shares space

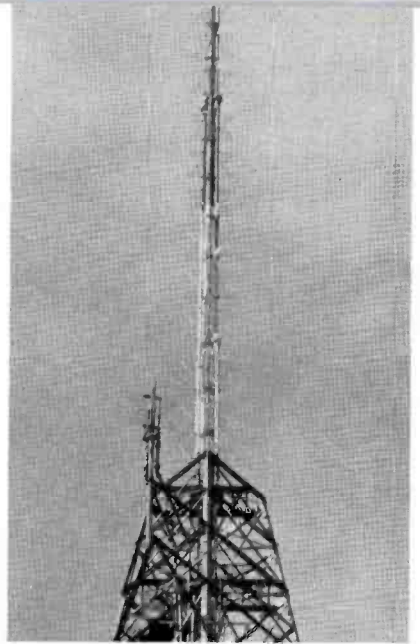

FIG. 28. The emergency single-bay antenna has the same height as the tower (300 feet). The overall height of 12-bay antenna is 783 feet above sea level and 373 feet above ground.

with the TV transmitters. Its antenna is a 4-section Multi-V mounted inside the TV tower at the 200 foot level and produces an effective radiated power of 20 kilowatts. Although the program content of the FM transmitter is the responsibility of the Radio Division, WTOP Television is charged with its operation by reason of its physical location.

FIG. 29. TT-5A standby transmitter on the left and high power TT-50AH on the right are both monitored by one control console. TV master control extends to the lower right.





FIG. 30. RCA TJ-50A mobile unit and Plymouth Station Wagon film unit.

## TV REMOTE FACILITIES, HOUSE MONITORING & STUDIO CLOCK SYSTEM

by **GRANVILLE KLINK, JR.**, CHIEF ENGINEER, WTOP GENERAL ENGINEERING



With the construction of a new plant, specifically for radio and television, monitoring facilities in non-technical areas became a necessary addition throughout the new building. To make these facilities useful and efficient, the system had to be planned to feed numerous locations without undue wiring and expense. The RCA Type SX-8B television Antenaplex system in conjunction with two of the TM-41A Monitrans has fulfilled the television monitoring need in Broadcast House.

Rigorous conditions were imposed on the monitoring system by strong RF fields radiated from the 12-bay TV antenna, 316 KW ERP, and 20 KW ERP by an FM antenna mounted in the center of the tower. The tower, 300 feet in height rises from ground level at the center of the building. Heavily shielded coaxial cable and metal "Q" flooring was counted on to keep stray RF fields out of the system. With these two attributes, no difficulty was encountered from this source.

The conventional television receiver performs the monitoring functions, both video and audio.

After positioning and orientation of the test antennas, a good signal pickup location on the roof of the building was found.

From this point, coaxial lines were fed from the antennas, including Channels 2, 4, 5, 7 and 9 into a conduit and thence to the equipment racks in television master control, located on the first floor.

From the equipment racks, the outputs of the seven strip amplifiers, including Channels 11 and 13, into which the two monitrans feed, are combined and RG11U coaxial line carries the composite signal into the first floor electrical closet. The closet is a riser which connects all floors of the building by means of a vertical shaft. There, each leg of a four-way splitting transformer feeds via RG11U to electrical closets on the second through the fifth floors. (The first floor monitors are fed directly from TV master control.) At these points, the feed is split again by a 12-way splitting transformer.

From the 12-way splitting transformer outputs, RG59U cable is pulled through the metal cells of the "Q" flooring, running the entire length of the building. These metal cells, which are approximately 3½" wide and 1½" deep, make up the basic construction of the upper floors in Broadcast House. Most any location can be reached on these floors by routing the feeder cables through this type of flooring.

When routing requires crossing the cells, it is only necessary to pull the cable to the nearest header and then cross over into the required cell. The "Q" cells are designated in groups of three such as, AC, telephone and audio-video. Each monitoring location, office or audition room, on a given floor receives its signals via RG59U from one of the legs of the 12-way splitting transformer in an electrical closet. For isolation from the rest of the system, a 12DB pad is installed in the conduit box where the line terminates at the monitoring location. A coaxial fitting is mounted in this box into which the front end of the TV receiver is connected. Before the signals enter the receiver another 12DB pad is inserted in the feed to the receiver for further isolation. This additional loss causes no detrimental effects to the received signals as there is ample signal voltage at all feed points.

The two RCA monitrans perform a desirable function. One is normalled to the incoming video and audio as received from the CBS television network. The other monitran can be switched across an available audio-video channel to pipe program material to the entire system. All television receivers at the monitoring point can view this program material by switching the

tuner to the monitran channel, 13 in this case.

When the entire system was under test, we had difficulty in locating the Channel 9 antenna in a position to receive as clean and ghost-free a picture as desired. This problem was finally solved by using a probe in the transmitter output line feeding the antenna transfer switch. The probe was inserted in the 3/8" coaxial line on the antenna side of the diplexer. The signal was then fed through a 20 DB pad and into the Channel 9 strip amplifier. This method provided a much desired picture throughout the entire monitoring system.

### REMOTE FACILITIES

The major item of WTOP Television's remote equipment is an RCA TJ-50A Mobile Unit. Three Type TK-30A field camera chains can be operated from this unit. RCA OP-6 and OP-7 audio amplifiers are normally used for sound pickup. A 6KVA gasoline generator mounted in a trailer can be hitched to the mobile unit or a station wagon for use at locations where no local power is available. Two sets of TTR-1B microwave equipment are available for remote programs. Other facilities include off the air monitoring, two-way PL and pack transmitters. In the event of a last minute field job where time does not permit audio circuits to be installed, a 50 watt FM transmitter can be used as an RF audio link back to the studios. Its receiving antenna is mounted at the 100 foot level on the antenna tower. Provisions have also been made to anchor microwave tripods at two locations on the roof of Broadcast House in addition to a platform on the 100 foot level of the tower.

FIG. 31. House monitor located in main lobby. Receiver is mounted on runners which permit chassis to slide out for servicing.

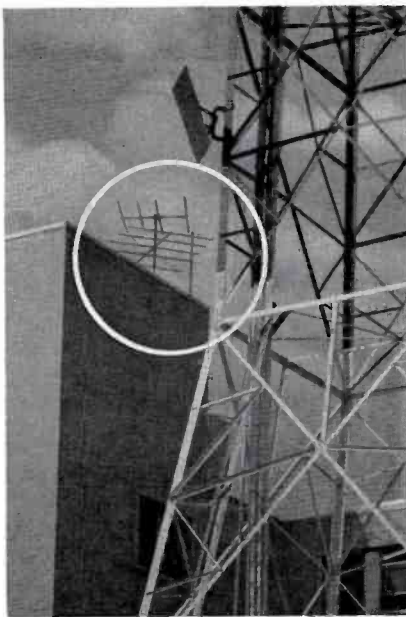

FIG. 32. View of receiving antenna for "Antenaplex" system.

### MOBILE FILM UNIT

For portable film operations, we have equipped a Plymouth station wagon with a Stancil-Hoffman Type S-5 Sound on Film Recorder as well as Auricon Sound on Film cameras. This film unit carries a bank of six, six volt storage batteries which drive a converter supplying 110 volts, AC at approximately 300 watts. With this type of portable operation, the AC frequency of the power supply is an important factor. A rheostat in the DC input to the converter adjusts the AC output to the proper frequency. A variac is used in the output to control the AC line voltage. There is sufficient power to operate one Auricon 16 MM sound camera with double system sound. Portable lighting gear, as well as spring wound cameras are also included in the unit. In order to facilitate using this film unit for parades, inaugurations and the like, a steel deck is fastened to the top of the wagon. This platform will accommodate cameras or a microwave dish, whichever is appropriate. Helper springs have been installed on the wagon to handle the extra equipment weight. A hitch is mounted on the rear to accommodate the 6 KVA portable generator. The reasoning behind using a station wagon for this type of operation is peculiar to the city of Washington. The station wagon is permitted in the numerous parks and other areas normally restricted to trucks. This proves to be an important factor in producing film stories.

### RADIO MONITORING FACILITIES

Radio monitoring facilities also had to be considered in the original planning of Broadcast House. These facilities already in existence at the former studio location had to be expanded to service more monitoring points. When radio master control was moved into the new building, all audio monitoring equipment was left in the racks, which were moved intact.

The system consists of three 50-watt McIntosh 50 W-2 amplifiers which feed three separate program buses. A "T" pad in connection with a multi-position switch at each monitoring location allows the selection of any of three sources. One program source is fed from the outgoing channel to the AM and FM transmitters. The other source is across the incoming CBS feed and the third source is an audition channel which can be patched to any appropriate program output. The three program buses are fed from radio master control on the third floor, through cable trenches into the third floor electrical closet. The circuits are distributed from audio terminal blocks into the metal "Q" flooring in the same manner as described in the TV monitoring facilities.

Some areas in the building contain both the radio monitoring and TV monitoring systems. This was according to original planning when it was thought that certain personnel would be required to observe both the TV and radio operations.

### STUDIO CLOCK SYSTEM

As is a well known fact, radio and television switching operations, particularly network, are performed on a strict time basis. With this in mind, several types of clock systems were considered in the early

FIG. 33. "Antenaplex" strip amplifiers and monitors, rack mounted in equipment room adjacent to television master control.

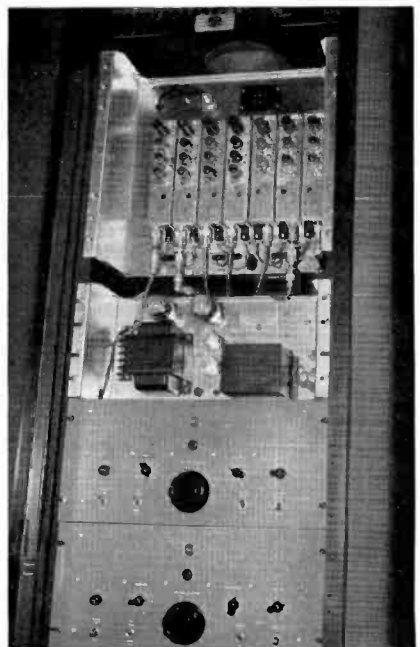

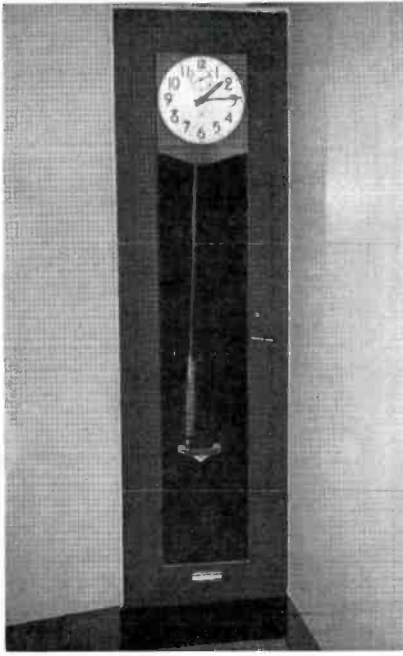

FIG. 34. IBM master clock recessed in the wall behind the FM transmitter in TV master control.

planning stages. One such system utilized a high frequency correction signal transmitted to the clocks by means of the AC power circuits. In the process of testing, this was found impractical. High frequency leakage into the video channels was sufficient to interfere with picture transmission.

Finally, the IBM Clock System utilizing slave clocks operated from the 110V AC power source was adopted. Each slave clock is designed to gain one second per minute. An AC correction signal is transmitted on the AC line to each clock on the half minute, which resets the clock one half second slow. By this means, all clocks show the correct time on the minute. Checking the master clock periodically against WWV, the Bureau of Standards Time Service, insures a negligible variation in the system.

Some forty clocks in the building are controlled by the master clock located in television master control. In the television studios, provisions have been made to use a slave clock mounted on a camera dolly if the need arises.

#### MAINTENANCE AT WTOP

The General Engineering Division of WTOP Inc. has, as one of its main responsibilities, maintenance of all television and radio equipment in Broadcast House. It includes the TV transmitter, FM transmitter, studio and remote gear. While the staff at Wheaton, Maryland does routine maintenance on the 50 KW transmitter,

General Engineering can be called upon to lend a hand at Wheaton when needed. Any piece of electronic equipment to be re-ramped, designed or redesigned also falls under this division. An able technical man, Assistant Chief Engineer, William J. Jones, follows many of these projects to their final conclusion.

Other activities under the General Engineering Division include initiating new projects pertaining to the improvement of equipment and its operation. Also dealing with some outside problems such as interference reports, checking field measurements, investigating viewers and listeners complaints on the reception of our signals.

Well equipped shops with test gear and machinery augment the maintenance operation in Broadcast House. There are three areas set aside in the basement for this purpose.

The laboratory area houses most of the test equipment. For accessibility, it is placed on shelving built above the work benches. Numerous oscilloscopes, sweep

68B audio oscillator and a General Radio noise and distortion analyzer can be wheeled to the various control rooms.

The machine and carpentry shop is adjacent to the laboratory area. A metal lathe, band saw, power hack saw, along with grinders, electric drills, paint sprayer, jointer and sander are available to the maintenance crews.

WTOP maintenance assures a state of readiness and dependability for the massive job which must be done in handling broadcast operations in a city such as the Nation's Capital.



FIG. 35. Radio Studio No. 1 with IBM clock over control room window. Opposite end of the studio has another clock in full view of technician.

oscillators, signal generators, voltohmmysts, capacity and resistance bridges, color test gear, tube checkers and the like comprise this equipment. A type 524 D Tektronic scope is mounted on a scope-mobile for portable use. General Radio equipment for measuring harmonics up to 1000 mc is also available.

Sync, blanking and driving signals as well as an output from the Antenaplex and monitrans are fed into the laboratory for shooting trouble on live cameras, stab-amplifiers, receivers, etc. These circuits are terminated in coaxial fittings at convenient points on the work benches.

Another area is used for maintenance of less complicated gear such as tape recorders and audio equipment. To facilitate the measurement of audio equipment throughout the plant, a portable cabinet rack containing a Daven 6C measuring set,

FIG. 36. Television Studio No. 12 announce booth showing clock and monitors. All announce booths are equipped with the same facilities.





# WTOP RADIO FACILITIES

by DONALD H. SAUNDERS, CHIEF ENGINEER, WTOP RADIO

A flexible system for accommodating the unpredictable demands of a network operation dedicated to the rapid dissemination of news prescribed the present layout of the radio facilities at WTOP Broadcast House.

The key to the versatility of the radio facilities at Broadcast House is the extended control dispatch system. The equipment associated with the dispatch system permits an elaboration of transmitting and monitoring facilities which could only have been effected by costlier and more laborious means.

The engineering department is faced with innumerable problems of an emergency nature. To meet these demands, master control has provided the program department with a multitude of incoming circuits from all important news centers in Washington, transmitting circuits to points overseas, network facilities and copious facilities for coordinating these operations. To accommodate temporary facilities sixty channels are available in master control.

Jack fields which are accessible, permit a flexibility of operation which is limited only by the ingenuity of the operator.

Though master control is dominated by the presence of the dispatch system console, seven enclosed racks with heat removal ducts appropriately allocate incoming circuits, outgoing circuits, monitoring equipment, test equipment, receivers, tape equipment, distribution amplifiers and power. Each rack contains power for its equipment and all amplifiers are of the shelf variety and can be removed from the front for service or substitution in the event of failure. Master control is further augmented by studio facilities which have been arranged adjacent to the dispatch system console. An RCA 76 series console with tape and disc machines comprise this area and is strategically located with respect to adjacent studios so that adequate vision is afforded the operator for live programs. All units have been terminated in terminal blocks with sufficient latitude to

permit relocation or expansion should the need arise.

Five studios have been integrated with other facilities on the third floor of Broadcast House so that quick and easy inter-course can be readily effected. All studios have been provided with RCA studio equipment. The sub control rooms contain 76 series consolettes, 70C turntables, extra cueing and monitoring facilities, the extended control system, and tape. The extended control feature of the dispatch system permits operation independent of master control, however this feature is seldom exploited because of network monitoring requirements. To lighten the load in master control operation is usually performed on a preset basis with inter-studio switching performed by the local operator. Network switching is done by master control. As is customary in network operation, programs involving instantaneous switching are diverted to studios.

The operations afforded by the dispatch system permits a fluidity of switching that greatly alleviates strain on the master control operator. Any of the outgoing lines can be selected by the studio operator upon release of that facility by the preceding operation. Protective circuits prohibit the accidental or deliberate actuation of the transfer mechanism until the operator releases control. Only master control can change the sequence or assume control of the operation. Each outgoing channel has its own control panel which is located on the control console in master control. By means of press buttons and selector switches its switching operation can be integrated with the whole either on a delayed basis or simultaneous basis. Should it be desired, the channel involved can be excluded from a multi-switch operation.

As a by-product of the equipment associated with the dispatch system, an elaborate system of cueing and monitoring has been devised. Monitoring facilities for all incoming and outgoing channels appear in every studio. Channels in use can be monitored visually and aurally.

The frequency of live remote pick-ups has declined with the advent of tape equipment. The latitude in editing and the ability to gather material on an impromptu basis for integration into the daily operations schedule on a delayed basis has resulted in a greatly expanded use of this medium. As a result a substantial part of the radio facilities at Broadcast House is devoted to the preparation and use of tape.

Disc recording and playback is by no means relegated to a minor role at Broadcast House. Ease of cueing and general handling makes this item the choice when

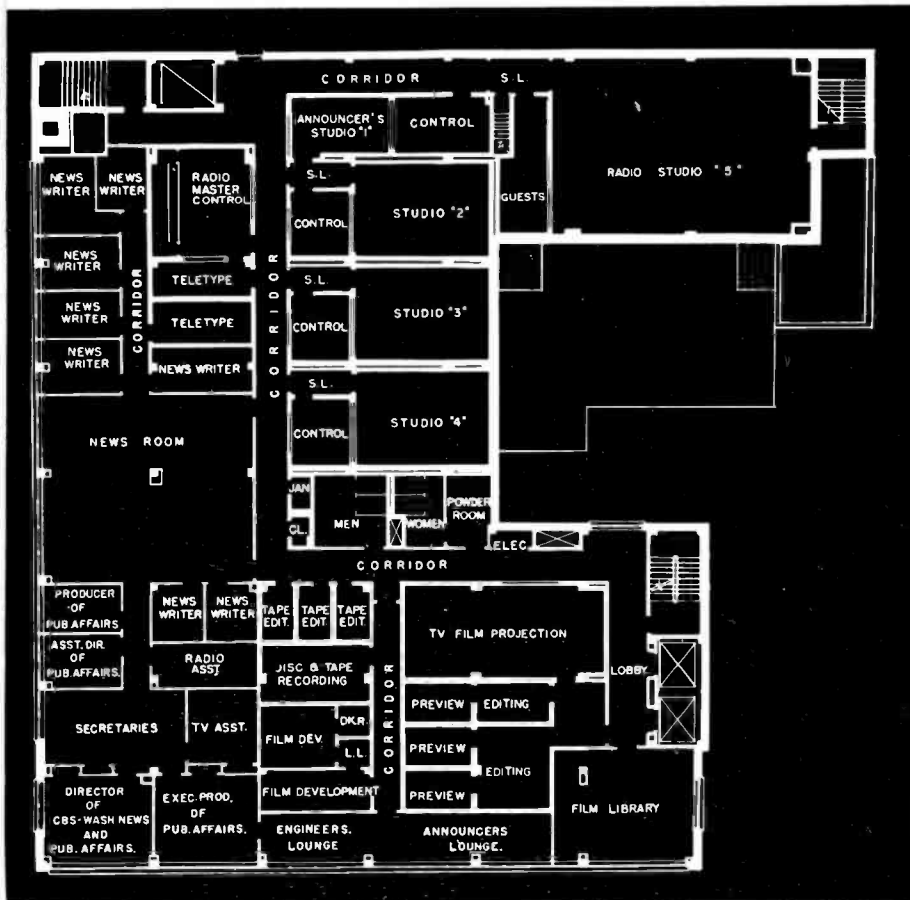

FIG. 37. Radio facilities, news rooms and telecine occupy the third floor. Master control is strategically located as the center of radio activities.



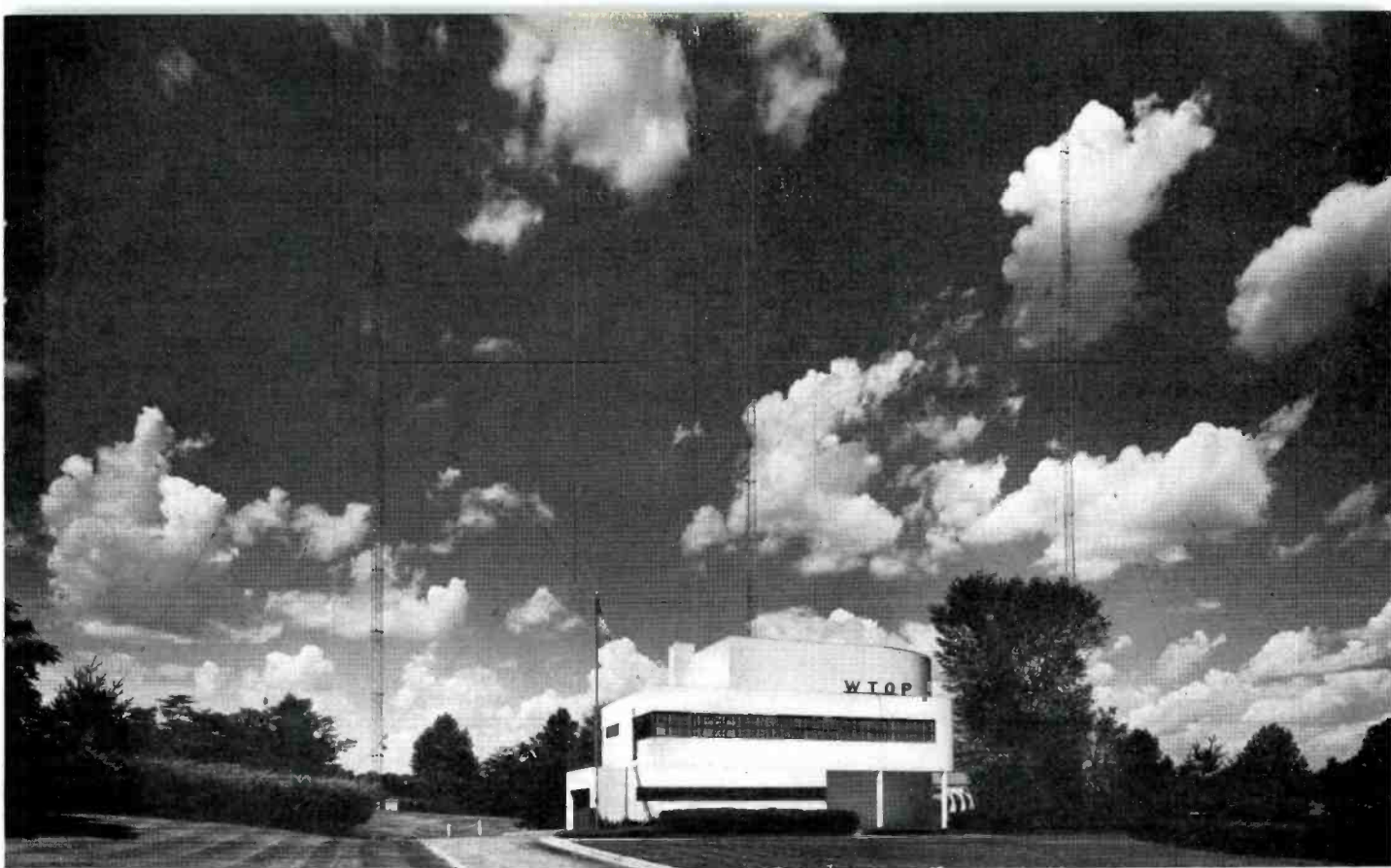

FIG. 38. Three 337-foot towers on the 13-acre site at Wheaton, Maryland, have identified WTOP's modern 50 KW transmitter building since 1940.

editing and high fidelity can be compromised. To facilitate the use of disc operation an efficiently laid out room on the third floor of Broadcast House contains two disc recorders and two tape machines all interconnected so that dubbing and other operations can be accomplished.

As the news center of the world, Washington, D. C., demands a fluidity of operation of unprecedented scope. WTOP meets these demands by providing an appreciable niche in the lower recesses of Broadcast House for remote facilities. A spacious room near the garage provides storage and work area for the maintenance of the special remote gear peculiar to WTOP's requirements. Ten remote amplifiers, a completely adapted RCA 76 consolette, tape and disc equipment, microphones of all types, and special microphone bridging devices for multiple feeds have been allocated accessible space on the shelves which occupy the wall space.

WTOP's remote gear is supplemented by special equipment required for multiple feeds. On the occasion of presidential pickups, WTOP's engineers because of their familiarity with the routine of travel and functions, have become an important part of the presidential retinue. WTOP-CBS labelled RCA OP-5s have been a familiar sight on presidential remotes. When called upon, WTOP's remote crews provide other networks and independent stations with

programs from its microphones. This is accomplished by a bridging amplifier which furnishes program at microphone level so that the receiver may produce and direct his own program. In this manner the President's speaking stand is unencumbered by a battery of microphones. The bridging amplifier has been designed so that 10 points can be fed and an important aspect of the device is the isolation provided at each point. Short circuits or cross talk has negligible effect on the remaining circuits. Two bridging amplifiers of this type are customarily used on presidential pickups so that emergency measures can be taken.

A modern building of contemporary design houses WTOP's big voice at Wheaton, Maryland.

At the transmitter six engineers and

their supervisor, William Kriz, watch over the Doherty high efficiency 50 KW. The Building is circular with the transmitter forming the nucleus. The ground level contains the garage, storage facilities, incoming power equipment, etc.

Continuity of service is assured by two incoming power lines. Automatic devices interchange the lines in the event of failure of the regular power line. Should all power sources fail, a 95 KW gasoline driven Fairbanks-Morse generator located on the ground level is automatically brought into service by the same control mechanism. Sufficient power is available from the generator to furnish building utilities and the transmitter on reduced power. WTOP operates 24 hours a day with efficient uninterrupted service.

FIG. 39. The operating position in Studio 4 sub control room affords 100 per cent visibility into the studio. The RCA 76 consolette dominates this scene. The nearby 70C turntables and the extended control panel lends to the ease of operation.

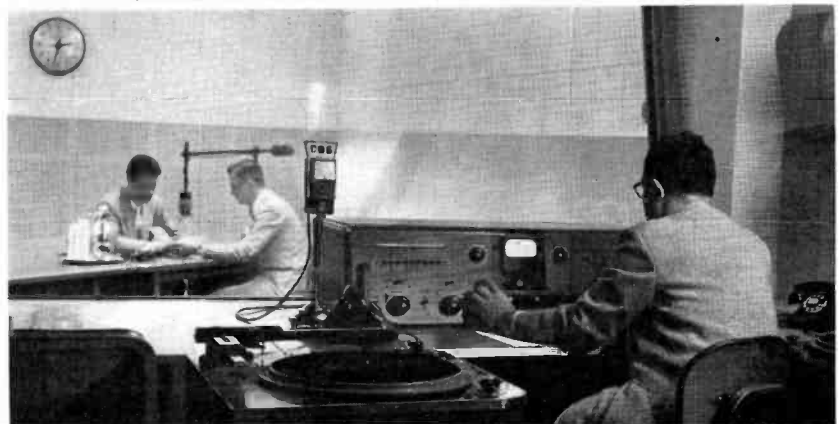

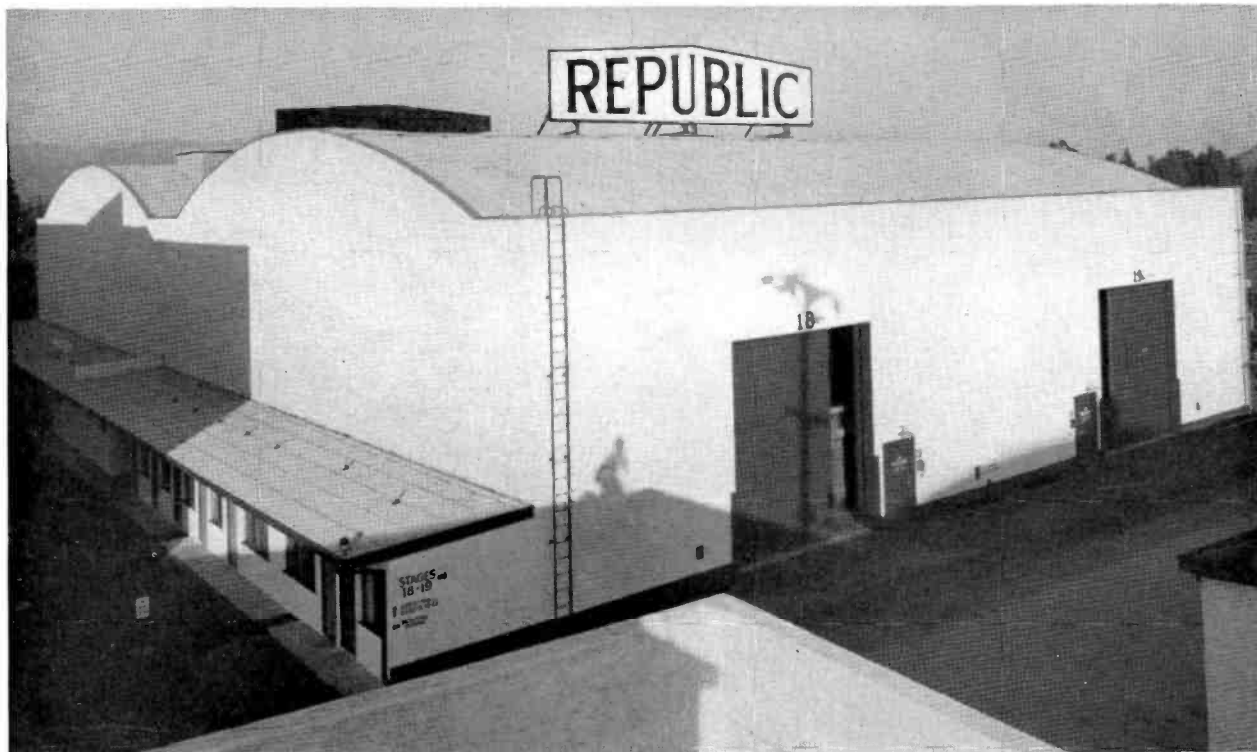

FIG. 1. Republic multiple sound stage building.

## REPUBLIC STUDIO MULTIPLE STAGE DESIGN

*EDITOR'S NOTE: Although the building described in this article was designed for motion picture production (particularly pictures for TV) it is similar in many respects to the television studio buildings now being planned by larger stations. For this reason, TV studio designers should find much of interest in this article. The discussion of sound insulation between stages (studios) should be particularly helpful. The emphasis on efficiency and functional design is noteworthy in that it closely parallels the most recent trend in TV studio building design.*

Republic Studios recently completed the construction of a multiple stage consisting of four sound stages, each 60' x 100', a hairdressing and makeup department and 12 dressing rooms and restrooms, all located under a common roof. This structure was planned to relieve overburdened stage facilities resulting from increased production schedules, particularly television pictures.

In planning this building attention was primarily directed towards efficient production operation by providing integrated facilities in a central convenient location. Emphasis was placed on the requirement that set construction and preparation could be carried on in one or more stages while

by  
**D. J. BLOOMBERG\***  
**JOHN POND\***  
**M. RETTINGER\*\***

normal production continued in an adjacent stage. The adoption of an individual stage size of sixty by one hundred feet (60' x 100') was not the result of a haphazard guess but rather the selection after a careful study of operations on small and medium size stages.

A noise level survey was conducted at the proposed site which established maximum noise levels in the order of 75 db. For normal dialogue recording the ambient noise level on a sound stage should be 30 db or lower. Therefore the exterior wall insulation against air-borne noise was determined as a minimum of 45 db. On the other hand, the maximum noise levels resulting from normal stage activities are more nearly in the order of 85 db. Therefore, the average transmission loss of the walls between the stages was determined as a minimum of 55 db.

The stages are equipped with an air flow system which has two operating cycles: one for high speed evacuation of gases, etc., having a complete air change cycle in three minutes, and a low speed control which provides a complete air change in six minutes. These controls can be worked automatically from the remote switchboard or manually by the sound mixer on the set. The fresh air circulation is drawn from an air chamber under the stage flooring through acoustic air traps into the stage proper.

The sound stage floor design was given particular study to derive a floor that would be noiseless and maintain proper rigidity under peak stage load conditions. The design specifications required a floor carrying capacity of 500 lbs. per square foot with a deflection of not greater than .09" (5/65") under uniform load and .145" (9/64") under a concentrated load of 2500 lbs. per square foot. The floor supports are constructed of concrete columns

\* Engineering Dept., Republic Studios, Studio City, Calif.

\*\* Engineering Dept., RCA Victor Division, Hollywood, Calif.

5' on center, 6x12 structural girders 5' apart, 2x8 joists 12" on center, 1x6 diagonal sub-floor, and 1x4 T&G vertical grain pine finish floor. The sub-floor and finish floor are both nailed through to the joists with #10 coated nails by a pneumatic nailer to insure a tight fit and even penetration.

One of the novel features contained in this structure is a newly designed pedestrian door which is an acoustic safety door with panic latches (see Fig. 3). This door has been adopted as a standard unit throughout the studio. This acoustic door consists of two partitions and is constructed in the following manner.

The first partition or inner door section is comprised of 2 sheets of  $\frac{3}{4}$ " exterior grade plywood laminated with a solid sheet of  $\frac{1}{16}$ " lead. This unit is mounted on the inner face of the second partition with B. F. Goodrich #10 vibro insulators providing a  $\frac{1}{2}$ " air space between the door segments. The second partition is constructed of a layer of 1" plywood facing the air space, 4" of rockwool, and two additional  $\frac{3}{4}$ " plywood sheets separated by a membrane of 20 gauge steel. The first partition section contacts one complete rubber seal on the door frame and the second partition contacts the door frame in two steps. Thus, the two door partitions make three complete contact seals with the door

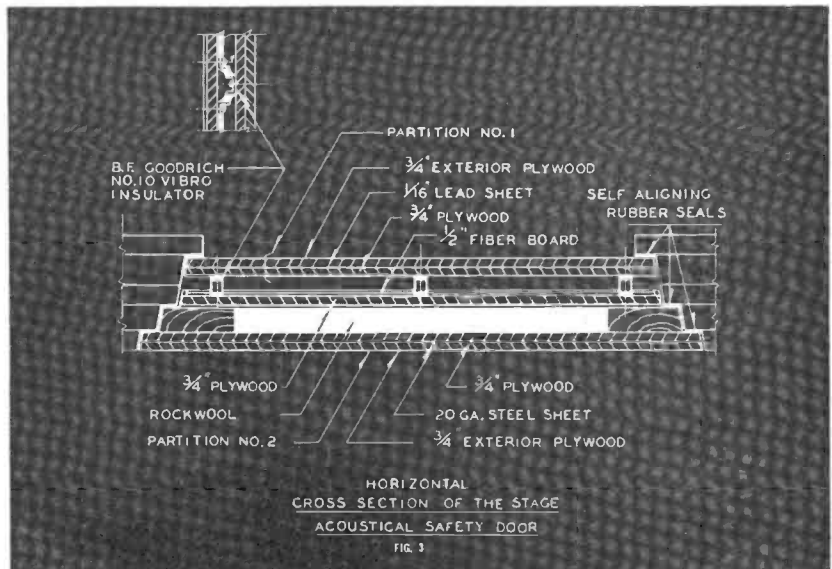

FIG. 3.

frame. When the door is closed the first partition, being mounted on rubber vibro insulators from the first section to the second. The three points of contact are actually forced into rubber seals thereby preventing air borne sound leakage. Actual acoustic measurements made with a General Radio

Sound Level meter indicates a sound transmission loss of 45 db at 1000 cycles.

Another novel feature is the equipment stage door which runs on a railroad type I section steel track with manual operation through chain reduction drive and an automatic self-sealing feature (Fig. 4). These stage doors weigh approximately  $3\frac{1}{2}$  tons

FIG. 2. Multiple sound stage building under construction.

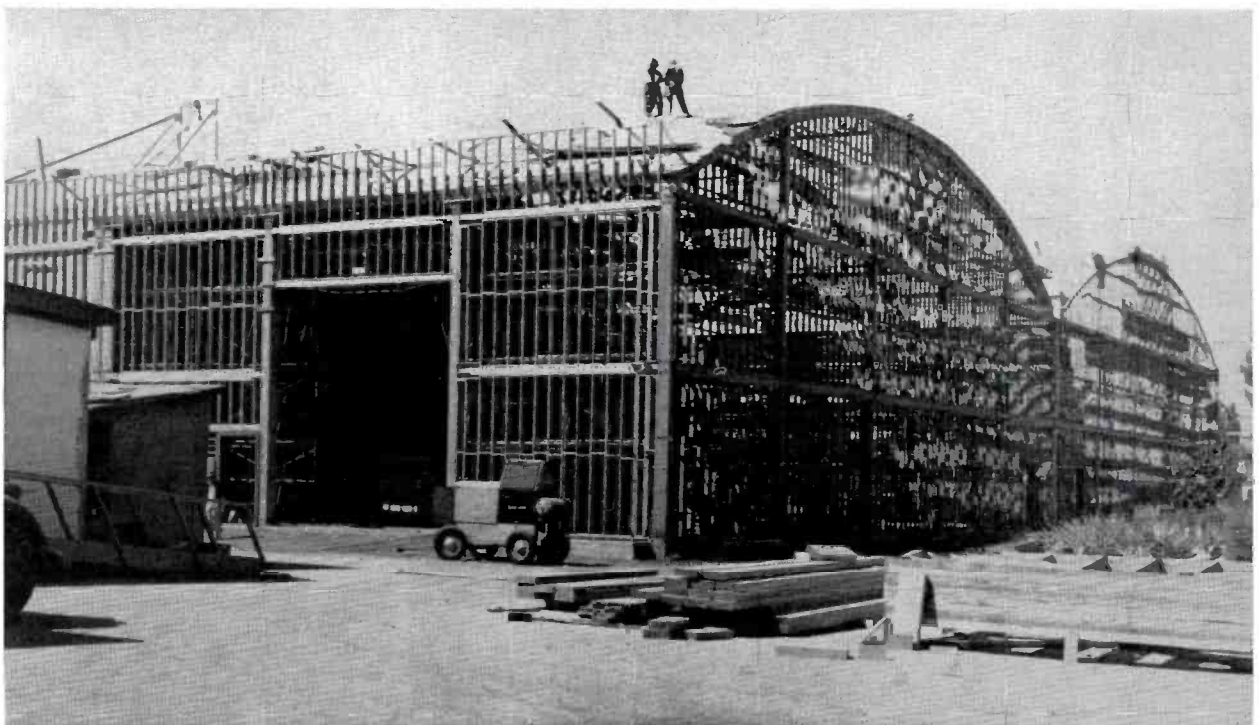

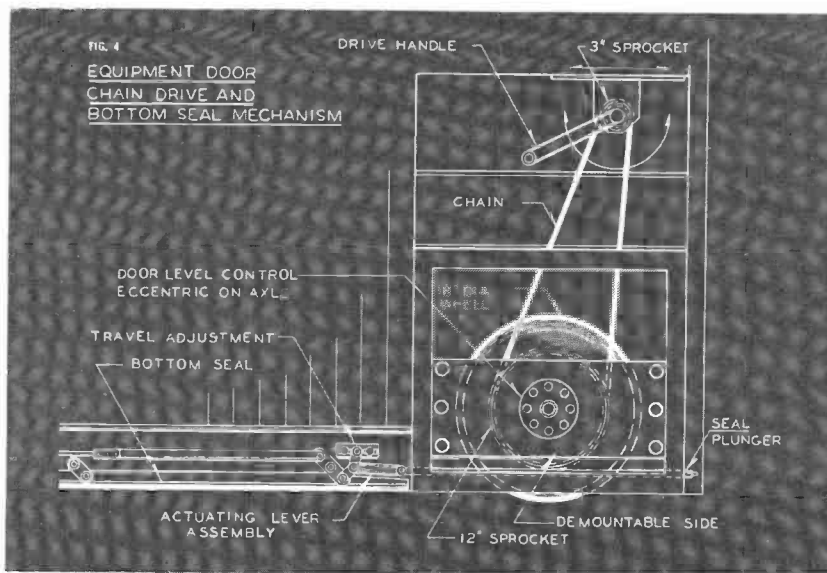

FIG. 4.

each and can be opened or closed with ease by one person. The automatic self-sealing feature becomes effective in the last inch of door closing. A plunger in the door is depressed by the door stop and thereby actuates a lever system which lowers the bottom door seal against the cement threshold with sufficient pressure to provide a satisfactory sound seal.

In the early days of sound recording, comparatively little was known about providing economic yet adequate sound insulation of sound stages. Thus, in one case a stage was constructed which consisted of two 1-foot thick concrete walls, separated from each other by a 2-foot air space. The

cost of the building was, of course, very high and the time of construction relatively long. This particular stage was, of course, excessively well insulated, since a single 1-foot thick concrete wall would at that site have been more than enough to provide a sufficiently low noise level in the interior. On the other hand, some sound stages were constructed which carried so little sound insulation that additional construction was required subsequently, which again made for a high building cost. Today, the construction of sound stages has been well studied and well carried out in practice. In general, three factors contribute towards noise in the studio.

FIG. 5.

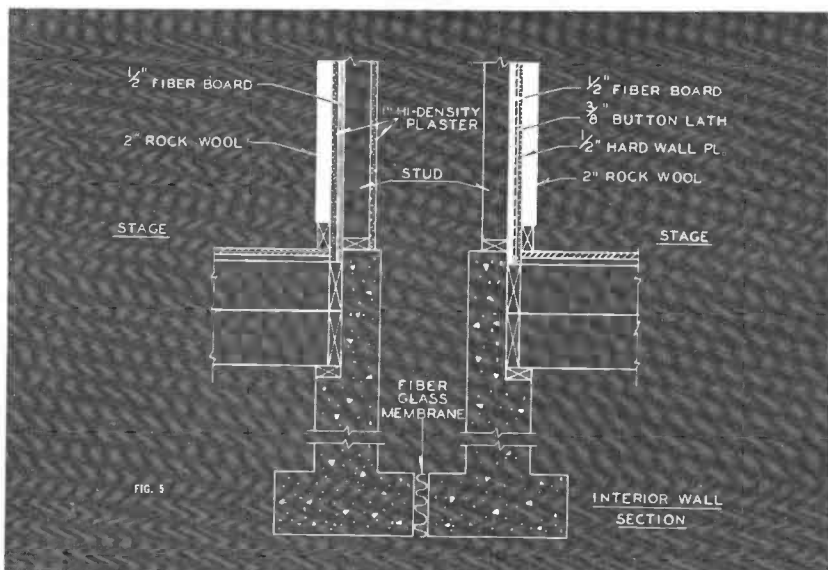

FIG. 5

1. The transmission of air borne sounds through such openings as doors, ventilators, cable openings, etc.
2. The transmission of solid-borne vibrations, such as a hammering, tamping, etc.
3. By the direct transmission through various parts of the building construction, which parts act as diaphragms put into motion by the air-borne vibrations striking them.

It is also well known that in the case of homogeneous walls of various types, the sound insulation is determined chiefly by the mass of the wall per unit area. The manner in which the edges of the material are fastened to the structural surroundings is generally less important than the weight of the wall per the unit area. This is certainly so in the case of large panels, although for smaller sections, some deviation may be said to exist. It is also frequently thought that in the case of homogeneous single section walls, certain types of material are endowed with special sound insulation qualities. Thus, the use of sheet lead or fiberboard or cork board is often recommended as being especially helpful in preventing the transmission of the sound through them. But this is not so. A cork board, of such thickness as to weigh as much as a sheet of lead of given thickness, has much the same sound transmissive properties, except perhaps at the frequency where resonance occurs. Another popular misconception is that heavy walls are effective as sound insulators. It is true that sound insulation can be increased by making a homogeneous wall thicker, but the increase in sound transmission is relatively small when a doubling of wall thickness occurs. Thus, a 12-inch thick concrete wall has a transmission loss\* of only 6 db greater than a 6-inch thick concrete wall. If, however, a concrete wall were made of two 6-inch thick partitions, which are structurally isolated from each other, then the transmission loss would be double that of a single 6-inch concrete wall. This property of sound insulation is so noteworthy that it may well be repeated in slightly different words: thus, doubling the thickness of a homogeneous wall increases the transmission loss by less than 6 db, whereas when two homogeneous walls are structurally isolated from each other, the transmission losses of the two walls may be added

\* The numerical measure of the reduction of sound intensity level is expressed by the term "transmission loss", which is defined as "ten times the logarithm to the base 10 of the reciprocal of the transmittivity, T, which is the ratio of the rate of transmitted sound energy away from the partition to the rate of flow of incident sound energy."

arithmetically. To cite a specific example, let us assume that a single homogeneous wall has a transmission loss of 30 db. Making this wall twice as thick increased the transmission loss to 35 db. If two walls (Fig. 5) are built which are structurally isolated from each other, each wall having a transmission loss of 30 db, then the combined transmission loss of the two walls is 60 db.

The transmission loss of an elastically restrained non-porous partition is given by:

$$T.L. = 10 \log_{10} \left\{ \frac{(r + 2R)^2}{4R^2} + \frac{\pi^2 F^2 m^2 \left[ 1 - \left( \frac{f_0}{s} \right)^2 \right]^2}{R^2} \right\}$$

where  $r$  = internal dissipative resistance of partition

$R$  = specific acoustic resistance of air = 41.5 (grams per square centimeter per second)

$m$  = partition mass per square centimeter

$f_0$  = resonant frequency of partition =  $\frac{1}{2\pi} \sqrt{\frac{S}{M}}$

$s$  = stiffness of wall (dyne per centimeter)

$M$  = mass of wall (grams)

When  $r$  is small compared to  $R$  and the exiting frequency is considerably higher than the resonant frequency of the partition, the transmission loss becomes—

$$T.L. = 20 \log \frac{\pi F m}{R} = -22.44 + 20 \log F m$$

It has also been learned that when a single wall (Fig. 6) of a given weight is constructed, the transmission loss of this wall can be increased considerably if the wall is made of two or more different layers or skins. It is true that the surface which is struck by the sound is set into vibration as a diaphragm, but this energy has to be transferred to the next layer and then to another layer, and so on. By proper combination of the materials, this energy transfer may be made quite small, which thereby increases the transmission loss of the wall. By the same token, of course, it becomes rather difficult to predict in advance the transmission loss of a wall when it is constructed in a complicated manner by using several different building materials separated from each other by air layers.

It is also often believed that the transmission loss of a wall can be increased considerably by the introduction of a filler

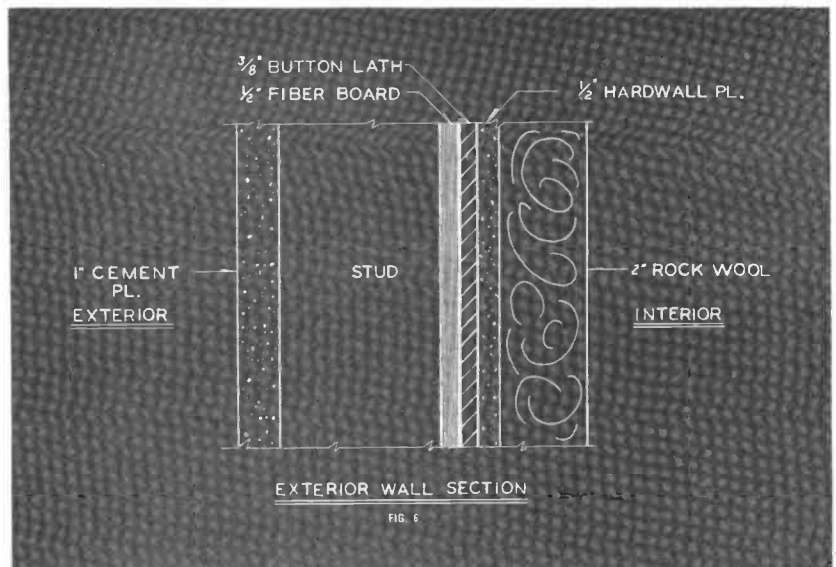

FIG. 6.

between the outside and the inside layer of a stud wall. This may be of advantage for lighter partitions, but for heavier construction an empty air space is acoustically often the best insulator. This is particularly true if the filler is solid so that it will pack down and act as a tie between the two surfaces.

In general, for heavy construction, a double wall provides the most effective sound insulation. In the building under discussion, it was desired to construct four stages under a common roof, each stage being 60 feet wide and 100 feet long. It was also required that it be possible to carry on normal stage activities in any one

of the stages without disturbing those in another stage. This required that the partitions between the stages be made of a double wall construction, each wall resting on its own foundation.

Sound transmission loss tests conducted of the walls between stages showed a loss of 48 db at 100 cycles, and 59 db at 300 cycles. Above 300 cycles the transmission loss was in excess of 59 db and could no longer be measured with the equipment available for the purpose.

Sound transmission loss tests conducted on the outside walls of the stages showed a loss of 30 db at 100 cycles, and 55 db at 1000 cycles.

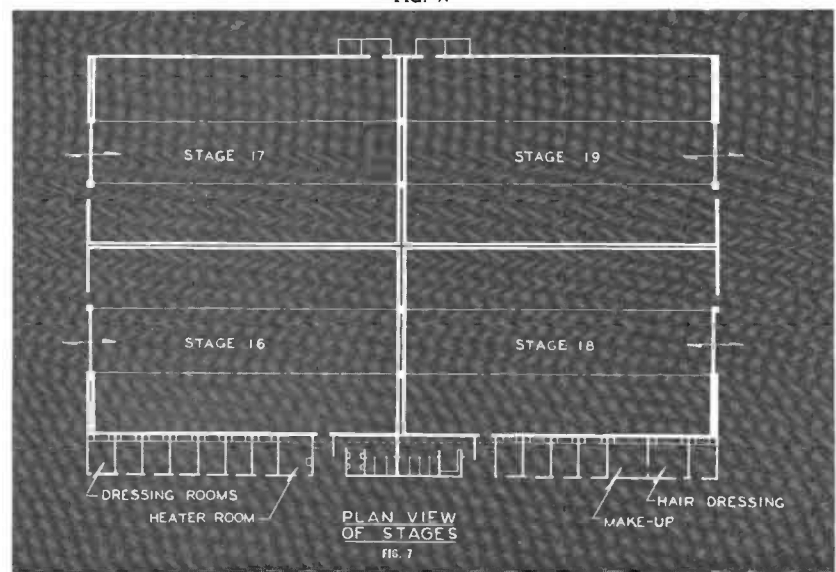

FIG. 7.



FIG. 1 (left). Power crews connect power to the WCBI transmitter building preparatory to installation of the "all RCA" installation of radio and TV for WCBI. The new site is four miles northeast of center of Columbus, on Highway 12.



FIG. 2. The just-completed WCBI transmitter building, 32 by 32 feet, is shown in this view. Made of all concrete, and designed for future expansion on the 90 acre WCBI "Antenna Farm," the building features steel casement windows, glass wool insulation, ventilated ceiling loft, a flat-top roof and plenty of parking space. The deep well and pump house is shown at the rear of building.

THE STORY  
OF A **1KW-AM** AT **WCBI**  
COLUMBUS, MISSISSIPPI



FIG. 3. Byron Fincher (left) sales representative of Radio Corporation of America, Dallas, Texas; Bob McRaney, general manager of the Mid-South Network and WCBI, and (standing), Dana Pratt, field sales manager for Radio Corporation of America, Camden, N. J., as contracts were signed for RCA transmitting equipment to be installed by WCBI enabling a switch from 1340 KC to 550 KC and an increase in power to 1,000 watts.

**By BOB McRANEY**  
General Manager

Back in 1939, a young man with plans and ambition visioned a radio station for his Community. The young man was Birney Imes, Jr., son of the illustrious and dynamic Editor and Publisher of the Commercial Dispatch, Birney Imes, Sr. The community was Columbus, Mississippi. Columbus was the trade center for Northeast Mississippi and was destined to continue its economical and industrial growth, thus young Imes turned to radio as a new medium of expression and advertising for his Community. After consulting with representatives of RCA, complete station equipment was purchased, including one of the first 250-K RCA Transmitters, RCA monitoring equipment and a complete studio layout of console, turn-

tables, microphones, remote equipment and associated items. WCBI went on the air in October, 1940, operating full time with 250 watts on a local channel of 1340 KC. The station was an immediate hit with the people of the area. Uncle Sam called and Lieutenant Birney Imes, Jr. went to war as an officer in the local unit of the National Guard.

In December of 1940 Bob McRaney, a native Mississippian who had seen service with WSGN in Birmingham, Ala. and had assisted in the opening and operation of radio stations in Hattiesburg, Laurel, Miss. and Monroe, La. arrived in Columbus to assume the post of General Manager of WCBI. Came the war and its resultant

freeze on construction of radio stations and the curtailment of vital materials. WCBI served its Community with distinction during the war, winning many citations for its War Bond Drives, Recruiting activities and Community service.

Rapid growth of the Community and a desire to better serve the Community and the expanding trade area prompted Imes and McRaney to begin plans for expansion. Several additional local stations had been built by the pair in Mississippi and WCBI became the headquarters for The Mid South Network, with five additional stations scattered over Mississippi.

Plans began for seeking the best possible frequency and the maximum power for

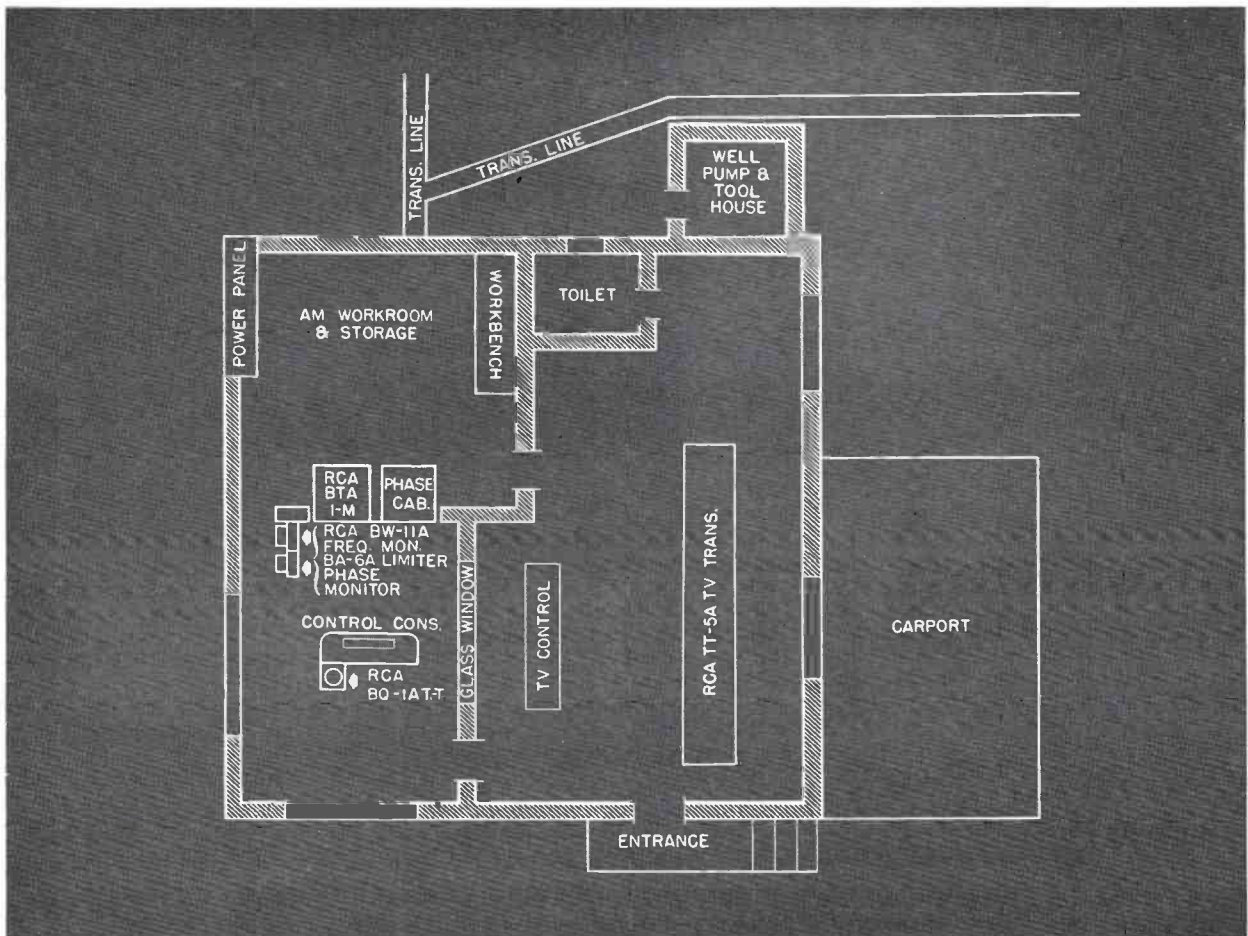

FIG. 4. WCBI, Columbus, Mississippi, Radio-TV Transmitter plant. Building is 32 by 32 feet—all concrete construction, as shown pictorially in Fig. 2.

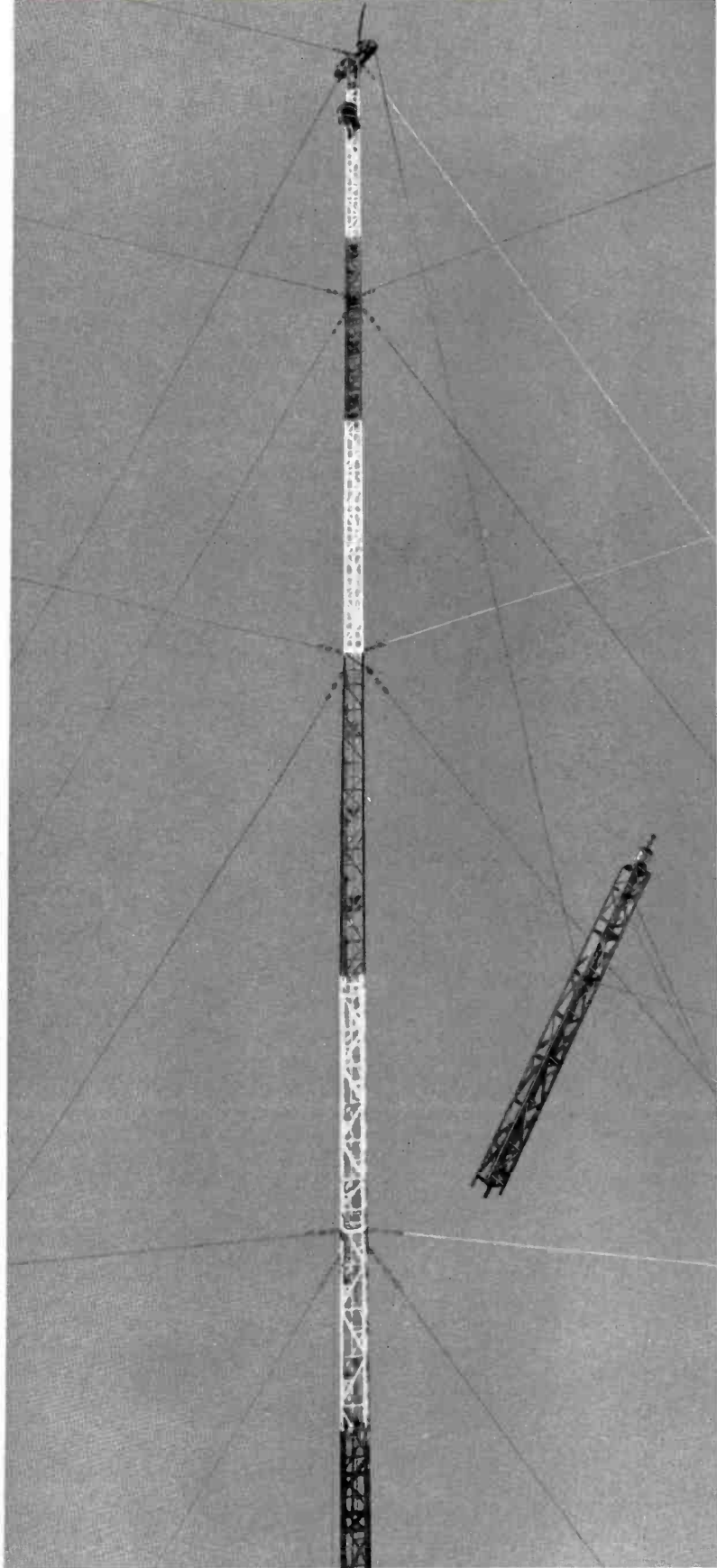

FIG. 5. Last section of the 325-foot Andrews tower is hoisted to the top of the tower. Tower crews erected the four towers in four days. Entire tower and ground system contract was handled by RCA, through Andrews Tower Company of Fort Worth, Texas.



FIG. 6. Shown in front of the BTA-1M and the phasing cabinet, is Tom McFerrin, chief engineer of WCBI, who supervised the complete installation of the new kilowatt plant. The two cabinets will be framed with moulding around the edge of the opening to form a perfect installation from standpoint of convenience and appearance.



FIG. 7. Tom McFerrin, chief engineer for WCBI and The Mid-South Network, inspects the phasing gear before sliding phasing cabinet into position beside the BTA-1M 1 kilowatt transmitter at the WCBI transmitter.



FIG. 8. Creosote-treated raceway from the WCBI transmitter house to tower #3 shown in this view carries the transmission line, power cable, supervisory wires, sampling lines and communication wires between the towers and the transmitter house.



WCBI. Engineering studies produced information that 550 KC. a favorable regional frequency would work in Columbus, provided a directional antenna system was employed. On August 17, 1953, an Application was filed with the FCC, requesting permission to change frequency of WCBI from 1340 KC to 550 KC, and increase power from 250 watts unlimited to 1,000 watts daytime and 500 watts nighttime, utilizing a directional antenna array day and night. On September 29, 1954, the FCC made final a grant of the application. Then followed rush orders for equipment, signing of leases for land, which had previously been selected as the transmitter and tower site. RCA representatives came to Columbus to assist with the planning of the equipment and to assist with engineering and installation problems. A contract was signed with Byron Fincher, RCA Representative of the Dallas office and Dana Pratt, Broadcast Field Sales of Camden, N. J. office of RCA for a complete "RCA all the way" installation. Equipment ordered included the RCA BTA-1M transmitter, phasing equipment for the four tower directional array, four Andrews towers, 325 feet above ground,

transmission line, line termination equipment, phase monitor, RCA BW-11A Frequency Monitor, BA-6A Limiting Amplifier, RCA BQ-1A Turntable and amplifier, dehydrating equipment, ring-type lighting transformers, sampling coils, isolation coils and all associated equipment. Construction started within a matter of days and a 32 x 32 foot all concrete building was erected on the ninety acre transmitter site. Raceways with metal lined ducts were set in the concrete floor. The control room was sound proofed and provisions were made to include additional space for the new WCBI-TV transmitter. A deep well was drilled, the area landscaped, a driveway built to the building and the towers and ground system installed within thirty days.

Equipment arrived on schedule and installation was made rapidly. All work at the transmitter was under the supervision of Thomas McFerrin, veteran Chief Engineer of WCBI and The Mid South Network. Tests were scheduled for early 1955 with on the air date expected to be approximately February 15, 1955.

Latest engineering studies indicated that

the new signal radiated from the new plant would give WCBI a coverage of an area encompassing over 6,000 square miles, in which there are sixty important towns and trade areas. This represents an increase of 1084.3% in area to be served. Population to be served within the coverage area of the new WCBI transmitting plant is now increased by 429.6%. A large segment of both Mississippi and Alabama will receive service from the new transmitter. WCBI will operate full time and features a strong lineup of local features, local news and sports and special events. WCBI also operates as a fulltime Mutual Network affiliate.

Further expansion of WCBI includes the installation of WCBI-TV, on VHF Channel 4, which will be a part of the new transmitting plant. WCBI recently purchased an RCA TT-5A Television transmitter and associated equipment and expects to erect a 500 foot tower adjacent to the transmitter building and commence television transmission from the WCBI "Antenna Farm" early next Summer. WCBI-TV expects to operate with both NBC and CBS networks.

FIG. 9. Aerial view of the 90 acre WCBI "Antenna Farm," located about five miles from Columbus, Mississippi, on Highway 12. The four 325-foot towers form a parallelogram. The ground radials reach to a point 450 feet from the base of each tower. Over 10,000 pounds of copper wire was buried in the ground. The transmitter building is shown to the right. The new WCBI-TV tower, 500 feet above the ground, will be located near the transmitter building.

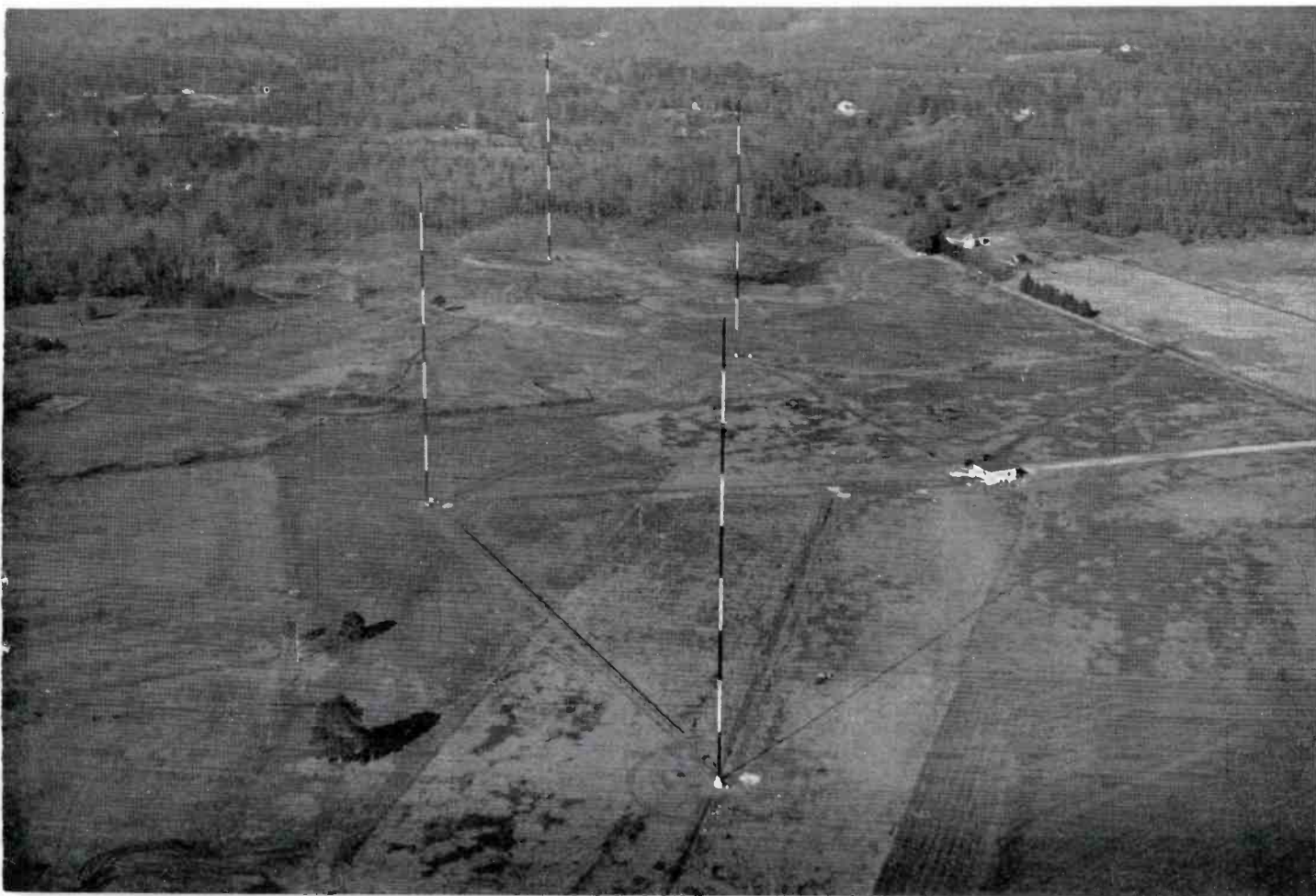

# HOW TO MAKE AN "ILLUMINANT C" GREY SCALE MONITOR

## *Description Of Unit Used By NBC In Standardizing The Adjustment Of Color Monitors And Color Receivers*

by  
**E. P. BERTERO**  
Engineering Development Group  
National Broadcasting Company

### Introduction

The proper adjustment of the color monitors and color receivers in a TV station is necessary if continued transmission of good color pictures is to be achieved. One of the most important requirements of the adjustment is to make all the monitors and receivers in the plant "look alike." The "Illuminant C" Grey Scale, the construction and use of which is described in this article, is very helpful in standardizing monitor and receiver adjustment.

### Color Monitors and Color Receivers

A color receiver or color monitor can, with the aid of test signals and an oscilloscope, be completely aligned except for one adjustment. The adjustment for which

complete instrumentation has yet to be developed is the adjustment for "white." In present day color receivers and monitors a total of 7 controls must be adjusted to realize the complete adjustment for white (or more precisely the achromatic reproduction of luminance information at the proper color temperature). The controls are adjusted to realize not only the proper "white" or color temperature, but also at the minimum and maximum brightness the set is to be operated. In our operational experience at NBC we have learned that when two or more monitors are viewed simultaneously either adjacent to each other, or one at the receiving location and one at the sending location, it is of utmost importance that the monitors be adjusted in identical fashion, both in color temperature and in maximum and minimum brightness. Needless to say there is urgent need for some form of instrumentation to make all the color monitors in the plant look alike and look the same from day to day.

### Instrumentation

To date, there have been two avenues of approach in developing operational type instrumentation for setting up color monitors to the proper color temperature and brightness. One approach has been to set up the monitor by a visual method. The second approach has been to use photocells. We at NBC have tried both forms of instrumentation. The pros and cons of each method are lengthy and will not be dealt with at this time. It will suffice to say that neither approach proved to be operationally successful.

Since our formal approach to the problem appeared fruitless we next felt that an interim solution should be sought since such a solution would be better than no solution. It was on this basis that the "Illuminant C" Grey Scale was developed. It was reasoned that although operational instrumentation independent of human vision had not been developed, the human

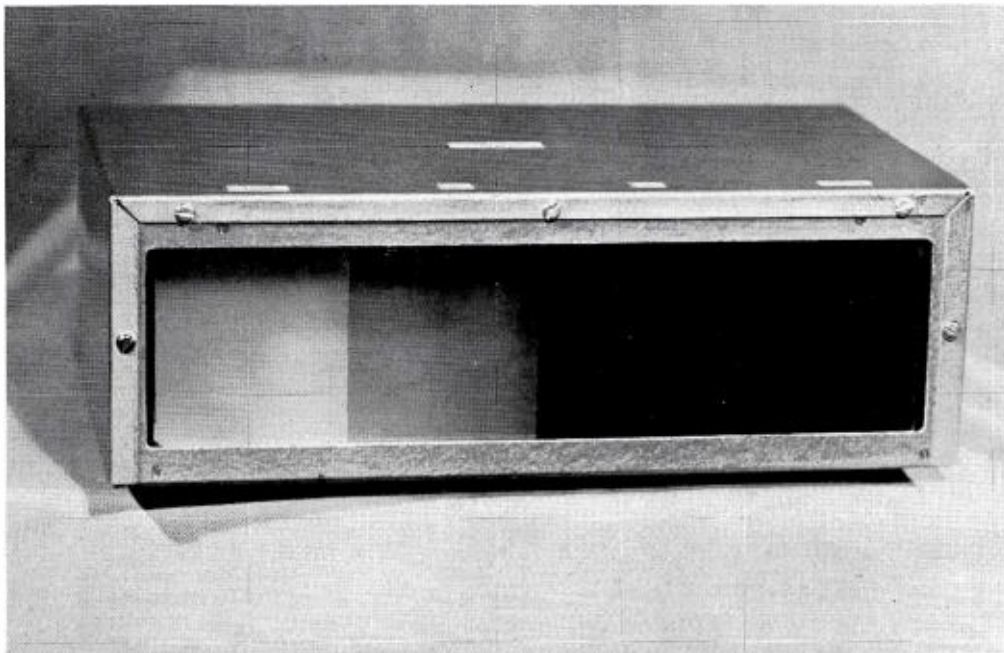

FIG. 1. The "Illuminant C" Grey Scale Monitor used by NBC engineers is housed in a small aluminum box which can be placed on or near a color monitor or color receiver while adjusting for proper setting of "white". Standardization of color pictures is greatly improved by using the monitor as a comparison standard.

FIG. 2. The grey scale monitor consists essentially of a fluorescent light source modified by a filter and diffusing material. Interior view is shown here. Construction details are given in text.

eye is the final judge of acceptable color pictures. The average observer has, however, very poor color memory. It was felt that if a source of light of the proper color temperature were located adjacent to the monitor it would afford a reference to which the monitor was to be adjusted. At this point the Colorimetrist will point out such factors as anomolous color vision among individuals, adaptability, environment, etc., all arguments which are not in favor of the use of the "Illuminant C" Grey Scale. Our experience indicates however, that when monitors were set up using the "Illuminant C" Grey Scale as a reference we obtained a factor of reproducibility of results from day to day which heretofore could not be realized. It has been found that this factor of reproducibility of results is far more important than it is to get a perfect "Illuminant C."

#### What Is "Illuminant C"

"Illuminant C" is one of those illuminants arbitrarily standardized in the Science of Colorimetry. Classically it is defined as the quality of light omitted by a black body at 6740° Kelvin. It is defined as a certain energy distribution in the visible spectrum. In practice, a source "C" is representative of average daylight such as that from a completely overcast sky.

Historically it was NTSC that specified that the "Chrominance signal is so proportioned that it vanishes for the chromaticity of CIE Illuminant C ( $x = 0.310$ ,  $y = 0.316$ )."

This Specification implied that luminance information be reproduced on a color receiver or monitor as "Illuminant C." The choice of "Illuminant C" was determined by two factors:

1. Compatibility—A color receiver receiving black and white pictures is to look like a black and white receiver (high color temperature).
2. Color picture brightness—With a given red phosphor limitation, an apparently brighter picture is obtained when the tricolor tube is balanced for "Illuminant C" than if it were balanced to a lower color temperature.

The FCC in adapting NTSC signal specification did not, of course, define receiver performance. The FCC did promulgate rules governing signals radiated by a transmitter. In "Rules Governing Color

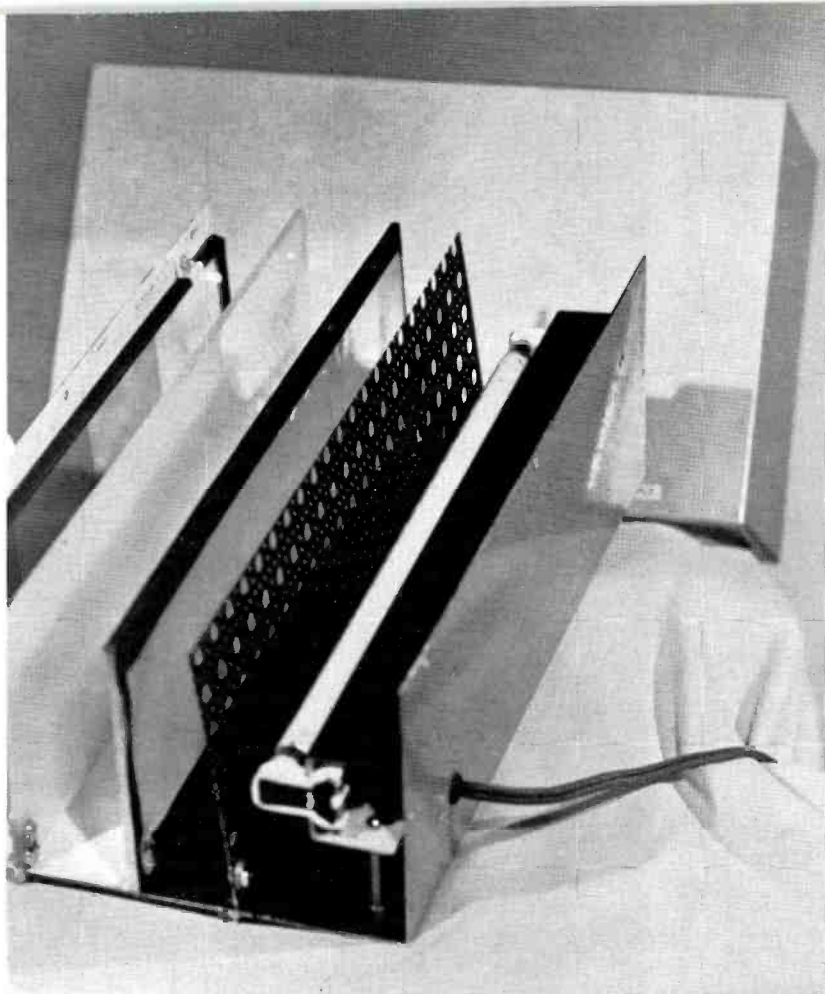

Television Transmission" Section 3.681 (V) reads as follows: "The radiated chrominance subcarrier shall vanish on the reference white of the scene" (see footnote). The footnote at the bottom of the page reads "The numerical values of the signal specification assume that this condition will be reproduced as CIE Illuminant C ( $x = 0.310$ ,  $y = 0.316$ )."

#### Construction of "Illuminant C" Grey Scale:

The "Illuminant C" Grey Scale consists of a source of light suitably modified in spectral distribution by a filter and diffusing material. It is a metameric match to a standard source of "Illuminant C." The accuracy to which the secondary source of "Illuminant C" matches the standard source is inherently high simply because of the color comparator method used and the agreement of multiple observer tests. For those concerned our standard source of illuminant was obtained by the Davis Gibson method as outlined by Arthur C. Hardy in the "Handbook of Colorimetry."

The drawings and photographs (Fig. 1-4) indicate the construction detail of the

"Illuminant C" Grey Scale. The complete unit is 12" wide, 4" high and 7" deep. It weighs 4 pounds, 7 ounces. A light from a daylight fluorescent lamp is attenuated by a perforated metal screen. The light is then modified in the visible spectrum by an Eastman Kodak 78C Wratten Filter and by two spaced pieces of diffusing plexiglass.

The highly diffused source of "Illuminant C" thus provides the rear illumination for the Grey Scale consisting of a clear area and three pieces of neutral density gelatin filters. The Grey Scale was arbitrarily chosen to be 0, .2, .5 and 1.3 density steps. The scale can be considered to be linear transmission grey scale. The actual type of scale and the number of steps is not of prime importance in this application since it is not to be used for photometric or sensitometric purposes. The choice of wratten was made to provide a contrast range of 20 to 1, the present limitation of the practical contrast range of the tricolor tube under average viewing conditions.

The second valuable reference afforded by the "Illuminant C" Grey Scale is a

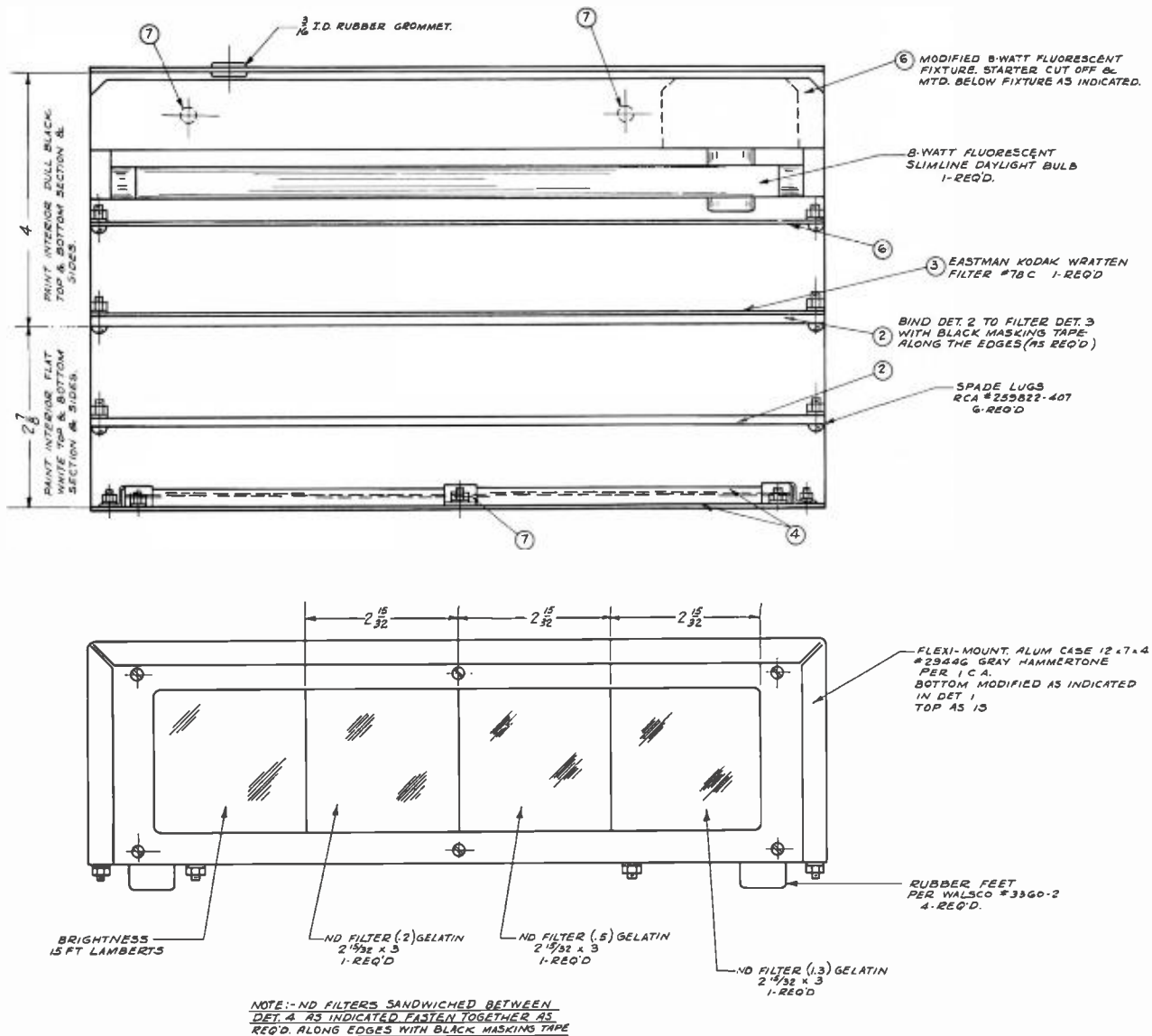

FIG. 3. Assembly of the "Illuminant C" Grey Scale Monitor is shown in this drawing. Numbers in circles refer to detail drawings on opposite page.

brightness reference. The first step (0 density) has been adjusted to be 15-foot lamberts. The brightness adjustment is made by judiciously choosing the proper ratio of holes to metal per unit of area of the attenuator mentioned and by relatively small position adjustments of fluorescent light fixture. The fluorescent lamps are aged for 100 hours to reach stabilized light output. The lamp is rated for 7500 hours. The figure of 15-foot lamberts was reached by averaging the brightness readings of white of color bars periodically over a period of a month on our 16-inch receivers. The meter used to make brightness readings is the Photo Research Spectra Brightness Spot Meter.

#### Use of "Illuminant C" Grey Scale

It is intended that the grey scale be turned on and placed on top of the receiver or monitor to be adjusted. It is assumed that the receiver or monitor has been previously adjusted as per instruction manual. Experience has proved that color bars with I and Q turned off at the colorplexer or a step generator provide the best signals to adjust for white. A monochrome feed can also be used if suggested test signals are not available. The procedure is then followed as per receiver instruction book using the Grey Scale to provide a reference for maximum and minimum brightness steps of proper color temperature. The two other steps of the Grey Scale

provide intermediate values of grey to assist the observer in adjusting for a complete achromatic rendition of the receiver.

#### Maintenance and Calibration

The "Illuminant C" Grey Scale requires practically no maintenance. Like any other light source it should be inspected occasionally and cleared of any accumulation of dust on the grey scale, diffusing material and lamp fixture. Since the light emitted by all sources of illumination is reduced with usage, it is recommended that the first step of the scale (clear area) be occasionally checked for proper intensity. Initially each unit is adjusted to read 15-foot lamberts using a "Spot Brightness Meter." Where

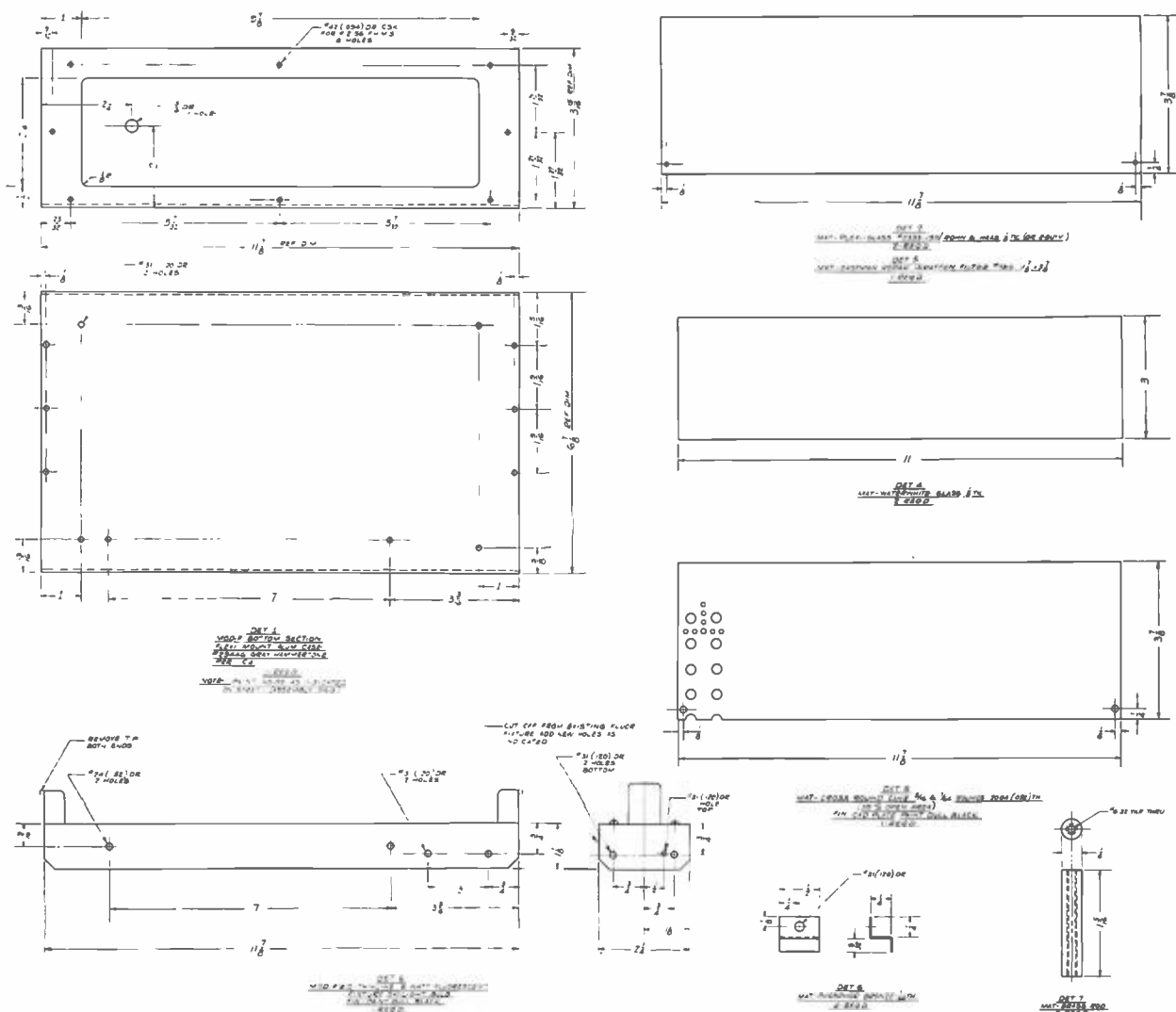

FIG. 4. Mechanical details of parts which make up the "Illuminant C" Grey Scale Monitor. Note that scale is not the same in all drawings.

this meter is not available equivalent relative readings for other more commonly used meters are:

- G. E. Exposure meter—1 on low scale
- Weston Master II meter—3.2 on low scale

In each instance the sensitive portion of the meter is held against the first step (maximum transmission) of the grey scale to measure light intensity. Should it be found that the intensity is low locating the lamp fixture closer to the attenuator screen should provide the necessary illumination. Should the intensity still be insufficient then change the lamp.

### Conclusion

In the short time that the "Illuminant C" Grey Scale has been used in our color operation, it has proven to be a useful tool in realizing a uniformity of results in monitor adjustment not obtainable in the past. It is hoped that the unit is only an interim solution to the problem. Ideally we seek instrumentation that requires the operator to make adjustment by meter readings only, rather than to make adjustments governed by the operators color judgment. However, in the meantime, the "Illuminant C" Grey Scale has been very helpful in our operation and it is likely that other broadcasters will find it equally useful.

### PARTS LIST

#### Illuminant "C" Grey Scale Monitor

- 1 Flexi-Mount Al. Case 12 x 7 x 4 ICA #29446
- 2 Pieces Plexi-Glass #2333-150 1 1/8 x 3 7/8 x 1/8
- 4 ND Filters 3 x 3 Gelatin (.2, .5, 1, + .3)
- 2 Pieces Waterwhite Glass 11 x 3
- 1 Piece Perforated Metal—39% open area
- 1 8 Watt Fluorescent Fixture, Daylight Bulb (cutoff starter and mount underneath)
- 1 78C Gelatin Filter 1 1/8 x 3 7/8
- 4 Phosphor Bronze Clips
- 6 Spade Lugs
- 1 6-foot Line Cord
- 4 Rubber Feet Walsco #3360-2
- 1 Line Cord Switch Hubbell—5 amp—250V

# PROGRESS REPORT ON COLOR TELEVISION

## Watts Talks About Color Plans; Tube Division Shows New Facilities For Production of 21-inch Color Kinescope; RCA Victor TV Division Announces New Color Receivers

**EDITOR'S NOTE:** *On April 12th the RCA Tube Division invited the press to its Lancaster Plant to see the greatly increased color tube production facilities now being installed and to hear a progress report on tube manufacturing techniques. In welcoming the visitors, W. W. Watts, Executive Vice President, Electronic Products, Radio Corporation of America, gave them a brief résumé of the color situation which we feel sure will be of unusual interest to television broadcasters. For this reason we are departing from our usual practice and printing Mr. Watts' talk, in full, below.*

*Following Mr. Watts, on the April 12th program, Mr. C. Price Smith, Manager of Color Kinescope Engineering for the RCA Tube Department, described the technical manufacturing and performance features of the RCA 21AXP22 Color Kinescope. Because of the great importance of this tube to the whole color television program we are reproducing on following pages most of Mr. Smith's talk, together with photographs of color kinescope production made in the Lancaster Plant. We believe that most BROADCAST NEWS readers will find both of these talks of great interest.*

*On May 4th the RCA Victor Division announced two entirely new color receivers. Pictures of these, with preliminary information, are shown on Pg. 42.*

### by **W. WALTER WATTS**

**Executive Vice President**

**Electronic Products**

**Radio Corporation of America**

All of us are deeply grateful to you for taking the time to come here to listen to our progress report on color television. We feel sure that what you see and hear at Lancaster today will be regarded in the future as one of the most important mileposts in the transition of color from the introductory stage to its broad adoption by the electronics industry for mass production.

As you all know, several organizations have been inventing, testing, announcing, and promoting their answer to the color television picture tube problem. The goal, of course, has been a color tube so good, so simple and so adaptable to manufacturing that these organizations would be willing to risk the millions of dollars necessary to put it into mass production.

RCA has that color tube. And RCA has the courage and the confidence to take the

financial risk. This is no mere statement of what we propose to do at some vague date in the future. Here, today, we will give you concrete evidence of our commitments and action to bring color TV to the mass market.

Stories have been published in the past to the effect that our early steps and those of others left much to be desired. The stories were right—but we had to go through those steps to learn the answer. We have the answer today—RCA's color tube has been tested and proved through substantial factory production; it has proved itself on the receiver production line; and it has stood the test of nationwide introduction to the public.

With that proof behind us, we have complete confidence in our future program. We are sure that the RCA 21-inch Round Metal Color Tube will be the practical answer to low cost color TV. New space to be provided by the buildings under construction here at Lancaster is to be used for color tube production. From the 50,000 square feet used here last year for color tube production, we have expanded to 132,000 square feet, plus supporting area for offices and storage.

We are building for ourselves, and have ordered from others, millions of dollars worth of machinery to mechanize and speed up our production. Much of this you can see in our factory today.

To date, we have built a substantial quantity of color tubes of the 21-inch design. Our program calls for rapid build-up of the monthly production rate. Much has been written about shrinkage or scrap—the number of tubes that you must discard out of each production run. I can tell you that we have sharply reduced the shrinkage rate, and expect soon to be approaching the same rate we have achieved in black-and-white tube production.

Let's look back a moment. The year 1954 saw us bring this tube to reality. We announced its design in July—promised to demonstrate it in September, which we did

—and made initial deliveries of both tubes and sets before the end of the year. In January, our experience was so good—and our confidence in the future so great—that we reduced the price of the tube from \$175 to \$100 to set makers.

We now believe we can meet reasonable demand for color tubes—and can accelerate our program to keep pace with the set makers. We believe that a number of other tube makers now share our confidence and will produce this type of tube as a demand develops.

As you know, the RCA Victor Television Division produced a limited quantity of receivers from December through February. An announcement regarding the production of RCA's new simplified color set was made on May 4 (see Pg. 43). The production of this new color receiver will be geared to public demand.

As for programming, there will be an expansion of NBC's color presentations about which you have enthused during the past and current season. Let's talk for a moment about color programming. There is so much excitement about color, and it gets so much publicity, that color programs automatically attract more viewers and are more talked about than most shows.

For instance, fourteen of the first twenty-two NBC Spectaculars have been in the magic top 15, and the average audience for all Spectaculars shown thus far exceeds 35,000,000 people per show. The high public interest that NBC has set out to create in color is evident from a mere recital of some of the show titles: "Lady in the Dark," "State of the Union," "Babes in Toyland," "Yellowjack," "The Women," "Follies of Suzy," "Naughty Marietta," and the outstanding one of all, "Peter Pan" with Mary Martin.

Virtually every nighttime program on the NBC network has been done at least once in color, not only for experiment's sake, but also to encourage sponsors of regularly scheduled programs to move into color. The Ford Theatre already has spon-



FIG. 1. The RCA 21-inch color television picture tube, left, is shown here in comparison with the 15-inch color tube with which RCA launched commercial production of color TV in March 1954. The 21-inch color tube utilizes the same operating principles as those of the previous RCA color kinescopes. It is a shadow-mask design employing a three-beam gun. An important feature is the thermally compensated formed shadow mask. It has a deflection angle of 70 degrees which permits an increased picture area with short tube length. In addition, it uses phosphors on the faceplate of the tube, a metal envelope, and a short electromagnetically converged gun.

sored color shows on a weekly basis. And we expect more sponsors to take similar action this fall, both on a weekly basis and on an occasional basis. We believe that many of the half-hour film shows will be the first to make the transition. Worthington Miner has, in experimental stages, a new color series to be called "Frontier."

Looking ahead more widely to next fall, NBC expects to do in color, segments of "Today" and "Home." Similarly, it will colorcast portions of "Tonight," starring Steve Allen.

On Sundays, NBC will have two color series, one in the afternoon, the other at night. The earlier will be the great new Maurice Evans dramatic series, from 4 to 5:30 p.m. The evening show will be a series of variety spectaculars, from 7:30 to 9:00.

On Saturday nights, NBC will continue Max Liebman's series of Spectaculars—musicals by such composers as Richard Rodgers, Jerome Kern, Victor Herbert, Sigmund Romberg, Rudolf Friml, Vincent Youmans, Cole Porter and George Gershwin.

On Monday nights, the Producers Showcase will continue in full color with such plays as Arthur Koestler's "Darkness at Noon" and Robert Sherwood's "Petrified Forest," the latter starring Humphrey Bogart, Henry Fonda and Lauren Bacall.

In the sports field, NBC plans to inject some exciting new uses of color and, to complement the mock Army battle of last spring at Fort Meade, NBC hopes to work with another of the armed services in developing another big color program linked to the nation's defense activities.

Those are the plans so far, and the Fall color schedule is not yet completely planned. We know that other color programming opportunities will occur, and that the season will create high excitement in color programs.

Thus, it becomes evident that there is a strong supporting program to move color television forward as rapidly as possible. But nowhere is RCA's determination more evident than it is here at Lancaster. We have brought all the set makers here—all of the tube makers have been here—to absorb our enthusiasm, our confidence and our success. Because reactions of those who have heard and seen our story confirm the soundness of our program, we felt that we could invite the press to see for themselves that the key element in color TV—the picture tube—is "off the ground."

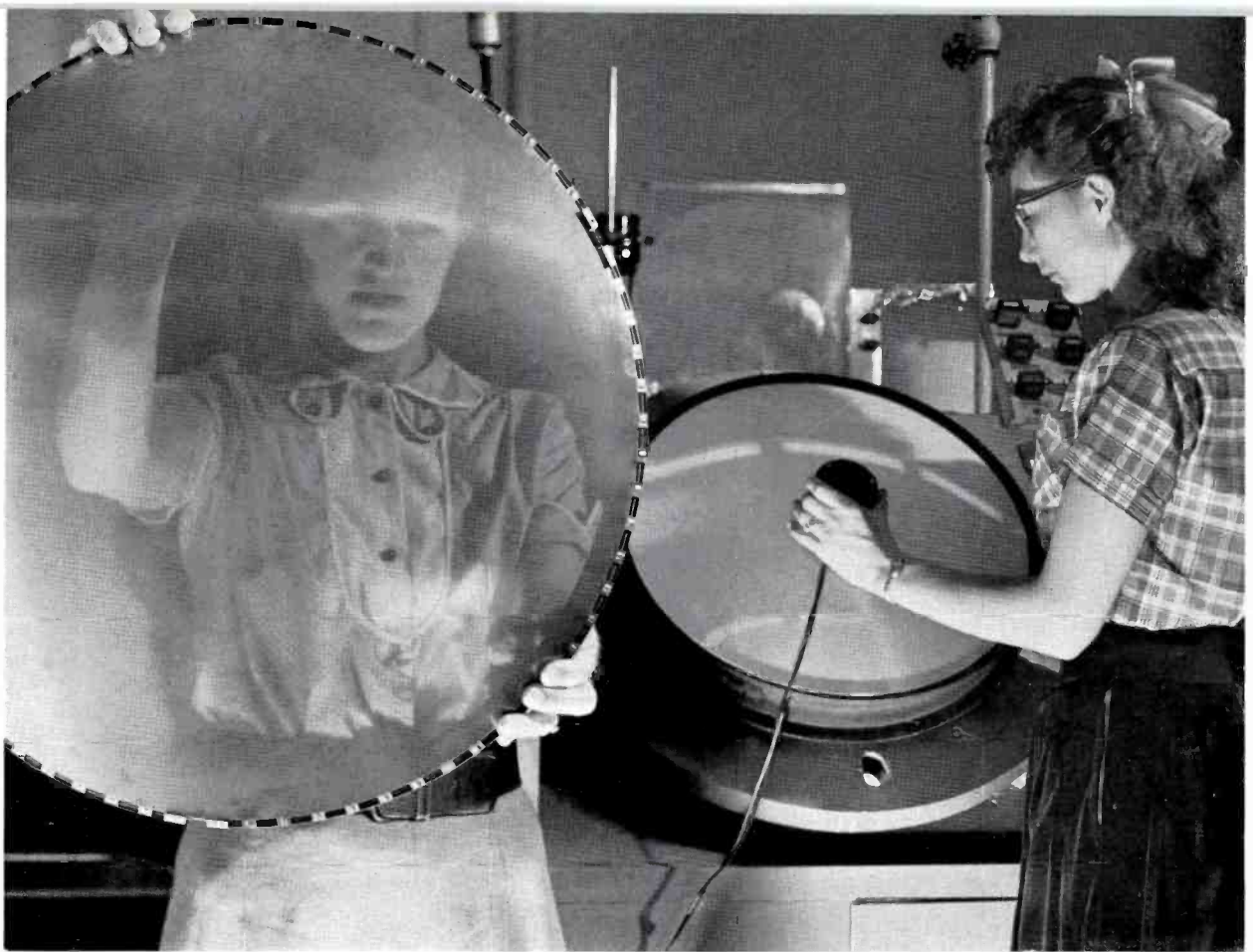

FIG. 2. RCA 21-inch round metal color television picture tube in production at the RCA Tube Division plant in Lancaster, Pennsylvania. Operator at right is directing an ultraviolet source on the faceplate of a color kinescope to "excite" color phosphors for examination of the screen. At left, another operator inspects the tube's shadow mask which contains more than a third of a million accurately-positioned holes. The mask is made of cupro nickel. .0075 inches thick. Holes are accurately etched from both sides of the sheet to produce sharply defined holes of approximately 10 mils diameter. The mask is drawn to spherical shape, plated and blackened, and mounted on a stabilized ring of cold rolled steel.

## PRODUCTION OF RCA 21AXP22 COLOR KINESCOPES

by **C. PRICE SMITH**  
 Manager, Color Kinescope Engineering  
 RCA Tube Division  
 Radio Corporation of America

We want to take this opportunity to welcome you to the Lancaster plant because it gives us an opportunity to explain from both manufacturing and performance standpoints the technical features of the 21AXP22 color kinescope that make it an exceptionally good tube.

The RCA 21-inch color kinescope (Fig. 1) has a picture area of 260 square inches, a maximum diameter of  $20\frac{9}{16}$  inches and a maximum overall length of  $25\frac{5}{16}$  inches. It is a three-gun, formed shadow-mask type tube with an aluminized tricolor phosphor dot screen. The three electron beams from the gun are electrostatically focussed and mechanically and magnetically converged. Maximum ratings for the tube are 25,000

Fig. 3  
 Dimensions of 21-inch Color Kinescope  
 Compared with 21-inch Black-and-White Kinescope

	BLACK-AND-WHITE KINESCOPE TYPE 21ZP4-B	COLOR KINESCOPE 21-INCH METAL
Picture Dimensions* (Min.):		
Area .....	245 sq. in.	260 sq. in.
Width .....	$19\frac{1}{8}$ in.	$19\frac{5}{16}$ in.
Height .....	$14\frac{3}{16}$ in.	$14\frac{1}{2}$ in.
* 4 x 3 aspect ratio		
Tube Dimensions (Max.):		
Width .....	$20\frac{3}{8}$ in.	—
Height .....	$15\frac{1}{16}$ in.	—
Diagonal or Diameter .....	$21\frac{11}{32}$ in.	$20\frac{11}{16}$ in.
Over-all Length .....	$23\frac{13}{32}$ in.	$25\frac{3}{8}$ in.
Deflection Angle (Diagonal) .....	70°	70°
Weight .....	24 lbs.	28 lbs.



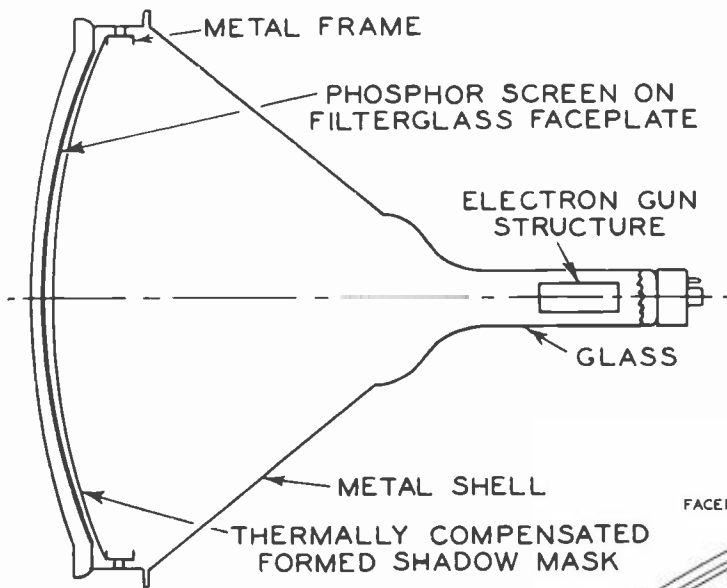

FIG. 4 (left). The construction of the RCA 21-inch color picture tube is indicated in this simplified drawing. The metal envelope is made in two sections. The spherical  $\frac{1}{4}$ -inch glass faceplate is sealed to the straight-sided panel section, and the funnel and neck tubing are sealed to the conical section. These two sections are joined by welding their integral flanges. Metal, rather than glass, was chosen for the envelope of this tube because it made possible a considerably lighter tube and because the metal shell of the tube would act as a magnetic shield. The phosphor screen is formed on the faceplate by a photographic process utilizing each tube's mask as its photographic negative. The method of mounting the mask in the shell is shown in Fig. 5. The gun, which consists of three separate electron guns, is shown in Fig. 6.

FIG. 5 (right). Cutaway drawing showing the method used to mount the mask assembly in the panel section of the metal tube shell. The entire assembly is suspended on the ends of three leaf springs which have holes fitted over the ends of tapered studs. This mounting arrangement allows the mask assembly to move and expand during the high-temperature exhaust cycle and then return to its original position when the tube reaches room temperature. The development of this method of mounting the mask assembly overcame one of the most serious problems in the production of shadow mask tubes.

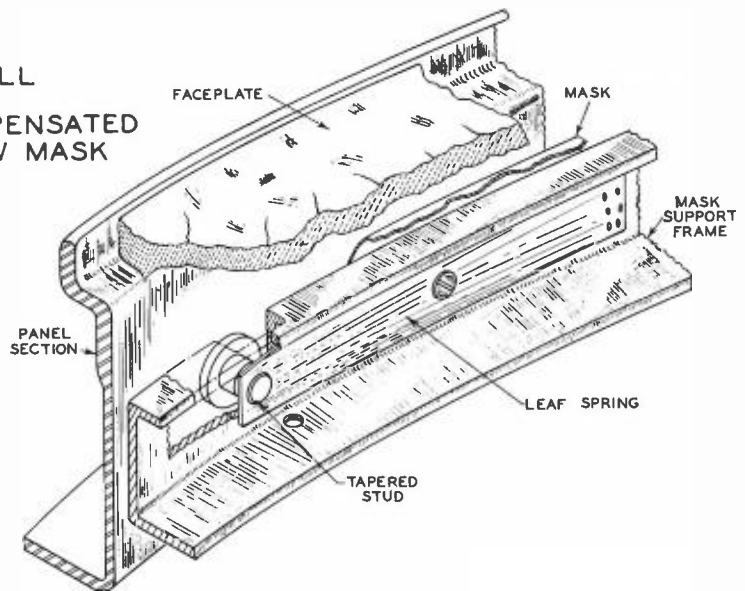

Fig. 5 shows a close-up of the actual parts used in this practical design of mask mounting. We refer to it as frictionless design since the entire assembly is suspended on the ends of three leaf springs which have holes fitted over the end of tapered studs. This is in contrast to other systems, tried out by us and by other manufacturers, which rely upon sliding metal or glass parts carrying V grooves fitting over glass or metal bosses. We have learned, through experience, that this is a very unreliable and difficult method of producing color tubes. In our design there are no sliding parts and the only friction involved is that of the flexure of the leaf springs themselves. We have been delighted with this design from the standpoint of performance as well as in the ease of production.

volts with an ultor current of 800 microamperes. From an average scene, the tube will produce a picture with highlights of 25 foot-lamberts or more.

The tube uses a perforated shield or mask (Fig. 2) which shadows portions of the phosphor screen and permits the electron beams to strike certain other portions. The performance of this tube, to a large degree, depends upon maintaining an accurate register of the holes in the mask with the phosphor dots on the screen. This accuracy must be of the order of a few mils over the entire screen area. The 21AXP22 design incorporates an accurate registering method which we believe is responsible for the excellent line-up of the aperture mask with the phosphor dots. I am referring to the system of mounting the mask assembly so that it can move and expand during the high-temperature exhaust cycle and then return to its original position when the tube reaches room temperature. This was be-

lieved to be one of the most serious problems in the development of a shadow mask tube.

If you had asked anyone in the tube manufacturing business, as recently as six months to a year ago, whether or not a shadow mask tube could be made with good quality in high production, you would probably have been told that the tube could be made with fair quality but that one of the most serious problems of scrap, i.e., percentage of defective tubes, that would be encountered would be that of mechanical misregistry. It is likely, too, that you would have been told that this problem would be a long and difficult one to overcome. We are pleased to tell you that we have almost completely overcome any problems related to mechanical registry of the mask holes with the phosphor dots in the 21AXP22. This statement is based on the yield of good tubes from production quantities.

In the factory, the tube is assembled by operators without the use of gauge blocks, dial indicators, or other complicated registering equipment. Once the three leaf



FIG. 6. Operator examining the three-gun assembly during fabrication of the RCA-21AXP22 Color Kinescope at the RCA Tube Division plant, Lancaster, Pa. The three guns are converged mechanically and magnetically and are focused electrostatically. Provisions are made for individual adjustment of each beam radially, and the blue gun beam may be adjusted laterally as well. This design permits dynamic convergence during the scanning of the tube.

springs are positioned over the tapered stud, we know the mask assembly has been replaced in exactly the same position as in previous insertions. This reliability in being able to replace the mask in the top cap has been a major factor in the production we have achieved to date.

I would like to point out that this tube design has been reduced to its simplest form, a form that makes for ease of assembly and lower manufacturing costs. Basically, the tube consists of the following parts:

- a. *The top cap*, consisting of a metal ring with the glass face plate sealed in place. The face plate is made of high-quality drawn sheet glass,  $\frac{1}{4}$ -inch thick.
- b. *The funnel assembly* consisting of a metal funnel to which a glass neck has been sealed. Both metal ring and funnel are obtained from a single blank of metal slightly larger than the finished diameter of the tube. This economy of material is achieved by a spinning process.
- c. *The gun mounting*, consisting of three separate electron guns, is assembled here in our plant from parts also made here. The three guns are converged mechanically and magnetically and are focused electrostatically. Provisions are made for individual adjustment of each beam radially, and the blue gun beam may be adjusted laterally, as well. This same design permits dynamic convergence during the scanning of the tube.
- d. *The mask assembly* consists of a thin sheet of cupro nickel, .0075 inches thick, in which more than three hundred thousand holes are accurately etched from both sides of the sheet to produce sharply defined holes of approximately 10 mils diameter. This mask is drawn to spherical shape, plated and blackened, and mounted on a stabilized ring of cold rolled steel. The entire assembly is referenced to the screen phosphor dots by the three leaf springs.

In factory production there is an automatic positioning of parts throughout the assembly of the tube, including a reference between the top cap and the mask assembly established by the "leaf-spring-tapered stud" arrangement mentioned previously. In addition, the top cap is referenced on

FIG. 7. Checking 21-inch color picture tubes in "lighthouses" at the RCA Lancaster Plant. In this operation a beam of near-ultraviolet light is directed through the shadow mask onto a layer of phosphor solution which has been deposited on the faceplate of the tube. The solution includes a "photoresist" which is used to bind the phosphor particles to the faceplate. Normally this photoresist is soluble in water, but after exposure to near-ultraviolet light it polymerizes to such a degree that it is insoluble in water. To develop an exposed pattern, it is only necessary to wash the screen with warm water. To obtain the three-color dot pattern the process must be repeated three times. For each of the three exposures, the ultraviolet lamp is placed in positions corresponding to the same positions which the electron beams will occupy when passing through the deflecting yokes in the finished tube.

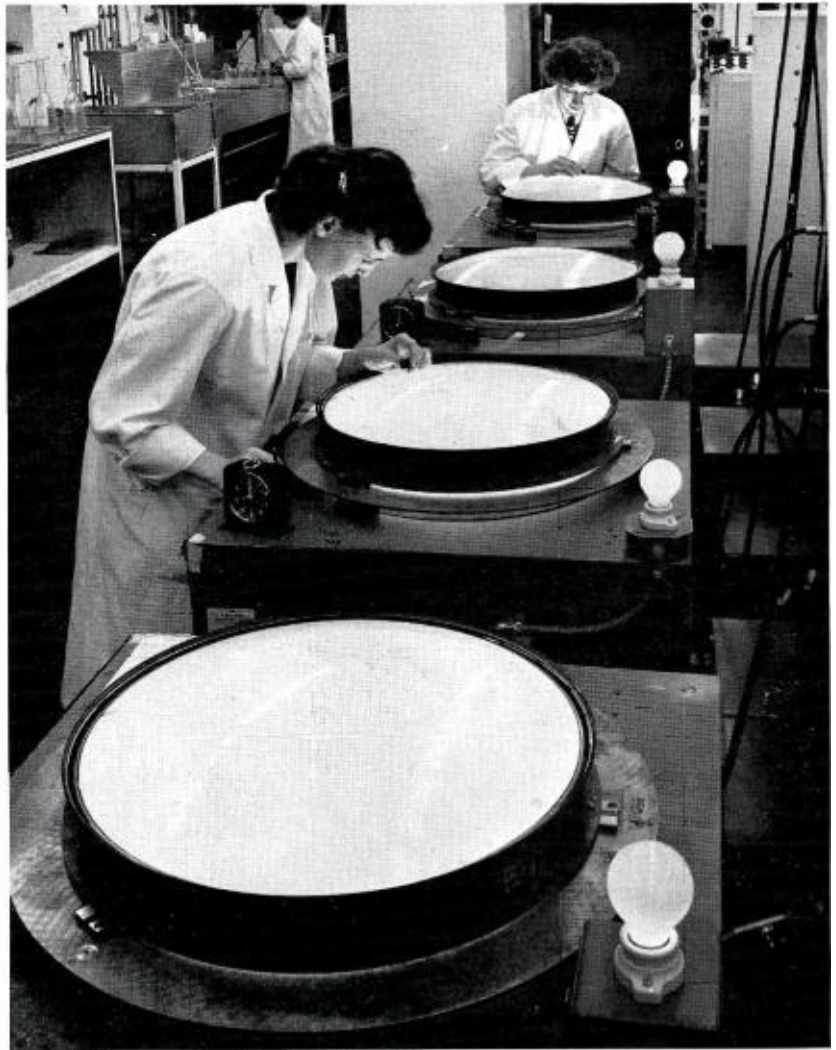

the lighthouse (Fig. 7) by means of the three dimples resting in V grooves on the lighthouse. Also, these same dimples position the top cap with respect to the lower funnel assembly in the final assembly of these two parts. Further, the three guns are angularly located with respect to the lower funnel assembly by means of the V grooves present in the lower funnel. This design has created ease of assembly, insured accurate positioning of the tube parts and increased the yield of good tubes.

The RCA 21-inch color tube is strong mechanically due to its round shape and the type of metal construction employed. That it can withstand considerable abuse has been proved by our packaging tests and the results of our manufacturing operations.

The tube is light in weight. A glass bulb of comparable size weighs approximately 37 pounds, compared to 24 pounds for the RCA tube. This difference means that the metal tube is less subject to thermal shock in processing, is easier to handle, and less costly to ship.

The closure weld on the 21AXP22 is a reliable vacuum-tight seal, as shown by our metallurgical cross sections and our life testing of tubes. This is a fast, low-temperature closure which permits accurate positioning of the parts prior to welding, with the assurance that they will not lose this accuracy while the bulb is being closed. Our manufacturing operations have proved that this is a practical and reliable process.

Because of this type of bulb construction, we feel that our engineers have been able

to determine the corrections necessary to obtain proper performance of the tube. I am referring to tolerances of gun alignment, errors in the yoke, dynamic convergence errors, and the effect of stray magnetic fields. Of real value, we believe, is the fact that the metal shell of the tube acts as a magnetic shield. The extent of this can be readily demonstrated by observing with a microscope the beam landing on the phosphor dots of a metal shell tube and comparing the resulting view with that seen on a tube with non-magnetic bulb structure.

To prove this point, our engineers have constructed a magnetically shielded room to determine the effect of the earth's magnetic field. What we have learned is this: Unlike the glass tube, there is no need for additional magnetic shields with the 21AXP22. The metal bulb collects, to a

FIG. 8 (right). RCA 21-inch color kinescopes approach the end of a production line at the plant in Lancaster. At the final test position each tube receives an operating check.

fair degree, the earth's magnetic field, and the remaining portions of this field are left close to the edge of the tube where it is nullified by the use of a magnetic field equalizer unit, developed by our engineers.

We believe that all of these factors add up to the production of a large-size color kinescope of good quality at the lowest cost.

The 21AXP22 has been produced in commercial quantities and with excellent commercial quality for the past six months.

From engineering and manufacturing considerations, the round tube can be produced at a lower cost than any other tube design of comparable size and quality.

In conclusion, let me repeat: The 21AXP22 is a high quality, large picture tube at the lowest equipment price and it is ready now. With it, RCA has the necessary receiving tubes, components, etc., to form a complete package for color television.



FIG. 9. This new RCA Color Receiver is the "Seville" (Model 21CT661), a lowboy console with a single 8-inch speaker. Legs can be removed for table mounting. Suggested list price is \$795.

FIG. 10. This deluxe RCA Color Receiver is the "Director" (Model 21CT662), an open-face console with two 8-inch speakers. Suggested list price is \$895.



## RCA VICTOR ANNOUNCES TWO NEW 21-INCH COLOR TV RECEIVERS WITH SIMPLIFIED CIRCUITS AND 26 TUBES

Two newly-designed and completely restyled 21-inch RCA Victor color television receivers, featuring greatly simplified electronic circuits, were announced on May 4th by Robert A. Seidel, Executive Vice-President, Consumer Products, Radio Corporation of America.

One of the instruments, the "Seville" lowboy console, has a suggested list price of \$795, lowest to date for a 21-inch compatible color receiver. The other set, the "Director", is an open face console with a suggested list price of \$895.

"Limited quantities of the new receivers will be shipped to distributors across the country within the next few weeks," said Mr. Seidel. "Retail dealers are expected to begin offering the sets to consumers in early June, but quantities will be limited. Our plans to produce and market the new color receivers represent another major step in the nationwide establishment of color television.

"While quantities of the new RCA Victor receivers will be limited during the forth-

coming months, the RCA Victor Television Division has made plans to turn out color receivers in larger numbers than ever before, with production mounting each month."

Both of the new receivers—the "Director" (Model 21CT662) and the "Seville" (Model 21CT661)—will be available in either mahogany or light finish. The "Seville" marks the first time RCA Victor has offered a console-type color receiver, all of the previous RCA Victor color sets having been open face consoles. The legs of the "Seville" model are easily detached, thus making the receiver readily adaptable for use in public rooms where space is a consideration. While the circuitry of both new receivers is fundamentally the same, the cabinet measurements, of necessity, are different and the "Director" model will have two 8-inch loudspeakers and the "Seville" one.

The new color TV sets have 26-tube chassis, a reduction of 14 tubes from the 40 used in RCA Victor's previous 21-inch color receivers.

"It has taken nine years of development to reduce the number of tubes in black-and-white sets from 30 to 20," Mr. Seidel said. "But the experience gained in black-and-white, plus outstanding advances in color, has enabled us in one year to reduce the number of tubes in our color sets from 40 to 26, including the color picture tube. And, as in the case of black-and-white receivers, this reduction has been accomplished not by sacrificing performance but by improving it."

He said reduction in the tube complement and improved performance were the results of:

- 1—The development and use of entirely new circuit designs not previously available.
- 2—The use of engineering and production techniques—such as printed circuits in various parts of the chassis—which had been previously tested and proven in black-and-white receivers.
- 3—The use of newly-developed RCA dual-purpose rectifier and triode-pentode tubes.

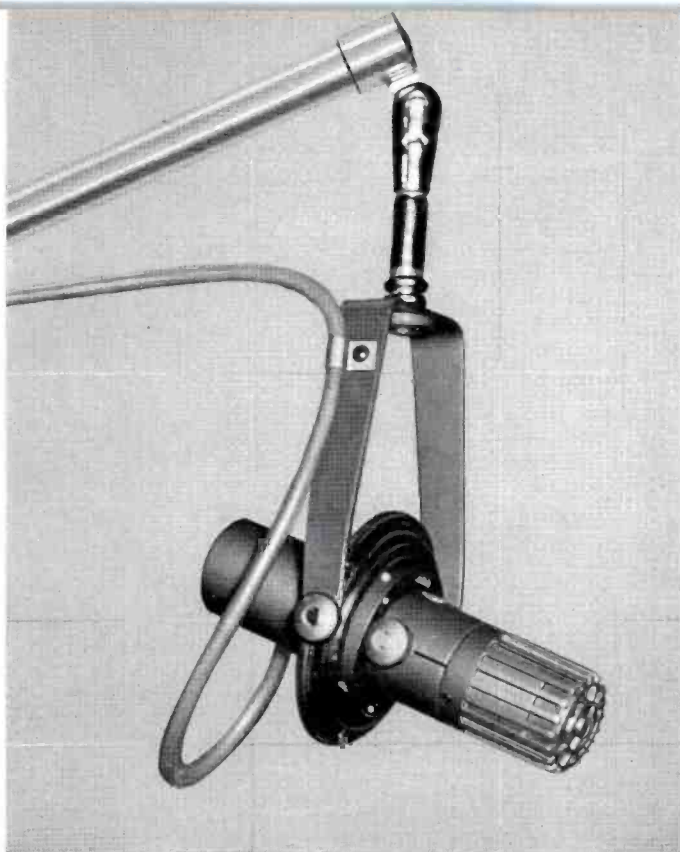

FIG. 1. The BK-5A is an excellent microphone for TV boom operation. New and improved shock mount affords simple, reliable, noise-free handling.

*The New*  
**BK-5A**  
**UNIAXIAL**  
**MICROPHONE**

**Television's Most Versatile  
 Sound Pickup Unit**

**by J. W. O'NEILL & R. M. CARRELL**

Engineering Products  
 Transducer Design Group

For more than fifteen years the RCA Type 77D Polydirectional Microphone has been the pride of many small broadcasters and the standard of performance of the network stations. Throughout the rapid growth of television in the past ten years, the 77D has been the best all around microphone available; it has found near-universal acceptance for television broadcasting. The RCA Type BK-5A Uniaxial Microphone was primarily designed for television broadcasting as a successor to the 77D. Called Uniaxial because the direction of maximum sensitivity has been made to coincide with the major axis of the microphone, the Type BK-5A features new styling which blends function and appearance into one coherent whole.

The Type BK-5A is built for simple and sure handling when mounted on a boom. One of the features which contributes to this is the radically improved shock mount, shown in Fig. 1. This is an adaptation of a panel meter shock mount originally designed for military use. It effectively isolates the microphone from the boom support and does not itself generate any noise. It eliminates the rubber band mounting, which is noisy and requires frequent replacement of the rubber bands. The shock mount for the Type BK-5A will last the life of the microphone.

For stand mounting, the Type BK-5A is furnished with a cast fork cradle tapped with a  $\frac{1}{8}$ " straight pipe thread. This thread will receive the RCA Standard Cushion Mount Adapter (Stock No. 93973) which is required when using on Desk Stand, Type 91-C. The front of the grill of the Type BK-5A has a bullseye motif, presenting an obvious talking target.

Complementing the new styling, the Type BK-5A features improved acoustical performance. Compared to the Type 77D microphone there is increased resistance to gun blast, better directional properties, and the sensitivity to wind noise has been reduced. These are accomplished while maintaining the sensitivity slightly higher than that of the Type 77D microphone.

**Gun Blast Resistance**

There have been many occasions where ribbon microphones have been damaged during television shows by guns being fired close to the microphone. Tests at RCA's David Sarnoff Research Center showed that the ribbon damage was not done by the steep-fronted blast wave, but rather by the concussion wave that followed as the air moved into the vacuum created by the explosion. The concussion wave contains mainly low frequency components. If it were possible to isolate the ribbon from

these components, a considerable measure of protection would be effected. To accomplish this, two layers of fine mesh cloth are supported in front of the ribbon by the horn-like structure shown in Fig. 8. These form an acoustical filter which reduces the concussion wave of gun blasts.

In laboratory tests, it was possible to fire .38 caliber blanks as close as three feet (3') to the microphone and .32 caliber blanks as close as one and one-half feet (1½') without any measurable effect on the performance. The tests were made with the gun fired at right angles to the microphone and directly in front of it.



FIG. 2. BK-5A Microphone with Wind Screen, MI-11011, and Boom Mount, MI-11012.

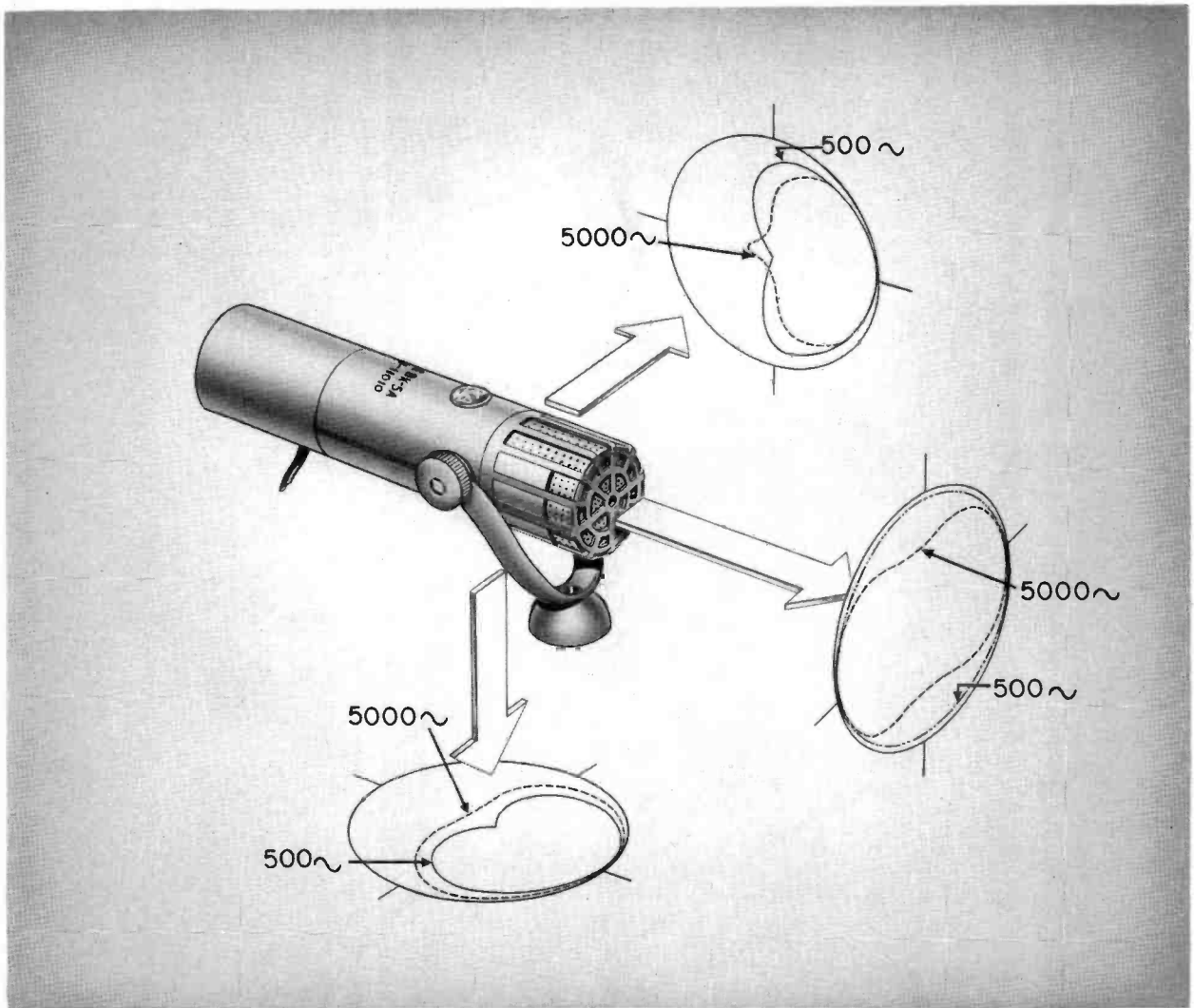

FIG. 3. Perspective view of the BK-5A showing the high frequency and low frequency directional characteristics about the major axes. At low frequencies, the pickup pattern is a true cardioid. At 5000 CPS and above, the pattern becomes fan shaped. This can be utilized to reduce pickup of scraping noises from the floor of a television set. The direction patterns shown in above sketch are illustrated in more detail in Fig. 7.

#### Directional Characteristics

The directional properties of the BK-5A in the mid-frequency region is essentially a cardioid with an eighteen decibel front-to-back ratio. The high frequency directional properties have been improved over the Type 77D, both in pickup angle and in front-to-back ratio. This is done by changing the configuration of the acoustic circuit.

In the Type 77D, there is one port at the back of the ribbon, which in combination with the acoustic labyrinth gives it its directional properties. In the Type BK-5A there are two ports, one placed at each end of the ribbon. These act in cooperation with a short horn-like structure in front

of the ribbon (supporting the blast filter) to give a fan-like directional pattern above five thousand cycles per second. See Fig. 3. The ribbon in the Type BK-5A is mounted vertically, placing the high frequency "fan" in a horizontal plane. This can be used to minimize foot scuffing, or other high pitched sounds, which may come from the floor of the television set.

#### Wind Noise Sensitivity

The wind noise sensitivity of the Type BK-5A is some five decibels less than that of the Type 77D. RCA has developed a technique for the quantitative measurement of the sensitivity of microphones to wind noise, which was described by one of the

authors before the Audio Engineering Society at the October 1954 meeting, and is described in detail beginning on page 52 of this issue.

Briefly, the method consists of fastening the microphone to the end of a long pendulum which moves through the still air of an anechoic chamber. Peak velocities up to twenty miles per hour are possible at the microphone. A tentative standard test velocity of ten miles per hour has been chosen. The noise generated by the microphone can be readily analyzed by a high speed recorder and an octave band filter.

A summary of the wind noise spectra of the Type 77D in comparison with the Type

BK-5A is shown in Fig. 4. In the presentation of the spectra, compensation has been made for the different sensitivity levels of the two microphones. The overall wind noise level can be further reduced by setting the voice-music switch in the  $V_1$  position.

In applications where even greater immunity to wind noise is required, a wind screen, shown in Fig. 2, is available as an accessory. Fig. 4 also compares the wind noise sensitivity of the Type BK-5A with and without the wind screen, demonstrating the effectiveness of the screen.

### Construction

A sectional view of the Type BK-5A, illustrating its rugged and compact construction, is shown in Fig. 8. The microphone is a fusion of four systems; the magnetic circuit, the acoustic circuit, the electrical circuit, and the mechanical integration of these three into the case.

The air gap flux density is in excess of 11,000 gauss, maintained by two Alnico V magnets and the magnetic grade iron yoke and pole pieces.

The acoustic circuit consists of the horn and screen assembly in front of the ribbon and the acoustic connector and labyrinth behind. The horn-screen assembly has already been described. The acoustic connector effects a transition from the long narrow air gap slot to the square cross section of the labyrinth pipe. The acoustic connector also has the two phase shifting ports. The ports are covered with an acoustically controlled cloth to form the proper impedance in the opening. This impedance and the acoustic resistance of the labyrinth in conjunction with the physical separation of the front and rear pickup points give the Type BK-5A its superior unidirectional characteristic. The acoustic labyrinth is a pipe approximately thirty-one inches long folded into the form of a cylinder. It is damped along its length to eliminate resonances so that it acts as a pure acoustic resistance over a substantial part of the frequency range.

The electrical circuit consists of the corrugated aluminum foil ribbon, a line matching transformer, the response compensation reactor, and the associated wiring. The cable has cadmium bronze conductors for extended life. The transformer and reactor are well shielded, and the wiring is balanced for external fields. The result is a hum sensitivity rating of  $-128$  dbm, the lowest attained by a magnetically energized microphone. The output impedances available are 30, 150, and 250

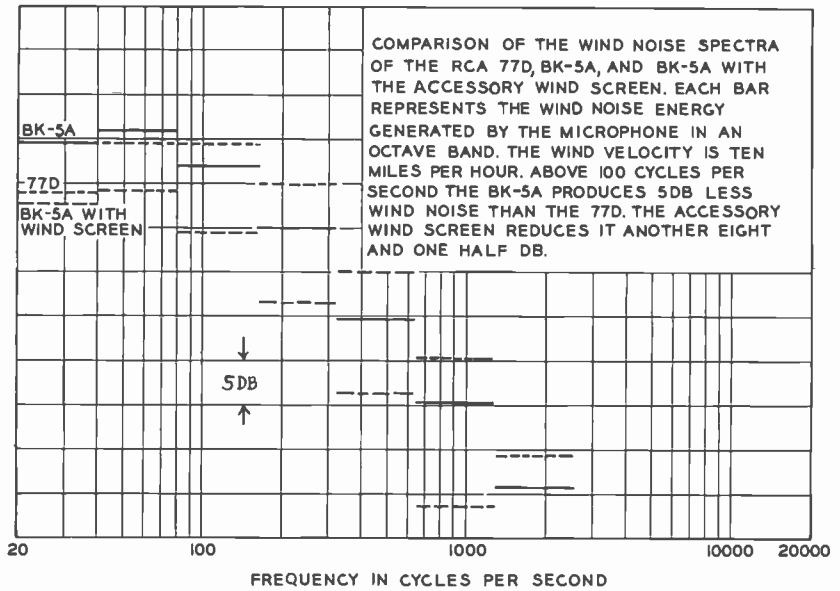

FIG. 4.

ohms. The impedance may be changed by relocating the cable connections at the terminal board in the rear cover cavity. Performance of the microphone will not be affected by removing the rear cover to change the output connections. A magnetic screen in front of the ribbon minimizes any accumulation of magnetic dirt in the critical parts of the microphone.

The mechanical integration of the three systems is accomplished as shown in Fig. 8. Encasing the elements is done by covering the motor with a strong die cast zinc cover. The labyrinth is also a zinc die casting, the outside forming the center section of the microphone and the cavity inside the ring of tubes housing the transformer and reactor. The rear cover cavity



FIG. 6. BK-5A mounted on Type 91-C Desk Stand. RCA Standard Cushion Mount Adapter (Stock No. 93973) is required in this application.

FIG. 5. FREQUENCY RESPONSE OF THE BK-5A MICROPHONE SHOWING THE EFFECT OF THE VOICE MUSIC SWITCH

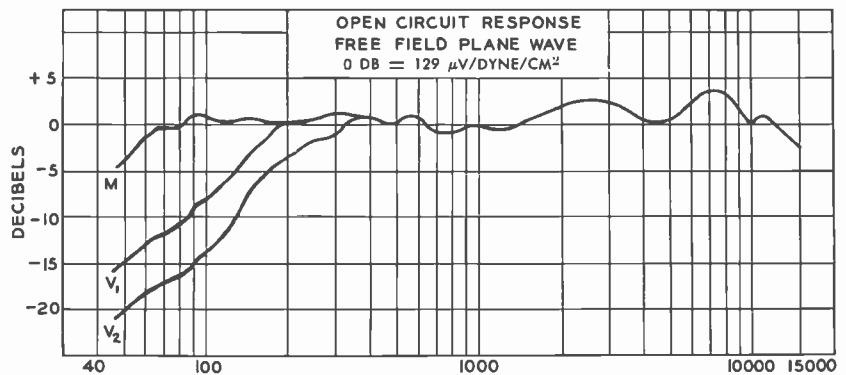
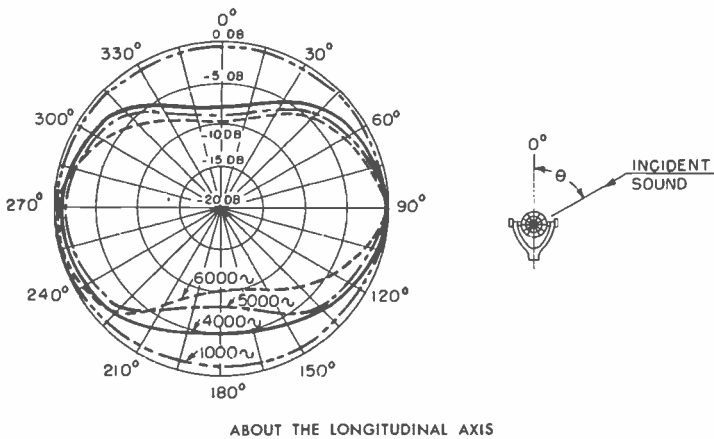
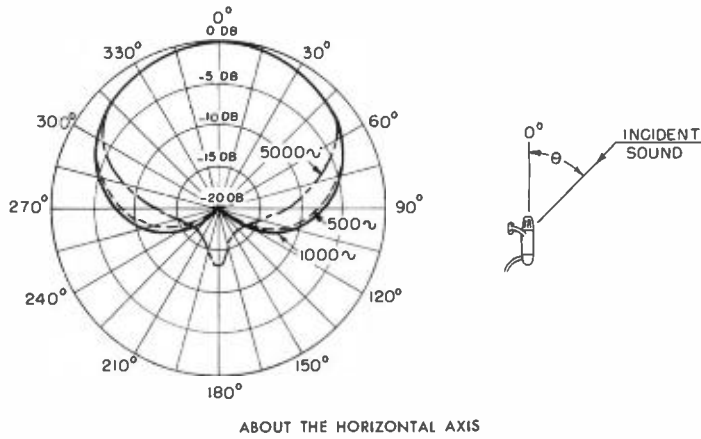
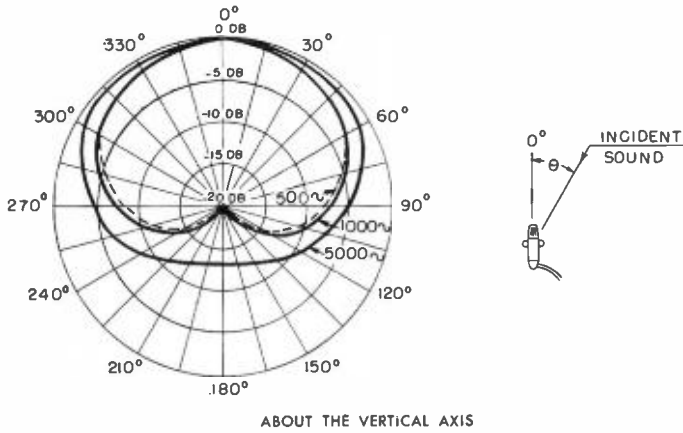



FIG. 7. Directional characteristics of the BK-5A Microphone.



is reserved for output terminal board, reactor switch, and cable clamp.

The frequency response characteristic of the BK-5A is shown in Fig. 5. The high frequency response above 10 kilocycles is more uniform than has been heretofore possible. The output level is  $-56$  dbm.

The Type BK-5A is equipped with a voice-music switch giving two degrees of low frequency roll-off, as shown in Fig. 5. This feature may be used to attenuate low frequency noise in a studio. It may also be used to compensate for the increase in low frequency response obtained when the speaker is near the microphone.

The Type BK-5A is the latest of a distinguished line of acoustic tools for the broadcast and television industry. Its premium performance, classic styling and ease of handling will meet with wide acceptance for many years to come.

FIG. 8. Cutaway view of BK-5A.

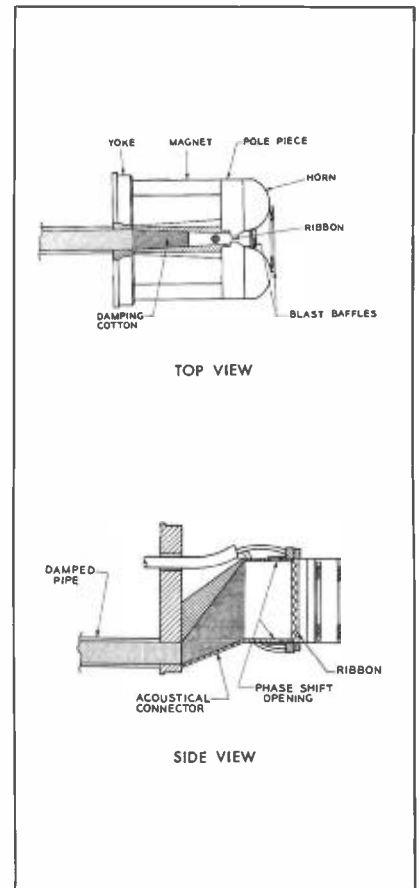
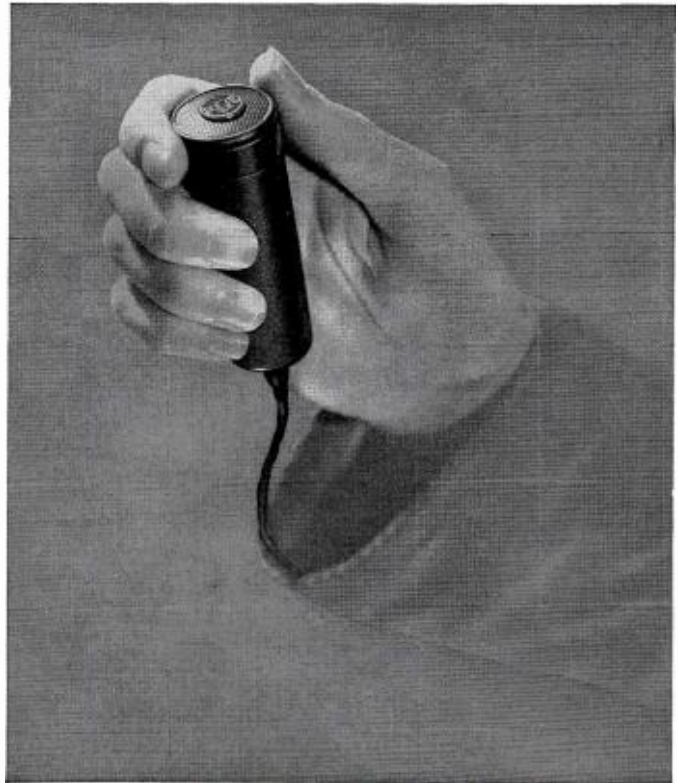

FIG. 1. The BK-6A "personal" microphone is small enough to be concealed in a man's hand.



# THE BK-6A MICROPHONE

## Designed for Personal Use

By L. M. WIGINGTON  
and R. M. CARRELL

Engineering Products Transducer Design Group

FIG. 2. BK-6A Microphone used as "necktie" mike. May be mounted beneath the necktie or exposed.

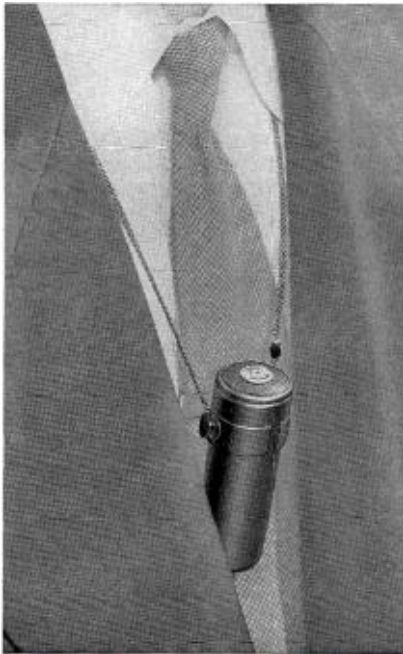

In recognition of the need for high quality microphones that can be placed in a television scene without dominating it, RCA has pioneered in miniaturizing the highly reliable ribbon and dynamic microphones for television use.

The KB-2C, introduced ten years ago, was the first ribbon miniature microphone built to broadcast standards. The BK-4A, named the Starmaker, was the first low impedance cylindrical or "stick" microphone. The rugged BK-1A has had very wide acceptance because of its attractive styling and compact size.

To this family is now added the extremely small BK-6A, a dynamic microphone especially designed to be worn by the performer or concealed on the set. The BK-6A is small enough to be concealed within a man's hand, as shown in Fig. 1. It is supplied with a clip and lanyard so that it may be suspended about the neck, as seen in Fig. 2.

A microphone which is to be worn on the chest must have special characteristics not required by microphones which are used more conventionally. Primary among these, of course, is a minimum of bulk and weight. Equally important, the microphone

must have a frequency response characteristic which will yield a proper overall speech balance.

The human voice spectrum measured at the chest differs very considerably from the spectrum measured directly in front of the face, where the microphone is normally placed in AM broadcasting and sound recording. The sound field near the chest has emphasized low, and attenuated high frequencies as compared with a position 18 inches in front of the face.

A microphone whose frequency response would be ideal when placed in front of the speaker will yield poor speech quality when placed on the chest. A suitable chest or lapel microphone will have a frequency response which is quite different from the normal high quality announce microphone.

It is possible to make quantitative measurements of the relative speech spectra in front of the face and on the chest as an aid to the development of a well balanced chest microphone. An instrument for doing this is called an integrating audiospectrometer. An audiospectrometer built in RCA's Camden laboratories is shown in Fig. 3. The spectrometer consists of tape

recorder, an electronic variable band pass filter, an amplifier, a rectifier, a timer, and an electro-mechanical integrator.

A "Real Voice" comparison of the BK-6A and 77D microphones was made with the audiospectrometer using each microphone to record phonetically balanced speech samples. The 77D was placed 18 inches from the speaker's lips, and set in the Unidirectional and VI positions. The BK-6A was suspended by its lanyard 10 inches below the speaker's lips. The test sentence was "Joe took father's shoe bench out, she was waiting at my lawn." This sentence contains the same distribution of speech sounds as occur in ordinary English speech; it is a standard speech sentence.

The sections of tape containing the test sentences spoken through each microphone were cut out and formed into continuous loops which could be played endlessly through the recorder while the sample was analyzed.

Each speech sample was analyzed by passing the recorder output through the bandpass filter to an amplifier and a rectifier, then through a timer to the integrator. The filter was set for successive octave pass bands, and the total energy in the band was summed up by the integrator. The integrator was allowed to run for thirty seconds for each octave band. This allowed 9 or 10 passes of the test sentence through the recorder.

The averaged real voice spectra of five male subjects obtained by this procedure are shown in Fig. 5. The energy in each octave band falls off rapidly above 800 cps as the average energy content of human speech falls off in this manner. The thing which is desired is to obtain the same spectrum from the 77D and the BK-6A for an average talker. This comparison can be more readily made if the difference between the output of the 77D and the BK-6A for an average talker is plotted. This is done at the bottom of Fig. 5. Here the output of the 77D for each octave band is normalized to the BK-6A output in the same band.

The similarity between the real voice spectra obtained with the 77D and the BK-6A indicates that the overall balance when the BK-6A is worn on the chest is very nearly the same as would be obtained if the speaker were addressing a 77D. This has been confirmed by subjective listening tests.

The frequency response characteristic in the BK-6A needed to obtain this balance is shown in Fig. 5. When the microphone is worn on the chest or lapel, the face of the microphone points directly at the lips.

It is most sensitive to high frequency sounds in this direction. The low pitched chest sounds are attenuated. The high frequency sensitivity is needed to reproduce the sibilants which give crispness and definition to speech and which are weaker near the chest than elsewhere.

The BK-6A's utility is not limited to use as a chest microphone. It is also well suited to placement on a table for panel shows, or it may be hand-held during an interview. It may also be concealed on a television set. When properly used in these applications, the BK-6A will yield well-

balanced speech reproduction as well as when it is worn on the chest.

The high-frequency directional characteristics of the BK-6A are the important consideration when the microphone is to be used away from the chest. In common with any microphone of finite size, the high-frequency response of the BK-6A is strongly reinforced by diffraction effects when the microphone is in a free sound field. This pressure doubling effect, as it is sometimes called, varies with the angle of incidence of the sound waves. For a cylindrical microphone, the effect is strong-

FIG. 3. An audio spectrometer built in RCA Camden laboratories to provide a "Real Voice" comparison of the BK-6A and 77D microphones.

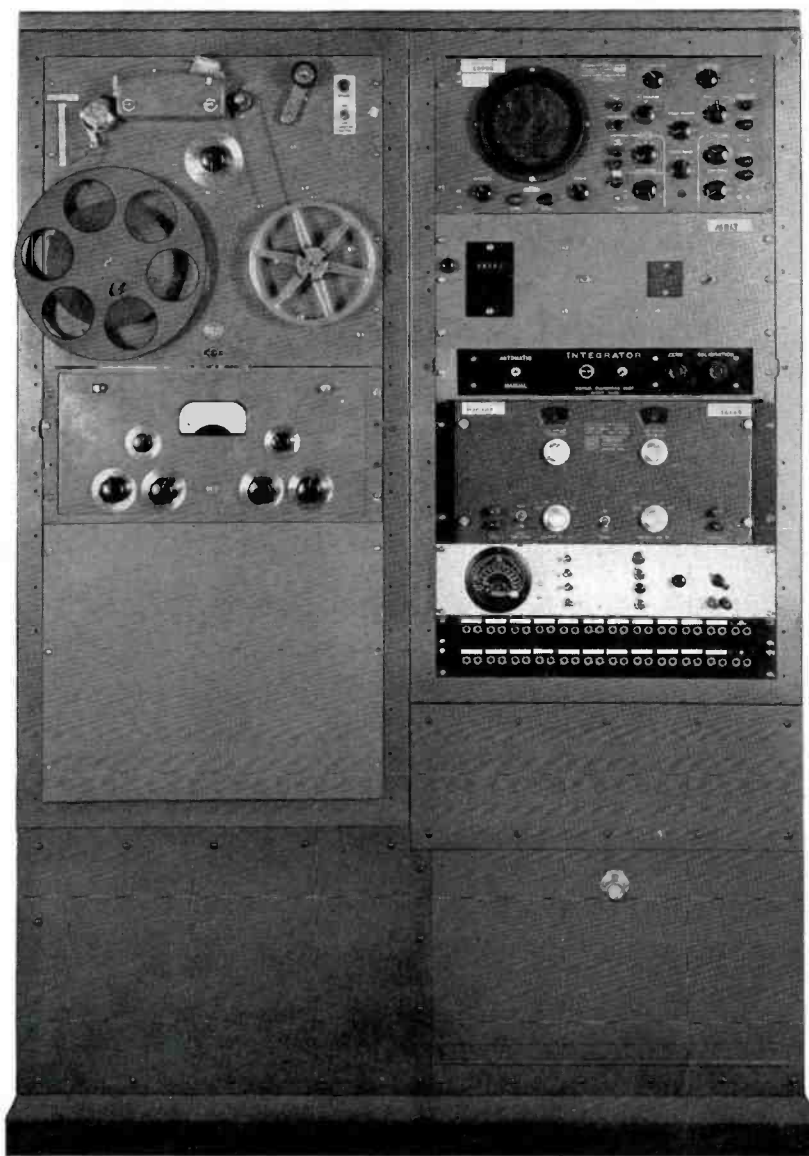

est when sounds arrive along the axis of the microphone.

If a speaker talks directly into a BK-6A along its axis, when the microphone is some distance away from him, the pressure doubling will result in an excessively crisp high end response. If the microphone is oriented so that the speaker talks across the microphone instead of directly into it, the microphone will respond in the manner indicated by the 90 degree curve of Fig. 6, giving a more proper speech balance.

If the general rule is followed of talking across the BK-6A instead of into it, the microphone will be found to have very wide utility where the speaker must talk "off mike."

There is another factor to be considered in getting the greatest use from the BK-6A. The technique of microphone placement for broadcasting and recording has a long and venerable tradition; it is only very recently that much attention has been given to the problems occasioned in putting microphones on the performers, and still expecting good speech quality.

From the work that has been done, the indications are that the speech spectrum may vary radically between different locations a few inches apart on the chest. Thus a chest microphone such as the BK-6A may sound very good at one spot on the speaker's chest and not so good at a spot a few inches away.

It is in a situation such as this that the integrating audiospectrometer is an invaluable tool. The results of some preliminary investigation of the speech spectra at different parts of the chest are given in Fig. 6.

In this series, speech samples were made on several male subjects using a Western Electric 640AA condenser microphone in three positions; 18 inches from the lips directly in front of the face, and on the chest, pointing upwards, at 10 and 13 inches from the lips. The octave band spectra were obtained in the manner described above in comparing the 77D and the BK-6A. Fig. 8 shows the average spectra at 10 and 13 inches with the spectra at 18 inches as a reference. It may be seen that distribution of the speech energy at the two positions is quite different. The data shown are averages. Some subjects showed greater variation in speech spectra with the position of the microphone than others.

For some subjects, at the 10-inch position, the frequencies between 1600 and 6000 cps were attenuated by as much as 10 decibels as compared with the position

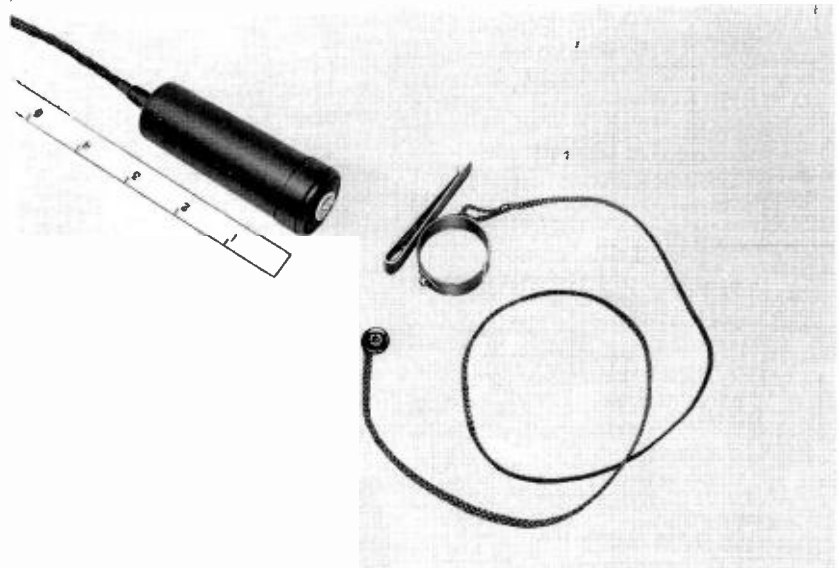

FIG. 4. Size is compared to an inch scale. Also shown are clip and lanyard for versatile mounting.

13 inches below the lips. Others showed much smaller variation.

The BK-6A, when hung up by its lanyard about the neck, is located about 10 inches below the lips. The microphone is compensated to give proper speech balance for an average subject when placed in this position. This position may not be the optimum one for all speakers. In general, it

seems as if the chin casts a high frequency "shadow" over the upper portion of the chest.

If the microphone is placed on the lapel or low on the chest, it may receive more of the sibilants than if it is placed high on the chest under the chin.

It is not possible, of course, to design the compensation of the microphone for all

FIG. 5. OCTAVE BAND REAL VOICE SPECTRA OF BK-6A & 77D

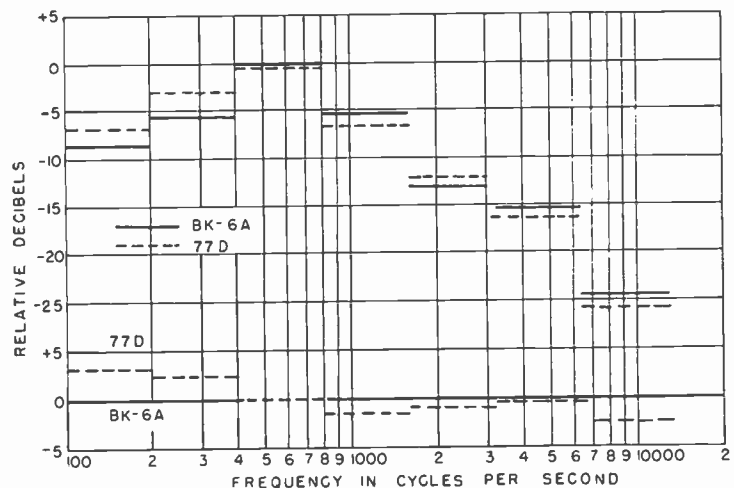

RELATIVE SPECTRA WITH BK-6A NORMALIZED TO FLAT RESPONSE

# FREQUENCY RESPONSE OF BK-6A MICROPHONE

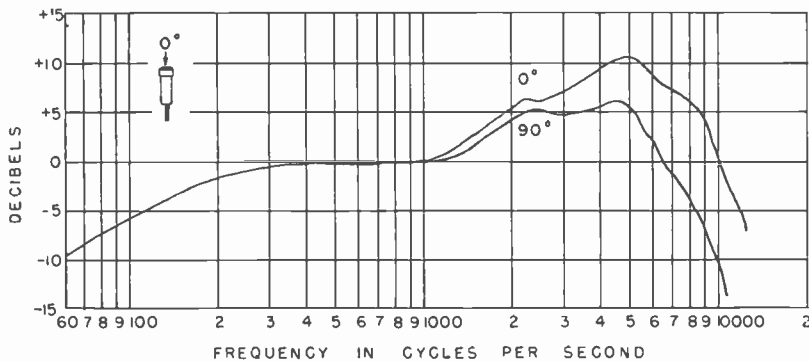

FIG. 6.

possible speakers who may use it. The broadcaster should be aware of the variation in the voice quality at different parts of the chest. A position which gives good results for some speakers may not be optimum for others.

The reduction in size has been effected without any major loss in sensitivity; the output level is  $-60$  dbm, corresponding to the RETMA rating of  $G_m = -152$  db. The microphone may be connected for 250, 150, or 30 ohms output impedance; it is supplied connected for 250 ohms.

The mechanical design of the BK-6A has been well adapted for television use. The finish is the standard TV grey. The styling is graceful but very simple, permit-

ting the microphone to blend into any surroundings. Ruggedness has not been reduced in making a small microphone.

The cable is specially designed for the BK-6A. The conductors are cadmium bronze, ordinarily used only in military equipment where the utmost in flex life and strength is required. The insulation is pure latex. The shielding consists of a double layer of conducting cotton and a light metallic braid. The conducting cotton provides a complete electrostatic shield for the leads. The metal braid is in contact with the conducting cotton throughout the length of the cable to minimize the series resistance of the shield. The outer covering of tough brown nylon braid pro-



FIG. 7. View showing BK-6A Microphone "secluded" in a corsage of flowers.

ducts the cable. The brown braid is neutral to the television cameras, but is easily separated from the power cables on the floor of a set.

The BK-6A is a worthy addition to the distinguished family of RCA acoustic tools, microphones and loudspeakers, for the broadcast industry.

FIG. 8.

## RELATIVE REAL VOICE SPECTRA AT 18" FROM FACE AND ON CHEST 10" AND 13" BELOW LIPS

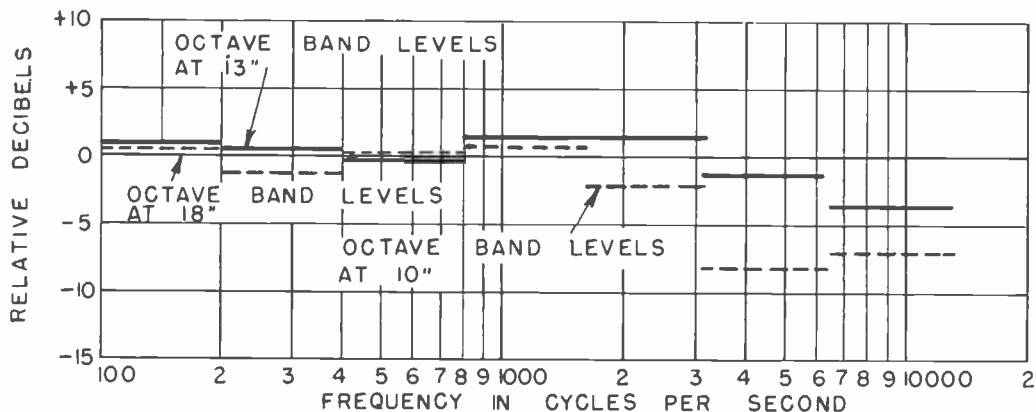



FIG. 1. Producing a standard, controllable quiet wind by use of a pendulum device in the transducer design laboratories at the RCA Camden Plant.

## THE MEASUREMENT OF WIND NOISE IN MICROPHONES\*

by R. M. CARRELL

Engineering Products Transducer Design Group

During the development of a new microphone a large number of characteristics are tested and evaluated. Many of these find their way into the published specifications. The published ratings of microphones spec-

ify such things as sensitivity, frequency response, output impedance, directional characteristics, and hum sensitivity. The techniques for the measurement of these characteristics are fairly well standardized,

so a purchaser may use the specifications as a guide in selecting a suitable microphone for his application.

There are several secondary characteristics which are normally not specified in

numerical terms, such as sensitivity to mechanical shock and sensitivity to wind noise. These have not been specified for lack of any simple means of testing these characteristics and obtaining a meaningful number or graph as a figure of merit.

The wind noise sensitivity of a microphone has a direct bearing on its utility out of doors, or where it is used by a performer who works very close to the microphone.

The first step in the systematic reduction of the noise generated by a microphone exposed to a wind is a method of producing a standard, controllable, quiet wind. This is done in the Transducer Design Laboratories at the Camden Plant by means of the pendulum shown in Fig. 1.

The pendulum is a very simple and primitive means of moving air quietly past the microphone. It is desired to measure the noise generated by the microphone structure in moving air; thus it is essential that the moving air be completely free of any turbulence or noise except that produced by the microphone itself.

Any fan or blower, unless equipped with an elaborate muffler, will make more noise than the air rushing past the microphone. A motor driven boom which could whirl the microphone in a circular arc has similar difficulties; the measurements would be confused by mechanical noise transmitted through the boom mounting.

The pendulum shown in Fig. 1 is suspended by a single leaf spring at its upper end. The spring is a completely noiseless hinge. The pendulum is maintained in motion by pulling on a string attached near the upper end of the pendulum bar. Although this is a primitive means of driving the pendulum, it has the strong virtue of being noise free. The cable is tightly bound to the bar to prevent it slapping the bar while it is in motion.

The noise output of the microphone as it swings is amplified and recorded by the high speed graphic recorder shown in Fig. 1. The signal can be passed through the variable electronic filter shown immediately below the recorder. This filter has continuously adjustable upper and lower cutoff frequencies and a cutoff slope of 24 db/octave. The filter may be set to pass only a narrow band of frequencies so that the noise within any given band may be

measured. By making a series of measurements in a number of adjacent bands, a spectrogram of the wind noise can be prepared.

A wind noise spectrogram of a 77D microphone is shown in Fig. 2. In this figure, the noise spectra of the microphone in the Unidirectional, Bidirectional and Nondirectional positions are represented by cross hatched blocks. The upper edge of the block is the relative noise level when the microphone is moving forward, the lower edge, the noise level when it is moving backwards. The width of the blocks is one octave, the settings of the bandpass filter for each reading.

It is interesting that the low frequency wind noise sensitivity in the Nondirectional setting is much less than in the Unidirectional or Bidirectional settings. This is related to the fact that in the Nondirectional position, the ribbon is closed off on one side, which is connected to a sealed, damped pipe. In the other positions both sides of the ribbon are open to the continuous flow of air past the magnet structure. Under these conditions, the ribbon tends to vibrate like the reed in a harmonica or other wind reed instrument. Because the resonant frequency of the ribbon is low—below 70 cps—this vibration takes place as a low frequency flutter. The tendency to flutter is greatly reduced when

the back of the ribbon is closed off, as in the Nondirectional setting.

Microphones with stiffer moving systems, such as the dynamic type like the BK-1A, are not subject to ribbon flutter. However, the wind noise sensitivity of the BK-1A is actually somewhat greater than the 77D in the Nondirectional position, especially below 100 cps. This is because the front grille of the BK-1A is very close to the diaphragm, whereas the ribbon of the 77D is over an inch from the screen at all points. The most effective windscreening yet found is fine cloth located as far as possible from the diaphragm or ribbon. This is opposed to the current trend toward microphones having smaller silhouettes.

Much of the work being done with the wind noise pendulum is exploratory—testing materials and comparing the noise spectrograms with subjective listening quality. When more is known, a wind noise sensitivity rating may become a standard part of RCA microphone specifications along with the hum pickup rating first introduced by RCA some years ago.

The wind pendulum was constructed by R. E. Ulrich and F. K. Rogers of the RCA Electronics Products Division.

\* Adapted from a paper presented at the October 1954 meeting of the Audio Engineering Society.

FIG. 2.  
WIND NOISE SPECTRA OF TYPE 77D MICROPHONE

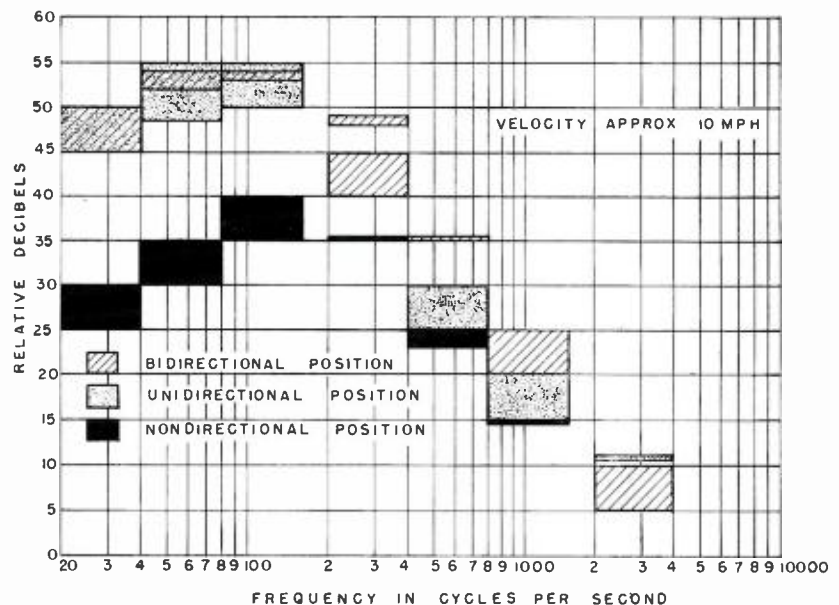

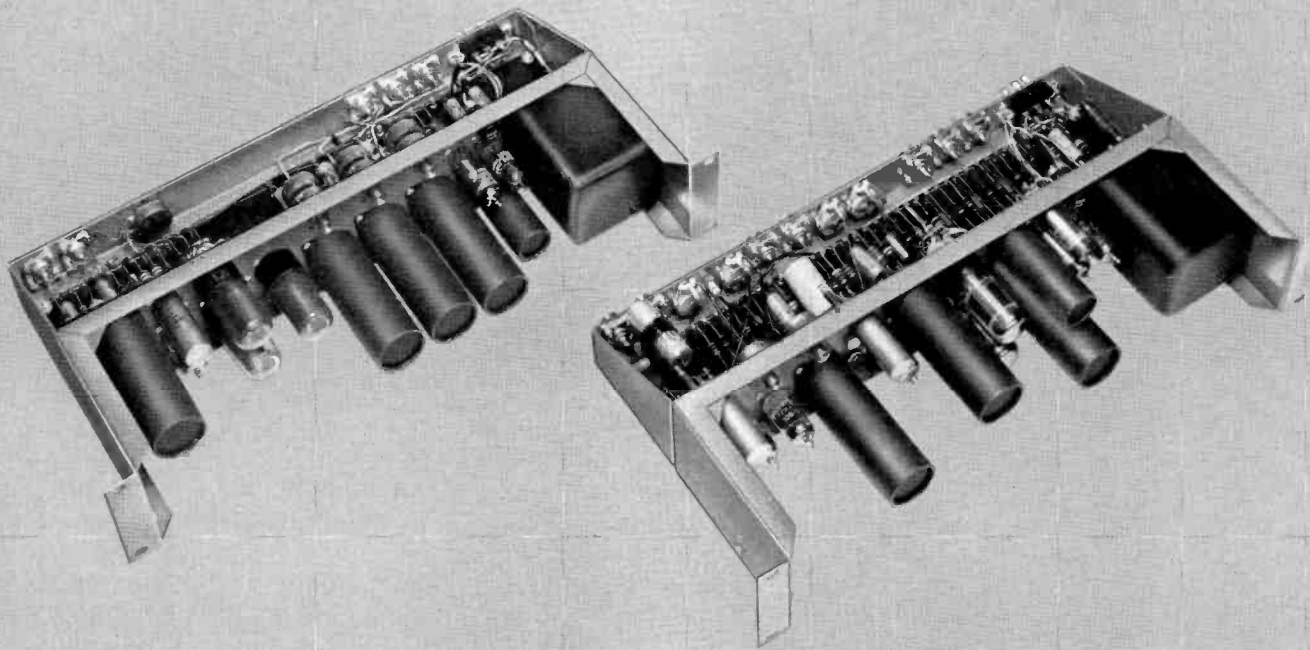

FIG. 1. Two new Distribution Amplifiers are pictured above. At left is the TA-4A Pulse Distribution Amplifier and at right is the TA-3A Video Distribution Amplifier.

# NEW DISTRIBUTION AMPLIFIERS FOR TELEVISION BROADCASTING STUDIOS

by **ROBERT G. THOMAS**  
RCA Engineering Products Division

A tremendous accumulation of operating experience has enabled the television broadcast industry to re-appraise its equipment requirements. An examination of signal distribution facilities has resulted in new thinking with regard to the performance and application of this class of equipment.

For example, it has been found desirable for considerations involving performance, systems layout and economy to employ signal distribution equipment designed specifically for either video distribution or pulse distribution. Video systems require linear amplifiers to insure exact reproduction of the signal, while on the other hand, pulse systems may actually utilize a great degree of non-linearity to advantage in improving the signal. Furthermore, while video systems are equalized for flat frequency response, improved performance for pulse operation is afforded by compensation for optimum transient response—a condition opposed in many respects to that required for video. These factors, in addition to the

widely different line levels encountered, are ample justification for dividing the functions of distribution amplifiers.

Distribution systems employing long coaxial transmission lines, i.e. in excess of approximately fifty feet in length, will provide best performance characteristics only if terminated at both receiving and sending ends. Therefore, amplifiers used to feed long transmission lines should have an output impedance equal to the surge impedance of the line. This is called sending-end termination, and will minimize standing waves on the line that would otherwise degrade the signal, particularly in color television systems.

The new RCA product designs reflect circuit and tube development which manifest themselves as a high order of stability, maximum power efficiency, and compactness. These three factors have a profound influence on initial equipment cost and maintenance cost. Two new amplifiers embodying these considerations are the RCA

TA-3A Video Distribution Amplifier and the RCA TA-4A Pulse Distribution Amplifier shown in Fig. 1.

## RCA TA-4A Pulse Distribution Amplifier

Practical television systems operations usually dictate the use of only one synchronizing generator for the entire plant. In large installations where there are many studios, often located at considerable distances from the sync generator, there is a need for a system of pulse distribution wherein the individual timing and blanking signals from the sync generator may be fed over transmission lines to a multiplicity of remote points.

The TA-4A Pulse Distribution Amplifier has been designed to meet all of the requirements of both large and small television pulse distribution systems. Fig. 2 is a diagram of the amplifier showing the essential circuit layout in block form. This figure reveals the use of two coaxial input connectors, J1 and J2, arranged in parallel



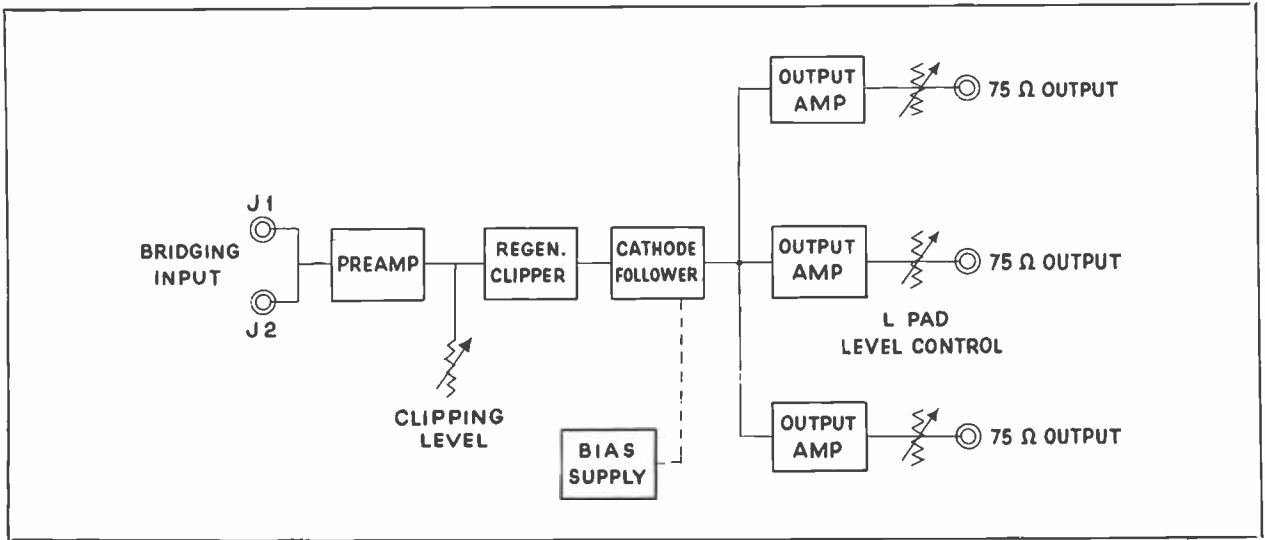

FIG. 2. Block diagram of the TA-4A Pulse Distribution Amplifier.

to allow the bridging of the amplifier across a line. The input impedance of the TA-4A is high enough to bridge several of these units across a 75 ohm line without serious detrimental effects.

The first stage of the TA-4A is a 6U8 pentode preamplifier with shunt peaking in the plate circuit. The peaking inductance is made large enough to provide fast rise time and therefore minimum delay in the starting of the regenerative clipper. By using low screen voltage in this stage some degree of clipping is obtained.

In the following stage a 6BQ7A dual triode is utilized as a regenerative clipper, in which a new pulse is formed that is entirely independent of the input pulse except for timing. The regenerative clipper is essentially a switch that is turned on and off by the leading and trailing edges of the input signal. The switching action is very rapid, and depends only on circuit parameters so that the rise time of the output pulse is quite short, about 0.6 microsecond, regardless of the rise time of the input pulse. During the interval between the actual switching processes, the output of the regenerative clipper is constant and free of any spurious disturbances on the input signal such as overshoot, hum, tilt, low frequency surges and random pulse noise.

To preserve the excellent characteristics of the signal from the clipper a 6U8 triode cathode follower is interposed between the regenerative clipper output and the three wide band output amplifiers. This is also shown in Fig. 2.

A separate triode connected 6W6 is used for each of the three output stages. The plate circuits are independent, while the grids are connected in parallel. The 6U8 cathode follower isolates the capacitive load of the output stage from the regenerative clipper plate circuit in order to main-

tain a short rise time. Introduction of tilt on vertical blanking is minimized thru the use of a 2.7 second coupling time constant between the regenerative clipper and cathode follower. The load resistor of the cathode follower is returned to a negative potential, provided by an internal regulated

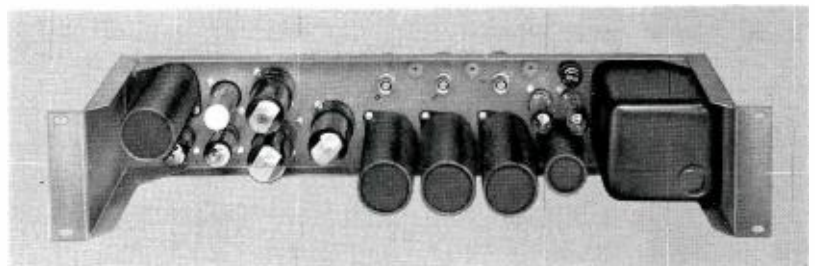

FIG. 3. Front view of TA-4A. All output amplitude controls and test points are accessible from this side of the amplifier to facilitate setting up line levels.

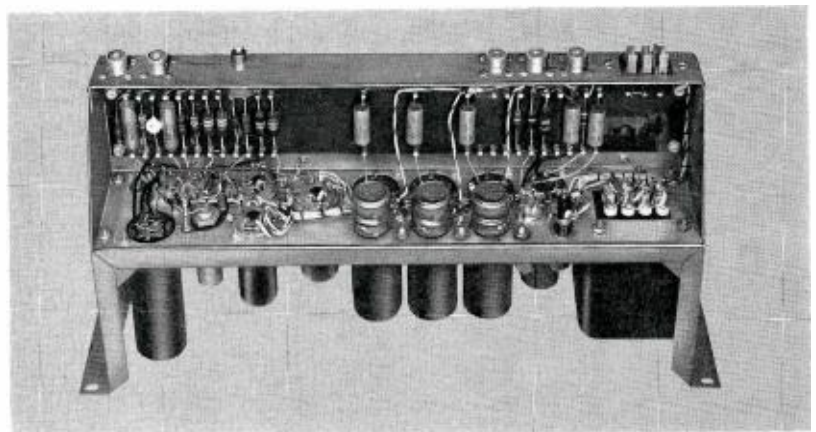

FIG. 4. Wiring side of TA-4A showing accessibility of components and cable receptacles.

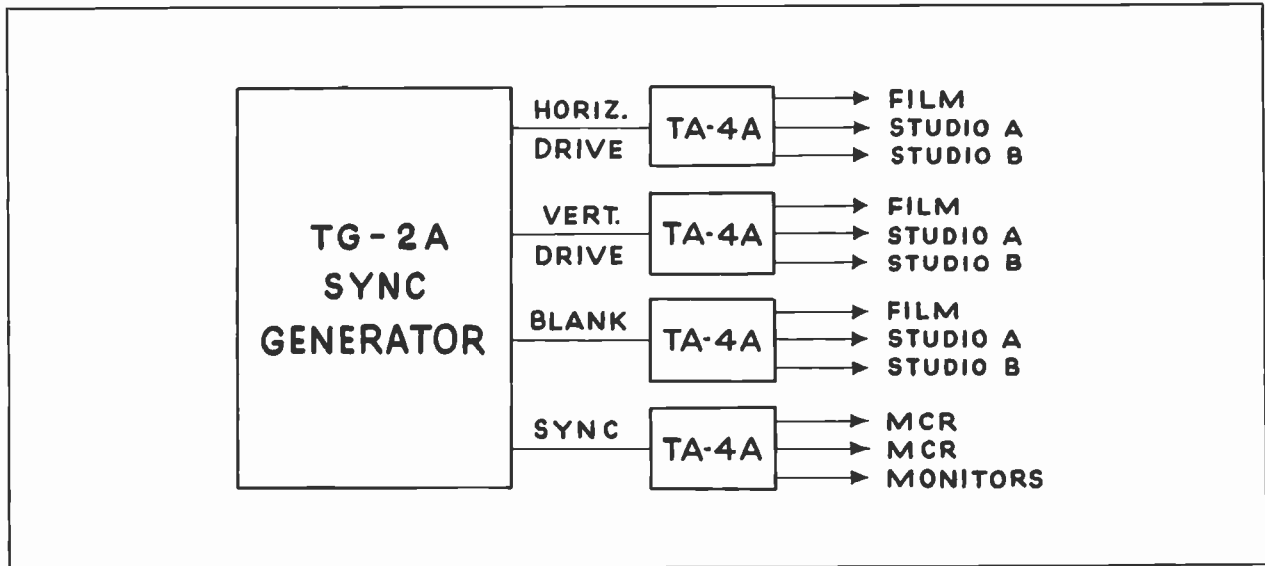

FIG. 5. Typical Pulse Distribution System employing TA-4A Amplifiers to provide optimum performance and reliability. The TA-4A is also often used at studio locations to further distribute signals and to remove waveform degradation.

supply. Bias on the cathode follower is such that its cathode is at -22 volts, and by virtue of direct coupling, bias on the output amplifiers is also -22 volts. The A.C. component at the plate of the regenerative clipper is only 20 volts, so the 6W6 grids are never driven positive, thereby avoiding emission and loading difficulties generally associated with positive grid operation.

Each output amplifier drives a separate output line through individual 75 ohm "L" pads. The "L" pads are ganged carbon composition potentiometers to provide smooth, continuously variable, adjustment of output level for three independent lines. The 75 ohm constant output impedance resulting from the use of "L" pads is an important factor in reducing pulse distortion in systems where long transmission lines with several impedance discontinuities such as patch boards, junction boxes, and capacitive terminations are used.

A 250 microfarad capacitor couples the 6W6 plate signal to the "L" pad. By use of a capacitor of this size, it is possible to limit low frequency tilt on vertical blanking to less than 1.5 percent.

The circuits employed in the TA-4A provide excellent power efficiency. In comparison with previous methods of pulse distribution, the TA-4A provides an improvement of over three-to-one in both current requirements and space requirements, considering sending-end terminated lines. One RCA 580-D power supply will accommodate three TA-4A amplifiers. Component

layout, visible in Figs. 3, and 4, has allowed for adequate heat dissipation without sacrificing electrical characteristics in a unit occupying only 3½ inches of rack space performance. A one-piece steel back plate provides an accessible mounting surface for signal and power receptacles as well as suitable shielding in installations with several amplifiers mounted adjacent to one another.

Fig. 5 is a diagram of a typical television pulse distribution system utilizing

TA-4A Distribution Amplifiers. The amplifier will operate with Blanking, Sync, Horizontal Drive and Vertical Drive pulses without any adjustment for the particular type signal to be used. Any input signal level between 2 and 8 volts peak-to-peak will insure proper operation even though tilt, hum, bounce, overshoots and long rise time may be present. Examples of the way in which the TA-4A treats these deficiencies are shown in the waveform photographs of Figs. 6 and 7.

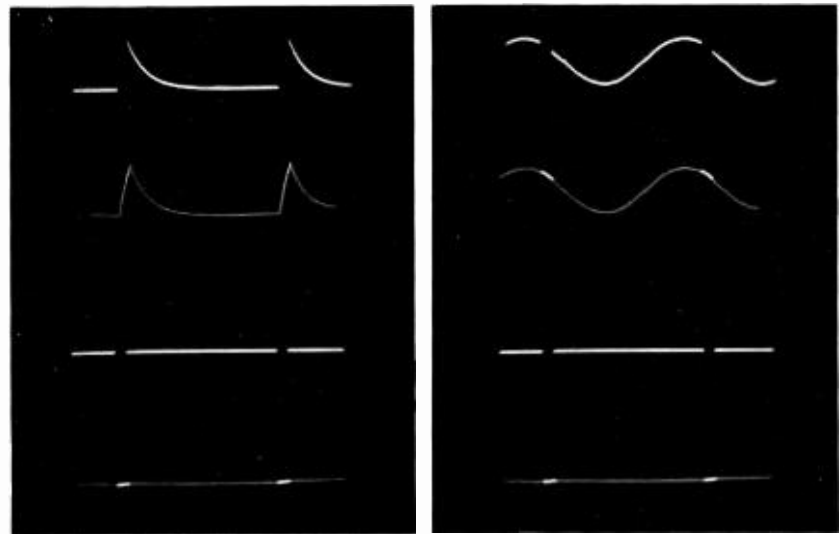

FIG. 6. Defects frequently encountered with pulse signals are tilt and 60 cycle hum. Waveforms at (a) show elimination of tilt, and in (b) removal of a hum component from blanking.

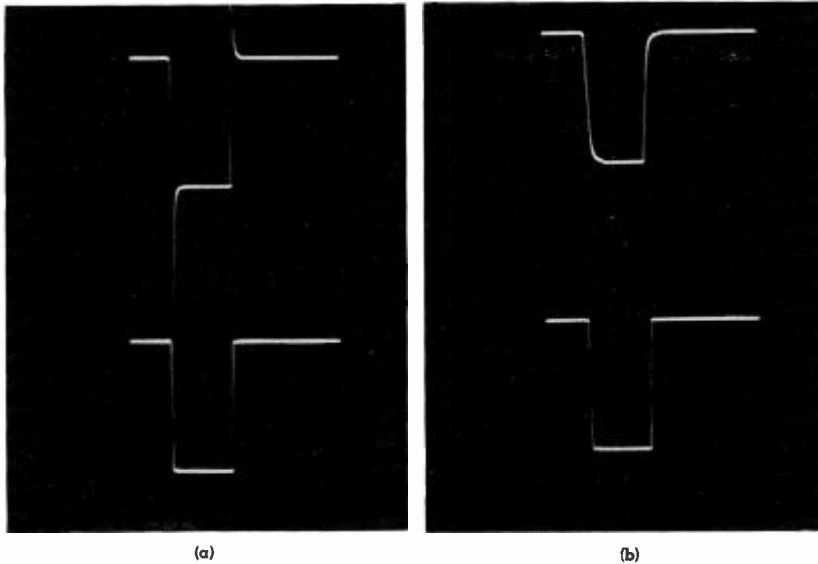

FIG. 7. Waveform photographs showing the effectiveness of the TA-4A in removing overshoot (a), and restoring rise time (b). Regenerated horizontal drive at output is shown at bottom of photographs.

There are four adjustable controls in the TA-4A. Three are output level controls—one for each output line—while the fourth is the Clipping Level Control in the regenerative clipper grid circuit. Clipping level is the amplitude of the input signal at which the regenerative switch is initiated. This control is set at the factory for optimum operation and requires adjustment only in event of tube replacement or unusual operating conditions.

The maximum output level and load current requirements vary with signal duty cycle, the extreme case being mixed blanking with a duty cycle of approximately 25 percent. However, with this signal, more than four volts peak-to-peak is available at the output and the load current is less than 125 milliamperes. The level at each output is adjustable from zero to maximum by means of the front panel-mounted gain controls. Test jacks are provided for convenient signal level measurements.

#### RCA TA-3A Video Distribution Amplifier

In broadcast video distribution systems, it is generally found necessary to feed a signal from a given location to several remotely located points. For example, master control output is fed to a line monitor located in the control room, to the station transmitter or STL, and in many cases, to the telephone company for network distribution. It is not feasible to utilize the expedient of bridging at various points on a long transmission line. Dis-

continuities in the characteristic impedance of the line would cause reflections, resulting in serious deterioration of picture quality. To avoid this complication, several individual amplifiers may be located near the signal source. Bridging with as many amplifiers as needed may then be accomplished without affecting impedance matching. The RCA TA-1A has been used frequently in this type of service. See Fig. 8.

Individual channel distribution amplifiers, while they often simplify bridging for multiple feeds, present an operational problem in that the program line signal does not pass thru the same circuits as the

monitoring signal. As a result, loss of signal to a network feed caused by failure of the network line amplifier would not be indicated on the monitor, since the monitor amplifier would still be functioning properly. Conversely, interruption of the signal at the monitor would not necessarily mean failure of the network feed. This can easily be seen from observation of Fig. 8.

To circumvent this problem, a single channel amplifier might be used to feed several lines with their sending ends paralleled as shown in Fig. 9. Now, although the monitor displays a signal equivalent to the network signal, there exists the obvious disadvantage of disturbances occurring on the monitor line, directly affecting the network signal. Disturbances frequently occurring in practical operating circumstances are 60-cycle hum due to ground loops, reflections caused by accidental removal of terminations or use of capacitive terminations, and transients resulting from proximity to heavy electrical equipment such as air conditioners and elevators. Monitoring lines, particularly house monitoring lines, are often quite long and subject to any or all of these spurious signal sources. What is needed, then, is an arrangement similar to that of Fig. 9 with the additional requirement that disturbances on one line will not influence other lines. Isolation of this sort is best obtained using an amplifier with very low output impedance to feed several lines through series resistors. The method by which this is done is illustrated in Fig. 10. If the output impedance is made sufficiently low and the building-out resistors made large, a spurious signal developed on the monitor line will be greatly attenuated before reaching

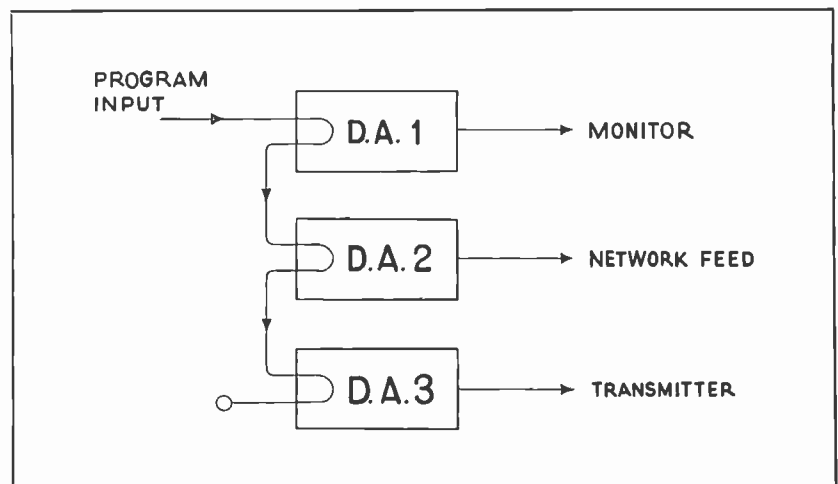

FIG. 8. When separate channels are used to distribute video as shown here, failure of the network line amplifier would go unobserved on the monitor.

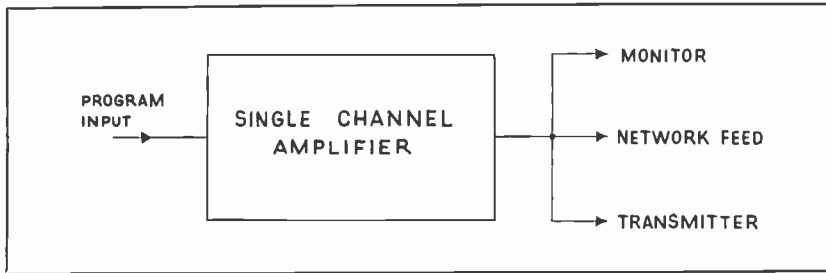

FIG. 9. Monitor indicates presence of network signal, although local interference on monitor line will feed directly into network and transmitter feeds.

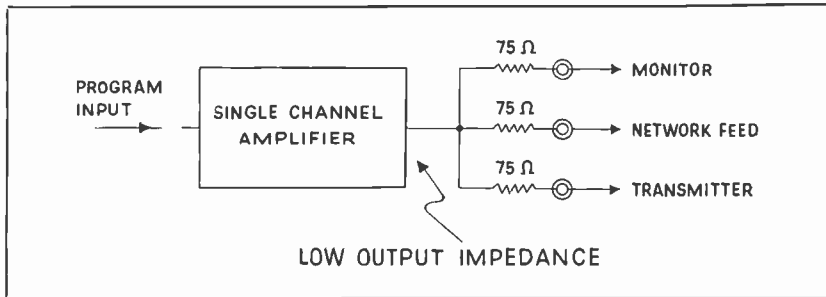

FIG. 10. In addition to providing necessary isolation between output lines, a distribution amplifier utilizing the principle illustrated here will terminate the sending end of a transmission line. The RCA TA-3A is of this configuration.

other lines, thereby resulting in an insignificant influence on the network channel.

An additional benefit to performance is derived from the output circuit of Fig. 10 if the series resistances are equal to the surge impedance of the transmission line, providing sending-end termination of the line. Fig. 11 shows the improvement in frequency response afforded by the sending-end termination used in the TA-3A.

Fig. 12 is a block diagram of the TA-3A. Two feedback amplifiers are used. The first amplifier has a gain of two; it feeds the video gain control. The second feedback amplifier has unity gain; it feeds the three output lines through the output isolation network. The maximum over-all gain, from input to output is 2.

The input signal is fed through bridging inputs J1 or J2 to the grid of V1, a 6BQ7A dual triode. V1 is connected as a series amplifier. A configuration of this type offers considerable advantage over the conventional single tube amplifier. Curvature in the transfer characteristic is cancelled to a great extent due to the "single-ended push-pull" operation of this circuit, resulting in excellent linearity. Also, for a given static tube current, almost twice as much a-c load current swing is obtained with the series amplifier compared with the conventional tube and load resistor combination.

Referring again to Fig. 12, it may be seen that V1 drives another series amplifier, a 5687 dual triode, V2. The 5687 output is coupled through a capacitor to the video gain control. Part of the signal at the output is fed back to the cathode of V1. The resulting degeneration reduces the gain of the feedback pair and in effect improves frequency response, linearity, and stability.

The movable arm of the gain control potentiometer feeds the video signal of desired amplitude to the second feedback amplifier. In this amplifier paralleled 6U8 pentode sections, V3A and V4A amplify the signal. A cathode follower drives the output tubes with the amplified signal.

The output stage consists of two 6BX7 tubes in a series-parallel arrangement providing adequate signal current swing to drive three 75 ohm transmission lines through a complex isolation and matching network. A fraction of the signal at the input to the isolation network is introduced into the cathode circuit of V3A and V4A for negative feedback. In addition to the performance improvements already described, negative voltage feedback lowers the output impedance of the amplifier. It will be recalled that this was one of the conditions required for good isolation between output lines.

The TA-3A has provision for sync addition. If desired, a sync signal is fed

through J3 or J4, which allow bridging, to the grid of the 6U8 triode amplifier V3B. The amplified sync is mixed with the video at the cathode of V1. Sync amplitude is adjustable from zero to 0.4 volt by means of a potentiometer in the plate circuit of V3B. The sync level control circuit has negligible effect on video level or frequency response.

The high frequency response may be made flat within  $\pm 0.3$  db to 8 megacycles. Adjustment is accomplished by means of two variable capacitors in each feedback amplifier. There are no peaking coils in the amplifier.

Through the use of carefully designed low frequency coupling circuits and direct coupled feedback paths, the low frequency characteristics of the TA-3A are excellent. The frequency response is only 0.3 db down at one cycle per second with a gradual roll-off below that point. There is no rise in gain at low frequencies as often associated with extended low frequency response.

Referring again to the block diagram, Fig. 12, V8 is an OB2 that regulates screen voltage for V3A and V4A. A bias supply consisting of a 6X4 rectifier and OB2 regulator provides fixed negative bias for the 6BX7 output tubes, enabling twice as

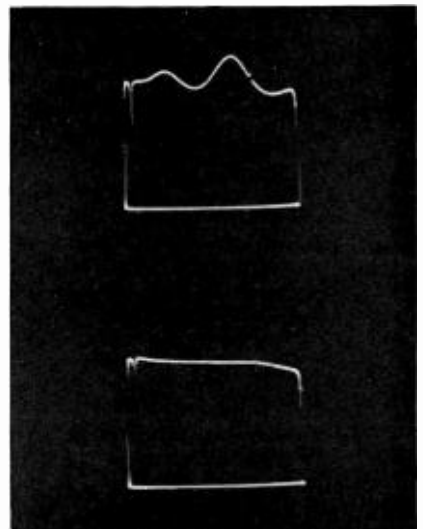

FIG. 11. Sweep frequency response of 75 feet of RG-11/U terminated at the receiving end with 75 ohms shunted with 100 mmf. This is a typical input capacity for switchers and paralleled bridge inputs. The upper curve was obtained by feeding the cable with an amplifier with high impedance output (TA-1A). A TA-3A, which provides a good termination at the sending end of the line, was used for the lower curve. Note the uniform response obtained with the TA-3A as a result of minimized reflections. Marker is at 8 megacycles.

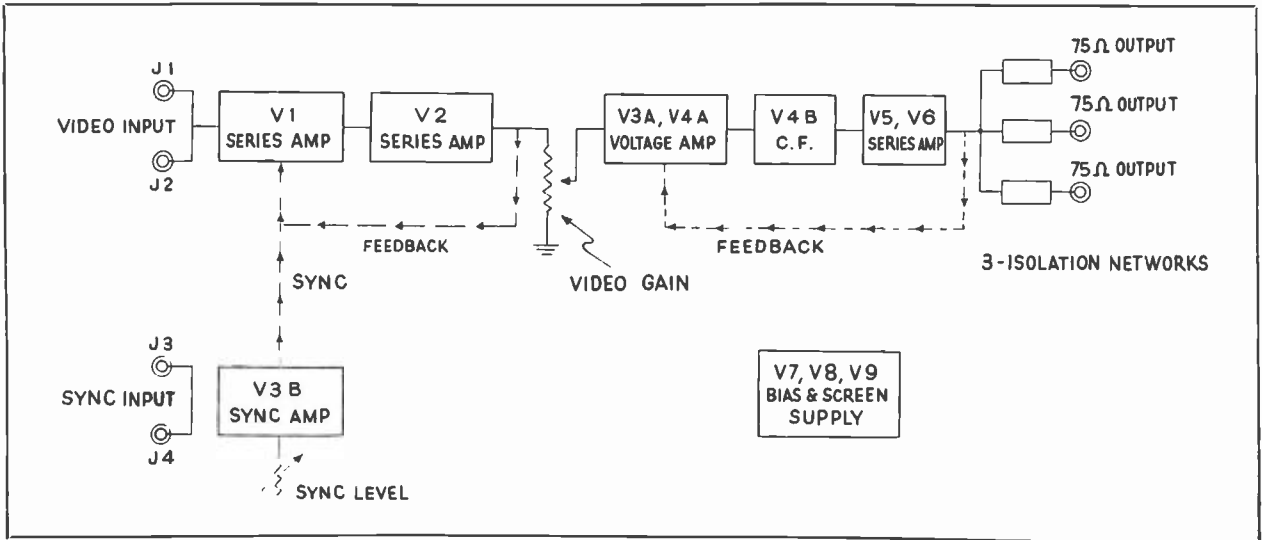

FIG. 12. Block diagram of the TA-3A Video Distribution Amplifier.

much gain from this stage as would be possible with cathode bias. Adequate reserve in the output stage prevents excessive plate dissipation in event of bias supply failure. In addition to tube bias the negative supply furnishes current to balancing circuits at the output of both feedback amplifiers to eliminate a small potential that would otherwise result from the direct coupled feedback circuit.

Physical appearance of the TA-3A is similar to the TA-4A. Fig. 13 shows mechanical details. The chassis is a standard 3½ inch bath-tub type with a back plate providing shielding and a mounting surface for all coaxial receptacles and variable capacitors for high frequency compensation. Video and sync level controls and test points are accessible from the front of the chassis for convenience in setting and measuring signal levels.

Considering sending-end terminated outputs, the TA-3A offers an advantage of over two-to-one in plate supply current

and three-to-one in rack space requirements compared with the TA-1A. With the exception of the 5687, all tubes are receiving types that are easily obtainable, or which may be stocked as spares with a minimum investment. The 5687 is a reliable type requiring very infrequent replacement.

With a simple modification, the usefulness of the TA-3A is greatly enhanced. The modification simply consists of incorporating a relay in the sync adding circuit so that sync addition may be controlled at a remote point. When used in conjunction with a TS-5A Studio Switcher to feed other studio facilities as shown in Fig. 14, the modified TA-3A will replace a stabilizing amplifier for the sync mixing function. It is unnecessary to clamp the output of a TS-5A. The sync interlock relay added to the TA-3A will be actuated by control circuits in the switcher to remove local sync when a remote signal is switched through, or to add sync for local signals. Such a system is applicable in studio installations

where the switcher does not feed a transmitter directly. When the switcher output goes directly to the transmitter, a stabilizing amplifier must be used to furnish the sync stretch function.

When the versatility offered by the fader circuits in the TS-5A is not needed, a very simple and economical switching system may be had by using a TA-3A in conjunction with one or two TS-2A Video Switches. The switch assemblies have spare contacts suitable for operating the sync interlock circuits.

Because of the high frequency attenuation introduced by coaxial cables, long lines require equalization that generally attenuates low frequencies to make the over-all response flat. Passive equalizers of this type insert a constant loss of 3 to 6 db which can be recovered through the use of a TA-3A.

FIG. 13. Tube side of the TA-3A. Compact construction and high power efficiency minimizes rack space requirements.

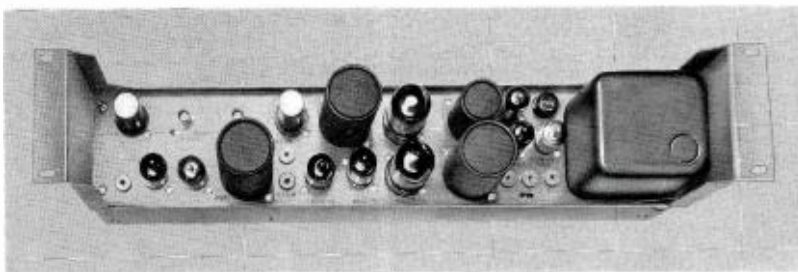
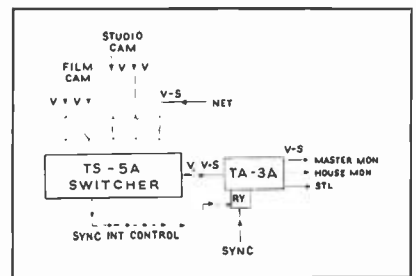
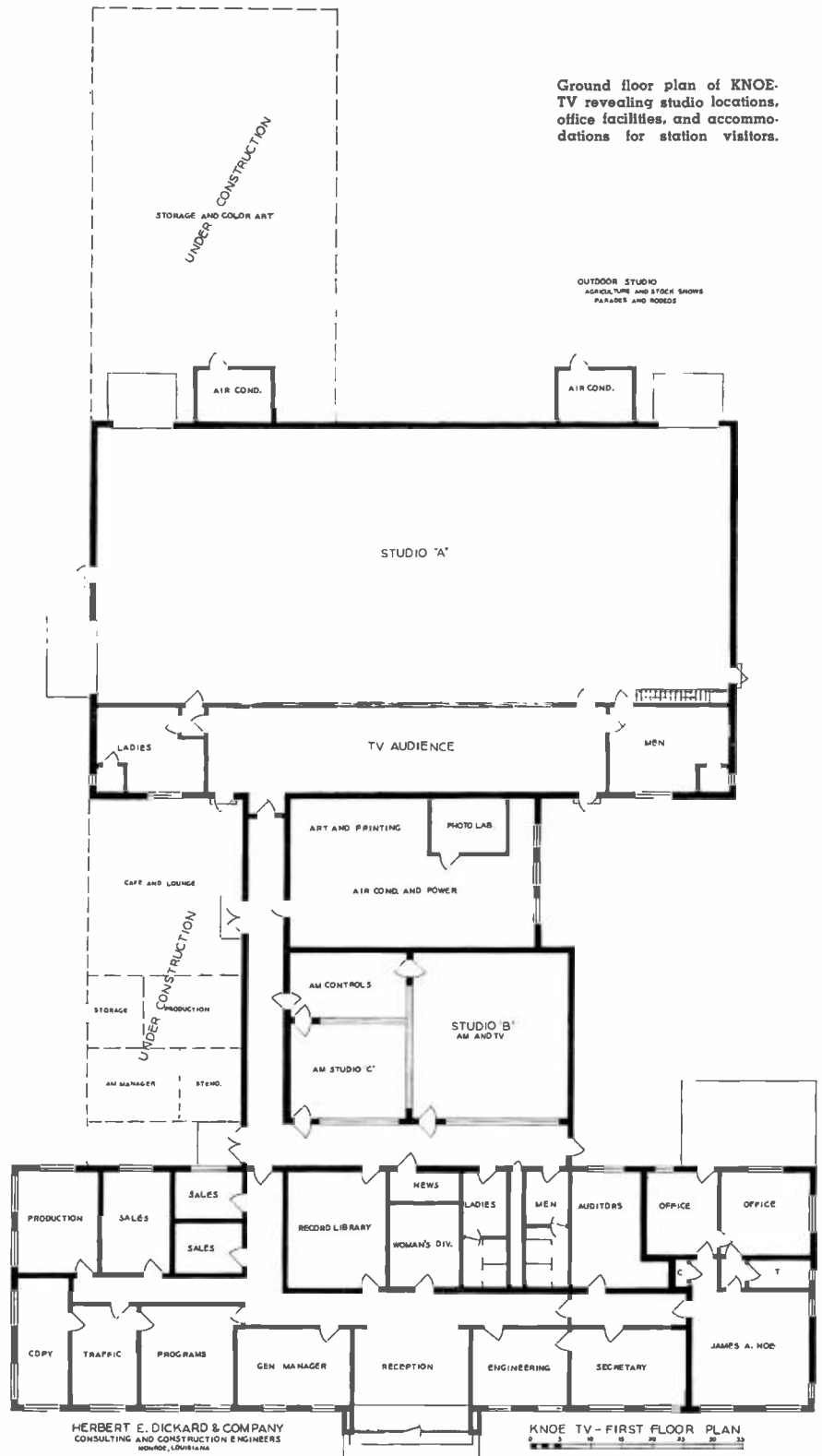

FIG. 14. A TA-3A modified to include sync interlock can be used to replace a stabilizing amplifier when clamping and sync stretch are not required. A typical example is shown here. The modified TA-3A may also be used in conjunction with a TS-2A Video Switcher for an economical switching system.



Ground floor plan of KNOE-TV revealing studio locations, office facilities, and accommodations for station visitors.



HERBERT E. DICKARD & COMPANY  
CONSULTING AND CONSTRUCTION ENGINEERS  
WINDYBROOK, LOUISIANA

KNOE TV - FIRST FLOOR PLAN  
0 5 10 15 20 25 30 35



## "Careful Planning Pays Off For Station KNOE-TV"

When the Freeze was lifted by the FCC in 1952, former Governor James A. Noe, owner of KNOE, 5000 watt outlet at Monroe, Louisiana, and WNOE, 50,000 watt outlet at New Orleans, decided to enter the field of television at Monroe, Louisiana.

In order to maintain the primary motive of public service in television as he maintained in radio with KNOE, Monroe and at WNOE, New Orleans, the following considerations were foremost in the planning of the station:

(1) Since the geographical location of Monroe, Louisiana is such that there are numerous towns in all directions from Monroe, from a few miles out to 75 and 100 miles distance, it was decided to begin operations with as near to maximum power as possible.

(2) To plan a large television studio to allow for maximum utilization of local shows and local talent.

(3) In all phases of planning, the idea of future expansion for the building and facilities for color was a prime prerequisite.

by  
**RAY BOYD**  
Director of Engineering

(4) To have a large visitors' room where the visitors could have an unrestricted view of the show in progress without interfering in any way with the show.

(5) To arrange to have maximum flexibility of facilities with maximum efficiency of manpower.

With the above considerations in mind, the KNOE-TV project as shown in the pictures was designed and constructed by Herbert E. Dickard & Company, Consulting and Construction Engineers, Monroe, Louisiana. This concern also designed and constructed KNOE-AM, Monroe and WNOE, New Orleans.

The site selected for KNOE-TV was a plot of ten acres almost centrally located between the expanded residential areas of Monroe.

Since maximum power had been decided

upon, a 25-KW RCA transmitter, an RCA 12-bay antenna and a 500-foot tower by J. J. Philips of San Antonio, Texas was originally considered. However, it was

**JAMES ALBERT NOE**, ex-governor of Louisiana and owner and operator of Station KNOE-TV.



To begin TV operations with as near maximum effective radiated power as possible, Station KNOE installed the RCA Model TT-26BH. This transmitter with its sliding doors and small, easily handled cubicles provides station with an economical installation and low operation costs. Shown above is a section of the transmitter and associated rack equipment in the transmitter room.

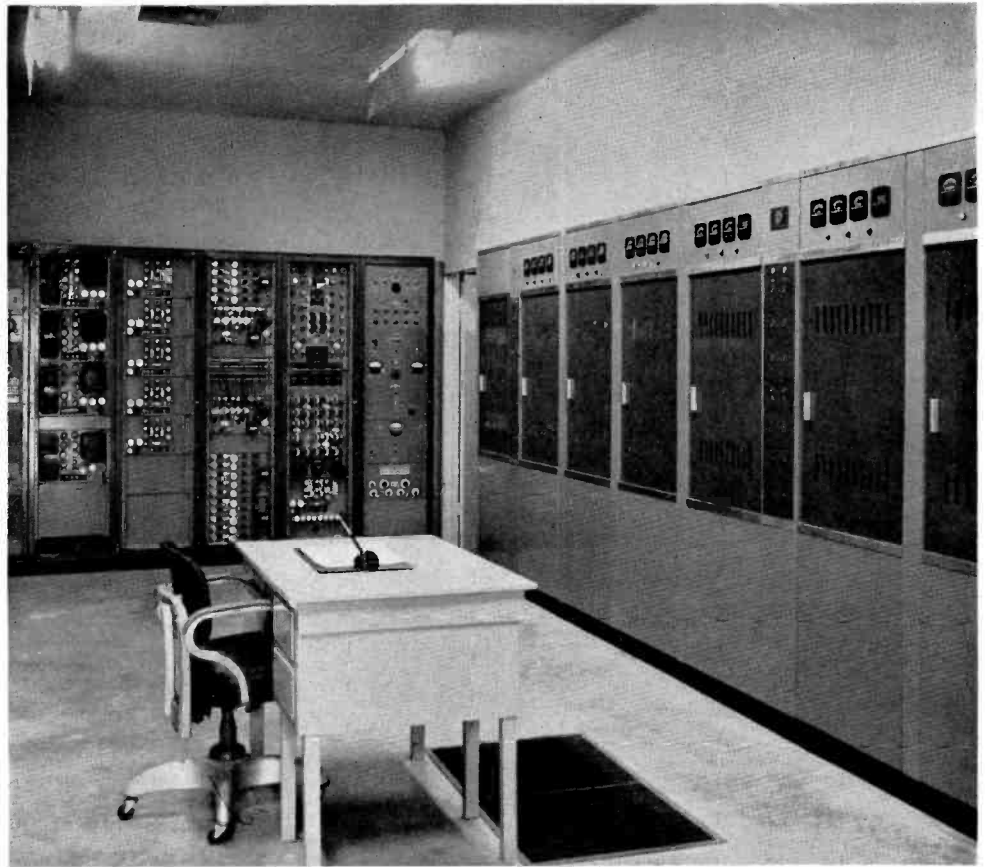

Master control position at Monroe TV station is model of efficiency. Large glass balcony affords view into main television studio area. Control area is directly above TV audience affording both same view of studio activities.



found by examining our proposed coverage maps that there was an area in the northeast corner of the state of Louisiana that would not be covered by the Grade A or B contours of any VHF station. It was then decided by Mr. Noe and Paul Goldman, Manager of KNOE-AM-TV to have the tower constructed to 700 feet height in order to serve this area with a strong VHF signal. This would give KNOE-TV an ERP of 230 KW.

With the fine performance and dependability of the RCA 5000 watt transmitter and equipment at KNOE-AM, Monroe and the RCA 50,000 watt transmitter at WNOE, New Orleans, it was decided to completely equip KNOE-TV with RCA equipment. The RCA 25-KW transmitter (TT-25BH) was selected because it would economically provide an ERP of over 200 kilowatts.

The construction of the building was started in April, 1953, but due to 40 days of intermittent rain, the construction proceeded slowly; however, when the rainy season ended, work on construction was accelerated to make up for the lost time.

Our studio and associated equipment began arriving the latter part of July and at the same time, Mr. Philips began the construction of the tower. By the latter part of August, the tower was completed

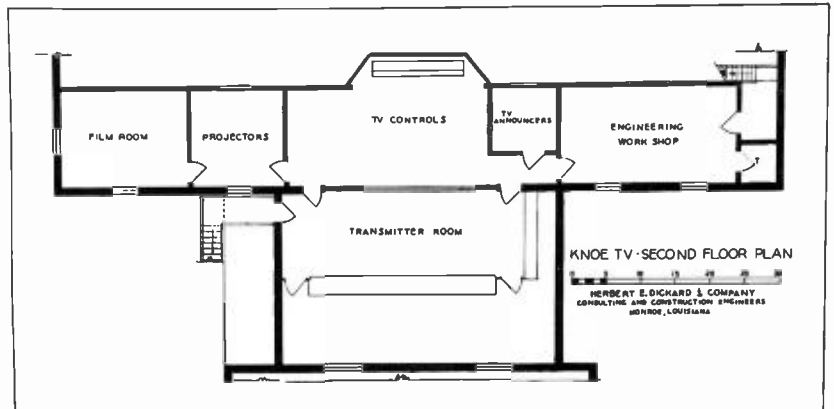

Transmitting equipment, film and projection room and engineering facilities for Station KNOE-TV occupy spacious quarters on second floor of modern air-conditioned building.

with the antenna mounted on top and the dual transmission lines complete to the base of the tower. Also, the major part of the studio equipment had been mounted in place and the wiring completed by the competent engineers of KNOE-TV, Freddy Roberts, Technical Supervisor, Stamps Sheppard, Ed Love and Courtland McCoy under the supervision of Jack Ratliff, Chief Engineer and the author.

RCA had promised early delivery of the 25-KW transmitter, and KNOE-TV there-

fore published and planned the opening of the new station for September 27, 1953.

Plans having been made, all efforts were exerted to maintain this opening date. Arrangements were made to have the transmitter delivered from Camden, New Jersey to Monroe, Louisiana by Greyvan Lines with two operators driving straight through.

When the transmitter arrived, crews were standing by to uncrate and set the transmitter in place. When the transmitter

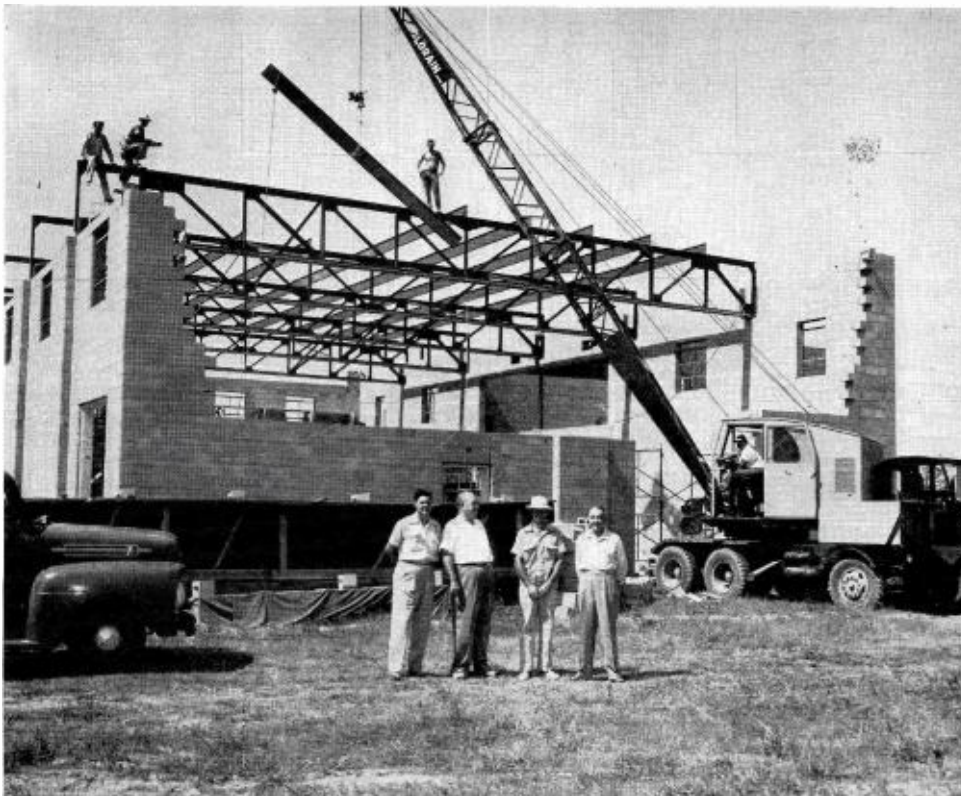

Modern facilities for Station KNOE-TV (Channel 8) at Monroe, La., shown under construction during summer of 1953. Station enjoys unexcelled location on 10-acre plot centrally located between residential areas of Monroe. Posed in foreground (left to right): Ray Boyd, vice-president and technical director, Ex-Governor J. A. Noe, A. C. Washam, masonry contractor, and Herbert E. Dickard, consulting engineer.

Action scene taken in KNOE's studio during origination of local program saluting Commercial Solvents on their five million dollar expansion program at Monroe, La. RCA supplied complete video, audio and lighting equipment to this southern TV station.

was in place, the engineers of KNOE-TV went to work around the clock to complete the wiring to the transmitter. When the wiring was completed, the RCA service engineers arrived to tune and check out the transmitter. Ten days from the time our 25-KW transmitter left the RCA factory at Camden, New Jersey, KNOE-TV was on the air with full regular programming.

A few highlights of KNOE-TV's opening day included a parade consisting of 35 bands from the different high schools in our coverage area, Girl Scouts, Boy Scouts, American Legion, etc. Also in the parade were 15 beauty queens from all sections of Louisiana.

Sharkey and his Dixieland Band was engaged for a two-week stand for the Grand Opening and music and dancing was enjoyed by all from the large studio of KNOE-TV.

Some of the dignitaries attending the opening were: Governor Robert F. Kennon

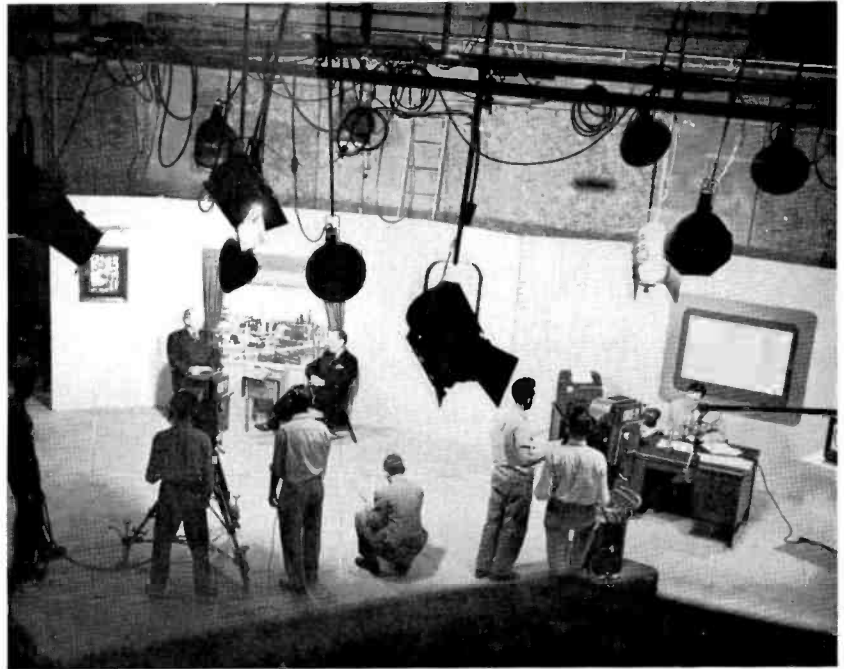

of Louisiana, Lt. Governor C. E. "Cap" Barham of Louisiana, Ex-Governor Jimmy Davis of Louisiana, Representative of the Governor of Arkansas, U. S. Senator Russell B. Long, U. S. Senator Allen Ellender,

Congressman Otto E. Passman. Mayor Coon of Monroe, Mayor Norris of West Monroe, along with approximately 150 mayors and city councilmen from the cities and towns of KNOE-TV's coverage area. Other notables attending the Grand Opening were: Frank Headley of H-R Representatives, Sheldon Hickox, Director of Station Relations of NBC, William A. Kelley, Manager of Station Relations of NBC (Southwest area), Dana Pratt, RCA National Sales Manager, Transmitter Division of Camden, New Jersey, Wiley Wenger, RCA Sales Representative of Dallas, Texas, Warren Wood, KNOE-TV Attorney of Washington, D. C., Benton Paschall, Manager of WNOE, New Orleans, along with the personnel of WNOE.



Lee Hunt, film director (left), and Leon Nolan, chief photographer (right), examining the process of feeding four picture sources into an iconoscope camera chain.

The record of performance of the KNOE-TV equipment supplied by RCA stands at less than 3 hours of lost air time in over 18 months of operation with a daily operating schedule from 6:45 A.M. to midnight.

The tubes in the transmitter are giving exceptional service. With over 7500 hours of operation on the 6166 in the visual 10 KW section, it is still going strong. The original fourteen 5762 tubes in the 25 KW visual and aural transmitter are still in use after 7500 hours with the exception of one tube which had an open filament at 850 hours. The original iconoscope tube in the film chain was replaced after 5000 hours of operation.



# NOW...

## RCA PRINTED CIRCUIT

### PLUG-IN AMPLIFIERS FOR BROADCAST USE!

*Provide These Outstanding Benefits...*

**SMALL SIZE** . . . Considerably smaller than previous Broadcast Audio Amplifiers the RCA printed circuit series occupies about  $\frac{1}{2}$  the rack and shelf space formerly needed. You free rack space for other AM and TV equipment, reduce rack and mounting shelf costs.

**HANDLING EASE** . . . Quick, safe and effortless installation or removal is assured by compact, light weight construction. Dependable 15-pin keyed connectors provide fool-proof positioning for rapid "in and out" handling. Connecting pins are gold plated to assure excellent electrical contact.

**UNIFORM PERFORMANCE** . . . The printed circuit assures uniformity and excellent frequency response. All units achieve extra dependability through use of hermetically sealed transformers. Each amplifier is provided with output terminals and a switch to facilitate current metering.

**REDUCED-SIZE ACCESSORIES** . . . Accessories such as BR-22A mounting shelf and BX-21A power supply used with the printed circuit amplifiers have also been "miniaturized." Example: shelf BR-22A, only  $\frac{5}{4}$ " high can accommodate the following combinations of equipment: 10 BA-21A Preamplifiers, 3 BA-23A Program Amplifiers plus 1 BA-21A, 2 BX-21A Power Supplies plus 2 BA-21A, 2 BA-24A Monitor Amplifiers.

*For complete details of the many further advantages of RCA's printed circuit amplifiers, call your nearest RCA Broadcast Representative. Ask for literature.*



**RADIO CORPORATION of AMERICA**  
ENGINEERING PRODUCTS DIVISION  
CAMDEN, N.J.



**BA-21A PREAMPLIFIER** . . . Ideal as a microphone preamplifier, turntable preamplifier or booster amplifier. May be used as isolation amplifier by adding an MI-11278-E or F bridging volume control. Due to its small size, it may be placed in a control console, control desk or transcription turntable cabinet. One to ten of these units may be installed in a single BR-22A panel and shelf assembly.

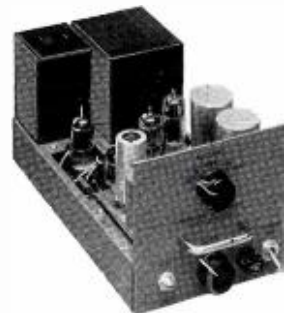

**BA-23A PROGRAM AMPLIFIER** . . . A versatile high-fidelity amplifier using special high-quality components and providing maximum accessibility. High gain and low distortion make it without equal as (1) program or line amplifier, (2) bridging amplifier, (3) isolation amplifier. Three BA-23A amplifiers can be mounted on BR-22A shelf with space for an additional amplifier.

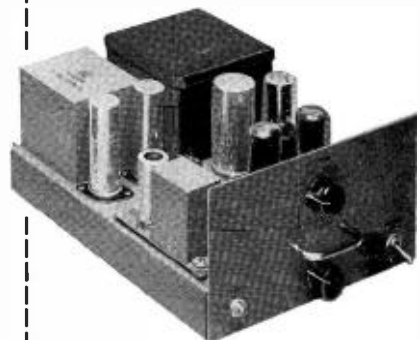

**BA-24A MONITORING AMPLIFIER** . . . A high fidelity, high-gain, flexible 8-watt amplifier suitable for monitoring, audition, recording and talk-back uses. Also serves as a program or line amplifier. Excellent for transcription playback booths, since the 105 db gain will operate a speaker (LC-1A) directly from the output of a turntable (70-series). Also an excellent recording amplifier.



**Good for  
COLOR**

# Extra Program Versatility from **NEW RCA TS-11A Switcher**

The TS-11A is a "nine-input" switcher designed to handle composite or non-composite video switching for color or monochrome. Two rows of push buttons feed a manual fader assembly; a third row feeds a preview channel. A program transfer switch is provided to interchange the preview and fader busses with the output busses so that the fader section can be used for previewing fades, lap dissolves and superimpositions. This makes it possible to use the fader channels for rehearsals while the preview channel handles the "on-air" signal. The fader assembly feeds a mixing circuit and three output amplifiers which are a part of the TS-11A, eliminating the need for installing elaborate distribution amplifier systems external to the switcher. The new switcher is free of microphonics and low frequency tilt and bounce, so that a stabilizing amplifier need not be added as part of the switching system.

For further information about this exclusive RCA development get in touch with your RCA Broadcast Sales Representative. In Canada, write RCA Victor Ltd., Montreal.



The TS-11A Switcher is supplied with an RCA console housing (MI-26266-B), a TM-6B master monitor and power supplies to form a complete versatile system.



RCA PIONEERED AND DEVELOPED COMPATIBLE COLOR TELEVISION  
**RADIO CORPORATION of AMERICA**  
 ENGINEERING PRODUCTS DIVISION CAMDEN, N. J.

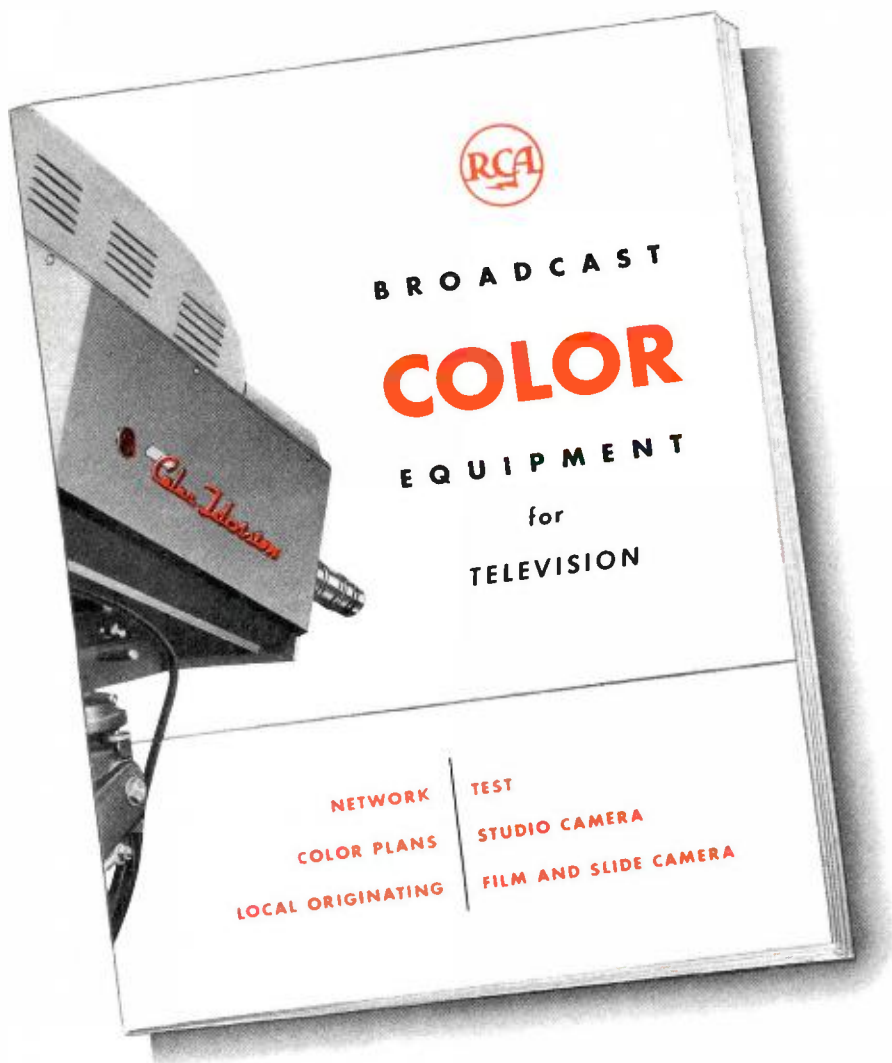

- Network Equipment
- Test Equipment
- 3V Color Film and Slide Equipment
- Live Camera Equipment
- Switching Equipment
- Sync and Color Originating Equipment

## NOW READY...

*An Indispensable Guide for Color Planning*

In its 108 pages, this catalog provides just about everything the station man wants to know about color TV planning. *First*, its 28-page explanatory section contains the most timely, factual and authentic discussion of color planning ever written. Entitled "How to Plan for Color" it includes up-to-the-minute considerations of network programming, film programming, live studio programming. *Second*, the catalog describes and illustrates all the latest RCA equipments for color television to fit these plans—immediately.

This informative catalog is fundamental to color station operation—the only book of its kind! And it's ready NOW.

*For your copy of this new RCA catalog on Broadcast Color Equipment for Television ask your Broadcast Sales Representative. Or write Section 503, RCA Engineering Products Division, Camden, N.J. on your station letterhead.*

**108**  
**PAGE**  
**CATALOG**



*RCA Pioneered and Developed Compatible Color Television*  
**RADIO CORPORATION of AMERICA**  
ENGINEERING PRODUCTS DIVISION  
CAMDEN, N. J.

# NEW VIDICON

RCA's Superior



**For  
MULTIPLEXING,  
or direct use!**

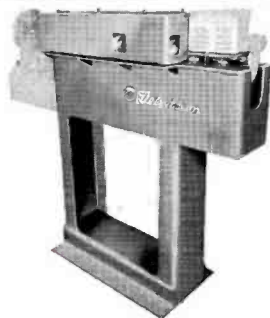

RCA's TK-21 Vidicon Film Camera can be used with RCA's Multiplexer, TP-11, for multiple picture inputs (see illustration opposite page). Or, it can be mounted directly on any of the RCA TV Projectors—such as the TP-16, TP-35, or TP-6A (see above).

# film-camera

film

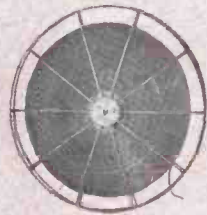

camera chain

**D**EVELOPED HAND IN HAND with the new RCA-6326 VIDICON tube, RCA's TK-21 Film Camera does for *film* picture quality what the RCA Image Orthicon Camera has done for "live" picture quality.

**"Live" picture sharpness!**

For unsurpassed picture detail, choose the RCA Vidicon film camera! It's the only film pick-up system with enough signal output (and low enough noise in the signal) to use *aperture response correction*. Aperture response correction brings picture detail to maximum sharpness (detail resolution, 100% at 350 lines) while holding a high signal-to-noise ratio. *Benefit:* You produce finer film pictures . . . with a quality you get from your studio camera.

**"Live" picture contrast!**

The RCA Vidicon adds "studio" realism to your film pictures. The gamma characteristic of the Vidicon tube is ideal for film reproduction . . . 0.65, constant over a dynamic range of 150 to 1. *Benefit:* You get more realistic film pictures than ever before possible.

**Low light source requirements!**

The high light sensitivity of the RCA VIDICON film camera enables you to reduce projection lamp voltage, reduce heating, increase lamp life substantially.

**Edge-lighting, shading eliminated!**

The RCA VIDICON operates entirely without edge-lighting, electrical shading, and any other form of supplemental lighting. *Benefit:* You adjust "wall focus" and "beam" from day to day . . . then this camera *virtually runs by itself*.

**RCA VIDICON Film-Camera Chain TK-21 Includes:**

- |                                    |  |
|------------------------------------|--|
| I VIDICON Camera MI-26021          | I TM-6B Master Monitor MI-26136-A        |
| I RCA-6326 VIDICON Tube MI-26671   | I Master Monitor Kinescope MI-26655      |
| I Control Chassis MI-26061         | I Master Monitor C-R Tube MI-26665       |
| I Deflection Chassis MI-26081      | I Blower MI-26579-B                      |
| I Remote Control Panel MI-26241    | I Console Housing MI-26266-B             |
| 2 WP-33B Power Supplies MI-26085-B | I Camera Cable & Connectors MI-26725-A10 |

For the finest TV film reproduction you've ever seen, specify an RCA VIDICON film-camera system. Ask your RCA Broadcast Sales Representative for technical details. In Canada, write RCA-Victor Ltd., Montreal.

RCA PIONEERED AND DEVELOPED COMPATIBLE COLOR TELEVISION



**RADIO CORPORATION of AMERICA**  
ENGINEERING PRODUCTS DIVISION

CAMDEN, N.J.

**4 picture sources  
in multiplexed use!**

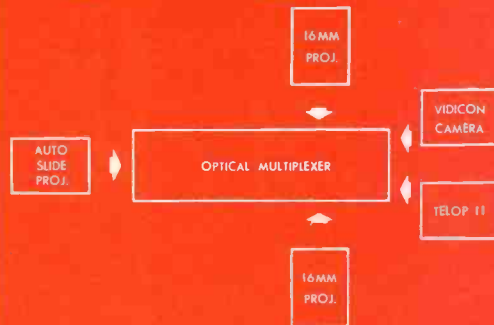

An RCA Multiplexer, Type TP-II allows a single Vidicon Camera to accept up to four film picture sources—two 16mm or 35mm film projectors, a TP-3B, 35mm automatic slide projector, and a Telop II slide and opaque projector. The multiplexer is pictured above in a multi-input film system using two RCA TP-6A professional film projectors.

# BTA-5H!

# Newest

## with 6 Major

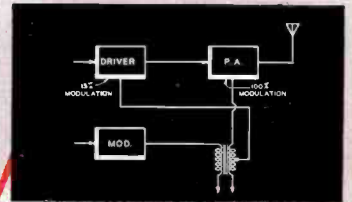

1. Bi-Level Modulation improves linearity and fidelity . . . saves power.

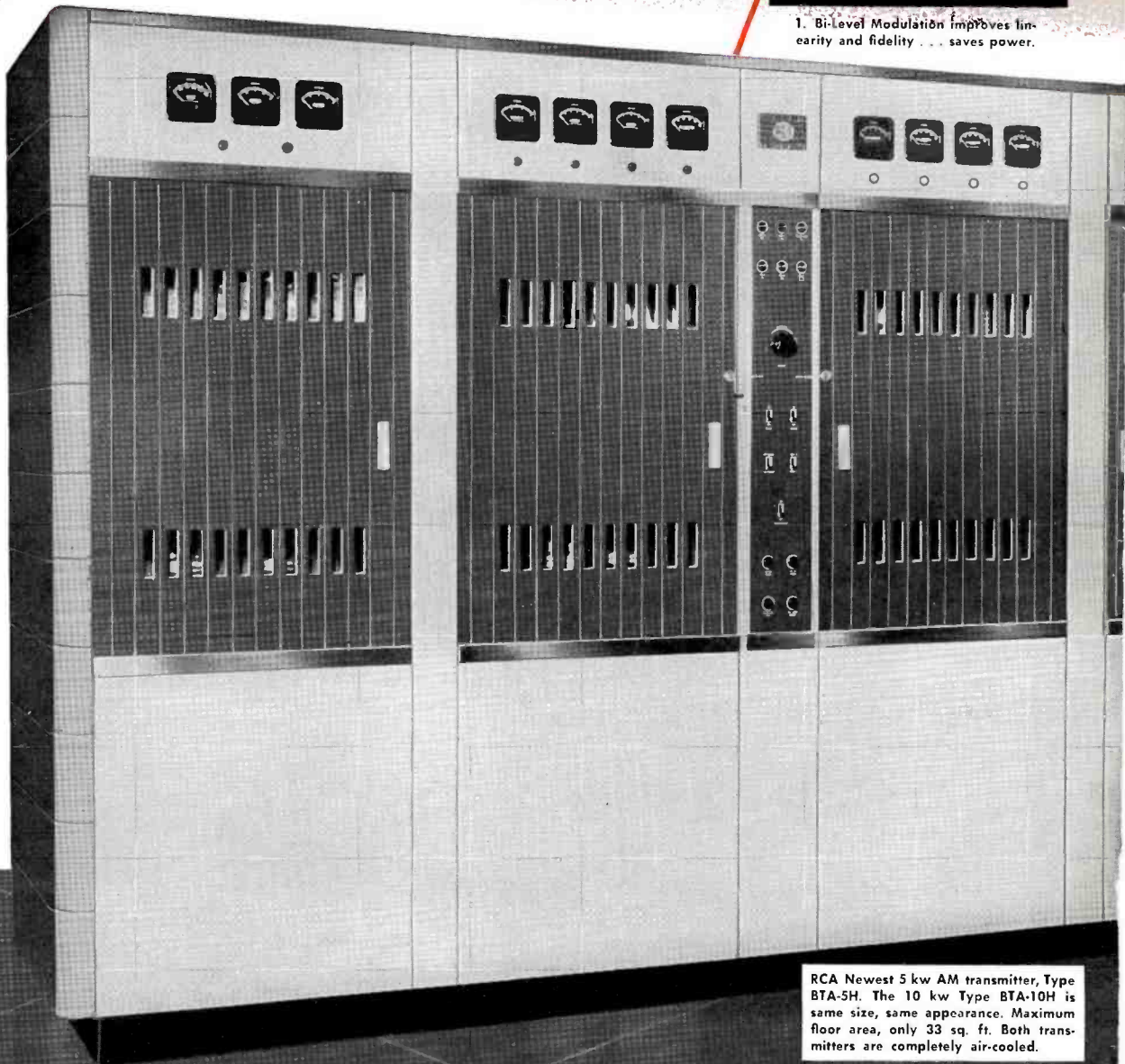

RCA Newest 5 kw AM transmitter, Type BTA-5H. The 10 kw Type BTA-10H is same size, same appearance. Maximum floor area, only 33 sq. ft. Both transmitters are completely air-cooled.



# RCA 5-KW "AM"

## Benefits, Including Bi-Level Modulation

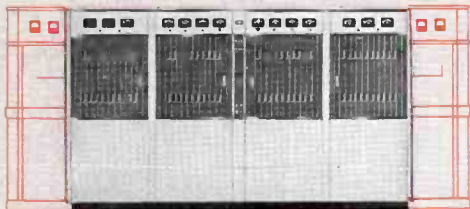

2. Up to 40% less floor area than previous "5 kw's"



3. Power tube costs reduced

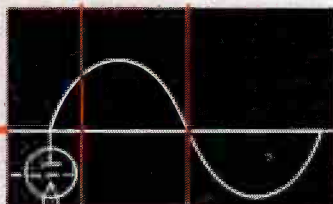
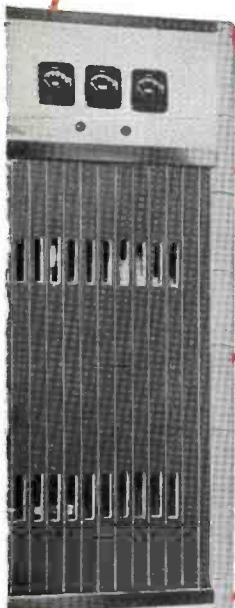

4. 1/60th second arc-back protection



5. Lower power bills



6. Sliding doors—front and rear

### Just read these exclusive features...

- 1 Bi-level modulation, accomplished by adding a controlled amount of audio to the r-f driver increases efficiency, reduces power consumption and reduces distortion. Linearity of the power amplifier is greatly improved by varying the drive in proportion to the modulation.
- 2 BTA-5H requires less "operating" floor space than other 5 kw's—saves up to 40% floor area. Entire transmitter is only 84" high, 130" wide, 32½" deep.
- 3 BTA-5H is the only "5 kw" with such low tube costs. Power and modulator stages use the new small size, lightweight RCA-5762—costing less than half that of power types in most "5 kw's."
- 4 It's the ONLY "5kw" with "split-cycle" overload and voltage protection—using thyatron-controlled rectifiers. Circuits work so fast audiences cannot detect "off-air" breaks.
- 5 BTA-5H holds power bills to the LOWEST in the "5-kw" field through smaller power tubes, fewer stages, fewer tubes (only 23 tubes and 7 different types).
- 6 BTA-5H is equipped with horizontally-sliding doors front and back. Benefits:
  - ✓ Saves over 60 square feet of floor area
  - ✓ Provides more elbow room for operator
  - ✓ Makes it easier to get at transmitter.

For all the facts about this new 5 kw transmitter . . . call your nearest RCA Sales Representative. Also ask for bulletin B.6535 shown at right.



**RADIO CORPORATION of AMERICA**  
ENGINEERING PRODUCTS DEPARTMENT  
CAMDEN, N. J.

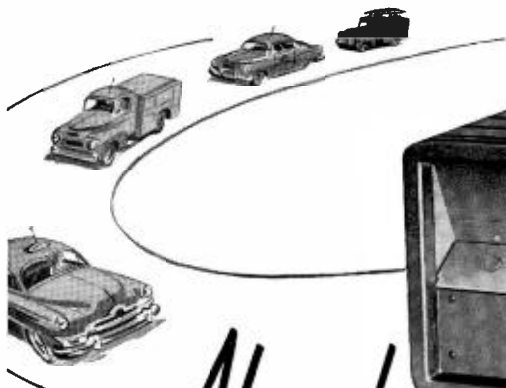

*Ahead*

*...in Styling!...in Performance!*

## New RCA *Carfone* ONE FIFTY 2-Way Radio

Performance-wise, as well as appearance-wise, this is the finest 2-way radio equipment that RCA has ever offered. Engineered for top performance, clearest voice reception, minimum maintenance and low-cost servicing, its features represent planning that is years ahead.

Among the built-in advantages you'll welcome now and benefit from in the years to come . . .

### IN THE DESK STATION

- Styled for convenience
- Best frequency stability, without ovens
- Rainbow Tuning—color directed, all top adjustments
- Dual frequency operation, if needed
- Full coverage of 148-174 mc—without change of components

### IN THE MOBILE UNIT

- Complete 6-12 volt convertibility
- Best frequency stability, without ovens
- Fewest tube types and fewest tubes
- Single Vibrator power supply
- Sealed Selectivity
- Most compact



*"Get the Best!"*



MAIL COUPON BELOW FOR MORE DETAILS

 <b>RADIO CORPORATION</b> <b>of AMERICA</b> <small>COMMUNICATIONS EQUIPMENT CAMDEN, N. J.</small>	Radio Corporation of America Communications Equipment Dept. 129Q, Building 15-1, Camden, N. J. Please send me information on the new RCA Carfone "150" 2-Way Radio.
	NAME _____ TITLE _____ COMPANY _____ ADDRESS _____ CITY _____ ZONE _____ STATE _____



• Horizontal wipe



• Vertical split

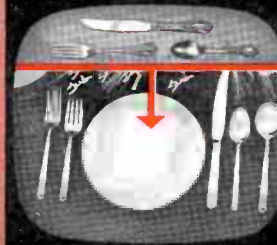

• Vertical wipe



• Vertical wedge wipe



• Diagonal wipe



• Horizontal split



• Diamond insert and wipe



• Controllable corner insert



• Horizontal wedge wipe

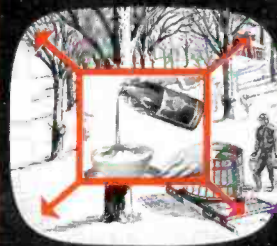

• Rectangular insert and wipe



• Controllable corner insert



• Optional special effect

# 12 ways to present your "commercial"

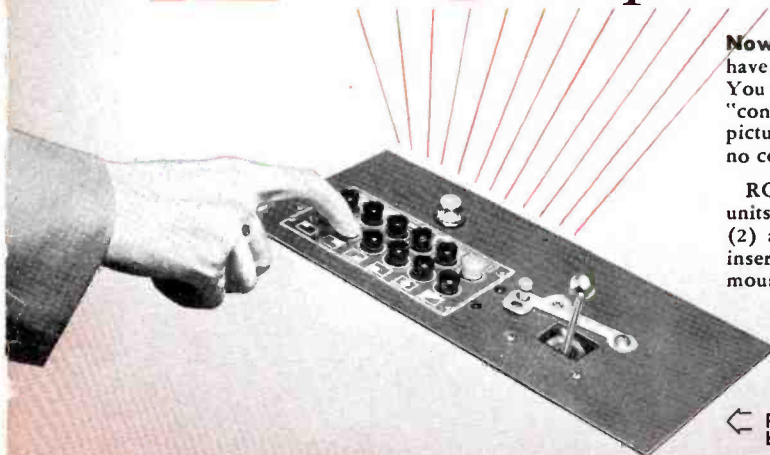

Now—with RCA's new Special Effects Equipment—you can have these 12 attention-getting effects right at your fingertips. You push the button for the effect you want. You swing the "control stick" (rotatable 360°) and put the selected effect in the picture wherever you want it. It's simple, inexpensive—requires no complicated equipment or extra cameras.

RCA's Special Effects Equipment consists of just two separate units; (1) a TG-15A control panel (shown below) and generator, (2) and a TA-15A amplifier. The Special Effects Panel can be inserted in any RCA Console housing. The other units can be mounted in your video racks. Installation couldn't be easier.

For quick delivery, order your RCA Special Effects Equipment direct from your RCA Broadcast Sales Representative.

← RCA Special Effects Control Panel—with 12 push-button selection and 360° rotatable stick control.



**RADIO CORPORATION of AMERICA**  
ENGINEERING PRODUCTS DEPARTMENT  
CAMDEN, N. J.

Right From WKBN-TV's Station Log...

9,493 HOURS ON-AIR\*

RCA-6181—  
the power tetrode  
that put commercial  
UHF-TV on the air.



...and still going strong!

\* Reported, December 27, 1954

... says B. T. Wilkins, Chief Engineer at WKBN-TV

"After 9,493 hours' service in the aural section of our 12½-KW UHF, this air-cooled RCA-6181 power tetrode is still delivering peak performance! In fact, the performance of this tube compares very favorably with routine proof-of-performance measurements taken on a brand new tube!" So states B. T. Wilkins, Chief Engineer at UHF station WKBN-TV, CBS affiliate in Youngstown, Ohio.

Performance records such as this are no accident! RCA power tubes are engineered for top performance. They're conservatively rated and have great reserve of filament emission. RCA power tubes enjoy the reputation of paying off in lower capital investment per hour of tube performance—lower operating cost—minimum down time.

Ask your local RCA Tube Distributor about the complete line of RCA power tubes he carries for Radio and TV broadcast operations.

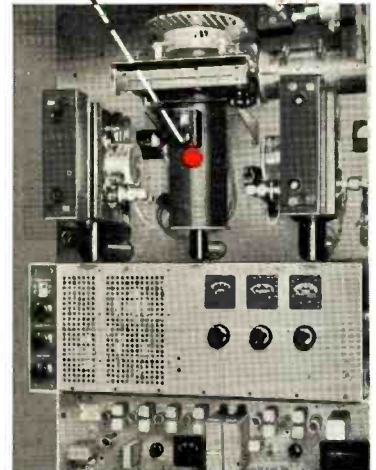

RCA-6181 tube and cavity in the driver stage of the aural section of WKBN-TV's 12½-KW UHF transmitter.



**RADIO CORPORATION of AMERICA**  
ELECTRON TUBES

HARRISON, N.J.

3J2580

PRINTED  
IN  
U.S.A.