

# BROADCAST NEWS

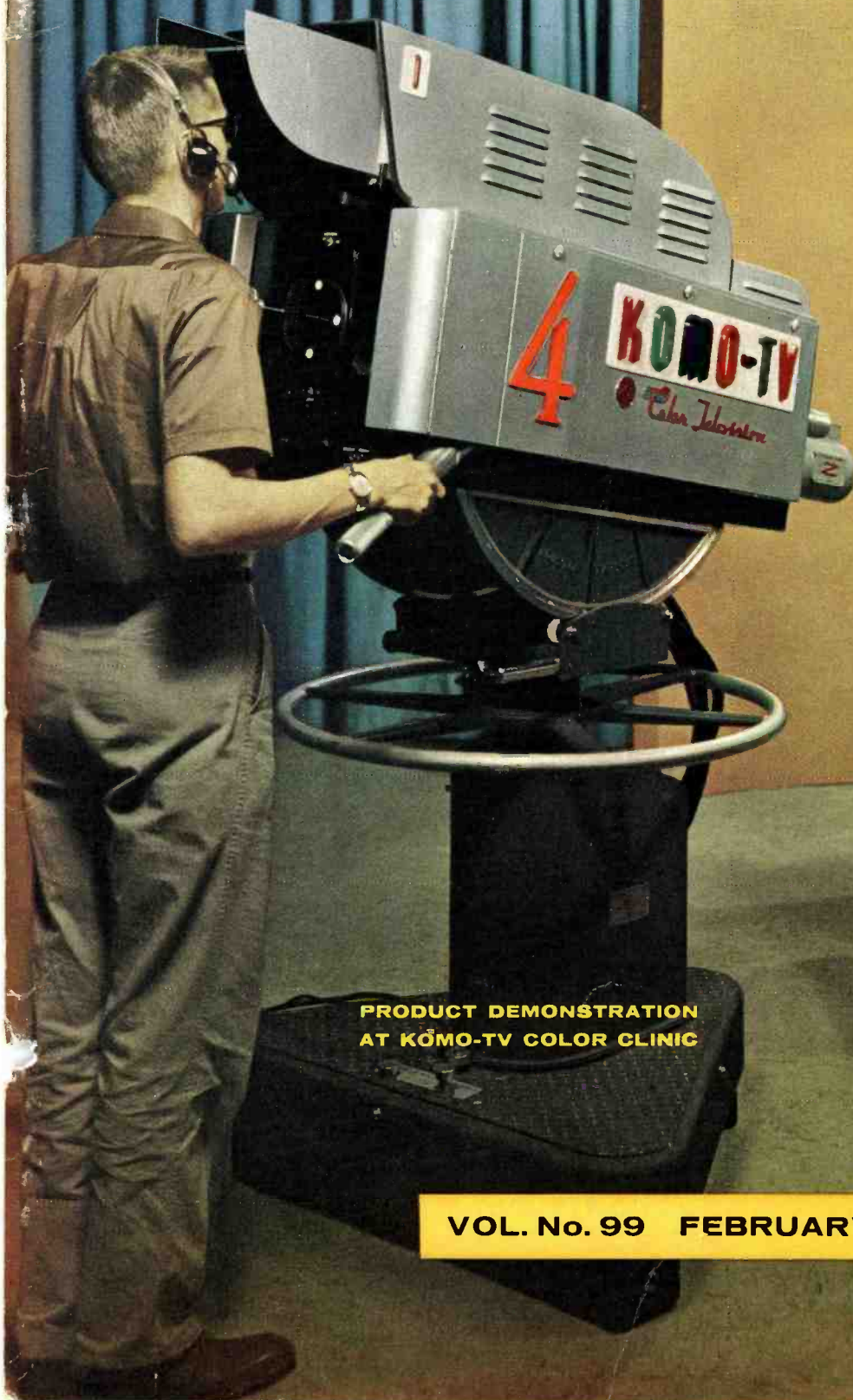

PRODUCT DEMONSTRATION  
AT KOMO-TV COLOR CLINIC

VOL. No. 99 FEBRUARY 1958



# Planning a Radio Station ?

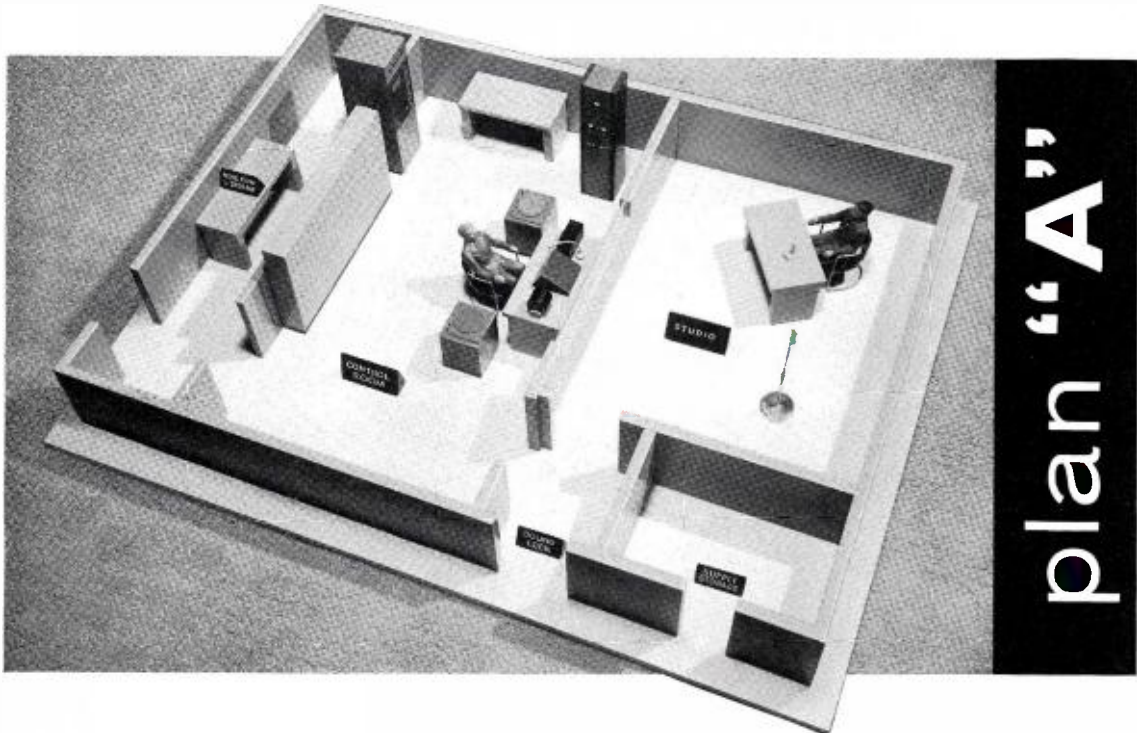

## Here's Plan "A" that requires a minimum investment!

For the small station operator who plans to start with a modest amount of capital, Plan "A" will prove desirable. It provides for economical "combined" studio-transmitter operation offering the programming requirements for records, control room announce, one studio, tape facilities, network and remotes.

Plan "A" permits operation with a minimum of personnel. It is designed for a single operator-announcer to work directly from control room. The equipment location makes this practicable,

since turntables, tape recorder, control console and record rack are all within easy reach.

While Plan "A" is ideal for most small stations, it is just one of three basic plans that can be modified to meet your needs exactly.

Building layouts, together with a discussion of equipment requirements, and current trends are included in a new brochure. For your free copy, write to RCA, Department B-22, Building 15-1, Camden, N.J. In Canada: RCA VICTOR Company Limited, Montreal.

**RCA** . . . *your first source of help in station planning*



TM&© 1967

**RADIO CORPORATION of AMERICA**

BROADCAST AND TELEVISION EQUIPMENT

CAMDEN, N. J.

Vol. No. 99

February, 1958

# BROADCAST NEWS

*published by*

**RADIO CORPORATION OF AMERICA  
BROADCAST & TELEVISION EQUIPMENT DEPARTMENT  
CAMDEN, NEW JERSEY**

*In U.S.A. - - - \$4.00 for 12 issues*

**PRICE**

*In Canada - - - \$5.00 for 12 issues*

## CONTENTS

	Page
COLOR VIDEO TAPE RECORDER . . . . .	6
KGHL-TV GETS FIRST TRAVELING WAVE ANTENNA . . . . .	8
A NEW AURAL AND VISUAL TV EXCITER . . . . .	10
PLANNING A RADIO STATION—PART III . . . . .	14
FISHER RADIO STATIONS . . . . .	26
HOW KOMO-TV USES COLOR CLINICS . . . . .	36
WUNC-TV—NORTH CAROLINA ETV STATION . . . . .	52
TRANSISTORIZED TURNTABLE PREAMPLIFIER . . . . .	78

---

*Copyright 1958, Radio Corporation of America, Broadcast & Television Equipment Department, Camden, N. J.*

PRINTED  
IN  
U.S.A.





**Type BK-1A Pressure Microphone**—High-fidelity "Commentator" pressure microphone, non-directional in character. An ideal announce mike for speakers. It assures clear, crisp speech and is well suited for remote pickup.



**Type BK-5A Uniaxial Microphone with Desk Stand**—Standard of the television industry, highly directional, with high front to back ratio. Unidirectional characteristic simplifies microphone and camera placement. (See boom-type below.)

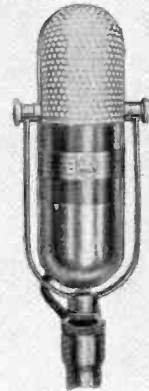

**Type 77-DX Polydirectional Microphone**—Excellent for both voice and music. The standard of the broadcast industry. Variety of directional characteristics, with high sensitivity over entire frequency range, assures high quality reproduction.

# A Microphone

## Immediately Available from RCA!

Whatever your special microphone requirements, RCA can meet them exactly.

Look at the variety of models now offered. You can get pressure-type microphones—such as the BK-1A, SK-45, or BK-6B—and velocity-types—the BK-5A, 77-DX or SK-46. There are microphones for radio or TV station use; for intercom, paging, or PA use. Also mikes for announce, music, or both; for desk, boom, personal use—unidirectional, bidirectional, polydirectional.

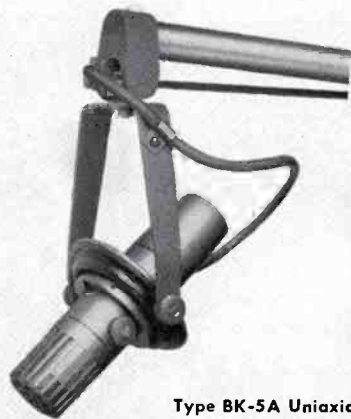

**Type BK-5A Uniaxial Microphone with Boom Mount.** Specially engineered for the television industry to reduce camera noise and interference. Newly designed boom mount combines superior mechanical isolation with rugged durability. Also available with wind screen for outdoor use.

## Also A Complete Line of Microphone Accessories...





**Type SK-45 Pressure Microphone—** Rugged, announce microphone of the dynamic type, suitable for talk-back or cue-in purposes. Economical, light in weight, small in size. Designed for high or low impedance use.



**Type BK-6B Miniature Microphone—** Small but tough, this new personal microphone is easily concealed in hand or clothing. Only half the size and weight of previous models. Offers excellent speech balance when talking "off mike." Wide range frequency response.



**Type SK-46 Velocity Microphone—** Good low-cost studio velocity microphone for speech or music. Provides bidirectional characteristic over wide frequency range. Designed for high or low impedance use.

# for Every Need...

For the finest microphones that money can buy, or for quality, low-cost, utility microphones... when you come to RCA, you know the microphone will be right—whatever the type. It has to reflect the standards for which the RCA symbol has long been famous.

... available for immediate delivery. All represent today's greatest microphone values. For information concerning any of the microphones illustrated, write today for descriptive literature. Bulletins describing desk stands, floor stands, and booms, also available.

Ask your RCA Broadcast Sales Representative



Tmkfs ©

**RADIO CORPORATION of AMERICA**

BROADCAST AND TELEVISION EQUIPMENT

CAMDEN, N. J.

In Canada: RCA VICTOR Company Limited, Montreal

# New "Traveling

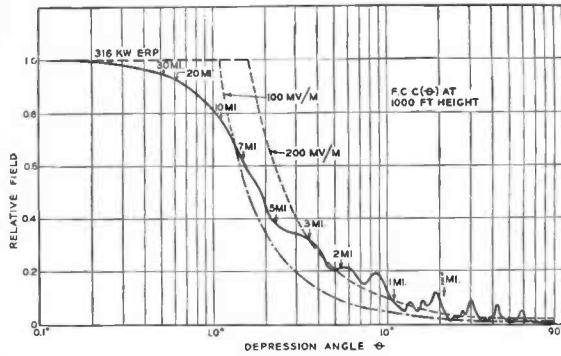

## CHANNEL 10

GAIN OF 18 ANTENNA PATTERN  
(CALCULATED)

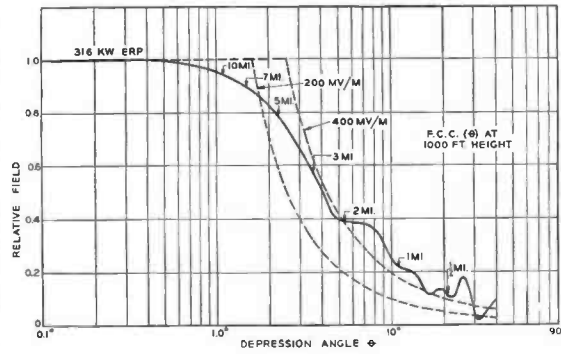

## CHANNEL 7

GAIN OF 8 ANTENNA PATTERN  
(MEASURED)

FOR HIGH-BAND  
VHF OMNIDIRECTIONAL  
SERVICE

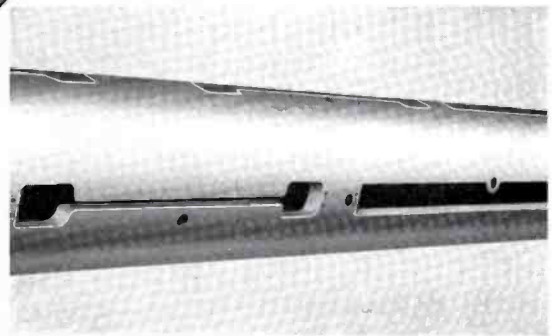

CLOSE-UP OF ANTENNA SHOWING  
UNIQUE SLOT RADIATOR DESIGN



**RADIO**

TMK(±) ®





# Wave" Antenna

**Combines Improved Electrical Characteristics  
with Mechanical Simplicity and Economy . . .  
for High Power TV Applications**

**Here is a VHF high-band antenna that has an inherently low VSWR and produces better patterns. A new design, based on slot radiators, results in improved circularity. This new antenna also features low wind resistance and better weather protection.**

## **INHERENTLY LOW VSWR**

The traveling-wave nature of the feed results in a low VSWR along the antenna. This characteristic inherently gives the antenna a good input VSWR without any compensating or matching devices. The input tee has been broad-banded to provide a smooth transition from the transmission line to the antenna.

## **ALMOST IDEAL VERTICAL PATTERN**

A vertical pattern is obtained which is an extremely smooth null-less pattern—see accompanying patterns. This provides the service area at most locations with a uniformly high field strength. Gains from approx. 6 to 20 at VHF high band can be obtained.

## **IMPROVED CIRCULARITY**

The individual patterns produced by slot radiators when added in phase quadrature result in an over-all pattern with improved circularity. In addition, there are no external elements in the field. This design combines radiating elements, feed system and antenna structure in one unit, giving excellent horizontal circularity.

## **LOW WIND RESISTANCE**

### **AND WEATHER PROTECTION**

The smooth cylindrical shape of the antenna is ideal for reducing wind load and has high structural strength. It is designed to withstand a wind pressure of 50 psf on flats, or  $33\frac{1}{2}$  on cylindrical surfaces. In addition, the absence of protruding elements minimizes the danger of ice damage. The steel outer conductor is hot-dip galvanized for better conductivity and protection. The inner conductor of the antenna is rigidly supported at the bottom end without having to rely on any insulator type of support to carry the dead weight. The pole is designed for tower mounting with a buried section extending into the tower. The pole socket carries the dead weight of the antenna. Polyethylene slot covers are fastened to the pole over every slot.

## **SIMPLIFIED FEED SYSTEM**

The feed system is completely inside the antenna, hence any effects on the pattern have been eliminated. The feed system is a simplified one consisting of a large coax line and coupling probes.

*The RCA "Traveling Wave" Antenna can provide you with the answer to your need for a VHF High Band Antenna which combines mechanical simplicity and economy, especially in high-gain, high-power applications. Your RCA Broadcast Representative will gladly help with TV antenna planning. See him for details on this new antenna. In Canada: RCA VICTOR Company Limited, Montreal.*

**C O R P O R A T I O N   o f   A M E R I C A**

**BROADCAST AND TELEVISION EQUIPMENT • Camden, N. J.**

# color PROCESSING IN RCA VIDEO TAPE RECORDER

**NEW SIGNAL-PROCESSING TECHNIQUES ARE  
KEY TO COLOR PERFORMANCE**

*by A. H. LIND, Manager, Audio and Mechanical Devices Engineering*

The equipment requirements for reproducing color TV signals from magnetic tape are more stringent than they are for monochrome TV signals. First, the response at the high end of the video channel must permit the chrominance information to pass. Second, a tight phase relationship between the average subcarrier burst frequency and phase and the hue modulated subcarrier must be present in the transmitted color signal.

In the RCA TRT-1AC Color Video Tape Recorder the speed of the head wheel when reproducing a recorded signal is maintained sufficiently constant to introduce very little phase shift in the color subcarrier during any given TV line. However, the phase relation in a succession of color subcarrier bursts is subject to spurious shifts due to slow, minute variations in head wheel speed and small errors in the quadrature relation of the playback heads. If, as is usually the case in color TV receivers, the local subcarrier oscillator is locked to the incoming subcarrier bursts in a manner that averages many bursts, the demodulated color signal would display hue errors as a function of the timing inaccuracies. At the present state of the speed control art, the resulting picture would be unusable.

The system shown in the simplified block diagram, Fig. 2, is used quite successfully to correct for the small timing errors and thus eliminate the related color distortion. The basic technique is to cancel out color phase drift in the chrominance signal by translating this signal to a higher frequency spectrum, and then heterodyning this translated signal with a signal which also contains the phase drift and is of such a frequency that the difference signal frequencies fall back into the original frequency band. If this signal is derived from a signal recorded on the tape, it will contain the same phase-drift effects as those in the translated chrominance signal, but the difference signal obtained by heterodyning will be free of phase drift because errors have been cancelled by subtraction.

The video input signal (see Fig. 2), which contains color phase drift is divided into two frequency bands by filters. The higher frequency band contains the chrominance information. This 3 to 4 mc band of signals is translated to a 22.8 to 23.8 mc band by mixing it with a 19.8 mc signal. The 19.8 mc signal is obtained by multiplication of a local crystal subcarrier oscillator. The signal in the 22.8 to 23.8 mc band still contains the color phase drift.



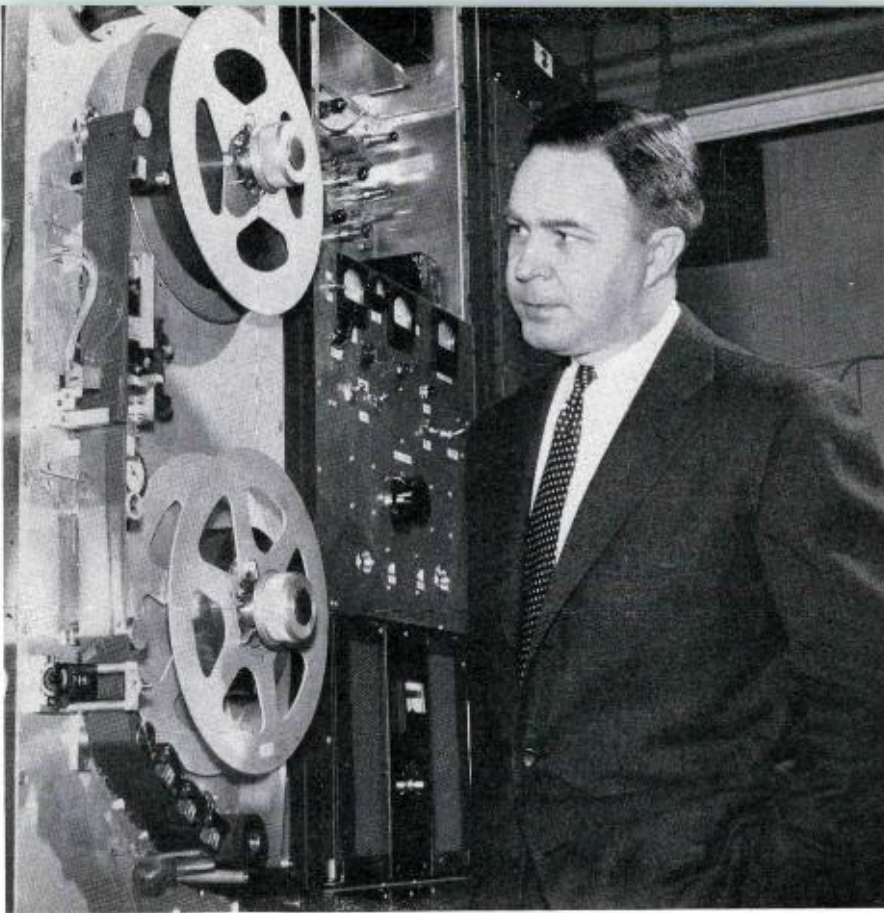

FIG. 1. Prototype of the Color Video Tape Recorder and the author.

The reference signal is the color sub-carrier burst which conveniently is an inherent part of the color video signal. However, the subcarrier burst must be used to precisely control a local oscillator that can provide a continuous subcarrier. By using a burst-controlled oscillator which is synchronized by each burst and sustains the oscillation for the remainder of the TV line, the output subcarrier is effectively step modulated a line at a time in accordance with the color phase drift present. This signal is translated to 19.8 mc by mixing it with a 16.2 mc signal which is also obtained by multiplication from the local color subcarrier signal (see Fig. 2). Next, the 22.8 to 23.8 mc signal is mixed with the 19.8 mc signal. Both signals contain color phase drift. A difference sideband signal of 3 to 4 mc in which the phase drift has been cancelled is produced. The color stabilized 3 to 4 mc signal is then added to the 0 to 3 mc luminance signal to reconstitute the color video signal. A burst-restorer unit reinserts a new sub-carrier burst to insure a clean, well-shaped burst on the output color signal.

The output signal resulting from these color-processing techniques is a composite color signal ready for transmission.

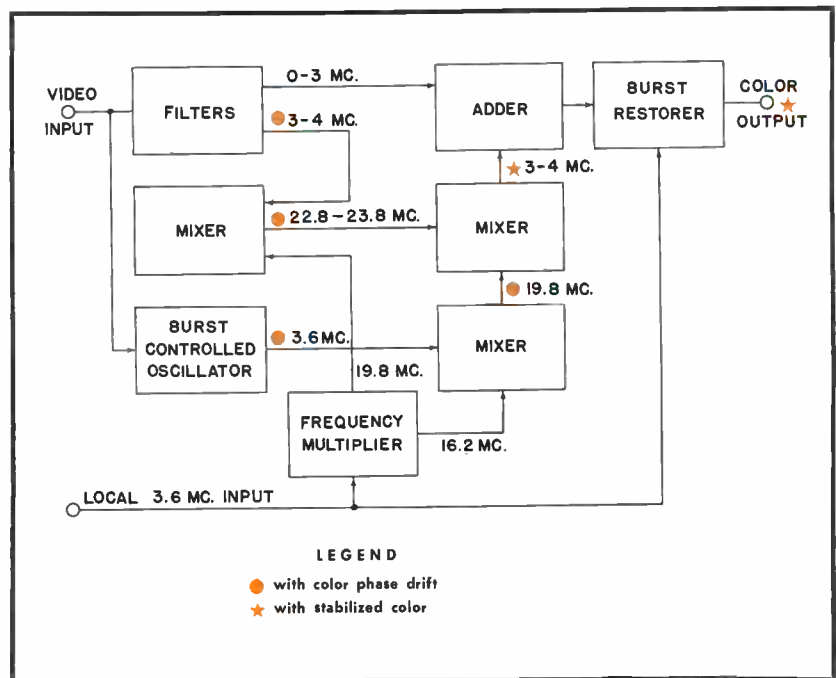
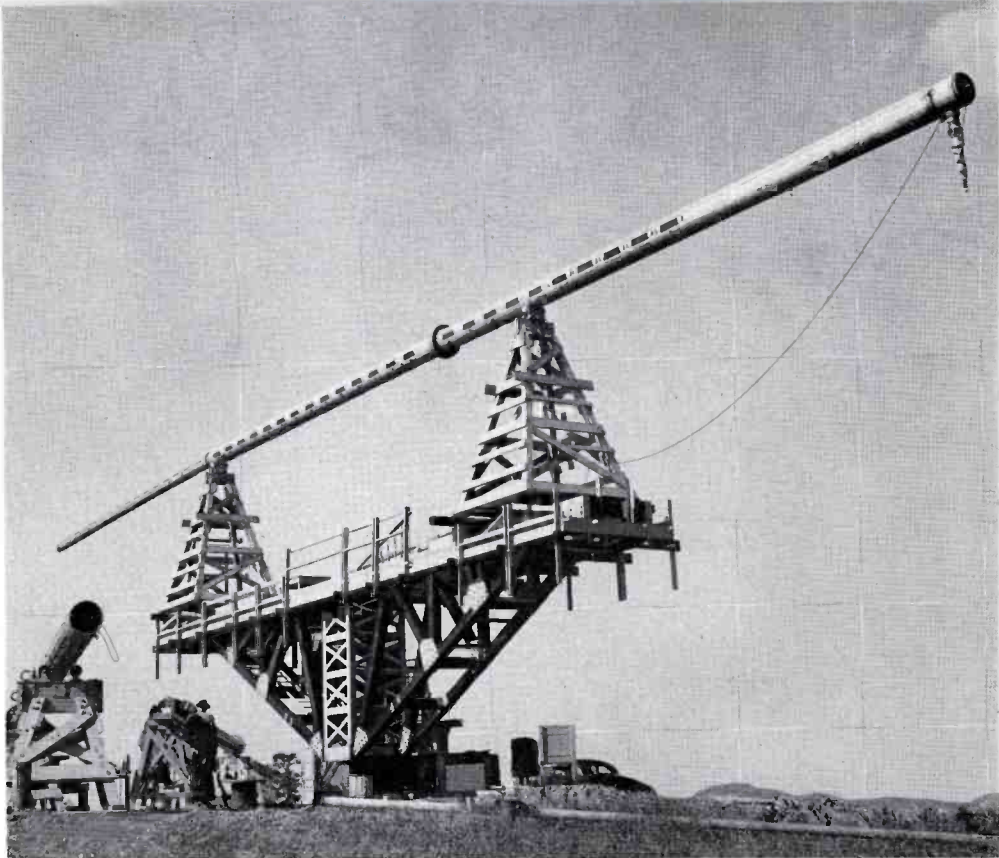

FIG. 2. Simplified block diagram of color processing circuits.

FIG. 1. Traveling Wave Antenna for KGHL-TV is tested on giant 15-ton turntable at the RCA Antenna Test Laboratory. The Channel 8 antenna spans 114 ft. and weighs more than 23,000 lbs.



## KGHL-TV GETS FIRST TRAVELING WAVE ANTENNA

*Pattern Measurements Checked Out at RCA Antenna Test Laboratory*

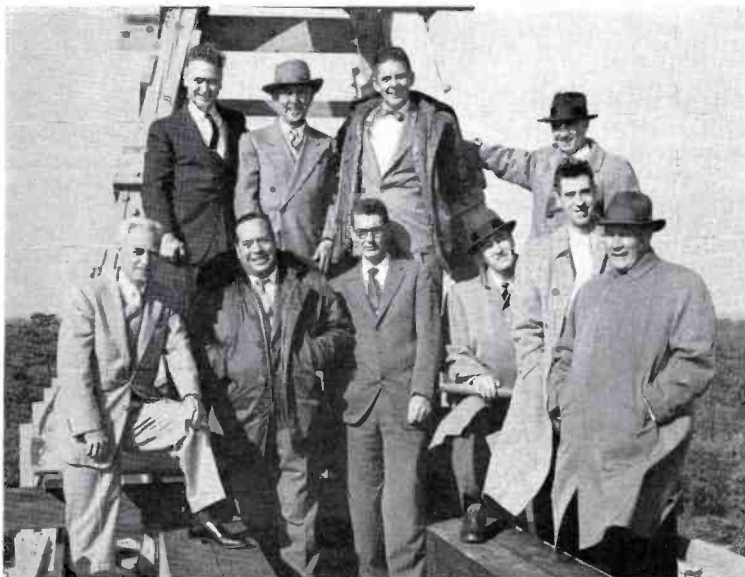

FIG. 2. Jeff Kiichli, KGHL-TV General Manager, Ray Rohrer of Jansky and Bailey join RCA personnel atop the test turntable. In the bottom row, left to right, are E. C. Tracy, Kiichli, I. T. Newton, B. K. Kellom, H. H. Westcott, M. S. Siukola; top row, D. Pratt, G. A. Kumpf, Rohrer and H. E. Gihring.

Prior to shipment and recent installation at KGHL-TV, Billings, Montana, the first Traveling Wave Antenna produced by RCA was thoroughly tested and pattern-proved at the RCA Antenna Test Laboratory, Gibbsboro, New Jersey. Final check-out of the antenna was witnessed by Jeff Kiichli, KGHL-TV General Manager and Ray Rohrer of Jansky and Bailey, the station's consultants. This new antenna provides a power gain of 15 and is teamed with an RCA 25-KW Transmitter, Type TT-25BH. The transmitter-antenna combination provides maximum power on Channel 8.

The Traveling Wave Antenna features high-power handling capacity with improved pattern characteristics. Its simplicity of mechanical construction leads to decreased wind loading and economical installation. Engineered to eliminate external antenna elements, the antenna is of streamlined, slotted-cylinder design with built-in radiating elements and a simplified feed system. Details of the traveling wave design are described in a previous article.<sup>1</sup>

<sup>1</sup> "Traveling Wave Antenna." BROADCAST NEWS, Vol. No. 94, April, 1957.



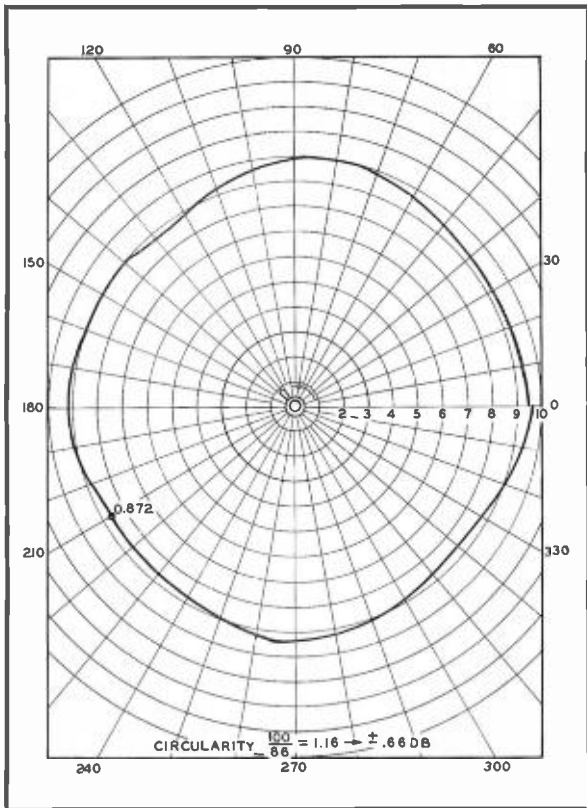

FIG. 3. Measured horizontal pattern of the Channel 8 TW antenna. Note the excellent circularity of the pattern;  $\pm 0.66$  db.

The Channel 8 antenna is 114-feet tall and weighs more than 23,000 pounds. It has been erected on a 417-foot RCA/Ideco tower providing a total elevation of more than 4,200 feet above sea level.

The horizontal and vertical patterns shown on these pages are a result of the test conducted at the RCA Antenna Laboratory in Gibbsboro. Figure 3 shows the measured horizontal pattern, which shows excellent circularity;  $\pm 0.66$  db. Both measured and calculated vertical plane patterns are shown in Fig. 5. The excellent close-in coverage characteristics of the TW-15A Channel 8 antenna can be seen here. This also reveals how closely the measured pattern coincides with the calculated pattern.

Pattern measurements at the test site have substantiated KGHL-TV's confidence in the Traveling Wave design. Circularity of pattern has been directly achieved since there are no external radiators or bulky feed systems to interfere. In addition, simplified mechanical construction has led to economical installation of both the antenna and supporting structure.



FIG. 4. KGHL-TV Manager Kiichli checks the measured patterns with E. C. Tracy, Manager, Broadcast and Television Equipment Department, and Matti Siukola, Antenna Project Engineer, prior to shipment of the equipment.

FIG. 5. Measured and calculated vertical plane patterns. Note the close-in coverage characteristics of Type TW-15A Antenna.

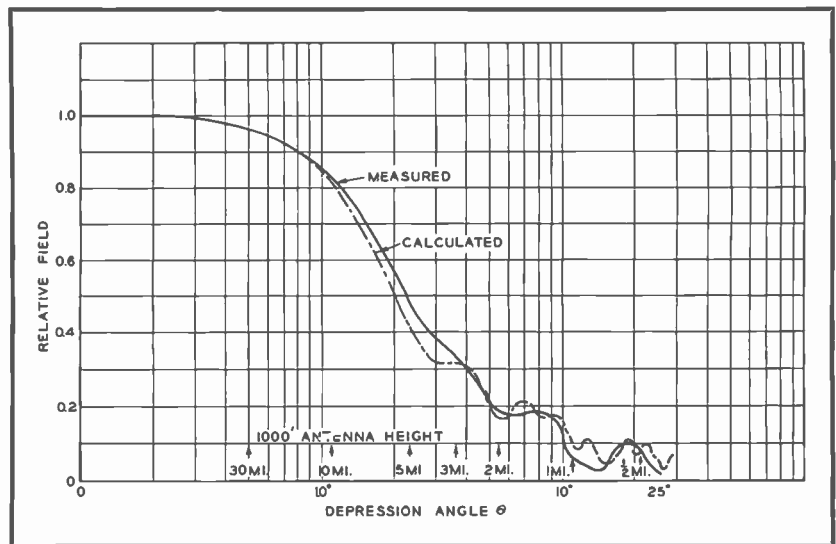



TT-25CL, 25-Kw Low-Band Transmitter

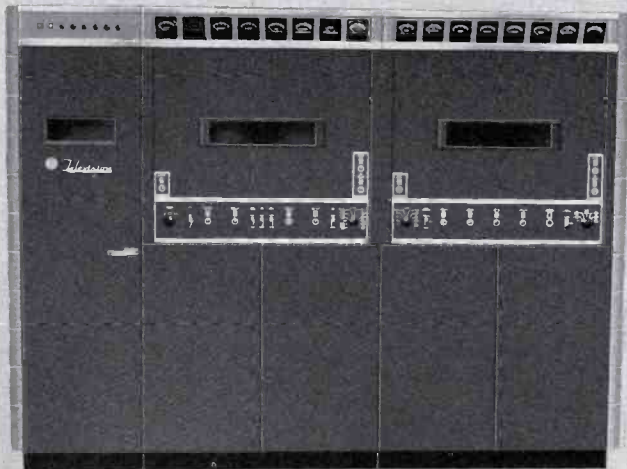
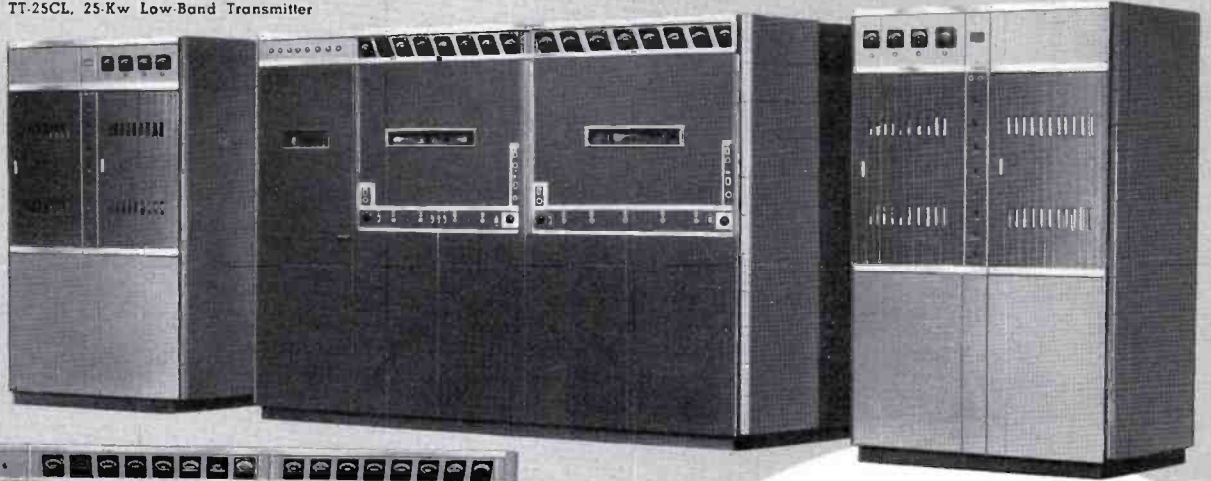

TT-6AL, 6-Kw  
Low-Band  
Transmitter



TT-2BL, 2-Kw Low-Band Transmitter

TTL-500AL/AH, 500-Watt Low  
Power Transmitter

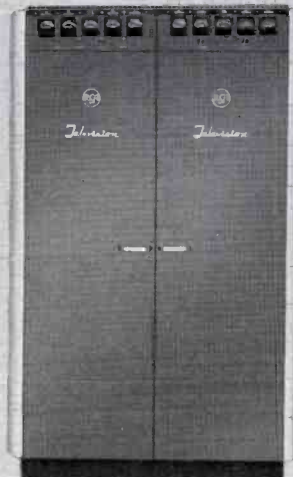

TTL-100AL/AH, 100-Watt Low Power  
Transmitter



# A NEW AURAL AND VISUAL TV EXCITER

by H. E. Small  
*Broadcast and Television Engineering*

In order to minimize the intercarrier-subcarrier beat in a television picture during color transmission, it is necessary to accurately maintain the 4.5 megacycle separation between the aural and visual carriers. This separation is automatically maintained to within a few hundred cycles by a novel frequency control circuit in a new TV exciter.

This TV exciter unit is used in the new line of RCA low-band VHF Transmitters, Types TT-2BL, TT-6AL and TT-25CL. It is also used in new low-power Transmitters, Types TTL-100AL/AH and TTL-500AL/AH. All of these transmitters are pictured at left.

A block diagram of the exciter as designed for the low channels is shown in Figure 1. Both the aural and visual oscillators operate at one-twelfth of their respective carrier frequencies, and similar multiplier chains follow each. The output amplifier at the end of each chain puts out about five watts at carrier frequency.

A new feature in the visual RF chain is the use of a spare crystal oscillator to allow remote switching of crystals without a relay in the r-f circuit. The two oscillators are identical, and both of their outputs are connected to the grid of the following stage. One of the oscillators is

biased beyond cutoff by high cathode bias while the other is oscillating. A latching-type relay, which can be operated by a switch on the exciter chassis or from a remote point, switches the bias from one oscillator to the other.

These oscillators are untuned and operate at a very low level. Hence, the frequency cannot be affected by plate tuning. The crystal heating, due to r-f current, is negligible. The crystal temperature is accurately maintained by thermostatically controlled ovens.

The aural master oscillator is of the Hartley type and is frequency modulated by means of a reactance-tube circuit connected across the oscillator plate tank. The grids of the two reactance tubes, which are connected push-pull, are excited with the r-f voltage coupled from the plate tank. The r-f voltages on the two grids are 180 degrees out of phase with respect to each other, and each is 90 degrees out of phase with respect to the oscillator plate. Thus, one tube appears as a capacitive reactance and the other appears as an inductive reactance across the oscillator tank. The magnitude of the reactive plate current in each tube will vary with the voltage applied to each respective grid, and the oscillator frequency will vary accordingly. Hence, the oscillator frequency will vary

at an audio rate when an audio voltage is applied between the two grids, and the mean frequency can be controlled by the bias voltage applied to one grid. This bias voltage is supplied by the automatic frequency control circuit.

Since both oscillators (aural and visual) operate at one-twelfth of their respective carrier frequencies, their difference frequency will always be one-twelfth of the 4.5 mc carrier separation, or 375 kc.

Therefore, a 375 kc signal is obtained by mixing signals from the two oscillators. Since one of the beating signals is frequency modulated, the difference frequency will have the same amount of frequency deviation. The deviation at this point is approximately plus and minus 2 kc for 100 percent modulation. In order to reduce this deviation to a point where it will not upset the frequency detector, the 375 kc signal is heterodyned up to 1875 kc and then divided by one hundred. The maximum deviation at the detector input is then only about 20 cycles per second, and the mean frequency of 18.75 kc is still high enough to permit use of tuned circuits using fairly small components.

If the crystal oscillator which supplies the reference frequency is also used as the heterodyne oscillator, any frequency drift in the crystal will cause both signals feed-

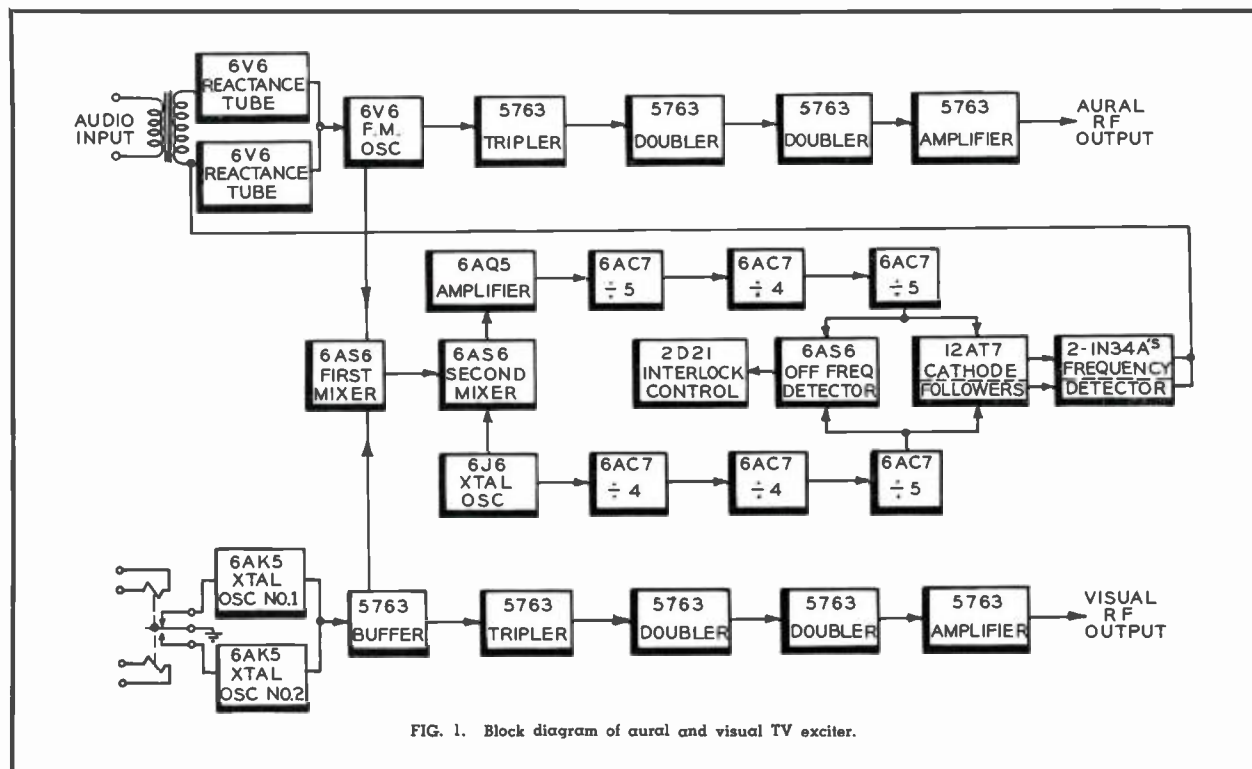

FIG. 1. Block diagram of aural and visual TV exciter.

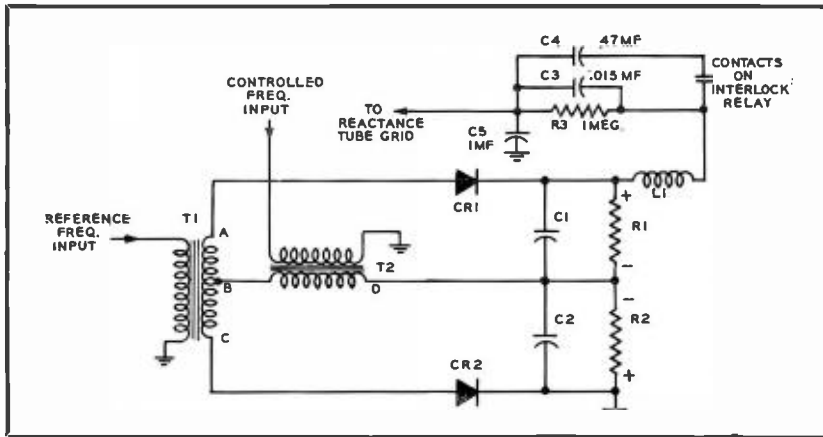

FIG. 2. Schematic diagram of the detector circuit.

ing the frequency detector to drift in the same direction. If separate oscillators were used, they could drift in opposite directions, and the resultant error could be 9 times as great for the same crystal tolerance. However, in order to take advantage of this feature, it becomes necessary to divide the crystal frequency down from 1500 kc to 18.75 kc for comparison in the frequency detector. This is a division of eighty and is accomplished in three stages similar to those which give a division of one hundred in the other divider chain.

The heart of the frequency control system is the frequency detector circuit which compares the controlled frequency signal with the reference frequency signal and produces a d-c voltage of the proper magnitude and polarity such as to maintain the controlled signal at a constant frequency. A schematic of the detector circuit is shown in Figure 2.

In the first analysis of the circuit, it will be assumed that the f-m oscillator is exactly on frequency with no correction

bias applied to the reactance tube grid. Under this condition the two input frequencies are the same and the circuit functions as a phase detector. Figure 3(a) shows a vector relationship of the voltages applied to the circuit under these conditions. The reference frequency signal is applied to T1, and the voltage developed across the top half of the secondary is represented by vector BA, while the voltage developed across the lower half is represented by vector BC. The two voltages are equal in magnitude and 180 degrees out of phase.

The controlled frequency signal is applied to T2, and the voltage developed across its secondary is represented by vector BD. This vector is 90 degrees out of phase with each of the other two. The voltage impressed across each crystal rectifier (CR1 and CR2) and its associated load (R1 and R2) is then the vector sum of the series voltages, E1 and E2 respectively. Since the magnitudes of E1 and E2 are equal, the d-c voltages developed across

R1 and R2 will be equal and of the polarity shown in Figure 2. Hence, the voltages as measured from the top of R1 to ground will be zero.

If the master oscillator frequency begins to drift because of a temperature change or component aging or for any other reason, the relative phase of the two input signals to the detector will change. Figure 3(b) shows the vector relationship of the signals when the master oscillator frequency has started to decrease. Since the magnitude of E1 is now greater than E2, the d-c voltage across R1 will be greater than that across R2 and a net positive voltage will result from the top of R1 to ground.

This positive voltage, when applied to the reactance tube grid, will change the reactance across the oscillator tank so as to maintain the same center frequency. The phase relationship remains as shown in Figure 3(b) maintaining the corrective bias at the proper value.

Figure 3(c) shows the vector relationship of the detector voltages when the master oscillator frequency has tended to increase. The voltage across R2 will now be greater than that across R1 and the net voltage applied to the reactance tube grid will be negative.

The operation of the circuit shown in Figure 2, is merely that of a conventional phase detector; and as would be expected, all possible combinations of the input frequencies will be found at the output. The high frequency components are filtered out by capacitors C1 and C2 and choke L1. The RC filter, consisting of R3 and C5, prevents the difference frequency components from being fed back to the reactance tube grid.

The phase detector as described above is limited in operation to a phase differ-

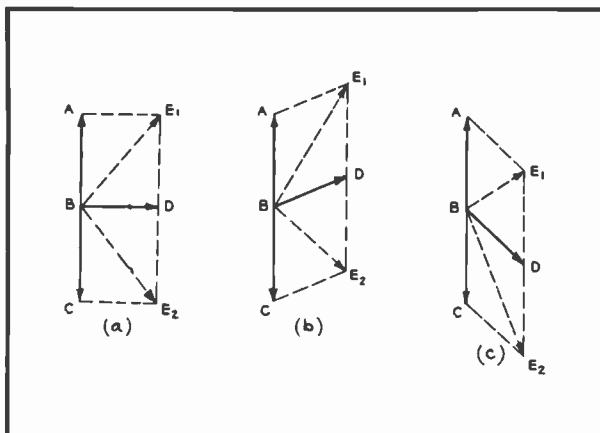

FIG. 3. Vector representation of frequency detector signal voltages.

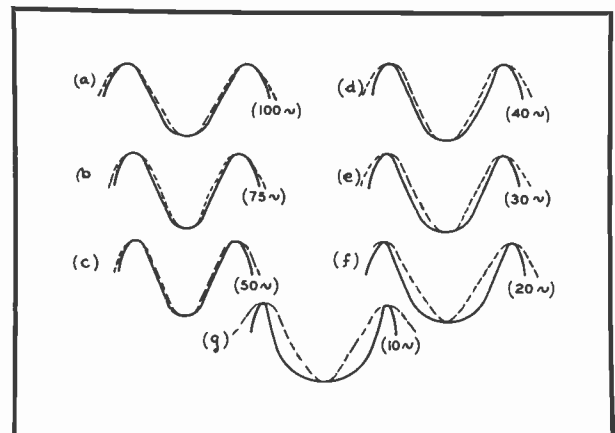

FIG. 4. Frequency detector output waveforms at various beat frequencies.



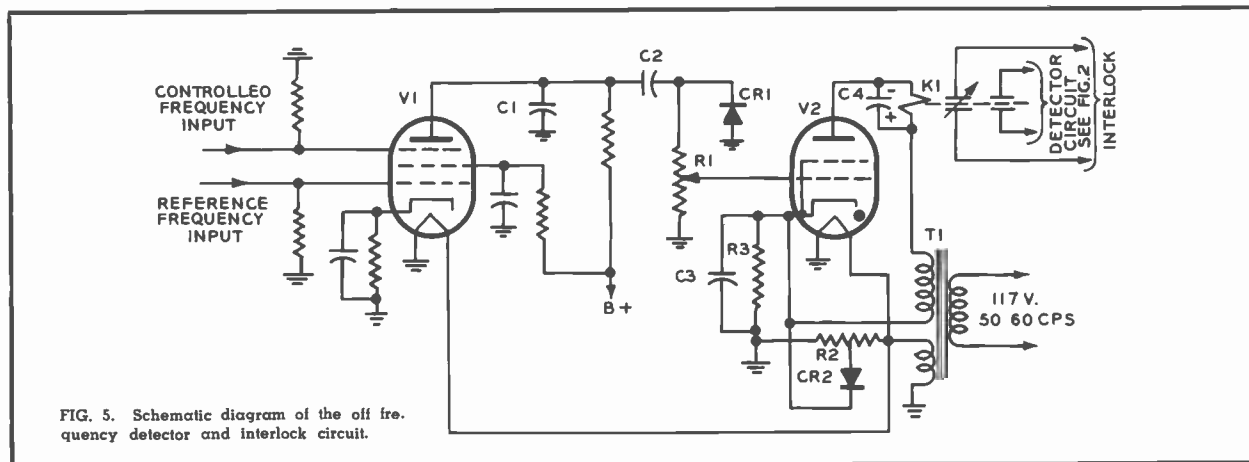

FIG. 5. Schematic diagram of the off frequency detector and interlock circuit.

ence between the two signals of plus or minus 90 degrees. This is equivalent to only a few hundred cycles change of the master oscillator frequency. This means that the circuit would have a very limited pull-in range and that the master oscillator would have to be manually adjusted each time it was turned on from a cold start. This obstacle is overcome by the addition of a capacitor (C3) across resistor R3. This changes entire operation of circuit.

A capacitive voltage divider consisting of capacitors C3 and C5 across the detector output allows a small amount of the beat frequency to be fed back to the reactance tube grid. This beat frequency signal then causes the master oscillator frequency to swing in both directions at the difference frequency rate. The amount of frequency deviation is proportional to the amplitude of the signal at the reactance tube grid; and in order to produce sufficient swing without objectional audio frequency feedback, capacitor C3 is made small and is paralleled by a larger capacitor C4 which is switched in only when the master oscillator is hunting. The switching is done automatically by the off-frequency interlock circuit to be described.

If the signal at the reactance tube grid is sinusoidal, there will be no d-c component and the mean frequency of the master oscillator will remain unchanged. However, the beat signal at the frequency detector output, when it is not locked in, is non-symmetrical and has a d-c component of the proper polarity to change the mean frequency of the master oscillator toward its correct frequency.

To illustrate how the non-symmetrical waveform is developed take an example in which the master oscillator is 10 kc low when the power is applied to the equip-

ment. The signal applied to T2 (Fig. 2) will then be 0.1 kc low and a difference frequency of 0.1 kc will be fed back to the reactance tube grid.

The master oscillator will then swing above and below the tuned frequency one hundred times per second. The dashed line curve of Figure 4(a) is the waveform of the beat frequency which would appear at the junction of L1 and R3 if C5 were shorted. If this waveform were fed back to the reactance tube through a blocking capacitor, the solid line waveform would appear at the same point. Note that the solid line waveform is slightly distorted so that its axis no longer represents zero d-c voltage.

The positive peak of the solid line waveform in Figure 4(a) is produced as the master oscillator frequency swings further away from its frequency, and the negative peak is produced as it approaches its correct frequency. As the controlled frequency approaches the reference frequency, the beat becomes increasingly slower, and the distorted waveform is produced. The d-c component produced across C5 is of the polarity such as to change the master oscillator frequency toward its correct frequency.

Figures 4(b) through 4(g) are the same as Figure 4(a) except for the frequency of the beat. Note that the beat frequency becomes lower and lower, the distortion becomes greater and greater producing a correspondingly increasing d-c component. The waveforms shown can be produced by blocking the d-c component from the reactance tube and by tuning the master oscillator for the desired beat frequency. However, when the d-c component is fed to the reactance tube grid, the beat frequency automatically decreases until it is

zero. The system is then "locked in" and the d-c voltage maintains that condition.

A schematic of the off-frequency detector and interlock circuit is shown in Figure 5. Stage V1 is a mixer which is fed from the last divider in each of the two chains. When the aural master oscillator is on frequency, both input frequencies will be 18.75 kc. The plate load of the stage is by-passed by capacitor C1 which is a low impedance to the beating frequencies and their sum. Since the difference frequency is zero, there will be output from the stage.

If for any reason there is a difference between the two beating frequencies, the difference frequency component will appear across the plate load and will be rectified by crystal CR1. A positive d-c voltage will then appear across resistor R1. If this voltage exceeds the fixed cathode bias applied to the thyatron V2, the tube will conduct and relay K1 will be energized. One set of contacts on K1 is in the transmitter interlock circuit and prevents plate power from being applied to stages following the exciter unless the AFC circuit is locked in. Another set of contacts is used to switch in the capacitor (C4 of Figure 2) previously mentioned.

In practice R1 is a fixed voltage divider and the sensitivity of the circuit is controlled by the bias adjustment R2. This adjustment is set so that the low modulating frequencies will not trigger the thyatron, but so that any difference in the beating frequencies will cause it to fire. Under these conditions it is not possible to radiate an aural signal which is off frequency.

The author wishes to thank Mr. Nils J. Oman for his contributions to this article. Messrs. Oman and Joseph G. Beard are co-inventors of the frequency control circuit described herein.

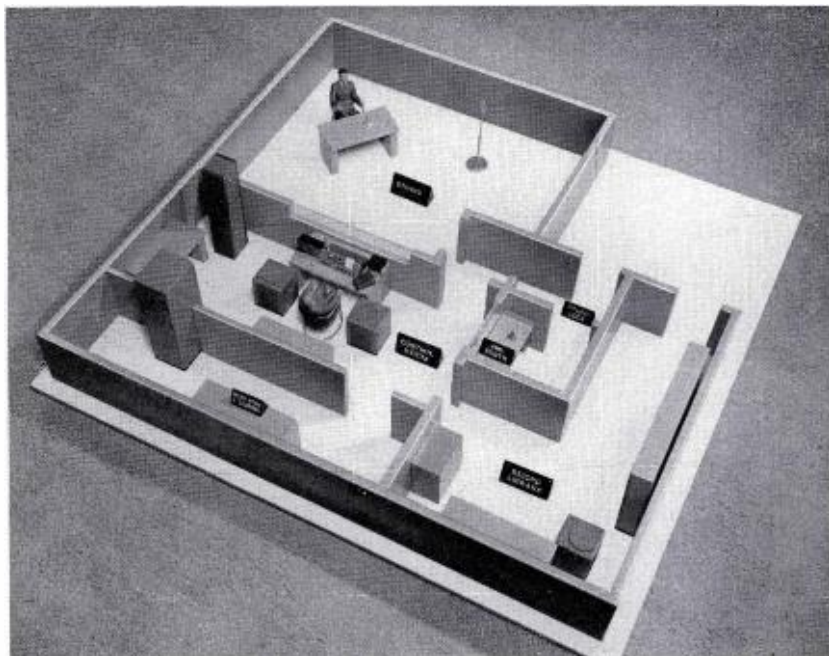

FIG. 1. This is Plan "B," one of the three basic plans. It is designed for the community-type radio station.

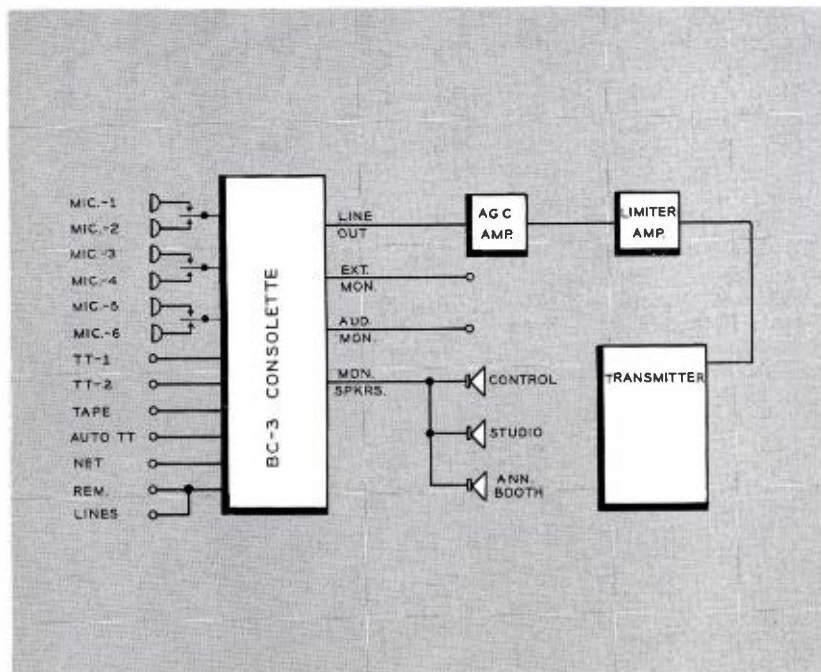

FIG. 2. This is a simplified block diagram of Plan "B" showing how the system goes together.

# Planning

## PART THREE:

This article is the third in a series of planning articles, and is designed to help the broadcaster become familiar with accepted installation practices and maintenance procedures. Part I of the series covered three basic plans for a radio station while Part II covered the transmitter and building requirements. Installation and maintenance logically follow as a part of the task of putting a station on the air and keeping it there.

Installation procedures are of importance to the broadcaster, because the quality of the installation is directly related to the quality of performance. A careless installation will result in poor performance regardless of the quality of the equipment purchased.

Maintenance, likewise, is a very important part of a station's daily operation. A careful preventative maintenance schedule will increase equipment life, and longer equipment life will produce a greater return on the investment. It might be noted here that the quality of the equipment selected will also have a great effect on its life expectancy.

### Installation

It must be recognized that installation is an area wherein the approach will vary with the station plan, local conditions, etc. The advice of an engineering consultant is a necessity during planning and installation. In this discussion no attempt will be made to fix hard and fast rules, but an

# a Radio Station

## Suggested Installation and Maintenance

### Procedures for Transmitter, Antenna, and Studio Equipment

outline of suggested procedures and practices, based on experience, may be used as a guide.

Plan "B" is used as an example in this article, because it is an intermediate sized installation. It will be well to review this plan referring to Figs. 1 and 2. This is a combination studio and transmitter operation. It could be either directional or non-directional, because both types of antenna systems will be considered.

Installation will proceed much more rapidly when performed in a systematic order. Installation can be scheduled as follows: building, tower foundations, tower erection, tower lighting equipment, copper ground system, inside technical equipment, outside technical equipment, antenna resistance measurements, equipment tests, tune-up of phasing equipment, pattern measurements of directional antenna systems, proof of performance, and program tests. Some of these steps may be done concurrently but all should be planned and performed in an orderly manner, so that installation will proceed smoothly.

#### Installation Procedure

All details of the building plans should be complete before installation begins. The equipment should be ordered and contractual details with the supplier consummated. A delivery schedule should be worked out with the supplier.

The construction work can then begin. At the outset, materials should be released

for shipment: first the foundation material for the tower, following that a release of the tower itself, then tower lighting equipment, and finally the copper screens, strap and wire for the ground system. Upon the arrival of these items the installation of the antenna system can begin.

The specific location of the building and the tower should be precisely designated by the consultant, and should be confirmed by a surveyor in accordance with the location specified on the construction permit. In many areas a special building permit will be required for the tower. Certainly the building construction should follow accepted standards and should observe local building ordinances and codes.

Here are a few construction suggestions, that apply to radio broadcast stations. It is good practice to make sure that all conductive metals utilized in the station, such as duct work, conduits, steel lintels, metal window frames, etc., are all bonded together and securely connected to the station's ground system. If air-conditioning is used, zoning of the system should be utilized because of the diversified requirement for the various areas. Proper ventilation and cooling should be provided for the technical equipment. Areas that are sound-proofed, such as studios, should be well ventilated.

#### Tower Foundations

Naturally the tower foundations are first, and the foundation requirements for

a specific tower will vary with local soil conditions. Generally, standard foundation specifications for a given tower will be supplied by the manufacturer. They will be based on normal soil conditions. Normal soil should have an allowable pressure of not less than 4,000 lbs. per sq. ft. The soil should not require blasting, cribbing, or filling and obviously sand, swamp, mud, rock, or frozen ground can not be called normal.

If there is a possibility that the soil is not normal, consult the city or county engineer who may have the necessary information. If this information is not available, then test borings should be made to obtain an accurate soil analysis. Then foundations can be designed to satisfy the condition of the soil. This is a worthwhile safety measure.

The foundations may then be put in according to the manufacturer's specifications. After the concrete foundations are poured, ample time should be allowed for the new concrete to cure. The required curing time will vary with local weather and ground conditions. This requirement does not necessarily slow progress; during this period the tower sections can be painted, and the insulated guy wires can be fabricated. The tower lighting kit can also be prepared for installation. Care should be taken that CAA lighting regulations are observed during construction.



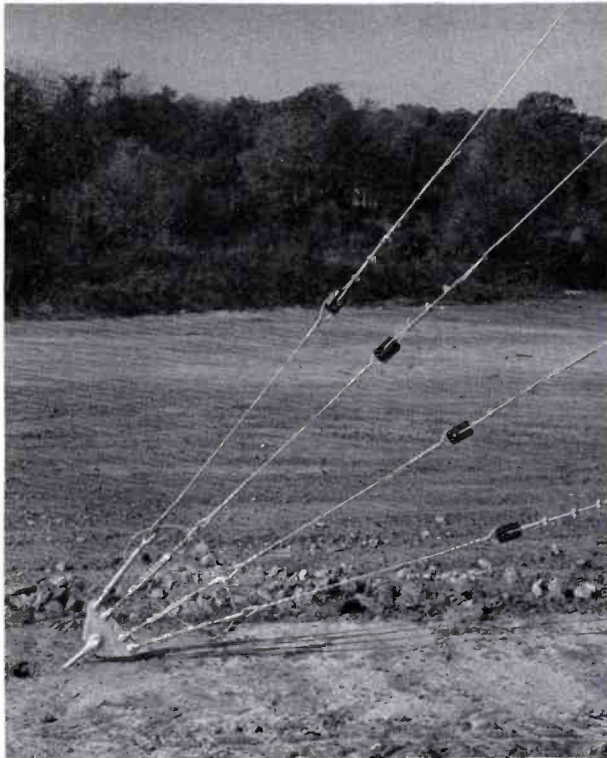

FIG. 3. This shows the details of assembly at a ground anchor point. Note how the guy wires are served, the location of the insulators, and the way a cable is looped through the turnbuckles to prevent them from turning.

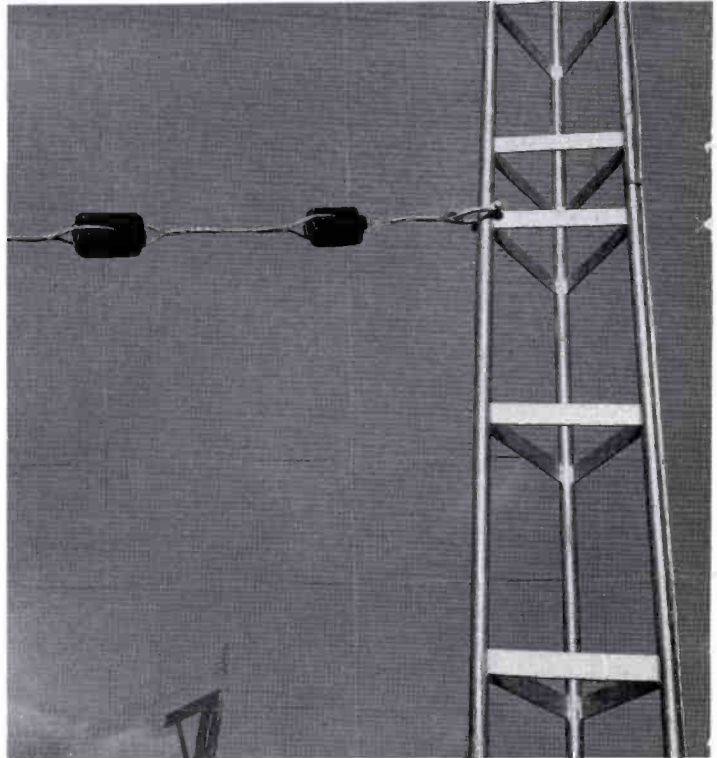
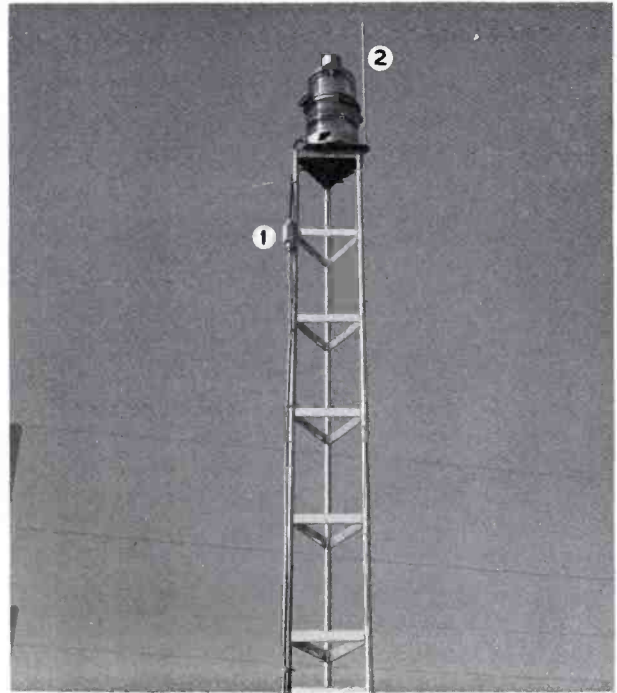

FIG. 4. A typical guy point assembly; note how cable is served and use of clevis and thimble at pull-off point. At this point larger insulators are used to increase the leakage resistance between guy wire and tower. This reduces the hazard of static discharge from guy wire to tower.

FIG. 5. Two sections of tower are being bolted together. The joint should provide electrical continuity as well as structural strength.



FIG. 6. A typical 300mm beacon installation. Observe the location of the junction box (1) and the lightning rod protector (2).



### Tower Erection

The tower, guy wires, etc., should all be assembled in accordance with the manufacturer's specifications. Many times there are certain practices that creep into the erection process, that come from personal opinion, or an expeditious method. These are not always sound, and should not be accepted unless a thorough check is made with the supplier. As time goes by, new techniques in tower design and assembly principles come along, based on experience and sound analysis; such as: tower members vs. windload presented, the number and size of guy insulators, the use of clevises vs. the guy wire through the insulators, the use of guy clips vs. serving of the cables, etc. Figures 3 through 7 illustrate techniques that are very acceptable. But again let a reputable consultant decide what is best for a particular installation.

### Tower Inspection

An inspection should be made after the tower is erected. Here are some of the things that should be observed:

1. Make sure that all joints of the tower structure are electrically continuous. With galvanized welded towers fabricated in sections then bolted together at the section joints, be sure that there is no paint between the joints, and that the bolts are pulled tight. If it is a non-galvanized tower it must be painted between the joints and a tack weld should be made across the joints to insure electrical continuity.
2. Painting and lighting must be in accordance with CAA requirements, as specified on the Construction Permit.
3. Check for any unpainted spots on the tower, where the paint may be chipped off or a new weld has been made. These should be painted as soon as possible.
4. See that the lighting circuits operate properly. Make sure that the lighting cable is securely fastened to the tower in accordance with the specifications. Make sure that all junctions are weatherproof.
5. Make sure the tower is plumb, and that guy tensions are uniform.
6. The guy wires at the guy anchor points should be grounded securely.

FIG. 7. This is a typical insulated tower base showing the lightning protector horn gap. The gap should be adjusted so that a surge of lightning will arc over—but not modulation peaks.

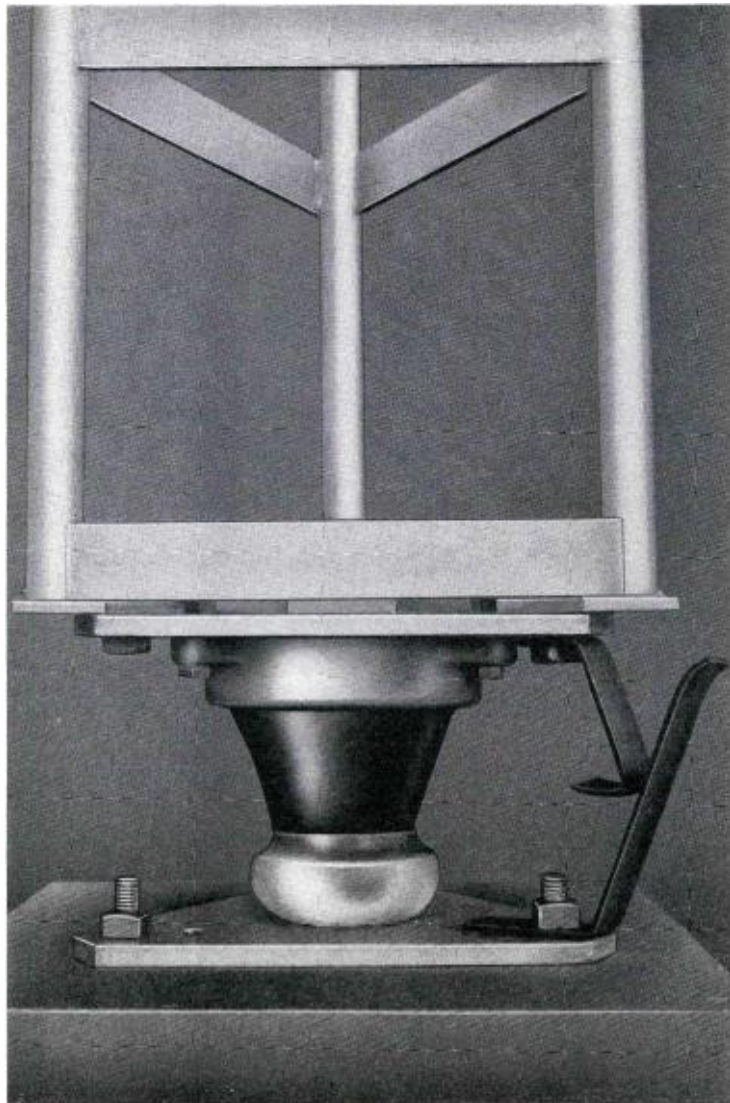

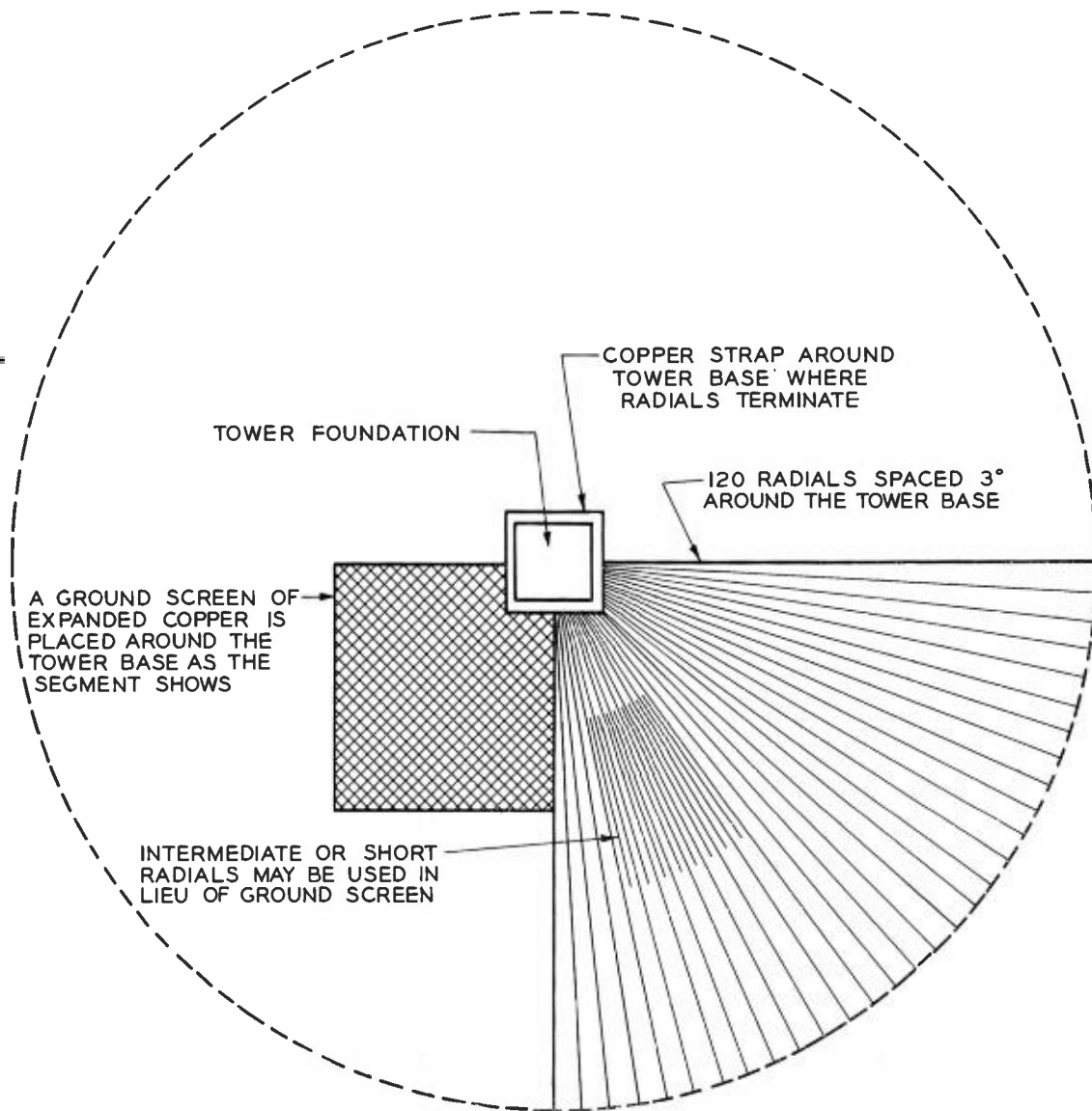

FIG. 8. A typical ground system constructed about the antenna. Radials are placed around the base of the tower to form a complete circle. A ground screen is positioned all the way around tower base. (Note: drawing shows radials and ground screen in only one quadrant, whereas both actually go completely around tower.)



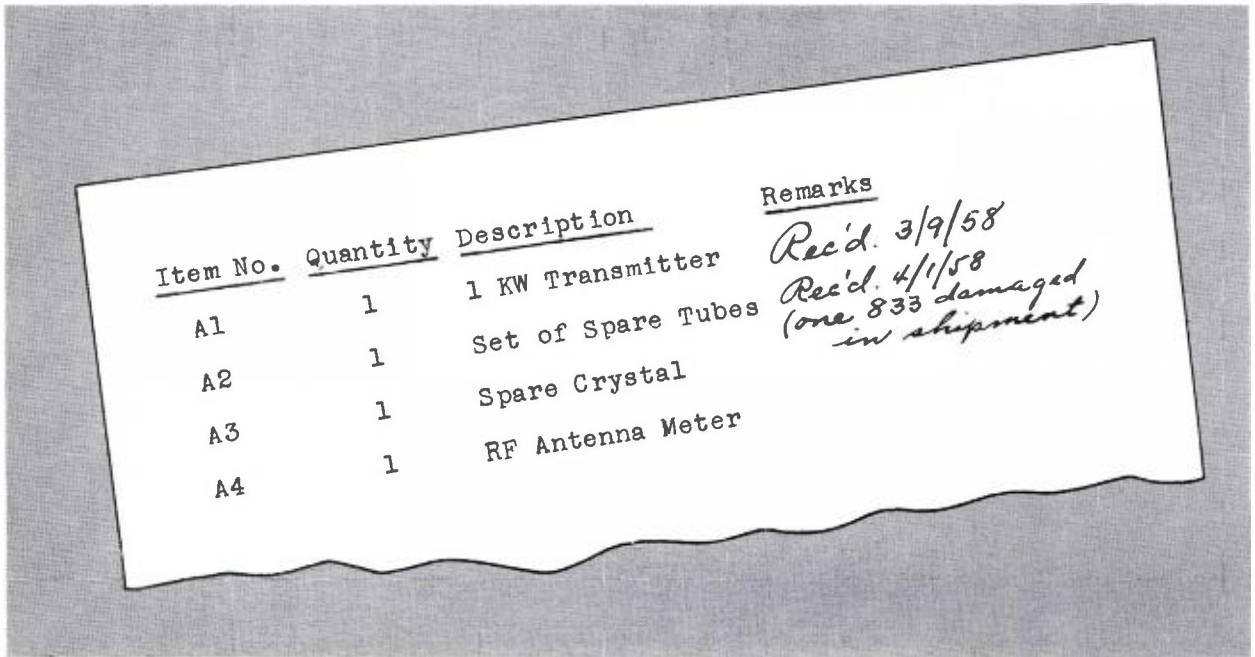

FIG. 10. This is a sample of a typical equipment list. As equipment arrives it is checked with the list, and any missing or damaged items are noted.

### Receiving the Equipment

As the building nears completion, the rest of the equipment should be released for shipment. Allow ample time for delivery. In purchasing a complete station, it should be recognized that it is only complete when it is all put together. Its completeness is made up of many items ranging from a terminal board to a transmitter.

Equipment should be received in an orderly manner, and it is well to establish a systematic procedure for checking the equipment as it arrives. At this time, a complete equipment list should be prepared from the contract in the suggested form shown in Fig. 10.

In this manner there will be a running record of receiving dates, and one can quickly determine any missing items, and also note any shipping damage, etc. This record will provide an easy reference at all times. Carefully unpack all equipment as soon as it arrives, and check each part with the packing sheets. Do not discard any packing materials until everything has been checked. By following this suggestion the chance of throwing away any parts will be eliminated. Any shipping damage or shortage should be noted immediately, and should be reported at once to both the supplier and the carrier.

### Installing the Transmitter

Carefully unpack the transmitter, and make a thorough check with the packing sheets. *Identify each item.* Several of the heavy components will have been removed from the transmitter for shipment, along with the tubes, frequency-determining parts and certain power-determining components, and these should now be installed in the transmitter.

Position the transmitter in the desired location and assemble it following the instructions supplied with the unit. *Be sure to read the Instruction Book.* Regardless of how many transmitters one has installed, experience reveals that 95 per cent of the delays in achieving transmitter performance results from failure to comply with the specific instructions supplied with the equipment. Furthermore, *make sure that any addendas are observed.* Addendas are very important because they usually reflect changes that result from field experience with the equipment. After the transmitter is assembled, make a check to be sure that all instructions have been faithfully followed.

### Transmitter Input and Monitoring Equipment

This equipment should be installed at the same time the transmitter is installed,

the most important items being the frequency and modulation monitors—and the phase monitor if a directional antenna system is used. This group of equipment would also logically include the limiter amplifier, jack panel, house monitor amplifier and switch and fuse panel (see Fig. 16). A look at the Plan "B" block diagram, and a careful study of the instruction book supplied with each equipment item should supply sufficient practical guidance to make the units operational. Beyond that, sound wiring practices must be observed. This may be a good place to note that a good station ground must be established. The transmitter and all other station equipment must be connected to it via copper strap or heavy copper bus wire.

### Transmission Line

Erection of the tower and the basic installation of the transmitter have now been covered. At this time they should be connected. There are several ways to do this, but only the two most commonly used systems will be considered—(1) a non-directional series fed antenna system and (2) a directional antenna system. A coaxial transmission line is commonly used to make the connection.

### Ground System Installation

The ground system is a very important part of the antenna system, but it is sometimes neglected. The actual length and number of radials, along with the size and shape of the ground mat, located around the tower base, should be determined by the consultant. Typical ground system drawings are shown in Figs. 8 and 9. Proper electrical bonding of the ground screen and the radials around the tower base is extremely important. If the transmitter building is located close to the tower, or within the circumference of the ground system, a copper bus or strap should go around the building at the foundation with all radials approaching the building bonded to it. If a multiple tower installation is utilized, bonding is required between the individual ground systems. All bonding should be made with silver solder or bronze weld.

The ground system radials should normally be buried just below the surface of the ground, and they should be deep enough to protect them from mechanical damage. Exact depth will depend on local conditions and should be indicated by a consultant. Like foundations, ground systems require good soil conditions. Radials are normally installed with machinery; therefore, the ground should not contain rocks, tree stumps, or other obstructions. Frozen ground is not suitable. The radials should lie in a straight line from the tower base, thus there can be no obstacles in the area of the ground system. The ground screen can be installed essentially at the surface; however, it should be deep enough to protect it from any mechanical damage.

Until RF is fed to the tower, a temporary ground should be connected to the

tower itself. This will minimize the possibility of damage during the construction period due to a static charge build-up on the guy wires, or due to lightning during the construction period.

If it is a shunt-fed tower, a permanent ground should be made at the base of the tower with heavy copper cable or strap to the ground system. However, if the tower is series fed, the temporary ground must be removed from the tower, and a permanent ground should be made to the bottom of the base insulator. The lightning protective ball gap or horn gap supplied should be properly adjusted following the recommended procedure of closing the gap to about  $\frac{1}{4}$  to  $\frac{1}{8}$  inch. With this adjustment, a surge of lightning will arc over the gap, but there will be no arc on modulation peaks.

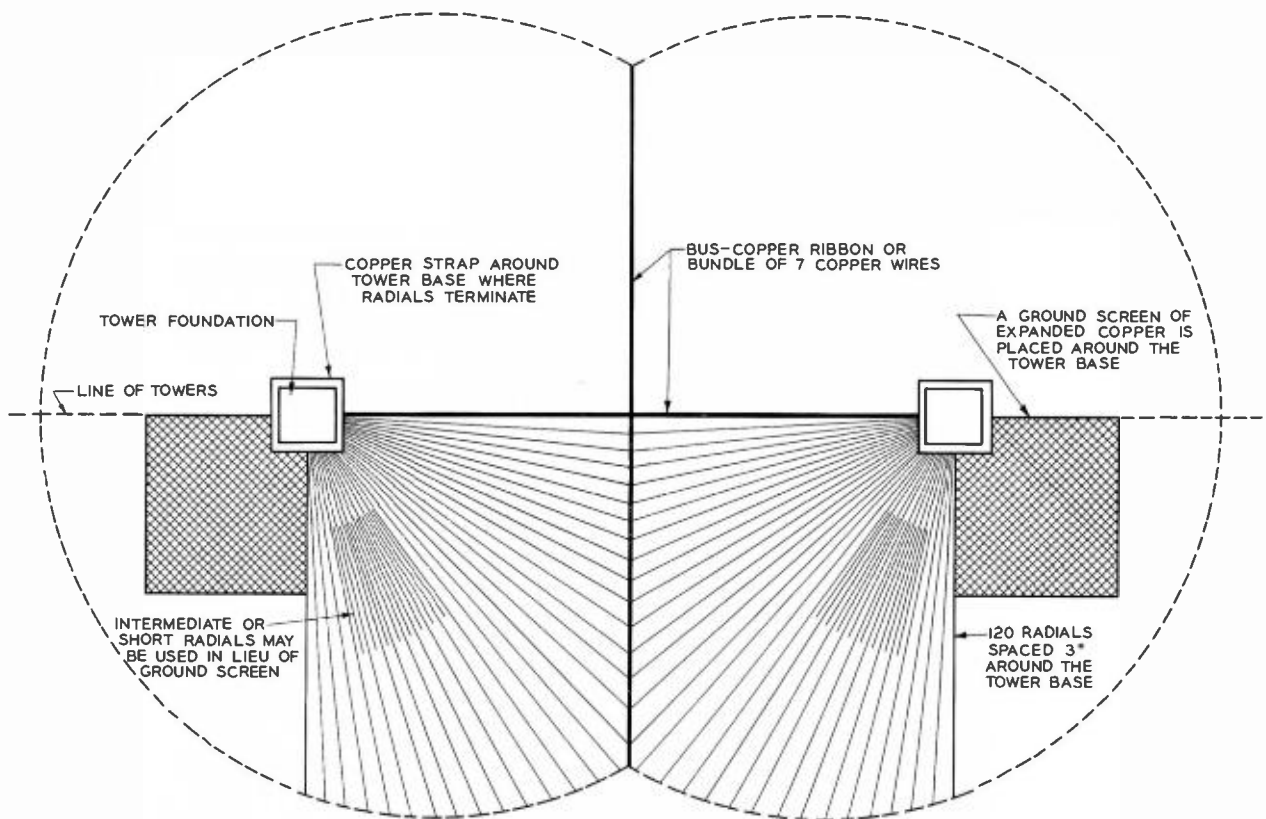

FIG. 9. This shows a ground system for a two-tower installation. Note that the radials from each tower are bonded together where they meet. The two-tower installation is the same as the single tower except where the radials meet.

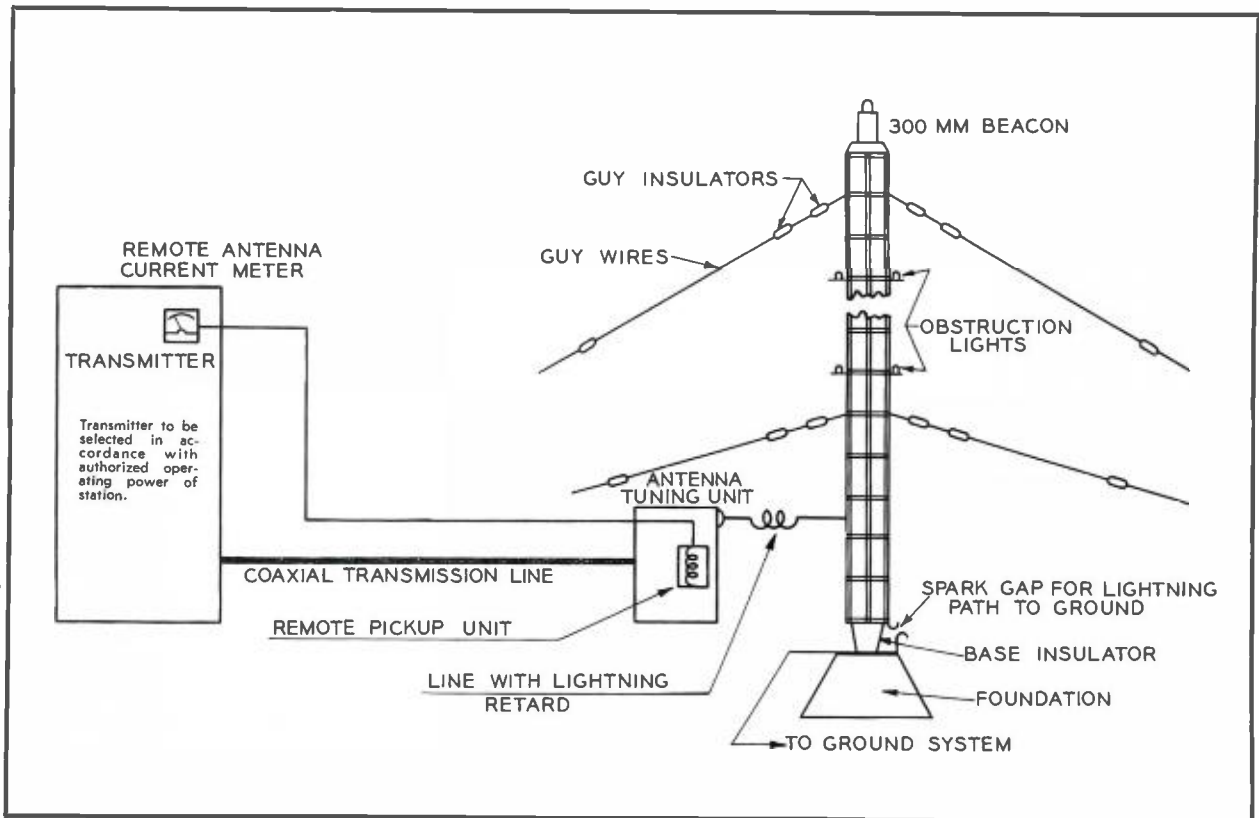

FIG. 11. This is a typical single tower system. Note how the remote antenna current is measured at the transmitter, and also observe the position of the tower lights.

### Non-Directional Antenna

Let us, at this point, consider the connecting of the transmitter to a non-directional, series-fed antenna system, using coaxial transmission line and a line-terminating unit. (See Fig. 11.) Regardless of the type of coaxial line selected, the procedure is basically the same. It is good practice to run the line up through the bottom of the transmitter cabinet to the proper terminal points. (A word of caution—make sure that both the inner conductor and outer conductor of the line are securely connected to the proper terminals.) Then the line should leave the building through a wiring trench. At this point a decision has to be made: is the transmission line to be run to the tower underground, or above the surface on supporting posts? (See Fig. 12.) The consultant will determine which is best. If it is decided to make the run underground, be sure that the type of line selected is recommended for that application.

Then comes the installation of the line terminating unit, sometimes referred to as the antenna tuning unit. It is a network

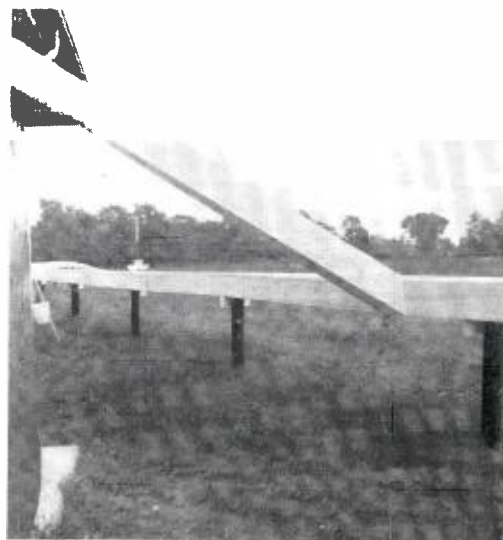

FIG. 12. This is a typical wiring trough that carries the transmission line from the transmitter to the antenna tuning unit.



designed for the purpose of matching the transmission line to the tower. (See Figs. 13 and 14.)

Now would be a good time to measure the radiation resistance of the tower. An RF bridge is required for this measurement. It is also a good time to tune up the line terminating unit, and though not absolutely necessary, in most cases it would be wise to set up the output network on the transmitter while the RF bridge and associated equipment are available.

When all of the foregoing steps are completed, make a run-through on the transmitter tuning procedure, with power off. Become familiar with all of the adjustments and controls. If a dummy antenna load is available, the transmitter should be operated into it. If not, the next step would be to obtain permission from the FCC to conduct equipment tests (check with the consultant for procedure). Then proceed with tune-up and test operations, in accordance with FCC regulations, feeding power to the antenna system.

The transmitter input and monitoring equipment should be installed for the initial tests to comply with FCC test regulations. The installation of this equipment will be covered subsequently.

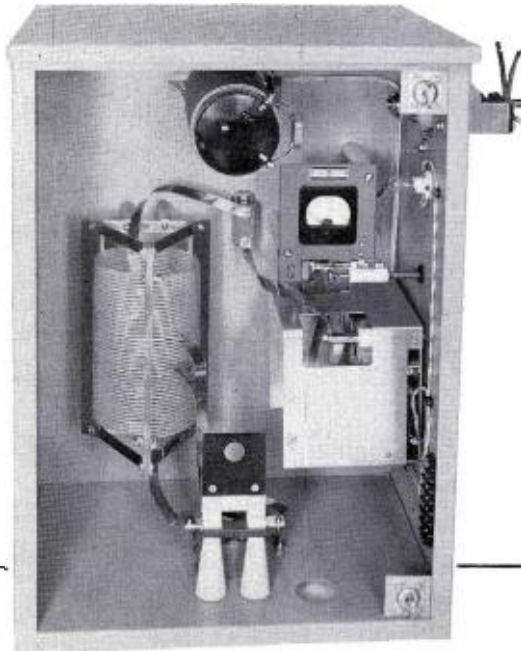

FIG. 13. This is the BPA-21D antenna tuning unit; it is usually located at the base of the tower. The lighting choke coil is shown in the top center of the cabinet.

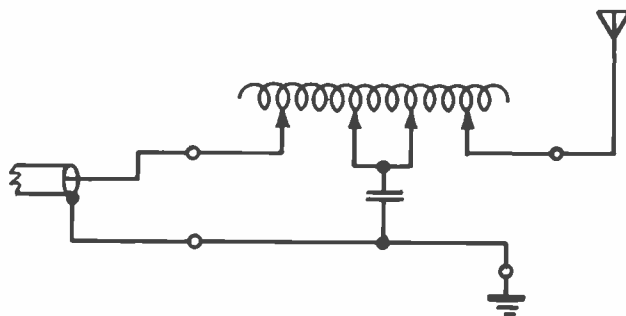

FIG. 14. Simplified schematic diagram of tuning unit shown in Fig. 13.

#### Directional Antenna

With a directional antenna system, a different procedure is followed. The transmission line will first be connected to a phasing and branching cabinet. Generally the connection is made across the top of the phasing and branching cabinets. More than one coaxial line will be going out to the line terminating units, to the multiple tower array (see Fig. 15). The same procedure for running the multiple transmission lines to the towers apply, for both directional and non-directional systems. However, it now becomes necessary not only to determine the towers' resistance and adjust the matching networks, but to make the proper adjustments on the phasing and branching equipment. This is all a part of "tuning up the directional." This should only be attempted by highly qualified personnel or the consultant, because it is a job that requires skill and an intimate knowledge of "directional systems."

Many precise field measurements will be required to determine the actual radiation pattern. It must match the pattern specified on the construction permit. All of these latter measurements will be made with the transmitter in operation, in accordance with FCC regulations governing equipment tests.

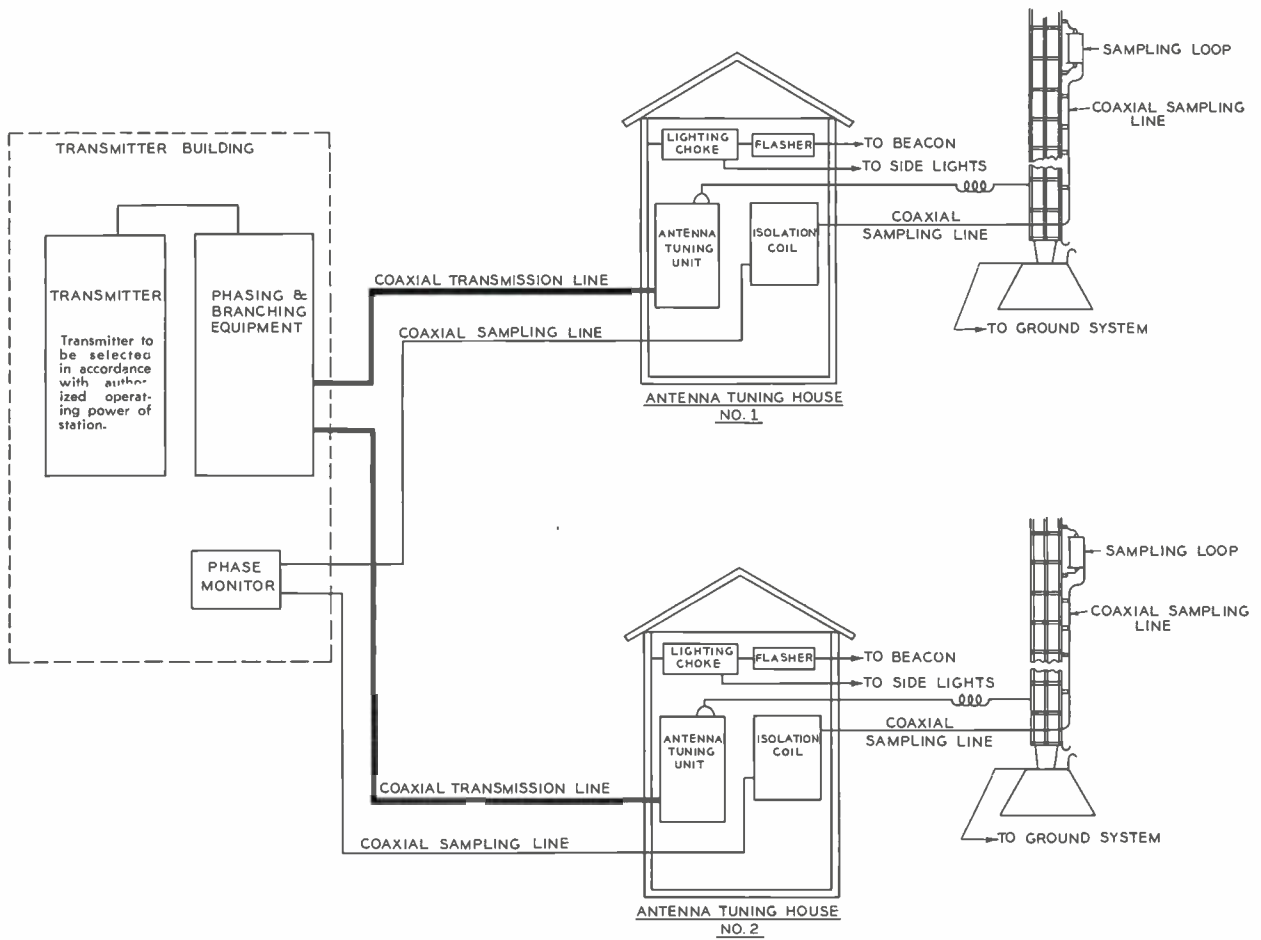

FIG. 15. This shows how the phasing and branching equipments are used to feed a two-tower directional antenna system.

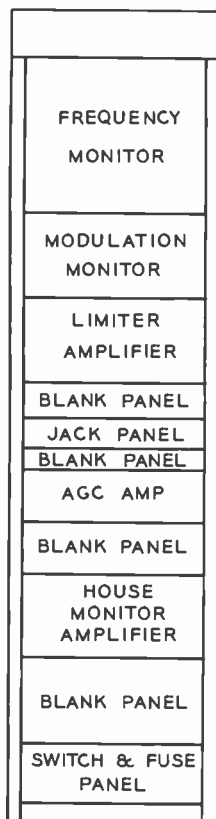

FIG. 16. Equipment rack layout for Plan "B."

### Control Room and Studio Equipment

The major items in this group would be the console, turntables, monitor speakers, microphone cables and connectors, and the AGC amplifier. Jack panels, terminal blocks, on-air lights, attenuation pads, etc., also became a part of it. Review Plan "B" diagrams again (Figs. 2 and 16), and associate the equipment items with it. Study the Instruction Book with the equipment at hand, become familiar with the proper terminal designations and adjustment procedures.

The console is the heart of the control system, and a common but important practice should be observed in keeping any leads carrying AC well-separated from the audio wiring. High-level audio wiring should be separated from the low-level audio wiring, for example, monitor output wiring should not be cabled with microphone wiring.

The turntables are perhaps next in importance, because in most stations they are the major source of program material. Install the pickup arms, pickups, and the equalized preamplifier carefully. Be precise

in making the required adjustments. In days gone by this was not too important, but today the use of micro-groove records, 1 mil styli, very lightweight tone arms, lower recording levels, and the necessity for high quality reproduction makes turntable equipment assembly a very important and delicate operation. Treat them accordingly. All components of the assembly should be properly grounded to the station ground.

Microphone cable runs are sometimes a source of concern, but not if the proper type of cable is used and certain precautions observed. First of all, two or three conductor shielded cable should be used, and the shield be covered (insulated). The shield should be grounded at one point only, and that is as near to the input of the associated preamplifier as practical. (See Fig. 17.) If a third conductor is used, it should be connected to the third pin of the microphone receptacle, but the shield should not. The third conductor should then be tied to the shield, at the preamplifier ground point (see Fig. 18 for details).

### Importance of Maintenance

Much improvement has been made over the years in the reliability of broadcast station equipment. With this improvement has come a tendency to sheer neglect of good maintenance practices. A preventative maintenance schedule should be established and adhered to, just as you would maintain

a fine automobile by performing regular maintenance services. The purchase of broadcast station equipment represents a substantial investment, and a reasonable annual expenditure for good maintenance will sustain the value of the investment.

The appearance of building and grounds is usually a clue to the kind of maintenance the equipment is receiving. Dirt is the major enemy of electronic and electrical apparatus. A visit to a local power plant or telephone exchange will demonstrate the importance attached to cleanliness where electrical devices are utilized. A clean, well-kept station also makes it an asset to the community. Furthermore, this contributes to the morale of the employees, and they will attach more significance to their jobs.

### "Demon Dust"

The number one enemy of equipment is the innocent little dust particles that sift in, collect, and form hazards. Dust can prevent proper heat dissipation, change electrical value of components, cause arcing or burning across high voltage points. (Many station fires have been started in this way.) They prevent proper electrical contact of relays and switches. Dust filters are provided on most transmitters, yet they are somewhat limited in their effectiveness. Wherever practical, the air brought into the building should be filtered; in extremely dusty areas, the use of precipi-

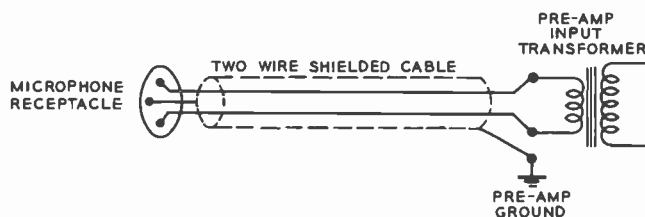

FIG. 17. At one end the shield is connected to the third pin on the microphone receptacle, at other end the shield is connected to the preamplifier ground.

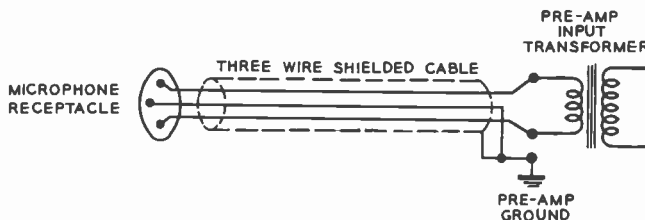

FIG. 18. A typical three-wire microphone circuit. Observe that the third wire is connected to the third pin on the microphone receptacle and that the third wire is grounded with the shield at the amplifier.



trons should be considered. Any improvement in dust elimination will certainly contribute to the improved reliability of the equipment.

#### Maintenance Suggestions

Here are some general maintenance considerations. Wherever air filters are utilized, they should be cleaned or changed at regular intervals. Routine visual inspection should be made. Note any loose connections, especially where screw type terminals are used, because they sometimes loosen with vibration. Look for any components that are changing color, shape, or any other signs of deterioration. Check all moving and rotating items for proper functions. Keep switches and relays clean. More operational failures are caused by dirty switch and relay contact than result from actual equipment failure. At the same time, the operating temperatures of various components must be observed. Small fuses are sometimes used in low current circuits—they will deteriorate with age—thus it is a good practice to change them once a year.

Perhaps it is well to mention here that most instruction books have some specific suggestions for maintenance of individual pieces of equipment. Refer to the instruction books for detailed maintenance procedure.

The antenna system requires maintenance. However, since this is outside equipment, it often suffers from neglect. Weeds should be kept cut around the towers. The spark gaps need regular attention; they should be kept clean. Pressurized lines should be inspected regularly for leaks. Remote antenna meter must be checked

and calibrated against the base current meter at regular intervals. The tower structure should be inspected carefully at least once a year for any loose bolts, chipped paint, and rusty spots. Guy wire tensions and insulators should also be inspected. The tower lighting equipment should be gone over carefully for any loose or defective cable. Adjustments of the flashers, and the photo-electric tower light control are necessary, because the tower lighting equipment must meet CAA requirements.

Here are some suggestions that may not show up in the instruction books: The modulation monitor should be checked with an oscilloscope, at regular intervals to insure its accuracy. The same applies to the frequency monitor, it must be checked with an outside frequency measuring service at monthly intervals. The limiter amplifier should be set up as a part of the transmitter equipment, and it should be checked when the modulation monitor is checked to achieve peak modulation with the desired amount of limiting.

Regarding studio equipment: frequency response, noise, and distortion measurements should be made more frequently than the once-a-year overall "proof of performance" tests, required by the FCC. Turntables must be checked for speed with an accurate stroboscope, for frequency response with a test record, and for stylus pressure with a weight gauge. Stylus should be inspected and changed, when necessary, to prevent damage to valuable records, as well as maintain program quality. A station sells "good sound." Properly maintained equipment will sound good.

Maintenance schedules will vary from station to station, but each station should

have some regular maintenance schedule. It is good practice to check all station equipment at least four times a year in addition to proof of performance measurements.

#### Tools, Test Equipment and Parts

The well-equipped radio station will have adequate hand tools and test equipment or easy access to them. A suggested list is shown in the table below (Fig. 19).

A supply of replacement tubes should be stocked with the FCC minimum requirements considered as the base. In addition, some spare parts are recommended, and a suggested list can be made available by your equipment supplier.

#### Conclusion

This concludes the series of three articles "Planning A Radio Station." These have been presented for the new broadcaster as well as for the established broadcaster. These articles have been designed to assist in planning new stations and in modernizing existing installations. They provide advice by experienced station engineers on best technical practices, and enable any radio station to keep in step with modern concepts in radio broadcasting.

#### Editor's Note:

The series of articles "Planning a Radio Station" consists of the following:

Part I—"Studio Plans and Equipment for 3 Basic Types of Stations." BROADCAST NEWS, Vol. No. 97, October, 1957

Part II—"Transmitter Equipment and Building Requirements: Remote Control: Towers and Antenna Systems." BROADCAST NEWS, Vol. No. 98, Dec., 1957

Part III—"Suggested Installation and Maintenance Procedures," see page 14.

These articles are available in reprint form. Simply address RCA, Dept. BTV-258, Building 15-1, Camden, New Jersey.

#### HAND TOOLS

Heavy Duty, Dual-heat 200/275 Soldering Gun  
5 lb. Spool Resin Core Solder  
Extra-long Chain-nose Pliers  
Short-nose Needle-Point Pliers  
Thin-nose Pliers  
Needle-point Diagonal Pliers for Stripping and Cutting  
¼ Inch Electric Drill  
Hexnut Driver Set—Seven Wrenches  
Dual Purpose Screwdriver Kit  
Set Round Blade 2, 4 and 6 inch Screwdrivers  
Tank Type Vacuum Cleaner  
Standard Speedex Wire Stripper  
Scotch No. 33 Electrical Tape—6 Rolls

#### TEST AND MEASURING EQUIPMENT

Audio Oscillator  
Noise and Distortion Meter  
Transmission Measuring Set or a Set of Calibrated Attenuation Pads  
Volt-Ohm Meter or VTVM  
Oscilloscope  
Tube Tester  
Field Intensity Meter

FIG. 19. A list of hand tools (left) that are necessary for the well-equipped radio station. The test equipment (right) will prove helpful when performing routine maintenance, and when making the yearly "Proof of Performance Checks."

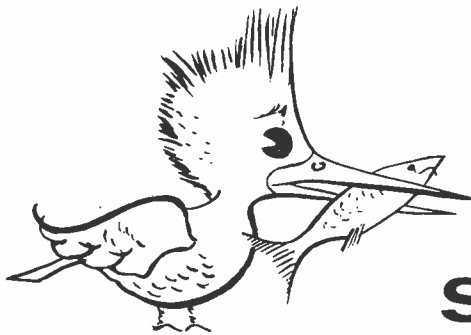

# FISHER RADIO STATIONS

**KUMA**, Pendleton; **KBZY**, Salem; and **KUGN**, Eugene —  
Serve Wheat, Farm and Timber Communities of Oregon



FIG. 1. Founder of Fisher Stations is C. H. Fisher who is currently one of the principal stockholders of KVAL-TV, Eugene, and KPIC-TV, Roseburg.

With local programming tailored to the likes and needs of two-thirds of Oregon's populace outside of metropolitan Portland, the Fisher radio stations serve the areas of the state's great natural resources. KBZY and KUGN, located in the rich Willamette Valley, cover the state's agricultural and timber centers. KUMA, in northeastern Oregon, is centered amidst Oregon's wheat lands. The installation of a fourth station, soon to be constructed at The Dalles, will complete the chain of Fisher station coverage of the Columbia and Willamette River Valleys (see map, Fig. 5).

The Fisher stations have two main operating principles in common. First: each station programs heavily to local interests—KBZY, agriculture; KUGN, timber; and KUMA, wheat. Secondly: each operates with RCA broadcast equipment—KBZY with a 250-watt transmitter, BTA-250M; KUGN with a 5-kilowatt transmitter, BTA-5G; and KUMA, a 5-kilowatt transmitter, BTA-5H.

Fisher stations were founded by C. H. Fisher. Oldest of the stations is KUGN in Eugene which began operation in 1946. An NBC affiliate, this station operates at 590 KC with 5 KW-day, 1 KW-night. KUGN-FM operates at 99.1 mc at 0.38 KW. Station KUMA in Pendleton began operation in 1955. An independent station it broadcasts on 1290 KC at 5 KW. Newcomer to the Fisher group is KBZY which began operation just last year. Operating on 1490 KC at 250 watts, KBZY is also an NBC affiliate.

Each of the stations has been designed to fit the area which it serves. Modes of operations and programming vary in each case to best satisfy the desires of local audiences. Equipment for each of the stations has likewise been chosen to fit the local format.



FIG. 2. Carl O. Fisher, President of Fisher Stations and General Manager, KUGN.



FIG. 3. Al Bauer, General Manager and Farm Director, KBZY.



FIG. 4. Ted A. Smith, Vice-President of Fisher Stations and General Manager, KUMA.

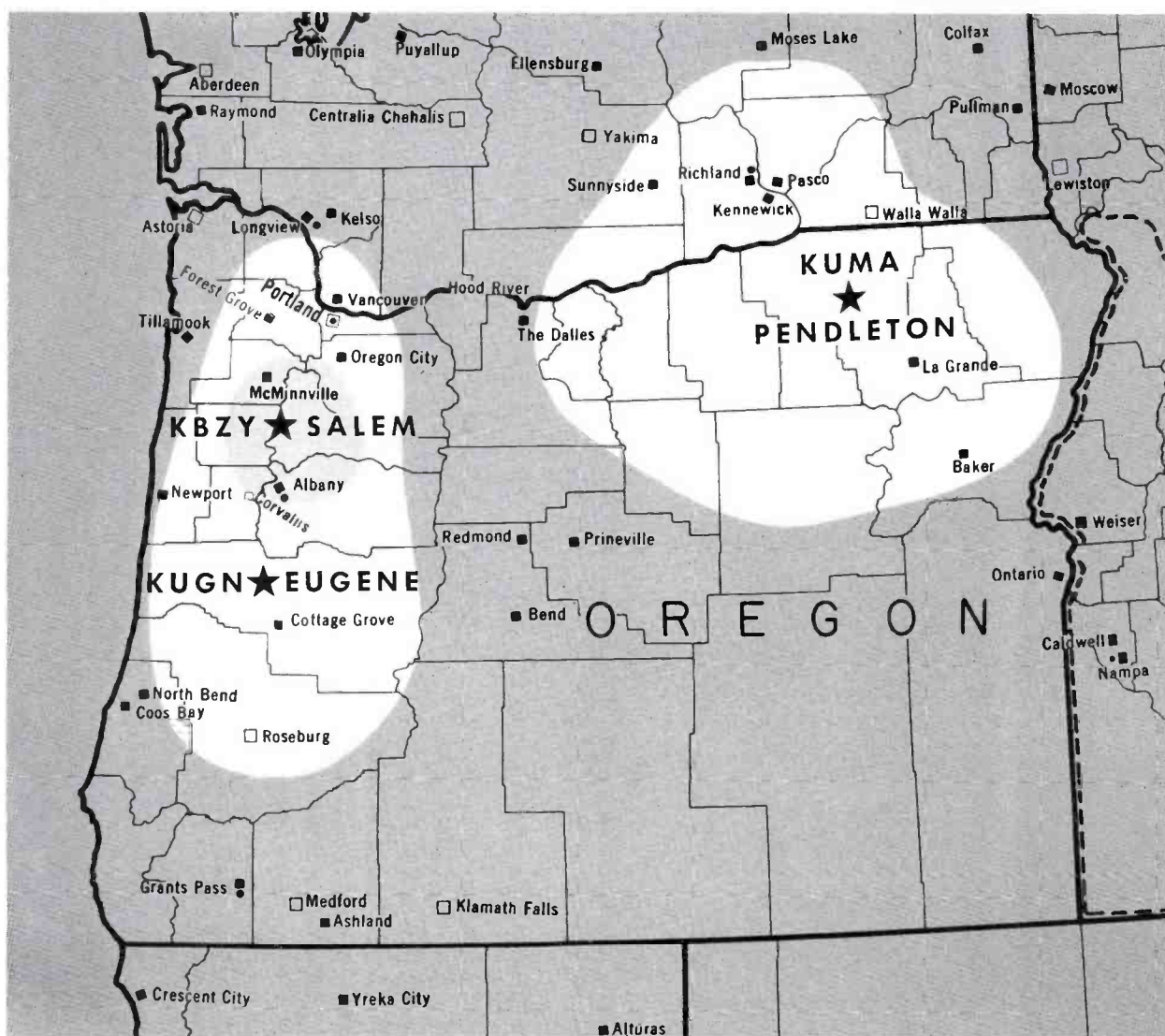

FIG. 5. Fisher Station chain covers rich Columbia and Willamette River Valleys.



## KUGN, EUGENE

"The time is 6:33 a.m., the temperature 62 degrees, humidity, 41 percent . . . your station KUGN AM and FM."

Most of the foregoing is familiar to radio listeners and broadcasters alike. However, at KUGN one additional bit of information has been added to time and temperature announcements . . . the humidity. This is most important to KUGN listeners, since it's the humidity that determines whether workers can go into the forests on any particular day. Because of fire danger, all lumber operations cease at times when the humidity is less than 30 percent.

### Own Weather Station

Since weather reports are so important to local listeners, KUGN has built its own weather station. This is equipped with rain gauge, maximum and minimum reading thermometers and a hygrometer (dry bulb, wet bulb type) for relative humidity determinations. The thermometers and hygrometer are installed in a louvered enclosure shown in Fig. 6. This has been constructed just outside the KUGN building and serves to shield the apparatus from the direct sun and rain.

While this simple equipment cannot provide data necessary for weather forecasts, it does provide a constant check on local conditions. Time, temperature and humidity announcements are made at each station break. The announcer on duty makes a weather check hourly, day and evening.

The weather station has also enabled KUGN to initiate a weather data service which local residents telephone and get pertinent weather data, day or night. Automatic telephone answering devices are used for this purpose. Announcements are made throughout the program day, plugging this service sponsored by two local merchants.

### On-the-Spot Local Coverage

A KUGN remote mobile unit provides local news coverage as well as broadcasts of special events. Basketball and football games are broadcast from the University of Oregon. Disc-jockey programs are scheduled regularly from the showrooms of local merchants. Also, a KUGN news center has been set up in the Eugene Hotel in the downtown area. The center is equipped with teletype and other newsroom facilities. All local news programs originate from this location, which has window display space for sponsor promotions.

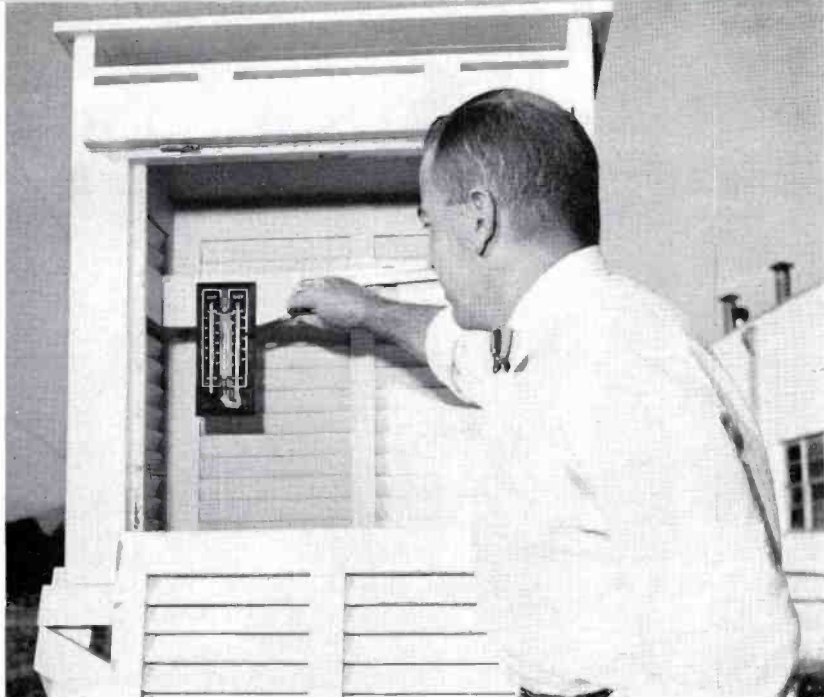

FIG. 6. Program Director, Bob Houglum, takes a humidity reading at KUGN's own weather station. Louvered enclosure shields instruments from sun and rain.



FIG. 7. Events at the Loggers Congress Equipment Fair are covered by a KUGN mobile unit, perched on new log-lifting equipment.



FIG. 8. OP-6/OP-7 Remote Pickup Equipment is used to originate d-j programs from local stores.



FIG. 9. KUGN news center has been set-up in the lobby of the Eugene Hotel. The center includes facilities for originating news interview and record programs.

#### Station Layout

Both studio and transmitter operations for KUGN-AM/FM are carried on at a single site. A one-story, stucco building houses the operations; its layout is shown in Fig. 11.

Nucleus of technical operations is the AM control room adjacent to AM and FM transmitter facilities. Here an RCA BC-76C consolette and BCS-2A subcontrol are used to handle all the station's programming needs. The control room looks into both Studio "A" and Studio "B" as well as the transmitter room, which houses RCA transmitters, BTF-250A for FM and BTA-5G for AM.

#### Combined Operation

KUGN is a typical example of a combined transmitter-studio site. It is located on the outskirts of Eugene and there is also sufficient room for the installation of a tower with adequate ground system. The location is both convenient and easily accessible to station personnel and clients.

RCA equipment, purchased in 1946, continues in operation providing varied program fare—NBC network, local music, news and special events. In catering to local needs, the station has been able to render maximum service to the residents of southwestern Oregon.

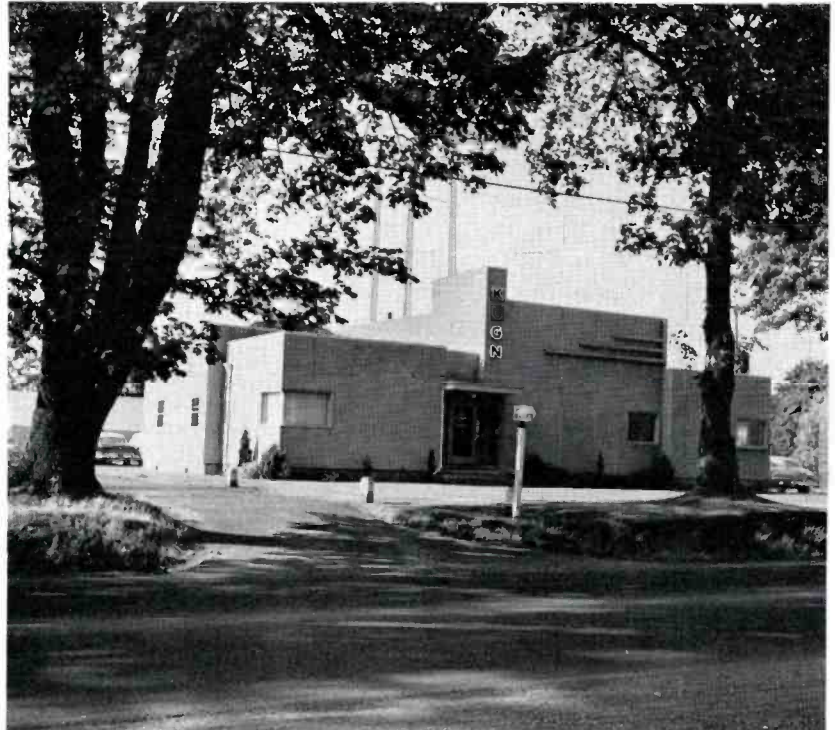

FIG. 10. Combined studio-transmitter operations are carried on in this single-story, stucco building on the outskirts of Eugene.



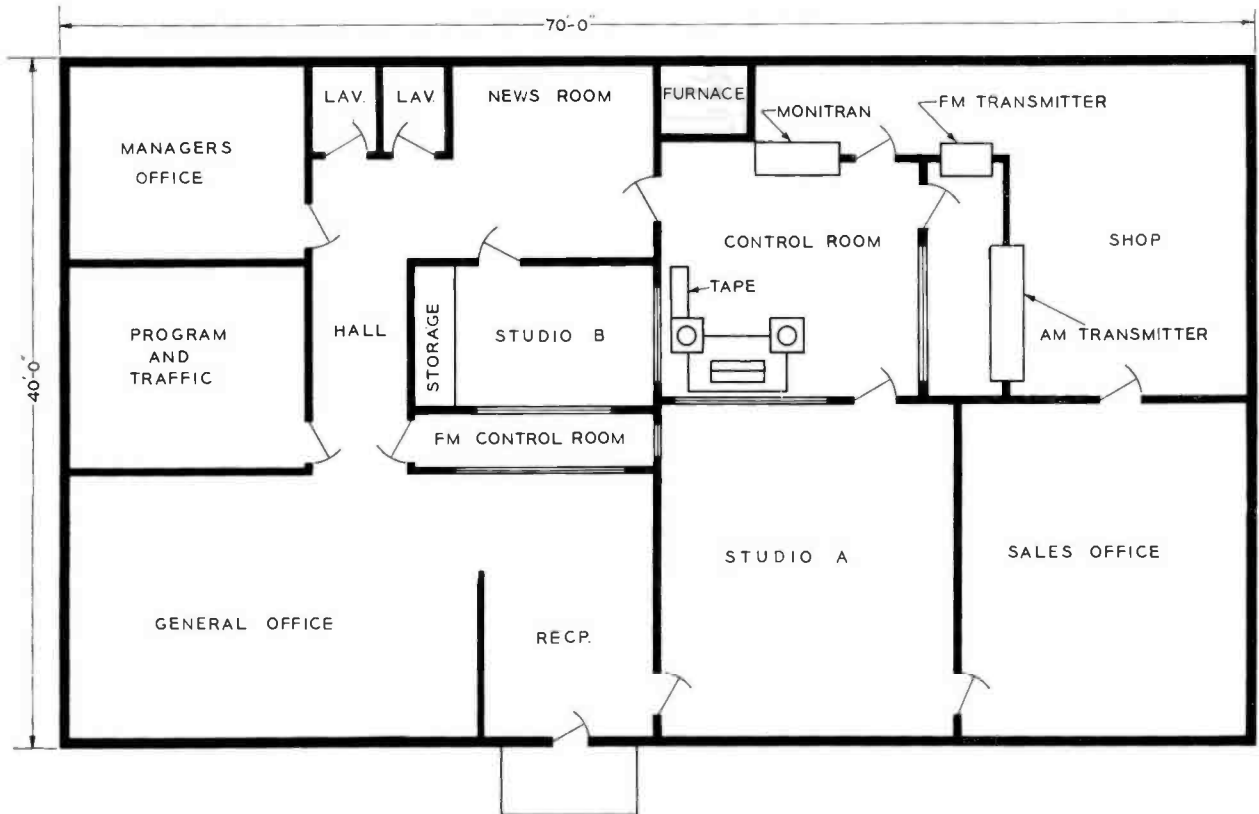

FIG. 11. Layout of the combined studio-transmitter installation for KUGN-AM/FM.

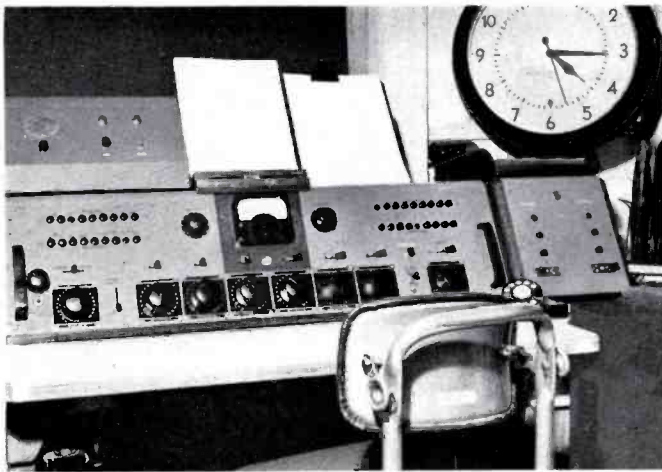

FIG. 12. A BC-76C studio console and BCS-2A subcontrol have been in service since the station began operation—over ten years ago.

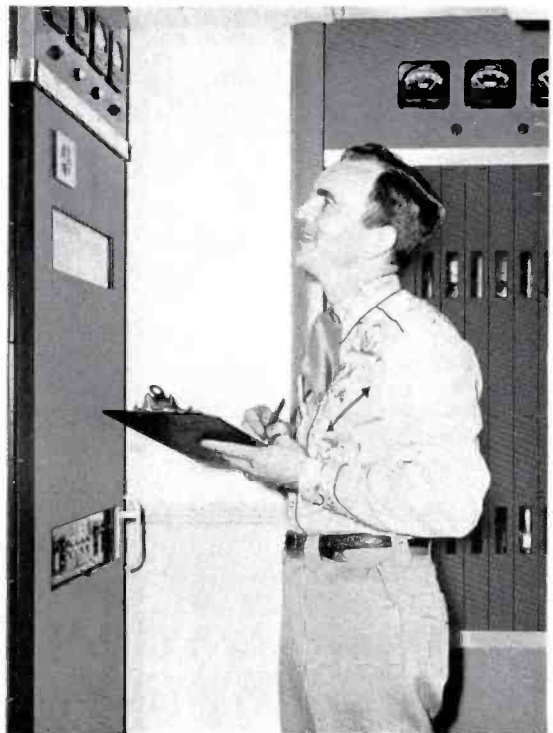

FIG. 13. George Hathaway, KUGN Chief Engineer, checks over the BTF-250A FM Transmitter. Part of the BTA-5G AM Transmitter can be seen in the background.



## KBZY, SALEM

The 250-watter of the Fisher stations. KBZY, is located in Oregon's state capital in the heart of the rich Willamette Valley farm lands. Strong emphasis is placed on programs to farm listeners; Manager Al Bauer having long experience as one of the nation's leading radio farm directors. The station news staff completely covers the local scene, and broadcasts special events from the centers of community activity such as the Meier and Frank rooftop auditorium shown in Fig. 14. In addition to these programs, NBC network and "middle-of-the-road" music make up the station's programming.

### Center-City Studio

Sales offices and studio are in center-city Salem on the second-floor balcony of the Heider Television Store. Figure 15 shows the layout of these facilities. Center of technical operations is the control room, which houses remote control and monitoring racks, tape-recording equipment and a master-console desk built by station personnel.

Figure 16 shows the specially constructed control desk. It was designed to

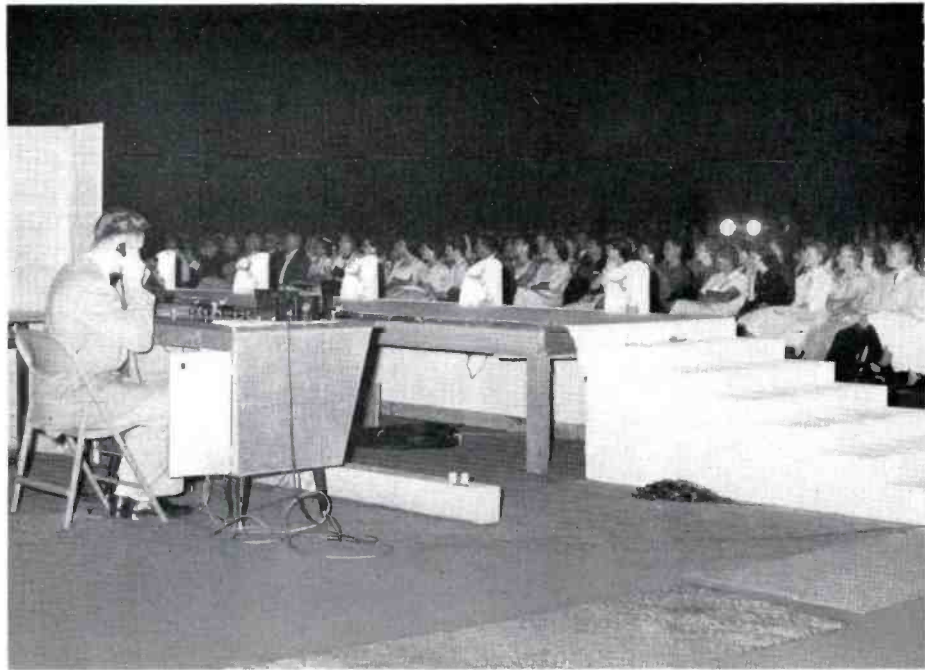

FIG. 14. Remote from the rooftop auditorium of Meier and Frank Department Store is typical of KBZY coverage of local interest events.

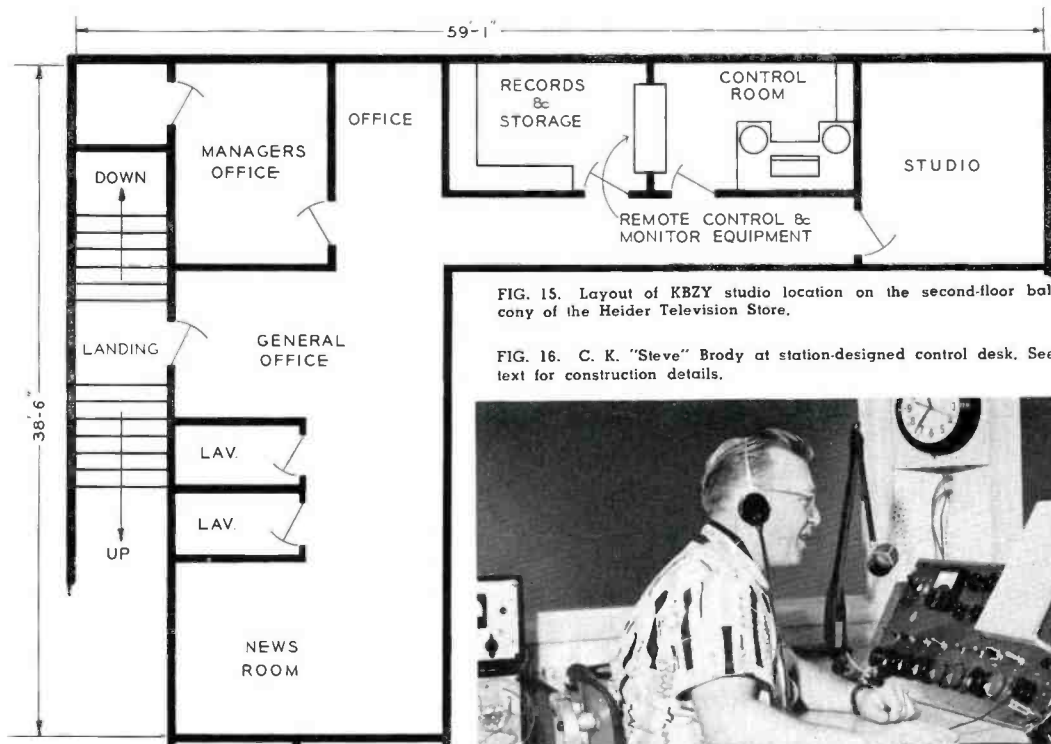

FIG. 15. Layout of KBZY studio location on the second-floor balcony of the Heider Television Store.

FIG. 16. C. K. "Steve" Brody at station-designed control desk. See text for construction details.





FIG. 17. The KBZY transmitter building houses rack of remote-control equipment and BTA-250M Transmitter.

mount standard radio equipments, laid out for maximum operator convenience. The desk top is fabricated of plywood covered with wear-resistant formica and cut out so that the operator can be seated close to the console between twin turntables. In this position he is within easy reach of all operating equipment. Mounted to the desk top is a Dazor microphone stand.

The two BQ-2B Turntables were purchased without housings so that they could be incorporated into the desk unit. The BC-3B Consolette, inset into the desk top, includes a convenient script rack which adds to the utility and compactness of the arrangement. For ease of servicing, the front panel of the consolette may be swung forward on its hinge to give access to the plug-in components. Access to the turntable mechanisms is provided in the desk design by including hinged doors at either side of the operator position.

#### Remote-Controlled Transmitter

While studios and business offices are conveniently located in center-city Salem, the KBZY transmitter building is located outside of town. The site was selected to provide most advantageous radiation and coverage characteristics. The transmitter is operated by remote control from the studios for utmost economy.

The transmitter building is inexpensively compact of frame construction covered with plywood. It is of minimum size (about 8 by 10 feet) and houses the BTA-250M Transmitter, remote control and monitoring equipment as well as a small engineering workshop. Rising above the building is the station's 225-foot guyed tower (see Fig. 18).

The combined economy and facility of RCA equipment in a remote controlled installation, ideally suit a 250-watt operation. This, together with wise management and strong local programming, contribute to KBZY's rapid rise to success in Salem.

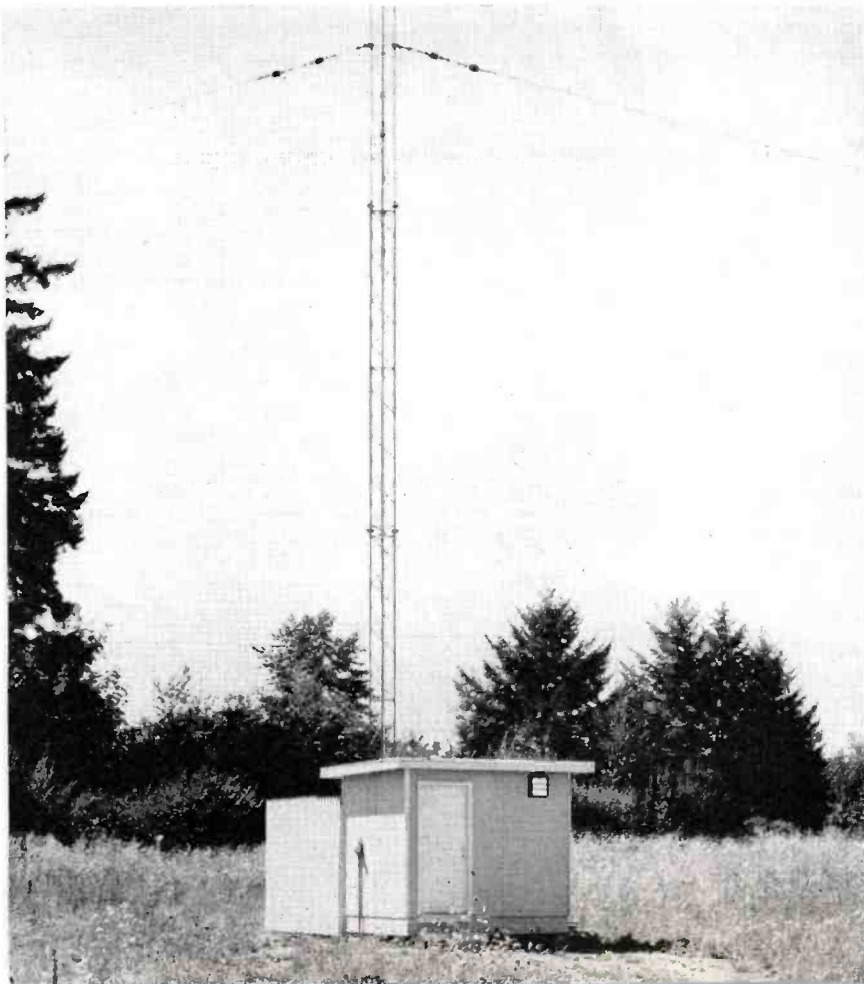

FIG. 18. Of frame construction, the transmitter building is inexpensively compact. To the rear of the building is a 225-foot guyed tower.



## KUMA, PENDLETON

The outstanding radio remote of the year for station KUMA is on-the-spot coverage of the world-famous Pendleton Round-Up. Each year in mid-September residents of KUMA-land relive the days of the Old West—complete with parades, authentic pioneer costumes, Indians and world-championship rodeo events. The Round-Up is unique among rodeos of its size in that it is planned and executed solely by local citizens working together. KUMA coverage of the event is representative of the station's policy of reporting to listeners all community activities.

Local news is reported by means of complete news facilities. A radio-equipped mobile unit is used for on-the-spot news coverage. Remote lines connect the station with centers of community interest: the rodeo grounds, local churches, and others. A regularly scheduled program, the "KUMA Koffee Hour," originates daily from a local restaurant and presents interviews with special guests on timely topics of local interest.

Pendleton is centered in the richest agricultural area in Oregon. Wheat is the most important farm product, with peas and animal products following close behind. As a result, two special farm programs are scheduled each day. One is presented by and for the Pendleton Grain Growers, Inc., a co-operative association which maintains grainaries throughout the area. The other consists of market data reports and weather information direct from their sources of origination.

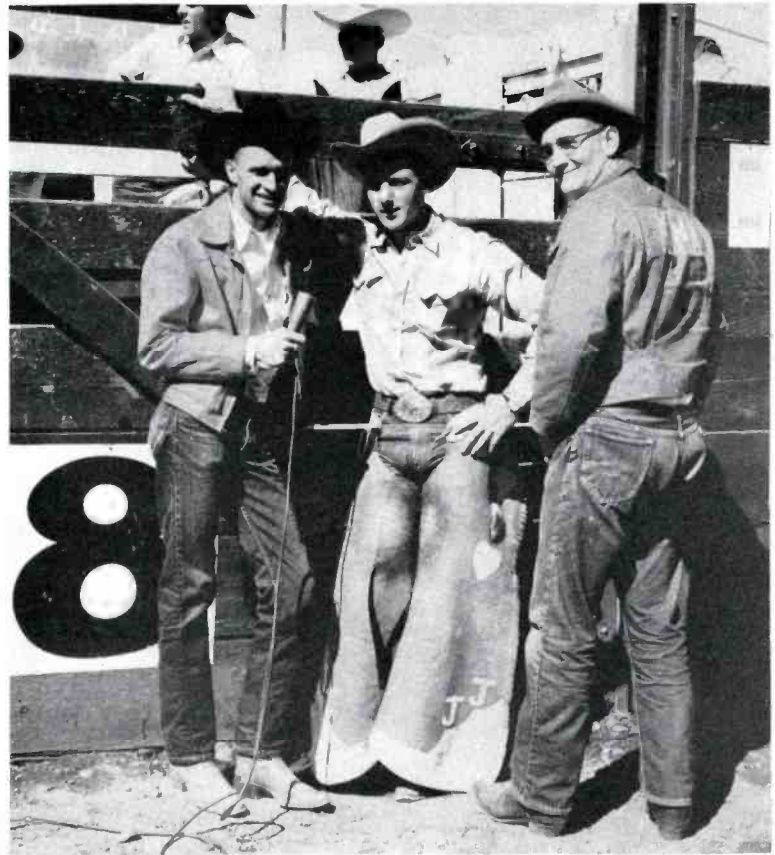

FIG. 19. Scene from the 1957 Pendleton Round-Up. Roving reporters filled in color between rodeo events.



FIG. 20. KUMA remote car broadcasts on the spot from scene of plane crash. Manager Ted Smith gets eye-witness report.



FIG. 21. Regularly scheduled "KUMA Koffee Hours" bring news and interviews with special guests from local restaurant.





FIG. 22. Remotes, studio shows, music programs are all channeled through versatile BC-2B studio console in control room of station KUMA.

### Equipment Handles Diversity of Programming

KUMA has selected RCA equipment to handle its wide variety of local programming. The remotes, studio shows, music programs are all channeled through an RCA Studio Console, BC-2B. Versatility of this equipment is demonstrated by the special adaptations the station has made to handle some of its special program techniques. A close up of the console is shown in Fig. 22. Adjacent to it is a specially designed housing which incorporates auxiliary control of the following functions: (top to bottom groupings) beeper control and indicator for off-telephone recording; Conelrad Monitor switch controls and indicator; and remote start-and-stop buttons for the station's tape recorders. Also two pots have been located at either side of the VU meter on the console. The left pot is a volume control for a cue amplifier which is mounted beneath the desk, and the right pot is a control for putting telephone conversations directly "ON-AIR."

The BQ-2A 3-Speed Transcription Turntables provide the fidelity and versatility needed for musical programs. Type BK-1A Microphones serve an all-purpose function at the control console and on remotes. These microphones are used exclusively by the station, with the exception of one SK-46 Microphone used with the radio mobile unit.

A newly constructed, ranch-style building houses KUMA's studio and offices. The layout is shown in Fig. 24. The transmitter building is located on the outskirts of Pendleton about three miles from the studio site.

### Latest Design 5-KW Transmitter

KUMA began operation with a 1-KW Transmitter, Type BTA-1M. Upon approval to increase power, the station installed the latest model RCA 5-KW Transmitter, Type BTA-5H, retiring its "one-kilowatt" to standby. Figure 26 pictures the transmitter building and antenna array. Transmitter control, shown in Fig. 25, includes all facilities for program origination—turntables, tape recorders, BC-5A Control Console and BQ-1A Microphone.

### Area-ized Coverage for Area-ized Programming

RCA equipment has provided KUMA with the kind of coverage required to reach the widespread farm and ranch communities of northeastern Oregon. KUMA programs give listeners a wide selection of information and entertainment tailored to their tastes.



FIG. 23. A newly constructed ranch-style building houses the KUMA studio and offices.

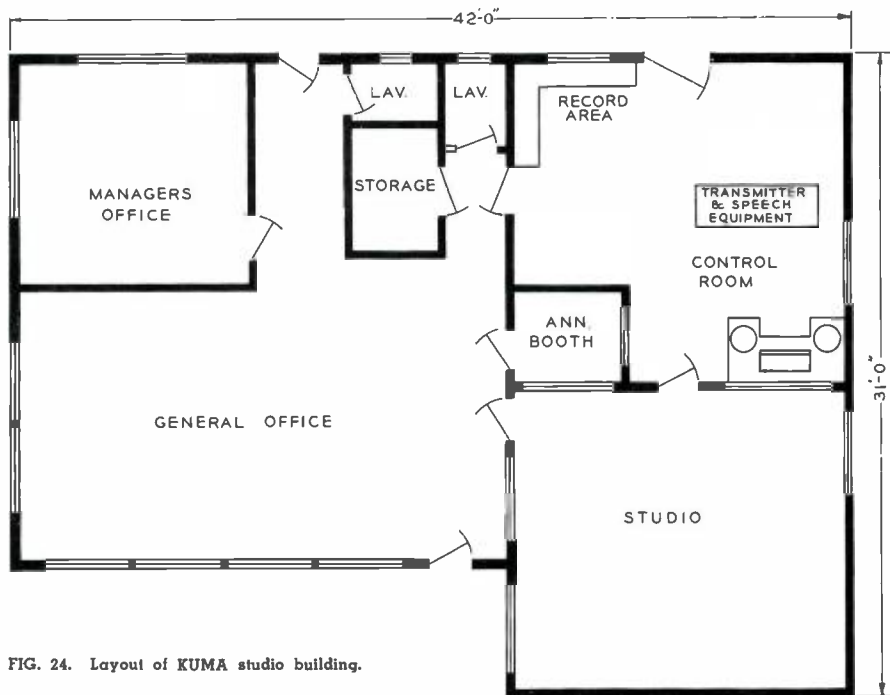

FIG. 24. Layout of KUMA studio building.

### Equipped to Individual Requirements

Each of the Fisher stations has found an equipment combination to satisfy its mode of operation. At KUGN an RCA 5-KW transmitter has provided more than ten years of day-in and day-out service plus blanket coverage of the Willamette Valley in a combined studio-transmitter installation. The "250-watter" at KBZY provides economical remote control operation in order to capitalize on a convenient center-city location and still retain the excellent radiation characteristics of the transmitter site. At KUMA coverage of widespread farm communities is accomplished with an RCA 5-kilowatt transmitter in a separated studio-transmitter installation. Thus the Fisher stations have chosen for each installation the type of plan and equipment best suited for the local broadcast operation.

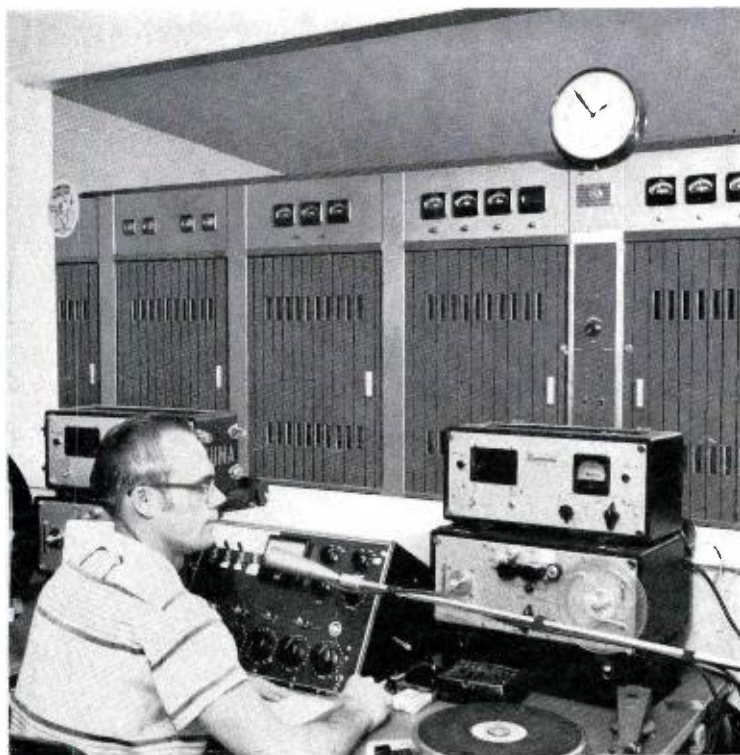

FIG. 25. Transmitter control location includes all facilities for program origination. Here a BC-5A console handles all program requirements.

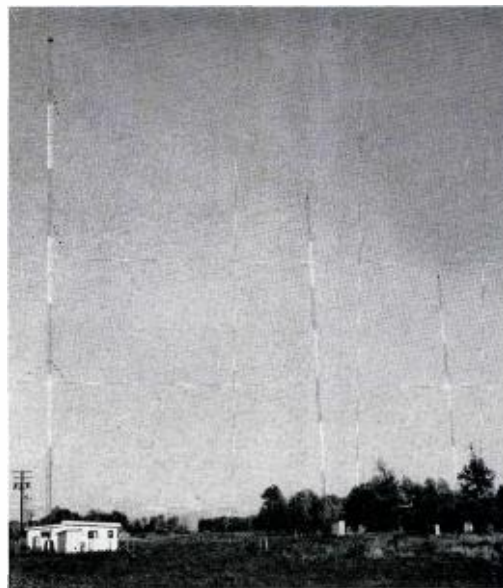
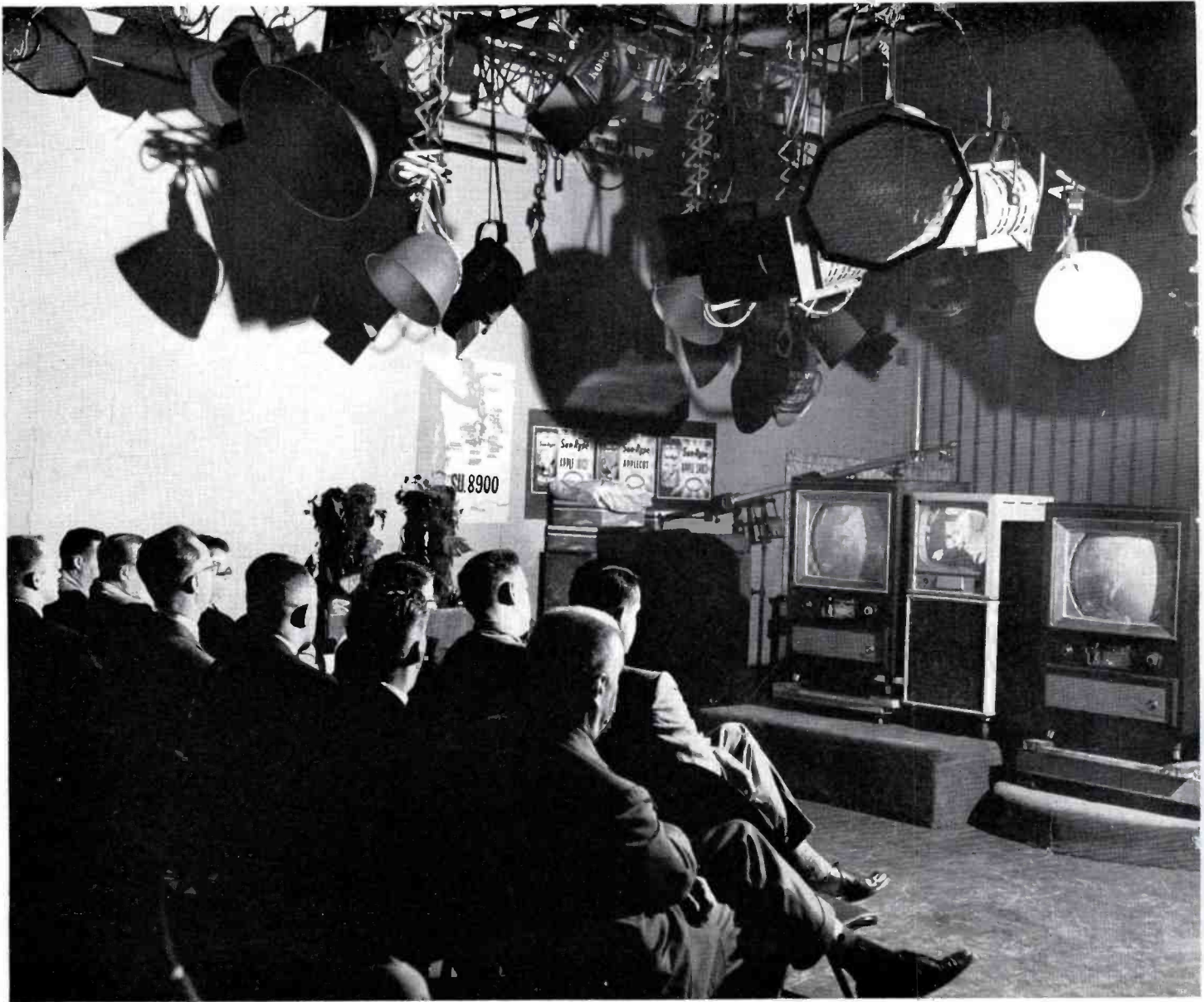

FIG. 26. KUMA transmitter house and antenna array is located on the outskirts of Pendleton.



# HOW KOMO-TV USES

FIG. 1. Guests of KOMO-TV view Color Clinic presentation in studio. Two RCA 21-inch color TV sets are used. Between them is a 17-inch, black-and-white monitor employed for contrast.





# COLOR CLINICS

Since August 1956, KOMO-TV in Seattle, Washington, has been conducting color clinics for local advertising agencies and sponsors to illustrate what color television can do for specific products, and how to best present products in the new medium. The station is equipped with a TK-26 3-V color film system, capable of handling movies, slides, opaques and small product displays; also two TK-41 live color studio cameras. Demonstrations are put on in one studio and viewed on 21-inch color TV sets by the audience in an adjoining studio via a closed-circuit arrangement. These clinics are run approximately monthly and have attracted a great deal of interest in color TV.

According to W. W. Warren, Executive Vice-President and General Manager of KOMO, the most frequent reaction of an agency or client is a *state of shock*, although products submitted in advance are used for the demonstrations. As a result, they usually want to have a return engagement for trying films and art designs they have prepared. Greatest interest seems to be in packaging. Executives from many industries, as well as manufacturers' representatives, attend these clinics. (The latter frequently request, as a result of the clinic, to be informed in advance of future network color programs planned by major national manufacturers so that they can tie in locally.)

According to C. E. Miller, Chief Engineer of KOMO, "One company had a real light package with lots of white in the label and an over-all highly reflective plastic surface. Our demonstration revealed that the bright lights used for color TV gave their package a washed-out look. So they redesigned and now use color farther down in the gray scale but still bright, attractive, and completely acceptable."

Either one large agency or several smaller agencies are invited to each clinic. The agencies bring most of their key per-

sonnel, including artists and copywriters. Account executives usually bring along their most important clients—those whose products are most sensitive to color. Attendance ranges from 30 to 40—equally divided between agency and client personnel. Typical sponsors are luggage manufacturers, paint manufacturers, hotel chains, airlines and meat packers.

The clinic begins at 8 A.M. with an informal get-acquainted breakfast in a private dining room at a nearby restaurant. At nine o'clock the audience is seated in the studio, listening to three minutes of introductory remarks about color TV. Then the program appears on the TV screen and lasts for approximately one-half hour. Afterward, the audience enters the originating studio, looks over the color equipment; examines the products, backgrounds and techniques involved in the demonstrations; asks questions and frequently arranges for future demonstrations of specific products. Within two hours the clinic is usually ended.

After the first few clinics, in order to test reactions, KOMO distributed questionnaires which agencies returned to the station and gave data for guidance in planning future clinics.

Five questions were asked:

- 1) What was your over-all reaction?
- 2) Can you name the most important aspect of demonstration?
- 3) Can you name the least important aspect of demonstration?
- 4) What are some client comments?
- 5) Do you have any suggestions for improving clinic?

Illuminating information was given in response to these questionnaires in quite some detail and was quite frank. Here are the most significant points:





FIG. 2. Color Clinic evokes intense concentration. Agency men and sponsors alike display keen interest in the presentation. It's produced like a regular program, using on-air standards.

#### *Most Important*

1. Relationship of product (or package) color to background.
2. Showing client's package under different conditions and viewing one's own film.
3. Problems involved in duplicating true product colors when contrasted with demonstrator's hands.
4. Limitations of contrast range.
5. Fact that problems are all capable of solution—requiring only experiment.

#### *Least Important*

1. Technical descriptions of cameras.
2. Seeing oneself on color TV . . . though interesting.
3. How the equipments work.
4. Technical transmission descriptions (could be eliminated).
5. Technical demonstration of cameras.

#### *Client Comments*

1. Could see need to work on colors prior to going into color TV advertising.
2. Display of product exceptionally interesting.
3. Impressed with opportunities; aware of problems; appreciate KOMO knowhow.
4. Felt color had been well used on demonstrated commercials; would be practical tool to use.

#### *Suggestions for Improving Clinic*

1. Take the product out of the package.
2. Demonstrate use of short film to show what it adds.

3. Show title cards and slides.

4. Introduce like a regular program.

5. Move a little faster—tighten production toward air-show standards.

6. Have a question-and-answer period.

#### **Professional Presentation**

Evidently many of the foregoing suggestions have been incorporated into the clinic format because the one witnessed on May 21, 1957, was certainly a *professional* presentation in every sense of the word. From beginning to end it moved smoothly, at an attention-getting pace, with bits of entertainment and product demonstrations interspersed between the heavy stuff. Two 21-inch, color-TV sets were used with a black-and-white 17-inch monitor between them to show the contrast.

Bill Hubbach, KOMO Sales Manager, addressed the group in the viewing studios for a few minutes before the program went on. He mentioned that the 21-inch color sets before the audience were the same type one would have in his home—that it was only necessary to plug in and connect the antenna to get a color picture. Next, he gave a few statistics on set sales and color promotion in the area. (Color set sales have increased 50 per cent since KOMO began actively promoting color.) "Advertisers will want it because of impact," he said. "Within two years the race will be on. Now is the time to prepare."



### Typical Format

The program began in black and white but switched to color within a few seconds, thereby, portraying at the outset the vividness of color versus black and white. Then followed a series of shots showing several attractive subjects including girls and flowers. Immediately thereafter, the announcer introduced one of the station engineers and a short dialogue and demonstration ensued.

Technical talk was limited to mention of the three primary colors used for color TV: the compatible system; the color camera with its three tubes, and the color receiver with its three-gun picture tube.

Lighting was introduced with the comment that like color photography, more light is required than for black and white. A demonstration followed, showing that by control of quality and placement of lights the same color setting in the studio could be used to depict a day or an evening scene, without color confusion.

Contrast range was dealt with next using a large white card about 30 by 40 inches. As the video operator adjusted for the white, the audience could see the flesh tones fall. This led to a short discussion of what to avoid in order to keep within the contrast range.

Next, an aluminum cooker with its highly reflective surface was the subject of demonstration. Means of killing the extreme highlights were given. Capabilities of the color TV system were shown by using a lithographed point-of-sale piece supplied by the cooker manufacturer. It reproduced beautifully together with the product—on close up. Illustrations could

be clearly seen, sales points could be read, and the product was attractive.

At this point, a bit of diversion was provided by a fast cut to a model adjusting her stocking. This led to dialogue between announcer and model then finally to a display of various colored textile fabrics by the model. Directly after this a dancer entertained for a few minutes, thereby showing different color sets and costumes.

### Product Demonstrations

After the dancer, KOMO Art Director Bob Dinsmore appeared on camera, wearing a painter's cap (which advertised and was supplied by an agency account), busily stirring a bucket of white paint. He stopped, picked up a small tube, squeezed some of its color contents (client's product) into the bucket and began stirring again. As he did the white paint began to change color.

This provided the art director an opportunity to talk about adapting from black and white to color. He spoke briefly on contrast factor, black-and-white ratio, in-between tones. How the middle tones are more pleasing. The importance of avoiding great masses of black or white—except for occasional dramatic effect.

Continuing then with paint as one of the product displays of the day, a typical point-of-sale display, as found in a paint dealer's store, was brought on camera. This was a counter rack containing several hundred small swatches of different colors. The camera closed down on the display. Hands were used to pick out individual swatches so they could be demonstrated large size and in actual color.

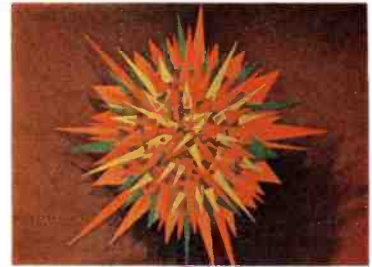

FIG. 3. Dramatic color burst opens Color Clinic.



FIG. 4. Use of model relieves any tendency to monotony.



FIG. 5. Art Director, Bob Dinsmore, demonstrates typical product pitch.

FIG. 6. From left to right: Hal Wenzler, Account Executive, Burke Advertising Agency, examines product demonstration with clients Russ Miller and Don Bechtel, Sales Manager, respectively, of Preservative Paint Company.



FIG. 7. "Color TV would be a natural for our product," according to Russ Miller (center). "Color TV would be wonderful advertising for our company-owned paint stores as well as our dealers."







FIG. 8. Engineer Ralph Mifflin and Production Manager Al Stewart discuss lighting and contrast.



FIG. 9. This demonstration shows that products require proper background color.



FIG. 10. Yellow background produces too much "competition" for this package.

FIG. 11. After session in receiving studio, agency men and clients gather in originating studio for a look at color TV equipment.



FIG. 12. Many clients want their picture taken alongside the color cameras for publicity use in their industry magazines.



### Background Demonstration

A can of salmon with attractive three-color label occupied the stage for this next demonstration. Different solid color backgrounds were tested to show the importance of picking a color that compliments rather than detracts from the product package.

It was shown that one can "read" a color into an object by merely a change of background. This psychophysical phenomenon was demonstrated using a can with label that contained red, dark blue, and white bands in its design. The can was shown against black, pink, blue, yellow and red backgrounds. Blue proved highly complimentary. Yellow was too competitive, it was higher in intensity than the package (can). Red led to bleeding of the red in the label.

### Color Film and Slides

Switching from live color to the 3-V film system, the announcer explained that 3-V means one vidicon for each of the three primary colors employed for color TV. Typical slides of commercial spots in color were projected. There followed a showing of colored film. A typical color news film of the type used in KOMO's daily "Deadline" program was also projected. This provided an opportunity for saying something about the fast processing for color film, developed by KOMO, which makes it possible to shoot and show on the same day.

The program (demonstration) portion of the clinic ended with a short interchange

between announcer and a TV industry journalist on the subject of color TV across the nation. (Visitors to the areas are frequently incorporated in the clinic programs to add variety and validity.)

### Audience Reaction

After the formal program, agency men and their clients streamed into the originating studio for a look at color TV cameras and, especially, at product demonstrations. There were numerous questions about backgrounds and package design. Arrangements were made for future showings of products and films for experimental purposes.

William M. Burke, President of the agency bearing his name, requested a photograph of clients before the color camera. Messrs. Allan Kurtzman and Ted Rich, President and General Manager, respectively, of James Henry Packing Company posed beside the TK-41. They wanted this picture for their industry magazine, THE NATIONAL PROVISIONER. Food products, they thought, would be a natural for color TV advertising—especially after seeing one of their packaged hams unwrapped and the appetizingly natural color of the product displayed close up.

Ralph E. Malone and Wm. L. Bishop, President and General Manager, respectively, of Westside Ford, Inc., wanted to pose before one of the color sets with the Japanese dancer from the International Trade Fair. This Kodachrome transparency, they said, would be used by the



FIG. 13. Mieko Hamano, Japanese model from Tokyo, poses with R. E. Malone and W. L. Bishop of Westside Ford, Inc.

FORD TIMES, since automobile manufacturers are already large users of color TV advertising. Local tie-in would be the next logical step.

Hal Wenzler, Account Executive, brought his client for a picture of product demonstration. "It's (color TV) a natural for our product," remarked Russ Miller, Sales Manager of Preservative Paint Company. He and Don Bechtel, Store Manager, posed with Hal at the paint-stirring demonstration, then again at the dealer-counter display. "We serve Washington, Oregon, Alaska, Hawaii, and have been in business for 50 years. Color TV would be wonderful advertising for our nine company-owned stores and 65 dealers."



FIG. 14. Left to right: William M. Burke, President of ad agency bearing his name and clients Allan Kurtzman and Ted Rich, President and General Manager, respectively, of James Henry Packing Co.

FIG. 15. Group of agency men and advertisers together with KOMO-TV production men arrange for future private demonstration of products on color TV.



Reactions like these prove the value of KOMO color clinics. Its generating a lot of interest and good will. Here are some testimonials extracted from agency letters:

#### Agency No. 1

*"The KOMO TV Color Clinic was a refreshing experience. I thought your people handled it extremely well. The breakfast was good and we got over to the station promptly to find that the color presentation was fabulously interesting. Something over twenty of our staff was involved, as well as quite a few clients, and I think probably the strongest thing I could say with respect to my feeling on the worthiness of this presentation would be simply to admit that the 30 or 40 hours of overhead involved was very well worth while."*

#### Agency No. 2

*"Thanks very much for the wonderful production job you guys did at the color clinic. Also, many thanks for promoting our apples around the station. I really appreciated the information gleaned from the meeting, and hope we can have another one in the near future."*

#### Agency No. 3

*"On behalf of our company and all our clients and friends who attended—I want to thank you sincerely for arranging for the color clinic. It was very enlightening. I had many mentions afterward of the value that this was going to prove. Everybody had a good word for the clear way in which KOMO explained the handling of live color, color films and slides."*

#### Agency No. 4

*"I have delayed writing this letter primarily to receive the reaction of our clients as well as those of our staff to the color clinic conducted by your organization in our behalf. We are happy to report that each and every one of those in attendance expressed nothing but praise for the amount of knowledge and background they received relative to their future plans in packaging and presentation. We would like to thank you and your staff for the opportunity of attending this clinic as well as for the fine co-operation that each and everyone of your people extended to us. Co-operation such as this between agency, client and media cannot help but build more effective relations."*



There have been specific cases of advertisers who were helped in preparation for color TV. One company, for example, had planned to put out new labels but changed its mind after viewing the result on the KOMO color clinic demonstration. They redesigned the new label so that film commercials in color have better impact.

Many sponsors see the reasons for testing packages and products before embarking upon new designs. They become aware of the general advertising pattern and know where to come for advice in preparation for color TV advertising.

### Color Chronology

In August, 1954, KOMO made the first colorcast in the area originating on the NBC network. This was a production for the Defense Department from Fort Meade, Maryland. On May 21, 1955, began the first regular programming of color using

the 3-V film system. And in September, of the same year, KOMO put into operation a Color Stripe Generator so that area TV servicemen could adjust color TV sets at any time of the program day.

January, 1956, the first TK-41 color TV studio camera was received and on February 1, KOMO presented the first locally produced live show in color to the Pacific Northwest. Washington's Governor, Arthur B. Langlie, hailed the arrival of color TV as "another step forward in Washington State's broadcast industry that is growing apace with the Northwest itself." A few days later, KOMO announced a new fast processing (90 minutes) of color film, which permits same day use for news program.

KOMO conversion to an all-color station on the local level took another step forward in July of 1956, when its second TK-41 color TV camera went into operation. Color

clinics for local agencies and sponsors were inaugurated the following month and have since been held regularly (approximately monthly) in KOMO studios to illustrate what color can do for specific products, and how best to present these products on color TV.

Near the end of 1956, in co-operation with SK&F laboratories and the local medical society, KOMO put on the air what it believed to be the world's first live colorcast of a surgical operation (see BROADCAST NEWS, Vol. No. 95, June, 1957). At the beginning of 1957 over 80 hours of color programming were on the air monthly including live, film and network. This year a new facility is being added: opaque pickup and lens extension equipment for the TK-26 3-V color film system. In effect, this provides a third live-color camera suitable for large slides, opaques and small product display.

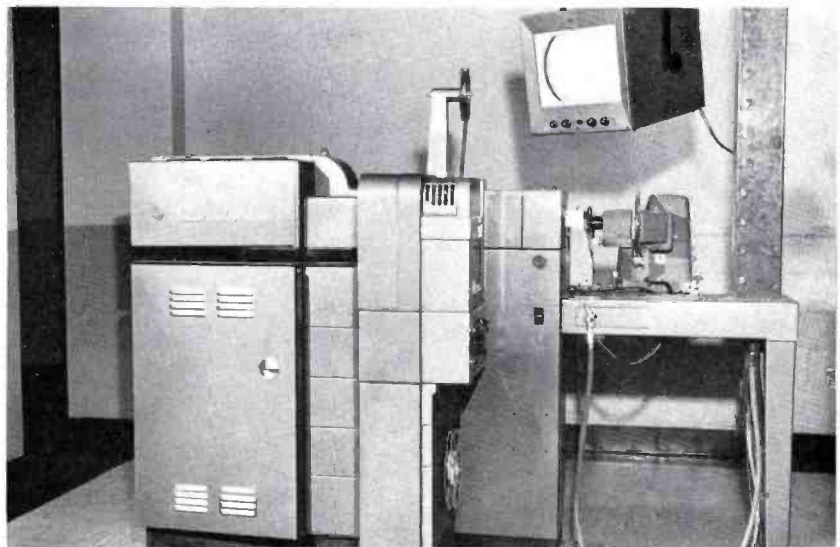

FIG. 16. TV film equipment includes three complete chains. Shown here is the TK-26 3-V Color Film Camera with TP-15 Multiplexer, TP-3 35mm Slide Projector and TP-16 Film Projector.



FIG. 17. This is control position of 3-V Color Film System. Note cabinet at left, used for filing of all currently operational 35mm slides. The push-button switch at lower right controls the input to the TM-10B Color Monitor. This monitor can be switched to either incoming Network, Line out to transmitter, Studio B-C, or the 3-V Color Film Camera.





FIG. 18. The kitchen set used on "Cookbook Quiz" occupies one end of Studio C. Set contains two complete kitchens, one using electric utilities and one using gas utilities so that either or both may be featured as desired. This is an example of a set originally designed for monochrome television. It is planned to re-do the kitchen using colored utilities with pleasing combinations of color and color patterns on cabinets and tables so as to produce a good color picture, yet one with sufficient contrast to produce a good monochrome picture as well.



FIG. 19. Studio B-C control room with T.D. Fred Fowler at the black-and-white camera controls and Director Ed Lackner at the studio switcher. All black and white live camera equipment at the studios (a total of four chains), is of the field type, thereby, allowing it to be transported into the field for use on remotes as necessary.



FIG. 20. Audio Operator Barbara McKenna at the controls of the audio console in Studio B-C control room.

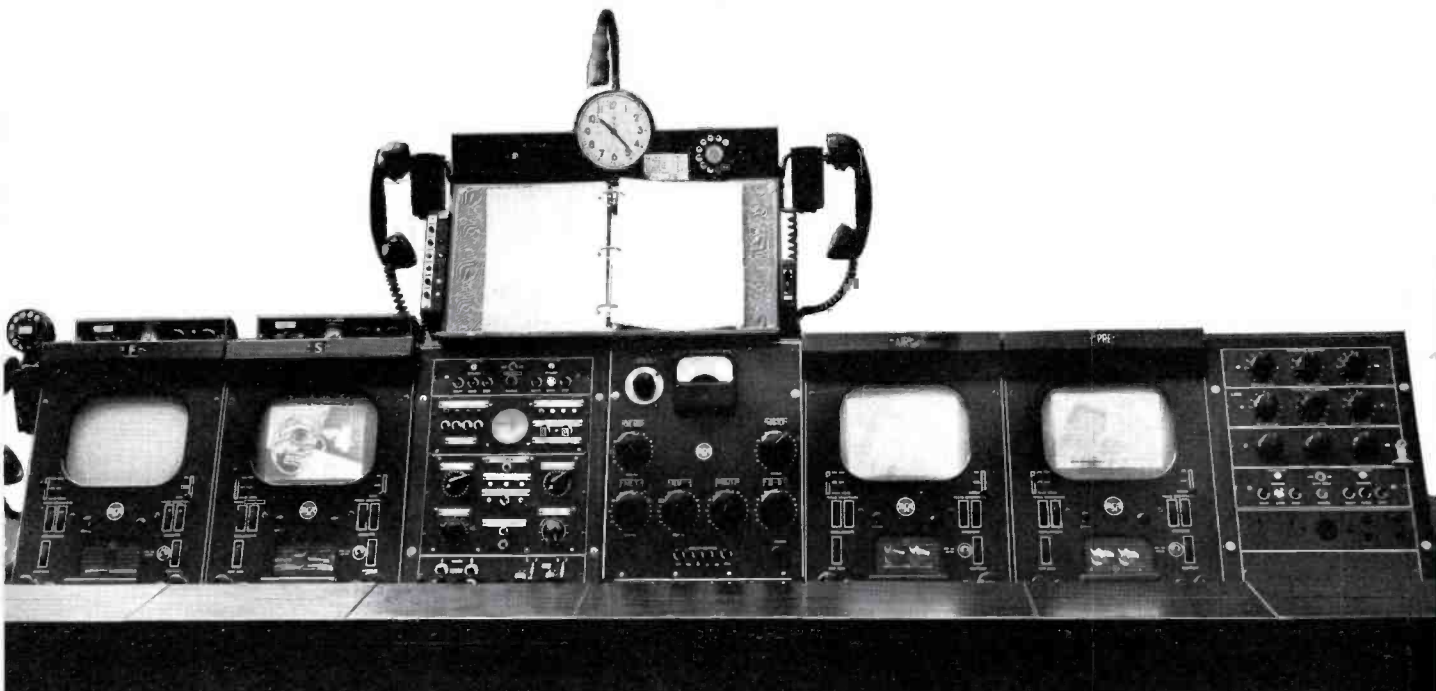

FIG. 21. KOMO-TV master control console. On the left Section 1 contains a TK-21A vidicon film camera control, Section 2 a TK-20D iconoscope slide camera chain; Sections 3 and 4 are projector remote controls and an RCA TC-4 audio/video switcher (shown in more detail in Figure 22). Section 5 contains a TS-10 switcher and line out master monitor; Section 6 a preview monitor, the input controlled by a 12-position, push-button switch located on the sloping section of the console desk. The last section contains stab. amp controls and projector controls for the RCA TP-16 and TP-3 projectors used on the 3-V System.

FIG. 22. This is a close-up of Sections 3 and 4 of the master console. In Section 3 at the left the top unit is a projector remote control panel for two model 250 film projectors multiplexed into a TK-21A vidicon camera. The next unit is an intercom and signalling unit comprising a 5 station push-to-talk intercom, and flasher, signal lights and controls to the master control announce booth adjoining the master control room. The third unit contains remote positioning and changeover controls for two Selectroslide 35mm slide projectors. These projectors and a Baloptican 4 by 5 inch projector are multiplexed into a TK-20D iconoscope camera. The bottom unit of the panel holds polarity reversing controls for the film cameras and remote sound focus controls and indicators for either front or back emulsion film in the projectors. The sloping section shows the ring and talk key controls for eight incoming order wire telephone lines.

Section 4, also shown in close-up here is a standard TC-4 audio/video switcher modified for a fifth input to the audio mixer. This input is the output of the master control announce booth where an auxiliary mixer console accommodates turntables and announce microphone.

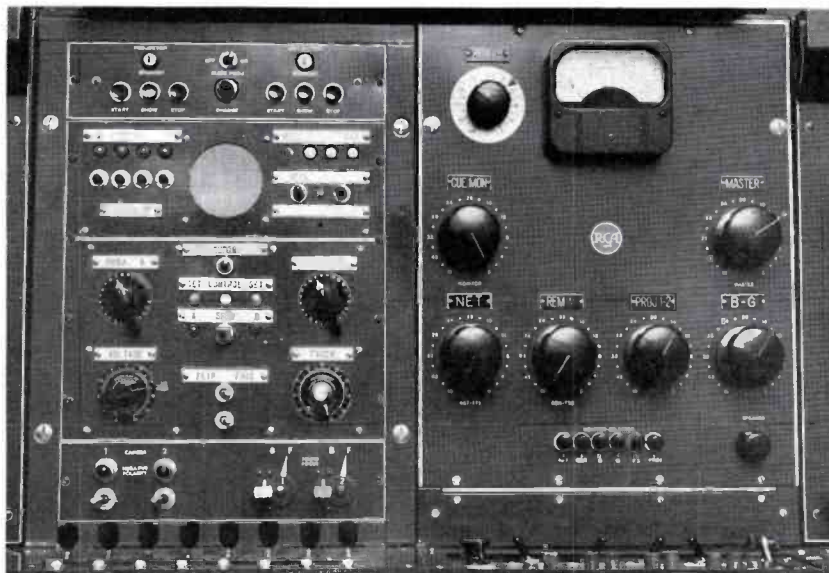

FIG. 23. A portion of master control as seen through the window of the announce booth, with engineers Ed Boyd, (obscured), and Jack Kerr. Immediately to the left but out of the picture, are slide and film camera and projectors.

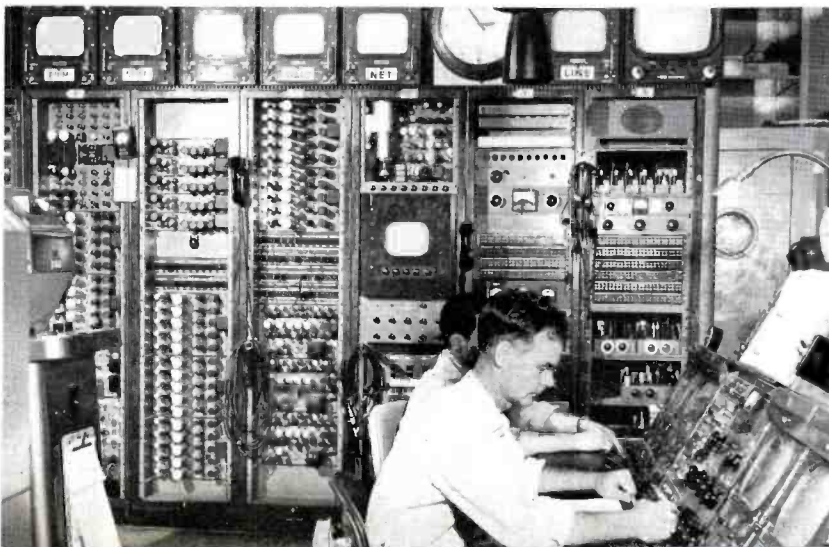





FIG. 24. Studio G control room showing audio control and a view out into the audience area.

FIG. 25. The KOMO-TV transmitter building approximately one mile from the studio site atop 450 ft. Queen Anne Hill in Seattle. The tower mounts a 6-bay superturnstile antenna with 100 KW ERP on Channel 4 at an over-all height of 1,000 feet AMSL, and an auxiliary 1-bay antenna at a lower elevation on the tower. Transmitting equipment includes the main 25-KW TT-25BL and an auxiliary 2-KW transmitter. Either of these transmitters can feed either the 1-bay or the 6-bay antenna.

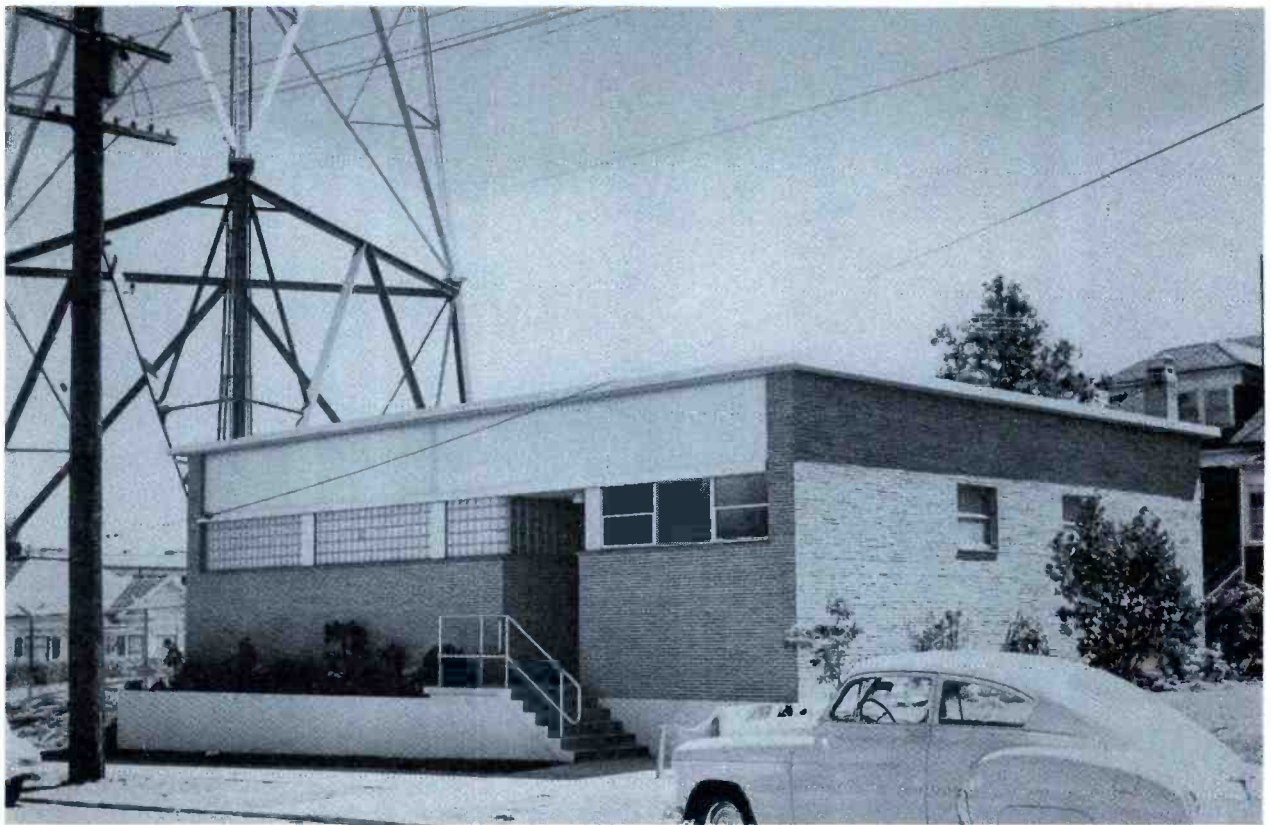





FIG. 26. Through these hands . . . to Arden Skoog, film editor and her librarian and assistant, Sheila Lind and Art Pattison, falls the task of editing and preparing the thousands of feet of film necessary to a television station.



FIG. 27. TV News prepares to meet "Deadline." A state of ordered confusion prevails as editors Robinson and Jackson ready copy for the evening news color program.



FIG. 28. News Cameramen Ramaley and Sierer return from an assignment. Station wagon used by News Department has been fitted with mobile telephone, a receiver and converter for police broadcasts (note portable movie light).



FIG. 29. Giant 110-inch sports lens in use at annual hydroplane race on Lake Chelan. This gives viewers a close-up of all action. At a distance of one mile this lens can close down on a man in the cockpit of the boat.



FIG. 30. Designed and built by Howard Moses, of the KOMO-TV Engineering Staff, the 110-inch lens is constructed of a 12-inch diameter Fiberglass tube, 7 feet long. At the rear end is mounted an aluminized front surface parabolic mirror. This was ground from a 2-inch Pyrex blank, 10 inches in diameter. It brings light rays to a focus at a point 110 inches from its surface. In the forward part of the tube is a diagonal mirror. It reflects the light rays through a series of front surface mirrors, contained in a light-tight housing between lens and TV camera, to one port in the turret. The image is formed at the photo-cathode of the image orthicon camera tube. Lens and mirror construction are highly accurate, there is minimum light loss and color aberration. An 80-inch lens can also be accommodated in the same tube in place of the 110-inch lens. A smaller tube is used to accommodate a 50-inch lens. The tube is held in place by a Duralumin framework that fastens to the TV camera. The tubes are painted white to prevent thermal air currents from rising inside, which would cause optical aberrations. Each tube is complete in its own special packing case as shown. The mirrors and light chambers are carried in separate cases. These lenses are used with black-and-white cameras only.

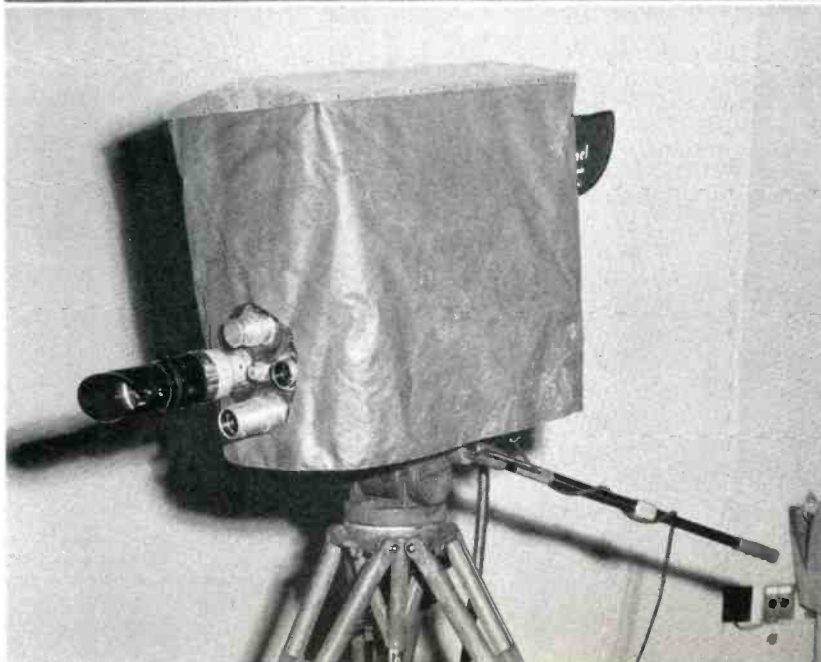

FIG. 31. TV raincoat constructed for camera. Made of a lightweight, waterproof cloth material, it provides ample air circulation and protection from inclement weather on outside remotes, yet is easily and quickly removed.



### Color Programming

There are three daily shows, Monday through Friday, in color. "Window" is a five-minute presentation at 2 P.M., sponsored by a local department store. Typical store products such as furniture, clothing, and fabrics are displayed in live action. "Captain Puget" is a half-hour live Monday-through Friday colorcast for youngsters from 5 to 5:30 P.M. "Deadline" is a 15-minute news show from 5:30 to 5:45 P.M. It's sponsored by a major oil company and won a national award for "best

local news program." From 5:45 to 6:00 P.M. "Dateline" takes over. This 15-minute color show includes national news and the weather.

In addition to these daily color shows, "Color Fair" a full hour show is put on approximately monthly. In format it's a "little spectacular" and, like the network show, of high quality. Subjects include: "Carnival in Color," "Flight Through Space," "Gaslight Follies," "The Upper Room," "Speak Easily," and "Spring Song."

On Saturdays, a popular half-hour show for children, "Quizdown" is frequently done in color. Fourth and fifth grades compete in teams on subjects they study; history, spelling, geography, etc. "Colorama" is an hour or a half-hour color film program presented on both Saturdays and Sundays.

Special color programs are received live from the network plus the daily "Matinee Theatre" (11 A.M. to 12 Noon PST). Other network color programs are delayed via lenticular film.

### "LITTLE SPECTACULARS"



FIG. 32. Typical scenes taken from various live "Color Fair" shows featuring Pacific Northeast talent.





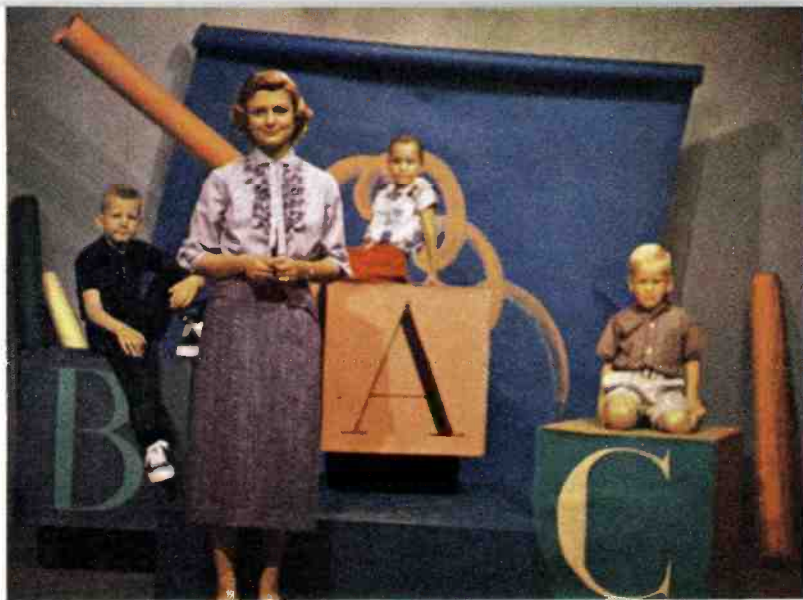

**"WINDOW"**

FIG. 33. Featuring Pat Spier, this is a Monday through Friday color program sponsored by a local department store.



**"DATELINE"**

FIG. 34. Featuring Bruce Caldwell, a 15 minute daily color program that includes national news and the weather.



**"DEADLINE"**

FIG. 35. Features Associate News Editor Keith Jackson and News Editor Herb Robinson. This award winning local news program is a 15 minute color presentation from 5:30 to 5:45 P.M.



FIG. 36. TK-41 color camera control room console consisting of monitors and control equipment for two live color cameras. This room also contains an equipment rack housing the two colorplexers associated with the cameras. Windows opening out into Studio B at the right.

### Color Engineering

"The decision by our management to procure color equipment early has been of considerable assistance in permitting us to become thoroughly familiar with the problems and to handle color shows properly," reports C. E. Miller, Chief Engineer. "We can now handle two color shows back-to-back with the same facility and perfection that we do a black-and-white show. This has been possible because we have been able to train our men to handle all phases of color.

"At the outset we learned the fundamentals from RCA color seminars; our early experience with network programs; and the operation of our 3-V film chain. The real experiences came when we got our live cameras. Since then, we have been in the process of rotating our men so that each receives four to six weeks training on live color cameras and color film equipment operations, both in the studio and in the control rooms.

To date, we have checked out ten men and expect to complete the training of all

cameramen and camera control men by late 1958.

"At the outset, there were a few problems—now we have learned how to handle most of them."

### Color Production

Art Director, Bob Dinsmore, believes, "It's much more interesting and effective to work in color. For example, texture is given considerable leeway in color in contrast to the flat tones that black-and-white reproductions give to most objects. Since texture gives variations to color, we can use this fundamental to enhance our settings and backgrounds.

"For background sets and shapes requiring onetime use, we usually prefer cardboard cutouts. These are inexpensively and rapidly prepared. Further, they can be colored to suit without delay.

"We have found that certain rubber-base paints are excellent for color TV. However, because of the premixed hues of these paints we often tone or brighten them by the addition of pure color water paints or tempera paints."

### Color Lighting

For lighting, it has been discovered that simply pouring more on is not quite the answer. In experiments by the engineering department, it appears that collimated light (spots rather than scoops) are frequently to be preferred since they give a better color effect.

A new lighting board was installed in the areaway between KOMO Studios B and C, and lighting capacity was increased so that both studios can be lighted for color simultaneously. Also, shows can be run back-to-back. A case in point: Daily at 5 P.M., the color show "Spotlight" goes on in Studio B using two separate sets. Meanwhile, in Studio C, preparations go ahead for "Deadline" and "Date Line" the news and weather color shows, in which three sets, a product display, an opaque set up and a crawl will be used. A few seconds before 5:30, one of the color cameras is moved through the areaway from Studio B to C and the switch is made without difficulty. Lighting for all of these sets is handled from the central board by one lighting engineer.

FIG. 37. Various experimental backgrounds testing the uses of basic materials and design techniques. Used as mood or design backgrounds for musical numbers on "Spotlight," a half hour musical variety show.

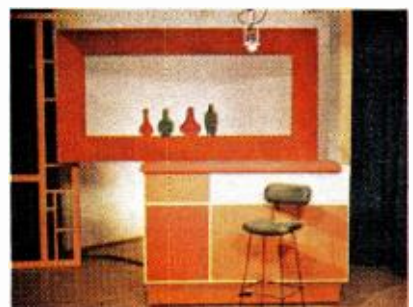



### Color Promotion

At the beginning of each daily "Cookbook Quiz" program, a group of some 50 women view the five minute color TV show "Window" on 21-inch color sets, contrasted with a black-and-white picture. They usually express considerable amazement at the beauty and perfection of color TV. This effort goes on five times weekly, hence, each week 250 additional families become aware of color TV by this means.

KOMO further promotes color around color shows by means of 20-second color spots. These same spots are also used before network color shows and during station breaks.

By far and away the best promotion is by means of the color clinics. Here the potential customer is being reached as well as potential set owners. Hereby, KOMO builds a sure future for color TV.

### Color Decision

"We believe that color television is the medium at its best," states W. W. Warren, Executive Vice-President and General Manager. "And since we live in a world of color, we are merely portraying people, places and things as they really are. We believe the values to the advertisers are enormous and that we are placing ourselves in position to share these gains."

"Just as we went from radio to TV—color is the next forward step," emphasized Dave Crockett, Manager of Programming. "Color adds a third dimension to the picture that you cannot get from black and white. Color also adds a new dimension of interest. *It's the next money in the advertising business.*"

"We wanted to get into color early to learn something about it," added Cliff Miller. "We wanted to get in early to train our people to handle color properly."

"It was the decision of our board of directors," summarized Bill Warren, "that the time is *now*. Over a period of a little less than 19 months, KOMO installed and put into operation facilities for 1) network color, 2) film equipment, 3) live color cameras. Our experience to date has shown that we made the right decision." The success of KOMO color clinics certainly testifies to the soundness of the decision to go into color early.



FIG. 38. W. W. Warren, Executive Vice-President and General Manager, KOMO stations.



FIG. 39. C. E. Miller, Chief Engineer, KOMO stations.

FIG. 40. Dave Crockett, Mgr. of Programming.

FIG. 41. Bill Hubbach, Sales Manager.







FIG. 1. Station WUNC-TV's identification letters were created by using first letter of each division of the consolidated university as illustrated in above photo.



FIG. 2. Herbert W. Reichert, Associate Professor of German, University of North Carolina, conducting program "Deutsch für Alle," at the Chapel Hill Studio.

## WUNC-TV — NORTH CAROLINA ETV STATION BRINGS COLLEGES TO THE COMMUNITIES

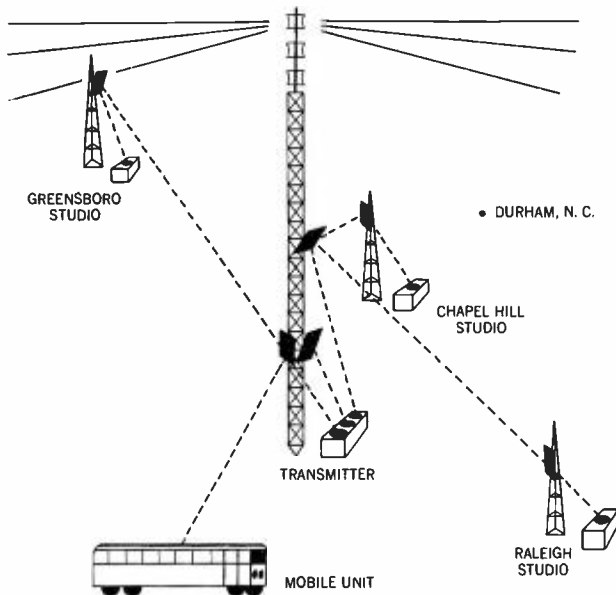

FIG. 5. Simplified diagram showing how three WUNC-TV studios, at separate locations, together with mobile unit are connected to the transmitter by means of a microwave relay system.



FIG. 6. The Hon. Luther H. Hodges, left, Governor of North Carolina, and William C. Friday, President of the Consolidated University of North Carolina, checking final details prior to broadcast.

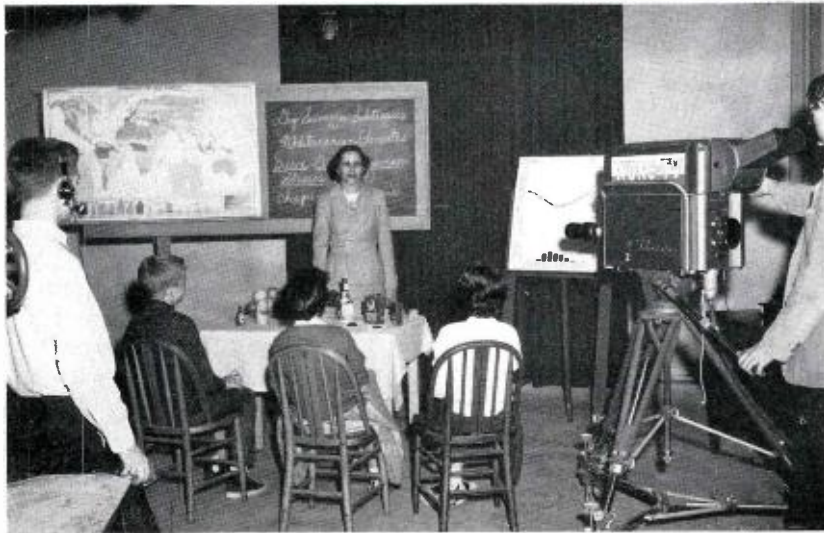

FIG. 3. Production scene from a series "Geography Comes to Life," one of the first WUNC-TV in-school programs.



FIG. 4. Assist. Professor of Radio, TV and Motion Pictures, John S. Clayton, explains workings of TK-31 camera to students in TV production class, during nonbroadcast hours.

*Adult Education Programs, Together With In-School Enrichment Programs and Credit Courses, are Giving Students Opportunity to Get Training and Enable Teachers to Perfect Their Techniques*

WUNC-TV went on the air January 8, 1955, after intense preparatory programming which began in August of 1954. It is operated by the Consolidated University of North Carolina, which includes three institutions of higher learning: University of North Carolina, at Chapel Hill; North Carolina State College, at Raleigh; and Woman's College, at Greensboro, North Carolina. Studios are located at each of these three institutions, while a 100-kw maximum power Channel 4 transmitter is centrally located at Chatham, near the Chapel Hill studio. The three studios are connected to the transmitter via microwave relay links. Master control and film facilities are located at the transmitter.

In practice, the system works like this: The three directors have regular meetings to plan a consolidated program covering a period of four months. Then each director is responsible for his portion of the total program. Each campus has a faculty council that deliberates upon the new programs being considered, and each director works together with his council to make final program arrangements. Representing the Consolidated University, the

Provost meets with representatives from each of the three councils to handle matters of general policy, such as requests for special programs by non-University groups.

In addition to the intra-University programs, there are such public service programs as those featuring, the Boy Scouts, public schools, the General Assembly (state legislature), Governor's addresses, the state Council of Churches, League of Women Voters, etc.

The complete program day for the consolidated operations runs as follows:

Monday-Friday	8:45-11:00 A.M. 12:15- 2:00 P.M. 5:30-10:05 P.M.
Saturday	6:30- 9:00 P.M.
Sunday	9:45 A.M.-12 Noon 6:30- 9:00 P.M.

On Wednesdays, school programs continue throughout the afternoon, giving the station a 13 hour and 20 minute day of continuous programming. Saturday programs are usually sports and film shows.

Films from the Educational Television and Radio Center at Ann Arbor are used throughout the week. On Sunday morning, former Chancellor Robert House teaches the Sunday School lesson. Religious films and church services follow. These services are rebroadcast live by a state network of 6 commercial stations.

Although it is not the customary ETV practice to program a 7-day week, WUNC-TV believes the audiences can be held better by daily programming, including both Saturday and Sunday.

Weekday morning, junior and senior high school students throughout the wide Piedmont (center) section of the state watch their arithmetic, science, and history lessons every day from Channel 4. The new "vertical programming plan" began in the Fall of 1957. Wednesday will be the first complete program day. Next it is hoped to schedule a full broadcast day on Tuesday. This will continue until the week days are fully scheduled. Thus, full use will be made of available facilities to offer a maximum of service to the people of North Carolina.



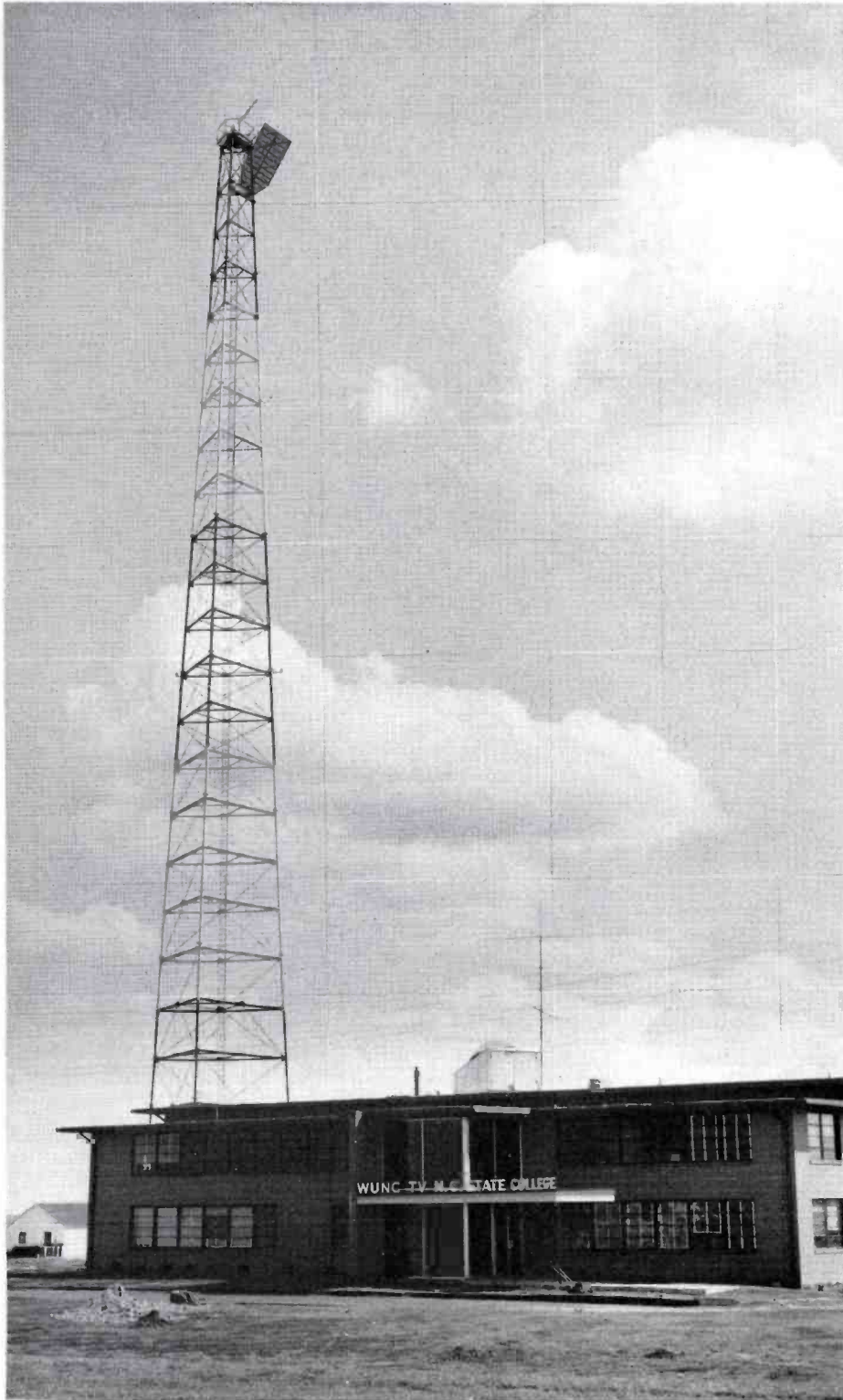

FIG. 7. Raleigh studio and tower. A 200-foot tower holds passive reflector, receiving antenna. Superstructure on roof houses 1-watt, 7,000-mc microwave transmitter. Pole-mounted, ground plane antenna is for 26-mc 2-way radio.

## STUDIOS AT RALEIGH

At the state capitol in Raleigh, the North Carolina State College has constructed a two-story, masonry structure 60 by 120 feet to house studio facilities for program originations from what is essentially a state college of agriculture and engineering. Consequently, the program format finds peculiar expression in such shows as "Today on the Farm" and "Science and Society."

Heading the Raleigh studios is Roy J. Johnston who is Director of Television for North Carolina State College. Together with a staff of five—Engineer-in-charge, Production Director, Staff Artist, Secretary, Production Assistant—he runs the programs originating here.

By education and temperament, Johnston is ideally suited to the job of ETV director. He combines the experience of the educator with the talents of the production expert. Johnston has taught University English, theatre and speech. He has had four years of commercial TV as Program Director or Operations Director at WLTV, WETV, WRBL, and WRDW. Bringing this professional background to Raleigh has made it possible for the faculty here to provide *educational television* for the viewers rather than merely televised education.

### Studio A

The main studio at Raleigh is 45 by 45 feet, large enough to accommodate five sets at one time, and is constructed and equipped in the same manner as commercial studios. The ceiling is approximately 20 feet high and supports a TV lighting system consisting of 24 C-1315 scoops (1500 watt), five "sun spot" long-range scoops (15,000 watts), five 6 inch Kleigel Spotlights (150 watt), eight 8 inch Kleigel Spotlights (1000 watt), four C-1581 pattern projector spots (750 watt), one C-1568 follow spot with iris (1000 watt), four 6-light 42 inch fluorescent banks, and 30 pantographs. The lighting board, designed and built by the station engineers, is standard for all the campus studios. The studio is air conditioned. For best acoustic results the walls are covered with Fiberglas, held in place by course mesh wire. As many as 200 persons have been accommodated in the studio for a single show.

Equipment in this studio includes two Type TK-11 TV Cameras, Microphone Boom and Stand, Microphone Boom and Perambulator. Provision for hanging drapes near the walls and fastening flats to the walls is incorporated. A prop storage area and shop are located nearby. Thus sets can be changed without too



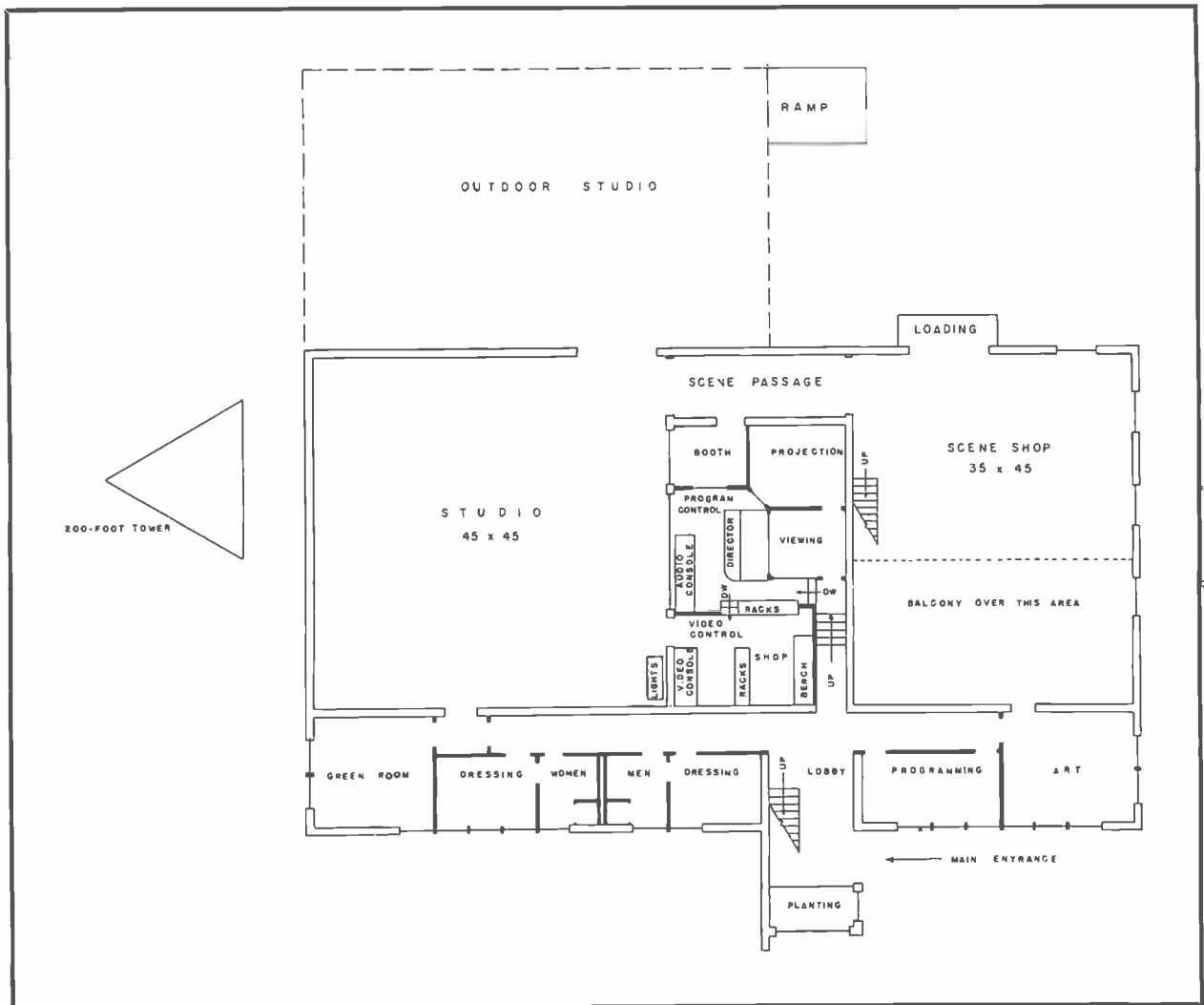

FIG. 8. Ground floor of State College Studio in Raleigh. (Offices are located on the second floor, in the front section of the building.)

much delay or undue effort, just as in commercial TV stations.

#### Studios B and C

Studio B is an area 35 by 45 feet, which is used mainly for shop shows. Portable lighting equipment is used. Cameras are wheeled in from the main studio.

Studio C is an outdoor studio used mainly for farm shows involving bees, live stock, farm equipment, etc., which must take place in the open fields. Cameras are moved out from the main studio for these shows. Sometimes the mobile studio is used.

#### Control Room

One control room handles all studios and also the remote programs. The control

room is divided into three areas: camera control, director's control, and announce booth. The director's control room is raised above and overlooks the main studio through a large picture window. The announce booth overlooks both the studio and the director's control room. In addition, an area behind the director's control room is available for a viewing room accommodating 15 persons since it overlooks both the control room and the studio.

The camera control contains camera control units, master monitors and rack equipment for cameras, and the microwave. Here the video operator adjusts the electronic circuits of the cameras to give best results. Four equipment racks act as a

divider between camera control and director's control.

In the director's control room, the audio operator is seated at the front, close to the window, while the director and the switching operator are seated at an elevated desk in the center. A BC-2B Audio Console, two model 530 three-speed turntables, and a tape recorder are all operated from the audio operator's position. A TS-5 Video push-button switcher and fader mechanism and a two bank preview/direct-take switch are built into the director's desk. This simple 4-bank control board allows the director to preview and to select the on-air picture and provide programming features such as fades, dissolves, and superimpositions. Four

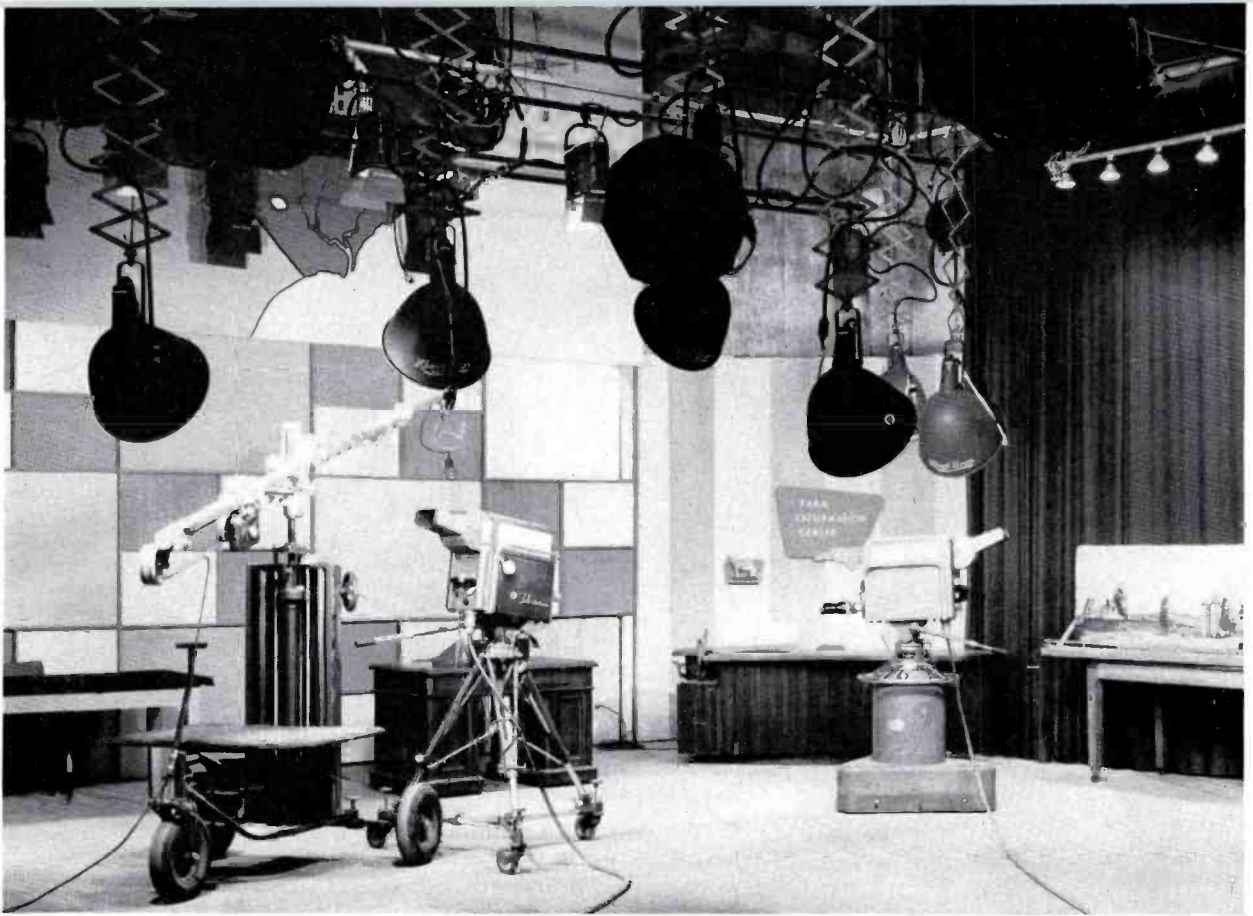

FIG. 9. State College studio with set for "Today on the Farm," which is rebroadcast over commercial stations on channels 5 and 12.



FIG. 10. Lower level of Raleigh control room and studio as seen from the director/switcher desk.

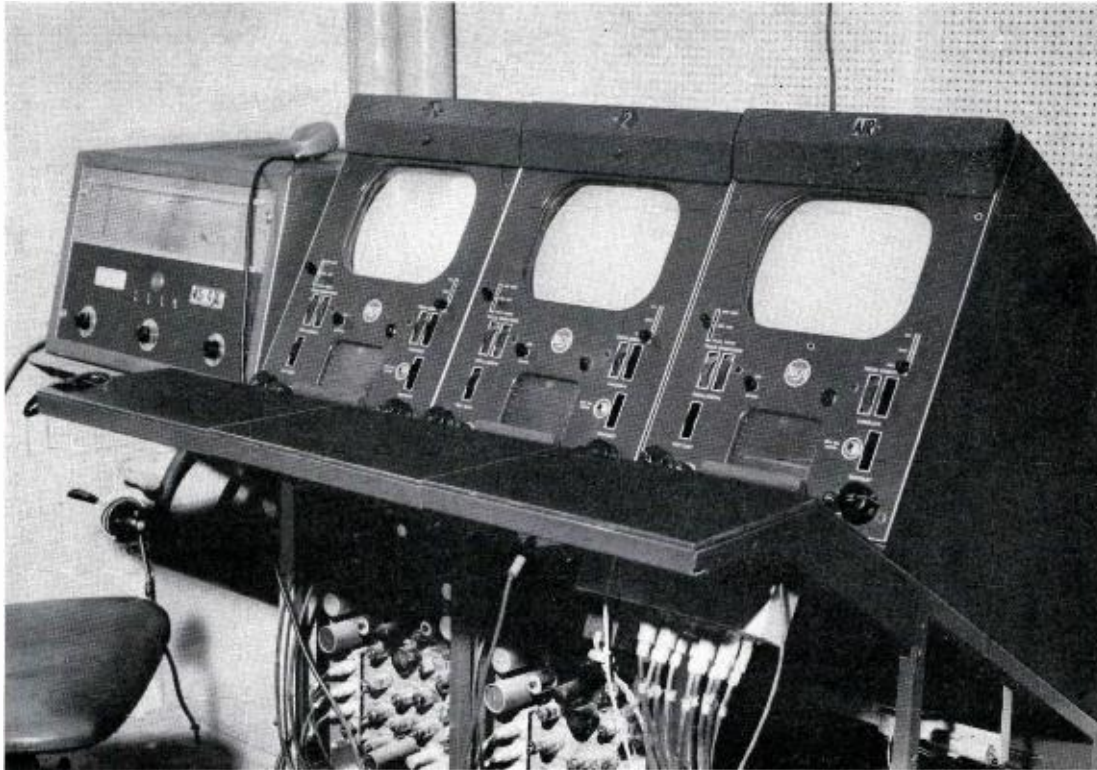

FIG. 11. North Carolina State College's control room showing (at left) RCA 2-way radio unit and (at right) camera control units and master monitor.

overhead picture monitors permit the director to see Camera 1, Camera 2, preview, and on-air pictures.

#### Raleigh Programs

In addition to the farm show, there are other adult education programs emanating from the Raleigh Studios. Of these, "Science and Society," a one-hour weekly program which deals with the conciliation of religion and science, has proved to be most successful. The North Carolina Prisons Bureau is now co-sponsoring the program, making it part of the official prison rehabilitation program. As part of the program, college instructors pay visits to prisoners to counsel them. Graduation ceremonies for those completing a prescribed course are also held in the prison.

"Russia—Past and Present" has proved to be another popular one-hour weekly show. Kinescope recordings of "Science and Society" and "Russia—Past and Present" were used at the Harvard Summer School during the 1957 session.

Many of the remote programs are done

from Raleigh since the legislature and governor are housed here and official activities are quite frequent. One of the more extensive remotes at Raleigh was the Gubernatorial Inauguration ceremonies in February, 1957. Five cameras were employed at three different locations. Microwave installations fed the signal back to the Raleigh studio. This was a two-day affair covering the inaugural ball, the actual inauguration ceremonies, and the grand parade. Also, on the following day, the governor's opening address to the legislature was covered.

On another occasion, a complete extra session of the legislature lasting five days was covered, as far as is known this is the first time in the nation that a complete legislative session has been telecast. Cameras were moved as the legislature moved: from legislative chambers to a state auditorium, and then to the municipal auditorium (where the legislature finally met because of lack of space in the state auditorium).

Since the Raleigh studio building is 50

to 100 feet higher than the rest of the city, most remotes from Raleigh can be worked into the studios using a microwave antenna on a roof-mounted tripod.

#### The Future at State College

In the Spring of 1958, full-credit courses already scheduled on the other campuses are planned for State College. Plans are currently being formulated and resources explored for the possibilities of televising seven hours a week of mathematics and science to the high schools in the Channel 4 area. The Raleigh studio, utilizing the faculty of North Carolina State College would offer supplementary material in chemistry, biology and general science with complete high-school credit courses being given in algebra, plane geometry, solid geometry, and trigonometry.

Current scheduling for adult viewing includes a well-balanced television diet of erudition and recreation including such programs as "Psychology in Action," "Southern Authors," "Art of Living," and "Family Fun."



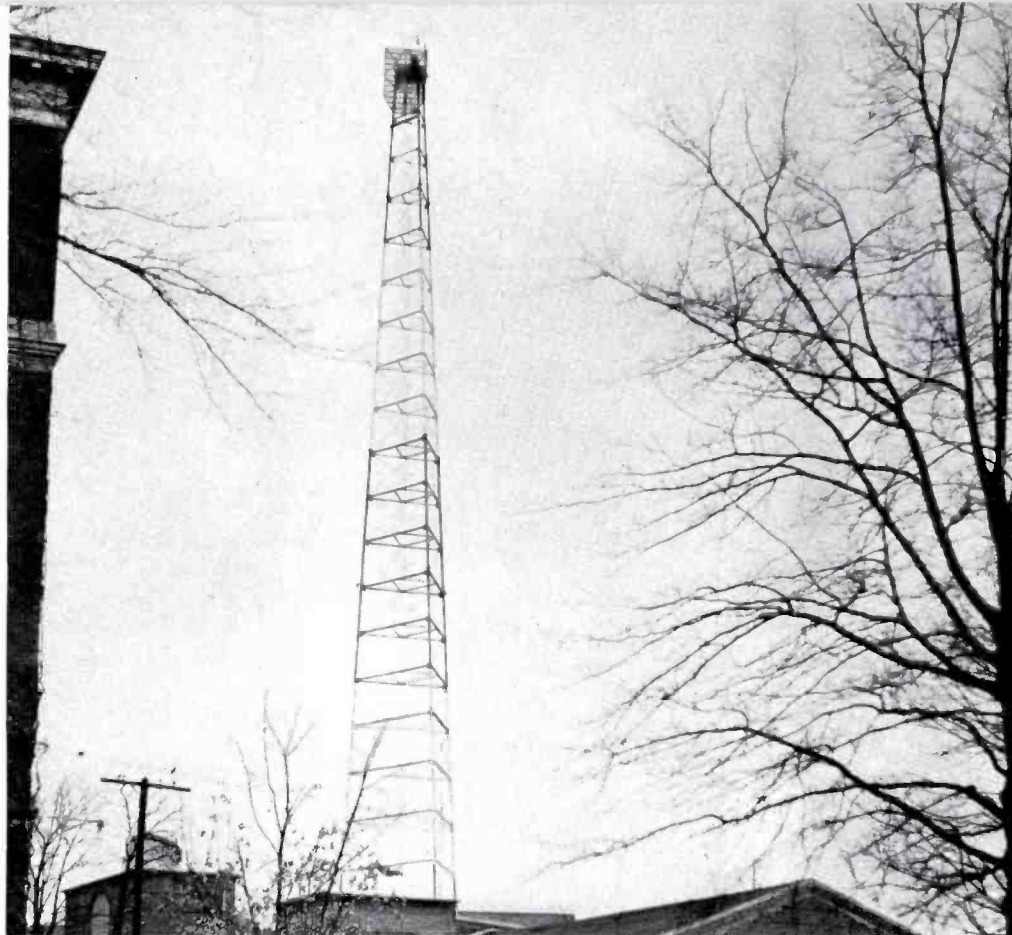

FIG. 12. Tower of WUNC-TV studio at Woman's College, Greensboro, N. C.

### STUDIO AT GREENSBORO

Another one of the three studio centers of WUNC-TV is located at the Woman's College, Greensboro, North Carolina, which is one of the institutions making up the Consolidated University. Operations of this studio are under the supervision of Mr. Emil W. Young, Jr., Director of Television at Greensboro. Programs are relayed from this studio by microwave to the transmitter at Chatham—a distance of some forty miles through one repeater station enroute.

Mr. Young has a permanent staff of four to conduct operations at Greensboro studio: Program Manager, Production Assistant, Woman's Director, and Engineer. In addition, part-time help from the Woman's College is employed.

Like his colleagues at the other two studios (Raleigh and Chapel Hill) Director Young is responsible to the Chairman of the local Faculty Committee on Television. Although Greensboro is a women's college, some 50 percent of the faculty are men. Students in the Drama Depart-

ment of the Woman's College use the TV studio as a laboratory.

### Facilities at Greensboro

The studio proper is a 60 by 60 foot area, air conditioned and equipped with professional equipment. For best acoustic effects, studio walls are covered with Fiberglass, covered by wire. Thus excellent effects are obtained using either a single instrument or a full orchestra. Ceiling height is 20 feet, which provides space for large sets and lighting facilities. A rear screen projector and screen are standard equipment. For property storage, a 20 by 20 foot area is nearby; also a scene shop 30 by 30 feet. The students do most of the art and scene work.

Two TV Cameras type TK-11A are used. One is tripod mounted, the other is on a pedestal mount. Two boom microphones are available, one of which is perambulator. Audio equipment includes BK-1A Announce, 77-DX Polydirectional and BK-5 Miniature Microphones.

For studio lighting, there are eight light battens containing 10 lighting fixtures each



FIG. 13. Woman's College Studio, WUNC-TV, Greensboro, North Carolina.

and six smaller battens, containing 6 each at right angles. These overhead lighting battens, counterweighted, can be raised and lowered easily. The lighting-board, similar in all campus studios, has been designed and built by WUNC-TV engineers. Five banks of lights can be pre-set. This provides for fast and easy operation of lighting circuits.

In one corner of the studio, an announce booth, 10 by 12 feet, is located directly on the floor level. It contains large windows, and also serves as a small auxiliary studio. Moreover, it is used for direct film projection (to be described later).

#### Control Room

The area behind the studio is divided into three rooms: video control, work room, and control room proper. Video control contains the camera control and rack equipment. The work area behind the racks, provides a convenient place for routine maintenance. The control room itself is elevated seven feet above, and contains a large window overlooking the studio. A BC-2B control console with two turntables and a tape recorder handle audio requirements.

The director's desk is further elevated two feet above the control room floor.

Five monitors are used: Line, Camera 1, Camera 2, Film, and Preview/off-air. Remote control for slides and film is also located here. The Type TS-5A Video Switcher and a two-bank preview/direct-take switch provide for normal switching and preview needs. Intercom facilities include a circuit to Chapel Hill studio and to the Chatham transmitter.

The Greensboro studio contains a film area with a vidicon camera chain. Also there is film equipment donated by WFMY-TV. Operation of slide and film projectors is both local and remote.



FIG. 14. Marlene Klett at TV camera in studio of Woman's College.

Director Young, a graduate of RCA Institutes and formerly an engineer at WFMY-TV, has designed and built several pieces of equipment to expedite operations. An effective "shadow-box" device he designed makes it possible to use a 16-mm film projector for direct projection into a regular studio camera. The film is projected (reflected from a front surface mirror, for right to left reversal) onto a ground glass screen and the camera is focused on the screen. For the occasional use of studio film, the camera is simply dollied to a prescribed point near the announce booth and focused on the image. Another TV studio device designed by the staff is an inexpensive crawl that employs a sewing machine motor and gives a choice of five different speeds.

#### Closed-Circuit TV

On several occasions, closed-circuit programs have been fed to various classrooms. For a recent PTA meeting, for example, cables were run to eight different rooms. Regular 21 inch TV receivers and a monitran was used for both picture and sound. Since the results have been very satisfactory, it is a possibility that closed circuit TV may be used for teaching some classes. It is planned to run two-way RG-11/U 72-ohm cable to several key campus buildings for permanent closed circuit TV use.

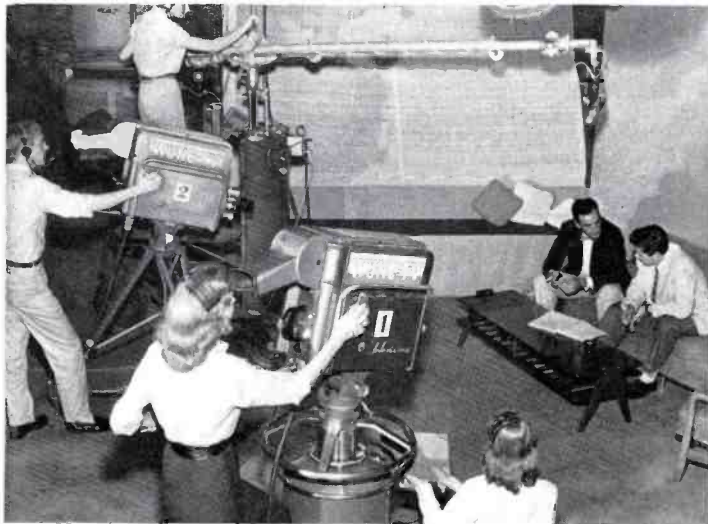

FIG. 15. Camera 2, Henry Johnston; Boom, Leslie Radcliffe; Camera 1, Marlene Klett; Floor Dir., Rita Parish; Talent Bob Hennon and Harry Thornton.

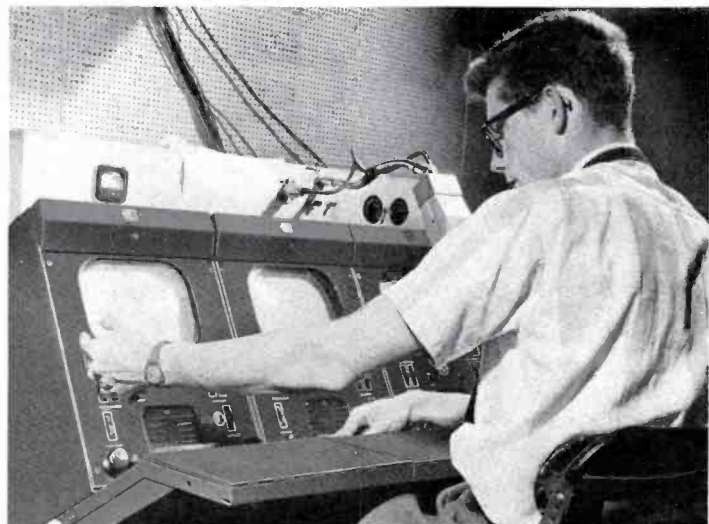

FIG. 16. Edward Graves at video control.



### Greensboro Programs

The Greensboro Studio is now producing 26 half-hour programs each week covering a wide range of subjects. These include the Ford Foundation experimental programs—on the junior high and high school levels, and credit courses on the college level. In the realm of adult education, the Greensboro studio offers a women's program four days each week from 1:30 to 2:00 P.M., "Lecture Hall," a photography program, and "Prelude" a weekly program of fine music. There will be two programs especially for the elementary age child, one "Music in the Air," which is televised during school hours and is channeled into participating schools as part of their music education. The other, still in the planning stage, will be seen early in the evenings on Fridays and will deal with arts, crafts, and music. Another new program, designed to interest teenagers and their parents is the "Junior Engineers" produced by boys and girls from a local high school. There are no Saturday programs, but church services originate from Greensboro every three months. One program produced at Greensboro won national recognition by the Educational Television and Radio Center at Ann Arbor. Called "Christmas Painting" it has been produced for distribution by the Center.



FIG. 17. Emil W. Young, Jr., Director of Television at Greensboro.



FIG. 18. Frances Nooe acting as audio operator.

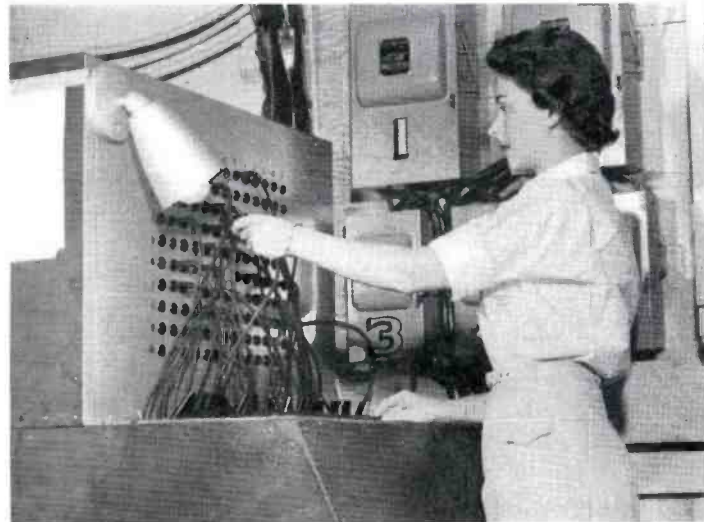

FIG. 19. Louise Crumbley at light board.



FIG. 20. Swain Hall—University of North Carolina at Chapel Hill. Here is location of Communication Center, Dept. of Radio, Television and Motion Pictures, WUNC (FM), and WUNC-TV (Chapel Hill Studio).

#### STUDIOS AT CHAPEL HILL

Here at Chapel Hill is located another of the three major studio units making up the consolidated WUNC-TV operation. This studio is located in the Communication Center of the University at Chapel Hill, one of the three institutions included in the Consolidated University of North Carolina. Programs are relayed via microwave to the transmitter at Chatham—a distance of some eight miles.

#### Communication Center

Several related communications activities are brought together in Chapel Hill

to form the University's pioneering Communication Center, established in 1945. The Department of Radio, Television and Motion Pictures is housed in Swain Hall at Chapel Hill (the same building that houses the local WUNC-TV studio). This is an academic department granting MA and BA degrees with majors in communications. The teaching staff is a separate organization from that of the television station, but during nonbroadcast hours students use facilities of both the radio and TV studios as laboratories and, in some cases, also serve as part-time em-

FIG. 21. Each summer, the Department of Radio, Television, and Motion Pictures, in co-operation with the North Carolina Association of Broadcasters, sponsors a High-School, Radio-Television Institute. Here the Institute students rehearse a radio program. The Institute's TV production classes are held in WUNC-TV's Chapel Hill Studio during nonbroadcast hours.

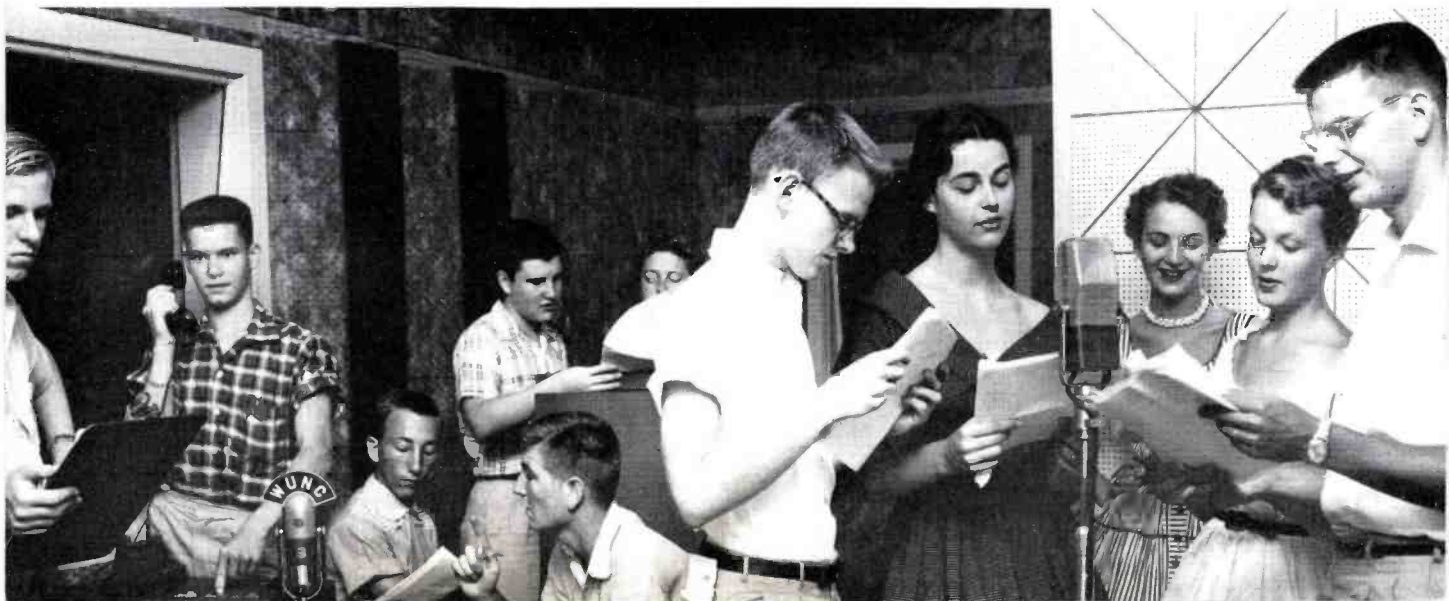

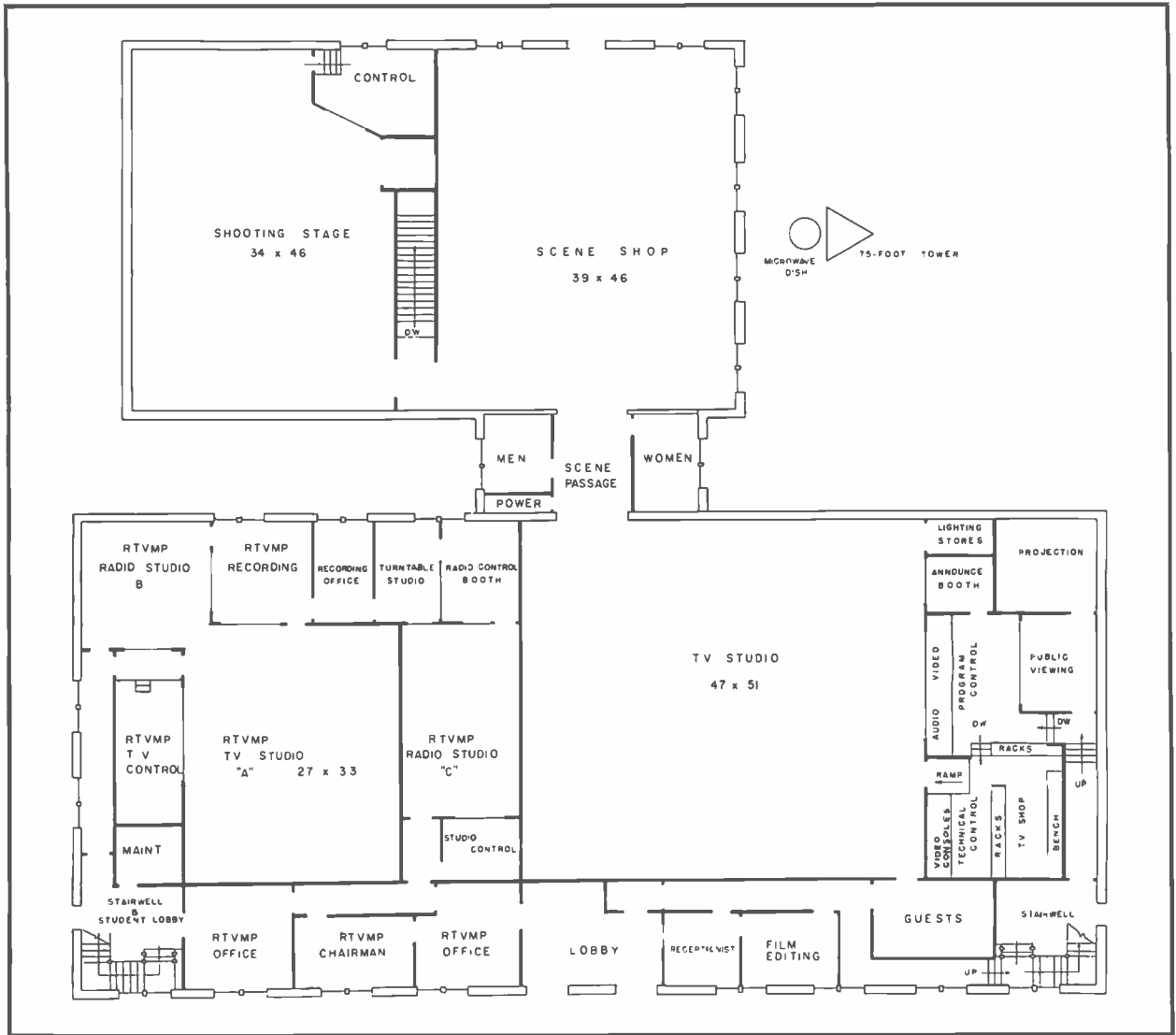

FIG. 22. First floor plan of Swain Hall at University of North Carolina. WUNC-TV occupies the entire right side of the building, with the Department of Radio, Television, and Motion Pictures on the left. WUNC (FM) is in the basement on the left. Offices are situated on the second floor.

employees. Professor Earl Wynn, who is Director of the Communication Center, is also Chairman of this Department.

Upon majoring in speech and the theatre at Northwestern University, Earl Wynn came to Chapel Hill in 1938 to teach speech, dramatic literature, and radio. He was active in the development of the radio department in 1940 but was diverted to the military from 1942 to 1946. Upon his return he founded and became Director of Communication Center at Chapel Hill, bringing together all of the various communications media: movies, film strips, radio and television.

#### Facilities at Chapel Hill Studios

The Chapel Hill TV studios are run by John Young, Assistant Director of TV, who has been with the University for 10 years. Mr. Young majored in radio, then taught radio and TV production for several years. He managed the radio broadcast operation, then in 1956 moved into TV. (The radio station, WUNC, is mainly an FM music station, also programming news and special events and operates daily from 7 P.M. to 11:30 P.M.)

There is one large TV studio in Swain Hall, in addition to a shooting stage for

motion pictures, adaptable to TV use, and two radio studios which can also be used for television when needed. The TV studio is 40 by 60 feet with a 29 foot ceiling and is professionally equipped.

There are two TK-11 Cameras, one with field mount, the other with studio mounting. Audio equipment includes perambulator boom mike as well as an assortment of announce and personal microphones. Lighting units are supported by 1½ inch conduit, which is hung from supporting members by chains. The standard lighting control board is also used here.



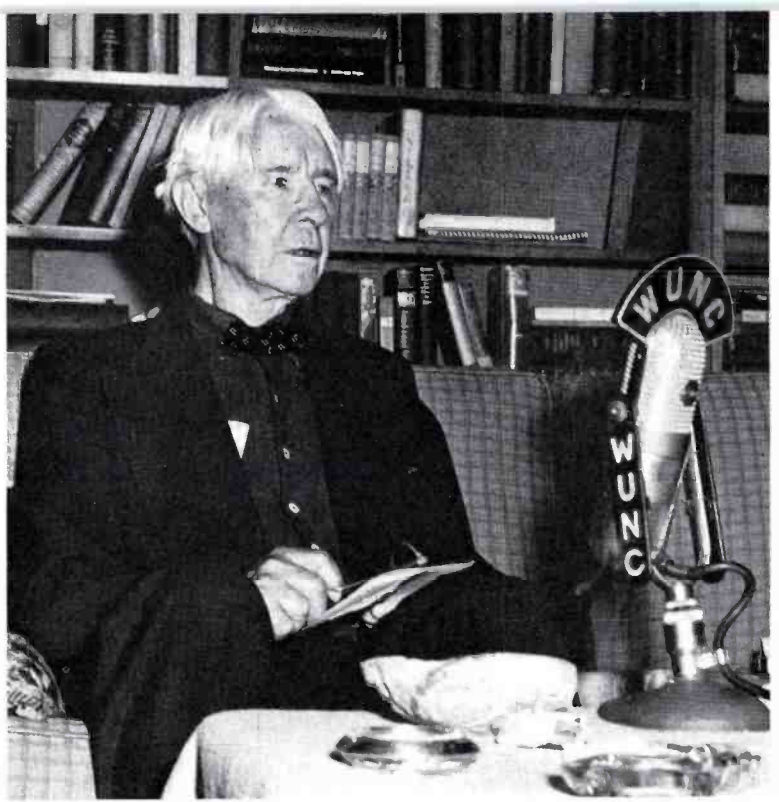

FIG. 23. Noted author, Carl Sandburg, recording program in Communication Center which produced radio series titled "Listen America."

FIG. 24. WUNC (FM) studios. Background, left to right: Jo Ellen Wade, Claire Cheney and Arnold Culbreth. In foreground, Robert Carswell.



FIG. 25. Production scene from "American Adventure" radio series. Actors are George Brenholtz and Jo Ellen Wade; sound technician, John Langston.

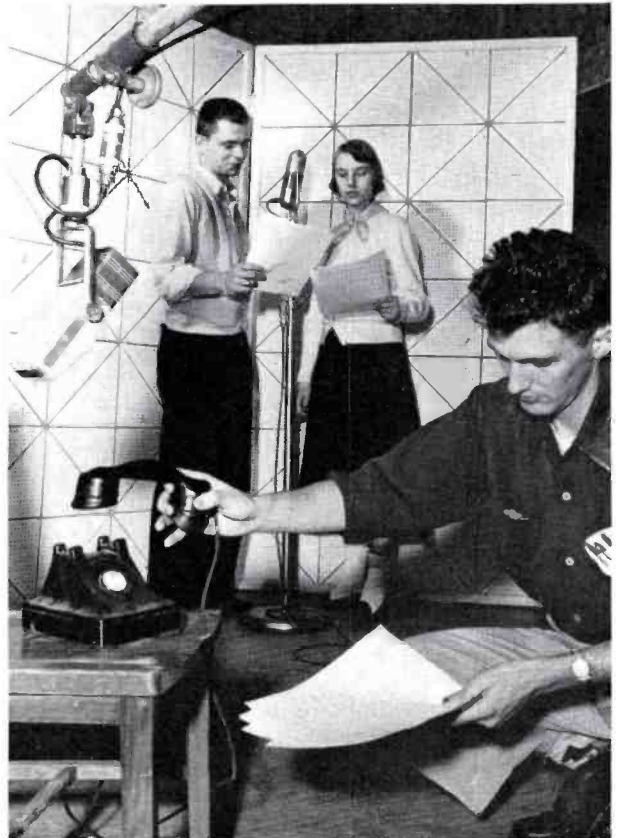



FIG. 26. Chapel Hill Studio program "Know Your Schools" featuring a panel of university faculty with studio audience. A biweekly program in co-operation with the UNC School of Education.

The following lighting units are used:

Type	Number
Fresnel Spotlights, 8", 1000w. ....	20
Fresnel Spotlights, 6", 500w. ....	9
Fresnel Spotlights, 6", 750w. ....	4
Fresnel Spotlights, 8", 2000w. ....	8
Lekolights, 6", 750w. ....	4
Elipsoidal, 6", 2000w. ....	1
Followspot, 8", 2000w. ....	1
Scoops, 18", 1500w. ....	14
Long-range Scoops, 1000w. ....	6
Sunspot, 1000w. ....	1
Slimline Fluorescents, 64" ....	4

A continuous track runs around three walls so that drapes can be easily and quickly moved into position to create settings. In addition, there are special sets for news and sports. Facilities for rear projection add to the complement of studio equipment. For best acoustics the studio walls are lined with Fiberglas panels. Additional Fiberglas panels are also suspended from the (false) ceiling. The studio is air-conditioned.

#### Studio Control Area

This area, directly behind the studio, is divided into two spaces: the video control room and director's control room. Video equipment consists of field camera control units (Type No. TK-31A. MI-26066). One wall of the video control is formed by the rack equipments. Behind the racks is an area that serves as a small workshop.



FIG. 27. Scene from program done in co-operation with the School of Nursing at UNC, in Chapel Hill Studio.

FIG. 28. Rehearsal for one of the biweekly "Project Health" series. On right is John E. Young, Assistant Director of Television for Chapel Hill Studio.

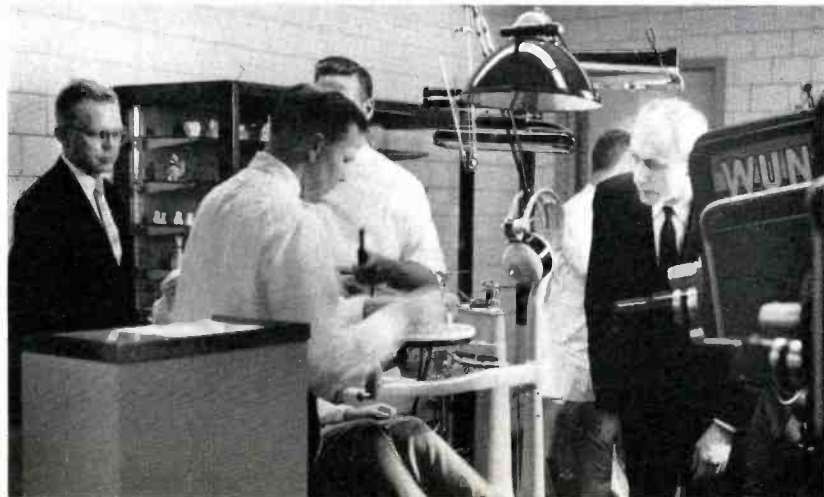





FIG. 29. Production scene during "Boyd and the Bible" series from Chapel Hill Studio. On the left is Dr. Bernard Boyd, Chairman of the UNC Dept. of Religion; the cameraman is Bill Wall.



FIG. 30. Production scene from a series of film spots on "Highway Safety."

FIG. 31. Eleanor Dare and her puppet friend, Honey Bear, entertain some young visitors on their weekly "Draw Me a Story" from the Chapel Hill Studio of WUNC-TV.



The director's control room is 15 by 18 feet on a level three feet higher than the studio and contains a large window overlooking the studio. An audio console together with two turntables is stationed at the left, directly against the window. The director's console is in the center of the room, for maximum convenience in watching studio operations as well as viewing monitors. There are four monitors: Camera 1, Camera 2, Line and Preview. (In addition, there is room available for a film monitor.) The switcher is a type TS-5A and a 2-Bank Preview/Direct-take switcher. They can be operated by director.

Behind the director's control room is an elevated viewing room that seats some twenty persons. To the right of the director's control is an announce booth with BK-1A Microphone and windows overlooking both studio and control room. Facilities also include a large property storage area, a crew lounge, and a scene shop.

#### Chapel Hill Programs

Programming at Chapel Hill includes a series of in-school presentations. For the elementary grades, there are half hour weekly shows such as "Play Period." For high school students there are half hour weekly vocational guidance programs such as "Careers for You." There are no credit courses yet, but plans are afoot for in-service programs to be done by master teachers, in such subjects as physics, science and speech—to teach the teachers.





FIG. 32. Assistant Professor of Radio, Television and Motion Pictures, John S. Clayton, demonstrating directing techniques to class in TV production. Seated left to right: Claire Cheney, Jean Rayburn, John Clayton, Louise Coffee and Hugh Downing. Standing, Mary Lou Watson and Earl Wynn, Chairman, Dept. of RTVMP.

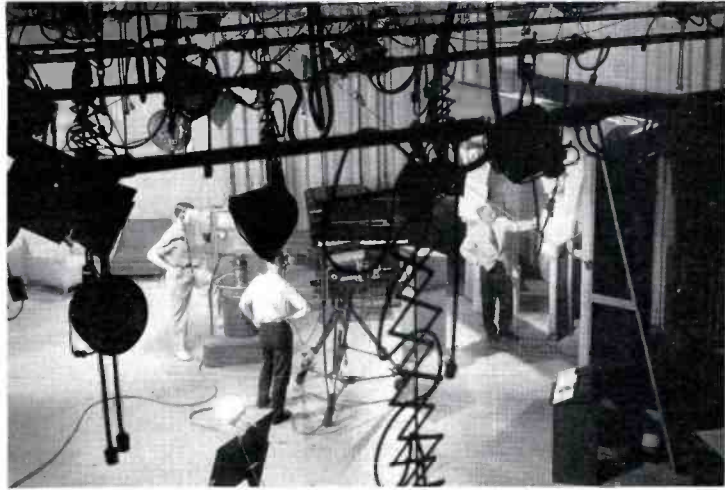
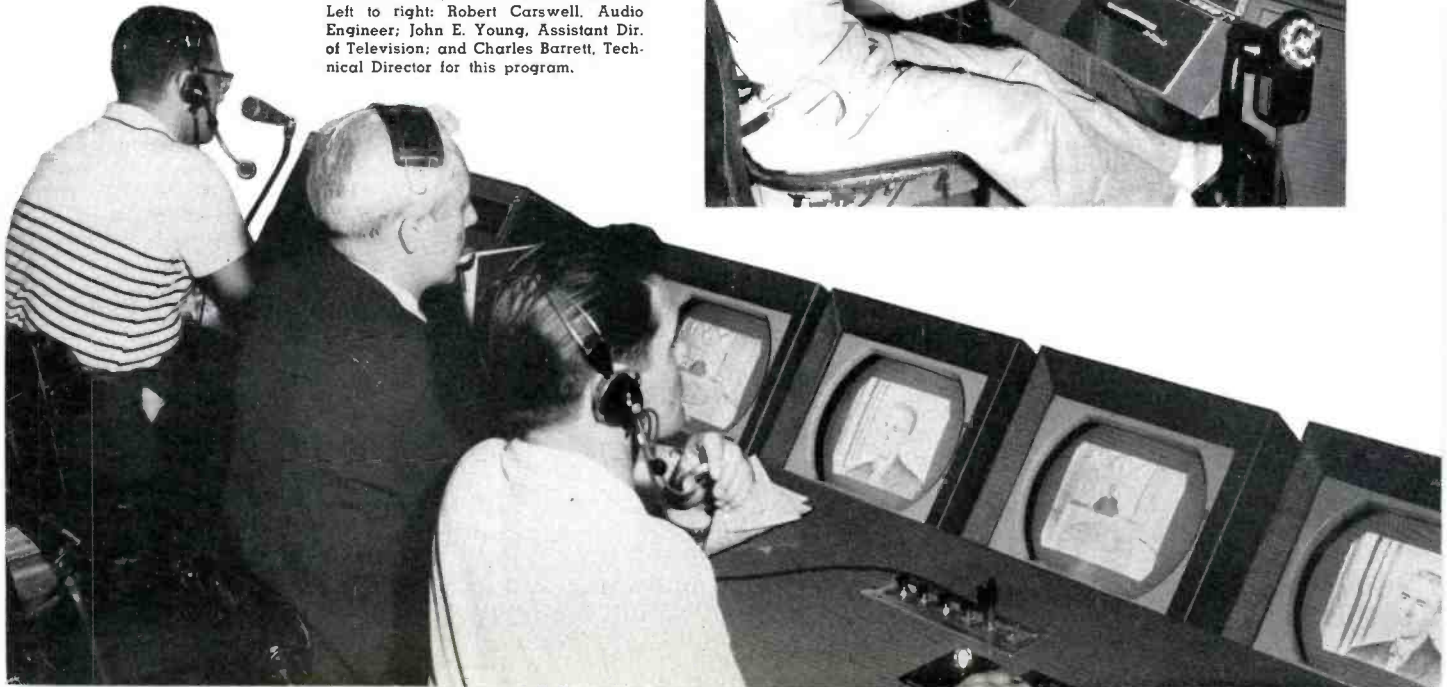

FIG. 33. Chapel Hill production scene during program "Deutsch für Alle" (credit course in Elementary German).

FIG. 34. Frank E. Farrow, Studio Engineer, at video control, in Chapel Hill Studio.



FIG. 35. Chapel Hill studio control. Left to right: Robert Carswell, Audio Engineer; John E. Young, Assistant Dir. of Television; and Charles Barrett, Technical Director for this program.



### WUNC-TV REMOTE AND NETWORK PROGRAMS

Remotes using as many as five cameras have been done by the WUNC-TV mobile studio. Originations for NBC "Wide Wide World" and ABC "Medical Horizons" have been made from Durham and near-by Duke Hospital.

The NBC Educational TV series is also being run by WUNC-TV. This is considered to be a fine program, a real contribution to the cause of educational television.

Normally, program ratings for WUNC-TV run in the order of 2 to 5 percent, but when a basketball game is on, the rating skyrockets to as high as 33 percent.

To obtain faculty co-operation on as wide a scale as possible, a series of programs are planned that take in much variety in talent. Since there are approximately 7000 students at Chapel Hill, the

faculty amounts to some 1000 members, of which 600 are full faculty members. In order to have as many departments participate as possible, five series are scheduled using rotating talent. This gives many faculty members a chance to participate, indoctrinates the faculty widely, and also creates a feeling of good will.

### Broadvision

This is an excellent example of co-operation with local broadcasters whereby WUNC-TV puts on the picture part of basketball games, while the audio is a play-by-play description via commercial radio. In this way, both WUNC-TV and the radio broadcasters get large audiences. Since North Carolina's basketball team has been a national attraction, this kind of programming rates high with the viewing public.

It gets people acquainted with their state university as never before. Experience has shown that they buy TV sets and install

expensive antenna systems just to get WUNC-TV "Broadvision" and, in so doing, take the first step towards bringing all other of the consolidated university's programs into their homes.

### THE CONSOLIDATED FUNCTIONS

As the Consolidated University of North Carolina went forward in its move toward an educational television station it called in Alan B. MacIntyre, an engineer from its North Carolina State College, to do some engineering and coverage studies for Messrs. Carmichael and Wynn. MacIntyre had returned to NC State College to do graduate work and teach electrical engineering, being with the Engineering Research Department when he was called into educational television. His previous experience had been with a radio station, with Naval Research Labs and Naval Shipyards as an electronics officer during World War II. The basic planning for the station was turned over to Mr. Robert F.

FIG. 36. WUNC-TV transmitter site is approximately eight miles southwest of Chapel Hill, atop Terrell's Mountain, Chatham County. Note plastic "bubbles" in roof, housing microwave dishes.



FIG. 37. Note passive microwave reflectors mounted part way up the antenna tower.

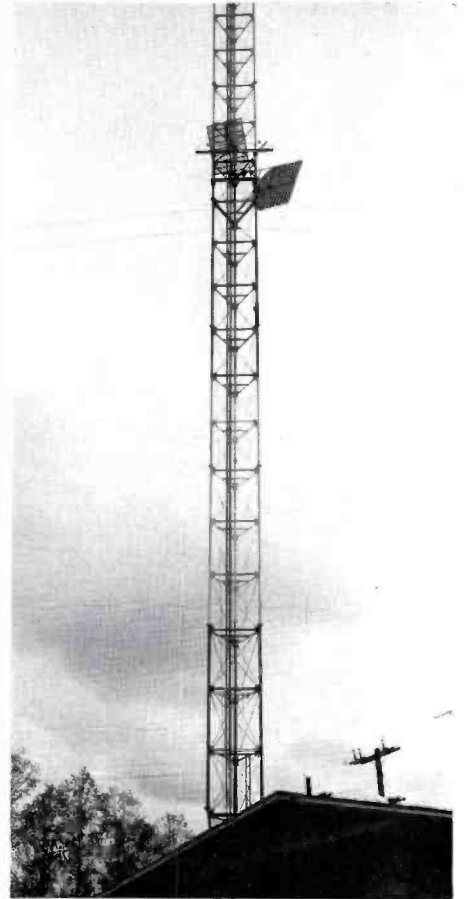

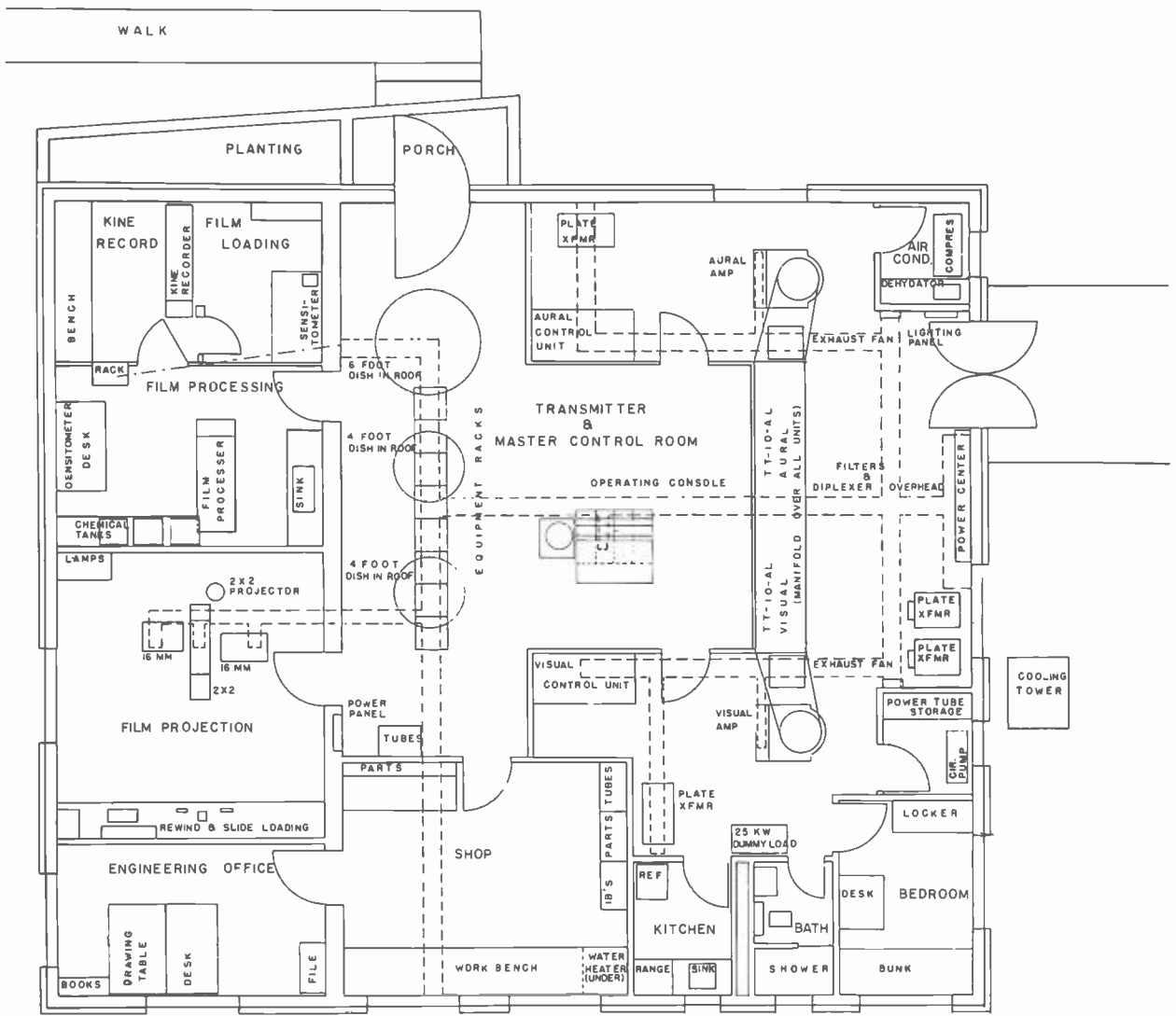

FIG. 38. Chatham building housing transmitter, master control, film, and kinescope recording.

Schenkkan who was then Director of Television, and to Mr. MacIntyre, who became Chief Engineer. Architectural plans were worked out with the firm of Lowenstein-Atkinson who served as architects for remodeling at Greensboro and Chapel Hill, for the new studio building at Raleigh, and the new transmitter building. A. D. Ring and Associates were retained as consulting engineers for the Channel 4 and eight auxiliary license applications.

The detailed plans, equipment selection, building sites, microwave paths, studio and transmitter wiring plans, studio lighting, mobile unit design were all carried out locally by the chief engineer and the small engineering staff that was present at the time. Charles Idol, Engineer-in-Charge of the Raleigh studio; Ed Gill, Transmitter Supervisor; and R. Taylor Rogers who is now doing kine recording

and other engineering duties, were all active in the original planning of the station. These men came, as others have later, to WUNC-TV on a full time basis with the hope of continuing their education at one of the nearby colleges when they could. One Master of Science in Electrical Engineering has resulted with the research being done on Unisync, a project of interest to the station, that makes possible laps and dissolves or cuts between any or all studios and film at master control. One Bachelor of Science has been granted and three other men in the engineering organization are part-time students when they have the chance.

The present consolidated functions of transmitter, mobile unit, film, kine recording and traffic are carried out by five engineering people, a film coordinator and editor, a traffic manager, and part-time

bookkeeping help from the Chapel Hill studio and kine consultation from Ross Scroggs of the Communication Center.

The Consolidated Engineering Office directs the engineering policy of the station, though the Directors at the three campuses actually set up the working schedules for their people. The Engineering Office maintains specialized microwave, video, and audio test equipment that is used at the studios on a regular or when needed basis. Large purchases of tubes and parts are made by the consolidated office which is reimbursed as the supplies are distributed to the studios.

#### Transmitter Building

The Channel 4, WUNC-TV transmitter and Consolidated Engineering Office are in the transmitter building situated atop a 60 acre site known as Terrell's Mountain. This is approximately 8 miles from



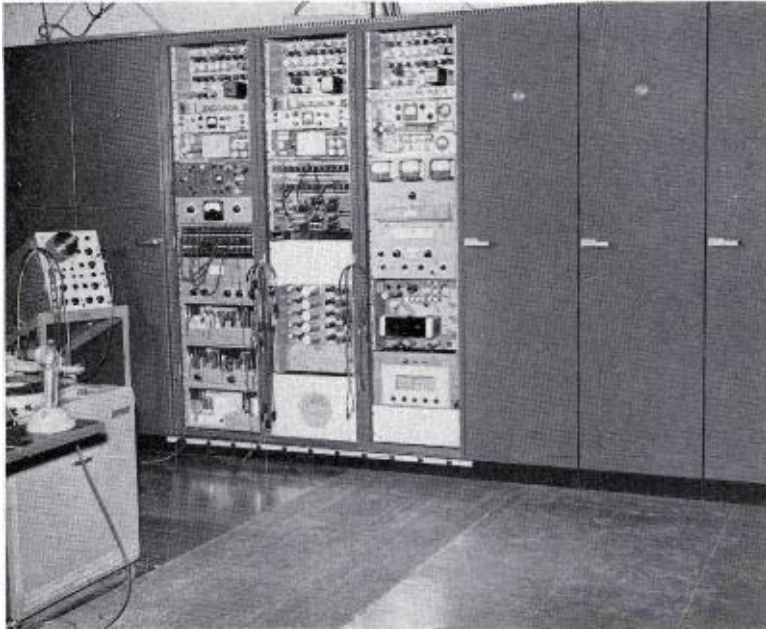

FIG. 39. Equipment racks at WUNC-TV transmitter/master control room. (See text for description of equipment contained in racks.)

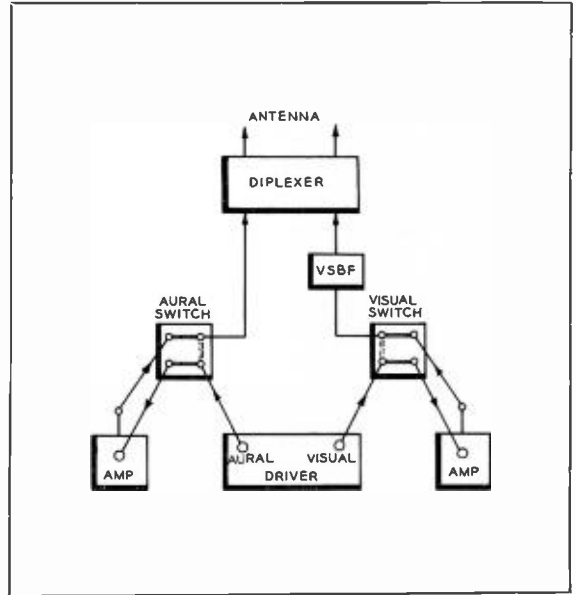

FIG. 40. Solid (horizontal) lines indicate normal, full-power operation. The dotted (vertical) lines indicate power cutback. With the "U" switch section removed, access is provided for connection of dummy load to driver or amplifier output.

the Chapel Hill studio, 27 miles from the Raleigh studio, and 40 miles from the Greensboro studio. The building site is 750 feet above sea level and some 250 feet above the town of Chapel Hill. The 83-foot, 6-bay, superturnstile atop the 715-foot tower puts the center of the 100-kw radiated power at 990 feet above average terrain. The resultant coverage shows a 70 mile Grade B radius in all directions with good reception consistently reported to the east beyond the 70-mile radius in the flat Coastal Plain section of the state. In another sense of the word, coverage is a direct function of the type of programming. For example, when the North Carolina No. 1 basketball team was playing, the station reported, "We got coverage."

The transmitter building was functionally designed and oriented with respect to the tower to provide roof-top, interior mounting for the three microwave receiving dishes and RF heads. Space for the 25-kw transmitter, kine recording and processing, film camera and projectors, and the appropriate service areas were designed around specific equipment with a little room left for expansion here and there. The resulting plan, Fig. 38 shows the arrangement in the single-story masonry structure with the bedroom, kitchen, bath, shop, and office to support the primary functions. The TT-25BL transmitter with the TT-10AL driver is arranged with manual  $3\frac{1}{8}$  inch power cutback switches

installed as shown in Fig. 40 to provide dummy load insertion points as well as power cut-back with only two switches. The switches, based on a standard RCA model, were designed for this application by MacIntyre. Although the driver need only produce about 3 kw to produce the required 100-kw (ERP) from the amplifier, the driver can be made to deliver enough power in the cutback condition to be of reasonable value. The RF plumbing is over-head in the space behind the transmitter, which forms a "U" around the four consoles of master control. Eight racks face the driver behind the open end of the "U."

A manifold is installed above all the transmitter cabinets to form a complete air duct for connection to either outside exhaust fans or inside heating ducts. The building is air conditioned except for the space behind the transmitter, but, since the front and rear of the transmitter are separated by walls and doors it is possible to feed any desired amount of cooled air to mix with outside air to keep the transmitter air supply at a satisfactory level. The open-bottom 25-kw amplifiers and the wire ducts feeding them are sealed with caulking compound to prevent floor dust from entering without benefit of the air cleaners.

The eight racks beyond the open end of the "U" contain:

- RACK 1. Tape record, RT-11
- RACK 2. Monoscope, TK-1A; Vidicon, TK-21; Sync Generator, TG-2A; Sync Distribution amp, TA-4A.
- RACK 3. Greensboro Stab Amp, TA-5D; Microwave Control Unit, KTR-100; Rack scope; VU meter panel; Audio Limiter, BA-5; program and monitor audio amplifiers.
- RACK 4. Chapel Hill Stab Amp, TA-5D; Microwave Control Unit, KTR-100; Video Distribution Amplifiers, TA-3A's; video patch panels; Video Dist. Amp. TA-1A; Low Pass Filter; Final Stab Amp, TA-5D.
- RACK 5. Raleigh Stab Amp, TA-5D; Microwave Control Unit, TLR-3A; Frequency and Modulation Monitor, HP-335E; Sideband Response Analyzer, BW-5A; Demodulator BW-4A; Conelrad equipment.
- RACK 6. Six 580-D power supplies for stab amps and distribution amplifiers.
- RACK 7. Three WP-33B power supplies for vidicon and master monitors; TLR-3A power supply.
- RACK 8. AT&T microwave equipment and terminal equipment.

A ninth rack is built into the wall between kine recording and processing, to house monitor and sound recording amplifiers, intermodulation meter and linearity generator and power supply; equipment used primarily in the kine operation.

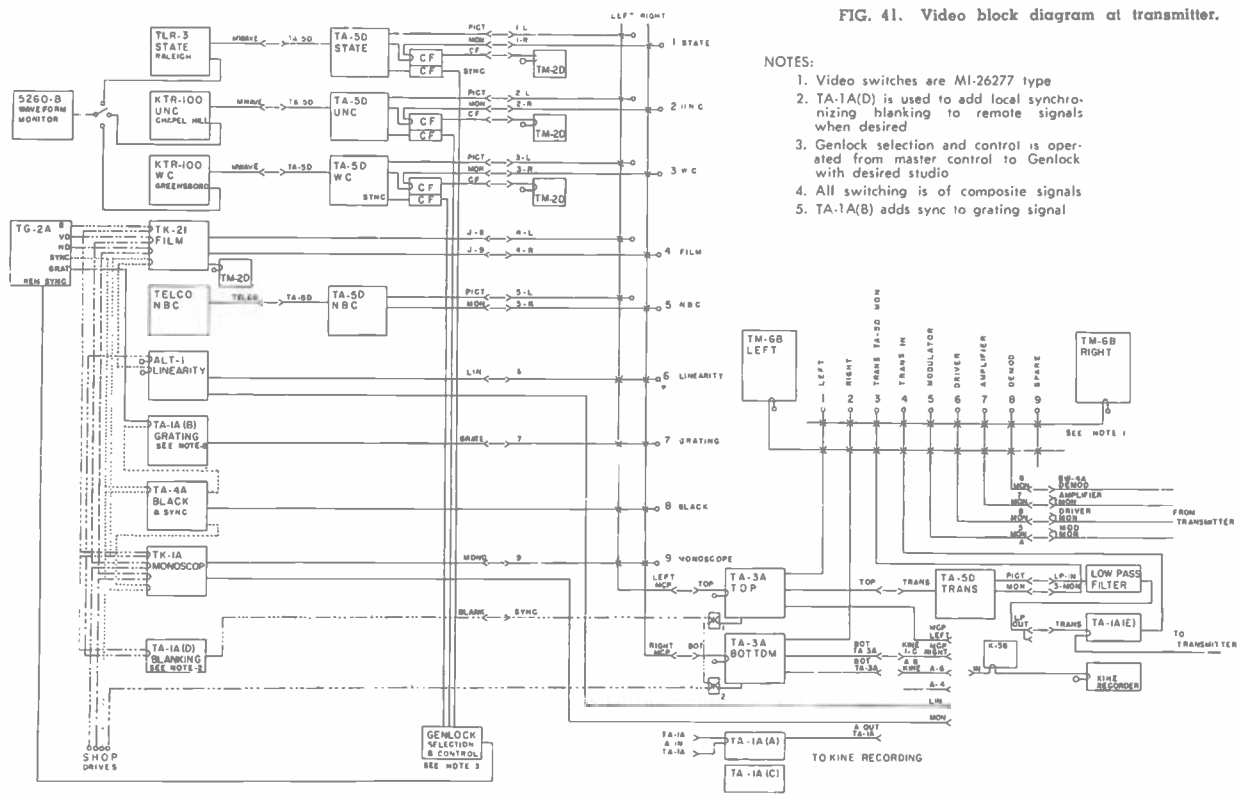
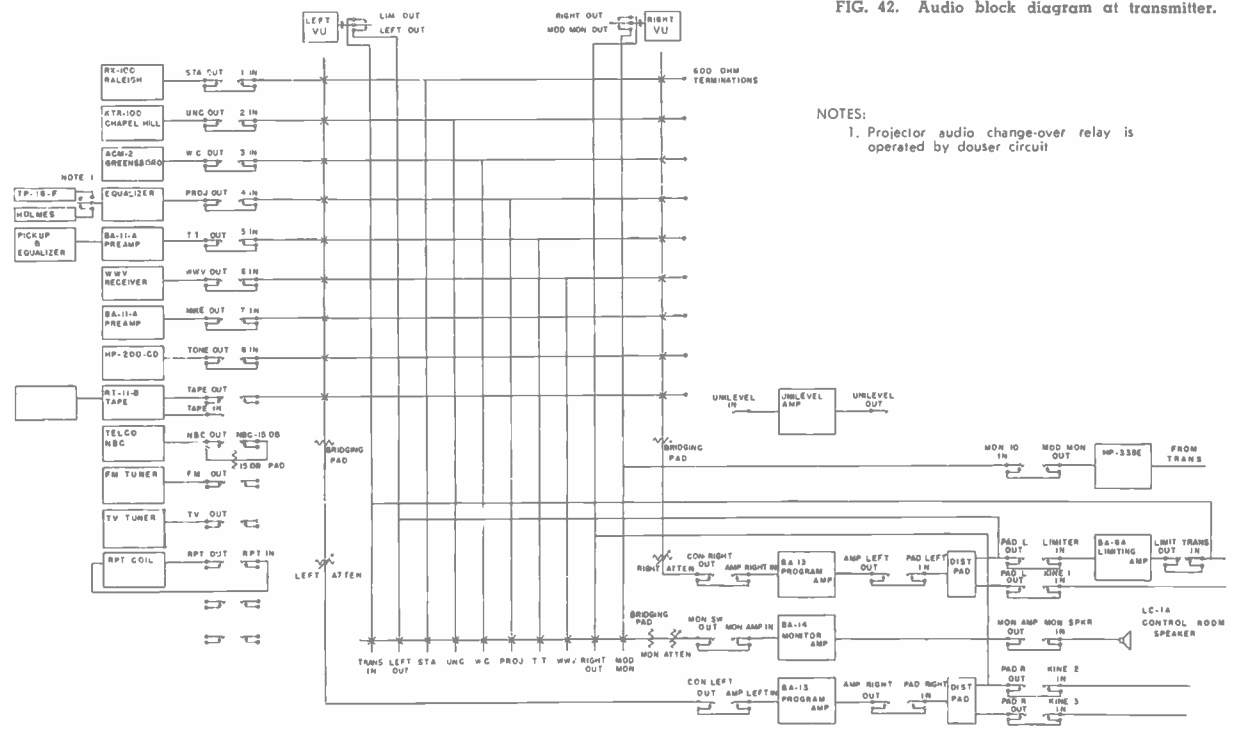

FIG. 41. Video block diagram at transmitter.

- NOTES:
1. Video switches are MI-26277 type
  2. TA-1A(D) is used to add local synchronizing blanking to remote signals when desired
  3. Genlock selection and control is operated from master control to Genlock with desired studio
  4. All switching is of composite signals
  5. TA-1A(B) adds sync to grating signal

FIG. 42. Audio block diagram at transmitter.



- NOTES:
1. Projector audio change-over relay is operated by douser circuit

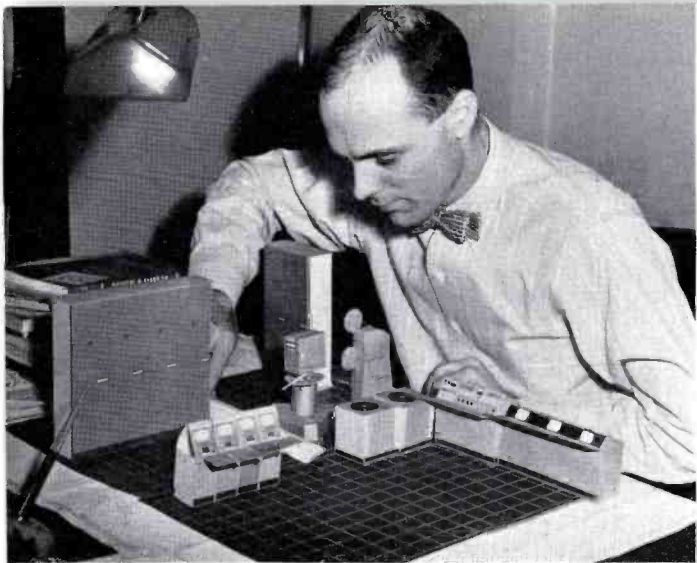

FIG. 43. WUNC-TV Chief Engineer, Alan B. MacIntyre planning control room size and layout, using RCA equipment models.

### Master Control

Master control at the transmitter handles all film and slides between programs as well as film programs and intra-studio switching. Efficiency of film handling is achieved since all film material is shipped to and edited at Chapel Hill. Since the week-day programming is largely live, a considerable saving in equipment is achieved with the one film center. Standard TM-6B's tripling as preview, air, and vidicon monitors with appropriate push button switches are housed in four consoles:

1. Master monitor, TM-6B.
2. Tape recorder remotes; Genlock remotes; 2-projector and disc slide remotes; Drum slide remote. Vidicon controls are on the sloped panel.
3. Dual channel audi-video switcher with four sets of remote stab amp controls; audio monitor selectors. Video monitor selectors are on the slope panel.
4. Master monitor, TM-6B.

The master control console, a WUNC-TV design around standard amplifiers and switches, provides for convenient control and switching for preview of all the video and audio material in the building. Either TM-6B can monitor any source. Casual picture monitoring is provided by three TM-2D monitors mounted in the wall over the visual control unit. These monitors, with no horizontal AFC, connected immediately after the stab amps, show trouble in microwave and studio sync generator at a glance. Quantitative microwave signal measurements are made with the rack mounted scope at least on a daily basis. A number of simplified daily procedures have been developed for measurements on both the picture and the sound channels from the microwave units.

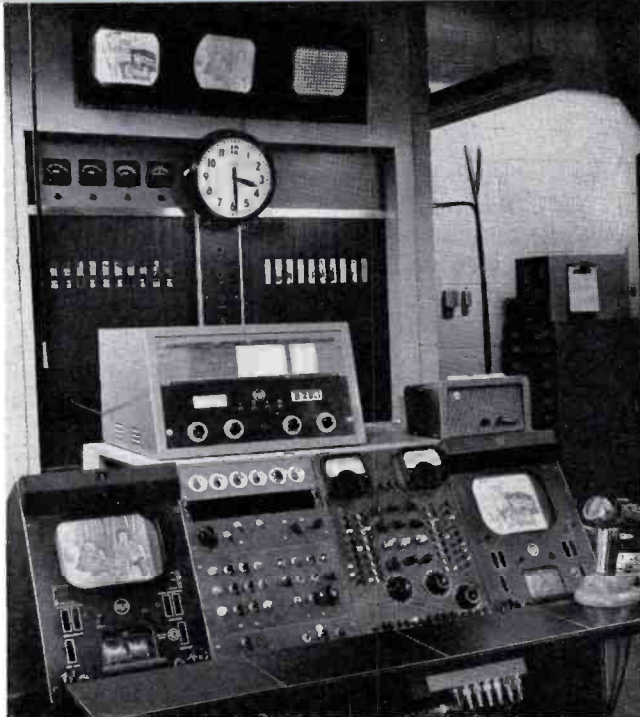

FIG. 44. WUNC-TV master control console at transmitter (note RCA 2-way radio communication unit on top of console).

FIG. 45. Edward Gill, WUNC-TV Transmitter Supervisor.

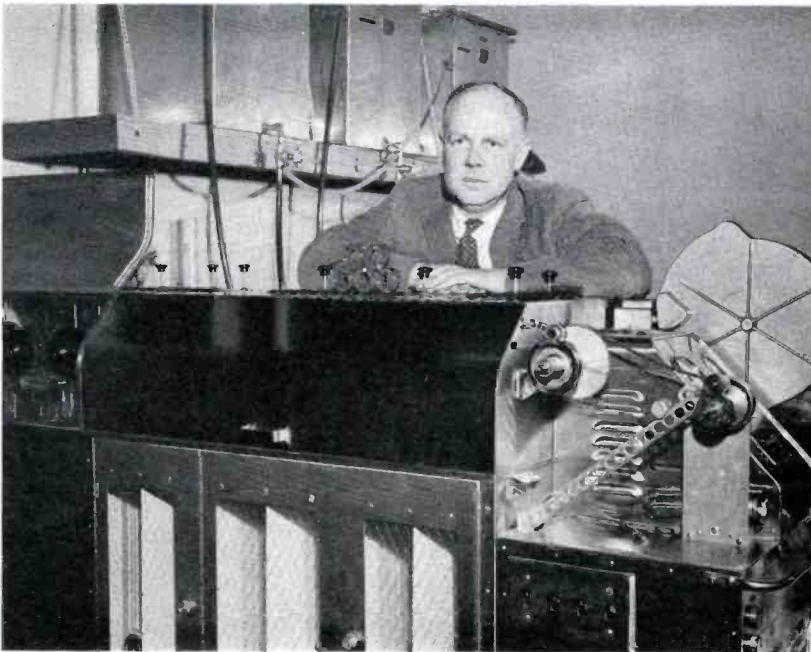





FIG. 46. Taylor Rogers, WUNC-TV Transmitter Engineer, at film and slide chains located at transmitter site.

FIG. 47. Ross E. Scroggs, Associate Director, UNC Communication Center, at Kinescope processor located in transmitter building.



#### Film Room

At this time, all film facilities for the entire system are located at the transmitter although vidicon equipments are being added at the studios as funds become available. The film projection room is equipped with a TK-21 vidicon film camera, TP-11 Multiplexer, a TP-3A 35-mm dual-disc slide projector, a Selectroslide 35-mm slide projector, a TP-16F 16-mm motion picture projector (also an old Holmes 16-mm machine given as a gift).

From here all film and slides for the various shows from the three campuses are handled. Facility to genlock with any studio from the Master Control Panel (via Unisync) makes for film integration as desired. Projector control is normally remote, from the Master Control Panel, but local operation is also available at the machines.



FIG. 48. WUNC-TV mobile unit for handling remote origination. Equipment includes two TV cameras, video control and audio. Also microwave relay and communication equipment.



FIG. 49. William B. Bloom, left. Chapel Hill Studio Staff and James Botsford, Transmitter Engineer, setting up remote unit at UNC School of Dentistry for series, titled "Project Health."

#### Remote Unit

The mobile remote unit was designed by Chief Engineer MacIntyre, using an Aerocoach highway bus contributed by Carolina Trailways. The conversion was done by Trailways and the equipment installed by the WUNC-TV engineers. The unit was originally designed to use two RCA field camera control units in the usual way. When it became impossible to purchase enough equipment to put two cameras and camera control units in each studio and in the remote unit too, it was decided to put camera control units only in the mobile unit and use cameras from any studio. The unit now has permanent studio video equipment, to handle two cameras. Extra camera control units have been added to bring the capacity up to four or five cameras on several occasions. The unit is frequently used in Raleigh, the capitol of North Carolina, for official state functions such as legislative proceedings and addresses by the governor. Network feeds have been handled for "Wide Wide World" and "Medical Horizons."

Standard studio equipment is used where possible, TG-2A's for sync, and WP-33B's



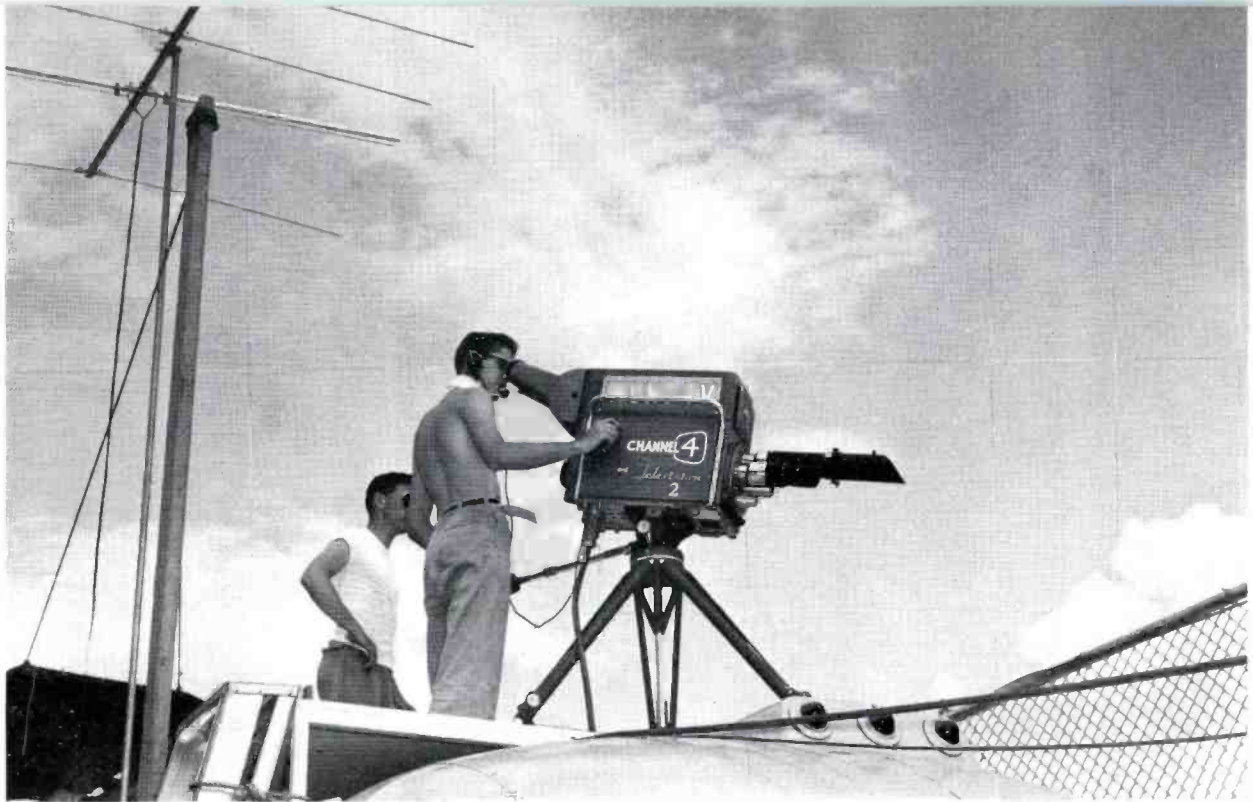

FIG. 50. WUNC-TV remote unit in use at NCAA Tennis Matches, Chapel Hill, 1955.

FIG. 51. Interior of WUNC-TV remote unit: left foreground, director's desk and switcher; right foreground, audio desk; left center, video control; rear, power supplies and microwave transmitter.

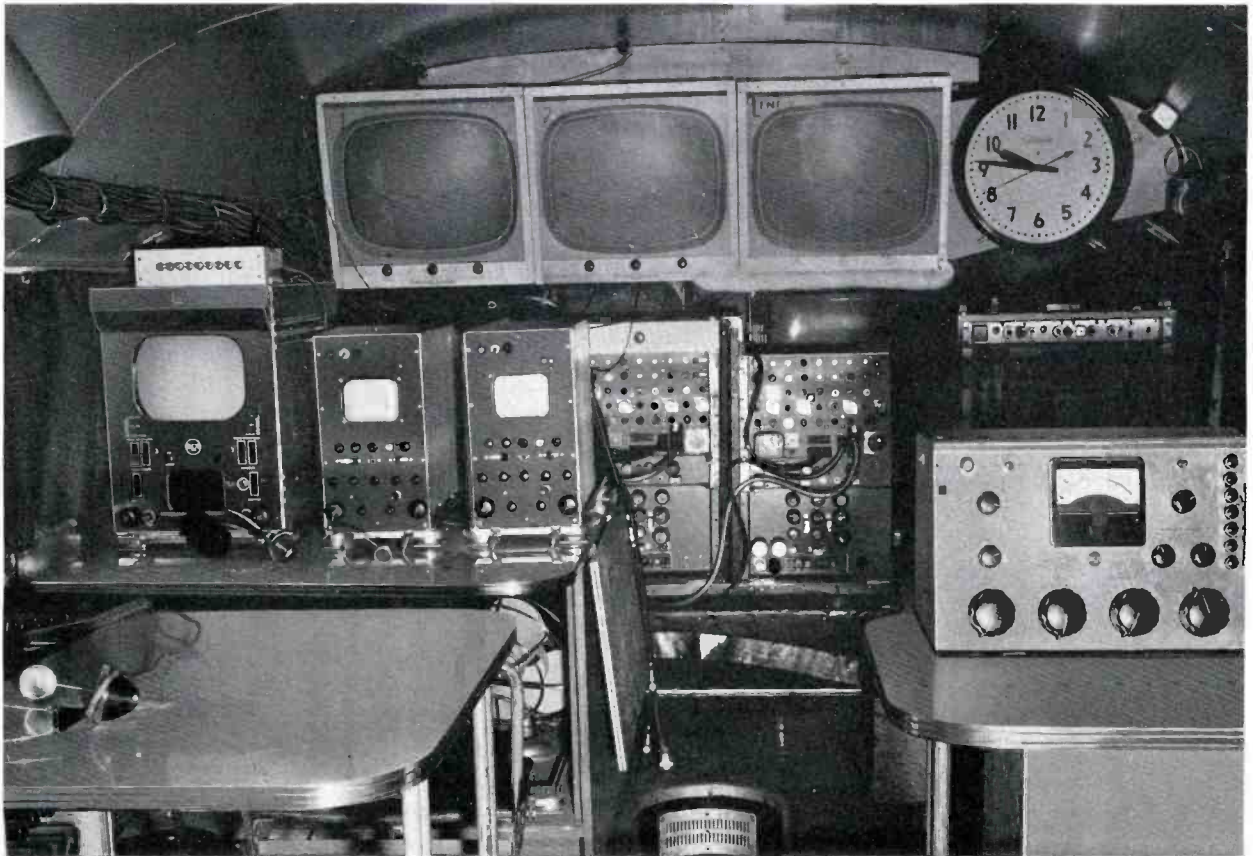





FIG. 52. Alan MacIntyre, Chief Engineer, at director's control of remote unit, using VHF 2-way radio communication system.

and 580-D's for power. The TS-30A switcher is flush mounted in the director's table. The TM-6B is on the video control desk with an auxiliary switch bank to aid in camera balance. Both these units are powered by a TY-31 field power supply which is mounted under the video desk. The sync generators, camera processing amplifiers, and power supplies are in shock-mounted half racks across the rear. In front of them there are three control desks: Camera control (video), Director's control, and audio. Although a standard bus is used, only six double seats remain (facing the picture monitors to the rear). These seats accommodate the production assistant and people working on network feeds.

Cables and accessory equipment are carried in what had been the under seat luggage compartments of the bus, which are accessible directly from the outside. Also, there has been installed a power reel, 110-volt, for winding the camera

cables in. The cables are wound with the plugs inward, on specially designed and fabricated reels, so that they are not subject to damage. Also, the cables are wound double—so it's accomplished in half the time. Since the unit normally carries 2200 feet of camera, power, and multi-mike cable on reels, this is significant.

The mobile unit is air conditioned by two 1-ton units operated on 220 volts ac. There is a complete RCA 2-way radio system installed to permit communication with the originating studio or the transmitter. A specially built 110-volt AC supply with automatic change back to battery is normally used.

The audio desk is equipped with two BN-2A consolettes which provide for eight mike inputs, and also provide for two separate audio outputs when desired. There is also a BA-14 for monitors and auxiliary feeds and two small PA amplifiers and speakers for handling program return

FIG. 53. Mobile unit's exterior compartments showing storage and carrying space for cameras, camera cables, dollies and tripods. Power-driven cable winder is installed in forward (right) end of compartment space (note foot-operated switch on ground).

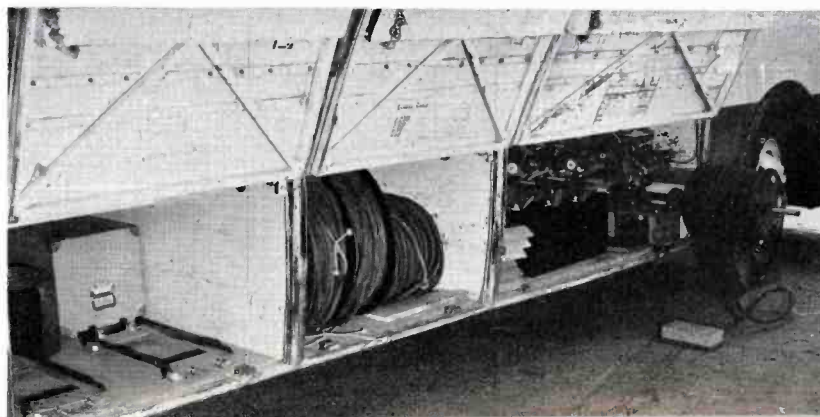

feeds. A small attenuator-matching unit and a varied set of adapter cables permit the use of house feeds, tape recorders, or other high or low local sources directly into the mike inputs. Intercom, program sound, business phone and PL circuits are wired to the strategic points and terminate at a single location for telephone company connection. A 1-watt, 7000-mc, microwave relay unit with two or four foot dishes for audio and video is part of the standard complement of equipment.

### Studio Video

The video plans for all the studios are identical. Fig. 54 shows the simple arrangement. The double bank switches, modified MI-26227, operate on a precedence basis providing only one output when two buttons in the same column are pushed but are satisfactory in the application used here. Although effects equipment still has not been installed, the space and the circuits from the TA-3A's are available. Vidicon camera equipment is being installed this year in two studios to be used for slides, models and graphics.

### Studio Lighting

One of the early projects of the engineering group was the design of a reasonably priced but flexible lighting switchboard for the three studios. Taylor Rogers designed the lighting together with Chief Engineer MacIntyre. The final plan was based on the use of 20-ampere laboratory jacks and plugs, 15 ampere magnetic circuit breakers for each hot circuit and 60-ampere magnetic breakers for group masters.

All instrument wiring to pigtails and base outlets terminates in small, single conductor recessed male receptacles on a 3 by 4 foot vertical steel panel. The arrangement of the one-inch diameter receptacles on the panel is similar to the physical arrangement of the outlets in the studio. On a horizontal panel at the base of the jack field and mounted in telephone switchboard fashion is a double row of insulated female jacks on super-flexible No. 12 wires and a double row of 15-ampere breakers. Each cord is connected to a 15-ampere breaker, which in turn is one of 5 or 6 similar breakers controlled by a 6-ampere group master.

The space below the breakers and patch cords was designed to accommodate a number of 5-kw dimmers which were to be wired to certain group masters. The dimmers have not yet been installed.

Wiring on the battens is somewhat varied with the studios and is done either with building wire within a Condulet bat-

ten system or simply with stage cable strapped to conventional battens. In all cases the neutrals are returned to neutral busses in the lighting switchboard. Instrument connection is with two-wire 20-ampere twist-lock connectors, on pigtails hanging about 3 feet below the battens.

A small portable lighting switchboard, six 20-ampere circuits, is carried with the mobile unit. This panel uses the same type input connector as the mobile unit itself to permit greater flexibility in power for lighting and equipment. Several hundred feet of stage cable and a small number of scoops are carried at all times with supplementary equipment supplied by the originating studio.

### Unique Organization

It was at Chapel Hill that the idea of bringing the University to the community through television first took root. Dr. Frank Porter Graham, then President of the Consolidated University of North Carolina, and William D. Carmichael, Jr.,

Vice-President and Finance Officer, were the significant figures behind the movement. Earl Wynn, who is now Director of the University Communication Center, which includes the Chapel Hill TV Studio, assisted in the movement, drawing on his military experience in the realm of communications and his earlier interest and experience in radio.

The TV project was financed by joint state and community support sparked by the personal effort of Mr. Carmichael. For 1955-56, the first biennium of operation, a budget of some \$145,000 was gotten together. Of this, \$108,000 was appropriated by the state legislature, while the remaining \$37,000 was donated by public spirited citizens and businessmen. For 1957-58 practically the same size budget had been set, and this time the full sum was appropriated by the North Carolina General Assembly. This substantially supports the operation of the three studios at the three institutions, and the consolidated

functions of engineering, film procurement, and traffic.

Although each studio has grown to be an autonomous unit, which makes a completely centralized consolidation impracticable, a fine spirit of cooperation prevails. Indeed, the diversity of programs from each studio adds to the overall attractiveness, resulting in a type of consolidated program that would be almost impossible to obtain otherwise. The University at Chapel Hill is in an ideal position to contribute liberal arts programs and special area series in medicine, law, and the like. State College in Raleigh provides specialized farm and scientific programming, in addition to its general programming. And the Woman's College adds fine arts, women's features, and the like. Furthermore, the competitive forces brought into play by the unique organization of three independent studio units spurs each to outdo the other, not only in terms of professional techniques, but in terms of subject matter and efficiency of operation.

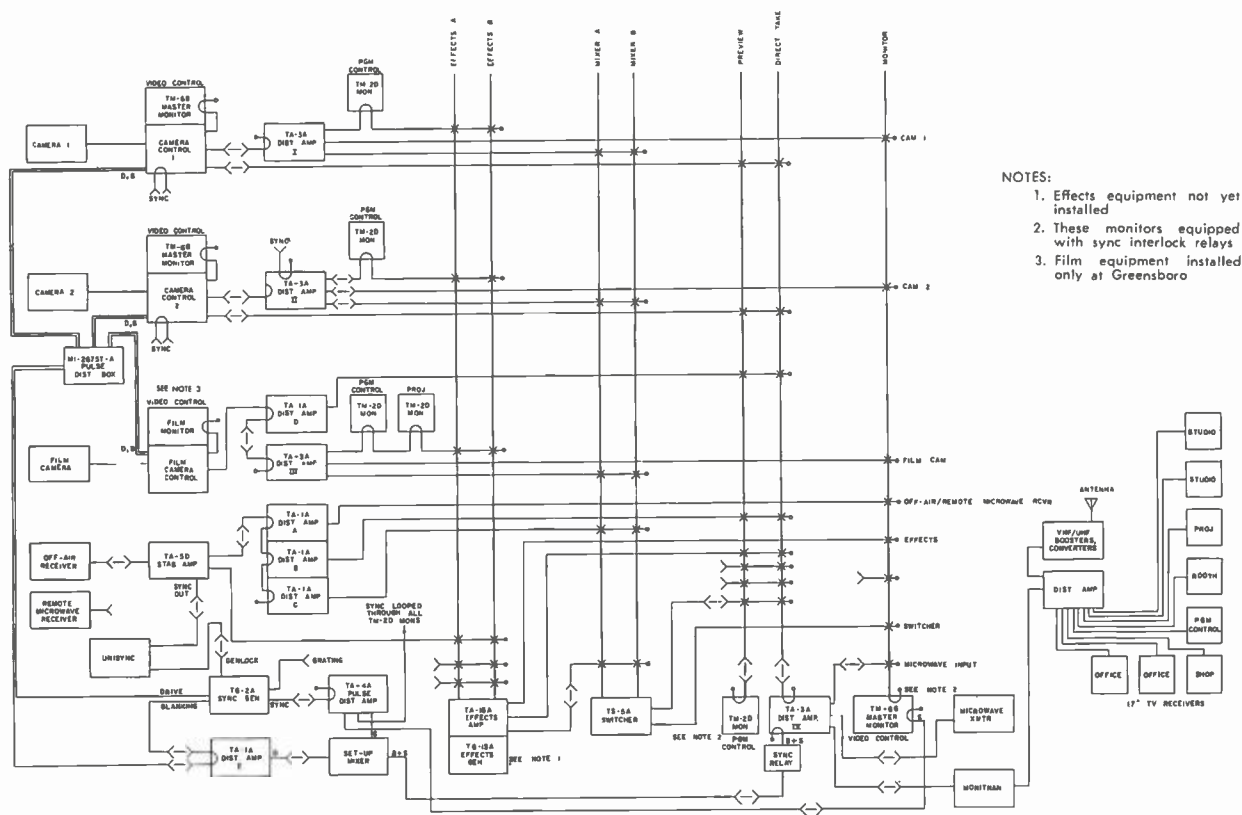

FIG. 54. Common video system used at all WUNC-TV studios.

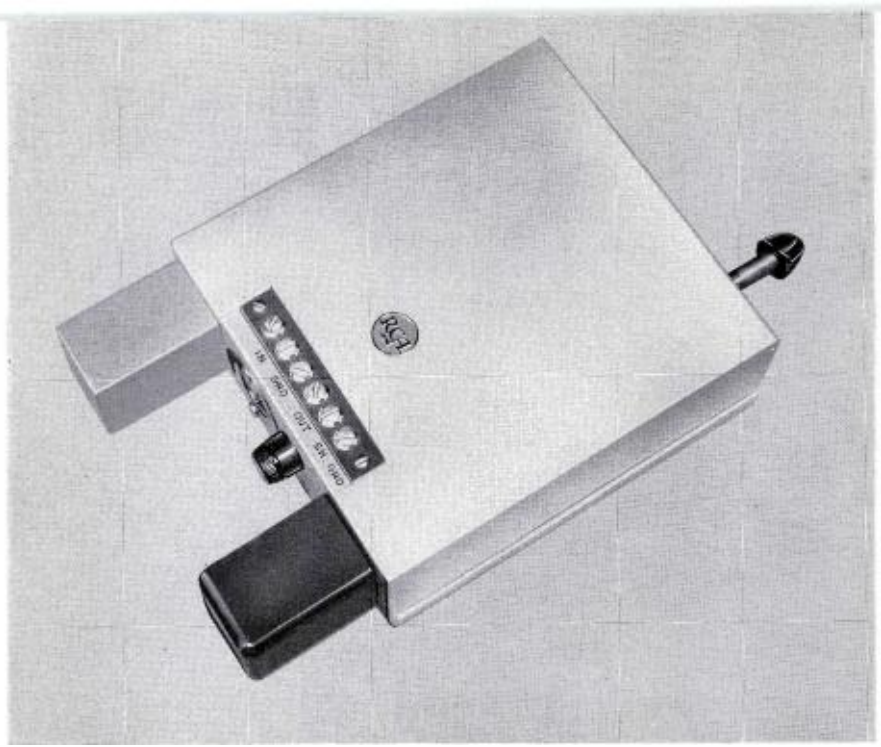

FIG. 1. This shows the self-contained BA-26A Transistorized Preamplifier. Note the terminal board and convenient power receptacle.

# TRANSISTORIZED TURNTABLE PREAMPLIFIER

*Features Built-in Equalization and Self-Contained Power Supply; Mounts Directly in Turntable Cabinet*

by GEORGE C. WEILENMANN, *Product Analyst, Broadcast Audio Products*

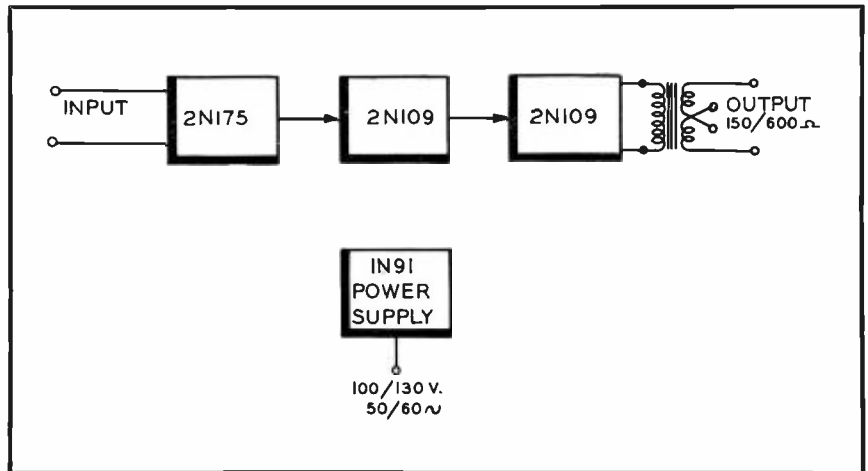

FIG. 2. Simplified block diagram of the BA-26A. The input can accommodate any broadcast low-impedance type of reluctance pick-up cartridge, while the output can match any line from 150 to 600 ohms.



The increased use of the "Disc Jockey" concept of broadcast programming has developed a very strong demand for reliable transcription systems. As a result, the BA-26A Transistorized Turntable Pre-amplifier was designed to provide reliable operation with a minimum of operating attention. Transistors were included in the design to offer the advantages of low-power drain, freedom from microphonics and small size. The physical arrangement of the BA-26A enables the unit to be mounted directly in the BQ-2B turntable cabinet, or equivalent professional turntable with convenient access to the controls. The output can be fed directly into the control console, thus providing convenient adjustment of gain controls from the operating position.

#### Design Features

The BA-26A preamplifier has a total power consumption of only two watts. Since the transistors have an extremely long period of life expectancy, the unit can be left in continuous operation. Because the BA-26A is to be used as a turntable preamplifying device only, equalization has been built into the electrical design, thus eliminating the need for an external or separately contained equalizing unit. A switching arrangement was included to provide selection of three ranges of frequency response: *normal operation, high*



FIG. 3. This shows the BA-26A mounted in a BQ-2B Three-Speed Turntable. Observe the convenient position of the BA-26A response selector switch—next to the turntable motor switch.

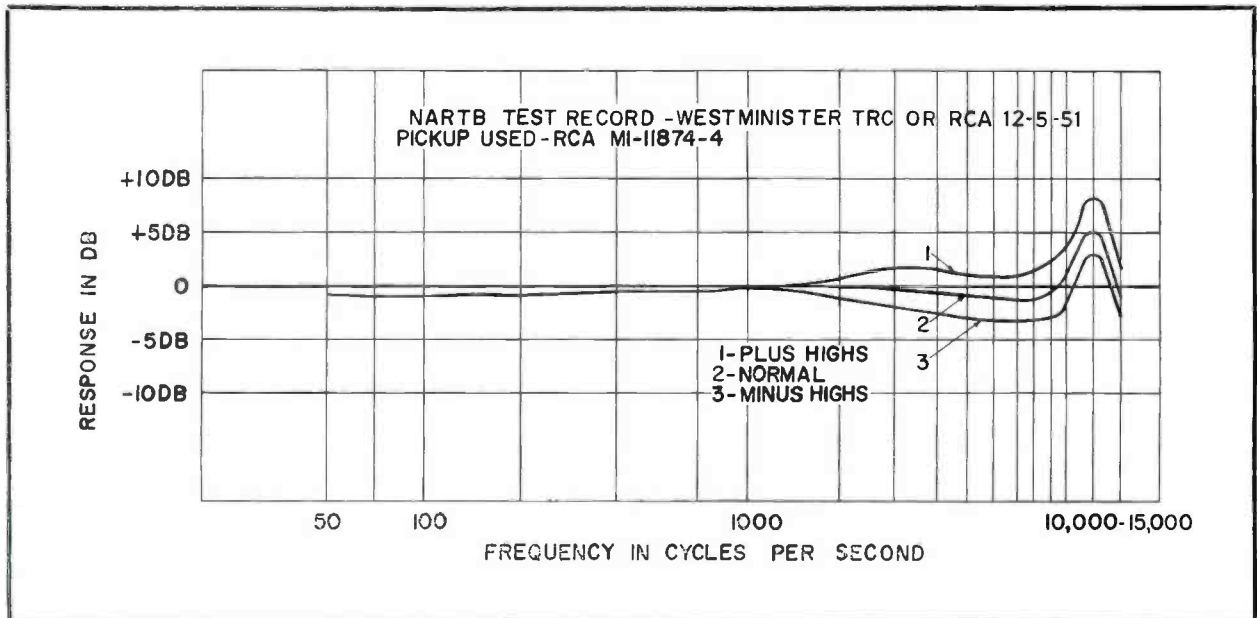

FIG. 4. Variable frequency response can be obtained with the built-in selective feedback feature of the BA-26A. A separate equalizer is not required.

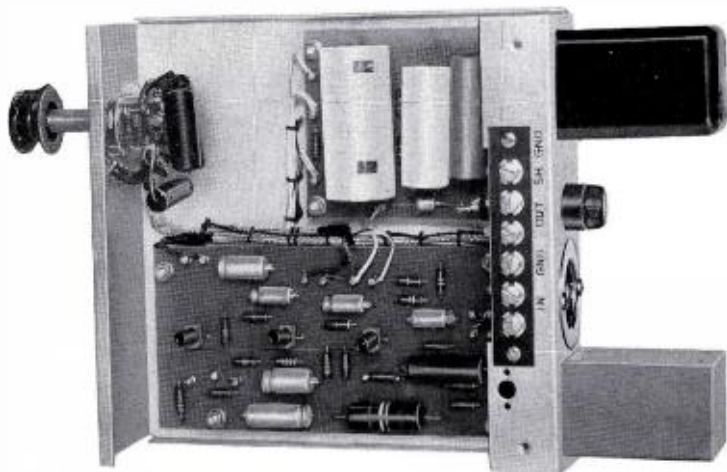

FIG. 5. This is the BA-26A with the cover removed. The preamplifier and its power supply are built on separate etched wiring boards. The response selector switch (left) is mounted at the top of the chassis. This type of construction provides trouble-free operation.

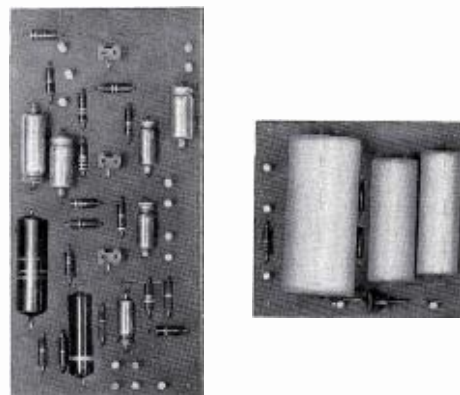

FIG. 6. Here are the two etched wiring boards used in the BA-26A. Note the location of components on the top sides of the wiring boards (Etched wiring is underneath.)

frequency roll-off, and increased high frequency response. All of these features have been included in an amplifier that is only  $10\frac{3}{4}$  inches high by  $2\frac{1}{2}$  inches wide and  $6\frac{5}{8}$  inches deep (see Fig. 1).

The BA-26A has been designed to accommodate the RCA pickup cartridge, but by means of a very simple wiring change it can accept any professional low-impedance type reluctance cartridge. Etched wiring circuitry is also utilized to permit compact and trouble-free type of operation.

#### Incorporates Selective Feedback

In the BA-26A selective feedback has been utilized to provide an output response that conforms to the most recent NARTB/RIAA recommended curve. Obviously this eliminates the separate and bulkier filter units that have been an accepted part of most previous turntable preamplifier systems. This means the elimination of the interconnection wiring between the amplifier and the filter units which had made previous equipments susceptible to the problem of hum pickup from stray magnetic fields. In the BA-26A this is not a problem, since the unit is self-contained, and the need for transformer type input components has been avoided due to the low impedance characteristics of the tran-

sistor input stage. The input impedance of the BA-26A preamplifier will accommodate the RCA (MI-11874-4) 1 mil. pickup or the (MI-11874-5) 2.5 mil. unit. It will also perform very satisfactorily with other low impedance reluctance type of broadcast pickups by the simple change of an input terminal jumper.

#### Specifications

The BA-26A uses a low-noise 2N175 transistor in the input stage followed by two stages of 2N109 transistors (see Fig. 2). Output impedances of 150 or 600 ohms are available by proper selection of transformer output terminals. Power supply for the BA-26A is self-contained and a 1N91 germanium diode rectifier is used. The BA-26A circuit arrangement provides a signal-to-noise ratio of better than 58 db, and the output level at 1,000 cycles is approximately  $-20 \text{ dbm} \pm 2 \text{ db}$ . Distortion at  $-20 \text{ dbm}$  output is less than 1.5 per cent from 50 to 15,000 cps.

#### Simplified Layout

The BA-26A features a simplified mechanical layout that permits external connections to a terminal board, which is conveniently mounted on the lower side of the amplifier. The response selectivity switch has an extended shaft arrangement that allows the preamplifier to fit into the

upper part of the turntable cabinet (see Fig. 3). In this manner the switch control is available from a convenient position at the table top of the turntable. This is the same position that was normally occupied by the filter switch that had been in common use with a separate and external filter. A protective fuse is accessible from the base of the amplifier by means of a convenient lock-in type of fuse holder and a separate 110-volt socket arrangement is provided that permits safe insertion of a female-type connector. A metal cover can be detached by simply removing two machine screws, thus making all of the components readily accessible, as shown in Fig. 5.

#### Part of a System

The BA-26A becomes an excellent companion unit to the BQ-2B Transcription Turntables and the BC-3B or BC-3C Consolettes. The output of the BA-26A can be connected directly into the consolettes input controls, thus providing convenient adjustment of gain control settings from the operator's control position. The BA-26A, of course, is also an excellent companion unit for other professional type transcription turntables and console equipment having 150/600 ohm inputs that operate at a  $-20 \text{ dbm}$  input level.

ASSURING THE MOST FOR YOUR EQUIPMENT DOLLAR

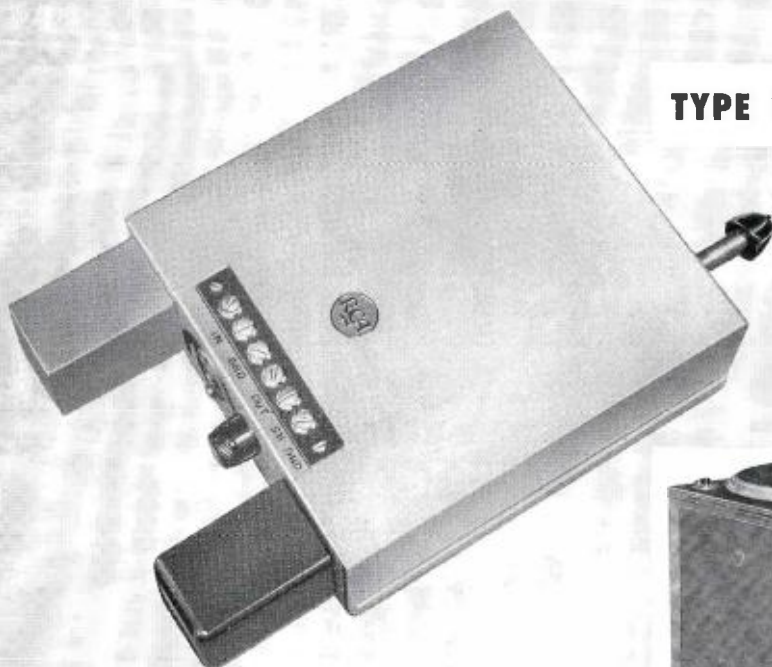

**TYPE BA-26A**



**TRANSISTORIZED**

## **TURNTABLE EQUALIZING PREAMPLIFIER**

The BA-26A is designed to mount in same position and space previously occupied by RCA Type MI-11877 passive equalizer.

*Designed to provide both amplification and equalization of turntable output!*

This compact equipment makes a modern replacement for bulkier combinations of separate amplifier and equalizing filters. Designed to provide both amplification and equalization of output of studio transcription turntables employing either the RCA Type MI-11874-4 or RCA Type MI-11874-5 Pickup Heads. The entire unit is completely self-contained including a-c power supply. Built-in equalization conforms to new industry standards of both NAB

and RIAA. A three position switch compensates for variations in transcriptions and records. Etched wiring circuits provide stable, trouble-free operation. Transistors are employed throughout to assure freedom from microphonics. Absence of inductances make the BA-26 insensitive to stray hum field pickup, greatly simplifying installation. Mounts easily in turntable, provides essentially noise-free operation and long equipment life.

*For full particulars about the new BA-26A Transistorized Turntable Equalizing Preamplifier, see your RCA Broadcast Representative. In Canada: RCA Victor Company, Limited, Montreal.*



**RADIO CORPORATION of AMERICA**

BROADCAST AND TELEVISION EQUIPMENT

CAMDEN, N. J.



# THE RCA VIDEO FOR COLOR AND MONOCHROME

**Combines the Picture Quality of Live Presentations  
with the Storage and Rerun Benefits of Film**

#### **Immediate Playback**

No processing involved. Rerun immediately. Use as often as desired. Store program material for use at any time.

#### **Sound Monitoring and Dubbing**

Sound monitor head provides simultaneous playback during recording. Separate sound erase head permits dubbing and re-recording without disturbing picture information.

#### **Operating Convenience**

Special operative instructions can be recorded along with picture information, thanks to independent cue channel. A tape footage indicator provides precise cueing reference. Both local and remote controls are included.

#### **Built-in Erase Head**

Built-in head completely erases tape prior to recording. It is de-energized in playback.

#### **Air Lubricated Tape Guides**

New design tape guides precisely control the tape path. Air lubricated and virtually frictionless, they permit control of lateral positioning without distortion of tape edge.

#### **Handles Color and Monochrome**

Records and reproduces all standard video signals, color or monochrome, with equal facility . . . Available also for monochrome only. The ability of the RCA Video Tape Recorder to handle both color and monochrome program material with excellent results makes it a useful facility for television stations.

*Orders are being accepted now. You can get the whole story from your RCA Representative. Or write for descriptive literature. In Canada: RCA VICTOR Company Limited, Montreal*



Tmk(s) ®

**RADIO CORPORATION of AMERICA**

BROADCAST AND TELEVISION EQUIPMENT

CAMDEN, N. J.

# TAPE RECORDER

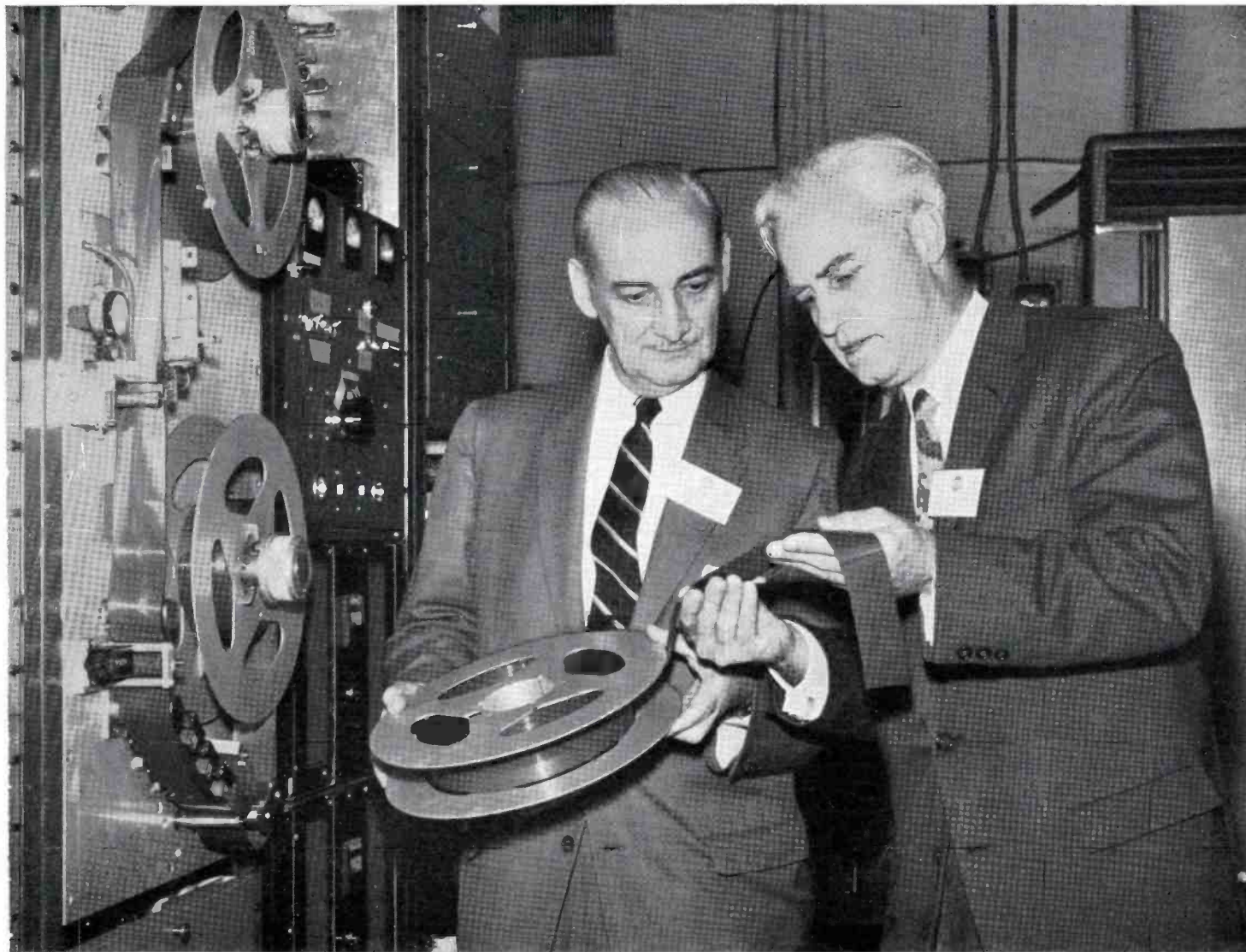

PROGRAM AUDIO

VIDEO TRACKS

CONTROL AND CUE TRACKS

Close-up of RCA Video Tape Recorder as viewed by Thomas E. Howard, Vice-President, WBTV and E. C. Tracy, Manager, RCA Broadcast and Television Equipment.

## SOUND AND PICTURE TRACKS ON VIDEO TAPE

This is a magnified view (2 $\frac{3}{4}$ X) of a small piece of recorded 2-inch video tape. It has been treated to make the recorded tracks visible. Picture information is recorded in transverse lines. Program sound is recorded longitudinally along the left edge. Servo control and cue information are recorded longitudinally along the right edge.

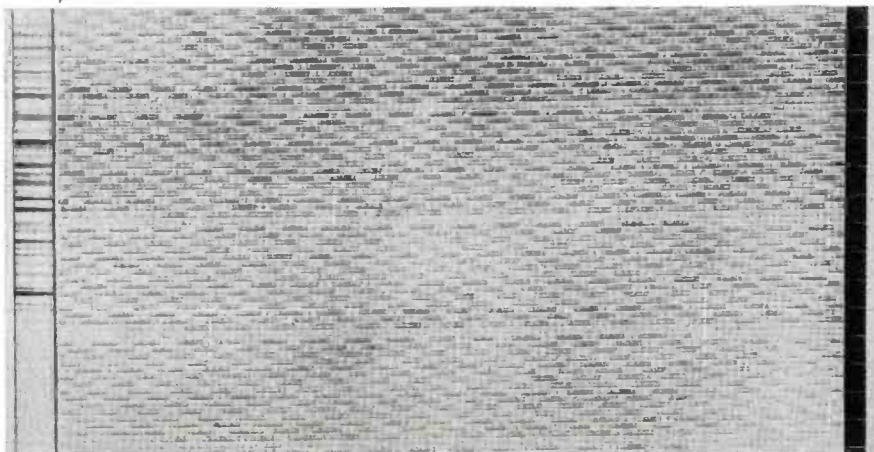



# How to "Saturate"

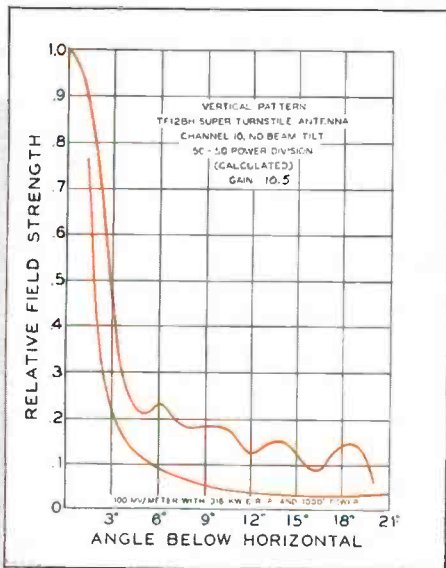

**Vertical Field Pattern of new RCA TF-12BH 50-kw antenna. Note complete absence of vertical nulls. Operated in conjunction with an RCA 50-kw TT-50AH transmitter, this antenna will "saturate" your service area with strong signals.**

**RCA 50-kw VHF transmitter. TT-50AH** Now in regular production, this transmitter is the ultimate in high power for channels 7 to 13. P.A.'s operate with standard power tetrodes (obtained from any RCA Tube Distributor).

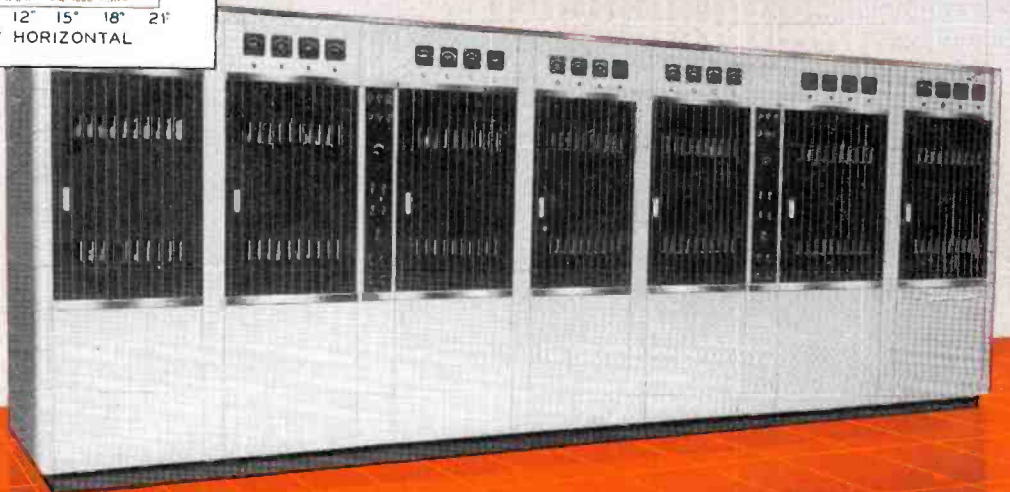



# an entire service area

(CHANNELS 7 TO 13)



## RCA's new 50-kw VHF transmitter, and an RCA TF-12BH Superturnstile antenna, will "flood" your service area with strong signals — close in AND far out!

Tailored to "consultants' specifications," RCA's 50-kw antenna-transmitter combination is your answer for maximum ERP and "saturation" coverage on channels 7 to 13.

### "Rain" your signals in all directions!

No need to "beam" to reach specific areas. You get saturation everywhere—close in *and* far out. Reason: RCA's TF-12BH high-gain antenna delivers two to three times the required field strength—even in minimum signal areas. And it makes no difference whether you use an extremely high tower—or one of average height. This is the one transmitter-antenna combination that develops 316 KW ERP—with power to spare!

### Antenna System takes full 50-kw input!

RCA's TF-12BH high-gain antenna and antenna components will take the full output of the 50-kw VHF transmitter—with a high factor of safety. Designed for pedestal

or for tower-mounting, RCA antennas withstand windloads of 110 miles, and more. A unique switchable feed system enables you to switch power from one part of the antenna to another QUICKLY—an important advantage that will keep you on-air during an emergency.

### A 50-kw VHF System—completely matched!

RCA can supply 50-kw systems matched precisely for peak performance—from antenna, transmitter, transmission line, fittings, tower, r-f loads, wattmeters, and diplexers—to the hundreds of individual components required by the carefully planned station plant.

### Qualified planning help is vital!

For experienced assistance in planning a transmitter-antenna system that will literally "blanket" your service area with strong signals, call your RCA Broadcast Sales Representative. *He knows systems-planning from A to Z.*

RCA PIONEERED AND DEVELOPED COMPATIBLE COLOR TELEVISION



**RADIO CORPORATION of AMERICA**  
BROADCAST AND TELEVISION EQUIPMENT • CAMDEN, N. J.

# A new standard of performance for color television systems... The **RCA TM-21** Color Monitor

This new color control monitor is a reference standard for evaluating the quality of color television pictures from any source. Providing the most precise and brilliant color picture available . . . this new monitor accurately reproduces the scene *as the camera sees it*.

**QUALITY CONTROL OF COLOR PROGRAMMING**—The TM-21 is used in Color Camera Chains, Switching Systems, Master Control and Transmitting Control for monitoring color picture quality. It is the basic instrument for checking registration, shading and deflection linearity . . . color fidelity of the entire TV system . . . chroma to monochrome ratio . . . color phase or hue adjustments.

**BEST POSSIBLE COLOR**—When used to display color pictures in clients' rooms and executive offices, the TM-21 lets the station put its "best color foot forward." Clients will be impressed by the bright, high definition picture.

**COLOR ACCURACY AIDS PROGRAM PRODUCTION**—Production departments can use the new monitor for accurate continuity control of color programming. Producers and directors will get a true color picture of what's happening on the set. Costume and background colors can be seen in proper relationship. Lighting can be accurately evaluated, production aided.

**SIMPLIFIED MONITOR ALIGNMENT**—Initial adjustment is extremely simple. Built-in test switch reduces set-up time to minutes. Screen grid selector switch provides quick viewing of primary colors.

**LONG-TIME STABILITY**—Once set up, monitor adjustments "hold." Extra stability has been designed into brightness, contrast, decoder, convergence, and linearity circuits.

---

Get maximum return from your color TV investment! Ask your RCA Broadcast and Television representative for further information on the new TM-21 Color Monitor. In Canada: Write RCA VICTOR Company Limited, Montreal.



## Check these additional technical features:

- Feedback techniques and precision components provide long-term stability.
- Automatic brightness tracking for color balance.
- Convergence circuits designed for rapid setup.
- DC restoration at black level, stabilized by feedback.
- Stabilized diode demodulators.
- All components and tubes easily accessible.
- Automatic wide-band operation during monochrome picture intervals.
- Stabilized black level shows effects of pedestal adjustments, aids close control of color in picture low-lights.



Tmk(s) ©

**RADIO CORPORATION of AMERICA**

BROADCAST AND TELEVISION EQUIPMENT

CAMDEN, N. J.



# NEW AGC PROGRAM AMPLIFIER

TYPE BA-25A



Designed for  
Automatic Control  
of Audio Program Level

## Features:

- Small, compact, plug-in construction.
- Feedback circuits assure excellent frequency response—low harmonic distortion at any degree of gain reduction.
- Provides automatic fading or remote gain control.
- Self-contained power supply.
- Metering switch provides quick tube check.
- Convenient front panel controls.
- Stabilized bias voltage.

**Now** you can improve your station coverage. This new RCA Program Amplifier with automatic gain control can maintain a nearly constant average output level over wide variations of average input level, thereby assuring maximum performance of your limiting amplifier.

Now you can prepare for unattended AM programming system. The amplifier is also used in conjunction with an external bias source for remote gain control or automatic fading permitting remote audio operation.

Other uses include its application as a master gain control for program line, microwave input audio control, automatic fader control, or straight program amplifier without level control (by removing tube disabling the automatic level control circuit).

Premium performance and ease of operation will assure years of successful application.

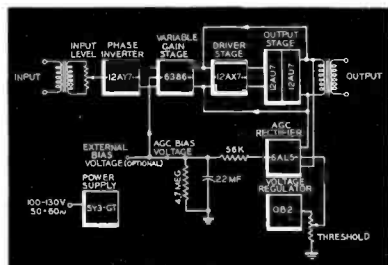

Ask your RCA Broadcast Sales Representative for complete information. In Canada: write RCA VICTOR Company Limited, Montreal.



**RADIO CORPORATION of AMERICA**

BROADCAST AND TELEVISION EQUIPMENT

CAMDEN, N. J.

Tmk (s) ®

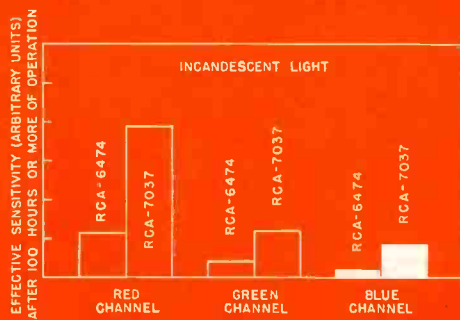

RCA-7037—The New Standard in Color Camera Tubes. More than twice the average sensitivity of any previous color Image Orthicon—in each channel of color-camera systems.

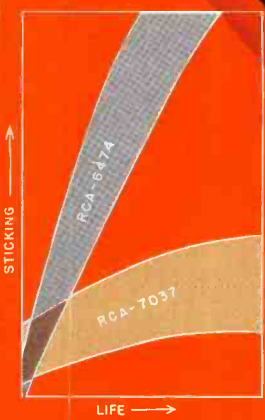

*new*

# IMAGE ORTHICON

*for Color*

You are looking at the new RCA-7037, an improved image orthicon that has much higher sensitivity—will outperform and outlast any other image orthicon—and retain high sensitivity throughout life.

Here are a few of the outstanding advantages of this new tube: (1) Higher effective sensitivity to red, green, and blue permits reduction in lighting level or lens aperture, (2) Increased ratio of blue to red sensitivity provides better balance of the effective sensitivity between color channels with incandescent lighting, (3) A new “stabilized” target greatly reduces any tendency toward an increase in picture “sticking” throughout the life span of the tube—and thus makes possible more hours of service and lowered camera operating cost, (4) Super-Dynode design insures freedom from dynode burn, (5) Micro-Mesh does away with defocusing to kill moiré and mesh pattern, and allows full aperture correction to improve picture-detail contrast.

RCA-7037 can be used in place of Type 6474 in all modern color-TV cameras—without changing color filters. RCA-7037's are available now—from your RCA Industrial Tube Distributor.

For a technical bulletin, write RCA Commercial Engineering, Section A-12-0, Harrison, N. J.

### How RCA-7037 can improve your Color Operations

- Reduces operating costs 3 ways—
  - in lower studio lighting costs, both initially and throughout tube life
  - in lower air-conditioning costs in station studios
  - in lower camera-operating costs
- Gives you greater freedom in staging and lighting techniques
- Delivers longer tube life
- Provides “stabilized” target operation
- Extends tube pro-rata warranty from 350 to 500 hours
- Extends 100% tube warranty from 15 hours to 50 hours



**RADIO CORPORATION OF AMERICA**

® Electron Tube Division

Harrison, N. J.





## SEE THE DIFFERENCE COLOR TV MAKES

Food looks so real, you more than see the difference — you almost taste it.

Sports *come alive*. Watch the red-shirted halfback blaze into that big blue line. And look at the heroine in tonight's play. No longer a study in gray, she's a dazzling redhead in a golden dress. And what a difference!

You can now enjoy thrills like this every

single day because RCA believed in Color TV from the very first and put its skills and a fortune behind this belief. The result—reasonably priced Color TV that is *performance-proved*—created a new dimension in home entertainment. And it has given you one more good reason to depend on RCA for the first and best in electronics — today, and tomorrow, too.



**RADIO CORPORATION OF AMERICA**