

# Radio Shopper

RADIO'S TECHNOLOGY PUBLICATION

Radio for Radio People: *BNetRadio*



It's an internet streaming "radio station" for broadcasters. BNetRadio is a pop rock/oldies format, with special programming and commercials directed at the professional broadcast industry. Special programming includes: produced vignettes with news, information and interviews with broadcast industry authorities and folks "in the know," about what's happening in the television and radio biz. The commercials are for pro broadcast products and services. PSA avails are offered to broadcast related organizations.

With the help of several broadcast industry equipment, software and services providers, they call "partners," BNet radio emanates from a state-of-the-art digital studio at the Broadcast Net offices in Houston, Texas.

Here's how it's all put together. The station automation system is the new Starmax Studio software from BTSG Software. Over 2,900 of the top rated oldies (50s-90s) on hard disk are from Halland Broadcast Services and are scheduled with Music 1 scheduling software. The Image Jingles are the "Boss Radio" package, originally done by PAMS, and sung for BNetRadio by KenR, Inc. Traffic and billing is done with CBSI software.

The audio card is a Digigram PCX440np, which feeds to a Logitek digital engine/router, controlled by their virtual console. The entire studio, digital and analog, is wired with CAT5. All ins and out are run to a Radio Systems Studio Hub patch panel. Processing is done by a Telos Omnia.net and fed to a Telos Audioactive real time MP3 Encoder/Server.

The output is TCP/IP, and is fed on the net, through special interface software, to a Microsoft Media encoder at Video2Net (a bandwidth provider) for distribution on the net from several locations worldwide. Their massive bandwidth can provide thousands of simultaneous streams to listeners worldwide.

Other studio peripherals include RE-27 microphones feeding Symetrix 528A mike processors, Symetrix monitor amp driving JBL 4206 monitors, and a Gentner hybrid telephone interface. They use Cool Edit Pro for production. BNetRadio is licensed for music streaming by ASCAP and BMI.

The stream is at 32kb stereo, so you will need a good 40K+ internet connection to get an solid stream. As the stream is MP3, a recent version of Microsoft Media Player is needed. If you don't have it, it is free on the Microsoft website.

While the majority of the programming is fully automated, you can occasionally catch them doing live-assist jocking. There will be a studio-cam, so you might get to see personnel on the air, or doing production. Mostly, you'll see the equipment and software in action. They hope to present industry-related "events" on-line from time to time. They are open to any suggestions for programming of industry value. They want to make the communication interactive, and welcome your input.

They also hope to make BNetRadio a valuable industry information source, and the next step in internet marketing of broadcast products and services.

Give them a listen at <http://www.bnetradio.com>

Radio Shopper, ISSN 1069-6148, is published monthly, 12 times a year, by Media Magazines Inc., 511 18th Street SE, Rochester, MN 55904. Radio Shopper is copyright 2000, Media Magazines Inc., and may not be reproduced or stored in any form without the written permission of the publisher.

BULK RATE  
U.S. POSTAGE  
PAID  
MPLS., MN  
PERMIT NO. 596

## Radio Shopper

511 18th Street SE, Rochester, MN 55904

Raymond C. Topp — Editor and Publisher

Phone: 507-280-9668 Fax: 507-280-9143

E-Mail: [radio@broadcast.net](mailto:radio@broadcast.net)

Website-1: [www.radioshopper.com](http://www.radioshopper.com)

Website-2: [www.radiolinks.net](http://www.radiolinks.net)

Classified Ad Deadline: 04-25-00

Fax: (507) 280-9143



Website Classified Ad Form:

[www.radioshopper.com/adform.html](http://www.radioshopper.com/adform.html)



In This Issue

In the Public Interest ----- 3  
Top 10 Lame Excuses to FCC

Station Stories ----- 4  
Be an Engineer in 3 Three Steps

Radio Net ----- 9  
Digital Automation Software

State of the Art ----- 12  
Communication Industry News

Special Equipment Sale -- 19  
Brand new equipment listings.

Shopper Service Sheet -- 19  
Radio Products and Services

Surplus/Demo Gear ----- 23  
Good Deals on Good Stuff

Radio Shopper ----- 25-30  
Used equipment **FOR SALE**

Radio Shopper ----- 31  
Used equipment **WANTED**

[www.radioshopper.com](http://www.radioshopper.com)  
[www.radiolinks.net](http://www.radiolinks.net)

# HE HALL Electronics

[www.halls.com](http://www.halls.com)  
[sales@halls.com](mailto:sales@halls.com)



PHONE 804-984-4255

FAX 804-984-3299

706 Rose Hill Dr. Charlottesville Va. 22901

Complete Service for many Brands. Call For Details

## Rebuilt Equipment with Warranties

Fidelipac MX12L stereo slide console \$2,895

Harris Medalist 10 stereo slide console \$2,295

Harris Medalist 8 stereo slide console \$1,895

Otari MX-5050BII reel to reel \$895

Tascam DA-30 MKII DAT \$595

Orban 422A studio gated compressor limiter \$295

Samson TD dual diversity wireless mic \$249

Shure SCM 268 mini mic mixer \$249

## Lots of Great Used and Rebuilt Gear!

Check Our Web Site,  
And See Our **RS 'Want Ad'**  
For Much More!

[sales@halls.com](mailto:sales@halls.com) [www.halls.com](http://www.halls.com) [tech@halls.com](mailto:tech@halls.com)

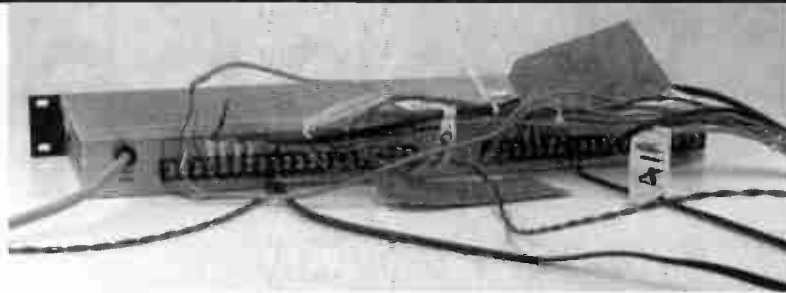

FIX YOUR RATS NEST WITH  
**THE NEW RADIO SYSTEMS DA 4x4a**  
 with removable barrier strip connectors

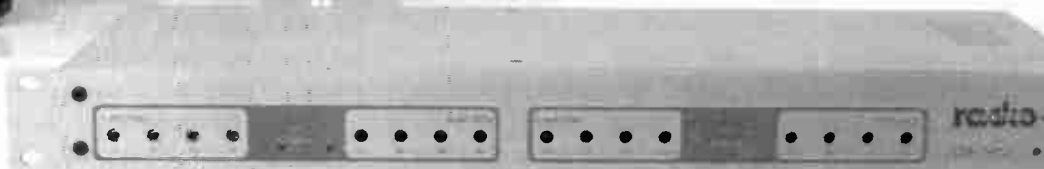
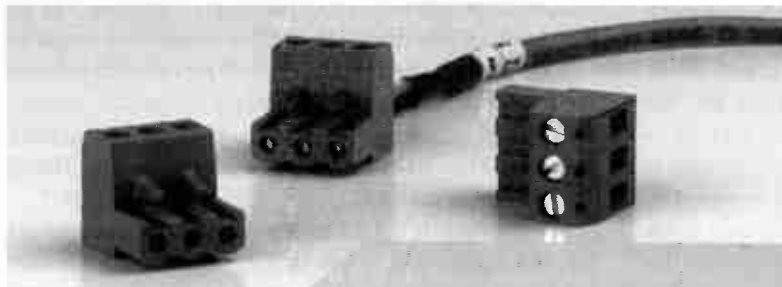

three-pin removable barrier strips for every input and output insure easy installation and service  
 front panel level sets, audio and peak LED indicators for each section  
 four independent sections: configurable as 4x4, 2x6 or 1x16 outputs via rear panel jumpers  
 internal extra low noise toroidal power supply /120/240 selectable /CE certified  
 super specifications: .002% total harmonic distortion, -102 dB signal to noise (below +4 dBm out), channel separation < -105dB



601 Heron Drive, Bridgeport, New Jersey 08014 (609) 467-8000, (609) 467-3044 fax  
 www.radiosystems.com e-mail:sales@radiosystems.com

**We Sell At Least One ECO FM Transmitter Per Day!!**

**ENERGY-ONIX** ECO Transmitters are the most popular FM Transmitters ever built. There are at least 1000 of these transmitters operating world wide.

They utilize one zero bias triode operating in a grounded grid mode and incorporate a solid state driver and frequency agile exciter. Their reliability is unprecedented and their prices are realistic.

Do you want to know more details? Contact our office or your neighbor — he must have an ECO transmitter. Or, better yet — visit our modern 35,000 sq. ft. factory in beautiful “Upstate” New York and “Kick the Tires.”

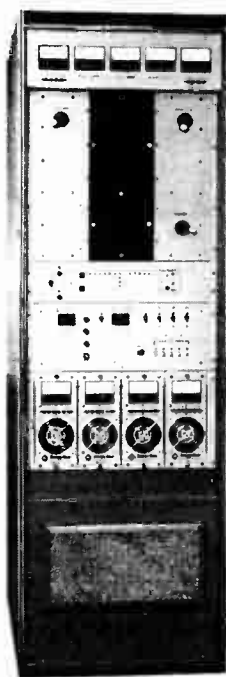

**HERE ARE SOME OF THE REASONS**

- ◆ Honest Prices
- ◆ Understandable Control System
- ◆ Single, Long Life, Triode in Grounded Grid Configuration
- ◆ No Neutralization Required
- ◆ Minimum Plate Voltage (7500 Volts for 25KW Output)
- ◆ Solid State IPA with Loads of Reserve
- ◆ Automatic Power Output Control
- ◆ VSWR Foldback and Trip Control
- ◆ Extremely Long Tube Life
- ◆ Personalized Technical Support from Competent Engineers who Designed These Transmitters
- ◆ Models Available at 4, 6, 8, 10, 15, 22, 25, 30, 40 & 50KW
- ◆ Manufactured in our U.S.A. Factory



**ENERGY-ONIX**  
 BROADCAST EQUIPMENT CO., INC.

**“The Transmitter People”**

P.O. Box 801, 1306 River St., Valatie, NY 12184  
 VOICE: 518-758-1690/888-324-6649 FAX: 518-758-1476  
 E-MAIL: [energy-onix@energy-onix.com](mailto:energy-onix@energy-onix.com)  
 WEB PAGE: [www.energy-onix.com](http://www.energy-onix.com)

# In the Public Interest



## Ken's Top 10 List of Lame Excuses to the FCC

By Ken Orchard

E-Mail: PIFILE@aol.com Phone: 760-243-4733

### Ken's Top 10 List of Lame Excuses for Bad Public Files

- 10) "We're too busy with sales and collections. The owners want results."
  - 9) "I thought all that stuff was deregulated."
  - 8) "We're gamblers. If we end up getting fined . . . it's just the cost of 'doing business'."
  - 7) "I've been in radio for years, the only 'public' we ever get is concert ticket winners."
  - 6) "Our engineer handles all that stuff. I'm sure he's on top of it."
  - 5) "Our receptionist handles all that stuff. I'm sure she's on top of it."
  - 4) "Our program director handles all that stuff. I'm sure he's on top of it."
  - 3) "File? My secretary is always behind on her filing, otherwise she does a great job."
  - 2) "The previous owners must have taken it - along with two cassette players."
- And the number one lame excuse: "What's a Public Inspection File?"

The FCC doesn't accept these excuses. As I told you in my previous articles, the Field Offices of the FCC were changed over to "Enforcement Bureau's." During the first two months, from January 1 to February 29, 2000, the FCC's Enforcement Bureau Offices had issued nearly 120 FCC Communications Act Violations.

Some of these violations were simple things that all program directors and air personalities should know - making a proper station identification. The FCC is out there listening to your stations.

This past Sunday, I was traveling along the Interstate from Las Vegas toward Los Angeles, enjoying the Dodger Broadcast on one of their affiliate stations. The board operator missed the legal station identification at both the Noon, and 1:00 p.m. hours. According to my National Association of Broadcasters Inspection Checklist, the fine for failure to provide station ID is \$1,000. Your \$6.00 per hour board operator potentially could cost you more than their entire monthly salary.

One station, who received a fine for an FCC violation, was given thirty days to respond to the FCC. This station was then served another Notice Of Violation, failed to respond, and was cited with an *additional* fine of \$4,000.

Other violations, recently issued by the FCC, have been for the failure to maintain an effective locked fence, around the base of each antenna having radio frequency potential at the base. A Virginia station was fined \$9,000 for this.

An FM station was fined for failure to maintain power with 90 to 105% of authorized TPO. Another potential problem? If your EAS equipment is not installed or operational, your station could be fined \$8,000. Another example: Failure to maintain Issues-Program Lists can result in a fine of up to \$10,000.

Failure to designate a Chief Operator for your station could result in additional fines. And last month, failure to maintain a station log and numerous other violations have resulted in FCC Enforcement Bureau fines - all over the country.

Having a contest? Do your jocks realize that broadcasting conversations without prior authorization can result in a fine of \$4,000? Does that even cover their salary? To most of us who have been in the broadcast industry for many years, this particular law is standard operating procedure. However, there are rookie personalities who may not be completely aware of the FCC rules, and are jeopardizing your station's revenues for a "cute bit" on the air.

Last month I wrote about a group I have been working with, who was in the process of purchasing an AM/FM combo in the West. I visited the station for several days, and found that the potential FCC risk factor could have resulted in fines of \$27,000 for the seller!

Yes, just like purchasing real estate, the Escrow Company requires an inspector to come out to make sure the roof and termite inspector has been there to insure that the property meets industry standards. I am the termite inspector. I found many "bugs" at these stations, cleaned them up, and saved the seller and buyer a great amount of money that the FCC could have fined them in a future inspection.

During the process of the sale, the buyer and seller must agree on who will be responsible for FCC compliance. If this is not done to the satisfaction of the FCC, attorneys will then begin arguing over who will ultimately be responsible to, not only pay the fines, but cover the cost of bringing the station in non-compliance up to standards. The FCC doesn't care *who* incurs the cost, as long as it gets done.

It is more prudent for the parties involved to negotiate this in the beginning, or better yet, if the current station owner would just take the effort to be certain they are meeting the Compliance Laws set forth by the FCC, a great deal of cost and headache will be avoided.

These western stations, that I consulted with, were saved \$27,000 in potential fines. How much more did I save them in potential legal fees if these problems were not addressed?

Now, the new owners can begin with a clean slate, and the confidence that when the FCC shows up (and I *do* mean when) they are in full compliance. Don't put a \$6.00 per hour board operator in charge of your Public Inspection Files, and full FCC Compliance of your million dollar investment!

I have listed only a few of the FCC violation citations issued in the first couple of months of 2000. You cannot wave a magic wand and erase these violations in a few days or weeks. Last summer, a California broadcaster with multiple stations was fined \$71,000. Here it is eight months later, and I'm still working with them trying to clear up these violations. This is a huge undertaking for their attorneys, owner and myself. - Radio Shopper -

Ken Orchard is an expert with Public Inspection Files, FCC compliance and Due Diligence Reports. With 40 years experience in the broadcast industry, he has helped many stations avoid costly fines and problems. Ken Orchard can be contacted at 760-243-4733, or Email him at PIFILE@aol.com.

**ERI**® ELECTRONICS RESEARCH, INC.

## SHPX series FM antenna

- For single or multiple frequencies
- 15 Mhz duplex bandwidth
- 120 kw input power rating

**Accept No Imitations!**

ERI® 812-925-6000  
7777 Gardner Road  
Chandler, IN 47610  
www.ERInc.com

Keep This Ad For Future Reference

**B**ROADCAST  
**E**QUIPMENT  
**S**ALES & ENGINEERING INC.

**BROADCAST SPECIALS**

P.O. Box 1300  
Raymond, MS 39154  
(601) 857-8573  
FAX: (601) 857-2346  
Email: bes@ucmail.com

---

**ANTENNACRAFT.**  
FM RECEIVE ANTENNAS

- SCA
- EAS
- FM RECEIVER
- MODULATION MONITOR

Broadband 88-108 MHz

6 element . . . . . \$32.95  
10 element . . . . . \$55.95  
13 element . . . . . \$72.95

Immediate shipment from stock.  
RG-6 coax & connectors available.

**RF Radiation Signs**  
9" x 12" - Aluminum

**CAUTION**  
HIGH LEVEL  
RADIO FREQUENCY ENERGY AREA

**NO TRESPASSING**

**\$14.95 EA.**

---

**DURO-TEST**  
LIGHTNING

Obstruction Type 424  
**\$4.25 EA.**

We stock solid state & mechanical flashers

Code Beacon Type 683  
**\$29.50 EA.**

Replaces type 682 beacon.

**CALL B.E.S.**

**FOR THE BEST PRICES ANYWHERE ON THE PLANET!**

Autogram	Burk Technology
CCA Transmitters	Circuit Research Labs
Fidelipac/Dynamax	Inovonics
Jampro Antennas	Radio Systems
Sine Systems	TFT

*Many other product lines available.*

**Fax your equipment list today!**  
**We love package deals!**

---

• 601-857-8573 •

# S.C.M.S. Inc.

Low Prices — Experienced Staff  
New and Re-built — R.F. and Audio

*This Month's Special*

## Used Transmitter Sale

BE Model FM-3.5B	BE Model FM-5B
BE Model FM-30	(2) CCA Model FM-2500G
Harris Model FM-20K	Gates Model FM-20H3
(2) Gates Model FM-2.5H3	RCA Model BTF-20E1

All units may be purchased with, or without warranty.  
Tuned and tested with warranty, or as-is.  
Call for details and pricing.

## S.C.M.S. INC.

10201 Rodney Blvd., Pineville, NC 28134

*You Know We Know Radio*

Call Toll-Free: 800-438-6040

Fax: 704-889-4540

Website: <http://www.scmsinc.com> E-Mail: [sales@scmcinc.com](mailto:sales@scmcinc.com)

Attention: AM, FM & TV Broadcasters  
and Recording Studios

*The Classic is Back!*

## SYMMETRA-PEAK 2000™

Audio purists once again have the ideal passive tool to deal with problem voices. Years ago, Symmetra-Peak™ was the industry standard for restoration of voice symmetry ahead of any voice processing.

Modern day audio processing systems imitate, but never duplicate, the basic tonal balance provided by the totally passive Symmetra-Peak™.

Best of all, Symmetra-Peak 2000™ has been shrunk in size so it can be installed inside your audio console or equipment enclosure without wasting valuable rack panel space. The price has also been shrunk, without sacrificing quality or performance. (Flat 15-20,000 Hz ±0.5dB)

By designing Symmetra-Peak 2000™ only for 600 ohm balanced operation, with compact modular mounting, its modern miniature introductory price is only \$299.00 FOB Carle Place, NY, plus any local taxes.

SYMMETRA-PEAK 2000™ is our newest quality product and we at Kahn Communications are most proud to add it to our menu of advanced high value broadcast products, which include POWER-side™ and POWER-side-CLEAR™.

### KAHN COMMUNICATIONS, INC.

338 Westbury Avenue  
Carle Place, New York 11514

New York Sales Office

212-983-6765

800-570-0722

## Station Stories

“Be a Broadcast Engineer in Three Easy Steps”



By Andy Soule – Dover-Foxcroft, Maine

E-Mail: [doctorradio@yahoo.com](mailto:doctorradio@yahoo.com) Fax: 206-493-1305

I'm expecting to hear Sally Struthers add this to her list of correspondence courses any day now. There are so many who like to play engineer. From jocks fooling with the processing, to the owner trying to save a few bucks – “doing it himself.” I blame Bob Vila for this. All those years he played Mr. Know-it-all on the PBS series This Old House. If you watched carefully though, you noticed that Bob never actually did anything but talk. Norm was doing the work. Norm knew what he was doing and, in the end, the world was good, and Norm finally got his own show . . . and every tool imaginable.

Some thoughts this month, after an interesting event at home. My furnace started making a horrible noise, accompanied by a sour smell. I feared the worst. My two year old son had surely dropped a toy down the vent, and the blower was grinding to a halt. I went down to the cellar and looked things over, then decided it would be better to call someone who does that for a living, and avoid making a late, frustrating night of it.

Standing there, hands, on my hips, watching this guy take my heating system apart, I started thinking. Would I have asked a disk jockey to fix this? At many stations, where there is no technical personnel on staff, it could very well happen. How about that GM fixing the brakes on your wife's car? Wouldn't do that would you? Imagine the typical radio sales person working air traffic control at Logan?

Running a radio station is hard enough. Technical decisions and operations must be done by technical people. Sure, changing an air filter on the transmitter is a simple job. Even that DJ could probably do it. But will the DJ notice that the weld on the harmonic filter has broken, and it is hanging there by the bullet? Will the GM recognize a jiggling IPA meter as oscillations that should be tracked down? Will that web-page nerd understand that everything sounds like crap because he hooked up the audio card in production with seven adapters, then stripped wire with his teeth, and made a splice with duct tape . . . and coiled up the excess on the power supply?

I can't understand how some “Professionals” justify operating a high technology business, with inadequate technical personnel on hand. Yet it is happening all too often. It is not just poor business practice – someone could get killed! I recently talked to a jock who had been ordered to replace a rectifier tube years ago, by his GM. He was successful, but never knew about shorting sticks until months later. It's a wonder no one had been killed, because they didn't know safety procedures around this stuff. I'm sure the same GM would be willing to send the first volunteer that came along to re-lamp the tower too (almost certainly after the last bulb had burnt out).

When I called my oil company for help, late at night, they were happy to come right over. We have an old house, and buy lots of oil from them. Would they have been so eager to serve if I was not a regular customer? When a station that ignores their equipment until it fails, then calls, bleating for help, will you go? Is it worth losing sleep, knowing a regular, good paying customer needs your full attention tomorrow?

In the end, my son was vindicated, and the cat implicated. With the blower pulled out of the ducting, we discovered an unlucky mouse had wandered into the fan. The front half was jammed in the tines of the fan, and his little head was making the ‘WHACK-WHACK-WHACK’ sound that prompted my call. The rest of him was certainly blown up into the heat exchanger, which explains the smell. I'll bet that mouse had been watching Bob Vila.

### From the Arc & Spark Department:

A gathering of engineers was being planned recently, and a friend suggested that we have a cook-out. “What do you suggest,” I asked, “Cook hot dogs on our soldering irons?”

I'm sure there are many more possibilities. I have an uncle who moonlights as a registered Maine guide. He does taxidermy, and always has all sorts of wild game in his freezer. Last time I was there, he had a dehydrator set up, and was making Moose Jerky. That warm breeze out the top of a DX10 would be perfect for making Moose Jerky. Has anyone tried microwave-style cooking at lower frequencies? I've always wondered how long it would take to warm a frozen 7-11 burrito in my BE FM30B. Or how about making a grilled cheese sandwich by wedging it in between the horn gaps on your AM tower?

But seriously, If you want to demonstrate the need for real radio engineers, who know about safety concerns around the radio station to management, try this little experiment a high school teacher did in my first day in Basic Electricity class. Take a small wooden board, about 6" x 12", and put two nails through it, about 6" apart in the center. Cut the receptacle end off an extension cord, strip the wires, and secure each one to a nail. Stick a hot dog on so a nail pierces each end. Plug it in, and stand back. Unplug after sixty seconds, or when hot dog turns black, whichever comes first.

If you're feeling creative, build a little chair and draw a face on your little ‘hot dog man’, and send it to school with your kid for the science fair.

(Continued on page 6)

Everything you need  
for your studio project...  
in ONE place.

www.**SystemsStore.com**

Getting Things... Right

A Division of **RDA Systems**

314-872-8222  
888-616-7980

The World's Best  
Power Tubes  
Sold By The  
World's Best  
Distributors

QUALITY • RELIABILITY • SERVICE

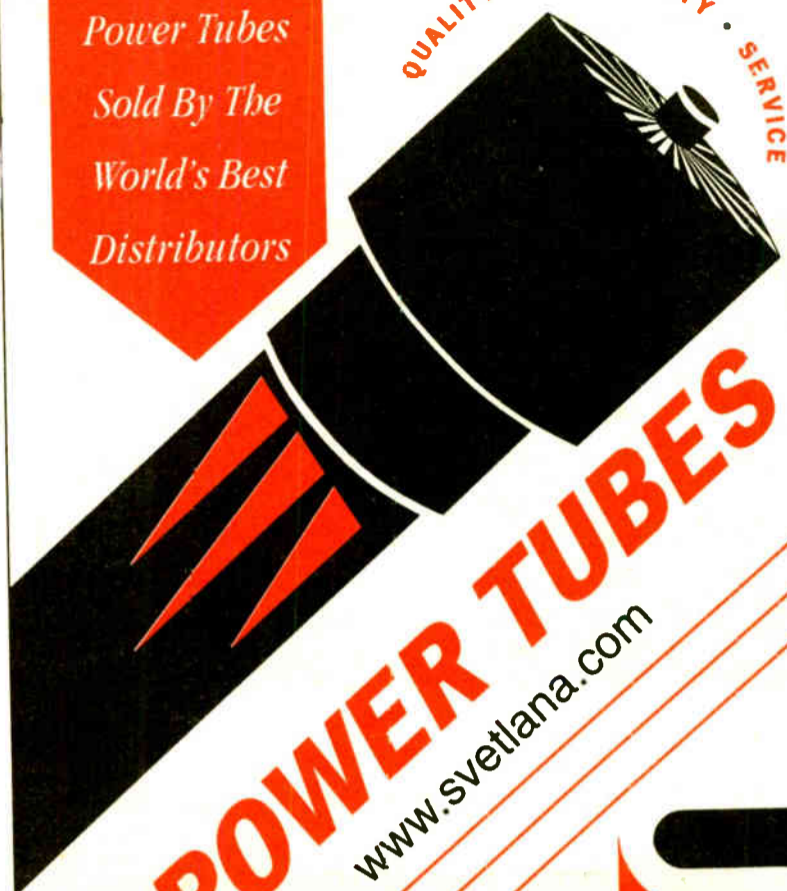

**POWER TUBES**  
www.svetlana.com

**Svetlana**  
ELECTRON DEVICES

HQ: 8200 S. Memorial Parkway Huntsville, AL 35801 Phone: 256-882-1344 Fax: 256-880-8077  
Mktg & Eng.: 3000 Alpine Road Portola Valley, CA 94028 Phone: 650-233-0429 Fax: 650-233-0439

**BSW**

BROADCAST SUPPLY WORLDWIDE

# CLEARANCE SALE

Amazing Values on Demo Equipment!

Here's your chance to get additional savings on quality demo equipment. Subject to availability.  
Many other used and demo products in stock. See our web page [www.bswusa.com](http://www.bswusa.com).

## FEATURED SPECIAL

Get Our Lowest Price on  
Sony's Portable MD Recorder



### Sony MZ-B3

This MiniDisc recorder has the professional capabilities you need for daily reporting. It features a built-in mic plus a mic input jack for use with external mics, built-in speaker, automatic date/time function and voice-activated recording. A remote control and AC adaptor are included. Call us today while supplies last.

**Sony MZB3 Only \$699.00**

ORDER TOLL FREE

**1-800-426-8434**

Qty.	Mfr.	Model #	Description	List Price	BSW Price
<b>Miscellaneous Demo Equipment</b>					
1	AKG	HSD200STD	dynamic headset with connectors	\$240.00	\$109.00
1	Audioarts	SP60	simple phone module for R-60 console	\$631.00	\$489.00
1	Audiometrics	51900	studio mic boom (gray)	\$160.00	\$99.00
1	Crown	D75A	power amplifier (40 watts/channel)	\$641.00	\$419.00
1	Ebtech	Swizz Army	audio tester	\$149.95	\$99.00
1	Ebtech	HE	hum eliminator (2-channel)	\$74.95	\$49.00
1	Ebtech	LLS	line level converter/hum eliminator (2 ch.)	\$89.95	\$59.00
1	Echo	Darla	digital audio card/interface	\$399.00	\$249.00
1	Echo	Layla	digital audio card/interface	\$799.00	\$549.00
1	Electro-Voice	RE50	omni handheld dynamic microphone	\$286.00	\$129.00
1	Excalibur	HC-1	telephone handy coupler	\$99.00	\$69.00
1(pr)	JBL	Control1	compact monitor speakers (pair)	\$308.00	\$199.00/pr.
1	Marantz	PMD201	2-head portable cassette recorder	\$379.00	\$209.00
1	Marantz	PMD222	3-head portable cassette recorder	\$449.00	\$319.00
1	Marantz	PMD510XLR	dual cassette deck with XLR balancing kit	\$1,058.00	\$699.00
1	Marantz	PMD520	3-head professional cassette deck	\$999.00	\$690.00
1	Middle Atlantic	CD1RACK	single space CD holder (holds 6 CDs)	\$42.25	\$20.00
1	Minnetonka	MXTRAX	multitrack software	\$499.00	\$330.00
1	Radio Design Labs	RUMX5	mixer, 5 input, mic/line	\$255.00	\$129.00
1	Rolls	MX54	4-channel mixer, battery powered	\$120.00	\$49.00
1	Symetrix	420	stereo power amp (20 watts/channel)	\$429.00	\$285.00
2	Telos	140	100 Delta digital hybrid	\$2,180.00	\$1,799.00

EXTENDED HOURS: 6AM TO 6PM PACIFIC 9AM TO 9 PM EASTERN FAX: 800-231-7055 INTERNET: <http://www.bswusa.com>

# Powerfully Simple



- F** \* Plays mp3, wav and many other popular audio formats
- E** \* Plays many video formats
- A** \* Automatic Overlap (segues) and Fade outs
- T** \* Schedule Spots and Liners
- U** \* Only Requires One Soundcard (any brand)
- R** \* Plays Live Satellite Feeds
- E** \* Full Blown Automation or Live Assist
- S** \* Logs time and date of files played
- \* Silence Detection for on-air security
- \* Windows 95/98

**Download Free Demo**  
<http://www.raduga.net>  
**Or call for more info!**  
**513-887-0714**

**BENEFITS**

- \* Easy to Use
- \* Free Support
- \* Up and running in minutes
- \* Many features, little training required

Finally, a software package for radio that doesn't require a degree in computers.

# Raduga

Radio Station Automation Software



## FM & TV Antenna Systems

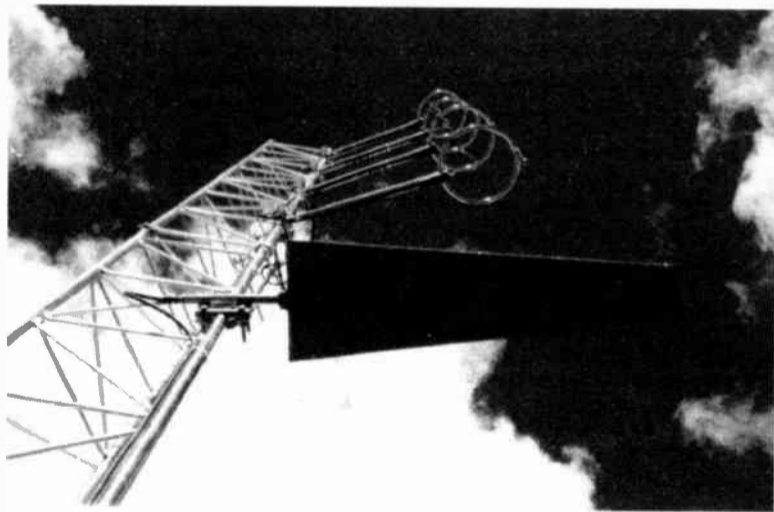

FM Antennas Educational circular polarization			FM Antennas Low power circular polarization			FM Antennas Medium power circular polarization		
MP-1	\$250	0.6Kw	GP-1	\$350	2Kw	SGP-1	\$690	4Kw
MP-2	\$680	0.8Kw	GP-2	\$1,350	4Kw	SGP-2	\$2,690	8Kw
MP-3	\$980	0.8Kw	GP-3	\$1,900	6Kw	SGP-3	\$3,595	10Kw
MP-4	\$1,280	0.8Kw	GP-4	\$2,600	6Kw	SGP-4	\$4,500	10Kw
MP2-4	\$1,820	2Kw	GP-5	\$3,150	6Kw	SGP-5	\$5,300	10Kw
MP3-5	\$2,270	3Kw	GP-6	\$3,700	6kw	SGP-6	\$6,100	10Kw
MP3-6	\$2,740	3kw						

Other power configurations contact OMB America

TV UHF panels, VHF panels, Yagis, UHF-VHF power dividers, and Connectors. There is enough stock at our facility in Miami for quick delivery. Please, contact our Sales Department at OMB America:

3100 NW 72 Ave #112  
 Miami FL 33122  
 Phone 305-4770974 Fax:305 4770611  
 Toll free: 1-888-OMB 4 USA



## Station Stories

"Be a Broadcast Engineer in Three Easy Steps"



Continued from page 4.

### Don't Find Yourself in These Situations!

The sale was about to be closed, and the new owners insisted that all PCB components, leaking or not, be removed. So a filter cap in the auxiliary transmitter was carefully disposed of. Unfortunately, a replacement was not available when that transmitter was needed in an emergency. End result, the station was off the air for a day, for no real good reason.

"You know, it says right in the rules, that you're supposed to have a cleared path to the towers," said the FCC inspector, trudging through two-and-a-half feet of snow, out to check base current readings. Twenty feet closer to the doghouse, he fell flat on his face.

What would you say to the boss's son, who had worked his way up from car washer to oil changer, at the family car dealership. On his first day, he properly drained the oil and changed the filter on a customer's car. Then he filled it up with fresh motor oil. I mean he *filled* it up to the top!

Perhaps I've told you before about the tower crew that dropped part of an FM bay off a five-hundred-foot tall tower? The piece was quite mangled when found on the ground, so they took it to the local Texaco station, and welded it back into, more-or-less, the correct shape.

If your AM is simulcasting another station via the output from an FM radio, shame on you! But just make sure the cleaning people understand that they are not allowed to change that radio to the station they want to listen to. Andrew "Dice" Clay tapes are also a no-no.

Then there was the overnight jock who, having observed the station's contract engineer replacing light bulbs in the console, took it upon himself to change out one that had just gone bad during the night. Imagine his surprise, when half the faders stopped working in the middle of his show. Bright idea . . . dim choice of bulbs.

Ever get to the transmitter site and discover you've left the tools behind? The whole purpose of the trip was to adjust something that requires something no bigger than a greenie. Try hammering on the end of a paperclip, to get a flat edge. It works!

Will IBOC be Conelrad compliant? If all our EAS boxes are outlawed by the patent office, we'll have to do something - right? And, who really wants to go back to the long tones? I'm prepared now! On my web site, I placed a photo of a box I've had for a while, and always suspected it was an old Conelrad detector, and now it has been confirmed. What to do with it? Maybe Ebay . . .

### Station Story:

Last month we discussed senseless vandalism in our station story. Recently, Andy Linton, of Waterford, Ireland, created a web-page to commemorate a fine transmitter that was also a victim of needless destruction. He has included several before and after photo's, and a brief history of the rig. You can see the page at: <http://www.esatclear.ie/~alinton/>.

This Station Stories column is about you and your experiences on the technical side of broadcasting. Have a funny story, or a good tale to tell about fire and disaster? How did you make something of nothing, to make your station work? Please share your items of interest with me, and I'll pass it along to our colleagues in the trenches. Fax me at 801-457-2555, Email to [doctorradio@yahoo.com](mailto:doctorradio@yahoo.com), or visit my ramshackle web page at [www.geocities.com/doctorradio](http://www.geocities.com/doctorradio). - Radio Shopper -

Transmitters, Antennas, STL Systems

[superiorbroadcast.com](http://superiorbroadcast.com)

Contact: Jimmie Joynt

800-279-3326 Fax: 800-644-5958

## WARNING LIGHTS

NAB Special - \$99<sup>00</sup> ea. - Any Color

"ON-THE-AIR" and "RECORDING" - Studio warning lights. Black or silver, early style, with long life lamps.

Call Jasoni Electronics at: 702-791-3394

# The Choice is Easy! CartWorks™

## Live Assist/Cart Replacement

The first truly user friendly digital audio system. A perfect replacement for those aging cart machines. Operate manually like a six deck cart machine or use Script Automation for advanced live assist features.

You won't need a staff of computer wizards to operate it either. Because CartWorks is designed to look and operate like traditional broadcast equipment, it's easy to learn and use.

## Satellite Automation

All the features of our Live Assist workstations plus advanced Satellite Automation. Includes 8X2 stereo audio switcher and everything you need for live, local sounding satellite automation.

CartWorks' powerful Script Automation provides more than just the standard features. Extended control capabilities tackle even the most demanding applications.

And there's no macro language to learn. It's all controlled from a simple Windows' point and click interface.

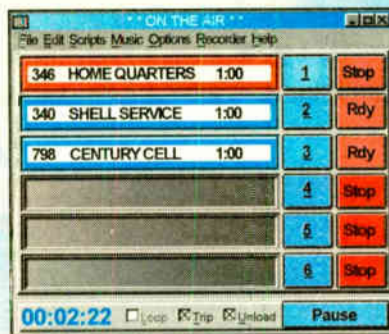

10:27:35



Time	Cart	Title	Artist	Length	Intro	End	Type	A
16:33:23	L004	Intro 2		00:05			INT	
16:33:28	DA LIVE	Spot Set		03:00			COM	
16:36:48	J007	Longer Sets		00:11			INT	
16:36:58	M12	Armageddon II	Def Leppard	04:54	:22		F MUS	
16:41:53	V018	Voice Track 18		00:05			VTR	
16:41:58	M170	Party Town	Glen Fry	02:49	:06		C MUS	
16:44:26	V018	Voice Track 18		00:05			VTR	
16:44:54	M817	Listen to Her heart	Tom Petty	02:49	:11		C MUS	
16:47:42	DA LIVE	Spot Set		03:00			COM	
16:50:42	J005	Today's Best Music		00:08			INT	
16:50:48	M336	Dance The Night Away	Van Halen	02:47	:13		F MUS	
16:53:36	V017	Voice Track 17		00:20			VTR	

## Music-On-Hard-Drive

Designed after the original CartWorks friendly user interface, here's a professional Music-On-Hard-Drive system that's simple to operate yet powerful.

Sound *live* 24-hours a day with pre-recorded, In-context voice tracks that match what's actually on the air.

To keep things simple, Spot sets are played from a familiar cart deck. Music log events are played from a music log.

CartWorks MHD accepts logs from most any of your favorite music schedulers. Or use our included Quick Scheduler.

Switching between automated and live assist modes is as simple as pressing a single button. And options are available to easily add Satellite Automation. CartWorks MHD won't drain your budget or your brain.

Like all CartWorks products, it's backed by 24-hour technical support.

NAB Booth  
R-3489

To learn more, call dbm Systems today...  
1-800-795-7234

Prices Start at **\$4,995** Complete!

Visit our web site...  
<http://www.cartworks.com>

## PHASETEK INC.

550 California Road, Unit 11  
Quakertown, PA 18951

Phone: 800-PHASETEK  
215-536-6648

Fax: 215-536-7180

EXPERIENCE

### CUSTOM MANUFACTURED:

- Antenna Phasing Systems
- Control Systems
- AM/MF Antenna Tuning Units
- Diplexers (NDA/DA and expanded band)
- Triplexers
- Transmitter Combiners
- Dummy Loads (with matching networks)
- Tower Detuning Units/Skirts
- Broadband Matching Networks
- Tunable Skirt Assemblies (TSA's)
- Isolation Transformers

DEPENDABLE

### RELIABLE & DEPENDABLE RF COMPONENTS & PARTS:

- Variable & Fixed Inductors
- Variable & Fixed Vacuum Capacitors
- Fixed Mica Capacitors
- RF Contactors
- Vacuum RF Contactors
- Test Jacks and Accessories
- Static Drain and Lighting Chokes
- Isolation Inductors
- Sampling Loops
- Dial Counters and Couplers
- Transmission Line Terminations
- Ribbon Clips and Tubing Clamps
- Horn Gaps
- Toroidal Current Transformers
- And More!

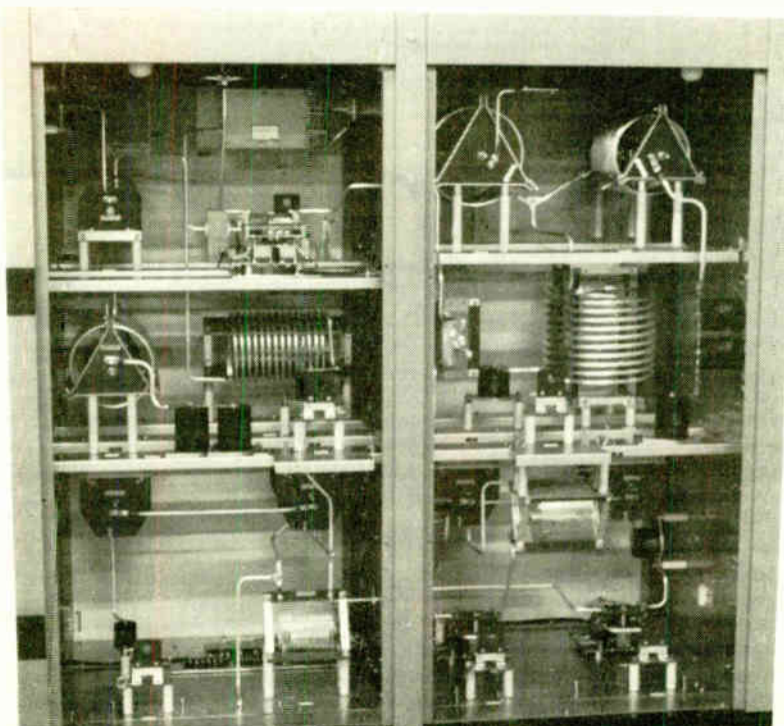

Custom Phasing Systems

QUALITY

Phasetek's experienced staff of engineers and production personnel are dedicated to provide the broadcast industry the highest quality, custom designed phasing equipment.

PHASETEK'S manufacturing facility and components expertise are available to design and fabricate any type of inductor or special RF component. Our engineering and production staff's years of experience and commitment to quality are available to fill any special requirements.

VALUE

### OTHER SERVICES AVAILABLE:

- Phasing System Design
- Engineering & Technical Field Support
- AM & FM Installations.

# THE FUTURE OF AUDIO PROCESSING



Only two controls

Operate the system skillfully in minutes

100% Digital Signal Processing Analog to Digital sample rate adaptive

Straight forward touch-screen programming

Your choice of excellent factory sound presets

Power User Controls to create your own custom settings

Dronto you own unique sound identity

Non-volatile memory to store your settings

## features

	MILLENNIUM®	OPTIMOD® 8200	OMNIA® FM HOT
Touch Screen Control	yes	no	no
32 bit Floating Point Processor	yes	no	no
AES/EBU Rate Adaptive Digital Interface included	yes	no \$1,495 extra	yes
Hardware & Software upgrades included at no charge	1 year	no	no
Final Limiter Sample Rate	256 kHz	128 kHz	48 kHz (virtual 192 kHz)
# of Audio Processing Bands	5	5	4
Available in colors	yes	no	no
Warranty (parts & labor)	3 years	1 year	2 years
Base Price	\$10,950	\$9,595	\$10,700
Price with extras	\$10,950	\$11,090	\$10,700

*Millennium is a registered trademark of CRL, Inc.  
Optimod is a registered trademark of Orban, Inc.  
Omnia is a registered trademark of TLS Corporation.*



# millennium

# Clear... & Real Loud

Call for information on free upgrades and trade-ins.

Circuit Research Labs, Inc.  
2522 West Geneva Drive  
Tempe, Arizona 85282-3192 U.S.A.  
(800) 535-7648  
(602) 438-0888  
Fax (602) 438-8227  
E-mail: [crl@crlsystems.com](mailto:crl@crlsystems.com)  
Internet: [www.crlsystems.com](http://www.crlsystems.com)



# RadioNet

## Digital Automation and Live-Assist Software

By Rick Hall – Touchbase Sound and Design

E-mail: rhall@broadcast.net Website: www.touchbase.worlded.net



Because of the latest trends of technology, it seems that many radio stations are cutting back on their on-air staff. The latest developments in computers and the creation of MP3 are a key aspect to this. In-studio computers are replacing thousands of human disc jockeys each year. The in-studio computers, sometimes known as DCS, live assist, automation, voice tracker, and many others, are taking over the field of radio.

Hundreds of companies are now creating software programs that can be used in your studio to run your station without a disc jockey behind the control board. Thousands of stations are running human-free during the late evening hours, early morning hours, and even weekends.

Because there are hundreds of software and hardware titles for you to choose from, don't plan on making a decision over night. Some may be too basic for your needs, too advanced for your computer skills, and maybe even too pricey for your station's budget.

If your station is interested in using an automation system, live assist system, etc., you should first sit down and decide what your needs are. If you have basic needs, chances are they can be fulfilled a heck of a lot easier.

I'd like to help you shop for a computer system, compare software and hardware titles, based upon their complexity. This is not a review, however, just a chance for you to see what is available.

### BSI

If you require a software title that will play all of your jingles, commercials, liners, beds, etc., then consider using a program called OnScreen Cart Machine, which is produced by BSI ([www.bsiusa.com](http://www.bsiusa.com)).

According to BSI's web site, "More than 3,000 broadcast stations worldwide are using WaveCart. BSI's WaveCart replaces radio station cart machines, providing lightning fast digital audio for just a fraction of the cost of other systems."

What is neat about using a program such as WaveCart, you can record spots, liners and jingles onto your PC hard drive with CD fidelity. WaveCart uses a special type of technology called Rapid Fire®, which means that audio startup is instant. WaveCart can even rotate spots according to exact percentages. Priced around \$299, this software package could be just what your station is looking for.

### MegaSeg

If your station requires a software program that would be one notch above a "cart eliminator," then maybe you should check out a live-assist software program. Though almost all programs listed here are to be used with a Microsoft Windows computer, two programs, I have discovered, can be used with an Apple Macintosh.

MegaSeg, which is produced by Fidelity Media ([www.megaseg.com](http://www.megaseg.com)), is an excellent program to be used to automate the play of music. MegaSeg has become popular by many mobile disc jockeys. MegaSeg, which is usually priced around \$200, can be purchased for \$99 under a special sale, which ends on April 30.

MegaSeg is promoting using their software program with the new Apple Macintosh iMac. Though the iMac may be out of your price range, don't fret. MegaSeg can be used with any type of Macintosh that has a 150 MHz or better PowerPC processor, Mac OS 8.0 or better, QuickTime 4 "Full" install, and an average of 10 MB per song (however, if the songs are formatted in the MP3 4:1 compression format, then an average of 2.3MB is required per song). A used Macintosh laptop will do the trick. Though they are very pricey, you can more than likely find a bargain on an on-line auction service such as Ebay ([www.ebay.com](http://www.ebay.com)).

### OnTheAir

Another Macintosh solution is OnTheAir, which is produced by Intelligent Broadcasting Systems, Inc. OnTheAir Studio is an application designed to play back any types of sound files, and mix them for real, live-assist use. It supports everything, starting from simple AIFF to the new MPEG Layer III (MP3) files and it is able to cross-fade, cut or mix any type of sound file format.

Though this may sound all good and fancy, the documentation included contains this clause, "Currently, MP3 files are played synchronously through QuickTime 4 [the latest version of Apple QuickTime]. That means that the playback can be interrupted by various user operations like dragging, copying files, accessing the network, etc."

But there is hope. The next paragraph reads, "All other sound file formats (including MPEG Layer I & II) play totally asynchronously, which means they are immune to this problem *except* when you mount or un-mount removable media (CD-ROMs, JAZ, ZIP etc.)."

OnTheAir Studio can play sound files that consist of the following formats; AIFF (Audio Interchange File Format), AIFC (Same as AIFF, but compressed), Sound Designer II, WAVE (Windows), MPEG Layer 1, 2 and 3 (also known as MP3), and QuickTime (audio only).

If you are interested in using OnTheAir Studio, I suggest that you check out the company's web site at [www.softronmedia.com/ibs/radio.html](http://www.softronmedia.com/ibs/radio.html). The program requires a Power Macintosh or MacOS compatible computer, a PowerPC processor (180 MHz or higher), QuickTime 3.0 or later (QuickTime 4.0 is needed for VU-Meters and MP3 playback), 32 MB of RAM, and a monitor capable of displaying 640x480 pixels in 256 colors. The retail price of OnTheAir Studio is \$495.

If your station or organization can not support the Apple Macintosh format, don't worry, there are still hundreds of other software titles that will support your operating system.

(Continued on page 10)

## BROADBAND FM RF AMPLIFIERS

Three power levels to meet your needs  
300 Watts • 600 Watts • 1.2 Kilo-watts

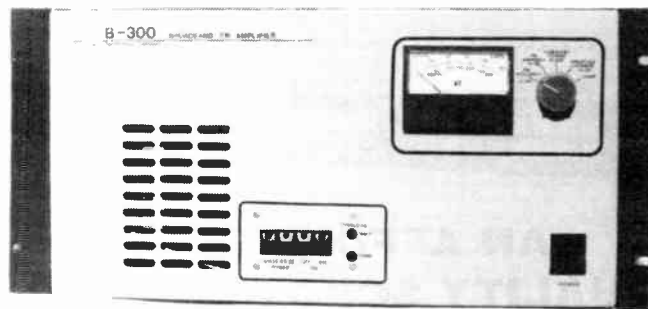

### Features:

- 100% solid state
- No tuning required
- Rugged power supply
- VSWR, current & temperature overloads
- Power trim standard
- Full remote control capability, with outputs for all main parameters
- Compact 19" rack mount design.

## Broadcast Technology Company

PO Box 751, Lamar, Colorado 81052

Phone: 719-336-3902

## Satellite tools

Get the functionality you need out of your satellite systems with Broadcast Tools' flexible line of satellite controllers. Choose from three models and a variety of mounting options to best fit your application.



### DSC-20 Dual Satellite Controller

The only programmable satellite controller available! The DSC-20 adds remote control capability to the Scientific-Atlanta Encore, DSR-3610, AD-4595, Virtex StarGuide II and Com Stream receivers, allowing memory/service - audio changing by automation systems or contact closures. Customized programming is accomplished with a NON-DEDICATED computer.



### USC-16 Universal Satellite Controller

Offers remote control capabilities with multiple channel/memory selection for the Scientific-Atlanta 7300/DAT-32 series, Encore, DSR-3610 and AD-4595; Comtech/Fairchild DART-384, and Ariel type receivers. The USC-16 also provides four open collectors outputs to control transponder selection.



### XP-3 Transponder Controller

Provides remote crystal/transponder selection for the Scientific Atlanta, Comtech/Fairchild and Ariel receivers. The XP-3 allows selection of the three Transponder channels via the users control equipment or switch contacts.

Check out our web site for product information, list pricing and a list of distributors!

Voice: 360 . 428 . 6099

Fax: 360 . 428 . 6719

**BROADCAST**  
*tools* inc.

E-mail: [bt@broadcasttools.com](mailto:bt@broadcasttools.com) Internet: [www.broadcasttools.com](http://www.broadcasttools.com)



Continued from page 9.

## Raduga

Raduga, was developed by the Spry Group, with the intent to be the designers and distributors of low priced, professional Radio Broadcast Software. It is perfect for small and medium market radio (both AM & FM), non-commercial/educational, , Internet radio, Part 15 Low Power AM and Low Power FM Radio Stations (LPPFM).

Version 3.0 has many key features that any radio station could find useful – small or large. Raduga is easy to use and understand, has an uncluttered interface, is PC-based and Windows 98 compatible. Supported files include Mp2, Mp3, WAV, RA, RM, RAM. There's support for MP3 Variable Bit Rate Format, full automation or live-assist, overlap (segueing of songs) with any single soundcard, and there's nine Instant Fire Hot Keys for assigning specific files.

It works like a cart machine, scheduling spots, jingles, PSA's, announcements, and programs to fire automatically at exact times. It also includes an Event Scheduler, Scheduled Event Warning System, Schedule Play/Stop Commands, Drag and Drop compatible, Built in Windows Explorer Tree Create and save Playlists., Create and save Mini-Playlists (a playlist within a playlist).

There's six different Play Modes including Normal, Manual, Repeat, Random, Shuffle and Intro Scan . . . Silence Detection to Minimize On-Air System Failure, Automatic Logging of Times and Play Sequence, Independent Variable, Overlapping for each song, Multi-Language Support, Built-In Help System, and hundreds of other features. With all these features, Raduga is priced at only \$529.00. A demo can be downloaded at the manufacturer's website ([www.raduga.net](http://www.raduga.net))

## EZ Automation

EZ Automation, which is another live-assist/automation solution for the Microsoft Windows environment, is available on the Internet at [www.voicetracking.com](http://www.voicetracking.com).

EZ Automation also has many neat features: Up-coming events can be changed easily, even when the system is on the air, Liner Buttons allow jocks to insert liners or sound effects, Satellite Ready Switcher, 16-Channel Audio Switcher w/ faders & silence sensor, will connect up to 15 different audio sources or networks into the automation system.

The Announcer/Scheduler plays custom liners specific to each announcer, the Fill Function allows automation to join news networks at specific time. It supports music on hard drive or satellite, music segues between songs, and Voice Tracking. You can do a live sounding air shift in less than 30 minutes, Voice Track from home, and send via Email (optional). Basic music and spot scheduling software are included, there's a Basic Spot Affidavit system, Digital Waveform Editing on one computer without on-air interruption, and it has separate audio outputs for on-air and production. It plays MPEG II wave files (BWF) and allows you to edit them too!

EZ Automation's price is based on the hardware that is required to run the software program. The system's hardware includes a Complete Pentium II 400 MHz Computer system, 2 PCI Audio Cards w/ overlapping audio (Mpeg II Compliant), 15" Monitor, Keyboard, 56K Modem, Mouse, Cool Edit software, 8.4 GB Hard drive, 64 Meg PC100 RAM, 16 Channel Audio Switcher w/ faders & silence sensor, and EZ Automation software for Windows NT 4.0. A base price for a system with complete "turnkeys" packages is only \$3450.00. The complete system can be leased for less than \$125.00 per month.

## The M Street Group Directory

Over 780 U.S. Groups - Key Executive Names  
Phone & Fax Numbers - Mailing Addresses  
Stations Owned or Operated

**Only \$175<sup>00</sup>**

**800-248-4242 Available Now! 615-251-1525**

## The M Street Radio Directory

Over 15,000 U.S. and Canadian Radio Stations  
Both Commercial & Non-Commercial Stations  
12+ Arbitron Numbers - Accurate Formats by State  
Ownership and LMA's - Over 380 Markets  
Cross-referenced by Call Letters, Past Calls & Freq.

**Only \$65<sup>00</sup> (+\$5.00 S&H)**

**800-248-4242 Available Now! 615-251-1525**

[www.radiolinks.net](http://www.radiolinks.net) - [www.radioshopper.com](http://www.radioshopper.com)

**AFFORDABLE!**

# UNIVERSAL XE-1000 SCPC AUDIO RECEIVER



## AN AFFORDABLE QUALITY SCPC RECEIVER

New, affordable, frequency-agile receiver, direct channel entry by keyboard, selectable companding 1:1, 2:1, 3:1, wide/narrow bandwidth, de-emphasis selectable, 950-1450 MHz, line output 600 ohms, muting, transponder agile, LNB power supply, 50-channel memory, full baseband output, high-quality audio. Every needed feature at a sensible price (lowest in the industry). Write or call for full information on this quality receiver—the answer for your station. Networks call for prices.

**REMOTE ACCESS AUTOMATION (OPTION)**

**CALL OR FAX FOR PRICING AND INFORMATION**

Phone: (828) 293-2222 Fax: (828) 293-2221

**UNIVERSAL ELECTRONICS, INC.**  
Communications Specialists

4515 Little Savannah Road, Cullowhee, NC 28723-2648

## FM Transmitters

### Solid State transmitters

EM-20/30  
EM-100  
EM-250  
EM-500  
EM-1000

- \* Externally synthesized
- \* Easy maintenance
- \* Parts and technical support
- \* Strong construction

### Tube transmitters

EM-1000V  
EM-2000V  
EM-5000V  
EM-10000V  
EM-15000V



3100 NW 72 Ave #112  
Miami, FL 33122  
Phone-305-477 0974 /73  
Fax 305-477 0611  
E-Mail: [ombradiotv@aol.com](mailto:ombradiotv@aol.com)

## HIGH VOLTAGE RECTIFIERS

Encapsulated or Convection Cooled Assemblies

[www.rectifiers.com](http://www.rectifiers.com)

What do you do look for when you want to buy rectifiers for your transmitters? Chances are, you want reliability first, fair prices and fast service.

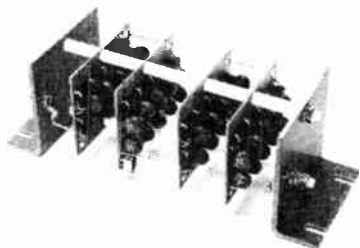

For over 14 years EMI has built the most reliable encapsulated and air-cooled rectifier assemblies made in the US. That's why the people at Continental Electronics chose EMI's rectifiers, beginning in 1993, for all of their fine line of broadcast transmitters. You'll find our rectifiers in Harris, BE, CCA, Gates, Collins, QEI, McMartin, and most any other make you can think of.

Because we have people in our organization that have been contract and field service engineers, we know how much reliability means to you. Like you, we're in the business too. We know how much fair prices mean to you as well.

When you have a transmitter failure, we're here for you 24 hours a day. When you want to upgrade an older transmitter, to install more modern rectifiers, we can help you. Our industrial and military customers all over the world depend on us. You can do. Call us today.

*Remember – We are the Rectifier People*

**ELECTRONICS MANUFACTURING INC.**

Please visit our website at — [www.rectifiers.com](http://www.rectifiers.com)

7890 Crary Station Rd Phone: 800-556-3618  
 PO Box 526 Fax: 334-649-8233  
 Semmes, Alabama 36575 E-Mail: [lcagle@zebra.net](mailto:lcagle@zebra.net)

We accept VISA, MASTERCARD, and AMERICAN EXPRESS



## the PETER DAHL CO. for custom transformers

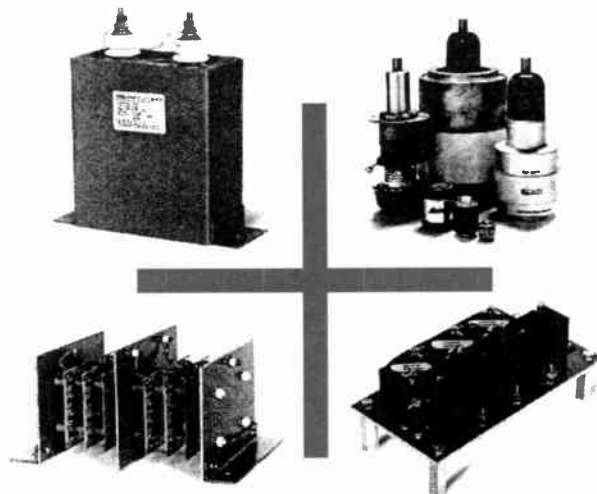

DC filter capacitors • variable capacitors  
 custom rectifier assemblies • transient suppressors  
 and then some...

**Peter Dahl Co.**

write or fax for an extensive catalog

915 751-2300 • fax: 915 751-0768 • 5869 Waycross • El Paso, TX 79924  
[www.pwdahl.com](http://www.pwdahl.com) • [pwdco@pwdahl.com](mailto:pwdco@pwdahl.com)



**Econco**

**REBUILT POWER TUBES**



*Approximately  
 One Half the Cost of New  
 3,000 Hour Unconditional Guarantee*

*Call for Our Price List*

**Econco** 1318 Commerce Ave. Woodland, CA 95695  
 Phone: 530-662-7553 Fax: 530-666-7760 Telex: 176756  
 Toll Free: 800-532-6626 From Canada: 800-848-8841

## TRANSCOM CORP.

*Serving the Broadcast Industry Since 1978*

For Information and the Latest Prices:  
 Visit our Internet Website — [www.fmamtv.com](http://www.fmamtv.com)  
 Send your e-mail requests to: [transcom@fmamtv.com](mailto:transcom@fmamtv.com)

**Fine Used AM & FM Transmitters and New Equipment**  
 The best deals on Celwave products, Andrew Cable and Shively antennas.

FM Xmtrs	100 W	1985	Harris FM100K, Single Phase
	1 kW	1981	Harris FM-1K
	2.0 kW	1996	BE FM-2C Solid State, 1-Phase
	2.5 kW	1976	Collins 831D, Single Phase
	2.5 kW	1984	Harris FM-2.5K
	3 kW	1975	CSI FM3000E
	5 kW	1985	Harris FM-5K
	5 kW	1989	Harris HT-5, Single Phase
	5 kW	1978	RCA BTF-5ES2
	5 kW	1967	Collins 830E
AM Xmtrs	6 kW	1994	Henry 6000D
	12 kW	1996	CCA 12,000GZ
	22 kW	1978	Collins 831G2C
	1 kW	1979	Harris MW1A, 1-Phase
	1 kW	1979	Harris MW1A, 1-Phase
	1 kW	1993	Continental 314T, Solid State
	5 kW	1981	Harris MW-5A
	5 kW	1984	Harris SX-5
	10 kW	1978	Harris BC-10H
	50 kW	1978	Continental 317C-1
50kW	1982	Harris MW-50B	

PO Box 26744, Elkins Park, PA 19027  
 800-441-8454 215-938-7304 Fax: 215-938-7361

# On-Screen Cart Machine

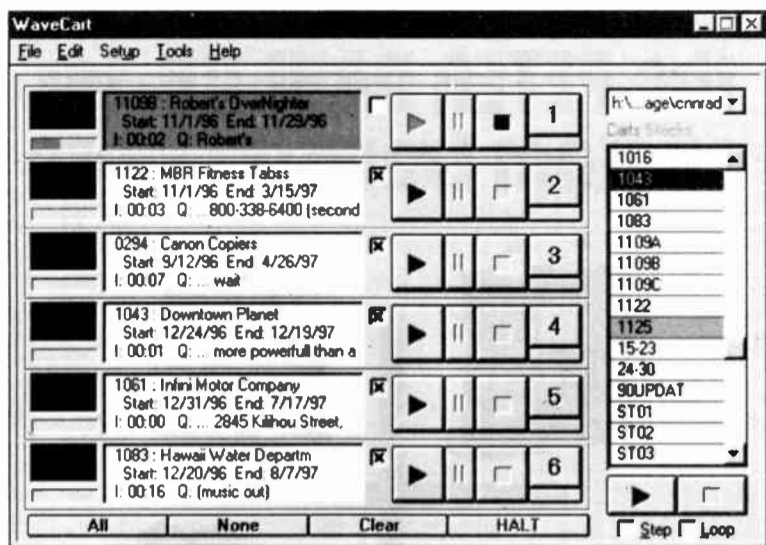

Yes... it's true. An easy-to-use on-screen digital cart machine that runs on a regular PC. WaveCart uses standard or compressed WAV files. Thanks to our exclusive RadidFire® technology, playback is instantaneous. Rotating cart & overlap capability. WaveCart comes with its own digital audio editor. Up to ten on-screen decks. Windows 3.1 or 95.

**24 HOUR  
FREE  
TECH SUPPORT**

**888-BSIUSA1**

Try Before You Buy.

Download the Actual Software!

[www.bsiusa.com](http://www.bsiusa.com)

Only  
**\$249**

**BSI**  
Broadcast Software International

## Superior Broadcast Products

Quality Products at Reasonable Prices

### FM Transmitters

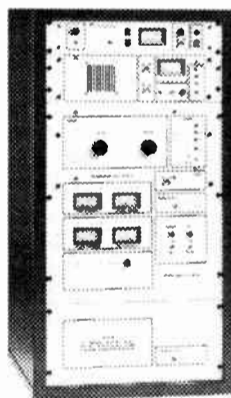

High Performance Solid State Exciter  
Solid State IPA Amplifier  
One Year Limited Warranty  
Factory Service  
On site check out by factory  
personal available

1,000 watt .....	\$5,990.00
2,500 watt .....	\$11,990.00
5,000 watt .....	\$18,990.00
10,000 watt .....	\$24,990.00
15,000 watt .....	\$34,990.00
20,000 watt .....	\$37,990.00

\* RF Coaxial  
Patch Panels  
\* FM Combiners

### FM Antennas

All Power Levels 500 watts to  
20,000 watts per bay  
As low as.....\$395.00 per bay



20 Watt Solid State Exciter - \$995.00

Solid State FM Transmitters with Digital Exciter

120 watt .....	\$2,800.00	2,000 watt .....	\$12,900.00
300 watt .....	\$3,500.00	3,000 watt .....	\$19,990.00
1,000 watt .....	\$7,990.00	5,000 watt .....	\$29,990.00

FM AMPLIFIERS 100 watt.....\$995.00 300 watt.....\$1,790.00 500 watt.....\$2,990.00	FM STL Both Transmitter & Receiver <b>\$3,500.00</b>	FREQUENCY AGILE FM TRANSLATOR <b>\$2,500.00</b>
--	--	---

Contact **Jimmie Joynt** 17194 Preston Road, Suite 123-297 • Dallas, Texas 75248  
Ph: 972/473-2577 • 800/279-3326 • Fax 972/473-2578 • 800/644-5958  
Email: sbp@pulse.net web site: www.sbpjji.com

## State of the Art

Communications Industry News



By Chip Morgan — President of CMBE Inc.

E-Mail: [Chip@cmbe.com](mailto:Chip@cmbe.com) Phone: 800-801-2623

### Wireless Doesn't Mean Radio Anymore

There's a lot more affecting the radio industry than satellite radio, webcasting and consolidation.

Advances in communications have made each mobile phone and computer-enabled appliance an interactive transceiver easily operated by children. With programming and interactive data streams on these devices, and the latest marketing and sales technology (Internet), you can see the future of broadcasting and how it interacts with retailing, point of purchase displays, billboards and every form of advertising and marketing we know.

Radio people laughed a little bit, in the early days, when engineers started talking about interactive radio. We wondered who would be interested in impulse buying of music, or coupons from advertisers. Nobody could foresee the way the market would change. But now, that the crystal ball is less cloudy, some interesting developments should be carefully considered.

### Put it on Your Phone Bill

You've probably heard about the Coke machines in Finland, that operate via cell phone. Dial the phone number of the soda machine, and it delivers a Coke. You pay later on your *phone bill!* You've probably also heard about how mobile phone technology is poised to deliver the Internet over the phone. Stop thinking about just the streaming audio possibilities for a minute – think about the connectivity.

Think about the Bluetooth standard. Bluetooth is an open specification that companies adopt on a royalty-free basis. The standard calls for a short-range radio built into anything . . . that enables information exchange on the free, universal 2.45 GHz industrial, scientific, and medical (ISM) band. As more devices adopt Bluetooth technology, all internet appliances will seamlessly and automatically interface. The standard supports healthy data rates in a combination of circuit-and packet-switching. Each "voice" channel supports a 64 Kbit/s synchronous link, and the asynchronous channel can support an asymmetric link of up to 721 Kbit/s in either direction, while permitting 57.6 Kbit/s in the return direction.

Bluetooth devices form small, ad hoc networks, referred to as piconets. A piconet can have between two and eight devices actively communicating with each other, but additional devices can be "parked" and accessed when required. The bottom-line is that, it's a short-distance radio system that realizes the dream of maximizing bandwidth by allowing multiple re-use of frequencies in very small cells.

But it's more than that. It makes a cell phone a cash register, and the phone company the bank! With Bluetooth, any device can communicate with a cellphone. Push the "buy" button on the phone and get another candy bar. Imagine telling your phone to watch for a specific price on an item, then walking down a street and your phone tells you that a store has a great deal inside on the item. But just as you're about to push the "Buy" button, the phone finds a *better* deal. You glance in the window and decide to support the local economy. Just press "Buy" and it'll be delivered to you. Who needs a shopping bag?

This modern miracle let's you buy anything and everything this way . . . and you'll pay for it, too, because you can't live without a phone. Naturally this technology could be built into radios. Will it?

### CoolTown Beacons

A similar software called E-Squirt comes from the Hewlett-Packard Labs' CoolTown research project, which is HP's testbed for future mobile technologies. E-Squirt lets users interact with "CoolTown Beacons," simple devices that broadcast a URL wirelessly. The software will allow PDAs, mobile phones, wristwatches and other devices to access Web content and services by wirelessly sending, or "squirt," a URL pointer. It uses infrared (IR) to squirt a URL to a PC, DVD player or any device that has Internet access or is networked to a device that does.

HP Labs is also exploring the potential of wearable computing in the form of a technically enhanced jacket called the BlazerJet. Depending on personal style, the BlazerJet, which is powered by NiMH mobile phone batteries and runs a stripped-down version of Linux, comes as a business blazer, motorcycle jacket or vest. The technology is sewn into the jacket. A microphone-to-speech command system is used for input and a tiny earpiece notifies the wearer of incoming information. "Pingers," which are used as an alert system, ping out the identity of an object or place by transmitting its Web address. They may be located outside shops or restaurants, and they match information about locations with data stored in your handheld.

(Continued on page 14)

Place Your Classifieds – [www.radioshopper.com](http://www.radioshopper.com)

# Affordable Digital Automation

24 HOUR  
**FREE**  
TECH SUPPORT

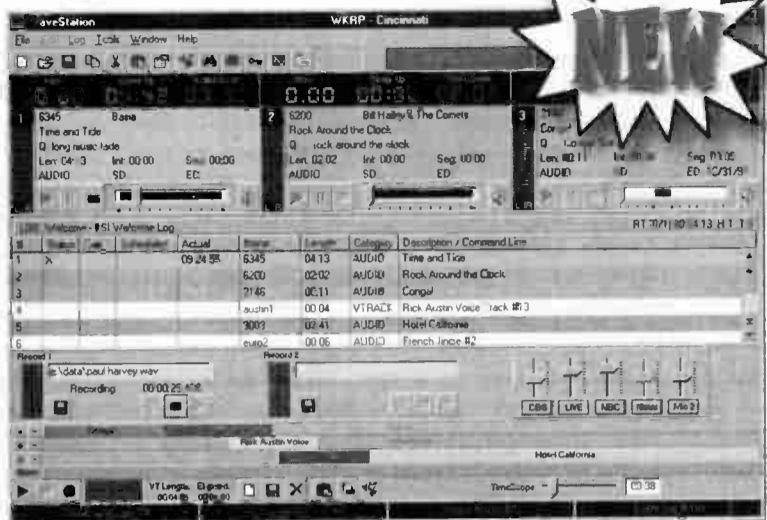

Our new WaveStation 3.0 has all the features of the \$50,000 automation systems, but is priced reasonably like software, not gold-plated broadcast hardware. We often hear, "It can't be true!" More than 1000 satisfied users prove the contrary. WaveStation includes a powerful digital audio editor and uses standard or compressed audio files, including MP3. On-screen Voice-Track editing, time-shift recording, serial port control. WebCast ready. Full automation, satellite, voice track and live assist. Windows 95, 98 or NT.

**888-BSIUSA1**

Try Before You Buy.  
Download the Actual Software!

[www.bsiusa.com](http://www.bsiusa.com)

Only  
**\$999**

**BSI**  
Broadcast Software International

# POWER TUBES!



We have a full selection of all electron tubes required to keep stations on the air all the time. Here are some popular types:

4CX250B	4CX35,000C	3CX15,000A3	PL347/TH347
4CX5000A	3CX1500A7	3CX10,000A7	PL382/TH382
4CX10,000D	3CX2500F3	3CX15,000A7	PL667A/Y667A
4CX15,000A	3CX10,000A3	PL328/TH328	PL1057/YL1057

Plus...Graphite Anodes (new development)  
3-500ZG, 4-400CG, 833D

When you buy from Penta, you're assured of

**BEST WARRANTIES**

Up to 12,000 hours or three years

**COMPETITIVE PRICING**

New tubes at near-rebuilt prices!

**SUPERIOR SERVICE**

Immediate delivery from stock!



**PENTA LABORATORIES**

21113 Superior Street, Chatsworth, CA 91311  
phone: 818-882-3872 • fax: 818-882-3968

**800-421-4219**

## Complete used broadcast equipment solutions.

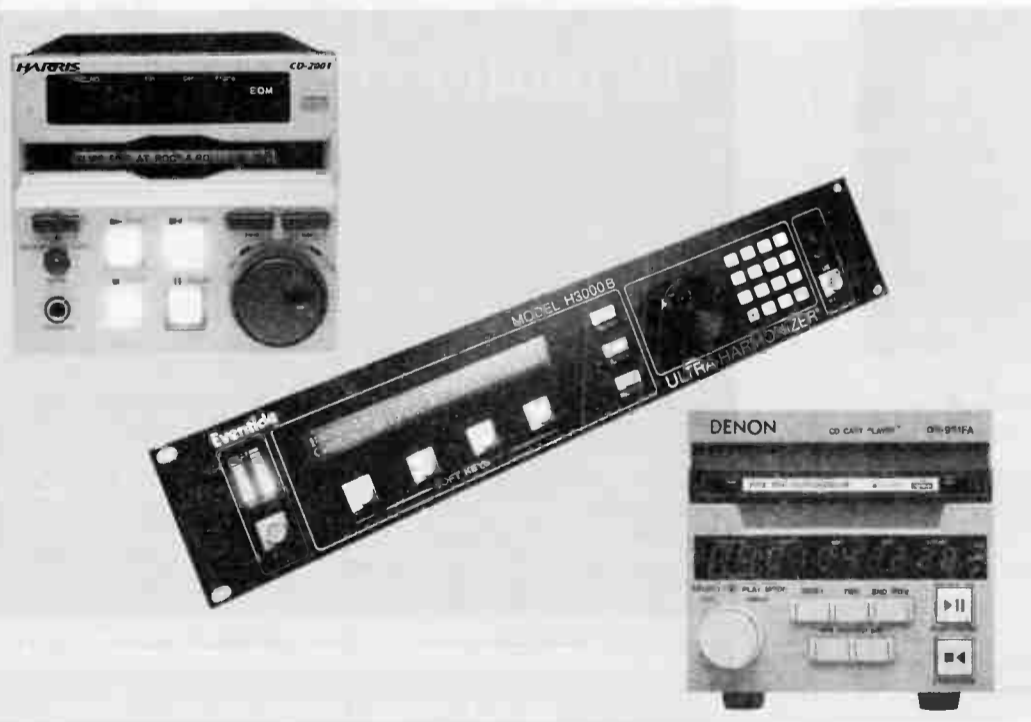

Harris used equipment department is offering specials on the following equipment\*.

Gentner 6X Headphone Amp - \$295

ITC Delta Stereo Player (reconditioned) - \$395

Harris 2001 CD Player - \$895

Denon DN-951FA CD Player - \$895

Eventide H3000B Stereo Signal Processor - \$1595

With Harris' low prices, you can be sure you get the most value for your money. Whether you're buying, trading, or selling, call Harris for quality, selection, service and price.

\*Items are limited and subject to change.

WIRELESS • BROADCAST • NETWORK SUPPORT

1-800-300-0733 • [www.harris.com/communications](http://www.harris.com/communications)

next level solutions

**HARRIS**

# INTRODUCING **FlipJack**

**NEW!**



## CELL PHONE INTERFACE MIXER

The FlipJack is a new addition to the Conex line of cell phone interface products. The FlipJack is designed to interface to the Motorola brand StarTac cell phones or other cell phones that have a 2.5 mm hands-free adapter jack.

### Features Include:

- Compact, self-contained unit. Just 3.5" x 1.5" x 4"
- Two XLR Balanced Mic inputs, one switchable to balanced line-level input
- Front panel LED level and low battery indicator
- Headphone jack with a level control
- Tuner Input for off-air monitoring
- Balanced line-level output
- All IC's are socketed for easy maintenance.
- Interconnect Cable provided
- Transformer isolated inputs and outputs
- Operates from it's own 9 V alkaline battery
- Adapter available for driving a dial-up telephone if cell connection not available.



FOR MORE INFORMATION  
**1-800-645-1061**  
[www.conex-electro.com](http://www.conex-electro.com)

**CONEX** ELECTRO SYSTEMS

1602 Carolina St PO Box 1342 Bellingham WA 98227  
phone: 360.734.4323 fax: 360.676.4822

## State of the Art

Communications Industry News



Continued from page 12.

### Xybernaut

But why not just bring the entire computing environment with you, in the form of a portable CPU? Rather than have different devices that have to sync up, Xybernaut, the wearable computing firm, envisions that people will carry the computer core (the "brains") and "dock" it with keyboards and monitors, cell phones, car dashboards, TVs and other devices. Xybernaut has patented its invention, which is a sealed device smaller than a PDA, with a connection port on one side to link with hardware. It's useful only after being docked into an "enclosure," or shell, such as a cell phone, which interacts with the outside world. It comes with 128 megabytes of RAM and two gigabytes of storage and is expected to cost less than \$1,000.

Speculation aside, one thing is for sure: Cell phones will play a central role in the future of wireless mobility. And according to industry experts, phones will evolve into a product that weighs about 3 ounces and is the size of a business card, but offers a more useful screen, keypad and color. The point is, while the radio industry is still trying to decide how to go digital, the lowly telephone can already do almost anything. Hello? - *Radio Shopper* -

*Chip Morgan is President of CMBE, Inc. - a consulting firm specializing in new technologies and ideas in broadcasting. The firm publishes a free daily email newsletter with the latest developments in broadcasting. You can find out more at [www.cmbe.com](http://www.cmbe.com).*

The  
Right  
Connections

[BroadcastSystems.com](http://BroadcastSystems.com)

800 801 2623

## OMNICAST <sup>1kW FM</sup> Transmitter



**FCC Approved • In Stock**

- High performance at a low cost.
- Extremely low distortion. Very quiet operation (S/N) 70dB typical.
- Completely broadband >20 MHz, easy frequency changes.
- Compact RF Power module.
- Protected for short/open circuit, over current, over temperature, etc.
- RF Output Power = 1000W (nominal), 1100 W (typical).
- Built-in RF Harmonic filter and true wattmeter.
- High spectral purity (-95 dBc spurious, -75dBc Harmonics).
- AC mains (110/220V) single or three phase (optional) operation. Switch mode PWS.
- Compact hi-power, intelligently designed to minimize spare parts.
- Maintenance free. No need to clean or substitute air filters.

**Richardson Electronics**  
Engineered Solutions

40W267 Keslinger Road • P.O. Box 393  
LaFox, IL 60147-0393  
Tel: (800) 348-5580 Fax: (630) 208-2550  
E-Mail: [edg@rell.com](mailto:edg@rell.com)

Visit us on the Internet at: [www.radiotvnet.com](http://www.radiotvnet.com)

### Celenza Communications Consultant

**FM Frequency Searches – \$250**

Commercial or Non-Commercial Low Power Studies  
Application, Amendments & Upgrades, Field Work, Inspections

Phone: 631-928-6506 Fax: 631-928-1905  
41 Kathleen Crescent, Coram, NY 11727

# Shively Labs

*Reach for Ratings!*  
*Shively Antennas Deliver Coverage!*

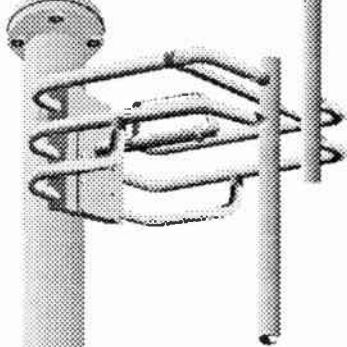

- Superior Engineering
- Multistation Solutions
- Filters & Combiners
- Translators
- Reliable Pattern Studies
- Coax

**FM & TV Antennas  
 and Related RF Equipment**

**because ... it pays to be heard!**

P.O. Box 389, Bridgton, ME 04009 USA  
 Tel.: (207) 647-3327 FAX: (207) 647-8273  
 1-888-SHIVELY e-mail: sales@shively.com  
 Web: www.shively.com  
 - An Employee-Owned Company -

## Model MBC-1

### MESSAGE BOARD CONTROLLER

THE MBC-1 TURNS AN OFF THE SHELF MESSAGE DISPLAY INTO AN INFORMATION CENTER FOR YOUR CONTROL ROOM. RELEASE YOUR STUDIOS FROM THE CONFUSING ARRAY OF FLASHING STROBES AND COLORED INDICATOR LIGHTS. HOTLINE FLASHERS, NEWS WIRE ALERTS, DOOR BELLS... THESE INDICATORS HAVE BECOME A CLUTTERED NUISANCE AND ARE NOTHING MORE THAN AN ANNOYANCE FOR YOUR STAFF TO IGNORE.

NOW COMBINE ALL THOSE WARNING INDICATORS INTO A SINGLE DISPLAY DEVICE THAT GIVES YOUR STAFF THE MESSAGE IN PLAIN ENGLISH. SOUND TOO GOOD TO BE TRUE?



#### FEATURES

- 15 prioritized signaling inputs
- momentary or latched inputs
- pre-programmed "starter" messages
- fully programmable display messages
- text and graphics in messages
- wide variety of display devices
- multiple displays from one controller

WE SPECIALIZE IN RELIABLE  
 COST EFFECTIVE PRODUCTS FOR  
 YOUR BROADCAST RELATED NEEDS

**Innovative solutions!**



615 • 228 • 3500 (VOX)  
 615 • 227 • 2367 (FAX)  
 615 • 227 • 2393 (F.O.D.)  
 WWW.SINESYSTEMS.COM

**FM TRANSMITTER 500W  
 THIS IS REAL GOOD!**



**BUT THIS IS BETTER**  
 IF YOU TAKE IN ACCOUNT THE  
 FOLLOWING:

- \* TECHNICAL SUPPORT
- \* SPARE PARTS IN STOCK
- \* STOCK AVAILABLE
- \* REPAIR STATION
- \* HIGH QUALITY COMPONENTS
- \* COMPLETE INSTRUMENTATION
- \* FAST ALARMS SYSTEM
- \* 18 MONTHS WARRANTY
- \* AUTOMATIC RECOVERY

www.omb.com



# BESCO

Internacional

**World Leader  
 in  
 AM - FM  
 Transmitters**

*"Now in our 34th year"*

**100 AM & FM Pre-Owned Units in Stock**

- ✓ ALL - Powers
- ✓ ALL - Manufacturers
- ✓ ALL - Instruction Books
- ✓ ALL - Complete
- ✓ ALL - Spares

*Call and take advantage of our liberal trade-in plan.*

*Tune and test on your frequency, available on site.*

*Complete inventory on request.*

**Dick Witkovski — President**

**Robert Malany — National & International Sales**

**Besco Internacional**

5946 Club Oaks Drive, Dallas, TX 75248

Phone (214) 630-3600 Fax (972) 487-9029

Visit our website: [www.besco-int.com](http://www.besco-int.com)

# Frequency Agile STL Systems

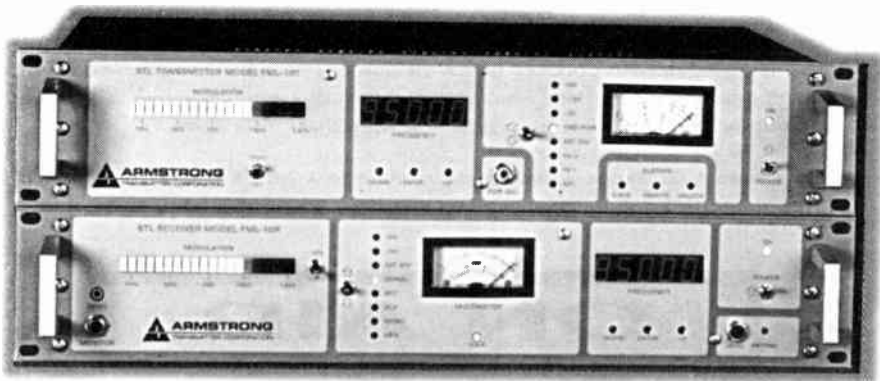

▲ If you are looking to deliver clean, crisp audio to your transmitter via microwave, Armstrong FML-10 STL system offers unsurpassed audio purity in a rock-solid, feature-packed package.

▲ Built to tough manufacturing standards throughout, FML-10 system features microprocessor controllers, advanced PLL circuitry, ultra linear VCO and front panel frequency programmability with digital frequency readout.

▲ Currently in service at over 300 stations in 21 countries, this field proven design is a "rock-solid" STL choice for any station.

**Complete System Under \$5500.00**  
Same Day Shipping  
30 Day Money Back Guarantee



**ARMSTRONG**

TRANSMITTER CORPORATION

4835 N. Street • Marcellus, NY 13108 • PH: 315/673-1269 • Fax: 315/673-9972  
E-mail: info@armstrongtx.com • www.armstrongtx.com

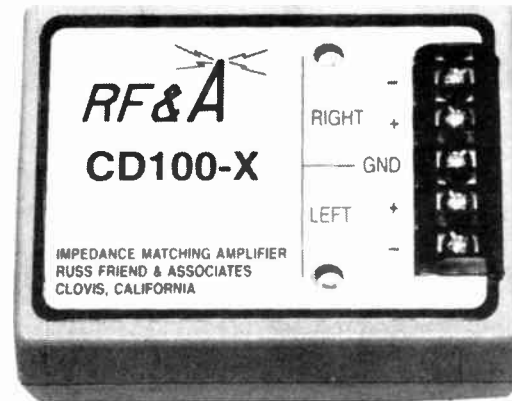

## CD100-X Compact Disc Adapter-Amplifier

Matches any consumer compact disc player or cassette deck to broadcast console input.

Only \$109.00 FOB factory or from any broadcast dealer.

**Best Buy in an Impedance Matching Amplifier**

### Russ Friend and Associates

342 North Sunnyside

Clovis, CA 93611

Phone 559-298-6838 Fax 559-298-8270

*Turntable Parts and Felts for Russco, Collins TT-20, Sparta*

# Rock Solid Dependability

*There are certain things in life that you can count on,  
month after month . . . year after year.*

## Smartcasters:

- Launched the digital revolution in 1989
- Have served the broadcast industry for 10 years
- Continue to innovate with cutting-edge technology
- Are industry leaders for dependability
- Are backed by the industry's best on line support
- Thousands are in service all over the world

**On the Smartcasters' 10th birthday,  
it's time to find out how this  
time-tested product could be serving you.**



Phone: 800-747-6278 Fax: 712-852-5030  
Email info@smartsbroadcast.com

The Optimod® FM 8200 sounds BIG and is BIG...  
in EVERYTHING.

- Sound Quality (just listen)
- Features (too many to list)
- Physical Size (4 rack spaces high)
- Price (just under 10 Grand list)
- Warranty - One Year

Optimod is a registered trademark of Orban, Inc.



**5 Band Digital Stereo Generator / Audio Processor /  
Limiter / Stereo Enhancer**

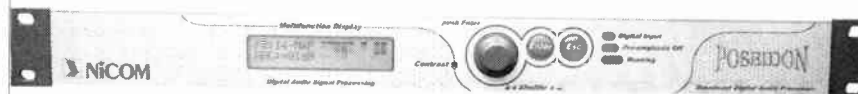

The POSEIDON sounds BIG and is BIG...  
in Everything...except Size & Price.

- Sound Quality (just listen)
- Features (too many to list)
- Physical Size (only 1 rack space high)
- Price (\$3790. list)
- Warranty - Two Years

Contact us for distributor information

Tel: 619.477.6298 • Fax: 619.477.6296  
2626 Southport Way Ste B • National City, CA 91950  
www.NicomUSA.com • info @NicomUSA.com



**The Source That Makes It Happen!**



EIMAC tubes offer a great value to broadcasters through reliable and efficient performance. They are available immediately from our extensive inventory.



Support from our large inventory of EIMAC sockets will minimize your maintenance requirements and provide trouble free performance from your EIMAC tube.

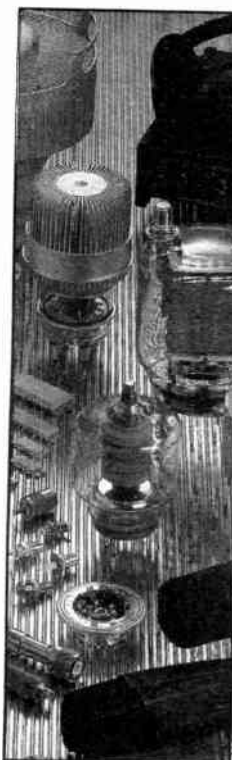

**Broadcast Products**

**Transmitter Components**

- Power Tubes
- Sockets & Accessories
- Capacitors
- Cavities
- RF Amplifiers, Modules & Pallets
- RF Connectors/ Lightning Protectors
- RF Power Transistors

**Studio Products**

- CD/Players/Recorders
- CRTs
- Camera Tubes
- Cassette Recorders
- Headphones
- Microphones
- Wireless Microphone Systems

*and many more products!*



**Richardson Electronics**

**Engineered Solutions**

**1-800-348-5580**

Internet: [www.rell.com](http://www.rell.com)

Visit the website at [www.eimac.com](http://www.eimac.com)

**DigiStor II Multi-Message Digital Audio Recorder**

Stores up to 16 minutes of audio with a 6.5 kHz bandwidth.



**Features:**

- Network news delay
- Traffic & weather reports
- Translator ID, local inserts
- Call-in listener phone info lines
- Message-on-hold
- News & actuality telco lines
- SAP channel identifier
- 'Travelers information' radio

DigiStor II supports multiple play modes (single, repeat, auto-sequence), and features full remote control capability, an "eom" tally output, and an automatic phone coupler for auto-answer message playback via phone lines. Messages are stored in non-volatile memory and are retained even if power is off. No backup battery is needed.

*DigiStor II is in stock at all Henry Engineering distributors.*

For more information contact:

**Henry Engineering**

503 Key Vista Dr, Sierra Madre, CA 91024

Phone: 626-355-3656 Website: [www.henryeng.com](http://www.henryeng.com)

**Distributary™**

Secure Selective Data Delivery  
[www.distributary.com](http://www.distributary.com)

- Move Huge Audio Files Without Clogging Email
- Set up your own Virtual Private File Network (VPFN) between your stations or groups
- Share audio, video, traffic, reports, spreadsheets, sales presentations, demos & more
- Sending a compressed and encrypted file package just once delivers to all selected stations
- Imbed detailed traffic and automation info and a memo with each file and package
- Great for VT voice tracking & remote production
- Tested on Windows® 95/98/NT/2000
- Delivers to all platforms, even Apple® & Linux®
- Uses all data connections, even 28.8K dial-up
- No commitments, hassles or monthly fees
- PC based, no proprietary hardware required

**Distributary Delivers**

Tired of inflexible, audio-only proprietary delivery systems that require dedicated bandwidth and constant supervision? Distributary is an open, easy to use, selective one-to-many file delivery system.

**Download the Free Demo Now**



Electric Works Corp begins its 20th year in broadcasting with the introduction of Distributary. Join our 2000+ past customers at our website or email us at [info@distributary.com](mailto:info@distributary.com)

Now RDL® makes Digital life a lot simpler with 8 New Products featuring

**Sure-Lok™**

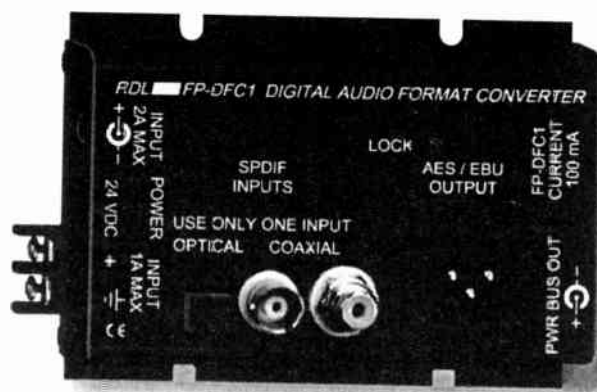

New Flat-Pak™ Series

- ✓ FP-DFC1 Digital Format Converter
- ✓ RU-AEC1 D to A Converter
- ✓ RU-AED4 AES/EBU Digital Audio Distributor
- ✓ RU-AEX4 AES/EBU Digital Audio Selector
- ✓ RU-SPC1 D to A Converter
- ✓ RU-SPD4 SPDIF Digital Audio Distributor
- ✓ RU-SPX4 SPDIF Digital Audio Selector
- ✓ RU-UDC1 Universal Digital Converter

For format conversion, switching and distribution, RDL has a digital product for you; each featuring Sure-Lok. The auto-recovery circuitry that monitors the most frequent causes of latch-up and reinitiates digital signal lock, bringing a higher level of stability in a variety of professional environments.



Toll free (800) 281-2683  
Local (805) 684-5415  
Document Server (800) 391-0017  
Europe (+31) 20-6238 983  
Web Page [www.rdlnet.com](http://www.rdlnet.com)

## Tough Consoles for your Tough Remotes



**JK Audio** Remote Broadcast Gear

800-JK Audio 815-786-2929  
800-552-8346 Fax: 815-786-8502

www.jkaudio.com

# FREE\*

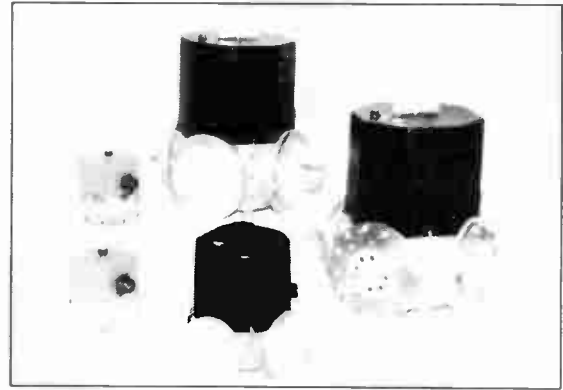

## WHY NOT SWITCH TO MCI?

	<u>PRICE</u>
• Quality	7/8" \$2,550
• Delivery	1 5/8" \$2,900
• Reliability	3 1/8" \$3,800
• Performance	4 1/16" \$5,400
• Broadband	6 1/8" \$6,800
• Compact Size	

Control panels available; call for pricing.

\*Shipping in Continental USA - Regular ground services - Switches only

For More Information Call:



**MICRO COMMUNICATIONS, INC.**

P.O. Box 4365, Manchester, NH 03108-4365  
Toll Free: 1-800-545-0608 Fax: 603-624-4822

Website: [www.mcibroadcast.com](http://www.mcibroadcast.com)

E-Mail: [mcisales@sprynet.com](mailto:mcisales@sprynet.com)

# Audio VAULT

+

# VAULT XPRESS

## = Super Human Power WITHOUT THE PRICE!

VAULTXPRESS® lets you manage all your radio studio needs in a single environment -- combining production, automation, knowledge management, and Internet technologies.

VAULTXPRESS® is built around world renowned AudioVAULT® technology so your station will compete with the "big boys" **without paying a big price!**

- Very User-Friendly User Interfaces.
- Pick and Choose the Studio Software You Need.
- Competitive Upgrade Packages.
- Easily Integrates with Existing Software.
- In Depth Training and 24/7 Support.
- Same AudioVAULT® Tools Without the PRICE!

Starting  
**Below \$200.00/MONTH**

**CALL TODAY!**

888.232.3268 or 217.224.9600

[www.AudioVAULT.com](http://www.AudioVAULT.com)

### Sample Screen Shots



AV-AIR

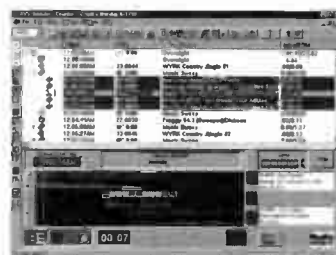

AV-SCHEDULER

**NAB Booth  
R3682**

### VAULTXPRESS Features

- Designed specifically for smaller radio operations.
- Complete modular design allows users to pick and choose the application and hardware they want to purchase for their unique environment.
- VERY user-friendly graphical user interfaces to accommodate personal preferences and localization.
- Works with off-the-shelf sound cards.
- Tight security features to protect data from malicious users.
- Office application compatible.
- Strong documentation and help files.
- Play lists can be administered locally or remotely.
- Works with standard computer hardware.
- Complete automation, satellite or live-assist.
- On-screen voice-track editor.
- Drag-and-drop program log building and editing.
- Edit a program log while it's on-the-air.
- Integrates with existing billing software.
- Program scheduling tools.
- Audio and text management tools.
- Live-assist and station automation tools.
- Reliable audio archiving.
- Import schedules from virtually any traffic and music scheduling program.
- Supports rapid voice tracking.
- Complete on-air copy management solution.
- In-depth on-site training and off-site classroom instruction.



Leaders Look to BE  
[www.AudioVAULT.com](http://www.AudioVAULT.com)



## Radio Surplus Collection For Sale

**Equipment Racks.** Heavy duty, 6 foot high, pre-drilled mounting holes, all steel. Most have electric sockets and can handle equipment with front, or front and rear rack ears \$80 each.

**Scully 1/4" professional analog 1/4" Reel to Reel machine** in roll around rack with above meter bridge. I have not tried out yet, but looks good & was taken out of the radio station production room (very big & heavy). \$200

**2) Tandberg Radio Fabrinnk Model 15-21 Series 15 reel to reels.** This matching pair are in very nice cosmetic condition and are built in nice wooden cases. I manually tuned the take up reel since the main belt is broken in both machines from sitting. The front comes right off with six small screws and looks fairly easy to replace. Already boxed together. \$120 for pair.

**Viking model 235 reel to reel machine.** Tag on back says TD-235 Match Box. Front looks like a brushed type metal or stainless steel. \$25 obo.

**Wollensak 3M model 5000 analog reel.** Speeds are 1-7/8, 3-3/4, 7-1/2 IPS. I haven't tried out as I don't have a power cable. Was told that it was used to record high school concerts for radio broadcast. \$60

**3M M-79 open faced 1/4" reel machine** in "VERY" nice condition, built-in roll around console with above meter bridge. Slow logging speed + 7/15/30 speeds. A very nice robust professional machine that weighs 200lbs, with hard notebook manual. \$750

**Box of large RF coils** - that's what the box says. It came out of the engineers main work area. \$30

**Big box full of Hoffman Easy Vision Television service parts,** like #4255-A (there are at least 16 shiny looking tubes with 5-7 places to connect on the end and say mFd with numbers on them, there are other new related boxes of parts of which I don't know what they are. (ARE NEW OLD STOCK IN ORIGINAL BOXES). Will sell all for. \$15

**Two large boxes of new motors,** still in packed boxes from Oriental Motor. Japan S-301 motors - 7.5W 115V 1500/1800 RPM. F30500 Reaction Motor - 50/60 Hz 0.35xQ30A Impedance protected. (Make decent offer.)

**Antenna lightning arrester.** Joslyn P/N 1936-09 \$25

**BIG RESISTORS.** Carborundum C 886-SP2-L, 20 ohms P/M 20% 60 watts. I have over 50 in box (new). \$18

**Rectifiers:** Box of 34 radiator style, new old stock for amps, plus some other related items. All for. \$15

**Box says Strain Relief:** Efcor 3/4 has what looks to be pipe threads on one end, the other end has a plastic sleeve and is open on both ends - is about 1 3/4 long. \$15 for box of over 25 new ones

**Allen Dumont Laboratories Type 303-AR Cathode Ray Oscillograph.** \$45

**Allen Dumont Labs Oscilloscope,** for WE type 2577-KS 15586. \$45

**Ampex Model 300E Vacuum tube voltmeter,** made by Bellantine Labs, 30CPS-200KCS, back screws are: amp, null, 250V, 6.3V. Front has: AC Volts & decibel meter, and Volts & Full scale switch, and L-R Sockets. I plugged in, lit up. \$70 obo.

**Amplifier Corp of America Model 590 Type A-1 Sensitive flutter meter.** \$50

**B & W - Barker & Williamson Inc.** - Nidek 400 Distortion meter. Very good cosmetically, but power cable is dry and cracked. \$45

**Belden wire.** 8450-T-1000, 22 AWG solid twisted pair Beldfoil shielded miniature PVC plastic jacketed cable, rated 300 volts. Big reel is new

wire. I do not know how many feet are or this large roll of wire. \$20

**Beta Scope Model 8519** Non destructive thickness gauge. Mfg for Twin City Testing Corp. by the LIONEL Electronic Labs (Make decent offer.)

**Calrad,** small transistorized stereo/or/mono microphone mixer in black metal case. 4 channel with four 1/4 inputs and L/R stereo RCA outputs. (I believe it uses a 9 volt battery.) \$10

**Central Scientific Corp Decade Resistor,** NO 82821C, Chicago USA. \$30

**Channel Master model 6708** all channel UHF converter. Has channel selector, fine tuning & on/off knobs on front, power cable. I never plugged up, looks OK though. \$5

**Do-All Model 740A TV-Generator.** \$20

**Eico Model 1078** Voltage & amp meter. (Make offer.)

**Eico Model 1120** Capacitor substitution box. \$20

**Electronics Model 36-616** CRT tester & rejuvenator, full color & B&W with instruction booklet and case. \$20

**Electro-Voice Model 502** heavy duty looking transformer 1/4 to XLR cable. \$15 obo.

**Federal Aviation Agency Type FA-5682** power supply. \$20 obo.

**Garrard Model AX-20** record changer. Made in England TA-MK II, with Harmon-Kardon warranty papers, warranty service card and complete original service manual. It looks real nice cosmetically. The bottom wood pieces were taken apart, packed away & stored many years by my audio friend. It has sat for so long that the rubber pieces have most likely dried out. I plugged it in & the motor kicked right in, but it didn't want to turn. Has been boxed up for many years. \$30

**General Cambridge Radio Company Type 1301-A.** Low distortion oscillator.

**General Radio Corp Decade Att. transformer type 578-A.** \$12

**General Radio Corp distortion & noise meter,** Type 1932-A, rack mounts. \$45

**Heathkit Model AV-3.** Has a RMS volt meter & audio/VTVM knob. I broke a piece out of the meter cover moving it, but no damage was done the meter itself. \$10

**HeathKit Model T-3** Visual-Aural signal tracer. (Make offer.)

**HeathKit G1** signal generator (Make offer.)

**HeathKit Model 1G-16** Sine square audio generator. \$40

**Hewlett Packard 206 A** audio signal generator.

**Hewlett Packard 330B & 330C** distortion analyzer.

**Hewlett Packard Model 400** Vacuum tube voltmeter. (3) @ \$35 each.

**Lambda Electronics** Power supply. \$35

**LFI Type J control,** model 232 Auto Temp. Control. Looks nice (Make offer)

**Mart Electronics Remote control system.** RMC-2AXS and RMC-2AXT(A). \$150

**Nems Clarke Type 108 E,** phase monitor. \$37

**National Radio Institute (NRI) Model 12** vacuum tube voltmeter. Looks good with power cord.

**Ohmite VT variable transformer** No-VTS-5, (looks good with cord). \$30 firm.

**Oscilloscope FM Radar.** AN/USM Dept of the Navy, Bureau of Aeronautics; Model Engineering & MFG Co. OS-4A/AP; in nice metal box with carry handles. \$50

**Radio City Products Model 663A** electronics Multi-Tester. Good cosmetics & handle, but power cable is dry cracked. \$50 obo. (Has a cool classic look.)

**Regency FM-Televerter Model RC-103.** \$6

**Rutherford Electronics B7B** Mod 2 pulse generator. (Make offer.)

**Sencore Model TDC22** transistor crystal diode checker with instruction booklet. \$35 obo.

**Sherwood Electronic Labs Inc Model S3MX,** FM Stereo Multiplex, Stereo MX adapter. Box of two tube units, each has 2-RCA MX & FM inputs. 4-RCA outputs: A, Tape, B, Tape. Plugged in, both units lit up. One is missing a face plate. (Make reasonable offer.)

**Shure/Bogen microphone Model no 710BG** crystal mic. Brown in color, made in USA by Shure Bro's, inc. Chicago, USA for Bogen. \$40

**Simpson Model #383-A** Capacohmmeter. Capacitance & in-circuit leakage tester. Plastic meter cover is cracked, but lit right up when I plugged it in. \$40 obo.

**Sonlight audible signal Alarm panel A2,** by PR Mallory & Co inc. \$20

**SPARTA AUTOMATION EQUIPMENT.** Will sell for one money (make reasonable offer) \*Sparta Model REM-1052 Automation remote control, cable, panels, misc auto. \*Sparta Model RS-3100 RS-4100 Random Access. \*Sparta REM-25 Remote control, cables, etc. \*3-SpartaMation cart automation systems, mounted in metal racks. \*Sparta LAM 1 Line/monitor amplifier, has two VU meters, 2 rack space with black external box with fuse and cable.

**Tektronix Type RM31A** Oscilloscope. Brushed metal front finish and Tektronix type 122 low level amplifier. \$200 for both.

**Tektronix Type S61A** Oscilloscope. Vertical Type 3S76 sampling dual trace/Horizontal Type 3T77 sampling sweep. \$45

**University Model PP-1T** "Powerpage" with microphone and nice leather shoulder strap, but no speaker. Battery compartment in clean without rust, etc. \$10 (Uses lantern batteries.)

**Voltampere Corp DC power supply.** 0-40V 0-50A pp7545-B10. Full rack mount width with ears and pull-out handles, height 7", 19" deep, weight 90lbs. (Make offer.)

**Weston Instruments Model 1240** tester. Looks nice. \$30

**ART Studio Nightbass** Professional bass guitar preamp processor with hundreds of preset and user effects. This \$900 stereo bass processor does everything and is solid state + uses two 12AX7 tubes. Purchased this piece of equipment for myself, but only used it a few times and it is just sitting. I have never rack mounted it and it works perfect and comes with the manuals and original box. Absolute mint. \$440 + shipping.

*All items are sold as is, and price does not include shipping. I would also like to have a mic similar to a Neumann, to do studio work.*

Contact: Will Dougherty Jr.

Email: wldrec@hotmail.com

Phone: 573-998-3117 Home

## Surplus Equipment Sales

## Transmitters, Exciters, Antennas

**Gates/Harris Model FM-20G,** 20kW FM transmitter, 240V, 3-phase, good driver and final tubes. From the late 60's, but very clean and supplied with newer exciter. \$5,800

**Gates/Harris FM-10B,** 10kW FM transmitter with good tubes, harmonic filter, directional coupler. Older model completely refurbished with newer exciter. \$4,600

**QEI Model 695,** FM exciter, variable output, frequency-agile, modem design. \$1,600

**QEI Model 675,** FM exciter, 20 watts output, setup on your frequency. \$950

**Collins Model 310Z-2,** FM exciter, composite input, 20 watts output, crystal change to your frequency. \$600

**RCA/Dielectric Model BFC-3,** 3-bay high-power CP antenna on 106.1, with radomes and matching transformer. \$1,200

Also have a large selection of AM phasor and ATU components. Coils — fixed and variable, mica caps, vacuum capacitors — fixed and variable, toroidal transformers, RF contactors, J-Plugs, RF ammeters, and porcelain insulators.

## Consoles and Mixers

**Collins Model Audio Rock 10,** 10-fader stereo air console. \$1,400

**Ward Beck Model R1200,** 12-slide fader stereo air console. \$1,500

**Ramsa Model WR-8616,** 16-slide fader, 4-bus production console. \$1,200

**BE Spotmaster Model 5M100A,** 5-channel mono air console. \$400

**Shure Model M267,** 4-mic/line in, mono mixer. Mic/line level output. \$250

**Shure Model M258,** 4-mic/1-aux in mixer. Mic level output. \$130

**Shure SE30,** compressor mixer with 3 mic inputs. \$200

**Pacific Rec and Eng Model MM-8,** 8-track monitor line mixer. \$200

## Studio Gear

**Audiometrics CD-10,** broadcast CD player. \$500

**BE Series 2100,** mono cart players. Slimline style, primary and sec tones, (2) available at \$225 each.

**BE Model 3200RPS,** stereo cart recorder. Compact desktop machine, with 2 VU meters. \$400

**ITC Model RP,** stereo cart recorder. 3 tones, 2 available at \$350 each.

**CRL Model IPP-100,** Instant Personality Mic Processor. 18 programmable setups with variable compression, gating, parametric EQ, mic/line inputs, key lock security. \$600

Also have a large selection of studio accessories. On-air lights, turntable preamps, mic processing, digital delays, wireless mics, newer tip/ring/sleeve patchbays, audio and control cable.

*All equipment has been refurbished, cleaned and Guaranteed to be in good working condition. Shipping charges additional.*

For more detailed info, and to order, call:

**Bill Stallman at: 610-664-4539**

**Surplus Equipment Sales**

PO Box 2193, Bala Cynwyd, PA 19004

# Shopper Service Sheet

## Components & Rebuilding Services

Rebuilding service for most audio equipment  
Tascam and Otari authorized service  
Tape heads for most cart machines in stock  
Lots of new and used audio and RF components

**HE HALL**  
**Electronics**

Phone (804) 984-4255  
Fax (804) 984-3299

Specialized Products and Services  
for the Radio Broadcast Industry



**Svetlana**  
Electron Devices

## Quality Power Tubes

Manufactured in Russia's largest power tube factory.  
Shipment from USA stock.

Phone 256-882-1344 Fax 256-880-8077

## Chris Scott & Associates

Bowling Green, KY

FAX (270) 781-1232 Ph. (270) 781-5301

Solve blanketing interference with FM notch filters & traps



Automate NPR programs with the **PAUSE DETECTOR**

online catalog:

[WWW.SCOTT-INC.COM](http://WWW.SCOTT-INC.COM)

## RF PARTS & COMPONENT SALE



- Jennings Vacuum Variable Caps
- Door-Knob Capacitors
- Broadcast Power Tubes
- High Voltage Capacitors

**Low Prices!!  
Don't Miss Out!!**

Call for a current inventory & price list.

**ACE ELECTRONIC PARTS**

3210 Antoine Dr, Houston, TX 77092

Phone: 713-688-8114 Fax: 713-688-7167 [aceelect@wt.net](mailto:aceelect@wt.net)

## Amperex, Eimac, RCA, Svetlana

### Power Tubes & RF Transistors

3CX400A7/8874, 3CX3000A7, 3-500ZG,  
4CX250B, 4CX250R/7580W, 4-65, 4-125A, 4-400C,  
4CX300A, 4CX350A, 4CX400A, 6146B, 807, 811,  
833C, and more.

Call Westgate at: 800-213-4563

## LOW COST NOAA/NWS RECEIVER

- Very sensitive - up to 70 miles with outside antenna (BNC connector).
- Great for multiple studio locations, mobile operation, custom installations.
- Built in speaker plus remote audio and alarm outputs for EAS decoders, etc.
- All 7 channels, including new split channels

• Only \$139.00

• We also make WWV Receivers and nbfm link xmtrs & rcvrs.

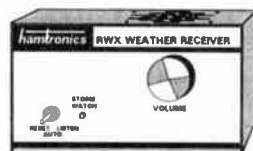

**hamtronics, inc.**

65-J Moul Rd; Hilton NY 14468-9535  
Phone 716-392-9430, Fax -9420

[www.hamtronics.com](http://www.hamtronics.com); e-mail: [jv@hamtronics.com](mailto:jv@hamtronics.com)

## Scully & Ampex

Parts, Service and Accessories

We have acquired the entire line of VIF products.

### Sequoia Electronics



422 Avenida Abetos, San Jose, CA 95123  
(800) 848-4428 Fax (408) 363-0957



## EQUIPMENT FINANCING

- ♦ FAST, EASY APPROVALS
- ♦ We Specialize in Broadcasting Equipment
- ♦ No Financials Necessary up to \$150,000
- ♦ True Lease or Finance Lease Option
- ♦ New or Used Equipment

LOANS BY PHONE  
Call Jeff Wetter Toll-Free  
for Complete Information!

**(800)699-FLEX**

24hr. Fax (972)599-0650

Contact Us at Our Web Address:  
[www.flexlease.com](http://www.flexlease.com)

**FLEXLEASE, Inc.**  
COMMERCIAL EQUIPMENT FINANCING



FM Allocation Study — \$149.00

Complete FCC FM Application — \$1,200.00

Full Color Coverage Maps (any contour) — \$69.00

Multi-Signal, AM & FM Duopoly Maps — \$349.00

### Scientific Broadcast Systems

1680 Highway 62 NE, Corydon, IN 47112

Phone: 812-738-3482

## FREE 44pg Catalog & 80 Audio/Video Applic.



PWR SUPP, EQ, 250 PRODUCTS  
PHONO, MIC,  
TRANS, ACN,  
TAPE, VIDEO,  
LINE, OSC

PRESS  
BOXES

1-in/8-out Video/Audio  
1-in/16-out Video/Audio  
2-in/24-out Audio Only  
1-in/32-out Video/Audio

Video & Audio Dist Amps.  
RGB-Sync Dist. Amps.

Routing Switchers



**OPAMP LABS INC (323) 934-3566**

1033 N Sycamore Av LOS ANGELES CA, 90038

[www.opamplabs.com](http://www.opamplabs.com)

## Broadcast Equipment Repair

- AM Antenna Monitors
- AM/FM Modulation Monitors
- Audio Processing
- Exciters
- RPU Transmitters/Receivers
- STL Transmitter/Receivers
- Test Equipment
- Transmitter Field Repair

Rapid Turnaround - Professional Service

**DCS**

DIVERSIFIED COMMUNICATIONS SYSTEMS

9139 PA Route 18, Cranesville, PA 16410

Richard C. Pogson (814) 756-3053 Email: [rpogson@aol.com](mailto:rpogson@aol.com)

Radio Automation  
Software

- ♦ Professional
- ♦ Affordable
- ♦ Easy to use

**\$529**

**Raduga**



Phone: 513-887-0714

Free Demo Download:

<http://www.raduga.net>

# Shopper Service Sheet

## — KARSKY'S —

Cart Re-Winding Specialist

3 REASONS FOR USING OUR SERVICE:

1. Fast service.
2. Replace broken carts at no charge.
3. We have ITC/Scotchcarts available.

KARSKY's CART REWINDING

236 Bengal Drive, Rapid City, SD 57701 Phone 1-800-349-9928

Specialized Products and Services  
for the Radio Broadcast Industry

## COMMERCIAL RADIO COMPANY

ORIGINAL PARTS, NEW AND USED FOR  
RCA, GATES & COLLINS TRANSMITTERS

CAPACITORS: MICA TRANSMITTING - CERAMIC RF  
VARIABLE AIR - FIXED AND VARIABLE VACUUM  
NON-PCB OIL FILLED CAPACITORS AND  
NON-PCB TRANSMITTER REPLACEMENT KITS AVAILABLE  
OVERNIGHT SHIPPING - MANY STOCK ITEMS

Phone 802-226-7582

Fax 802-226-7738

## Audio Cart Rebuilding

**\$1.00** (Plus parts and tape.)

50¢ Trade-In On New Tapex NAB Carts

Write or call for brochure and price list.

Vic Blacketer — Mastertone Company Inc.

3608 Davison Road, Des Moines, IA 50310

Phone 515-274-3087 Fax 515-255-9224

## 1 Balanced Input — 5 Balanced Outputs

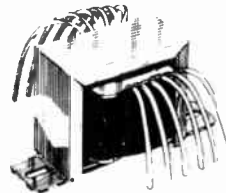

9K-600-6 Audio Distribution Transformer

Replaces expensive distribution amplifiers.  
Balanced, floating inputs and outputs.  
Economical, reliable audio routing.

P.O. Box 1561, Bellevue, WA 98009

Phone: 425-454-2040

Website: www.audisar.com

**audisar**

## DA HOOK

Safety Grounding Hook  
Solid Brass Hook & Hardware.  
Fiberglass Rod Handle. #10  
Copper Cable & Alligator Clip.

To purchase or for more technical data, telephone, write or e-mail home page:

Wilk Science and Technology Inc.

1112 North Grove Avenue, Oak Park, Illinois 60302

Telephone & FAX: (708) 524-8588

http://imembers.gnn.com/AMumpower/edwilk.htm

## DA GAP

Lightning Dissipation Gap  
Available with Horn or Ball  
Dissipaters. Patented (#5,661,262)  
Hot Adjustment Mechanism.

## MICRO CONTROLS CO.

FULL SERVICE TO ALL WE MANUFACTURE  
New and Factory Rebuilt

STL • SUB-CARRIER RECEIVER • SUB-CARRIER GENERATOR  
REMOTE CONTROL • POWER SPLITTER • LP DATA SYSTEM  
CUSTOM RF SYSTEM DEVELOPMENT

MICRO CONTROLS CO.

E-Mail: microcom@why.net

800-788-6123 or 817-295-0965

## Solar Electric Power

For Remote Translators or Transmitters

Individual Components or Turn-Key Systems

Anything Solar Electric

888-917-9764

## It Fits in the Smallest of Studios!

"The small studio syndrome problem solver."

It's the Quality Built "Pro Studio 1"  
Unbeatable Quality and Price for Only

**\$1295<sup>00</sup>**

So why buy a "short-term" plastic and metal  
furniture system, when you can have a real  
furniture system, that will last for years?

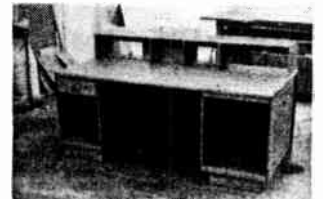

**SPACEWISE®** Call Spacewise now: 800-775-3660

## WANTED!

Older audio equipment for immediate purchase!

Especially compressors & mic preamps.

Langevin, RCA, Pultec, Universal Audio, Fairchild, Collins, WE, Altec, etc.

Microphones: Neumann, AKG, RCA, Telefunken, etc.

U.R.E.I. Compressors: Models 1176, LA-2, LA-3, LA-4

Mark Linett

Phone: 818-244-1909 Fax: 818-500-0742 yrplace@earthlink.net



Svetlana

## RF POWER TUBES

& High Voltage Rectifiers

In stock for immediate delivery



We stock a broad line of Power Tubes, RF Power Transistors, Capacitors, Tube Sockets,  
Bird Wattmeters, etc. Orders received by 2 p.m. PST/5 p.m. EST shipped same day.

On-line Catalog: <http://www.rfparts.com>

Established 1968

(760) 744-0500

(800) RF-PARTS

(800) 737-2787

• Fax •  
(760) 744-1943



**RF PARTS™**

435 SOUTH PACIFIC ST.  
SAN MARCOS, CA 92069

• E-mail •  
rfp@rfparts.com

Se Habla Español

We Export

## Windows NT Automation Systems

- Music on Hard Drive
- Satellite Automation
- 90+ Hours of Audio
- Voice Tracking
- Music Scheduling
- PII 400 MHz, 64 MB
- Digital Editing

Only \$125<sup>00</sup>

per Month

\$3,450<sup>00</sup>

Phone: 810-724-2638

www.voicetracking.com

## Best Automatic Telephone Coupler — Best Price!

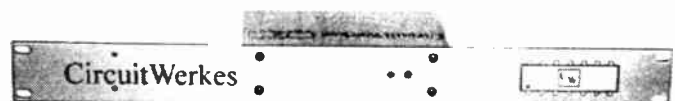

CircuitWerkes

Listen Lines - Concert Lines - Remotes

Balanced In/Out - Selectable Rings - Auto-Connect/Disconnect

**CircuitWerkes**

Phone: 352-335-6555 Website: www.circuitwerkes.com

# Shopper Service Sheet

## Bay Country Broadcast Equipment

Your #1 Source for Quality Used Broadcast Equipment

Call us for our latest list of quality, in stock radio broadcast equipment, or view it at our website:

<http://www.baycountry.com>

Also looking to buy quality equipment, fax your list today.

### Bay County Broadcast Equipment

7117 Olivia Rd, Baltimore, MD 21220  
Phone: 410-335-3136 Fax: 786-513-0812

## We supply all LPFM needs

FMP20:15W 12V portable exciter-\$724.95

PLFM100: drop in exciter upgrade-\$249.95

CSG10: Stereo gen w/comp clip-\$379.95

### The LPFM Leader!- JT Communications

579 NE 44th Ave. Ocala, FL USA 34470-1421  
352-236-0744 fax 352-236-5130 requests 877-791-2997  
email: [jtcomm@atlantic.net](mailto:jtcomm@atlantic.net)—[www.atlantic.net/~jtcomm](http://www.atlantic.net/~jtcomm)

## Specialized Products and Services for the Radio Broadcast Industry

### Power Quality & Protection is no longer an "option," it's a "must!"

In today's "high tech" Broadcast environment, sensitive solid state electronics demand "clean power." Since 1987, we've offered a complete line of Power Quality Products to the broadcast industry.

- Lightning/Surge Protectors for Coax, Studio & Transmitters
- Power Conditioners
- Voltage Regulators
- Generators
- UPS Systems (1&3 phase)
- Inverters/Converters
- Batteries
- Ground Rods
- Grounding Systems

Energy Control Systems - Fort Worth Texas  
800-383-6956 ~ [www.ecsintl.com](http://www.ecsintl.com)

## Freeland Quality Rebuilt Tubes WHAT A DEAL!

Now get Freeland's great rebuilt tubes and their great warranty (same as new) for less money than from Freeland direct!



Electronics Manufacturing Inc.  
PO Box 526, Semmes, AL 36575  
[www.rectifiers.com](http://www.rectifiers.com)

Phone: (800) 556-3619  
Fax: (334) 649-8233  
E-Mail: [lcagle@zebra.net](mailto:lcagle@zebra.net)

## EZ RAZE™ Antenna Mast

- Adjustable height from 10 ft. to 40 ft.
- KD height 5 ft. (store in trunk of most cars).
- Omni-directional.
- Erect in 5 minutes by one person.
- Attach yagi or whip antenna, lights or speakers.
- Easily carried & erected almost anywhere.

800-538-4977

[www.AntennaMast.com](http://www.AntennaMast.com)

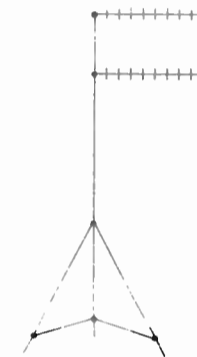

## TELFAX

### PHONE REMOTE UNITS

#### — Parts & Service —

We provide repair service and sell parts for the following models of Telfax Remote Mixers:  
X-30 - TFX-31 - TFX-131 - TEN-32 - TEN-44

Telfax Replacement Battery Packs, AC Adapters, and Misc Parts  
Contact: A/Q America - Phone: 515-432-5780 Fax: 630-604-6493

## FM FREQUENCY SEARCH - \$149 FCC FM APPLICATIONS - \$1149 Amendments & Upgrades



LPFM APPLICATIONS - \$949  
COLOR COVERAGE MAPS - \$59

MBC Consulting (903) 572-8550  
[engineer@mbcradio.org](mailto:engineer@mbcradio.org)

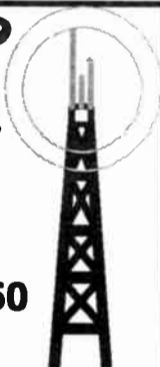

## Directional Antenna Maintenance Upper Midwest Area

40 years experience in the RF field.  
Need to re-do your LTU on your single stick?

Give us a call at: 715-268-2233  
E-Mail at: [radiorey@spacestar.net](mailto:radiorey@spacestar.net)

## SOUTHWESTERN ACOUSTICS

Totally Hand-Crafted SPEAKER CABINETS

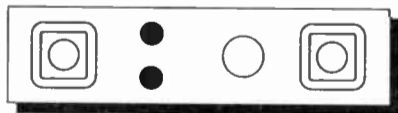

Hand-crafted speaker cabinets. All sizes, from \$69.95 a pair, on up.

Call: 1-888-513-9420

## ENGINEERS, COLLECTORS, DO -IT- YOURSELFERS

Stop reading this and get on my website.

[www.spacestar.net/users/radiorey/](http://www.spacestar.net/users/radiorey/)

Have you ever seen so much stuff?  
I have two pole barns full, and my wife says haul it to the dump.  
I can't do that; some of this stuff is brand new, or nearly new.  
Or, it's pretty good, or it's older than the hills.

Make an Offer!

## D&C Electronics Co.

- New Tubes -

We have the alternatives for all your needs,  
at the lowest prices, direct from our stock!

EIMAC, SVETLANA, PRO-TEK®, EEV, and many others.

352-688-2374 or 800-881-2374

VISA & MASTERCARD Accepted

## Newsflash . . . Not All UPS Systems are Created Equal

Don't trust your mission-critical, sensitive loads to just any UPS. Best Power, one of the world's largest mfrs. of single-phase UPS's, offers a complete line to the Broadcast Industry, ranging from 250VA, to 15kVA single-phase & 10kVA to 220kVA three-phase.

Fortress Rackmount Series 750VA/450W, 3.5" h x 17.5" w only \$449

Energy Control Systems - Fort Worth Texas  
800-383-6956 ~ [www.ecsintl.com](http://www.ecsintl.com)



"Your systems's not complete without one."



## Hall Electronics

Fidelipac MX12L, 12 channel modular linear fader dual stereo mixer. Current model. Nice - \$2,895  
 Harris Medalist 10, modular 10-channel linear fader dual stereo mixer. Rebuilt - \$2,295  
 Harris Medalist 8, modular 8-channel linear fader dual stereo mixer. Rebuilt - \$1,895  
 Orban 422A, mono gated compressor limiter de-esser. Tested, Nice - \$295  
 Otari MX-5050BII, 1/2-track 7.5/15 IPS stereo reel to reel recorder. Rebuilt - \$895  
 Tascam DA-30 MKII, DAT recorders in like new excellent condition. Tested - \$595  
 Samson Concert TD, rack mount dual diversity wireless mic with new A-T lavalier mic. Tested, Nice - \$249  
 ITC classic mono 3D, cart machine. Absolutely mint with HE audio cards. Rebuilt - \$395  
 Gentner 'People Link,' acoustic telephone interface EC/ES teleconference hybrid system. Tested - \$295  
 Phonic PMX1600A, 16-channel rack mount slide pot mic/line mixer with EQ, digital meters, etc. Tested - \$295  
 ATI BC8DSL, 8-slide pot stereo console with power supply. Rebuilt \$795  
 Musicam CDQ-1000 G-722, Bi-Directional 10 kHz mono codec. Tested - \$1,395  
 Musicam CCS Micro 56, 7.5 kHz 56kb/s codec w/Adtran ISU 2 X 64 service unit. Tested - \$895  
 ATI 416, quad 1x4 mono or 2x8 stereo distribution amplifier. Rebuilt - \$259  
 Datatek, stereo audio & video distribution amp with 2) 507 audio DA cards and 1) D-603 video DA card. Rebuilt - \$295  
 Shure SCM 268, mini mono mic mixer with LED meter. Like new - \$249  
 Shure M-67 'classic,' 4 pot mic mixers. Rebuilt - \$125  
 Marantz PMD-201, portable mono pro cassette recorder. Tested - \$149  
 Ramko P-MAS12/1, 12input desk top monitor amplifier & speaker. Tested - \$49  
 ITC Delta, record/play & play only cart machines. Rebuilt Mono R/P \$595; Play - \$295  
 ITC RP Series, classic premium line cart machines. Rebuilt Mono R/P - \$395; Play - \$195  
 ITC Delta III 3D, stereo play cart machine. Tested - \$495  
 Senrheiser, large area infrared hearing assist system with SI-1013 mono transmitter, power supply, 4) SZI 1019 high power radiators, 16) HD 406S & 4) HDI 407S headsets plus more. This system is in good physical shape but is sold as-is and untested. \$695  
 PDMC, multi-channel line driver 1 X 10 mono power distribution amplifier for mass telephone line feeds. Tested - \$195  
 Lightning Protection Corp. LPC-11765, 120V single phase pro lightning protectors. New surplus - \$20 each or 6/\$100  
 RF Ammeters for AM stations: Used 445; New Surplus (as available) \$65

*Tested equipment generally includes manuals and 30 day warranty. We will be listing MANY MORE ITEMS on our web site, www.halls.com, this month!*

*All rebuilt and New Surplus equipment includes manuals and a 90 day warranty from Hall Electronics. Please check our website for more great deals!*

*If you have equipment you want cleared out, give us a call! We will be glad to discuss removing it both good and not so good and marketing it for you!*

The Only Source You Need for Digital, Pro Audio and RF Broadcast Equipment

**Contact: Jon Hall  
Hall Electronics**

706 Rose Hill Drive  
Charlottesville, VA 22901

Phone: 804-984-4255

Website: [www.halls.com](http://www.halls.com)

E-Mail: [sales@halls.com](mailto:sales@halls.com)

## B.E.S. Surplus

TECHNICS SL-1200 MK2 Turntable w/Stanton cartridge. \$350  
 RUSSCO FMSB Stereo phono preamp. \$25  
 SHURE SM58 Hand held microphone. \$45  
 HENRYSTEREOSWITCH3-input stereoswitcher. \$100  
 SHURE M67 Portable mic/line mixer. \$125  
 SHURE M68 Portable microphone mixer. \$75  
 SYMETRIX A-220 20-watt per channel stereo monitor amplifier. \$150  
 PEAVEY CS400 400W 2-channel power amplifier. \$250  
 PEAVEY CS800 800W 2-channel power amplifier. \$400  
 ALTEC 9440A 800W 2-channel power amplifier. \$450  
 ORBAN 418A Stereo limiter. \$300  
 UREI 530 9-band stereo graphic equalizer. \$100  
 INOVONICS 375 Record amplifier for Ampex. \$100  
 CBS 444 Audimax III mono AGC. \$100  
 TASCAM RC71 Remote control box for model 32 reel machine. New in box. \$45  
 MARK ANTENNA P-972GN 6-foot 940-960 MHz. grid type microwave antenna w/feedhorn. New in crate. \$1,000  
 JAMPRO JMPC-1 1-bay medium power FM antenna w/mounting bracket. \$400  
 BIRD 5177 20kW harmonic filter w/ 3-1/8" flanges. \$1000  
 BIRD 43 Thru-line wattmeter. \$170  
 BIRD8137 150 watt dummy load, 50 ohm with "N" female connector. \$100  
 BIRD DA75/U 500 watt dummy load, 50 ohm with "N" female connector. \$175  
 BIRD 8890-300 2.5 kW dummy load. \$700  
 DIELECTRIC 8952-A 3-1/8 inch in-line wattmeter w/ 25kW element. \$700  
 ANDREW 1-5/8 inch end terminal connector for AM. \$75  
 MYAT 3-1/8 inch to "N" female reducer. \$125  
 CABLEWAVE 3-1/8" to 1-5/8" taper reducer. \$125  
 ANDREW 87G/87R Gas block or gas pass connector for 1-5/8 inch air Heliac. \$75  
 ANDREW 78ARM Gas pass connector for type HJ8-50B 3-inch air Heliac. New in box. \$200  
 RCABTR-30A RCA remote control w/Hallikainen TEL172 digital telemetry option. Needs repair, sold "as-is". \$125  
 CCA 2500D 2.5kW 3-phase AM transmitter. Complete w/full documentation & amp; set of tubes. Needs rebuilding, sold "as-is." \$2,000  
 CSI T-5-A 5kW AM transmitter, two cabinet, 3-phase w/frequency at upper end of dial. \$7,500  
 GATES BC-1G 1kW AM transmitter @ 1290 kHz. \$1,500  
 TFT 753 AM modulation monitor w/754 4-channel preselector. \$600  
 BELAR SCM-1 SCA modulation monitor @ 67 kHz. \$125  
 HEWLETT PACKARD 141T Spectrum analyzer main-frame with 8552B IF, 8553L, 8554B, 8555A plug-ins. Frequency range DC to 1400 MHz. \$1,600  
 TEKTRONIX 496 Spectrum analyzer. DC-18 gig. \$3,400  
 POTOMAC AA51/AG51 Oscillator, distortion test set. Mint physically but has problem w/distortion analyzer. Sold "as-is." \$1,000  
 FIDELIPAC CTR100 Cart record/play stereo. \$400  
 FIDELIPAC CTR100 Cart player stereo. \$200  
 ITC DELTA 3-deck stereo player. \$500  
 BE 3200RP Cart record/play stereo. Old machine but new, never used. \$300  
 ITC SP Cart player stereo, \$125; mono, \$100  
 AUDICORD TDS-6 Twin play stereo. \$125  
 ITC ESL-IV Spice finder/eraser. \$125

### 10-DAY RETURN POLICY.

B.E.S. NOW ACCEPTS MASTER CARD, VISA, DISCOVER & AMERICAN EXPRESS.

Contact: Jeff Corkren

Phone: 601-857-8573

Fax: 601-857-2346

Amateur Call: W5PPB

E-Mail: [jcorkren@ucmail.com](mailto:jcorkren@ucmail.com)

**Broadcast Equipment Sales**

PO Box 1300, Raymond, MS 39154

## Bay Country Broadcast

*Buy — Sell — Trade*  
Quality Used Equipment

Autogram AC-8 Stereo 8 channel console. \$1,498  
 Belar FMM-2 Mod Monitor, FMS-2 Stereo Monitor, RFA-1 RF A. \$1,800  
 Conex AS-101 10-stereo in, 1-stereo out, audio routing switcher (2 available). \$450  
 Conex AS-501 relay board switcher (2 mounted in AS-95 auxiliary chassis). \$100  
 Electro-Voice model 309 shock mount (new, 4 available). \$59  
 Eventide BD-955, 15 kHz mono digital delay with catch-up feature (factory refurbished). \$1,095  
 Gentner Digital Hybrid III auto gain, auto null, digital phone hybrid (new, 7 available). \$975  
 Gentner Digital Hybrid 1 (great addition to your phone system). \$550  
 Gentner SPH-5E, single line phone hybrid (with built-in selectable freq. extension). \$395  
 Harris Medalist, 10-channel, 30-input stereo console (rotary pots). \$1,695  
 Marti RPT-30 RPU with receiver. \$1,395  
 Moseley 505C composite STL (type accepted). \$2,895  
 M.S.I. CP-803 composite clipper with rack mount ("Loud but Legal") \$650  
 Orban Optimod 8100A/1 analog FM processor. \$2,795  
 Sine Systems RFC-1B + RP-8 relay panel. \$750  
 Texar Audio Prisms Pair multi-band processors with 5 card and cover plate. \$1,695  
 Texar RFC-1 replacement Card-5 for the Orban 8100A. \$450

*We now have  
"CRL Systems Select Stock"  
equipment for sale.  
Call or e-mail with your needs.*

**Now Available:  
Tektronix 2710 Spectrum Analyzer  
for Rent. Call for Details.**

**15-day Return Guarantee  
References Supplied Upon Request  
Major Credit Cards Accepted**

Contact:

Steve Scarborough at:  
410-335-3136

Web Site: <http://www.baycountry.com>

**Bay Country Broadcast Equipment**

7117 Olivia Rd, Baltimore, MD 21220

E-Mail: [baycountry@pcbank.net](mailto:baycountry@pcbank.net)

**Do you have equipment for sale?  
Fax your list to: 786-513-0812**



## Jasoni Electronics

3149 E. Desert Inn Road, Ste 94,  
Las Vegas, NV 89121

**Studio Switcher:** New, custom deluxe, stereo audio switcher. Lighted VU meters. New, with manual. Puts production room on the air from either of two main studios. Great studio backup system. \$459 prepaid.

**Stereo Source Selector.** 12-source outputs to 2-console inputs. Deluxe model designed for satellite receiver switching to audio console. Xfmr balanced, many special features. \$575 prepaid.

**Audio Distribution System.** 2 channel inputs, 10 stereo outputs, 2 rack-space size. \$395 prepaid.

**Matrix Switcher.** Model 2000 NEW Demo. Yields 8 outputs from any of 2 stereo sources. Production room delight. Product sheet available. \$149 prepaid.

**Audio Oscillator.** Model SS-2B, small variable sine oscillator, 20-20kHz and pink noise, audio test set. Manual and auto-sweep in two ranges. Complete with stereo XLR/RCA connectors and (2) 9-volt batteries. AC power adapter included. A toolkit must. New, \$165 prepaid.

**Cetec model 7000 character encoder.** Encodes cart tapes for automation, rack mount, with cables, no manual. \$45, prepaid.

**Magnecord model PT-6 transport.** Can be restored, good motors, extra parts. \$75 prepaid.

**Yamaha model MVS-1,** natural sound master volume controller. With manual. \$60 prepaid.

**Audio transformers.** Misc. UTC, Chicago, Triad, Ampex, Thordarson, Stancor. Large selection of Sescom. Call or write for list. Low prices.

**Tech manuals.** Harris, BE, Sparta, ITC, Heathkit, Dynakit, Ampex, and more. Call or write for list. Low prices.

**Realistic Model TV-100.** Stereo TV receiver. 2-VHF and 1-UHF bands. Very nice tuner. \$70 prepaid.

**Sparta Equipment Catalog.** Sparta equipment catalog #101, early 1976, in good condition. \$40 prepaid.

**Studio Warning Lights.** (10) On-Air, (10) Recording. (5) Black and (5) silver, early style, with long life lamps. \$119 each black, \$139 each silver.

**4) Studio Warning Light Controllers,** model WLI-2. Controls 2 studio warning lights. Steady or flashing operation, switch selected. Operates from 5-35 VDC, silent solid state performance. \$79 prepaid.

**(2) ITC 3D,** (1973) mono cart decks for parts. \$185 each or \$350 for both, prepaid.

**(3) In-Out Adapter Systems,** accepts XLR, 1/4", RCA & 1/8" mini jacks. Rocker switches select mono/stereo & unbal/bal. Ideal interface to audio console. One rack space. Includes in/out pre-wired connectors. New, \$169, prepaid.

**(30) Scotch No. 996** recording tape on 10.5" aluminum reels, in heavy duty plastic boxes, new. \$15 each, prepaid.

**CATV Converter.** New, Panasonic Model TZ-PC1402N. With remote control, 72 programmable channels. \$39 prepaid.

**VU Metering Bridge.** For monitoring 4 discrete audio channels. Use with Mackie 1604 mixers. Analog lighted VU meters. 2 rack size. \$359 prepaid.

**VU Metering Bridge.** For monitoring 4 discrete audio channels. Use with Mackie 1604 mixers. LED vertical VU meters. 2 rack size. \$439 prepaid.

Contact:

Dan Peluso at: 702-791-3394

## Riggins

### Used & Demo Equipment

BE Model 5S250A console.

BE Digitalk

BE Model 5404 3-deck stereo cart machine.

BE Model 3200RPS cart machine.

2) BE Model 3104PS cart machines.

BE Model 3204 RPS cart machine.

Spotmaster Model 505C cart deck.

Spotmaster Model 505C/R cart deck.

Spotmaster Model 500C cart deck.

McMartin Model 245E stereo synthesizer.

Stanton Model 310B TT preamp.

2) RF&A Model CDX-100

2) Russco Model Pro-8 TT's/arms.

Russco Matchmaker mike preamp/line amp.

Microtrak Ditty Desk (portable).

Microtrak sports remote.

2) BSM portable remote mixers.

Ampex AG-350 mono reel deck, new heads.

Ampex Model AG-440-2 reel deck.

Teac Model A-610 reel deck.

Otari Model MX-5050 reel deck.

Dynamax Model CTR-100PS cart deck.

Dynamax EDS-10 (needs work).

CBS Volumax Model 4000A (needs work).

Gates cart machine (plug-in cans), for parts.

2) ITC 3D cart decks. Rebuildable

Several ITC Premium RPS/RP & P, for parts.

Audicord Model RP, mono cart deck.

2) Sparta 700 Series RP cart decks, for parts.

ADC Model PPA-3-18 pre-wired patch bay.

ATI Model M1000-2 mike preamp.

ATI Model M1000-1 mic preamp, xfmr out.

ATI Matchmaker, matching amplifier.

ATI Model P100 mono phono preamp.

ATI Model L1000-1 line amplifier.

ESE Model 371 timer.

Scully Model 250 reel recorder.

Revox Model PR-99 stereo reel recorder.

3) UMC Beucart playback cart decks.

### New and Used Tape Cartridges

Master Cart, HT - over 200

Standard Tape - over 200

380 Series - over 300

Most need new pressure pads.

### Sennheiser Mics:

MD-441

MD-441 Demo

MD-402U

MD-211

MC21-N

MD-411 HML

### Shure Mics:

SM-11C

SM-57LC

SM-85

SM-18W

SM-54

PS-1

C501E-10

AKG Mics: D-109

D-202 E1

For more information contact:

### Riggins Electronic Sales

3272 E. Willow, Long Beach, CA 908105

Phone: 562-598-7007

## South Jersey Broadcast

Reconditioned QEI Broadcast Products

### Purchase Includes:

A complete set of manuals,  
and tuned and tested on your frequency.

*WE are the only pre-owned  
Broadcast Equipment supplier  
with a full ONE YEAR WARRANTY*

QEI Model 675, FM exciters. \$1,250

QEI Model 675T150, FM amplifiers. \$1,750

QEI Model 675T300, FM amplifiers. \$2,450

QEI Model 675T500, FM amplifiers. \$3,000

QEI Model 675T600, FM amplifiers. \$3,550

QEI Model 811, SCA generators. \$500

QEI Model 772, stereo generators. \$600

## WANTED: DEAD OR ALIVE

QEI 675 FM Exciters

QEI 695 FM Exciters

QEI Low Power FM Transmitters

150 to 600 Watts

*Call or Fax us for discounted prices  
on new QEI Equipment*

*Call or fax us for your LPFM needs.*

Visit our Website at:

<http://sjbroadcast.com>

### Contacts

#### South Jersey Broadcast

Frank Miazga 610-876-3875

E-Mail [sjb@broadcast.net](mailto:sjb@broadcast.net)

#### S&C Communications

Bob Brown 609-232-1625

E-Mail [S&Comm@broadcast.net](mailto:S&Comm@broadcast.net)

## Beautiful Music

Experience the Magnificence of

*Beautiful Music*

... Like No Other

*24 Hours a day, via satellite,  
to radio stations in the U.S.A.*

Write for a free demo or call:

### Broadcast Associates

Route 4 Box 197, Coushatta, LA 71019

Phone: 318-932-6704

[www.radioshopper.com](http://www.radioshopper.com)  
[www.radiolinks.net](http://www.radiolinks.net)



# FOR SALE

# Radio-Classifieds

Classified Ads Are Free!  
Fax them to: 507-280-9143



## Audio Amplifiers

Audio Amps, Power & Pre-Amps

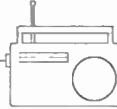

### Bogen Model C-20A

2 watt audio amplifier.  
CONDITION: Call PRICE: Call for price.  
CONTACT: Jim PHONE: 419-782-8591  
Please call.

### Raymer Model 810-100A

PA amplifier.  
CONDITION: Call PRICE: Call for price.  
CONTACT: Jim PHONE: 419-782-8591  
Please call.

### 2) QSC Model MX-700

Audio amplifiers.  
CONDITION: Call PRICE: Call for price.  
CONTACT: Jim PHONE: 419-782-8591  
Please call.

### Primus Model P-21/m

Microphone/line amplifier.  
CONDITION: Call PRICE: Call for price.  
CONTACT: Jim PHONE: 419-782-8591  
Please call.

### ATI Model M-1000

Microphone/line amplifier.  
CONDITION: Call PRICE: Call for price.  
CONTACT: Jim PHONE: 419-782-8591  
Please call.

### Ramko Model MLA2E

Dual microphone/line amplifier.  
CONDITION: Call PRICE: Call for price.  
CONTACT: Jim PHONE: 419-782-8591  
Please call.

### NAD Model 1300

Selector/pre-amplifier.  
CONDITION: Call PRICE: Call for price.  
CONTACT: Jim PHONE: 419-782-8591  
Please call.

### Primus Model P-21/m

Microphone/line amplifier, with rack mount.  
CONDITION: Call PRICE: Call for price.  
CONTACT: Jim PHONE: 419-782-8591  
Please call.

### Crown Model DC-150

Stereo power amplifier.  
CONDITION: Excellent PRICE: \$250  
CONTACT: John Price PHONE: 214-321-6576  
Price Recording, 2651 Globe Ave, Dallas, TX 75228

### Crown Amplifier

Stereo power amplifier.  
CONDITION: Excellent PRICE: \$275  
CONTACT: John Price PHONE: 214-321-6576  
Price Recording, 2651 Globe Ave, Dallas, TX 75228

### 2) ATI Model L-1000

Dual program amplifiers.  
CONDITION: Good PRICE: \$100 each.  
CONTACT: Kevin McNamara PHONE: 301-865-1011  
PO Box 926, New Market, MD 21774

## Audio Distribution

DA's, Routing, Switching, Patching

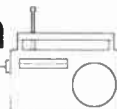

### 3) Burk Model LX

Program audio switchers.  
CONDITION: Call PRICE: Call for price.  
CONTACT: Jim PHONE: 419-782-8591  
Please call.

### 3) Ramko Model ARA-1612CP2

Router remote control panels.  
CONDITION: Call PRICE: Call for price.  
CONTACT: Jim PHONE: 419-782-8591  
Please call.

### Radio Systems Model DA-16

Audio distribution amplifier.  
CONDITION: Good PRICE: \$150  
CONTACT: John Felz PHONE: 310-546-6451  
Music of Your Life, 4605 Lankersham, N Hollywood, CA 91602

### ADC Pro-Patch

2x24 audio patch panel. 1-3/4" rack, normals brought out.  
CONDITION: Good PRICE: \$450  
CONTACT: Kevin McNamara PHONE: 301-865-1011  
PO Box 926, New Market, MD 21774

### Gentner Model 10A

10x2 audio switcher.  
CONDITION: Good PRICE: \$200  
CONTACT: Kevin McNamara PHONE: 301-865-1011  
PO Box 926, New Market, MD 21774

### ATI Model 2008

1x4 audio DA. Balanced I/O, in un-opened box.  
CONDITION: Brand new. PRICE: \$350  
CONTACT: Tom Babarese PHONE: 856-222-0636  
Bibb Technical Svcs., 625 Devon Ave, Moorestown, NJ 08057

## Audio Processors

Audio Proc, EQ, Effects, Filters



### Yamaha Model SPX-1000

Audio effects processor.  
CONDITION: Call PRICE: Call for price.  
CONTACT: Darrin Warner PHONE: 765-935-2443  
Big "D" Broadcast, 2225 Airport Rd, Centerville, IN 47330

### Orban Model 8100/A

Optimod processor with "0" card.  
CONDITION: Call PRICE: \$2,800  
CONTACT: Darrin Warner PHONE: 765-935-2443  
Big "D" Broadcast, 2225 Airport Rd, Centerville, IN 47330

### Yamaha Model SPX-900

Audio effects processor.  
CONDITION: Call PRICE: Call for price.  
CONTACT: Darrin Warner PHONE: 765-935-2443  
Big "D" Broadcast, 2225 Airport Rd, Centerville, IN 47330

### CRL Audio Signature

Audio processor unit.  
CONDITION: Good PRICE: Call for price.  
CONTACT: Dean Pearce PHONE: 601-693-2381  
Broadcasters-Publishers, 4307 Hwy 39, Meridian, MS 39301

### Aphex Model 720 Dominator

Stereo peak leveler.  
CONDITION: Excellent PRICE: \$700  
CONTACT: Fred Migliore PHONE: 800-341-1480  
1480 East Radio, 1425 Holiday Blvd, Merrit Island, FL 32952

### Symetrix Model 422

Stereo audio leveler.  
CONDITION: Excellent PRICE: \$399  
CONTACT: Fred Migliore PHONE: 800-341-1480  
1480 East Radio, 1425 Holiday Blvd, Merrit Island, FL 32952

### Orban Model 8100 1A

FM processor unit.  
CONDITION: Excellent PRICE: \$2,600  
CONTACT: Fred Migliore PHONE: 800-341-1480  
1480 East Radio, 1425 Holiday Blvd, Merrit Island, FL 32952

### Thompson Model VE-2

Vocal eliminator. Separates vocals from music.  
CONDITION: Call PRICE: \$75  
CONTACT: Greg Blanchard PHONE: 541-501-9168  
bionet@uswest.net

### DAP Model 310

AGC peak limiter audio processor. Adj. low/mid/high band.  
CONDITION: Excellent PRICE: \$250 or B.O.  
CONTACT: Greg Blanchard PHONE: 541-501-9168  
bionet@uswest.net

### dBx Model 150

Stereo noise reduction unit, with rack mount.  
CONDITION: Excellent PRICE: \$300 or B.O.  
CONTACT: Greg Blanchard PHONE: 541-501-9168  
bionet@uswest.net

### CRL Model SPP-800

Stereo audio preparation processor.  
CONDITION: Call PRICE: \$200  
CONTACT: Greg Blanchard PHONE: 541-501-9168  
bionet@uswest.net

### 2) Gentner Prism II

FM audio processors.  
CONDITION: Call PRICE: Call for price.  
CONTACT: Jim PHONE: 419-782-8591  
Please call.

### Orban Model 8100XT

Optimod XT chassis.  
CONDITION: Call PRICE: Call for price.  
CONTACT: Jim PHONE: 419-782-8591  
Please call.

### 2) Sabine Model FBX-900

Feedback eliminators.  
CONDITION: Call PRICE: Call for price.  
CONTACT: Jim PHONE: 419-782-8591  
Please call.

### Orban Model 8100

Optimod with California Digital "Digimod 2000."  
CONDITION: Call PRICE: Call for price.  
CONTACT: Jim PHONE: 419-782-8591  
Please call.

### Digital Audio Model TC-4

Broadcast digital audio processor.  
CONDITION: Call PRICE: Call for price.  
CONTACT: Jim PHONE: 419-782-8591  
Please call.

### Eventide Model BD-980

Audio delay unit.  
CONDITION: Call PRICE: Call for price.  
CONTACT: Jim PHONE: 419-782-8591  
Please call.

### dBx Model 140A

Audio noise reduction system.  
CONDITION: Good PRICE: \$100  
CONTACT: Kevin McNamara PHONE: 301-865-1011  
PO Box 926, New Market, MD 21774

### Henry Mix-Minus

Summing amplifier.  
CONDITION: Good PRICE: \$40  
CONTACT: Kevin McNamara PHONE: 301-865-1011  
PO Box 926, New Market, MD 21774

### Modulation Sciences Model CP-803

Composite audio clipper.  
CONDITION: Good PRICE: \$575  
CONTACT: Kevin McNamara PHONE: 301-865-1011  
PO Box 926, New Market, MD 21774

### Gates Top-Level

Stereo audio limiter.  
CONDITION: Good PRICE: \$250  
CONTACT: Mark Schakow PHONE: 605-374-3424  
Mark Schakow Recording, 307 4th Ave E, Lemmon, SD 57638

### Symetrix Model 501

Audio limiter. (Will trade for Gates Sta-Level.)  
CONDITION: Excellent PRICE: \$200 + shipping.  
CONTACT: Mark Schakow PHONE: 605-374-3424  
Mark Schakow Recording, 307 4th Ave E, Lemmon, SD 57638

### (2) dBx Model 163

Audio compressors.  
CONDITION: Call PRICE: \$125 for both.  
CONTACT: Scott Gardner PHONE: 540-728-7935  
PO Box 387, Hillsville, VA 24343

### Symetrix Model 425

Dual audio compressor/limiter.  
CONDITION: Call PRICE: \$325  
CONTACT: Scott Gardner PHONE: 540-728-7935  
PO Box 387, Hillsville, VA 24343

### Cinema Engineering Model 4031B

Audio equalizer.  
CONDITION: Please call PRICE: Call for price.  
CONTACT: Tim Coffman PHONE: 858-571-5031  
Please call.

### Blonder Tongue

9-band tube type audio equalizer.  
CONDITION: Please call PRICE: Call for price.  
CONTACT: Tim Coffman PHONE: 858-571-5031  
Please call.

### CBS Model 410 FM Volumax

Audio limiter/ compressor. Fair cosmetics.  
CONDITION: Works PRICE: \$225  
CONTACT: Tom Babarese PHONE: 856-222-0636  
Bibb Technical Svcs., 625 Devon Ave, Moorestown, NJ 08057

### CBS Audimax III

Auto level controller. Good cosmetics.  
CONDITION: Works PRICE: \$225  
CONTACT: Tom Babarese PHONE: 856-222-0636  
Bibb Technical Svcs., 625 Devon Ave, Moorestown, NJ 08057

Audio Processors — Continued on Next Page ⇨ ⇨

# FOR SALE

# Radio-Classifieds

Classified Ads Are Free!  
Fax them to: 507-280-9143



## Audio Processors

*Continued from previous page.*



### Stereo Equalizers

10-band audio equalizers. Rackmount.  
CONDITION: Very good. PRICE: \$99 each.  
CONTACT: Tom Babarese PHONE: 856-222-0636  
Bibb Technical Svcs., 625 Devon Ave, Moorestown, NJ 08057

### Orban Model 412A

Mono compressor/limiter.  
CONDITION: Good PRICE: \$185  
CONTACT: Tom Babarese PHONE: 856-222-0636  
Bibb Technical Svcs., 625 Devon Ave, Moorestown, NJ 08057

## Cart Machines

*Cart Machines, Tape & Supplies*

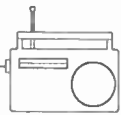

### (10) Cart Racks

Wall-mount cart racks. Must pick up.  
CONDITION: Call PRICE: \$20 each.  
CONTACT: Carl Ford PHONE: 704-857-1101  
Ford Broadcasting, PO Box 8146, Kannapolis, NC 28083

### Dynamax Model CTR-10

Cart recorder/reproducer/eraser, with free carts and rack.  
CONDITION: Very good. PRICE: \$400  
CONTACT: Jenny Zhao PHONE: 703-760-8911  
WCBC Radio, 8150 Leesburg Pike #1107, Vienna, VA 22182

### 2) ITC Model 99A

Cart recorders with ELSA. Need repair.  
CONDITION: Call PRICE: Call for price.  
CONTACT: Jim PHONE: 419-782-8591  
Please call.

### Dynamax Model CTR-13

Record/play cart machine.  
CONDITION: Call PRICE: Call for price.  
CONTACT: WELD Radio PHONE: 304-538-6062  
HC 85 Box 1A, Fisher, WV 26818

### 4) Dynamax Model CTR-11

Playback cart machines.  
CONDITION: Call PRICE: Call for price.  
CONTACT: WELD Radio PHONE: 304-538-6062  
HC 85 Box 1A, Fisher, WV 26818

## Compact Disc

*CD's, DAT, Mini-Disc*



### 3) Sony Model MDS-JE520

Mini-disk recorders with rack mount kits. Never used.  
CONDITION: Mint! PRICE: \$250 ea., \$625 all.  
CONTACT: J.B. Williams PHONE: 301-739-1450  
Midnight Blue, 12824 Lauran Rd, Hagerstown, MD 21742

### Denon Model DN-950

CD player. Needs repair.  
CONDITION: Call PRICE: Call for price.  
CONTACT: Jim PHONE: 419-782-8591  
Please call.

### Audiometrics Model CD-10

CD player. Needs repair.  
CONDITION: Call PRICE: Call for price.  
CONTACT: Jim PHONE: 419-782-8591  
Please call.

### Denon Model DN-950FA

CD player. Needs repair.  
CONDITION: Call PRICE: Call for price.  
CONTACT: Jim PHONE: 419-782-8591  
Please call.

### Technics Model SLP-1200

Tabletop CD player.  
CONDITION: Call PRICE: Call for price.  
CONTACT: Jim PHONE: 419-782-8591  
Please call.

### Sony Model TCD-7

Portable DAT rec. + SBM-1 super-bit mapping adapter & mike.  
CONDITION: Call PRICE: \$550  
CONTACT: Richard Dewese PHONE: 419-748-8430  
WLMB-TV, PO Box 4, McClure, OH 43534

## Consoles

*Consoles and Mixers*



### LPB Model S-21B Signature II

10-channel mono console.  
CONDITION: Call PRICE: \$1,695  
CONTACT: Darrin Warner PHONE: 765-935-2443  
Big "D" Broadcast, 2225 Airport Rd, Centerville, IN 47330

### Autogram Model

10-channel rotary pot console.  
CONDITION: Call PRICE: Call for price.  
CONTACT: Jim PHONE: 419-782-8591  
Please call.

### Kenera Model 10/2

Console in wooden transit case.  
CONDITION: Call PRICE: Call for price.  
CONTACT: Jim PHONE: 419-782-8591  
Please call.

### Ramsa Model WR-133

8-channel audio mixer.  
CONDITION: Call PRICE: Call for price.  
CONTACT: Jim PHONE: 419-782-8591  
Please call.

### Peavy Model PA-700S

7-channel mixer with PA amplifier.  
CONDITION: Call PRICE: Call for price.  
CONTACT: Jim PHONE: 419-782-8591  
Please call.

### 2) Shure Model M-267

Audio mixers.  
CONDITION: Call PRICE: Call for price.  
CONTACT: Jim PHONE: 419-782-8591  
Please call.

### Broadcast Electronics Model

4-channel rotary pot console.  
CONDITION: Call PRICE: Call for price.  
CONTACT: Jim PHONE: 419-782-8591  
Please call.

### Tascam Model M-520

20-channel mixer.  
CONDITION: Call PRICE: Call for price.  
CONTACT: Jim PHONE: 419-782-8591  
Please call.

### Kelsey Pro 2/3 Series

8-channel audio mixer, in case.  
CONDITION: Call PRICE: Call for price.  
CONTACT: Jim PHONE: 419-782-8591  
Please call.

### Ampex Model 1599A

6-channel audio mixer unit.  
CONDITION: Excellent PRICE: \$295  
CONTACT: John Price PHONE: 214-321-6576  
Price Recording, 2651 Globe Ave, Dallas, TX 75228

### Ampex Model AM10-6x2

Audio mixer unit.  
CONDITION: Excellent PRICE: \$295  
CONTACT: John Price PHONE: 214-321-6576  
Price Recording, 2651 Globe Ave, Dallas, TX 75228

### Tascam Model M-320B

Mixer/console. 20-in, 4-out. Complete with manual.  
CONDITION: Immaculate PRICE: \$1,000 + shipping.  
CONTACT: Mike Peterson PHONE: 812-234-9770  
WSDM Radio, 1215 Wabash Ave, Terre Haute, IN 47807

### RCA Model

4-channel mic mixer. Early transistor model (Radio Liberty).  
CONDITION: Call PRICE: Make offer.  
CONTACT: Scott Gardner PHONE: 540-728-7935  
PO Box 387, Hillsville, VA 24343

### Tascam Model M-320B

Mixing audio console. Needs general cleaning.  
CONDITION: Good PRICE: \$750 or B.O.  
CONTACT: Stevan White PHONE: 806-351-8559  
KGNC Radio, 3505 Olsen Blvd #117, Amarillo, TX 79102

### Tapco/Peavy Model Remote Unit in Carrying Trunk

Tapco 6100R mixer, Peavy CS-800 PA, Peavy 1210AS 800H spkrs.  
CONDITION: Call PRICE: \$1,700 for all.  
CONTACT: Steve King Prod. PHONE: 336-764-4681  
203 Candy Lane, Lexington, NC 27295

### Biamp Model 1621

16x2x1, with mon, aux, efx, inserts, 4-band EQ, 2 returns.  
CONDITION: Very good. PRICE: \$385  
CONTACT: Tom Babarese PHONE: 856-222-0636  
Bibb Technical Svcs., 625 Devon Ave, Moorestown, NJ 08057

### Yamaha Model M-508

8x2, +2 aux, balanced I/O, phantom, 3-band equalizer.  
CONDITION: Very good. PRICE: \$285  
CONTACT: Tom Babarese PHONE: 856-222-0636  
Bibb Technical Svcs., 625 Devon Ave, Moorestown, NJ 08057

## Digital Audio

*Digital Audio, Editors, Storage*

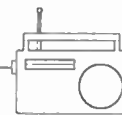

### Arrakis Digilink 3

With Gem 20 remote i/face & 9 GB HD. Monitor, keyboard.  
CONDITION: Excellent PRICE: \$4,000 or B.O.  
CONTACT: Tim Moriarty PHONE: 219-248-8915  
WJHS Radio, 600 N Whitley St, Columbia City, IN 46725

## FM Antennas

*FM Antennas, Filters, Combiners*

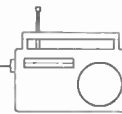

### Phelps Dodge Model

4-bay FM antenna, with heaters, tuned to 98-101 MHz.  
CONDITION: Good PRICE: \$2,000  
CONTACT: Alfred Fromm PHONE: 918-335-5093  
Jalcom Comm., PO Box 3334, Bartlesville, OK 74006

### Shively Model

4-bay FM antenna, with radomes, tuned to 99-100.5 MHz.  
CONDITION: Very good. PRICE: \$1,500  
CONTACT: Alfred Fromm PHONE: 918-335-5093  
Jalcom Comm., PO Box 3334, Bartlesville, OK 74006

### SWR Model

3-bay antenna, w/ radomes, on 103.1 MHz. W/ hardware.  
CONDITION: Good PRICE: \$2,500 + shipping.  
CONTACT: Ken Bryant PHONE: 304-536-1310  
Rt 60 W Harts Run, White Sulphur Springs, WV 24986

### ERI Model 1105-6A

6-bay, CP, end-fed antenna, tuned to 93.5 MHz. Do de-icer.  
CONDITION: Perfect PRICE: Make offer.  
CONTACT: Mike Fagan PHONE: 304-258-1010  
WDHC, 1010 Radio Station Rd, Berkeley Springs, WV 25411

### Phelps-Dodge FM Antenna

2-bay antenna, on 97.7 MHz. Can be re-tuned. With u-bolts.  
CONDITION: Excellent PRICE: Call for price.  
CONTACT: Vernon Uecker PHONE: 530-533-1340  
KWEW Radio, PO Box 1340, Oroville, CA 95966

### Cablewave FM Antenna

2-bay FM antenna, tuned to 101.7 MHz.  
CONDITION: Call PRICE: Best offer.  
CONTACT: WELD Radio PHONE: 304-538-6062  
HC 85 Box 1A, Fisher, WV 26818

### Cablewave FM Antenna

2-bay FM antenna, tuned to 101.7 MHz, with de-icers.  
CONDITION: Call PRICE: Best offer.  
CONTACT: WELD Radio PHONE: 304-538-6062  
HC 85 Box 1A, Fisher, WV 26818

## Generators

*Stereo, SCA, RBDS, Tone*

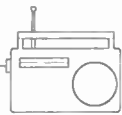

### CRL Modulation Signature

Stereo generator unit.  
CONDITION: Good PRICE: Call for price.  
CONTACT: Dean Pearce PHONE: 601-693-2381  
Broadcasters-Publishers, 4307 Hwy 39, Meridian, MS 39301

### Marcom Model 203

Stereo generator. Needs repair.  
CONDITION: Call PRICE: Call for price.  
CONTACT: Jim PHONE: 419-782-8591  
Please call.

### Excalibur Model CDA-12A

3-output composite DA.  
CONDITION: Call PRICE: Call for price.  
CONTACT: Jim PHONE: 419-782-8591  
Please call.

# FOR SALE

# Radio-Classifieds

Classified Ads Are Free!  
Fax them to: 507-280-9143



## Mics & Speakers

*Mics, Speakers, Headphones*

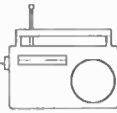

### Electro-Voice Model 654

Microphone.  
CONDITION: Excellent PRICE: \$85  
CONTACT: John Price PHONE: 214-321-6576  
Price Recording, 2651 Globe Ave, Dallas, TX 75228

### JBL and Altec Models

Speaker drivers.  
CONDITION: Excellent PRICE: Call for prices.  
CONTACT: John Price PHONE: 214-321-6576  
Price Recording, 2651 Globe Ave, Dallas, TX 75228

### Electro-Voice Model 636

Microphone.  
CONDITION: Excellent PRICE: \$65  
CONTACT: John Price PHONE: 214-321-6576  
Price Recording, 2651 Globe Ave, Dallas, TX 75228

### Telex Model WT-200

Wireless mic and transmitter.  
CONDITION: Excellent PRICE: \$125  
CONTACT: John Price PHONE: 214-321-6576  
Price Recording, 2651 Globe Ave, Dallas, TX 75228

### Telex Model WT-50

Wireless mic and transmitter.  
CONDITION: Excellent PRICE: \$125  
CONTACT: John Price PHONE: 214-321-6576  
Price Recording, 2651 Globe Ave, Dallas, TX 75228

### Electro-Voice Model 666

Microphone.  
CONDITION: Call PRICE: \$175  
CONTACT: John Price PHONE: 214-321-6576  
Price Recording, 2651 Globe Ave, Dallas, TX 75228

### Shure Model 330

Ribbon microphone.  
CONDITION: Please call PRICE: Call for price.  
CONTACT: Tim Coffman PHONE: 858-571-5031  
Please call.

### Shure Model 56-S

Microphone  
CONDITION: Please call PRICE: Call for price.  
CONTACT: Tim Coffman PHONE: 858-571-5031  
Please call.

### 2) Electro-Voice Model DO-56

Handheld shock-mounted version of 635.  
CONDITION: Call PRICE: \$40  
CONTACT: Tom Babarese PHONE: 856-222-0636  
Bibb Technical Svcs., 625 Devon Ave, Moorestown, NJ 08057

### Electro-Voice Model DO-56

Omn-directional microphone.  
CONDITION: Call PRICE: \$39  
CONTACT: Tom Babarese PHONE: 856-222-0636  
Bibb Technical Svcs., 625 Devon Ave, Moorestown, NJ 08057

### 2) Electro-Voice Model 644

"Sound Spot" dynamic shotgun microphones.  
CONDITION: Good PRICE: \$89  
CONTACT: Tom Babarese PHONE: 856-222-0636  
Bibb Technical Svcs., 625 Devon Ave, Moorestown, NJ 08057

### Electro-Voice Model 644

Dynamic shotgun microphone.  
CONDITION: Good PRICE: \$85  
CONTACT: Tom Babarese PHONE: 856-222-0636  
Bibb Technical Svcs., 625 Devon Ave, Moorestown, NJ 08057

## Misc. Equipment

*Miscellaneous Gear and Parts*

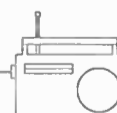

### Service Literature for MW Technicians

3,000 folders, 1983-1988. Tube guitar amps, amps, TV's, etc.  
CONDITION: Mostly un-used. PRICE: \$300  
CONTACT: James Cunningham PHONE: 580-265-4496  
KEOR Radio, Route 2 Box 113B, Stonewall, OK 74871

### Kroy Model

Lettering machine with extra font wheels.  
CONDITION: Call PRICE: Call for price.  
CONTACT: Jim PHONE: 419-782-8591  
Please call.

### UTC Series

Ouncer transformers.  
CONDITION: Call PRICE: \$25  
CONTACT: John Price PHONE: 214-321-6576  
Price Recording, 2651 Globe Ave, Dallas, TX 75228

### McLean Model Blower

Squirrel-cage blower, 4 RU, with filter.  
CONDITION: Very good. PRICE: \$75  
CONTACT: Tom Babarese PHONE: 856-222-0636  
Bibb Technical Svcs., 625 Devon Ave, Moorestown, NJ 08057

## Monitors & Rcvrs

*Mod & Antenna Monitors, EAS*

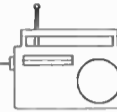

### Assorted Receivers

Assorted hi-fi receivers, amps, cassette decks.  
CONDITION: Call for list. PRICE: Cheap  
CONTACT: Tom Babarese PHONE: 856-222-0636  
Bibb Technical Svcs., 625 Devon Ave, Moorestown, NJ 08057

### Johnson Model ST4A

Crystal type SCA receiver.  
CONDITION: Very good. PRICE: \$50  
CONTACT: Dave Jackway PHONE: 800-944-0630  
SCS Radio Technology, 5742 Fairoak, Springfield, MO 65810

### SCA Radios

Analog type SCA radio receivers.  
CONDITION: New PRICE: \$40 and up.  
CONTACT: Dave Jackway PHONE: 800-944-0630  
SCS Radio Technology, 5742 Fairoak, Springfield, MO 65810

### TFT Model EAS-940A Relay

Audio relay for model 911 EAS.  
CONDITION: Good PRICE: Call for price.  
CONTACT: Dean Pearce PHONE: 601-693-2381  
Broadcasters-Publishers, 4307 Hwy 39, Meridian, MS 39301

### TFT Model EAS-911 Endec

EAS encoder/decoder unit.  
CONDITION: Good PRICE: Call for price.  
CONTACT: Dean Pearce PHONE: 601-693-2381  
Broadcasters-Publishers, 4307 Hwy 39, Meridian, MS 39301

### Belar Model

Stereo monitor with manual.  
CONDITION: Excellent PRICE: \$150  
CONTACT: Greg Blanchard PHONE: 541-501-9168  
bionet@uswest.net

### Belar Model

Stereo modulation monitor with manual.  
CONDITION: Excellent PRICE: \$150  
CONTACT: Greg Blanchard PHONE: 541-501-9168  
bionet@uswest.net

### 60) Dynamic Sounds Model MT-808

FM/SCA receivers, 2-band AC/DC radios.  
CONDITION: New PRICE: \$15 each.  
CONTACT: Jenny Zhao PHONE: 703-760-8911  
WCBC Radio, 8150 Leesburg Pike #1107, Vienna, VA 22182

### TFT Model 760

EBS generator/receiver.  
CONDITION: Call PRICE: Call for price.  
CONTACT: Jim PHONE: 419-782-8591  
Please call.

### TFT Model 886

EBS generator/receiver.  
CONDITION: Call PRICE: Call for price.  
CONTACT: Jim PHONE: 419-782-8591  
Please call.

### TFT Model 730

SCA monitor.  
CONDITION: Call PRICE: Call for price.  
CONTACT: Jim PHONE: 419-782-8591  
Please call.

### Belar Model FMS-1

FM stereo monitor.  
CONDITION: Call PRICE: Call for price.  
CONTACT: Jim PHONE: 419-782-8591  
Please call.

### 2) Johnson Model ST4A

SCA receivers.  
CONDITION: Call PRICE: Call for price.  
CONTACT: Jim PHONE: 419-782-8591  
Please call.

### Belar Model FMM-1

FM modulation monitor.  
CONDITION: Call PRICE: Call for price.  
CONTACT: Jim PHONE: 419-782-8591  
Please call.

### Potomac Instruments Model AM-19D

Three-tower, DA-2 antenna monitor.  
CONDITION: Good PRICE: \$1,000  
CONTACT: Kevin McNamara PHONE: 301-865-1011  
PO Box 926, New Market, MD 21774

### Belar Model

AM RF amplifier. Currently on 1290 kHz. Easy to re-tune.  
CONDITION: Call PRICE: \$300  
CONTACT: Scott Gardner PHONE: 540-728-7935  
PO Box 387, Hillsville, VA 24343

### Assorted Receivers

Assorted hi-fi receivers, amps, cassette decks.  
CONDITION: Call for list. PRICE: Cheap  
CONTACT: Tom Babarese PHONE: 856-222-0636  
Bibb Technical Svcs., 625 Devon Ave, Moorestown, NJ 08057

## Reel & Cassette

*Reel-to-Reel and Cassette Decks*



### Marantz Model PMD-520

Cassette deck.  
CONDITION: New PRICE: \$450  
CONTACT: Carl Ford PHONE: 704-857-1101  
Ford Broadcasting, PO Box 8146, Kannapolis, NC 28083

### Ampex Model AG-350

7.5/15 IPS Full-track reel transport only.  
CONDITION: Works well. PRICE: \$50 + UPS  
CONTACT: Edward Lightman PHONE: Please write  
WEDL Radio, 550 Merchant St, Ambridge, PA 15003

### Tascam Model NO-32

Reel to reel recorder, with free tapes.  
CONDITION: Almost new. PRICE: \$1,500  
CONTACT: Jenny Zhao PHONE: 703-760-8911  
WCBC Radio, 8150 Leesburg Pike #1107, Vienna, VA 22182

### Otari Model MX-5050

8-track recorder with new reels.  
CONDITION: Excellent PRICE: Negotiable  
CONTACT: Jeremy Lane PHONE: 318-381-1041  
1109 Hudson Ln, Monroe, LA 71201

### Otari Model MX-5050B2HD

Reel machine.  
CONDITION: Call PRICE: Call for price.  
CONTACT: Jim PHONE: 419-782-8591  
Please call.

### Otari Model MX-5050BII

Reel machine with stand. Heavy use.  
CONDITION: Call PRICE: Call for price.  
CONTACT: Jim PHONE: 419-782-8591  
Please call.

### Tascam Model 42B

2-channel reel recorder with stand and AQ65 auto-locator.  
CONDITION: Call PRICE: Call for price.  
CONTACT: Jim PHONE: 419-782-8591  
Please call.

### Sony Model PCM-800

8-track digital audio recorder.  
CONDITION: Like new. PRICE: Call for price.  
CONTACT: Jim PHONE: 419-782-8591  
Please call.

### Tascam Model 44

4-channel reel recorder with rack mount.  
CONDITION: Call PRICE: Call for price.  
CONTACT: Jim PHONE: 419-782-8591  
Please call.

### Tascam Model 112MKII

Cassette deck, with rack mount.  
CONDITION: Call PRICE: Call for price.  
CONTACT: Jim PHONE: 419-782-8591  
Please call.

### Otari Model MX-5050BII

Reel machine.  
CONDITION: Call PRICE: Call for price.  
CONTACT: Jim PHONE: 419-782-8591  
Please call.

Reel & Cassette — Continued on Next Page ⇨ ⇩

# FOR SALE

# Radio-Classifieds

Classified Ads Are Free!  
Fax them to: 507-280-9143



## Reel & Cassette

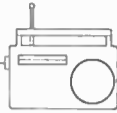

Continued from previous page.

### Otari Model MX-5050B2HD

Reel machine. Needs repair.  
CONDITION: Call PRICE: Call for price.  
CONTACT: Jim PHONE: 419-782-8591  
Please call.

### Otari Model MX-5050MKIII

8-track, 1/2-inch recorder with stand.  
CONDITION: Call PRICE: Call for price.  
CONTACT: Jim PHONE: 419-782-8591  
Please call.

### Ampex Models

Pre-amps and transformers.  
CONDITION: Call PRICE: \$40  
CONTACT: John Price PHONE: 214-321-6576  
Price Recording, 2651 Globe Ave, Dallas, TX 75228

### Ampex Series Heads

Set of new heads. 8-track, 1-inch.  
CONDITION: Excellent PRICE: \$750  
CONTACT: John Price PHONE: 214-321-6576  
Price Recording, 2651 Globe Ave, Dallas, TX 75228

### Otari Model CB-111

Auto-locator unit.  
CONDITION: Excellent PRICE: \$250  
CONTACT: John Price PHONE: 214-321-6576  
Price Recording, 2651 Globe Ave, Dallas, TX 75228

### Ampex Series Heads

Set of new heads. 16-track, 2-inch.  
CONDITION: Excellent PRICE: \$350 each.  
CONTACT: John Price PHONE: 214-321-6576  
Price Recording, 2651 Globe Ave, Dallas, TX 75228

### Ampex Model 351

Reel to reel transports.  
CONDITION: Call PRICE: Best offers.  
CONTACT: John Price PHONE: 214-321-6576  
Price Recording, 2651 Globe Ave, Dallas, TX 75228

### Ampex Model 440C

Reel to reel, in console.  
CONDITION: Call PRICE: \$995  
CONTACT: John Price PHONE: 214-321-6576  
Price Recording, 2651 Globe Ave, Dallas, TX 75228

### Ampex Model 354-2

Stereo tube recorder in console.  
CONDITION: Excellent PRICE: \$695  
CONTACT: John Price PHONE: 214-321-6576  
Price Recording, 2651 Globe Ave, Dallas, TX 75228

### MCI Model JH-110B

Stereo reel to reel, in console.  
CONDITION: Excellent PRICE: \$750  
CONTACT: John Price PHONE: 214-321-6576  
Price Recording, 2651 Globe Ave, Dallas, TX 75228

### Ampex Model 440

Stereo reel to reel, in console, with Ampex 6-channel mixer.  
CONDITION: Call PRICE: \$750  
CONTACT: John Price PHONE: 214-321-6576  
Price Recording, 2651 Globe Ave, Dallas, TX 75228

### MCI Series

Stereo electronics set B-C.  
CONDITION: Excellent PRICE: \$150  
CONTACT: John Price PHONE: 214-321-6576  
Price Recording, 2651 Globe Ave, Dallas, TX 75228

### Ampex Model

Servo motor amplifier.  
CONDITION: Call PRICE: \$300  
CONTACT: John Price PHONE: 214-321-6576  
Price Recording, 2651 Globe Ave, Dallas, TX 75228

### (100+) Ampex Type 456 Grand Mastering Tape

1/4-inch on metal reels with boxes. Used one time, one pass.  
CONDITION: Used once. PRICE: \$9.99 each.  
CONTACT: Kris Stevens Ent. PHONE: 818-225-7585  
5010 N Pkwy Calabasas Ste 202, Calabasas, CA 91302

### Otari Model MX-70

8-channel, 1-inch reel recorder. Must pick up.  
CONDITION: Very good. PRICE: \$3,000 or B.O.  
CONTACT: Richard Dewese PHONE: 419-748-8430  
WLMB-TV, PO Box 4, McClure, OH 43534

### Ampex Model 440B

8-track, 1" recorder in plug/play condition. 89% headlife.  
CONDITION: Very good. PRICE: \$1,375  
CONTACT: Rumble Culture Rec. PHONE: 323-871-1750  
PO Box 67691, Century City, CA 90067

### Akai Model X-1722W

1/4-track, 3.75/7.5 IPS, mic/phono in, int. spk, st/mon head  
CONDITION: Very good. PRICE: \$95  
CONTACT: Tom Babarese PHONE: 856-222-0636  
Bibb Technical Svcs., 625 Devon Ave, Moorestown, NJ 08057

### Roberts Model 450

7", 3-head, 1.85/3.75/7.5 IPS, Crossfield heads, mic/line.  
CONDITION: Very good. PRICE: \$89  
CONTACT: Tom Babarese PHONE: 856-222-0636  
Bibb Technical Svcs., 625 Devon Ave, Moorestown, NJ 08057

### Sony Model 250

1/4-track, 3.75/7.5 IPS, 7", mic/line, compact, wood case.  
CONDITION: Very good. PRICE: \$69  
CONTACT: Tom Babarese PHONE: 856-222-0636  
Bibb Technical Svcs., 625 Devon Ave, Moorestown, NJ 08057

### Akai Model X-150D

1/4-track, 3.75/7.5 IPS, Crossfield heads, no record.  
CONDITION: As is. PRICE: \$25  
CONTACT: Tom Babarese PHONE: 856-222-0636  
Bibb Technical Svcs., 625 Devon Ave, Moorestown, NJ 08057

### Teac Model A-6100

10-inch, 7.5/15 IPS, 2-track mastering deck, 1/4-track PB.  
CONDITION: Fair cosmetics. PRICE: \$250  
CONTACT: Tom Babarese PHONE: 856-222-0636  
Bibb Technical Svcs., 625 Devon Ave, Moorestown, NJ 08057

### Scully Model 280

7.5/15 IPS, 1/4-inch, 2-track stereo, Ruslang console.  
CONDITION: Call PRICE: \$595 (can ship)  
CONTACT: Tom Babarese PHONE: 856-222-0636  
Bibb Technical Svcs., 625 Devon Ave, Moorestown, NJ 08057

### Teac Model 3300SX

10-inch, 7.5 IPS, 1/4-track stereo, fair cosmetics.  
CONDITION: Works well. PRICE: \$250  
CONTACT: Tom Babarese PHONE: 856-222-0636  
Bibb Technical Svcs., 625 Devon Ave, Moorestown, NJ 08057

### Heathkit Model

Mono tube reel with separate TE-1 electronics, mic/line.  
CONDITION: Call PRICE: \$95  
CONTACT: Tom Babarese PHONE: 856-222-0636  
Bibb Technical Svcs., 625 Devon Ave, Moorestown, NJ 08057

## Remote Control



Remote Control, Telemetry, Status

### Burk Model IP-8

Interface panel.  
CONDITION: New PRICE: Call for price.  
CONTACT: Jim PHONE: 419-782-8591  
Please call.

### Moseley Model MRC-1

Remote terminal.  
CONDITION: Call PRICE: Call for price.  
CONTACT: Jim PHONE: 419-782-8591  
Please call.

### Burk Model ARC-16

Studio unit.  
CONDITION: New PRICE: Call for price.  
CONTACT: Jim PHONE: 419-782-8591  
Please call.

### 2) Burk Model IP-8

Interface panels.  
CONDITION: Call PRICE: Call for price.  
CONTACT: Jim PHONE: 419-782-8591  
Please call.

### Burk Model ARC-16

16-channel control unit.  
CONDITION: Call PRICE: Call for price.  
CONTACT: Jim PHONE: 419-782-8591  
Please call.

### Moseley Model MRC-1

Studio control terminal.  
CONDITION: Call PRICE: Call for price.  
CONTACT: Jim PHONE: 419-782-8591  
Please call.

### Burk Model ARC-16

Transmitter control. 16-channel w/phone & voice synth.  
CONDITION: Almost new. PRICE: Call for price.  
CONTACT: Jim PHONE: 419-782-8591  
Please call.

### 2) Burk Model TC-8

Remote controls.  
CONDITION: Call PRICE: Call for price.  
CONTACT: Jim PHONE: 419-782-8591  
Please call.

### Gentner Model VRC-2000

Remote control, complete w/ battery backup, 2 relay panels.  
CONDITION: Call PRICE: \$1,500 or B.O.  
CONTACT: Tom Holmes PHONE: 217-223-5292  
KRRY Radio, Quincy IL

## RPU & STL



RPU, STL, TSL, 2-Way Radio

### Mark Model 9A72GN

STL dish, 940-950 MHz.  
CONDITION: Like new. PRICE: \$750  
CONTACT: Alfred Fromm PHONE: 918-335-5093  
Jalcom Comm., PO Box 3334, Bartlesville, OK 74006

### Marti Model RPT-2

2 watt UHF transmitter.  
CONDITION: Like new. PRICE: \$500 or B.O.  
CONTACT: Craig Jerome PHONE: 561-564-4754  
WPAW Radio, PO Box 650215, Vero Beach, FL 32915

### Moseley Model TMR-1

Telemetry receiver.  
CONDITION: Call PRICE: \$50  
CONTACT: Darrin Warner PHONE: 765-935-2443  
Big "D" Broadcast, 2225 Airport Rd, Centerville, IN 47330

### Bearcat Model 800-XLT

VHF-UHF-800 MHz scanner.  
CONDITION: Call PRICE: \$40 + UPS  
CONTACT: Edward Lightman PHONE: Please write  
WEDL Radio, 550 Merchant St, Ambridge, PA 15003

### Marti Model SCR-8H

Subcarrier receiver.  
CONDITION: Call PRICE: Call for price.  
CONTACT: Jim PHONE: 419-782-8591  
Please call.

### 2) Comrex Model CTA

IFB transmitters.  
CONDITION: Call PRICE: Call for price.  
CONTACT: Jim PHONE: 419-782-8591  
Please call.

### 2) Marti Model R-10

STL receivers.  
CONDITION: Call PRICE: Call for price.  
CONTACT: Jim PHONE: 419-782-8591  
Please call.

### 3) Marti Model HRC-8A

RF combiners for 950 MHz STL  
CONDITION: Call PRICE: Call for price.  
CONTACT: Jim PHONE: 419-782-8591  
Please call.

### TFT Model 8610A

STL receiver.  
CONDITION: Call PRICE: Call for price.  
CONTACT: Jim PHONE: 419-782-8591  
Please call.

### Moseley SCD-8

Subcarrier receiver.  
CONDITION: Call PRICE: Call for price.  
CONTACT: Jim PHONE: 419-782-8591  
Please call.

### Motorola Model T34RTA3000BA

Micor 2-way mobile unit.  
CONDITION: Call PRICE: Call for price.  
CONTACT: Jim PHONE: 419-782-8591  
Please call.

### 2) Moseley Model PCL-606/C

Composite STL transmitters.  
CONDITION: Call PRICE: Call for price.  
CONTACT: Jim PHONE: 419-782-8591  
Please call.

RPU and STL — Continued on Next Page



# FOR SALE

# Radio-Classifieds

Classified Ads Are Free!  
Fax them to: 507-280-9143



## RPU & STL

*Continued from previous page.*

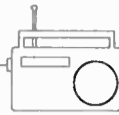

### 2) Moseley Model PCL-606/C

Composite STL receivers.  
CONDITION: Call PRICE: Call for price.  
CONTACT: Jim PHONE: 419-782-8591  
Please call.

### 3) dB Products Model 4096

950 MHz duplexers (sold by Marti)  
CONDITION: Call PRICE: Call for price.  
CONTACT: Jim PHONE: 419-782-8591  
Please call.

### 2) Motorola Model MX-330

Handles 2-way units.  
CONDITION: Call PRICE: Call for price.  
CONTACT: Jim PHONE: 419-782-8591  
Please call.

### 2) Motorola Converta-Coms

Mobile mount/power supply for handhelds.  
CONDITION: Call PRICE: Call for price.  
CONTACT: Jim PHONE: 419-782-8591  
Please call.

### 2) Marti Model STL-10

STL transmitters.  
CONDITION: Call PRICE: Call for price.  
CONTACT: Jim PHONE: 419-782-8591  
Please call.

### Moseley Model TRC-1

Telemetry return receiver.  
CONDITION: Call PRICE: Call for price.  
CONTACT: Jim PHONE: 419-782-8591  
Please call.

### TFT Model DMM-9200

Digital encoder/decoder for STL.  
CONDITION: Call PRICE: \$2,500 + shipping.  
CONTACT: Mike Peterson PHONE: 812-234-9770  
WSDM Radio, 1215 Wabash Ave, Terre Haute, IN 47807

### Vocom Model

35 watt linear amplifier for 950 MHz band. Used one month.  
CONDITION: Like new. PRICE: \$600 or B.O. + shipping.  
CONTACT: Mike Peterson PHONE: 812-234-9770  
WSDM Radio, 1215 Wabash Ave, Terre Haute, IN 47807

### Wilburt Hurry-Up Mast

Goes to 25-feet, complete with base & antenna mount.  
CONDITION: Call PRICE: \$800 or B.O.  
CONTACT: Tom Holmes PHONE: 573-221-3450  
KHMO Radio, Hannibal, MO

## Satellite Equip.

*Dishes, Receivers, Demods, Etc.*

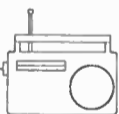

### Scientific Atlanta Model 7300 Receiver

With Sedat, 7.5 dual audio, voice/cue, 15/19/32 xtals.  
CONDITION: Call PRICE: Call for price.  
CONTACT: Dennis Royer Sr. PHONE: 804-292-4146  
WKLTV Radio, PO Box 300, Blackstone, VA 23824

### Harris Model 6550

Satellite receiver.  
CONDITION: Call PRICE: Call for price.  
CONTACT: Jim PHONE: 419-782-8591  
Please call.

### Microdyne Model 1100-PCDR(s)

SCPC satellite receiver.  
CONDITION: Call PRICE: Call for price.  
CONTACT: Jim PHONE: 419-782-8591  
Please call.

### Sedat Card for S/A 7300 Receiver

20kHz DAT decoder card for BPSK wideband receiver.  
CONDITION: Excellent PRICE: \$1,000 or B.O.  
CONTACT: Robert Fink PHONE: 530-283-1370  
Carousel Broadcasting, 395 Main St, Quincy, CA 95971

### Scientific Atlanta Model 7300

Wideband BPSK receiver. Includes 7.5 and 15 kHz decoders.  
CONDITION: Great PRICE: \$2,000 or B.O.  
CONTACT: Robert Fink PHONE: 530-283-1370  
Carousel Broadcasting, 395 Main St, Quincy, CA 95971

## Studio Equipment

*Clocks, Racks, Furniture, Etc.*

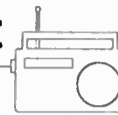

### (10) Cart Racks

Wall-mount cart racks. Must pick up.  
CONDITION: Call PRICE: \$20 each.  
CONTACT: Carl Ford PHONE: 704-857-1101  
Ford Broadcasting, PO Box 8146, Kannapolis, NC 28083

### 2) ADC Icon

Wall-mounted termination blocks.  
CONDITION: New PRICE: \$80 for both.  
CONTACT: Kevin McNamara PHONE: 301-865-1011  
PO Box 926, New Market, MD 21774

### ADC Pro-Patch

2x24 audio patch panel. 1-3/4" rack, normals brought out.  
CONDITION: Good PRICE: \$450  
CONTACT: Kevin McNamara PHONE: 301-865-1011  
PO Box 926, New Market, MD 21774

### ADC Patchbay

52 point long-frame single space patch bay.  
CONDITION: Call PRICE: \$75  
CONTACT: Tom Babarese PHONE: 856-222-0636  
Bibb Technical Svcs., 625 Devon Ave, Moorestown, NJ 08057

### ADC Patchbay

48 point long-frame Pro-Patch with normals brought out.  
CONDITION: Call PRICE: \$250  
CONTACT: Tom Babarese PHONE: 856-222-0636  
Bibb Technical Svcs., 625 Devon Ave, Moorestown, NJ 08057

## Telephone Audio

*Hybrids, Cell, Talkshow, ISDN*



### (2) Gentner Model EFT-100

Frequency extenders with (3) hybrid couplers, (1) teleproc.  
CONDITION: Excellent PRICE: Make offer.  
CONTACT: C. Damon PHONE: 602-705-5779  
KZZA Radio, 5501 E Empire Ave, Flagstaff, AZ 86004

### Comrex Model DXR.1

Telco transmission unit.  
CONDITION: Call PRICE: \$695  
CONTACT: Darrin Warner PHONE: 765-935-2443  
Big "D" Broadcast, 2225 Airport Rd, Centerville, IN 47330

### Henry Mix-Minus Plus

Audi mix-minus unit.  
CONDITION: Call PRICE: \$95  
CONTACT: Darrin Warner PHONE: 765-935-2443  
Big "D" Broadcast, 2225 Airport Rd, Centerville, IN 47330

### 3) Telos "Echo"

Digital voice storage/retrieval system.  
CONDITION: Call PRICE: Call for price.  
CONTACT: Jim PHONE: 419-782-8591  
Please call.

### Gentner Telecoupler

Telephone interface unit.  
CONDITION: Call PRICE: Call for price.  
CONTACT: Jim PHONE: 419-782-8591  
Please call.

### Gentner Teleswitch

Telephone interface console.  
CONDITION: Call PRICE: Call for price.  
CONTACT: Jim PHONE: 419-782-8591  
Please call.

### 2) Telos Model

Auxiliary console power supplies.  
CONDITION: Call PRICE: Call for price.  
CONTACT: Jim PHONE: 419-782-8591  
Please call.

### Gentner Model

Teleprocessor unit.  
CONDITION: Call PRICE: Call for price.  
CONTACT: Jim PHONE: 419-782-8591  
Please call.

### Telos Model 10

Telephone system console. 1 button top missing.  
CONDITION: Call PRICE: Call for price.  
CONTACT: Jim PHONE: 419-782-8591  
Please call.

### 2) Telos Model 10

Telephone system main unit.  
CONDITION: Call PRICE: Call for price.  
CONTACT: Jim PHONE: 419-782-8591  
Please call.

### 4) Model 111C

Repeat coils.  
CONDITION: Call PRICE: \$55  
CONTACT: Tom Babarese PHONE: 856-222-0636  
Bibb Technical Svcs., 625 Devon Ave, Moorestown, NJ 08057

## Test Equipment

*Tools, Bench, Field, Wattmeters*

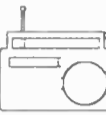

### Crown Model RTA-2

Real-time audio analyzer.  
CONDITION: Call PRICE: Call for price.  
CONTACT: Jim PHONE: 419-782-8591  
Please call.

### Gates Model M-3625

Gain test set.  
CONDITION: Call PRICE: Call for price.  
CONTACT: Jim PHONE: 419-782-8591  
Please call.

### HP Model 5306

Multimeter unit.  
CONDITION: Call PRICE: Best offer.  
CONTACT: John Price PHONE: 214-321-6576  
Price Recording, 2651 Globe Ave, Dallas, TX 75228

### Eico Model 150

Solid state signal tracer.  
CONDITION: Call PRICE: \$100  
CONTACT: John Price PHONE: 214-321-6576  
Price Recording, 2651 Globe Ave, Dallas, TX 75228

### BK Precision Dyna-Jet

Tube tester.  
CONDITION: Call PRICE: \$195  
CONTACT: John Price PHONE: 214-321-6576  
Price Recording, 2651 Globe Ave, Dallas, TX 75228

### Tektronix Model DM-502A

Multimeter.  
CONDITION: Call PRICE: \$150  
CONTACT: John Price PHONE: 214-321-6576  
Price Recording, 2651 Globe Ave, Dallas, TX 75228

### Tektronix Model DM-501A

Multimeter.  
CONDITION: Call PRICE: \$150  
CONTACT: John Price PHONE: 214-321-6576  
Price Recording, 2651 Globe Ave, Dallas, TX 75228

### HP Model 5308A

Frequency counter.  
CONDITION: Call PRICE: Best offer.  
CONTACT: John Price PHONE: 214-321-6576  
Price Recording, 2651 Globe Ave, Dallas, TX 75228

### HP Model 353A

100 dB attenuator.  
CONDITION: Call PRICE: \$65  
CONTACT: John Price PHONE: 214-321-6576  
Price Recording, 2651 Globe Ave, Dallas, TX 75228

### Bird Model 3126 RF Wattcher

With 3-1/8" un-flanged line section, 3W & 30kW elements.  
CONDITION: Good PRICE: \$500  
CONTACT: Kevin McNamara PHONE: 301-865-1011  
PO Box 926, New Market, MD 21774

### Delta Model TCA-20EX

RF ammeter, TCT-1 torroid and 50-foot cable.  
CONDITION: Good PRICE: \$500  
CONTACT: Kevin McNamara PHONE: 301-865-1011  
PO Box 926, New Market, MD 21774

### Potomac Instruments Model FIM-41

AM field strength meter, w/ wood case & book. 535-5000 kHz.  
CONDITION: Excellent PRICE: \$2,400  
CONTACT: W.H. Bradley P.E. PHONE: 918-245-5603  
300 W 41 St, Sand Springs, OK 74063

### Potomac Instruments Model FIM-71

FM field strength meter, with wood carrying case & manual.  
CONDITION: Excellent PRICE: \$2,500  
CONTACT: W.H. Bradley P.E. PHONE: 918-245-5603  
300 W 41 St, Sand Springs, OK 74063



## Towers & Coax

Towers, Transmission Line, Etc.

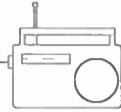

### Triangle Paint Goldstone #6

1 un-opened gallon of HD high-reflectance M/W ant coating.  
CONDITION: Un-opened PRICE: \$50 or B.O.  
CONTACT: James Steele PHONE: 912-729-6000  
WKBK Radio, PO Box 2525, Kingsland, GA 31548

### Shively Model

FM iso-coupler.  
CONDITION: Call PRICE: Call for price.  
CONTACT: Joe Davis PHONE: 806-259-3511  
KLSR Radio, PO Box 400, Memphis, TX 79245

### Andrew and Cablewave Types

1/2" thru 3" air and foam surplus cable. Up to 1000' runs.  
CONDITION: Un-used. PRICE: Call for prices.  
CONTACT: John White PHONE: 757-546-7007  
Material Spec., PO Box 65054, Virginia Beach, VA 23467

### Andrew Type HJ-50A

1-5/8", air dielectric, factory sealed cable.  
CONDITION: New sealed. PRICE: \$9.95 per foot.  
CONTACT: John White PHONE: 757-546-7007  
Material Spec., PO Box 65054, Virginia Beach, VA 23467

### Andrew Coaxial Cable

180-feet of 7/8" air dielectric coaxial cable.  
CONDITION: Used PRICE: \$2.00/ft. + shipping.  
CONTACT: Ken Bryan PHONE: 304-536-1310  
Rt 60 W Harts Run, White Sulphur Springs, WV 24986

### Rohn Model

120-foot, 12-inch face tower with guys and turnbuckles.  
CONDITION: Good PRICE: \$400  
CONTACT: Robert Rega PHONE: 814-939-7303  
RD 6 Box 79, Punxsutawny, PA 15767

### Rohn Model SSV

340-foot, 3-legged self-supporting tower. With drawings.  
CONDITION: Excellent PRICE: Make offer.  
CONTACT: Salem Antenna PHONE: 610-260-9881  
Please call.

## Transmitters

AM, FM, Exciters, RF Amps, Etc.

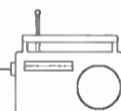

### TTC Model XL-1

Dual output translator, with manuals. Low hours.  
CONDITION: Excellent PRICE: \$1,850  
CONTACT: C. Damon PHONE: 602-705-5779  
KZZA Radio, 5501 E Empire Ave, Flagstaff, AZ 86004

### QEI Model FMQ-3500

3500 watt FM transmitter with exciter. Presently on the air.  
CONDITION: Good PRICE: Call for price.  
CONTACT: Cris PHONE: 816-628-5959  
Please call.

### Continental Model 802B

Frequency-agile FM exciter.  
CONDITION: Call PRICE: \$3,400  
CONTACT: Darrin Warner PHONE: 765-935-2443  
Big "D" Broadcast, 2225 Airport Rd, Centerville, IN 47330

### RCA Model BTE-115

10 watt, frequency adjustable exciter, with manual.  
CONDITION: Excellent PRICE: \$1,200 or B.O.  
CONTACT: Greg Blanchard PHONE: 541-501-9168  
bionet@uswest.net

### Collins Model 20V-3

1kW transmitter. On air now, ready to haul. Some spares.  
CONDITION: Good PRICE: Call for price.  
CONTACT: Jack Scott PHONE: 518-725-7175  
WENT Radio, Harrison St Ext, Gloversville, NY 12078

### Harris Model MW-50

50kW AM transmitter w/ 4 spare finals, manuals, new stack.  
CONDITION: Very good. PRICE: \$20,000  
CONTACT: Jay Whitehurst PHONE: 504-362-9800  
WLNO Radio, 401 Whitney Ave #160, Gretna, LA 70056

### Collins Model 20F

1kW AM transmitter, tuned to 1570 kHz. Working condition.  
CONDITION: Call PRICE: Free of charge.  
CONTACT: Jerry PHONE: 708-331-7840  
Please call.

### RCA Model BTA-1MX

1kW AM transmitter. Good for parts.  
CONDITION: Call PRICE: Call for price.  
CONTACT: Jerry PHONE: 708-331-7840  
Please call.

### McMartin Model BFM-8000

FM exciter.  
CONDITION: Call PRICE: Call for price.  
CONTACT: Jim PHONE: 419-782-8591  
Please call.

### Continental Model 802A

FM exciter.  
CONDITION: Call PRICE: Call for price.  
CONTACT: Jim PHONE: 419-782-8591  
Please call.

### RCA Model BTF-20E1

20 kW FM transmitter, with spare transmitter parts.  
CONDITION: Great PRICE: Call for price.  
CONTACT: Joe Davis PHONE: 806-259-3511  
KLSR Radio, PO Box 400, Memphis, TX 79245

### Collins Model 830F

10kW FM transmitter. Parts available.  
CONDITION: Call PRICE: Call for price.  
CONTACT: Joe Davis PHONE: 806-259-3511  
KLSR Radio, PO Box 400, Memphis, TX 79245

### Energy-Onix Legend 1000

1000 watt solid state FM transmitter, tuned to 91.1 MHz.  
CONDITION: Very good (1992) PRICE: \$6,000  
CONTACT: John Wilsbach PHONE: 717-948-9136  
WMSS Radio, 214 Race St, Middletown, PA 17057

### CCA FM Transmitter

100 Watt transmitter. No exciter, needs IPP.  
CONDITION: Call PRICE: \$3,750 or B.O.  
CONTACT: Joseph Bahr PHONE: 787-728-0364  
Islands FM, PO Box 6556, San Juan, PR 00914

### Harris FM Transmitter

2.5 kW, good for parts or rebuild. No exciter or plate xfmr.  
CONDITION: Call PRICE: \$2,000 or B.O.  
CONTACT: Joseph Bahr PHONE: 787-728-0364  
Islands FM, PO Box 6556, San Juan, PR 00914

### Bext Model

25 watt, frequency-agile exciter. 5 years old.  
CONDITION: Call PRICE: \$1,000 + shipping.  
CONTACT: Ken Bryan PHONE: 304-536-1310  
Rt 60 W Harts Run, White Sulphur Springs, WV 24986

### Sintronic Model

3500W FM stereo transmitter. Rebuilt, w/new rebuilt tubes.  
CONDITION: Excellent PRICE: \$5,000 + shipping.  
CONTACT: Ken Bryant PHONE: 304-536-1310  
Rt 60 W Harts Run, White Sulphur Springs, WV 24986

### AM Transmitter

0.1 watt, FCC approved. 1+ mile range.  
CONDITION: New PRICE: \$698  
CONTACT: Mark PHONE: 800-444-8255  
RS@TalkingHouse.com

### Continental Model 317C3

50kW AM transmitter on 670. Well maintained, some spares.  
CONDITION: Works great. PRICE: \$35,000 or B.O.  
CONTACT: Mel Lang PHONE: 954-781-0699  
langcom@concentric.net

### FM Stereo Transmitter System

QE1 20W amp, Ramsey limiter, FM-25 Ramsey transmitter.  
CONDITION: New PRICE: \$500  
CONTACT: Robert Rega PHONE: 814-939-7303  
RD 6 Box 79, Punxsutawny, PA 15767

## Turntables

Turntables and Preamps

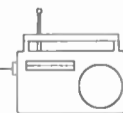

### Russco Model

Studio turntables. Must pick up.  
CONDITION: Call PRICE: \$50 each.  
CONTACT: Carl Ford PHONE: 704-857-1101  
Ford Broadcasting, PO Box 8146, Kannapolis, NC 28083

### Russco Model B

2-speed turntable with no arm.  
CONDITION: Call PRICE: \$100  
CONTACT: Darrin Warner PHONE: 765-935-2443  
Big "D" Broadcast, 2225 Airport Rd, Centerville, IN 47330

### Russco Model B

2-speed turntable with arm.  
CONDITION: Call PRICE: \$195  
CONTACT: Darrin Warner PHONE: 765-935-2443  
Big "D" Broadcast, 2225 Airport Rd, Centerville, IN 47330

### Sony Model

Turntable with base.  
CONDITION: Call PRICE: Call for price.  
CONTACT: Jim PHONE: 419-782-8591  
Please call.

### Lynn Axis Model

Turntable with base.  
CONDITION: Call PRICE: Call for price.  
CONTACT: Jim PHONE: 419-782-8591  
Please call.

## Tubes & HV

Tubes, HV Caps, Rectifiers, Xfms



### Type 6166/7007

Broadcast power tube.  
CONDITION: New rebuild. PRICE: \$2,500  
CONTACT: Dean Bass PHONE: 616-795-9020  
6140 Bamum Rd, Middleville, MI 49333

### Rectifier Tubes

(7) 872A tubes/(2) 810 tubes.  
CONDITION: Used, good. PRICE: \$35/\$10 for all.  
CONTACT: Dean Bass PHONE: 616-795-9020  
6140 Bamum Rd, Middleville, MI 49333

### 4CX5000A Type

Broadcast power tube.  
CONDITION: New PRICE: \$500  
CONTACT: Dean Bass PHONE: 616-795-9020  
6140 Bamum Rd, Middleville, MI 49333

### RCA, GE, Sylvania, Others

Many types, good, tested, and in boxes.  
CONDITION: Good & tested. PRICE: Priced low.  
CONTACT: James Cunningham PHONE: 580-265-4496  
KEOR Radio, Route 2 Box 113B, Stonewall, OK 74871

### 5000 Tubes for Sale

Some Western Electric on org. boxes. Octal, octal, acorn.  
CONDITION: Good PRICE: Call for prices.  
CONTACT: James Cunningham PHONE: 580-265-4496  
KEOR Radio, Route 2 Box 113B, Stonewall, OK 74871

### Varian Klystron Types

VA-221C, VA-220C, VA-222C, VA-259B (used) & VA-269B (new).  
CONDITION: Call PRICE: \$100 or B.O.  
CONTACT: James Cunningham PHONE: 580-265-4496  
KEOR Radio, Route 2 Box 113B, Stonewall, OK 74871

### Nuvistor Tubes

Assorted varieties.  
CONDITION: Call PRICE: \$25  
CONTACT: John Price PHONE: 214-321-6576  
Price Recording, 2651 Globe Ave, Dallas, TX 75228

**Fax - Email - Web**  
**Send Us Your Classifieds**  
**May Issue Deadline, 04-25-00**

Fax: (507) 280-9143

E-Mail: [radio@broadcast.net](mailto:radio@broadcast.net)

Website Classified Ad Form:  
[www.radioshopper.com/adform.html](http://www.radioshopper.com/adform.html)

**www.radiolinks.net**

This is your one-stop source for  
all radio-oriented web-links.

# WANTED

# Radio-Classifieds

If You Need Something — Place Your Ad on This Page

Classified Ads Are Free!  
Fax them to: 507-280-9143



### Type 6697 Transmitting Tube

Looking for this transmitting tube, in good condition.  
CONTACT: Alan Weiner PHONE: 207-985-7547  
WBCQ Radio, 97 High St, Kennebunk, ME 04043

### Gentner Microtel

Need this telephone interface unit, in working condition.  
CONTACT: Bill Schuler PHONE: 573-221-3450  
KHMO Radio, 119 N 3rd St, Hannibal, MO 63401

### Gates Stereo Yard Console

Need this console. Need good cosmetics, need not work.  
CONTACT: Bill Tash PHONE: 727-547-4940  
Contact by fax only.

### Auditronics Model 310

Looking for this console, or channels and parts.  
CONTACT: Chuck Bear PHONE: 813-879-9769  
Bear Tracks Audio, 314 N Clearview Ave, Tampa, FL 33609

### Shure Model M-267

Looking for this microphone mixer, in excellent condition.  
CONTACT: David Easley PHONE: 901-427-3346  
AMFM Inc, 122 Radio Rd, Jackson, TN 38301

### AM Transmitters

Need unit to 1kW. Will remove within 250 mi. of Phoenix, AZ.  
CONTACT: George Portell Jr. PHONE: 480-986-5797  
Communications Consultants, 3212 N 83rd St, Mesa, AZ 85207

### Rhode and Schwarz Model EK-07

Looking for this communications receiver.  
CONTACT: Harry Weber PHONE: 708-499-1882  
4805 West 107th St, Oak Lawn, IL 60453

### JBL Model 4320 Speaker

Looking for these studio monitors in good condition.  
CONTACT: J.B. Williams PHONE: 301-739-1450  
Midnight Blue Studios, 12824 Laurant Rd, Hagerstown, MD 21742

### Collins Radio Catalogs

Looking for literature, catalogs, and manuals of any kind.  
CONTACT: Jim Stizinger PHONE: 661-259-2011  
23800 Via Irama, Valencia, CA 91355

### Storey System Chip Burner

Need chip burner for EPROM 2516-2716, also MCI proc board.  
CONTACT: John Price PHONE: 214-321-6576  
Price Recording, 2651 Globe Ave, Dallas, TX 75228

### Chip Burner Manual

Need manual for Storey System chip burner.  
CONTACT: John Price PHONE: 214-321-6576  
Price Recording, 2651 Globe Ave, Dallas, TX 75228

### Rohn 65G Tower

Looking for 180-foot guyed tower.  
CONTACT: Jose Papo Fernandez PHONE: Please mail.  
J.A. Fernandez, PO Box 3047, Bayamon, PR 00960

### STL Dishes

Looking for (2) 8-foot STL dishes on 950 MHz.  
CONTACT: Joseph Bahr PHONE: 787-728-0364  
Islands FM, PO Box 6556, San Juan, PR 00914

### Rohn 65G or 55G Tower

Looking for 180-foot tower.  
CONTACT: Joseph Bahr PHONE: 787-728-0364  
Islands FM, PO Box 6556, San Juan, PR 00914

### FM Antenna

Need 10-bay FM, medium power antenna. 9-10kW, 106.1 MHz.  
CONTACT: Joseph Bahr PHONE: 787-728-0364  
Islands FM, PO Box 6556, San Juan, PR 00914

### RCA Model BTA-1M Circuit Breakers

Tx circuit breakers for LP, MOD, PLATE & FILAMENT circuits.  
CONTACT: Keith PHONE: 541-672-4427  
Please call.

### RCA Model BK-5B Mike Windscreen

Looking for ball windscreens and special boom mount.  
CONTACT: Kevin Gersham PHONE: 818-769-3054  
Another Dimension, 4431 Ledge Ave, Toluca Lake, CA 91602

### CBS Volumax Model 4100/4110 or 410/411

Looking for mono/stereo models, complete or in parts.  
CONTACT: Kevin Smith PHONE: 518-884-0505  
PO Box 277, Burnt Hills, NY 12027

### LPB or Radio Systems Low Power Transmitters

Looking for solid state AM, 5-30 watts.  
CONTACT: Kevin Smith PHONE: 518-884-0505  
PO Box 277, Burnt Hills, NY 12027

### Record Collections

Looking for 50's 45 RPM Rockabilly, DO-Wop, and Country.  
CONTACT: Kim Gutzke PHONE: 612-869-4963  
7134 15th Ave S., Minneapolis, MN 55423

### Limiters and Processors

Looking for audio limiters and processors.  
CONTACT: Kim Gutzke PHONE: 612-869-4963  
7134 15th Ave S., Minneapolis, MN 55423

### Turntables and Arms

Looking for turntables and tone arms.  
CONTACT: Kim Gutzke PHONE: 612-869-4963  
7134 15th Ave S., Minneapolis, MN 55423

### Record Cutting Equipment

Need equipment, literature, styli, and recording blanks.  
CONTACT: Kim Gutzke PHONE: 612-869-4963  
7134 15th Ave S., Minneapolis, MN 55423

### GE, RCA, Sylvania Tubes

EL84, EL34, 6V6, 6L6, 5881 & 6550 pwr tubes. 9-pins also.  
CONTACT: Mark Schakow PHONE: 605-374-3424  
Mark Schakow Recording, 307 4th Ave E, Lemmon, SD 57638

### Gates Sta-Level Limiter

Looking for one or two units of this type.  
CONTACT: Mark Schakow PHONE: 605-374-3424  
Mark Schakow Recording, 307 4th Ave E, Lemmon, SD 57638

### Wilkinson Model LA1B

Looking for this limiter to make stereo pair.  
CONTACT: Mark Schakow PHONE: 605-374-3424  
Mark Schakow Recording, 307 4th Ave E, Lemmon, SD 57638

### Gregg Labs

Looking for this grey, multiband limiter. (Lots of meters.)  
CONTACT: Paul Wende PHONE: 604-205-7628  
1395 Boundary Rd, Vancouver, BC V5K4T9

### Orban Model 9000

Looking for this Optimod, in any condition, working or not.  
CONTACT: Paul Wende PHONE: 604-205-7628  
1395 Boundary Rd, Vancouver, BC V5K4T9

### Broadcast Electronics Audiovault

Looking for mother board, daughter board or complete system.  
CONTACT: Pete Schartel PHONE: 816-792-1140  
KCXL Radio, 310 S LaFrenz Rd, Liberty, MO 64068

### Hnat Hinds Model SX-87 Manuals

Looking for setup and operating manuals for this unit.  
CONTACT: Rob Backstrom PHONE: 412-278-4103  
Burbach Broadcasting, 104 Broadway Ave, Carnegie, PA 15106

### Orban 622/642B

Need these parametric equalizers. Working or minor repairs.  
CONTACT: Rumble Culture Recordings PHONE: 323-871-1750  
PO Box 67691, Century City, CA 90067

### Altec 250

Need this 1950's audio mixer. Working or minor repairs.  
CONTACT: Rumble Culture Recordings PHONE: 323-871-1750  
PO Box 67691, Century City, CA 90067

### Altec 1566

Need this microphone preamp. Working or minor repairs.  
CONTACT: Rumble Culture Recordings PHONE: 323-871-1750  
PO Box 67691, Century City, CA 90067

### Ramsey Model FM-100 or FM-100W Radio Transmitter

Looking for FM stereo transmitter, in working condition.  
CONTACT: Scott Gardner PHONE: 540-728-7935  
PO Box 387, Hillsville, VA 24343

### Microphones.

Looking for Neumann, Shure, RCA, Beyer, AKG, Altec.  
CONTACT: Tim Cofmann PHONE: 858-571-5031  
Please call.

### Audio Equalizers

Looking for parametric, passive, and others.  
CONTACT: Tim Cofmann PHONE: 858-571-5031  
Please call.

### Audio Processors and Equalizers

Need Universal Audio, Urei, Altec, dBx, Collins, Gate, RCA.  
CONTACT: Tim Cofmann PHONE: 858-571-5031  
Please call.

### Kodak Model Ekt III

Looking for this auto-focus slide projector.  
CONTACT: Tom Babarese PHONE: 856-222-0636  
Bibb Technical Services, 625 Devon Ave, Moorestown, NJ 08057

### FM Antenna

Looking for a CP high-power, 4-bay FM antenna, on 98.3 MHz.  
CONTACT: WHAY Radio PHONE: 606-376-2218  
69 Courthouse Sq, Whitely City, KY 42653

## Misc. Equipment Wanted

WANTED: Broadcast equipment inventories of both older and newer equipment, parts, microphones, etc. STL's, ANY audio processing equipment (old, new, & in between too!), RF components, and exciters especially wanted.

We will be glad to come inspect or clean out both the good and the not so good too in many cases! We can purchase selectively or trade towards new equipment or rebuilt equipment. [04/00\*]

Jon Hall - Hall Electronics (Email: jon@halls.com)  
Phone: 804-984-4255 Fax: 804-984-3299

**BROADCAST EQUIPMENT:** I purchase select broadcast, recording, and sound related equipment working or non-working. Please fax, mail, or e-mail list with model number, description, condition, and asking price. Looking for test equipment catalogs (HP, TEK, GR, Fluke, Etc.) prior to 1985. Looking for Rotron blower motors for CCA, Harris, McMartin, Harris, etc. Working or not working. [04/00\*]

Jeff Corkren (E-mail: bes@ucmail.com)  
B.E.S., PO Box 20331, Jackson, MS 39289-1331  
Phone: 601-857-8573 Fax: 601-857-2346

**BROADCAST EQUIPMENT:** Cart machines, carts, Shafer automation equipment, open-reel decks, 4-track open-reel tape, turntables, and equipment racks. All in good condition. Best offer on all items. [04/00]

### Al Cannon

WERO Radio, Highway 17 South, Washington, NC 27889  
Phone: 252-946-2162

**VINTAGE GEAR:** Looking for vintage broadcasting gear of all types. From 1920's to 1970's. I have items to trade, or will pay fair prices for nice equipment. [04/00\*]

### Robert Van Dyke

Caffrey house Inc., 2 Squires Ave, East Quogue, NY 11942  
Phone: 516-728-9835

**VINTAGE GEAR:** Looking for tube power amps: McIntosh models MC-30, 40, 60, 75, MC-225, MC-240, MC-275, MI-60, 75, 20W-2, 50W-2. Marantz models 2, 5, 8B, and 9. Altec models 1520, 1530, 1568, 1569, 1570, and others.

**VINTAGE SPEAKERS:** Looking for cabinets, horns, drivers, cross-overs and woofers from: Altec, Electro-Voice, JBL, Western Electric, Jensen, Quad, Tannoy, Goodman.

**HI-FI/COMMERCIAL GEAR:** Scott, Dynaco, Fisher, RCA, Ampex. Quad, Leak, Eico, Harmon Kardon, etc. [04/00\*]

### Sonny Goodson - Sunshine Sound

1413 Magnolia Ln, Midwest City, OK 73110  
Phone: 405-737-3312

## Records and Tapes Wanted

**AUDIO TAPE:** Looking for recording reels for Tascam 48. Ampex 456, 1/2-inch tape, 2500' on reels. Need 4 reels. [03/00]

### Stephen Peters

WHAW Radio, 300 Harrison Ave, Weston, WV 26452  
Phone: 304-269-5555

**RADIO SHOWS on CD:** Casey Kasem, Dick Clark, Dick Bartley, and Ricks Dees, with or without cue sheets. Complete sets only. We pay shipping charges. [03/00]

### Darryl Dietz

**General Power Products**  
971 Poincianan Rd, Venice, FL 34293  
Phone: 800-329-1222

**HISTORY OF ROCK & ROLL:** Looking for History of Rock and Roll, and the History of Country Music, on audio cassettes.

**AIRCHECKS:** Looking for airchecks from Oklahoma and around the world. From the 50's, 60's, and 70's.

**OKLAHOMA BOMBING:** Looking for audio and video news stories and documentaries on the Oklahoma City bombing, from anywhere around the world.

**HOCKEY GAMES:** Looking for NHL and other professional games on VHS video and audio cassettes. [04/00\*]

### Bill Stewart - Radio Research

PO Box 272081, Oklahoma City, OK 73137

**AIRCHECKS:** Looking for airchecks from the 50's, 60's, and 70's, from any and all markets. Country, Top-40, Beautiful Music, and Soul. Also looking for radio-related stories and related video on VHS.

**PLAY-BY-PLAY:** Looking for play-by-play and NHL and/or their play-by-play of Pro Hockey games, especially Boston Bruins; audio and video. [04/00\*]

### Bill Scott - OCA

PO Box 365, Mustang, OK 73064

**RECORDS:** Looking for phonograph records. 33/45/78, from the 50's and 60's. Top prices paid for records in very good, or better condition. Will travel. No Big band, opera or Broadway shows. Looking for Rock, Country, Jazz, Blues, Soul, Movie Soundtracks, male and female vocalists. [04/00\*]

### Bill Berry - Karavan Broadcasting

15306 Conroe Dr, Conroe, TX 77384  
Phone: 800-321-2920  
Email: weberry@icc.net

## Non-Profit & Donations

Non-profit looking for a low-power FM exciter and transmitter or stereo generator. It's time to help another. I am grateful if you can send this item to the address below. [04/00]

### Peter Pellot - Invasion

HC 4 Box 44865, Aguadilla, PR 00603  
Phone: 787-882-3086 / 787-243-1095

In exchange for a gift certificate on a 501C3 corporation letterhead, we would like a donation of (1) Tektronix Model 4663 CAD plotter. This unit plots up to 17" x 22" paper. You ship. [03/00]

### Edward Wilk - Wilk Science and Technology

1112 N Grove Ave, Oak Park, IL 60302  
Phone: 708-524-8588

Non-commercial, community radio station is looking for donations of equipment. Transmitters, cart machines, cassette decks, etc., will be accepted. We need entire FM equipment and we're not picky! [03/00]

### Aubrey Presley - KGTO Radio

Dallas, TX  
Phone: 214-333-0463

Tatama FM stereo, a non-commercial Spanish radio station, is looking for donations of equipment, transmitters, consoles, exciters, cart machines, antennas, etc. Will pay shipping. [03/00]

Phone: 415-641-7333

# WireReady is Ready When You Are



*WireReady has been serving broadcasters for 10 years. WireReady is used by 2000 stations and radio networks from small markets to the majors. Systems include 24-hour 800 support, free upgrades, dial-in setup and training.*

## **NewsRoom Systems:**

### **NewsReady**

Simple DOS-based newsroom system captures newswires, and lets your staff print or read just the news and forecasts they need. Offers built-in word-processing for producing local news on the same computer.

Works with all major wire services and network feeds.

Purchase for single computer, or for sharable multi-user LAN configurations.

\$1,295 1<sup>st</sup> computer, \$695 per additional

### **NewsReady32 LE**

The 32-bit GUI windows based, point and click version of NewsReady.

For Win95, Win98, NT, and Win2000 workstations and PCI based hardware.

Purchase for single computer, or for sharable multi-user LAN configurations.

\$1,295 1<sup>st</sup> computer, \$695 per additional. LE stands for light edition.

### **NewsReady32**

Complete text and digital audio system for newsrooms. All the features of NewsReady32 LE, but adds integrated digital audio recording, editing, and on-air delivery capabilities for the entire newsroom. Adds comprehensive local news management, rundowns, audio logging, calendar based future file and schedule planning.

Purchase for single computer, or for sharable multi-user LAN/WAN configurations.

Now being deployed in major Clear Channel news stations coast to coast.

\$2,495 1<sup>st</sup> computer, \$1,295 per additional.

## **Hard-Drive Automation Systems**

### **MusicReady**

Complete hard-drive based system that handles live-assist, satellite, music-on-hard drive and voice tracking.

Software and audio cards package for both a production and on-air computer for \$5,995. Broadcast Tools satellite switcher and relay controller interface packages start at \$1,200. We'll setup the system on your computers, or we'll turnkey the whole system with industrial-class rack-mounted computer packages that start at \$4,000 and feature Pentium processors 128MB of RAM and 25GB of storage. This simple-to-use system is very versatile and supports as much storage as you want. We also help program all your schedules and provide interactive training at no extra charge. One of only a select few systems good enough to be sold and backed by many major broadcast dealers.

All prices quoted above are subject to change. Prices shown for newsroom systems are for software licenses only. Computers are supplied by customer or purchased separately. Costs are one-time license fees which entitle the purchaser to use the software forever. WireReady does not charge mandatory monthly or annual fees. 24-hour 800 support and free upgrades are included for 1<sup>st</sup> year only. Support after first year is by subscription at customer's option for an additional annual fee. See published rate schedule on our web site. All new systems are guaranteed Y2K compliant. Existing customers should check their versions and our web site's Y2K statement to determine if their version is Y2K compliant. WireReady is a registered trademark. NewsReady, NewsReady LE, NewsReady32, and MusicReady are trademarks of WireReady.

# WireReady<sup>NSI</sup>

(800) 833-4459

56 Hudson Street

Northboro, MA 01532

<http://www.wireready.com>